

WD-A165 619

OCEAN CONSTRUCTION PLATFORM COMPENDIUM(U) NAVAL
FACILITIES ENGINEERING COMMAND WASHINGTON DC CHESAPEAKE
DIU SEP 78 CHES/NAUFAC-FFO-1-78(17)

1/2

UNCLASSIFIED

F/G 13/2

NL



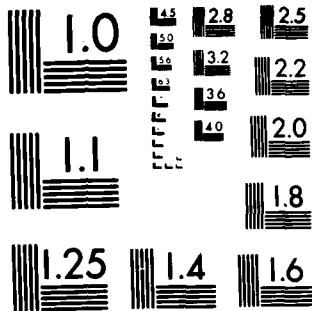

MICROCOPY RESOLUTION TEST CHART
NATIONAL BUREAU OF STANDARDS-1963-A

AD-A165 619

NAVFACENGCOM

OCEAN FACILITIES PROGRAM

OCEAN CONSTRUCTION PLATFORM COMPENDIUM

DTIC
S MAR 21 1980 D

DISTRIBUTION STATEMENT A
Approved for public release;
Distribution Unlimited

THIS IS A COPY

Unclassified
SECURITY CLASSIFICATION OF THIS PAGE

AD-A165 619

REPORT DOCUMENTATION PAGE

1a. REPORT SECURITY CLASSIFICATION
Unclassified

1b. RESTRICTIVE MARKINGS

2a. SECURITY CLASSIFICATION AUTHORITY

3. DISTRIBUTION AVAILABILITY OF REPORT
Approved for public release;
distribution is unlimited

2b. DECLASSIFICATION/DOWNGRADING SCHEDULE

4. PERFORMING ORGANIZATION REPORT NUMBER
FPO-1-78(17)

5. MONITORING ORGANIZATION REPORT #

6a. NAME OF PERFORM. ORG.
Ocean Engineering
& Construction
Project Office
CHESNAVFACENGCOM

7a. NAME OF MONITORING ORGANIZATION

6c. ADDRESS (City, State, and Zip Code)
BLDG. 212, Washington Navy Yard
Washington, D.C. 20374-2121

7b. ADDRESS (City, State, and Zip)

8a. NAME OF FUNDING ORG.

9. PROCUREMENT INSTRUMENT IDENT #

8c. ADDRESS (City, State & Zip)

10. SOURCE OF FUNDING NUMBERS
PROGRAM PROJECT TASK WORK UNIT
ELEMENT # # # ACCESS #

11. TITLE (Including Security Classification)
Ocean Constructin Platform Compendium

12. PERSONAL AUTHOR(S)

13a. TYPE OF REPORT 13b. TIME COVERED
FROM TO

14. DATE OF REP. (YYMMDD) 15. PAGES
8/78 100

16. SUPPLEMENTARY NOTATION

17. COSATI CODES
FIELD GROUP SUB-GROUP

18. SUBJECT TERMS (Continue on reverse if nec.)
Platforms, Ocean construction

19. ABSTRACT (Continue on reverse if necessary & identify by block number)
The Naval Facilities Engineering Command is responsible for the administration of the Navy military construction program, facilities planning, facility maintenance and utility operations, real property inventory management, and natural resources and pollution control programs. It performs material (Cont)

20. DISTRIBUTION/AVAILABILITY OF ABSTRACT 21. ABSTRACT SECURITY CLASSIFICATION
SAME AS RPT.

22a. NAME OF RESPONSIBLE INDIVIDUAL
Jacqueline B. Riley
DD FORM 1473, 84MAR

22b. TELEPHONE 22c. OFFICE SYMBOL
202-433-3881
SECURITY CLASSIFICATION OF THIS PAGE

BLOCK 19 (Con't)

support functions related to public works, floating cranes, pontoons and moorings, ocean structures, and to transportation, construction, and weight-handling equipment. NAVFAC also provides engineering and technical services in nuclear core power and radioisotope power devices. NAVFAC established the Ocean Facilities Engineering and Construction Program to enable the Command to fulfill its assigned responsibilities with regard to the planning and installation of ocean structures, moorings, and associated equipment. In carrying out these responsibilities, floating platforms are frequently required for site surveys, for logistics support, and for performance of ocean construction work. The purpose of this compendium is to provide information on the physical and performance characteristics of available platforms. These data are to be used in the selection of platforms for ocean construction projects and in the development of project execution plans.



DTIC

ELECTE

MAK 2 1 1986

D

NAVFACENGCOM

OCEAN FACILITIES PROGRAM

OCEAN CONSTRUCTION PLATFORM COMPENDIUM

REPRINT

FPO-1-78 (17)

AUGUST 1978

DISTRIBUTION STATEMENT A
Approved for public release;
Distribution Unlimited



OFF COPY

COMPENDIUM OF OCEAN CONSTRUCTION PLATFORMS

FOREWORD

□ **PURPOSE:** The Naval Facilities Engineering Command is responsible for the administration of the Navy military construction program, facilities planning, facility maintenance and utility operations, real property inventory management, and natural resources and pollution control programs. It performs material support functions related to public works, floating cranes, pontoons and moorings, ocean structures, and to transportation, construction, and weight-handling equipment, NAVFAC also provides engineering and technical services in nuclear shore power and radioisotope power devices. NAVFAC established the Ocean Facilities Engineering and Construction Program to enable the Command to fulfill its assigned responsibilities with regard to the planning and installation of ocean structures, moorings, and associated equipment. In carrying out these responsibilities, floating platforms are frequently required for site surveys, for logistics support, and for performance of ocean construction work. The purpose of this compendium is to provide information on the physical and performance characteristics of available platforms. These data are to be used in the selection of platforms for ocean construction projects and in the development of project execution plans.

□ **CLASSIFICATION OF OCEAN CONSTRUCTION PLATFORMS:** For the purposes of this compendium, an ocean construction platform is defined as any available platform that is either designed for or may be readily adapted for the performance of an ocean construction task. Additionally, ocean construction is defined as the construction, installation, maintenance, repair, or recovery of any fixed or moored ocean facility. These broad definitions cover an extremely wide range of vessels and therefore some further breakdown or classification is needed.

In the majority of ocean construction tasks, an important preliminary is the acquisition of data relative to the physical environment in which the task is to be performed. For a few areas of the world, adequate data have been collected and published but, most often, a survey of a particular area is required to obtain the necessary data. Specific types of platforms are required that are properly equipped to perform the needed measurements and to collect the needed data. Generally

these platforms are categorized as Hydrographic or Oceanographic Survey Vessels. For a given construction task the required measurements may demand anything from a fully equipped oceangoing research ship to a rowboat supplied with a sounding lead. Thus the category of Ocean Construction Survey Platforms covers a wide range of vessels from which the best available can be selected. Such platforms may also be needed during the course of construction to monitor changes that take place in the physical environment.

Another type of vessel usually needed for the performance of work in the ocean can be categorized as an Ocean Construction Logistics Platform. Vessels in this category fulfill many functions related to the transportation, movement, and support of personnel, construction material, and the equipment required for ocean construction work as well as the on-site storage of materials or the housing of personnel.

The final category bears the designation Ocean Construction Work Platform. This category covers all vessels from which work is actually performed such as the raising and lowering of weights, the laying of pipe or cables, or the implantment of equipment on the bottom. Work platforms may be used to tend divers, to support construction power equipment such as generators, compressors, and welding machines, or they may be merely ocean stations that serve as points for navigational fixes, communications centers, or cable or pipeline terminal floatation units.

The above categories involve the type of work that a given platform is designed to perform; the next step is to indicate in what areas of the ocean these types of work can be performed by a specific kind of platform. Based both on environmentally related factors, and on factors applicable to vessel design, two general divisions have been selected, e.g., Seagoing Platforms and Inshore Platforms. The term seagoing applies to any vessel that, under its own power or under tow, is capable of ocean transit under all weather conditions. When a vessel is placed in the seagoing category, as defined herein, there should be no question of its hydrodynamic, structural, or hydro-

COMPENDIUM OF OCEAN CONSTRUCTION PLATFORMS

FOREWORD (Continued)

static ability to withstand the rigors of a trans-oceanic voyage across any of the world's oceans at any time of the year. *Inshore*, on the other hand, is a term covering all ocean construction platforms that cannot be considered *seagoing* platforms. The bottom line for equipment in this category comprises platforms that can be used only in totally protected waters such as rivers and harbors; this latter type of equipment is not applicable to ocean construction projects.

Thus the platforms covered by this compendium have been divided into the following categories:

- Seagoing Survey Platforms*
- Inshore Survey Platforms*
- Seagoing Logistics Platforms*
- Inshore Logistics Platforms*
- Seagoing Work Platforms*
- Inshore Work Platforms*

On all platform data sheets this classification appears in the first line of the left hand side of the title block. The particular ship or class of ships to which these data are applicable is designated in the right hand side of the title block.

PLATFORM DATA PROVIDED: The data to be presented on any one platform is dependent upon the potential utilization of that platform in ocean construction projects. Obviously there is no reason to include any more data than will be needed but, on the other hand, it is essential that all information required in Project Execution Plan (PEP) preparation be made available. The minimum amount of data required on any type of platform included in this compendium is that required to describe a survey platform used for *inshore* operations. This is essentially a narrative or tabular presentation of the general characteristics of a platform and may be fitted on a single page. For *seagoing* survey platforms, the same narrative/tabular presentation of physical and performance characteristics is required but, in addition, an inboard profile and deck arrangements are needed; these draw-

ings can be on a single additional page. For *seagoing* logistics platforms, the above data must be supplemented by more detailed drawings of cargo stowage spaces, deck loading capacities, and, in the case of towed systems, curves of barge resistance and tug tow rope pull as functions of speed. The same type of data are required for *logistics* platforms employed in *inshore* operations. When dealing with *work* platforms, for either *seagoing* or *inshore* operations, the data to be included in a compendium is, in some cases, much more detailed calling for additional pages of tables, curves, and drawings.

For each platform included in the compendium there is a minimum of one page comprising a narrative description giving a general picture of its physical and performance characteristics. The narrative gives general information on the physical characteristics — geometry, hydrostatic features, structural configuration, machinery parameters, and outfit — and on the performance characteristics — speed and resistance, propulsion capability, maneuvering and control, position determination, mission support features and platform motions.

For platforms requiring greater depth of detail, additional pages are provided, each page containing drawings, curves, narrative, or tabular data as needed to fulfill the presentation requirements. The format for each such additional page is standardized so the project planner will know exactly what he can expect to find insofar as degree of detail is concerned. The type of data provided is designated by titles listed in the lower line of the left hand side of the title block. The following listing gives a general idea of what may be covered in these supplementary pages.

Physical Characteristics

Geometry

Outboard/Inboard Profiles and Deck Arrangements
Additional Deck Arrangements Drawings

Lines Drawing

Hydrostatic Features

Displacement and Other Curves
Cross Curves of Stability



Dist of Special

A-1

COMPENDIUM OF OCEAN CONSTRUCTION PLATFORMS

FOREWORD (Continued)

Floodability Curves
Structural Configuration
Midship Section Drawing
Strength Distribution Curves
Machinery Parameters
Narrative and Tabulation of Machinery Data
Machinery Arrangements
Outfit Characteristics
Equipment Tabulation
Deck Arrangement with Lines Handling Details
Performance Characteristics
Speed and Resistance
Hydrodynamic Resistance vs Speed Curves
Aerodynamic Resistance vs Speed and Angle
Propulsion Capability
Free Running Performance Curves
Tow & Performance Curves
Maneuvering and Control
Maneuvering Performance Curves
Position Determination
Detailed Description of Positioning Performance
Mission Support Features
Detailed Description of Mission Support Performance
Platform Motions
Predicted Motion Curves

The data presented for any given platform could range from one to twenty pages depending upon the kinds of information required by a project planner. This arrangement has the advantage that a platform can be included in the compendium as soon as the general narrative page has been provided; additional pages with greater detail can be included as they are developed.

□ **PROJECT EXECUTION PLAN DRAWINGS:** In addition to the profile and arrangement drawings that have been included for most of the platforms contained within this compendium there are drawings for each platform called either Project Execution Plan or PEP drawings. The intent is that these drawings, which bear a minimum number of legends, or space designations, shall be used in the preparation of project execution plans. They can be utilized in the layout of deck equipment or in illustrating, to a smaller scale, the preparations being made for an assigned project. They are included in the compendium primarily to illustrate what is available in the way of 105 mm negatives from which enlarged tracings can be reproduced for use in project planning activities. On these drawings the titular information has been reduced to an absolute minimum.

Each page of this compendium has been reproduced to 50% of its original size on 105 mm film negatives. This practice is in accordance with NAVDOCKS P-336 of February 1960 entitled "Operating Manual, 105 mm Filming System". All drawings, whether done for the compendium or for use in project execution plans, are drawn precisely to scale; all pages of the compendium are available in the form of 105 mm negatives which are stored in the Criteria and Methods file at the Ocean Facilities and Construction Project Office, Chesapeake Division, Naval Facilities Engineering Command, at the Washington Navy Yard.

When developing a project execution plan, these 105 mm negatives can be reproduced, to any size desired, on tracing paper. Any additional details, such as lifting gear or stowed items, can be drawn on the tracing. The resulting tracing can be reduced to page size for inclusion in the PEP, or can be used as an operational or ship alteration drawing as required. Each PEP drawing shows a dimensional line that will serve to instruct the reproduction activity as to the blowup size required to produce a platform drawing to the desired scale.

COMPENDIUM OF OCEAN CONSTRUCTION PLATFORMS

FOREWORD (Continued)

The process of developing a finished project execution plan illustration and the utilization of plans generated by the foregoing procedures is best described by a specific example. The example selected is a project involving SEACON, the NAVFACENGCOM ocean construction platform, for replacing acoustic arrays at the Atlantic Fleet Weapons Training Facility off St. Croix, Virgin Islands. For this project, drawings were prepared to a scale of one-quarter inch to the foot for use in placing construction equipment on the deck of SEACON for the transit from Little Creek, Virginia to St. Croix, and for use in load handling and cable handling during the ocean construction phases of this project. Reduced drawings, illustrating the steps involved in the retrieval and implantment of arrays, were prepared for inclusion in Op. Plan No. 213; one such drawing is given on the following page.

The first step in the utilization of the Ocean Construction Platform Compendium, and the associated 105 mm negative files, was to prepare an expanded arrangement of the SEACON main deck, from frame 15 to the transom, the primary area of concern. This was made from the 105 mm negative of the Project Execution Plan -- Outboard Profile and Main Deck Arrangement. The blowup was thirteen times the size of the negative. This projected photograph was printed on translucent paper from which a diazo sepia print was made on mylar. The diazo mylar sepia consists of the image printed in a brown dye on the back of a mylar sheet; this forms a high quality tracing from which additional diazo prints can be made. (In this case, the project engineer was furnished a black line diazo print on which he could lay out the basic equipment to be used in the operation.) The sepia dye on the back of the mylar can be removed, where desired, by use of a diazo solvent. India ink, applied with standard drafting instruments, can be used on the front surface of the mylar to augment the image imprinted on the back of the mylar. One additional technique can be used to augment the diazo mylar sepia which consists of having additional detail drawings printed on adhesive backed film. These are transparent elements that will adhere either to the front or to the back of the diazo mylar sepia;

when a diazo print is made of a mylar sheet to which these adhesive films are affixed, it appears as a part of the original drawing.

For the SEACON St. Croix operation, several elements of cable and load handling equipment were to be welded to the deck of the ship and were to remain in position throughout the operation. These included the Pengo Winch, the Pengo Take-up Reel, the Cross Deck Winch, the P&H 325-TC Crane, and the Grove Hydraulic Crane. For each of these units, the 105 mm negatives for the compendium plan-view drawings were extracted and photographic projection prints were made on translucent paper to the base scale of one-quarter inch per foot. From these photographic prints, diazo sepias were made on adhesive backed film and attached to the deck layout mylar in the positions indicated by the project engineer. Additionally, an A-Frame, to be installed over the stern roller specifically for this test, was drawn in on the face of the tracing. Where any overlap occurred, the diazo solvent was used to eliminate barge details or equipment outlines below the superimposed unit. Additional lettering was then applied to the face of the mylar using either India ink or rub-on lettering as applicable.

From this basic layout of equipment fixed to the SEACON deck for the operation, a black line print was made and forwarded to the shipyard as a guide for the actual installation. Another four black line prints were used by the project engineer, along with cut-outs of the remaining equipment, to arrange the deck layouts for the remaining operational sequences. For each sequential layout, either adhesive backed film layouts were developed or, as in the case of rectangular vans set on deck, the equipment outlines were made using basic drawing equipment with India ink on the front surface of the mylar.

From each mylar tracing a black line diazo print was made; these were composite prints showing all desired details of the operation to a one-quarter inch per foot scale. Photographic reductions in the ratio of 4.25:1 were made for use in the project execution plan as exemplified on the following page. Additionally the tracings for each drawing were available to the project engineer for any number of prints required in connection with carrying out the construction operations.

COMPENDIUM OF OCEAN CONSTRUCTION PLATFORMS

TABLE OF CONTENTS

Inshore Logistics Platform: LCM-6 Landing Craft Mechanized

Physical and Performance Characteristics
Overall Geometry -- Outboard Profile and Weather Deck
Internal Arrangements -- Inboard Profile and Cargo Deck
Internal Arrangements -- Typical Sections Amidships
Hull Form Delineation -- Curves of Form
Hull Form Delineation -- Cross Curves of Stability
Project Execution Plan Drawing -- Outboard Profile and Weather Deck
Project Execution Plan Drawing -- Inboard Profile and Cargo Deck
Project Execution Plan Drawing -- Cross Section

Inshore Logistics Platform: LCM-8 Landing Craft Mechanized

Physical and Performance Characteristics
Overall Geometry -- Outboard Profile and Weather Deck
Overall Geometry -- Bow-On View
Internal Arrangements -- Inboard Profile & Structure Below Cargo Flat
Hull Form Delineation -- Curves of Form
Deck Machinery -- Bow Ramp Handling
Project Execution Plan Drawing -- Outboard Profile and Weather Deck
Project Execution Plan Drawing -- Inboard Profile & Structure Below

Inshore Logistics Platform: LCU-501 Landing Craft Utility

Physical and Performance Characteristics
Overall Geometry -- Outboard Profile and Main Deck
Internal Arrangements -- Inboard Profile & Arrangements
Project Execution Plan Drawing -- Outboard Profile and Main Deck
Project Execution Plan Drawing -- Inboard Profile & Arrangements

Seagoing Logistics Platform: LCU-1466 Landing Craft Utility

Physical and Performance Characteristics
Overall Geometry -- Outboard Profile and Main Deck
Internal Arrangements -- Inboard Profile & Arrangements
Project Execution Plan Drawing -- Outboard Profile and Main Deck
Project Execution Plan Drawing -- Inboard Profile & Arrangements

Seagoing Logistics Platform: LCU-1610 Landing Craft Utility

Physical and Performance Characteristics
Overall Geometry -- Outboard Profile and Weather Deck
Internal Arrangements -- Inboard Profile & Arrangements
Project Execution Plan Drawing -- Outboard Profile and Weather Deck
Project Execution Plan Drawing -- Inboard Profile & Arrangements

Inshore Work Platform: 3 x 14 Warping Tug for LST Side Carry

Physical and Performance Characteristics
Overall Geometry -- Outboard Profile and Deck Arrangement
Assembly of N.L. Series Pontoons
Project Execution Plan Drawing -- Outboard Profile & Deck Arrangement

Seagoing Work Platform: R/V H.J.W. FAY

Physical and Performance Characteristics
Overall Geometry -- Outboard Profile & Arrangement of Decks
Internal Arrangements -- Inboard Profile & Forecastle Deck
Internal Arrangements -- Hold Arrangement & Main Deck
Hull Form Delineation -- Curves of Form
Project Execution Plan Drawing -- Hold, Main Deck & Forecastle Deck

COMPENDIUM OF OCEAN CONSTRUCTION PLATFORMS

TABLE OF CONTENTS (Continued)

Seagoing Work Platform: R/V A.B. WOOD II

Physical and Performance Characteristics
 Overall Geometry -- Outboard Profile and Weather Deck
 Internal Arrangements -- Inboard Profile and Lower Deck
 Project Execution Plan Drawing -- Outboard Profile & Weather Deck
 Project Execution Plan Drawing -- Inboard Profile & Lower Deck

Inshore Work Platform: USCGS TERN, WLI 80801

Physical and Performance Characteristics
 Overall Geometry -- Outboard Profile
 Overall Geometry -- Main Deck & Upper Deck Arrangements
 Internal Arrangements -- Inboard Profile, Flat Arrangement
 Hull Form Delineation -- Curves of Form
 Deck Machinery -- Gantry Crane
 Project Execution Plan Drawing -- Main Deck & Pilot House
 Project Execution Plan Drawing -- Inboard Profile & Flat

Seagoing Survey Platform: AGS-26 Oceanographic Survey Ship

Physical and Performance Characteristics
 Overall Geometry -- Outboard Profile and Forecastle Deck
 Internal Arrangements -- Inboard Profile and Main Deck
 On-Board Computer Capability
 Project Execution Plan Drawing -- Outboard Profile, Forecastle Deck
 Project Execution Plan Drawing -- Inboard Profile and Main Deck

Inshore Logistics Platform: BOSTON WHALER

Physical Characteristics
 Physical and Performance Characteristics
 Overall Geometry -- Outboard Profile and Main Deck
 External Arrangements -- Weather Protection Systems
 Project Execution Plan Drawing -- Outboard Profile and Main Deck

Seagoing Work Platform: NAVFACENGCOM - SEACON

Physical and Performance Characteristics
 Overall Geometry -- Outboard Profile and Main Deck
 Internal Arrangements -- Inboard Profile and Deck Arrangements
 Load Handling Equipment -- Hydraulic Crane Profile
 Load Handling Equipment -- Hydraulic Crane Plan and End Views
 Load Handling Equipment -- P & H Crane Plan and Profile
 Load Handling Equipment -- Cross Deck Winch
 Cable Handling Equipment -- Pengo Winch, Model 200
 Cable Handling Equipment -- Pengo Winch, Model 7100-124
 Project Execution Plan Drawing -- Outboard Profile and Main Deck
 Project Execution Plan Drawing -- Inboard Profile and Arrangements

Inshore Logistics Platform: LARC V

Physical and Performance Characteristics
 Overall Geometry
 Project Execution Plan Drawing -- Overall Geometry

Inshore Operations Logistics Platform: 50' WORKBOAT

Physical and Performance Characteristics
 Overall Geometry -- Outboard Profile and Weather Deck
 Internal Arrangements -- Inboard Profile & Lower Deck Arrangements
 Typical Cross Sections -- Bow-On View
 Hull Form Delineation -- Curves of Form
 Hull Form Delineation -- Cross Curves of Stability
 Project Execution Plan Drawing -- Outboard Profile and Weather Deck
 Project Execution Plan Drawing -- Inboard Profile and Lower Deck

Seagoing Work Platform: YFRT-257 RANGE TENDER (AUTEC)

Physical and Performance Characteristics
 Overall Geometry -- Inboard Profile & Main Deck Arrangement
 Internal Arrangements -- Hold Arrangement and Sections
 Project Execution Plan Drawing -- Inboard Profile & Main Deck
 Project Execution Plan Drawing -- Hold Arrangement and Sections

- GEOMETRY:** THE LCM-6 (MOD 2) IS A BOX-SHAPED LANDING CRAFT WITH MACHINERY SPACE AND PROPULSION AFT AND AN OPEN CARGO WELL FORWARD TERMINATING IN A RAMP AT THE BOW. OVERALL LENGTH, INCLUDING THE RAMP IN STOWED CONDITION IS 56.00 FEET; LOAD WATERLINE LENGTH IS 53.00 FEET. MOLDED BEAM, AT WATERLINE AND AT MAIN DECK IS 14.00 FEET; MAXIMUM BEAM OVER FENDERS IS 14.13 FEET. FULL LOAD DRAFT IS 3.50 FEET ABOVE THE BASELINE WHICH LIES ALONG THE KEEL. HOWEVER, THE TWIN SKEGS AFT EXTEND 0.43 FEET BELOW THE BASELINE, GIVING A DRAFT AT MARKS OF 4.13 FEET. THE DEPTH AMIDSHIPS, KEEL TO MAIN DECK, IS 7.05 FEET WITH A 0.75" HIGH BULKWARK WHICH RISES TO A HEIGHT ABOVE THE KEEL OF 9.25 FEET AT THE BOW. THE CARGO DECK IS 1.5 FEET ABOVE THE KEEL AMIDSHIPS AND RISES TO THE LOAD WATERLINE LEVEL AT THE BOW.
- HYDROSTATICS:** DISPLACEMENT TO THE LOAD WATERLINE IS 133,500 POUNDS, SALT WATER. THE WEIGHT OF THE CRAFT IN HOISTING CONDITION (LIGHT SHIP) IS 56,000 POUNDS. CARGO CAPACITY IS 68,000 POUNDS WITH THE BALANCE OF THE DISPLACEMENT RESERVED FOR FUEL, STORES, AND PERSONNEL. IN LIGHT CONDITION THE CENTER OF GRAVITY IS 2.00 FEET ABAFT MIDSHIPS. WHEN LOWERED INTO THE WATER THE CRAFT HAS A MEAN DRAFT OF 1.80 FEET AND A TRIM BY THE STERN OF 0.57 FEET.
- STRUCTURE:** THE BASIC STRUCTURE IS OF ALL WELDED STEEL. TRANSVERSE FRAMES ARE SPACED AT 3.00 FEET WITH A TRANSVERSE WATERTIGHT BULKHEAD AT EVERY THIRD FRAME IN THE CARGO COMPARTMENT AREA. THESE BULKHEADS EXTEND FROM KEEL TO CARGO FLAT IN THE CENTER AND UP TO THE MAIN DECK IN THE WING TANKS. THE AFTER CARGO FLAT TRANSVERSE BULKHEAD FORMS THE FORWARD BULKHEAD OF THE MACHINERY SPACE AT FRAME 13-5; THE AFTER ENGINE ROOM BULKHEAD, AT FRAME 17, SEPARATES THE MACHINERY SPACE FROM THE LAZARETTE AT THE STERN. THE MAIN SUPPORT FOR THE CARGO FLAT COMPRISES SIX 6" X 4" X 12" I BEAMS THAT ARE IN TURN SUPPORTED BY THE TRANSVERSE FRAMES AND BULKHEADS.
- MACHINERY:** THE MAIN PROPULSION MACHINERY OF THE LCM-6 COMPRISES TWO, MODEL 64H19, GRAY MARINE DIESEL ENGINES. THESE ARE 2-CYCLE, 6-CYLINDER, 4.25-INCH BORE, 5-INCH STROKE ENGINES; COMPRESSION RATIO IS 16:1 WITH A 425 CUBIC INCH DISPLACEMENT. BOTH ENGINES ROTATE CLOCKWISE, HAVE SOLID INJECTION AND FRESH WATER COOLING USING A KEEL CONDENSER COOLING UNIT. THEY ARE STARTED ELECTRICALLY BY A 24 VOLT BATTERY SYSTEM OR, IN SOME CASES HYDRAULICALLY. BILGE AND BALLAST PUMPS COMPRISE A 150 GPM, 2-INCH DIAMETER SUCTION PUMP AND A 250 GPM, 2 1/2-INCH DIAMETER SUCTION PUMP MANUFACTURED BY MARINE PRODUCTS CO. AND A 250 GPM, 2 1/2-INCH DIAMETER SUCTION PUMP MADE BY FAIRBANKS-MORSE. THE MAIN PRODUCTS CO. CIRCULATING PUMP HAS A CAPACITY OF 10 GPM.
- OUTFIT:** THE BOW RAMP IS LOWERED BY GRAVITY AND RAISED BY POWER FROM A MOTOR-DRIVEN HOIST WINCH LOCATED ON THE PORT SIDE IN THE MACHINERY SPACE. THE HOIST CABLE RUNS ALONG THE MAIN DECK, THROUGH SHEAVES ON DECK AND WITHIN THE RAMP, AND TERMINATES ON THE MAIN DECK, STARBOARD SIDE. TREADLE CONTROL FOR LATCHES AND CONTROL OF BRAKES AND HOIST POWER ARE LOCATED IN THE PILOT HOUSE. ANCHOR, STOWED ON STARBOARD SIDE, IS MAN HANDLED; LIFTING EYES, CARGO LASHING RINGS, MOORING CLEATS, AND TOWING STAPLES ARE INSTALLED AS REQUIRED FOR MISSION. NAVIGATING LIGHTS AND A RADIO TRANSCEIVER ARE PROVIDED.
- SPEED AND PROPULSION:** THE CRAFT IS FITTED WITH TWO, 3-BLADED, 2.0-FOOT DIAMETER BY 1.42 FOOT PITCH, RIGHT HAND, BRONZE ALLOY PROPELLERS DESIGNED FOR A SPEED OF 9.00 KNOTS AT 1400 RPM AND 385 SHAFT HORSEPOWER AT MAXIMUM DIESEL RATING OF 450 HORSEPOWER. MAXIMUM SPEED IN LOADED CONDITION IS 8.69 KNOTS. FUEL CAPACITY IS 450 GALLONS GIVING AN ENDURANCE OF 250 NAUTICAL MILES AT 7.25 KNOTS.
- MANEUVERING AND CONTROL:** ENGINE STARTING, SPEED, AND ROTATION DIRECTION OF BOTH MAIN ENGINES ARE CONTROLLED FROM THE PILOT HOUSE CONTROL STAND. A PAIR OF HANDLES ACTIVATE LINKAGES THAT OPERATE CLUTCHES, THROTTLES, AND REVERSE GEARS IN SEQUENCE WITH FORE AND AFT MOTION OF THE HANDLES. IDLING SPEED OF THE ENGINES IS ABOUT 600 RPM GIVING PROPELLER ROTATION OF 400 RPM WHEN CLUTCHED IN AHEAD OR ASTERN. A STEERING WHEEL ON THE CONTROL STAND, THROUGH A CHAIN DRIVE INTO THE MACHINERY SPACE OPERATES A CONTROL ROD AND LINKAGES THAT TURN THE TWO RUDDERS IN TANDEM. RUDDERS, APPROXIMATELY THREE SQUARE FEET EACH, ARE DIRECTLY BEHIND THE TWO PROPELLERS IN THE STERN TUNNELS GIVING GOOD AHEAD MANEUVERING CONTROL. ASTERN STEERING IS MOST EFFECTIVELY ACCOMPLISHED BY ALTERING ROTATION DIRECTION OF THE PORT AND STARBOARD PROPELLERS.
- MISSION SUPPORT:** THE LCM-6 IS DESIGNED TO TRANSPORT CARGO, TROOPS, AND VEHICLES FROM SHIP TO BEACH. THE CRAFT MAY BE CARRIED ABOARD AN ATTACK TRANSPORT, CARGO VESSEL, OR IN THE WELL DECK OF AN LSD. FOR OFFLOADING FROM A SHIP IT IS PROVIDED WITH LIFTING EYES CAPABLE OF SUPPORTING THE ENTIRE CRAFT IN LIGHT CONDITION AND WITH MATCHING SLINGS. THE FOREFOOT IS STIFFENED AND SLOPED FOR BEACHING AND THE PROPELLERS AND RUDDERS ARE PROTECTED FROM BOTTOMING STRESSES BY SKEGS. A BOW RAMP, WITH TRACTION TREADS IS PROVIDED FOR OFF-LOADING VEHICLES TO A BEACH; THE CARGO DECK IS ALSO FITTED WITH TRACTION TREADS AND ADEQUATELY STRUCTURED TO SUSTAIN THE LOADING OF THE ENTIRE CARGO WEIGHT IN WHEELED OR TRACKED VEHICLES. ADEQUATE PROVISION IS MADE FOR SECURING CARGO AND PROTECTING IT FROM SEAWAY MOTIONS.

INSHORE OPERATIONS LOGISTICS PLATFORM
PHYSICAL AND PERFORMANCE CHARACTERISTICS

LCM-6: LANDING CRAFT MECHANIZED

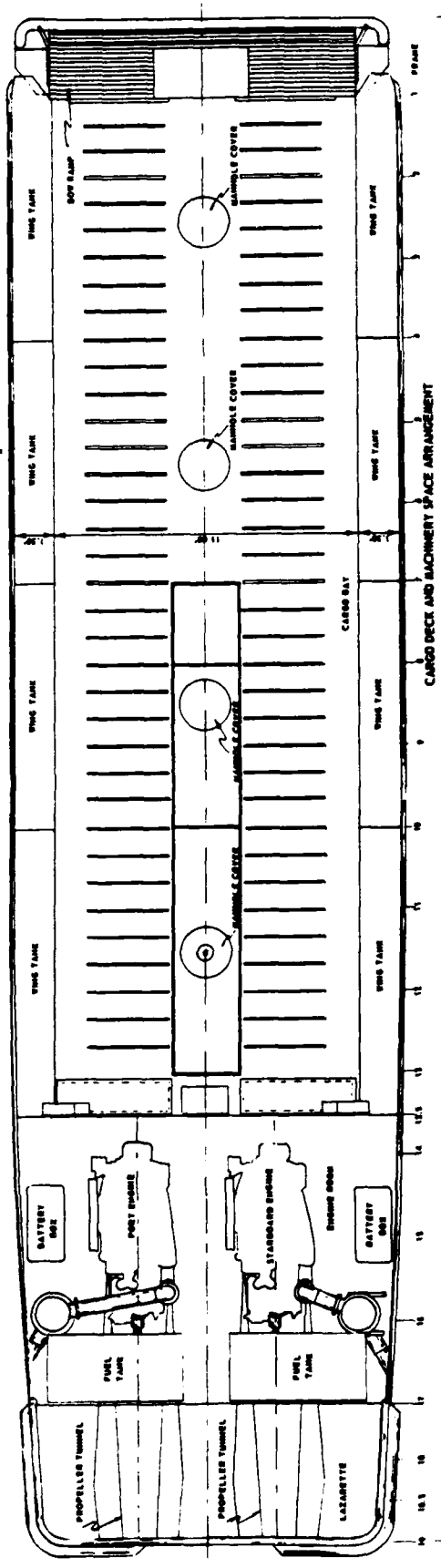

CARGO DECK AND MACHINERY SPACE ARRANGEMENT

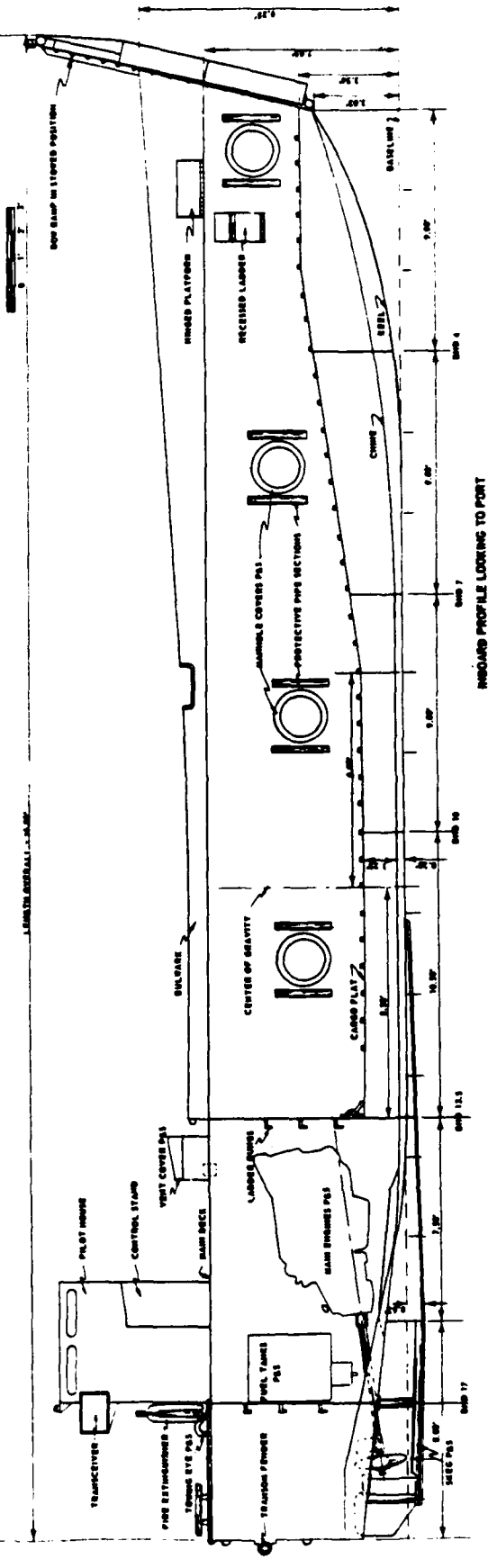

INBOARD PROFILE LOOKING TO PORT

INSHORE OPERATIONS LOGISTICS PLATFORM
INTERNAL ARRANGEMENTS

LCM-6 LANDING CRAFT MECHANIZED

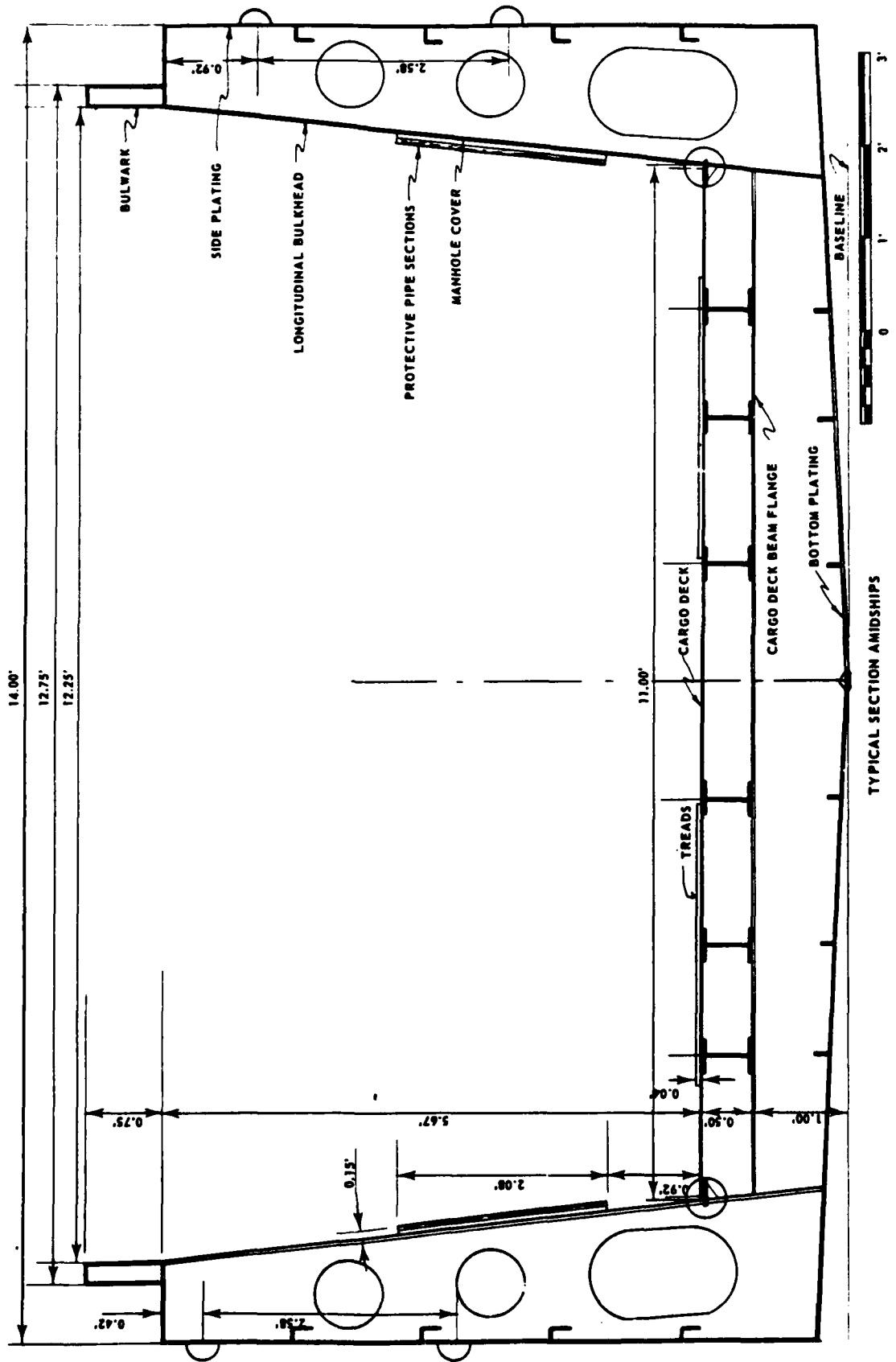

INSHORE OPERATIONS LOGISTICS PLATFORM
 INTERNAL ARRANGEMENTS

LCM-6: LANDING CRAFT MECHANIZED

LOAD WATERLINE VALUES: LENGTH, B.P. - 53.00 FT.; DRAFT, FROM BASELINE - 3.50 FT.; DISPLACEMENT - 133,500 LBS., S.W.

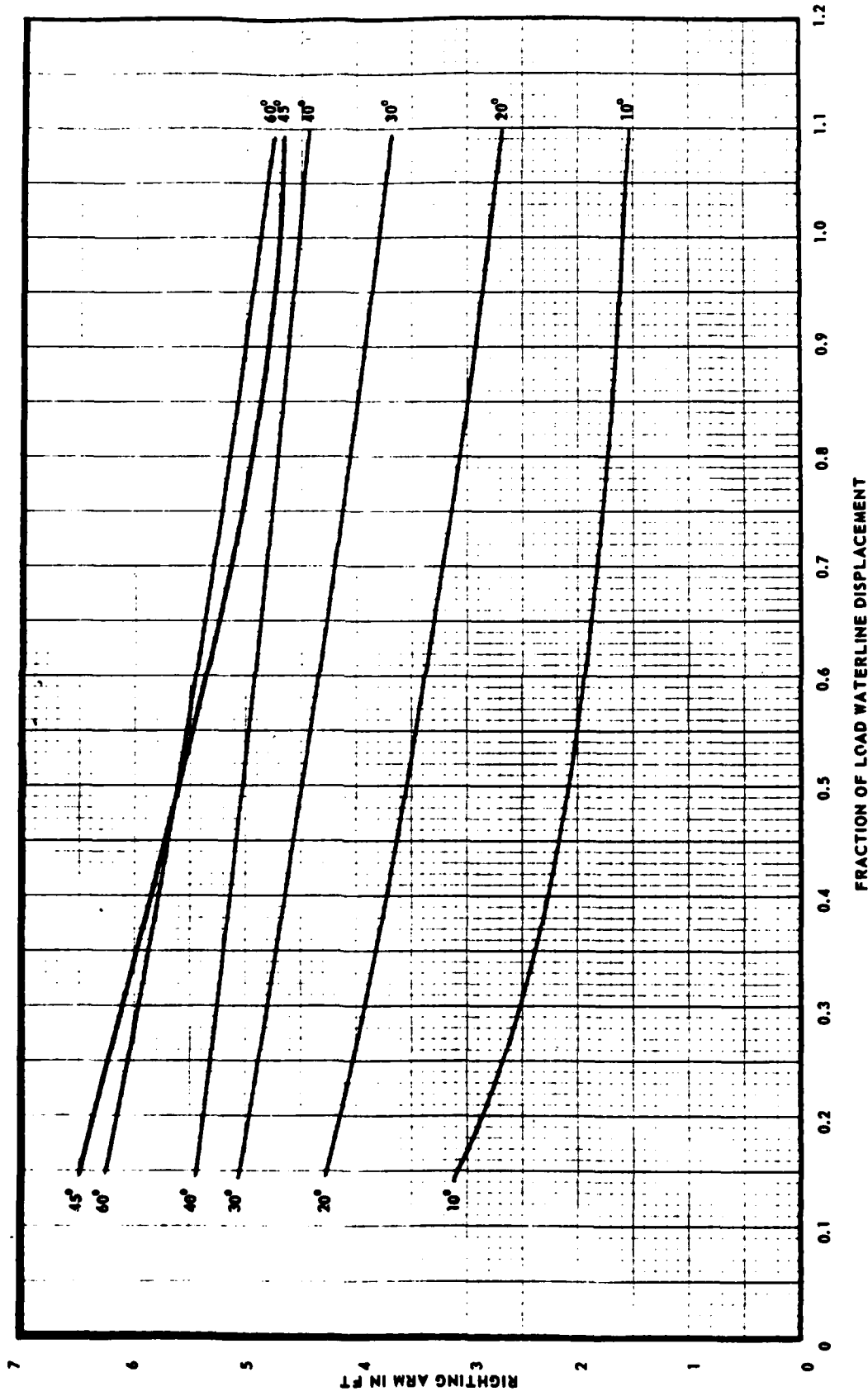

INSHORE OPERATIONS LOGISTICS PLATFORM
 HULL FORM DELINEATION - CROSS CURVES OF STABILITY

LCM-6: LANDING CRAFT MECHANIZED

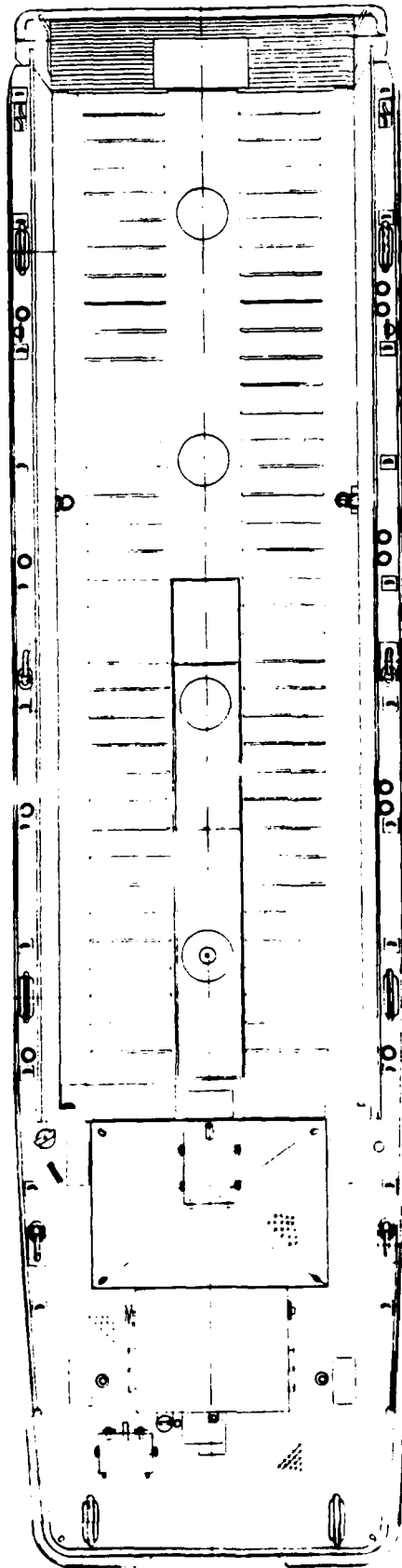

WEATHER DECK PLAN

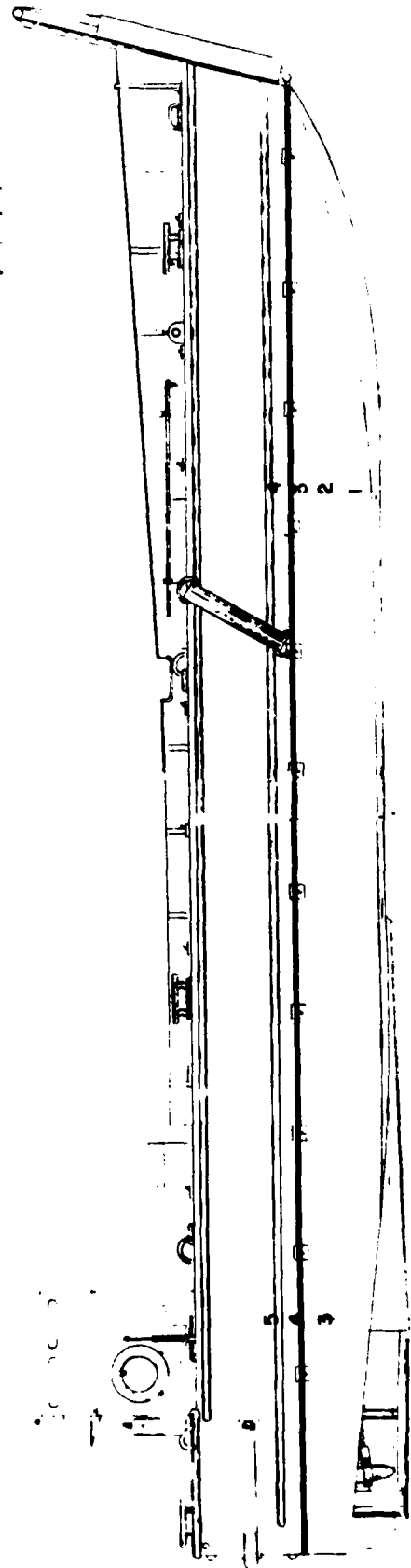

OUTBOARD PROFILE

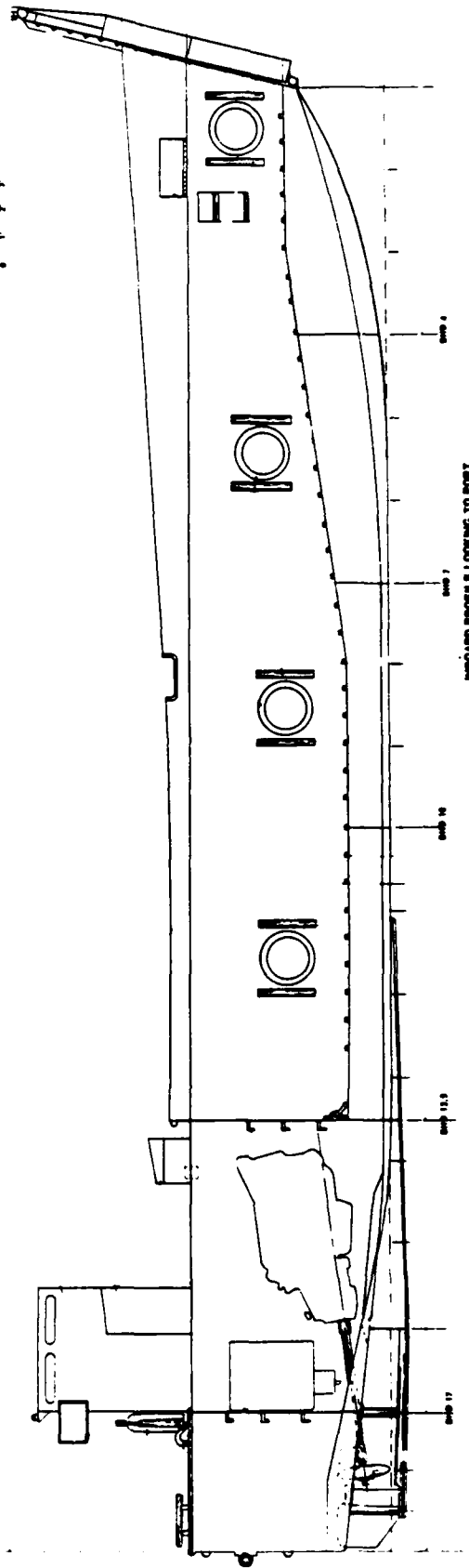
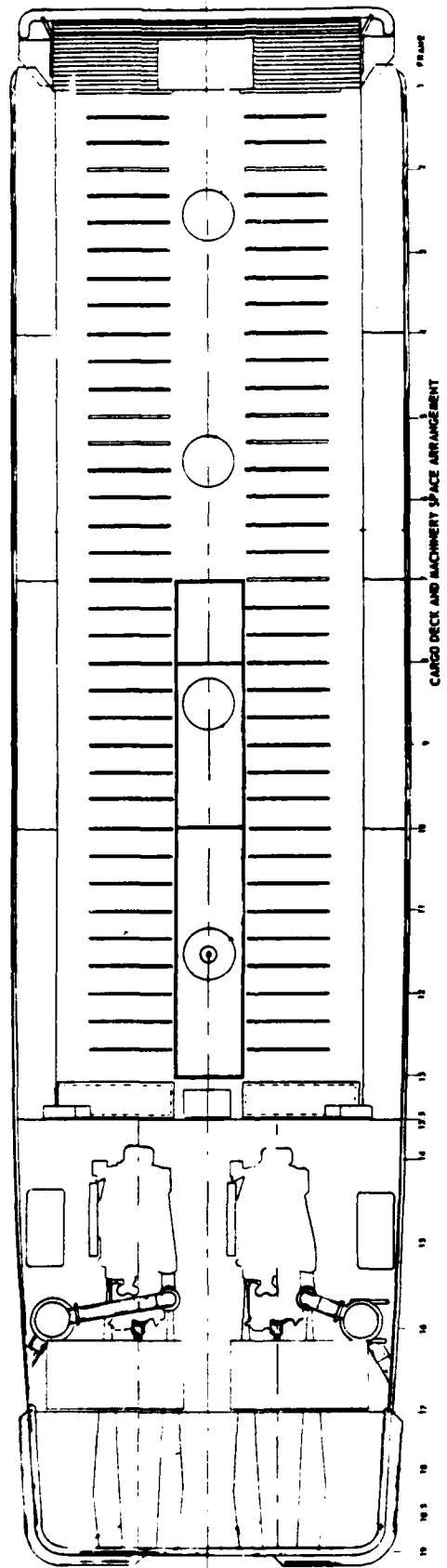

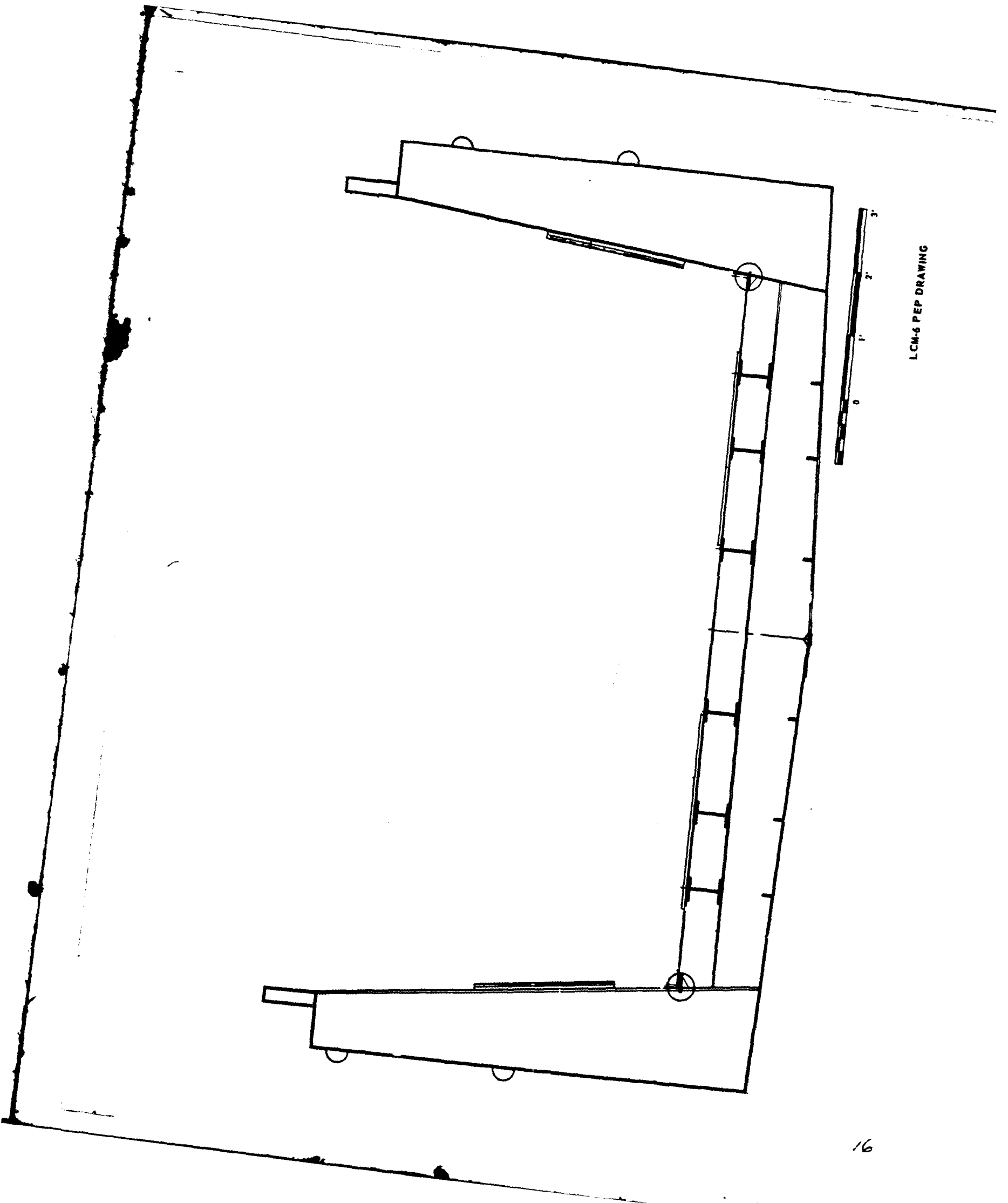

LCM-6 PEP DRAWING

1) GEOMETRY: THE LCM-8 (MOD 1, MARK VIII) IS A BOX-SHAPED LANDING CRAFT WITH MACHINERY SPACE AND PROPULSION AFT AND AN OPEN CARGO WELL FORWARD TERMINATING IN A RAMP AT THE BOW. OVERALL LENGTH, INCLUDING THE RAMP IN THE STOWED CONDITION, IS 74.00 FEET. THE HULL LENGTH IS 71.56 FEET, AND THE LOAD WATERLINE LENGTH IS 63.29 FEET. THE EXTREME BEAM IS 21.05 FEET AND THE LOAD WATERLINE DRAFT IS 4.50 FEET ABOVE THE BASELINE. THE TWIN SKEGS AFT EXTEND 0.44 FEET BELOW THE BASELINE GIVING A MAXIMUM DRAFT AT THE STERN OF 4.94 FEET. THE MAIN DECK AT THE TRANSOM IS 8.50 FEET ABOVE THE BASELINE AND RISES TO A HEIGHT OF 10.75 FEET ABOVE THE BASELINE AT THE FORWARD END OF THE HULL PROPER; DEPTH AMIDSHIPS IS 9.33 FEET. THE CARGO FLAT RISES FROM 5.19 FEET ABOVE THE BASELINE AFT TO A MAXIMUM HEIGHT OF 5.93 FEET ABOVE THE BASELINE FORWARD. THE CARGO WELL IS 42 FEET LONG BY 15 FEET WIDE.

2) HYDROSTATICS: DISPLACEMENT TO THE LOAD WATERLINE IS 266,000 POUNDS, SALT WATER. CARGO CAPACITY IS 134,400 POUNDS AND THE WEIGHT OF THE CRAFT, FULLY FUELED AND PROVISIONED IS 131,600 POUNDS.

3) STRUCTURE: THE BASIC STRUCTURE IS OF ALL-WELDED STEEL ALTHOUGH LATER MODELS HAVE BEEN CONSTRUCTED OF WELDED ALUMINUM WHICH SAVES APPROXIMATELY 22,000 POUNDS IN HULL WEIGHT. TRANSVERSE FRAMES ARE SPACED AT 1.50 FEET WITH A TRANSVERSE WATERTIGHT BULKHEAD EVERY FOURTH FRAME; TRANSVERSE FLOORS ARE INSTALLED HALFWAY BETWEEN BULKHEADS. LONGITUDINAL FRAMING CONSISTS OF BOTTOM STRINGERS AND LONGITUDINAL DECK GIRDERS SPACED EVERY 1.50 FEET OFF THE CENTERLINE. A LONGITUDINAL TRUSS RUNS THE ENTIRE LENGTH OF THE HULL ALONG THE CENTERLINE AND ADDITIONAL TRUSSES RUN THE LENGTH OF THE CARGO COMPARTMENT. 4.58 FEET OFF THE CENTERLINE PORT AND STARBOARD TO GIVE THE CARGO FLAT THE CAPACITY TO CARRY THE CONCENTRATED LOADING OF AN M-48 OR AN M-60 TANK (APPROXIMATELY 48 TONS) OR THE DISTRIBUTED LOAD OF 60 TONS OF CARGO. THE WING WALLS RUNNING ALONG THE LENGTH OF THE CARGO COMPARTMENT ARE DIVIDED INTO EIGHT WATERTIGHT TANKS PORT AND STARBOARD.

4) MACHINERY: MAIN PROPULSION COMPRISES TWO TWIN DETROIT DIESEL ENGINES, MODEL 12005A STARBOARD AND 12005B PORT. THESE ARE 6 CYLINDER ENGINES WITH A BORE OF 4.25 INCHES, A STROKE OF 5.00 INCHES AND A DISPLACEMENT OF 425 CUBIC INCHES PER ENGINE. ALL FOUR ENGINES ARE RATED AT 300 HORSEPOWER EACH AT 1800 RPM WITH THE STARBOARD ENGINE HAVING RIGHT HAND ROTATION AND THE PORT ENGINE, LEFT HAND ROTATION. BOTH PAIRS OF ENGINES ARE FITTED WITH AN ALLISON HYDRAULIC TRANSMISSION. THEY ARE STARTED EITHER ELECTRICALLY OR HYDRAULICALLY. THE MAIN ENGINES ARE FRESH WATER COOLED BY 9 GALLON PER ENGINE CAPACITY SYSTEMS WHICH IN TURN ARE COOLED BY SEA WATER PUMPED THROUGH A PAIR OF HEAT EXCHANGERS. ALL PUMPS ARE DRIVEN OFF THE MAIN ENGINES. THE LCM-8 IS FITTED WITH A HYDRAULIC STEERING SYSTEM WHICH OPERATES THE TWO RUDDERS IN TANDEM.

5) OUTFIT: THE BOW RAMP IS BOTH RAISED AND LOWERED HYDRAULICALLY BY A PAIR OF WINCHES LOCATED BELOW THE CARGO FLAT FORWARD OF THE ENGINE COMPARTMENT. THESE WINCHES MAY BE OPERATED INDIVIDUALLY OR IN TANDEM TO ACHIEVE GREATER HOIST SPEED. EMERGENCY LOWERING BY GRAVITY IS PROVIDED TOGETHER WITH EMERGENCY RAISING BY MEANS OF A CHAIN HOIST. A 75 POUND ANCHOR WITH 3/8-INCH CHAIN HAS TO BE MAN-HANDLED OVERBOARD WHEN REQUIRED. ON SOME MODELS A PORTABLE CANOPY CARGO COVER IS PROVIDED. LIFTING EYES, CARGO LASHING FITTINGS, BITTS, AND CLEATS ARE PROVIDED. THE VESSEL IS EQUIPPED WITH A REMOTE MAGNETIC HEADING SYSTEM, STATIC ISOLATION EQUIPMENT, AND FOUR RADIO SETS: AN/GRC-106, AN/SRC-32, AN/VRC-46, AND AN/VRC-47.

6) SPEED AND PROPULSION: THE CRAFT IS FITTED WITH TWO, 3-BLADED 34-INCH DIAMETER BY 24-INCH PITCH PROPELLERS, RIGHT HAND ON THE STARBOARD SHAFT AND LEFT HAND ON THE PORT SHAFT. EACH PROPELLER IS DESIGNED TO ABSORB 600 HORSEPOWER AT AN ENGINE SPEED OF 1800 RPM. MAXIMUM SPEED IN THE LOADED CONDITION IS 9.00 KNOTS. FUEL CAPACITY IS 864 GALLONS AND RANGE AT CRUISING SPEED IS ABOUT 150 NAUTICAL MILES IN THE LOADED CONDITION.

7) MANEUVERING AND CONTROL: ENGINE STARTING, SPEED, AND ROTATION DIRECTION OF BOTH TWIN ENGINES ARE CONTROLLED FROM THE PILOT HOUSE. A PAIR OF HANDLES ACTIVATES LINKAGES THAT OPERATE CLUTCHES, THROTTLES, AND REVERSE GEARS IN SEQUENCE WITH FORE AND AFT MOTION OF THE HANDLES. A STEERING WHEEL ON THE CONTROL STAND, THROUGH A HYDRAULIC TELEMOTOR SYSTEM, OPERATES PISTONS THAT ACTUATE RUDDER MOTION FOR STEERING. RUDDERS, APPROXIMATELY THREE FEET SQUARE EACH ARE DIRECTLY BEHIND THE TWO PROPELLERS GIVING GOOD AHEAD MANEUVERING CONTROL. ASTERN MANEUVERING CONTROL IS MOST EFFECTIVELY ACCOMPLISHED BY ALTERING ROTATION DIRECTION OF THE PORT AND STARBOARD PROPELLERS.

8) MISSION SUPPORT: THE LCM-8 LANDING CRAFT IS DESIGNED TO TRANS-PORT CARGO, TROOPS, AND VEHICLES FROM SHIP-TO-SHORE, SHORE-TO-SHORE OR IN RETROGRADE MOVEMENTS. IT MAY BE UTILIZED FOR LIGHTERAGE AND UTILITY WORK IN HARBORS. IT IS INTENDED FOR USE IN ROUGH OR EXPOSED WATERS AND IS CAPABLE OF OPERATING THROUGH BREAKERS AND GROUNDING ON A BEACH DUE TO THE STIFFENING AND SLOPE OF THE FOREFOOT. PROPELLERS AND RUDDERS ARE PROTECTED FROM BOTTOMING STRESSES BY SKEGS. A BOW RAMP WITH TRACTION TREADS IS PROVIDED FOR OFF-LOADING VEHICLES TO A BEACH. THE CARGO DECK IS ALSO FITTED WITH TRACTION TREADS AND IS ADEQUATELY STRUCTURED TO SUPPORT LIVE LOADS. PROVISION IS MADE FOR SECURING CARGO AND PROTECTING IT FROM SEA WAY MOTIONS.

INSHORE OPERATIONS LOGISTICS PLATFORM
PHYSICAL AND PERFORMANCE CHARACTERISTICS

LCM-8: LANDING CRAFT MECHANIZED

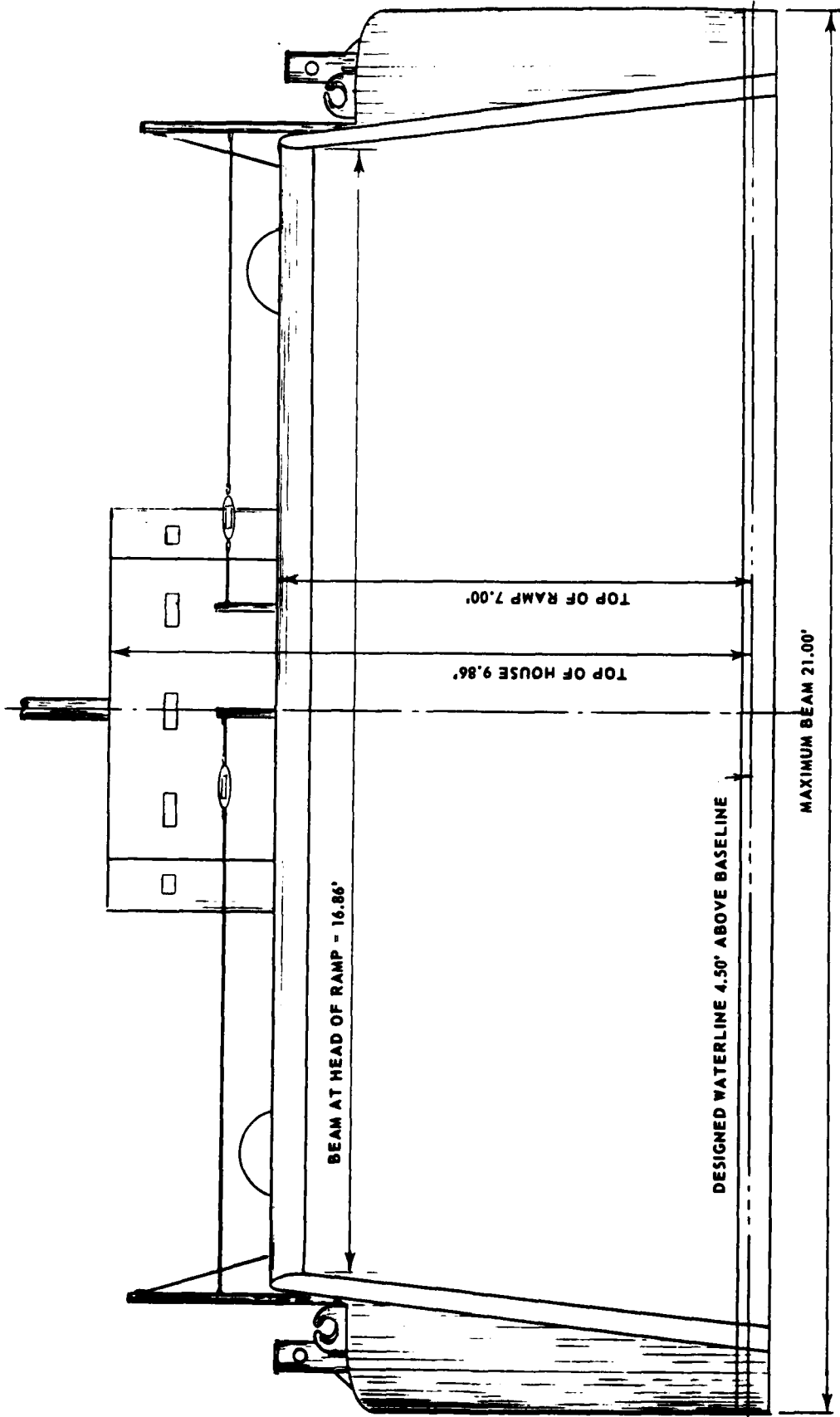

BOW-ON VIEW ABOVE WATERLINE

INSHORE OPERATIONS LOGISTICS PLATFORM OVERALL GEOMETRY	LCM-8: LANDING CRAFT MECHANIZED
---	---------------------------------

LOAD WATERLINE VALUES: LENGTH, WATERLINE - 63.29 FT; DRAFT, FROM BASE LINE - 4.50 FT; DISPLACEMENT - 266,000 LBS, S.W.

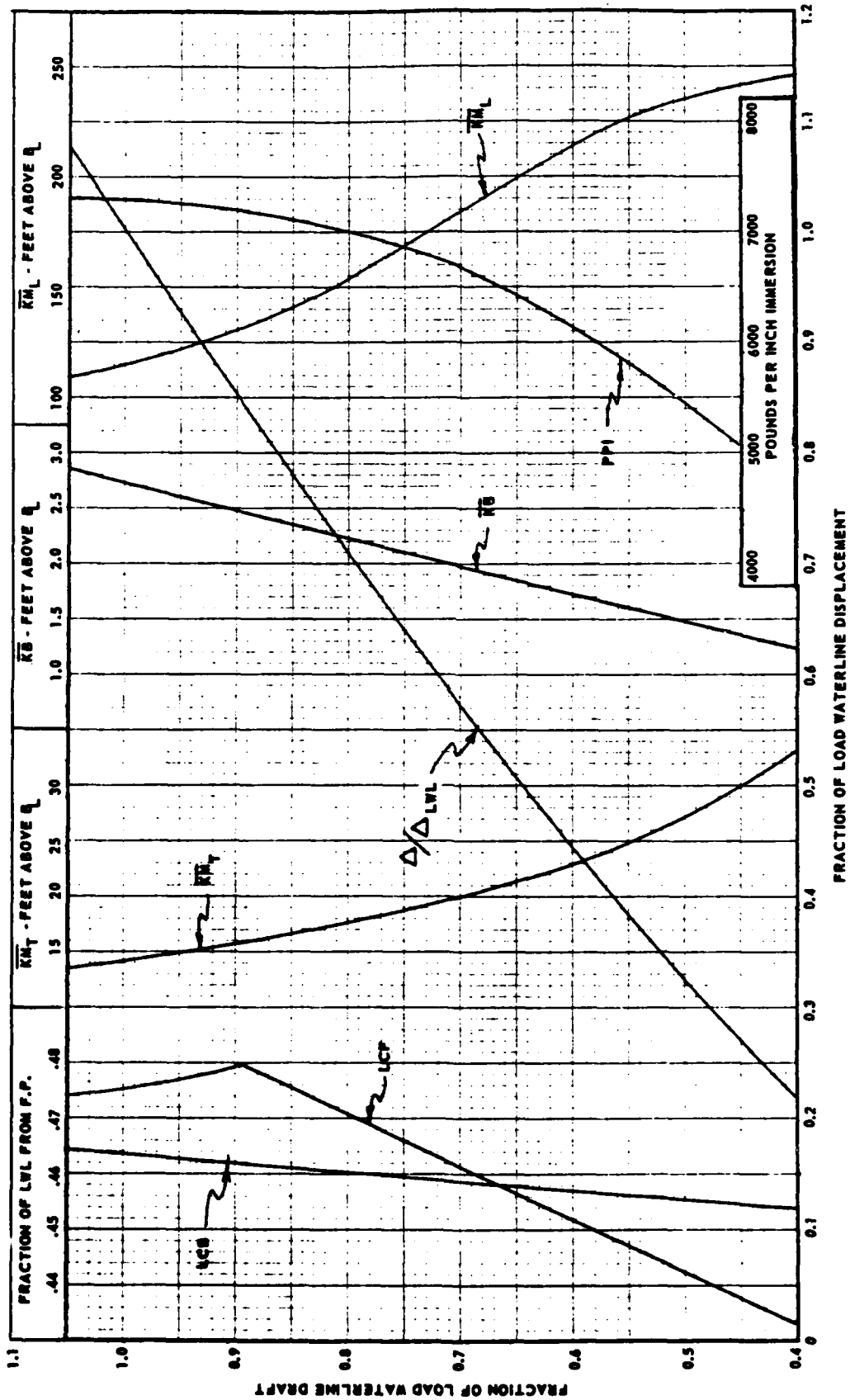

INSHORE OPERATIONS LOGISTICS PLATFORM
HULL FORM DELINEATION - CURVES OF FORM

LCM-8: LANDING CRAFT MECHANIZED

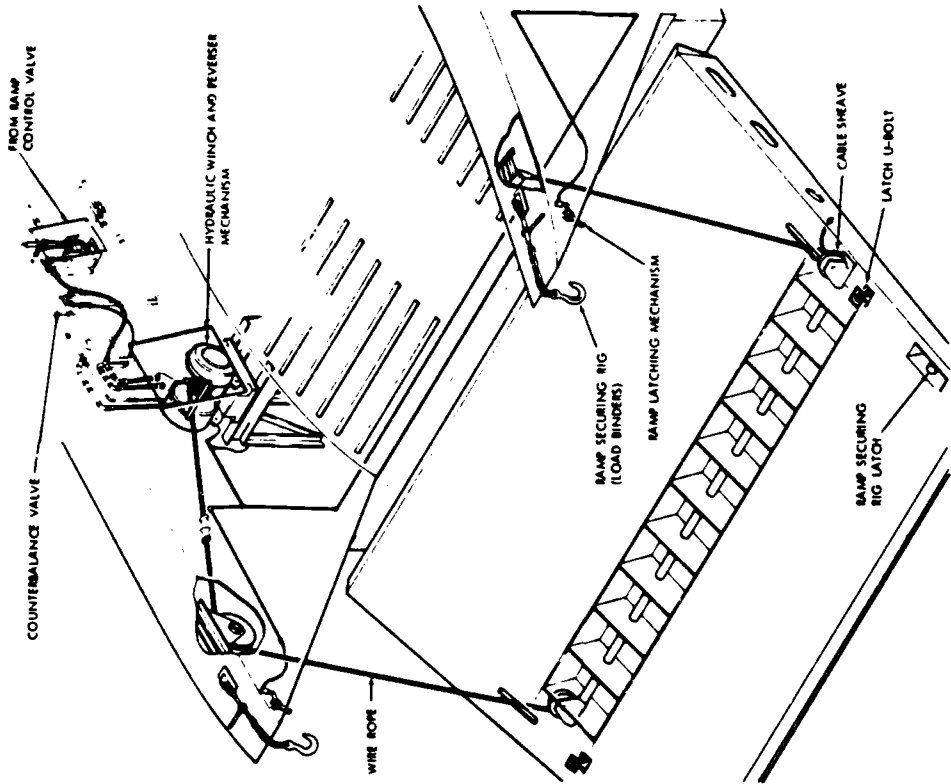
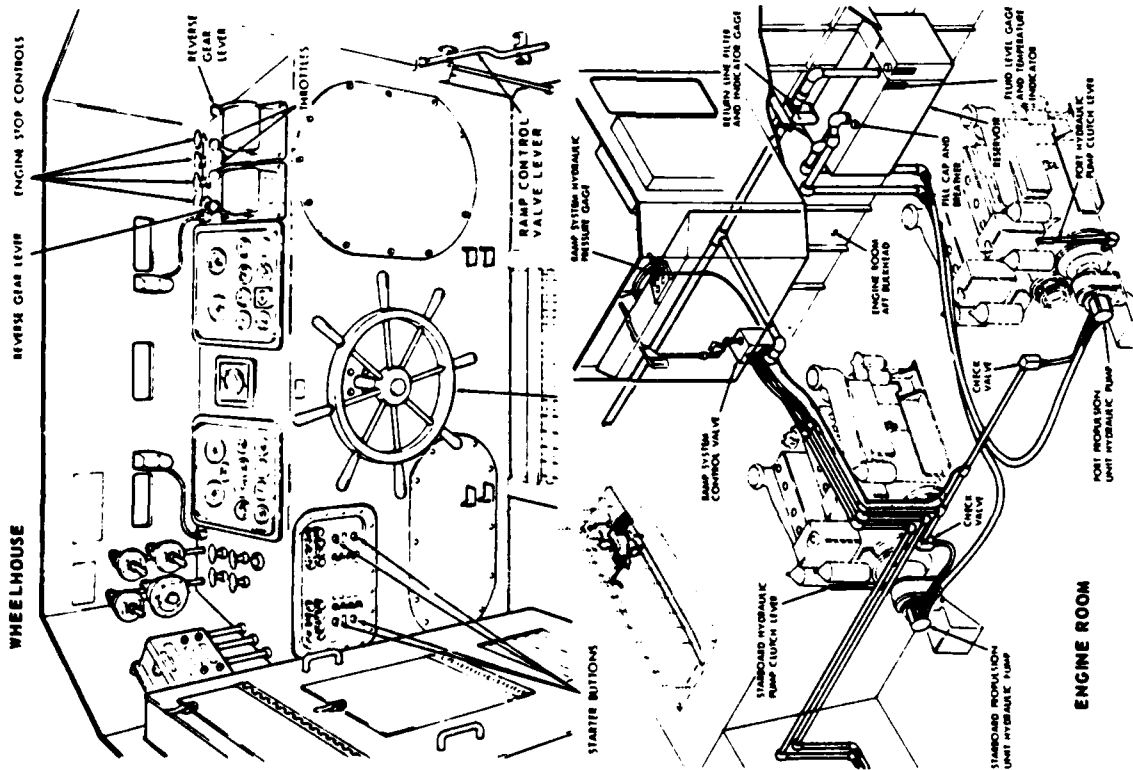

LCM-8: LANDING CRAFT MECHANIZED

INSHORE OPERATIONS LOGISTICS PLATFORM DECK MACHINERY - BOW RAMP HANDLING

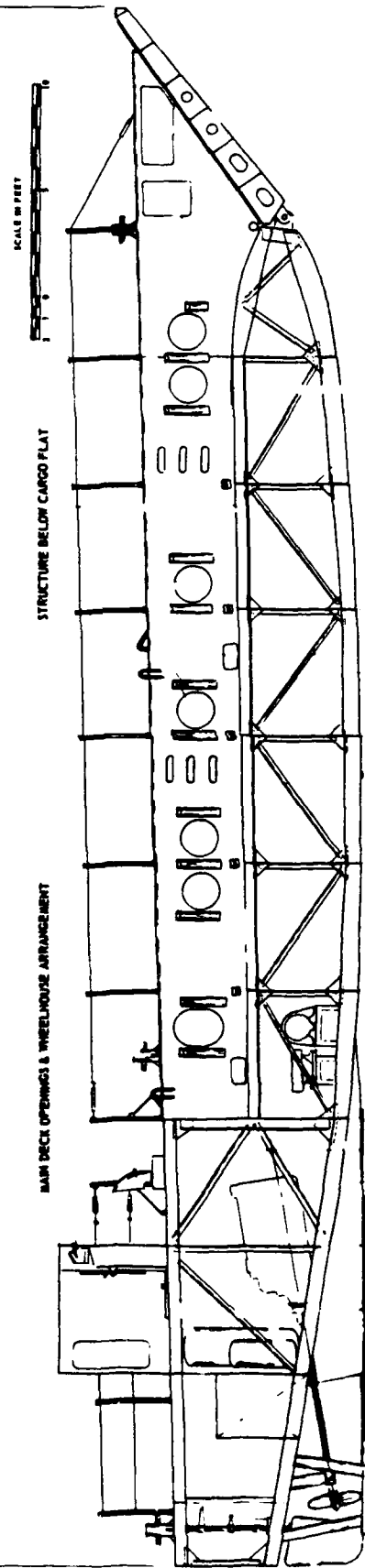
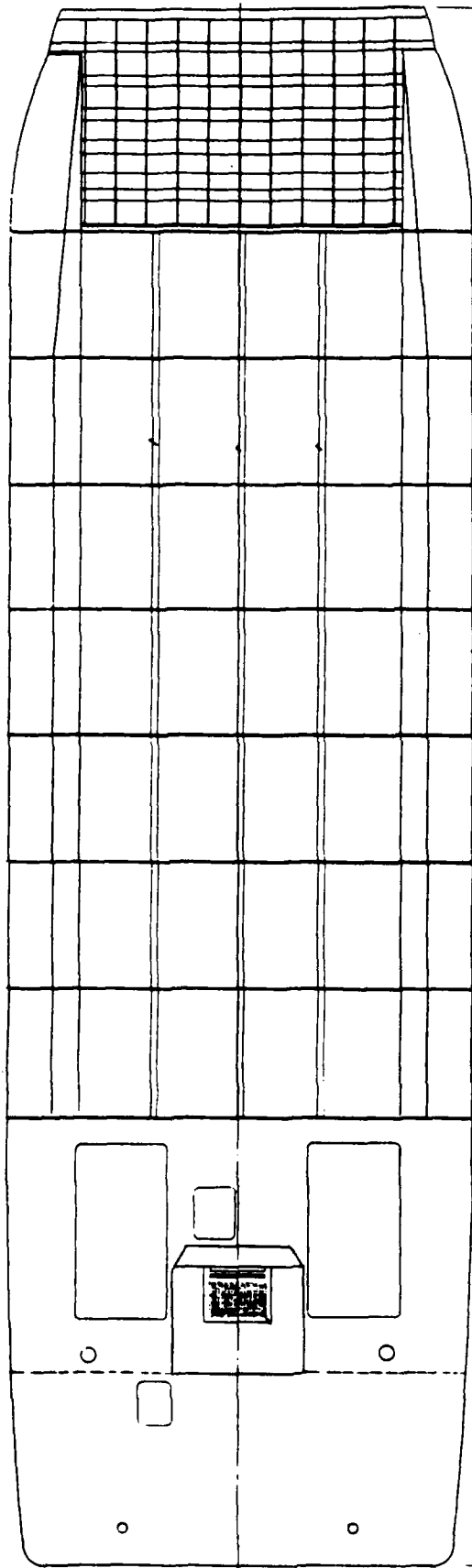

INBOARD PROFILE
LCM-8 PEP DRAWING

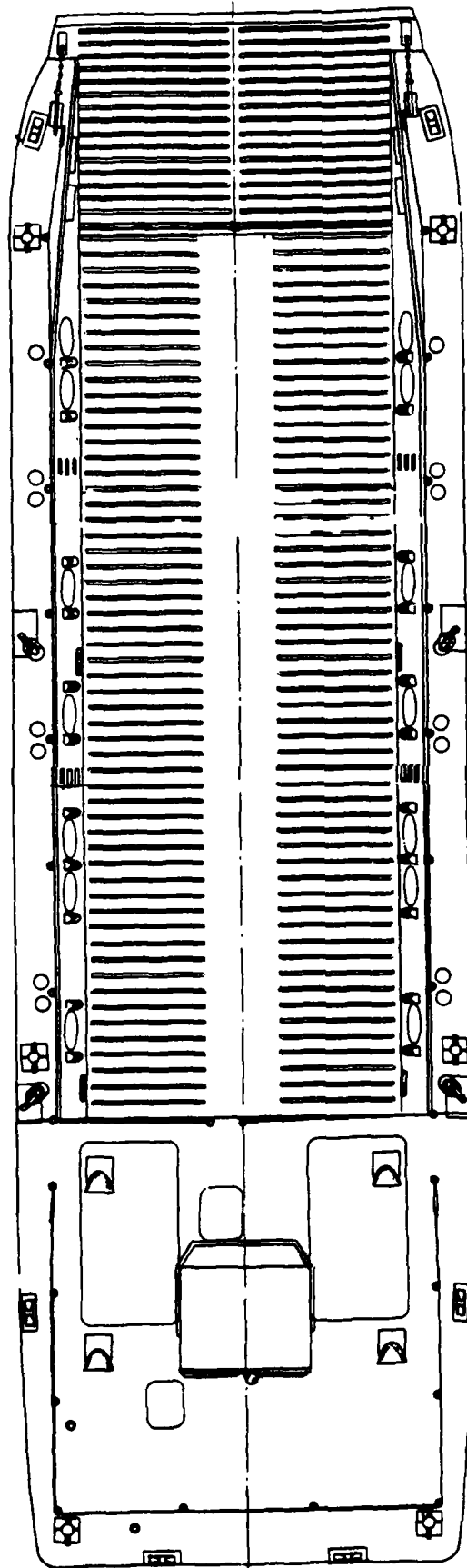

WEATHER DECK PLAN

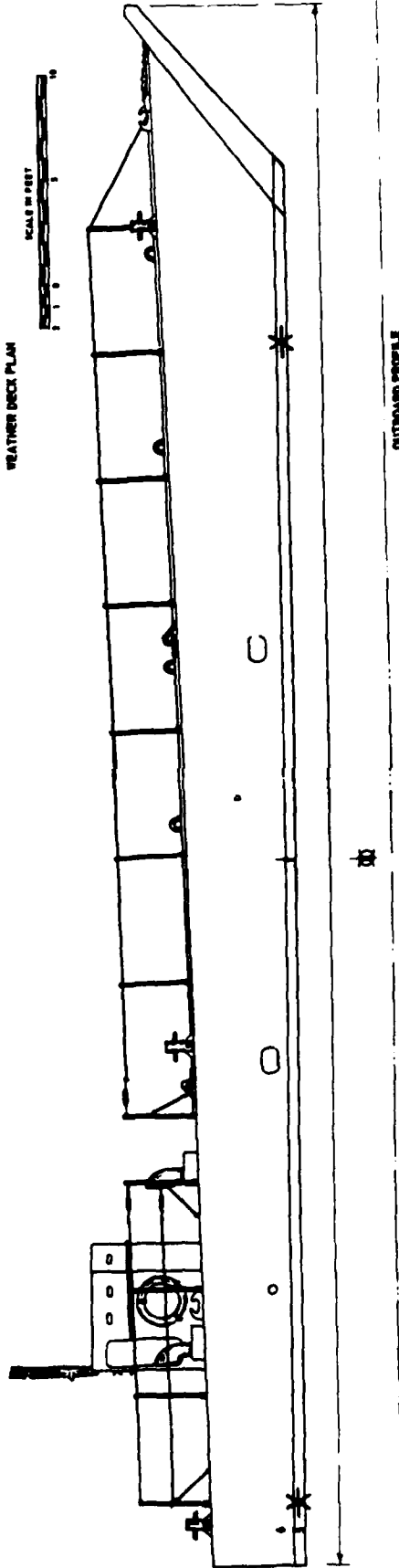

OUTBOARD PROFILE

LCM-8 PEP DRAWING

GEOMETRY AND HYDROSTATICS: THE LCU-501 CLASS OF UTILITY LANDING CRAFT WERE ORIGINALLY RATED AS LANDING CRAFT, TANK (LC(T)6)). IN 1949, THEY WERE REDESIGNATED AS UTILITY LANDING SHIPS (LSU) TO REFLECT VARIED EMPLOYMENT. IN 1952, THE DESIGNATION WAS CHANGED TO UTILITY LANDING CRAFT (LCU) AND THEY WERE CLASSIFIED AS SERVICE CRAFT. THERE ARE PRESENTLY 23 ACTIVE UTILITY LANDING CRAFT IN THE LCU-501 CLASS SERIES, THE LCU-509, WHICH WAS RECLASSIFIED AS YFU-54 IN MARCH OF 1966, IS TYPICAL OF THIS CLASS. THE TOTAL OVERALL LENGTH INCLUDING THE STERN ANCHOR BRACE IS 119.00 FEET. THE ACTUAL HULL LENGTH IS 114.50 FEET. THE LENGTH BETWEEN PERPENDICULARS IS 105.00 FEET. EXTREME BEAM IS 32.75 FEET AND THE DEPTH TO THE VEHICLE DECK AMIDSHIPS IS 5.50 FEET, WITH A BULKWARK EXTENDING UP TO 10.00 FEET ABOVE THE BASELINE. THE MEAN DESIGN DRAFT IS 3.75 FEET TO THE MOLDED BASELINE. HEIGHT TO THE TOP OF THE FORWARD ANCHOR LIGHT MAST FROM THE DESIGN WATER LINE IS 21.17 FEET AND THE HEIGHT TO THE TOP OF THE MAIN MAST FROM THE DESIGN WATERLINE IS 44.08 FEET. WHEN THE MAST IS STOWED ON DECK THE HIGHEST POINT IS THE T.C.S. ANTENNA ATOP THE PILOT HOUSE. THE HEIGHT OF THE TOP OF THIS ANTENNA FROM THE DESIGN WATERLINE IS 27.08 FEET. LIGHT DISPLACEMENT IS 140 TONS SALT WATER AND LOAD DISPLACEMENT IS 310 TONS SALT WATER. QUARTERS ARE PROVIDED FOR THE 2 C.P.O.'S AND 11 CREW MEMBERS IN THREE 3 TIER BERTHS AND TWO 2 TIER BERTHS.

STRUCTURE: THE VESSEL IS CONSTRUCTED OF ALL WELDED STEEL. TRANSVERSE FRAMES ARE SPACED 2.00 FEET FROM THE FORE PERPENDICULAR THROUGH FRAME 52 WHICH IS 1.00 FEET FORWARD OF THE TRANSOM. THE STRUCTURAL SUPPORT FOR THE CARGO DECK IS PROVIDED BY EIGHT TRANSVERSE BULKHEADS. NON-TIGHT LONGITUDINAL BULKHEADS, 3.50 FEET OFF CENTERLINE, RUN THE ENTIRE LENGTH AND WATERTIGHT BULKHEADS, 10.75 FEET OFF CENTERLINE RUN 82.00 FEET THROUGH THE ENGINE ROOM TO THE FORE PEAK TANK. THESE SHIPS WERE CONSTRUCTED IN THREE SECTIONS FOR TRANSPORTATION TO ADVANCE BASES. THE FORWARD SECTION EXTENDED 30.00 FEET FROM THE FORE PERPENDICULAR TO FRAME 15, WITH THE BOW RAMP IN THE RAISED POSITION, THE TOTAL LENGTH OF THIS SECTION IS 39.50 FEET. THE MIDSECTION EXTENDED FROM FRAME 15 TO FRAME 39 FOR A TOTAL LENGTH OF 48.00 FEET. THE AFTER SECTION EXTENDED FROM FRAME 39 TO THE TRANSOM WITH A TOTAL LENGTH OVER THE ANCHOR BRACE OF 31.50 FEET.

IT IS PROBABLE THAT THE JOINTS BETWEEN SECTIONS ARE PERMANENTLY WELDED ON ALL EXISTING VESSELS OF THIS CLASS.

OUTFIT: THE STERN ANCHOR IS STOWED OVER THE PORT SIDE OF THE TRANSOM FOR READY RELEASE AND RETRIEVAL DURING BEACHING OPERATIONS. THE ANCHOR WINCH IS LOCATED ON THE POOP DECK PORT SIDE ABOVE THE CREWS QUARTERS. THE BOW RAMP IS LOWERED BY GRAVITY AND RAISED WITH A BLOCK AND TACKLE ARRANGEMENT USING A HAND RAMP HOIST ON THE STARBOARD SIDE OR A POWERED RAMP WINCH ON THE PORT SIDE. A LEVER ARM, SIMILAR TO A GAFF BOOM, IS WELDED TO THE BASE OF THE MAIN MAST AND EXTENDS AFT WHERE A STAY CONNECTS THE END TO THE UPPER PART OF THE MAST AND A CABLE RUNS DOWN TO A HAND WINCH MOUNTED ON THE POOP DECK, STARBOARD SIDE, THAT IS USED FOR LOWERING THE MAST TO A HORIZONTAL POSITION ALONG THE PILOT HOUSE TOP. A FORESTAY AND BRACES ARE FITTED TO SUPPORT THE MAST WHEN IT IS CRANKED UP TO THE VERTICAL POSITION. A GRATING WALKWAY AT POOP DECK LEVEL CONNECTS THE PORT AND STARBOARD DECK HOUSES FOR ATHWARTSHIP ACCESS. THIS WALKWAY CAN BE REMOVED FOR MOVING VEHICLES ALONG THE MAIN DECK AFT.

MACHINERY AND PROPULSION: THE LCU-501 CLASS LANDING CRAFT ARE PROPELLED BY THREE 225 BRAKE HORSEPOWER GRAY MARINE DIESEL ENGINES. THE PROPULSION SYSTEM DRIVES THE SHIPS AT A MAXIMUM SPEED OF 9.00 KNOTS. AT A CRUISING SPEED OF 7.00 KNOTS, THE 11.12 TON FUEL CAPACITY GIVES A RANGE OF 700 NAUTICAL MILES.

MISSION SUPPORT: THE LCU-509, WHICH IS TYPICAL OF THE LCU-501 CLASS SERIES, IS A LIGHT BUT EXTREMELY RUGGED VESSEL DESIGNED FOR DIRECT "ON THE BEACH" LOADING AND UNLOADING. THE NATURE OF THE VESSEL ALSO PERMITS LOADING AND UNLOADING AT THE STERN. HAVING A LIGHT DRAFT, IT IS IDEALLY SUITED FOR OPERATION ON INLAND WATERWAYS, OR ON ANY OTHER SHALLOW WATER. EQUIPPED WITH A BOW RAMP, CARGO SUCH AS VEHICLES AND LIVE STOCK CAN BE DRIVEN DIRECTLY FROM THE BEACH ON TO THE CRAFT. THE VESSEL IS CAPABLE OF TRANSPORTING A MAXIMUM OF FOUR TANKS OR 200 TONS OF CARGO. THE BOTTOM IS ESPECIALLY DESIGNED FOR "BEACHING" WITH A RESULTING MINIMIZATION OF DANGER FROM SNAGS AND SANDBARS. DOCKING FACILITIES ARE NOT REQUIRED.

INSHORE OPERATIONS LOGISTICS PLATFORM
PHYSICAL AND PERFORMANCE CHARACTERISTICS

LCU-501 CLASS: LANDING CRAFT UTILITY

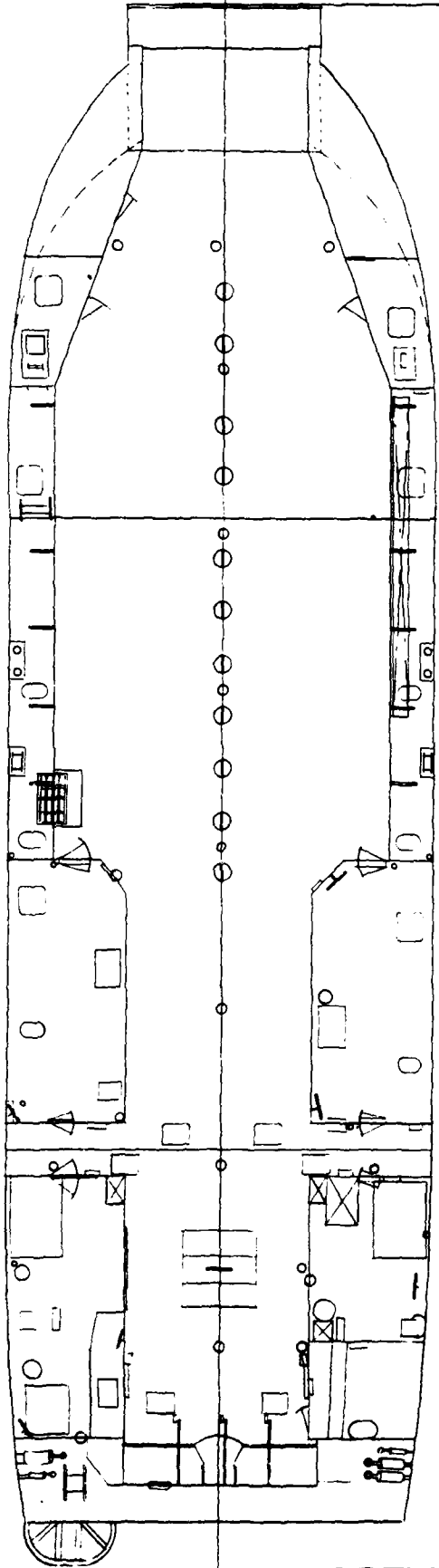

MAIN DECK ARRANGEMENT

DIMENSION A - 119.00'

SCALE IN FEET
 2 1 0 5 10

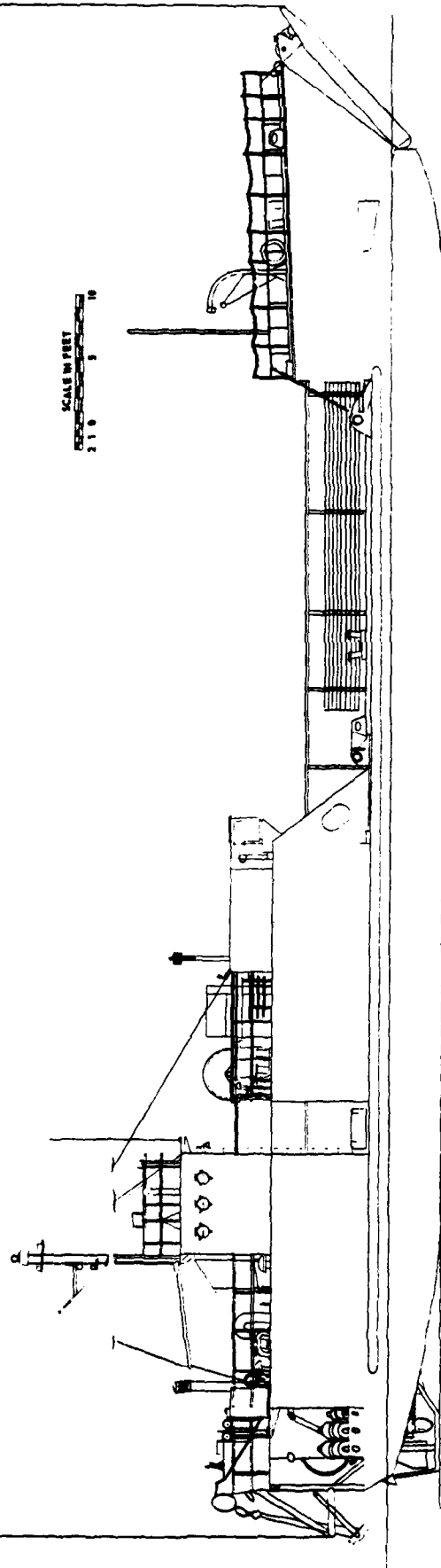

OUTBOARD PROFILE

LCU-901 CLASS
 PEP DRAWING

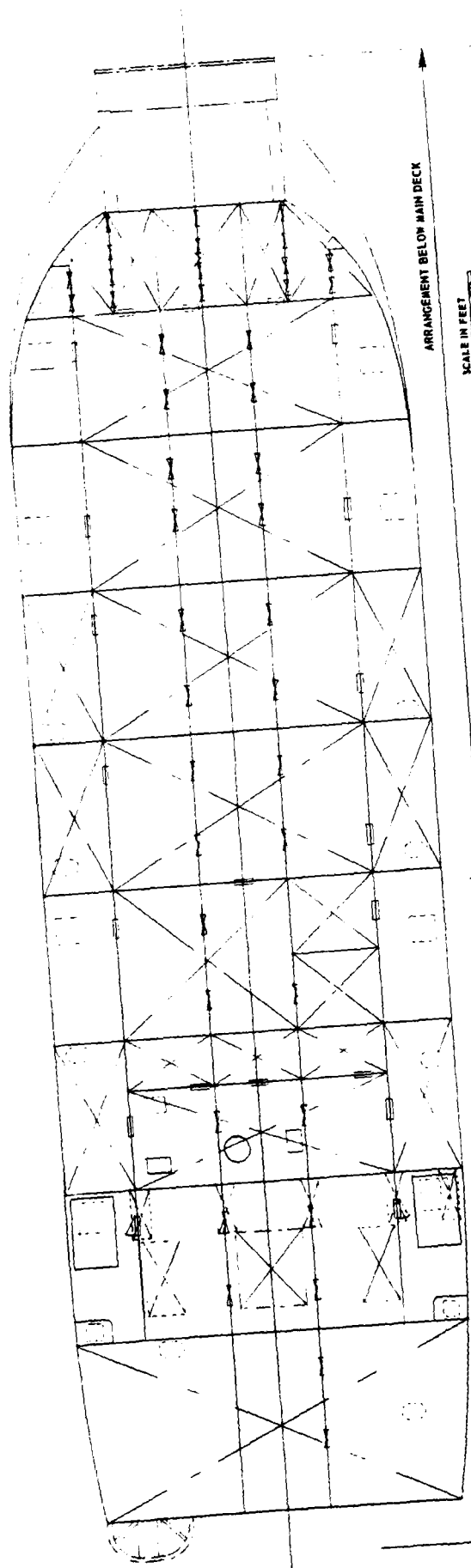

SCALE IN FEET
1" = 10'

DIMENSION A - 112.00'

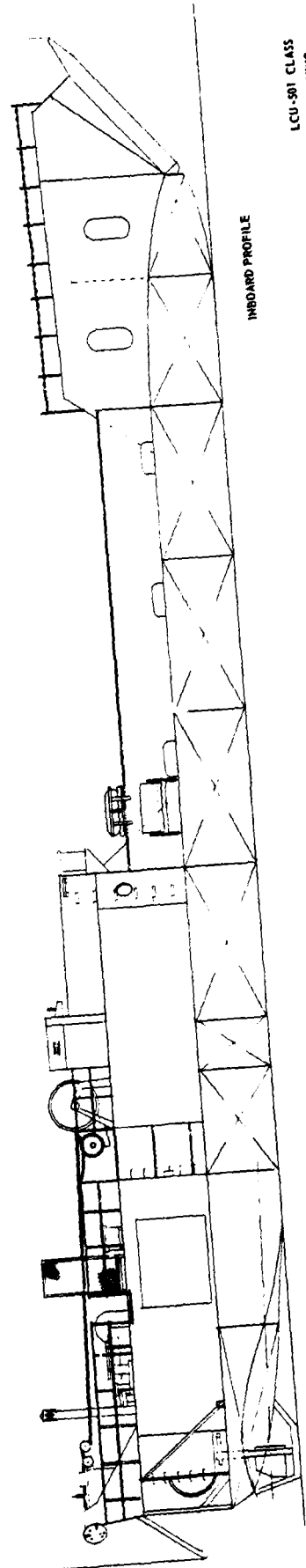

LCU-801 CLASS
PEP DRAWING

INFLATABLE LIFE RAFTS ARE PROVIDED SUFFICIENT FOR ALL PERSONNEL ABOARD. BOTH MASTS AND THE BOILER SMOKE PIPE ARE HINGED TO STOW ON DECK WHEN THE CRAFT IS LOADED ABOARD SHIP. BITTS AND CHOCKS ARE PROVIDED AS NECESSARY FOR LINE HANDLING AND A GYPSY HEAD ON THE ANCHOR WINCH SERVES FOR POWER WINCHING WHEN REQUIRED. THE RAMP HANDLING WINCH AND CONTROL IS LOCATED IN THE PORT WING WALL FORWARD, WITH RAMP HANDLING GEAR RUNNING ALONG THE FORECASTLE DECK PORT AND STARBOARD TO RAISE AND LOWER THE RAMP GATE.

□ MACHINERY AND PROPULSION: THE LCU 1466 CLASS LANDING CRAFT ARE PROPELLED BY THREE GENERAL MOTORS 6-71 DIESEL ENGINES, RATED AT 225 HORSEPOWER EACH, GEARED TO THE THREE PROPELLER SHAFTS. LCU 1582, AND LATER CRAFT OF THIS CLASS, ARE FITTED WITH KORT NOZZLES FOR IMPROVED DEAD PULL PERFORMANCE. ON THESE LATTER CRAFT, THE PROPELLER DIAMETER IS 39 INCHES AND DIAMETER OVER THE NOZZLE IS 47 INCHES. THE PROPELLERS AND NOZZLES ARE IN SHALLOW TUNNELS WITH A RUDDER FITTED AFT EACH PROPELLER. MAXIMUM SPEED, UNDER LOADED CONDITIONS, WITH ALL THREE ENGINES AT FULL POWER IS ESTIMATED AT 8 KNOTS. THE PROPELLERS ARE DIRECTLY IN LINE WITH THE THREE MAIN ENGINES, ONE ON CENTERLINE AND THE OTHER TWO 8.00 FEET OFF CENTERLINE PORT AND STARBOARD. THE PROPELLERS ARE CONNECTED THROUGH REVERSE-REDUCTION GEARS THAT ARE CONTROLLED FROM THE PILOT HOUSE ALONG WITH THE ENGINE THROTTLE CONTROL SYSTEM. THE RUDDERS, EACH ABOUT FIVE SQUARE FEET IN AREA, ARE CONTROLLED FROM THE PILOT HOUSE THROUGH A HYDRAULIC TORQUE AMPLIFICATION SYSTEM. ELECTRIC POWER TO THE SHIP IS PROVIDED BY TWO DIESEL-GENERATORS INSTALLED IN GENERATOR ROOMS OUTBOARD OF THE MAIN ENGINE ROOM, PORT AND STARBOARD.

□ MISSION SUPPORT: THE PRIMARY MISSION OF THE LCU-1466 CLASS IS TO TRANSPORT VEHICLES AND CARGO FROM SHIP TO SHORE. SEAGOING CAPABILITY IS LIMITED. THE CARGO DECK, ADEQUATELY STIFFENED TO CARRY 60-TON TANKS, HAS A CLEAR AREA 56.00 FEET LONG BY 33.50 FEET WIDE PLUS AN AREA 22.00 FEET LONG EXTENDING FORWARD FROM THE FULL WIDTH OF THE CARGO BAY TO THE 14.50 FOOT WIDE RAMP GATE. THE ENTIRE CARGO DECK IS FITTED WITH LASHING SOCKETS WITH 8.00 FOOT CENTER SPACING FOR SECURING VEHICLES AND OTHER CARGO.

□ GEOMETRY AND HYDROSTATICS: THE LCU 1466 CLASS OF UTILITY LANDING CRAFT ARE ENLARGED VERSIONS OF THE WORLD WAR II LC'Ts, CONSTRUCTED DURING THE EARLY 1950'S. SEVERAL OF THIS CLASS HAVE BEEN REDESIGNATED AS YFU'S. THE CLASS SHOWN ON THE ACCOMPANYING DRAWINGS, LCU 1608 AND 1609, HAVE BEEN REDESIGNATED AS YFU-91 AND YFU-96 RESPECTIVELY, BUT ARE TYPICAL OF THE ENTIRE CLASS. HULL LENGTH, OVERALL IS 115.19 FEET; TOTAL LENGTH OVER THE STERN ANCHOR IS 120.00 FEET; LENGTH BETWEEN PERPENDICULARS IS 106.25 FEET. EXTREME BEAM IS 34.00 FEET AND MOLDED DEPTH AMIDSHIPS IS 6.00 FEET. THE MEAN LOAD DRAFT IS 5.33 FEET ABOVE THE MOLDED BASELINE. HEIGHT TO THE TOP OF THE FORWARD ANCHOR LIGHT MAST IS 15.67 FEET AND TO THE TOP OF THE STERN LIGHT MAST IS 11.92 FEET. THE TOP OF THE RADAR ANTENNA ABOVE THE MEAN LOAD DRAFT LINE IS 37.10 FEET AND THE TOP OF THE PORT SIDE WHIP ANTENNA IS 37.75 FEET ABOVE THE MEAN LOAD DRAFT LINE. QUARTERS ARE PROVIDED FOR TWO CPO'S IN ONE 2-TIER BERTH AND FOR TWELVE CREW IN FOUR 3-TIER BERTHS. LIGHT DISPLACEMENT IS 180 TONS SALT WATER AND LOAD DISPLACEMENT IS 360 TONS SALT WATER.

□ STRUCTURE: THE BASIC STRUCTURE IS OF ALL-WELDED STEEL. TRANSVERSE FRAMES ARE SPACED 2.00 FEET FROM THE FORE PERPENDICULAR THROUGH FRAME 52 WHICH IS 2.25 FEET FORWARD OF THE TRANSOM. THE SHIP IS CONSTRUCTED IN THREE SECTIONS FOR TRANSPORTATION TO ADVANCED BASES. THE FORWARD SECTION EXTENDS 30.00 FEET FROM FRAME 0 TO FRAME 15 WITH A 9.00 FOOT BOW RAMP EXTENSION. THE MIDDLE SECTION EXTENDS 46.00 FEET FROM FRAME 15 TO FRAME 38, AND THE STERN SECTION MAKES UP THE REMAINING 30.25 FEET OF LENGTH. LONGITUDINAL BULKHEADS, 5.25 FEET OFF CENTERLINE, RUN FROM THE BOW RAMP AFT TO THE FORWARD ENGINE ROOM BULKHEAD BETWEEN THE SHELL AND THE CARGO DECK; THESE ARE NON-WATERTIGHT BULKHEADS BUT THE STRUCTURAL INTEGRITY IS MAINTAINED BY USING FRAMED ARCHES FOR ACCESS BETWEEN CENTER AND SIDE COMPARTMENTS. THE CARGO DECK IS FURTHER STRENGTHENED BY SEVEN TRANSVERSE WATERTIGHT BULKHEADS AND FIVE WEB FRAMES IN THE SPACE BELOW THE CARGO DECK AND BY SEVENTEEN 9' X 4' TEE LONGITUDINAL DECK BEAMS THAT RUN THE LENGTH OF THE CARGO DECK.

□ OUTFIT: THE STERN ANCHOR IS STOWED OVER THE PORT SIDE OF THE TRANSOM FOR READY RELEASE AND RETRIEVAL DURING BEACHING OPERATIONS. HANDLING GEAR AND WINCH ARE LOCATED ON THE POOP DECK AFT.

SEAGOING LOGISTICS PLATFORM
PHYSICAL AND PERFORMANCE CHARACTERISTICS

LCU - 1466 CLASS: LANDING CRAFT UTILITY

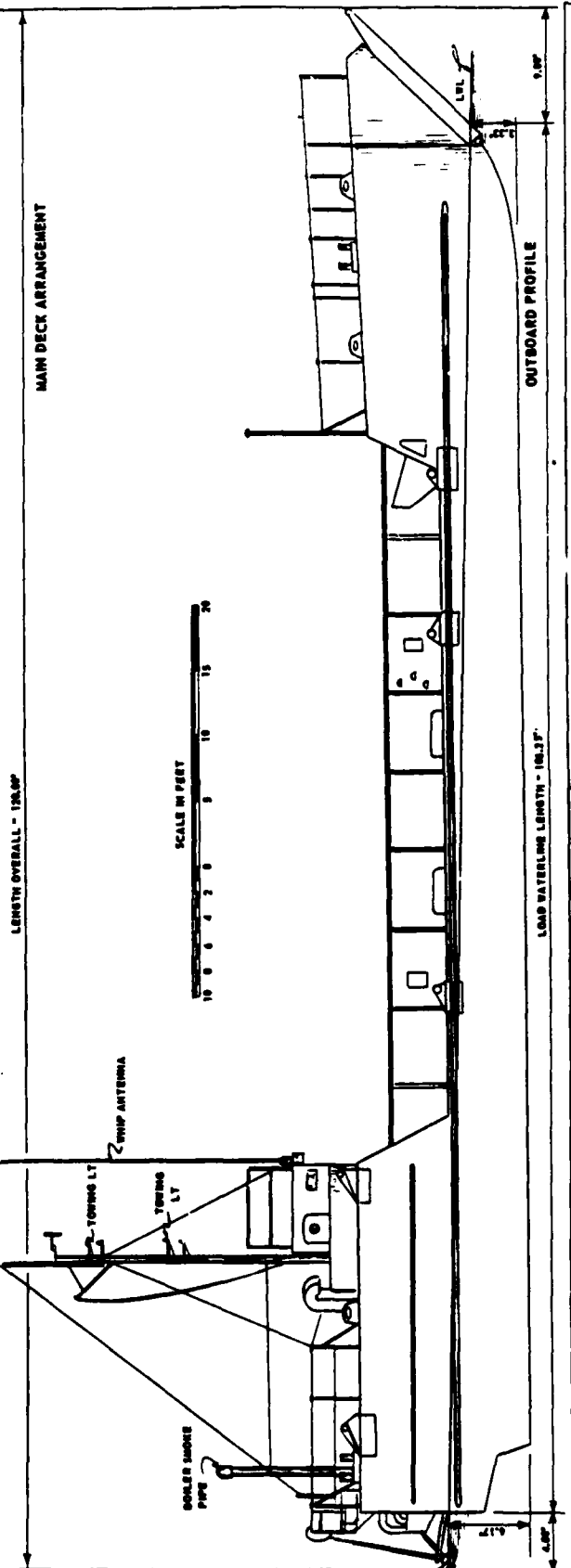
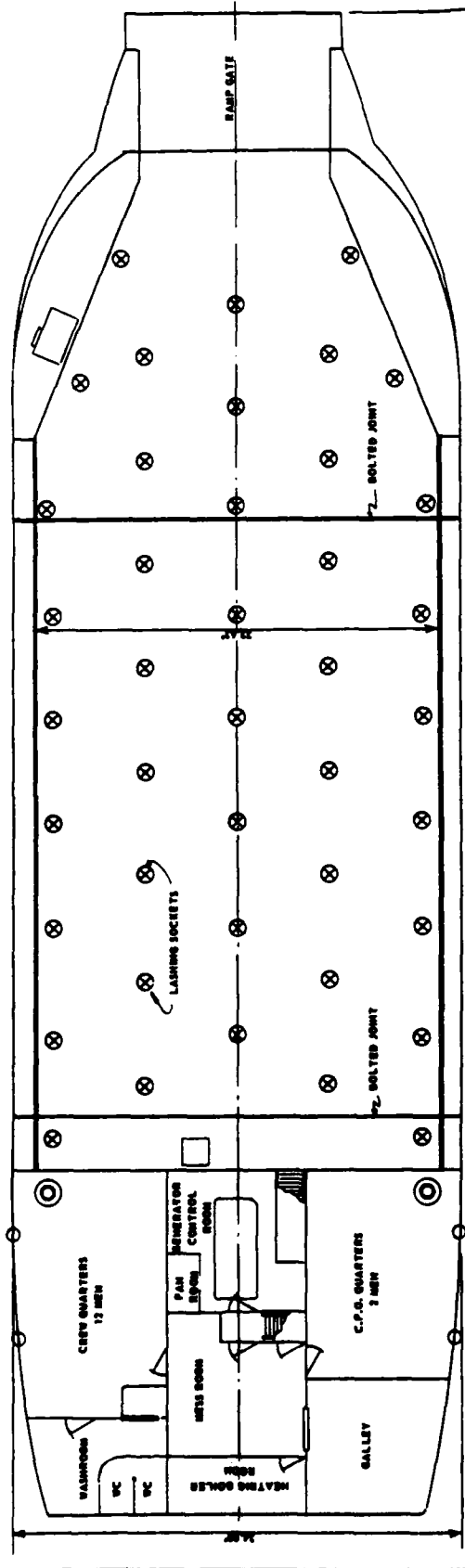

SEAGOING LOGISTICS PLATFORM
 OVERALL GEOMETRY

LCU-1465 CLASS: LANDING CRAFT UTILITY

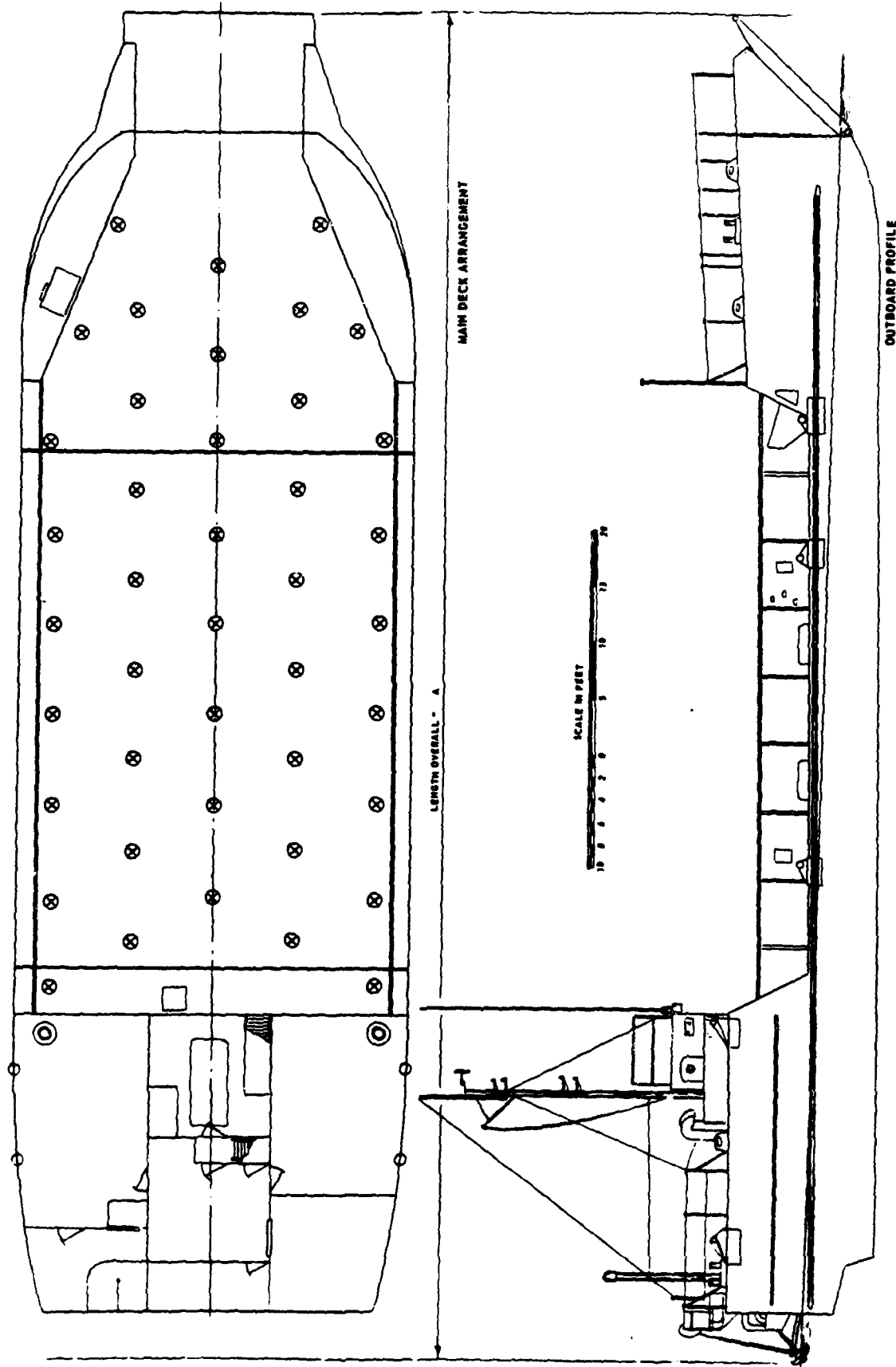

LCU-1666 CLASS
PEP DRAWING

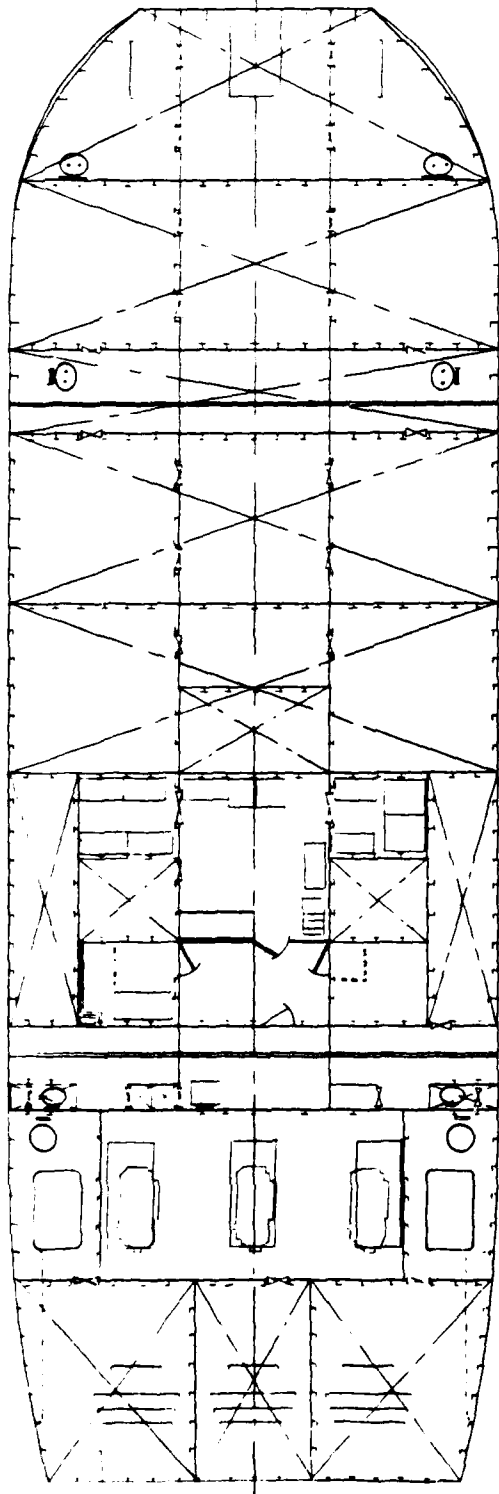

ARRANGEMENT BELOW CARGO DECK

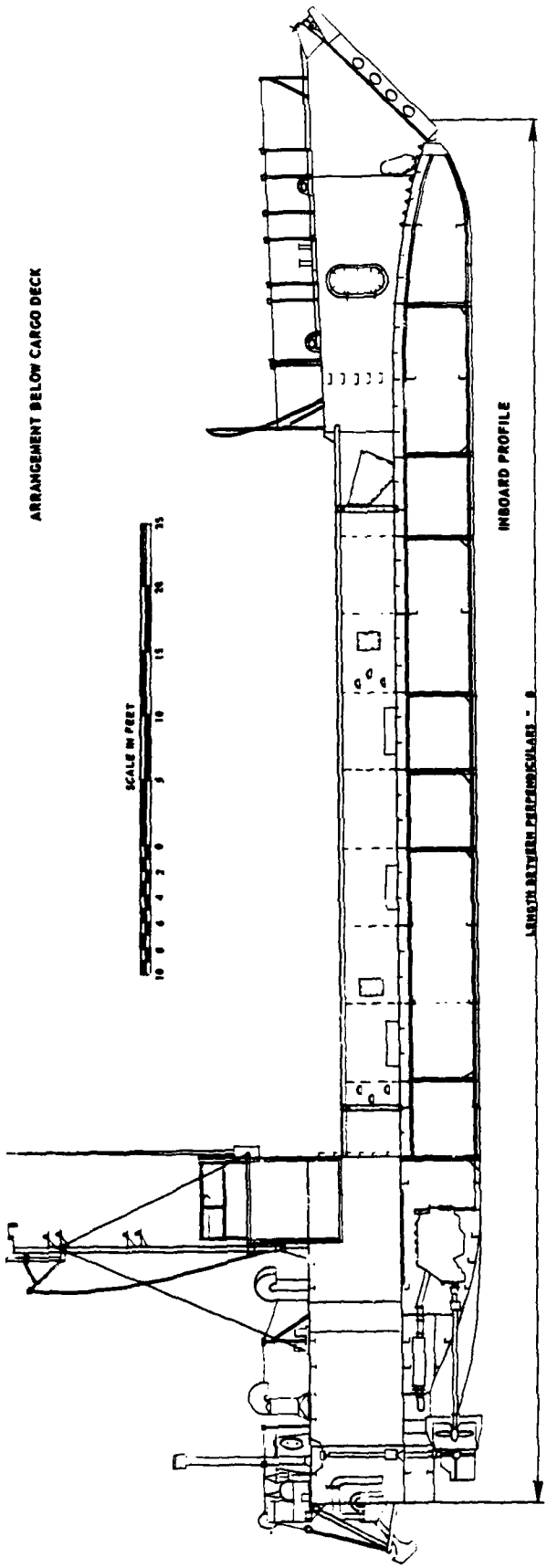

INBOARD PROFILE

LENGTH BETWEEN PERPENDICULARS - 8

LCU 1466 CLASS
PEP DRAWING

- GEOMETRY AND HYDROSTATICS: THERE ARE SOME 47 ACTIVE UTILITY LANDING CRAFT IN THE LCU-1610 SERIES; FOUR OTHERS HAVE BEEN RECLASSIFIED AS YFB'S AND SEVEN AS YFU'S. THESE SHIPS HAVE AN OVERALL LENGTH OF 136.25 FEET AND A LENGTH BETWEEN PERPENDICULARS OF 134.00 FEET. BEAM IS 29.00 FEET AND DEPTH TO THE VEHICLE DECK MIDSHIPS IS 8.00 FEET. WITH A BULKWARK EXTENDING UP TO 12.50 FEET. LANDING DISPLACEMENT, CARRYING THREE T-43 TANKS, IS 374 TONS WHICH GIVES A DRAFT FORWARD OF 3.92 FEET AND A DRAFT AFT OF 7.13 FEET. LIGHT DISPLACEMENT IS 193 TONS. THE SHIPS ARE FITTED WITH BOTH A BOW RAMP AND A STERN GATE TO ALLOW THROUGH PASSAGE OF VEHICLES; ALL HOUSE STRUCTURE IS ON THE STARBOARD SIDE ONLY. MAXIMUM HEIGHT TO THE TOP OF THE MAST IS 34.13 FEET ABOVE THE DESIGN WATERLINE. WHEN THE MAST IS STOWED ON DECK, THE HIGHEST POINT IS THE RADAR ATOP THE PILOT HOUSE WHICH IS 20.63 FEET ABOVE THE WATERLINE. BERTHS ARE PROVIDED FOR TWO CPO'S, A CREW OF FOUR, AND EIGHT TRANSIENTS.
- STRUCTURE: THE VESSEL IS CONSTRUCTED OF ALL-WELDED STEEL (EXCEPT FOR LCU-1637 WHICH IS ALUMINUM) WITH TRANSVERSE FRAMES SPACED AT 1.75 FEET THROUGHOUT THE ENTIRE LENGTH. FOURTEEN TRANSVERSE BULKHEADS PROVIDE STRUCTURAL SUPPORT FOR THE CARGO DECK; EACH BULKHEAD IS STIFFENED WITH TEE-BEAMS SPACED AT 1.75 FEET. THERE ARE NO LONGITUDINAL STRUCTURAL BULKHEADS WITHIN THE HOLD BUT 12-INCH DEEP WEB-PLATE KEELSONS AND LONGITUDINAL DECK GIRDERS RUN THE ENTIRE LENGTH OF THE SHIP, 4.50 FEET OFF CENTERLINE PORT AND STARBOARD. THESE ARE SUPPLEMENTED BY HULL AND DECK LONGITUDINALS SPACED 1.75 FEET TO GIVE ADEQUATE SUPPORT FOR CARRYING 60 TON TANKS ON THE CARGO DECK.
- OUTFIT: LIFE SAVING EQUIPMENT INCLUDES ONE 15-MAN INFLATABLE LIFEBOAT AND FOUR LIFE RINGS. CLEATS, CHOCKS, AND BITTS ARE INSTALLED ALONG THE DECK EDGE PORT AND STARBOARD SUFFICIENT FOR LINE HANDLING. THE STERN ANCHOR IS STOWED HANGING FROM AN A-FRAME ON THE STARBOARD SIDE AFT AT FRAME 70; THE ANCHOR LINE RUNS THROUGH FAIRLEADS TO THE ANCHOR WINDLASS COMPARTMENT IN THE HOLD WHERE THE WINCH DRUM IS ON THE CENTERLINE BETWEEN FRAMES 64 AND 65. THE STERN GATE IS HANDLED BY A PAIR OF DECK WINCHES AND A PAIR OF DAVITS LOCATED JUST FORWARD OF THE GATE ON THE CARGO DECK PORT AND STARBOARD. THE BOW RAMP WINCH IS LOCATED IN THE RAMP HANDLING MACHINERY COMPARTMENT IN THE HOLD FORWARD WITH CABLES PASSING THROUGH THE PORT AND STARBOARD VOID SPACES BETWEEN THE CARGO DECK AND
- THE FORECASTLE DECK. RAMP RAISING AND LOWERING CONTROLS ARE LOCATED ON THE STARBOARD SIDE FORWARD.
- MACHINERY AND PROPULSION: THE CONVENTIONAL SHIP OF THIS CLASS IS PROPELLED BY FOUR 250 BRAKE HORSEPOWER DIESEL ENGINES COUPLED THROUGH REVERSE-REDUCTION GEARS TO TWO SHAFTS. THE 3.50 FOOT DIAMETER PROPELLERS ARE HOUSED IN 4.50 FOOT DIAMETER KORT NOZZLES TO INCREASE DEAD PULL PERFORMANCE. WITH CONVENTIONAL RUDDERS ABAFT EACH PROPELLER. THE DESIGN SHOWN IN THE ACCOMPANYING DRAWINGS IS POWERED BY THE TWO 500 BHP ENGINES THAT ARE USED ON A FEW SHIPS OF THIS CLASS AND ALSO HAS A PAIR OF FLANKING RUDDERS FORWARD OF EACH MAIN SCREW FOR IMPROVED MANEUVERING PERFORMANCE IN THE ASTERN MODE OF OPERATION. IN ALL SHIPS, ENGINE THROTTLE AND REVERSE CONTROLS ARE ACTUATED ON THE BRIDGE FROM THE MAIN STEERING STAND. THIS PROPULSION SYSTEM DRIVES THE SHIPS AT A MAXIMUM SPEED OF 10.20 KNOTS. AT A CRUISING SPEED OF 8.00 KNOTS, THE 3840 GALLON FUEL CAPACITY GIVES A RANGE OF 1200 NAUTICAL MILES. ELECTRIC POWER IS PROVIDED BY TWO DIESEL-GENERATORS, ONE LOCATED IN THE FORWARD ENGINE ROOM AND ONE IN THE AFTER ENGINE ROOM, TOGETHER WITH THE CORRESPONDING POWER DISTRIBUTION SWITCHBOARDS.
- MISSION SUPPORT: WITH THE STERN GATE AND BOW RAMP UP, IN THE SEAGOING CONDITION, THE CLEAR LENGTH ALONG THE CARGO DECK IS 112.75 FEET. AHEAD AND ASTERN OF THE DECK HOUSE STRUCTURE THE CLEAR DECK WIDTH IS 22.00 FEET AND ABEAST OF THE DECK HOUSE STRUCTURE IT IS 18.00 FEET. THE BOW RAMP WIDTH IS 14.50 FEET AND THE STERN GATE IS 19.00 FEET WIDE. THROUGHOUT THIS AREA, DECK SOCKETS ARE SPACED EVERY 5.00 FEET FORE AND AFT AND IN THREE PARALLEL ROWS, SEVEN FEET APART ATHWARTSHIPS. IN ADDITION, BUMPER SOCKETS ARE INSTALLED ALONG THE RAIL, PORT AND STARBOARD, AND NUMEROUS PAD EYES ARE PROVIDED FOR LASHING DOWN HEAVY CARGO. THESE VESSELS ARE SO CONSTRUCTED THAT THEY CAN BE CUT INTO THREE SEPARATE SECTIONS FOR OVERSEAS TRANSPORT WITH FIELD CUTTING LINES BETWEEN FRAMES 27 AND 28, JUST FORWARD OF THE DECK HOUSE, AND BETWEEN FRAMES 49 AND 50, AT A BREAK IN THE DECK HOUSE STRUCTURE. ALTHOUGH THE BASIC MISSION OF THE LCU-1610 CLASS IS AS A LOGISTICS PLATFORM WITH BEACHING CAPABILITIES, THIS CLASS OF VESSELS CAN READILY BE CONVERTED TO SERVE IN A NUMBER OF OCEAN CONSTRUCTION WORK PLATFORM CAPACITIES, PARTICULARLY THOSE REQUIRING CLEAR DECK SPACE AND THROUGH PASSAGE, FORE AND AFT.

SEAGOING LOGISTICS PLATFORM
PHYSICAL AND PERFORMANCE CHARACTERISTICS

LCU - 1610 CLASS: LANDING CRAFT UTILITY

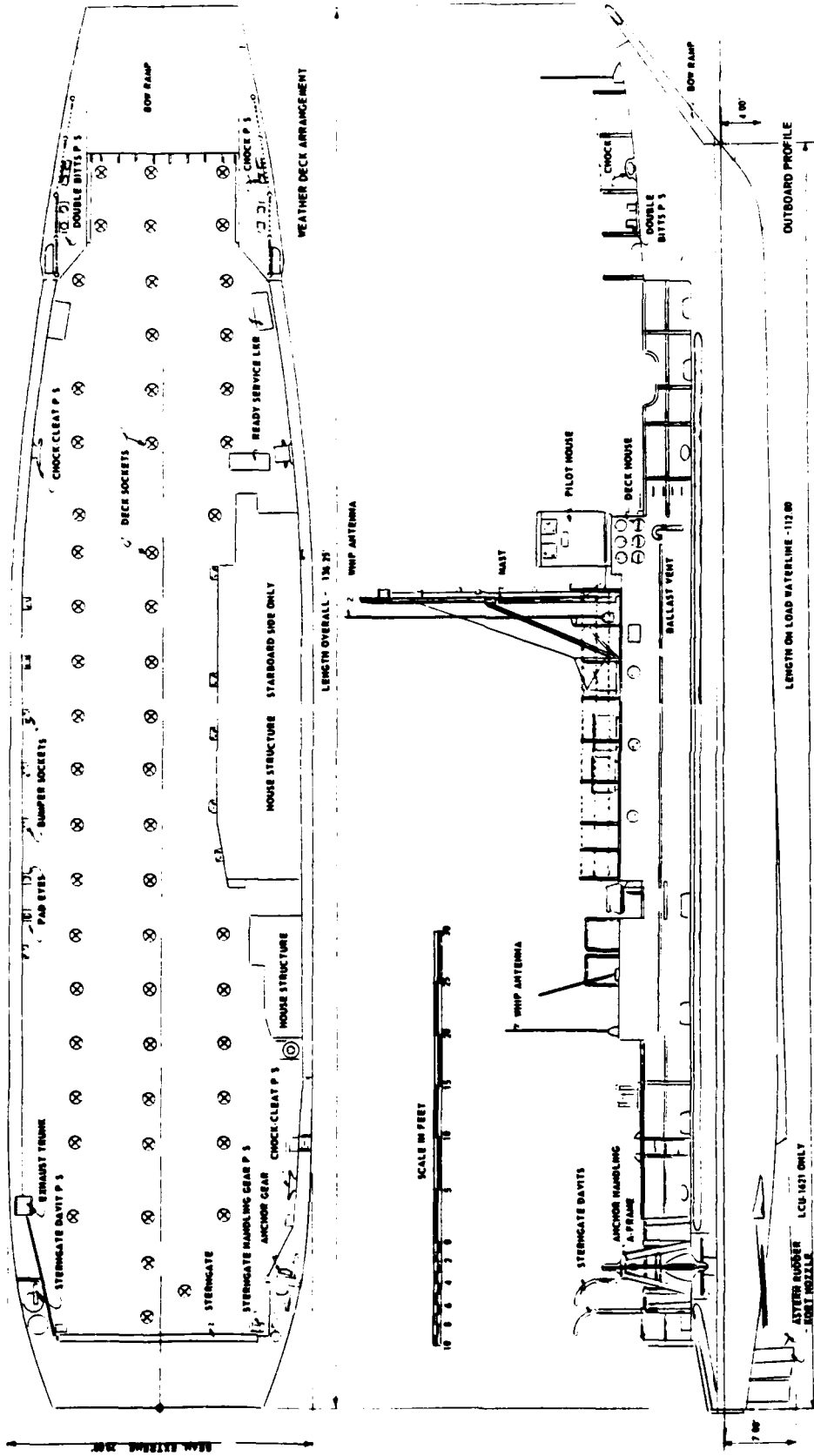

SEAGOING LOGISTICS PLATFORM
OVERALL GEOMETRY

LCU - 1610 CLASS: LANDING CRAFT UTILITY

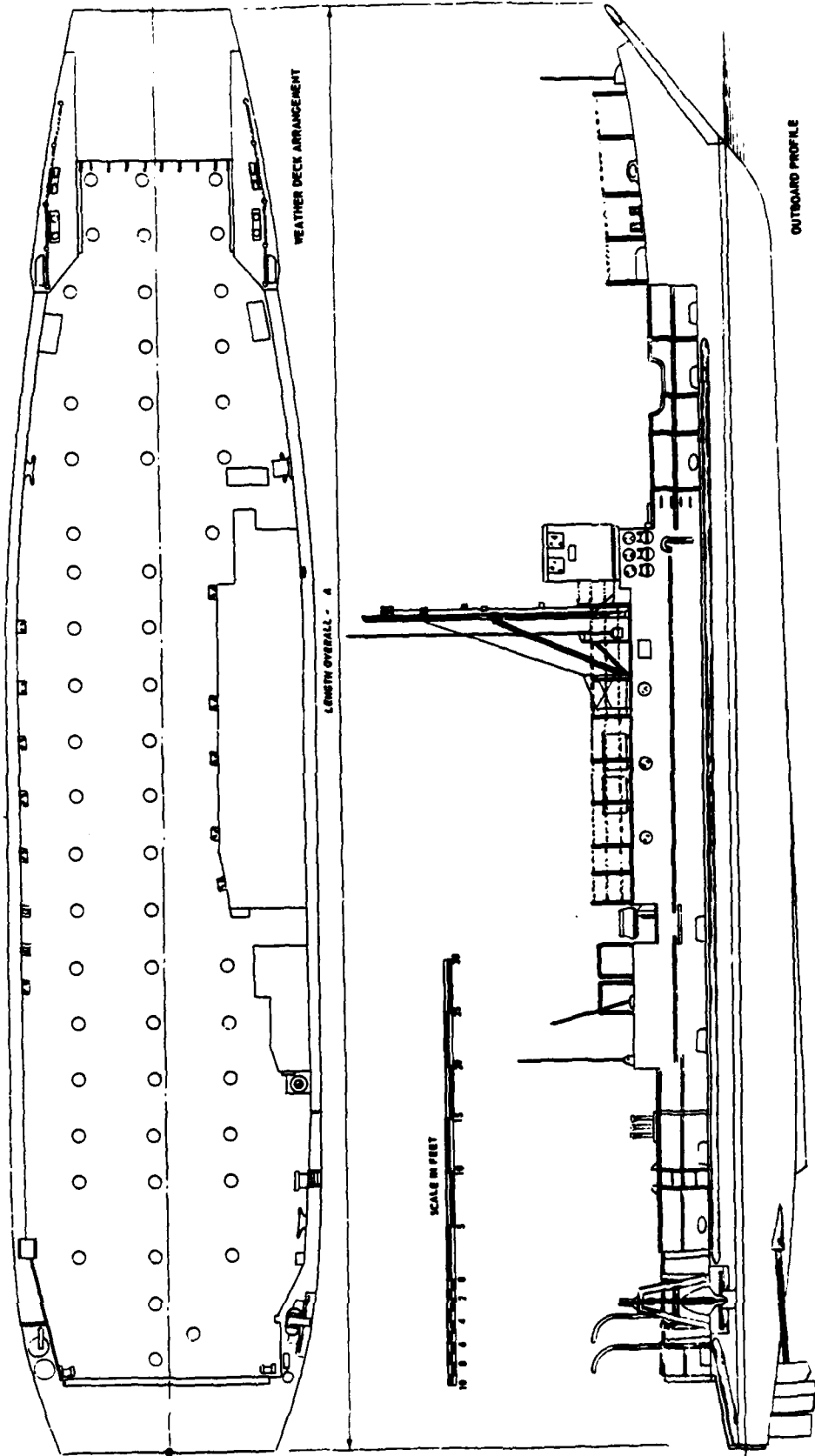

LCU-1619 CLASS
PEP DRAWING

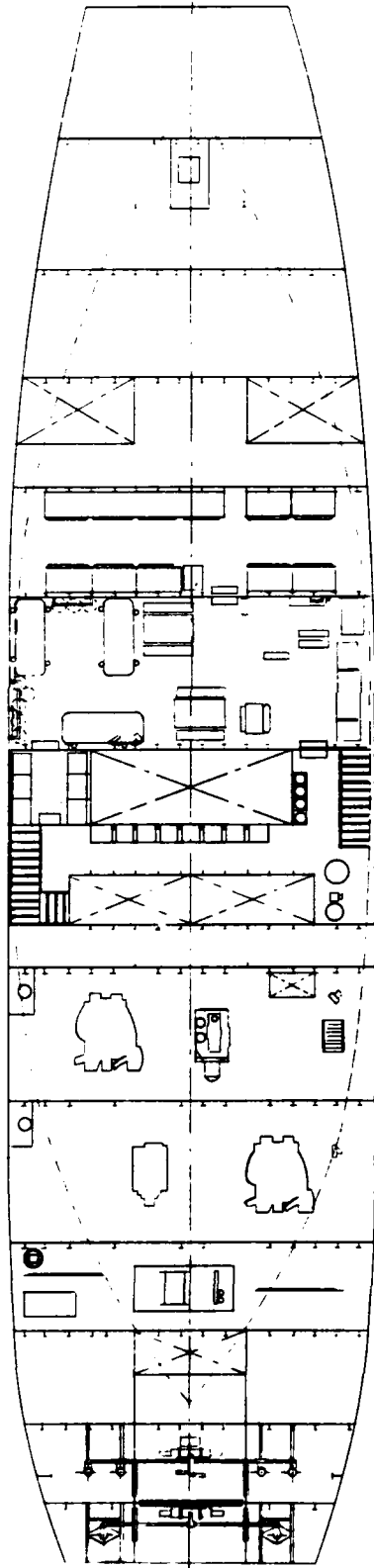

ARRANGEMENT BELOW CARGO DECK

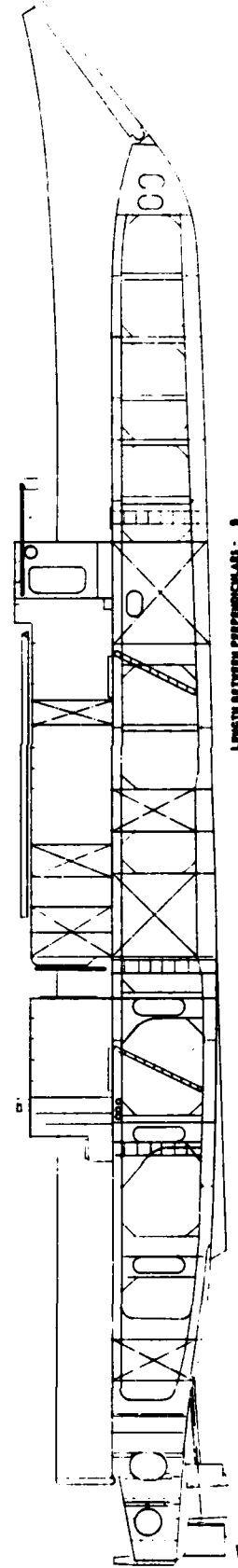

INBOARD PROFILE

LCU 1610 CLASS
PEP DRAWING

- GEOMETRY AND HYDROSTATICS: WARPING TUGS DESIGNED BY THE NAVAL FACILITIES ENGINEERING COMMAND ARE CONFIGURED FROM THE N. L. EQUIPMENT P-SERIES PONTOONS. THEY EMPLOY 37 OF THE N. L. P-1 RECTANGULAR PONTOONS AND 6 OF THE N. L. P-2 TRAPEZOIDAL PONTOONS USED AS BOW AND STERN RAKE ENDS. THE N. L. P-1 PONTOONS ARE 5' X 5' X 7'; THREE OF THESE UNITS ARE FITTED THE LONG DIMENSION ATWARTSHIPS GIVING A TOTAL BEAM FOR THE TUG OF 21.25 FEET INCLUDING CONNECTING HARDWARE. THE TWO OUTBOARD PONTOON ASSEMBLIES EACH COMPRISE 12 P-1 PONTOONS, WITH A P-2 PONTOON AT THE BOW AND AT THE STERN, FOR A TOTAL LENGTH, INCLUDING HARDWARE, OF 84.25 FEET. THE CENTERLINE ASSEMBLY HAS 13 P-1 PONTOONS WITH A P-2 PONTOON FORE AND AFT FOR A TOTAL LENGTH OF 89.96 FEET. THIS IS THE OVERALL LENGTH OF THE BASIC HULL, EXCLUDING FENDERS. EACH PONTOON, INCLUDING ITS CONNECTION HARDWARE, WEIGHS APPROXIMATELY ONE LONG TON; THE P-1 PONTOONS, WITH THEIR 35 SQUARE FOOT WATERPLANE AREA, DRAW ABOUT ONE FOOT OF WATER. THUS THE MEAN DRAFT OF THE ASSEMBLED WARPING TUG, BEFORE THE ADDITION OF DECK HOUSE, BRIDGE, A-FRAME, PROPULSION UNITS, AND WINCH IS VERY CLOSE TO 1.00 FOOT. IN THIS CONDITION THE TUG HAS A METACENTRIC HEIGHT OF 46.60 FEET.
- STRUCTURE: EACH P-1 PONTOON IS CONSTRUCTED OF 3/16" STEEL PLATE WITH 3" X 3" X 3/16" VERTICAL ANGLE STIFFENERS SPACED 1.75' ALONG THE 7.00' LENGTH AND 1.67' ALONG THE 5.00' DIMENSION. THESE STIFFENERS AND ALL JOINTS ARE COMPLETELY WELDED THROUGHOUT AND GUSSETS ARE PROVIDED AT THE CORNERS BOTH FOR SECURING SIDE AND DECK FRAMING AND FOR PREVENTING RACKING OF THE ASSEMBLED UNIT. THE P-2 PONTOONS ARE SIMILARLY CONSTRUCTED EXCEPT THAT THE SLOPING PLATES, USED FOR BOW AND STERN FAIRING, ARE 3/8" THICK. AT THE FOUR CORNERS OF THE DECK AND AT THE FOUR CORNERS OF THE BOTTOM, RECESSED WELDMENTS ARE FITTED IN TO PROVIDE FOR BOLTS AND NUTS USED IN SECURING CONTIGIOUS PONTOONS TO THE CONNECTING HARDWARE. THIS HARDWARE, OR "JEWELRY" COMPRISES 6" X 6" X 1/2" STEEL ANGLES AND 8" X 8" X 1/2" STEEL ANGLES, BOLTED TO THE PONTOONS TOP AND BOTTOM, AND TO EACH OTHER BY 3/4" STEEL BOLTS AND NUTS. THE ENTIRE ASSEMBLED STRUCTURE OF THE WARPING TUG HAS ADEQUATE STRENGTH TO WITHSTAND LAUNCHING FROM THE SIDE OF AN LST AND TO WITHSTAND MANY YEARS OF EXPOSURE TO THE MARINE ENVIRONMENT. ALTHOUGH THIS PONTOON SERIES HAS BEEN DISCONTINUED, THE UNITS ARE STILL AVAILABLE IN MANY MILITARY STOCK CENTERS.

- PROPULSION MACHINERY: PROPULSION POWER FOR THE WARPING TUG IS PROVIDED BY TWO HARBORMASTER MARINE TRACTORS INSTALLED ON THE STERNS OF THE TWO OUTBOARD ROWS OF PONTOONS. ALTHOUGH MANY DIFFERENT TYPES AND SIZES OF THESE OUTBOARD PROPULSION UNITS ARE AVAILABLE IN NAVY STOCK, IT WOULD APPEAR FROM DRAWINGS AND DATA FURNISHED THAT THE UNITS SHOWN ARE MODEL 0-462, RATED AT 180 HORSE-POWER EACH. PROPELLERS ARE 5-FOOT DIAMETER BY 4-FOOT PITCH TURNING AT 308 RPM AT MAXIMUM AVAILABLE ENGINE POWER AND AT ABOUT 250 RPM AT RATED POWER. EACH PROPULSION UNIT CAN DEVELOP A DEAD PULL THRUST OF UP TO 5000 POUNDS IF THE PROPELLER IS ADEQUATELY SUBMERGED. EACH PROPELLER CAN ROTATE ABOUT ITS VERTICAL SHAFT THROUGH 360° AND CAN BE ELEVATED TO A HORIZONTAL POSITION BY A HYDRAULIC SYSTEM POWERED BY THE ENGINE; HYDRAULIC REVERSE GEARS ARE ALSO PROVIDED, A 32 VOLT ELECTRIC STARTING SYSTEM IS INSTALLED IN EACH ENGINE. STEERING, ELEVATING, AND ENGINE OPERATING CONTROLS ARE INSTALLED DIRECTLY ON THE AFTER SIDE OF THE ENGINE ALLOWING THE OPERATOR A CLEAR FORWARD VIEW FOR MANEUVERING. EACH UNIT IS FITTED WITH A HEAT EXCHANGER FOR COOLING AND EACH UNIT WEIGHS ABOUT 16700 POUNDS. A 275 GALLON FUEL TANK IS INSTALLED ON THE CENTERLINE OF THE WARPING TUG JUST FORWARD OF THE TWO PROPULSION UNITS.
- OUTFIT AND MISSION SUPPORT: THE PRIMARY MISSION OF THE WARPING TUG IS TO HANDLE THE PONTOON CAUSEWAYS USED IN MAKING UP AN LST TO THE BEACH. IT TOWS THE PONTOONS INTO POSITION, SECURES THEM TOGETHER, PLANTS ANY REQUIRED ANCHORS, AND THEN MAINTAINS TENSION ON THE SYSTEM OUT FROM THE BEACH UNTIL THE LST IS IN POSITION FOR MAKE UP. THE CUTFIT FURNISHED TO SUPPORT THIS MISSION CAPABILITY COMPRISES A SHEAVE MOUNTED IN AN A-FRAME OVERHANGING THE BOW, A DOUBLE DRUM WINCH AMIDSHIPS, AND A 2500 POUND ANCHOR HOUSED IN A READILY RELEASABLE STOWAGE POSITION AT THE STERN. FOUR PAIRS OF DOUBLE BITTS ARE INSTALLED FOR ALONGSIDE TOWING, A DECK HOUSE IS INSTALLED FOR STOWING EQUIPMENT, AND A SMALL BRIDGE STRUCTURE IS ERCTED FROM WHICH OPERATIONS CAN BE DIRECTED. THE ANCHOR CABLE PASSES THROUGH TUNNELS IN THESE TWO STRUCTURES ALONG THE DECK CENTERLINE. ALL DECK EQUIPMENT OVER FOUR INCHES IN HEIGHT BETWEEN THE LAUNCHING ANGLE AND THE CENTERLINE OF THE TUG MUST BE REMOVED WHEN PREPARING FOR SIDE LOADING ON AN LST. THE OUTBOARD PROPULSION UNITS ARE USED PRIMARILY FOR POSITIONING AND TOWING.

INSHORE WORK PLATFORM PHYSICAL AND PERFORMANCE CHARACTERISTICS	3 X 14 WARPING TUG FOR LST SIDE CARRY
---	---------------------------------------

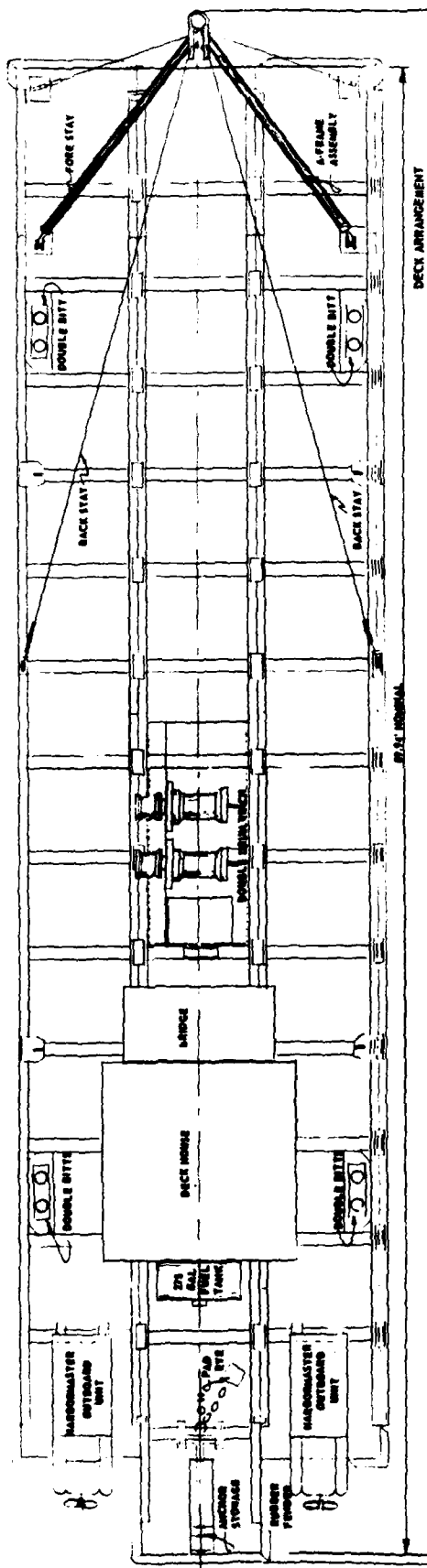

LENGTH OVERALL - 72.34'

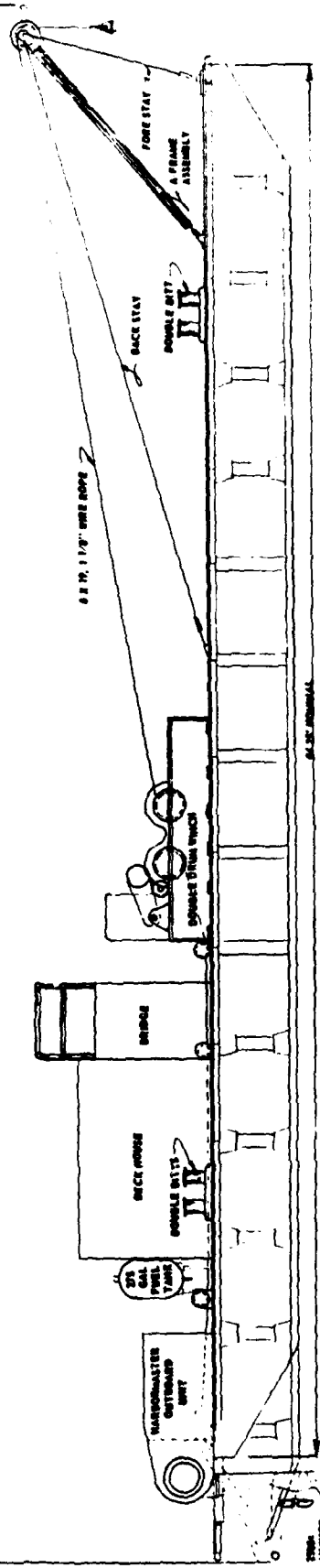

INSHORE WORK PLATFORM
OVERALL GEOMETRY

3 X 1 1/2 WARPING TUG
FOR LST SIDE CARRY

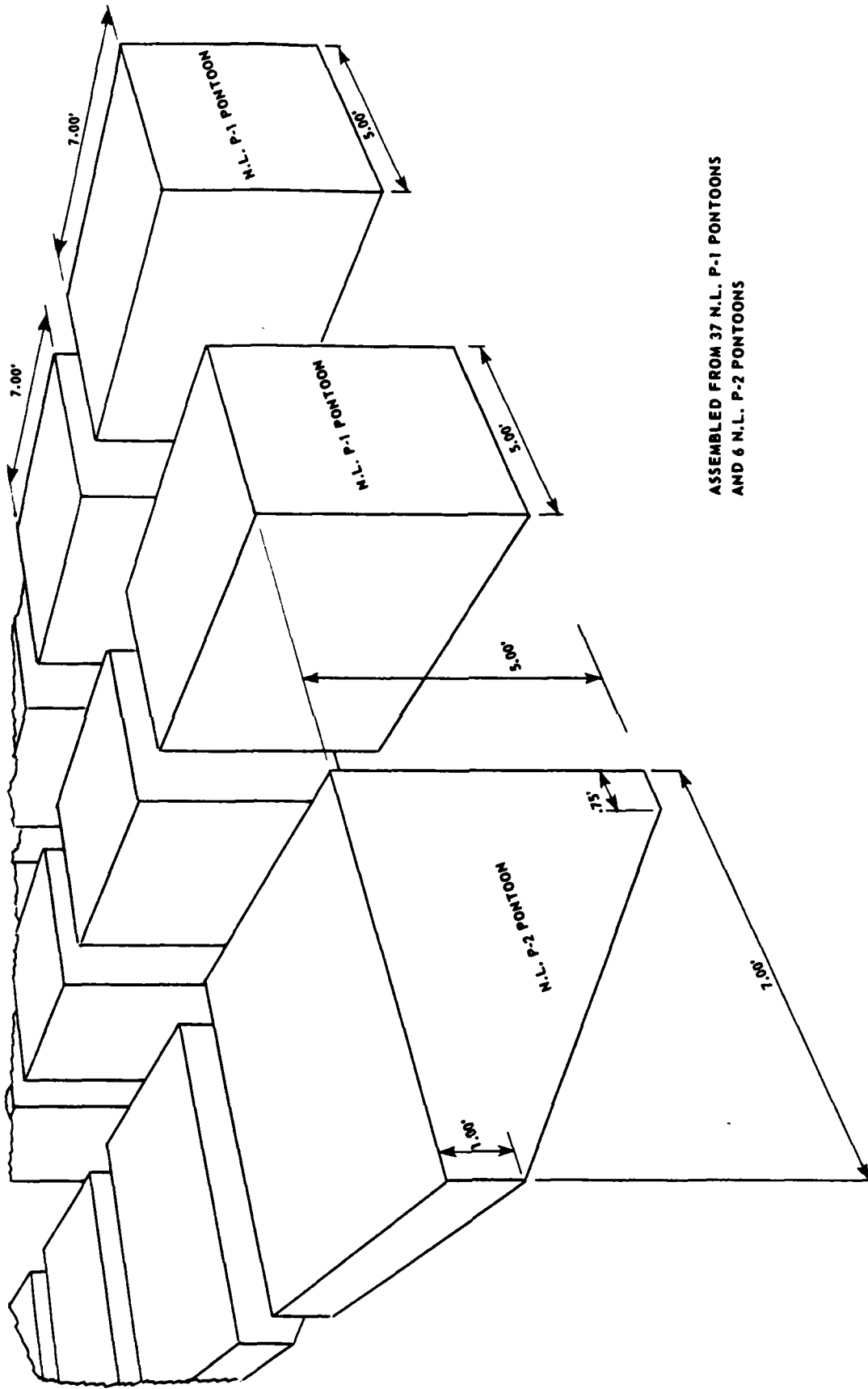

ASSEMBLED FROM 37 M.L. P-1 PONTOONS
AND 6 M.L. P-2 PONTOONS

<p>3 X 14 WARPING TUG FOR LST SIDE CARRY</p>	<p>INSHORE WORK PLATFORM ASSEMBLY OF M.L. SERIES PONTOONS</p>
--	---

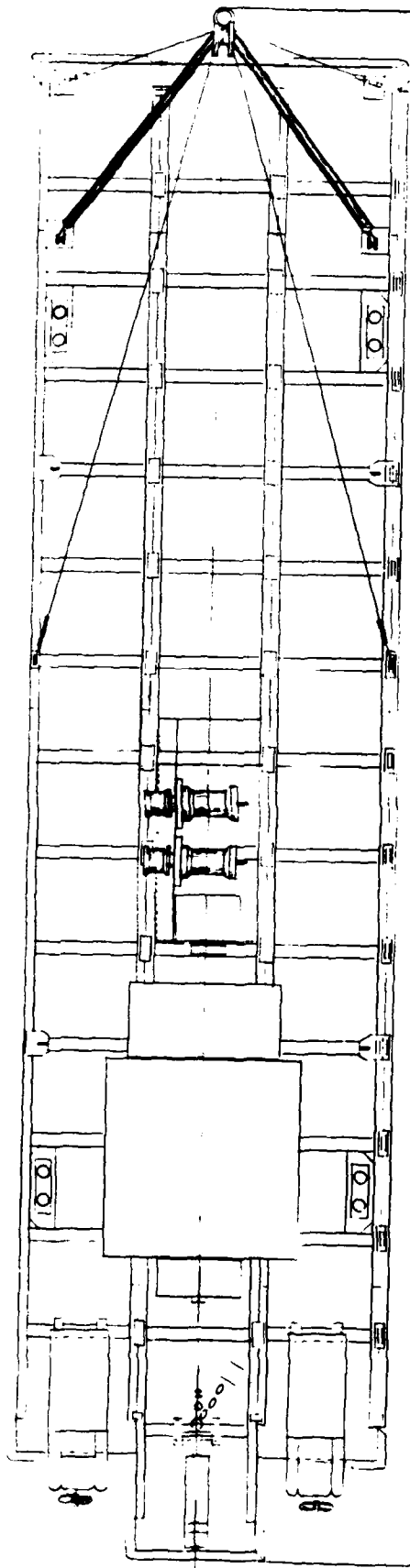

DECK ARRANGEMENT

LENGTH OVERALL - A

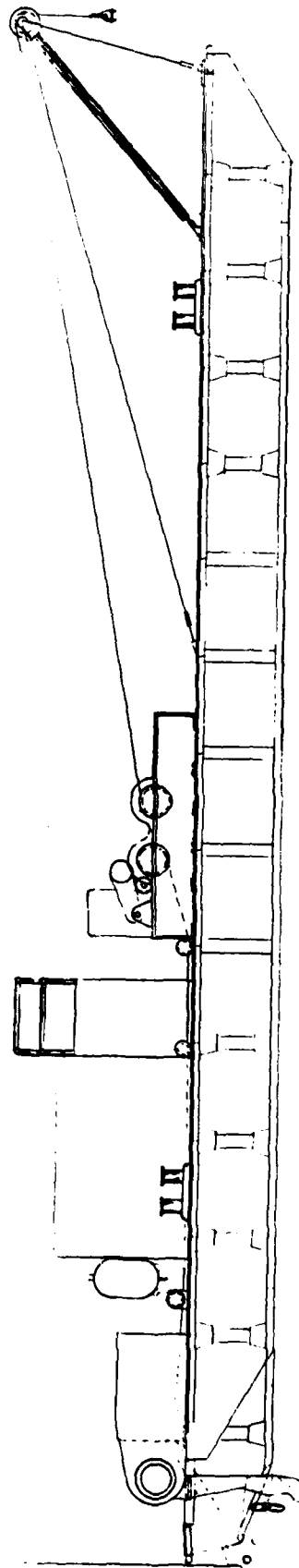

OUTBOARD PROFILE

WARPING TUG
PEP DRAWING

GEOMETRY: THE H. J. W. FAY WAS ORIGINALLY BUILT AS A GEOPHYSICAL RESEARCH SHIP FOR A MAJOR OIL COMPANY. OVERALL LENGTH IS 178.50 FEET WITH A LENGTH OF 175.00 FEET AT THE 11.33 FOOT LOAD WATERLINE; BEAM, MAXIMUM AMIDSHIPS IS 32.00 FEET; DEPTH AMIDSHIPS IS 13.00 FEET. THE SHIP HAS A REGISTERED GROSS TONNAGE OF 461, A NET TONNAGE OF 132 AND ACCOMMODATIONS FOR ITS NORMAL CREW OF 13 OFFICERS AND MEN AS WELL AS PASSENGER FACILITIES IN SUPPORT OF ITS MISSION.

HYDROSTATICS: THE SHIP HAS A SALT WATER DISPLACEMENT OF 1070 TONS IN THE LOADED CONDITION WITH A FREEBOARD TO THE MAIN DECK AMIDSHIPS OF 1.67 FEET. IN LIGHT CONDITION, AT A DRAFT OF 9.50 FEET, THE SHIP DISPLACES 813 TONS, S. W. IN LOAD CONDITION, THE LONGITUDINAL CENTER OF BUOYANCY, LCB, IS 4.90 FEET ABOARD THE MIDSHIP SECTION AND THE CENTER OF FLOTATION IS 10.68 FEET ABOARD THE MIDSHIP SECTION; THE TRANSVERSE METACENTER IS 15.70 FEET ABOVE THE KEEL, THE LONGITUDINAL METACENTER IS 240.00 FEET ABOVE THE KEEL, AND THE CENTER OF BUOYANCY IS 6.23 FEET ABOVE THE KEEL. THE CHANGE IN DISPLACEMENT PER INCH IMMERSION IS 10.83 TONS.

STRUCTURE: THE FAY CARRIES A U. S. COAST GUARD CERTIFICATE OF INSPECTION AND IS CLASSED (A)(E) BY THE AMERICAN BUREAU OF SHIPPING. TRANSVERSE FRAMES ARE SPACED AT 2.50 FEET FOR THE MAJOR PART OF THE SHIP LENGTH. ADDITIONAL LONGITUDINAL STRUCTURAL MEMBERS ARE INCORPORATED TO PROVIDE SUPPORT FOR HEAVY MISSION EQUIPMENT ON THE FORECASTLE DECK FORWARD AND ON THE FORECASTLE AND MAIN DECKS AFT.

MACHINERY: EACH OF THE TWO GENERAL MOTORS MAIN PROPULSION DIESELS IS RATED AT 2400 HORSEPOWER. ADDITIONAL PROPULSIVE POWER IS PROVIDED BY DUAL ACTIVE RUDDERS WITH MOTORS RATED AT 200 HORSEPOWER EACH AND BY DUAL BOW THRUSTERS WITH MOTORS ALSO RATED AT 200 HORSEPOWER EACH. ALL ELECTRIC GENERATING EQUIPMENT IS DRIVEN BY GENERAL MOTORS DIESELS. THIS COMPRISES TWO 180 KW AND TWO 150 KW, 60 HZ AC GENERATOR SETS PLUS AN EMERGENCY DIESEL GENERATOR. THE EVAPORATOR PLANT HAS A CAPACITY OF 1900 GALLONS OF FRESH WATER PER DAY.

OUTFIT: A CRANE WITH A SWINGING BOOM AND WINCH IS PERMANENTLY INSTALLED ON THE FORECASTLE DECK AFT WHICH SERVES BOTH FOR HANDLING THE LAUNCH AND FOR LOADING SUPPLIES AND GEAR. ADDITIONAL

WINCHES ARE PROVIDED FOR LINE HANDLING AND A WINDLASS FORWARD IS INSTALLED FOR ANCHOR HANDLING. RADIO AND NAVIGATION EQUIPMENT CONSISTS OF ONE RF COMM HF5B AND ONE SIMPSON VHF-FM RADIO TELEPHONE. A BENDIX AUTOMATIC DIRECTION FINDER, A DECCA TRUE MOTION RADAR, A SPERRY GYROCOMPASS AND COURSE RECORDER, AND A MELCO MODE A C AUTO TRACKING LORAN. SONAR EQUIPMENT INCLUDES A RAYTHEON 60-FATHOM RECORDING ECHO-SOUNDER, AN EDO AN UQN-1 12 KHZ 6000 FATHOM RECORDING ECHO-SOUNDER, AND A SIMRAD FISH FINDER.

SPEED AND PROPULSION: THE FAY HAS A CRUISING SPEED OF 12 KNOTS AND A RANGE OF 4900 NAUTICAL MILES. THE TWIN SCREW MAIN PROPULSION SYSTEM IS SUPPLEMENTED BY THE TWO ACTIVE RUDDERS WITH PROPELLERS IN NOZZLES THAT PROVIDE TAKE-HOME CAPABILITY IN THE EVENT OF MAIN PROPULSION SYSTEM FAILURE.

MANEUVERING AND CONTROL: THE DUAL ACTIVE RUDDERS AND THE DUAL BOW THRUSTERS GIVE THE SHIP UNIQUE CAPABILITY OF DYNAMICALLY POSITIONING ITSELF OVER ANY SPOT IN THE OCEAN FLOOR AS WELL AS PRECISE MANEUVERING CONTROL WHEN WORKING OVER THE STERN. BRIDGE STEERING AND ENGINE CONTROLS ARE PROVIDED AS WELL AS REMOTE STEERING AND ENGINE CONTROL FROM AN AUXILIARY STATION OVERLOOKING THE AFTER WORK AREA. AN AUTOMATIC PILOT IS PROVIDED FOR HEADING CONTROL AND REMOTE REPEATERS FOR THE GYROCOMPASS ARE INSTALLED BOTH ON THE BRIDGE WINGS AND IN THE LABORATORY. INDEPENDENT INTERCOM SYSTEMS ARE INSTALLED FOR BOTH SHIP AND SCIENTIST USE WITH ON-DECK LOUD-MAILING AND TALKBACK PROVIDED.

MISSION SUPPORT: IN ADDITION TO CREW ACCOMMODATIONS THERE ARE PASSENGER ACCOMMODATIONS FOR 19 PERSONS IN 2- AND 4-BERTH STATEROOMS THAT ARE FULLY HEATED AND AIR CONDITIONED. A 3-BED HOSPITAL IS ALSO PROVIDED. A FLUME STABILIZATION SYSTEM IS INSTALLED TO PERMIT WORK IN ROUGH WEATHER. THE INTERIOR LABORATORY AREA COVERS 1000 SQUARE FEET. EXTERNAL WORK DECK AREA INCLUDES 1125 SQUARE FEET ON THE MAIN DECK AFT AND 1250 SQUARE FEET ON THE FORECASTLE DECK AFT. OVER THE STERN LOAD HANDLING CAPABILITY IS AIDED BY A CUT AWAY BULKWARK SECTION ON THE FAN TAIL WITH THE MAIN DECK FREEBOARD AT THE STERN VARYING BETWEEN 3.25 AND 4.25 FEET FROM LOADED TO LIGHT CONDITION. APPLICATIONS OF THIS VESSEL LISTED BY THE OWNER INCLUDE: MULTIOBJECTIVE GENERAL OCEANOGRAPHY, LONG-RANGE SURVEYS, DEEP AND HEAVY CORING, WEAPONS TESTS, DEPLOYMENT AND RECOVERY OF MEDIUM LARGE HEAVY ACOUSTICAL AND OTHER ARRAYS, RESEARCH SUBMARINE TENDER, LIGHT HELICOPTER CARRIER.

SEAGOING WORK PLATFORM
PHYSICAL AND PERFORMANCE CHARACTERISTICS

R. V. H. J. W. FAY
(FORMERLY ARTEMIS)

OWNED BY TRACOR MARINE
CHARTERED TO U.S. GEOLOGICAL SURVEY

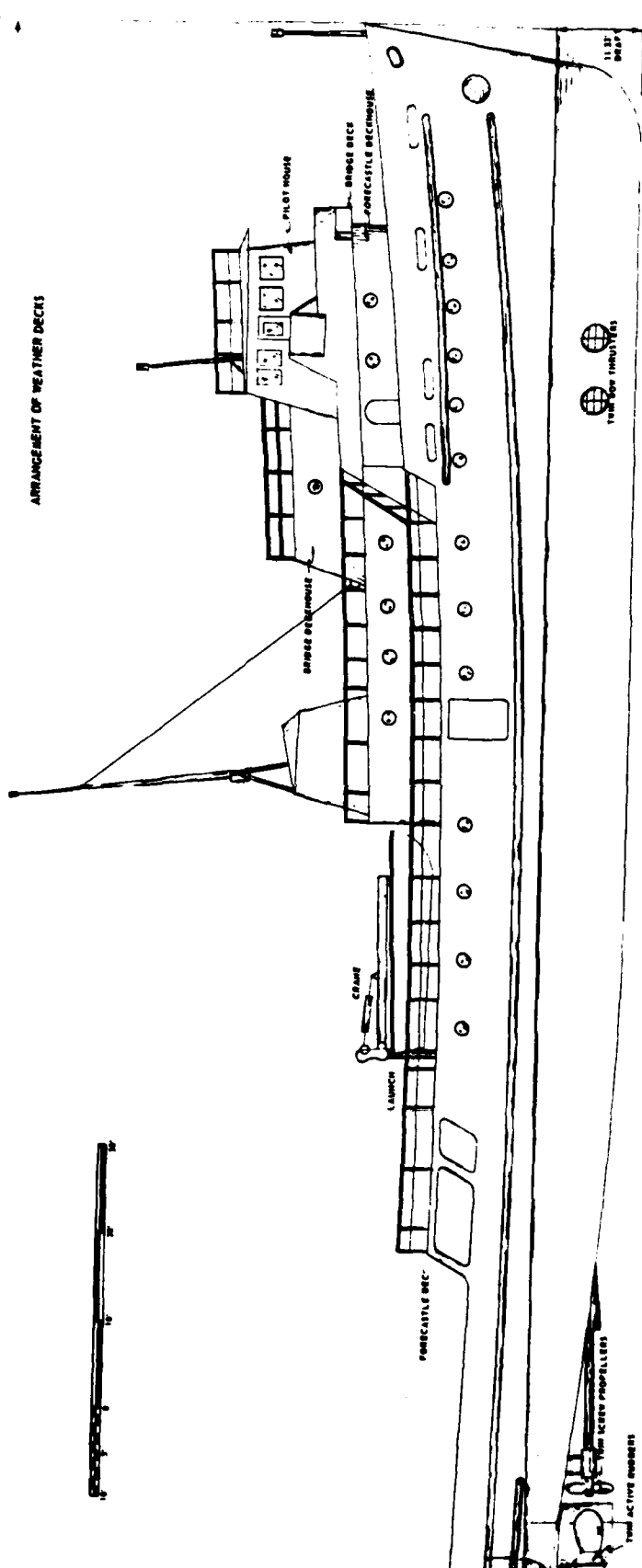
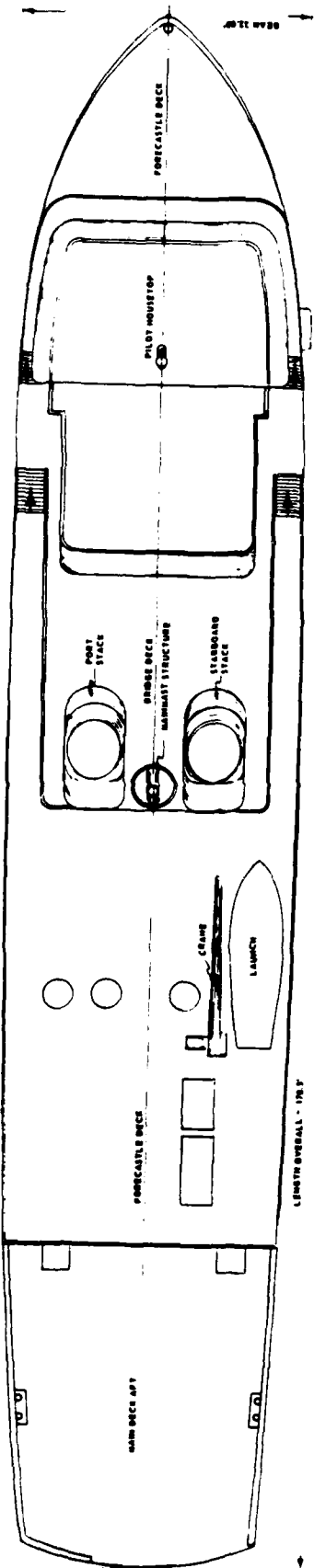

<p>SEAGOING WORK PLATFORM OVERALL GEOMETRY</p>	<p>R/V H. J. W. FAY (FORMERLY ARTEMIS)</p>	<p>OWNED BY TRACOR MARINE CHARTERED TO U. S. GEOLOGICAL SURVEY</p>
--	--	--

LOAD WATERLINE VALUES: LENGTH, B.P. - 175.00 FT.; DRAFT, FROM BASELINE - 11.33 FT.; DISPLACEMENT - 1070 TONS, S.W.

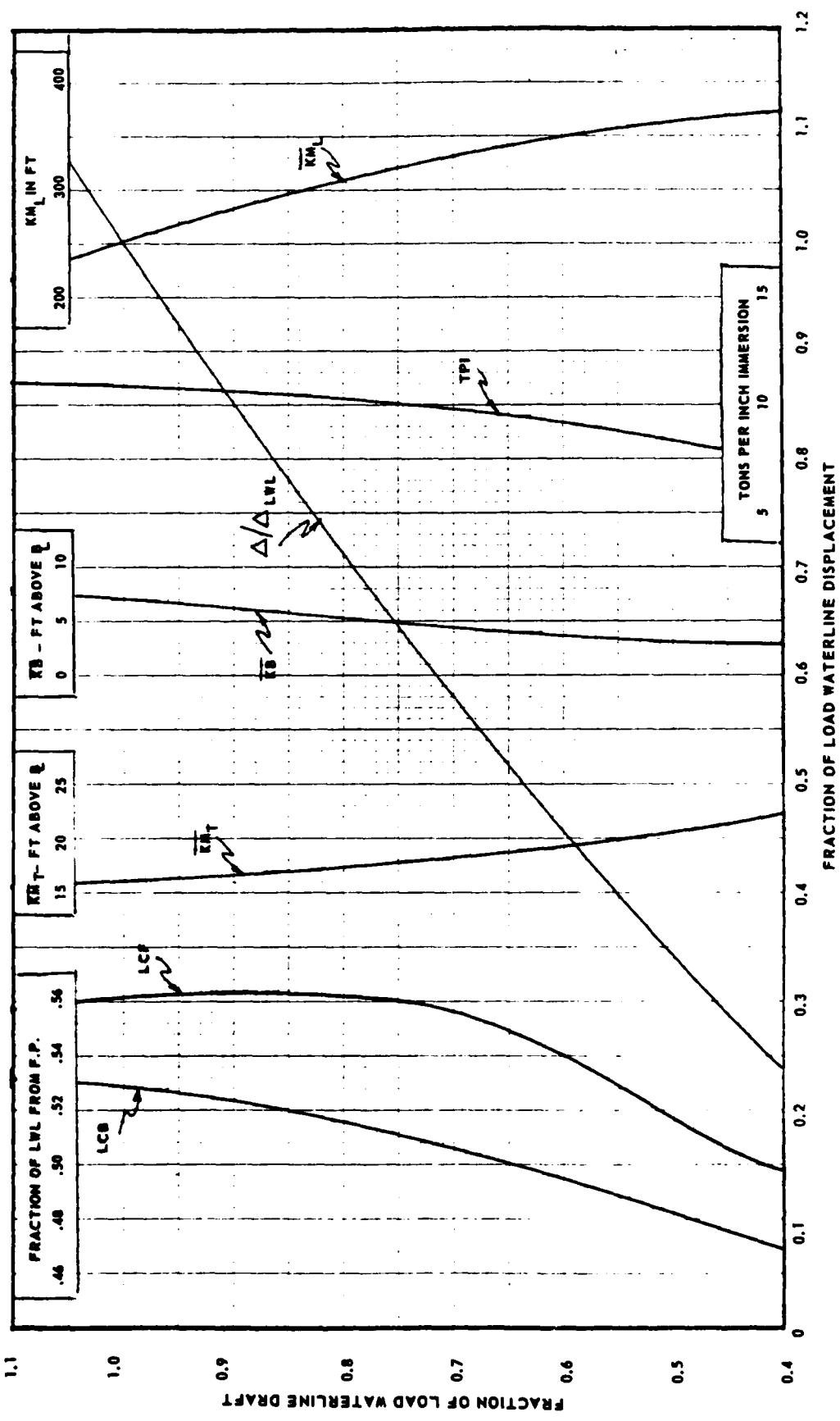

SEAGOING WORK PLATFORM	R/V H.J.W.FAY	OWNED BY TRACOR MARINE
HULL FORM DELINEATION - CURVES OF FORM	(FORMERLY ARTEMIS)	CHARTERED TO U.S. GEOLOGICAL SURVEY

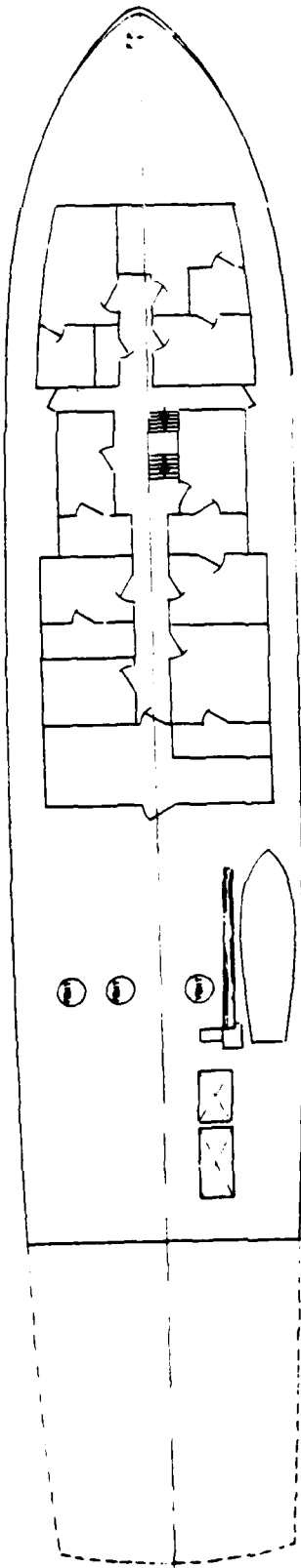

FORECASTLE DECK ARRANGEMENT

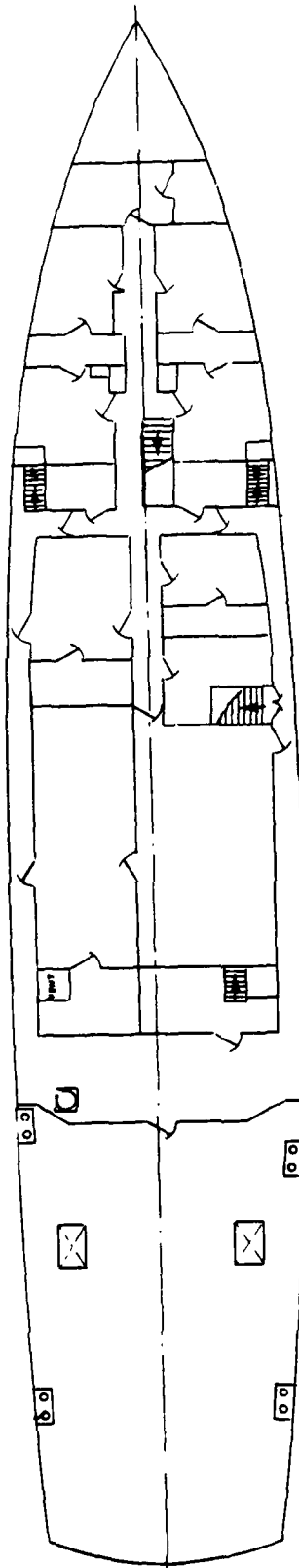

MAIN DECK ARRANGEMENT

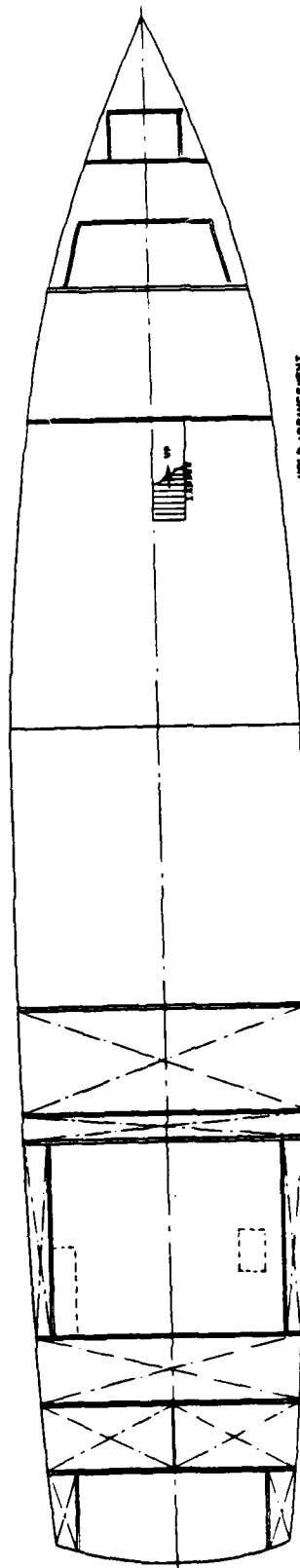

HOLD ARRANGEMENT

- GEOMETRY:** THE R/V A.B. WOOD II HAS A DECK LENGTH OF 150 FEET; INCLUDING THE WORKING PLATFORM FOR THE BOW SHEAVE THE OVERALL LENGTH IS 137.75 FEET. THE LENGTH ON THE 10.00 FOOT LOAD WATERLINE IS 145.75 FEET. BEAM IS 34.00 FEET AND THE DEPTH AMIDSHIPS IS 13.00 FEET. THE SHIP HAS A REGISTERED GROSS TONNAGE OF 195, AND ACCOMMODATIONS FOR ITS NORMAL CREW OF 7 OFFICERS AND MEN.
- HYDROSTATICS:** THE SHIP HAS A MAXIMUM SALT WATER DISPLACEMENT OF 750 TONS AT THE 10.00 FOOT WATERLINE AND FREEBOARD TO THE WORKING DECK IS 3.00 FEET. WITH ITS BROAD BEAM THE WOOD IS EXCEPTIONALLY STABLE. IN ADDITION, IT IS EQUIPPED WITH A FLUME STABILIZATION SYSTEM THAT KEEPS SEAWAY MOTIONS TO A MINIMUM FOR OPTIMUM WORK PERFORMANCE IN HEAVY WEATHER.
- STRUCTURE:** THE WOOD WAS DESIGNED AND CONSTRUCTED OF ALL-WELDED STEEL AS AN OCEAN WORK PLATFORM. THE HOUSE STRUCTURE FORWARD EXTENDS FOR ONLY ABOUT 50 FEET ABAFT THE BOW WITH THE REMAINING 100 FEET OF THE WEATHER DECK AVAILABLE FOR EQUIPMENT AND HANDLING GEAR. THE 2900 SQUARE FOOT WORKING AREA IS SPECIALLY STRENGTHENED TO TAKE THE CONCENTRATED LOADS OF CRANES, WINCHES, AND OTHER HEAVY WEIGHTS.
- MACHINERY:** EACH OF THE TWO CATERPILLAR MAIN PROPULSION DIESEL ENGINES ARE RATED AT 765 HORSEPOWER. SUPPLEMENTARY PROPULSION POWER IS PROVIDED BY THE 100 HORSEPOWER ACTIVE RUDDER ON THE CENTERLINE AFT OF THE TWO MAIN SCREWS. ADDITIONALLY THE SHIP IS FITTED WITH A 100 HORSEPOWER TUNNEL-TYPE BOW THRUSTER. THE ELECTRICAL SYSTEM IS POWERED BY TWO GENERAL MOTORS 100KW, 60HZ, AC DIESEL-GENERATORS PLUS AN EMERGENCY DIESEL GENERATOR. THE TWIN STACKS, EACH SERVING A MAIN ENGINE AND A GENERATOR ENGINE ARE LOCATED AT THE DECK EDGE TO MAXIMIZE THE CENTERLINE WORKING AREA.
- OUTFIT:** A PETTIBONE MODEL 70 CRANE IS PERMANENTLY INSTALLED ON THE MAIN DECK AT ABOUT HALF-LENGTH OF THE WORKING AREA; THIS CRANE HAS A BOOM EXTENDABLE TO 85 FEET WITH A CAPACITY OF 35 TONS AT A 10-FOOT RADIUS. THERE ARE THREE ANCHOR WINCHES, TWO ON THE AFTER END OF THE FORECASTLE DECK AND ONE AFT ON THE MAIN DECK. THE DRUM CAPACITY OF EACH OF THESE WINCHES IS 7000 FEET OF 3/4-INCH
- WIRE:** PULL CAPABILITY IS 30,000 POUNDS ON THE FIRST LAYER AND 10,000 POUNDS ON A FULL DRUM; TAKE-UP SPEED IS 100 FEET PER MINUTE ON THE FIRST LAYER AND 300 FEET PER MINUTE ON THE FULL DRUM. THE CROSS-DECK WINCH, JUST ABAFT THE HOUSE STRUCTURE, HAS TWO DRUMS 17.5 INCHES LONG WITH 40-INCH DIAMETER FLANGES; EACH DRUM HAS A CAPACITY OF 2000 FEET OF 3/4-INCH WITH A 12,000 POUND PULL AT 230 FEET PER MINUTE ON THE NINTH LAYER. FOR HANDLING HEAVY WEIGHTS OVER THE BOW, THERE ARE MOUNTED THREE SHEAVES, 7.50 FEET IN DIAMETER WITH A WORKING PLATFORM FOR HANDLING AND OBSERVATION; THERE IS A CABLE PASSAGEWAY THROUGH THE FORECASTLE DECKHOUSE TO RUN CABLE FROM THESE SHEAVES BACK TO THE CROSS-DECK WINCH. RADIO EQUIPMENT CONSISTS OF ONE KONEL, ONE APELCO AM MARINE BAND, ONE RF COMM HFSSB, AND ONE RF COMM VHF-FM RADIO TELEPHONE. NAVIGATION EQUIPMENT INCLUDES A DECCA, 48 MILE RANGE RADAR, A KELVIN-HUGHES, A/C MODE LORAN, A SPERRY GYROCOMPASS, AUTOPILOT, AND REMOTE REPEATERS, AND A RAYTHEON 400 FATHOM RECORDING ECHO-SOUNDER. SEPARATE INTERCOM SYSTEMS ARE PROVIDED FOR SHIP AND SCIENTIFIC PARTY USE AS WELL AS ON-DECK LOUD-MAILING AND TALKBACK CAPABILITY.
- PROPULSION AND MANEUVERING:** THE CRUISING RANGE IS 6800 NAUTICAL MILES AT A CRUISING SPEED OF 10.50 KNOTS. THE ACTIVE RUDDER CAN BE USED TO INCREASE SLIGHTLY THE CRUISING SPEED. TO SERVE AS A TAKE HOME DEVICE IN CASE OF MAIN ENGINE FAILURE AND, IN CONJUNCTION WITH THE BOW THRUSTER, GIVES THE SHIP A LIMITED DYNAMIC POSITIONING AND GOOD STATION KEEPING CAPABILITY. THE MAIN ENGINES, AS WELL AS THE TWO THRUSTERS AND THE STEERING SYSTEM ARE CONTROLLED FROM THE PILOT HOUSE; THE AUTOPILOT CAN BE USED IN CONTROLLING THE RUDDERS FOR COURSEKEEPING AT SEA.
- MISSION SUPPORT:** IN ADDITION TO CREW ACCOMMODATIONS THERE ARE PASSENGER ACCOMMODATIONS IN ONE, TWO, AND FOUR-BERTH STATEROOMS FOR TOTAL OF 17 PERSONS; THESE QUARTERS ARE FULLY HEATED AND AIR-CONDITIONED. LABORATORY SPACE HAS BEEN MINIMIZED TO 75 SQUARE FEET, PRIMARILY USED FOR OVERBOARD TELEVISION MONITORING, IN ORDER TO MAXIMIZE THE DECK SPACE AVAILABLE FOR OVERBOARD LOAD HANDLING. HOWEVER, PORTABLE, STEEL-CONSTRUCTION, AIR-CONDITIONED LABORATORIES CAN BE MOUNTED ON DECK AND SUPPLIED WITH POWER, WATER, AND AIR AS REQUIRED. FOR CURRENT USAGE, ONE ELECTRONICS POD AND AN ORDNANCE-MANS POD OF THIS TYPE ARE INSTALLED.

<p style="text-align: center;">SEAGOING WORK PLATFORM PHYSICAL AND PERFORMANCE CHARACTERISTICS</p>	<p style="text-align: center;">R/V A.B. WOOD II: OWNED BY TRACOR MARINE CHARTERED TO MSC</p>
--	--

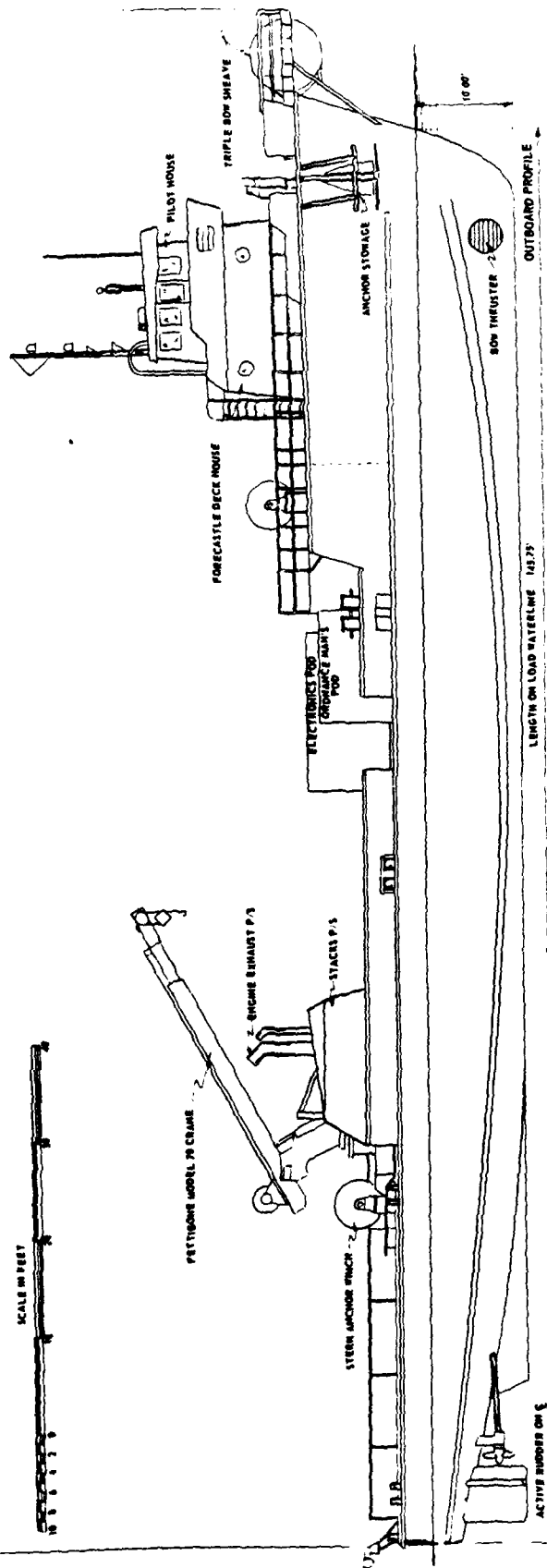
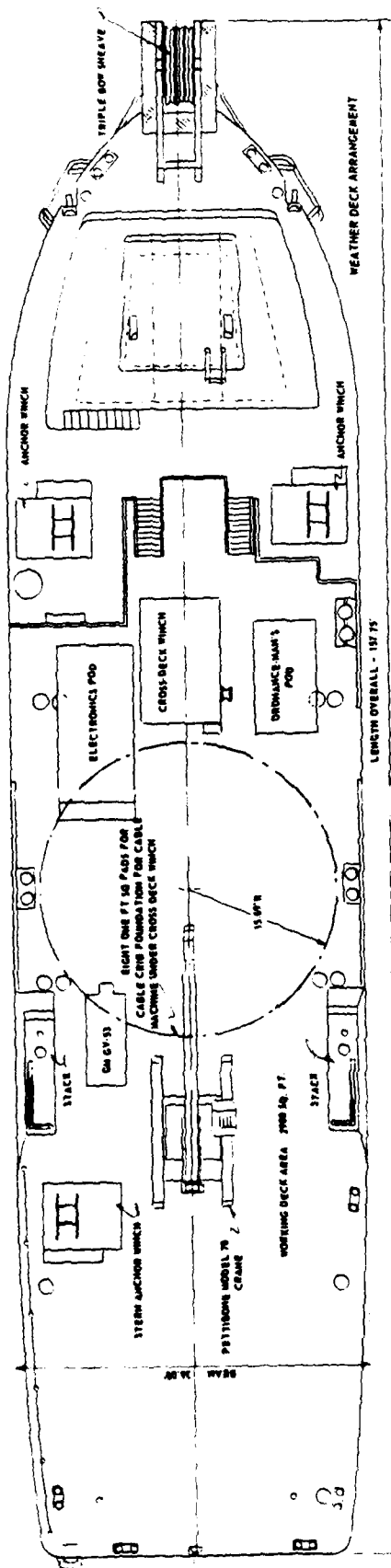

SEAGOING WORK PLATFORM
OVERALL GEOMETRY

R/V A. B. WOOD II

OWNED BY TRACOR MARINE
CHARTERED TO MSC

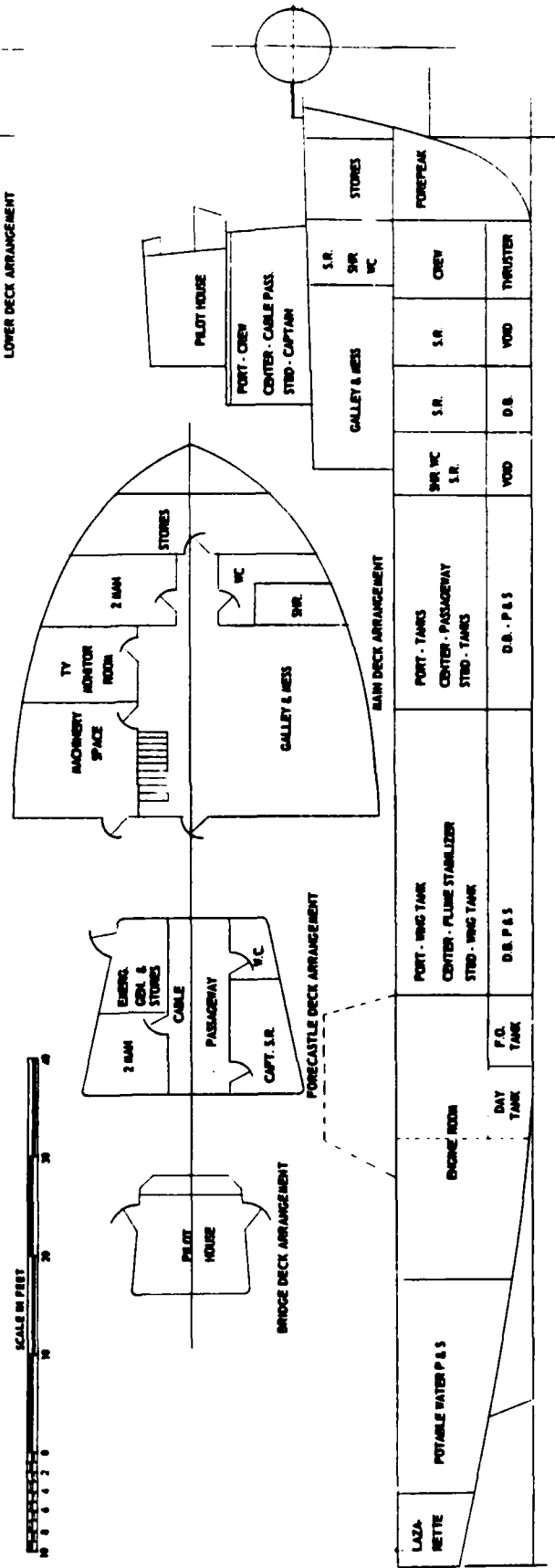
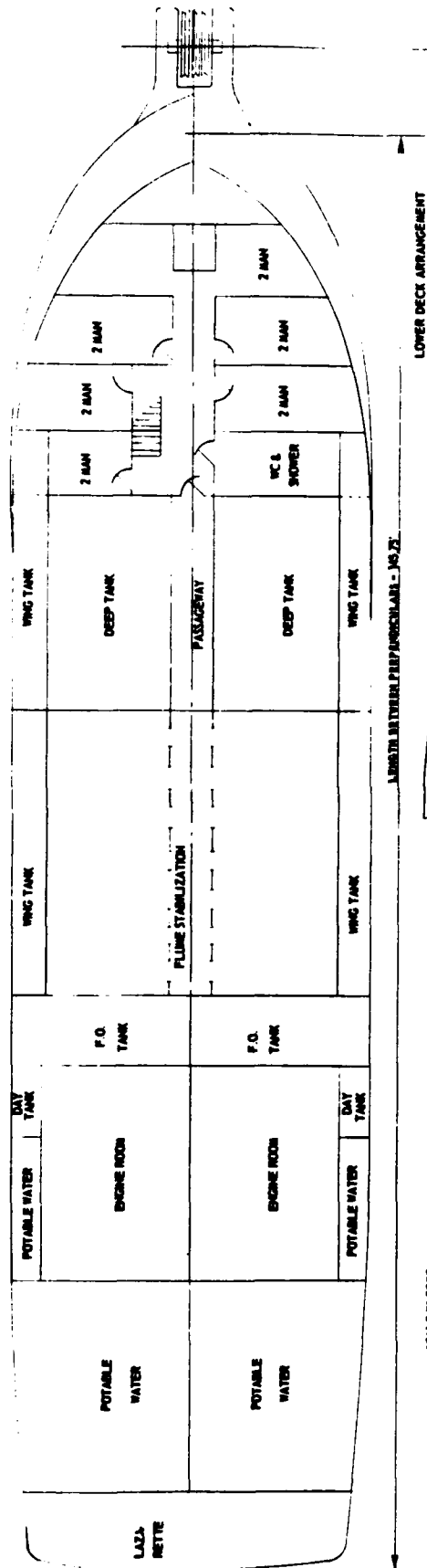

INBOARD PROFILE

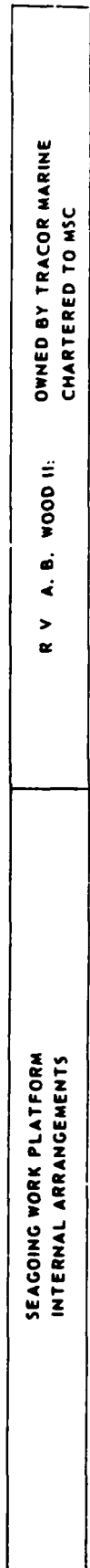

SEAGOING WORK PLATFORM
INTERNAL ARRANGEMENTS

R V A. B. WOOD II;
OWNED BY TRACOR MARINE
CHARTERED TO MSC

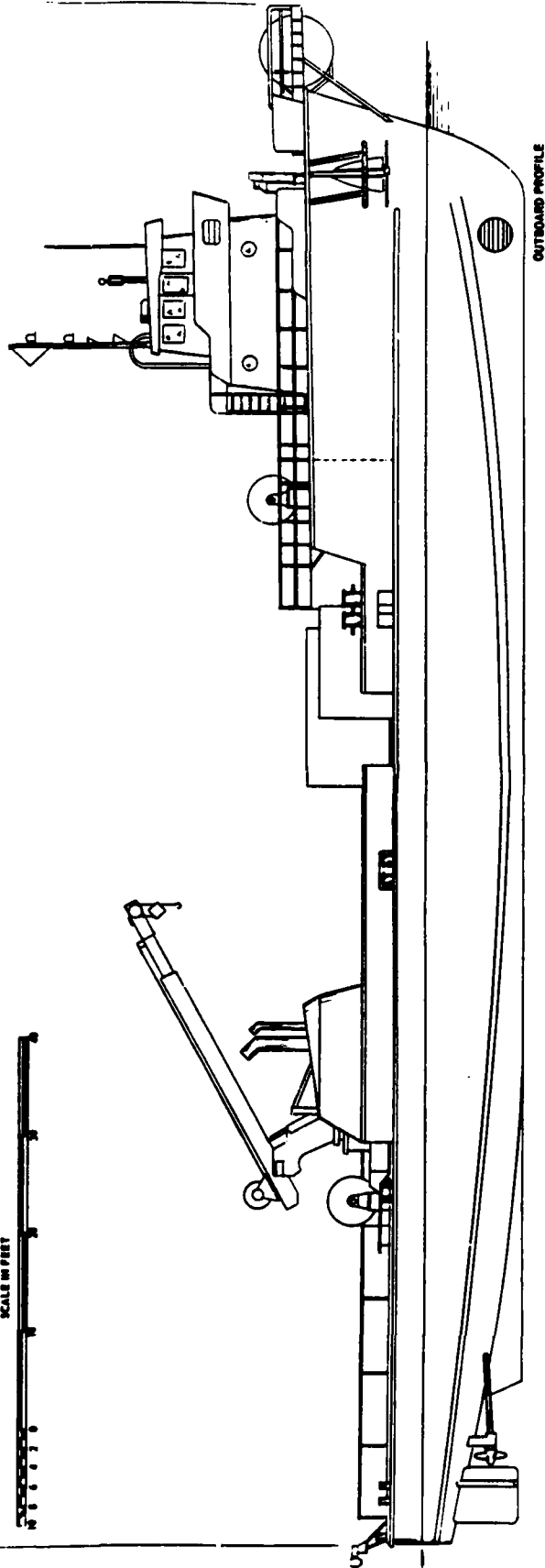
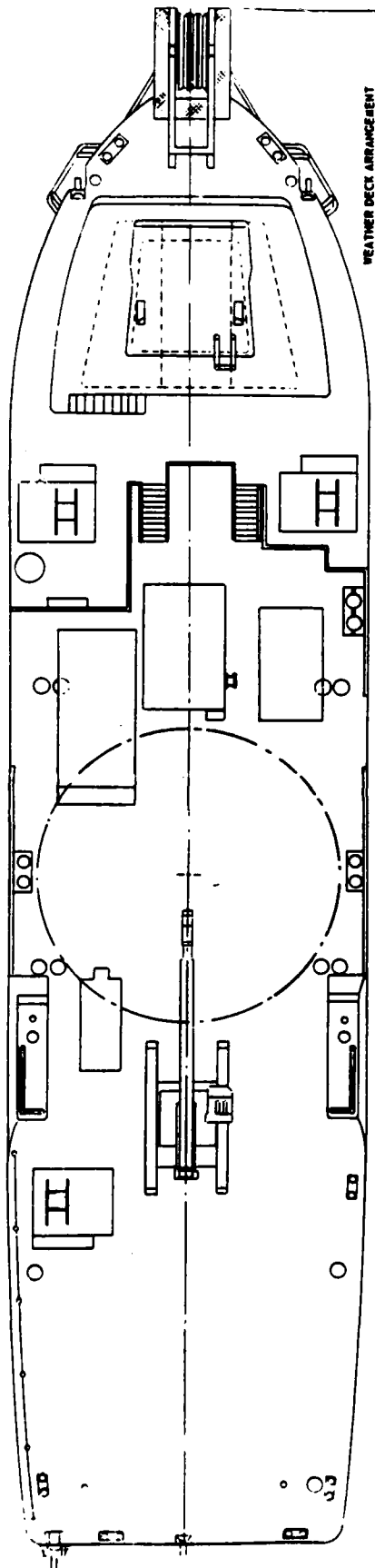

R/Y A. S. WOOD '11
PEP DRAWING

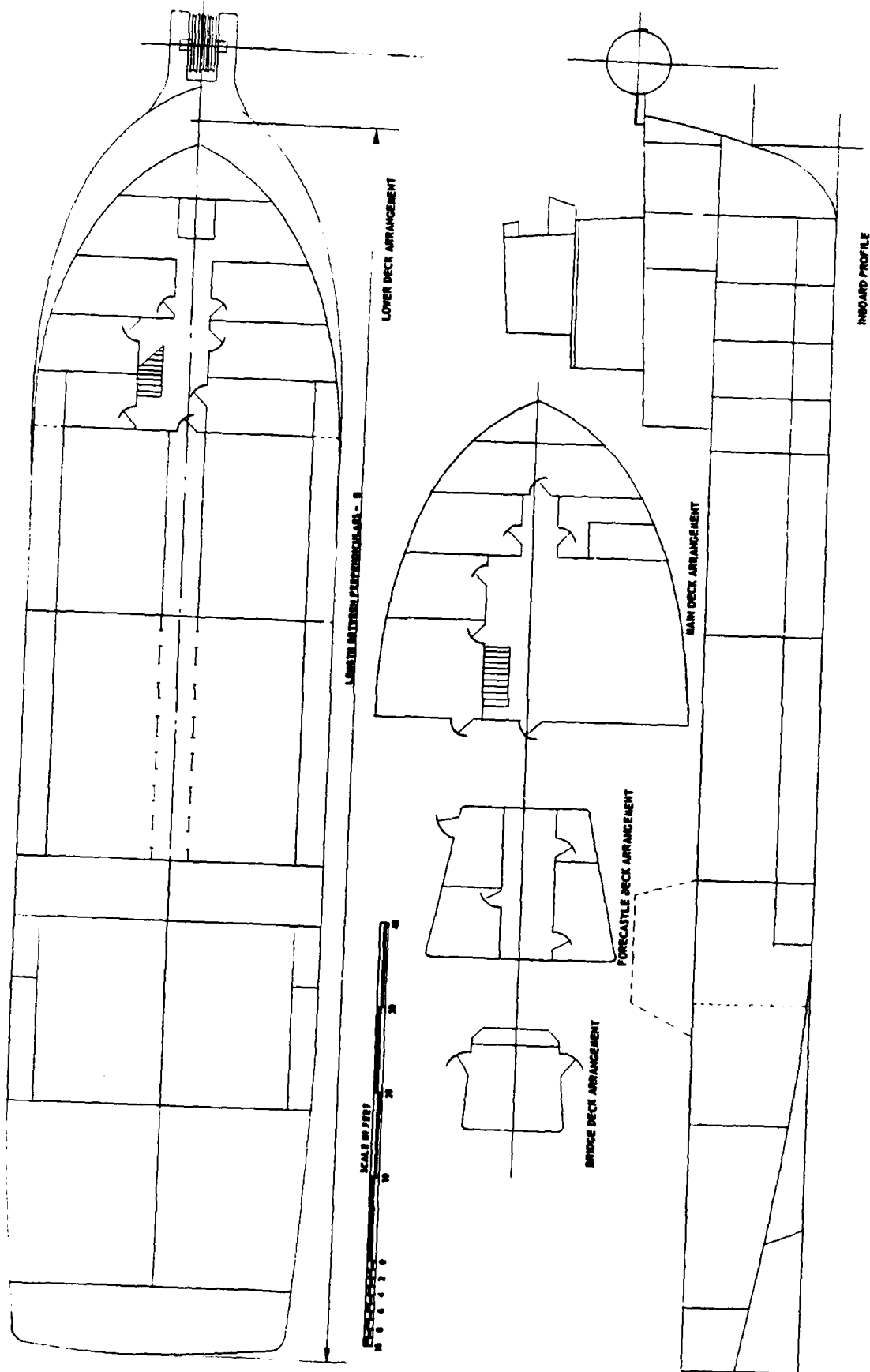

R. V. A. B. WOOD H
PEP DRAWING

GEOMETRY: THE USCGS TERN IS A PROTOTYPE FOR A NEW CLASS OF INLAND BUOY TENDERS WITH A HOUSE STRUCTURE FORWARD, A LARGE OPEN DECK AFT, AND A CUTAWAY STERN SERVICED BY A TRAVELING GANTRY CRANE. OVERALL LENGTH IS 80.81 FEET. ON THE 4.77 FOOT DESIGN WATERLINE, THE LENGTH IS 75.00 FEET, AND THE MOLDED BEAM IS 22.98 FEET. THE MOLDED BEAM AT THE DECK AMIDSHIPS IS 24.25 FEET AND THE MAXIMUM BEAM OVER GUARDS IS 24.75 FEET. MOLDED DEPTH AMIDSHIPS TO THE MAIN DECK AT SIDE IS 11.78 FEET. THE VESSEL SECTIONS FORWARD OF AMIDSHIPS COMPRISES STRAIGHT LINE ELEMENTS RUNNING FROM THE KEEL TO A LOWER CHINE, TO AN UPPER CHINE, AND THENCE TO THE MAIN DECK. AFT OF AMIDSHIPS THE UPPER AND LOWER CHINES MERGE AND THE BOTTOM STRUCTURE IS FORMED INTO TWO CONCAVE SEMI-TUNNELS ABOVE THE MAIN PROPELLERS.

HYDROSTATICS: THE DISPLACEMENT TO THE DESIGN WATERLINE IS 134.2 TONS SALT WATER. AT A DRAFT OF 5.75 FEET, WITH ABOUT ONE-THIRD TOTAL TANKAGE AND 35 TONS OF BUOY LOAD, STORES, AND EQUIPMENT THE DISPLACEMENT IS ESTIMATED AT 168 TONS SALT WATER. THIS SAME MAXIMUM DISPLACEMENT IS REACHED WITH TOTAL TANKAGE AND NO BUOY LOAD. LEVEL TRIM CONDITIONS CAN BE MAINTAINED FROM THE DESIGN WATERLINE TO THE MAXIMUM WATERLINE WITH CORRECT DISTRIBUTION OF THE BUOY LOAD AND LIQUID IN TANKS.

STRUCTURE: THE BASIC HULL STRUCTURE IS OF ALL-WELDED STEEL. THE MAIN DECK EXTENDS FROM A POINT 12.60 FEET ABOVE THE BASELINE AT THE STEM TO A POINT 11.00 FEET ABOVE THE BASELINE AT THE STERN. THERE IS A FLAT 6.25 FEET ABOVE THE BASELINE IN THE BOW THRUSTER COMPARTMENT; FOR THE REMAINDER OF THE LENGTH, A FLAT 4.50 FEET ABOVE THE BASELINE COMPRISES THE ONLY OTHER DECK. TRANSVERSE FRAMING CONSISTS OF TEN WATERTIGHT BULKHEADS OR WEB FRAMES SPACED AT ROUGHLY EIGHT FEET. LONGITUDINAL FRAMING CONSISTS OF TEE BEAMS, SPACED AT APPROXIMATELY 1.75 FEET RUNNING FORE AND AFT UNDER THE MAIN DECK AND THE 4.5 FOOT FLAT AS WELL AS ALONG THE SIDE AND BOTTOM SHELL. THE CENTER VERTICAL KEEL IS ALSO A TEE BEAM 12-INCHES DEEP AND THE HOLD BELOW THE 4.5 FOOT FLAT IS DIVIDED INTO THREE COMPARTMENTS BY TWO LONGITUDINAL BULKHEADS RUNNING THE LENGTH OF THE SHIP, 4.25 FEET OFF CENTERLINE. THE GUNWALE AT THE INTERSECTION OF THE MAIN DECK AND THE SIDE IS SQUARE STRUCTURAL TUBING RUNNING THE LENGTH OF THE SHIP.

MACHINERY: MAIN PROPULSION MACHINERY CONSISTS OF TWO GENERAL MOTORS DIESELS DRIVING HYDRAULIC PUMPS. THESE HYDRAULIC PUMPS SUPPLY POWER TO THREE HYDRAULIC MOTOR-DRIVEN RIGHT-ANGLE DRIVE PROPULSION UNITS. THE TWO AFTER PROPULSORS ARE THE MAIN PROPULSION UNITS AND ARE RATED AT 235 HORSEPOWER EACH. THEY EXTEND DOWN THROUGH WELLS IN THE AFTER END OF THE MACHINERY SPACE. 6.00 FEET OFF CENTERLINE AND THEIR LOWER GUARDS EXTEND TO SIX INCHES

BELOW THE BASELINE; THESE UNITS ARE FIXED VERTICALLY BUT CAN ROTATE THROUGH 360 DEGREES. THE BOW THRUSTER IS ALSO DRIVEN BY A HYDRAULIC MOTOR AND IS RATED AT 125 HORSEPOWER. IT CAN BE RETRACTED UP INTO HULL BELOW THE 6.25 FOOT FLAT WITH THE MAXIMUM EXTENDED DEPTH OF ITS LOWER GUARD REACHING THE BASELINE. IT TOO CAN BE STEERED THROUGH 360 DEGREES. AUXILIARY MACHINERY COMPRISES TWO DIESEL GENERATOR SETS, TWO AIR COMPRESSORS, AND A HEATING BOILER PLUS FIRE AND BILGE PUMPS, FRESH WATER PUMPS, AND FUEL OIL TRANSFER PUMPS.

OUTFIT & MISSION SUPPORT: THE ANCHOR IS HANDLED USING A PORTABLE ANCHOR DAVIT WITH THE ANCHOR LINE STOWED ON A REEL IN THE BOW THRUSTER COMPARTMENT. IMMEDIATELY ABAFT THE HOUSE STRUCTURE ON THE MAIN DECK IS A SINKER AND CHAIN WINCH USED FOR HAULING BUOY ANCHOR CHAIN OVER THE STERN ROLLER AND DEPOSITING IT INTO THE SINKER AND CHAIN HOLD THROUGH THE FLUSH HATCH AMIDSHIPS. A GANTRY CRANE PROVIDES THE PRIMARY MEANS OF HANDLING BUOYS OVER THE STERN. THIS CRANE RIDES ON RAILS THAT RUN FORE AND AFT AT A LEVEL OF 3.00 FEET ABOVE THE MAIN DECK, 10.50 FEET OFF CENTERLINE PORT AND STARBOARD. THE BOTTOM OF THE CROSS TRUSS-WORK CLEARS THE MAIN DECK BY 18.00 FEET. ON TOP OF THE CROSS TRUSS STRUCTURE ARE MOUNTED TWO BOOMS RUNNING FORE AND AFT, 7.00 FEET OFF CENTERLINE. EACH BOOM IS MOUNTED ON A PIVOT AT THE FORWARD END OF THE CROSS TRUSS AND IS SUPPORTED BY WHEELS RIDING ON A CURVED RAIL AT THE AFTER END OF THE CROSS TRUSS. EACH BOOM CAN SWING ± 45 DEGREES FROM ITS FORE AND AFT POSITION DRIVEN BY A HYDRAULIC PISTON. THIS PERMITS THE AFTER END OF EACH BOOM, AND ITS 5/8-INCH, 3 TON LIFTING CABLE TO SWING FROM THE CENTERLINE OF THE SHIP TO THE OUTBOARD EDGE OF THE MAIN DECK. WITH THE 50-FOOT FORE AND AFT TRAVEL OF THE GANTRY THIS GIVES COMPLETE COVERAGE OF THE WORKING AREA. TIE DOWN SOCKETS ARE INSTALLED EVERY 4-5 FEET OVER THE WORKING AREA; WELLS ARE PROVIDED FOR BUOY STOWAGE. COMPLEMENT IS 7 ENLISTED MEN.

SPEED, PROPULSION, AND MANEUVERING: BOTH MAIN PROPELLERS ARE 4-BLADED, RIGHT HAND, CAST NICKEL MANGANESE BRONZE, WITH A DIAMETER OF 38.189 INCHES, A PITCH OF 39.37 INCHES, AND A DEVELOPED AREA OF 626 SQUARE INCHES. THEY ARE DESIGNED TO ABSORB 235 SHAFT HORSEPOWER AT 543 RPM. THE BOW THRUSTER PROPELLER, ALSO 4-BLADED AND RIGHT HAND, IS 31.890 INCHES IN DIAMETER WITH A PITCH OF 17.323 INCHES AND A DEVELOPED AREA OF 506 SQUARE INCHES. IT IS DESIGNED TO ABSORB 125 SHAFT HORSEPOWER AT 738 RPM. MAXIMUM SPEED, WITH ALL THREE PROPELLERS IN OPERATION, IS 10 KNOTS IN THE FULLY LOADED CONDITION AT 5.75 FEET DRAFT. INDIVIDUAL CONTROL IS PROVIDED FOR THE DIRECTION AND MAGNITUDE OF THRUST FROM EACH PROPELLOR. THIS RESULTS IN EXCESSIVE MANEUVERABILITY WHICH REQUIRES EITHER AN EXPERIENCED OPERATOR OR A NEW MANEUVERING CONTROL. RANGE IS 4800 MILES AT ECONOMIC SPEED OF 5.4 KNOTS AND 1800 MILES AT 10 KNOTS.

INSHORE OPERATIONS WORK PLATFORM
PHYSICAL AND PERFORMANCE CHARACTERISTICS

USCGS TERN: WLI 80801

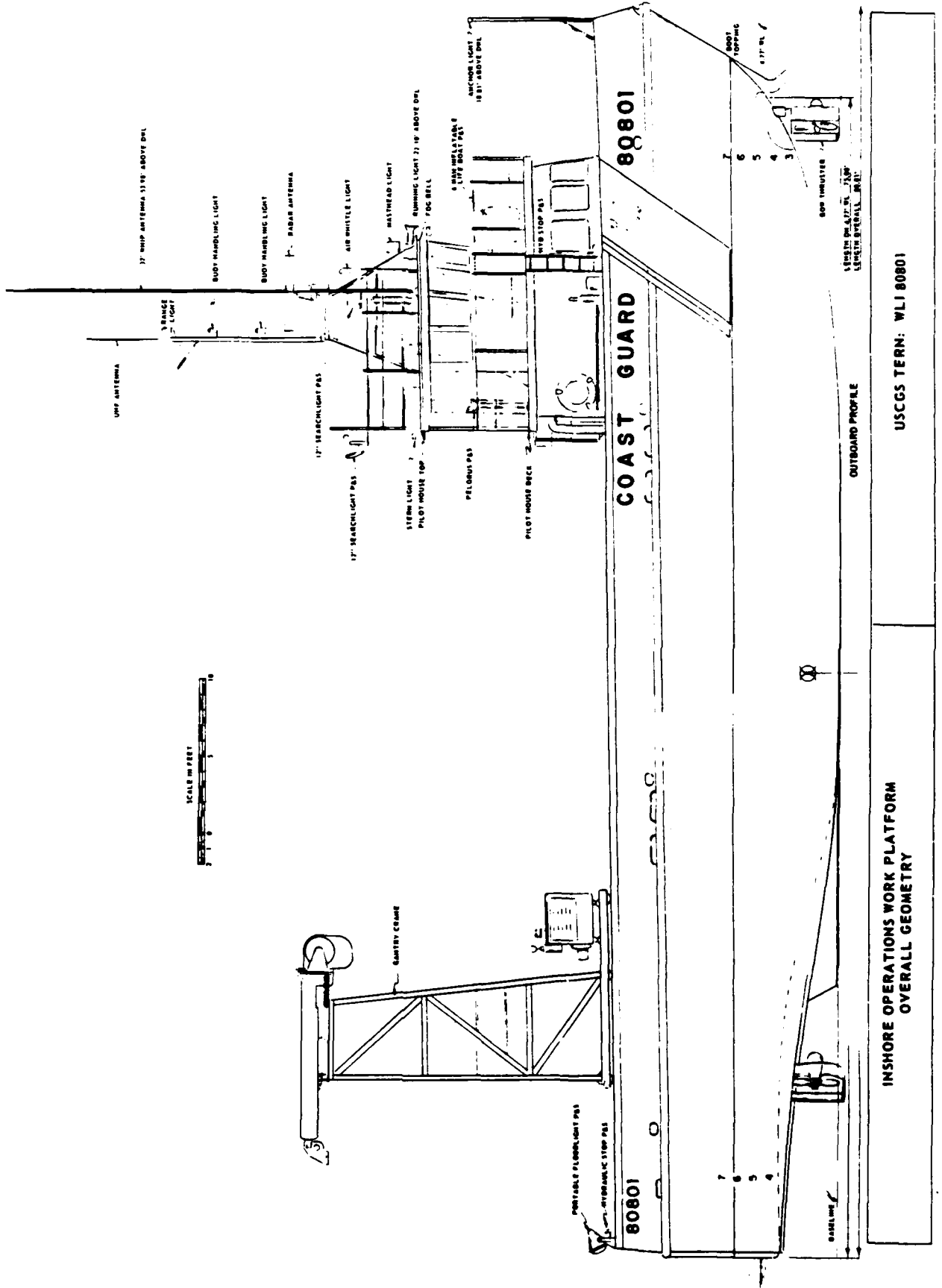

INSHORE OPERATIONS WORK PLATFORM
OVERALL GEOMETRY

USCGC TERN: WLI 80801

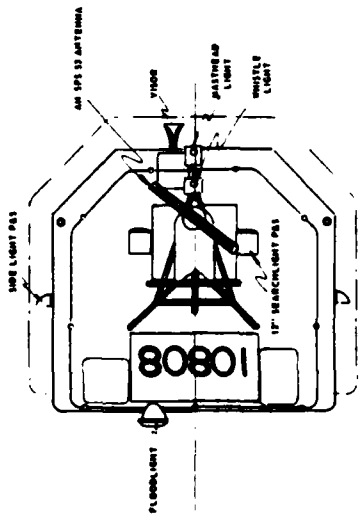

PILOTHOUSE TOP

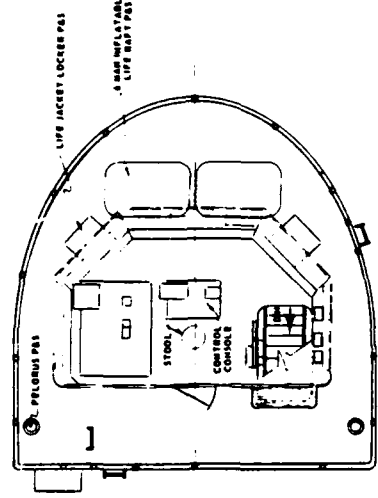

PILOT HOUSE DECK

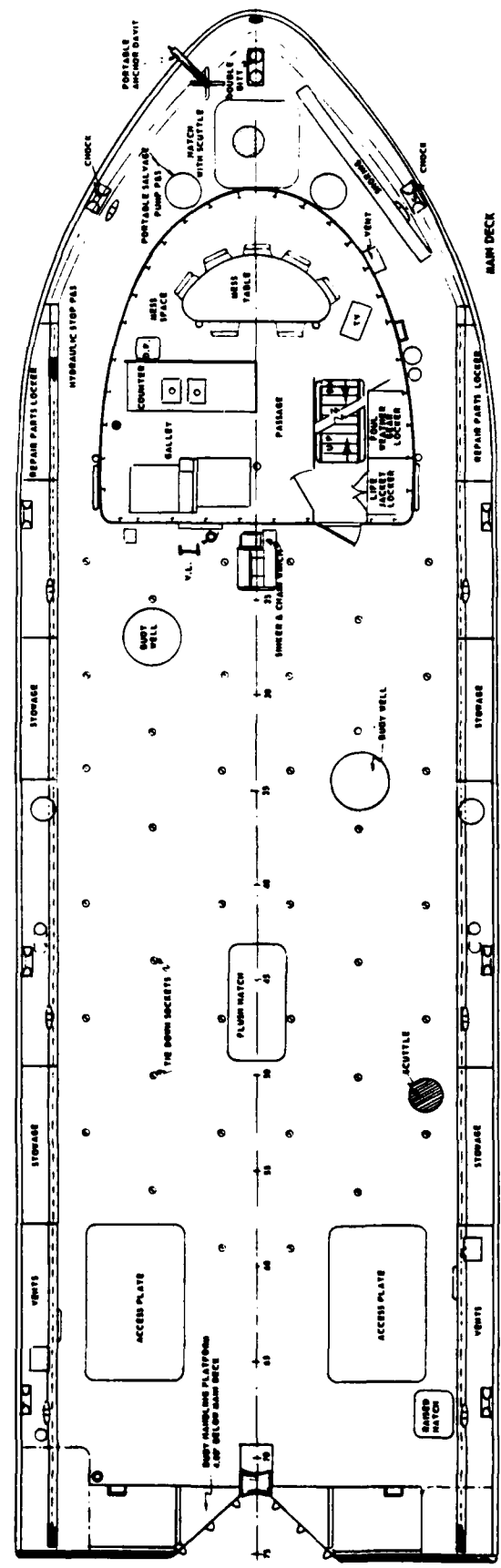

USCGS TERN: WLI 80801

INSHORE OPERATIONS WORK PLATFORM
OVERALL GEOMETRY

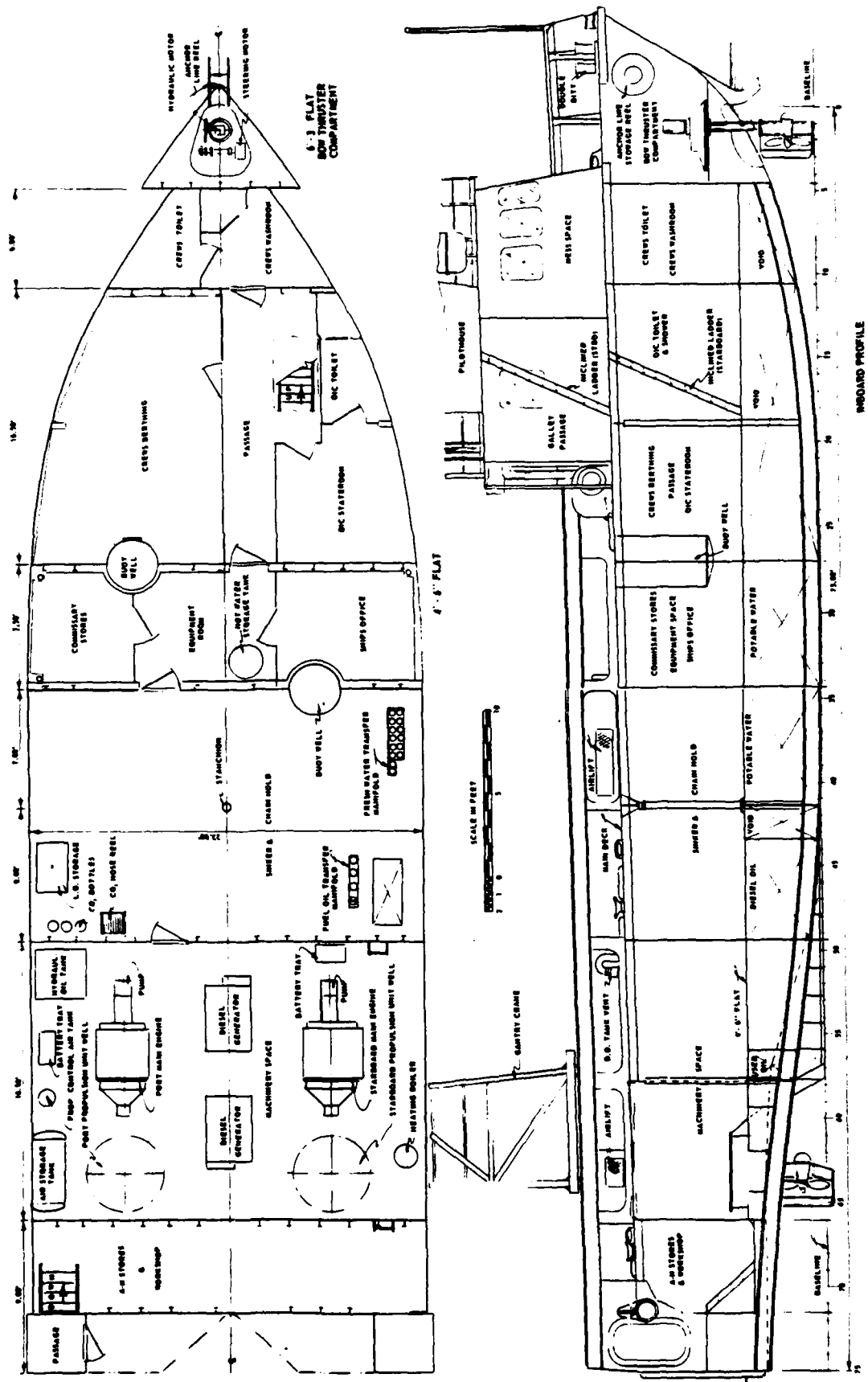

USCGS TERN: WLJ 80801

INSHORE OPERATIONS WORK PLATFORM
INTERNAL ARRANGEMENTS

LOAD WATERLINE VALUES: LENGTH, WATERLINE - 75.00 FT; DRAFT, FROM BASELINE - 4.77 FT; DISPLACEMENT - 134.2 TONS, S.W.

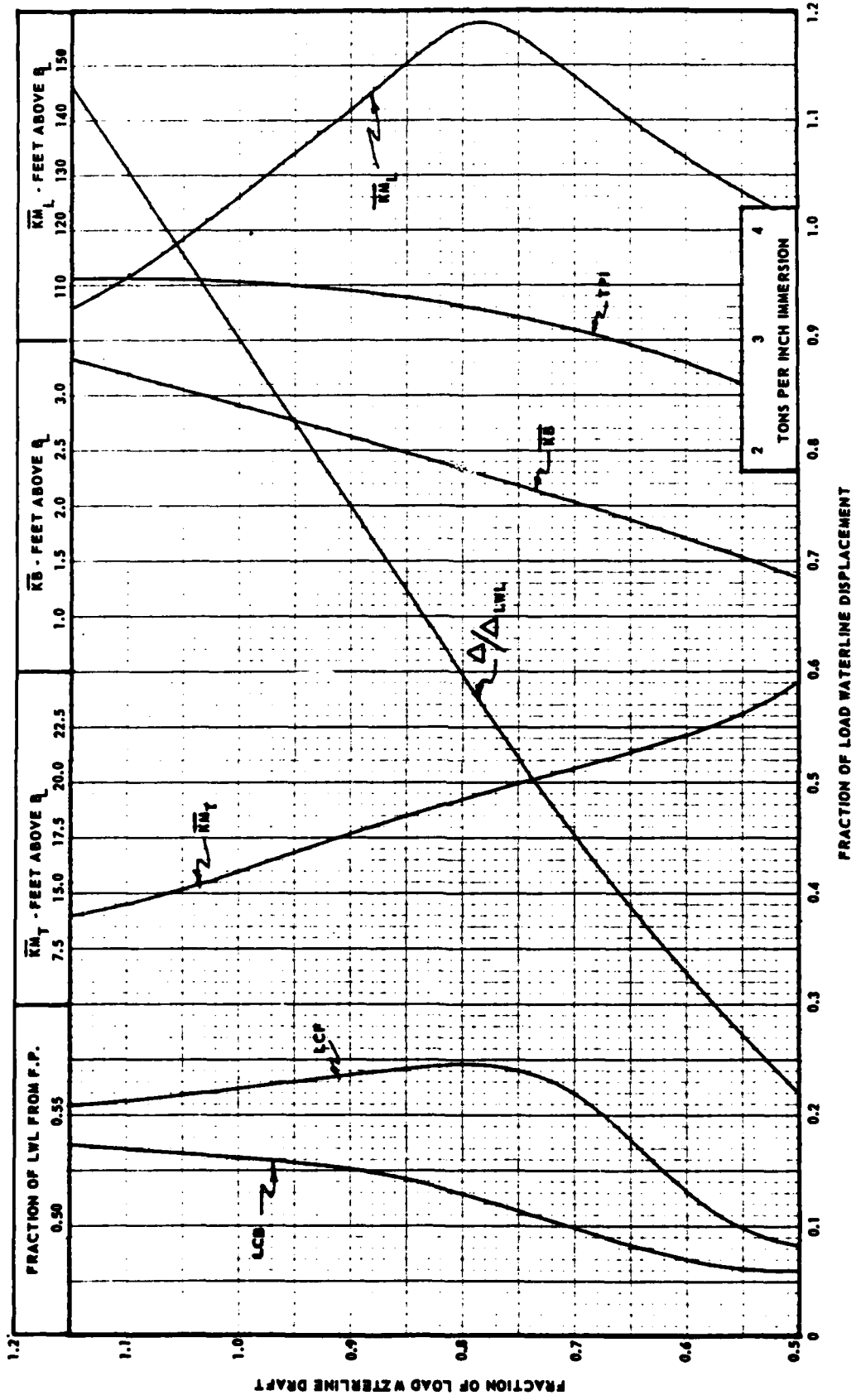

INSHORE OPERATIONS WORK PLATFORM
HULL FORM DELINEATION - CURVES OF FORM

USCGS TERM: WLI 80801

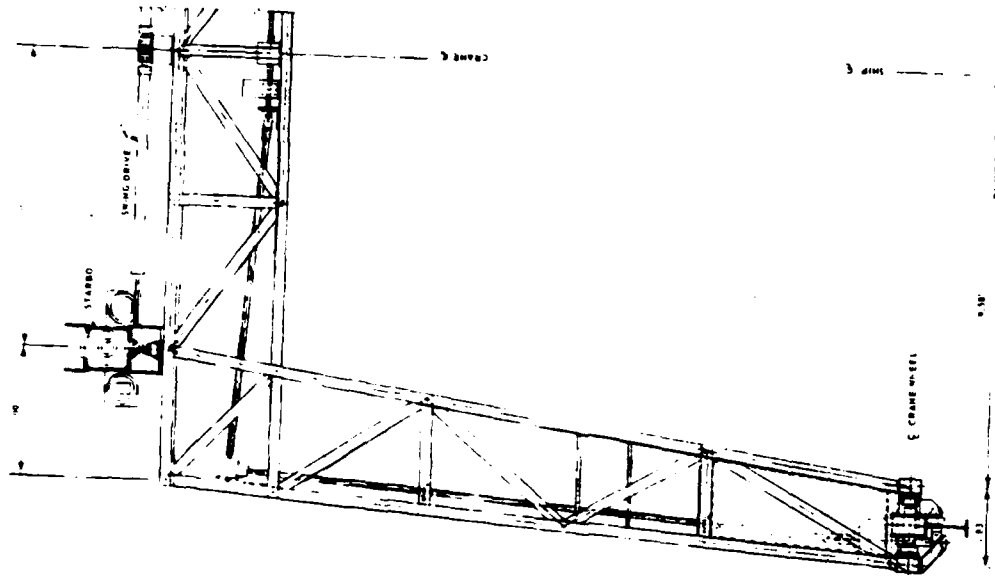

STARBOARD SIDE OF GANTRY CRANE LOOKING AFT. SECTION A-A

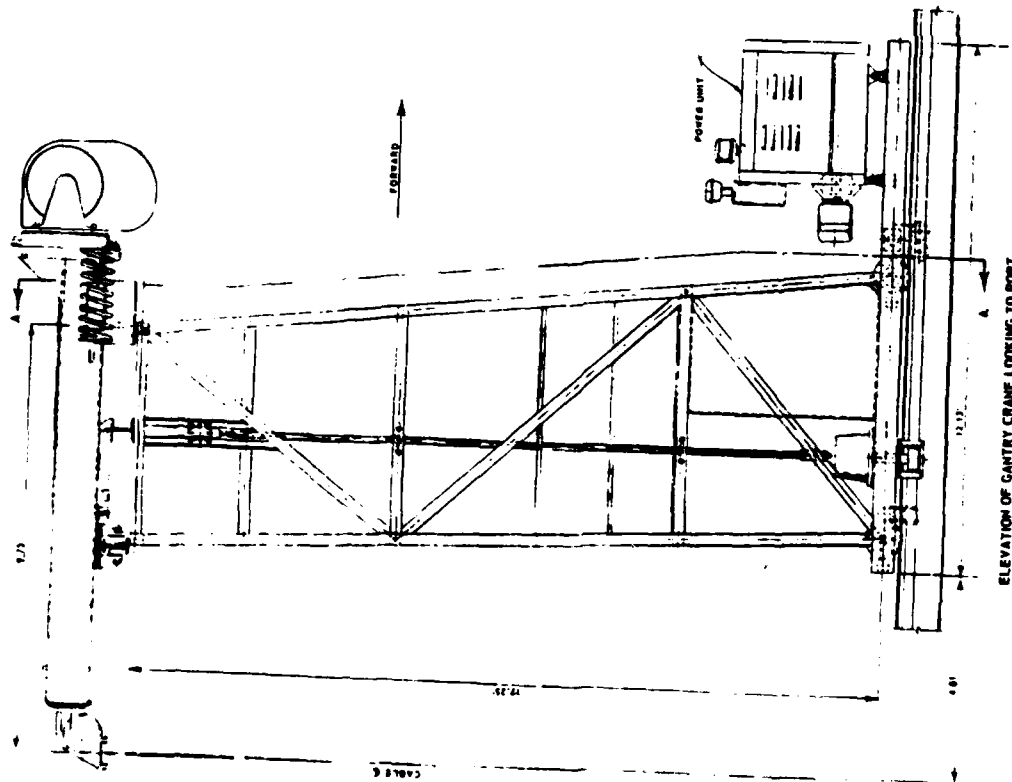

ELEVATION OF GANTRY CRANE LOOKING TO PORT

INSHORE OPERATIONS WORK PLATFORM
DECK MACHINERY - GANTRY CRANE

USCGS TERN: WLI 80801

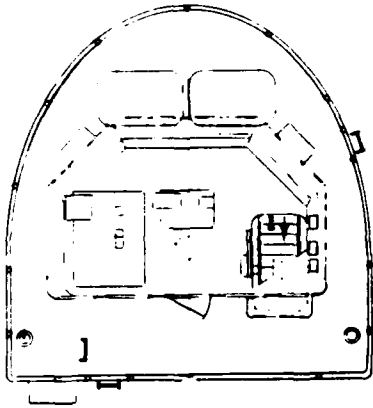

PILOT HOUSE DECK

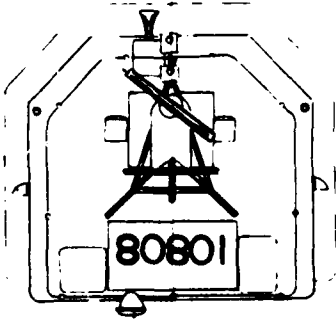

PILOT HOUSE TOP

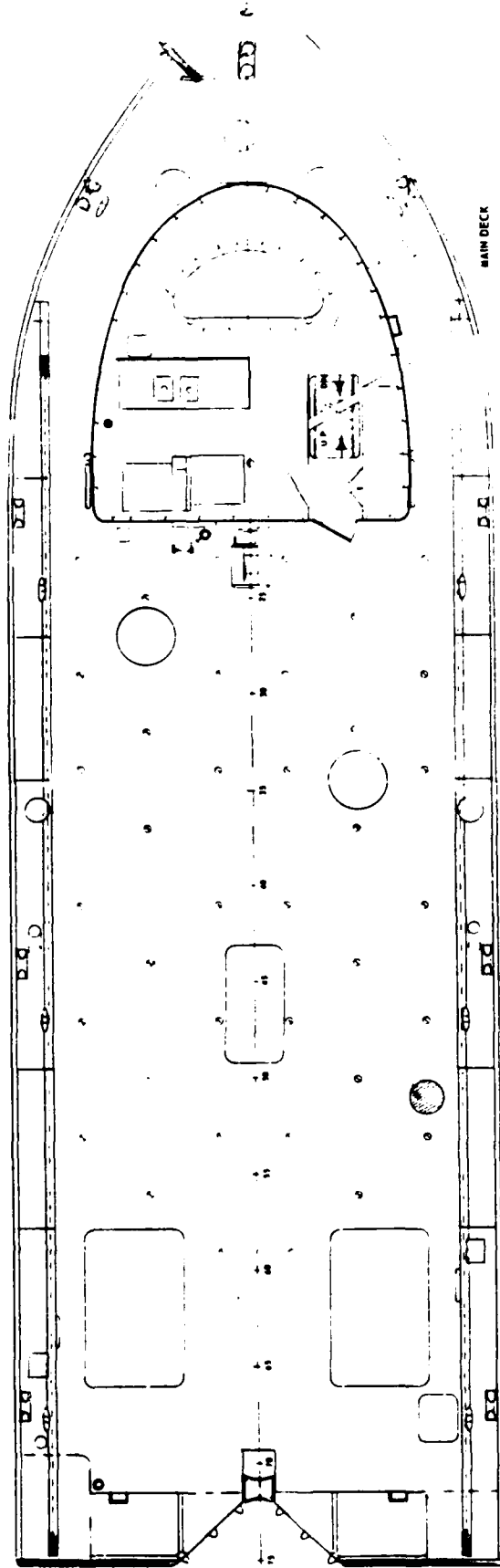

MAIN DECK

USCGS TERN
PEP DRAWING

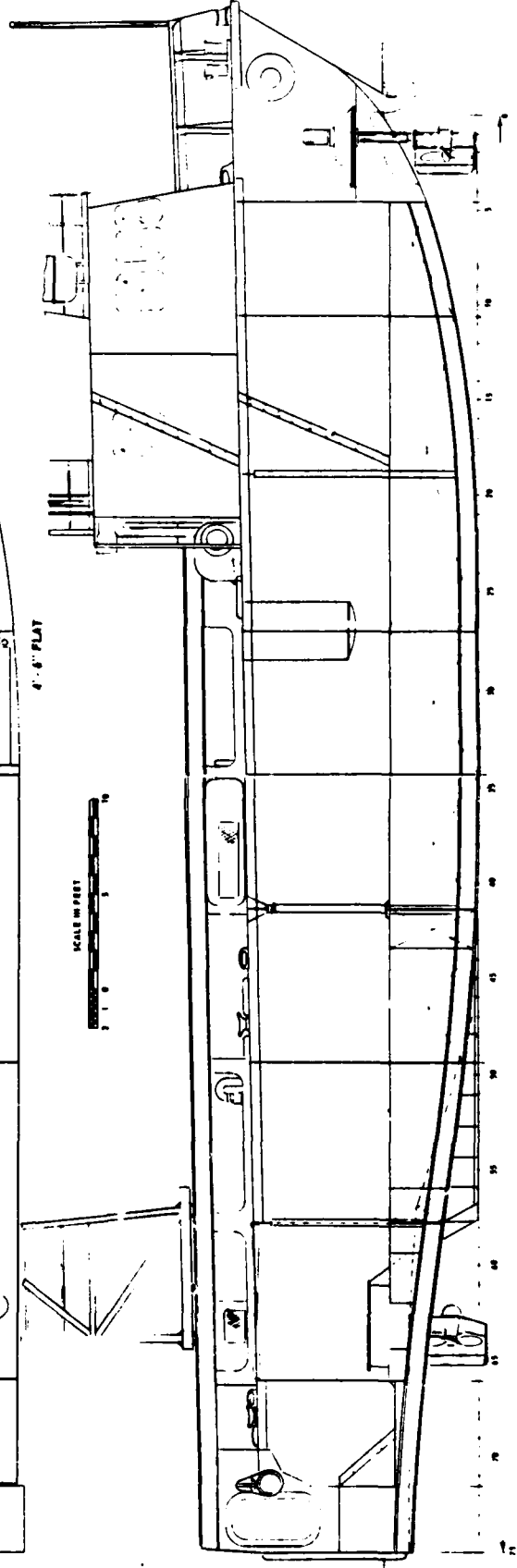
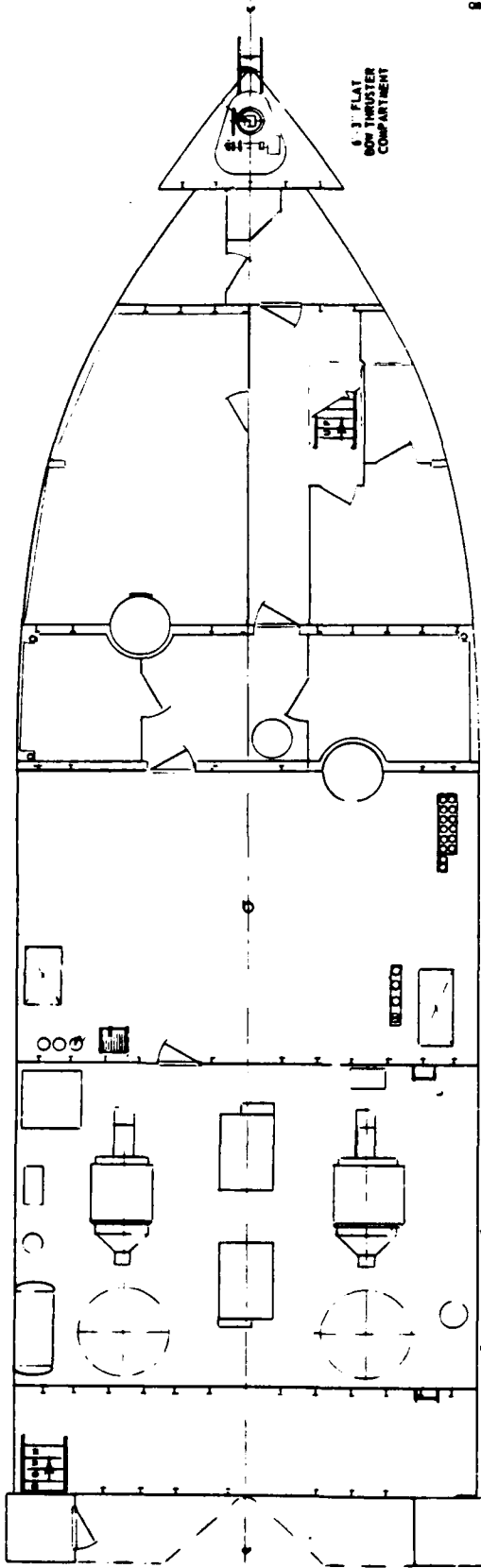

□ GEOMETRY AND HYDROSTATICS: THE AGS-26 CLASS INCLUDES USNS SILAS BENT (AGS-26), USNS KAME (AGS-27), AND USNS WILKES (AGS-33). USNS WYMAN (AGS-34) HAS THE SAME HULL BUT DIFFERENT MISSION AND OUTFITTING. THE WILKES WAS SPECIFICALLY BUILT FOR HYDROGRAPHIC AND OCEANOGRAPHIC SURVEY WORK. LENGTH OVERALL IS 285.75 FEET WITH A LENGTH ON THE 15.00 FOOT DESIGN WATERLINE OF 265.00 FEET. BEAM IS 48.25 FEET AND HEIGHT TO THE TOP OF THE RADAR ANTENNA IS 110.00 FEET. KEEL DRAFT AT THE DESIGN WATERLINE IS 14.00 FEET FORWARD AND 15.75 FEET AFT WITH MAXIMUM DRAFT OVER THE SONAR DOME OF 19.00 FEET. ACCOMMODATIONS ARE PROVIDED FOR 13 OFFICERS AND 35 CREW AS WELL AS FOR SCIENTIST ACCOMMODATIONS. THE SHIP HAS A FULL LOAD DISPLACEMENT, SALT WATER, OF 2600 TONS AND A LIGHT LOAD DISPLACEMENT OF 1900 TONS.

□ STRUCTURE: THE WILKES IS OF WELDED STEEL CONSTRUCTION, DIVIDED INTO TEN COMPARTMENTS LONGITUDINALLY BY WATERTIGHT BULKHEADS EXTENDING FROM THE KEEL TO THE MAIN DECK. BELOW THE MAIN DECK THERE ARE TWO PLATFORMS RUNNING THE FULL LENGTH OF THE SHIP AND AN INNER BOTTOM COVERING 172 FEET OF THE MID-LENGTH. ABOVE THE MAIN DECK, THE FORECASTLE DECK (01 LEVEL) EXTENDS 59 FEET AFT OF THE FORE PERPENDICULAR WITH THREE DECKS ABOVE IT. THE SHIP IS TRANSVERSELY FRAMED WITH 21-INCH FRAME SPACING FOR THE FORWARD 52.5 FEET AND 24-INCH FRAME SPACING FOR THE REMAINDER.

□ MACHINERY: THE SINGLE SCREW IS DRIVEN BY A 3600 HORSEPOWER ELECTRIC MOTOR POWERED BY TWO DIESEL-GENERATORS. THE SHIP IS ALSO EQUIPPED WITH A 350 HORSEPOWER TUNNEL-THRUSTER AND A 250 HORSEPOWER ACTIVE RUDDER ABOARD THE PROPELLER. AUXILIARY POWER INCLUDES ONE TANDEN AC/DC, 300 KW-450V DIESEL-GENERATOR, TWO AC, 300 KW-450V DIESEL-GENERATORS, ONE STANDBY TANDEN AC/DC, 300KW-450V GAS TURBINE GENERATOR AND ONE AC, 60KW-450V DIESEL GENERATOR FOR QUIET SHIP OPERATION, AND AN EMERGENCY AC DIESEL-GENERATOR WITH A 25KW CAPACITY AT 450 VOLTS. THREE, 400 GPM CENTRIFUGAL FIRE PUMPS ARE INSTALLED.

□ OUTFIT: THE WILKES CARRIES A BOSTON WHALER, A 24 FOOT MOTOR LIFEBOAT, AND A 22 FOOT LIFEBOAT AS WELL AS ADEQUATE LIFE RAFTS FOR ALL PERSONNEL. THERE IS AN ELECTRO-HYDRAULIC TELESCOPING BOOM CRANE AFT WITH A CAPACITY OF 2500 POUNDS AT 48 FOOT OUTREACH AND A STORES CRANE FORWARD WITH A CAPACITY OF 4500 POUNDS AT 40 FOOT OUTREACH. ADDITIONALLY IT HAS A HYDRAULIC STERN U-FRAME (10000# LIFT/50000# SWL), A STARBOARD SIDE U-FRAME (6000# LIFT/30000# SWL), A HYDRAULIC HYDROGRAPHIC DAVIT (2000# LIFT/5000# SWL), AND AN INTER-MEDIATE HYDRAULIC A-FRAME (2000# LIFT/12000# SWL). WINCHING FACILITIES INCLUDE THE FOLLOWING CAPACITIES: THREE DRUMS - 45000' - 9/16" WIRE ROPE; ONE DRUM - 30000' - 3/8" WIRE ROPE; TWO DRUMS - 30000' - 3/16" WIRE ROPE; ONE DRUM - 9000' - 3/16" WIRE ROPE; MAGNETOMETER WINCH - 1000' - 3/4" CABLE; TWO SEISMIC ARCS CABLE PULLERS; ONE SEISMIC HYDROPHONE WINCH. NAVIGATIONAL EQUIPMENT INCLUDES: 3CM AND 10CM RADAR; EM LOG; LORAN-A; OMEGA; MK-19-3C GYROCOMPASS; NAVIGATIONAL FATHOMETER; RDF; WIND SPEED INDICATOR.

□ PROPULSION AND MANEUVERING: THE 5-BLADE, 10-FOOT DIAMETER PROPELLER DRIVES THE SHIP AT 15 KNOTS FULL SPEED AT 180 RPM. CRUISING SPEED IS 14 KNOTS WITH A RANGE OF 7200 MILES AND AN ENDURANCE OF 60 DAYS. MAIN PROPULSION CONTROL STATIONS ARE LOCATED IN THE ENGINE ROOM, PILOT HOUSE, AND AFTER STEERING STATION ALONG WITH CONTROLS FOR THE ACTIVE RUDDER AND THE BOW THRUSTER. THIS GIVES THE SHIP A LIMITED DYNAMIC POSITIONING CAPABILITY FOR STATION KEEPING AT SEA.

□ MISSION SUPPORT: THE WILKES HAS ACCOMMODATIONS FOR 27 SCIENTISTS IN ADDITION TO THE OPERATING CREW. IT CARRIES STANDARD CORING, GRAB SAMPLE, DREDGING, AND BIOLOGICAL TRAWLING EQUIPMENT, UNDERWATER CAMERAS, AND MANSON AND MISKEN WATER SAMPLING EQUIPMENT. SEARCH AND SURVEY EQUIPMENT INCLUDE: SATELLITE NAVIGATION SYSTEM (2); LORAN-C(2); LORAN-A(2); RADAR REPEATER; MAGNETOMETER; GRAVITY METER; 12 KHZ NARROW BEAM AND WIDE BEAM ECHO SOUNDERS; SEISMIC PROFILING SYSTEM; SYSTD SYSTEM; PDP-9 DATA COLLECTION AND PROCESSING COMPUTER SYSTEMS; EXPENDABLE BATHY THERMOGRAPH SYSTEM; SEA SURFACE TEMPERATURE SYSTEM. MISSION RELATED SPACES (AREAS IN SQUARE FEET) ARE AS FOLLOWS: ELECTRONIC RECORDING LAB (700); SURVEY CONTROL CENTER (100); ACOUSTICS LAB (400); GEOLOGICAL LAB (400); DATA PROCESSING (200); PHOTOGRAPHIC PROCESSING (150); GRAVITY ROOM (100); SEISMIC CAPACITOR BANK ROOM (120); ELECTRONICS WORKSHOP (120); METEOROLOGICAL LAB (200); WORKSHOPS (600); DEEP SEA GEAR STORAGE (300); DRY SCIENTIFIC STORES (250); EXPLOSIVES MAGAZINE (300); CONFERENCE/LIBRARY SPACE (250); SCIENTIFIC FREEZE AND CHILL BOXES (72).

□ COMPUTER CAPABILITY: THE OCEANOGRAPHIC DATA ACQUISITION SYSTEM (ODAS) IS A COMPUTER SYSTEM ON MAYOCEANO'S AGS-26 CLASS SHIPS FOR COLLECTING AND PROCESSING GEOPHYSICAL AND OCEANOGRAPHIC DATA AT SEA. THE SYSTEM CONSISTS OF TWO DIGITAL EQUIPMENT CORPORATION PDP-9 COMPUTERS CONNECTED THROUGH A DRUM; ONE DEDICATED TO GEOPHYSICAL AND NAVIGATION DATA ACQUISITION, THE OTHER SERVING AS A BACKUP FOR ACQUISITION AND FOR DATA PROCESSING. SYSTD DATA ARE COLLECTED BY A PLESSEY 9040 OR 9006 SENSOR AND DECK EQUIPMENT. PRELIMINARY PROCESSING IS DONE BY A SERIES OF PROGRAMS THAT SORT AND AVERAGE THE DATA, THEN PROFILE EACH PARAMETER AGAINST DEPTH. PROFILES ARE EXAMINED BY AN OCEANOGRAPHER AND CORRECTIONS APPLIED AS NEEDED. FINAL PROCESSING INCLUDES CALCULATING VARIOUS DERIVED PARAMETERS, GENERATING A FINAL TAPE FOR EACH STATION, FINAL PLOT-TING OF DATA, LISTING PARAMETERS AT CERTAIN DEPTHS, AND STACKING DATA OF SEVERAL STATIONS ONTO A SINGLE TAPE FOR TRANSMITTAL TO MAYOCEANO. INITIAL PROCESSING CAN BE COMPLETED FOR A DOWNCAST BEFORE THE "FISH" IS BACK ON DECK. A STATION OF 4,000 METERS REQUIRES ABOUT 5 HOURS COMPUTER TIME TO PROCESS COMPLETELY.

SEAGOING SURVEY PLATFORM
PHYSICAL AND PERFORMANCE CHARACTERISTICS

AGS - 26 CLASS: OCEANOGRAPHIC SURVEY SHIP

THE OCEANOGRAPHIC DATA ACQUISITION SYSTEM (ODAS) IS A COMPUTER SYSTEM INSTALLED ABOARD THREE AGS-26 CLASS SHIPS UNDER THE OPERATIONAL CONTROL OF THE U.S. NAVAL OCEANOGRAPHIC OFFICE. THE SYSTEM IS NOW ABOARD THE USNS SILAS BENT, USNS KANE, AND USNS WILKES. ODAS COLLECTS AND PROCESSES GEOPHYSICAL, OCEANOGRAPHIC, AND NAVIGATION DATA AT SEA.

THE BASIC ODAS HAS TWO 16 K DEC POP-9 COMPUTERS WITH A SHARED 131 K WORD DRUM AND A WIDE VARIETY OF SENSOR INTERFACES AND PERIPHERAL DEVICES. THE TWO COMPUTERS (ACQUISITION AND PROCESSING) ARE 16 K WORD GENERAL PURPOSE COMPUTERS WITH 16 BITS PER WORD. THE ACQUISITION COMPUTER IS DEDICATED TO COLLECTING AND RECORDING UNDERWAY DATA, AND THE COLLECTING, PROCESSING, AND DISPLAY OF NAVIGATIONAL DATA. THE PROCESSING COMPUTER IS USED BOTH AS A BACKUP FOR THE ACQUISITION COMPUTER AND FOR PROCESSING BOTH UNDERWAY AND ON-STATION DATA.

THE ACQUISITION SYSTEM USES DATA COLLECTED BY SURVEY INSTRUMENTS SUCH AS ECHO SOUNDERS, MAGNETOMETERS, AND SEA-SURFACE THERMOMETERS AND BY NAVIGATION INSTRUMENTS SUCH AS AUTOTRACKING LORAN RECEIVERS, SATELLITE RECEIVERS, ELECTRO-MAGNETIC (EM) LOGS, AND SHIP GYROS (ALL CONNECTED THROUGH SENSOR INTERFACES). THESE DATA ARE SAMPLED AND PROCESSED BY PROGRAMS RESIDENT IN THE COMPUTER AND OR PROGRAMS STORED ON THE DRUM. THE DATA ARE RECORDED ON MAGNETIC TAPE AND PERIODIC SAMPLES ARE LOGGED ON TELETYPE. THE TAPE IS REMOVED EACH DAY FROM THE ACQUISITION SYSTEM AND PROCESSED THROUGH A SET OF PROGRAMS VERY SIMILAR TO PROGRAMS APPLIED TO SVSTD DATA. THE ACQUISITION FUNCTION OF THE PROCESSING COMPUTER CAN BE SELECTED BY A SWITCH WHICH TRANSFERS ALL THE SENSORS AND ACQUISITION PERIPHERALS TO THE PROCESSING COMPUTER WHICH RETAINS ALL OF ITS PERIPHERALS.

THE PROCESSING HARDWARE IS THE 16 K COMPUTER PLUS A WIDE VARIETY OF PERIPHERAL DEVICES. THE DRUM IS NOT CONSIDERED AS PART OF THE PROCESSOR BECAUSE IT STORES THE ACQUISITION SYSTEM PROGRAMS. THE SOFTWARE CONSISTS OF PROGRAMS STORED ON DEC TAPES: A SMALL FILE-ORIENTED MAGNETIC TAPE SYSTEM DEVELOPED BY DEC. FOUR DEC TAPE DRIVES ARE AVAILABLE: ONE FOR THE EXECUTIVE SYSTEM, ANOTHER FOR THE PROCESSING PROGRAMS, AND TWO FOR GENERAL USE. MAGNETIC TAPE IS HANDLED ON TWO TU20 SYNCHRONOUS TAPE DRIVES. THE OPERATOR CONSOLE DEVICE IS A KSR-35 TELETYPE. A HIGH SPEED PAPER TAPE READER PUNCH IS AVAILABLE BUT LITTLE USED EXCEPT FOR READING SETUP PROGRAMS. A CARD READER IS USED FOR PROGRAM CONTROL INFORMATION SUCH AS SETTING UP PLOTTER LIMITS, AND FOR LOW VOLUME INPUT. CARDS ARE MANUALLY PUNCHED ON AN IBM 29 KEYPUNCH WHICH IS ALSO THE OUTPUT FOR A DIGITIZER TABLE. A 132 COLUMN HIGH SPEED LINE PRINTER IS USED FOR LISTING AND MONITORING DATA DURING PROCESSING. TWO CALCOMP DRUM PLOTTERS, 11-INCH AND 30-INCH UNITS, ARE USED FOR GRAPHICS.

PRELIMINARY PROCESSING IS DONE BY A SERIES OF PROGRAMS THAT SORT AND AVERAGE THE DATA. THEN PROFILE EACH PARAMETER AGAINST DEPTH. PROFILES ARE EXAMINED BY AN OCEANOGRAPHER AND CORRECTIONS APPLIED AS NEEDED. FINAL PROCESSING INCLUDES CALCULATING VARIOUS DERIVED PARAMETERS, GENERATING A FINAL TAPE FOR EACH STATION, FINAL PLOTTING OF DATA, LISTING PARAMETERS AT CERTAIN DEPTHS, AND STACKING DATA OF SEVERAL STATIONS ONTO A SINGLE TAPE. THE DATA FLOW IS SHOWN IN THE DIAGRAM TO THE RIGHT.

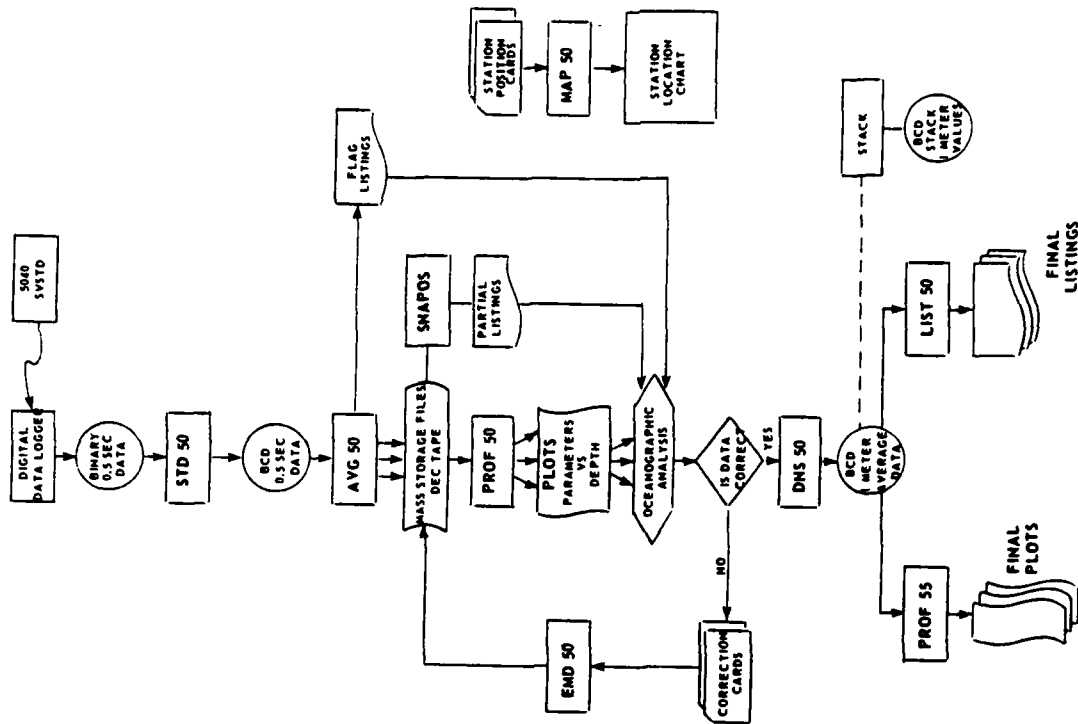

SEAGOING SURVEY PLATFORM
ON-BOARD COMPUTER CAPABILITY

AGS-26 CLASS: OCEANOGRAPHIC SURVEY SHIP

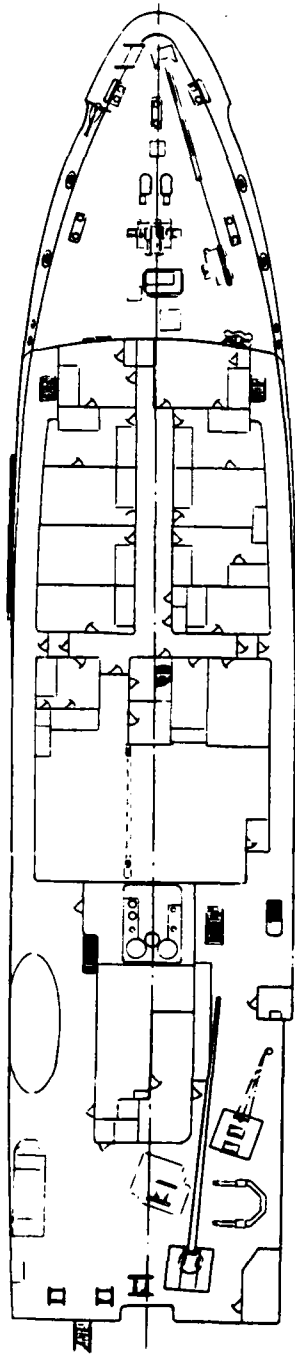

FORECASTLE DECK

LENGTH OVERALL - A

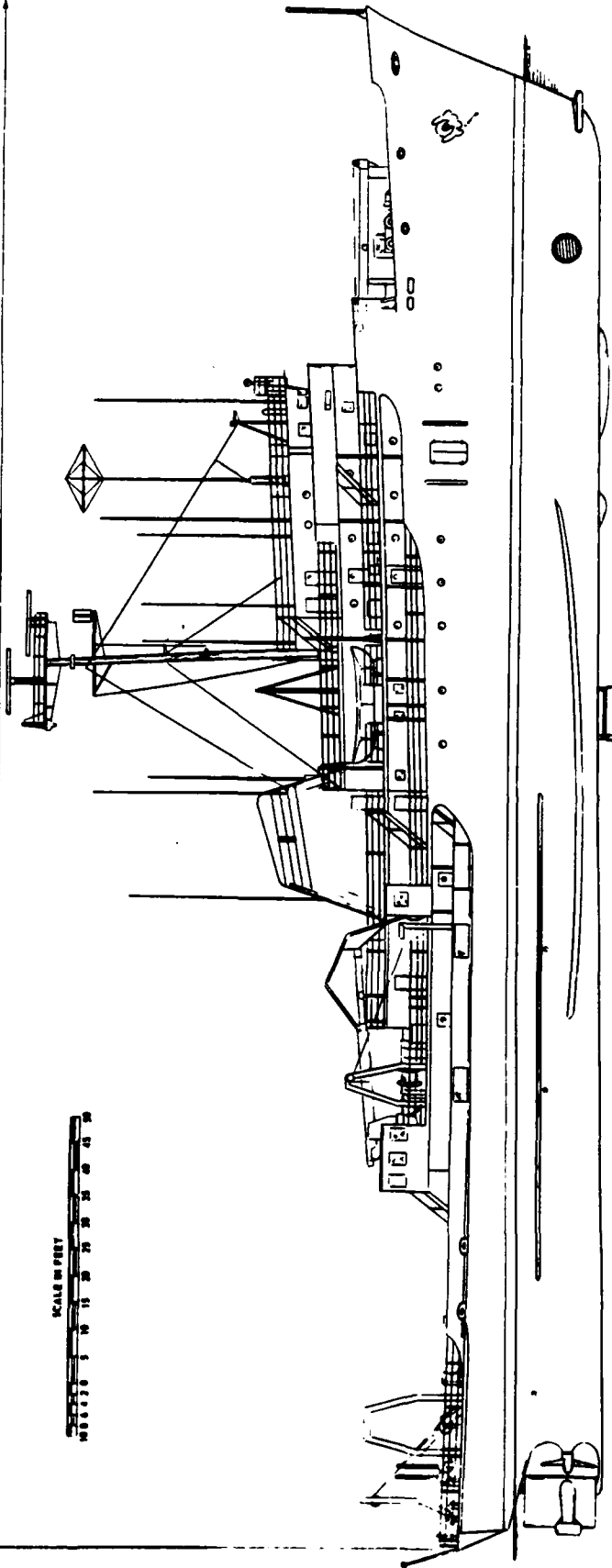

USNS MILRES - AGS-31 (AGS-N CLASS)
PEP DRAWING

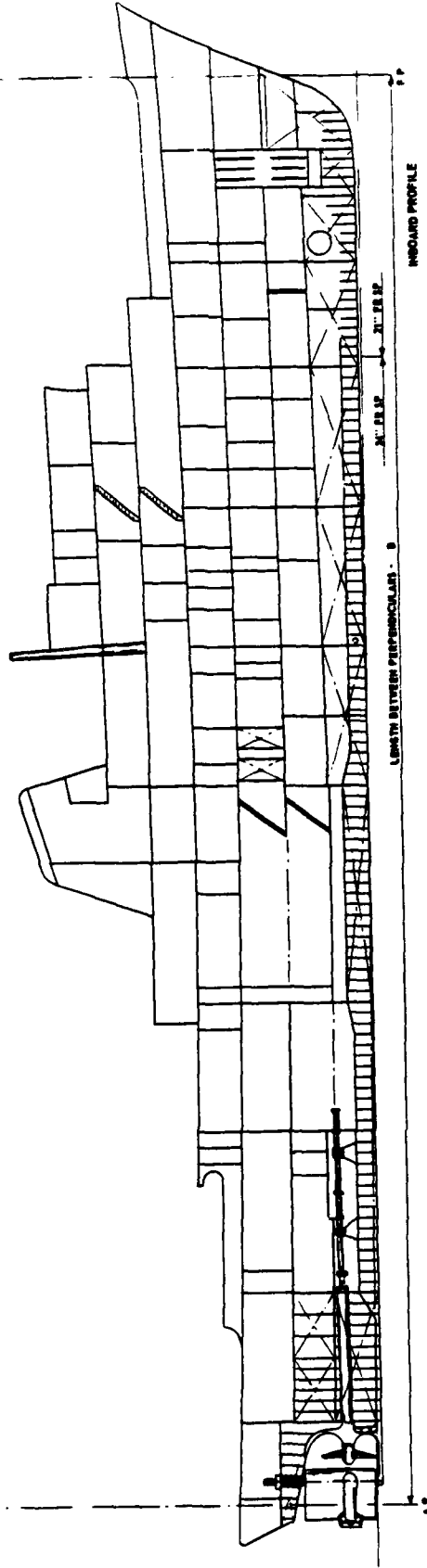
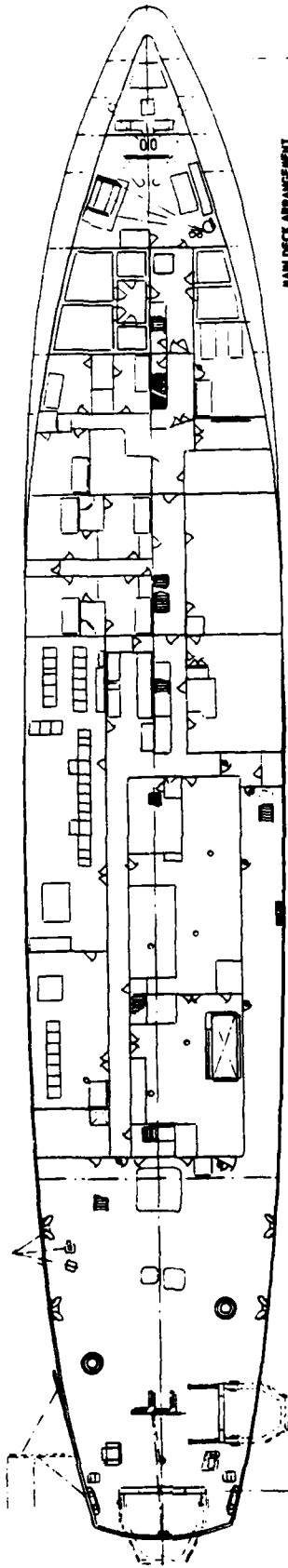

USNS WILKES - AGS-33 (AGS-26 CLASS)
PEP DRAWING

□ **GEOMETRY:** THE BOSTON WHALER IS A FIBERGLASS BOAT WHOSE CONSTRUCTION UTILIZES A STRUCTURAL FOAM CORE FOR HULL INTEGRITY AND RIGIDITY. THERE ARE PRESENTLY TEN DIFFERENT MODELS OF BOSTON WHALERS BEING BUILT, WITH OVERALL LENGTHS RANGING FROM 9'2" TO 21'4". THE MAXIMUM BEAM RANGES FROM 4'4" TO 7'4". THE OUTRAGE 19, TYPICAL OF THE BOSTON WHALER SERIES, IS USED ON THE FOLLOWING PAGE TO ILLUSTRATE THE OVERALL GEOMETRY OF THESE PLATFORMS.

□ **HYDROSTATICS:** THESE BOATS, WHICH HAVE A HIGH STRENGTH-TO-WEIGHT RATIO, RANGE IN WEIGHT FROM 125 LBS. TO 1800 LBS.

□ **STRUCTURE:** THE RESULT OF THE SANDWICH METHOD OF CONSTRUCTION IS A BOAT WITH GREAT HULL STRENGTH AND FLOTATION. IT PROVIDES A RIGID FOAM CORE THAT IS STABLE, INCREASING THE LIFE OF THE BOAT. FOAM COMPLETELY FILLS THE SPACE BETWEEN THE INSIDE AND OUTSIDE HULLS AND WELDS ITSELF TO THE FIBERGLASS SKINS TO FORM A RUGGED ONE-PIECE UNIT. THE FIBERGLASS SKIN IS SUPPORTED OVER ITS ENTIRE SURFACE INCREASING THE HULL'S RIGIDITY AND STRENGTH.

□ **SEAWORTHINESS:** BOSTON WHALER HULLS HAVE BEEN DESIGNED WITH SEAWORTHINESS AS A PRIME OBJECTIVE. THE FORWARD HULL SPONSONS GIVE THE BOAT STABILITY AT REST. THE SAME SPONSONS DIG IN WHEN THE BOAT IS BEING PUSHED BY A FOLLOWING SEA, EXPOSING, IN EFFECT, THREE KEELS TO THE WATER. THE BLUNT, FULL BOW SECTIONS OF BOSTON WHALERS GIVE EXTRA BUOYANCY WHEN PLUNGING INTO HEAVY SEAS. THE COMBINATION OF THE HIGH FOAM VOLUME AND THE LOW FREEBOARD GIVES BOSTON WHALERS A GREAT SAFETY MARGIN SHOULD A BOAT BE DAMAGED OR SWAMPED. THE HIGH FOAM VOLUME ENSURES FLOTATION EVEN IN THE WORST CONCEIVABLE CIRCUMSTANCES. THE LOW FREEBOARD POSITIONS THE ENGINE POWER HEAD ABOVE GUNWALE LEVEL AND THEREFORE ALWAYS ABOVE WATER AND CAPABLE OF BEING RUN. THE LOW FREEBOARD NOT ONLY CONTRIBUTES TO SAFETY BUT ALSO MAKES THE BOATS MORE FUNCTIONAL AS PLATFORMS AS THEY ARE LESS AFFECTED BY CROSSWINDS MAKING THEM EASIER TO MANEUVER IN STRONG WINDS.

SPECIFICATIONS

MODEL	DIMENSION A	BEAM	WEIGHT (LB.)	MAXIMUM HORSEPOWER	MINIMUM HORSEPOWER	SWAMPED BUOYANCY
SQUALL 9'	9'2"	4'4"	125	3	-	600 LBS.
STANDARD 11'	11'4"	5'0"	210	10	-	750 LBS.
SPORT 11'	11'4"	5'0"	220	20	-	750 LBS.
SPORT 13'	13'4"	5'5"	300	40	9.5	950 LBS.
SPORT 15'	15'3"	5'8"	450-500	75	25	1650 LBS.
SPORT 17'	16'7"	6'2"	650-850	100	40	2000 LBS.
SAKONNET/MONTAUK 17'	16'7"	6'2"	770-900	100	40	2000 LBS.
BASS BOAT/NEWPORT 17'	16'7"	6'2"	950	100	40	2000 LBS.
OUTRAGE/REVENGE 19'	19'4"	7'4"	1500-1600	170	65	4000 LBS.
OUTRAGE/REVENGE 21'	21'4"	7'4"	1600-1800	200	65	3700 LBS.

INSHORE OPERATIONS LOGISTICS PLATFORM
PHYSICAL CHARACTERISTICS

TYPICAL BOSTON WHALERS

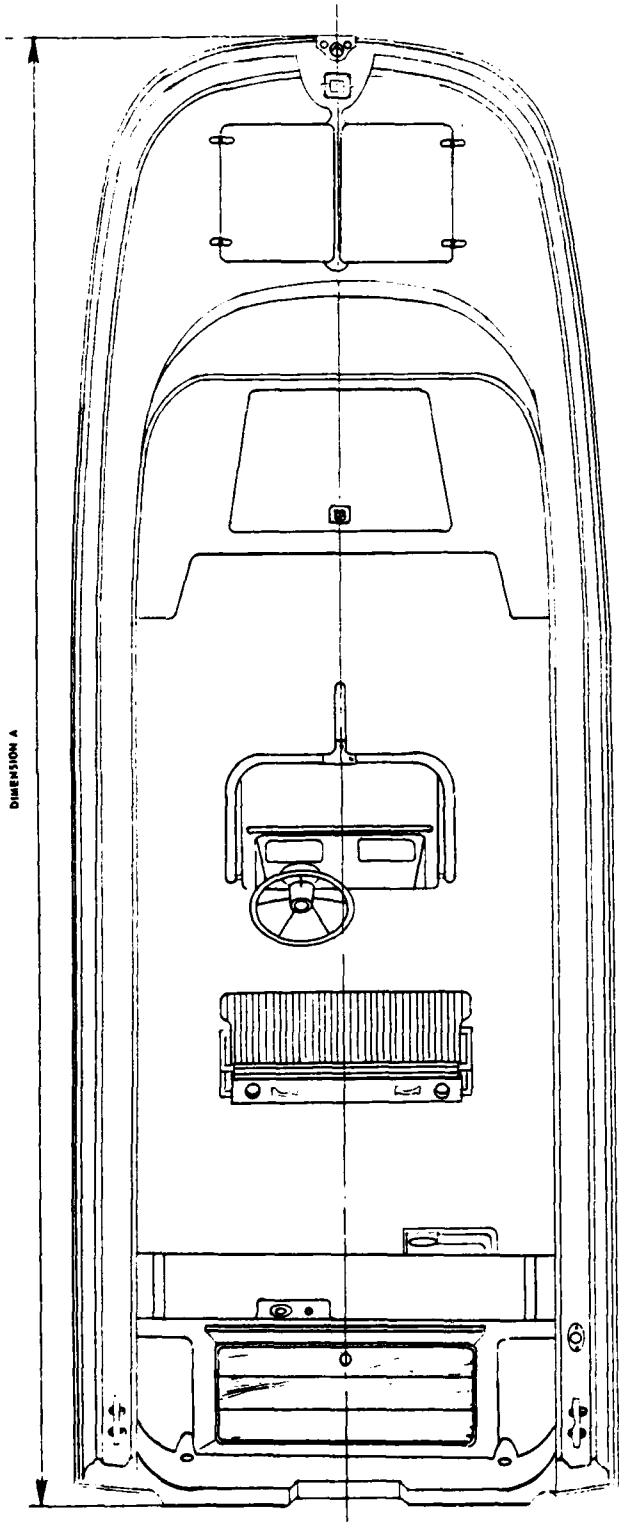

DECK ARRANGEMENT

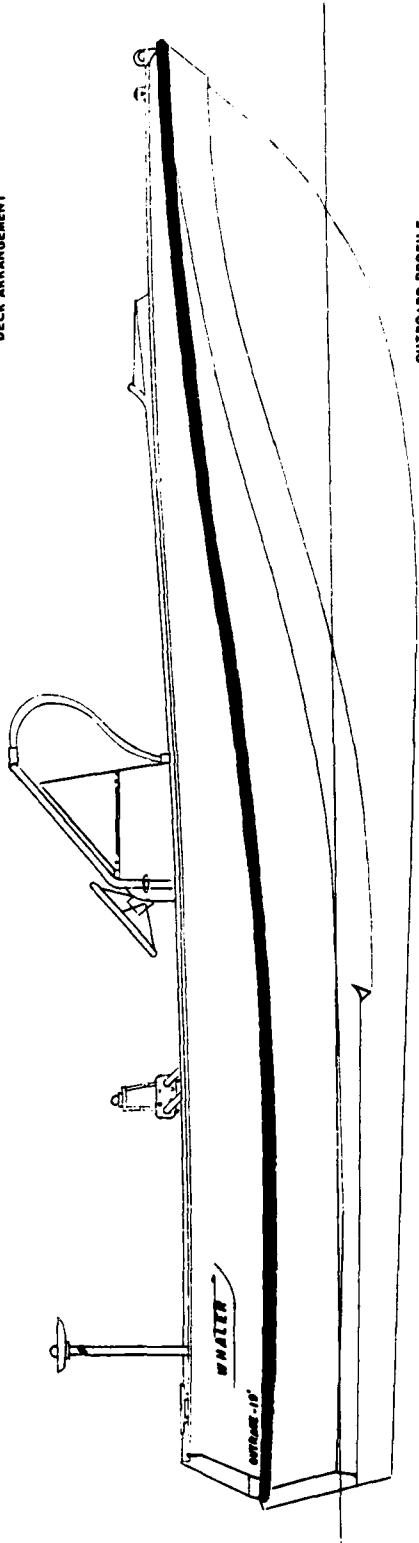

OUTBOARD PROFILE

INSHORE OPERATIONS LOGISTICS PLATFORM
OVERALL GEOMETRY

TYPICAL BOSTON WHALER

□ **OUTFIT:** EACH COMPONENT THAT IS ADDED TO THE HULL STRUCTURE OF THE BOSTON WHALER IS DESIGNED TO PERFORM A SPECIFIC FUNCTION. THE RAILS, MADE OF STAINLESS STEEL, ARE FAR STRONGER AND MORE RESISTANT TO CORROSION THAN NORMAL ALUMINUM RAILS. THE BOW RAILS ARE HIGH TO PROVIDE SECURITY AND SAFETY FOR THE BOATS' OCCUPANTS. FOR MAXIMUM RIGIDITY AND LEVERAGE THE RAILS ARE SECURED WITH TWO STANCHION SUPPORTS, ONE HIGH AND ONE LOW. THE BOW CHOCKS, MADE OF CAST BRONZE, ARE DESIGNED TO PREVENT RUB RAIL WEAR. HEAVY DUTY RUB RAILS ARE SECURELY FIXED TO THE HULL AND HAVE AN INSERT WHICH IS EASILY RENEWED IF NECESSARY. OUTRIGGERS ON THE 16', 19', AND 21' ARE MOUNTED ON THE CONSOLE RAIL IN SPECIALLY DESIGNED ALUMINUM CASTINGS. STERN LIGHTS ON THE 19- AND 21-FOOT BOATS ARE SIX FEET ABOVE THE FLOOR AND HAVE AN ANTI-GLARE SHIELD FOR NIGHT WORK. SEATING OPTIONS MAY BE INSTALLED IN MANY OF THE 17-, 19-, AND 21-FOOT MODELS BECAUSE OF THEIR SPACIOUS INTERIORS. THE OPTIONS ADD TO THE VERSATILITY OF THE BOAT





AND ENABLE THE OPERATOR TO CUSTOM RIG THE BOAT FOR HIS NEEDS. FIVE OF THE COMMON OPTIONS INCLUDE UPHOLSTERED SWIVEL SEAT, REVERSIBLE PILOT SEAT, 4 MAN SEAT, REVENGE STORAGE SEAT, AND COOLER SEATS.

□ **MACHINERY AND PROPULSION:** THE BOSTON WHALER SERIES CAN BE PROPELLED THROUGH THE WATER WITH A VARIETY OF ENGINES RANGING IN POWER FROM A SINGLE 10 HORSEPOWER ENGINE ON THE 13-FOOT MODEL TO TWIN 85-HORSEPOWER ENGINES ON THE 19- AND 21-FOOT OUTRAGE MODELS FOR A COMBINED TOTAL POWER OF 170 HORSES. THE RANGE OF SPEEDS FOR THE SERIES IS FROM 18 MPH WITH A 13-FOOT BOAT TO A TOP SPEED OF 44 MPH WITH A 19-FOOT OUTRAGE. THE AVERAGE SPEED FOR THE SERIES IS BETWEEN 30 AND 35 MPH. THE TABLES BELOW GIVE SPEEDS WHICH ARE APPROXIMATE AND CAN VARY WITH MAKE AND CONDITION OF ENGINE, WIND AND WATER CONDITIONS, AND BOAT DISPLACEMENT.

SINGLE ENGINE PERFORMANCE IN MILES PER HOUR										
HORSEPOWER	10	20	40	50	65	85	115	135	150	
13'4"	18	25	36							
16'7"			26	30	34	38				
19'4" OUTRAGE					30	34	40	42	44	
21'4" OUTRAGE					28	32	36	40	42	
19'4" REVENGE						30	34	37	38	
21'4" REVENGE						28	32	35	36	
DUAL ENGINES PERFORMANCE IN MILES PER HOUR										
HORSEPOWER	2-40'S		2-50'S		2-65'S		2-85'S			
19'4" OUTRAGE	30		34		38		44			
21'4" OUTRAGE	28		32		36		42			

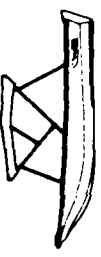
INSHORE OPERATIONS LOGISTICS PLATFORM
PHYSICAL AND PERFORMANCE CHARACTERISTICS

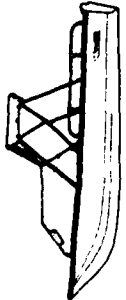
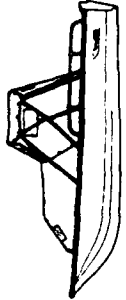
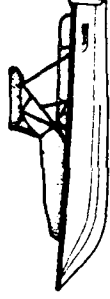
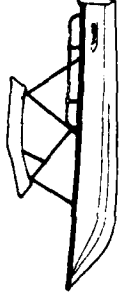
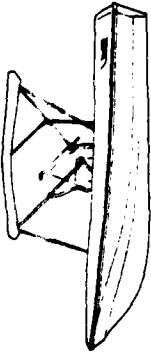
TYPICAL BOSTON WHALERS

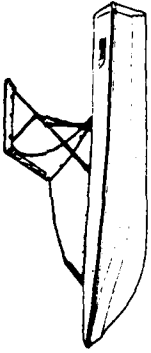
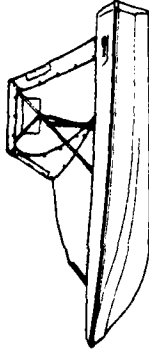
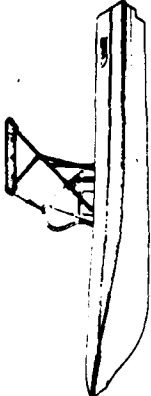
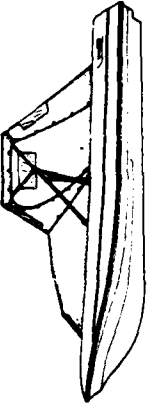
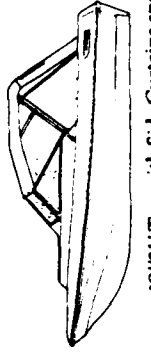
 <p>13' Forward Shelter with Aft Curtain. For mooring or trailering.</p>	 <p>13' Sun Top.</p>	 <p>13' Flying Top Set. Addition of Weather Curtain Set completes enclosure.</p>	 <p>Sakonnet/Montauk Forward Shelter with Aft Curtain. For mooring or trailering.</p>
 <p>Sakonnet/Montauk Flying Top Set.</p>	 <p>Sakonnet/Montauk Flying Top Set with Weather Curtain Set.</p>	 <p>Sport 17' Flying Top Set.</p>	 <p>17' Sun Top.</p>
 <p>Outrage 19' Sun Top. (Shown on 19' Outrage 19' Flying Top Set.)</p>	 <p>Outrage 19' Forward Shelter with Aft Curtain. For mooring or trailering. (Shown on 19' Outrage 19' Flying Top Set.)</p>	 <p>Outrage 19' Flying Top Set. (Shown on 19' Outrage 19' Flying Top Set.)</p>	 <p>Outrage 19' Flying Top Set with Weather Curtain Set.</p>
 <p>Outrage 19' Flying Top only. (Shown on 21' Outrage 21' Flying Top Set.)</p>	 <p>Outrage 21' Flying Top Set with Weather Curtain Set.</p>	 <p>Revenge 19' Flying Top with Side Curtains and Drop Curtain. (Shown on 19' Revenge 19' Flying Top Set.)</p>	<p>WEATHER PROTECTION SYSTEMS FOR A SERIES OF TYPICAL BOSTON WHALERS</p>

INSHORE OPERATIONS LOGISTICS PLATFORM
EXTERNAL ARRANGEMENTS

TYPICAL BOSTON WHALERS

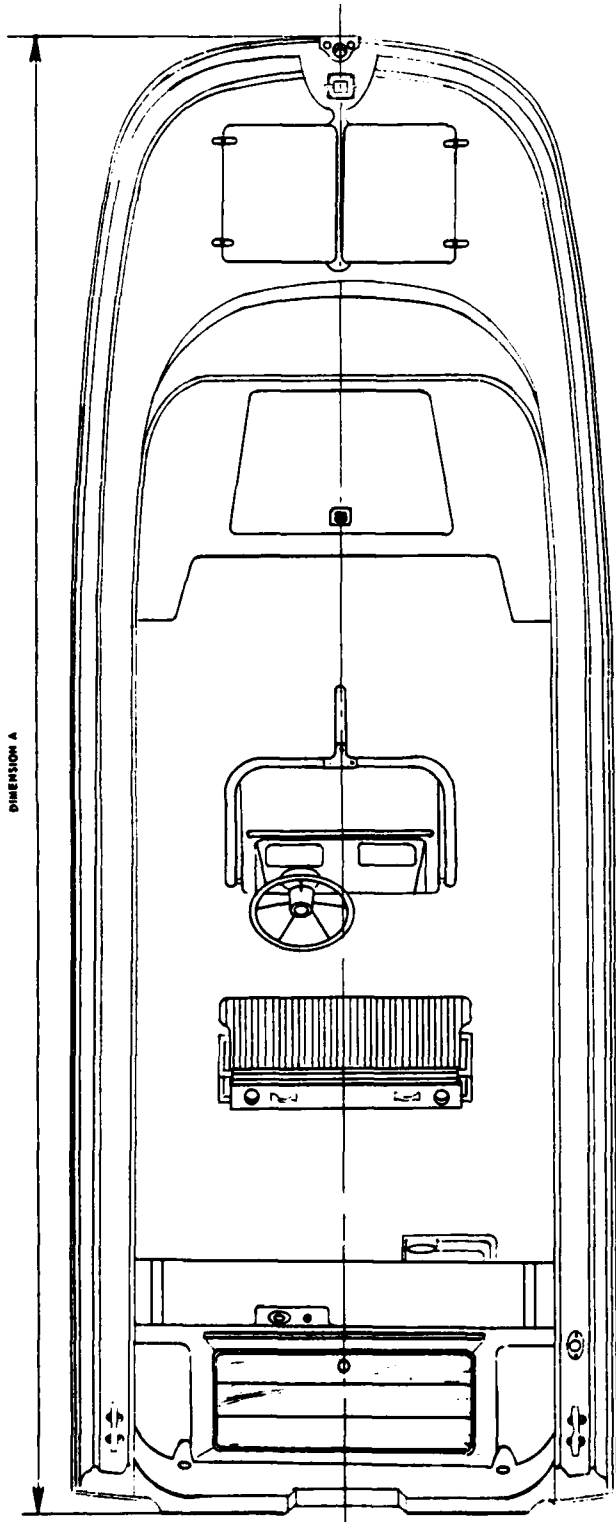

DECK ARRANGEMENT

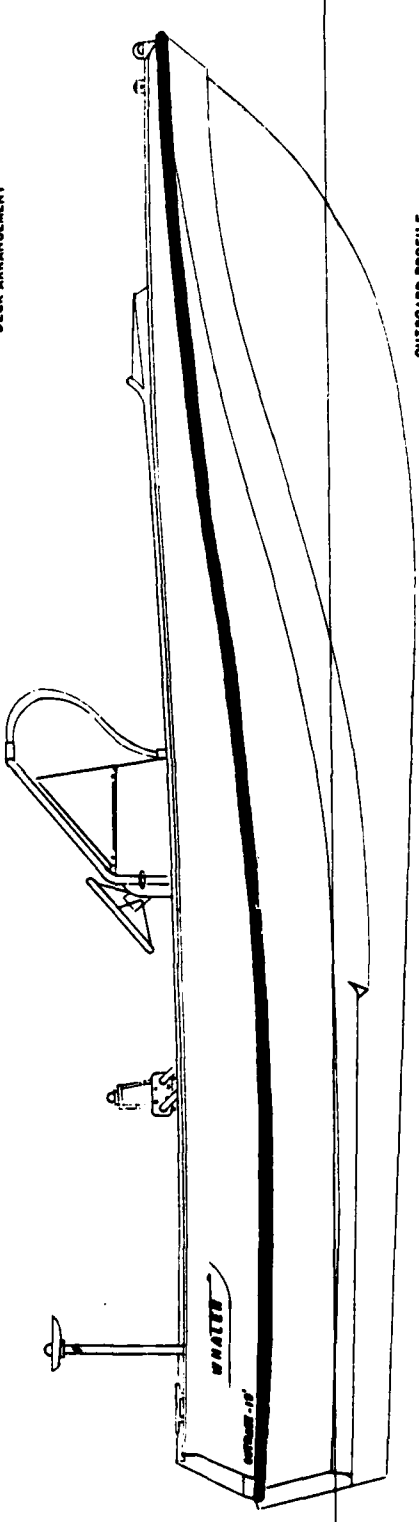

OUTBOARD PROFILE

TYPICAL BOSTON WHALER
PEP DRAWING

□ GEOMETRY: THE NAVFACENGCOM SEACON WAS CONVERTED TO AN OCEAN CONSTRUCTION PLATFORM IN 1974. THE HULL USED FOR CONVERSION, A NON-SELF-PROPELLED SEAGOING BARGE DESIGNATED YFNB-33, WAS LAST USED BY NASA FOR TRANSPORTING SATURN ROCKET COMPONENTS TO CAPE CANAVERAL. THE BASIC BARGE HULL HAS A LENGTH OVERALL OF 260 FEET WITH A BEAM OF 48 FEET. IT HAS A SPOON SHAPED BOW AND A TYPICAL RAKE-ENDED BARGE STERN, AND IS FITTED WITH A PAIR OF SKEGS FOR STABILITY IN TOWING. DEPTH TO THE MAIN DECK WHICH RUNS THE FULL LENGTH OF THE SHIP, IS 15 FEET ABOVE THE BASELINE. RAMPS, PORT AND STARBOARD, RUN FROM THE MAIN DECK, 50 FEET AFT OF THE BOW, UP TO THE FORECASTLE DECK, WHICH EXTENDS 26 FEET AFT OF THE BOW AT A HEIGHT OF 23.75 FEET ABOVE THE BASELINE. THE MAIN DECKHOUSE RUNS FROM THE AFTER END OF THE FORECASTLE DECK TO THE MIDSHIP SECTION, 130 FEET AFT OF THE BOW. THE REMAINING 130 FEET OF THE MAIN DECK AFT IS AVAILABLE FOR CONSTRUCTION EQUIPMENT AND ACTIVITIES. THE MAIN DECKHOUSE HAS A BEAM OF 40 FEET AND A HEIGHT OF 12.50 FEET ABOVE THE MAIN DECK. TWO DECK HOUSES ABOVE THE MAIN DECKHOUSE ARE PROVIDED. THE 02 LEVEL EXTENDS FROM 38 FEET TO 114 FEET AFT OF THE BOW AT A HEIGHT OF 36 FEET ABOVE THE BASELINE, AND HAS A BEAM OF 32 FEET. THE 03 LEVEL, OR TOP OF HOUSE, EXTENDS FROM 38 FEET TO 82 FEET AFT OF THE BOW AT A HEIGHT OF 44 FEET ABOVE THE BASELINE, AND HAS A BEAM OF 12 FEET.

□ HYDROSTATICS: THE BASIC YFNB HULL HAD A SALT WATER DISPLACEMENT OF 3000 TONS AT A DRAFT OF 10.0 FEET WHICH WAS THE DESIGN DRAFT FOR THIS PARTICULAR HULL. SEACON IS SO OUTFITTED THAT IT WILL HAVE A FULL LOAD DISPLACEMENT OF 3648 TONS SALT WATER AT A MEAN DRAFT OF 12.74 FEET WITH A TRIM OF 2.80 FEET BY THE STERN. FOR THIS CONDITION THE CENTER OF GRAVITY IS 10.36 FEET ABOVE THE KEEL AND 136.70 FEET AFT OF THE FORE PERPENDICULAR; THE HEIGHT OF THE CENTER OF BUOYANCY IS 6.49 FEET ABOVE THE KEEL AND THE METACENTRIC HEIGHT, CORRECTED FOR FREE SURFACE, IS 11.50 FEET. IN THE LIGHT SHIP CONDITION, THE SHIP DISPLACES 1240 TONS SALT WATER AT A MEAN DRAFT OF 4.80 FEET WITH A TRIM OF 0.83 FEET BY THE BOW. FOR THIS CONDITION, THE CENTER OF GRAVITY IS 15.50 FEET ABOVE THE KEEL AND 122.40 FEET AFT OF THE FORE PERPENDICULAR; THE HEIGHT OF THE CENTER OF BUOYANCY IS 2.50 FEET ABOVE THE KEEL AND THE METACENTRIC HEIGHT, CORRECTED FOR FREE SURFACE, IS 28.05 FEET.

□ STRUCTURE: THE BASIC STRUCTURE IS OF ALL WELDED STEEL, TRANSVERSE FRAMED. FRAME SPACING IS 2.00 FEET FROM THE FORE PERPENDICULAR TO THE FORE PEAK BULKHEAD AT FRAME 7 AND 6.00 FEET FROM THERE AFT TO WATERTIGHT BULKHEAD 11 AT THE AFTER END OF THE FORWARD PROPULSION ROOM. SPACING BETWEEN FRAMES 11 AND 12 AND BETWEEN 22 AND 23 IS 12.00 FEET AND THE INTERVENING FRAMES ARE SPACED 16.00 FEET. AT THE STERN, IN THE AFTER PROPULSION MACHINERY ROOM, SPACING IS 6.00 FEET BETWEEN FRAMES 23 AND 27 AND FROM THERE TO THE TRANSOM THE SPACING IS 2.00 FEET. THE MAIN DECK IS BOTH THE FREEBOARD DECK AND THE STRENGTH DECK WITH ALL NINE TRANSVERSE WATERTIGHT BULKHEADS TERMINATING AT THAT DECK. A 3.00 FOOT DEEP INNER BOTTOM RUNS THE LENGTH OF THE SHIP BETWEEN THE PROPULSION MACHINERY SPACES EXCEPT IN WAY OF THE 32.00 BY 16.00 FOOT CENTERWELL.

□ MACHINERY: THE THREE VOITH-SCHNEIDER VERTICAL AXIS ROTATING BLADE PROPELLERS ARE EACH DRIVEN BY DIESEL ENGINES THROUGH HYDRAULIC POWER TRANSMISSIONS AND CLUTCHES. THE ENGINES TURN AT A CONSTANT SPEED OF 1800 RPM WHICH IS REDUCED TO 600 RPM INPUT TO THE PROPELLERS;

THE PROPELLER BLADE ROTORS TURN AT 140 RPM AND ALL THRUST AND MANEUVERING CONTROL IS EXERCISED BY VARYING PROPELLER BLADE PITCH. THE FORWARD ENGINE IS A GM 12-71 DIESEL RATED AT 360 HORSEPOWER AT 1800 RPM. EACH OF THE TWO AFTER PROPELLERS IS DRIVEN BY TWIN GM 6-71 ENGINES, ALSO RATED AT 360 HORSEPOWER AT 1800 RPM. AUXILIARY POWER IS FURNISHED BY TWO GM 6-71 ENGINES EACH DRIVING A 250 KW/400 VOLT A.C. GENERATOR. THIS POWER IS TRANSFORMED DOWN TO 115 VOLTS FOR ALL SHIPBOARD USES. THESE GENERATORS ARE LOCATED IN THE PORT SIDE OF THE AUXILIARY MACHINERY SPACE BETWEEN FRAMES 12 AND 14. THE STARBOARD SIDE OF THIS SPACE IS THE PUMP ROOM CONTAINING ALL PUMPING MACHINERY REQUIRED FOR BALLASTING AND FOR OIL TRANSFER.

□ OUTFIT: SEACON IS OUTFITTED FOR MAXIMUM EFFECTIVENESS AS AN OCEAN CONSTRUCTION PLATFORM. INCLUDED IS A CENTER WELL, 32 X 16 FEET, WITH HINGED BOTTOM DOORS AND PORTABLE HATCH COVERS AT THE MAIN DECK LEVELS. THE FORWARD HALF OF THE WELL IS COVERED BY A ROLLING CURTAIN DOOR EXTENDING FROM THE 01 LEVEL DOWN TO THE MAIN DECK TO PERMIT WORKING THROUGH THE WELL IN INCLEMENT WEATHER. A STERN ROLLER IS PROVIDED FOR WORK OVER THE TRANSOM AND FOUNDATIONS ARE FITTED TO THE MAIN DECK TO SUPPORT A CROSS DECK WINCH, WHICH CAN WORK OVER THE STERN OR THROUGH THE CENTER WELL, AND A PENGU CONSTANT TENSION WINCH FOR CABLE HANDLING. RAILS ARE INSTALLED TO SUPPORT A TRAVELING GANTRY CRANE TO COVER THE ENTIRE AFTER PORTION OF THE MAIN DECK. THE HOLD, BETWEEN FRAMES 20 AND 24, IS RIGGED FOR STORAGE OF CABLE ON REELS OR TO SERVE AS A CABLE TANK WITH ADDITIONAL STORAGE BETWEEN FRAMES 22 AND 23. TWIN CAPSTANS ARE PROVIDED FOR ANCHOR HANDLING FORWARD AND A STERN ANCHOR CAN BE HANDLED OVER THE STERN ROLLER. THE SHIP IS FITTED WITH ALL MODERN AIDS FOR POSITION FINDING BY LORAN, SATELLITE, OR SONAR NAVIGATION PLUS A GYROCOMPASS AND SPEED MEASURING EQUIPMENT.

□ MANEUVERING AND CONTROL: THE SHIP IS CAPABLE OF DYNAMIC POSITIONING WITH CONTROLS LOCATED BOTH IN THE PILOT HOUSE AND IN THE CONTROL ROOM. POSITION CAN BE ESTABLISHED EITHER BY AN AMF ATNAV ACUSTIC LOCATION SYSTEM, A HONEYWELL RS-7 ACOUSTIC TRANSPONDER SYSTEM, OR THE NAVFAC MINIRANGER SYSTEM. HEADING CONTROL IS AUTOMATICALLY MAINTAINED BY A C. PLATH AUTOPILOT WORKING IN COMBINATION WITH THE TANO STEERING SYSTEM AND TRANSLATION IS MANUALLY CONTROLLED WITH A JOYSTICK IN RESPONSE TO LATERAL POSITION INDICATORS ON EACH CONTROL CONSOLE. THIS COMBINATION ACTUATES THE PITCH CHANGING MECHANISM ON ALL THREE PROPELLERS TO PRODUCE THE REQUIRED TRANSLATIONAL FORCES AND ROTATIONAL MOMENTS. THE VESSEL HAS A MAXIMUM AHEAD SPEED OF 7.50 KNOTS BUT NORMALLY TRANSITS TO AN OCEAN CONSTRUCTION STATION UNDER TOW.

□ MISSION SUPPORT: SEACON IS SPECIFICALLY DESIGNED FOR OCEAN CONSTRUCTION ACTIVITIES. IT HAS AIR CONDITIONED QUARTERS AND MESSING FACILITIES FOR A TOTAL OF 50 PERSONS, 18 TO 23 OF WHICH ARE VESSEL OPERATORS AND THE REMAINDER ARE CONSTRUCTION PERSONNEL. THESE ACTIVITIES ARE DIRECTED FROM THE CONTROL STATION WHICH HAS AN UNOBSTRUCTED VIEW OF THE AFTER DECK AND TELEVISION MONITORS OF OTHER AREAS WHERE WORK IS BEING PERFORMED INCLUDING UNDERWATER CAMERAS. A TRAVELING GANTRY CRANE, CURRENTLY BEING PROCURED, WILL PROVIDE FOR THE HANDLING OF HEAVY LOADS ACROSS THE DECK AND OVER THE STERN. A CROSS-DECK WINCH WILL HANDLE LOADS THROUGH THE CENTER WELL, AND A CABLE WINCH SERVES FOR HANDLING ELECTRICAL AND ACOUSTICAL CABLES. PASSIVE ANTI-ROLLING TANKS ARE INSTALLED TO KEEP MOTIONS TO A MINIMUM WHEN USED IN CONJUNCTION WITH THE AUTOMATIC HEADING CONTROL FOR SHIP ORIENTATION.

SEAGOING WORK PLATFORM
PHYSICAL AND PERFORMANCE CHARACTERISTICS

NAVFACENGCOM-SEACON

SKAGIT HOIST MODEL: BU-140-YD-CHR
 TYPE: 2-140-M

REEL SIZE:	OUTSIDE DIAMETER	3.92 FT
	CORE DIAMETER	1.67 FT
	BETWEEN FLANGES	2.00 FT
LENGTH, OVERALL		14.75 FT
LENGTH, FRAME		13.75 FT
WIDTH, OVERALL		9.44 FT
WIDTH, FRAME		5.15 FT
HEIGHT, OVERALL		7.00 FT
HEIGHT, UPPER REEL CENTER		4.49 FT
HEIGHT, LOWER REEL CENTER		2.50 FT

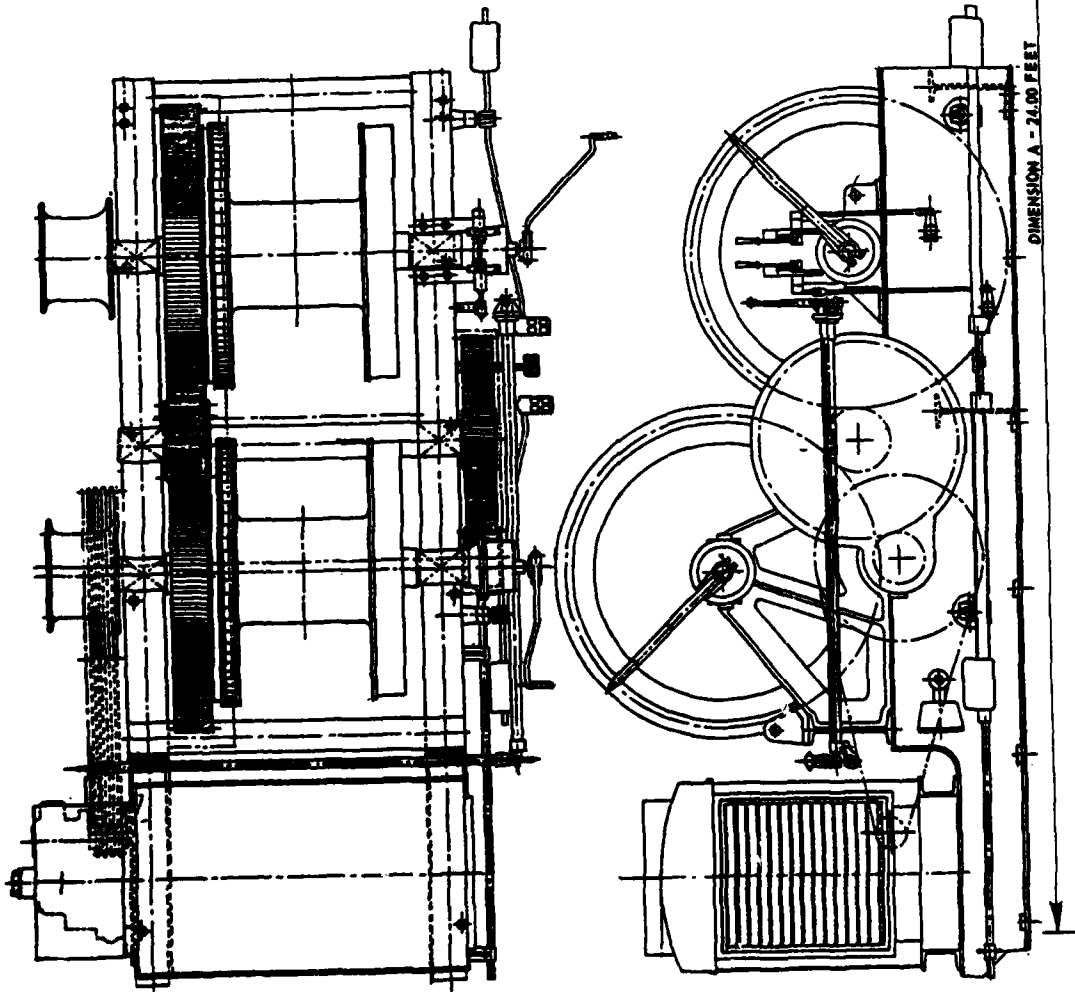

SCALE IN FEET



AUXILIARY CROSS DECK WINCH

DIMENSION A - 24.00 FEET

SEAGOING WORK PLATFORM
 CABLE HANDLING EQUIPMENT

NAYFACNGCOM - SEACON

PENGO WINCH MODEL 7100-124

REEL SIZE: OUTSIDE DIAMETER: 8.00 FT
 CORE DIAMETER: 3.63 FT
 WIDTH OVERALL: 5.50 FT
 BETWEEN FLANGES: 4.75 FT
 CENTERLINE ABOVE BASE: 4.71 FT
 BASE LENGTH, AXIAL: 9.25 FT
 BASE WIDTH: 7.00 FT

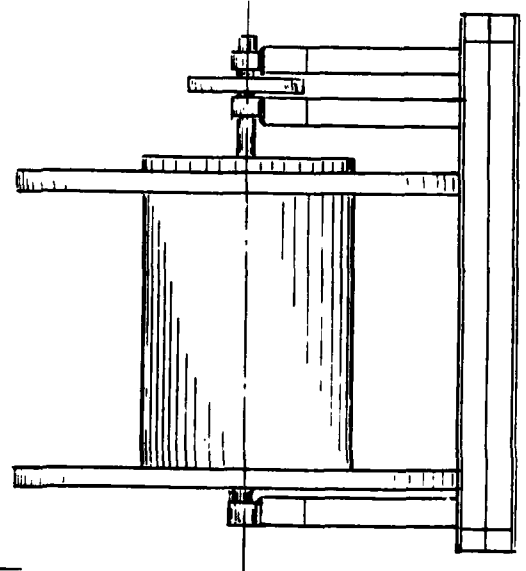
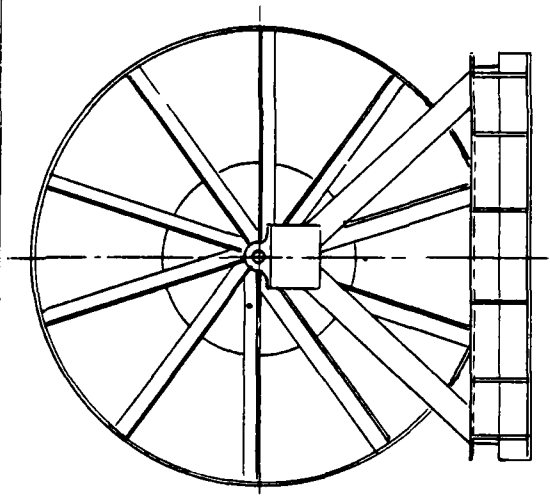
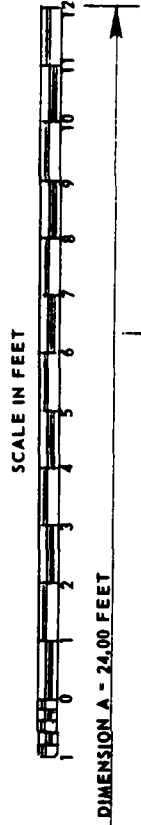
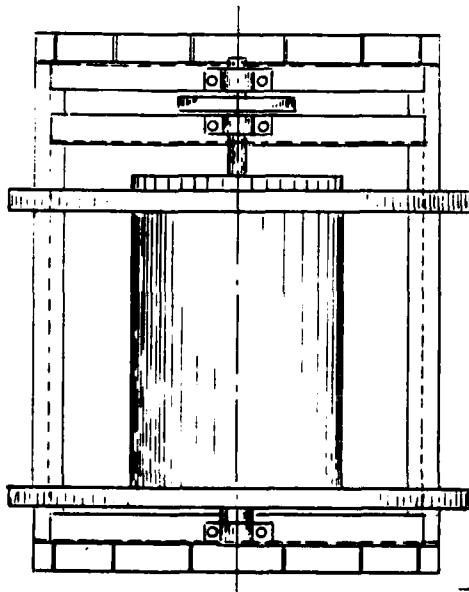

SEAGOING WORK PLATFORM
 CABLE HANDLING EQUIPMENT

NAVFACEGCOM - SEACON

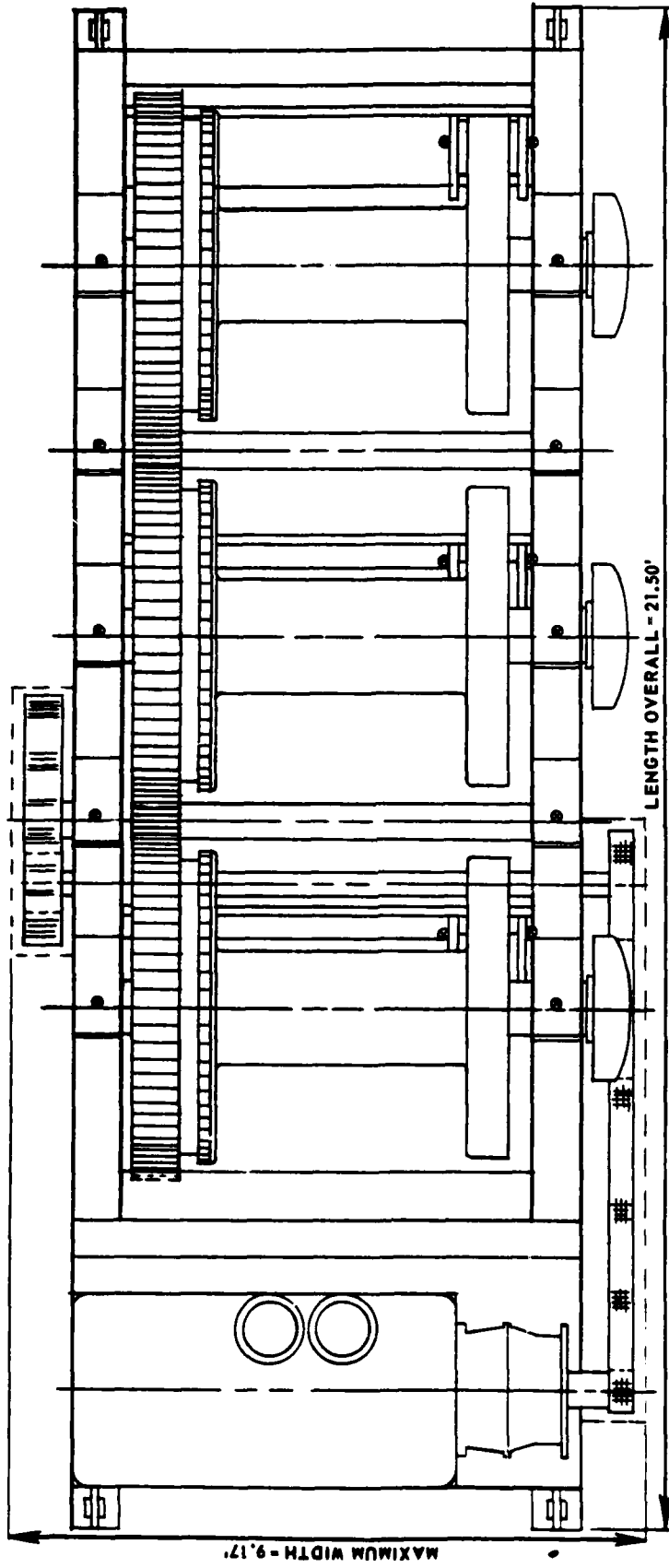

MAXIMUM WIDTH - 9.17'

LENGTH OVERALL - 21.50'

CROSS DECK WINCH

<p>SEAGOING WORK PLATFORM LOAD HANDLING EQUIPMENT</p>	<p>NAVFACEGCOM - SEACON</p>
---	-----------------------------

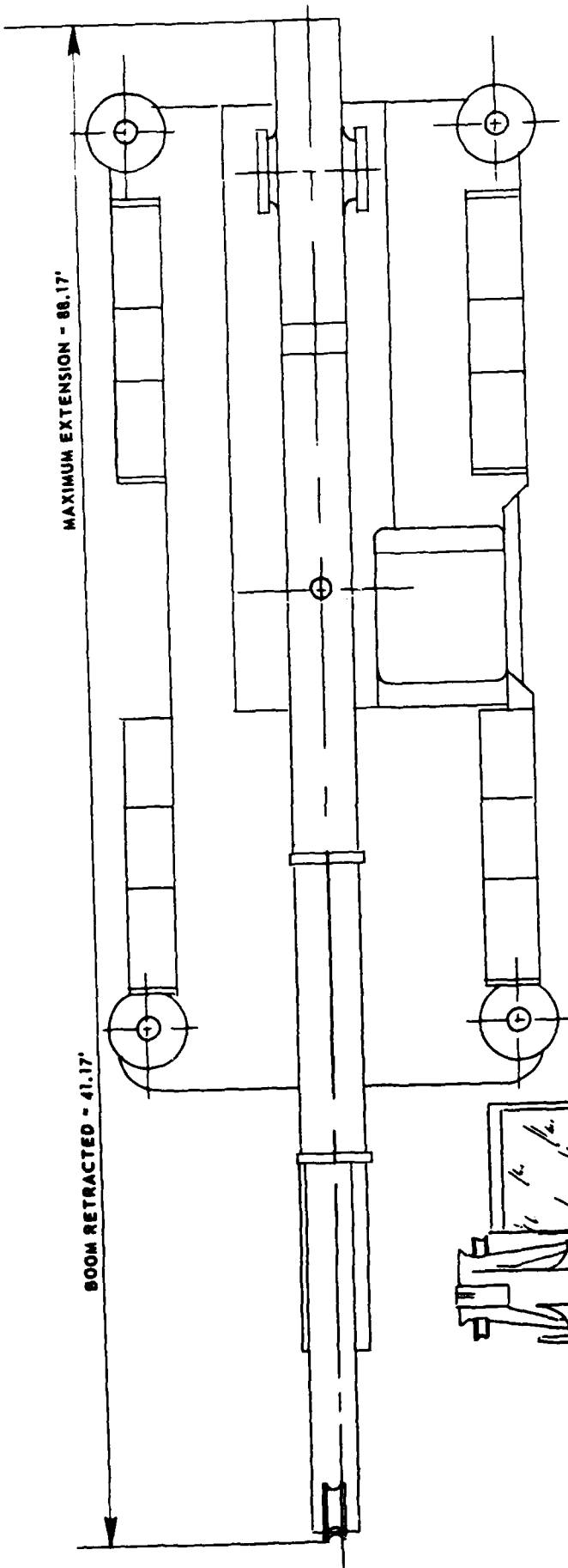

PLAN VIEW

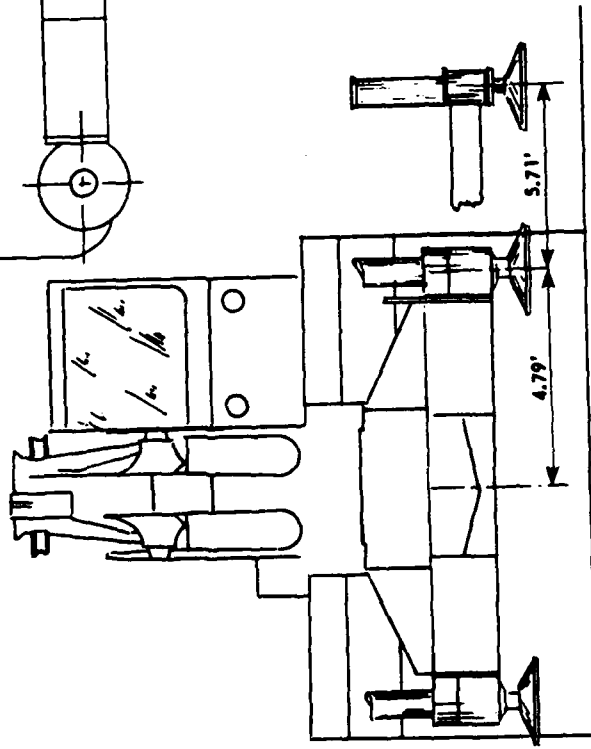

END VIEW SHOWING MAX. EXTENSION

HYDRAULIC CRANE
GROVE MFG. CO.

NAVYACENGCOM - SEACON

SEAGOING WORK PLATFORM
LOAD HANDLING EQUIPMENT

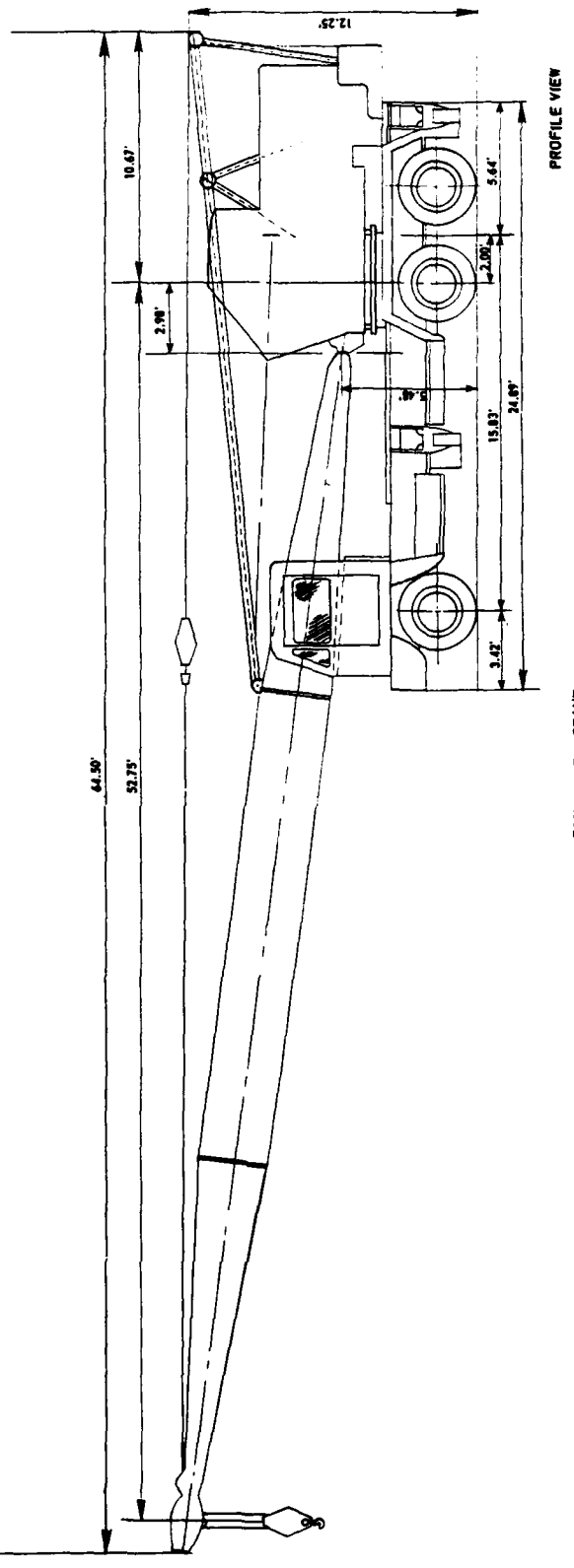
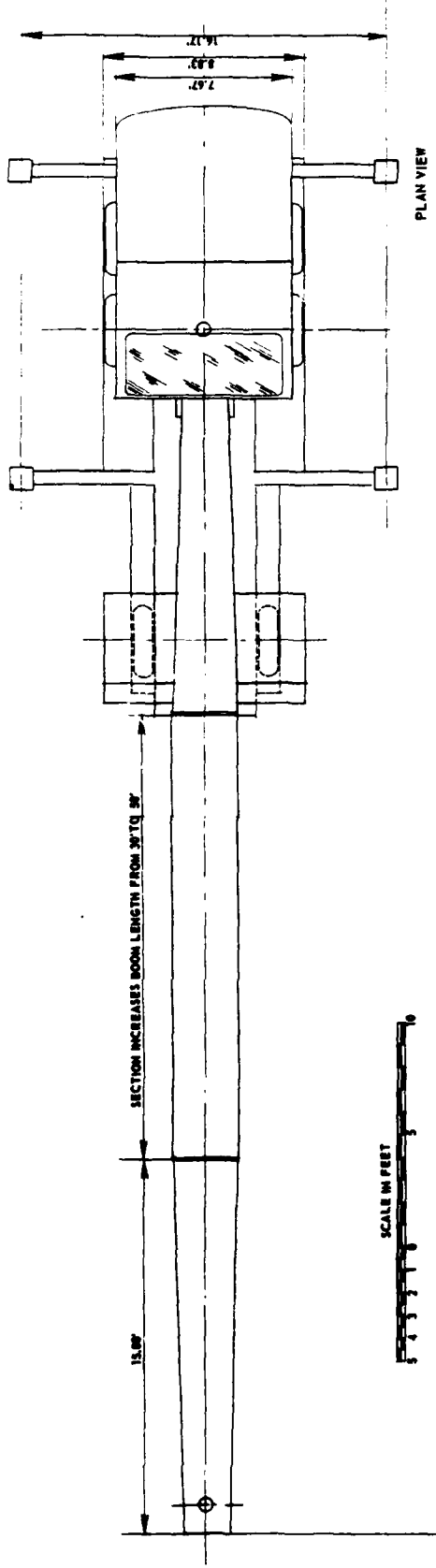

SEAGOING WORK PLATFORM
LOAD HANDLING EQUIPMENT

NAVFACNSCOM-SEACON

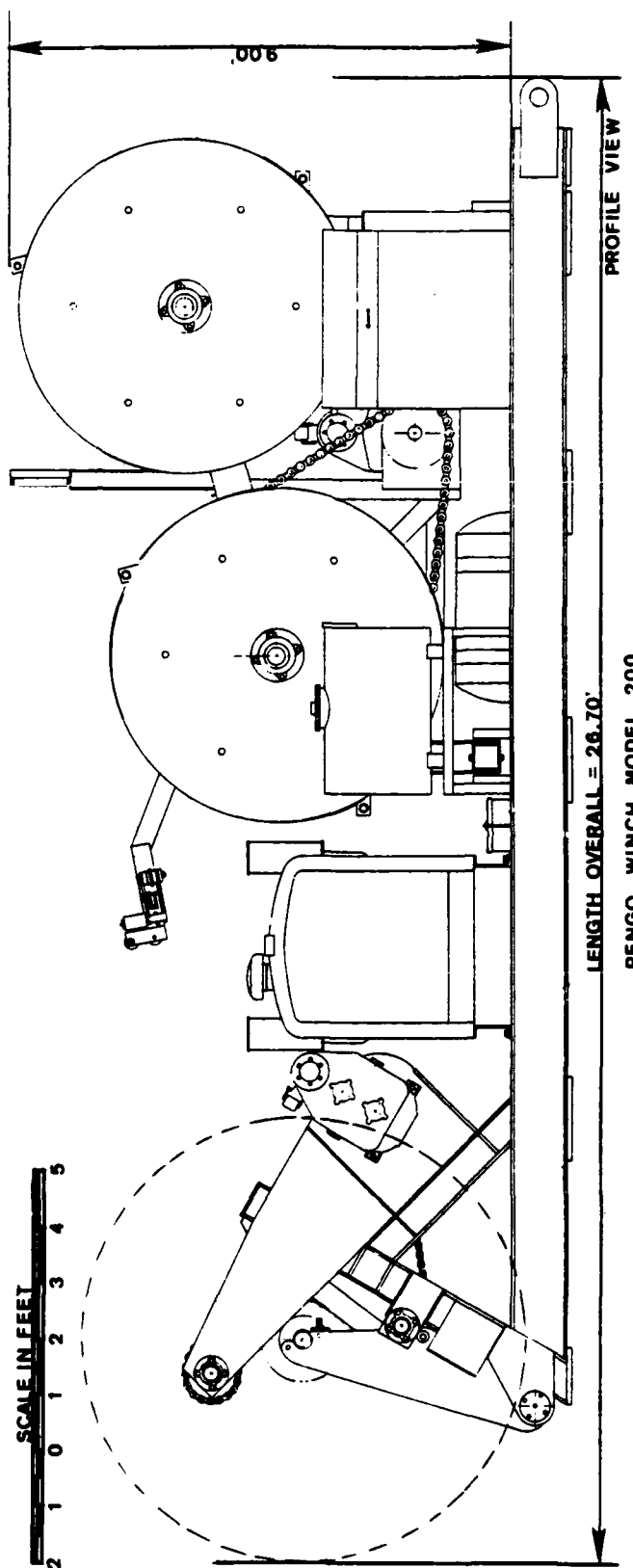
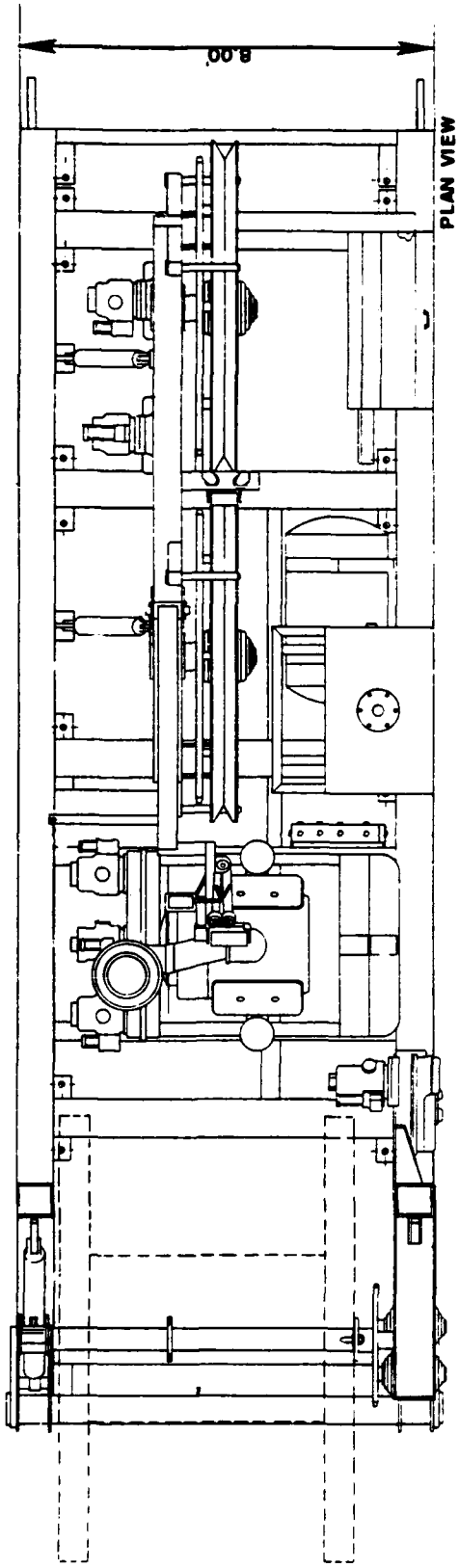

SEAGOING WORK PLATFORM
CABLE HANDLING EQUIPMENT

NAVFACEGCOM -SEACON

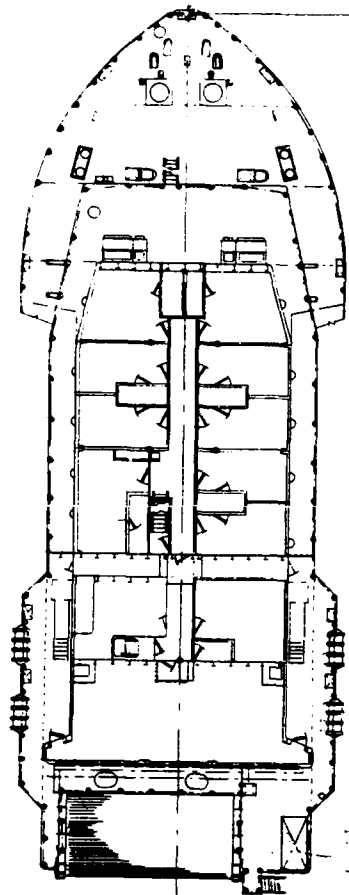

01 LEVEL ARRANGEMENT

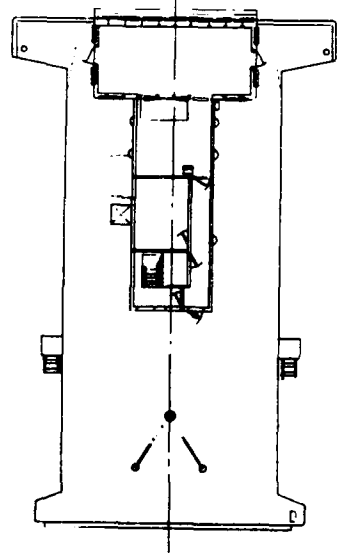

02 LEVEL ARRANGEMENT

DIMENSION A - 20.00'

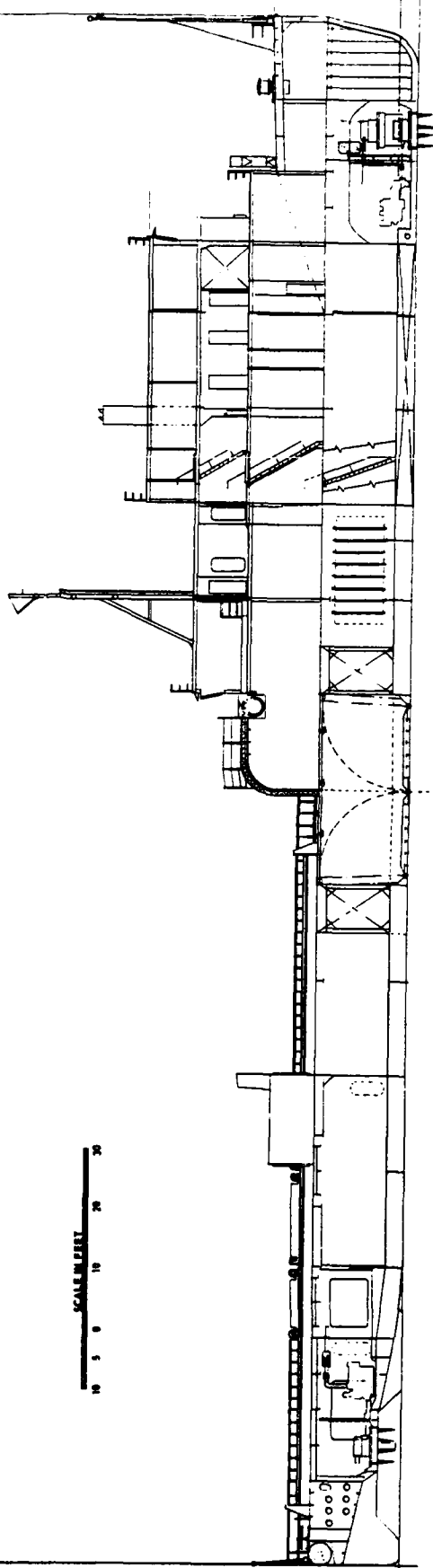

INBOARD PROFILE

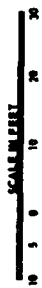

NAVFACECOM-SEACON
PEP DRAWING

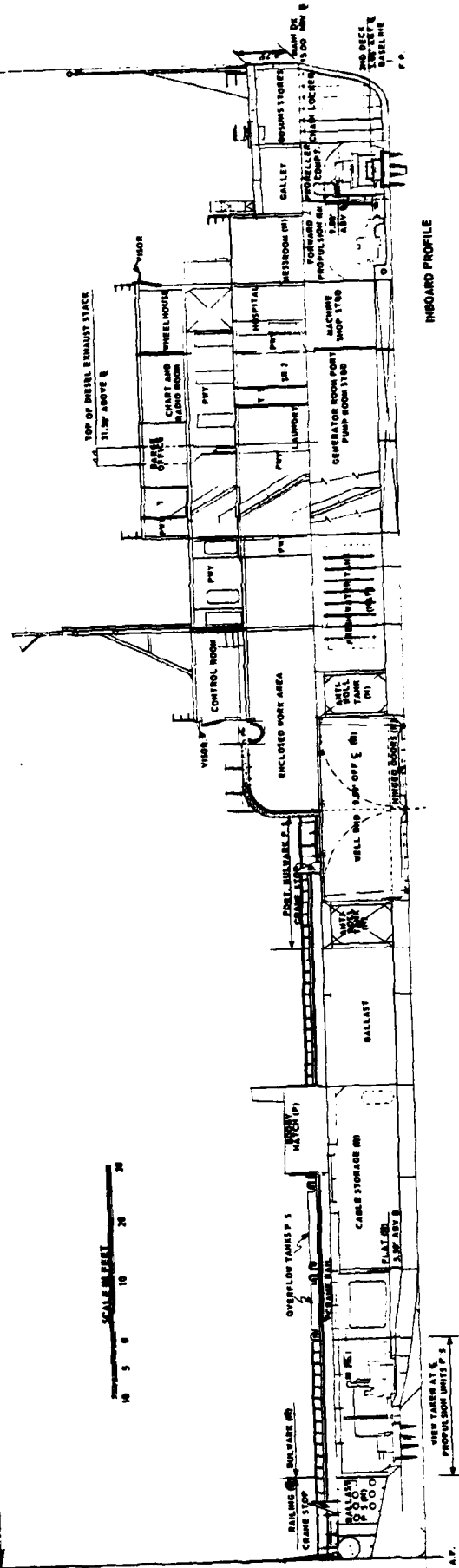
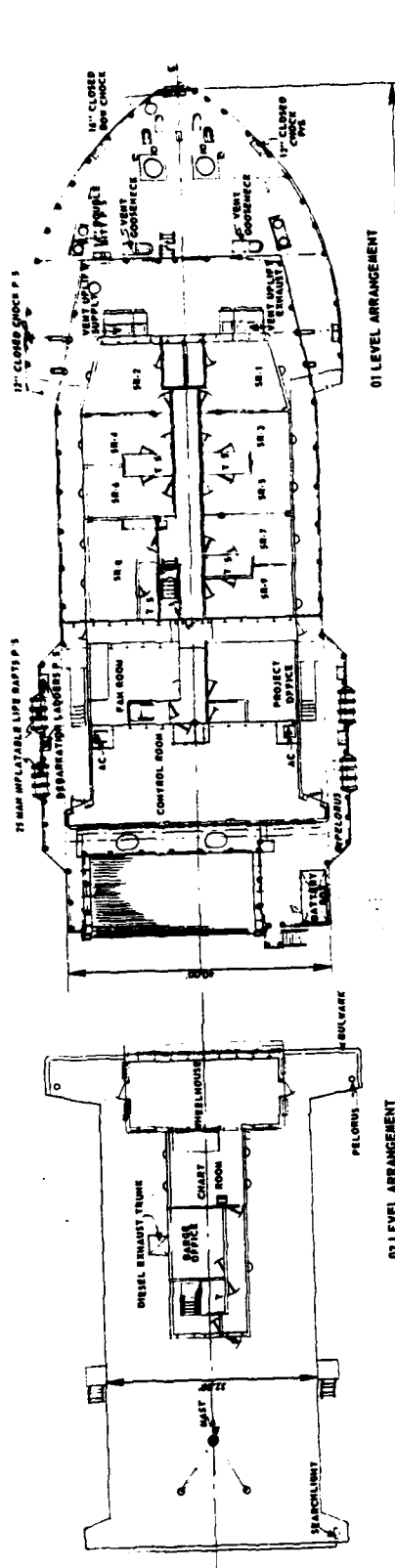

NAVFACNGCOM - SEASON

SEAGOING WORK PLATFORM
INTERNAL ARRANGEMENTS

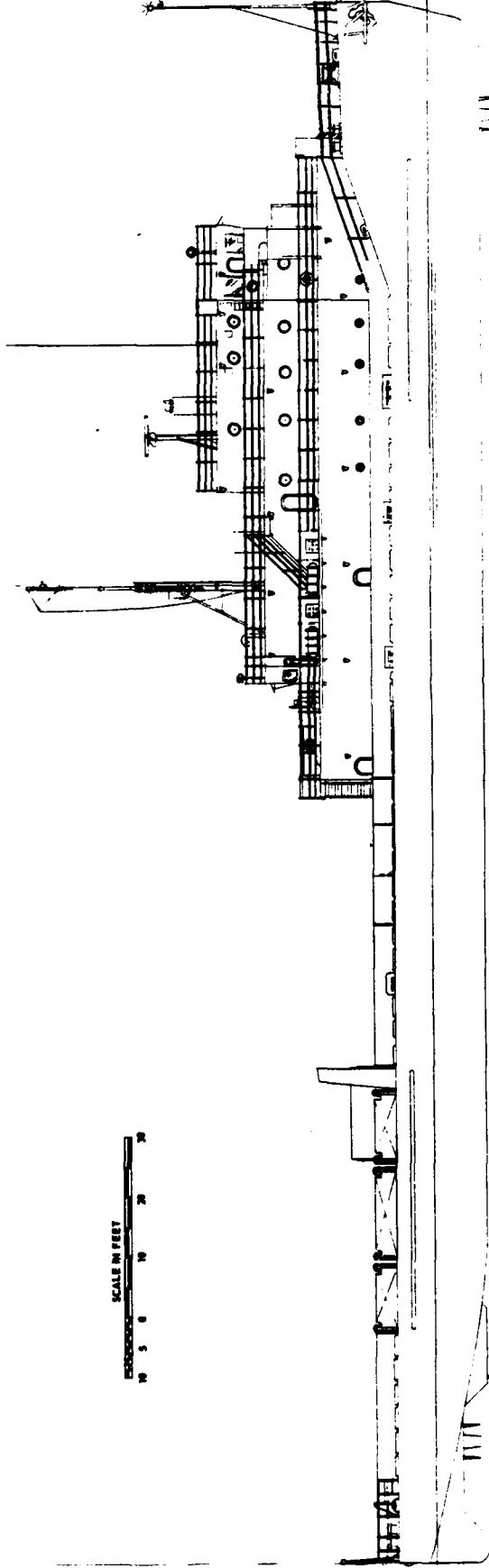
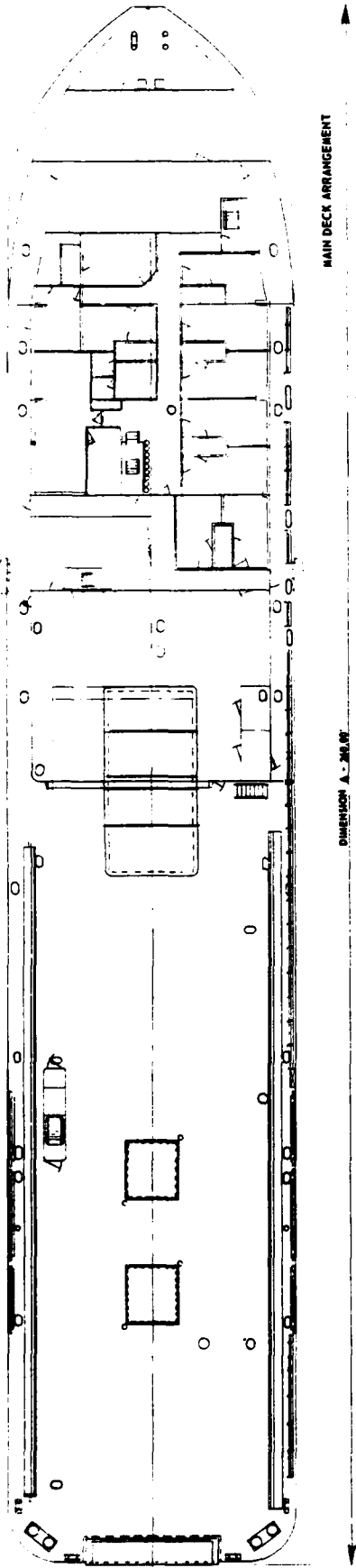

NAVFACENGCOR - SEACON
PEP DRAWING

GEOMETRY AND HYDROSTATICS: THE LARC V (LIGHTER AMPHIBIOUS RESUPPLY CARGO) IS A VEHICLE WHICH IS CAPABLE OF BEING OPERATED ON BOTH LAND AND WATER. THE AMPHIBIOUS LIGHTER HAS AN OVERALL LENGTH OF 35.00 FEET, A MAXIMUM WIDTH OVER THE FENDERS OF 10.00 FEET AND A MAXIMUM HEIGHT TO THE TOP OF THE CAB OF 10.17 FEET. THE TOTAL NET WEIGHT, DRY, IS 19,000 POUNDS WHILE THE TOTAL GROSS WEIGHT IS APPROXIMATELY 30,000 POUNDS. THE CARGO DECK, WHICH IS CAPABLE OF TRANSPORTING A MAXIMUM PAYLOAD OF 10,000 POUNDS, IS 16.00 FEET LONG, 9.75 FEET WIDE AND HAS A DEPTH OF 2.42 FEET. THERE IS A LOADED CLEARANCE OF 2.00 FEET BETWEEN THE HULL AND THE GROUND. AN OVERHEAD CLEARANCE OF 10.33 FEET IS REQUIRED FOR THE TRANSPORTATION OF THE LARC V.

STRUCTURE: THE VEHICLE IS CONSTRUCTED WITH AN ALUMINUM FRAME SUPPORTING AN ALUMINUM HULL, DECK, AND CAB. THE LIGHTER IS MOUNTED ON FOUR RIGIDLY SUPPORTED WHEELS AND THE STRUCTURE IS DESIGNED TO SUPPORT THE TOTAL CRAFT WEIGHT ON DIAGONALLY OPPOSITE PAIRS OF WHEELS OVER THE RANGE OF VERTICAL ACCELERATIONS THAT MAY BE ENCOUNTERED. AN ALUMINUM CANOPY CAN BE INSTALLED TO COVER THE CAB IN THE CASE OF INCLEMENT WEATHER. THE FLUSH DECK HAS A HIGH CENTER OF GRAVITY WHICH FACILITATES THE SELF-BAILING FEATURE.

OUTFIT: THE VESSEL REQUIRES A CREW OF TWO PERSONS FOR ITS OPERATION. THE CARGO DECK IS FITTED WITH TEN CARGO TIE DOWN HOOKS AND FOUR LOAD CENTERING DEVICES. THERE ARE TWO HEADLIGHTS LOCATED AT THE FRONT OF THE VEHICLE AND ONE STERN LIGHT. TO PROVIDE ACCESS TO THE ENGINE, THE VEHICLE HAS TWO ENGINE HATCHES, TWO MUFFLER GUARDS, FOUR ENGINE HATCH HANDLES AND ONE LIFTING FRAME. TWO MANUAL BILGE PUMPS ARE INCORPORATED FOR USE IF THE THREE HYDRAULIC BILGE PUMPS FAIL. A MARKER BUOY LOCATES THE LIGHTER IF IT SHOULD SINK IN LESS THAN 100 FEET OF WATER. FOUR 18:00 X 25 TIRES WITH A 12 PLY RATING ARE USED TO SUPPORT THE VEHICLE. PRESSURES OF 9 PSIG AND 18 PSIG ARE RECOMMENDED FOR THE FRONT TIRES FOR SOFT AND HARD TERRAIN RESPECTIVELY WHILE 14 PSIG AND 22 PSIG ARE RECOMMENDED FOR THE REAR TIRES ON SOFT AND HARD TERRAIN RESPECTIVELY. FOUR DRY-CHARGED, TWELVE VOLT, 100 AMPERE HOURS BATTERIES ARE USED. THE TWO FUEL TANKS HAVE A CAPACITY OF 72 GALLONS EACH.

MACHINERY AND PROPULSION: THE ENGINE IS AN INDUSTRIAL GASOLINE ENGINE OF 270 GROSS HORSEPOWER AT 3200 RPM OF WHICH 30 HORSE-

POWER IS CONSUMED IN THE AUXILIARY EQUIPMENT LEAVING 240 HORSEPOWER FOR PROPULSION. FOR WATER PROPULSION, A 30 INCH DIAMETER, 30 INCH PITCH PROPELLER IS USED WHICH IS LOCATED IN A HOUSING AT THE REAR OF THE CRAFT WITH A ROAD CLEARANCE OF 1.33 FEET. THE LIGHTER IS CAPABLE OF TRAVELING AT A MAXIMUM SPEED OF 30 MPH ON LAND AND 10 MPH IN THE WATER. THE HIGH RANGE OPERATING RADIUS WITH NO LOAD ON LAND IS 250 MILES AND IS 40 MILES IN WATER. FOR A FULL LOAD, THIS OPERATING RADIUS IS DECREASED TO 200 MILES ON LAND BUT REMAINS 40 MILES IN THE WATER. SPEED LOSS DUE TO WAVE ACTION IS TO BE EXPECTED AND IS DIFFERENT ONLY IN DEGREE BETWEEN THE AMPHIBIAN AND A VESSEL OF SIMILAR DIMENSIONS. FOR THE LARC V SPEED LOSSES COMPARED TO STILL-WATER SPEED AT 225 PROPELLER HORSEPOWER ARE 2% FOR 1.2-LENGTH WAVE, 16% FOR THE 2.0-LENGTH WAVE AND 7% FOR THE 4.0-LENGTH WAVE. THE CRITICAL WAVE LENGTH FOR THE LARC V IS 200 FEET.

MANEUVERING AND CONTROL: THE POWER STEERING SYSTEM ON THE AMPHIBIOUS LIGHTER WILL PERMIT RELATIVELY EASY STEERING. BASICALLY, THE STEERING ON LAND IS ACCOMPLISHED BY FULL HYDRAULIC POWER AND IN WATER BY THE RUDDER. THE TYPE OF TERRAIN (SAND, MUD, OR HARD ROADS) WILL AFFECT LAND STEERING AS WITH ANY AUTOMOTIVE VEHICLE. UNDER IDEAL CONDITIONS SUCH AS HARD SMOOTH SURFACES THE OUTSIDE TURNING RADIUS IS 35.60 FEET WHILE THE INSIDE RADIUS IS 26.50 FEET. THE TURNING RADIUS WILL INCREASE AS THE TERRAIN BECOMES SOFTER. THE LIGHTER IS CAPABLE OF BEING STEERED IF THE HYDRAULIC POWER SHOULD BE LOST BUT MUCH MORE STEERING EFFORT WILL BE REQUIRED; IN WATER THE STEERING WHEEL WILL TURN THE FRONT WHEELS AND THE RUDDER AT ALL TIMES. THE AMPHIBIOUS LIGHTER IS CAPABLE OF GOING UP EXTREMELY STEEP GRADES AS HIGH AS 60%. THE VEHICLES HAVE AN ANGLE OF APPROACH OF 31 DEGREES AND AN ANGLE OF DEPARTURE OF 28 DEGREES.

MISSION SUPPORT: THE ALUMINUM AMPHIBIOUS LIGHTER IS USED TO CARRY CARGO FROM AN OFF-SHORE SUPPLY SHIP TO A BEACH FOR ADVANCED BASE SUPPLY WITH A TOTAL CARGO CAPACITY OF 10,000 POUNDS. IT ALSO SERVES AS A DIVE BOAT OR POWER SUPPLY FOR UNDERWATER WORK. IT ALSO CAN BE USED FOR MOVING PERSONNEL AND EQUIPMENT ACROSS BOTH LAND AND WATER FROM A BASE TO A CONSTRUCTION SITE.

INSHORE OPERATIONS LOGISTICS PLATFORM
PHYSICAL AND PERFORMANCE CHARACTERISTICS

LIGHTER, AMPHIBIOUS, RESUPPLY, CARGO: LARC V

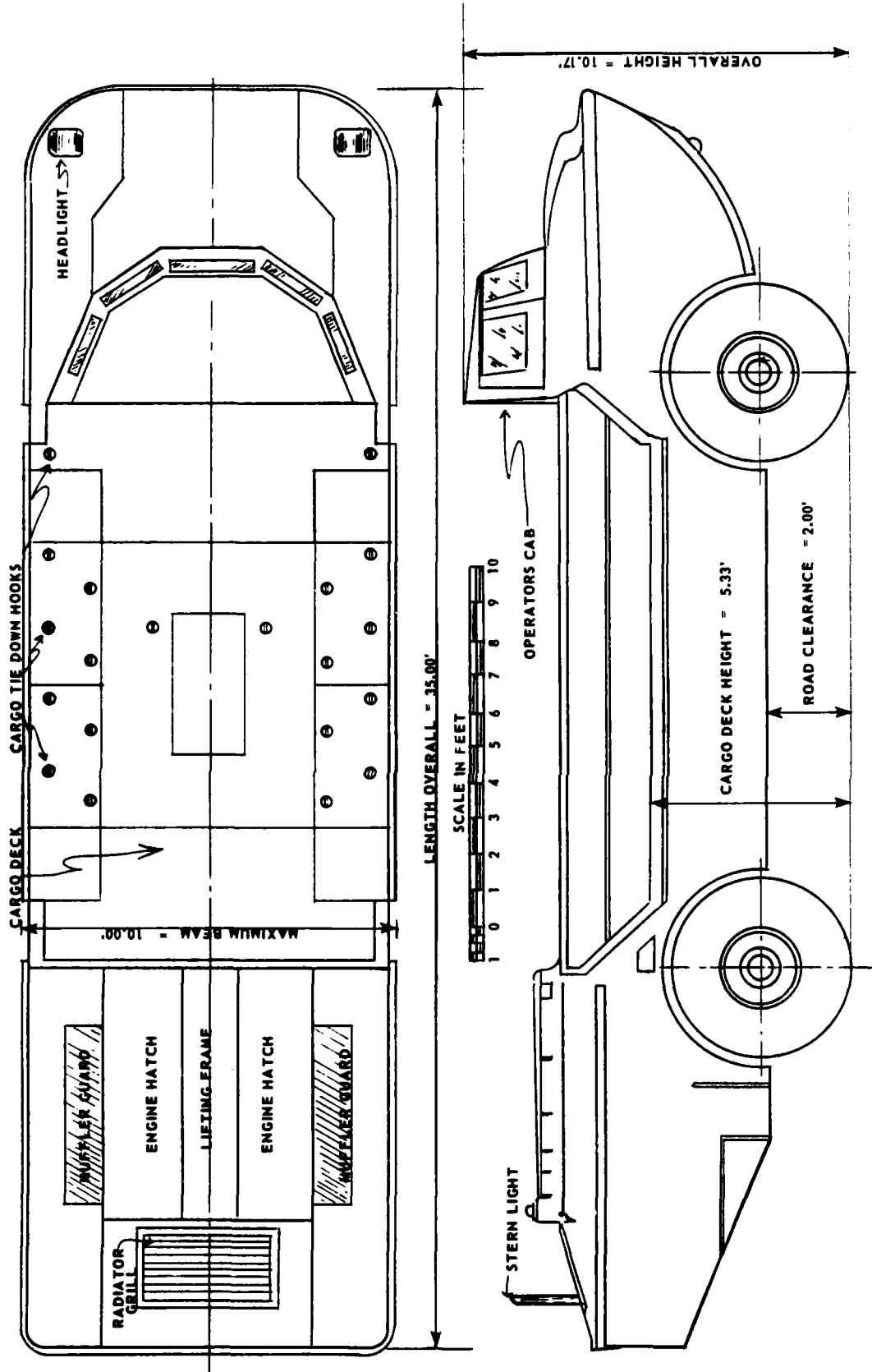

INSHORE OPERATIONS LOGISTICS PLATFORM OVERALL GEOMETRY

LIGHTER, AMPHIBIOUS, RESUPPLY, CARGO: LARC V

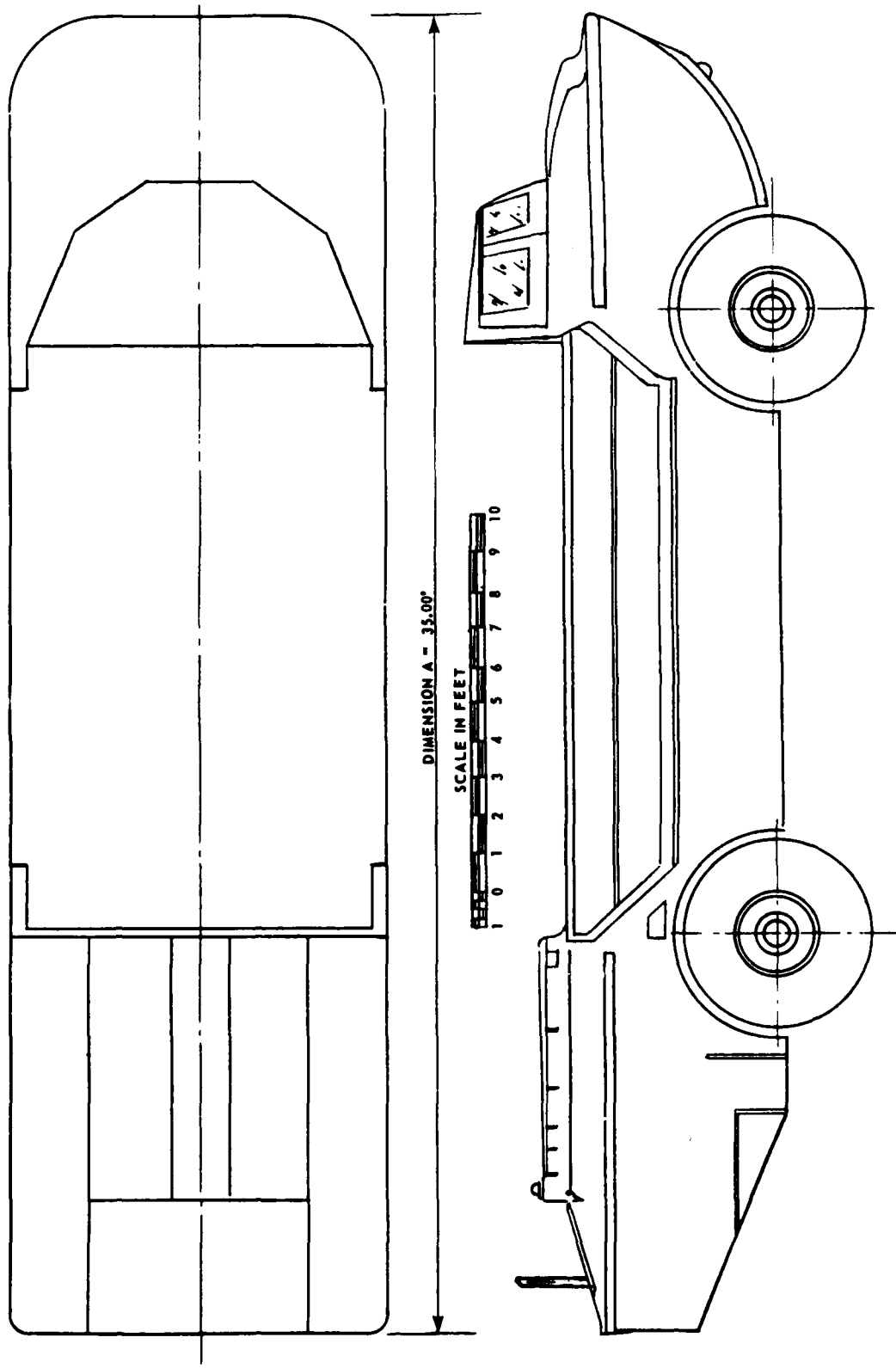

LIGHTER, AMPHIBIOUS, RESUPPLY, CARGO: LARC V
PEP DRAWING

□ GEOMETRY: THE 50' LCM WORKBOAT IS A BOX-SHAPED CRAFT WITH MACHINERY SPACE AND PROPULSION AFT AND AN OPEN CARGO WELL FORWARD. THE OVERALL LENGTH, INCLUDING THE PUSH PADS AT THE BOW AND THE FEND-ER AT THE STERN, IS 51.17 FEET AND THE LENGTH BETWEEN PERPENDICULARS IS 50.00 FEET. THE LOAD WATERLINE LENGTH, AT A KEEL DRAFT OF 2.50 FEET AMIDSHIPS, IS 44.42 FEET. THE EXTREME BEAM IS 14.33 FEET. THE TWIN SKEGS AFT EXTEND 0.63 FEET BELOW THE KEEL LINE GIVING A MAXIMUM DRAFT AT THE STERN OF 3.13 FEET. THE DEPTH AMIDSHIPS, KEEL TO MAIN DECK, IS 7.05 FEET WITH A BULWARK WHICH RISES FROM 7.80 FEET ABOVE THE KEEL AMIDSHIPS TO A HEIGHT ABOVE THE KEEL OF 8.72 FEET AT THE BOW. THE TOP OF THE PILOT HOUSE IS 7.50 FEET ABOVE THE MAIN DECK OR 14.55 FEET ABOVE THE KEEL AMIDSHIPS. THE CARGO WELL IS 25.00 FEET LONG BY 11.00 FEET WIDE. THE DESIGN BASELINE IS ~~6' 7" BELOW~~ THE KEEL LINE.

□ HYDROSTATICS: DISPLACEMENT TO THE LOAD WATERLINE IS ~~24,700~~ ^{29,000} POUNDS, SALT WATER. THE WEIGHT OF THE CRAFT IN HOISTING CONDITION (LIGHT SHIP) IS 54,000 POUNDS; CENTER OF GRAVITY IN LIGHT CONDITION IS 3.33 FEET ABAFT AMIDSHIPS. TRANSVERSE METACENTRIC IS 9.7 FEET ABOVE THE KEEL IN THE LOAD CONDITION.

□ STRUCTURE: THE BASIC STRUCTURE IS OF ALL WELDED STEEL. TRANSVERSE FRAMES ARE SPACED AT 3.00 FEET FROM THE BOW TO FRAME 15; 2.00 FEET BETWEEN FRAMES 15 AND 16; 3.00 FEET BETWEEN FRAMES 16 AND 17. FIVE TRANSVERSE WATERTIGHT BULKHEADS ARE LOCATED THROUGHOUT THE LENGTH OF THE VESSEL, FOUR OF WHICH ARE IN THE CARGO COMPARTMENT AREA. THESE BULKHEADS EXTEND FROM KEEL TO CARGO FLAT IN THE CENTER AND UP TO THE MAIN DECK IN THE WING TANKS. THE AFT CARGO FLAT TRANSVERSE BULKHEAD FORMS THE FORWARD BULKHEAD OF THE MACHINERY SPACE HALFWAY BETWEEN FRAMES 11 AND 12; THE AFT ENGINE ROOM BULKHEAD AT FRAME 15, SEPARATES THE MACHINERY SPACE FROM THE LAZARETTE AT THE STERN. THE MAIN SUPPORT FOR THE CARGO FLAT COMPRISES SIX 6" X 4" X 12# I BEAMS THAT ARE IN TURN SUPPORTED BY THE TRANSVERSE FRAMES.

□ MACHINERY: MAIN PROPULSION MACHINERY COMPRISES TWO DETROIT DIESEL ENGINES MODEL 6071A STARBOARD AND 6072A PORT. THESE ARE 6 CYLINDER ENGINES WITH A BORE OF 4.25 INCHES, A STROKE OF 5.00 INCHES AND A DISPLACEMENT OF 425 CUBIC INCHES PER ENGINE. EACH ENGINE IS RATED AT 235 HP AT 2300 RPM. BOTH MAIN ENGINES ROTATE CLOCKWISE, HAVE SOLID INJECTION, AND FRESH WATER, KEEL CONDENSER COOLING UNITS. THEY ARE STARTED ELECTRICALLY BY A 24 VOLT BATTERY SYSTEM. BILGE AND ENGINE COOLING WATER PUMPS OF 250 GPM CAPACITY ARE MOUNTED ON BOTH PORT AND STARBOARD MAIN ENGINES AND ARE BELT DRIVEN FROM THE ENGINES.

□ OUTFIT: THE ANCHOR, STOWED ON THE STARBOARD SIDE IS MAN-HANDED OVERBOARD; LIFTING EYES, CARGO LASHING RINGS, MOORING CLEATS AND TOWING STAPLES ARE INSTALLED AS REQUIRED FOR MISSION. NAVIGATING LIGHTS AND A MAGNETIC COMPASS SENSOR ARE INSTALLED ON THE MAST. THE COMPASS SIGNAL IS TRANSMITTED TO A READOUT UNIT IN THE PILOT HOUSE.

□ SPEED AND PROPULSION: THE CRAFT IS FITTED WITH TWO 3 BLADED, 2.0 FOOT DIAMETER BY 1.42 FOOT PITCH, RIGHT HAND BRONZE ALLOY PROPELLERS DESIGNED FOR A SPEED OF 9.00 KNOTS AT 1400 PROPPELLER RPM AND 385 SHAFT HORSEPOWER AT MAXIMUM DIESEL RATING OF 450 HORSEPOWER. MAXIMUM SPEED IN LOADED CONDITION IS 8.69 KNOTS. FUEL CAPACITY IS 490 GALLONS GIVING AN ENDURANCE OF 272 NAUTICAL MILES AT 7.25 KNOTS.

□ MANEUVERING AND CONTROL: ENGINE STARTING AND SPEED OF BOTH MAIN ENGINES ARE CONTROLLED FROM THE PILOT HOUSE CONTROL STAND AS IS PROPELLER REVERSAL FOR ASTERN OPERATION. A PAIR OF HANDLES ACTIVATES LINKAGES THAT OPERATE CLUTCHES, THROTTLES, AND REVERSE GEARS IN SEQUENCE WITH FORE AND AFT MOTION OF THE HANDLES. A STEERING WHEEL ON THE CONTROL STAND, THROUGH A CHAIN DRIVE INTO THE MACHINERY SPACE, OPERATES A CONTROL ROD AND LINKAGES THAT TURN THE TWO RUDDERS IN TANDEM. RUDDERS APPROXIMATELY THREE SQUARE FEET EACH, ARE DIRECTLY BEHIND THE TWO PROPELLERS IN THE STERN TUNNELS GIVING GOOD AHEAD MANEUVERING CONTROL. ASTERN STEERING IS MOST EFFECTIVELY ACCOMPLISHED BY ALTERING ROTATION DIRECTION OF THE PORT AND STARBOARD PROPELLERS.

□ MISSION SUPPORT: THE 50 FOOT LCM WORKBOAT HAS BEEN DESIGNED AS A REPLACEMENT FOR THE LCM-6 LANDING CRAFT FOR MANY OF THE APPLICATIONS WHERE THE LATTER VEHICLE WAS USED IN OTHER THAN THE AMPHIBIOUS OPERATIONS FOR WHICH IT WAS DESIGNED. IT CAN BE USED AS A TUG OR PUSHBOAT OR FOR TRANSPORTING PERSONNEL, CARGO, OR EQUIPMENT DURING OCEAN CONSTRUCTION OPERATIONS. IT IS STRUCTURALLY CAPABLE OF BEACHING BUT NO BOW RAMP IS PROVIDED FOR OFF-LOADING OF VEHICLE CARGO. THE CRAFT MAY BE CARRIED ABOARD AN ATTACK TRANSPORT, CARGO VESSEL, OR IN THE WELL DECK OF AN LSD. FOR OFFLOADING FROM A SHIP IT IS PROVIDED WITH LIFTING EYES WITH MATCHING SLINGS, CAPABLE OF SUPPORTING THE ENTIRE CRAFT IN LIGHT CONDITION. PROVISIONS ARE MADE FOR SECURING CARGO AND PROTECTING IT FROM SEAWAY MOTIONS.

INSHORE OPERATIONS LOGISTICS PLATFORM
PHYSICAL AND PERFORMANCE CHARACTERISTICS

50' LCM WORKBOAT

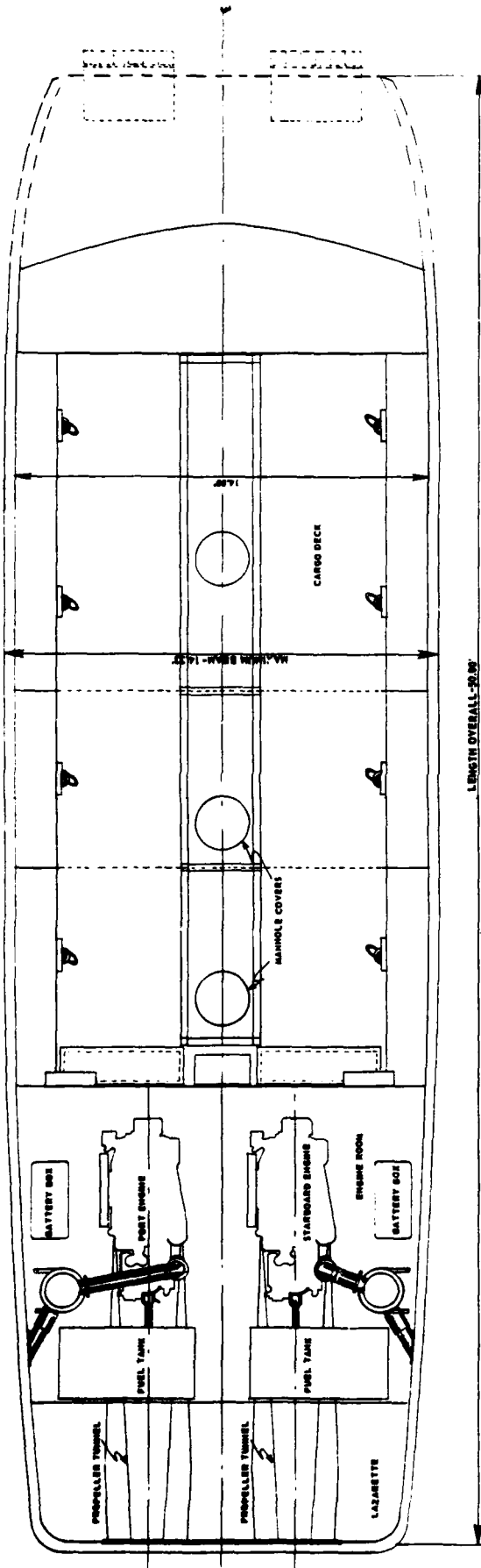

CARGO DECK AND MACHINERY SPACE ARRANGEMENT

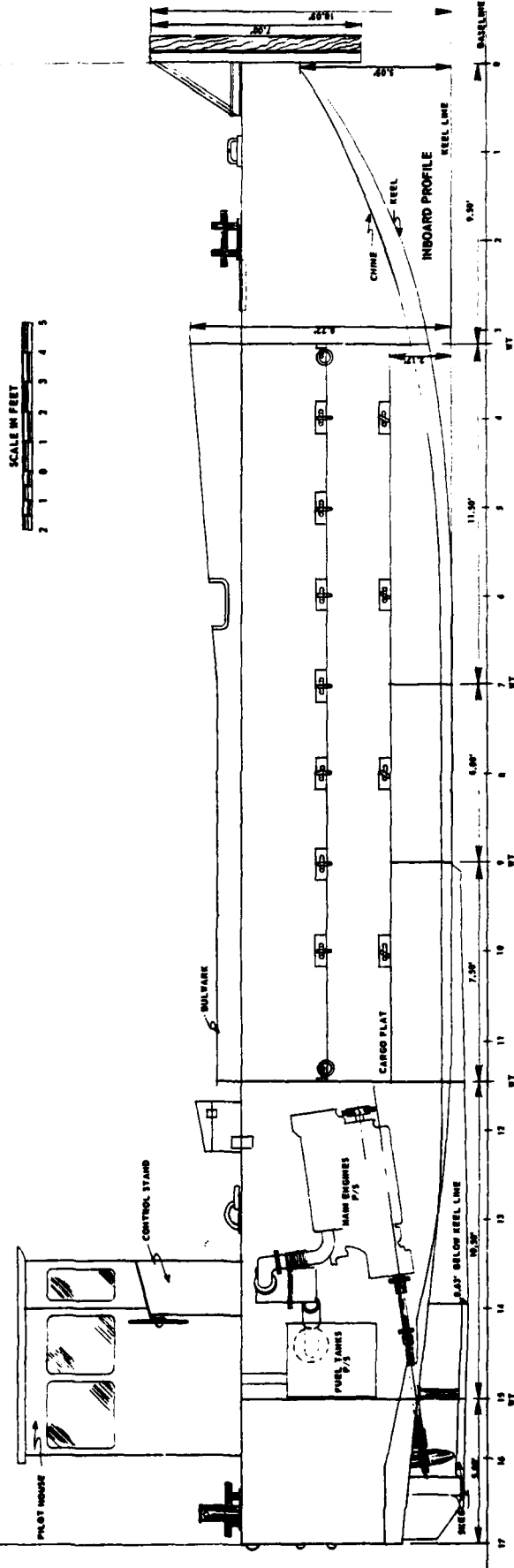

50' LCM WORKBOAT
 INSHORE OPERATIONS LOGISTICS PLATFORM
 INTERNAL ARRANGEMENTS

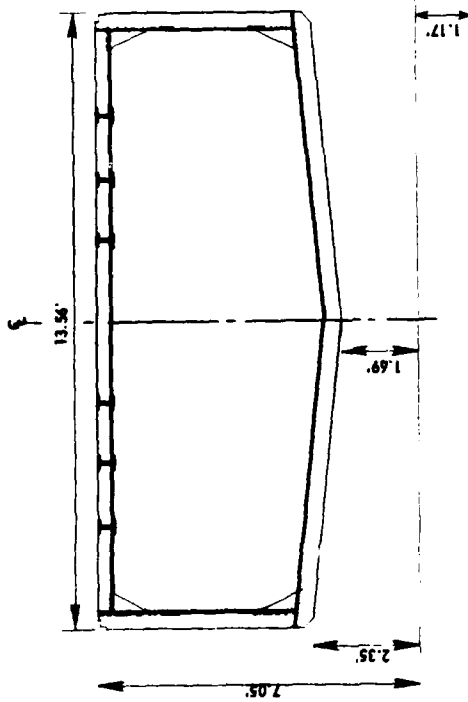

SECTION AT FORWARD END OF LOAD WATERLINE

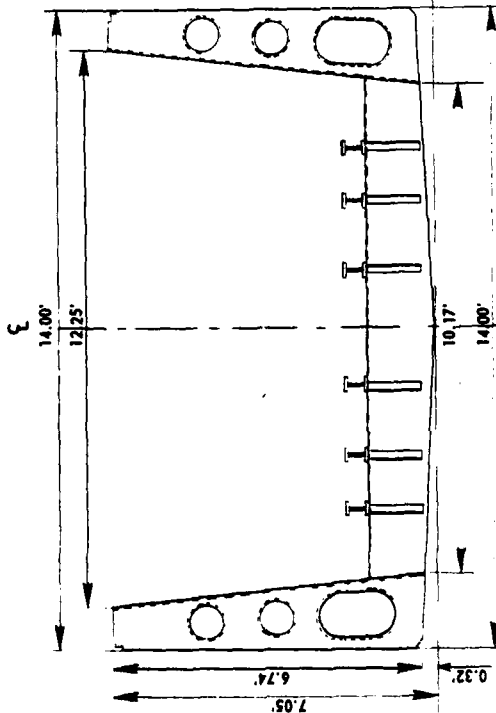

MIDSHIP SECTION

INSHORE OPERATIONS LOGISTICS PLATFORM
TYPICAL CROSS SECTIONS

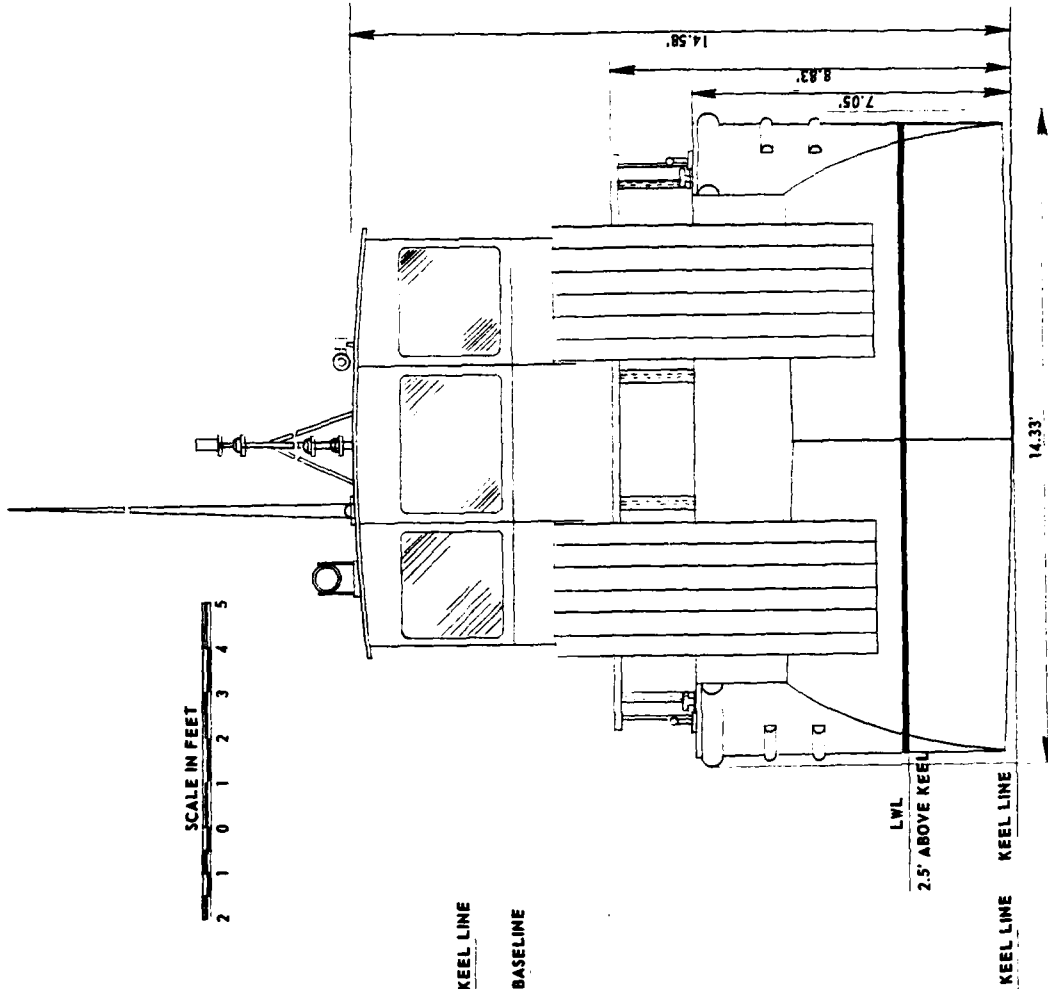

BOW-ON VIEW

50' LCM WORKBOAT

LOAD WATERLINE VALUES: LENGTH, B.P. - 50.00 FT.; DRAFT, FROM KEEL LINE - 2.50 FT.; DISPLACEMENT - 74,700 LBS., S.W.

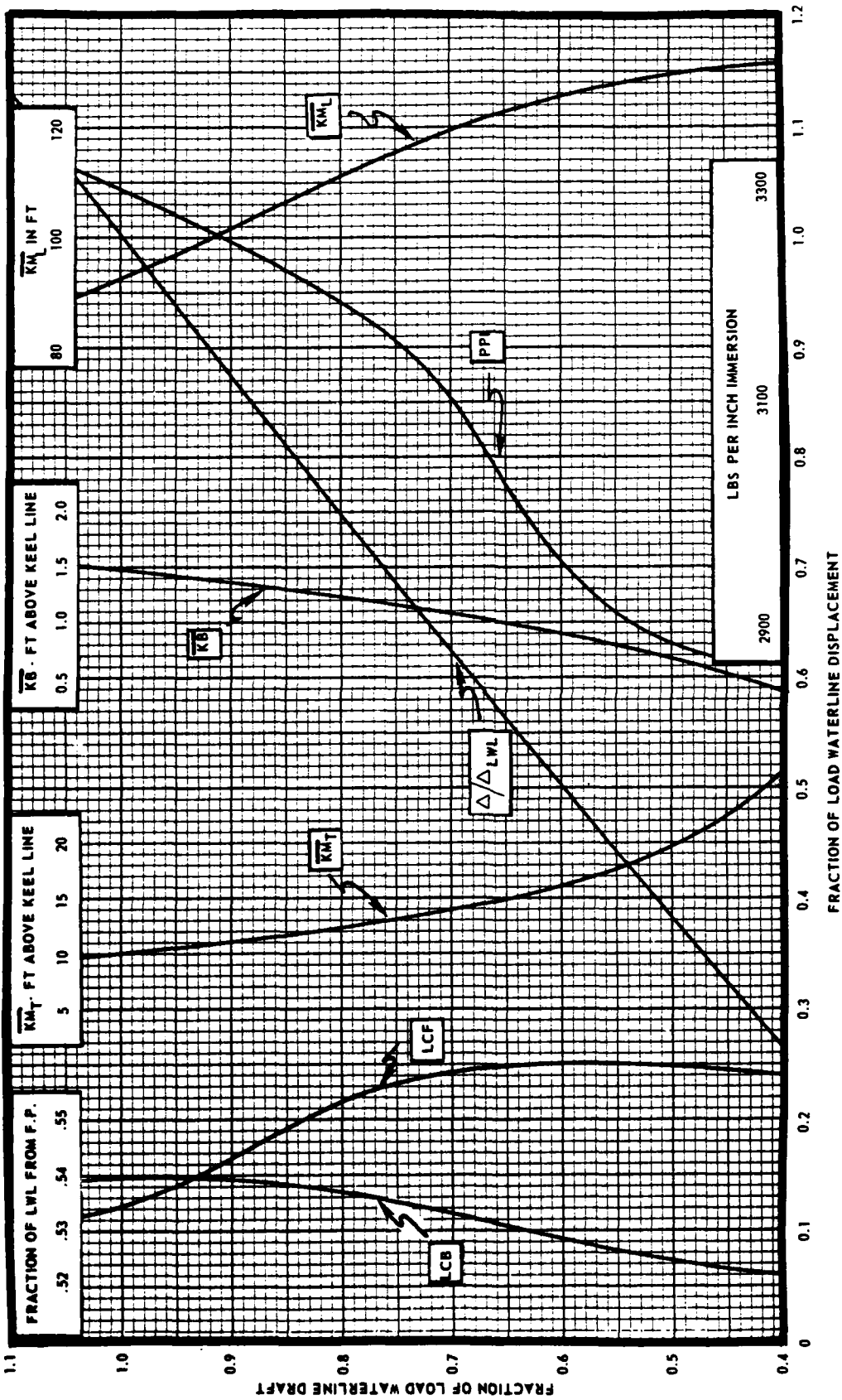

INSHORE OPERATIONS LOGISTICS PLATFORM
 HULL FORM DELINEATION - CURVES OF FORM

50' LCM WORKBOAT

LOAD WATERLINE VALUES: LENGTH, B.P. = 50.00 FT.; DRAFT, FROM KEEL LINE = 2.50 FT.; DISPLACEMENT = 74,700 LBS., S.W.

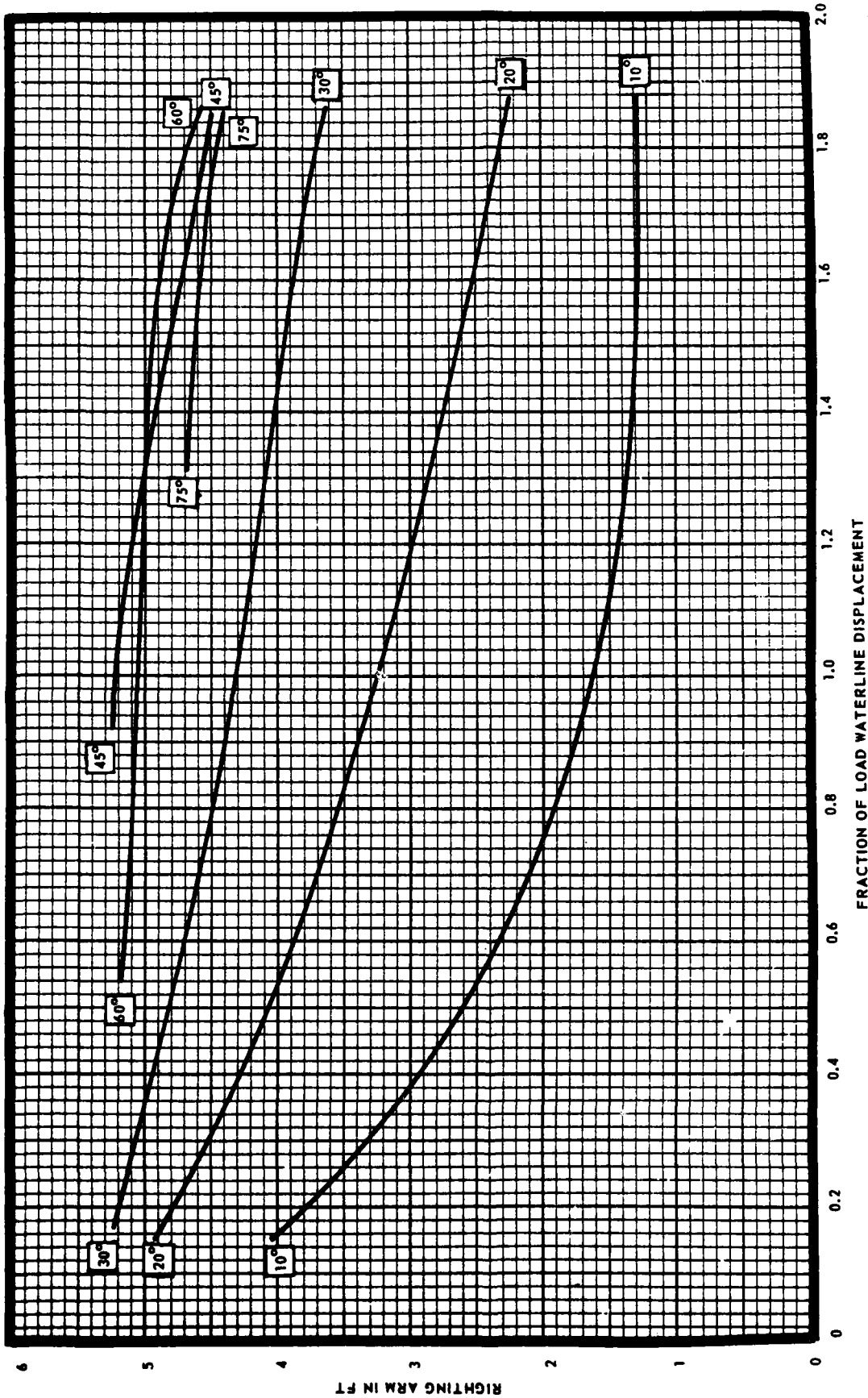

INSHORE OPERATIONS LOGISTICS PLATFORM
HULL FORM DELINEATION-CROSS CURVES OF STABILITY

50' LCM WORKBOAT

AD-A165 619

OCEAN CONSTRUCTION PLATFORM COMPENDIUM(U) NAVAL
FACILITIES ENGINEERING COMMAND WASHINGTON DC CHESAPEAKE
DIU SEP 78 CHES/NAUFAC-FFO-1-78(17)

2/2

UNCLASSIFIED

F/G 13/2

NL



END
DATE
FILMED
87

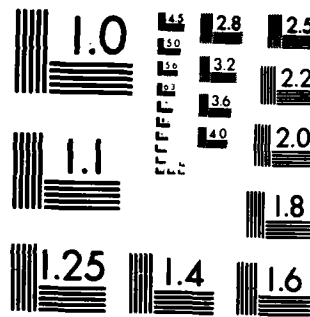

MICROCOPY RESOLUTION TEST CHART
NATIONAL BUREAU OF STANDARDS-1963 A

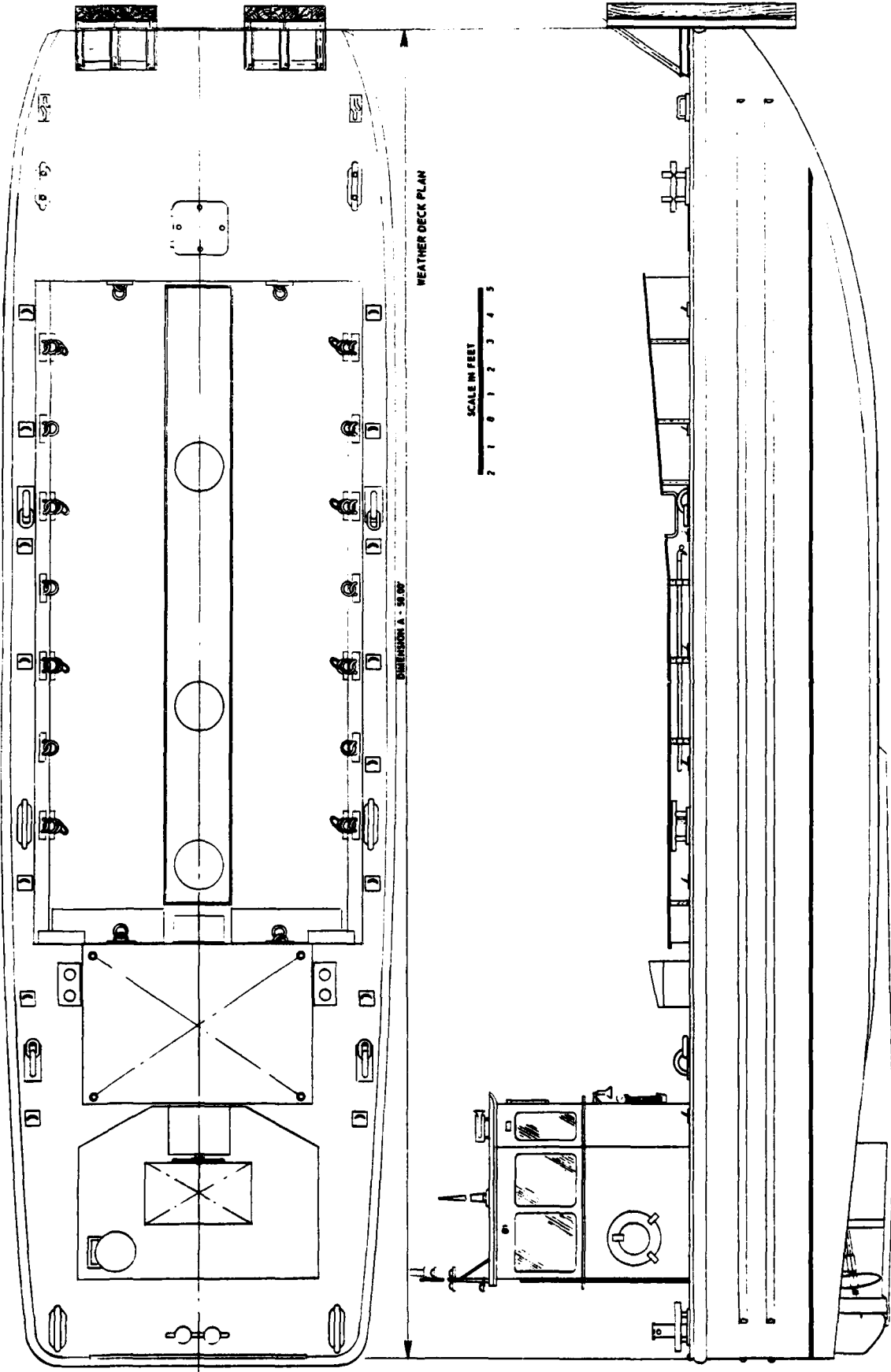

WEATHER DECK PLAN

OVERALL LENGTH: 59' 00"

SCALE IN FEET
0 1 2 3 4 5

OUTBOARD PROFILE

LCM 50' WORKBOAT
PEP DRAWING

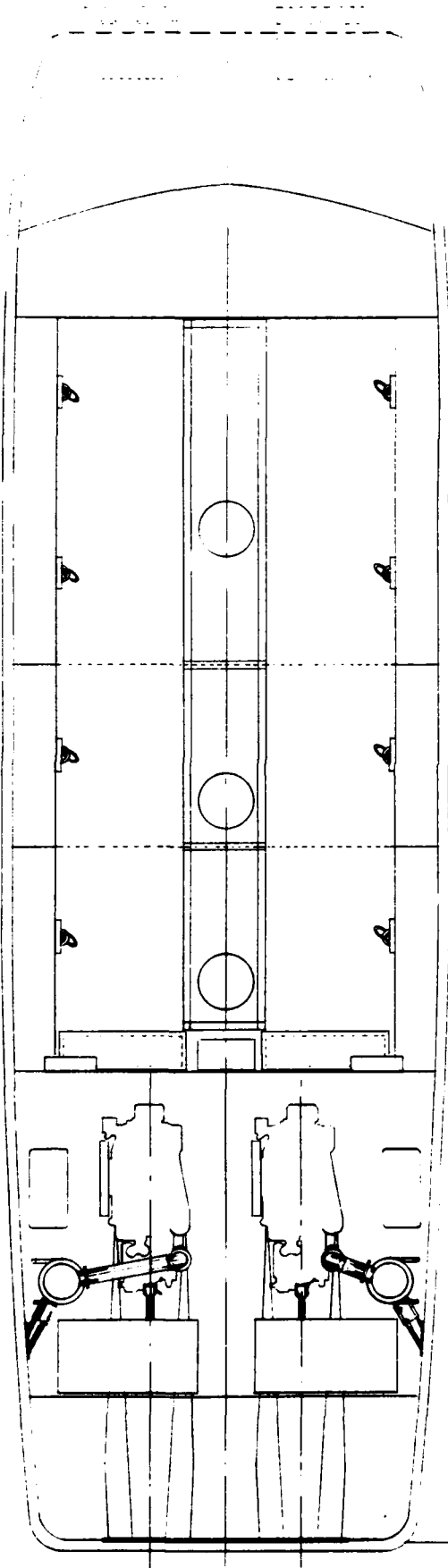

DIMENSION A-30.00'

CARGO DECK AND MACHINERY SPACE ARRANGEMENT

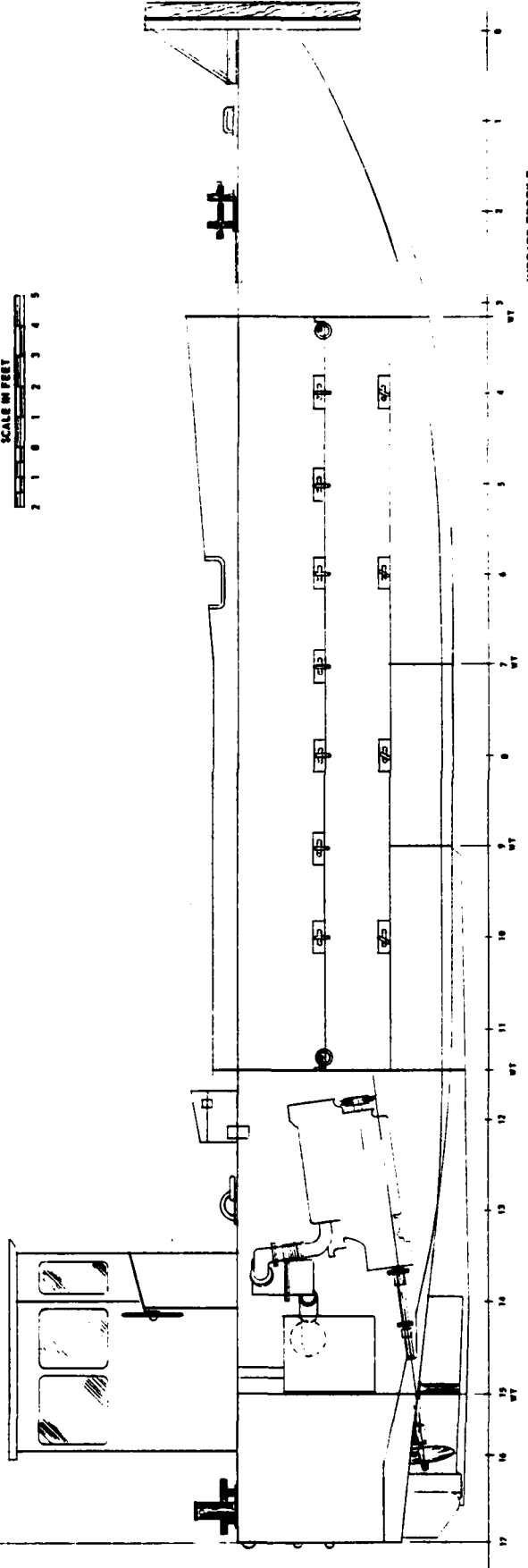

INBOARD PROFILE

95 LCA WORKBOAT
PEP DRAWING

□ GEOMETRY: THE YFRT-257 RANGE TENDER IS A CONVERTED CARGO VESSEL USED FOR LAUNCHING AND RETRIEVING TORPEDOES AT THE ATLANTIC UNDERWATER TEST AND EVALUATION CENTER (AUTEC) OFF ANDROS ISLAND IN THE BAHAMAS. THE SHIP HAS A LENGTH OVERALL, INCLUDING FENDERS, OF 132.75 FEET AND A LENGTH BETWEEN PERPENDICULARS OF 132.00 FEET. THE BEAM IS 30.00 FEET AND THE DEPTH AT SIDE AMIDSHIPS IS 12.30 FEET. A DECKHOUSE 44.00 FEET LONG BY 18.00 FEET WIDE EXTENDS AFT FROM 61.20 FEET ABOARD THE BOW; THE LONGITUDINAL CENTERLINE OF THIS MAIN DECK HOUSE IS 2.66 OFF THE SHIP CENTERLINE TO PORT. ON THE DECK ABOVE THE MAIN DECK HOUSE ARE THE PILOT HOUSE AND RADIO ROOM; THIS UPPER HOUSE STRUCTURE IS SYMMETRICAL ABOUT THE CENTERLINE AND MEASURES 17.50 FEET LONG BY 11.33 FEET WIDE.

□ HYDROSTATICS: THE RANGE TENDER IS NORMALLY TRIMMED TO AN EVEN KEEL CONDITION FOR UNDERWATER TORPEDO LAUNCHING. AT A DRAFT OF 8.00 FEET THE SHIP DISPLACES APPROXIMATELY 633 TONS SALT WATER. STATIC STABILITY IN THIS CONDITION IS ADEQUATE BUT, DUE TO ITS CONFIGURATION, THE ROLLING AND PITCHING CHARACTERISTICS LEAVE SOMETHING TO BE DESIRED. BECAUSE OF ITS RELATIVELY BROAD BEAM AND LOW CENTER OF GRAVITY, THE SHIP HAS EXCESSIVE METACENTRIC HEIGHT WHICH RESULTS IN A RELATIVELY SHORT PERIOD OF ROLL AND THUS SEA KINDLNESS SUFFERS TO SOME EXTENT.

□ STRUCTURE: THE YFRT-257 IS OF STEEL CONSTRUCTION AND IS TRANSVERSELY FRAMED WITH TWENTY-TWO FRAMES SPACED AT 6.00 FEET. AN INNER BOTTOM EXTENDS FROM THE FORE PEAK BULKHEAD TO INTO THE AFTER PEAK TANK SUBDIVIDED BY A CENTERLINE KEELSON. IN THE MIDSHIP AREA THERE ARE THREE TRANSVERSE WATERTIGHT BULKHEADS EXTENDING FROM THE KEEL TO THE MAIN DECK. AN ADDITIONAL TRANSVERSE BULKHEAD AT FRAME 4 SEPARATES THE FORWARD TRIM TANKS FROM THE POTABLE WATER TANKS. THESE BULKHEADS PROVIDE THE REQUIRED SUBDIVISION FOR A TWO-COMPARTMENT SHIP. THE MIDSHIP TRANSVERSE BULKHEADS, TOGETHER WITH A LONGITUDINAL CENTERLINE BULKHEAD, PROVIDE TWO DEEP TANKS FOR SALT WATER BALLAST AND TWO FOR DIESEL OIL. THERE ARE NO TRANSVERSE OR LONGITUDINAL BULKHEADS IN THE ENGINE ROOM AREA BUT SUPPORT FOR THE MAIN DECK IS PROVIDED BY CENTERLINE STANCHIONS RUNNING FROM THE TANK TOP TO THE MAIN DECK AT FRAMES 13, 14, 17, AND 18.

□ MACHINERY: THE TWIN SCREWS OF FOUR FOOT DIAMETER ARE EACH DRIVEN BY A GEARED DIESEL ENGINE OF AN ESTIMATED 300 HORSEPOWER. SHAFTS ARE SPACED ON 10.00 FOOT CENTERS. THE SINGLE RUDDER, ON CENTERLINE, HAS AN AREA OF ABOUT 55 SQUARE FEET AND IS DRIVEN BY A STEERING ENGINE CONTROLLED FROM THE PILOT HOUSE. ADDITIONAL MACHINERY COM-

PRISES A DIESEL GENERATOR FOR POWERING DECK MACHINERY AND A DIESEL DRIVEN AIR COMPRESSOR TO PROVIDE COMPRESSED AIR FOR LAUNCHING TORPEDOES.

□ OUTFIT: A MOTOR-DRIVEN TWO DRUM WINCH IS INSTALLED JUST FORWARD OF THE MAIN DECK HOUSE FOR HANDLING THE SINGLE BOOM FOOTED ON THE MAIN DECK HOUSE TOP; THE WINCH DRUMS CONTROL BOTH THE TOPPING LIFT AND THE HOISTING LINE. WHEN LOADING TORPEDOES FROM SHORE, OR RETRIEVING THEM FROM OVERTSIDE, THE BOOM VANGS CAN BE HANDLED MANUALLY OR THE GYPSY HEADS ON THE WINCH CAN BE UTILIZED. AN ANCHOR WINDLASS, ALSO MOTOR-DRIVEN, IS PROVIDED ON THE MAIN DECK FORWARD WITH A SPARE ANCHOR STOWED AFT OF THE MAIN DECK HOUSE. THE CHAIN LOCKER IS JUST BELOW THE ANCHOR WINDLASS AND BOATSWAIN STORES ARE CARRIED FORWARD OF THE CHAIN LOCKER ABOVE THE FORE PEAK TANK AND BELOW THE MAIN DECK. TWO SETS OF DOUBLE BITTS ARE INSTALLED PORT AND STARBOARD FOR MOORING. A 12 FOOT WHERRY IS STOWED ATOP THE MAIN DECK HOUSE ON THE STARBOARD SIDE OF THE ENGINE EXHAUST CASING; IT CAN BE MANUALLY HANDLED OVER THE SIDE BY A SINGLE SWINGING DAVIT. A RAISED HATCH, 24.00 FEET LONG BY 4.00 FEET WIDE IS FITTED IN THE MAIN DECK FORWARD OF THE WINCH FOR LOWERING TORPEDOES INTO THE FORWARD HOLD. PERSONNEL ACCESS TO THIS HOLD IS PROVIDED BY A LADDER COVERED BY A BOOBY HATCH ON THE PORT SIDE OF THE MAIN DECK FORWARD OF THE MAIN DECK HOUSE.

□ MISSION SUPPORT: AS A RANGE TENDER, THE YFRT-257 WORKS OUT OF THE AUTEC BASE ON ANDROS ISLAND AND IS NEVER MORE THAN A FEW MILES FROM SHORE. OVERNIGHT ACCOMMODATIONS THEREFORE ARE NOT REQUIRED AND THE ONLY BERTHING FACILITY IS THE CAPTAIN'S STATEROOM. HOWEVER, A GALLEY, MESSROOM, WARDROOM, AND WR AND WC FACILITIES ARE PROVIDED FOR THE DAY CREWS WORKING ABOARD. THE PRIMARY MISSION ACTIVITY IS THE LAUNCHING OF TORPEDOES OF VARIOUS DESIGNS AND SIZES TO CHECK THEIR ACOUSTIC SIGNATURES AND ACOUSTIC HOMING CAPABILITIES ON THE AUTEC RANGE. THE PLATFORM HAS BEEN FITTED FOR THIS PURPOSE WITH AN AW TORPEDO TUBE, MK25 MOD 0, TWO SURFACE SHIP TORPEDO LAUNCHERS FOR MK32 TORPEDOES, AND A RACK FOR MK44/46 TORPEDOES ON THE MAIN DECK. PROVISION HAS BEEN MADE FOR UNDERWATER LAUNCHING OF TORPEDOES THROUGH A 30 INCH RAM CATAPULT TORPEDO TUBE IN THE BOW, PORT SIDE, AND A SECOND BOW TUBE HAS BEEN DESIGNED INTO THE SHIP ON THE STARBOARD SIDE. A TRACK ALONG THE MAIN DECK, PORT, IS PROVIDED FOR A TORPEDO HANDLING DOLLY FOR RUNNING MK25 TORPEDOES FROM THE FORWARD STORAGE TO THE LAUNCHER AFT.

SEAGOING WORK PLATFORM
PHYSICAL AND PERFORMANCE CHARACTERISTICS

YFRT-257: RANGE TENDER (AUTEC)

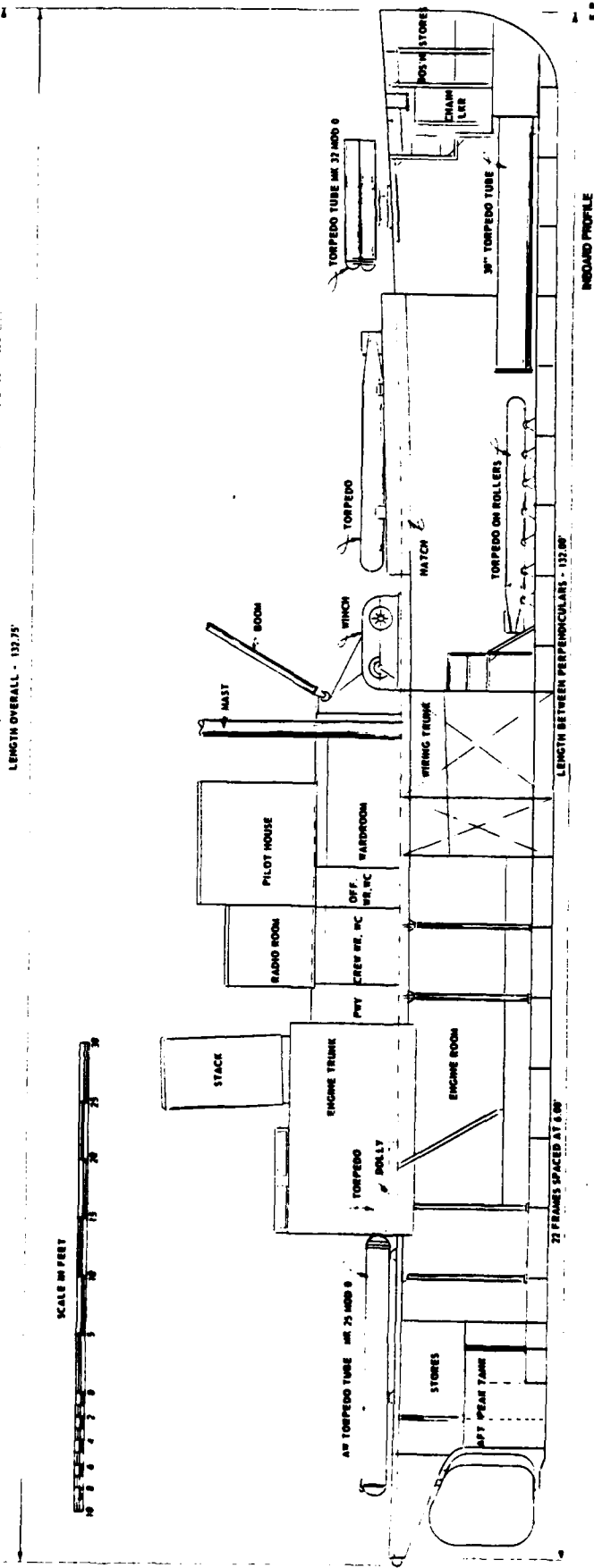
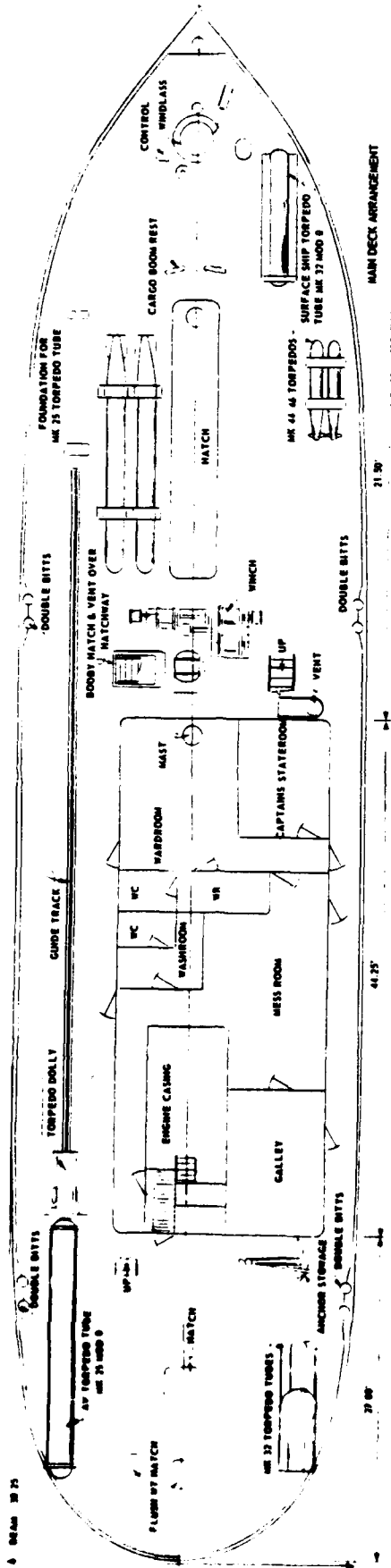

SEAGOING WORK PLATFORM
 OVERALL GEOMETRY
 YFRT - 257: RANGE TENDER (AUTEC)

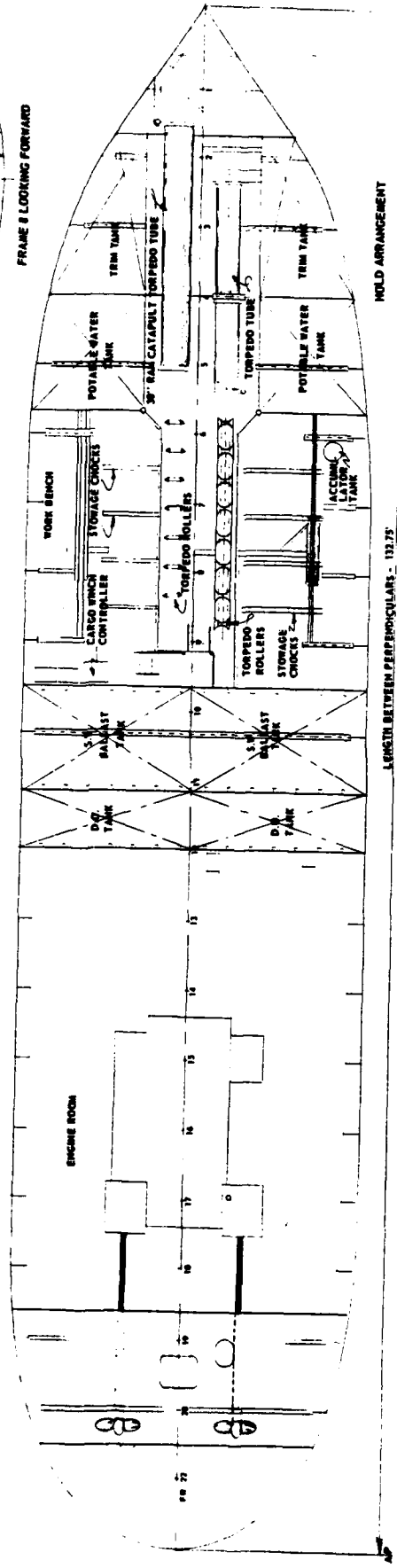
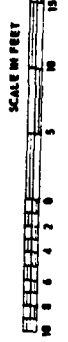
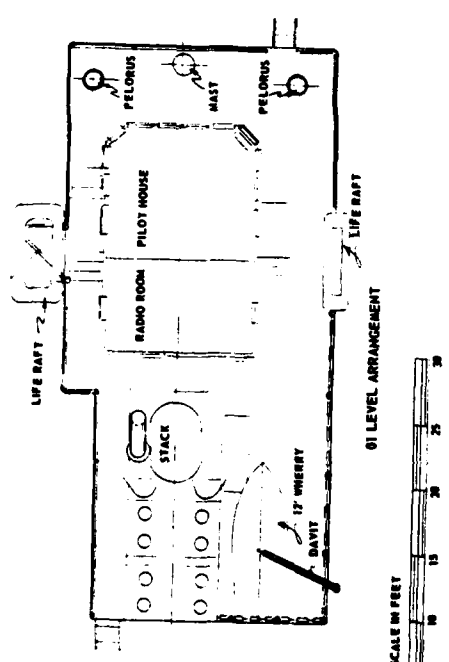
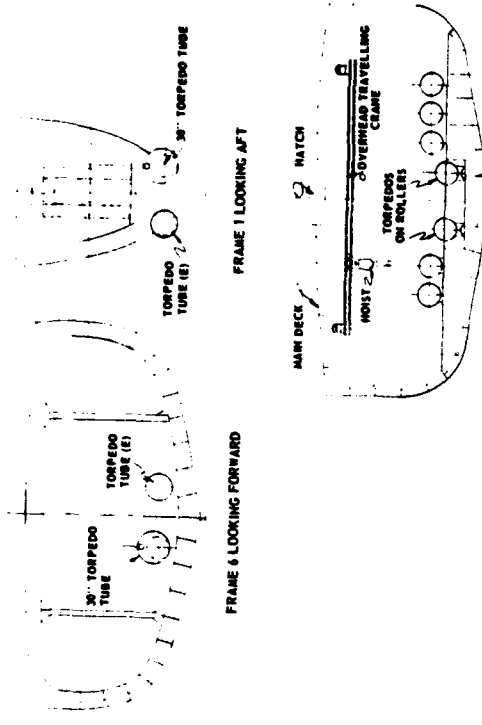

SEAGOING WORK PLATFORM
INTERNAL ARRANGEMENTS

YFRT - 257: RANGE TENDER (AUTEC)

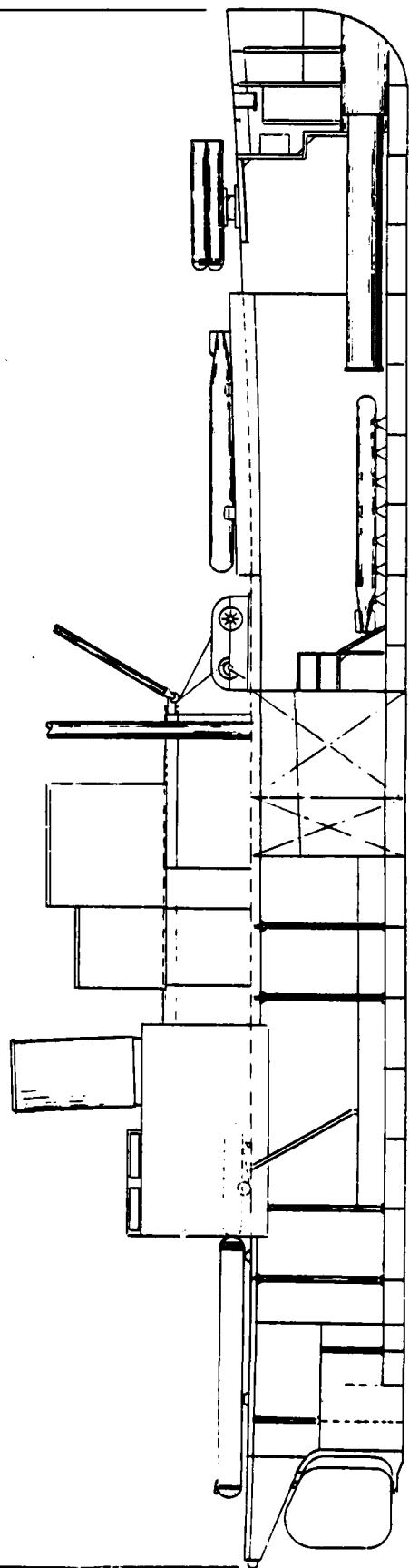
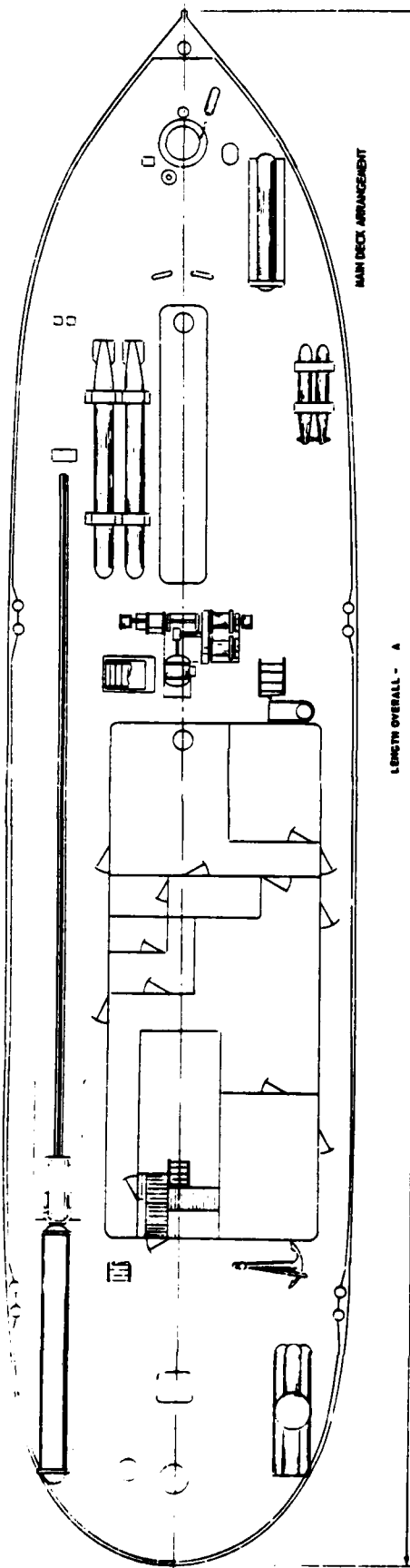

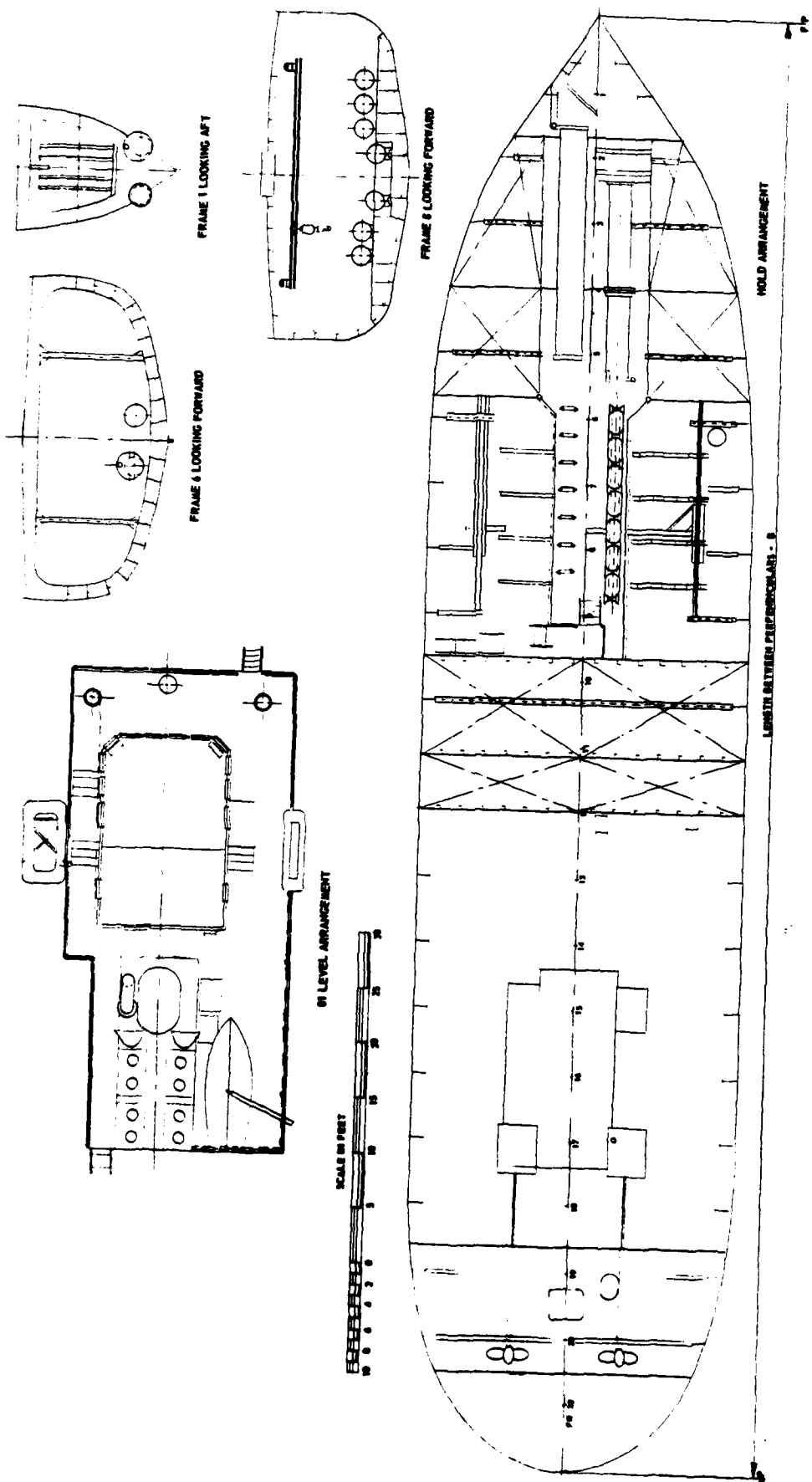

YPR1.251
 PEP DRAWING

DATE
FILMED
-88