

MICROCOPY RESOLUTION TEST CHART
NATIONAL BUREAU OF STANDARDS-1963-A

12

UNCLASSIFIED

RANRL-TM-(EXT)-7/85

AR NUMBER: AR-003-431



AD-A164 585

DEPARTMENT OF DEFENCE
DEFENCE SCIENCE AND TECHNOLOGY ORGANISATION
WEAPONS SYSTEMS RESEARCH LABORATORY

R.A.N. RESEARCH LABORATORY

**RANRL TECHNICAL MEMORANDUM
(EXTERNAL) No. 7/85**

DATA REPORT FOR RANRL OCEANOGRAPHIC CRUISE No. 23/83
(MAY/JUNE 1983 - EAST INDIAN OCEAN)

THE UNITED STATES NATIONAL
TECHNICAL INFORMATION SERVICE
IS AUTHORISED TO
REPRODUCE AND SELL THIS REPORT

**DTIC
ELECTE
FEB 19 1986**

*Original contains color
plates: All DTIC reproductions
will be in black and
white*

by

L.J. HAMILTON

DTIC FILE COPY

Technical Memoranda are of a tentative nature, representing the views of the author(s),
and do not necessarily carry the authority of the Laboratory.

APPROVED FOR PUBLIC RELEASE

COPY No:

Commonwealth of Australia
MAY 1985

UNCLASSIFIED

86 2 18 184

UNCLASSIFIED

RANRL-TM-(EXT)-7/85

(i)

AR-003-431

DEPARTMENT OF DEFENCE
DEFENCE SCIENCE AND TECHNOLOGY ORGANISATION
WEAPONS SYSTEMS RESEARCH LABORATORY
RAN RESEARCH LABORATORY



© Commonwealth of Australia 1985

RANRL TECHNICAL MEMORANDUM (EXTERNAL) NO. 7/85

DATA REPORT FOR RANRL OCEANOGRAPHIC CRUISE No. 23/83
(May/June 1983 - East Indian Ocean)

L.J. HAMILTON



ABSTRACT

Data from eighteen Nansen stations to 1500 metres taken from HMAS COOK on RANRL Cruise No. 23/83 in the eastern Indian Ocean in May-June 1983 are presented as tables and graphs. Temperature-depth cross-sections from XBT data are also included, both for HMAS COOK and other vessels. Geostrophic current values are given and some routine data analysis made. Several very broad scale contour plots are drawn, assuming data to be quasi-synoptic, and some brief comparisons made with satellite imagery.

Technical memoranda are of a tentative nature, represent the views of the Author(s), and do not necessarily carry the authority of the Laboratory.

POSTAL ADDRESS: The Superintendent, MARITIME SYSTEMS DIVISION, WSRL
RAN Research Laboratory
PO Box 706, DARLINGHURST NSW 2010

UNCLASSIFIED

DATA REPORT FOR RANRL CRUISE NO. 23/83
(ON HMAS COOK FOR 23 MAY TO 15 JUNE 1983)

	<u>Page No.</u>
INDEX	
1. INTRODUCTION	2
2. THE DATA	3
3. MEASUREMENT PROCEDURES AND METHODS OF CALCULATING DERIVED QUANTITIES	4
4. RESULTS	5
4.1 SEA SURFACE TEMPERATURE (SST)	5
4.2 SEA SURFACE SALINITY	5
4.3 TEMPERATURE AT 250 METRES DEPTH (T250)	6
4.4 MIXED LAYER DEPTH (MLD)	6
4.5 TEMPERATURE DEPTH CROSS SECTIONS	7
4.6 SURFACE CIRCULATION	11
4.7 WATER MASS TYPES	12
4.8 SATELLITE IMAGERY	15
5. SUMMARY AND REMARKS	17
ACKNOWLEDGMENTS	18
REFERENCES	19
LIST OF FIGURES	21
LIST OF TABLES	22
FIGURES 1 to 44	
TABLES I to XXXVII	
	Note: All tables are on left hand side and figures on the right hand side of the opened document.
DISTRIBUTION	At rear
DOCUMENT CONTROL DATA SHEET	At rear

1. INTRODUCTION

The principal function of this document is to present Nansen station data obtained during RANRL cruise 23/83 on HMAS COOK in the Indian Ocean from Perth to Darwin from 23 May to 17 June 1983, the inaugural oceanographic cruise of HMAS COOK. Temperature-depth cross-sections obtained from expendable bathy-thermograph (XBT) are also given, and some first look data analysis made. Several very broad scale contour plots of parameters are made and briefly compared to satellite imagery.

Data from magnetometer survey and coring will be published by other institutions. About the time of the cruise five other vessels were transiting the area, giving a unique opportunity for wide quasi-synoptic data coverage. These other vessels were HMAS CANBERRA, MORESBY, SWAN, TURRENS, and the CSIRO vessel FRV SOELA. For details of the actual cruise and other information such as coring see the cruise report (Scott, 1983). Further details on the FRV SOELA cruises may be found in the CSIRO summaries for cruises S03/83, leg 1 (Stevens, 1983) and leg 2 (Leech, 1983).

The cruise track for RANRL 23/83 is shown in Fig. 16. Station positions and waypoints are listed in Table XIX with Nansen stations being identified by both letters and numbers. Cruise tracks for the other vessels in the area are shown in Fig. 17(a). The dates of the cruises are shown pictorially in Fig. 17(b) for weekly intervals of cruise track.

A list of figures is provided on page 21, and a list of tables on page 22. Figures and tables are placed after page 22, with all tables on the left hand side and all figures on the right hand side of the opened document.

Distribution /	
Availability Codes	
Dist	Avail and/or Special
A-1	

2. THE DATA

Eighteen Nansen stations were taken in all, with sampling for temperature and salinity to 1500 metres depth. Listings of the temperature, salinity, depth data and derived quantities such as density of specific volume, potential temperature and sound-speed for the stations are given in Tables I to XVIII of this report for both observed and standard depths. A list of tables is given on page 22. A composite T-S (temperature vs salinity) plot is shown in Fig. 18. Profiles of temperature, salinity, sigma-t (σ_T), and sound-speed for stations 1 to 15 are given in Figs 1 to 15. (The four parameters for each station are overplotted). Temperature-depth cross-sections obtained from XBT data are given in Figs 19 to 29. See the List of Figures on page 21 for details.

Geostrophic current components between selected pairs of stations are given in Tables XXIII to XXXVII. The currents are given relative to the surface. Current profiles are also shown with the tables.

Contour diagrams of sea-surface-temperature (SST), surface salinity, temperature field at 250 metres depth (T250), and inferred surface circulation are given in Figs 30 to 41. Note that all diagrams are of a somewhat speculative nature, as data spacing is often sparse, and was obtained over the period May 23 to June 23 (and June 30). (See Fig. 17(b) for cruise times).

Examples of satellite imagery available for the cruise period are shown in Figs 43 and 44.

3. MEASUREMENT PROCEDURES AND METHODS OF CALCULATING DERIVED QUANTITIES

The Nansen stations were taken using standard procedures described in US Naval Oceanographic Office Publication No. 607 "Instruction Manual for Obtaining Oceanographic Data" using Nansen type sampler bottles and Watanabe-Keiki protected and unprotected deep sea reversing thermometers (DSRT), range 0-30°C. Conductivities of seawater samples were measured using an inductive salinometer.

DSRT temperatures were processed and reversal depths calculated using program TCOR described in Hamilton (1982). Derived quantities such as potential temperature and dynamic height were calculated using program HYDR described in the same memorandum. A check list is given in Table XX of references to the algorithms used in the programs.

4. RESULTS

4.1 Sea Surface Temperature (SST) (See Figs 30, 38)

SST contours have been drawn as if all data were synoptic.

Frontal structure is evident from 21°S, 103°E to Fremantle, with contours becoming parallel to the coast. There are warmer patches at 15°S, 120°E and 13°S, 115°E. Relatively colder water occurs to the west and south of Sumba. Little thermal relief is seen for the area north and north-west of Broome. Fig. 30 may be compared with Fig. 5 of Rochford (1962), where the locations of colder northern waters and a 28°C patch are similar to those found here. The tendency for SST to vary little in the north is supported by GOSSTCOMP SST charts for the same period. See Figs 31 to 34. Cooler water off the Port Hedland area is also seen on the GOSSTCOMP charts at 25°C. Fig. 38 shows more detail from Port Hedland to south of Sumba. Section 4.8 discusses satellite imagery available for the area.

4.2 Sea Surface Salinity (See Fig. 35)

Data is available from HMAS COOK only at Nansen station sites. Further data was obtained in the Port Hedland area by FRV SOELA. A front occurs between stations I and M. The frontal structure seen in SST from Fremantle to 21°S, 103°E is also seen in the salinity. Highest surface salinity (35.91 ppt) occurs at station F and the lowest (34.13 ppt) south of Sumba at stations X and CC, (with salinity then increasing shorewards). For the few data points available surface salinity tends to show the same pattern as SST. Fig. 35 may be compared to Fig. 3 of Rochford (1962).

4.3 Temperature at 250 Metres Depth (T250) (See Figs 37,40)

Frontal structure is seen from 21°S, 103°E to Fremantle, similar to the SST structure of Fig. 30. Warmer water is seen north-west of Geraldton, suggesting eddy or meander structure. Also see Fig. 19, a temperature depth cross-section where this eddy feature is seen at XBT 395; and Fig. 20 (XBT 68, 69). Fig. 40 for the North West Shelf area to Sumba shows a warmer area about 13-14°S, 119-120°E.

4.4 Mixed Layer Depth (MLD) (See Figs 36, 39)

Mixed layers were generally seen over the whole of the HMAS COOK cruise track, ranging from about 50 to 90 metres depth. The area south of station CC however, (south of colder water below Sumba) had zero layer depth. From station FF to shore mixed layers extended to the bottom. MLD of 5 metres or less are also seen between stations 11 and 14 (on the edge of the North West shelf, a possible upwelling region). Fig. 39 shows more detail from Port Hedland to south of Sumba.

4.5 Temperature - Depth Cross Sections (See Figs 19 to 29)

Cross sections are shown for all cruise tracks in Fig. 17, other than for HMAS COOK, where only selected sections have been drawn. Brief comments on the sections are given below. Stippling on the diagrams show the depth of the mixed layer.

HMAS CANBERRA (See Fig.19)

An eddy-type feature is located at XBT 395. Isotherms slope down from XBT 396 to 398 indicating a southwards flowing current to depths below 300 metres. The slope of isotherms between XBT 377 and 378 indicates flow to the east.

HMAS COOK (See Figs 20, 21, 22, 23, 24)

Fig. 20

XBT 68, 69 show the eddy formation seen in HMAS CANBERRA cross-section. The surface front seen in Fig. 30 for SST between F and G is seen to be a sub-surface feature also with colder water at F. XBT 61 to 64 show a current flowing to the south-west (or south) to depths greater than 270 metres, with the feature skewing seawards and showing a return component below 270 metres.

The section from M to N shows warmer surface waters with isotherms generally depressed by up to 50 metres more than section G to H (or E to H) at all depths, indicating warmer waters at all depths, in agreement with the trends of SST contours in Fig. 30.

Fig. 21

Isotherms from XBT 108 to 112 indicate a current flowing to the south-east. XBT 113 shows depressed isotherms to 225 metres, then elevated isotherms below this depth, at the edge of the shelf, indicating a possible different flow regime between surface and deeper waters. This may be an indication of the undercurrent reported by Thompson and Cresswell (1983).

Fig. 22

Isotherms deepen shorewards (50-60 metres over 240 nm) indicating a flow to the southwest (between O and P) and to the west (Port Hedland to U) on the average.

XBT 133 indicates a cold core feature and XBT 124 indicates flow at the depth of the shelf break.

MLD are generally 60 to 70 metres depth on this section.

Fig. 23

Isotherms deepen southwards (by 30-40 metres over 240 nm) indicating a flow to the south-west, otherwise the section is largely featureless. MLD deepen slightly from 70 to 90m from XBT 186 to XBT 174 but are shallow from XBT 189 to 187.

Fig. 24

Between station CC and XBT 232 a current to the south-west is indicated to about 200 metres depth, below which the flow may reverse, with the 15°C isotherm appearing as a boundary. About XBT 247 a flow with return is indicated below 100 metres off the shelf break. Colder surface water is seen at XBT 249, separating two surface bodies of roughly equal temperature, both well mixed to 90 metres or to the bottom in waters shallower than 90 metres near the coast.

HMAS MORESBY (See Figs 25, 26, 27)

Fig. 25

This is a detailed section from $31^{\circ}30'S$, $115^{\circ}E$ to $30^{\circ}42'S$, $114^{\circ}E$. Warm surface waters to 70 metres and deeper are seen at XBT 45. The warm waters lie on the edge of a cold feature about XBT 48. Isotherms are elevated from XBT 49 to 47 above 200 metres, but depressed below that depth. Isotherms are depressed from XBT 48 to 43 above 200 metres, (190 metres over 35 nm) indicating flow to the south-west above that depth. XBT 48 would therefore appear to be the boundary of warm surface waters flowing south-west and cold surface water flowing north-east.

MLD are shallow in the cold-core feature, and deepen shorewards to 150 metres. MLD are also shallow in the frontal zone about XBT 45, which appears as a shallow excursion of warm water.

Fig. 26

Depressed isotherms from XBT 54 to 53 indicate a current flowing to the south-west. At XBT 57 there is some suggestion of the eddy feature seen by HMAS COOK and CANBERRA but the XBT are of doubtful quality. The surface front between XBT 61 and 62 is shown not to extend as markedly with depth as on the section for HMAS COOK which is farther south. Isotherms below 150 metres generally shallow to the north from XBT 66 to 80, i.e. waters at depth get colder to the north along this section.

Rochford (1969) p5 attributes this shallowing of isotherms to dynamic uplift caused by the dynamic northern boundary of the South Equatorial current, which flows to the west.

Fig. 27

This shows a section from Cocos Island to Western Java and return. Surface waters exhibit temperatures over 29°C. MLD range from 15 to 70 metres, being about 50 metres on the average.

HMAS SWAN (See Fig. 28)

From northwest of Broome to south of Lombok Island isotherms become shallower, as also seen on the HMAS MORESBY section, indicating a general flow to the south-west. An eddy feature is located about XBT 115 and 116, with colder surface waters about XBT 113. The eddy feature also appears situated about XBT 395 of HMAS CANBERRA.

MLD range from 50 to 100 metres.

HMAS TURRENS (See Fig. 29)

Isotherms shallow northwards from XBT 310 to 299, indicating a general flow to the west. Structure between XBT 313 to 314 suggests flow into the coast.

4.6 SURFACE CIRCULATION

There is insufficient data to properly resolve circulation patterns.

A speculative diagram of the surface circulation patterns suggested by dynamic height values and XBT data is given in Fig. 41. The geostrophic current component relative to 1000 metres at right angles between stations for stations 1 to 6 ranged from 3 to 10 cm/sec (between stations 1 and 6, and 4 and 5 respectively.) For stations 7 to 15 components from 11 to 17 cm/sec were calculated. The South Equatorial Current is apparently seen as a flow to the west below the north-most station. XBT may show indications of the south Java current. (see Fig. 19, XBT 377-378). There appears to be an eddy or meander feature west of Geraldton, and flow into coastal areas from North West Cape to north of Geraldton.

Tables XXIII to XXXVII give geostrophic current component between pairs of stations for selected station pairs relative to the surface. Geostrophic current profiles are also shown.

4.7 WATER MASSES

Water masses in the survey area are tentatively identified using temperature-salinity curves, profiles of parameters with depth, and salinity and temperature cross-sections, using the definitions of previous researchers.

Principal water masses found were South Indian Central, Antarctic Intermediate, Banda Intermediate, with various surface waters. The characteristics of water masses in the Indian Ocean as described by Rochford are given in Table XXI and XXII. The reader is also referred to Rochford (1961) Figs 2, 19; (1962), Fig.17; (1964) Figs 4, 5 for T-S curves, and the positions of hydrological zones.

Fig. 18 shows the T-S curves for RANRL cruise 23/83, and water mass extents (after Rochford). The numbers (1) to (6) are identified in Table XXI. Several water masses are clearly identified with clarification needed at points marked * on the diagram. The northern and southern stations lie in different T-S regimes above 500 metres depth. More positive identification of some water masses thought to be present is not possible without oxygen or other information.

Fig. 42 is a salinity cross-section with data from Nansen stations 1, 2, 4 and 5 showing South Indian Central (SIC) and Antarctic Intermediate water (AIW) masses along the southern leg of the HMAS COOK cruise. SIC water appears as a salinity maximum from the surface to 125 metres and deeper, and AIW as a salinity minimum along 900 metres depth.

The marked surface salinity front between stations 4 and 5 seen earlier in Fig. 3b is seen to be caused by subtropical SIC water underlying less saline surface water.

Correspondences between salinity and temperature cross-sections may be seen in the data. The cold surface water at F in Fig. 20 is seen in Fig. 42 to correspond to high salinity water (35.91 ppt) of the SIC as does the separation of the 21°C and 22°C isotherms about 100 metres depth at E. Lower salinity waters south of Sumba also have lower temperature than waters closer to north-west Australia.

Profiles of salinity, temperature, and sigma-t also show characteristics pointing to water masses. Figs 1, 2, and 4 (for stations 1, 2 and 4) show a shift to lower density at 600, 650, and 700 metres, which in Fig. 1 and 2 (for stations 1 and 2) and possibly station 4 is caused by elevated temperature (up to 2°C) at these depths. From Rochford (1964) page 47 the kink in stations 1, 2 and 4 may be caused by low salinity waters of the subtropical oxygen maximum drifting north on about the 26.80 sigma-t surface.

The T-S curves show the surface waters at stations 5 and 6 to have the same characteristics as the surface waters for stations northwest of Broome (except for stations 12 and 13) indicating a possible spread of this water to the south-west as far west as 103°E. There is no station data from the cruise between the two areas to confirm or deny this possibility, but it fits with Rochford (1969) who observed a drift of higher temperature, low salinity water to the south and southwest in May (his Fig. 47).

Fig. 6 shows a sub-surface salinity maximum of 35.84 ppt indicating a northward flow of SIC water intruding station 6 water between a depth of 100 to 300 metres. This sub-surface salinity maximum is also seen in stations 1, 3, 4 and 5 with values in ppt being 35.91 (130m), 35.86 (150m), 35.83 (150m), and 35.76 (195m). The SIC occurs on the surface at station 2. This appears consistent with observations by Rochford (1969) (his Fig.13).

Stations 11 to 15 (Figs 11-15) have the same water type at depth below about 100-200 metres, with salinity varying little below 200 to 300 metres. Stations 7, 8, 9 show a salinity maximum at 200 metres of 34.78, 34.70 and 34.66 ppt with sigma-t of 25.33, 25.86, and 25.67 respectively. These sigma-t values are consistent with Rochford's definition of the tropical oxygen minimum (3), but the maximum may also be the influence of some other water type. A salinity maximum of 34.84 ppt occurs at 300 metres depth at station 10.

4.8 SATELLITE IMAGERY

Imagery is available from two sources

- (i) a low resolution image from Macquarie University encompassing the whole of Australia
- (ii) colour images of the West Australian area from the western Australian Institute of Technology (WAIT). WAIT images are presented here for information in Fig. 43.

The WAIT images shown are the copies held at RANRL only and images for other times may exist which would enable the build-up of a composite image over the cruise dates. Features traced from selected Macquarie images are shown as a time series in Fig. 44. Heavier shading shows warmer waters.

The images do not cover all areas of the HMAS COOK cruise track, and in general the data coverage obtained on the cruise is too sparse to permit detailed comparisons of the satellite images and ship data.

Correspondences can be seen, however, with warm water flowing polewards along the coast south of North West Cape to below 30°S in the Macquarie images of May 19 and 25 being seen in the general shape of the 24°C isotherm in Fig. 30. The image for June 13 also shows this feature with the water clearly joined to waters on the North West Shelf.

The 28°C patch north of Port Hedland in Fig. 30 is seen as part of a body of warmer water off the coast extending from north of Darwin (130°E) to about 118°E in the Macquarie image for May 30, and the image for May 31 shows a warm patch in this location, as does the image for June 21. In

almost all Macquarie images there is a band of cold water along the coast from North West Cape (113°E) to Broome, evidence of which is seen in the temperature data in this area from FRV SOELA, and in HMAS COOK engine room inlet temperatures.

The available satellite imagery is useful in complementing the ship data. With further enhancement more features could perhaps be brought out for more detailed analysis.

5. SUMMARY AND REMARKS

This was essentially a workup cruise for HMAS COOK, and problems were had with equipment. The ship thermo-salinograph did not function, resulting in the loss of continuous surface salinity and temperature records. Near surface temperature readings recorded from a hull mounted sensor were found to be unreliable because of flow stoppages leading to overheating. The hydrology winch meter was found to be giving incorrect readings. Lack of the HMAS COOK data logger resulted in loss of continuous records for meteorological parameters. The ship salinometer was found to be unserviceable so that salinity samples could not be analysed on board during the cruise as planned. These problems are described in the cruise report (Scott, 1983).

Despite these teething problems, useful oceanographic data was obtained over a wide area off the West Australian coast, which when combined with the data from other sources for the cruise period will add to the oceanographic data base for the region.

Broad scale analyses of the data have been made here in the forms of contour plots of temperatures, salinity, and surface circulation, and temperature and salinity cross sections with depth. Geostrophic currents were less than one third of a knot. Some oceanographic features have been identified but most analysis is of a highly speculative nature because data is not truly synoptic nor of high spatial density. A preliminary comparison of ship data with satellite imagery shows some correspondence of features.

ACKNOWLEDGMENTS

Mr S. Gay and G. Hopwood from the University of Sydney assisted in on-board processing of temperature data. The Australian Oceanographic Data Centre made available for analysis XBT traces from naval vessels. Data from FRV SUELA cruises were supplied by Mr G. Leech of CSIRO. Satellite imagery was supplied by Dr D. Myers, Western Australian Institute of Technology. This additional input has greatly increased the data return for the cruise period. The report was written at the request of Mr B. Scott, cruise leader and planner, of Ocean Sciences Group RANRL.

REFERENCES

- Bryden, H.L. (1973). New polynomials for thermal expansion, adiabatic temperature gradient and potential temperature of sea water. *Deep-Sea Res.*, 20, 401-408.
- Hamilton L.J. (1982). RANRL Technical Memorandum (Internal) No. 9/82 RANRL Oceanographic Station Computing Programs for Desktop Computer Usage (U). Unpublished document.
- Leech, G. (1983). FRV 'SOELA' Cruise Summary S03/83 (Leg 2) CSIRO Marine Laboratories
- Lewis, E.L. (1980). The Practical Salinity Scale and Its Antecedents *IEEE Journal of Oceanic Engineering*, Vol OE-5, No. 1, January 1980.
- Millero, J.M. and Poisson, A. (1981). International One-atmosphere Equation of Sea-water. *Deep-Sea Research*. Vol. 28 A No. 6. pp 625-629. (Errata - *Deep-Sea Research* (1982) Vol. 29, No. 2A, pp 284).
- Millero, J., Chen C., Bradshaw, A., Schleicher, K. (1980). A New High Pressure Equation of State for Sea-water. *Deep-Sea Research*, Vol. 27A, pp 255-264.
- Rochford, D.J. (1961). Hydrology of the Indian Ocean. I. The water masses in intermediate depths of the south-east Indian Ocean. *Aust. J. mar. Freshwat. Res.* 12, 129-49.
- Rochford, D.J. (1962). Hydrology of the Indian Ocean. II. The surface waters of the south-east Indian Ocean and Arafura Sea in the spring and summer. *Aust. J. mar. Freshwat. Res.* 13, 226-51.
- Rochford, D.J. (1964). Hydrology of the Indian Ocean. III. Water masses of the upper 500 metres of the south-east Indian Ocean. *Aust. J. mar. Freshwat. Res.* 15, 25-55.
- Rochford, D.J. (1969). Seasonal variations in the Indian Ocean along 110°E, I: hydrological structure of the upper 500 metres. *Aust. J. mar. Freshwat. Res.* 20, 1-50.
- Saunders, P.M. (1981). Practical Conversion of Pressure to Depth. *Journal of Physical Oceanography*, Vol. 11, pp 573-574.
- Scott, B.D. (1983). Cruise Report for HMAS COOK. RANRL Cruise 23/83. 23 May-17 June 1983. RAN Research Laboratory Oceanographic Cruise Report.
- Stevens, J. (1983). FRV 'Soela' Cruise Summary S03/83 (Leg 1) CSIRO Marine Laboratories.
- Sverdrup, H.U. (1947). Note on the Correction of Reversing Thermometers. *Journal of Marine Research*, Vol. 6, No. 2, pp 136-138.
- Thompson, R.O.R.Y and Cresswell, G.R. (1983). The Leeuwin Current and Undercurrent. *Tropical Ocean-Atmosphere Newsletter*, No. 19, 10-11.

Wilson, W.D. (1960). Equation for the Speed of Sound in Sea-water.
Journal of the Acoustical Society of America, Vol. 32, No. 10
pp 1357.

Wüst, G. (1933). Thermometric Measurement of Depth. Hydrog. Rev. 10(1) :
28-49.

LIST OF FIGURES

- Fig. 1 to 15 Profiles of Density (σ_t), Salinity, Sound Speed, and Temperature with Depth for Station 1 to Station 15.
- Fig. 16 Cruise Track. HMAS COOK. Cruise RANRL 23/83.
- Fig. 17(a) Cruise Tracks of Vessels in the Indian Ocean for May-June 1983.
- Fig. 17(b) Cruise Dates in Weekly Intervals.
- Fig. 18 T-S Curves and Water Masses.
- Fig. 19-29 XBT Cross Sections.
- Fig. 19 XBT Cross Section HMAS CANBERRA 05-09 June 1983
- Fig. 20 RANRL 23/83 23-27 May, 30 May - 1 June
- Fig. 21 RANRL 23/83 01-02 June 1983
- Fig. 22 RANRL 23/83 07-08 June 1983
- Fig. 23 RANRL 23/83 10-11 June 1983
- Fig. 24 RANRL 23/83 13-14 June 1983
- Fig. 25 HMAS MORESBY 1315-1800 GMT 22 May 1983
- Fig. 26 HMAS MORESBY 01-06 June 1983
- Fig. 27 HMAS MORESBY 20-22 and 28-30 June 1983
- Fig. 28 HMAS SWAN 31 May - 08 June 1983
- Fig. 29 HMAS TORRENS 30 May - 03 June 1983
- Fig. 30 Sea Surface Temperature Contours (drawn from XBT data)
- Fig. 31 GOSSTCOMP SST 07 June 1983 20-65°S, 90-140°E
- Fig. 32 GOSSTCOMP SST 07 June 1983 10°N-25°S, 90-140°E
- Fig. 33 GOSSTCOMP SST 14 June 1983 20-65°S, 90-140°E
- Fig. 34 GOSSTCOMP SST 14 June 1983 10°N-25°S, 90-140°E
- Fig. 35 Surface Salinity
- Fig. 36 Mixed Layer Depth (MLD)(from XBT data)
- Fig. 37 T250 (Temperature Field at 250 Metres Depth) (from XBT data)
- Fig. 38 SST North West Shelf Area to Sumba (from XBT data)
- Fig. 39 MLD North West Shelf Area to Sumba (from XBT data)
- Fig. 40 T250 North West Shelf Area to Sumba (from XBT data)
- Fig. 41 Surface Circulation Patterns
- Fig. 42 Salinity Depth Cross Sections RANRL 23/83 Station 1 to Station 5
- Fig. 43 Satellite Imagery (Western Australian Institute of Technology)
- Fig. 44(a)-(h) Satellite Imagery (Macquarie University)

LIST OF TABLES

Tables I to XVIII	Nansen Station Data for Stations 1 to 18
Table XIX	List of Waypoints and Station Positions
Table XX	References to Algorithms used to Process Station Data
Table XXI	Water Masses of the Upper 500 Metres of the Indian Ocean (Rochford, 1969)
Table XXII	The Water Masses in the Intermediate Depths of the South-East Indian Ocean (Rochford, 1961).
Tables XXIII - XXXVII	Geostrophic Current Component between Selected Station Pairs

<u>Table</u>	<u>Stations</u>
XXIII	1 - 2
XXIV	2 - 4
XXV	4 - 5
XXVI	4 - 6
XXVII	2 - 6
XXVIII	7 - 8
XXIX	7 - 9
XXX	8 - 10
XXXI	9 - 10
XXXII	10 - 11
XXXIII	9 - 11
XXXIV	10 - 12
XXXV	11 - 12
XXXVI	12 - 13
XXXVII	14 - 15

114110m 1
DATE= 24/05/1983

29.175 113.06E
TIME= 1350GMT

RANRL 23/83
SONIC DEPTH= 9999

DEPTH m	TEMP °C	SALINITY Ppt	SIGMA-T	A.S.V CL/T	OX ML/L	POT.TEMP °C	S.S M/Sec	Dyn.m
0	23.04	35.69	24.445	347.5	0.00	23.04	1530.9	
5	22.36	35.71	24.673	328.3	0.00	22.29	1530.1	
10	21.02	35.91	25.184	282.1	0.00	20.99	1528.1	
15	18.61	35.75	25.123	194.3	0.00	16.78	1517.1	
20	14.45	35.33	25.355	173.5	0.00	14.39	1510.3	
25	10.51	34.89	25.779	134.4	0.00	10.46	1498.4	
30	7.97	34.57	26.136	121.4	0.00	7.91	1492.5	
35	4.32	34.31	26.261	85.0	0.00	4.25	1481.3	
40	3.70	34.05	26.342	71.9	0.00	3.62	1483.0	
45	2.99	34.62	27.583	59.3	0.00	2.89	1485.9	
50	2.50	34.75	27.689	49.8	0.00	2.37	1490.1	
55								
60	23.04	35.69	24.445	347.5	0.00	23.04	1530.9	0.000
65	22.96	35.69	24.462	346.4	0.00	22.96	1530.8	0.035
70	22.82	35.70	24.501	343.3	0.00	22.81	1530.7	0.086
75	22.12	35.77	24.577	255.7	0.00	22.51	1530.4	0.170
80	22.11	35.76	24.722	324.1	0.00	22.28	1529.8	0.252
85	21.60	35.56	24.888	309.2	0.00	21.98	1529.0	0.330
90	19.60	35.58	25.331	249.5	0.00	19.57	1524.4	0.472
95	16.61	35.71	25.137	193.0	0.00	16.63	1516.7	0.584
100	14.65	35.49	25.112	171.3	0.00	14.81	1511.5	0.676
105	11.74	35.73	25.570	159.1	0.00	13.00	1506.0	0.761
110	10.49	34.67	25.782	134.3	0.00	10.35	1498.2	0.807
115	7.47	34.71	25.838	131.4	0.00	9.41	1496.3	1.036
120	6.11	34.59	25.913	123.7	0.00	8.21	1493.3	1.163
125	4.77	34.42	26.234	90.8	0.00	4.71	1480.4	1.360
130	3.41	34.49	27.391	76.4	0.00	3.83	1480.3	1.545
135	2.14	34.59	27.532	63.8	0.00	3.15	1484.6	1.756
140	1.57	34.55	27.694	57.4	0.00	2.18	1486.5	1.878

Table I Nansen Station Data for Station 1

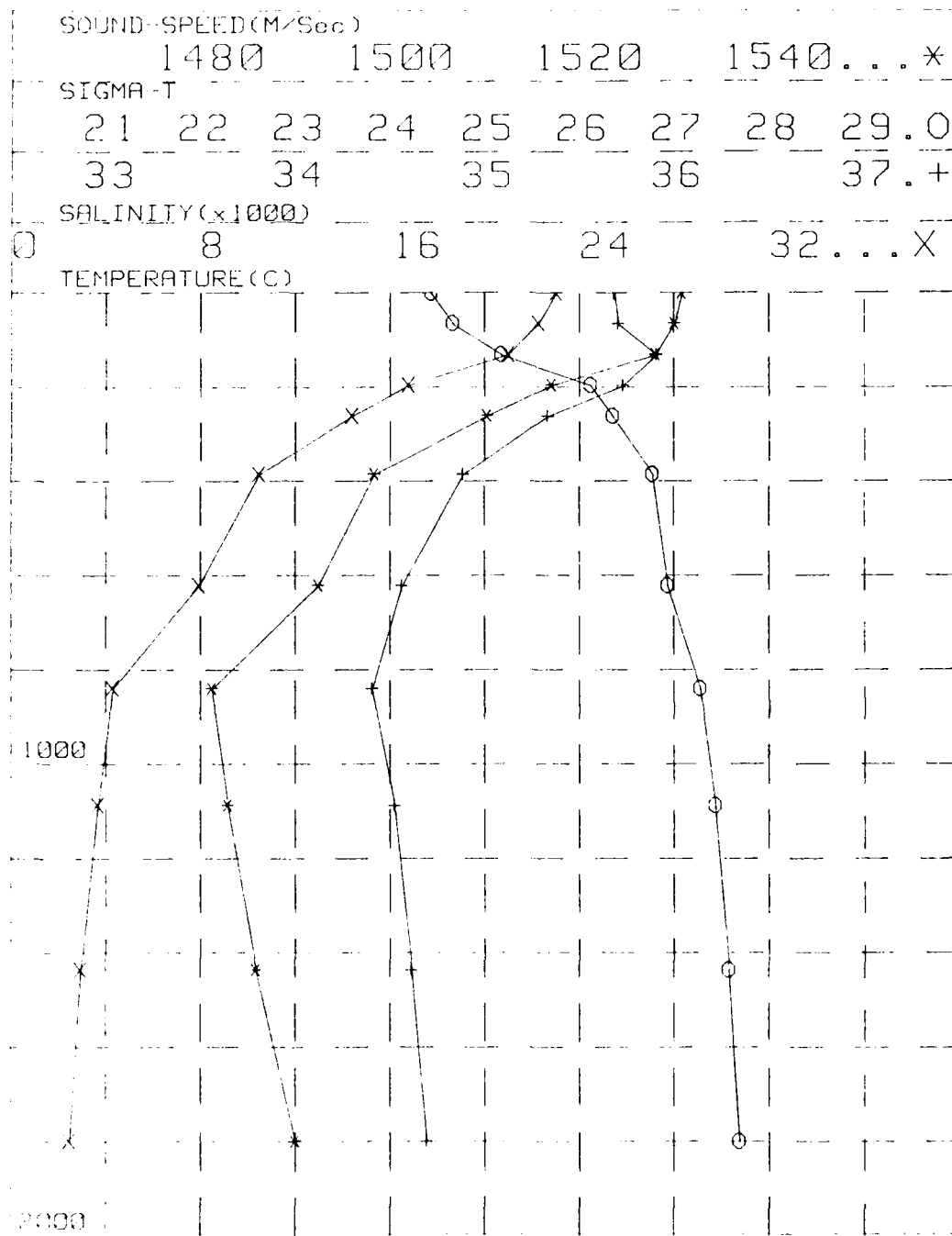

Fig. 1 Profiles of Density (σ_t), Salinity, Sound Speed, and Temperature with Depth for Station 1.

STAT. N 2 26.175 108.01E RANRL 23/83
 DATE= 25/05/83 TIME= 2225GMT SONIC DEPTH= 9999

DEPTH	TEMP	SALINITY	SIGMA-T	S.S.V	Ox	POT.TEMP	S.S		
m	°C	Ppt		CL/T	ML/L	°C	m/Sec	Dyn.cm	
085	0	21.99	35.91	24.916	302.8	0.00	21.99	1528.5	
085	76	18.52	35.82	25.772	223.9	0.00	18.51	1520.2	
085	153	15.68	35.70	26.361	170.1	0.00	15.66	1512.9	
085	209	13.40	35.35	26.584	149.7	0.00	13.37	1505.9	
085	247	12.85	35.21	26.587	150.4	0.00	12.82	1504.7	
085	409	10.31	34.84	26.772	135.4	0.00	10.26	1498.0	
085	552	8.06	34.58	26.939	122.1	0.00	7.99	1493.5	
085	910	4.89	34.48	27.275	88.6	0.00	4.81	1484.9	
085	1159	4.01	34.58	27.450	72.6	0.00	3.92	1485.5	
085	1515	3.11	34.64	27.588	59.7	0.00	3.00	1487.8	
085	1874	2.48	34.70	27.694	49.6	0.00	2.34	1491.2	
ISL	0	21.99	35.91	24.916	302.8	0.00	21.99	1528.5	0.000
ISL	10	21.50	35.90	25.044	290.9	0.00	21.49	1527.3	.030
ISL	25	20.78	35.89	25.228	274.0	0.00	20.77	1525.6	.072
ISL	50	19.63	35.86	25.510	248.0	0.00	19.62	1522.9	.138
ISL	75	18.56	35.82	25.763	224.8	0.00	18.55	1520.3	.198
ISL	100	17.75	35.78	25.985	204.5	0.00	17.74	1518.5	.252
ISL	150	15.81	35.71	26.343	171.7	0.00	15.79	1513.3	.347
ISL	200	13.40	35.35	26.584	149.7	0.00	13.37	1505.9	.427
ISL	250	12.80	35.20	26.591	150.1	0.00	12.76	1504.5	.502
ISL	300	11.92	35.07	26.654	144.9	0.00	11.89	1502.2	.576
ISL	400	10.43	34.85	26.763	136.1	0.00	10.38	1498.3	.717
ISL	500	9.62	34.73	26.812	133.0	0.00	9.56	1496.9	.850
ISL	600	8.70	34.63	26.882	127.3	0.00	8.64	1495.0	.978
ISL	800	6.01	34.50	27.146	101.3	0.00	5.94	1487.6	1.210
ISL	1000	4.55	34.52	27.346	82.2	0.00	4.47	1485.0	1.393
ISL	1300	3.62	34.60	27.509	67.2	0.00	3.52	1486.3	1.616
ISL	1500	3.14	34.64	27.583	60.2	0.00	3.03	1487.7	1.743

Table II Nansen Station Data for Station 2

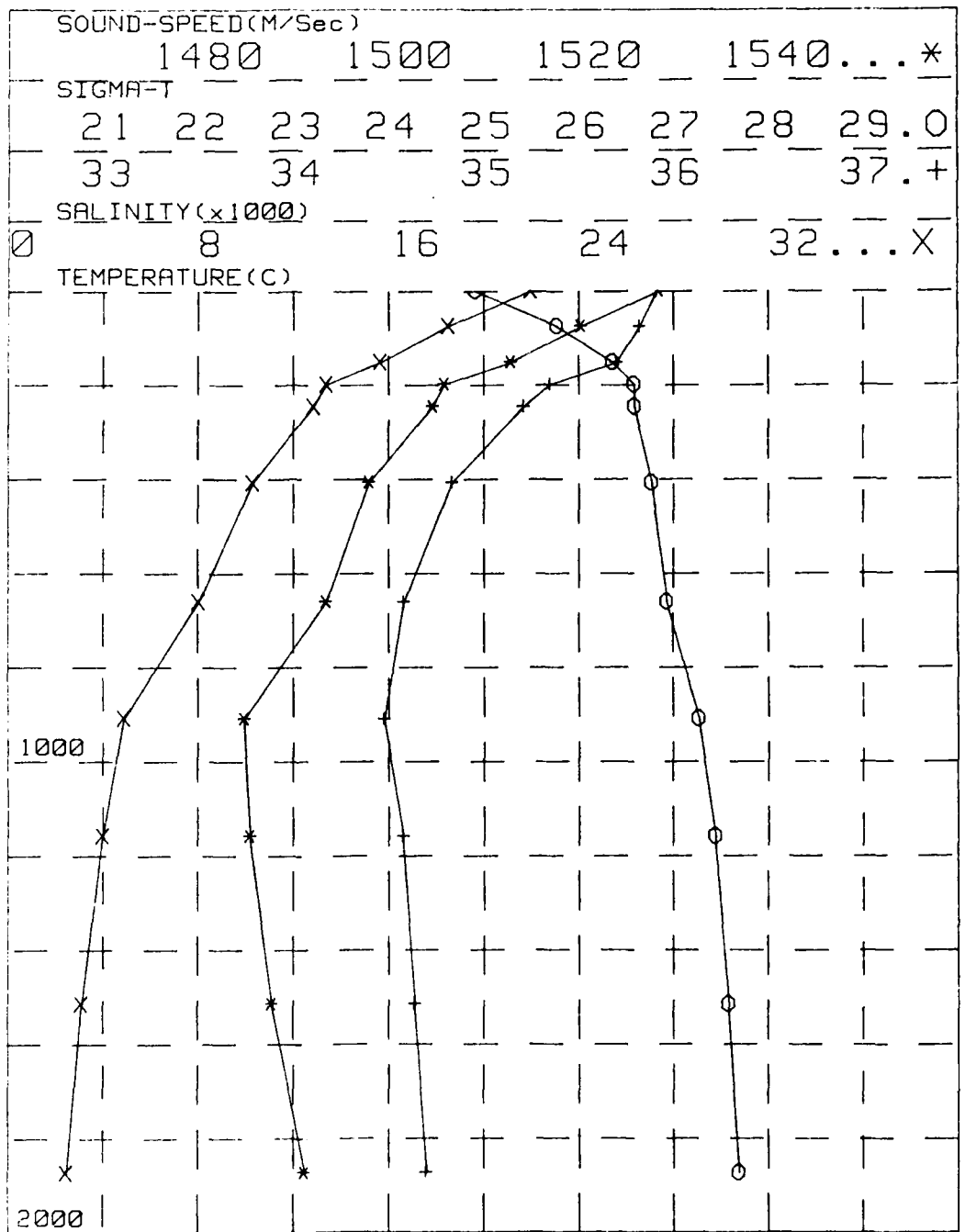

Fig. 2 Profiles of Density (σ_{τ}), Salinity, Sound Speed, and Temperature with Depth for Station 2.

STATION 3 21.245 103.15E RANRL 23/83
 DATE= 28/05/83 TIME= 0222GMT SONIC DEPTH= 4250

DEPTH	TEMP	SALINITY	SIGMA-T	A.S.V	OX	POT.TEMP	S.S	
m	*C	Ppt		CL/T	ML/L	*C	M/Sec	Dyn.m
083 0	24.43	35.41	23.824	406.8	0.00	24.43	1533.9	
083 50	23.74	35.73	24.274	365.8	0.00	23.73	1533.5	
083 100	20.12	35.80	25.343	265.7	0.00	20.10	1525.0	
083 150	18.49	35.86	25.812	222.7	0.00	18.46	1521.4	
083 200	17.31	35.84	26.089	197.8	0.00	17.28	1518.8	
15L 0	24.43	35.41	23.824	406.8	0.00	24.43	1533.9	0.000
15L 10	24.29	35.49	23.865	403.3	0.00	24.29	1533.8	.040
15L 25	24.09	35.60	23.972	393.7	0.00	24.08	1533.7	.099
15L 50	23.74	35.73	24.274	365.8	0.00	23.73	1533.5	.193
15L 75	21.63	35.77	24.884	308.6	0.00	21.67	1528.7	.278
15L 100	20.12	35.80	25.343	265.7	0.00	20.10	1525.0	.351
15L 150	18.49	35.86	25.812	222.7	0.00	18.46	1521.4	.473
15L 200	17.31	35.84	26.089	197.8	0.00	17.28	1518.8	.578

Table III Nansen Station Data for Station 3

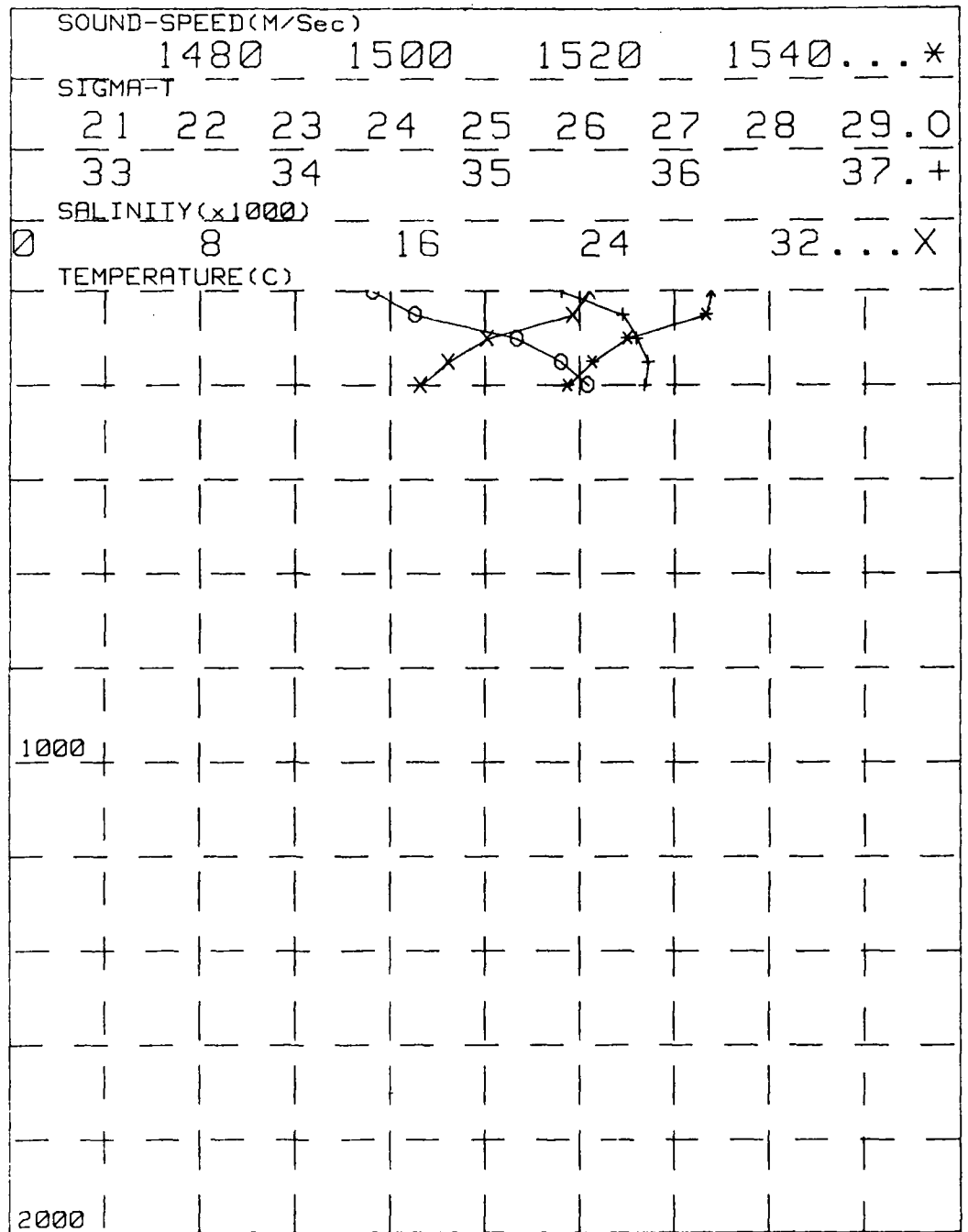

Fig. 3 Profiles of Density (σ_T), Salinity, Sound Speed, and Temperature with Depth for Station 3.

STATION 4 23.095 106.31E RANRL 23/83
 DATE= 29/05/83 TIME= 0523GMT SONIC DEPTH= 5410

DEPTH	TEMP	SALINITY	SIGMA-T	A.S.V	OX	POT.TEMP	S.S		
m	°C	Ppt		CL/T	ML/L	°C	M/Sec	Dyn.M	
005	0	24.03	35.53	24.033	386.9	0.00	24.03	1533.1	
005	50	22.88	35.67	24.474	346.7	0.00	22.87	1531.3	
005	99	19.86	35.81	25.418	258.5	0.00	19.84	1524.3	
005	150	18.05	35.83	25.898	214.4	0.00	18.02	1520.1	
005	200	16.18	35.72	26.261	181.2	0.00	16.15	1515.2	
005	298	13.65	35.38	26.556	135.2	0.00	13.61	1508.4	
005	498	9.82	34.77	26.806	133.5	0.00	9.76	1497.6	
005	696	7.29	34.51	26.996	116.2	0.00	7.22	1491.0	
005	896	4.90	34.52	27.310	85.3	0.00	4.83	1484.8	
005	1194	3.94	34.68	27.535	64.9	0.00	3.85	1485.9	
005	1493	3.11	34.67	27.610	57.6	0.00	3.00	1487.4	
15L	0	24.03	35.53	24.033	386.9	0.00	24.03	1533.1	0.000
15L	10	23.96	35.55	24.079	382.9	0.00	23.95	1532.7	.039
15L	25	23.70	35.59	24.188	373.1	0.00	23.69	1532.2	.094
15L	50	22.88	35.67	24.474	346.7	0.00	22.87	1531.3	.183
15L	75	21.18	35.75	25.015	296.1	0.00	21.17	1527.4	.264
15L	100	19.86	35.81	25.428	257.6	0.00	19.81	1524.3	.334
15L	150	18.05	35.83	25.898	214.4	0.00	18.02	1520.1	.452
15L	200	16.15	35.72	26.265	180.8	0.00	16.12	1515.1	.551
15L	250	14.82	35.54	26.427	166.5	0.00	14.79	1511.6	.638
15L	300	13.61	35.37	26.559	154.9	0.00	13.56	1508.3	.719
15L	400	11.54	35.03	26.691	143.6	0.00	11.49	1502.4	.866
15L	500	9.79	34.77	26.808	133.4	0.00	9.74	1497.5	1.007
15L	600	8.59	34.61	26.889	126.3	0.00	8.43	1494.2	1.136
15L	800	5.87	34.52	27.175	98.4	0.00	5.80	1487.0	1.364
15L	1000	4.55	34.60	27.405	76.7	0.00	4.47	1485.1	1.538
15L	1300	3.63	34.67	27.579	60.8	0.00	3.53	1486.4	1.744

Table IV Nansen Station Data for Station 4

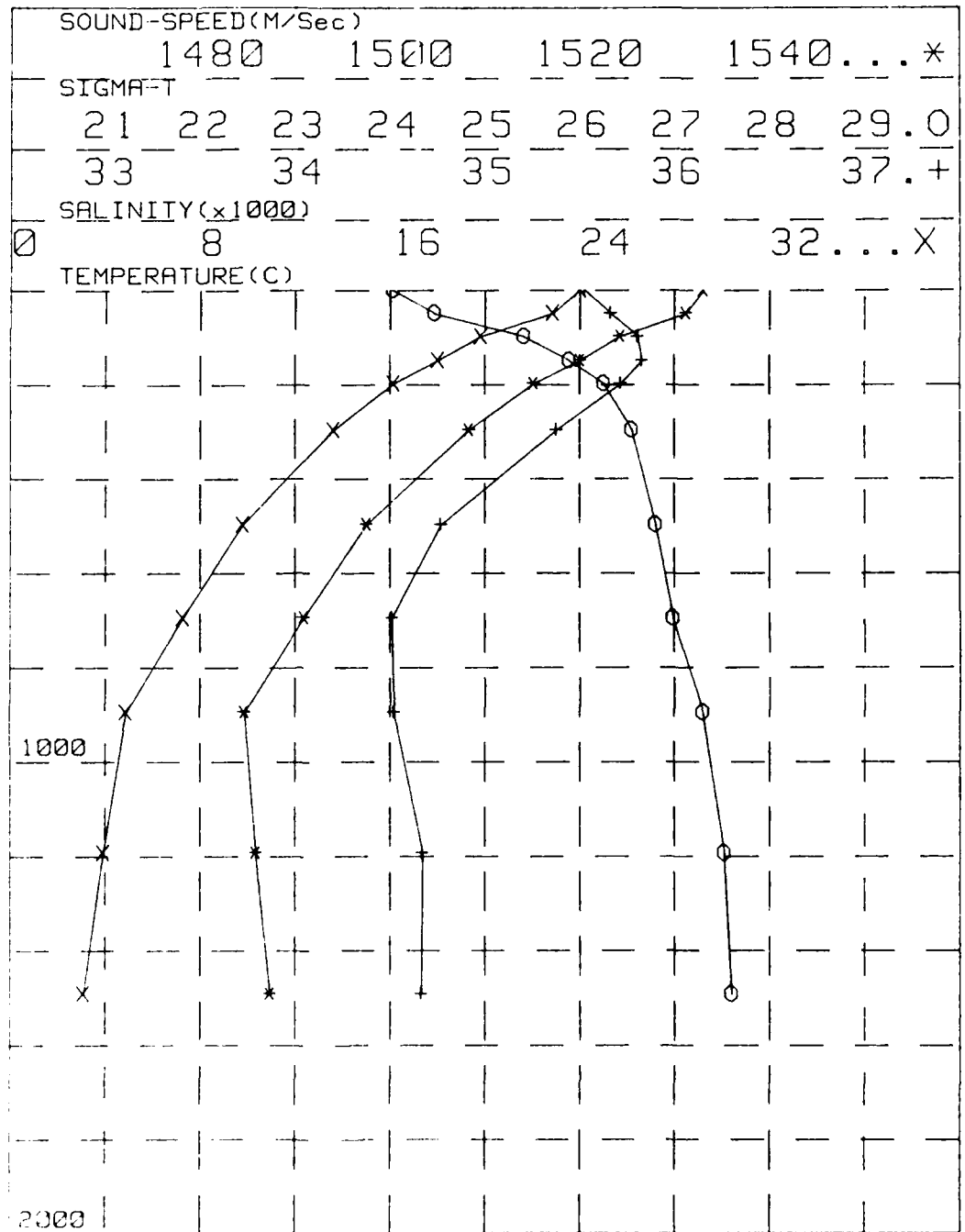

Fig. 4 Profiles of Density (σ_T), Salinity, Sound Speed, and Temperature with Depth for Station 4.

STATION 5 20.26S 104.35E RANRL 23/82
 DATE= 30/05/83 TIME= 1800GHT SONIC DEPTH= 4880

DEPTH	TEMP	SALINITY	SIGMA-T	A.S.V	OX	POT.TEMP	S.S		
m	*C	Ppt		CL/T	ML/L	*C	M/Sec	Dyn.m	
085	0	25.75	34.71	22.896	495.4	0.00	25.75	1536.3	
085	39	25.79	34.73	22.895	497.1	0.00	25.78	1537.0	
085	97	21.95	35.31	24.470	348.8	0.00	21.93	1529.3	
085	146	19.63	35.74	25.429	259.1	0.00	19.60	1524.4	
085	195	18.04	35.76	25.846	220.8	0.00	18.01	1520.7	
085	294	15.17	35.59	26.389	171.6	0.00	15.12	1513.5	
085	492	8.91	34.78	26.800	134.1	0.00	9.85	1497.9	
085	690	7.02	34.54	27.052	110.4	0.00	6.95	1489.9	
085	887	5.47	34.58	27.284	98.7	0.00	5.39	1487.0	
085	1182	4.48	34.65	27.457	73.5	0.00	4.38	1488.0	
085	1477	3.47	34.66	27.568	62.7	0.00	3.36	1488.7	
ISL	0	25.75	34.71	22.896	495.4	0.00	25.75	1536.3	0.000
ISL	10	25.76	34.72	22.896	495.9	0.00	25.76	1536.4	.050
ISL	25	25.78	34.72	22.895	496.5	0.00	25.77	1536.7	.124
ISL	50	24.97	34.84	23.230	465.5	0.00	24.96	1535.4	.247
ISL	75	23.27	35.10	23.929	399.7	0.00	23.25	1531.9	.356
ISL	100	21.79	35.35	24.545	341.8	0.00	21.77	1528.9	.449
ISL	150	19.50	35.75	25.467	255.7	0.00	19.47	1524.1	.598
ISL	200	17.89	35.76	25.879	217.9	0.00	17.86	1520.4	.716
ISL	250	16.43	35.68	26.175	191.0	0.00	16.38	1516.7	.819
ISL	300	14.98	35.56	26.403	170.2	0.00	14.93	1512.9	.910
ISL	400	12.06	35.09	26.628	149.8	0.00	12.01	1504.2	1.071
ISL	500	9.77	34.77	26.810	133.1	0.00	9.71	1497.4	1.213
ISL	600	8.17	34.61	26.940	121.0	0.00	8.11	1492.9	1.340
ISL	800	6.07	34.56	27.193	97.2	0.00	5.99	1487.9	1.559
ISL	1000	5.09	34.61	27.358	82.4	0.00	5.01	1487.4	1.737
ISL	1300	4.08	34.65	27.508	68.7	0.00	3.97	1488.3	1.964

Table V Nansen Station Data for Station 5

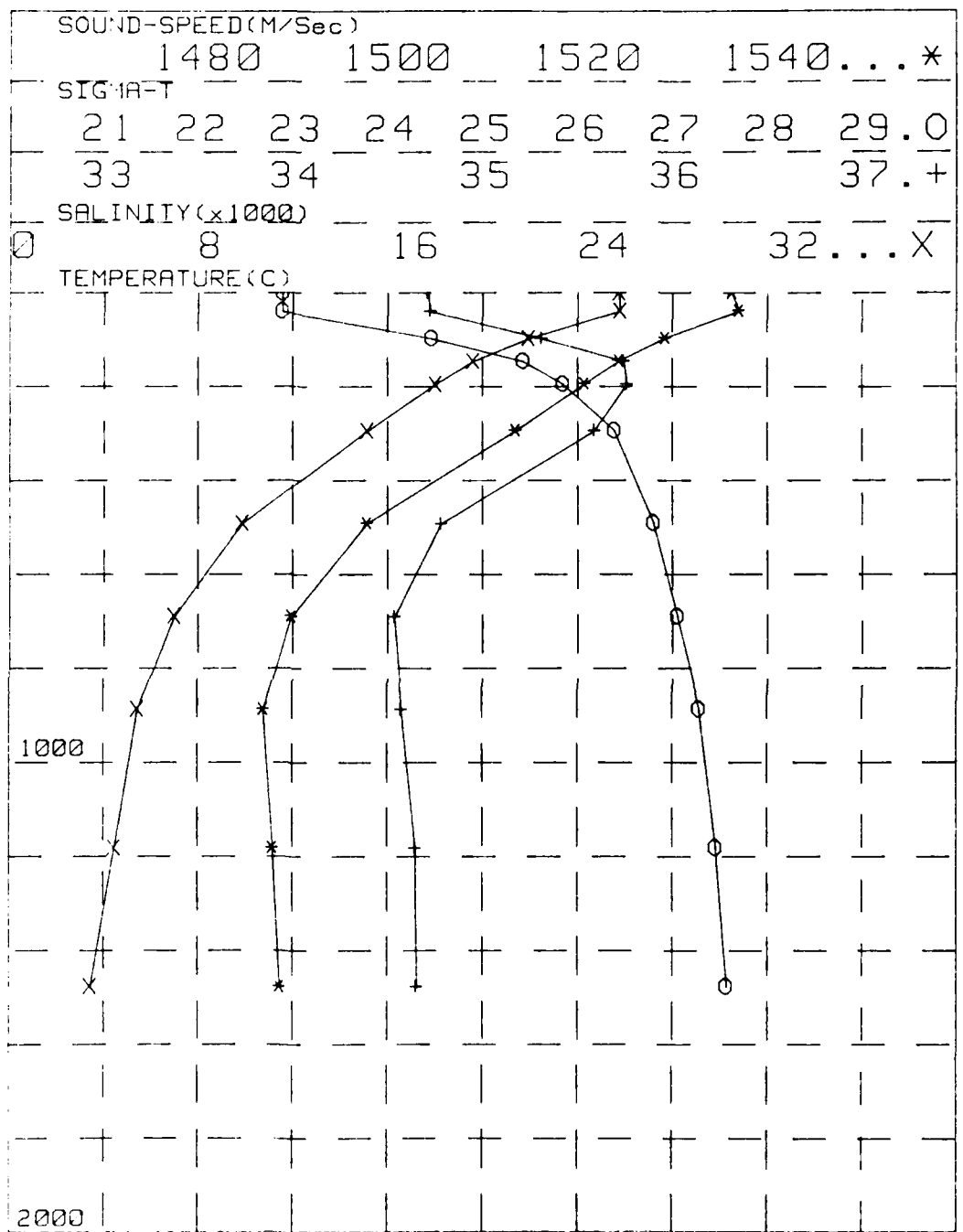

Fig. 5 Profiles of Density (σ_t), Salinity, Sound Speed, and Temperature with Depth for Station 5.

1481106
DATE= 01-08-83

14.925 110.47E
TIME= 06106NT

RANKL 23/83
SONIC DEPTH= 2970

DEPTH	TEMP	SALINITY	SIGMA-T	A.S.V	OX	POT. TEMP	S.S		
m	°C	Pct		CL/T	ML/L	°C	m/Sec	Dyn.M	
085	0	26.06	35.12	23.109	475.1	0.00	26.06	1537.4	
085	48	26.05	35.16	23.142	473.9	0.00	26.04	1538.2	
085	97	22.53	35.16	24.190	375.6	0.00	22.51	1530.6	
085	146	17.59	35.64	25.282	273.1	0.00	19.57	1524.1	
085	194	18.50	35.84	25.788	226.5	0.00	18.47	1522.1	
085	291	14.51	35.51	26.475	163.0	0.00	14.47	1511.2	
085	485	9.77	34.76	26.802	133.7	0.00	9.71	1497.2	
085	686	6.14	34.70	27.301	85.8	0.00	6.08	1486.5	
085	882	5.26	34.59	27.322	84.7	0.00	5.18	1486.1	
085	1182	4.50	34.52	27.452	73.4	0.00	4.21	1487.2	
085	1481	3.43	34.56	27.576	61.7	0.00	3.32	1488.6	
15L	0	26.06	35.12	23.109	475.1	0.00	26.06	1537.4	0.000
15L	19	26.06	35.13	23.116	474.8	0.00	26.06	1537.6	.047
15L	25	26.05	35.15	23.126	474.4	0.00	26.05	1537.8	.119
15L	59	25.89	35.16	23.184	469.9	0.00	25.88	1537.9	.237
15L	75	24.99	35.16	23.714	420.2	0.00	24.02	1533.9	.348
15L	100	22.39	35.18	24.273	367.7	0.00	22.28	1530.0	.447
15L	150	19.53	35.58	25.328	268.8	0.00	19.50	1524.0	.606
15L	200	18.22	35.82	25.840	221.6	0.00	18.19	1521.4	.728
15L	250	16.06	35.65	26.227	185.9	0.00	16.02	1515.5	.831
15L	300	14.27	35.46	26.487	162.0	0.00	14.22	1510.5	.918
15L	400	11.75	35.01	26.635	149.1	0.00	11.70	1503.1	1.072
15L	500	9.47	34.76	26.846	129.5	0.00	9.41	1496.3	1.212
15L	600	7.38	34.73	27.143	100.8	0.00	7.32	1489.9	1.330
15L	800	5.60	34.63	27.307	85.7	0.00	5.53	1486.2	1.511
15L	1000	4.87	34.60	27.374	80.3	0.00	4.79	1486.5	1.678
15L	1300	3.95	34.64	27.502	62.9	0.00	3.84	1487.7	1.801

Table VI Nansen Station Data for Station 6

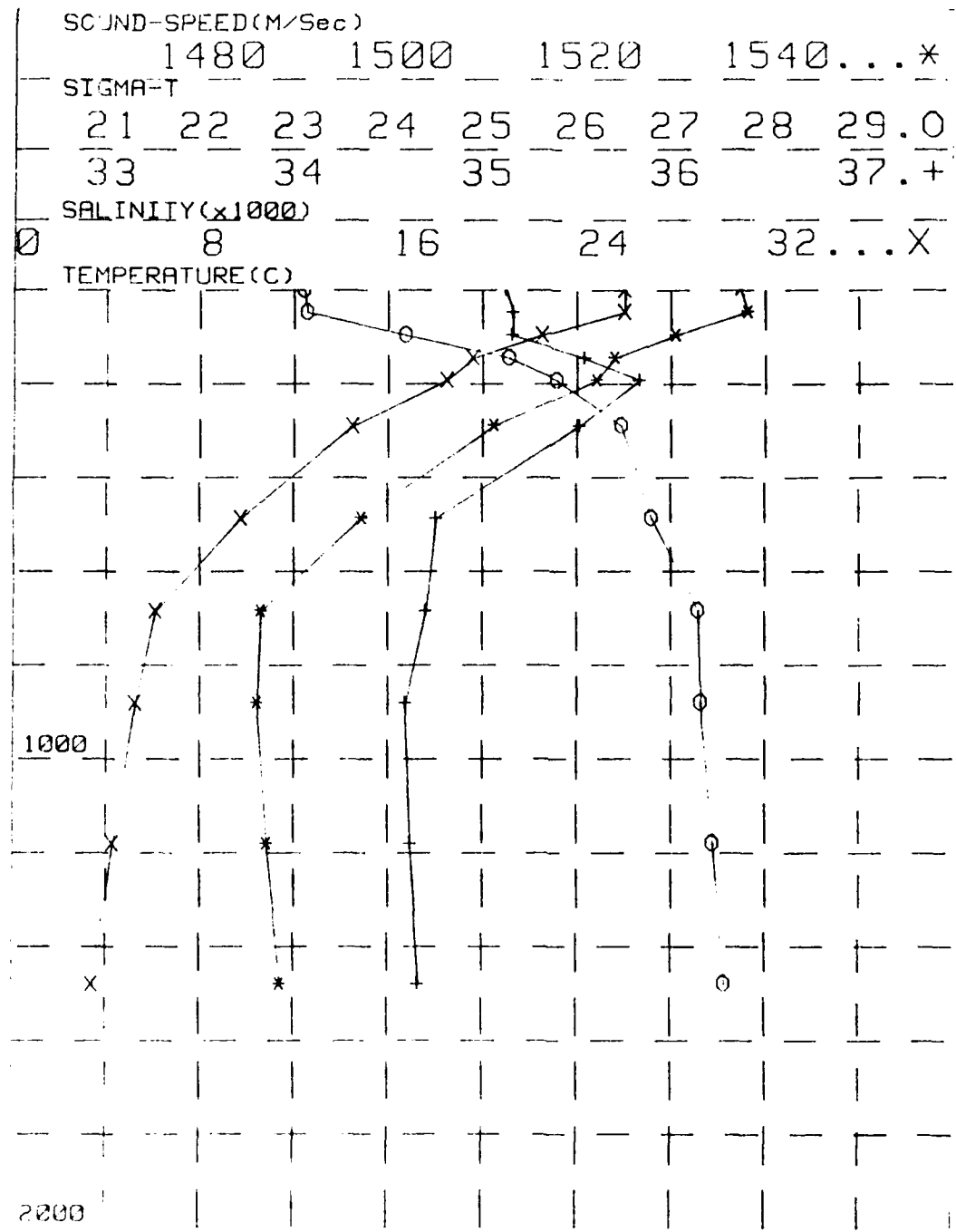

Fig. 6 Profiles of Density (σ_T), Salinity, Sound Speed, and Temperature with Depth for Station 6.

STATION 7
DATE= 07/06/83

16.475 118.50E
TIME= 1537GMT

RANRL 23/83
SONIC DEPTH= 1444

DEPTH	TEMP	SALINITY	SIGMA-T	A.S.V	OX	POT.TEMP	S.S		
m	*C	°pt		CL/T	ML/L	*C	M/Sec	Dyn.M	
085	0	27.38	34.52	22.234	558.7	0.00	27.38	1539.7	
085	48	27.22	34.53	22.294	554.9	0.00	27.21	1540.2	
085	76	24.41	34.59	23.211	469.0	0.00	24.39	1534.5	
085	140	20.01	34.75	24.569	340.7	0.00	19.98	1524.2	
085	190	17.11	34.79	25.327	269.6	0.00	17.08	1516.7	
085	285	12.56	34.73	26.270	181.2	0.00	12.52	1503.7	
085	475	8.97	34.71	26.915	121.9	0.00	8.82	1493.6	
085	665	6.78	34.64	27.169	98.8	0.00	6.72	1488.7	
085	855	5.41	34.51	27.318	85.1	0.00	5.34	1486.3	
15L	0	27.33	34.52	22.234	558.7	0.00	27.38	1539.7	0.000
15L	10	27.35	34.52	22.247	557.9	0.00	27.34	1539.8	.056
15L	25	27.30	34.52	22.265	556.7	0.00	27.29	1540.0	.139
15L	50	27.14	34.53	22.322	552.3	0.00	27.13	1540.0	.278
15L	75	25.86	34.55	22.747	512.6	0.00	25.85	1537.7	.411
15L	100	23.92	34.51	23.353	455.5	0.00	23.94	1533.5	.532
15L	150	19.50	34.76	24.708	327.6	0.00	19.47	1522.9	.726
15L	200	16.95	34.78	25.446	258.5	0.00	16.51	1515.1	.872
15L	250	14.03	34.75	25.971	209.3	0.00	13.99	1507.9	.991
15L	300	12.21	34.73	26.335	175.2	0.00	12.17	1502.7	1.087
15L	400	10.14	34.72	26.707	141.0	0.00	10.09	1497.0	1.248
15L	500	9.58	34.70	26.955	118.3	0.00	8.50	1492.8	1.378
15L	600	7.41	34.66	27.094	105.7	0.00	7.35	1490.1	1.491
15L	800	5.73	34.62	27.285	86.1	0.00	5.66	1486.7	1.684

Table VII Nansen Station Data for Station 7

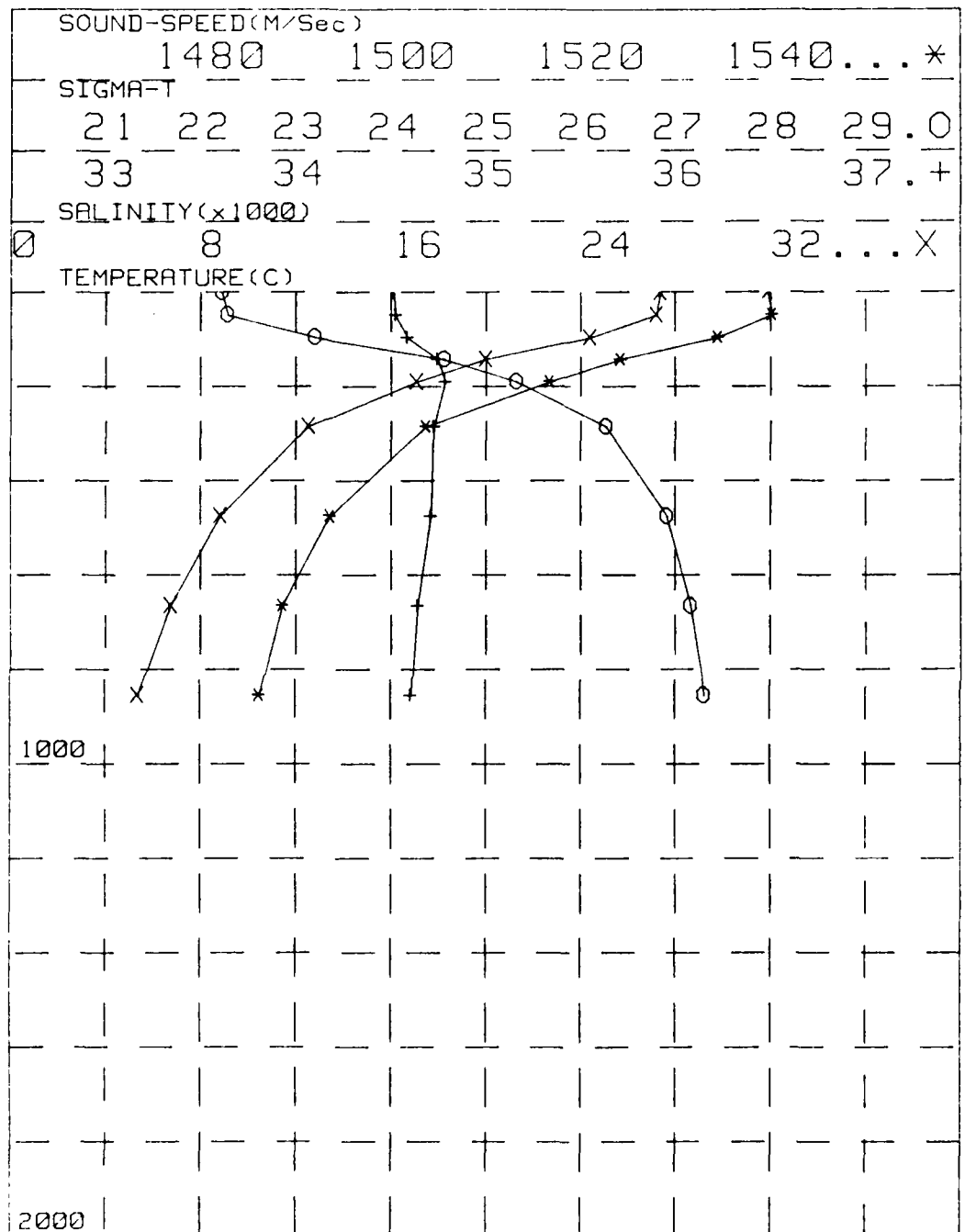

Fig. 7 Profiles of Density (σ_T), Salinity, Sound Speed, and Temperature with Depth for Station 7.

174.00
DATE= 09-08/83

15.235
TIME= 044956T

117.53E
RANRL 23/83
SONIC DEPTH= 5695

DEPTH	TEMP	SALINITY	SIGMA-T	A.S.M	OX	POT.TEMP	S.S	
m	°C	Ppt		CL/T	ML/L	°C	m/Sec	Dyn.cm
080	27.13	34.41	22.230	559.1	0.00	27.13	1539.0	
085	26.79	34.35	22.344	540.7	0.00	26.78	1539.3	
090	22.14	34.70	23.950	398.4	0.00	22.12	1529.1	
095	18.37	34.73	24.971	302.4	0.00	18.34	1519.7	
100	14.75	34.73	25.857	218.7	0.00	14.72	1509.6	
105	11.11	34.69	26.426	166.0	0.00	11.14	1499.0	
110	8.21	34.60	26.922	121.1	0.00	8.21	1491.5	
115	6.20	34.61	27.170	98.8	0.00	6.53	1488.4	
120	5.37	34.62	27.321	85.3	0.00	5.39	1487.1	
125	4.36	34.63	27.447	74.0	0.00	4.28	1487.6	
130	3.54	34.67	27.556	62.9	0.00	3.43	1489.1	
135	2.71	34.71	27.650	559.1	0.00	27.13	1539.0	0.000
140	27.06	34.72	27.723	555.4	0.00	27.06	1539.1	.056
145	26.96	34.47	22.337	549.9	0.00	26.95	1539.2	.139
150	26.78	34.35	22.441	540.7	0.00	26.78	1539.3	.275
155	24.31	34.64	23.275	462.3	0.00	24.29	1534.0	.401
160	20.04	34.70	23.972	396.3	0.00	20.04	1528.9	.509
165	18.18	34.75	23.719	298.3	0.00	18.18	1519.2	.683
170	14.63	34.77	23.871	217.7	0.00	14.63	1509.3	.811
175	12.67	34.67	23.183	138.6	0.00	12.67	1503.4	.914
180	11.09	34.59	23.438	107.2	0.00	11.09	1493.8	1.003
185	9.46	34.60	23.715	139.8	0.00	9.46	1494.6	1.157
190	8.16	34.60	23.909	120.4	0.00	8.16	1491.4	1.288
195	7.25	34.51	23.155	105.2	0.00	7.25	1487.6	1.303
200	5.89	34.62	23.259	90.9	0.00	5.89	1487.5	1.601
205	4.96	34.63	23.389	81.1	0.00	4.96	1487.2	1.772
210	3.96	34.65	23.505	69.8	0.00	3.96	1488.1	1.989

Table VIII Nansen Station Data for Station 8

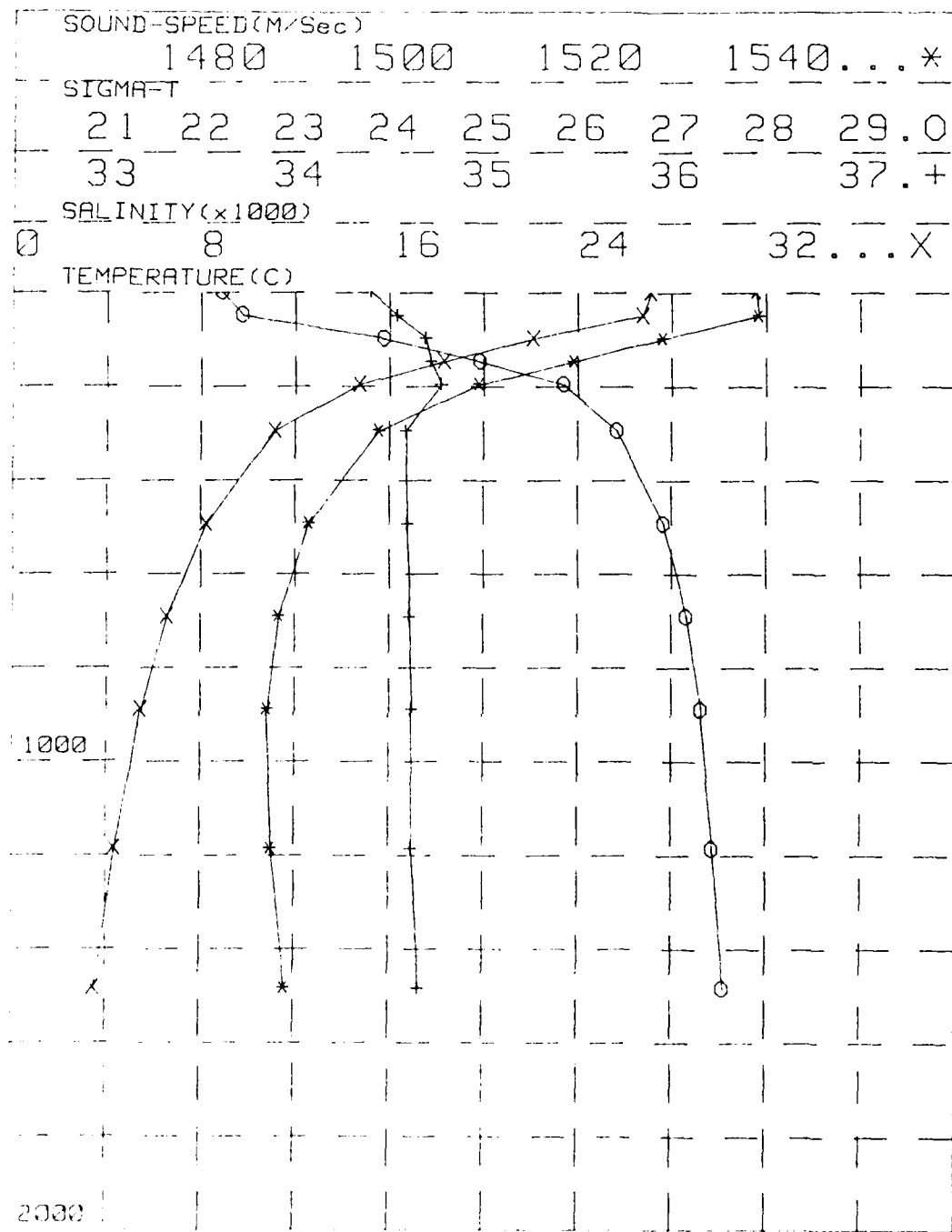

Fig. 8 Profiles of Density (σ_t), Salinity, Sound Speed, and Temperature with Depth for Station 8.

STATION 9 15.01E 119.08E RANRL 23/85
 DATE= 09/08/83 TIME= 023700F SONIC DEPTH= 2200

DEPTH	TIME	SALINITY	TEMPER	CLWT	OX	POT. TEMP	S.S	Dyn.m
m	hr	Ppt	°C	ML/L	ML/L	°C	M. Sec	
085	0	34.56	22.294	553.0	0.00	27.29	1519.6	
085	49	34.47	22.353	559.9	0.00	27.21	1540.1	
085	90	34.56	23.757	416.8	0.00	22.43	1529.7	
085	148	34.50	24.991	309.0	0.00	19.23	1519.2	
085	197	34.56	25.366	237.1	0.00	15.16	1519.8	
085	245	34.59	26.407	167.6	0.00	11.22	1499.2	
085	492	34.66	26.940	119.5	0.00	8.40	1492.3	
085	689	34.62	27.181	97.7	0.00	6.49	1489.1	
085	886	34.61	27.319	85.4	0.00	5.35	1486.9	
085	1183	34.62	27.443	74.5	0.00	4.28	1487.5	
085	1481	34.67	27.577	63.7	0.00	3.32	1487.6	
15L	0	34.56	22.294	553.0	0.00	27.29	1519.6	0.000
15L	10	34.53	22.286	554.2	0.00	27.27	1519.7	.055
15L	25	34.49	22.273	558.0	0.00	27.25	1539.9	.139
15L	50	34.48	22.267	555.7	0.00	27.19	1539.9	.228
15L	75	34.52	23.698	479.0	0.00	24.59	1534.6	.408
15L	100	34.56	23.810	411.9	0.00	22.24	1529.2	.520
15L	150	34.60	24.937	305.6	0.00	19.09	1519.8	.699
15L	200	34.65	25.694	234.5	0.00	15.01	1510.4	.834
15L	250	34.61	26.108	195.8	0.00	12.92	1501.9	.942
15L	300	34.59	26.425	166.1	0.00	11.74	1499.0	1.033
15L	400	34.64	26.729	138.7	0.00	9.60	1492.2	1.188
15L	500	34.66	26.952	118.4	0.00	8.30	1491.0	1.317
15L	600	34.63	27.085	106.3	0.00	7.25	1489.6	1.430
15L	800	34.62	27.264	90.2	0.00	5.30	1487.2	1.626
15L	1000	34.62	27.365	81.4	0.00	4.93	1487.1	1.797
15L	1500	34.63	27.494	69.7	0.00	3.89	1487.9	2.024

Table IX Nansen Station Data for Station 9

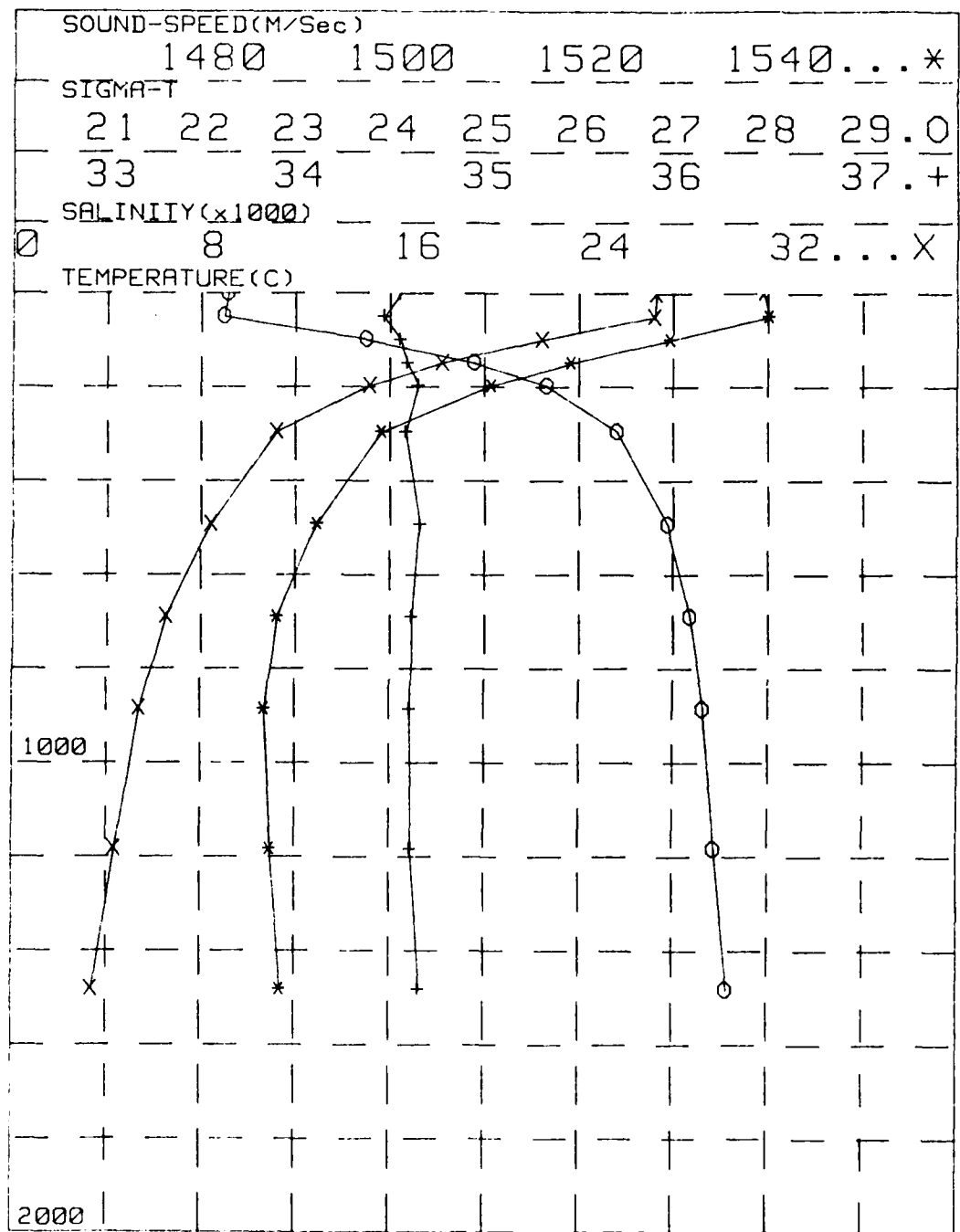

Fig. 9 Profiles of Density (σ_T), Salinity, Sound Speed, and Temperature with Depth for Station 9.

STA-10W 10 13.885 118.43E RANRL 23/93
 DATE= 9-06-83 TIME= 1753GHT SONIC DEPTH= 5668

DEPTH	TEMP	SALINITY	SIGMA-T	A.S.V	OX	POT.TEMP	S.S	
m	*C	Ppt		CL/T	ML/L	*C	M/Sec	Dyn.m
05	27.33	34.34	22.114	570.2	0.00	27.33	1539.4	
06	27.31	34.34	22.123	571.4	0.00	27.30	1540.2	
08	23.23	34.48	23.173	444.0	0.00	23.21	1531.6	
10	20.03	34.54	24.394	357.6	0.00	20.03	1524.2	
12	16.61	34.55	25.253	276.8	0.00	16.61	1515.2	
095	12.16	34.84	26.435	165.8	0.00	12.12	1502.7	
085	8.39	34.61	26.938	119.7	0.00	8.34	1492.1	
080	6.60	34.62	27.173	78.5	0.00	6.53	1488.4	
075	5.59	34.61	27.295	88.0	0.00	5.51	1487.6	
070	4.31	34.62	27.444	74.6	0.00	4.31	1487.7	
065	3.46	34.67	27.565	63.3	0.00	3.46	1489.2	
131	27.33	34.34	22.114	570.2	0.00	27.33	1539.4	0.000
132	27.33	34.34	22.116	570.4	0.00	27.32	1539.6	.057
133	27.32	34.34	22.119	570.8	0.00	27.31	1539.8	.143
134	27.31	34.34	22.123	571.4	0.00	27.30	1540.2	.285
135	25.11	34.42	22.867	501.1	0.00	25.09	1535.6	.420
136	23.17	34.48	23.492	442.2	0.00	23.15	1531.5	.539
137	19.98	34.54	24.413	355.8	0.00	19.96	1524.0	.738
138	16.59	34.55	25.268	275.4	0.00	16.55	1515.0	.896
139	14.12	34.73	25.939	212.3	0.00	14.08	1508.2	1.020
140	12.11	34.84	26.141	165.2	0.00	12.07	1502.6	1.116
141	9.97	34.72	26.727	139.0	0.00	9.93	1496.4	1.269
142	8.35	34.55	26.944	119.2	0.00	8.29	1492.0	1.400
143	7.34	34.63	27.077	107.1	0.00	7.28	1489.7	1.514
144	6.02	34.61	27.242	72.6	0.00	5.95	1487.8	1.712
145	5.11	34.61	27.354	62.7	0.00	5.02	1487.6	1.887
146	4.05	34.64	27.494	70.0	0.00	3.94	1488.1	2.116

Table X Nansen Station Data for Station 10

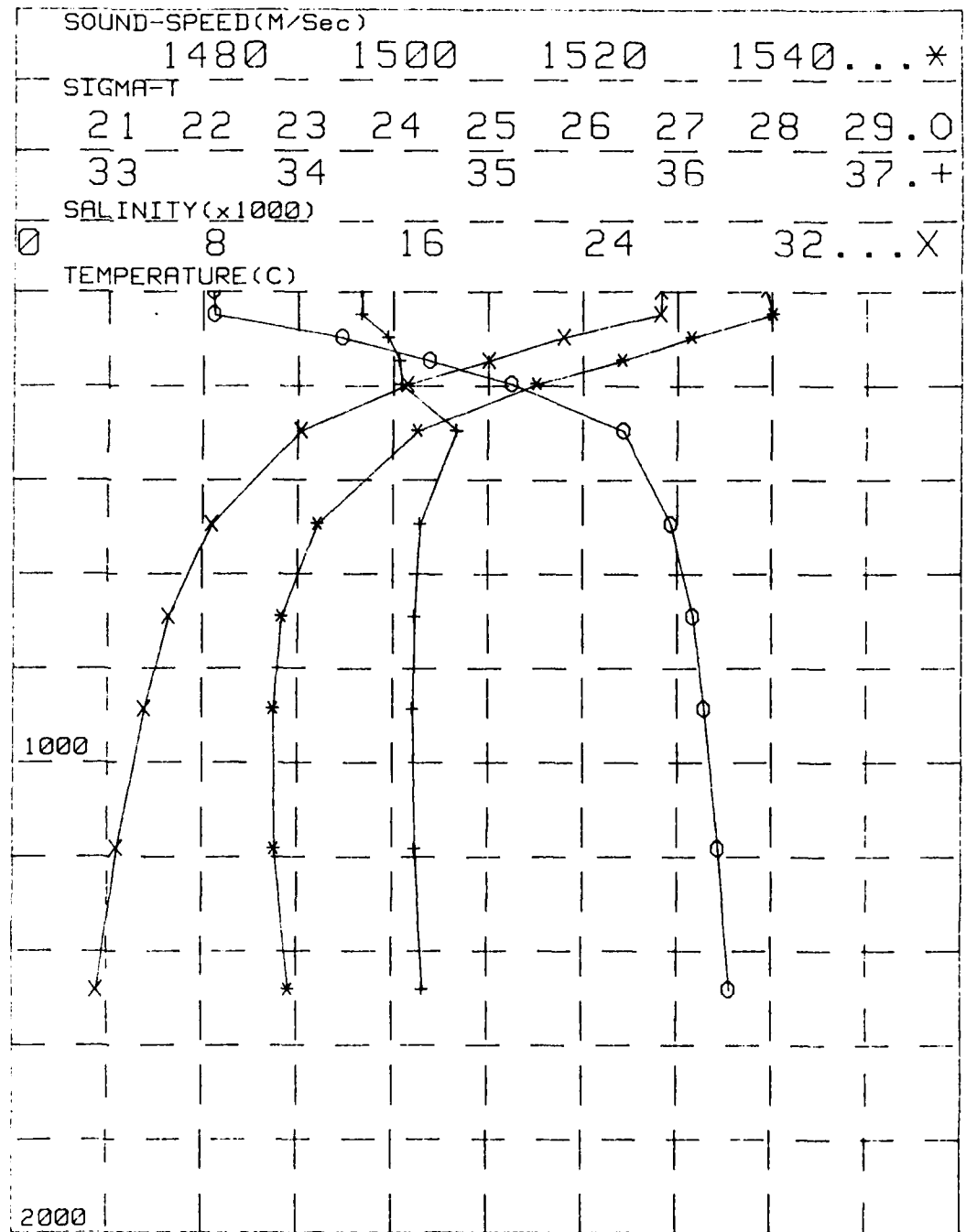

Fig.10 Profiles of Density (σ_t), Salinity, Sound Speed, and Temperature with Depth for Station 10.

STATION 11
DATE= 10/26/83

14.085 120.53E
TIME= 1548GMT

RANRL 23/83
SONIC DEPTH= 2450

DEPTH	TEMP	SALINITY	SIGMA-T	A.S.V	OX	POT.TEMP	S.S	
m	°C	Ppt		CL/T	mL/L	°C	m/Sec	Dyn.cm
000	27.50	34.40	22.106	571.0	0.00	27.50	1539.9	
001	27.49	34.41	22.119	571.8	0.00	27.48	1540.7	
002	27.78	34.51	23.342	456.5	0.00	23.74	1532.9	
003	19.82	34.58	24.572	340.5	0.00	19.49	1522.7	
004	16.22	34.59	25.380	264.6	0.00	16.19	1513.9	
005	12.11	34.59	26.247	183.4	0.00	12.07	1502.2	
006	8.52	34.63	26.907	122.7	0.00	8.47	1492.5	
007	6.61	34.61	27.169	98.9	0.00	6.55	1488.3	
008	5.52	34.61	27.307	86.7	0.00	5.44	1487.2	
009	4.28	34.62	27.456	73.0	0.00	4.19	1487.0	
010	3.55	34.66	27.560	63.6	0.00	3.44	1488.9	
100	27.50	34.40	22.106	571.0	0.00	27.50	1539.9	0.000
101	27.50	34.40	22.109	571.1	0.00	27.50	1540.0	0.057
102	27.49	34.40	22.113	571.4	0.00	27.49	1540.3	0.133
103	27.42	34.41	22.143	569.4	0.00	27.41	1540.5	0.288
104	25.57	34.47	22.767	510.7	0.00	25.56	1536.9	0.421
105	23.57	34.51	23.401	451.0	0.00	23.55	1532.5	0.541
106	19.29	34.59	24.628	335.2	0.00	19.27	1522.1	0.737
107	15.02	34.59	25.422	260.6	0.00	15.99	1513.3	0.886
108	13.79	34.59	25.897	216.1	0.00	13.75	1506.9	1.006
109	12.00	34.59	26.269	181.4	0.00	11.96	1501.9	1.106
110	9.90	34.62	26.650	146.8	0.00	9.93	1496.3	1.273
111	8.41	34.63	26.921	121.3	0.00	8.36	1492.2	1.408
112	7.36	34.62	27.067	108.1	0.00	7.30	1489.8	1.524
113	5.96	34.61	27.252	91.6	0.00	5.89	1487.6	1.722
114	4.97	34.61	27.371	80.8	0.00	4.89	1487.1	1.895
115	3.92	34.63	27.504	68.6	0.00	3.82	1487.6	2.119

Table XI Nansen Station Data for Station 11

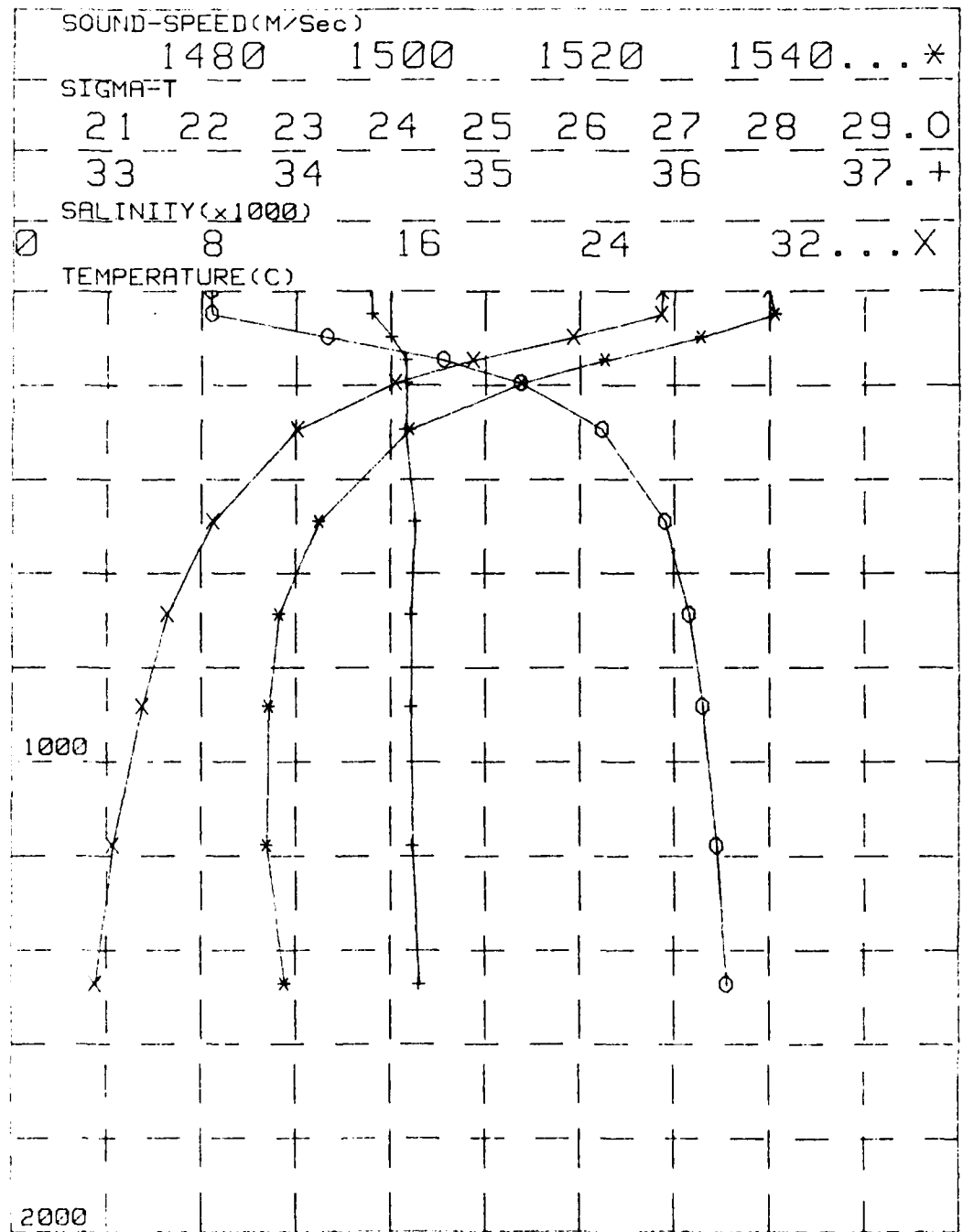

Fig.11 Profiles of Density (σ_{τ}), Salinity, Sound Speed, and Temperature with Depth for Station 11.

STATION 12 11.105 110.42E RANRL 23/83
 DATE= 11/06/83 TIME= 1320GMT SONIC DEPTH= 6493

DEPTH	TEMP	SALINITY	SIGMA-T	A.S.V	OX	POT.TEMP	S.S		
m	*C	Ppt		CL/T	ML/L	*C	M/Sec	Dyn.n	
086	0	26.79	34.13	22.130	538.7	0.00	26.79	1538.0	
086	49	25.82	34.29	22.450	529.7	0.00	25.81	1536.8	
086	99	20.55	34.55	24.372	367.6	0.00	20.53	1524.7	
086	149	17.30	34.55	25.097	290.2	0.00	17.28	1516.3	
086	199	14.62	34.56	25.713	232.5	0.00	14.59	1508.9	
086	297	10.97	34.55	26.427	165.8	0.00	10.93	1498.2	
086	493	8.19	34.61	26.939	119.3	0.00	8.14	1491.2	
086	596	6.51	34.59	27.166	99.0	0.00	6.45	1487.9	
086	882	5.41	34.60	27.306	86.3	0.00	5.33	1486.7	
086	1177	4.23	34.61	27.450	73.5	0.00	4.19	1487.0	
086	1473	3.35	34.62	27.599	59.3	0.00	3.24	1488.1	
ISL	0	26.79	34.13	22.130	538.7	0.00	26.79	1538.0	0.000
ISL	10	26.59	34.15	22.217	560.8	0.00	26.59	1537.7	.056
ISL	25	26.30	34.20	22.348	548.8	0.00	26.29	1537.4	.140
ISL	50	25.99	34.30	22.601	525.6	0.00	25.68	1536.5	.274
ISL	75	22.83	34.46	23.560	434.8	0.00	22.81	1530.0	.396
ISL	100	20.48	34.55	24.290	365.9	0.00	20.46	1524.5	.497
ISL	150	17.24	34.55	25.111	288.9	0.00	17.22	1516.2	.661
ISL	200	14.58	34.56	25.722	231.7	0.00	14.55	1508.8	.791
ISL	250	12.53	34.55	26.123	194.2	0.00	12.50	1502.7	.898
ISL	300	10.92	34.55	26.437	164.9	0.00	10.88	1498.0	.989
ISL	400	9.37	34.59	26.732	138.1	0.00	9.33	1494.1	1.142
ISL	500	8.12	34.61	26.949	118.4	0.00	8.07	1491.1	1.272
ISL	600	7.19	34.60	27.075	107.1	0.00	7.13	1489.1	1.385
ISL	800	5.84	34.60	27.253	91.2	0.00	5.77	1487.1	1.583
ISL	1000	4.93	34.60	27.364	81.3	0.00	4.85	1486.7	1.754
ISL	1200	3.87	34.64	27.512	67.8	0.00	3.77	1487.4	1.978

Table XII Nansen Station Data for Station 12

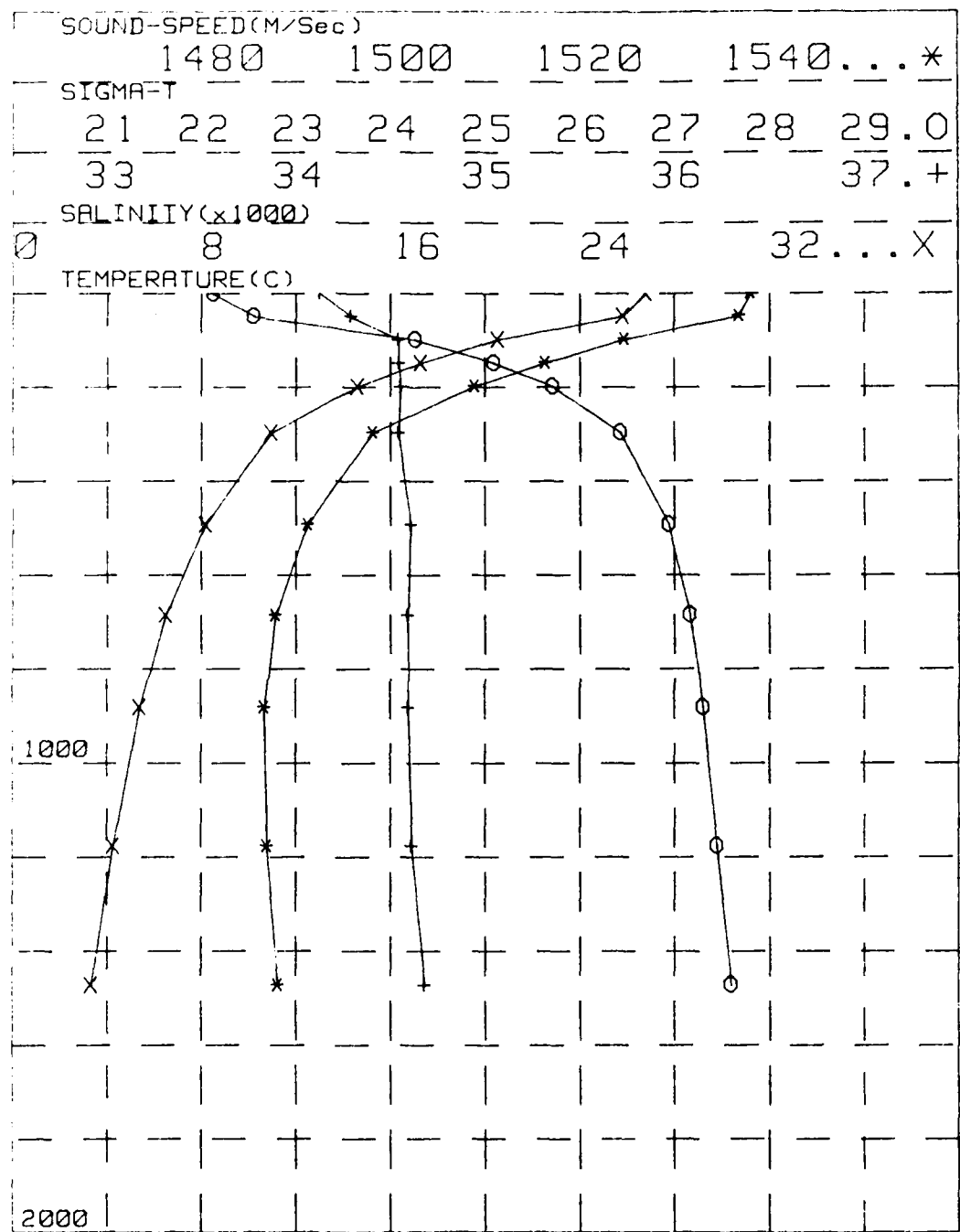

Fig.12 Profiles of Density (σ_t), Salinity, Sound Speed, and Temperature with Depth for Station 12.

STATION 13
DATE= 13/06/83

11.015 120.10E
TIME= 1150GMT

RANRL 23/83
SONIC DEPTH= 1554

DEPTH	TEMP *C	SALINITY Ppt	SIGMA-T	A.S.V CL/T	OX ML/L	POT.TEMP *C	S.S M/Sec	Dyn.M
05	27.04	34.14	22.057	575.7	0.00	27.04	1538.6	
08	24.28	34.48	23.167	471.4	0.00	24.27	1533.3	
09	20.42	34.53	24.293	365.5	0.00	20.40	1524.3	
06	17.12	34.54	25.134	286.6	0.00	17.10	1515.8	
08	15.91	34.55	25.429	259.8	0.00	15.98	1512.9	
06	12.03	34.54	26.227	185.2	0.00	11.99	1501.9	
08	8.18	34.60	26.935	119.6	0.00	8.13	1491.1	
08	6.69	34.58	27.132	102.4	0.00	6.63	1488.5	
08	5.69	34.60	27.276	89.8	0.00	5.61	1487.8	
08	4.12	34.62	27.471	71.1	0.00	4.03	1486.3	
15	27.04	34.14	22.057	575.7	0.00	27.04	1538.6	0.000
15L	26.57	34.23	22.282	554.5	0.00	26.56	1537.8	.057
15L	25.77	34.35	22.622	522.7	0.00	25.76	1536.4	.137
15L	24.20	34.48	23.193	469.0	0.00	24.18	1533.1	.261
15L	22.16	34.51	23.800	411.9	0.00	22.15	1528.5	.372
15L	20.24	34.55	24.338	361.3	0.00	20.23	1523.9	.469
15L	17.06	34.54	25.150	285.1	0.00	17.04	1515.6	.630
15L	15.72	34.56	25.468	256.2	0.00	15.69	1512.4	.756
15L	13.59	34.54	25.910	214.8	0.00	13.55	1506.2	.964
15L	11.95	34.54	26.261	182.0	0.00	11.91	1501.5	1.254
15L	9.64	34.57	26.677	143.4	0.00	9.59	1495.0	1.650
15L	8.03	34.60	26.948	118.5	0.00	8.03	1490.9	2.083
15L	7.27	34.59	27.054	109.2	0.00	7.21	1489.4	2.597
15L	6.10	34.59	27.219	94.9	0.00	6.03	1488.1	3.201
15L	5.03	34.6	27.359	82.1	0.00	4.97	1487.2	3.778

Table XIII Nansen Station Data for Station 13

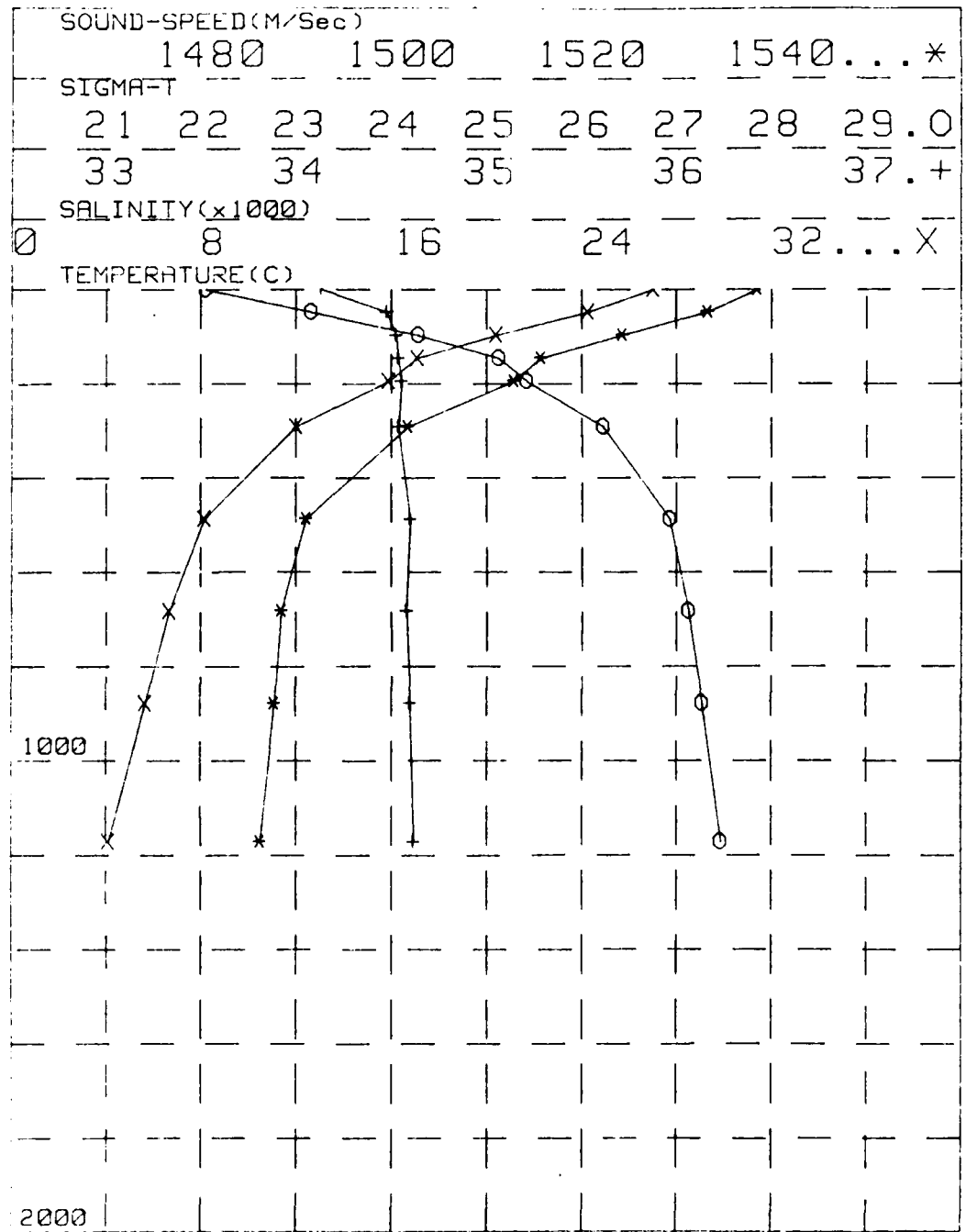

Fig.13 Profiles of Density (σ_t), Salinity, Sound Speed, and Temperature with Depth for Station 13.

STATION 14
DATE= 10-06-83

10.40S 102.15E
TIME= 0655GMT

RANRL 23/83
SONIC DEPTH= 482

DEPTH	TEMP	SALINITY	SIGMA-T	A.S.V	OX	POT.TEMP	S.S	
m	°C	Pst		CL/T	ML/L	°C	m/Sec	Dyn.cm
0	27.48	34.56	22.231	559.1	0.00	27.48	1540.0	
5	27.37	34.55	22.234	557.9	0.00	27.36	1540.6	
10	25.12	34.55	22.268	492.4	0.00	25.10	1536.3	
15	20.79	34.64	24.279	368.7	0.00	20.76	1526.3	
20	17.95	34.59	24.974	303.6	0.00	17.92	1519.1	
25	13.75	34.60	25.929	213.1	0.00	13.71	1507.0	
30	10.75	34.58	26.498	159.1	0.00	10.71	1497.5	
35	8.64	34.58	26.688	141.5	0.00	8.60	1494.3	
40	8.91	34.57	26.800	131.4	0.00	8.87	1492.4	
45	27.48	34.56	22.231	559.1	0.00	27.48	1540.0	0.000
50	27.46	34.55	22.237	558.8	0.00	27.46	1540.1	.056
55	27.42	34.55	22.247	558.5	0.00	27.42	1540.3	.140
60	27.37	34.55	22.264	557.9	0.00	27.36	1540.6	.279
65	26.21	34.55	22.540	532.4	0.00	26.19	1539.1	.415
70	25.12	34.55	22.868	492.4	0.00	25.10	1536.3	.542
75	20.79	34.64	24.279	368.7	0.00	20.76	1526.3	.757
80	17.95	34.59	24.974	303.6	0.00	17.92	1519.1	.925
85	13.75	34.60	25.929	213.1	0.00	13.71	1507.0	1.054
90	10.75	34.58	26.498	159.1	0.00	10.71	1497.5	1.147
95	8.64	34.57	26.600	131.4	0.00	8.87	1492.4	1.291

Table XIV Nansen Station Data for Station 14

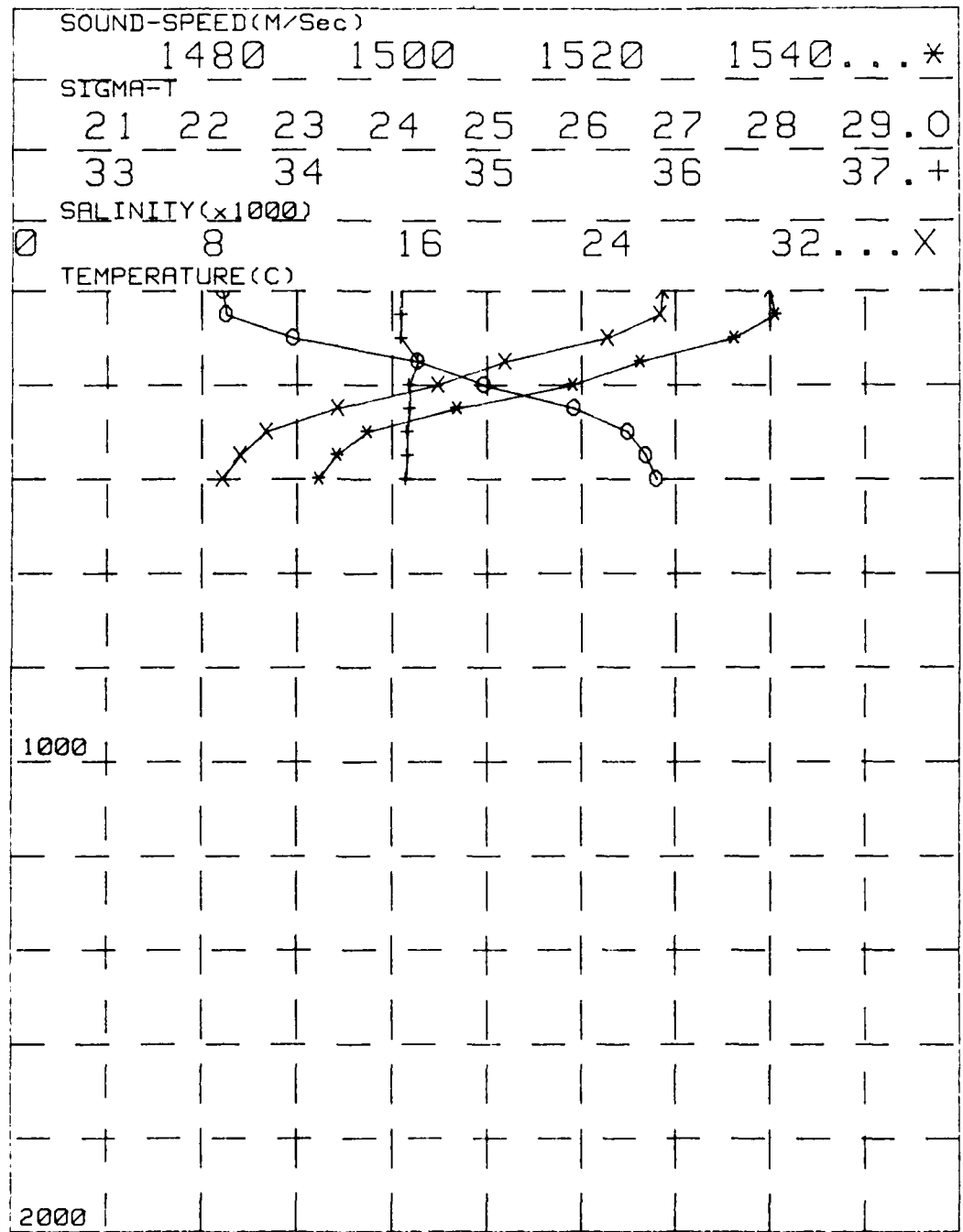

Fig.14 Profiles of Density (σ_T), Salinity, Sound Speed, and Temperature with Depth for Station 14.

STATION 15 14.03S 122.58E RANRL 23/83
 DATE= 14/06/83 TIME= 1300GMT SONIC DEPTH= 266

	DEPTH	TEMP	SALINITY	SIGMA-T	A.S.V	OX	POT.TEMP	S.S	
	m	*C	Ppt		CL/T	ML/L	*C	M/Sec	Dyn.m
086	0	27.31	34.62	22.337	548.9	0.00	27.31	1539.7	
086	25	27.27	34.63	22.351	548.6	0.00	27.26	1540.0	
086	50	27.26	34.62	22.349	549.8	0.00	27.25	1540.4	
086	75	27.27	34.64	22.359	549.8	0.00	27.25	1540.9	
086	100	26.95	34.67	22.488	538.4	0.00	26.93	1540.6	
086	125	25.43	34.59	22.901	499.9	0.00	25.40	1537.4	
086	150	23.02	34.58	23.615	432.3	0.00	22.99	1532.0	
086	175	20.37	34.62	24.372	360.6	0.00	20.34	1525.6	
086	200	18.62	34.61	24.820	318.5	0.00	18.58	1521.1	
086	225	14.72	34.60	25.728	231.8	0.00	14.69	1509.7	
ISL	0	27.31	34.62	22.337	548.9	0.00	27.31	1539.7	0.000
ISL	10	27.29	34.62	22.344	548.6	0.00	27.29	1539.8	.055
ISL	25	27.27	34.63	22.351	548.6	0.00	27.26	1540.0	.137
ISL	50	27.26	34.62	22.349	549.8	0.00	27.25	1540.4	.274
ISL	75	27.27	34.64	22.359	549.8	0.00	27.25	1540.9	.412
ISL	100	26.95	34.67	22.488	538.4	0.00	26.93	1540.6	.548
ISL	150	23.02	34.58	23.615	432.3	0.00	22.99	1532.0	.794
ISL	200	18.62	34.61	24.820	318.5	0.00	18.58	1521.1	.978

Table XV Nansen Station Data for Station 15

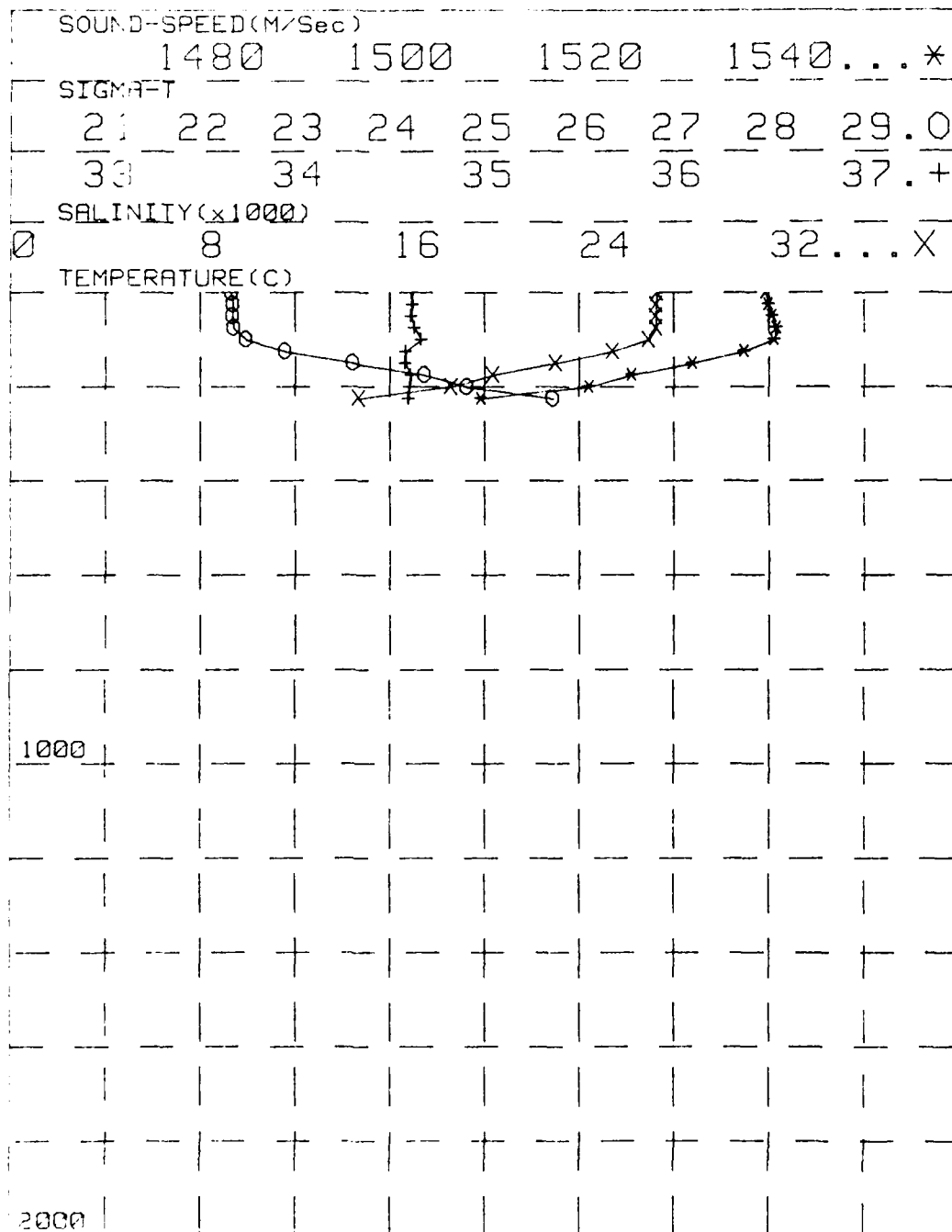

Fig.15 Profiles of Density (σ_t), Salinity, Sound Speed, and Temperature with Depth for Station 15.

STATION 10 14.203 123.39E PANRL 23/83
 DATE= 14.06.83 TIME= 1751GMT SONIC DEPTH= 97

DEPTH	TEMP	SALINITY	SIGMA-T	A.G.V	OX	POT.TEMP	S.S	
m	°C	Pss	kg/m ³	CL/T	μM/L	°C	m/Sec	Dyn.cm
085	27.11	34.87	22.438	539.2	0.00	27.11	1539.3	
086	27.10	34.87	22.442	539.3	0.00	27.09	1539.7	
088	27.10	34.87	22.440	541.0	0.00	27.09	1540.1	
089	27.12	34.87	22.438	542.4	0.00	27.10	1540.6	
18L	27.11	34.87	22.438	539.2	0.00	27.11	1539.3	0.000
18L	27.10	34.87	22.442	539.3	0.00	27.09	1539.7	.054
18L	27.10	34.87	22.440	541.0	0.00	27.09	1540.1	.135
18L	27.10	34.87	22.440	541.0	0.00	27.09	1540.1	.270
18L	27.12	34.87	22.438	542.4	0.00	27.10	1540.6	.405

Table 101 Hansen Station Data for Station 10

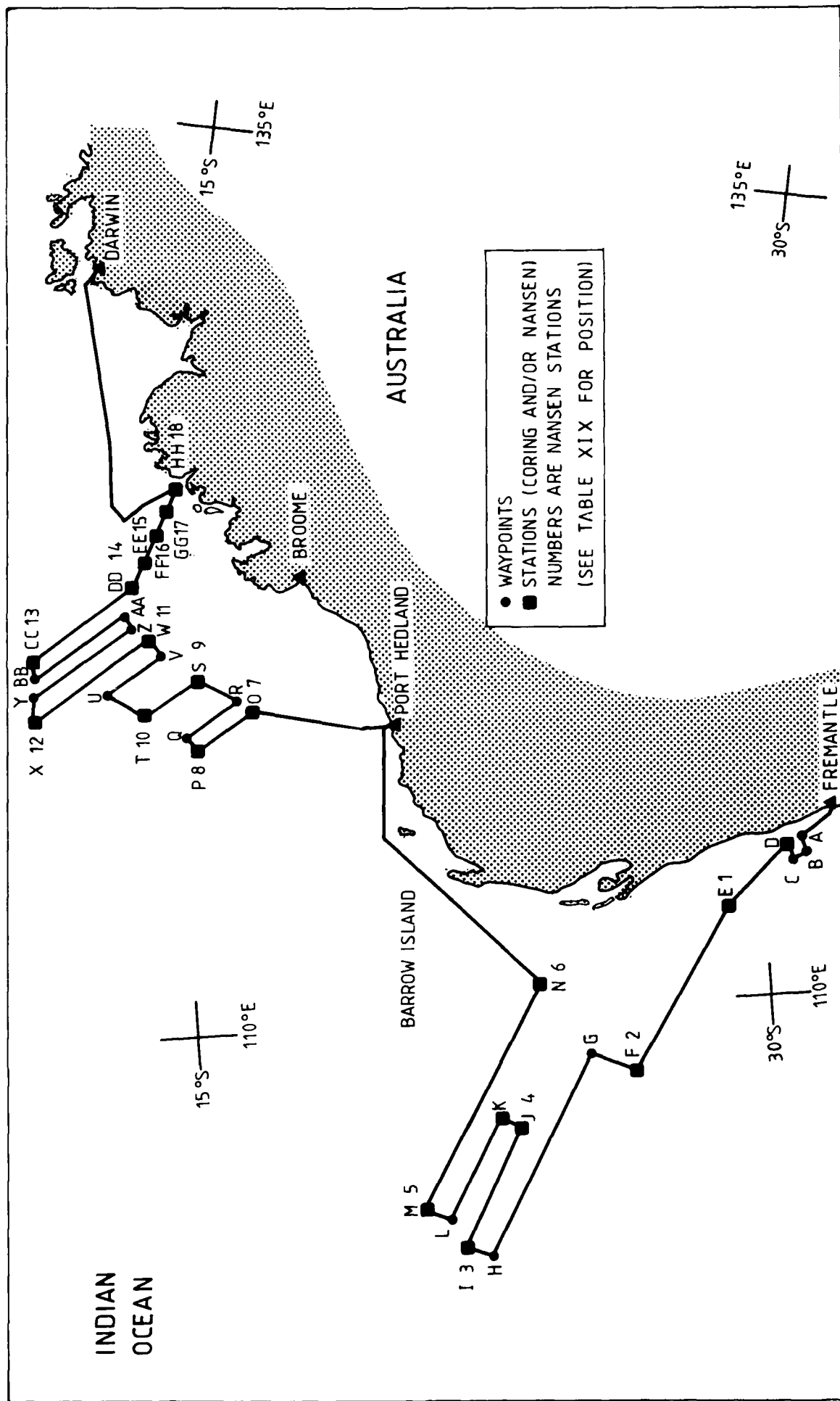

Fig. 16. Cruise track HMAS Cook Cruise RANRL 23/83 May 23 to June 15, 1983.

STATION 17 14.32S 124.19E RANRL 23/83
 DATE= 14/03/83 TIME= 2236GMT SONIC DEPTH= 63

DEPTH	TEMP	SALINITY	SIGMA-T	A.S.V	OX	POT.TEMP	S.S		
m	*C	Ppt		CL/T	ML/L	*C	M/Sec	Dyn.m	
0BS	0	27.34	34.75	22.423	540.7	0.00	27.34	1539.9	
0BS	10	27.36	34.75	22.414	541.9	0.00	27.36	1540.1	
0BS	20	27.33	34.75	22.427	541.1	0.00	27.33	1540.2	
0BS	30	27.32	34.75	22.426	541.6	0.00	27.31	1540.3	
0BS	40	27.33	34.74	22.422	542.4	0.00	27.32	1540.5	
0BS	50	27.34	34.75	22.425	542.5	0.00	27.33	1540.7	
ISL	0	27.34	34.75	22.423	540.7	0.00	27.34	1539.9	0.000
ISL	10	27.36	34.75	22.414	541.9	0.00	27.36	1540.1	.054
ISL	25	27.32	34.75	22.426	541.3	0.00	27.32	1540.3	.135
ISL	50	27.34	34.75	22.425	542.5	0.00	27.33	1540.7	.271

Table XVII Nansen Station Data for Station 17

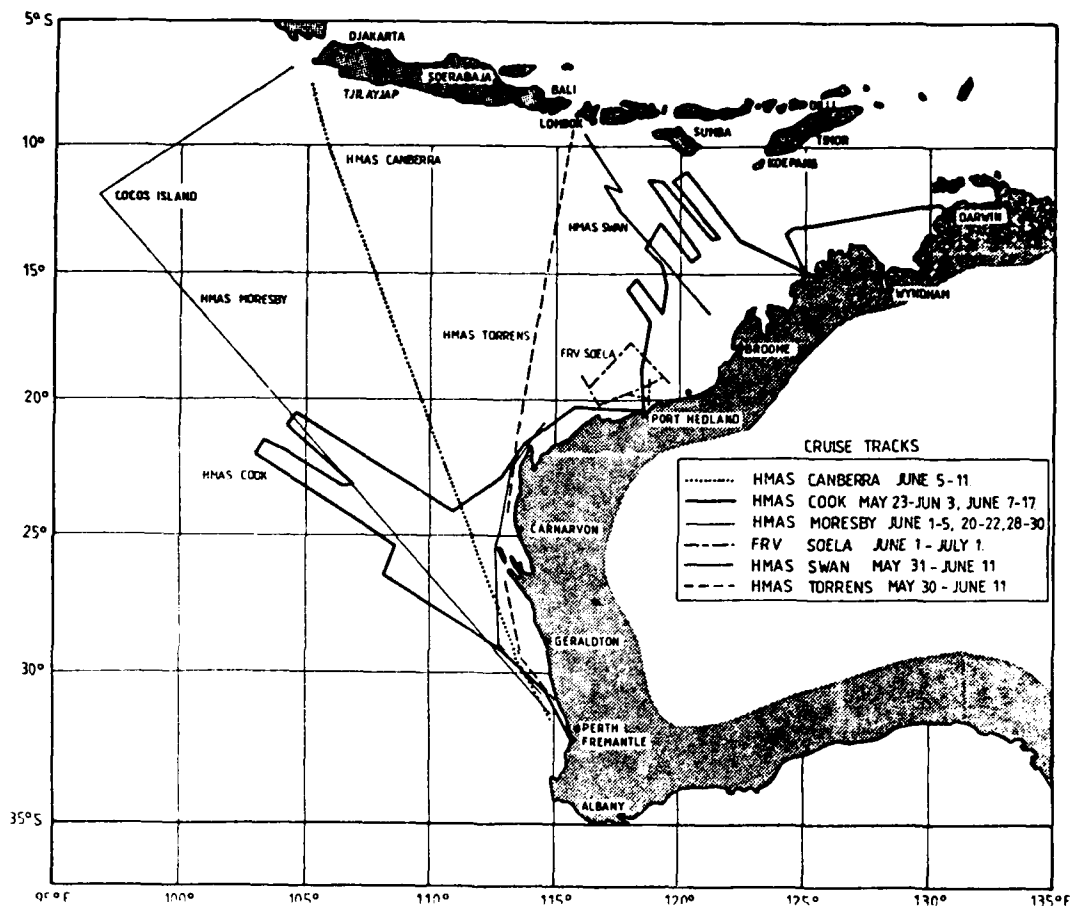

Fig. 17(a) Cruise Tracks of Vessels in the Indian Ocean for May-June 1983.

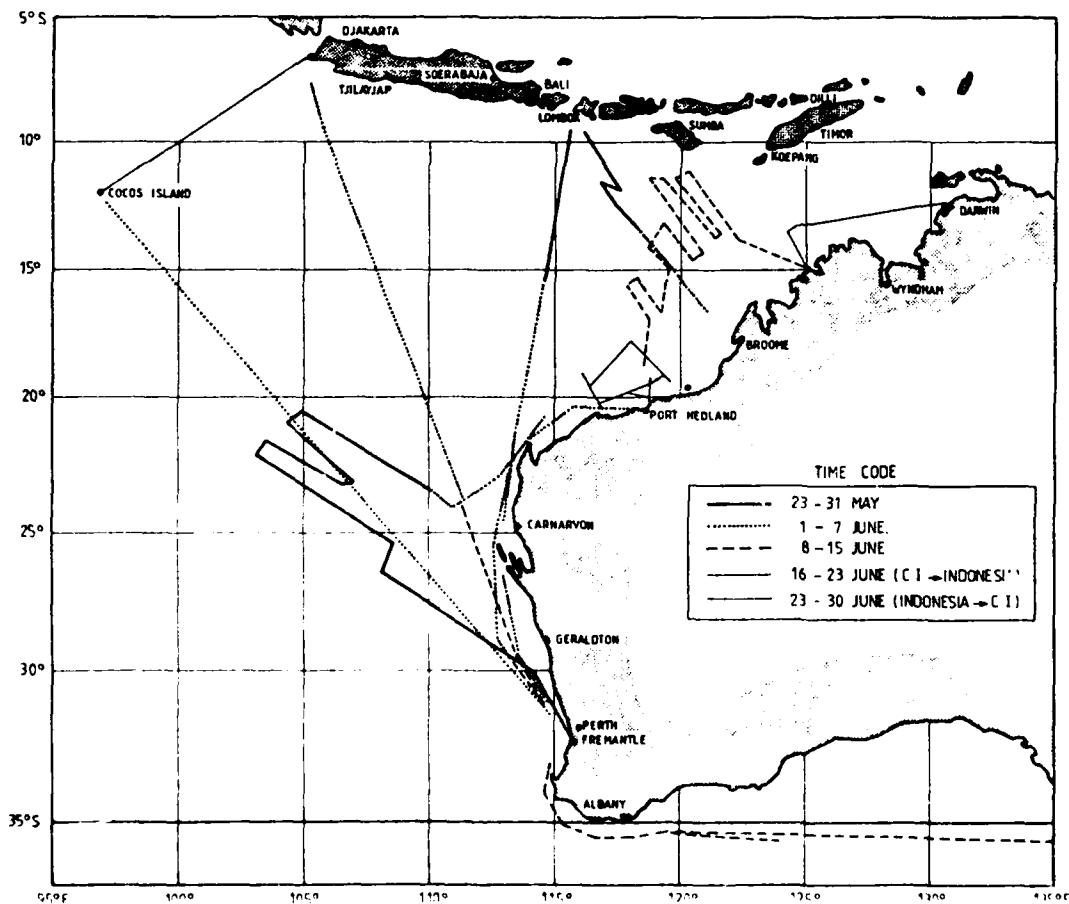

Fig. 17(b) Cruise Dates in Weekly Intervals.

STATION 18 14.50S 125.00E RANRL 23/83
 DATE= 15/05/83 TIME= 0410GMT SONIC DEPTH= 39

	DEPTH	TEMP	SALINITY	SIGMA-T	A.S.V	OX	POT.TEMP	S.S	
	m	°C	Ppt		CL/T	ML/L	°C	M/Sec	Dyn.m
DBS	0	26.43	34.51	22.533	530.1	0.00	26.43	1537.6	
DBS	10	26.37	34.51	22.551	528.8	0.00	26.37	1537.6	
DBS	20	26.31	34.52	22.575	526.9	0.00	26.31	1537.7	
DBS	30	26.23	34.57	22.642	520.9	0.00	26.22	1537.7	
ISL	0	26.43	34.51	22.533	530.1	0.00	26.43	1537.6	0.000
ISL	10	26.37	34.51	22.551	528.8	0.00	26.37	1537.6	.053
ISL	25	26.27	34.54	22.603	524.4	0.00	26.27	1537.7	.132

Table XVIII Nansen Station Data for Station 18

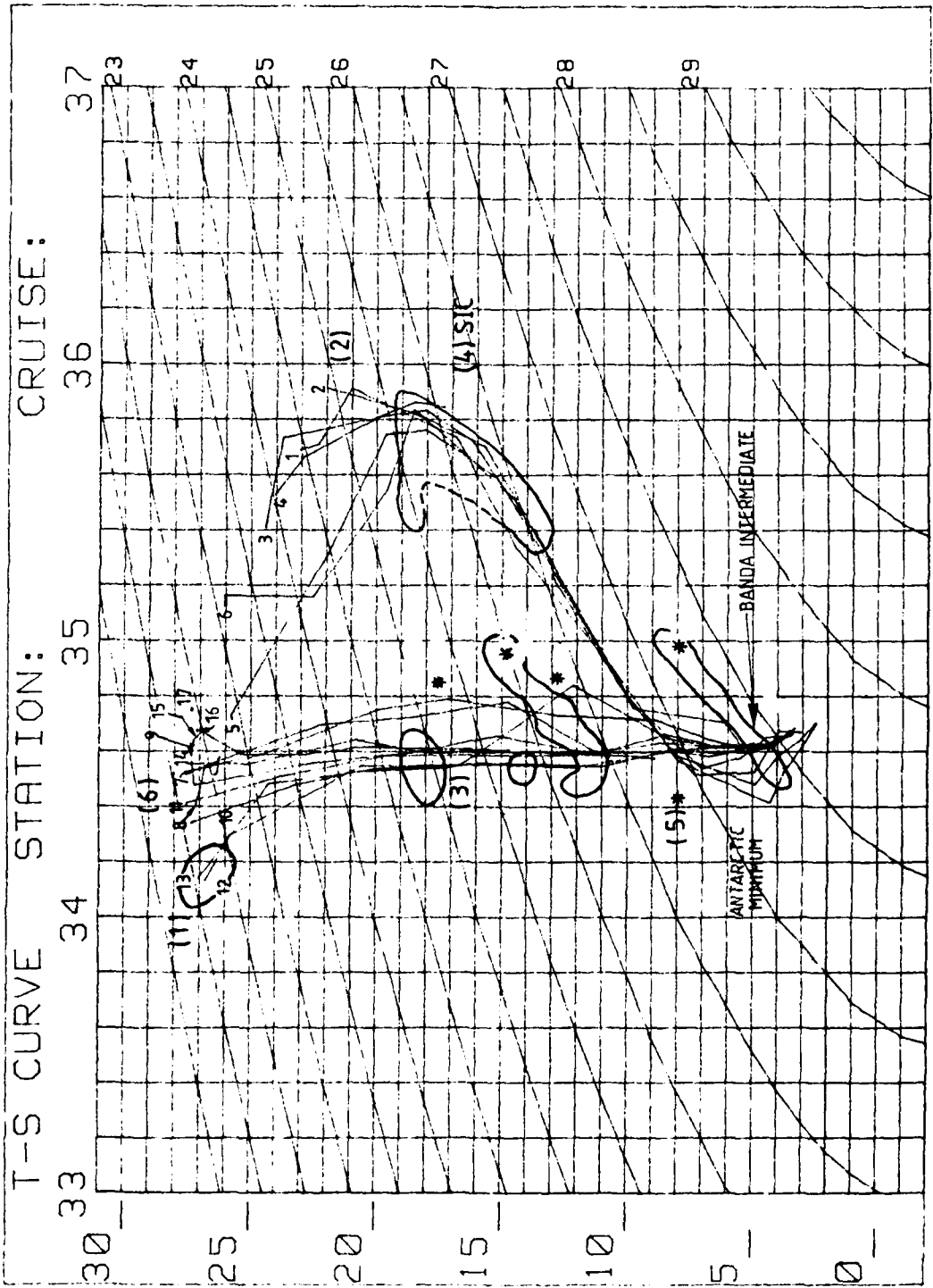

Figure 18. TEMPERATURE-SALINITY CURVES AND WATER MASSES
 Numbers in brackets are likely water types (after Rochford)
 Smaller numerals are station numbers

POSITION	NANSEN STATION NUMBER	LATITUDE S	LONGITUDE E	REMARKS
A		31 00	114 56	Fremantle waypoint
B		31 10	114 22	waypoint
C		30 51	114 10	waypoint
D		30 41	114 46	D, C
E	1	29 17	113 06	N, C
F	2	26 17	108 01	N, C
G		25 12	108 42	waypoint
H		22 00	103 00	waypoint
I	3	21 24	103 19	N, C
I-J		21 56	104 15	C
J	4	23 09	106 31	N, C
K		23 08	107 00	C
L		21 00	104 12	waypoint
M	5	20 26	104 35	N, C
N	6	24 02	110 47	N, C, Port Hedland
O	7	16 47	118 50	N, C
P	8	15 23	117 53	N, C
Q		15 06	118 12	waypoint
R		16 30	119 12	waypoint
S	9	15 21	119 36	N, C
T	10	13 58	118 43	N, C
U		13 00	119 15	waypoint
V		14 27	120 21	waypoint
W	11	14 08	120 53	N, C
X	12	11 10	118 42	N, C
Y		11 10	119 15	waypoint
Z		13 48	121 15	waypoint
AA		13 36	121 30	waypoint
BB		11 10	119 40	waypoint
CC	13	11 01	120 10	N, C
DD	14	13 46	122 15	N
EE	15	14 03	122 58	N, C
FF	16	14 20	123 39	N, C
GG	17	14 32	124 19	N
HH	18	14 50	125 00	N, C

Station key: N = Nansen cast, C = core, D = dredge

TABLE XIX- LIST OF WAYPOINTS AND STATION POSITIONS

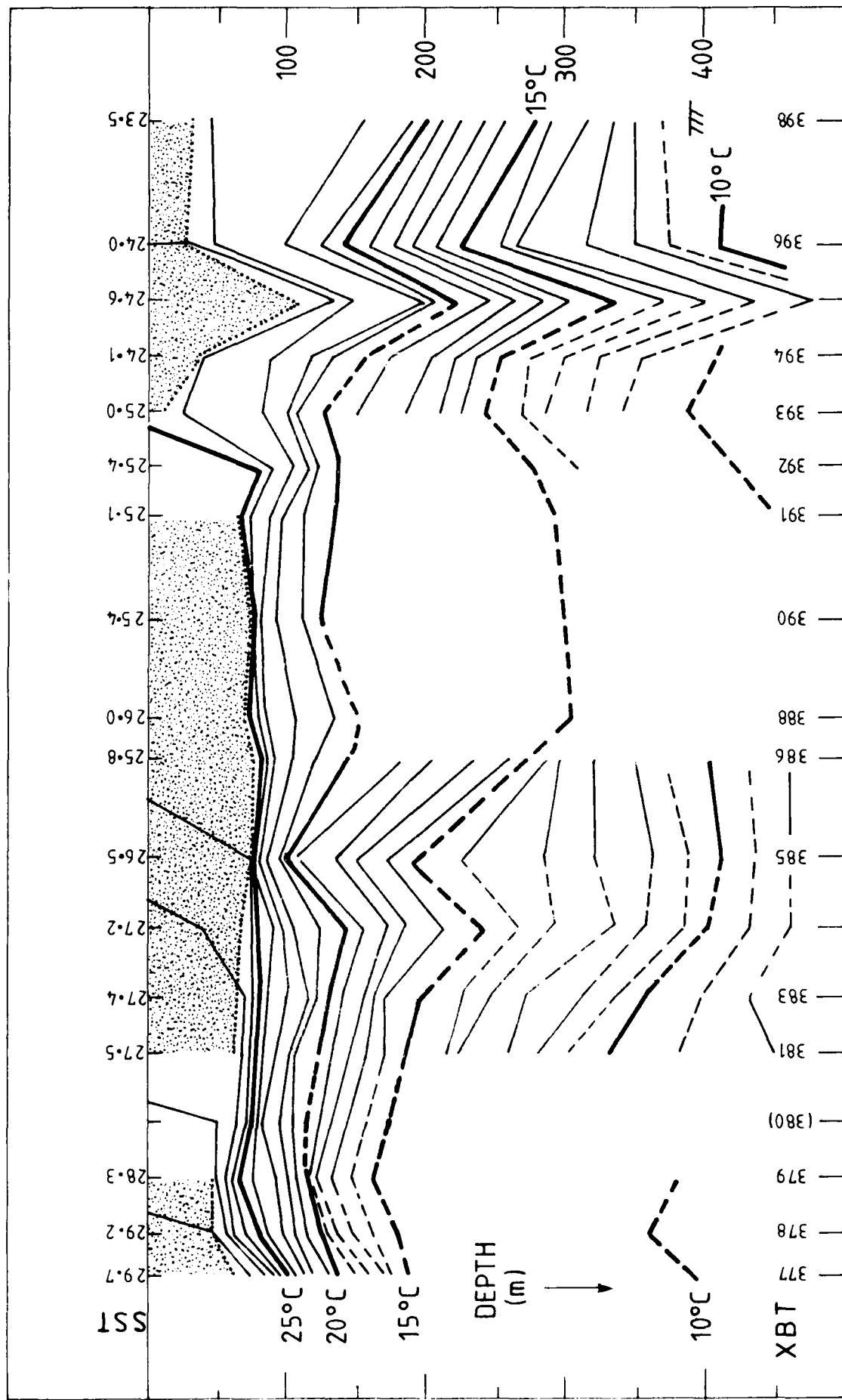

Fig. 19. XBT cross section HMAS Canberra 5-9 June 1983.
 from 7° 30'S, 105°E to 31° 10'S, 114° 50'E.

CALCULATION	REFERENCE
DSRT Temperature Correction DSRT Reversal Depth	SVERDRUP (1947) WÜST (1933)
Conductivity to Salinity Depth to Pressure Density - One Atmosphere - High Pressure Potential Temperature Sound Speed	LEWIS (1980) SAUNDERS (1981) MILLERO and POISSON (1981) MILLERO, CHEN, BRADSHAW and SCHLEICHER (1980) BRYDEN (1973) WILSON (1960)

TABLE XX - REFERENCES TO ALGORITHMS USED TO PROCESS
NANSEN STATION DATA

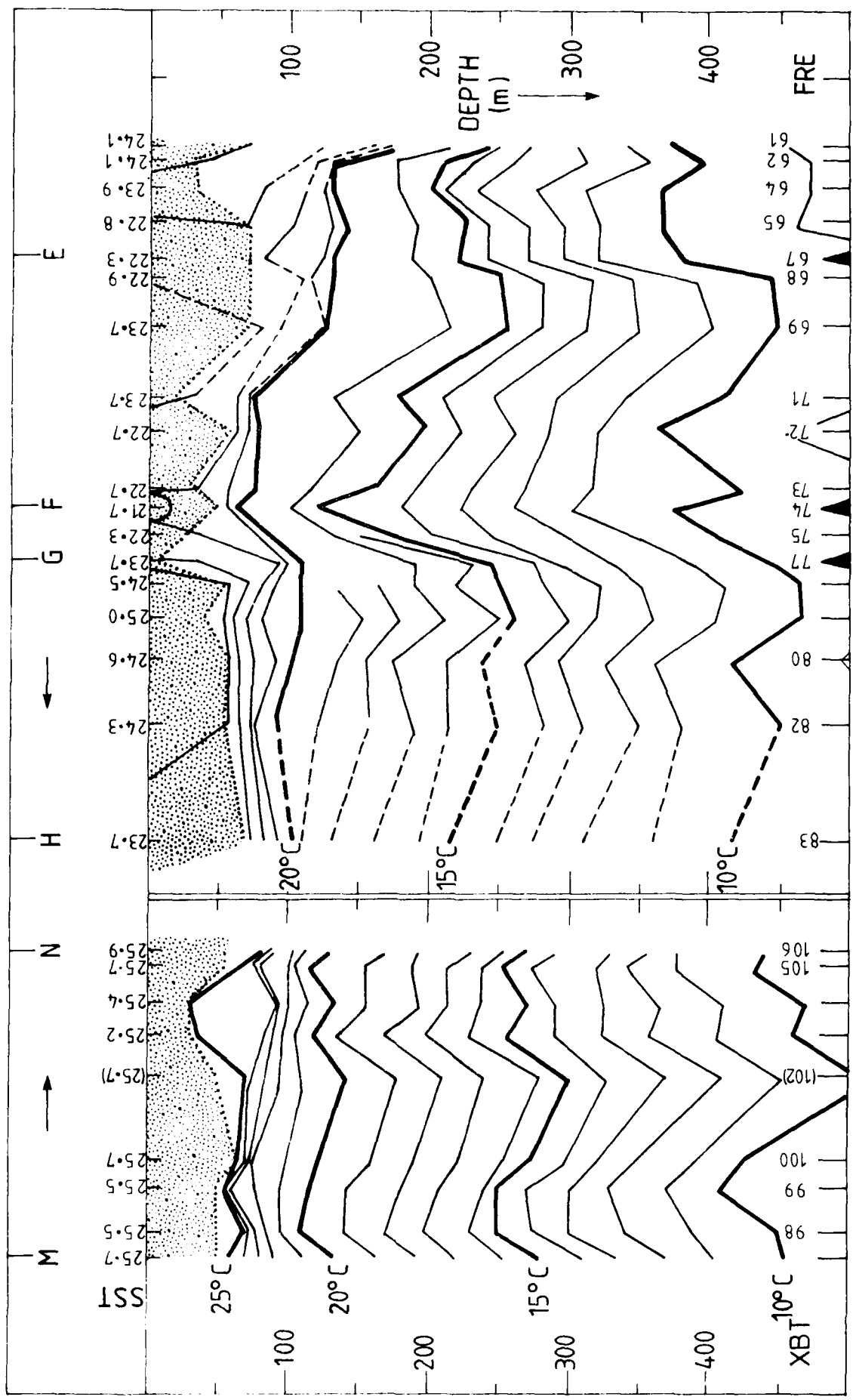

Fig. 20. XBT cross section RANRL 23/83 23-27 May & 30 May - 1 June 1983. Fremantle to 22°S, 103°E and 20°30'S, 104°30'E to 24°S, 111°E.

HYDROLOGICAL STRUCTURE OF THE UPPER 500 METRES

- (1) Surface (0-50 m), low salinity (less than 35.00‰) high temperature (greater than 25°C), tropical waters which spread south of 20°S in autumn and winter.
- (2) Surface (0-50 m), high salinity (greater than 35.90‰), lower temperature (20-22°C), subtropical waters carried north to about 25°S in summer by the West Australian Current.
- (3) Subsurface (100-150 m), low salinity (less than 35.00‰), low oxygen (less than 3.50 ml/l.), tropical water spreading south to about 26°S, on the 25.00 sigma-t surface in late summer and autumn. (Fig. 48 gives σ_t 25.00 - 26.00).
- (4) Subsurface (200-300 m), high salinity (greater than 35.80‰), subtropical waters of the South Indian Central region, spreading north on about the 26.00 sigma-t surface to about 12°S in summer, and to about 16°S in winter.
- (5) Subsurface (400-500 m), low salinity (less than 35.00‰) waters of the subtropical oxygen maximum (greater than 4.50 ml/l) drifting north on about the 26.80 sigma-t surface to about 12°S in summer, and to about 14°S in winter.
- (6) West-flowing surface (0-50 m) waters of the South Equatorial Current with salinities around 34.50‰, and temperature greater than 26°C, between latitudes 10 and 14°S. Near the northern boundary of the South Equatorial Current an accumulation of low salinity water (less than 35.00‰) formed the Equatorial Frontal Zone extending to depths of around 400 m. This Frontal Zone generally formed a southern limit to the spread of north Indian Ocean water masses.
- (7) However, Persian Gulf waters spread south below the Frontal Zone to c. 15°S where mixtures of Persian Gulf and subtropical oxygen maximum waters occurred during the whole of the year.
- (8) North Indian Ocean water masses at depths less than 400 m (e.g. counter-current (100 m) and Arabian Central (200 m)) occurred south of this Zone only in summer to about 15°S. At other times of the year these water masses were absorbed by mixing with waters of the Equatorial Frontal Zone.
- (9) Waters of the east flowing Sumatra-Java Current (salinity less than 34.00‰, temperature greater than 27.5°C) were detected only in January 1963 at around 9°30'S.
- (10) Very low salinity (less than 33.00‰) surface waters in May-June around 10°S were carried by currents out of the Java and Banda Seas and were not a result of the Sumatra-Java Current.

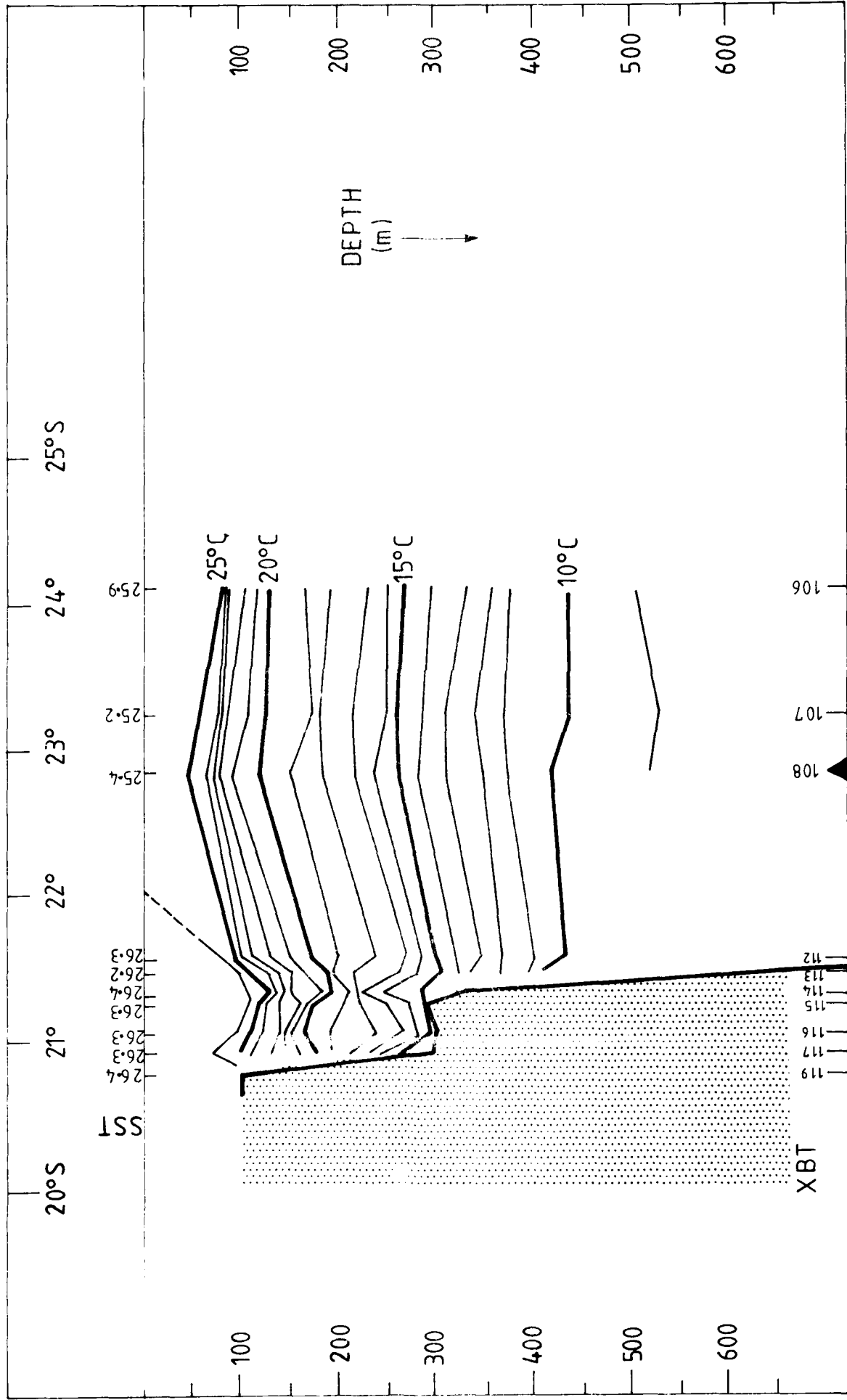

Fig. 21. XBT cross section RANRL 23/83 1 - 2 June, 1983. from Station N to Barrow Island.

Three water masses have been identified from maxima and minima in temperature-salinity diagrams for intermediate depths of the south-east Indian Ocean.

- (i) The Antarctic Intermediate occurred as a salinity minimum with the density range of 27.00 - 25.28 σ_t .
- (ii) The North-West Indian Intermediate (Red Sea Water) was found as a salinity maximum with the σ_t range 27.20 - 27.50.
- (iii) The Banda Intermediate, lying below the North-West Indian Intermediate (Red Sea), had the characteristic of a salinity minimum within the σ_t range of 27.28 - 27.59.

TABLE XXII THE WATER MASSES IN INTERMEDIATE DEPTHS OF THE SOUTH-EAST INDIAN OCEAN (ROCHFORD, 1961)

SECTION THROUGH STATIONS 1 AND 2
 DISTANCE BETWEEN STATIONS= 601.0 KM
 CURRENT RELATIVE TO 0 METRES

DEPTH m	CURRENT cm/sec	TRANSPORT **
0	0.0	0.00
10	0.1	.01
25	0.3	.07
50	0.8	.36
75	1.6	.92
100	2.9	1.90
150	3.7	4.34
200	3.8	7.28
250	4.5	10.18
300	4.5	13.03
400	4.7	18.02
500	4.6	22.41
600	4.5	26.66
800	4.2	33.04
1000	3.8	37.60
1500	3.4	45.22
2000	3.0	49.97

PROFILE OF CURRENT VS DEPTH

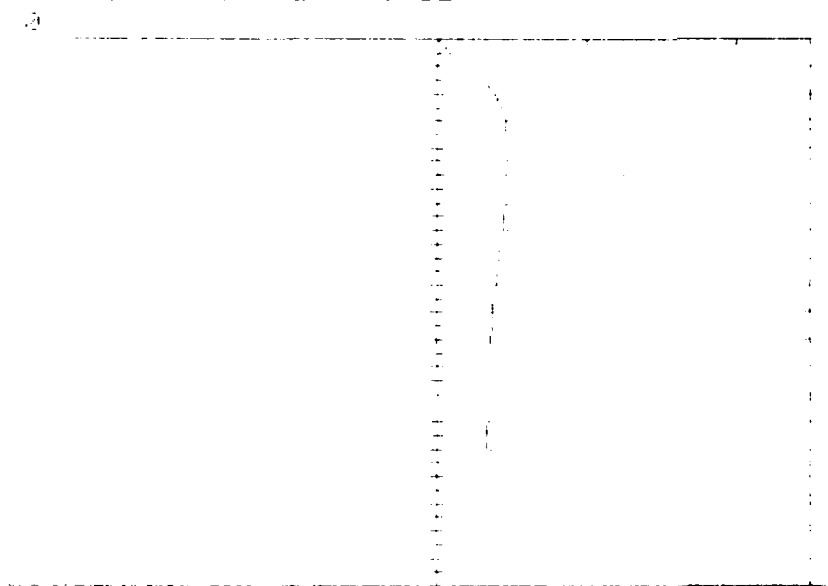

Table XXIII. Geostrophic Current Component at Right Angles between Nansen Stations 1 and 2 relative to the surface.

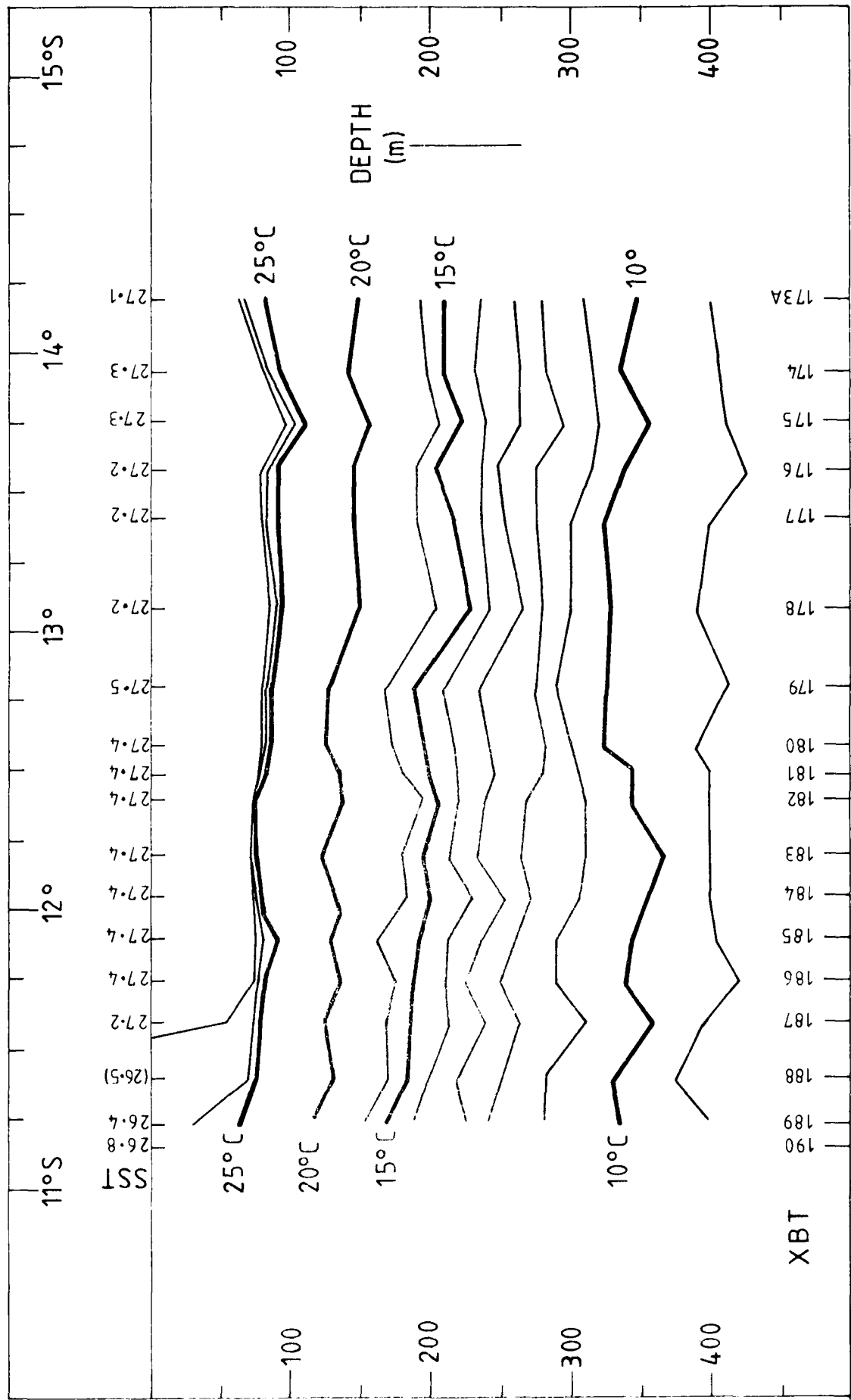

Fig. 23. XBT cross section RANRL 23/83 10-11 June 1983 from 14°08'S, 120°53'E (Station W) to 11°10'S, 118°42'E (Station X)

SECTION THROUGH STATIONS 2 AND 4
 DISTANCE BETWEEN STATIONS = 379.9 KM
 CURRENT RELATIVE TO 0 METRES

DEPTH m	CURRENT Cm/sec	TRANSPORT **
0	0.0	0.00
10	-1.4	-1.03
25	-1.9	-1.22
50	-2.9	-1.90
75	-3.6	-2.03
100	-3.6	-3.37
150	-4.6	-6.52
200	-5.4	-10.25
250	-6.4	-14.73
300	-6.7	-17.86
400	-6.8	-25.40
500	-6.8	-33.03
600	-6.8	-40.04
800	-6.8	-52.34
1000	-6.8	-62.16
1200	-5.6	-72.69

ALOG OF CURRENT VS DEPTH

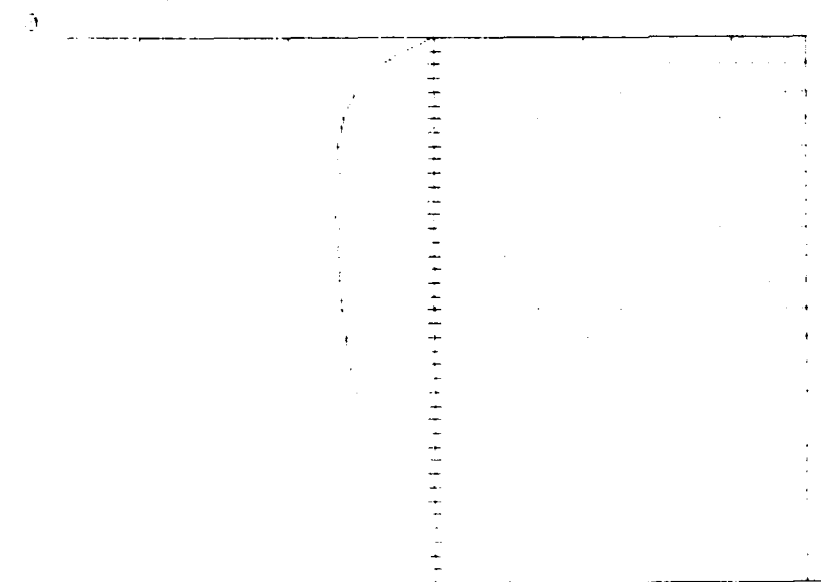

Table XXIV Geostrophic Current Component at Right Angles between Nansen Stations 2 and 4 relative to the surface.

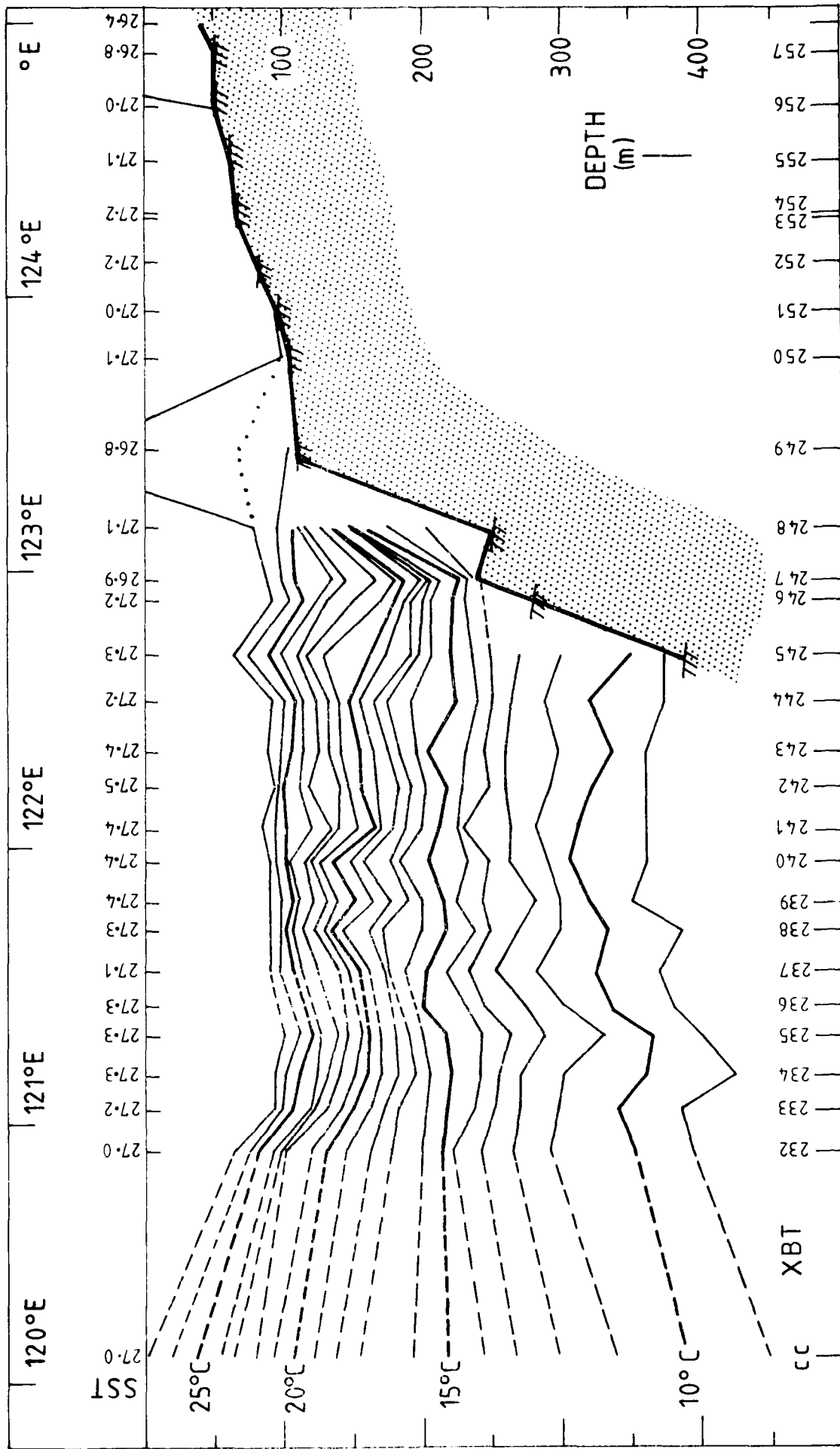

Fig. 24. XBT cross section Cruise RANRL 23/83 13-14 June, 1983.
 From 11°00'S, 120°10'E to 14°50'S, 125°00'E.

SECTION THROUGH STATIONS 4 AND 5
 DISTANCE BETWEEN STATIONS= 362.0 KM
 CURRENT RELATIVE TO 0 METRES

DEPTH m	CURRENT Cm/sec	TRANSPORT ←*
0	0.0	0.00
10	-1.6	-1.05
25	-3.5	-3.36
50	-3.2	-1.53
75	-4.7	-3.34
100	-5.9	-5.50
150	-7.4	-10.71
200	-8.4	-16.25
250	-9.2	-22.31
300	-9.8	-28.33
400	-10.3	-40.25
500	-10.5	-51.39
600	-10.4	-61.41
800	-9.9	-78.84
1000	-10.2	-100.69
1200	-11.2	-143.47

PLOT OF CURRENT VS DEPTH

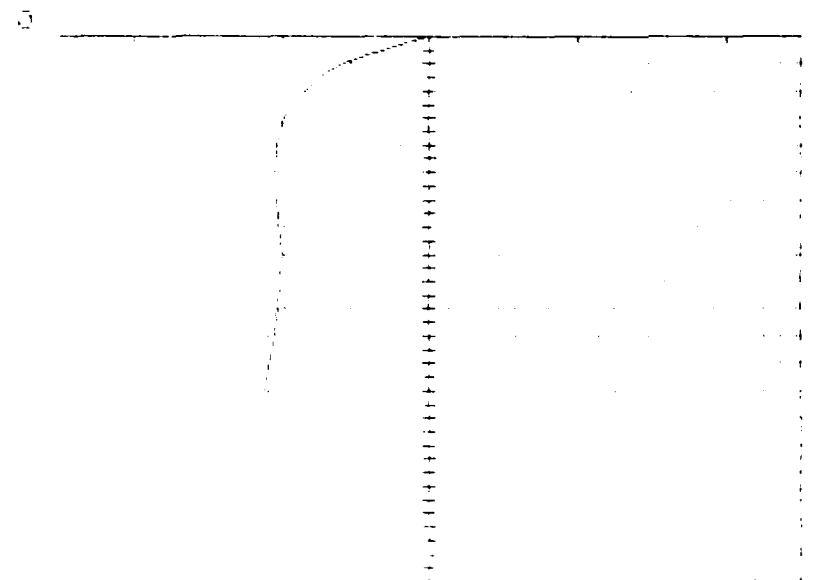

Table XXV Geostrophic Current Component at Right Angles between Nansen Stations 4 and 5 relative to the surface.

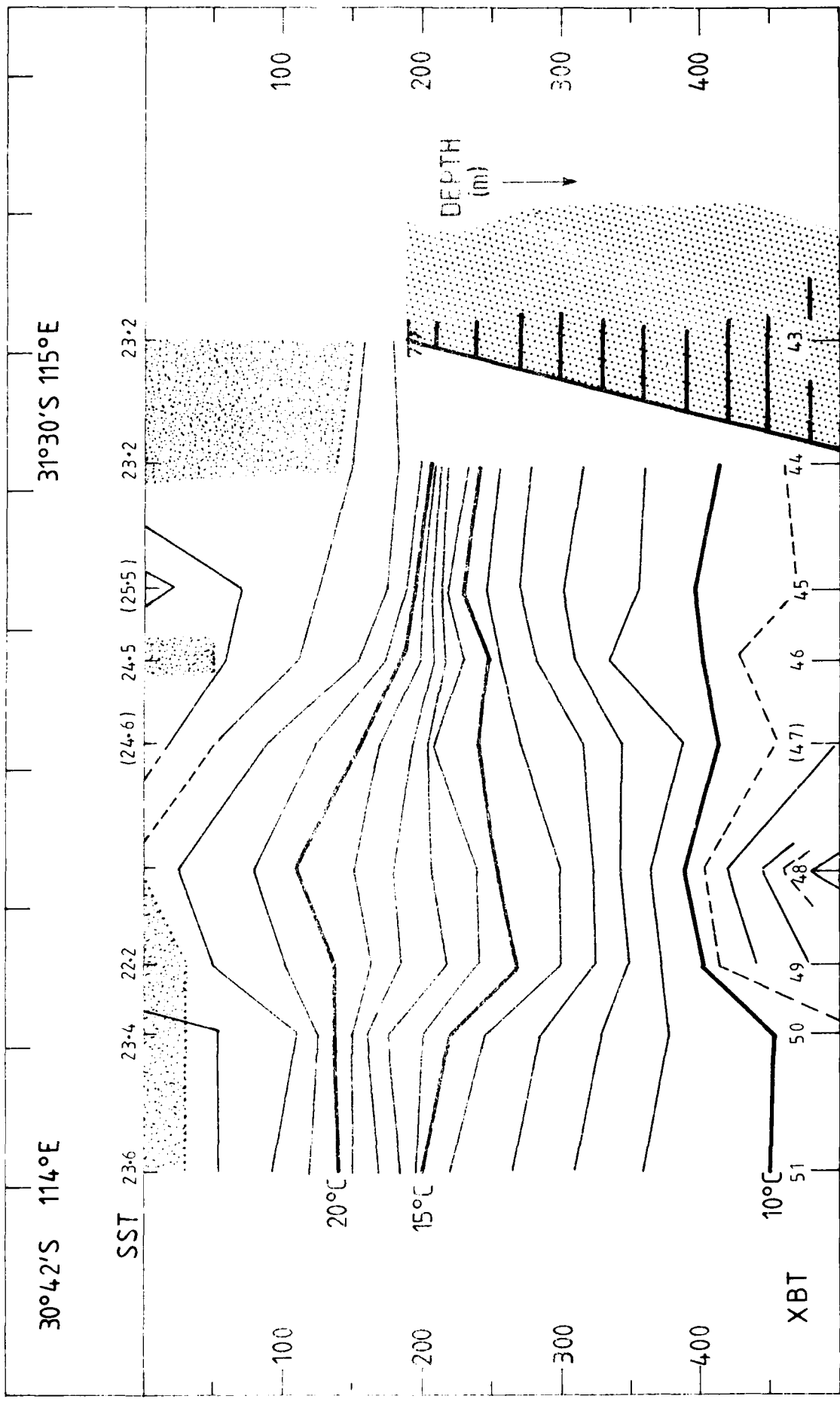

Fig. 25. XBT cross section HMAS Moresby 1315-1800 GMT 22 May 1983.
 from 31°33'S, 115°01'E to 30°42'S, 114°01'E.

SECTION THROUGH STATIONS 4 AND 6
 DISTANCE BETWEEN STATIONS= 445.7 KM
 CURRENT RELATIVE TO 0 METRES

DEPTH m	CURRENT Cm/sec	TRANSPORT ←*
0	0.0	0.00
10	-0.4	-0.03
25	-0.5	-0.22
50	-2.1	-0.97
75	-3.2	-2.29
100	-4.3	-4.10
150	-5.9	-8.43
200	-6.8	-12.05
250	-7.4	-17.86
300	-7.7	-22.24
400	-7.8	-30.58
500	-7.9	-38.53
600	-7.5	-44.30
800	-5.6	-45.76
1000	-5.4	-54.48
1200	-5.0	-78.52

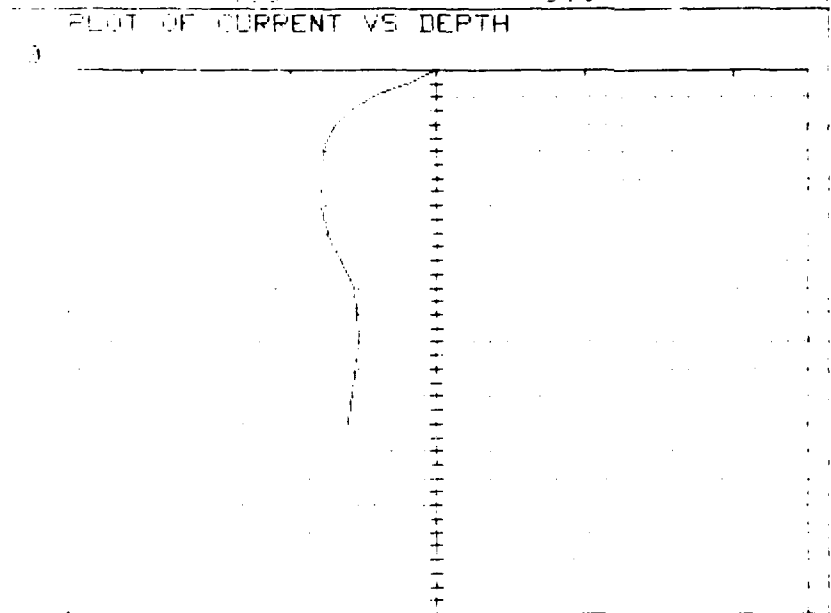

Table XXVI Geostrophic Current Component at Right Angles between Nansen Stations 4 and 6 relative to the surface.

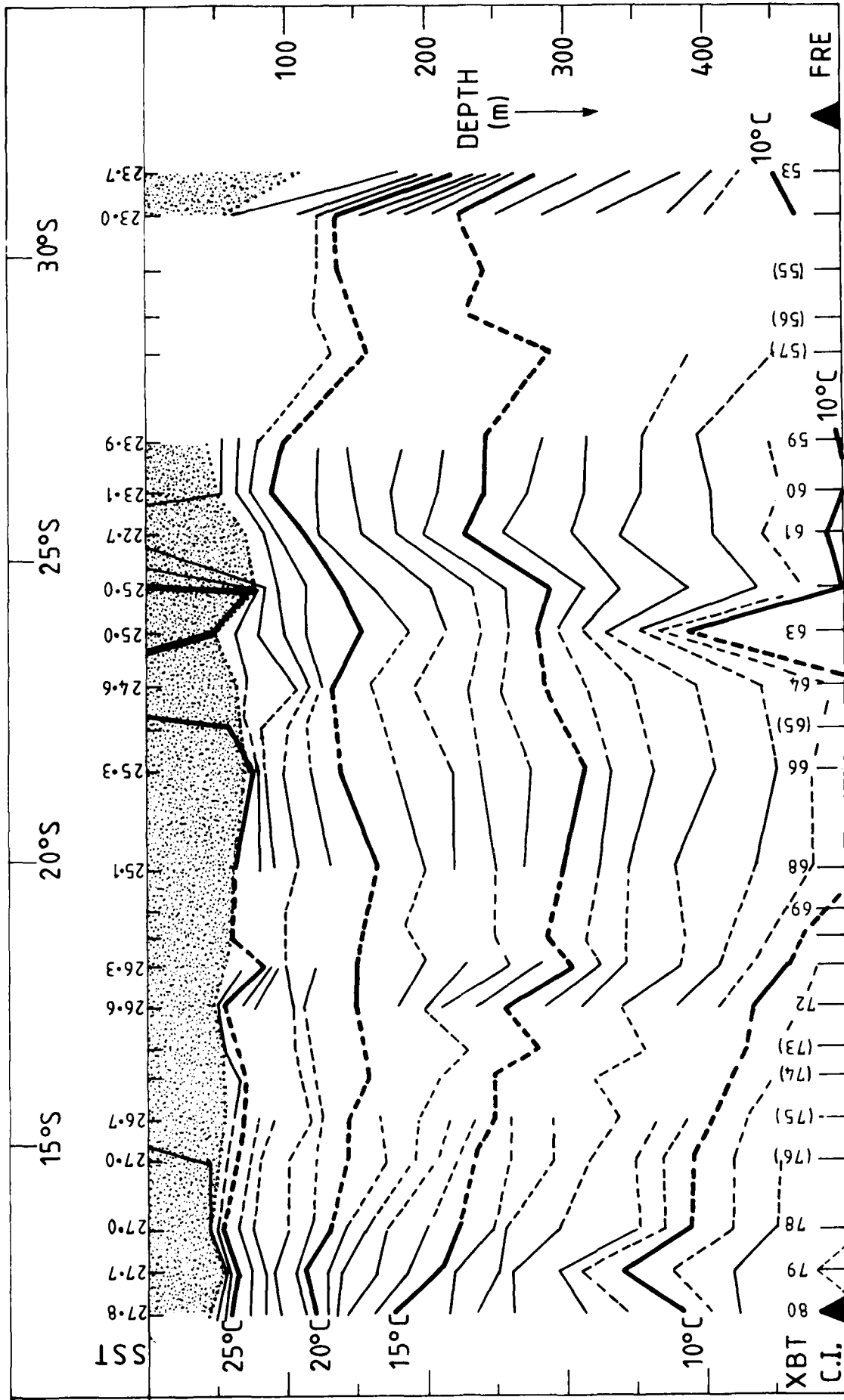

Fig. 26. XBT cross section HMAS Moresby 1 - 6 June 1983.
from Fremantle to Cocos Island.

SECTION THROUGH STATIONS 2 AND 6
 DISTANCE BETWEEN STATIONS= 374.3 KM
 CURRENT RELATIVE TO 0 METRES

DEPTH m	CURRENT Cm/sec	TRANSPORT **
0	0.0	0.00
10	-1.8	-1.07
25	-2.0	-4.46
50	-4.3	-11.99
75	-6.5	-48.59
100	-8.4	-79.97
150	-11.2	-159.95
200	-13.0	-240.86
250	-14.2	-341.12
300	-14.7	-427.76
400	-15.6	-596.63
500	-15.6	-761.16
600	-15.2	-896.63
800	-12.3	-1035.55
1000	-12.3	-1231.12
1000	-12.3	-160.57

PLLOT OF CURRENT VS. DEPTH

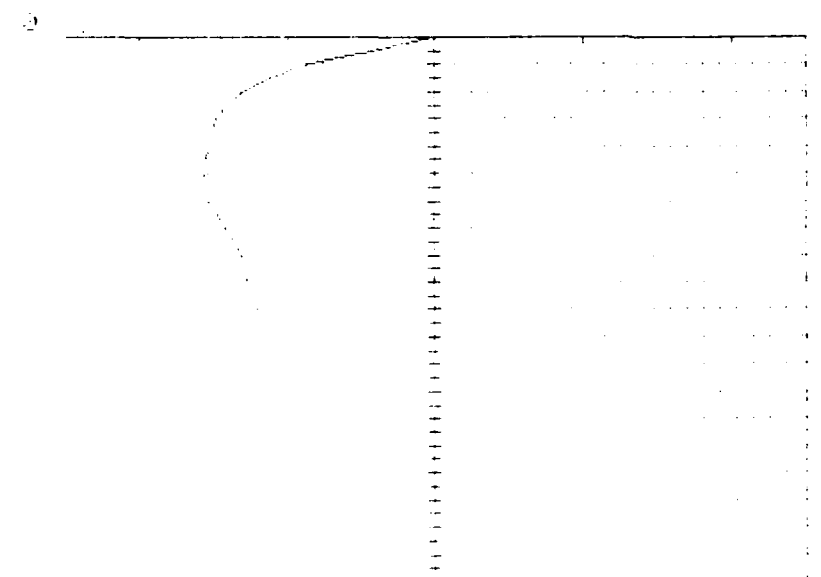

Table XXVII Geostrophic Current Component at Right Angles between Nansen Stations 2 and 6 relative to the surface.

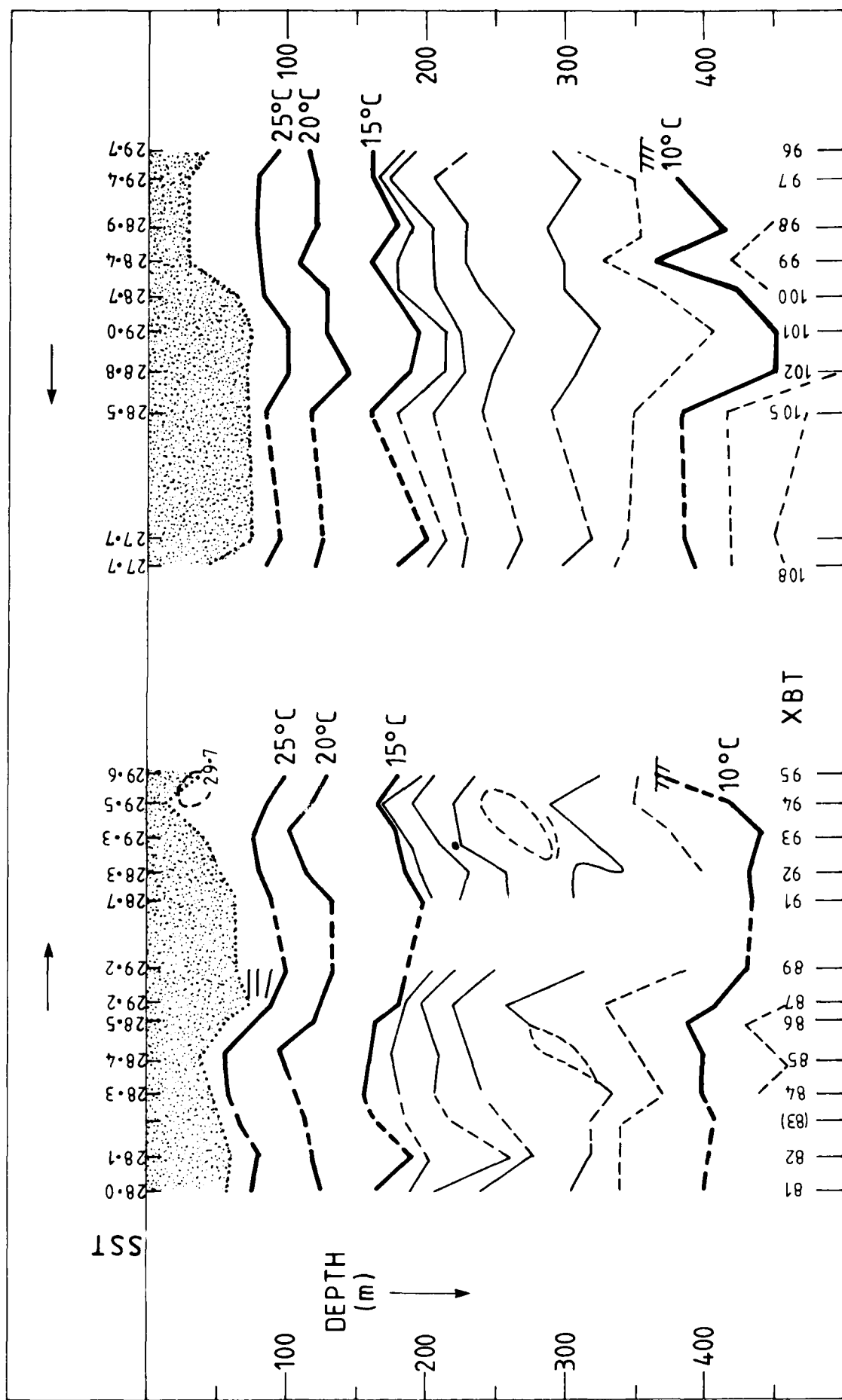

Fig. 27. XBT cross sections HMAS Moresby 20-22 & 28-30 June 1983 from Cocos Island to Sunda Strait (and return).

SECTION THROUGH STATIONS 7 AND 8
 DISTANCE BETWEEN STATIONS= 185.8 KM
 CURRENT RELATIVE TO 0 METRES

DEPTH m	CURRENT Cm/sec	TRANSPORT **
0	0.0	0.00
10	0.0	0.00
25	.1	.02
50	.5	.20
75	1.3	.86
100	3.0	2.74
150	5.8	8.06
200	8.1	15.19
250	10.3	24.23
300	11.2	31.94
400	12.1	46.64
500	12.0	58.17
600	11.7	68.68
800	11.1	87.28

② PLOT OF CURRENT VS DEPTH

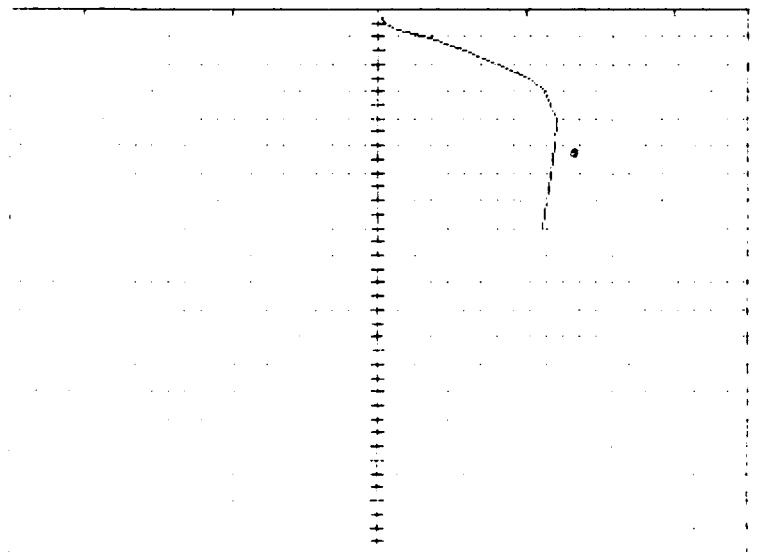

Table XXVIII Geostrophic Current Component at Right Angles between Nansen Stations 7 and 8 relative to the surface.

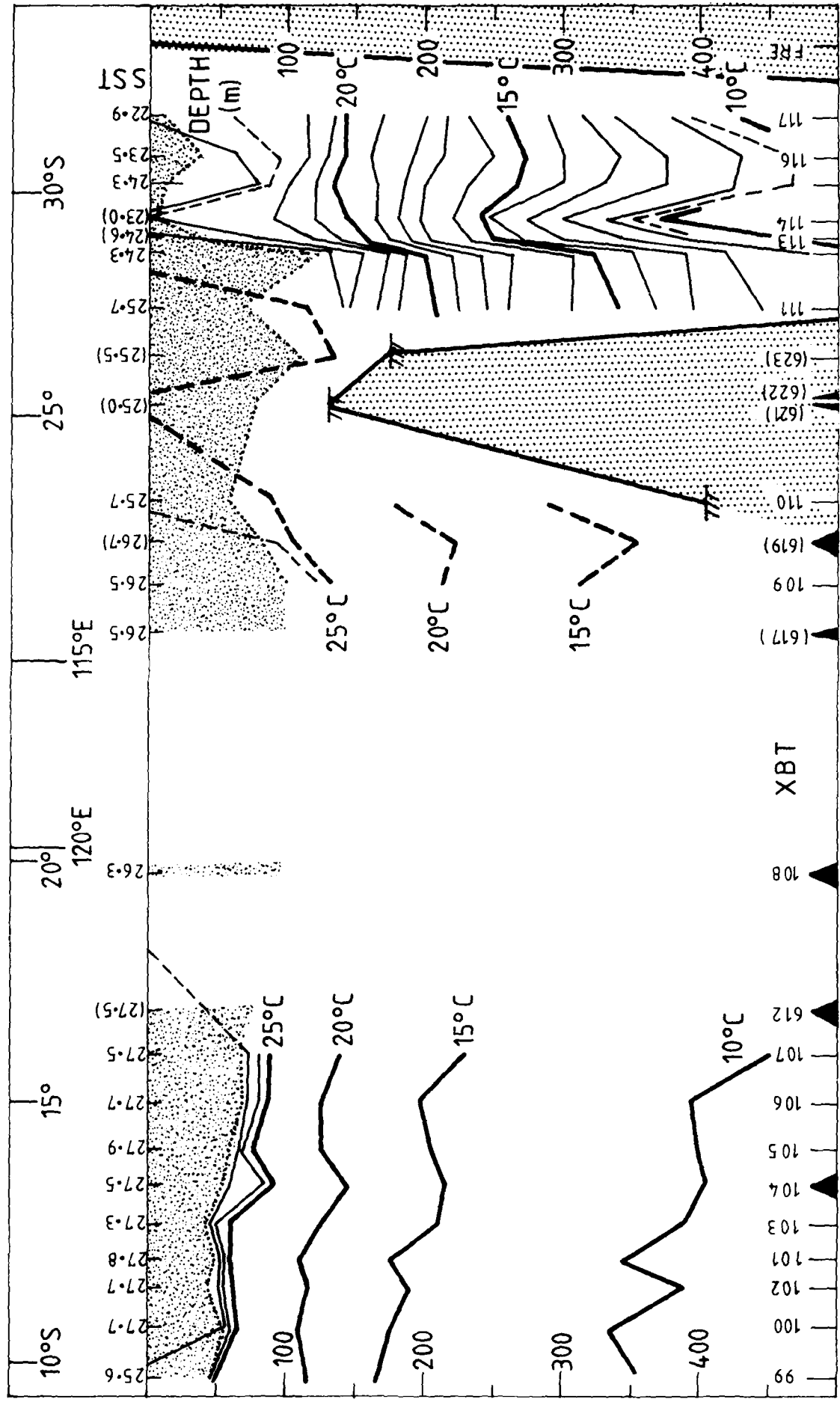

Fig. 28. XBT cross section from Lombok to Fremantle HMAS Swan 31 May - 8 June 1983

SECTION THROUGH STATIONS 7 AND 9
 DISTANCE BETWEEN STATIONS = 175.2 KM
 CURRENT RELATIVE TO 0 METRES

DEPTH	CURRENT cm/sec	TRANSPORT
0	0.0	0.00
10	0.1	0.01
25	0.2	0.03
50	0.3	0.08
75	0.4	0.14
100	0.5	0.21
150	0.7	0.34
200	0.9	0.44
250	1.1	0.55
300	1.2	0.66
400	1.4	0.84
500	1.7	1.02
600	2.0	1.20
800	2.8	1.68

FIGURE OF CURRENT VS DEPTH

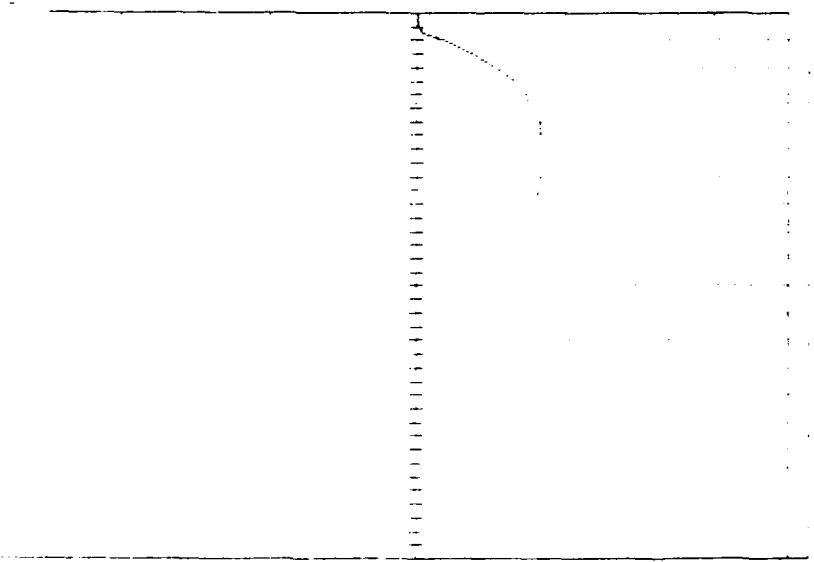

Table XXIX Geostrophic Current Component at Right Angles between Nansen Stations 7 and 9 relative to the surface.

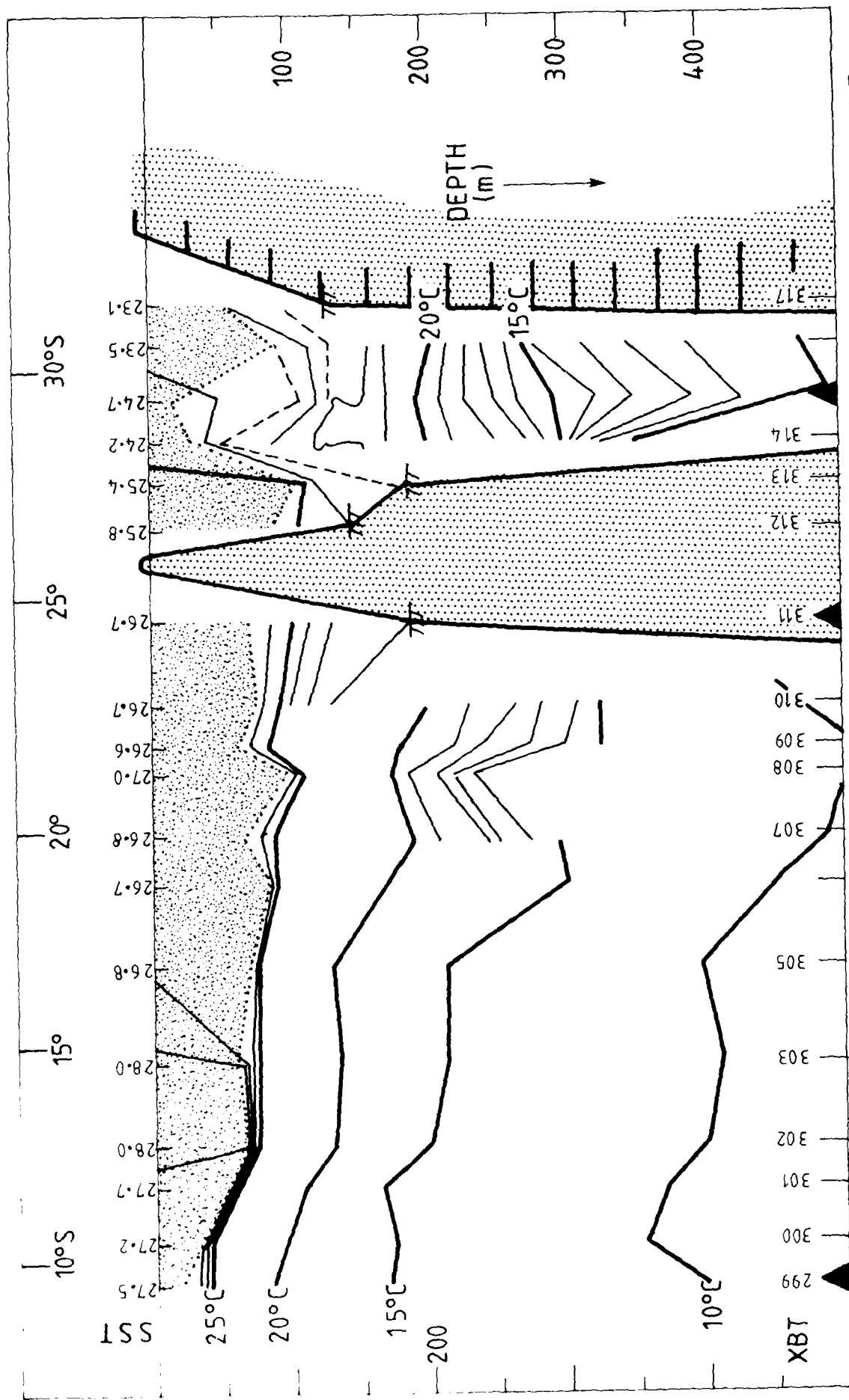

Fig. 29. XBT cross section HMAS Torrens 30 May - 3 June 1983.

from Bali to Fremantle.

SECTION THROUGH STATIONS 8 AND 10
 DISTANCE BETWEEN STATIONS= 181.2 KM
 CURRENT RELATIVE TO 0 METRES

DEPTH m	CURRENT Cm/sec	TRANSPORT **
0	0.0	0.00
10	-1.2	-0.02
25	-1.6	-0.13
50	-1.6	-0.72
75	-2.6	-1.99
100	-4.4	-4.13
150	-6.3	-11.63
200	-12.6	-23.69
250	-15.8	-37.41
300	-16.9	-48.22
400	-16.8	-64.93
500	-15.7	-81.17
600	-16.5	-97.02
800	-16.5	-129.96
1000	-17.1	-168.62
1300	-17.5	-224.71

PLOT OF CURRENT VS DEPTH

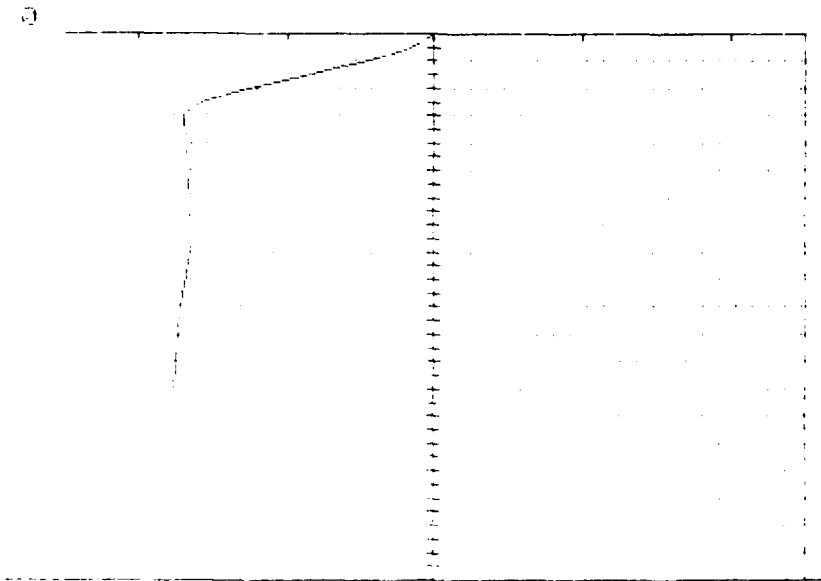

Table XXX Geostrophic Current Component at Right Angles between Nansen Stations 8 and 10 relative to the surface.

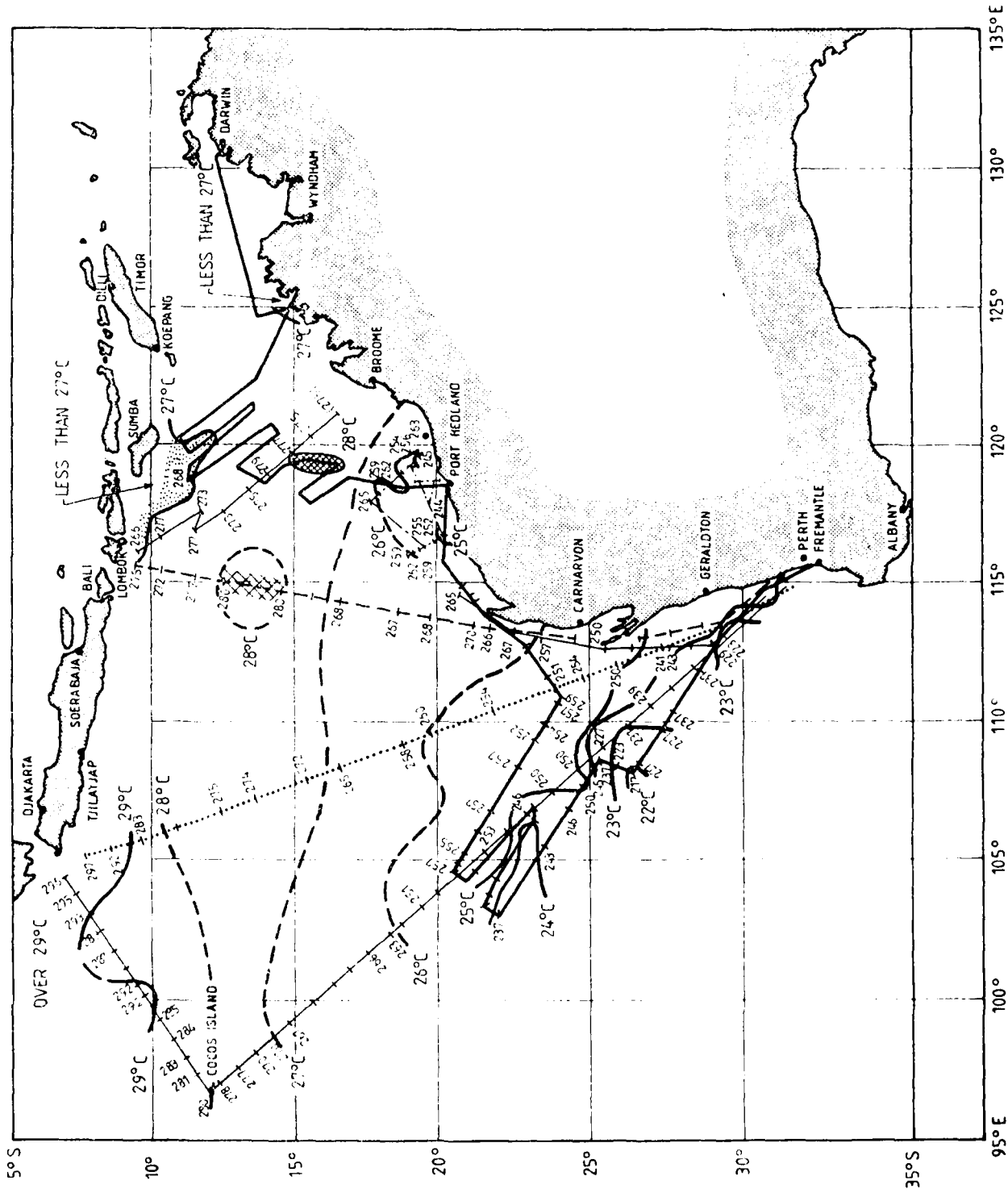

Fig. 30 Sea Surface Temperature Contours (drawn from XBT data)

SECTION THROUGH STATIONS 9 AND 10
 DISTANCE BETWEEN STATIONS = 180.8 KM
 CURRENT RELATIVE TO 0 METRES

DEPTH m	CURRENT Cm/sec	TRANSPORT
0	0.0	0.00
10	-1.3	-1.12
25	-1.4	-1.14
50	-1.7	-1.53
75	-1.6	-1.42
100	-1.8	-1.56
150	-5.9	-8.21
200	-9.2	-17.45
250	-11.0	-27.34
300	-12.3	-35.18
400	-12.2	-47.22
500	-12.9	-59.91
600	-12.5	-72.91
800	-13.9	-100.64
1000	-13.5	-132.61
1300	-13.9	-177.16

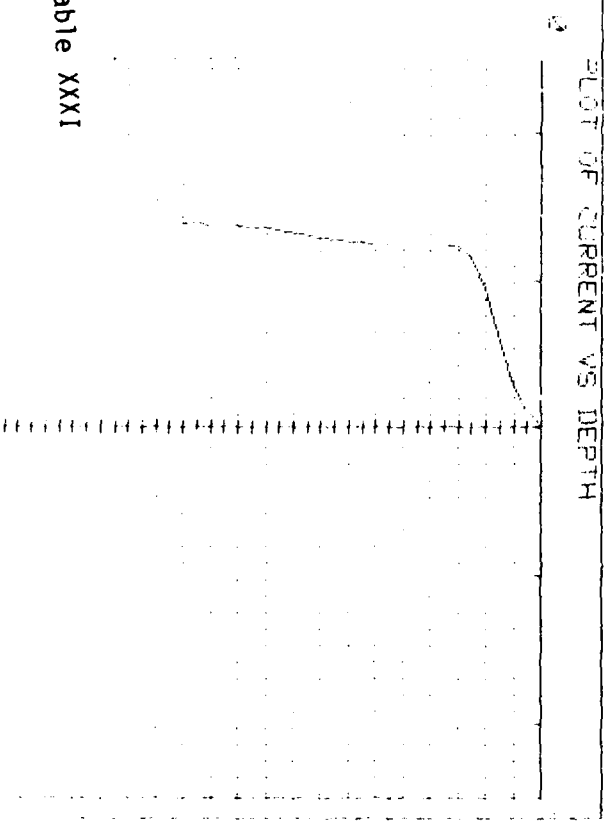

Table XXXI

Geostrophic Current Component at Right Angles between Nansen Stations 9 and 10 relative to the surface.

SECTION THROUGH STATIONS 10 AND 11
 DISTANCE BETWEEN STATIONS = 232.4 KM
 CURRENT RELATIVE TO 0 METRES

DEPTH m	CURRENT Cm/sec	TRANSPORT
0	0.0	0.00
10	-1.0	-0.90
25	-0.0	-0.00
50	-0.0	-0.00
75	-1.0	-1.05
100	-1.0	-1.25
150	-1.0	-1.17
200	-1.2	-1.77
250	-1.5	-3.74
300	-1.1	-3.52
400	-1.4	-5.32
500	-1.0	-4.55
600	-1.2	-6.67
800	-1.5	-11.19
1000	-1.5	-16.50
1300	-1.3	-14.25

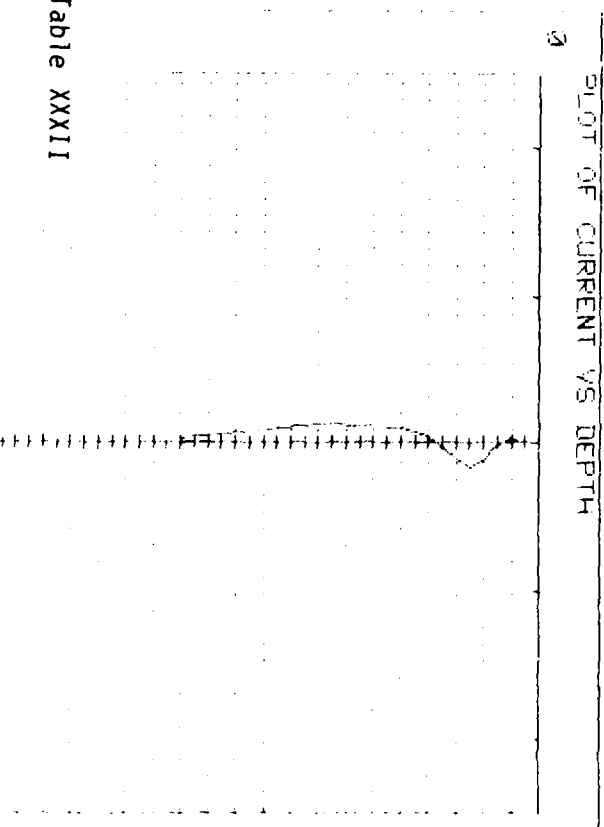

Table XXXII

Geostrophic Current Component at Right Angles between Nansen Stations 10 and 11 relative to the surface.

GOSSTCOMP SEA SURFACE TEMPERATURE

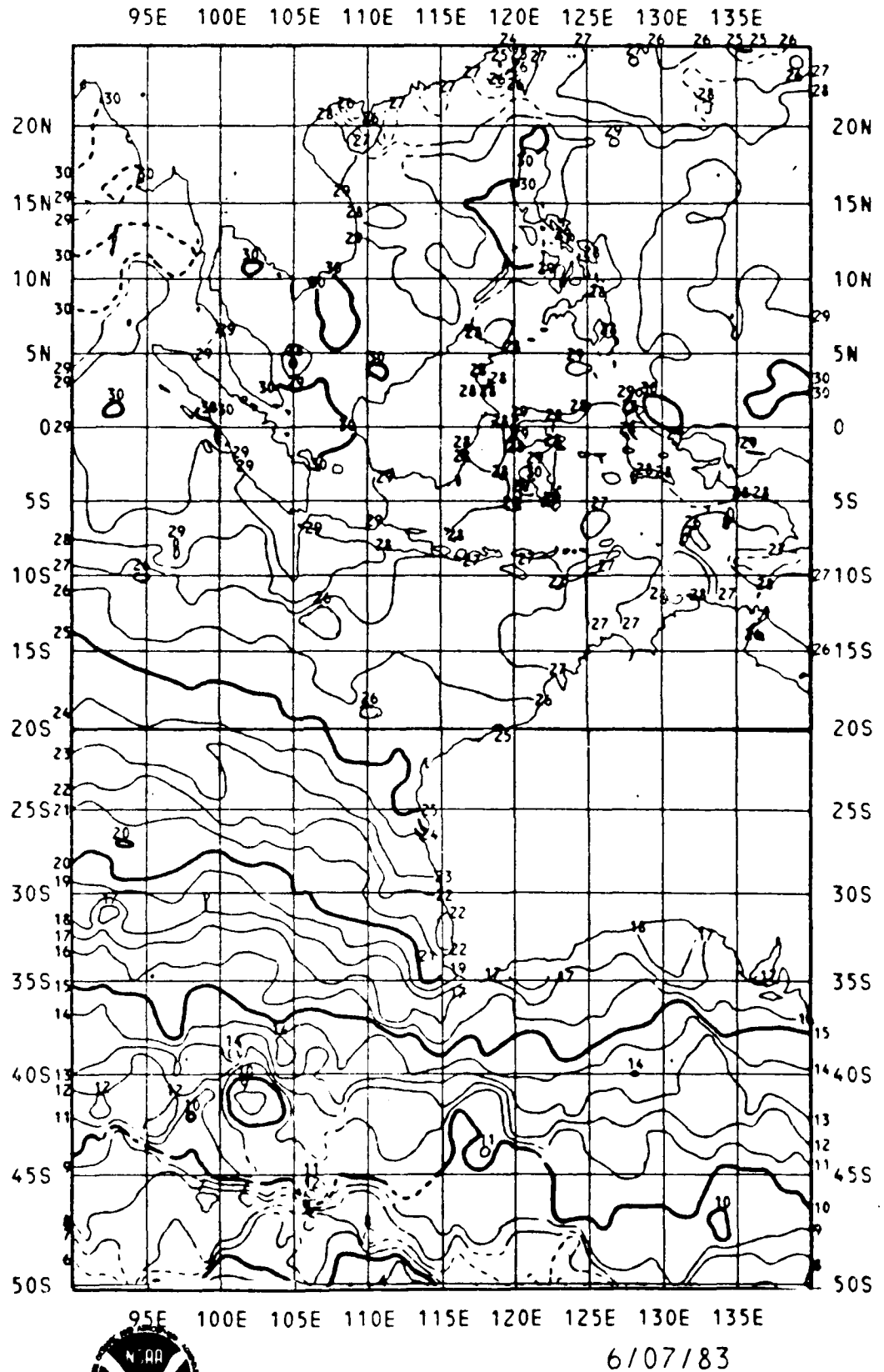

Fig. 31

GOSSTCOMP SST

07 June 1983

20-65°S, 90-140°E

Fig. 32

GOSSTCOMP SST

07 June 1983

10°N-25°S, 90-140°E

DEPTH	CURRENT RELATIVE TO	CURRENT	TRANSPORT
0	0 METRES	6.0	0.00
10	0 METRES	-1.2	-1.02
25	0 METRES	-1.6	-1.4
50	0 METRES	-1.8	-1.51
75	0 METRES	-1.8	-1.52
100	0 METRES	-3.0	-2.77
150	0 METRES	-5.3	-7.55
200	0 METRES	-7.3	-13.72
250	0 METRES	-8.9	-21.11
300	0 METRES	-10.2	-29.01
400	0 METRES	-11.5	-45.45
500	0 METRES	-12.7	-60.99
600	0 METRES	-13.0	-75.56
800	0 METRES	-13.4	-104.28
1000	0 METRES	-13.6	-133.25
1200	0 METRES	-13.5	-155.75

SECTION THROUGH STATIONS 9 AND 11
DISTANCE BETWEEN STATIONS= 165.2 KM
PLOT OF CURRENT VS DEPTH

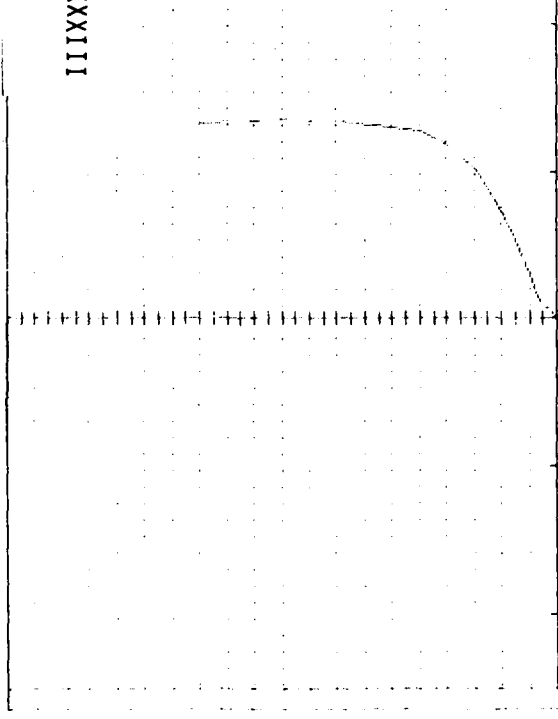

Table XXXIII

Geostrophic Current Component at Right Angles between Nansen Stations 9 and 11 relative to the surface.

DEPTH	CURRENT RELATIVE TO	CURRENT	TRANSPORT
0	0 METRES	0.0	0.00
10	0 METRES	1.1	0.00
25	0 METRES	1.3	0.06
50	0 METRES	1.4	0.30
75	0 METRES	1.5	1.65
100	0 METRES	4.3	5.39
150	0 METRES	7.8	10.93
200	0 METRES	10.6	20.02
250	0 METRES	12.3	29.15
300	0 METRES	12.8	36.82
400	0 METRES	12.9	49.82
500	0 METRES	13.0	59.11
600	0 METRES	13.0	76.38
800	0 METRES	13.1	103.01
1000	0 METRES	13.5	132.45
1200	0 METRES	14.0	179.19

SECTION THROUGH STATIONS 10 AND 12
DISTANCE BETWEEN STATIONS= 377.1 KM
PLOT OF CURRENT VS DEPTH

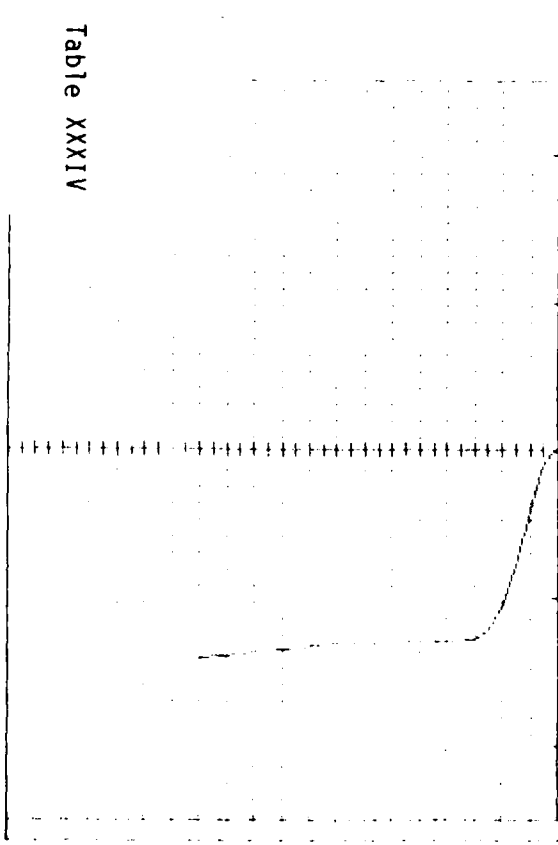
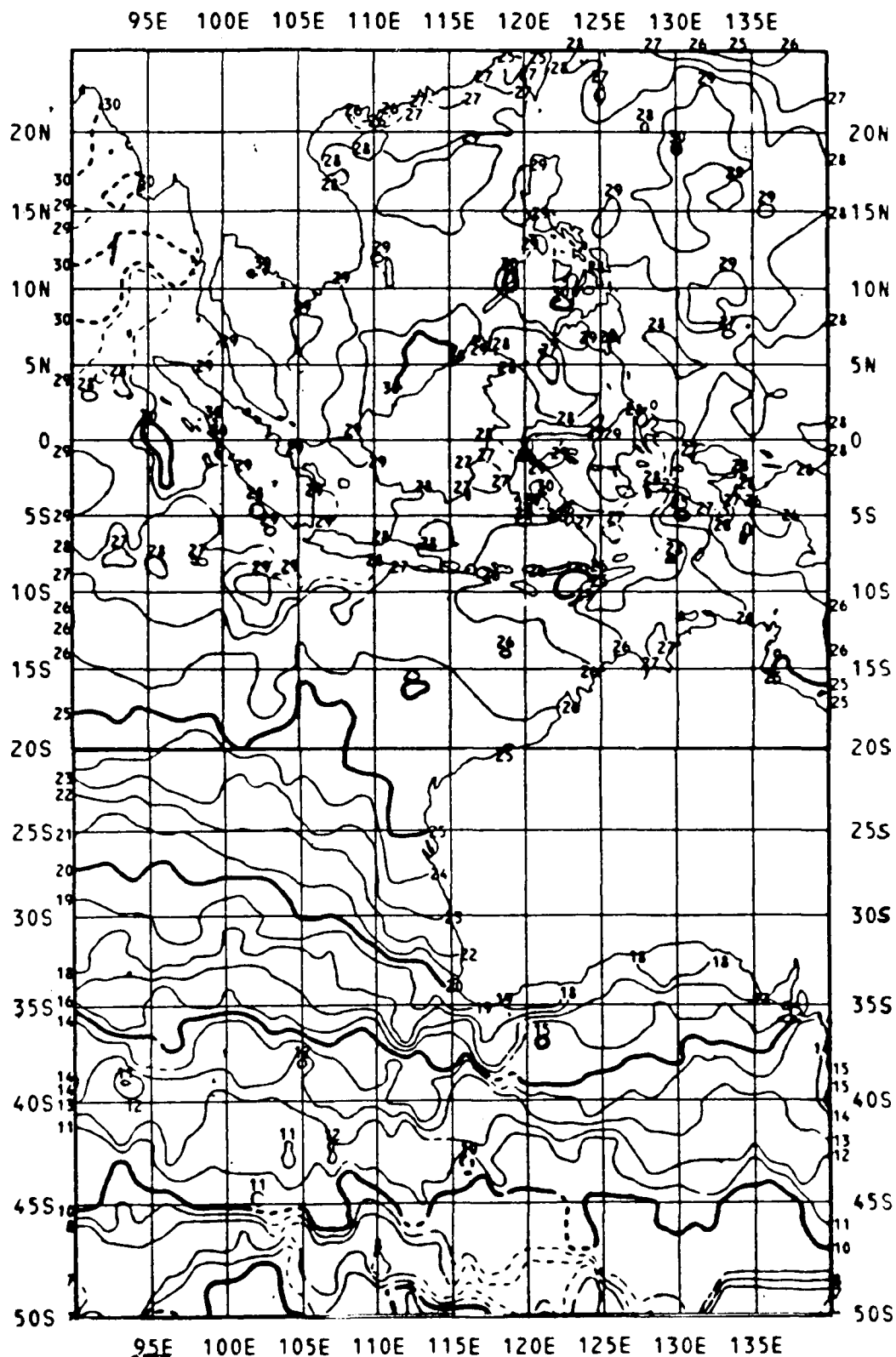

Table XXXIV

Geostrophic Current Component at Right Angles between Nansen Stations 10 and 12 relative to the surface.

GOSSTCOMP SEA SURFACE TEMPERATURE



6/14/83



Fig. 33	GOSSTCOMP SST	14 June 1983	20-65°S,	90-140°E
Fig. 34	GOSSTCOMP SST	14 June 1983	10°N-25°S,	90-140°E

SECTION THROUGH STATIONS 11 AND 12
 DISTANCE BETWEEN STATIONS= 406.1 KM
 CURRENT RELATIVE TO 0 METRES

DEPTH m	CURRENT Cm/sec	TRANSPORT **
0	0.0	0.00
10	0.0	0.00
25	.2	.05
50	.9	.39
75	1.9	1.32
100	3.4	3.13
150	5.9	8.30
200	7.3	13.86
250	8.3	19.81
300	9.1	25.99
400	10.1	38.79
500	10.5	50.97
600	10.7	62.45
800	10.8	84.34
1000	10.8	106.36
1300	10.9	139.20

PLOT OF CURRENT VS DEPTH

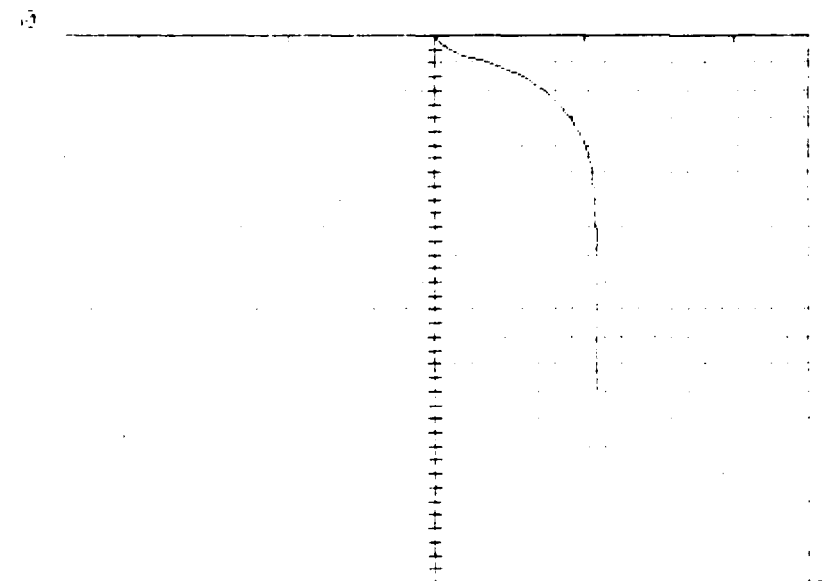

Table XXXV Geostrophic Current Component at Right Angles between Nansen Stations 11 and 12 relative to the surface.

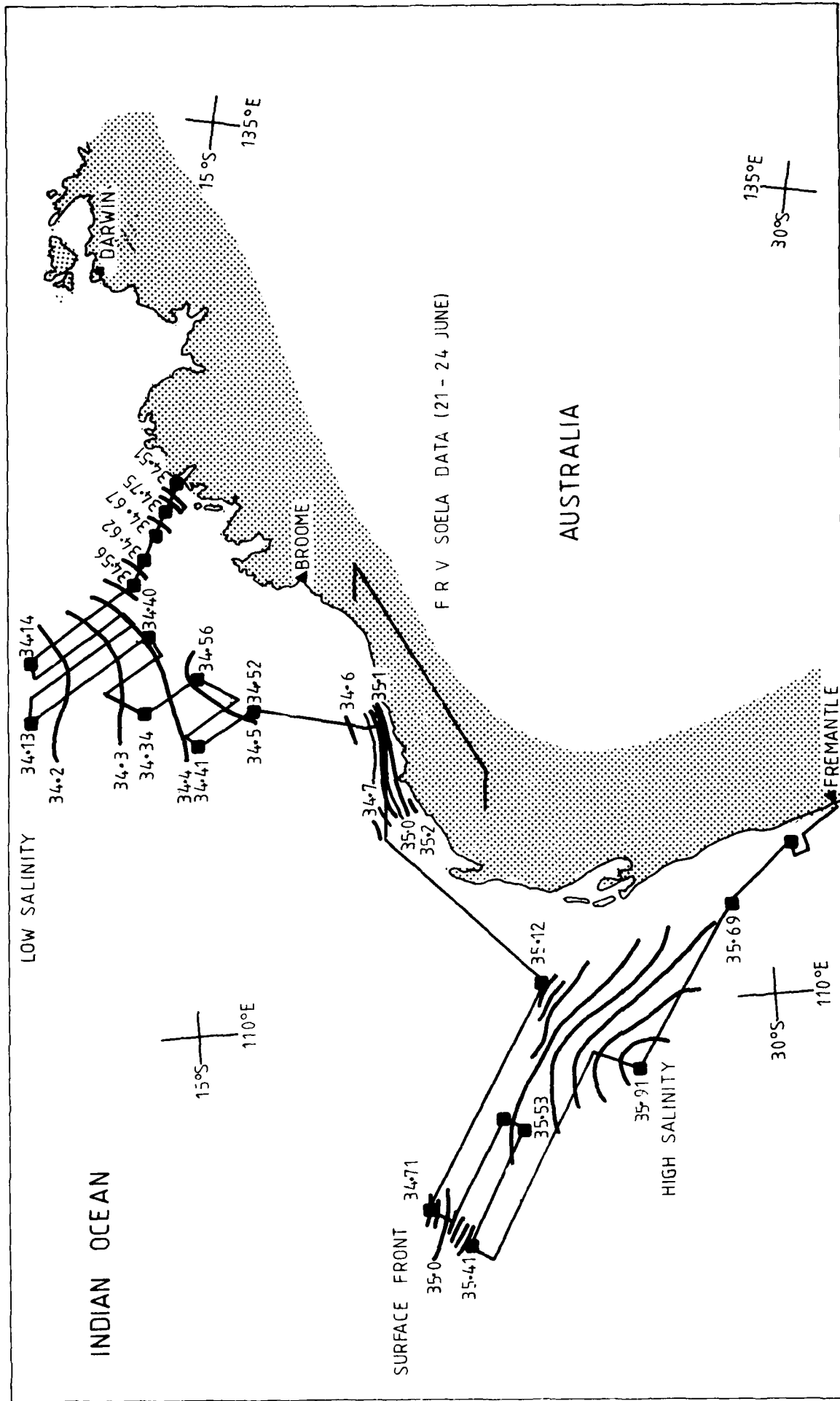

Fig.35 Surface salinity (drawn from Nansen station data) RANRL cruise 23/83 (see Fig.16 for station numbers) May 24 to June 24, 1983.

SECTION THROUGH STATIONS 12 AND 13
 DISTANCE BETWEEN STATIONS= 160.9 KM
 CURRENT RELATIVE TO 0 METRES

DEPTH	CURRENT Cm/sec	TRANSPORT **
0	0.0	0.00
10	-0.0	-0.01
25	.5	.09
50	2.9	1.29
75	5.5	3.72
100	5.3	5.92
150	6.8	9.85
200	5.6	11.09
250	3.1	8.17
300	1.1	4.18
400	-1.8	-5.32
500	-2.5	-10.49
600	-2.7	-14.05
800	-4.0	-28.92
1000	-5.2	-47.72

FIGURE OF CURRENT VS DEPTH

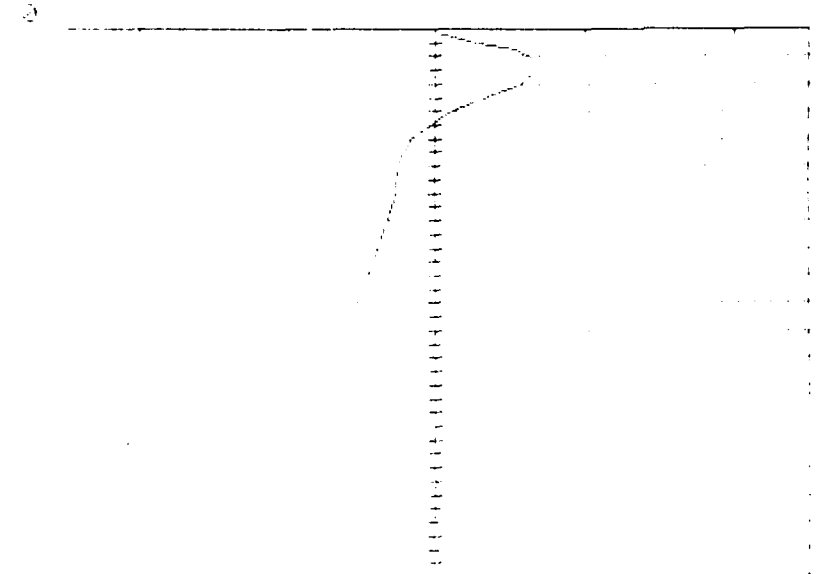

Table XXXVI Geostrophic Current Component at Right Angles between Nansen Stations 12 and 13 relative to the surface.

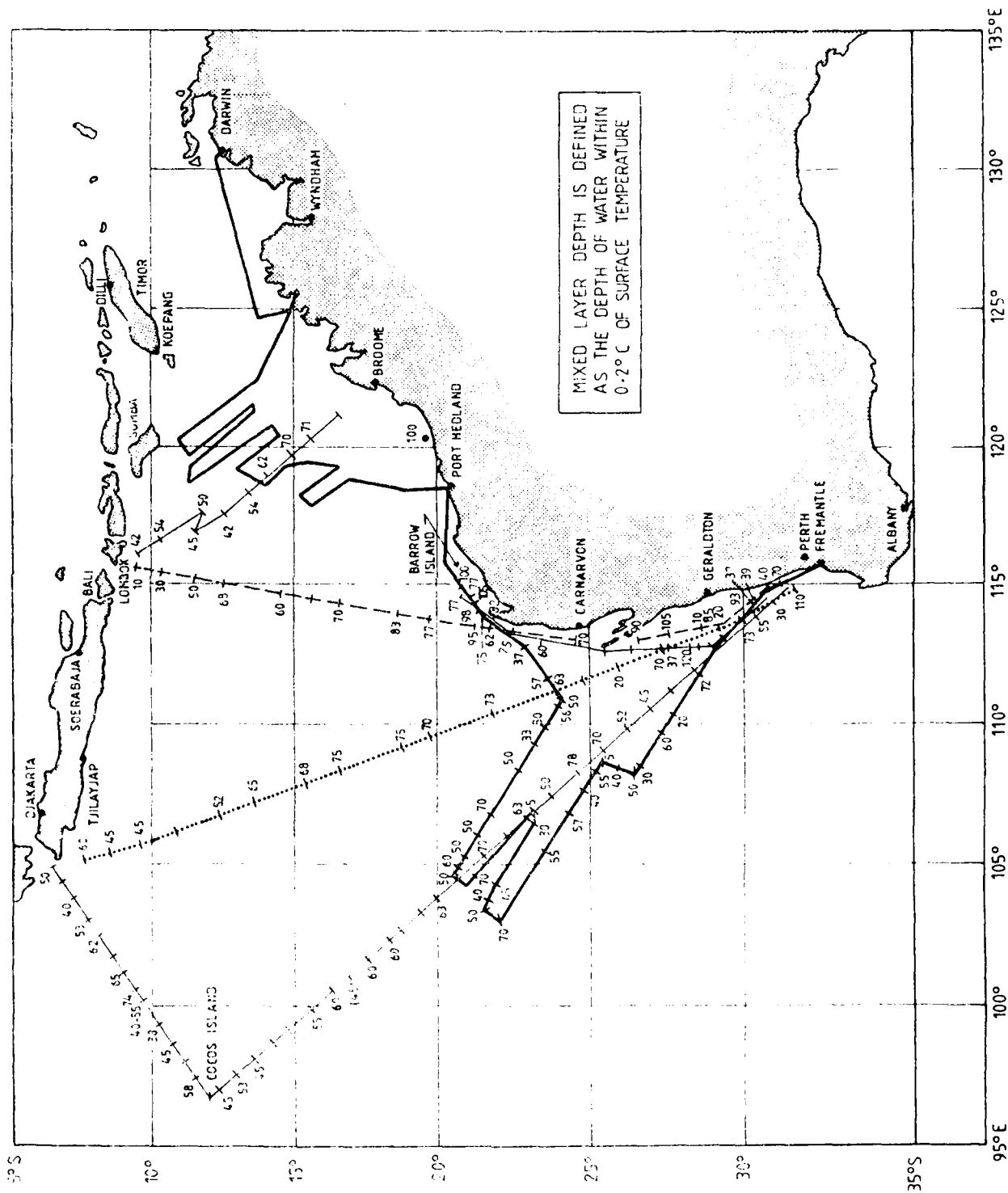

Fig. 36 Mixed Layer Depth (MLD)(from λ BT data)

SECTION THROUGH STATIONS 14 AND 15
 DISTANCE BETWEEN STATIONS= 83.5 KM
 CURRENT RELATIVE TO 0 METRES

DEPTH	CURRENT	TRANSPORT
m	Cm/sec	**
0	0.0	0.00
10	.3	.03
25	.9	.20
50	1.6	.78
75	.9	.75
100	-2.7	-1.72
150	-12.7	-17.18
200	-18.7	-33.42

FIG. 1. CURRENT VS DEPTH

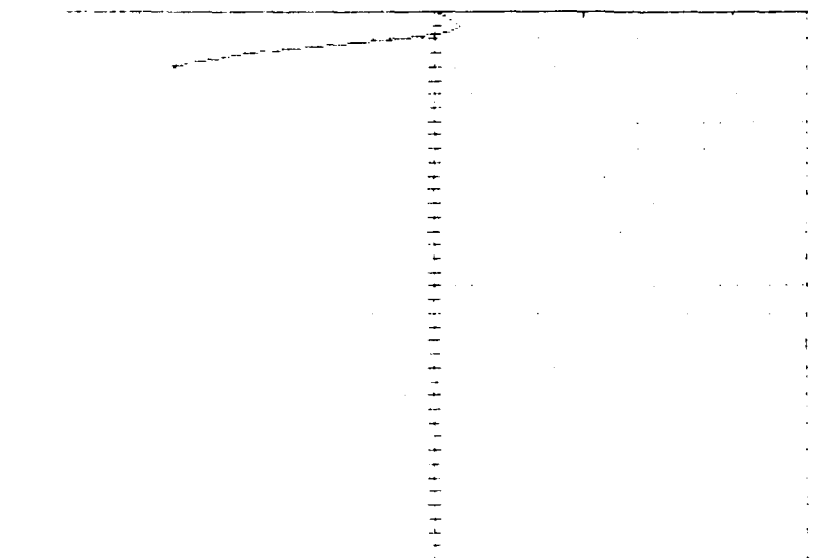

Table XXXVII Geostrophic Current Component at Right Angles between Nansen Stations 14 and 15 relative to the surface.

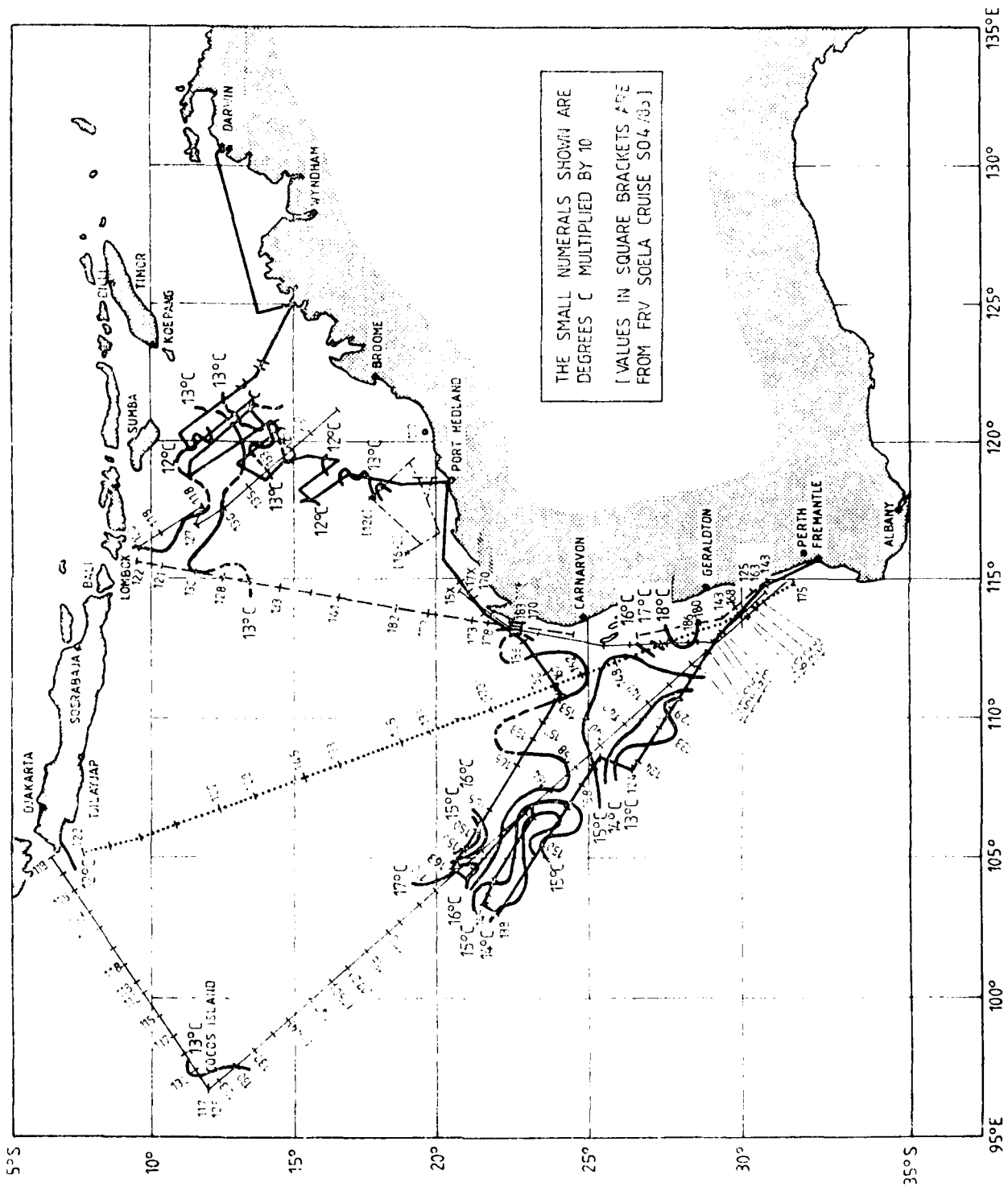

Fig. 37 T250 (Temperature Field at 250 Metres Depth) (from XBT data)

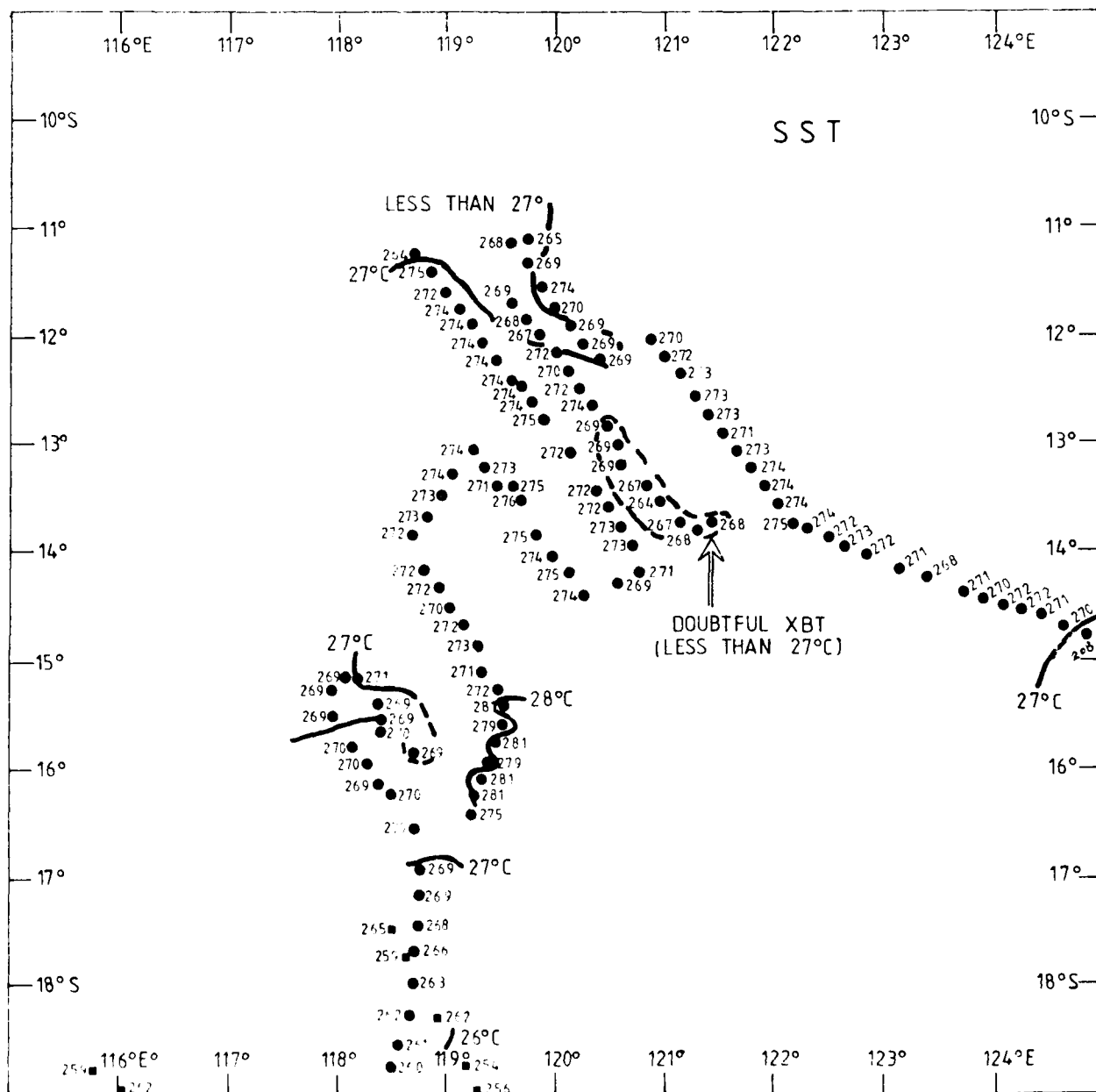

Fig. 33

SST North West Shelf Area to Gamba (from XBT data)

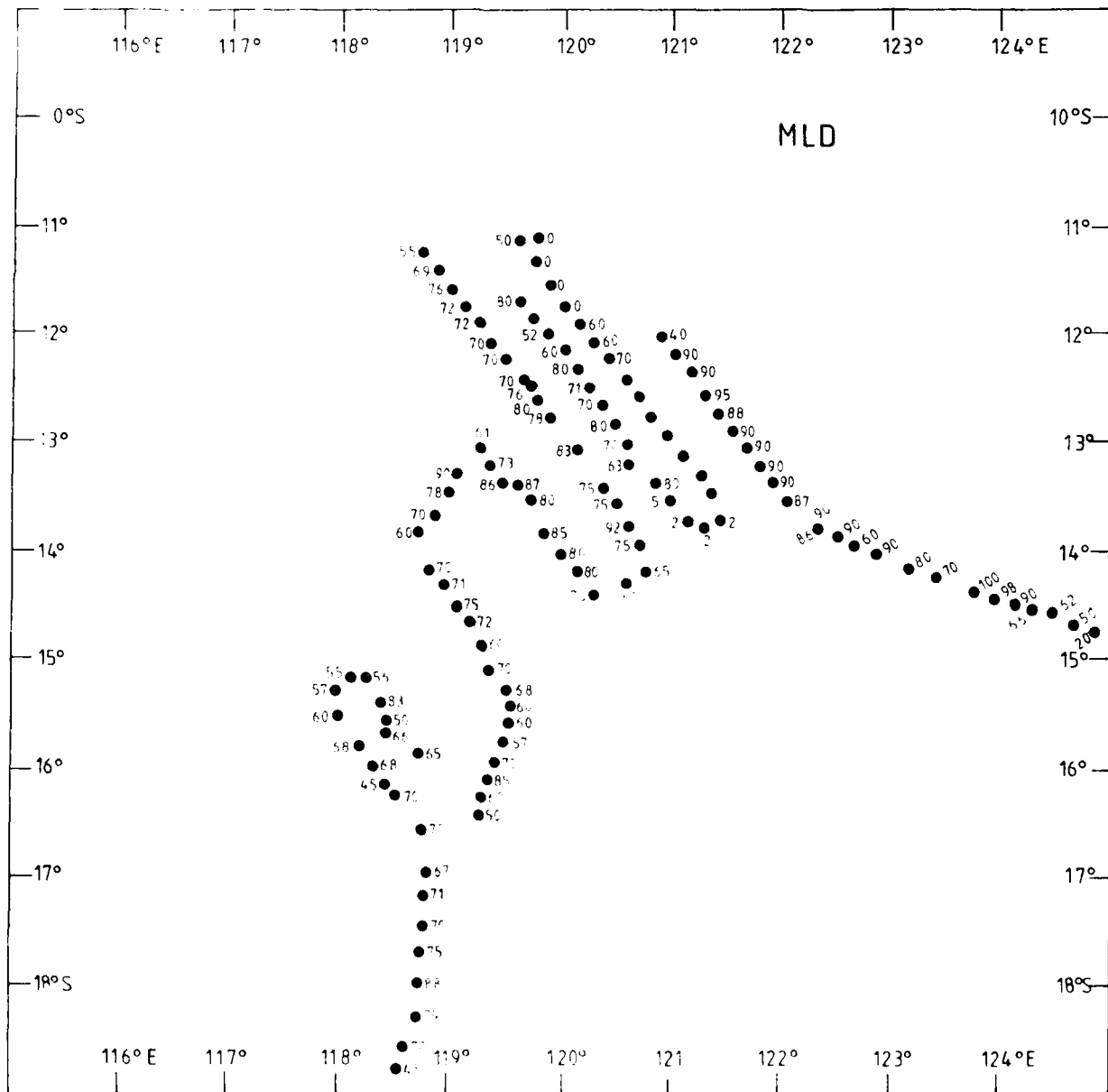
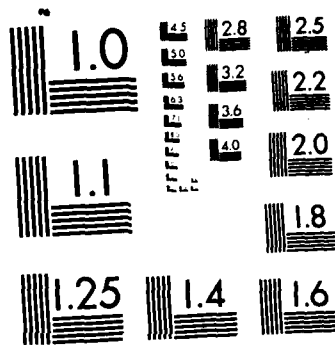

Fig. 39

MLD North West Shelf Area to Sumba (from XBT data)

AD-A164 585 DATA REPORT FOR RANRL OCEANOGRAPHIC CRUISE NUMBER 23/83 2/2
(MAY/JUNE 1983 - (U) ROYAL AUSTRALIAN NAVY RESEARCH
LAB EDGECLIFF L J HAMILTON MAY 85 RANRL-TM-(EXT)-7/85
UNCLASSIFIED F/G 8/18 NL





MICROCOPY RESOLUTION TEST CHART
NATIONAL BUREAU OF STANDARDS-1963-A

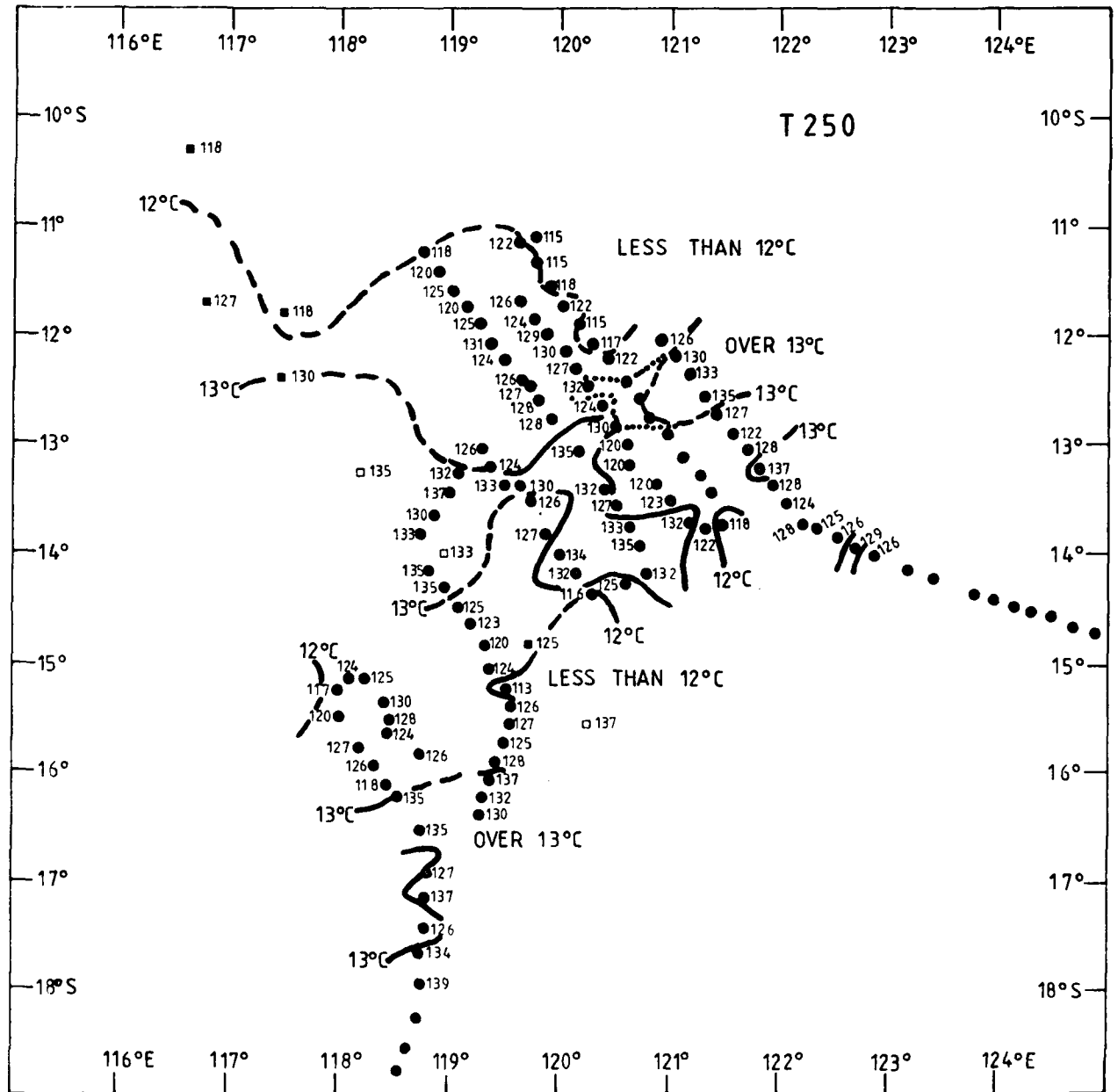

Fig. 40

T250 North West Shelf Area to Sumba (from XBT data)

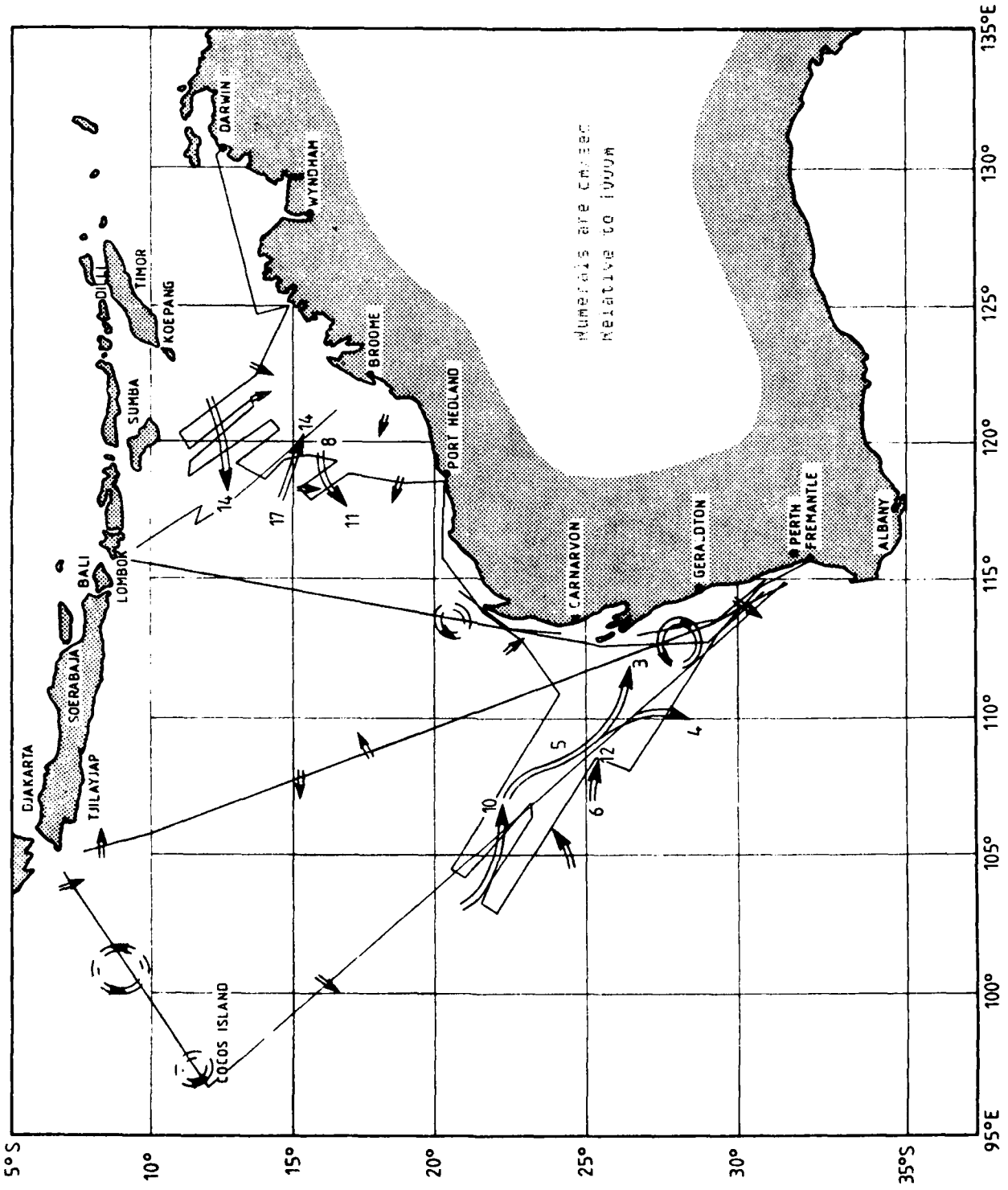

Fig. 41 Surface Circulation Patterns

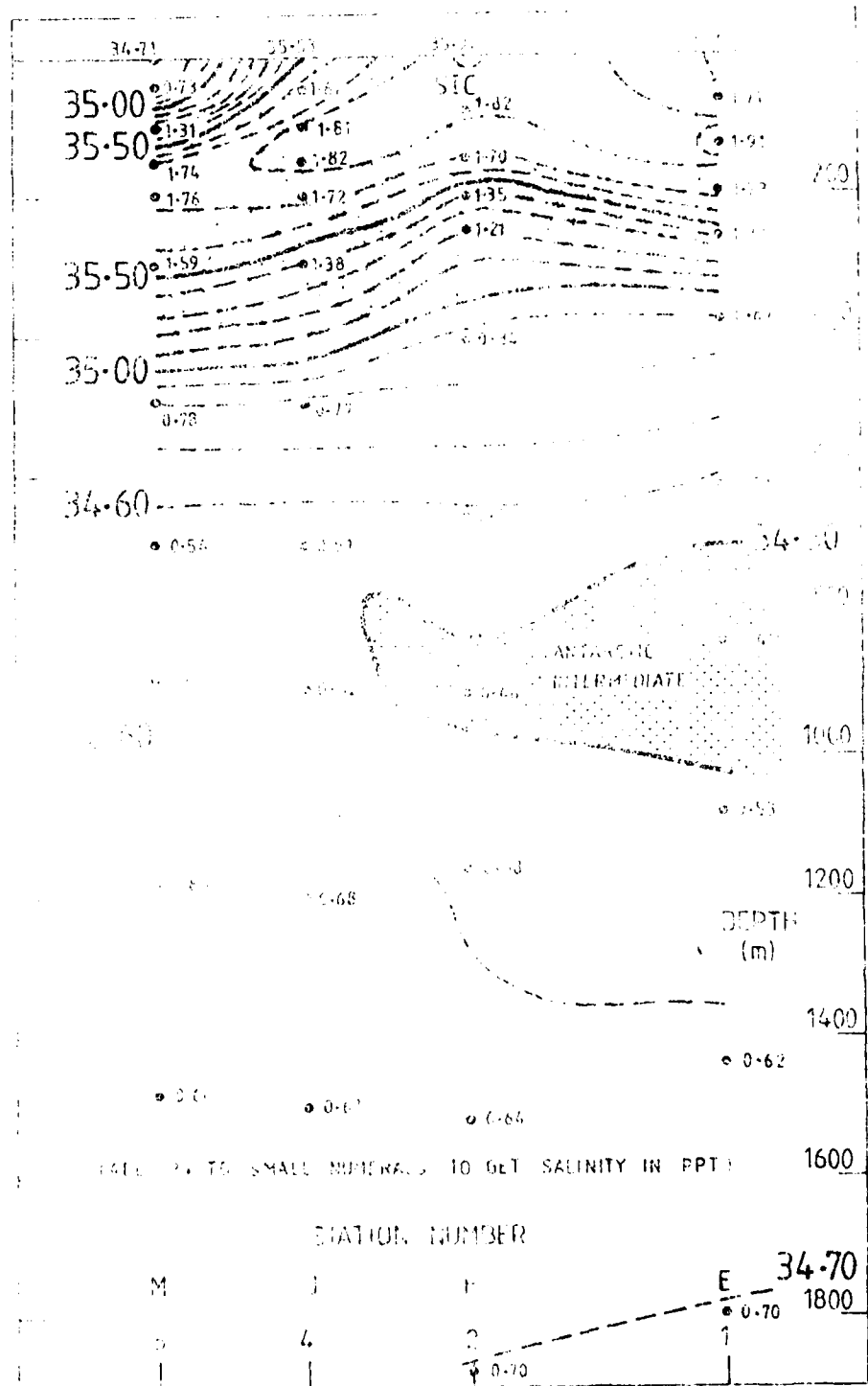

Fig 42 Salinity depth cross section. RANRL 23/83
Station 1 to Station 5

N7-10120 QMKLK 10-6-83
600/2136 1/2048 -6x200M



N7-10120 QMKLK 10-6-83
600/2136 1/2048 -6x200M



N7-480 QMKLK 6-7-83
500/3572 1/2048 -6x200M

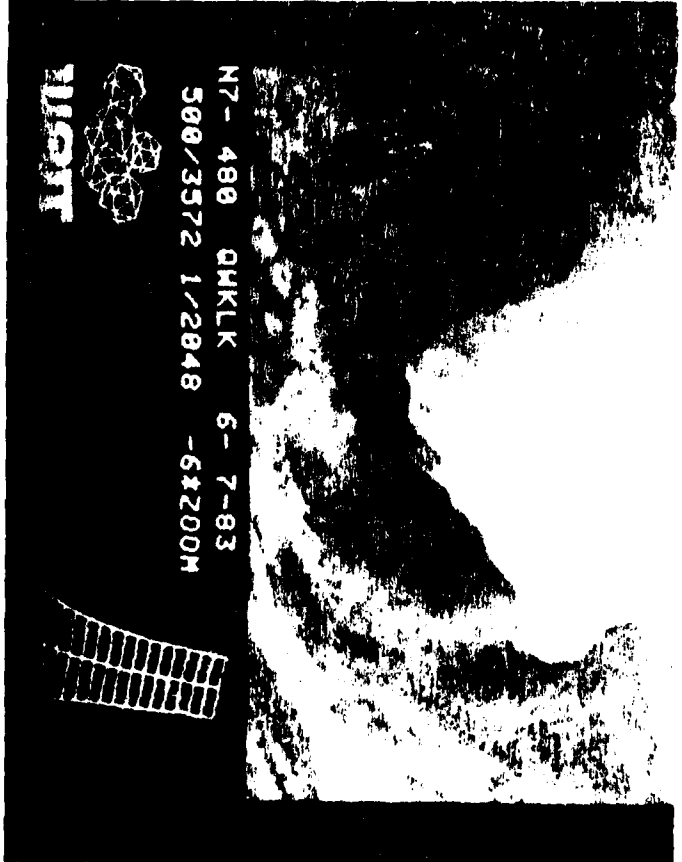

N7-459 QMKLK 4-7-83
500/3572 1/2048 -6x200M



TRISAT
SATELLITE AND ELECTRONIC RESEARCH



Satellite Imagery (Courtesy Australian Institute of Technology)



N7-9682 QMKLK 10-5-83
750/2286 1/1790 -6*200M

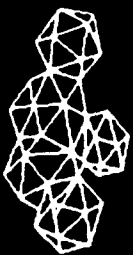

WPAAT

WPAAT INC. 1000 E. 10TH AVE. DENVER, CO 80202

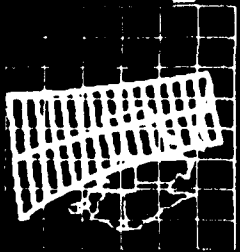

N7-9894 QMKLK 25-5-83
900/2436 1/2048 -6*200M



WPAAT

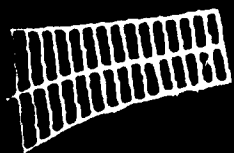

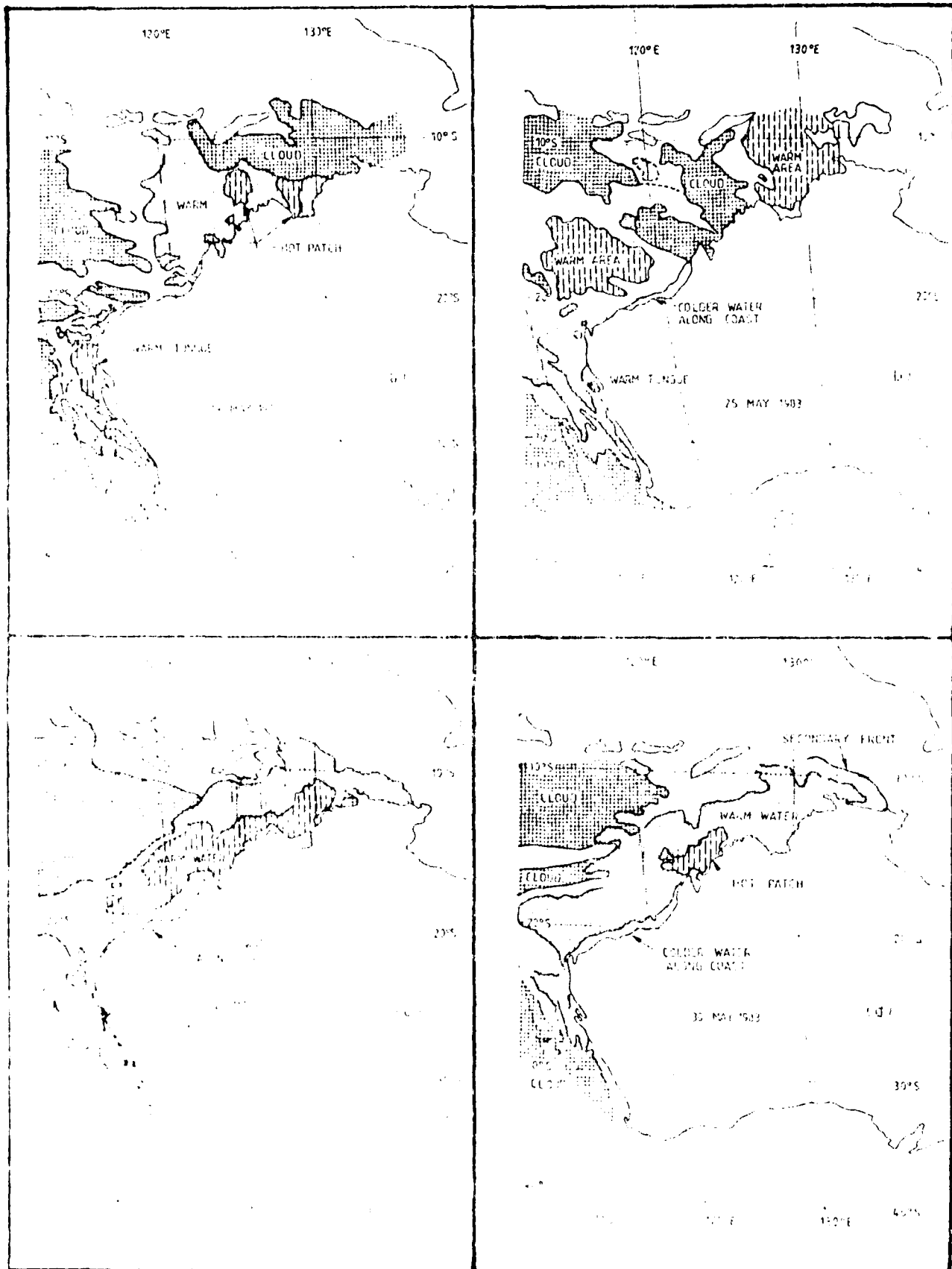

Fig. 4d. (a-d) Satellite Imagery (Macquarie University)

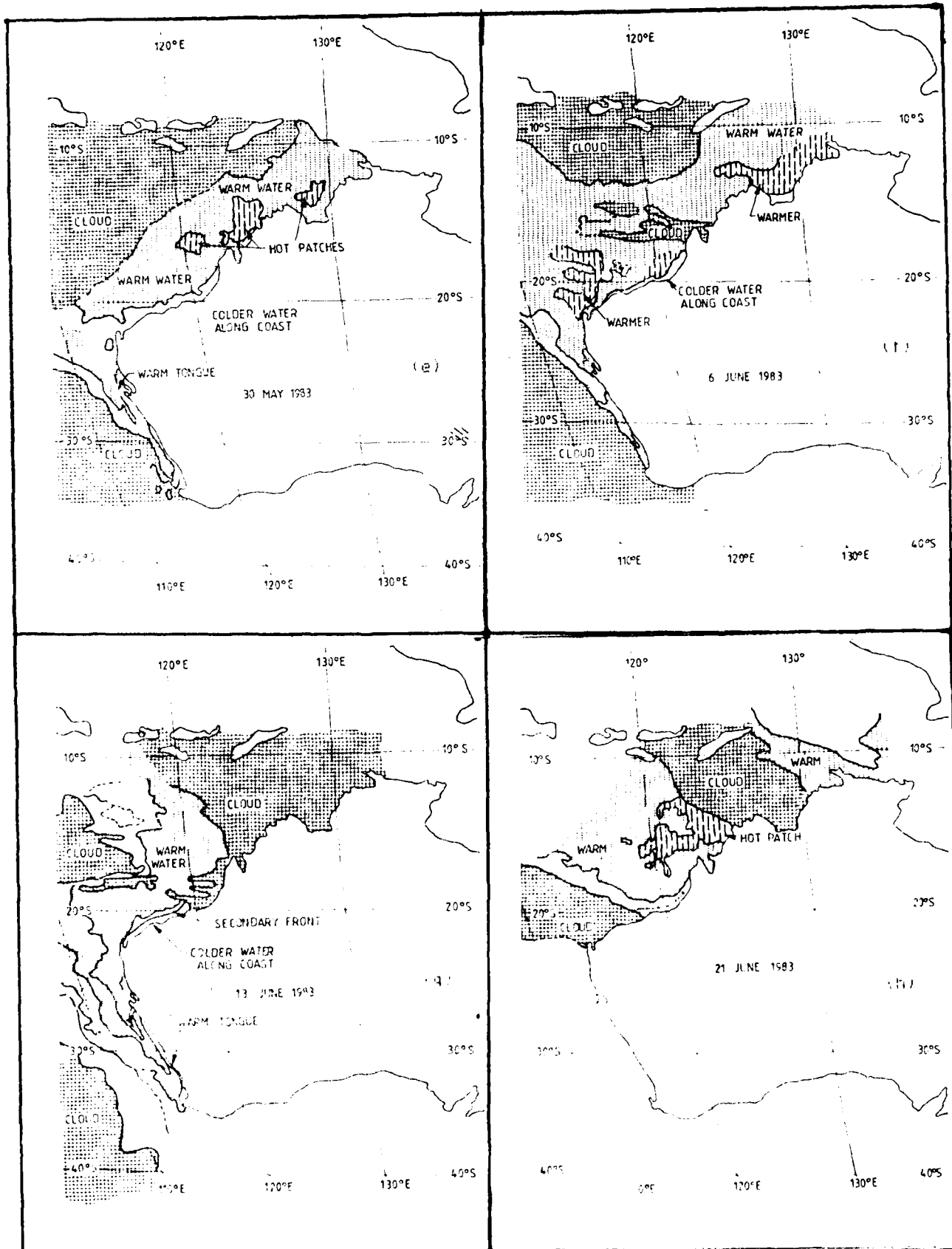

Fig. 44(e)-(h) Satellite Imagery (Macquarie University)

DISTRIBUTION LIST

Copy No.

AUSTRALIA

Chief Defence Scientist)	
Deputy Chief Defence Scientist)	
Controller, External Relations Projects and)	1
Analytical Studies (DSTU))	
Superintendent Science and Technology Programs)	
Deputy Director, Scientific and Technical		
Intelligence, JIU		2
OIC, Document Exchange Centre, DISB		3
Librarian, Technical Reports Centre, Defence		
Central Library, Campbell Park		4
Librarian, DRCS		5
Librarian H Block, Victoria Barracks, Melbourne		6
Counsellor Defence Science - Washington)	
Defence Science Advisor - London)	Data Control Sheet only
Director RAN, Australian Joint Anti-Submarine School		7
Director RAN Tactical School HMAS WATSON		8
Naval Scientific Adviser		9
Air Force Scientific Adviser		10
DUM, HYDRU RAN		11
Secretary, RAN Oceanographic Committee		12
Senior Met. Officer, NAS Nowra		13
SOU HYDRU RAN		14
HMAS COOK		15
Librarian, CSIRO Div. of Oceanography		16
OIC Australian Oceanographic Data Centre		17
Director, Weapons Systems Research Laboratory		18
RANRL Dr M. Hall		19
Mr W. Hill		20
Dr M. Lawrence		21
Dr P.J. Mulhearn		22
Mr B. Scott		23
HUSG, RANRL		24
Author		25 - 26
RANRL Master Copy		27
RANRL		28 - 32

CSIRO	Dr S. Humphries	33
	Mr A. Pearce, CSIRO Marine Laboratories, WA	34
MACQUARIE UNIVERSITY	Dr J. Veevers	35
SYDNEY UNIVERSITY	Mr S. Gay	36
	Mr B.V. Hamon	37
	Mr G. Hopwood	38
	Mr S. O'Gallagher	39
	Dr M. Tomczak	40
WAIT	Dr D. Myers	41
	Dr J. Penrose	42
AGPS		43
National Library of Australia		44
UNITED STATES OF AMERICA		
	Center for Naval Analysis	45
	Defence Technical Information Center (via DISB)	46 - 57
UNITED KINGDOM		
	Defence Research Information Centre (via DISB)	58 - 59
CANADA		
	Director Scientific Information Services (via DISB)	60
NEW ZEALAND		
	Ministry of Defence (via DISB)	61
SPARE		62 - 71

DOCUMENT CONTROL DATA

1 a. AR No AR- 003-431	1. b. Establishment No RANRL-TM- (EXT) -7/85	2. Document Date May 1985	3. Task No 84/007
4. Title DATA REPORT FOR RANRL CRUISE NO. 23/83 (May/June 1983 - East Indian Ocean)		5. Security a. document UNCLAS	6. No Pages 112
		b. title c. abstract UNCLAS UNCLAS	7. No Refs 17
8. Author(s) L.J. Hamilton		9. Downgrading Instructions N/A (UNCLAS)	
10. Corporate Author and Address RAN RESEARCH LABORATORY PO BOX 706 DARLINGHURST NSW 2010 AUSTRALIA		11. Authority (as appropriate) a. Sponsor b. Security c. Downgrading d. Approval a. Ocean Sciences Group b. HOSG c. N/A (UNCLAS) d. DWSRL	
12. Secondary Distribution (of this document) Approved for public release Overseas enquirers outside stated limitations should be referred through ASDIS, Defence Information Services Branch, Department of Defence, Campbell Park, CANBERRA ACT 2601			
13. a. This document may be ANNOUNCED in catalogues and awareness services available to ... No limitations			
13. b. Citation for other purposes (ie casual announcement) may be (select) unrestricted (or) as for 13 a.			
14. Descriptors HMAS COOK Indian Ocean Nansen Station Physical Oceanography XBT.		15. COSATI Group 0802 0810	
16. Abstract Data from eighteen Nansen Stations to 1500 metres taken from HMAS COOK on RANRL Cruise 23/83 in the eastern Indian Ocean in May-June 1983 are presented as tables and graphs. Temperature-depth cross-sections from XBT data are also included, both for HMAS COOK and other vessels. Geostrophic current values are given and some routine data analysis made. Several very broad scale contour plots are drawn, assuming data to be quasi-synoptic, and some brief comparisons made with satellite imagery. Technical memoranda are of a tentative nature, represent the views of the author(s), and do not necessarily carry the authority of the laboratory.			

This page is to be used to record information which is required by the Establishment for its own use but which will not be added to the DISTIS data base unless specifically requested.

16. Abstract <i>(Contd)</i>		
17. Imprint		
18. Document Series and Number	19. Cost Code	20. Type of Report and Period Covered
21. Computer Programs Used		
22. Establishment File Ref(s)		

DTIC

END

4-86