

AD-A164 143

INTRODUCTION TO THE MICROCOMPUTERS FOR SOLVING RADAR
AND ELECTRONIC WARFARE PROBLEMS(U) NAVAL POSTGRADUATE
SCHOOL MONTEREY CA C D VERGOS DEC 85

1/3

UNCLASSIFIED

F/G 17/9

NL



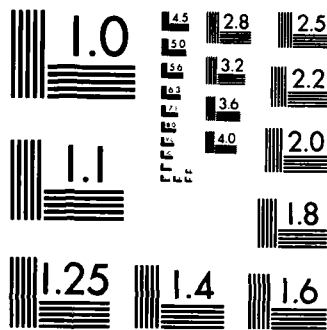

MICROCOPY RESOLUTION TEST CHART
NBS-1963-A

2

NAVAL POSTGRADUATE SCHOOL Monterey, California

AD-A164 143



DTIC
ELECTE
FEB 14 1986
S D
B

THESIS

INTRODUCTION TO THE MICROCOMPUTERS FOR
SOLVING RADAR ELECTRONIC WARFARE PROBLEMS
AND
by
Constantinos D. Vergos
December 1985

Thesis Advisor: Harold A. Titus

DTIC FILE COPY

Approved for public release; distribution is unlimited

86 2 14 023

REPORT DOCUMENTATION PAGE

1a. REPORT SECURITY CLASSIFICATION Unclassified		1b. RESTRICTIVE MARKINGS	
2a. SECURITY CLASSIFICATION AUTHORITY		3. DISTRIBUTION / AVAILABILITY OF REPORT Approved for public release; distribution is unlimited	
2b. DECLASSIFICATION / DOWNGRADING SCHEDULE		5. MONITORING ORGANIZATION REPORT NUMBER(S)	
4. PERFORMING ORGANIZATION REPORT NUMBER(S)		5. MONITORING ORGANIZATION REPORT NUMBER(S)	
6a. NAME OF PERFORMING ORGANIZATION Naval Postgraduate School	6b. OFFICE SYMBOL (if applicable) Code 62	7a. NAME OF MONITORING ORGANIZATION Naval Postgraduate School	
6c. ADDRESS (City, State, and ZIP Code) Monterey, California 93943-5100		7b. ADDRESS (City, State, and ZIP Code) Monterey, California 93943-5100	
8a. NAME OF FUNDING / SPONSORING ORGANIZATION	8b. OFFICE SYMBOL (if applicable)	9. PROCUREMENT INSTRUMENT IDENTIFICATION NUMBER	
8c. ADDRESS (City, State, and ZIP Code)		10. SOURCE OF FUNDING NUMBERS	
		PROGRAM ELEMENT NO.	PROJECT NO.
		TASK NO.	WORK UNIT ACCESSION NO.
11. TITLE (Include Security Classification) INTRODUCTION TO THE MICROCOMPUTERS FOR SOLVING RADAR AND ELECTRONIC WARFARE PROBLEMS			
12. PERSONAL AUTHOR(S) Vergos, Constantinos D.			
13a. TYPE OF REPORT Master's Thesis	13b. TIME COVERED FROM _____ TO _____	14. DATE OF REPORT (Year, Month, Day) 1985, December	15. PAGE COUNT 251
16. SUPPLEMENTARY NOTATION			
17. COSATI CODES		18. SUBJECT TERMS (Continue on reverse if necessary and identify by block number)	
FIELD	GROUP	MTI radar, AMTI, Doppler, Microcomputers; Radar and Electronic Warfare, COSRO, CONSCAN,	
19. ABSTRACT (Continue on reverse if necessary and identify by block number)			
<p>This thesis has been written to solve different types of problems through microcomputers in the radar and electronic warfare field. These problems are offered as subjects at the Naval Postgraduate School in Courses EC 4432/33, EC 4484, and EC 3431.</p> <p>The computer programs that solve these computer problems have been written in an interactive method because it is user friendly and also</p>			
20. DISTRIBUTION / AVAILABILITY OF ABSTRACT <input checked="" type="checkbox"/> UNCLASSIFIED/UNLIMITED <input type="checkbox"/> SAME AS RPT. <input type="checkbox"/> DTIC USERS		21. ABSTRACT SECURITY CLASSIFICATION Unclassified	
22a. NAME OF RESPONSIBLE INDIVIDUAL Prof. Harold A. Titus		22b. TELEPHONE (Include Area Code) (408) 646-2560	22c. OFFICE SYMBOL Code 62Ts

#19 - ABSTRACT - (CONTINUED)

so that anyone can change any given parameter or characteristics of radars and jammers and thus study their performance for the purpose of using or designing them.

Accession For	
NTIS GRA&I	<input checked="" type="checkbox"/>
DTIC TAB	<input type="checkbox"/>
Unannounced	<input type="checkbox"/>
Justification	
Distribution/	
Availability Codes	
Dist. Special	
A-1	

Approved for public release; distribution is unlimited

Introduction to the Microcomputers for Solving Radar and
Electronic Warfare Problems

by

Constantinos D. Vergos
Lieutenant, Hellenic Navy
B.S., Hellenic Naval Academy, 1977

Submitted in partial fulfillment of the
requirements for the degree of

MASTER OF SCIENCE IN ELECTRICAL ENGINEERING

from the

NAVAL POSTGRADUATE SCHOOL

December 1985

Author:

Constantinos Vergos

Approved by:

H. A. Titus, Thesis Advisor

J. M. Bouldry, Second Reader

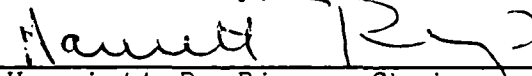
Harriett B. Rigas, Chairman

Department of Electrical and Computer Engineering

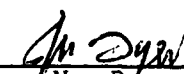
John N. Dyer

Dean of Science and Engineering

ABSTRACT

This thesis has been written to solve different types of problems through microcomputers in the radar and electronic warfare field. These problems are offered as subjects at the Naval Postgraduate School in Courses EC 4432/33, EC 4484, and EC 3431.

The computer programs that solve these computer problems have been written in an interactive method because it is user friendly and also so that anyone can change any given parameter or characteristics of radars and jammers and thus study their performance for the purpose of using or designing them.

See p 11

TABLE OF CONTENTS

I.	INTRODUCTION -----	10
II.	EQUATIONS AND FIGURES -----	13
III.	RADAR PROBLEMS -----	42
	A. PROBLEM #1: DETECTION -----	42
	B. PROBLEM #2: DETECTION LOSS -----	43
	C. PROBLEM #3: MAXIMUM RANGE -----	44
	D. PROBLEM #4: FM-RANGING, DOPPLER -----	49
	E. PROBLEM #5: BLIND SPOTS IN DOPPLER -----	51
	F. PROBLEM #6: MTI -----	51
	G. PROBLEM #7: POWER, NOISE POWER, S/N -----	52
	H. PROBLEM #8: MTI-CHASS DISCRIMINATOR -----	57
	I. PROBLEM #9: MTI-CHASS-CLUTTER DISCRIMINATOR -	58
	J. PROBLEM #10: PHASED ARRAY-BW -----	59
	K. PROBLEM #11: PULSE RADAR-RMAX -----	60
	L. PROBLEM #12: TWS, PROBABILITY OF DETECTION --	62
	M. PROBLEM #13: RECEIVER'S BANDWIDTH -----	65
	N. PROBLEM #14: BLIND SPEED--MTI -----	67
	O. PROBLEM #15: MTI WEIGHTS--DELAYS -----	68
IV.	EW PROBLEMS -----	71
	A. PROBLEM #1: DETECTION RANGE, UNAMBIGUOUS RANGE -----	71
	B. PROBLEM #2: ARRAY BROADSIDE POWER GAIN -----	77
	C. PROBLEM #3: JAMMER'S REPEATER GAIN, JAMMER'S OUTPUT POWER -----	79

D.	PROBLEM #4: PULSE-COMPRESSION RADAR, NOISE JAMMING POWER -----	83
E.	PROBLEM #5: STAND OFF SPOT NOISE JAMMER -----	87
F.	PROBLEM #6: CHAFF, AVERAGE CROSS SECTION OF DIPOLES -----	90
G.	PROBLEM #7: SIGNAL-TO-CLUTTER RATIO, POWER SPECTRA DENSITY OF JAMMER -----	91
H.	PROBLEM #8: WEIGHTING FILTERS -----	94
I.	PROBLEM #9: MTI FILTERS, CHAFF DIPOLES -----	98
J.	PROBLEM #10: MINIMUM DETECTABLE SIGNAL -----	99
V.	CONCLUSION -----	101
	APPENDIX A -----	103
	APPENDIX B -----	176
	LIST OF REFERENCES -----	249
	INITIAL DISTRIBUTION LIST -----	250

LIST OF TABLES

1. PROPERTIES OF WEIGHTING FUNCTION ----- 41

LIST OF FIGURES

2.1	Probability of detection for a sine wave in a noise as a function of the signal-to-noise (power) ratio and the probability of false alarm -----	26
2.2	Integration-Improvement factor square law detector -----	27
2.3	Integration loss as a function of n , P_d , and n_f --	28
2.4	Comparison of detection probabilities for five different models of target fluctuation -----	29
2.5	Additional signal-to-noise ratio required to achieve a particular probability of detection, when the target cross section fluctuates with a non fluctuating target -----	30
2.6	Integration-improvement factor as a function of the number of pulses integrated for the five types of target fluctuation considered -----	31
2.7	Improvement factor for each filter of an 8-pulse doppler filter bank with uniform weighting as a function of the clutter spectral width (standard deviation) -----	32
2.8	Improvement factor for an N-pulse delay-line canceler with optimum weights (solid curves) and binomial weights (dashed curves) as a function of the clutter spectral width -----	33
2.9	Improvement factor for a 3-pulse (double canceler) MTI cascaded with an 8-pulse filter bank, or integrator, with uniform amplitude weights ----	34
2.10	Improvement factor for a 3-pulse (double canceler) MTI cascaded with an 8-pulse filter bank, or integrator, with 25-db Chebyshev weights -----	35
2.11	Effect of a nonzero clutter doppler frequency on the improvement factor of a three-pulse canceler -----	36

2.12	Improvement factor of a three pulse canceler limited by platform motion -----	37
2.13	Power spectra of various clutter targets -----	38
2.14	Portion of the received signal spectrum in the vicinity of the RF carrier frequency f_o , for a pulse-doppler AMTI radar -----	39
2.15	MTI improvement factor as a function of the RMS velocity spread of clutter for a two-delay canceler (no feedback) -----	40

I. INTRODUCTION

The intent of this thesis is to solve diverse types of problems in the field of radar and Electronic Warfare, with the help of microcomputers, in order to help training officers to better understand this area of technology.

Many of our Naval Officers today have microcomputers which they take to sea with them. In addition a new MIL-SPEC Hewlett-Packard microcomputer is becoming operational on all Naval combatants. These PC's have the potential for providing an excellent resource in the tactical training of the officer in problems in electronic warfare and radar. All too often at sea these technical problems are brushed aside and left for civilian technicians. There is however a great need for the technically trained officer to be able to handle the changing technical EW radar situations. These sample problems may provide help in attacking some of the problems that the operating Naval officer will encounter.

Microsoft Basic and the interactive method have been used to write the programs that solve these problems. Microsoft Basic is an easy language for anyone to understand and as a result, the user can easily modify the programs. Also, because Microsoft Basic is available in every microcomputer, there is no need for one to make changes to run these programs on different microcomputers. The interactive method gives one the opportunity to input any chosen data and the ability, by

changing this data, to study the different performances of radar and jammers.

In solving these problems, the following have been taken into account: The performance of the radars, the ability of the radars to track targets, the design of radars for special purposes, and the design and study of different types of jammers. Special emphasis has been given to select these problems so that there would be a diverse field of different types of radars and jammers for numerous purposes, including their use in different conditions of operations. This selection of problems has been done in such a way that they can help a training officer to comprehend and perceive or to help an engineer evaluate a radar or a jammer he/she may wish to design. *System: The programming language, steps*

In Chapter II, the author presents material which is needed to solve the problems of Chapters III and IV. A brief explanation for each equation is given as in Skolnik [Ref. 1].

The third part of this thesis encompasses problems that refer entirely to radars.

The fourth part deals with the problems of radars and jammers and how dissimilar types of jammers affect the radars, problems in which different categories of transmitting and receiving antennas are examined, and problems on different types of jamming techniques. Most of these problems have been taken from [Ref. 3].

The conclusion drawn from this software development is contained in Chapter V, Conclusion.

Appendix A lists the computer programs and outputs from the results of each radar problem of Chapter II.

The contents of Appendix B are similar to Appendix A but deal with electronic warfare problems.

II. EQUATIONS AND FIGURES

The problems addressed here cover a wide range of questions that one might encounter in radar and EW. For example, what detection probability is required? What is the maximum range given a radar's power and target RCS? What range inaccuracies are involved when FM ranging and what problems in doppler radar occur in terms of blind spots? What improvements are gained from MTI radar in a clutter environment? How can the radar receiver power be computed, as well as the noise power, and signal-to-noise ratios? What are critical parameters in an MTI-chaff discriminator? In a phased array system, what is the beamwidth and phase shift between elements? These and many other problems are addressed.

Herein are the functional relationships in the field of radar and electronic warfare which are used to solve the problems in Chapters III and IV. They are given with a brief description in [Refs. 1,2,3].

Maximum Unambiguous Range:

$$R_{unamb} = \frac{c}{2f_p} \quad (1)$$

where:

f_p = pulse repetition frequency, Hz;

C = speed of light = 3×10^8 m/s.

The factor 2 appears in the denominator because of the two-way propagation of radar.

Maximum radar range in terms of radar and target parameters:

$$R_{\max} = \left[\frac{P_t G A_e \sigma}{(4\pi)^2 S_{\min}} \right] \quad (2)$$

where:

P_t = transmitted power, watts;

G = antenna gain;

A_e = antenna effective aperture, m^2 ;

= radar cross section, m^2 ;

S_{\min} = minimum detectable signal, watts.

The radar equation (2) with some modifications becomes:

$$R_{\max}^4 = \frac{P_{av} G A \rho_a \sigma n E_i(n)}{(4\pi)^2 k T_o F_n (B_r) f_p (S/N)_l L_s} \quad (2a)$$

where:

- R_{\max} = maximum radar range, m;
 G = antenna gain;
 A = antenna aperture, m^2
 ρ_a = antenna efficiency;
 n = number of hits integrated
 $E_i(n)$ = integration efficiency (less than unity)
 L_s = system losses (greater than unity) not included in other parameters;
 σ = radar cross section of target, m^2
 F_n = noise figure;
 k = Boltzmann's constant = 1.38×10^{-23} J/deg.
 T_o = standard temperature = $290^\circ k$
 B = receiver bandwidth, Hz;
 τ = pulse width, s;
 f_p = pulse repetition frequency, Hz
 $(S/N)_1$ = signal-to-noise ratio required at receiver output (based on single-hit detection).

Equation 2(a) is written in terms of power; it can also be written in terms of energy with the following modifications:

(a) The energy in the transmitted pulse is

$$E_t = P_{av}/f_p = P_t \tau .$$

(b) The signal-to-noise power ratio $(S/N)_1$ can be replaced by the signal-to-noise energy ratio $(E/N_0)_1$, where $E = s/\tau$ (received signal energy), and $N_0 = N/B$ (noise energy).

(c) $B\tau \approx 1$, and $T_0 F_N = T_S =$ system noise temperature.

Then, the radar equation 2(a) can be written as:

$$R_{\max}^4 = \frac{E_{\tau} G A \rho_a \sigma_n E_i(n)}{(4\pi)^2 k T_S (E/N_0)_1 L_s} \quad (2b)$$

Equation 2(b) is applied to rectangular pulses, and if matched filter detection is employed, can be applied to other waveforms as well.

Thermal-noise power, generated by a receiver is:

$$N_n = k T B_n \quad (3)$$

where:

B_n = receiver's bandwidth, Hz;

T_S = temperature at which the noise power is generated, degrees kelvin;

k = Boltzmann's constant = 1.38×10^{-23} J/deg.

Minimum detectable signal S_{\min} :

$$S_{\min} = k T_0 B_n F_n (S_0/N_0)_{\min} \quad (4)$$

where:

k = Boltzmann's constant = 1.38×10^{-23} J/deg.;

T_0 = standard temperature = 290 degrees kelvin;

B_n = receiver's bandwidth, Hz;

F_n = receiver's noise figure;

$(S_o/N_o)_{\min}$ = minimum ratio of output (IF) signal-to-noise ratio, required for detection.

False alarm probability: Pf_a ,

$$Pf_a = \frac{1}{T_{fa} \times B_{IF}} \quad (5)$$

$$T_{fa} = \frac{1}{B_{IF}} \exp \frac{V_T^2}{2\psi_o^2} \quad (5a)$$

where:

T_{fa} = false alarm time;

B_{IF} = bandwidth of the IF amplifier;

V_T = threshold voltage

ψ_o = noise voltage.

Number of pulses n_B , returned from a point target, as the radar antenna scans through its beamwidth is:

$$n_B = \frac{\theta_B f_p}{\dot{\theta}_s} = \frac{\theta_B f_p}{\omega_m} \quad (6)$$

where:

θ_B = antenna beamwidth, deg.;

f_p = pulse repetition frequency, Hz;

$\dot{\theta}_s$ = antenna scanning rate, deg/s;

w_m = antenna scan rate, rpm.

Integration efficiency $E_i(n)$,

$$E_i(n) = \frac{(S/N)_1}{n(S/N)_n} \quad (7)$$

where:

$(S/N)_1$ = signal-to-noise ratio of a single pulse required to produce given probability of detection (for $n = 1$);

$(S/N)_n$ = signal-to-noise ratio per pulse required to produce some probability of detection when n pulses are integrated at the same P_d and P_{FA} ;

n = number of pulses integrated.

False alarm number, n_f :

$$n_f = \frac{1}{P_{fa}} \quad (8)$$

where:

P_{fa} = false alarm probability.

Collapsing loss, $L_i(m,n)$:

$$L_i(m,n) = \frac{L_i(m+n)}{L_i(n)} \quad (9)$$

where:

$L_i(m+n)$ = integration loss for $(m+n)$ pulses;
 $L_i(n)$ = integration loss for n pulses;
 n = noise pulses;
 m = signal-plus-noise pulses.

Doppler frequency shift, f_d :

$$f_d = \frac{2u_r}{\lambda} = \frac{2 u_r f_o}{c} \quad (10)$$

where:

u_r = relative (or radial) velocity of target with respect to radar;
 f_o = transmitted frequency;
 c = velocity of propagation = 3×10^8 w/s

If f_d is in Hz, u_r in knots, and λ in meters, then

$$f_d = \frac{1.03u_r}{\lambda} \quad (10a)$$

Beat frequency, f_r :

$$f_r = \dot{f}_o T = \frac{2R}{c} \dot{f}_o \quad (11)$$

where:

\dot{f}_o = rate of change of the carrier frequency.

Blind speeds, u_n :

$$u_n = \frac{n\lambda}{2T_p} = \frac{n\lambda f_p}{2} \quad n = 1, 2, 3, \dots \quad (12)$$

where:

f_p = pulse repetition frequency, Hz;

λ = wavelength of radiated frequency, w.

If λ is measured in meters, f_p in Hz, and the relative velocity in knots, the blind speeds are:

$$u_n = \frac{n\lambda f_p}{1.02} \doteq n\lambda f_p \quad (12a)$$

Clutter attenuation, CA:

$$CA = \frac{0.5}{1 - \exp(-2\pi^2 T^2 \sigma_c^2)} \quad (13)$$

where:

π = 3.14159;

T = time delay of the delay line;

σ_c = rms frequency clutter spread.

If the exponent in the denominator of Eq. (13) is small, then

$$CA = \frac{a f_p^2}{2\pi^2 f_o^2} \quad (13a)$$

where:

- a = parameter dependent upon clutter = $c^2/8\sigma_u^2$;
 σ_u = rms velocity spread;
 f_p = pulse repetition frequency;
 f_o = radar carrier frequency.

Improvement factor of 2 pulse canceller,

$$I_{1c} = \frac{a f_p^2}{\pi^2 f_o^2} \quad (14)$$

Improvement factor for a double delay line canceller

$$I_{2c} = \frac{a^2 f_p^4}{2\pi^4 f_o^4} \quad (15)$$

Power antenna gain,

$$G = P_r G_D \quad (16)$$

where:

- P_r = radiation efficiency factor;
 G_D = directive gain of the antenna.

The gain G , and the effective area A_e of a lossless antenna are related by

$$G = \frac{4 \pi A_e}{\lambda^2} = \frac{4 \pi p_o A}{\lambda^2} \quad (16a)$$

$$Ae = p_a A$$

where:

λ = wavelength of radiated energy, m;

A = physical area of antenna;

p_a = antenna aperture efficiency.

Also, the relationship between the gain and the beamwidth of an antenna is given by

$$G \doteq \frac{20,000}{\theta_B \phi_B} \quad (16b)$$

where θ_B , ϕ_B are half power beamwidths, in degrees, measured in the two principal planes.

Array antenna radiation pattern,

$$G(\theta) = G_c(\theta)G_a(\theta) \quad (17)$$

where:

$G_c(\theta)$ = element factor;

$G_a(\theta)$ = array factor.

Half power beamwidth,

$$\theta_B = \frac{0.886 \lambda}{N_d \cos \theta_o} \quad (18)$$

where:

λ = wavelength, m;

- N = number of error elements;
 d = distance that the array elements are spaced, m;
 θ_0 = beam position off broadside.

Phase shift between adjacent elements of the array,

$$\phi = 2\pi(d/\lambda)\sin \theta_0 \quad (19)$$

where d , λ , θ_0 are defined as in Eq. (18).

Distance between radar and target along the line of sight,

$$d_0 = \sqrt{2kaha_1} + \sqrt{2kaha_2} \quad (20)$$

where:

- a = earth's radius;
 k = factor account for refraction due to a uniform gradient of refraction,;
 h_1, h_2 = heights of radar antenna and target, respectively.

Power received from the clutter,

$$c = \frac{P_t G A_e \sigma_c}{(4\pi)^2 R^4} \quad (21)$$

where:

- P_t = transmitter power;
 G = antenna gain;
 A_e = antenna effective aperture;
 R = range
 σ_c = clutter cross section.

Signal power returned from a target with cross section σ_t ,

$$S = \frac{P_t G A_e \sigma_t}{(4\pi)^2 R^4} \quad (22)$$

Range of a 0th radar,

$$R^4 = \frac{P_{av} G_t G_r \lambda^2 \sigma F_p^2 T_c}{(4\pi)^3 N_u (S/N) L_s} \quad (23)$$

where: R = range;
 P_{av} = average power;
 G_t = transmitting antenna gain;
 G_r = receiving antenna gain;
 λ = wavelength;
 σ = target cross section;
 F_p = factor to account for the one-way propagation effects;
 T_c = coherent processing gain;
 N_u = receiver noise power per unit bandwidth;
 (S/N) = signal-to-noise (power) ratio;
 L_s = system losses.

Cross over range,

$$R_{ss}^2 = \frac{P_{tr} G_r \sigma B_j J}{P_{ts} G_j 4\pi B_r S} \quad (24)$$

where:

P_{tr} = radar transmitter power;

- P_{tj} = jammer transmitter power;
 G_r = radar antenna gain;
 G_j = jammer antenna gain;
 σ = target cross section;
 B_j = jammer bandwidth;
 B_r = radar signal bandwidth;
 J/S = jammer-to-radar signal (power) ratio at the output of the IF required to mask the radar signal.

Jammer noise power per hertz at the radar,

$$N_{oJ} = \frac{P_{tj} G_j A_e}{4 \pi R^2 B_j} \quad (25)$$

where:

- A_e = effective receiving aperture of the radar antenna;
 R = range of jammer from radar;
 G_j = jammer antenna gain;
 B_j = jammer bandwidth;
 P_{tj} = jammer transmitter power.

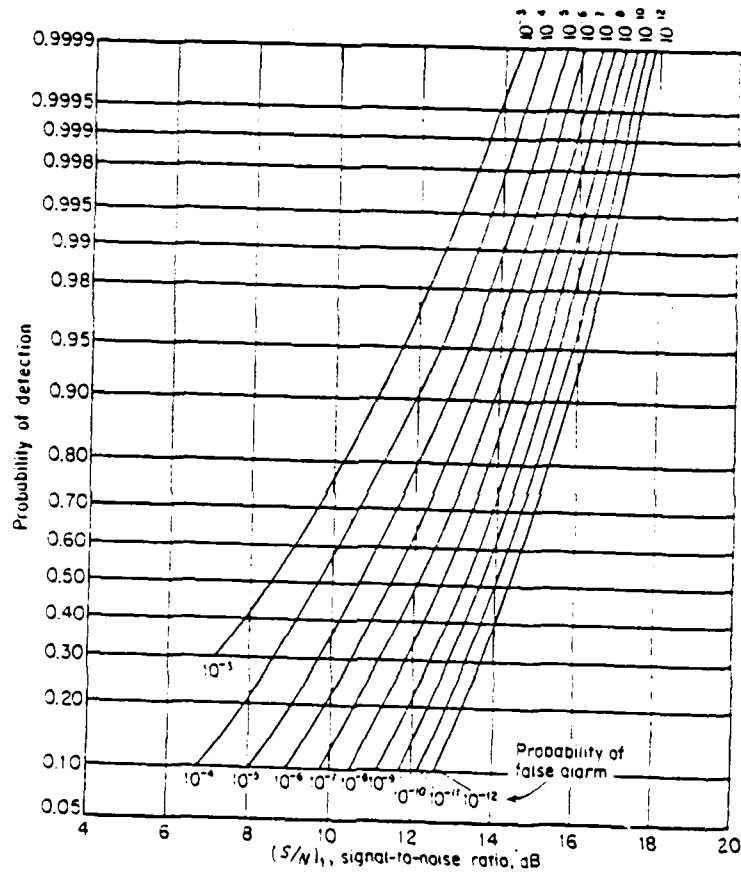

Figure 2.1. Probability of detection for a sine wave in noise as a function of the signal-to-noise (power) ratio and the probability of false alarm

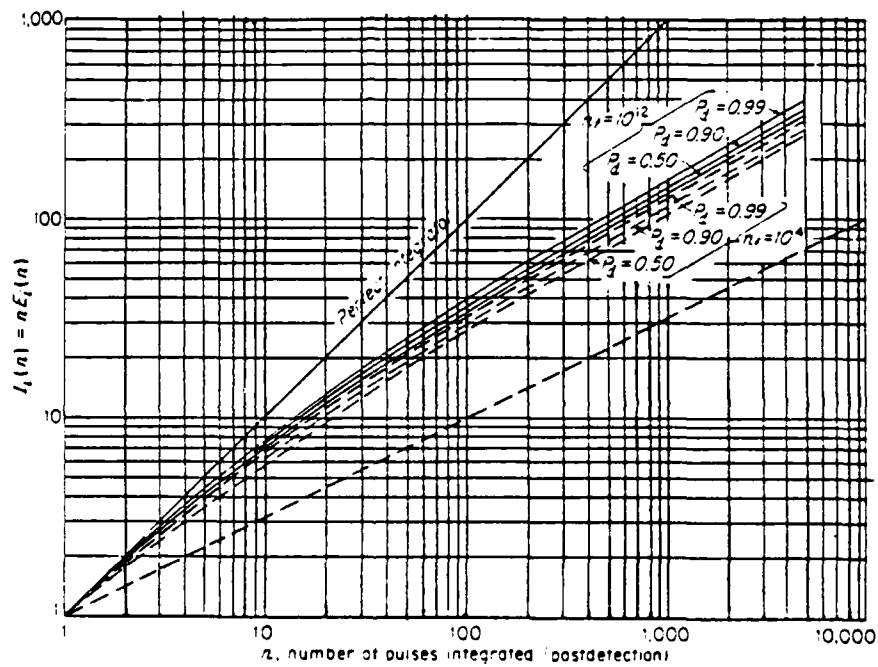

Figure 2.2. Integration-improvement factor, square law detector, P_d = probability of detection, $n_f = T_{fa} =$ false alarm number, $T_{fa} =$ average time between false alarms, B = bandwidth

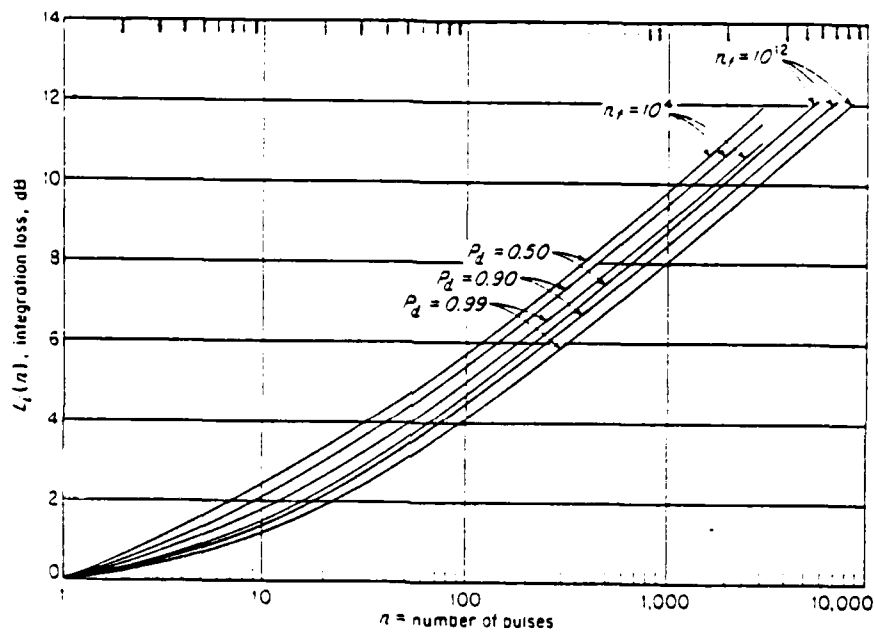

Figure 2.3. Integration loss as a function of n , the number of pulses integrated F_d , and n_f

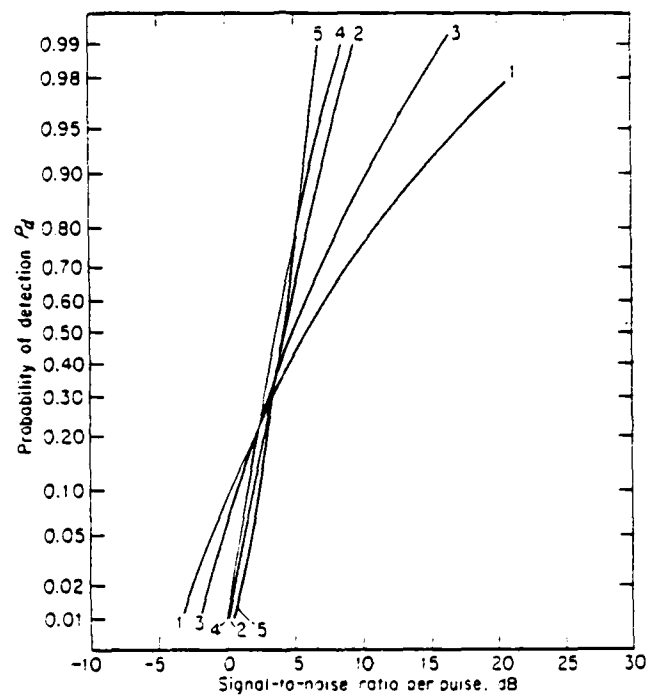

Figure 2.4. Comparison of detection probabilities for five different models of target fluctuation for $n = 10$ pulses integrated and false-alarm number $n_f = 10^8$

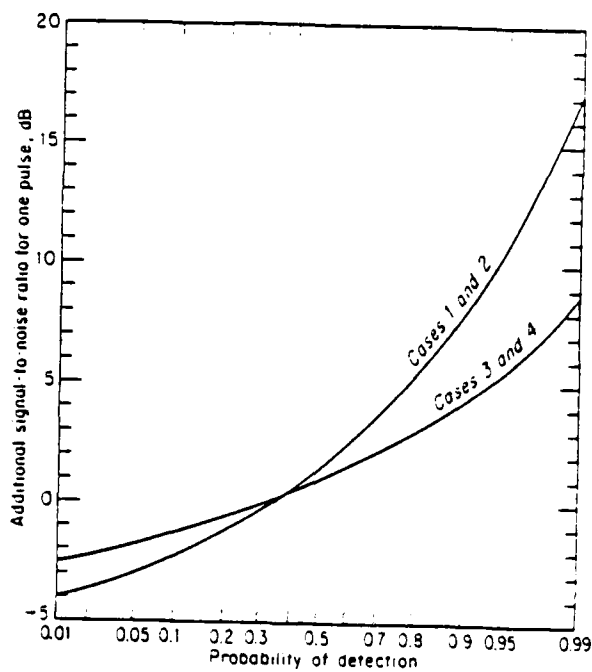

Figure 2.5. Additional signal-to-noise ratio required to achieve a particular probability of detection, when the target cross section fluctuates, as compared with a non fluctuating target; single hit, $n = 1$. (To be used in conjunction with Fig. 2.1 to find $(S/N)_1$)

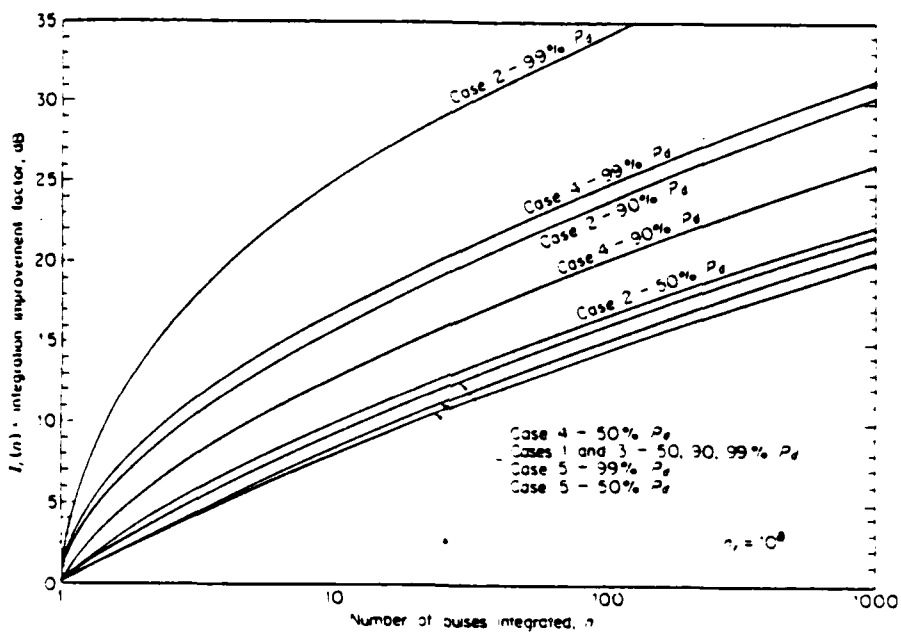

Figure 2.6. Integration-improvement factor as a function of the number of pulse integrated for the five types of target fluctuation considered

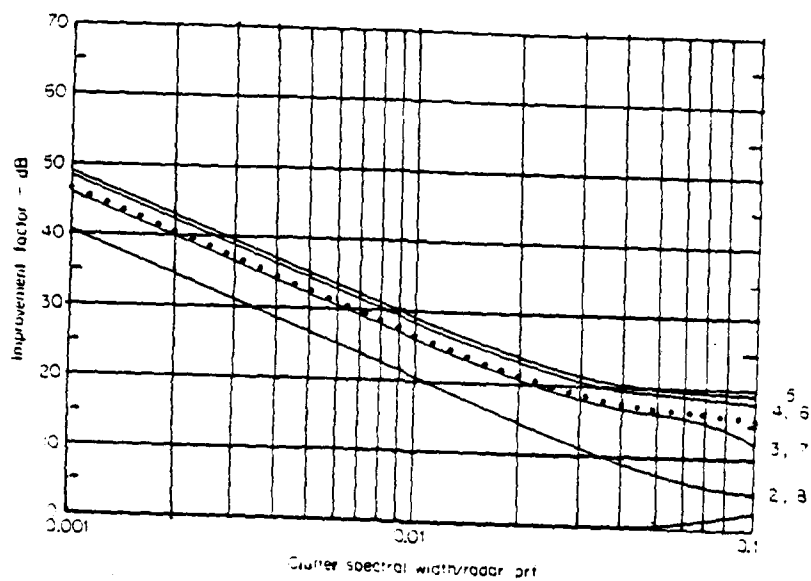

Figure 2.7. Improvement factor for each filter of an 8-pulse doppler filter bank with uniform weighting as a function of the clutter spectral width (standard deviation). The average improvement factor for all filters is indicated by the dotted curve

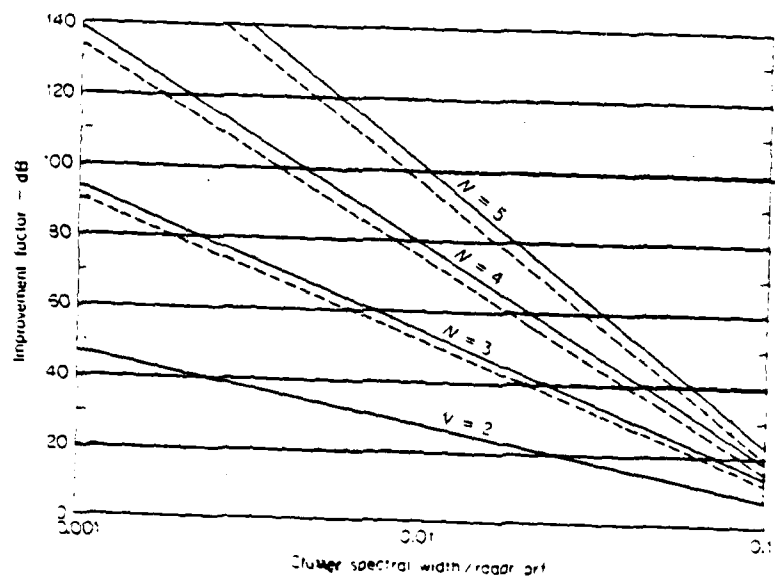

Figure 2.8. Improvement factor for a N-pulse canceler with optimum weights (solid curves) and binomial weights (dashed curves), as a function of the clutter spectral width

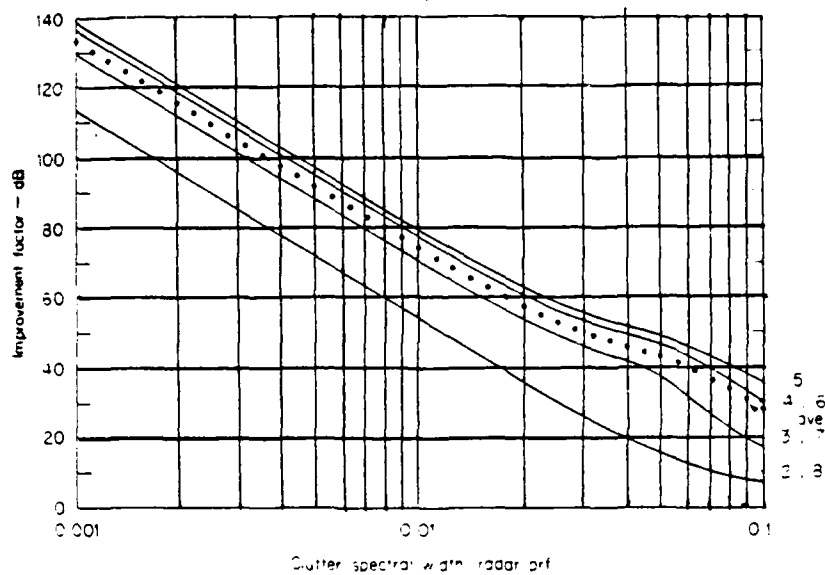

Figure 2.9. Improvement factor for a three-pulse (double canceler) MTI cascaded with an 8-pulse filter bank, or integrator, with uniform amplitude weights. The improvement for all filters is indicated by the dotted curve.

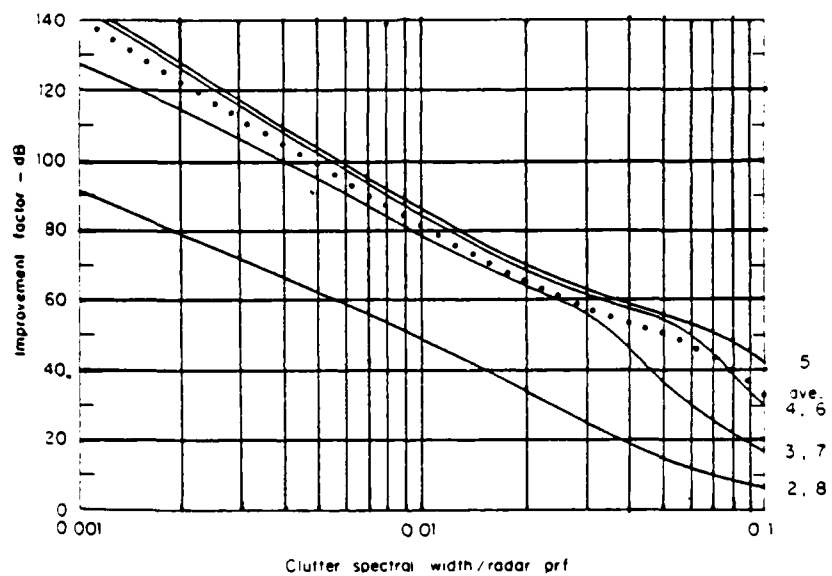

Figure 2.10. Improvement factor for a three-pulse (double canceler) MTI cascaded with an 8-pulse filter bank, or integrator, with 25-db Chebyshev weights. The improvement for all filters is indicated by the dotted curve

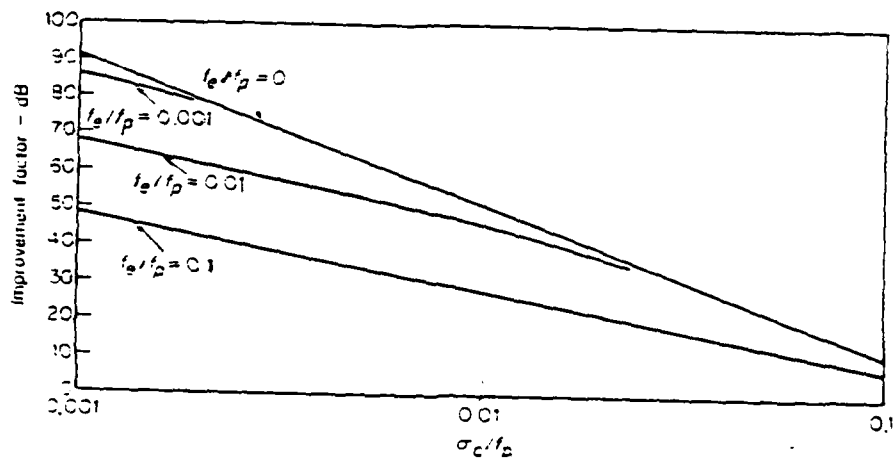

Figure 2.11. Effect of a nonzero clutter doppler frequency on the improvement factor of a three pulse canceler. f_0 = mean frequency of the clutter spectrum, f_p = pulse repetition frequency

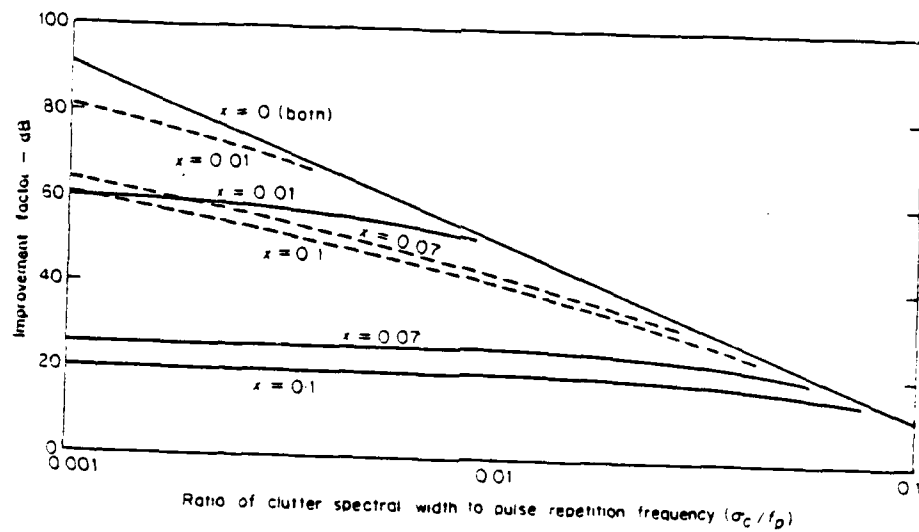

Figure 2.12. Improvement factor of a three-pulse canceler limited by platform motion (solid lines). Effect of the DPCA compensation (dashed lines). x is the fraction of the antenna aperture that the antenna is displaced per interpulse period. ($x = 0$ corresponds to no platform motion)

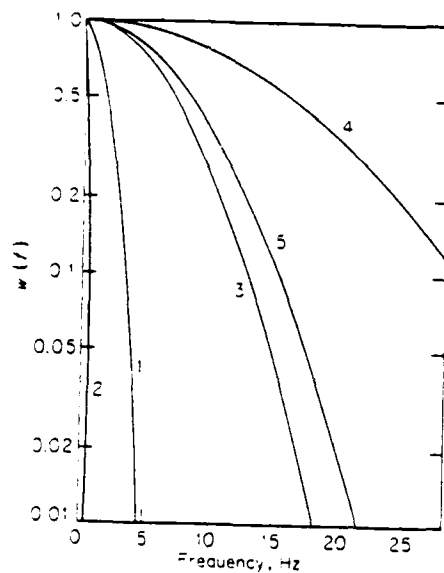

Figure 2.13. Power spectra of various clutter targets
 (1) Heavily wooded hills, 20 mi/h wind blowing
 ($a = 2.3 \times 10^{17}$); (2) sparsely wooded hills,
 calm day ($a = 3.9 \times 10^{19}$); (3) sea echo, windy
 day ($a = 1.41 \times 10^{16}$); (4) rain clouds
 ($a = 2.8 \times 10^{15}$); (5) chaff ($a = 1 \times 10^{16}$)

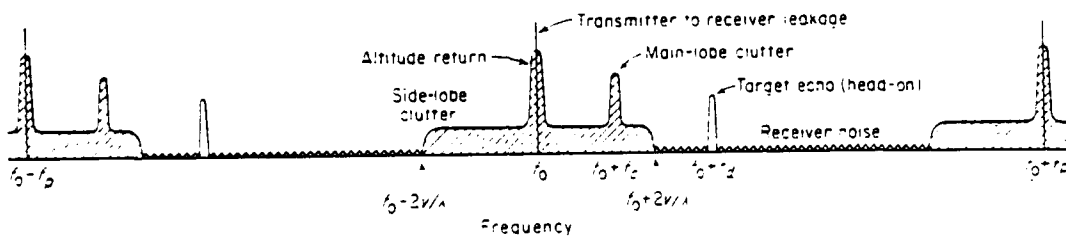

Figure 2.14. Portion of the received signal spectrum of the RF carrier frequency f_0 , for a pulse-doppler AMTI radar

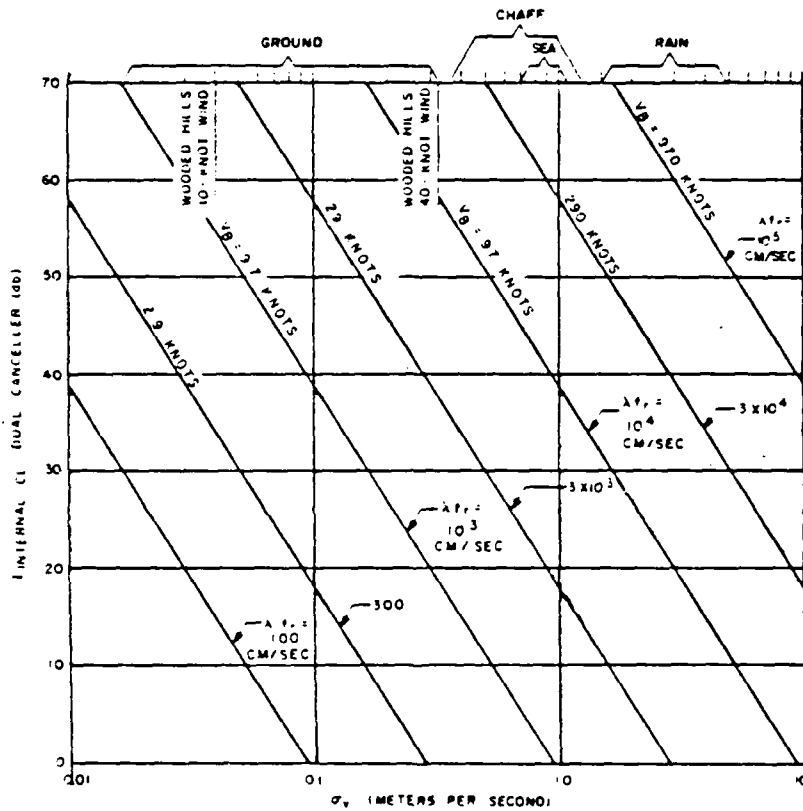

Figure 2.15. MTI improvement factor as a function of the RMS velocity spread of clutter for a two-delay canceler (no feedback)

Comparison of several types of spectral weighting functions:

TABLE 1
PROPERTIES OF WEIGHTING FUNCTION

<u>Weighting Function</u>	<u>Peak Sidelobe db</u>	<u>Loss db</u>	<u>Mainlobe width (relative)</u>	<u>Sidebbe decay function</u>
Uniform	-13.2	0	1.0	1/t
$0.33+0.66\cos^2(\pi\ell/B)$	-25.7	0.55	1.23	1/t
$\cos^2(\pi\ell/B)$	-31.7	1.76	1.65	1/t ³
Taylor ($\bar{n} = 8$)	-40	1.14	1.41	1/t
Dolph-Chebyshev	-40	1.35	1
$0.08+0.92\cos^2(\pi\ell/B)$ (Hamming)	-42.8	1.34	1.50	1/t

B = bandwidth

III. RADAR PROBLEMS

A. PROBLEM #1: DETECTION

Consider the design of a shipboard search radar. False alarm rate is an annoying problem for the radar operator. Threshold detection is to be used. The bandwidth of the I-F amplifier is $B_{I-F} = 4$ MHz. Calculate the threshold-to-rms noise voltage () for a mean time between false alarms, T_{fa} , of:

- a) 5 minutes
- b) 50 minutes
- c) 500 minutes

Solution

From Eq. (2.26) (Skolnik, pg. 25)

$$T_{fa} = \frac{1}{B_{IF}} \exp \frac{V_T^2}{2\psi_0^2} \quad (1)$$

where:

$$\begin{aligned} T_{fa} &= \text{false alarm time;} \\ B_{IF} &= \text{bandwidth of the amplifier;} \\ V_T &= \text{threshold voltage;} \\ \psi_0^{1/2} &= \text{rms noise voltage.} \end{aligned}$$

From Eqn. (1),

$$V_t / \sqrt{\psi_0} = 2 \{ 2n(T_{fa} \cdot B_{IF}) \}^{1/2} \quad (2)$$

Substituting in Eq. (2) the values of T_{fa} and B_{IF} we find for:

Part a:

threshold-to-rms noise voltage: $V_T/\sqrt{\psi_0} = 6.466$ (numeric) or
8.106 db.

Part b:

threshold-to-rms noise voltage: $V_t/\sqrt{\psi_0} = 6.813$ (numeric) or
8.333 db.

Part c:

threshold-to-rms noise voltage: $V_t/\sqrt{\psi_0} = 7.143$ (numeric) or
8.538 db.

B. PROBLEM #2: DETECTION LOSS

For a non-fading target, with probability of detection $P_d = 0.99$ and a false alarm number $n_f = 10^{12}$ with non-coherent integration, find the collapsing loss, if

- a) $n = 10$ and $m = 10$
- b) $n = 10$ and $m = 90$

Solution

From Figure 2.8(a) (Skolnik, pg. 31) we can find the integration loss for $L_i(m+n)$ and $L_i(n)$, since the probability of detection P_d and the false alarm number n_f are known.

$$L_i(m+n) = L_i(10+10) = L_i(20) = 1.9 \text{ db}$$

$$L_i(n) = L_i(10) = 1.3 \text{ db}$$

From Eq. (2.52) (Skolnik, Pg. 59),

$$L_i(m,n) = \frac{L_i(m+n)}{L_i(n)} \quad (3)$$

where:

$$\begin{aligned} L_i(m,n) &= \text{collapsing loss;} \\ L_i(m+n) &= \text{integration loss for } m+n \text{ pulses;} \\ L_i(n) &= \text{integration loss for } n \text{ pulses.} \end{aligned}$$

Substituting in Eq. (3), the values of $L_i(20)$ and $L_i(10)$, we get the collapsing loss,

$$L_i(10,10) = 1.9 - 1.3 = 0.6 \text{ db or } 1.14815 \text{ (numeric)}$$

Part b:

From the same Figure 2.8(a), we can find that

$$L_i(m+n) = L_i(90+10) = L_i(100) = 4.1 \text{ db}$$

$$L_i(n) = L_i(10) = 1.3 \text{ db}$$

Substituting in Eq. (3) the values of $L_i(100)$ and $L_i(10)$ we get the collapsing loss

$$L_i(90,10) = 4.1 - 1.3 = 2.8 \text{ db or } 1.905 \text{ numeric.}$$

C. PROBLEM #3: MAXIMUM RANGE

A pulse radar uses a magnetron with a peak power $P_t = 1.0$ Mw, a pulse width $\tau = 1.0 \mu\text{s}$, and a pulse repetition frequency $f_p = 250$ Hz. It operates at $\lambda = 10$ cm, and the effective antenna aperture $A_e = 200 \text{ m}^2$. Ten pulses are integrated after

detection. The receiver noise figure $F_n = 10$ db and it has a noise bandwidth $B_n = 1.0$ MHz. Plumbing losses $L_p = 3.0$ db and the beam shape $L_{bs} = 2.0$ db. Exponential (continuous) integration is used, resulting in a reduction by a factor of 0.85 in the integration efficiency. Threshold detection is used with a false alarm probability $P_{fa} = 10^{-9}$.

- a) Find the maximum unambiguous range
- b) Find the maximum range for a detection probability $P_d = 0.99$ on a target with $\sigma_{av} = 1$ m² average cross section, if fading follows the Rayleigh power distribution law and occurs from pulse to pulse (case 2). Assume there is no atmospheric attenuation.

Solution:

From Eq. 1.2 (Skolnik, Pg. 3) the maximum unambiguous range is

$$R_{unamb} = \frac{c}{2f_p} \quad (4)$$

where:

- c = velocity of the light = 3×10^8 , m/s;
 f_p = pulse repetition frequency, Hz;

so,

$$R_{unamb} = \frac{3 \times 10^8}{2 \times 250} = 6 \times 10^5 \text{ m} = 600 \text{ km.}$$

Part b:

From Eq. 2.54 (Skolnik, Pg. 62) the maximum radar range is given by the formula,

$$R_{\max}^4 = \frac{P_{\text{av}} G A \rho_a \sigma n E_i(n)}{(4\pi)^2 k T_o F_n (B_n \tau) f_p (S/N)_1 L_s} \quad (5)$$

where:

- R_{\max} = maximum radar range, m;
- G = antenna gain;
- A = antenna aperture, m^2
- ρ_a = antenna efficiency;
- n = number of hits integrated;
- $E_i(n)$ = integration efficiency (less than unity);
- L_s = system losses (greater than unity) not included in other parameters;
- σ = radar cross section of target, m^2 ;
- F_n = noise figure;
- k = Boltzmann's constant = 1.38×10^{-23} J/deg.;
- T_o = standard temperature = 290 k;
- B_n = receiver bandwidth, Hz;
- τ = pulse width, seconds;
- f_p = pulse repetition frequency, Hz;
- $(S/N)_1$ = signal-to-noise ratio required at receiver output (based on single-hit detection).

From Eq. 2.43 (Skolnik, Pg. 52),

$$P_{\text{av}} = P_t \tau f_p \quad (6)$$

where:

- P_{av} = the average radar power, w;
- P_t = the average transmitter power, w;

τ = pulse width, s;

f_p = pulse repetition frequency, Hz.

From Eqn. 7.9 (Skolnik, Pg. 227),

$$G = \frac{4\pi A_e}{\lambda^2} = \frac{4\pi\rho_a A}{\lambda^2} \quad (7a)$$

$$A_e = A\rho_a \quad (7b)$$

where:

A_e = effective area;

A = physical area of antenna;

ρ_a = antenna aperture efficiency;

λ = wavelength.

The total system losses are:

$$L_s = L_p + L_{bs} \quad (8)$$

where:

L_s = system losses, db;

L_p = plumbing losses, db;

L_{bs} = beam shape, db.

So,

$$L_s = 3 + 2 = 5 \text{ db} = 3.1622$$

From Fig. 2.7 (Skolnik, Pg. 28), the signal-to-noise ratio

$(S/N)_1 \doteq 15.9$ db, for probability of detection $P_d = 0.99$

and false alarm probability $P_{fa} = 10^{-9}$. From Fig. 2.23 (Skolnik, Pg. 48) the additional signal-to-noise ratio $(S/N)_{ladd} \doteq 17.2$ db for case 2 and $P_d = 0.99$. So,

$$(S/N)_{lTOT} = (S/N)_1 + (S/N)_{ladd} \quad (9)$$

so $(S/N)_{lTOT} = 15.9 + 17.2 = 33.1$ db or 2041 (numeric).

From Fig. 2.24 (Skolnik, Pg. 49) the integration improvement factor $I_i(n) = 25$ db = 316.22 (numeric),

$$I_i(n) = nE_i(n) \quad (10)$$

where:

$I_i(n)$ = integration improvement factor, db;

$E_i(n)$ = integration efficiency;

n = number of hits integrated.

From Eq. (10),

$$E_i(n) = \frac{I_i(n)}{n} \quad (10a)$$

and because we have a reduction by 0.85 in the integration efficiency, Eq. (10a) becomes

$$E_i(n) = \frac{I_i(n)}{n} \times 0.85 \quad (10b)$$

so

$$E_i(n) = \frac{316.22}{10} \times 0.85 = 26.537$$

Now substituting Eqs. (6), (7a), (7b), (8), (9), (10) in Eq. (5), and simplifying, we get

$$\begin{aligned}
 R_{\max} &= \frac{P_t A_e^2 \sigma_n E_i(n) 0.85}{(4\pi) k t_o F_n B_n \lambda^2 (S/N)_{\text{TOT}} L_s} \quad 1/4 \quad (11) \\
 &= \frac{(1 \times 10^6) \times (200)^2 \times 1 \times 26.537 \times 10}{(4\pi) \times 1.38 \times 10^{-23} \times 290 \times 10 \times (1 \times 10^6) \times (0.1)^2 \times 2041.73 \times 3.1622} \\
 &= 758.57 \text{ km}
 \end{aligned}$$

D. PROBLEM #4: FM-RANGING, DOPPLER

A CW FM radar operates at $f_o = 10.5$ GHz. The frequency increases at a rate $\dot{f}_o = 2$ GHz/sec for $T = 990$ microseconds, and then returns to its original value in $T_r = 10$ microseconds.

- Calculate the frequency shift of the echo from a target at a range $R = 5000$ yards
- Calculate the range error due to doppler shift if the closing rate of the radar and target $U_r = 25$ ft/sec.

Solution:

From Eq. 3.10 (Skolnik, Pg. 82)

$$f_r = \dot{f}_o T \quad (11a)$$

$$f_r = \dot{f}_o 2R/C \quad (11b)$$

where:

- f_r = the beat frequency due to the target range;
- \dot{f}_o = rate that the frequency changes;
- T = rate that takes an echo signal to return;

R = target range;

C = speed of light = 3×10^8 w/d.

So, from Eq. (11b) the frequency shift is:

$$f_r = \frac{2 \times 10^9 \times 2 \times 5.000 \times 0.914}{3 \times 10^8} = 60.933 \text{ kHz}$$

Part b:

From Eq. 3.2(a) (Skolnik, Pg. 69)

$$f_d = \frac{2U_r}{\lambda} \quad (12)$$

where:

f_d = doppler frequency shift, Hz;

U_r = relative velocity, m/s;

λ = wavelength of radiated energy, m.

So, from Eq. (12),

$$f_d = \frac{2 \times 25 \times 0.305 \times 10.5 \times 10^9}{3 \times 10^8} = 533.75 \text{ Hz}$$

The range error is given by the

$$\Delta R = \frac{R \times f_d}{f_r} \quad (13)$$

So,

$$\Delta R = \frac{5000 \times 533.75}{60.933 \times 10^3} = 43.798 \text{ yards} = 40.03125 \text{ m}$$

or 0.4% m = 0.4379% yards.

E. PROBLEM #5: BLIND SPOTS IN DOPPLER

A 9 GHz radar operates with a pulse width $\tau = 1 \mu\text{s}$ and a PRF $f_p = 1000 \text{ Hz}$.

- a) What is the first blind speed?
- b) A jet aircraft is flying $U_{\text{air}} = 600 \text{ knots}$. If the above radar detects the aircraft, will there be a doppler ambiguity? Explain.

Solution:

From Eq. 4.8 (Skolnik, Pg. 108)

$$U_{\text{lbl}} = \frac{\lambda f_p}{2} \quad (14)$$

where:

- U_{lbl} = the first bline speed, m/s;
 λ = wavelength, Hz;
 f_p = pulse repetition frequency, Hz.

So, the first blind speed is

$$U_{\text{lbl}} = \frac{c}{f} \frac{f_p}{2} = \frac{3 \times 10^8 \times 1000}{2 \times 9 \times 10^9} = 16.66 \text{ m/s} = 32.36 \text{ knots}$$

Part b:

Since $U_{\text{air}} = 600 \text{ knots} > U_{\text{lb}} = 32.36 \text{ knots}$, there will be a doppler ambiguity.

F. PROBLEM #6: MTI

A 1000 Hz PRF radar with a clutter spectral width $\sigma_c = 10 \text{ Hz}$, uses a 3 pulse delay line canceller, with optimal weighting. What is the MTI improvement factor in db?

Solution:

$$\frac{\text{Clutter spectral width}}{\text{radar PRF}} = \frac{\sigma_c}{f_p} = \frac{10}{1000} = 0.01 \quad (15)$$

From Figure 4.25 (Skolnik, Pg. 124) the MTI improvement factor $I = 55$ db, for a 3-pulse delay-line canceller, with optimum weights, and $\sigma_c/f_p = 0.01$.

G. PROBLEM #7: POWER, NOISE POWER, S/N

The following data for a pulse radar is available:

Peak power $p_p = 200$ kw;

Pulse repetition rate $r_p = 300$ Hz;

Pulse width $\tau = 60$ microsec;

False alarm time $T_{fa} = 2.2$ hrs;

Receiver noise figure $r_n = 65$ db;

Transmitter frequency, $f_o = 400$ MHz;

IF: $F_{IF} = 120$ MHz;

IF bandwidth: $B_{IF} = 1.25$ MHz;

Antenna power gain: $G_a = 21$ db;

Minimum detectable signal MDS = -115 dbm.

- a) What is the average output power?
- b) What is the noise power? How does it compare to the minimum detectable signal? What is the rms threshold power to noise ratio if no pulse integration is performed?
- c) For a target of $\sigma = 1$ sq. m cross section which fluctuates from pulse to pulse according to the one-plus-Rayleigh power distribution, what is the minimum signal to noise ratio required to achieve a probability of detection if $n = 30$ pulses are integrated after post-detection?

- d) Use $(S/N)_{\min} = 4$ db as the answer to the above problem instead of the solution you obtained. Assume the total system loss $L_s = 1$ db. What is the maximum range of the radar for the detection of the target described above with probability of detection $P_d = 0.5$?
- e) If the radar has a minimum range $R = 10.5$ km, what is its approximate TR recovery time?

Solution:

Part a:

From Eq. 2.43 (Skolnik, Pg. 52) the average output power may be written as:

$$P_{av} = P_p \times \tau \times f_p \quad (16)$$

where:

P_p = peak power, w;

τ = width of the transmitted rectangular pulses, sec.;

f_p = pulse repetition rate.

So,

$$P_{av} = (200 \times 10^3) \times (60 \times 10^{-6}) \times 300 = 3.6 \text{ kw}$$

Part b:

From Eq. 2.2 (Skolnik, Pg. 18) the noise power N_n generated by a receive of bandwidth B_{IF} at a temperature T (degrees Kelvin) is equal to

$$N_n = k T B_{IF} \quad (17)$$

where:

$k =$ Boltzmann's constant $= 1.38 \times 10^{-23}$ J/deg.;

$T = 290^\circ$ Kelvin (room temperature).

So,

$$\begin{aligned} N_n &= (1.38 \times 10^{-23}) \times 290 \times (1.25 \times 10^6) = 5 \times 10^{-15} \text{ watts} \\ &= -113 \text{ dbm.} \end{aligned}$$

The noise power $N_n = -113 \text{ dbm} > \text{MDS} = -115 \text{ dbm}$.

From Eq. 2.26 (Skolnik, Pg. 25) the threshold power to noise ratio is equal to

$$\frac{V_T^2}{2\psi_0} = \ln(T_{fa} \times B_{IF}) \quad (18)$$

where:

$T_{fa} =$ false alarm time;

$B_{IF} =$ bandwidth of the amplifier;

$V_T =$ threshold voltage,

$\psi_0^{1/2} =$ rms noise voltage.

So,

$$\frac{V_T^2}{2\psi_0} = \ln(22 \times 3600 \times 1.25 \times 10^6) = \ln(9.9 \times 10^9) = 13.6 \text{ db}$$

Part c:

From Figure 2.7 (Skolnik, Pg. 28), for probability of detection $P_d = 0.5$ and false alarm probability $P_{fa} = \frac{1}{T_{fa} \times B_{IF}} = \frac{1}{2.2 \times 3600 \times 1.25 \times 10^6} \doteq 10^{-10}$, the signal-to-noise ratio $(S/N)_1 \doteq 13.6$ db.

From Figure 2.23 (Skolnik, Pg. 48) the additional signal-to-noise ratio for one pulse is $(S/N)_{10dd} = 1.0$ db. So,

$$(S/N)_{1TOT} = (S/N)_1 + (S/N)_{10dd} = 13.6 + 1.0 = 14.6 \text{ db}$$

(case 4).

From Figure 2.24 (Skolnik, Pg. 49) for $P_d = 0.5$ and for $n = 30$ integrated pulses the integration improvement factor $I_i(n) = 11.4$ db.

The minimum signal to noise ratio $(S/N)_{30} = \frac{(S/N)_{1TOT}}{I_i(n)} = 14.6 \text{ (db)} - 11.4 \text{ (db)} = 3.2 \text{ db}$.

Part d:

The basic radar range equation may be written as:

$$R_{\max}^4 = \frac{P_t G_a^2 \lambda^2 \sigma}{(4\pi)^3 k T B_{IF} F_n (S/N)_{30} L_s} \quad (19)$$

A simple way to handle the mathematics is to convert all of the factors to db and then add and subtract.

Numerator

$$\begin{aligned} P_t &= 200 \times 10^3 \text{ watts} = && +53.0 \text{ dbw} \\ G_a^2 &= 2 \times 21 \text{ db} = && +42.0 \text{ db} \end{aligned}$$

$$\lambda^2 = \left(\frac{3 \times 10^8}{400 \times 10^6} \right)^2 = 0.5625 = -12.5 \text{ db (negative because of characteristic)}$$

$$\sigma = 1 \text{ sq. m} = + 0.0 \text{ db}$$

$$\Sigma N = +92.5 \text{ dbw}$$

Denominator

$$(4\pi)^3 = 3 \times 10.97 \text{ db} = + 32.9 \text{ db}$$

$$kT_o = 4 \times 10^{-21} \text{ W/Hz} = - 204 \text{ dbw}$$

$$B_{IF} = 1.25 \times 10^6 \text{ Hz} = + 60.9 \text{ db}$$

$$F_n = 6.5 \text{ db} = + 6.5 \text{ db}$$

$$(S/N)_{30} = 4 \text{ db} = + 4.0 \text{ db}$$

$$L_s = 1 \text{ db} = + 1.0 \text{ db}$$

$$\Sigma D = -98.7 \text{ dbw}$$

$$R_{\max} = \frac{1}{4} [\Sigma N - \Sigma D] = \frac{1}{4} [92.5 - (-98.7)] = 47.8 \text{ db}$$

$$= 60.25 \text{ km}$$

Part e:

The recovery time is equal to

$$T_R = \frac{2R}{c} - \tau = \frac{2 \times 10.5 \times 10^3}{3 \times 10^8} - 60 \times 10^6 = 10 \text{ } \mu\text{sec.}$$

H. PROBLEM #8: MTI-CHAFF DISCRIMINATOR

A 6 GHz, 1000 Hz PRF MTI radar uses a double delay line canceller against chaff. What is its improvement factor in db?

Solution:

The improvement factor, for a double canceller is given in Eq. 4.26 (Skolnik, Pg. 133) and is equal to:

$$I_{2c} = \frac{a^2 f_p^4}{2\pi^4 f_o^2} \quad (20)$$

where:

f_p = the pulse repetition frequency, Hz;

f_o = the operating frequency, Hz;

π = 3.14159

a = parameter dependent upon clutter.

The parameter $a = c^2/8\sigma_u^2$, where $c = 3 \times 10^8$ m/s, σ_u = the rms velocity spread.

From Figure 13 (Skolnik, Pg. 16-17), the rms velocity spread varies from $\sigma_{U1} = 0.4$ m/s to $\sigma_{U2} = 1$ m/s, so

$$a_1 = \frac{c^2}{8 \sigma_{U1}^2} = \frac{(3 \times 10^8)^2}{8 \times (0.4)^2} \doteq 7 \times 10^{16} \quad \text{and}$$

$$a_2 = \frac{c^2}{8 \sigma_{U2}^2} = \frac{(3 \times 10^8)^2}{8 \times (1)^2} = 1.125 \times 10^{16}$$

So, the improvement factor for $a_1 = 7 \times 10^{16}$ is

$$I_{2c_1} = \frac{a_1^2 f_p^4}{2\pi^4 f_o^4} = \frac{(7 \times 10^{16})^2 \times (1000)^4}{2 \times \pi^4 \times (6 \times 10^9)^4}$$

$$= 1.94 \times 10^4 = 43 \text{ db}$$

and for $a_2 = 1.125 \times 10^6$, is

$$I_{2c_2} = \frac{(1.125 \times 10^6)^2 \times (1000)^4}{2 \times \pi^4 \times (6 \times 10^9)^4} = 501.18 = 27 \text{ db}$$

So, the improvement factor is from 43 db to 27 db.

I. PROBLEM #9: MTI-CHAFF-CLUTTER DISCRIMINATOR

Find the approximate reduction in the improvement factor, I, in db from the near ideal case, when the PRF $f_p = 300$ Hz, and the clutter doppler frequency is shifted on the average by $f_e = 30$ Hz and the rms clutter spread is approximately $c = 3$ Hz. Assume a three pulse canceller.

Solution:

$$\text{The } \frac{\text{rms clutter spread}}{\text{pulse repetition freq.}} = \frac{3}{300} = 0.01.$$

Also, the

$$\frac{\text{mean freq. of the clutter spectrum}}{\text{pulse repetition freq.}} = \frac{30}{300} = 0.1$$

So, from Figure 4.34 (Skolnik, Pg. 141) the reduction of the improvement factor $I = 24$ db, for the near ideal case and for three pulse canceller.

J. PROBLEM #10: PHASED ARRAY-BW

The radar AN/FPS - 108 (COBRA DANE) is designed to scan up to 60 degrees off the antenna center axis. Assume the separation between two adjacent active array elements $d = 210$ cm and the radar is operating at $f_0 = 1250$ MHz. The diameter of the phase array antenna is $D = 29$ m.

- a. What is the phase difference between two array elements along the horizontal direction if the antenna is steered along this direction, 10 degrees off center?
- b. What is the beamwidth at this angle, if each array element has the same output power?

Solution:

Part a:

In order for the main beam of the radiation pattern to be positioned at an angle $\theta_0 = 10^\circ$, the phase shift between adjacent elements of the array must be:

$$\phi = 2\pi \frac{d}{\lambda} \sin \theta_0 \quad (21)$$

where:

d = separation between two adjacent elements, m;

λ = wavelength, m;

θ_0 = degrees of center, of the position of the antenna.

So, the phase difference between two adjacent array elements

$$= \frac{2 \cdot \pi \cdot 0.2 \cdot 1250 \times 10^6}{3 \cdot 10^8} \sin(10) = 52.09^\circ \text{ (0.9 radians)}$$

Part b:

From Eq. 8.13 (Skolnik, Pg. 284) the half-power beamwidth is equal to:

$$\theta_B = \frac{0.866 \lambda}{N d \cos \theta_0} \quad (22)$$

where:

N = number of elements = 1;

d = diameter of phase array antenna, m;

θ_0 = degrees of center, of the position of the antenna;

λ = wavelength, m.

So, the beamwidth at $\theta_0 = 10^\circ$, for the same output power of each array element is equal to:

$$\begin{aligned} \theta_B &= \frac{0.866 \times 3 \times 10^8}{1 \times 29 \times 1250 \times 10^6 \times \cos 10} = 7.28 \times 10^{-3} \text{ radians} \\ &= 0.417^\circ \end{aligned}$$

K. PROBLEM #11: PULSE RADAR-RMAX

Estimate the maximum range R_{\max} for the following pulse radar system:

Antenna gain $G_a = 21 \text{ db};$

Peak power $P_t = 2 \text{ MW};$

Frequency $f_0 = 500 \text{ MHz};$

Ambient Temperature $T_a = 62^\circ\text{F}$

Receiver bandwidth $B_n = 1 \text{ MHz};$

Target: Jet airliner with $\sigma = 5 \text{ m}^2$;

Receiver noise figure $F_n = 10 \text{ dbw}$;

Pulselength $\tau = 3 \text{ microsec.}$;

$I_i(n) = nE_i(n) = 16.5 \text{ db.}$

It is desired that the probability of detection be at least 90% and that the false alarm rate not exceed 10^{-11} . Assume system losses are compatible with an airport surveillance radar system $L_s = 6 \text{ db.}$

Solution:

The basic radar range equation may be written as:

$$R_{\text{max}}^4 = \frac{P_t G_m^2 \lambda_o^2 \sigma n E_i(n)}{(4\pi)^3 k T_o B_n F_n (S/N)_1 L_s} \quad (23)$$

For the numerator:

$P_t = 2 \times 10^6 \text{ watts} =$	+ 63 dbw
$G_o^2 = 2 \times 21 \text{ dbi} =$	+ 42 db
$\lambda_o^2 = 0.36 \text{ m}^2 =$	- 4.4 db
$\sigma = 5 \text{ m}^2 =$	+ 7.0 db
$nE_i(n) = 16.5 \text{ db} =$	+ 16.5 db
ΣN	= + 124.1 dbw

Denominator:

$(4\pi)^3 = 3 \times 10.97 \text{ db} =$	+ 32 db
$kT_o = 4 \times 10^{-21} \text{ w/Hz} =$	- 204 dbw
$B_n = 10^6 \text{ Hz} =$	+ 60 db
$F_n = 10 \text{ db} =$	+ 10 db

$$\begin{aligned}
 (S/N)_1 &= 15.4 \text{ db} = && + 15.4 \\
 L_s &= 6 \text{ db} = && + \underline{6 \text{ db}} \\
 \Sigma D & && = -79.7 \text{ dbw}
 \end{aligned}$$

$$\begin{aligned}
 R_{\max} &= \frac{1}{4}[\Sigma N - \Sigma D] = \frac{1}{4}[124.1 - (-79.7)] \\
 &= \frac{203.8}{4} \text{ db} = 51 \text{ db}
 \end{aligned}$$

$$R_{\max} = 122.5 \text{ km} = 67.2 \text{ n. miles}$$

L. PROBLEM #12: TWS, PROBABILITY OF DETECTION

The AN/SPC-10 radar has the following operating parameters:

Frequency	5600 MHz
Power (peak)	200 Lw
PRF	625 Hz
Pulse width	1.4 microsec.
Antenna scan rate	16 Hz
Azimuth beamwidth (3 db)	1.5 degrees
Antenna gain)	33 db
Receiver noise bandwidth	1 MHz
Receiver noise figure	9.88 db
System losses (ahead of receiver)	5 db
False alarm time	2 days
Antenna noise temperature	75 degrees K
PPI display + operator	

- (a) Calculate the number of hits/scan on a point target
- (b) Determine the single pulse S/N in db required to achieve a detection probability of 0.95

- (c) Determine the integration improvement factor
- (d) Calculate the minimum detectable signal power in dbw
- (e) Calculate the peak effective radiated power in dbw
- (f) Calculate the effective area of the antenna in square meters
- (g) Calculate the maximum free space detection range in km for a detection probability of 0.95 (with false alarm time = 2 days) on a 0 dbsw non-fluctuating point target

Solution:

Part a:

The number of pulses n_B returned from a point target as the radar antenna scans through its beamwidth is

$$n_B = \frac{\theta_B}{2 \times 180} T_s f_p = \left(\frac{1.5}{360}\right) \times \left(\frac{60}{16}\right) \times (625)$$

$$= 9.77 \text{ hits/scan}$$

Part b:

The probability of false alarm is

$$P_{fa} = \frac{1}{T_{fa} B_{IF}} = \frac{1}{(2 \times 24 \times 3600 \text{ sec})(10^6 \text{ Hz})} = 58 \times 10^{-12}$$

From Figure 2.7 (Skolnik, Pg. 28) the signal-to-noise (power) ratio is $(S/N)_1 \doteq 16 \text{ db}$ for $P_d = 0.95$ and $P_{fa} = 58 \times 10^{-12}$

Part c:

From Figure 2.8(a) (Skolnik, Pg. 31), incoherent integration of 9 pulses gives $I_i(9) = 7 = 8.4 \text{ db}$.

Part d:

The minimum detectable signal power is given as

$$\text{MDS } k T_o B_n F_n = 138 \times 10^{-23} \times 290 \times 10^6 \times 9.727 = -134.1 \text{ dbw}$$

Part e:

The peak effective radiated power is equal to:

$$P_{\text{eff}} = P_t G_t \quad (24)$$

where:

$$P_t = 200 \times 10^3 \text{ W} = 53 \text{ db (transmitter power);}$$

$$G_t = 33 \text{ db (antenna gain).}$$

So,

$$P_{\text{eff}} = 53 + 33 = 86 \text{ dbw.}$$

Part f:

The antenna effective area is equal to:

$$A_e = \frac{\lambda^2}{4\pi} \times G = \frac{(5.35 \times 10^{-2})^2}{4\pi} \times 2000$$

$$A_e = 0.456 \text{ m}^2 \approx -3.4 \text{ dbsm}$$

Part g:

The maximum radar range R_{max} is equal to

$$R_{\text{max}} = \frac{P_t G_t A_e \sigma I_i(n)}{(4\pi)^2 k T_o \left(\frac{T_a + T_e}{T_o}\right) B_n (S/N)_1 L_s} \quad (25)$$

$$(1) \quad 10 \log_{10} (4\pi)^2 = 22 \text{ db}$$

$$(2) \quad 10 \log_{10} \left(\frac{T_a + T_e}{T_o} \right) = 10 \log_{10} \left(\frac{75 + 2530}{290} \right) = 9.53 \text{ db}$$

$$10 \log_{10} (R_{\max}^4) = [86 \text{ dbw} - 3.4 \text{ db} + 0 \text{ dbsw} + 8.4 \text{ db}] \\ - [22 \text{ db} - 204 + 9.53 + 60 + 16 + 5]$$

$$10 \log_{10} R_{\max}^4 = 182.5 \text{ db}$$

$$R_{\max} = 10^{4.56} = 36,307 \text{ m.}$$

So,

$$R_{\max} = 36.3 \text{ km } (P_d = 0.95 \text{ on } 0 \text{ dbsw target})$$

M. PROBLEM #13: RECEIVER'S BANDWIDTH

A 10 GHz CW doppler radar of single sideband superheterodyne design, has the block diagram shown in Figure 3.4, pg. 75 of [Ref. 2]. The radar is to be designed to measure the speed of vehicles with RCS = 10 dBsm traveling at velocities up to 100 mi/hrs at ranges up to 1/2 miles. For reliable operation, a signal-to-noise ratio and 15 db is required at the output of the IF amplifier. The receiver noise figure is $F = 7.25 \text{ db}$, plumbing loss is 2 db and $T_a = 300 \text{ degrees K}$. The transit and receive antennas have gains of 20 db each.

- (a) Calculate the required receiver bandwidth
- (b) Calculate the required receiver input signal power in dbm

- (c) Calculate the one way free space loss in db for a target vehicle at a range of 1/2 miles
- (d) Calculate the required transmitter output power

Solution

Part a:

$$U_{rmax} = 100 \text{ mi/hrs} = 44.72 \text{ m/sec}$$

$$f_d = \frac{2U_r f_o}{c} = \frac{2 \times 44.72 \times 10^{10} \text{ Hz}}{3 \times 10^8} = 2981 \text{ Hz}$$

$$B = 2f_d = 5962 \text{ Hz} \doteq \text{ GkHz}$$

Part b:

The receiver input signal power is equal to:

$$S_{in} = k(T_a + T_e)B(S/N)_{out} = kT_o \left(\frac{T_a + T_e}{T_o}\right)B(S/N)_{out}$$

(1) $kT_o = -174 \text{ dbw/Hz}$

(2) $\frac{T_a + T_e}{T_o} = \frac{300 + 1250}{290} = 5.34 = 7.28 \text{ db}$

(3) $B = 6 \text{ kHz} = 37.8 \text{ db Hz}$

So,

$$S_{in} = -174 + 7.3 + 37.8 + 15 = -114 \text{ dbm.}$$

Allocate 1/2 of the plumbing loss to the receiver (1 db).

Taking this into account, we would require

$$S_{in} = -113 \text{ dbm.}$$

Part c:

The one way free space loss is equal to

$$L_{bf} = 10 \log_{10} \left(\frac{4\pi R}{\lambda} \right)^2 = 10 \log_{10} \left(\frac{4\pi \times 805 \text{ m}}{0.03} \right)^2$$

$$L_{bf} = 110.6 \text{ db.}$$

Part d:

The required transmitter output power is:

$$P_t = P_{eff} - G_\sigma + (2L_{bf} - G_r - G_t) \quad (26)$$

$$G_\sigma = 10 \log_{10} \frac{4\pi\sigma}{\lambda^2} = 41.4 \text{ db}$$

So from Eq. (26) we get

$$P_t = -113 \text{ dbm} - 41.4 \text{ db} + (2 \times 110.6 - 20 - 20)$$

$$P_t = 26.8 \text{ dbm}$$

If we assign the remaining 1 db of plumbing loss to the transmitter, we obtain

$$P_t = 27.8 \text{ dbm} = 603 \text{ m Watts.}$$

N. PROBLEM #14: BLIND SPEED--MTI

An 1 GHz MTI radar operates with a 4 period stagger T1:T2:T3:T4 = 25:30:27:31 and $T_{avg} = 0.001$ sec. Calculate the periods T1 ~ T4 and the first blind speed in knots.

Solution:

$$\frac{T_1 + T_2 + T_3 + T_4}{4} = T_{\text{avg}} = 10^{-3} \text{ sec} \quad (27)$$

$$\frac{25}{T_1} = \frac{30}{T_2} = \frac{27}{T_3} = \frac{31}{T_4} \quad (28)$$

Substituting Eq. (28) in Eq. (27), we have

$$\frac{25}{25} T_1 + \frac{30}{25} T_1 + \frac{27}{25} T_1 + \frac{31}{25} T_1 = 10^{-3}$$

$$\frac{113 T_1}{100} = 10^{-3}$$

$$T_1 = 884.96 \text{ } \mu\text{sec}$$

$$T_2 = 1061.9 \text{ } \mu\text{sec}$$

$$T_3 = 955.76 \text{ } \mu\text{sec}$$

$$T_4 = 1097.35 \text{ } \mu\text{sec}$$

The first blind speed is (in knots)

$$U_1 = \frac{\lambda f_p}{1.02} \left(\frac{25 + 30 + 27 + 31}{4} \right) = \frac{0.3 \times 10^3}{1.02} = 8309 \text{ knots}$$

O. PROBLEM #15: MTI WEIGHTS--DELAYS

An MTI radar operates at a frequency 1 GHz with PRF = k KHz.

- (a) Calculate the first blind speed in knots
- (b) Sketch a block diagram of a 4 pulse canceler for this radar. Show correct weights and delays
- (c) Calculate the clutter rejection in db at a frequency of 25 Hz for the 4 pulse canceler

- (d) If a target with a radial velocity of 200 knots is viewed with this radar, of what frequency will the bipolar video fluctuate?

Solution:

Part a:

$$U_{\text{bl}} = \frac{\lambda f_p}{1.02} = \frac{3 \times 10^8 \times 1000}{10^9 \times 1.02} = 294.118 \text{ knots}$$

Part b:

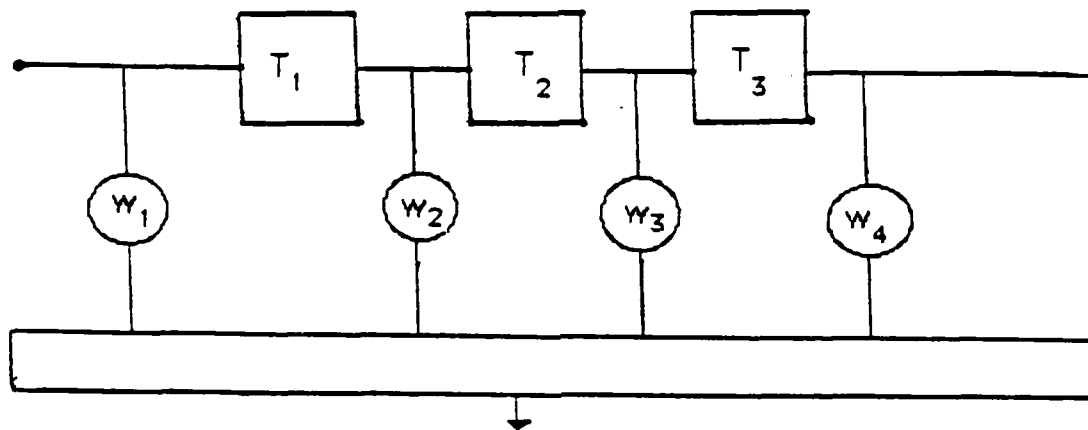

$$T_1 = T_2 = T_3 = 10^{-3} \text{ sec}$$

$$W_i = (-1)^{i-1} \frac{n!}{(n-i+1)! (i-1)!} \quad \begin{array}{l} i = 1, 2, 3, 4 \\ n = 3 \end{array}$$

$$W_1 = (-1)^0 \frac{3!}{3!0!} = 1$$

$$W_2 = (-1)^1 \frac{3!}{2!1!} = -3$$

$$W_3 = (-1)^2 \frac{3!}{1!2!} = 3$$

$$w_4 = (-1)^3 = \frac{3!}{0!3!} = -1$$

Part c:

The relative response of the 4 pulse canceler is

$$\frac{H(f)}{H(f_p/2)} = \sin^3(\pi f T)$$

For $F_d = 25$ Hz, the clutter rejection is

$$- 20 \log_{10} \sin^3\left(\frac{\pi 25}{1000}\right) = -60 \log(.078)$$

$$R_{\text{rejection}} = 66.3 \text{ db}$$

Part d:

The bipolar video fluctuates at the doppler frequency

$$f_d = \frac{2U_r f_o}{c}$$

if U_r is in knots,

$$f_d = \frac{1.03 U_r}{\lambda} = \frac{1.03 \times 200}{.3}$$

$$f_d = 686.7 \text{ Hz}$$

IV. EW PROBLEMS

A. PROBLEM #1: DETECTION RANGE, UNAMBIGUOUS RANGE

A shipboard surface search radar has the following characteristics:

Frequency	$f_o = 5600$ MHz
Pulse width (long)	$T_l = 1.3$ s
Pulse width (short)	$T_s = 0.25$ s
Power output (peak)	$P_t = 200$ kw
PRF	$f_p = 650$ Hz
Bandwidth (long pulse)	$B_{re} = 1$ MHz
Bandwidth (short pulse)	$B_{rs} = 5$ MHz
Antenna scan frequency	$W_m = 16$ RPM
Azimuth beamwidth	$\phi_B = 1.5^\circ$
Elevation beamwidth	$\theta_B = 14^\circ$
Antenna noise temperature	$T_u = 75$ degrees k
False alarm probability	$p = 1E-11$
Receiver noise figure	$F_n = 10$ db

The radar polarization is linear and deflections are made by an operator using a PPI display.

- (a) Calculate the maximum detection range for a 1 square meter non-fluctuating target, assuming that a detection probability $P_d = 0.95$ is required. Neglect the effect of reflections from the sea surface
- (b) Calculate the maximum unambiguous range of the radar
- (c) Calculate the range at which an aircraft with RCS = 10 dBsm will be detected with $P_d = 0.95$. Assume the target is non-fluctuating and the radar is operating in the long pulse mode.

- (d) Assume the radar antenna is 50 ft above the sea surface. For the case where the above aircraft is at the maximum detection range, calculate the minimum altitude at which the radar can see the target in a standard atmosphere
- (e) Suppose that the radar signal is received by the aircraft above using a circular polarized antenna with 0 db gain. What is the single pulse power (in dbm) at the antenna output terminals, when the aircraft is at the maximum detection range? (Assume system loss $L_s = 3$ db)
- (f) Calculate the camouflage factor c , for this radar as given by Boyd et al., for the long pulse mode
- (g) Suppose the aircraft above carries a noise jammer and transmits a 30 MHz, circular, polarized spot noise signal, covering the radar passband

Assuming a $J/S = 5$ db is required to work the target, calculate the Jammer output power required to achieve a 10 nautical miles burnthrough range, when the radar is operated in the long pulse mode, if a 0 db gain jamming antenna is used.

Solution:

The maximum detection range is equal to

$$R_{\max} = \left[\frac{P_t G_a A_e \sigma_n E_i(n)}{(4\pi)^2 k (T_a + T_e) B_n (S/N)_{\max}} \right]^{1/4} \quad (1)$$

where:

$$(1) P_t = \text{peak output power} = 200 \times 10^3$$

$$(2) G_a = \text{antenna gain} = \frac{41250}{\theta_B \phi_B} = \frac{41250}{14 \times 1.5}$$

$$\doteq 1964 = 32.9 \text{ db}$$

$$(3) \quad A_e = \text{antenna aperture} = \frac{\lambda^2 G_a}{4\pi} = \frac{c}{f_o} \frac{G_a}{4\pi}$$

$$= \left(\frac{3 \times 10^8}{5600 \times 10^6} \right) \frac{1964}{4\pi} = 0.449 \text{ w}^2$$

$$(4) \quad = \text{radar cross section of target} = 1 \text{ m}^2$$

$$(5) \quad \text{Number of hits integrated} = \frac{\phi_B f_p T_s}{2\pi}$$

$$= \frac{1.5}{360} \times (650 \text{ sec}^{-1}) \left(\frac{60}{16} \right) \text{ sec} = 10 \text{ pulses}$$

$$(6) \quad \text{From Fig. 2.8(a) (Skolnik, Pg. 31), } nE_i(n) = I_1(10) = 7$$

$$(7) \quad T_e = \text{effective noise temperature} = (F_n - 1)T_o$$

where $F_n = 10 \text{ db} = 10$ (numeric) and $T_o = 290^\circ\text{K}$, the standard temperature. So

$$T_e = (10-1)290 = 2610^\circ\text{K}.$$

$$(8) \quad k(T_a + T_e)B_{re} = 1.38 \times 10^{-23} (75 + 2610) 10^6$$

$$= 3.7 \times 10^{-14} \text{ watts (long pulse)}$$

$$(9) \quad (S/N)_1 = \text{signal-to-noise ratio required at receiver output} = 16 \text{ db} = 39.8 \text{ (numeric) from Figure 2.7 (Skolnik, Pg. 28).}$$

Using Eq. (1), we find that the maximum range is

$$R_{\max \ell} = \frac{(2 \times 10^5 \text{ w}) (1964) (0.449 \text{ w}^2) (1 \text{ w}^2) (7)}{(4\pi)^2 (3.7 \times 10^{-14} \text{ w}) 40}$$

$\doteq 47.9 \text{ km}$ for the long pulse, and

and

$$R_{\max s} = R_{\max \ell} \left(\frac{B_{re}}{B_{rs}} \right)^{1/4} = 47.9 (1/s)^{1/4} = 32.08 \text{ km}$$

for the short pulse

So, for $\sigma = 1 \text{ m}^2$ and $P_d = 0.95$,

$$R_{\max} = 47.9 \text{ km (long pulse)}$$

$$R_{\max} = 32.08 \text{ km (short pulse)}$$

Part b:

The maximum unambiguous range R_u is equal to

$$R_u = \frac{c}{2f_p} = \frac{3 \times 10^8}{2.650} = 230.77 \text{ km}$$

Part d:

For a $\sigma = 10 \text{ m}^2$ target, the detection range will be $10^{1/4} = 1.78$ times greater than that for a $\sigma = 1 \text{ m}^2$ target. So, the range at which an aircraft will be detected with $\sigma = 10 \text{ m}^2$, $P_d = 0.95$ will be

$$R = 1.78 \times R_{\max} = 1.78 \times 47.96 = 85.36 \text{ km}$$

Part d:

The distance between radar and target along the line of sight is:

$$d_o = \sqrt{2h_1} + \sqrt{2h_2} \quad (2)$$

where:

h_1, h_2 = heights of radar antenna and target, respectively;

h = 50 ft;

d_o = 85.3 km = 52.9 miles.

So, from Eq. (1),

$$\sqrt{2 \times 50} + \sqrt{2h_2} = 52.9 \text{ or } h_2 = 923.77 \text{ ft,}$$

is the minimum altitude at which the radar can see the target.

Part e:

The single pulse power at the antenna output terminal is

$$P_r = \frac{P_t G_a \lambda^2 G_r}{(4\pi)^2 R^2 (4\pi) L_p} \quad (3)$$

where:

- (1) P_t = peak output power $P_t = 200 \text{ kw}$
- (2) G_a = antenna gain (calculated in part a)
= 32.9 db = 1964 (numeric)
- (3) G_r = receiver antenna gain = 0 db = 1 (numeric)
- (4) λ = wavelength = $c/f_o = \frac{3 \times 10^8}{5600 \times 10^6} = 0.0526 \text{ m}$
- (5) R = range at which an aircraft will be detected with
RCS = 10 m^2 (calculated in part c) = 85.3 km
- (6) L_p = system losses = 3 db = 2 (numeric)

Using Eq. (3),

$$P_r = \frac{(2 \times 10^5 \text{ w})(1964)(0.0536)^2 (1)}{(4\pi)^2 (83.5 \times 10^3 \text{ m})^2 (2)} = -33.082 \text{ dbm}$$

Part f:

The camouflage factor c is

$$C = \frac{4}{\left(1 + \frac{1}{T_e B_{re}}\right)^2} \times \left(\frac{f}{k}\right)^{1/3} \quad (4)$$

where $k = 1640$ or 400 , $T_e = \text{Pulse width (long)} = 1.3 \text{ } \mu\text{s}$

From Eq. (4), we get

$$C_1 = \frac{4}{\left(1 + \frac{1}{1.3 \times 10^{-6} \times 10^6}\right)^2} \times \left(\frac{650}{1640}\right)^{1/3} = 2.66 \text{ db}$$

$$C_2 = \frac{4}{\left(1 + \frac{1}{1.3 \times 10^{-6} \times 10^6}\right)^2} \times \left(\frac{650}{400}\right)^{1/3} = 4.7 \text{ db}$$

Part g:

The jammer output power P_j is equal to:

$$P_j = \frac{P_t G_a \sigma g^2 L_p C}{4\pi R_B^2 B_{re} C_j} \quad (5)$$

where:

- (1) $P_t = \text{peak output power} = 2 \times 10^5 \text{ watts};$
- (2) $R_B = \text{Burnthrough range in m} = 18.5 \times 10^3 \text{ m}$
- (3) $\sigma = \text{target radar cross section} = 10 \text{ m}^2$

- (4) G_a = is the antenna gain = 1964 (numeric)
- (5) L_p = system losses = 2 (numeric)
- (6) C = J/s = 15 db = 31.6 (numeric)
- (7) B_{re} = bandwidth for long pulse = 10^6 Hz
- (8) B_r = Freq. the jammer transmits = 30×10^6 Hz
- (9) C_j = gain of the jamming antenna
- (10) g = propagation factor (Assume = 1)

From Eq. (5), we get

$$P_j = \frac{(2 \times 10^5 \text{ w})(1964)(10 \text{ m}^2)(2)(31.6)}{4\pi(18.5 \times 10^3 \text{ m})^2(1 \text{ MHz})(1)} = 5.77 \text{ w/MHz}$$

or $P_j = .197 \text{ w/MHz}$ for $B_r = 30 \text{ MHz}$

B. PROBLEM #2: ARRAY BROADSIDE POWER GAIN

The AN/SPS-85 is a multifunction phased array radar used for search and track of missiles and satellites. The operating frequency $f_o = 442 \text{ MHz}$ and the transmit antenna is $d_1 \times d_2 = 26.9 \times 26.9 \text{ m}$ rectangular array of $N = 5184$ elements. Assume that the illumination efficiency of this array $p_i = 0.65$ and that the feed and phase shifter losses amount to $p_R = 1.8 \text{ db}$ for each element.

- (a) Calculate the array broadside power gain
- (b) Estimate the (pencil) beamwidth
- (c) Calculate the spacing between elements assuming that they are uniformly spaced

(d) Calculate the directive gain of an element

(Hint: Assume uniform illumination when making this calculation and use the pattern multiplication theorem.)

Solution:

Part a:

The array broadside power gain G_p is equal to

$$G_p = \frac{4\pi A_e}{\lambda^2} \quad (6)$$

$$\text{where } \lambda = \text{wavelength} = \frac{c}{f_o} = \frac{3 \times 10^8}{442 \times 10^6} = 0.678 \text{ m}$$

$$A_e = \text{antenna effective area} = p_i p_R A$$

where:

$$p_i = \text{illumination efficiency of the array} = 0.65;$$

$$p_R = \text{phase shifter losses} = 10^{-.18} = 0.66;$$

$$A = \text{area of the antenna} = 26.9 \times 26.9 = 723.6 \text{ m}^2$$

So,

$$A_e = (0.65)(0.66)(723.6) = 310.4 \text{ m}^2$$

Using Eq. (6) with the above values we get

$$A_e = \frac{(4\pi)(310.4)}{(0.678)^2} = 8476.75 \text{ (numeric)} = 39.28 \text{ db}$$

Part b:

The beamwidth is given by

$$\theta = \left[\frac{41250}{G_p/P_R} \right]^{1/2} = \left[\frac{41250}{\frac{8476.75}{0.66}} \right]^{1/2} \doteq 1.8^\circ$$

Part c:

The spacing between elements, assuming that they are uniformly spaced is

$$d = \frac{d_1}{N^{1/2}} = \frac{26.9}{72} = 0.374 \text{ m} = 0.55 \lambda$$

Part d:

The directive gain of the array is equal to:

$$G_{\text{darray}} = G_{\text{delem}} * G_{\text{dgroup}} \quad (7)$$

where:

$$G_{\text{dgroup}} = 5184;$$

$$G_{\text{darray}} = 12795$$

So

$$G_{\text{dee}} = \frac{G_{\text{darray}}}{G_{\text{dgroup}}} = \frac{12795}{5184} = 2.47 = 3.9 \text{ db}$$

C. PROBLEM #3: JAMMER'S REPEATER GAIN, JAMMER'S OUTPUT POWER

A conical scan radar missile seeker has the following parameters:

output power (peak)	$P_t = 1$ watt
Boresight antenna gain	$G_a = 38$ db
Antenna polarization	linear
Frequency	$f_o = 93.7$ GHz
RF losses	$L_p = 3$ db
Receiver noise bandwidth	$B_n = 500$ MHz
Receiver noise figure	$F_n = 11$ db
Pulse width	$T = 50$ ns
PRF	$f_p = 100$ kHz
integration time	$T_i = 50$ msec

The clear weather attenuation at this frequency $A_t = 0.4$ db/km and the sky temperature for cloudy conditions $T_a = 270$ degrees K. A repeater jammer is to be designed to protect a target with $RCS = 14.8$ dbsm.

- (a) Calculate the maximum unambiguous range for this seeker
- (b) The jammer uses circular polarized antennas with 10 degree pencil beam. Calculate the repeater gain required to realize a J/s of 10 db
- (c) Calculate the jammer output power required at a range $R = 1$ km
- (d) Assume that the seeker antenna has RF losses $RFL = 1$ db, an illumination efficiency $r_i = 60\%$, a crossover loss $L_{co} = 1$ db and a pencilbeam pattern which is approximately Gaussian in shape. Calculate the diameter of the seeker dish antenna
- (e) Calculate the squint angle

Solution:

Part a:

The maximum unambiguous range is equal to

$$R_u = \frac{c}{2f_p} = \frac{1.5 \times 10^5 \text{ kw/sec}}{10^5 \text{ Hz}} = 1.5 \text{ km}$$

Part b:

For the calculation of the gain of the repeater we have

$$S' = \frac{P_t G_a e^{-aR} \sigma}{4\pi R^2} \quad (8)$$

and

$$J' = \frac{P_t G_a e^{-aR}}{4\pi R^2} \frac{A_e G_e G_a}{L_p^2} \text{ watts} \quad (9)$$

Substituting Eq. (8) into Eq. (9), we get

$$\frac{S'}{J'} = \frac{A_e G_e G}{L_p^2 \sigma}$$

or

$$G_e = \left(\frac{J'}{S'}\right) \frac{L_p^2 \sigma}{A_e G_a} \quad (10)$$

for 10° beam $\rightarrow G = \frac{41250}{10^2} = 412.5 = 26.2 \text{ db}$

$$A_e = \frac{\lambda^2}{4\pi} G = \frac{(3.2 \times 10^{-3} \text{ m})^2}{4\pi} 412.5 = 3.36 \times 10^{-4} \text{ m}^2$$

$$G_e = \frac{(10)(2)^2 (30.2 \text{ m}^2)}{(3.36 \times 10^{-4} \text{ m}^2)(412.5)} = 8716 \text{ or } 39.4 \text{ db}$$

Part c:

The jammer output power at a range $R = 1 \text{ km}$ is given

as:

$$P_{out} = \frac{P_t G_a e^{-aR}}{4\pi R^2} \frac{A_e}{L_p} G_e \quad (11)$$

where:

- P_t = output power (peak) = 1w;
 G_t = boresight antenna gain = 38 db \doteq 6310;
 e^{-aR} = $e^{-.4/10}$ = propagation attenuation;
 A_e = effective antenna apertue;
 G_e = Repeat gain anetnna;
 L_p = RF losses = 3 db = 2 (numeric)

So, from Eq. (10) we get:

$$\begin{aligned}
 P_{out} &= \frac{(1 \text{ w})(6310)(10^{-.4/10})(3.36 \times 10^{-4} \text{ m}^2)(8716)}{(4\pi)(10^3 \text{ m})^2(2)} \\
 &= 0.67 \text{ mw}
 \end{aligned}$$

Part d:

The effective aperture of the antennat

$$A_e = p_R p_i A = \frac{\lambda^2}{4\pi} G = p_R p_i \frac{\pi D^2}{4} \rightarrow D = \frac{\lambda}{\pi} \sqrt{G/p_R p_i}$$

where:

- p_R = $10^{-1/10}$ = 0.794;
 p_i = .6
 G = $G_t + 1$ (db) = 38 + 1 = 39 db = 7943 (numeric)

So,

$$D = \frac{(3.2 \text{ mm})}{\pi} \sqrt{7943 / (.794)(.6)} = 131 \text{ mm} = 13.1 \text{ cm}$$

Part e:

$$G = G_o e^{-2.776 (\theta_q / \theta_B)^2}$$

$$-1 \text{ db crossover loss} \rightarrow \frac{G}{G_o} = .7943$$

$$.2.776 (\theta_q / \theta_B)^2 = \ln\left(\frac{G}{G_o}\right)$$

$$\theta_q / \theta_B = .288$$

$$\theta_B = \sqrt{41253 / G_d} = \sqrt{41253 / 10^4} = 2.03$$

So, the squint angle $\theta_q = (.288)(2.03) = .58$ degrees

D. PROBLEM #4: PULSE-COMPRESSION RADAR, NOISE JAMMING POWER

A shipboard pulse compression radar with a phased array antenna has the following parameters:

Array size	A = 3.65 m 3.65 m
Frequency	$f_o = 3.3$ GHz
Feed and phase shifter losses	$L_{fp} = 2.5$ db/element
Sidelobe level	S.L. = 30 db below mainbeam
Illumination efficiency	$p_i = 0.5$
Polarization	linear
Output power	$P_t = 4$ mw
2TW	TW = 1000

Weighting filter loss	$L_w = 3 \text{ db}$
Integration (of compressed pulses)	coherent
Minimum output S/N for automatic detection	$(S/N)_{\min} = 13 \text{ db}$

A raid of cruise missiles each having RCS = 3 dBsm have been launched at the ship. Two special purpose noise jamming ECN aircraft have been positioned at a range $R = 100 \text{ km}$ to provide screening. Each aircraft carrier $C_r = 18$ carcinotrons and is configured with circular polarized high gain, steerable jamming antennas, such that the ERP = 10 kw/tube. The bandwidth of the noise has been matched to the radar receiver bandwidth. Assume that the propagation factor $g = 1$.

- Calculate the effective area and power gain of the phased array
- Calculate the noise jamming power at the output of the phased array(receiver input). Assume that the jammers are in the radar antenna sidelobes
- Calculate the single pulse echo signal power at the output of the phased array assuming a cruise missile is illuminated at a range $R_1 = 80 \text{ km}$
- Calculate the single pulse J/S at the receiver input and at the receiver output
- Calculate the number of pulses that must be integrated to achieve burnthrough against a cruise missile at a range $R_2 = 80 \text{ km}$. Assume the integration efficiency is 1

Solution:

The effective area of the phased array

$$A_e = p_i p_R A = (0.5)(10^{-2.5})(3.65 \text{ m})^2 = 3.75 \text{ m}^2$$

where:

p_i = the illumination efficiency;

p_R = the phase shifter loss;

A = area of the array.

The power gain

$$G_p = \frac{4\pi A_e}{\lambda^2} = \frac{(4\pi)(3.75 \text{ m}^2)}{\left[\frac{3 \times 10^8}{3.3 \times 10^9}\right]^2} = 5696$$

Part b:

Noise jammer power is equal to:

$$P_j = \frac{P_t C_j A_e}{4\pi R^2 L_m} \quad (12)$$

where:

P_j = the jammer power = 10^4 watts;

G_j = jammer gain = $2 \times 18 = 36$;

A_e = effective area of the array = 3.75 m^2

R = the range = $100 \text{ km} = 10^5 \text{ m}$

L_m = the losses = $3 \text{ db} = 2$ (numeric)

So

$$\begin{aligned} P_j &= \frac{(2 \times 18 \times 10^4)(3.75 \times 10^{-3} \text{ m}^2)}{(4\pi)(10^5 \text{ m})^2(2)} \\ &= 5.37 \times 10^{-9} \text{ watt or } -82.7 \text{ dbw or } -52.69 \text{ dbm} \end{aligned}$$

Part c:

The single pulse echo signal power is

$$S = \frac{P_t G_p \sigma A_e}{(4\pi R_1)^2} \quad (13)$$

where:

- P_t = output power = 4×10^6 watt;
 G_p = power gain of the array 5696;
 σ = RCS = 3 dbsm = 0.5 m^2 ;
 R_1 = range of the cruise missile = 80 km

So,

$$\begin{aligned} S &= \frac{(4 \times 10^6 \text{ w})(5696)(0.5 \text{ m}^2)(3.75 \text{ m}^2)}{(4\pi)^2 (80 \times 10^3 \text{ m})^4} \\ &= 6.61 \times 10^{-12} \text{ watt or } -111.8 \text{ dbw or } -81.8 \text{ dbm} \end{aligned}$$

Part d:

The single pulse $(J/S)_{in}$ at the input of the receiver is

$$(J/S) = (-52.69 \text{ dbm}) - (-81.8 \text{ dbm}) = 29.2 \text{ db}$$

where:

- J = jammer noise power = -52.69 dbm from part (b);
 S = echo signal power = -81.8 dbm from part (c).

The single pulse S/J at the receiver output is

$$(S/J)_{out} = (S/J)_{in} + (2TW) - L_w = -29.2 \text{ db} + 30 \text{ db} - 3 \text{ db} = -2.2 \text{ db}$$

So,

$$(J/S)_{out} = +2.2 \text{ db}$$

Part e:

For perfect coherent integration we get

$$\begin{aligned} I_i(n) &= n = (S/N)_{min} - (-S/J)_{out} = 13 + 2.2 \\ &= 15.2 \text{ db} \rightarrow n = 33 \text{ pulses} \end{aligned}$$

E. PROBLEM #5: STAND OFF SPOT NOISE JAMMER

A mortar location radar has the following operating characteristics:

frequency	$f_o = 16.1 \text{ GHz}$
peak power	$P_t = 80 \text{ kw}$
antenna mainbeam gain	$G_a = 46 \text{ db}$
antenna sidelobe gain	$G_p = 16 \text{ db}$
PRF	$f_p = 8600 \text{ MHz}$
pulse width	$T = 0.25 \text{ } \mu\text{sec}$
receiver noise figure	$F_n = 12 \text{ db}$
receiver noise bandwidth	$B_n = 5 \text{ MHz}$
antenna noise temperature	$T_a = 290 \text{ degrees K}$
antenna sector coverage	$S_s = 25 \text{ degrees}$
antenna scan rate	$S_r = 167 \text{ scan/sec}$
antenna polarization	linear
plumbing losses	$L_p = 3 \text{ db}$

This radar is to be jammed by a standoff spot noise jammer. The jammer has the following characteristics:

Type	FM/noise
Power output	$P_s = 100 \text{ w (cw)}$
PF noise bandwidth	$B_{rf} = 20 \text{ MHz}$
Antenna gain	$G_j = 23 \text{ db}$
Antenna polarization	circular

- (a) Calculate the noise jamming power which can be ejected into this radar receiver through the radar antenna sidelobes from a range $R = 20 \text{ km}$, in clear weather. Assume a line-of-sight path and neglect atmospheric absorption
- (b) With the jammer positioned at $R = 20 \text{ km}$ as described above, the $J/S = 24 \text{ db}$, when a certain mortar round passes through the radar beam at a range $R_1 = 4 \text{ km}$. If the required camouflage factor is $c = 0 \text{ db}$, at what range will these rounds burn through?

Solution:

The noise jamming power is given by the equation

$$J = \frac{P_j G_j B_n A_e}{4 \pi R^2 L_p} \quad (14)$$

where:

$$P_j = \text{jammer output power} = \frac{100 \text{ w}}{20 \text{ MHz}} = 5 \text{ w/MHz}$$

$$G_j = \text{jammer antenna gain} = 23 \text{ db} = 200 \text{ (numeric)}$$

$$B_n = \text{receiver noise bandwidth} = 5 \text{ MHz}$$

$$A_e = \text{effective antenna area} = G_p \lambda^2 / 4\pi$$

where $G_p = \text{antenna sidelobe gains} = 16 \text{ db or } 40$

$$\lambda = \text{wavelength} = c/f_o = 3 \times 10^8 / 16.1 \times 10^9$$

$$= 0.0186 \text{ w}$$

So,

$$A_e = \frac{(0.0186 \text{ w})^2}{4\pi} (40) = 1.1 \times 10^{-3} \text{ m}^2$$

$$L_p = \text{plumbing losses} = 3 \text{ db or } 2 \text{ (numeric)}$$

$$R = \text{range} = 20 \text{ km} = 20 \times 10^3 \text{ m}$$

Thus from (14)

$$J = \frac{(5 \text{ w/MHz}) (200) (5 \text{ MHz}) (1.1 \times 10^{-3} \text{ m}^2)}{(4\pi) (20 \times 10^3 \text{ m})^2 (2)}$$

$$J = 0.549 \times 10^{-9} \text{ watts}$$

$$J = -92.6 \text{ dbm}$$

$$J = -62.6 \text{ dbm}$$

Part b:

J is constant for a standoff jammer while S varies as $1/R^4$.

Therefore

$$(J/S) = \text{const } R^4$$

$$\frac{(J/S)_2}{(J/S)_1} = \left(\frac{R_2}{R_1}\right)^4 \rightarrow R_2 = R_1 \left[\frac{(J/S)_2}{(J/S)_1}\right]^{1/4}$$

$$R_2 = 4 \text{ km} \left[\frac{1}{251}\right]^{1/4} = 1 \text{ km}$$

$$(J/S)_1 = \text{noise jammer (1)} = 1$$

$$(J/S)_2 = \text{noise jammer (2)} = 24 \text{ db or } 251 \text{ (numeric)}$$

F. PROBLEM #6: CHAFF, AVERAGE CROSS SECTION OF DIPOLES

Suppose that a chaff package is to be designed to produce a cloud cross-section with an average value of $S_1 = 10$ dbsm. Individual dipoles are Al Fl01 with cross sectional dimensions of 0.5×5 inches. For frequencies of 1, 2, 5 and 10 Ghz, make a table which shows the following information:

- (a) The average cross-section of one dipole
- (b) The number of dipoles required to achieve an average cloud cross-section of 10 dbsm
- (c) The weight of material per square meter of RCS

Assume the dipoles are uncoupled.

Solution:

$$\lambda = \frac{3 \times 10^{10}}{f} \text{ cm/sec}$$

$$\bar{\sigma} = .5 \lambda^2$$

$$N = \frac{\sigma_{\text{avg}}}{\bar{\sigma}}$$

$$V = \left(\frac{1}{2} \times 10^{-3} \text{ in}\right) \left(5 \times 10^{-3} \text{ in}\right) \left(2.54 \text{ cm/in}\right)^2$$

$$V = \left(1.61 \times 10^{-6} \text{ cm}^2\right) \lambda$$

$$m = \rho_{\text{AL}} V,$$

$$\rho_{\text{AL}} = 2.7 \text{ gm/cm}^3$$

$$1 \text{ lb} = 454 \text{ gm}$$

f [GHz]	λ [cm]	$\bar{\sigma}$ [cm ²]	N	V [cm ³]	w [grms]	$\frac{w}{\sigma_{avg}}$ [gr/m ²]	$\frac{\#}{\sigma_{avg}}$ [lb/m ²]
1	30	135	741	0.35	0.97	0.096	0.0002
2	15	33.75	2962.9	0.71	1.9	0.19	0.0004
5	6	5.4	18.5 K	1.8	4.8	0.48	0.0001
10	3	1.35	74.07 K	3.6	9.7	0.96	0.002

G. PROBLEM #7: SIGNAL-TO-CLUTTER RATIO, POWER SPECTRA DENSITY OF JAMMER

An MTI radar with a single delay line canceler has the following operating characteristics:

Peak power	$P_t = 1$ MW
Pulse width	$T = 14$ μ s
PRF	$f_p = 800$ Hz
Antenna gain	$G_a = 26$ db
Frequency	$f_o = 1$ GHz
Receiver noise bandwidth	$B_n = 1.5$ MHz
Antenna scan rate	$W_m = 10$ RPM
Azimuth beamwidth	$\theta_B = 3.9$ degrees
Receiver noise figure	$F_n = 9.0$ db
Antenna noise temperature	$T_a = 100$ degrees K
Plumbing losses	$L_p = 2$ db
Display	PPI (video int.)
False alarm probability	$P_{fa} = 1E-12$

- For the non-MTI mode, calculate the maximum range at which this radar can detect a non-fluctuating 0 dbsm target with a detection probability $P_d = 0.9$
- Suppose that this radar is operated in the MTI mode against a target aircraft with RCS = 10 dbsm immersed

in a chaff cloud with a cross section of 500 sq. meters. The target is 30 km from the radar and closing with radial velocity $r = 300$ knots. Assume that the power spectral density of the chaff return is as given in Skolnik, Figure 4.29. Calculate the target signal-to-clutter ratio at the output of the delay line canceler.

Solution:

Part a:

The maximum radar range may be written as

$$R_{\max} = \left[\frac{P_t G_a A_e \sigma I_i(n)}{(4\pi)^2 k(T_a + T_e) B_n (S/N)_1 L_s} \right]^{1/4}$$

where:

$$P_t = \text{peak power} = 10^6 \text{ W};$$

$$G_a = \text{antenna gain} = 26 \text{ db} = 398 \text{ (numeric)};$$

$$A_e = \text{effective area}$$

$$= \frac{\lambda^2 G_a}{4\pi} = \left(\frac{c}{f_u}\right)^2 \frac{G_a}{4\pi} = \left(\frac{3 \times 10^9}{10^9}\right)^2 \frac{398}{4\pi} = 2.85 \text{ m}^2$$

$$\sigma = \text{radar cross section} = 1 \text{ m}^2$$

$$kT_e = (F_n - 1)T_o = (7.94 - 1)290 = 2013.55$$

$$\begin{aligned} k(T_a + T_e)B_n &= 1.38 \times 10^{-23} (100 + 2013.55) 1.5 \times 10^6 \\ &= 43.7 \times 10^{-15} \text{ w} \end{aligned}$$

$$(S/N)_1 = \text{signal-to-noise ratio (from Figure 2.7 (Skolnik, Pg. 28))}$$

$$= 15.8 \text{ db} = 38 \text{ (for } P_{fa} = 1E-12 \text{ and } P_d = 0.9)$$

$$\begin{aligned}\bar{n} &= \text{pulses integrated} = f_p \frac{\theta_B}{w_m} \\ &= (800 \text{ sec}^{-1})(3.9^\circ)/(360^\circ/6 \text{ sec}) = 52 \text{ pulses}\end{aligned}$$

$$I_1(52) \doteq 23.5 = 13.7 \text{ db (Figure 2.8 a/b (Skolnik, Pg. 31))}$$

Thus,

$$R_{\text{max}} = \left[\frac{(10^6 w)(398)(2.85 \text{ m}^2)(1 \text{ m}^2)(23.5)}{(4\pi)^2 (43.7 \times 10^{-15} w)(38)(1.58)} \right]^{1/4}$$

$$R_{\text{max}} = 89.46 \text{ km}$$

Part b:

Since the target and chaff cloud are only 30 km from the radar the returns will be well above the thermal noise level and the receiver will be clutter dominated.

$$\frac{S_{\text{avg}}}{C_{\text{out}}} = \frac{|H(f_d)|^2 S_{\text{in}}}{C_{\text{in}}/CA} = |H(f_d)|^2 CA(S/C)_{\text{in}}$$

$$f_d(\text{Hz}) = \frac{1.03 U_r}{\lambda} = \frac{1.03(300 \text{ knots})}{0.3 \text{ m}} \text{ (Skolnik, Eq. 3.26)}$$

$$f_d = 1030 \text{ Hz}$$

$$\begin{aligned}|H(f_d)|^2 &= |2 \sin(\pi f_d T_p)|^2 = 4 \sin^2[\pi(1030/800)] \\ &= 2.47\end{aligned}$$

$$CA = \frac{.5}{1 - e^{-2\pi^2 T_p^2 \sigma_c^2}} \doteq \frac{af_p^2}{2\pi^2 f_o^2} \quad (G_c \ll f_p)$$

(Eq. 4.23 and 4.24 from Skolnik, Pg. 132-133)

From Figure 4.29 (Skolnik) for chaff $a = 10^{16}$ and

$$\sigma_c^2 = \frac{f_o^2}{2a} = 50 \quad \text{so} \quad CA = \frac{(10^{16})(800)^2}{2\pi^2(10^9)^2} = 324 = 25.1 \text{ db}$$

$$(S/C)_{in} = \sigma_{tH}/\sigma_{chaff} = 10/500 = 1/50 = -17 \text{ db}$$

So,

$$(S/C)_{out} = (1/50)(2.47)(324) = 16 = 12 \text{ db}$$

H. PROBLEM #8: WEIGHTING FILTERS

An airborne periscope detecting radar has the following characteristics:

Frequency	$f_o = 9.510 \text{ GHz (linear chirp)}$
Peak power	$P_t = 500 \text{ kw}$
PRF	$f_p = 1500 \text{ Hz}$
Pulse width	$T = 500 \text{ nanoseconds}$
Weighting filter	Hamming
Antenna gain	$G_a = 35 \text{ db}$
Polarization	Vertical
Azimuth beamwidth	$\theta_B = 2.4 \text{ degrees}$
Antenna scan rate	$w_m = 300 \text{ RPM}$
Plumbing losses	$L_p = 5 \text{ db}$
R_x noise figure	$R_x = 7.5 \text{ db}$

An ASW aircraft with this radar encounters a submarine with periscope exposed under the following conditions:

Aircraft altitude	$H_a = 2000 \text{ ft}$
Range to submarine	$R_s = 16 \text{ kyards}$
Periscope RCS	$RCS = 1 \text{ m}^2$

- (a) Assume that the sea clutter spikes resolved by this high resolution radar have an average duration $t_{fa} = 2$ sec and that the sea state 2-3 statistics shown in [Ref. 1, Figure 13.5] apply. How many db above the median clutter level must a threshold be set to achieve a 100 seconds false alarm time when the receiver is clutter dominated?
- (b) Calculate the single pulse signal-clutter power ratio at the radar receiver input
- (c) At the output of the weighting filter calculate the 3 db width of the compressed pulse and the peak signal-mean clutter power ratio
- (d) Assume that a 5 second scan-scan post detection integration period is employed to separate targets (which remain) from clutter spikes (which go away). Calculate the integration improvement

Solution:

Part a:

For the clutter waveform

$$P_{fa} = \frac{t_{fa}}{T_{fa}} = \frac{2 \text{ sec}}{100 \text{ sec}} = 0.02$$

Using Figure 13.5 (Skolnik) for $P_{fa} = 0.02$, $\sigma_c/\sigma_{cmed} = 12.5$ db threshold must be set 12.5 db above the median clutter power level.

Part b:

From Eq. 13.6 (Skolnik, Pg. 472), the signal power S returned from a target with cross section σ is

$$S = \frac{P_t G_a \sigma A_e}{(4\pi)^2 R^4 L_p}$$

where:

AD-A164 143

INTRODUCTION TO THE MICROCOMPUTERS FOR SOLVING RADAR
AND ELECTRONIC WARFARE PROBLEMS(U) NAVAL POSTGRADUATE
SCHOOL MONTEREY CA C D VERGOS DEC 85

2/3

UNCLASSIFIED

F/G 17/9

ML

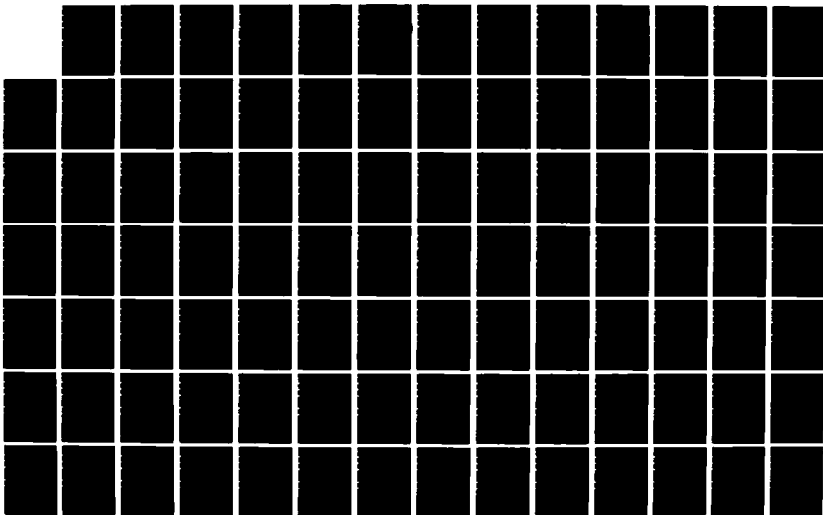

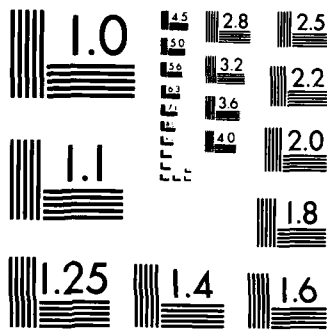

MICROCOPY RESOLUTION TEST CHART
NBS-1963-A

$$P_t = 500 \times 10^3 \text{ w} = 87 \text{ dbm}$$

$$G_a = 35 \text{ db} = 3162 \text{ (numeric)}$$

$$\sigma = 1 \text{ w}^2 = 0 \text{ db}$$

$$A_e = (\lambda^2/4\pi) G_a = \frac{(0.03)^2}{4\pi} 3162 = .227 \text{ m}^2 = -6.4 \text{ dbm}$$

$$4\pi = 11 \text{ db}$$

$$R = 16 \times 10^3 = 9.09 \text{ mi} = 14.64 \text{ km} = 41.65 \text{ dbm}$$

$$L_p = 5 \text{ db}$$

$$S = [87 \text{ dbm} + 35 - 6.470] - [11 \times 2 + 41.65 \times 4 + 5] \\ = -78 \text{ dbm}$$

The echo from surface clutter is

$$C = \frac{P_t G_a A_e \sigma_o \theta_B (CT/2) \sec(\psi)}{(4\pi)^2 R^3 (L_p/2)} \quad (\text{Eq. 13.5 from Skolnik, Pg. 472})$$

Part b:

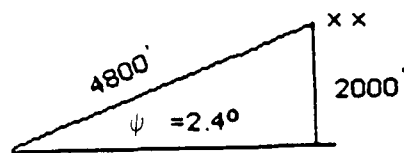

$\psi = \text{grazing angle}$

$$\theta_B = 2.4^\circ = .042 \text{ rad} = -13.8 \text{ dbrad}$$

$$CT/2 = (1.5 \times 10^8 \text{ m/s}) (0.5 \times 10^{-6} \text{ sec})$$

$$\sec \psi = 1/\cos \psi \doteq 1 \quad (\psi = 2.4^\circ)$$

From Figure 13.3 (Skolnik, Pg. 475), $\sigma_o = -32 \text{ db}$

Thus

$$C = [87 \text{ dbm} + 35 - 6.4 - 32 - 13.8 + 18.6 + 0] \\ - [11 \times 2 + 41.65 \times 3 + 2.5] = -61.1 \text{ dbm}$$

So,

$$(S/C)_{in} = (-78 \text{ dbm}) - (-61.1 \text{ dbm}) = -16.9 \text{ db}$$

Part c:

For the Hamming filter [Ref. 1], the peak sidelobe $S_{LL} = -42.8 \text{ db}$, the loss = 1.34 and the relative mainlobe width = 1.5. So the width of the compressed pulse at the output of the weighting filter is

$$T_c = \frac{T}{TW} \times 1.5 = \frac{(500 \times 10^{-9} \text{ sec})(1.5)}{(500 \times 10^{-9} \text{ sec})(0.5 \times 10^9 \text{ Hz})} \\ = 3 \times 10^{-9} \text{ sec}$$

The improvement in S/C is

$$10 \log_{10}(2 TW) - 1.34 \text{ db} = 25.7 \text{ db}$$

so

$$(S/C)_{out} = (-16.9 \text{ db}) + (25.7 \text{ db}) \doteq 8 \text{ db}$$

Part d:

$$\# \text{ hits/scan} = \frac{\theta_B^f p}{6 w_n} = \frac{2.4^\circ \sqrt{1500}}{6 \sqrt{300}} = 2$$

$$\# \text{ hits} = (2 \frac{\text{hits}}{\text{scan}}) \sqrt{\left(\frac{300}{60}\right)} \sqrt{(5 \text{ sec})} = 50 \text{ hits}$$

From Figure 2.80 (Skolnik, Pg. 31) $I_i(5) = 25.118 = 14$ db
 with integration $(S/C) = 14$ db + 8 db = 22 db.

I. PROBLEM #9: MTI FILTERS, CHAFF DIPOLES

An MTI radar has the following characteristics:

Frequency	$f_o = 1.3$ GHz
Peak power	$P_t = 2$ mw
Antenna gain	$G_a = 35$ db
Azimuth beamwidth	$\theta_B = 1.3$ degrees
Elevation coverage	0.2-45 degrees
Antenna scan rate	$w_n = 5$ RPM
PRF	$f_p = 360$ Hz
Pulse width	$T = 6$ μ sec
Receiver noise figure	$F_n = 8$ db

Assume that this radar has a 2 pulse canceler. An aircraft with RCS = 10 dbsm at a range of 100 km is to be protected with a chaff corridor. Assume that the chaff return has Gaussian power spectral density with RMS velocity spread 1.0 m/s. Calculate the number of half wave chaff dipoles per resolution cell required to produce a minimum clutter-target signal ratio of 10 db at the output of the MTI filter.

Solution:

The best improvement the delay line canceler will provide is

$$\frac{(S/C)_{out}}{(S/C)_{in}} = \frac{C_{in}}{C_{out}} \times \frac{S_{out}}{S_{in}} = CA |H(f)|^2 = \frac{f_p^2 \lambda^2}{16\pi^2 \sigma_u^2} 4$$

$$= \frac{(360 \text{ Hz})^2 (.231 \text{ w})^2}{4\pi^2 (1 \text{ w/sec})^2}$$

$$I_{\max} = 175 = 22.4 \text{ db}$$

With the target at 100 km, the receiver will be clutter dominated. We require

$$(S/C)_{\text{in}} = -10 \text{ db} - 22.4 \text{ db} = \frac{1}{1750}$$

or

$$\frac{\sigma_t}{N\sigma} = \frac{\sigma_t}{N(0.15\lambda)^2} = (S/C)_{\text{in}}$$

$$N = \frac{10}{(0.15 \times .231^2 w^2) (1/1750)} = 2.19 \times 10^6 \text{ dipoles}$$

(in resolution cell)

J. PROBLEM #10: MINIMUM DETECTABLE SIGNAL

An HF compressive receive is to be designed to sweep the 2-32 MHz band 25 times per second and to provide a frequency resolution of 2 Khz.

- (a) Calculate the bandwidth and time delay required of the compressive filter for this receiver
- (b) Calculate the MDS of this receiver, assuming a receiver noise figure of 3 db and an antenna noise temperature of 290°K

Solution:

Part a:

$$\frac{W}{T} = \frac{32 - 2}{1/25 \text{ sec}} = \frac{30 \text{ MHz}}{1/25 \text{ sec}} = 750 \text{ MHz/sec}$$

$$T1 = \frac{1}{\Delta f} = \frac{1}{2 \cdot 10^3 \text{ Hz}} = .5 \times 10^{-3} \text{ sec (time delay)}$$

$$W = \left(\frac{W1}{T}\right) \times T = 750 \times (0.5 \times 10^{-3}) = 375 \text{ kHz (bandwidth)}$$

Part b:

$$T_e = (F-1)290 = (1.99-1)290 = 288.626 \text{ K}$$

$$\text{NDS} = k(T_a + T_e)B_n \frac{1}{2Tw} \quad \text{but } B_n = w \text{ so}$$

$$\text{NDS} = k(T_a + T_e) \frac{1}{2T} = -170.9 + 3 + 30 \text{ dbm} = -138 \text{ dbm}$$

V. CONCLUSION

The programs were written for solving problems of radar and Electronic Warfare. They are in easy-to-understand Basic language. They were written in the interactive method. As a result these programs are "user friendly." They were very time consuming to write in this mode. The interactive method is very amenable to work with and should be helpful to the Naval officer, in the field of radar and electronic warfare. Using the same problems but with parameters of other systems, one can understand the performance of different types of radar and jammers.

Many subroutines and interation loops are used so that even one who has little experience in programming can read and easily comprehend the programs and can expand or modify them according to his needs.

The author hopes that these programs will be an assistance to students, and Naval officers involved in radar and electronic warfare.

The programming language is Microsoft Basic so that anyone can work on these programs on any IBM or IBM-compatible computer as well as Apple microcomputers without requiring any modifications in these programs.

These programs may be used on boardship to aid in the technical aspects of a tactical operation. They may be used by the Naval officer in program management in radar and

electronic warfare systems or in evaluation and design at a Naval laboratory. On board ship as a combat information center officer or Electronic Warfare officer these problems addressed arise innumerable times. As an example, your ship is in the Indian Ocean and there is a threat of an antiship cruise missile whose radar parameters you are aware of (i.e., Harpoon, Automat, or Exocet) and it is your responsibility to provide shipboard defense. If per chance you have worked with these problems and you are familiar with characteristics of your defense systems, the more viable ECM action can be made. For instance, you are aware of your ships radar cross section as a function of aspect angle relative to the missile threat. You are aware of the radar cross section of your chaff loads and you are aware of the power outputs and characteristics of your decoys. Using the enclosed programs and the variations of the parameters associated with them should allow you to obtain a better understanding of what actions you should take for ships defense. It is only through the working of many problems of these types in many different tactical scenarios that a proper technical expertise in radar and EW can be obtained.

Lastly, the author believes that this group of problems were selected to include a variety of timely and useful situations that one may encounter in the radar and electronic warfare field.

APPENDIX A

A listing of the radar computer programs is provided and an output of the results for each one of these programs is also included.

```

10 PRINT :PRINT TAB(30); " PROBLEM #1"
20 PRINT TAB(30); "-----"
30 LPRINT :LPRINT TAB(30); " PROBLEM #1"
40 LPRINT TAB(30); "-----"
50 PRINT :PRINT "ENTER THE BANDWIDTH OF THE AMPLIFIER WITHOUT UNITS : B=?"
60 INPUT B
70 PRINT :PRINT "WHAT ARE THE UNITS OF THE BANDWIDTH?"
80 PRINT "1. HZ"
90 PRINT "2. KHZ"
100 PRINT "3. MHZ"
110 PRINT "4. GHZ"
120 INPUT A$ 'input selection
130 IF A$="1" THEN B=B
140 IF A$="2" THEN B=B*1000
150 IF A$="3" THEN B=B*1000000I
160 IF A$="4" THEN B=B*1000000000#
170 PRINT :PRINT " ENTER THE FALSE ALARM TIME WITHOUT UNITS: T=?"
180 INPUT T
190 PRINT :PRINT " WHAT ARE THE UNITS OF THE FALSE ALARMTIME?"
200 PRINT "1. seconds"
210 PRINT "2. minutes"
220 PRINT "3. hours"
230 INPUT B$ 'input selection
240 IF B$="1" THEN T=T
250 IF B$="2" THEN T=T*60
260 IF B$="3" THEN T=T*3600
270 REM : calculation of the threshold -to-rms ratio
280 LET X=SQR(2*LOG(B*T)) ' numeric value
290 LET M=.4342945#
300 LET X1=10*M*LOG(X) ' db value
310 IF A$="1" THEN LPRINT :LPRINT " THE BANDWIDTH B=";B;"HZ"
320 IF A$="2" THEN B=B/1000 :LPRINT :LPRINT " THE BANDWIDTH B=";B;"KHZ"
330 IF A$="3" THEN B=B/1000000I :LPRINT :LPRINT " THE BANDWIDTH B=";B;"MHZ"
340 IF A$="4" THEN B=B/1000000000# :LPRINT :LPRINT " THE BANDWIDTH B=";B;"GHZ"
350 IF B$="1" THEN LPRINT :LPRINT " THE FALSE ALARM TIME T=";T;"sec"

```

```
360 IF B$="2" THEN T=T/60:LPRINT:LPRINT "THE FALSE ALARM TIME T=";T;"min"
370 IF B$="3" THEN T=T/3600:LPRINT:LPRINT "THE FALSE ALARM TIME T=";T;"Hrs"
380 PRINT:PRINT "THE THRESHOLD-TO-RMS NOISE VOLTAGE
      V/SQR(YO)=";X;"(numeric)";"or";X1;"(db)"
390 LPRINT:LPRINT "THE THRESHOLD-TO-RMS NOISE VOLTAGE
      V/SQR(YO)=";X;"(numeric)";"or";X1;"(db)"
400 PRINT:PRINT "DO YOU WANT TO USE THIS PROGRAM FOR DIFFERENT OR THE SAME DATA
      Y/N?"
410 INPUT C$
420 IF LEFT$(C$,1)="Y" OR LEFT$(C$,1)="y" THEN 40
430 END
```

PROBLEM 1

THE BANDWIDTH $B = 4\text{ MHz}$

THE FALSE ALARM TIME $T = 5\text{ min}$

THE THRESHOLD-TO-RMS NOISE VOLTAGE $V/\text{SQR}(Y_0) = 6.466156$ (numeric) or 8.106462 (db)

THE BANDWIDTH $B = 4\text{ MHz}$

THE FALSE ALARM TIME $T = 50\text{ min}$

THE THRESHOLD-TO-RMS NOISE VOLTAGE $V/\text{SQR}(Y_0) = 6.812954$ (numeric) or 8.333355 (db)

THE BANDWIDTH $B = 4\text{ MHz}$

THE FALSE ALARM TIME $T = 500\text{ min}$

THE THRESHOLD-TO-RMS NOISE VOLTAGE $V/\text{SQR}(Y_0) = 7.142935$ (numeric) or 8.538767 (db)

```

10 PRINT : PRINT TAB(30); " PROBLEM #2 "
20 PRINT TAB(30); "-----"
30 LPRINT : LPRINT TAB(30); " PROBLEM #2 "
40 LPRINT TAB(30); "-----"
50 PRINT : PRINT " ENTER THE NUMBER OF THE m NOISE PULSES "
60 INPUT A " # OF m NOISE PULSES
70 PRINT : PRINT " 1. m="A
80 LPRINT : LPRINT " 1. m="A
90 PRINT : PRINT " ENTER THE NUMBER OF THE n SIGNAL-PLUS-NOISE PULSES "
100 INPUT B " # OF n SIGNAL-PLUS-NOISE PULSES
110 PRINT : PRINT " 2. n="B
120 LPRINT : LPRINT " 2. n="B
130 PRINT : PRINT " FROM Fig. 2.8 (b) (SKOLNIK Pg 31) YOU CAN FIND THE INTEGRATION LOSS
FOR  $L_I(m+n)$  AND  $L_I(n)$ , SINCE YOU KNOW  $P_d, m, n$ , WHICH ARE GIVEN IN THE PROBLEM"
140 LET C=A+B
150 PRINT : PRINT " ENTER THE VALUE OF THE  $L_I("C")$ "
160 INPUT D " THIS IS THE VALUE OF  $L_I(m+n)$  IN db"
170 PRINT : PRINT " 3. THE INTEGRATION LOSS FOR  $L_I("C")$ "="D;"db"
180 LPRINT : LPRINT " 3. THE INTEGRATION LOSS FOR  $L_I("C")$ "="D;"db"
190 PRINT : PRINT " ENTER THE VALUE OF THE  $L_I("B")$ "
200 INPUT E " THIS IS THE VALUE OF  $L_I(n)$  IN db"
210 PRINT : PRINT " 4. THE INTEGRATION LOSS FOR  $L_I("B")$ "="E"db"
220 LPRINT : LPRINT " 4. THE INTEGRATION LOSS FOR  $L_I("B")$ "="E"db"
230 *****
240 REM: CALCULATION OF THE COLLAPSING LOSS
251 *****
260 LET F=D-E : F1=F/10 : F1=10^F1 " CONVERSION FROM "db" TO "NUMERIC"
270 PRINT : PRINT " 5. THE COLLAPSING LOSS  $L_I("A", "B")$ "="F1;"NUMERIC";" OR";F;"db"
280 LPRINT : LPRINT " 5. THE COLLAPSING LOSS  $L_I("A", "B")$ "="F1;"NUMERIC";" OR";F;"db"
290 PRINT : PRINT " DO YOU WANT TO TRY AGAIN FOR DIFFERENT OR THE SAME DATA Y/N?"
300 INPUT G$ "INPUT SELECTION
310 IF LEFT$(G$,1)="Y" OR LEFT$(G$,1)="y" THEN LPRINT : LPRINT : LPRINT TAB(15);"
*****";GOTO 050
320 END

```

PROBLEM#2

1. $m = 10$
2. $n = 10$
3. THE INTEGRATION LOSS FOR $L_1(20) = 1.9$ db
4. THE INTEGRATION LOSS FOR $L_1(10) = 1.3$ db
5. THE COLLAPSING LOSS $L_1(10,10) = 1.148154$ NUMERIC OR .6 db

1. $m = 90$
2. $n = 10$
3. THE INTEGRATION LOSS FOR $L_1(100) = 4.1$ db
4. THE INTEGRATION LOSS FOR $L_1(10) = 1.3$ db
5. THE COLLAPSING LOSS $L_1(90,10) = 1.905461$ NUMERIC OR 2.8 db

```

10  REM :      **** MAIN PROGRAM ****
20  PRINT : PRINT TAB(30); " *** PROBLEM #3 ***"
30  LPRINT : LPRINT TAB(30); " *** PROBLEM #3 ***"
40  GOSUB 90 : GOSUB 430
50  GOSUB 780 : GOSUB 840
60  GOSUB 930 : GOSUB 1180
70  GOTO 1360
80  REM *****
90  REM      SUBPROGRAM THAT INPUTS THE DATA
100 REM *****
110 PRINT : PRINT " ENTER THE MAGNETRONS PEAK POWER Pt IN MEGAWATTS"
120 INPUT Pt
130 PRINT : PRINT " ENTER THE PULSE WIDTH Tw IN MICROSEC"
140 INPUT Tw
150 PRINT : PRINT " ENTER THE PULSE REPETITION FREQUENCY fp IN HZ"
160 INPUT fp
170 PRINT : PRINT " ENTER THE OPERATION WAVELENGTH IN CENTEMETERS"
180 INPUT l
190 PRINT : PRINT " ENTER THE EFFECTIVE ANTENNA APERTURE Ae IN SQUARE METERS"
200 INPUT Ae
210 PRINT : PRINT " ENTER THE #OF HITS INTEGRATED n"
220 INPUT n
230 PRINT : PRINT " ENTER THE NOISE BANDWIDTH IN MEGAHERTZ"
240 INPUT Bn
250 PRINT : PRINT " ENTER THE RECEIVER NOISE FIGURE F1 IN db"
260 INPUT F1
270 PRINT : PRINT " ENTER THE PLUMBING LOSSES Lp1 IN db"
280 INPUT Lp1
290 PRINT : PRINT " ENTER THE BEAM SHAPE Lbs IN db"
300 INPUT Lbs
310 PRINT : PRINT " ENTER THE FACTOR BY WHICH THE INTEGRATION EFFICIENCY IS REDUCED"
320 INPUT e
330 PRINT : PRINT " ENTER THE FALSE ALARM PROBABILITY Pf"
340 INPUT Pf
350 PRINT : PRINT " ENTER THE PROBABILITY OF DETECTION Pd"

```

```

360 INPUT Pd
370 PRINT : PRINT " ENTER THE TARGET AVERAGE CROSS SECTION  $S_{av}$  IN SQUARE METERS"
380 INPUT  $S_{av}$ 
390 PRINT : PRINT " ENTER THE CASE THAT YOU ARE : CASE 1,CASE2...?"
400 INPUT A$
410 RETURN
420 REM *****
430 REM SUBROGRAM THAT PRINTS THE INPUT DATA
440 REM *****
450 LPRINT : LPRINT "G I V E N" : LPRINT "-----"
460 PRINT : PRINT "1.  $P_t=$  ; $P_t$  ;"MW" SPC(17); " : MAGNETRON'S PEAK POWER"
470 LPRINT : LPRINT "1.  $P_t=$  ; $P_t$  ;"MW" SPC(17); " : MAGNETRON'S PEAK POWER"
480 PRINT : PRINT "2I  $T_w=$  ; $T_w$  ;"MICSEC" SPC(13); " : PULSE WIDTH "
490 LPRINT : LPRINT "2I  $T_w=$  ; $T_w$  ;"MICSEC" SPC(13); " : PULSE WIDTH "
500 PRINT : PRINT "3.  $f_p=$  ; $f_p$  ;"HZ" SPC(15); " : PULSE REPETITION FREQUENCY "
510 LPRINT : LPRINT "3.  $f_p=$  ; $f_p$  ;"HZ" SPC(15); " : PULSE REPETITION FREQUENCY "
520 PRINT : PRINT "4.  $\lambda=$  ; $\lambda$  ;"centimeters" SPC(8); " : OPERATION WAVELENGTH "
530 LPRINT : LPRINT "4.  $\lambda=$  ; $\lambda$  ;"centimeters" SPC(8); " : OPERATION WAVELENGTH "
540 PRINT : PRINT "5.  $A_e=$  ; $A_e$  ;"square meters" SPC(4); " : EFFECTIVE ANTENNA APERTURE "
550 LPRINT : LPRINT "5.  $A_e=$  ; $A_e$  ;"square meters" SPC(4); " : EFFECTIVE ANTENNA APERTURE "
560 PRINT : PRINT "6.  $n=$  ; $n$  SPC(19); " : #OF HITS INTEGRATED "
570 LPRINT : LPRINT "6.  $n=$  ; $n$  SPC(19); " : #OF HITS INTEGRATED "
580 PRINT : PRINT "7.  $B_n=$  ; $B_n$  ;"MHZ" SPC(16); " : NOISE BANDWIDTH"
590 LPRINT : LPRINT "7.  $B_n=$  ; $B_n$  ;"MHZ" SPC(16); " : NOISE BANDWIDTH"
600 PRINT : PRINT "8.  $F_1=$  ; $F_1$  ;"db" SPC(16); " : RECEIVER NOISE FIGURE"
610 LPRINT : LPRINT "8.  $F_1=$  ; $F_1$  ;"db" SPC(16); " : RECEIVER NOISE FIGURE"
620 PRINT : PRINT "9.  $L_{p1}=$  ; $L_{p1}$  ;"db" SPC(16); " : PLUMBING LOSSES"
630 LPRINT : LPRINT "9.  $L_{p1}=$  ; $L_{p1}$  ;"db" SPC(16); " : PLUMBING LOSSES"
640 PRINT : PRINT "10.  $L_{bs}=$  ; $L_{bs}$  ;"db" SPC(15); " : BEAM SHAPE"
650 LPRINT : LPRINT "10.  $L_{bs}=$  ; $L_{bs}$  ;"db" SPC(15); " : BEAM SHAPE"
660 PRINT : PRINT "11.  $\epsilon=$  ; $\epsilon$  SPC(17); " : FACTOR BY WHICH INTEGRATION EFF. IS REDUCED"
670 LPRINT : LPRINT "11.  $\epsilon=$  ; $\epsilon$  SPC(17); " : FACTOR BY WHICH INTEGRATION EFF. IS REDUCED"
680 PRINT : PRINT "12.  $P_f=$  ; $P_f$  SPC(14); " : FALSE ALARM PROBABILITY"
690 LPRINT : LPRINT "12.  $P_f=$  ; $P_f$  SPC(14); " : FALSE ALARM PROBABILITY"
700 PRINT : PRINT "13.  $P_d=$  ; $P_d$  SPC(16); " : PROBABILITY OF DETECTION"

```

```

710 LPRINT : LPRINT "13. Pd=";Pd SPC(16) " : PROBABILITY OF DETECTION"
720 PRINT : PRINT "14. Sav=";Sav;"sq.meters" SPC(8) " : TARGET AVERAGE CROSS SECTION"
730 LPRINT : LPRINT "14. Sav=";Sav;"sq.meters" SPC(8) " : TARGET AVERAGE CROSS SECTION"
740 PRINT : PRINT "15. YOU 'RE CASE 15" SPC(10);A$
750 LPRINT : LPRINT "15. YOU 'RE CASE 15" SPC(10);A$
760 RETURN
770 REM: *****
780 REM: SUBR. THAT CALCULATES THE MAX. UNAB. RANGE
790 REM: *****
800 LET C=3*10^8 'm/s
810 LET Runeb=C/(2*f*p)
820 RETURN
830 REM: *****
840 REM: SUBR. THAT PRINTS THE OUTPUT FOR PART a
850 REM: *****
860 PRINT : PRINT "PART a:"
870 LPRINT : LPRINT "PART a:"
880 LPRINT "-----"
890 PRINT : PRINT " 1(a). Runeb=";Runeb/1000;"KM", " : THE MAX. UNAB. RANGE"
900 LPRINT : LPRINT " 1(a). Runeb=";Runeb/1000;"KM", " : THE MAX. UNAB. RANGE"
910 RETURN
920 REM: *****
930 REM: SUBR. THAT CALCULATES THE MAX. RANGE
940 REM: *****
950 LET Bn=Bn*10^6 'CONVERSION FROM MHZ TO HZ
960 LET Pt=Pt*10^6 'CONVERSION FROM Mw TO w
970 LET K=1.38*(10^(-23)) 'BOLTZMAN'S CONSTANT IN j/deg.
980 LET T0=290 'STANDARD TEMPERATURE IN KELVIN
990 LET PI=3.14159
1000 LET Ff=Ff/10 : Ff1=10^Ff 'CONVERSION FROM db TO NUMERIC
1010 LET Ls=Lp1+Lbs 'SYSTEM LOSSES IN db
1020 LET Ls1=Ls/10 : Ls2=10^Ls1 'CONVERSION FROM db TO NUMERIC
1030 LET l=1/100 'CONVERSION FROM cm TO m
1040 PRINT : PRINT " FROM Fig. 2.7 (SKOLNIK Pg. 28) YOU CAN FIND THE (S/N)1 SINCE YOU KNOW
Pd AND P1"

```

```

1050 PRINT : PRINT " ENTER THE VALUE OF THE (S/N)1 IN db"
1060 INPUT A1
1070 PRINT : PRINT "SINCE YOU ARE IN CASE2 FROM Fig. 2.23 (SKOLNIK Pg. 48) YOU CAN FIND
THE ADDITIONAL (S/N)1 ad"
1080 PRINT : PRINT " ENTER THE VALUE OF THE (S/N)1 ad"
1090 INPUT A2
1100 LET A=A1+A2 : A3=A/10 : A4=10*A3 THIS IS THE VALUE OF THE (S/N)1 tot IN db AND
IN NUMERIC
1110 PRINT : PRINT " SINCE YOU KNOW THE # OF HITS INTEGRATED (NONCOHERENT) FROM Fig.
2.24 (SKOLNIK Pg. 49) YOU CAN FIND THE INTEGRATION IMR. FACTOR I1"
1120 PRINT : PRINT " ENTER THE VALUE OF THE INTEGRATION IMR. FACTOR"
1130 INPUT I1
1140 LET I11=I1/10 : I12=10*I11
1150 LET Rmax=SQR(SQR((Pt*(Ae^2)*Sav*I12*.85)/(4*PI*K*T0*F11*Bn*(1^2)*A4*Ls2)))
1160 RETURN
1170 REM:*****
1180 REM: SUBR. THAT PRINTS THE OUTPUT FOR PART b
1190 REM:*****
1200 PRINT : PRINT : PRINT " PART b:"
1210 LPRINT : LPRINT : LPRINT " PART b:"
1220 LPRINT " -----"
1230 PRINT : PRINT " 2(a). Ls=";Ls;"db", " : TOTAL SYSTEM LOSSES"
1240 LPRINT : LPRINT " 2(a). Ls=";Ls;"db", " : TOTAL SYSTEM LOSSES"
1250 PRINT : PRINT " 2(b). (S/N)1=";A1;"db", " : SIGNAL-TO-NOISE RATIO"
1260 LPRINT : LPRINT " 2(b). (S/N)1=";A1;"db", " : SIGNAL-TO-NOISE RATIO"
1270 PRINT : PRINT " 2(c). (S/N)1 ad=";A2;"db", " : ADDITIONAL SIGNAL-TO-NOISE RATIO"
1280 LPRINT : LPRINT " 2(c). (S/N)1 ad=";A2;"db", " : ADDITIONAL SIGNAL-TO-NOISE RATIO"
1290 PRINT : PRINT " 2(d). (S/N)tot=";A;"db", " : TOTAL SIGNAL-TO-NOISE RATIO"
1300 LPRINT : LPRINT " 2(d). (S/N)tot=";A;"db", " : TOTAL SIGNAL-TO-NOISE RATIO"
1310 PRINT : PRINT " 2(e). I1(n)=";I1;"db", " : INTEGRATION IMR. FACTOR"
1320 LPRINT : LPRINT " 2(e). I1(n)=";I1;"db", " : INTEGRATION IMR. FACTOR"
1330 PRINT : PRINT " 2(f). Rmax=";Rmax/1000;"KM", " : MAXIMUM RANGE"
1340 LPRINT : LPRINT " 2(f). Rmax=";Rmax/1000;"KM", " : MAXIMUM RANGE"
1350 RETURN
1360 PRINT : PRINT " DO YOU WANT TO TRY FOR DIFFERENT OR THE SAME DATA Y/N?"

```

```
1370 INPUT C$
1380 IF LEFT$(C$,1)="Y" OR LEFT$(C$,1)="y" THEN 40
1390 END
```

*** PROBLEM #3 ***

G I V E N

1. $P_t = 1 \text{ MW}$: MAGNETRON'S PEAK POWER
2. $T_w = 1 \text{ MICSEC}$: PULSE WIDTH
3. $f_p = 250 \text{ HZ}$: PULSE REPETITION FREQUENCY
4. $\lambda = 10 \text{ centimeters}$: OPERATION WAVELENGTH
5. $A_e = 200 \text{ square meters}$: EFFECTIVE ANTENNA APERTURE
6. $n = 10$: # OF HITS INTEGRATED
7. $B_n = 1 \text{ MHZ}$: NOISE BANDWIDTH
8. $F_f = 10 \text{ db}$: RECEIVER NOISE FIGURE
9. $L_{p1} = 3 \text{ db}$: PLUMBING LOSSES
10. $L_{bs} = 2 \text{ db}$: BEAM SHAPE
11. $\alpha = .85$: FACTOR BY WHICH INTEGRATION EFF. IS REDUCED
12. $P_f = 1E-08$: FALSE ALARM PROBABILITY
13. $P_d = .99$: PROBABILITY OF DETECTION
14. $S_{av} = 1 \text{ sq.meters}$: TARGET AVERAGE CROSS SECTION
15. YOU'RE CASE IS : CASE2

PART a:

- 1(a). $R_{unab} = 600 \text{ KM}$: THE MAX. UNAB. RANGE

PART b:

- 2(a). $L_s = 5 \text{ db}$: TOTAL SYSTEM LOSSES
- 2(b). $(S/N)_1 = 15.9 \text{ db}$: SIGNAL-TO-NOISE RATIO
- 2(c). $(S/N)_{1ed} = 17.2 \text{ db}$: ADDITIONAL SIGNAL-TO-NOISE RATIO
- 2(d). $(S/N)_{tot} = 33.1 \text{ db}$: TOTAL SIGNAL-TO-NOISE RATIO
- 2(e). $I_1(n) = 25 \text{ db}$: INTEGRATION IMR. FACTOR
- 2(f). $R_{max} = 758.5743 \text{ KM}$: MAXIMUM RANGE

```

10 PRINT : PRINT TAB(30); " PROBLEM #4"
20 LPRINT : LPRINT TAB(30); " PROBLEM #4"
30 LPRINT TAB(30); "-----"
40 *****
50 REM: MAIN PROGRAM
60 *****
70 GOSUB 160 : GOSUB 310
80 GOSUB 440 : GOSUB 570
90 PRINT : PRINT "DO YOU WANT TO TRY AGAIN FOR DIFFERENT OR THE SAME DATA Y/N ?"
100 INPUT A$
110 IF LEFT$(A$,1)="Y" OR LEFT$(A$,1)="y" THEN 70
120 END
130 *****
140 REM: SUBROUTINES
150 *****
160 ***** SUBROUTINE THAT INPUTS THE GIVEN DATA *****
170 PRINT : PRINT " ENTER THE OPERATION FREQUENCY f IN GHZ"
180 INPUT f
190 PRINT : PRINT " ENTER THE RATE THAT THE FREQUENCY CHANGES f0 IN GHZ/SEC"
200 INPUT f0
210 PRINT : PRINT " ENTER THE DURATION OF THE CHANGING FREQ. T IN ms"
220 INPUT T
230 PRINT : PRINT " ENTER THE TIME THE FREQ. TAKES TO RETURN TO ITS ORIGINAL VALUE Tr IN
ms"
240 INPUT Tr
250 PRINT : PRINT " ENTER THE THE RANGE OF THE TARGET R IN Yards"
260 INPUT R
270 PRINT : PRINT " ENTER THE RELATIVE VELOCITY Ur IN ft/sec"
280 INPUT Ur
290 RETURN
300 *****
310 REM: SUBROUTINE THAT PRINTS THE INPUT DATA
320 *****
330 LPRINT : LPRINT " G I V E N "
340 LPRINT "-----"

```



```

350 LPRINT:LPRINT "1. f=";f;"GHZ"TAB(19);" : OPERATING FREQUENCY"
360 LPRINT:LPRINT "2. f0=";f0;"GHZ/SEC"TAB(19);" : RATE THAT THE FREQUENCY CHANGE"
370 LPRINT:LPRINT "3. T=";T;"ms"TAB(19);" : DURATION OF THE CANGE"
380 LPRINT:LPRINT "4. Tr=";Tr;"ms"TAB(19);" : TIME THE FREQ. NEEDS TO RETURN"
390 LPRINT TAB(17);"  TO ITS ORIGINAL VALUE"
400 LPRINT:LPRINT "5. R=";R;"Yards"TAB(19);" : RANGE OF THE TARGET"
410 LPRINT:LPRINT "6. Ur=";Ur;"ft/sec"TAB(19);" : RELATIVE VELOCITY"
420 RETURN
430*****
440 REM:SUBROUTINE WHICH CALCULATE AND PRINTS PART a
450*****
460 LET f0=f0*10^9      'CONVERTION FROM GHZ/SEC TO HZ/SEC
470 LET R=R*.914      'CONVERTION FROM Yards TO Meters
480 LET C=3*10^8      'm/sec
490 LET fr = f0*2*R/C   'FREQUENCY SHIFT
500 PRINT:PRINT:PRINT " PART a:"
510 LPRINT:LPRINT:LPRINT " PART a:"
520 LPRINT "-----"
530 PRINT:PRINT " 1(a). fr=";fr/1000;"KHZ";" : FREQUENCY SHIFT"
540 LPRINT:LPRINT " 1(a). fr=";fr/1000;"KHZ";" : FREQUENCY SHIFT"
550 RETURN
560*****
570 REM:SUBROUTINE THAT CALCULATE AND PRINTS PART b
580*****
590 LET f=f*10^9      'CONVERTION FROM GHZ TO HZ
600 LET Ur=Ur*.305    'CONVERTION FROM ft/sec TO m/s
610 LET l=C/f         'WAVELENGTH IN meters
620 LET fd=2*Ur/l     'DOPPLER SHIFT
630 LET dR=R*fd /fr   'RANGE ERROR IN METERS
640 LET dR1=dR/100    '% RANGE ERROR
650 PRINT:PRINT:PRINT " PART b:"
660 LPRINT:LPRINT:LPRINT " PART b:"
670 LPRINT "-----"
680 PRINT:PRINT " 1(b). fd=";fd;"HZ";" : DOPPLER SHIFT"
690 LPRINT:LPRINT " 1(a). fd=";fd;"HZ";" : DOPPLER SHIFT"

```

```
700 PRINT : PRINT "1(b). dR=";dR;"m";" OR";dR/.914;"Yards" ;" : RANGE ERROR"
710 LPRINT : LPRINT "1(b). dR=";dR;"m";" OR";dR/.914;"Yards" ;" : RANGE ERROR"
720 PRINT : PRINT "1(c). dR1=";dR1;"m";" OR";dR1/.914;"Yards" ;" : % RANGE ERROR"
730 LPRINT : LPRINT "1(c). dR1=";dR1;"m";" OR";dR1/.914;"Yards" ;" : % RANGE ERROR"
740 RETURN
```

PROBLEM #4

GIVEN

1. $f = 10.5 \text{ GHz}$: OPERATING FREQUENCY
2. $f_0 = 2 \text{ GHz/SEC}$: RATE THAT THE FREQUENCY CHANGE
3. $T = 990 \text{ ms}$: DURATION OF THE CHANGE
4. $T_r = 10 \text{ ms}$: TIME THE FREQ. NEEDS TO RETURN
TO ITS ORIGINAL VALUE
5. $R = 5000 \text{ Yards}$: RANGE OF THE TARGET
6. $U_r = 25 \text{ ft/sec}$: RELATIVE VELOCITY

PART a:

- 1(a). $f_r = 60.933333 \text{ KHZ}$: FREQUENCY SHIFT

PART b:

- 1(a). $f_d = 533.75 \text{ HZ}$: DOPPLER SHIFT
- 1(b). $dR = 40.03125 \text{ m OR } 43.79787 \text{ Yards}$: RANGE ERROR
- 1(c). $dR1 = .4003125 \text{ m OR } .4379787 \text{ Yards}$: % RANGE ERROR

```

10 PRINT:PRINT:PRINT TAB(30);" PROBLEM #5"
20 LPRINT:LPRINT:LPRINT TAB(30);" PROBLEM #5"
30 PRINT TAB(30);"-----"
40 LPRINT TAB(30);"-----"
50 GOSUB 90 :GOSUB 210
60 GOSUB 310 :GOSUB 410
70 GOTO 510
80 *****
90 REM: SUBROUTINE THAT INPUTS THE DATA
100*****
110 PRINT:PRINT " ENTER THE OPERATING FREQ. f IN GHZ"
120 INPUT f
130 PRINT:PRINT " ENTER THE PULSE WIDTH t IN ms"
140 INPUT t
150 PRINT:PRINT " ENTER THE PULSE REPETITION FREQ. fp IN HZ"
160 INPUT fp
170 PRINT:PRINT " ENTER THE AIRCRAFT'S VELOCITY Uair IN Knots"
180 INPUT Uair
190 RETURN
200*****
210 REM: SUBROUTINE THAT PRINTS THE INPUT DATA
220*****
230 LPRINT:LPRINT:LPRINT " G I V E N"
240 LPRINT "-----"
250 LPRINT:LPRINT " 1. f=";f;"GHZ"TAB(18);": OPERATING FREQ."
260 LPRINT:LPRINT " 2. t=";t;"ms"TAB(18);": PULSE WIDTH"
270 LPRINT:LPRINT " 3. fp=";fp;"HZ"TAB(18);": PULSE REPETITION FREQ."
280 LPRINT:LPRINT " 4. Uair=";Uair;"Knots";": AIRCRAFT'S VELOCITY"
290 RETURN
300*****
310 REM: SUBROUTINE THAT CALCULATE AND PRINTS Uair
320*****
330 LET f=f*10^9
340 LET C=3*10^8
350 LET l=C/f

```

```

360 LET U1b=1*1p/2
370 PRINT :PRINT :PRINT "U1b=";U1b;"m/s";" OR";U1b/.515;"Knots";" : FIRST BLIND SPEED"
380 LPRINT :LPRINT :LPRINT "U1b=";U1b;"m/s";" OR";U1b/.515;"Knots";" : FIRST BLIND
SPEED"
390 RETURN
400*****
410 REM: SUBROUTINE THAT FINDS IF THERE IS A DOPPLER AMBIGUITY
420*****
430 IF Uair>U1b/.515 THEN GOTO 440 ELSE 460
440 PRINT :PRINT " THERE IS A DOPPLER AMBIGUITY SINCE ";Uair;"Knots";" >";U1b/.515;"Knots"
450 LPRINT :LPRINT " THERE IS A DOPPLER AMBIGUITY SINCE ";Uair;"Knots";"
>";U1b/.515;"Knots"
460 IF Uair<U1b/.515 THEN GOTO 480 ELSE 470
470 IF Uair=U1b/.515 THEN GOTO 480 ELSE 500
480 PRINT :PRINT " THERE ISN'T A DOPPLER AMBIGUITY SINCE ";Uair;"Knots";" < or
=";U1b/.515;"Knots"
490 LPRINT :LPRINT " THERE ISN'T A DOPPLER AMBIGUITY SINCE ";Uair;"Knots";" < or
=";U1b/.515;"Knots"
500 RETURN
510 PRINT :PRINT " DO YOU WANT TO TRY AGAIN FOR DIFFERENT OR THE SAME DATA Y/N ?"
520 INPUT B$
530 IF LEFT$(B$,1)="Y" OR LEFT$(B$,1)="y" THEN 30
540 END

```

PROBLEM #5

GIVEN

1. $f = 9 \text{ GHz}$: OPERATING FREQ.
2. $t = 1 \text{ ms}$: PULSE WIDTH
3. $f_p = 1000 \text{ Hz}$: PULSE REPETITION FREQ.
4. $U_{air} = 600 \text{ Knots}$: AIRCRAFT'S VELOCITY

$U_{1b} = 16.66667 \text{ m/s}$ OR 32.36246 Knots : FIRST BLIND SPEED

***** THERE IS A DOPPLER AMBIGUITY SINCE $600 \text{ Knots} > 32.36246 \text{ Knots}$ *****

```

10 PRINT : PRINT TAB(30); " PROBLEM #6"
20 PRINT "-----"
30 LPRINT : LPRINT TAB(30); "PROBLEM #6"
40 LPRINT TAB(30); "-----"
50 GOSUB 120 : GOSUB 430
60 GOSUB 520 : GOSUB 620
70 PRINT : PRINT " DO YOU WANT TO TRY AGAIN FOR DIFFERENT OR THE SAME DATA Y/N?"
80 INPUT E$
90 IF LEFT$(E$,1)="Y" OR LEFT$(E$,1)="y" THEN 50
100 END
110*****SUBROUTINES*****
120 *      INPUTS THE DATA
130*****
140 PRINT : PRINT " ENTER THE P.R.F  $f_p$  IN HZ"
150 INPUT  $f_p$  : PRINT : PRINT " 1.  $f_p=$ "; $f_p$ ;"HZ"
160 PRINT : PRINT " ENTER THE CLUTTER SPECTRAL WIDTH  $S_c$  IN HZ"
170 INPUT  $S_c$  : PRINT : PRINT "2.  $S_c=$ "; $S_c$ ;"HZ"
180 PRINT : PRINT " ENTER THE NUMBER OF THE DELAY LINE CANCELER"
190 PRINT " WITH OPTIMAL WEIGHTING N"
200 INPUT n : PRINT : PRINT " 3. N=";N
210 PRINT : PRINT " IS THE INPUT DATA CORRECT Y/N?"
220 INPUT A$
230 IF LEFT$(A$,1)="Y" OR LEFT$(A$,1)="y" THEN 410
240 PRINT : PRINT "WHAT OF THE FOLLOWING DO YOU WANT TO CHANGE?"
250 PRINT : PRINT " 1. THE P.R.F?"
260 PRINT : PRINT " 2. THE SPECTRAL CLUTTER WIDTH?"
270 PRINT : PRINT " 3. THE NUMBER OF THE DELAY LINE CANCELER?"
280 INPUT B$
290 IF B$="1" THEN PRINT : PRINT " ENTER THE P.R.F  $f_p$  IN HZ"
300 IF B$="1" THEN INPUT  $f_p$  : PRINT : PRINT " 2.  $f_p=$ "; $f_p$ ;"HZ" : GOTO 350
310 IF B$="2" THEN PRINT : PRINT " ENTER THE CLUTTER SPECTRAL WIDTH"
320 IF B$="2" THEN INPUT  $S_c$  : PRINT : PRINT " 2.  $S_c=$ "; $S_c$ ;"HZ" : GOTO 350
330 IF B$="3" THEN PRINT : PRINT " ENTER THE NUMBER OF THE DELAY LINE CANCELER"
340 IF B$="3" THEN INPUT N : PRINT : PRINT " 3. N=";N : GOTO 350
350 PRINT : PRINT " IS EVERYTHING O.K NOW Y/N?"

```

```

360 INPUT C$
370 IF LEFT$(C$,1)="Y" OR LEFT$(C$,1)="y" THEN GOTO 410
380 PRINT : PRINT "WHAT DO YOU WANT TO CHANGE"
390 PRINT : PRINT "HIT ANY KEY IN YOUR KEYBOARD AND THE COMPUTER WILL WORK FOR YOU"
400 INPUT D$ : GOTO 250
410 RETURN
420*****
430 *      PRINTS THE INPUT DATA      *
440*****
450 LPRINT : LPRINT " G I V E N"
460 LPRINT "-----"
470 LPRINT : LPRINT " 1. fp=";fp;"HZ" ,": P.R.F"
480 LPRINT : LPRINT " 2. Sc=";Sc;"HZ" ,": CLUTTER SPECTRAL WIDTH"
490 LPRINT : LPRINT " 3. N=";N ,": #OF DELAY LINE CANCELER WITH OPTIMAL WEIGHTING"
500 RETURN
510*****
520 *      CALCULATIONS      *
530*****
540 PRINT : PRINT " FROM Fig. 4.25 (SKOLNIK Pg. 124) YOU CAN FIND THE IMPROVEMENT FACTOR"
550 PRINT " SINCE YOU KNOW"
560 PRINT : PRINT " a. N=";N ,": #OF DELAY LINE CANCELER"
570 PRINT " b. Sc/fp=";Sc/fp ,": CLUTTER SPECTRAL WIDTH/RADAR P.R.F"
580 PRINT : PRINT " ENTER THE INTEGRATION IMR. FACTOR"
590 INPUT I
600 RETURN
610*****
620 *      PRINTS THE OUTPUT      *
630*****
640 PRINT : PRINT : PRINT " OUTPUT"
650 LPRINT : LPRINT : LPRINT " OUTPUT"
660 LPRINT "-----"
670 PRINT : PRINT " 1. Sc/fp=";Sc/fp ,": CLUTTER SPECTRAL WIDTH/RADAR P.R.F"
680 LPRINT : LPRINT " 1. Sc/fp=";Sc/fp ,": CLUTTER SPECTRAL WIDTH/RADAR P.R.F"
690 PRINT : PRINT " 2. I=";I;"db" ,": INTEGRATION IMR. FACTOR"
700 LPRINT : LPRINT " 2. I=";I;"db" ,": INTEGRATION IMR. FACTOR"

```

710 RETURN

PROBLEM#6

GIVEN

1. $f_p = 1000$ HZ : P.R.F
2. $S_c = 10$ HZ : CLUTTER SPECTRAL WIDTH
3. $N = 3$: #OF DELAY LINE CANCELER WITH OPTIMAL WEIGHTING

OUTPUT

1. $S_c/f_p = .01$: CLUTTER SPECTRAL WIDTH/RADAR P.R.F
2. $I = 55$ db : INTEGRATION IMR. FACTOR

```

10 PRINT : PRINT TAB(30); " PROBLEM #7"
20 PRINT TAB (30); " -----"
30 REM ***** VARIABLES *****
40 LET C=3*10^8           'm/s
50 LET PI=3.141593#
60 LET M=.4342945#
70 LET K=1.38*10^-23      'BOLTZMAN CONSTANT IN j/Deg
80 LET T0=290             'STANDARD TEMPERATURE IN KELVIN
90 GOSUB 160 : GOSUB 2080 : GOSUB 810 : GOSUB 2260 : GOSUB 930 : GOSUB 2330
100 GOSUB 1160 : GOSUB 2480 : GOSUB 1760 : GOSUB 2640 : GOSUB 1960 : GOSUB 2730
110 PRINT : PRINT " DO YOU WANT TO TRY AGAIN FOR DIFFERENT OR THE SAME DATA Y/N?"
120 INPUT A$
130 IF LEFT$(A$,1)="Y" OR LEFT$(A$,1)="y" THEN 20
140 END
150 *****
160 *   INPUTS THE DATA
170 *****
180 PRINT : PRINT " ENTER THE PEAK POWER Pp IN Kw"
190 INPUT Pp : PRINT : PRINT " 1. Pp=";Pp;"Kw"
200 PRINT : PRINT " ENTER THE P.R.F Fp IN HZ"
210 INPUT Fp : PRINT : PRINT " 2. Fp=";Fp;"HZ"
220 PRINT : PRINT " ENTER THE PULSE WIDTH T IN micsec"
230 INPUT T : PRINT : PRINT " 3. T=";T;"micsec"
240 PRINT : PRINT " ENTER THE FALSE ALARM TIME Tfa IN Hrs"
250 INPUT Tfa : PRINT : PRINT " 4. Tfa=";Tfa;"Hrs"
260 PRINT : PRINT " ENTER THE RECEIVER NOISE FIGURE F IN db"
270 INPUT F : PRINT : PRINT " 5. F=";F;"db"
280 PRINT : PRINT " ENTER THE TRANSMITTER FREQ. FO IN MHZ "
290 INPUT FO : PRINT : PRINT " 6. FO=";FO;"MHZ"
300 PRINT : PRINT " ENTER THE IF FREQ. FI1 IN MHZ"
310 INPUT FI1 : PRINT : PRINT " 7. FI1=";FI1;"MHZ"
320 PRINT : PRINT " ENTER THE IF BANDWIDTH BI1 IN MHZ"
330 INPUT BI1 : PRINT : PRINT " 8. BI1=";BI1;"MHZ"
340 PRINT : PRINT " ENTER THE ANTENNA POWER GAIN G IN db"
350 INPUT G : PRINT : PRINT " 9. G=";G;"db"

```

```

360 PRINT : PRINT " ENTER THE MINIMUM DETECTABLE SIGNAL M.D.S IN dbm"
370 INPUT M.D.S : PRINT : PRINT " 10. M.D.S=";M.D.S;"dbm"
380 PRINT : PRINT " IS THE INPUT DATA CORRECCT Y/N?"
390 INPUT B$
400 IF LEFT$(B$,1)="Y" OR LEFT$(B$,1)="y" THEN 790
410 PRINT : PRINT " WHAT OF THE FOLLOWING DO YOU WANT TO CHANGE?"
420 PRINT : PRINT " 1. THE PEAK POWER?"
430 PRINT : PRINT " 2. THE P.R.F?"
440 PRINT : PRINT " 3. THE PULSE WIDTH?"
450 PRINT : PRINT " 4. THE FALSE ALARM TIME?"
460 PRINT : PRINT " 5. THE RECEIVER NOISE FIFURE?"
470 PRINT : PRINT " 6. THE TRANSMITTER FREQ.?"
480 PRINT : PRINT " 7. THE IF FREQ.?"
490 PRINT : PRINT " 8. THE IF BANDWIDTH?"
500 PRINT : PRINT " 9. ANTENNA POWER GAIN?"
510 PRINT : PRINT " 10. THE MINIMUM DET. SIGNAL?"
520 INPUT C$
530 IF C$="1" THEN PRINT : PRINT " ENTER THE PEAK POWER Pp IN Kw"
540 IF C$="1" THEN INPUT Pp : PRINT : PRINT " 1. Pp=";Pp;"Kw" : GOTO 730
550 IF C$="2" THEN PRINT : PRINT " ENTER THE P.R.F Fp IN HZ"
560 IF C$="2" THEN INPUT Fp : PRINT : PRINT " 2. Fp=";Fp;"HZ" : GOTO 730
570 IF C$="3" THEN PRINT : PRINT " ENTER THE PULSE WIDTH T IN micsec"
580 IF C$="3" THEN INPUT T : PRINT : PRINT " 3. T=";T;"micsec" : GOTO 730
590 IF C$="4" THEN PRINT : PRINT " ENTER THE FALSE ALARM TIME Tfa IN Hrs"
600 IF C$="4" THEN INPUT Tfa : PRINT : PRINT " 4. Tfa=";Tfa;"Hrs" : GOTO 730
610 IF C$="5" THEN PRINT : PRINT " ENTER THE RECEIVER NOISE FIGURE F IN db"
620 IF C$="5" THEN INPUT F : PRINT : PRINT " 5. F=";F;"db" : GOTO 730
630 IF C$="6" THEN PRINT : PRINT " ENTER THE TRANSMITTER FREQ. FO IN MHZ"
640 IF C$="6" THEN INPUT FO : PRINT : PRINT " 6. FO=";FO;"MHZ" : GOTO 730
650 IF C$="7" THEN PRINT : PRINT " ENTER THE IF FREQ. FIF IN MHZ"
660 IF C$="7" THEN INPUT FIF : PRINT : PRINT " 7. FIF=";FIF;"MHZ" : GOTO 730
670 IF C$="8" THEN PRINT : PRINT " ENTER THE IF BANDWIDTH BIF IN MHZ"
680 IF C$="8" THEN INPUT BIF : PRINT : PRINT " 8. BIF=";BIF;"MHZ" : GOTO 730
690 IF C$="9" THEN PRINT : PRINT " ENTER THE ANTENNA POWER GAIN G IN db"
700 IF C$="9" THEN INPUT G : PRINT : PRINT " 9. G=";G;"db" : GOTO 730

```

```

710 IF C$="10" THEN PRINT :PRINT " ENTER THE MINIMUM DETECTABLE SIGNAL M.D.S IN dbm"
720 IF C$="10" THEN INPUT M.D.S :PRINT :PRINT " 10. M.D.S=";M.D.S;"dbm" : GOTO 730
730 PRINT :PRINT " IS EVERYTHING O.K NOW?"
740 INPUT D$
750 IF LEFT$(D$,1)="Y" OR LEFT$(D$,1)="y" THEN GOTO 790
760 PRINT :PRINT " WHAT DO YOU WANT TO CHANGE AGAIN?"
770 PRINT :PRINT "HIT ANY KEY IN YOUR KEYBOARD AND EVERYTHING WILL WORK FOR YOU"
780 INPUT E$ : GOTO 420
790 RETURN
800 *****
810 ' CALCULATION FOR PART 1:
820 *****
830 PRINT :PRINT " NOW IS CALCULATED PART 1:"
840 LET Pp=Pp*103 'CONVERSION FROM Kw TO w
850 LET T=T*10-6 'CONVERSION FORM msec TO sec.
860 LET Pav=Pp*Fp*T 'AVERAGE OUTPUT POWER
870 LET Pav=Pav/1000 'CONVERSION FROM w TO Kw
880 PRINT :PRINT :PRINT " PART 1:"
890 PRINT "-----"
900 PRINT :PRINT " 1. Pav=Pp*Fp*T=";Pav;"Kw";": AVERAGE OUTPUT POWER"
910 RETURN
920 *****
930 ' CALCULATION FOR PART 2:
940 *****
950 PRINT :PRINT " NOW IS CALCULATED PART 2:"
960 PRINT :PRINT :PRINT " PART 2:"
970 PRINT "-----"
980 LET B1f=B1f*106 'CONVERSION FROM MHZ TO HZ
990 LET Pn=K*T0*B1f 'NOISE POWER
1000 LET Pn1=10*M*LOG(Pn) 'CONVERSION FROM w TO dbw
1010 LET Pn2=Pn1+30 'CONVERSION FROM dbw TO dbm
1020 PRINT :PRINT " 2(a). Pn=K*T0*B1f=";Pn;"W";" OR ";CINT(Pn2);"dbm";": NOISE POWER"
1030 IF (Pn2>M.D.S) THEN GOTO 1090 ELSE 1040
1040 IF (Pn2<M.D.S) THEN GOTO 1100 ELSE 1050
1050 IF (Pn2=M.D.S) THEN GOTO 1110

```

```

1060 LET Tfe=Tfe*3600           'CONVERTION FROM Hrs TO Sec.
1070 LET A=LOG(Tfe*Bif)
1080 LET A=10*M*LOG(A) : GOTO 1120           'CONVERTION FROM NUMERIC TO db
1090 PRINT : PRINT " 2(b). THE NOISE POWER IS GREATER THAN THE M.D.S" : GOTO 1060
1100 PRINT : PRINT " 2(b). THE NOISE POWER IS SMALLER THAN THE M.D.S" : GOTO 1060
1110 PRINT : PRINT " 2(b). THE NOISE POWER IS EQUAL TO THE M.D.S" : GOTO 1060
1120 PRINT : PRINT " 2(c).  $(Vt^2)/(2Y0)=ln(Tfe*Bif)=$  ;CSNG(A);"db";" : R.M.S THRESHOLD POWER
    TO NOISE RATIO"
1130 PRINT : PRINT TAB(55);"IF NO PULSE INTEGRATION IS PERFORMED"
1140 RETURN
1150 *****
1160 ' CALCULATION FOR PART 3:
1170 *****
1180 PRINT : PRINT " NOW IS CALCULATED PART 3:"
1190 PRINT : PRINT " ENTER THE TARGET CROSS SECTION Sc IN SQ METERS"
1200 INPUT Sc
1210 PRINT : PRINT " ENTER THE PROBABILITY OF DETECTION Pd"
1220 INPUT Pd
1230 PRINT : PRINT " ENTER THE # OF PULSES THAT ARE INTEGRATED AFTER POST-DETECTION"
1240 INPUT n
1250 PRINT : PRINT " IS THE INPUT DATA CORRECCT Y/N?"
1260 INPUT F$
1270 IF LEFT$(F$,1)="Y" OR LEFT$(F$,1)="y" THEN 1460
1280 PRINT : PRINT " WHAT OF THE FOLLOWING DO YOU WANT TO CHANGE?"
1290 PRINT : PRINT " 1. THE CROSS SECTION?"
1300 PRINT : PRINT " 2. THE PROBABILITY OF DETECTION?"
1310 PRINT : PRINT " 3. THE # OF INTEGRATED PULSES?"
1320 INPUT G$
1330 IF G$="1" THEN PRINT : PRINT " ENTER THE CROSS SECTION Sc IN SQ. METERS"
1340 IF G$="1" THEN INPUT Sc : GOTO 1390
1350 IF G$="2" THEN PRINT : PRINT " ENTER THE PROBABILITY OF DETECTION Pd"
1360 IF G$="2" THEN INPUT Pd : GOTO 1390
1370 IF G$="3" THEN PRINT : PRINT " ENTER THE # OF PULSES TO BE INTEG. n"
1380 IF G$="3" THEN INPUT n : GOTO 1390
1390 PRINT : PRINT " IS EVERYTHING O.K NOW?"

```

```

1400 INPUT H$
1410 IF LEFT$(H$,1)="Y" OR LEFT$(H$,1)="y" THEN GOTO 1460
1430 PRINT : PRINT "WHAT DO YOU WANT TO CHANGE AGAIN?"
1440 PRINT : PRINT "HIT ANY KEY IN YOUR KEYBOARD AND EVERYTHING WILL WORK FOR YOU"
1450 INPUT I$: GOTO 1290
1460 LET Pfa=1/(Tfa*B1f)          'PROBABILITY OF FALSE ALARM
1470 PRINT : PRINT "SINCE YOU KNOW THE PROBABILITY OF FALSE ALARM Pfa=";Pfa;"
1480 PRINT : PRINT "THE PROBABILITY OF DETECTION Pd=";Pd;"FROM Fig. 2.7 (SKOLNIK Pg. 28)"
1490 PRINT : PRINT "YOU CAN FIND THE (S/N)1"
1500 PRINT : PRINT "ENTER THE (S/N)1 IN db"
1510 INPUT S1
1520 PRINT : PRINT "SINCE YOUR FLUCTUATION CASE IS CASE 4 FROM Fig. 2.23 (SKOLNIK Pg. 48)"
1530 PRINT : PRINT "YOU CAN FIND THE ADDITIONAL (S/N)1ad"
1540 PRINT : PRINT "ENTER THE ADDITIONAL (S/N)1ad IN db"
1550 INPUT S2
1560 LET S3=S1+S2
1570 PRINT : PRINT "FROM Fig. 2.24 (SKOLNIK Pg. 49) YOU CAN FIND THE INTEGR. IMR. FACTOR"
1580 PRINT : PRINT "ENTER THE INTEGR. IMR. FACTOR I1(n) IN db"
1590 INPUT I
1600 LET S4=S3-I
1610 PRINT : PRINT : PRINT "PART 3:"
1620 PRINT "-----"
1630 PRINT : PRINT "3(e). Sc=";Sc;"eq. m"; " : TARGET CROSS SECTION"
1650 PRINT : PRINT "3(b). Pd=";Pd;" : PROBABILITY OF DETECTION"
1660 PRINT : PRINT "3(c). n=";n;" : # OF INTEGRATED PULSES"
1670 PRINT : PRINT "3(d). YOUR MODEL IS IN CASE 4"; " : SWERLING MODEL"
1680 PRINT : PRINT "3(e). Pfa=1/(Tfa*B1f)=";Pfa;" : PROBABILITY OF FALSE ALARM"
1690 PRINT : PRINT "3(f). (S/N)1=";S1;"db"; " : (S/N)1 FOR ONE PULSE INTEGRATED FROM Fig. 2.7"
1700 PRINT : PRINT "3(g). (S/N)1ad=";S2;"db"; " ADDITIONAL (S/N) FROM Fig. 2.7"
1710 PRINT : PRINT "3(h). (S/N)1tot=";S3;"db"; " : TOTAL (S/N) FROM Fig. 2.23"
1720 PRINT : PRINT "3(i). I1(n)=";I;"db"; " : INTEGR. IMR. FACTOR FOR 30 PULSES FROM Fig. 2.24"
1730 PRINT : PRINT "3(k). (S/N)30=(S/N)1tot/I1(n)=";S4;"db"; " : THE MIN. (S/N) REQUIRED TO
ACHIEVE Pd=0.5"
1740 RETURN
1750 *****

```

```

1760 ' CALCULATIONS FOR PART 4:
1770*****
1780 PRINT: PRINT " NOW IS CALCULATED PART 4:"
1790 PRINT: PRINT " ENTER THE VALUE OF THE (S/N)min IN db"
1800 INPUT S
1810 PRINT: PRINT " ENTER THE TOTAL SYSTEM LOSSES Ls IN db"
1820 INPUT Ls
1830 LET F1=F/10 : F2=10^F1          'CONVERSION FROM db TO NUMERIC
1840 LET G1=G/10 : G2=10^G1          'CONVERSION FROM db TO NUMERIC
1850 LET Ls1=LS/10 : Ls2=10^Ls1     'CONVERSION FROM db TO NUMERIC
1860 LET F0=F0*10^6 : I=C/F0
1870 LET S5=S/10 : S6=10^S5         'CONVERSION FROM db TO NUMERIC
1880 LET R=(Pp*(G2^2)*(I^2)*Sc/(((4*PI)^3)*K*T0*F2*B1f*S6*Ls2))^(1/4)
1890 PRINT: PRINT: PRINT " PART 4:"
1900 PRINT " -----"
1910 PRINT: PRINT " 4(a). (S/N)min=";S;"db"
1920 PRINT: PRINT " 4(b). Ls=";Ls;"db"; " : TOTAL SYSTEM LOSSES"
1930 PRINT: PRINT " 4(c).
R=(Pp*(G^2)*(I^2)*Sc/(((4*PI)^3)*(K*T0*F*B1f)*(S/N)min*Ls))^(1/4)=";CSNG(R/1000);"KMF";
MAX.RANGE"
1940 RETURN
1950*****
1960 ' CALCULATIONS FOR PART 5:
1970*****
1980 PRINT: PRINT " NOW IS CALCULATED PART 5:"
1990 PRINT: PRINT " ENTER THE MIN. RADAR RANGE R1 IN KM"
2000 INPUT R1
2010 LET TR=2*R1*1000/C-T           'RECOVERY TIME
2020 PRINT: PRINT: PRINT " PART 5:"
2030 PRINT " -----"
2040 PRINT: PRINT " 5(a). R1=";R1;"KM"; " : MIN. RADAR RANGE"
2050 PRINT: PRINT " 5(b). TR=(2*R1*1000/C)-T=";TR*10^6;"micsec"; " : RECOVERY TIME"
2060 RETURN
2070*****
2080 ' SUBROUTINE THAT PRINTS THE INPUT DATA

```



```

2090*****
2100 LPRINT : LPRINT TAB(30); " PROBLEM #7"
2110 LPRINT TAB (30); " -----"
2120 LPRINT : LPRINT : LPRINT " G I V E N "
2130 LPRINT "-----"
2140 LPRINT : LPRINT " 1. Pp=";Pp;"Kw", " : PEAK POWER"
2150 LPRINT : LPRINT " 2. Fp=";Fp;"HZ", " : P.R.F"
2160 LPRINT : LPRINT " 3. T=";T;"micsec", " : PULSE WIDTH"
2170 LPRINT : LPRINT " 4. Tfe=";Tfe;"Hrs", " : FALSE ALARM TIME"
2180 LPRINT : LPRINT " 5. F=";F;"db", " : RECEIVER NOISE FIGURE"
2190 LPRINT : LPRINT " 6. FO=";FO;"MHZ", " : TRANSMITTED FREQ."
2200 LPRINT : LPRINT " 7. F1f=";F1f;"MHZ", " : IF FREQUENCY"
2210 LPRINT : LPRINT " 8. B1f=";B1f;"MHZ", " : IF BANDWIDTH"
2220 LPRINT : LPRINT " 9. G=";G;"db", " : ANTENNA POWER GAIN"
2230 LPRINT : LPRINT " 10. M.D.S=";M.D.S;"dbm", " : MIN. DETECTABLE SIGNAL"
2240 RETURN
2250*****
2260 ' SUBROUTINE THAT PRINTS PART 1:
2270*****
2280 LPRINT : LPRINT : LPRINT " PART 1:"
2290 LPRINT "-----"
2300 LPRINT : LPRINT " 1. Pav=Pp*Fp*T=";Pav;"Kw", " : AVERAGE OUTPUT POWER"
2310 RETURN
2320*****
2330 ' SUBROUTINE THAT PRINTS PART 2:
2340*****
2350 LPRINT : LPRINT : LPRINT " PART 2:"
2360 LPRINT "-----"
2370 LPRINT : LPRINT " 2(a). Pn=K*T0*B1f=";Pn;"W", " OR ";CINT(Pn2);"dbm", " : NOISE POWER"
2380 IF (Pn2>M.D.S) THEN GOTO 2410 ELSE 2390
2390 IF (Pn2<M.D.S) THEN GOTO 2420 ELSE 2400
2400 IF (Pn2=M.D.S) THEN GOTO 2430
2410 LPRINT : LPRINT " 2(b). THE NOISE POWER IS GREATER THAN THE M.D.S" : GOTO 2440
2420 LPRINT : LPRINT " 2(b). THE NOISE POWER IS SMALLER THAN THE M.D.S" : GOTO 2440
2430 LPRINT : LPRINT " 2(b). THE NOISE POWER IS EQUAL THE M.D.S"

```

```

2440 LPRINT : LPRINT " 2(c).  $(Vt^2)/(2Y0)=ln(Tf0*B1f)=$  ;CSNG(A);"db"; " : R.M.S THRESHOLD
POWER TO NOISE RATIO"
2450 LPRINT : LPRINT TAB(55); "IF NO PULSE INTEGRATION IS PERFORMED"
2460 RETURN
2470*****
2480 ' SUBROUTINE THAT PRINTS PART 3:
2490*****
2500 LPRINT : LPRINT : LPRINT " PART 3:"
2510 LPRINT "-----"
2520 LPRINT : LPRINT " 3(a). Sc= ;Sc;"sq. m"; " : TARGET CROSS SECTION"
2530 LPRINT : LPRINT " 3(b). Pd= ;Pd, " : PROBABILITY OF DETECTION"
2540 LPRINT : LPRINT " 3(c). n= ;n, " : # OF INTEGRATED PULSES"
2550 LPRINT : LPRINT " 3(d). YOUR MODEL IS IN CASE4, " : SWERLING MODEL"
2560 LPRINT : LPRINT " 3(e). Pfa= 1/(Tf0*B1f)= ;Pfa, " : PROBABILITY OF FALSE ALARM"
2570 LPRINT : LPRINT " 3(f). (S/N)1= ;S1;"db"; " : (S/N)1 FOR ONE PULSE INTEGRATED FROM Fig
2.7"
2580 LPRINT : LPRINT " 3(g). (S/N)1ed= ;S2;"db"; " : ADDITIONAL (S/N) FROM Fig. 2.7"
2590 LPRINT : LPRINT " 3(h). (S/N)1tot= ;S3;"db"; " : TOTAL (S/N) FROM Fig. 2.23"
2600 LPRINT : LPRINT " 3(i). I1(n)= ;I;"db"; " : INTEGR. IMR. FACTOR FOR 30 PULSES FROM Fig.
2.24"
2610 LPRINT : LPRINT " 3(k). (S/N)30=(S/N)tot/I1(n)= ;S4;"db"; " : THE MIN. (S/N) REQUIRED TO
ACHIEVE Pd=0.5"
2620 RETURN
2630*****
2640 ' SUBROUTINE THAT PRINTS PART 4:
2650*****
2660 LPRINT : LPRINT : LPRINT " PART 4:"
2670 LPRINT "-----"
2680 LPRINT : LPRINT " 4(a). (S/N)min= ;S;"db"
2690 LPRINT : LPRINT " 4(b). Ls= ;Ls;"db"; " : TOTAL SYSTEM LOSSES"
2700 LPRINT : LPRINT " 4(c).
R=(Pp*(G^2)*(1^2)*Sc/(((4*PI)^3)*(K*TO*F*BIF)*(S/N)min*Ls))^(1/4)= ;CSNG(R/1000);"KM";
MAX.RANGE"
2710 RETURN
2720*****

```

2730 * SUBROUTINE THAT PRINTS PART 5:

2740*****

2750 LPRINT : LPRINT : LPRINT " PART 5:"

2760 LPRINT "-----"

2770 LPRINT : LPRINT " 5(a). R1=";R1;"KM"; " : MIN. RADAR RANGE"

2780 LPRINT : LPRINT " 5(b). TR=(2*R1*1000/C)-T=";TR*10⁶;"micsec"; " : RECOVERY TIME"

2790 RETURN

PROBLEM#7

G I V E N

1. $P_p = 200 \text{ Kw}$: PEAK POWER
2. $F_p = 300 \text{ HZ}$: P.R.F
3. $T = 60 \text{ micsec}$: PULSE WIDTH
4. $T_{fa} = 2.2 \text{ Hrs}$: FALSE ALARM TIME
5. $F = 6.5 \text{ db}$: RECEIVER NOISE FIGURE
6. $F_0 = 400 \text{ MHZ}$: TRANSMITTED FREQ.
7. $F_{if} = 120 \text{ MHZ}$: IF FREQUENCY
8. $B_{if} = 1.25 \text{ MHZ}$: IF BANDWIDTH
9. $G = 21 \text{ db}$: ANTENNA POWER GAIN
10. $M.D.S = -115 \text{ dbm}$: MIN. DETECTABLE SIGNAL

PART 1 :

1. $P_{av} = P_p * F_p * T = 3.6 \text{ Kw}$: AVERAGE OUTPUT POWER

PART 2 :

- 2(a). $P_n = K * T_0 * B_{if} = 5.0025 \text{d} - 15 \text{ W}$ OR -113 dbm : NOISE POWER
- 2(b). THE NOISE POWER IS GREATER THAN THE M.D.S
- 2(c). $(V_t^2) / (2Y_0) = \ln(T_{fa} * B_{if}) = 13.6203 \text{ db}$: R.M.S THRESHOLD POWER TO NOISE RATIO
IF NO PULSE INTEGRATION IS PERFORMED

PART 3 :

- 3(a). $S_c = 1 \text{ sq. m}$: TARGET CROSS SECTION
- 3(b). $P_d = .5$: PROBABILITY OF DETECTION
- 3(c). $n = 30$: # OF INTEGRATED PULSES
- 3(d). YOUR MODEL IS IN CASE 4 : SWERLING MODEL
- 3(e). $P_{fa} = 1 / (T_{fa} * B_{if}) = 1E-10$: PROBABILITY OF FALSE ALARM
- 3(f). $(S/N)_1 = 13.6 \text{ db}$: (S/N)1 FOR ONE PULSE INTEGRATED FROM Fig 2.7
- 3(g). $(S/N)_{1ad} = 1 \text{ db}$: ADDITIONAL (S/N)
- 3(h). $(S/N)_{1tot} = 14.6 \text{ db}$: TOTAL (S/N)

PART 4:

4(a). $(S/N)_{min} = 4 \text{ db}$

4(b). $L_s = 1 \text{ db}$: TOTAL SYSTEM LOSSES

4(c). $R = (P_p \cdot (G^2) \cdot (1^2) \cdot S_c / (((4 \cdot \pi)^3) \cdot (K \cdot T_0 \cdot F \cdot BIF) \cdot (S/N)_{min} \cdot L_s))^{(1/4)} = 59.7151 \text{ KM}$:
RANGE

PART 5:

5(a). $R_1 = 10.5 \text{ KM}$: MIN. RADAR RANGE

5(b). $TR = (2 \cdot R_1 \cdot 1000 / C) - T = 10 \text{ micsec}$: RECOVERY TIME

```

10 PRINT : PRINT TAB(30); " PROBLEM #8"
20 PRINT TAB (30); " -----"
30 LPRINT : LPRINT TAB(30); " PROBLEM #8"
40 LPRINT TAB (30); " -----"
50 GOSUB 120 : GOSUB 490
60 GOSUB 650 : GOSUB 790
70 PRINT : PRINT " DO YOU WANT TO TRY AGAIN FOR DIFFERENT OR THE SAME DATA Y/N?"
80 INPUT A$
90 IF LEFT$(A$,1)="Y" OR LEFT$(A$,1)="y" THEN 50
100 END
110 *****
120 *   INPUTS THE DATA   *
130 *****
140 PRINT : PRINT " ENTER THE OPERATING FREQ. f IN GHZ"
150 INPUT f : PRINT : PRINT " 1. f=";f;"GHZ"
160 PRINT : PRINT " ENTER THE P.R.F fp IN HZ"
170 INPUT fp : PRINT : PRINT " 2. fp=";fp;"HZ"
180 PRINT : PRINT " FROM Fig. 13 (SKOLNIK Handbook Pg. 17-16) AND FOR CHAFF YOU CAN FIND"
190 PRINT " THE RANGE OF THE R.M.S VELOCITY SPREAD"
200 PRINT : PRINT " ENTER THE LOWER VALUE Su1 OF THE R.M.S VELOCITY SPREAD IN m/s"
210 INPUT Su1 : PRINT : PRINT " 3. Su1=";Su1;"m/s"
220 PRINT : PRINT " ENTER THE UPPER VALUE Su2 OF THE R.M.S VELOCITY SPREAD IN m/s"
230 INPUT Su2 : PRINT : PRINT " 4. Su2=";Su2;"m/s"
240 PRINT : PRINT " IS THE INPUT DATA CORRECCT Y/N?"
250 INPUT B$
260 IF LEFT$(B$,1)="Y" OR LEFT$(B$,1)="y" THEN 470
270 PRINT : PRINT " WHAT OF THE FOLLOWING DO YOU WANT TO CHANGE?"
280 PRINT : PRINT " 1. THE OPERATING FREQ.?"
290 PRINT : PRINT " 2. THE P.R.F?"
300 PRINT : PRINT " 3. THE LOWER VALUE OF THE R.M.S VELOCITY SPREAD?"
310 PRINT : PRINT " 4. THE UPPER VALUE OF THE R.M.S VELOCITY SPREAD?"
320 INPUT C$
330 IF C$="1" THEN PRINT : PRINT " ENTER THE OPERATING FREQ. f IN GHZ"
340 IF C$="1" THEN INPUT f : PRINT : PRINT " 1. f=";f;"GHZ" : GOTO 410
350 IF C$="2" THEN PRINT : PRINT " ENTER THE P.R.F fp IN HZ"

```

```

360 IF C$="2" THEN INPUT fp : PRINT : PRINT " 2. fp=";fp;"HZ" : GOTO 410
370 IF C$="3" THEN PRINT : PRINT " ENTER THE LOWER VALUE OF THE R.M.S VELOCITY SPREAD
    Su1 IN m/s"
380 IF C$="3" THEN INPUT Su1 : PRINT : PRINT " 3. Su1=";Su1;"m/s" : GOTO 410
390 IF C$="4" THEN PRINT : PRINT " ENTER THE UPPER VALUE OF THE R.M.S VELOCITY SPREAD
    Us2 IN m/s"
400 IF C$="4" THEN INPUT Su2 : PRINT : PRINT " 4. Us2=";Us2;"m/s" : GOTO 410
410 PRINT : PRINT " ISEVERYTHING O.K NOW?"
420 INPUT D$
430 IF LEFT$(D$,1)="Y" OR LEFT$(D$,1)="y" THEN GOTO 470
440 PRINT : PRINT " WHAT DO YOU WANT TO CHANGE AGAIN?"
450 PRINT : PRINT "HIT ANY KEY IN YOUR KEYBOARD AND EVERYTHING WILL WORK FOR YOU"
460 INPUT E$ : GOTO 280
470 RETURN
480*****
490 PRINTS THE INPUT DATA
500*****
510 PRINT : PRINT " G I V E N "
520 PRINT " -----"
530 LPRINT : LPRINT " G I V E N "
540 LPRINT " -----"
550 PRINT : PRINT " 1. f=";f;"GHZ"TAB(20);" : OPERATING FREQUENCY"
560 LPRINT : LPRINT " 1. f=";f;"GHZ"TAB(20);" : OPERATING FREQUENCY"
570 PRINT : PRINT " 2. fp=";fp;"HZ"TAB(20);" : P.R.F"
580 LPRINT : LPRINT " 2. fp=";fp;"HZ"TAB(20);" : P.R.F"
590 PRINT : PRINT " 3. Su1=";Su1;"m/s"TAB(20);" : LOWER VALUE OF THE R.M.S VELOCITY
    SPREAD"
600 LPRINT : LPRINT " 3. Su1=";Su1;"m/s"TAB(20);" : LOWER VALUE OF THE R.M.S VELOCITY
    SPREAD"
610 PRINT : PRINT " 4. Su2=";Su2;"m/s"TAB(20);" : UPPER VALUE OF THE R.M.S VELOCITY
    SPREAD"
620 LPRINT : LPRINT " 4. Su2=";Su2;"m/s"TAB(20);" : UPPER VALUE OF THE R.M.S VELOCITY
    SPREAD"
630 RETURN
640*****

```

```

650   CALCULATIONS
660*****
670 LET f=f*10^9           'conversion from GHz to Hz
680 LET C=3*10^8           'm/s
690 LET PI=3.14159
700 LET a1=C^2/(8*Su1^2)   'parameter dependent upon clutter
710 LET a2=C^2/(8*Su2^2)   'parameter dependent upon clutter
720 LET I2c1=a1^2*fp^4/(2*PI^4*f^4) 'improvement factor
730 LET I2c2=a2^2*fp^4/(2*PI^4*f^4) 'improvement factor
740 LET M=.4342945*
750 LET I2c1=CINT(10*M*LOG(I2c1))      'conversion from numeric to db
760 LET I2c2=CINT(10*M*LOG(I2c2))      'conversion from numeric to db
770 RETURN
780*****
790   PRINTS THE OUTPUT
800*****
810 PRINT:PRINT " OUTPUT"
820 PRINT " -----"
830 LPRINT:LPRINT " OUTPUT"
840 LPRINT " -----"
850 PRINT:PRINT " 1. a1=C^2/(8*Su1^2)=",a1,"; PARAMETER DEPENDENT UPON CLUTTER"
860 LPRINT:LPRINT " 1. a1=C^2/(8*Su1^2)=",a1,"; PARAMETER DEPENDENT UPON CLUTTER"
870 PRINT:PRINT " 2. a2=C^2/(8*Su2^2)=",a2,"; PARAMETER DEPENDENT UPON CLUTTER"
880 LPRINT:LPRINT " 2. a2=C^2/(8*Su2^2)=",a2,"; PARAMETER DEPENDENT UPON CLUTTER"
890 PRINT:PRINT " 3. I2c1=a1*fp^4/(2*PI^4*f^4)=",I2c1,"db"; " IMPROVEMENT FACTOR"
900 LPRINT:LPRINT " 3. I2c1=a1*fp^4/(2*PI^4*f^4)=",I2c1,"db"; " IMPROVEMENT FACTOR"
910 PRINT:PRINT " 4. I2c2=a2*fp^4/(2*PI^4*f^4)=",I2c2,"db"; " IMPROVEMENT FACTOR"
920 LPRINT:LPRINT " 4. I2c2=a2*fp^4/(2*PI^4*f^4)=",I2c2,"db"; " IMPROVEMENT FACTOR"
930 PRINT:PRINT " THE IMPROVEMENT FACTOR IS FROM";I2c1,"db"; " TO";I2c2,"db"
940 LPRINT:LPRINT " THE IMPROVEMENT FACTOR IS FROM";I2c1,"db"; " TO";I2c2,"db"
950 RETURN

```

PROBLEM #8

GIVEN

1. $f = 6 \text{ GHz}$: OPERATING FREQUENCY
2. $f_p = 1000 \text{ Hz}$: P.R.F
3. $Su_1 = .4 \text{ m/s}$: LOWER VALUE OF THE R.M.S VELOCITY SPREAD
4. $Su_2 = 1 \text{ m/s}$: UPPER VALUE OF THE R.M.S VELOCITY SPREAD

OUTPUT

1. $a_1 = C^2 / (8 * Su_1^2) = 7.03125D+16$: PARAMETER DEPENDENT UPON CLUTTER
 2. $a_2 = C^2 / (8 * Su_2^2) = 1.125D+16$: PARAMETER DEPENDENT UPON CLUTTER
 3. $I_{c1} = a_1 * f_p^4 / (2 * \pi^4 * f^4) = 43 \text{ db}$: IMPROVEMENT FACTOR
 4. $I_{c2} = a_2 * f_p^4 / (2 * \pi^4 * f^4) = 27 \text{ db}$: IMPROVEMENT FACTOR
- **** THE IMPROVEMENT FACTOR IS FROM 43 db TO 27 db ****

```

10 PRINT : PRINT TAB(30); " PROBLEM #9"
20 PRINT TAB (30); " -----"
30 LPRINT : LPRINT TAB(30); " PROBLEM #9"
40 LPRINT TAB (30); " -----"
50 GOSUB 120 : GOSUB 420
60 GOSUB 560 : GOSUB 630
70 PRINT : PRINT " DO YOU WANT TO TRY AGAIN FOR DIFFERENT OR THE SAME DATA Y/N?"
80 INPUT A$
90 IF LEFT$(A$,1)="Y" OR LEFT$(A$,1)="y" THEN 50
100 END
110 *****
120 *   INPUTS THE DATA   *
130 *****
140 PRINT : PRINT " ENTER THE MEAN FREQ. OF THE CLUTTER SPECTRUM IN HZ"
150 INPUT fe : PRINT : PRINT " 1. fe=";fe;"HZ"
160 PRINT : PRINT " ENTER THE P.R.F fp IN HZ"
170 INPUT fp : PRINT : PRINT " 2. fp=";fp;"HZ"
180 PRINT : PRINT " ENTER THE R.M.S CLUTTER SPREAD Sc IN HZ"
190 INPUT Sc : PRINT : PRINT " 3. Sc=";Sc;"HZ"
200 PRINT : PRINT " IS THE INPUT DATA CORRECCT Y/N?"
210 INPUT B$
220 IF LEFT$(B$,1)="Y" OR LEFT$(B$,1)="y" THEN 400
230 PRINT : PRINT " WHAT OF THE FOLLOWING DO YOU WANT TO CHANGE?"
240 PRINT : PRINT " 1. THE MEAN FREQ. OF THE CLUTTER SPECTRUM?"
250 PRINT : PRINT " 2. THE P.R.F?"
260 PRINT : PRINT " 3. THE R.M.S CLUTTER SPREAD?"
270 INPUT C$
280 IF C$="1" THEN PRINT : PRINT " ENTER THE MEAN FREQ. OF THE CLUTTER SPECTRUM fe IN
    HZ"
290 IF C$="1" THEN INPUT fe : PRINT : PRINT " 1. fe=";fe;"HZ" : GOTO 340
300 IF C$="2" THEN PRINT : PRINT " ENTER THE P.R.F fp IN HZ"
310 IF C$="2" THEN INPUT fp : PRINT : PRINT " 2. fp=";fp;"HZ" : GOTO 340
320 IF C$="3" THEN PRINT : PRINT " ENTER THE R.M.S CLUTTER SPREAD Sc IN HZ"
330 IF C$="3" THEN INPUT Sc : PRINT : PRINT " 3. Sc=";Sc;"HZ" : GOTO 340
340 PRINT : PRINT " ISEVERYTHING O.K NOW?"

```

```

350 INPUT D$
360 IF LEFT$(D$,1)="Y" OR LEFT$(D$,1)="y" THEN GOTO 400
370 PRINT : PRINT "WHAT DO YOU WANT TO CHANGE AGAIN?"
380 PRINT : PRINT "HIT ANY KEY IN YOUR KEYBOARD AND EVERYTHING WILL WORK FOR YOU"
390 INPUT E$: GOTO 230
400 RETURN
410*****
420 PRINTS THE INPUT DATA
430*****
440 PRINT : PRINT "G I V E N"
450 PRINT "-----"
460 LPRINT : LPRINT "G I V E N"
470 LPRINT "-----"
480 PRINT : PRINT "1. fe=";fe;"HZ"TAB(20);" : MEAN FREQUENCY OF THE CLUTTER SPECTRUM"
490 LPRINT : LPRINT "1. fe=";fe;"HZ"TAB(20);" : MEAN FREQUENCY OF THE CLUTTER SPECTRUM"
500 PRINT : PRINT "2. fp=";fp;"HZ"TAB(20);" : P.R.F"
510 LPRINT : LPRINT "2. fp=";fp;"HZ"TAB(20);" : P.R.F"
520 PRINT : PRINT "3. Sc=";Sc;"HZ"TAB(20);" : R.M.S CLUTTER SPREAD"
530 LPRINT : LPRINT "3. Sc=";Sc;"HZ"TAB(20);" : R.M.S CLUTTER SPREAD"
540 RETURN
550*****
560 CALCULATIONS
570*****
590 LET F1=Sc/fp 'r.m.s clutter spread/pulse rep.freq.
600 LET F2=fe/fp 'mean freq. of the clutter spectrum/pulse rep. freq.
610 RETURN
620*****
630 PRINTS THE OUTPUT
640*****
650 PRINT : PRINT : PRINT "OUTPUT"
660 PRINT "-----"
670 LPRINT : LPRINT : LPRINT "OUTPUT"
680 LPRINT "-----"
690 PRINT : PRINT "1. Sc/fp=";F1;" : R.M.S CLUTTER SPREAD/P.R.F"
700 PRINT : PRINT "2. fe/fp=";F2;" : MEAN FREQ. OF THE CLUTTER SPECTRUM/P.R.F"

```

```

710 LPRINT : LPRINT " 1.  $S_c/f_p =$ ; F1; " : R.M.S CLUTTER SPREAD/P.R.F"
720 LPRINT : LPRINT " 2.  $f_e/f_p =$  F2; " : MEAN FREQ. OF THE CLUTTER SPECTRUM/P.R.F"
730 PRINT : PRINT " SINCE YOU KNOW THAT  $S_c/f_p =$ ; F1; " AND " ;  $f_e/f_p =$ ; F2
740 PRINT : PRINT " FROM FIG. 4.34 (SKOLNIK Pg. 141) YOU CAN FIND THE IMR. FACTOR IN db"
750 PRINT : PRINT " ENTER THE VALUE OF THE IMR. FACTOR"
760 INPUT I
770 PRINT : PRINT " 3. I = ; I; "db; " : REDUCTION OF THE IMR. FACTOR FOR THE NEAR IDEAL CASE,"
780 PRINT : PRINT TAB(16); "ASSUMING A THREE PULSE CANCELER"
790 LPRINT : LPRINT " 3. I = ; I; "db; " : REDUCTION OF THE IMR. FACTOR FOR THE NEAR IDEAL
CASE,"
800 LPRINT : LPRINT TAB(19); "ASSUMING A THREE PULSE CANCELER"
810 RETURN

```

PROBLEM #9

GIVEN

1. $f_e = 30 \text{ Hz}$: MEAN FREQUENCY OF THE CLUTTER SPECTRUM
2. $f_p = 300 \text{ Hz}$: P.R.F
3. $S_c = 3 \text{ Hz}$: R.M.S CLUTTER SPREAD

OUTPUT

1. $S_c/f_p = .01$: R.M.S CLUTTER SPREAD/P.R.F
2. $f_e/f_p = .1$: MEAN FREQ. OF THE CLUTTER SPECTRUM/P.R.F
3. $I = 24 \text{ db}$: REDUCTION OF THE IMR. FACTOR FOR THE NEAR IDEAL CASE,
ASSUMING A THREE PULSE CANCELER

```

10 PRINT :PRINT TAB(30); " PROBLEM # 10"
20 PRINT TAB (30); " -----"
30 GOSUB 100 : GOSUB 500
40 GOSUB 700 : GOSUB 880
50 PRINT : PRINT " DO YOU WANT TO TRY AGAIN FOR DIFFERENT OR THE SAME DATA Y/N?"
60 INPUT A$
70 IF LEFT$(A$,1)="Y" OR LEFT$(A$,1)="y" THEN 30
80 END
90 *****
100 *   INPUTS THE DATA   *
110 *****
120 PRINT : PRINT " ENTER THE OPERATING FREQ. f0 IN MHZ"
130 INPUT f0 : PRINT : PRINT " 1. f0=";f0;"MHZ"
140 PRINT : PRINT " ENTER THE SCAN ANGLE OFF ,ANTENNA CENTER AXIS THs IN Deg."
150 INPUT THs : PRINT : PRINT " 2. THs=";THs;"Deg."
160 PRINT : PRINT " ENTER THE SEPARATION BETWEEN THE TWO ADJACENT ARRAY ELEMENTS d1
    IN cm"
170 INPUT d1 : PRINT : PRINT "3. d1=";d1;"cm"
180 PRINT : PRINT " ENTER THE DIAMETER OF THE PHASE ARRAY ANTENNA d IN m"
190 INPUT d : PRINT : PRINT " 4. d=";d;"m"
200 PRINT : PRINT " ENTER THE OFF CENTER ANGLE WHERE THE ANTENNA IS STEERED TH0 IN
    Deg."
210 INPUT TH0 : PRINT : PRINT "5. TH0=";TH0;"Deg."
220 PRINT : PRINT " IS THE INPUT DATA CORRECT Y/N?"
230 INPUT B$
240 IF LEFT$(B$,1)="Y" OR LEFT$(B$,1)="y" THEN 480
250 PRINT : PRINT " WHAT OF THE FOLLOWING DO YOU WANT TO CHANGE?"
260 PRINT : PRINT " 1. THE OPERATING FREQ?"
270 PRINT : PRINT " 2. THE SCAN ANGLE OFF ,ANTENNA CENTER AXIS?"
280 PRINT : PRINT " 3. THE SEPARATION BETWEEN THE TWO ADJACENT ARRAY ELEMENTS?"
290 PRINT : PRINT " 4. THE DIAMETER OF THE PHASE ARRAY ANTENNA?"
300 PRINT : PRINT " 5. THE OFF CENTER ANGLE WHERE THE ANTENNA IS STEERED?"
310 INPUT C$
320 IF C$="1" THEN PRINT : PRINT " ENTER THE OPERATING FREQ. IN MHZ"
330 IF C$="1" THEN INPUT f0 : PRINT : PRINT " 1. f0=";f0;"MHZ" : GOTO 420
340 IF C$="2" THEN PRINT : PRINT " ENTER THE SCAN ANGLE OFF ,ANTENNA CENTER AXIS THs IN
    Deg."
350 IF C$="2" THEN INPUT THs : PRINT : PRINT " 2. THs=";THs;"Deg." : GOTO 420
360 IF C$="3" THEN PRINT : PRINT " ENTER THE SEPARATION BETWEEN THE TWO ADJACENT

```

```

ARRAYELEMENTS d1 IN cm"
370 IF C$="3" THEN INPUT d1:PRINT:PRINT " 3. d1=";d1;"cm":GOTO 420
380 IF C$="4" THEN PRINT:PRINT " ENTER THE DIAMETER OF THE PHASE ARRAY ANTENNA d IN
m"
390 IF C$="4" THEN INPUT d:PRINT:PRINT " 4. d=";d;"m":GOTO 420
400 IF C$="5" THEN PRINT:PRINT " ENTER THE OFF CENTER ANGLE WHERE THE ANTENNA IS
STEERED TH0 IN Deg."
410 IF C$="5" THEN INPUT TH0:PRINT:PRINT "5ITH0=";TH0;"Deg.":GOTO 420
420 PRINT:PRINT " IS EVERYTHING O.K NOW?"
430 INPUT D$
440 IF LEFT$(D$,1)="Y" OR LEFT$(D$,1)="y" THEN GOTO 480
450 PRINT:PRINT " WHAT DO YOU WANT TO CHANGE AGAIN?"
460 PRINT:PRINT " HIT ANY KEY IN YOUR KEYBOARD AND EVERYTHING WILL WORK FOR YOU"
470 INPUT E$:GOTO 260
480 RETURN
490*****
500 PRINTS THE INPUT DATA
510*****
520 PRINT:PRINT " G I V E N"
530 PRINT "-----"
540 PRINT:PRINT " 1. f0=";f0;"MHZ", " : OPERATING FREQUENCY"
550 PRINT:PRINT " 2. THs=";THs;"Deg.", " : SCAN ANGLE OFF ,ANTENNA CENTER AXIS"
560 PRINT:PRINT " 3. d1=";d1;"cm", " : SEPARATION BETWEEN THE TWO ADJACENT
ARRAYELEMENTS"
570 PRINT:PRINT " 4. d=";d;"m", " : DIAMETER OF THE PHASE ARRAY ANTENNA"
580 PRINT:PRINT " 5. TH0=";TH0,"Deg.", " : THE OFF CENTER ANGLE WHERE THE ANTENNA IS
STEERED"
590 LPRINT:LPRINT TAB(30);" PROBLEM # 10"
600 LPRINT TAB(30);"-----"
610 LPRINT:LPRINT " G I V E N"
620 LPRINT "-----"
630 LPRINT:LPRINT " 1. f0=";f0;"MHZ", " : OPERATING FREQUENCY"
640 LPRINT:LPRINT " 2. THs=";THs;"Deg.", " : SCAN ANGLE OFF ,ANTENNA CENTER AXIS"
650 LPRINT:LPRINT " 3. d1=";d1;"cm", " : SEPARATION BETWEEN THE TWO ADJACENT
ARRAYELEMENTS"
660 LPRINT:LPRINT " 4. d=";d;"m", " : DIAMETER OF THE PHASE ARRAY ANTENNA"
670 LPRINT:LPRINT " 5. TH0=";TH0,"Deg.", " : THE OFF CENTER ANGLE WHERE THE ANTENNA IS
STEERED"
680 RETURN

```

```

690*****
700  '   CALCULATION FOR PART 1 :
710*****
720 LET PI=3.141593#
730 LET C=3*10^8
740 LET f0=10*10^6
750 LET l=C/f0
760 LET d1=d1/100
770 LET PHI=2*PI*(d1/l)*SIN(TH0*PI/180)
780 LET PHI1=180*PHI/PI      'Deg.
790*****
800  '   CALCULATION FOR PART 2 :
810*****
820 LET K=.866
830 LET N=1
840 LET B.W=K*1/(N*d*(COS(TH0*PI/180)))
850 LET B.W1=180*B.W/PI      'Deg.
860 RETURN
870*****
880  '   PRINTOUT FOR PART 1 and PART 2
890*****
900 PRINT:PRINT:PRINT " PART 1:"
910 PRINT "-----"
920 LPRINT:LPRINT:LPRINT " PART 1:"
930 LPRINT "-----"
940 PRINT:PRINT " 1. PHI=2*PI*(d/l)*SIN(TH0)=",CSNG(PHI),"rad";" OR ";CSNG(PHI1),"Deg.;"
   : PHASE DIFFERENCE BETWEEN TWO ARRAY ELEMENTS"
950 LPRINT:LPRINT " 1. PHI=2*PI*(d/l)*SIN(TH0)=",CSNG(PHI),"rad";" OR ";CSNG(PHI1),"Deg.;"
   : PHASE DIFFERENCE BETWEEN TWO ARRAY ELEMENTS"
960 PRINT:PRINT:PRINT " PART 2:"
970 PRINT "-----"
980 LPRINT:LPRINT:LPRINT " PART 2:"
990 LPRINT "-----"
1000 PRINT:PRINT " 2. B.W=K*1/(N*d1*COS(TH0))=",CSNG(B.W),"rad";" OR ";CSNG(B.W1),"Deg.;"
   : BEAMWIDTH AT 10 Deg. FOR THE SAME OUTPUT OF ARRAY ELEMENT"
1010 LPRINT:LPRINT " 2. B.W=K*1/(N*d1*COS(TH0))=",CSNG(B.W),"rad";" OR
   : CSNG(B.W1),"Deg.;" : BEAMWIDTH AT 10 Deg. FOR THE SAME OUTPUT OF ARRAY ELEMENT"
1020 RETURN

```

PROBLEM # 10

G I V E N

1. $f_0 = 1250$ MHz : OPERATING FREQUENCY
2. $\theta_s = 60$ Deg. : SCAN ANGLE OF ANTENNA CENTER AXIS
3. $d_1 = 20$ cm : SEPARATION BETWEEN THE TWO ADJACENT ARRAY ELEMENTS
4. $d = 29$ m : DIAMETER OF THE PHASE ARRAY ANTENNA
5. $\theta_0 = 10$ Deg. : THE OFF CENTER ANGLE WHERE THE ANTENNA IS STEERED

PART 1:

1. $\phi = 2 * \pi * (d_1 / \lambda) * \sin(\theta_0) = .90922$ rad OR 52.0945 Deg. : PHASE DIFFERENCE BETWEEN TWO ARRAY ELEMENTS

PART 2:

2. $B.W = k * 1 / (N * d_1 * \cos(\theta_0)) = 7.27746E-03$ rad OR $.416968$ Deg. : BEAMWIDTH AT 10 Deg. FOR THE SAME OUTPUT OF ARRAY ELEMENT

```

10 PRINT : PRINT TAB(30) " PROBLEM #11 "
20 PRINT TAB(30); " -----"
30 GOSUB 100 : GOSUB 840
40 GOSUB 1210
50 PRINT : PRINT " DO YOU WANT TO TRY AGAIN FOR DIFFERENT OR THE SAME DATA Y/N?"
60 INPUT D$
70 IF LEFT$(D$,1)="Y" OR LEFT$(D$,1)="y" THEN 30
80 END
90 "*****"
100 INPUTS THE DATA
110 "*****"
120 PRINT : PRINT " ENTER THE ANTENNA GAIN  $G_a$  IN dbi"
130 INPUT  $G_a$  : PRINT : PRINT " 1.  $G_a=$ "; $G_a$ ;"db"
140 PRINT : PRINT " ENTER THE PEAK POWER  $P_t$  IN Mw"
150 INPUT  $P_t$  : PRINT : PRINT " 2.  $P_t=$ "; $P_t$ ;"Mw"
160 PRINT : PRINT " ENTER THE OPERATING FREQ.  $f_o$  IN MHz"
170 INPUT  $f_o$  : PRINT : PRINT " 3.  $f_o=$ "; $f_o$ ;"MHz"
180 PRINT : PRINT " ENTER THE AMBIENT TEMPERATURE  $T_a$  IN KELVIN"
190 INPUT  $T_a$  : PRINT : PRINT " 4.  $T_a=$ "; $T_a$ ;"KELVIN"
200 PRINT : PRINT " ENTER THE RECEIVER BANDWIDTH  $B_n$  IN MHz"
210 INPUT  $B_n$  : PRINT : PRINT " 5.  $B_n=$ "; $B_n$ ;"MHz"
220 PRINT : PRINT " ENTER THE TARGET RADAR CROSS SECTION  $S$  IN sq.m"
230 INPUT  $S$  : PRINT : PRINT " 6.  $S=$ "; $S$ ;"sq.m"
240 PRINT : PRINT " ENTER THE RECEIVER NOISE FIGURE  $F$  IN db"
250 INPUT  $F$  : PRINT : PRINT " 7.  $F=$ "; $F$ ;"db"
260 PRINT : PRINT " ENTER THE P.R.F  $f_p$  IN Hz"
270 INPUT  $f_p$  : PRINT : PRINT " 8.  $f_p=$ "; $f_p$ ;"Hz"
280 PRINT : PRINT " ENTER THE PULSE LENGTH  $t$  IN microsec."
290 INPUT  $t$  : PRINT : PRINT " 9.  $t=$ "; $t$ ;"microsec."
300 PRINT : PRINT " ENTER THE INTEGRATION IMR. FACTOR  $I_1(n)$  IN db"
310 INPUT  $I_1$  : PRINT : PRINT " 10.  $I_1(n)=$ "; $I_1$ ;"db"
320 PRINT : PRINT " ENTER THE PROBABILITY OF DETECTION  $P_d$ "
330 INPUT  $P_d$  : PRINT : PRINT " 11.  $P_d=$ "; $P_d$ 
340 PRINT : PRINT " ENTER THE FALSE ALARM RATE  $P_{fa}$ "
350 INPUT  $P_{fa}$  : PRINT : PRINT " 12.  $P_{fa}=$ "; $P_{fa}$ 

```

```

360 PRINT : PRINT " ENTER THE SYSTEM LOSSES Ls IN db"
370 INPUT Ls : PRINT : PRINT " 13. Ls=";Ls;"db"
380 PRINT : PRINT " IS THE INPUT DATA CORRECT Y/N?"
390 INPUT A$
400 IF LEFT$(A$,1)="Y" OR LEFT$(A$,1)="y" THEN 620
410 PRINT : PRINT " WHAT OF THE FOLLOWING DO YOU WANT TO CHANGE?"
420 PRINT : PRINT " 1. THE ANTENNA GAIN?," 2. THE PEAK POWER?"
430 PRINT : PRINT " 3. THE OPERATING FREQ.?" 4. THE AMBIENT TEMPERATURE?"
440 PRINT : PRINT " 5. THE RECEIVER BANDWIDTH?," 6. THE TARGET CROSS SECTION?"
450 PRINT : PRINT " 7. THE RECEIVER NOISE FIGURE?," 8. THE P.R.F?"
460 PRINT : PRINT " 9. THE PULSE LENGTH?," 10. THE INTEGRATION IMR. FACTOR?"
470 PRINT : PRINT " 11. THE PROBABILITY OF DETECTION?," 12. THE FALSE ALARM RATE?"
480 PRINT : PRINT " 13. THE SYSTEM LOSSES?"
490 INPUT C$
500 IF C$="1" THEN PRINT : PRINT " ENTER THE ANTENNA GAIN Ga IN dbi"
510 IF C$="1" THEN INPUT Ga : PRINT : PRINT " 1. Ga=";Ga;"dbi" : GOTO 760
520 IF C$="2" THEN PRINT : PRINT " ENTER THE PEAK POWER Pt IN Mw"
530 IF C$="2" THEN INPUT Pt : PRINT : PRINT " 2. Pt=";Pt;"Mw" : GOTO 760
540 IF C$="3" THEN PRINT : PRINT " ENTER THE OPERATING FREQ. fo IN MHZ"
550 IF C$="3" THEN INPUT fo : PRINT : PRINT " 3. fo=";fo;"MHZ" : GOTO 760
560 IF C$="4" THEN PRINT : PRINT " ENTER THE AMBIENT TEMPERATURE Ta IN KELVIN"
570 IF C$="4" THEN INPUT Ta : PRINT : PRINT " 4. Ta=";Ta;"KELVIN" : GOTO 760
580 IF C$="5" THEN PRINT : PRINT " ENTER THE RECEIVER BANDWIDTH Bn IN MHZ"
590 IF C$="5" THEN INPUT Bn : PRINT : PRINT " 5. Bn=";Bn;"MHZ" : GOTO 760
600 IF C$="6" THEN PRINT : PRINT " ENTER THE TARGET RADAR CROSS SECTION S IN sq.m"
610 IF C$="6" THEN INPUT S : PRINT : PRINT " 6. S=";S;"sq.m" : GOTO 760
620 IF C$="7" THEN PRINT : PRINT " ENTER THE RECEIVER NOISE FIGURE F IN db"
630 IF C$="7" THEN INPUT F : PRINT : PRINT " 7. F=";F;"db" : GOTO 760
640 IF C$="8" THEN PRINT : PRINT " ENTER THE P.R.F fp IN Hz"
650 IF C$="8" THEN INPUT fp : PRINT : PRINT " 8. fp=";fp;"Hz" : GOTO 760
660 IF C$="9" THEN PRINT : PRINT " ENTER THE PULSE LENGTH t IN microsec."
670 IF C$="9" THEN INPUT t : PRINT : PRINT " 9. t=";t;"microsec." : GOTO 760
680 IF C$="10" THEN PRINT : PRINT " ENTER THE INTEGRATION IMR. FACTOR I1(n) IN db"
690 IF C$="10" THEN INPUT I1 : PRINT : PRINT " 10. I1(n)=";I1;"db" : GOTO 760
700 IF C$="11" THEN PRINT : PRINT " ENTER THE PROBABILITY OF DETECTION Pd"

```

```

710 IF C$="11" THEN INPUT Pd:PRINT:PRINT " 11. Pd=";Pd:GOTO 760
720 IF C$="12" THEN PRINT:PRINT " ENTER THE FALSE ALARM RATE Pfa"
730 IF C$="12" THEN INPUT Pfa:PRINT:PRINT " 12. Pfa=";Pfa:GOTO 760
740 IF C$="13" THEN PRINT:PRINT " ENTER THE SYSTEM LOSSES Ls IN db"
750 IF C$="13" THEN INPUT Ls:PRINT:PRINT " 13. Ls=";Ls;"db":GOTO 760
760 PRINT:PRINT " IS EVERYTHING O.K NOW?"
770 INPUT B$
780 IF LEFT$(B$,1)="Y" OR LEFT$(B$,1)="y" THEN GOTO 820
790 PRINT:PRINT " WHAT DO YOU WANT TO CHANGE AGAIN?"
800 PRINT:PRINT " HIT ANY KEY IN YOUR KEYBOARD AND EVERYTHING WILL WORK FOR YOU
MALAKA"
810 INPUT F$:GOTO 410
820 RETURN
830 *****
840 PRINTS THE INPUT DATA
850 *****
860 LPRINT:LPRINT TAB(30);" PROBLEM #11"
870 LPRINT TAB(30);" -----"
880 LPRINT:LPRINT " G I V E N"
890 LPRINT " -----"
900 PRINT:PRINT " G I V E N"
910 PRINT " -----"
920 PRINT:PRINT " 1. Ga=";Ga;"db" SPC(9);": ANTENNA GAIN"
930 LPRINT:LPRINT " 1. Ga=";Ga;"db" SPC(9);": ANTENNA GAIN"
940 PRINT:PRINT " 2. Pt=";Pt;"Mw" SPC(10);": PEAK POWER"
950 LPRINT:LPRINT " 2. Pt=";Pt;"Mw" SPC(10);": PEAK POWER"
960 PRINT:PRINT " 3. fo=";fo;"MHz" SPC(7);": OPERATING FREQ."
970 LPRINT:LPRINT " 3. fo=";fo;"MHz" SPC(7);": OPERATING FREQ."
980 PRINT:PRINT " 4. To=";To;"KELVIN" SPC(5);": AMBIENT FREQ."
990 LPRINT:LPRINT " 4. To=";To;"KELVIN" SPC(5);": AMBIENT FREQ."
1000 PRINT:PRINT " 5. Bn=";Bn;"MHz" SPC(9);": RECEIVER BANDWIDTH"
1010 LPRINT:LPRINT " 5. Bn=";Bn;"MHz" SPC(9);": RECEIVER BANDWIDTH"
1020 PRINT:PRINT " 6. S=";S;"sq.m" SPC(9);": TARGET RADAR CROSS SECTION"
1030 LPRINT:LPRINT " 6. S=";S;"sq.m" SPC(9);": TARGET RADAR CROSS SECTION"
1040 PRINT:PRINT " 7. F=";F;"db" SPC(10);": RECEIVER NOISE FIGURE"

```

```

1050 LPRINT : LPRINT " 7. F=";F;"db" SPC(10); " : RECEIVER NOISE FIGURE"
1060 PRINT : PRINT " 8. fp=";fp;"Hz" SPC(8); " : P.R.F"
1070 LPRINT : LPRINT " 8. fp=";fp;"Hz" SPC(8); " : P.R.F"
1080 PRINT : PRINT " 9. t=";t;"microsec." SPC(4); " : PULSE LENGTH"
1090 LPRINT : LPRINT " 9. t=";t;"microsec." SPC(4); " : PULSE LENGTH"
1100 PRINT : PRINT " 10. I1(n)=";I1;"db" SPC(3); " : INTEGRATION IMR. FACTOR"
1110 LPRINT : LPRINT " 10. I1(n)=";I1;"db" SPC(3); " : INTEGRATION IMR. FACTOR"
1120 PRINT : PRINT " 11. Pd=";Pd SPC(10); " : PROBABILITY OF DETECTION"
1130 LPRINT : LPRINT " 11. Pd=";Pd SPC(10); " : PROBABILITY OF DETECTION"
1140 PRINT : PRINT " 12. Pfa=";Pfa; " : FALSE ALARM RATE"
1150 LPRINT : LPRINT " 12. Pfa=";Pfa; " : FALSE ALARM RATE"
1160 PRINT : PRINT " 13. Ls=";Ls;"db" SPC(9); " : SYSTEM LOSSES"
1180 LPRINT : LPRINT " 13. Ls=";Ls;"db" SPC(9); " : SYSTEM LOSSES"
1190 RETURN
1200 *****
1210 ' CALCULATION & PRINTOUT
1220 *****
1230 PRINT : PRINT : PRINT " OUTPUT"
1240 PRINT " -----"
1250 LPRINT : LPRINT : LPRINT " OUTPUT"
1260 LPRINT " -----"
1270 LET C=3*10^8
1280 LET fo=fo*10^6
1290 LET I=C/fo
1300 LET K=1.38*10^-23
1310 LET T=290
1320 LET PI=3.14159
1330 LET Pt=Pt*10^6
1340 LET Bn=Bn*10^6
1350 LET M=.4342945*
1360 PRINT : PRINT " FROM Fig. 2.7 (Skolnik Pg. 28) YOU CAN FIND THE (S/N) I SINCE YOU KNOW
:
1370 PRINT : PRINT " Pd=";Pd, "&,"Pfa=";Pfa
1380 PRINT : PRINT " ENTER THE (S/N) I SN IN db"
1390 INPUT SN

```

```

1400 LET Pt=10*M*LOG(Pt) : I=10*M*LOG(I) : S=10*M*LOG(S)
1410 LET SUM1=Pt+2*Ge+2*I+I+S
1420 LET Bn=10*M*LOG(Bn)
1430 LET A=(4*PI)^3 : A=10*M*LOG(A)
1440 LET B=K*T : B=10*M*LOG(B)
1450 LET SUM2=A+B+Bn+F+SN+Ls
1460 LET Rmax=(SUM1-SUM2)/4 : Rmax=Rmax/10 : Rmax=10^Rmax
1470 PRINT : PRINT : PRINT " Rmax=";CSNG(Rmax/1000);"Km"; " or";
      CSNG(Rmax/(1000*1.85));"n. miles"; " : MAX. RADAR RANGE"
1480 LPRINT : LPRINT : LPRINT " Rmax=";CSNG(Rmax/1000);"Km"; " or";
      CSNG(Rmax/(1000*1.85));"n. miles"; " : MAX. RADAR RANGE"
1490 RETURN

```

PROBLEM #11

GIVEN

1. $G_a = 21$ db : ANTENNA GAIN
2. $P_t = 2$ MW : PEAK POWER
3. $f_o = 500$ MHz : OPERATING FREQ.
4. $T_a = 62$ KELVIN : AMBIENT FREQ.
5. $B_n = 1$ MHz : RECEIVER BANDWIDTH
6. $S = 5$ sq.m : TARGET RADAR CROSS SECTION
7. $F = 10$ db : RECEIVER NOISE FIGURE
8. $f_p = 300$ Hz : P.R.F
9. $t = 3$ microsec. : PULSE LENGTH
10. $I I(n) = 16.5$ db : INTEGRATION IMR. FACTOR
11. $P_d = .9$: PROBABILITY OF DETECTION
12. $P_{fa} = .1E-12$: FALSE ALARM RATE
13. $L_s = 6$ db : SYSTEM LOSSES

OUTPUT

$R_{max} = 123.481$ Km or 66.7464 n. miles : MAX. RADAR RANGE

```

10 PRINT : PRINT TAB(30) " PROBLEM #12 "
20 PRINT TAB(30); " -----"
30 GOSUB 100 : GOSUB 1040 : GOSUB 1380 : GOSUB 1490
40 GOSUB 1690 : GOSUB 1840 : GOSUB 1950 : GOSUB 2110
50 PRINT : PRINT " DO YOU WANT TO TRY AGAIN FOR DIFFERENT OR THE SAME DATA Y/N?"
60 INPUT D$
70 IF LEFT$(D$,1)="Y" OR LEFT$(D$,1)="y" THEN 20
80 END
90 *****
100 INPUTS THE DATA
110 *****
120 PRINT : PRINT " ENTER THE OPERATING FREQ. fo IN MHz"
130 INPUT fo : PRINT : PRINT " 1. fo=";fo;"MHz"
140 PRINT : PRINT " ENTER THE PEAK POWER Pt IN KW"
150 INPUT Pt : PRINT : PRINT " 2. Pt=";Pt;"KW"
160 PRINT : PRINT " ENTER THE P.R.F fp IN Hz"
170 INPUT fp : PRINT : PRINT " 3. fp=";fp;"Hz"
180 PRINT : PRINT " ENTER THE PULSE WIDTH t IN microsec."
190 INPUT t : PRINT : PRINT " 4. t=";t;"microsec."
200 PRINT : PRINT " ENTER THE ANTENNA SCAN RATE Wm IN Hz"
210 INPUT Wm : PRINT : PRINT " 5. Wm=";Wm;"Hz"
220 PRINT : PRINT " ENTER THE AZIMUTH BEAMWIDTH A.B IN deg."
230 INPUT A.B : PRINT : PRINT " 6. A.B=";A.B;"deg."
240 PRINT : PRINT " ENTER THE ANTENNA GAIN Ga IN db"
250 INPUT Ga : PRINT : PRINT " 7. Ga=";Ga;"db"
260 PRINT : PRINT " ENTER THE RECEIVER NOISE BANDWIDTH Bn IN MHz"
270 INPUT Bn : PRINT : PRINT " 8. Bn=";Bn;"MHz"
280 PRINT : PRINT " ENTER THE RECEIVER NOISE FIGURE F IN db"
290 INPUT F : PRINT : PRINT " 9. F=";F;"db"
300 PRINT : PRINT " ENTER THE SYSTEM LOSSES Ls IN db"
310 INPUT Ls : PRINT : PRINT " 10. Ls=";Ls;"db"
320 PRINT : PRINT " ENTER THE FALSE ALARM TIME Tfa IN days"
330 INPUT Tfa : PRINT : PRINT " 11. Tfa=";Tfa;"days"
340 PRINT : PRINT " ENTER THE ANTENNA NOISE TEMPERATURE Tθ IN KELVIN"
350 INPUT Tθ : PRINT : PRINT " 12. Tθ=";Tθ;"Kelvin"

```



```

420 PRINT : PRINT " IS THE INPUT DATA CORRECT Y/N?"
430 INPUT A$
440 IF LEFT$(A$,1)="Y" OR LEFT$(A$,1)="y" THEN 1020
450 PRINT : PRINT " WHAT OF THE FOLLOWING DO YOU WANT TO CHANGE?"
460 PRINT : PRINT " 1. THE OPERATING FREQ.?"
470 PRINT : PRINT " 2. THE PEAK POWER?"
480 PRINT : PRINT " 3. THE P.R.F.?"
490 PRINT : PRINT " 4. THE PULSE WIDTH?"
500 PRINT : PRINT " 5. THE ANTENNA SCAN RATE?"
510 PRINT : PRINT " 6. THE AZIMUTH BEAMWIDTH?"
520 PRINT : PRINT " 7. THE ANTENNA GAIN?"
530 PRINT : PRINT " 8. THE RECEIVER NOISE BANDWIDTH?"
540 PRINT : PRINT " 9. THE RECEIVER NOISE FIGURE?"
550 PRINT : PRINT " 10. THE SYSTEM LOSSES?"
560 PRINT : PRINT " 11. THE FALSE ALARM TIME?"
570 PRINT : PRINT " 12. THE ANTENNA NOISE TEMPERATURE?"
580 INPUT C$
590 IF C$="1" THEN PRINT : PRINT " ENTER THE OPERATING FREQ. fo IN MHz"
600 IF C$="1" THEN INPUT fo : PRINT : PRINT " 1. fo=";fo;"MHz" : GOTO 820
610 IF C$="2" THEN PRINT : PRINT " ENTER THE PEAK POWER Pt IN KW"
620 IF C$="2" THEN INPUT Pt : PRINT : PRINT " 2. Pt=";Pt;"KW" : GOTO 820
630 IF C$="3" THEN PRINT : PRINT " ENTER THE P.R.F fp IN Hz"
640 IF C$="3" THEN INPUT fp : PRINT : PRINT " 3. fp=";fp;"Hz" : GOTO 820
650 IF C$="4" THEN PRINT : PRINT " ENTER THE PULSE WIDTH t IN microsec."
660 IF C$="4" THEN INPUT t : PRINT : PRINT " 4. t=";t;"microsec." : GOTO 820
670 IF C$="5" THEN PRINT : PRINT " ENTER THE ANTENNA SCAN RATE Wm IN Hz"
680 IF C$="5" THEN INPUT Wm : PRINT : PRINT " 5. Wm=";Wm;"Hz" : GOTO 820
690 IF C$="6" THEN PRINT : PRINT " ENTER THE AZIMUTH BEAMWIDTH A.B IN deg."
700 IF C$="6" THEN INPUT A.B : PRINT : PRINT " 6. A.B=";A.B;"deg." : GOTO 820
710 IF C$="7" THEN PRINT : PRINT " ENTER THE ANTENNA GAIN Go IN db"
720 IF C$="7" THEN INPUT Go : PRINT : PRINT " 7. Go=";Go;"db" : GOTO 820
730 IF C$="8" THEN PRINT : PRINT " ENTER THE RECEIVER NOISE BANDWIDTH Bn IN MHz"
740 IF C$="8" THEN INPUT Bn : PRINT : PRINT " 8. Bn=";Bn;"MHz" : GOTO 820
750 IF C$="9" THEN PRINT : PRINT " ENTER THE RECEIVER NOISE FIGURE F IN db"
760 IF C$="9" THEN INPUT F : PRINT : PRINT " 9. F=";F;"db" : GOTO 820

```

```

770 IF C$="10" THEN PRINT : PRINT " ENTER THE SYSTEM LOSSES Ls IN db"
780 IF C$="10" THEN INPUT Ls : PRINT : PRINT " 10. Ls=";Ls;"db" : GOTO 820
780 IF C$="11" THEN PRINT : PRINT " ENTER THE FALSE ALARM TIME Tfa IN days"
790 IF C$="11" THEN INPUT Tfa : PRINT : PRINT " 11. Tfa=";Tfa;"days" : GOTO 820
800 IF C$="12" THEN PRINT : PRINT " ENTER THE ANTENNA NOISE TEMPERATURE Ta IN
    KELVIN"
810 IF C$="12" THEN INPUT Ta : PRINT : PRINT " 12. Ta=";Ta;"Kelvin" : GOTO 820
820 PRINT : PRINT " IS EVERYTHING O.K NOW?"
970 INPUT B$
980 IF LEFT$(B$,1)="Y" OR LEFT$(B$,1)="y" THEN GOTO 1020
990 PRINT : PRINT " WHAT DO YOU WANT TO CHANGE AGAIN?"
1000 PRINT : PRINT " HIT ANY KEY IN YOUR KEYBOARD AND EVERYTHING WILL WORK FOR YOU
    MALAKA"
1010 INPUT F$ : GOTO 460
1020 RETURN
1030*****
1040 PRINTS THE INPUT DATA
1050*****
1060 LPRINT : LPRINT TAB(30); " PROBLEM #12"
1070 LPRINT TAB(30); " -----"
1080 LPRINT : LPRINT " G I V E N"
1090 LPRINT " -----"
1100 PRINT : PRINT " G I V E N"
1110 PRINT " -----"
1120 PRINT : PRINT " 1. fo=";fo;"MHz" SPC(7); " : OPERATING FREQ."
1130 LPRINT : LPRINT " 1. fo=";fo;"MHz" SPC(7); " : OPERATING FREQ."
1140 PRINT : PRINT " 2. Pt=";Pt;"KW" SPC(9); " : PEAK POWER"
1150 LPRINT : LPRINT " 2. Pt=";Pt;"KW" SPC(9); " : PEAK POWER"
1160 PRINT : PRINT " 3. fp=";fp;"Hz" SPC(9) " : P.R.F"
1170 LPRINT : LPRINT " 3. fp=";fp;"Hz" SPC(9) " : P.R.F"
1180 PRINT : PRINT " 4. t=";t;"microsec" SPC(4); " : PULSE WIDTH"
1190 LPRINT : LPRINT " 4. t=";t;"microsec" SPC(4); " : PULSE WIDTH"
1200 PRINT : PRINT " 5. Wm=";Wm;"Hz" SPC(10); " : ANTENNA SCAN RATE"
1210 LPRINT : LPRINT " 5. Wm=";Wm;"Hz" SPC(10); " : ANTENNA SCAN RATE"
1220 PRINT : PRINT " 6. A.B=";A.B;"deg." SPC(6); " : AZIMUTH BEAMWIDTH"

```

```

1230 LPRINT : LPRINT " 6. A.B=";A.B;"deg." SPC(6); " : AZIMUTH BEAMWIDTH"
1240 PRINT : PRINT " 7. Ga=";Ga;"db" SPC(10); " : ANTENNA GAIN"
1250 LPRINT : LPRINT " 7. Ga=";Ga;"db" SPC(10); " : ANTENNA GAIN"
1260 PRINT : PRINT " 8. Bn=";Bn;"MHZ" SPC(10); " : RECEIVER NOISE BANDWIDTH"
1270 LPRINT : LPRINT " 8. Bn=";Bn;"MHZ" SPC(10); " : RECEIVER NOISE BANDWIDTH"
1280 PRINT : PRINT " 9. F=";F;"db"; SPC(9); " : RECEIVER NOISE FIGURE"
1290 LPRINT : LPRINT " 9. F=";F;"db"; SPC(9); " : RECEIVER NOISE FIGURE"
1300 PRINT : PRINT " 10. Ls=";Ls;"db" SPC(10); " : SYSTEM LOSSES"
1310 LPRINT : LPRINT " 10. Ls=";Ls;"db" SPC(10); " : SYSTEM LOSSES"
1320 PRINT : PRINT " 11. Tfa=";Tfa SPC(11); " : FALSE ALARM TIME"
1330 LPRINT : LPRINT " 11. Tfa=";Tfa SPC(11); " : FALSE ALARM TIME"
1340 PRINT : PRINT " 12. Ta=";Ta;"Kelvin" SPC(5); " : ANTENNA NOISE TEMPERATURE"
1350 LPRINT : LPRINT " 12. Ta=";Ta;"Kelvin" SPC(5); " : ANTENNA NOISE TEMPERATURE"
1360 RETURN
1370 *****
1380 ' CALCULATION & PRINTOUT FOR PART a:
1390 *****
1400 PRINT : PRINT : PRINT " PART a:"
1410 PRINT " -----"
1420 LPRINT : LPRINT : LPRINT " PART a:"
1430 LPRINT " -----"
1440 LET Ts=60/Wm:n=CSNG(A.B*Ts*fp/360)
1450 PRINT : PRINT " n=";n; " : # OF HITS PER SCAN"
1460 LPRINT : LPRINT " n=";n; " : # OF HITS PER SCAN"
1470 RETURN
1480 *****
1490 ' CALCULATION & PRINTOUT FOR PART b:
1500 *****
1510 PRINT : PRINT : PRINT " PART b:"
1520 PRINT " -----"
1530 LPRINT : LPRINT : LPRINT " PART b:"
1540 LPRINT " -----"
1550 LET Tfa=Tfa*24*3600:Bn=Bn*106:Pfa=CSNG(1/(Tfa*Bn))
1560 PRINT : PRINT " ENTER THE PROBABILITY OF DETECTION Pd"
1570 INPUT Pd

```

```

1580 PRINT:PRINT " FROM FIG. 2.7 (Skolnik Pg. 28) YOU CAN FIND THE (S/N)1 SINCE THE :
1590 PRINT:PRINT " Pfa=";Pfa,"&","Pd=";Pd
1600 INPUT SN
1610 PRINT:PRINT " a. Pd=";Pd;" : PROBABILITY OF DETECTION"
1620 PRINT:PRINT " b. Pfa=";Pfa;" : PROBABILITY OF FALSE ALARM"
1630 PRINT:PRINT " c. (S/N)1=";SN;"db";" : (S/N) FOR SINGLE PULSE"
1640 LPRINT:LPRINT " a. Pd=";Pd;" : PROBABILITY OF DETECTION"
1650 LPRINT:LPRINT " b. Pfa=";Pfa;" : PROBABILITY OF FALSE ALARM"
1660 LPRINT:LPRINT " c. (S/N)1=";SN;"db";" : (S/N) FOR SINGLE PULSE"
1670 RETURN
1680*****
1690 ' CALCULATION & PRINTOUT FOR PART c:
1700*****
1710 PRINT:PRINT:PRINT " PART c:"
1720 PRINT "-----"
1730 LPRINT:LPRINT:LPRINT " PART c:"
1740 LPRINT "-----"
1750 PRINT:PRINT " FROM Fig. 2.8(a), (Skolnik Pg. 31) YOU CAN FIND THE INTEGRATION
IMPROVEMENT"
1760 PRINT:PRINT " FOR INCOHERENT INTEGRATION OF n=";"n";"PULSES"
1770 PRINT:PRINT " ENTER THE INTEGRATION IMR. II(n)"
1780 INPUT II
1790 II1=CSNG(10*.4342945**LOG(II))
1800 PRINT:PRINT " II(n)=";II;"numeric";" or";II1;"db"
1810 LPRINT:LPRINT " II(n)=";II;"numeric";" or";II1;"db"
1820 RETURN
1830*****
1840 ' CALCULATION & PRINTOUT FOR PART d:
1850*****
1860 PRINT:PRINT:PRINT " PART d:"
1870 PRINT "-----"
1880 LPRINT:LPRINT:LPRINT " PART d:"
1881 LPRINT "-----"
1890 LET K=1.38*10^-23:T0=290:F=F/10:F=10^F
1900 LET MDS=K*T0*F*8n-MDS1-CSNG(10*.4342945**LOG(MDS))

```

```

1910 PRINT:PRINT "M.D.S=";MDS1;"dbw";": MINIMUM DETECTABLE SIGNAL POWER"
1920 LPRINT:LPRINT "M.D.S=";MDS1;"dbw";": MINIMUM DETECTABLE SIGNAL POWER"
1930 RETURN
1940*****
1950 ' CALCULATION & PRINTOUT FOR PART e & f:
1960*****
1970 PRINT:PRINT:PRINT "PART e & f:"
1980 PRINT "-----"
1990 LPRINT:LPRINT:LPRINT "PART e & f:"
1991 LPRINT "-----"
2000 LET Pt=Pt*10^3:Pt1=CINT(10*.4342945**LOG(Pt))
2010 LET Peff=Pt1+Ga
2020 LET Pi=3.14159:Ga=Ga/10:Ga=10^Ga
2030 LET C=3*10^8:fo=fo*10^6:l=C/fo
2040 LET Ae=CSNG(1^2*Ga/(4*Pi))
2050 PRINT:PRINT "e. Peff=";Peff;"dbw";": PEAK EFFECTIVE RADIATED POWER"
2060 PRINT:PRINT "f. Ae=";Ae;"sq.m";": EFFECTIVE AREA OF THE ANTENNA "
2070 LPRINT:LPRINT "e. Peff=";Peff;"dbw";": PEAK EFFECTIVE RADIATED POWER"
2080 LPRINT:LPRINT "f. Ae=";Ae;"sq.m";": EFFECTIVE AREA OF THE ANTENNA "
2090 RETURN
2100*****
2110 ' CALCULATION & PRINTOUT FOR PART g:
2130*****
2140 PRINT:PRINT:PRINT "PART g:"
2150 PRINT "-----"
2160 LPRINT:LPRINT:LPRINT "PART g:"
2161 LPRINT "-----"
2170 PRINT:PRINT "ENTER THE CROSS SECTION OF THE NON FLUCTUATING TARGET RCS IN db"
2180 INPUT RCS
2190 LET Ls=Ls/10:Ls=10^Ls:Te=(F-1)*T0:RCS=RCS/10:RCS=10^RCS
2200 LET SN=SN/10:SN=10^SN
2210 LET Rmax=CSNG((Pt*Ga*Ae*RCS*11/((4*Pi)^2*K*(Te+T0)*Bn*SN*Ls))^(1/4))
2220 PRINT:PRINT "Rmax=";Rmax/1000;"KM";": MAXIMUM RANGE"
2230 LPRINT:LPRINT "Rmax=";Rmax/1000;"KM";": MAXIMUM RANGE"
2240 RETURN

```

PROBLEM # 12

G I V E N

1. $f_o = 5600$ MHz : OPERATING FREQ.
2. $P_t = 200$ KW : PEAK POWER
3. $f_p = 625$ Hz : P.R.F
4. $t = 1.4$ microsec : PULSE WIDTH
5. $W_m = 16$ Hz : ANTENNA SCAN RATE
6. $A.B = 1.5$ deg. : AZIMUTH BEAMWIDTH
7. $G_a = 33$ db : ANTENNA GAIN
8. $B_n = 1$ MHz : RECEIVER NOISE BANDWIDTH
9. $F = 9.88$ db : RECEIVER NOISE FIGURE
10. $L_s = 5$ db : SYSTEM LOSSES
11. $T_{fa} = 2$: FALSE ALARM TIME
12. $T_a = 75$ Kelvin : ANTENNA NOISE TEMPERATURE

PART a:

$n = 9.76563$: # OF HITS PER SCAN

PART b:

- a. $P_d = .95$: PROBABILITY OF DETECTION
- b. $P_{fa} = 5.78704D-12$: PROBABILITY OF FALSE ALARM
- c. $(S/N)_1 = 16$ db : (S/N) FOR SINGLE PULSE

PART c:

$H(n) = 7$ numeric or 8.45098 db

PART d:

M.D.S = -134.097 dbw : MINIMUM DETECTABLE SIGNAL POWER

PART e & f:

- e. $P_{eff} = 86$ dbw : PEAK EFFECTIVE RADIATED POWER

PART g:

Rmax= 36.5283 KM: MAXIMUM RANGE

```

10 PRINT : PRINT TAB(30); " PROBLEM #13 "
20 PRINT TAB(30); " -----"
30 GOSUB 100 : GOSUB 710 : GOSUB 990
40 GOSUB 1110 : GOSUB 1240 : GOSUB 1350
50 PRINT : PRINT " DO YOU WANT TO TRY AGAIN FOR DIFFERENT OR THE SAME DATA Y/N?"
60 INPUT D$
70 IF LEFT$(D$,1)="Y" OR LEFT$(D$,1)="y" THEN 30
80 END
90 *****
100 INPUTS THE DATA
110 *****
120 PRINT : PRINT " ENTER THE OPERATING FREQ. fo IN GHz"
130 INPUT fo : PRINT : PRINT " 1. fo=";fo;"GHz"
140 PRINT : PRINT " ENTER THE RADAR CROSS SECTION OF THE VEHICLES RCS IN dbsm"
150 INPUT RCS : PRINT : PRINT " 2. RCS=";RCS;"dbsm"
160 PRINT : PRINT " ENTER THE TRAVELING SPEED OF THE VEHICLES U IN mi/hrs"
170 INPUT U : PRINT : PRINT " 3. U=";U;"mi/hrs"
180 PRINT : PRINT " ENTER THE RANGE THE RADAR WILL DETECT THE VEHICLES R IN MILES"
190 INPUT R : PRINT : PRINT " 4. R=";R;"miles"
200 PRINT : PRINT " ENTER THE (S/N) REQUIRED AT THE OUTPUT OF THE IF AMPLIFIER SNout IN
db"
210 INPUT SNout : PRINT : PRINT " 5. (S/N)out=";SNout;"db"
220 PRINT : PRINT " ENTER THE RECEIVER NOISE FIGURE F IN db"
230 INPUT F : PRINT : PRINT " 6. F=";F;"db"
240 PRINT : PRINT " ENTER THE PLUMBING LOSSES Lp IN db"
250 INPUT Lp : PRINT : PRINT " 7. Lp=";Lp;"db"
260 PRINT : PRINT " ENTER THE NOISE TEMPERATURE OF THE RECEIVER T0 IN KELVIN"
270 INPUT T0 : PRINT : PRINT " 8. T0=";T0;"Kelvin"
280 PRINT : PRINT " ENTER THE GAIN Gt OF THE TRANSMIT ANTENNA & Gr OF THE RECEIVE
ANTENNA IN db"
290 INPUT Gr,Gt : PRINT : PRINT " 9. Gt=";Gt, "Gr=";Gr;"db"
300 PRINT : PRINT " IS THE INPUT DATA CORRECT Y/N?"
310 INPUT A$
320 IF LEFT$(A$,1)="Y" OR LEFT$(A$,1)="y" THEN 690
330 PRINT : PRINT " WHAT OF THE FOLLOWING DO YOU WANT TO CHANGE?"

```



```

340 PRINT : PRINT " 1. THE OPERATING FREQ.?"
350 PRINT : PRINT " 2. THE VEHICLES RADAR CROSS SECTION?"
360 PRINT : PRINT " 3. THE VELOCITY OF THE VEHICLES?"
370 PRINT : PRINT " 4. THE RANGE OF THE VEHICLES?"
380 PRINT : PRINT " 5. THE (S/N) AT THE OUTPUT OF THE RECEIVER?"
390 PRINT : PRINT " 6. THE RECEIVER NOISE FIGURE?"
400 PRINT : PRINT " 7. THE PLUMBING LOSSES?"
410 PRINT : PRINT " 8. THE AMBIENT TEMPERATURE?"
420 PRINT : PRINT " 9. THE GAIN OF THE TRANSMIT & RECEIVE ANTENNA?"
430 INPUT C$
440 IF C$="1" THEN PRINT : PRINT " ENTER THE OPERATING FREQ. fo IN GHZ"
450 IF C$="1" THEN INPUT fo : PRINT : PRINT " 1. fo=";fo;"GHZ" : GOTO 620
460 IF C$="2" THEN PRINT : PRINT " ENTER THE RADAR CROSS SECTION OF THE VEHICLES RCS
INdbsm"
470 IF C$="2" THEN INPUT RCS : PRINT : PRINT " 2. RCS=";RCS;"dbsm" : GOTO 620
480 IF C$="3" THEN PRINT : PRINT " ENTER THE TRAVELING SPEED OF THE VEHICLES U IN
mi/hrs"
490 IF C$="3" THEN INPUT U : PRINT : PRINT " 3. U=";U;"mi/hrs" : GOTO 620
500 IF C$="4" THEN PRINT : PRINT " ENTER THE RANGE THE RADAR WILL DETECT THE
VEHICLES R IN MILES"
510 IF C$="4" THEN INPUT R : PRINT : PRINT " 4. R=";R;"miles" : GOTO 620
520 IF C$="5" THEN PRINT : PRINT " ENTER THE (S/N) REQUIRED AT THE OUTPUT OF THE IF
AMPLIFIER SNout INdb"
530 IF C$="5" THEN INPUT SNout : PRINT : PRINT " 5. (S/N)out=";SNout;"db" : GOTO 620
540 IF C$="6" THEN PRINT : PRINT " ENTER THE RECEIVER NOISE FIGURE F IN db"
550 IF C$="6" THEN INPUT F : PRINT : PRINT " 6. F=";F;"db" : GOTO 620
560 IF C$="7" THEN PRINT : PRINT " ENTER THE PLUMBING LOSSES Lp IN db"
570 IF C$="7" THEN INPUT Lp : PRINT : PRINT " 7. Lp=";Lp;"db" : GOTO 620
580 IF C$="8" THEN PRINT : PRINT " ENTER THE NOISE TEMPERATURE OF THE RECEIVER Ta IN
KELVIN"
590 IF C$="8" THEN INPUT Ta : PRINT : PRINT " 8. Ta=";Ta;"Kelvin" : GOTO 620
600 IF C$="9" THEN PRINT : PRINT " ENTER THE GAIN Gt OF THE TRANSMIT ANTENNA & Gr OF
THE RECEIVE ANTENNA IN db"
610 IF C$="9" THEN INPUT Gr,Gt : PRINT : PRINT " 9. Gt=";Gt,"Gr=";Gr;"db" : GOTO 620
620 PRINT : PRINT " IS EVERYTHING O.K NOW?"

```

```

630 INPUT B$
640 IF LEFT$(B$,1)="Y" OR LEFT$(B$,1)="y" THEN GOTO 690
650 PRINT : PRINT " WHAT DO YOU WANT TO CHANGE AGAIN?"
670 PRINT : PRINT " HIT ANY KEY IN YOUR KEYBOARD AND EVERYTHING WILL WORK FOR YOU
MALAKA"
680 INPUT F$ : GOTO 340
690 RETURN
700 *****
710 PRINTS THE INPUT DATA
720 *****
730 LPRINT : LPRINT TAB(30); " PROBLEM #13"
740 LPRINT TAB(30); " -----"
750 LPRINT : LPRINT " G I V E N"
760 LPRINT " -----"
770 PRINT : PRINT " G I V E N"
780 PRINT " -----"
790 PRINT : PRINT " 1. f0=";f0;"GHz" SPC(10); " : OPERATING FREQ."
800 LPRINT : LPRINT " 1. f0=";f0;"GHz" SPC(10); " : OPERATING FREQ."
810 PRINT : PRINT " 2. RCS=";RCS;"dbsm" SPC(9); " : VEHICLES RADAR CROSS SECTION"
820 LPRINT : LPRINT " 2. RCS=";RCS;"dbsm" SPC(9); " : VEHICLES RADAR CROSS SECTION"
830 PRINT : PRINT " 3. U=";U;"mi/hrs" SPC(7); " : VEHICLES'S TRAVELING VELOCITY"
840 LPRINT : LPRINT " 3. U=";U;"mi/hrs" SPC(7); " : VEHICLES'S TRAVELING VELOCITY"
850 PRINT : PRINT " 4. R=";R;"miles" SPC(9); " : RADAR-VEHICLE RANGE"
860 LPRINT : LPRINT " 4. R=";R;"miles" SPC(9); " : RADAR-VEHICLE RANGE"
870 PRINT : PRINT " 5. (S/N)out=";SNout;"db" SPC(5); " : SIGNAL-TO-NOISE RATIO AT THE
OUTPUT OF THERECEIVER"
880 LPRINT : LPRINT " 5. (S/N)out=";SNout;"db" SPC(5); " : SIGNAL-TO-NOISE RATIO AT THE
OUTPUT OF THERECEIVER"
890 PRINT : PRINT " 6. F=";F;"db" SPC(10); " : RECEIVER NOISE FIGURE"
900 LPRINT : LPRINT " 6. F=";F;"db" SPC(10); " : RECEIVER NOISE FIGURE"
910 PRINT : PRINT " 7. Lp=";Lp;"db" SPC(12); " : PLUMBING LOSSES"
920 LPRINT : LPRINT " 7. Lp=";Lp;"db" SPC(12); " : PLUMBING LOSSES"
930 PRINT : PRINT " 8. T0=";T0;"Kelvin" SPC(6); " : AMBIENT TEMPERATURE"
940 LPRINT : LPRINT " 8. T0=";T0;"Kelvin" SPC(6); " : AMBIENT TEMPERATURE"
950 PRINT : PRINT " 9. Gt=";Gt; " Gr=";Gr;" db" SPC(1); " : TRANSMIT & RECEIVE ANTENNAS

```

GAIN

960 LPRINT :LPRINT " 9. Gt=";Gt;" Gr=";Gr;" db" SPC(1);": TRANSMIT & RECEIVE ANTENNAS

GAIN

970 RETURN

980 *****

990 * CALCULATION & PRINTOUT OF PART a:

1000*****

1010 PRINT :PRINT :PRINT " PART a:"

1020 PRINT "-----:"

1030 LPRINT :LPRINT :LPRINT " PART a:"

1040 LPRINT "-----:"

1050 LET fo=fo*10⁹ : U=U*.447 : R=R*1610 : C=3*10⁸

1060 LET fd=2*u*fo/C : B=CINT(2*fd)

1070 PRINT :PRINT "B=";B/1000;"KHz";": RECEIVER BANDWIDTH"

1080 LPRINT :LPRINT "B=";B/1000;"KHz";": RECEIVER BANDWIDTH"

1090 RETURN

1100*****

1110 * CALCULATION & PRINTOUT OF PART b:

1120*****

1130 PRINT :PRINT :PRINT " PART b:"

1140 PRINT "-----:"

1150 LPRINT :LPRINT :LPRINT " PART b:"

1160 LPRINT "-----:"

1170 LET K=1.38*10⁻²³ : T0=290 : F=F/10 : F=10^F : Te=(F-1)*T0

1180 LET SNout=SNout/10 : SNout=10^{SNout}

1190 LET Sinp=K*(Ta+Te)*B*SNout : Sinp=CINT(10*.4342945**LOG(Sinp)+(Lp/2)+30)

1200 PRINT :PRINT "Sinp=";Sinp;"dbm";": RECEIVER INPUT SIGNAL POWER"

1210 LPRINT :LPRINT "Sinp=";Sinp;"dbm";": RECEIVER INPUT SIGNAL POWER"

1220 RETURN

1230*****

1240 * CALCULATION & PRINTOUT OF PART c:

1250*****

1260 PRINT :PRINT :PRINT " PART c:"

1270 PRINT "-----:"

1280 LPRINT :LPRINT :LPRINT " PART c:"

```

1290 LPRINT "-----:
1300 LET I=C/f0 : PI=3.14159 : Lbf=CSNG(10*.4342945**2*LOG(4*PI*R/I))
1310 PRINT : PRINT " Lbf=";Lbf;"db"; " : ONE WAY FREE SPACE LOSSES FOR TARGET VEHICLES AT
ARANGER=";R/1610;"miles"
1320 LPRINT : LPRINT " Lbf=";Lbf;"db"; " : ONE WAY FREE SPACE LOSSES FOR TARGET VEHICLES
AT ARANGER=";R/1610;"miles"
1330 RETURN
1340 *****
1350 ' CALCULATION & PRINTOUT OF PART d:
1360 *****
1370 PRINT : PRINT : PRINT " PART d:"
1380 PRINT "-----:
1390 LPRINT : LPRINT : LPRINT " PART d:"
1400 LPRINT "-----:
1410 LET RCS=RCS/10 : RCS=10^-RCS : Gs=10*.4342945**LOG(4*PI*RCS/I^2)
1420 LET Pt=CSNG(Sinp-Gs+(2*Lbf-Gt-Gr)+(Lp/2))
1430 PRINT : PRINT " Pt="; Pt;"dbm"; " : TRANSMITTER OUTPUT POWER"
1440 LPRINT : LPRINT " Pt=";Pt;"dbm"; " : TRANSMITTER OUTPUT POWER"
1450 RETURN

```

PROBLEM # 13

GIVEN

1. $f_0 = 10 \text{ GHz}$: OPERATING FREQ.
2. $RCS = 0 \text{ dbsm}$: VEHICLES RADAR CROSS SECTION
3. $U = 100 \text{ mi/hrs}$: VEHICLES'S TRAVELING VELOCITY
4. $R = .5 \text{ miles}$: RADAR-VEHICLE RANGE
5. $(S/N)_{out} = 15 \text{ db}$: SIGNAL-TO-NOISE RATIO AT THE OUTPUT OF THE RECEIVER
6. $F = 7.25 \text{ db}$: RECEIVER NOISE FIGURE
7. $L_p = 2 \text{ db}$: PLUMBING LOSSES
8. $T_e = 300 \text{ Kelvin}$: AMBIENT TEMPERATURE
9. $G_t = 20 \text{ Gr} = 20 \text{ db}$: TRANSMIT & RECEIVE ANTENNAS GAIN

PART a:

$B = 5.96 \text{ KHz}$: RECEIVER BANDWIDTH

PART b:

$S_{in} = -113 \text{ dbm}$: RECEIVER INPUT SIGNAL POWER

PART c:

$L_{bf} = 110.558 \text{ db}$: ONE WAY FREE SPACE LOSSES FOR TARGET VEHICLES AT A RANGE $R = .5 \text{ miles}$

PART d:

$P_t = 27.6663 \text{ dbm}$: TRANSMITTER OUTPUT POWER

```

10 PRINT : PRINT TAB(30); " PROBLEM # 14"
20 PRINT TAB(30); " -----"
30 LPRINT : LPRINT TAB(30); " PROBLEM # 14"
40 LPRINT TAB(30); " -----"
50 PRINT : PRINT " ENTER THE OPERATING FREQ. f0 IN GHZ"
60 INPUT f0: PRINT : PRINT " 1. f0=";f0;"GHZ"
70 PRINT : PRINT " ENTER THE # OF THE STAGGER PERIODS n"
80 INPUT n: PRINT : PRINT " 2. n=";n
90 PRINT : PRINT " ENTER THE STAGGER PERIODS n1,n2,n3,n4"
100 INPUT n1,n2,n3,n4: PRINT : PRINT " 3. T1:T2:T3:T4=";n1;"n2":"n3":"n4
110 PRINT : PRINT " ENTER THE TIME AVERAGE Tavg IN sec."
120 INPUT Tavg: PRINT : PRINT " 4. Tavg=";Tavg;"sec."
130 PRINT : PRINT : PRINT " G I V E N"
140 PRINT " -----"
150 LPRINT : LPRINT : LPRINT " G I V E N"
160 LPRINT " -----"
170 LPRINT : LPRINT " 1. f0=";f0;"GHZ" SPC(10); " : OPERATING FREQ."
180 LPRINT : LPRINT " 2. n=";n SPC(14); " : # OF STAGGER PERIODS"
190 LPRINT : LPRINT " 3. T1:T2:T3:T4=";n1;"n2":"n3":"n4; " : RATIO OF STAGGER PERIODS"
200 LPRINT : LPRINT " 4. Tavg=";Tavg;"sec."; " : TIME AVERAGE"
230 PRINT : PRINT " 1. f0=";f0;"GHZ" SPC(10); " : OPERATING FREQ."
240 PRINT : PRINT " 2. n=";n SPC(10); " : # OF STAGGER PERIODS"
250 PRINT : PRINT " 3. T1:T2:T3:T4=";n1;"n2":"n3":"n4; " : RATIO OF STAGGER PERIODS"
260 PRINT : PRINT " 4. Tavg=";Tavg;"sec."; " : TIME AVERAGE"
270 PRINT : PRINT : PRINT " PART a:"
280 PRINT " -----"
290 LPRINT : LPRINT : LPRINT " PART a:"
300 LPRINT " -----"
310 LET SUM=n1+n2+n3+n4
320 LET T1=n*n1/SUM*Tavg:T2=n*n2/SUM*Tavg:T3=n*n3/SUM*Tavg:
330 LET T4=n*n4/SUM*Tavg
340 LET T1=CSNG(T1*10^6):T2=CSNG(T2*10^6):T3=CSNG(T3*10^6):T4=CSNG(T4*10^6)
350 PRINT : PRINT " 1. T1=";T1;"microsec.," 2. T2=";T2;"microsec."
360 PRINT : PRINT " 3. T3=";T3;"microsec.," 4. T4=";T4;"microsec."
370 LPRINT : LPRINT " 1. T1=";T1;"microsec.," 2. T2=";T2;"microsec."

```

```

380 LPRINT : LPRINT " 3. T3=";T3;"microsec.," 4.T4=";T4;"microsec."
390 PRINT : PRINT : PRINT " PART b:"
400 PRINT "-----"
410 LPRINT : LPRINT : LPRINT " PART b:"
420 LPRINT "-----"
430 LET C=3*10^8 : fo=fo*10^9 : l=C/fo
440 LET U1bl=1*(1/Tavg)*(1/1.02)*(SUM/n)
450 PRINT : PRINT " U1bl=";CINT(U1bl);"Knots";": FIRST BLIND SPEED"
460 LPRINT : LPRINT " U1bl=";CINT(U1bl);"Knots";": FIRST BLIND SPEED"
470 PRINT : PRINT " DO YOU WANT TO TRY AGAIN WORKER Y/N?"
480 INPUT A$
490 IF LEFT$(A$,1)="Y" OR LEFT$(A$,1)="y" THEN 50
500 END

```

PROBLEM # 14

GIVEN

1. $f_0 = 1 \text{ GHz}$: OPERATING FREQ.
2. $n = 4$: # OF STAGGER PERIODS
3. $T_1:T_2:T_3:T_4 = 25 : 30 : 30 : 27 : 31$: RATIO OF STAGGER PERIODS
4. $T_{\text{avg}} = .001 \text{ sec.}$: TIME AVERAGE

PART a:

1. $T_1 = 884.956 \text{ microsec.}$
2. $T_2 = 1061.95 \text{ microsec.}$
3. $T_3 = 955.752 \text{ microsec.}$
4. $T_4 = 1097.35 \text{ microsec.}$

PART b:

$U(b) = 8309 \text{ Knots}$

```

10 PRINT : PRINT TAB(30); " PROBLEM # 15"
20 PRINT TAB(30); " -----"
30 LPRINT : LPRINT TAB(30); " PROBLEM # 15"
40 LPRINT TAB(30); " -----"
50 DIM N(50),A(50),B(50),W(50)
60 PRINT : PRINT " ENTER THE OPERATING FREQ. f0 IN GHz"
70 INPUT f0 : PRINT : PRINT " 1. f0=";f0;"GHz"
80 PRINT : PRINT " ENTER THE P.R.F fp IN KHz"
90 INPUT fp : PRINT : PRINT " 2. fp=";fp;"KHz"
100 PRINT : PRINT " ENTER NUMBER OF PULSE CANCELLER n, (maximum you can enter for this
    program is n=49)"
110 INPUT n : PRINT : PRINT " 3. n=";n
120 PRINT : PRINT " ENTER FREQ. f IN Hz, WHERE THE CLUTTER REJECTION WILL BE
    CALCULATED"
130 INPUT f : PRINT : PRINT " 4. f=";f;"Hz"
140 PRINT : PRINT " ENTER THE RADIAL VELOCITY OF THE TARGET Ur IN Knots"
150 INPUT Ur : PRINT : PRINT " 5. Ur=";Ur;"Knots"
160 *****
170 PRINTS THE INPUT DATA
180 *****
190 LPRINT : LPRINT : LPRINT " G I V E N"
200 LPRINT " -----"
210 LPRINT : LPRINT " 1. f0=";f0;"GHz" SPC(10); " : OPERATING FREQ."
220 LPRINT : LPRINT " 2. fp=";fp;"KHz" SPC(10); " : P.R.F"
230 LPRINT : LPRINT " 3. n=";n SPC(14); " : NUMBER OF PULSE CANCELLER"
240 LPRINT : LPRINT " 4. f=";f;"Hz" SPC(11); " : FREQ. WHERE THE CLUTTER REJECTION WILL BE
    CALCULATED"
250 LPRINT : LPRINT " 5. Ur=";Ur;"Knots" SPC(6); " : RADIAL VELOCITY OF THE TARGET"
260 *****
270 CALCULATIONS FOR PARTS a,b,c,d
280 *****
290 LET f0=f0*10^9 : fp=fp*10^3 : C=3*10^8
300 LET l=C/f0 : U1b1=CSNG(l*fp/1.02)
310 PRINT : PRINT : PRINT " PART a:"
320 PRINT " -----"

```

```

330 LPRINT : LPRINT : LPRINT " PART a:"
340 LPRINT " -----"
350 PRINT : PRINT " U1bl=";U1bl;"Knots"; " : FIRST BLIND SPEED"
360 LPRINT : LPRINT " U1bl=";U1bl;"Knots"; " : FIRST BLIND SPEED"
370 PRINT : PRINT : PRINT " PART b:"
380 PRINT " -----"
390 LPRINT : LPRINT : LPRINT " PART b:"
400 LPRINT " -----"
410 FOR I=1 TO n-1
420     N(0)=1 : N(I)=I
430     N(I)=N(I-1)*I
440 NEXT I
450 FOR J=1 TO n
460     B(J)=J-1
470     B(1)=1
480     B(0)=1
490     A(0)=1
500     A(J)=B(J)*A(J-1) : PRINT A(J)
510     W(J)=(-1)^(J-1)*N(n-1)/(N(n-J)*A(J))
520 NEXT J
530 PRINT : PRINT " 1. T1 = T2 = T3 =" ; 1/fp ; "sec." ; " : DELAYS OF THE 4 PULSE CANCELER"
540 LPRINT : LPRINT " 1. T1 = T2 = T3 =" ; 1/fp ; "sec." ; " : DELAYS OF THE 4 PULSE CANCELER"
550 PRINT : PRINT " 2. THE WEIGHTS OF THE 4 PULSE CANCELER ARE : " : PRINT
560 LPRINT : LPRINT " 2. THE WEIGHTS OF THE 4 PULSE CANCELER ARE : " : LPRINT
570 FOR I=1 TO n
580     PRINT " W( ; I ; ) " ; "=" ; W(I) ; " : " : LPRINT " W( ; I ; ) " ; "=" ; W(I) ; " : "
590 NEXT I
600 PRINT : PRINT : PRINT " PART c:"
610 PRINT " -----"
620 LPRINT : LPRINT : LPRINT " PART c:"
630 LPRINT " -----"
640 LET PI=3.14159 : REJ.=CSNG(-60*.4342945**LOG(SIN(PI*f/fp)))
650 PRINT : PRINT " REJ.=" ; REJ. ; "db" ; " : CLUTTER REJECTION AT f=" ; f ; "Hz"
660 LPRINT : LPRINT " REJ.=" ; REJ. ; "db" ; " : CLUTTER REJECTION AT f=" ; f ; "Hz"
670 PRINT : PRINT : PRINT " PART d:"

```

```
680 PRINT "-----"
690 LPRINT : LPRINT : LPRINT " PART d:"
700 LPRINT "-----"
710 LET fd=CSNG(1.03*Ur/1)
720 PRINT : PRINT " fd=";fd;"Hz"; " : DOPPLER FREQ. WHERE THE BIPOLAR VIDEO WILL
FLUCTUATE"
730 LPRINT : LPRINT " fd=";fd;"Hz"; " : DOPPLER FREQ. WHERE THE BIPOLAR VIDEO WILL
FLUCTUATE"
740 PRINT : PRINT " DO YOU WANT TO TRY AGAIN FOR DIFFERENT OR THE SAME DATA Y/N?"
750 INPUT A$
760 IF LEFT$(A$,1)="Y" OR LEFT$(A$,1)="y" THEN 60
770 END
```

PROBLEM # 15

GIVEN

1. $f_0 = 1 \text{ GHz}$: OPERATING FREQ.
2. $f_p = 1 \text{ KHz}$: P.R.F
3. $n = 4$: NUMBER OF PULSE CANCELLER
4. $f = 25 \text{ Hz}$: FREQ. WHERE THE CLUTTER REJECTION WILL BE CALCULATED
5. $U_r = 200 \text{ Knots}$: RADIAL VELOCITY OF THE TARGET

PART a:

$U|b| = 294.118 \text{ Knots}$: FIRST BLIND SPEED

PART b:

1. $T_1 = T_2 = T_3 = .001 \text{ sec.}$: DELAYS OF THE 4 PULSE CANCELER
 2. THE WEIGHTS OF THE 4 PULSE CANCELER ARE :
- $W(1) = 1 . W(2) = -3 . W(3) = 3 . W(4) = -1 .$

PART c:

$\text{REJ.} = 66.3214 \text{ db}$: CLUTTER REJECTION AT $f = 25 \text{ Hz}$

PART d:

$f_d = 686.667 \text{ Hz}$: DOPPLER FREQ. WHERE THE BIPOLAR VIDEO WILL FLUCTUATE

APPENDIX B

A listing of the Electronic Warfare computer programs is provided as well as an output of the results for each one of these programs.

```

10 PRINT:PRINT TAB(30); " PROBLEM # 1 "
11 PRINT TAB(30); " -----"
20 GOSUB 100:GOSUB 850:GOSUB 1060:GOSUB 1510
30 GOSUB 1620:GOSUB 1750:GOSUB 1890:GOSUB 2070:GOSUB 2260
40 PRINT:PRINT " DO YOU WANT TO TRY AGAIN FOR DIFFERENT OR THE SAME DATA Y/N?"
50 INPUT D$
60 IF LEFT$(D$,1)="Y" OR LEFT$(D$,1)="y" THEN 20
70 END
80 *****
90 INPUTS THE DATA
100 *****
110 PRINT:PRINT " ENTER THE OPERATING FREQ. f0 IN MHZ"
120 INPUT f0:PRINT:PRINT " 1. f0=";f0;"MHZ"
130 PRINT:PRINT " ENTER THE PULSE WIDTH (long) T1 IN MICSEC."
140 INPUT T1:PRINT:PRINT " 2. T1=";T1;"MICSEC"
150 PRINT:PRINT " ENTER THE PULSE WIDTH (short) Ts IN MICSEC."
160 INPUT Ts:PRINT:PRINT " 3. Ts=";Ts;"MICSEC."
170 PRINT:PRINT " ENTER THE PEAK OUTPUT POWER Pr IN KW"
180 INPUT Pr:PRINT:PRINT " 4. Pr=";Pr;"KW"
190 PRINT:PRINT " ENTER THE P.R.F fp IN HZ"
200 INPUT fp:PRINT:PRINT " 5. fp=";fp;"HZ"
210 PRINT:PRINT " ENTER THE BANDWIDTH (long pulse) Br1 IN MHZ"
220 INPUT Br1:PRINT:PRINT " 6. Br1=";Br1;"MHZ"
230 PRINT:PRINT " ENTER THE BANDWIDTH (short pulse) Brs IN MHZ"
240 INPUT Brs:PRINT:PRINT " 7. Brs=";Brs;"MHZ"
250 PRINT:PRINT " ENTER THE ANTENNA SCAN FREQ. Wm IN R.P.M"
260 INPUT Wm:PRINT:PRINT " 8. Wm=";Wm;"R.P.M"
270 PRINT:PRINT " ENTER THE AZIMUTH BEAMWIDTH A.B IN Deg."
280 INPUT A.B:PRINT:PRINT " 9. A.B=";A.B;"Deg."
290 PRINT:PRINT " ENTER THE ELEVATION BEAMWIDTH E.B IN Deg."
300 INPUT E.B:PRINT:PRINT " 10. E.B=";E.B;"Deg."
310 PRINT:PRINT " ENTER THE ANTENNA NOISE TEMPERATURE T0 IN KELVIN"
320 INPUT T0:PRINT:PRINT " 11. T0=";T0;"KELVIN"
330 PRINT:PRINT " ENTER THE FALSE ALARM PROBABILITY Pfa"
340 INPUT Pfa:PRINT:PRINT " 12. Pfa=";Pfa

```

```

350 PRINT : PRINT " IS THE INPUT DATA CORRECT Y/N?"
360 INPUT A$
370 IF LEFT$(A$,1)="Y" OR LEFT$(A$,1)="y" THEN 820
380 PRINT : PRINT " WHAT OF THE FOLLOWING DO YOU WANT TO CHANGE?"
390 PRINT : PRINT " 1. THE OPERATING FREQ.?"
400 PRINT : PRINT " 2. THE PULSE WIDTH (long) ?"
410 PRINT : PRINT " 3. THE PULSE WIDTH (short) ?"
420 PRINT : PRINT " 4. THE PEAK OUTPUT POWER"
430 PRINT : PRINT " 5. THE P.R.F"
440 PRINT : PRINT " 6. THE BANDWIDTH FOR THE LONG PULSE?"
450 PRINT : PRINT " 7. THE BANDWIDTH FOR THE SHORT PULSE?"
460 PRINT : PRINT " 8. THE ANTENNA SCAN FREQ.?"
470 PRINT : PRINT " 9. THE AZIMUTH BEAMWIDTH?"
480 PRINT : PRINT " 10. THE ELEVATION BEAMWIDTH?"
490 PRINT : PRINT " 11. THE ANTENNA NOISE TEMPERATURE?"
500 PRINT : PRINT " 12. THE FALSE ALARM PROBABILITY?"
510 INPUT C$
520 IF C$="1" THEN PRINT : PRINT " ENTER THE OPERATING FREQ. f0 IN MHZ"
530 IF C$="1" THEN INPUT f0 : PRINT : PRINT " 1. f0=";f0;"MHZ" : GOTO 760
540 IF C$="2" THEN PRINT : PRINT " ENTER THE PULSE WIDTH (long) T1 IN MICSEC."
550 IF C$="2" THEN INPUT T1 : PRINT : PRINT " 2. T1=";T1;"MICSEC." : GOTO 760
560 IF C$="3" THEN PRINT : PRINT " ENTER THE PULSE WIDTH (short) Ts IN MICSEC."
570 IF C$="3" THEN INPUT Ts : PRINT : PRINT " 3. Ts=";Ts;"MICSEC." : GOTO 760
580 IF C$="4" THEN PRINT : PRINT " ENTER THE PEAK POWER OUTPUT Pr IN KW"
590 IF C$="4" THEN INPUT Pr : PRINT : PRINT " 4. Pr=";Pr;"KW" : GOTO 760
600 IF C$="5" THEN PRINT : PRINT " ENTER THE P.R.F pf IN HZ"
610 IF C$="5" THEN INPUT pf : PRINT : PRINT " 5. pf=";pf;"HZ" : GOTO 760
620 IF C$="6" THEN PRINT : PRINT " ENTER THE BANDWIDTH (long pulse) Br1 IN MHZ"
630 IF C$="6" THEN INPUT Br1 : PRINT : PRINT " 6. Br1=";Br1;"MHZ" : GOTO 760
640 IF C$="7" THEN PRINT : PRINT " ENTER THE BANDWIDTH (short pulse) Brs IN MHZ"
650 IF C$="7" THEN INPUT Brs : PRINT : PRINT " 7. Brs=";Brs;"MHZ" : GOTO 760
660 IF C$="8" THEN PRINT : PRINT " ENTER THE ANTENNA SCAN FREQ. Wm IN R.P.M"
670 IF C$="8" THEN INPUT Wm : PRINT : PRINT " 8. Wm=";Wm;"R.P.M" : GOTO 760
680 IF C$="9" THEN PRINT : PRINT " ENTER THE AZIMUTH BEAMWIDTH A.B IN Deg."
690 IF C$="9" THEN INPUT A.B : PRINT : PRINT " 9. A.B=";A.B;"Deg." : GOTO 760

```

```

700 IF C$="10" THEN PRINT : PRINT " ENTER THE ELEVATION BEAMWIDTH E.B IN Deg."
710 IF C$="10" THEN INPUT E.B : PRINT : PRINT " 10. E.B=";E.B;"Deg." : GOTO 760
720 IF C$="11" THEN PRINT : PRINT " ENTER THE ANTENNA NOISE TEMPERATURE Ta IN KELVIN"
730 IF C$="11" THEN INPUT Ta : PRINT : PRINT " 11. Ta=";Ta;"KELVIN" : GOTO 760
740 IF C$="12" THEN PRINT : PRINT " ENTER THE FALSE ALARM PROBABILITY Pfa"
750 IF C$="12" THEN INPUT Pfa : PRINT : PRINT " 12. Pfa=";Pfa;; GOTO 760
760 PRINT : PRINT " IS EVERYTHING O.K NOW?"
770 INPUT B$
780 IF LEFT$(B$,1)="Y" OR LEFT$(B$,1)="y" THEN 820
790 PRINT : PRINT " WHAT DO YOU WANT TO CHANGE AGAIN?"
800 PRINT : PRINT " HIT ANY KEY IN YOUR KEYBOARD AND EVERYTHING WILL WORK FOR YOU
MALAKA"
810 INPUT F$ : GOTO 390
820 RETURN
830 *****
840 PRINTS THE INPUT DATA
850 *****
860 LPRINT : LPRINT TAB(30); " PROBLEM # 1"
870 LPRINT TAB(30); " -----"
880 LPRINT : LPRINT " G I V E N"
890 LPRINT " -----"
900 PRINT : PRINT " G I V E N"
920 LPRINT : LPRINT " 1. f0=";f0;"MHZ" TAB(20); " : OPERATING FREQ."
930 LPRINT : LPRINT " 2. Tl=";Tl;"MICSEC." TAB(20); " : PULSE WIDTH (long)"
940 LPRINT : LPRINT " 3. Ts=";Ts;"MICSEC." TAB(20); " : PULSE WIDTH (short)"
950 LPRINT : LPRINT " 4. Pr=";Pr;"KW" TAB(20); " : PEAK OUTPUT POWER"
960 LPRINT : LPRINT " 5. fp=";fp;"HZ" TAB(20); " : P.R.F"
970 LPRINT : LPRINT " 6. Brl=";Brl;"MHZ" TAB(20); " : BANDWIDTH (long pulse)"
980 LPRINT : LPRINT " 7. Brs=";Brs;"MHZ" TAB(20); " : BANDWIDTH (short pulse)"
990 LPRINT : LPRINT " 8. Wm=";Wm;"R.P.M" TAB(20); " : ANTENNA SCAN FREQ."
1000 LPRINT : LPRINT " 9. A.B=";A.B;"Deg." TAB(20); " : AZIMUTH BEAMWIDTH"
1010 LPRINT : LPRINT " 10. E.B=";E.B;"Deg." TAB(20); " : ELEVATION BEAMWIDTH"
1020 LPRINT : LPRINT " 11. Ta=";Ta;"KELVIN" TAB(20); " : ANTENNA NOISE TEMPERATURE"
1030 LPRINT : LPRINT " 12. Pfa=";Pfa TAB(20); " : FALSE ALARM PROBABILITY"
1040 RETURN

```



```

1050*****
1060   CALCULATION & PRINTOUT FOR PART e
1070*****
1080 PRINT : PRINT : PRINT " PART e:"
1090 PRINT "-----"
1100 LPRINT : LPRINT : LPRINT " PART e:"
1110 LPRINT "-----"
1120 PRINT : PRINT " ENTER RADAR'S CROSS SECTION OF TARGET  $S_{av}$  IN sq.m"
1130 INPUT S
1140 PRINT : PRINT " ENTER THE PROBABILITY OF DETECTION  $P_d$ "
1150 INPUT Pd
1160 PRINT : PRINT " ENTER THE RECEIVER'S NOISE FIGURE  $F_1$  IN db"
1170 INPUT F1
1180 LET n=CINT(A.B*fp*60/(360*Wm))
1190 PRINT : PRINT " FROM Fig. 2.8(a) (SKOLNIK Pg.31) YOU CAN FIND THE INTEGRATION IMR.
      FACTOR  $I_1(n)$  IN db"
1200 PRINT : PRINT " SINCE YOU KNOW : "
1210 PRINT : PRINT " (a).  $n=A.B*f_p*60/(360*W_m)=$ ; n; " : #OF HITS INTEGRATED"
1220 PRINT : PRINT " (b).  $P_d=$ ; Pd; " : PROBABILITY OF DETECTION"
1230 PRINT : PRINT " ENTER THE INTEGRATION IMR. FACTOR  $I_1(n)$  (numeric value)"
1240 INPUT I1
1250 PRINT : PRINT " FROM Fig. 2.7 (SKOLNIK Pg. 28) YOU CAN FIND THE (S/N)1 IN db"
1260 PRINT : PRINT " ENTER THE (S/N)1 IN db"
1270 INPUT A
1280 LET T0=290           'KELVIN
1290 LET K=1.38*10^-23   'BOLTZMAN'S CONSTANT
1300 LET PI=3.14159
1310 LET C=3*10^8        'm/s
1320 LET f0=f0*10^6      'conversion from MHz to Hz
1330 LET Br1=Br1*10^6    'conversion from MHz to Hz
1340 LET Pr=Pr*10^3      'conversion from MW to W
1350 LET l=C/f0          'm/s
1360 LET G=41250l/(A.B*E.B) 'ANTENNA GAIN
1370 LET Ae=l^2*G/(4*PI) 'antenna effective aperture
1380 LET F2=F1/10 : F3=10^F2

```

```

1390 LET Te=(F3-1)*T0
1400 LET B=K*T0*(Te+Te)*Br1/290
1410 LET A1=A/10: A2=10*A1
1420 LET R=CSNG(SQR(SQR(Pr*G*Ae*S*I1/((4*PI)^2*B*A2)))) 'long pulse
1430 LET R1=CSNG(R*(1/5)^(1/4)) 'short pulse
1450 PRINT:PRINT " 1(a).
      R=Pr*G*Ae*Sev*n*E1(n)/((4*PI)^2*K*(Te+Te)*Br1*(S/N)max.)^(1/4)=",R/1000,"KM";
      MAX.DETECTION RANGE FOR THE LONG PULSE"
1460 PRINT:PRINT " 2(a). R1=R*(1/5)^(1/4)=",R1/1000,"KM"; " : MAX RANGE FOR THE SHORT
      PULSE"
1470 LPRINT:LPRINT " 1(a).
      R=Pr*G*Ae*Sev*n*E1(n)/((4*PI)^2*K*(Te+Te)*Br1*(S/N)max.)^(1/4)=",R/1000,"KM";
      MAX.DETECTION RANGE FOR THE LONG PULSE"
1480 LPRINT:LPRINT " 2(a). R1=R*(1/5)^(1/4)=",R1/1000,"KM"; " : MAX RANGE FOR THE SHORT
      PULSE"
1490 RETURN
1500 *****
1510 ' CALCULATION & PRINTOUT FOR PART b:
1520 *****
1530 PRINT:PRINT:PRINT " PART b:"
1540 PRINT " -----"
1550 LPRINT:LPRINT:LPRINT " PART b:"
1560 LPRINT " -----"
1570 LET Ru=CSNG(C/(2*f0))
1580 PRINT:PRINT " 1(b). Ru=",Ru/1000,"KM" " : MAX. UNAMBIGUOUS RANGE"
1590 LPRINT:LPRINT " 1(b). Ru=",Ru/1000,"KM" " : MAX. UNAMBIGUOUS RANGE"
1600 RETURN
1610 *****
1620 ' CALCULATION & PRINTOUT FOR PART c:
1630 *****
1640 PRINT:PRINT:PRINT " PART c:"
1650 PRINT " -----"
1660 LPRINT:LPRINT:LPRINT " PART c:"
1670 LPRINT " -----"
1680 PRINT:PRINT " ENTER THE RADAR CROSS SECTION IN dbsm"

```

```

1690 INPUT S1ev
1700 LET R2=CSNG(R/1000*10^(1/4))
1710 PRINT : PRINT " 1(c). R2=10^(1/4)*R=";R2;"KM"; " RANGE AT WHICH THE AIRCRAFT WILL BE
      DETECTED FOR R.C.S= 10sq.m & FOR THE LONG PULSE"
1720 LPRINT : LPRINT " 1(c). R2=10^(1/4)*R=";R2;"KM"; " RANGE AT WHICH THE AIRCRAFT WILL BE
      DETECTED FOR R.C.S= 10sq.m & FOR THE LONG PULSE"
1730 RETURN
1740 *****
1750 * CALCULATION & PRINTOUT FOR PART d:
1760 *****
1770 PRINT : PRINT : PRINT " PART d:"
1780 PRINT "-----"
1790 LPRINT : LPRINT : LPRINT " PART d:"
1800 LPRINT "-----"
1810 PRINT : PRINT " ENTER THE RADAR ANTENNA HEIGHT ABOVE THE SEA h1 IN ft"
1820 INPUT h1
1830 LET h2=(R2/1.61-SQR(2*h1))^2
1840 LET h2=CSNG(h2/2)
1850 PRINT : PRINT " 1(d). h2=R2(m1)-SQR(2*h1(ft))/2=";h2;" ft"; " : MIN. ALTITUDE AT WHICH
      THE RADAR CAN SEE THE TARGET"
1860 LPRINT : LPRINT " 1(d). (h2=R2(m1)-SQR(2*h1(ft))/2=";h2;" ft"; " : MIN. ALTITUDE AT WHICH
      THE RADAR CAN SEE THE TARGET"
1870 RETURN
1880 *****
1890 * CALCULATION & PRINTOUT FOR PART e:
1900 *****
1910 PRINT : PRINT : PRINT " PART e:"
1920 PRINT "-----"
1930 LPRINT : LPRINT : LPRINT " PART e:"
1940 LPRINT "-----"
1950 PRINT : PRINT " ENTER THE CIRCULARY POLARIZED ANTENNA'S GAIN G0 IN db"
1960 INPUT G0
1970 LET G1=G0/10 : G2=10^G1
1980 PRINT : PRINT " ENTER THE TOTAL SYSTEM LOSSES Ls IN db"
1990 INPUT Ls

```

```

2000 LET Ls1=Ls/10:Ls2=10*Ls1
2010 P=Pr*G*1^2*G2/((4*PI)^2*(R2*1000)^2*Ls2)
2020 LET P=CSNG(10*.4342945**LOG(P)+30)
2030 PRINT:PRINT " 1(e). P=Pr*G*1^2*G2/((4*PI)^2*R2^2*Ls)=",P;"dbm";": SINGLE PULSE POWER
      AT THE ANTENNA TERMINALS OUTPUT"
2040 LPRINT:LPRINT " 1(e). P=Pr*G*1^2*G2/((4*PI)^2*R2^2*Ls)=",P;"dbm";": SINGLE PULSE
      POWER AT THE ANTENNA TERMINALS OUTPUT"
2050 RETURN
2060 *****
2070 ' CALCULATION & PRINTOUT FOR PART f:
2080 *****
2090 PRINT:PRINT:PRINT " PART f:"
2100 PRINT "-----"
2110 LPRINT:LPRINT:LPRINT " PART f:"
2120 LPRINT "-----"
2130 LET K1=1640
2140 LET K2=400
2150 LET T1=T1*10^-6
2160 LET Cf=4/(1+(1/(T1*Br1))^2)*(fp/K1)^(1/3)
2170 LET Cf1=4/(1+(1/(T1*Br1))^2)*(fp/K2)^(1/3)
2180 LET Cf=CSNG(10*.4342945**LOG(Cf))
2190 LET Cf1=CSNG(10*.4342945**LOG(Cf1))
2200 PRINT:PRINT " 1(f). Cf=4/(1+(1/(T1*Br1))^2)*(fp*K)^(1/3)=",Cf;"db";": CAMOUFLAGE
      FACTOR FORK=",K1
2210 PRINT:PRINT " 2(f). Cf1=4/(1+(1/(T1*Br1))^2)*(fp*K)^(1/3)=",Cf1;"db";": CAMOUFLAGE
      FACTOR FORK=",K2
2220 LPRINT:LPRINT " 1(f). Cf=4/(1+(1/(T1*Br1))^2)*(fp*K)^(1/3)=",Cf;"db";": CAMOUFLAGE
      FACTOR FORK=",K1
2230 LPRINT:LPRINT " 2(f). Cf1=4/(1+(1/(T1*Br1))^2)*(fp*K)^(1/3)=",Cf1;"db";": CAMOUFLAGE
      FACTOR FORK=",K2
2240 RETURN
2250 *****
2260 ' CALCULATION & PRINTOUT FOR PART g:
2270 *****
2280 PRINT:PRINT:PRINT " PART g:"

```

```

2290 PRINT "-----"
2300 LPRINT : LPRINT : LPRINT " PART g:"
2310 LPRINT "-----"
2320 PRINT : PRINT " ENTER THE VALUE OF THE S/J IN db"
2330 INPUT C1 : C2=C1/10 : C3=10*C2
2340 PRINT : PRINT " ENTER THE BURNTHROUGH RANGE Rb IN n.miles"
2350 INPUT Rb
2360 LET Rb=Rb*1.85*10^3
2370 PRINT : PRINT " ENTER THE THE FREQ. Br IN MHZ THE JAMMER TRANSMITS"
2380 INPUT Br : Br=Br*10^6
2390 PRINT : PRINT " ENTER THE GAIN OF THE JAMMING ANTENNA Gj IN db"
2400 INPUT Gj : Cj1=Cj/10 : Cj2=10*Cj1
2410 Pj=CSNG(Pr*G*S1av*Lv*Cs2*(4*PI*Rb^2*Br1*Cj2))
2420 Pj1=CSNG(Pr*G*S1av*Lv*Cs2*(4*PI*Rb^2*Br*Cj2))
2430 PRINT : PRINT " 1(g).Pj=Pr*G*Sav*Lv*(S/J)/(4*PI*Rb^2*Br1*Cj)=",Pj*10^6;"W/MHz";":
      JAMMER OUTPUT POWER FOR LONG PULSE"
2440 PRINT : PRINT " 2(g).Pj=Pr*G*Sav*Lv*(S/J)/(4*PI*Rb^2*Br*Cj)=",Pj1*10^6;"W/MHz";":
      JAMMER OUTPUT POWER FOR Br="Br/10^6;"MHz
2450 LPRINT : LPRINT " 1(g).Pj=Pr*G*Sav*Lv*(S/J)/(4*PI*Rb^2*Br1*Cj)=",Pj*10^6;"W/MHz";":
      JAMMER OUTPUT POWER FOR LONG PULSE"
2460 LPRINT : LPRINT " 2(g).Pj=Pr*G*Sav*Lv*(S/J)/(4*PI*Rb^2*Br*Cj)=",Pj1*10^6;"W/MHz";":
      JAMMER OUTPUT POWER FOR Br="Br/10^6;"MHz
2470 RETURN

```

PROBLEM #1

GIVEN

1. $f_0 = 5600 \text{ MHz}$: OPERATING FREQ.
2. $T_1 = 1.3 \text{ MICSEC.}$: PULSE WIDTH (long)
3. $T_s = .25 \text{ MICSEC.}$: PULSE WIDTH (short)
4. $P_r = 200 \text{ KW}$: PEAK OUTPUT POWER
5. $f_p = 650 \text{ HZ}$: P.R.F
6. $B_{r1} = 1 \text{ MHZ}$: BANDWIDTH (long pulse)
7. $B_{rs} = 5 \text{ MHZ}$: BANDWIDTH (short pulse)
8. $\omega_m = 16 \text{ R.P.M}$: ANTENNA SCAN FREQ.
9. $A.B = 1.5 \text{ Deg.}$: AZIMUTH BEAMWIDTH
10. $E.B = 14 \text{ Deg.}$: ELEVATION BEAMWIDTH
11. $T_a = 75 \text{ KELVIN}$: ANTENNA NOISE TEMPERATURE
12. $P_{fa} = 1E-11$: FALSE ALARM PROBABILITY

PART a:

1(a). $R = \sqrt[4]{\frac{P_r G A_e S_{av} n E_i(n)}{(4\pi)^2 K (T_a + T_e) B_{r1} (S/N)_{max}}} = 47.972 \text{ KM}$: MAX
DETECTION RANGE FOR THE LONG PULSE

2(a). $R_1 = R \sqrt[4]{1/5} = 32.0808 \text{ KM}$: MAX RANGE FOR THE SHORT PULSE

PART b:

1(b). $R_u = 230.769 \text{ KM}$: MAX. UNAMBIGUOUS RANGE

PART c:

1(c). $R_2 = 10^{1/4} R = 65.3076 \text{ KM}$ RANGE AT WHICH THE AIRCRAFT WILL BE DETECTED FOR
 $R.C.S = 10 \text{ sq.m}$ & FOR THE LONG PULSE

PART d:

1(d). $h_2 = R_2(m) - \sqrt{R_2^2(m) - 2h_1(ft)} / 2 = 923.902 \text{ ft}$: MIN. ALTITUDE AT WHICH THE RADAR CAN SEE
THE TARGET

PART e:

1(e). $P = Pr * G * 1^2 * G^2 / ((4 * \pi)^2 * R^2 * Ls) = -33.0829 \text{ dbm}$: SINGLE PULSE POWER AT THE ANTENNA TERMINAL OUTPUT

PART f:

1(f). $Cf = 4 / (1 + (1 / (Tl * Br))^2) * (fp * K)^{1/3} = 2.66218 \text{ db}$: CAMOUFLAGE FACTOR FOR $K = 1640$

2(f). $Cf1 = 4 / (1 + (1 / (Tl * Br))^2) * (fp * K)^{1/3} = 4.70479 \text{ db}$: CAMOUFLAGE FACTOR FOR $K = 400$

PART g:

1(g). $Pj = Pr * G * Sev * Ls * (S / J) / (4 * \pi * Rb^2 * Br * Cj) = 5.76344 \text{ W/MHz}$: JAMMER OUTPUT POWER FOR LONG PULSE

2(g). $Pj = Pr * G * Sev * Ls * (S / J) / (4 * \pi * Rb^2 * Br * Cj) = .192115 \text{ W/MHz}$: JAMMER OUTPUT POWER FOR $Br = 30 \text{ MHz}$

```

10 PRINT : PRINT TAB(30) " PROBLEM #2 "
20 PRINT TAB(30); " -----"
30 GOSUB 100 : GOSUB 530 : GOSUB 690
40 GOSUB 840 : GOSUB 950 : GOSUB 1060
50 PRINT : PRINT " DO YOU WANT TO TRY AGAIN FOR DIFFERENT OR THE SAME DATA Y/N?"
60 INPUT D$
70 IF LEFT$(D$,1)="Y" OR LEFT$(D$,1)="y" THEN 30
80 END
90 *****
100 INPUTS THE DATA
110 *****
120 PRINT : PRINT " ENTER THE OPERATING FREQ. f0 IN MHZ "
130 INPUT f0 : PRINT : PRINT " 1. f0=";f0;"MHZ "
140 PRINT : PRINT " ENTER THE DIMENSIONS OF THE RECTANGULAR TRANSMIT ANTENNA d1,d2
    IN METERS "
150 INPUT d1,d2 : PRINT : PRINT " 2. d1xd2="d1 "x" d2 " m"
160 PRINT : PRINT " ENTER THE #OF ELEMENTS OF THE RECT. ARRAY,TRANSMIT ANTENNA N "
170 INPUT N1 : PRINT : PRINT " 3. N=";N1
180 PRINT : PRINT " ENTER THE ILLUMINATION EFFICIENCY OF THE ARRAY Rr"
190 INPUT Rr : PRINT : PRINT " 4. Rr=";Rr
200 PRINT : PRINT " ENTER THE TOTAL LOSSES Ls (feed & phase shifter) IN db"
210 INPUT Ls : PRINT : PRINT " 5. Ls=";Ls;"db"
220 PRINT : PRINT " IS THE INPUT DATA CORRECT Y/N?"
230 INPUT A$
240 IF LEFT$(A$,1)="Y" OR LEFT$(A$,1)="y" THEN 500
250 IF A$="y" THEN 1041
260 IF A$="N" THEN PRINT " WHAT OF THE FOLLOWING DO YOU WANT TO CHANGE?"
270 IF A$="n" THEN PRINT " WHAT OF THE FOLLOWING DO YOU WANT TO CHANGE?"
280 PRINT : PRINT " 1. THE OPERATING FREQ.?"
290 PRINT : PRINT " 2. THE DIMENSIONS OF THE RECT.ARRAY?"
300 PRINT : PRINT " 3. #OF THE ELEMENTS?"
310 PRINT : PRINT " 4 ILLUMINATION EFFICIENCY?"
320 PRINT : PRINT " 5 THE TOTAL LOSSES?"
330 INPUT C$
340 IF C$="1" THEN PRINT : PRINT " ENTER THE OPERATING FREQ. f0 IN MHZ"

```



```

350 IF C$="1" THEN INPUT f0 : PRINT : PRINT " 1. f0=";f0;"MHz" : GOTO 440
360 IF C$="2" THEN PRINT : PRINT " ENTER THE DIMENSIONS OF THE RECT. TRANSMIT
    ANTENNA d1,d2 IN METERS"
370 IF C$="2" THEN INPUT d1,d2 : PRINT : PRINT " 2. d1xd2="d1 "x" d2 " m" : GOTO 440
380 IF C$="3" THEN PRINT : PRINT " ENTER THE # OF ELEMENTS OF THE RECT.
    ARRAY, TRANSMIT ANTENNA"
390 IF C$="3" THEN INPUT N1 : PRINT : PRINT " 3. N=";N1 : GOTO 440
400 IF C$="4" THEN PRINT : PRINT " ENTER THE ILLUMINATION EFFICIENCY OF THE ARRAY Rr"
410 IF C$="4" THEN INPUT Rr : PRINT : PRINT " 4. Rr=";Rr : GOTO 440
420 IF C$="5" THEN PRINT : PRINT " ENTER THE TOTAL LOSSES Ls (feed & phase shifter) IN
    db"
430 IF C$="5" THEN INPUT Ls : PRINT : PRINT " 5. Ls=";Ls;"db" : GOTO 440
440 PRINT : PRINT " IS EVERYTHING O.K NOW?"
450 INPUT B$
460 IF LEFT$(B$,1)="Y" OR LEFT$(B$,1)="y" THEN 500
470 PRINT : PRINT " WHAT DO YOU WANT TO CHANGE AGAIN?"
480 PRINT : PRINT " HIT ANY KEY IN YOUR KEYBOARD AND EVERYTHING WILL WORK FOR YOU
    MALAKA"
490 INPUT F$ : GOTO 280
500 RETURN
510 *****
520 PRINTS THE INPUT DATA
530 *****
540 LPRINT : LPRINT TAB(30); " PROBLEM #2"
550 LPRINT TAB(30); " -----"
560 LPRINT : LPRINT " G I V E N"
570 LPRINT " -----"
580 LPRINT : LPRINT " 1. f0=";f0;"MHz" TAB(20) " : OPERATING FREQ."
590 LPRINT : LPRINT " 2. d1xd2="d1 "x" d2 " m" TAB(20); " : DIMENSIONS OF THE ARRAY
    ANTENNA"
600 LPRINT : LPRINT " 3. N=";N1 TAB(20); " : # OF ELEMENTS OF THE ARRAY ANTENNA"
610 LPRINT : LPRINT " 4. Rr=";Rr TAB(20); " : ILLUMINATION EFF. OF THE ARRAY"
620 LPRINT : LPRINT " 5. Ls=";Ls;"db" TAB(20); " : TOTAL LOSSES (feed & phase shifter)"
670 RETURN
680 *****

```

```

690  ' CALCULATION & PRINTOUT FOR PART a:
700  '*****
710  PRINT : PRINT : PRINT " PART a:"
720  PRINT " -----"
730  LPRINT : LPRINT : LPRINT " PART a:"
740  LPRINT " -----"
750  LET Ls1=10^(-Ls/10) : A=d1*d2
760  LET Ae=Rr*Ls1*A : PI=3.14159
770  LET C=3*10^8 : f0=f0*10^6
780  LET l=C/f0 : Gp=CSNG(4*PI*Ae/(l^2))
790  LET Gp1=CSNG(10*.4342945**LOG(Gp))
800  PRINT : PRINT " 1(a). Gp=4*PI*Ae/(l^2)=";Gp;" numeric";" or";Gp1;"db";" : POWER GAIN"
810  LPRINT : LPRINT " 1(a). Gp=4*PI*Ae/(l^2)=";Gp;" numeric";" or";Gp1;"db";" : POWER GAIN"
820  RETURN
830  '*****
840  ' CALCULATION & PRINTOUT FOR PART b:
850  '*****
860  PRINT : PRINT : PRINT " PART b:"
870  PRINT " -----"
880  LPRINT : LPRINT : LPRINT " PART b:"
890  LPRINT " -----"
900  LET TH=CSNG(SQR(41250l/(Gp/Ls1)))
910  PRINT : PRINT " 1(b). TH=SQR(41250l/(Gp/Ls1))=";TH;"Deg."; " : BEAMWIDTH"
920  LPRINT : LPRINT " 1(b). TH=SQR(41250l/(Gp/Ls1))=";TH;"Deg."; " : BEAMWIDTH"
930  RETURN
940  '*****
950  ' CALCULATION & PRINT OUT FOR PART c:
960  '*****
970  PRINT : PRINT : PRINT " PART c:"
980  PRINT " -----"
990  LPRINT : LPRINT : LPRINT " PART c:"
1000 LPRINT " -----"
1010 LET d=CSNG(d1/SQR(N1))
1020 PRINT : PRINT " 1(c). d=d1/SQR(N1)=";d;" : SPACING BETWEEN ELEMENTS"
1030 LPRINT : LPRINT " 1(c). d=d1/SQR(N1)=";d;" : SPACING BETWEEN ELEMENTS"

```

```
1040 RETURN
1050*****
1060 * CALCULATION & PRINTOUT FOR PART d:
1070*****
1080 PRINT:PRINT:PRINT "PART d:"
1090 PRINT "-----"
1100 LPRINT:LPRINT:LPRINT "PART d:"
1110 LPRINT "-----"
1120 LET Gdel=CSNG(12795/N1)
1130 LET Gdel1=CSNG(10*.4342945**LOG(Gdel))
1140 PRINT:PRINT "1(d). Gdel=Gdarray/Gdgroup=";Gdel;"numeric;" or";Gdel1;"db";":
DIRECTIVE GAIN OF AN ELEMENT"
1150 LPRINT:LPRINT "1(d). Gdel=Gdarray/Gdgroup=";Gdel;"numeric;" or";Gdel1;"db";":
DIRECTIVE GAIN OF AN ELEMENT"
1160 RETURN
```

PROBLEM#2

GIVEN

1. $f_0 = 442 \text{ MHz}$: OPERATING FREQ.
2. $d_1 \times d_2 = 26.9 \times 26.9 \text{ m}$: DIMENSIONS OF THE ARRAY ANTENNA
3. $N = 5184$: *OF ELEMENTS OF THE ARRAY ANTENNA
4. $R_r = .65$: ILLUMINATION EFF. OF THE ARRAY
5. $L_s = 1.8 \text{ db}$: TOTAL LOSSES (feed & phase shifter)

PART a:

1(a). $G_p = 4 \cdot \pi \cdot A_e / (\lambda^2) = 8476.75$ numeric or 39.2823 db : POWER GAIN

PART b:

1(b). $\theta_H = \text{SQR}(41250 / (G_p / L_s)) = 1.79307 \text{ Deg.}$: BEAMWIDTH

PART c:

1(c). $d = d_1 / \text{SQR}(N) = .373611$: SPACING BETWEEN ELEMENTS

PART d:

1(d). $G_{d1} = G_{darray} / G_{dgroup} = 2.46817$ numeric or 3.92375 db : DIRECTIVE GAIN OF AN ELEMENT

AD-R164 143

INTRODUCTION TO THE MICROCOMPUTERS FOR SOLVING RADAR
AND ELECTRONIC WARFARE PROBLEMS(U) NAVAL POSTGRADUATE
SCHOOL MONTEREY CA C D VERGOS DEC 85

3/3

UNCLASSIFIED

F/G 17/9

NL

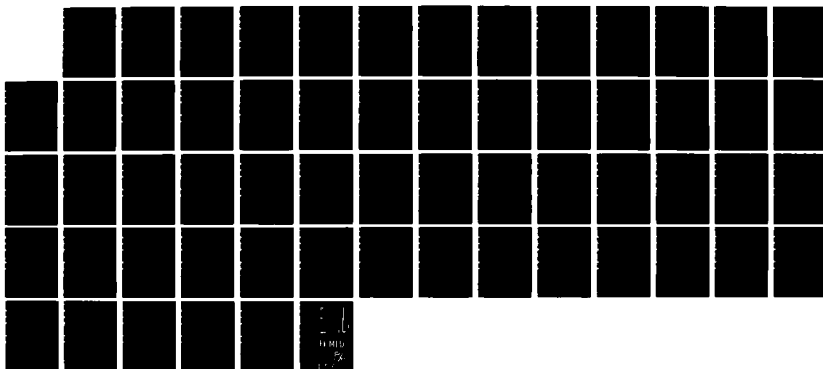

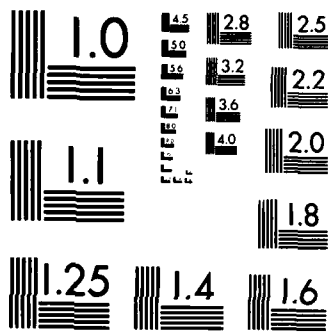

MICROCOPY RESOLUTION TEST CHART
NBS-1963-A

```

10 PRINT : PRINT TAB(30) " PROBLEM #3 "
20 PRINT TAB(30); " -----"
30 GOSUB 100 : GOSUB 1170
40 GOSUB 1430 : GOSUB 1590
50 PRINT : PRINT " DO YOU WANT TO TRY AGAIN FOR DIFFERENT OR THE SAME DATA Y/N?"
60 INPUT D$
70 IF LEFT$(D$,1)="Y" OR LEFT$(D$,1)="y" THEN 30
80 END
90 *****
100 INPUTS THE DATA
120 *****
130 PRINT : PRINT " ENTER THE OUTPUT PEAK POWER Pt IN W"
140 INPUT Pt : PRINT : PRINT " 1. Pt=";Pt;"W"
150 PRINT : PRINT " ENTER THE BORESIGHT ANTENNA GAIN Gt IN db"
160 INPUT Gt : PRINT : PRINT " 2. Gt=";Gt;"db"
170 PRINT : PRINT " ENTER THE OPERATING FREQ. f0 IN GHz"
180 INPUT f0 : PRINT : PRINT " 3. f0=";f0;"GHz"
190 PRINT : PRINT " ENTER THE RF LOSSES Lp IN db"
200 INPUT Lp : PRINT : PRINT " 4. Lp=";Lp;"db"
210 PRINT : PRINT " ENTER THE RECEIVER NOISE BANDWIDTH Bn IN MHz"
220 INPUT Bn : PRINT : PRINT " 5. Bn=";Bn;"MHz"
230 PRINT : PRINT " ENTER THE RECEIVER NOISE FIGURE F IN db"
240 INPUT F : PRINT : PRINT " 6. F=";F;"db"
250 PRINT : PRINT " ENTER THE PULSE WIDTH T IN ns"
260 INPUT T : PRINT : PRINT " 7. T=";T;"ns"
270 PRINT : PRINT " ENTER THE P.R.F fp IN KHz"
280 INPUT fp : PRINT : PRINT " 8. fp=";fp;"KHz"
290 PRINT : PRINT " ENTER THE INTEGRATION TIME Ti IN msec."
300 INPUT Ti : PRINT : PRINT " 9. Ti=";Ti;"msec."
310 PRINT : PRINT " ENTER THE WEATHER ATTENUATION At IN db/KM"
320 INPUT At : PRINT : PRINT " 10. At=";At;"db/KM"
330 PRINT : PRINT " ENTER THE SKY TEMPERATURE T0 IN KELVIN"
340 INPUT T0 : PRINT : PRINT " 11. T0=";T0;"KELVIN"
350 PRINT : PRINT " ENTER THE TARGET RCS IN dbsm"
360 INPUT RCS : PRINT : PRINT " 12. RCS=";RCS;"dbsm"

```

```

370 PRINT : PRINT " ENTER THE DEG. OF THE PENCIL BEAM PB (part b)"
380 INPUT PB : PRINT : PRINT " 13. PB=";PB;"Deg."
390 PRINT : PRINT " ENTER THE (J/S) JS IN db (part b)"
400 INPUT JS : PRINT : PRINT " 14. (J/S)=";JS;"db"
410 PRINT : PRINT " ENTER THE RANGE R IN KM (part c)"
420 INPUT R : PRINT : PRINT " 15. R=";R;"KM"
430 PRINT : PRINT " ENTER THE RF LOSSES RFL IN db (part d)"
440 INPUT RFL : PRINT : PRINT " 16. RFL=";RFL;"db"
450 PRINT : PRINT " ENTER THE ILLUMINATION EFFICIENCY r1 (part d)"
460 INPUT r1 : PRINT : PRINT " 17. r1=";r1
470 PRINT : PRINT " ENTER THE CROSSOVER LOSSE Lco IN db"
480 INPUT Lco : PRINT : PRINT " 18. Lco=";Lco;"db"
490 PRINT : PRINT " IS THE INPUT DATA CORRECT Y/N?"
500 INPUT A$
510 IF LEFT$(A$,1)="Y" OR LEFT$(A$,1)="y" THEN 1150
520 PRINT " WHAT OF THE FOLLOWING DO YOU WANT TO CHANGE?"
530 PRINT : PRINT " 1. OUTPUT PEAK POWER?"
540 PRINT : PRINT " 2. THE BORESIGHT ANTENNA GAIN?"
550 PRINT : PRINT " 3. THE OPERATING FREQ.?"
560 PRINT : PRINT " 4. THE RF LOSSES?"
570 PRINT : PRINT " 5. THE RECEIVER'S NOISE BANDWIDTH?"
580 PRINT : PRINT " 6. THE RECEIVER'S NOISE FIGURE?"
590 PRINT : PRINT " 7. THE PULSE WIDTH?"
600 PRINT : PRINT " 8. THE P.R.F.?"
610 PRINT : PRINT " 9. THE INTEGRATION TIME?"
620 PRINT : PRINT " 10. THE WEATHER ATTENUATION?"
630 PRINT : PRINT " 11. THE SKY TEMPERATURE?"
640 PRINT : PRINT " 12. THE TARGET'S RCS?"
650 PRINT : PRINT " 13. THE PENCIL BEAMWIDTH?"
660 PRINT : PRINT " 14. THE (J/S) RATIO?"
670 PRINT : PRINT " 15. THE RANGE?"
680 PRINT : PRINT " 16. THE RF LOSSES for part c?"
690 PRINT : PRINT " 17. THE ILLUMINATION EFFICIENCY?"
700 PRINT : PRINT " 18. THE CROSSOVER LOSS?"
710 INPUT C$

```



```

720 IF C$="1" THEN PRINT : PRINT " ENTER THE OUTPUT PEAK POWER Pt IN W"
730 IF C$="1" THEN INPUT Pt : PRINT : PRINT " 1. Pt=";Pt;"W" : GOTO 1090
740 IF C$="2" THEN PRINT : PRINT " ENTER THE BORESIGHT ANTENNA GAIN Gt IN db"
750 IF C$="2" THEN INPUT Gt : PRINT : PRINT " 2. Gt=";Gt;"db" : GOTO 1090
760 IF C$="3" THEN PRINT : PRINT " ENTER THE OPERATING FREQ. f0 In GHz"
770 IF C$="3" THEN INPUT f0 : PRINT : PRINT " 3. f0=";f0;"GHz" : GOTO 1090
780 IF C$="4" THEN PRINT : PRINT " ENTER THE RF LOSSES Lp IN db"
790 IF C$="4" THEN INPUT Lp : PRINT : PRINT " 4. Lp=";Lp;"db" : GOTO 1090
800 IF C$="5" THEN PRINT : PRINT " ENTER THE RECEIVER NOISE BANDWIDTH Bn IN MHZ"
820 IF C$="5" THEN INPUT Bn : PRINT : PRINT " 5. Bn=";Bn;"MHZ" : GOTO 1090
830 IF C$="6" THEN PRINT : PRINT " ENTER THE RECEIVER NOISE FIGURE F IN db"
840 IF C$="6" THEN INPUT F : PRINT : PRINT " 6. F=";f;"db" : GOTO 1090
850 IF C$="7" THEN PRINT : PRINT " ENTER THE PULSE WIDTH T IN ns"
860 IF C$="7" THEN INPUT T : PRINT : PRINT " 7. T=";T;"ns" : GOTO 1090
870 IF C$="8" THEN PRINT : PRINT " ENTER THE P.R.F fp IN KHz"
880 IF C$="8" THEN INPUT fp : PRINT : PRINT " 8. fp=";fp;"KHz" : GOTO 1090
890 IF C$="9" THEN PRINT : PRINT " ENTER THE INTEGRATION TIME T1 IN msec."
900 IF C$="9" THEN INPUT T1 : PRINT : PRINT " 9. T1=";T1;"msec." : GOTO 1090
910 IF C$="10" THEN PRINT : PRINT " ENTER THE WEATHER ATTENUATION At IN db/KM"
920 IF C$="10" THEN INPUT At : PRINT : PRINT " 10. At=";At;"db/KM" : GOTO 1090
930 IF C$="11" THEN PRINT : PRINT " ENTER THE SKY TEMPERATURE Ta IN KELVIN"
940 IF C$="11" THEN INPUT Ta : PRINT : PRINT " 11. Ta=";Ta;"KELVIN" : GOTO 1090
950 IF C$="12" THEN PRINT : PRINT " ENTER THE TARGET RCS IN dbsm"
960 IF C$="12" THEN INPUT RCS : PRINT : PRINT " 12. RCS=";RCS;"dbsm" : GOTO 1090
970 IF C$="13" THEN PRINT : PRINT " ENTER THE DEG. OF THE PENCIL BEAM PB (part b)"
980 IF C$="13" THEN INPUT PB : PRINT : PRINT " 13. PB=";PB;"Deg." : GOTO 1090
990 IF C$="14" THEN PRINT : PRINT " ENTER THE (J/S) JS IN db (part b)"
1000 IF C$="14" THEN INPUT JS : PRINT : PRINT " 14. (J/S)=";JS;"db" : GOTO 1090
1010 IF C$="15" THEN PRINT : PRINT " ENTER THE RANGE R IN KM (part c)"
1020 IF C$="15" THEN INPUT R : PRINT : PRINT " 15. R=";R;"KM" : GOTO 1090
1030 IF C$="16" THEN PRINT : PRINT " ENTER THE RF LOSSES RFL IN db (part d)"
1040 IF C$="16" THEN INPUT RFL : PRINT : PRINT " 16. RFL=";RFL;"db" : GOTO 1090
1050 IF C$="17" THEN PRINT : PRINT " ENTER THE ILLUMINATION EFFICIENCY r1 (part d)"
1060 IF C$="17" THEN INPUT r1 : PRINT : PRINT " 17. r1=";r1 : GOTO 1090
1070 IF C$="18" THEN PRINT : PRINT " ENTER THE CROSSOVER LOSSE Lco IN db"

```

```

1080 IF C$="18" THEN INPUT Lco : PRINT : PRINT " 18. Lco=";Lco;"db" : GOTO 1090
1090 PRINT : PRINT " IS EVERYTHING O.K NOW?"
1100 INPUT B$
1110 IF LEFT$(B$,1)="Y" OR LEFT$(B$,1)="y" THEN 1150
1120 PRINT : PRINT " WHAT DO YOU WANT TO CHANGE AGAIN?"
1130 PRINT : PRINT " HIT ANY KEY IN YOUR KEYBOARD AND EVERYTHING WILL WORK FOR YOU
MALAKA"
1140 INPUT F$ : GOTO 530
1150 RETURN
1160 *****
1170 PRINTS THE INPUT DATA
1180 *****
1190 LPRINT : LPRINT TAB(30); " PROBLEM #3"
1200 LPRINT TAB(30); " -----"
1210 LPRINT : LPRINT " G I V E N"
1220 LPRINT " -----"
1230 LPRINT : LPRINT " 1. Pt=";Pt;"W" SPC(10); " : OUTPUT PEAK POWER"
1240 LPRINT : LPRINT " 2. Gt=";Gt;"db" SPC(8); " : BORESIGHT ANTENNA GAIN"
1250 LPRINT : LPRINT " 3. f0=";f0;"GHz" SPC(5); " : OPERATING FREQ."
1260 LPRINT : LPRINT " 4. Lp=";Lp;"db" SPC(9); " : RF LOSSES"
1270 LPRINT : LPRINT " 5. Bn=";Bn;"MHz" SPC(6); " : RECEIVER NOISE BANDWIDTH"
1280 LPRINT : LPRINT " 6. F=";f;"db" SPC(9); " : RECEIVER NOISE FIGURE"
1290 LPRINT : LPRINT " 7. T=";T;"ns" SPC(9); " : PULSE WIDTH"
1300 LPRINT : LPRINT " 8. fp=";fp;"KHz" SPC(6); " : P.R.F"
1310 LPRINT : LPRINT " 9. T1=";T1;"msec." SPC(5); " : INTEGRATION TIME"
1320 LPRINT : LPRINT " 10. At=";At;"db/KM" SPC(4); " : WEATHER ATTENUATION"
1330 LPRINT : LPRINT " 11. Ta=";Ta;"KELVIN" SPC(2); " : SKY TEMPERATURE"
1340 LPRINT : LPRINT " 12. RCS=";RCS;"dbsm" SPC(2); " : TARGET RCS"
1350 LPRINT : LPRINT " 13. PB=";PB;"Deg." SPC(5); " : DEG. OF THE PENCIL BEAM"
1360 LPRINT : LPRINT " 14. (J/S)=";JS;"db" SPC(4); " : (J/S)"
1370 LPRINT : LPRINT " 15. R=";R;"KM" SPC(9); " : RANGE"
1380 LPRINT : LPRINT " 16. RFL=";RFL;"db" SPC(7); " : RF LOSSES for part d"
1390 LPRINT : LPRINT " 17. r1=";r1 SPC(9); " : ILLUMINATION EFFICIENCY"
1400 LPRINT : LPRINT " 18. Lco=";Lco;"db" SPC(7); " : CROSSOVER LOSS"
1410 RETURN

```

```

1420 *****
1430 * SUBROUTINE THAT CONVERTS UNITS
1440 *****
1450 LET M=.4342945*
1460 LET PI=3.14159 : C=3*10^8
1470 LET f0=f0*10^9 : fp=fp*10^3
1480 LET R=R*10^3 : l=C/f0
1490 LET Gt1=Gt/10 : Gt2=CINT(10^Gt1)
1500 LET Lp1=Lp/10 : Lp2=10^Lp1
1510 LET RCS1=RCS/10 : RCS2=CSNG(10^RCS1)
1520 LET ra=10^(-1/10)
1530 LET Gtot=Gt+RFL : Gtot1=Gtot/10 : Gtot2=CINT(10^Gtot1)
1540 LET Lco1=Lco/10 : Lco2=CSNG(10^(-Lco1))
1550 LET Gd=Gt+RFL+Lco
1560 LET Gd1=Gd/10 : Gd2=10^Gd1
1570 RETURN
1580 *****
1590 * PRINTS THE RESULTS
1600 *****
1610 PRINT : PRINT : PRINT " PART (a) : "
1620 PRINT " -----"
1630 LPRINT : LPRINT : LPRINT " PART (a) : "
1640 LPRINT " -----"
1650 LET Ru=c/(2*fp)*(1/1000)
1660 PRINT : PRINT " a. Ru=";Ru;"KM"; " : MAX. UNAMBIGUOUS RANGE"
1670 LPRINT : LPRINT " a. Ru=";Ru;"KM"; " : MAX. UNAMBIGUOUS RANGE"
1680 PRINT : PRINT : PRINT " PART (b) : "
1690 PRINT " -----"
1700 LPRINT : LPRINT : LPRINT " PART (b) : "
1710 LPRINT " -----"
1720 LET G=412501/(PB^2) : Ae=1^2*G/(4*PI)
1730 LET Ge=JS*(Lp2^2)*RCS2/(Ae*G)
1740 LET Ge1=CSNG(10*M*LOG(Ge))
1750 PRINT : PRINT " b. Ge=";Ge1;"db"; " : REPEATER GAIN REQUIRED FOR (J/S)=";JS;"db"
1760 LPRINT : LPRINT " b. Ge=";Ge1;"db"; " : REPEATER GAIN REQUIRED FOR (J/S)=";JS;"db"

```

```

1770 PRINT : PRINT : PRINT " PART (c) : "
1780 PRINT "-----"
1790 LPRINT : LPRINT : LPRINT " PART (c) : "
1800 LPRINT "-----"
1810 LET Pout=Pt*Gt2*(10^(-At/10))*Ae*Ge/(4*PI*R^2*Lp2)
1820 LET Pout=CSNG(Pout*1000) 'mW
1830 PRINT : PRINT " c. Pout=";Pout;"mW"; " : JAMMER OUTPUT POWER"
1840 LPRINT : LPRINT " c. Pout=";Pout;"mW"; " : JAMMER OUTPUT POWER"
1850 PRINT : PRINT : PRINT " PART (d) : "
1860 PRINT "-----"
1870 LPRINT : LPRINT : LPRINT " PART (d) : "
1880 LPRINT "-----"
1890 LET D=CSNG(1/PI*SQR(Gtot2/(ra*ri))*100) 'cm
1900 PRINT : PRINT " d. D=";D;"cm"; " : DIAMETER OF THE SEEKER DISH ANTENNA"
1910 LPRINT : LPRINT " d. D=";D;"cm"; " : DIAMETER OF THE SEEKER DISH ANTENNA"
1920 PRINT : PRINT : PRINT " PART (e) : "
1930 PRINT "-----"
1940 LPRINT : LPRINT : LPRINT " PART (e) : "
1950 LPRINT "-----"
1960 LET THb=SQR(412531/Gd2)
1970 LET THq=((LOG(Lco2))/(-2.776))^(1/2)*THb:THq=CSNG(THq)
1980 PRINT : PRINT " e. THq=";THq;"Deg."; " : SQUINT ANGLE"
1990 LPRINT : LPRINT " e. THq=";THq;"Deg."; " : SQUINT ANGLE"
2000 RETURN

```

PROBLEM#3

GIVEN

1. $P_t = 1 \text{ W}$: OUTPUT PEAK POWER
2. $G_t = 38 \text{ db}$: BORESIGHT ANTENNA GAIN
3. $f_0 = 93.7 \text{ GHz}$: OPERATING FREQ.
4. $L_p = 3 \text{ db}$: RF LOSSES
5. $B_n = 500 \text{ MHz}$: RECEIVER NOISE BANDWIDTH
6. $F = 11 \text{ db}$: RECEIVER NOISE FIGURE
7. $T = 50 \text{ ns}$: PULSE WIDTH
8. $f_p = 100 \text{ KHz}$: P.R.F
9. $T_i = 50 \text{ msec.}$: INTEGRATION TIME
10. $A_t = .4 \text{ db/KM}$: WEATHER ATTENUATION
11. $T_e = 270 \text{ KELVIN}$: SKY TEMPERATURE
12. $RCS = 14.8 \text{ dbsm}$: TARGET RCS
13. $PB = 10 \text{ Deg.}$: DEG. OF THE PENCIL BEAM
14. $(J/S) = 10 \text{ db}$: (J/S)
15. $R = 1 \text{ KM}$: RANGE
16. $RFL = 1 \text{ db}$: RF LOSSES for part d
17. $\eta_i = .6$: ILLUMINATION EFFICIENCY
18. $L_{co} = 1 \text{ db}$: CROSSOVER LOSS

PART (a):

a. $R_u = 1.5 \text{ KM}$: MAX. UNAMBIGUOUS RANGE

PART (b):

b. $G_e = 39.376 \text{ db}$: REPEATER GAIN REQUIRED FOR $(J/S) = 10 \text{ db}$

PART (c):

c. $P_{out} = .658953 \text{ mW}$: JAMMER OUTPUT POWER

PART (d):

D= 13.1568 cm : DIAMETER OF THE SEEKER DISH ANTENNA

PART (e):

e. THq= .58496 Deg. : SQUINT ANGLE

```

10 PRINT : PRINT TAB(30); " PROBLEM #4"
20 PRINT TAB(30); " -----"
30 GOSUB 100 : GOSUB 1050 : GOSUB 1300
40 GOSUB 1480 : GOSUB 1640 : GOSUB 1800 : GOSUB 1960
50 PRINT : PRINT " DO YOU WANT TO TRY AGAIN FOR DIFFERENT OR THE SAME DATA Y/N?"
60 INPUT D$
70 IF LEFT$(D$,1)="Y" OR LEFT$(D$,1)="y" THEN 30
80 END
90 *****
100 INPUTS THE DATA
110 *****
120 PRINT : PRINT " ENTER THE ARRAY SIZE d1,d2 IN METERS"
130 INPUT d1,d2 : PRINT : PRINT " 1. d1xd2=";d1"x"d2" m"
140 PRINT : PRINT " ENTER THE OPERATING FREQ. f0 IN GHZ"
160 INPUT f0 : PRINT : PRINT " 2. f0=";f0;"GHZ"
170 PRINT : PRINT " ENTER THE FEED & PHASE SHIFTER LOSSES Lfp IN db"
180 INPUT Lfp : PRINT : PRINT " 3. Lfp=";Lfp;"db"
190 PRINT : PRINT " ENTER THE SIDELobe LEVEL S.L IN db"
200 INPUT S.L : PRINT : PRINT " 4. S.L=";S.L;"db"
210 PRINT : PRINT " ENTER THE ILLUMINATION EFFICIENCY r1"
220 INPUT r1 : PRINT : PRINT " 5. r1=";r1
230 PRINT : PRINT " ENTER THE OUTPUT POWER P0 IN Mw"
240 INPUT P0 : PRINT : PRINT " 6. P0=";P0;"Mw"
250 PRINT : PRINT " ENTER THE VALUE OF THE TWO T.W"
260 INPUT T.W : PRINT : PRINT " 7. T.W=";T.W
270 PRINT : PRINT " ENTER THE WEIGHTING FILTER LOSS Lm IN db"
280 INPUT Lm : PRINT : PRINT " 8. Lm=";Lm;"db"
290 PRINT : PRINT " ENTER THE VALUE OF THE MIN. OUTPUT FOR AUTOMATIC DETECTION, S1 IN
db"

```

```

300 INPUT S1:PRINT:PRINT " 9. (S/N)min=";S1;"db"
310 PRINT:PRINT " ENTER THE R.C.S OF THE CRUISE MISSILES Sev IN dbsm"
320 INPUT Sev:PRINT:PRINT " 10. Sev=";Sev;"dbsm"
330 PRINT:PRINT " ENTER THE RANGE OF THE TWO NOISE JAMMERS R IN KM"
340 INPUT R:PRINT:PRINT " 11. R=";R;"KM"
350 PRINT:PRINT " ENTER THE #OF CARCINOTRONS THAT EACH JAMMER CARRIES Cr"
360 INPUT Cr:PRINT:PRINT " 12. Cr=";Cr
370 PRINT:PRINT " ENTER THE ERP Pj IN KW"
380 INPUT Pj:PRINT:PRINT " 13. Pj=";Pj;"KW/tube"
390 PRINT:PRINT " ENTER THE PROPAGATION FACTOR g"
400 INPUT g:PRINT:PRINT " 14. g=";g
410 PRINT:PRINT "NOW GO TO PART c&e OF THE PROBLEM AND ENTER THE FOLLOWING:"
420 PRINT:PRINT " ENTER THE RANGE THAT THE CRUISE MISSILE IS ILLUMINATED R1 IN KM"
430 INPUT R1:PRINT:PRINT " 15. R1=";R1;"KM"
450 PRINT:PRINT " ENTER AGAIN THE RANGE THAT THE CRUISE MISSILE IS ILLUMINATED R2 IN
  KM (for part e)"
460 INPUT R2:PRINT:PRINT " 16. R2=";R2;"KM"
470 PRINT:PRINT " ENTER THE INTEGRATION EFFICIENCY E1"
480 INPUT E1:PRINT:PRINT " 17. E1(n)=";E1
490 PRINT:PRINT " IS THE INPUT DATA CORRECT Y/N?"
500 INPUT A$
510 IF LEFT$(A$,1)="Y" OR LEFT$(A$,1)="y" THEN 1030
520 PRINT:PRINT " WHAT OF THE FOLLOWING DO YOU WANT TO CHANGE?"
530 PRINT:PRINT " 1. THE SIZE OF THE ARRAY?", " 2. THE OPERATING FREQ.?"
540 PRINT:PRINT " 3. THE FEED AND PHASE SHIFTER LOSSES?", " 4. THE SIDELobe LEVEL?"
550 PRINT:PRINT " 5. THE ILLUMINATION EFFICIENCY?", " 6. THE OUTPUT POWER?"
560 PRINT:PRINT " 7. THE VALUE OF THE TWO TW?", " 8. THE WEIGHTING FILTER LOSS?"
570 PRINT:PRINT " 9. THE VALUE OF THE (S/N)min?", " 10. THE RCS OF THE CRUISE MISSILE?"
580 PRINT:PRINT " 11. THE RANGE OF THE TWO NOISE JAMMERS?",

```



```

590 PRINT : PRINT " 12. THE #OF CANCINOTRONS?", " 13. THE ERP?"
600 PRINT : PRINT " 14. THE PROPAGATION FACTOR?", " 15. THE RANGE OF THE CRUISE MISSILE
    (part c)?"
610 PRINT : PRINT " 16. THE RANGE OF THE CRUISE MISSILE (part e)?", " 17. THE INTEGRATION
    EFFICIENCY?"
620 INPUT C$
630 IF C$="1" THEN PRINT : PRINT " ENTER THE ARRAY SIZE d1,d2 IN METERS"
640 IF C$="1" THEN INPUT d1,d2 : PRINT : PRINT " 1. d1xd2=";d1"x"d2" m" : GOTO 970
650 IF C$="2" THEN PRINT : PRINT " ENTER THE OPERATING FREQ. f0 IN GHZ"
660 IF C$="2" THEN INPUT f0 : PRINT : PRINT " 2. f0=";f0;"GHZ" : GOTO 970
670 IF C$="3" THEN PRINT : PRINT " ENTER THE FEED & PHASE SHIFTER LOSSES Lfp IN db"
680 IF C$="3" THEN INPUT Lfp : PRINT : PRINT " 3. Lfp=";Lfp;"db" : GOTO 970
690 IF C$="4" THEN PRINT : PRINT " ENTER THE SIDELobe LEVEL S.L IN db"
700 IF C$="4" THEN INPUT S.L : PRINT : PRINT " 4. S.L=";S.L;"db" : GOTO 970
710 IF C$="5" THEN PRINT : PRINT " ENTER THE ILLUMINATION EFFICIENCY ri"
720 IF C$="5" THEN INPUT ri : PRINT : PRINT " 5. ri=";ri : GOTO 970
730 IF C$="6" THEN PRINT : PRINT " ENTER THE OUTPUT POWER Pa IN Mw"
740 IF C$="6" THEN INPUT Pa : PRINT : PRINT " 6. Pa=";Pa;"Mw" : GOTO 970
750 IF C$="7" THEN PRINT : PRINT " ENTER THE VALUE OF THE TWO T.W"
760 IF C$="7" THEN INPUT T.W : PRINT : PRINT " 7. T.W=";T.W : GOTO 970
770 IF C$="8" THEN PRINT : PRINT " ENTER THE WEIGHTING FILTER LOSS Lm IN db"
780 IF C$="8" THEN INPUT Lm : PRINT : PRINT " 8. Lm=";Lm;"db" : GOTO 970
790 IF C$="9" THEN PRINT : PRINT " ENTER THE VALUE OF THE MIN. OUTPUT FOR
    AUTOMATIC DETECTION, S1 IN db"
800 IF C$="9" THEN INPUT S1 : PRINT : PRINT " 9. (S/N)min=";S1;"db" : GOTO 970
810 IF C$="10" THEN PRINT : PRINT " ENTER THE R.C.S OF THE CRUISE MISSILES Sav IN
    dbsm"
820 IF C$="10" THEN INPUT Sav : PRINT : PRINT " 10. Sav=";Sav;"dbsm" : GOTO 970
830 IF C$="11" THEN PRINT : PRINT " ENTER THE RANGE OF THE TWO NOISE JAMMERS R IN

```

```

KM
840 IF C$="11" THEN INPUT R : PRINT : PRINT " 11. R=";R;"KM" : GOTO 970
850 IF C$="12" THEN PRINT : PRINT " ENTER THE #OF CARCINOTRONS THAT EACH JAMMER
    CARRIESCr"
860 IF C$="12" THEN INPUT Cr : PRINT : PRINT " 12. Cr=";Cr : GOTO 970
870 IF C$="13" THEN PRINT : PRINT " ENTER THE ERP Pj IN KW"
880 IF C$="13" THEN INPUT Pj : PRINT : PRINT " 13. Pj=";Pj;"KW/tube" : GOTO 970
890 IF C$="14" THEN PRINT : PRINT " ENTER THE PROPAGATION FACTOR g"
900 IF C$="14" THEN INPUT g : PRINT : PRINT " 14. g=";g : GOTO 970
910 IF C$="15" THEN PRINT : PRINT " ENTER THE RANGE THAT THE CRUISE MISSILE IS
    ILLUMINATED R1 IN KM"
920 IF C$="15" THEN INPUT R1 : PRINT : PRINT " 15. R1=";R1;"KM" : GOTO 970
930 IF C$="16" THEN PRINT : PRINT " ENTER AGAIN THE RANGE THAT THE CRUISE MISSILE
    IS ILLUMINATED R2 IN KM (for part e)"
940 IF C$="16" THEN INPUT R2 : PRINT : PRINT " 16. R2=";R2;"KM" : GOTO 970
950 IF C$="17" THEN PRINT : PRINT " ENTER THE INTEGRATION EFFICIENCY E1"
960 IF C$="17" THEN INPUT E1 : PRINT : PRINT " 17. E1(n)=";E1 : GOTO 970
970 PRINT : PRINT " IS EVERYTHING O.K NOW?"
980 INPUT B$
990 IF LEFT$(B$,1)="Y" OR LEFT$(B$,1)="y" THEN 1030
1000 PRINT : PRINT " WHAT DO YOU WANT TO CHANGE AGAIN?"
1010 PRINT : PRINT " HIT ANY KEY IN YOUR KEYBOARD AND EVERYTHING WILL WORK FOR YOU
    MALAKA"
1020 INPUT F$ : GOTO 530
1030 RETURN
1040 *****
1050 PRINTS THE INPUT DATA
1060 *****
1070 LPRINT : LPRINT TAB(30); " PROBLEM #4"

```

```

1080 LPRINT TAB(30); "-----"
1090 LPRINT : LPRINT " G I V E N"
1100 LPRINT "-----"
1110 LPRINT : LPRINT " 1. d1xd2=";d1"x"d2"m" TAB(20); " : ARRAY SIZE"
1120 LPRINT : LPRINT " 2. f0=";f0;"GHZ"TAB(20); " : OPERATING FREQ."
1130 LPRINT : LPRINT " 3. Lfp=";Lfp;"db" TAB(20); " : FEED & PHASE SHIFTER LOSSES"
1140 LPRINT : LPRINT " 4. SL=";SL;"db" TAB(20); " : SIDELobe LEVEL"
1150 LPRINT : LPRINT " 5. ri=";ri TAB(20); " : ILLUMINATION EFFICIENCY"
1160 LPRINT : LPRINT " 6. Pe=";Pe;"Mw" TAB(20); " : OUTPUT POWER"
1170 LPRINT : LPRINT " 7. T.W=";T.W TAB(20); " : VALUE OF THE TWO TW"
1180 LPRINT : LPRINT " 8. Lm=";Lm;"db" TAB(20); " : WEIGHTING FILTER LOSS"
1190 LPRINT : LPRINT " 9. (S/N)min=";S1;"db" TAB(20); " : (S/N)min FOR AUT. DETECTION"
1200 LPRINT : LPRINT " 10. Sev=";Sev;"dbsm" TAB(20); " : R.C.S FOR THE CRUISE MISSILE"
1210 LPRINT : LPRINT " 11. R=";R;"KM" TAB(20); " : RANGE OF THE TWO NOISE JAMMERS"
1220 LPRINT : LPRINT " 12. Cr=";Cr TAB(20); " : #OF CANCELLOTRONS"
1230 LPRINT : LPRINT " 13. Pj=";Pj;"KW/tube" TAB(20); " : ERP VALUE"
1240 LPRINT : LPRINT " 14. g=";g TAB(20); " : PROPAGATION FACTOR"
1250 LPRINT : LPRINT " 15. R1=";R1;"KM" TAB(20); " : RANGE OF THE CRUISE MISSILE (part c)"
1260 LPRINT : LPRINT " 16. R2=";R2;"KM" TAB(20); " : RANGE OF THE CRUISE MISSILE (part e)"
1270 LPRINT : LPRINT " 17. E1(n)=";E1 TAB(20); " : INTEGRATION EFFICIENCY"
1280 RETURN
1290*****
1300 ' CALCULATION AND PRINTOUT FOR PART e:
1310*****
1320 PRINT : PRINT : PRINT " PART e:"
1330 LPRINT : LPRINT : LPRINT " PART e:"
1340 PRINT "-----"
1350 LPRINT "-----"
1360 LET PI=3.14159 : f0=f0*10^9 : C=3*10^8

```

```

1370 LET A=d1*d2
1380 LET l=C/10
1390 LET Lfp1=10*(-Lfp/10)
1400 LET Ae=CSNG(A*Lfp1*ri)
1410 LET Gp=CINT(4*PI*Ae/(l^2))
1420 PRINT:PRINT " 1(e). Ae=A*Lfp1*ri=";Ae;"sq.m";": EFFECTIVE AREA OF THE PHASED
ARRAY"
1430 LPRINT:LPRINT " 1(e). Ae=A*Lfp1*ri=";Ae;"sq.m";": EFFECTIVE AREA OF THE PHASED
ARRAY"
1440 PRINT:PRINT " 2(e). Gp=4*PI*Ae/(l^2)=";Gp;": POWER GAIN OF PHASED ARRAY"
1450 LPRINT:LPRINT " 2(e). Gp=4*PI*Ae/(l^2)=";Gp;": POWER GAIN OF PHASED ARRAY"
1460 RETURN
1470*****
1480 ' CALCULATION AND PRINTOUT FOR PART b:
1490*****
1500 PRINT:PRINT:PRINT " PART b:"
1510 LPRINT:LPRINT:LPRINT " PART b:"
1520 PRINT "-----"
1530 LPRINT "-----"
1540 LET Pj=Pj*10^3
1550 LET Lm1=Lm/10:Lm2=10*Lm1
1560 LET R=R*10^3
1570 LET J=CSNG(2*Cr*Pj*Ae/(4*PI*R^2*Lm2*T.W))
1580 LET J1=CSNG(10*.4342945**LOG(J)) 'dbw VALUE
1590 LET J2=CSNG(J1+30) 'dbm VALUE
1600 PRINT:PRINT " 1(b). J=Gj*Pj**Ae/(4*PI*R^2*Lm2*T.W)=";J;"W";" OR";J1;"dbw";" OR
";J2;"dbm"
1610 LPRINT:LPRINT " 1(b). J=Gj*Pj**Ae/(4*PI*R^2*Lm2)=";J;"W";" OR";J1;"dbw";"
OR";J2;"dbm"

```

```

1620 RETURN
1630*****
1640 ' CALCULATION AND PRINTOUT FOR PART c:
1650*****
1660 PRINT : PRINT : PRINT " PART c:"
1670 LPRINT : LPRINT : LPRINT " PART c:"
1680 PRINT "-----"
1690 LPRINT "-----"
1700 LET Pa=Pa*10^6
1710 LET Slev=10^(-Sav/10)
1720 LET R1=R1*10^3
1730 LET S2=CSNG(Pa*Gp*Slev*Ae/((4*PI*R1^2)^(2)))
1740 LET S3=CSNG(10*.4342945**LOG(S2)) 'dbw
1750 LET S4=CSNG(S3+30) 'dbm
1760 PRINT : PRINT " 1(c). S=Pa*Gp*Slev*Ae/((4*PI*R1^2)^(2))=";S2;"W";" OR";S3;"dbw";" OR
";S4;"dbm";": SINGLE PULSE ECHO SIGNAL POWER"
1770 LPRINT : LPRINT " 1(c). S=Pa*Gp*Slev*Ae/((4*PI*R1^2)^(2))=";S2;"W";" OR";S3;"dbw";"
OR";S4;"dbm";": SINGLE PULSE ECHO SIGNAL POWER"
1780 RETURN
1790*****
1800 ' CALCULATION AND PRINTOUT FOR PART d:
1810*****
1820 PRINT : PRINT : PRINT " PART d:"
1830 LPRINT : LPRINT : LPRINT " PART d:"
1840 PRINT "-----"
1850 LPRINT "-----"
1860 LET T.W1=10*.4342945**LOG(T.W)
1870 LET B=CSNG(J2-S4)
1880 LET C=CSNG(-B+T.W1-Lm)

```

```

1890 LET C=-C
1900 PRINT : PRINT " 1(d). (J/S)In=J2-S4=";B;"dbm"; " : THE SINGLE PULSE (J/S) AT THE
RECEIVERINPUT"
1910 LPRINT : LPRINT " 1(d). (J/S)In=J2-S4=";B;"dbm"; " : THE SINGLE PULSE (J/S) AT THE
RECEIVERINPUT"
1920 PRINT : PRINT " 2(d). (S/J)out=(S/J)In+(T.W)-Lm=";C;"db"; " : THE SINGLE PULSE (J/S) AT
THERECEIVER OUTPUT"
1930 LPRINT : LPRINT " 2(d). (S/J)out=(S/J)In+(T.W)-Lm=";C;"db"; " : THE SINGLE PULSE (J/S)
AT THE RECEIVER OUTPUT"
1940 RETURN
1950*****
1960 * CALCULATION AND PRINTOUT FOR PART e:
1970*****
1980 PRINT : PRINT : PRINT " PART e:"
1990 LPRINT : LPRINT : LPRINT " PART e:"
2000 PRINT "-----"
2010 LPRINT "-----"
2020 LET II=S1+C
2030 LET II1=II/10 : II2=10*II1
2040 PRINT : PRINT " 1(e). II(n)=n=";CINT(II2); " : #OF PULSES INTEGR. IN PERFECT INTEGRATOR"
2050 LPRINT : LPRINT " 1(e). II(n)=n=";CINT(II2); " : #OF PULSES INTEGR. IN PERFECT
INTEGRATOR"
2060 RETURN

```

PROBLEM#4

GIVEN

1. $d_1 \times d_2 = 3.65 \times 3.65 \text{ m}$: ARRAY SIZE
2. $f_0 = 3.3 \text{ GHz}$: OPERATING FREQ.
3. $L_{fp} = 2.5 \text{ db}$: FEED & PHASE SHIFTER LOSSES
4. $S.L. = 30 \text{ db}$: SIDELobe LEVEL
5. $r_l = .5$: ILLUMINATION EFFICIENCY
6. $P_a = 4 \text{ MW}$: OUTPUT POWER
7. $T.W. = 1000$: VALUE OF THE TWO TW
8. $L_m = 3 \text{ db}$: WEIGHTING FILTER LOSS
9. $(S/N)_{\min} = 13 \text{ db}$: (S/N)_{min} FOR AUT. DETECTION
10. $S_{av} = 3 \text{ dbsm}$: R.C.S FOR THE CRUISE MISSILE
11. $R = 100 \text{ KM}$: RANGE OF THE TWO NOISE JAMMERS
12. $C_r = 18$: *OF CANCELLING TUBES
13. $P_j = 10 \text{ KW/tube}$: ERP VALUE
14. $g = 1$: PROPAGATION FACTOR
15. $R_1 = 80 \text{ KM}$: RANGE OF THE CRUISE MISSILE (part c)
16. $R_2 = 80 \text{ KM}$: RANGE OF THE CRUISE MISSILE (part e)
17. $E_i(n) = 1$: INTEGRATION EFFICIENCY

PART a:

- 1(a). $A_e = A \cdot L_{fp} \cdot r_l = 3.7459 \text{ sq.m}$: EFFECTIVE AREA OF THE PHASED ARRAY
- 2(a). $G_p = 4 \cdot \pi \cdot A_e / (\lambda^2) = 5696$: POWER GAIN OF PHASED ARRAY

PART b:

- 1(b). $J = G_j \cdot P_j \cdot A_e / (4 \cdot \pi \cdot R^2 \cdot L_m \cdot T.W.) = 5.37835 \text{ E-09 W OR } -82.6935 \text{ dbw OR } -52.6935 \text{ dbm}$

PART c:

- 1(c). $S = P_a \cdot G_p \cdot S_{av} \cdot A_e / ((4 \cdot \pi \cdot R_1^2)^2) = 6.61313 \text{ D-12 W OR } -111.796 \text{ dbw OR } -81.796 \text{ dbm}$
SINGLE PULSE ECHO SIGNAL POWER

PART d:

1(d). $(J/S)_{in} = J^2 - 54 = 29.1025 \text{ dbm}$: THE SINGLE PULSE (J/S) AT THE RECEIVER INPUT

2(d). $(S/J)_{out} = (S/J)_{in} + (T.W) - L_m = 2.1025 \text{ db}$: THE SINGLE PULSE (J/S) AT THE RECEIVER OUTPUT

PART e:

1(e). $11(n) = n = 32$: # OF PULSES INTEGR. IN PERFECT INTEGRATOR

```

10 PRINT : PRINT TAB(30) " PROBLEM #5 "
20 PRINT TAB(30); " -----"
30 GOSUB 100 : GOSUB 1120 : GOSUB 1480
40 GOSUB 1680
50 PRINT : PRINT " DO YOU WANT TO TRY AGAIN FOR DIFFERENT OR THE SAME DATA Y/N?"
60 INPUT D$
70 IF LEFT$(D$,1)="Y" OR LEFT$(D$,1)="y" THEN 30
80 END
90 *****
100 INPUTS THE DATA
110 *****
120 PRINT : PRINT " ENTER THE OPERATING FREQ f0 IN GHz"
130 INPUT f0 : PRINT : PRINT " 1. f0=";f0;"GHz"
140 PRINT : PRINT " ENTER THE PEAK POWER P0 IN KW"
150 INPUT P0 : PRINT : PRINT " 2. P0=";P0;"KW"
160 PRINT : PRINT " ENTER THE ANTENNA MAIN BEAM GAIN G0 IN db"
170 INPUT G0 : PRINT : PRINT " 3. G0=";G0;"db"
180 PRINT : PRINT " ENTER THE ANTENNA SIDELOBE GAIN Gp IN db"
190 INPUT Gp : PRINT : PRINT " 4. Gp=";Gp;"db"
200 PRINT : PRINT " ENTER THE P.R.F IN MHz"
210 INPUT fp : PRINT : PRINT " 5. fp=";fp;"MHz"
220 PRINT : PRINT " ENTER THE PULSE WIDTH T IN micsec."
230 INPUT T : PRINT : PRINT " 6. T=";T;"micsec."
240 PRINT : PRINT " ENTER THE RECEIVER NOISE FIGURE F IN db"
250 INPUT F : PRINT : PRINT " 7. F=";F;"db"
260 PRINT : PRINT " ENTER THE RECEIVER NOISE BANDWIDTH Bn IN MHZ"
270 INPUT Bn : PRINT : PRINT " 8. Bn=";Bn;"MHZ"
280 PRINT : PRINT " ENTER THE ANTENNA NOISE TEMPERATURE Ta IN KELVIN"
290 INPUT Ta : PRINT : PRINT " 9. Ta=";Ta;"KELVIN"
300 PRINT : PRINT " ENTER THE ANTENNA SECTOR COVERAGE Ss IN Deg."
310 INPUT Ss : PRINT : PRINT " 10. Ss=";Ss;"Deg."
320 PRINT : PRINT " ENTER THE ANTENNA SCAN RATE Sr"
330 INPUT Sr : PRINT : PRINT " 11. Sr=";Sr;"scans/sec"
340 PRINT : PRINT " ENTER THE OUTPUT POWER OF THE JAMMER Pj IN W"
350 INPUT Pj : PRINT : PRINT " 12. Pj=";Pj;"W"

```

```

360 PRINT : PRINT " ENTER THE RF NOISE BANDWIDTH OF THE JAMMER Brf IN MHZ"
370 INPUT Brf : PRINT : PRINT " 13. Brf=";Brf;"MHZ"
380 PRINT : PRINT " ENTER THE ANTENNA GAIN OF THE JAMMER Gj IN db"
390 INPUT Gj : PRINT : PRINT " 14. Gj=";Gj;"db"
400 PRINT : PRINT " ENTER THE RANGE WHERE THE JAMMER IS POSITIONED R IN KM"
410 INPUT R : PRINT : PRINT " 15. R=";R;"KM"
420 PRINT : PRINT " ENTER THE (J/S) RATIO J.S IN db"
430 INPUT J.S : PRINT : PRINT " 16. J.S=";J.S;"db"
440 PRINT : PRINT " ENTER THE CAMOFLAGE FACTOR CF IN db"
450 INPUT CF : PRINT : PRINT " 17. CF=";CF;"db"
460 PRINT : PRINT " ENTER THE PLUMBING LOSSES Lp IN db"
470 INPUT Lp : PRINT : PRINT " 18. Lp=";Lp;"db"
480 PRINT : PRINT " ENTER RANGE AT WHICH THE MORTOW ROUND PASSES THROUGH THE
RADAR BEAM R1 IN KM"
490 INPUT R1 : PRINT : PRINT " 19. R1=";R1;"KM"
500 PRINT : PRINT " IS THE INPUT DATA CORRECT Y/N?"
510 INPUT A$
520 IF LEFT$(A$,1)="Y" OR LEFT$(A$,1)="y" THEN 1100
530 PRINT : PRINT " WHAT OF THE FOLLOWING DO YOU WANT TO CHANGE?"
540 PRINT : PRINT " 1. THE OPERATING FREQ?," 2. THE PEAK POWER?"
550 PRINT : PRINT " 3. THE ANTENNA MAIN BEAM GAIN?," 4. THE ANTENNA SIDELobe GAIN?"
560 PRINT : PRINT " 5. P.R.F?," 6. THE PULSE WIDTH?"
570 PRINT : PRINT " 7. THE RECEIVER NOISE FIGURE?," 8. THE RECEIVER NOISE BANDWIDTH?"
580 PRINT : PRINT " 9. THE ANTENNA NOISE TEMPERATURE?," 10. THE ANTENNA SECTOR
COVERAGE?"
590 PRINT : PRINT " 11. THE ANTENNA SCAN RATE?," 12. THE JAMMER'S OUTPUT POWER?"
600 PRINT : PRINT " 13. THE JAMMER'S RF NOISE BANDWIDTH?," 14. THE JAMMER'S ANTENNA
GAIN?"
620 PRINT : PRINT " 15. THE RANGE POSITION OF THE JAMMER?," 16. THE (J/S) OF THE
JAMMER?"
630 PRINT : PRINT " 17. THE CAMOFLAGE FACTOR?," 18. THE PLUMBING LOSSES?"
640 PRINT : PRINT " 19. THE RANGE AT WHICH THE MORTOW ROUND PASSES THROUGH THE
RADARBEAM?"
650 INPUT C$
660 IF C$="1" THEN PRINT : PRINT " ENTER THE OPERATING FREQ fo IN GHz"

```

```

670 IF C$="1" THEN INPUT f0 : PRINT : PRINT " 1. f0=";f0;"GHz" : GOTO 1040
680 IF C$="2" THEN PRINT : PRINT " ENTER THE PEAK POWER P0 IN KW"
690 IF C$="2" THEN INPUT P0 : PRINT : PRINT " 2. P0=";P0;"KW" : GOTO 1040
700 IF C$="3" THEN PRINT : PRINT " ENTER THE ANTENNA MAIN BEAM GAIN Ga IN db"
710 IF C$="3" THEN INPUT Ga : PRINT : PRINT " 3. Ga=";Ga;"db" : GOTO 1040
720 IF C$="4" THEN PRINT : PRINT " ENTER THE ANTENNA SIDELobe GAIN Gp IN db"
730 IF C$="4" THEN INPUT Gp : PRINT : PRINT " 4. Gp=";Gp;"db" : GOTO 1040
740 IF C$="5" THEN PRINT : PRINT " ENTER THE P.R.F IN MHz"
750 IF C$="5" THEN INPUT fp : PRINT : PRINT " 5. fp=";fp;"MHz" : GOTO 1040
760 IF C$="6" THEN PRINT : PRINT " ENTER THE PULSE WIDTH T IN micsec."
770 IF C$="6" THEN INPUT T : PRINT : PRINT " 6. T=";T;"micsec." : GOTO 1040
780 IF C$="7" THEN PRINT : PRINT " ENTER THE RECEIVER NOISE FIGURE F IN db"
790 IF C$="7" THEN INPUT F : PRINT : PRINT " 7. F=";F;"db" : GOTO 1040
800 IF C$="8" THEN PRINT : PRINT " ENTER THE RECEIVER NOISE BANDWIDTH Bn IN MHz"
810 IF C$="8" THEN INPUT Bn : PRINT : PRINT " 8. Bn=";Bn;"MHz" : GOTO 1040
820 IF C$="9" THEN PRINT : PRINT " ENTER THE ANTENNA NOISE TEMPERATURE Ta IN KELVIN"
830 IF C$="9" THEN INPUT Ta : PRINT : PRINT " 9. Ta=";Ta;"KELVIN" : GOTO 1040
840 IF C$="10" THEN PRINT : PRINT " ENTER THE ANTENNA SECTOR COVERAGE Ss IN Deg."
850 IF C$="10" THEN INPUT Ss : PRINT : PRINT " 10. Ss=";Ss;"Deg." : GOTO 1040
860 IF C$="11" THEN PRINT : PRINT " ENTER THE ANTENNA SCAN RATE Sr"
870 IF C$="11" THEN INPUT Sr : PRINT : PRINT " 11. Sr=";Sr;"scans/sec" : GOTO 1040
880 IF C$="12" THEN PRINT : PRINT " ENTER THE OUTPUT POWER OF THE JAMMER Pm IN W"
890 IF C$="12" THEN INPUT Pj : PRINT : PRINT " 12. Pj=";Pj;"W" : GOTO 1040
900 IF C$="13" THEN PRINT : PRINT " ENTER THE RF NOISE BANDWIDTH OF THE JAMMER Brj IN
    MHz"
910 IF C$="13" THEN INPUT Brj : PRINT : PRINT " 13. Brj=";Brj;"MHz" : GOTO 1040
920 IF C$="14" THEN PRINT : PRINT " ENTER THE ANTENNA GAIN OF THE JAMMER Gj IN db"
930 IF C$="14" THEN INPUT Gj : PRINT : PRINT " 14. Gj=";Gj;"db" : GOTO 1040
940 IF C$="15" THEN PRINT : PRINT " ENTER THE RANGE WHERE THE JAMMER IS POSITIONED R
    IN KM"
950 IF C$="15" THEN INPUT R : PRINT : PRINT " 15. R=";R;"KM" : GOTO 1040
960 IF C$="16" THEN PRINT : PRINT " ENTER THE (J/S) RATIO J.S IN db"
970 IF C$="16" THEN INPUT J.S : PRINT : PRINT " 16. J.S=";J.S;"db" : GOTO 1040
980 IF C$="17" THEN PRINT : PRINT " ENTER THE CAMOFLAGE FACTOR CF IN db"
990 IF C$="17" THEN INPUT CF : PRINT : PRINT " 17. CF=";CF;"db" : GOTO 1040

```

```

1000 IF C$="18" THEN PRINT : PRINT " ENTER THE PLUMBING LOSSES Lp IN db"
1010 IF C$="18" THEN INPUT Lp : PRINT : PRINT " 18. Lp=";Lp;"db" : GOTO 1040
1020 IF C$="19" THEN PRINT : PRINT " ENTER THE RANGE AT WHICH THE MORTOW ROUND
PASSESTHROUGH THE RADAR BEAM"
1030 IF C$="19" THEN INPUT R1 : PRINT : PRINT " 19. R1=";R1;"KM" : GOTO 1040
1040 PRINT : PRINT " IS EVERYTHING O.K NOW?"
1050 INPUT B$
1060 IF LEFT$(B$,1)="Y" OR LEFT$(B$,1)="y" THEN GOTO 1100
1070 PRINT : PRINT " WHAT DO YOU WANT TO CHANGE AGAIN?"
1080 PRINT : PRINT " HIT ANY KEY IN YOUR KEYBOARD AND EVERYTHING WILL WORK FOR YOU
MALAKA"
1090 INPUT F$ : GOTO 540
1100 RETURN
1110 *****
1120 PRINTS THE INPUT DATA
1130 *****
1140 LPRINT : LPRINT TAB(30); " PROBLEM #5"
1150 LPRINT TAB(30); " -----"
1160 LPRINT : LPRINT " G I V E N"
1170 LPRINT "-----"
1180 LPRINT : LPRINT " 1. f0=";f0;"GHZ" TAB(20); " : OPERATING FREQ"
1190 LPRINT : LPRINT " 2. Pp=";Pp;"KW" TAB(20); " : PEAK POWER"
1200 LPRINT : LPRINT " 3. Gp=";Gp;"db" TAB(20); " : ANTENNA MAIN BEAM GAIN"
1210 LPRINT : LPRINT " 4. Gs=";Gs;"db" TAB(20); " : ANTENNA SIDELobe GAIN"
1220 LPRINT : LPRINT " 5. fp=";fp;"MHZ" TAB(20); " : P.R.F"
1230 LPRINT : LPRINT " 6. T=";T;"micsec." TAB(20); " : PULSE WIDTH"
1240 LPRINT : LPRINT " 7. F=";F;"db" TAB(20); " : RECEIVER NOISE FIGURE"
1250 LPRINT : LPRINT " 8. Bn=";Bn;"MHZ" TAB(20); " : RECEIVER NOISE BANDWIDTH"
1260 LPRINT : LPRINT " 9. Ta=";Ta;"KELVIN" TAB(20); " : ANTENNA NOISE TEMPERATURE"
1270 LPRINT : LPRINT " 10. Ss=";Ss;"Deg." TAB(20); " : ANTENNA SECTOR COVERAGE"
1280 LPRINT : LPRINT " 11. Sr=";Sr;"scans/sec" TAB(20); " : ANTENNA SCAN RATE"
1290 LPRINT : LPRINT " 12. Pj=";Pj;"W" TAB(20); " : OUTPUT POWER OF THE JAMMER"
1300 LPRINT : LPRINT " 13. Brf=";Brf;"MHZ" TAB(20); " : RF NOISE BANDWIDTH OF THE JAMMER"
1400 LPRINT : LPRINT " 14. Gj=";Gj;"db" TAB(20); " : ANTENNA GAIN OF THE JAMMER"
1410 LPRINT : LPRINT " 15. R=";R;"KM" TAB(20); " : RANGE WHERE THE JAMMER IS POSITIONED"

```

```

1420 LPRINT : LPRINT " 16. J.S=";J.S;"db" TAB(20); " : (J/S) RATIO"
1430 LPRINT : LPRINT " 17. CF=";CF;"db" TAB(20); " : CAMOFLAGE FACTOR"
1440 LPRINT : LPRINT " 18. Lp=";Lp;"db" TAB(20); " : PLUMBING LOSSES"
1450 LPRINT : LPRINT " 19. R1=";R1;"KM"; TAB(20); " : RANGE AT WHICH THE MORTOW ROUND
PASSES THROUGH THE RADAR BEAM"
1460 RETURN
1470*****
1480 ' CALCULATION & PRINTOUT FOR PART a:
1490*****
1500 PRINT : PRINT : PRINT " PART a:"
1510 PRINT " -----"
1520 LPRINT : LPRINT : LPRINT " PART a:"
1530 LPRINT " -----"
1540 LET Pj=Pj/Brf 'W/MHZ
1550 LET Gj1=Gj/10:Gj2=CINT(10*Gj1)
1560 LET Lp1=Lp/10:Lp2=CINT(10*Lp1)
1570 LET C=3*10^8 : f0=f0*10^9 : l=C/f0 : R=R*10^3
1580 LET PI=3.14159
1590 LET Gp1=Gp/10:Gp2=CINT(10*Gp1)
1600 LET Ae=Gp2*1^2/(4*PI)
1610 LET J=CSNG(Pj*Gj2*Bn*Ae/(4*PI*R^2*Lp2))
1620 LET J1=CSNG(10*.4342945**LOG(J))
1630 LET J2=CSNG(J1+30)
1640 PRINT : PRINT " 1(a). J=Pj*Gj*Bn*Ae/(4*PI*R^2*Lp)=";J;"W"; " OR";J1;"dbW";
OR";J2;"dbm"; " : NOISE JAMMING POWER"
1650 LPRINT : LPRINT " 1(a). J=Pj*Gj*Bn*Ae/(4*PI*R^2*Lp)=";J;"W"; " OR";J1;"dbW";
OR";J2;"dbm"; " : NOISE JAMMING POWER"
1660 RETURN
1670*****
1680 ' CALCULATION & PRINTOUT FOR PART b:
1690*****
1700 PRINT : PRINT : PRINT " PART b:"
1710 PRINT " -----"
1720 LPRINT : LPRINT : LPRINT " PART b:"
1730 LPRINT " -----"

```

```
1740 LET J.S1=J.S/10:J.S2=CINT(10*J.S1)
1750 LET J.S3=0 'because CF=0
1760 LET J.S4=J.S3/10 : J.S5=10*J.S4
1780 LET R2=CINT(R1*((J.S5/J.S2)^(1/4)))
1790 PRINT:PRINT " 1(b).R2=(R1*((J/S)2/(J/S)1)^(1/4))=";R2;"KM";": RANGE AT WHICH THE
ROUNDSBURNSTROUGH"
1800 LPRINT:LPRINT " 1(b).R2=(R1*((J/S)2/(J/S)1)^(1/4))=";R2;"KM";": RANGE AT WHICH
THE ROUNDS BURNSTROUGH"
1810 RETURN
```

PROBLEM#5

GIVEN

1. $f_0 = 16.1 \text{ GHz}$: OPERATING FREQ
2. $P_a = 80 \text{ KW}$: PEAK POWER
3. $G_a = 46 \text{ db}$: ANTENNA MAIN BEAM GAIN
4. $G_p = 16 \text{ db}$: ANTENNA SIDELobe GAIN
5. $f_p = 8600 \text{ MHz}$: P.R.F
6. $T = .25 \text{ msec}$: PULSE WIDTH
7. $F = 12 \text{ db}$: RECEIVER NOISE FIGURE
8. $B_n = 5 \text{ MHz}$: RECEIVER NOISE BANDWIDTH
9. $T_e = 290 \text{ KELVIN}$: ANTENNA NOISE TEMPERATURE
10. $S_s = 25 \text{ Deg.}$: ANTENNA SECTOR COVERAGE
11. $S_r = 167 \text{ scans/sec}$: ANTENNA SCAN RATE
12. $P_j = 100 \text{ W}$: OUTPUT POWER OF THE JAMMER
13. $B_{rf} = 20 \text{ MHz}$: RF NOISE BANDWIDTH OF THE JAMMER
14. $G_j = 23 \text{ db}$: ANTENNA GAIN OF THE JAMMER
15. $R = 20 \text{ KM}$: RANGE WHERE THE JAMMER IS POSITIONED
16. $J/S = 24 \text{ db}$: (J/S) RATIO
17. $CF = 0 \text{ db}$: CAMOFLAGE FACTOR
18. $L_p = 3 \text{ db}$: PLUMBING LOSSES
19. $R_1 = 4 \text{ KM}$: RANGE AT WHICH THE MORTOW ROUND PASSES THROUGH THE RADAR BEAM

PART a:

1(a). $J = P_j * G_j * B_n * A_e / (4 * \pi * R^2 * L_p) = .549682 \text{ E-09 W OR } -92.5989 \text{ dbw OR } -62.5989 \text{ dbm}$:
NOISE JAMMING POWER

PART b:

1(b). $R_2 = (R_1 * ((J/S)^2 / (J/S)_1))^{(1/4)} = 1 \text{ KM}$: RANGE AT WHICH THE ROUNDS BURNS THROUGH

```

10 PRINT:PRINT TAB(30);" PROBLEM #6"
20 PRINT TAB(30);"-----"
30 LPRINT:LPRINT TAB(30);" PROBLEM #6"
40 LPRINT TAB(30);"-----"
50 DIM F(4),I(4),Sav(4),N(4),V(4),m(4),m1(4),m2(4)
60 PRINT:PRINT " ENTER THE AVERAGE VALUE OF THE CLOUD CROSS SECTION S1 IN dbsm"
70 INPUT S1
80 PRINT:PRINT " ENTER THE CROSS SECTION OF THE INDIVIDUAL DIPOLES S2,S3 IN
millinches"
90 INPUT S2,S3
100 PRINT:PRINT " ENTER THE STEP OF THE FREQ. f(1),f(2),...IN GHz"
110 INPUT f(1),f(2),f(3),f(4)
120 LET C=3*10^10 'cm/s
130 LET f(1)=f(1)*10^9:f(2)=f(2)*10^9:f(3)=f(3)*10^9:f(4)=f(4)*10^9
140 LET S4=S2*S3*10^-6*(2.54)^2 'conversion from inches to cm.sq.
150 FOR I=1 TO 4
160 I(I)=C/f(I)
170 Sav(I)=.15*I(I)^2
180 N(I)=S1*100/Sav(I)
190 N(I)=CSNG(100*N(I))
200 V(I)=CSNG(S4*I(I)*N(I))
210 m(I)=CSNG(2.7*V(I))
220 m1(I)=CSNG(m(I)/S1)
230 m2(I)=CSNG(m(I)/(455*S1))
240 NEXT I
250 PRINT:PRINT " G I V E N"
260 PRINT "-----"
270 LPRINT:LPRINT " G I V E N"
280 LPRINT "-----"
290 PRINT:PRINT " a. S1=";S1;"dbsm";": AVERAGE VALUE OF THE CLOUD CROSS SECTION"
300 LPRINT:LPRINT " a. S1=";S1;"dbsm";": AVERAGE VALUE OF THE CLOUD CROSS SECTION"
310 PRINT:PRINT " b. S2xS3=";S2"x"S3;"ml.Inch";": CROSS SECTIONAL DIMENSIONS OF THE
INDIVIDUAL DIPOLES"
320 LPRINT:LPRINT " b. S2xS3=";S2"x"S3;"sq.m";": CROSS SECTIONAL DIMENSIONS OF THE
INDIVIDUAL DIPOLES"

```



```

330 PRINT:PRINT "c. f=";f(1)/10^9;f(2)/10^9;f(3)/10^9;f(4)/10^9;"GHz";": FREQ. STEPS"
340 LPRINT:LPRINT "c. f=";f(1)/10^9;f(2)/10^9;f(3)/10^9;f(4)/10^9;"GHz";": FREQ. STEPS"
350 PRINT:PRINT:PRINT " OUTPUT"
360 PRINT "-----"
370 LPRINT:LPRINT:LPRINT " OUTPUT"
380 LPRINT "-----"
390 FOR I=3 TO 60
400 PRINT "-";
410 LPRINT "-";
420 NEXT I
430 PRINT:PRINT " f [GHz]","l[cm]","Sav[cm sq.]"," N"
440 LPRINT:LPRINT " f [GHz]","l[cm]","Sav[cm sq.]"," N"
450 FOR I=3 TO 60
460 PRINT "-";
470 LPRINT "-";
480 NEXT I
490 PRINT:PRINT f(1)/10^9,l(1),Sav(1),N(1)
500 LPRINT:LPRINT f(1)/10^9,l(1),Sav(1),N(1)
510 FOR I=3 TO 60
520 PRINT "-";
530 LPRINT "-";
540 NEXT I
550 PRINT:PRINT f(2)/10^9,l(2),Sav(2),N(2)
560 LPRINT:LPRINT f(2)/10^9,l(2),Sav(2),N(2)
570 FOR I=3 TO 60
580 PRINT "-";
590 LPRINT "-";
600 NEXT I
610 PRINT:PRINT f(3)/10^9,l(3),Sav(3),N(3)
620 LPRINT:LPRINT f(3)/10^9,l(3),Sav(3),N(3)
630 FOR I=3 TO 60
640 PRINT "-";
650 LPRINT "-";
660 NEXT I
670 PRINT:PRINT f(4)/10^9,l(4),Sav(4),N(4)

```

```

680 LPRINT :LPRINT 1(4)/10^9,1(4),Sov(4),N(4)
690 FOR I=3 TO 60
700 PRINT "-";
710 LPRINT "-";
720 NEXT I
730 PRINT :PRINT :PRINT "TABLE CONTINUE:"
740 LPRINT :LPRINT :LPRINT "TABLE CONTINUE:"
750 PRINT :PRINT " V[cu.cm]"," m[grms]","m/S1[grms/sq.m]"," m/S1[lbs/sq.m]"
760 LPRINT :LPRINT " V[cu.cm]"," m[grms]","m/S1[grms/sq.m]"," m/S1[lbs/sq.m]"
770 FOR I=3 TO 60
780 PRINT "-";
790 LPRINT "-";
800 NEXT I
810 PRINT :PRINT V(1),m(1),m1(1),m2(1)
820 LPRINT :LPRINT V(1),m(1),m1(1),m2(1)
830 FOR I=3 TO 60
840 PRINT "-";
850 LPRINT "-";
860 NEXT I
870 PRINT :PRINT V(2),m(2),m1(2),m2(2)
880 LPRINT :LPRINT V(2),m(2),m1(2),m2(2)
890 FOR I=3 TO 60
900 PRINT "-";
910 LPRINT "-";
920 NEXT I
930 PRINT :PRINT V(3),m(3),m1(3),m2(3)
940 LPRINT :LPRINT V(3),m(3),m1(3),m2(3)
950 FOR I=3 TO 60
960 PRINT "-";
970 LPRINT "-";
980 NEXT I
990 PRINT :PRINT V(4),m(4),m1(4),m2(4)
1000 LPRINT :LPRINT V(4),m(4),m1(4),m2(4)
1010 PRINT :PRINT " DO YOU WANT TO TRY AGAIN ANOHTE Y/N?"
1020 INPUT A$

```

```
1030 IF LEFT$(A$,1)="Y" OR LEFT$(A$,1)="y" THEN LPRINT : LPRINT : GOTO 60
1040 END
```

PROBLEM#6

GIVEN

- a. $S_1 = 10$ dbm : AVERAGE VALUE OF THE CLOUD CROSS SECTION
 b. $S_2 \times S_3 = .5 \times 5$ ml.inch : CROSS SECTIONAL DIMENSIONS OF THE INDIVIDUAL DIPOLES
 c. $f = 1 \ 2 \ 5 \ 10$ GHz : FREQ. STEPS

OUTPUT

f [GHz]	l [cm]	S_{av} [cm sq.]	N
1	30	135	740.741
2	15	33.75	2962.96
5	6	5.4	18518.5
10	3	1.35	74074.1

TABLE CONTINUE:

V [cu.cm]	m [grms]	m/S_1 [grms/sq.m]	m/S_1 [lbs/sq.m]
358422	.967739	.0967739	.00021269
.716844	1.93548	.193548	.00042538
1.79211	4.8387	.48387	.00106345
3.58422	9.67739	.967739	.0021269

```

10 PRINT : PRINT TAB(30); " PROBLEM #7 "
20 PRINT TAB(30); " -----"
30 GOSUB 100 : GOSUB 1080
40 GOSUB 1390 : GOSUB 1840
50 PRINT : PRINT " DO YOU WANT TO TRY AGAIN FOR DIFFERENT OR THE SAME DATA ?"
60 INPUT D$
70 IF LEFT$(D$,1)="Y" OR LEFT$(D$,1)="y" THEN 30
80 END
90 *****
100 INPUTS THE DATA
110 *****
120 PRINT : PRINT " ENTER THE PEAK POWER Pp IN MW"
130 INPUT Pp : PRINT : PRINT " 1. Pp=";Pp;"MW"
140 PRINT : PRINT " ENTER THE PULSE WIDTH T IN micsec."
150 INPUT T : PRINT : PRINT " 2. T=";T;"micsec."
160 PRINT : PRINT " ENTER THE P.R.F fp IN Hz"
170 INPUT fp : PRINT : PRINT " 3. fp=";fp;"Hz"
180 PRINT : PRINT " ENTER THE ANTENNA GAIN Ga IN db"
190 INPUT Ga : PRINT : PRINT " 4. Ga=";Ga;"db"
200 PRINT : PRINT " ENTER THE OPERATING FREQ. f0 IN GHz"
210 INPUT f0 : PRINT : PRINT " 5. f0=";f0;"GHz"
220 PRINT : PRINT " ENTER THE RECEIVER NOISE BANDWIDTH Bn IN MHz"
230 INPUT Bn : PRINT : PRINT " 6. Bn=";Bn;"MHz"
240 PRINT : PRINT " ENTER THE ANTENNA SCAN RATE Wm IN RPM"
250 INPUT Wm : PRINT : PRINT " 7. Wm=";Wm;"RPM"
260 PRINT : PRINT " ENTER THE AZIMUTH BEAMWIDTH A.B IN Deg."
270 INPUT A.B : PRINT : PRINT " 8. A.B=";A.B;"Deg."
280 PRINT : PRINT " ENTER THE RECEIVER NOISE FIGURE F IN db"
290 INPUT F : PRINT : PRINT " 9. F=";F;"db"
300 PRINT : PRINT " ENTER THE ANTENNA NOISE TEMPERATURE Ta IN KELVIN"
310 INPUT Ta : PRINT : PRINT " 10. Ta=";Ta;"KELVIN"
320 PRINT : PRINT " ENTER THE PLUMBING LOSSES Lp IN db"
330 INPUT Lp : PRINT : PRINT " 11. Lp=";Lp;"db"
340 PRINT : PRINT " ENTER THE FALSE ALARM PROBABILITY Pfa"
350 INPUT Pfa : PRINT : PRINT " 12. Pfa=";CSNG(Pfa)

```

```

360 PRINT : PRINT "NOW GO TO PART a AND INPUT THE DATA"
370 PRINT : PRINT "ENTER THE CROSS SECTION OF THE NON-FLUCTUATING TARGET S IN dbsm"
380 INPUT S : PRINT : PRINT " 13. S=";S;"dbsm"
390 PRINT : PRINT "ENTER THE PROBABILITY OF DETECTION Pd"
400 INPUT Pd : PRINT : PRINT " 14. Pd=";Pd
410 PRINT : PRINT "GO TO PART b AND INPUT THE DATA"
420 PRINT : PRINT "ENTER THE CROSS SECTION OF THE TARGET AIRCRAFT S1 IN dbsm"
430 INPUT S1 : PRINT : PRINT " 15. S1=";S1;"dbsm"
440 PRINT : PRINT "ENTER THE CROSS SECTION OF THE CHAFF CLOUD S2 IN sq.m"
450 INPUT S2 : PRINT : PRINT " 16. S2=";S2;"sq.m"
460 PRINT : PRINT "ENTER THE RADAR-TARGET DISTANCE R IN KM"
470 INPUT R : PRINT : PRINT " 17. R=";R;"KM"
480 PRINT : PRINT "ENTER THE RADIAL VELOCITY OF THE TARGET U1 IN KNOTS"
490 INPUT U1 : PRINT : PRINT " 18. U1=";U1;"KNOTS"
500 PRINT : PRINT "IS THE INPUT DATA CORRECT Y/N?"
510 INPUT A$
520 IF LEFT$(A$,1)="Y" OR LEFT$(A$,1)="y" THEN 1060
530 PRINT : PRINT "WHAT OF THE FOLLOWING DO YOU WANT TO CHANGE?"
540 PRINT : PRINT " 1. THE PEAK POWER?," 2. THE PULSE WIDTH?"
550 PRINT : PRINT " 3. THE PRF?," 4. THE ANTENNA GAIN?"
560 PRINT : PRINT " 5. THE OPERATING FREQ?," 6. RECEIVER'S NOISE BANDWIDTH?"
570 PRINT : PRINT " 7. THE ANTENNA SCAN RATE?," 8. THE AZIMUTH BANDWIDTH?"
580 PRINT : PRINT " 9. THE RECEIVER'S NOISE FIGURE?," 10. THE ANTENNA NOISE
    TEMPERATURE?"
590 PRINT : PRINT " 11. THE PLUMBING LOSSES?," 12. THE FALSE ALARM PROBABILITY?"
600 PRINT : PRINT " 13. THE CROSS SECTION OF THE TARGET IN PART a?," 14. THE
    PROBABILITY OF DETECTION OF PART a?"
610 PRINT : PRINT " 15. THE AIRCRAFT'S CROSS SECTION IN PART b?," 16. THE CHAFF'S CROSS
    SECTION OF PART b?"
620 PRINT : PRINT " 17. THE RANGE OF THE TARGET?," 18. THE RADIAL VELOCITY OF THE
    AIRCRAFT?"
630 INPUT C$
640 IF C$="1" THEN PRINT : PRINT "ENTER THE PEAK POWER Pp IN MW"
650 IF C$="1" THEN INPUT Pd : PRINT : PRINT " 1. Pd=";Pd;"MW" : GOTO 1000
660 IF C$="2" THEN PRINT : PRINT "ENTER THE PULSE WIDTH T IN micsec."

```

```

670 IF C$="2" THEN INPUT T : PRINT : PRINT " 2. T=";T;"micsec." : GOTO 1000
680 IF C$="3" THEN PRINT : PRINT " ENTER THE P.R.F fp IN Hz"
690 IF C$="3" THEN INPUT fp : PRINT : PRINT " 3. fp=";fp;"Hz" : GOTO 1000
700 IF C$="4" THEN PRINT : PRINT " ENTER THE ANTENNA GAIN Ga IN db"
710 IF C$="4" THEN INPUT Ga : PRINT : PRINT " 4. Ga=";Ga;"db" : GOTO 1000
720 IF C$="5" THEN PRINT : PRINT " ENTER THE OPERATING FREQ. fo IN GHz"
730 IF C$="5" THEN INPUT fo : PRINT : PRINT " 5. fo=";fo;"GHz" : GOTO 1000
740 IF C$="6" THEN PRINT : PRINT " ENTER THE RECEIVER NOISE BANDWIDTH Bn IN MHz"
750 IF C$="6" THEN INPUT Bn : PRINT : PRINT " 6. Bn=";Bn;"MHz" : GOTO 1000
760 IF C$="7" THEN PRINT : PRINT " ENTER THE ANTENNA SCAN RATE Wm IN RPM"
770 IF C$="7" THEN INPUT Wm : PRINT : PRINT " 7. Wm=";Wm;"RPM" : GOTO 1000
780 IF C$="8" THEN PRINT : PRINT " ENTER THE AZIMUTH BEAMWIDTH A.B IN Deg."
790 IF C$="8" THEN INPUT A.B : PRINT : PRINT " 8. A.B=";A.B;"Deg." : GOTO 1000
800 IF C$="9" THEN PRINT : PRINT " ENTER THE RECEIVER NOISE FIGURE F IN db"
810 IF C$="9" THEN INPUT F : PRINT : PRINT " 9. F=";F;"db" : GOTO 1000
820 IF C$="10" THEN PRINT : PRINT " ENTER THE ANTENNA NOISE TEMPERATURE Ta IN
KELVIN"
830 IF C$="10" THEN INPUT Ta : PRINT : PRINT " 10. Ta=";Ta;"KELVIN" : GOTO 1000
840 IF C$="11" THEN PRINT : PRINT " ENTER THE PLUMBING LOSSES Lp IN db"
850 IF C$="11" THEN INPUT Lp : PRINT : PRINT " 11. Lp=";Lp;"db" : GOTO 1000
860 IF C$="12" THEN PRINT : PRINT " ENTER THE FALSE ALARM PROBABILITY Pfa"
870 IF C$="12" THEN INPUT Pfa : PRINT : PRINT " 12. Pfa=";CSNG(Pfa) : GOTO 1000
880 IF C$="13" THEN PRINT : PRINT " ENTER THE CROSS SECTION OF THE NON-FLUCTUATING
TARGET S IN dbsm"
890 IF C$="13" THEN INPUT S : PRINT : PRINT " 13. S=";S;"dbsm" : GOTO 1000
900 IF C$="14" THEN PRINT : PRINT " ENTER THE PROBABILITY OF DETECTION Pd"
910 IF C$="14" THEN INPUT Pd : PRINT : PRINT " 14. Pd=";Pd : GOTO 1000
920 IF C$="15" THEN PRINT : PRINT " ENTER THE CROSS SECTION OF THE TARGET AIRCRAFT
S1 IN dbsm"
930 IF C$="15" THEN INPUT S1 : PRINT : PRINT " 15. S1=";S1;"dbsm" : GOTO 1000
940 IF C$="16" THEN PRINT : PRINT " ENTER THE CROSS SECTION OF THE CHAFF CLOUD S2 IN
sq.m"
950 IF C$="16" THEN INPUT S2 : PRINT : PRINT " 16. S2=";S2;"sq.m" : GOTO 1000
960 IF C$="17" THEN PRINT : PRINT " ENTER THE RADAR-TARGET DISTANCE R IN KM"
970 IF C$="17" THEN INPUT R : PRINT : PRINT " 17. R=";R;"KM" : GOTO 1000

```

```

980 IF C$="18" THEN PRINT : PRINT " ENTER THE RADIAL VELOCITY OF THE TARGET Ut IN
KNOTS"
990 IF C$="18" THEN INPUT Ut : PRINT : PRINT " 18. Ut=";Ut;"KNOTS" : GOTO 1000
1000 PRINT : PRINT " IS EVERYTHING O.K NOW?"
1010 INPUT B$
1020 IF LEFT$(B$,1)="Y" OR LEFT$(B$,1)="y" THEN GOTO 1060
1030 PRINT : PRINT " WHAT DO YOU WANT TO CHANGE AGAIN?"
1040 PRINT : PRINT " HIT ANY KEY IN YOUR KEYBOARD AND EVERYTHING WILL WORK FOR YOU
MALAKA"
1050 INPUT F$ : GOTO 540
1060 RETURN
1070*****
1080 PRINTS THE INPUT DATA
1090*****
1110 LPRINT : LPRINT TAB(30); " PROBLEM #7"
1120 LPRINT TAB(30); " -----"
1130 LPRINT : LPRINT : LPRINT " G I V E N"
1140 LPRINT " -----"
1150 LPRINT : LPRINT " 1. Pp=";Pp;"MW" , " : PEAK POWER"
1160 LPRINT : LPRINT " 2. T=";T;"micsec." , " : PULSE WIDTH"
1170 LPRINT : LPRINT " 3. fp=";fp;"Hz" , " : PRF"
1180 LPRINT : LPRINT " 4. Ga=";Ga;"db" , " : ANTENNA GAIN"
1190 LPRINT : LPRINT " 5. fo=";fo;"GHZ" , " : OPERATING FREQ."
1200 LPRINT : LPRINT " 6. Bn=";Bn;"MHZ" , " : RECEIVER NOISE BANDWIDTH"
1210 LPRINT : LPRINT " 7. Wm=";Wm;"RPM" , " : ANTENNA SCAN RATE"
1220 LPRINT : LPRINT " 8. A.B=";A.B;"Deg." , " : AZIMUTH BEAMWIDTH"
1230 LPRINT : LPRINT " 9. F=";F;"db" , " : RECEIVER'S NOISE FIGURE"
1240 LPRINT : LPRINT " 10. Ta=";Ta;"KELVIN" , " : ANTENNA NOISE TEMPERATURE"
1250 LPRINT : LPRINT " 11. Lp=";Lp;"db" , " : PLUMBING LOSSES"
1260 LPRINT : LPRINT " 12. Pfa=";CSNG(Pfa) , " : FALSE ALARM PROBABILITY"
1270 LPRINT : LPRINT " GIVEN DATA FOR PART a:"
1280 LPRINT " -----"
1290 LPRINT : LPRINT " 1. S=";S;"obsm" , " : TARGET'S CROSS SECTION"
1300 LPRINT : LPRINT " 2. Pd=";Pd , " : PROBABILITY OF DETECTION"
1310 LPRINT : LPRINT " GIVEN DATA FOR PART b:"

```



```

1320 LPRINT "-----"
1330 LPRINT : LPRINT " 1. S1=";S1;"dbsm", " : AIRCRAFT'S CROSS SECTION"
1340 LPRINT : LPRINT " 2. S2=";S2;"sq.m", " : CHAFF'S CROSS SECTION"
1350 LPRINT : LPRINT " 3. R=";R;"KM", " : RADAR-TARGET DISTANCE"
1360 LPRINT : LPRINT " 4. Ut=";Ut;"knots", " : RADIAL VELOCITY OF THE AIRCRAFT"
1370 RETURN
1380*****
1390 ' CALCULATION & PRINTOUT FOR PART a:
1400*****
1410 LET PI=3.14159 : C=3*108 'm/s
1420 LET K=1.38*10-23 'BOLTZMAN'S CONST. j/deg.
1430 LET T0=290 'KELVIN
1440 LET f0=f0*109 : f=C/f0
1450 LET Pp=Pp*106
1460 LET Ga1=Ga/10 : Ga2=CINT(106Ga1)
1470 LET Ae=CSNG(12*Ga2/(4*PI)) 'effective area
1480 LET Lp1=Lp/10 : Lp2=CSNG(106Lp1)
1490 LET Sa=S/10 : Sb=106Sa
1500 LET F1=F/10 : F2=106F1
1510 LET Te=CINT((F2-1)*T0)
1520 LET Bn=Bn*106
1530 PRINT : PRINT " NOW FROM Fig. 2.7 (SKOLNIK Pg. 28) YOU CAN FIND THE (S/N) : SINCE YOU
NOW:"
1540 PRINT : PRINT "a. Pd=";Pd
1550 PRINT : PRINT "b. Pfa=";CSNG(Pfa)
1560 PRINT : PRINT " ENTER THE (S/N) I, SN IN db"
1570 INPUT SN
1580 LET SN1=SN/10 : SN2=CINT(106SN1)
1590 LET n=f0*A.B/(6*wm)
1600 PRINT : PRINT " FROM Fig. 2.8(a) (SKOLNIK Pg. 31) YOU CAN FIND THE INTEGR. IMR. FACTOR
SINCE THE PROGRAM CALCULATED FOR YOU:"
1610 PRINT : PRINT "a. n=";n
1620 PRINT : PRINT "b. Pd=";Pd
1630 PRINT : PRINT "c. nf=";CSNG(1/Pfa)
1640 PRINT : PRINT " ENTER THE INTEGR. IMR. FACTOR II(n), I: I"

```

```

1650 INPUT I11
1660 LET I1=CSNG(10*.4342945**LOG(I11))
1670 LET Rmax=(Pp*Ga2*Ae*Sb*I11/((4*PI)^2*K*(Te+T0)*Bn*SN2*Lp2))^(1/4)
1680 PRINT : PRINT : PRINT " PART a:"
1690 PRINT "-----"
1700 LPRINT : LPRINT : LPRINT " PART a:"
1710 LPRINT "-----"
1720 PRINT : PRINT " 1. n=";n; " : #OF HITS INTEGRATED"
1730 PRINT : PRINT " 2. (S/N)1=";SN;"db"; " : THE SIGNAL-TO-NOISE RATIO "
1740 PRINT : PRINT " 3. I1(n)=";I11; " : THE INTEGR. IMPR. FACTOR"
1750 PRINT : PRINT " 4. nf=";CSNG(1/Pfa); " : FALSE ALARM NUMBER"
1760 PRINT : PRINT " 5.
Rmax=(Pp*Ga2*Ae*S*I1(n)/((4*PI)^2*K*(Te+T0)*Bn*(S/N)1*Lp))^(1/4)=";CSNG(Rmax/1000)
"; " : MAX. RANGE"
1770 LPRINT : LPRINT " 1. n=";n; " : #OF HITS INTEGRATED"
1780 LPRINT : LPRINT " 2. (S/N)1=";SN;"db"; " : THE SIGNAL-TO-NOISE RATIO "
1790 LPRINT : LPRINT " 3. I1(n)=";I11; " : THE INTEGR. IMPR. FACTOR"
1800 LPRINT : LPRINT " 4. nf=";CSNG(1/Pfa); " : FALSE ALARM NUMBER"
1810 LPRINT : LPRINT " 5.
Rmax=(Pp*Ga2*Ae*S*I1(n)/((4*PI)^2*K*(Te+T0)*Bn*(S/N)1*Lp))^(1/4)=";CSNG(Rmax/1000)
"; " : MAX. RANGE"
1820 RETURN
1830 *****
1840 ' CALCULATION & PRINTOUT OF PART b:
1850 *****
1860 LET fd=1.03*Uf/1
1870 LET H=CSNG(4*(SIN(PI*fd/fp))^2)
1880 LET A=1E+16
1890 LET CA=A*fp^2/(2*PI^2*f0^2)
1900 LET CA=CINT(CA)
1910 LET CA1=CSNG(10*.4342945**LOG(CA))
1920 LET SCIn=S1/S2
1930 LET SC=CINT(10*.4342945**LOG(SCIn))
1940 LET SCout=CINT(SCIn*H*CA)
1950 LET SCout=CINT(10*.4342945**LOG(SCout))

```

```
1960 PRINT : PRINT : PRINT " PART b:"
1970 PRINT "-----"
1980 LPRINT : LPRINT : LPRINT " PART b:"
1990 LPRINT "-----"
2000 PRINT : PRINT " 1.(S/C)out=";SCout;"db";": SIGNAL-TO-CLUTTER RATIO AT THE OUTPUT
    OF THE DELAY LINE CANCELLER"
2010 LPRINT : LPRINT " 1.(S/C)out=";SCout;"db";": SIGNAL-TO-CLUTTER RATIO AT THE OUTPUT
    OF THE DELAY LINE CANCELLER"
2020 RETURN
```

PROBLEM #7

GIVEN

1. $P_p = 1 \text{ MW}$: PEAK POWER
2. $T = 1.4 \text{ micsec.}$: PULSE WIDTH
3. $f_p = 800 \text{ Hz}$: PRF
4. $G_a = 26 \text{ db}$: ANTENNA GAIN
5. $f_0 = 1 \text{ GHz}$: OPERATING FREQ.
6. $B_n = 1.5 \text{ MHz}$: RECEIVER NOISE BANDWIDTH
7. $\omega_m = 10 \text{ RPM}$: ANTENNA SCAN RATE
8. $A.B = 3.9 \text{ Deg.}$: AZIMUTH BEAMWIDTH
9. $F = 9 \text{ db}$: RECEIVER'S NOISE FIGURE
10. $T_e = 100 \text{ KELVIN}$: ANTENNA NOISE TEMPERATURE
11. $L_p = 2 \text{ db}$: PLUMBING LOSSES
12. $P_{fa} = 1E-12$: FALSE ALARM PROBABILITY

GIVEN DATA FOR PART a:

1. $S = 0 \text{ dbsm}$: TARGET'S CROSS SECTION
2. $P_d = .9$: PROBABILITY OF DETECTION

GIVEN DATA FOR PART b:

1. $S_1 = 10 \text{ dbsm}$: AIRCRAFT'S CROSS SECTION
2. $S_2 = 500 \text{ sq.m}$: CHAFF'S CROSS SECTION
3. $R = 30 \text{ KM}$: RADAR-TARGET DISTANCE
4. $U_t = 300 \text{ knots}$: RADIAL VELOCITY OF THE AIRCRAFT

PART a:

1. $n = 52$: # OF HITS INTEGRATED
 2. $(S/N)_1 = 15.8 \text{ db}$: THE SIGNAL-TO-NOISE RATIO
 3. $l_1(n) = 23.5$: THE INTEGR. IMPR. FACTOR
 4. $n_f = 1E+12$: FALSE ALARM NUMBER
5. $R_{max} = (P_p * G_a * A_e * S * l_1(n) / ((4 * \pi)^2 * K * (T_e + T_a) * B_n * (S/N)_1 * L_p))^{1/4} = 89.4639 \text{ KM MAX RANGE}$

PART D:

: (S/C)_{out} = 12 db : SIGNAL-TO-CLUTTER RATIO AT THE OUTPUT OF THE DELAY LINE CANCELLER

```

10 PRINT : PRINT TAB(30); " PROBLEM #8"
20 PRINT TAB(30); " -----"
30 GOSUB 100 : GOSUB 1020 : GOSUB 1250
40 GOSUB 1410 : GOSUB 1680 : GOSUB 1890
50 PRINT : PRINT " DO YOU WANT TO TRY AGAIN FOR DIFFERENT OR THE SAME DATA (Y/N)?"
60 INPUT D$
70 IF LEFT$(D$,1) = "Y" OR LEFT$(D$,1) = "y" THEN 30
80 END
90 *****
100 INPUTS THE DATA
110 *****
120 PRINT : PRINT " ENTER THE RANGE OF THE OPERATING FREQ. (f10,f20 IN GHz)"
130 INPUT f10,f20 : PRINT : PRINT " 1. f10=";f10,"f20=";f20;"GHz"
140 PRINT : PRINT " ENTER THE PEAK POWER Pp IN KW"
150 INPUT Pp : PRINT : PRINT " 2. Pp=";Pp;"KW"
160 PRINT : PRINT " ENTER THE PRF fp IN Hz"
170 INPUT fp : PRINT : PRINT " 3. fp=";fp;"Hz"
180 PRINT : PRINT " ENTER THE PULSEWIDTH T IN nsec."
190 INPUT T : PRINT : PRINT " 4. T=";T;"nsec."
200 PRINT : PRINT " ENTER THE ANTENNA GAIN Ga IN db"
210 INPUT Ga : PRINT : PRINT " 5. Ga=";Ga;"db"
220 PRINT : PRINT " ENTER THE AZIMUTH BEAMWIDTH A.B IN Deg."
230 INPUT A.B : PRINT : PRINT " 6. A.B=";A.B;"Deg."
240 PRINT : PRINT " ENTER THE ANTENNA SCAN RATE Wm IN RPM"
250 INPUT Wm : PRINT : PRINT " 7. Wm=";Wm;"RPM"
260 PRINT : PRINT " ENTER THE PLUMBING LOSSES Lp IN db"
270 INPUT Lp : PRINT : PRINT " 8. Lp=";Lp;"db"
280 PRINT : PRINT " ENTER THE Rx NOISE FIGURE Rx IN db"
290 INPUT Rx : PRINT : PRINT " 9. Rx=";Rx;"db"
300 PRINT : PRINT " ENTER THE AIRCRAFT'S ALTITUDE Ha IN ft"
310 INPUT Ha : PRINT : PRINT " 10. Ha=";Ha;"ft"
320 PRINT : PRINT " ENTER THE RANGE TO SUBMARINE Rs IN Kyards"
330 INPUT Rs : PRINT : PRINT " 11. Rs=";Rs;"Kyards"
340 PRINT : PRINT " ENTER THE PERISCOPE RCS IN sq. m"
350 INPUT RCS : PRINT : PRINT " 12. RCS=";RCS;"sq.m"

```

```

360 PRINT : PRINT " NOW GO TO PART (a) AND INPUT : "
370 PRINT : PRINT " ENTER THE AVERAGE DURATION OF THE SEA CLUTTER SPIKES t1fa IN sec."
380 INPUT t1fa : PRINT : PRINT " 13. t1fa=" ; t1fa ; "sec."
390 PRINT : PRINT " ENTER THE FALSE ALARM TIME Tfa IN sec."
400 INPUT Tfa : PRINT : PRINT " 14. Tfa=" ; Tfa ; "sec."
410 PRINT : PRINT " NOW FROM PART (d) INPUT : "
420 PRINT : PRINT " ENTER THE POST DETECTION INTEGRATION PERIOD Ts IN sec."
430 INPUT Ts : PRINT : PRINT " 15. Ts=" ; Ts ; "sec."
440 PRINT : PRINT " IS THE INPUT DATA CORRECT Y/N?"
450 INPUT A$
460 IF LEFT$(A$,1)="Y" OR LEFT$(A$,1)="y" THEN 1000
470 PRINT " WHAT OF THE FOLLOWING DO YOU WANT TO CHANGE?"
480 PRINT : PRINT " 1. THE RANGE OF THE OPERATING FREQ.?"
490 PRINT : PRINT " 2. THE PEAK POWER?"
500 PRINT : PRINT " 3. THE P.R.F?"
510 PRINT : PRINT " 4. THE PULSEWIDTH?"
520 PRINT : PRINT " 5. THE ANTENNA GAIN?"
530 PRINT : PRINT " 6. THE AZIMUTH BEAMWIDTH?"
540 PRINT : PRINT " 7. THE ANTENNA SCAN RATE?"
550 PRINT : PRINT " 8. THE PLUMBING LOSSES?"
560 PRINT : PRINT " 9. THE Rx NOISE FIGURE?"
570 PRINT : PRINT " 10. THE AIRCRAFT'S ALTITUDE?"
580 PRINT : PRINT " 11. THE RANGE TO SUBMARINE?"
590 PRINT : PRINT " 12. THE PERISCOPE RCS?"
600 PRINT : PRINT " 13. THE AVERAGE DURATION OF THE SPIKES?"
610 PRINT : PRINT " 14. THE FALSE ALARM TIME?"
620 PRINT : PRINT " 15. THE POST DETECTION INTEGRATION PERIOD?"
630 INPUT C$
640 IF C$="1" THEN PRINT : PRINT " ENTER THE RANGE OF THE OPERATING FREQ. f10,f20 IN
    GHz"
650 IF C$="1" THEN INPUT f10,f20 : PRINT : PRINT " 1. f10=" ; f10 ; "f20=" ; f20 ; "GHz" : GOTO 940
660 IF C$="2" THEN PRINT : PRINT " ENTER THE PEAK POWER Pp IN KW"
670 IF C$="2" THEN INPUT Pp : PRINT : PRINT " 2. Pp=" ; Pp ; "KW" : GOTO 940
680 IF C$="3" THEN PRINT : PRINT " ENTER THE PRF fp IN Hz"
690 IF C$="3" THEN INPUT fp : PRINT : PRINT " 3. fp=" ; fp ; "Hz" : GOTO 940

```

```

700 IF C$="4" THEN PRINT : PRINT " ENTER THE PULSEWIDTH T IN nsec."
710 IF C$="4" THEN INPUT T : PRINT : PRINT " 4. T=";T;"nsec." : GOTO 940
720 IF C$="5" THEN PRINT : PRINT " ENTER THE ANTENNA GAIN Ga IN db"
730 IF C$="5" THEN INPUT Ga : PRINT : PRINT " 5. Ga=";Ga;"db" : GOTO 940
740 IF C$="6" THEN PRINT : PRINT " ENTER THE AZIMUTH BEAMWIDTH A.B IN Deg."
750 IF C$="6" THEN INPUT A.B : PRINT : PRINT " 6. A.B=";A.B;"Deg." : GOTO 940
760 IF C$="7" THEN PRINT : PRINT " ENTER THE ANTENNA SCAN RATE Wm IN RPM"
770 IF C$="7" THEN INPUT Wm : PRINT : PRINT " 7. Wm=";Wm;"RPM" : GOTO 940
780 IF C$="8" THEN PRINT : PRINT " ENTER THE PLUMBING LOSSES Lp IN db"
790 IF C$="8" THEN INPUT Lp : PRINT : PRINT " 8. Lp=";Lp;"db" : GOTO 940
800 IF C$="9" THEN PRINT : PRINT " ENTER THE Rx NOISE FIGURE Rx IN db"
810 IF C$="9" THEN INPUT Rx : PRINT : PRINT " 9. Rx=";Rx;"db" : GOTO 940
820 IF C$="10" THEN PRINT : PRINT " ENTER THE AIRCRAFT'S ALTITUDE Ha IN ft"
830 IF C$="10" THEN INPUT Ha : PRINT : PRINT " 10. Ha=";Ha;"ft" : GOTO 940
840 IF C$="11" THEN PRINT : PRINT " ENTER THE RANGE TO SUBMARINE Rs IN Kyards"
850 IF C$="11" THEN INPUT Rs : PRINT : PRINT " 11. Rs=";Rs;"Kyards" : GOTO 940
860 IF C$="12" THEN PRINT : PRINT " ENTER THE PERISCOPE RCS IN sq. m"
870 IF C$="12" THEN INPUT RCS : PRINT : PRINT " 12. RCS=";RCS;"sq.m" : GOTO 940
880 IF C$="13" THEN PRINT : PRINT " ENTER THE AVERAGE DURATION OF THE SEA CLUTTER
    SPIKES t1fa IN sec."
890 IF C$="13" THEN INPUT t1fa : PRINT : PRINT " 13. t1fa=";t1fa;"sec." : GOTO 940
900 IF C$="14" THEN PRINT : PRINT " ENTER THE FALSE ALARM TIME Tfa IN sec."
910 IF C$="14" THEN INPUT Tfa : PRINT : PRINT " 14. Tfa=";Tfa;"sec." : GOTO 940
920 IF C$="15" THEN PRINT : PRINT " ENTER THE POST DETECTION INTEGRATION PERIOD Ts IN
    sec."
930 IF C$="15" THEN INPUT Ts : PRINT : PRINT " 15. Ts=";Ts;"sec." : GOTO 940
940 PRINT : PRINT " IS EVERYTHING O.K NOW?"
950 INPUT B$
960 IF LEFT$(B$,1)="Y" OR LEFT$(B$,1)="y" THEN 1000
970 PRINT : PRINT " WHAT DO YOU WANT TO CHANGE AGAIN?"
980 PRINT : PRINT " HIT ANY KEY IN YOUR KEYBOARD AND EVERYTHING WILL WORK FOR YOU
    MALAKA"
990 INPUT F$ : GOTO 480
1000 RETURN
1010 *****

```



```

1020 PRINTS THE INPUT DATA
1030 *****
1040 LPRINT LPRINT TAB(30); " PROBLEM #8"
1050 LPRINT TAB(30); " -----"
1060 LPRINT : LPRINT " G I V E N"
1070 LPRINT " -----"
1080 LPRINT : LPRINT " 1. f10=";f10;"f20=";f20;"GHZ" SPC(1); " : RANGE OF THE OPERATING
    FREQ."
1090 LPRINT : LPRINT " 2. Pp=";Pp;"KW" SPC(10); " : PEAK POWER"
1100 LPRINT : LPRINT " 3. fp=";fp;"Hz" SPC(9); " : P.R.F"
1110 LPRINT : LPRINT " 4. T=";T;"nsec." SPC(8); " : PULSEWIDTH"
1120 LPRINT : LPRINT " 5. Ga=";Ga;"db" SPC(11); " : ANTENNA GAIN"
1130 LPRINT : LPRINT " 6. A.B=";A.B;"Deg." SPC(6); " : AZIMUTH BEAMWIDTH"
1140 LPRINT : LPRINT " 7. Wm=";Wm;"RPM" SPC(9); " : ANTENNA SCAN RATE"
1150 LPRINT : LPRINT " 8. Lp=";Lp;"db" SPC(12); " : PLUMBING LOSSES"
1160 LPRINT : LPRINT " 9. Rx=";Rx;"db" SPC(10); " : Rx NOISE FIGURE"
1170 LPRINT : LPRINT " 10. Ha=";Ha;"ft" SPC(8); " : AIRCRAFT'S ALTITUDE"
1180 LPRINT : LPRINT " 11. Rs=";Rs;"Kyards" SPC(6); " : RANGE TO SUBMARINE"
1190 LPRINT : LPRINT " 12. RCS=";RCS;"sq.m" SPC(8); " : PERISCOPE'S RCS"
1200 LPRINT : LPRINT " 13. t1fa=";t1fa;"sec." SPC(7); " : AVERAGE DURATION OF THE SEA
    CLUTTERSPIKES"
1210 LPRINT : LPRINT " 14. Tfa=";Tfa;"sec." SPC(6); " : FALSE ALARM TIME"
1220 LPRINT : LPRINT " 15. Ts=";Ts;"sec." SPC(9); " : POST DETECTION INTEGRATION PERIOD"
1230 RETURN
1240 *****
1250 ' CALCULATION & PRINTOUT FOR PART (a)
1260 *****
1270 PRINT : PRINT : PRINT " PART (a)"
1280 PRINT " -----"
1290 LPRINT : LPRINT : LPRINT " PART (a)"
1300 LPRINT " -----"
1310 LET Pfa=t1fa/Tfa
1320 PRINT : PRINT " FROM Fig. 13.5 (SKOLNIK Pg. 479) YOU CAN FIND THE THRESHOLD LEVEL
    "TRSH" SINCE YOU KNOW:"
1330 PRINT PRINT " a. Pfa=";Pfa; " : PROBABILITY OF FALSE ALARM"

```

```

1340 INPUT " b. THE SEA STATE IS", K$
1350 PRINT : PRINT " ENTER THE THRESHOLD LEVEL REQUIRED TO ACHIEVE  $P_{fe} =$ ";  $P_{fa}$ 
1360 INPUT TRSH
1370 LPRINT : LPRINT " 1(a).  $P_{fe} =$ ";  $P_{fa}$ ; " : FALSE ALARM PROBABILITY"
1380 LPRINT : LPRINT " 2(a). THRESHOLD = ", TRSH; " db"; " : LEVEL THAT THE THRESH. MUST BE SET
ABOVE THE MEDIAN CLUTTER TO ACHIEVE  $P_{fe} =$ ";  $P_{fa}$ 
1390 RETURN
1400*****
1410 ' CALCULATION & PRINTOUT FOR PART (b)
1420*****
1430 PRINT : PRINT : PRINT " PART (b)"
1440 PRINT " -----"
1450 LPRINT : LPRINT : LPRINT " PART (b)"
1460 LPRINT " -----"
1470 LET C=3*10^8 : PI=3.14159 : f20=f20*10^9
1480 LET I=C/f20
1490 LET Ga1=Ga/10 : Ga2=CINT(10*Ga1)
1500 LET Lp1=Lp/10 : Lp2=10*Lp1
1510 LET Pp=Pp*10^3
1520 LET Ae=CSNG(Ga2*1^2/(4*PI))
1530 LET Rs=Rs*10^3*.914
1540 LET sec=CINT(1/COS(A.B*PI/180))
1550 LET T=T*10^-9
1560 PRINT : PRINT " FROM FIG 13.3 (SKOLNIK Pg. 475) YOU CAN FIND THE CROSS SECTION SINCE
YOU KNOW : "
1570 PRINT : PRINT " THE GRAZING ANGLE = ", sec; " & THE POLARIZATION"
1580 PRINT : PRINT " ENTER THE CROSS SECTION  $S_o$  IN db"
1590 INPUT So : So1=So/10 : So2=10*So1
1600 LET S=CSNG(Pp*Ga2*RCS*Ae/((4*PI)^2*Rs^4*Lp2))
1610 LET C1=CSNG(Pp*Ga2*Ae*So2*(A.B*PI/180)*(C*T/2)*sec/((4*PI)^2*Rs^3*(Lp2/2)))
1620 LET SC=S/C1
1630 LET SC=CSNG(10*.4342945**LOG(SC))
1640 PRINT : PRINT " 1(b). (S/C)m = ", SC; " db"; " : SINGLE PULSE SIGNAL-TO-CLUTTER RATIO AT
THE RADAR RECEIVER INPUT"
1650 LPRINT : LPRINT " 1(b). (S/C)m = ", SC; " db"; " : SINGLE PULSE SIGNAL-TO-CLUTTER RATIO AT

```

THE RADAR RECEIVER INPUT

1660 RETURN

1670*****

1680 ' CALCULATION & PRINTOUT FOR PART (c)

1690*****

1700 PRINT:PRINT:PRINT ' PART (c)'

1710 PRINT '-----'

1720 LPRINT:LPRINT:LPRINT ' PART (c)'

1730 LPRINT '-----'

1740 PRINT:PRINT ' FROM TABLE I 1.1 (SKOLNIK Pg.426) SINCE YOU KNOW THE WEIGHTING
FILTER YOU USE, YOU CAN FIND:'

1750 INPUT 'a. THE PEAK SIDELobe SLL IN db',SLL

1760 INPUT 'b. THE LOSS IN db',LOSS

1770 INPUT 'c. MAINLOBE WIDTH (relative) M.W',M.W

1780 LET f10=f10*10^9

1790 LET W=f20-f10

1800 LET Tc=T/(T*W)*M.W

1810 LET A=CSNG(10*.4342945**LOG(2*T*W)-LOSS)

1820 LET SC1=SC+A

1830 PRINT:PRINT ' 1(c). Tc=";Tc;"sec."; " : 3 db WIDTH OF THE COMPRESSED PULSE"

1840 PRINT:PRINT ' 2(c). (S/C)out=";SC1;"db"; " : SIGNAL-MEAN CLUTTER POWER"

1850 LPRINT:LPRINT ' 1(c). Tc=";Tc;"sec."; " : 3 db WIDTH OF THE COMPRESSED PULSE"

1860 LPRINT:LPRINT ' 2(c). (S/C)out=";SC1;"db"; " : SIGNAL-MEAN CLUTTER POWER"

1870 RETURN

1880*****

1890 ' CALCULATION & PRINTOUT FOR PART (d)

1900*****

1910 PRINT:PRINT:PRINT ' PART (d)'

1920 PRINT '-----'

1930 LPRINT:LPRINT:LPRINT ' PART (d)'

1940 LPRINT '-----'

1950 LET ns=A.B*f_p/(6*W_m)

1960 LET n=ns*(300/60)*T_s

1970 PRINT:PRINT ' FROM FIG 2.8(a) (SKOLNIK Pg. 31) YOU CAN FIND THE n(n) SINCE YOU KNOW

```

1980 PRINT:PRINT " a. #OF HITS=";n
1990 PRINT:PRINT " b. YOU'RE IN POST DETECTION CASE"
2000 PRINT:PRINT " ENTER THE INTEGRATION IMPR. FACTOR II "
2010 INPUT II
2020 LET II=C:INT(10*.4342945**LOG(II))
2030 LET B=SC1+II
2040 PRINT:PRINT " 1(d). n=";n; " : #OF HITS"
2050 PRINT:PRINT " 2(d). II(n)=";II;"db"; " : INTEGRATION IMPR. FACTOR"
2060 PRINT:PRINT " 3(d). (S/C)=(S/C)out+II(n)=";B;"db"; " : INTEGR. IMPROVEMENT"
2070 LPRINT:LPRINT " 1(d). n=";n; " : #OF HITS"
2080 LPRINT:LPRINT " 2(d). II(n)=";II;"db"; " : INTEGRATION IMPR. FACTOR"
2090 LPRINT:LPRINT " 3(d). (S/C)=(S/C)out+II(n)=";B;"db"; " : INTEGR. IMPROVEMENT"
2100 RETURN

```

PROBLEM#8

GIVEN

1. $f_0 = 9.5$ to 10 GHz : RANGE OF THE OPERATING FREQ.
2. $P_p = 500$ KW : PEAK POWER
3. $f_p = 1500$ Hz : P.R.F
4. $T = 500$ nsec. : PULSEWIDTH
5. $G_a = 35$ db : ANTENNA GAIN
6. $A.B = 2.4$ Deg. : AZIMUTH BEAMWIDTH
7. $W_m = 300$ RPM : ANTENNA SCAN RATE
8. $L_p = 5$ db : PLUMBING LOSSES
9. $R_x = 7.5$ db : Rx NOISE FIGURE
10. $H_a = 2000$ ft : AIRCRAFT'S ALTITUDE
11. $R_s = 16$ Kyards : RANGE TO SUBMARINE
12. $RCS = 1$ sq.m : PERISCOP'S RCS
13. $t_{1f} = 2$ sec. : AVERAGE DURATION OF THE SEA CLUTTER SPIKES
14. $T_{fa} = 100$ sec. : FALSE ALARM TIME
15. $T_s = 5$ sec. : POST DETECTION INTEGRATION PERIOD

PART (a)

- 1(a). $P_{fa} = .02$: FALSE ALARM PROBABILITY
- 2(a). THRESHOLD = 12.5 db : LEVEL THAT THE THRESH. MUST BE SET ABOVE THE MEDIAN CLUTTER TO ACHIEVE $P_{fa} = .02$

PART (b)

- 1(b). $(S/C)_m = -17.6325$ db : SINGLE PULSE SIGNAL-TO-CLUTTER RATIO AT THE RADAR RECEIVER INPUT

PART (c)

- 1(c). $T_c = .000000003$ sec. : 3 db WIDTH OF THE COMPRESSED PULSE
- 2(c). $(S/C)_{out} = 8.0172$ db : SIGNAL-MEAN CLUTTER POWER

PART (d)

1(d). n= 50 : #OF HITS

2(d). $I_1(n)$ = 14 db : INTEGRATION IMPR. FACTOR

3(d). $(S/C) = (S/C)_{out} + I_1(n) = 22.0172$ db: INTEGR. IMPROVEMENT

```

10 PRINT : PRINT TAB(30); " PROBLEM #9 "
20 PRINT TAB(30); " -----"
30 GOSUB 90 : GOSUB 890 : GOSUB 1100
40 PRINT : PRINT " DO YOU WANT TO TRY AGAIN FOR DIFFERENT OR THE SAME DATA /Y/N?"
50 INPUT D$
60 IF LEFT$(D$,1)="Y" OR LEFT$(D$,1)="y" THEN 30
70 END
80 *****
90 INPUTS THE DATA
100 *****
110 PRINT : PRINT " ENTER THE OPERATING FREQ. f0 IN GHz"
120 INPUT f0 : PRINT : PRINT " 1. f0=";f0;"GHz"
130 PRINT : PRINT " ENTER THE PEAK POWER Pp IN MW"
140 INPUT Pp : PRINT : PRINT " 2. Pp=";Pp;"MW"
150 PRINT : PRINT " ENTER THE ANTENNA GAIN Ga IN db"
160 INPUT Ga : PRINT : PRINT " 3. Ga=";Ga;"db"
170 PRINT : PRINT " ENTER THE AZIMUTH BEAMWIDTH A.B IN Deg."
180 INPUT A.B : PRINT : PRINT " 4. A.B=";A.B;"Deg."
190 PRINT : PRINT " ENTER THE ELEVATION COVERAGE ECmin,ECmax IN Deg."
200 INPUT ECmin,ECmax : PRINT : PRINT " 5. ECmin=";ECmin;" ECmax=";ECmax;" Deg."
210 PRINT : PRINT " ENTER THE ANTENNA SCAN RATE Wm IN RPM"
220 INPUT Wm : PRINT : PRINT " 6. Wm=";Wm;"RPM"
230 PRINT : PRINT " ENTER THE P.R.F fp IN Hz"
240 INPUT fp : PRINT : PRINT " 7. fp=";fp;"Hz"
250 PRINT : PRINT " ENTER THE PULSE WIDTH T IN microsec."
260 INPUT T : PRINT : PRINT " 8. T=";T;"microsec."
270 PRINT : PRINT " ENTER THE RECEIVER NOISE FIGURE F IN db"
280 INPUT F : PRINT : PRINT " 9. F=";F;"db"
290 PRINT : PRINT " ENTER THE AIRCRAFT'S RADAR CROSS SECTION RCS IN dbsm"
300 INPUT RCS : PRINT : PRINT " 10. RCS=";RCS;"dbsm"
310 PRINT : PRINT " ENTER THE RANGE OF THE AIRCRAFT R IN Km"
320 INPUT R : PRINT : PRINT " 11. R=";R;"Km"
330 PRINT : PRINT " ENTER THE CHAFF RMS VELOCITY SPREAD Su IN m/sec."
340 INPUT Su : PRINT : PRINT " 12. Su=";Su;"m/sec."
350 PRINT : PRINT " ENTER THE CLUTTER-TARGET SIGNAL RATIO (S/N)out IN db"

```

```

360 INPUT SNout : PRINT : PRINT " 13. SNout=";SNout;"db"
370 PRINT : PRINT " IS THE INPUT DATA CORRECT Y/N?"
380 INPUT A$
390 IF LEFT$(A$,1)="Y" OR LEFT$(A$,1)="y" THEN 870
400 PRINT " WHAT OF THE FOLLOWING DO YOU WANT TO CHANGE?"
410 PRINT : PRINT " 1. THE OPERATING FREQ.?"
420 PRINT : PRINT " 2. THE PEAK POWER?"
430 PRINT : PRINT " 3. THE ANTENNA GAIN?"
440 PRINT : PRINT " 4. THE AZIMUTH BEAMWIDTH?"
450 PRINT : PRINT " 5. THE RANGE OF THE ELEVATION COVERAGE?"
460 PRINT : PRINT " 6. THE ANTENNA SCAN RATE?"
470 PRINT : PRINT " 7. THE P.R.F?"
480 PRINT : PRINT " 8. THE PULSE WIDTH?"
490 PRINT : PRINT " 9. THE RECEIVER NOISE FIGURE?"
500 PRINT : PRINT " 10. THE AIRCRAFT'S RADAR CROSS SECTION?"
510 PRINT : PRINT " 11. THE RANGE OF THE AIRCRAFT?"
520 PRINT : PRINT " 12. THE CHAFF'S RMS VELOCITY SPREAD?"
530 PRINT : PRINT " 13. THE CLUTTER-TARGET SIGNAL RATIO?"
540 INPUT C$
550 IF C$="1" THEN PRINT : PRINT " ENTER THE OPERATING FREQ. f0 IN GHz"
560 IF C$="1" THEN INPUT f0 : PRINT : PRINT " 1. f0=";f0;"GHz" : GOTO 810
570 IF C$="2" THEN PRINT : PRINT " ENTER THE PEAK POWER Pp IN MW"
580 IF C$="2" THEN INPUT Pp : PRINT : PRINT " 2. Pp=";Pp;"MW" : GOTO 810
590 IF C$="3" THEN PRINT : PRINT " ENTER THE ANTENNA GAIN Ga IN db"
600 IF C$="3" THEN INPUT Ga : PRINT : PRINT " 3. Ga=";Ga;"db" : GOTO 810
610 IF C$="4" THEN PRINT : PRINT " ENTER THE AZIMUTH BEAMWIDTH A.B IN Deg."
620 IF C$="4" THEN INPUT A.B : PRINT : PRINT " 4. A.B=";A.B;"Deg." : GOTO 810
630 IF C$="5" THEN PRINT : PRINT " ENTER THE ELEVATION COVERAGE ECmin,ECmax IN Deg."
640 IF C$="5" THEN INPUT ECmin,ECmax : PRINT : PRINT " 5. ECmin=";ECmin;"
    ECmax=";ECmax;" Deg." : GOTO 810
650 IF C$="6" THEN PRINT : PRINT " ENTER THE ANTENNA SCAN RATE Wm IN RPM"
660 IF C$="6" THEN INPUT Wm : PRINT : PRINT " 6. Wm=";Wm;"RPM" : GOTO 810
670 IF C$="7" THEN PRINT : PRINT " ENTER THE P.R.F fp IN Hz"
680 IF C$="7" THEN INPUT fp : PRINT : PRINT " 7. fp=";fp;"Hz" : GOTO 810
690 IF C$="8" THEN PRINT : PRINT " ENTER THE PULSE WIDTH T IN microsec."

```



```

700 IF C$="8" THEN INPUT T : PRINT : PRINT " 8. T=";T;"microsec.": GOTO 810
710 IF C$="9" THEN PRINT : PRINT " ENTER THE RECEIVER NOISE FIGURE F IN db"
720 IF C$="9" THEN INPUT F : PRINT : PRINT " 9. F=";F;"db": GOTO 810
730 IF C$="10" THEN PRINT : PRINT " ENTER THE AIRCRAFT'S RADAR CROSS SECTION RCS IN
    dbsm"
740 IF C$="10" THEN INPUT RCS : PRINT : PRINT " 10. RCS=";RCS;"dbsm": GOTO 810
750 IF C$="11" THEN PRINT : PRINT " ENTER THE RANGE OF THE AIRCRAFT R IN Km"
760 IF C$="11" THEN INPUT R : PRINT : PRINT " 11. R=";R;"Km": GOTO 810
770 IF C$="12" THEN PRINT : PRINT " ENTER THE CHAFF RMS VELOCITY SPREAD Su IN m/sec."
780 IF C$="12" THEN INPUT Su : PRINT : PRINT " 12. Su=";Su;"m/sec.": GOTO 810
790 IF C$="13" THEN PRINT : PRINT " ENTER THE CLUTTER-TARGET SIGNAL RATIO (S/N)out IN
    db"
800 IF C$="13" THEN INPUT SNout : PRINT : PRINT " 13. SNout=";SNout;"db": GOTO 810
810 PRINT : PRINT " IS EVERYTHING O.K NOW?"
820 INPUT B$
830 IF LEFT$(B$,1)="Y" OR LEFT$(B$,1)="y" THEN GOTO 870
840 PRINT : PRINT " WHAT DO YOU WANT TO CHANGE AGAIN?"
850 PRINT : PRINT " HIT ANY KEY IN YOUR KEYBOARD AND EVERYTHING WILL WORK FOR YOU
    MALAKA"
860 INPUT F$ : GOTO 410
870 RETURN
880 *****
890 PRINTS THE INPUT DATA
900 *****
910 LPRINT : LPRINT TAB(30); " PROBLEM #9"
920 LPRINT TAB(30); " -----"
930 LPRINT : LPRINT " G I V E N"
940 LPRINT " -----"
950 LPRINT : LPRINT " 1. f0=";f0;"GHz" SPC(15); " : OPERATING FREQ."
960 LPRINT : LPRINT " 2. Pp=";Pp;"MW" SPC(18); " : PEAK POWER"
970 LPRINT : LPRINT " 3. Gc=";Gc;"db" SPC(17); " : ANTENNA GAIN"
980 LPRINT : LPRINT " 4. A.B=";A.B;"Deg." SPC(13); " : AZIMUTH BEAMWIDTH"
990 LPRINT : LPRINT " 5. ECmin=";ECmin;" ECmax=";ECmax;" Deg.": " : RANGE OF ELEVATION
    COVERAGE"
1000 LPRINT : LPRINT " 6. Wm=";Wm;"RPM" SPC(17); " : ANTENNA SCAN RATE"

```

```

1010 LPRINT:LPRINT " 7. fp=";fp;"Hz" SPC(16);":P.R.F"
1020 LPRINT:LPRINT " 8. T=";T;"microsec." SPC(12);": PULSE WIDTH"
1030 LPRINT:LPRINT " 9. F=";F;"db" SPC(19);": RECEIVER NOISE FIGURE"
1040 LPRINT:LPRINT " 10. RCS=";RCS;"dbsm" SPC(13);": AIRCRAFT'S RADAR CROSS SECTION"
1050 LPRINT:LPRINT " 11. R=";R;"Km" SPC(16);": RANGE OF THE AIRCRAFT"
1060 LPRINT:LPRINT " 12. Su=";Su;"m/sec." SPC(13);": CHAFF RMS VELOCITY SPREAD"
1070 LPRINT:LPRINT " 13. SNout=";SNout;"db" SPC(11);": CLUTTER-TARGET SIGNAL RATIO
(S/N)out"
1080 RETURN
1090*****
1100 ' CALCULATION & PRINTOUT OF THE OUTPUT
1120*****
1130 PRINT:PRINT:PRINT " OUTPUT"
1140 PRINT " -----"
1150 LPRINT:LPRINT:LPRINT " OUTPUT"
1160 LPRINT " -----"
1170 LET C=3*10^8
1180 LET f0=f0*10^9
1190 LET l=C/f0
1200 LET PI=3.14159
1210 LET lmax=CINT(fp^2*l^2/(16*PI^2*Su)*(4))
1220 LET lmaxl=CSNG(10*.4342945**LOG(lmax))
1230 PRINT:PRINT " THE BEST IMPROVEMENT THE DELAY LINE CANCELER WILL PROVIDE IS:"
1240 PRINT:PRINT " lmax=";lmax;"numeric";" OR";lmaxl;"db"
1250 LPRINT:LPRINT " THE BEST IMPROVEMENT THE DELAY LINE CANCELER WILL PROVIDE IS:"
1260 LPRINT:LPRINT " lmax=";lmax;"numeric";" OR";lmaxl;"db"
1270 LET SNin=-SNout-lmaxl
1280 LET SNin=SNin/10:SNin=10^SNin
1290 LET N=CSNG(RCS/(.15*l^2*SNin))
1300 PRINT:PRINT " N=";N;": DIPOLES IN RESOLUTION CELL"
1310 LPRINT:LPRINT " N=";N;": DIPOLES IN RESOLUTION CELL"
1320 RETURN

```

PROBLEM#9

GIVEN

- | | |
|---|---|
| 1. $f_0 = 1.3$ GHz | : OPERATING FREQ. |
| 2. $P_p = 2$ MW | : PEAK POWER |
| 3. $G_a = 35$ db | : ANTENNA GAIN |
| 4. $A.B = 1.3$ Deg. | : AZIMUTH BEAMWIDTH |
| 5. $EC_{min} = .2$ $EC_{max} = 45$ Deg. | : RANGE OF ELEVATION COVERAGE |
| 6. $\omega_m = 5$ RPM | : ANTENNA SCAN RATE |
| 7. $f_p = 360$ Hz | : P.R.F |
| 8. $T = 6$ microsec. | : PULSE WIDTH |
| 9. $F = 8$ db | : RECEIVER NOISE FIGURE |
| 10. $RCS = 10$ dbsm | : AIRCRAFT'S RADAR CROSS SECTION |
| 11. $R = 100$ Km | : RANGE OF THE AIRCRAFT |
| 12. $S_u = 1$ m/sec. | : CHAFF RMS VELOCITY SPREAD |
| 13. $SN_{out} = 10$ db | : CLUTTER-TARGET SIGNAL RATIO $(S/N)_{out}$ |

OUTPUT

THE BEST IMPROVEMENT THE DELAY LINE CANCELER WILL PROVIDE IS

$I_{max} = 175$ numeric OR 22.4304 db

$N = 2190750$: DIPOLES IN RESOLUTION CELL

```

10 PRINT : PRINT TAB(30); " PROBLEM #10"
20 PRINT TAB(30); " -----"
30 GOSUB 100 : GOSUB 510
40 GOSUB 540 : GOSUB 790
50 PRINT : PRINT " DO YOU WANT TO TRY AGAIN FOR DIFFERENT OR THE SAME DATA (Y/N)?"
60 INPUT D$
70 IF LEFT$(D$,1)="Y" OR LEFT$(D$,1)="y" THEN 30
80 END
90 *****
100 INPUTS THE DATA
110 *****
120 PRINT : PRINT " ENTER THE SWEEP RANGE F1,F2 OF THE HF RECEIVER IN MHz"
130 INPUT F1,F2 : PRINT : PRINT " 1. F1-F2=";F1;"-";F2;"MHz"
140 PRINT : PRINT " ENTER THE TIME THAT THE RECEIVER SWEEPS THE ABOVE RANGE OF FREQ."
150 INPUT T : PRINT : PRINT " 2. T=";T;"times/sec."
160 PRINT : PRINT " ENTER THE FREQ. RESOLUTION DF IN KHz"
170 INPUT DF : PRINT : PRINT " 3. DF=";DF;"KHz"
180 PRINT : PRINT " ENTER THE RECEIVER NOISE FIGURE F IN db"
190 INPUT F : PRINT : PRINT " 4. F=";F;"db"
200 PRINT : PRINT " ENTER THE ANTENNA NOISE TEMPERATURE Ta IN KELVIN"
210 INPUT Ta : PRINT : PRINT " 5. Ta=";Ta;"KELVIN"
220 PRINT : PRINT " IS THE INPUT DATA CORRECT Y/N?"
230 INPUT A$
240 IF LEFT$(A$,1)="Y" OR LEFT$(A$,1)="y" THEN 490
250 PRINT : PRINT " WHAT OF THE FOLLOWING DO YOU WANT TO CHANGE?"
260 PRINT : PRINT " 1. THE SWEEP RANGE?"
270 PRINT : PRINT " 2. THE TIME THE RECEIVER SWEEPS THE ABOVE RANGE?"
280 PRINT : PRINT " 3. THE FREQ. RESOLUTION?"
290 PRINT : PRINT " 4. THE RECEIVER'S NOISE FIGURE?"
300 PRINT : PRINT " 5. THE ANTENNA NOISE TEMPERATURE?"
310 INPUT C$
320 IF C$="1" THEN PRINT : PRINT " ENTER THE SWEEP RANGE F1,F2 OF THE HF RECEIVER IN
    MHz"
330 IF C$="1" THEN INPUT F1,F2 : PRINT : PRINT " 1. F1-F2=";F1;"-";F2;"MHz" : GOTO 430
340 IF C$="2" THEN PRINT : PRINT " ENTER THE TIME THAT THE RECEIVER SWEEPS THE ABOVE

```

RANGE OF FREQ."

```

350 IF C$="2" THEN INPUT T : PRINT : PRINT " 2. T=";T;"times/sec." : GOTO 430
360 IF C$="3" THEN PRINT : PRINT " ENTER THE FREQ. RESOLUTION DF IN KHz"
370 IF C$="3" THEN INPUT DF : PRINT : PRINT " 3. DF=";DF;"KHz" : GOTO 430
380 IF C$="4" THEN PRINT : PRINT " ENTER THE RECEIVER NOISE FIGURE F IN db"
390 IF C$="4" THEN INPUT F : PRINT : PRINT " 4. F=";F;"db" : GOTO 430
400 IF C$="5" THEN PRINT : PRINT " ENTER THE ANTENNA NOISE TEMPERATURE Ta IN KELVIN"
420 IF C$="5" THEN INPUT Ta : PRINT : PRINT " 5. Ta=";Ta;"KELVIN" : GOTO 430
430 PRINT : PRINT " IS EVERYTHING O.K NOW?"
440 INPUT B$
450 IF LEFT$(B$,1)="Y" OR LEFT$(B$,1)="y" THEN GOTO 490
460 PRINT : PRINT " WHAT DO YOU WANT TO CHANGE AGAIN?"
470 PRINT : PRINT " HIT ANY KEY IN YOUR KEYBOARD AND EVERYTHING WILL WORK FOR YOU
MALAKA"
480 INPUT F$ : GOTO 260
490 RETURN
500 *****
510 PRINTS THE INPUT DATA
520 *****
530 LPRINT : LPRINT TAB(30); " PROBLEM #10"
540 LPRINT TAB(30); " -----"
550 LPRINT : LPRINT " G I V E N"
560 LPRINT " -----"
570 LPRINT : LPRINT " 1. F1-F2=";F1-"F2;"MHZ" TAB(20); " : SWEEP RANGE OF THE HF
RECEIVER"
580 LPRINT : LPRINT " 2. T=";T;"times/sec." TAB(20); " : TIME THAT THE RECEIVER SWEEPS THE
ABOVE RANGE OF FREQ."
590 LPRINT : LPRINT " 3. DF=";DF;"KHz" TAB(20); " : FREQ. RESOLUTION"
600 LPRINT : LPRINT " 4. F=";F;"db" TAB(20); " : RECEIVER NOISE FIGURE"
610 LPRINT : LPRINT " 5. Ta=";Ta;"KELVIN" TAB(20); " : ANTENNA NOISE TEMPERATURE"
620 RETURN
630 *****
640 CALCULATION & PRINTOUT FOR PART a:
650 *****
660 LET W1=(F2-F1)/(1/T)

```

```

670 LET T1=1/(DF*10^3)
680 LET W=W1*T1*1000  'KHz
690 PRINT : PRINT : PRINT " PART a:"
700 PRINT " -----";
710 LPRINT : LPRINT : LPRINT " PART a:"
720 LPRINT " -----"
730 PRINT : PRINT " W=";W;"KHz"; " : BANDWIDTH OF THE RECEIVER'S FILTER"
740 LPRINT : LPRINT " W=";W;"KHz"; " : BANDWIDTH FOR RECEIVER'S FILTER"
750 PRINT : PRINT " T=";T1;"sec."; " : TIME DELAY FOR RECEIVER'S FILTER"
760 LPRINT : LPRINT " T=";T1;"sec."; " : TIME DELAY FOR RECEIVER'S FILTER"
770 RETURN
780 *****
790 ' CALCULATION & PRINTOUT FOR PART b:
800 *****
810 LET T0=Ta : F1=F/10 : F2=10^F1
820 LET Te=(F2-1)*T0 : K=1.38*10^-23
830 LET MDS=K*(Ta+Te)*(1/(2*T1))
840 LET MDS=CINT(10*.4342945**LOG(MDS))
850 LET MDS=MDS+F+30
860 PRINT : PRINT : PRINT " PART b:"
870 PRINT " -----";
880 LPRINT : LPRINT : LPRINT " PART b:"
890 LPRINT " -----"
900 PRINT : PRINT " M.D.S=";MDS;"dbm"
910 LPRINT : LPRINT " M.D.S=";MDS;"dbm"
920 RETURN

```

PROBLEM # 10

GIVEN

1. $F_1 - F_2 = 2 - 32 \text{ MHz}$: SWEEP RANGE OF THE HF RECEIVER
2. $T = 25 \text{ times/sec.}$: TIME THAT THE RECEIVER SWEEPS THE ABOVE RANGE OF FREQ.
3. $DF = 2 \text{ KHz}$: FREQ. RESOLUTION
4. $F = 3 \text{ db}$: RECEIVER NOISE FIGURE
5. $T_a = 290 \text{ KELVIN}$: ANTENNA NOISE TEMPERATURE

PART a:

$W = 375 \text{ KHz}$: BANDWIDTH OF THE RECEIVER'S FILTER

$T = .0005 \text{ sec.}$: TIME DELAY FOR RECEIVER'S FILTER

PART b:

$M.D.S = -138 \text{ dbm}$

LIST OF REFERENCES

1. Skolnik, M.I., Introduction to Radar Systems, McGraw-Hill, N.Y., 1962.
2. Skolnik, M.I., Radar Handbook, McGraw-Hill, New York, 1970.
3. Knorr, J.B., Homework Problems for Electronic Warfare, Naval Postgraduate School, Monterey, California, 1984 (unpublished).
4. Van Brunt, L.B., Applied ECM, EW Engineering, Inc., 1978.

INITIAL DISTRIBUTION LIST

	No. Copies
1. Defense Technical Information Center Cameron Station Alexandria, Virginia 22304-6145	2
2. Library, Code 0142 Naval Postgraduate School Monterey, California 93943-5100	2
3. Hellenic Navy General Staff Geniko Epitelio Novtikou Stratopedo Papagou Athenes, Greece	4
4. Professor Harold A. Titus, Code 62Ts Department of Electrical and Computer Engineering Naval Postgraduate School Monterey, California 93943-5100	3
5. Professor J.M. Bouldry, Code 62Bo Department of Electrical and Computer Engineering Naval Postgraduate School Monterey, California 93943-5100	1
6. Lt. C. Vergos, HoN Bouboulinas 12 Hulargos 155-62 Athenes, Greece	4

END

FILMED

3

-86

DTIC