

MICROCOPY RESOLUTION TEST CHART
INTERNATIONAL BUREAU OF STANDARDS-1963-A



US Environmental
Protection
Agency

AD-A164 065



US Army Corps
of Engineers

**FIELD VERIFICATION PROGRAM
(AQUATIC DISPOSAL)**

12

TECHNICAL REPORT D-85-9

**CHEMICAL AND BIOLOGICAL CHARACTERIZATION
OF BLACK ROCK HARBOR DREDGED MATERIAL**

by

Peter F. Rogerson, Steven C. Schimmel
Gerald Hoffman

US Environmental Protection Agency
Environmental Research Laboratory
Narragansett, Rhode Island 02882



DTIC
ELECTE
FEB 7 1986
S A D

September 1985
Final Report

Approved For Public Release; Distribution Unlimited

DTIC FILE COPY

Prepared for DEPARTMENT OF THE ARMY
US Army Corps of Engineers
Washington, DC 20314-1000

and US Environmental Protection Agency
Washington, DC 20460

Monitored by Environmental Laboratory
US Army Engineer Waterways Experiment Station
PO Box 631, Vicksburg, Mississippi 39180-0631

9 6 2 6 0 9 5

Destroy this report when no longer needed. Do not return
it to the originator.

The findings in this report are not to be construed as an official
Department of the Army position unless so designated
by other authorized documents

The contents of this report are not to be used for
advertising, publication, or promotional purposes.
Citation of trade names does not constitute an
official endorsement or approval of the use of
such commercial products.

The D-series of reports includes publications of the
Environmental Effects of Dredging Programs:
Dredging Operations Technical Support
Long-Term Effects of Dredging Operations
Interagency Field Verification of Methodologies for
Evaluating Dredged Material Disposal Alternatives
(Field Verification Program)

SUBJECT: Transmittal of Field Verification Program Technical Report Entitled
"Chemical and Biological Characterization of Black Rock Harbor
Dredged Material"

TO: All Report Recipients

1. This is one in a series of scientific reports documenting the findings of studies conducted under the Interagency Field Verification of Testing and Predictive Methodologies for Dredged Material Disposal Alternatives (referred to as the Field Verification Program or FVP). This program is a comprehensive evaluation of environmental effects of dredged material disposal under conditions of upland and aquatic disposal and wetland creation.

2. The FVP originated out of the mutual need of both the Corps of Engineers (Corps) and the Environmental Protection Agency (EPA) to continually improve the technical basis for carrying out their shared regulatory missions. The program is an expansion of studies proposed by EPA to the US Army Engineer Division, New England (NED), in support of its regulatory and dredging missions related to dredged material disposal into Long Island Sound. Discussions among the Corps' Waterways Experiment Station (WES), NED, and the EPA Environmental Research Laboratory (ERLN) in Narragansett, RI, made it clear that a dredging project at Black Rock Harbor in Bridgeport, CT, presented a unique opportunity for simultaneous evaluation of aquatic disposal, upland disposal, and wetland creation using the same dredged material. Evaluations were to be based on technology existing within the two agencies or developed during the six-year life of the program.

3. The program is generic in nature and will provide techniques and interpretive approaches applicable to evaluation of many dredging and disposal operations. Consequently, while the studies will provide detailed site-specific information on disposal of material dredged from Black Rock Harbor, they will also have great national significance for the Corps and EPA.

4. The FVP is designed to meet both Agencies' needs to document the effects of disposal under various conditions, provide verification of the predictive accuracy of evaluative techniques now in use, and provide a basis for determining the degree to which biological response is correlated with bioaccumulation of key contaminants in the species under study. The latter is an important aid in interpreting potential biological consequences of bioaccumulation. The program also meets EPA mission needs by providing an opportunity to document the application of a generic predictive hazard-assessment research strategy applicable to all wastes disposed in the aquatic environment. Therefore, the ERLN initiated exposure-assessment studies at the aquatic disposal site. The Corps-sponsored studies on environmental consequences of aquatic disposal will provide the effects assessment necessary to complement the EPA-sponsored exposure assessment, thereby allowing ERLN to develop and apply a hazard-assessment strategy. While not part of the Corps-funded FVP, the EPA exposure assessment studies will complement the Corps' work, and together the Corps and the EPA studies will satisfy the needs of both agencies.

SUBJECT: Transmittal of Field Verification Program Technical Report Entitled
"Chemical and Biological Characterization of Black Rock Harbor
Dredged Material"

5. In recognition of the potential national significance, the Office, Chief of Engineers, approved and funded the studies in January 1982. The work is managed through the Environmental Laboratory's Environmental Effects of Dredging Programs at WES. Studies of the effects of upland disposal and wetland creation are being conducted by WES and studies of aquatic disposal are being carried out by the ERLN, applying techniques worked out at the laboratory for evaluating sublethal effects of contaminants on aquatic organisms. These studies are funded by the Corps while salary, support facilities, etc., are provided by EPA. The EPA funding to support the exposure-assessment studies followed in 1983; the exposure-assessment studies are managed and conducted by ERLN.

6. The Corps and EPA are pleased at the opportunity to conduct cooperative research and believe that the value in practical implementation and improvement of environmental regulations of dredged material disposal will be considerable. The studies conducted under this program are scientific in nature and will be published in the scientific literature as appropriate and in a series of Corps technical reports. The EPA will publish findings of the exposure-assessment studies in the scientific literature and in EPA report series. The FVP will provide the scientific basis upon which regulatory recommendations will be made and upon which changes in regulatory implementation, and perhaps regulations themselves, will be based. However, the documents produced by the program do not in themselves constitute regulatory guidance from either agency. Regulatory guidance will be provided under separate authority after appropriate technical and administrative assessment of the overall findings of the entire program.

James Choromokos, Jr., Ph.D., P.E.
Director, Research and Development
U. S. Army Corps of Engineers

Bernard D. Goldstein, M.D.
Assistant Administrator for
Research and Development
U. S. Environmental Protection
Agency

Unclassified

SECURITY CLASSIFICATION OF THIS PAGE (When Data Entered)

REPORT DOCUMENTATION PAGE		READ INSTRUCTIONS BEFORE COMPLETING FORM
1. REPORT NUMBER Technical Report D-85-9	2. GOVT ACCESSION NO. ADA 164 063	3. RECIPIENT'S CATALOG NUMBER
4. TITLE (and Subtitle) CHEMICAL AND BIOLOGICAL CHARACTERIZATION OF BLACK ROCK HARBOR DREDGED MATERIAL	5. TYPE OF REPORT & PERIOD COVERED Final report	
	6. PERFORMING ORG. REPORT NUMBER	
7. AUTHOR(s) Peter F. Rogerson, Steven C. Schimmel, Gerald Hoffman	8. CONTRACT OR GRANT NUMBER(s)	
9. PERFORMING ORGANIZATION NAME AND ADDRESS US Environmental Protection Agency Environmental Research Laboratory Narragansett, Rhode Island 02882	10. PROGRAM ELEMENT, PROJECT, TASK AREA & WORK UNIT NUMBERS Field Verification Program (Aquatic Disposal)	
11. CONTROLLING OFFICE NAME AND ADDRESS DEPARTMENT OF THE ARMY, US Army Corps of Engineers, Washington, DC 20314-1000 and US Environmental Protection Agency, Washington, DC 20460	12. REPORT DATE September 1985	
	13. NUMBER OF PAGES 123	
14. MONITORING AGENCY NAME & ADDRESS (if different from Controlling Office) US Army Engineer Waterways Experiment Station Environmental Laboratory PO Box 631, Vicksburg, Mississippi 39180-0631	15. SECURITY CLASS. (of this report) Unclassified	
	15a. DECLASSIFICATION/DOWNGRADING SCHEDULE	
16. DISTRIBUTION STATEMENT (of this Report) Approved for public release; distribution unlimited.		
17. DISTRIBUTION STATEMENT (of the abstract entered in Block 20, if different from Report)		
18. SUPPLEMENTARY NOTES Available from National Technical Information Service, 5285 Port Royal Road, Springfield, Virginia 22161. Appendix B was prepared on microfiche and is enclosed in an envelope attached to the back cover of this report.		
19. KEY WORDS (Continue on reverse side if necessary and identify by block number) Dredging--Connecticut--Black Rock Harbor (LC) Black Rock Harbor (Conn.) (LC) Marine sediments--Analysis (LC) Dredged material (WES) Aquatic biology (LC)		
20. ABSTRACT (Continue on reverse side if necessary and identify by block number) - Black Rock Harbor, Bridgeport, Conn., dredged material contained substan- tial concentrations of both organic and inorganic contaminants, many of which were shown to be biologically available to the blue mussel, <u>Mytilus edulis</u> , in a laboratory bioassay. Tissue PCB concentrations were 44% of the concentration found in the sediment (6800 ng/g), while tissue concentrations of parent poly- nuclear hydrocarbons were 28% of sediment concentrations that ranged up to 9800 ng/g. Also present in the sediment were Cu, Cr, Zn, Pb, Ni, Cd, and (Continued)		

Unclassified

SECURITY CLASSIFICATION OF THIS PAGE (When Data Entered)

Unclassified

SECURITY CLASSIFICATION OF THIS PAGE(When Data Entered)

20. ABSTRACT (Continued). *11/10/77*

Hg at 2380, 1430, 1200, 380, 140, 23, and 1.7 $\mu\text{g/g}$, respectively. Of these, Cu, Cr, Pb, Ni, and Cd accumulated in the mussels.

In acute solid phase toxicity tests, the sediment was lethal to only one of the eleven species tested, Ampelisca abdita, although behavioral changes were observed in two additional species, both infaunal species. No effect was noted with epibenthic or water column species in either solid phase or in combination with suspended particulate phase.

This investigation is the first phase in developing field-verified bio-assessment evaluations for the Corps of Engineers and the US Environmental Protection Agency regulatory program for dredged material disposal. This report is not suitable for regulatory purposes; however, appropriate assessment methodologies that are field verified will be available at the conclusion of this program.



Unclassified

SECURITY CLASSIFICATION OF THIS PAGE(When Data Entered)

PREFACE

This report describes work performed by the U.S. Environmental Protection Agency (EPA) Environmental Research Laboratory, Narragansett, R.I. (ERLN), as part of the Interagency Field Verification of Testing and Predictive Methodologies for Dredged Material Disposal Alternatives Program (Field Verification Program (FVP)). This Program is sponsored by the Office, Chief of Engineers (OCE), and is assigned to the U.S. Army Engineer Waterways Experiment Station (WES), under the purview of the Environmental Laboratory's (EL) Environmental Effects of Dredging Programs (EEDP). The OCE Technical Monitors for FVP were Drs. William L. Klesch and Robert J. Pierce. The objective of this interagency program is to field verify existing predictive techniques for evaluating the environmental consequences of dredged material disposal under aquatic, wetland, and upland conditions. The aquatic portion of the FVP study is being conducted by ERLN, with the wetland and upland portions conducted by WES.

The principal ERLN investigators for this aquatic study were Drs. Peter Rogerson and Gerald Hoffman, Analytical Chemists, and Mr. Steven Schimmel, Aquatic Toxicologist. Laboratory exposure system design was coordinated by Mr. Jay Sinnett, Ms. Dianne Black, Dr. Wayne Davis, and Mr. John Sewall. Organic chemical sample preparation and analysis were conducted by Ms. Sharon Pavignano, Mr. Larry LeBlanc, Ms. Adria Elskus, Mr. Robert Bowen, and Mr. Curt Norwood under the supervision of Drs. Rogerson and James Lake. Inorganic chemical preparation and analysis was conducted under the supervision of Dr. Gerald Hoffman, and assisted by Mr. Frank Osterman, Mr. Warren Boothman, and

Mr. Dennis Migneault. Biological testing was conducted by Dr. John Scott, Dr. Paul Schauer, Mr. Walter Berry, Ms. Suzanne Lussier Gentile, Ms. Michele Redmond, Ms. Melissa Hughes, Dr. Chris Deacutis, Dr. Grace MacPhee, and Ms. Ann Kuhn. Data management and analysis was conducted by Mr. Jeffery Rosen.

The EPA Technical Director for the FVP was Dr. John H. Gentile; the Technical Coordinator was Mr. Walter Galloway; and the Project Manager was Mr. Allan Beck.

The study was conducted under the direct management of Drs. Thomas M. Dillon and Richard K. Peddicord of the Contaminant Mobility and Criteria Group (CMCG), Ecosystem Research and Simulation Division (ERSD), EL; and under the general management of Dr. Charles R. Lee, Chief, CMCG, Mr. Donald L. Robey, Chief, ERSD, and Dr. John Harrison, Chief, EL. The FVP Coordinator was Mr. Robert L. Lazor, and the Program Managers were Mr. Charles C. Calhoun, Jr., and Dr. Robert M. Engler. The report was edited by Ms. Jamie W. Leach of the WES Publications and Graphic Arts Division.

During preparation of this report, COL Tilford C. Creel, CE, and COL Robert C. Lee, CE, were Commanders and Directors of WES and Mr. F. R. Brown was Technical Director. At the time of publication, COL Allen F. Grum, USA, was Director and Dr. Robert W. Whalin was Technical Director.

This report should be cited as follows:

Rogerson, P.F., Schimmel, S.C., and Hoffman, G. 1985. "Chemical and Biological Characterization of Black Rock Harbor Dredged Material," Technical Report D-85-9, prepared by US Environmental Protection Agency, Narragansett, R.I., for the US Army Engineer Waterways Experiment Station, Vicksburg, Miss.

CONTENTS

	<u>Page</u>
PREFACE	1
LIST OF FIGURES	4
LIST OF TABLES	6
PART I: INTRODUCTION	8
Background	8
Purpose	8
Scope	9
PART II: GENERAL METHODS AND MATERIALS	12
Sediment Collection and Preservation	13
Sediment Dosing System	16
PART III: CHEMICAL CHARACTERIZATION METHODS AND MATERIALS	20
Contaminant Uptake Test	20
Sample Preparation	25
Sample Analysis	32
PART IV: BIOLOGICAL CHARACTERIZATION METHODS AND MATERIALS	36
Overview	36
Annelids	40
Molluscs	43
Arthropods	47
Fishes	52
PART V: RESULTS AND DISCUSSION	61
Chemical Characterization	61
Biological Characterization	90
PART VI: CONCLUSIONS AND RECOMMENDATIONS	104
REFERENCES	108
APPENDIX A: CHEMICAL DATA.....	A1
APPENDIX B: ACUTE TOXICITY DATA SHEETS*.....	B1

* Appendix B was prepared on microfiche and is enclosed in an envelope attached to the back cover of this report.

LIST OF FIGURES

<u>No.</u>		<u>Page</u>
1	Principal components of sediment characterization.....	13
2	Central Long Island Sound disposal site and South reference site.....	14
3	Black Rock Harbor, Connecticut, source of dredged material... 16	
4	Sediment dosing system with chilled water bath and argon gas supply.....	18
5	Suspended sediment feedback control loop and strip chart recorder.....	19
6	Blue mussel (<u>Mytilus edulis</u>) contaminant uptake system.....	21
7	Suspended sediment dilution system, distribution chamber, and exposure chambers used for acute toxicity tests.....	39
8	Distribution and exposure chambers used for solid phase and suspended particulate phase exposure of <u>Yoldia limatula</u> , <u>Mulinia lateralis</u> , and <u>Ampelisca abdita</u>	46
9	Total ion current profiles of the 28-day exposed mussels analyzed by GC-MS with a 4°/min (50-330) temperature programming rate.....	62
10	Total ion current profiles of the 28-day control mussels analyzed by GC-MS with a 4°/min (50-330) temperature programming rate.....	63
11	Total ion current profiles of the Black Rock Harbor FVP reference sediment analyzed by GC-MS with a 4°/min (50-330) temperature programming rate.....	72
12	Concentration of PAH compounds in Black Rock Harbor sediment and exposed and control mussels.....	75
13	Concentration of sum of C-1 through C-4 alkyl homologs of PAH's measured in Black Rock Harbor sediment and control and exposed mussels.....	76
14	Distribution of Cr versus Fe in mussels from the Black Rock Harbor exposure.....	84
15	Distribution of Pb versus Fe in mussels from the Black Rock Harbor exposure.....	85

LIST OF FIGURES (Cont'd)

<u>No.</u>		<u>Page</u>
16	Distribution of Cd versus Fe in mussels from the Black Rock Harbor exposure.....	85
17	Distribution of Zn versus Fe in mussels from the Black Rock Harbor exposure.....	86
18	Distribution of Cu versus Fe in mussels from the Black Rock Harbor exposure.....	87
19	Distribution of As versus Fe in mussels from the Black Rock Harbor exposure.....	88
20	Distribution of Mn versus Fe in mussels from the Black Rock Harbor exposure.....	88

LIST OF TABLES

<u>No.</u>		<u>Page</u>
1	Summary of Experimental Conditions for the Contaminant Uptake Study with <u>Mytilus edulis</u>	25
2	Test Species, Exposure Conditions, and Food Used for Solid Phase Biological Assays for Sediment Characterization.....	37
3	Test Species, Exposure Conditions, and Food for Suspended Particulate Phase Assays for Sediment Characterization.....	44
4	Single Replicate PCB Concentrations as Aroclor®1254 in ng/g Dry Weight Including Chlorine Number Distributions by Mass Spectrometry.....	64
5	Parent Polynuclear Aromatic Hydrocarbons Found in the Exposed Mussels and Black Rock Harbor Sediment.....	66
6	Mean Concentrations + Standard Deviation of Parent PAH Compounds Found in Exposed and Control Mussels and in Black Rock Harbor Sediment in ng/g Dry Weight.....	68
7	Mean Concentrations + Standard Deviation of the Sum of C-1 Through C-4 Alkyl Homologs of PAH's Found in Exposed and Control Mussels and in Black Rock Harbor Sediment Quantitated as Each Parent PAH.....	69
8	Distribution of Five Silicone-like Compounds in Exposed and Control Mussels and Black Rock Harbor Sediment Measured as GC-MS Area Counts/Gram Dry Weight.....	70
9	Organic Contaminants in Black Rock Harbor Sediment, ng/g Dry Weight, One Replicate.....	73
10	Distribution of Trace Elements in g/g Dry Weight in Exposed and control Mussels.....	78
11	Average Metal Concentrations in Black Rock Harbor Barrel #00 and Barrel #LL Sediment Samples.....	80
12	Ratios of Trace Metal Accumulations in Exposed and Control Mussels.....	82
13	Toxicity of Solid Phase Black Rock Harbor (Connecticut) Dredged Material to 11 Species of Marine Invertebrates and Fishes.....	91

LIST OF TABLES (Cont'd)

<u>No.</u>		<u>Page</u>
14	Percent of <u>Yoldia</u> not Burrowed into Sediment over Time for Solid Phase Test No. 1 and Suspended Phase Test No. 1.....	93
15	Summary of Response Percent Mortality of <u>Ampelisca abdita</u> after 96-hr Exposure in Solid Phase Tests with Black Rock Harbor Sediment.....	96
16	Toxicity of Black Rock Harbor Dredged Material, as Suspended Sediment, to Ten Species of Marine Invertebrates and Fishes.....	100

CHEMICAL AND BIOLOGICAL CHARACTERIZATION OF
BLACK ROCK HARBOR DREDGED MATERIAL

PART I: INTRODUCTION

Background

1. The U.S. Army Corps of Engineers (CE) and the U.S. Environmental Protection Agency (EPA) are jointly conducting a comprehensive Field Verification Program (FVP) to evaluate the risk associated with various disposal options for dredged material. The approach being used in the FVP is to evaluate and field validate assessment methodologies for predicting the environmental impacts of dredged material disposal in aquatic, upland, and wetland environments. The research, evaluation, and field verification of the upland and wetland disposal options is being conducted by the Environmental Laboratory, U.S. Army Engineer Waterways Experiment Station (WES), Vicksburg, Miss. The application and field verification of predictive methodologies for the aquatic disposal option is being conducted by the EPA Environmental Research Laboratory (ERL-N), Narragansett, R.I.

Purpose

2. The aquatic disposal alternative of the FVP is being used as a site-specific case study to evaluate a hazard assessment research strategy. Hazard assessment in terms of this study is a process by which data on exposure and effects are assembled and interpreted to determine the potential for harm to the aquatic environment that could

result from the ocean disposal of a particular material. To measure this hazard, information on the duration and intensity of exposure (exposure assessment) of organisms and the concentrations of contaminants in the materials disposed at the site (predicted environmental concentration) is coupled with concentrations of the contaminants determined to be toxic to individual species, populations, and communities in laboratory toxicity studies (effects assessment). When properly synthesized, these data provide an estimate of the probability (risk) of unacceptably altering the aquatic environment as a result of the disposal of the materials. The verification of hazard assessment is comprised of two components: verification of an individual method or protocol between the lab and field, and verification of the prediction of risk to the aquatic environment. Within this context, hazard assessment contains parallel predictive laboratory and field verification components. The achievement of the goal of hazard assessment requires the development and verification of assessment protocols for defining exposure and effects.

Scope

3. The first research component in the aquatic portion of the FVP is sediment characterization, which includes chemical and biological characterization of the dredged material.

Chemical characterization

4. Chemical characterization is focused on determining what chemical contaminants are present in the dredged material and, of

these, which bioaccumulate and constitute a potential threat to man and the ecosystem. The approach taken in chemical characterization is to allow the environment, in the form of an organism (Mytilus edulis), to indicate contaminants of biological importance from the dredged material. These contaminant profiles can then be compared with chemical profiles both from the bulk sediment analysis and a more detailed sediment chemistry analysis of organic contaminants. This approach has several advantages over chemical screening for preselected compounds (e.g., 129 priority pollutants):

- a. Chemical screening of preselected chemicals generally results in a large number of chemicals being classified as nondetectable.
- b. Preselection reduces the number of contaminants examined.

Eliminating preselection and allowing an organism to bioaccumulate contaminants increases the probability of detection, reduces the risk of a biologically important contaminant not being detected, and focuses the research and monitoring efforts on those contaminants known to bioaccumulate. The one element of uncertainty in this approach is that there may be contaminants which go undetected that are biologically active but do not bioaccumulate. The risk of this occurring, however, is considered to be relatively negligible.

Biological characterization

5. Biological characterization focuses on "worst-case" toxicological evaluation of dredged material. As such, the exposure regimes do not necessarily reflect actual field conditions. The approach selected is to

adapt existing toxicological protocols for use with solid and suspended particulate phase flow-through tests for both indigenous and "surrogate" test species. Each acute toxicity test will be evaluated for its applicability and sensitivity for detecting and measuring dredged material effects. Determinations of test and method variability and reproducibility will be made where appropriate. Finally, results from these tests will be used to help design exposure conditions for future sub-lethal biological effects tests.

PART II: GENERAL METHODS AND MATERIALS

6. The principal components of this study and their interrelationships are schematically represented in Figure 1. The methods for sediment characterization begin with the suspended sediment (SS) dosing system. This system is designed to maintain reservoirs of reference sediment and dredged material under defined anoxic conditions and to quantitatively deliver them through recirculating loops to test systems.

7. In studies on chemical characterization, known quantities of suspended dredged material were delivered to the contaminant uptake system containing the bivalve mollusc Mytilus edulis, where chemical analyses were conducted for contaminants within the tissues, dissolved in the water, and in the particulate phase from the sediment dosing system. These analyses were compared with sediment chemical analyses to determine which of the many sediment contaminants were bio-accumulated.

8. The suspended sediment dosing system also interfaced with a series of experimental components in the studies for biological characterization. Sediment suspensions were first quantitatively delivered to a controlled dilution system. Here, diluted sediment suspensions were maintained using a transmissometer-microprocessor feedback system. These suspensions then flowed into multiported distribution systems which fed a constant, prescribed dilution of suspension to the suspended sediment toxicity test chambers. Toxicological information was produced for polychaetous annelids, bivalve molluscs, arthropods (crustaceans), and fishes.

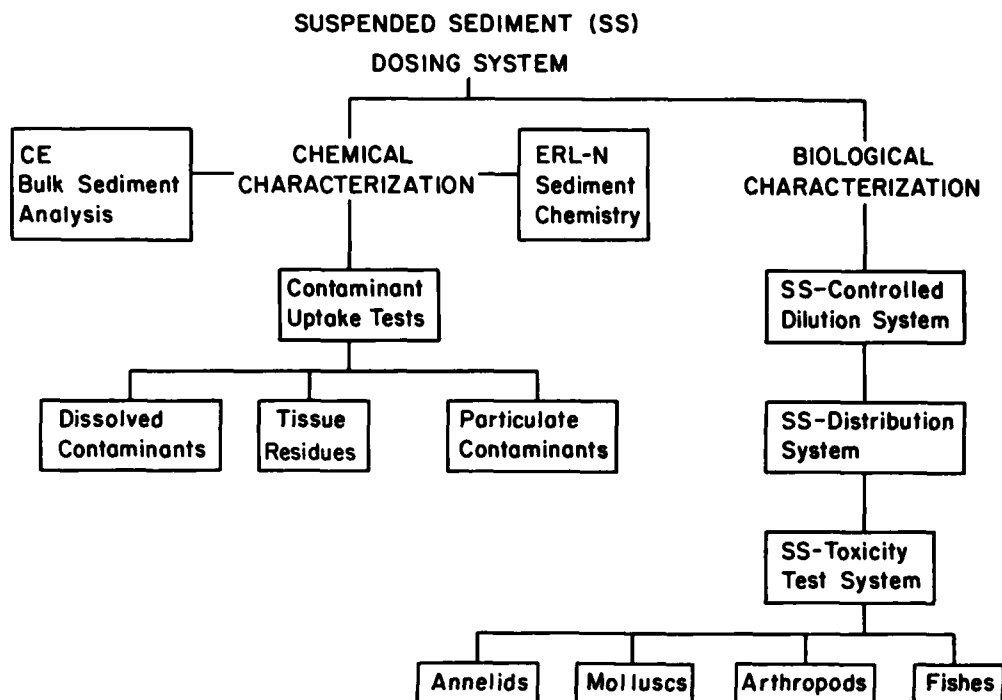

Figure 1. Principal components of sediment characterization

Sediment Collection and Preservation

Reference sediment

9. Reference sediment (REF) for the FVP sediment characterization studies was collected from the South Reference site (41°7.95"N and 72°52.7"W), which is approximately 700 m south of the southern perimeter of the Central Long Island Sound (CLIS) disposal site (Figure 2). Reference sediment was collected with a Smith-MacIntyre grab sampler (0.1 m²) in both August and December 1982. Sediment collected on each date was returned to the laboratory, press sieved (wet) within 48 hr through a 2-mm mesh stainless steel screen, homogenized, and stored at 4°C until used for experimental purposes. Sediment from the

August collection was stored in 32 cm x 61 cm x 25 cm (38 L) polypropylene containers. Sediment in each container was allowed to reach room temperature and rehomogenized (mixed) prior to use.

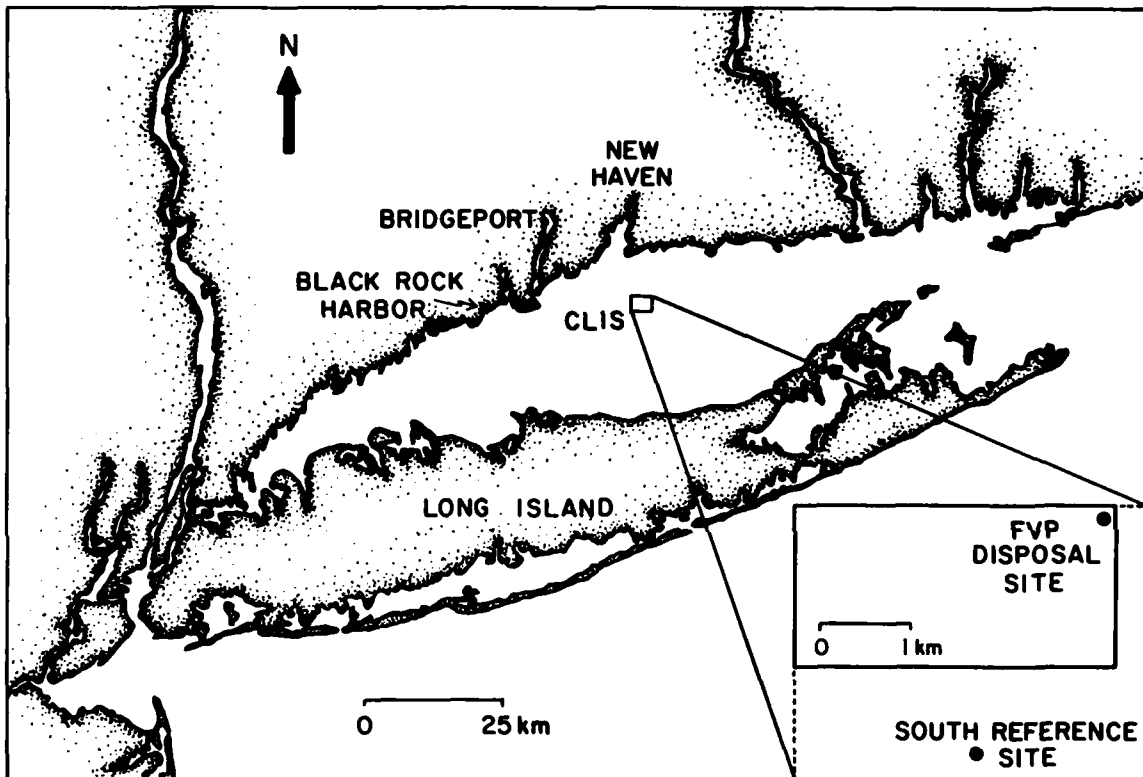

Figure 2. Central Long Island Sound disposal site and South reference site

Sediment from the December collection was stored in 3.8-L glass jars with polypropylene lids. Each jar of material was coded with a collection date, batch number, bottle number, and the name of the person to whom the material was assigned.

Black Rock Harbor sediment

10. Black Rock Harbor is located in Bridgeport, Conn. (Figure 3), with the approximate coordinates of 73°13"W and 41°9" N. The study reach begins 400 m south of the fork in Cedar Creek and extends seaward for approximately 1700 m. Black Rock Harbor (BRH) bottom sediments were collected at 25 locations within the study area using a 0.1-m² gravity box corer to a depth of 1.21 m and placed in 210-L barrels and transported in a refrigerated truck (at 4°C) to WES. The contents of the 25 barrels were emptied into a nitrogen-purged cement mixer and homogenized. The homogenized sediment was then redistributed to the 25 barrels and aliquots were taken from each for sediment chemical analysis. Thirteen barrels were then transported to ERL-N in a refrigerated truck and stored at 4°C. The remaining 12 barrels were stored at WES. At ERL-N, the contents of each barrel were completely homogenized, wet sieved prior to use through a 1-mm mesh sieve to remove large particles, and distributed to 3.8-L brown reagent bottles. During the distribution process, the sediment was repetitively mixed. To ensure that the contents in the bottles were consistent, 400-ml samples were taken from before the 1st, 25th, and 50th bottle for moisture content and chemical analysis. Each bottle was coded with barrel number, date, and the name of the person to whom the material was assigned, and then stored at 4°C.

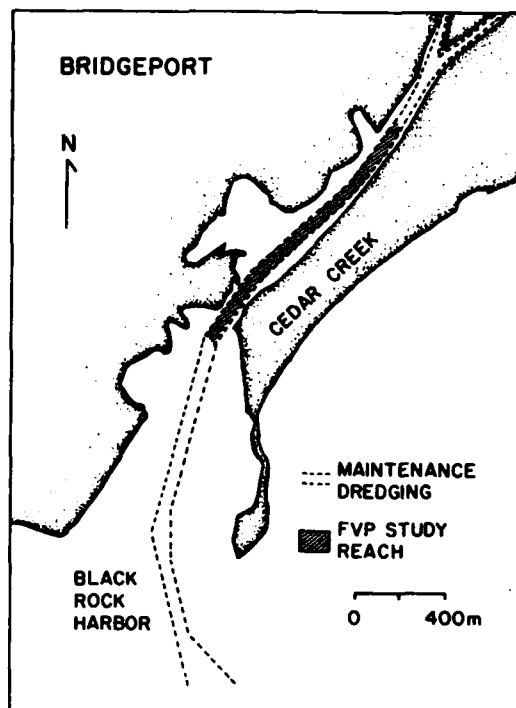

Figure 3. Black Rock Harbor, Connecticut, source of dredged material

Sediment Dosing System

11. Two identical sediment dosing systems were constructed to simultaneously provide either BRH or REF as suspended sediment to several toxicity tests (Figure 4). The dosing systems consisted of conical-shaped slurry reservoirs placed in a chilled fiberglass chamber, a diaphragm pump, a 4-L separatory funnel, and several return loops that directed the particulate slurry through dosing valves. The slurry reservoirs (40 cm diam by 55 cm high) contained 40 L of slurry comprised of 37.7 L of filtered seawater and 2.3 L of either BRH or REF sediment. The fiberglass chamber (94 cm x 61 cm x 79 cm high) was maintained between 4° and 10°C

using an externally chilled water source. (The slurry was chilled to minimize microbial degradation during the test.) Polypropylene pipes (3.8 cm diam) placed at the bottom of the reservoir cones were connected to Teflon® diaphragm pumps (16 to 40 L/min capacity). This type of pump was used to circulate the slurry but minimize abrasion so that the physical properties and particle sizes of the material remained as unchanged as possible. The separatory funnel was connected to the pump and returned to the reservoir by polypropylene pipes. The separatory funnel served two functions: (a) to ensure that a constant head pressure was provided by the overflow, and (b) to serve as a connection for the manifold located 4 cm below the constant head level. The manifold served to distribute the slurry by directing a portion of the flow from the funnel (through 6 mm inside diameter polypropylene tubes) through the Teflon® dosing valves (Figures 4 and 5) and back to the reservoir. At the dosing valves, the slurry was mixed with seawater for the mussel contaminant uptake study and the acute toxicity studies. Argon gas was provided at the rate of 200 ml/min to the reservoir and separatory funnel to minimize oxidation of the sediment/seawater slurry. Narragansett Bay seawater filtered (to 15 μ) through sand filters was used for the contaminant uptake and toxicity studies. The dosing valves were controlled by a microprocessor connected to a transmissometer (Figure 5). The microprocessor was programmed to deliver a pulse with a duration of 0.1 sec up to continuous pulse delivery and at intervals from once every second to once every hour. Under transmissometer control, the microprocessor responds by modulating the pulse length to achieve the desired setpoint of suspended

sediment measured as turbidity (Sinnott and Davis 1983). The transmissometer-microprocessor system was used to control the suspended sediment concentrations in the mussel contaminant uptake study and the acute toxicity studies.

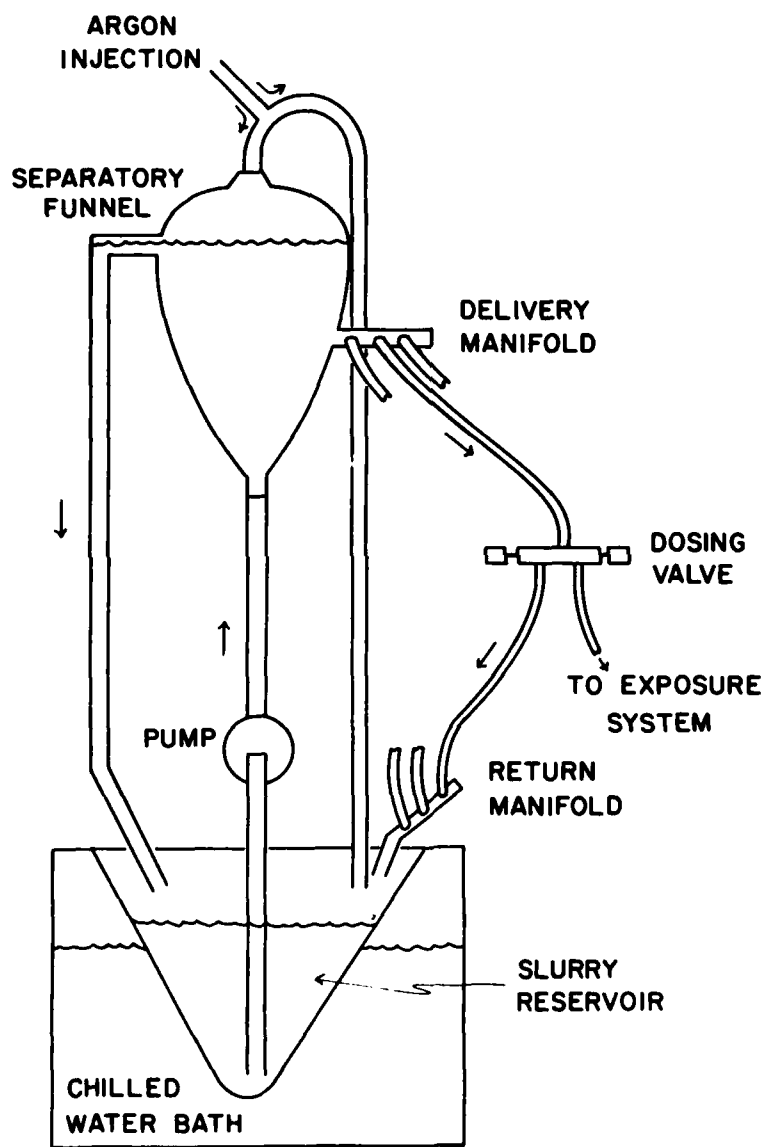

Figure 4. Sediment dosing system with chilled water and argon gas supply

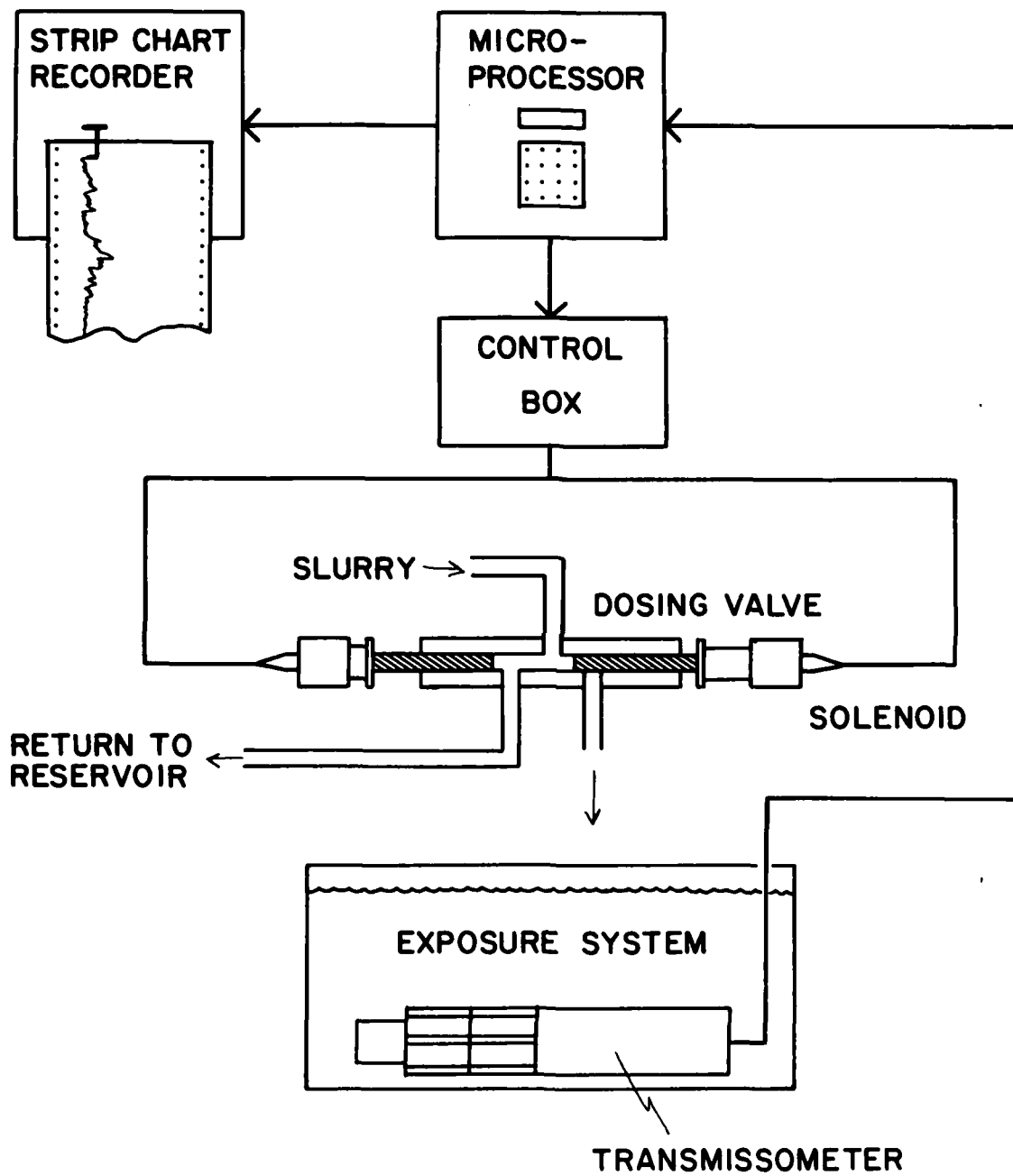

Figure 5. Suspended sediment feedback control loop and strip chart recorder

PART III: CHEMICAL CHARACTERIZATION METHODS AND MATERIALS

Contaminant Uptake Test

Mussel collection

12. The blue mussel (Mytilus edulis) was used to determine the bioavailability of certain contaminants within BRH materials in a 28-day test. One month prior to exposure, mussels were collected from a well studied area in Narragansett Bay, R.I., that was relatively free of contaminants (Phelps et al. 1983; Phelps and Galloway 1980). Test organisms, 50 to 70 mm shell length, were temperature acclimated from 5° to 15°C at the rate of 1°C per day, then held in unfiltered, flowing seawater until initiation of the experiment.

Exposure system

13. The system used to expose blue mussels to BRH material in the 28-day flowing seawater test is shown in Figure 6. The exposure apparatus consisted of a fiberglass resin-coated plywood tank (123-L capacity) partitioned into two compartments. Filtered seawater entering the mixing chamber at 2 L/min was vigorously combined with the BRH material and the mussels' food, marine algae (a mixture of Phaeodactylum tricorutum and T-Isochrysis galbana). The mixture cascaded over a partition into the exposure chamber containing the mussels and a transmissometer which measured the amount of suspended particulates in the water. To ensure that the particles were rapidly and evenly dispersed throughout the tank, water was collected through a manifold near the

transmissometer and returned to the mixing chamber at a rate of 38 L/min. Polypropylene or polyethylene plumbing materials were used throughout.

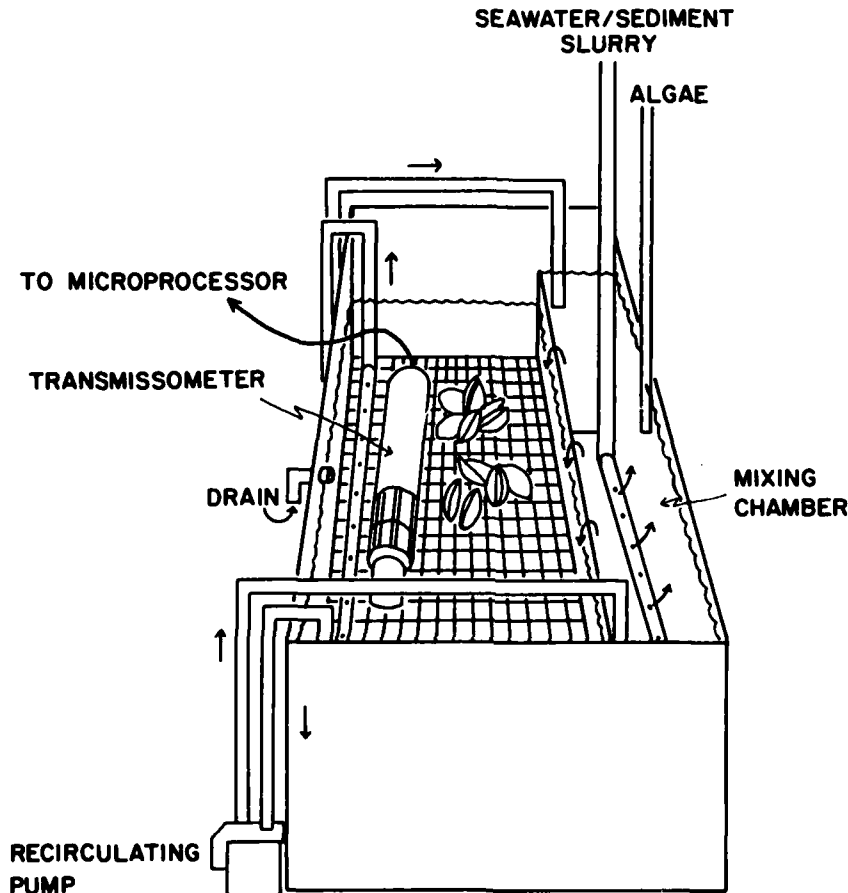

Figure 6. Blue mussel (*Mytilus edulis*) contaminant uptake system

14. The sediment dosing system delivered BRH sediment directly into the mussel exposure chamber via the dosing valve which was controlled by the microprocessor and transmissometer. As the mussels removed the suspended particles below the desired concentration, the microprocessor opened the dosing valve to deliver the BRH suspension and simultaneously turned on a peristaltic pump to deliver algae to

the chamber. Delivery volumes by the valve and peristaltic pump were adjusted to maintain a constant ratio of sediment and algae during a microprocessor pulse. In response to a transmissometer signal every 5 min, the microprocessor modulated the pulse length to achieve an exposure concentration in the chamber of 9.5 mg/L of suspended particles, consisting of 9 mg/L sediment and 0.5 mg/L algae (30×10^6 cells/L). This concentration of suspended sediments was estimated to be below the concentration that would stress or adversely affect the organisms. A preliminary test demonstrated no appreciable mortality, histopathological responses, or adverse changes in scope for growth (SFG) after 2 weeks of exposure to 20 mg/L.

15. The control for this experiment was designed to verify that contaminants observed in the mussels were accumulated from BRH material rather than from the seawater or the algal cultures. The control exposure was conducted in an identical test apparatus, except that no sediment suspension was delivered to the chamber. Instead, a suspended particulate concentration of 0.5 mg/L consisting entirely of algae was maintained by the microprocessor feedback system.

Experimental conditions

16. Test methods. Whenever possible, the general bioconcentration test methods used were from "Proposed Standard Practice for Conducting Bioconcentration Tests with Fishes and Saltwater Bivalve Molluscs," (American Society For Testing and Materials (ASTM) 1980a). Although not specifically intended for suspended sediment testing, the general recommendations defining test animal care, handling and acclimation procedures,

seawater quality, and acceptable exposure conditions were suitable for this test.

17. Prior to placing animals in the test chambers, 20 mussels were randomly selected from the mussel holding system for organic and inorganic chemical analysis to determine the baseline residues in the mussels before the exposures began. At the start of the 28-day uptake study, 300 mussels were placed in each of the BRH and control chambers. During the test, 20 mussels from the BRH chamber were sampled for chemical analysis on days 7, 14, and 28. Twenty mussels from the control chamber were sampled on day 28.

18. From each sample, eight mussels were frozen (-20°C) whole for possible future use. The remaining twelve mussels were separated into three groups of four each, the soft tissues removed and homogenized. A 2-g sample from each of the homogenates was used for inorganic analyses and the remainder for organic analyses.

19. Suspended particulate concentrations. Twice each week suspended particulate concentrations from the control and exposure chambers were analyzed by dry weight determination and by electronic particle counting (1μ to 40μ particle range). The dry weight determinations were conducted according to Standard Methods (American Public Health Association (APHA) 1976) with the following modifications. The filters were washed with a 50-ml aliquot of deionized water before sample filtration, and followed by three 10-ml rinses of deionized water immediately after sample filtration to remove salt. Measurements of dissolved oxygen salinity, temperature, and ammonia-nitrogen were made to document water quality (Table 1). All of the water quality measurements

were well within the guidelines established by ASTM. Mortality over the 28-day period was 13% for the exposed mussels and 6% for the controls. The dry weight of suspended particulates in the exposure tank did not fluctuate from the nominal level of 9.5 mg/L by more than 15%. Dry weight of suspended particulates in the control tank exceeded the nominal level of 0.5 mg/L by an average of 1.2 mg/L; however, the total number of particles (26×10^6 particles/L) within the size range of the algal species used and of the size which mussels filter efficiently was within 2% of the nominal level of 30×10^6 particles/L. This discrepancy appeared to be due to mussel fecal pellets suspended in the water samples taken for dry weight measurements. Maintenance of the exposure system required routine cleaning of tanks and replacement of BRH sediment in the sediment dosing system. On these occasions, the system had to be shut down and the concentration of suspended particulates did not remain within ASTM guidelines; however, this condition comprised only 1% of the 28-day exposure period.

Table 1

Summary of Experimental Conditions for the Contaminant UptakeStudy with Mytilus edulis*

<u>Parameter</u>	<u>Control</u>	<u>Exposure</u>
Suspended solids, dry wt, mg/L	1.72 ± 0.18 (1.45 - 2.02)	9.32 ± 0.58 (8.19 - 10.33)
Particle density, No./L	2.6 ± 0.3 X 10 ⁷ (2.0 - 3.1 X 10 ⁷)	12 ± 1.3 X 10 ⁷ (9.6 - 13.7 X 10 ⁷)
Temperature, °C	15.7 ± 0.4 (15.0 - 16.4)	15.6 ± 0.3 (15.4 - 16.4)
Dissolved oxygen, mg/L	7.5 ± 0.6 (7.0 - 8.5)	7.6 ± 0.4 (7.1 - 8.4)
Salinity, ppt	28.4 ± 1.8 (24 - 30)	28.4 ± 1.8 (24 - 30)
Un-ionized ammonia, µg/L	2.9 ± 1.29 (0.64 - 5.40)	3.83 ± 1.68 (1.04 - 6.40)

* Tabular values are mean and standard deviation (N = 9) with the range denoted by parentheses.

Sample PreparationMussels

20. Organic. The analytical procedures described below represent the state-of-the-art in marine organic analysis and have been intercalibrated with several oceanographic laboratories. EPA recognized analytical methods, while available for these classes of contaminants, have been developed primarily for freshwater and wastewater systems. These methods required extensive modification and intercalibration when applied to marine systems for the types of matrices and levels of detection required in this study.

21. Each of the separate sample homogenates from above was treated as a separate sample with appropriate blanks carried through the entire procedure. To each sample was added 15 ml of acetone and the mixture homogenized for 20 sec and then centrifuged at 1750 rpm for 5 min. The fluid layer was decanted into a 1-L separatory funnel containing 150 ml of pre-extracted water. The acetone extraction and centrifugation were repeated once more and the extracts combined in the separatory funnel. The extraction and centrifugation were repeated twice more using 25 ml of Freon® 113 as the solvent. Because of the density of Freon®, the solvent was withdrawn from the bottom of the centrifuge tubes using a syringe. The Freon® extracts were combined in the separatory funnel which was then shaken and the Freon® layer drawn off. The remaining aqueous layer was extracted twice more with 50 ml of Freon® each time. The Freon® extracts were combined and the aqueous layer discarded.

22. To remove interfering biogenic material and some residual particulates, the combined Freon® extracts were passed through the first column (2 x 25 cm of 100% activated 100 to 200 mesh silicic acid). For sediment samples 2.5 cm of activated copper powder was added to the top of the first column to remove elemental sulfur. The column was then rinsed with 25 ml Freon® followed by 50 ml of methylene chloride. The eluate was collected and volume reduced in a round bottom flask fitted with a Kuderna-Danish and 3-ball Snyder column. The solvent was exchanged to hexane as the sample approached 5 ml. Final volume reduction to 5 ml was accomplished by placing the sample in a concentrator tube

and having it blown down with a gentle stream of helium (ultra-high purity).

23. The 5-ml sample extracts were then charged onto a 0.9 cm x 45 cm second column of 5% deactivated 100 to 200 mesh silica gel. Three fractions were collected from the column. Fraction 1 (PF-50) consisted of 50 ml of pentane; fraction 2 (F-2) consisted of 35 ml of 20% methylene chloride in pentane; and fraction 3 (F-3) consisted of 35 ml of methylene chloride. The PF-50 fraction was designed to collect the PCB's and related materials, while fraction F-2 was designed to collect aromatic hydrocarbons. The F-3 fraction collected more polar material, which will be analyzed in detail at a later date. Each column fraction was reduced in volume by Kuderna-Danish evaporation as above, with the solvent changed to hexane. The final sample volume of 1 ml was achieved by adding 1 ml of heptane to the sample in a 10-ml concentrator tube. Glass ebullators and microsnyder columns were added and the samples reduced on a tube heater at 110°C to 1 ml. The extracts were then divided in half between sealed glass ampules for archival storage and screw cap vials for gas chromatographic and mass spectrometric analysis.

24. All glassware used for the collection, storage, extraction, and analysis of samples was washed with Alconox®, rinsed 4 times with hot tap water, 4 times with deionized water, capped with aluminum foil, and muffled for 6 hours at 450°C. Immediately prior to use glassware was rinsed 3 times with an appropriate solvent.

25. Stainless steel centrifuge bottles were washed as glassware and then rinsed twice with methanol, twice with methylene chloride, and twice with hexane immediately prior to use.

26. Polytrons® used for homogenization and extraction samples were washed as glassware and then placed in an ultrasonic bath in graduated cylinders filled first with methanol, methylene chloride, and then with hexane prior to use.

27. Glass fiber filters were placed individually in aluminum foil and muffled for 6 hours at 450°C. The stainless steel filter housing was washed and rinsed with acetone and hexane prior to use.

28. Inorganic. From each sample homogenate, described in paragraphs 20-27, about 2 g of wet tissue was taken for inorganic analysis, placed in a tared beaker, and weighed. The samples were oven dried at 110°C for 2 days, cooled in a desiccator, and weighed. Ten milliliters of reagent grade nitric acid was added to each sample, which was then allowed to digest at room temperature in a hood for 24 hours. The samples were heated at 60°C for several days until complete dissolution of the sample had occurred. The samples were then evaporated to near dryness at 90-95°C, and cooled to room temperature. Three milliliters of 30% hydrogen peroxide was slowly added in 1-ml increments to reduce the intensity of the effervescent reaction. The solutions were then heated to 60°C for 24 hours, evaporated to near dryness, and cooled to room temperature. At this point the clear and colorless solutions were transferred to 25-ml volumetric flasks with several rinses of 5% nitric acid, and were diluted to the mark with 5% nitric acid. The solutions were then transferred to screw cap polyethylene bottles.

Fifty-milliliter quantities of trace metal stripped seawater (Davey et al. 1979) were treated like mussel samples in order to estimate the metal blank values for the Polytron® homogenization procedure for the mussel samples. All procedures used to prepare the glass centrifuge tubes and Polytron® were identical to that used for mussel samples. The seawater remained in contact with the operating Polytron® for the same period of time required for homogenization of the mussel samples. Three 10-ml quantities from each centrifuge tube were then pipetted into beakers and processed like the 2-g (wet weight) homogenized mussel tissue.

Sediments

29. Organic. The methods which follow were used for the extraction and analysis of BRH sediment. Approximately 10 g of wet sediment was placed in a stainless steel centrifuge tube, and 50 ml of acetone was added. The mixture was homogenized for 40 seconds using a brass-bearing equipped Polytron®, and then centrifuged at 10,000 rpm for 5 minutes. The acetone was decanted in a 1-L separatory funnel containing 150 ml of pre-extracted deionized water. The extraction and centrifugation steps were repeated once more and all extracts were combined in the separatory funnel. The aqueous layer in the separatory funnel was extracted three times with 50 ml of Freon® 113 each time and the extracts were combined in a 500-ml Erlenmeyer flask. Extracts were frozen to remove water.

30. The sediment Freon® extracts were subjected to the same two column chromatographic separations as were the tissue sample extracts,

except for the addition of a 2.5-cm activated copper powder layer to the first column for the removal of elemental sulfur. The copper powder was activated by washing it with 8N HCl, followed by a deionized water rinse and then a methanol and methylene chloride rinse. The first column removed biogenic material and the second column separated the sample into the non-polar PF-50 fraction which contained PCB's and other similar materials; an F-2 fraction, which contained primarily aromatic hydrocarbons; and an F-3 fraction, which contained more polar material and will be analyzed later. The samples were reduced in volume and split for analysis and archival storage as described above. Similar analytical methods have been reported by Lake et al. (1979).

31. Inorganic. After thoroughly homogenizing the sediment contained in a barrel (see homogenization of sediment) nine samples were taken for analysis from each barrel. These nine samples included three from the top, three from the middle, and three from the bottom. The wet weight of each sample was determined. Samples from barrel #00 were ladled into 400-ml Pyrex beakers and samples from barrel #LL were ladled into 250-ml acid-cleaned polyethylene bottles. The wet weight of all samples was then determined. The samples were frozen and then freeze dried in a Virtis[®] lypholyzer (model #10-145MR-BA) for 2 days. The dry weight of each sample was then determined.

32. Samples from barrel #00 were acidified with a total of 50 ml of concentrated HNO₃ (reagent grade). The acid was added in 10-ml aliquots since BRh sediment is very reactive to acid. All reaction was allowed to subside before the next addition of acid was made. After several days the samples were heated at 60°C. The sediment samples

were subsequently evaporated down to approximately 10 ml after which 30% H₂O₂ was added in 2-ml aliquots until 50 ml had been added. The H₂O₂ was added cautiously since BRH sediment reacts vigorously with strong oxidizing agents. The samples were evaporated down to approximately 25 ml and filtered through acid-rinsed (5% HNO₃) Whatman® 41 filter paper into 250-ml volumetric flasks. The beakers were rinsed with 25-ml quantities of 5% HNO₃. The rinse solution was also filtered through the filter paper and added to the volumetric flask. The volumetric flasks were brought up to volume with 5% HNO₃. The solutions were then transferred to polyethylene bottles fitted with polyethylene screw caps. Two empty beakers were taken through the entire concentrated acid dissolution procedure to estimate applicable metal blanks.

33. Dilute NHO₃ (5%) was added to the 250-ml bottles containing sediment from barrel #LL and allowed to stand at room temperature for 1 week. The caps were loosely placed on top of each bottle during the first few hours since gas (probably H₂S) is liberated during this elution process. The bottles were shaken vigorously once each day. After 1 week the samples were filtered through acid-rinsed Whatman® 41 filter paper into acid-cleaned polyethylene bottles. No H₂O₂ was added to these samples. Two empty bottles were taken through the entire dilute acid dissolution procedure to estimate applicable metal blanks. The two dissolution techniques were used to determine if different metal concentrations would be obtained for BRH sediment samples.

Sample Analysis

Organic

34. Electron capture gas chromatographic analyses were conducted on a Hewlett-Packard model 5840 gas chromatograph equipped with a 30-m DB-5 fused silica capillary column from J&W. The chromatograph was temperature programmed from 80°C to 290°C at 10°C/min with a 4-min hold at 80°C. Flame ionization gas chromatographic analyses were conducted on a Carlo Erba Fractovap gas chromatograph also equipped with a 30-m DB-5 fused silica capillary column from J&W. The temperature was programmed from 60°C to 325°C at 10°C/min with a 4-min hold.

35. Gas chromatograph/mass spectrometric (GC/MS) analysis was conducted on a Finnigan model 4500 equipped with a J&W DB-5 30-m fused silica capillary column. The capillary column was connected directly to the mass spectrometer with no interface present so that the effluent from the column passed directly into the ionization source of the mass spectrometer. The mass spectrometer was operated through a standard Incos data system and was tuned to meet EPA quality assurance specifications using decafluorotriphenylphosphine. The ionizing current was typically set at 300 uA and 70 V, and the instrument operated such that 100 pg of polynuclear aromatic hydrocarbons from naphthalene to benzopyrene gave easily quantifiable signals on their molecular ions with signal-to-noise ratios of 50:1 or better. The mass spectrometer's gas chromatograph was programmed from 50°C to 330°C typically at 10°C/min with a 2-min hold at 50°C, but was occasionally programmed at 4°C/min for higher chromatographic resolution.

36. All instruments were calibrated with authentic standards each day quantitation was attempted. The concentrations of the standards used were chosen to be close to the levels of the materials of interest, and periodic linearity checks were made to ensure the proper performance of each system. In some cases, authentic standards were not available, such as for the alkyl homologs of the aromatic hydrocarbons. In this case, the numbers reported are a low estimate of the actual amount present, because the response factors for these homologs were assumed to be equal to those of the corresponding PAH's, and the alkylated homologs all have a decreased molecular ion intensity compared to the corresponding PAH's.

37. We also did not have standards for biphenyl, acenaphthene, fluorene, and the aromatics with molecular weights greater than 252. Since the molecular weights of biphenyl (154), acenaphthene (154), and fluorene (166) lie between those of naphthalene (128) and anthracene and phenanthrene (MW's 178), the response factors of these three compounds were estimated by averaging the response factor of naphthalene with the average of the response factors of phenanthrene and anthracene. Response factors for the aromatics heavier than the 252's were taken to be the same as that for the 252's.

Inorganic

38. All flame atomization (FA) atomic absorption (AA) analysis was done with a Perkin-Elmer atomic absorption instrument (Model 603). All Hg determinations were done by the method of Hatch and Ott (1968) using a Perkin-Elmer mercury/hydride system (Model MHS-1) adapted to

the 603 AA. The transient Hg signals were recorded with a Perkin-Elmer strip chart recorder (Model 56). All heated graphite atomization (HGA) atomic absorption determinations were conducted with a Perkin-Elmer HGA unit (Model 500) coupled to a Perkin-Elmer atomic absorption instrument (Model 5000) retrofitted with a Zeeman HGA background correction unit. The Model 500 HGA unit was equipped with an auto injector (Model AS-40). The transient HGA-AA signals were recorded with a Perkin-Elmer strip chart recorder (Model 56) and also sent automatically to a Perkin-Elmer data station microcomputer (Model 3600). Software supplied with the data station reduced the transient signals to a peak height and peak area for each element determined. The instrument set-up procedures for the FA-AA, MHS-1, and HGA-AA determinations were in accordance with procedures described in "Methods For Chemical Analysis of Water and Wastes" (EPA 1979) and are also found in the manufacturer's reference manuals.

39. The AA instruments were calibrated each time samples were analyzed for a given element. Instrument calibrations were generally checked after every five samples had been atomized into the flame unit, injected into the HGA unit, or pipetted into the MHS-1 sample reaction flask. All samples were analyzed at least twice to determine signal reproducibility; most were analyzed three times. Generally one sample was determined by the method of standard addition, and one procedural blank sample was analyzed for each 15 samples processed.

40. All elements (i.e., Fe, Zn, Mn, Cu, Pb, Cd, Cr, and Ni) except Hg and As were determined in the sediment samples by FA-AA. Mercury was determined only in the BRH barrel #00 samples by the

MHS-1-AA technique. Arsenic could not be determined in the sediment samples because of a chemical interference. At this time the cause of the chemical interference is under investigation.

41. Due to the limited sample size of the mussel samples (i.e., 2 g wet weight), only Fe and Zn could be determined by conventional FA-AA. All other elements (i.e., Mn, Cu, Pb, Cd, Cr, and As) were determined by HGA-AA. All mussel samples determined by HGA-AA were matrix matched before analysis. A matrix solution containing 10% seawater and 90% 0.16 N nitric acid (V/V) was used as a diluent for both standards and samples. Samples were diluted with this matrix modification solution so that the sample extracts never exceeded 20% of the total volume of the solution analyzed. Standards were made up in an identical manner to the samples.

PART IV: BIOLOGICAL CHARACTERIZATION METHODS AND MATERIALS

Overview

Methods

42. The 4-day (96-hr) and 10-day flow-through toxicity tests described below generally followed the methods prescribed by "Standard Practice for Conducting Acute Toxicity Tests with Fishes, Macroinvertebrates, and Amphibians" (ASTM 1980b). Although these acute toxicity test methods were not specifically designed for suspended sediment or solid phase sediment tests, they provided recommendations for test animal care, handling, and acclimation, as well as guidelines for experimental designs, water quality parameters, statistical analyses, and general quality criteria that were suitable for the sediment tests. Holding and acclimation conditions for each species were similar or identical to the test conditions (Table 2).

43. Toxicity tests. For each species, two types of flow-through toxicity tests were conducted:

- a. Solid phase, in which BRH sediment or REF sediment was placed in the bottom of the exposure chambers and filtered seawater allowed to flow over the sediment
- b. Suspended particulate phase, in which suspensions of the sediments (25 mg/L) were dosed in combination with a solid phase sediment (either REF or a no-effect percentage of BRH as determined by the solid phase tests).

The solid phase tests represent conditions similar to that on the disposal mound in an undisturbed (quiescent) state; the tests combining solid phase and suspended sediments represent the conditions on the disposal mound in a dynamic state.

Table 2
 Test Species, Exposure Conditions, and Food Used for Solid Phase
 Biological Assays for Sediment Characterization

Species	N*	Exposure Time days	Salinity ppt	Temperature °C	Seawater Flow Rate, ml/min	Photoperiod hrs	Food
<u>Annelids</u>							
<u>Neanthes arenaceodentata</u>	3	10	30 (30-32)**	19 (19.8-20.1)	51	14	none
<u>Nephtys incisa</u>	3	10	31 (30-32)	20 (19-21)	52	14	none
<u>Molluscs</u>							
<u>Yoldia limatula</u>	2	10	28 (27-30)	19 (18-21)	50	14	none
<u>Mulinia lateralis</u>	2	10	29 (18-30)	19.5 (18-21)	45 to 80	14	none
<u>Arthropods</u>							
<u>Mysidopsis bahia</u>	3	4	29 (26-30)	25 (23-26)	35	12	<u>Artemia nauplii</u>
<u>Ampelisca abdita</u>	6	4	30	20 (19-21.5)	45 to 80	14	none
<u>Fishes</u>							
<u>Menidia menidia</u>	2	4	30 (30-30)	20.5 (20-20.8)	45	12	<u>Artemia nauplii</u>
<u>Cyprinodon variegatus</u>	2	4	29 (28-30)	21.2 (20.2-21.9)	45 to 50	12	none
<u>Ammodytes americanus</u>	2	4	30 (30-30)	10 (9-11.5)	34	12	none
larvae	6	4	29 (26-32)	10.5 (8.2-11.2)	21 to 34	12	<u>Brachionus plicatilis</u>
<u>Paralichthys dentatus</u>	2	4	28 (26-30)	20 (19.5-20.8)	43 to 49	12	<u>Artemia nauplii</u>
<u>Pseudopleuronectes americanus</u>	2	4	29 (26-32)	10 (9-11)	35 to 40	12	<u>Artemia nauplii</u>

* N = number of tests conducted.

** Parentheses denote ranges.

44. In the solid phase tests, a measured quantity of BRH, REF, or a mixture of the two sediments was placed in an exposure chamber and filtered seawater allowed to flow over the material. Introduction of the test animals into the exposure chambers was delayed 2 to 24 hr after starting the seawater flow to allow settling of any suspended material. After the animals were placed in the chambers, the sediments were left undisturbed until the end of the test. Test species, exposure conditions, and food used in the solid phase tests are listed in Table 2.

45. All tests (solid and suspended sediment phase) were conducted with sand-filtered Narragansett Bay seawater at approximately 30 ppt salinity. The photoperiod simulated a natural cycle for the time of year these tests were conducted (Tables B1 to B52). Test temperatures were generally held at 20°C; however, two species (Ammodytes and Pseudopleuronectes) required 10°C.

46. The performance of suspended particulate phase tests required the interfacing of three experimental modules: the suspended sediment (SS) controlled dosing system, the SS dilution system, and the SS toxicity test system. The suspended sediment dosing system (Figure 4) supplied REF and BRH sediments at a concentration of 5.75 percent (2.3 L of sediment in 37.7 L of seawater) to the suspended sediment dilution system (Figure 7). This system consists of individual (REF and BRH) 72-L glass aquaria containing a transmissometer to measure turbidity and a recirculating submersible pump and manifold to maintain a uniform particle distribution. Temperature-controlled filtered seawater was introduced into the aquaria on demand. A suspended sediment concentration (BRH and REF) of 25 mg/L was maintained for all

acute tests by the microprocessor-transmissometer feedback loop (Figure 5) that controlled the pulse duration of the dosing valves of the suspended sediment dosing systems (Figure 4). From the aquaria, uniform 25-mg/L suspensions of sediment (REF and BRH) under constant head pressure, flowed by gravity through polypropylene tubing to distribution chambers (Figure 7). The distribution chambers, 3.8-L glass jars, had nine ports to distribute the 25-mg/L suspensions to eight separate exposure chambers. The ninth port, an overflow, functioned to maintain a constant head pressure. A seawater distribution chamber containing temperature-controlled, filtered seawater without sediment was provided as an additional control for all experiments.

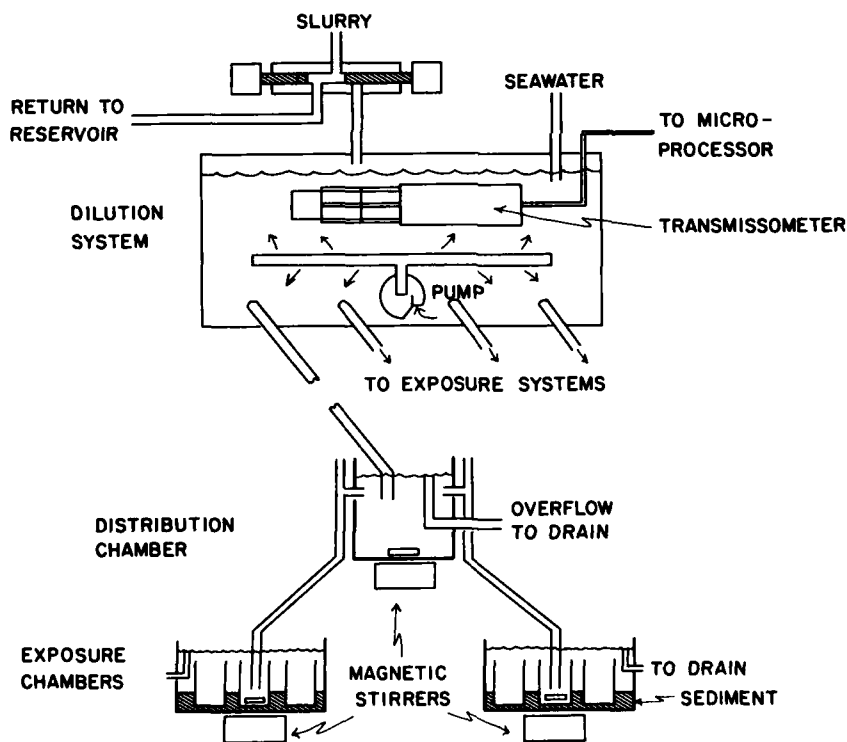

Figure 7. Suspended sediment dilution system, distribution chamber, and exposure chambers used for acute toxicity tests

47. Statistics. Toxicity test data were analyzed by probit analysis (Finney 1971) if a dose-response relationship could be defined in the tests. In cases where only two treatments were tested, a Chi-square test was used to determine whether significant differences ($P < 0.05$) in mortality or a sublethal effect were observed.

Annelids

Collection, culture, and holding

48. Two species of polychaete annelids, Nephtys incisa and Neanthes arenaceodentata Moore (Nereis acuminata Ehlers), were used for the acute tests. Nephtys incisa were collected with a Smith-McIntyre dredge from the South reference site (Figure 2) in August and October 1982 and February 1983. The worms were sieved (0.5 mm) from the sediment on board ship, sorted into size classes, placed into sediment from that station, and transported back to ERL-N. Worms were held in the sediment with filtered Narragansett Bay water flowing over them. If temperature acclimation was needed, the seawater temperature was raised about 2°C/day until the test temperature was reached and then held for at least 10 days at that temperature prior to testing.

49. Nephtys incisa were fed prawn flakes (ADT-Prime®, Aquatic Diet Technology, Inc., Brooklyn, N.Y.) directly on the sediment surface during holding. At the start of the test, worms were sieved (0.335-mm mesh seive) out of the sediment and placed in the test chambers. All tests with N. incisa were conducted with juveniles. Neanthes arenaceodentata were from laboratory cultures (original stock from

D. J. Reish, California State University, Long Beach, Calif.). Worms were cultured at $20 \pm 1^\circ\text{C}$ and fed prawn flakes. Either adults or juveniles were used for toxicity tests.

Solid phase tests

50. The solid phase tests were conducted in glass crystallizing dishes (150 x 75 mm). Each dish contained a 100-ml glass beaker (48 x 67 mm) in the center of the dish. The inflow water (sand-filtered Narragansett Bay seawater) was directed into this beaker (which contained no sediment), flowed out of the beaker over the sediment surface, and overflowed the edge of the crystallizing dish. Flow rates were approximately 50 ml/min. Each dish contained 400 ml of sediment (2.5 to 3.5 cm deep). Neanthes arenaceodentata were also exposed in individual chambers constructed from glass Petri dishes (50 mm diameter) with a nylon mesh collar (8 cm high) glued into the Petri dish. The chambers were placed in a glass box that received a constant inflow of seawater and had a siphon at the outflow to create a fluctuating water level in the box (Pesch and Morgan 1978). The sediment layer in the individual chambers was 1 cm deep.

51. The exposure concentrations used in the solid phase tests were: 100, 75, 50, 25, and 0 percent BRH (100 percent REF). The mixtures of the two sediments were made volumetrically, mixed thoroughly, and then distributed to the exposure chambers. An aliquot of sediment was taken, weighed, and dried a minimum of 24 hr, and reweighed to establish the wet-dry ratio for each exposure concentration. The sediment was placed in the empty crystallizing dishes and the seawater

turned on. After a minimum of 2 hr, the inflow water was turned off, some water poured off so that the water level was below the edge of the dish and the worms were added. Approximately 1 hr later, each dish was checked to be certain all the worms had burrowed into the sediment, then the inflow water was turned back on. Worms were not fed during the test. Three tests were conducted with N. incisa, two with similar size worms from two different collections, and one with larger worms (Tables B1 to B3). Three tests were conducted with N. arenaceodentata, two tests with adult males in the two different exposure chambers and one test with juveniles.

Suspended particulate phase test

52. The suspended particulate tests were conducted in test chambers similar to those used in the solid phase tests. Each crystallizing dish (150 x 75 mm) contained 400 ml sediment (2.5 to 3.5 cm deep). A smaller glass crystallizing dish (60 x 35 mm) was placed in the center of the larger dish. The inflow water (water with suspended particulate matter) was directed into the smaller crystallizing dish, which contained no sediment. A Teflon[®]-coated stir bar kept the particulate matter in suspension as it overflowed into the larger crystallizing dish. Neanthes arenaceodentata were exposed only in the crystallizing dishes (not individual chambers) because the results of previous solid phase tests indicated that the crystallizing dishes were suitable containers for this species.

53. Exposure conditions for the solid phase portion of the suspended particulate tests were 100 percent REF or 100 percent BRH.

These two solid phase exposure conditions in combination with the two suspended sediment exposures (25 mg/L REF or BRH) gave a total of four exposure treatments. The test was conducted four times with N. incisa juveniles and twice with N. arenaceodentata juveniles. The procedure for adding the sediment and worms was the same as in the solid phase test except for the first two tests with N. incisa where the inflowing seawater was not turned off when the worms were placed in the dishes (see Results section). Worms were not fed during these tests (Table 3).

54. During the tests, all exposure chambers were examined daily for the appearance of any worms on the surface of the sediment. On the last day of the test (day 10), measurements were made on the burrows visible through the side of the dishes. The depth of the deepest burrow and estimated average depth of the burrows were noted. Then the sediment was sieved (0.335-mm sieve mesh) and the worms retrieved and counted. Any missing worms were presumed dead from toxic effects. Since a weight gain in 10-day treatments was not expected, dry weights were taken merely to establish the size of the worms used in the test.

Molluscs

Collection, culture, and holding

55. Yoldia limatula and Mulinia lateralis, the two species of molluscs used in the acute toxicity tests, were sieved out of sediments from the South reference site on board ship in October 1982 and January and February 1983 (Tables B10-B13). The organisms were then returned to the laboratory where they were sorted from shell material and placed

Table 3
Test Species, Exposure Conditions, and Food for Suspended Particulate
Phase Assays for Sediment Characterization

Species	N*	Exposure Time days	Salinity ppt	Temperature °C	Seawater Flow Rate, ml/min	Photoperiod hrs	Food
Annelids							
<u>Neanthes</u> <u>arenaceodentata</u>	1	10	27 (25-30)**	20 (19.8-20.5)	99	12	none
<u>Nephtys</u> <u>incisa</u>	2	10	28 (25-30)	20 (19.2-20.5)	98	12	none
Molluscs							
<u>Yoldia</u> <u>limatula</u>	1	10	27.5 (25-30)	20.5 (20-21)	50	14	none
<u>Mulinia</u> <u>lateralis</u>	2	10	27.5 (25-30)	20.5 (19.8-21)	50	14	none
Arthropods							
<u>Nysidopsis</u> <u>bahia</u>	2	4	30 (28-31)	21 (20-21)	90	12	<u>Artemia</u> <u>nauplii</u>
<u>Ampelisca</u> <u>abdita</u>	2	4	28 (27-29)	21 or 8 (20.5-21.5)(7.5-8.5)	60	14	none
Fishes							
<u>Menidia</u> <u>menidia</u>	2	4	30 (30-30)	20 (19.6-20.3)	80 to 90	12	<u>Artemia</u> <u>nauplii</u>
<u>Cyprinodon</u> <u>variegatus</u>	2	4	27 (25-29)	19.5 (19.3-20.1)	80 to 90	12	none
<u>Ammodytes</u> <u>americanus</u>	2	4	29 (28-30)	10 (8.2-11.6)	86 to 92	12	<u>Brachionus</u> <u>plicatilis</u>
<u>Pseudopleuronectes</u> <u>americanus</u>	2	4	28 (26-29)	10.2 (8.2-12.7)	80 to 95	12	<u>Artemia</u> <u>nauplii</u>

* N = number of tests conducted.

** Parentheses denote ranges.

in containers of REF sediment. The newly collected organisms were acclimated to 20°C at the rate of 1°C/day. Mulinia lateralis were fed the diatom Phaeodactylum tricornutum daily; Y. limatula were fed the REF sediment.

Solid phase tests

56. Solid phase toxicity tests were conducted with Yoldia and Mulinia for 10 days at approximately 20°C and 30 ppt. The exposure system consisted of three 70- by 50-mm glass crystallizing dishes containing test sediment (65 mm deep) placed on a glass rack 3 cm off the bottom of a 3.8-L glass jar with a siphon to drain. Filtered seawater entered the exposure system at a flow rate of 45 to 80 ml/min, depending on the test species, and was circulated within the system by a Teflon®-coated stir bar operated by a water-driven stirrer. Each exposure system was placed in a 20°C water bath of recirculating seawater and monitored with a continuous temperature recorder. Organisms were added 6 to 24 hr after the sediments were distributed to the exposure chambers. Experimental concentrations were 100% BRH and 100% REF for Mulinia, and 100, 66, 50, 33, 25, and 0 percent BRH for Yoldia. The water content was determined for all sediment combinations. Each treatment consisted of two replicates. A minimum of two replications of each test were conducted to satisfy statistical design criteria.

Suspended particulate phase tests

57. For the suspended particulate exposures, 25-mg/L BRH and REF slurries (previously mixed in the suspended sediment dilution aquaria,

Figure 7) were each delivered to a crystalizing dish (17 cm x 9 cm) fitted with a standpipe to maintain a constant water level (Figure 8). Material was kept in suspension with a water-driven stirrer and stir bar. To adjust flow rates to each exposure container, U-shaped glass siphons were set at the desired height. The suspension was collected by small glass funnels that drained through polypropylene tubing to the exposure chambers. Flow rates were measured daily (Table 3).

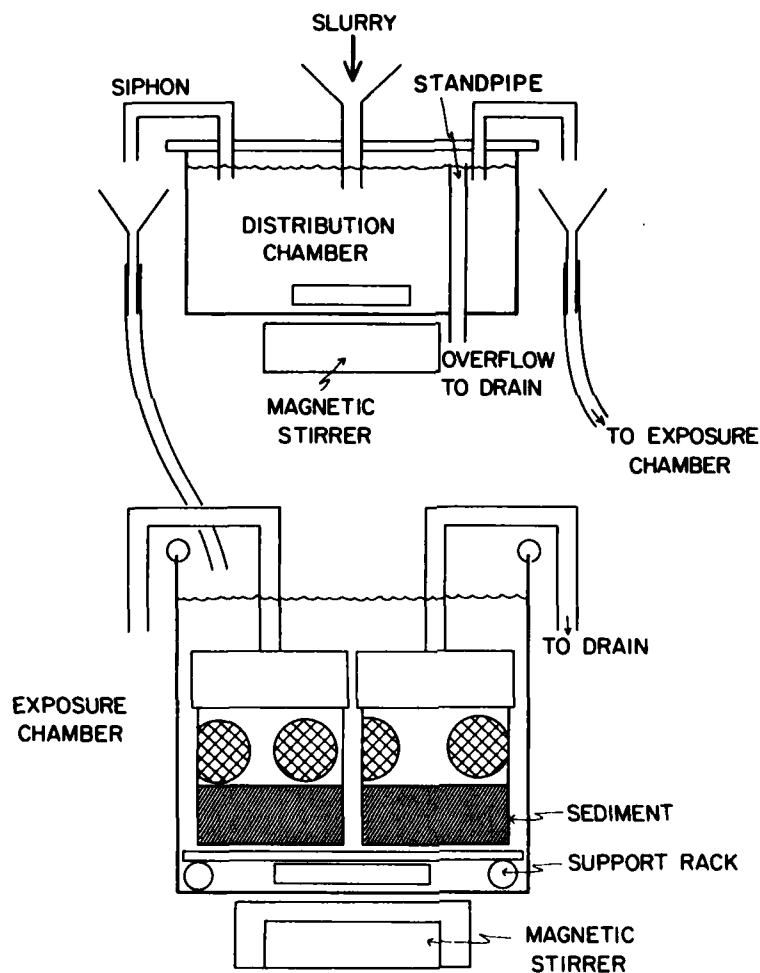

Figure 8. Distribution and exposure chambers used for solid phase and suspended particulate phase exposure of Yoldia limatula, Mulinia lateralis, and Ampelisca abdita

58. Sediment suspensions were monitored at least twice during each test using the dry weight measurement as described in the contaminant uptake test.

Arthropods

59. An estuarine mysid, Mysidopsis bahia, and a benthic amphipod, Ampelisca abdita, were the two species of arthropods used in both the solid phase and the suspended particulate phase toxicity tests (Tables B16-B28).

Collection, culture, and holding

60. Mysidopsis bahia were cultured in the laboratory for several generations according to methods described in Gentile et al. (1982) under conditions identical to those used in the toxicity tests. Cultures were maintained in filtered (15) Narragansett Bay seawater at 28 ± 2 ppt salinity and $25^\circ \pm 2^\circ\text{C}$ temperature with a photoperiod of 14 hr light. Cultures were fed daily ad libitum 24-hr posthatch Artemia salina from the reference strain (Sorgeloos 1980). Reference brine shrimp were used because they were high in nutritional value, had a high hatching percentage, and were low in contaminants.

61. Ampelisca abdita were collected from Long Island Sound or Narrow River, Rhode Island, and transported unsieved to the laboratory in native sediment. The sediments were then sieved and the recovered animals placed in presieved native or reference sediment for acclimation. These animals were acclimated to the test temperature (20°C) at the rate of $1^\circ\text{C}/\text{day}$. During acclimation, Ampelisca were fed daily ad libitum

with the diatom Phaeodactylum tricornutum. Animal collection dates and location are listed in Appendix Tables B21-B28.

Solid phase tests

62. Three flow-through acute toxicity tests were completed with M. bahia. Continuous-flow bioassays were conducted with a diluter system modified from Mount and Brungs (1967) and an exposure system from Sosnowski, Germond, and Gentile (1979). The exposure system employed a siphon-flush mechanism that produced ten turnovers (volume additions) per day (Table 2). Bioassays were maintained at a temperature of $25^{\circ} \pm 2^{\circ}\text{C}$ and salinity of 28 ± 2 ppt and illumination of 1000 lux on a 14-hr light cycle. Sediment from BRH and REF (at room temperature) was stirred and shaken vigorously before mixing to obtain the desired percentage for each treatment. The sediment was added to the exposure cups to a depth of 2 cm and allowed to remain in the system overnight in flowing seawater before animals were introduced. Treatments for all assays were: 100, 75, 50, and 25 percent BRH with a REF control and a seawater control (no sediment).

63. The first test employed two exposure cups per replicate, for a total of 20 animals per treatment (Table B16). Dissolved oxygen and salinity were not monitored during this test. Cups for this test were glass Petri dishes (100 mm diameter) with a 250- μ nylon screen forming the sides. The cups were removed daily for monitoring. Test organisms could be seen most easily over the sediment by shining an intense beam of light horizontally from the side of the test cup at the sediment/water interface.

64. For the second and third tests, five 24- to 30-hr postrelease juveniles were randomly distributed into each of three exposure cups per two replicates for a total of 30 organisms per exposure concentration. Each cup was fed 24-hr posthatch reference Artemia salina daily and removed after 96 hr exposure to determine mortality. Dissolved oxygen was measured by Winkler titration on days 1 and 4 of these tests. Cups in these tests were glass jars (70 mm in diameter x 83 mm high) with a 32-mm-diam hole on either side covered with 250- μ nylon screen, and were removed for monitoring only at the end of the test (96 hr).

65. In the solid phase toxicity tests with Ampelisca abdita acclimated organisms were sieved from their holding sediments, outsized and dead organisms discarded, and the remainder sequentially distributed into 100-ml plastic beakers of 20 organisms each. At least 40 organisms were preserved for size determination and the remaining beakers of organisms were transferred to experimental chambers and checked after 1 hr in order to replace any organisms that had not burrowed. Two exposure chambers (40 organisms) per treatment were placed in the exposure system.

66. The amphipod exposure system was similar to that used for the bivalve molluscs, except that each 3.8-L jar contained two exposure chambers that consisted of 0.24-L glass jars, with four 2.5-cm-diam holes covered with 0.4-mm mesh nylon screening. These small jars were fitted with polypropylene lids and self-starting siphons. The water flowed through the screens, into the exposure chambers, and out through the siphons to the drains (Figure 8).

67. Exposure chambers were checked daily and the number of individuals dead, moribund, on the sediment, and on the water surface were

recorded. The number of molts and condition of the tubes constructed were also monitored. At the conclusion of each assay, the sediment in all containers was sieved and the animals counted. Any animals missing were assumed to be dead. LC50's were based on records of dead animals only.

Suspended particulate phase tests

68. Suspended sediment toxicity tests with Mysidopsis bahia were conducted using the same test apparatus as that used for the annelid studies (Figure 7). Test organisms used for the studies were cultured, held, and acclimated using the same procedures as those used in the solid phase tests. Two distribution chambers (one for BRH and one for REF, Figure 7) delivered mixtures of filtered seawater and sediment slurry at a final particulate load of 25 mg/L. A third distribution chamber delivered only filtered seawater to the control treatment. Test chambers consisted of 2-L glass culture dishes that held three exposure cups (glass jars with netted holes as in the solid phase tests). The exposure cups were held above the bottom of the test chamber by a glass grid to allow a stir bar to mix the particulate suspension. A siphon in the culture dish provided a vertical excursion of the test suspension for additional mixing. Flow of the test suspension into the chambers, calibrated daily, was approximately 90 ml/min.

69. Bioassays were maintained at a temperature of $21^{\circ} \pm 1^{\circ}\text{C}$, salinity was 28 ± 2 ppt, and illumination was 1000 lux on a 12-hr light cycle. Dissolved oxygen was measured on days 1 and 4 of the 4-day tests. The suspended particulate concentration was measured in both treatments

daily with an electronic particle counter. For a period of 8 days, particle counts were made daily from the splitters, exposure chambers, and exposure cups to determine the consistency of the suspended particle density. Thereafter, counts were made daily in the exposure chambers only.

70. Five 24- to 30-hr postrelease juveniles were randomly distributed into each of three exposure cups per two replicates for a total of 30 animals per treatment. Each cup was fed 24-hr posthatch reference Artemia salina daily, and removed after 96 hr exposure to monitor mortality.

71. The suspended particulate phase Ampelisca exposure system was similar to that used for the bivalve molluscs (Figure 8). In addition, in these studies, intermediate exposures of BRH sediment between 100 percent BRH and 0 percent BRH (100% REF) were used. To achieve varying degrees of exposure to the dredged material, but still maintain constant particle densities, a siphon and collection tube from both suspension systems (REF and BRH) were directed to a single exposure chamber. For example, to get one third BRH and two thirds REF (33 percent BRH exposure) at 60 ml/min, 20 ml/min of BRH and 40 ml/min of REF would be combined. A 66 percent exposure would be just the opposite: 40 ml/min BRH and 20 ml/min REF. Flow rates were measured daily. The bioassay monitoring schedule was identical to that previously described for solid phase tests with Ampelisca.

Fishes

72. Five species of fishes were exposed to solid phase BRH material and four species to suspended particulate phase BRH material. Two species, the Atlantic silverside (Menidia menidia) and sheepshead minnow (Cyprinodon variegatus), have been used routinely in aquatic toxicology; the remaining three, the American sand lance (Ammodytes americanus), summer flounder (Paralichthys dentatus), and winter flounder (Pseudopleuronectes americanus), have not been routinely used but represent fish species likely to be directly exposed to the disposal of dredged material. Menidia menidia and C. variegatus are estuarine species that spawn their demersal, adhesive eggs in salt marsh areas during the warm months of the year. Ammodytes americanus is an early winter spawner that deposits its eggs in or on sand substrates. Paralichthys dentatus ranges inshore to well offshore and spawns in the winter and produces a pelagic egg whereas P. americanus is a near-shore species that spawns in the early spring and produces a demersal egg mass.

Collection, culture, and holding

73. Menidia menidia (Atlantic silverside) eggs and larvae were obtained from field-collected adults (Succotash salt marsh, Rhode Island) that were induced to spawn in the laboratory. The spawning method was that described by Middaugh and Takita (1983) with some minor changes: current velocity was not altered to mimic tidal flow in some of the spawning tanks and a flow-through seawater system was used rather

than a recirculating system. Seawater temperature was maintained at 18° to 20°C and salinity range was 28 to 30 ppt. Eggs were released and fertilized by adults onto acrylic fiber mats approximately 20 x 20 x 10 cm. Mats containing eggs were transferred to 5-L hatching jars within 48 hr of fertilization and gently aerated. Newly hatched fish were initially fed rotifers (Brachionus plicatilis), followed by a daily feeding of newly hatched Artemia sp. (reference strain, Sorgeloos 1980) after the first 2 days. Embryo development, hatching, and larval development took place within a temperature range of 18° to 21°C and a salinity range of 29 to 31 ppt.

74. Cyprinodon variegatus (sheepshead minnow) larvae were obtained from eggs spawned in the laboratory. The methods used were similar to those by Hansen et al. (1978). Adult sheepshead, obtained from a salt marsh on Santa Rosa Island, Escambia County, Florida, were kept in a 160-L aquarium supplied with flowing seawater (300 ml/min). The temperature in the tank was 26°C (25.5° to 26.5°C) and the salinity was 30 ppt (29 to 31 ppt). The fish were contained in a nylon basket in the tank so that the eggs spawned fell through the bottom of the basket and onto a collecting screen below. The eggs were incubated at 20° to 23°C. (One set of eggs, those used in replicate 1 of the second suspended phase test, were incubated at 30°C to accelerate hatching.) After hatching, the larvae were fed reference (Sorgeloos 1980) brine shrimp (Artemia sp.) daily.

75. Ammodytes americanus (American sand lance) adults were collected from the Merrimac River, Massachusetts, in November 1982 and

transported to ERL-N.* They were maintained at ambient seawater temperature in 1.1-m-diam tanks containing approximately 5 cm of sand. From November 1982 through January 1983 the water temperature decreased from 15° to 8°C and the photoperiod was changed from 11 hr light to 9 hr light. At 8°C the adults were spawned artificially into basins and the eggs were coated with diatomaceous earth. The embryos were transferred to mesh baskets suspended in basins of seawater. The basins were maintained in an incubator at 8.0° to 10.2°C. Photoperiod increased from 9 to 12 hr light; salinity was maintained at 28 to 32 ppt (by the addition of deionized water), and the seawater was gently aerated. The larvae were maintained under identical conditions and immediately after hatching were fed rotifers (Brachionus plicatilis). Larvae for the suspended particulate tests were provided by the NMFS Laboratory, Narragansett, R.I., and maintained under the conditions described above until testing.

76. Summer flounder (Paralichthys dentatus) were obtained from natural spawnings of laboratory-held brood stock at the NMFS-Narragansett, R.I. The eggs were spawned in 18°C and 30 ppt salinity seawater and hatched 3 days later. The larvae were reared in black plastic containers as described by Klein-MacPhee (1981). The average rearing temperature was 14°C (13.6° to 15.2°C), salinity averaged 30 ppt (29 to 30 ppt).

* The taxonomy of the sand lance in the literature is unclear; however, the fish collected most closely resembled A. americanus; personal communication, Mr. Lawrence Buckley, National Marine Fisheries Service (NMFS), Narragansett, R.I.

77. Larvae were fed laboratory-cultured rotifers (B. plicatilis) for approximately 3 weeks when they were fed newly hatched reference strain (Klein-MacPhee, Howell, and Beck 1982) Artemia nauplii. They were then transferred to 47-cm-diam fiberglass tanks supplied with filtered, flowing seawater at $16^{\circ} \pm 1^{\circ}\text{C}$ and 29 to 30 ppt. After metamorphosis, which occurred in 90 percent of the animals at 7 weeks posthatch, the juveniles were used only in the solid phase toxicity tests as there were insufficient animals to conduct the suspended sediment tests.

78. Adult winter flounder (Pseudopleuronectes americanus) were collected in Narragansett Bay, R.I., in November and December 1982. The fish were transported to ERL-N and maintained in 2.4-m-diam tanks provided with flowing seawater at ambient temperature and salinity (2.4° to 12.2°C , 27 to 30 ppt). They were allowed to ripen naturally and the fish first spawned 7 February 1983. The eggs of a single female were stripped manually into a plastic dishpan treated with diatomaceous earth to prevent clumping (Smigielski and Arnold 1972). Incubation techniques, collection, and rearing are described in Klein-MacPhee, Howell, and Beck (1982). Incubation temperature and salinities ranged from 3.8° to 5.2°C and 28 to 30 ppt, respectively, and larvae hatched 6 to 8 days postfertilization. Larval-rearing temperatures and salinities ranged from 8.5° to 9.6°C and 28 to 30 ppt, respectively. Winter flounder larvae were fed in a manner similar to summer flounder and were switched to reference strain (Sorgeloos 1980) Artemia approximately 1 month posthatch.

79. A second batch of eggs were obtained on 23 February 1983. Embryos and larvae were cultured as described above; incubation temperatures and salinities ranged from 4.2° to 6.1°C and 28 to 30 ppt, respectively. Larval rearing temperatures and salinities varied from 7.6° to 9.3°C and 27 to 30 ppt, respectively.

Solid phase tests

80. Menidia menidia solid phase tests were conducted in 19-cm-diam by 10-cm-deep glass crystallization dishes. A continuous inflow of filtered seawater was provided to each dish. Height of the water column (8 to 9 cm) in each dish was controlled by a 4-mm-diam glass capillary outflow surrounded by a nylon screen (Figure 7). Water volume in the dish was 2.5 L, and there were approximately 25 turnovers per day (Tables B29 and B30).

81. Three experimental treatments were used: a seawater control (no sediment), 100 percent BRH sediment (600 ml/dish), and 100 percent REF sediment (600 ml/dish). Each treatment was replicated, and this test regime was performed twice.

82. After a flushing period of 2 to 4 hr following sediment addition, 12 silverside larvae (7 to 10 mm total length (TL), 10 to 14 days old) were gently released into each dish. Flow rates for solid phase tests were 44 to 45 ml/min and salinity was 30 ppt. Exposure dishes were checked daily for temperature, salinity, flow rate, and number of larvae alive, moribund, and dead. Dissolved oxygen concentrations were measured midway through the test period to document

water quality. Larvae were fed daily with approximately 30% body wet weight of newly hatched reference brine shrimp.

83. Cyprinodon variegatus solid phase tests were conducted as described for Menidia menidia above. The tests were conducted at 20° to 22°C and 28 to 30 ppt salinity, at flow rates of 45 to 50 ml/min (Table B33 and B34). The test larvae were fed newly hatched reference brine shrimp on day 0, 1, 2, and 3 for the first test and only on day zero in the second test. Dissolved oxygen measurements were taken only during the second test.

84. Ammodytes americanus embryonic solid phase tests were conducted using the same general exposure chamber design described for annelid solid phase tests. Embryos were placed inside sediment-covered, mesh-bottomed glass tubes (45 X 15 mm) settled into 300 ml of sediment contained in 110-mm-diam glass finger bowls, with two embryo chambers (five embryos per chamber) per finger bowl. Two finger bowls were submerged in a 30-L water bath (9.0° to 11.5°C and 28 to 32 ppt salinity). Siphons and a central water well ensured an oxygenated flow of water over the embryos. Two tests were conducted using seawater (SW) and REF controls and 25%, 50%, 75%, and 100% BRH (Tables B37 and B38). Samples of the sediment were taken for moisture content as described for molluscs.

85. Ammodytes americanus larval solid phase tests were conducted in finger bowls (85 mm diameter) surrounded by 250- μ mesh, creating a column 80 to 90 mm high. The mesh column was welded together at the seam and glued to the finger bowl with silicone adhesive. Each cup held 100 ml of sediment and two or three chambers were placed in a

water bath to a depth 10 to 20 mm below the top of the 250- μ mesh column. Five larvae were placed per dish. Test conditions ranged from 9.0° to 11.0°C, 26 to 30 ppt salinity, and 12 hr light (Tables B39 to B44). Two tests were conducted using the three concentrations: SW, 100% REF, and 100% BRH; and four using the six concentrations mentioned under the embryonic tests (Tables B39-B44). Larvae were fed rotifers (Brachionus plicatilis) twice daily at a concentration of 2 to 3 rotifers/ml or greater. Dissolved oxygen measurements were taken only during the final test.

86. Paralichthys dentatus (summer flounder) larvae were exposed to the REF and BRH sediments in the manner described above for the Menidia menidia solid phase tests except that the fish were fed brine shrimp at the rate of approximately 100% of their body weight per day. In the first test the temperature varied from 20.2° to 20.8°C. The salinity was 30 ppt throughout the test, and the flow rates varied from 42 to 45 ml/min (Tables B47 and B48).

87. Pseudopleuronectes americanus (winter flounder) larvae were exposed to REF and BRH sediments in the manner described above for the Menidia menidia solid phase tests except that all fish dead or missing after 24 hr were assumed to have died or been lost as a result of handling and were replaced. The flow rate in these tests was 37 ml/min and the temperature varied from 9.0 to 11.0°C. In the first test the salinity varied from 30 to 32 ppt, in the second it varied from 26 to 29 ppt (Tables B49 and B50).

Suspended particulate phase tests

88. Menidia menidia suspended particulate tests were conducted in the same crystallization dishes described in the solid phase tests above, and included 600 ml/dish of BRH or REF sediment in the appropriate treatment dishes. Treatments used for these tests were: seawater controls (no sediment or particulates), BRH (25 mg/L), and REF (25 mg/L). In these tests, the inflowing seawater or seawater and suspended particulates were introduced to each dish by the distribution chambers previously described (Figure 7). Each inflow discharged into a 150-ml beaker located in the center of each dish, and a spinning stir bar maintained the particulates in suspension in the beaker. The lip of this beaker was higher than the water level of the crystallization dish to protect fish larvae from the mixing vortex.

89. Two tests were performed using 12 larvae per treatment, and each treatment was replicated once. Flow rates for these tests were 80 to 90 ml/min; temperature and salinity ranges were 19.6° to 20.3°C and 26 to 30 ppt, respectively. Suspended particulate concentration was measured by dry weight of a 100-ml water sample and two Coulter counts from each treatment (dish) over the course of the test. Dishes were monitored daily for temperature, salinity, flow rate, and number of larvae live, moribund, or dead. Dissolved oxygen concentrations were measured midway through the exposure period. Fish larvae were fed a daily ration of 30% body wet weight of newly hatched reference brine shrimp (Tables B31 and B32). High daily rations were needed because of the relatively high flow rates.

90. Cyprinodon variegatus suspended particulate tests were conducted as described for Menidia menidia above at a temperature of 19.3° to 20.1°C at a flow rate of 80 to 90 ml/min. During the first suspended particulate test the salinity ranged from 25 to 26 ppt, and during the second test, from 28 to 29 ppt (Tables B35 and B36).

91. Ammodytes americanus suspended particulate tests were conducted as described above for Menidia menidia, except 15 larvae were used per treatment and larvae lost or dead within 24 hr of the beginning of the test were replaced. During the two tests the temperature ranged from 8.2° to 11.6°C, the salinity from 28 to 30 ppt, and the flow rates from 89 to 90 ml/min (Tables B45 and B46). The larvae were 28 to 32 days old (obtained from NMFS, Narragansett) and were fed rotifers (Brachionus plicatilis) twice daily.

92. Pseudopleuronectes americanus suspended particulate tests were conducted as described for Menidia menidia, except that larvae lost or dead within 24 hr of the beginning of the test were replaced. The temperature in the exposure chambers containing no sediment in the suspended particulate tests varied from 8.2° to 10.2°C, the temperatures in the exposure chambers containing sediment were slightly higher (9.0° to 11.1°C in REF and 9.8° to 12.7°C in BRH). The flow rate varied from 85 to 95 ml/min in the first test, and from 80 to 90 ml/min in the second. In the first test (Table B51) the salinity varied from 26 to 29 ppt; in the second test (Table B52) the salinity was constant at 28 ppt.

PART V: RESULTS AND DISCUSSION

Chemical Characterization

Organic contaminants

93. Mussel analysis. Results of analyses of the 28-day exposed mussels by GC/MS are shown by the total ion current profiles of fractions PF-50 and F-2 in Figure 9. The richness of these two traces is in marked contrast to the traces shown in Figure 10 for the control mussels. Within the PF-50 fraction of the exposed mussels (Figure 9) there are large quantities of naturally occurring biogenic compounds which also show up in Figure 10a. The large humplike structure in Figure 9 is known as the Unresolved Complex Mixture which is frequently seen in association with petroleum contamination, and consists primarily of hydrocarbons of an aliphatic nature (Boehm and Quinn 1977; Stegeman and Teal 1973). The high resolution capillary column run of this fraction was examined for unknown organic compounds of a nonaliphatic structure. In addition to DDE and the PCB isomers containing from two to eight chlorine atoms, evidence was found which suggests that many unusual compounds exist in this fraction. However, even with the extreme resolution afforded by the 4°C/min runs on 30-m capillary columns, the coelution of many compounds effectively hinders the determination of a complete spectrum for any given compound. Although tentative identifications were not possible, the incomplete spectra could still be used as recognizable characteristics of the dredged material.

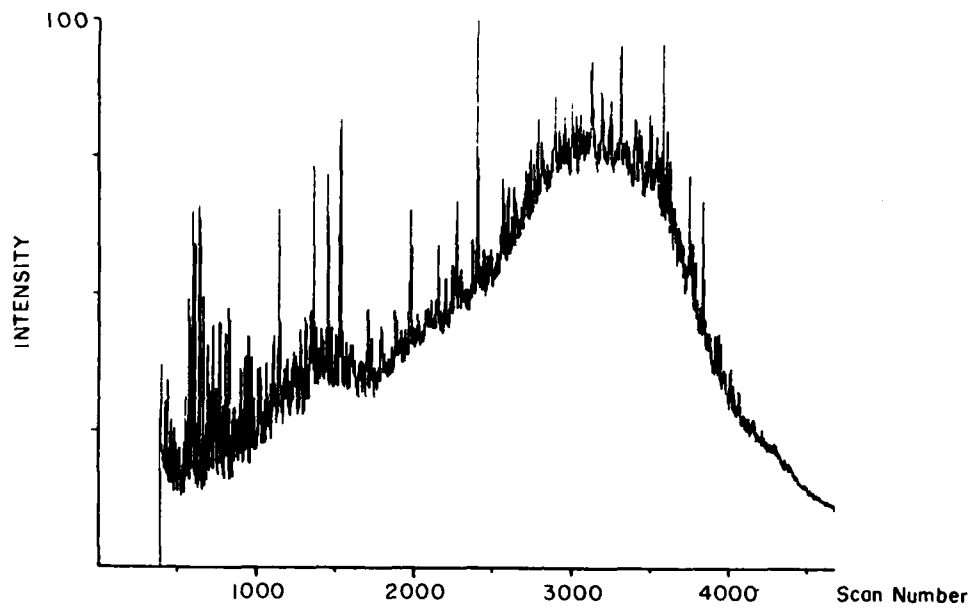

a. FRACTION PF-50

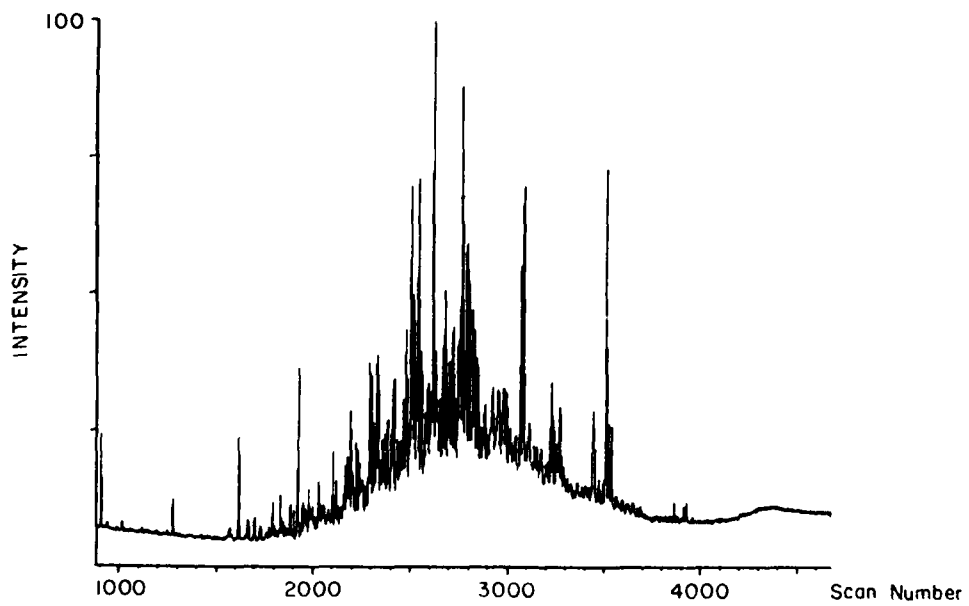

b. FRACTION F-2

Figure 9. Total ion current profiles of the 28-day exposed mussels analyzed by GC-MS with a 4°/min (50-330) temperature programming rate

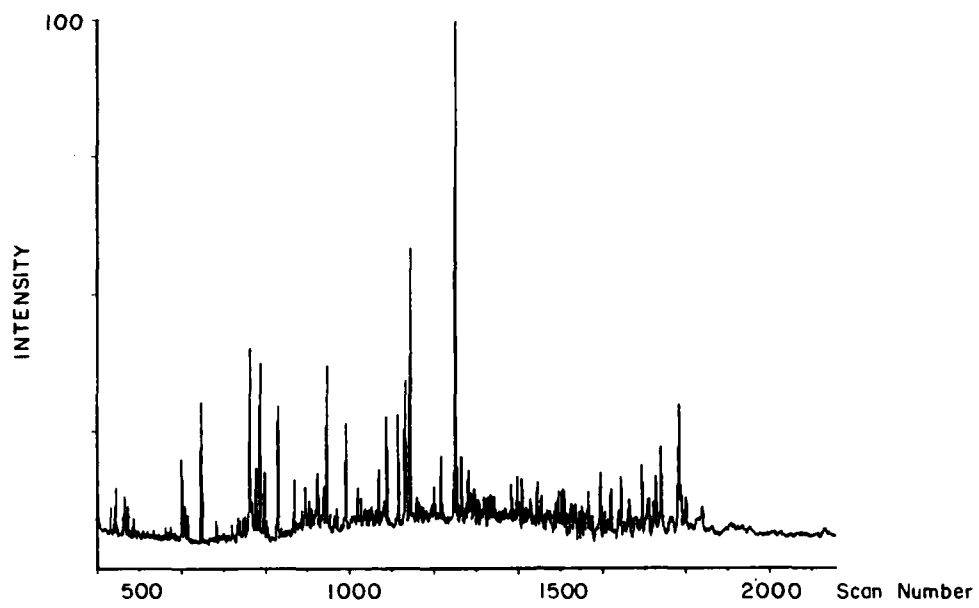

a. FRACTION PF-50

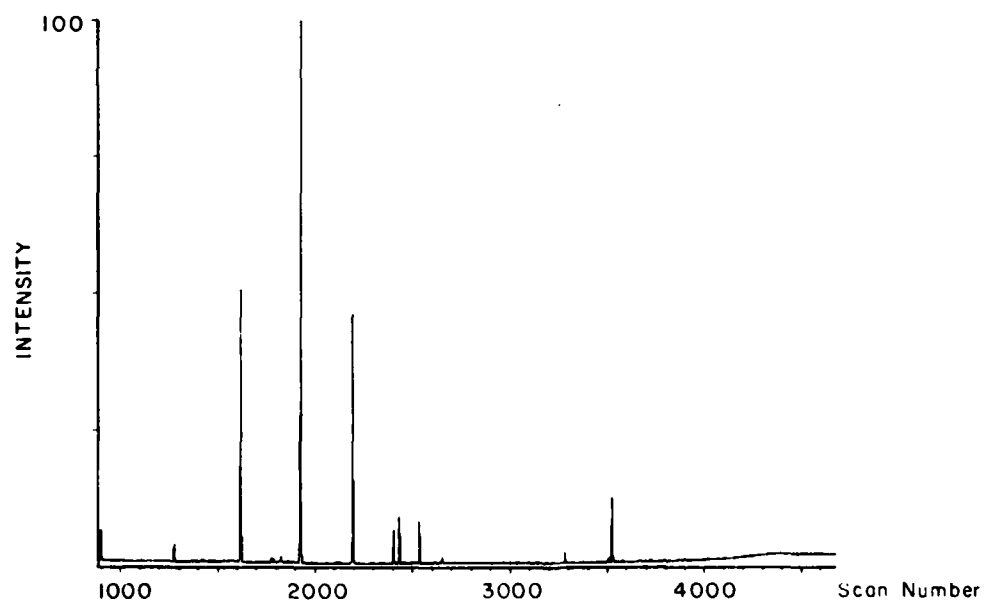

b. FRACTION F-2

Figure 10. Total ion current profiles of the 28-day control mussels analyzed by GC-MS with a 4°/min (50-330) temperature programming rate

94. PCB's were analyzed by both capillary column electron capture gas chromatography for the total quantity of material present measured as Aroclor 1254, and by GC/MS for their relative chlorine number distributions. Both results are shown in Table 4. The chlorine number distributions were calculated from uncorrected mass spectrometer molecular ion area measurements and so do not reflect differences in response factors for different PCB's.

Table 4
Single Replicate PCB Concentrations as Aroclor® 1254
in ng/g Dry Weight Including Chlorine
Number Distributions by Mass Spectrometry

<u>Sample</u>	<u>Total PCB ng/g</u>	<u>Cl_x PCB</u>						
		<u>di</u>	<u>tri</u>	<u>tetra</u>	<u>penta</u>	<u>hexa</u>	<u>hepta</u>	<u>octa</u>
Day 0	74	0	6	22	24	20	2	0
Day 28 Control	84	2	9	22	22	20	3	0
Day 7 Exposed	2000	37	390	740	520	290	30	1
Day 14 Exposed	1100	34	240	420	310	89	6	0
Day 28 Exposed	3000	58	600	960	890	420	67	0
BRH Sediment	6800	130	960	2500	1500	1500	130	3

95. Aromatic hydrocarbons form a class of compounds that are strongly accumulated by mussels from Black Rock Harbor sediment. This class can be divided into two groups: the parent polynuclear aromatic hydrocarbons, and their alkylated homologs. There has been no attempt made to quantitate each structural isomer of the parent aromatic hydrocarbons, or to identify the particular structural or positional isomer of their alkyl homologs. Rather, the alkyl homologs are identified as being associated with a particular molecular weight parent PAH which has been substituted with alkyl chains having a total of from 1 to 4 carbon atoms. These are referred to as C-1 to C-4 substituents, and could refer to any combination of methyl-, ethyl-, propyl-, or butyl-groups which might add up to the correct number of alkyl substituent carbons.

96. Table 5 lists the parent PAH's found in this study, along with their molecular weights. The molecular weights form a convenient short-hand notation for these compounds when referring to the parent compounds, and, with the addition of the C-1 and C-4 nomenclature mentioned above, their homologs as well. Also because of chromatographic overlap, alkyl homolog distributions (AHD's) of different PAH's having the same molecular weight cannot be separated except in the case of the two 154's. Thus, for consistency, all PAH's of a given molecular weight should be treated as a single measurement when being compared with alkyl homolog distributions.

97. Appendix Tables A1-A7 list the PAH concentrations and the concentrations of each alkyl homolog, including the variability associated with the three replicates measured on the mussel samples.

Table 5
Parent Polynuclear Aromatic Hydrocarbons Found in the Exposed Mussels
and Black Rock Harbor Sediment

<u>Compound</u>	<u>Molecular Weight</u>
Naphthalene	128
Biphenyl	154-Bi
Acenaphthene	154-An
Fluorene	166
Phenanthrene	
Anthracene	178
Pyrene	
Fluoranthene	202
Benz(a)anthracene	
Chrysene	228
Triphenylene	
Benzofluoranthenes	
Benzopyrenes	252
Perylene	
Benzoperylene	
Dibenzopyrene	276
and others	
Dibenzanthracenes	
Benzocrysenes	278
and others	
Coronene	
or similar	300
Dibenzocrysenes	
and others	302

Response factors for the alkyl homologs were assumed to be the same as the parent PAH. This leads to low but reproducible estimates of the homolog concentrations. Also, response factors for the 154's, 166, and those over 276 were estimated as described above. Tables 6 and 7 are summary tables of the aromatic hydrocarbon data; the average PAH concentration for each treatment is shown in Table 6, and the concentration of the sum of each alkyl homolog distribution from C-1 to C-4 is shown in Table 7.

98. The total ion current profile of the day 28 control mussels (Figure 10b) contains five peaks that have been tentatively identified as silicones. These identifications are based on library spectra matches and isotope ratio calculations for silicon. Spectra and retention time of authentic standards were not yet available to verify their identifications. However, the compounds have spectra similar to dodecamethylcyclohexasiloxane and decamethylcyclopentasiloxane. There were a series of five of these peaks which could be measured in most samples. Table 8 lists the results of these measurements, expressed as arbitrary area counts per gram of mussel (or sediment) dry weight. This allows measurements made between samples of different weight to be compared even though there were no standards available with which valid quantitations could be obtained. Although the exposed mussels seem to take up these siloxane compounds, the day 28 control samples had considerably more of them and the Black Rock Harbor sediment had no more than the analytical blank. Therefore, these contaminants seem to originate from the dosing system and not from the sediment.

Table 6
Mean Concentrations ± Standard Deviation of Parent PAH Compounds
found in Exposed and Control Mussels and in
Black Rock Harbor Sediment in ng/g Dry Weight

Compound	PAH Concentration, ng/g Dry Weight					Black Rock Harbor Sediment
	Day 0	Day 7	Day 14	Day 28	Day 28 Control	
128	0.8 +0.4	0.5 +0.1	1.1 +0.3	0.6 +0.3	0.5 +1.0	17
154Bi	1.3 +0.2	1.9 +0.6	2.9 +1.0	3.5 +2.1	5.3 +2.0	54
154AN	0.7 +0.4	3.6 +0.8	4.7 +1.2	3.8 +1.8	1.2 +0.2	120
166	1.4 +0.4	14 +1	8.3 +1.3	12 +3.7	1.2 +0.4	370
178	7.2 +1.6	220 +25	140 +21	180 +35	6.7 +1.5	2700
202	34 +8	2600 +460	1100 +160	2000 +470	19 +2.5	7100
228	8.5 +2.3	1800 +230	840 +160	1800 +360	3.1 +1.1	9800
252	15 +5	1300 +230	610 +100	1600 +210	5.8 +1.7	8600
276	3.3 +0.7	250 +67	120 +22	280 +50	1.6 +0.9	9100
278	<0.4	140 +26	68 +17	160 +20	<0.6	4400
300	<0.1	11 +2.8	2.9 +0.9	9.3 +0.8	<0.1	130
302	<0.3	66 +13	17 +5	56 +9	<0.1	2700

Table 7
Mean Concentrations ± Standard Deviation of the Sum of C-1 Through C-4 Alkyl Homologs of PAH's Found in Exposed and Control Mussels and in Black Rock Harbor Sediment Quantitated as Each Parent PAH

Compound	<u>Σ C-1 through C-4 Alkyl Homologs, ng/g Dry Weight</u>					Black Rock Harbor Sediment
	<u>Day 0</u>	<u>Day 7</u>	<u>Day 14</u>	<u>Day 28</u>	<u>Day 28 Control</u>	
128	8.6 +2.9	390 +120	270 +65	300 +100	16 +2.3	3400
154Bi	9.7 +2.2	710 +92	450 +150	720 +230	27 +3.5	2900
154AN	3.0 +1.0	300 +41	160 +15	280 +80	7.8 +0.8	1100
166	14 +3.4	1100 +130	540 +110	1100 +250	23 +4.8	3400
178	38 +6.7	5600 +990	2600 +500	5000 +1400	39 +7.1	13000
202	12 +1.9	3500 +650	1600 +290	3400 +690	7.7 +2.9	8300
228	5.9 +1.6	1500 +290	710 +150	1800 +290	1.3 +0.6	13000
252	<6	510 +100	220 +45	590 +79	<5	4800

99. The mass spectrometric data of the day 28 mussel F-2 fraction was also examined in detail for other compounds of interest which might be hidden by the high aromatic hydrocarbon content of the sample. The molecular weights of the aromatic hydrocarbons form a steadily increasing elution series as the temperature of the gas chromatograph is increased. The mass spectral data collected above the molecular weights of the currently eluting aromatics can be examined at high

Table 8
Distribution of Five Silicone-like Compounds in Exposed
 and Control Mussels and Black Rock Harbor Sediment Measured
 as GC/MS Area Counts/Gram Dry Weight

GC/MS Scan Number	Response of Silicone-like Peaks Per Gram Dry Weight					
	Day 0	Day 7	Day 14	Day 28	Day 28 Control	Sediment
1277	7200 +3300	17,000 +1500	18,000 +2500	23,000 +5900	28,000 +2600	1800
1619	6200 +500	39,000 +2100	15,000 +3200	48,000 +17,000	550,000 +120,000	1500
1927	28,000 +1000	79,000 +6700	12,000 +1700	86,000 +39,000	1140,000 +150,000	480
2194	10,000 +800	41,000 +4400	5400 +560	45,000 +21,000	412,000 +73,000	480
2432	5700 +5500	9900 +1000	2100 +210	10,000 +4100	53,000 +13,000	330

sensitivity for the presence of anomalously heavy compounds. Many of these compounds tend to be chlorinated organics because of the increased weight of the chlorine substituents. Several members of the DDT series were identified in this manner as was a compound tentatively identified as Ethylan, another chlorinated insecticide. In addition to these identified compounds, this technique extracted the spectra of numerous other contaminants which have yet to be identified, many of which may contain oxygen. Although not yet identified, these spectra and retention times can serve as identification labels or fingerprints for the same compounds in further laboratory or field studies.

100. Sediment analysis. The Black Rock Harbor sediment material has been analyzed for the same contaminants as described for the mussels, with the exception of the anomalously heavy F-2 components. Figure 11 shows the sediment total ion current profiles for the PF-50 and F-2 fractions. Although the PF-50 fractions show some qualitative differences compared to the day 28 exposed mussel PF-50 fraction in Figure 9, the F-2 fraction is very similar to the exposed mussel F-2 shown in Figure 10. PCB's in the sediment were measured both by capillary column electron capture gas chromatography and by mass spectrometry. The gas chromatographic measurements were quantitated against Aroclor® 1254, while the mass spectrometry measurements were for chlorine number distributions. Both measurements are reported in Table 4 along with the mussel results.

101. The same polynuclear aromatic hydrocarbon measurements were made for the sediment as for the mussels. The alkyl homolog distributions in Black Rock Harbor sediment for each of the PAH's from 128 to 302 are shown with those of the mussels in Appendix A. Tables A1-A7 contain the tabulated concentrations of each PAH and each alkyl homolog concentration from C-1 through C-4. Sediment concentrations are summarized in Table 9.

102. Accumulation. The results of the sediment characterization mussel bioaccumulation study show that both PCB's and aromatic hydrocarbons were accumulated from Black Rock Harbor sediment in as little as 7 days. Total PCB's, measured by capillary column gas chromatography using electron capture and quantitating against Aroclor® 1254, show a large increase in the exposed mussels over the levels in both the

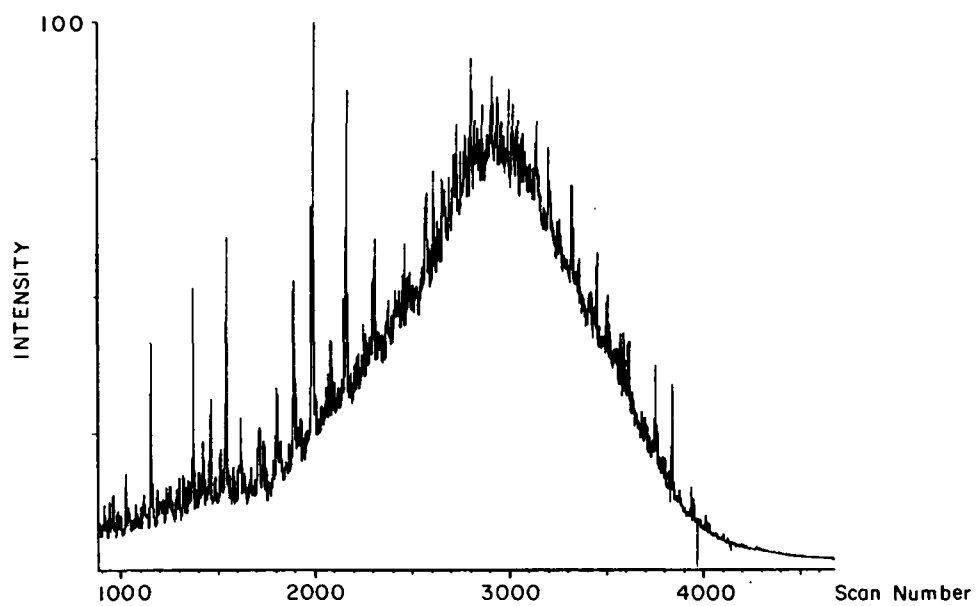

a. FRACTION PF-50

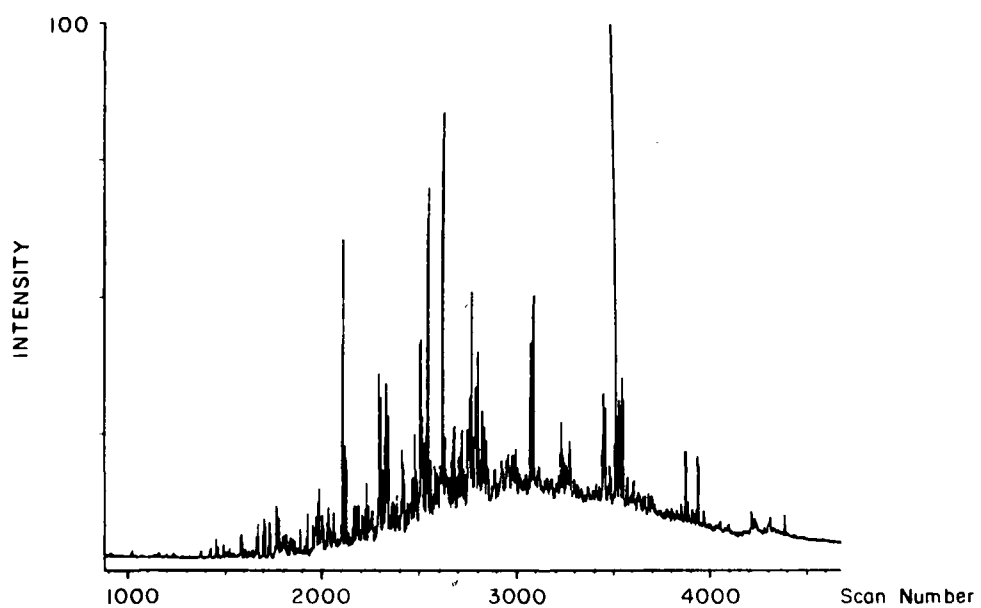

b. FRACTION F-2

Figure 11. Total ion current profiles of the Black Rock Harbor FVP sediment analyzed by GC-MS with a $4^{\circ}/\text{min}$ (50-330) temperature programming rate

Table 9
Organic Contaminants in Black Rock Harbor Sediment, ng/g Dry Weight,
One Replicate

<u>Compound</u>	<u>Concentration</u>	
	<u>PAH</u>	<u>AHD</u>
128	17	3400
154 Bi	54	2900
154 An	120	1100
166	370	3400
178	2700	13000
202	7100	8300
228	9800	13000
252	8600	4800
276	9100	-
278	4400	-
300	130	-
302	2700	-
PCB's	6800	

pre-exposed and the day 28 controls, as shown in Table 4. Both controls remained quite constant at about 80 ng/g dry weight, while the three exposure period samples showed uptake to between 1100 and 3000 ng/g dry weight. There is an increase in the PCB levels as the exposure time increases, although the value at day 14 is anomalously low for unknown reasons. By the end of the 28-day uptake period, the mussels had accumulated PCB's to a level approaching half of that in the sediment, while at day 7 they had accumulated levels that were almost one third that of the sediment. Both sampling periods demonstrate a sizable uptake of PCB's and indicate the clear biological availability of this contaminant.

103. Table 4 also shows the distribution of PCB isomers into the various chlorine number groups from two chlorine atoms per molecule to eight chlorine atoms per molecule. The lower chlorine number groups correspond to PCB compounds having relatively low log P (octanol-water partition coefficient) values, while the higher chlorine number groups have relatively higher log P values. The two control samples, day 0 and day 28 control, are similar in the amount and pattern of their PCB distributions, although there are some minor differences at chlorine numbers 4, 5, and 6. These similarities are consistent with lower Narragansett Bay mussels being held in a control tank with filtered lower Narragansett Bay water flowing through.

104. The three exposure times also show remarkably similar PCB patterns. The day 28 exposed sample shows slightly elevated levels of Cl-5 and Cl-6 PCB's, but these differences are quite small. A comparison of the PCB patterns of the three exposed samples with that of the Black Rock Harbor sediment in Table 4 reveals that there are no large pattern changes even between the sediment and the exposed mussels. The mussels may have accumulated slightly more of the Cl-3 PCB's than were present in the sediment, and they might have accumulated slightly less of the Cl-6 PCB's than were in the sediment.

105. Aromatic hydrocarbons form the second class of chemical contaminants which are strongly accumulated by mussels exposed to Black Rock Harbor sediment. Tables 6 and 7 summarize the data for the concentrations of both parent PAH and for the sum of the alkyl homolog series from C-1 to C-4. The amount of parent PAH's taken up by the exposed organisms compared with that in the sediment and the control

organisms is shown in Figure 12, while the amount of the summed alkyl homologs is shown in Figure 13 for the same samples. The biological availability of aromatic hydrocarbons in the sediment is dramatic. The concentration of the most intense PAH's, 202 to 252, shows an increase of a factor of about 100 over control concentrations. In contrast to these dramatic uptakes after only a week of exposure, the levels do not markedly increase over the subsequent 21 days. As with the PCB's, the 14-day sample is anomalously low.

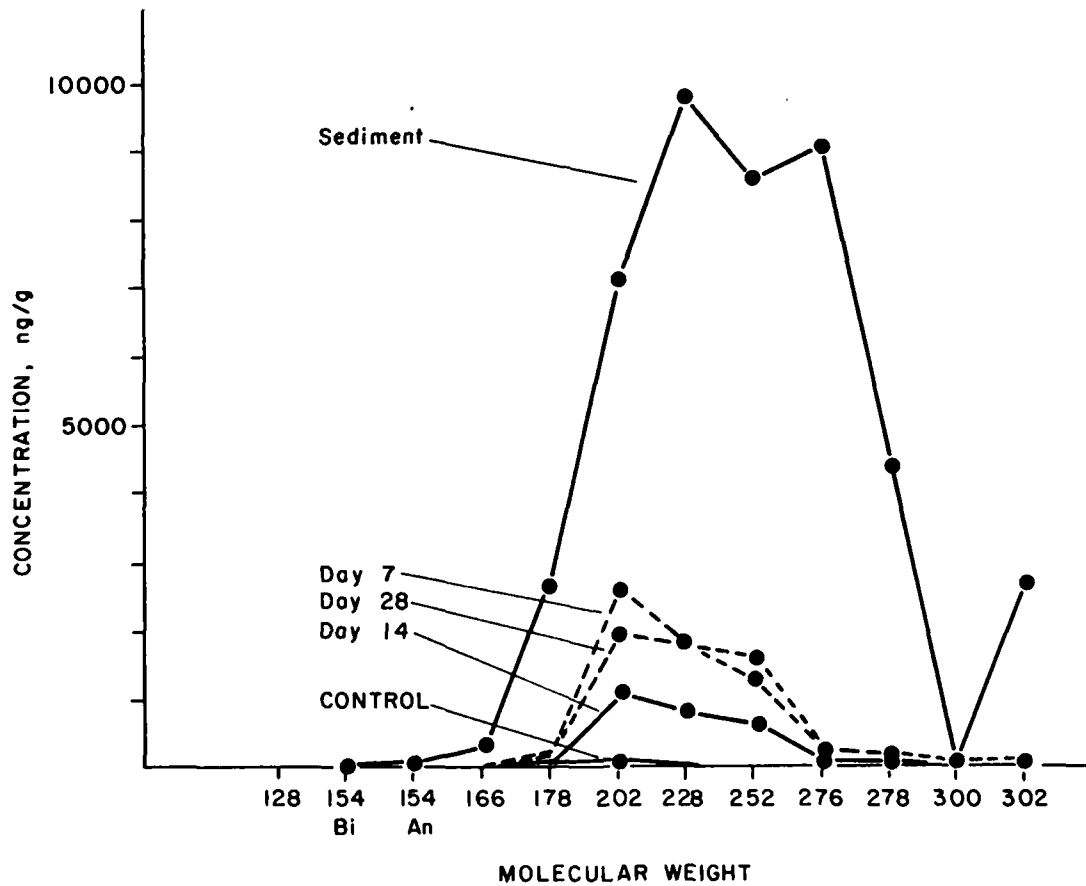

Figure 12. Concentration of PAH compounds in Black Rock Harbor sediment and exposed and control mussels

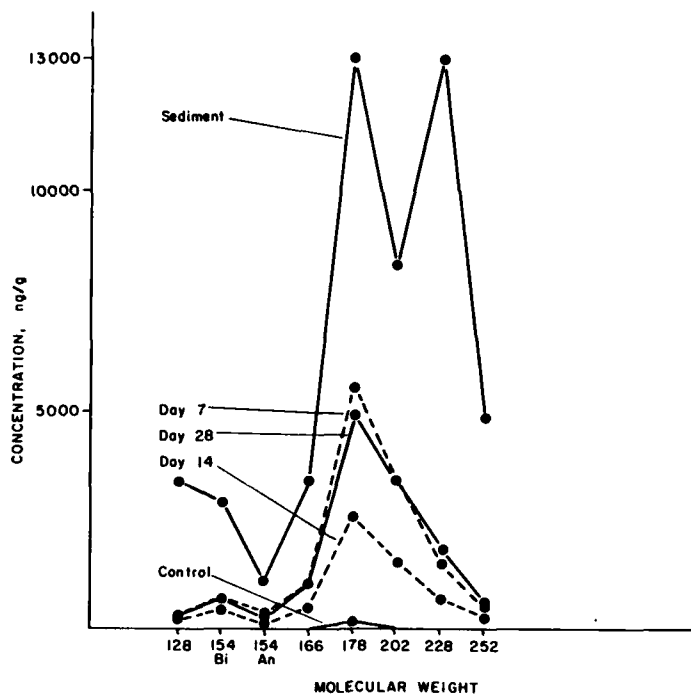

Figure 13. Concentration of sum of C-1 through C-4 alkyl homologs of PAH's measured in Black Rock Harbor sediment and control and exposed mussels

106. In contrast to the PCB patterns, which showed similar uptake for each isomer, the PAH patterns are quite variable. The maximum uptake is near PAH 202, where the mussels' levels are approximately one third of the sediment levels. However, for early PAH's from 128 to 166, mussel uptake levels are only about 5% of the sediment levels and, for PAH's above 252, the uptake may be even smaller than 5%. If one can assume that the PAH's are all in a form equally biologically available, which has not yet been shown, then it follows that the mussels are selecting a particular fraction of the PAH's for uptake which is not based on log P since the octanol-water partitioning coefficient for PAH's continues to increase as molecular weight increases.

107. Table 7 shows approximately the same pattern for the summed alkyl homologs as for the PAH's. The lighter PAH homologs are present in the mussels at levels around 10% of the levels in the sediment, while the homologs of the most concentrated PAH's, 178 and 202, are present in the mussels at levels nearly one third those of the sediment. Again, the heavier PAH homolog ratios decrease to about 10% of the sediment values. The homologs of PAH's above 252 were hardly detectable in the mussels at all. Therefore, the mussels are selecting a similar fraction of the alkyl homologs as they did for the PAH's. Assuming equal availability, this again is not consistent with a strict log P uptake model.

Inorganic contaminants

108. Mussels. Due to the limited sample size (approximately 2 g of homogenized wet weight of tissue), only Fe and Zn could be determined by conventional flame atomic absorption. All other elements (i.e., Mn, Cu, Pb, Cd, Cr, and As) were determined by heated graphite atomization. The amount of sample available to do the mercury analysis by the cold vapor technique was inadequate to detect low concentrations of mercury. Nickel could not be reliably determined on this limited sample size even with HGA-AA. The average and the standard deviation of the average for each set of mussel samples collected from the control and exposure chambers are given in Table 10. All of the individual elemental concentrations determined for the mussel samples are given in Table A10. The average method blank for the mussel samples is also given in Table A10. The average method blank was

calculated by dividing the average absolute μg value for each element by the average homogenized mussel dry weight. All elements (except Cu) determined in the blanks were below the detection limits of the analysis methodology employed in this study. The percent recovery of metal spikes added to the mussel samples prior to analysis are given in Table A11. The percent spike recovery for all elements determined in the mussel samples was greater than 80% and less than 110%.

Table 10
Distribution of Trace Elements in $\mu\text{g/g}$ Dry Weight in Exposed and Control Mussels

Element	Trace Metal Concentration, $\mu\text{g/g}$ Dry Weight				
	Day 0	Day 7	Day 14	Day 28	Day 28 Control
Fe	199	357	330	500	213
SD	± 26	± 41	± 6	± 191	± 7
Mn	11	12	31	11	13
SD	± 0.7	± 3	± 10	± 4.9	± 7
Zn	149	286	160	333	221
SD	± 76	± 58	± 18	± 84	± 63
Cu	25	62	75	55	17
SD	± 23	± 23	± 7	± 18	± 5
Pb	4.7	11	8.5	14	6.5
SD	± 0.1	± 1.5	± 0.9	± 4.7	± 2.6
Cd	2.7	4.7	3.1	7.0	2.8
SD	± 0.3	± 0.7	± 0.5	± 1.9	± 0.5
Cr	2.3	15	12	25	2.0
SD	± 0.3	± 1.6	± 1.3	± 11	± 0.5
As	8.2	8.6	7.3	8.9	7.4
SD	± 0.6	± 1.0	± 0.4	± 1.1	± 1.0

109. Sediments. The inorganic chemical composition for the two barrels (#00 and #LL) of Black Rock Harbor sediment is given in Table 11. The average, standard deviation of the average, and the percent standard deviation of the average are given. The wet to dry weight ratio is also given for the two barrels of sediment. All of the data used to calculate these averages are given in Tables A8 and A9 for Barrel #00 and Barrel #LL, respectively. The metal concentrations for the two blank samples for each barrel are also given in Tables A8 and A9. The blank metal concentrations are given in units of $\mu\text{g/g}$ to easily show the large difference between the samples and the blanks. The average dry weight values calculated for the two sets of barrel samples were used to convert the absolute μg values to $\mu\text{g/g}$ concentrations for an easy comparison to the samples. No values for As are listed in this table since a chemical interference was detected during the analysis (for both HGA-AA and MHS-1 hydride generation techniques) of these sediment samples. At this time the cause of the chemical interference for the As determinations for BRH sediment samples is under investigation. The overall results indicate that the BRH barrel samples are reasonably homogeneous between barrels if reasonable precautions are taken to remix each barrel before being sampled. What appear to be small differences between Fe and Mn for the barrels are probably due to the two different preparation techniques that were used to dissolve the metals that were determined. The #00 samples were dissolved in hot concentrated nitric acid while the #LL samples were simply eluted with 5% nitric acid at room temperature. The similarity of the results indicates that the metals reported here are

Table 11
Average Metal Concentrations in Black Rock Harbor Barrel #00 and
 Barrel #LL Sediment Samples*

<u>Element</u>	<u>Barrel #00</u>	<u>Barrel #LL</u>
Fe	29,600	29,600
SD	809	623
%SD	2	2
Mn	359	280
SD	37	5
%SD	10	1
Zn	1200	1210
SD	59	50
%SD	4	4
Cu	2380	2540
SD	112	64
%SD	4	2
Pb	378	413
SD	16	18
%SD	4	4
Cd	23.4	24.7
SD	0.9	0.7
%SD	3.7	2.9
Cr	1430	1300
SD	77	30
%SD	5	2
Ni	139	169
SD	4	5
%SD	3	3
Hg	1.7	-
SD	0.1	-
%SD	4.0	-
wet/dry	3.22	3.03
SD	.02	0.17
%SD	1	5.6

* All concentrations are in µg/g dry weight. The standard deviation and percent standard deviation are also given.

probably all present as sulfides or some other easily solubilized anion. Manganese has a difference of about 30% for the two barrels of sediment. This difference is undoubtedly related to the two preparation techniques prior to analysis. It should be pointed out that the two preparation techniques were used simply to ascertain the magnitude of differences that would be obtained by the two acid extraction methods.

110. Accumulation. Statistically (Student-t test, $P < 0.05$) there is no difference between the mean time zero mussel control samples and the mean 28-day mussel control samples. There is no significant difference between the mean Mn, Zn, and As in the control and exposed samples for the 28th day sampling period ($P < 0.05$). However, there is a significant difference between the means for the 28-day control mussel samples and the 28-day exposed mussel samples for all of the other elements determined. The elemental ratios (calculated from the data in Table A11) of the 28-day exposure mussel samples and the 28-day control mussel samples show that a significant uptake of several of the trace elements had occurred in the mussel test organism. These data are presented in Table 12. The elemental ratios of the 28-day control mussels and the day 0 control mussel samples are also given in this table. Any elemental ratio that approximates 1 (taking the standard deviation into account) indicates no significant uptake or change in content for that element in the test organism. Essentially, all the control sample ratios are not different from 1, if the standard deviation is taken into account. For the day 28 dosed samples, however, only Mn and As have a ratio of approximately 1. The most obvious uptake of any of the metal ratios listed in Table 12 is Cr. The ratio

of uptake (exposed/control) for this element is approximately 13. There is no indication that equilibrium has been obtained for Cr during this bioaccumulation period of 28 days. The control samples, however, show no change for Cr content during the same time period. All other metals determined in the mussel samples tend to indicate minor amounts of uptake.

Table 12
Ratios of Trace Metal Accumulations in Exposed and Control Mussels

<u>Element</u>	<u>28-day control ± SD</u> <u>0-day control</u>	<u>28 day exposed ± SD</u> <u>28 day control</u>
Fe	1.1 ± 0.1	2.4 ± 0.9
Mn	1.2 ± 0.7	0.9 ± 0.6
Zn	1.5 ± 0.9	1.5 ± 0.6
Cu	0.7 ± 0.6	3.2 ± 1.4
Pb	1.4 ± 0.6	2.1 ± 1.1
Cd	1.0 ± 0.2	2.5 ± 0.8
Cr	0.9 ± 0.2	12.8 ± 6.4
As	0.9 ± 0.1	1.2 ± 0.2

111. To determine if any relationships exist between any of the metals determined for the homogenized mussel samples, linear least square regression equations were calculated for all metals versus the Fe concentration for each sample. In the regression line calculations, Fe was used as the dependent variable and the other metals were made

the independent variable. The plots are shown in Figures 14 through 20. The number of sample pairs (i.e., mussel concentrations of x and y) must be considered in order to evaluate the significance of the calculated correlation coefficient. In addition, the probability (P), which indicates the possibility of a correlation coefficient being significant due to random sampling from an uncorrelated population, should also be considered. Values of P of 0.10 and 0.01 indicate the possibility that 10% and 1%, respectively, of the time, a significant correlation of x to y may occur due to random errors. All the correlation coefficients used in the following discussion are based on P values of 0.01 (i.e., 99% probability that a real correlation exists between x and y). For example, 15 data pairs require a correlation coefficient greater than 0.641 to be at the 1% level of significance (Fisher 1958). The x intercept of the regression line indicates how much of the mean Fe mussel concentration of the dependent variable (x) is not associated with the mean independent variable (y). The slope of the line is in effect the relative mussel concentration of Fe associated with the total of the other metals determined. All of the data for all the samples are plotted in these figures. The open circles represent samples collected from the BRH exposure chamber and the solid circles represent mussel samples collected from the control chamber.

112. At the 1% level of significance Cr, Pb, and Cd have a good correlation with Fe. The correlation coefficients for Fe versus Cr, Pb, and Cd are 0.978, 0.940, and 0.860, respectively. The linear least squares regression plots for Fe versus Cr, Pb, and Cd are given in Figures 14, 15, and 16. Qualitatively these three figures show the

relative increase of Cr, Pb, Cd, and Fe in BRH sediment-exposed mussels compared to these same metals in control mussel samples. The equations for these regression lines are given below:

$$[\text{Fe}] = 167 + 13.5 [\text{Cr}]$$

$$[\text{Fe}] = 32.5 + 32.3 [\text{Pb}]$$

$$[\text{Fe}] = 67.3 + 62.5 [\text{Cd}]$$

The predictive utility of the above regression equations are not certain at this time. However, it would be interesting to apply these equations to metal concentrations determined in mussel samples collected from Long Island Sound which are exposed to BRH sediment.

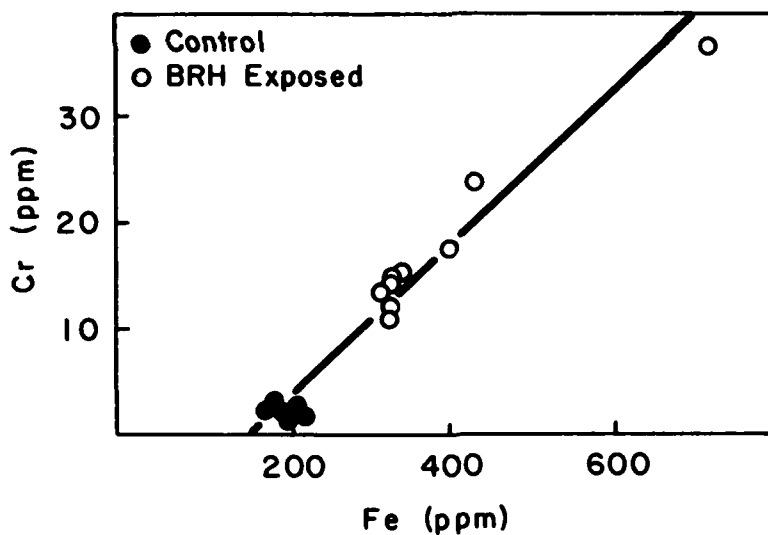

Figure 14. Distribution of Cr versus Fe in mussels from the Black Rock exposure

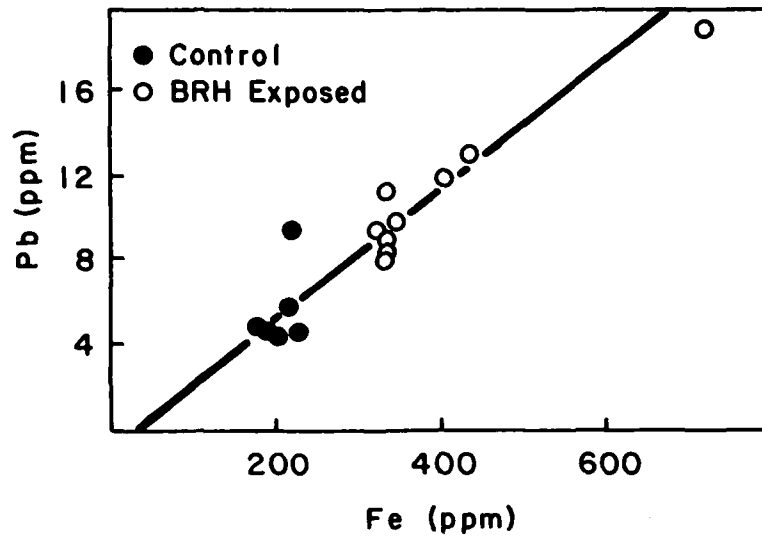

Figure 15. Distribution of Pb versus Fe in mussels from the Black Rock exposure

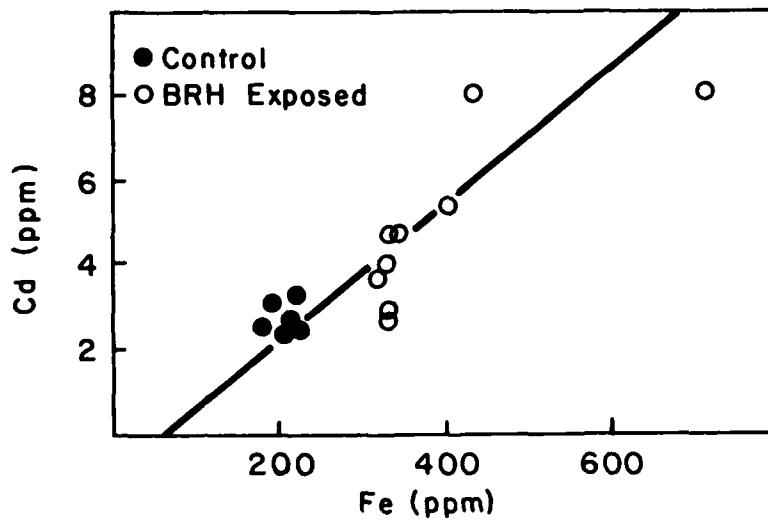

Figure 16. Distribution of Cd versus Fe in mussels from the Black Rock Harbor exposure

113. The correlation coefficients for Zn and Cu with Fe are close to the correlation coefficient required for a P value of 0.01. The correlation coefficients for Fe versus Zn and Cu are 0.710 and 0.628, respectively. The regression plots for these elements are shown in Figures 17 and 18. From Figure 17 it can be seen that there is almost no increase for the Zn concentration determined in mussels collected from the exposure chamber versus the control chamber. The linear least squares regression equations for these plots are given below:

$$[\text{Fe}] = 76.7 + 1.06 [\text{Zn}]$$

$$[\text{Fe}] = 171 + 3.16 [\text{Cu}]$$

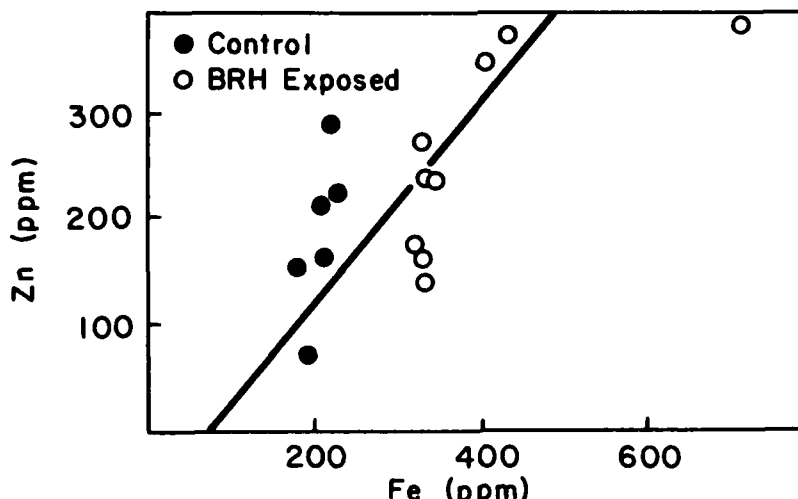

Figure 17. Distribution of Zn versus Fe in mussels from the Black Rock Harbor exposure

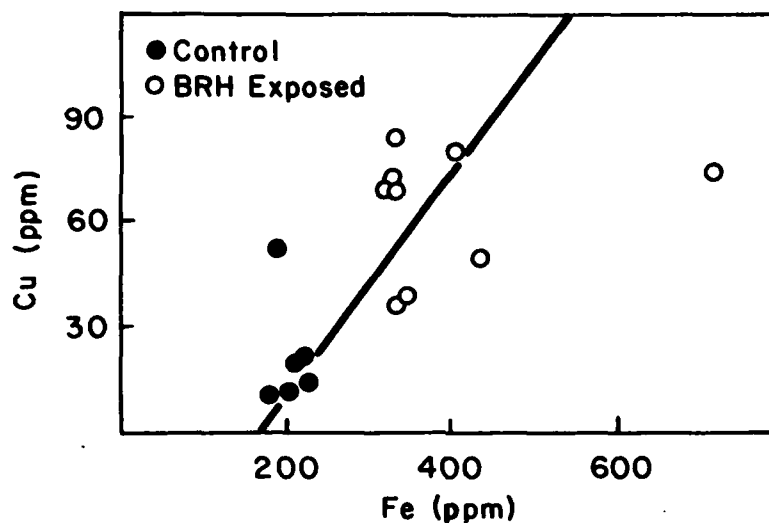

Figure 18. Distribution of Cu versus Fe in mussels from the Black Rock Harbor exposure

114. Both As and Mn have correlation coefficients that are below the required value for a correlation at a P value of 0.01. The correlation coefficients for As and Mn versus Fe are 0.589 and 0.132, respectively. The regression plots for these elements are shown in Figures 19 and 20. The plots of Mn and As versus Fe demonstrate that these two elements are of little value for showing BRH sediment uptake in mussel test organisms. The linear least squares regression equations for these plots are given below:

$$[\text{Fe}] = -349 + 82.8 [\text{As}]$$

$$[\text{Fe}] = 290 + 1.89 [\text{Mn}]$$

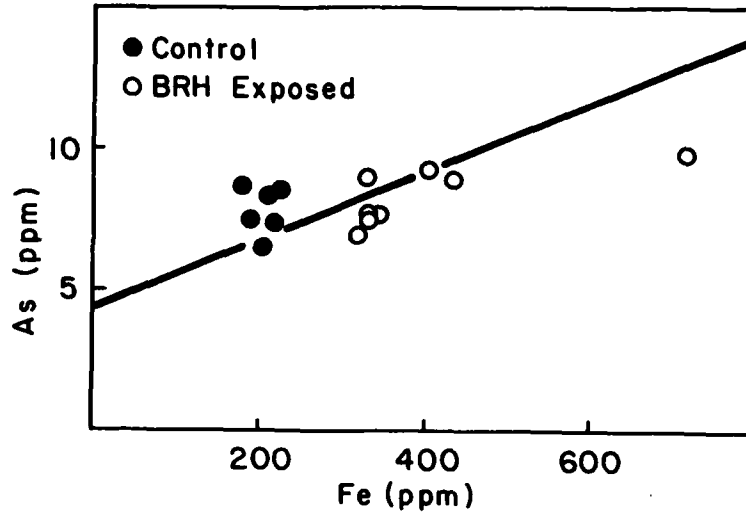

Figure 19. Distribution of As versus Fe in mussels from the Black Rock Harbor exposure

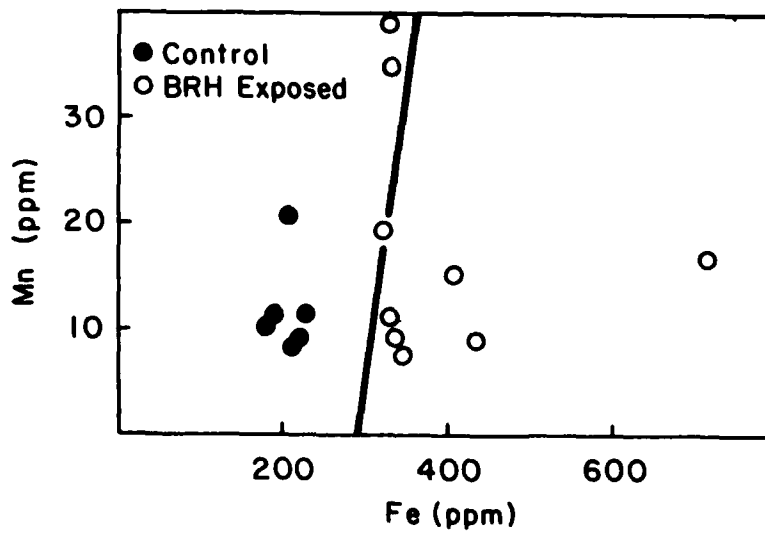

Figure 20. Distribution of Mn versus Fe in mussels from the Black Rock Harbor exposure

115. Several of the elements showed an increase in concentration in the first 7 days of the uptake period. Like the uptake of the organic compounds determined in this study, the day 14 samples appeared to resemble a period of depuration for several of the elements measured. A notable exception was Mn, which showed its highest concentration during the day 14 sampling period. No explanation is easily formulated for either this observed depuration for most of the metals determined or the erratic uptake behaviour of Mn during this sampling date.

116. The fact that several of the elements have shown that an uptake plateau was not reached during the study indicates that a longer time period may be warranted to study the bioaccumulation of metals in this marine organism. A longer time period can have two beneficial factors. First, the amount of an element may increase in the test organism to a level where it may be possible to determine interelemental ratios after subtracting control organism concentrations for the elements in question. With the present data, the day 28 exposed organism concentrations are too close to the control sample data to make reliable subtractions in all cases except for Cr. Second, a longer uptake period would give a better evaluation of a long-term effect on the organism.

Biological Characterization

Solid phase tests

117. Nephtys incisa. In three solid phase tests with N. incisa there were no mortalities due to Black Rock Harbor (BRH) sediment in 10 days (Tables 13, B1-B3). No worms were seen out of their burrows on the sediment surface in any treatment. There was a slight difference in the burrow depth in the different treatments. The depth of the burrows decreased as the percentage of BRH sediment increased. For example, in one experiment (Table B1) the deepest burrow was 1.8 cm in the 25% BRH treatment but only 0.6 cm in the 100% BRH treatment, and the estimated average burrow depths in those treatments were 1.2 and 0.4 cm, respectively. The difference in the burrowing depth in the sediment indicates that the worms are behaving somewhat differently in the BRH sediment than in the REF sediment, but this parameter is not particularly useful in short-term sediment characterization tests because we do not know what a difference in burrow depth means. At best it can be used as a signal to indicate that there may be some effect in these treatments in longer term experiments.

118. Neanthes arenaceodentata. In three solid phase tests with N. arenaceodentata (two with adult males and one with juveniles) there were no mortalities due to the BRH sediments (Table 13). Control mortality was 0% in both tests with adults and 5% in the one test with juveniles (Tables B6-B8). In the tests with adults, one worm from the 100% BRH and one from the 75% BRH treatments came to the surface of the sediment on day 3 and remained there for the rest of the test.

AD-A164 865

CHEMICAL AND BIOLOGICAL CHARACTERIZATION OF BLACK ROCK
HARBOR DREDGED MATERIAL(U) ARMY ENGINEER WATERWAYS
EXPERIMENT STATION VICKSBURG MS ENVIR..

213

UNCLASSIFIED

P F ROGERSON ET AL. SEP 85 WES/TR/D-85-9

F/G 6/6

NL

								END						
								FILED						
								14						
								176						

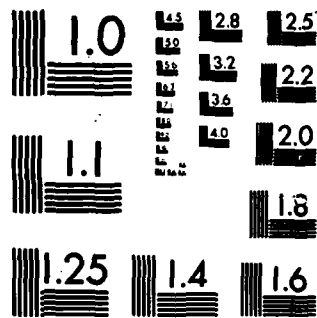

MICROCOPY RESOLUTION TEST CHART
NATIONAL BUREAU OF STANDARDS-1963-A

Table 13
Toxicity of Solid Phase Black Rock Harbor (Connecticut) Dredged Material
to 11 Species of Marine Invertebrates and Fishes

<u>Species</u>	<u>Test Duration</u> <u>days</u>	<u>LC50*</u> <u>or</u> <u>NOEC**</u>	<u>Behavioral or</u> <u>Other Effects</u>
<u>Annelids</u>			
<u>Nephtys</u> <u>incisa</u>	10	NOEC = 100% BRH	Indication of decrease in burrow depth with BRH mat
<u>Neanthes</u> <u>arenaceodentata</u>	10	NOEC = 100% BRH	none
<u>Molluscs</u>			
<u>Yoldia limatula</u>	10	NOEC = 66% BRH	Burrowing impaired at 50% BRH. No feeding at any BRH mixture
<u>Mulinia lateralis</u>	10	NOEC = 100% BRH	none
<u>Arthropods</u>			
<u>Mysidopsis bahia</u>	4	NOEC = 100% BRH	none
<u>Ampelisca abdita</u>	4	LC50 = 27.2 and 29.8%	Tube building impaired in all BRH conc including 12.5%
<u>Fishes</u>			
<u>Menidia menidia</u>	4	NOEC = 100% BRH	none
<u>Cyprinodon variegatus</u>	4	NOEC = 100% BRH	none
<u>Ammodytes americanus</u>	4	NOEC = 100% BRH	none
	embryo	4	Inconclusive
	larvae	4	not definitive
	4	4	Inconclusive
<u>Paralichthys</u> <u>dentatus</u>	4	NOEC = 100% BRH	none
<u>Pseudopleuronectes</u> <u>americanus</u>	4	inconclusive	-

*LC50 = concentration lethal to an estimated 50% of the test organisms.

**NOEC = no observed effect concentration; effect noted is mortality.

These two worms appeared normal otherwise. None of the juveniles appeared on the surface of the sediment except to search for food. Because control mortality was 0% in both types of test chambers (individual cups and crystallizing dishes), adult N. arenaceodentata do not have to be exposed in individual cups, if they are given enough sediment and are not crowded even though these worms are cannibalistic. Future tests with N. arenaceodentata will be conducted in the crystallizing dishes.

119. Yoldia limatula. In a preliminary test, Y. limatula were exposed to 25 and 50% BRH sediment and experienced no significant mortality over a 10-day period (Table 13). However, the ability to burrow into these sediments was impaired (Table 14). These results indicated that a true 10-day exposure was not produced, so a second solid phase test was conducted in which, after day 2, the Yoldia in all treatments were gently pushed into the sediment, the posterior end down. The animals then burrowed deeper into the sediment. The concentrations of BRH sediment and percent mortalities for this test were as follows: 0% BRH, 0% mortality; 33% BRH, 2.5% mortality; 66% BRH, 7.5% mortality; and 100% BRH, 35% mortality (Table B11). Even though exposure times for the two tests are not comparable, neither produced significant mortalities at or below 66% BRH. The 35% mortality at 100% BRH was statistically significant (Chi-square, $P < 0.05$).

Table 14
 Percent of Yoldia not Burrowed into Sediment Over Time for
 Solid Phase Test No. 1 and Suspended Phase Test No. 1

Treatment	Day 1	Percent Not Burrowed										Day 10 Number Dead/ Number Exposed	
		2	3	4	5	6	7	8	9	10			
Solid Phase 1													
Reference	1.6	0	0	0	0	0	0	0	0	0	0	0	0/61
25% BRH	45	36.7	26.7	15	11.7	10	13.3	6.7	5	5	5	5	0/60
50% BRH	63.3	51.7	41.7	33.3	23.3	18.3	15	13.3	11.7	8.3	8.3	8.3	1/60
Suspended 1													
REF Susp/REF Solid	7.5	0	0	0	0	0	0	0	0	0	0	0	0/40
REF Susp/50% BRH	35	10	10	5	0	5	0	2.5	0	0	0	0	3/40
BRH Susp/REF	55	22.5	17.5	12.5	0	0	0	0	0	0	0	0	0/40
BRH Susp/50% BRH	72.5	40	25	20	10	7.5	5	5	2.5	2.5	2.5	2.5	1/40

120. In addition to the effects on burrowing, the BRH sediment inhibited Yoldia feeding. This bivalve is a subsurface deposit feeder which expels unused sediment and feces at the sediment-water interface, creating a mound of sediment on the surface. These mounds were very apparent in all control (REF) treatments. In all solid phase BRH exposures, no feeding mounds were seen. Consequently, long-term exposure may be expected to produce effects on the growth potential of this bivalve.

121. Mulinia lateralis. There were no lethal or behavioral effects of BRH sediment on M. lateralis (Tables 13, B13, and B14).

122. Mysidopsis bahia. The arthropod M. bahia showed no acute effects following a 96-hr exposure to 100% BRH or REF sediment. The first test, using exposure cups with screen sides, was monitored daily for mortality by removing and replacing each cup. This process stirred up the sediment and created a heavy suspension of particles which made it very difficult to see the test organisms and also created a suspended particulate as well as a solid phase test. Although an LC50 for this test could not be calculated, there was an apparent dose-related response (Table B16).

123. In order to expose the test species to the solid phase only, the second and third tests were not checked until day 4. The cups, therefore, remained undisturbed and no particulate matter was suspended. There was no 96-hr LC50 with either of these tests and no dose-related response (Tables 13 and B16-B18).

124. Dissolved oxygen in these tests was not affected by the sediment, and temperature and salinity were within acceptable limits (Tables 2 and B16-B18).

125. Ampelisca abdita. Table 15 shows 96-hr mortality as a result of exposures to BRH sediments ranging from 50 to 12.5% mixtures, with both local (from the Narrow River, R.I. (NR), local collection site) sediment and REF sediment as controls. Bioassay methods using Ampelisca require use of a local sediment for control treatments. These tests, for each population, are shown in Table 15 for comparison with the REF sediment. The Long Island (LI) Ampelisca are more sensitive to BRH mixed with local Long Island Sound sediment, than with REF sediment. The NR Ampelisca experienced no differences in BRH-induced mortality when exposed to either REF or NR control sediments from either REF or NR. There was 100% mortality for Narrow River amphipods to 100% BRH sediment in these and all other preliminary tests. There was some variability in the quantitative dose response for the six tests. In all cases, however, 25% BRH produced statistically significant mortalities (chi-square, $P < 0.05$). The ability to build tubes was impaired at all BRH exposures and histological analysis showed tissue damage in the tube-building glands (P.P. Yevich, ERL-N, Personal Communication).

Table 15
Summary of Response Percent Mortality of Ampelisca abdita after 96-hr Exposure in
Solid Phase Tests with Black Rock Harbor Sediment *

Popula- tion	Mean size mm	N per conc.	Control Sediment	Test #	Percent Black Rock Harbor Sediment			LC50 % BRH
					50%	25%	12.5%	
LI	6.51	40	REF	1	33.0	25.0	7.5	
LI	4.84	40	LI	2	74.8	56.1	10.9	
NR	5.53	30	REF	3	83.3	63.3	3.3	
NR	5.67	30	REF	4	80.0	63.3	0.0	
NR	5.34	80	NR	5	84.8	45.0	1.8	27.16
NR	6.80	40	REF	6	61.0	49.1	11.6	29.8

* Amphipods were collected from Narrow River (NR) and Long Island Sound (LI). Control sediments for Black Rock Harbor mixtures were collected from Narrow River (NR), Long Island Sound (LI), and Reference Station South (REF).

126. Menidia menidia. Larvae of M. menidia showed no acute effects following a 96-hr exposure to 100% BRH or REF sediment. No mortality occurred in any treatment (SW control; 100% REF; 100% BRH) for either of the two tests conducted using the solid phase test regime (Tables B29 and B30). No obvious behavioral changes were observed in swimming behavior at the end of the test period, and all fish appeared to be feeding on the brine shrimp supplied. Dissolved oxygen concentrations were close to saturation for all treatments.

127. Cyprinodon variegatus. Larvae of C. variegatus appeared to be unaffected by the solid phase of either REF or BRH. A single mortality occurred in one seawater control of the first test (Table B33). Dissolved oxygen was at or above saturation. Mortality in the control appeared to be the result of gas supersaturation. In the second test, the dissolved oxygen was close to saturation in all treatments (Table B34).

128. Ammodytes americanus. Embryos of A. americanus appeared to be unaffected by the solid phases of both REF and BRH. Mortalities occurred, but not in response to dose (Tables B37 and B38).

129. Ammodytes americanus larval solid phase tests showed high mortality at 100% BRH when three treatments (SW, REF, and 100% BRH) were used (Tables B39 and B40). A chi-square test showed significant differences between mortalities in the 100% REF and 100% BRH ($P < 0.01$). Subsequent testing with six treatments showed high control mortality (100% REF) as well as high mortality across the BRH treatments (Tables B41-B44). These tests generally showed higher mortality at higher

concentrations of BKH sediment, but test and probit analysis (Finney 1971) results were inconclusive.

130. Ammodytes americanus has not been used extensively in laboratory tests and the high mortality in these tests can probably be attributed to handling stress. Further testing of this species is required to find the optimum method of handling, the optimum age for testing, and the most suitable bioassay chamber to minimize control mortality. Dissolved oxygen measurements were taken only once during all the solid phase tests. Dissolved oxygen was assumed to be at saturation, but the measurements taken at the time of the last test (Table B44) were below saturation, and could have contributed to the high mortality observed during these tests.

131. Paralichthys dentatus. The fish P. dentata appeared to be unaffected by the presence of either REF or BRH in the solid phase. Control and REF mortalities were within accepted ASTM limits (<10%) for both tests. Dissolved oxygen was at or near saturation in all the exposure chambers (Tables B47 and B48).

132. Pseudopleuronectes americanus. The results of the solid phase tests with winter flounder larvae were not conclusive. In test 1 there was significantly (chi-square test, $P < 0.05$) higher mortality in REF than there was in BRH. In the second test there was significantly (chi-square test, $P < 0.05$) higher mortality in BRH than there was in REF. In both tests there was a tendency for the larvae in the exposure chambers containing both REF and BRH sediment to stay in the water column more of the time than the larvae in the seawater controls. The

dissolved oxygen concentration was at or near saturation in all treatments in both tests (Tables B49 and B50).

Suspended particulate tests

133. Nephtys incisa. In two suspended particulate tests with Nephtys incisa no toxic effect was seen (Table B4 and B5). Mortality was 5% or less in all treatments. During the test, no worms appeared on the sediment surface. There were no differences in the estimated average depth of burrows in the various treatments (Table 16).

134. In two earlier suspended particulate tests with N. incisa a toxic effect (25 and 20% mortality) was seen in the 25 mg/L BRH suspended particulate, 100% BRH solid phase treatment. However, in a review of the procedures for these two tests, we discovered that we had not turned off the inflow water when we added the worms to the treatment dishes. When we repeated the tests (above), we saw no toxic effects in any treatments. We concluded that the "mortalities" in the first two tests were not real and probably resulted from the worms not burrowing into the sediment in the beginning of the test. Therefore, it is important that the procedures outlined in the methods section be followed carefully to avoid this problem.

135. Neanthes arenaceodonta. In the suspended particulate tests with N. arenaceodonta, no toxic effect was seen in any treatment (mortality 10% or less, Table B9a and B9b). No worms appeared on the surface in any treatments except to search for food (a normal activity).

Table 16
 Toxicity of Black Rock Harbor (Connecticut) Dredged Material, as Suspended Sediment,
 to 10 Species of Marine Invertebrates and Fishes

Species	Test Duration days	LC50* or NOEC**	Behavioral or Other Effects
<u>Annelids</u>			
<u>Nephtys incisa</u>	10	NOEC = 100% solid and 25 mg/L suspended BRH material	None
<u>Neanthes arenaceodentata</u>	10	NOEC = 100% solid and 25 mg/L suspended BRH material	None
<u>Molluscs</u>			
<u>Yoldia limatula</u>	10	NOEC = 100% solid and 40 mg/L suspended BRH material	No burrowing in 50% BRH solid phase mat
<u>Mulinia lateralis</u>	10	NOEC = 100% solid and 40 mg/L suspended BRH material	None
<u>Arthropods</u>			
<u>Mysidopsis bahia</u>	4	NOEC = 100% solid and 25 mg/L suspended BRH material	None
<u>Ampelisca abdita</u>	4	NOEC = 0% solid and 20 mg/L suspended BRH material	None
<u>Fishes</u>			
<u>Menidia menidia</u>	4	NOEC = 100% solid and 25 mg/L suspended BRH material	None
<u>Cyprinodon variegatus</u>	4	NOEC = 100% solid and 25 mg/L suspended BRH material	None
<u>Ammodytes americanus</u>	4	Not definitive	-
<u>Pseudopleuronectes americanus</u>	4	NOEC = 100% solid and 25 mg/L suspended BRH material	None

*LC50 = concentration lethal to an estimated 50% of the test organisms.

**NOEC = no observed effect concentration, effect noted is mortality.

136. Yoldia limatula. There were no mortalities with Yoldia exposed to 40 mg/L BRH suspension with either REF or 50% BRH sediment as a solid phase (Tables B10 to B12). In the treatments with 50% BRH as a solid phase, the same nonburrowing response that was noted in the solid phase tests was seen.

137. Mulinia lateralis. Mulinia experienced no mortalities when exposed to 40 mg/L BRH suspended particulates with 100% BRH in the solid phase (Tables B13 to B15).

138. Mysidopsis bahia. The arthropod M. bahia showed no acute effects from a 96-hr exposure to 25 mg/L BRH or REF particulate. The two 96-hr tests for the particulate phase were conducted at 21°C rather than 25°C as in the solid phase tests, however; the lower temperature had no effect on the survival of the test species.

139. In the first test, the control was without reference sediment; in the second test the control contained reference sediment. No difference in mortality occurred between either of these two treatments or between particulate phase controls and the controls from the solid phase tests.

140. The levels of exposure for the particulate phase tests were representative of the worst case situation with the highest level of BRH particulate load (25 mg/L) and 100% BRH sediment compared to the identical condition with reference particulate and sediment. Neither test showed any effect on survival at 96 hours (Tables 16, B19, and B20).

141. Dissolved oxygen, temperature, and salinity remained within acceptable limits throughout the tests (Tables 2, B19, and B20). Electronic particle counts showed consistency for particle density in the splitters, exposure chambers, and test chambers.

142. Ampelisca abdita. The species A. abdita experienced no significant mortalities when exposed to 20 mg/L BRH at 20°C (Table B27) or when exposed to 25 mg/L BRH at 8°C (Table B28). In both cases, a no-effect level of 0% BRH was used in the solid phase (Table 16).

143. Menidia menidia. Larvae of M. menidia showed no significant acute effects following a 96-hr exposure to suspended particulates of BRH or REF sediment (Table 16). A single mortality occurred in one SW control dish (Table B31). Although it was difficult to observe fish swimming in the REF and BRH exposure dishes, it could be discerned during daily counts that fish were feeding on the brine shrimp ration. Larvae appeared to be swimming normally at the termination of these experiments. Dissolved oxygen was close to saturation for all treatments.

144. Cyprinodon variegatus. The fish C. variegatus appeared to be unaffected by exposure to either the BRH or the REF sediments in suspended phase at the nominal concentration of 25 mg/L (Table 16). There were no mortalities in any of the treatments in either test, and the behavior of the larvae appeared to be unaffected by the suspended sediment. Dissolved oxygen was close to saturation in all treatments (Tables B35 and B36).

145. Ammodytes americanus. Suspended sediment test results for A. americanus were inconclusive as to the effect of the suspensions of 100% REF or BRH on the larvae (Tables B45 and B46).

146. Psuedopleuronectes americanus. Larvae of P. americanus did not appear to be adversely affected by the presence of suspended REF or BRH at the nominal concentration of 25 mg/L (Table 16). In the first test there were only two mortalities, one in the seawater control and one in BRH (Tables B51 and B52). In the second test, there were some mortalities in all of the treatments (5 out of 24 in the seawater control, 5 out of 19 in REF, and 4 out of 22 in BRH), but there was no significant difference between the REF and the BRH in either test. Dissolved oxygen was at or near saturation in all exposure dishes during both tests. As in the solid phase tests with the P. americanus, there was more of a tendency for the larvae to stay in the water column in the exposure chambers containing sediment than in those containing no sediment.

PART VI: CONCLUSIONS AND RECOMMENDATIONS

147. Black Rock Harbor dredged material contained substantial concentrations of both organic and inorganic contaminants that were biologically available to the blue mussel Mytilus edulis in a suspended particulate bioaccumulation study. PCB's were present in the sediment at 6800 ng/g (ppb), while PAH's of molecular weights between 128 and 302 were present at concentrations between 17 and 9100 ng/g. Alkyl homologs of the PAH's of molecular weights between 128 and 252 were also present in the sediment at concentrations between 110 and 13000 ng/g, measured as the sum of alkyl homologs between C-1 and C-4. Of the organic contaminants present in the sediment, mussels accumulated PCB's to a tissue concentration of 3000 ng/g, which is 44% of the concentration in the sediment. PAH's of molecular weights 202, 228, and 252 were accumulated to tissue concentrations between 1600 and 2000 ng/g, which are between 18 and 28% of the concentrations in the sediment. Other PAH's were accumulated to lesser extents. Alkyl homologs of the PAH's were also accumulated, with a maximum tissue concentration of 5000 ng/g for the 178 alkyl homologs, which is 38% of the sediment concentration. Other alkyl homologs from molecular weight PAH's of 166 through 228 were accumulated to levels between 110 and 3400 ng/g; these tissue concentrations are between 14 and 41% of the sediment concentration. Although these concentrations of contaminants accumulated in mussels were after a 28 day exposure, the concentrations in the mussels after only 7 days were close to the same concentrations for many of the contaminants.

148. Inorganic contaminants were also present in Black Rock Harbor sediment, but an interference precluded the measurement of As. With the exception of Mn, Zn, As, and Hg, which were below the limit of detection, all other trace metals showed statistically significant ($P < .05$) increases over controls during the 28 day mussel uptake study. The greatest uptake was for Cr, which reached a concentration of 25 $\mu\text{g/g}$ at the end of the bioaccumulation compared to a control concentration of 1.96 $\mu\text{g/g}$. Other trace metals were taken up to a lesser degree, including Cd which reached a concentration of 7 $\mu\text{g/g}$ compared to a control value of 2.8 $\mu\text{g/g}$. Compared to the sediment concentration, the organisms accumulated to only 2% of the Cr, but 28% of the Cd sediment concentration values.

149. In contrast to the organic contaminants which reached high concentrations relatively early in the bioaccumulation study, many trace metals had not reached plateau concentrations by the end of the 28-day study. Therefore, although many organic contaminants should be detected in a shorter test, significant accumulation from inorganic contaminants could be overlooked.

150. Black Rock Harbor material as solid phase or in combination with the suspended particulate phase was acutely lethal to one of the eleven species tested and caused behavioral changes in two species. Only with Ampelisca abdita was the material sufficiently toxic to produce 96-hr LC50 values (27.2 and 28.2% BRH, solid phase; Tables B25 and B26). In addition, the amphipod's tube building was impaired in all BRH concentration down to 12.5%, the lowest concentration tested.

Yoldia limatula failed to burrow into sediment containing 25% BRH or higher and did not feed even when gently pushed into the sediments.

151. All species except Ammodytes americanus proved suitable for testing dredged material in this study. As stated earlier, A. americanus has never before (to our knowledge) been used in aquatic toxicology and much must be learned in the handling and culture of the species before acceptable control survival (<10%; ASTM 1980b) can be attained. A strong effort will continue in developing the species for toxicity testing because it is an important link in marine food chains in coastal waters of the northeastern United States (Sherman et al. 1981) and may be impacted by dredged material disposal.

152. Three of the five infaunal species tested (A. abdita, N. incisa, and Y. limatula) were sensitive to BRH material in acute tests, whereas no epibenthic or water column species showed sensitivity to the material either in solid phase or in combination with the suspended particulate phase. For the affected species, the most important factor was the concentration (or presence) of BRH solid phase material. Without further data from long-term tests, including measurements of energetics, histopathology, etc., one can only speculate on the reason for the differing sensitivities, but it may be related to whether or not the BRH solid phase material is in contact with the species. For example, larval A. americanus and M. menidia seldom directly contact the benthos. Conversely, infaunal species such as Y. limatula and A. abdita are in intimate contact with the sediment, and thus the toxic properties of the BRH material are available by direct contact or by

ingestion. Longer term exposures and more detailed studies may reveal the factors causing the different sensitivities.

153. The reproducibility of the effects observed in the solid phase and in combination with the suspended particulate phase for the species tested was very good. No significant differences were observed in replicate solid phase tests with N. incisa, N. arenaceodentata, M. lateralis, M. bahia, A. abdita, M. menidia, C. variegatus, P. dentata, and P. americanus. As stated earlier, further research is needed with A. americanus to obtain the necessary control survival and test reproducibility; Y. limatula tests were not precisely replicated (Tables B10 and B11), but the mortality observed in the two tests was correlated well with BRH concentration.

154. Replicates from suspended particulate tests, like the solid phase replicates, showed excellent reproducibility. No significant differences in results of the replicates were observed in N. incisa, M. lateralis, M. bahia, M. menidia, C. variegatus, and P. americanus. Suspended particulate test results obviously depended upon the reliability of the dosing system. Once the initial problems were solved, the microprocessor, transmissometer, and dosing valve system worked well. Generally, the particulate concentration was maintained within 10% of the desired values.

REFERENCES

American Public Health Association. 1976. Standard Methods for the Examination of Water and Wastewater, 14th ed., Washington, DC.

American Society for Testing and Materials. 1980a. "Proposed Standard Practice for Conducting Bioconcentration Tests with Fishes and Saltwater Bivalve Molluscs," Draft 5, Philadelphia, Pa.

_____. 1980b. "Standard Practice for Conducting Acute Toxicity Tests with Fishes, Macroinvertebrates, and Amphibians," ASTM E-729-80, Philadelphia, Pa.

Boehm, P.D. and J.G. Quinn. 1977. "The Persistence of Chronically Accumulated Hydrocarbons in the Hard Shell Clam Mercenaria mercenaria," Marine Biology, Vol 44, pp 227-233.

Davey, E.W., J.H. Gentile, S.J. Erickson, and P. Betzer. 1979. "Removal of Trace Metals from Marine Culture Media," Limnol. Oceanogr. 15: 486-488.

Environmental Protection Agency. 1979. "Methods for Chemical Analysis of Water and Wastes," U.S. Environmental Monitoring and Support Laboratory, Office of Research and Development, EPA/600-4-79-020.

Finney, D.J. 1971. Probit Analysis, Cambridge University Press, Great Britain.

Fisher, R.A. 1958. Statistical Methods for Research Workers, New York, Hafner Publ. Co. Inc.

Gentile, S.M., J. H. Gentile, J. Walker, and J.F. Heltshe. 1982. "Chronic Effects of Cadmium on Two Species of Mysid Shrimp: Mysidopsis bahia and Mysidopsis bigelowi," Hydrobiologia, Vol 93, pp 195-204.

Hansen, D.J., Parrish, P.R., Schimmel, S.C. and Goodman, L.R. 1978. "Life-Cycle Toxicity Tests Using Sheepshead Minnows (Cyprinodon variegatus)."
In: "Bioassay Procedures for Ocean Disposal Permit Program." United States Environmental Protection Agency, National Environmental Research Center Ecological Research Series, EPA-600/9-78/010:109-117, Environmental Research Laboratory, Gulf Breeze, Florida.

Hatch, W.R. and W.L. Ott. 1968. "Determination of Sub-Microgram Quantities of Mercury by Atomic Absorption Spectroscopy," Anal. Chem. 40: 2085.

Klein-MacPhee, G., Howell, W.H., and Beck, A.D. 1982. "Comparison of a Reference Strain and Four Geographical Strains of Artemia as Food for Winter Flounder (Pseudopleuronectes americanus) Larvae," Aquaculture, Vol 29, pp 279-288.

Klein-MacPhee, G. 1981. "Effects of Stocking Density on Survival of Laboratory Cultured Summer Flounder (Paralichthys dentatus) Larvae," Rapports et Procees Verbeux Reunion de Conseil International de Exploration de Mer, Vol 178, pp 505-506.

Lake, J.L., Norwood, C.B., Dimock, C. and Bowen, R. 1979. "Origins of Polycyclic Aromatic Hydrocarbons in Estuarine Sediments," Geochimica et Cosmochimica Acta, Vol 43, pp 1847-1853.

Lake, J.L., Rogerson, P.F., and Norwood, C.B. 1981. "A Polychlorinated Dibenzofuran and Related Compounds in an Estuarine Ecosystem," Environmental Science and Technology, Vol 15, pp 549-553.

Middaugh, D.P. and Takita, T. 1983. "Tidal and Diurnal Spawning Cues in the Atlantic Silverside, Menidia menidia," Environmental Biology of Fish, Vol 8, No. 2, pp 97-104.

Mount, D.L., and Brungs, W.A. 1967. "A Simplified Dosing Apparatus for Fish Toxicological Studies," Water Research, Vol 1, pp 21-29.

Pesch, C.E. and Morgan, D. 1978. "Influence of Sediment in Copper Toxicity Test With the Polychaete Neanthes arenaceodentata," Water Research, Vol 12, pp 747-751.

Phelps, D.K., and W.B. Galloway. 1980. "A Report on the Coastal Environmental Assessment Stations (CEAS) Program." In: Rapp. P. -v. Reun. Cons. Int. Explor. Mer. 179: pp. 76-81.

Phelps, D.K., Galloway, W.B., Reynolds, B.H., Nelson, W.G., Hoffman, G.L., Lake, J.L., Barszcz, C., Thurberg, F.P., Kraikowski, J., and K. Jenkins. 1983. "Evaluation Report: Use of Caged Mussel Transplants for Monitoring Fate and Effects of Ocean Disposal in the New York Bight Apex," Prepared for the Office of Regulations and Standards, ERLN Contribution No. 586.

Sherman, K., Jones, C., Sullivan, L., Smith, W., Berrier, P. and Ejsymont, L. 1981. "Congruent Shifts in Sand Eel Abundance in Western and Eastern North Atlantic Ecosystems," Nature, Vol 291, pp 486-489.

Sinnett, J.C. and Davis, W.R. 1983. "A Programmable Turbidostat for Suspended Particles in Laboratory Aquaria," Journal of Experimental Marine Biology and Ecology, In Press.

Smigielski, A.S. and Arnold, C.R. 1972. "Separating and Incubating Winter Flounder Eggs," Progressive Fish Culturist, Vol 34, pp 118.

Sorgeloos, P. 1980. "Availability of Reference Artemia Cysts," Marine Ecology - Progress Series, Vol 3, pp 363-364.

Sosnowski, S.L., Germond, D.J., and Gentile, J.H. 1979. "The Effect of Nutrition on the Response of Field Populations of the Calanoid Copepod Acartia tonsa to Copper," Water Research, Vol 13, pp 449-452.

Stegeman, J.J. and Teal, J.M. 1973. "Accumulation, Release and Retention of Petroleum Hydrocarbons by the Oyster, Crassostrea virginica," Marine Biology, Vol 22, pp 37-44.

APPENDIX A: CHEMICAL DATA

Appendix Tables A1-A7 list the concentration of each polynuclear aromatic hydrocarbon and its alkylated homolog from C-1 through C-4 for the three replicates of day 7, 14, and 28 and for the three replicates of both the day 0 and day 28 controls. Also given are the same measurements for Black Rock Harbor sediment and for the analytical blank associated with these analyses.

Appendix Tables A8-A11 give complete metal concentration data for all sediment and mussel samples.

Table A1
Day 0 control concentrations of PAH and Aklyl Homologs
for replicates A, B, and C

Compound	Concentration, ng/g Dry Weight				
	PAH	C-1	C-2	C-3	C-4
128 A	1.2	0.6	2.3	4.4	4.4
B	0.5	0.3	1.3	2.6	1.8
C	0.8	0.7	2.2	2.4	2.8
154B1 A	1.6	0.9	2.1	3.8	4.5
B	1.3	0.5	1.6	2.2	2.9
C	1.1	0.5	2.4	3.6	4.2
154An A	0.9	-	1.4	2.0	0
B	0.3	-	0.8	1.1	-
C	1.0	-	1.6	2.1	-
166 A	1.8	1.0	4.6	9.2	3.2
B	1.1	0.6	2.7	5.6	2.4
C	1.3	1.0	3.7	7.0	2.4
178 A	9.1	11	19	11	3.2
B	6.1	7.4	12	8.1	3.3
C	6.5	8.6	15	11	3.4
202 A	42	8.7	2.7	1.5	0.6
B	27	5.4	3.0	1.1	0.6
C	34	7.7	3.6	1.5	0.4
228 A	9.7	2.0	1.5	2.6	-
B	5.9	1.3	1.6	1.4	-
C	10	3.2	2.3	1.9	-
252 A	17	<6.6	<0.7	<0.3	<0.1
B	11	6.3	<0.4	<0.2	<0.1
C	18	<5.9	<0.2	<0.1	<0.1
276 A	4.0				
B	2.7				
C	3.2				
278 A	<0.4				
B	<0.2				
C	<0.6				
300 A	<0.1				
B	<0.1				
C	<0.1				
302 A	<0.3				
B	<0.5				
C	<0.2				

Table A2
Day 7 exposed concentrations of PAH and Alkyl Homologs
for replicates A, B, and C

Compound		Concentration, ng/g Dry Weight				
		PAH	C-1	C-2	C-3	C-4
128	A	0.4	0.5	7.1	80	190
	B	0.5	0.6	15	170	330
	C	0.6	0.5	9.1	120	250
154Bi	A	1.5	6.8	70	200	380
	B	1.6	7.0	79	240	490
	C	2.5	7.4	70	200	280
154An	A	2.9	15	76	160	-
	B	4.4	23	110	200	-
	C	3.6	19	93	190	-
166	A	14	72	260	430	340
	B	13	71	270	490	370
	C	15	66	250	370	260
178	A	190	930	1900	1500	870
	B	240	1200	2400	2000	1200
	C	220	970	1800	1400	800
202	A	230	1600	950	490	170
	B	3100	2200	1200	640	250
	C	2300	1600	900	460	160
228	A	1700	830	380	140	49
	B	2100	1100	480	180	65
	C	1700	800	320	110	40
252	A	1200	300	110	36	10
	B	1600	410	150	53	14
	C	1200	290	100	39	13
276	A	220				
	B	330				
	C	210				
278	A	120				
	B	170				
	C	130				
300	A	9.4				
	B	14				
	C	9.0				
302	A	57				
	B	81				
	C	60				

Table A3
Day 14 exposed concentrations of PAH and Alkyl Homologs
for replicates A, B, and C

Compound	Concentration, ng/g Dry Weight				
	PAH	C-1	C-2	C-3	C-4
128 A	0.8	0.5	8.4	65	120
B	1.0	1.3	16	110	190
C	1.4	1.6	16	96	180
154Bi A	2.3	2.6	28	89	170
B	2.4	4.6	43	140	400
C	4.1	3.9	40	120	300
154An A	3.4	18	42	84	-
B	5.3	-	63	110	-
C	5.5	-	63	110	-
166 A	6.8	33	100	170	120
B	8.8	52	150	230	200
C	9.3	44	130	230	160
178 A	120	390	720	590	300
B	160	530	1000	890	540
C	150	480	980	810	440
202 A	930	630	360	180	80
B	1200	850	540	300	99
C	1200	840	510	260	72
228 A	660	340	140	49	16
B	950	520	220	76	29
C	910	490	180	57	20
252 A	490	140	38	8.3	<0.9
B	680	190	65	18	<4.0
C	650	150	49	12	<2.2
276 A	97				
B	140				
C	110				
278 A	52				
B	85				
C	67				
300 A	2.1				
b	3.8				
C	2.7				
302 A	12				
B	22				
C	16				

Table A4
Day 28 Exposed concentrations of PAH and Alkyl Homologs
for replicates A, B, and C

Compound	Concentration, ng/g Dry Weight				
	PAH	C-1	C-2	C-3	C-4
128 A	0.5	0.8	10	100	250
B	0.4	0.3	4.4	53	130
C	1.0	1.4	15	130	220
154Bi A	2.8	7.0	78	250	620
B	1.8	5.0	46	140	300
C	5.8	7.5	71	200	430
154An A	3.8	21	100	210	-
B	2.0	13	54	120	-
C	5.6	41	98	180	-
166 A	13	67	290	520	420
B	7.9	44	180	310	270
C	15	62	220	590	290
178 A	210	1000	2300	2100	1300
B	140	650	1400	1300	810
C	180	730	1400	1300	840
202 A	2500	1900	1300	750	280
B	1600	1300	910	550	210
C	1800	1400	940	560	210
228 A	2200	1300	570	200	58
B	1500	970	440	140	49
C	1700	1000	450	170	46
252 A	1800	450	160	47	12
B	1400	350	120	31	10
C	1500	400	140	45	10
276 A	330	*			
B	230				
C	280				
278 A	180				
B	140				
C	160				
300 A	9.6				
B	8.4				
C	9.9				
302 A	62				
B	46				
C	60				

Table A5
Day 28 control concentrations of PAH and Alkyl Homologs
for replicates A, B, and C

Compound		Concentration, ng/g Dry Weight				
		PAH	C-1	C-2	C-3	C-4
128	A	0.5	0.6	2.3	4.7	9.5
	B	0.5	0.6	1.6	4.0	7.6
	C	0.6	0.7	2.5	5.5	9.6
154B1	A	6.5	3.6	5.5	9.0	12
	B	3.0	1.8	5.5	7.2	9.0
	C	6.3	3.4	4.6	8.7	12
154An	A	1.0	-	3.6	5.0	-
	B	1.1	-	3.4	3.5	-
	C	1.4	-	4.0	3.8	-
166	A	1.4	2.6	7.6	11	6.6
	B	0.8	1.7	6.0	7.9	2.5
	C	1.4	2.4	7.5	9.3	4.1
178	A	6.8	14	16	11	4.9
	B	5.1	12	11	6.2	2.5
	C	8.1	15	14	7.6	3.3
202	A	22	5.3	3.1	2.1	0.5
	B	17	3.3	1.3	0.9	<0.3
	C	19	4.4	1.1	0.7	0.5
228	A	4.3	1.9	<1.8	<1.4	<5.5
	B	2.4	1.0	<0.8	<0.9	<4.1
	C	2.5	0.9	<1.1	<1.4	<7.0
252	A	7.8	<4.1	<0.5	<0.2	<0.1
	B	4.8	<3.0	<0.1	<0.1	<0.1
276	A	2.2				
	B	<1.0				
	C	0.9				
278	A	<0.9				
	B	<0.3				
	C	0.6				
300	A	<0.1				
	B	<0.1				
	C	<0.1				
302	A	<0.1				
	B	<0.1				
	C	<0.1				

Table A6
Analytical blank concentrations of PAH and Alkyl Homologs
of previous samples

Compound	Concentration, ng/g Dry Weight				
	PAH	C-1	C-2	C-3	C-4
128	0.6	0.3	<0.8	0.5	<0.4
154B1	0.7	<0.2	<0.3	<0.4	<0.3
154An	0.6	-	<0.1	<0.1	-
166	0.2	2.5	<0.3	<1.3	<0.1
178	0.6	0.5	<0.4	<0.3	<0.2
202	0.7	<0.1	<0.1	<0.1	<0.1
228	0.7	<0.1	<0.2	<1.0	<0.1
252	0.7	<2.4	<0.1	<0.1	<0.1
276	<0.1				
278	<0.1				
300	<0.1				
302	<0.1				

Table A7
Black Rock Harbor FVP sediment PAH and Alkyl Homolog
concentrations in ng/g dry weight

Compound	Concentration, ng/g Dry Weight				
	PAH	C-1	C-2	C-3	C-4
128	17	67	420	1200	1700
154Bi	54	130	520	760	1500
154An	120	140	420	500	-
166	370	610	930	1100	790
178	2700	3500	3900	3200	2300
202	7100	3800	2200	1500	770
228	9800	5400	3900	2200	1200
252	8600	2700	1500	580	-
276	9100				
278	4400				
300	130				
302	2700				

Table A8
Metal Concentrations for Black Rock Harbor Barrel #00.
 All Sediment Samples were Dissolved with Hot Concentrated HNO₃.
 All Concentrations are in ug/g Dry Weight

	Fe	Mn	Zn	Cu	Pb	Cd	Cr	Ni	Hg
TOP									
1	31000	403	1190	2350	384	24.5	1400	141	1.8
2	28400	369	1090	2140	346	23.5	1260	133	1.6
3	28900	303	1150	2390	365	23.8	1380	144	1.7

AVE	29400	326	1130	2293	365	23.9	1346	139	1.7
SD	1130	52	41	109	15	0.4	61	4	0.1
ZSD	3	16	3	4	4	1.8	4	3	7.0

MIDDLE									
1	30400	326	1290	2480	403	23.2	1540	144	1.7
2	30100	417	1280	2490	383	24.1	1460	147	1.7
3	29800	384	1150	2270	364	22.2	1410	139	1.6

AVE	30100	375	1240	2413	383	23.2	1470	143	1.7
SD	244	37	63	101	15	0.8	53	3	0.1
ZSD	1	10	5	4	4	3.4	3	2	4.0

BOTTOM									
1	29400	348	1210	2410	381	23.8	1460	131	1.7
2	28700	371	1200	2420	380	21.7	1460	139	1.7
3	30100	408	1220	2520	400	23.9	1510	141	1.8

AVE	29400	375	1210	2450	387	23.1	1476	137	1.7
SD	571	24	8	49	9	1.0	23	4	0.1
ZSD	1	6	1	2	2	4.4	1	3	1.0

BARREL									
AVE	29600	359	1200	2385	378	23.4	1431	139	1.7
SD	809	37	59	112	16	0.9	77	4	0.1
ZSD	2	10	4	4	4	3.7	5	3	4.0

BLANK 1	0.90	0.025	0.34	0.25	0.14	0.056	0.014	0.20	<0.01
BLANK 2	0.84	0.014	0.39	0.34	0.17	0.056	0.017	0.56	<0.01

Table A9
Metal Concentrations for Black Rock Harbor Barrel #LL.
All Sediment Samples were Eluted with 5% HNO₃.
All Concentrations are Given in ug/g Dry Weight

	Fe	Mn	Zn	Cu	Pb	Cd	Cr	Ni
TOP								
1	26400	284	1290	2560	421	25.4	1380	172
2	26500	278	1210	2510	431	24.8	1350	166
3	27200	284	1240	2650	427	25.7	1350	168

AVE	26700	282	1250	2570	426	25.3	1360	168
SD	355	2	33	57	4	0.4	14	2
%SD	1	1	2	2	1	1.5	1	1

MIDDLE								
1	26300	274	1180	2500	436	24.0	1330	168
2	28000	280	1282	2670	416	25.6	1380	184
3	26700	286	1244	2510	377	24.1	1360	170

AVE	27000	280	1240	2560	409	24.6	1360	174
SD	712	4	42	77	24	0.7	20	7
%SD	2	1	3	3	5	3.0	1	4

BOTTOM								
1	26100	269	1150	2530	393	23.5	1350	164
2	26200	272	1180	2490	397	24.4	1280	164
3	25800	278	1150	2490	425	24.9	1310	167

AVE	26000	273	1160	2500	405	24.3	1310	165
SD	169	3	14	18	14	0.6	28	1
%SD	1	1	1	1	3	2.4	2	1

BARREL								
AVE	26600	278	1210	2540	413	24.7	1340	169
SD	623	5	50	64	18	0.7	30	5
%SD	2	1	4	2	4	2.9	2	3

BLANK 1	1.9	0.07	1.19	1.03	0.055	0.032	0.048	0.79
BLANK 2	1.3	0.03	0.32	0.71	0.063	0.048	0.024	0.95

Table A10
Metal Concentrations Determined for Mytilus edulis
Control Samples and Black Rock Harbor Exposed Samples.
All Concentrations in ug/gram Dry Weight

SAMPLE		Fe	Mn	Zn	Cu	Pb	Cd	Cr	As
DAY	1	404	15.6	350	81.3	11.9	5.37	17.2	9.37
	2	334	9.5	236	68.6	11.2	4.71	14.6	7.43
	3	332	11.3	272	36.3	8.9	4.00	14.2	8.95

AVE		357	12.1	286	62.0	10.7	4.69	15.3	8.58
SD		41	3.2	58	23.2	1.5	0.69	1.6	1.02
ZSD		11	25	20	37	14	15	10	12

DAY	1	322	19.7	176	68.6	9.50	3.67	13.3	6.94
	2	333	38.9	163	73.6	8.20	2.73	10.8	7.33
	3	333	24.9	142	83.3	7.87	2.93	12.0	7.67

AVE		329	31.1	160	75.2	8.52	3.11	12.0	9.31
SD		6	10.1	17	7.4	0.86	0.49	1.3	0.37
ZSD		2	32	11	10	10	16	10	5

DAY	1	715	16.8	386	74.9	19.0	8.09	36.4	9.86
	2	348	7.6	236	39.9	9.8	4.72	15.1	7.76
	3	437	9.2	376	50.2	13.0	8.09	23.6	9.00

AVE		500	11.2	333	55.0	13.9	6.97	25.1	8.87
SD		191	4.9	84	18.0	4.7	1.94	10.7	1.06
ZSD		38	44	25	33	34	28	43	12

(continued)

Table A10 (Cont'd)

CONTROL SAMPLES									
SAMPLE		Fe	Mn	Zn	Cu	Pb	Cd	Cr	As
DAY 0	1	189	11.4	70	51.8	4.73	3.09	2.64	7.45
	2	178	10.4	154	10.1	4.85	2.54	2.08	8.62
	3	229	11.6	223	14.2	4.57	2.50	2.07	8.50

AVE		199	11.1	149	25.4	4.72	2.71	2.26	8.19
SD		26	0.7	76	23.0	0.14	0.32	0.32	0.64
ZSD		13	6	51	91	3	12	14	8

DAY 28	1	220	9.3	289	20.9	9.42	3.32	2.53	7.37
	2	212	8.1	164	19.7	5.81	2.69	1.81	8.38
	3	206	21.0	210	11.8	4.40	2.35	1.55	6.45

AVE		213	12.8	221	17.4	6.54	2.79	1.96	7.40
SD		7	7.1	63	5.0	2.59	0.49	0.50	0.96
ZSD		3	55	29	28	40	18	26	13

BLANK SAMPLES									
AVE		<1.9	<0.06	<0.6	>0.3	<0.06	<0.01	<0.06	<0.2

Table A11

Percent Recovery of Metals Spiked into Mussel Samples

<u>Element</u>	<u>µg Added</u>	<u>µg Found</u>	<u>% Recovery</u>
Fe	15.0	14.5	96.7
	62.5	59.8	95.6
Zn	25.0	25.2	101
	37.5	38.5	103
Mn	2.50	2.66	106
	2.50	2.95	118
Cu	2.50	2.31	92.4
	2.50	2.38	95.2
Pb	1.25	1.07	85.6
	2.50	2.34	93.6
Cd	0.625	0.630	101
	0.625	0.660	106
Cr	2.50	2.43	97.2
	2.50	2.44	97.6
As	2.50	2.28	91.2
	2.50	2.17	86.8

AD-A164065

WES TR D-85-9 APPENDIX B: ACUTE TOXICITY DATA SHEETS

3 of 9



APPENDIX B: ACUTE TOXICITY DATA SHEETS

ACUTE TOXICITY DATA SHEET
COE/ERLN FVP

STUDY PLAN: 1

INVESTIGATOR: C. PESCH/SCHAUER

EXPERIMENT DESCRIPTION: SOLID

DATE OF TEST: 820820

TEST NUMBER: 1

SPECIES: NEPHTYS INCISA

** EXPERIMENTAL CONDITIONS **

TEMPERATURE: 19.00 DEGREES CENTIGRADE RANGE: 19.00 - 20.00

SALINITY: 30.00 PARTS PER THOUSAND RANGE: 30.00 - 30.00

EXPOSURE DURATION: 11 DAYS

PHOTOPERIOD: 14 HOURS

FLOW RATE: 52 MLS/MIN

VOLUME ADDITIONS/DAY 101

NUMBER OF ANIMALS/REPLICATE: 20

NUMBER OF REPLICATES/TREATMENT: 1

ANIMAL'S LIFE STAGE: JUVENILE AGE: DAYS SIZE: MILLIMETERS

CONTROLS: REF (COLLECTED AUG. 17, 1982)

FOOD USED NONE

EXPOSURE CONCENTRATIONS (1)		OXYGEN	ANIMALS	***** NUMBER DEAD *****				
NOMINAL	MEASURED(2)	MG/L	USED PER	***** AT DAY *****				
			TREATMENT	1	2	3	4	10
			4 DAY 10					
REF			20					0
25%BRH			20					1
50%BRH			20					0
75%BRH			20					0
100% BRH			20					0

96 HOUR LC50

SIZE: 0.69 +/- 0.21MG DW

NO EFFECT CONCENTRATION 100% BRH

WORMS COLLECTED CLIS SO. REF. 8/17/83

(1) PERCENT FOR SOLID PHASE TESTS

(2) MILLIGRAMS/LITER FOR SUSPENDED PARTICULATE TESTS; DRY WEIGHTS OR COULTER COUNTS OR BOTH.

ACUTE TOXICITY DATA SHEET
COE/ERLN FVP

STUDY PLAN: 1

INVESTIGATOR: C. PESCH/SCHAUER

EXPERIMENT DESCRIPTION: SOLID

DATE OF TEST: 820820

TEST NUMBER: 2

SPECIES: NEPHTYS INCISA

** EXPERIMENTAL CONDITIONS **

TEMPERATURE: 19.00 DEGREES CENTIGRADE RANGE: 19.00 - 20.00

SALINITY: 30.00 PARTS PER THOUSAND RANGE: 30.00 - 30.00

EXPOSURE DURATION: 11 DAYS

PHOTOPERIOD: 14 HOURS

FLOW RATE: 52 MLS/MIN VOLUME ADDITIONS/DAY 101

NUMBER OF ANIMALS/REPLICATE: 12

NUMBER OF REPLICATES/TREATMENT: 1

ANIMAL'S LIFE STAGE: JUVENILE AGE: DAYS SIZE: MILLIMETERS

CONTROLS: REF (COLLECTED AUG. 17, 1983)

FOOD USED NONE

EXPOSURE CONCENTRATIONS (1)		OXYGEN	ANIMALS	***** NUMBER DEAD *****				
NOMINAL	MEASURED(2)	MG/L	USED PER	***** AT DAY *****				
			TREATMENT	1	2	3	4	10
			4 DAY 10					
REF			12					0
25%BRH			12					0
50%BRH			12					0
75%BRH			12					0
100% BRH			12					1

96 HOUR LC50

NO EFFECT CONCENTRATION 100%BRH

SIZE: 2.37 +/- 0.80 MG DW. WORMS COLLECTED CLIS 50. REF 8/17/82

(1) PERCENT FOR SOLID PHASE TESTS

(2) MILLIGRAMS/LITER FOR SUSPENDED PARTICULATE TESTS; DRY WEIGHTS OR COULTER COUNTS OR BOTH.

ACUTE TOXICITY DATA SHEET
COE/ERLN FVP

STUDY PLAN: 1

INVESTIGATOR: C. PESCH/SCHAUER

EXPERIMENT DESCRIPTION: SOLID

DATE OF TEST: 821030

TEST NUMBER: 3

SPECIES: NEPHTYS INCISA

** EXPERIMENTAL CONDITIONS **

TEMPERATURE: 20.00 DEGREES CENTIGRADE RANGE: 20.00 - 21.00

SALINITY: 31.00 PARTS PER THOUSAND RANGE: 30.00 - 32.00

EXPOSURE DURATION: 10 DAYS

PHOTOPERIOD: 10 HOURS

FLOW RATE: 54 MLS/MIN VOLUME ADDITIONS/DAY 104

NUMBER OF ANIMALS/REPLICATE: 21

NUMBER OF REPLICATES/TREATMENT: 1

ANIMAL'S LIFE STAGE: JUVENILE AGE: DAYS SIZE: MILLIMETERS

CONTROLS: REF (COLLECTED AUG, 17 1982)

FOOD USED NONE

EXPOSURE CONCENTRATIONS (1)		OXYGEN	ANIMALS	NUMBER DEAD				
NOMINAL	MEASURED(2)	MG/L	USED PER TREATMENT 4 DAY 10	AT DAY				
				1	2	3	4	10
REF			21					0
25%BRH			21					0
50%BRH			21					0
75%BRH			21					0
100% BRH			21					0

96 HOUR LC50

SIZE: 0.93 +/- 0.34MG DW

NO EFFECT CONCENTRATION 100%BRH

WORMS COLLECTED CLIS SO. REF. 10/5/82

(1) PERCENT FOR SOLID PHASE TESTS

(2) MILLIGRAMS/LITER FOR SUSPENDED PARTICULATE TESTS; DRY WEIGHTS OR COULTER COUNTS OR BOTH.

ACUTE TOXICITY DATA SHEET
COE/ERLN FVP

STUDY PLAN: 1

INVESTIGATOR: C. PESCH/SCHAUER

EXPERIMENT DESCRIPTION: SUSPENDED

DATE OF TEST: 830429

TEST NUMBER: 1

SPECIES: NEPHTYS INCISA

** EXPERIMENTAL CONDITIONS **

TEMPERATURE: 21.00 DEGREES CENTIGRADE RANGE: 20.00 - 21.00

SALINITY: 28.60 PARTS PER THOUSAND RANGE: 26.00 - 30.00

EXPOSURE DURATION: 10 DAYS

PHOTOPERIOD: 12 HOURS

FLOW RATE: 101 MLS/MIN

VOLUME ADDITIONS/DAY 195

NUMBER OF ANIMALS/REPLICATE: 20

NUMBER OF REPLICATES/TREATMENT: 1

ANIMAL'S LIFE STAGE: JUVENILE AGE: DAYS SIZE: MILLIMETERS

CONTROLS: 25 MG REF/REF

FOOD USED NONE

EXPOSURE CONCENTRATIONS (1)		OXYGEN	ANIMALS	*===== NUMBER DEAD =====*				
NOMINAL	MEASURED(2)	MG/L	USED PER TREATMENT	*===== AT DAY =====*				
			4 DAY 10	1	2	3	4	10
25 MG REF/REF	29.39		20					1
25 MG BRH/REF	28.70		20					0
25 MG REF/BRH	29.39		20					1
25 MG BRH/BRH	28.70		20					0

96 HOUR LC50

NO EFFECT CONCENTRATION 25 MG BRH/BRH

SIZE: 3.56 +/- 0.89 MG DW. WORMS COLLECTED CLIS SO. REF. 04/12/83

(1) PERCENT FOR SOLID PHASE TESTS

(2) MILLIGRAMS/LITER FOR SUSPENDED PARTICULATE TESTS; DRY WEIGHTS OR COULTER COUNTS OR BOTH.

ACUTE TOXICITY DATA SHEET
COE/ERLN FVP

STUDY PLAN: 1

INVESTIGATOR: C. PESCH/SCHAUER

EXPERIMENT DESCRIPTION: SUSPENDED

DATE OF TEST: 830531

TEST NUMBER: 2

SPECIES: NEPHTYS INCISA

** EXPERIMENTAL CONDITIONS **

TEMPERATURE: 20.50 DEGREES CENTIGRADE RANGE: 20.00 - 21.00

SALINITY: 28.00 PARTS PER THOUSAND RANGE: 27.00 - 30.00

EXPOSURE DURATION: 10 DAYS

PHOTOPERIOD: 15 HOURS

FLOW RATE: 100 MLS/MIN

VOLUME ADDITIONS/DAY 192

NUMBER OF ANIMALS/REPLICATE: 20

NUMBER OF REPLICATES/TREATMENT: 1

ANIMAL'S LIFE STAGE: JUVENILE

AGE: DAYS SIZE: MILLIMETERS

CONTROLS: 25 MG REF/REF

FOOD USED NONE

EXPOSURE CONCENTRATIONS (1)		OXYGEN	ANIMALS	*===== NUMBER DEAD =====*				
NOMINAL	MEASURED(2)	MG/L	USED PER	*===== AT DAY =====*				
			TREATMENT	1	2	3	4	10
			4 DAY 10					
25 MG REF/REF	25.60		20					0
25 MG BRH/REF	25.60		20					0
25 MG REF/BRH	25.60		20					1
25 MG BRH/BRH	25.60		20					0

96 HOUR LC50

NO EFFECT CONCENTRATION 25 MG BRH/BRH

SIZE: 3.86 +/- 0.81 MG DW. WORMS COLLECTED CLIS. SD. REF. 04/12/83

(1) PERCENT FOR SOLID PHASE TESTS

(2) MILLIGRAMS/LITER FOR SUSPENDED PARTICULATE TESTS; DRY WEIGHTS OR COULTER COUNTS OR BOTH.

ACUTE TOXICITY DATA SHEET
COE/ERLN FVP

STUDY PLAN: 1

INVESTIGATOR: C. PESCH/SCHAUER

EXPERIMENT DESCRIPTION: SOLID

DATE OF TEST: 820823

TEST NUMBER: 1

SPECIES: NEANTHES ARENACEODENTATA

** EXPERIMENTAL CONDITIONS **

TEMPERATURE: 19.00 DEGREES CENTIGRADE RANGE: 19.00 - 20.00

SALINITY: 30.00 PARTS PER THOUSAND RANGE: 30.00 - 30.00

EXPOSURE DURATION: 10 DAYS

PHOTOPERIOD: 14 HOURS

FLOW RATE: 44 MLS/MIN VOLUME ADDITIONS/DAY 20

NUMBER OF ANIMALS/REPLICATE: 1

NUMBER OF REPLICATES/TREATMENT: 10

ANIMAL'S LIFE STAGE: ADULT AGE: 86 DAYS SIZE: MILLIMETERS

CONTROLS: REF (COLLECTED AUG. 17, 1982)

FOOD USED NONE

EXPOSURE CONCENTRATIONS (1)		OXYGEN	ANIMALS	*===== NUMBER DEAD =====*				
NOMINAL	MEASURED(2)	MG/L	USED PER	*===== AT DAY =====*				
			TREATMENT	1	2	3	4	10
			4 DAY 10					
REF			10					0
25% BRH			10					0
50% BRH			10					0
75% BRH			10					0
100% BRH			10					0

96 HOUR LC50

NO EFFECT CONCENTRATION 100%BRH

SIZE: 52 SEGMENTS, CUP EXPERIMENT, WORMS FROM LAB CULTURES

(1) PERCENT FOR SOLID PHASE TESTS

(2) MILLIGRAMS/LITER FOR SUSPENDED PARTICULATE TESTS; DRY WEIGHTS OR COULTER COUNTS OR BOTH.

ACUTE TOXICITY DATA SHEET
COE/ERLN FVP

STUDY PLAN: 1

INVESTIGATOR: C. PESCH/SCHAUER

EXPERIMENT DESCRIPTION: SOLID

DATE OF TEST: 820823

TEST NUMBER: 2

SPECIES: NEANTHES ARENACEODENTATA

** EXPERIMENTAL CONDITIONS **

TEMPERATURE: 19.00 DEGREES CENTIGRADE RANGE: 19.00 - 20.00

SALINITY: 30.00 PARTS PER THOUSAND RANGE: 30.00 - 30.00

EXPOSURE DURATION: 10 DAYS

PHOTOPERIOD: 14 HOURS

FLOW RATE: 52 MLS/MIN VOLUME ADDITIONS/DAY 101

NUMBER OF ANIMALS/REPLICATE: 10

NUMBER OF REPLICATES/TREATMENT: 1

ANIMAL'S LIFE STAGE: ADULT AGE: 86 DAYS SIZE: MILLIMETERS

CONTROLS: REF (COLLECTED AUG. 17, 1982)

FOOD USED NONE

EXPOSURE CONCENTRATIONS (1)		OXYGEN	ANIMALS	***** NUMBER DEAD *****				
NOMINAL	MEASURED(2)	MG/L	USED PER	***** AT DAY *****				
			TREATMENT	1	2	3	4	10
			4 DAY 10					
REF			10					0
25% BRH			10					0
50% BRH			10					0
75% BRH			10					0
100% BRH			10					0

96 HOUR LC50

NO EFFECT CONCENTRATION 100% BRH

SIZE: 52 SEGMENTS, DISH EXPERIMENT, WORMS FROM LAB CULTURES

(1) PERCENT FOR SOLID PHASE TESTS

(2) MILLIGRAMS/LITER FOR SUSPENDED PARTICULATE TESTS, DRY WEIGHTS OR COULTER COUNTS OR BOTH.

ACUTE TOXICITY DATA SHEET
COE/ERLN FVP

STUDY PLAN: 1

INVESTIGATOR: C. PESCH/SCHAUER

EXPERIMENT DESCRIPTION: SOLID

DATE OF TEST: 821202

TEST NUMBER: 3

SPECIES: NEANTHES ARENACEODENTATA

** EXPERIMENTAL CONDITIONS **

TEMPERATURE: 20.00 DEGREES CENTIGRADE RANGE: 19.80 - 20.10

SALINITY: 30.00 PARTS PER THOUSAND RANGE: 30.00 - 32.00

EXPOSURE DURATION: 10 DAYS

PHOTOPERIOD: 9 HOURS

FLOW RATE: 56 MLS/MIN VOLUME ADDITIONS/DAY 108

NUMBER OF ANIMALS/REPLICATE: 23

NUMBER OF REPLICATES/TREATMENT: 1

ANIMAL'S LIFE STAGE: JUVENILE AGE: DAYS SIZE: MILLIMETERS

CONTROLS: REF (COLLECTED AUG. 23, 1982)

FOOD USED NONE

EXPOSURE CONCENTRATIONS (1)		OXYGEN	ANIMALS	*===== NUMBER DEAD =====				
NOMINAL	MEASURED(2)	MG/L	USED PER TREATMENT	*===== AT DAY =====				
			4 DAY 10	1	2	3	4	10
REF			23					1
25% BRH			23					0
50% BRH			23					0
75% BRH			23					1
100% BRH			23					0

96 HOUR LC50

NO EFFECT CONCENTRATION 100%BRH

SIZE: 1.69 +/- 0.76 MG DW, WORMS FROM LAB CULTURES

(1) PERCENT FOR SOLID PHASE TESTS

(2) MILLIGRAMS/LITER FOR SUSPENDED PARTICULATE TESTS; DRY WEIGHTS OR COULTER COUNTS OR BOTH.

ACUTE TOXICITY DATA SHEET
COE/ERLN FVP

STUDY PLAN: 1

INVESTIGATOR: C. PESCH/SCHAUER

EXPERIMENT DESCRIPTION: SUSPENDED

DATE OF TEST: 830309

TEST NUMBER: 1

SPECIES: NEANTHES ARENACEODENTATA

** EXPERIMENTAL CONDITIONS **

TEMPERATURE: 20.00 DEGREES CENTIGRADE RANGE: 19.80 - 20.50

SALINITY: 27.00 PARTS PER THOUSAND RANGE: 25.00 - 30.00

EXPOSURE DURATION: 10 DAYS

PHOTOPERIOD: 12 HOURS

FLOW RATE: 99 MLS/MIN

VOLUME ADDITIONS/DAY 190

NUMBER OF ANIMALS/REPLICATE: 30

NUMBER OF REPLICATES/TREATMENT: 1

ANIMAL'S LIFE STAGE: JUVENILES

AGE:

DAYS

SIZE:

MILLIMETERS

CONTROLS: 25 MG REF/REF

FOOD USED NONE

EXPOSURE CONCENTRATIONS (1)		OXYGEN	ANIMALS	*===== NUMBER DEAD =====*				
NOMINAL	MEASURED(2)	MG/L	USED PER	*===== AT DAY =====*				
			TREATMENT	1	2	3	4	10
			4 DAY 10					
25 MG REF/REF			30					3
25 MG BRH/REF			30					3
25 MG REF/BRH			30					1
25 MG BRH/BRH			30					3

96 HOUR LC50

NO EFFECT CONCENTRATION 25 MG BRH/BRH

SIZE: 1.03 +/- 0.43 MG DW, WORMS FROM LAB CULTURES.

(1) PERCENT FOR SOLID PHASE TESTS

(2) MILLIGRAMS/LITER FOR SUSPENDED PARTICULATE TESTS; DRY WEIGHTS OR COULTER COUNTS OR BOTH.

ACUTE TOXICITY DATA SHEET
COE/ERLN FVP

STUDY PLAN: 1

INVESTIGATOR: C. PESCH/SCHAUER

EXPERIMENT DESCRIPTION: SUSPENDED

DATE OF TEST: 830429

TEST NUMBER: 2

SPECIES: NEANTHES ARENACEODENTATA

** EXPERIMENTAL CONDITIONS **

TEMPERATURE: 21.00 DEGREES CENTIGRADE RANGE: 20.00 - 21.00

SALINITY: 28.60 PARTS PER THOUSAND RANGE: 26.00 - 30.00

EXPOSURE DURATION: 10 DAYS

PHOTOPERIOD: 12 HOURS

FLOW RATE: 101 MLS/MIN

VOLUME ADDITIONS/DAY 195

NUMBER OF ANIMALS/REPLICATE: 20

NUMBER OF REPLICATES/TREATMENT: 1

ANIMAL'S LIFE STAGE: JUVENILE AGE: 44 DAYS SIZE: MILLIMETERS

CONTROLS: 25 MG REF/REF

FOOD USED NONE

EXPOSURE CONCENTRATIONS (1)		OXYGEN	ANIMALS	*----- NUMBER DEAD -----*				
NOMINAL	MEASURED(2)	MG/L	USED PER	*----- AT DAY -----*				
			TREATMENT	1	2	3	4	10
			4 DAY 10					
25 MG REF/REF	29.39		20					0
25 MG BRH/REF	28.70		20					1
25 MG REF/BRH	29.39		20					0
25 MG BRH/BRH	28.70		20					1

96 HOUR LC50

NO EFFECT CONCENTRATION 25 MG BRH/BRH

SIZE: 4.55 +/- 1.26 MG DW. WORMS FROM LAB CULTURES

(1) PERCENT FOR SOLID PHASE TESTS

(2) MILLIGRAMS/LITER FOR SUSPENDED PARTICULATE TESTS; DRY WEIGHTS OR COULTER COUNTS OR BOTH.

Table 10

ACUTE TOXICITY DATA SHEET
COE/ERLN FVP

STUDY PLAN: 1

INVESTIGATOR: SCOTT/REDMOND

EXPERIMENT DESCRIPTION: SOLID

DATE OF TEST: 830215

TEST NUMBER: 1

SPECIES: YOLDIA LIMATULA

** EXPERIMENTAL CONDITIONS **

TEMPERATURE: 19.00 DEGREES CENTIGRADE RANGE: 18.00 - 20.00

SALINITY: 29.00 PARTS PER THOUSAND RANGE: 28.00 - 30.00

EXPOSURE DURATION: 10 DAYS

PHOTOPERIOD: 14 HOURS

FLOW RATE: 50 MLS/MIN VOLUME ADDITIONS/DAY 19

NUMBER OF ANIMALS/REPLICATE: 10

NUMBER OF REPLICATES/TREATMENT: 6

ANIMAL'S LIFE STAGE: JUVENILE AGE: DAYS SIZE: MILLIMETERS

CONTROLS: SOUTH REFERENCE SEDIMENT

FOOD USED NONE

EXPOSURE CONCENTRATIONS (1)		OXYGEN	ANIMALS	NUMBER DEAD				
NOMINAL	MEASURED(2)	MG/L	USED PER TREATMENT	AT DAY				
			4 DAY 10	1	2	3	4	10
REF			61					0
25% BRH			60					0
50% BRH			60					1

96 HOUR LC50 NOT CALCULATED NO EFFECT CONCENTRATION LESS THAN 50% BRH
ORGANISMS COLLECTED LIS SOUTH REF SITE 830111, 3.54 +/- 0.84MM(N=30). REF
SEDIMENT BATCH 2, 821207. BRH BARREL 00, BOTTLE 40.

(1) PERCENT FOR SOLID PHASE TESTS

(2) MILLIGRAMS/LITER FOR SUSPENDED PARTICULATE TESTS; DRY WEIGHTS OR COULTER
COUNTS OR BOTH.

ACUTE TOXICITY DATA SHEET
COE/ERLN FVP

STUDY PLAN: 1

INVESTIGATOR: SCOTT/REDMOND

EXPERIMENT DESCRIPTION: SOLID

DATE OF TEST: 830321

TEST NUMBER: 2

SPECIES: YOLDIA LIMATULA

** EXPERIMENTAL CONDITIONS **

TEMPERATURE: 20.00 DEGREES CENTIGRADE RANGE: 19.00 - 21.00

SALINITY: 28.00 PARTS PER THOUSAND RANGE: 27.00 - 29.00

EXPOSURE DURATION: 10 DAYS

PHOTOPERIOD: 14 HOURS

FLOW RATE: 70 MLS/MIN

VOLUME ADDITIONS/DAY 26

NUMBER OF ANIMALS/REPLICATE: 10

NUMBER OF REPLICATES/TREATMENT: 4

ANIMAL'S LIFE STAGE: JUVENILE AGE: DAYS SIZE: MILLIMETERS

CONTROLS: SOUTH REFERENCE SEDIMENT

FOOD USED NONE

EXPOSURE CONCENTRATIONS (1)		OXYGEN	ANIMALS	***** NUMBER DEAD *****				
NOMINAL	MEASURED(2)	MG/L	USED PER TREATMENT 4 DAY 10	***** AT DAY *****				
				1	2	3	4	10
REF			40					0
33% BRH			40					1
66% BRH			40					3
100% BRH			40					14

96 HOUR LC50 NOT CALCULATED NO EFFECT CONCENTRATION LESS THAN 66% BRH
ORGANISMS COLLECTED LIS SOUTH REF SITE, 830216, 3.04 +/- 0.38MM(N=10). REF
SEDIMENT BATCH 2, BOTTLE 20, 821207. BRH BARREL 00, BOTTLE 43.

(1) PERCENT FOR SOLID PHASE TESTS

(2) MILLIGRAMS/LITER FOR SUSPENDED PARTICULATE TESTS; DRY WEIGHTS OR COULTER
COUNTS OR BOTH.

ACUTE TOXICITY DATA SHEET
COE/ERLN FVP

STUDY PLAN: 1

INVESTIGATOR: SCOTT/REDMOND

EXPERIMENT DESCRIPTION: SUSPENDED

DATE OF TEST: 830308

TEST NUMBER: 1

SPECIES: YOLDIA LIMATULA

** EXPERIMENTAL CONDITIONS **

TEMPERATURE: 20.50 DEGREES CENTIGRADE RANGE: 20.00 - 21.00

SALINITY: 28.00 PARTS PER THOUSAND RANGE: 25.00 - 30.00

EXPOSURE DURATION: 10 DAYS

PHOTOPERIOD: 14 HOURS

FLOW RATE: 50 MLS/MIN VOLUME ADDITIONS/DAY 19

NUMBER OF ANIMALS/REPLICATE: 10

NUMBER OF REPLICATES/TREATMENT: 4

ANIMAL'S LIFE STAGE: JUVENILE AGE: DAYS SIZE: MILLIMETERS

CONTROLS: SOUTH REF SUSPENDED/REF SOLID

FOOD USED NONE

EXPOSURE CONCENTRATIONS (1)		OXYGEN	ANIMALS	*===== NUMBER DEAD =====*				
NOMINAL	MEASURED(2)	MG/L	USED PER	*===== AT DAY =====*				
			TREATMENT	1	2	3	4	10
			4 DAY 10					
REF/REF	33.59		40					0
REF/50% BRH	38.90		40					3
BRH/REF	35.70		40					0
BRH/50% BRH	37.29		40					1

96 HOUR LC50 NOT CALCULATED NO EFFECT CONCENTRATION 37.3MG/L BRH/50% BRH
 ORGANISMS COLLECTED LIS SOUTH REF SITE, 830216, 3.70 +/- 0.38MM(N=10). SOLID PHASE
 REF SEDIMENT BATCH2, BOTTLES 1, 17; BRH BARREL 00, BOTTLE 43. MG/L BY DRY WEIGHTS.
 (1) PERCENT FOR SOLID PHASE TESTS
 (2) MILLIGRAMS/LITER FOR SUSPENDED PARTICULATE TESTS; DRY WEIGHTS OR COULTER
 COUNTS OR BOTH.

ACUTE TOXICITY DATA SHEET
COE/ERLN FVP

STUDY PLAN: 1

INVESTIGATOR: SCOTT/REDMOND

EXPERIMENT DESCRIPTION: SUSPENDED

DATE OF TEST: 830503

TEST NUMBER: 2

SPECIES: YOLDIA LIMATULA

** EXPERIMENTAL CONDITIONS **

TEMPERATURE: 20.00 DEGREES CENTIGRADE RANGE: 19.00 - 21.50

SALINITY: 27.00 PARTS PER THOUSAND RANGE: 26.00 - 29.00

EXPOSURE DURATION: 10 DAYS

PHOTOPERIOD: 14 HOURS

FLOW RATE: 50 MLS/MIN VOLUME ADDITIONS/DAY 19

NUMBER OF ANIMALS/REPLICATE: 10

NUMBER OF REPLICATES/TREATMENT: 4

ANIMAL'S LIFE STAGE: JUVENILE AGE: DAYS SIZE: MILLIMETERS

CONTROLS: SOUTH REF SUSPENDED/REF SOLID

FOOD USED NONE

EXPOSURE CONCENTRATIONS (1)		OXYGEN	ANIMALS	***** NUMBER DEAD *****				
NOMINAL	MEASURED(2)	MG/L	USED PER	***** AT DAY *****				
			TREATMENT	1	2	3	4	10
			4 DAY 10					
REF/REF	18.70		40					0
REF/50% BRH	17.30		40					5
BRH/REF	13.25		40					0
BRH/50% BRH	13.65		40					10

96 HOUR LC50 NOT CALCULATED

NO EFFECT CONCENTRATION

ORGANISMS COLLECTED LIS SOUTH REF SITE, 830412, 3.70 +/- 0.46MM(N=10). SOLID PHASE
REF SEDIMENT BATCH2, BOTTLE46; BRH BARREL LL, BOTTLE 27. MG/L BY DRY WEIGHTS.

(1) PERCENT FOR SOLID PHASE TESTS

(2) MILLIGRAMS/LITER FOR SUSPENDED PARTICULATE TESTS; DRY WEIGHTS OR COULTER
COUNTS OR BOTH.

ACUTE TOXICITY DATA SHEET
COE/ERLN FVP

STUDY PLAN: 1 IN IGATOR: SCOTT/REDMOND
 EXPERIMENT DESCRIPTION: SOLID DATE OF TEST: 821027
 TEST NUMBER: 1 SPECIES: MULINIA LATERALIS

** EXPERIMENTAL CONDITIONS **

TEMPERATURE: 20.50 DEGREES CENTIGRADE RANGE: 20.00 - 21.00
 SALINITY: 30.00 PARTS PER THOUSAND RANGE: -
 EXPOSURE DURATION: 10 DAYS
 PHOTOPERIOD: 14 HOURS
 FLOW RATE: 50 MLS/MIN VOLUME ADDITIONS/DAY 19
 NUMBER OF ANIMALS/REPLICATE: 6
 NUMBER OF REPLICATES/TREATMENT: 4
 ANIMAL'S LIFE STAGE: ADULT AGE: DAYS SIZE: MILLIMETERS
 CONTROLS: SOUTH REFERENCE SEDIMENT
 FOOD USED NONE

EXPOSURE CONCENTRATIONS (1)		OXYGEN	ANIMALS	*----- NUMBER DEAD -----*				
NOMINAL	MEASURED(2)	MG/L	USED PER	*----- AT DAY -----*				
			TREATMENT	1	2	3	4	10
			4 DAY 10					
REF			24					0
100% BRH			24					0

96 HOUR LC50 NOT CALCULATED NO EFFECT CONCENTRATION 100% BRH
 ORGANISMS COLLECTED LIS SOUTH REF SITE 821020, 7.19 +/- 0.23MM(N=8). REF
 SEDIMENT BATCH 1, 820824. BRH BARREL 00, BOTTLE 15.

(1) PERCENT FOR SOLID PHASE TESTS

(2) MILLIGRAMS/LITER FOR SUSPENDED PARTICULATE TESTS; DRY WEIGHTS OR COULTER
 COUNTS OR BOTH.

ACUTE TOXICITY DATA SHEET
COE/ERLN FVP

STUDY PLAN: 1

INVESTIGATOR: SCOTT/REDMOND

EXPERIMENT DESCRIPTION: SOLID

DATE OF TEST: 830215

TEST NUMBER: 2

SPECIES: MULINIA LATERALIS

** EXPERIMENTAL CONDITIONS **

TEMPERATURE: 19.00 DEGREES CENTIGRADE RANGE: 18.00 - 20.00

SALINITY: 29.00 PARTS PER THOUSAND RANGE: 28.00 - 30.00

EXPOSURE DURATION: 10 DAYS

PHOTOPERIOD: 14 HOURS

FLOW RATE: 50 MLS/MIN VOLUME ADDITIONS/DAY 19

NUMBER OF ANIMALS/REPLICATE: 10

NUMBER OF REPLICATES/TREATMENT: 4

ANIMAL'S LIFE STAGE: JUVENILE AGE: DAYS SIZE: MILLIMETERS

CONTROLS: SOUTH REFERENCE SEDIMENT

FOOD USED PHAEOACTYLUM(BEFORE TEST)

EXPOSURE CONCENTRATIONS (1)		OXYGEN	ANIMALS	*===== NUMBER DEAD =====*				
NOMINAL	MEASURED(2)	MG/L	USED PER	*===== AT DAY =====*				
			TREATMENT	1	2	3	4	10
			4 DAY 10					
REF			40					0
100% BRH			40					0

96 HOUR LC50 NOT CALCULATED

NO EFFECT CONCENTRATION 100% BRH

ORGANISMS COLLECTED LIS SOUTH REF SITE 830111, 2.34 +/- 0.30MM(N=10). REF
SEDIMENT BATCH 2, 821207. BRH BARREL 00, BOTTLE 40.

(1) PERCENT FOR SOLID PHASE TESTS

(2) MILLIGRAMS/LITER FOR SUSPENDED PARTICULATE TESTS; DRY WEIGHTS OR COULTER
COUNTS OR BOTH.

ACUTE TOXICITY DATA SHEET
COE/ERLN FVP

STUDY PLAN: 1

INVESTIGATOR: SCOTT/REDMOND

EXPERIMENT DESCRIPTION: SUSPENDED

DATE OF TEST: 830308

TEST NUMBER: 1

SPECIES: MULINIA LATERALIS

** EXPERIMENTAL CONDITIONS **

TEMPERATURE: 20.50 DEGREES CENTIGRADE RANGE: 20.00 - 21.00

SALINITY: 28.00 PARTS PER THOUSAND RANGE: 25.00 - 30.00

EXPOSURE DURATION: 10 DAYS

PHOTOPERIOD: 14 HOURS

FLOW RATE: 50 MLS/MIN VOLUME ADDITIONS/DAY 19

NUMBER OF ANIMALS/REPLICATE: 10

NUMBER OF REPLICATES/TREATMENT: 4

ANIMAL'S LIFE STAGE: JUVENILES AGE: DAYS SIZE: MILLIMETERS

CONTROLS: SOUTH REF SUSPENDED/REF SOLID

FOOD USED PHAEOACTYLUM(BEFORE TEST)

EXPOSURE CONCENTRATIONS (1)		OXYGEN	ANIMALS	***** NUMBER DEAD *****				
NOMINAL	MEASURED(2)	MG/L	USED PER TREATMENT	***** AT DAY *****				
			4 DAY 10	1	2	3	4	10
REF/REF	45.40		40					0
REF/BRH	42.40		40					0
BRH/REF	39.90		40					1
BRH/BRH	37.29		40					0

96 HOUR LC50 NOT CALCULATED NO EFFECT CONCENTRATION 100%BRH, 37.3MG/L/BRH
 ORGANISMS COLLECTED LIS SOUTH REF SITE, 830111, 3.02 +/- 0.32MM(N=10). SOLID PHASE
 REF SEDIMENT BATCH2, BOTTLES 1, 17; BRH BARRELOO, BOTTLE 43. MG/L BY DRY WEIGHTS.
 (1) PERCENT FOR SOLID PHASE TESTS
 (2) MILLIGRAMS/LITER FOR SUSPENDED PARTICULATE TESTS; DRY WEIGHTS OR COULTER
 COUNTS OR BOTH.

ACUTE TOXICITY DATA SHEET
COE/ERLN FVP

STUDY PLAN: 1

INVESTIGATOR: LUSSIER

EXPERIMENT DESCRIPTION: SOLID

DATE OF TEST:

820927

TEST NUMBER: 1

SPECIES: MYSIDOPSIS BAHIA

** EXPERIMENTAL CONDITIONS **

TEMPERATURE: 24.00 DEGREES CENTIGRADE RANGE: 23.00 - 25.00

SALINITY: 30.00 PARTS PER THOUSAND RANGE: 29.00 - 30.00

EXPOSURE DURATION: 4 DAYS

PHOTOPERIOD: 12 HOURS

FLOW RATE: 35 MLS/MIN VOLUME ADDITIONS/DAY 15

NUMBER OF ANIMALS/REPLICATE: 10

NUMBER OF REPLICATES/TREATMENT: 2

ANIMAL'S LIFE STAGE: POSTLARVAE AGE: 1 DAYS SIZE: MILLIMETERS

CONTROLS: SEAWATER AND SOUTH REFERENCE

FOOD USED REF A. SALINA DAILY 1 ML

EXPOSURE CONCENTRATIONS (1)		OXYGEN	ANIMALS	*===== NUMBER DEAD =====*				
NOMINAL	MEASURED(2)	MG/L	USED PER	*===== AT DAY =====*				
			TREATMENT	1	2	3	4	10
			4 DAY 10					
SW			20				1	
REF			20				0	
25% BRH			20				0	
50% BRH			20				1	
75% BRH			20				3	
100% BRH			20				4	

96 HOUR LC50 NOT APPL

NO EFFECT CONCENTRATION 100%

(1) PERCENT FOR SOLID PHASE TESTS

(2) MILLIGRAMS/LITER FOR SUSPENDED PARTICULATE TESTS, DRY WEIGHTS OR COULTER COUNTS OR BOTH.

ACUTE TOXICITY DATA SHEET
COE/ERLN FVP

STUDY PLAN: 1

INVESTIGATOR: LUSSIER

EXPERIMENT DESCRIPTION: SOLID

DATE OF TEST: 830301

TEST NUMBER: 2

SPECIES: MYSIDOPSIS BAHIA

** EXPERIMENTAL CONDITIONS **

TEMPERATURE: 25.00 DEGREES CENTIGRADE RANGE: 24.00 - 25.00

SALINITY: 30.00 PARTS PER THOUSAND RANGE: 30.00 - 30.00

EXPOSURE DURATION: 4 DAYS

PHOTOPERIOD: 12 HOURS

FLOW RATE: 35 MLS/MIN VOLUME ADDITIONS/DAY 15

NUMBER OF ANIMALS/REPLICATE: 15

NUMBER OF REPLICATES/TREATMENT: 2

ANIMAL'S LIFE STAGE: POSTLARVAE AGE: 1 DAYS SIZE: MILLIMETERS

CONTROLS: SEAWATER AND SOUTH REFERENCE

FOOD USED REF A. SALINA DAILY 1 ML

EXPOSURE CONCENTRATIONS (1)		OXYGEN	ANIMALS	*===== NUMBER DEAD =====*				
NOMINAL	MEASURED(2)	MG/L	USED PER	*===== AT DAY =====*				
			TREATMENT	1	2	3	4	10
			4 DAY 10					
SW		7.75	30					1
REF		7.50	30					0
25% BRH		7.55	30					1
50% BRH		7.65	30					3
75% BRH		7.20	30					2
100% BRH		7.44	30					1

96 HOUR LC50 NOT APPLICABLE

NO EFFECT CONCENTRATION 100%

(1) PERCENT FOR SOLID PHASE TESTS

(2) MILLIGRAMS/LITER FOR SUSPENDED PARTICULATE TESTS; DRY WEIGHTS OR COULTER COUNTS OR BOTH.

ACUTE TOXICITY DATA SHEET
COE/ERLN FVP

STUDY PLAN: 1

INVESTIGATOR: LUSSIER

EXPERIMENT DESCRIPTION: SOLID

DATE OF TEST: 830308

TEST NUMBER: 3

SPECIES: MYSIDOPSIS BAHIA

** EXPERIMENTAL CONDITIONS **

TEMPERATURE: 25.00 DEGREES CENTIGRADE RANGE: 25.00 - 26.00

SALINITY: 28.00 PARTS PER THOUSAND RANGE: 26.00 - 30.00

EXPOSURE DURATION: 4 DAYS

PHOTOPERIOD: 12 HOURS

FLOW RATE: 35 MLS/MIN VOLUME ADDITIONS/DAY 15

NUMBER OF ANIMALS/REPLICATE: 15

NUMBER OF REPLICATES/TREATMENT: 2

ANIMAL'S LIFE STAGE: POST LARVA AGE: 1 DAYS SIZE: MILLIMETERS

CONTROLS: SEAWATER AND SOUTH REFERENCE

FOOD USED REF A. SALINA DAILY 1 ML

EXPOSURE CONCENTRATIONS (1)		OXYGEN	ANIMALS	***** NUMBER DEAD *****				
NOMINAL	MEASURED(2)	MG/L	USED PER TREATMENT 4 DAY 10	***** AT DAY *****				
				1	2	3	4	10
SW		7.15	30					7
REF		7.30	30					1
25% BRH		7.20	30					0
50% BRH		6.90	30					5
75% BRH		7.25	30					2
100% BRH		7.00	30					5

96 HOUR LC50 NOT APPLICABLE

NO EFFECT CONCENTRATION 100%

(1) PERCENT FOR SOLID PHASE TESTS

(2) MILLIGRAMS/LITER FOR SUSPENDED PARTICULATE TESTS; DRY WEIGHTS OR COULTER COUNTS OR BOTH.

ACUTE TOXICITY DATA SHEET
COE/ERLN FVP

STUDY PLAN: 1

INVESTIGATOR: LUSSIER

EXPERIMENT DESCRIPTION: SUSPENDED

DATE OF TEST

830314

TEST NUMBER: 1

SPECIES: MYSIDOPSIS BAHIA

** EXPERIMENTAL CONDITIONS **

TEMPERATURE: 21.00 DEGREES CENTIGRADE RANGE: 20.00 - 21.00

SALINITY: 30.00 PARTS PER THOUSAND RANGE: 28.00 - 31.00

EXPOSURE DURATION: 4 DAYS

PHOTOPERIOD: 12 HOURS

FLOW RATE: 90 MLS/MIN VOLUME ADDITIONS/DAY 130

NUMBER OF ANIMALS/REPLICATE: 15

NUMBER OF REPLICATES/TREATMENT: 2

ANIMAL'S LIFE STAGE: POSTLARVAE AGE: 1 DAYS SIZE: MILLIMETERS

CONTROLS: SEAWATER

FOOD USED REF. A. SALINA DAILY 1 ML

EXPOSURE CONCENTRATIONS (1)		OXYGEN	ANIMALS	*===== NUMBER DEAD =====*				
NOMINAL	MEASURED(2)	MG/L	USED PER TREATMENT	*===== AT DAY =====*				
			4 DAY 10	1	2	3	4	10
SEAWATER		9.00	30					1
REFERENCE	200860.00	7.70	30					0
25MGBRH/100%BRH	263172.00	7.85	30					2

96 HOUR LC50 NOT APPLICABLE NO EFFECT CONCENTRATION 25MGBRH/100BRH
 MEASURED CONCENTRATIONS ARE COULTER COUNTS IN PARTICLES/ML (100 um MANOMETER)

(1) PERCENT FOR SOLID PHASE TESTS

(2) MILLIGRAMS/LITER FOR SUSPENDED PARTICULATE TESTS; DRY WEIGHTS OR COULTER
COUNTS OR BOTH.

ACUTE TOXICITY DATA SHEET
COE/ERLN FVP

STUDY PLAN: 1

INVESTIGATOR: LUSSIER

EXPERIMENT DESCRIPTION: SUSPENDED

DATE OF TEST

830319

TEST NUMBER 2

SPECIES: MYSIDOPSIS BAHIA

** EXPERIMENTAL CONDITIONS **

TEMPERATURE: 21.00 DEGREES CENTIGRADE RANGE: 21.00 - 21.00

SALINITY: 29.00 PARTS PER THOUSAND RANGE: 28.00 - 29.00

EXPOSURE DURATION: 4 DAYS

PHOTOPERIOD: 12 HOURS

FLOW RATE: 90 MLS/MIN

VOLUME ADDITIONS/DAY 130

NUMBER OF ANIMALS/REPLICATE: 15

NUMBER OF REPLICATES/TREATMENT: 2

ANIMAL'S LIFE STAGE: POSTLARVAE AGE: 1 DAYS SIZE: MILLIMETERS

CONTROLS: SEAWATER OVER SOUTH REFERENCE

FOOD USED REF A. SALINA DAILY 1 ML

EXPOSURE CONCENTRATIONS (1)		OXYGEN	ANIMALS	*===== NUMBER DEAD =====*				
NOMINAL	MEASURED(2)	MG/L	USED PER TREATMENT	*===== AT DAY =====*				
			4 DAY 10	1	2	3	4	10
REFERENCE		8.39	30					5
SEAWATER/S. REF		9.20	30					3
25MGBRH/100%BRH:		8.94	30					2

96 HOUR LC50 NOT APPLICABLE

NO EFFECT CONCENTRATION 25MGBRH/100BRH

MEASURED CONCENTRATIONS ARE COULTER COUNTS IN PARTICLES/ML (100 μ m MANDMETER)

(1) PERCENT FOR SOLID PHASE TESTS

(2) MILLIGRAMS/LITER FOR SUSPENDED PARTICULATE TESTS; DRY WEIGHTS OR COULTER COUNTS OR BOTH.

ACUTE TOXICITY DATA SHEET
COE/ERLN FVP

STUDY PLAN 1

INVESTIGATOR: SCOTT/REDMOND

EXPERIMENT DESCRIPTION: SOLID

DATE OF TEST

820901

TEST NUMBER: 1

SPECIES: AMPELISCA SP

** EXPERIMENTAL CONDITIONS **

TEMPERATURE: 19.50 DEGREES CENTIGRADE RANGE: 19.00 - 20.00

SALINITY: 30.00 PARTS PER THOUSAND RANGE: -

EXPOSURE DURATION: 4 DAYS

PHOTOPERIOD: 14 HOURS

FLOW RATE: 50 MLS/MIN VOLUME ADDITIONS/DAY 19

NUMBER OF ANIMALS/REPLICATE: 20

NUMBER OF REPLICATES/TREATMENT: 2

ANIMAL'S LIFE STAGE: ADULT AGE: DAYS SIZE: MILLIMETERS

CONTROLS: SOUTH REFERENCE SEDIMENT

FOOD USED NONE

EXPOSURE CONCENTRATIONS (1)		OXYGEN	ANIMALS	*===== NUMBER DEAD =====*				
NOMINAL	MEASURED(2)	MG/L	USED PER	*===== AT DAY =====*				
			TREATMENT	1	2	3	4	10
			4 DAY 10					
REF			40					3
25% BRH			40					10
50% BRH			40					14

96 HOUR LC50

NO EFFECT CONCENTRATION

ORGANISMS COLLECTED LIS 820817, 6.51 +/- 0.94MM(N=20). REF SEDIMENT BATCH 1, 820824. BRH BARREL 00, BOTTLE 15

(1) PERCENT FOR SOLID PHASE TESTS

(2) MILLIGRAMS/LITER FOR SUSPENDED PARTICULATE TESTS. DRY WEIGHTS OR COULTER COUNTS OR BOTH.

ACUTE TOXICITY DATA SHEET
COE/ERLN FVP

STUDY PLAN: 1

INVESTIGATOR: SCOTT/REDMOND

EXPERIMENT DESCRIPTION: SOLID

DATE OF TEST: 820727

TEST NUMBER: 2

SPECIES: AMPELISCA SP

** EXPERIMENTAL CONDITIONS **

TEMPERATURE: 21.00 DEGREES CENTIGRADE RANGE: 20.50 - 21.50

SALINITY: 30.00 PARTS PER THOUSAND RANGE: -

EXPOSURE DURATION: 4 DAYS

PHOTOPERIOD: 14 HOURS

FLOW RATE: 50 MLS/MIN VOLUME ADDITIONS/DAY 19

NUMBER OF ANIMALS/REPLICATE: 20

NUMBER OF REPLICATES/TREATMENT: 2

ANIMAL'S LIFE STAGE: ADULT AGE: DAYS SIZE: MILLIMETERS

CONTROLS: LI SOUND SEDIMENT(NATIVE)

FOOD USED NONE

EXPOSURE CONCENTRATIONS (1)		OXYGEN	ANIMALS	*===== NUMBER DEAD =====*				
NOMINAL	MEASURED(2)	MG/L	USED PER	*===== AT DAY =====*				
			TREATMENT	1	2	3	4	10
			4 DAY 10					
LI SOUND			40				4	
25% BRH			40				22	
50% BRH			40				30	
75% BRH			40				33	
100% BRH			40				35	

96 HOUR LC50 CANNOT BE DETERMINED NO EFFECT CONCENTRATION LESS THAN 25% BRH
ORGANISMS COLLECTED LIS 820715, 4.84 +/- 0.72MM(N=19) LIS SEDIMENT COLLECTED
820715, BRH BARREL 00, BOTTLE 6

(1) PERCENT FOR SOLID PHASE TESTS

(2) MILLIGRAMS/LITER FOR SUSPENDED PARTICULATE TESTS, DRY WEIGHTS OR COULTER
COUNTS OR BOTH.

ACUTE TOXICITY DATA SHEET
COE/ERLN FVP

STUDY PLAN: 1

INVESTIGATOR: SCOTT/REDMOND

EXPERIMENT DESCRIPTION: SOLID

DATE OF TEST:

820901

TEST NUMBER: 3

SPECIES: AMPELISCA SP

** EXPERIMENTAL CONDITIONS **

TEMPERATURE: 19.50 DEGREES CENTIGRADE RANGE: 19.00 - 20.00

SALINITY: 30.00 PARTS PER THOUSAND RANGE: -

EXPOSURE DURATION: 4 DAYS

PHOTOPERIOD: 14 HOURS

FLOW RATE: 50 MLS/MIN VOLUME ADDITIONS/DAY 19

NUMBER OF ANIMALS/REPLICATE: 30

NUMBER OF REPLICATES/TREATMENT: 1

ANIMAL'S LIFE STAGE: ADULT AGE: DAYS SIZE: MILLIMETERS

CONTROLS: SOUTH REFERENCE SEDIMENT

FOOD USED NONE

EXPOSURE CONCENTRATIONS (1)		OXYGEN	ANIMALS	*===== NUMBER DEAD =====*				
NOMINAL	MEASURED(2)	MG/L	USED PER	*===== AT DAY =====*				
			TREATMENT	1	2	3	4	10
			4 DAY 10					
REF			30				1	
25% BRH			30				19	
50% BRH			30				25	

96 HOUR LC50 CANNOT BE DETERMINED NO EFFECT CONCENTRATION LESS THAN 25%BRH
ORGANISMS COLLECTED NR 820719, 5.53 +/- 0.39MM(N=30). REF SEDIMENT BATCH 1,
820824. BRH BARREL 00, BOTTLE 15

(1) PERCENT FOR SOLID PHASE TESTS

(2) MILLIGRAMS/LITER FOR SUSPENDED PARTICULATE TESTS, DRY WEIGHTS OR COULTER
COUNTS OR BOTH.

ACUTE TOXICITY DATA SHEET
COE/ERLN FVP

STUDY PLAN: 1

INVESTIGATOR: SCOTT/REDMOND

EXPERIMENT DESCRIPTION: SOLID

DATE OF TEST: B20901

TEST NUMBER: 4

SPECIES: AMPELISCA SP

** EXPERIMENTAL CONDITIONS **

TEMPERATURE: 19.50 DEGREES CENTIGRADE RANGE: 19.00 - 20.00

SALINITY: 30.00 PARTS PER THOUSAND RANGE: -

EXPOSURE DURATION: 4 DAYS

PHOTOPERIOD: 14 HOURS

FLOW RATE: 50 MLS/MIN VOLUME ADDITIONS/DAY 19

NUMBER OF ANIMALS/REPLICATE: 30

NUMBER OF REPLICATES/TREATMENT: 1

ANIMAL'S LIFE STAGE: ADULT AGE: DAYS SIZE: MILLIMETERS

CONTROLS: SOUTH REFERENCE SEDIMENT

FOOD USED NONE

EXPOSURE CONCENTRATIONS (1)		OXYGEN	ANIMALS	***** NUMBER DEAD *****				
NOMINAL	MEASURED(2)	MG/L	USED PER	***** AT DAY *****				
			TREATMENT	1	2	3	4	10
			4 DAY 10					
REF			30					0
25% BRH			30					19
50% BRH			30					24

96 HOUR LC50 CANNOT BE DETERMINED NO EFFECT CONCENTRATION LESS THAN 25% BRH
ORGANISMS COLLECTED NR B20901, 5 67 +/- 0.48MM(N=30) REF SEDIMENT BATCH 1,
B20824. BRH BARREL 00, BOTTLE 15

(1) PERCENT FOR SOLID PHASE TESTS

(2) MILLIGRAMS/LITER FOR SUSPENDED PARTICULATE TESTS; DRY WEIGHTS OR COULTER
COUNTS OR BOTH.

ACUTE TOXICITY DATA SHEET
COE/ERLN FVP

STUDY PLAN: 1

INVESTIGATOR: SCOTT/REDMOND

EXPERIMENT DESCRIPTION: SOLID

DATE OF TEST: 821203

TEST NUMBER: 5

SPECIES: AMPELISCA SP

** EXPERIMENTAL CONDITIONS **

TEMPERATURE: 21.00 DEGREES CENTIGRADE RANGE: 20.50 - 21.50

SALINITY: 30.00 PARTS PER THOUSAND RANGE: -

EXPOSURE DURATION: 10 DAYS

PHOTOPERIOD: 14 HOURS

FLOW RATE: 50 MLS/MIN VOLUME ADDITIONS/DAY 19

NUMBER OF ANIMALS/REPLICATE: 20

NUMBER OF REPLICATES/TREATMENT: 4

ANIMAL'S LIFE STAGE: ADULT AGE: DAYS SIZE: MILLIMETERS

CONTROLS: NARROW RIVER SEDIMENT(NATIVE)

FOOD USED PHAEOACTYLUM(BEFORE TEST)

EXPOSURE CONCENTRATIONS (1)		OXYGEN	ANIMALS	*===== NUMBER DEAD =====*				
NOMINAL	MEASURED(2)	MG/L	USED PER	*===== AT DAY =====*				
			TREATMENT	1	2	3	4	10
			4 DAY 10					
NR			80	80			1	3
12.5% BRH			80	80			3	26
25% BRH			80	80			36	71
50% BRH			80	80			67	80

96 HOUR LC50 27.16(25-50)% BRH NO EFFECT CONCENTRATION LESS THAN 12.5% BRH
 10 DAY LC50=15.26(12.5-25)% BRH. ORGANISMS COLLECTED NARROW R. 820901, 5.33 +/-
 0.69MM(N=40). NR SEDIMENT COLLECTED 820901. BRH BARREL 00, BOTTLE 29.

(1) PERCENT FOR SOLID PHASE TESTS

(2) MILLIGRAMS/LITER FOR SUSPENDED PARTICULATE TESTS, DRY WEIGHTS OR COULTER
COUNTS OR BOTH.

ACUTE TOXICITY DATA SHEET
COE/ERLN FVP

STUDY PLAN: 1

INVESTIGATOR: SCOTT/REDMOND

EXPERIMENT DESCRIPTION: SOLID

DATE OF TEST: 830201

TEST NUMBER: 6

SPECIES: AMPELISCA SP

** EXPERIMENTAL CONDITIONS **

TEMPERATURE: 20.50 DEGREES CENTIGRADE RANGE: 20.00 - 21.00

SALINITY: 30.00 PARTS PER THOUSAND RANGE: -

EXPOSURE DURATION: 4 DAYS

PHOTOPERIOD: 14 HOURS

FLOW RATE: 50 MLS/MIN VOLUME ADDITIONS/DAY 19

NUMBER OF ANIMALS/REPLICATE: 20

NUMBER OF REPLICATES/TREATMENT: 2

ANIMAL'S LIFE STAGE: ADULT AGE: DAYS SIZE: MILLIMETERS

CONTROLS: SOUTH REFERENCE SEDIMENT

FOOD USED PHAEOACTYLUM(BEFORE TEST)

EXPOSURE CONCENTRATIONS (1)		OXYGEN	ANIMALS	*===== NUMBER DEAD =====*				
NOMINAL	MEASURED(2)	MG/L	USED PER	*===== AT DAY =====*				
			TREATMENT	1	2	3	4	10
			4 DAY 10					
REF			40				5	
12.5% BRH			40				12	
25% BRH			40				19	
50% BRH			40				24	

96 HOUR LC50 29.79(18.14-72.82) NO EFFECT CONCENTRATION LESS THAN 12.5% BRH
 ORGANISMS COLLECTED NARROW R. 820901, 6.80 +/- 0.77MM(N=20). REF SEDIMENT
 BATCH 1, 820824. BRH BARREL 00, BOTTLE 40.

(1) PERCENT FOR SOLID PHASE TESTS

(2) MILLIGRAMS/LITER FOR SUSPENDED PARTICULATE TESTS; DRY WEIGHTS OR COULTER
COUNTS OR BOTH.

ACUTE TOXICITY DATA SHEET
COE/ERLN FVP

STUDY PLAN: 1

INVESTIGATOR: SCOTT/REDMOND

EXPERIMENT DESCRIPTION: SUSPENDED

DATE OF TEST

830318

TEST NUMBER: 1

SPECIES: AMPELISCA SP

** EXPERIMENTAL CONDITIONS **

TEMPERATURE: 21.00 DEGREES CENTIGRADE RANGE: 20.50 - 21.50

SALINITY: 28.00 PARTS PER THOUSAND RANGE: 28.00 - 29.00

EXPOSURE DURATION: 4 DAYS

PHOTOPERIOD: 14 HOURS

FLOW RATE: 60 MLS/MIN VOLUME ADDITIONS/DAY 23

NUMBER OF ANIMALS/REPLICATE: 20

NUMBER OF REPLICATES/TREATMENT: 4

ANIMAL'S LIFE STAGE: ADULT AGE: DAYS SIZE: MILLIMETERS

CONTROLS: SOUTH REF SUSPENDED/REF SOLID

FOOD USED PHAEOACTYLUM(BEFORE TEST)

EXPOSURE CONCENTRATIONS (1)		OXYGEN	ANIMALS	*===== NUMBER DEAD =====*				
NOMINAL	MEASURED(2)	MG/L	USED PER	*===== AT DAY =====*				
			TREATMENT	1	2	3	4	10
			4 DAY 10					
REF/REF	22.39		80					15
33% BRH/REF	22.70		81					13
66% BRH/REF	18.89		80					10
BRH/REF	18.20		80					20

96 HOUR LC50 NOT CALCULATED NO EFFECT CONCENTRATION 100%BRH, 18.2MG/L/REF
 ORGANISMS COLLECTED NARROW R. 830204, 6.90 +/- 0.92MM(N=40). SOLID PHASE REF SED
 IMENT BATCH 2, BOTTLE 19. MG/L DETERMINED BY DRY WEIGHT MEASUREMENTS.

(1) PERCENT FOR SOLID PHASE TESTS

(2) MILLIGRAMS/LITER FOR SUSPENDED PARTICULATE TESTS; DRY WEIGHTS OR COULTER
COUNTS OR BOTH.

ACUTE TOXICITY DATA SHEET
COE/ERLN FVP

STUDY PLAN: 1

INVESTIGATOR: SCOTT/REDMOND

EXPERIMENT DESCRIPTION: SUSPENDED

DATE OF TEST: 830404

TEST NUMBER: 2

SPECIES: AMPELISCA SP

** EXPERIMENTAL CONDITIONS **

TEMPERATURE: 8.00 DEGREES CENTIGRADE RANGE: 7.50 - 8.50

SALINITY: 28.00 PARTS PER THOUSAND RANGE: -

EXPOSURE DURATION: 4 DAYS

PHOTOPERIOD: 14 HOURS

FLOW RATE: 60 MLS/MIN VOLUME ADDITIONS/DAY 23

NUMBER OF ANIMALS/REPLICATE: 20

NUMBER OF REPLICATES/TREATMENT: 4

ANIMAL'S LIFE STAGE: ADULT AGE: DAYS SIZE: MILLIMETERS

CONTROLS: SOUTH REF SUSPENDED/REF SOLID

FOOD USED NONE

EXPOSURE CONCENTRATIONS (1)		OXYGEN	ANIMALS	***** NUMBER DEAD *****				
NOMINAL	MEASURED(2)	MG/L	USED PER	***** AT DAY *****				
			TREATMENT	1	2	3	4	10
			4 DAY 10					
REF/REF	26.89		80				0	
33% BRH/REF	25.79		80				0	
66% BRH/REF	24.70		80				0	
BRH/REF	23.29		80				1	

96 HOUR LC50 NOT CALCULATED NO EFFECT CONCENTRATION 100%BRH, 23.3MG/L/REF
ORGANISMS COLLECTED NARROW R. 830404, 7.50 +/- 0.73MM(N=40). SOLID PHASE REF
SEDIMENT BATCH 2, BOTTLE 28. MG/L DETERMINED BY DRY WEIGHT MEASUREMENTS.

(1) PERCENT FOR SOLID PHASE TESTS

(2) MILLIGRAMS/LITER FOR SUSPENDED PARTICULATE TESTS, DRY WEIGHTS OR COULTER
COUNTS OR BOTH.

ACUTE TOXICITY DATA SHEET
COE/ERLN FVP

STUDY PLAN: 1

INVESTIGATOR: SCOTT/REDMOND

EXPERIMENT DESCRIPTION: SUSPENDED

DATE OF TEST: 830502

TEST NUMBER: 3

SPECIES: AMPELISCA SP

** EXPERIMENTAL CONDITIONS **

TEMPERATURE: 20.00 DEGREES CENTIGRADE RANGE: 19.00 - 21.50

SALINITY: 27.00 PARTS PER THOUSAND RANGE: 25.00 - 28.00

EXPOSURE DURATION: 4 DAYS

PHOTOPERIOD: 14 HOURS

FLOW RATE: 50 MLS/MIN VOLUME ADDITIONS/DAY 19

NUMBER OF ANIMALS/REPLICATE: 20

NUMBER OF REPLICATES/TREATMENT: 4

ANIMAL'S LIFE STAGE: JUVENILE AGE: DAYS SIZE: MILLIMETERS

CONTROLS: SOUTH REF SUSPENDED/REF SOLID

FOOD USED PHAEOACTYLUM(BEFORE TEST)

EXPOSURE CONCENTRATIONS (1)		OXYGEN	ANIMALS	***** NUMBER DEAD *****				
NOMINAL	MEASURED(2)	MG/L	USED PER	***** AT DAY *****				
			TREATMENT	1	2	3	4	10
			4 DAY 10					
REF/REF	15.95		80				3	
BRH/REF	12.85		80				7	

96 HOUR LC50 NOT CALCULATED NO EFFECT CONCENTRATION 100%BRH, 12.8MG/L/REF
 ORGANISMS COLLECTED NARROW R., FEB. 1983, 3.40 +/- 0.34MM(N=19). SOLID PHASE REF
 SEDIMENT BATCH2, BOTTLE 46. MG/L DETERMINED BY DRY WEIGHT MEASUREMENTS
 (1) PERCENT FOR SOLID PHASE TESTS
 (2) MILLIGRAMS/LITER FOR SUSPENDED PARTICULATE TESTS, DRY WEIGHTS OR COULTER
 COUNTS OR BOTH.

ACUTE TOXICITY DATA SHEET
COE/ERLN FVP

STUDY PLAN: 1

INVESTIGATOR: SCHIMMEL

EXPERIMENT DESCRIPTION: SOLID

DATE OF TEST: 830211

TEST NUMBER: 1

SPECIES: MENIDIA MENIDIA

**** EXPERIMENTAL CONDITIONS ****

TEMPERATURE: 20.50 DEGREES CENTIGRADE RANGE: 20.40 - 20.60
 SALINITY: 30.00 PARTS PER THOUSAND RANGE: 30.00 - 30.00
 EXPOSURE DURATION: 4 DAYS
 PHOTOPERIOD: 12 HOURS
 FLOW RATE: 44 MLS/MIN VOLUME ADDITIONS/DAY 25
 NUMBER OF ANIMALS/REPLICATE: 12
 NUMBER OF REPLICATES/TREATMENT: 2
 ANIMAL'S LIFE STAGE: LARVAL AGE: 10 DAYS SIZE: 10 MILLIMETERS
 CONTROLS: SEAWATER AND REFERENCE
 FOOD USED REF BRINE SHRIMP

EXPOSURE CONCENTRATIONS (1)		OXYGEN	ANIMALS	***** NUMBER DEAD *****				
NOMINAL	MEASURED(2)	MG/L	USED PER TREATMENT	***** AT DAY *****				
			4 DAY 10	1	2	3	4	10
SW		7.59	24	0	0	0	0	0
100% REF		7.30	24	0	0	0	0	0
100% BRH		7.25	24	0	0	0	0	0

96 HOUR LC50 NO EFFECT CONCENTRATION 100% BRH
 NO MORTALITIES OR OBVIOUS BEHAVIORAL EFFECTS OBSERVED OVER THE 96 H TEST PERIOD.

- (1) PERCENT FOR SOLID PHASE TESTS
- (2) MILLIGRAMS/LITER FOR SUSPENDED PARTICULATE TESTS, DRY WEIGHTS OR COULTER COUNTS OR BOTH.

ACUTE TOXICITY DATA SHEET
COE/ERLN FVP

STUDY PLAN: 1

INVESTIGATOR: SCHIMMEL

EXPERIMENT DESCRIPTION: SOLID

DATE OF TEST: 830221

TEST NUMBER: 2

SPECIES: MENIDIA MENIDIA

** EXPERIMENTAL CONDITIONS **

TEMPERATURE: 20.40 DEGREES CENTIGRADE RANGE: 20.00 - 20.80

SALINITY: 30.00 PARTS PER THOUSAND RANGE: 30.00 - 30.00

EXPOSURE DURATION: 4 DAYS

PHOTOPERIOD: 12 HOURS

FLOW RATE: 45 MLS/MIN VOLUME ADDITIONS/DAY 26

NUMBER OF ANIMALS/REPLICATE: 12

NUMBER OF REPLICATES/TREATMENT: 2

ANIMAL'S LIFE STAGE: LARVAL AGE: 10 DAYS SIZE: 7 MILLIMETERS

CONTROLS: SEAWATER AND REFERENCE

FOOD USED REF BRINE SHRIMP

EXPOSURE CONCENTRATIONS (1)		OXYGEN	ANIMALS	*===== NUMBER DEAD =====*				
NOMINAL	MEASURED(2)	MG/L	USED PER TREATMENT	*===== AT DAY =====*				
			4 DAY 10	1	2	3	4	10
SW		7.55	24	0	0	0	0	0
100% REF		7.45	23	0	0	0	0	0
100% BRH		7.34	23	0	0	0	0	0

96 HOUR LC50
NO MORTALITIES OBSERVED.

NO EFFECT CONCENTRATION 100% BRH

(1) PERCENT FOR SOLID PHASE TESTS

(2) MILLIGRAMS/LITER FOR SUSPENDED PARTICULATE TESTS; DRY WEIGHTS OR COULTER
COUNTS OR BOTH.

ACUTE TOXICITY DATA SHEET
COE/ERLN FVP

STUDY PLAN: 1

INVESTIGATOR: SCHIMMEL

EXPERIMENT DESCRIPTION: SUSPENDED

DATE OF TEST

830308

TEST NUMBER: 1

SPECIES: MENIDIA MENIDIA

** EXPERIMENTAL CONDITIONS **

TEMPERATURE: 19.90 DEGREES CENTIGRADE RANGE: 19.60 - 20.30

SALINITY: 26.50 PARTS PER THOUSAND RANGE: 26.00 - 27.00

EXPOSURE DURATION: 4 DAYS

PHOTOPERIOD: 12 HOURS

FLOW RATE: 80 MLS/MIN

VOLUME ADDITIONS/DAY 46

NUMBER OF ANIMALS/REPLICATE: 12

NUMBER OF REPLICATES/TREATMENT: 2

ANIMAL'S LIFE STAGE: LARVAL

AGE: 17 DAYS

SIZE:

10 MILLIMETERS

CONTROLS: SEAWATER AND REFERENCE

FOOD USED REF BRINE SHRIMP

EXPOSURE CONCENTRATIONS (1)		OXYGEN	ANIMALS	*===== NUMBER DEAD =====*				
NOMINAL	MEASURED(2)	MG/L	USED PER	*===== AT DAY =====*				
			TREATMENT	1	2	3	4	10
			4 DAY 10					
SW		7.90	24	0	0	0	1	
25MG/L BRH	18.45	7.59	22	0	0	0	0	
25MG/L REF	24.85	7.59	24	0	0	0	0	

96 HOUR LC50

NO EFFECT CONCENTRATION 25MG/L BRH

SEAWATER PARTICULATE CONC NOT MEASURED. REF AND BRH PARTICULATE CONC

MEASURED BY DRY WT OF 100ml WATER SAMPLES/DISH

(1) PERCENT FOR SOLID PHASE TESTS

(2) MILLIGRAMS/LITER FOR SUSPENDED PARTICULATE TESTS, DRY WEIGHTS OR COULTER COUNTS OR BOTH.

ACUTE TOXICITY DATA SHEET
COE/ERLN FVP

STUDY PLAN 1

INVESTIGATOR: SCHIMMEL

EXPERIMENT DESCRIPTION: SUSPENDED

DATE OF TEST

830314

TEST NUMBER: 2

SPECIES: MENIDIA MENIDIA

** EXPERIMENTAL CONDITIONS **

TEMPERATURE: 20.00 DEGREES CENTIGRADE RANGE: 19.80 - 20.30

SALINITY: 29.60 PARTS PER THOUSAND RANGE: 29.00 - 30.00

EXPOSURE DURATION: 4 DAYS

PHOTOPERIOD: 12 HOURS

FLOW RATE: 90 MLS/MIN VOLUME ADDITIONS/DAY 52

NUMBER OF ANIMALS/REPLICATE: 12

NUMBER OF REPLICATES/TREATMENT: 2

ANIMAL'S LIFE STAGE: LARVAL AGE: 10 DAYS SIZE: 8 MILLIMETERS

CONTROLS: SEAWATER AND REFERENCE

FOOD USED REFERENCE BRINE SHRIMP

EXPOSURE CONCENTRATIONS	IS	1)	OXYGEN	ANIMALS	*===== NUMBER DEAD =====*				
					2)	MG/L	USED PER	*===== AT DAY =====*	
NOMINAL				TREATMENT	1	2	3	4	10
				4 DAY 10					
SW		8.35	7.90	24	0	0	1	0	
25MG/L BRH		23.45	7.65	24	0	0	0	0	
25MG/L REF		18.05	7.80	23	0	0	0	0	

96 HOUR LC50 NO EFFECT CONCENTRATION 25 MG/L PARTICULATE
SINGLE MORTALITY IN SW CONTROL. PARTIC MEASURED BY DRY WT OF 100ML WATER
SAMPLE FROM EACH DISH.

(1) PERCENT FOR SOLID PHASE TESTS.

(2) MILLIGRAMS/LITER FOR SUSPENDED PARTICULATE TESTS, DRY WEIGHTS OR COULTER
COUNTS OR BOTH.

ACUTE TOXICITY DATA SHEET
COE/ERLN FVP

STUDY PLAN: 1

INVESTIGATOR: SCHIMMEL

EXPERIMENT DESCRIPTION: SOLID

DATE OF TEST: 830131

TEST NUMBER: 1

SPECIES: CYPRINODON VARIEGATUS

** EXPERIMENTAL CONDITIONS **

TEMPERATURE: 21.90 DEGREES CENTIGRADE RANGE: 21.80 - 21.90

SALINITY: 30.00 PARTS PER THOUSAND RANGE: 30.00 - 30.00

EXPOSURE DURATION: 4 DAYS

PHOTOPERIOD: 12 HOURS

FLOW RATE: 50 MLS/MIN VOLUME ADDITIONS/DAY 34

NUMBER OF ANIMALS/REPLICATE: 12

NUMBER OF REPLICATES/TREATMENT: 2

ANIMAL'S LIFE STAGE: LARVAL AGE: 1 DAYS SIZE: 3 MILLIMETERS

CONTROLS: SW AND REF

FOOD USED ARTEMIA, 100% BDY WT/DAY

EXPOSURE CONCENTRATIONS (1)		OXYGEN	ANIMALS	*===== NUMBER DEAD =====*				
NOMINAL	MEASURED(2)	MG/L	USED PER	*===== AT DAY =====*				
			TREATMENT	1	2	3	4	10
			4 DAY 10					
SW			24	0	0	0	1	
REF			24	0	0	0	0	
100%BRH			24	0	0	0	0	

96 HOUR LC50

NO EFFECT CONCENTRATION 100%BRH

DISSOLVED OXYGEN DATA ARE NOT AVAILABLE FOR THIS TEST, BUT THE DISSOLVED GAS LEVELS WERE AT OR ABOVE SATURATION IN ALL OF THE EXPOSURE CHAMBERS.

(1) PERCENT FOR SOLID PHASE TESTS

(2) MILLIGRAMS/LITER FOR SUSPENDED PARTICULATE TESTS, DRY WEIGHTS OR COULTER COUNTS OR BOTH.

ACUTE TOXICITY DATA SHEET
COE/ERLN FVP

STUDY PLAN: 1

INVESTIGATOR: SCHIMMEL

EXPERIMENT DESCRIPTION: SOLID

DATE OF TEST: 830214

TEST NUMBER: 2

SPECIES: CYPRINODON VARIEGATUS

** EXPERIMENTAL CONDITIONS **

TEMPERATURE: 20.50 DEGREES CENTIGRADE RANGE: 20.20 - 20.70
 SALINITY: 29.00 PARTS PER THOUSAND RANGE: 28.00 - 30.00
 EXPOSURE DURATION: 4 DAYS
 PHOTOPERIOD: 12 HOURS
 FLOW RATE: 45 MLS/MIN VOLUME ADDITIONS/DAY 31
 NUMBER OF ANIMALS/REPLICATE: 12
 NUMBER OF REPLICATES/TREATMENT: 2
 ANIMAL'S LIFE STAGE: LARVAL AGE: 14 DAYS SIZE: 7 MILLIMETERS
 CONTROLS: SW AND REF
 FOOD USED NONE

EXPOSURE CONCENTRATIONS (1)		OXYGEN	ANIMALS	*===== NUMBER DEAD =====*				
NOMINAL	MEASURED(2)	MG/L	USED PER	*===== AT DAY =====*				
			TREATMENT	1	2	3	4	10
			4 DAY 10					
SW		7.85	24	0	0	0	0	0
REF		7.59	24	0	0	0	0	0
100%BRH		7.55	24	0	0	0	0	0

96 HOUR LC50

NO EFFECT CONCENTRATION 100%BRH

(1) PERCENT FOR SOLID PHASE TESTS

(2) MILLIGRAMS/LITER FOR SUSPENDED PARTICULATE TESTS; DRY WEIGHTS OR COULTER COUNTS OR BOTH.

ACUTE TOXICITY DATA SHEET
COE/ERLN FVP

STUDY PLAN: 1

INVESTIGATOR: SCHIMMEL

EXPERIMENT DESCRIPTION: SUSPENDED

DATE OF TEST: 830307

TEST NUMBER: 1

SPECIES: CYPRINODON VARIEGATUS

** EXPERIMENTAL CONDITIONS **

TEMPERATURE: 19.90 DEGREES CENTIGRADE RANGE: 19.80 - 20.00
 SALINITY: 26.00 PARTS PER THOUSAND RANGE: 25.00 - 26.00
 EXPOSURE DURATION: 4 DAYS
 PHOTOPERIOD: 12 HOURS
 FLOW RATE: 80 MLS/MIN VOLUME ADDITIONS/DAY 55
 NUMBER OF ANIMALS/REPLICATE: 11
 NUMBER OF REPLICATES/TREATMENT: 2
 ANIMAL'S LIFE STAGE: LARVAL AGE: 31 DAYS SIZE: 10 MILLIMETERS
 CONTROLS: SW AND REF
 FOOD USED NONE

EXPOSURE CONCENTRATIONS (1)		OXYGEN	ANIMALS	*===== NUMBER DEAD =====*				
NOMINAL	MEASURED(2)	MG/L	USED PER TREATMENT	*===== AT DAY =====*				
			4 DAY 10	1	2	3	4	10
SW		7.95	22	0	0	0	0	0
25MG/L BRH	22.10	7.20	22	0	0	0	0	0
25MG/L REF	21.35	7.59	22	0	0	0	0	0

96 HOUR LC50

NO EFFECT CONCENTRATION 25MG/L BRH

MEASURED CONCENTRATIONS ARE FROM SINGLE DRY WEIGHT DETERMINATIONS. DATA FOR SW1 AND SW2 ARE NOT AVAILABLE

(1) PERCENT FOR SOLID PHASE TESTS

(2) MILLIGRAMS/LITER FOR SUSPENDED PARTICULATE TESTS; DRY WEIGHTS OR COULTER COUNTS OR BOTH.

ACUTE TOXICITY DATA SHEET
COE/ERLN FVP

STUDY PLAN: 1

INVESTIGATOR: SCHIMMEL

EXPERIMENT DESCRIPTION: SUSPENDED

DATE OF TEST: 830321

TEST NUMBER: 2

SPECIES: CYPRINODON VARIEGATUS

** EXPERIMENTAL CONDITIONS **

TEMPERATURE: 19.60 DEGREES CENTIGRADE RANGE: 19.30 - 20.10

SALINITY: 28.20 PARTS PER THOUSAND RANGE: 28.00 - 29.00

EXPOSURE DURATION: 4 DAYS

PHOTOPERIOD: 12 HOURS

FLOW RATE: 90 MLS/MIN VOLUME ADDITIONS/DAY 62

NUMBER OF ANIMALS/REPLICATE: 11

NUMBER OF REPLICATES/TREATMENT: 2

ANIMAL'S LIFE STAGE: LARVAL AGE: 30 DAYS SIZE: 12 MILLIMETERS

CONTROLS: SEAWATER AND REFERENCE

FOOD USED NONE

EXPOSURE CONCENTRATIONS (1)		OXYGEN	ANIMALS	*===== NUMBER DEAD =====*				
NOMINAL	MEASURED(2)	MG/L	USED PER	*===== AT DAY =====*				
			TREATMENT	1	2	3	4	10
			4 DAY 10					
SW	3.40	8.25	22	0	0	0	0	0
25MG/L BRH	28.95	8.30	22	0	0	0	0	0
25MG/L REF	21.45	8.15	22	0	0	0	0	0

96 HOUR LC50

NO EFFECT CONCENTRATION 25MG/L BRH

FISH FOR REPLICATE 1 WERE 48 DAYS OLD AND 13.4 MM. LONG. THE FISH IN REPLICATE 2 WERE 12 DAYS OLD AND 9.7 MM. LONG

(1) PERCENT FOR SOLID PHASE TESTS

(2) MILLIGRAMS/LITER FOR SUSPENDED PARTICULATE TESTS, DRY WEIGHTS OR COULTER COUNTS OR BOTH.

ACUTE TOXICITY DATA SHEET
COOPERLN FVP

STUDY PLAN: 1

INVESTIGATOR: SCHIMMEL

EXPERIMENT DESCRIPTION: SOLID

DATE OF TEST: 830118

TEST NUMBER: 1

SPECIES: AMMODYTES AMERICANUS

** EXPERIMENTAL CONDITIONS **

TEMPERATURE: 10.20 DEGREES CENTIGRADE RANGE: 9.50 - 11.50
 SALINITY: 30.00 PARTS PER THOUSAND RANGE: 30.00 - 30.00
 EXPOSURE DURATION: 4 DAYS
 PHOTOPERIOD: 12 HOURS
 FLOW RATE: 34 MLS/MIN VOLUME ADDITIONS/DAY 6
 NUMBER OF ANIMALS/REPLICATE: 10
 NUMBER OF REPLICATES/TREATMENT: 2
 ANIMAL'S LIFE STAGE: EMBRYONIC AGE: 18 DAYS SIZE: 1 MILLIMETERS
 CONTROLS: SW AND REF
 FOOD USED

EXPOSURE CONCENTRATIONS (1)		OXYGEN	ANIMALS	*===== NUMBER DEAD =====*				
NOMINAL	MEASURED(2)	MG/L	USED PER TREATMENT	*===== AT DAY =====*				
			4 DAY 10	1	2	3	4	10
SW		9.10	20					1
REF		9.10	20					2
25%BRH		9.10	18					1
50%BRH		9.10	18					1
75%BRH		9.10	20					2
100%BRH		9.10	18					1

96 HOUR LC50

NO EFFECT CONCENTRATION 100%BRH

(1) PERCENT FOR SOLID PHASE TESTS
 (2) MILLIGRAMS/LITER FOR SUSPENDED PARTICULATE TESTS; DRY WEIGHTS OR COULTER COUNTS OR BOTH.

ACUTE TOXICITY DATA SHEET
COE/ERLN FVP

STUDY PLAN: 1

INVESTIGATOR: SCHIMMEL

EXPERIMENT DESCRIPTION: SOLID

DATE OF TEST: 830125

TEST NUMBER: 2

SPECIES: AMMODYTES AMERICANUS

** EXPERIMENTAL CONDITIONS **

TEMPERATURE: 10.00 DEGREES CENTIGRADE RANGE: 9.00 - 10.50

SALINITY: 30.00 PARTS PER THOUSAND RANGE: 30.00 - 30.00

EXPOSURE DURATION: 4 DAYS

PHOTOPERIOD: 12 HOURS

FLOW RATE: 34 MLS/MIN VOLUME ADDITIONS/DAY 6

NUMBER OF ANIMALS/REPLICATE: 10

NUMBER OF REPLICATES/TREATMENT: 2

ANIMAL'S LIFE STAGE: EMBRYONIC AGE: 25 DAYS SIZE: 1 MILLIMETERS

CONTROLS: SW AND REF

FOOD USED

EXPOSURE CONCENTRATIONS (1)		OXYGEN	ANIMALS	*===== NUMBER DEAD =====				
NOMINAL	MEASURED(2)	MG/L	USED PER	*===== AT DAY =====				
			TREATMENT	1	2	3	4	10
			4 DAY 10					
SW		9.10	23					2
REF		9.10	20					0
25%BRH		9.10	18					0
50%BRH		9.10	22					0
75%BRH		9.10	18					1
100%BRH		9.10	18					0

96 HOUR LC50

NO EFFECT CONCENTRATION 100%BRH

(1) PERCENT FOR SOLID PHASE TESTS

(2) MILLIGRAMS/LITER FOR SUSPENDED PARTICULATE TESTS; DRY WEIGHTS OR COULTER COUNTS OR BOTH.

ACUTE TOXICITY DATA SHEET
COE/ERLN FVP

STUDY PLAN 1

INVESTIGATOR: SCHIMMEL

EXPERIMENT DESCRIPTION: SOLID

DATE OF TEST

830217

TEST NUMBER 1

SPECIES: AMMODYTES AMERICANUS

** EXPERIMENTAL CONDITIONS **

TEMPERATURE 9.90 DEGREES CENTIGRADE RANGE: 9.00 - 11.00

SALINITY: 30.00 PARTS PER THOUSAND RANGE: 28.00 - 32.00

EXPOSURE DURATION: 4 DAYS

PHOTOPERIOD 12 HOURS

FLOW RATE: 34 MLS/MIN VOLUME ADDITIONS/DAY 6

NUMBER OF ANIMALS/REPLICATE: 15

NUMBER OF REPLICATES/TREATMENT: 2

ANIMAL'S LIFE STAGE: LARVAL AGE: 14 DAYS SIZE: 8 MILLIMETERS

CONTROLS: SW AND REF

FOOD USED ROTIFERS: 2X/DAY; 0.6ML/LAR/DAY

EXPOSURE CONCENTRATIONS (1)		OXYGEN	ANIMALS	*===== NUMBER DEAD =====*				
NOMINAL	MEASURED(2)	MG/L	USED PER TREATMENT	*===== AT DAY =====*				
			4 DAY 10	1	2	3	4	10
SW		9.10	28	2	1	1	0	
REF		9.10	28	3	1	3	2	
100%BRH		9.10	29	6	8	2	6	

96 HOUR LC50

NO EFFECT CONCENTRATION REF

(1) PERCENT FOR SOLID PHASE TESTS.

(2) MILLIGRAMS/LITER FOR SUSPENDED PARTICULATE TESTS, DRY WEIGHTS OR COULTER COUNTS OR BOTH.

ACUTE TOXICITY DATA SHEET
COE/ERLN FVP

STUDY PLAN: 1

INVESTIGATOR: SCHIMMEL

EXPERIMENT DESCRIPTION: SOLID

DATE OF TEST: 830222

TEST NUMBER: 2

SPECIES: AMMODYTES AMERICANUS

** EXPERIMENTAL CONDITIONS **

TEMPERATURE: 10.00 DEGREES CENTIGRADE RANGE: 9.50 - 10.00

SALINITY: 30.00 PARTS PER THOUSAND RANGE: 28.00 - 30.00

EXPOSURE DURATION: 4 DAYS

PHOTOPERIOD: 12 HOURS

FLOW RATE: 34 MLS/MIN VOLUME ADDITIONS/DAY 6

NUMBER OF ANIMALS/REPLICATE: 15

NUMBER OF REPLICATES/TREATMENT: 2

ANIMAL'S LIFE STAGE: LARVAL AGE: 18 DAYS SIZE: 10 MILLIMETERS

CONTROLS: SW AND REF

FOOD USED ROTIFERS; 2X/DAY; 0.6ML/LAR/DAY

EXPOSURE CONCENTRATIONS (1)		OXYGEN	ANIMALS	*===== NUMBER DEAD =====*				
NOMINAL	MEASURED(2)	MG/L	USED PER TREATMENT	*===== AT DAY =====*				
			4 DAY 10	1	2	3	4	10
SW		9.10	30	2	0	2	0	
REF		9.10	29	4	4	1	2	
100%BRH		9.10	30	5	2	4	10	

96 HOUR LC50

NO EFFECT CONCENTRATION REF

(1) PERCENT FOR SOLID PHASE TESTS.

(2) MILLIGRAMS/LITER FOR SUSPENDED PARTICULATE TESTS, DRY WEIGHTS OR COULTER COUNTS OR BOTH.

ACUTE TOXICITY DATA SHEET
COE/ERLN FVP

STUDY PLAN: 1

INVESTIGATOR: SCHIMMEL

EXPERIMENT DESCRIPTION: SOLID

DATE OF TEST:

830303

TEST NUMBER: 1

SPECIES: AMMODYTES AMERICANUS

** EXPERIMENTAL CONDITIONS **

TEMPERATURE: 10.20 DEGREES CENTIGRADE RANGE: 10.00 - 10.50

SALINITY: 30.00 PARTS PER THOUSAND RANGE: 30.00 - 30.00

EXPOSURE DURATION: 4 DAYS

PHOTOPERIOD: 12 HOURS

FLOW RATE: 21 MLS/MIN VOLUME ADDITIONS/DAY 8

NUMBER OF ANIMALS/REPLICATE 10

NUMBER OF REPLICATES/TREATMENT: 2

ANIMAL'S LIFE STAGE: LARVAL AGE: 28 DAYS SIZE: 12 MILLIMETERS

CONTROLS: SW AND REF

FOOD USED ROTIFERS; 2X/DAY; 0.8ML LAR/DAY

EXPOSURE CONCENTRATIONS (1)		OXYGEN	ANIMALS	***** NUMBER DEAD *****				
NOMINAL	MEASURED(2)	MG/L	USED PER TREATMENT	***** AT DAY *****				
			4 DAY 10	1	2	3	4	10
SW		9.10	20	2	1	0	0	
REF		9.10	19	2	3	3	2	
25%BRH		9.10	20	5	0	3	1	
50%BRH		9.10	20	5	5	6	6	
75%BRH		9.10	19	4	3	1	4	
100%BRH		9.10	20	5	8	1	1	

96 HOUR LC50

NO EFFECT CONCENTRATION

(1) PERCENT FOR SOLID PHASE TESTS.

(2) MILLIGRAMS/LITER FOR SUSPENDED PARTICULATE TESTS, DRY WEIGHTS OR COULTER COUNTS OF BOTH.

ACUTE TOXICITY DATA SHEET
COE/ERLN FVP

STUDY PLAN 1

INVESTIGATOR: SCHIMMEL

EXPERIMENT DESCRIPTION: SOLID

DATE OF TEST: 83J310

TEST NUMBER: 2

SPECIES: AMMODYTES AMERICANUS

** EXPERIMENTAL CONDITIONS **

TEMPERATURE 10.00 DEGREES CENTIGRADE RANGE: 9.00 - 10.50

SALINITY: 27.60 PARTS PER THOUSAND RANGE: 26.00 - 30.00

EXPOSURE DURATION: 4 DAYS

PHOTOPERIOD 12 HOURS

FLOW RATE: 21 MLS/MIN VOLUME ADDITIONS/DAY 8

NUMBER OF ANIMALS/REPLICATE: 10

NUMBER OF REPLICATES/TREATMENT: 2

ANIMAL'S LIFE STAGE: LARVAL AGE: 31 DAYS SIZE: 15 MILLIMETERS

CONTROLS: SW AND REF

FOOD USED ROTIFERS; 2X/DAY; 0.8ML/LAR/DAY

EXPOSURE CONCENTRATIONS (1)		OXYGEN	ANIMALS	***** NUMBER DEAD *****				
NOMINAL	MEASURED(2)	MG/L	USED PER TREATMENT 4 DAY 10	***** AT DAY *****				
				1	2	3	4	10
SW		9.30	19	4	0	0	0	
REF		9.30	17	8	3	1	0	
25%BRH		9.30	19	5	2	1	1	
50%BRH		9.30	17	7	1	0	0	
75%BRH		9.30	16	7	2	1	2	
100%BRH		9.30	18	12	3	0	1	

96 HOUR LC50

NO EFFECT CONCENTRATION

(1) PERCENT FOR SOLID PHASE TESTS

(2) MILLIGRAMS/LITER FOR SUSPENDED PARTICULATE TESTS, DRY WEIGHTS OR COULTER COUNTS OR BOTH

ACUTE TOXICITY DATA SHEET
COE/ERLN FVP

STUDY PLAN: 1

INVESTIGATOR: SCHIMMEL

EXPERIMENT DESCRIPTION: SOLID

DATE OF TEST: B30318

TEST NUMBER 1

SPECIES: AMMODYTES AMERICANUS

** EXPERIMENTAL CONDITIONS **

TEMPERATURE: 10.50 DEGREES CENTIGRADE RANGE: 10.00 - 11.00

SALINITY: 26.80 PARTS PER THOUSAND RANGE: 26.00 - 30.00

EXPOSURE DURATION: 4 DAYS

PHOTOPERIOD: 12 HOURS

FLOW RATE: 21 MLS/MIN VOLUME ADDITIONS/DAY 8

NUMBER OF ANIMALS/REPLICATE: 10

NUMBER OF REPLICATES/TREATMENT: 2

ANIMAL'S LIFE STAGE: LARVAL AGE: 41 DAYS SIZE 17 MILLIMETERS

CONTROLS: SW AND REF

FOOD USED ROTIFERS; 2X/DAY; 1.0ML/LAR/DAY

EXPOSURE CONCENTRATIONS (1)		OXYGEN	ANIMALS	***** NUMBER DEAD *****				
NOMINAL	MEASURED(2)	MG/L	USED PER TREATMENT 4 DAY 10	***** AT DAY *****				
				1	2	3	4	10
SW		9.30	20	5	1	3	1	
REF		9.30	18	10	2	2	1	
25%BRH		9.30	19	15	1	1	1	
50%BRH		9.30	20	11	2	4	0	
75%BRH		9.30	20	14	1	3	0	
100%BRH		9.30	20	18	0	1	0	

96 HOUR LC50

NO EFFECT CONCENTRATION

(1) PERCENT FOR SOLID PHASE TESTS

(2) MILLIGRAMS/LITER FOR SUSPENDED PARTICULATE TESTS; DRY WEIGHTS OR COULTER COUNTS OR BOTH.

ACUTE TOXICITY DATA SHEET
COE/ERLN FVP

STUDY PLAN: 1

INVESTIGATOR: SCHIMMEL

EXPERIMENT DESCRIPTION: SOLID

DATE OF TEST

830328

TEST NUMBER: 2

SPECIES: AMMODYTES AMERICANUS

** EXPERIMENTAL CONDITIONS **

TEMPERATURE: 9.40 DEGREES CENTIGRADE RANGE: 8.50 - 10.00

SALINITY: 31.00 PARTS PER THOUSAND RANGE: 30.00 - 32.00

EXPOSURE DURATION: 4 DAYS

PHOTOPERIOD: 12 HOURS

FLOW RATE: 21 MLS/MIN VOLUME ADDITIONS/DAY 8

NUMBER OF ANIMALS/REPLICATE: 10

NUMBER OF REPLICATES/TREATMENT: 2

ANIMAL'S LIFE STAGE: LARVAL AGE: 25 DAYS SIZE: 12 MILLIMETERS

CONTROLS: SW AND REF

FOOD USED ROTIFERS; 2X/DAY; 1. OML/LAR/DAY

EXPOSURE CONCENTRATIONS (1)		OXYGEN	ANIMALS	***** NUMBER DEAD *****				
NOMINAL	MEASURED(2)	MG/L	USED PER TREATMENT 4 DAY 10	***** AT DAY *****				
				1	2	3	4	10
SW		8.05	20	2	0	2	1	
REF		7.80	20	3	1	3	0	
25%BRH		7.80	20	5	2	1	1	
50%BRH		7.00	20	8	1	3	3	
75%BRH		8.00	20	6	2	7	3	
100%BRH		6.90	20	8	5	1	1	

96 HOUR LC50

NO EFFECT CONCENTRATION

(1) PERCENT FOR SOLID PHASE TESTS

(2) MILLIGRAMS/LITER FOR SUSPENDED PARTICULATE TESTS, DRY WEIGHTS OR COULTER COUNTS OR BOTH.

ACUTE TOXICITY DATA SHEET
COE/ERLN FVP

STUDY PLAN: 1

INVESTIGATOR: SCHIMMEL

EXPERIMENT DESCRIPTION: SUSPENDED

DATE OF TEST:

830405

TEST NUMBER: 1

SPECIES: AMMODYTES AMERICANUS

** EXPERIMENTAL CONDITIONS **

TEMPERATURE: 9.60 DEGREES CENTIGRADE RANGE: 8.20 - 11.20

SALINITY: 29.60 PARTS PER THOUSAND RANGE: 28.00 - 30.00

EXPOSURE DURATION: 4 DAYS

PHOTOPERIOD: 12 HOURS

FLOW RATE: 89 MLS/MIN VOLUME ADDITIONS/DAY 52

NUMBER OF ANIMALS/REPLICATE: 15

NUMBER OF REPLICATES/TREATMENT: 2

ANIMAL'S LIFE STAGE: LARVAL AGE: 28 DAYS SIZE: 12 MILLIMETERS

CONTROLS: SW AND REF

FOOD USED ROTIFERS; 2X/DAY; 20-25ML/DAY

EXPOSURE CONCENTRATIONS (1)		OXYGEN	ANIMALS	*===== NUMBER DEAD =====*				
NOMINAL	MEASURED(2)	MG/L	USED PER	*===== AT DAY =====*				
			TREATMENT	1	2	3	4	10
			4 DAY 10					
SW	6.30	10.60	30	0	1	0	0	
25MG/L BRH	19.95	9.75	29	0	13	7	3	
25MG/L REF	21.85	10.05	30	0	6	6	1	

96 HOUR LC50

NO EFFECT CONCENTRATION SEE COMMENTS

NOT A DEFINITIVE TEST; EXPOSURE CONCENTRATIONS WERE MEASURED BY DRY WEIGHTS.

(1) PERCENT FOR SOLID PHASE TESTS

(2) MILLIGRAMS/LITER FOR SUSPENDED PARTICULATE TESTS, DRY WEIGHTS OR COULTER COUNTS OR BOTH.

ACUTE TOXICITY DATA SHEET
COE/ERLN FVP

STUDY PLAN: 1

INVESTIGATOR: SCHIMMEL

EXPERIMENT DESCRIPTION: SUSPENDED

DATE OF TEST: 830409

TEST NUMBER: 2

SPECIES: AMMODYTES AMERICANUS

** EXPERIMENTAL CONDITIONS **

TEMPERATURE: 10.50 DEGREES CENTIGRADE RANGE: 9.20 - 11.60
 SALINITY: 28.00 PARTS PER THOUSAND RANGE: 28.00 - 28.00
 EXPOSURE DURATION: 4 DAYS
 PHOTOPERIOD: 12 HOURS
 FLOW RATE: 90 MLS/MIN VOLUME ADDITIONS/DAY 52
 NUMBER OF ANIMALS/REPLICATE: 15
 NUMBER OF REPLICATES/TREATMENT: 2
 ANIMAL'S LIFE STAGE: LARVAL AGE: 32 DAYS SIZE: 14 MILLIMETERS
 CONTROLS: SW AND REF
 FOOD USED ROTIFERS; 2X/DAY; 20-25ML/DAY/D

EXPOSURE CONCENTRATIONS (1)		OXYGEN	ANIMALS	*===== NUMBER DEAD =====*				
NOMINAL	MEASURED(2)	MG/L	USED PER TREATMENT	*===== AT DAY =====*				
			4 DAY 10	1	2	3	4	10
SW	10.39	9.80	30	0	0	0	8	
25MG/L BRH	20.75	9.55	31	0	5	1	1	
25MG/L REF	21.75	9.80	30	0	7	6	6	

96 HOUR LC50 NO EFFECT CONCENTRATION SEE COMMENTS
 NOT A DEFINITIVE TEST; A MECHANICAL PROBLEM CAUSED DAY 4 SW MORTALITIES. EXPOSURE CONCENTRATIONS WRE MEASURED BY DRY WEIGHTS.
 (1) PERCENT FOR SOLID PHASE TESTS
 (2) MILLIGRAMS/LITER FOR SUSPENDED PARTICULATE TESTS. DRY WEIGHTS OR COULTER COUNTS OR BOTH.

ACUTE TOXICITY DATA SHEET
COE/ERLN FVP

STUDY PLAN: 1

INVESTIGATOR: SCHIMMEL

EXPERIMENT DESCRIPTION: SOLID

DATE OF TEST: 830221

TEST NUMBER: 1

SPECIES: PARALICHTHYS DENTATUS

** EXPERIMENTAL CONDITIONS **

TEMPERATURE: 20.50 DEGREES CENTIGRADE RANGE: 20.20 - 20.80

SALINITY: 30.00 PARTS PER THOUSAND RANGE: 30.00 - 30.00

EXPOSURE DURATION: 4 DAYS

PHOTOPERIOD: 12 HOURS

FLOW RATE: 45 MLS/MIN VOLUME ADDITIONS/DAY 31

NUMBER OF ANIMALS/REPLICATE: 12

NUMBER OF REPLICATES/TREATMENT: 2

ANIMAL'S LIFE STAGE: LARVAL AGE: 120 DAYS SIZE: 18 MILLIMETERS

CONTROLS: SW AND REF

FOOD USED ARTEMIA, 100% BODY WT/DAY

EXPOSURE CONCENTRATIONS (1)		OXYGEN	ANIMALS	*===== NUMBER DEAD =====*				
NOMINAL	MEASURED(2)	MG/L	USED PER TREATMENT	*===== AT DAY =====*				
			4 DAY 10	1	2	3	4	10
SW		7.75	23	0	0	0	0	0
REF		7.85	22	0	0	0	0	0
100%BRH		8.89	24	0	0	0	0	0

96 HOUR LC50

NO EFFECT CONCENTRATION 100%BRH

THE DISSOLVED OXYGEN VALUE FOR 100%BRH2 IS PROBABLY AN ERROR, THERE WAS NO EVIDENCE OF SUPERSATURATION.

(1) PERCENT FOR SOLID PHASE TESTS

(2) MILLIGRAMS/LITER FOR SUSPENDED PARTICULATE TESTS, DRY WEIGHTS OR COULTER COUNTS OR BOTH.

ACUTE TOXICITY DATA SHEET
COE/ERLN FVP

STUDY PLAN: 1

INVESTIGATOR: SCHIMMEL

EXPERIMENT DESCRIPTION: SOLID

DATE OF TEST: B30415

TEST NUMBER: 2

SPECIES: PARALICHTHYS DENTATUS

** EXPERIMENTAL CONDITIONS **

TEMPERATURE: 20.30 DEGREES CENTIGRADE RANGE: 19.50 - 20.50

SALINITY: 27.00 PARTS PER THOUSAND RANGE: 28.00 - 26.00

EXPOSURE DURATION: 4 DAYS

PHOTOPERIOD: 12 HOURS

FLOW RATE: 42 MLS/MIN VOLUME ADDITIONS/DAY 29

NUMBER OF ANIMALS/REPLICATE: 8

NUMBER OF REPLICATES/TREATMENT: 2

ANIMAL'S LIFE STAGE: LARVAL AGE: 120 DAYS SIZE: 19 MILLIMETERS

CONTROLS: SW AND REF

FOOD USED ARTEMIA, 100% BODY WT/DAY

EXPOSURE CONCENTRATIONS (1)		OXYGEN	ANIMALS	***** NUMBER DEAD *****				
NOMINAL	MEASURED(2)	MG/L	USED PER TREATMENT 4 DAY 10	***** AT DAY *****				
				1	2	3	4	10
SW		8.15	16	0	0	0	0	0
REF		8.39	16	0	0	1	0	0
100%BRH		7.70	16	0	0	0	1	0

96 HOUR LC50
DEAD FOUND ON DAY 1 WERE REPLACED

NO EFFECT CONCENTRATION 100% BRH

(1) PERCENT FOR SOLID PHASE TESTS.

(2) MILLIGRAMS/LITER FOR SUSPENDED PARTICULATE TESTS. DRY WEIGHTS OR COULTER COUNTS OR BOTH.

ACUTE TOXICITY DATA SHEET
COE/ERLN FVP

STUDY PLAN: 1

INVESTIGATOR: SCHIMMEL

EXPERIMENT DESCRIPTION: SOLID

DATE OF TEST: 830328

TEST NUMBER: 1

SPECIES: PSEUDOPLEURONECTES AMERICANUS

** EXPERIMENTAL CONDITIONS **

TEMPERATURE: 9.30 DEGREES CENTIGRADE RANGE: 9.00 - 9.60

SALINITY: 30.40 PARTS PER THOUSAND RANGE: 30.00 - 32.00

EXPOSURE DURATION: 4 DAYS

PHOTOPERIOD: 12 HOURS

FLOW RATE: 37 MLS/MIN VOLUME ADDITIONS/DAY 25

NUMBER OF ANIMALS/REPLICATE: 12

NUMBER OF REPLICATES/TREATMENT: 2

ANIMAL'S LIFE STAGE: LARVAL AGE: 42 DAYS SIZE: 7 MILLIMETERS

CONTROLS: SW AND REF

FOOD USED ARTEMIA, 100%BODY WT/DAY

EXPOSURE CONCENTRATIONS (1)		OXYGEN	ANIMALS	*===== NUMBER DEAD =====*				
NOMINAL	MEASURED(2)	MG/L	USED PER TREATMENT	*===== AT DAY =====*				
			4 DAY 10	1	2	3	4	10
SW		9.80	12	0	1	1	0	
REF		9.40	24	0	1	2	2	
100%BRH		9.05	22	0	0	0	0	

96 HOUR LC50

NO EFFECT CONCENTRATION 100%BRH

DEAD AND MISSING WERE REPLACED AFTER TWENTY FOUR HOURS. ONE SEAWATER CONTROL WAS LOST.

(1) PERCENT FOR SOLID PHASE TESTS

(2) MILLIGRAMS/LITER FOR SUSPENDED PARTICULATE TESTS; DRY WEIGHTS OR COULTER COUNTS OR BOTH.

ACUTE TOXICITY DATA SHEET
COE/ERLN FVP

STUDY PLAN: 1

INVESTIGATOR: SCHIMMEL

EXPERIMENT DESCRIPTION: SOLID

DATE OF TEST: 830404

TEST NUMBER: 2

SPECIES: PSEUDOPLEURONECTES AMERICANUS

** EXPERIMENTAL CONDITIONS **

TEMPERATURE: 10.50 DEGREES CENTIGRADE RANGE: 10.00 - 11.00

SALINITY: 27.80 PARTS PER THOUSAND RANGE: 26.00 - 29.00

EXPOSURE DURATION: 4 DAYS

PHOTOPERIOD: 12 HOURS

FLOW RATE: 37 MLS/MIN VOLUME ADDITIONS/DAY 25

NUMBER OF ANIMALS/REPLICATE: 12

NUMBER OF REPLICATES/TREATMENT: 2

ANIMAL'S LIFE STAGE: LARVAL AGE: 49 DAYS SIZE: 7 MILLIMETERS

CONTROLS: SW AND REF

FOOD USED ARTEMIA, 100% BODY WT/DAY

EXPOSURE CONCENTRATIONS (1)		OXYGEN	ANIMALS	*===== NUMBER DEAD =====*				
NOMINAL	MEASURED(2)	MG/L	USED PER	*===== AT DAY =====*				
			TREATMENT	1	2	3	4	10
			4 DAY 10					
SW		9.85	23	0	0	0	0	0
REF		9.60	22	0	0	0	1	
100%BRH		10.00	24	0	4	5	0	

96 HOUR LC50

NO EFFECT CONCENTRATION

DEAD WERE REPLACED AFTER THE FIRST 24 HOURS.

(1) PERCENT FOR SOLID PHASE TESTS

(2) MILLIGRAMS/LITER FOR SUSPENDED PARTICULATE TESTS; DRY WEIGHTS OR COULTER COUNTS OR BOTH.

ACUTE TOXICITY DATA SHEET
COE/ERLN FVP

STUDY PLAN: 1

INVESTIGATOR: SCHIMMEL

EXPERIMENT DESCRIPTION: SUSPENDED

DATE OF TEST: 830404

TEST NUMBER: 1

SPECIES: PSEUDOPLEURONECTES AMERICANUS

** EXPERIMENTAL CONDITIONS **

TEMPERATURE: 9.40 DEGREES CENTIGRADE RANGE: 8.20 - 11.80

SALINITY: 28.20 PARTS PER THOUSAND RANGE: 26.00 - 29.00

EXPOSURE DURATION: 4 DAYS

PHOTOPERIOD: 12 HOURS

FLOW RATE: 90 MLS/MIN VOLUME ADDITIONS/DAY 62

NUMBER OF ANIMALS/REPLICATE: 12

NUMBER OF REPLICATES/TREATMENT: 2

ANIMAL'S LIFE STAGE: LARVAL AGE: 49 DAYS SIZE: 7 MILLIMETERS

CONTROLS: SW AND REF

FOOD USED ARTEMIA, 100%BODY WT/DAY

EXPOSURE CONCENTRATIONS (1)		OXYGEN	ANIMALS	*===== NUMBER DEAD =====*				
NOMINAL	MEASURED(2)	MG/L	USED PER	*===== AT DAY =====*				
			TREATMENT	1	2	3	4	10
			4 DAY 10					
SW	8.39	10.19	24	0	1	0	0	
25MG/L BRH	33.04	9.75	24	0	0	1	0	
25MG/L REF	27.50	10.10	23	0	0	0	0	

96 HOUR LC50

NO EFFECT CONCENTRATION 25MG/L BRH

MEASURED CONCENTRATIONS ARE MEANS OF TWO DRY WEIGHT DETERMINATIONS, EXCEPT FOR BRH1 WHICH IS FROM A SINGLE DRY WEIGHT DETERMINATION 24 HR DEAD REPLACED.

(1) PERCENT FOR SOLID PHASE TESTS

(2) MILLIGRAMS/LITER FOR SUSPENDED PARTICULATE TESTS; DRY WEIGHTS OR COULTER COUNTS OR BOTH.

ACUTE TOXICITY DATA SHEET
COE/ERLN FVP

STUDY PLAN: 1

INVESTIGATOR: SCHIMMEL

EXPERIMENT DESCRIPTION: SUSPENDED

DATE OF TEST: 830409

TEST NUMBER: 2

SPECIES: PSEUDOPLEURONECTES AMERICANUS

** EXPERIMENTAL CONDITIONS **

TEMPERATURE: 10.40 DEGREES CENTIGRADE RANGE: 9.20 - 12.70

SALINITY: 28.00 PARTS PER THOUSAND RANGE: 28.00 - 28.00

EXPOSURE DURATION: 4 DAYS

PHOTOPERIOD: 12 HOURS

FLOW RATE: 88 MLS/MIN VOLUME ADDITIONS/DAY 60

NUMBER OF ANIMALS/REPLICATE: 12

NUMBER OF REPLICATES/TREATMENT 2

ANIMAL'S LIFE STAGE: LARVAL AGE: 55 DAYS SIZE: 7 MILLIMETERS

CONTROLS: SW AND REF

FOOD USED ARTEMIA, 100%BODY WT/DAY

EXPOSURE CONCENTRATIONS (1)		OXYGEN	ANIMALS	*===== NUMBER DEAD =====*				
NOMINAL	MEASURED(2)	MG/L	USED PER TREATMENT	*===== AT DAY =====*				
			4 DAY 10	1	2	3	4	()
SW	3.10	9.40	24	0	2	2	1	
25MG/L BRH	23.60	9.10	22	0	1	2	1	
25MG/L REF	21.15	9.19	19	0	3	1	1	

96 HOUR LC50

NO EFFECT CONCENTRATION 100%BRH

MEASURED CONCENTRATIONS ARE MEANS OF TWO DRY WEIGHT DETERMINATIONS, EXCEPT FOR SW1 WHICH IS FROM A SINGLE DETERMINATION. 24 HOUR DEAD WERE REPLACED.

(1) PERCENT FOR SOLID PHASE TESTS

(2) MILLIGRAMS/LITER FOR SUSPENDED PARTICULATE TESTS, DRY WEIGHTS OR COULTER COUNTS OR BOTH.