

AD-A164 018

PREDICTING THE EFFECTS OF OVERLOADS ON SUSTAINED-LOAD
CRACK GROWTH IN A H. (U) AIR FORCE INST OF TECH
WRIGHT-PATTERSON AFB OH SCHOOL OF ENGI. R L HASTIE
DEC 85 AFIT/GA/AA/85D-6 F/G 11/6

1/2

UNCLASSIFIED

NL

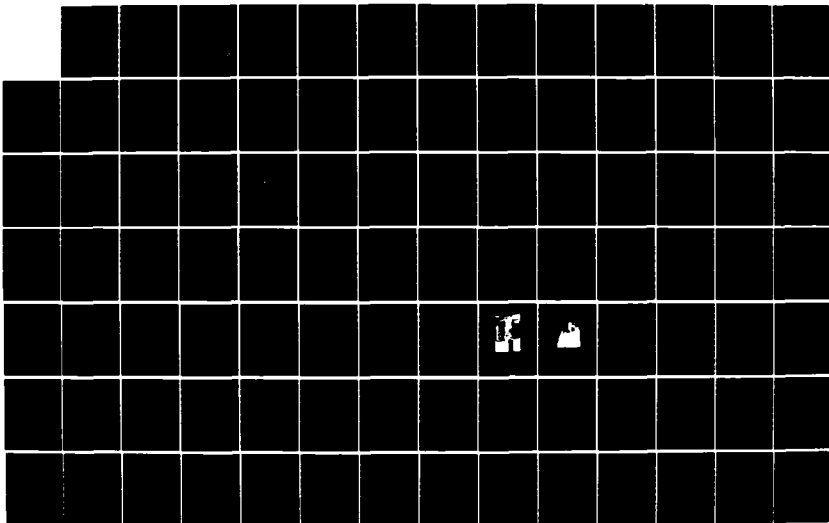

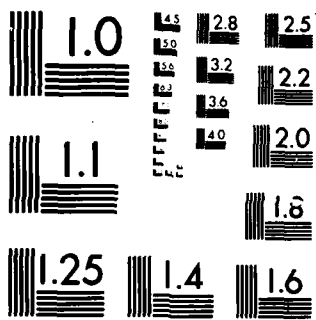

MICROCOPY RESOLUTION TEST CHART
NATIONAL BUREAU OF STANDARDS-1963-A

1

AD-A164 018



PREDICTING THE EFFECTS OF OVERLOADS
ON SUSTAINED-LOAD CRACK GROWTH
IN A HIGH-TEMPERATURE SUPERALLOY

THESIS

Robert L. Hastie Jr.
Captain, USAF

AFIT/GA/AA/85D-6

S DTIC
ELECTE
FEB 12 1986
B

DISTRIBUTION STATEMENT A
Approved for public release
Distribution Unlimited

DTIC FILE COPY

DEPARTMENT OF THE AIR FORCE
AIR UNIVERSITY
AIR FORCE INSTITUTE OF TECHNOLOGY

Wright-Patterson Air Force Base, Ohio

86 2 12 069

AFIT/GA/AA/85D-6

PREDICTING THE EFFECTS OF OVERLOADS
ON SUSTAINED-LOAD CRACK GROWTH
IN A HIGH-TEMPERATURE SUPERALLOY

THESIS

Robert L. Hastie Jr.
Captain, USAF

AFIT/GA/AA/85D-6

DTIC
ELECTE
FEB 12 1986
S D
B

Approved for public release; distribution unlimited

AFIT/GA/AA/85D-6

PREDICTING THE EFFECTS OF OVERLOADS
ON SUSTAINED-LOAD CRACK GROWTH
IN A HIGH-TEMPERATURE SUPERALLOY

THESIS

Presented to the Faculty of the School of Engineering
of the Air Force Institute of Technology
Air University

In Partial Fulfillment of the
Master of Science in Astronautical Engineering

Robert L. Hastie Jr., B.S.
Captain, USAF

December 1985

Approved for public release; distribution unlimited

Table of Contents

	<u>Page</u>
Preface.....	ii
List of Figures.....	iv
List of Tables.....	vi
Abstract.....	vii
I. Introduction.....	1
Background.....	1
Objective.....	4
II. Retardation Model Theory.....	5
Wheeler Model.....	5
Willenborg Model.....	8
Overload Model.....	9
III. Computer Model Development.....	18
Overload Program.....	18
CRACKS Program.....	29
IV. Application of Retardation Models.....	37
V. Proof Test Experiments.....	48
Test Apparatus.....	48
Crack Measurement Procedure.....	55
VI. Experimental Results and Discussion.....	68
VII. Conclusions and Recommendations.....	76
Conclusions.....	76
Recommendations.....	78
Bibliography.....	79
Appendix A: Heat Treatment History of Specimens.....	81
Appendix B: Overload Program Source Code.....	82
Appendix C: CRACKS Program Source Code.....	89
Vita.....	128

List of Figures

<u>Figure</u>	<u>Page</u>
1. Schematic diagram of the plastic zones at the crack tip.....	7
2. Variation of K_{eff}/K_s as a function of normalized crack advancement from the crack tip in the overload plastic zone.....	12
3. Delay Times Resulting from 20 Percent Overloads at Various Stress Intensities.....	14
4. Delay Times Resulting from 50 Percent Overloads at Various Stress Intensities.....	15
5. α Functions for 20 and 50 Percent Overloads.....	17
6. MSE Model Fitted to Sustained-Load Baseline Data....	21
7. Overload Program Load History Input Example.....	24
8. Crack Jumps from Overload Cycles at Various K Levels.....	27
9. Overload Model Predictions to Proof Test 84-507 Using Various Jump Functions.....	28
10. MSE Curve Shift Using the B Parameter and R Ratio...	30
11. Graphical Representation of Equivalent Sustained-Load Fatigue Cycles.....	33
12. Crack Length versus Time for 20 Percent Overload at Low K.....	40
13. Crack Length versus Time for 20 Percent Overload at Medium K.....	41
14. Crack Length versus Time for 20 Percent Overload at High K.....	42
15. Crack Length versus Time for 50 Percent Overload at Low K.....	43
16. Crack Length versus Time for 50 Percent Overload at Medium K.....	44

<u>Figure</u>	<u>Page</u>
17. Crack Length versus Time for 50 Percent Overload at High K.....	45
18. Best Fit Shaping Exponent (m) for 20 Percent Overload at Low K.....	46
19. Best Fit Shaping Exponent (m) versus K.....	47
20. Test System Schematic.....	50
21. Compact Tension Specimen.....	51
22. Creep Frame Photograph.....	53
23. Instrumented Specimen Photograph.....	54
24. Location of Input and Output Leads on Specimen.....	57
25. Thermal versus Output Voltage Specimen 84-502.....	58
26. Thermal versus Output Voltage Specimen 84-503.....	59
27. Thermal versus Output Voltage Specimen 84-504.....	60
28. Average Crack Size and Tunneling Correction Term....	62
29. Calibration Curve A_{opt} versus V/V_o	64
30. Calibration Curve V/V_o versus A_{opt}	65
31. Overload Effect on Calibration Data.....	66
32. Crack Length versus Time Specimen 84-504.....	69
33. Crack Length versus Time Specimen 84-503.....	70
34. Crack Length versus Time Specimen 84-502.....	72
35. Crack Length versus Time Specimen 84-507.....	73

List of Tables

<u>Table</u>	<u>Page</u>
1. Specimen Dimensions and Applied Load.....	52

Abstract

This study investigates methods of modeling the effects of overloads on high-temperature sustained-load crack growth. In addition to a model previously developed for this specific problem, a computer program developed for low-temperature, high-frequency cyclic load applications was evaluated. Sustained-load hold times were converted to equivalent fatigue cycles to analyze a load spectrum, consisting of sustained-load with periodic overloads. The CRACKS crack growth program was used with the Wheeler and Willenborg models used to account for crack growth retardation due to overloads.

Predictions were compared with experimental test data generated on specimens of Inconel 718 at 650 C with periodic overloads of either 20 or 50 percent. Crack measurements were made using a electric potential system. The application of the electric potential system to crack growth measurement following overloads was extensively evaluated. It was concluded that the system had to be recalibrated after each overload due to a sudden advancement in crack length.

The retardation models were found to require empirical parameters that depend upon the stress intensity level for

each overload application. Using relationships developed for these parameters, the CRACKS program using the Wheeler model was found to be capable of predicting the time-to-failure for sustained-loading with periodic overloads within 20 percent of test data. The Willenborg model was found to be inapplicable to this problem because it depends solely on stress ratio which has no physical meaning for sustained-loading. The Wheeler model, on the other hand, could generally be applied to sustained-load crack growth using equivalent fatigue cycles. In conjunction with the CRACKS computer program, this could provide a powerful new method for evaluating crack growth under general engine mission spectra including the effects of overloads.

PREDICTING THE EFFECTS OF OVERLOADS
ON SUSTAINED-LOAD CRACK GROWTH
IN A HIGH-TEMPERATURE SUPERALLOY

I. Introduction

Background

Design trends for modern engines have emphasized increased performance with higher thrust/weight ratios, while also requiring improved engine durability and maintainability. Engine components must therefore be designed to endure the increasing severity in operating conditions. Until recently, the method used to predict the useful service life of engine components was based on statistical life models. This method was very conservative and would retire an entire population of engine disks when it was predicted that, statistically, 1 in 1000 disks would develop a 0.03-inch fatigue-induced crack [1]. Although this method helped preclude disk failures, significant useful life remained in the other 999 disks retired. Estimates placed this residual useful life at greater than 10 more lifetimes for 80 percent of the disks retired [2].

Under the new "Retirement-for-Cause" concept initiated by the USAF, this additional useful life can be utilized by adopting an inspection criterion applied to components after a specific period of time. If the inspected components pass this criterion, they may be returned to service. The criterion is based on fracture mechanics calculations to determine what minimum crack size, if undetected, would grow to failure before the next inspection.

Fracture mechanics is also the basis for predicting crack growth as required by the Engine Structural Integrity Program (ENSIP) specification [3]. The ENSIP specification requires a damage tolerant design approach be applied to structural critical components on all future USAF engine designs. Under this approach, initial flaws or defects are assumed to exist in the components when they enter service. Analysis of components along with verification testing must demonstrate that the initial flaws will not grow to a catastrophic size within the design lifetime of the component.

It is clear that successful implementation of the Retirement-for-Cause program and the ENSIP design approach depends upon technical capability in two key areas. The first is a Nondestructive Evaluation (NDE) procedure used to determine the largest initial flaw size existing in a component after an inspection. This initial flaw size is then assumed to exist in all components. The second is the

capability to use analytical prediction models to accurately predict the crack propagation from the initial crack size to failure.

There are numerous crack growth rate prediction models with varying degrees of complexity. Most of these models have been developed for application to airframe components under typical airframe spectra including large numbers of cycles with periodic overloads. For engine applications, the spectra are simpler, involving fewer cycles and only occasional overloads. No complex interaction models have been developed for engine spectrum loading which involves both cyclic and sustained-loading.

Simple crack growth models usually calculate the growth cycle-by-cycle by integrating a crack growth rate equation. More complex models used in airframe analysis include retardation routines to account for the decrease in growth rate following a peak overload cycle. These models do not address crack growth under sustained (hold-time) loading which is present in a typical engine spectrum. CRACKS [4] which represents the state-of-the-art in airframe spectrum crack growth analysis is a complex prediction program used to analytically calculate crack growth under large spectrums of cyclic loading. This program includes the Wheeler and Willenborg models for predicting retardation effects.

Objective

This thesis explores one aspect of the complex crack-growth-rate prediction problem. Specifically, this thesis explores the applicability of existing crack-growth retardation models, developed for high-frequency, low-temperature airframe applications, to high-temperature sustained-load crack growth retardation. Procedures will be developed to convert sustained-load time to equivalent fatigue cycles so that classical Wheeler and Willenborg retardation models can be used in the CRACKS computer program to predict sustained-load crack growth rates following overloads. The retardation models will be applied to data obtained from previous experimental work as well as new experimental proof tests to verify each model's capability.

II. Retardation Model Theory

In this study three plastic zone retardation models were examined. First was the Wheeler model [5] which reduces the crack growth rate da/dn to account for retardation. Second was the Willenborg model [6] which accounts for retardation by reducing the maximum and minimum stress intensity factors. Also, the minimum stress intensity factor, if negative, is truncated at zero. Finally was the Overload model developed by K. Harms, T. Weerasooriya, and T. Nicholas [7] [8] which accounts for retardation by reducing the stress intensity factor K , to a lower effective value K_{eff} , after each overload. The theory behind each of these models is discussed in the following sections.

Wheeler Model

The basis for the Wheeler, Willenborg, and Overload models is that an overload cycle produces an extended plastic zone that retards crack growth. Thus, in figure 1, r_p represents the plastic zone due to sustained-loading and \bar{r}_p represents the plastic zone due to an applied overload. As long as a_1 is less than a_2 , the sustained-load crack is growing in the overload plastic zone at a slower or retarded rate. The Wheeler model predicts this retardation effect by reducing the crack growth rate while growing through the

overload plastic zone. The crack growth rate da/dn is reduced by multiplication with a retardation parameter C_p . This parameter depends on the ratio of the current sustained-load plastic zone size to the previous overload plastic zone size raised to a shaping exponent m . If the sustained-load plastic zone grows past the prior overload plastic zone, no retardation is predicted. In terms of the symbols used in figure 1, the retardation parameter is defined as,

$$C_p = \left(\frac{r_p}{a_2 - a_1 + r_p} \right)^m \quad \text{for } a_1 < a_2 \quad (1)$$

and

$$C_p = 1 \quad \text{for } a_1 \geq a_2 \quad (2)$$

where r_p = extent of current yield zone

$a_2 - a_1 + r_p$ = distance from crack tip to elastic plastic interface

m = shaping exponent

The shaping exponent m is used to calibrate the retardation model with experimental data. Generally, m has been found to be a material dependent constant.

Once the shaping exponent is defined for the given material, the value of C_p is substituted into equation 3.

$$\frac{da}{dn} \text{ (retarded)} = C_p \frac{da}{dn} \text{ (non-retarded)} \quad (3)$$

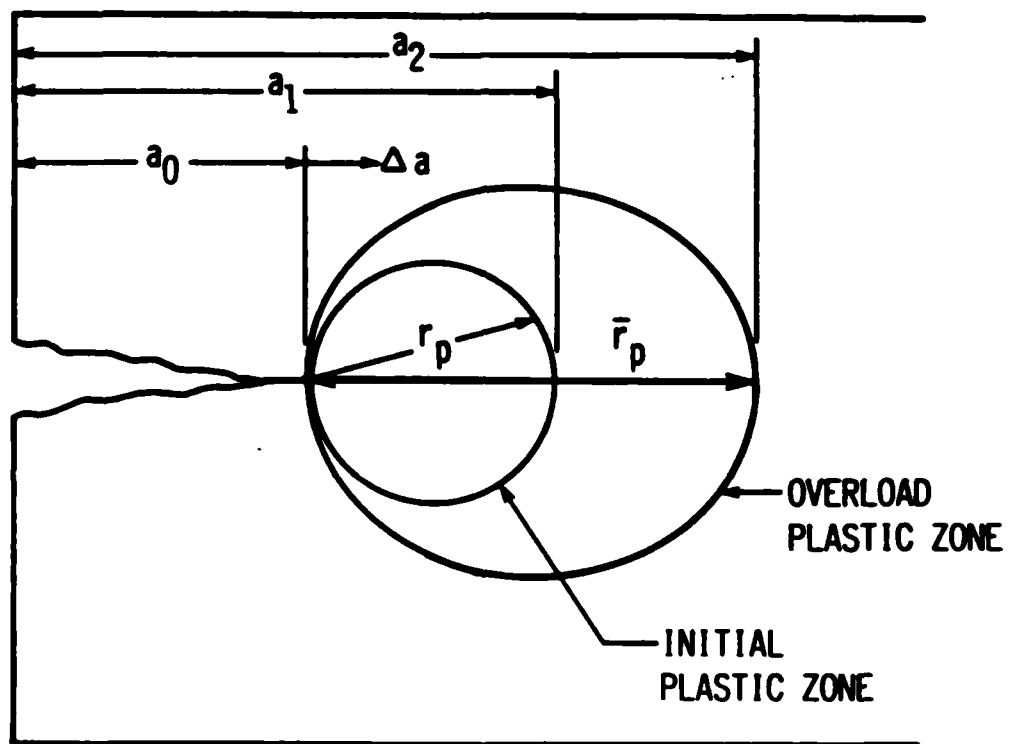

Figure 1 Schematic diagram of the plastic zones at the crack tip.

The Wheeler model accounts for retardation by substituting da/dn (retarded) for da/dn (non-retarded) while the crack is growing through the overload plastic zone. The numerical procedures used to implement the Wheeler model are contained in the CRACKS program.

Willenborg Model

The Willenborg model like the Wheeler model is based on yield zone analyses. The retardation effect is accounted for by a reduction in stress intensity factor. The reduction factor is calculated by first finding an equivalent stress, σ_{ap} , that will produce a plastic zone from the current crack tip location to the edge of the overload plastic zone. Referring to figure 1, this corresponds to a plastic zone of radius of $\bar{r}_p - \Delta a$. Second, a stress reduction factor, σ_{red} , is calculated by subtracting the currently applied maximum stress σ_{max} from σ_{ap} .

$$\sigma_{red} = \sigma_{ap} - \sigma_{max} \quad (4)$$

When the crack growth amount Δa plus the current plastic zone size r_y equals the overload plastic zone size \bar{r}_y , the value of σ_{red} is set equal to zero, since the crack propagation is no longer retarded. Third, effective values of the currently applied stresses are calculated by:

$$(\sigma_{\max})_{\text{eff}} = \sigma_{\max} - \sigma_{\text{red}} \quad (5)$$

$$(\sigma_{\min})_{\text{eff}} = \sigma_{\min} - \sigma_{\text{red}} \quad (6)$$

If either effective stress is less than zero, it is set equal to zero. Finally, using the effective maximum and minimum stress values, effective stress intensity factors are calculated. This produces the following retardation relationships.

$$[K_{\max}, K_{\min}]_{\text{eff}} = [K_{\max} - K_{\text{red}}, K_{\min} - K_{\text{red}}] \quad (7)$$

$$\text{where } K_{\text{red}} = K_{\text{ap}} - K_{\max} \quad \text{for } a_1 < a_2$$

$$K_{\text{red}} = 0 \quad \text{No retardation for } a_1 \geq a_2$$

After each crack growth increment a new value of σ_{ap} is calculated. The corresponding new value of K_{red} , calculated using equation (4), is substituted into equation (7), yielding the new K_{eff} values for the next growth increment.

Overload Model

This model uses a linear cumulative damage concept to sum the growth contributions of a single overload fatigue cycle and growth due to sustained load. The basis for the Overload model, like the Wheeler and Willenborg models, is that an overload cycle produces an extended plastic zone that retards crack growth. The plastic zone concept is illustrated schematically in figure 1. The sustained load and overload fatigue cycle have stress intensity factors

K_s and K_m and plastic zone radii denoted by r_p and \bar{r}_p respectively. The distances from the center of the crack to the edge of the plastic zones due to sustained loading and a fatigue overload cycle applied when the crack length was a_0 are labeled a_1 and a_2 . For a crack advancement Δa from a_0 , the crack tip will be in an overload plastic zone until $\Delta a = a_2 - a_1$. While in this plastic zone the growth rate will be retarded. The Overload model uses a reduced value of stress intensity factor, K_{eff} , to account for the retarded growth rate. For modeling purposes, K_{eff} is taken in the form:

$$K_{eff} = K_s [1 - \alpha \exp (-\beta \Delta a)] \quad (8)$$

where K_{eff} = effective (reduced) stress intensity factor

K_s = sustained-load stress intensity factor

α, β = modeling parameters

Δa = incremental crack extension

The parameter β is chosen such that steady-state crack growth will resume after the crack has traversed the overload plastic zone. Mathematically, it is desired to have K_{eff} approach K_s when Δa approaches $(\bar{r}_p - r_p)$. This is accomplished by letting

$$\beta \Delta a = \pi \sqrt{2}. \quad (9)$$

When $\Delta a = \bar{r}_p - r_p$, the resulting value of K_{eff}/K approaches

unity to within one percent as shown in figure 2. The plane stress plastic zone sizes for the overload cycle and sustained load are given by,

$$\begin{aligned} \bar{r}_p &= [K_m / \sigma_y]^2 / \pi \\ r_p &= [K_s / \sigma_y]^2 / \pi \end{aligned} \quad (10)$$

where σ_y is the uniaxial tension yield stress of the material. Substituting $\Delta a = \bar{r}_p - r_p$ and equation (10) into equation (9) yields an expression for β :

$$\beta = \frac{\sqrt{2} \pi^2 \sigma_y^2}{K_s^2 (\tau^2 - 1)} \quad (11)$$

where the overload ratio τ is defined by:

$$\tau = \frac{K_m}{K_s} \quad (12)$$

Observing equation (11) it is noted β is only a function of material properties and test conditions. β therefore cannot be used as an adjustable parameter to fit experimental data. This leaves the parameter α given in equation (8), to be adjusted to fit experimental data. The value of α chosen determines K_{eff} immediately after an overload application and therefore can be used to model the reduced value of sustained-load crack growth rate. The effect of varying α on the ratio of K_{eff}/K_s is seen in figure 2. Also this figure demonstrates how the Overload

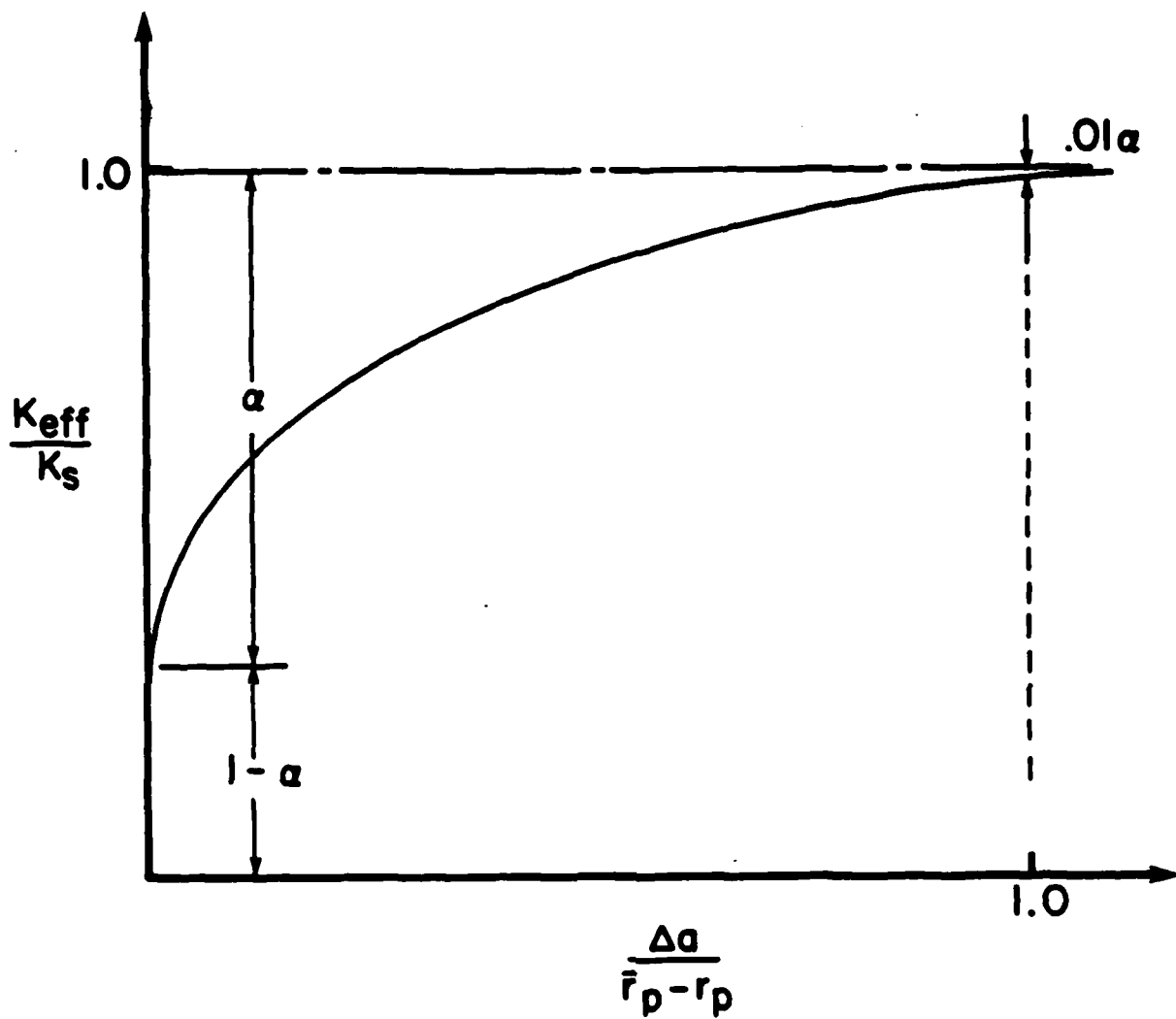

Figure 2 Variation of K_{eff}/K_s as a function of normalized crack advancement from the crack tip in the overload plastic zone.

model uses a decreasing exponential to asymptotically approach the normal crack growth.

In a prior investigation, Harms made experimental measurements of the delay time before normal sustained-load crack growth resumed after an overload was applied. Harms [7] noted that delay times and, hence, the value of K_{eff} changed systematically with K . Plots of the delay times Δt_r versus K level for the 20% and 50% overload cases tested by Harms are shown in figures 3 and 4. The boundaries of the data were used to approximate the average delay time (Δt_{avg}) curve. Using an iteration process, values of α were chosen with a specified value of K to generate a Δt_r for the model. Adjustments in α were made until Δt_r calculated and Δt_{avg} agreed reasonably well. Harms repeated this process over the full range of K values to define a functional relationship for Δt_r , K , and α .

The functionals developed were expressed in non-dimensional terms as α/α^* and K/K^* where α^* and K^* are threshold values. K^* , a material property, was substituted into equation (1) for K_{eff} with $\Delta a = 0$ and $\alpha = \alpha^*$. Solving for α^* yields $\alpha^* = 1 - (K^* / K_s)$ with the limiting values being:

$$\frac{\alpha}{\alpha^*} = 1 \quad \text{total crack arrest} \quad (13)$$

$$\frac{\alpha}{\alpha^*} = 0 \quad \text{no retardation.} \quad (14)$$

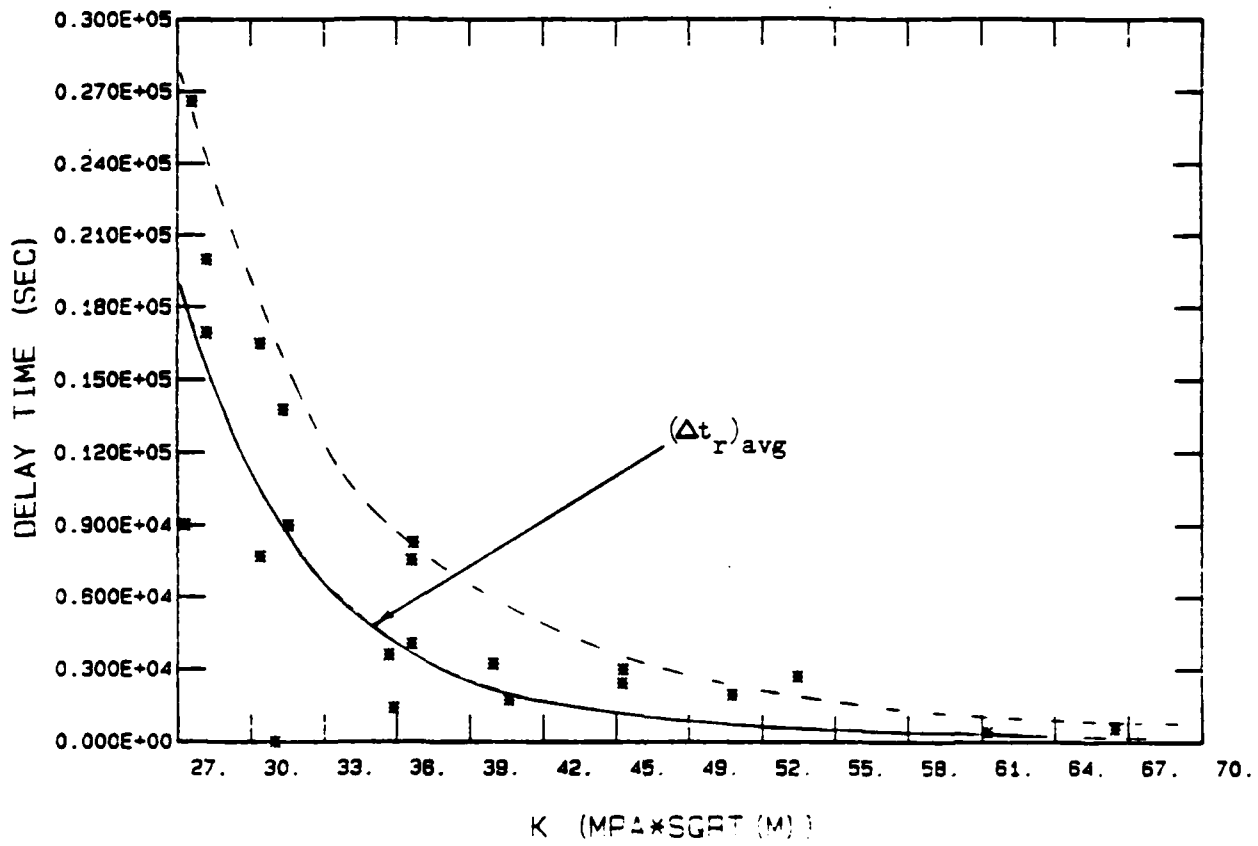

Figure 3 Delay Times Resulting from 20 Percent Overloads at Various Stress Intensities.

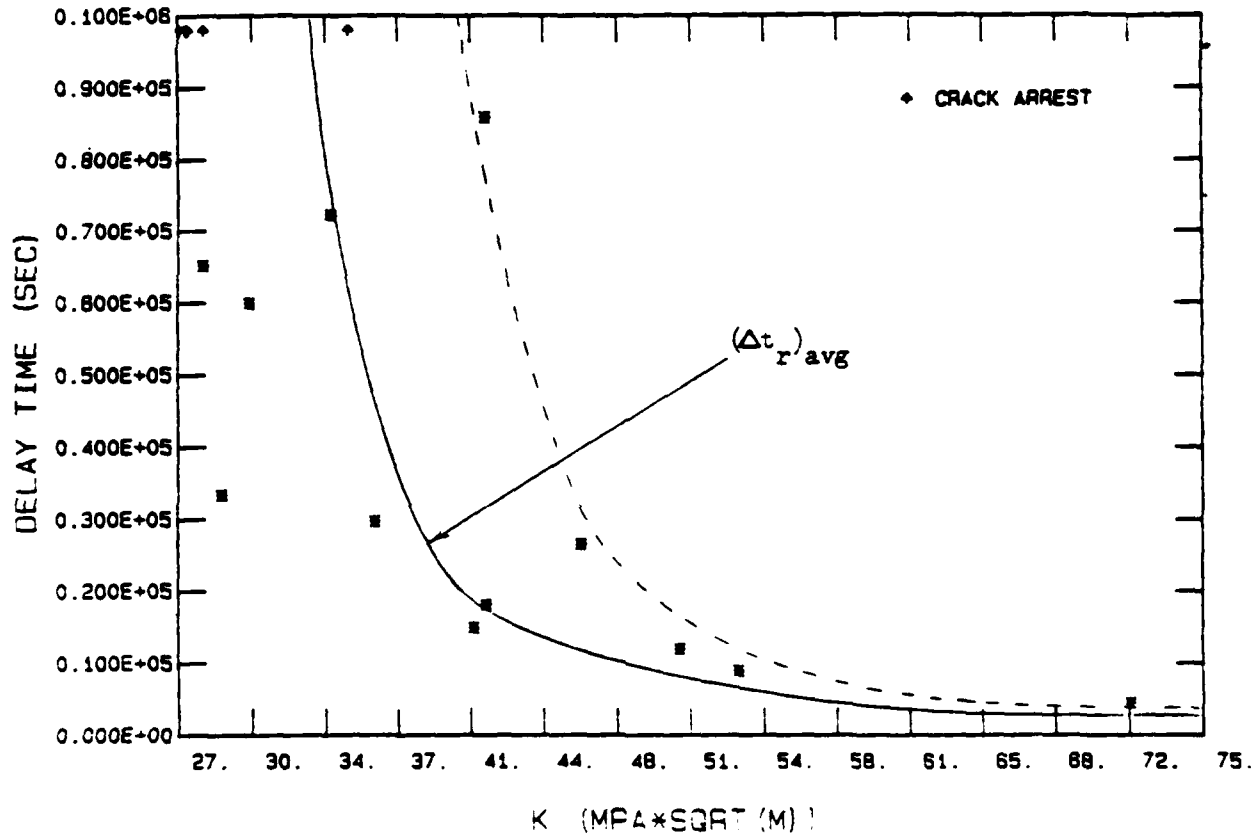

Figure 4 Delay Times Resulting from 50 Percent Overloads
at Various Stress Intensities.

The α versus K curves generated by Harms for 20% and 50% overloads, normalized to the threshold values, are shown in figure 5. The curves were fit with a polynomial equation. The equation for the 20% overload case is

$$\alpha = \alpha^* [(-.0730791E-01) (K/K^*)^3 + (0.303086) (K/K^*)^2 - (0.422108) (K/K^*) + (0.117517E-01)] \quad (15)$$

while that for the 50% overload case is

$$\alpha = \alpha^* [(-.121127E-01) (K/K^*)^2 + (0.239231E-01) (K/K^*) + (0.987133)] \quad (16)$$

With α and β defined, the Overload model's retardation effect was calculated using equation (8). The K_{eff} value obtained from this equation is used to account retardation while within the overload plastic zone.

It is apparent all three of the retardation models discussed are numerically cumbersome. Therefore, computer programs were developed to implement the retardation calculations.

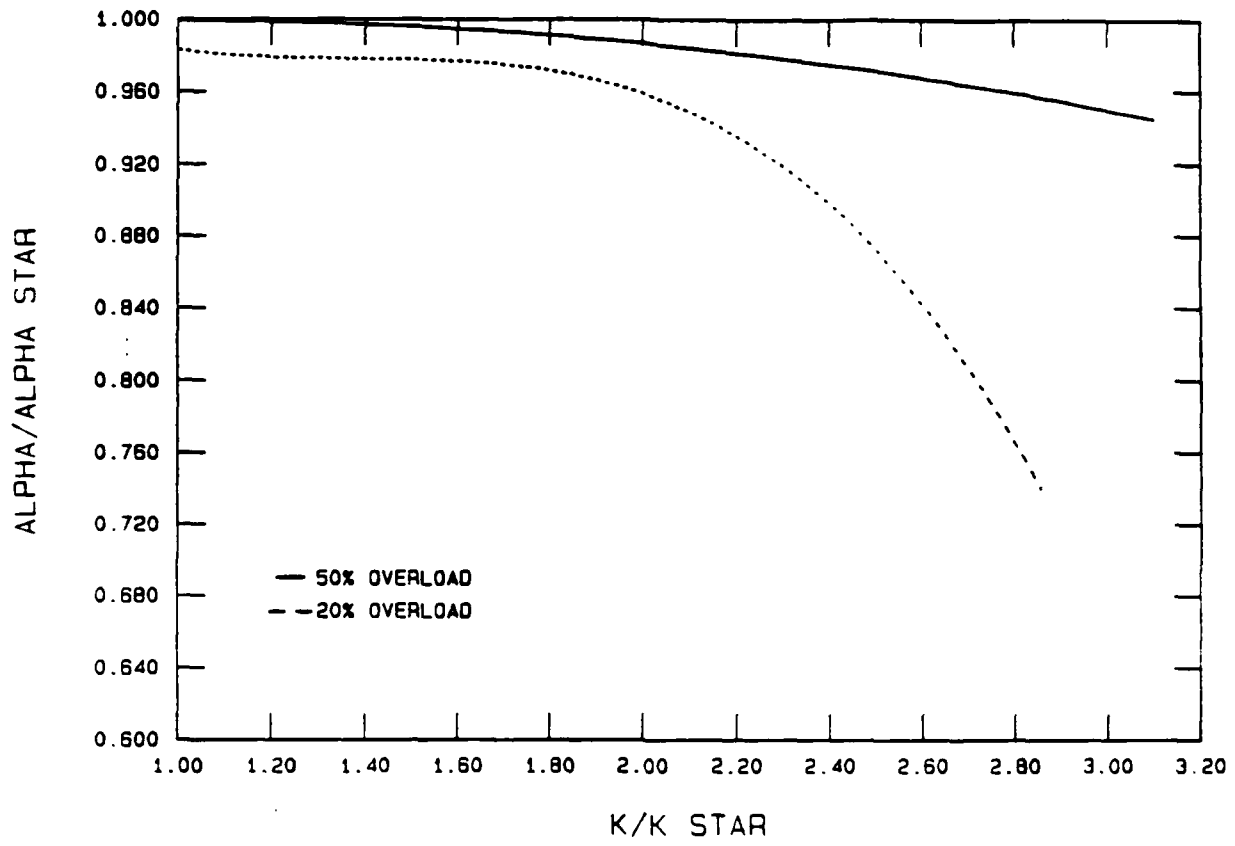

Figure 5 α Functions for 20 and 50 Percent Overloads.

III. Computer Model Development

In this study two computer programs were used to perform the numerical calculations required to predict the crack growth. First, a computer program called "Overload" was written to integrate a creep crack growth rate (da/dt) equation and incorporate the Overload retardation model. The second program used was the CRACKS program which integrates a fatigue crack growth (da/dn) equation. To use this program for sustained-load crack growth required converting sustained load time into equivalent fatigue cycles. The crack growth due to a simple spectrum of sustained-load (represented by equivalent fatigue cycles) with periodic overloads was analyzed using the CRACKS program. Both the Wheeler and Willenborg retardation schemes were used in CRACKS. After completing the growth predictions, equivalent cycles were converted back to sustained load time. The theory and assumptions associated with each model will be discussed in detail in the following sections.

Overload Program

This program was written to carry out the numerical calculations required to use the Overload retardation model. A listing of the program is contained in appendix 3. The input data for this program are the initial crack size,

load history, sustained-load crack growth rate, and compact tension specimen dimensions. At anytime, for a given crack length and sustained-load amplitude, the stress intensity factor is calculated using the compact tension solution [9] below:

$$K = \frac{P}{b \sqrt{w}} \frac{(2+a/w) f(a/w)}{(1-a/w)^{3/2}} \quad (17)$$

where K = Stress Intensity factor

$$f(a/w) = (0.886 + 4.64(a/w) - 13.32(a/w)^2 + 14.72(a/w)^3 + 5.6(a/w)^4)$$

a = Crack length

P = Applied load

b = Specimen thickness

w = Specimen width

Once K is known, the crack growth rate is determined from the crack growth rate equation relating da/dt to K . A Modified Sigmoidal Equation (MSE) is used to represent this relationship. The MSE model, developed by General Electric [10], uses the various coefficients in the following equation to fit a sigmoidal curve through the data.

$$da/dt = [\exp(B)] [K/K^*]^P [\ln(K/K^*)]^Q [\ln(K_c/K)]^D \quad (18)$$

where da/dt = Crack growth rate

K = Current stress intensity value

K^* = Threshold stress intensity value

K_c = Critical Stress intensity value

B, P, Q, D = Fitting parameters of the curve

In this equation, K^* and K_c are in units of $(\text{MPa m}^{1/2})$ and da/dt is calculated in units of (m/sec) . The remaining constants are non-dimensional. Harms [3] determined the sigmoidal coefficients by fitting the data from his constant sustained-load baseline test. The test data, along with the best-fit MSE coefficients, are shown in figure 6.

With the relationship between a , K and da/dt known, it is possible to find the time it takes to grow from an initial crack size of a_i to final crack length a_f using:

$$\Delta t = \int_{a_i}^{a_f} \frac{da}{da/dt_{\text{MSE}}} \quad (19)$$

This integration is carried out numerically by dividing the region of crack growth $(a_f - a_i)$ into a finite number of increments Δa and summing the time to grow each increment. For each small increment, Δa , the value of K is calculated for the end points and for any intermediate crack lengths from equation (17). Similarly, da/dt is determined for the end points and for discrete points in between using equation (18). The numerical integration of each increment Δa is performed via Simpson's rule [11]. The total time to grow from a_i to a_f is obtained by summing the time to grow each Δa interval. Since Simpson's is rule only a numerical approximation of the exact integral of the function, care was taken to ensure that proper accuracy was carried through the calculations.

84-493-DD4

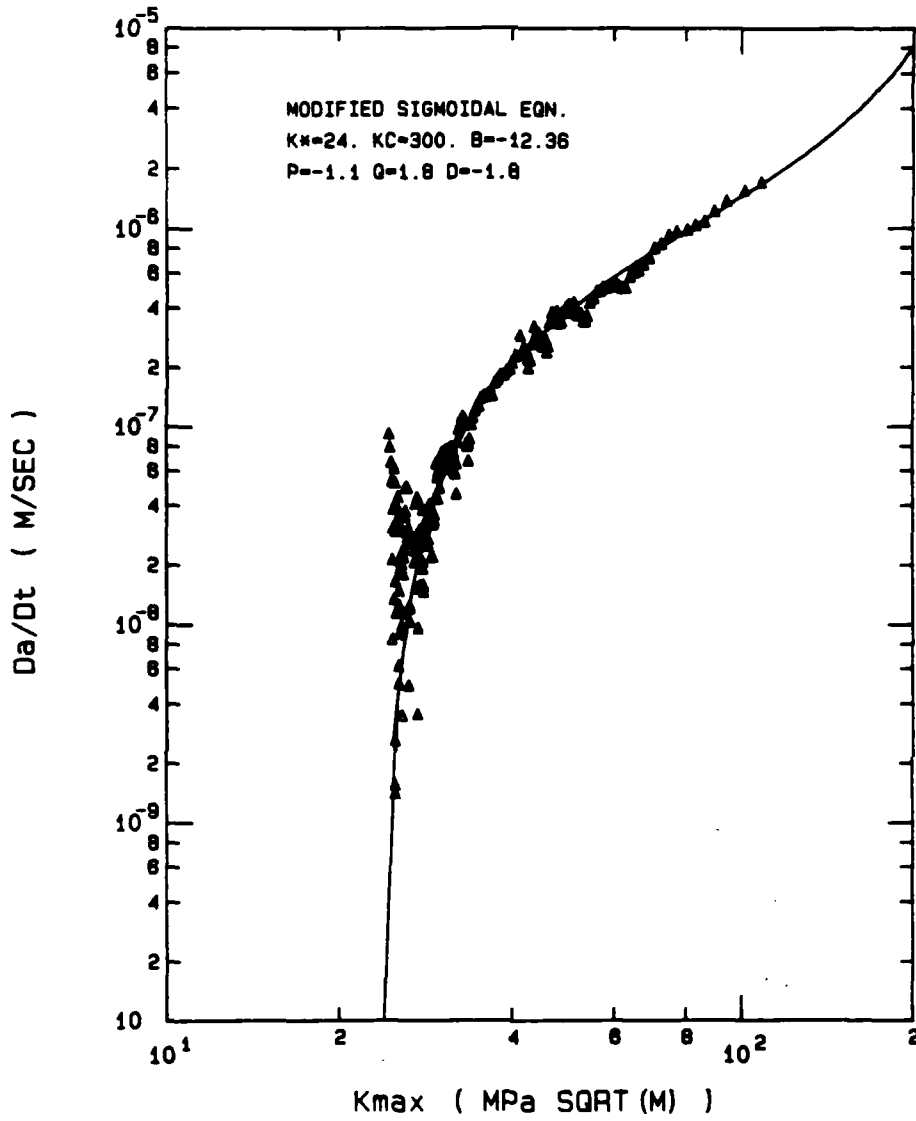

Figure 6 MSE Model Fitted to Sustained-Load Baseline Data.

The accuracy of the integration was controlled in two ways. First, the interval of total crack length ($a_f - a_i$) was divided into a number of increments (Δa). The size of each increment was based on the initial stress intensity level at the beginning of the interval and was determined as follows. Values of $(da/dt)_{MSE}$ were calculated at various K-levels. These values were multiplied by 100 seconds to obtain the crack length interval (Δa_{100}) which produces 100 seconds of sustained load growth. Linear functions were used to represent Δa_{100} as a function of K, in a manner that insured the growth time interval was always less than 100 seconds. The effect of this first step was to use small Δa intervals at lower K values and larger Δa intervals as K increased, thus limiting the total time required for the crack to grow through any interval to less than 100 seconds, for any value of crack length or K.

Each Δa interval was then numerically integrated using Simpson's rule. The numerical integration errors were minimized by testing the Simpson's integration subroutine for convergence. This was accomplished by integrating each crack length interval at least twice. The program started by using two subintervals within each Δa interval. This interval was then integrated again doubling the number of subintervals. The difference of the values of the time calculated to grow through the interval using these two integrations was compared with a convergence value; this

value was calculated by multiplying a tolerance, set at 0.0001, by the time calculated to grow through the crack interval. Since this time increment was always near 100 seconds, the convergence value corresponded to approximately 0.01 seconds difference between the calculated times using the two successive integrations. If the difference exceeded 0.01 seconds, another integration was performed, with the number of subintervals being doubled again. This procedure was repeated until the convergence criterion was satisfied. Assuming that each Δa interval resulted in an error of 0.01 seconds, the cumulative error for the total time predictions is no greater than 10 seconds based on a maximum number of 1000 intervals corresponding to a total test time of approximately 10^5 seconds.

The numerical integration scheme was applied to a loading history which involved a constant sustained-load with periodic overloads. The input load history for each specimen specified the times at which overloads were applied and the percentage of overload. An example of how the load history was entered into the program is shown in figure 7.

The program integrates repeated Δa intervals, equal to approximately 100 seconds of sustained load time, until the total time exceeded the time when the next overload was applied. At this point, the time when the last Δa interval started and the time it took to grow the last Δa interval were known. Using a linear interpolation, the length of the

last Δa interval was reduced so that the total growth time equaled the time when the overload was applied. At this point, the retardation effect due to the overload was added in the model. This was accomplished by calculating a reduced stress intensity factor, K_{eff} , defined by equation (8). In this equation, the modeling parameter β was related to the overload plastic zone size, while the parameter α was defined by fitting experimental data. During the retarded growth K_{eff} was substituted for K in equation (18) until the crack grew through the overload plastic zone.

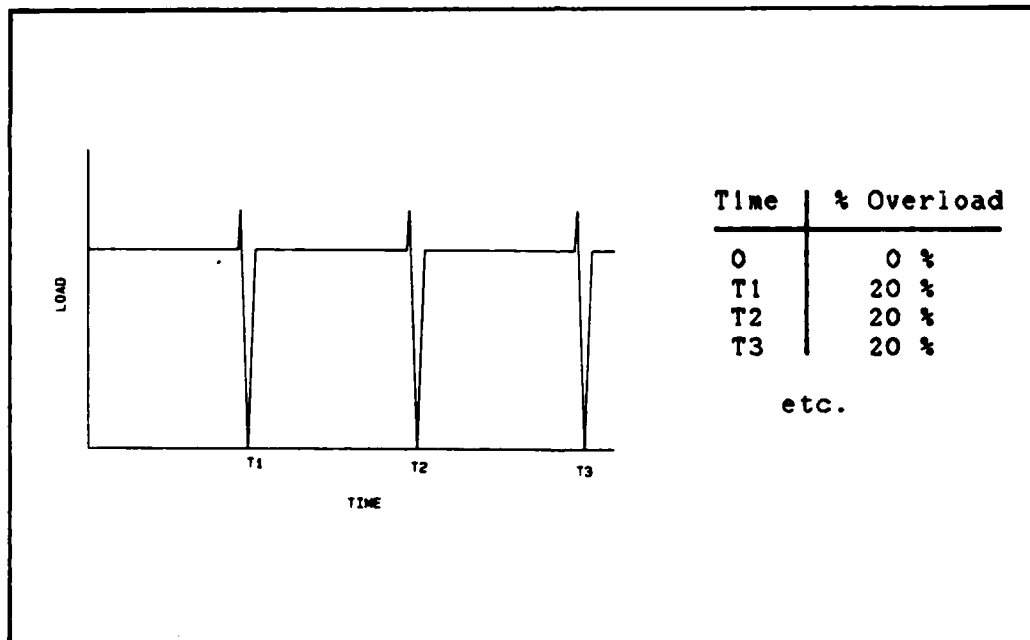

Figure 7 Overload Program Load History Input Example.

Harms [7] noted that each time an overload cycle was applied an apparent jump in crack length occurred. This same jump phenomenon was also noted by Larsen and Nicholas [12] in their study of crack-growth transients at elevated temperature. The amount of crack jump seemed to correlate with the K level at overload application. However, Harms's data for jump versus K level, shown in figure 8, contained a large amount of scatter making it difficult to fit a functional relationship. Harms therefore assumed a constant value of 0.381 mm jump in crack length at each overload. In an attempt to improve the estimation of the jump function, several other functional relationships were investigated.

First, a function relating the amount of jump to the K level at overload application, normalized to the threshold K^* value of $24 \text{ MPa m}^{1/2}$, was tried. This function takes the form of

$$\text{Jump} = 0.2 * (K/K^*) \text{ mm} \quad (20)$$

and is labeled curve 1 in figure 8. The second function used the Log of the K level at overload application, normalized to the threshold K^* value of $24 \text{ MPa m}^{1/2}$. The resulting function takes the form of

$$\text{Jump} = 1.25 * \text{Log}(K/K^*) \text{ mm} \quad (21)$$

and is labeled curve 2 in figure 8. Finally, a linear function with an initial jump of 0.381 mm at threshold

Increasing to .508 mm jump near the critical stress intensity was tried. This function is labeled curve 3 in figure 8. Also shown in this figure is the constant 0.381 mm jump used by Harms, labeled curve 4.

The proof test, conducted by Harms, was analyzed using each jump function to predict the increment in crack length caused by the overload cycle. The resulting predictions are shown in figure 9. Curves 1 and 2 correspond to jump functions in equations 20 and 21, respectively these functions underestimated the jump at low K values. The resulting predictions had significant delay times. Curve 3 corresponded to the linearly increasing jump function, and was the most exact prediction of the total time to failure for this test. The constant jump of 0.381 mm, labeled curve 4, predicted the total time to failure to within 4 percent. Since the constant jump used by Harms gave predictions within normal test scatter, it was decided to use a constant jump of 0.381mm for all further calculations. This also allowed a direct comparison of Harms's work with the other retardation models.

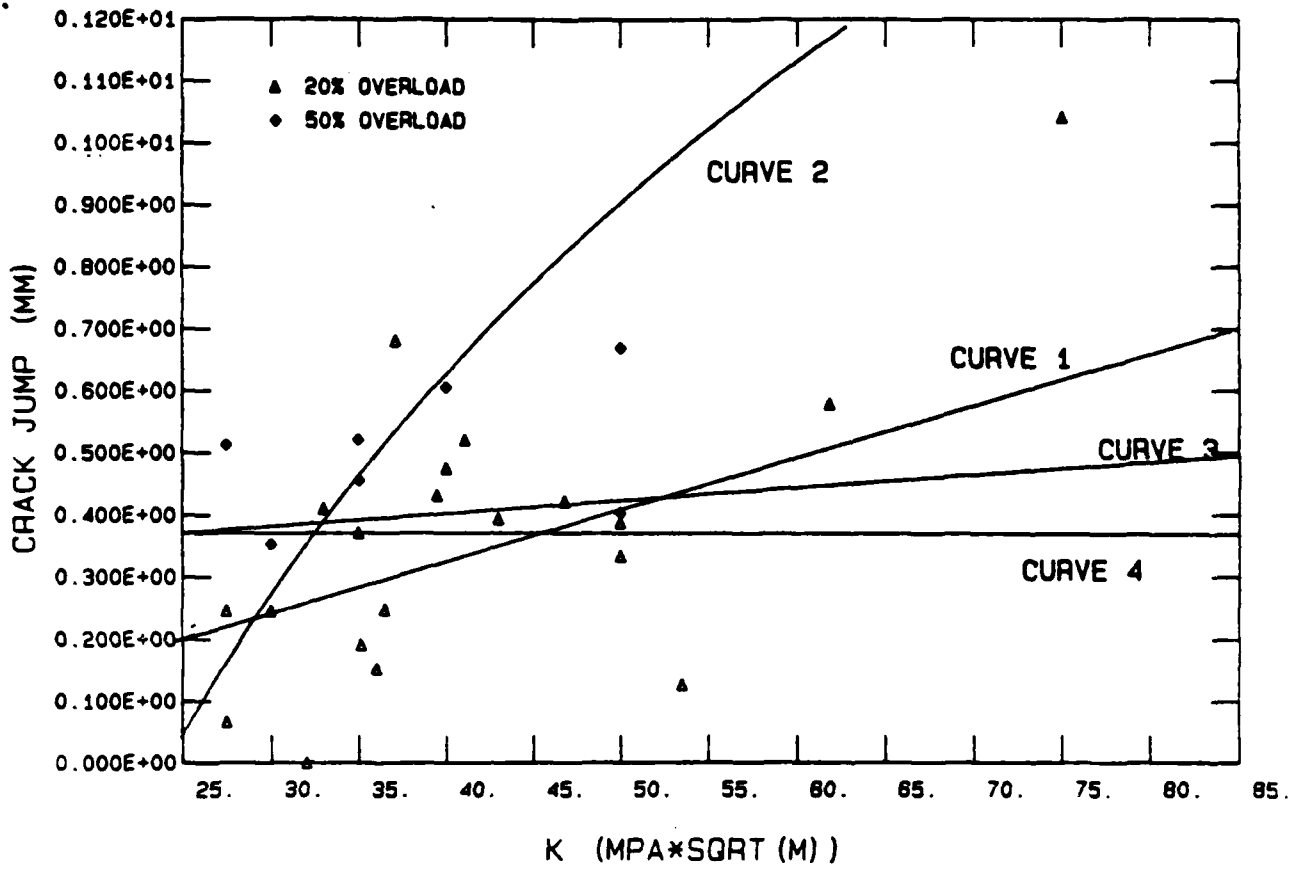

Figure 8 Crack Jumps from Overload Cycles at Various K Levels.

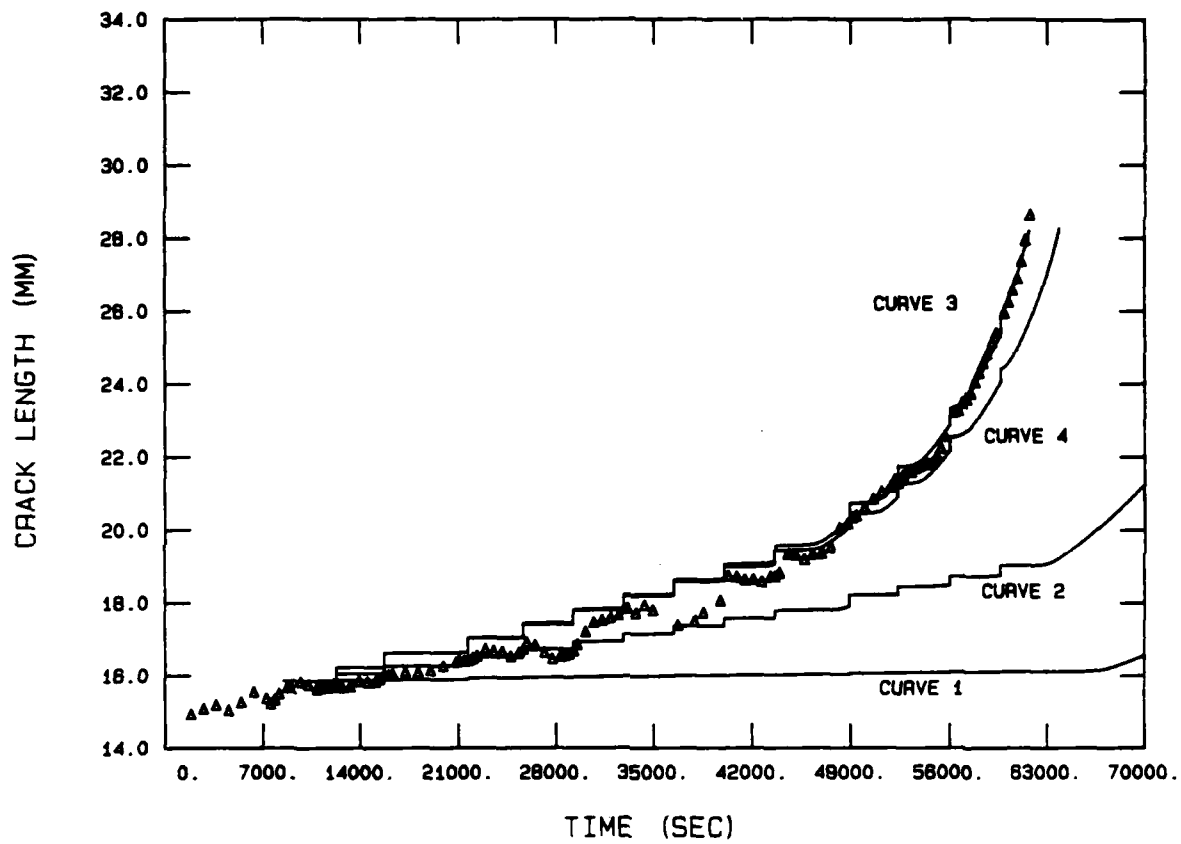

Figure 9 Overload Model Predictions to Proof Test
84-507 Using Various Jump Functions.

CRACKS Program

This program was developed by R. M. Engle [4] to predict crack growth in airframe applications where high frequency, low temperature spectrum loading occurs. The objective here was to modify the original program so that it could be used to analyze high temperature sustained loading with periodic overloads. A technique was developed for converting sustained loading to equivalent fatigue cycles. This technique and all required programing changes made within CRACKS are described next.

The process of converting sustained load creep crack growth to equivalent fatigue cycles was achieved by setting da/dn equal to da/dt at equivalent ΔK and K_{max} stress intensity levels. A one-to-one correspondence would equate one fatigue cycle to one second of sustained load. Since CRACKS can only use one crack growth rate equation, a method of representing both the rate of growth due to sustained loading and overload fatigue cycles with the same equation was needed. The growth rate due to an overload cycle was approximated using previously generated test data [13] for Inconel 718 at 650 C, with an R ratio of 0.1 and frequency of 0.01 Hz. This frequency is approximately that of the single overload cycle in the experimental part of the investigation. This data is labeled 83266G test data and shown in figure 10. Also shown in the figure is the baseline

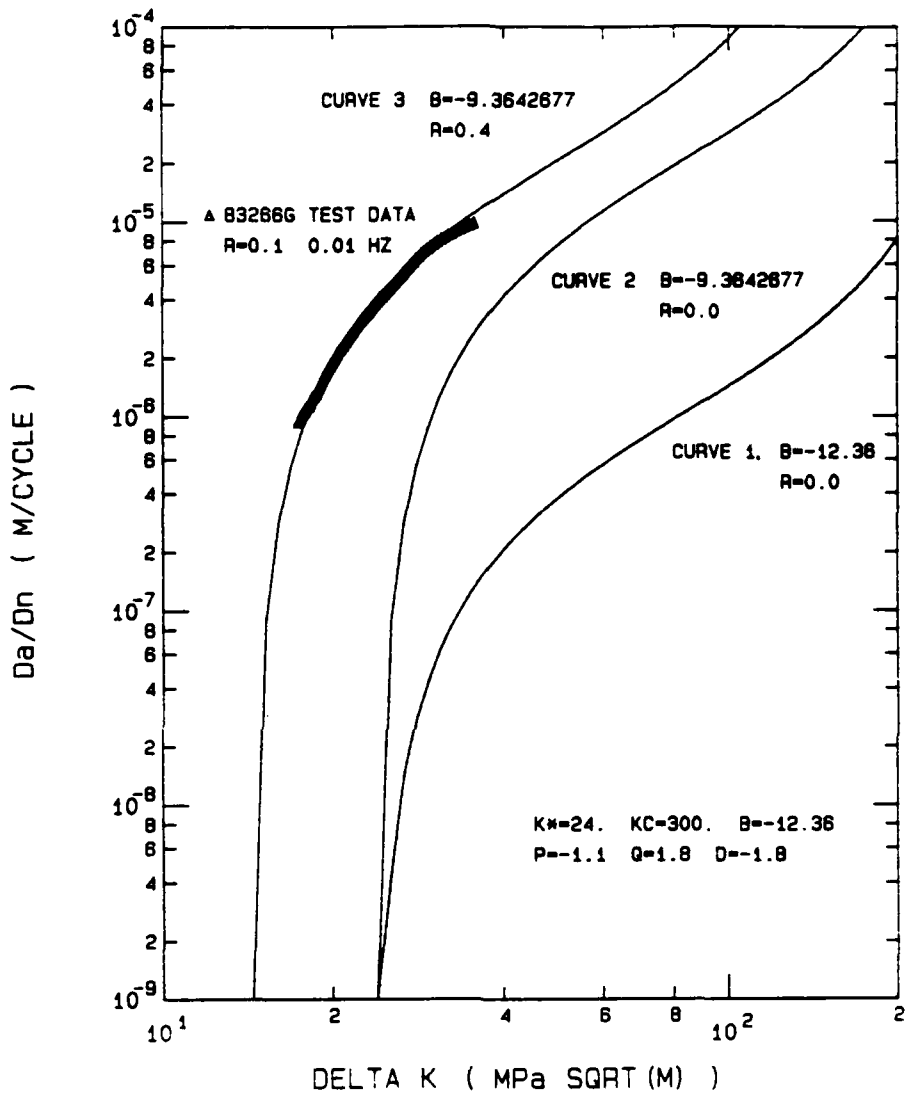

Figure 10 MSE Curve Shift Using the B Parameter and R Ratio.

sustained-load sigmoidal curve, developed by Harms, and labeled curve 1. The sustained-load growth rate da/dt (m/sec) given by curve 1 equals the cyclic growth rate da/dn (m/cycle). Thus, one second of sustained-load is equal to one fatigue cycle. In order to have the same curve represent both the sustained loading and overload cycles a vertical and horizontal shift of curve 1 was needed. Referring to the sustained load sigmoidal equation below

$$da/dt = [\exp(B)] * [K/K^*]^P * [\ln(K/K^*)]^Q * [\ln(K_c/K)]^D \quad (22)$$

the parameter B can be used to absorb a rate multiplication constant into the equation. Using a trial and error procedure, a factor of 20 was found to vertically shift the curve to a position where an additional horizontal shift placed the curve on the crack growth rate data for overload cycles. The new B value was found by solving the following equation for B

$$\exp B = 20 \exp B_{old} \quad (23)$$

The new value for B and the associated new sigmoidal curve is labeled curve 2 in figure 10. The cyclic growth da/dn (m/cycle) now equals 20 times the sustained-load growth rate da/dt (m/sec). Thus, 20 seconds of sustained-load is equal to one fatigue cycle. The horizontal shift was accomplished using an R ratio shift. The cyclic sigmoidal equation shown below

$$da/dn = [\exp(B)] * (\Delta K / \Delta K^*)^P * [\ln(\Delta K / \Delta K^*)]^Q * [\ln(\Delta K_c / \Delta K)]^D \quad (24)$$

can be modified for R ratio effects by replacing ΔK with $\Delta K * (1 - R)$, ΔK^* with $\Delta K^* * (1 - R)$, and ΔK_c with $\Delta K_c * (1 - R)$. Again, using trial and error, it was found that an R ratio of 0.4 produced the desired horizontal shift. The resulting sigmoidal equation with fixed a value for $\Delta K^* = \Delta K^* * (1 - 0.4)$ and $\Delta K_c = \Delta K_c * (1 - 0.4)$ is labeled curve 3 in figure 10. Both the sustained load and overload cycle can be modeled by varying the R ratio to represent the different cycles. The sustained loading is modeled using 1 cycle equals 20 seconds of sustained loading at an R ratio of 0.4. The overload cycle is modeled as 1 cycle equals 1 overload cycle at an R ratio of 0.0. A graphical representation of these cycles is shown in figure 11. Since $\Delta K = \Delta K * (1 - R)$ and $R = 0.4$ for the sustained loading, it is easily seen that the R ratio dependence cancels out of equation (24) for sustained loading. The sustained load crack growth rate then in essence is defined by curve 2 in figure 10. Remembering that the threshold and critical stress intensity factors are fixed at values corresponding to an R ratio of 0.4 and the overload cycle is modeled with an R ratio of 0.0, the overload cycle crack growth rate is calculated using curve 3 in figure 10 with $\Delta K = \Delta K * (1 - 0.0)$ or just ΔK .

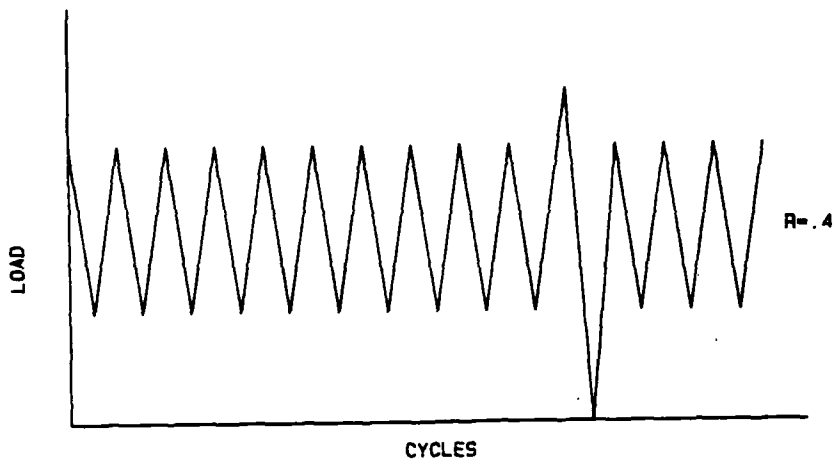
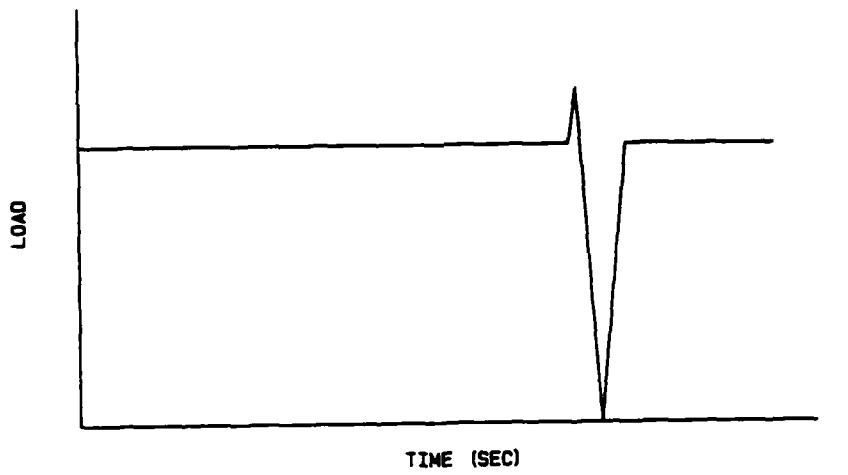

Figure 11 Graphical Representation of Equivalent Sustained-Load Fatigue Cycles.

Implementation of the method developed to change sustained loading into equivalent fatigue cycles required several changes to the CRACKS program. The source listing of the program used in this study is contained in appendix 3. Before describing the detailed changes within the program, a brief description of the overall program will be presented.

The CRACKS program consists of twenty two routines of which sixteen are basic to crack growth calculations and six others are used to implement the retardation models. Detailed descriptions of each routine is contained in the CRACKS manual [4]. The overall supervisory routine CRACKS4 calls each of the other subroutines as needed during the calculations. Only the major changes made within each subroutine will be described, although each change usually required changing other subroutines that used the same common blocks.

The first change was to include the sigmoidal crack growth rate equation in the RATE subroutine. This required changing the input and output subroutines to read and write the sigmoidal coefficients. Also, equation (24) was programed in the RATE subroutine for use whenever the crack growth rate was required by the main CRACKS4 routine.

The second change was to include the ASTM compact tension stress intensity solution, given by equation (17), in the BETA subroutine. The CRACKS program calculates all K

values using the equation

$$K = \sigma Y \sqrt{\pi a} \quad (25)$$

where K = Stress intensity level
 σ = Stress or load
 Y = Variable defining case solution
 a = Current crack length

The variable Y is used to define the case solution for the type geometry being analyzed. Y was set equal to equation (17) divided by $\sigma\sqrt{\pi a}$. Whenever the stress intensity value for a given crack length was needed, the subroutine K was called. This subroutine called the BETA subroutine where a new value for Y was calculated for substitution into equation (25).

The final change made in CRACKS affected the numerical integration method used in the program. CRACKS was written to handle a very large number of fatigue cycles. Crack growth due to large spectra of cycles are calculated using a linear approximation technique in order to save computation time. The basis for the approximation is the assumption that the damage parameters remain constant over some small increment of crack growth Δa . Engle [14] found the linear approximation in CRACKS to be an excellent balance between accuracy and computational efficiency for very large spectra. However, when smaller constant amplitude spectra were analyzed, the program was more efficient using a

cycle-by-cycle Runge-Kutta numerical integration method [14]. During the check-out phase of the CRACKS program, it was found that the linear approximation did not provide the same accuracy as the Overload program for constant sustained loading. Therefore, the program was changed to eliminate the linear approximation and use the Runge-Kutta cycle-by-cycle integration method. With this change in place both the Overload and CRACKS programs predicted exactly the same results for constant sustained-load growth containing no overloads.

Results from the CRACKS program were obtained in terms of equivalent fatigue cycles of growth. This required a separate Fortran program to convert cycles back into sustained load time by multiplying the equivalent cycles by 20 seconds per cycle.

Both the Overload and CRACKS programs were now capable of predicting sustained load crack growth with periodic overloads. The retardation effect overload cycles produced was estimated using the Overload model in the Overload program and the Wheeler and Willenborg models in the CRACKS program. The next step in developing the programs was to compare the analytical predictions of each model to experimental test data.

IV. Application of Retardation Models

Each retardation model was applied to typical test segments using the computer programs described in section III to predict how sustained load crack growth was affected by overload cycles. Six segments of crack growth data with average delay times were selected from Harms's work for analysis. The segments included both 20 % and 50 % overloads applied at low ($30 \text{ MPa m}^{1/2}$), medium ($40 \text{ MPa m}^{1/2}$), and high ($50 \text{ MPa m}^{1/2}$) stress intensity levels. The test data for each segment, shown in figures 12 through 17, start at an initial crack length which already includes the crack length jump produced by the overload cycle. Crack growth predictions using the Overload, Wheeler, and Willenborg retardation models were computed for each segment to provide a comparison between the predictive capabilities of each model. Several observations were made on the flexibility of each retardation model to predict the test data. Discussion of each of the observations and their effects follows.

The Overload model's flexibility to match test data is contained in the α parameter in equation (8). This parameter controls the delay time before normal crack growth resumes after an overload. Harms used his test data to develop expressions for α as a function of stress intensity level for 20 % and 50 % overload ratios. These expressions, given by equations (15) and (16), were used in the Overload

model. Thus all the model variables were predefined before the test segment were analyzed. The predictions for each of the six segments are shown in figures 12 through 17.

The Wheeler model had flexibility to fit test data by changing the shaping exponent m . The shaping exponent m is an empirical parameter dependent upon material and stress history [15]. The value of m for fatigue cycling generally ranges from 1.0 to 3.5 . During analysis of the six test segments the shaping exponent m was treated as a variable to fit the Wheeler model to the test data. Figure 18 shows how the best fit value of m was found by trial and error for a typical test segment. A constant value of m equal to 6.0 accurately predicted the 20 % overload segments. The best fit value of m for the 50 % overload segments was related to the stress intensity level at overload application and varied between 6.0 and 3.5 . This relationship between m and K is shown in figure 19. In general, the shaping exponent decreases as K increases at higher overload ratios. A similar trend was seen in the α parameter which is used to fit experimental data in the Overload model. Accurate predictions of retardation at higher overload ratios depends upon relating α or m to the stress intensity at overload application. At lower overload ratios α was still related to the stress intensity level but a constant value of m was found to adequately predict the retardation affect. The resulting Wheeler predictions using the best fit values of m

are shown in figures 12 through 17.

The Willenborg model does not have a parameter, like the Overload and Wheeler models, for use in fitting test data. Instead the model accounts for retardation by reducing the equivalent sustained load fatigue cycle of

$$\Delta K = K_{\max} - K_{\min} \quad (26)$$

$$\text{with } R = K_{\min} / K_{\max} = .4$$

to an effective value calculated by substituting $[K_{\max}]_{\text{eff}}$, $[K_{\min}]_{\text{eff}}$ from equation (7) into equation (26) to get

$$\Delta K_{\text{eff}} = [\Delta K_{\max}]_{\text{eff}} - [\Delta K_{\min}]_{\text{eff}} \quad (27)$$

$$\text{with } R_{\text{eff}} = [K_{\min}]_{\text{eff}} / [K_{\max}]_{\text{eff}}$$

Application of the Willenborg model to the test segments showed that R_{eff} did not equal the equivalent fatigue cycle R ratio of 0.4. This is due to the truncation of the minimum K_{eff} value at zero and the reduction of both K_{\max} and K_{\min} by K_{red} as defined in equation (7). Therefore, the model would not predict the same retardation effect if the equivalent sustained load cycles were modeled at different R ratios. The resulting predictions using the Willenborg model with the equivalent fatigue cycle modeled with an R ratio of 0.4 are shown in figures 12 through 17. Since the Willenborg retardation model was dependent on the modeling technique used to represent the sustained load time it was eliminated from further consideration in this study.

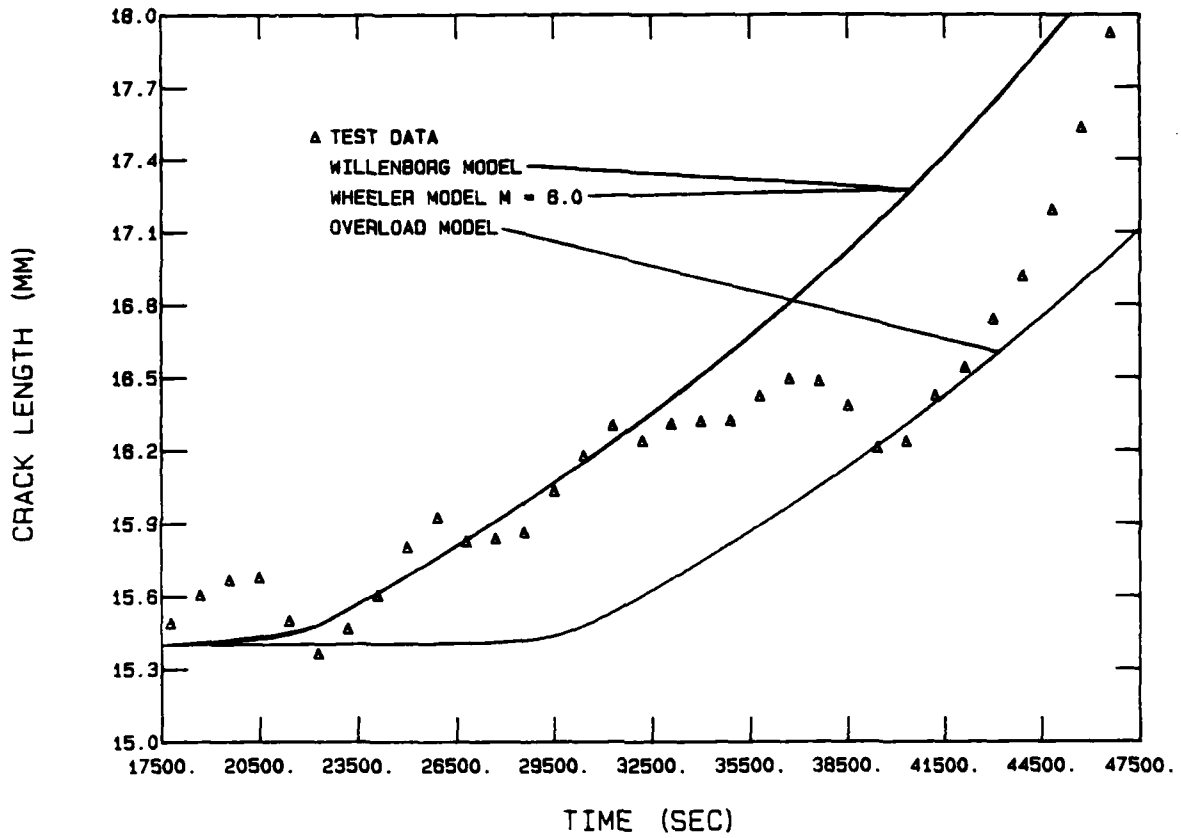

Figure 12 Crack Length versus Time for
20 Percent Overload at Low K.

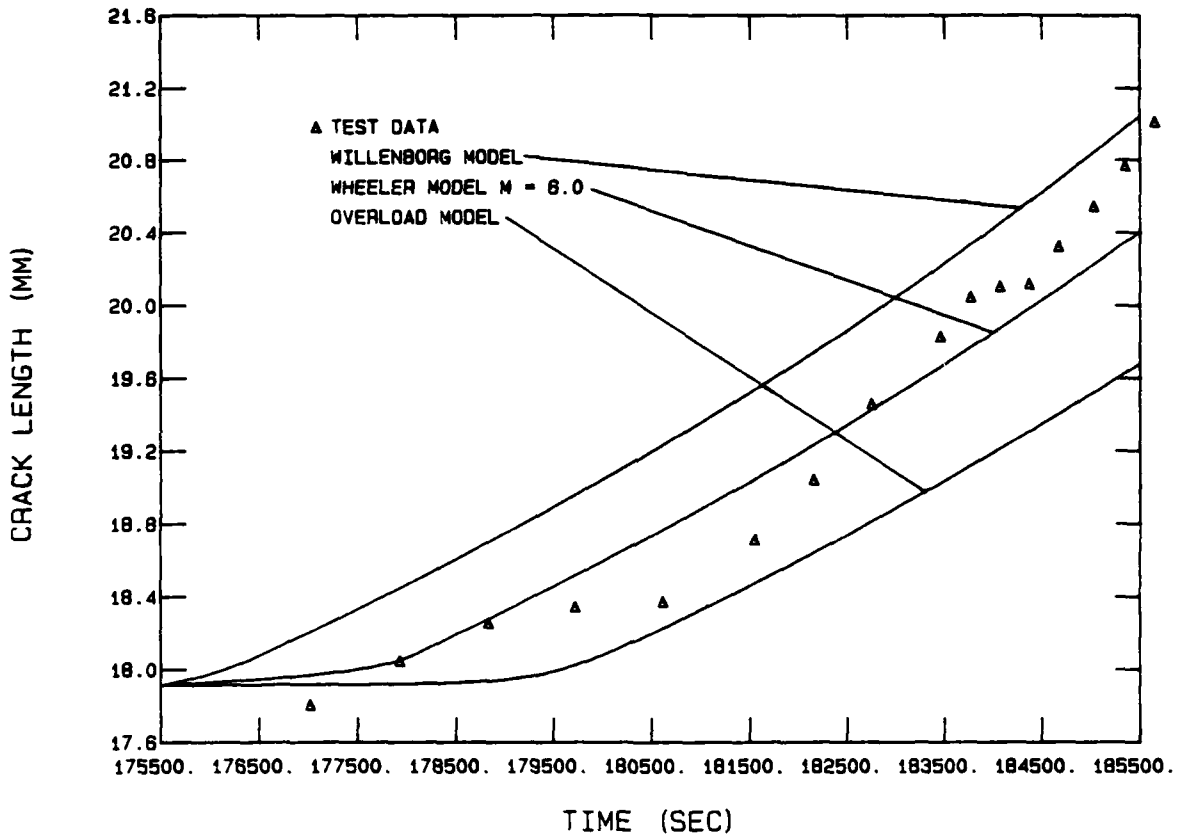

Figure 13 Crack Length versus Time for
 20 Percent Overload at Medium K.

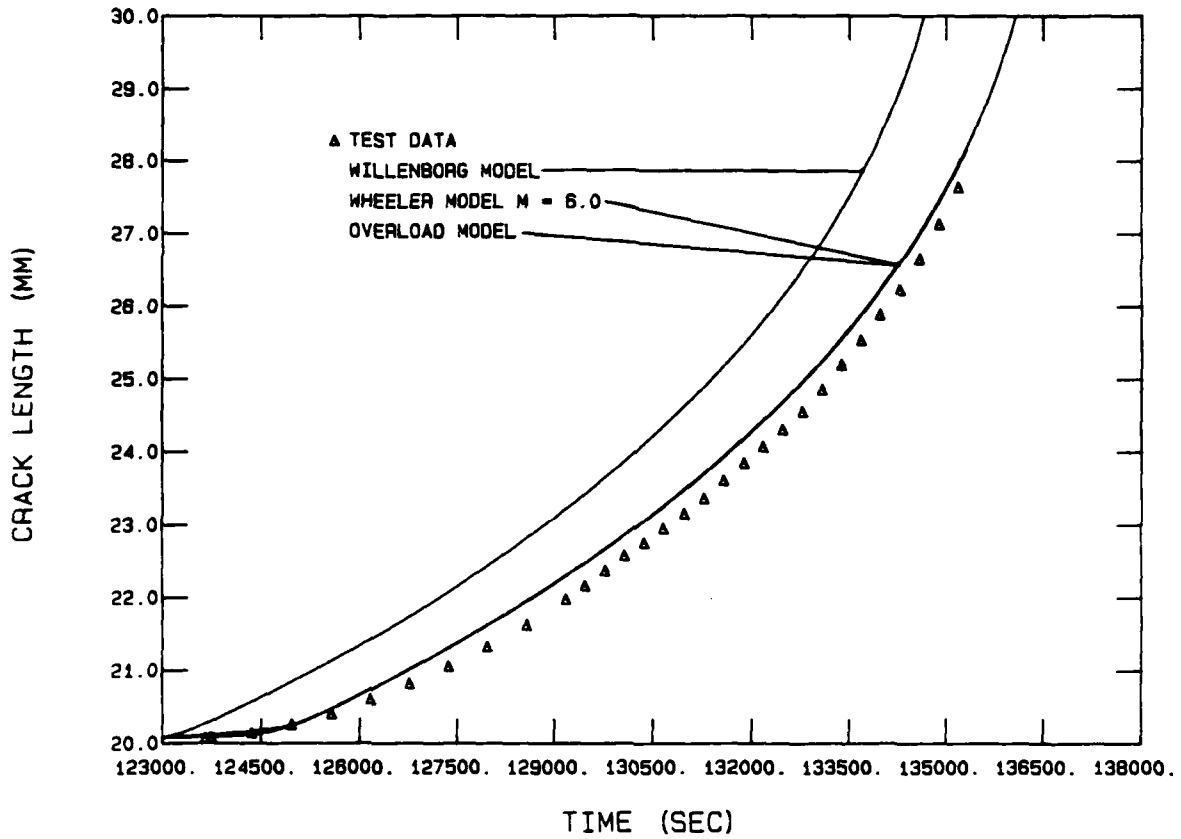

Figure 14 Crack Length versus Time for
20 Percent Overload at High K.

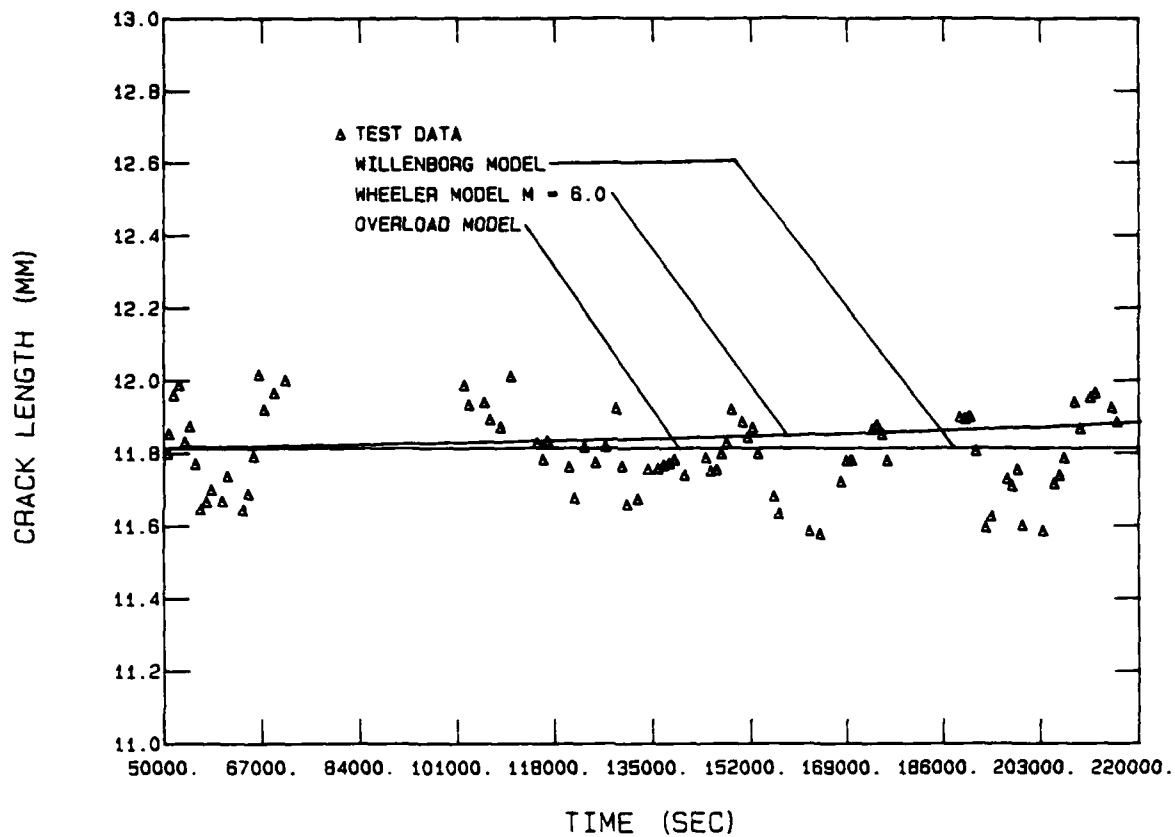

Figure 15 Crack Length versus Time for
50 Percent Overload at Low K.

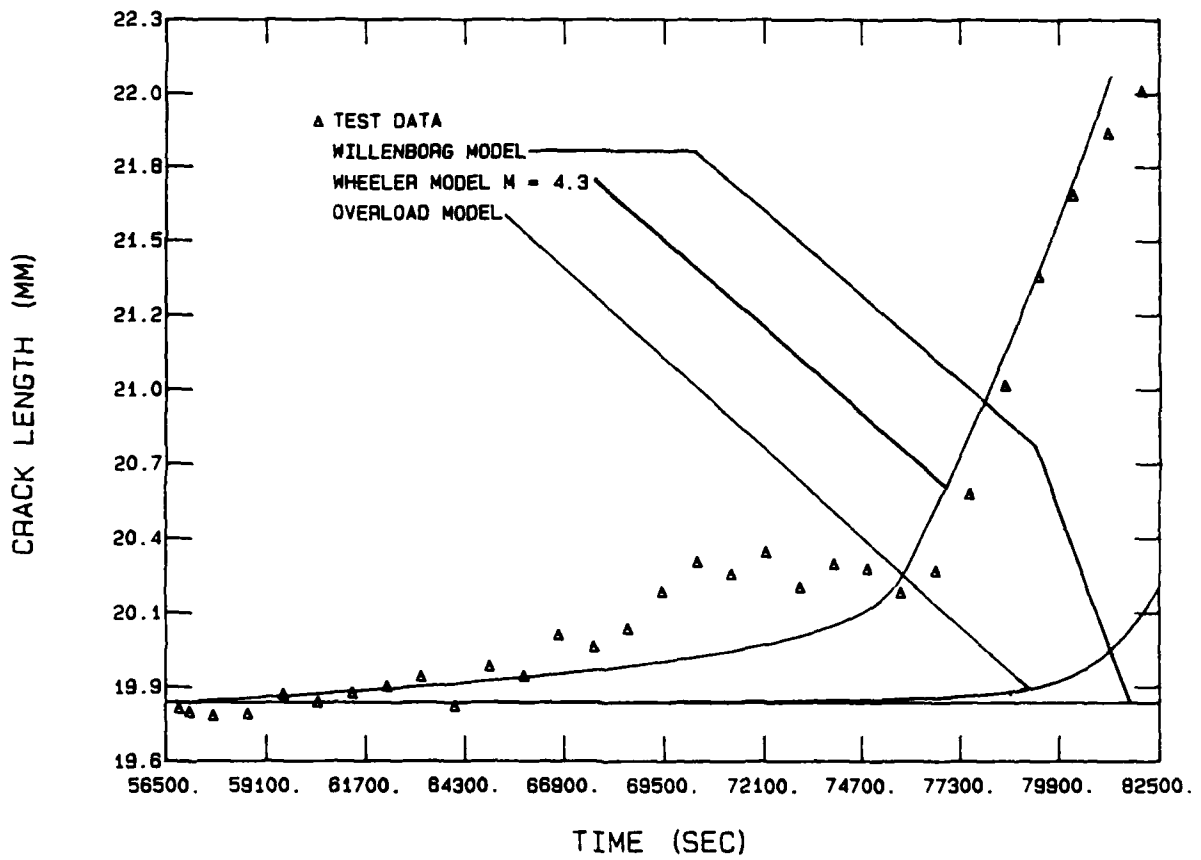

Figure 16 Crack Length versus Time for
 50 Percent Overload at Medium K.

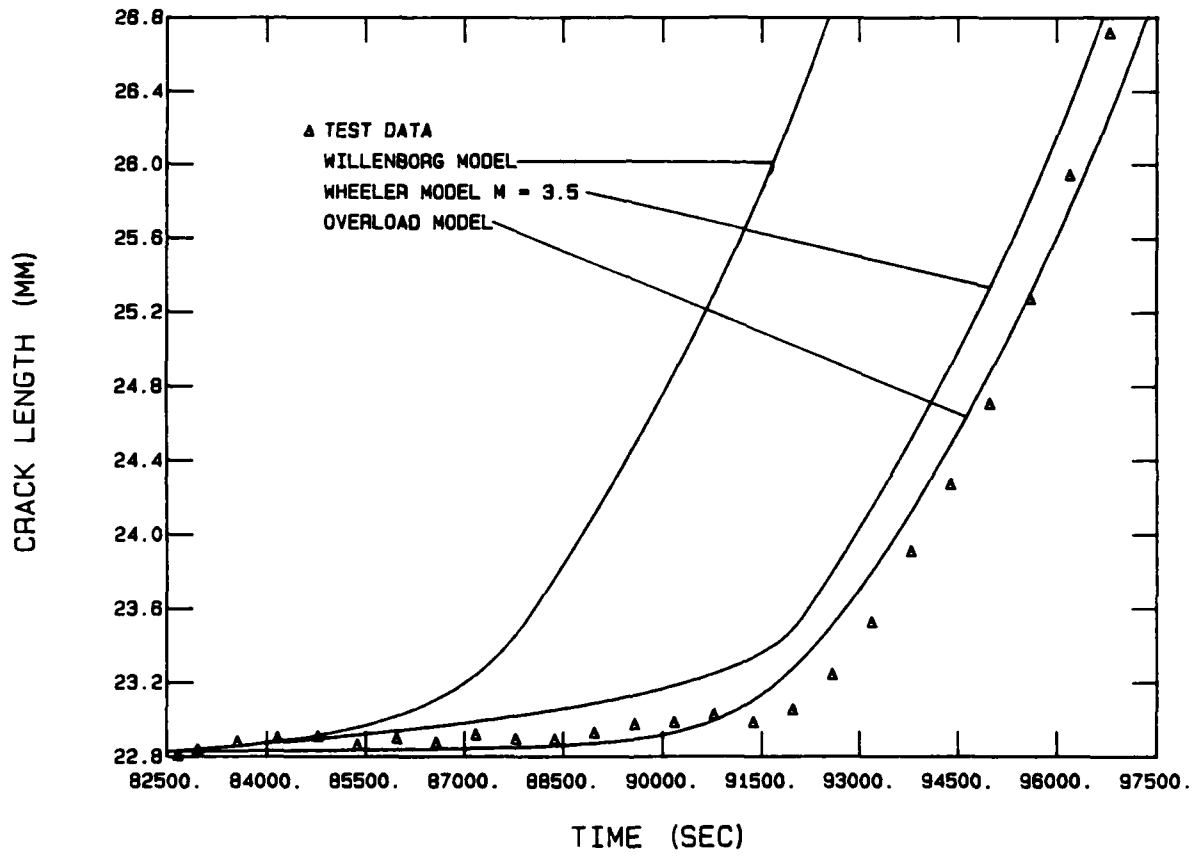

Figure 17 Crack Length versus Time for
50 Percent Overload at High K.

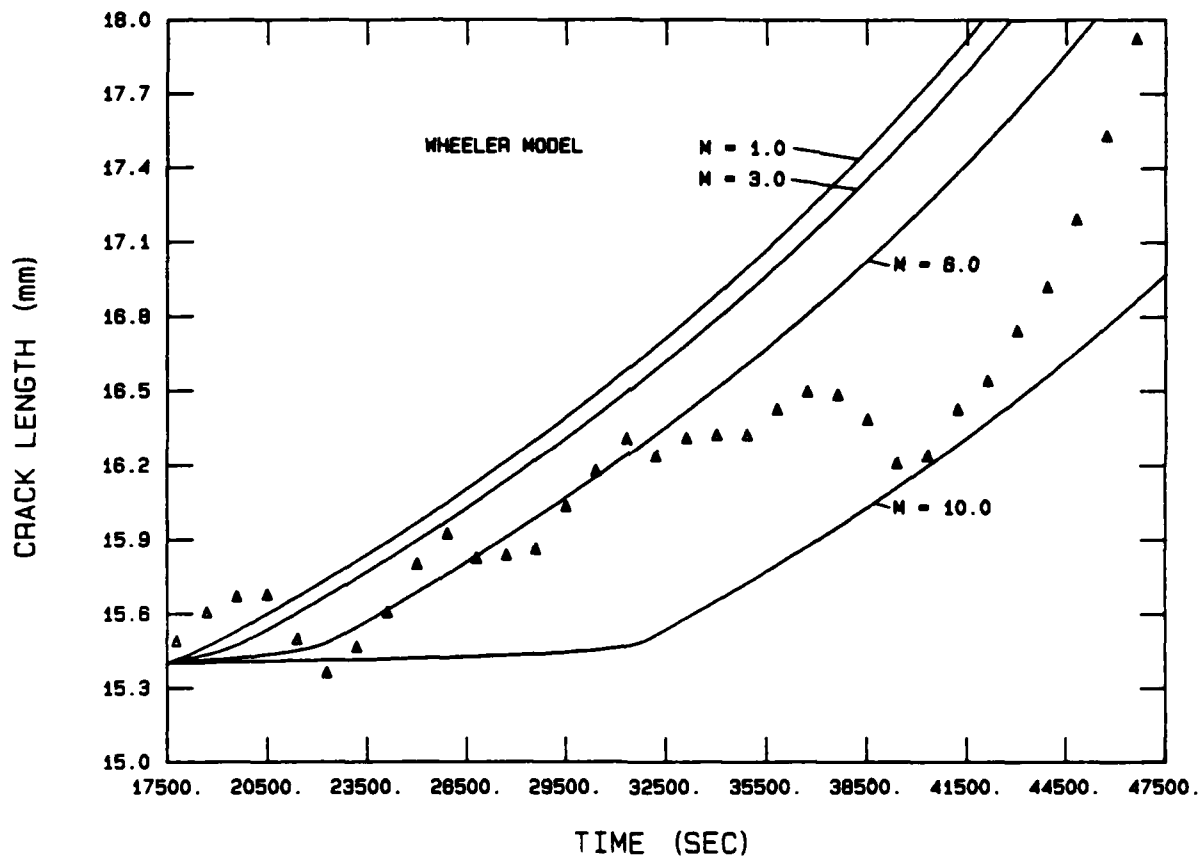

Figure 18 Best Fit Shaping Exponent (n)
for 20 Percent Overload at Low K.

WHEELER M COEF

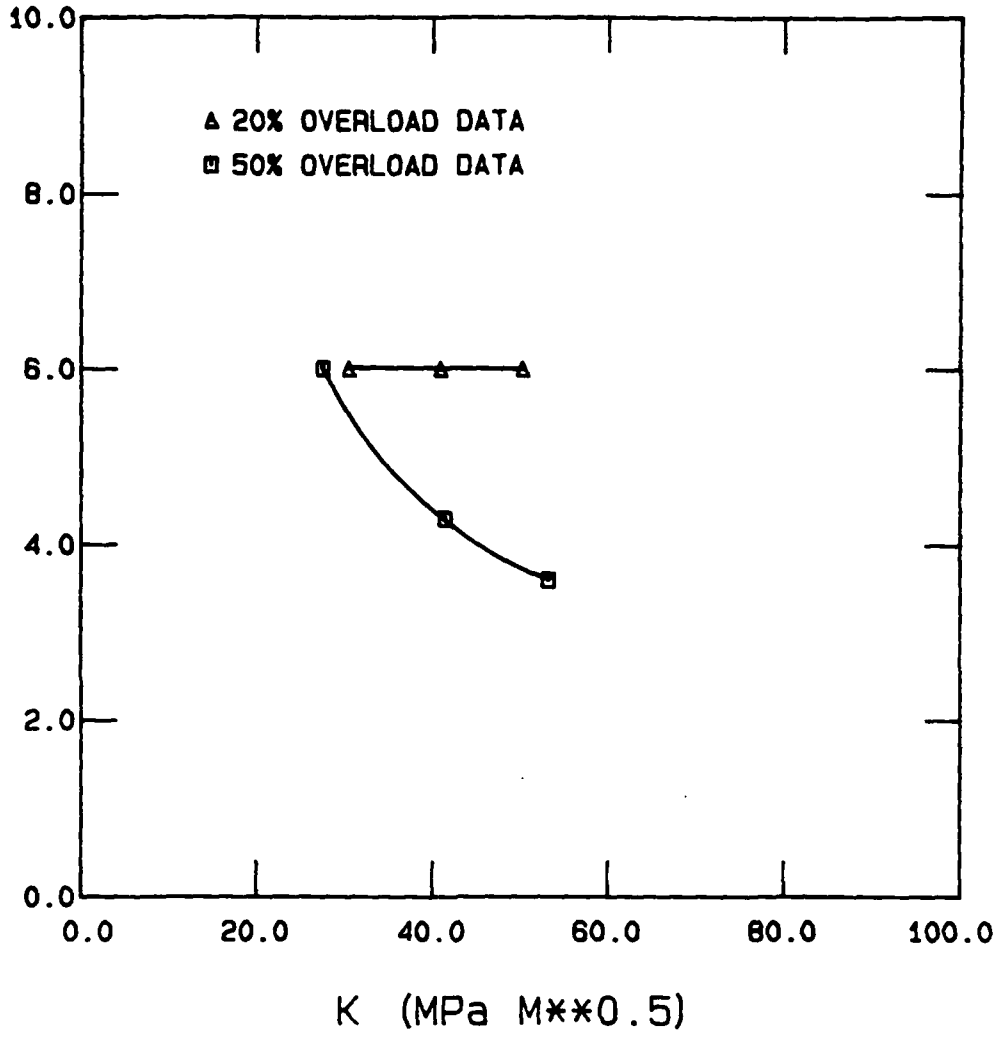

Figure 19 Best Fit Shaping Exponent (a) versus K.

V. Proof Test Experiments

Several proof tests were conducted to provide additional test data to verify the prediction capability of the retardation models. A description of the test apparatus and crack measurement procedures used during testing follows.

Test Apparatus

The experimental data for the proof tests was gathered using a semi-automated creep test system employing electric potential drop and optical readings to monitor crack length. The Air Force Wright Aeronautical Laboratories, Materials Laboratory, Wright-Patterson Air Force Base, Oh. provided the facilities and equipment to conduct the testing. The test system schematic is shown in figure 20. The test setup included the following components:

1. 12,000 lb Swedish creep test frame
2. Resistance heated furnace with power controlers
3. Tektronix 4051 microcomputer
4. Daytronic 9000 signal processor
5. Hewlett-Packard 3478A IEEE-488 digital voltmeter
6. Two Gaertner traveling microscopes
7. Current supply source

The 12,000 lb.-capacity Swedish creep frame was used to

load the specimens. The frame is constructed using a lever and fulcrum principle. The weights were suspended at the end of a 20 to 1 lever arm. The other end reacts to this mechanical advantage with a load line containing the specimen. Dynamic loading of the specimen is avoided by the use of a hydraulic ram which can support a fraction or all of the suspended weight. As pressure is added or removed from the ram, it removes or adds the load to the specimen in a smooth manner. Periodic overloads were applied by unloading the specimen, adding the calculated overload weight to the end of the lever arm, and reloading the specimen. Removing overloads was done using the same procedure except for removing the weights.

The compact tension specimens were mounted in the load line using load rods with Inconel 718 clevises and holding pins. An electric potential technique, to be discussed below, was used to measure crack length. To accommodate this system, the specimen was electrically isolated from the creep frame by using insulated sleeves and pins to connect the load transfer rods. A load cell to measure the applied load to the specimen was included in the load line. The load cell readings were used to ensure the hydraulic ram released the entire load to the specimen. The specimen's configuration and nominal dimensions are shown in figure 21. In addition, the individual test specimen's dimensions and the applied loads are listed in table 1.

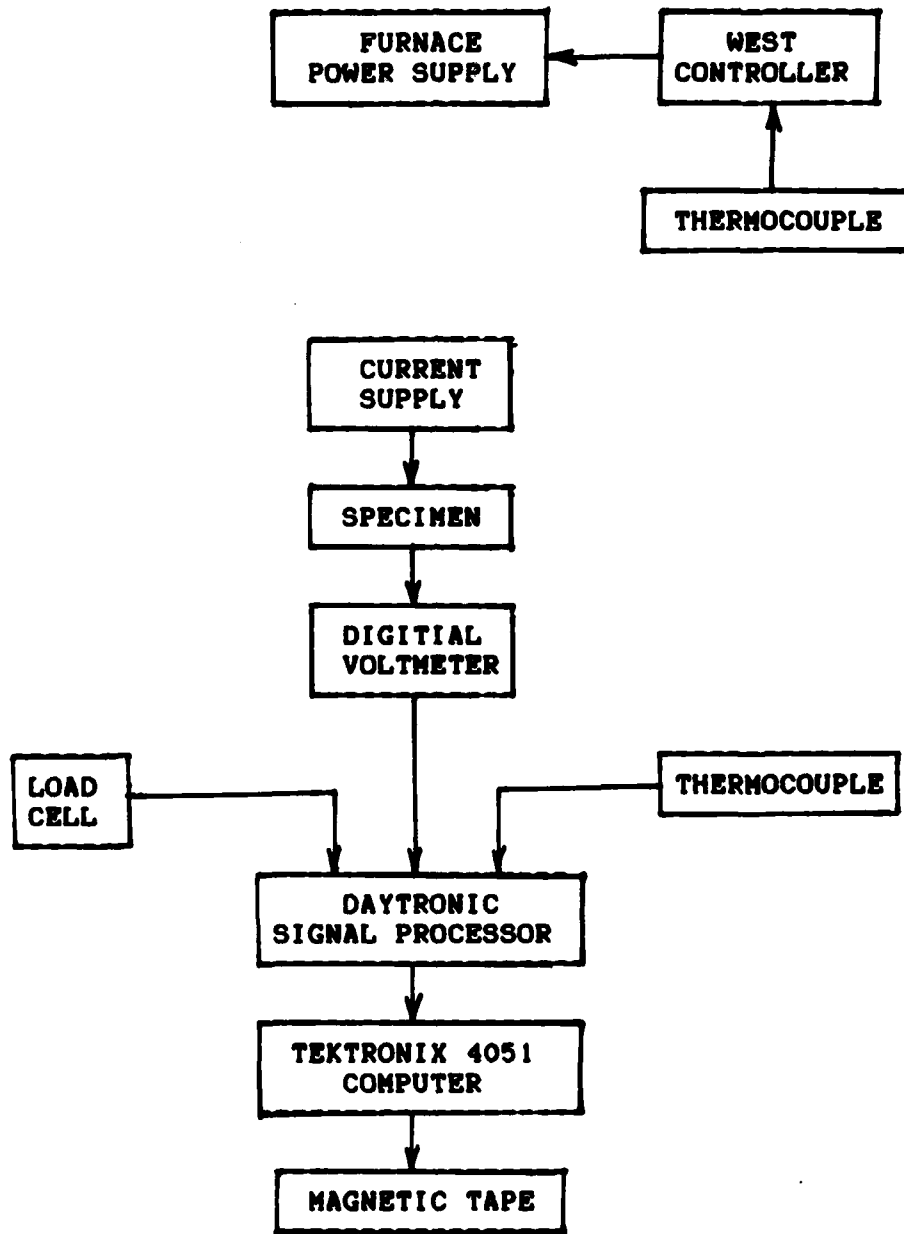
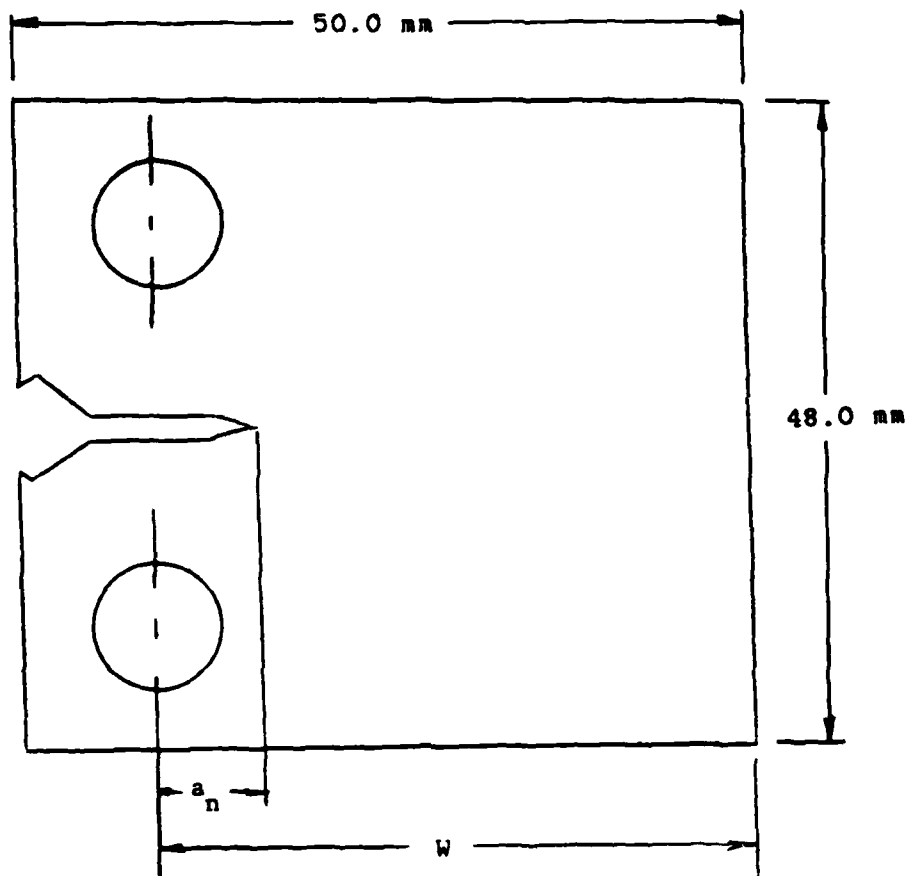

Figure 20 Test System Schematic.



$a_n = 7.0 \text{ mm}$

$W = 40.0 \text{ mm}$

thickness (B) = 10.0 mm

Figure 21 Compact Tension Specimen.

Specimen	a_i (mm)	Width (mm)	Thickness (mm)	Load (KN)
84-502	10.381	39.969	10.008	12.188
84-503	10.665	40.008	10.033	12.023
84-504	10.267	40.018	10.008	12.677

Table 1 Specimen Dimensions and Applied Load.

The two piece resistance furnace was mounted on the creep frame as shown in figure 22. The oven was closed around the specimen and sealed with a flameproof wadding. The wadding material also served to insulate the leads for the electric potential system from the oven and frame. The furnace was constructed with four independently controlled power zones. The power to each zone is controlled by a time-proportioning West controller. The controller used a thermostat feedback loop to hold the oven's temperature constant. Two K-type, chromel-alumel, thermocouples were spot welded to the specimens and are shown in figure 23. One was used by the controller and the other served as a backup (connected to the Daytronic controller for periodic monitoring).

The Tektronix 4051 microcomputer was used as the data-acquisition system for the tests. The Tektronix was programed to take electric potential readings at predetermined time intervals. The time input signal sent to the Tektronix was provided by the Daytronic controller.

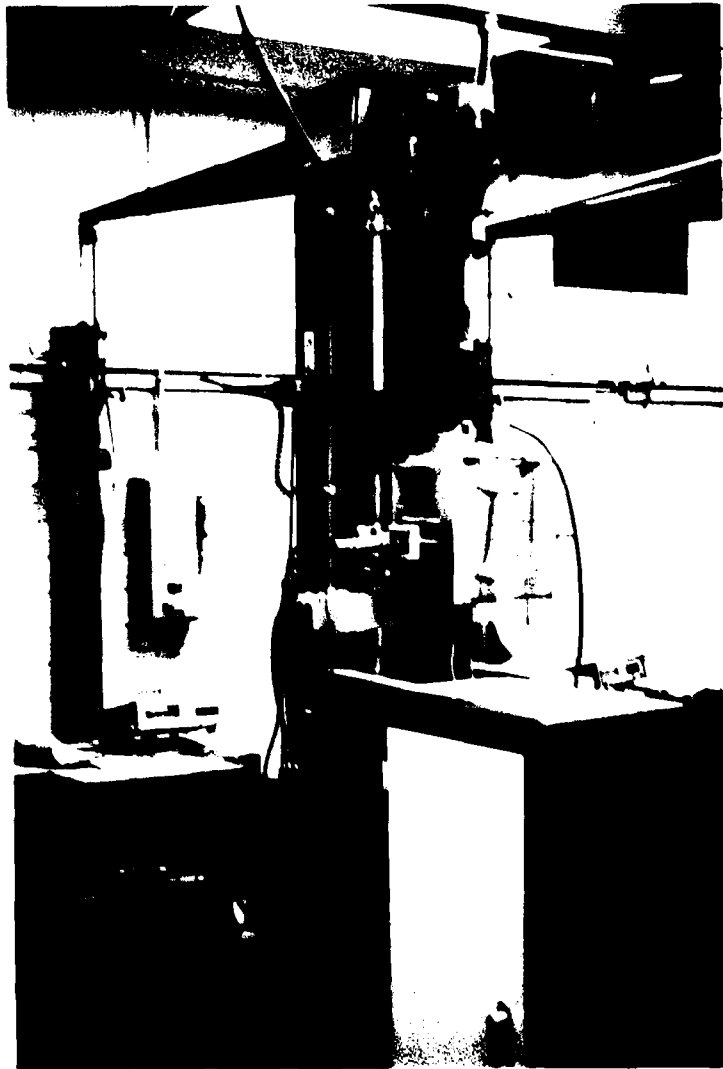

Figure 22 Creep Frame Photograph.

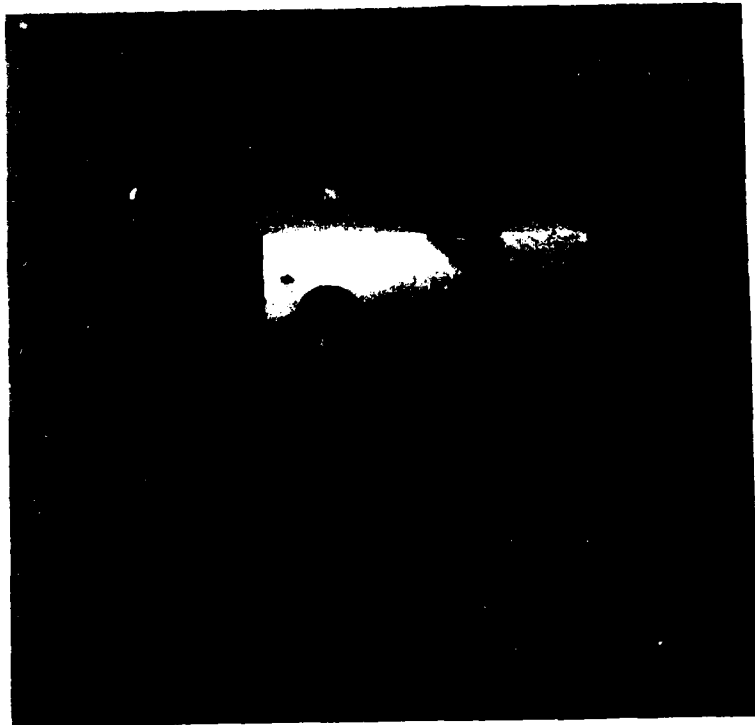

Figure 23 Instrumented Specimen Photograph.

Similarly, the Hewlett Packard 3478A IEEE-488 programmable voltmeter provided the voltage reading when requested by the Tektronix's program. The two received signals were then recorded on magnetic tape. This information was later transferred to the host PDP 11/24 computer for use in the data reduction procedures to obtain crack length from voltage. In addition, optical crack length measurements were obtained through the viewing ports on each side of the resistance furnace using two Gaertner traveling microscopes. The crack length measurement was displayed on a digital readout to an accuracy of 0.0254 mm. However, due to optical problems in determining exactly where the crack ended, measurements were reproducible to an accuracy on the order of 0.05 mm. The optical crack length measurements were manually recorded periodically along with time and the corresponding voltage readings from the electric potential system in order to provide data for later correlation of crack length to voltage.

Crack Measurement Procedure

The proof experiments utilized a D.C. Electric Potential (EP) measurement system augmented with optical readings to monitor crack length. The EP system is based on the fact that when a current is passed through a conducting body an electric field is generated. The field shape and intensity depend upon such factors as applied current,

geometry shape and material properties. The EP system relies on relating changes in the EP field at the output leads to changes in geometry due to crack growth.

One of the instrumented specimens is shown in figure 23. The input and output leads were welded to the specimen at the locations shown in figure 24. The input leads, made of Inconel 718, were connected to a constant 10.0 amp current source. The output voltage was measured from nichrome wire leads spot welded on the specimen front surface. Nichrome wire was used for the output leads due to its superior oxidation resistance at elevated temperature. However, joining two dissimilar materials produces a thermocouple effect as the joint temperature is changed. This thermal voltage adds algebraically to the voltage generated due to the resistance in the specimen. It should be noted that the thermal voltage is present even when the applied input current is removed from the specimen. It was therefore possible to periodically measure the thermal voltage by shutting the current supply off. Plots of the output voltage versus thermal voltage (V_{th}) were generated for each test specimen and are shown in figures 25 through 27. The data were fitted with a linear equation using a least squares regression to yield thermal voltage as a function of output voltage reading. This thermal voltage was calculated at each data point and subtracted from the output voltage reading.

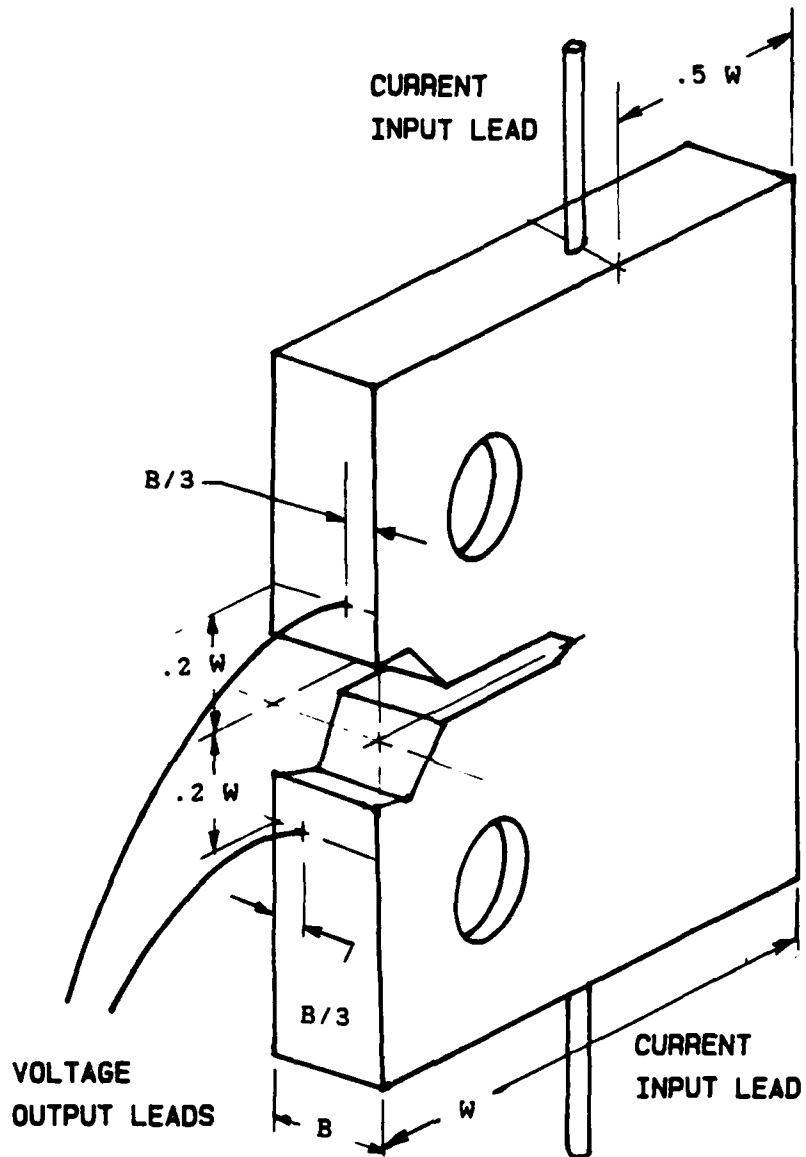

Figure 24 Location of Input and Output Leads on Specimen.

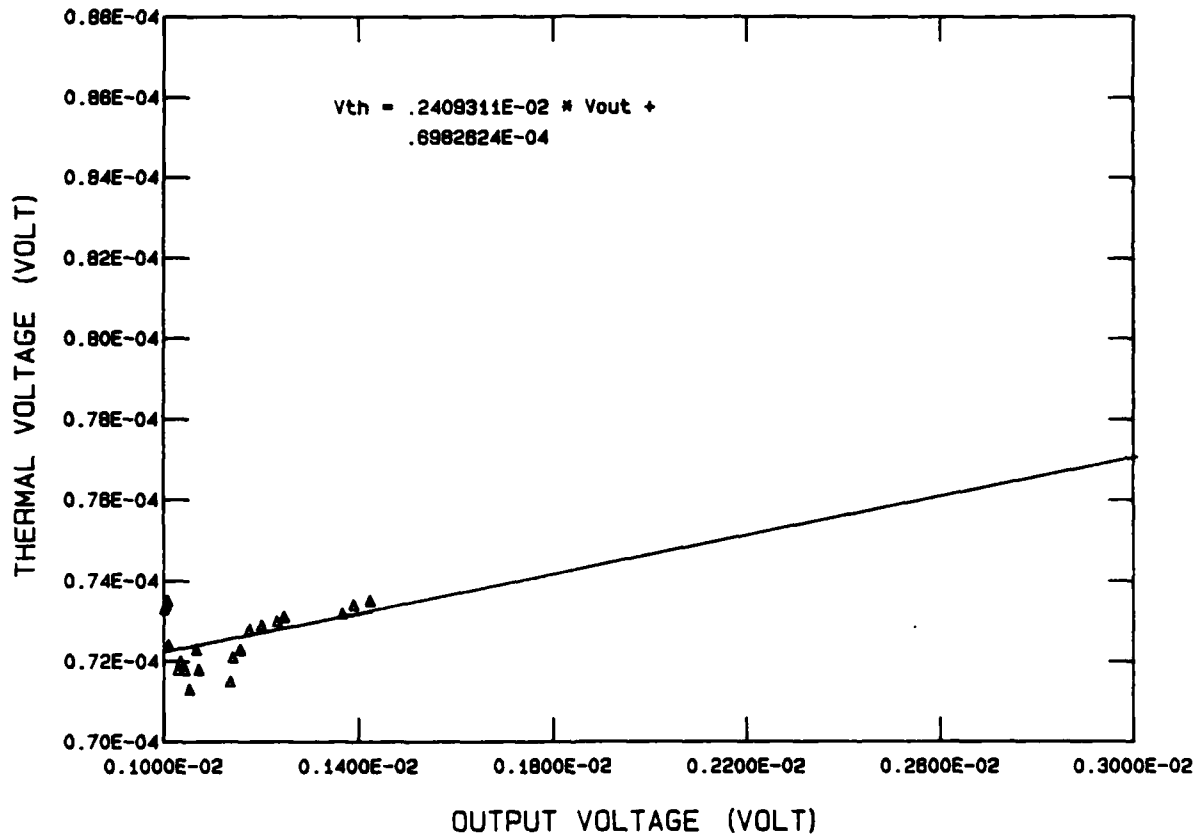

Figure 25 Thermal versus Output Voltage
Specimen 84-502.

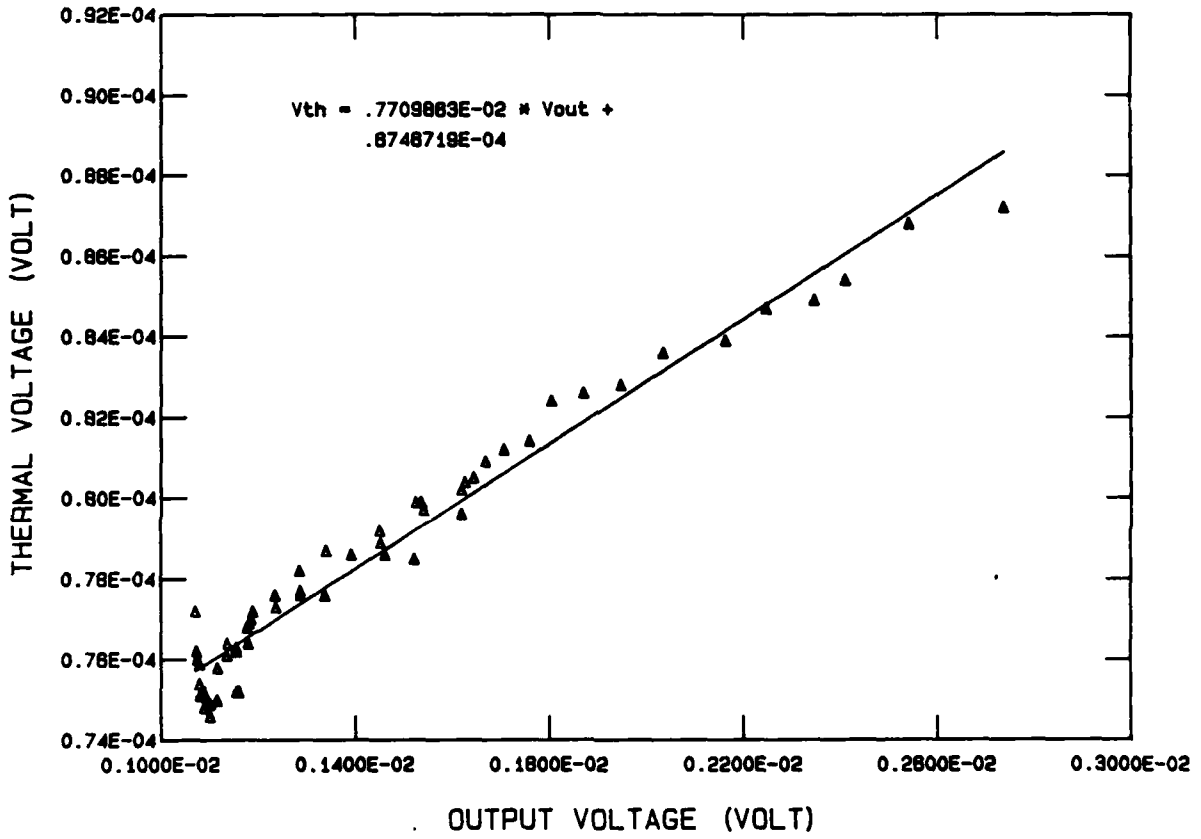

Figure 26 Thermal versus Output Voltage
Specimen 84-503.

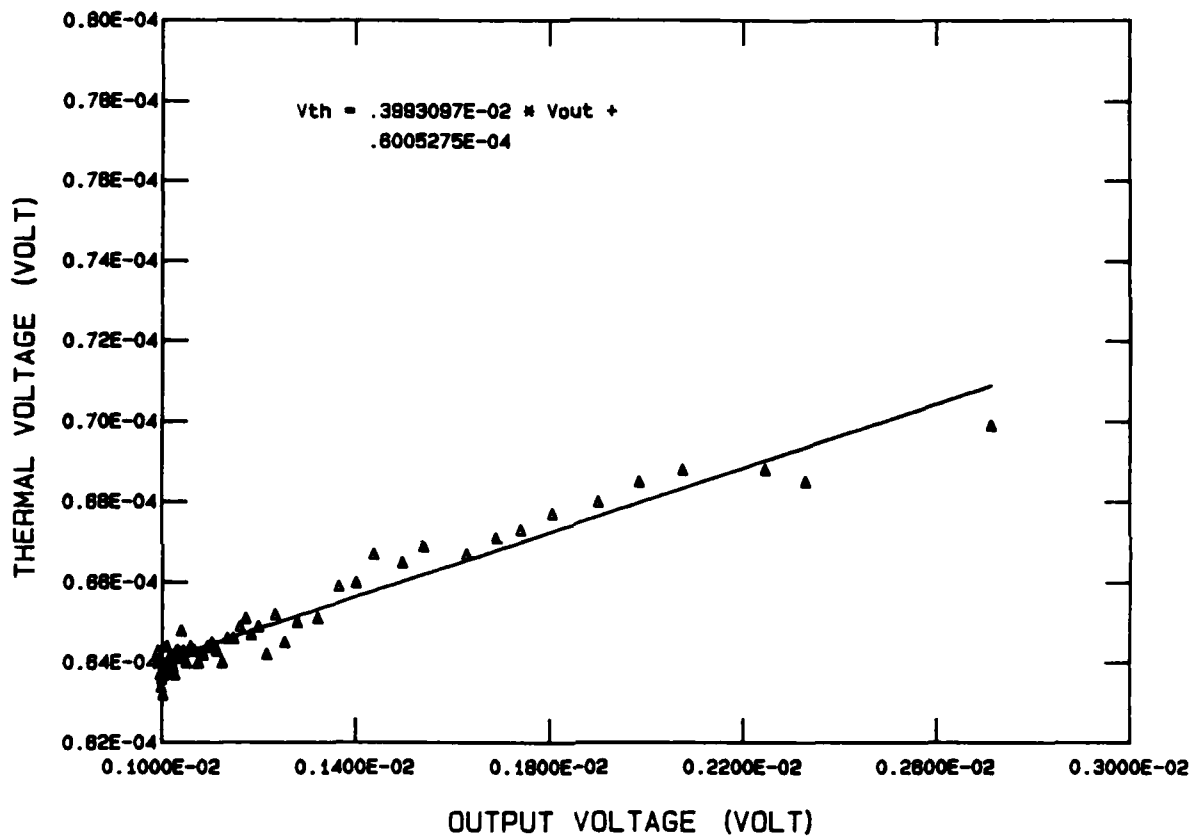

Figure 27 Thermal versus Output Voltage
Specimen 84-504.

Specimen 84-504-EE5 was tested to provide a calibration curve relating crack length to output voltage under conditions of sustained-load crack growth with no applied overloads. The initial voltage reading, minus thermal voltage, was called the initial reference voltage V_0 . The initial crack size corresponding to V_0 was measured using a method similar to the one recommended in ASTM E399 [16]. An optical microscope, equipped with a measurement table, was used to make a five point through-the-thickness measurement of the initial crack tip profile on the ruptured specimen. The weighted average, defined in figure 28, was used to calculate an average crack size and a crack tunneling correction factor to account for the increased crack depth at the center of the crack front. The tunneling correction factor was used to bias the surface optical measurements, made at locations a_1 and a_5 in figure 28, to obtain a average crack depth. Calibration specimen 84-504-EE5 had an average tunneling value of 0.445 mm. This value was added to each optical reading to get a corrected a_{opt} value.

A functional relationship between a_{opt} and voltage readings (minus thermal voltage, and normalized to the referenced voltage V_0) was developed using a least squares polynomial fitting program. H. H. Johnson [17] developed complex functions for calibrating crack length measurements to voltage. However, Johnson's results showed that the crack-starter geometry strongly influences the

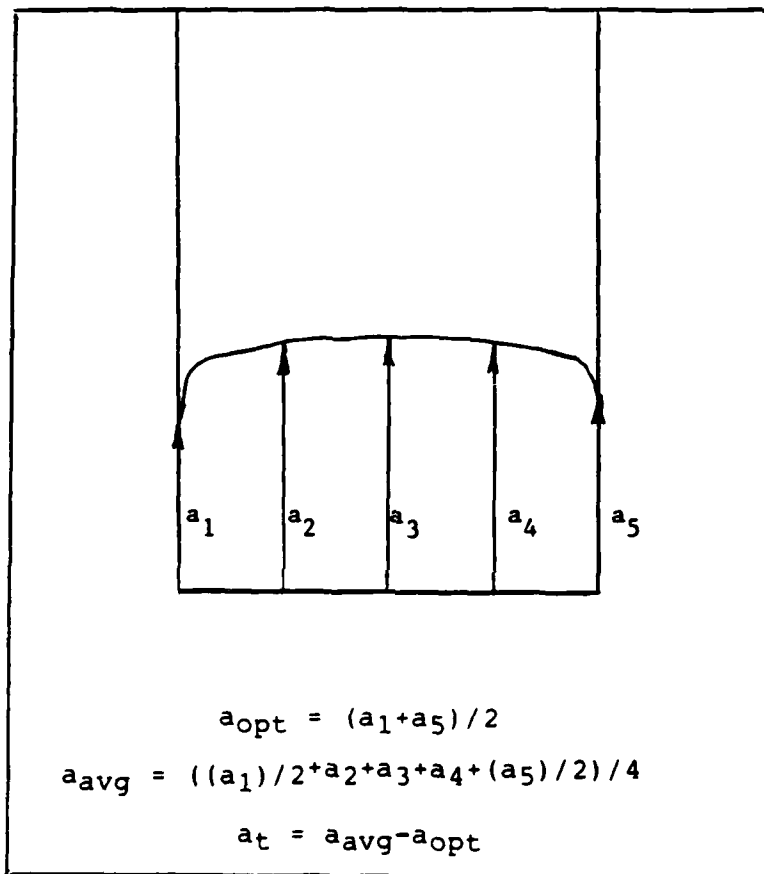

Figure 28 Average Crack Size and Tunneling Correction Term.

calibration between crack length and measured potential. Therefore for simplicity, an eighth order polynomial was used which was found to adequately fit the experimental data and is shown in figure 29. The polynomial equation for crack length as a function of normalized voltage is,

$$\begin{aligned}
 a = & -332.1731 + 1503.861 (V/V_0)^1 - 2932.647 (V/V_0)^2 \\
 & + 3220.104 (V/V_0)^3 - 2176.264 (V/V_0)^4 \\
 & + 927.0209 (V/V_0)^5 - 243.1114 (V/V_0)^6 \\
 & + 35.90090 (V/V_0)^7 - 2.286718 (V/V_0)^8 \quad (\text{inch})
 \end{aligned} \tag{28}$$

The inverse of this function, normalized voltage as a function of a_{opt} , was also generated and is shown in figure 30. The corresponding polynomial equation is,

$$\begin{aligned}
 V/V_0 = & -29.66971 + 364.3393 (a)^1 - 1859.148 (a)^2 \\
 & + 5319.197 (a)^3 - 9330.943 (a)^4 \\
 & + 10274.08 (a)^5 - 6926.514 (a)^6 \\
 & + 2612.860 (a)^7 - 422.2600 (a)^8
 \end{aligned} \tag{29}$$

where (a) is measured in inches.

This equation was used to calculate the initial voltage (V_0) for specimens with different initial crack sizes. Knowing the initial crack size and corresponding voltage reading (V), an effective V_0 was calculated using equation 29. Substituting the ratio of $V/V_{0_{eff}}$ into equation 28 yields the correct initial flaw size for the specimen.

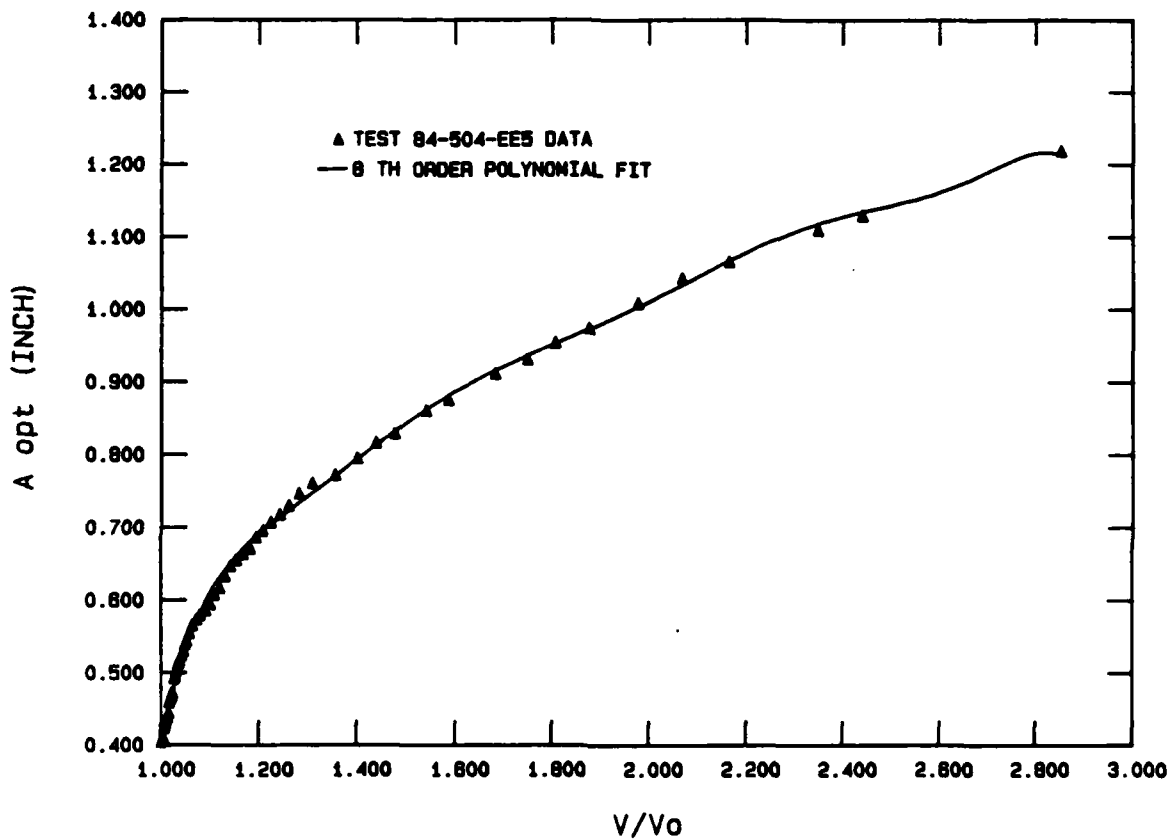

Figure 29 Calibration Curve A_{opt} versus V/V_0 .

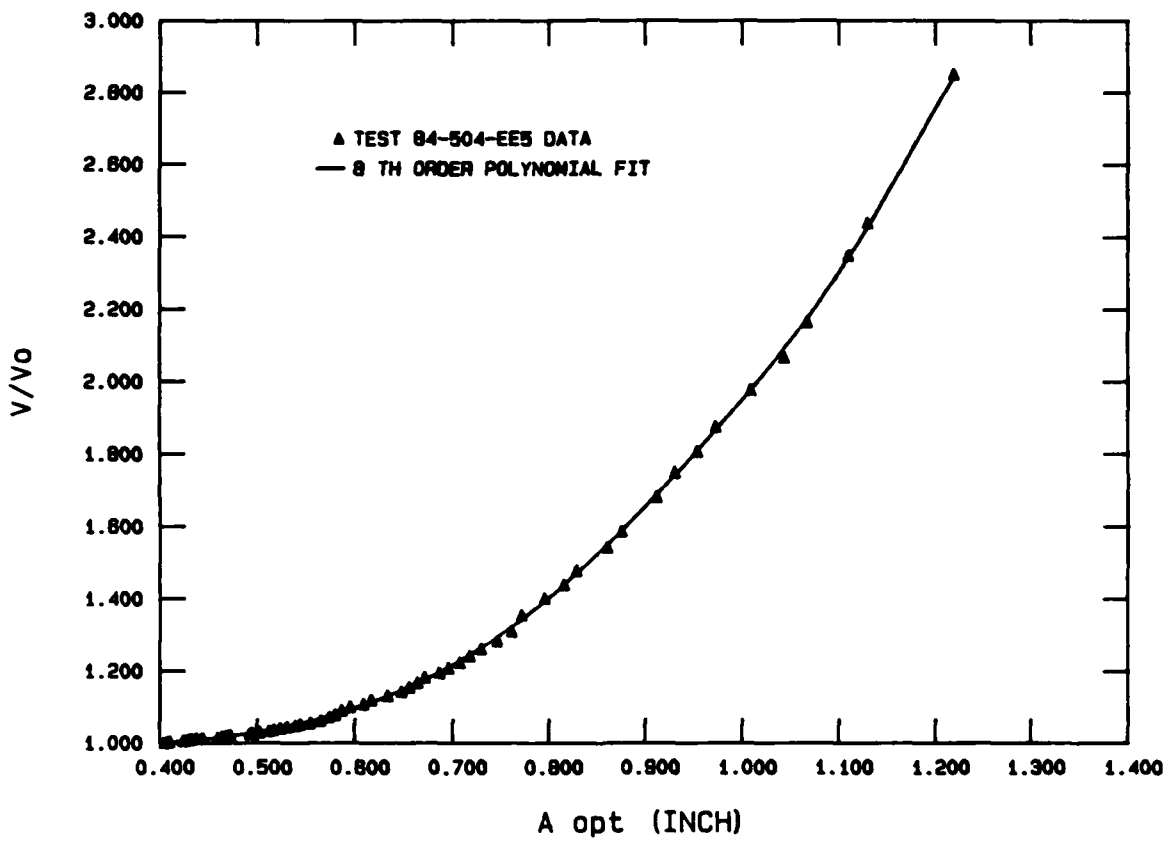

Figure 30 Calibration Curve V/V_0 versus A_{opt} .

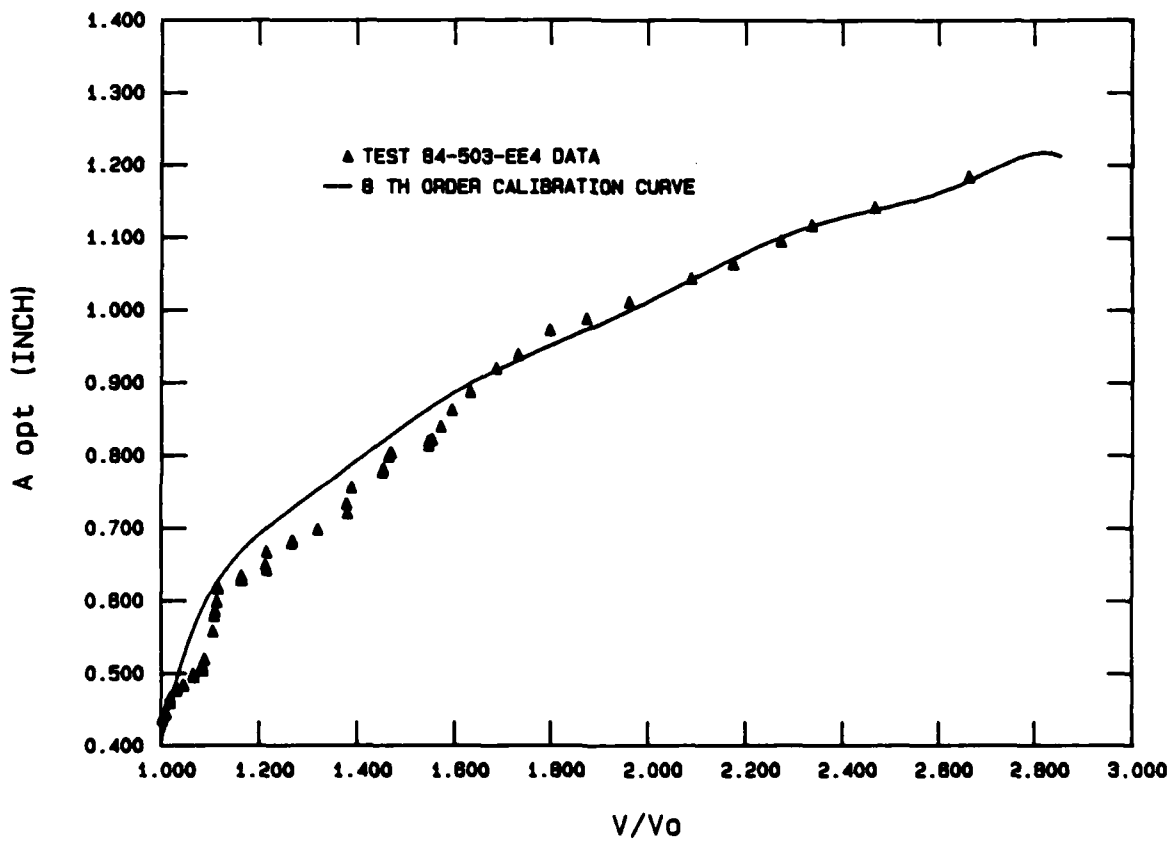

Figure 31 Overload Effect on Calibration Data.

In the tests involving overloads, it was found that each overload caused the a_{opt} versus voltage to shift from the calibration curve. This effect is shown in figure 31. After each overload, there is a period where voltage increases without an appreciable increase in the optical crack size. One explanation is that the crack changes shape with the edge breaking through during the overload cycle. This would account for the jump in optical measurement after each overload. As the crack starts to grow again, evidenced by increasing voltage readings, the surface growth may lag since the crack may tunnel to restore its preferred flaw shape. Although the exact mechanism that cause the deviations from the calibration curve are not fully understood, their effect may be negated by recalibrating the equation after each overload. The procedure is the same one used to calibrate the equation to different initial flaw sizes. Using equation 29 and the a_{opt} and voltage reading taken after each overload, a new V_0 was calculated. This V_0 was used to normalize voltage readings until the next overload.

The experimental voltage readings recorded by the Tektronix 4051 computer were reduced using the procedures described in this section. The resulting crack growth histories were compared with the analytical predictions and are discussed in the next section.

VI. Experimental Results and Discussion

Experiments were performed in the course of this study in order to obtain additional crack growth data for evaluating the prediction capability of the retardation models. An electric potential crack-measurement system was used for taking crack length measurements during sustained loading with periodic overloads. The applicability of this system to crack growth following overload was investigated.

Three specimens were used in the experimental work. One was used as a calibration specimen for the electric potential system. The other two specimens were used for the proof tests. In addition, a third proof test, conducted by Harms, was also used to evaluate the retardation models.

The crack growth prediction for the calibration specimen 84-504 is shown in figure 32. This specimen was subjected to sustained loading at 650 C with no overloads. As expected, both the Overload and Wheeler models predicted the same growth, since no retardation cycles were applied. The analytical prediction for time to failure was within 20% of the actual test data. This is well within the normal 2X scatter in crack growth data associated with variations in material properties.

Specimen 84-503 was tested with 20 % overloads applied each hour. The test data and retardation model predictions are shown in figure 33. The test was divided into two

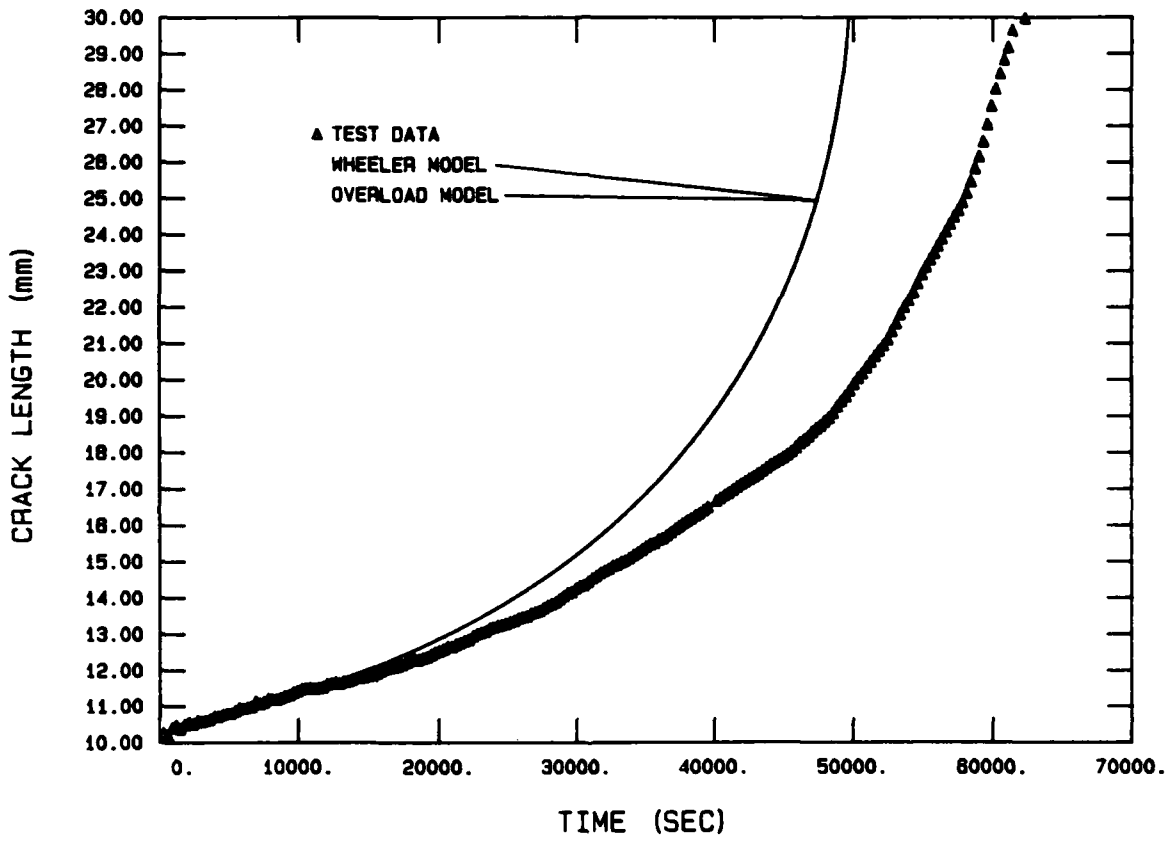

Figure 32 Crack Length versus Time Specimen 84-504.

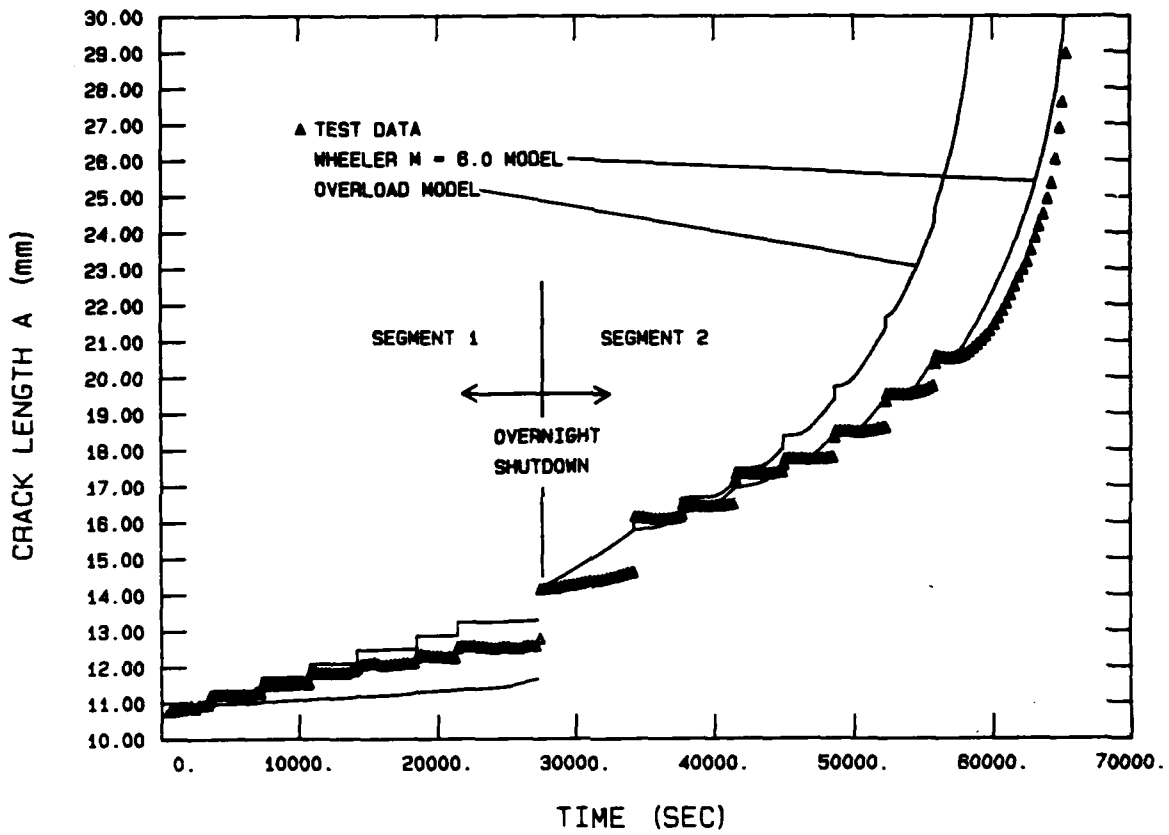

Figure 33 Crack Length versus Time Specimen 84-503.

segments, due to an overnight shutdown in the testing. In the first segment, the crack growth appears to be dominated by the crack jump due to the overload cycle. The Overload model overestimated this jump, while the calculated growth increment from the 0.01 Hz overload cycle before the Wheeler model is applied underestimated it. During the overnight shutdown, the load was removed from the specimen while the temperature was held constant at 650 C. Since the specimen experienced thermal soaking during this shutdown, reloading of the specimen was followed by at least an hour of sustained load growth to re-establish the previous growth rate. The overnight shutdown provided a heat tinted region visible on the fracture surface after the specimen fractured. Optical readings were taken of the crack tip profile to adjust the tunneling correction factor which was then added to the optical surface measurements. The Wheeler model overestimated the total time to failure for the second segment by 1 %. The Overload model underestimated the growth in the same segment by approximately 16 % .

Specimen 84-502 was tested with 20 % overload cycles applied at low 30 (MPa $m^{1/2}$), medium (40 MPa $m^{1/2}$) and high 50 (MPa $m^{1/2}$) stress intensity levels. The effects of the jumps on the crack length, due to overload cycles, was minimized by applying just three overload cycles during the test. The test data and retardation predictions are shown in figure 34. Both models predicted the total time of

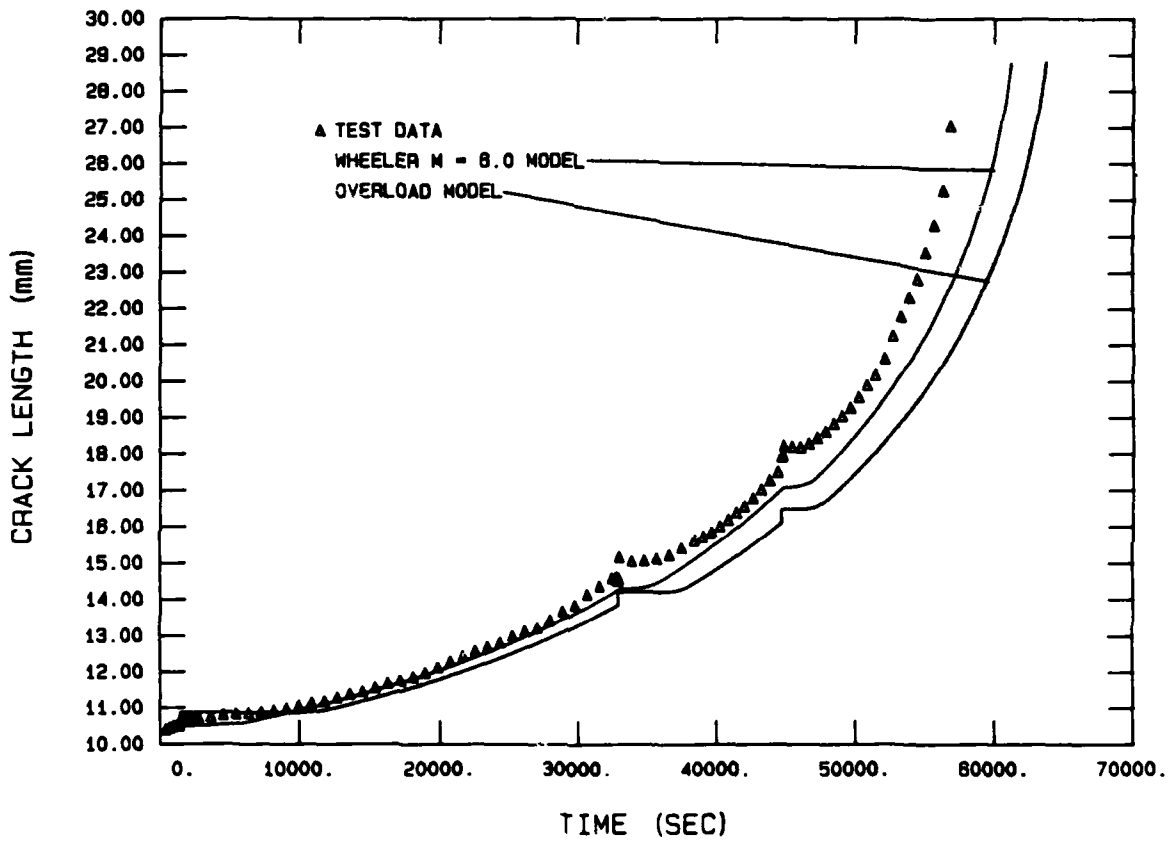

Figure 34 Crack Length versus Time Specimen 84-502.

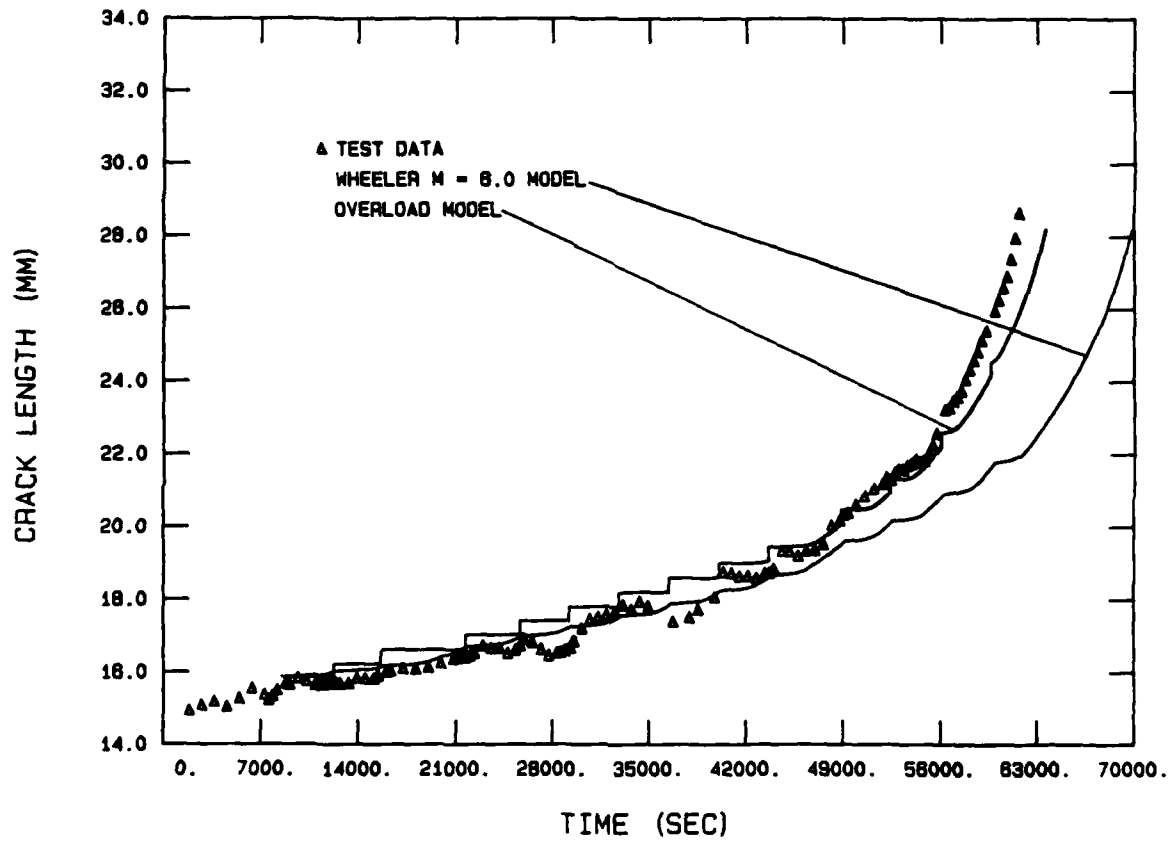

Figure 35 Crack Length versus Time Specimen 84-507.

growth within 10 % of the test data. It was also noted that the retardation predictions were similar in shape to the test data. In general, the models gave better predictions of total time-to-failure when the effect of the crack jumps was minimized.

In addition to the tests conducted as part of this study, the proof test conducted by Harms was analyzed. The test data and retardation predictions are shown in figure 35. The test spectrum consisted of 20 % overload applied each hour. The prediction of the Overload model was within 4 % of the total time-to-failure, but was dependent on the jump in crack length to account for crack growth at lower stress intensity levels. The Wheeler model again underestimated the growth due to the overload cycles and therefore predicted a growth time longer than the actual data.

Accurate prediction of the retardation caused by overload cycles requires empirically defining the α parameter for the Overload model and the shaping exponent m for the Wheeler model. These variables were defined for a specific overload ratio, temperature and test geometry. Both α and m were found to depend upon the stress intensity level at overload application. Using the predefined values of α and m from section IV, both models predicted the retardation effect of overload cycles, when the cycles were applied far enough apart so that no interactions occurred

between cycles. When the overload cycles were applied at closer intervals, the crack growth was dominated by the jumps in the crack length caused by the overload cycles. As seen in the predictions in figures 33 and 35, the Overload model did not accurately in predict the jump in crack length when overload cycles were applied. Defining a function relating the jump in crack length to the current stress intensity level was difficult due to the large scatter in crack length jump measurements. An attempt was made to reduce the scatter in crack length jump measurements by using an electric potential system to measure the crack length. This attempt was unsuccessful mainly due to the electric potential system requiring recalibration via an optical crack measurement after each overload. Optical crack measurements on a specimen under sustained loading are difficult because the crack tip is not sharply defined. Instead, the crack tip looks like a deformation zone, with the exact tip location unknown. The accuracy of both models for predicting crack growth when the overload cycles interact could be improved by further refinement of the jump function.

Overall both retardation programs predicted the total time to failure within the normal 2X scatter associated with variations in material properties. Using the CRACKS program it is possible to analyze spectra of engine fatigue cycles with the sustained-load growth between cycles included.

VII. Conclusions and Recommendations

Conclusions

During the course of this study several observations were made on the applicability of using existing retardation models, developed for airframe application, to predict sustained load crack growth retardation. It was found that:

1.) The crack growth rate for sustained loading (da/dt) and overload fatigue cycles (da/dn) can be represented by one crack growth rate equation. This is accomplished by modeling the sustained load time as equivalent fatigue cycles. The equivalent cycle's period and R ratio are adjusted to obtain the overload fatigue cycle's crack growth rate. The equivalent sustained load fatigue cycles and overload cycles were analyzed using the CRACKS crack growth prediction program developed for airframe cyclic loading. The CRACKS program is capable of predicting the total time to failure within 20 % of experimental data.

2.) The Overload and Wheeler retardation models depend on empirical parameters that are related to the stress intensity level at overload application.

3.) The jump function dominates the crack growth in the Overload model when the overload cycles are spaced close enough to interact.

4.) The Willenborg retardation model modifies the fatigue cycle's R ratio when accounting for retardation.

Thus, the retardation model was dependent on the R ratio chosen for the equivalent sustained load fatigue cycles and was deemed unacceptable for use.

5.) The electric potential crack measurement system is affected by overload cycles and requires recalibration after an overload cycle is applied.

This study verified that the Overload retardation model predicts sustained-load crack growth with periodic overload within normal test data scatter. In addition, procedures were developed to convert sustained loading into equivalent fatigue cycles and analyze crack growth using the CRACKS program. The CRACKS program, with the Wheeler retardation model selected to account for retardation effects, is capable of predicting the total time to failure within 20 % for tests consisting of sustained-load with periodic overloads.

The modified CRACKS program offers the unique capability to analyze sustained-loading and fatigue cycle loading together.. This capability can be readily applied to complex engine spectra, consisting of fatigue cycles with hold times, to predict the crack growth in engine components.

Recommendations

In this study it was found that the electric potential system for measuring crack length was affected by periodic overloads. Additional investigation is required to understand how electric potential crack measurements made on fatigue loaded specimens with periodic overloads compare with sustained-loaded specimens with periodic overloads.

This study used Inconel 718 material exclusively for experimental testing. Additional testing should be performed to determine if the models apply to other materials. Another nickel-base superalloy such as Rene 95 is recommended.

Finally, the retardation parameters for the Overload and Wheeler models should be developed for a wider range of overload ratios and used to analyze a more complex spectrum.

Bibliography

1. Hill, R. J., Reimann, W. H., and Ogg, J. S., "A Retirement-For-Cause Study of an Engine Turbine Disk:", AFWAL-TR-81-2094. Wright-Patterson AFB, OH 1981.
2. Harris, J. A., Sims, D. L., and Annis, C. G., "Concept Definition: Retirement for Cause of F100 Rotor Components", AFWAL-TR-80-4118. Wright-Patterson AFB. OH 1980.
3. Military Standard: Engine Structural Integrity Program, MIL-STD-1783 (USAF) 30 November 1984.)
4. Engle, R.M., "CRACKS, A FORTRAN IV Digital Computer Program for Crack Propagation Analysis," AFFDL-TR-70-107, Air Force Flight Dynamics Laboratory, Wright-Patterson Air Force Base, Oh, Oct. 1970
5. Wheeler, O.E., "Spectrum Loading and Crack Growth", Journal of Basic Engineering, March 1972, pp 181-186.
6. Willenborg, J., Engle, R.M., and Wood, H.A., "A Crack Growth Retardation Model Using an Effective Stress Concept", AFFDL-TM-71-1-FBR, Wright-Patterson AFB, Oh, Jan 1971
7. Harms K. E., "Overload Effects on Sustained Load Crack Growth at Elevated Temperatures", AFIT Thesis, AFIT/GAE/AA/84D-8, Wright-Patterson AFB, Oh, 1984.
8. Weerasooriya, T., Nicholas, T., "Overload Effects in Sustained Load Crack Growth in Inconel 718", AFWAL-TR-85-4121. Wright-Patterson AFB, OH 1985.
9. Annual Book of ASTM Standards, Part 10; Metals-Mechanical, Fracture, and Corrosion Testing; Erosion and Wear; Effect of Temperature, E 647-83, page 719, 1983.
10. Utah, D. A. General Electric Company, "Crack Growth Modeling in an Advanced Powder Metallurgy Alloy", AFWAL-TR-80-4098, Wright-Patterson AFB, OH 1980.
11. Kreyszig, E., Advanced Engineering Mathematics, Fifth Edition, New York, John Wiley and Sons, 1983, pp 788-789.
12. Larsen J. M. and Nicholas, T. "Load Sequence Crack Growth Transients in a Superalloy at Elevated Temperature", Fracture Mechanics: Fourteenth Symposium Volume II: Testing and Applications, ASTM Society for Testing and Materials, 1983, pp II-536-II-552.

13. Haritos, G.K., Nicholas, T. and Painter, G.O., "Evaluation of Crack Growth Models for Elevated Temperature Fatigue," Eighteenth National Symposium on Fracture Mechanics, ASTM STP XXX, American Society for Testing and Materials, 1985, pp xx-yy
14. Engle, R. M. "Damage Accumulation Techniques in Damage Tolerance Analysis", ASTM STP 842, American Society for Testing and Materials, 1984, pp. 25-35.
15. Collins, J. A., Failure of Materials in Mechanical Design, New York, John Wiley and Sons, 1981, Ch. 8.
16. Annual Book of ASTM Standards, Part 10; Metals-Mechanical, Fracture, and Corrosion Testing; Erosion and Wear; Effect of Temperature, 1981.
17. Johnson, H. H., "Calibrating the Electric Potential Method for Studying Slow Crack Growth", Materials Research and Standards, Vol. 5, No. 9, 1965

Appendix A

Heat Treatment History of Test Specimens

Anneal at 968 C for 1 hour - air cool

Age harden at 718 C for 8 hours - furnace cool to 621 C

Age harden at 621 C for a total of an additional 10 hours

Appendix B.

OVERLOAD PROGRAM

```
C PROGRAM OVERLD
  DOUBLE PRECISION V
  REAL*4 LOWER, KUP, KLOW, N, LOWW, KINIT, LOWERR, KLOWW,
  1KUPP, LOWR, LOAD, K
  INTEGER*4 PIECES, D, YNCR, NAME(7)
  DIMENSION TITLE(60), SBTITL(60), TIME(20), OL(20)
  COMMON/LYIA1/PI, Q, TOL, W, B, T, R,
  1QUE, PEA, BEE, DEE, DKSTAR, TOUGH, DKCRIT,
  2TRIG, LOWW, DAGER, NSKIP
C DEFAULTS FOR DIAGNOSTIC OPTION
  DATA V/0/, PI/3.14159/, TOL/.0001/, R/.0/, ZERO/0.0/, T/.25/, TRIG/1./
C ***** OPEN FILES 2:INPUT 1:OUTPUT 3:PLOT *****
  WRITE (5,40)
  40 FORMAT (' WHAT IS YOUR INPUT FILE? ', $)
  READ (5,90) NAME
  OPEN (UNIT=2, NAME=NAME, TYPE='OLD')
  WRITE (5,50)
  50 FORMAT (' WHAT SHOULD YOUR OUTPUT FILE BE CALLED? ', $)
  READ (5,90) NAME
  OPEN (UNIT=1, NAME=NAME, TYPE='NEW')
  WRITE (5,60)
  60 FORMAT (' WHAT SHOULD YOUR PLOT FILE BE CALLED? ', $)
  READ (5,90) NAME
  OPEN (UNIT=3, NAME=NAME, TYPE='NEW')
  90 FORMAT (11A2)
C ***** ALL FILES ATTACHED *****
C
C ***** READ INPUT FILE *****
  READ (2,1120) TITLE
  READ (2,1120,END=1590) SBTITL
  READ (2,*) TOUGH, LOWW, R, YIELD
  READ (2,*) BEE, DKSTAR, PEA, QUE, DEE
  READ (2,*) B, LOAD, W
  WRITE (5,105)
  WRITE (5,110)
  105 FORMAT (' DO YOU WANT TO BREAK OUT ON A CRACK LENGTH')
  110 FORMAT (' OR AT THE KIC STRESS INTENSITY [1=A, 0=KIC]-->', $)
  READ (5,*) AFIN
  IF (AFIN.EQ.1) GO TO 150
  AFIN=10000.
  GO TO 160
  150 WRITE (5,155)
  155 FORMAT (' INPUT YOUR FINAL CRACK LENGTH, INCHES-->', $)
  READ (5,*) AFIN
C ***** END OF INPUT *****
C
C ***** PRINT OUTPUT FORMATS ON FILES *****
```

```

160 WRITE (1,1130) TITLE
    WRITE (3,1130) TITLE
    WRITE (5,1130) TITLE
    WRITE (1,1130) SBTITL
    WRITE (3,1130) SBTITL
    WRITE (5,1130) SBTITL
    WRITE (1,740) TOUGH,R
    WRITE (1,850) YIELD
    WRITE (1,830) B,W
    WRITE (1,930) BEE,DKSTAR,PEA
    WRITE (1,940) DKSTAR,QUE
    WRITE (1,950) TOUGH,DEE
    WRITE (1,1270)
    WRITE (1,1280)
740 FORMAT (' FRACTURE TOUGHNESS:',F6.2,/, ' STRESS RATIO:',F5.3)
830 FORMAT (' THICKNESS: ',F7.5,/, ' WIDTH:',F7.5)
850 FORMAT (' YIELD STRENGTH:',F6.2)
930 FORMAT (' da/dN=EXP[' ,F6.2, ' ]*[[DELTA-K/' ,F6.2, ' ]**' ,F6.2, ' ]*')
940 FORMAT (' [[ln[DELTA-K/' ,F6.2, ' ]]**' ,F6.2, ' ]*')
950 FORMAT (' [[ln[' ,F6.2, '/DELTA-K]**' ,F6.2, ' ]')
1120 FORMAT (60A2)
1130 FORMAT (1X,60A2)
1270 FORMAT (35X, ' delta')
1280 FORMAT (1X, ' N(x1000)', 10X, ' a', 9X, ' LOAD', 2X,
    1' K ', 1X, ' da/dN ', 1X, ' PIECES')
C ***** END OF HEADERS *****
C
C ***** READ IN SPECTRUM LOAD *****
    NA=1
    95 READ (2,*,END=100) TIME(NA),DL(NA)
    NA=NA+1
    GO TO 95
    100 NA=NA-1
C *****
    TOUGH=(1.0-R)*TOUGH
    DKCRIT=TOUGH
    TOUGH=TOUGH*.95
1210 STAR=1.0
    KUP=0
    V=TIME(1)
    SIGMA=LOAD
C ***** START OF SPECTRUM INTEGRATION *****
    DO 1570 NS=1,NA
    DAGER=DL(NS)
    NSKIP=0
    DOL=0
    U=LOWW
1290 LOWER=U
C *****
C
1320 CALL SIMP(SUM,LOWER,UPPER,SIGMA,KLOW,KUP,PIECES,YIELD,STAR,PYTC,
    1CALPHA,BETA,DOL)

```

```

C
C ***** Check if initial K is greater than K1c *****
  IF (KLOW.LT.TOUGH)GO TO 1360
  WRITE (5,1330)
  WRITE (1,1330)
1330 FORMAT (10X,' *****SPECIMEN FAILED ON LOADING*****')
  GO TO 1490
C
1360 VN=V
  V=V+(SUM/1000)
C ***** CHECK IF INTEGRATED TIME IS MORE THAN THE NEXT OVERLOAD *
C
  IF (NS.EQ.NA) GO TO 1370
  IF (V.LT.TIME(NS+1)) GO TO 1370
  IF (NSKIP.EQ.1) GO TO 1370
  PYTIT=PYTCH*(TIME(NS+1)-VN)/(SUM/1000.)
  UPPER=LOWER+PYTIT
C ***** EXTRA PRINT TO CHECK LINEAR PYTCH INCREMENT *****
C   WRITE (1,1331) V,VN,NS,PYTIT,LOWER,UPPER,SUM
C1331 FORMAT (1X,'V= ',F15.6,' VN = ',F15.6,' NS= ',I2,'/',' PYTIT= ',
C   1F15.10,'/',' LOWER= ',F16.13,' UPPER= ',F16.13,' SUM = ',F9.3)
C *****
  V=VN
  NSKIP=1
  GO TO 1320
C
1370 CALL FINDF2 (KLOW,F2)
  DADNL=1/F2
  CALL FINDF2 (KUP,F2)
  DADNU=1/F2
  IF (U.EQ.LOWW) WRITE (1,1421)VN,LOWER,SIGMA,KLOW,DADNL,PIECES
C
C ***** CONVERSION FROM ENGLISH TO METRIC TO WRITE PLOT FILE *****
C
  CBETA=BETA
  CBETA=CBETA/25.4
  1/INCHES-->1/MILLIMETERS
C
  LOWERR=LOWER*25.4
  INCHES-->MILLIMETERS
  DADNLL=DADNL*0.0254
  INCHES PER CYCLE-->METERS PER CYCLE
C
  KLOWW=KLOW*1.0989
  KSI ROOT INCHES-->MPA ROOT METERS
C
  UPPERR=UPPER*25.4
  DADNUU=DADNU*0.0254
  VV=V*1000
  KUPP=KUP*1.0989
  VVN=VN*1000.
C   IF (U.EQ.LOWW) WRITE(3,1375) CALPHA,CBETA

```



```

IF (U.EQ.LOWW) WRITE (3,*) VVN,LOWERR,DADNLL,KLOWW
IF (U.EQ.LOWW) WRITE (5,1420)VN,LOWER,SIGMA,KLOW,DADNL,PIECES
WRITE (1,1420) ,V,UPPER,SIGMA,KUP,DADNU,PIECES
WRITE (3,*) ,VV,UPPERR,DADNUU,KUPP
WRITE (5,1420) ,V,UPPER,SIGMA,KUP,DADNU,PIECES
C1375 FORMAT(' ALPHA = ',F8.5,/, ' BETA = ',F8.5)
1420 FORMAT (1X,F15.3,F9.6,F9.2,F7.2,E10.3,I7)
1421 FORMAT (1X,F15.4,F9.6,F9.2,F7.2,E10.3,I7)
1430 IF ((KUP.GT.TOUGH).OR.(UPPER.GE.AFIN)) GO TO 1490
IF (NSKIP.EQ.1)GO TO 1560
U=U+PYTCH
CALL CPYTCH (KUP,PYTCH)
GO TO 1290
1490 WRITE (1,1500)
1500 FORMAT (6X,' C-T SPECIMEN, SANS PLASTIC-ZONE CORRECTION')
GO TO 1590

C
C ***** ENTER JUMP FUNCTION *****
C
1560 XJUMP=.015
LOWW=U+XJUMP

C
WRITE (1,1561) XJUMP,KUP
1561 FORMAT(1X,'XJUMP = ',F15.10,' KUP= ',F6.2)
1570 CONTINUE
C ***** END DO LOOP *****
1590 CALL EXIT
END

C
SUBROUTINES IN DESCENDING ORDER OF USE,FIRST,SIMPSON'S RULE APPROX
SUBROUTINE SIMP(SUM,LOWER,UPPER,SIGMA,KLOW,KUP,PIECES,YIELD,STAR,
1PYTCH,CALPHA,BETA,DOL)
COMMON/LYIA1/PI,Q,TOL,W,B,T,R,
1DUE,PEA,BEE,DEE,DKSTAR,TOUGH,DKCRIT,
2TRIG,LOWW,DAGER,NSKIP
REAL*4 K,N,LOWER,KLOW,KUP,LOWW
INTEGER*4 PIECES
PIECES=2
X=LOWER/T
CALL CT(SIGMA,X,K,F2,YIELD,STAR,PYTCH,CALPHA,BETA,DOL)
IF (X.EQ.LOWW/T)
1CALL CAL(SIGMA,X,K,F2,YIELD,STAR,PYTCH,CALPHA,BETA,DOL)
KLOW=K
IF (X.EQ.LOWW/T) CALL CPYTCH(K,PYTCH)
IF (NSKIP.NE.1) UPPER=LOWER+PYTCH
ESUM=F2
DELTA=(UPPER-LOWER)/PIECES
EVSUM=0
X=(LOWER+DELTA)/T
CALL CT(SIGMA,X,K,F2,YIELD,STAR,PYTCH,CALPHA,BETA,DOL)
ODSUM=F2
X=UPPER/T
CALL CT(SIGMA,X,K,F2,YIELD,STAR,PYTCH,CALPHA,BETA,DOL)

```

```

      KUP=K
      ESUM=ESUM+F2
      SUM=(ESUM+4*ODSUM)*DELTA/3
1600  PIECES=PIECES*2
      SUM1=SUM
      DELTA=(UPPER-LOWER)/PIECES
      EVSUM=EVSUM+ODSUM
      ODSUM=0
      L=IFIX(FLOAT(PIECES)/2)
      DO 1610 I=1,10000
      Z=LOWER+DELTA*(2*I-1)
      X=Z/T
      CALL CT(SIGMA,X,K,F2,YIELD,STAR,PYTCH,CALPHA,BETA,DOL)
      ODSUM=ODSUM+F2
1610  IF (I.EQ.L) GO TO 1620
1620  SUM=(ESUM+4*ODSUM+2*EVSUM)*DELTA/3
      IF (ABS(SUM-SUM1).GT.ABS(TOL*SUM)) GO TO 1600
      RETURN
      END
C     SUBROUTINE FOR CALCULATING CALPHA FOR THE CT RETARDATION
C     MODEL (20% AND 50% OVERLOAD CASES)
      SUBROUTINE CAL(SIGMA,X,K,F2,YIELD,STAR,PYTCH,CALPHA,BETA,DOL)
      COMMON/LYIA1/PI,Q,TOL,W,B,T,R,
1     IQUE,PEA,BEE,DEE,DKSTAR,TOUGH,DKCRIT,
2     TRIG,LOWW,DAGER,NSKIP
      REAL*4 K,N,LOWW
      IF (DAGER.EQ.0.) CALPHA=0.
      IF (DAGER.EQ.0.) GO TO 1679
      SK=K/DKSTAR
      CAS=1-1/SK
      IF (DAGER.EQ.50) GO TO 1675
      BETA=(SQRT(2.0)*PI**2*YIELD**2)/(1.44*K**2)
      CACAS=(-.730791E-01)*SK**3 + (.303086)*SK**2 -
1     (.422108)*SK + 0.117517E01
      GO TO 1677
1675  BETA=(SQRT(2.0)*PI**2*YIELD**2)/(1.25*K**2)
      CACAS=(-.121127E-01)*SK**2 + (.239231E-01)*SK + 0.987133
1677  CALPHA=CACAS*CAS
1679  DOL=1
      CALL CT(SIGMA,X,K,F2,YIELD,STAR,PYTCH,CALPHA,BETA,DOL)
      RETURN
      END
C     SUBROUTINE FOR COMPACT TENSION SPECIMENS
C     IN THIS ROUTINE, "SIGMA" IS A LOAD, NOT A STRESS!!!
      SUBROUTINE CT(SIGMA,X,K,F2,YIELD,STAR,PYTCH,CALPHA,BETA,DOL)
      COMMON/LYIA1/PI,Q,TOL,W,B,T,R,
1     IQUE,PEA,BEE,DEE,DKSTAR,TOUGH,DKCRIT,
2     TRIG,LOWW,DAGER,NSKIP
      REAL*4 K,M1,M2,M3,N,LOWW
      ALPHA=X*T/W
      M1=SIGMA/(B*(SQRT(W)))
      M2=(2+ALPHA)/((1-ALPHA)**1.5)

```

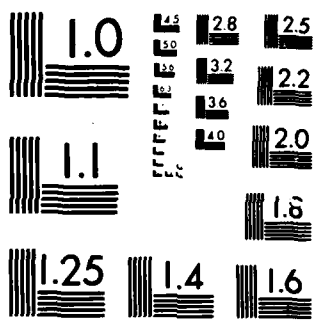
MICROCOPY RESOLUTION TEST CHART
NATIONAL BUREAU OF STANDARDS-1963-A

```

M3=0.886+(4.64*ALPHA)-(13.32*(ALPHA**2))+
1(14.72*(ALPHA**3))-(5.6*(ALPHA**4))
K=M1*M2*M3*(1.0-R)
IF ((X.EQ.LOWW/T) .AND. (DOL.EQ.0)) GO TO 1760
DELA=X*T-LOWW
STAR=CALPHA*EXP(-BETA*DELA)
EFFK=K*(1-STAR)
K=EFFK
1760 CALL FINDF2(K,F2)
RETURN
END
SUBROUTINE FINDF2(K,F2)
C SUBROUTINE SELECTING F2 BASED MODIFIED SIGMODAL EQN ONLY
REAL*4 K,N,LOWW
INTEGER*4 CINH
COMMON/LYIA1/PI,Q,TOL,W,B,T,R,
1QUE,PEA,BEE,DEE,DKSTAR,TOUGH,DKCRIT,
2TRIG,LOWW,DAGER,NSKIP
C *****
CINH=2
C ** USE MODIFIED SIGMODAL EQN ONLY CINH=2 *****
IF (CINH.NE.2) GO TO 1840
IF (K.GT.DKSTAR) GO TO 1830
WRITE (5,1800) K
WRITE (5,1810) DKSTAR
WRITE (5,1820)
1800 FORMAT (' YOUR INITIAL DELTA-K IS ',F5.2,', AND THIS IS SMALL-')
1810 FORMAT (' ER THAN YOUR DELTA-K THRESHOLD OF ',F5.2,', THIS')
1820 FORMAT (' WILL GIVE THE MSE INDIGESTION. TRY AGAIN.')
CALL EXIT
STOP
1830 F2=1.0/(EXP(BEE)*((K/DKSTAR)**PEA)*((ALOG10(
1K/DKSTAR)**QUE)*((ALOG10(DKCRIT/K)**DEE))
1840 IF (CINH.EQ.1) F2=1.0/(10.0**(S1*(SINH(S2*((ALOG10(K))+S3))
1+S4))
IF (CINH.EQ.0) F2=(K**(-N))/C
RETURN
END
C ***** SUBROUTINE TO CALCULATE PYTCH INCREMENT FOR SIMP *****
SUBROUTINE CPYTCH(K,PYTCH)
REAL*4 K
COMMON/LYIA1/PI,Q,TOL,W,B,T,R,
1QUE,PEA,BEE,DEE,DKSTAR,TOUGH,DKCRIT,
2TRIG,LOWW,DAGER,NSKIP
IF (K .LE. 22.77) PYTCH=.00001
IF (22.77 .LT. K .AND. K .LE. 30.0)
1PYTCH=(.002*K-.045)/53.5
IF (30.0 .LT. K)
1PYTCH=(.0004*K-.01)/7.0
RETURN
END

```

Sample Input

TYPE I502T.DAT
30 SEPT 85 SPECIMEN 84-502, EE3 RLH
SPECIMEN 84-502, EE3 AT 1200 DEG F
272.73, .4087, 0., 120.
-8.69, 21.00, -1.1, 1.8, -1.8
.394, 2.740, 1.5736
0.0, 0.0
1.426, 20.0
32.888, 20.0
44.707, 20.0

Appendix C.

Modified CRACKS Program

```
PROGRAM CRACKS4(INPUT,OUTPUT,TAPE5=INPUT,TAPE6=OUTPUT,TAPE7,TAPE1)000100
COMMON/DATA/ EQN,NASA,J1PR,J2PR,J3PR,J4PR,J5PR,AZERO,AMAX,NZERO 000110
INTEGER EQN 000120
REAL NZERO 000130
COMMON/RDATA/ MODEL,RETARD,PLSTRN,OVL D,SIGMAX,SIGMIN,ASUBP,SMALLM 000140
INTEGER RETARD,PLSTRN 000150
COMMON/MDATA/ MATID(18),C,SMALLN,CARRAY(100),SNARAY(100),KSUBC, 000160
/ KSUBQ,SIGMAY,DELKTH,RMULT,RCUT,OLMAX 000170
REAL KSUBC,KSUBQ 000180
COMMON/LDATA/SMAX( 20,10),SMIN( 20,10),CYCLES( 20,10),NLYRS(10), 000190
/ NBLKS,IBLKS( 50 ),ISEGS( 50 ),NSEGS 000200
COMMON/STEPS/ISEG,J1,J2,J3,J4,J5,ISTOP,NORTRD 000210
COMMON/CORFAC/ ISURF,RATIO,PHI,THICK,IBETA(10),BETA(10),NPTS, 000220
/ AOVERB(100),BTABLE(100),NPTS2,ADVRB2(100), 000230
/ BTABL2(100),ASTART(10),ASTOP(10) 000240
COMMON/OUTPOT/KMAX,KMAXA,DELTAK,IFLT,DADNPR 000250
REAL KMAX,KMAXA 000260
WRITE(6,3000) 000270
IRSTR = 0 000280
MOD1 = 0 000290
RTARD1 = 0 000300
ICASE = 0 000310
1 ICASE = ICASE + 1 000320
ISPEC=0 000330
5 IFLT=0 000340
RETARD = 0 000350
JSTART=1 000360
OVL D = 0.0 000370
IF(RTARD1.EQ.0) GO TO 10 000380
NORTRD = 0 000390
MODEL = MOD1 000400
10 ISPEC = ISPEC + 1 000410
CALL INPUT(ICASE,ISPEC,IRSTR) 000420
IF(ISTOP.NE.0) GO TO 1 000430
IF(IRSTR.GE.4) GO TO 1150 000440
20 A = AZERO 000450
CYC = NZERO 000460
ABLK = AZERO 000470
DO 1000 J1=JSTART,NBLKS 000480
DO 900 J2=1,NSEGS 000490
ISEG = ISEGS(J2) 000500
IBLK = IBLKS(J2) 000510
NLYR = NLYRS(ISEG) 000520
DO 800 J3=1,IBLK 000530
IFLT = IFLT + 1 000540
DO 700 J4=1,NLYR 000550
```

DN = CYCLES(J4, ISEG)	000560
CYCSVE = CYC	000570
500 CALL GRWCRK(CYC, A, DN)	000580
IF(A.LT.AMAX) GO TO 550	000590
WRITE(6,3600) A, AMAX, IFLT	000600
GO TO 1100	000610
550 IF (ISTOP.NE.2) GO TO 600	000620
DN = CYCSVE + DN - CYC	000630
ISTOP = 0	000640
ISURF = 0	000650
IF(DN.GT.0.0) GO TO 500	000660
600 IF(ISTOP.NE.0) GO TO 1100	000670
IF(IFLT.EQ.1) CALL OUTPUT(CYC, A)	000680
IF(J4PR.EQ.0) GO TO 700	000690
IF(MOD(IFLT, J4PR).EQ.0) CALL OUTPUT(CYC, A)	000700
700 CONTINUE	000710
IF(J3PR.EQ.0) GO TO 800	000720
IF(MOD(IFLT, J3PR).NE.0) GO TO 800	000730
WRITE(6,3050) IFLT, ISEG, A	000740
800 CONTINUE	000750
IF(J2PR.EQ.0) GO TO 900	000760
IF(MOD(J2, J2PR).NE.0) GO TO 900	000770
WRITE(6,3100) J2, J1, A	000780
900 CONTINUE	000790
IF(IRSTRT.EQ.3) CALL RESTRT(CYC, A, IRSTRT)	000800
IF(J1PR.EQ.0) GO TO 1000	000810
IF(MOD(J1, J1PR).NE.0) GO TO 1000	000820
DELA = A - ABLK	000830
GROWTH = A - AZERO	000840
ABLK = A	000850
WRITE(6,3200) J1, A, DELA, GROWTH	000860
1000 CONTINUE	000870
GROWTH = A - AZERO	000880
WRITE(6,3500) CYC, A, GROWTH	000890
1100 IF(NORTRD.EQ.0) GO TO 1300	000900
1150 ICHECK = IRSTRT + 1	000910
GO TO (1,5,10,1,1200,1250), ICHECK	000920
1200 CALL RESTRT(CYC, A, IRSTRT)	000930
AZERO = A	000940
NZERO = CYC	000950
JSTART = J1 - 1	000960
GO TO 20	000970
1250 CALL RESTRT(CYC, A, IRSTRT)	000980
AZERO = A	000990
NZERO = CYC	001000
JSTART = J1 + 1	001010
NBLKS = NBLKS + J1	001020
GO TO 20	001030
1300 ISPEC = ISPEC + 1	001040
WRITE(6,2000)	001050
WRITE(6,2900) ICASE, ISPEC	001060
WRITE(6,3300)	001070

```

RTARD1 = 1                                001080
MOD1 = MODEL                              001090
MODEL = 0                                  001100
ISTOP = 0                                  001110
RETARD = 0                                 001120
NORTRD = 1                                 001130
OVLD = 0.0                                001140
IFLT = 0                                   001150
GO TO 20                                    001160
2000 FORMAT(1H1)                           001170
2900 FORMAT(1H1,70(1H*)/26X,5HCASE ,I2,4HRUN ,I2/1X,70(1H*)) 001180
3000 FORMAT(1H1,70(1H*)/1X,70(1H*)//1X,29(1H*),12H CRACKS IV 29(1H*) 001190
1// 20X,9HVERSION 6,12X,9H09/21/79 /30X,13HR.M.ENGLE JR./18X, 001200
2 36HAIR FORCE FLIGHT DYNAMICS LABORATORY//26X,10HAFFDL(FBE)/ 001210
3 26X,19HATTN(R.M.ENGLE JR.)/26X,17HW-PAFB,OHIO 45433// 001220
4 26X,12H513-255-6104//1X,70(1H*)/1X,70(1H*) ) 001230
3050 FORMAT(15H END OF FLIGHT I5,9H MISSION,I2,7X,14HCRACK LENGTH =,F 001240
/10.5) 001250
3100 FORMAT(15H END OF SEGMENT,I6,9H OF BLOCK,I5,5X,14HCRACK LENGTH =, 001260
/F10.5) 001270
3200 FORMAT(14H0 END OF BLOCK,I5,20X,14HCRACK LENGTH =,F10.5/ 001280
/5X,19HGROWTH THIS BLOCK =,F10.5,5X,14HTOTAL GROWTH =,F10.5//) 001290
3300 FORMAT(///1X,70(1H*)/24X,33HRERUN OF CASE WITH NO RETARDATION/ 001300
/ 1X,70(1H*)) 001310
3500 FORMAT(1H0,70(1H*)/ 5X,14HTOTAL CYCLES =,F12.2,5X,20HFINAL CRACK 001320
/LENGTH =,F10.5/22X,20HTOTAL CRACK GROWTH =,F10.5/1X,70(1H*)/1H1) 001330
3600 FORMAT(1H0,70(1H*)/ 1X,20HCURRENT CRACK LENGTHF10.5/31H EXCEEDS A001340
/ALLOWABLE CRACK LENGTH,F10.5/9X17H IN FLIGHT NUMBER,I6/1X,70(1H*))001350
END 001360
SUBROUTINE OUTPUT(CYC,A) 001370
C 001380
COMMON/RDATA/ MODEL,RETARD,PLSTRN,OVLD,SIGMAX,SIGMIN,ASUBP,SMALLM 001390
INTEGER RETARD,PLSTRN 001400
COMMON/LDATA/SMAX( 20,10),SMIN( 20,10),CYCLES( 20,10),NLYRS(10), 001410
/ NBLKS,IBLKS( 50 ),ISEGS( 50 ),NSEGS 001420
COMMON/MDATA/ MATID(18),C,SMALLN,CARRAY(100),SNARAY(100),KSUBC, 001430
/ KSUBQ,SIGMAY,DELKTH,RMULT,RCUT,OLMAX 001440
COMMON/DATA/EQN,NASA,J1PR,J2PR,J3PR,J4PR,J5PR,AZERO,AMAX,NZERO 001450
REAL KSUBC,KSUBQ 001450
COMMON/STEPS/ISEG,J1,J2,J3,J4,J5,ISTOP,NORTRD 001460
COMMON/OUTPUT/KMAX,KMAXA,DELTA,K,IFLT,DADNPR 001470
REAL KMAX,KMAXA,KMXEFF 001480
DATA NOP/O/
IF(RETARD.EQ.0) GO TO 100 001490
C 001500
C 001510
C 001520
GO TO (10,20,30,40,50), MODEL 001530
10 CALL WHELER(CYC,A,DDNRET) 001540
GO TO 90 001550
20 CALL WLNBRG(CYC,A,DDNRET) 001560
GO TO 90 001570

```

30	DDNRET = DADNPR	001580
	GO TO 90	001590
40	CONTINUE	001600
50	CONTINUE	001610
90	KMXEFF = KMAX	001620
	DLKEFF = DELTAK	001630
C		001640
C	DETERMINE UNRETARDED QUANTITIES CORRESPONDING TO CURRENT CRACK	001650
C	LENGTH	001660
C		001670
100	CONTINUE	001680
	SIGMAX = SMAX(J4, ISEG)	001690
	SIGMIN = SMIN(J4, ISEG)	001700
	CALL RATE(CYC, A, DADN)	001710
	IF(MODEL.NE.0.AND.RETARD.NE.0) GO TO 200	001720
	KMXEFF = KMAX	001730
	DLKEFF = DELTAK	001740
	DDNRET = DADN	001750
C		001760
C	PRINT HEADER AT TOP OF EACH PAGE	001770
C		001780
200	CONTINUE	001790
	IF(J4.EQ.1) WRITE(6,2000)	001800
	IF(J4.EQ.1 .AND. NOP.EQ.0) WRITE(1,2000)	
	IF(J4.EQ.1 .AND. NOP.EQ.0) WRITE(1,2001)NZERO,AZERO	
2001	FORMAT(16X,F10.1,1X,F9.6)	
	NOP=NOP+1	
	RETFAC = DDNRET/DADN	001810
	IF(DADN .EQ. 0.0) RETFAC = 0.0	001820
	WRITE(6,2100) IFLT, ISEG, J4, CYC, A, DLKEFF, KMXEFF, DDNRET, RETFAC	001830
	WRITE(1,2100) IFLT, ISEG, J4, CYC, A, DLKEFF, KMXEFF, DDNRET, RETFAC	
	RETURN	001840
2000	FORMAT(2X*FLT MSN Lyr CYCLES*7X*A*4X	001850
	/*DELTA K K MAX*5X*DA/DN RETARD*)	
2100	FORMAT(15,2X,13,2X,13,1X,F10.1,1X,F9.6,1X,	001870
	/F7.2,1X,F7.2,1X,E10.3,1X,F7.3)	001880
	END	001890
	SUBROUTINE INPUT(ICASE, ISPEC, IRSTRT)	001900
C		001910
C	READS LABELED SECTIONS OF DATA DECK IN ANY ORDER.	001920
C	PRINTS OUT PROBLEM AND SOLUTION DESCRIPTION.	001930
C		001940
	COMMON/DATA/ EQN,NASA,J1PR,J2PR,J3PR,J4PR,J5PR,AZERO,AMAX,NZERO	001950
	INTEGER EQN	001960
	REAL NZERO	001970
	COMMON/RDATA/ MODEL,RETARD,PLSTRN,DVLD,SIGMAX,SIGMIN,ASUBP,SMALLM	001980
	INTEGER RETARD,PLSTRN	001990
	COMMON/MDATA/ MATID(18),C,SMALLN,CARRAY(100),SNARAY(100),KSUBC,	002000
	/ KSUBQ,SIGMAY,DELKTH,RMULT,RCUT,OLMAX	002010
	REAL KSUBC,KSUBQ	002020
	COMMON/LDATA/SMAX(20,10),SMIN(20,10),CYCLES(20,10),NLYRS(10),	002030
	/ NBLKS,IBLKS(50),ISEGS(50),NSEGS	002040

	COMMON/STEPS/ISEG, J1, J2, J3, J4, J5, ISTOP, NORTRD	002050
	COMMON/CORFAC/ ISURF, RATIO, PHI, THICK, IBETA(10), BETA(10), NPTS,	002060
	/ ADOVERB(100), BTABLE(100), NPTS2, ADOVRB2(100),	002070
	/ BTABL2(100), ASTART(10), ASTOP(10)	002080
	DIMENSION CARD(18), TITLE(18), SEGTTL(18, 50)	002090
	REAL LODLAB(3)	002100
	REAL LABEL(3)	002110
	REAL SPCTRM(3), ENDLDS(3), IEND(3), LTITLE(3)	002120
	REAL TAG(2)	002130
	REAL EQNS(3), MATL(3), LIMITS(3), ANAL(3), LOADS(3), END(3)	002140
	REAL DADN(3), WALK(3)	002150
	REAL EQUAT(3), DELK(3)	002160
	REAL FORMAN(3), PARIS(3), NASAL(3), BLANK(3), SIGMOID(3)	
	REAL SURF(3), RET(3), BETAL(3), BETAE(3), SIGMAS(3), DELTAS(3)	002180
	REAL AMEANS(3), ENDSPC(3), TRSHLD(3), LRSTRT(3), KPRT(3)	002190
C	THE NEXT 3 CARDS ADDED FOR CLOSUR	002200
	COMMON/CLOS/CF, CCOEF, CFEXP, B, BOL, NSAT	002210
	REAL NSAT	002220
	COMMON/CLOSIC/SC, SPEAK, PRVMX, APEAK, SC1, SC2, SC3, PRVMN	002230
	DATA SPCTRM /4HSPEC, 4HTRUM, 1H /, ENDLDS /3HEND, 4HLOAD, 1HS/	002240
	+ , IEND /3HEND, 4HDATA, 1H /, LTITLE /4HTITL, 1HE, 1H /	002250
	DATA EQNS /4HEQUA, 4HTION, 1H /, MATL /4HMATE, 4HRIAL, 1H /	002260
	+ , LIMITS /4HLIMI, 2HTS, 1H /, ANAL /4HANAL, 4HYSIS, 1H /	002270
	+ , LOADS /4HLOAD, 1HS, 1H /, END /3HEND, 2*1H /	002280
	DATA DADN /4HDA/D, 1HN, 1H /, WALK /4HWALK, 2HER, 1H /	002290
	DATA FORMAN /4HFORM, 2HAN, 1H /, PARIS /4HPARI, 1HS, 1H /	002300
	+ , NASAL /4HNASA, 2*1H /, BLANK /3*1H /, SIGMOID/4HSIGM, 3HOID, 1	
	+H /	
	DATA SURF /4HSURF, 3HACE, 1H /, RET /4HRETA, 2HRD, 1H /	002320
	+ , BETAL /4HBETA, 2*1H /, BETAE /3HEND, 2*1H /	002330
	+ , SIGMAS /4HMAX-, 3HMIN, 1H /, DELTAS /4HR-DE, 4HLTA , 1H /	002340
	DATA AMEANS /4HMEAN, 4H-ALT, 1H /, ENDSPC /3HEND, 4HSPEC, 1HR/	002350
	+ , TRSHLD /4HTHRE, 4HSHOL, 1HD /, LRSTRT /4HREST, 3HART, 1H /	002360
	+ , KPRT /4HPRIN, 1HT, 1H /	002370
	ISTOP = 0	002380
	IF (ISPEC.GT.1) GO TO 6	002390
C	INITIAL CONDITIONS FOR CLOSUR	002400
	SC = 0.	002410
	SC1 = 0.	002420
	SC2 = 0.	002430
	SC3 = 0.	002440
	SPEAK = 0.	002450
	PRVMX = 0.	002460
	PRVMN = 0.	002470
	APEAK = 0.	002480
C	END OF INITIAL CONDITIONS FOR CLOSUR	002490
	IRSTRT = 0	002500
	NORTRD = 1	002510
	EQN = 1	002520
	NASA=0	002530
	NPTS=0	002540
	NPTS2=0	002550

ISURF=0	002560
MODEL=0	002570
J1PR = 1	002580
J2PR = 0	002590
J3PR = 0	002600
J4PR = 0	002610
J5PR = 0	002620
RATIO = 1.0	002630
RCUT = 1.	002640
KSUBC = 68000.	002650
KSUBQ = KSUBC	002660
C = 5.0E-13	002670
SMALLN = 3.0	002680
DELKTH = 0.	002690
RMULT = 0.	002700
DO 5 J=1,10	002710
BETA(J) = 0.0	002720
5 IBETA(J) = 0.0	002730
6 READ(5,1000) LABEL	002740
IF(EOF(5)) 9999,7	002750
7 WRITE(6,2900) ICASE,ISPEC	002760
IF(IRSTRT.NE.0) WRITE(6,3400)	002770
GO TO 10	002780
1 READ(5,1000)LABEL	002790
IF(EOF(5)) 9998,10	002800
10 IF(LABEL(1) .EQ. LTITLE(1) .AND. LABEL(2) .EQ. LTITLE(2)	002810
+ .AND. LABEL(3) .EQ. LTITLE(3)) GO TO 100	002820
IF(LABEL(1) .EQ. KPRT(1) .AND. LABEL(2) .EQ. KPRT(2)	002830
+ .AND. LABEL(3) .EQ. KPRT(3)) GO TO 150	002840
IF(LABEL(1) .EQ. EQNS(1) .AND. LABEL(2) .EQ. EQNS(2)	002850
+ .AND. LABEL(3) .EQ. EQNS(3)) GO TO 200	002860
IF(LABEL(1) .EQ. MATL(1) .AND. LABEL(2) .EQ. MATL(2)	002870
+ .AND. LABEL(3) .EQ. MATL(3)) GO TO 300	002880
IF(LABEL(1) .EQ. TRSHLD(1) .AND. LABEL(2) .EQ. TRSHLD(2)	002890
+ .AND. LABEL(3) .EQ. TRSHLD(3)) GO TO 350	002900
IF(LABEL(1) .EQ. LIMITS(1) .AND. LABEL(2) .EQ. LIMITS(2)	002910
+ .AND. LABEL(3) .EQ. LIMITS(3)) GO TO 400	002920
IF(LABEL(1) .EQ. ANAL(1) .AND. LABEL(2) .EQ. ANAL(2)	002930
+ .AND. LABEL(3) .EQ. ANAL(3)) GO TO 500	002940
IF(LABEL(1) .EQ. LOADS(1) .AND. LABEL(2) .EQ. LOADS(2)	002950
+ .AND. LABEL(3) .EQ. LOADS(3)) GO TO 600	002960
IF(LABEL(1) .EQ. SPCTRM(1) .AND. LABEL(2) .EQ. SPCTRM(2)	002970
+ .AND. LABEL(3) .EQ. SPCTRM(3)) GO TO 660	002980
IF(LABEL(1) .EQ. LRSTRT(1) .AND. LABEL(2) .EQ. LRSTRT(2)	002990
+ .AND. LABEL(3) .EQ. LRSTRT(3)) GO TO 680	003000
IF(LABEL(1) .EQ. IEND(1) .AND. LABEL(2) .EQ. IEND(2)	003010
+ .AND. LABEL(3) .EQ. IEND(3)) GO TO 700	003020
WRITE(6,9020) LABEL	003030
ISTOP = 1	003040
GO TO 1	003050
100 READ(5,1010) NTITLE	003060
DO 110 I=1,NTITLE	003070

READ(5,1000) CARD	003080
WRITE(6,2005) CARD	003090
WRITE(1,2005) CARD	
110 CONTINUE	003100
GO TO 1	003110
150 READ(5,1010) J1PR,J2PR,J3PR,J4PR,J5PR	003120
GO TO 1	003130
200 READ(5,1002) EQUAT,DELK	003140
IF(EQUAT(1) .EQ. FORMAN(1) .AND. EQUAT(2) .EQ. FORMAN(2)	003150
+ .AND. EQUAT(3) .EQ. FORMAN(3))EQN = 1	003160
IF(EQUAT(1) .EQ. PARIS(1) .AND. EQUAT(2) .EQ. PARIS(2)	003170
+ .AND. EQUAT(3) .EQ. PARIS(3))EQN = 2	003180
IF(EQUAT(1) .EQ. DADN(1) .AND. EQUAT(2) .EQ. DADN(2)	003190
+ .AND. EQUAT(3) .EQ. DADN(3))EQN = 3	003200
IF(EQUAT(1) .EQ. WALK(1) .AND. EQUAT(2) .EQ. WALK(2)	003210
+ .AND. EQUAT(3) .EQ. WALK(3))EQN = 4	003220
IF(EQUAT(1) .EQ. SIGMOID(1) .AND. EQUAT(2) .EQ. SIGMOID(2)	
+ .AND. EQUAT(3) .EQ. SIGMOID(3))EQN = 5	
IF(DELK(1) .EQ. NASAL(1) .AND. DELK(2) .EQ. NASAL(2)	003230
+ .AND. DELK(3) .EQ. NASAL(3))NASA = EQN	003240
IF(NASA.NE.0) GO TO 260	003250
GO TO (210,220,230,240,250),EQN	003260
210 WRITE(6,2010)	003270
GO TO 1	003280
220 WRITE(6,2020)	003290
GO TO 1	003300
230 WRITE(6,3030)	003310
GO TO 1	003320
240 CONTINUE	003330
WRITE(6,3050)	003340
GO TO 1	003350
250 CONTINUE	003360
WRITE(6,3070)	
GO TO 1	003370
260 GO TO (270,280,285,290,295), NASA	003380
270 WRITE(6,2030)	003390
GO TO 1	003400
280 WRITE(6,2040)	003410
GO TO 1	003420
285 WRITE(6,3040)	003430
GO TO 1	003440
290 CONTINUE	003450
WRITE(6,3060)	003460
GO TO 1	003470
295 CONTINUE	003480
300 READ(5,1000) MATID	003490
WRITE(6,2050) MATID	003500
CALL CNDIN(EQN)	003510
GO TO 1	003520
350 READ(5,1020) DELKTH,RMULT	003530
WRITE(6,2260) DELKTH,RMULT	003540
GO TO 1	003550

400	READ(5,1020) AZERO,AMAX,NZERO,RCUT	003560
	IF(RCUT.EQ.0.) RCUT =1.	003570
	IF(AMAX.EQ.0.) GO TO 410	003580
	WRITE(6,2070) AZERO,AMAX,NZERO	003590
	WRITE(6,2075) RCUT	003600
	GO TO 1	003610
410	AMAX=1.0E+50	003620
	WRITE(6,2080) AZERO,NZERO	003630
	WRITE(6,2075) RCUT	003640
	GO TO 1	003650
500	READ(5,1070) LABEL,CON1,CON2,CON3,CON4,CON5,CON6	003660
	IF(LABEL(1) .EQ. SURF(1) .AND. LABEL(2) .EQ. SURF(2)	003670
	+ .AND. LABEL(3) .EQ. SURF(3)) GO TO 510	003680
	IF(LABEL(1) .EQ. RET(1) .AND. LABEL(2) .EQ. RET(2)	003690
	+ .AND. LABEL(3) .EQ. RET(3)) GO TO 520	003700
	IF(LABEL(1) .EQ. BETAL(1) .AND. LABEL(2) .EQ. BETAL(2)	003710
	+ .AND. LABEL(3) .EQ. BETAL(3)) GO TO 530	003720
	IF(LABEL(1) .EQ. BETAE(1) .AND. LABEL(2) .EQ. BETAE(2)	003730
	+ .AND. LABEL(3) .EQ. BETAE(3)) GO TO 1	003740
	WRITE(6,9020) LABEL	003750
	ISTOP = 1	003760
	GO TO 1	003770
510	ISURF=1	003780
	CZERO=CON1	003790
	THICK=CON2	003800
	RATIO=AZERO/(2.*CZERO)	003810
	SMALLK = SQRT((CZERO**2 - AZERO**2) / CZERO**2)	003820
	CKSQD = 1.0 - SMALLK**2	003830
	CALL CELI2(PHI,SMALLK,1.0,CKSQD,IER)	003840
	WRITE(6,2090) RATIO,THICK,PHI	003850
	IF(IER.EQ.0) GO TO 500	003860
	WRITE(6,9030)	003870
	ISTOP = 1	003880
	GO TO 500	003890
520	MODEL=CON1+0.5	003900
	PLSTRN=CON2+1.5	003910
	NORTRD = CON4 + 0.5	003920
	OVLD = CON5	003930
	ASUBP = CON6	003940
	IF(NORTRD.NE.0) WRITE(6,2170)	003950
	GO TO (521,522,523,524,525),MODEL	003960
521	SMALLM=CON3	003970
	WRITE(6,2100) SMALLM	003980
	GO TO 526	003990
522	WRITE(6,2105)	004000
	OLMAX = CON3	004010
	IF(OLMAX.NE.0.) WRITE(6,2106) OLMAX	004020
	GO TO 526	004030
523	CONTINUE	004040
	WRITE(6,2107)	004050
	READ(5,1020) CF,CCOEF,CFEXP,B,BOL,NSAT	004060
	WRITE(6,2108) CCOEF,CF,CCOEF,CFEXP,B,BOL,NSAT	004070

RETARD = 1	004080
GO TO 526	004090
524 CONTINUE	004100
525 WRITE(6,3000)	004110
MODEL=2	004120
526 GO TO (527,528),PLSTRN	004130
527 WRITE(6,2180)	004140
PLSTRN = PLSTRN - 1	004150
GO TO 500	004160
528 WRITE(6,2190)	004170
PLSTRN = PLSTRN - 1	004180
GO TO 500	004190
530 I = CON1 + 0.5	004200
IBETA(I)=I	004210
GO TO(531,532,533,534,535,536,537,538,539),I	004220
531 BETA(I)=CON2	004230
ASTART(I)=CON3	004240
ASTOP(I)=CON4	004250
IF(ASTART(I).EQ.0.) ASTART(I) = AZERO	004260
IF(ASTOP(I).EQ.0.) ASTOP(I) = 1.E50	004270
WRITE(6,2110) BETA(I),ASTART(I),ASTOP(I)	004280
GO TO 500	004290
532 BETA(I)=CON2	004300
ASTART(I)=CON3	004310
ASTOP(I)=CON4	004320
IF(ASTART(I).EQ.0.) ASTART(I) = AZERO	004330
IF(ASTOP(I).EQ.0.) ASTOP(I) = 1.E50	004340
WRITE(6,2120) BETA(2),ASTART(I),ASTOP(I)	004350
GO TO 500	004360
533 BETA(I)=CON3	004370
NPTS=CON2+0.5	004380
ASTART(I)=CON4	004390
ASTOP(I)=CON5	004400
IF(ASTART(I).EQ.0.) ASTART(I) = AZERO	004410
IF(ASTOP(I).EQ.0.) ASTOP(I) = 1.E50	004420
IF(NPTS.LE.0.OR.NPTS.GT.100) GO TO 540	004430
READ(5,1000) CARD	004440
READ(5,1040) (AVERB(J),BTABLE(J),J=1,NPTS)	004450
WRITE(6,2130) BETA(I),ASTART(I),ASTOP(I),CARD,	004460
1 (AVERB(J),BTABLE(J),J=1,NPTS)	004470
GO TO 500	004480
534 BETA(I)=CON3	004490
NPTS2=CON2+0.5	004500
ASTART(I)=CON4	004510
ASTOP(I)=CON5	004520
IF(ASTART(I).EQ.0.) ASTART(I) = AZERO	004530
IF(ASTOP(I).EQ.0.) ASTOP(I) = 1.E50	004540
IF(NPTS2.LE.0.OR.NPTS2.GT.100) GO TO 540	004550
READ(5,1000) CARD	004560
READ(5,1040) (AVERB2(J),BTABL2(J),J=1,NPTS2)	004570
WRITE(6,2140) BETA(I),ASTART(I),ASTOP(I),CARD,	004580
1 (AVERB2(J),BTABL2(J),J=1,NPTS2)	004590

	GO TO 500	004600
535	CONTINUE	004610
	BETA(I) = CON2	004620
	ASTART(I) = CON3	004630
	ASTOP(I) = CON4	004640
	IF (ASTART(I).EQ.0.0) ASTART(I) = AZERO	004650
	IF (ASTOP(I).EQ.0.0) ASTOP(I) = 1.0E50	004660
	WRITE(6,2200) BETA(I),ASTART(I),ASTOP(I)	004670
	GO TO 500	004680
536	CONTINUE	004690
	BETA(I) = CON2	004700
	ASTART(I) = CON3	004710
	ASTOP(I) = CON4	004720
	IF (ASTART(I).EQ.0.0) ASTART(I) = AZERO	004730
	IF (ASTOP(I).EQ.0.0) ASTOP(I) = 1.0E50	004740
	WRITE(6,2205) BETA(I),ASTART(I),ASTOP(I)	004750
	GO TO 500	004760
537	CONTINUE	004770
	BETA(I) = CON2	004780
	THICK = CON3	004790
	ASTART(I) = CON4	004800
	ASTOP(I) = CON5	004810
	IF (ASTART(I) .EQ. 0.0) ASTART(I) = AZERO	004820
	IF (ASTOP(I) .EQ. 0.0) ASTOP(I) = 1.E50	004830
	WRITE(6,2206) BETA(I),THICK,ASTART(I),ASTOP(I)	004840
	GO TO 500	004850
538	CONTINUE	004860
	BETA(I) = CON2	004870
	THICK = CON3	004880
	ASTART(I) = CON4	004890
	ASTOP(I) = CON5	004900
	IF (ASTART(I) .EQ. 0.0) ASTART(I) = AZERO	004910
	IF (ASTOP(I) .EQ. 0.0) ASTOP(I) = 1.E50	004920
	WRITE(6,2207) BETA(I),THICK,ASTART(I),ASTOP(I)	004930
	GO TO 500	004940
539	CONTINUE	004950
	BETA(I) = CON2	
	THICK = CON3	
	ASTART(I) = CON4	
	ASTOP(I) = CON5	
	IF (ASTART(I) .EQ. 0.0) ASTART(I) = AZERO	
	IF (ASTOP(I) .EQ. 0.0) ASTOP(I) = 1.E50	
	WRITE(6,2208) BETA(I),THICK,ASTART(I),ASTOP(I)	
	GO TO 500	004960
540	WRITE(6,9000) IBETA(I)	004970
	IBETA(I)=0	004980
	GO TO 500	004990
600	READ(5,1050) NBLKS,LPRT, (TITLE(I), I=1,18)	005000
	WRITE(6,2000) (TITLE(I), I=1,18),NBLKS	005010
	IF (LPRT.LT.0) GO TO 1	005020
	ISEG = 0	005030

```

605 ISEG = ISEG + 1                                005040
    READ(5,1002) LODLAB,(SEGTTL(I,ISEG),I=1,18)    005050
    LYR=1                                           005060
    IF( LODLAB(1) .EQ. SIGMAS(1) .AND. LODLAB(2) .EQ. SIGMAS(2) 005070
    + .AND. LODLAB(3) .EQ. SIGMAS(3) ) GO TO 610 005080
    IF( LODLAB(1) .EQ. DELTAS(1) .AND. LODLAB(2) .EQ. DELTAS(2) 005090
    + .AND. LODLAB(3) .EQ. DELTAS(3) ) GO TO 620 005100
    IF( LODLAB(1) .EQ. AMEANS(1) .AND. LODLAB(2) .EQ. AMEANS(2) 005110
    + .AND. LODLAB(3) .EQ. AMEANS(3) ) GO TO 630 005120
    IF( LODLAB(1) .EQ. ENLDS(1) .AND. LODLAB(2) .EQ. ENLDS(2) 005130
    + .AND. LODLAB(3) .EQ. ENLDS(3) ) GO TO 662 005140
    WRITE(6,9020) LODLAB                            005150
    ISTOP = 1                                       005160
    GO TO 1                                          005170
C                                                    005180
C    LOAD SPECTRUM INPUT AS MAX AND MIN STRESSES    005190
C                                                    005200
610 READ(5,1030) TAG,SMAX(LYR,ISEG),SMIN(LYR,ISEG),CYCLES(LYR,ISEG) 005210
    IF( TAG(1) .EQ. END(1) .AND. TAG(2) .EQ. END(2) ) GO TO 650 005220
C                                                    005230
C    PRESENT PROGRAM DOES NOT CONSIDER COMPRESSIVE LOADS 005240
C                                                    005250
C    EXCEPT FOR CLOSURE MODEL WHICH DOES         005260
C                                                    005270
    IF ( MODEL .EQ. 3 ) GO TO 618                   005280
    IF(SMAX(LYR,ISEG).LT.0.) SMAX(LYR,ISEG)=0.     005290
    IF(SMIN(LYR,ISEG).LT.0.) SMIN(LYR,ISEG) = 0.   005300
618 LYR=LYR+1                                       005310
    GO TO 610                                       005320
620 IF(LPRT.EQ.0)                                    005330
    1WRITE(6,3010) ISEG,(SEGTTL(I,ISEG),I=1,18)  005340
    IF(LPRT.EQ.0) WRITE(6,2210)                   005350
625 READ(5,1030) TAG,DELSIG,R,CYCLES(LYR,ISEG)    005360
    IF( TAG(1) .EQ. END(1) .AND. TAG(2) .EQ. END(2) ) GO TO 650 005370
    IF(LPRT.EQ.0)                                    005380
    1WRITE(6,2220) LYR,TAG,DELSIG,R,CYCLES(LYR,ISEG) 005390
C                                                    005400
C    PRESENT PROGRAM DOES NOT CONSIDER COMPRESSIVE LOADS 005410
C                                                    005420
    IF(DELSIG.LT.0.) DELSIG=0.                     005430
    IF(R.LT.0.)R=0.                                 005440
    SMAX(LYR,ISEG)=DELSIG/(1.-R)                   005450
    SMIN(LYR,ISEG)=SMAX(LYR,ISEG)-DELSIG          005460
    LYR=LYR+1                                       005470
    GO TO 625                                       005480
630 IF(LPRT.EQ.0)                                    005490
    1WRITE(6,3010) ISEG,(SEGTTL(I,ISEG),I=1,18)  005500
    IF(LPRT.EQ.0) WRITE(6,2230)                   005510
635 READ(5,1030) TAG,SMEAN,SALT,CYCLES(LYR,ISEG) 005520
    IF( TAG(1) .EQ. END(1) .AND. END(2) .EQ. TAG(2) ) GO TO 650 005530
    IF(LPRT.EQ.0)                                    005540
    1WRITE(6,2240) LYR,TAG,SMEAN,SALT,CYCLES(LYR,ISEG) 005550

```

C		005560
C	PRESENT PROGRAM DOES NOT CONSIDER COMPRESSIVE LOADS	005570
C		005580
	SMAX(LYR, ISEG)=SMEAN+SALT	005590
	IF(SMAX(LYR, ISEG).LT.0.) SMAX(LYR, ISEG)=0.	005600
	SMIN(LYR, ISEG)=SMEAN-SALT	005610
	IF(SMIN(LYR, ISEG).LT.0.) SMIN(LYR, ISEG)=0.	005620
	LYR=LYR+1	005630
	GO TO 635	005640
650	NLYRS(ISEG) = LYR-1	005650
	GO TO 605	005660
C		005670
C	READ IN COMPOSITION OF SPECTRUM	005680
C		005690
660	READ(5, 1010)NSEGS, IPRT	005700
	READ(5, 1060) (IBLKS(I), ISEGS(I), I=1, NSEGS)	005710
	IF(IPRT.EQ.0) WRITE(6, 2250) NSEGS	005720
	IFLTS = 0	005730
	DO 661 I=1, NSEGS	005740
	IFLTS = IFLTS + IBLKS(I)	005750
	IF(IPRT.EQ.0) WRITE(6, 2255) I, IBLKS(I), ISEGS(I), IFLTS	005760
661	CONTINUE	005770
	GO TO 1	005780
662	NNSEG = ISEG - 1	005790
	IF(LPRT.NE.0) GO TO 1	005800
	DO 670 ISEG =1, NNSEG	005810
	WRITE(6, 2270) ISEG, (SEGTTL(I, ISEG), I=1, 18)	005820
	LYRS = NLYRS(ISEG)	005830
	TOTCYC = 0.0	005840
	DO 665 J2=1, LYRS	005850
	TOTCYC = TOTCYC + CYCLES(J2, ISEG)	005860
	WRITE(6, 2280) J2, SMAX(J2, ISEG), SMIN(J2, ISEG), CYCLES(J2, ISEG),	005870
	1 TOTCYC	005880
665	CONTINUE	005890
670	CONTINUE	005900
	GO TO 1	005910
680	READ(5, 1060) IRSTRT	005920
	ICHECK = IRSTRT + 1	005930
	GO TO (1, 685, 685, 690, 695, 695), ICHECK	005940
685	WRITE(6, 2150)	005950
	GO TO 1	005960
690	WRITE(6, 2160)	005970
	GO TO 1	005980
695	WRITE(6, 2165)	005990
	GO TO 1	006000
700	WRITE(6, 2015) (TITLE(I), I=1, 18)	006010
	RETURN	006020
999B	IF(IRSTRT .NE. 0) WRITE(6, 9010)	006030
9999	STOP	006040
C		006050
1000	FORMAT(20A4)	006060
1002	FORMAT(2A4, A2, 17A4, A2)	006070

1010 FORMAT(16I5) 006080
1020 FORMAT(8E10.0) 006090
1030 FORMAT(A4,A1,7E10.0) 006100
1040 FORMAT(2E10.0) 006110
1050 FORMAT(2I5,17A4,A2) 006120
1060 FORMAT(2I5) 006130
1070 FORMAT(2A4,A2,7E10.0) 006140
2000 FORMAT(1H0, 1X,17A4,A2// 5X,I6,19H BLOCKS IN SPECTRUM) 006150
2005 FORMAT(2X,17A4,A2) 006160
2010 FORMAT(1H0, 1X,50HCRACK PROPAGATION ANALYSIS USING FORMAN'S EQUATION 006170
10N / 4X,44HDA/DN=C*(DELTA K)**N/((1-R)*KSUBC-DELTA K) 006180
2 / 5X,51HWHERE K IS OF THE FORM K=SIGMA*SQRT(PI*A)*BETA) 006190
2015 FORMAT(//1X,29(1H*),12HEND OF INPUT,29(1H*)/////1H1,1X,70(1H*)/ 006200
/1X,26(1H*),18HCRACKS IV ANALYSIS,26(1H*)/1X,17A4,A2/ 006210
/1X,70(1H*)//) 006220
2020 FORMAT(1H0, 1X,50HCRACK PROPAGATION ANALYSIS USING PARIS' EQUATION 006230
1 /16X,21HDA/DN=C*(DELTA K)**N / 5X,51HWHERE K IS OF THE FORM . 006240
2.. K=SIGMA*SQRT(PI*A)*BETA) 006250
2030 FORMAT(1H0, 1X,50HCRACK PROPAGATION ANALYSIS USING FORMAN'S EQUATION 006260
10N / 4X,44HDA/DN=C*(DELTA K)**N/((1-R)*KSUBC-DELTA K) 006270
2 / 5X,51HWHERE K IS OF THE FORM K=SIGMA*SQRT(A)*BETA) 006280
2040 FORMAT(1H0, 1X,50HCRACK PROPAGATION ANALYSIS USING PARIS' EQUATION 006290
1 /16X,21HDA/DN=C*(DELTA K)**N / 5X,51HWHERE K IS OF THE FORM . 006300
2.. K=SIGMA*SQRT(A)*BETA) 006310
2050 FORMAT(1H0, 1X,20A4) 006320
2070 FORMAT(1H0, 1X,27HINITIAL HALF CRACK LENGTH = E16.8/2X,35HMAXIMUM 006330
1HALF CRACK LENGTH ALLOWED = E16.8/1H0, 1X,22HINITIAL CYCLE NUMBER 006340
2 ,F11.2) 006350
2075 FORMAT(1H0, 1X,11HR CUTOFF = ,F6.3) 006360
2080 FORMAT(1H0, 1X,27HINITIAL HALF CRACK LENGTH = E16.8 /1H0, 1X,22HIN 006370
INITIAL CYCLE NUMBER = ,F11.2) 006380
2090 FORMAT(1H0, 1X,34HSURFACE FLAW ANALYSIS WITH A/2C OF F5.2 / 5X,21H 006390
1MATERIAL THICKNESS IS ,F8.5/ 5X,19HSHAPE FACTOR PHI = ,F8.5) 006400
2100 FORMAT(1H0, 1X,41HWHEELER'S RETARDATION MODEL WITH SMALLM = ,F6.3) 006410
2105 FORMAT(1H0,1X,*WILLENBORG RETARDATION MODEL*) 006420
2106 FORMAT(1H0,1X,*GALLAGHER-MODIFIED WILLENBORG RETARDATION MODEL */ 006430
2X*WHERE...*/ 5X,27HPHI = (1-THRESHOLD/K MAX)/(,F5.2,3H-1)) 006440
C FORMATS FOR CLOSURE INPUT/OUTPUT DATA 006450
2107 FORMAT(1H0, 1X,18HCLOSURE MODEL WITH) 006460
2108 FORMAT(1H0, 1X,16HCLOSURE FACTOR =,F6.4,3H+ (,F6.4,1H-,F6.4, 006470
1 10H)*(1.-R)**F6.4,/ 5X,33HEXPONENT FOR DECREASING CLOSURE =, 006480
/ F6.3,/ 006490
2 5X,34HEFFECTIVENESS AFTER ONE OVERLOAD =,F6.4/ 006500
3 5X,36HNUMBER OF OVERLOADS FOR SATURATION =,F6.0) 006510
2110 FORMAT(1H0, 1X,40HCORRECTION FACTOR BETA(1) IS A CONSTANT / 5X,9H 006520
1BETA(1) = ,E16.8/ 5X,16HAPPLIED FROM A= ,E16.8,7H TO A = ,E16.8) 006530
2120 FORMAT(1H0, 1X,54HCORRECTION FACTOR BETA(2) IS FINITE WIDTH CORRECO 006540
1TION /5X28HBETA(2) = SQRT(SEC(PI*A/B)) / 006550
25X*WHERE THE EFFECTIVE PLATE WIDTH W = *E16.8/ 006560
35X*APPLIED FROM A = *E16.8,* TO A = *E16.8) 006570
2130 FORMAT(1H0, 1X,54HCORRECTION FACTOR BETA(3) IS A TABULAR FUNCTION 006580
1OF A/L / 5X,10HWHERE L = ,E16.8 / 5X,16HAPPLIED FROM A = ,E16.8,7006590

2H TO A = ,E16.8// 1X,18A4// 8X,3HA/L,16X,7HBETA(3)/(5X,E15.8,5X, 006600
 3E15.8)) 006610
 2140 FORMAT(1H0, 5X,55HCORRECTION FACTOR BETA(4) IS A TABULAR FUNCTION 006620
 10F A/L1 / 5X,10HWHERE L = E16.8/ 5X,16HAPPLIED FROM A = ,E16.8,7H006630
 2 TO A = ,E16.8// 1X,18A4// 8X,3HA/L,16X,7HBETA(4)/(5X,E15.8,5X,E1006640
 35.8)) 006650
 2150 FORMAT(1H0, 1X,35HTHIS CASE WILL BE RESTARTED ON-LINE) 006660
 2160 FORMAT(1H0, 1X,36HTHIS CASE WILL BE RESTARTED OFF-LINE / 006670
 1 48H RESTART DATA WILL BE WRITTEN ON LOGICAL UNIT 7) 006680
 2165 FORMAT(1H0,1X,36HTHIS CASE WILL BE RESTARTED OFF-LINE / 006690
 1 48H RESTART DATA WILL BE READ FROM LOGICAL UNIT 7) 006700
 2170 FORMAT(1H0, 1X,40HAUTOMATIC UNRETARDED SOLUTION SUPPRESSED) 006710
 2180 FORMAT(1H0, 1X,41HPLANE STRESS YIELD ZONE CONDITION ASSUMED) 006720
 2190 FORMAT(1H0, 1X,41HPLANE STRAIN YIELD ZONE CONDITION ASSUMED) 006730
 2200 FORMAT(1H0, 1X,71HCORRECTION FACTOR BETA(5) IS UNIAXIAL BOWIE SOLU006740
 1TION FOR A SINGLE CRACK/ 5X,35HFROM A CIRCULAR HOLE OF RADIUS R = 006750
 2E16.8 / 5X,16HAPPLIED FROM A = ,E16.8,8H TO A = ,E16.8) 006760
 2205 FORMAT(1H0, 1X,68HCORRECTION FACTOR BETA(6) IS UNIAXIAL BOWIE SOLU006770
 1TION FOR TWO CRACKS /5X,35HFROM A CIRCULAR HOLE OF RADIUS R = , 006780
 2E16.8 / 5X,17HAPPLIED FROM A = ,E16.8,8H TO A = ,E16.8) 006790
 2206 FORMAT(1H0, 1X,58HCORRECTION FACTOR BETA(7) IS ASTM COMPACT TENSIO006800
 1N SPECIMEN/ 5X,15HWITH A WIDTH OF,E16.8/ 006810
 / 5X,16HAND THICKNESS OF,E16.5/ 006820
 2 5X,17HAPPLIED FROM A = ,E16.8,8H TO A = ,E16.8) 006830
 2207 FORMAT(1H0, 1X,61HCORRECTION FACTOR BETA(8) IS GRUMMAN COMPACT TEN006840
 1SION SPECIMEN/ 5X,15HWITH A WIDTH OF,E16.8/ 006850
 / 5X,16HAND THICKNESS OF,E16.5/ 006860
 2 5X,17HAPPLIED FROM A = ,E16.8,8H TO A = ,E16.8) 006870
 2208 FORMAT(1H0, 1X,71HCORRECTION FACTOR BETA(9) IS ASTM E647-83 FOR A
 1COMPACT TENSION SPEIMEN/ 5X,15HWITH A WIDTH OF,E16.8/ 006880
 / 5X,16HAND THICKNESS OF,E16.5/ 006890
 2 5X,17HAPPLIED FROM A = ,E16.8,8H TO A = ,E16.8) 006900
 2210 FORMAT(2X*LAYER*4X*LABEL*7X*DELTA*9X*R*4X*CYCLES PER*/ 006910
 /23X*SIGMA*16X*LAYER*//) 006920
 2220 FORMAT(3X, I2, 5X, 2A4, 1X, E13.5, 1X, F7.4, 2X, F10.2) 006930
 2230 FORMAT(2X*LAYER*4X*LABEL*8X*MEAN*6X*ALTERNATING*3X 006940
 /*CYCLES PER*/23X*STRESS*8X*STRESS*7X*LAYER*//) 006950
 2240 FORMAT(3X, I2, 5X, 2A4, 1X, E13.5, 1X, E13.5, 2X, F10.2) 006960
 2250 FORMAT(1H1, 1X, I6, 52H SEGMENT SPECTRUM APPLIED IN THE FOLLOWING SEQ006970
 /UENCE //1X*SEGMENT*11X*FLIGHTS PER*6X*MISSION*11X*CUMULATIVE*/ 006980
 /21X*MISSION*28X*FLIGHTS*//) 006990
 2255 FORMAT(3X, I2, 17X, I4, 12X, I2, 17X, I5) 007000
 2260 FORMAT(1H0, 1X, 19HTHRESHOLD DELTA K = ,E17.8, 7H (1.0-(,F6.3, 4H)*R))006980
 2270 FORMAT(1H1, 70(1H*)/ 5X, 34HSTRESS SPECTRUM FOR MISSION NUMBER, I3/ 006990
 /2X, 17A4, A2/1X, 70(1H*)//2X*LAYER*5X*MAXIMUM*7X*MINIMUM*7X 007000
 /*CYCLES*6X*CUMULATIVE*/13X*STRESS*8X*STRESS*8X*PER*8X 007010
 /*CYCLES PER*/40X*LAYER*9X*MISSION*//) 007020
 2280 FORMAT(3X, I2, 4X, 4(F12.3, 2X)) 007030
 2900 FORMAT(1H1, 70(1H*)/26X, 5HCASE , I2, 5X, 4HRUN , I2/1X, 70(1H*)) 007040
 3000 FORMAT(1H0, 70(1H*)/ 5X, 66HINACTIVE RETARDATION MODEL CHOSEN.EFFEC007050
 1TIVE STRESS MODEL ASSUMED. /1X, 70(1H*)) 007060
 3010 FORMAT(1H1, 5X, 33HINPUT SPECTRUM FOR MISSION NUMBER, I4/ 5X, 18A4) 007070

```

3030 FORMAT(1H0, 1X,65HCRACK PROPAGATION ANALYSIS USING DIRECT INPUT OF007080
1 DA/DN VS.DELTA K / 5X,51H WHERE K IS OF THE FORM ....SIGMA*SQRT(P007090
2I*A)*BETA ) 007100
3040 FORMAT(1H0, 1X,65HCRACK PROPAGATION ANALYSIS USING DIRECT INPUT OF007110
1 DA/DN VS.DELTA K / 5X,51HWHERE K IS OF THE FORM .... K=SIGMA*SQR007120
2T(A)*BETA ) 007130
3050 FORMAT(1H0, 1X,50HCRACK PROPAGATION ANALYSIS USING WALKER'S EQUATI007140
10N/ 7X,35HDA/DN=C*(DELTA K/((1-R)**(1-M)))**N / 5X,52HWHERE K IS 007150
2OF THE FORM .... K=SIGMA*SQRT(PI*A)*BETA ) 007160
3060 FORMAT(1H0, 1X,50HCRACK PROPAGATION ANALYSIS USING WALKER'S EQUATI007170
10N/ 7X,35HDA/DN=C*(DELTA K/((1-R)**(1-M)))**N / 5X,51HWHERE K IS 007180
2F THE FORM .... K=SIGMA*SQRT(A)*BETA ) 007190
3070 FORMAT(1H0, 1X,50HCRACK PROPAGATION ANALYSIS USING SIGMOIDAL EQN.
1 / 7X,60HDA/DN=EXP(B) (DELTA K/DELTA K)**P (LN(DELTA K/DELTA K*)
2)**Q/12X,26H (LN(DELTA KC/DELTA K))**D / 5X,51HWHERE K IS OF THE F...
30RM .... K=SIGMA*SQRT(PI*A)*BETA )
3400 FORMAT(1H0,70(1H*)/21X,40HRERUN OF CASE WITH THE FOLLOWING CHANGES007200
/ / 1X,70(1H*)) 007210
9000 FORMAT(1H0, 70(1H*)/ 5X,51HNUMBER OF POINTS IN TABULAR CORRECTION 007220
1FACTOR BETA(I1,*) EXCEEDS 100.*/* CORRECTION FACTOR WILL BE IGNORE007230
2D.*/1X, 70(1H*)) ) 007240
9010 FORMAT(1H0, 70(1H*)/ 5X,38HERROR IN DECK SETUP.E-O-F ENCOUNTERED. 007250
1 /1X, 70(1H*)) 007260
9020 FORMAT(1H0, 70(1H*)/ 5X,48HINCORRECT LABEL CARD ENCOUNTERED.LABEL 007270
+READ WAS ,2A4,A2,1H*/ 1X,64HEXECUTION SUPPRESSED.PROGRAM WILL COMPO07280
2LETE INPUT DATA PROCESSING/1X, 70(1H*)) 007290
9030 FORMAT(1H0, 70(1H*)/ 1X,71HERROR IN CALCULATING PHI.PROGRAM REQUIR007300
+ES (AZERO/2(CZERO))SQD .LE. 0.5/ 1X,65HEXECUTION SUPPRESSED. PROG007310
+RAM WILL COMPLETE INPUT DATA PROCESSING/1X, 70(1H*)) 007320
END 007330
SUBROUTINE DELTA(A, DELTAK, KMAX, R) 007340
COMMON/RDATA/ MODEL, RETARD, PLSTRN, OVLD, SIGMAX, SIGMIN, ASUBP, SMALLM 007350
INTEGER RETARD, PLSTRN 007360
COMMON/MDATA/ MATID(18), C, SMALLLN, CARRAY(100), SNARAY(100), KSUBC, 007370
/ KSUBQ, SIGMAY, DELKTH, RMULT, RCUT, DLMAX 007380
REAL KSUBC, KSUBQ 007390
COMMON/CORFAC/ ISURF, RATIO, PHI, THICK, IBETA(10), BETA(10), NPTS, 007400
/ ADVERB(100), BTABLE(100), NPTS2, ADVRB2(100), 007410
/ BTABL2(100), ASTART(10), ASTOP(10) 007420
REAL KMAX, KMIN 007430
CALL K(SIGMIN, A, KMIN) 007440
CALL K(SIGMAX, A, KMAX) 007450
R = 0.0 007460
IF( KMAX .NE. 0.0 ) R = KMIN/KMAX 007470
DELTAK=KMAX-KMIN 007480
RETURN 007490
END 007500
REAL FUNCTION TRP2(T, X, Y, M) 007510
007520
DIMENSION T(100), Z(4), D(6) 007530
007540
L1=0 007550

```

X1=X	007560
Y1=Y	007570
I = T(1) / 1000. + 1.	007580
J = AMOD(T(1),1000.) + 1.	007590
L=J*M	007600
I1=J*3+1	007610
I2=I*J	007620
M1=M	007630
DO 10 K=I1, I2,L	007640
IF(X1-T(K)) 20,20,10	007650
10 CONTINUE	007660
K=I2+1-J	007670
20 DO 30 L=4, J, M1	007680
IF (Y1-T(L)) 40,40,30	007690
30 CONTINUE	007700
L=J	007710
40 L1=L1+1	007720
DO 50 MN=1, 3	007730
N=L+MN-3	007740
N1=K+(J*(L1-3))+N-1	007750
D(MN)=T(N)	007760
50 D(MN+3)=T(N1)	007770
60 Z(L1)=D(4)+(Y1-D(1))*((D(5)-D(4))/(D(2)-D(1))+(007780
1Y1-D(2))/(D(3)-D(1))*((D(6)-D(5))/(D(3)-D(2))	007790
2-(D(5)-D(4))/(D(2)-D(1))))	007800
IF (L1-3)40,70,90	007810
70 DO 80 MN=1, 3	007820
D(MN+3)=Z(MN)	007830
N1=K+(J*(MN-3))	007840
80 D(MN)=T(N1)	007850
L1=4	007860
Y1=X	007870
GO TO 60	007880
90 TRP2=Z(4)	007890
RETURN	007900
END	007910
SUBROUTINE RESTRT(CYC,A,IRSTRT)	007920
COMMON/DATA/I1(7),R1(3)	007930
COMMON/RDATA /I2(3),R2(5)	007940
COMMON/MDATA /I3(18),R3(209)	007950
COMMON/LDATA/R4(600),I4(112)	007960
COMMON/STEPS /I5(8)	007970
COMMON/CORFAC /I6,R5(3), I7(10),R6(10), I8,R7(200), I9,R8(220)	007980
COMMON/MKCRVE/R9(100)	007990
COMMON/OUTPUT/R10(3), I10(2)	008000
REWIND 7	008010
INOUT = IRSTRT - 2	008020
GO TO (100,200,200),INOUT	008030
C	008040
C WRITE RESTART TAPE	008050
C	008060
100 WRITE(7) I1,R1, I2,R2, I3,R3	008070

	WRITE(7) R4, I4, I10	008080
	WRITE(7) I5, I6, R5, I7, R6, I8, R7, I9, R8, R9, R10, CYC, A	008090
	RETURN	008100
C		008110
C	READ RESTART TAPE	008120
C		008130
200	READ (7) I1, R1, I2, R2, I3, R3	008140
	READ (7) R4, I4, I10	008150
	READ (7) I5, I6, R5, I7, R6, I8, R7, I9, R8, R9, R10, CYC, A	008160
	WRITE(6, 2000) CYC, A	008170
	RETURN	008180
2000	FORMAT(1H0, 70(1H*)) / 5X, 43HRESTART TAPE READ. THIS RUN BEGINS AT	008190
	1YCLE , E16.8/5X, 24H WITH A CRACK LENGTH OF , F9.5/1X, 70(1H*))	008200
	END	008210
	SUBROUTINE CNDIN(IEQN)	008220
	COMMON/MDATA/ MATID(18), C, SMALLN, CARRAY(100), SNARAY(100), KSUBC,	008230
	/ KSUBQ, SIGMAY, DELKTH, RMULT, RCUT, QLMAX	008240
	COMMON/PARIS/C1, SN1, DKCOM, C2, SN2	008250
	COMMON /DIRECT/ NDADN	008260
	COMMON /WALKER/ CWALK, EXPM, EXPN	008270
	COMMON /SIGMOID/DKSTAR, TOUGH, BEE, PEA, QUE, DEE	
	REAL KSUBC, KSUBQ	008280
	GO TO (100, 300, 200, 400, 500), IEQN	008290
100	READ(5, 1200) C, SMALLN, KSUBC	008300
	WRITE(6, 2700) C, SMALLN, KSUBC	008310
	GO TO 600	008320
200	READ(5, 1100) PTS	008330
	NDADN = PTS + 0.5	008340
	READ(5, 1100) (CARRAY(I), SNARAY(I), I = 1, NDADN)	008350
	WRITE(6, 2000)	008360
	WRITE(6, 2100) (CARRAY(I), SNARAY(I), I = 1, NDADN)	008370
	DO 250 J=1, NDADN	008380
250	SNARAY(J) = ALOG10(SNARAY(J))	008390
	GO TO 600	008400
300	READ(5, 1200) C1, SN1, DKCOM, C2, SN2	008410
	IF(DKCOM.GT.0.) GO TO 350	008420
	C2 = C1	008430
	SN2 = SN1	008440
	WRITE(6, 2550) C1, SN1	008450
	GO TO 600	008460
350	WRITE(6, 2600) C1, SN1, DKCOM, C2, SN2, DKCOM	008470
	GO TO 600	008480
400	READ(5, 1200) CWALK, EXPM, EXPN	008490
	WRITE(6, 2500) CWALK, EXPM, EXPN	008500
	GO TO 600	008510
500	READ(5, 1200) DKSTAR, TOUGH, BEE, PEA, QUE, DEE	
	WRITE(6, 2520) BEE, DKSTAR, PEA, DKSTAR, QUE, TOUGH, DEE	
2520	FORMAT(1X, 10HDA/DN=EXP(, F12.7, 12H)*((DELTA-K/, F12.7, 3H)**, F6.2, 1H)	
	1, 1H* / 1X, 13H((LN(DELTA-K/, F12.7, 4H)**), F6.2, 2H)*	
	2/, 1X, 5H((LN(, F12.7, 12H/DELTA-K)**), F6.2, 1H))	
600	READ(5, 1100) KSUBQ, SIGMAY	008530
	WRITE(6, 2400) KSUBQ, SIGMAY	008540

```

1100 FORMAT(2E10.0)                                008550
1200 FORMAT(8E10.0)                                008560
2000 FORMAT(1H0, 1X,32HDIRECT INPUT OF DA/DN VS DELTA K//34X,7HDELTA K 008570
      1 ,14X,5HDA/DN )                               008580
2100 FORMAT( 5X,2E20.8)                             008590
2400 FORMAT(1H0, 1X,7HKSUBQ = ,E15.8,5X,15HYIELD STRESS = ,E15.8 ) 008600
2500 FORMAT(1H0, 1X,3HC =,E16.8,5X,3HM =,F6.4,5X,3HN =,F6.3)      008610
2550 FORMAT(1H0,1X,30HLINEAR PARIS FIT AS FOLLOWS /                008620
      /      5X,E12.4,11H(DELTA K)** ,F5.3)                    008630
2600 FORMAT(1H0, 1X,29HBILINEAR PARIS FIT AS FOLLOWS/ 5X,E12.4,11H(DELT008640
      1A K)** ,F5.3,22H FOR DELTA K LESS THAN,E16.8/5X,E12.4,11H(DELTA K)*008650
      2* ,F5.3,22H FOR DELTA K MORE THAN ,E16.8 )              008660
2700 FORMAT(1H0, 1X,3HC =,E16.8,5X,8HSMALLN =,F6.3,5X,7HKSUBC =,E16.8) 008670
      RETURN                                                    008680
      END                                                        008690
      BLOCK DATA                                              008700
      COMMON/MKCRVE/ MK(100)                                  008710
      REAL MK                                                  008720
C      INITIALIZATION VALUES FOR FIRST 84 ELEMENTS OF MK      008730
      DATA      MK/                                          008740
      1      11006.,0.05,0.10,0.20,0.30,0.40,0.50,          008750
      2      0.0,1.00,1.00,1.00,1.00,1.00,1.00,          008760
      3      0.1,1.01,1.01,1.01,1.01,1.01,1.00,          008770
      4      0.2,1.03,1.03,1.02,1.02,1.01,1.00,          008780
      5      0.3,1.06,1.06,1.04,1.03,1.02,1.00,          008790
      6      0.4,1.12,1.12,1.08,1.05,1.02,1.00,          008800
      7      0.5,1.22,1.18,1.14,1.08,1.03,1.00,          008810
      8      0.6,1.34,1.30,1.22,1.13,1.06,1.01,          008820
      9      0.7,1.48,1.42,1.31,1.20,1.08,1.02,          008830
      A      0.8,1.64,1.57,1.41,1.26,1.13,1.04,          008840
      B      0.9,1.77,1.68,1.50,1.32,1.18,1.08,          008850
      C      1.0,1.84,1.75,1.59,1.38,1.22,1.10/          008860
      END                                                        008870
      SUBROUTINE CELI2(RES,AK,A,B,IER)                        008880
C      .....                                                    008890
C      SUBROUTINE CELI2                                       008910
C      PURPOSE                                                008920
C      COMPUTES THE GENERALIZED COMPLETE ELLIPTIC INTEGRAL OF 008930
C      SECOND KIND.                                           008940
C      USAGE                                                  008950
C      CALL CELI2(RES,AK,A,B,IER)                             008960
C      DESCRIPTION OF PARAMETERS                              008970
C      RES - RESULT VALUE                                     008980
C      AK - MODULUS (INPUT)                                  008990
C      A - CONSTANT TERM IN NUMERATOR                       009000
C      B - FACTOR OF QUADRATIC TERM IN NUMERATOR           009010
C      IER - RESULTANT ERROR CODE WHERE                     009020
C      009030
C      009040
C      009050
C      009060

```

C	IER=0 NO ERROR	009070
C	IER=1 AK NOT IN RANGE -1 TO +1	009080
C		009090
C	REMARKS	009100
C	FOR AK = +1,-1 THE RESULT VALUE IS SET TO 1.E75 IF B IS	009110
C	POSITIVE, TO -1.E75 IF B IS NEGATIVE.	009120
C	SPECIAL CASES ARE	009130
C	K(K) OBTAINED WITH A = 1, B = 1	009140
C	E(K) OBTAINED WITH A = 1, B = CK*CK WHERE CK IS	009150
C	COMPLEMENTARY MODULUS.	009160
C	B(K) OBTAINED WITH A = 1, B = 0	009170
C	D(K) OBTAINED WITH A = 0, B = 1	009180
C	WHERE K, E, B, D DEFINE SPECIAL CASES OF THE GENERALIZED	009190
C	COMPLETE ELLIPTIC INTEGRAL OF SECOND KIND IN THE USUAL	009200
C	NOTATION, AND THE ARGUMENT K OF THESE FUNCTIONS MEANS	009210
C	THE MODULUS.	009220
C		009230
C	SUBROUTINES AND FUNCTION SUBPROGRAMS REQUIRED	009240
C	NONE	009250
C		009260
C	METHOD	009270
C	DEFINITION	009280
C	RES=INTEGRAL((A+B*T*T)/(SQRT((1+T*T)*(1+(CK*T)**2))*(1+T*T))	009290
C	SUMMED OVER T FROM 0 TO INFINITY).	009300
C	EVALUATION	009310
C	LANDENS TRANSFORMATION IS USED FOR CALCULATION.	009320
C	REFERENCE	009330
C	R.BULIRSCH, NUMERICAL CALCULATION OF ELLIPTIC INTEGRALS	009340
C	AND ELLIPTIC FUNCTIONS, HANDBOOK SERIES SPECIAL FUNCTIONS,	009350
C	NUMERISCHE MATHEMATIK VOL. 7, 1965, PP. 78-90.	009360
C		009370
C	009380
C		009390
C	IER=0	003400
C		009410
C	TEST RANGE	009420
C		009430
C	CK=AK*AK	009440
C	IF(CK-1.) 20,20,10	009450
C	10 IER=1	009460
C	RETURN	009470
C		009480
C	COMPUTE COMPLEMENTARY MODULUS	009490
C		009500
C	20 GEO=SQRT(1.0-CK)	009510
C	IF(GEO) 70,30,70	009520
C		009530
C	SET RESULT VALUE = OVERFLOW	009540
C		009550
C	30 IF(B) 40,60,50	009560
C	40 RES=-1.E38	009570
C	RETURN	009580

50	RES=1.E38	009590
	RETURN	009600
60	RES=A	009610
	RETURN	009620
C		009630
C	COMPUTE INTEGRAL	009640
C		009650
70	ARI=1.	009660
	AA=A	009670
	AN=A+B	009680
	W=B	009690
80	W=W+AA*GEO	009700
	W=W+W	009710
	AA=AN	009720
	AARI=ARI	009730
	ARI=GEO+ARI	009740
	AN=W/ARI+AN	009750
C		009760
C	TEST OF ACCURACY	009770
C		009780
	IF(AARI-GEO-1.E-4*AARI) 100,100,90	009790
90	GEO=SQRT(GEO*AARI)	009800
	GEO=GEO+GEO	009810
	GO TO 80	009820
100	RES=.78539816*AN/ARI	009830
	RETURN	009840
	END	009850
	SUBROUTINE GRWCRK(CYC,A, DN)	009860
	COMMON/PDATA/ MODEL,RETARD,PLSTRN,OVL D,SIGMAX,SIGMIN,ASUBP,SMALLM	009870
	INTEGER RETARD,PLSTRN	009880
	COMMON/LDATA/SMAX(20,10),SMIN(20,10),CYCLES(20,10),NLYRS(10),	009890
	/ NBLKS,IBLKS(50),ISEGS(50),NSEGS	009900
	COMMON/STEPS/ISEG,J1,J2,J3,J4,J5,ISTOP,NORTRD	009910
	EXTERNAL RATE,WHELER,WLNBRG	009920
	SIGMAX = SMAX(J4,ISEG)	009930
	SIGMIN = SMIN(J4,ISEG)	009940
	IF(MODEL.GT.0) GO TO 100	009950
	CALL RK1DES(CYC,A, DN,RATE)	009960
	RETURN	009970
100	GO TO (110,120,130,140,150),MODEL	009980
110	CALL YLDZNE(CYC,A, DN,WHELER)	009990
	GO TO 200	010000
120	CALL YLDZNE(CYC,A, DN,WLNBRG)	010010
	GO TO 200	010020
130	CONTINUE	010030
	CALL CLOSUR(CYC,A, DN)	010040
	GO TO 200	010050
140	CONTINUE	010060
150	CONTINUE	010070
200	RETURN	010080
	END	010090

```

SUBROUTINE TRANS(A,ATRANS,CYCTR)                                010100
COMMON/LDATA/SMAX( 20,10),SMIN( 20,10),CYCLES( 20,10),NLYRS(10), 010110
/ NBLKS,IBLKS( 50 ),ISEGS( 50 ),NSEGS                                010120
COMMON/STEPS/ISEG,J1,J2,J3,J4,J5,ISTOP,NORTRD                    010130
COMMON/CORFAC/ ISURF,RATIO,PHI,THICK,IBETA(10),BETA(10),NPTS,    010140
/ AOVERB(100),BTABLE(100),NPTS2,AOVRB2(100),                      010150
/ BTABL2(100),ASTART(10),ASTOP(10)                                  010160
ATRANS = THICK                                                    010170
IF(A.LT.ATRANS)RETURN                                             010180
100 AEFF = ATRANS/(2.*RATIO)                                       010190
A = AEFF                                                            010200
ISTOP = 2                                                           010210
WRITE(6,1000) A,CYCTR                                             010220
1000 FORMAT(1H0, 70(1H*)/ 5X,55HTRANSITION TO A THRU CRACK OF EFFECTIVE 010230
1 LENGTH, AEFF = ,F9.5,4H AT ,F12.2,7H CYCLES/1X, 70(1H*))      010240
RETURN                                                              010250
END                                                                  010260
SUBROUTINE RATE (CYCLE,A,DADN)                                     010270
COMMON/DATA/ EQN,NASA,J1PR,J2PR,J3PR,J4PR,J5PR,AZERO,AMAX,NZERO 010280
INTEGER EQN                                                         010290
REAL NZERO                                                           010300
COMMON/MDATA/ MATID(18),C,SMALLN,CARRAY(100),SNARAY(100),KSUBC, 010310
/ KSUBQ,SIGMAY,DELKTH,RMULT,RCUT,OLMAX                              010320
REAL KSUBC,KSUBQ                                                    010330
COMMON/LDATA/SMAX( 20,10),SMIN( 20,10),CYCLES( 20,10),NLYRS(10), 010340
/ NBLKS,IBLKS( 50 ),ISEGS( 50 ),NSEGS                                010350
COMMON/STEPS/ISEG,J1,J2,J3,J4,J5,ISTOP,NORTRD                    010360
COMMON/CORFAC/ ISURF,RATIO,PHI,THICK,IBETA(10),BETA(10),NPTS, 010370
/ AOVERB(100),BTABLE(100),NPTS2,AOVRB2(100),                      010380
/ BTABL2(100),ASTART(10),ASTOP(10)                                  010390
COMMON/OUTPUT/ KMAX,KMAXA,DELTAK,IFLT,DADNPR                       010400
COMMON/PARIS/C1,SN1,DKCOM,C2,SN2                                   010410
COMMON/DIRECT/ NDADN                                               010420
COMMON /WALKER/ CWALK,EXPM,EXPN                                     010430
COMMON /SIGMOID/DKSTAR,TOUGH,BEE,PEA,QUE,DEE
REAL KMAX                                                            010440
REAL KMAXA                                                           010450
CALL DELTA(A,DELTAK,KMAX,R)                                         010460
IF(ISTOP .NE. 0)GO TO 575                                          010470
IF( R. GE. RCUT) R = RCUT                                           010480
CALL K(SMAX(J4,ISEG),A,KMAXA)                                       010490
IF(DELTAK.LE.0.0) GO TO 300                                         010500
IF(ISURF.EQ.0) GO TO 50                                             010510
CALL TRANS(A,ATRANS,CYCLE)                                          010520
IF(A.LT.ATRANS) GO TO 50                                           010530
RETURN                                                                010540
50 THRLD = DELKTH*(1.0-RMULT*R)                                     010550
IF (DELTAK.LE.THRLD) GO TO 300                                       010560
GO TO (100,200,230,240,250),EQN                                    010570
100 DENOM = (1.0 - R) * KSUBC - DELTAK                               010580
IF(KMAXA.GE.KSUBQ) GO TO 400                                         010590
IF(DENOM.LE.0.0) GO TO 525                                          010600

```

	DADN=(C*(DELTAK)**SMALLN)/DENOM	010610
	RETURN	010620
200	DELKC = KSUBQ - KMAXA	010630
	IF(DELKC.LE.0.0) GO TO 400	010640
	C = C1	010650
	SMALLN = SN1	010660
	IF(DELTAK.GE.DKCOM) C = C2	010670
	IF(DELTAK.GE.DKCOM) SMALLN = SN2	010680
	DADN=C*(DELTAK)**SMALLN	010690
	RETURN	010700
230	DADN = TBLKUP(CARRAY,SNARRAY,NDADN,100,DELTAK)	010710
	DADN = 10.**DADN	010720
	IF(KMAXA.GE.KSUBQ) GO TO 400	010730
	RETURN	010740
240	IF(KMAXA.GE.KSUBQ) GO TO 400	010750
	DADN=CWALK*(DELTAK/((1.-R)**(1.-EXPM)))*EXPN	010760
	RETURN	010770
250	IF(KMAXA.GE.KSUBQ) GO TO 400	
	TOUG=TOUGH*(1.-.4)	
	IF(DELTAK.GE.TOUG) GO TO 260	
	XKSTAR=DKSTAR*(1.-.4)	
	IF(DELTAK.LE.XKSTAR) GO TO 300	
	DADN=EXP(BEE)*((DELTAK/XKSTAR)**PEA)*((ALOG(DELTAK/XKSTAR))**QUE)	
	1*((ALOG(TOUG/DELTAK))**DEE)	
	RETURN	
260	ISTOP=1	
	WRITE(6,270)	
270	FORMAT(1H0, 70(1H*)/ 5X,50HDELTA-K EXCEEDS THE TOUGHNESS PROB. IS	
	1 TERMINATED/1X,70(1H*)/1H0, 1X,26HLAST CALCULATED VALUES ARE///	
	2)	
	GO TO 575	
300	DADN=0.0	010780
	RETURN	010790
400	ISTOP = 1	010800
	WRITE(6,500)	010810
500	FORMAT(1H0, 70(1H*)/ 5X,46HKMAX APPLIED EXCEEDS KSUBQ. PROBLEM TER	010820
	MINATED/1X, 70(1H*)/1H0, 1X,26HLAST CALCULATED VALUES ARE///)	010830
	GO TO 575	010840
525	WRITE(6,550)	010850
550	FORMAT(1H0, 70(1H*)/ 5X,49HDELTA K EXCEEDS (1-R)KSUBC. PROBLEM IS	010860
	1 TERMINATED/1X,70(1H*)/1H0, 1X,26HLAST CALCULATED VALUES ARE///)	010870
	ISTOP = 1	010880
575	CONTINUE	010890
	WRITE(6,600) J1,J2,ISEG,IFLT,J4,CYCLE,A,KMAXA,KMAX,DELTAK,DADN	010900
600	FORMAT(5X,18HBLOCK IN SPECTRUM ,I4/	010910
	/ 5X,18HSEGMENT NUMBER ,I4/	010920
	/ 5X,18HMISSION NUMBER ,I4/	010930
	/ 5X,18HFLIGHT NUMBER ,I6/	010940
	/ 5X,18HLAYER IN MISSION ,I4/	010950
	5 5X,18HACCUMULATED CYCLES,E16.8/	010960
	6 5X,18HCRACK LENGTH ,E16.8/	010970
	7 5X,18HKMAX APPLIED ,E16.8/	010980

8	5X, 18HKMAX EFFECTIVE	,E16.8/	010990
9	5X, 18HDELTA K	,E16.8/	011000
/	5X, 18HDA/DN	,E16.8)	011010
	RETURN		011020
	END		011030
	SUBROUTINE K(SIGMA, A, KM)		011040
	COMMON/CORFAC/DUMMY(14), BETA(10), DUMMY1(422)		011050
	COMMON/DATA/ EQN, NASA, J1PR, J2PR, J3PR, J4PR, J5PR, AZERO, AMAX, NZERO		011060
	INTEGER EQN		011070
	REAL NZERO		011080
	REAL KM		011090
	DATA PI/3.14159265/		011100
	CALL BETAS (SIGMA, A, BETAT, Q)		011110
	IF(NASA.NE.0) GO TO 100		011120
	KM=SIGMA*SQRT(PI*A)*BETAT		011130
	RETURN		011140
100	KM=SIGMA*SQRT(A)*BETAT		011150
	RETURN		011160
	END		011170
	SUBROUTINE BETAS(SIGMA, A, BETAT, Q)		011180
	COMMON/MDATA/ MATID(18), C, SMALLN, CARRAY(100), SNARRAY(100), KSUBC,		011190
	/ KSUBQ, SIGMAY, DELKTH, RMULT, RCUT, OLMAX		011200
	REAL KSUBC, KSUBQ		011210
	COMMON/STEPS/ ISEG, J1, J2, J3, J4, J5, ISTOP, NORTRD		011220
	COMMON/CORFAC/ ISURF, RATIO, PHI, THICK, IBETA(10), BETA(10), NPTS,		011230
	/ AOVERB(100), BTABLE(100), NPTS2, AOVBR2(100),		011240
	/ BTABL2(100), ASTART(10), ASTOP(10)		011250
	COMMON/MKORVE/ MK(100)		011260
	REAL MK, MSUBK, M1		011270
	BETAT=1.0		011280
	MSUBK=1.0		011290
	Q=1.0		011300
	PI = 3.14159265		011310
5	DO 100 I=1, 10		011320
	J=IBETA(I)		011330
	IF(J.EQ.0) GO TO 100		011340
	IF(A.LT.ASTART(J). OR .A.GT.ASTOP(J)) GO TO 100		011350
	GO TO(10, 20, 30, 40, 50, 60, 70, 80, 90), J		011360
			011370
C			011380
C	CONSTANT MULTIPLIER		011390
C			011400
10	BETAT = BETAT * BETA(J)		011410
	GO TO 100		011420
			011430
C			011440
C	FINITE WIDTH SECANT CORRECTION		011450
C			011460
20	HOLE = BETA(5)+BETA(6)		011470
	SMALLC=A		011480
	IF(ISURF.NE.0) SMALLC=A/(2.*RATIO)		011490
	SMALLK = (SMALLC + HOLE)/BETA(J)		011500
	IF(SMALLK.GT.0.5) GO TO 200		
	BETAT = BETAT*SQRT(1./COS(PI*SMALLK))		

	GO TO 100	011510
C		011520
C	TABULAR CORRECTION FACTOR	011530
C		011540
30	SMALLK=A/BETA(J)	011550
	BETAT=BETAT*TBKUP(AOVRB,BTABLE,NPTS,100,SMALLK)	011560
	GO TO 100	011570
C		011580
C	SECOND TABULAR CORRECTION FACTOR	011590
C		011600
40	SMALLK=A/BETA(J)	011610
	BETAT=BETAT*TBKUP(AOVRB2,BTABL2,NPTS2,100,SMALLK)	011620
	GO TO 100	011630
C		011640
C	BOWIE SOLUTION FOR SINGLE CRACK FROM CIRCULAR HOLE	011650
C		011660
50	BETAT = BETAT * (0.6762062 + (0.8733015/(0.3245442+A/BETA(J))))	011670
	GO TO 100	011680
C		011690
C	BOWIE SOLUTION FOR DOUBLE CRACK FROM CIRCULAR HOLE	011700
C		011710
60	BETAT = BETAT * (0.9438510 + (0.6805078/(0.2771965+A/BETA(J))))	011720
	GO TO 100	011730
C		011740
C	SOLUTION FOR ASTM COMPACT TENSION SPECIMEN USING J. C. NEWMAN	011750
C	EQUATION (12) FROM 'STRESS ANALYSIS OF THE COMPACT SPECIMEN	011760
C	INCLUDING THE EFFECTS OF PIN LOADING'	011770
70	AW = A/BETA(I)	011780
	BETAT = BETAT*(4.55-40.32*AW+414.7*AW**2.-1698.*AW**3.	011790
1	+3781.*AW**4.-4287.*AW**5.+2017.*AW**6.)/SQRT(BETA(I)*A*PI)/	011800
2	THICK	011810
	GO TO 100	011820
C	SOLUTION FOR GRUMMAN COMPACT TENSION SPECIMEN	011830
C	H/W = .95 D/W = .25	011840
80	AW = A/BETA(I)	011850
	POLY = .1229+16.4098*AW-37.395*AW**2.+54.7667*AW**3.	011860
	IF (AW .LE. 0.5) GO TO 81	011870
	POLY = 114.054-830.132*AW+2327.177*AW**2.-2890.811*AW**3.	011880
1	+1382.306*AW**4.	011890
81	BETAT = BETAT*POLY/SQRT(PI*A)/THICK	011900
	GO TO 100	011910
C	SOLUTION FOR COMPACT TENSION SPECIMEN FROM ASTM E 747-83	
C	CONSTANT-LOAD-AMPLITUDE FATIGUE CRACK GROWTH RATES ABOVE	
C	10-08 M/CYCLE	
90	AW=A/BETA(I)	
	BETAT=BETAT*(2.+AW)*(.886+4.64*AW-13.32*AW**2.+14.72*AW**3.	
1	-5.6*AW**4.)/((THICK*(1-AW)**1.5)*SQRT(BETA(I)*PI*A))	
100	CONTINUE	011930
	IF(ISURF.EQ.0) RETURN	011940
C		011950
C	SURFACE FLAW CORRECTION	011960
C	FROM NEWMAN - NASA TN D-8244	011970

C	Q=PHI**2.0-0.212*(SIGMA/SIGMAY)**2.0	011980
	ADVERT=A/THICK	011990
	ADVERC=2.*RATIO	012000
	P=2.+8.*ADVERC**3.	012010
	M1=1.13-0.1*ADVERC	012020
	MSUBK=(SQRT(Q/ADVERC)-M1)*ADVERT**P	012030
	BETAT=BETAT*(M1+MSUBK)/SQRT(Q)	012040
	RETURN	012060
200	WRITE(6,1000)	012070
1000	FORMAT(1H0, 70(1H*)/ 5X,52HCRACK LENGTH EXCEEDS PLATE WIDTH. TERMINATE PROBLEM. / 70(1H*))	012080
	ISTOP = 1	012090
	RETURN	012100
	END	012110
	SUBROUTINE YLDZNE(CYC,A, DN,FR)	012120
C		012130
C	THIS ROUTINE CONTROLS APPLICATION OF THE WHEELER MODEL AND THE	012140
C	EFFECTIVE STRESS(WILLENBORG)MODEL BASED ON THE PROGRESS THRU A	012150
C	YIELD ZONE(ASUBP)DUE TO AN OVERLOAD.	012160
C		012170
C		012180
	COMMON/RDATA/ MODEL,RETARD,PLSTRN,OVLDD,SIGMAX,SIGMIN,ASUBP,SMALLM	012190
	INTEGER RETARD,PLSTRN	012200
	COMMON/LDATA/SMAX(20,10),SMIN(20,10),CYCLES(20,10),NLYRS(10),	012210
	/ NBLKS,IBLKS(50),ISEGS(50),NSEGS	012220
	COMMON/MDATA/ MATID(18),C,SMALLN,CARRAY(100),SNARAY(100),KSUBC,	012230
	/ KSUBQ,SIGMAY,DELKTH,RMULT,RCUT,OLMAX	012240
	REAL KSUBC,KSUBQ	012250
	COMMON/STEPS/ISEG,J1,J2,J3,J4,J5,ISTOP,NORTRD	012260
	REAL KMAX,KOVLDD	012270
	EXTERNAL FR,RATE,DNDA	012280
	CYCF = CYC + DN	012290
	IF(RETARD.EQ.1) GO TO 100	012300
C		012310
C	IS THIS LAYER SUBJECT TO RETARDATION &	012320
C		012330
C	IF(SMAX(J4,ISEG).GE.OVLDD) GO TO 800	012340
C		012350
C	RETARDATION IS APPLIED.	012360
C		012370
C	RETARD = 1	012380
C		012390
C	DETERMINE EXTENT OF ELASTIC-PLASTIC INTERFACE	012400
C		012410
	CALL K(OVLDD,A,KOVLDD)	012420
	RSUBY = RY(KOVLDD,PLSTRN)	012430
	ASUBP = A + RSUBY	012440
C		012450
C	WILL FIRST CYCLE OF THIS LAYER CAUSE ASUBP TO BE EXCEEDED &	012460
C		012470
100	CALL SIGEFF(A,ASUBP,SIGMAY)	012480
	IF(RETARD.EQ.0) GO TO 800	012490

	CALL K(SIGMAX,A,KMAX)	012500
	RSUBY1 = RY(KMAX,PLSTRN)	012510
	IF(A+RSUBY1.LT.ASUBP) GO TO 200	012520
	RETARD = 0	012530
	GO TO 800	012540
C		012550
C	THIS LAYER IS SUBJECT TO RETARDATION.	012560
C	ASSUME THAT RETARDATION APPLIES OVER THE ENTIRE LAYER.	012570
C		012580
	200 CYC1 = CYC	012590
	AA = A	012600
	CALL RK1DES(CYC1,AA,DN,FR)	012610
	IF(ISTOP.NE.0) RETURN	012620
	IF(AA.GT.ASUBP) GO TO 400	012630
	CALL K(SIGMAX,AA,KMAX)	012640
	RSUBY = RY(KMAX,PLSTRN)	012650
C		012660
C	CHECK ASSUMPTION.	012670
C		012680
	IF(AA+RSUBY.GE.ASUBP) GO TO 400	012690
	CYC = CYC1	012700
	A = AA	012710
	RETURN	012720
C		012730
C	ENTIRE LAYER IS NOT RETARDED	012740
C	CALCULATE DELTA A AND ITS ASSOCIATED YIELD ZONE(RSUBY) SUCH THAT	012750
C	(A+DA+RSUBY = ASUBP) TO A GIVEN TOLERANCE(TOL)	012760
C		012770
	400 TOL = 1.0E-5	012780
	RED = 1.0	012790
	SUBT = 0.1	012800
	CYC1 = CYC	012810
	AA = A	012820
	500 DA = (ASUBP-(AA+RSUBY1)) * RED	012830
	CALL SIGEFF(AA+DA,ASUBP,SIGMAY)	012840
	CALL K(SIGMAX,AA+DA,KMAX)	012850
	RSUBY = RY(KMAX,PLSTRN)	012860
	IF(AA+DA+RSUBY.LT.ASUBP) GO TO 700	012870
	RED = RED - SUBT	012880
	GO TO 500	012890
	600 RED = RED + SUBT	012900
	SUBT = SUBT/10.	012910
	GO TO 500	012920
	700 IF(SUBT.GT.TOL) GO TO 600	012930
C		012940
C	KNOWING DN, DETERMINE NUMBER OF CYCLES IN THIS LAYER REQUIRED	012950
C	TO PRODUCE DA.	012960
C		012970
	CALL RUNKUT(AA,CYC1,DA,DNDA)	012980
	IF(ISTOP.NE.0) RETURN	012990
	CYC = CYC1	013000
	A = AA	013010

C		013020
C	REMAINDER OF LAYER IS NOT SUBJECT TO RETARDATION.	013030
C	USE UNRETARDED DADN FUNCTION(RATE)	013040
C		013050
	RETARD = 0	013060
	DN = CYCF - CYC	013070
	IF(DN.LE.0.0) RETURN	013080
C		013090
C	UNRETARDED DADN FUNCTION	013100
C		013110
	800 SIGMAX = SMAX(J4, ISEG)	013120
	SIGMIN = SMIN(J4, ISEG)	013130
	OVL D = SIGMAX	013140
	CALL RK1DES(CYC, A, DN, RATE)	013150
	RETURN	013160
	END	013170
	REAL FUNCTION RY(K, PLSTRN)	013180
	COMMON/MDATA/ MATID(18), C, SMALLN, CARRAY(100), SNARAY(100), KSUBC,	013190
	/ KSUBQ, SIGMAY, DELKTH, RMULT, RCUT, OLMAX	013200
	REAL KSUBC, KSUBQ	013210
	REAL K	013220
	INTEGER PLSTRN	013230
	DATA PI, ROOT2 /3.1415926, 2.828428/	013240
	IF(K.LE.0.) GO TO 999	013250
	RY = ((K/SIGMAY)**2.)/(2.*PI)	013260
	IF(PLSTRN.NE.0) RY = RY/ROOT2	013270
	RETURN	013280
	999 RY= 0.0	013290
	RETURN	013300
	END	013310
	SUBROUTINE DNDA(A, CYC, DDNINV)	013320
C		013330
C	THIS ROUTINE CALCULATES THE NUMBER OF CYCLES IN A LAYER OVER	013340
C	WHICH RETARDATION IS APPLIED	013350
C		013360
	COMMON/RDATA/ MODEL, RETARD, PLSTRN, OVL D, SIGMAX, SIGMIN, ASUBP, SMALLM	013370
	INTEGER RETARD, PLSTRN	013380
	GO TO (10, 20), MODEL	013390
	10 CALL WHELER(CYC, A, DADN)	013400
	GO TO 30	013410
	20 CALL WLNBRG(CYC, A, DADN)	013420
	30 DDNINV = 1.0/DADN	013430
	RETURN	013440
	END	013450
	SUBROUTINE WLNBRG(CYC, A, DADN)	013460
C		013470
C	THIS ROUTINE BRINGS THE EFFECTIVE STRESSES GENERATED BY THE	013480
C	WILLENBORG MODEL INTO THE UNRETARDED GROWTH RATE EQUATIONS.	013490
C		013500
	COMMON/RDATA/ MODEL, RETARD, PLSTRN, OVL D, SIGMAX, SIGMIN, ASUBP, SMALLM	013510
	INTEGER RETARD, PLSTRN	013520
	COMMON/MDATA/ MATID(18), C, SMALLN, CARRAY(100), SNARAY(100), KSUBC,	013530

/	KSUBQ, SIGMAY, DELKTH, RMULT, RCUT, OLMAX	013540
	REAL KSUBC, KSUBQ	013550
	CALL SIGEFF(A, ASUBP, SIGMAY)	013560
	CALL RATE(CYC, A, DADN)	013570
	RETURN	013580
	END	013590
	SUBROUTINE SIGEFF(A, ASUBP, SIGMAY)	013600
C		013610
C	THIS ROUTINE COMPUTES THE EFFECTIVE STRESSES FOR USE IN THE	013620
C	WILLENBORG MODEL. THE EFFECTIVE STRESSES ARE STORED IN LOCATIONS	013630
C	'SIGMAX' AND 'SIGMIN' IN COMMON BLOCK /RDATA/.	013640
C		013650
C		013660
	COMMON/DATA/IDUM1, NASA, IDUM2(5), DUM3(3)	013670
	COMMON/RDATA/ MODEL, RETARD, PLSTRN, OVLD, SIGMAX, SIGMIN, DUMMY, SMALLM	013680
	INTEGER RETARD, PLSTRN	013690
	COMMON/LDATA/SMAX(20, 10), SMIN(20, 10), CYCLES(20, 10), NLYRS(10),	013700
/	NBLKS, IBLKS(50), ISEGS(50), NSEGS	013710
	COMMON/STEPS/ISEG, J1, J2, J3, J4, J5, ISTOP, NORTRD	013720
	COMMON/MDATA/MATID(18), C, SMALLN, CARRAY(100), SNARAY(100), KSUBC,	013730
1	KSUBQ, DUMMY, DELKTH, RMULT, RCUT, OLMAX	013740
	REAL KSUBC, KSUBQ, KMAX	013750
		013760
C	PUT APPLIED STRESSES IN SIGMAX AND SIGMIN	013770
C		013780
C		013790
	SIGMAX = SMAX(J4, ISEG)	013800
	SIGMIN = SMIN(J4, ISEG)	013810
	IF(MODEL.EQ.2) GO TO 100	013820
	RETURN	013830
100	CALL BETAS(SIGMAX, A, BETAT, QMAX)	013840
	IF(A.GT.ASUBP) GO TO 200	013850
	SIGREF = (SIGMAX*SQRT(2.0*(ASUBP-A)/A))/BETAT	013860
	IF(NASA.NE.0) SIGREF=SIGREF*SQRT(3.1415926)	013870
	IF(PLSTRN.NE.0) SIGREF = SIGREF * SQRT(2.828428)	013880
	SIGRED = SIGREF - SIGMAX	013890
	CALL DELTA(A, DELTAK, KMAX, R)	013900
	THRSLD = DELKTH*(1.-RMULT*R)	013910
	PHI = (1.-THRSLD/KMAX)/(OLMAX-1.)	013920
	IF(OLMAX.EQ.0.) PHI = 1.	013930
	SIGRED = PHI * SIGRED	013940
	IF(SIGRED.LE.0.0) GO TO 200	013950
	SIGMAX = SIGMAX - SIGRED	013960
	IF(SIGMAX.LT.0.0) SIGMAX = 0.0	013970
	SIGMIN = SIGMIN - SIGRED	013980
	IF(SIGMIN.LT.0.0) SIGMIN = 0.0	013990
	RETURN	014000
200	RETARD = 0	014010
	RETURN	014020
	END	014030
	SUBROUTINE WHEELER(CYC, A, DADN)	014040
C		014050
C	THIS ROUTINE APPLIES THE WHEELER CORRECTION TO THE UNRETARDED	014050

C	GROWTH RATE	014060
C		014070
	COMMON/RDATA/ MODEL, RETARD, PLSTRN, OVLD, SIGMAX, SIGMIN, ASUBP, SMALLM	014080
	INTEGER RETARD, PLSTRN	014090
	CSUBP = 1.0	014100
C		014110
C	DETERMINE EXTENT OF CURRENT YIELD ZONE	014120
C		014130
	CALL K(SIGMAX, A, KMAX)	014140
	RSUBY = RY(KMAX, PLSTRN)	014150
	IF(A + RSUBY .GE. ASUBP) GO TO 20	014160
C		014170
C	CALCULATE WHEELER'S RETARDATION PARAMETER	014180
C		014190
	CSUBP = (RSUBY/(ASUBP-A))* SMALLM	014200
20	CALL RATE(CYC, A, DADN)	014210
	DADN = CSUBP * DADN	014220
	RETURN	014230
	END	014240
	SUBROUTINE RK1DES(CYC, A, DCYC, F)	014250
C		014260
	EXTERNAL F	014270
	COMMON/STEPS/ ISEG, J1, J2, J3, J4, J5, ISTOP, NORTD	014280
	IF(DCYC .GE. 1.) GO TO 300	
	CYCF=CYC+DCYC	014300
	A0=A	014310
50	H=0.005*A0	014320
	A1=A0+H	014330
	AGROW=A0+2.0*H	014340
	CALL F(CYC, A1, DADN)	014350
	IF(DADN.LE.0.) GO TO 200	014360
	IF(ISTOP.NE.0) GO TO 250	014370
	DCYCR=2.*H/DADN	014380
	IF(DCYCR.GT.DCYC) GO TO 100	014390
	CYC=CYC+DCYCR	014400
	DCYC=DCYC-DCYCR	014410
	A0=AGROW	014420
	GO TO 50	014430
100	DA=(CYCF-CYC)*DADN	014440
	A0=A0+DA	014450
200	CYC=CYCF	014460
	A=A0	014470
250	RETURN	014480
300	CALL RUNKUT(CYC, A, DCYC, F)	014490
	RETURN	014500
	END	014510
	FUNCTION TBLKUP(X, Y, N, NMAX, ARG)	014520
C		014530
C		014540
	DIMENSION X(NMAX), Y(NMAX)	014550
	DO 10 I=1, N	014560
	IF(X(I)-ARG) 10, 20, 20	014570

```

10 CONTINUE                                014580
   I=N                                      014590
20 IF (I-1)30,30,40                        014600
30 I=2                                       014610
40 SLOPE=(Y(I)-Y(I-1))/(X(I)-X(I-1))      014620
   TBLKUP=SLOPE*(ARG-X(I-1))+Y(I-1)       014630
   RETURN                                   014640
   END                                      014650
   SUBROUTINE CLOSUR(CYC,A1,DN)            014660
C                                          014670
C          EQUIVALENCE BETWEEN CRACKS 2 AND CLOSUR 014680
C          CRACKS 2          CLOSUR          014690
C          ASUBP             AP              014700
C          SMAX              S              014710
C          CYCLES            CYCLS         014720
C          ISEG              I              014730
C          J4                K              014740
C          SMALLN            AN      (NOT USED AS SMALLN ANYWAY) 014750
C          KSUBQ             AKC            014760
C          DELKTH            KTH           014770
C          A                 A1            014780
C          AMAX              AF            014790
C                                          014800
C                                          014810
COMMON/DATA/ EQN,NASA,J1PR,J2PR,J3PR,J4PR,J5PR,AZERO,AF ,NZERO 014820
INTEGER EQN                                014830
REAL NZERO                                 014840
COMMON/RDATA/ MODEL,RETARD,PLSTRN,DVLD,SIGMAX,SIGMIN,AP,SMALLM 014850
INTEGER RETARD,PLSTRN                    014860
COMMON/MDATA/ MATID(18),C,AN,CARRAY(100),SNARAY(100),KSUBC,    014870
/          AKC,SIGMAY, KTH,RMULT,RCUT,OLMAX                    014880
REAL KSUBC                                014890
COMMON/LDATA/ S( 20,10),SMIN( 20,10),CYCLS( 20,10),NLYRS(10), 014900
/          NBLKS,IBLKS( 50 ),ISEGS( 50 ),NSEGS                014910
COMMON/STEPS/ K,J1,J2,J3,I,J5,ISTOP,NORTRD                    014920
COMMON/CORFAC/ ISURF,RATIO,PHI,THICK,IBETA(10),BETA(10),NPTS, 014930
/          AOVERB(100),BTABLE(100),NPTS2,AOVRB2(100),        014940
/          BTABL2(100),ASTART(10),ASTOP(10)                   014950
COMMON/PARIS/C1,SN1,DKCOM,C2,SN2          014960
COMMON /DIRECT/ NDADN                      014970
COMMON/OUTPOT/XK,XKA,XKEFFN,IFLT,DADNPR   014980
COMMON/CLOS/CF,CCOEF,CFEXP,B,BOL,NSAT     014990
COMMON/CLOSIC/SC,SPEAK,PRVMX,APEAK,SC1,SC2,SC3,PRVMN        015000
REAL ISUM,KTHSG,KCOEF,KEXP,NOL,NSAT,NPR,NPREV,KTH           015010
DIMENSION Q(6),QQ(2)                                       015020
DATA PI/3.14159265/                                         015030
C                                          015040
C                                          015050
C                                          015060
C          CLOSURE FUNCTION                                015070
CLOSE(G1,G2) = G1*(CCOEF + (CF - CCOEF)*(1. + G2)**CFEXP) 015080

```

C		015090
C	FUNCTION FOR SC LT OR EQ SC INITIAL	015100
	DOWN(Z1,Z2,Z3) = Z1 - (Z1-SC3)*(Z2/Z3)**B	015110
C		015120
C	FUNCTIONS FOR SC GT SC INITIAL	015130
	SCONE(SC3) = SC3*BOL	015140
C		015150
C	FUNCTION FOR INCREASING CLOSURE STRESS	015160
	NPREV(SC,SC3,SC11) = 1.+(NSAT-1.)*(SC-SC11)/(SC3-SC11)	015170
C		015180
C		015190
C		015200
C	INITIALIZE PARAMETERS	015210
	IGROW = 0	015220
	MODE = 0	015230
	ITEM = 1	015240
	IGROW = 1	015250
	CYSUM = CYCLS(I,K)	015260
	NOL = 0.	015270
	ASTRT = A1	015280
	KLU = 1	015290
	R = 0.	015300
	IF (S(I,K) .NE. 0.) R = SMIN(I,K)/S(I,K)	015310
	SMNGR = SMIN(I,K)	015320
	IF (SPEAK .NE. 0.) GO TO 30	015330
	SINITL = S(I,K)	015340
	IF (SINITL .LE. 0.) SINITL = 0.05*SIGMAY	015350
	R = SMIN(I,K)/SINITL	015360
	CALL BETAS(S(I,K),A1,ALP,DE)	015370
	XK = SINITL*SQRT(PI*A1)*ALP	015380
	G1 = SINITL	015390
	G2 = R	015400
	IF (G2 .LT. -1.) G2 = -1.	015410
	SC = CLOSE(G1,G2)	015420
	SC1 = SC	015430
	SC2 = SC	015440
	SC3 = SC	015450
	SPEAK = SINITL	015460
	PRVMX = SINITL	015470
	PRVMN = SMIN(I,K)	015480
	APEAK = A1	015490
	AP = A1 + RY(XK,PLSTRN)	015500
	OMGA2 = AP	015510
	30 CONTINUE	015520
C		015530
C		015540
C	START ANALYSIS	015550
	100 ISUM = 0.	015560
C		015570
C		015580
	G1 = S(I,K)	015590
	G2 = R	015600

	IF (G2 + 1.) 104,105,105	015610
104	G2 = -1.	015620
105	SC3 = CLOSE(G1,G2)	015630
	IF(SMIN(I,K) - PRVMN) 5003,60,60	015640
C	MINIMUM STRESS ADJUSTMENT	015650
5003	CONTINUE	015660
	PRVMN = SMIN(I,K)	015670
	G1 = SPEAK	015680
	G2 = SMIN(I,K)/SPEAK	015690
	IF (G2 + 1.) 5005,5006,5006	015700
5005	G2 = -1.	015710
5006	SC1 = CLOSE(G1,G2)	015720
	G1 = PRVMX	015730
	G2 = SMIN(I,K)/PRVMX	015740
	IF (G2 + 1.) 57,58,58	015750
57	G2 = -1.	015760
58	SC3 = CLOSE(G1,G2)	015770
	G3 = ASTRT - APEAK	015780
	G4 = AP - APEAK	015790
	IF(G3/G4 .LT. 0.) G3=0.	015800
	SC2T = DOWN(SC1,G3,G4)	015810
	IF(SC2T - SC2) 59,60,60	015820
59	SC2 = SC2T	015830
60	SC = SC2	015840
	IF(S(I,K)-SC2) 450,450,5009	015850
5009	SMNGR = SC2	015860
	IF (SMIN(I,K)-SC2) 5010,5011,5011	015870
5010	SMNGR = SC2	015880
5011	CALL BETAS(S(I,K),A1,ALP,QE)	015890
	XKEFF=(S(I,K)-SMNGR)*SQRT(PI*A1)*ALP	015900
	CKTH = KTH*(1.-RMULT*R)	015910
	IF (R .LT. 0.) CKTH = KTH	015920
	IF(XKEFF*(1.-R)/(1.-CF) .LE. CKTH) GO TO 450	015930
5012	G1 = S(I,K)	015940
	G2 = R	015950
	IF (G2 + 1.) 93,94,94	015960
93	G2 = -1.	015970
94	SC3 = CLOSE(G1,G2)	015980
	IF (S(I,K) - SC3) 95,96,96	015990
95	SC3 = S(I,K)	016000
96	CONTINUE	016010
	IF(S(I,K) - SPEAK) 90,5013,5013	016020
5013	KLU = 3	016030
C		016040
C	INITIALIZATION FOR INTEGRATION ROUTINE	016050
C		016060
C	MODE = 1 IF CYCLS(I,K) .LT. 20 AND SC3 .LE. SC	016070
C	MODE = 2 IF CYCLS(I,K) .LT. 20 AND SC3 .GT. SC	016080
C	MODE = 3 IF CYCLS(I,K) .GE. 20, SC3.GT.SC AND N.LT.NSAT	016090
C	MODE = 4 IF CYCLS(I,K) .GE. 20 AND SC3 .LT. SC	016100
C	MODE = 5 IF CYCLS(I,K) .GF. 20 AND SC3 = SC	016110
C	INTEGRATION PERFORMED FOR MODE = 4 AND 5	016120

90	MODE = 5	016130
	IF (CYCLS(I,K) - 20.) 201,203,203	016140
201	MODE = 1	016150
	IF (SC - SC3) 202,205,205	016160
202	MODE = 2	016170
	GO TO 205	016180
203	IF (SC .EQ. SC3) GO TO 205	016190
	MODE = 3	016200
	IF (SC3 - SC) 204,205,205	016210
204	MODE = 4	016220
205	CONTINUE	016230
C		016240
C		016250
	DCYC = CYCLS(I,K)/30000.	016260
	IF (DCYC .LT. 1.0) DCYC = 1.0	016270
	NNCYC = CYCLS(I,K)/DCYC	016280
C		016290
C	START CYCLE - BY - CYCLE ANALYSIS	016300
C		016310
	DO 310 J = 1,NNCYC	016320
	IF (MODE - 3) 210,210,6000	016330
210	IF (SC3 - SC) 92,92,111	016340
92	GO TO (101,160,101,101),KLU	016350
101	IF (OMGA1) 5014,5015,5015	016360
5014	OMGA1 = 0.	016370
5015	IF (OMGA1/OMGA2 - 1.) 5017,5017,5016	016380
5016	OMGA1 = OMGA2	016390
5017	IF (OMGA1/OMGA2 .LT. 0.) OMGA1 = 0.	016400
	SC = DOWN(SC2,OMGA1,OMGA2)	016410
111	IF(SMIN(I,K) - SC) 5023,160,160	016420
5023	SMNGR = SC	016430
160	CONTINUE	016440
	GO TO 4050	016450
4051	CONTINUE	016460
	ISUM = ISUM + DCYC	016470
	CYC = CYC + DCYC	016480
	CYSUM = CYSUM - DCYC	016490
	DN = CYSUM	016500
	GO TO (138,501,501,501),ITEM	016510
138	CONTINUE	016520
	IF (MODE - 2) 143,144,144	016530
143	OMGA1 = A1 - ASTRT	016540
	IF (A1 - AP) 300,141,141	016550
141	KLU = 2	016560
	SC = SC3	016570
	AP = A1	016580
	GO TO 300	016590
144	SC11 = SCONE(SC3)	016600
	NPR = NPREV(SC,SC3,SC11)	016610
	IF (NPR) 145,146,146	016620
145	NPR = 0.	016630
146	NOL = NPR + DCYC	016640

	SC = SC11 + (SC3-SC11)*(NOL-1.)/(NSAT-1.)	016650
	IF (SC3 - SC) 147,147,300	016660
147	SC = SC3	016670
	IF (MODE - 2) 300,300,148	016680
148	MODE = 5	016690
300	CONTINUE	016700
310	CONTINUE	016710
311	CONTINUE	016720
	PRVMX = S(I,K)	016730
	SC2 = SC	016740
	GO TO (501,400,400,400),KLU	016750
400	CALL BETAS(S(I,K),A1,ALP,OE)	016760
	XK = S(I,K)*SQRT(PI*A1)*ALP	016770
	AP = A1 + RY(XK,PLSTRN)	016780
	APEAK = A1	016790
	SPEAK = S(I,K)	016800
	PRVMN = SMIN(I,K)	016810
	IF (SC3 - SC) 420,420,430	016820
420	SC1 = SC3	016830
	GO TO 501	016840
430	SC1 = SC	016850
	GO TO 501	016860
450	ISUM = ISUM + CYCLS(I,K)	016870
	CYC = CYC + CYCLS(I,K)	016880
	DN = 0.	016890
501	CONTINUE	016900
C		016910
	GO TO(500,600,620,503),ITEM	016920
503	ISTOP = 2	016930
	A1 = ATRANS/(2.*RATIO)	016940
	WRITE(6,1) A1,CYC	016950
	1 FORMAT(1H0, 70(1H*)/ 5X,55HTRANSITION TO A THRU CRACK OF EFFECTIVE	016960
	1 LENGTH, AEF = ,F9.5,4H AT ,F12.2,7H CYCLES /,1X, 70(1H*))	016970
	GO TO 50	016980
C		016990
C		017000
C	END OF CYCLE BY CYCLE ROUTINE	017010
C		017020
500	CONTINUE	017030
	GO TO 50	017040
C	A1 EXCEEDED AF (AMAX)	017050
600	ISTOP = 1	017060
	GO TO 50	017070
620	ISTOP = 1	017080
	WRITE(6,7)	017090
	7 FORMAT(1H0, 70(1H*)/ 5X,46HKMAX APPLIED EXCEEDS KSUBQ. PROBLEM TER	017100
	1MINATED/1X, 70(1H*)/1H0, 1X,26HLAST CALCULATED VALUES ARE///)	017110
	DELTAK = XK*(1.-R)	017120
	WRITE(6,8) J1,J2,I,IFLT,K,CYC,A1,XK,XKEFF,DELTAK,DADN	017130
8	FORMAT(5X,18HBLOCK IN SPECTRUM ,I4/	017140
/	5X,18HSEGMENT NUMBER ,I4/	017150
/	5X,18HMISSION NUMBER ,I4/	017160

/	5X,18HFLIGHT NUMBER	,I4/	017170
/	5X,18HLAYER IN MISSION	,I4/	017180
5	5X,18HACCUMULATED CYCLES	,E16.8/	017190
6	5X,18HCRACK LENGTH	,E16.8/	017200
7	5X,18HKMAX APPLIED	,E16.8/	017210
8	5X,18HKMAX EFFECTIVE	,E16.8/	017220
9	5X,18HDELTA K	,E16.8/	017230
/	5X,18HDA/DN	,E16.8)	017240
C			017250
C			017260
	50 CONTINUE		017270
	XKA = XK		017280
	RETURN		017290
C			017300
C			017310
C	GROWTH CALCULATIONS		017320
	4050 CONTINUE		017330
C	CHECK FOR XK (KMAXA) .GE. AKC (KSUBQ)		017340
	CALL BETAS(S(I,K),A1,ALP,GE)		017350
	XK = S(I,K) *SQRT(PI*A1)*ALP		017360
	IF(XK - AKC) 4062,4060,4060		017370
4060	ITEM = 3		017380
	DADN = 0.		017390
	GO TO (502,502,502,4062,4062),MODE		017400
4062	XKEFF = (S(I,K) - SMNGR)*SQRT(PI*A1)*ALP		017410
	XKEFFN = XKEFF/(1.-CF)		017420
	IF (EQN .EQ. 1) GO TO 9000		017430
	IF (EQN .EQ. 4) GO TO 9010		017440
	IF (EQN - 2) 8000,8000,8010		017450
	8000 CONTINUE		017460
C	BI-LINEAR PARIS EQUATION		017470
	C = C1		017480
	AN = SN1		017490
	IF (XKEFFN .GE. DKCOM) C = C2		017500
	IF (XKEFFN .GE. DKCOM) AN = SN2		017510
	DADN = C*XKEFFN**AN		017520
	GO TO 8020		017530
C			017540
	8010 CONTINUE		017550
C	TABULAR RATE VALUES		017560
	DADN = TBLKUP(CARRAY,SNARAY,NDADN,100,XKEFFN)		017570
	DADN = 10.**DADN		017580
	8020 CONTINUE		017590
	IF(RETARD.NE.0)DADNPR = DADN		017600
	A1 = A1 + DADN*DCYC		017610
	IF (A1 - AF)4064,4063,4063		017620
4063	ITEM = 2		017630
	GO TO 502		017640
4064	IF (ISURF .EQ. 0) GO TO 502		017650
	ATrans = THICK - (((XK/SIGMA)**2.)/(2.*PI))		017660
	IF (A1 .LT. ATRANS) GO TO 502		017670
	ITEM = 4		017680

502	GO TO (4051,6060),IGROW	017690
C		017700
C		017710
C	END OF CRACK GROWTH CALCULATIONS	017720
C		017730
C		017740
C		017750
C	INTEGRATION ROUTINE	017760
6000	CONTINUE	017770
	IF (MODE - 4) 6010,6010,6020	017780
6010	Q(1) = A1	017790
	Q(2) = AP	017800
	Z2 = A1 - ASTRT	017810
	Z3 = AP - ASTRT	017820
	IF (Z2/Z3 .LT. 0.) Z2 =0.	017830
	QQ(1) = DOWN(SC2,Z2,Z3)	017840
	QQ(2) = SC3	017850
	IF (ISURF .EQ. 0) GO TO 6030	017860
	IF (Q(2) .LT. THICK) GO TO 6030	017870
	Q(2) = THICK	017880
	Z2 = THICK - ASTRT	017890
	IF (Z2/Z3 .LT. 0.) Z2 =0.	017900
	QQ(2) = DOWN(SC2,Z2,Z3)	017910
	ISTOP = 2	017920
	GO TO 6030	017930
6020	Q(1) = A1	017940
	Q(2) = 1.10*A1	017950
	QQ(1) = SC3	017960
	QQ(2) = SC3	017970
	IF (ISURF .EQ. 0) GO TO 6030	017980
	IF (Q(2) .LT. THICK) GO TO 6030	017990
	Q(2) = THICK	018000
	ISTOP = 2	018010
6030	CONTINUE	018020
	SC = QQ(1)	018030
	DO 6100 KK = 1,2	018040
	A1 = Q(KK)	018050
	SMNGR = SMIN(I,K)	018060
	IF (SMIN(I,K) - QQ(KK)) 6045,6050,6050	018070
6045	SMNGR = QQ(KK)	018080
6050	IGROW = 2	018090
	GO TO 4050	018100
6060	GO TO (6070,6065,6065,6065), ITEM	018110
6065	GO TO (501,6068),KK	018120
6068	ITEM = 1	018130
	ISTOP = 0	018140
6070	KKK = KK + 2	018150
	KKKK = KK + 4	018160
	Q(KKK) = XKEFF	018170
	Q(KKKK) = DADN	018180
6100	CONTINUE	018190
	Q2 = (Q(3)-Q(4))/(Q(1)-Q(2))	018200

	Q1 = Q(3) - Q2*Q(1)	018210
	Q4 = (ALOG(Q(5)/Q(6)))/(ALOG(Q(3)/Q(4)))	018220
	Q3 = Q(5)/(Q(3)**Q4)	018230
	Q5 = 1. - Q4	018240
	DELTN = (Q(4)**Q5 - Q(3)**Q5)/(Q2*Q3*Q5)	018250
	IF (DELTN - CYSUM) 6200,6150,6250	018260
6150	CONTINUE	018270
6200	A1 = Q(2)	018280
	IF (AP - A1) 6210,6210,6220	018290
6210	AP = A1	018300
	KLU = 2	018310
	MODE = 5	018320
6220	ISUM = ISUM + DELTN	018330
	CYC = CYC + DELTN	018340
	CYSUM = CYSUM - DELTN	018350
	DN = CYSUM	018360
	IF (CYSUM - .01) 6260,6240,6240	018370
6240	IF (MODE - 4) 6010,6010,6020	018380
6250	Q(4) = (Q(3)**Q5+CYSUM*Q2*Q3*Q5)**(1./Q5)	018390
	Q(2) = (Q(4) -Q1)/Q2	018400
	DELTN = CYSUM	018410
	ISTOP = 0	018420
	GO TO 6150	018430
6260	SC = SC3	018440
6270	Z2 = A1 - ASTRT	018450
	Z3 = AP - ASTRT	018460
	IF (Z3 .LE. 0.) Z3 = Z2	018470
	IF (Z2/Z3 .LT. 0.) Z2 =0.	018480
	SC = DOWN(SC2,Z2,Z3)	018490
6280	GO TO 311	018500
C		018510
C		018520
C	END OF INTEGRATION ROUTINE	018530
C		018540
C		018550
C	DIAGNOSTICS FOR IMPROPER EQN	018560
	9000 WRITE(6,9005)	018570
	9005 FORMAT(1H0, 1X,44HCLOSURE MODEL CAN NOT ACCEPT FORMAN EQUATION /	018580
	1 40X,20HEXECUTION SUPPRESSED)	018590
	GO TO 9020	018600
	9010 WRITE(6,9015)	018610
	9015 FORMAT(1H0, 1X,44HCLOSURE MODEL CAN NOT ACCEPT WALKER EQUATION /	018620
	1 40X,20HEXECUTION SUPPRESSED)	018630
	9020 ISTOP = 1	018640
	XKA = XK	018650
	RETURN	018660
C		018670
C		018680
	END	018690
	SUBROUTINE RUNKUT(X,Y,DX,F)	018700
C		018710
	EXTERNAL F	018720

COMMON/STEPS/ISEG,J1,J2,J3,J4,J5,ISTOP,NORETRD	018730
10 X0=X	018740
X=X+DX	018750
H=DX	018760
20 IF (ABS(H).GT.ABS(X-X0)) H=X-X0	018770
30 Y0=Y	018780
HT=H	018790
XT=X0	018800
RMAXP=1.E37	018810
40 YT=Y0	018820
ASSIGN 50 TO K	018830
GO TO 100	018840
50 CONTINUE	018850
60 YP=Y	018860
70 HT=0.5*H	018870
ASSIGN 80 TO K	018880
GO TO 100	018890
80 CONTINUE	018900
90 YT=Y	018910
XT=X0+HT	018920
ASSIGN 150 TO K	018930
100 CALL F(XT,YT,P0)	018940
IF (ISTOP.EQ.0) GO TO 110	018950
X = XT	018960
Y = YT	018970
RETURN	018980
110 Y=YT+0.5*HT*P0	018990
CALL F(XT+0.5*HT,Y,P1)	019000
IF (ISTOP.EQ.0) GO TO 120	019010
X = XT+0.5*HT	019020
RETURN	019030
120 Y=YT+0.5*HT*P1	019040
CALL F(XT+0.5*HT,Y,P2)	019050
IF (ISTOP.EQ.0) GO TO 130	019060
X = XT+0.5*HT	019070
RETURN	019080
130 Y=YT+HT*P2	019090
CALL F(XT+HT,Y,P3)	019100
IF (ISTOP.EQ.0) GO TO 140	019110
X = XT+HT	019120
RETURN	019130
140 Y=YT+HT*(P0+2.*(P1+P2)+P3)/6.	019140
GO TO K, (50,80,150)	019150
150 RMAX=0.	019160
160 RMAX=AMAX1(RMAX,0.07*ABS((Y-YP)/Y))	019170
IF ((RMAX.GT.1.E-07).AND.(RMAX.LT.RMAXP)) GO TO 170	019180
X0=X0+H	019190
IF (X0.EQ.X) RETURN	019200
IF ((RMAX.LT.1.E-08). OR.(RMAX.GT.RMAXP)) H=H+H	019210
GO TO 20	019220
170 H=HT	019230
XT=X0	019240

180 YP=YT
190 YT=YO
RMAXP=RMAX
GO TO 70
END

019250
019260
019270
019280
019290

Sample Input

TITLE
1
LOW-MED-HIGH SPECIMEN 84-502, EE3, WHEELER M=6.0, 1 CYCLE=20 SEC
EQUATION
SIGMOID
MATERIAL
INCD 718 MSE FIT DA/DT TIMES 20
21.0 272.73 -5.6942677-1.1 1.8 -1.8
300.0 120.0
THRESHOLD
21.0 1.0
LIMITS
.4087 1.1330 0. 0.0
ANALYSIS
RETARD 1.0 0.0 6.0 1.0
BETA 9.0 1.5736 .394
END
LOADS
1 0 PROOF TEST SPECTRUM
MAX-MIN SUSTAINED LOAD EQUIVALENT OF 1 CYCLE = 20 SEC R=.4
2.740 1.096 1.
END
MAX-MIN OVERLOAD OF 20 PERCENT EQUIVALENT CYCLE
3.288 0.0 1.
END
END LOADS
SPECTRUM
7 0
72 1
1 2
1573 1
1 2
590 1
1 2
1000 1
RESTART
1
PRINT
1 0 0 1
END DATA

Vita

Robert L. Hastie Jr. was born on 18 November 1957 in Harrison, Pennsylvania. He graduated from Kiski Area high school in Vandergrift, Pennsylvania in 1975 and attended Grove City College. In, May 1979 he graduated Cum Laude and received a Bachelor of Science degree in Mechanical Engineering. Upon graduation, he received a commission in the USAF through the ROTC program. He was called to active duty in August 1979 and served as a Structural Strength Engineer in the Deputy for Engineering at the Aeronautical Systems Division (ASD) at Wright-Patterson AFB, Ohio. In November 1980 he was transferred to the Deputy for Propulsion within the ASD and was a Propulsion Durability Engineer for the F107, F100, TF-34, and F100 engines. In June 1984, Captain Hastie entered the School of Engineering, Air Force Institute of Technology, to earn a Master of Science degree in Astronautical Engineering.

Permanent address: RD 1 Box 295

Vandergrift, Pa 15690

UNCLASSIFIED

SECURITY CLASSIFICATION OF THIS PAGE

AD-A11408

REPORT DOCUMENTATION PAGE

1a. REPORT SECURITY CLASSIFICATION UNCLASSIFIED			1b. RESTRICTIVE MARKINGS			
2a. SECURITY CLASSIFICATION AUTHORITY			3. DISTRIBUTION/AVAILABILITY OF REPORT APPROVED FOR PUBLIC RELEASE: DISTRIBUTION UNLIMITED			
2b. DECLASSIFICATION/DOWNGRADING SCHEDULE						
4. PERFORMING ORGANIZATION REPORT NUMBER(S) AFIT/GA/AA/85D-6			5. MONITORING ORGANIZATION REPORT NUMBER(S)			
6a. NAME OF PERFORMING ORGANIZATION School of Engineering		6b. OFFICE SYMBOL (If applicable) AFIT/ENY	7a. NAME OF MONITORING ORGANIZATION			
6c. ADDRESS (City, State and ZIP Code) Air Force Institute of Technology			7b. ADDRESS (City, State and ZIP Code)			
8a. NAME OF FUNDING/SPONSORING ORGANIZATION		8b. OFFICE SYMBOL (If applicable)	9. PROCUREMENT INSTRUMENT IDENTIFICATION NUMBER			
8c. ADDRESS (City, State and ZIP Code)			10. SOURCE OF FUNDING NOS.			
			PROGRAM ELEMENT NO.	PROJECT NO.	TASK NO.	WORK UNIT NO.
11. TITLE (Include Security Classification) See Box 19			61102F	2302	PI	01
12. PERSONAL AUTHOR(S) Robert L. Hastie Jr., B.S., Captain, USAF						
13a. TYPE OF REPORT MS THESIS		13b. TIME COVERED FROM _____ TO _____		14. DATE OF REPORT (Yr., Mo., Day) 1985 December		15. PAGE COUNT 139
16. SUPPLEMENTARY NOTATION						
17. COSATI CODES			18. SUBJECT TERMS (Continue on reverse if necessary and identify by block number)			
FIELD	GROUP	SUB. GR.	Sustained-load, Crack Growth Rate, Crack Growth Retardation Elevated Temperature, Nickel-base Superalloy, CRACKS, Crack Growth Prediction Model, Wheeler, Willenborg			
20	11					
19. ABSTRACT (Continue on reverse if necessary and identify by block number)						
TITLE: PREDICTING THE EFFECTS OF OVERLOADS ON SUSTAINED-LOAD CRACK GROWTH IN A HIGH-TEMPERATURE SUPERALLOY						
THESIS CHAIRMAN: George K. Haritos, Major, USAF						
ABSTRACT: See Reverse						
Approved for public release: LAW AFR 190-17 <i>John E. W. CLAVER</i> 16 JAN 86 Branch for Research and Professional Development Air Force Institute of Technology (AFIT) Wright-Patterson AFB OH 45433						
20. DISTRIBUTION/AVAILABILITY OF ABSTRACT UNCLASSIFIED/UNLIMITED <input checked="" type="checkbox"/> SAME AS RPT. <input type="checkbox"/> DTIC USERS <input type="checkbox"/>			21. ABSTRACT SECURITY CLASSIFICATION UNCLASSIFIED			
22a. NAME OF RESPONSIBLE INDIVIDUAL George K. Haritos, Associate Professor			22b. TELEPHONE NUMBER (Include Area Code) (513)-255-2998		22c. OFFICE SYMBOL AFIT/ENY	

DD FORM 1473, 83 APR

EDITION OF 1 JAN 73 IS OBSOLETE.

UNCLASSIFIED
SECURITY CLASSIFICATION OF THIS PAGE

thesis

Abstract

This study investigates methods of modeling the effects of overloads on high-temperature sustained-load crack growth. In addition to a model previously developed for this specific problem, a computer program developed for low-temperature, high-frequency cyclic load applications was evaluated. Sustained-load hold times were converted to equivalent fatigue cycles to analyze a load spectrum, consisting of sustained-load with periodic overloads. The CRACKS crack growth program was used with the Wheeler and Willenborg models used to account for crack growth retardation due to overloads.

Predictions were compared with experimental test data generated on specimens of Inconel 718 at 650 C with periodic overloads of either 20 or 50 percent. Crack measurements were made using a electric potential system. The application of the electric potential system to crack growth measurement following overloads was extensively evaluated. It was concluded that the system had to be recalibrated after each overload due to a sudden advancement in crack length. ←

The retardation models were found to require empirical parameters that depend upon the stress intensity level for each overload application. Using relationships developed for these parameters, the CRACKS program using the Wheeler model was found to be capable of predicting the time-to-failure for sustained-loading with periodic overloads within 20 percent of test data. The Willenborg model was found to be inapplicable to this problem because it depends solely on stress ratio which has no physical meaning for sustained-loading. The Wheeler model, on the other hand, could generally be applied to sustained-load crack growth using equivalent fatigue cycles. In conjunction with the CRACKS computer program, this could provide a powerful new method for evaluating crack growth under general engine mission spectra including the effects of overloads.

END

FILMED

3-86

DTIC