

MICROCOPY RESOLUTION TEST CHART
NATIONAL BUREAU OF STANDARDS-1963-A

SHIP STRUCTURE COMMITTEE

THE SHIP STRUCTURE COMMITTEE is constituted to prosecute a research program to improve the hull structures of ships and other marine structures by an extension of knowledge pertaining to design, materials and methods of construction.

RAVN C. T. Lusk, Jr., USCG (Chairman)
Chief, Office of Merchant Marine
Safety
U. S. Coast Guard Headquarters

Mr. T. W. Fross
Associate Administrator for
Shipbuilding, Operations &
Research
Maritime Administration

Mr. P. M. Palermo
Executive Director
Ship Design & Integration
Directorate
Naval Sea Systems Command

Mr. J. B. Gregory
Chief, Technology Assessment
& Research Branch
Minerals Management Service

Mr. W. M. Hanson
Vice President
American Bureau of Shipping

Mr. T. W. Allen
Engineering Officer
Military Sealift Command

CDR D. B. Anderson, U. S. Coast Guard (Secretary)

SHIP STRUCTURE SUBCOMMITTEE

The SHIP STRUCTURE SUBCOMMITTEE acts for the Ship Structure Committee on technical matters by providing technical coordination for the determination of goals and objectives of the program, and by evaluating and interpreting the results in terms of structural design, construction and operation.

U. S. COAST GUARD

CAPT A. E. BERN
CAPT J. R. WALLACE
MR. J. S. SPENCER
MR. R. E. WILLIAMS

NAVAL SEA SYSTEMS COMMAND

MR. J. B. O'BRIEN (CHAIRMAN)
CDR R. BUBECK
MR. J. E. GAGORIK
MR. A. E. ENGLE
MR. S. G. ARNTSON (COTR)
MR. G. WOODS (COTR)

MARITIME ADMINISTRATION

MR. P. SKIBOLD
MR. H. O. HANMER
DR. W. N. MACLEAN
MR. H. W. TOOMA

NATIONAL ACADEMY OF SCIENCES COMMITTEE ON MARINE STRUCTURES

MR. A. DUDLEY HAFF - LIAISON
MR. R. W. RUMER - LIAISON

SOCIETY OF NAVAL ARCHITECTS & MARINE ENGINEERS

MR. W. O. HANMER - LIAISON
MR. F. SELLARS - LIAISON

WELDING RESEARCH COUNCIL

DR. G. W. OYLER - LIAISON

MILITARY SEALIFT COMMAND

MR. D. STRIN
MR. T. W. CHANNAN
MR. A. ATTENMEYER
MR. A. B. STAVOVY

AMERICAN BUREAU OF SHIPPING

DR. D. LIU
MR. I. L. STEIN
MR. B. MADALIN

MINERALS MANAGEMENT SERVICE

MR. R. GIANGERELLI
MR. R. C. E. SMITH

INTERNATIONAL SHIP STRUCTURES CONGRESS

MR. S. G. STIANSEN - LIAISON

AMERICAN IRON & STEEL INSTITUTE

MR. J. J. SCHMIDT - LIAISON

STATE UNIVERSITY OF NY MARITIME COLLEGE

DR. W. R. FORTER - LIAISON

U.S. COAST GUARD ACADEMY

LT J. TUTTLE - LIAISON

U.S. NAVAL ACADEMY

DR. R. BHATTACHARYA - LIAISON

U.S. MERCHANT MARINE ACADEMY

DR. C. B. ERM - LIAISON

Member Agencies:

United States Coast Guard
Naval Sea Systems Command
Maritime Administration
American Bureau of Shipping
Military Sealift Command
Minerals Management Service



**Ship
Structure
Committee**

Address Correspondence to:

Secretary, Ship Structure Committee
U.S. Coast Guard Headquarters, (G-M/TP 13)
Washington, D.C. 20593
(202) 426-2197

An Interagency Advisory Committee
Dedicated to the Improvement of Marine Structures SR-1294

The Ship Structure Committee has for the past ten years been interested in structural loadings and responses for both the grounding and collision scenarios. This volume reports on a Committee interest in assessing whether portable computers could possibly be used during salvage scenarios after a ship grounding so as to be a possible input for the salvage team.

This effort looked at possible analytical techniques, computer capabilities, system limitations and at various grounding scenarios to see if the use of portable computers would be feasible. Although the authors conclude that such is possible, they also correctly point out that "It cannot be overstressed that any salvage computations, no matter how accurate they may be, are still only guidelines to the salvage master and should never be used to override his judgement. However, they can be a valuable asset to him in many situations."

Clyde T. Lutz, Jr.
Rear Admiral, U. S. Coast Guard
Chairman, Ship Structure Committee

DTIC
ELECTE
DEC 05 1985
S D
D

Technical Report Documentation Page

1. Report No. SSC-324		2. Government Accession No. AD-A16221		3. Recipient's Catalog No.	
4. Title and Subtitle ANALYTICAL TECHNIQUES FOR PREDICTING GROUNDED SHIP RESPONSES				5. Report Date SEPTEMBER, 1983	
7. Author(s) J.D. PORRICELLI & J.H. BOYD (SEARLE CONS., LTD.)				6. Performing Organization Code	
9. Performing Organization Name and Address E.C.O., INC. 1036 Cape St. Claire Center Annapolis, Maryland 21401				8. Performing Organization Report No.	
12. Sponsoring Agency Name and Address U.S. DEPARTMENT OF TRANSPORTATION U.S. COAST GUARD OFFICE OF RESEARCH AND DEVELOPMENT WASHINGTON, D.C.				10. Work Unit No. (TNA/S)	
				11. Contract or Grant No. DTGG23-82-R-20058	
				13. Type of Report and Period Covered FINAL	
				14. Sponsoring Agency Code SR-1294	
15. Supplementary Notes This report was performed in cooperation and coordination with the Ship Structure Committee, Project SR-1294.					
16. Abstract This report documents the development of analytical techniques and computational capability for use by salvage response personnel in the case of a grounded ship. It has been concluded that the various analytical techniques can be accommodated within any number of existing portable computers with self-contained sources of power and that other forms of portable or shipboard computational devices are neither necessary nor particularly desirable. Although there are certain limitations to various aspects of the techniques, it is concluded that they will provide salvage response personnel with a much higher level of insight to the salvage situation than has been previously available and that certain of those limitations can be overcome in the near term future. The report also suggests their use prior to arrival on-scene so that salvage assets can be marshalled and deployed at an earlier stage of the salvage operation. It also recommends certain long-term goals in the case of structural analyses when the ship is damaged and in the case of very complex situations which may require shoreside engineering support. Finally, the report stresses that while improved salvage engineering calculation aids will provide better insight to the nature of the problem and strengthen the development of a salvage strategy, they are not a substitute for knowledge and experience in marine salvage.					
17. Key Words MARINE SALVAGE SALVAGE ENGINEERING SHIP GROUNDINGS AND STRANDINGS SALVAGE ANALYTICAL TECHNIQUES SALVAGE COMPUTATIONAL AIDS			18. Distribution Statement Document is available to the U.S. public through the National Technical Information Service, Springfield, VA. 22161		
19. Security Classif. (of this report) UNCLASSIFIED		20. Security Classif. (of this page) UNCLASSIFIED		21. No. of Pages 155	22. Price

Form DOT F 1700.7 (8-72) Reproduction of form and completed page is authorized

METRIC CONVERSION FACTORS

Approximate Conversions to Metric Measures

Symbol	When You Know	Multiply by	To Find	Symbol
LENGTH				
in	inches	2.5	centimeters	cm
ft	feet	30	centimeters	cm
yd	yards	0.9	meters	m
mi	miles	1.6	kilometers	km
AREA				
sq in	square inches	6.5	square centimeters	cm ²
sq ft	square feet	0.09	square meters	m ²
sq yd	square yards	0.8	square meters	m ²
sq mi	square miles	2.6	square kilometers	km ²
ac	acres	0.4	hectares	ha
MASS (weight)				
oz	ounces	28	grams	g
lb	pounds	0.45	kilograms	kg
	short tons (2000 lb)	0.9	tonnes	t
VOLUME				
cup	cup	0.24	liters	l
fl oz	fluid ounces	0.47	liters	l
qt	quarts	0.95	liters	l
gal	gallons	3.8	liters	l
cu ft	cubic feet	0.03	cubic meters	m ³
cu yd	cubic yards	0.76	cubic meters	m ³
TEMPERATURE (exact)				
°F	Fahrenheit temperature	5/9 (after subtracting 32)	Celsius temperature	°C

Approximate Conversions from Metric Measures

Symbol	When You Know	Multiply by	To Find	Symbol
LENGTH				
mm	millimeters	0.04	inches	in
cm	centimeters	0.4	inches	in
m	meters	3.3	feet	ft
km	kilometers	1.1	yards	yd
mi	miles	0.6	miles	mi
AREA				
cm ²	square centimeters	0.16	square inches	sq in
m ²	square meters	1.2	square yards	sq yd
ha	hectares	0.4	square miles	sq mi
km ²	hectares (10,000 m ²)	2.5	acres	ac
MASS (weight)				
g	grams	0.035	ounces	oz
kg	kilograms	2.2	pounds	lb
t	tonnes (1000 kg)	1.1	short tons	st
VOLUME				
ml	milliliters	0.03	fluid ounces	fl oz
l	liters	2.1	pints	pt
l	liters	1.06	quarts	qt
l	liters	0.26	gallons	gal
m ³	cubic meters	36	cubic feet	cu ft
m ³	cubic meters	1.3	cubic yards	cu yd
TEMPERATURE (exact)				
°C	Celsius temperature	9/5 (then add 32)	Fahrenheit temperature	°F

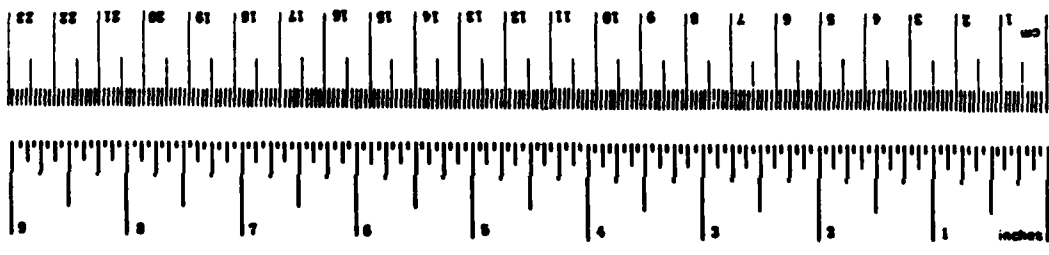

*1 in = 2.54 (exactly). For other exact conversions and more detailed tables, see NBS Misc. Publ. 286, Units of Weight and Measure, Price \$2.25, SD Catalog No. C13.10-286.

DISCLAIMER NOTICE

THIS DOCUMENT IS BEST QUALITY PRACTICABLE. THE COPY FURNISHED TO DTIC CONTAINED A SIGNIFICANT NUMBER OF PAGES WHICH DO NOT REPRODUCE LEGIBLY.

TABLE OF CONTENTS

<u>SECTION</u>		<u>PAGE</u>
I	INTRODUCTION	1
II	GROUNDING SCENARIOS	8
III	PORTABLE COMPUTATIONAL AIDS	17
IV	SHIPBOARD LOADING COMPUTERS	22
V	DATA AVAILABILITY	30
VI	ANALYTICAL TECHNIQUES	35
VII	FUNCTIONAL REQUIREMENTS	68
VIII	CONCLUSIONS AND RECOMMENDATIONS	73

Accession For	
NTIS CRA&I	<input checked="" type="checkbox"/>
DTIC TAB	<input type="checkbox"/>
Unannounced	<input type="checkbox"/>
Justification	
By	
Distribution/	
Availability Codes	
Dist	Avail and/or Special
A-1	23 26

2
QUALITY
CHECKED
3

TABLE OF CONTENTS
(CONT'D)

<u>APPENDIX</u>	<u>TITLE</u>	<u>PAGES</u>
A	BIBLIOGRAPHY	A-1 TO A-4
B	GROUNDING INCIDENT SCENARIOS	B-1 TO B-26
C	PORTABLE COMPUTERS	C-1 TO C-10
D	COMPARISON OF BLOCK COEFFICIENT (Cb) BY SEVEN DIFFERENT METHODS	D-1 TO D-4
E	ALGORITHMS AND ARRAYS FOR APPLICATIONS PROGRAM	E-1 TO E-20

LIST OF FIGURES

<u>NUMBER</u>	<u>TITLE</u>	<u>PAGE</u>
IV-1	BASIC DEDICATED, OFF-LINE, SHIPBOARD LOAD COMPUTER FLOW DIAGRAM	27
VI-1	COMPARISON OF ESTIMATED HYDROSTATIC PROPERTIES VERSUS ACTUAL HYDROSTATIC PROPERTIES	49
VI-2	LIGHT SHIP WEIGHT DISTRIBUTION FOR A BULK CARGO SHIP - ENGINEER ROOM AND AC- COMMODATIONS THREE-QUARTERS AFT FROM FP	60
VI-3	LIGHT SHIP WEIGHT DISTRIBUTION FOR A TANKER WITH AFT ENGINEER ROOM	61
VI-4	LIGHT SHIP WEIGHT DISTRIBUTION FOR A CONTAINER SHIP WITH FORWARD AND AFTER ACCOMMODATIONS	62
VI-5	GEOMETRY OF ESTIMATED BUOYANCY DISTRI- BUTION	65
VI-6	COMPARISON OF ACTUAL BUOYANCY DISTRI- BUTION VERSUS ESTIMATED BUOYANCY DISTRI- BUTION FOR A TANKER WITH $C_b = 0.80$	66
VII-1	DEVELOPMENT OF FUNCTIONAL REQUIREMENTS FOR PORTABLE COMPUTERS	69
D-1	COMPARISON OF LINES/CURVES FOR ESTIMATING C_b BY SEVEN DIFFERENT METHODS	D-4

LIST OF TABLES

<u>NUMBER</u>	<u>TITLE</u>	<u>PAGE</u>
IV-1	RATIOS OF MAXIMUM BENDING MOMENTS AND SHEAR FORCES TO MAXIMUM ALLOWABLE VALUES AND THEIR LOCATIONS FOR A VLCC IN FOUR LOADING CONDITIONS, STILL WATER CASE	23
VI-1	PARTIAL CONTAINER CARGO LINER CHARACTERISTIC COMPARISON	44
VI-2	CONTAINER SHIP CHARACTERISTIC COMPARISON	45
VI-3	PRODUCT TANKER CHARACTERISTIC COMPARISON	46
VI-4	BREAKBULK CARGO SHIP - ENGINE ROOM AND ACCOMMODATIONS THREE-QUARTERS AFT FROM FP	56
VI-5	TANKER WITH AFT ENGINE ROOM	57
VI-6	CONTAINER SHIP WITH FORWARD AND AFTER ACCOMMODATIONS	58
B-1	CRUDE TANKER GROUNDING, GALVESTON, TX	B-2
B-2	TANKER GROUNDING, PORT ARTHUR, TX	B-3
B-3	CONTAINER SHIP GROUNDING, HOUSTON, TX	B-4
B-4	RO/RO SHIP GROUNDING, SAN JUAN, PR	B-5
B-5	BARGE CARRIER GROUNDING, NEW ORLEANS, LA	B-6
B-6	GENERAL CARGO SHIP GROUNDING, MOBILE, AL	B-7
B-7	BULK CARRIER GROUNDING, TAMPA, FL	B-8
B-8	LNG GROUNDING, LAKE CHARLES, LA	B-9
B-9	CONTAINER SHIP GROUNDING, HONOLULU, HI	B-10
B-10	LNG GROUNDING, ALEUTIAN ISLANDS, AK	B-11

LIST OF TABLES
(CONT'D)

<u>NUMBER</u>	<u>TITLE</u>	<u>PAGE</u>
B-11	BULK CARRIER GROUNDING, PORTLAND, OR	B-12
B-12	OBO GROUNDING, LONG BEACH, CA	B-13
B-13	GENERAL CARGO SHIP GROUNDING, SAN FRANCISCO, CA	B-14
B-14	CRUDE TANKER GROUNDING, PUGET SOUND, WA	B-15
B-15	TANKER GROUNDING, SAN DIEGO, CA	B-16
B-16	CRUDE TANKER GROUNDING, PHILADELPHIA, PA	B-17
B-17	TANKER GROUNDING, PORTLAND, ME	B-18
B-18	CRUDE TANKER GROUNDING, PHILADELPHIA, PA	B-19
B-19	CONTAINER SHIP GROUNDING, NEW YORK, NY	B-20
B-20	BARGE CARRIER GROUNDING, CHARLESTON, SC	B-21
B-21	RO/RO SHIP GROUNDING, MOREHEAD CITY, NC	B-22
B-22	OBO GROUNDING, NORFOLK, VA	B-23
B-23	LNG GROUNDING, BOSTON, MA	B-24
B-24	GENERAL CARGO SHIP GROUNDING, BALTIMORE, MD	B-25
B-25	TANKER GROUNDING, WILMINGTON, NC	B-26
C-1	PORTABLE COMPUTER CHARACTERISTICS	C-1
D-1	COMPARISON OF BLOCK COEFFICIENT (Cb) CALCULATED BY SEVEN DIFFERENT METHODS	D-2

LIST OF ABBREVIATIONS

AP = after perpendicular	I_L = longitudinal moment of inertia	MTI_a = actual moment to change trim one inch
A_1 = $LBP/100$	I_T = transverse moment of inertia	MTI_e = estimated moment to change trim one inch
A_2 = LBP/LOA	KB = height of center of buoyancy above baseline	MTI_1 = full load moment to change trim one inch
B = beam	KC = height of center of gravity above baseline	MTI_2 = "new" condition moment to change trim one inch
B/D = beam-to-depth ratio	KM = height of transverse metacenter above baseline	OBO = ore/bulk/oil
BM = transverse metacentric radius	L = length	Osn = station ordinate for light ship weight distribution
BML = longitudinal metacentric radius	Lab = length of afterbody	R = ground reaction
Bpmb = buoyancy of parallel middle body	LBP = length between perpendiculars	RO/RO = roll-on/roll-off
Cb = block coefficient	LCB = longitudinal center of buoyancy	S = transverse effective point of application of R from centerline
C_l = longitudinal inertia coefficient	LCB _a = actual longitudinal center of buoyancy	TPI = tons per inch immersion
C_m = midship coefficient	LCB _e = estimated longitudinal center of buoyancy	TPI _a = actual tons per inch immersion
Cp = prismatic coefficient	LCB ₁ = full load longitudinal center of buoyancy	TPI _e = estimated tons per inch immersion
Csn = station constant for light ship weight distribution	LCB ₂ = "new" condition longitudinal center of buoyancy	TPI ₁ = full load tons per inch immersion
C_T = transverse inertia coefficient	LCF = longitudinal center of flotation	TPI ₂ = "new" condition tons per inch immersion
Cu = waterplane coefficient	LCF _a = actual longitudinal center of flotation	Q = longitudinal effective point of application of R from LCF
D = depth	LCF _e = estimated longitudinal center of flotation	V = speed, knots
dwt = deadweight	LCF ₁ = full load longitudinal center of flotation	v = speed, fps (feet per second)
dm = mean draft	LCF ₂ = "new" condition longitudinal center of flotation	V/\sqrt{L} = speed-length ratio
dmas = mean draft after stranding	LCC = longitudinal center of gravity	v/\sqrt{gL} = Froude number
dms = mean draft before stranding	Lfb = length of forebody	∇ = volumetric displacement
dm ₁ = full load mean draft	LNG = liquefied natural gas	θ = angle of list
dm ₂ = "new" condition mean draft	LOA = length overall	■ = midships
δdf = change in forward draft	LPG = liquefied petroleum gas	y ₁ ... y ₅ = ordinates of buoyancy distribution
δKM = change in KM	Lpmb = length of parallel middle body	b ₁ b ₅ = baseline distances of buoyancy distribution
Δ = displacement	MTI = moment to change trim one inch	
Δ _{F1} = full load displacement		
Δ _{L5} = light ship displacement		
Δ _s = stranded displacement		
FP = forward perpendicular		
f = ship-type coefficient for Cb		
GG _v = virtual rise in vertical center of gravity		
GM = transverse metacentric height		
GM _s = metacentric height as stranded		
GML = longitudinal metacentric height		

SECTION I

INTRODUCTION

1. Background

The development and implementation of any successful salvage strategy is contingent upon a proper evaluation of the situation and a comprehensive knowledge of salvage methods and experience in their use. Marine salvors must possess many skills including a total understanding of and sensitivity to all of the applicable engineering factors, the sea, and ships and their interaction with one another in a salvage situation. As Admiral Sullivan wrote thirty-five years ago, "Salvage is a branch of engineering, and salvage work, if it is to be successful, should, like other engineering work, be planned only when there is a complete appreciation of all of the factors influencing it". 1/

Salvage engineering computations are a series of naval architectural calculations that provide information required by a salvor to develop an overall salvage strategy and to insure that at any point in the physical implementation of that strategy, the ship is not placed in a more hazardous situation from both the stability and structural integrity points of view. The justifiable concern of society for environmental protection of the sea and the contiguous shore areas has further amplified and compounded the need for systematic salvage procedures.

The principles, methods and techniques of salvage engineering calculations have long been available and are well known to experienced salvors. Some of the calculations tend to be long and tedious; short-cut approximations have previously been acceptable. These approximate techniques have evolved due to input data limitations, computational aid limitations, and time limitations which are classically imposed upon salvage personnel. However, with today's larger and faster ships, a given percentage error may no longer be hidden in the background.

1/ Sullivan, William A., "Marine Salvage," Trans., SNAME, Vol. 56, 1948.

2. Overall Objective

The primary objective of this research project was to develop the requirements for calculation aids or an analytical capability for use in a salvage situation to overcome many of the input data limitations typically facing salvage response personnel and the limited computational capacity and time that they have historically been afforded.

This work effort is limited to stranding situations because these incidents represent the largest portion of commercial salvage work. ^{2/} Additionally, they represent a significant threat for the discharge of large amounts of hazardous polluting substances if the ship is not expeditiously and safely extracted from its stranded position, or not properly stabilized when subjected to the worsening forces of the elements in an exposed location. This work is further limited to "time-critical" situations which, if not resolved expeditiously, will deteriorate with and pose an increasing risk to the safety of the crew, the ship, its cargo, and the environment. Ships stranded at exposed locations require immediate, expert, professional assistance because the vagaries of the weather and the sea can quickly transform an apparently benign stranding into an operational, financial, and ecological catastrophe. Ships stranded in "sheltered" waters may require equally urgent corrective measures due to actual or potential threats to navigation, proximity of large population centers, and public outcry. In such instances prompt and proper salvage decisions and actions must be expeditiously undertaken if the ship and its cargo are to be salvaged and the salvor must be provided with an improved means of analytical capability to conduct his engineering assessment of the situation.

The notion of analytical capability means more than a computational device such as an electronic calculator. Specifically, this capability includes the necessary analytical techniques which: (1) are relatively easy to use; (2) are conducive to being used on devices which are portable; (3) do not require detailed

^{2/} Although the terms, "grounding" and "stranding" are usually taken to be synonymous, a "grounding" is sometimes referred to in the general context of a ship touching the bottom or ground which may or may not result in the ship being subsequently held there. The term, "stranding", on the other hand, generally implies the ship making contact with the bottom or ground and being held there or stranded. In any case, the terms, "groundings" and "strandings", are used interchangeably in this report and relate to the case of a ship being affixed to the ground after touching the bottom.

data inputs; (4) provide the necessary data outputs in an expeditious manner and in a readily comprehensible format; (5) do not necessarily require an external source of power; and, (6) provide sufficiently accurate results for salvage computations with limited data availability.

The recently developed compact, modest cost, programmable computers with self-contained power sources, including peripheral devices such as printers and magnetic tape drives are portable and utilitarian for a salvage situation. These programmable computers, when programmed with the proper software, can provide a salvor with greater on-scene computational capacity than he has had previously and can eliminate the computational time limitation which he may previously have faced. Thus, although other computational devices and mechanisms were investigated within this project, the emphasis for requirements is placed upon such portable computers.

3. General Engineering Considerations in a Stranding

Ship survivability is the foremost consideration of a salvor as he evolves and executes his salvage strategy. Indeed, it is the very essence of his purpose. Ship survivability, in the context of this work, means the maintenance or restoration of sufficient ship structural strength and positive ship stability while the ship is stranded, during the course of salvage operations to refloat the ship, and after it is refloated; i.e., the stricken ship must not capsize, sink, or suffer a massive structural failure during or after extraction. Maintaining or restoring structural strength and stability must be accomplished while the ship is subjected to the ground force, to major changes in list, trim, buoyancy, weight and weight distribution, to structural damage, to flooding, to changing tides and to the dynamic forces of wind and waves. Any successful salvage strategy requires at all times a comprehensive understanding of the magnitude and distribution of forces acting upon the ship.

In addition to ship survivability, a salvor has always considered cargo salvage. Recently the implications of the discharge of a hazardous polluting substance, either cargo or onboard consumable such as fuel oil, have become prominent in the salvage strategy. The desire to salvage cargo has also increased over the years because cargo values frequently exceed the insured value of the ships. Thus, the basic notion of ship survivability is really one of ship and cargo survivability and the prevention or minimization of the discharge of any hazardous polluting substances from the stricken ship during the course of salvage operations. Sometimes these requirements can be contravening compounding the development and implementation of the salvage strategy. A quick-response analytical capability would assist the salvor in demonstrating a rational basis to his plan and would resolve differences among the various involved parties.

A stranded ship poses three broad areas of concern to a salvor. They are: (1) the ability to remove the ship from the strand; (2) the ship's stability; and, (3) the ship's structural strength. As previously stated, the development of an effective salvage strategy and the assurance of its successful implementation, requires a comprehensive understanding of the engineering factors associated with the stranded ship. Salvage engineering calculations to determine the ground reaction and measure the stability and strength of the ship are generally approximations within useable working limits of effectiveness. The primary reason for this is that many of the controlling variables and ship characteristics which are required as input data are often difficult to measure or ascertain, or not available soon enough. These difficulties arise primarily because of the inability to quantify the situational factors such as underwater damage, tidal fluctuations, and stranded ship drafts. Intact ship characteristics which relate to stability and strength such as hydrostatic properties, centers of gravity, and structural adequacy likewise may be unavailable within a reasonable period of time.

In the stranded condition the ship loses buoyancy equal to the net loss of intact underwater volume. To salve the ship, this lost buoyancy must be restored by one or more of the following procedures:

- dragging the ship to deep water;
- removing the ground from beneath the ship;
- removing weight from the ship;
- recovering that lost buoyancy; and,
- providing additional buoyancy.

Obviously, the calculation of the force required to pull the ship off the ground and/or the amount of weight which is to be lightened, requires an estimate of that lost buoyancy. It is also important to determine the effective point of the center of grounding since this often will become the pivotal point of the ship.

When a ship runs aground and becomes stranded, the ground exerts an upward force over that portion of the ship's hull which is in contact with the ground and is equal in magnitude to the lost buoyancy. That ground pressure or its force equivalent in tons, has the same effects on draft, list, trim, and stability as if a weight equal in magnitude to the force of the ground pressure were removed from the location of the effective point of contact with the ground. In other words, there is an apparent or virtual weight loss from the ship at its baseline. This weight loss results in a loss of draft and a change in trim. The ship will also list if the effective ground force is located off the ship's centerline. As the ship's draft, trim, and list become altered and thus, its underwater volume, waterplane, and sections, its hydrostatic properties will vary accordingly. In addition, the virtual loss in weight at the lowest point in the ship creates a virtual rise in the ship's center of gravity. However, if a ship is stranded on a fairly flat bottom, there is little possibility of its capsizing even with a falling tide. 3/

After the ship has been refloated, stability problems frequently do arise and are more prevalent in ships that have: (1) experienced partial flooding in connection with the stranding which has not been corrected; (2) had extensive weight changes or movements to attain the necessary attitude required by the refloating operation; or, (3) a high position of the vertical center of gravity (KG).

The loading distribution throughout the length of the ship, the resultant shear forces and bending moments of the stranded ship, changes to these shear forces and bending moments as weights are added, removed, and shifted, and the reduction of the upwards ground force during the extraction process are also aspects of salvage engineering requiring consideration.

3/ For capsizing to occur, the ship would have to be stranded on a bottom which afforded no restraint to heeling, as for example, on a pinnacle or outcrop which was considerably higher in elevation than the surrounding bottom and where the ship can heel to its range of positive stability. Therefore, it is unlikely that a stranded ship will capsize, in the absence of other upsetting forces, unless its range of positive stability is much less than usual. Unless impaled, the ship would slide from the point of contact when the tangent of the angle between the bottom of the ship and the horizontal exceeds the coefficient of static friction between the ship's hull and the bottom upon which it is stranded. Generally, this angle is less than the range of positive stability.

When a ship becomes stranded and neither suffers structural damage nor is subjected to heavy bottom scouring action, it is unlikely that the ship will suffer a major structural failure due to the ground reaction by itself and/or any reasonable changes which may be made in the loading distribution during the course of the salvage operations. This is not to say that it is impossible to develop potentially critical stresses which could cause a structural failure, especially in the larger ships. However, this is not the reason why stranded ships sometimes break-up. Rather, these break-ups are primarily attributable to the loss in strength as a result of original damage sustained in stranding or additional damage from ship movements on the strand. The major problem that the intact ship structure will encounter will occur upon refloating and steps must be preplanned and quickly taken to alleviate any unfavorable load distribution upon that refloating.

For the intact hull structure, computed shear forces and bending moments can be compared to the maximum allowable values imposed by the classification society for the particular ship. Thus, as long as the actual shear forces and bending moments are maintained within those limits throughout the salvage operation, there should be no concern for structural failure.

If the ship has suffered major structural damage during the course of stranding, the problem is different. This difference stems from uncertainties in the definition of damage and, in the case of older ships, the actual material condition of the intact structure. Therefore, in the case of major structural damage, the ability to quantify the strength of the ship is severely limited.

The creation of local stresses sufficient to cause additional hull structural damage depends upon the magnitude of the ground reaction force, its effective point of application, the resultant weight distribution along the ship and the remaining buoyant forces acting upon the stranded ship. A subsequent fall in the tide will aggravate further the stress condition. The salvor must consider these factors as he manipulates weights and takes other actions to free the ship to avoid overstressing the ship's hull and further aggravating its structural condition.

If the stranded ship is lightly aground and subjected to wave action on a hard surface, ship movements can generate dynamic bottoming stresses that can cause structural failure. In addition, the net effect of wave action on a lightly stranded vessel regardless of the tidal action is to work the ship further aground. The impact of the wave crests against the sides and stern of the ship also tends to rotate the ship so that it may broach. Wave generated local currents can subsequently scour the supporting

bottom material under the bow and stern while building up material amidships, causing hogging stresses which ultimately can cause structural failure. While it is not suggested that the forces acting on a lightly aground ship and their impact upon hull stresses are definable in a quantitative sense, this issue is raised to demonstrate the need to quickly stabilize the ship in such a condition. The action taken to stabilize the ship is quantifiable and its impact must be evaluated by the salvor.

4. Organization of the Work Effort

In order to develop the requirements for analytical aids to support salvage response personnel in assessing a stranding situation and understanding the ongoing salvage operation, the work effort was organized into eight primary tasks.

The first task was a literature and data search on groundings, strandings, and salvage. (See Appendix A.) TASK 2 formulated a series of stranding scenarios based in part on that literature and data search and was continuously refined as additional information and feedback was attained. (See Section II and Appendix B.) TASK 3 identified and compiled information on and analyzed the availability and utility of portable computational aids for use by salvage response personnel. (See Section III and Appendix C.) TASK 4 similarly identified and compiled information on and analyzed the availability and capability of shipboard loading calculators/computers for use in a stranding situation. (See Section IV.)

The fifth task was a continuing dialogue with various marine salvage organizations for their feedback to the first four tasks as well as their inputs to TASKS 6 and 7. TASK 6 was an assessment of data availability and for obvious reasons was conducted early in the project. (See Section V.) TASK 7 was the development of the various analytical techniques and represents the major portion of the technical development of the project. (See Section VI.)

The eighth task developed the requirements for the overall analytical process and includes an extensive set of algorithms for future programming. (See Section VII and Appendix E.)

The final section of this report, Section VIII, contains the conclusions and recommendations for both near and long term Coast Guard program goals.

SECTION II
GROUNDING SCENARIOS

1. Background

The first objective of this particular task was to tabulate a series of "typical" scenarios for groundings including, if possible, the information and resources available to the salvage response team under various levels of time criticality, environmental conditions, and other controlling factors. The second objective was to use those scenarios to verify calculation needs; i.e., what is to be analyzed in various grounding or stranding situations so that a salvor may develop and implement a salvage strategy?

Any salvage strategy which may be developed for a particular stranding situation is governed by a series of controlling factors. These controlling factors may be broadly categorized into three subsets:

- environmental controlling factors which are location and/or time sensitive;
- intact ship controlling factors which vary with ship type, character, and condition; and,
- stranded ship controlling factors which vary with the character and extent of the strand and if the ship is damaged, the locations and extents of damage.

Environmental controlling factors include: the characteristics of the bottom and slope; the depths of water under and around the ship including the retraction path to deep water; the range and frequency of tidal action; the direction, strength, and variability of winds and currents; the direction, height, length and frequency of waves and swells; the proximity to the shore and surf; underwater visibility; short and long term exposure to the weather; and, others depending on special circumstances; e.g., sea ice, freezing weather, etc.

Intact ship controlling factors include: ship displacement, draft, trim, and list before the stranding; the weight distribution and loading condition before the stranding; hydrostatic data; stability data; reserve buoyancy; and, cargo and other variable weights.

Stranded ship controlling factors include: changes in drafts, trim, and list due to the stranding; damage sustained in the stranding as defined by local impact damage, impalement, location and extent of flooding, location and extent of overall damage, status of the propulsion and generating machinery, etc.; area of the ship in contact with the ground; type of contact; i.e., uneven, pinnacle, coefficient of friction, etc.; potential for additional damage during salvage refloating operations; and, stranded damaged stability characteristics.

Various combinations of these controlling factors describe a stranding situation as viewed from the salvage point of view. However, in almost all salvage incidents, the measure of these factors is largely dependent upon crew reports (which are frequently inaccurate) or more often on-site surveys and the salvor's ability to conduct those surveys; the availability and reliability of environmental or site specific data sources such as tide and current tables; the availability and reliability of ship information (either onboard or ashore) including hydrostatics, stability, loading, and structural data; and, the communication network between the site and shoreside sources of information.

2. Compilation of Scenarios

In compiling the various scenarios, the basic intent was to include variability in ship type, ship size, ship character, location, and other controlling factors such as weather condition, physical situation, etc., insofar as was reasonable and practical, for strandings within U.S. waters. The initial compilation emanated from actual incident reports. However, recognizing their information limitations, the initial compilation was reviewed and augmented where possible from individual narrative reports and other documents from the Literature Search as well as from professional marine salvors and salvage organizations.

At the outset of the compilation effort, it became apparent that available data on stranding incidents were extremely limited in a number of areas and especially in the case of the determination of ground reaction.

Inherent in the description of any stranding situation is the magnitude of the ground reaction. Depending upon the magnitude of that ground reaction, all other factors being equal, the variability in a salvage strategy can range from the simple passage of time to await a high tide condition to refloat the ship to a combination of awaiting a high tide and the employment of some modest tow forces, to a major lightering and extraction operation.

It was both perplexing and surprising to find that most otherwise complete salvage reports made available from all potential sources provided insufficient data to permit a recapitulation of the initial ground reaction. In fact, less than a dozen cases (including naval ships and commercial ship incidents which occurred outside U.S. waters) were found where that initial ground reaction was either directly given or could be calculated.

While it was never envisioned that most or even a sufficient sample of the U.S. incidents would provide or lend themselves to estimating the ground reaction, it was felt that samples from the world data would make it possible to estimate a given incident's ground reaction based upon typically known factors such as the ship's speed and displacement at the time of stranding. Unfortunately, the limited sample size did not permit such a correlation in a statistically significant sense. The data did, however, suggest that a relationship does exist between ground reaction, the ship's displacement, its speed squared, and other factors; i.e., the dissipation of the ship's kinetic energy. Therefore, where it was otherwise not possible to extract the initial ground reaction from incident data, those reactions were calculated from that limited sample of good information.

For each scenario tabulated in Appendix B of this report, a ground reaction is given. None are "actual" initial ground reactions. One is deduced from taking the difference in drafts before and after stranding and multiplying that difference by the product of 12 inches per foot and an estimated TPI value for the ship.

In two of the tabulated cases, the ground reaction was estimated from the incident reports which gave the amounts of weights which were lightened from the ships and the estimated tidal conditions at the times of stranding and the lightening operation. 4/

Grounding data for the purposes of ascertaining ground reaction are extremely limited. Other shortcomings of those data include: (1) the absence of any means to determine what ship characteristic data (e.g., hydrostatics) might have been available at the time of the incident; (2) the loading distribution on board the ship

4/ As a matter of note, before stranding drafts are very difficult to ascertain after the fact and are rarely recorded in any incident reports. Sometimes, after stranding drafts are not recorded within the incident reports and often, the state of the tide at the time of the strand is not verifiable.

at the time of stranding; (3) the contour and constituency of the bottom upon which the ship stranded; (4) the type and extent of contact; (5) limited environmental information (e.g., currents, underwater visibility, wave action, etc.); and, (6) the status of the main machinery and power generation plants.

Nonetheless, the 25 grounding scenarios which are tabulated in Appendix B illustrate the constraints within which a salvage response team may have to operate from the physical situation point of view. (A discussion of information availability is contained in Section V.)

3. Discussion of Results

The 25 scenarios contained in Appendix B were selected and derived from actual incident data to provide variability among ship types and character, ship sizes, location, and other factors such as environmental conditions and extents of damage. Each of those scenarios is subdivided into five major subsets and within each subset as follows:

- LOCATION OF CASUALTY
 - Port Area
 - Specific Site
- VESSEL CHARACTERISTICS
 - Type
 - Flag (U.S. or Foreign Flag)
 - Length
 - Beam
 - Draft
 - TPI
 - MTI
 - Displacement

- VESSEL CONDITION

- Load Condition
- Direction of Transit (Inbound or Outbound)
- Speed
- Draft After Stranding
- Ground Reaction

- SITE CONDITIONS

- Tidal Range
- Tidal Condition (at the time of stranding)
- Wind (speed and direction)
- Bottom Character.

The involved ships include four crude carriers (ranging in displacement from 63,500 tons to 146,900 tons); four product tankers (ranging in displacement from 42,000 tons to 61,700 tons); three container ships (ranging in displacement from 23,400 tons to 37,200 tons); two RORO ships (with displacements of 26,000 and 33,600 tons); two barge carriers (with displacements of 33,400 and 56,800 tons); three general cargo ships (ranging in displacement from 19,500 tons to 22,700 tons); two dry bulk carriers (with displacements of 29,600 and 39,500 tons); three LNG carriers (with cubic capacities ranging from 70,000 cubic meters to 125,000 cubic meters); and, two OBOs (with displacements of 89,900 and 107,400 tons).

Their speeds at grounding vary from 2.5 to 20.0 knots and the magnitudes of the ground reactions vary from approximately 1,600 tons to 10,000 tons. Their locations encompass port areas on the Atlantic, Gulf, and Pacific coasts of the U.S. and Puerto Rico, Alaska, and Hawaii.

In five of those scenarios (the 136,900-ton crude carrier in Puget Sound, the 42,000-ton tanker in San Diego, the 48,600-ton tanker in Portland, Maine, the 63,500-ton tanker in the Lower Delaware, and the 125,000-cubic meter LNG carrier in Boston), the initial ground reaction, the tidal condition at grounding, and the range of tides are such that the ship likely could be refloated on the subsequent high tide condition. The remaining 20 scenarios would require varying degrees of salvage assistance either in the form of tow forces or lightering or both. None of them would appear to be a potentially catastrophic situation. However, some would require some special off-loading salvage assets; at least four discharged oil on the water; and, all are potential pollution threats.

4. Calculation Needs In A Stranding Situation

As demonstrated by the previous subsection and Appendix B, the circumstances of stranded ships are varied; accordingly, their salvage can take many forms. Thus, when the controlling factors uniquely applicable to a given stranding situation are measured and applied correctly, they provide invaluable assistance to the salvor in preparing an effective evaluation of the situation and in developing an overall salvage strategy.

The results of salvage engineering calculations pertaining to ground reaction, ship stability, and ship strength are generally approximations since many of the controlling variables and ship characteristics are difficult to measure, ascertain, or evaluate. Because ship salvage calculations are rarely exact, they must be tempered with judgement and a comprehensive understanding of good salvage practice and seamanship. The salvor, in order to develop an effective salvage strategy, must understand the different forms of and controlling factors applicable to strandings. Among those controlling factors are:

- the character and slope of the bottom under the vessel;
- the depth of water under and around the vessel;
- the area of the vessel in contact with the ground;
- the condition, character, and type of vessel which is stranded;

- the vessel's draft and loading;
- the vessel's stability;
- the vessel's structural strength;
- the damage sustained in stranding;
- the damage anticipated during the salvage and refloating operation;
- the change in list and trim caused by the stranding;
- the vessel's position and attitude with respect to the shore and surf;
- the range of tides;
- the presence or absence of swells;
- the prevailing wave, current and weather conditions;
- the underwater visibility;
- the period of time that is anticipated for assistance to arrive on-scene and the capability of those resources.

Therefore, the effective development and implementation of any salvage strategy requires an understanding, careful measurement, and assessment of all of the foregoing and in particular, their interaction with and impact upon the magnitude and distribution of forces acting on the ship.

A ship's stability in its normal, intact floating situation is measured by all of the following:

- its initial stability or metacentric height;
- its range of stability;
- its maximum righting arm and the angle of heel at which that occurs; and,
- its dynamic stability.

Following a stranding, a deterioration in the ship's stability can occur because of any or all of the following:

- the removal of weights from points low in the ship;
- the addition of topside weights;
- the loss of reserve buoyancy due to weight additions or loss of watertight boundaries;
- flooding;
- free surface effects;
- free communication with the sea; and,
- list due to asymmetrical flooding or off-center weight changes.

When the ship initially runs aground, the ground reaction coupled with any flooding and/or loss of cargo that occurs can impact upon all of the foregoing except for the addition of topside weights. During the course of the salvage process, various weights may be removed from, added to, or shifted within the ship for various reasons including lightening, trimming, heeling, dewatering, the addition of topside weights in the form of salvage gear, etc. Although these factors are not apt to cause many difficulties to the ordinary seagoing ship while it is stranded, they may cause problems once the ship is refloated and subjected to the forces of a seaway or a towline. Therefore, it is essential that every action taken to refloat the ship be well planned and its implication on the ship's trim, list and stability be understood before any action is taken.

In addition to stability considerations, the salvor must always consider the impact of any action he takes upon the loading distribution of the ship so that the residual structural strength of the ship following stranding is not exceeded. If aground at one end, sagging stresses are increased and conversely, if the ship is aground on a ledge or pinnacle amidships, hogging stresses are increased. Normally, if a ship becomes stranded without incurring structural damage, the ground force alone will not ordinarily create a stress condition sufficient to cause structural failure. (Exceptions to this are where a "lightly" stranded ship is subjected to heavy wave action and is slammed against the bottom by passing waves or is broached by waves on a sand or gravel bottom and the bottom is subsequently scoured out at the ship extremities leaving the ship in an aggravated condition of hogging.)

Structural considerations present two problems. First, alterations to the loading of the ship must be made so that when the ship is refloated and subsequently subjected to the dynamic seaway forces, the ship will not be subjected to excessive bending moments and stresses. Second, the impact of any structural damage upon the hull girder's section modulus should be quantified. In other words, it is one thing to generate weight, buoyancy, and load curves for the intact ship's hull and it is another thing to determine whether the resultant shear forces and bending moments are within the strength limits of the remaining structure; i.e., stress intensity is compatible with the bending moment and the residual section modulus after damage.

SECTION III

PORTABLE COMPUTATIONAL AIDS

1. Background

The objective of TASK 3 was to identify, compile, and analyze existing portable computational aids (i.e., portable computers) and to determine their applicability for use by salvage response personnel. Initially, two possible approaches to this analysis were contemplated:

- that the anticipated input data, anticipated techniques, and desired output could be structured to be compatible with existing portable computer capabilities; or,
- that the analytical techniques useful for salvage computations would dictate the required inputs and the possible outputs. In this case, no prior consideration for the limitation of existing portable computer capability would be necessary and the hardware would have to be configured to suit the application, if possible, or new hardware developed.

As work proceeded on this task, it became evident that the second approach was clearly the path to be taken. Thus, the analytical techniques and required types of input were developed.

The next step involved surveying the various portable computers available and drawing some guidelines as to the minimum performance capability to suit the applications.

2. Overview of Portable Computers

The term "portable computer" generally refers to any computer that may be carried by hand and placed, as a matter of perspective, under an airline seat. Thus, anything from a hand-held programmable calculator to a unit the size of a portable sewing machine (weighing up to 34 pounds) may correctly be termed "portable computer". Generally, a portable non-hand-held computer provides more computing power, measured in random access memory (RAM) and read only memory (ROM) than do hand-held computers, because portable computers are larger and have more memory capacity than the hand-held machines.

There is a wide range of configurations among portable computers, some of which offer complex system capability, including peripherals such as modems, printers, disk drives, etc., all in an extremely compact package. Some portable models feature self-contained power supplies in the form of rechargeable batteries.

As a general overview, almost all portable, non-hand-held computers are equipped with a keyboard, varying amounts of user available memory, some type of display, non-volatile storage (i.e., retains program or data even if computer is switched off, either internally or externally) and operating system software. These are the only common features that all portable computers share.

Two of the major differences between systems are their volume of random access memory or RAM and the type of visual display that they utilize for presentation. RAM is the volatile memory available to the user, and is measured in kilobytes where each kilobyte contains approximately 1000, eight bit bytes. (A byte is the basic addressable unit of memory.) Portable computers range in available RAM from as little as 1 kilobyte in some of the hand-held models to as much as 704 kilobytes in some of the more elaborate systems. Types of displays available include the conventional Cathode Ray Tube (CRT) screen, the space and power saving Liquid Crystal Display (LCD) display, and the new electroluminescent display that provides a bright display similar to that of a CRT without the bulkiness normally accompanying a CRT screen.

3. Survey of Portable Computers

Appendix C contains a summary of existing portable computers, including such items as manufacturers, memory size, additional peripheral items the unit will accept, dimensions, weight, operating system, etc. The information gathered in the preparation of this appendix came from a variety of sources including some of the manufacturers of portable units, advertising material, and technical articles from industry publications. It is comprehensive and it provides data on a significant segment of the portable computer industry.

The Appendix is arranged in the form of a tabular summary. Each make and model is listed separately and the following information given:

- IBM compatibility - i.e., does the computer accept software designed for IBM computer systems;
- Dimensions - approximate length, width and height in inches, rounded to the nearest inch;
- Weight - approximate weight in either pounds or ounces, to the nearest whole number;
- Display size - the maximum number of columns by the maximum number of rows, unless noted otherwise;
- Type of display - either CRT, LCD, or electroluminescent display;
- Available memory (RAM) - maximum memory capacity available with the unit whether integral or optional;
- Integral disk drive - the number and size of any integral disk drive whether basic or optional equipment;
- Communication capability - the ability to communicate with other computers either through a modem or an acoustic coupler;
- Full-size keyboard - indicated by "yes" or "no";
- Peripheral devices available - a list of peripherals such as hard disk drives, printers, plotters, modems, card readers, battery packs, etc.;
- Operating system - generally, the operating system dictates what programs may run on the system. Those machines that can run more than one operating system can provide a degree of flexibility, but some operating systems are used more widely than others, and consequently, have more applications software written for them.

In acquiring hardware, application usually dictates the required software, and that software dictates the required hardware. There is obviously no pre-existing software to consider, but consideration should be given to units with self-contained power supply versus those that require an external power supply. Portable computers that feature rechargeable battery packs would be operable on board a stranded ship even if no electrical power were available. Thus, the salvage master, enroute to the stranded ship, would know that the computer would be able to operate. Conversely, the selection of a portable computer without the capability to operate with a self-contained power supply presupposes that there will be adequate power available aboard the stranded ship, and that the power standard will be compatible with the computer's requirement, which may or may not be a valid assumption.

While it might appear initially that a self-contained power supply should be a requirement, given the salvage environment, the decision is not necessarily clear-cut. Although the benefits of battery operation are clear, there are also drawbacks. Generally, the size of available memory for battery operated models is smaller; therefore, many models may have inadequate memory to store the program and necessary data. Also, since there is no way to predict exactly when a battery will fail, there is also the possibility that a battery operated computer could lose power in the midst of operation, a condition that results in the loss of the program as well as the data.

In their normal mode of operation, some battery operated computers trickle a very low current through the memory circuits which retains the program or data in the memory, even when the computer is switched off. However, if the power dies during operation, everything stored is lost. ^{5/} Clearly this indicates the need for some type of back-up, non-volatile storage (disk or cassette) that must accompany the computer.

The range of cost for the spectrum of portable computers currently available on the market ranges from one hundred to ten thousand dollars. The effective range of cost for portable computers which appear to be adequate for the salvage application is one thousand to four thousand dollars, if the various complex peripherals and extremely complex units are not considered. For portable computers with a self-contained source of power, the effective range of cost is approximately one thousand to two thousand five-hundred dollars.

^{5/} An exception to this is magnetic bubble memory which provides short-term non-volatile storage.

Aside from some personal preferences that have been developed over the course of this investigation, no one portable system or class of systems appears to have a significant advantage for the applications developed in this study. Outside of a requirement for an adequate volume of volatile memory capacity for the programs, any of the systems surveyed can adequately run the application programs envisioned. Even those systems with limited memory capacity could, with the addition of mass storage peripherals, such as cassette players or disk drives, run the required applications.

From the above discussion, it is apparent that the role of the portable system requires some additional definition prior to making system purchasing decisions. Characteristic of the additional definition would include the following:

- need for operating without external power;
- sophistication of the operators;
- size and type of display and/or output of the program; and,
- multiple use potential of the hardware.

Those definitions would focus the hardware search significantly, but until that time it can be generally stated that most portable computer systems would adequately handle the required application programs.

SECTION IV
SHIPBOARD LOADING COMPUTERS

1. Background

Traditionally, naval architects have endeavored to maintain allowable hull stresses within permissible limits. These limits are established from experience and empirical data, and are based on the assumption that a fully loaded ship will experience the maximum bending moment at or near amidships. Thus, for ships carrying an evenly distributed cargo it was often sufficient to simply know the bending moment amidships.

Because of newer and larger ship forms and with the greater diversification in cargo and cargo loading distribution, the expectation that the maximum bending moment will occur at or near amidships is no longer valid. Moreover, it is impractical to precalculate every potential loading condition when it is the intermediate loading conditions which may give rise to the most excessive stresses, even for the still water case. 6/

As an example, Table IV-1 gives the ratios of the maximum shear forces and bending moments to the classification society imposed maximum allowable values and their location along the length of the ship (relative to the forward perpendicular) for a VLCC in four different loading conditions for the still water case. For the two ballast conditions, two maximum to maximum allowable shear force ratios are given. These represent two maximum shear force values which occur in these conditions and which are equal in absolute magnitude (i.e., tons) but whose signs are opposite and whose ratios differ due to the variability in maximum allowable shear force along the length of the ship. Table IV-1 also shows that the maximum values for bending moment occur at various points along the ship's length (i.e., not necessarily amidships) and that the two ballast conditions produce a higher maximum bending moment than the full load condition produces. Therefore, where non-homogeneous loading conditions are anticipated, or where service conditions, significantly different from those for which the scantlings were approved, may arise, common practice aboard bulk carriers and on container and RORO ships is to provide a computational device to determine the suitability of any loading condition since hand calculations are not practicable.

6/ Various intermediate loading conditions can occur either due to partial loads or during the course of loading or discharging cargo.

TABLE IV-1: RATIOS OF MAXIMUM BENDING MOMENTS AND SHEAR FORCES TO MAXIMUM ALLOWABLE VALUES AND THEIR LOCATION FOR A VLCC a/ IN FOUR LOADING CONDITIONS, STILL WATER CASE

LOADING CONDITION	MAX. B.M./ MAX. ALLOW. B.M. <u>b/</u>	MAX. B.M. LOCATION	MAX. SHEAR/ MAX. ALLOW. SHEAR <u>c/</u>	MAX. SHEAR LOCATION
FULL LOAD, <u>d/</u> HOMOGENEOUS CARGO, ($\Delta = 288,100$)	-0.557	0.544L	-0.756	0.911L
BALLAST, <u>e/</u> ($\Delta = 157,100$)	0.918	0.633L	-0.643 0.720	0.362L 0.810L
BALLAST, <u>f/</u> ($\Delta = 136,700$)	0.642	0.684L	0.900 -0.662	0.241L 0.577L
DRYDOCKING, <u>g/</u> ($\Delta = 50,200$)	0.505	0.658L	0.500	0.911L

a/ VLCC WITH 5 SETS OF TANKS (CENTER AND PAIR OF WINGS PER SET); NO. 2 WING TANKS ARE DEDICATED BALLAST TANKS.

b/ MAX. ALLOW. B.M. = 2,110,000 FT. TONS THROUGHOUT SHIP'S LENGTH.

c/ MAX. ALLOW. S.F. VARIES FROM 9,500 TONS AT BEGINNING OF CARGO LENGTH TO 15,500 TONS AT AMIDSHIPS TO 11,700 TONS AT AFTER END OF CARGO LENGTH.

d/ ALL CARGO TANKS FILLED; NO. 2 WING TANKS EMPTY.

e/ $\Delta = 0.545 \Delta_{F.L.}$; WING TANKS NOS. 1, 2, 3, AND 5 AND NO. 4 CENTER TANKS FILLED.

f/ $\Delta = 0.474 \Delta_{F.L.}$; CENTER TANKS NOS. 1, 3, AND 5 AND NO. 2 WING TANKS FILLED.

g/ $\Delta = 0.174 \Delta_{F.L.}$; CENTER TANKS NOS. 1 AND 3 FILLED.

A number of types of these computational devices or loading computers are available. In general, they provide a means of determining the displacement, draft, and trim for a given distribution of cargo, and the attendant bending moments and shear forces at various locations along the length of the ship.

The primary objective of this task was to judge the capability of these onboard devices for use in a stranding situation by salvage response personnel. Achieving this objective necessitated an understanding of these devices; their availability throughout the world fleet; and their ability to accommodate the stranding situation and, in particular, the ground reaction.

2. Typical Shipboard Devices

The term, "shipboard loading computer," includes calculators ranging from a relatively simple, off-line, dedicated, electro-mechanical device which will calculate a ship's displacement, drafts, and its shear forces and bending moments at various locations along the ship's length to a multipurpose, non-dedicated, on-line microprocessor which can continuously calculate, display, and print all of the foregoing plus various intact and damaged stability factors.

Between these two extremes are many variations. A shipboard loading computer is a device which is preloaded with various ship arrangement, hydrostatic data, light ship data, and classification society imposed maximum allowable shear force and bending moment values and the necessary software to compute the shear forces and bending moments at amidships or at a number of predesignated points along the ship's length for a given loading condition. Ordinarily, the loading data is input in an off-line sense; that is, the cargo and other deadweight item loads are input by the Cargo Officer for each compartment. The output of such a basic device is generally displacement, deadweight and drafts (forward, amidships, and aft), and the shear forces and bending moments as a percentage of the corresponding maximum allowable values. Where a stability option is also included within the device, the outputs typically include trim, list, transverse metacentric height, vertical center of gravity, and free surface correction.

Basically, the computational device (without the stability option) takes the following preloaded input data:

- light ship weight distribution;
- compartment longitudinal center of gravity data;

- hydrostatic data;
- section area/Bonjean's curves; and,
- classification society maximum allowable shear force and bending moment values for amidships or any other pre-designated location along the length of the ship,

along with the user input weights of cargo and other deadweight items (by compartment) and calculates the following:

- total deadweight (the sum of all inputs);
- total displacement (the sum of the light ship weight plus all deadweight items);
- the corresponding mean draft (from the hydrostatics);
- the longitudinal center of gravity (by taking the sum of all the longitudinal moments and dividing by the total displacement);
- the forward and after drafts (by taking the trim arm (the difference between the longitudinal center of gravity and the longitudinal center of buoyancy), and multiplying that value by the displacement (i.e., the trimming moment), dividing the trimming moment by the moment to trim one inch to determine the trim (in inches), and adding or subtracting that trim, as appropriate, relative to the longitudinal center of flotation to determine the forward and after drafts);
- the total weight distribution (by adding the deadweight to the light ship weight distribution along the length of the ship);
- the buoyancy distribution for the trimmed ship (from the section area/Bonjean's curves so that the longitudinal centers of gravity and buoyancy are equal);
- the load distribution along the length of the ship (i.e., the algebraic sum of the weight and buoyancy distributions);

- the shear force at amidships or any other predesignated location along the length of the ship (by integrating the load distribution);
- the bending moment at amidships or any other predesignated location along the length of the ship (by integrating the shear force distribution); and,
- dividing the various calculated shear forces and bending moments by the classification society maximum allowable values.

The outputs, as previously stated, are the deadweight, total displacement, forward, amidships, and after drafts, and the shear forces and bending moments as a percentage of the maximum allowable values.

Figure IV-1 is a flow diagram of such a basic, dedicated, off-line, shipboard loading computer. Often, these devices are provided with some type of an alarm or "lock-out" mechanism to bring the operator's attention to or physically preclude "illegal inputs" (e.g., exceeding a tank's capacity) and unacceptable results such as stress numerals exceeding 100; i.e., the calculated maximum bending moment divided by the maximum allowable value is greater than one.

As previously indicated, the variation in shipboard loading computers is enormous. In addition to a basic intact stability option which may or may not use fixed maximum values of the vertical center of gravity and free surface moments (as opposed to actual calculated values for any particular loading condition), these devices can offer static stability, dynamic stability, and damaged stability options. Some offer an on-line option where a tank level gauging system is interconnected to the device for a continuous admeasurement of load distribution, shear forces, bending moments, and even sometimes, deflections; i.e., the double integration of the bending moment distribution.

In addition to offering all capabilities of dedicated units, the non-dedicated or multi-purpose varieties also offer options such as multi-colored column diagrams, tank tables, cargo piping diagrams and cargo loading and discharge programs (e.g., manifold pressure, recommended pump discharge pressure, actual pump discharge pressure, next pump speed change, next valve realignment, etc.) plus options such as spare parts and inventory control, survey records, voyage data analysis, planned maintenance and repair, and almost any other operational or routine ship administration task.

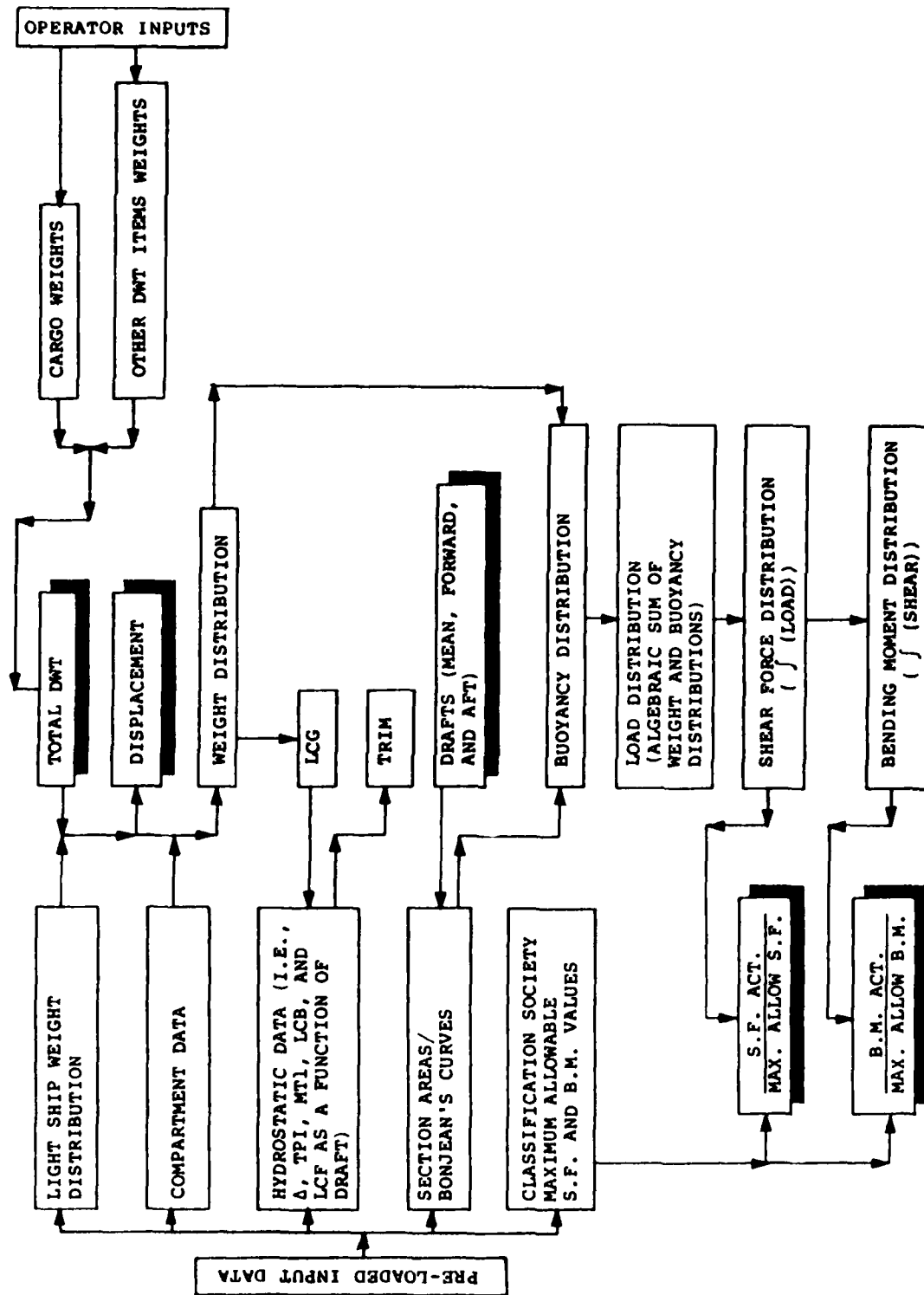

FIGURE IV-1: BASIC DEDICATED, OFF-LINE, SHIPBOARD LOAD COMPUTER FLOW DIAGRAM

The hardware available for these devices, also varies in the sense of input mechanisms, displays and hard copy as well as their direct interaction with other systems. Some of these devices offer mimic displays in conjunction with a keypad editor for numeric entries; others offer a full keyboard with a prompting CRT display. Outputs on the mimic display varieties are generally LEDs and a paper tape hardcopy. Those which employ full keyboards and a CRT generally give a full page CRT display as well as offering the option for a line printer for hard copy.

3. Loading Computer Availability

It is not possible to precisely quantify the availability of any form of a loading computer on any given ship. Approximately 15 to 20 percent of the world's 35,000 seagoing ships currently have some form of an onboard loading computational device.

Of those 6,000 units, approximately two-thirds of them or 4,000 units are carried onboard liquid or bulk carriers with the majority of them being on liquid bulk carriers or tankers. Thus, of the approximate 4,000 oil tankers of 2,000 GRT and greater which sail the seas today, it is estimated that somewhere between 2,500 and 3,000 of them carry some form of a loading computer.

At present, the trend with the newer, larger, and more complex ships is towards the provision of some form of loading computer especially on tankers, dry bulk carriers, container ships, and RORO ships. Moreover, various classification societies either have required or are anticipating their mandatory fitting on certain ships. For example, Bureau Veritas in their 1980 Rules, Amendment No. 2, require the installation of an approved loading calculator on all new construction after December 31, 1980, which exceed 150 meters in length and which carry dry or liquid cargo in bulk. They further require that similar existing ships be likewise outfitted by December 31, 1982. Other classification societies such as ABS, Lloyds, and det Norske Veritas are either in the process of following or expected to follow the lead of Bureau Veritas.

By the end of this decade, between the various classification society requirements for mandatory fitting of loading computers on the dry and liquid bulk carriers and the commercial trend to provide them for the new, large ships, it is probably a fair assumption to expect that somewhere in the vicinity of two fifths to one half of the world's seagoing fleet will have some form of an "approved" loading computer installed onboard.

4. Utility of Loading Computers in a Salvage Situation

In their present configuration, onboard loading computers cannot be used directly in a stranding situation because their present software configuration neither allows a "negative weight" input to simulate the ground reaction nor necessarily permits a discrete entry of the effective longitudinal point of application of that weight. ^{7/}

Another limitation of shipboard loading computers for use in a salvage situation is the "lock-out" features which are placed within the devices as safety measures. For example, many of these devices will not accept an illegal entry such as overloading a tank by weight although it is possible to do so volumetrically; others will not permit further computation or output when a limit, such as inadequate GM is calculated; and, most will not accommodate entries for the flooding of a space such as void spaces, cofferdams, pumprooms, or the engineroom unless they are provided with a so-called "damage control" option. There are similar limitations depending upon owner preference and the individual loading computer. Regardless of the particulars, all are intended to avoid the misuse of the device and to bring the operator's attention to unsafe conditions. In the normal course of ship operations such features are noteworthy and desirable. However, in a salvage situation these features may become impediments to the utility of the loading computer as a computational aid to salvage response personnel.

A potential impediment arises due to the variability in onboard loading computers previously discussed and, in particular, the ability of salvage response personnel to operate them. While there is no suggestion that their complexity requires especially trained operators for each device, even a relatively adaptable person will require some time to become familiar with each different design and to acclimate himself to its operation. The introduction of a foreign language even further complicates this aspect if the crew has abandoned the ship or if there are no English speaking personnel onboard who are conversant with the loading computer's operation.

The last issue with respect to the utility on any onboard loading computer in a salvage situation is one concerned with the desirability of modifying existing software within onboard loading computers to accommodate the stranding situation. Throughout the course of this work, ship operators have emphasized that they would not be in favor of such a capability on their onboard loading computers. They feel very strongly that loading computers should be used only for their intended purpose which is for the load analysis of an intact ship.

^{7/} It is, however, theoretically possible to simulate the ground reaction as "lost weight" and appropriately distributing it to approximate its point of application along the length of the ship.

SECTION V
DATA AVAILABILITY

1. Background

The objective of this task was to assess the availability and reliability of information concerning ship characteristics and other data which are likely to be available to a salvage response team in stranding situation such as those scenarios developed in Section II and tabulated in Appendix B. The ship characteristics include the curves of form or other data describing the hull form; weight distribution or loading data; other cargo information; capacity data; trim and stability information; and, structural information.

2. Input Data Needs

In principle, the computational needs of a salvor are not very different from those that naval architects routinely use in various aspects of ship design and, to a lesser extent, those that ship-board personnel use to ascertain various aspects of trim, stability, and strength. However, in practice, the salvor's needs differ because he is not afforded the luxuries of time, personnel and computational resources, and the detailed level of data inputs that the naval architect or the ship's officer has at his disposal.

For example, in a stranding situation if the salvor were to be provided with the ship's condition before and after stranding (displacement, drafts, loading, etc.); the state of the tide at the time of stranding; the characteristics of the bottom upon which the ship strands; and other existing and projected environmental controlling factors, along with:

- hydrostatic data for the trimmed and heeled ship attitudes;
- Bonjean's curves of section areas;
- the light ship characteristics (i.e., centers of gravity and weight);
- the weights and centers of cargo and other items of deadweight not included in the light ship data;

- compartment data (i.e., capacities, ullages, innages, and centers);
- pertinent structural data; and,
- extents of damage including flooding,

he could, given the time and resources, theoretically compute the magnitude of the effective ground reaction, its effective point of application, and assess the stability and structural condition of the stranded ship. Furthermore, he would be able to assess the implications of various actions that might be taken to extract the ship vis-a-vis the ship's stability and strength as it remains stranded, during the extraction process, and after it is returned to a free floating condition.

3. Data Availability In A Stranding Situation

The availability of the necessary or desirable ship characteristic data in any given situation can range over the spectrum from almost nothing to everything a salvor requires depending upon such factors as the ship type, its characteristics, its age, its ownership, the number of times the ship has changed ownership over its life, etc. Insofar as other data are concerned, their availability will also vary greatly depending upon the particular stranding site and in relation to proximity of shore and amount of traffic.

It is, therefore, extremely difficult, to make any statements concerning the expectation of data in a given situation. However, the following comments may provide some insight to the issue of data availability in a stranding situation:

- it is common to find that before stranding drafts are not known and it is difficult to extract those drafts from some "last known" draft and/or displacement condition;
- generally, the initially reported, as stranded drafts of the stricken ship are not related to a tidal condition and in any case, tend to be variously inaccurate especially if there is any kind of wave action present;

- in many instances, information concerning the state and range of the tide is difficult to ascertain especially in a remote area or certain offshore areas;
- insofar as hydrostatic data and data concerning the vertical center of gravity the longitudinal center of gravity, the metacentric height, etc. (which naval architects ordinarily expect to find within a trim and stability booklet) and other related information concerning capacities, arrangements, and other compartment data are concerned, these data will rarely, if ever, be made available to the salvor prior to his arrival on scene. Moreover, even after his arrival onboard the stricken ship, these data will not always be handed to him in a neat, concise form and probably will require prompting and probing by the salvor to eventually attain them from any available source. Although one would expect the ordinary seagoing ship to ultimately produce some version of these data, there have been isolated instances where such data are not or cannot be made available in any form in a timely fashion. Even when the best of such data are made available to the salvor, he must be sensitive to the limited applicability of the hydrostatics data given to him when large trim and heel attitudes are present since ordinarily, the available hydrostatics are for normal operating conditions; i.e., even keel or moderate angles of trim. In addition, the salvor must also exercise caution with respect to the applicability of the other data made available to him which may not reflect the impact of any significant modifications made to the ship over the years since the data was originally produced;
- insofar as other intact stability (i.e., righting arms, righting moments, range of stability, etc.) and damaged stability data are concerned, it would probably only be fair to expect the availability of such data on very specialized ship types and not ordinarily;

- it is common, especially on non-bulk carriers, to find limited weight and no buoyancy distribution data. Exceptions to this generalization might be in the cases of the newer and larger container and RORO ship types. This type of data will be more likely to be available on ships carrying loading computers (as described in Section IV) than on those ships which do not carry such devices;
- the amount of flooding caused by the stranding and subsequent structural damage and initially reported by the ship will be sketchy, variously inaccurate and probably not related to a state of the tide (or at least not consistently), or even entirely omitted;
- even after the arrival of a salvor on scene, the reconstruction of initial actions taken by shipboard personnel following the stranding; i.e., weight removals, additions, or movements is difficult;
- structural detail data will be available onboard few ships. Even when it is available, it is ordinarily impractical for the salvor to employ;
- the extent of damage that a ship might sustain in stranding may or may not be verifiable depending upon its location, access within the ship, underwater visibility, the extent of the strand, and survey methods; and,
- any data concerning the site or other physical situations factors and in particular, the ground condition and the retraction path, will not be ordinarily made available to the salvor prior to his arrival on scene. Moreover, even after his arrival on scene, his ability to acquire such data will be, as previously indicated, largely dependent upon the particular location, time, the underwater visibility, and the prevailing meteorological and oceanographical conditions.

However, if the stranded ship is owned or operated by a major shipping company, if it is a newer and complex ship type, and if it is a major maritime nation ship, one would tend to have a higher expectation of the various ship characteristic data being available.

Because a salvor might be afforded anything between no data and complete data, he must be prepared to operate in the worst case; i.e, little to no data. In addition and as previously stated, there is inevitably the problem of the applicability or limitations of that available data (which is ordinarily for "normal operating conditions" of the intact ship) for use in salvage situations where the conditions are anything but "normal" and the ship may not be intact.

Information concerning the distribution of cargo and other dead-weight items may be available or at least can be reasonably approximated, but other inputs such as the light ship weight distribution and buoyancy distributions are not generally available except as previously noted. Only certain bulk cargo ships are required to have loading manuals and they, in themselves, can neither directly provide the data required nor accommodate the special requirements for the stranded situation.

In summary, it may be said that a salvor will be fortunate to have the information provided in a trim and stability booklet such as hydrostatic and light ship data which, if available, he may use with some caution. In addition, he probably will be operating with extremely limited knowledge of weight and buoyancy distributions for use in any assessment of the structural situation.

SECTION VI
ANALYTICAL TECHNIQUES

1. General

Given the fact that on-scene information availability and reliability is sufficiently varied and may or may not be made available to the salvor in a timely fashion from any source, salvors have historically relied upon various approximation methods, consistent with computational aid limitations, to estimate the magnitude and distribution of forces upon a stranded ship and their implications on the ship's stability and strength. These approximation methods or short-cut analytical techniques, have evolved from hand calculations to the slide rule and nomographs to portable electronic calculators with various degrees of programmable capacity. As stated earlier in this text, the arrival of portable computers (such as those listed in Appendix C) has brought the computational capacity to a high level and, in fact, the method of analytical technique and accuracy of solution which these devices can operate on is limited only by data availability and/or by the time required to input those data.

With the expectation of a large variance in data availability and reliability, this work effort has developed analytical techniques which are sufficiently accurate for salvage engineering needs with an absolute minimum of data requirements and input operations.

The question then becomes at what minimum level of data input is there sufficient data for the salvor to conduct the necessary calculations on a portable computer consistent with his needs. Obviously, the analytic technique and the data availability issues are inseparable; i.e., the analytical technique is dependent upon data availability. For example, many of the current generation of portable computers, if furnished with all of the hull offsets, the magnitude and point of application of the ground reaction, the light ship data, cargo weights and distribution, compartment data, extents of damage, etc., can rigorously and accurately compute any and all stability information that a salvor might need. The problem, of course, is the data availability and the time to input that data in a contingency situation.

Therefore, it became apparent at the outset of the work that the only viable solution to accommodate the data variability was to assume that little or no data were available in developing analytical techniques that provide the necessary outputs for the salvor. While this is certainly not a unique approach, the computational capacity of the current generation of portable computers affords more rigorous techniques to be employed than has been previously possible with limited data input.

At first glance, the formidability of some of the equations contained within the analytical process may appear awesome for use in a salvage situation. However, it should be understood that all of these equations are to be preprogrammed within the portable computer and their individual and chained results calculated by the machine with only minimal inputs by the operator.

2. Stability Factors

Publications such as the ABS RECORD and LLOYD'S REGISTER OF SHIPPING, provide at least the following bits of information with respect to ship characteristics:

- length (overall and between perpendiculars);
- breadth (maximum and molded);
- depth (maximum and molded);
- maximum summer draft amidships;
- normal sea speed at normal service draft;
- bunker capacity; and,
- deadweight of cargo, stores, fuel, passengers, and crew carried by the ship when loaded to its maximum summer draft.

They do not, however, give the corresponding full load displacement, which by itself is needed and from which such factors as block coefficient and light ship weight can be derived. Therefore, in the absence of the displacement and other curves of form, the salvor is required to calculate, as a starting point, the full load displacement. This, in turn, requires an estimate of the block coefficient (C_b). In addition, the waterplane (C_w) and prismatic (C_p) coefficients are required to estimate the vertical center of buoyancy (KB), the metacentric radius (BM), the tons per inch immersion (TPI), the moment to change trim one inch (MT1), and the longitudinal center of buoyancy (LCB) or those elements of data which would be available within the hydrostatic properties for the full load condition.

For years naval architects have, in the conceptual and preliminary design phases of a ship, estimated block coefficient as a function of the speed-length ratio (V/\sqrt{L}) or the Froude number (v/\sqrt{gL}). Those equations for block coefficient have basically been regression lines derived from actual ship data and are as follows:

- (1) $C_b = 1.15 - 0.629 * (V/\sqrt{L})$ by Troost ^{8/};
- (2) $C_b = 1.05 - 0.5 * (V/\sqrt{L})$ by Alexander ^{8/};
- (3) $C_b = 1.137 - 0.6 * (V/\sqrt{L})$ by van Lammeren ^{8/};
- (4) $C_b = 1.22 - 0.709 * (V/\sqrt{L})$ by Minorsky ^{8/};
- (5) $C_b = 1.0 - (0.375 * (B/L + 1) * (V/\sqrt{L}))$ by Telfer ^{8/};

and;

(6) $C_b = 0.65 + 0.95 (V/\sqrt{L}) - 1.2 * (V/\sqrt{L})^2$ by Sabit ^{8/}.

It can be seen from these equations that the dependent variable, C_b , is a linear function of the independent variable, V/\sqrt{L} , except in the case of equation (5) which also varies C_b for a given V/\sqrt{L} by the beam to length ratio (B/L) and in the case of equation (6) which employs a second order equation. During the course of this work effort, a large number of ships, including the more modern types, were analyzed by conducting a regression analysis of C_b versus V/\sqrt{L} with a wide spectrum of ship types and ship age. From that analysis, the following relationship was developed:

(7) $C_b = 1.10736 - 0.550401 * (V/\sqrt{L})$;

with a correlation of 0.9202. After applying this equation to various ship types it became apparent that the resultant variance was a function of ship type and the equation was refined to be:

(8) $C_b = f * (1.10736 - 0.550401 * (V/\sqrt{L}))$, where

- $f = 1.08$ for a bulk carrier;
- $= 1.06$ for an LPG carrier;
- $= 1.04$ for an LNG carrier;
- $= 1.03$ for an OBO;

^{8/} Arkenbaut, S. et al, The Design of Merchant Ships,
H. Stam, Culemborj, The Netherlands, 2nd ed., 1959.

- = 1.03 for a lumber ship;
- = 1.025 for a product tanker/
chemical carrier;
- = 1.01 for a crude carrier;
- = 1.00 for a break bulk cargo ship;
- = 0.98 for a cargo liner;
- = 0.97 for a container ship;
- = 0.95 for a RORO ship; and,
- = 0.89 for a barge carrier.

Ideally, it would be preferable to have unique regression lines for each ship type but there were insufficient data available within all of the ship type categories to permit this. Accordingly, the "f" coefficient was employed.

Appendix D gives a sampling of various ship types and ship sizes and their actual block coefficients as compared to the values of C_b calculated by equations (1) to (6) and (8). It would appear that equation (8) tends to give better results than the others for two reasons. First, equation (8) is a more updated version containing the newer ship types and larger ships. Second, equation (8) contains a variable for ship type to which C_b is related.

From C_b , linear regression lines were developed for the waterplane (C_w) and prismatic (C_p) coefficients as follows:

$$(9) \quad C_w = 0.360 + 0.702 * (C_b) \text{ for a barge carrier;}$$

$$(10) \quad C_w = 0.325 + 0.702 * (C_b) \text{ for a container ship;}$$

$$(11) \quad C_w = 0.336 + 0.702 * (C_b) \text{ for a RORO ship;}$$

$$(12) \quad C_w = 0.306 + 0.702 * (C_b) \text{ for all other ship types;}$$

and,

$$(13) \quad C_p = 0.917 * (C_b) + 0.073$$

with correlations of 0.9541 and 0.9959 for equations (12) and (13) respectively with some variation in C_w for three particular ship types; i.e., barge carriers, container ships, and RORO ships whose waterplanes relative to their block coefficient are somewhat larger than the remainder of all ship types.

With these three coefficients of form, it is then possible to estimate the center of buoyancy (KB) from Posdunine's equation where,

$$(14) \quad KB = (C_w / (C_b + C_w)) * d_m$$

where d_m is the ship's mean draft.

By knowing KB, the transverse height of the metacenter (KM) is calculated by

$$(15) \quad KM = KB + BM$$

and,

$$(16) \quad BM = I_T / \nabla$$

where I_T is the transverse moment of inertia. I_T for shipshapes in general, may be expressed as

$$(17) \quad I_T = L * B^3 * C_T$$

In equation (17), C_T is the transverse inertia coefficient and is a function of the waterplane or C_w . C_T can be expressed as:

$$(18) \quad C_T = 0.125 * C_w - 0.045$$

By substituting equation (18) in equation (17) and then substituting this result in equation (16) with the appropriate expression for ∇ (the volumetric displacement),

$$(19) \quad BM = (L * B^3 * (0.125 * C_w - 0.045)) / (L * B * d_m * C_b),$$

or

$$(20) \quad BM = (B^2 * (0.125 * C_w - 0.045)) / (d_m * C_b)$$

Equation (15) then becomes,

$$(21) \quad KM = (C_w / (C_b + C_w)) * d_m + \frac{B^2 * (0.125 * C_w - 0.045)}{(d_m * C_b)}$$

Having an estimated value for C_w , permits a direct calculation of TPI where,

$$(22) \text{ TPI} = (L * B * C_w) / 420.$$

A calculation of MTI is somewhat more complex. The standard definition of MTI is

$$(23) \text{ MTI} = (\Delta * \text{GML}) / (12 * L),$$

where Δ is the displacement and GML is the longitudinal metacenter. Noting that GML may be approximated by BML (or the longitudinal metacentric radius which implies that the vertical centers of buoyancy and gravity are equal) then equation (23) may be rewritten as

$$(24) \text{ MTI} = (\Delta * \text{BML}) / (12 * L).$$

The BML, in turn, may be calculated by,

$$(25) \text{ BML} = I_L / \nabla,$$

where I_L is the longitudinal moment of inertia. I_L for shipshapes, in general, is,

$$(26) I_L = B * L^3 * C_L,$$

and C_L is the longitudinal inertia coefficient and is a function of the waterplane area or C_w and may be expressed as

$$(27) C_L = 0.143 * C_w - 0.0659.$$

Therefore,

$$(28) I_L = B * L^3 * (0.143 * C_w - 0.0659)$$

and,

$$(29) \text{ BML} = (B * L^3 * (0.143 * C_w - 0.0659)) / \nabla.$$

Since,

$$(30) \nabla = L * B * d_m * C_b,$$

then,

$$(31) \text{ BML} = (B * L^3 * (0.143 * C_w - 0.0659)) / (L * B * d_m * C_b),$$

and

$$(32) \text{ BML} = (L^2 * (0.143 * C_w - 0.0659)) / (d_m * C_b).$$

By substitution of equation (32) in equation (24),

$$(33) \text{ MT1} = (\Delta * L^2 * (0.143 * C_w - 0.0659)) / (d_m * C_b * 12 * L);$$

and, since Δ is equal to the volumetric displacement (V) divided by 35,

then,

$$(34) \text{ MT1} = (B * L^2 * (0.143 * C_w - 0.0659)) / 420.$$

The longitudinal center of buoyancy may be approximated as

$$(35) \text{ LCB} = L (0.5 - (0.175 * C_p - 0.125)).$$

The only other full load hydrostatic property which remains is the longitudinal center of flotation or LCF. Equations for LCF as a function of length and speed were developed from actual ship data as follows:

$$(36) \text{ LCF} = 0.5 * L * (V/160 + 0.914) \text{ for tankers;}$$

$$(37) \text{ LCF} = 0.485 * L * (V/100 + 0.9) \text{ for bulk carriers;}$$

$$(38) \text{ LCF} = 0.5 * L * (V/135 + 0.924) \text{ for single crew cargo ships;}$$

$$(39) \text{ LCF} = 0.5 * L (0.95/V + 1.03) \text{ for twin screw cargo ships with transom sterns; and,}$$

$$(40) \text{ LCF} = (0.5 * (V/135 + 0.924) + 0.23) * L \text{ for twin screw cargo ships with cruiser sterns.}$$

In looking at equations (36) to (40) for LCF, one might fairly ask for further variations by ship type, number of screws, and stern configuration. Unfortunately, data and time limitations did not permit additional subsets to be developed.

At this point, a recapitulation is in order. From very basic ship characteristic parameters, it has been possible to determine Δ , KM, TPI, MT1, LCB, and LCF for the full load condition. These hydrostatic properties have been developed from only limited data inputs of length between perpendiculars (LBP); molded beam (B); summer full load draft (dm); and, corresponding service speed (V) with some variations by ship type and insuring that the three coefficients of form employed (C_b , C_w , and C_p) are compatible with one another by making C_w and C_p dependent upon C_b . In addition, by adding the total deadweight as an input, one also knows light ship weight; i.e., the difference between full load displacement and total deadweight. The two questions that now become apparent are: (1) how good are the results; and, (2) what purpose do they serve in the absence of KG and LCG values insofar as the the stability picture is concerned?

The first question concerning results will be discussed later in the text. The second question is the same one that all naval architects are faced with in the early stages of a ship design in the absence of detailed weight estimates.

To overcome this dilemma, actual ship data were compiled on the metacentric height (GM) for the full load departure condition (corrected for any free surface) by ship type and then correlating those data to either the beam to depth ratio (B/D) or the beam, whichever gave better estimates. The results of this process are as follows:

- (41) $GM = 2.816 * (B/D) - 1.88$ for cargo liners and container ships;
- (42) $GM = 15.86 * (B/D) - 19.62$ for tankers in general;
- (43) $GM = 0.714 * (B/D) + 2.2$ for cargo ships in general;
- (44) $GM = 0.055 * B$ for barge carriers and RORO ships;
- (45) $GM = 0.065 * B$ for bulk carriers; and,
- (46) $GM = 0.075 * B$ for OBOs.

As might be suspected, the values for GM in the cases of some of the very specialized ships such as the barge carriers and RORO ships in particular, and to a lesser degree, for bulk carriers and OBOs, are somewhat tentative simply due to their relatively small population in the world fleet. Also, ships such as gas (LNG and LPG) carriers are so small in sample size and varied for particular cargoes that it was not possible to present any results relative to their GM. In any case, the simple combination of GM from equation (41) to (46) with the KM from equation (15) gives a good approximation of KG.

The similar estimate for LCG (full load) requires an additional bit of input and this is the ordinary trim at the full load departure condition. By multiplying the trim (in inches) by MT1, the trimming moment is obtained and the trimming moment divided by Δ gives the trimming arm; or,

$$(47) \text{ Trim} * \text{MT1} = \text{Trimming Moment}; \text{ and,}$$

$$(48) \text{ Trimming Moment} / \Delta = \text{Trim Arm.}$$

The trimming arm added to or subtracted from the LCB (depending upon the attitude of the trim) gives the LCG; or

$$(49) \text{ LCB} \pm \text{Trim Arm} = \text{LCG}$$

Results of the application of all of the foregoing relative to the trim and stability of the ship at the full load departure condition are given for three actual ships on Tables VI-1, -2, and -3. The three sample ships are a partial container-cargo liner, a container ship, and a product tanker. They do not necessarily provide the least errors and, in fact, have been selected to show some of the larger variances. Each of these three tables gives the basic ship characteristics as extracted from LLOYD'S REGISTER OF SHIPPING (with the exception of trim) and the estimated coefficients of form (C_b , C_w , and C_p), hydrostatic properties, and LCG, GM, and KG, versus the actual corresponding values for each of the three examples. These examples show that the estimated KM's are, on the average, less than one percent in error from the actual values with a maximum variance of approximately three percent. TPI's vary, on the average, by three percent with a maximum variance of five and a half percent. MT1's vary, on the average, by about eight percent with a maximum variance of 13.4 percent. Salvors, with careful work, can predict mean afloat drafts to within one or two percent for undamaged ships. The error in trim for the same cases can be on the order of 10 to 15 percent. This phenomenon is believed to be due to the inaccuracies inherent in using the ship's published MT1 data in cases of large trim plus the compounding error in estimating trimming moments. It is therefore submitted that the maximum variance of 13.4 percent in predicted MT1 noted above is of little concern since the "actual" figure may be far from the mark in a real salvage scenario. In the case of these three random examples, it should be noted that the partial container-cargo liner is a hull form that is underpowered. That is, the ship was originally designed for a higher speed (approximately 22 knots) but was ultimately powered for a 20-knot speed. This peculiar situation results in a estimation error of approximately 0.04 to 0.05 for the block and waterplane coefficients which in turn creates the rather high variance in the estimation of MT1. However, it is a good example to demonstrate the sensitivity of the MT1 estimation to C_b and C_w . It is equally important to note that all of the other properties for this ship are rather well correlated.

Table VI-1

Partial Container Cargo Liner
Characteristic Comparison ^{a/}

L = 534 Ft.
B = 81.33 Ft.
D = 45.25 Ft.
dm = 30.64 Ft.
V = 20 Kts
DWT = 12,900 Tons
Trim = 15.7 In. Aft

Coefficients	Estimated	Actual	Difference
C _b	0.618	0.566	+ 0.053
C _w	0.740	0.701	+ 0.039
C _p	0.640	0.590	+ 0.050
Hydrostatic Properties	Estimated	Actual	Difference
KM	33.27 Ft.	33.28 Ft.	- 0.01 Ft.
TPI	76.50 Tons	72.50 Tons	+ 4.00 Tons
MT1	2200 Ft. Tons	1940 Ft. Tons	+ 260 Ft. Tons
LCB From FP	274.00 Ft.	268.00 Ft.	+ 6.00 Ft.
LCF From FP	286.20 Ft.	286.50 Ft.	- 0.30 Ft.
Stability			
LCG From FP	275.50 Ft.	269.00 Ft.	+ 6.50 Ft.
GM (F.L. - CORR)	3.18 Ft.	3.30 Ft.	- 0.12 Ft.
KG	30.09 Ft.	29.60 Ft.	+ 0.49 Ft.

^{a/} For full load departure condition

Table VI-2
 Container Ship Characteristic Comparison ^{a/}

L = 581 Ft.
 B = 78 Ft.
 D = 54.50 Ft.
 dm = 29.65 Ft.
 V = 20.10 Kts
 DWT = 14,600 Tons
 Trim = 22.70 In. Aft

Coefficients	Estimated	Actual	Difference
C _b	0.635	0.628	+ 0.007
C _w	0.752	0.749	+ 0.003
C _p	0.656	0.644	+ 0.012
Hydrostatic Properties	Estimated	Actual	Difference
KM	31.89 Ft.	32.84 Ft.	- 0.95 Ft.
TPI	81.10 Ft.	81.10 Tons	0
MT1	2611 Ft. Tons	2750 Ft. Tons	- 139 Ft. Tons
LCB From FP	296.50 Ft.	300.60 Ft.	- 4.10 Ft.
LCF From FP	311.70 Ft.	318.70 Ft.	- 7.00 Ft.
Stability			
LCG From FP	300.10 Ft.	304.30 Ft.	- 4.20 Ft.
GM (F.L. - CORR)	2.15 Ft.	1.71 Ft.	+ 0.44 Ft.
KG	29.74 Ft.	30.20 Ft.	- 0.46 Ft.

^{a/} For full load departure condition

Table VI-3
Product Tanker Characteristic Comparison ^{a/}

L = 705 Ft.
B = 102 Ft.
D = 50 Ft.
dm = 38.50 Ft.
V = 16 Kts
DWT = 50,800 Tons
Trim = 25 In. Aft

Coefficients	Estimated	Actual	Difference
C _b	0.795	0.768	+ 0.027
C _w	0.864	0.835	+ 0.029
C _p	0.801	0.780	+ 0.021
Hydrostatic Properties	Estimated	Actual	Difference
KM	41.47 Ft.	41.20 Ft.	+ 0.27 Ft.
TPI	148 Tons	143 Tons	+ 5 Tons
MT1	6962 Ft. Tons	6550 Ft. Tons	+ 412 Ft. Tons
LCB From FP	341.80 Ft.	340.90 Ft.	+ 0.90 Ft.
LCF From FP	357.40 Ft.	356.10 Ft.	+ 1.30 Ft.
Stability			
LCG From FP	344.60 Ft.	343.60 Ft.	+ 1.00 Ft.
GM (F.L. - CORR)	12.73 Ft.	12.50 Ft.	+ 0.23 Ft.
KG	28.74 Ft.	28.00 Ft.	+ 0.74 Ft.

^{a/} For full load departure condition

To continue, the LCB's vary, on the average, by approximately one percent with a maximum variance of 2.2 percent. The LCF's vary, on the average, by less than one percent, with a maximum variance of 2.2 percent.

Insofar as the LCG, GM, and KG are concerned, the LCG's vary on the average, by approximately 1.4 percent with a maximum variance of 2.4 percent. GM's vary, in absolute units, by no more than one half of a foot or about one quarter of a foot on the average and KG's vary by less than a foot.

Viewing these results in the proper perspective of their intended use is extremely important. As stated earlier, salvage calculations tend to approximations with useable working limits of effectiveness and any basic calculations made by a salvor, at least in the initial stages of his assessment of the situation and his development of an overall strategy, are based upon information which is within a 20 percent range of the actual (but unknown) values. The results attained from this work are well within those limits in each case and, except for some very specialized ship types or non-conventional hull forms are within five percent of the actual values. Given the absolute minimum level of data input which is used herein to generate these ship characteristics, the results, for purposes of salvage, are far superior to anything else a salvor has been previously provided, and can be generated significantly faster.

Having developed a set of data for the full load departure condition, the next step is to translate those data to the ship condition just prior to stranding and after stranding. If either of those conditions do not create any significant variation in ship's draft, then the problem is a simple one of adding, removing, or moving weights with known centers of gravity and recalculating the ship's revised centers of gravity to measure the trim and stability in the revised condition since the variation in hydrostatic properties is small enough to ignore. On the other hand, if the resultant draft variation is great or there is excessive trim and/or list, then the problem becomes more complex.

In the case of the variability of hydrostatic properties with draft, KM simply does not vary significantly with draft until the draft is dramatically decreased (on the order of one third of the full load draft) and after which it increases. From actual ship data, TPI, MTI, LCB, and LCF will vary, in an approximate and general sense, as follows:

- TPI will decrease linearly as draft decreases at the rate of 0.75 percent of the full load TPI per foot of draft;
- MT1 will decrease linearly as draft decreases at the rate of 2.5 percent of the full load MT1 per foot of draft;
- the LCB will move forward linearly as draft decreases at the rate of 0.2 percent of the full load LCB per foot of draft; and,
- the LCF will likewise move forward linearly as draft decreases at the rate of 0.4 percent of the full load LCF per foot of draft.

Therefore, it can be assumed that KM will remain constant with very little error introduced while:

$$(50) \text{ TPI}_2 = \text{TPI}_1 - \text{TPI}_1 * (0.0075) * (\text{dm}_1 - \text{dm}_2);$$

$$(51) \text{ MT1}_2 = \text{MT1}_1 - \text{MT1}_1 * (0.025) * (\text{dm}_1 - \text{dm}_2);$$

$$(52) \text{ LCB}_2 = \text{LCB}_1 - \text{LCB}_1 * (0.002) * (\text{dm}_1 - \text{dm}_2); \text{ and}$$

$$(53) \text{ LCF}_2 = \text{LCF}_1 - \text{LCF}_1 * (0.004) * (\text{dm}_1 - \text{dm}_2)$$

where the subscripts 1 and 2 denote the full load and "new" condition respectively and with LCB and LCF being measured from the forward perpendicular (FP). Equations (50) through (53) must always be tempered with the notion that the constants are average values based upon conventional hull forms. Moreover, they, like all of the other analytic techniques shown herein, should never be considered as a substitute for rigorous naval architecture techniques to generate these parameters or as a substitute for trim and stability information in ordinary naval architectural work except, perhaps, in the very early stages of a design process. Rather, they have been developed for the salvage situation in the absence of that rigorous information, or in the interim until that rigorous information becomes available to the salvor.

Figure VI-1 gives a comparison of various estimated hydrostatic properties (TPI, MT1, LCB, and LCF) for a partial container cargo liner versus its actual values as a function of draft. As can be seen from that figure, the differences do not vary significantly with draft. At the very least, the errors do not change to any great degree as the draft departs from the full load condition. 9/

9/ It should also be noted that this ship is the one with the largest differences in its full load condition.

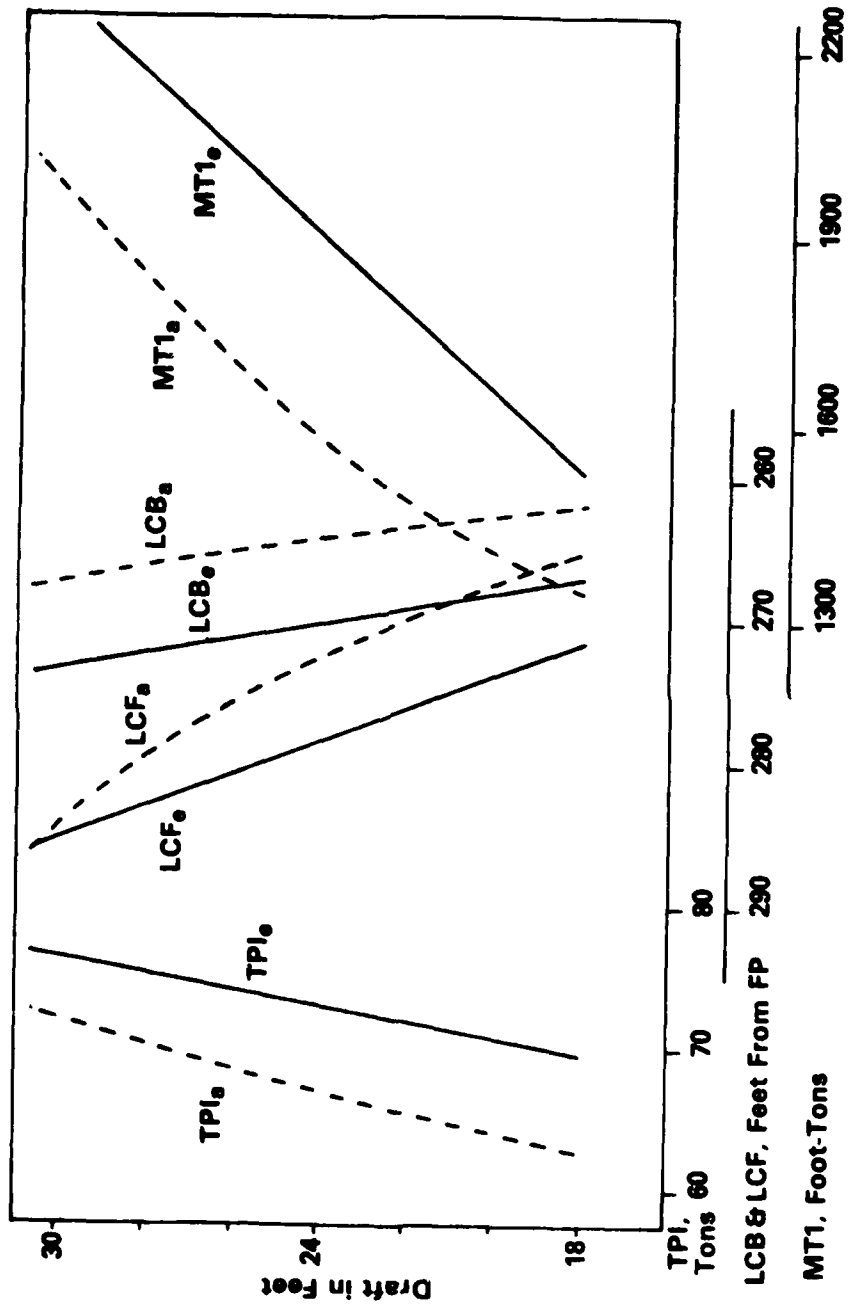

FIGURE VI-1 COMPARISON OF ESTIMATED HYDROSTATIC PROPERTIES (TPI_e, MT1_e, LCB_e, and LCF_e) VERSUS ACTUAL HYDROSTATIC PROPERTIES (TPI_a, MT1_a, LCB_a, and LCF_a)

Insofar as the problem that arises with distorted attitudes of trim and list is concerned, it should be noted that any displacement and other hydrostatic data that are found aboard ship, including those contained in trim and stability booklets and stability calculators, are for ordinary conditions of trim. Therefore, these data are limited in their applicability when large attitudes of trim and/or list are present, a likely situation in a stranding. With modern computer technology, it is theoretically possible to digitize hull offsets and to quickly and accurately generate hydrostatics for any combination of angles of trim and list. In a salvage situation, however, unless these offsets are digitized and available as input to a computer capable of generating the hydrostatic and other stability data for a particular trim and list condition and, equally as important, can be made available to the salvor in an expeditious manner the point becomes moot. The primary problem (apart from exchanging data between the scene and the onshore computer facility) may be stated as follows:

- first, do the offsets exist in a digitized form?
- second, if they do exist, are they or can they be made available? and,
- third, their availability notwithstanding, are they compatible in format for input to the computer?

Chances are that digitized offsets are only available on a relatively small number of the total world's population of ships. Second, their availability, or at least retrievability, in a timely fashion is probably not very good; and, third, even if they were available and retrievable, there is always the question of data compatibility with the computer and software at hand. In short, it is not reasonable to assume their existence and availability, at least in the initial, and oftentimes, most critical, stages of developing a salvage strategy.

In general, the salvor, with his calculations, must account for the variation in hydrostatic properties and other ship characteristics which occur due to excessive trim and list as well as the impact of possible flooding. In an ordinary sense of naval architecture, all of these factors may be taken into account and rigorously determined; however, it is one thing to have the luxury of data, time, and resources to conduct the computations; it is quite another thing to accomplish these same computations with limited data, time, resources, and in a highly stressful atmosphere.

Historically, salvors have successfully overcome these shortcomings by understanding the limits of whatever calculations they can make; by relying on their experience; and, by having a comprehensive understanding of ships in peril. Simply put, there is no substitute for good judgment in the absence of hard fact. Within this work effort, the problems that excessive ship attitudes create with salvage engineering computations have been duly recognized. To date, it has not been possible to develop some means to circumvent those problems with some quantitative or even quasi-quantitative means. Nonetheless, what has been developed and discussed to this point is a significant improvement for the salvor in computing various data points upon which a salvage strategy can be developed in the absence of actual ship characteristics and in the absence of information available from a trim and stability booklet.

Given the above information, and with the input of ship drafts, it is then a straightforward task first to estimate the ground reaction and its effective point of application and then to compute their impact upon both the stability and strength of the stranded ship. This statement is subject to the limitations previously discussed.

3. Ground Reaction

Frequently, only the most sketchy information is initially available following a ship's stranding. Lacking more accurate data, the salvor can estimate a ship's pre-stranding drafts by making appropriate deductions from the full load draft since the last port of departure. The state of the cargo can be predicted based on the type of ship, its route, and information from local authorities or agents. After-stranding drafts, when given, are frequently inaccurate due to the difficulty in reading drafts in the presence of wave action or in poor visibility. Furthermore, grounded draft, if given, is often not correlated with the state of the tide. Refinement of pre- and after-grounding drafts often is a process that continues for several hours, even days, and generally is not finally resolved until after the salvors board the ship. The experienced salvor will have to make his best estimates in such cases.

Knowing the ship's drafts after stranding and its drafts just prior to stranding, or using the best estimates, gives the net change in draft. The net change in draft, in turn, when combined with TPI, given the lost buoyancy or the effective ground reaction (R); or,

$$(54) R = (dmbs - dmas) * TPI * 12,$$

where d_{mb} is the mean draft before stranding and d_{ms} is the mean draft as stranded.

By taking R , the change in draft forward (δd_f), TPI and MT1, it is possible to estimate the effective longitudinal point of application of R from the literature, as follows:

$$(55) R = (2 * MT1 * TPI * (\delta d_f)) / (2 * MT1 + Q * TPI),$$

where δd_f is in inches and Q is the distance from the effective center of ground pressure to the LCF in feet. Rearranging equation (55) to solve for Q results in:

$$(56) Q = 2 * MT1 (\delta d_f / R - 1 / TPI).$$

The effective transverse point of application of R may be estimated from the heeling moment as follows:

$$(57) \text{heeling moment} = R * S * \cos \theta,$$

where S is the unknown transverse distance in feet measured from the ship's centerline and θ is the angle of list. From equilibrium, this heeling moment equals the righting moment or,

$$(58) \text{righting moment} = \Delta * GM * \sin \theta.$$

By combining equations (57) and (58), the following estimate of the effective transverse point of ground reaction is:

$$(59) S = (\Delta_g * GM_g * \tan \theta) / R,$$

where Δ_g is the displacement as stranded or Δ_{FL} minus R .

GM_s is the metacentric height as stranded which may be found from the following:

$$(60) GG_s = (R * KG) / (\Delta - R)$$

where GG_s is the virtual rise in the ship's center of gravity due to the ground reaction. Therefore,

$$(61) GM_s = GM \pm \delta KM - GG_s,$$

where KM is the change in metacentric height.

Since the change in KM (δKM) is generally quite small with change in draft and can be therefore ignored, then,

$$(62) GM_s = GM - GG_s.$$

By properly adding or subtracting weights from the full load departure condition to the condition just prior to stranding and then incorporating the ground reaction and its effective point of application, one arrives at a picture of the ship's stability while stranded. As previously discussed, the ship's stability while stranded is not apt to be a problem. However, as further actions are taken by the salvor to extract the ship from its stranded position by moving, adding, or removing weights, the resultant stability condition of the ship may be precarious once the ship is refloated. Therefore, the salvor must continuously judge the ship's stability as the various salvage actions occur. To do so, he must first ascertain the stability condition as he finds the ship stranded including the impact of any flooding, tide changes, free surface, and free communication that exists and as the overall stability picture changes with progressive salvage actions. These factors are not discussed herein since these are conventional methods published throughout the literature and are well known to naval architects and salvors.

4. Strength Factors

In addition to considering stability, a salvor must also consider ship strength. However, as stated within Section IV, any discussion of ship strength in a stranding situation must always be subdivided into those cases where there is little or no structure damage and those cases where there is significant structural damage.

In the case of little or no structural damage, it is possible to make rigorous computations of shear force and bending moment distributions along the length of ship (including the impact of the ground reaction on these factors) as the ship lies in the stranded condition, as weight changes are made, and as the ship ultimately floats free.

If a salvor were provided, before stranding, weight and buoyancy distributions and could make the necessary adjustments to those two distributions to account for the ground reaction and any weight losses and/or flooding, the problem would be that of computational capability and facility of data input; i.e., not long and tedious data inputs. Assuming for the moment that this capability and facility can be handled, it becomes a straightforward naval architectural technique to develop the "as stranded" load distribution and to integrate for shear forces and bending moments. In fact, except for the ground force input, this would be no different from standard loading computers which are found on many ships today.

However, the best information may only be the centers and weights of cargo, consumables, ballast, and perhaps, light ship data. Oftentimes, the salvor is not afforded all of these data. Nonetheless, even with these data he must distribute the weights along the length of the ship which may not be too monumental a task for cargoes which are carried in bulk and for consumables; but, he probably will be at a loss for the light ship weight distribution. To further compound his problem, meaningful buoyancy distribution data for the ship in the ordinary floating condition and in a stranded condition with distorted waterline attitudes are not available to him.

To help overcome these difficulties, the following technique, in conjunction with the assumption that cargo weight and consumable (e.g., fuel, water) weight distributions can and are input to the analysis, was developed in order to provide some insight to the strength picture of a stranded ship:

- first, a method to create the light ship weight distribution;
- second, a method to estimate the buoyancy distribution for the ship as loaded; and,
- third, a method to account for the ground force.

To create an estimate of the light ship weight distribution, a set of non-dimensional weight ordinates along the length of the ship were developed for a limited number of ship types. The ship types selected were a break bulk cargo ship, a container ship, and a tanker. Their variation in type and within types was simply based upon data availability and the number of variations (three) was in turn limited by time and resources. The description of the step-by-step procedure was as follows:

- the total of steel weight (excluding weight of superstructures), outfit weight, and margin weight was determined;
- the LCG of the above weight total was determined;
- the ordinate for the length of the parallel middle body was determined ("coffin diagram");
- the end ordinates of this diagram was determined by trial-and-error so as to get the same LCG as of the total weight described above;

- the weight diagram without machinery and superstructure was drawn;
- each item of the machinery group was positioned with respect to amidships (as dictated by experience);
- the LCG of the machinery group was determined by taking moments of the machinery items about amidships;
- the positions of the machinery weight items were adjusted to match the LCG of the machinery group;
- trapezoids for each piece of machinery were superimposed on the drawn weight diagram mentioned above; and,
- trapezoids for the superstructure were then superimposed.

The results of the foregoing were then adjusted to create an adjusted light ship weight diagram (consisting of rectangles) by:

- dividing the LBP into 20 stations;
- constructing an ordinate at each half station corresponding to the average ordinate of the previously developed light ship weight diagram;
- calculating the moments of the area bounding the ordinate and half station;
- dividing the total moment by the total area to determine the LCG of the diagram; and,
- checking the LCG of the light ship against actual values and adjusting as necessary.

From the foregoing, a set of station constants (Csn) was created for each of the 40 half stations for each of the three ship types. These station constants for each of the three ship types are given in Tables VI-4, -5, and -6. To then determine the ordinate (Osn) at each station for any particular ship simply becomes:

Table VI-4

Breakbulk Cargo Ship - Engine Room
and Accommodations Three-Quarter Aft
From FP

Station Number	Csn	Station Number	Csn
20 -20.5	0.367	9.5 -10	0.684
19.5-20	0.425	9 - 9.5	0.684
19 -19.5	0.657	8.5 - 9	0.684
18.5-19	0.619	8 - 8.5	0.684
18 -18.5	0.619	7.5 - 8	0.684
17.5-18	0.619	7 - 7.5	0.684
17 -17.5	0.638	6.5 - 7	0.684
16.5-17	0.657	6 - 6.5	0.657
16 -16.5	0.696	5.5 - 6	0.638
15.5-16	0.967	5 - 5.5	0.619
15 -15.5	0.986	4.5 - 5	0.599
14.5-15	1.218	4 - 4.5	0.580
14 -14.5	1.585	3.5 - 4	0.561
13.5-14	1.643	3 - 3.5	0.541
13 -13.5	1.547	2.5 - 3	0.522
12.5-13	0.831	2 - 2.5	0.503
12 -12.5	0.684	1.5 - 2	0.483
11.5-12	0.684	1 - 1.5	0.449
11 -11.5	0.684	0.5 - 1	0.425
10.5-11	0.684	0 - 0.5	0.406
10 -10.5	0.684	-0.55-0	0.387

Table VI-5

Tanker With Aft Engine Room

Station Number	Csn	Station Number	Csn
20 -20.615	0.417	10 -10.5	0.658
19.5-20	0.473	9.5-10	0.658
19 -19.5	0.567	9 - 9.5	0.658
18.5-19	0.904	8.5- 9	0.658
18 -18.5	1.016	8 - 8.5	0.658
17.5-18	1.043	7.5- 8	0.658
17 -17.5	0.904	7 - 7.5	0.658
16.5-17	0.668	6.5- 7	0.658
16 -16.5	0.668	6 - 6.5	0.658
15.5-16	0.668	5.5- 6	0.658
15 -15.5	0.658	5 - 5.5	0.658
14.5-14	0.658	4.5- 5	0.612
14 -14.5	0.658	4 - 4.5	0.598
13.5-14	0.658	3.5- 4	0.570
13 -13.5	0.658	3 - 3.5	0.567
12.5-13	0.658	2.5- 3	0.529
12 -12.5	0.658	2 - 2.5	0.515
11.5-12	0.658	1.5- 2	0.501
11 -11.5	0.658	1 - 1.5	0.473
10.5-11	0.658	0.5- 1	0.459
		0 - 0.5	0.431

Table VI-6
 Container Ship With Forward and Aft Accommodations

Station Number	Csn	Station Number	Csn
20.5-21	0.196	10 - 10.5	0.701
20 - 20.5	0.332	9.5- 10	0.701
19.5-20	0.468	9 - 9.5	0.701
19 - 19.5	0.559	8.5- 9	0.701
18.5-19	0.634	8 - 8.5	0.701
18 - 18.5	0.710	7.5- 8	0.701
17.5-18	0.770	7 - 7.5	0.701
17 - 17.5	0.876	6.5- 7	0.701
16.5-17	0.921	6 - 6.5	0.701
16 - 16.5	0.785	5.5- 6	0.701
15.5-16	0.785	5 - 5.5	0.701
15 - 15.5	1.208	4.5- 5	0.701
14.5-15	1.208	4 - 4.5	0.701
14 - 14.5	1.268	3.5- 4	0.679
13.5-14	1.329	3 - 3.5	0.664
13 - 13.5	1.359	2.5- 3	0.695
12.5-13	0.701	2 - 2.5	0.679
12 - 12.5	0.701	1.5- 2	0.664
11.5-12	0.701	1 - 1.5	0.634
11 - 11.5	0.701	0.5- 1	0.544
10.5-11	0.701	0 - 0.5	0.513

$$(63) O_{sn} = \frac{(C_{sn} * A_1 * A_2 * \Delta_{ls})}{(\sum C_{sn} * A_1 * A_2 * LBP/40)}$$

where A_1 is the LBP divided by 100, A_2 is the ratio of LBP to LOA and Δ_{ls} is the light ship weight which in turn can be determined from

$$(64) \Delta_{ls} = f_1 - \text{TOTAL DEADWEIGHT.}$$

Figures VI-2, -3, and -4 give those distributions on a non-dimensional ordinate scale for each of the three ship types.

Means were sought to accurately approximate cargo and other dead-weight items weight distributions by ship type and loading condition, but the number of combinations was so great and the results so sensitive to reasonable estimates that the effort was thwarted. Therefore, it was concluded that these weight distributions were required to be manually input by the salvor on a case-by-case basis in order to have the computer depict the total as loaded weight distribution. This evolution in actual practice will not be the time consuming process of former times. The program will only require the input of cargo weights and locations. The computer will then conduct the necessary manipulations.

Having to this point generated a weight distribution, the next problem became the generation of a corresponding approximation of buoyancy distribution. Buoyancy distribution is a function of the distribution of section areas which, as will be shown, may be approximated as a function of the block coefficient. To begin this process, the computer divides the ship's length into three units: the parallel middle body (L_{pmb}), the forebody (L_{fb}); and, the after body (L_{ab}) as follows:

$$(65) L_{pmb} = (1.74 * C_b - 1.002) * L;$$

$$(66) L_{fb} = (1.186 - 1.17 * C_b) * L; \text{ and,}$$

$$(67) L_{ab} = L - L_{pmb} - L_{fb}.$$

The buoyancy of the parallel middle body (B_{pmb}) is computed as follows:

$$(68) B_{pmb} = (L_{pmb} * B * d_m * K)/35,$$

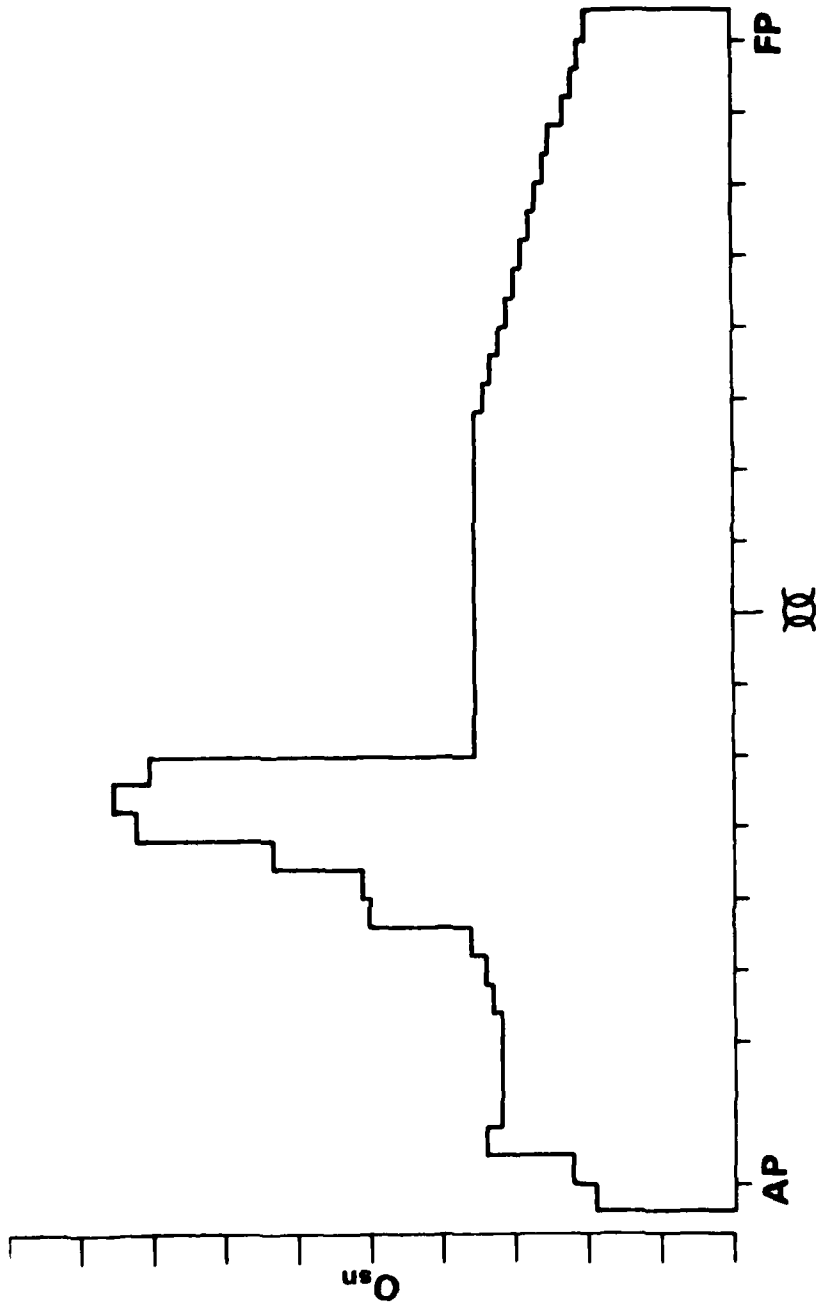

FIGURE VI-2 LIGHT SHIP WEIGHT DISTRIBUTION FOR A BREAK BULK CARGO SHIP - ENGINE ROOM AND ACCOMMODATIONS THREE-QUARTERS AFT FROM FP

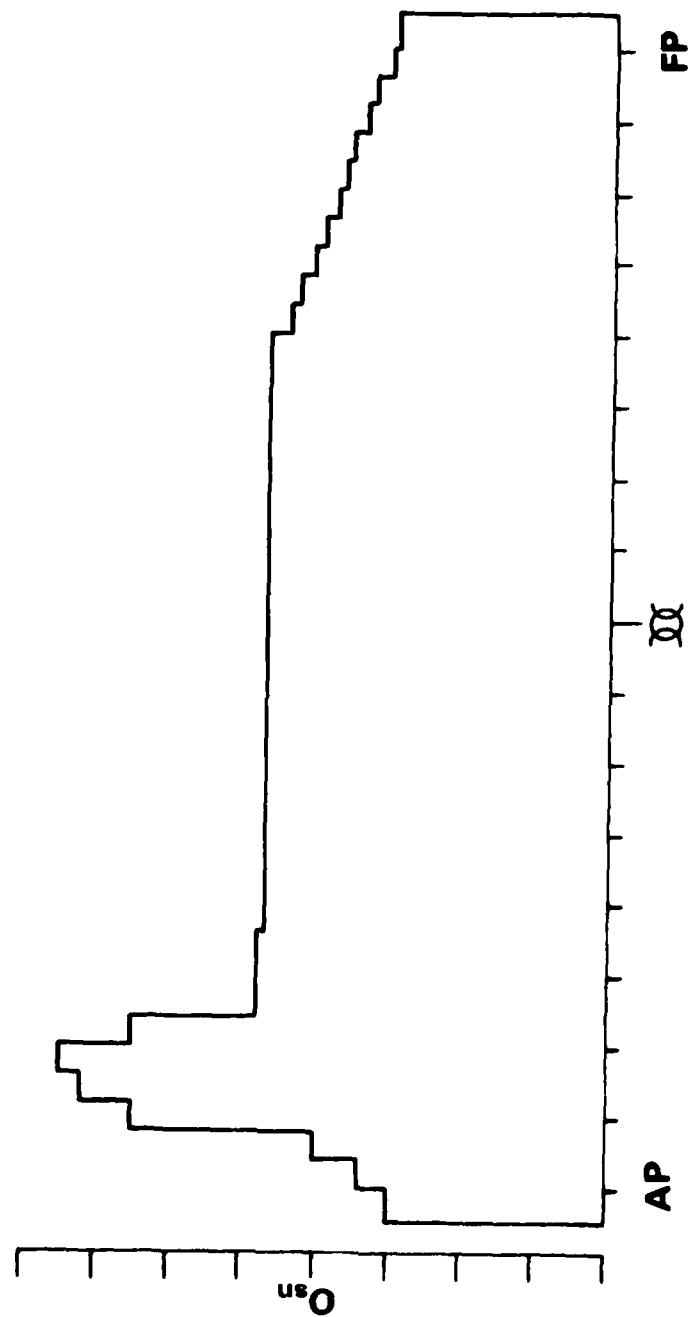

FIGURE VI-3 LIGHT SHIP WEIGHT DISTRIBUTION FOR A TANKER WITH AFT ENGINE ROOM

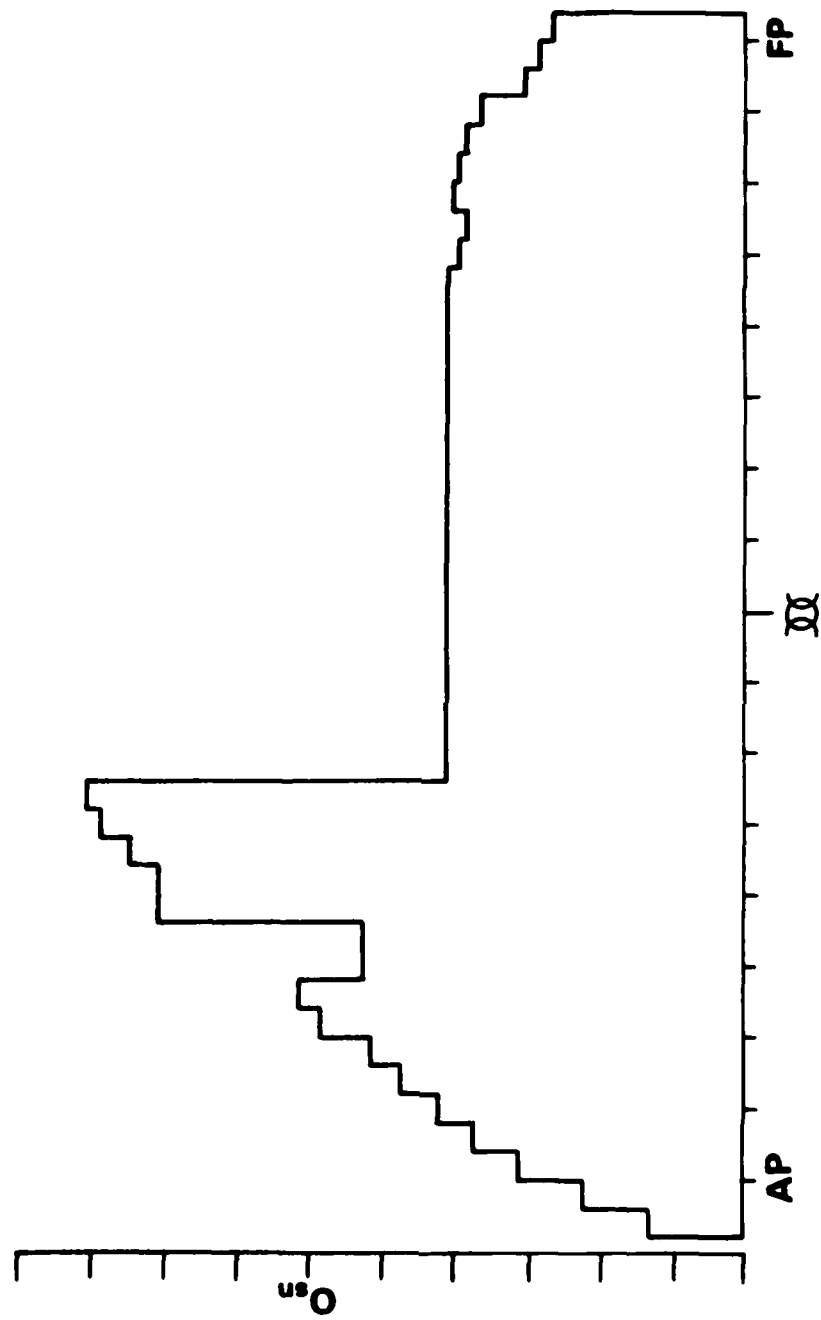

FIGURE VI-4 LIGHT SHIP WEIGHT DISTRIBUTION FOR A CONTAINER SHIP WITH FORWARD AND AFT ACCOMMODATIONS

where K is the midship coefficient (C_m) or C_b divided by C_p . The B_{pmb} divided by L_{pmb} then gives the first estimate of the constant buoyancy ordinate (y_3) throughout the parallel middle body length in tons per foot. In other words, the buoyancy throughout the parallel middle body is being estimated by a rectangle whose length is L_{pmb} and whose height or ordinate is y_3 . (See Figure VI-5.)

As shown on Figure VI-5, the buoyancy distribution within the forebody is estimated by two trapezoids which very closely approximate the curve of buoyancy distribution within the forebody. The baseline distance (b_1) of the forwardmost of the two trapezoids is determined from:

$$(69) \quad b_1 = (0.61 - 0.615 * C_b) * L$$

while the baseline distance of the second of the trapezoids is

$$(70) \quad b_2 = L_{fb} - b_1.$$

The common ordinate (y_2) to the two trapezoids is:

$$(71) \quad y_2 = C_b * y_3$$

and the ordinate of the forwardmost trapezoid just aft of the forward perpendicular (y_1) is:

$$(72) \quad y_1 = 0.04 * y_3.$$

Obviously, the common ordinate to the aftermost of the two trapezoids is equal to y_3 .

In the case of the after body, the baseline distance of the aftermost trapezoid (b_5) is simply $0.2L$ and therefore, the baseline distance (b_4) of the second trapezoid is:

$$(73) \quad b_4 = L_{ab} - 0.2 * L$$

and the common ordinate (y_4) of the two afterbody trapezoids which is located at this point is

$$(74) \quad y_4 = C_b * y_3,$$

which means y_4 is identical to y_2 .

Lastly, the ordinate just forward of the after perpendicular (y_5) is determined from:

$$(75) \quad y_5 = 0.08 * y_3.$$

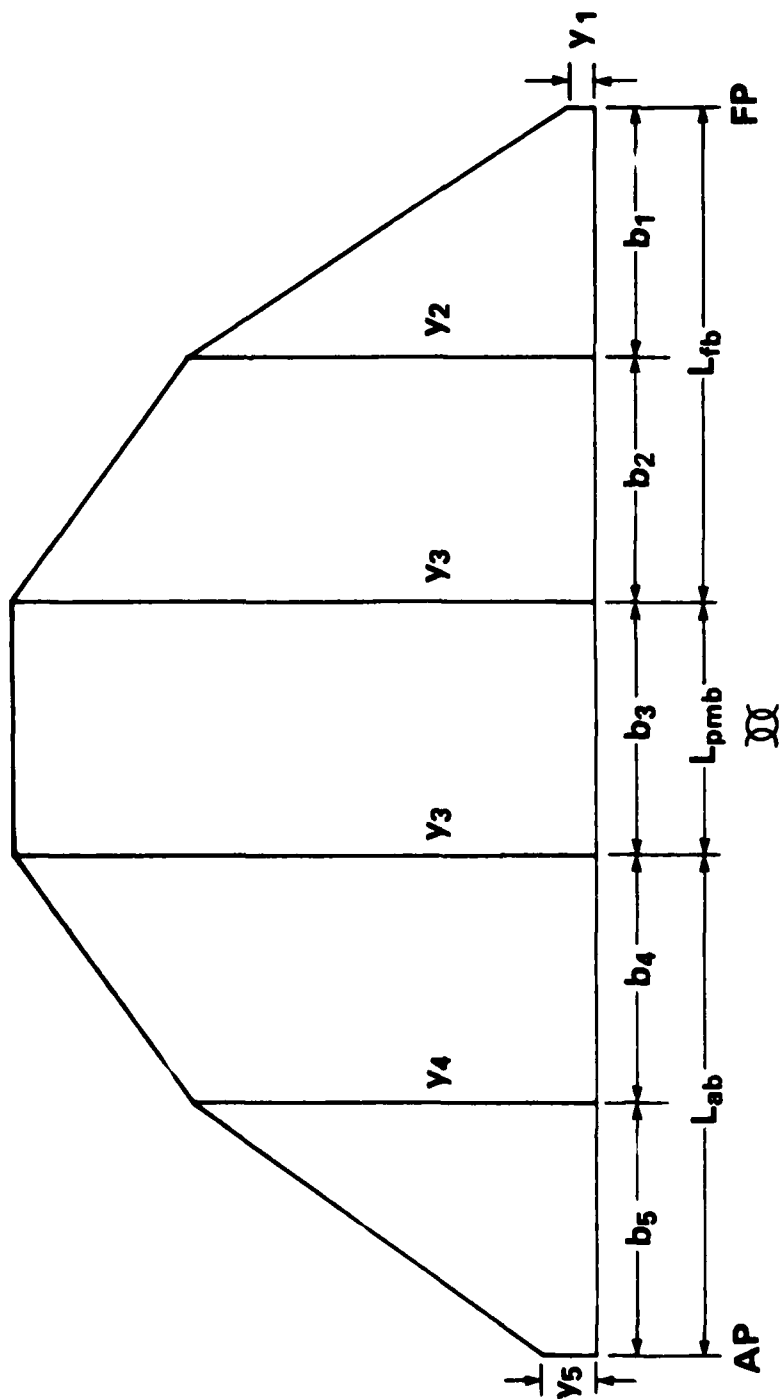

FIGURE VI-5 GEOMETRY OF ESTIMATED BUOYANCY DISTRIBUTION

Figure VI-6 compares the computer-generated first estimate of the buoyancy distribution of a tanker with a block coefficient of 0.8 (shown by the solid line) versus the tanker's actual buoyancy curve (shown by the dashed line). As can be seen from that figure, the differences are relatively minor in nature and are within acceptable limits for salvage purposes if the composite centroid or the LCB of the estimated buoyancy distribution coincides with the previously determined LCG.

If the first estimate of the buoyancy distribution does not give either the proper displacement or the coincidence of the LCB and LCG, then the y_2 , y_3 , and y_4 ordinates are adjusted by an iterative procedure to move the LCB forward or aft, as appropriate, until the LCB and LCG are within one-tenth of a foot of one another and the area under the buoyancy curve equals the displacement.

Once the buoyancy distribution is properly adjusted (in terms of displacement and LCB) it becomes a direct task for the computer to combine the weight and buoyancy distributions and the ground reaction to attain the resultant load distribution and to successively integrate that distribution and the resultant shear force distribution to determine the bending moment distribution. As changes are made to weights during the course of the salvage operation, and the ship is ultimately refloated, these distributions may be revised as necessary so that the salvor has good insight to the strength situation under the assumption that the ship has sustained no major structural damage; i.e., by comparing the calculated bending moment at any time to the maximum allowed by classification society rules which, in turn, is directly calculable within the computer program.

As stated earlier, where the ship has suffered major structural damage, the problem is altogether different due to a number of uncertainties in the definition of damage and, in the case of older ships, to the actual material condition of the intact structure. Therefore, in the case of major structural damage, the ability of a salvor to quantify the strength of the ship is severely limited.

In these instances where major structural damage has occurred, the best information that a salvor can be afforded is a continuous computation of the bending moments of the ship throughout the salvage operation.

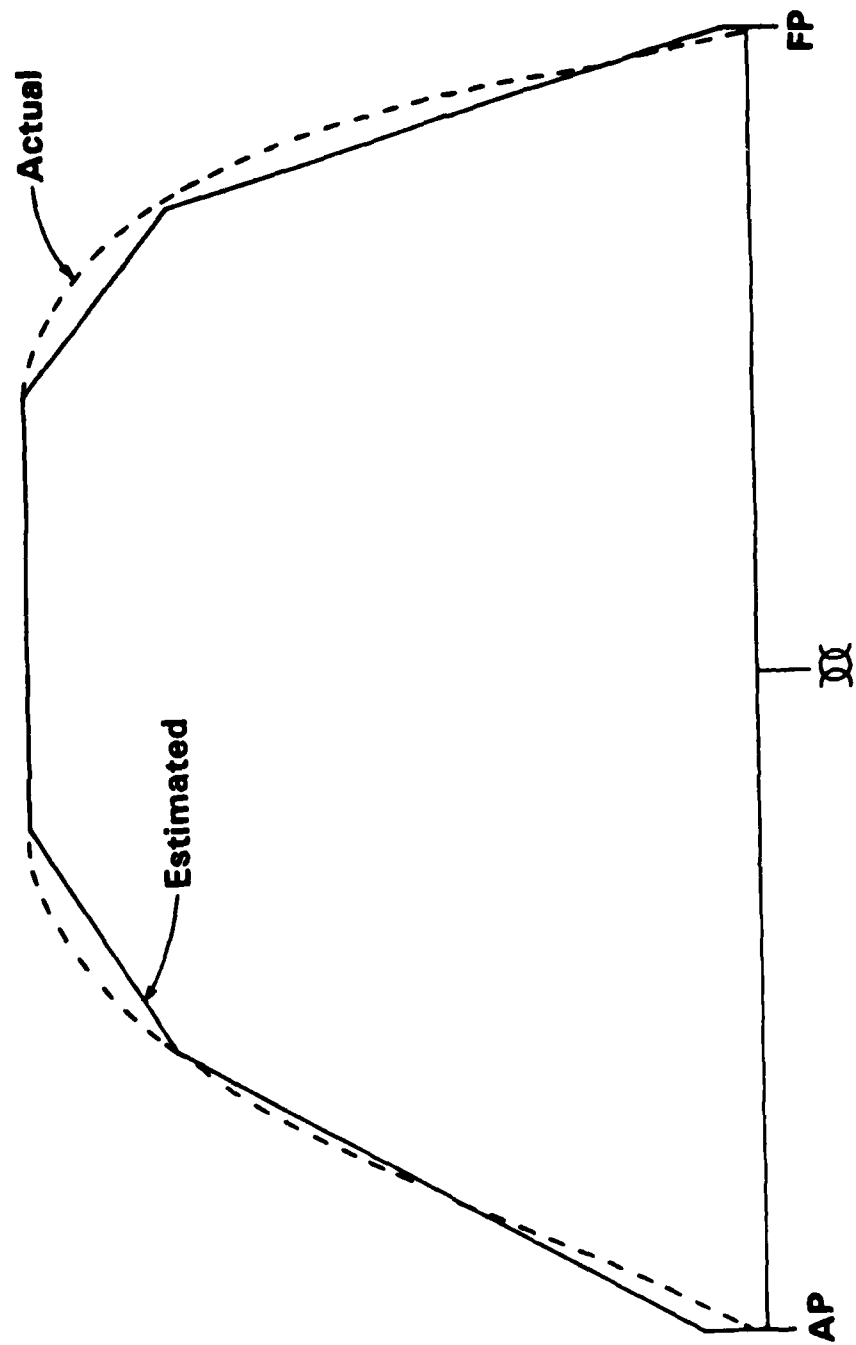

FIGURE VI-6 COMPARISON OF ACTUAL BUOYANCY DISTRIBUTION
 VERSUS ESTIMATED BUOYANCY DISTRIBUTION FOR
 A TANKER WITH $C_b = 0.80$

Another factor that should be understood within strength considerations is that the maximum allowable, total bending moment is the sum of the still water and maximum wave-induced bending moments. While stranded, the ship will be subjected to a modest wave-induced bending moment and the still water bending moment. That still water bending moment represents less than half of the total allowable bending moment which in turn has a factor of safety on the yield strength of 1.5.

When viewed from this perspective, it should be apparent that a ship which strands without significant structural damage and without subjection to heavy bottom scouring action is unlikely to undergo a major structural failure due to the ground reaction by itself and/or any reasonable changes may be made in the loading distribution during the course of the salvage operations. This is not to say that it is impossible for a massive structural failure to occur. However, this is not the reason why the stranded ships sometimes break-up. Rather, these break-ups are primarily attributable to the loss in strength as a result of original damage sustained in stranding or additional damage from ship movements on the strand.

The major structural problem that the intact ship structure will encounter will occur upon refloating and steps must be preplanned and quickly taken to alleviate any unfavorable load distribution upon refloating.

SECTION VII

FUNCTIONAL REQUIREMENTS

1. Introduction

This section contains the recommended hardware and software requirements for portable computational aids intended for use by salvage response personnel. These functional requirements are predicated upon the findings and results of all of the previous tasks; i.e., a portable computational device for the analyses of stranded ships with limited input data.

As discussed in Section III, the anticipated input data, the analytical techniques, and the desired output for salvage calculations cannot be structured to be compatible with existing portable computer capability. Rather, the combination of computational needs and input data availability dictate analytical techniques and computational outputs which in turn, requires a compatible computational capability. In other words, the software and hardware for portable computers must be capable of operating on the available input data and the compatible analytical technique which in turn gives the various outputs to meet the computational needs of a salvor. (See Figure VII-1.)

2. Software Requirements

From the basic analytical techniques developed in the previous section, a series of algorithms (i.e., step-by-step procedures for programming) and arrays were developed. The results of those algorithms and arrays are contained in Appendix E. The algorithms are subdivided as follows:

- a loop to calculate displacement as stranded from a last known displacement or draft (p. E-2);
- a loop to determine hydrostatic properties (i.e., KM, TPI, MT1, LCB, and LCF) when the curves of form are not available (pp. E-3 and E-4);
- a loop to determine as-stranded KG and LCG or KG2 and LCG2 (pp. E-5 and E-6);

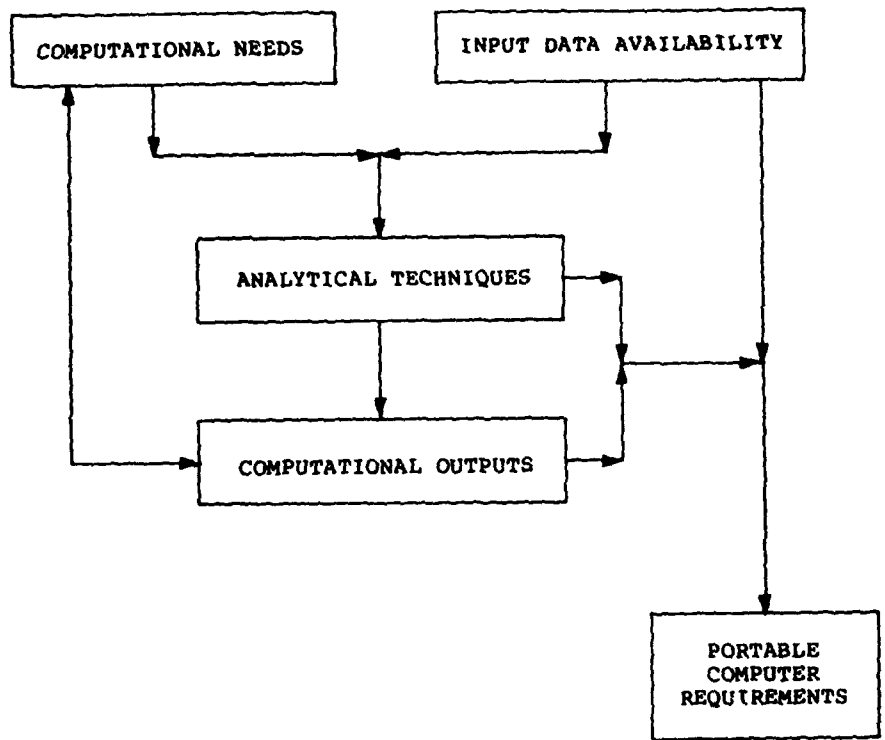

FIGURE VII-1 DEVELOPMENT OF FUNCTIONAL REQUIREMENTS FOR PORTABLE COMPUTERS

- an algorithm to determine R, KG, LCG, and trim as stranded and as progressive weight changes are made (pp. E-7, E-8, and E-9);
- an algorithm for miscellaneous factors including free surface, free communication, the change in R (δR) due to a change in the height of tide (δh), the net theoretical force (F) to free the ship including an array of the coefficient of friction (μ) versus bottom type, and the location of the neutral loading point (NP); i.e., the point at which weights may be added or removed without changing the magnitude of the ground reaction (pp. E-10 and E-11);
- an array of the "f" and "g" coefficients for determining Cb and Cw (p. E-12);
- an algorithm to determine the light ship weight distribution (p. E-13) to be used in conjunction with Tables VI-4, -5, and -6 for Csn on pages 61 to 63;
- an algorithm to determine the buoyancy distribution (pp. E-15 and E-16); and,
- an algorithm to calculate shear force and bending moment (pp. E-17 to E-20).

These algorithms and arrays represent the total software application requirements developed for this project. When they are properly chained together and programmed in a "user friendly" sense (i.e., prompts, displays, printouts, etc.) for the particular portable computer ultimately chosen, they will constitute a comprehensive computational package with various automatic default operations when certain input data are not available.

However, their limitations with respect to the applicability of the hydrostatics for large angles of trim and heel, to the limited number of ship types in the loop to determine light ship weight distribution, and to various specialized ship types which are not included therein should be especially noted by anyone using them. Moreover, it cannot be overemphasized that these and any other salvage engineering computations are an aid to the salvor and not a salvage solution by themselves; in other words, the results of any salvage computations require interpretation based on experience and used accordingly.

3. Hardware

a. Physical size and weight. The portable computation device including all peripheral equipment should be of such a size (in the "carry" mode) and weight so that it can be hand carried by salvage response personnel and as a matter of perspective, it should be capable of being stowed under an airline seat. Its weight and bulk should not create any undue hardship upon the persons carrying the unit. Moreover, it should not be either so heavy or cumbersome as to create a risk to the carrier when boarding a stranded ship via a pilot ladder or other similar means.

b. Self-contained power source. The portable computational device should be provided with a self-contained source of power so that no external power source is required for its operation. Rechargeable nickel-cadium batteries or other equivalent power supply should be provided. The capacity of the self-contained power source should be sufficient to operate the device, including all peripherals, for not less than 24 hours. In addition, a means to recharge the power source from an external source of power should be provided; i.e., an adaptor suitable for AC voltage inputs in the ranges of 90 to 130 VAC and 175 to 250 VAC at cycles between 48 to 66 hertz.

c. Random access memory (RAM). The portable computational device should be provided with sufficient random access memory to accommodate both the operating system software and the salvage computations. In addition, a back-up, non-volatile storage mechanism (e.g., disk, cassette, tape, etc.) must be provided to reload the device in the event of memory loss such as through battery dissipation. The total required RAM capacity of the computational device will depend in part upon the requirements of the operating system; however, it would appear that most existing portable computers with a RAM capacity of 32K could accommodate the salvage calculation needs developed herein although a 64K machine would allow more programming and operating flexibility, accommodate future expansions of the program, and probably permit the maximization of "user friendly" operations such as prompts and the visual display and printing of all inputs, outputs, and plotting options.

d. Peripheral devices. Peripheral interfaces should comply with RS-232C or IEEE-488. The portable computational device should be provided with a mass storage peripheral employing disks, cassettes, tapes, etc., with the ability to transfer data from that peripheral to the device and vice versa. In addition, the computer should be provided with a visual display to prompt the user for inputs and to display all inputs and outputs. The visual display should not be less than a 20 to 30 column, single row display. (From the practical point of view, the requirement for a self-contained source of power tends to eliminate a CRT-type display.) Further, a printer is to be provided to record all inputs and outputs and to be capable of providing a plotting function. Insofar as is reasonable and practical, all peripherals should be integral within the unit and should not, in any case, require excessive set-up operations and time by the user.

e. Other features. The portable computer should have a complete alpha-numeric keyboard in addition to any preprogrammed or user definable special function keys. The keyboard should be as near as is practicable to a full-size keyboard and it would be desirable to have a keypad editor; i.e., a calculator type numeric entry keypad. Communication capability through a modem or acoustic coupler or IBM compatibility is not necessary but consideration should be given to the inclusion of these features for additional flexibility and future applications.

From the technical applications point of view, there does not appear to be any advantage in stipulating a particular operating system. However, certain operating systems tend to have various advantages and disadvantages with respect to the area they require within the RAM, programming, user facilitation, speed, compatibility with other computers, and other standard user software application packages. Except for the RAM consideration, it would appear that for the dedicated salvage engineering application, the selection of the operating system is more of a function of preference, operator sophistication, and whether the device will be used for other applications and/or communicating with other computers. However, its language capability should be at least equivalent to existing ones.

SECTION VIII

CONCLUSIONS AND RECOMMENDATIONS

1. General

Historically, salvors have operated rather successfully with both limited data inputs and limited computational capacity when conducting their various salvage engineering calculations. The experienced salvor generally has no difficulty in reaching the "right" strategy. The problem is a matter of degree. Having an improved ability to quantify the stranding problem, particularly at a much earlier stage, will facilitate mobilization decisions such that the assets ultimately required will be made available much sooner than before. There will be fewer initially successful refloating efforts with less waste of time and less exposure of the stricken ship to additional risk.

The problems that arise in measuring and attaining situational data are inherent to a salvage situation; therefore, those data will always present some amount of uncertainty within salvage computations. In addition, the variance in the availability of intact ship characteristics will be so great that a salvor must always be prepared to operate with minimum actual data and must be capable of estimating those data quickly and with reasonable confidence.

Heretofore, those estimating techniques have been generalized and in some cases, have required long and tedious calculations under adverse circumstances. To help relieve this, the salvage profession, by necessity, has developed from experience, various analytical aids and estimating processes. Those techniques and processes can be greatly facilitated in accuracy and reliability as well as expedited by the use of portable computers supplied with the appropriate software for the analytical techniques developed herein.

2. Data Availability and Reliability

Data availability and reliability cannot be mandated or necessarily expected in salvage situations given the international character of shipping and its institutional constituency such as charter arrangements, single ship entities, etc. It would be convenient to find that every ship has the trim and stability booklet, loading manual, or other shipboard information that may be required by various national authorities, classification societies, or international conventions. However, many ships do not have or cannot

provide these data due to the ship's age, its owner, the number of times the ship has changed ownership, the type of ship, and may other factors. Thus, the expectation of readily finding that data onboard or retrieving it from some other source in a timely fashion, is so tenuous that it should be assumed that such data may not be available to the salvor; at least, not in the early, and most critical stages of a salvage operation.

Intact ship characteristic data are and will continue to be limited in availability, reliability, and timeliness to a salvor. This limitation need not create unsolvable impediments to the experienced salvor.

3. Calculations For Hydrostatics, KG, LCG, and Ground Reaction

It is believed that basic hydrostatic data (i.e., displacement, KM, TPI, MTL, LCB, and LCF) can be determined from minimal ship data for the full load condition and at ship drafts which vary significantly from that full load condition at a level of accuracy which is well within the limits required for salvage needs. In fact, given the accuracy that a ship's drafts may be read in a stranding situation in the presence of any wave action, the results which may be generated exceed that which has been previously available to salvage personnel.

Moreover, the estimation processes developed to provide the KG and LCG of the fully loaded ship are well within the needs of salvage engineering, and can only be improved upon by having actual data or conducting detailed weight estimates and distributions which is not very practical in a salvage situation.

With the foregoing information and other information such as the ship's drafts as stranded, the amount and location of cargo or other weight items that may have been lost as a result of the stranding, the amount and location of any flooding that may have occurred as a result of the stranding, and some point of reference which allows an estimation of the ship's condition just prior to stranding, the salvor is able to compute all of the following with respect to stability:

- first, the magnitude of the ground reaction and its effective point of application;
- second, the ship's stability as stranded, but recognizing that this normally is not a critical factor for most ships;

- third, the ship's stability as various changes in tide occur and weight movement and/or changes are made to extract the ship from its stranded condition; and,
- fourth, and perhaps most importantly, the ship's stability when it is refloated.

When a ship is lying at large angles of trim and heel, any and all hydrostatic data used in either stability or strength calculations will suffer in applicability due to these list and trim attitudes. In the absence of any other means (such as shoreside engineering support) to rigorously determine these properties for the actual ship attitudes, any calculations determined by the methods herein must be treated accordingly by all parties involved in the salvage operation.

It is RECOMMENDED, however, that prior to the programming process and the distribution of any portable computers to salvage response personnel, the Coast Guard institute a short-term, high priority research and development effort to provide the necessary analytical techniques to estimate hydrostatic properties for large angles of trim since larger than normal angles of trim are not uncommon in stranding situations.

Apart from the problem of large amounts of list and trim, the technique discussed herein along with the necessary pre-programmed computational device provides the salvor with a good picture of the magnitude and effective location of the ground reaction and the stability situation. More importantly, it permits the salvor to create his overall salvage strategy, at least from the trim and stability point of view and informs him of the implications of such actions as lightening, and moving weights, and the forces needed to physically pull the ship off the strand at various tidal and loading conditions. It also provides him with insight towards protecting the stranded ship where stability may be a problem and when the refloated ship where stability can often be a problem.

4. Calculations For Shear Forces and Bending Moments

From the so-called ship strength point of view, if the ship is not significantly damaged, then the load distributions (including the ground reaction and any flooding that may have occurred) may be developed. Those load distributions, which are quickly developed from an approximation of light ship weight distribution, inputs of cargo and other deadweight item weights and longitudinal centers of gravity, and an estimated buoyancy distribution can then be

successively integrated to determine very good estimates of shear forces and bending moments. In fact, it is submitted that these results will, for salvage purposes, approach those developed by shipboard loading calculators given the various inaccuracies of the preloaded hydrostatics and the situational factors.

However, one major limitation that this aspect of the analytical techniques is subjected to is the limited number of light ship distributions (by ship type and character) that were possible to develop within this project. Accordingly, it is RECOMMENDED that the Coast Guard institute a short-term research and development effort to expand the number of light ship weight distributions. Without additional variations, the applicability of the shear force and bending moment techniques developed to date are limited.

As previously discussed, the impact of the ground reaction, even under severe assumptions of stranding, will not ordinarily cause structural failure by itself in the absence of significant structural damage having occurred during the course of stranding.

The two problems that the salvor faces with regards to ship strength are as follows:

- first, in the absence of any significant structural damage, he must assure himself that the resultant changes in loading which are made to the ship during the course of the refloating operation do not create stresses which exceed the ship's intact strength while stranded, while being extracted, and most critical, immediately upon refloating; or,
- second, when significant structural damage has occurred, he must determine the stress level to which the damaged hull may be safely subjected.

In the first case, the techniques developed along with the capability of existing portable computers can quickly provide salvors with hull loading information for integration in their salvage strategies. In the second case, no present analytical technique can provide more than qualitative guidance with respect to strength.

In the situation where the ship structure is significantly damaged, the analytical technique developed herein becomes somewhat limited in that it cannot determine the ship's residual strength. However, that inability is not a function of the technique or capability as it is the combination of the lack of detailed intact

hull structure data and the uncertainty of the extent of structural damage. Even with the availability of detailed intact hull structural data, it must be understood that any analysis made employing any analytical technique will be subject to the same uncertainty problem of structural damage.

It is therefore RECOMMENDED that the Coast Guard in conjunction with the Ship Structure Committee create a long-term goal to develop a means by which limited structural data information can be used to estimate the ship's residual strength.

5. Predictive Ground Reaction and Pre-Arrival Assessment

Apart from the on-scene capability that the described analytical techniques afford a salvor, they can also provide a unique capability which has generally not been available to salvage response personnel. That capability is the formulation of an initial assessment of the situation before arriving on-scene and the marshalling of the required salvage assets. This could, in many cases, gain valuable time (i.e., certainly hours and frequently days) rather than awaiting arrival on-scene.

If experienced salvage response personnel were informed of a stranding and given the ship's name and its location, they could determine quickly the ship's approximate loading condition and make an educated guess of the ground reaction by knowing the ship's approximate speed at stranding, the bottom's approximate topography and constituency, and tidal conditions.

By telephoning owners, shipping agents, local authorities, pilots, etc. and from personal expertise and knowledge the salvor could compile these data in a matter of hours. The goal of this compilation would be to make a first order assessment of the stranding situation. The question that arises is whether the ground reaction in the absence of accurate draft information, can be estimated at this stage.

During the course of this project, it appeared to be possible to make a first order assessment of the ground reaction as a function of ship's speed and displacement at the time of stranding. It is still contended that this is feasible subject to the caveat that such a determination would be only a first order assessment due to the many variables which ultimately determine the actual ground reaction. As discussed in Section II, the problem that handicapped this development was not the analytic process, but rather one of limited data of actual stranding data which were made available.

A ship's kinetic energy is dissipated when it stops because of a grounding. There are many parameters involved in this process of energy dissipation. Nonetheless, one would expect to find some correlation between initial ground reaction and some function of displacement and speed squared. While no simple correlation could be developed, a more complex relationship of displacement, speed squared, and other ship's characteristics was found that suggests an order of magnitude prediction of ground reaction is possible. However, the data sample was insufficient to develop significant statistical correlation. Nonetheless, it is strongly suspected that given more data points, it would be possible to make a good, first order prediction of ground reaction on the basis of some function of ship speed and displacement.

Throughout the evolution of this development, it has been argued that there are so many variables that dictate ground reaction to render such an approach to be impractical. However, as long as such a result was clearly understood to be a first order estimation, it could be of tremendous advantage at the very early and critical state of a salvage operation. As previously stated, limited data suggest strongly that such estimates are reasonable and within working limits for their intended use.

For example, it would be extremely valuable for salvage response personnel, prior to their arrival on-scene, to know the particular requirements of the situation, the degree of lightening operations, and the limitation in salvage options caused by stability and strength considerations. This type of predictive capability is possible with the analytical and computational techniques described herein coupled with a means to predict ground reaction when meaningful information in the ship's drafts is not otherwise available.

Since this predictive capability would appear to be a significant asset to the Coast Guard, or anyone involved in salvage, it is RECOMMENDED that the Coast Guard institute a short-term, high priority goal to collect, analyze, and develop a technique to predict the ground reaction as a function of displacement and speed or other appropriate variables.

6. Other Limitations In The Use Of The Analytical Techniques

With respect to both stability and strength considerations in a salvage situation and in particular, to the engineering calculations, there are two cautionary notes that bear emphasis. First, it has been found that mixing actual data with calculated data in any set of salvage calculations tends to give results poorer than results achieved using, complete sets of actual or calculated

data; e.g., one explanation for this result seems to be that errors in estimating are oftentimes cancelled within the physical calculation process. Specifically, coefficients of form and hydrostatic properties must be compatible.

The secondary cautionary note pertains to the fact that salvage calculations always have been, are, and will provide information to the salvor with various degrees of accuracy. The analytical techniques developed herein, in conjunction with the computational capability of portable computers, can be used to facilitate and enhance a salvor's confidence in these calculations. They are a means to an end but they should not and cannot be the decision-maker. Simply put, there are too many facets of salvage which can only come from experience and any results used from the techniques developed herein should be tempered accordingly.

Moreover, the outcome of this project is not a panacea to all possible situations and more especially those which are very complex and, therefore, take more caution and time. In such instances, the complexities of the situation, if at all quantifiable, will, by their very nature require more engineering support than described herein or could be provided on-scene.

7. Computational Aids

It has been concluded that there are a number of portable computers with self-contained power sources available on the market today which can accommodate the calculation needs for salvage in a stranding situation. Accordingly, the use of other non-electronic calculation devices such as slide rules, nomographs, datalyzers, etc., do not appear to merit any consideration since there is no function that one of these devices can perform that the portable computer cannot perform. While arguments could be made for their employment as back-ups to the portable computer or to relieve the load on the portable computer, the arguments lack merit.

Although onboard loading computers could be modified to provide a portion of the necessary computational capability in a salvage situation, this modification is not especially recommended as a pursuit; the reasons being limited availability onboard, utility in the absence of power, the potential compromise of their reliability for their intended purpose, their potential misuse by shipboard personnel in a stranding situation, the reluctance of owners to provide this facility, and the potential conflict with classification society approval requirements.

Computational aids which are more extensive than the portable computers are discussed in a following subsection.

8. Users of Salvage Computational Aids

Although no suggestion is being made that Coast Guard contingency response personnel should or could be trained as and gain the experience of professional marine salvors, it is imperative that they possess a basic understanding of salvage if the results of any salvage engineering computations are to have any meaning to them. It is, therefore, RECOMMENDED that key contingency response personnel be exposed to some form of basic training in marine salvage and that senior personnel be educated in all aspects of salvage.

9. Other Long-Term Goals And Considerations

For the near-term future, the portable computer and analytical techniques developed herein (plus the short-term goal recommendations previously discussed in this section) can fulfill Coast Guard needs. However, for the long-term, the following are RECOMMENDED for Coast Guard consideration:

- the compilation of digitized hull offsets and compartment data, light ship weight, distribution, KG, and LCG, and pertinent structural data within an off-line computer facility for recall and analysis when required for extraordinary cases. While it is recognized that this could never be an all inclusive file, it could be a major advantage in such situations involving any one of the on-file or similar ships;
- as a corollary to the foregoing, the provision of communications capability within the portable computer system might, therefore be a judicious requirement. (Although there is some argument to be made about long-range data transmission capability in any situation and the availability of a communications medium in a salvage situation, it is believed that modern satellite communications can accommodate the data transmission and that such communications capability is becoming more widespread aboard ships); and,

- while it is not recommended that the Coast Guard become involved in the development of more detailed computational aids tailored to particular ships, it is recommended that the Coast Guard be aware of those systems which are available, especially within various major operating companies.

As a matter of caution in this regards, it should be emphasized that sometimes too much detailed information can be an impediment to a salvor in that: (1) the gain in refinement or detail is "noise" in the context of the ultimate decision taken and the time lost in conducting and assessing this level of detail; i.e., "better is the enemy of good enough"; and, (2) too much detail might tend to impede an otherwise acceptable and expeditious decision. It cannot be overstressed that any salvage computations, no matter how accurate they may be are still only guidelines to the salvage master and should never be used to override his judgment. However, they can be a valuable asset to him in many situations.

APPENDIX A
BIBLIOGRAPHY

BIBLIOGRAPHY

Arkenbaut, S. et al, The Design of Merchant Ships, H. Stam, Culemborj, The Netherlands, 2nd ed., 1959.

Baptist, C.N.T., Salvage Operations, London, Stanford Maritime Ltd., 1979.

Bergman, W.R., "Fundamental Salvage Computations," U.S. Naval School, Deep Sea Divers, revised, August, 1965.

Bissell, A.M., E.J. Oertel, and D.J. Livingston, Shipboard Damage Control, Annapolis, Md., U.S. Naval Institute, 1976.

Brady, E.M., Marine Salvage Operations, Centreville, MD., Cornell Maritime Press, 1960.

Clay, John S., "Salvage of Stranded Tank Vessels With Computer Assistance," Department of Ocean Engineering, University of Rhode Island, 1983.

Carithers, II, L.W., and E.P. Tibbert, Buoyant Lift Systems for the Salvage Navy, Naval Ocean Systems Command, Report No. NOSC-TR-731, San Diego, California, September, 1981.

Dickson, A.F., "Environmental Pollution. The New Dimension of Salvage," Maritime Association of the Port of New York and Marine Technology Society, International Symposium on Marine Pollution, New York, N.Y., October 1-3, 1979, pp. 75-85.

Dillon, E. Scott, "Basic Design" in Ship Design and Construction, edited by A.M. D'Arcangelo, New York, SNAME, 1969.

Huther, M. and J.C. Letourneur, "Investigation on Estimating the Grounding Length of the Ship," Association Technique Maritime et Aeronautique, Paris, 1978.

International Chamber of Shipping and Oil Companies International Marine Forum, "Peril at Sea and Salvage, A Guide for Masters," 2d ed., London, 1982.

Katsoulis, P.S., "Exponential Formula for Optimum Block Coefficients of Various Ships," Holland Shipbuilding, Vol. 24, No. 1, March, 1975.

Kelly, T.J., Damage Control, D. Van Nostrand Co., Inc., New York, N.Y., 2d ed., 1951.

LaDage, J. and L. Van Gemmert, Stability and Trim for the Ship's Officer, 2d ed., Princeton, N.J., D. Van Nostrand, Co., Inc., 1956.

"Longitudinal Strength" in Rules for Building and Classing Steel Vessels, American Bureau of Shipping, New York, 1982.

Maclin, Charles S., and Clarence M. Kunstmann, "Salvage and the Future", Naval Sea Systems Command, Naval Engineer's Journal, Vol. 91, No. 2, April, 1979, pp. 84-90.

MacNaught, D.F., "Strength of Ships" in Principles of Naval Architecture, edited by J.P. Comstock, New York, SNAME.

Madsen, S.A., "Salvage Operations Where Anti-Pollution is a Major Consideration," American Petroleum Institute, Proceedings 16th Annual Tanker Conference, Ponte Verdra Beach, Florida, May 10-12, 1971.

"Marine Salvage in the United States," Committee on the National Salvage Posture, Marine Board, Commission on Engineering and Technical Systems, National Research Council, Washington, D.C., 1982.

Milgram, Jerome, "Being Prepared for Future Argo Merchants," Massachusetts Institute of Technology, Technology Review, Vol. 79, No. 8, July - August, 1977, pp. 14-27.

Milwee, W.I., "Considerations in the Naval Architecture of Salvage Ships," Naval Engineers Journal, Vol. 90, No. 5, October, 1978, pp. 19-28.

Mitchell, E.B., "Role of the Supervisor of Salvage in Oil Pollution Abatement," American Petroleum Institute 16th Annual Tanker Conference, Ponte Vedra Beach, Florida, May 10-12, 1971, pp. 138-145.

"Model and Expanded Resistance Data," T & R Bulletin No. 1-14, SNAME, 1958.

Moore, C.S., "Intact Stability," in Principles of Naval Architecture, edited by J.P. Comstock, New York, SNAME, 1967.

Muller, J., Salvage and Recovery Data Book-Static Lift Forces Report No. NOSC-TD-264, Seaco, Inc., Kailua, Hawaii, June, 1979.

Naval Engineer's Journal, "Plastic Foams for Marine Salvage," Vol. 82, No. 4, August, 1970.

Pursey, H.J., Merchant Ship Stability, 6th ed., Brown, Son & Ferguson, Ltd., Glasgow, 1977.

Sabit, S., "The Analysis of the Series 60 Results," International Shipbuilding Progress, March, 1972.

Sea, Roy L., "High Seas Oil Spill Control Program of the Supervisor of Salvage USN," Proceedings of the 8th Annual Offshore Technology Conference, Houston, Texas, May 3-6, 1976.

Shipbuilding and Shipping Record, "Tanker Owners Apprehensive of Salvage Capabilities," Vol. 115, No. 3, January 16, 1970, p. 24.

Spicer, H.J., "American Institute of Merchant Shipping Tanker Salvage Committee," American Petroleum Institute, 16th Annual Tanker Conference, Ponte Vedra Beach, Florida, May 10-12, 1971, pp. 146-159.

Sullivan, William A., "Marine Salvage," Trans., SNAME, Vol. 56, 1948.

Tate, K.W., Development of a Hydrazine Gas Generation System for the Large Object Salvage System (LOSS), Naval Civil Engineering Lab, Port Hueneme, California, December, 1983.

Taylor, L.G., The Principles of Ship Stability, 5th ed., Brown, Son & Ferguson, Ltd., Glasgow, 1977.

Thomas, G.R. and B.S. Bowden, "The BSRA Methodical Series An Overall Presentation. Variation in Parallel Middle Body," R.I.N.A. Supplementary Papers, Vol. 119, July, 1977.

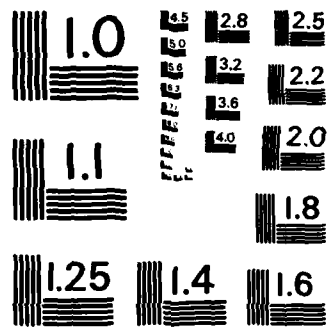

MICROCOPY RESOLUTION TEST CHART
NATIONAL BUREAU OF STANDARDS - 1963 - A

Troost, L., "Simplified Method for Preliminary Powering of Single Screw Merchant Ships," Trans., SNAME, Vol. 65, 1957.

U.S. Navy, Naval Ship Systems Command, Office of the Supervisor of Salvage, U.S. Naval Ship Salvage Manual, Washington, D.C., 1968.

White, G.W., Elementary Beam Theory and the Ship Girder," Stanford Maritime Ltd., London, 1979.

Zahn, A.S., "Grounding Characteristics and Effects," Maritime Administration Report NA/RD-920-77-57-T-5, Washington, D.C., January, 1977.

"Marine Salvage in the United States," Committee on the National Salvage Posture, Marine Board, Commission on Engineering and Technical Systems, National Research Council, Washington, D.C., 1982.

Milgram, Jerome, "Being Prepared for Future Argo Merchants," Massachusetts Institute of Technology, Technology Review, Vol. 79, No. 8, July - August, 1977, pp. 14-27.

Milwee, W.I., "Considerations in the Naval Architecture of Salvage Ships," Naval Engineers Journal, Vol. 90, No. 5, October, 1978, pp. 19-28.

Mitchell, E.B., "Role of the Supervisor of Salvage in Oil Pollution Abatement," American Petroleum Institute 16th Annual Tanker Conference, Ponte Vedra Beach, Florida, May 10-12, 1971, pp. 138-145.

"Model and Expanded Resistance Data," T & R Bulletin No. 1-14, SNAME, 1958.

Moore, C.S., "Intact Stability," in Principles of Naval Architecture, edited by J.P. Comstock, New York, SNAME, 1967.

Muller, J., Salvage and Recovery Data Book-Static Lift Forces Report No. NOSC-TD-264, Seaco, Inc., Kailua, Hawaii, June, 1979.

Naval Engineer's Journal, "Plastic Foams for Marine Salvage," Vol. 82, No. 4, August, 1970.

Pursey, H.J., Merchant Ship Stability, 6th ed., Brown, Son & Ferguson, Ltd., Glasgow, 1977.

Sabit, S., "The Analysis of the Series 60 Results," International Shipbuilding Progress, March, 1972.

Sea, Roy L., "High Seas Oil Spill Control Program of the Supervisor of Salvage USN," Proceedings of the 8th Annual Offshore Technology Conference, Houston, Texas, May 3-6, 1976.

Shipbuilding and Shipping Record, "Tanker Owners Apprehensive of Salvage Capabilities," Vol. 115, No. 3, January 16, 1970, p. 24.

Spicer, H.J., "American Institute of Merchant Shipping Tanker Salvage Committee," American Petroleum Institute, 16th Annual Tanker Conference, Ponte Vedra Beach, Florida, May 10-12, 1971, pp. 146-159.

Sullivan, William A., "Marine Salvage," Trans., SNAME, Vol. 56, 1948.

Tate, K.W., Development of a Hydrazine Gas Generation System for the Large Object Salvage System (LOSS), Naval Civil Engineering Lab, Port Hueneme, California, December, 1983.

Taylor, L.G., The Principles of Ship Stability, 5th ed., Brown, Son & Ferguson, Ltd., Glasgow, 1977.

Thomas, G.R. and B.S. Bowden, "The BSRA Methodical Series An Overall Presentation. Variation in Parallel Middle Body," R.I.N.A. Supplementary Papers, Vol. 119, July, 1977.

APPENDIX B
GROUNDING INCIDENT SCENARIOS

Table B-1

Location of Casualty	
Port Area	Galveston, TX
Specific Site	Bolivar Roads Channel
Vessel Characteristics	
Type	Crude Tanker
Flag	Foreign
Length (feet)	748.0
Beam (feet)	105.7
Draft (feet)	43.2
TPI (tons/inch)	161.9
MTI (foot-tons-inch)	8040
Displacement (tons)	77033
Vessel Condition	
Load Condition	Loaded
Direction of Transit	Inbound
Speed at Time of Incident (knots)	10.0
Draft After Incident (feet)	40.6
Ground Reaction (tons)	5000
Site Conditions	
Tidal Range (feet)	1.4
Tidal Condition	Beginning of flood
Wind Speed (knots) & Direction	SSE 10
Bottom Type	Soft
Damage	
None.	

Table B-2

Location of Casualty	
Port Area	Port Arthur, TX
Specific Site	Channel to Gulf south of R "32"
Vessel Characteristics	
Type	Tanker
Flag	U.S.
Length (feet)	638.0
Beam (feet)	89.0
Draft (feet)	36.2
TPI (tons/inch)	117.3
MTI (foot-tons-inch)	5018
Displacement (tons)	46992
Vessel Condition	
Load Condition	Loaded
Direction of Transit	Outbound
Speed at Time of Incident (knots)	15.0
Draft After Incident (feet)	32.0
Ground Reaction (tons)	5800
Site Conditions	
Tidal Range (feet)	1.9
Tidal Condition	Beginning of flood
Wind Speed (knots) & Direction	8 S
Bottom Type	Soft
Damage	
Bottom set-up near turn of bilge throughout most of cargo length but not leaking.	

Table B-3

Location of Casualty	
Port Area	Houston, TX
Specific Site	Houston Ship Channel, near Hog Island
Vessel Characteristics	
Type	Container
Flag	U.S.
Length (feet)	582.0
Beam (feet)	78.0
Draft (feet)	29.6
TPI (tons/inch)	81.3
MTI (foot-tons-inch)	2626
Displacement (tons)	23396
Vessel Condition	
Load Condition	Loaded
Direction of Transit	Inbound
Speed at Time of Incident (knots)	6.0
Draft After Incident (feet)	27.9
Ground Reaction (tons)	1600
Site Conditions	
Tidal Range (feet)	1.2
Tidal Condition	Beginning of flood
Wind Speed (knots) & Direction	9 SSE
Bottom Type	Soft
Damage	
None.	

Table B-4

Location of Casualty	
Port Area	San Juan, PR
Specific Site	Bajo Colnas, East of Isla da Cabras
Vessel Characteristics	
Type	RO/RO
Flag	U.S.
Length (feet)	643.0
Beam (feet)	92.0
Draft (feet)	28.1
TPI (tons/inch)	101.4
MtI (foot-tons-inch)	3363
Displacement (tons)	26016
Vessel Condition	
Load Condition	Loaded
Direction of Transit	Inbound
Speed at Time of Incident (knots)	5.0
Draft After Incident (feet)	26.8
Ground Reaction (tons)	1600
Site Conditions	
Tidal Range (feet)	1.0
Tidal Condition	Mid-tide
Wind Speed (knots) & Direction	10-15 E
Bottom Type	Rocky
Damage	
Bottom set-up, water leaking into double bottom, not impaled.	

Table B-5

Location of Casualty	
Port Area	New Orleans, LA
Specific Site	Head of Passes
Vessel Characteristics	
Type	Barge Carrier
Flag	U.S.
Length (feet)	740.0
Beam (feet)	105.0
Draft (feet)	39.0
TPI (tons/inch)	152.2
MTI (foot-tons-inch)	7020
Displacement (tons)	56759
Vessel Condition	
Load Condition	Loaded
Direction of Transit	Outbound
Speed at Time of Incident (knots)	5.5
Draft After Incident (feet)	37.6
Ground Reaction (tons)	2500
Site Conditions	
Tidal Range (feet)	1.3
Tidal Condition	Beginning of ebb
Wind Speed (knots) & Direction	8 NNW
Bottom Type	Soft
Damage	
None.	

Table B-6

Location of Casualty	
Port Area	Mobile, AL
Specific Site	Main Ship Channel/ Entrance Channel
Vessel Characteristics	
Type	General Cargo
Flag	Foreign
Length (feet)	496.0
Beam (feet)	72.0
Draft (feet)	32.3
TPI (tons/inch)	67.0
MTI (foot-tons-inch)	1975
Displacement (tons)	22649
Vessel Condition	
Load Condition	Loaded
Direction of Transit	Outbound
Speed at Time of Incident (knots)	13.0
Draft After Incident (feet)	28.3
Ground Reaction (tons)	3200
Site Conditions	
Tidal Range (feet)	1.5
Tidal Condition	Mid-tide
Wind Speed (knots) & Direction	10-15 N
Bottom Type	Soft
Damage	
Bottom set-up in localized areas; not leaking.	

Table B-7

Location of Casualty	
Port Area	Tampa, FL
Specific Site	Intersection Cut "A" and Cut "B" Channels
Vessel Characteristics	
Type	Bulk Carrier
Flag	Foreign
Length (feet)	620.0
Beam (feet)	78.0
Draft (feet)	33.5
TPI (tons/inch)	104.2
MTI (foot-tons-inch)	4534
Displacement (tons)	39500
Vessel Condition	
Load Condition	Loaded
Direction of Transit	Outbound
Speed at Time of Incident (knots)	9.5
Draft After Incident (feet)	31.1
Ground Reaction (tons)	2900
Site Conditions	
Tidal Range (feet)	2.3
Tidal Condition	High tide
Wind Speed (knots) & Direction	10 E
Bottom Type	Hard
Damage	
Double bottom in way of number 1 cargo hold flooded.	

Table B-8

Location of Casualty	
Port Area	Lake Charles, LA
Specific Site	Entrance Channel N of "27"
Vessel Characteristics	
Type	LNG
Flag	Foreign
Length (feet)	872.5
Beam (feet)	136.5
Draft (feet)	36.0
TPI (tons/inch)	244.6
MTI (foot-tons-inch)	14220
Displacement (tons)	97159
Vessel Condition	
Load Condition	Loaded
Direction of Transit	Inbound
Speed at Time of Incident (knots)	15.0
Draft After Incident (feet)	32.6
Ground Reaction (tons)	9800
Site Conditions	
Tidal Range (feet)	2.0
Tidal Condition	High tide (slack)
Wind Speed (knots) & Direction	10 S
Bottom Type	Mud
Damage	
None.	

Table B-9

Location of Casualty	
Port Area	Honolulu, HI
Specific Site	Off Diamond Head near Buoy "2"
Vessel Characteristics	
Type	Container
Flag	U.S.
Length (feet)	677.0
Beam (feet)	95.0
Draft (feet)	33.6
TPI (tons/inch)	114.5
MTI (foot-tons-inch)	4253
Displacement (tons)	37181
Vessel Condition	
Load Condition	Loaded
Direction of Transit	Inbound
Speed at Time of Incident (knots)	12.5
Draft After Incident (feet)	29.9
Ground Reaction (tons)	5000
Site Conditions	
Tidal Range (feet)	1.2
Tidal Condition	Mid-tide (in surf)
Wind Speed (knots) & Direction	12-15 ENE
Bottom Type	Rocky/coral
Damage	
Double bottom in way of numbers 1 and 3 cargo holds opened.	

Table B-10

Location of Casualty	
Port Area	Aleutian Islands, AK
Specific Site	North side of Umnak Island
Vessel Characteristics	
Type	LNG
Flag	Foreign
Length (feet)	754.4
Beam (feet)	111.5
Draft (feet)	33.0
TPI (tons/inch)	169.7
MTI (foot-tons-inch)	8353
Displacement (tons)	61172
Vessel Condition	
Load Condition	Loaded
Direction of Transit	to Japan
Speed at Time of Incident (knots)	6.0
Draft After Incident (feet)	31.6
Ground Reaction (tons)	2800
Site Conditions	
Tidal Range (feet)	3.5
Tidal Condition	High tide
Wind Speed (knots) & Direction	20 N
Bottom Type	Rocky
Damage	
Number 1 port wing tank opened at turn of bilge.	

Table B-11

Location of Casualty	
Port Area	Portland, OR
Specific Site	Columbia River, Fish Trap Shoal
Vessel Characteristics	
Type	Bulk Carrier
Flag	U.S.
Length (feet)	520.0
Beam (feet)	74.0
Draft (feet)	32.8
TPI (tons/inch)	80.7
MtI (foot-tons-inch)	2866
Displacement (tons)	29564
Vessel Condition	
Load Condition	Loaded
Direction of Transit	Outbound
Speed at Time of Incident (knots)	14.0
Draft After Incident (feet)	28.8
Ground Reaction (tons)	3800
Site Conditions	
Tidal Range (feet)	6.5
Tidal Condition	Mid-tide
Wind Speed (knots) & Direction	10 ESE
Bottom Type	Sand
Damage	
None.	

Table B-12

Location of Casualty	
Port Area	Long Beach, CA
Specific Site	Outer Harbor Anchorage
Vessel Characteristics	
Type	OBO
Flag	Foreign
Length (feet)	855.0
Beam (feet)	105.0
Draft (feet)	49.1
TPI (tons/inch)	193.9
MTI (foot-tons-inch)	11557
Displacement (tons)	107381
Vessel Condition	
Load Condition	Loaded
Direction of Transit	N/A
Speed at Time of Incident (knots)	2.5
Draft After Incident (feet)	48.4
Ground Reaction (tons)	1600
Site Conditions	
Tidal Range (feet)	3.7
Tidal Condition	Mid-tide
Wind Speed (knots) & Direction	10 E
Bottom Type	Mud
Damage	
None.	

Table B-13

Location of Casualty	
Port Area	San Francisco, CA
Specific Site	Oakland Inner Harbor Entrance Channel
Vessel Characteristics	
Type	General Cargo
Flag	U.S.
Length (feet)	487.0
Beam (feet)	70.0
Draft (feet)	31.0
TPI (tons/inch)	61.6
MTI (foot-tons-inch)	1687
Displacement (tons)	19503
Vessel Condition	
Load Condition	Loaded
Direction of Transit	Inbound
Speed at Time of Incident (knots)	8.0
Draft After Incident (feet)	28.4
Ground Reaction (tons)	1900
Site Conditions	
Tidal Range (feet)	4.0
Tidal Condition	High tide (slack)
Wind Speed (knots) & Direction	12-17 WNW
Bottom Type	Sand
Damage	
None.	

Table B-14

Location of Casualty	
Port Area	Puget Sound, WA
Specific Site	Guemes Channel
Vessel Characteristics	
Type	Crude Tanker
Flag	U.S.
Length (feet)	825.0
Beam (feet)	136.0
Draft (feet)	54.33
TPI (tons/inch)	228.9
MTI (foot-tons-inch)	12482
Displacement (tons)	136676
Vessel Condition	
Load Condition	Loaded
Direction of Transit	Inbound
Speed at Time of Incident (knots)	4.0
Draft After Incident (feet)	53.1
Ground Reaction (tons)	3400
Site Conditions	
Tidal Range (feet)	11.0
Tidal Condition	Mid-tide
Wind Speed (knots) & Direction	5-10 S
Bottom Type	Mud
Damage	
None.	

Table B-15

Location of Casualty	
Port Area	San Diego, CA
Specific Site	Ballast Point
Vessel Characteristics	
Type	Tanker
Flag	U.S.
Length (feet)	630.0
Beam (feet)	84.0
Draft (feet)	36.5
TPI (tons/inch)	106.0
MTI (foot-tons-inch)	4318
Displacement (tons)	42082
Vessel Condition	
Load Condition	Loaded
Direction of Transit	Inbound
Speed at Time of Incident (knots)	9.0
Draft After Incident (feet)	33.8
Ground Reaction (tons)	3400
Site Conditions	
Tidal Range (feet)	4.1
Tidal Condition	Beginning of flood
Wind Speed (knots) & Direction	9 S
Bottom Type	Mud
Damage	
Bottom set-up; numbers 1 and 2 cargo tanks leaking.	

Table B-16

Location of Casualty	
Port Area	Philadelphia, PA
Specific Site	Big Stone Beach
Vessel Characteristics	
Type	Crude Tanker
Flag	Foreign
Length (feet)	875.0
Beam (feet)	135.2
Draft (feet)	54.8
TPI (tons/inch)	243.0
MTI (foot-tons-inch)	14173
Displacement (tons)	146940
Vessel Condition	
Load Condition	Loaded
Direction of Transit	Inbound
Speed at Time of Incident (knots)	3.0
Draft After Incident (feet)	53.9
Ground Reaction (tons)	2600
Site Conditions	
Tidal Range (feet)	4.9
Tidal Condition	High tide
Wind Speed (knots) & Direction	40 NW
Bottom Type	Clay
Damage	
None.	

Table B-17

Location of Casualty	
Port Area	Portland, ME
Specific Site	Approach to Portland, Pine Tree Ledge "R" 4
Vessel Characteristics	
Type	Tanker
Flag	Foreign
Length (feet)	660.0
Beam (feet)	90.0
Draft (feet)	35.0
TPI (tons/inch)	124.4
MTI (foot-tons-inch)	5598
Displacement (tons)	48594
Vessel Condition	
Load Condition	Loaded
Direction of Transit	Inbound
Speed at Time of Incident (knots)	6.0
Draft After Incident (feet)	33.5
Ground Reaction (tons)	2200
Site Conditions	
Tidal Range (feet)	9.0
Tidal Condition	Low tide
Wind Speed (knots) & Direction	20-25 NE
Bottom Type	Rocky
Damage	
Forepeak and number 1S cargo tank opened.	

Table B-18

Location of Casualty	
Port Area	Philadelphia, PA
Specific Site	Entrance to Delaware Bay Five Fathom Shoal
Vessel Characteristics	
Type	Crude Tanker
Flag	Foreign
Length (feet)	740.0
Beam (feet)	90.21
Draft (feet)	42.83
TPI (tons/inch)	135.4
MTI (foot-tons-inch)	6580
Displacement (tons)	63543
Vessel Condition	
Load Condition	Loaded
Direction of Transit	Inbound
Speed at Time of Incident (knots)	14.0
Draft After Incident (feet)	39.1
Ground Reaction (tons)	6000
Site Conditions	
Tidal Range (feet)	4.9
Tidal Condition	One hour past beginning of flood
Wind Speed (knots) & Direction	Calm
Bottom Type	Hard
Damage	
Cargo tanks numbers 1 and 2 opened.	

Table B-19

Location of Casualty	
Port Area	New York, NY
Specific Site	Ambrose Channel, vicinity of Buoy "R" 6
Vessel Characteristics	
Type	Container
Flag	Foreign
Length (feet)	625.0
Beam (feet)	76.0
Draft (feet)	29.5
TPI (tons/inch)	88.1
MtI (foot-tons-inch)	3218
Displacement (tons)	25904
Vessel Condition	
Load Condition	Loaded
Direction of Transit	Inbound
Speed at Time of Incident (knots)	20.0
Draft After Incident (feet)	24.5
Ground Reaction (tons)	5300
Site Conditions	
Tidal Range (feet)	5.0
Tidal Condition	Mid-tide
Wind Speed (knots) & Direction	10-15 SSW
Bottom Type	Hard sand
Damage	
Double bottom tanks 1 to 3 opened; number 1 cargo tank flooding.	

Table B-20

Location of Casualty	
Port Area	Charleston, SC
Specific Site	Intersection Mt. Pleasant & Ft. Sumter Ranges
Vessel Characteristics	
Type	Barge Carrier
Flag	U.S.
Length (feet)	724.0
Beam (feet)	100.0
Draft (feet)	28.0
TPI (tons/inch)	131.7
MTI (foot-tons-inch)	5415
Displacement (tons)	33357
Vessel Condition	
Load Condition	Loaded
Direction of Transit	Outbound
Speed at Time of Incident (knots)	12.5
Draft After Incident (feet)	25.4
Ground Reaction (tons)	4100
Site Conditions	
Tidal Range (feet)	6.1
Tidal Condition	One hour before high tide
Wind Speed (knots) & Direction	6-10 N
Bottom Type	Soft
Damage	
Bottom set-up but intact.	

Table B-21

Location of Casualty	
Port Area	Morehead City, NC
Specific Site	Beaufort Inlet
Vessel Characteristics	
Type	RO/RO
Flag	U.S.
Length (feet)	734.0
Beam (feet)	93.0
Draft (feet)	29.6
TPI (tons/inch)	120.9
MTI (foot-tons-inch)	4833
Displacement (tons)	33569
Vessel Condition	
Load Condition	Loaded
Direction of Transit	Outbound
Speed at Time of Incident (knots)	15.0
Draft After Incident (feet)	25.8
Ground Reaction (tons)	5500
Site Conditions	
Tidal Range (feet)	3.6
Tidal Condition	One hour after high water
Wind Speed (knots) & Direction	8-12 SSW
Bottom Type	Fine sand
Damage	
No bottom damage.	

Table B-22

Location of Casualty	
Port Area	Norfolk, VA
Specific Site	Thimble Shoal
Vessel Characteristics	
Type	OBO
Flag	Foreign
Length (feet)	801.8
Beam (feet)	106.2
Draft (feet)	44.2
TPI (tons/inch)	181.0
MTI (foot-tons-inch)	10041
Displacement (tons)	89887
Vessel Condition	
Load Condition	Loaded
Direction of Transit	Outbound
Speed at Time of Incident (knots)	10.5
Draft After Incident (feet)	41.4
Ground Reaction (tons)	6100
Site Conditions	
Tidal Range (feet)	2.5
Tidal Condition	One hour after high water
Wind Speed (knots) & Direction	10-15 SSW
Bottom Type	Hard
Damage	
Double bottom in way of cargo holds numbers 1 and 2 opened.	

Table B-23

Location of Casualty	
Port Area	Boston, MA
Specific Site	Finn's Ledge
Vessel Characteristics	
Type	LNG
Flag	Foreign
Length (feet)	899.0
Beam (feet)	142.4
Draft (feet)	37.8
TPI (tons/inch)	257.9
MTI (foot-tons-inch)	15108
Displacement (tons)	106436
Vessel Condition	
Load Condition	In ballast
Direction of Transit	Outbound
Speed at Time of Incident (knots)	9.0
Draft After Incident (feet)	35.6
Ground Reaction (tons)	6800
Site Conditions	
Tidal Range (feet)	9.0
Tidal Condition	Mid-ebb
Wind Speed (knots) & Direction	10-15 WNW
Bottom Type	Rocky
Damage	
Bottom damage along turn of bilge from forepeake to number 5 cargo tank; cargo tanks intact.	

Table B-24

Location of Casualty	
Port Area	Baltimore, MD
Specific Site	Fort McHenry Channel
Vessel Characteristics	
Type	General Cargo
Flag	Foreign
Length (feet)	528.0
Beam (feet)	76.0
Draft (feet)	31.6
TPI (tons/inch)	71.3
MTI (foot-tons-inch)	2064
Displacement (tons)	22763
Vessel Condition	
Load Condition	Loaded
Direction of Transit	Outbound
Speed at Time of Incident (knots)	8.5
Draft After Incident (feet)	28.5
Ground Reaction (tons)	2600
Site Conditions	
Tidal Range (feet)	1.1
Tidal Condition	Beginning of ebb
Wind Speed (knots) & Direction	10 NW
Bottom Type	Sand
Damage	
None.	

Table B-25

Location of Casualty	
Port Area	Wilmington, NC
Specific Site	Snow's Marsh Channel
Vessel Characteristics	
Type	Tanker
Flag	U.S.
Length (feet)	705.0
Beam (feet)	102.0
Draft (feet)	37.7
TPI (tons/inch)	148.1
MTI (foot-tons-inch)	6981
Displacement (tons)	61711
Vessel Condition	
Load Condition	Loaded
Direction of Transit	Inbound
Speed at Time of Incident (knots)	12.0
Draft After Incident (feet)	34.4
Ground Reaction (tons)	5900
Site Conditions	
Tidal Range (feet)	4.5
Tidal Condition	Two hours before high tide
Wind Speed (knots) & Direction	10-15 SW
Bottom Type	Sand
Damage	
Numbers 1 and 2 center cargo tanks leaking.	

APPENDIX C
PORTABLE COMPUTERS

TABLE C-1

PORTABLE COMPUTER CHARACTERISTICS

MAKE	MODEL	IBM COMP. (L"xW"xH")	DIMENSIONS	WEIGHT (appx.)	DISPLAY SIZE	DISPLAY TYPE	RAM (max)	INTEGRAL DISK	COMM. CAPABLE	FULL-SIZE KEYBD	PERI-PHERALS	OPERATING SYSTEM
ACCESS MATRIX CORP.	Access	N	16x11x10	33 lbs	80x24	CRT	64K	2 5" F	yes	yes	Printer	CP/M 2.2
ADDICK & JOHNSON	Model 3000	N	20x15x9	28 lbs	80x24 (optional)	CRT	64K	2 5" F	yes	yes		TRS-DOS
ATHENA COMPUTER	Athens	N	15x12x3	16 lbs	80x4	LCD	64K	1 5" F	yes	yes		CP/M 2.2
CASIO INC.	FX700 P#	N	7x2x1	4 ozs	-	LCD	2K	-	no	no	cassette, Printer	C-B2 CASIO BASIC
CASIO INC.	FX802 P#	N	7x3x1	9 ozs	-	LCD	2K	-	no	no	cassette, integral Printer	C-B2 CASIO BASIC

TABLE C-1 (CONT'D)

COMMO- FOR BUS. MACHINES	Execu- tive 64	N	24x18x9	<20 lbs	40x25	CRT	64K	2 5" F (optional)	yes	yes	Printer, modem, hard disk (optional)	MS-DOS CP/M
COMPAQ COMPUTER CORP.	Compaq Portable Computer	Y	20x16x9	28 lbs	80x25	CRT	512K	2 5" F	yes	yes	IBM com- patible peripherals	MS-DOS
COMPUTER REVIEWS	DOT	N	15x16x8	30 lbs	132x25	CRT	704K	2 3" F	yes	yes	Integral Printer	MS-DOS CP/M 2.2
COMPUTER SHOP	Star- lite	N	16x16x8	34 lbs	80x24	CRT	64K	2 5" F	yes	yes	hard disk	CP/M
COMPUTER SYSTEMS	PC/8000	Y	19x17x8	30 lbs	80x25	CRT	512K	2 5" F (optional)	yes	yes	hard disk	MS-DOS CP/M

TABLE C-1 (CONT'D)

CORONA DATA SYSTEMS	Corona Portable PC	Y	20x20x8	30 lbs	80x25	CRT	512K	2 5" F (optional)	yes	yes	hard disk	MS-DOS CP/M-86
DIGITAL MICRO- SYSTEMS	MS 3F (the Fox)	N	18x15x8	30 lbs	80x25	CRT	64K	2 5" F	yes	yes		CP/M
DIGITAL MICRO- SYSTEMS	MS 15	N	18x15x8	36 lbs	80x25	CRT	64K	1 5" F	yes	yes		CP/M
DYN- LOGIC INFO-TECH	Hyperion	Y	8x11x9	21 lbs	80x25	CRT	256K	2 5" F	yes	yes		MS-DOS
EPSON AMERICA INC.	MS-200	N	11x8x2	4 lbs	20x4	LCD	64K		yes	yes		Microsoft BASIC

TABLE C-1 (CONT'D)

GRID SYSTEMS	Compass Y	15x11x2	10 lbs	53x24	electro-luminescent 384K	yes	no	floppy/hard disk, printer, telephone hand set
HEWLETT PACKARD	HP-41C* (CV)*	6x3x1	7 ozs	12 alpha 10 digit	LCD 6K	no	no	card reader, printer/plotter optical wand
HEWLETT PACKARD	HP-75	10x5x1	26 ozs	32x1	LCD 160K	yes	no	printer plotter cassette drive
JONES LIMITED	2100*	17x13x7	25 lbs	80x25	CRT 128K 2 3" F	yes	yes	printer, bus card, battery pack
MICRO SOURCE	M800-P Voyager	20x17x7	35 lbs	80x24	CRT 64K 2 5" F	yes	yes	hard disk drive

TABLE C-1 (CONT'D)

NON LINEAR SYSTEMS	KayPro II	N	18x16x9	26 lbs	80x25	CRT	64K	2 5" F	yes	yes	CP/M 2.2
OSBORNE COMPUTER CORP.	Executive	Y	21x13x9	28 lbs	80x25 (optional)	CRT	256K	2 5" F	yes	yes	auto. modem CP/M or UCSDP
OSBORNE COMPUTER CORP.	Osborne I	N	21x15x9	27 lbs	54x24	CRT	64K	2 5" F	yes	yes	CP/M
OTRONA ADVANCED SYSTEMS	Attache	N	14x12x6	18 lbs	80x24	CRT	64K	2 5" F	yes	yes	CP/M
PANA- SONIC	Link*	N	9x4x1	14 ozs	108x8 dot 26 char.	LCD	8K		yes	yes	printer, SnapFORTH RAM expansion, plotter

TABLE C-1 (CONT'D)

PERI- PHENAL SYSTEMS	Engine	N	18x17x8	18 lbs	80x24	CRT	25K	2 3/4"	F	yes	yes	battery pack, CP/M or RAM expansion. Telex modem	CP/M or RAM expansion. Telex modem
PERSONAL MICRO COMPUTERS	PMC Micromate	N	13x6x4	8 lbs	80x24	CRT	128K	4 9/16"	F	yes	yes	any device w/MS-DOS 2.0 but CP/M 2.2 parallel, or Con- tronics interface	CP/M or RAM expansion. Telex modem
QUANG COMPANY	MC MC 2000, 2000w, & 2000w	Y	5x4x1	20 ozs	26 char	LED	2K, 4K & 8K			yes	no	I/O adapter MS-DOS inter- face, printers, Perlar plotter, cassette files	PC/XT MS-DOS Printer plotter, cassette files
RADIO SHACK	PC1*	N	7x3x1	6 ozs	24 char	LED	1.5K			no	no	cassette, printer	BASIC
RADIO SHACK	PC2*	N	6x3x1	16 ozs	26 char	LED	10.5K			yes	no	cassette, printer	BASIC

TABLE C-1 (CONT'D)

RAD10 SWAX	TRS-80 Model 100*	N	12x18x2	4 lbs	40x8	LCD	32K	yes	yes	MS-BASIC
SEEDRA COMPUTER CORP.	Chemelion	Y	18x16x8	28 lbs	80x25	CRT	256K	yes	yes	MS-DOS, CP/M-86, CP/M-80, CP/M*
SWAP ELECTRONICS CORP.	PC 1250*	N	5x3x1	4 ozs	7x24	LCD	2.2K	no	no	Printer interface CPU
SWAP ELECTRONICS CORP.	PC 1500*	N	8x3x1	13 ozs	7x24	LCD	8K	yes	no	Printer interface CPU
STM ELECTRONICS CORP.	Pied Piper	N	20x11x4	13 lbs	80x24	LCD or CRT	64K	yes	yes	hard disk CPU

(optional)

TABLE C-1 (CONT'D)

TELECOM INDUSTRIES INC.	Novis 9	Y	18x16x9	23 lbs	80x25	CRT	64K	2 F	yes	yes	cluster controller	CP/M 2.2
TELECOM COMMUNICATIONS	Telerran 3000	N	13x10x3	9 lbs	80x4	LCD	64K		yes	yes	full-screen monitor, floppy disk drive	CP/M
TEXAS INSTRUMENTS	Compact Computer 400	N	10x6x1	22 ozs	31 char	LCD	34K (ROM)		yes	no	RS-232 inter-face, printer/plotter tape drive	TI
TIMEX COMPUTER CORP.	TimeX Sinclair 1000	N	7x6x1	12 ozs	32x24	CRT	16K		yes	no	printer, ROM module	SINCLAIR BASIC

* INDICATES SELF-CONTAINED POWER SUPPLY

(This page left blank intentionally)

APPENDIX D

**COMPARISON OF BLOCK COEFFICIENT (Cb)
BY SEVEN DIFFERENT METHODS**

TABLE D-1

COMPARISON OF BLOCK COEFFICIENT (Cb)
CALCULATED BY SEVEN DIFFERENT METHODS

Ship Type	L	B	V	Cb (actual)	V/V _L	1	2	3	4	5	6	8
Break Bulk	483	70.6	15	.715	.676	.725	.712	.732	.741	.71	.744	.736
	449.3	72.2	14.9	.733	.703	.708	.689	.715	.722	.694	.725	.72
	550	87	15.5	.78	.661	.734	.72	.74	.751	.713	.754	.766
Lumber	500	72	15	.759	.671	.728	.715	.735	.744	.712	.747	.76
	520	75	24	.563	1.052	.488	.524	.506	.474	.548	.321	.518
	487	70	18.6	.639	.843	.62	.629	.631	.622	.639	.598	.631
Container	525.5	79.5	22.5	.568	.982	.533	.559	.548	.524	.576	.426	.556
	544.5	82	23	.544	.986	.53	.557	.546	.521	.575	.421	.554
	528.5	76	20	.616	.87	.603	.615	.615	.603	.627	.588	.616
	670	85	21.5	.709	.831	.628	.635	.639	.631	.649	.611	.631
	900	105.8	26	.595	.867	.605	.617	.617	.606	.637	.572	.611
Ro-ro	880.5	105.5	33	.54	1.112	.45	.494	.47	.432	.533	.222	.48
	733	98.4	26.4	.534	.975	.537	.562	.552	.529	.585	.435	.554
	600.4	90	20.75	.604	.847	.617	.627	.629	.62	.635	.584	.609
	551.2	82	21	.581	.884	.587	.603	.6	.586	.615	.54	.584
	643	92	25	.528	.986	.53	.557	.545	.521	.577	.42	.536
	621.5	75	19.5	.664	.782	.688	.689	.688	.685	.671	.689	.643

TABLE D-1

COMPARISON OF BLOCK COEFFICIENT (Cb)
CALCULATED BY SEVEN DIFFERENT METHODS
(cont. inued)

Ship Type	L	B	V	Cb (actual)	V//L	1	2	3	4	5	6	8
Barge	797.3	100	20	.631	.708	.704	.686	.712	.718	.701	.721	.639
	740	105.8	18.6	.657	.684	.72	.708	.727	.735	.707	.739	.651
Tankers	748	105.7	15	.828	.548	.805	.776	.808	.831	.785	.81	.826
	843.2	134	17	.803	.585	.782	.757	.786	.805	.746	.785	.805
Crude	535	75	18.5	.688	.8	.647	.65	.657	.653	.688	.642	.694
	677	93	17.8	.75	.684	.72	.708	.727	.735	.708	.738	.749
	770	104	17.35	.801	.625	.787	.737	.782	.777	.734	.775	.782
	1316	207	16.7	.885	.46	.86	.82	.861	.884	.8	.833	.863
	1085	170	15.6	.864	.474	.882	.813	.853	.884	.795	.831	.885
OBO	925	145	15.5	.846	.51	.829	.785	.831	.859	.779	.822	.835
	861	134	16.6	.84	.586	.784	.767	.788	.819	.785	.803	.804
	801.8	106.2	16.4	.819	.579	.786	.76	.789	.809	.784	.788	.812
	925	145	15.5	.846	.51	.829	.785	.831	.859	.779	.822	.835
	1026.9	170.6	15.3	.841	.477	.85	.811	.851	.881	.791	.83	.87

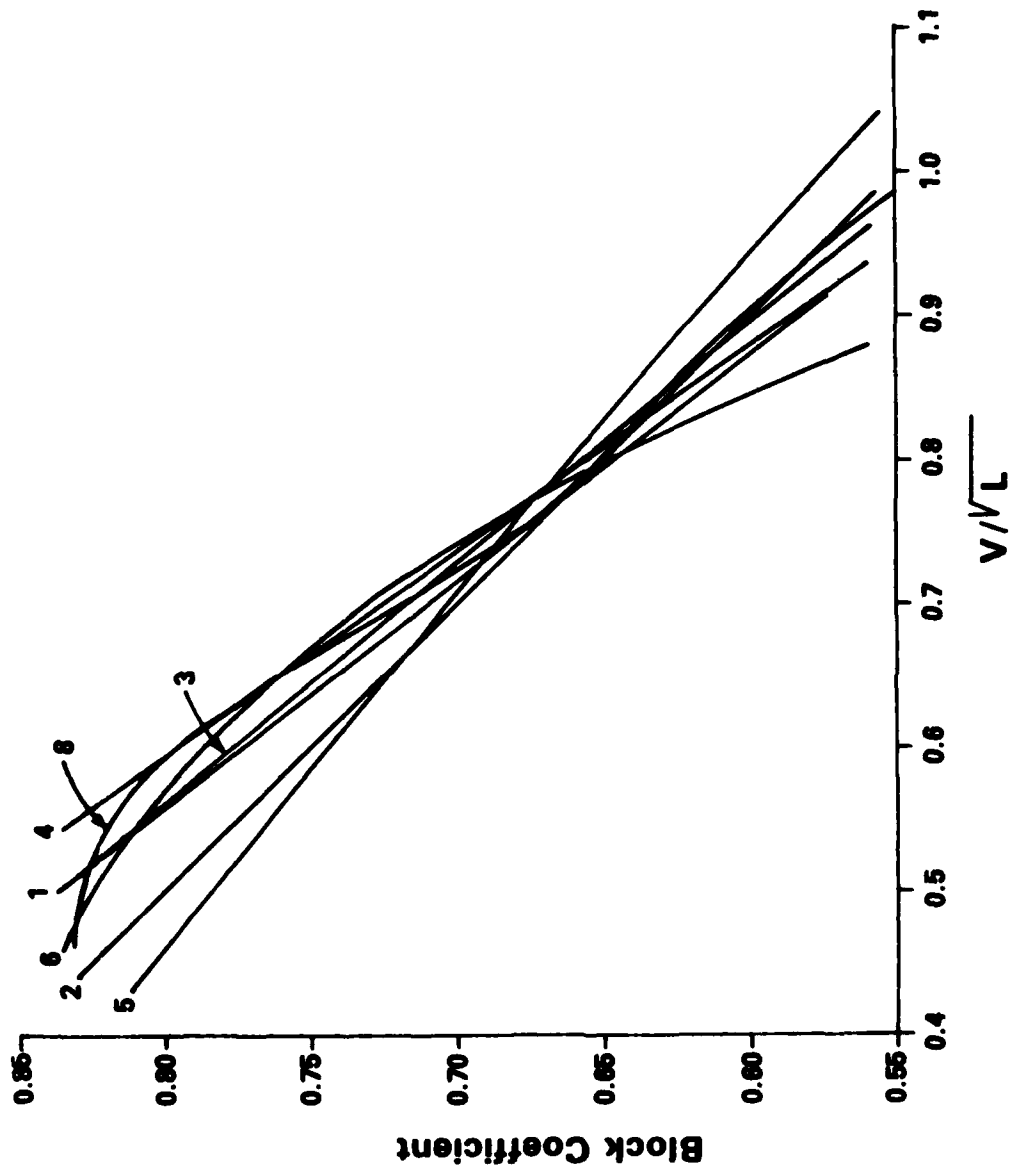
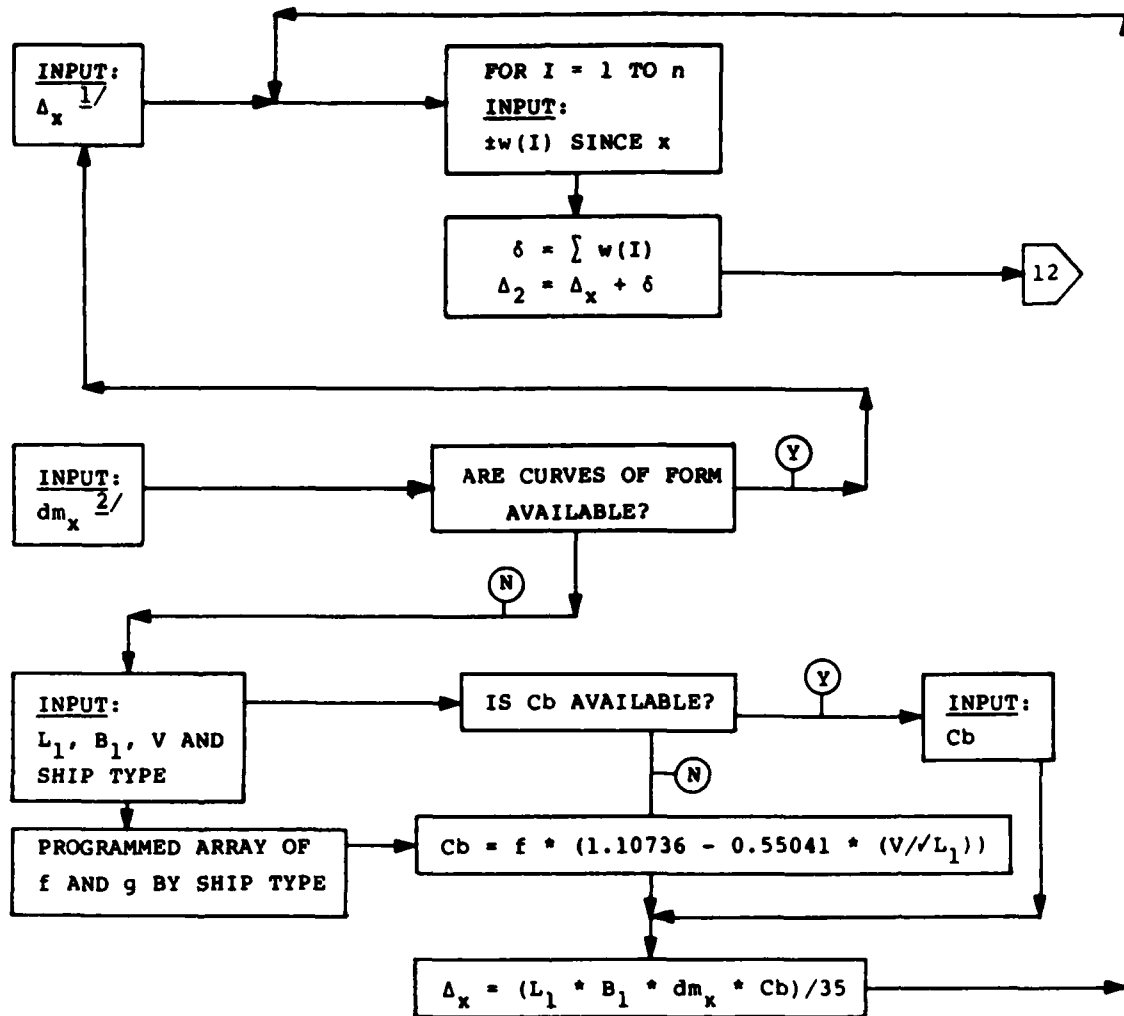

FIGURE D-1 COMPARISON OF LINES/CURVES FOR ESTIMATING C_b BY SEVEN DIFFERENT METHODS (WHERE LINE/CURVE NUMBERS REFER TO TEXT EQUATIONS)

APPENDIX E
ALGORITHMS AND ARRAYS
FOR APPLICATIONS PROGRAM

**ALGORITHM FOR LOOP TO CALCULATE Δ_2
FROM A LAST KNOWN DISPLACEMENT OR DRAFT**



1/ SUBSCRIPT "x" DENOTES LAST KNOWN CONDITION
 2/ TO BE USED WHEN dm_x KNOWN AND Δ_x IS UNKNOWN

ALGORITHM FOR LOOP WHEN
CURVES OF FORM ARE NOT
AVAILABLE

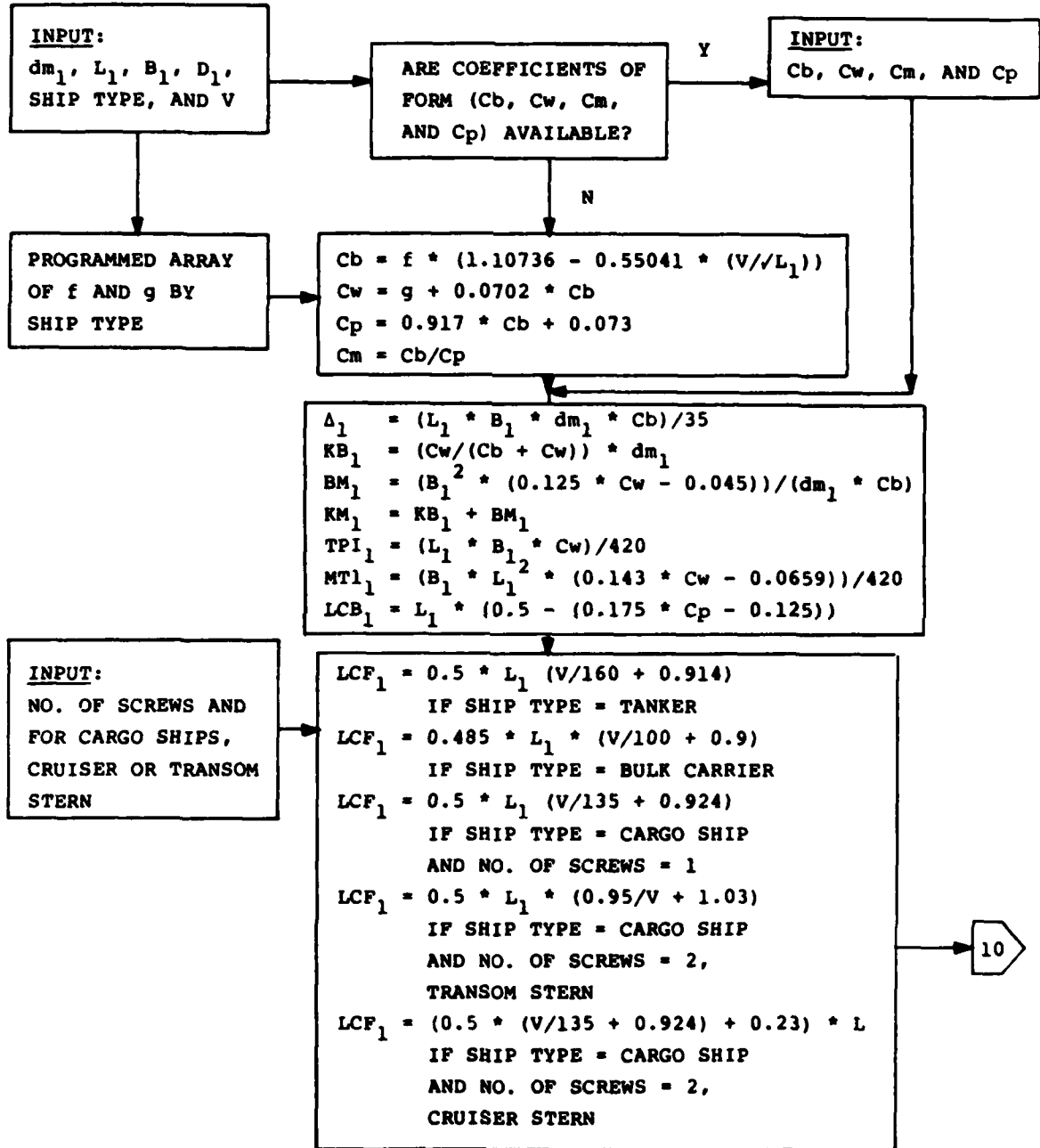

ALGORITHM FOR LOOP WHEN
CURVES OF FORM ARE NOT
AVAILABLE
(CONT'D)

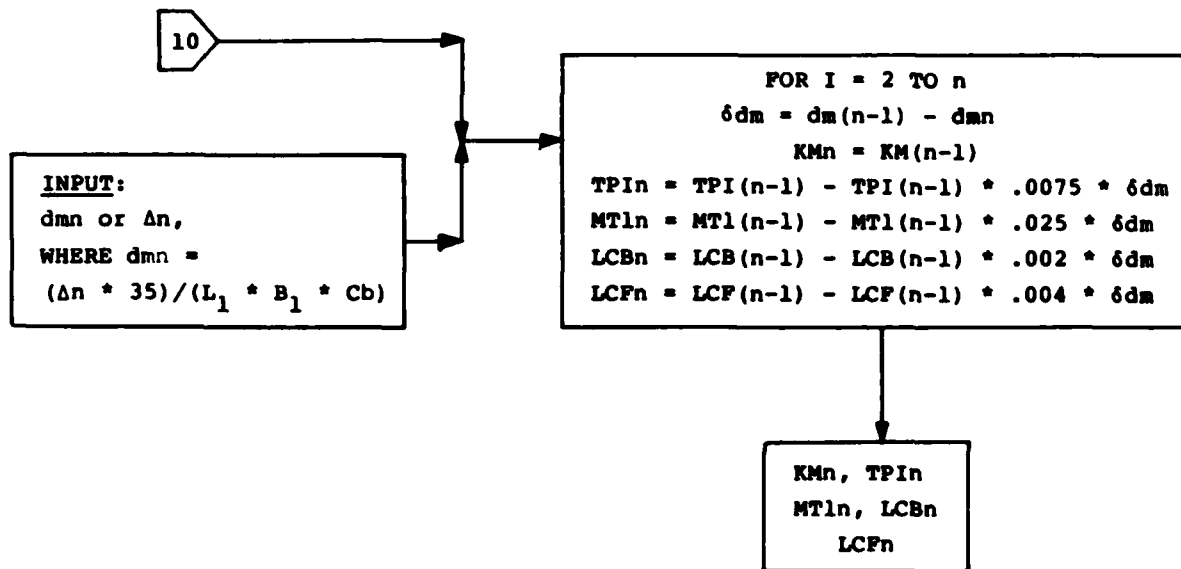

ALGORITHM FOR LOOP TO DETERMINE
KG₂ and LCG₂

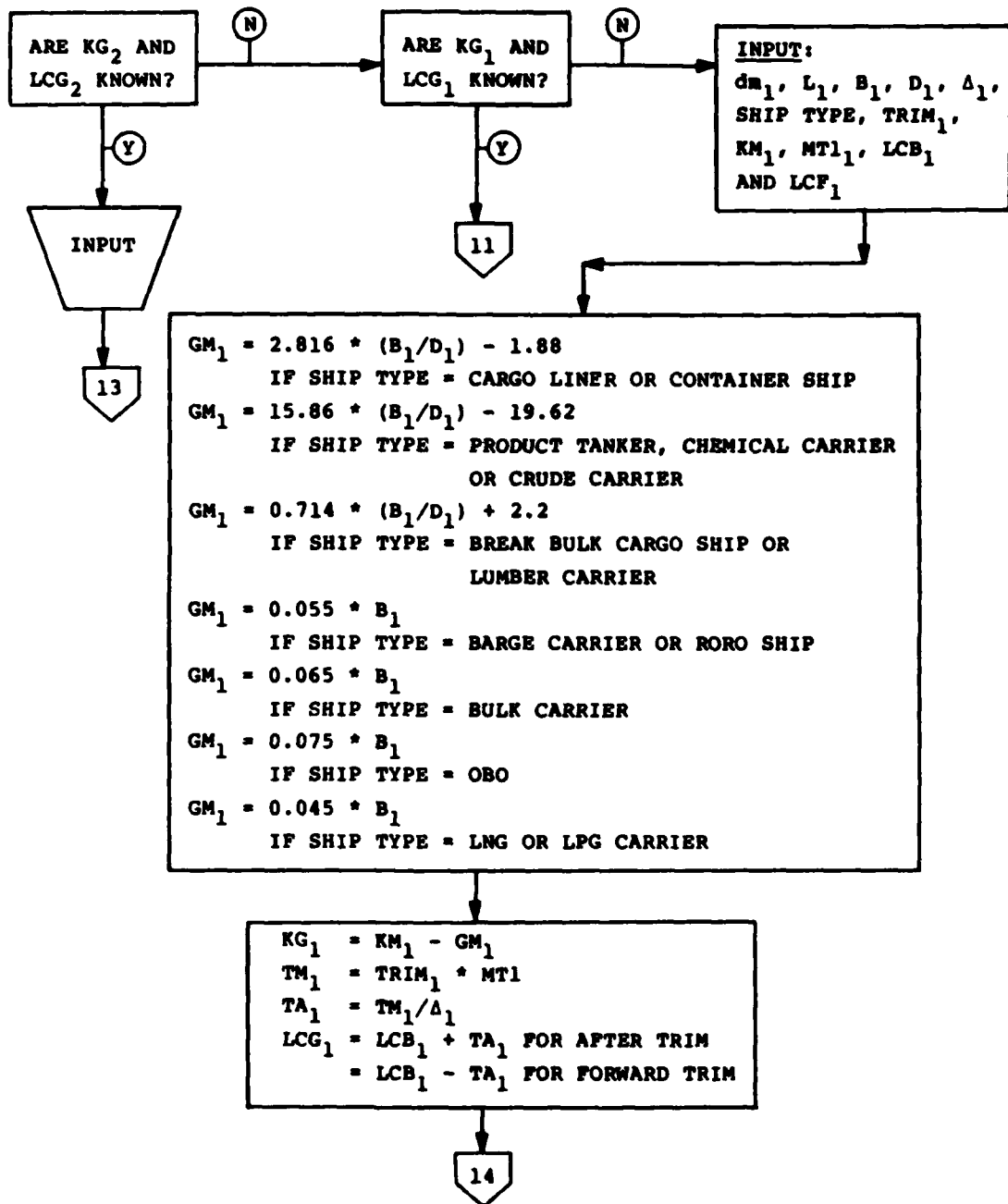

ALGORITHM FOR LOOP TO DETERMINE
KG₂ AND LCG₂
 (CONT'D)

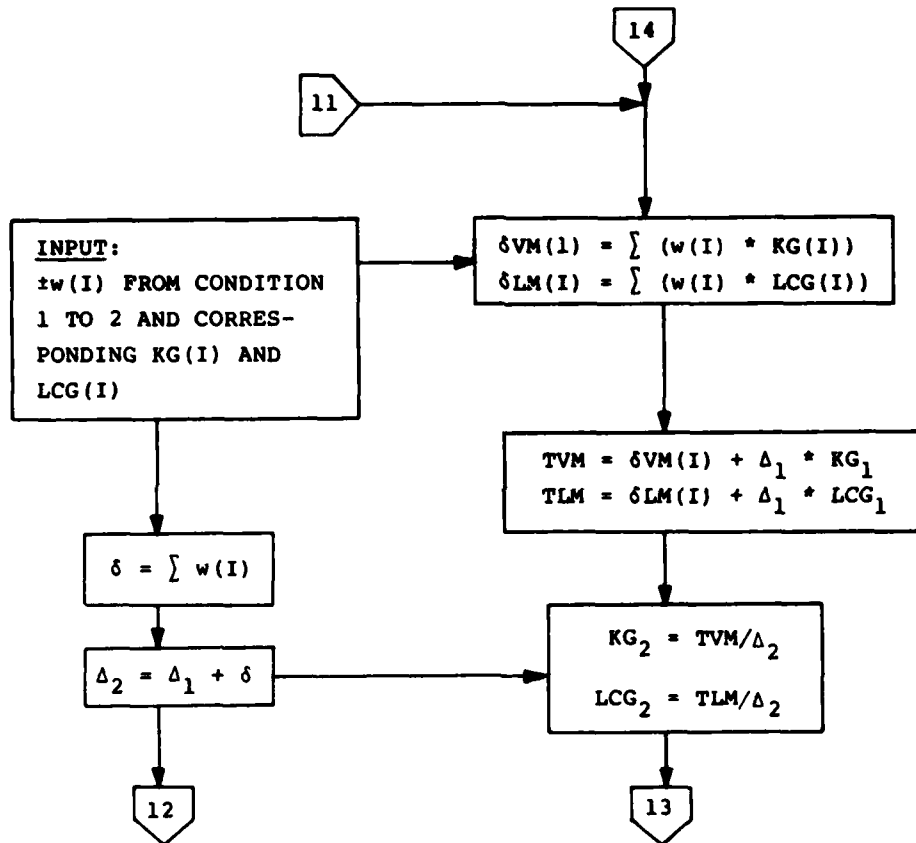

ALGORITHM TO DETERMINE R, KG, LCG AND TRIM AS STRANDED AND AS PROGRESSIVE WEIGHT CHANGES ARE MADE

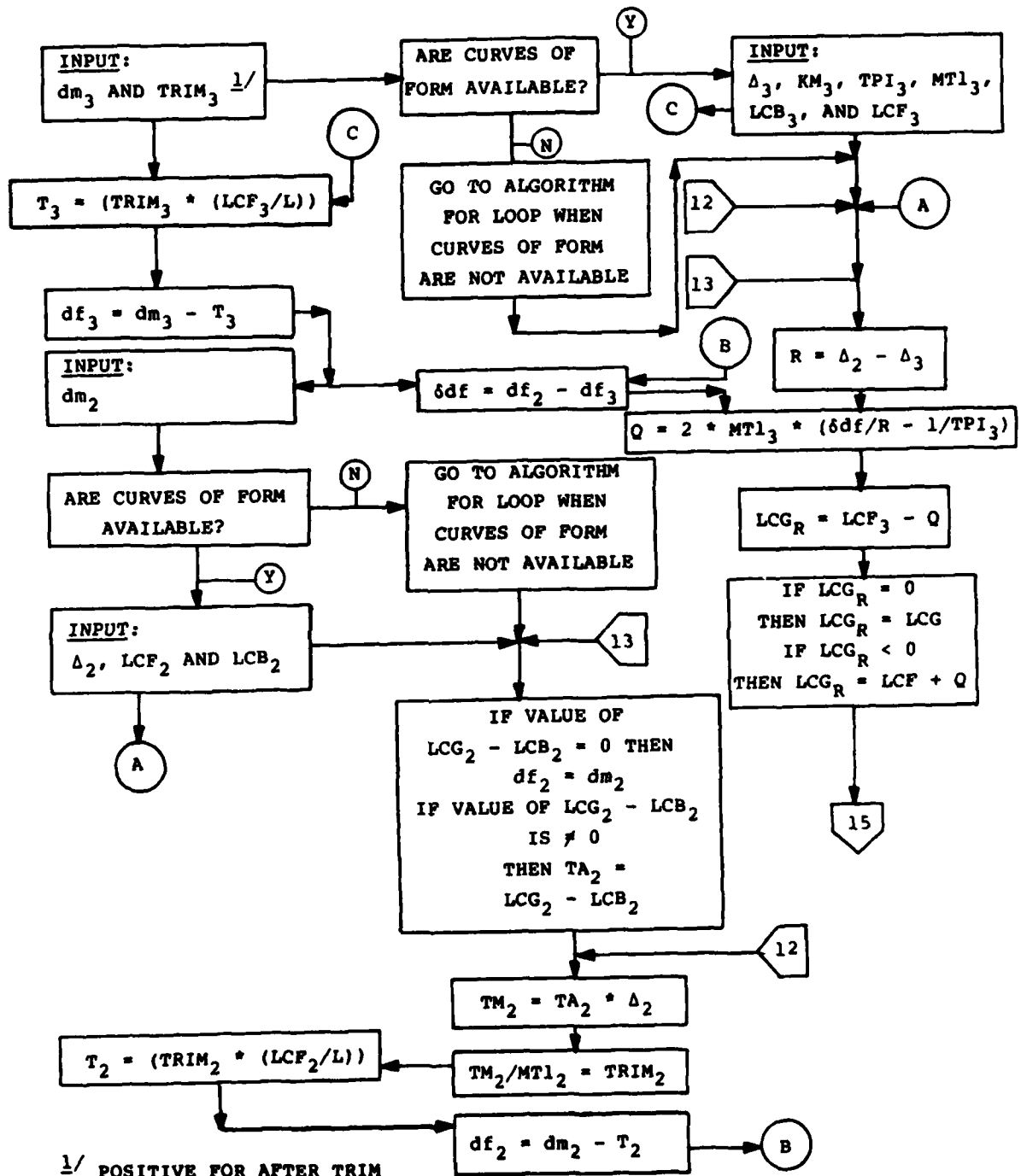

1/ POSITIVE FOR AFTER TRIM
NEGATIVE FOR FORWARD TRIM AND IN INCHES

ALGORITHM TO DETERMINE R, KG, LCG AND TRIM AS STRANDED AND A₃ PROGRESSIVE WEIGHT CHANGES ARE MADE
CONT'D)

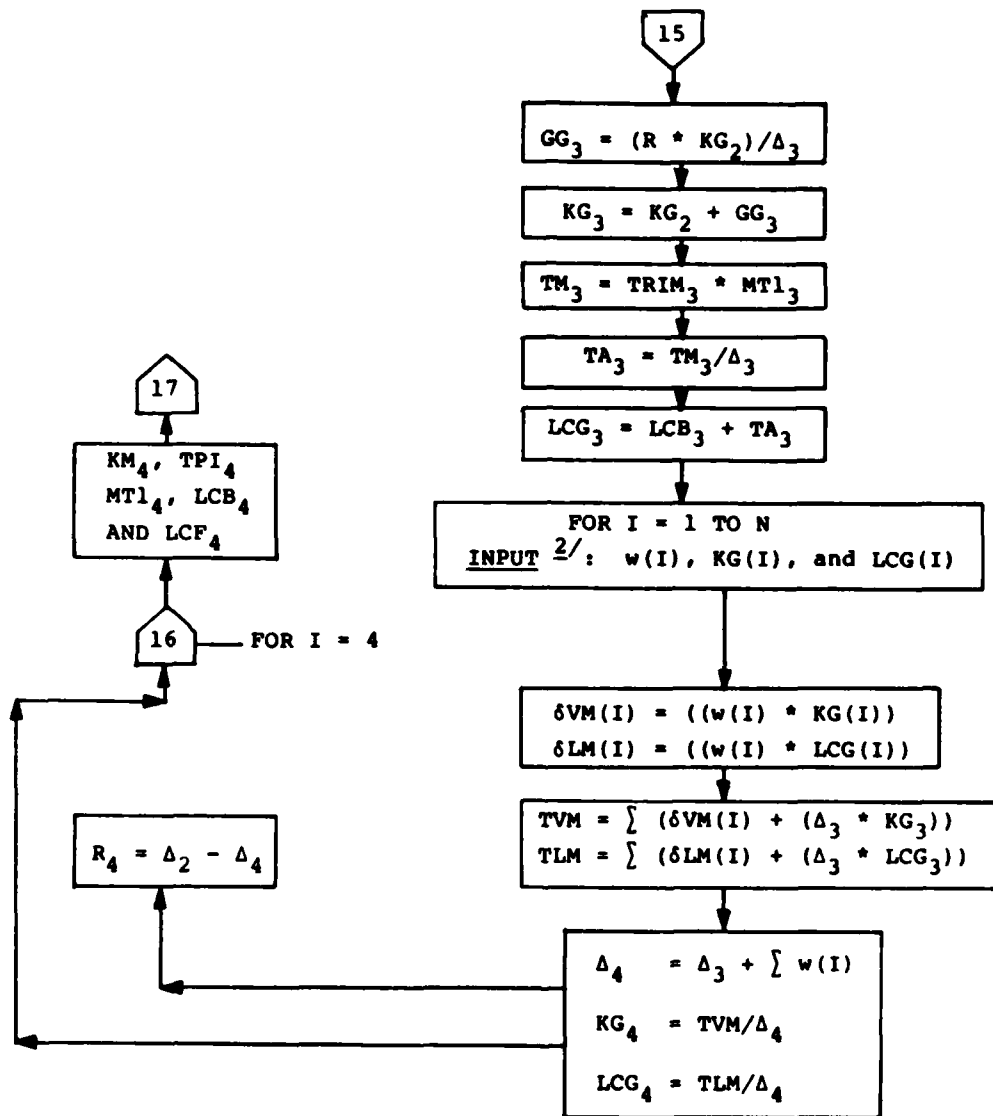

^{2/} FOR WEIGHTS ADDED (+),
 REMOVED (-), OR MOVED (±)

ALGORITHM TO DETERMINE R, KG, LCG
AND TRIM AS STRANDED AND AS PROGRESSIVE
WEIGHT CHANGES ARE MADE
 (CONT'D)

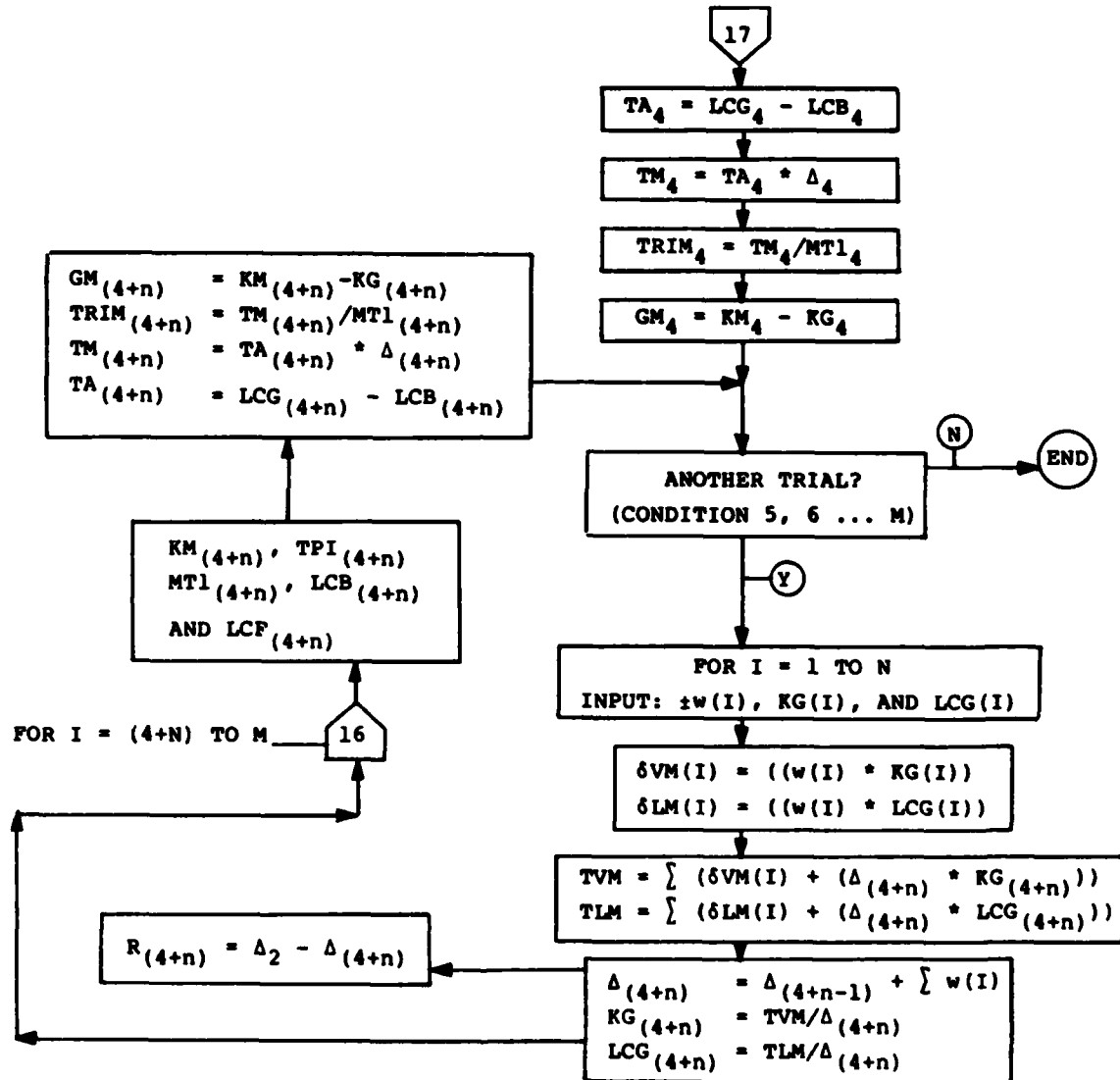

ALGORITHM FOR MISCELLANEOUS FACTORS

RISE IN KG DUE TO FREE SURFACE, GG'

WHERE, L' = LONGITUDINAL DIMENSION OF FREE SURFACE AREA

B' = TRANSVERSE DIMENSION OF FREE SURFACE AREA

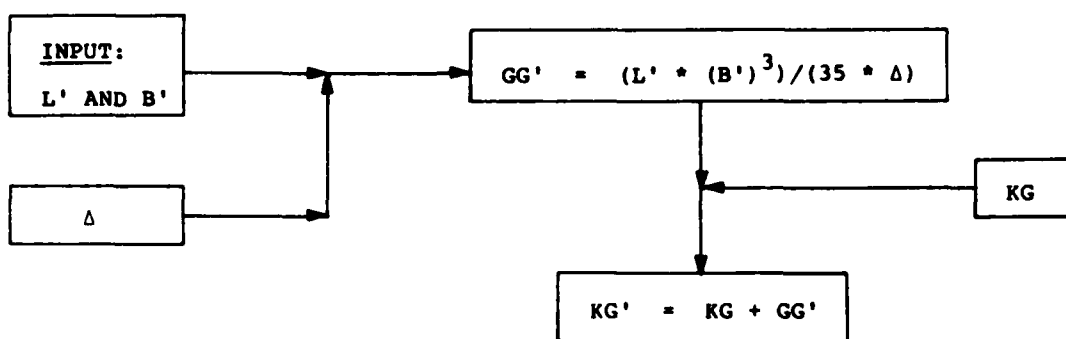

RISE IN KG DUE TO FREE COMMUNICATION, GG''

WHERE, a = FREE SURFACE AREA (L' * B')

t = TRANSVERSE DISTANCE FROM CENTER OF a TO SHIP CENTERLINE

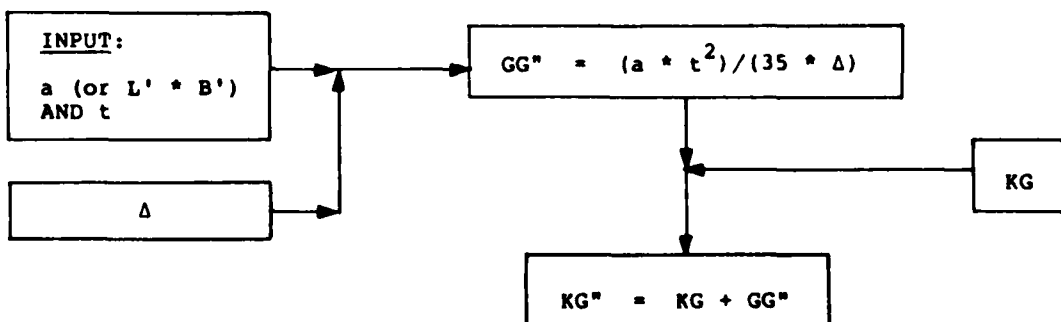

ALGORITHM FOR MISCELLANEOUS FACTORS
(CONT'D)

NET THEORETICAL FORCE, F

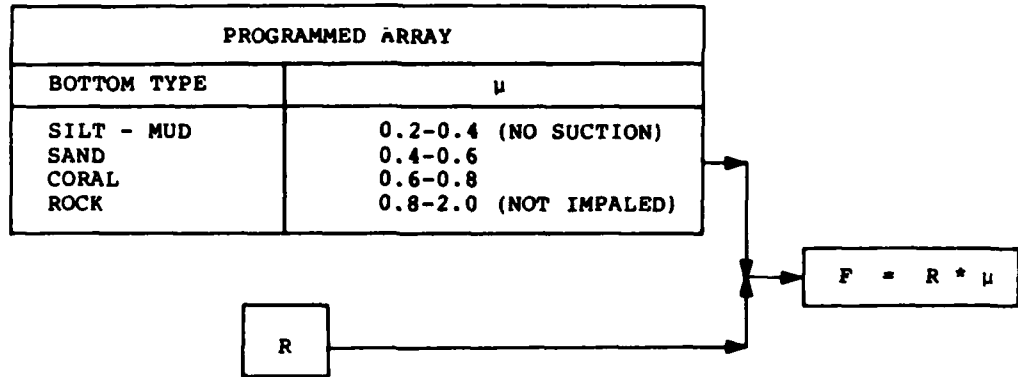

CHANGE IN R (δR) DUE TO CHANGE IN HEIGHT OF TIDE (δh)

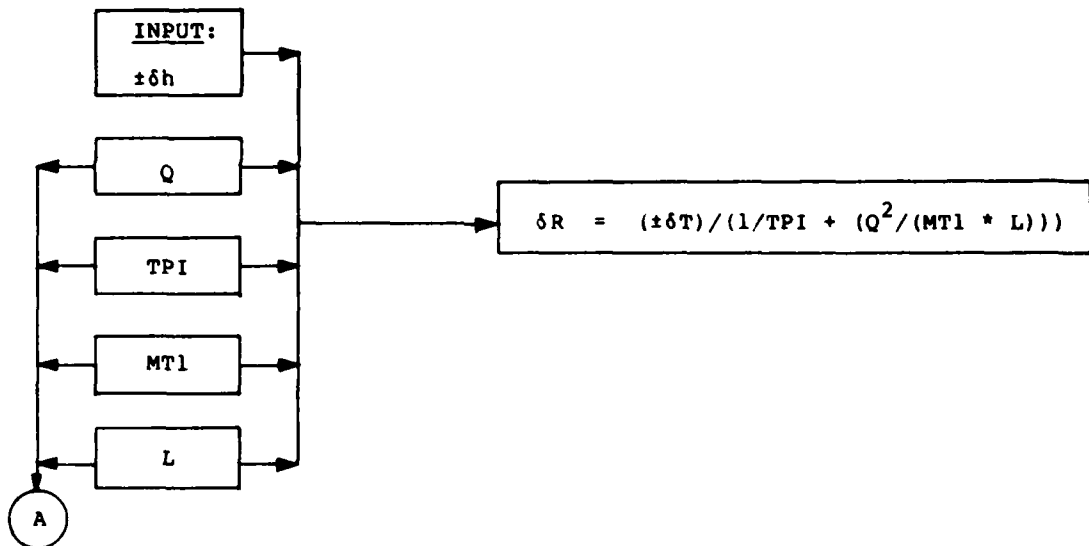

NEUTRAL LOADING POINT (NP) $\frac{1}{2}$



$\frac{1}{2}$ POINT AT WHICH WEIGHTS CAN BE ADDED/REMOVED WITH NO CHANGE IN R

PROGRAMMED ARRAY FOR "f" AND "g" COEFFICIENTS

SHIP TYPE	f	g
BULK CARRIER	1.08	0.306
LPG CARRIER	1.06	0.306
LNG CARRIER	1.04	0.306
OBO	1.03	0.306
LUMBER SHIP	1.03	0.306
PRODUCT TANKER/ CHEMICAL CARRIER	1.025	0.306
CRUDE CARRIER	1.01	0.306
BREAK-BULK CARGO SHIP	1.00	0.306
CARGO LINER	0.98	0.306
CONTAINER SHIP	0.97	0.325
RORO SHIP	0.95	0.336
BARGE CARRIER	0.89	0.360

ALGORITHM FOR LIGHT SHIP
WEIGHT DISTRIBUTION

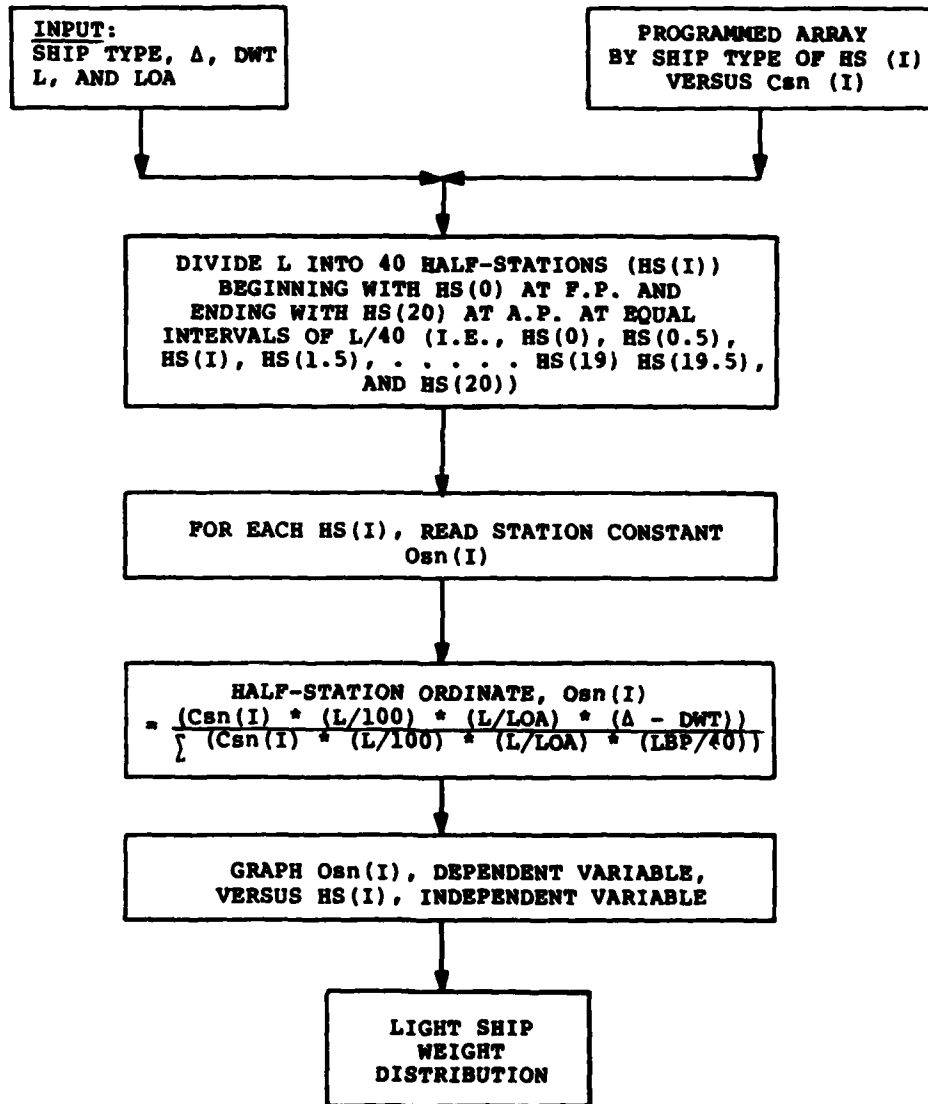

ALGORITHM FOR DWT
WEIGHT DISTRIBUTION

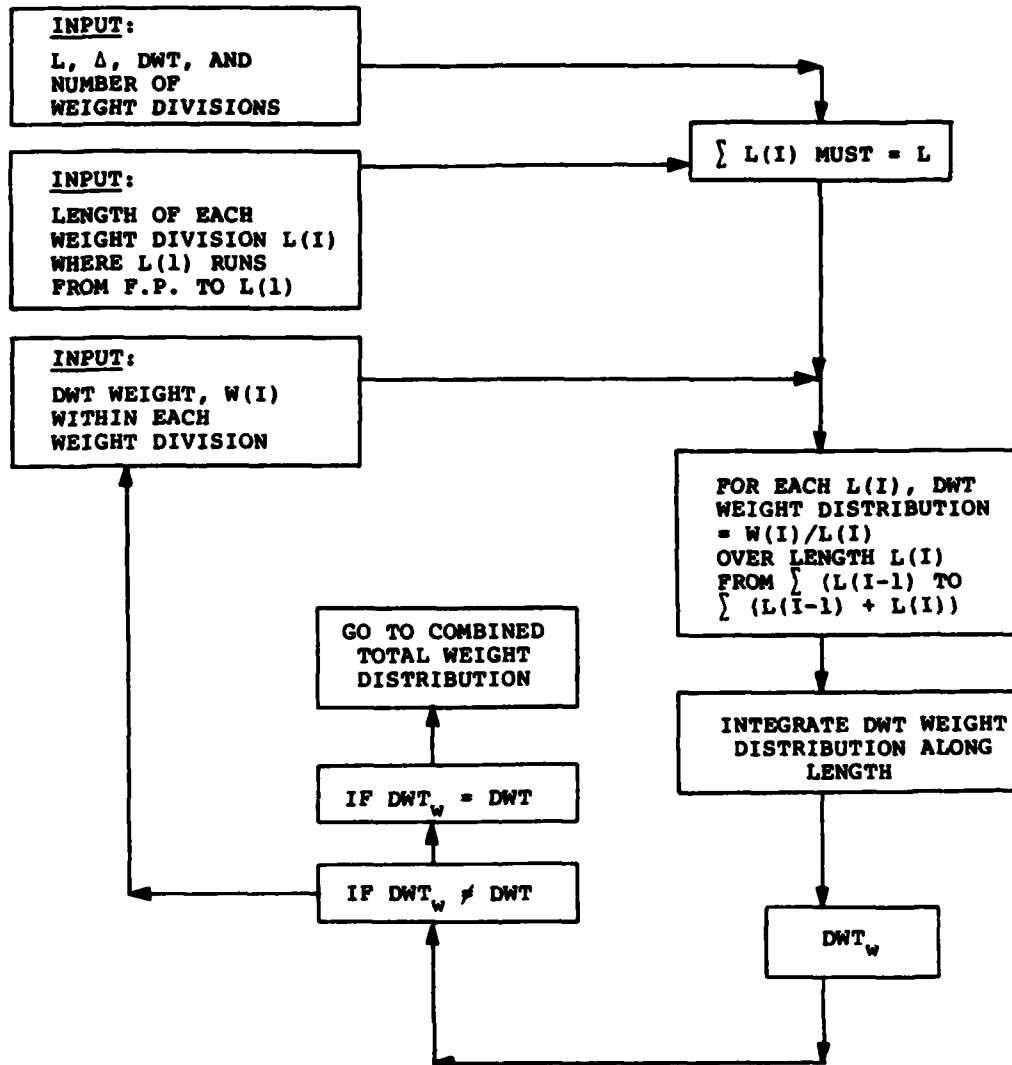

**ALGORITHM FOR
BUOYANCY DISTRIBUTION**

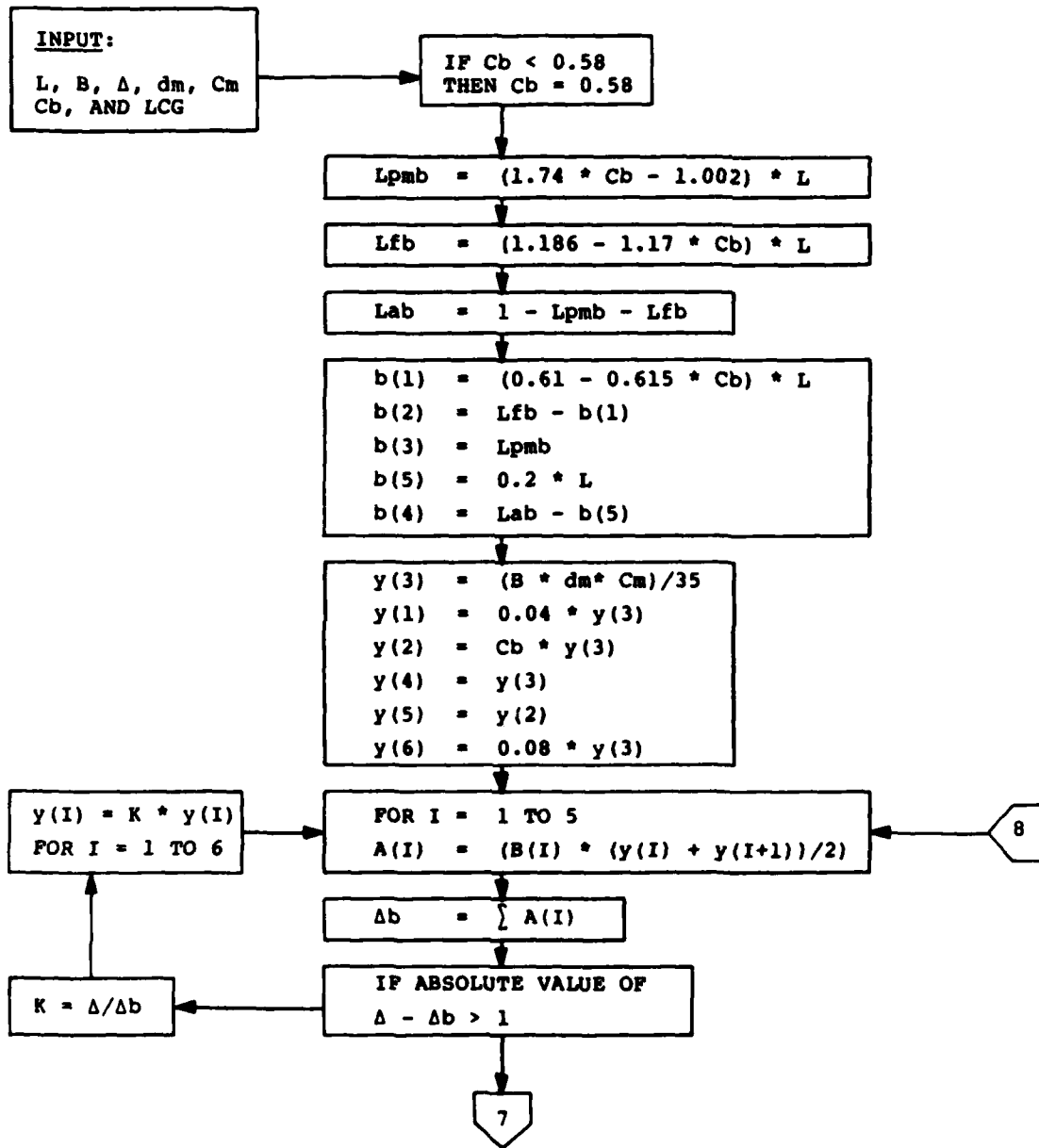

**ALGORITHM FOR
BUOYANCY DISTRIBUTION
(CONT'D)**

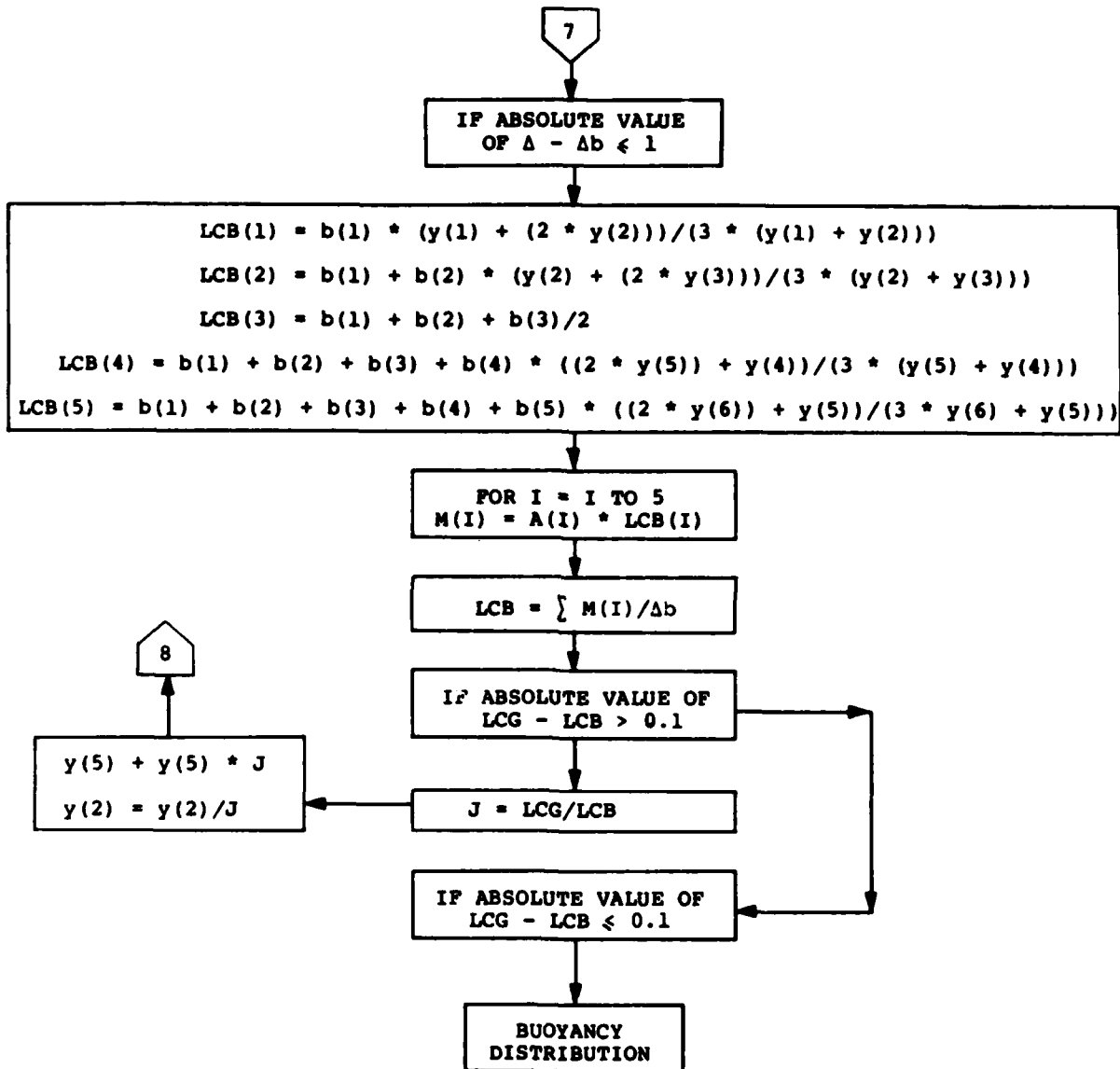

BASIC ALGORITHM FOR SHEAR FORCE
AND BENDING MOMENT CALCULATION

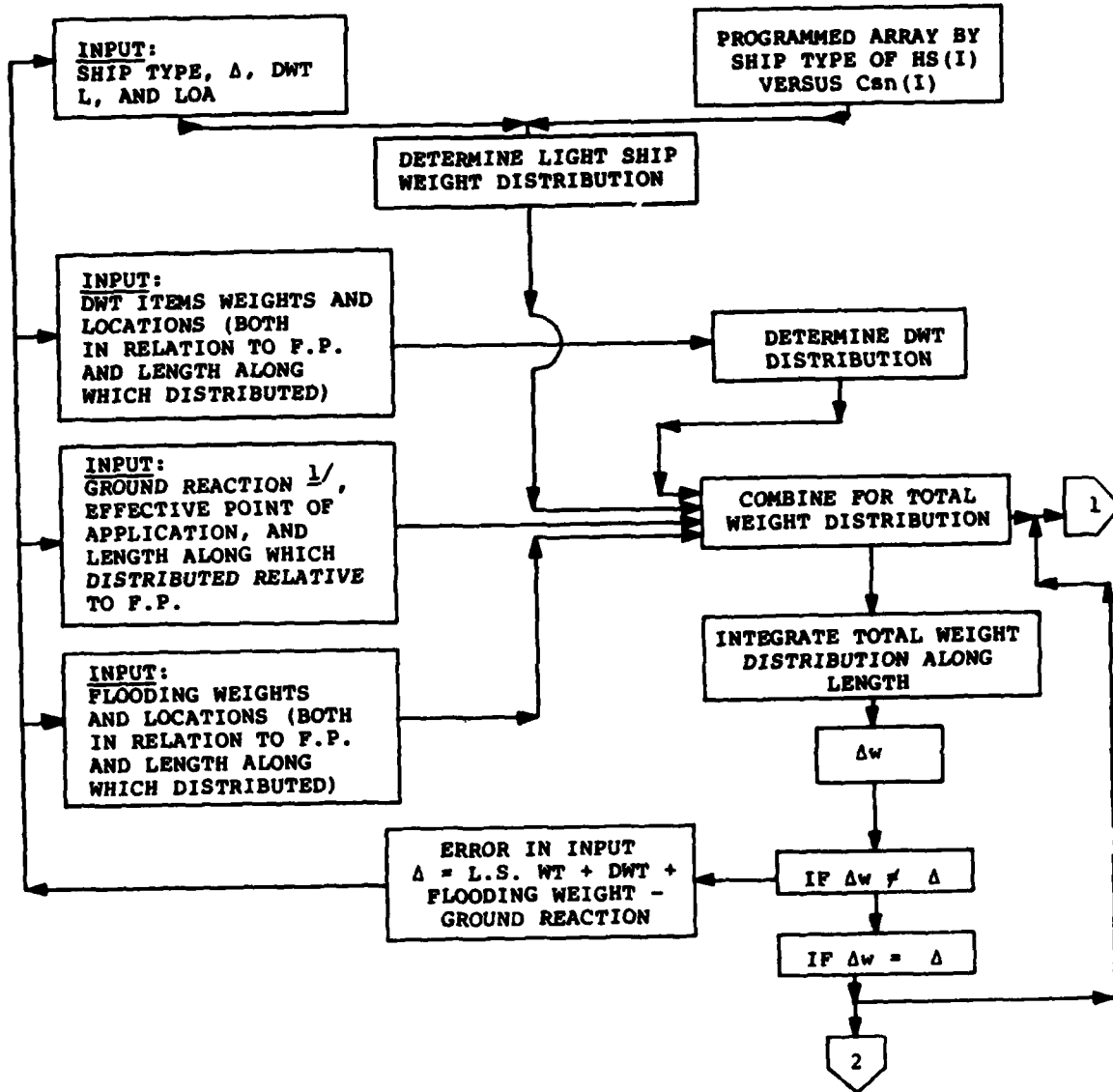

1/ GROUND REACTION IS NEGATIVE RELATIVE TO ALL OTHER WEIGHTS

BASIC ALGORITHM FOR SHEAR FORCE
AND BENDING MOMENT CALCULATION
CONT'D

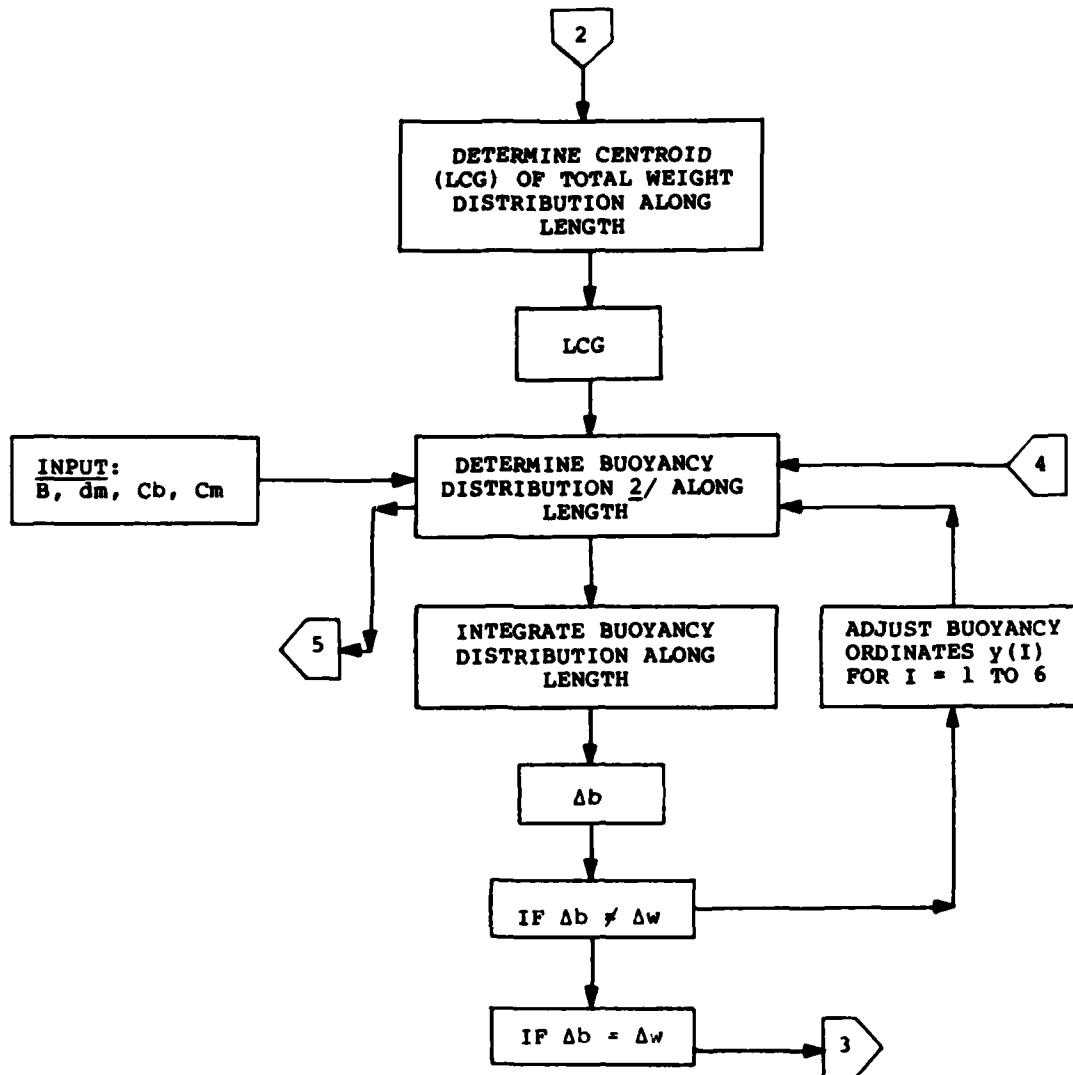

2/ BUOYANCY IS OPPOSITE IN DIRECTION TO WEIGHTS

BASIC ALGORITHM FOR SHEAR FORCE
AND BENDING MOMENT CALCULATION
(CONT'D)

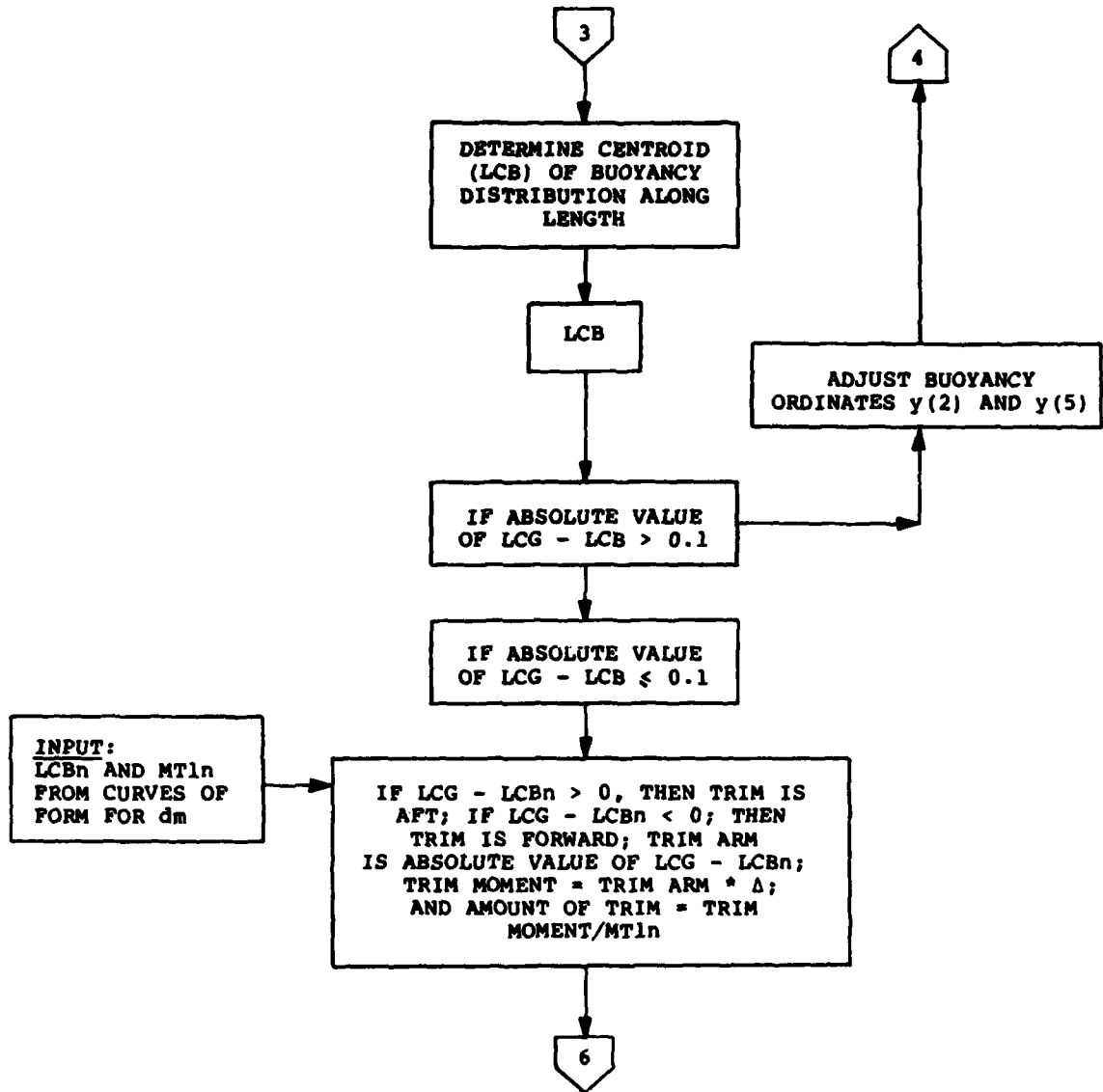

BASIC ALGORITHM FOR SHEAR FORCE
AND BENDING MOMENT CALCULATION
(CONT'D)

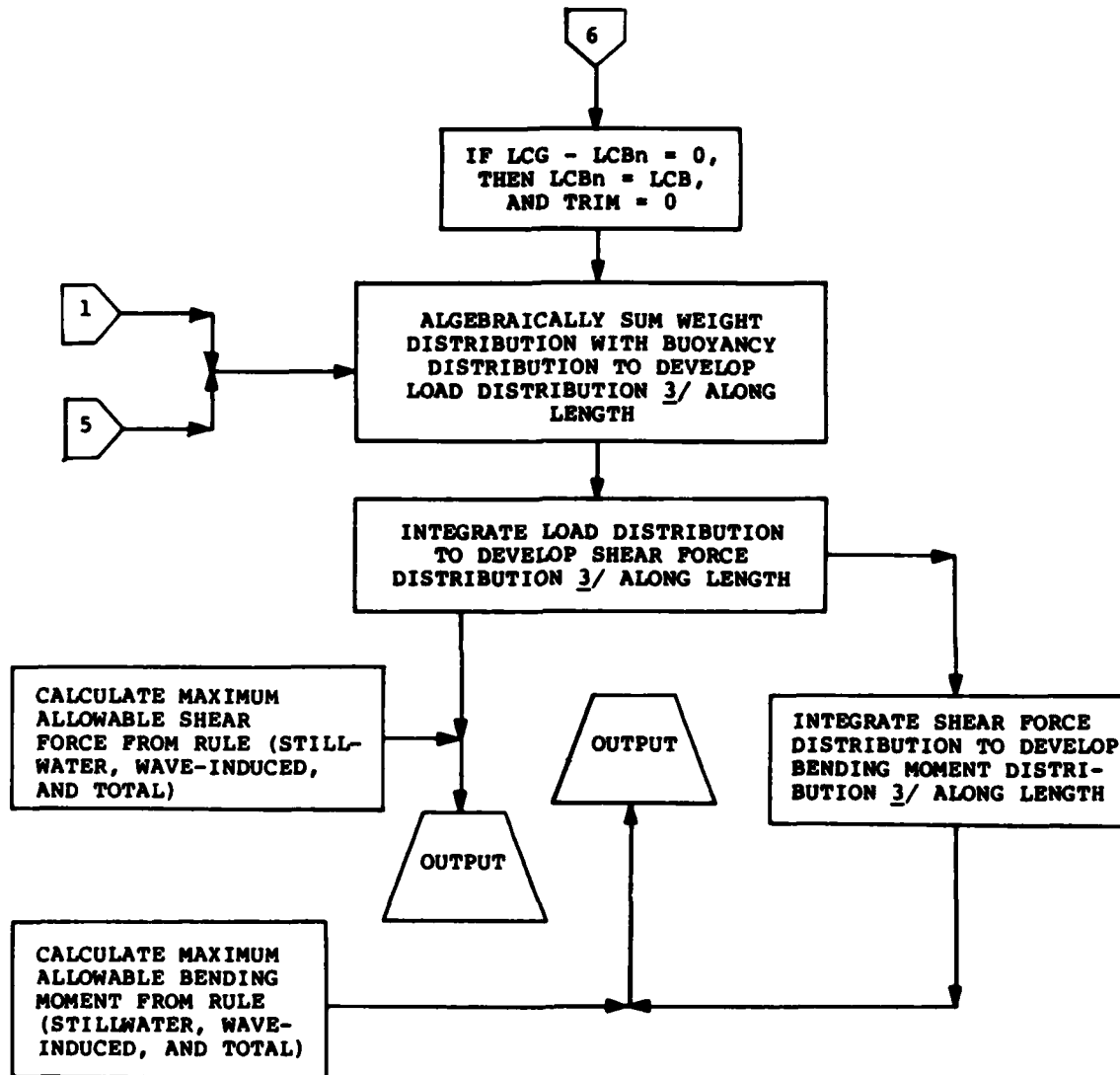

^{3/} AREA ABOVE ABCISSA MUST EQUAL AREA
BELOW ABCISSA FOR THIS DISTRIBUTION

END

FILMED

1-86

DTIC