

AD-A156 593

2

DTIC FILE COPY

DTIC  
SELECTED  
JUL 12 1985  
B

DISTRIBUTION STATEMENT A  
Approved for public release  
Distribution Unlimited

06 17 054

AD H 156 593

SECURITY CLASSIFICATION OF THIS PAGE (When Data Entered)

REPORT DOCUMENTATION PAGE		READ INSTRUCTIONS BEFORE COMPLETING FORM
1. REPORT NUMBER	2. GOVT ACCESSION NO.	3. RECIPIENT'S CATALOG NUMBER
4. TITLE (and Subtitle) The Development of a Neutron Evaporation Theory Code for the Thermal Fission of Uranium-235		5. TYPE OF REPORT & PERIOD COVERED Final Report 3 May 1985
7. AUTHOR(s) Rosener, Thomas J.		6. PERFORMING ORG. REPORT NUMBER
9. PERFORMING ORGANIZATION NAME AND ADDRESS Student, HDQA, MILPERCEN (DAPC-OPA-E) 200 Stovall Street Alexandria, Va. 22332		8. CONTRACT OR GRANT NUMBER(s)
11. CONTROLLING OFFICE NAME AND ADDRESS HQDA, MILPERCEN, ATTN: DAPC-OPA-E 200 Stovall Street Alexandria, Va. 22332		10. PROGRAM ELEMENT, PROJECT, TASK AREA & WORK UNIT NUMBERS
14. MONITORING AGENCY NAME & ADDRESS (if different from Controlling Office)		12. REPORT DATE 3 May 1985
		13. NUMBER OF PAGES 108
		15. SECURITY CLASS. (of this report) Unclassified
		15a. DECLASSIFICATION/DOWNGRADING SCHEDULE
16. DISTRIBUTION STATEMENT (of this Report) Approved for public release; distribution unlimited.		
17. DISTRIBUTION STATEMENT (of the abstract entered in Block 20, if different from Report)		
18. SUPPLEMENTARY NOTES Document is a thesis prepared at Rensselaer Polytechnic Institute, located in Troy, New York.		
19. KEY WORDS (Continue on reverse side if necessary and identify by block number) Fission; Prompt Neutron Spectrum; Uranium-235; liquid drop model; Semi-empirical mass formulas (Niles) &		
20. ABSTRACT (Continue on reverse side if necessary and identify by block number) The thermal fission of Uranium-235 is studied by the development of a computer code which uses evaporation theory based on the Weisskopf model for neutron emission from individual fission fragments. This computer code calculates a prompt neutron spectrum, total gamma ray energy, and average prompt neutron kinetic energy for the thermal fission of Uranium-235. All possible fission fragment combinations are considered, weighted by their fractional yields.		

THE DEVELOPMENT OF A NEUTRON EVAPORATION  
THEORY CODE FOR THE THERMAL FISSION OF URANIUM-235

by

Thomas J. Rosener

A Thesis Submitted to the Graduate  
Faculty of Rensselaer Polytechnic Institute  
in Partial Fulfillment of the  
Requirements for the Degree of  
MASTER OF SCIENCE

Approved:



---

Donald R. Harris  
Thesis Advisor

Rensselaer Polytechnic Institute  
Troy, New York

May 1985

## TABLE OF CONTENTS

	Page
LIST OF FIGURES . . . . .	iii
ACKNOWLEDGEMENT . . . . .	iv
ABSTRACT . . . . .	v
1. INTRODUCTION AND HISTORICAL PERSPECTIVE . . . . .	1
2. THEORY . . . . .	6
2.1 Mass Distribution . . . . .	6
2.2 Charge Distribution . . . . .	9
2.3 Mass and Binding Energy . . . . .	14
2.4 Nuclear Evaporation Theory . . . . .	24
3. CODE DEVELOPMENT . . . . .	30
3.1 Block Data Subprogram . . . . .	30
3.2 The Average Heavy and Light Masses . . . . .	30
3.3 Determination of Fragment Kinetic Energy Constant . . . . .	32
3.4 The Main Program Loop . . . . .	32
3.5 Binding Energy Subroutine . . . . .	37
3.6 Energy Subroutine . . . . .	39
3.7 Subroutine for Mass Correction . . . . .	44
4. DISCUSSION AND CONCLUSION . . . . .	62
LITERATURE CITED . . . . .	67
APPENDIX I - BLOCK DATA INPUT . . . . .	69
APPENDIX II - COMPUTER LISTING . . . . .	72
APPENDIX III - FRAGMENT MULTIPLICITIES . . . . .	88

<b>Accession For</b>	
NTIS GRA&I	<input checked="" type="checkbox"/>
DTIC TAB	<input type="checkbox"/>
Unannounced	<input type="checkbox"/>
Justification	
By _____	
Distribution/	
Availability Codes	
	Avail and/or
Dist	Special
A-1	



## LIST OF FIGURES

	Page
Fig. 2.1 Mass Yield Curve for Uranium-235 . . . . .	7
Fig. 2.2 Average Binding Energy Per Nucleon for Naturally Occuring Nuclides . . . . .	16
Fig. 2.3 Summary of Semi-empirical Liquid-Drop Model Treatment of the Average Binding Energy Curve . . . . .	19
Fig. 2.4 Naturally Occurring Nuclides for $Z < 83$ . . . . .	20
Fig. 3.1 Effective Distance Between Fission Fragments . . . . .	33
Fig. 3.2 A-Matrix for Mass Correction Subroutine . . . . .	49
Fig. 3.3 Mass Correction for Neutron Number . . . . .	52
Fig. 3.4 Mass Correction for Proton Number . . . . .	53
Fig. 3.5 Flowchart for the Neutron Evaporation Code . . . . .	54
Fig. 4.1 Determination of Adjustable Parameter RR . . . . .	63
Fig. 4.2 Prompt Neutron Spectrum for U-235 . . . . .	64

## ACKNOWLEDGEMENTS

The author wishes to express his gratitude to Dr. Donald R. Harris for the guidance and encouragement gained while working for him on this monumental undertaking. Discussions with Dr. Ivor Preiss of the Chemistry Department are also gratefully acknowledged.

Special thanks are extended to Elaine Verrastro for her painstaking word processing support. Finally, the author is especially grateful to his wife Ann and daughter Teri for their patience during the exhaustive work on this thesis.

## ABSTRACT

→ The thermal fission of Uranium-235 has been studied by developing a computer code that uses evaporation theory based on the Weisskopf model for neutron emission from individual fission fragments. This computer code calculates a prompt neutron spectrum for the thermal fission of Uranium-235, calculates the total gamma ray energy for the fission of Uranium-235, and calculates the average prompt neutron kinetic energy. Until now, evaporation theory codes used average values of mass and energy in determining prompt neutron spectra, and this code was developed to use all possible fission fragment combinations in order to eliminate this averaging. This approach is necessary to compute certain measured data such as the probability that 0,1,2,... neutrons are emitted per fission. This code <sup>uses</sup> utilizes subroutines to calculate rest masses, corrects the calculated rest mass to agree with experiment, and to determine the emitted neutron kinetic energies.

Evaporation theory codes have predicted low total gamma energy release in fission, but agree quite favorably with experiments in predicting the average prompt neutron kinetic energy. The prompt neutron spectrum obtained in this code has a high tail region, that is, below 0.5 MeV. The average kinetic energy of the neutrons agree very well with experiment, and the total gamma energy is lower than experiment, as previous evaporation theory codes have been. *more*

## CHAPTER 1

### INTRODUCTION AND HISTORICAL PERSPECTIVE

Fission is the process which occurs when a fissionable nucleus captures a neutron and splits into two lighter nuclei, increasing the stability of the system. When fission occurs, up to a half-dozen neutrons are emitted along with gamma rays, and at some time later, beta particles and neutrinos. The fission fragments formed as a result of fission are neutron rich and must decay to a more stable configuration. One of the most important products of the fission process is the prompt neutrons which are emitted within the first  $10^{-17}$  seconds of the split of the parent nucleus.

In the design of nuclear reactors, it is important to know the energy spectrum for the neutrons emitted as a result of the fissioning of the compound nucleus and the energy of the gamma rays emitted from the fission process. The neutrons are necessary for the sustenance of the fission process, and the gamma rays are a biological hazard and require shielding.

James Terrell, in 1958, published his study entitled "Fission Neutron Spectra and Nuclear Temperatures". His paper considered "the agreement with experiment of various theoretical predictions as to the energy spectrum of fission neutrons".<sup>1</sup> He also gathered information concerning nuclear temperatures from the measured spectra, and looked at how the neutron multiplicity (that is, the average number of neutrons emitted in the fissioning process) varies with the excitation energy. He also calculated a center of mass neutron spectrum



and calculated the effect of anisotropy of neutron emission on the laboratory spectrum. Terrell concludes that all experimental energy distributions for fission neutrons are indistinguishable from Maxwellian distributions and shows that distributions of essentially this form are predicted by Weisskopf's evaporation theory.

"Calculation from evaporation theory gives the observed distribution of neutron numbers; but calculated total gamma-ray energies are too low, unless gamma rays are emitted much more rapidly than commonly assumed."<sup>1</sup> Neutron multiplicity in Terrell's paper is determined to be 2.46 neutrons/fission.

In Terrell's paper, calculations are performed using an average light mass and an average heavy mass. His average mass of the heavy fragment to the light fragment is 1.47 for Uranium 235. A compilation of the average energy of fission neutrons is presented in his paper based on experimental methods. They are for U-235 + neutron:

Experimenter <sup>1</sup>	Energy Range (MeV)	$\bar{E}$ (MeV)	Method
Cranberg & Nereson	0.18 - 3	1.9806	Time of Flight
Frye & Rosen	0.35 - 12	1.9806	Photoplate
Mulkin	1 - 12	---	Photoplate
Nereson	0.4 - 7	---	Photoplate
Watt	3.3 - 17	2.00	Proportional Counter

The more recent research on the prompt neutron energy spectrum has been performed by David G. Madland and J. Rayford Nix, at Los

Alamos Scientific Laboratory. Again, average values of the light and heavy fission fragments are used. They use standard evaporation theory to calculate the neutron energy spectrum in the center-of-mass of a given fission fragment, and then transform into the laboratory system, taking into account that the average velocity of the light fragment is higher than the average velocity of the heavy fragment. The energy released in fission is based on seven heavy fission fragments. These fragments are 2 Iodine isotopes, 3 Xenon isotopes and 2 Cesium isotopes. For the total average fission-fragment kinetic energies, Madland and Nix used the experimental results of Unik et al., which are appropriate to thermal neutron induced fission, however, these are average values only. Their results show an average neutron multiplicity of 2.403 for thermal neutron induced fission of Uranium-235. In the laboratory system, the average energy of the prompt neutrons for 0.53 MeV induced fission and 0.60 MeV induced fission is 2.046 and 2.048 respectively. No kinetic energy results for thermal fission are given in their paper.

As seen in the literature, there is a need to apply first principles to the fission process for all possible fragment combinations in order to remove the averaging of fragment weight and kinetic energy. The code developed in this thesis uses first principles on all fission fragment combinations for the thermally induced fission of Uranium 235. Major items of interest are (1) to develop a neutron energy spectrum for thermal fission of Uranium-235, (2) determine the neutron multiplicity of Uranium-235, (3) determine the total gamma energy available on the fragments. Total gamma energy is determined

by the initial excitation energy in the case when no neutrons are emitted, and the residual energy in the case when neutrons are emitted, but energy remains which is below that required to emit a neutron. This total gamma energy is weighted by the yield of the particular nuclide and displayed as a result in the code.

Another development which this code will allow is the determination of the number of neutrons emitted from each possible fragment. This allows one to compute, by knowing the fractional yield of the nuclide and the number of neutrons emitted by the fragment, the contribution of the neutron multiplicity from each individual fragment.

The description of fission theory in Chapter 2 is presented largely in the form of quotations. The application to the code development is presented in parallel to the theory. In brief, the yield of each primary fission fragment is determined as the measured A-chain yield multiplied by a Gaussian probability distribution in charge. For a given primary fission fragment pair the rest mass energies are computed and subtracted from the mass energy of the fissioning nucleus. This energy decrement appears as the sum of the fragment excitation energies plus the kinetic energies of the separating fragments. The latter is determined in terms of the fragment charges and the distance  $RR$  between the fragments at the instant of scission. For an assumed  $RR$  the fragment kinetic energies are determined and, from the sum of excitation energies, a plausible assumption results in the initial excitation energy on each primary fission fragment. Next, computing the mass of the nucleus which would result if neutron emission occurred, it is determined whether neutron

emission is energetically possible. If so, the neutron kinetic energy in the fission fragment frame of reference is determined by evaporation theory, and we are again left with an excited nucleus. The process is repeated until neutron emission is not energetically possible, after which the total gamma deexcitation energy is recorded; the gamma emission spectrum is not computed. Finally, the neutron kinetic energy is transformed to the laboratory coordinate system. The calculations are repeated for all fission fragment pairs and for various values of  $RR$ . The best value of  $RR$  is chosen to give the best agreement with measured data.

## CHAPTER 2

### THEORY

#### 2.1 Mass Distribution

"One of the most characteristic features of fission is the asymmetric division of the fissioning nucleus, and for many years our most complete knowledge of the mass division came from radiochemical research."<sup>2</sup> "What particular fragment nuclides are produced by the given nucleus is a matter of chance and the range of gross fission products is roughly from bromine to barium in the periodic table. The concentration of fission nuclides depends on the atomic mass and the distribution curve has a curious saddleback shape (see Fig. 2.1). These are two well-defined maxima, at  $A = 95$  and  $A = 140$  (for the fission of U-235), roughly. The total yield is 200% since there are two fragments per fission. The total number of identified fission nuclides is about 300, including nearly 200 different  $\beta^-$  emitters."<sup>3</sup>

"The first work on fission yield and the introduction of the concept of fission yield were due to Fermi and his co-workers at Columbia."<sup>2</sup>

"The determination of the fission yield of a specific species consists of a number of steps.

1. A measured amount of non-radioactive carrier material of a given fission product element is added to a solution of uranium in which a known number of fission events has occurred.

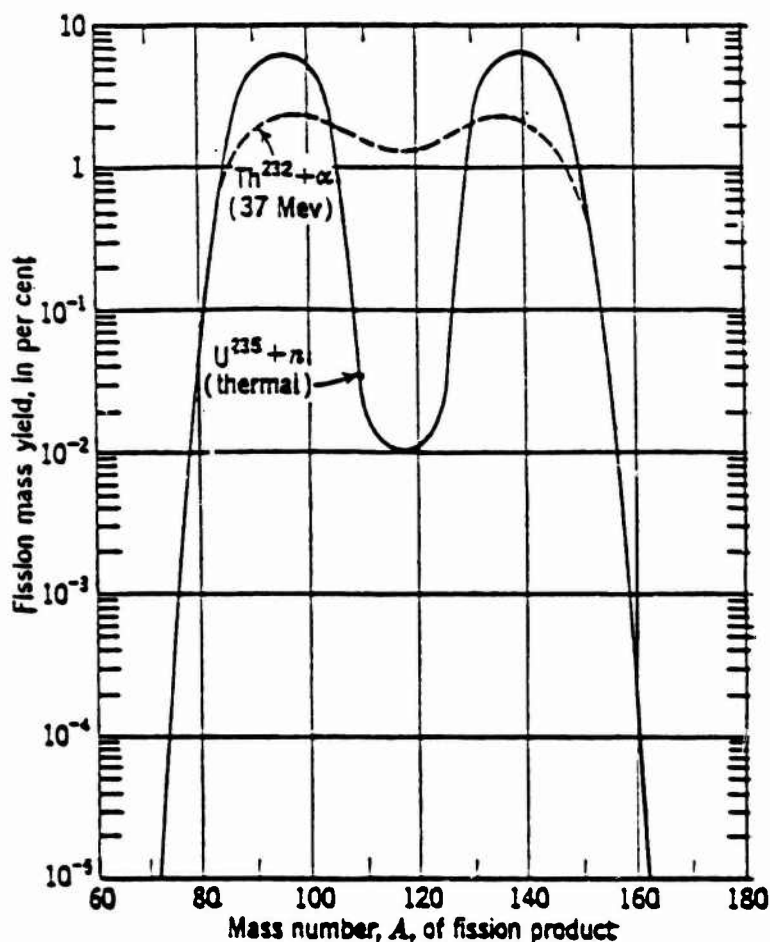

Fig. 2.1 Mass yield in the low-energy fission of U-235 by thermal neutrons (solid curve). The asymmetry is reduced when fission takes place from more highly excited levels of the compound nucleus. The dotted curve shows the mass yield for Th-232 + 37 MeV alpha particles, which also involves the compound nucleus U-236. (From R.D. Evans, The Atomic Nucleus, p. 393)

2. If it is necessary, chemical treatment is given this solution to insure complete isotopic exchange of the stable and radioactive isotopes of the element.
3. The solution is subjected to an analytical procedure to separate the element from the solution in a state of chemical and radioactive purity.
4. The fractional recovery of the inert carrier is determined by some quantitative analytical method. The chemical recovery of the tracer element is assumed equal to that for the inert carrier material.
5. The radiation of the purified radioelements are measured to identify the isotopes and to determine the absolute amounts of each species. Correction is made for radioactive decay from the time of fission to the time of counting.
6. From the counting data, the chemical yield data, and the known number of fission events the fission yield is calculated. The fission yield is defined as the percentage of fissions leading to the formation of a measured product.

It is to be noted that the radiochemical results do not in general give the independent yield of the specific isotope measured. Usually, the experimentally determined yield is the cumulative yield of the specific isotope, including any precursors which have undergone decay to the specific isotope before the chemical isolation occurred."<sup>2</sup>

"The largest error in determination of a fission yield lies in the evaluation of the absolute disintegration rate of the radioactive

species. In order to correct for the effects of absorbers [such as the window of the detector, the material, the source covering, etc.], it is usual to establish empirically the initial half-thickness of the radiation emitted by the source by means of the determination of an absorption curve. In many instances such a curve is complex. The establishment of an initial half-thickness, then, becomes a matter of interpretation and individual judgment".<sup>4</sup>

"In thermal neutron fission of most nuclei, an asymmetric mass split, with a ratio of heavy-to-light fragment mass ( $M_H/M_L$ ) of about 1.4, is much more likely than a symmetric mass split. With increasing bombarding energy the valley between the two humps in the fission-yield curve gradually fills in, so that, for example, with 14 MeV neutrons on U-235, the peak to valley ratio is only about 6 (compared to about 600 for thermal neutrons). When the bombarding energy reaches about 50 meV, the fission-yield curves for the highly fissile elements ( $Z > 90$ ) exhibit single broad humps with the valley completely filled in. It has recently been established that for the very heaviest elements, that is in the region of fermium, the probability of a symmetrical mass split again increases relative to the asymmetric modes, until, for the thermal-neutron fission of Fm-257, symmetric fission predominates."<sup>5</sup>

## 2.2 Charge Distribution

"An important part of the information that one would like to have about the fission process is the division of nuclear charge between the primary fission fragments. Unfortunately, to determine



this is a difficult experimental problem and the available data are limited. The reason for this difficulty is that the primary fragments are so far from beta stability that most of them have very short half-lives. Hence, by the time the necessary chemical separations have been carried out, the primary products have been completely converted into different elements. This is not true in the case of shielded nuclides, and their fission yields are of necessity independent rather than cumulative chain yields. A shielded nuclide is one which cannot be formed by beta decay because the isobaric nuclide of the next lower atomic number is stable."<sup>2</sup>

"Several postulates have been made concerning the manner in which the nuclear charge of the fissioning nucleus distributes itself between the two fragments:

- (1) The unchanged charge distribution (UCD) or constant charge ratio (CCR) postulate predicts that the two fragments will have the same charge density ( $Z_0/A_0$ ) as the fissioning nucleus. This type of charge division leads to chain lengths which are longer in the light fragment. Approximately equal chain lengths are observed in low-energy fission.
- (2) The postulate of minimum potential energy (MPE) proposed by R.D. Present (1947), postulated that nuclear charge distributes itself between fragments such that a minimum is achieved between the nuclear potential energy and the Coulomb energy. This corresponds to maximizing the excitation energy. The postulate predicts chain lengths

of the light fragments which are shorter than those of the heavy fragments.

- (3) The postulate of maximum energy release (MER) was proposed by Kennett and Thode (1956) to explain better the primary yields of nuclei in the region of  $Z=50$ . The maximum energy release is calculated as the difference between the mass of the fissioning nucleus and the masses of the primary fission products and neutrons emitted. The most probable nuclear charge which results from this method depends upon the mass formula that is used to determine the primary fission product masses.
- (4) The postulate of equal charge displacement (ECD) is essentially an empirical correlation of low-energy experimental data. The two basic assumptions of this postulate are (a) the most probable charges for complementary fission products be an equal number of charge units away from the valley of beta stability and (b) the distribution function about the most probable charge is symmetric and the same for all mass splits."<sup>6</sup>

"The postulate that the most probable division of charge in fission is the division that gives rise to fragments of equal effective chain length (equal charge displacement) may now be taken as a working hypothesis of the variation in nuclear charge among the primary fission products. It should be emphasized that this is essentially an empirical hypothesis. Its validity may be based on the fact that there is competition between the effects of splitting

of the nucleus to give a charge distribution not to greatly different from that of the fissioning nucleus, with perhaps slightly asymmetric charge distribution as suggested by Present, (Phys. Rev. 72:7 (1947)) and the effect of splitting to give minimal potential energy."<sup>7</sup>

"The shape of the distribution function which represents the relative probability  $P(Z)$  of forming a product with atomic number  $Z$  is assumed to be a Gaussian given by the relationship:

$$P(Z) = [1/(c\pi)^{1/2}] \exp[-(Z-Z_p)^2/c] \quad (2.1)$$

where  $c$  is a constant empirically determined."<sup>6</sup>

"This relationship holds for all mass numbers, with the parameter  $c = 0.79 \pm 0.14$  (for  $^{235}\text{U}$  fission by thermal neutrons). This corresponds to a full width at half maximum of  $1.50 \pm 0.12$  charge units. (Wahl et al. "Nuclear-Charge Distribution in Low-Energy Fission," Physical Review 126, 1112 (1962))."<sup>5</sup>

"From the assumption of equal charge displacement, one may write

$$(Z_{AL} - Z_{PL}) = (Z_{AH} - Z_{PH}) \quad (2.2)$$

where  $Z_A$  refers to the most stable charge,  $Z_p$  to the most probable charge, and the subscripts L and H refer to the light and heavy complementary primary products, respectively. The following relationships are valid for binary fission:

$$Z_{PL} + Z_{PH} = Z_0 \quad (2.3)$$

and

$$A_L + A_H = A_0 - \nu \quad (2.4)$$

where  $\nu$  is the number of neutrons emitted in the mass split. The most probable charge of a fission product of mass  $A$  is given by:

$$Z_p = Z_A - \frac{1}{2} (Z_A + Z_{(A_0 - \nu - A)} - Z_0) \quad (2.5)$$

Thus the  $Z_p$  function is defined in terms of the most stable masses."<sup>6</sup>

Wahl was able to determine the primary and cumulative yields of nine short lived isotopes of krypton and xenon by measuring the fractional cumulative yields of inert gases produced as fission products and captured in a thin layer of barium stearate powder. From this work, Wahl developed an empirical curve for  $Z_p$ . "Several of Wahl's students have contributed newer data on independent and cumulative yields which are significant for an analysis of the equal charge displacement hypothesis in its various formulations; the comprehensive summary paper on this work is a key paper in the literature on charge distribution."<sup>2</sup>

In order to code the equal charge displacement hypothesis a few variables must be defined.

$AN(IA)$  is the mass of the  $IA^{\text{th}}$  nuclide.

$ZN(IA,IZ)$  is the charge number of the  $IZ^{\text{th}}$  nuclide with mass number  $AN(IA)$ .

$ZA(IA)$  is the starting  $Z$  for the  $IA^{\text{th}}$  chain.

$NZ$  is the number of charge steps off the line of stability.

The Gaussian curve may be coded as follows:

The probability distribution is given by:

$$\frac{1}{\text{SQRT}(\text{CC} * 3.14159)} * \text{EXP}(-((\text{ZN}(IA,IZ) - Z_p(IA)) ** 2) / \text{CC}) \quad (2.6)$$

$\text{CC} = .79$

$\text{C1} = 1.0 / \text{SQRT}(\text{CC} * 3.14159)$

$YA(IA)/200.0$  is the chain yield divided by 200%, since the yield is given by the number out of 200 events that it will occur. The independent yield is given as the product of the chain yield/200.0 and the Probability Distribution for the specified Z-chain.

$$YZ(IA,IZ) = (YA(IA)/200.0)*C1*EXP(-((ZN(IA,IZ)-ZP(IA))**2)/CC) \quad (2.7)$$

After all yields are determined, the yield weighted average mass may be determined by summing up all of the products of yield and mass as:

$$\sum_{IA} [(YA(IA)/200.00)*AN(IA)] \quad (2.8)$$

and then divided by the sum of all yields:

$$\sum_{IA} YA(IA)/200.00 \quad (2.9)$$

So, the yield weighted average of all masses can be written:

$$(\overline{MASS}) = \frac{\sum_{IA} (YA(IA)/200.00)*AN(IA)}{\sum_{IA} (YA(IA)/200.00)} \quad (2.10)$$

This averaging is performed for two groups. First, all nuclides with  $4 < A < 114$  are considered in the light group. Second, all nuclides with  $115 < A < 235$  are considered in the heavy group. From this averaging process, the Average heavy fragment and average light fragment mass may be determined.

### 2.3 Mass and Binding Energy

"The liquid-drop model provides reasonable explanations for many phenomena which are inaccessible to the shell model. These phenomena are mainly:

- (1) Substantially constant density of nuclei with radius  $R \propto A^{1/3}$ .
- (2) Systematic dependence of the neutron excess (N-Z) on  $A^{5/3}$  for stable nuclides.
- (3) Approximate constancy of the binding energy per nucleon  $B/A$ , as well as its small but definite systematic trends with A (see Fig. 2.2).
- (4) Mass differences in families of isobars and the energies of cascade  $\beta$  transitions.
- (5) Systematic variation of  $\alpha$  decay energies with N and Z.
- (6) Fission by thermal neutrons of U-235 and other odd-N nuclides.
- (7) Finite upper bound Z and N of heavy nuclides produced in reactions and the non-existence in nature of nuclides heavier than [Pu-244].

which involve the masses and binding energy of nuclear ground levels; the energetics of  $\beta$ -decay,  $\alpha$  decay, and nuclear reactions; and the energetics of nuclear fission."<sup>8</sup>

"The basic premise of the liquid drop model of complex nuclei is that the number of nucleons in a typical nucleus is sufficiently large that the individuality of nucleons may be disregarded. While the treatment of such a system is most rigorously given by using the methods of quantum statistical mechanics, it is possible to arrive at three components of the expression for the energy of a complex nucleus by simple classical considerations. These components are the volume binding energy, the surface energy, and the coulomb energy."<sup>9</sup>

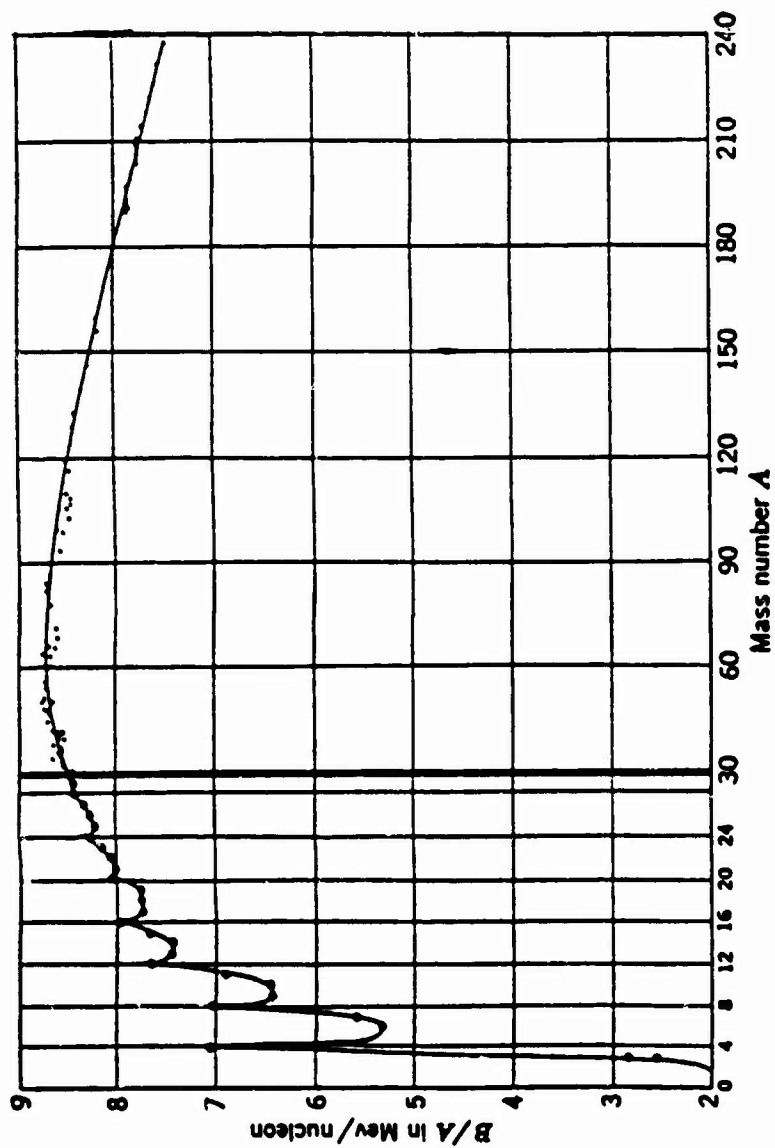

Fig. 2.2 Average binding energy  $B/A$  in MeV per nucleon for the naturally occurring nuclides, as function of mass number  $A$ . Note the change in magnification in the  $A$  scale at  $A=30$ . For  $A > 16$ ,  $B/A$  is roughly constant. (From R.D. Evans, The Atomic Nucleus, P. 299)

In addition to the three terms which may be given by classical considerations, there are also additional terms in the semi-empirical mass formula. These terms are called the symmetry terms, which Meyers and Swiatecki include in the volume term, the correction term to the Coulomb energy term and also the pairing energy term. These terms are discussed individually:

- (1) Volume Energy Term: "The first and dominant term, proportional to  $A$  and thus to the nuclear volume, expresses the fact that the binding energy is in first approximation proportional to the number of nucleons. This is a direct consequence of the short range and saturation character of the nuclear forces. The saturation is almost, though not entirely, complete when four nucleons, two protons and two neutrons, interact, as is indicated by the large observed binding energies of  ${}^4\text{He}$ ,  ${}^{12}\text{C}$ ,  ${}^{16}\text{O}$  and so on."<sup>5</sup>
- (2) Surface Energy Term: "The nucleons at the surface 'feel less interaction' than nucleons deep inside; compared to the latter, the external medium, vacuum, deprives them of more than half their partners. The volume energy term over-estimates the total binding, since the nucleus is finite. The lost binding is proportional to the number of nucleons at the surface, that is to the surface area. By assuming the nuclear drop to be a sphere, its surface area is given by  $4\pi r_0^2 A^{2/3}$  and the correction to be applied can be written as  $(\Delta B)_S = -a_S A^{2/3}$  where  $a_S$  is a constant."<sup>10</sup>  
With increasing nuclear size, the surface-to-volume ratio



decreases, and therefore this term becomes relatively unimportant."<sup>5</sup>

- (3) Coulomb Energy Term: "The above constitute the main feature of an electrically neutral drop. We must now consider the Coulomb interaction which acts between protons. This is a repulsive action, and therefore its contribution decreases the binding energy. It is responsible for the slow decrease of  $B/A$  beyond  $A \approx 60$ , as  $Z$  increases (Fig. 2.3). For all light nuclei, this contribution is small since the strong interaction is stronger than the electromagnetic interaction. If this contribution becomes appreciable for high  $Z$ , it is because the Coulomb interaction is of 'infinite' range, and therefore acts over the whole volume, whereas the strong interaction acts over a region of radius close to 1.5 Fermis."<sup>10</sup> "The electrostatic energy of a uniformly charged sphere of charge  $q$  and radius  $R$  is  $\frac{3}{5} \frac{q^2}{R}$  and since  $q = Ze$  and  $R = r_0 A^{1/3}$  for a nucleus of radius  $R$  and atomic number  $Z$ , we can write its electrostatic energy as  $(\frac{3e^2}{5r_0})Z^2A^{-1/3}$ . The coefficient  $(\frac{3e^2}{5r_0}) = 0.717$  MeV corresponds to an  $r_0$  value of 1.205 Fermis. Because of its  $Z^2$  dependence, the coulomb energy becomes increasingly important as  $Z$  increases and accounts for the fact that all stable nuclei with  $Z > 20$  contain more neutrons than protons (see Fig. 3.4) despite the symmetry energy that maximizes nuclear binding for  $N=Z$ ."<sup>5</sup>

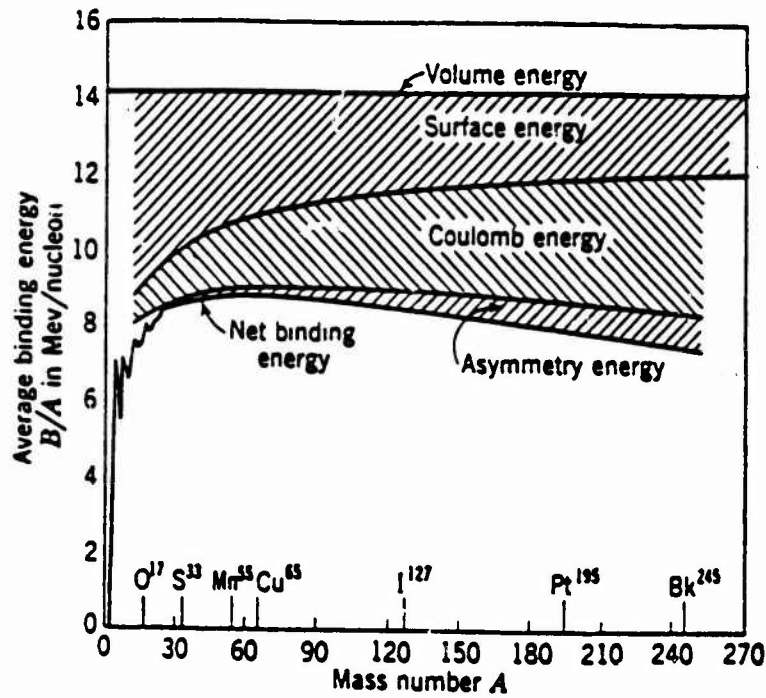

Fig. 2.3 Summary of the semi-empirical liquid-drop-model treatment of the average binding energy curve. Note how the decrease in surface energy and the increase in coulomb energy conspire to produce the maximum observed in  $B/A$  at  $A \approx 60$ . (From R.D. Evans, The Atomic Nucleus, p. 382)

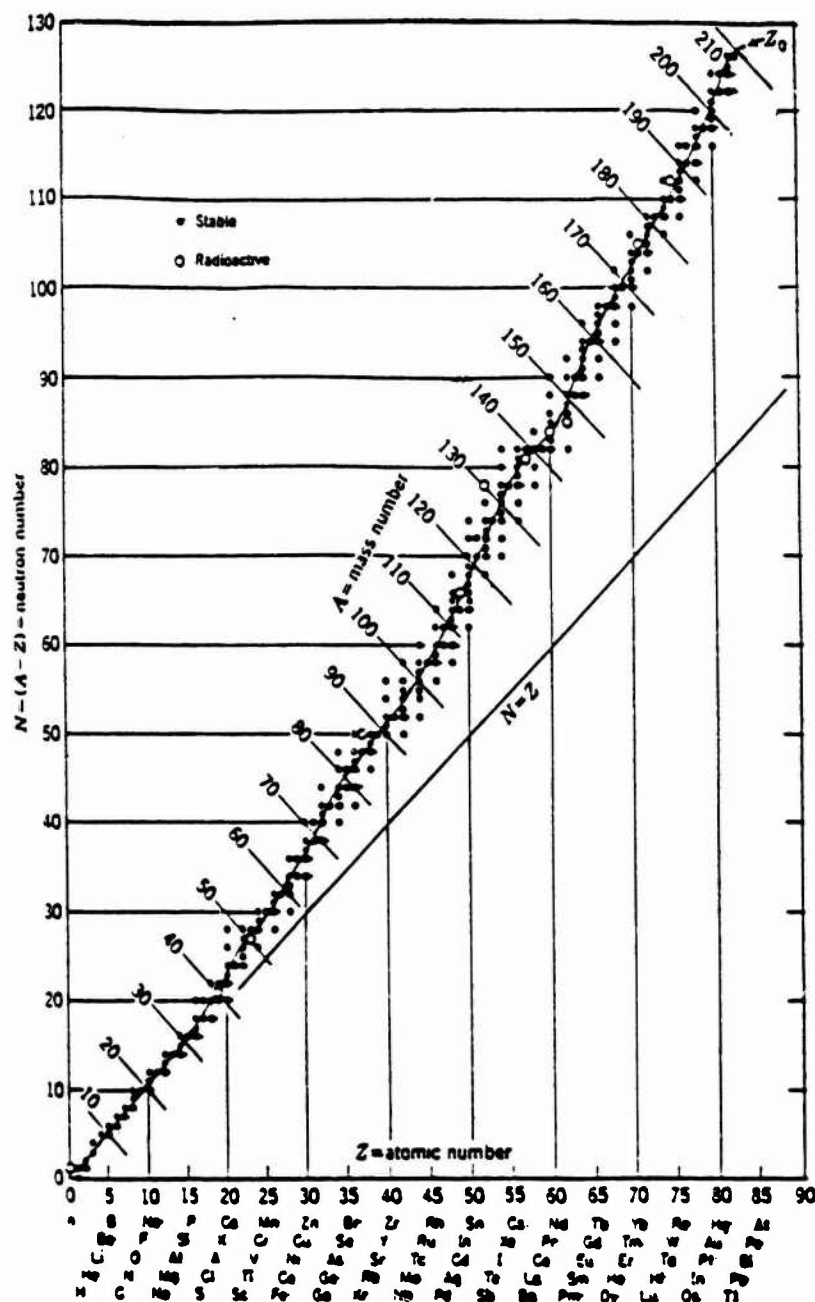

Fig. 2.4 The naturally occurring nuclides for  $Z < 83$ . The solid line shows the course of  $Z_0$ , which is the bottom of the mass energy valley, or the "line of  $\beta$  stability". The chemical elements are identified by their symbols along the  $Z$  axis. (From R.D. Evans, *The Atomic Nucleus*, p. 287)

- (4) Coulomb Energy Correction Term: "Nuclei are not uniformly charged, but have charge distributions with diffuse boundaries. The diffuse boundary gives rise to a correction to coulomb energy (lowering it), and this is expressed in the fourth term of the semiempirical mass formula."<sup>5</sup> This correction term, introduced by Meyers and Swiatecki is written as:  $(\pi^2 e^2 / (2r_0)) \cdot (d/r_0)^2 Z^2 / A$ , where  $d$  is given by 0.5461 Fermis, based on the Stanford electron scattering experiments. So this correction term can be written:  $1.211 Z^2 / A$ .
- (5) Symmetry Energy Term: The correction term proportional to  $(N-Z)^2 / A$  is included in both the volume energy term and the surface energy term in order that "the surface and volume energies vary in a parallel manner and, in particular, vanish simultaneously for a large neutron excess. (Conventional formulae without a composition-dependent surface energy correspond to a surface tension that retains its full standard value even when the neutron excess has made the volume binding vanish, and all cohesion has been lost").<sup>11</sup> "It reflects the observation that for a given  $A$  the binding energy due to nuclear forces (i.e., disregarding the Coulomb effect) is greatest for the nucleus with equal number of neutrons and protons and decreases symmetrically on both sides of  $N=Z$ . The simplest functional form expressing these empirical facts is a term in  $(N-Z)^2$ . The  $A^{-1}$  dependence of the symmetry energy comes

about because the binding energy contribution per neutron-proton pair is proportional to the probability of having such a pair within a certain volume (determined by the range of nuclear forces), and this probability in turn is inversely proportional to the nuclear volume. The extra stability of  $N=Z$  nuclei comes about at least in part through the Pauli exclusion principle since two identical nucleons cannot be in the same energy state, the lowest state for a given number of nucleons is attained (in the absence of Coulomb forces) for equal numbers of neutrons and protons."<sup>5</sup>

- (6) Pairing Energy Term: This correction term is due to the coupling of pairs of identical nucleons. "This term is a quantitative expression of the fact that binding energies for a given  $A$  depend somewhat on whether  $N$  and  $Z$  are even or odd. So called even-even nuclei (even  $Z$ -even  $N$ ) are the stablest and for them the pairing energy term may be taken as  $+11/A^{1/2}$ ; for even-odd (even  $Z$ -odd  $N$ ) and odd-even (odd  $Z$ -even  $N$ ) nuclei, the pairing energy term is zero; for odd-odd nuclei (odd  $Z$ -odd  $N$ ) the pairing energy term is  $-11/A^{1/2}$ . The greater stability of nuclei with filled energy states is apparent not only in the larger number of even-even nuclei but also in their greater abundance relative to the other types of nuclei. On the average, elements of even  $Z$  are much more abundant than those of odd  $Z$  (by a factor of about 10). For elements of even  $Z$  the

isotopes of even mass (even N) account in general for about 70 to 100 percent of the element. The general shape of the binding-energy curve (Fig. 2.3) with the maximum at  $A \cong 60$  comes about through opposing trends with mass number of the relative contributions of surface energy (decreasing with A) and coulomb and symmetry energies (increasing with A)."<sup>5</sup>

The semi-empirical mass formula can be written as:

$$E_B = c_1 A \left[ 1 - k \left( \frac{N-Z}{A} \right)^2 \right] - c_2 A^{2/3} \left[ 1 - k \left( \frac{N-Z}{A} \right)^2 \right] - c_3 Z^2 A^{-1/3} + c_4 Z^2 A^{-1} + \delta \quad (2.11)$$

"where  $E_B$  is the binding energy, that is, the energy required to dissociate the nucleus into its constituent nucleons, and A, Z and N are the mass number, proton number and neutron number respectively. With  $E_B$  expressed in MeV the coefficients take on the following values:

$$c_1 = 15.677 \text{ MeV}$$

$$c_2 = 18.56 \text{ MeV}$$

$$c_3 = 0.717 \text{ MeV}$$

$$c_4 = 1.211 \text{ MeV}$$

$$k = 1.79$$

$$\delta = \text{pairing term.}$$

The equation contains only six empirically adjusted parameters, yet this simple equation yields binding energies that agree with experimental values for each of

the approximately 1200 nuclides of known mass to within less than 10 MeV, and very much better than that for most. This represents a remarkable success for the liquid-drop model of the nucleus."<sup>5</sup>

The mass  $M$  of a neutral atom whose nucleus contains  $Z$  protons and  $N$  neutrons is:

$$M = ZM_H + N M_n - E_B \quad (2.12)$$

where  $E_B$  is the binding energy,  $M_H$  is the mass of the hydrogen atom and  $M_n$  is the mass of the neutron. By determining the binding energy for a nuclide, and knowing its constituents, the mass may easily be determined.

#### 2.4 Nuclear Evaporation Theory

"The application of quantum mechanics to the calculation of nuclear reactions heavy nuclei gives rise to extremely complicated expressions which cannot be treated by ordinary methods, since there is no approximate solution for this complex many-bodied problem on account of the intense interaction between the constituents of atomic nuclei. On the other hand Bohr has pointed out that just the extreme facility of energy exchange gives rise to a characteristic simplification of the course of every nuclear process initiated by a collision between a particle or a light quantum and a nucleus. It consists in the possibility of dividing the process into two well-separated stages. The first is the formation of a compound nucleus in a well-defined state in which the incident energy is shared among all the constituents, the second is the disintegration

of that compound system, which can be treated as quite independent of the first stage of the process. This conception has been extremely fruitful in the treatment of all kinds of nuclear reactions. Qualitative statistical conclusions about the energy exchange between the nuclear constituents in the compound state have led to simple explanations of many characteristic features of nuclear reactions. In particular, the use of thermodynamical analogies has proved very convenient for describing the general trend of nuclear processes. The energy stored in the compound nucleus can in fact be compared with the heat energy of a solid body or a liquid, and, as first emphasized by Frenkel, the subsequent expulsion of particles is analogous to an evaporation process."<sup>12</sup>

In the fission process, a neutron with a given amount of kinetic energy combines with a heavy nucleus to form a compound system. After the formation of the compound nucleus the disintegration stage may be treated separately in most cases from the formation stage "in a sense that the mode of disintegration of the compound system depends only on its energy, angular momentum, and parity, but not on the specific way in which has been produced. If the incident particle comes within the range of forces, its energy is quickly shared among all the constituents well before any re-emission can occur. The state of the compound system is then no longer dependent on the way it was formed."<sup>2</sup>

Consider the reaction  $a + X \rightarrow c + Y + b$ , where  $c$  is the compound nucleus. For the evaporation theory to be used to express the process after formation of the compound nucleus, the assumption is



made that "the probability that the compound nucleus  $c$  decays into channel  $\beta$  is given by:

$$G_c(\beta) = \frac{K_\beta^2 \sigma_c(\beta)}{\sum_Y K_Y^2 \sigma_c(Y)} \quad \text{where} \quad (2.13)$$

$G_c(\beta)$  = Branching ratio (relative decay probability) for the compound nucleus  $c$  to decay through channel  $\beta$ .

$K_\beta$  =  $|k_\beta| = \lambda_\beta^{-1}$ ; channel wave number in channel  $\beta$ .

$\sigma_c(\beta)$  = Cross section for the formation of the compound nucleus through channel  $\beta$ .

$\sum_Y K_Y^2 \sigma_c(Y)$  = Sum of  $K^2 \sigma_c$  extended over all channels  $\gamma$ , into which  $c$  can decay.

and therefore can be determined from the cross sections,  $\sigma_c$ ."29

The energy distribution of the emitted particles is first studied. "The kinetic energy in channel  $\beta$  is given by:

$$\epsilon_\beta = \epsilon_\alpha + Q_{\alpha\beta} \quad (2.14)$$

$\alpha$  = entrance channel

$\beta$  = exit channel

$Q_{\alpha\beta}$  =  $Q$  value for the reaction =  $E_{\alpha'} + E_{\alpha''} - E_{\beta'} - E_{\beta''}$  (single ' indicates states of nuclei and double ' indicates the states of the incident or emerging particle.)

Since most of this energy is the kinetic energy of the emitted particle  $b$ , and only a small part is the recoil energy of the residual nucleus  $Y$ , we consider  $\epsilon_\beta$  the kinetic energy of  $b$ .

We write here:  $\epsilon_\beta = \epsilon_{\beta Y} - E_\beta^*$ , where  $\epsilon_{\beta Y} = \epsilon + Q_{ab}$  and  $\epsilon = \epsilon_{\alpha 0}$  is the kinetic energy in the entrance channel (both  $a$  and  $X$  in their ground states), and represents the maximum value of  $\epsilon_\beta$ , which occurs if the residual nucleus  $Y$  remains in its ground state.  $E_\beta^*$  is the excitation energy of  $Y$  after the reaction and the difference between the energy of  $Y$  after the reaction and the energy of the ground state of  $Y$ . To every level  $E_\beta^*$  of the residual nucleus there corresponds an energy  $\epsilon_\beta$  of the outgoing particle, as long as  $E_\beta^* < \epsilon_{\beta Y}$ .<sup>13</sup>

The formation cross section  $\sigma_C$  generally increases with increasing channel energy (owing to better penetration of the barrier), except for neutrons with  $l = 0$  where  $\sigma_C$  decreases, but very slowly (proportionally to  $k^{-1}$  or  $\epsilon^{-1/2}$ ). In all cases the product  $k^2 \sigma_C$  which appears in Eq. (2.13) is a monotonically increasing function of the channel energy  $\epsilon$ . If the energy is high enough, a great many levels of the residual nucleus can be excited. The energy distribution of the particles becomes continuous when the energies  $E_\beta^*$  are closer together than the definition of the energy in the incident beam, or closer than the energy resolution of the experimental arrangement for detection of the reaction products. The shape of the distribution function  $G_b(\epsilon)d\epsilon$  for the number of particles  $b$  emitted between  $\epsilon$  and  $\epsilon + d\epsilon$  is then given by:

$$G_b(\epsilon)d\epsilon = \sum G_c(\beta) \quad (2.15)$$

$$\epsilon < \epsilon_\beta < \epsilon + d\epsilon$$

where the sum is extended over channels  $\beta$  whose energy lies within the energy interval  $d\epsilon$ . The number of terms in this sum is given by

the number of levels of the residual nucleus Y with an excitation energy  $E_\beta^*$  between E and E -  $d\epsilon$ , where  $E = \epsilon_{bY} - \epsilon$ . We call this number  $W_Y(E)d\epsilon$ , and  $W_Y(E)$  the level density.<sup>13</sup>

The level density can be used to determine the relative intensity distribution of the outgoing particles  $I_b(\epsilon)d\epsilon$  by the relationship:

$$I_b(\epsilon)d\epsilon = \text{constant } \epsilon \sigma_c(\beta) W_Y(\epsilon_{bY} - \epsilon) d\epsilon \quad (2.16)$$

where  $\sigma_c(\beta) = \sigma_c(\epsilon)$  is a function of the channel energy  $\epsilon = \epsilon_\beta$ .

"We obtain a rough estimate of the shape of  $I_b(\epsilon)$ , especially for neutrons, by introducing the following Taylor expansion of the logarithm of the level density:

$$\eta(E) = \log W(E) \quad (2.17)$$

around the maximum energy  $\epsilon_{bY}$  by which the residual nucleus Y can be excited.

$$\nu(\epsilon_{bY} - \epsilon) = \nu(\epsilon_{bY}) - \epsilon \left( \frac{d\nu}{dE} \right) (E = \epsilon_{bY}) + \dots \quad (2.18)$$

If the expansion is used to approximate  $W(\epsilon_{bY} - \epsilon)$  in the relationship for  $I_b(\epsilon)d\epsilon$ , we can absorb the factor coming from  $\nu(\epsilon_{bY} - \epsilon)$  into the constant and get:

$$I_b(\epsilon)d\epsilon = \text{constant } \epsilon \sigma_c(\epsilon) \exp - \frac{\epsilon}{\theta(\epsilon_{bY})} d\epsilon \quad (2.19)$$

where the function  $\theta$  is determined by:

$$\frac{1}{\theta} = \frac{d\nu}{dE} \quad (2.20)$$

$\theta$  has the dimensions of an energy and can be interpreted as a nuclear temperature. This is the well-known thermodynamical relation between entropy ( $\eta$ ) and temperature ( $\theta$ ).<sup>13</sup>

The application of the temperature concept to nuclear reactions can be understood in the following way: The incident particle 'a' enters the target nucleus and forms a highly excited compound nucleus. The excitation energy can be considered heat energy delivered by the impact of 'a' on the target. The heating of the compound system causes an evaporation of neutrons or other particles and the energy distribution of the emitted neutrons is similar to the Maxwell Distribution. The potential barrier distorts the Maxwell distribution for charged particles by depressing the emission of low energy particles.

The temperature which determines the Maxwell distribution is given by  $\theta (\epsilon_{bY})$ :

$$\theta (\epsilon_{bY}) = \frac{1}{(dn/dE)}; E = \epsilon_{bY} \quad (2.21)$$

It is the temperature of the residual nucleus Y at the excitation energy  $\epsilon_{bY}$  (i.e., the temperature of the residual nucleus after emission). In the case of the fissioning of U-236 into two fragments, the excitation energy of the fragments will be the important factor in determining the energy allowed for neutron emission.

## CHAPTER 3

### CODE DEVELOPMENT

The code to determine the prompt neutron spectra and neutron multiplicity for the thermal fission of U-235 is comprised of a main program, a block data subprogram, a mass correction subroutine, a binding energy subroutine, and a neutron kinetic energy subroutine.

#### 3.1 Block Data Subprogram

The Block Data Subprogram is used to initialize the large arrays, AN(IA) ZP(IA), YA(IA), and ZA(IA), which are the 95 values of the atomic number of the IA-th nuclide chain, the most probable charge number of the IA-th nuclide chain, the chain yield of IA-th nuclide chain, and the starting proton number for the IA-th chain. The values for AN(IA) range from 71.0 to 165.0, which is the atomic number range for the fission fragments of U-235. The values of ZP(IA) were taken from Table 52.10, Reference [7], the values for YA(IA) were found in Reference [14]. The values of ZA(IA) were taken from the chart of the nuclides by examining each nuclide chain and extracting the stable species of highest proton number (lowest neutron number). These values are passed to the main program in a common statement called COMMON/BLK/.

#### 3.2 The Average Heavy and Light Masses

The charge number of the IZ-th nuclide with mass number AN(IA) can be placed into an array ZN(IA,IZ) by using two DO-LOOPS over IA (number of nuclide chains) and IZ (number of nuclides in each chain)

and setting  $ZN(IA,IZ)$  equal to the starting nuclide of the chain ( $ZA(IA) - IZ + 1$ ) for  $IZ = 1$ , ( $NZ =$  the number of nuclides in the chain), so that the proton number of the  $IA$ -th chain starts with  $ZA(IA)$  and decreases by 1 until all nuclides of the chain have a proton number associated with it.

Knowing the chain yield for the  $IA$ -th chain ( $YA(IA)$ ), the yield of the  $IA, IZ$ -th nuclide can be calculated by using the Gaussian distribution formula:

$$YZ(IA,IZ) = (YA(IA)/200.00)*C1*exp(-((ZN(IA,IZ) - ZP(IA))**2)/CC) \quad (3.1)$$

where  $CC$  is an empirical constant approximately equal to 0.79 and  $C1$  is equal to  $1.0/\text{SQRT}(CC*3.14159)$ . All other terms are discussed above. The yield is divided by 200.0 because the fragment shows up twice in the loop. One time a fragment is the primary fragment, and another time it is a complementary fragment.

By using another DO LOOP, the product ( $PR(IA)$ ) of the yield and the mass number can be determined for all  $IA$ -chains. Atomic number 115 is chosen to be the cutoff point between light fragments and heavy fragments. Within this do loop, all products ( $PR(IA)$ ) are summed for the light fragment group, and for the heavy fragment group, and the chain yields for each group are also summed. The yield weighted average mass then can be calculated by dividing the sum of the products,  $PR(IA)$ , by the sum of the yields. In mathematical notation:

$$M_{ave} = \frac{\sum_i M_i * YA_i / 200.0}{\sum_i YA_i / 200.0} \quad (3.2)$$

The weighted averages are then printed as output, to give the average heavy fragment mass and the average light fragment mass.

### 3.3 Determination of Fragment Kinetic Energy Constant

The formula for the electrostatic repulsion of two charged spheres is used, with minor modification, to approximate its fragment kinetic energy (EF).

$$EF_{\text{total}} = \frac{Z(1) * Z(2) * e^2}{RR[(A(1))^{1/3} + (A(2))^{1/3}]} \quad (3.3)$$

where Z(1), A(1) are the proton number and atomic mass number of fragment 1 and Z(2), A(2) are the proton number and atomic mass number for fragment 2, e is the elementary charge, and RR is the effective distance (see Fig. 3.1) between the centers of the fragments at the moment the neck of the fissioning system splits and coulomb repulsion forces the fragments to repel away from each other. The value for RR is determined by plotting results for different values and obtaining an empirical "best fit". The value for e is  $4.80298 \times 10^{10}$  electrostatic units. The conversion constant is used to transform ergs to MeV  $1.60219 \times 10^{-6}$  ergs/MeV. Therefore we can state:

$$EF_{\text{total}} = \frac{Z(1) * Z(2)}{RR[(A(1))^{1/3} + (A(2))^{1/3}]} * \text{Constant} \quad (3.4)$$

where the constant is equal to 1.439899 and RR is in Fermis ( $10^{-13}$  centimeters).

### 3.4 The Main Program Loop

The greatest portion of the main program consists of two DO-LOOPS, one over IA (number of nuclide chains) and IZ (number of

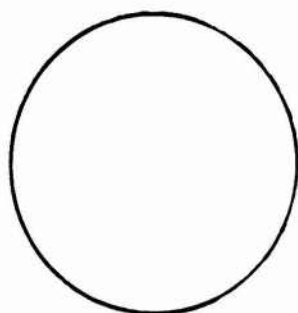

(a) Uranium 235 + neutron  $\rightarrow$  Uranium 236\*

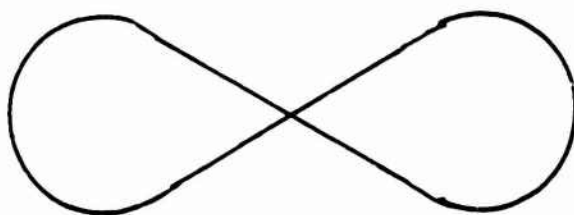

(b) Upon separation during fission process a "neck is formed"

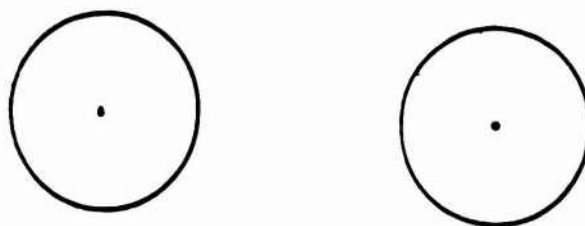

$\leftarrow$  - - - - - RR - - - - -  $\rightarrow$

(c) The two fragments are separated by an "effective distance" RR determined in this program to be 1.835 fermis ( $1.835 \times 10^{-13}$  centimeters)

Fig. 3.1 Effective Distance Between Fission Fragments



nuclides in the chain), which in effect performs all operations in the program for each possible fission fragment released in the binary fission (thermal neutron induced) of Uranium-235. The index IA is transformed to  $ID = NA - IA + 1$  (where  $NA =$  total number of chains) so that the heaviest chain is used first, and IZ is transformed to  $IE = NZ - IZ + 1$  (where  $NZ =$  total number of nuclides in the chain), so the smallest proton number is used first, and hence the largest neutron number nuclide is used to facilitate the neutron emission scheme used in the code.

The atomic number of fragment 1 is stored in  $A(1)$  and is equal to  $AN(ID)$ . The atomic number of fragment 2 is stored in  $A(2)$  and is equal to  $236.0 - AN(ID)$  so that the two fragments add up to the complex nucleus U-236's total number of nucleons which is 236. The proton number of fragment 1 is stored in  $Z(1)$  and is equal to  $ZN(ID,IE)$  and the proton number of fragment 2 is equal to  $92.0 - ZN(ID,IE)$  so that the sum of the proton numbers is equal to 92.0 which is the proton number for the complex nucleus U-236. The binding energy subroutine is called and the rest mass for fragment 1 and fragment 2 is returned so that the energy released (ER) in fission can be determined by subtracting the rest mass of the two fragments from the rest mass of the complex nucleus. By using  $Z(1)$ ,  $Z(2)$ ,  $A(1)$ ,  $A(2)$ , the fragment kinetic energy can be determined for the two fragments under consideration. In the main program, all ER and all EF are summed and an average ER and average EF can be computed after completion of the DO LOOP. The incident neutron, being of thermal energy, adds .025 eV to the system. Although this is an insignificant amount, it is in-

cluded. The total excitation energy ( $EE(ID,IE)$ ) of the fragments can be determined by:

$$EE(ID,IE) = ER + EN - EF \quad (3.5)$$

where  $EN$  is the incident neutron energy. The values for  $EE(ID,IE)$  are also summed up in order to determine an average excitation energy.

The binding energy subroutine is called a second time and enters the subroutine with the atomic mass numbers and proton numbers of fragment 1 and fragment 2. For each of these fragments, the rest mass is determined, and the rest mass  $RM(I)$ , neutron separation energy  $SEN$ ,  $SEN2$  and pairing energy  $T5(I)$  is determined for 9 successive neutron emissions in order to form neutron decay chains which can be examined to determine the number of neutrons emitted within the allowable energy of the system.

Fragment 1 (the heavy fragment) is examined first. The excitation energy on the heavy fragment ( $EEH$ ) can be computed by multiplying the excitation energy of the system by the fragment atomic mass number and dividing by the atomic mass number of U-236.

$$EEH = EE(ID,IE) * A(1) / 236.00 \quad (3.6)$$

Here, it is assumed that all 236 nucleons are in thermodynamic equilibrium and on the average, each nucleon shares an equal amount of residual energy in the nucleus. The separation energy of a neutron ( $SEN$ ) can be computed by:

$$SEN = 939.553 - (RM(I) - RM(I + 1)) \quad (3.7)$$

where 939.553 is the rest mass of the neutron,  $RM(I)$  is the rest mass of the fragment and  $RM(I + 1)$  is the rest mass of the next fragment in the neutron decay chain.

The maximum kinetic energy ( $E_{KMAX}$ ) of the emitted neutron from the heavy fragment is the excitation energy of the heavy fragment minus the separation energy of the neutron minus the pairing energy:

$$E_{KMAX} = EEH - SEN - T5(I) \quad (3.8)$$

The energy subroutine is called to determine a neutron energy, based on evaporation theory, for the emitted neutron. If the neutron is emitted, the multiplicity  $NU(ID,IE)$  for the fragment is increased by one. The excitation energy for the fragment ( $EEH$ ) is now equal to the maximum kinetic energy of the emitted neutron minus the kinetic energy ( $E_K(ID,IE,I)$ ) determined from the energy subroutine. This process is continued until the excitation energy ( $EEH$ ) is less than the sum of the separation energy of the neutron and the pairing energy of the fragment. When this occurs, the residual excitation energy ( $EEH$ ) can be set equal to the energy available for Gamma Decay ( $GEH$ ) from the heavy fragment.

The complementary (light) fragment also is considered in the same manner as the heavy fragment. In this portion of the program, the excitation energy of the light fragment is  $EEL$ , and the separation energy is  $SEN2$ .

The index counter ( $I$ ) ranges from 1 to 20. The numbers 1 through 10 are used for the heavy fragment decay chain and number 20 down to 11 are used for the light fragment decay chain.

The Gamma decay energy for the light fragment is called  $GEL$ . The total energy available for gamma emission ( $GE$ ) is then:

$$GE = GEH + GEL \quad (3.9)$$

The neutron multiplicity can be multiplied by the fractional yield of the nuclides and summed over all nuclides to get a yield weighted neutron multiplicity. Also, a yield weighted gamma energy is obtained.

This completes the main loop, and the values of the average release energy (ER), fragment total kinetic energy (EF), excitation energy (E), Gamma energy (GE) and the yield weighted neutron multiplicity is sent to output.

In order to produce a neutron kinetic energy spectrum, 20 energy bins are established in 0.5 MeV increments. The number of neutrons in each of these bins are stored in NN(1) through NN(20). This data forms the basis for a spectrum of the number of neutrons per energy bin versus the energy of the bins.

### 3.5 Binding Energy Subroutine

The binding energy subroutine utilizes the Meyer-Swiatecki mass formula to compute the rest mass and binding energies for the fission fragments in order to determine the release energy of the fission process. The rest mass of the fragments and the successive daughters of the neutron evaporation decay chain is computed in order to determine the separation energy of the emitted neutron.

The subroutine is entered with the atomic number A(I) of the heavy (I = 1) fragment and light (I = 2) fragment, Z(I) of the heavy fragment and light fragment, from which the neutron number U(I) is determined ( $U(I) = A(I) - Z(I)$ ).

The first time this routine is called, counter J is set equal to 2, denoting that the loop for rest mass calculation will be run twice, once for the heavy fragment, once for the light fragment.

The rest mass loop consists of computing the volume energy term T1, the surface energy term (T2), the coulomb energy term (T3), the coulomb correction term (T4) and the pairing energy term T5(I). The pairing energy term is placed in a vector to be used in the main program for determining the maximum kinetic energy of the emitted neutron ( $E_{KMAX} = EEH - SEN - T5(I)$ ). The pairing term can be one of three different relationships depending on whether A(I) is odd or even and whether Z(I) is odd or even, so a test is performed to determine whether A and Z are odd or even and the appropriate pairing term relationship is used. The Binding energy (BE) is determined by summing the five terms and the units are in MeV. In order to determine the binding energy in amu (BEA) the binding energy is divided by 931.5016 MeV per amu. The rest mass in MeV is equal to the negative of the binding energy in MeV plus the proton number times the rest mass of the proton plus the neutron number times the rest mass of the neutron.

$$RM(I) = BE(I) + Z(I) * 938.7906 + (A(I) - Z(I)) * 939.553 \quad (3.10)$$

The rest mass in amu is determined by dividing the rest mass in MeV by 931.5016 MeV per amu. In order to apply the rest mass corrections in MeV for proton and neutron number as determined in the rest mass correction subroutine (MASCOR) the terms YB(IMC) (neutron mass correction) and YD(IMA) (proton mass correction) are added to the rest mass in MeV (RM(I)). The subroutine returns to the main program (after the

first call) with the rest masses and pairing energies of the heavy and light fragments.

The second call of the binding energy subroutine enters with the atomic number AN(ID) and proton number ZN(ID,IE) of the heavy fragment. The neutron number U(I) is determined by subtracting the proton number from the atomic number. The heavy fragment and its nine successive evaporation decay daughters are stored in A(1) through A(10) with corresponding Z(1) through Z(10) (proton numbers) and U(1) through U(10) (neutron numbers). The complementary light fragment is stored in A(20) with a corresponding Z(20) and U(20). The nine successive decay products are stored in A(19) through A(11) with corresponding Z(19) through Z(11) (proton numbers) and U(19) through U(11) (neutron numbers). The rest mass is then determined for each of these fragments, requiring a 20 count loop, and this information is passed back into the main program so that the separation energy for the heavy fragment ( $SEN = 939.553 - (RM(I) - RM(I + 1))$ ) and the separation energy for the light fragment ( $SEN2 = 939.553 - (RM(I) - RM(I - 1))$ ) can be determined for use in the primary loop of the main program.

### 3.6 Energy Subroutine

The energy subroutine uses an evaporation theory model of determining the kinetic energy of the emitted nucleon. This subroutine is based on its work of I. Dostrovsky, Z. Fraenkel and G. Friedlander, which is based on the model of Weisskopf, and uses a Monte Carlo selection of the kinetic energy based on the evaporation spectrum.

The required input to the subroutine is the Atomic Number of the fission fragment  $A1(II)$ , the proton number of the fission fragment,  $Z1(II)$ , the neutron number of the fission fragment  $U1(II)$ , the excitation energy of the fission fragment (EEH for the heavy fragment and EEL for the light fragment), and the separation energy of the fission fragment (SEN for the heavy fragment, and SEN2 for the light fragment). The subroutine initially determines the level density parameter AU by the following empirical relationship:

$$AU = A((1. - 1.3 * THETA/A1(I))^{**2}) \quad (3.11)$$

where  $A = A1(II)/20.0$ , the atomic number divided by 20.0. A is the uncorrected level density parameter. THETA is the neutron number minus the proton number divided by the atomic number ( $THETA = (U1(II) - Z1(II))/A1(II)$ ). A test is performed to determine if  $A1(II)$  and/or  $Z1(II)$  is odd or even so that the appropriate pairing term DELTA can be determined.

If the subscript  $II < 10$ , this denotes the heavy fragment, and if  $II > 11$ , this denotes the complementary light fragment. Initially, the heavy fragment is used and the maximum kinetic energy RJ1 for the neutron emitted is computed by:

$$RJ1 = EEH - SEN - DELTA \quad (3.12)$$

The neutron kinetic energy selection scheme uses the substitution  $XX = EK(ID2, IE2, II) + BETA$  where EK is the kinetic energy of the emitted neutron and BETA is an empirical formula

$$BETA = (2.12 * A^{**(-2/3)} - 0.050)/(0.76 + 2.2 * A^{**(-1/3)}) \quad (3.13)$$

"With the inverse cross section as given by  $\sigma_c/\sigma_g = \alpha(1 + \beta\epsilon)$  where  $\alpha = 0.76 + 2.2 * A ** (-1/3)$  and  $\beta$  given as BETA above, and  $\sigma_c$  and  $\sigma_g$  are the capture and geometric sections respectively, and the level density is given by:

$$W(E) = C * \exp(2. * (AU(E - DELTA)) ** 1/2)$$

where DELTA = 0 for odd-odd nuclei, and DELTA  $\neq$  0 for other types.

The following equation is obtained for neutron emission.

$$PX(\epsilon)d\epsilon = \frac{g_n m_n r_0^2 A_n^{2/3}}{\pi h^{2/3}} \exp\{-2 * [AU_o(E - DELTA_o)] ** 1/2\} * \epsilon * \alpha (1 + \frac{BETA}{\epsilon}) * \exp\{2 * [AU_n * (E - SEN - DELTA_n - \epsilon)] ** 1/2\} d\epsilon$$

(3.14)

where the subscript o and n refer to the original and residual nucleus respectively and  $\epsilon$  is the kinetic energy of the neutron emitted. To simplify this notation, the substitution  $XX = \epsilon + BETA$  is made. By differentiation, the value XMAX for which  $PX(X)$  is a maximum may be found to be:

$$XMAX = [(AU * RJ1 + 0.25) ** 0.5 - 0.5]/AU$$

(3.15)

and now  $PX(X)$  may be normalized to  $PX(XMAX) = 1$ ; it then becomes:

$$PX(X) = \frac{XX}{XMAX} \exp\{AU * XMAX - [(AU * (RJ1 - XX)) ** 1/2]\}^{-16}$$

(3.16)

"The actual choice of a particular value of  $XX$  involves the consecutive drawing of two numbers between 0 and 1. The first random number RND(1) is used to choose a value of  $XX$  between 0 and RJ1 (the maximum possible kinetic energy for the given particle):

$$XX = RND(1) * RJ1$$

(3.17)



The second random number RND(2) determines whether the value of XX is to be accepted. If  $PX(XX) > RND(2)$ , accept the value of XX. If  $PX(XX) < RND(2)$ , reject the value of XX and select another set of random numbers."<sup>15</sup>

If  $XX - BETA$  is negative, another set of random numbers is selected to prevent negative energies which are not physically meaningful.

"The range of possible kinetic energies of the outgoing particle was divided into three regions, and a different procedure was used for each. (a) For the region  $XX < 2 * XMAX$ , the normalized  $PX(XX)$  was computed from Eq. (3.16) and the value compared with RND(2). If the computed value was smaller than RND(2), it was rejected and a new random number set (RND(1), RND(2)) is chosen. If the computed value of  $PX(XX)$  was greater than RND(2), the kinetic energy chosen by the first random number RND(1) was accepted and its value computed:

$$EK = XX - BETA \quad (3.18)$$

(b) In the second region,  $2 * XMAX < XX < 15 * XMAX$ , use was made of the fact that, for any positive value of XX, the probability given by a Maxwell distribution:

$$PX(XX) = \frac{XX}{XMAX} \exp [1 - (XX/XMAX)] \quad (3.19)$$

is greater than (or for  $XX = XMAX$  equal to) that given by Eq. (3.16)."<sup>15</sup> For this region the same procedure used in (a) above was used but  $PX(XX)$  was calculated using Eq. (3.19).

(c) For the region  $XX > 15 * XMAX$ , values were all rejected because of the very small probability of neutrons being found in this region.

Once the value of  $XX$  is accepted, then the kinetic energy  $EK(ID2, IE2, II)$  is calculated by  $EK(ID2, IE2, II) = XX - BETA$ .

The value for  $EK(ID2, IE2, II)$  is in the center of mass coordinate system and must be transformed into the laboratory system.

In the main program, the correction factors (for the heavy fragment,  $CL1$  and for the light fragment  $CL2$ ) are computed and passed into the subroutine by a common statement.

$$CL1 = \frac{939.553}{RM(1)} * \frac{RM(2)}{(RM(1) + RM(2))} * EF \quad (3.20)$$

$$CL2 = \frac{939.553}{RM(2)} * \frac{RM(1)}{(RM(1) + RM(2))} * EF \quad (3.21)$$

where  $RM(I)$  is the rest mass of the heavy (1) or the light (2) fragment and  $EF$  is the total kinetic energy of the fragments and 939.553 is the rest mass of the neutron.

The laboratory kinetic energy of the neutron being emitted is then:

$$EK(ID2, IE2, II) = CL1 + EK(ID, IE, II) + 2.0 * SQRT(CL1 * EK(ID2, IE2, II)) * COS(ANGLE) \quad (3.22)$$

where  $ANGLE$  is a randomly distributed angle between 0 and  $2\pi$ :

$$ANGLE = RND(3) * 6.283185 . \quad (3.23)$$

The light fragment also has a laboratory system kinetic energy:

$$EK(ID2, IE2, II) = CL2 + EK(ID, IE, II) + 2.0 * SQRT(CL2 * EK(ID2, IE2, II)) * COS(ANGLE)$$

Once these neutron kinetic energies are determined, a common statement passes them back into the main program and the new residual energy (EEH, EEL) is found.

### 3.7 Subroutine for Mass Corrections

The MASCOR subroutine performs a cubic spline fit of selected data points from the mass correction graphs for proton and neutron number as plotted by Myers and Swiatecki. The graph used for this subroutine is the experimental shell effect graph, Mass (experimental)-Mass (liquid drop), and the discrepancy between the two values is in MeV). The routine is performed for both neutron number and proton number and these correction terms are then transferred to main program and back into the binding energy subroutine where the values are added to the rest mass (in MeV) terms.

If the set of known points in increasing order are (UX(1), YM(1)), (UX(2), YM(2)), ..., (UX(NN), YM(NN)), then a spline fit is accomplished by connecting each pair of adjacent points with a section of a third-degree polynomial, matching up the sections so that the first and second derivatives are continuous at each point. Let ZK(1), ZK(2), ..., ZK(NN) be the values of the second derivative at the points. Then between points (UX(K), YM(K)) and (UX(K+1), YM(K+1)), the second derivative has the value

$$YM'' = ZK(K) \frac{UX(K+1) - UX(K)}{DK} + ZK(K+1) \frac{UX(K) - UX(K+1)}{DK} \quad (3.24)$$

$$\text{where } DK = UX(K+1) - UX(K) \quad (3.25)$$

Integrating Eq. (3.24) will result in getting a first derivative:

$$YM' = - ZK(K) [(UX(K+1) - UX)^2/2DK] + ZK(K+1) [(UX - UX(K))^2/2DK] + CN(1) \quad (3.26)$$

where CN(1) is the constant of integration.

Integrating once more will result in the equation of the curve:

$$YM = ZK(K) [(UX(K-1) - UX)^3/6DK] + ZK(K+1) [(UX - UX(K))^3/6DK] + CN(1) * UX + CN(2) \quad (3.27)$$

and again CN(2) is the constant obtained by integration.

Knowing that the curve passes through (UX(K), YM(K)) and (UX(K+1), YM(K+1)), the values of the integration constants may be obtained.

$$YM(K) = (ZK(K) * (DK ** 2)/6) + CN(1) * UX(K) + CN(2) \quad (3.28)$$

$$YM(K+1) = (ZK(K+1) * (DK**2)/6) + CN(1) * UX(K+1) + CN(2) \quad (3.29)$$

from which the values of CN(1) and CN(2) are:

$$CN(1) = [(YM(K+1) - YM(K))/DK] - [ZK(K+1) - ZK(K)] * DK/6 \quad (3.30)$$

$$CN(2) = [(YM(K) * UX(K+1) - YM(K+1) * UX(K))/DK] - [(ZK(K) * UX(K+1) - ZK(K+1) * UX(K)) * DK/6] \quad (3.31)$$

If the values for CN(1) and CN(2) are substituted into Eq. (3.27) the following expression is obtained

$$YM = [ZK(K)(UX(K+1) - UX)^3/6DK] + [ZK(K+1)(UX - UX(K))^3/6DK] + [(UX(K+1) - UX)(YM(K)/DK - ZK(K) * DK/6)] + [(UX - UX(K)) (YM(K+1)/DK - ZK(K+1) * DK/6)] \quad (3.32)$$

All the values in Eq. (3.32) are known with the exception of ZK(K) and ZK(K+1), which are the second derivatives at the endpoints of the interval.

"One condition which will help determine these values is that the slope at  $(UX(K), YM(K))$  as determined from Eq. (3.26) must be the same as that determined by the corresponding formula for the interval  $(UX(K-1), YM(K-1))$  to  $(UX(K), YM(K))$ . When the value of  $CN(1)$  from Eq. (3.30) is used in Eq. (3.26) the equation becomes:"<sup>16</sup>

$$YM' = - [ZK(K)(UX(K+1) - UX)^2/2DK] + [ZK(K+1)(UX - UX(K))^2/2DK] \\ + [(YM(K+1) - YM(K))/DK] - [(ZK(K+1) - ZK(K))DK/6] \quad (3.33)$$

For the interval preceding this one:

$$YM' = - [ZK(K-1)(UX(K) - UX)^2/2DK(K-1)] + [ZK(UX \\ - UX(K-1))^2/2DK(K-1)] + [(YM(K) - YM(K-1))/DK(K-1)] \\ - [(ZK(K) - ZK(K-1)) * DK(K-1)/6] \quad (3.34)$$

At the point  $(UX(K), YM(K))$  the following relationship is derived by setting Eq. (3.33) equal to Eq. (3.34).

$$ZK(K-1)(DK(K-1)/6) + ZK[(DK(K-1) + DK)/3] + ZK(K+1) * (DK(K)/6) \\ = [(YM(K+1) - YM(K))/DK] - [(YM(K) - YM(K-1))/DK(K-1)] \quad (3.35)$$

For each of the interval points,  $K = 2, 3, \dots, NN-1$  there is an equation like Eq. (3.35). "There are  $NN-2$  equations in the  $NN$  unknowns  $ZK(1), ZK(2), \dots, ZK(NN)$ . Two or more conditions may be specified in order to determine these equations completely. It is customary to place some additional condition on  $ZK(1)$  and  $ZK(NN)$ , the values of the second derivative at the endpoints. There are several reasonable choices for these values, and the particular choice will influence the shape of the fit, especially near the endpoints. We will require the third derivative to be continuous at  $(UX(2), YM(2))$  and  $(UX(NN-1), YM(NN-1))$ ."<sup>16</sup>

$$YM'' = - ZK(K)/DK(K) + ZK(K+1)/DK(K) \quad (3.36)$$

If the values for  $K = 1$  and  $K = 2$  are equated, as well as for  $K = NN-2$  and  $K = NN-1$ , we obtain:

$$- ZK(1)/DL(1) + ZK(2)(1/DK(1) + 1/DK(2)) - ZK(3)/DK(2) = 0 \quad (3.37)$$

and

$$\begin{aligned} - ZK(NN-2)/DK(NN-2) + ZK(NN-1)(1/DK(NN-2) + 1/DK(NN-1)) \\ - ZK(NN)/DK(NN-1) = 0 \end{aligned} \quad (3.38)$$

The above two equations along with Eq. (3.35) constitute  $NN$  equations in  $NN$  unknowns for  $ZK(1)$ ,  $ZK(2)$ , ...  $ZK(NN)$ . Upon solving these equations and the  $ZK(K)$  determined we can use Eq. (3.32) to find any value of  $YM$  for a given value of  $UX$  in the interval  $(UX(1), UX(NN))$ .

"Spline fit interpolation in the table of values  $(UX(1), YM(1))$ ,  $(UX(2), YM(2))$ , ...,  $(UX(NN), YM(NN))$  consists of determining which two points the given value of  $UX$  lies between and then finding  $YM$  by the formula:"<sup>16</sup>

$$\begin{aligned} YM = CN(1,K)*(UX(K+1) - UX)^3 + CN(2,K)*(UX - UX(K))^3 + \\ CN(3,K)*(UX(K+1) - UX) + CN(4,K) (UX - UX(K)) \end{aligned} \quad (3.39)$$

where the constants  $CN(1,K)$ , ,  $CN(4,K)$  can be determined by solving Eqs. (3.35), (3.37) and (3.38) for  $ZK(1)$ ,  $ZK(2)$ , ...,  $ZK(NN)$ :

$$CN(1,K) = ZK(K)/6DK(K) \quad (3.40)$$

$$CN(2,K) = ZK(K+1)/6DK(K) \quad (3.41)$$

$$CN(3,K) = YM(K)/DK(K) - ZK(K)*DK(K)/6 \quad (3.42)$$

$$CN(4,K) = YM(K+1)/DK(K) - ZK(K+1) * DK(K)/6 \quad (3.43)$$

By making the following definitions

$$PK(K) = DK(K)/6; K = 1, 2, \dots, NN-1 \quad (3.44)$$

$$EL(K) = (YM(K) - YM(K-1))/DK(K-1), K = 2, \dots, NN \quad (3.45)$$

$$BK(1) = 0 \quad (3.46)$$

$$BK(K) = EL(K+1) - EL(K); K = 2, \dots, NN-1 \quad (3.47)$$

$$BK(NN) = 0 \quad (3.48)$$

Then we can write the system of Eqs. (3.35, (3.37) and (3.38) in matrix form as:

$$\underline{A} \underline{Z} = b \quad (3.49)$$

where A is defined in Fig. 3.2.

Making use of the special nature of the above matrix the ZK(I) can be found and then the constant CN(I,J) determined by the routine on page below.

START

INPUT U(K), YM(K), K=1, ..., NN

DK(K) = UX(K+1) - UX(K)

PK(K) = DK(K)/6

EL(K) = (YM(K+1) - YM(K))/DK(K)

BK(K) = EL(K) - EL(K-1) K=2, ..., NN-1

AC(1,2) = -1 - DK(1)/DK(2)

AC(1,3) = DK(1)/DK(2)

AC(2,3) = PK(2) - PK(1)\*AC(1,2)

AC(2,2) = 2(PK(1) + PK(2)) - PK(1)\*AC(1,2)

AC(2,3) = AC(2,3)/AC(2,2)

BK(2) = BK(2)/AC(2,2)

AC(K,K) = 2(PK(K-1) + PK(K)) - PK(K-1)\*AC(K-1,K)

```

BK(K)=BK(K)-PK(K-1)*BK(K-1)
AC(K,K+1)=PK(K)/AC(K,K)
AC(NN,NN-1)=1+DK(NN-2)/DK(NN-1)+AC(NN,NN-1)*AC(NN-1,NN)
AC(NN,NN)=-DK(NN-2)/DK(NN-1)-AX(NN,NN-1)*AC(NN-1,NN)
BK(NN)=BK(NN-2)-AC(NN,NN-1)*(BK(NN-1)
ZK(NN)=BK(NN)/AC(NN,NN)
ZK(K)=BK(K)-AC(K,K+1)*ZK(K+1); K=M-1,...2
ZK(1)=-AC(1,2)*ZK(2)-AC(1,3)*ZK(3)
C(1,K),ZK(K)/6*DK(K)
C(2,K)=ZK(K+1)/6*DK(K)
C(3,K)=YM(K)/DK(K)-ZK(K)*PK(K)
C(4,K)=YM(K+1)/DK(K)-ZK(K+1)*P(K)
STOP"16

```

In the MASCOR subroutine the proton mass correction graph is interpolated first for twelve known points used as input and all interpolated values for the mass correction from proton number 22 to proton number 80 as output. The neutron mass correction graph is interpolated with twelve known points as input and the values for the mass correction for all neutron numbers from 31 to 120 as output. The output is transferred to the main program in a common statement in the arrays YC(IP) for neutron number IP, and YE(IP) for proton number IP.

The main program transfers these corrections to the binding energy subroutine and there the values are added to the rest mass RM(I) of the nuclide with the proton and neutron numbers matching the index of the correction factors. If for instance a nuclide (I) has a



proton number 40 and a neutron number 60, the correction factors YC(60) and YE(40) will be added to RM(I) of the nuclide I.

$$\begin{array}{cccccccc}
 -1/DK(1) & 1/DK(1)+1/DK(2) & -1/DK(2) & 0 & \dots & 0 & 0 & 0 \\
 PK(1) & 2(PK(1)+PK(2)) & PK(2) & 0 & \dots & 0 & 0 & 0 \\
 0 & PK(2) & 2(PK(2)+PK(3)) & PK(3) & \dots & 0 & 0 & 0 \\
 0 & \cdot & \cdot & \cdot & \dots & \cdot & \cdot & \cdot \\
 \text{where } A = & \cdot & \cdot & \cdot & \dots & \cdot & \cdot & \cdot \\
 \cdot & \cdot & \cdot & \cdot & \dots & \cdot & \cdot & \cdot \\
 \cdot & \cdot & \cdot & \cdot & \dots & \cdot & \cdot & \cdot \\
 0 & 0 & \dots & PK(NN-2) & 2(PK(NN-2)+PK(NN-1)) & PK(NN-1) & PK(NN-1) & PK(NN-1) \\
 0 & 0 & \dots & -1/DK(NN-2) & 1/DK(NN-2)+1/DK(NN-1) & -1/DK(NN-1) & -1/DK(NN-1) & -1/DK(NN-1)
 \end{array}$$

Fig. 3.2 A-Matrix for Mass Correction Subroutine

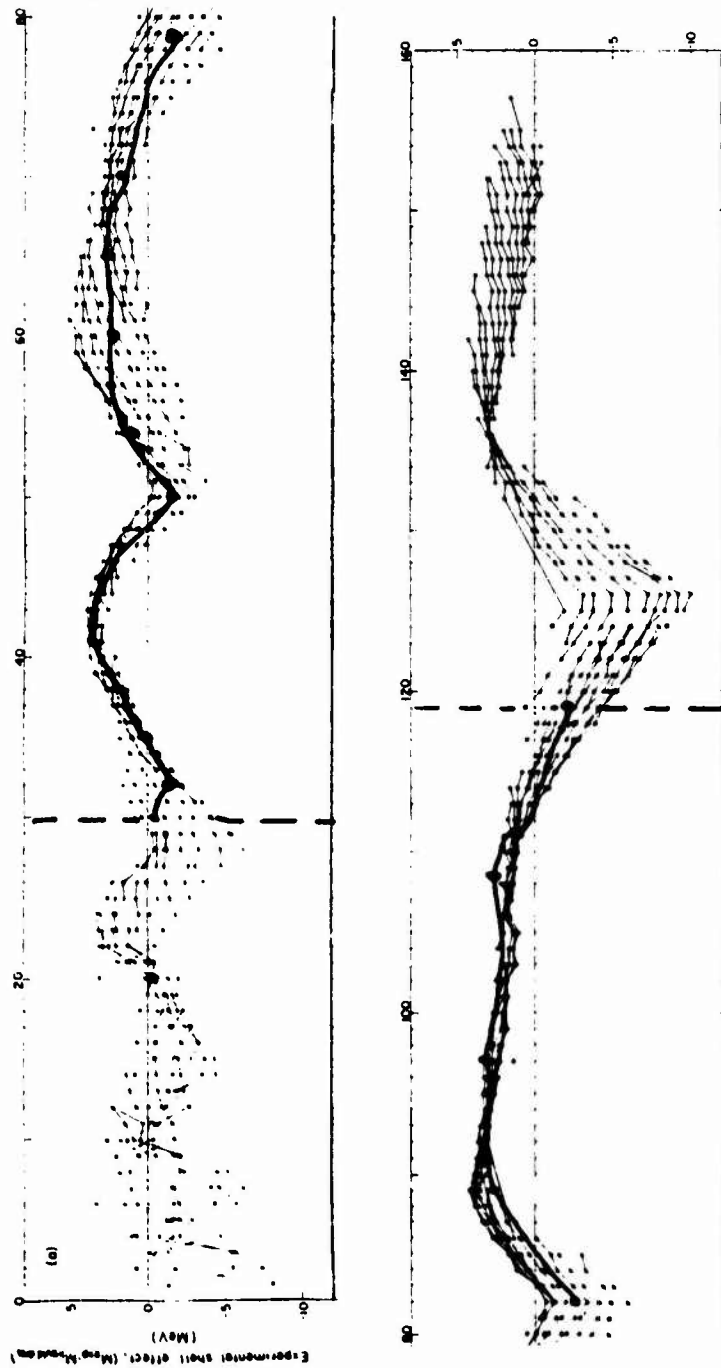

Fig. 3.3 A plot of the deviations of experimental masses from the liquid-drop model, for neutron number. Solid line indicates the corrections made in the mass correction subroutine.  
 ( From Meyers and Swiatecki)

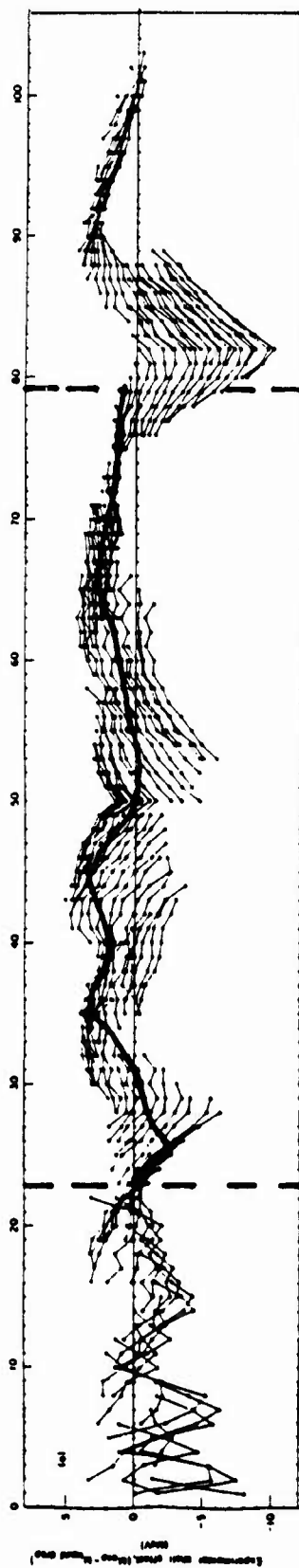

Fig. 3.4 A plot of the deviations of experimental masses from the liquid drop model, for proton number. Solid line indicates the corrections made in the mass correction subroutine. (From Meyers and Swiatecki)

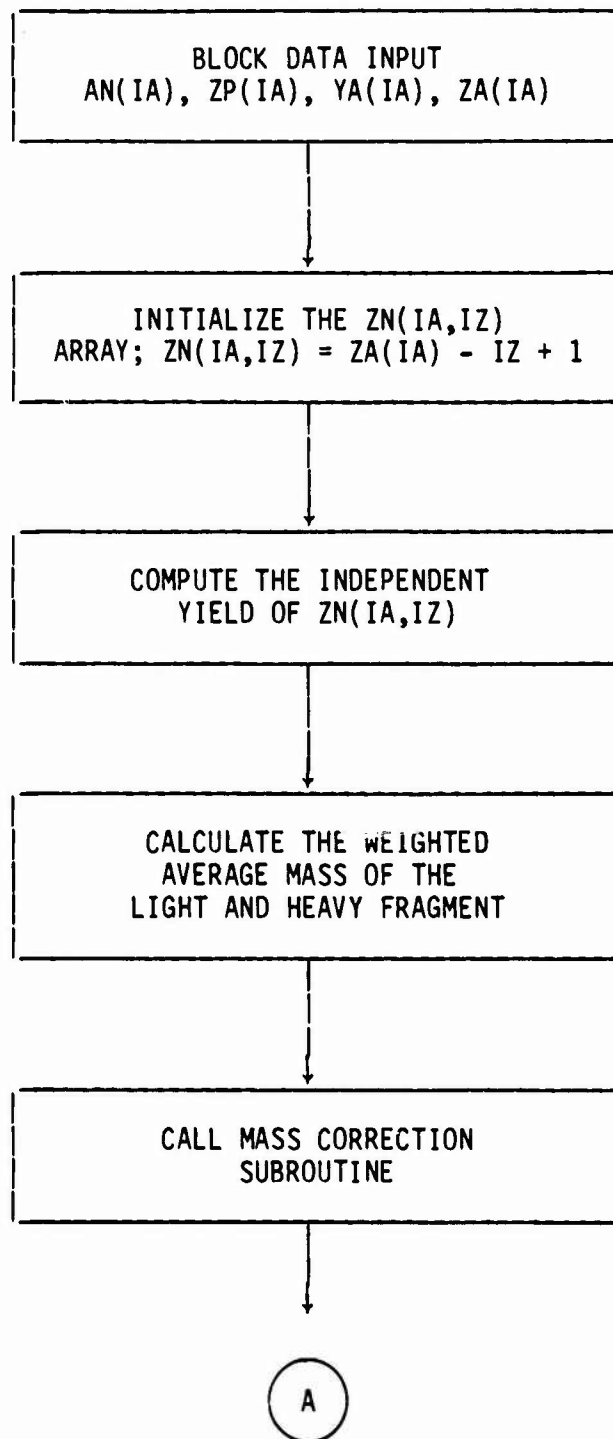
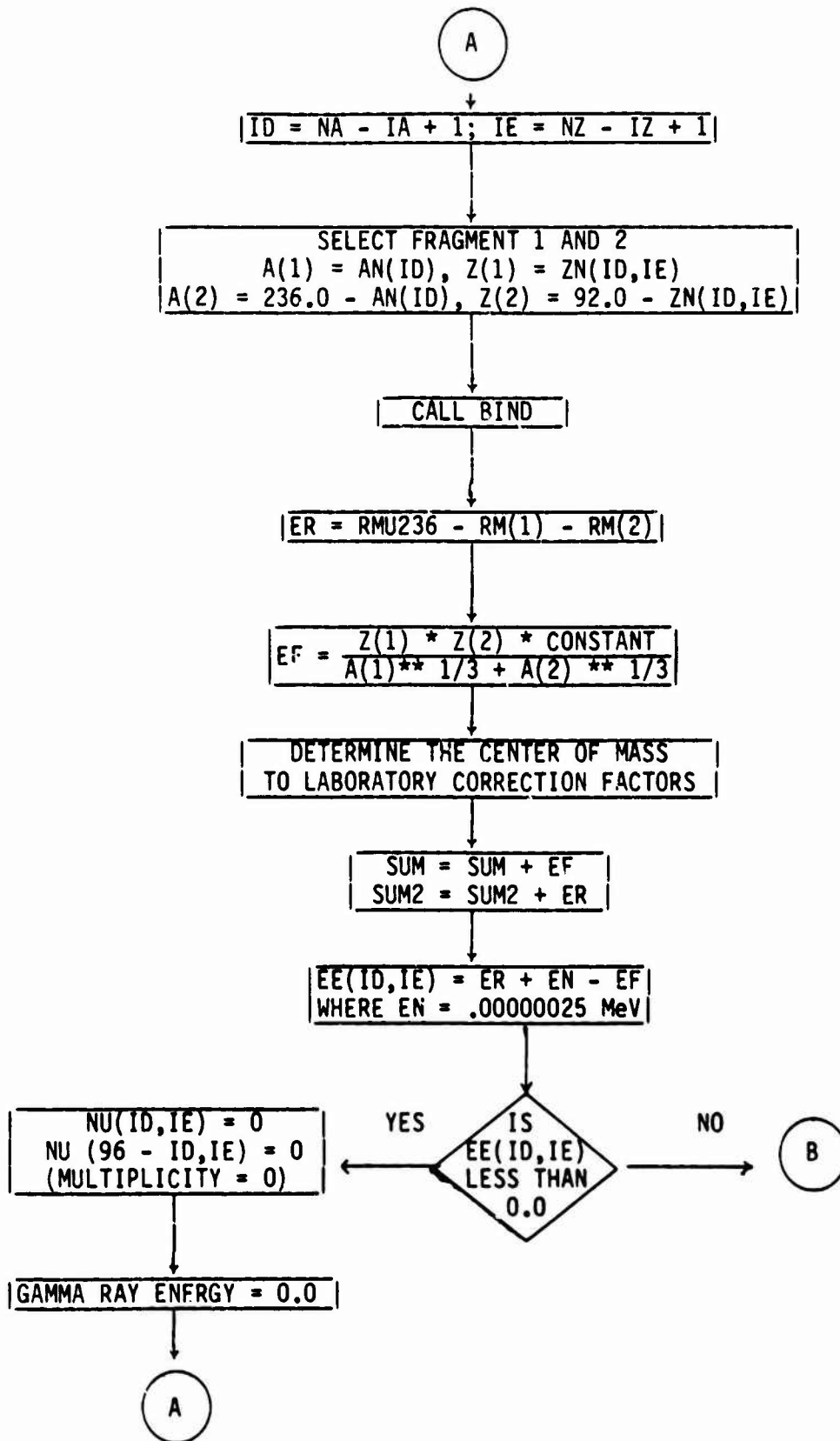
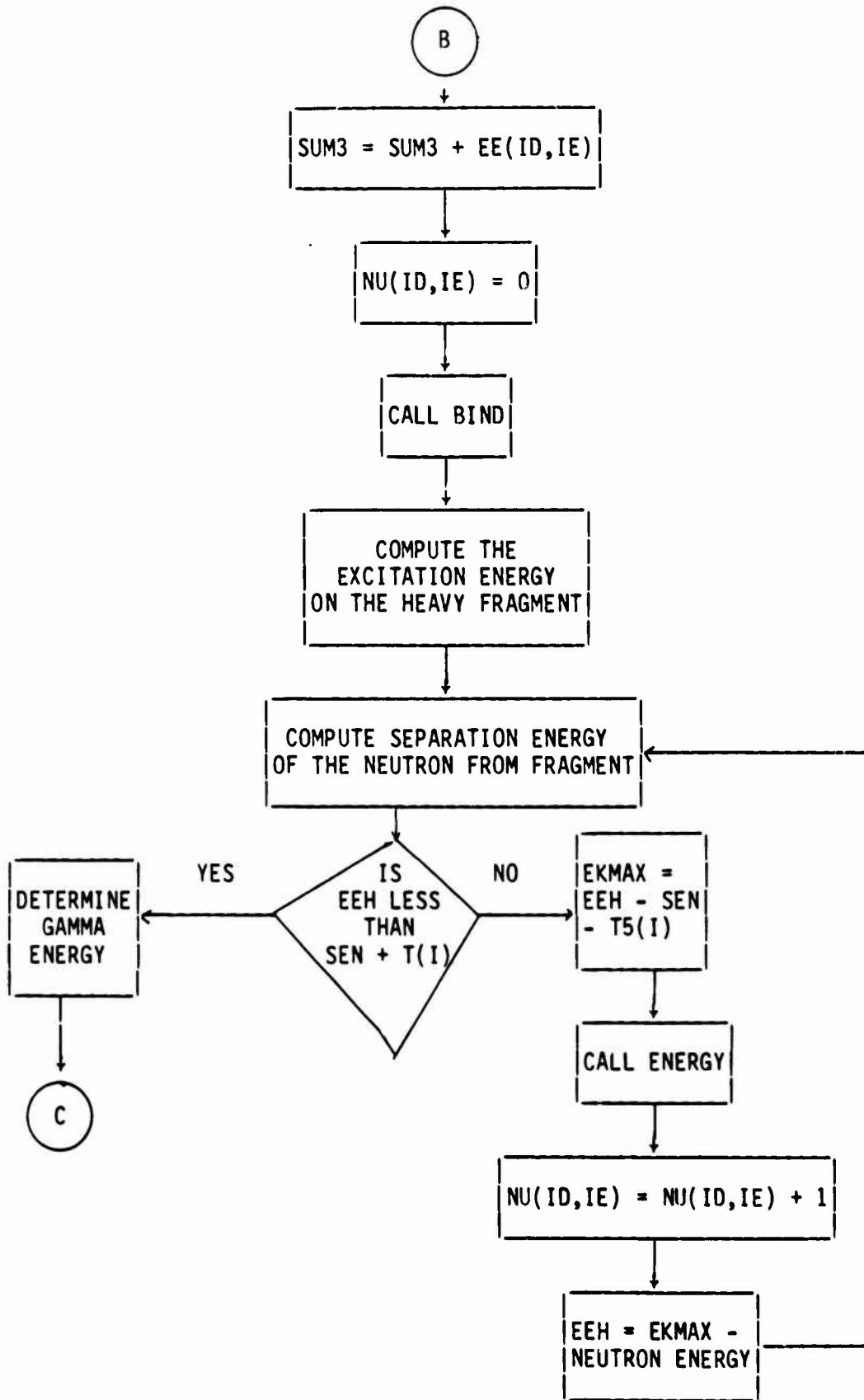
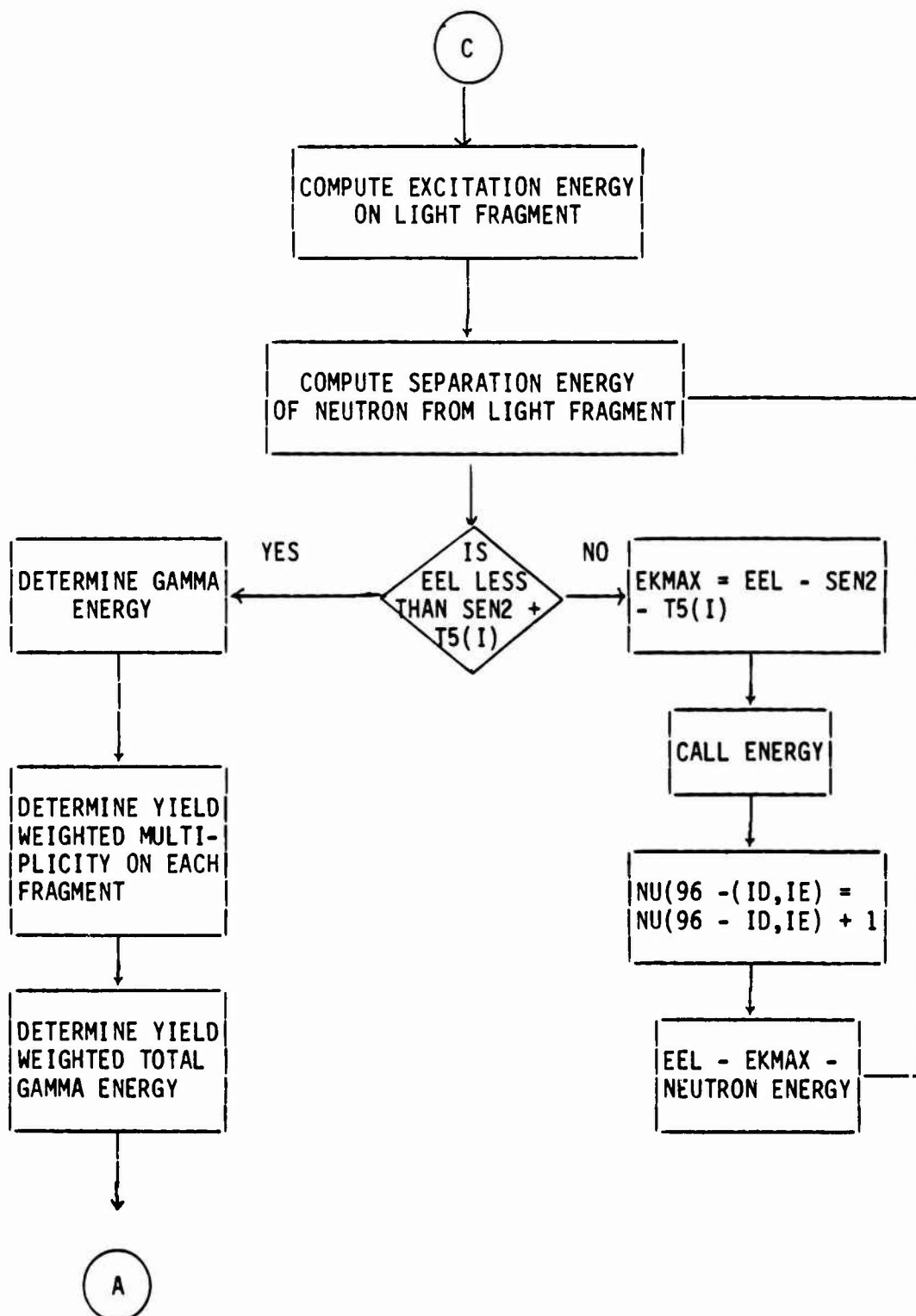

Fig. 3.5 Flowchart for the neutron evaporation code.







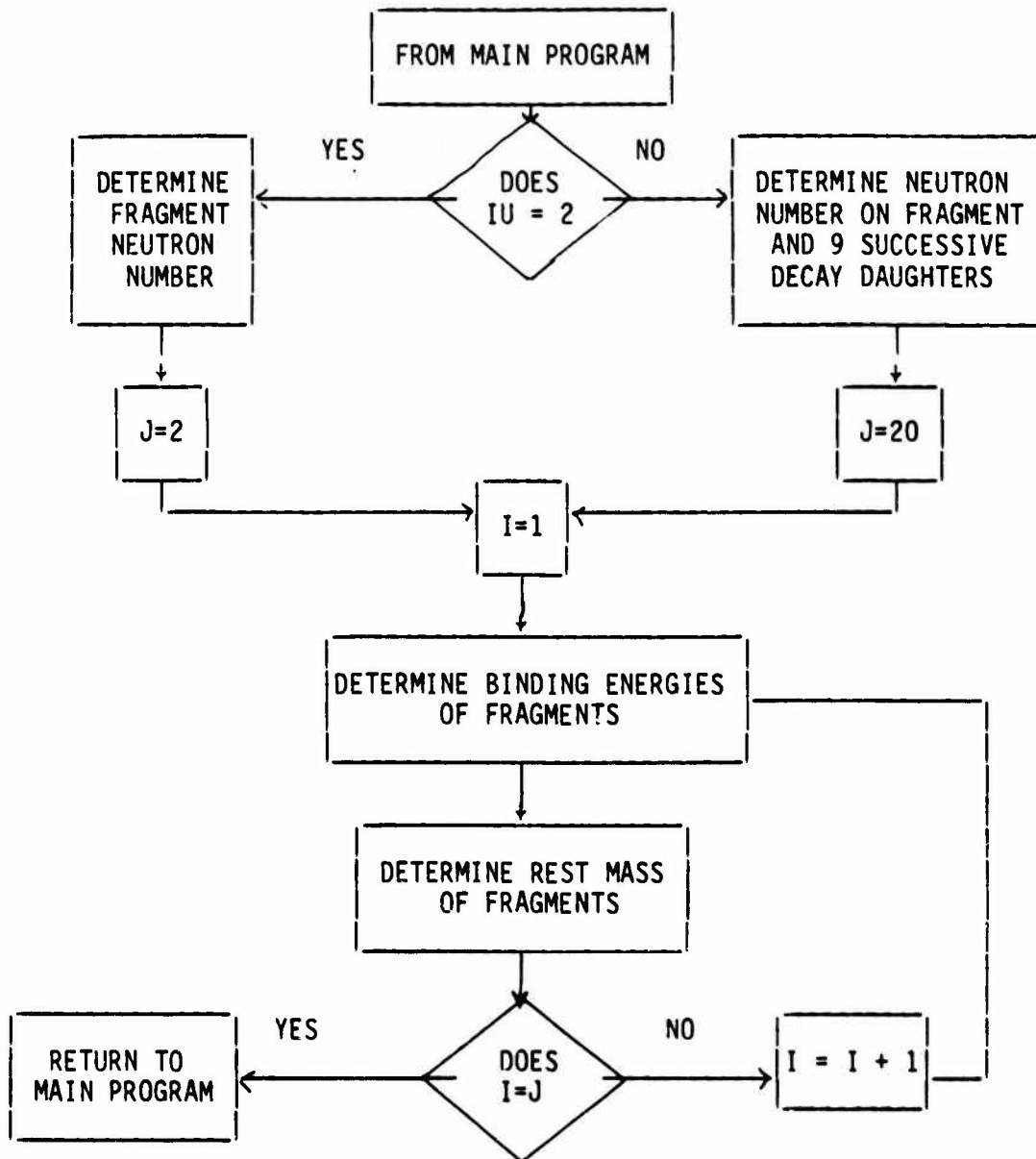

BINDING ENERGY SUBROUTINE

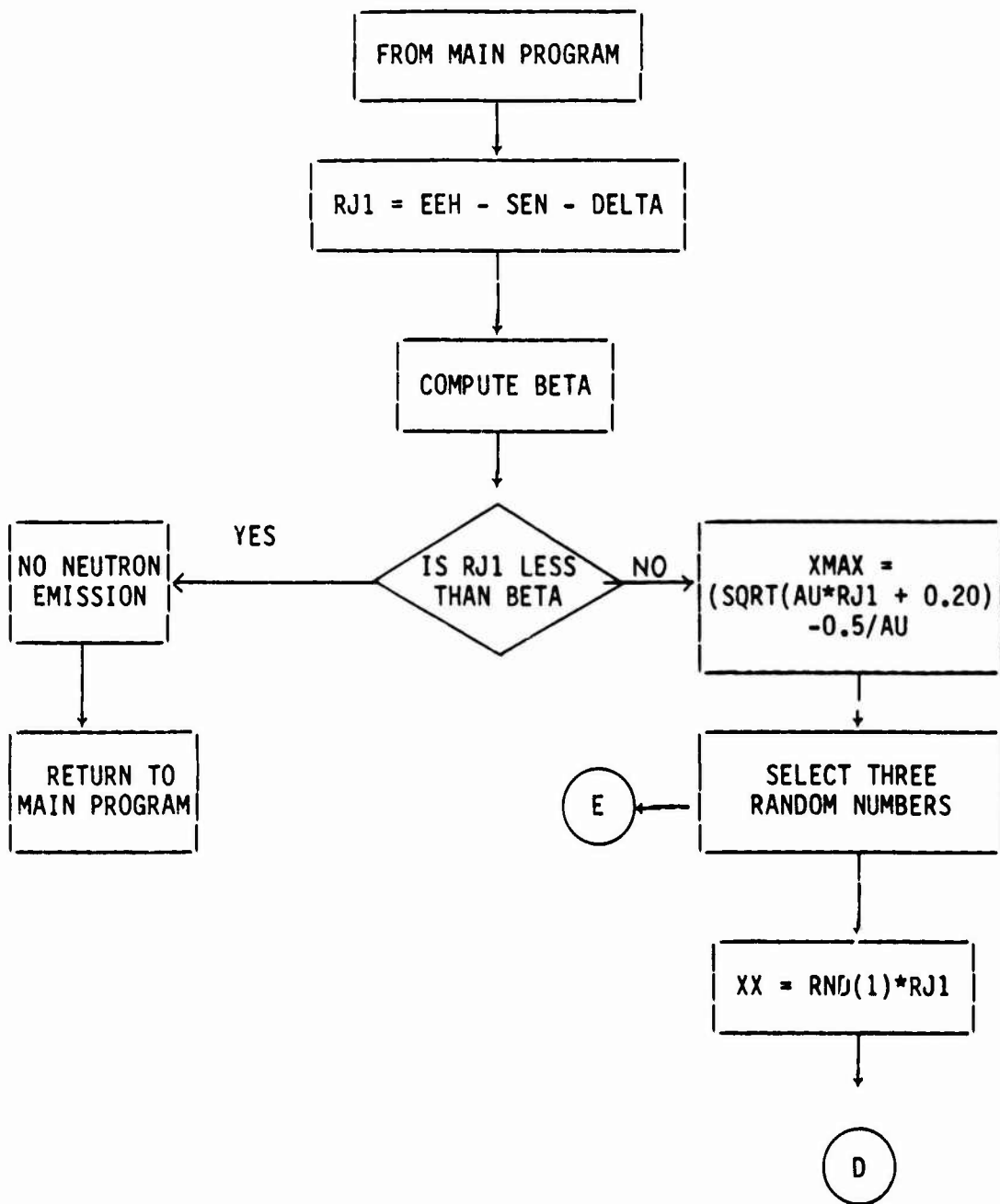
Energy Subroutine

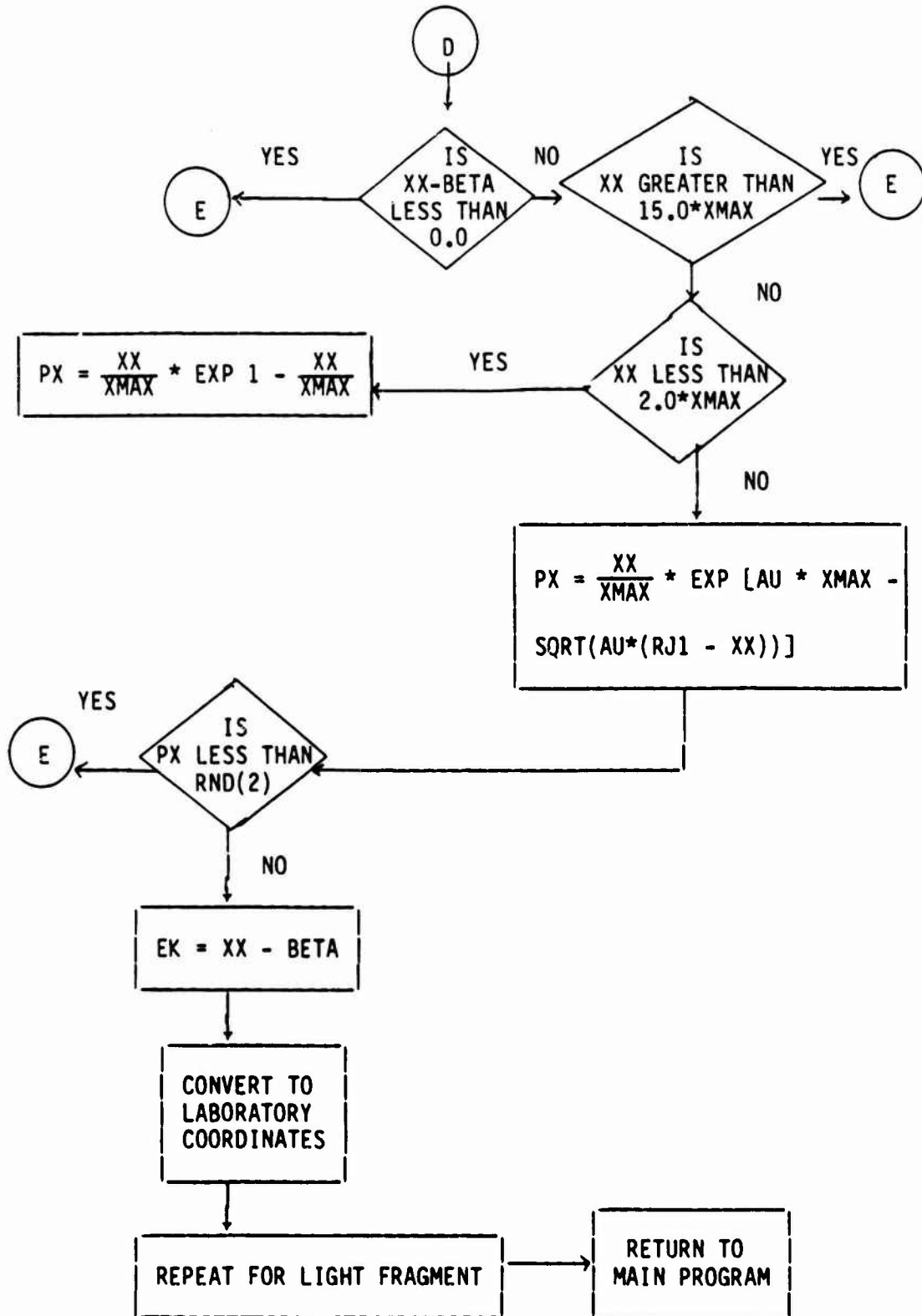

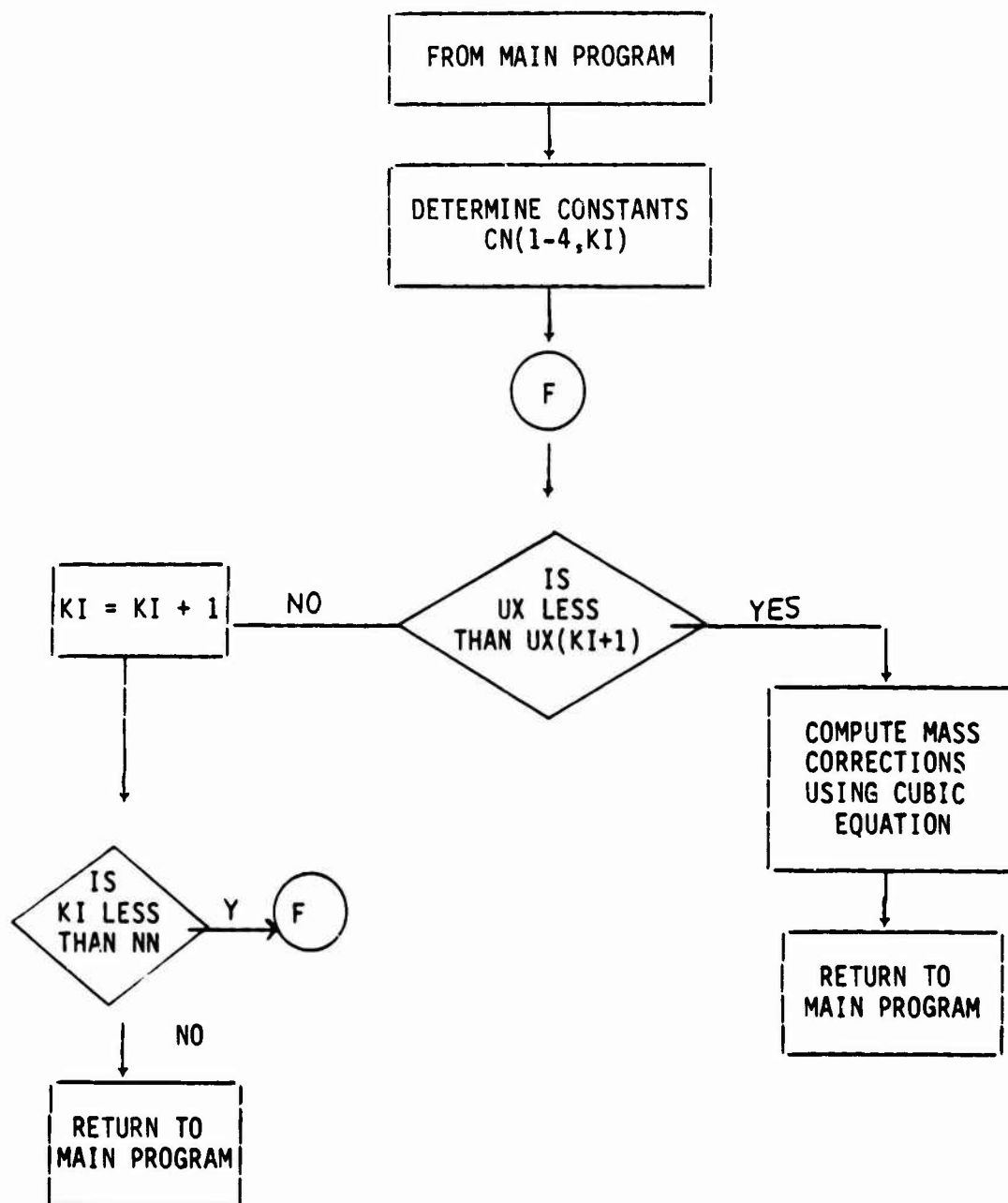
MASS CORRECTION SUBROUTINE

## CHAPTER 4

### DISCUSSION AND CONCLUSION

The code developed in this thesis calculates the total gamma energy released from the thermal fission of U-235, produces a prompt neutron spectrum, and determines the neutron multiplicity for the thermal fission of U-235. The code was run varying the adjustable parameter RR (see Fig. 4.1) in order to determine the optimum results. When the optimum values were obtained, the spectrum of prompt neutron energies was formed (see Fig. 4.2).

Using the value of 1.835 for RR, the total gamma energy is determined to be 3.2285 MeV/fission, and the average energy per neutron is calculated to be 1.986 MeV/neutron. During the processing of the code, it is interesting to edit the number of neutrons released by each of the individual fragments. The results of this edit are found in Appendix I. Another advantage of this code is that actual values of the energy released in fission are computed for each fragment, versus the use of average values for a heavy and light fragment, thereby increasing the accuracy of the computed excitation energies.

The prompt neutron spectrum produced in the program results in a spectrum that shows an abundance of very low energy neutrons in the first energy bin (that is less than 0.5 MeV). This can be explained by the fact that evaporation theory allows for the emission of any neutron from a fragment that has enough residual energy greater than the separation energy plus the pairing energy. No compensation for allowed or not allowed transitions based on angular momentum considerations is accounted for.

NEUTRON MULTIPLICITY-X-X-X  
 AVE NEUTRON ENERGY-Y-Y-Y  
 TOTAL GAMMA ENERGY-Z-Z-Z

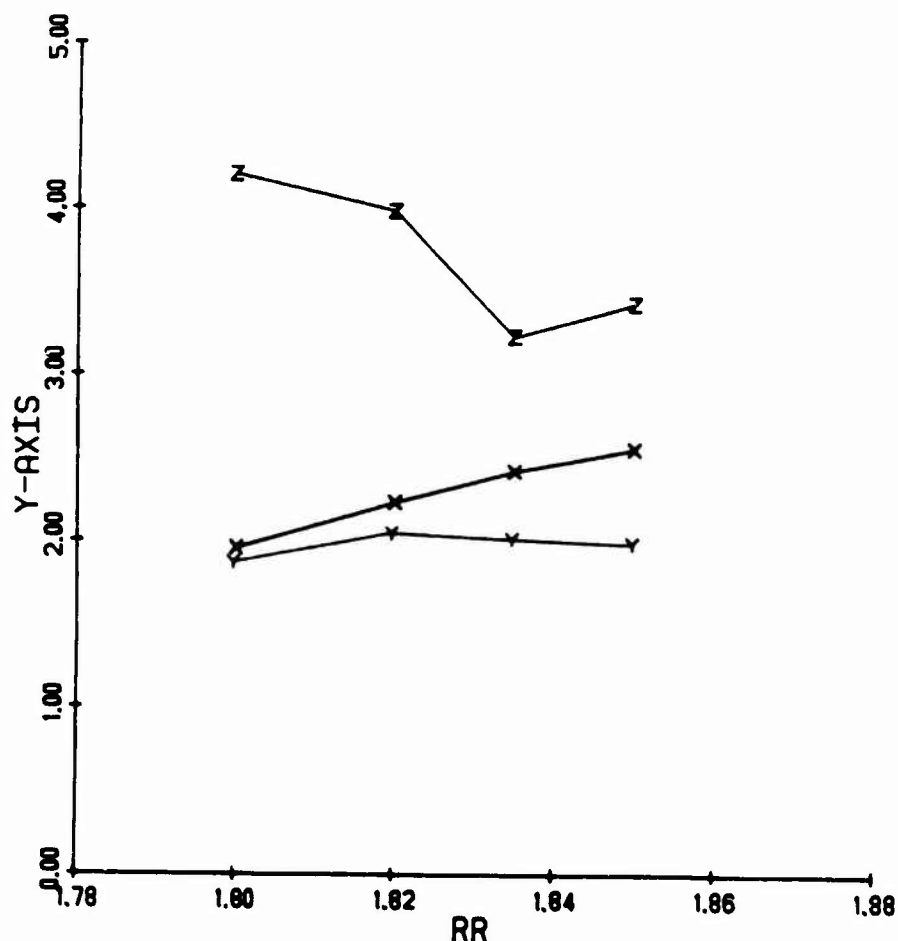

Fig. 4.1 This graph was used to determine a value for the adjustable parameter RR. The line labeled with X's represents the neutron multiplicity and units of the Y-axis are neutrons/fission. The line labeled with Y's represents the average neutron energy and the units for the Y-axis are MeV/neutron. The line labeled with Z's is the total gamma energy and the units for the Y-axis are MeV/fission. The optimum value is determined to be  $RR = 1.835$ .

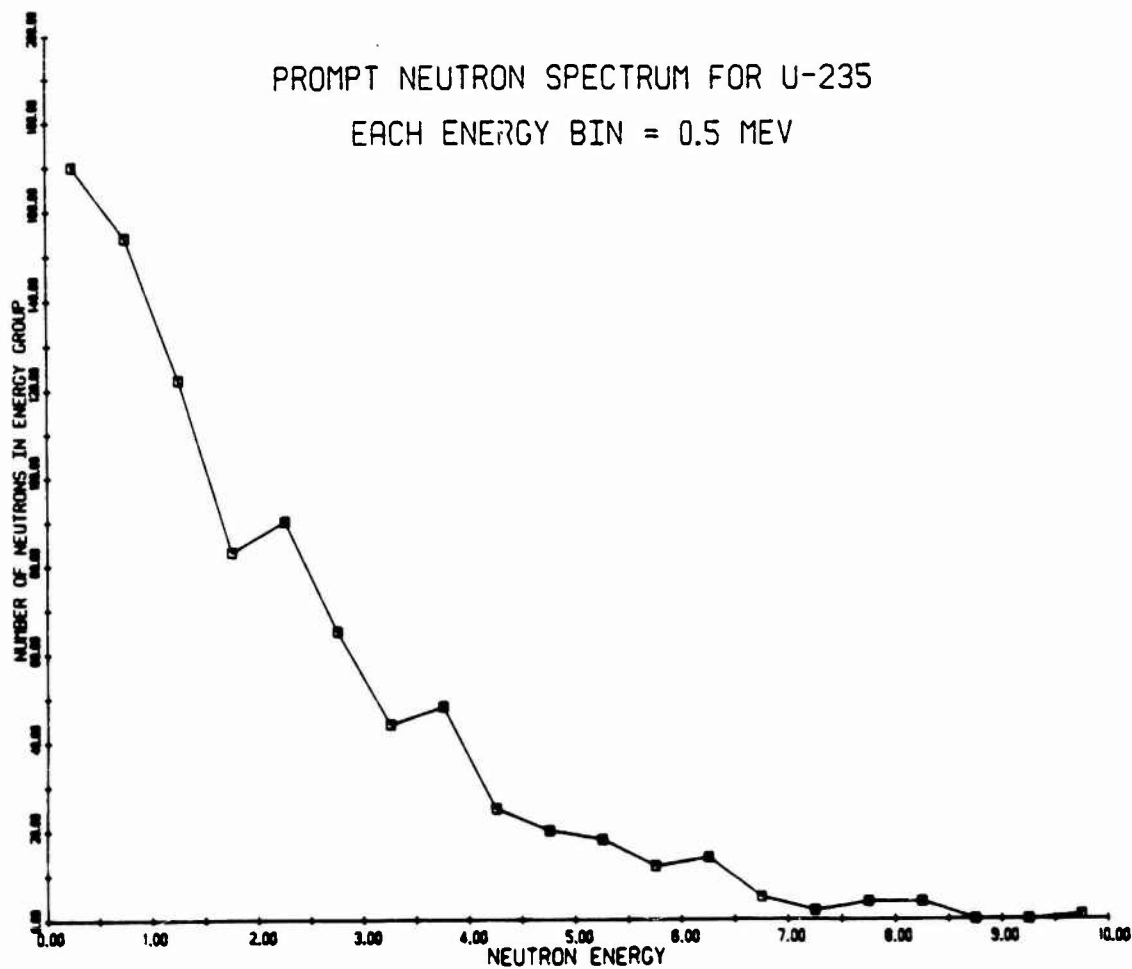

Fig. 4.2 This prompt neutron energy spectrum was generated from the code developed in this thesis. Each energy bin is 0.5 MeV. Each square represents the number of neutrons found in each particular energy bin.

The gamma energy is very low. As Terrell noted in his paper, the value of the gamma energy he obtained is approximately 4.9 MeV. This code obtains a value of 3.2285 MeV and the actual values based on a simplified model is approximately 6.7 MeV. This leads one to believe that gamma ray emission may compete more strongly with neutron emission, and that evaporation theory does not adequately treat the gamma emission problem adequately. Because there is great distortion involved in the fission process, a rapidly varying electric field may actually induce gamma emission instead of neutron emission.

Since the excitation energy is computed by using the energy release and the total fission fragment kinetic energies, any error induced into these values can cause an error in the excitation energy. For example, the parameter RR is held constant for all fission fragments. In reality, because of the varying sizes of the fission fragments, this parameter will vary, so the total kinetic energy will differ from the values computed in the code.

Another consideration which can cause a lower kinetic energy of the fission fragments is that the nucleus will "cool" with time so that the kinetic energy of the fragments decrease by the time the second neutron is emitted, leaving less residual energy for that neutron, and this can result in more residual energy for gamma emission.

The average kinetic energy of prompt neutrons emitted in the thermal fission of U-235 is very well predicted in the code. Terrell determined a value of 1.935 MeV which favorably agrees with experimental values found by Cranberg and Leachman. This code predicts a value of 1.986 MeV/neutron.



In summary, this code was developed in order to use all possible fission fragment combinations for the thermal fission of U-235 in order to predict a prompt neutron spectra, average prompt neutron energy, and total gamma energy. An additional feature of the code is its ability to determine the individual neutron multiplicity of each fragment produced in fission.

## LITERATURE CITED

1. Terrell, James, "Fission Neutron Spectra and Nuclear Temperatures", Physical Review, Vol. 113, Number 2, 1959.
2. Hyde, Earl K., The Nuclear Properties of the Heavy Elements, Vol. III, Prentice Hall Inc., Englewood Cliffs, 1964.
3. Littlefield, T.A., Atomic and Nuclear Physics, Van Nostrand and Company LTD., Princeton, 1968.
4. Steinburg, E.P. and Freeman, M.S., "Summary of the Results of Fission Yield Experiments," Radiochemical Studies: The Fission Products, Book 3, Coryell, Charles D. and Nathan Sugarman, Editors; McGraw-Hill Book Co., New York, 1951.
5. Friedlander, Gerhart, et al., Nuclear and Radiochemistry, John Wiley and Sons, New York, 1981.
6. Gindler, J.E. and Huizenga, J.R., "Nuclear Fission", Nuclear Chemistry, Yaffe, L. - editor, Academic Press, New York, 1968.
7. Glendenin, L.E., Coryell, C.D. and Edwards, R.R., "Distribution of Nuclear Charge in Fission", Radiochemical Studies: The Fission Products, Coryell, Charles D., and Nathan Sugarman, Editors; McGraw-Hill Book co., New York, 1951.
8. Evans, Robley, D., The Atomic Nucleus, McGraw-Hill Book Company, New York, 1955.
9. Green, Alex, E.S., Nuclear Physics, McGraw-Hill Book Company, New York, 1955.
10. Valentin, Luc, Subatomic Physics: Nuclei and Particles, Vol. I, North-Holland Publishing Company, Amsterdam, 1981.
11. Meyers, W.D., and W.J. Swiatecki, "Nuclear Masses and Deformations", Nuclear Physics, Vol. 81, North Holland Publishing Co., Amsterdam, 1966.
12. Weisskopf, V., "Statistics and Nuclear Reactions", Physical Review, Vol. 52, August 1937.
13. Blatt, John M. and Weisskopf, V., Theoretical Nuclear Physics, Springer-Verlay, 1952.
14. Crouch, E.A.C., "Fission Product Yields from Neutron Induced Fission", Atomic Data and Nuclear Data Tables, Vol. 19, 1977.

15. Dostrovsky, I., Fraenkel, Z., Friedlander, G., "Monte Carlo Calculations of Nuclear Evaporation Processes", Physical Review, Vol.. 116, Number 3, 1959.
16. Pennington, Ralph H., Introductory Computer Methods and Numerical Analysis, MacMillan Company, Canada, 1970.
17. Madland, David G. and Nix, R.J., New Calculation of Prompt Fission Neutron Spectra and Average Prompt Neutron Multiplicities, LA-UR-81-2968, Los Alamos, 1981.

## APPENDIX I

### BLOCK DATA INPUT

The following data is contained in the code as input and found in block data format. It is used in order to determine the independent yields of the individual nuclides in order to yield average the neutron multiplicity and total gamma energy computed in the code.

ATOMIC MASS	MOST PROBABLE Z	CHAIN YIELD	STARTING Z
71.00	28.50	0.00000	31.00
72.00	28.90	0.00001	32.00
72.00	29.20	0.00010	32.00
73.00	29.60	0.00034	34.00
74.00	30.00	0.00110	33.00
75.00	30.30	0.00310	34.00
76.00	30.60	0.00772	34.00
78.00	31.00	0.02050	36.00
79.00	31.30	0.04310	35.00
80.00	31.70	0.09530	36.00
81.00	32.00	0.20900	35.00
82.00	32.40	0.33400	36.00
83.00	32.80	0.53000	36.00
84.00	33.20	0.99300	38.00
85.00	33.50	1.32000	37.00
86.00	34.00	1.95000	38.00
87.00	34.40	2.54000	38.00
88.00	34.90	3.60000	38.00
89.00	35.30	4.76000	39.00
90.00	35.80	5.85000	40.00
91.00	36.30	5.91000	40.00
92.00	36.70	5.99000	42.00
93.00	37.20	6.38000	41.00
94.00	37.70	6.44000	42.00
95.00	38.10	6.51000	42.00
96.00	38.60	6.27000	44.00
97.00	39.00	6.03000	42.00
98.00	39.50	5.81000	44.00
99.00	40.00	6.14000	44.00
100.00	40.40	6.34000	44.00
101.00	40.80	5.12000	44.00
102.00	41.20	4.20000	46.00
103.00	41.50	3.15000	45.00
104.00	41.90	1.83000	46.00
105.00	42.30	0.98300	46.00
106.00	42.60	0.39400	48.00
107.00	42.90	0.10600	48.00
108.00	43.30	0.06330	48.00
109.00	43.60	0.02960	47.00
110.00	43.90	0.02350	48.00
111.00	44.30	0.01930	48.00
112.00	44.60	0.00958	50.00
113.00	44.90	0.00981	49.00
114.00	45.20	0.01010	50.00
115.00	45.50	0.01030	50.00
116.00	45.80	0.01020	50.00
117.00	46.10	0.01020	50.00
118.00	46.40	0.01060	50.00
119.00	46.70	0.01120	50.00

ATOMIC MASS	MOST PROBABLE Z	CHAIN YIELD	STARTING Z
120.00	47.00	0.01180	52.00
121.00	47.30	0.01200	51.00
122.00	47.60	0.01400	52.00
123.00	47.90	0.01580	52.00
124.00	48.20	0.02100	54.00
125.00	48.60	0.02870	52.00
126.00	48.90	0.05830	54.00
127.00	49.20	0.11500	53.00
128.00	49.50	0.28600	54.00
129.00	49.90	0.61200	54.00
130.00	50.20	1.57000	56.00
131.00	50.60	2.78000	54.00
132.00	51.00	4.29000	56.00
133.00	51.40	6.75000	55.00
134.00	51.80	7.74000	56.00
135.00	52.20	6.58000	56.00
136.00	52.60	6.33000	58.00
137.00	53.00	6.22000	56.00
138.00	53.40	6.91000	58.00
139.00	53.90	6.65000	57.00
140.00	54.40	6.31000	57.00
141.00	54.90	5.81000	58.00
142.00	55.40	5.91000	59.00
143.00	55.90	5.94000	60.00
144.00	56.40	5.38000	60.00
145.00	56.90	3.92000	62.00
146.00	57.30	2.96000	60.00
147.00	57.80	2.31000	60.00
148.00	58.20	1.67000	62.00
149.00	58.60	1.08000	62.00
150.00	59.00	0.64500	62.00
151.00	59.40	0.42400	62.00
152.00	59.80	0.26600	62.00
153.00	60.10	0.15900	63.00
154.00	60.50	0.07530	64.00
155.00	60.80	0.03240	63.00
156.00	61.20	0.01270	64.00
157.00	61.40	0.00631	64.00
158.00	61.80	0.00282	66.00
159.00	62.20	0.00106	65.00
160.00	62.40	0.00033	66.00
161.00	63.00	0.00000	66.00
162.00	64.00	0.00000	58.00
163.00	63.50	0.00000	66.00
164.00	64.00	0.00000	68.00
165.00	64.00	0.00000	67.00

## APPENDIX II

### COMPUTER LISTING

The following computer listing is a code to determine the neutron multiplicity, total gamma energy, prompt neutron spectrum, and neutron kinetic energies for the thermal fission of Uranium-235.

PROMPT NEUTRON SPECTRUM AND MULTIPLICITY CODE  
 PREPARED BY THOMAS J. ROSENER  
 DEFINITIONS  
 A(1),A(2)=ATOMIC NUMBER OF FRAGMENT 1 AND 2  
 AN(IA)= MASS OF THE IA-TH NUCLIDE  
 AU=CORRECTED LEVEL DENSITY PARAMETER  
 BE(1),BE(2)=BINDING ENERGY OF FRAGMENT 1 AND 2 (MEV)  
 BEA=BINDING ENERGY IN AMU  
 BETA=EMPIRICAL VALUE : FUNCTION OF ATOMIC NUMBER  
 BN=BINDING ENERGY OF THE LAST NEUTRON IN U-236  
 CC=EMPIRICAL CONSTANT EQUAL TO .79  
 CONST=FRAGMENT ENERGY CONSTANT  
 CN(1-4,K1)=CONSTANT IN THE CUBIC SPLINE FORMULA IN MASOR  
 DELTA=PAIRING ENERGY TERM IN SUBROUTINE ENERGY  
 DP=LEVEL DENSITY PARAMETER (A/11=236/11=21.45)  
 EE(IA,IZ)=EXCITATION ENERGY OF THE IA, IZ NUCLIDE  
 EEAVE=AVERAGE EXCITATION ENERGY  
 EEH=EXCITATION ENERGY ON HEAVY FRAGMENT  
 EEL=EXCITATION ENERGY ON LIGHT FRAGMENT  
 EF=FRAGMENT KINETIC ENERGY (TOTAL)  
 EFAVE=AVERAGE FRAGMENT (TOTAL) KINETIC ENERGY  
 EFH=KINETIC ENERGY OF HEAVY FRAGMENT  
 EFL=KINETIC ENERGY OF LIGHT FRAGMENT  
 EK=KINETIC ENERGY OF NEUTRON  
 EKMAX=MAXIMUM KINETIC ENERGY OF NEUTRON  
 EN=ENERGY OF THERMAL NEUTRON ( INCIDENT NEUTRON )  
 ENT=TOTAL OF THE NEUTRON KINETIC ENERGIES  
 ER=ENERGY RELEASED (DIFF IN RMU236 AND RM-FRAGMENTS)  
 ERAVE=AVERAGE ENERGY RELEASED  
 EU=CONVERSION CONSTANT (4.80324 X E-10 ESU/ELECT CHARGE)  
 GEH=GAMMA ENERGY ON THE HEAVY FRAGMENT  
 GEL=GAMMA ENERGY ON THE LIGHT FRAGMENT  
 GEWA=GAMMA ENERGY WEIGHTED BY YIELD  
 IA, IZ, I=COUNTERS FROM LOW TO HIGH  
 ID, IE, II=COUNTERS FROM HIGH TO LOW  
 KRN=THE PSEUDO-RANDOM NUMBER GENERATOR SEED  
 NA=NUMBER OF NUCLIDE CHAINS  
 NN=NUMBER OF KNOWN INPUT VALUES IN MASOR SUBROUTINE  
 NU(IA,IZ)=MULTIPLICITY OF THE IA, IZ NUCLIDE  
 NZ=NUMBER OF NUCLIDES IN ONE CHAIN  
 PX(ID, IE, II)=PROBABILITY OF SELECTION OF THE KINETIC ENERGY  
 OF THE NEUTRON USING A MAXWELLIAN DISTRIBUTION  
 RJ1, RJ2=MAXIMUM POSSIBLE VALUES OF THE KINETIC ENERGY OF THE  
 EMITTED NEUTRON  
 RM(1), RM(2)=REST MASS OF FRAGMENT 1 AND 2 (MEV)  
 RMA=REST MASS IN AMU  
 RMU236=REST MASS OF URANIUM-236



```

C RND(I)=THE I-TH RANDOM NUMBER
C RR=EMPIRICAL CONSTANT (1.835 FERMI)
C SEN=SEPERATION ENERGY OF NEUTRON FROM FRAGMENT
C T=TOTAL NUMBER OF NUCLIDES (NA X NZ)
C T1,T2,T3,T4,T5,=TERMS OF THE BINDING ENERGY EQUATION
C TT=COUNTER FOR NUMBER OF NEUTRONS EMITTED IN CODE
C U(1),U(2)=NEUTRON NUMBER OF FRAGMENT 1 AND 2
C UX(I)=INPUT FOR NUCLEON NUMBER IN MASOR SUBROUTINE
C WNH=WEIGHTED NEUTRON MULTIPLICITY FOR THE HEAVY FRAGMENT
C WNL=WEIGHTED NEUTRON MULTIPLICITY FOR THE LIGHT FRAGMENT
C WNU=WEIGHTED NEUTRON MULTIPLICITY
C XMAX=THE VALUE OF XX WHEN PX=1.0 (PX-MAX)
C XX=EK+BETA, THE KINETIC ENERGY PLUS BETA
C YA(IA)=CHAIN YIELD OF IA CHAIN
C YB(I)=CORRECTION TO MASS IN BIND SUBROUTINE (NEUTRON)
C YC(I)=CORRECTION TO MASS IN MASOR SUBROUTINE (NEUTRON)
C YD(I)=CORRECTION TO MASS IN MASOR SUBROUTINE (PROTON)
C YE(I)=CORRECTION TO MASS IN BIND SUBROUTINE (PROTON)
C YM(I)=CORRECTION TO MASS IN MASOR SUBROUTINE(INPUT)
C YZ(IA,IZ)=YIELD OF IA,IZ NUCLIDE
C Z(1),Z(2)=PROTON NUMBER FOR FRAGMENT 1 AND 2
C ZA(IA)=STARTING Z FOR CHAIN IA.
C ZN(IA,IZ)=CHARGE NUMBER OF IZ-TH NUCLIDE WITH MASS NUMBER
C ZP(IA)=THE MOST PROBABLE PROTON NUMBER OF THE IA-TH CHAIN
C BLOCK DATA SUBPROGRAM
C BLOCK DATA
C COMMON/BLK/AN,ZP,YA,ZA
C
C REAL AN(95)/71.0,72.0,72.0,73.0,74.0,75.0,76.0,78.0,79.0
1.80,0.81,0.82,0.83,0.84,0.85,0.86,0.87,0.88,0.89,0.90,0.
291.0,92.0,93.0,94.0,95.0,96.0,97.0,98.0,99.0,100.0,101.0,
3102.0,103.0,104.0,105.0,106.0,107.0,108.0,109.0,110.0,111.0,
4112.0,113.0,114.0,115.0,116.0,117.0,118.0,119.0,120.0,121.0,
5122.0,123.0,124.0,125.0,126.0,127.0,128.0,129.0,130.0,131.0,
6132.0,133.0,134.0,135.0,136.0,137.0,138.0,139.0,140.0,141.0,
7142.0,143.0,144.0,145.0,146.0,147.0,148.0,149.0,150.0,151.0,
8152.0,153.0,154.0,155.0,156.0,157.0,158.0,159.0,160.0,161.0,
9162.0,163.0,164.0,165.0/
C
C REAL ZP(95)/28.5,28.9,29.2,29.6,30.0,30.3,30.6,31.0,31.3,
131.7,32.0,32.4,32.8,33.2,33.5,34.0,34.4,34.9,35.3,35.8,36.3,
236.7,37.2,37.7,38.1,38.6,39.0,39.5,40.0,40.4,40.8,41.2,41.5,
341.9,42.3,42.6,42.9,43.3,43.6,43.9,44.3,44.6,44.9,45.2,45.5,
445.8,46.1,46.4,46.7,47.0,47.3,47.6,47.9,48.2,48.6,48.9,49.2,
549.5,49.9,50.2,50.6,51.0,51.4,51.8,52.2,52.6,53.0,53.4,53.9,
654.4,54.9,55.4,55.9,56.4,56.9,57.3,57.8,58.2,58.6,59.0,59.4,
759.8,60.1,60.5,60.8,61.2,61.6,61.8,62.2,62.4,63.0,64.0,63.5,
864.0,64.0/

```

```

C
REAL YA(95)/0.000000,0.000000,0.000000,0.000000,0.000102,0.00034,
1.0011,0031,00772,0205,0431,0953,209,334,53,993,
21.32,1.95,2.54,3.6,4.76,5.85,5.91,5.99,6.38,6.44,6.51,6.27,
36.03,5.81,6.14,6.34,5.12,4.2,3.15,1.83,983,394,106,0633,
4.0296,0235,0193,00958,009815,0101,0103,0102,0102,
5.0106,0112,0118,012,014,0158,021,0287,0383,115,286,
6.612,1.57,2.78,4.29,6.75,7.74,6.58,6.33,6.22,6.91,6.65,6.31,
75.81,5.91,5.94,5.38,3.92,2.96,2.31,1.67,1.08,645,424,266,
8.159,0.753,0.324,0.127,0.0631,0.0282,0.0106,0.0033,0.0,0.0,
90.0,0.0,0.0/

C
REAL ZA(95)/31.0,32.0,32.0,34.0,33.0,34.0,33.0,34.0,34.0,36.0,35.0,
136.0,35.0,36.0,36.0,38.0,37.0,38.0,38.0,38.0,39.0,40.0,40.0,
242.0,41.0,42.0,42.0,44.0,42.0,44.0,44.0,44.0,44.0,44.0,46.0,
345.0,46.0,46.0,48.0,47.0,48.0,47.0,48.0,48.0,50.0,49.0,50.0,
450.0,50.0,50.0,50.0,52.0,51.0,52.0,52.0,52.0,54.0,52.0,54.0,
553.0,54.0,54.0,56.0,54.0,56.0,55.0,56.0,56.0,58.0,56.0,58.0,
657.0,57.0,58.0,59.0,60.0,60.0,62.0,60.0,60.0,62.0,62.0,62.0,
762.0,62.0,63.0,64.0,63.0,64.0,64.0,64.0,66.0,65.0,66.0,66.0,68.0,
866.0,68.0,67.0/

C
END
IMPLICIT REAL*8(K)
DIMENSION NU(95,10),YZ(95,10),EE(95,10),PR(95),NN(50),TNN(50)
1,A0(2),Z0(2)
COMMON/BLK/AN(95),ZP(95),YA(95),ZA(95)
C THIS COMMON STATEMENT IS FOR THE REST MASS SUBROUTINE
COMMON/BND/A(20),Z(20),U(20),BE(20),BEA(20),RM(20),RMA(20),
12N(95,10),IU,ID,IE,IS(20)
C THIS COMMON STATEMENT IS FOR THE ENERGY SUBROUTINE
COMMON/EN/IA,A1(20),Z1(20),U1(20),EEH,EEL,SEN,SEN2,I,
11D2,IE2,EK(95,10,20),PX(95,10,20),RND(3),RC(20),CL1,CL2
C THIS COMMON IS FOR THE SEED OF THE RANDOM NUMBER GENERATOR
COMMON/SEED/KRN
C THIS COMMON IS FOR THE MASS CORRECTION SUBROUTINE
COMMON/MAS1/YC(120),YE(120)
C ESTABLISH THE SEED FOR THE RANDOM NUMBER
KRN=99.DO
C CC IS AN EMPIRICAL CONSTANT (APPROXIMATELY .79)
CC=.79
C1=1.0/SQRT(CC*3.14159)

C
ER=0.0
EF=0.0
DP=21.45
SUM=0.0
SUM2=0.0
SUM3=0.0
NA=95

```

```

NZ=10
C  FILL THE ZN(IA,IZ) ARRAY AND INITIALIZE EE(IA,IZ) TO 0,0
  00 100 IA=1,NA
  00 100 IZ=1,NZ
  EE(IA,IZ)=0.0
  ZN(IA,IZ)=ZA(IA)-IZ+1
C  COMPUTE THE INDEPENDENT YIELD OF ZN(IA,IZ)
C  YZ(IA,IZ)=(YA(IA)/200.0)*C1*EXP(-((ZN(IA IZ)-ZP(IA))**2)/CC)
C  100 CONTINUE
C  THIS PORTION OF THE PROGRAM CALCULATES THE WEIGHTED AVERAGE
C  MASS OF THE LIGHT AND HEAVY FRAGMENT
  TA=0.0
  SA=0.0
  Y1=0.0
  TH=0.0
  SH=0.0
  Y2=0.0
  00 45 IA=1,NA
C  DETERMINE THE PRODUCT OF THE YIELD AND THE MASS NUMBER
  PR(IA)=(YA(IA)/200.0)*AN(IA)
  IF(AN(IA).GE.115) GO TO 42
C  SUM UP THE PRODUCTS FOR THE LIGHT FRAGMENTS
  SA=SA+PR(IA)
  TA=TA+1.0
  Y1=Y1+YA(IA)/200.0
  IF(AN(IA).LT.115) GO TO 45
C  SUM UP THE PRODUCTS FOR THE HEAVY FRAGMENTS
  42 SH=SH+PR(IA)
  TH=TH+1.0
  Y2=Y2+YA(IA)/200.0
C  DETERMINE THE WEIGHTED AVERAGES
  WA=SA/Y1
  WH=SH/Y2
C  OUTPUT (AVERAGE LIGHT, AVERAGE HEAVY) FRAGMENT MASS
  WRITE(6,46)WA,WH
  46 FORMAT(2X,/, 'AVERAGE LIGHT MASS=', F12.6, 3X,
  1 'AVERAGE HEAVY MASS=', F12.6, /)
  DO 49 IA=1,NA
  DO 49 IZ=1,NZ
  DO 49 I=1,20
  49 EK(IA,IZ,I)=0.0
C  CALL MASCOR
C  RR IS A PARAMETER THAT MAY BE CHANGED WITHIN A FEW PERCENT
C  RR=1.835 FERMIS=1.835X10**-13 CM

```

```

C EU=4.80298X10**-10 ELECTROSTATIC UNITS
C CONVERSION CONSTANT=1.60210X10**-12 ERG/EV
C (EU**2)/(RR*CON. CONST)=1.439899/RR
  RR=1.835
  WRITE(6,468)RR
468 FORMAT(2X,/,2X,'THE VALUE OF RR IS',2X,F7.5,/)
C INITIALIZE THE WEIGHTED NEUTRON MULTIPLICITY
  WNL=0.0
  WNH=0.0
  WNU=0.0
C START WITH THE HEAVIEST NUCLIDE
  RMU236=236.045563*931.5016
  GT=0.0
  GEH=0.0
  GEL=0.0
  GEWA=0.0
  ENT=0.0
C
C THE FOLLOWING DO LOOP IS THE MAIN PORTION OF THE PROGRAM AND
C PERFORMS ALL OPERATIONS OVER ALL POSSIBLE NEUTRON-PROTON
C COMBINATIONS FOR THE FISSION SPLIT OF U-235 + A NEUTRON.
C
DO 500 IA=1,NA
DO 500 IZ=1,NZ
  ID=NA-IA+1
  ID2=ID
  A(1)=AN(ID)
  A(2)=236.-AN(ID)
  IE=NZ-IZ+1
  IE2=IE
  Z(1)=ZN(ID,IE)
  Z(2)=92.-ZN(ID,IE)
  IU=1
  CALL BIND
  ER=RMU236-RM(1)-RM(2)
  EF=(Z(1)*Z(2)*CONST)/(A(1)**(.333333)+A(2)**(.333333))
C DETERMINE THE CORRECTION FOR LABORATORY COORDINATES
  CL1=(939.553/RM(1))*(RM(2)/(RM(1)+RM(2)))*EF
  CL2=(939.553/RM(2))*(RM(1)/(RM(1)+RM(2)))*EF
  SUM=SUM+EF
  SUM2=SUM2+ER
C FOR THERMAL FISSION EN=2.5X10**-8 MEV
  EN=0.000000025
C EE(ID,IE)=ER+EN-EF(TOTAL)
  EE(ID,IE)=ER+EN-EF
  EEPN=EE(ID,IE)/236.0
  IF(EE(ID,IE).LT.0.0)GO TO 503
  TM=SQRT(EE(ID,IE)/DP)
  GO TO 504

```

```

503 WRITE(6,508)A(1),Z(1),U(1),RMA(1)
WRITE(6,517)A(2),Z(2),U(2),RMA(2)
WRITE(6,502)
502 FORMAT(2X,'EXCITATION ENERGY IS NEGATIVE')
NU(ID,IE)=0
NU(96-ID,IE)=0
TM=0.0
GE=0.0
GO TO 800
504 SUM3=SUM3+EE(ID,IE)
508 WRITE(6,508)A(1),Z(1),U(1),RMA(1)
508 FORMAT(2X,'A1=',F7.2,2X,'Z1=',F7.2,2X,'U1=',F7.2,2X,'RMA1=',E
112.6)
WRITE(6,517)A(2),Z(2),U(2),RMA(2)
517 FORMAT(2X,'A2=',F7.2,2X,'Z2=',F7.2,2X,'U2=',F7.2,2X,'RMA2=',E
112.6)
WRITE(6,509)EE(ID,IE),ER,EF
509 FORMAT(2X,'EE=',E12.6,2X,'ER=',E12.6,2X,'EF=',E12.6)
NU(ID,IE)=0
NU(96-ID,IE)=0
IU=2
A0(1)=A(1)
Z0(1)=Z(1)
A0(2)=A(2)
Z0(2)=Z(2)
U0(1)=A0(1)-Z0(1)
U0(2)=A0(2)-Z0(2)
CALL BIND
DO 799 IK=1,20
A1(IK)=A(IK)
Z1(IK)=Z(IK)
U1(IK)=U(IK)
799 RC(IK)=RM(IK)
I=1
C COMPUTE THE EXCITATION ENERGY ON THE HEAVY FRAGMENT
EEH=EE(ID,IE)*(A(I)/236.0)
C COMPUTE SEPERATION ENERGY OF NEUTRON FROM FRAGMENT
703 SEN=939.553-(RM(1)-RM(I+1))
IF(IA.EQ.10) GO TO 772
IF(IA.EQ.45) GO TO 772
IF(IA.EQ.91) GO TO 772
GO TO 775
772 WRITE(6,666)A(I),Z(I),U(I)
666 FORMAT(2X,'A=',F7.2,2X,'Z=',F7.2,2X,'U=',F7.2)
WRITE(6,114)I,RM(I),RM(I+1)
114 FORMAT(2X,'I=',I3,2X,'RM(I)=',E12.6,2X,'RM(I+1)=',E12.6)
WRITE(6,765)EEH,SEN
765 FORMAT(2X,'EEH=',F12.6,2X,'SEN=',F12.6)
775 IF(EEH.LT.SEN+T5(1)) GO TO 707
EKMAX=EEH-SEN-T5(1)

```

```

C SELECT A NEUTRON ENERGY SUCH THAT (0 .LE. EK .LE. EKMAX)
  II=I
  CALL ENERGY
  I=I+1
  IF (I.GT.10) GO TO 708
  NU(ID,IE)=NU(ID,IE)+1
  EEH=EKMAX-EK(ID,IE,I-1)
  GO TO 703

707 GEH=EEH
C COMPUTE THE EXCITATION ENERGY ON THE LIGHT FRAGMENT
708 I=20
  EEL=EE(ID,IE)*(A(I)/236.0)
C COMPUTE SEPARATION ENERGY OF NEUTRON FROM FRAGMENT
704 SEN2=939.553-(RM(I)-RM(I-1))
  IF (IA.EQ.10) GO TO 862
  IF (IA.EQ.45) GO TO 862
  IF (IA.EQ.91) GO TO 862
  GO TO 865
862 WRITE(6,667)A(I),Z(I),U(I)
667 FORMAT(2X,'A2=',F7.2,2X,'Z2=',F7.2,2X,'U2=',F7.2)
  WRITE(6,117)I, RM(I),RM(I-1)
117 FORMAT(2X,'I=',I3,2X,'RM(I)=' ,E12.6,2X,'RM(I-1)=' ,E12.6)
  WRITE(6,876)EEL, SEN2
876 FORMAT(2X,'EEL=',F12.6,2X,'SEN2=' ,F12.6)
865 IF (EEL.LT.SEN2+T5(I)) GO TO 808
  EKMAX=EEL-SEN2-T5(I)
C SELECT A NEUTRON ENERGY SUCH THAT (0 .LE. EK .LE. EMAX)
  II=I
  CALL ENERGY
  I=I-1
  IF (I.LT.11) GO TO 800
  NU(96-ID,IE)=NU(96-ID,IE)+1
  EEL=EKMAX-EK(ID,IE,I+1)
  GO TO 704
808 GEL=EEL
800 IQ=96-ID
  IF (IA.EQ.10) GO TO 769
  IF (IA.EQ.45) GO TO 769
  IF (IA.EQ.91) GO TO 769
  GO TO 802
767 WRITE(6,767)AO(1),ZO(1),AO(2),ZO(2)
769 FORMAT(2X,4(F12.6,3X))
801 WRITE(6,801)ID, IE, NU(ID,IE), IQ, IE, NU(IQ,IE)
802 FORMAT(2X,2('NU(',I3,',',I3,')=' ,I3,2X))
  WNL=YZ(IQ,IE)*NU(IQ,IE)
  WNH=YZ(ID,IE)*NU(ID,IE)
  WNU=WNU+WNL+WNH
  GEWA=GEWA+GEH*YZ(ID,IE)+GEL*YZ(IQ,IE)
  GE=GEH+GEL
  GT=GT+GE

```

```

500 CONTINUE
C THIS COMPLETES THE MAIN LOOP OF THE PROGRAM
C
T=NA*NZ
EFAVE=SU/M/T
ERAVE=SUM2/T
EEAVE=SUM3/T
CEAVE=CT/T
TT=0.0
DO 222 IS=1,50
222 NN(IS)=0
WRITE(6,332)
332 FORMAT(2X,/,2X,'IA',2X,'IZ',2X,'I',/,)
C SUM UP THE NEUTRON KINETIC ENERGIES
DO 123 IA=1,NA
DO 123 IZ=1,NZ
DO 123 I=1,20
IF(EK(IA,IZ,I).EQ.0.0) GO TO 123
ENT=ENT+EK(IA,IZ,I)
TT=TT+1.0
WRITE(6,333)IA,IZ,I,EK(IA,IZ,I)
333 FORMAT(2X,3(12,2X),1EK=,F12.6)
C DETERMINE THE ENERGY BIN OF THE NEUTRON
DO 343 IS=1,20
IF(EK(IA,IZ,I).GT.0.5*FLOAT(IS)) GO TO 343
NN(IS)=NN(IS)+1
GO TO 123
343 CONTINUE
123 CONTINUE
555 FORMAT(2X,'EFAVE',EFAVE,ERAVE,EEAVE
112.6,/)
WRITE(6,901)WNU
901 FORMAT(2X,'WEIGHTED NEUTRON MULTIPLICITY =',E12.6,/)
810 FORMAT(2X,'MEAN ENERGY AVAILABLE FOR GAMMA DECAY ON BOTH
1FRAGMENTS=',F12.6)
WRITE(6,803)CEWA
803 FORMAT(2X,'GAMMA WEIGHTED AVERAGE=',F12.6,/)
EAVE=(ENT/TT)*WNU
ENTAVE=ENT/TT
WRITE(6,811)EAVE
811 FORMAT(2X,'AVERAGE ENERGY AVAILABLE FOR NEUTRON EMISSION=',
1E12.6,/)
WRITE(6,812)ENTAVE
812 FORMAT(2X,'AVERAGE ENERGY PER EMITTED NEUTRON=',F12.6,/)
C NORMALIZE THE NUMBER OF NEUTRONS IN SPECTRUM TO 1
DO 813 IS=1,20
TNN(IS)=NN(IS)/TT

```

```

813 WRITE(6,814) IS,MN(IS),TNN(IS)
814 FORMAT(2X,'NN(',I2,')=',I4,2X,'NORM.=',F12.6)
WRITE(6,888)GT,I
888 FORMAT(2X,/,2X,'GT=',F12.6,2X,'T=',F12.6,/)
WRITE(6,815)ENT,TI
815 FORMAT(2X,'ENT=',F12.6,3X,'TI=',F12.6)
STOP
END
C
C SUBROUTINE BIND
C
COMMON/BND/A(20),Z(20),U(20),BE(20),BEA(20),RM(20),RMA(20),
1ZN(95,10),IU,ID,IE,T5(20)
COMMON/BLK/AN(95),ZP(95),YA(95),ZA(95)
COMMON/MAST/MB(120),YD(120)
C THIS PORTION OF THE PROGRAM COMPUTES THE BINDING ENERGIES AND
C REST MASSES (USING THE MEYER-SWIATECKI MASS FORMULA) FOR
C THE TWO FRAGMENTS
IF(IU.EQ.2) GO TO 415
DO 405 I=1,2
U(I)=A(I)-Z(I)
J=2
405 CONTINUE
C THIS PORTION OF THE PROGRAM COMPUTES THE BINDING ENERGIES AND
C REST MASSES FOR THE HEAVY AND LIGHT FRAGMENTS AND SUCCESSIVE
C NUCLESIDES FORMED AFTER NEUTRON EMISSION
IF(IU.EQ.1) GO TO 425
C HEAVY FRAGMENT
415 DO 410 I=1,10
A(I)=AN(ID)-FLOAT(I)+1.0
Z(I)=ZN(ID,IE)
U(I)=A(I)-Z(I)
J=20
410 CONTINUE
C LIGHT FRAGMENT
DO 411 IR=11,20
I=20-IR+1
A(I)=236.0-AN(ID)-FLOAT(IR)+11.0
Z(I)=92.0-ZN(ID,IE)
U(I)=A(I)-Z(I)
411 CONTINUE
425 DO 400 I=1,J
C COMPUTE EACH OF THE BINDING ENERGY EQUATION TERMS.
C
C T1 IS THE VOLUME ENERGY TERM
T1=15.677*A(I)*(1.0-1.79*((U(I)-Z(I))/A(I))**2)
C T2 IS THE SURFACE ENERGY TERM
T2=(-18.56)*(A(I)**(0.666666666))*(1.0-1.79*((U(I)-Z(I))/A(I))**2)

```



```

C T3 IS THE COULOMB ENERGY TERM
T3=(-0.717)*(Z(1)**2)/(A(1)**(0.3333333))
C T4 IS THE CORRECTION TO THE COULOMB ENERGY TERM DUE TO THE
C DIFFUSE BOUNDARY OF THE NUCLEUS
T4=1.211*(Z(1)**2)/(A(1))
C T5 IS THE PAIRING ENERGY TERM
C TEST FOR ODD A AND ODD Z FOR PAIRING TERM CALCULATION.
IF(AMOD(A(1),2).NE.0) GO TO 420
IF(AMOD(Z(1),2).NE.0) GO TO 430
T5(1)=11.0/SQRT(A(1))
GO TO 480
430 T5(1)=(-11.0)/SQRT(A(1))
GO TO 480
420 T5(1)=0.0
C COMPUTE THE BINDING ENERGY ( IN MEV)
480 BE(1)=T1+T2+T3+T4+T5(1)
BEA(1)=BE(1)/931.5016
C COMPUTE THE REST MASS IN MEV(CORRECTED)
IMC=U(1)
IMA=Z(1)
RM(1)=-BE(1)+Z(1)*938.7906+(A(1)-Z(1))*939.553+YB(IMC)+
1YD(IMA)
RMA(1)=RM(1)/931.5016
IF(10.EQ.86) GO TO 442
IF(10.EQ.51) GO TO 442
IF(10.EQ.5) GO TO 442
GO TO 400
442 WRITE(6,459)1, RM(1)
459 FORMAT(2X,1=' ',13,2X,'RM(1)=' ,E12.6)
400 CONTINUE
RETURN
END
C SUBROUTINE ENERGY
C
C IMPLICIT REAL*8(K)
COMMON/EN/IA,A1(20),Z1(20),U1(20),EEH,EEL,SEN,SEN2,11,
1102,1E2,EK(95,10,20),PX(95,10,20),RND(3),RC(20),CL1,CL2
COMMON/SE0/KRN
C THIS SUBROUTINE DETERMINES THE NEUTRON KINETIC ENERGY
C FROM EVAPORATION THEORY USING MONTE CARLO TECHNIQUE
C
C RESET VALUES TO 0.0
A=0.0
THETA=0.0
AU=0.0
BETA=0.0
DELTA=0.0
RJ1=0.0
RJ2=0.0

```

```

XMAX=0.0
XX=0.0
C
A=A1(11)/20.0
THE*A=(U1(11)-Z1(11))/A1(11)
AU=A*((1.0-1.3*THE*A/A1(11))**2)
IF(AMOD(A1(11),2.0).NE.0.0) GO TO 20
IF(AMOD(Z1(11),2.0).NE.0.0) GO TO 30
DELTA=11.0/SQRT(A1(11))
GO TO 80
30 DELTA=(-11.0)/SQRT(A1(11))
GO TO 80
20 DELTA=0.0
80 IF(11.GE.11) GO TO 150
C HEAVY FRAGMENT
RJ1=EEH-SEN-DELTA
BETA=(2.12*(A1(11)**(-.666666))-0.05)/(0.76+2.2*(A1(11))**
1(-.33333))
IF(RJ1.LT.BETA) GO TO 99
XMAX=(SQRT(AU*RJ1+0.25)-0.5)/AU
78 CALL GGUBS(KRN,3,RND)
55 XX=RND(1)*RJ1
IF(XX-BETA.LT.0.0) GO TO 78
IF(XX.GT.15.*XMAX) GO TO 78
IF(XX.LE.2.0*XMAX) GO TO 59
58 PX(ID2,IE2,11)=(XX/XMAX)*EXP(1.0-(XX/XMAX))
GO TO 51
59 PX(ID2,IE2,11)=(XX/XMAX)*EXP(AU*XMAX-SQRT(AU*(RJ1-XX)))
51 IF(PX(ID2,IE2,11).LE.RND(2)) GO TO 78
EK(ID2,IE2,11)=(XX-BETA)
C CONVERT TO LABORATORY COORDINATES
ANGLE=6.283185*RND(3)
EK(ID2,IE2,11)=CL1+EK(ID2,IE2,11)+2.0*SQRT(CL1*EK(ID2,IE2,
11))*COS(ANGLE)
IF(1A.EQ.10) GO TO 111
IF(1A.EQ.45) GO TO 111
IF(1A.EQ.91) GO TO 111
GO TO 150
111 WRITE(6,464)ID2,IE2,11,A1(11),Z1(11),CL1
464 FORMAT(2X,1D2,1D2,1F3,2X,1E2,1F13,2X,1I=,13,2X,1A1=',F
17.2,2X,1Z1=,1F7.2,2X,1CL1=,1E14.8)
WRITE(6,564)RC(11),RJ1,XX,XMAX,BETA,EEH,SEN
564 FORMAT(2X,1RC(11)=,1E12.7,2X,1RJ1=,1E12.7,2X,1XX=,1E12.7,
12X,1XMAX=,1E12.7,2X,1BETA=,1E12.7,2X,1EEH=,1E12.7,2X,
21SEN=,1E12.7)
C LIGHT FRAGMENT
150 RJ2=EEL-SEN2-DELTA
BETA=(2.12*(A1(11))**(-.666666))-0.05)/(0.76+2.2*(A1(11))**
1(-.33333))
IF(PJ2.LT.BETA) GO TO 99

```

```

XMAX=(SQRT(AU*RJ2+0.25)-0.5)/AU
88 CALL GCUBS(KRN,3,RND)
XX=RND(1)*RJ2
IF (XX-BETA.LT.0.0) GO TO 88
IF (XX.GT.15.0*XMAX) GO TO 88
IF (XX.LT.2.0*XMAX) GO TO 69
PX(ID2,IE2,II)=(XX/XMAX)*EXP(1.0-(XX/XMAX))
GO TO 61
69 PX(ID2,IE2,II)=(XX/XMAX)*EXP(AU*XMAX-SQRT(AU*(RJ2-XX)))
61 IF (PX(ID2,IE2,II).LE.RND(2)) GO TO 88
EK(ID2,IE2,II)=(XX-BETA)
C CONVERT TO LABORATORY COORDINATES
ANGLE=6.283185*RND(3)
EK(ID2,IE2,II)=CL2+EK(ID2,IE2,II)+2.0*SQRT(CL2*EK(ID2,IE2,
III))*COS(ANGLE)
IF (IA.EQ.10) GO TO 543
IF (IA.EQ.45) GO TO 543
IF (IA.EQ.91) GO TO 543
GO TO 101
543 WRITE(6,565)ID2,IE2,II,A1(II),Z1(II),CL2
565 FORMAT(2X,'I02=',I3,2X,'IE2=',I3,2X,'II=',I3,2X,'A1=',F
17-2,2X,'Z1=',F7-2,2X,'CL2=',E14,8)
WRITE(6,655)RC(II),RJ2,XX,XMAX,BETA,EEL,SEN2
655 FORMAT(2X,'RC(II)='E12.7,2X,'RJ2='E12.7,2X,'XX='E
112.7,2X,'XMAX='E12.7,2X,'BETA='E12.7,2X,'EEL='E
212.7,2X,'SEN2='E12.7)
GO TO 101
99 WRITE(6,119)
119 FORMAT(2X,'EXCITATION ENERGY IS TO LOW')
101 RETURN
ENO
C SUBROUTINE MASCOR
C
COMMON/MAS1/YC(120),YE(120)
COMMON/MAS2/UX(12),UU(120),YM(12),BK(120),ZK(120),PP(120),
2YU(120),OK(120),PK(120),EL(120),EL(120),CN(20,120),AC(120,20)
C INITIALIZE VALUES OF KNOWN POINTS
OO 103 I=1,2
IF (I.EQ.1) GO TO 1
C THE FOLLOWING DATA ARE FOR NEUTRON MASS CORRECTION
UX(1)=31.0
UX(2)=40.0
UX(3)=46.0
UX(4)=50.0
UX(5)=55.0
UX(6)=60.0
UX(7)=70.0
UX(8)=80.0
UX(9)=82.0

```

```

UX(10)=90.0
UX(11)=110.0
UX(12)=120.0
YM(1)=-2.0
YM(2)=3.0
YM(3)=2.0
YM(4)=-2.0
YM(5)=2.0
YM(6)=3.0
YM(7)=2.0
YM(8)=-2.0
YM(9)=-3.0
YM(10)=2.0
YM(11)=2.0
YM(12)=-3.0

```

GO TO 8  
C THE FOLLOWING DATA ARE FOR PROTON MASS CORRECTION

```

1 UX(1)=22.0
  UX(2)=28.0
  UX(3)=33.0
  UX(4)=40.0
  UX(5)=48.0
  UX(6)=50.0
  UX(7)=54.0
  UX(8)=57.0
  UX(9)=60.0
  UX(10)=62.0
  UX(11)=70.0
  UX(12)=80.0
  YM(1)=3.0
  YM(2)=-3.0
  YM(3)=3.0
  YM(4)=3.0
  YM(5)=2.0
  YM(6)=-2.0
  YM(7)=0.0
  YM(8)=1.0
  YM(9)=1.0
  YM(10)=2.0
  YM(11)=3.0
  YM(12)=2.0

```

8 NN=12  
C THIS PORTION OF THE PROGRAM CALCULATES THE CONSTANTS FOR  
C THE CUBIC SPLINE FORMULA.  
C

```

MM=NN-1
DO 2 KI=1,MM
DK(KI)=UX(KI+1)-UX(KI)
PK(KI)=DK(KI)/6.
2 EL(KI)=(YM(KI+1)-YM(KI))/DK(KI)

```

```

C
DO 3 KI=2,MM
3 BK(KI)=EL(KI)-EL(KI-1)
C
AC(1,2)=-1,-DK(1)/DK(2)
AC(1,3)=DK(1)/DK(2)
AC(2,3)=PK(2)-PK(1)*AC(1,3)
AC(2,2)=2.*(PK(1)+PK(2))-PK(1)*AC(1,2)
AC(2,3)=AC(2,3)/AC(2,2)
BK(2)=BK(2)/AC(2,2)
C
DO 4 KI=3,MM
AC(KI,2)=2.*(PK(KI-1)+PK(KI))-PK(KI-1)*AC(KI-1,3)
BK(KI)=BK(KI)-PK(KI-1)*BK(KI-1)
AC(KI,3)=PK(KI)/AC(KI,2)
4 BK(KI)=BK(KI)/AC(KI,2)
C
QT=DK(NN-2)/DK(NN-1)
AC(NN,1)=1.*QT+AC(NN-2,3)
AC(NN,2)=-QT-AC(NN,1)*AC(NN-1,3)
BK(NN)=BK(NN-2)-AC(NN,1)*BK(NN-1)
ZK(NN)=BK(NN)/AC(NN,2)
ML=NN-2
C
DO 6 IT=1,ML
KI=NN-IT
6 ZK(KI)=BK(KI)-AC(KI,3)*ZK(KI+1)
ZK(1)=-AC(1,2)*ZK(2)-AC(1,3)*ZK(3)
C
DO 7 KI=1,MM
QT=1./(6.*DK(KI))
C STORED CONSTANTS
CN(1,KI)=ZK(KI)*QT
CN(2,KI)=ZK(KI+1)*QT
CN(3,KI)=YM(KI)/DK(KI)-ZK(KI)*PK(KI)
7 CN(4,KI)=YM(KI+1)/DK(KI)-ZK(KI+1)*PK(KI)
IF(I.EQ.1) GO TO 110
DO 500 IT=31,120
UU(IT)=FLOAT(IT)
IF(UU(IT)-UX(IT)) 37,31,32
31 YC(IT)=YM(IT)
GO TO 500
32 KI=1
33 IF(UU(IT)-UX(KI+1)) 36,34,35
34 YC(IT)=YM(KI+1)
GO TO 500
35 KI=KI+1
36 YC(IT)=(UX(KI+1)-UU(IT))*(CN(1,KI)*(UX(KI+1)-UU(IT))**2+
1CN(3,KI))

```

```
37 YC(IT)=YC(IT)+(UU(IT)-UX(KI))*(CN(2,KI))*(UU(IT)-UX(KI))**2+
   1CN(4,KI))
   WRITE(6,76)IT, YC(IT)
76 FORMAT(2X, I3, 2X, F12.6)
500 CONTINUE
   GO TO 103
110 DO 600 IP=22,80
   PP(IP)=FLOAT(IP)
   IF(PP(IP)-UX(1)) 57,51,52
51 YE(IP)=YM(1)
   GO TO 600
52 KK=1
53 IF(PP(IP)-UX(KK+1)) 56,54,55
54 YE(IP)=YM(KK+1)
   GO TO 600
55 KK=KK+1
   IF(NN-KK) 57,57,53
56 YE(IP)=(UX(KK+1)-PP(IP))*(CN(1,KK)*(UX(KK+1)-PP(IP))**2+
   1CN(3,KK))
57 YE(IP)=YE(IP)+(PP(IP)-UX(KK))*(CN(2,KK)*(PP(IP)-UX(KK))**2+
   1CN(4,KK))
   WRITE(6,77)IP, YE(IP)
77 FORMAT(2X, I3, 2X, F12.6)
600 CONTINUE
103 RETURN
   END
```

## APPENDIX III

### FRAGMENT MULTIPLICITIES

The following data is a compilation of the individual neutron multiplicities for each fragment produced in the thermal fission of Uranium-235.  $A_1, Z_1$  are the atomic number and proton number of fragment 1, and  $A_2, Z_2$  are the atomic number and proton number for fragment 2.  $\nu$  represents the neutron multiplicity and the first one is for fragment 1 and the second one is for fragment 2. Only those fragment splits where one (or more) neutrons is emitted by either or both fragments is printed.

A1=165.000 Z1= 64.000 A2= 71.000 Z2= 28.000  
 NU( 95, 4)= 1 NU( 1, 4)= 0  
 A1=162.000 Z1= 63.000 A2= 74.000 Z2= 29.000  
 NU( 92, 6)= 1 NU( 4, 6)= 0  
 A1=161.000 Z1= 62.000 A2= 75.000 Z2= 30.000  
 NU( 91, 5)= 1 NU( 5, 5)= 0  
 A1=160.000 Z1= 61.000 A2= 76.000 Z2= 31.000  
 NU( 90, 6)= 1 NU( 6, 6)= 0  
 A1=160.000 Z1= 62.000 A2= 76.000 Z2= 30.000  
 NU( 90, 5)= 1 NU( 6, 5)= 0  
 A1=160.000 Z1= 63.000 A2= 76.000 Z2= 29.000  
 NU( 90, 4)= 1 NU( 6, 4)= 0  
 A1=159.000 Z1= 61.000 A2= 77.000 Z2= 31.000  
 NU( 89, 5)= 1 NU( 7, 5)= 0  
 A1=159.000 Z1= 62.000 A2= 77.000 Z2= 30.000  
 NU( 89, 4)= 1 NU( 7, 4)= 0  
 A1=158.000 Z1= 60.000 A2= 78.000 Z2= 32.000  
 NU( 88, 7)= 1 NU( 8, 7)= 0  
 A1=158.000 Z1= 61.000 A2= 78.000 Z2= 31.000  
 NU( 88, 6)= 1 NU( 8, 6)= 0  
 A1=158.000 Z1= 62.000 A2= 78.000 Z2= 30.000  
 NU( 88, 5)= 1 NU( 8, 5)= 0  
 A1=158.000 Z1= 63.000 A2= 78.000 Z2= 29.000  
 NU( 88, 4)= 1 NU( 8, 4)= 0  
 A1=157.000 Z1= 60.000 A2= 79.000 Z2= 32.000  
 NU( 87, 5)= 1 NU( 9, 5)= 0  
 A1=157.000 Z1= 61.000 A2= 79.000 Z2= 31.000  
 NU( 87, 4)= 1 NU( 9, 4)= 0  
 A1=157.000 Z1= 62.000 A2= 79.000 Z2= 30.000  
 NU( 87, 3)= 1 NU( 9, 3)= 0  
 A1=156.000 Z1= 59.000 A2= 80.000 Z2= 33.000  
 NU( 86, 6)= 1 NU( 10, 6)= 0  
 A1=156.000 Z1= 60.000 A2= 80.000 Z2= 32.000  
 NU( 86, 5)= 1 NU( 10, 5)= 0  
 A1=156.000 Z1= 61.000 A2= 80.000 Z2= 31.000  
 NU( 86, 4)= 1 NU( 10, 4)= 1  
 A1=156.000 Z1= 62.000 A2= 80.000 Z2= 30.000  
 NU( 86, 3)= 1 NU( 10, 3)= 0  
 A1=155.000 Z1= 59.000 A2= 81.000 Z2= 33.000  
 NU( 85, 5)= 1 NU( 11, 5)= 0  
 A1=155.000 Z1= 60.000 A2= 81.000 Z2= 32.000  
 NU( 85, 4)= 1 NU( 11, 4)= 0  
 A1=155.000 Z1= 61.000 A2= 81.000 Z2= 31.000  
 NU( 85, 3)= 1 NU( 11, 3)= 0  
 A1=155.000 Z1= 62.000 A2= 81.000 Z2= 30.000  
 NU( 85, 2)= 1 NU( 11, 2)= 1  
 A1=154.000 Z1= 58.000 A2= 82.000 Z2= 34.000  
 NU( 84, 7)= 1 NU( 12, 7)= 0  
 A1=154.000 Z1= 59.000 A2= 82.000 Z2= 33.000



NU( 84, 6) = 1 NU( 12, 6) = 0 Z2= 32.000  
 A1=154.000 Z1= 60.000 A2= 82.000  
 NU( 84, 5) = 1 NU( 12, 5) = 0 Z2= 31.000  
 A1=154.000 Z1= 61.000 A2= 82.000  
 NU( 84, 4) = 1 NU( 12, 4) = 1 Z2= 34.000  
 A1=153.000 Z1= 56.000 A2= 83.000  
 NU( 83, 6) = 1 NU( 13, 6) = 0 Z2= 33.000  
 A1=153.000 Z1= 59.000 A2= 83.000  
 NU( 83, 5) = 1 NU( 13, 5) = 0 Z2= 32.000  
 A1=153.000 Z1= 60.000 A2= 83.000  
 NU( 83, 4) = 1 NU( 13, 4) = 1 Z2= 31.000  
 A1=153.000 Z1= 61.000 A2= 83.000  
 NU( 83, 3) = 1 NU( 13, 3) = 0 Z2= 30.000  
 A1=153.000 Z1= 62.000 A2= 83.000  
 NU( 83, 2) = 0 NU( 13, 2) = 1 Z2= 35.000  
 A1=152.000 Z1= 57.000 A2= 84.000  
 NU( 82, 6) = 1 NU( 14, 6) = 0 Z2= 34.000  
 A1=152.000 Z1= 58.000 A2= 84.000  
 NU( 82, 5) = 1 NU( 14, 5) = 0 Z2= 33.000  
 A1=152.000 Z1= 59.000 A2= 84.000  
 NU( 82, 4) = 1 NU( 14, 4) = 1 Z2= 32.000  
 A1=152.000 Z1= 60.000 A2= 84.000  
 NU( 82, 3) = 1 NU( 14, 3) = 0 Z2= 31.000  
 A1=152.000 Z1= 61.000 A2= 84.000  
 NU( 82, 2) = 1 NU( 14, 2) = 1 Z2= 36.000  
 A1=151.000 Z1= 56.000 A2= 85.000  
 NU( 81, 7) = 1 NU( 15, 7) = 0 Z2= 35.000  
 A1=151.000 Z1= 57.000 A2= 85.000  
 NU( 81, 6) = 2 NU( 15, 6) = 0 Z2= 34.000  
 A1=151.000 Z1= 58.000 A2= 85.000  
 NU( 81, 5) = 2 NU( 15, 5) = 1 Z2= 33.000  
 A1=151.000 Z1= 59.000 A2= 85.000  
 NU( 81, 4) = 2 NU( 15, 4) = 1 Z2= 32.000  
 A1=151.000 Z1= 60.000 A2= 85.000  
 NU( 81, 3) = 1 NU( 15, 3) = 1 Z2= 36.000  
 A1=150.000 Z1= 56.000 A2= 86.000  
 NU( 80, 7) = 1 NU( 16, 7) = 0 Z2= 35.000  
 A1=150.000 Z1= 57.000 A2= 86.000  
 NU( 80, 6) = 1 NU( 16, 6) = 1 Z2= 34.000  
 A1=150.000 Z1= 58.000 A2= 86.000  
 NU( 80, 5) = 2 NU( 16, 5) = 0 Z2= 33.000  
 A1=150.000 Z1= 59.000 A2= 86.000  
 NU( 80, 4) = 1 NU( 16, 4) = 1 Z2= 32.000  
 A1=150.000 Z1= 60.000 A2= 86.000  
 NU( 80, 3) = 1 NU( 16, 3) = 0 Z2= 31.000  
 A1=150.000 Z1= 61.000 A2= 86.000  
 NU( 80, 2) = 0 NU( 16, 2) = 1 Z2= 36.000  
 A1=149.000 Z1= 56.000 A2= 87.000  
 NU( 79, 7) = 1 NU( 17, 7) = 0 Z2= 35.000  
 A1=149.000 Z1= 57.000 A2= 87.000

NU( 79, 6)= 2 NU( 17, 6)= 0 Z2= 34.000  
 A1=149.000 Z1= 58.000 A2= 67.000  
 NU( 79, 5)= 1 NU( 17, 5)= 1 Z2= 33.000  
 A1=149.000 Z1= 59.000 A2= 67.000  
 NU( 79, 4)= 1 NU( 17, 4)= 1 Z2= 32.000  
 A1=149.000 Z1= 60.000 A2= 67.000  
 NU( 79, 3)= 1 NU( 17, 3)= 1 Z2= 37.000  
 A1=148.000 Z1= 55.000 A2= 68.000  
 NU( 78, 8)= 1 NU( 18, 8)= 0 Z2= 35.000  
 A1=148.000 Z1= 56.000 A2= 68.000  
 NU( 78, 7)= 2 NU( 18, 7)= 0 Z2= 35.000  
 A1=148.000 Z1= 57.000 A2= 68.000  
 NU( 78, 6)= 1 NU( 18, 6)= 1 Z2= 34.000  
 A1=148.000 Z1= 58.000 A2= 68.000  
 NU( 78, 5)= 1 NU( 18, 5)= 1 Z2= 33.000  
 A1=148.000 Z1= 59.000 A2= 68.000  
 NU( 78, 4)= 1 NU( 18, 4)= 1 Z2= 38.000  
 A1=147.000 Z1= 54.000 A2= 69.000  
 NU( 77, 7)= 1 NU( 19, 7)= 0 Z2= 37.000  
 A1=147.000 Z1= 55.000 A2= 69.000  
 NU( 77, 6)= 1 NU( 19, 6)= 0 Z2= 36.000  
 A1=147.000 Z1= 56.000 A2= 69.000  
 NU( 77, 5)= 2 NU( 19, 5)= 1 Z2= 35.000  
 A1=147.000 Z1= 57.000 A2= 69.000  
 NU( 77, 4)= 2 NU( 19, 4)= 1 Z2= 34.000  
 A1=147.000 Z1= 58.000 A2= 69.000  
 NU( 77, 3)= 1 NU( 19, 3)= 1 Z2= 33.000  
 A1=147.000 Z1= 59.000 A2= 69.000  
 NU( 77, 2)= 1 NU( 19, 2)= 0 Z2= 38.000  
 A1=146.000 Z1= 54.000 A2= 90.000  
 NU( 76, 7)= 1 NU( 20, 7)= 0 Z2= 37.000  
 A1=146.000 Z1= 55.000 A2= 90.000  
 NU( 76, 6)= 2 NU( 20, 6)= 1 Z2= 36.000  
 A1=146.000 Z1= 56.000 A2= 90.000  
 NU( 76, 5)= 1 NU( 20, 5)= 1 Z2= 35.000  
 A1=146.000 Z1= 57.000 A2= 90.000  
 NU( 76, 4)= 1 NU( 20, 4)= 1 Z2= 34.000  
 A1=146.000 Z1= 58.000 A2= 90.000  
 NU( 76, 3)= 1 NU( 20, 3)= 0 Z2= 33.000  
 A1=146.000 Z1= 59.000 A2= 90.000  
 NU( 76, 2)= 1 NU( 20, 2)= 1 Z2= 38.000  
 A1=145.000 Z1= 54.000 A2= 91.000  
 NU( 75, 9)= 1 NU( 21, 9)= 0 Z2= 37.000  
 A1=145.000 Z1= 55.000 A2= 91.000  
 NU( 75, 8)= 2 NU( 21, 8)= 0 Z2= 36.000  
 A1=145.000 Z1= 56.000 A2= 91.000  
 NU( 75, 7)= 1 NU( 21, 7)= 1 Z2= 35.000  
 A1=145.000 Z1= 57.000 A2= 91.000  
 NU( 75, 6)= 2 NU( 21, 6)= 1 Z2= 34.000  
 A1=145.000 Z1= 58.000 A2= 91.000

NU( 75, 5) = 1 NU( 21, 5) = 1 Z2 = 39.000  
 A1 = 144.000 Z1 = 53.000 A2 = 92.000  
 NU( 74, 6) = 1 NU( 22, 6) = 0 Z2 = 38.000  
 A1 = 144.000 Z1 = 54.000 A2 = 92.000  
 NU( 74, 7) = 2 NU( 22, 7) = 0 Z2 = 37.000  
 A1 = 144.000 Z1 = 55.000 A2 = 92.000  
 NU( 74, 6) = 2 NU( 22, 6) = 1 Z2 = 36.000  
 A1 = 144.000 Z1 = 56.000 A2 = 92.000  
 NU( 74, 5) = 1 NU( 22, 5) = 1 Z2 = 35.000  
 A1 = 144.000 Z1 = 57.000 A2 = 92.000  
 NU( 74, 4) = 1 NU( 22, 4) = 1 Z2 = 34.000  
 A1 = 144.000 Z1 = 58.000 A2 = 92.000  
 NU( 74, 3) = 1 NU( 22, 3) = 0 Z2 = 40.000  
 A1 = 143.000 Z1 = 52.000 A2 = 93.000  
 NU( 73, 9) = 1 NU( 23, 9) = 0 Z2 = 39.000  
 A1 = 143.000 Z1 = 53.000 A2 = 93.000  
 NU( 73, 8) = 2 NU( 23, 8) = 0 Z2 = 38.000  
 A1 = 143.000 Z1 = 54.000 A2 = 93.000  
 NU( 73, 7) = 1 NU( 23, 7) = 1 Z2 = 37.000  
 A1 = 143.000 Z1 = 55.000 A2 = 93.000  
 NU( 73, 6) = 1 NU( 23, 6) = 1 Z2 = 36.000  
 A1 = 143.000 Z1 = 56.000 A2 = 93.000  
 NU( 73, 5) = 1 NU( 23, 5) = 1 Z2 = 35.000  
 A1 = 143.000 Z1 = 57.000 A2 = 93.000  
 NU( 73, 4) = 1 NU( 23, 4) = 1 Z2 = 34.000  
 A1 = 143.000 Z1 = 58.000 A2 = 93.000  
 NU( 73, 3) = 1 NU( 23, 3) = 1 Z2 = 40.000  
 A1 = 142.000 Z1 = 52.000 A2 = 94.000  
 NU( 72, 8) = 1 NU( 24, 8) = 0 Z2 = 39.000  
 A1 = 142.000 Z1 = 53.000 A2 = 94.000  
 NU( 72, 7) = 1 NU( 24, 7) = 1 Z2 = 38.000  
 A1 = 142.000 Z1 = 54.000 A2 = 94.000  
 NU( 72, 6) = 2 NU( 24, 6) = 1 Z2 = 37.000  
 A1 = 142.000 Z1 = 55.000 A2 = 94.000  
 NU( 72, 5) = 1 NU( 24, 5) = 1 Z2 = 36.000  
 A1 = 142.000 Z1 = 56.000 A2 = 94.000  
 NU( 72, 4) = 1 NU( 24, 4) = 1 Z2 = 35.000  
 A1 = 142.000 Z1 = 57.000 A2 = 94.000  
 NU( 72, 3) = 1 NU( 24, 3) = 1 Z2 = 40.000  
 A1 = 141.000 Z1 = 52.000 A2 = 95.000  
 NU( 71, 7) = 1 NU( 25, 7) = 0 Z2 = 39.000  
 A1 = 141.000 Z1 = 53.000 A2 = 95.000  
 NU( 71, 6) = 2 NU( 25, 6) = 0 Z2 = 38.000  
 A1 = 141.000 Z1 = 54.000 A2 = 95.000  
 NU( 71, 5) = 1 NU( 25, 5) = 1 Z2 = 37.000  
 A1 = 141.000 Z1 = 55.000 A2 = 95.000  
 NU( 71, 4) = 1 NU( 25, 4) = 1 Z2 = 36.000  
 A1 = 141.000 Z1 = 56.000 A2 = 95.000  
 NU( 71, 3) = 1 NU( 25, 3) = 1 Z2 = 35.000  
 A1 = 141.000 Z1 = 57.000 A2 = 95.000

NU( 71, 2)= 1 NU( 25, 2)= 0  
 A1=140.000 Z1= 51.000 A2= 96.000 Z2= 41.000  
 NU( 70, 7)= 1 NU( 26, 7)= 0  
 A1=140.000 Z1= 52.000 A2= 96.000 Z2= 40.000  
 NU( 70, 6)= 2 NU( 26, 6)= 0  
 A1=140.000 Z1= 53.000 A2= 96.000 Z2= 39.000  
 NU( 70, 5)= 2 NU( 26, 5)= 1  
 A1=140.000 Z1= 54.000 A2= 96.000 Z2= 38.000  
 NU( 70, 4)= 2 NU( 26, 4)= 1  
 A1=140.000 Z1= 55.000 A2= 96.000 Z2= 37.000  
 NU( 70, 3)= 2 NU( 26, 3)= 1  
 A1=140.000 Z1= 56.000 A2= 96.000 Z2= 36.000  
 NU( 70, 2)= 1 NU( 26, 2)= 1  
 A1=140.000 Z1= 57.000 A2= 96.000 Z2= 35.000  
 NU( 70, 1)= 0 NU( 26, 1)= 1  
 A1=139.000 Z1= 51.000 A2= 97.000 Z2= 41.000  
 NU( 69, 7)= 1 NU( 27, 7)= 0  
 A1=139.000 Z1= 52.000 A2= 97.000 Z2= 40.000  
 NU( 69, 6)= 2 NU( 27, 6)= 1  
 A1=139.000 Z1= 53.000 A2= 97.000 Z2= 39.000  
 NU( 69, 5)= 2 NU( 27, 5)= 1  
 A1=139.000 Z1= 54.000 A2= 97.000 Z2= 38.000  
 NU( 69, 4)= 1 NU( 27, 4)= 1  
 A1=139.000 Z1= 55.000 A2= 97.000 Z2= 37.000  
 NU( 69, 3)= 1 NU( 27, 3)= 1  
 A1=139.000 Z1= 56.000 A2= 97.000 Z2= 36.000  
 NU( 69, 2)= 1 NU( 27, 2)= 1  
 A1=138.000 Z1= 51.000 A2= 98.000 Z2= 41.000  
 NU( 68, 8)= 1 NU( 28, 8)= 1  
 A1=138.000 Z1= 52.000 A2= 98.000 Z2= 40.000  
 NU( 68, 7)= 2 NU( 28, 7)= 1  
 A1=138.000 Z1= 53.000 A2= 98.000 Z2= 39.000  
 NU( 68, 6)= 2 NU( 28, 6)= 1  
 A1=138.000 Z1= 54.000 A2= 98.000 Z2= 38.000  
 NU( 68, 5)= 1 NU( 28, 5)= 1  
 A1=138.000 Z1= 55.000 A2= 98.000 Z2= 37.000  
 NU( 68, 4)= 1 NU( 28, 4)= 1  
 A1=138.000 Z1= 56.000 A2= 98.000 Z2= 36.000  
 NU( 68, 3)= 0 NU( 28, 3)= 1  
 A1=137.000 Z1= 50.000 A2= 99.000 Z2= 42.000  
 NU( 67, 7)= 1 NU( 29, 7)= 0  
 A1=137.000 Z1= 51.000 A2= 99.000 Z2= 41.000  
 NU( 67, 6)= 2 NU( 29, 6)= 0  
 A1=137.000 Z1= 52.000 A2= 99.000 Z2= 40.000  
 NU( 67, 5)= 2 NU( 29, 5)= 1  
 A1=137.000 Z1= 53.000 A2= 99.000 Z2= 39.000  
 NU( 67, 4)= 2 NU( 29, 4)= 1  
 A1=137.000 Z1= 54.000 A2= 99.000 Z2= 38.000  
 NU( 67, 3)= 1 NU( 29, 3)= 1  
 A1=137.000 Z1= 55.000 A2= 99.000 Z2= 37.000

NU( 67, 2)= 1 MU( 29, 2)= 1  
 A1=137.000 Z1= 56.000 A2= 99.000 Z2= 36.000  
 NU( 67, 1)= 0 MU( 29, 1)= 1  
 A1=136.000 Z1= 50.000 A2=100.000 Z2= 42.000  
 NU( 66, 9)= 1 MU( 30, 9)= 0  
 A1=136.000 Z1= 51.000 A2=100.000 Z2= 41.000  
 NU( 66, 8)= 2 MU( 30, 8)= 1  
 A1=136.000 Z1= 52.000 A2=100.000 Z2= 40.000  
 NU( 66, 7)= 2 MU( 30, 7)= 1  
 A1=136.000 Z1= 53.000 A2=100.000 Z2= 39.000  
 NU( 66, 6)= 2 MU( 30, 6)= 1  
 A1=136.000 Z1= 54.000 A2=100.000 Z2= 38.000  
 NU( 66, 5)= 1 MU( 30, 5)= 1  
 A1=136.000 Z1= 55.000 A2=100.000 Z2= 37.000  
 NU( 66, 4)= 1 MU( 30, 4)= 1  
 A1=135.000 Z1= 50.000 A2=101.000 Z2= 42.000  
 NU( 65, 7)= 2 MU( 31, 7)= 1  
 A1=135.000 Z1= 51.000 A2=101.000 Z2= 41.000  
 NU( 65, 6)= 2 MU( 31, 6)= 1  
 A1=135.000 Z1= 52.000 A2=101.000 Z2= 40.000  
 NU( 65, 5)= 2 MU( 31, 5)= 1  
 A1=135.000 Z1= 53.000 A2=101.000 Z2= 39.000  
 NU( 65, 4)= 1 MU( 31, 4)= 1  
 A1=135.000 Z1= 54.000 A2=101.000 Z2= 38.000  
 NU( 65, 3)= 1 MU( 31, 3)= 1  
 A1=135.000 Z1= 55.000 A2=101.000 Z2= 37.000  
 NU( 65, 2)= 0 MU( 31, 2)= 1  
 A1=134.000 Z1= 49.000 A2=102.000 Z2= 43.000  
 NU( 64, 8)= 1 MU( 32, 8)= 0  
 A1=134.000 Z1= 50.000 A2=102.000 Z2= 42.000  
 NU( 64, 7)= 2 MU( 32, 7)= 1  
 A1=134.000 Z1= 51.000 A2=102.000 Z2= 41.000  
 NU( 64, 6)= 1 MU( 32, 6)= 1  
 A1=134.000 Z1= 52.000 A2=102.000 Z2= 40.000  
 NU( 64, 5)= 2 MU( 32, 5)= 1  
 A1=134.000 Z1= 53.000 A2=102.000 Z2= 39.000  
 NU( 64, 4)= 1 MU( 32, 4)= 1  
 A1=134.000 Z1= 54.000 A2=102.000 Z2= 38.000  
 NU( 64, 3)= 1 MU( 32, 3)= 1  
 A1=134.000 Z1= 55.000 A2=102.000 Z2= 37.000  
 NU( 64, 2)= 0 MU( 32, 2)= 1  
 A1=133.000 Z1= 49.000 A2=103.000 Z2= 43.000  
 NU( 63, 7)= 1 MU( 33, 7)= 0  
 A1=133.000 Z1= 50.000 A2=103.000 Z2= 42.000  
 NU( 63, 6)= 1 MU( 33, 6)= 1  
 A1=133.000 Z1= 51.000 A2=103.000 Z2= 41.000  
 NU( 63, 5)= 2 MU( 33, 5)= 2  
 A1=133.000 Z1= 52.000 A2=103.000 Z2= 40.000  
 NU( 63, 4)= 2 MU( 33, 4)= 1  
 A1=133.000 Z1= 53.000 A2=103.000 Z2= 39.000

NU( 63, 3)= 1 NU( 33, 3)= 2  
 A1=133.000 Z1= 54.000 A2=103.000 Z2= 38.000  
 NU( 63, 2)= 1 NU( 33, 2)= 1  
 A1=132.000 Z1= 49.000 A2=104.000 Z2= 43.000  
 NU( 62, 8)= 1 NU( 34, 8)= 1  
 A1=132.000 Z1= 50.000 A2=104.000 Z2= 42.000  
 NU( 62, 7)= 2 NU( 34, 7)= 1  
 A1=132.000 Z1= 51.000 A2=104.000 Z2= 41.000  
 NU( 62, 6)= 2 NU( 34, 6)= 1  
 A1=132.000 Z1= 52.000 A2=104.000 Z2= 40.000  
 NU( 62, 5)= 2 NU( 34, 5)= 1  
 A1=132.000 Z1= 53.000 A2=104.000 Z2= 39.000  
 NU( 62, 4)= 1 NU( 34, 4)= 1  
 A1=132.000 Z1= 54.000 A2=104.000 Z2= 38.000  
 NU( 62, 3)= 0 NU( 34, 3)= 1  
 A1=131.000 Z1= 48.000 A2=105.000 Z2= 44.000  
 NU( 61, 7)= 1 NU( 35, 7)= 0  
 A1=131.000 Z1= 49.000 A2=105.000 Z2= 43.000  
 NU( 61, 6)= 1 NU( 35, 6)= 1  
 A1=131.000 Z1= 50.000 A2=105.000 Z2= 42.000  
 NU( 61, 5)= 1 NU( 35, 5)= 1  
 A1=131.000 Z1= 51.000 A2=105.000 Z2= 41.000  
 NU( 61, 4)= 2 NU( 35, 4)= 2  
 A1=131.000 Z1= 52.000 A2=105.000 Z2= 40.000  
 NU( 61, 3)= 1 NU( 35, 3)= 2  
 A1=131.000 Z1= 53.000 A2=105.000 Z2= 39.000  
 NU( 61, 2)= 1 NU( 35, 2)= 1  
 A1=131.000 Z1= 54.000 A2=105.000 Z2= 38.000  
 NU( 61, 1)= 0 NU( 35, 1)= 1  
 A1=130.000 Z1= 48.000 A2=106.000 Z2= 44.000  
 NU( 60, 9)= 1 NU( 36, 9)= 0  
 A1=130.000 Z1= 49.000 A2=106.000 Z2= 43.000  
 NU( 60, 8)= 1 NU( 36, 8)= 1  
 A1=130.000 Z1= 50.000 A2=106.000 Z2= 42.000  
 NU( 60, 7)= 2 NU( 36, 7)= 1  
 A1=130.000 Z1= 51.000 A2=106.000 Z2= 41.000  
 NU( 60, 6)= 1 NU( 36, 6)= 1  
 A1=130.000 Z1= 52.000 A2=106.000 Z2= 40.000  
 NU( 60, 5)= 1 NU( 36, 5)= 1  
 A1=130.000 Z1= 53.000 A2=106.000 Z2= 39.000  
 NU( 60, 4)= 1 NU( 36, 4)= 1  
 A1=129.000 Z1= 48.000 A2=107.000 Z2= 44.000  
 NU( 59, 7)= 1 NU( 37, 7)= 1  
 A1=129.000 Z1= 49.000 A2=107.000 Z2= 43.000  
 NU( 59, 6)= 1 NU( 37, 6)= 1  
 A1=129.000 Z1= 50.000 A2=107.000 Z2= 42.000  
 NU( 59, 5)= 2 NU( 37, 5)= 1  
 A1=129.000 Z1= 51.000 A2=107.000 Z2= 41.000  
 NU( 59, 4)= 1 NU( 37, 4)= 2  
 A1=129.000 Z1= 52.000 A2=107.000 Z2= 40.000

NU( 59, 3) = 1 NU( 37, 3) = 1 Z2 = 39.000  
 A1=129.000 Z1= 53.000 A2=107.000  
 NU( 59, 2) = 0 NU( 37, 2) = 1 Z2 = 45.000  
 A1=128.000 Z1= 47.000 A2=108.000  
 NU( 58, 8) = 1 NU( 38, 8) = 0 Z2 = 44.000  
 A1=128.000 Z1= 48.000 A2=108.000  
 NU( 58, 7) = 1 NU( 38, 7) = 1 Z2 = 43.000  
 A1=128.000 Z1= 49.000 A2=108.000  
 NU( 58, 6) = 1 NU( 38, 6) = 1 Z2 = 42.000  
 A1=128.000 Z1= 50.000 A2=108.000  
 NU( 58, 5) = 1 NU( 38, 5) = 1 Z2 = 41.000  
 A1=128.000 Z1= 51.000 A2=108.000  
 NU( 58, 4) = 1 NU( 38, 4) = 1 Z2 = 40.000  
 A1=128.000 Z1= 52.000 A2=108.000  
 NU( 58, 3) = 1 NU( 38, 3) = 1 Z2 = 39.000  
 A1=128.000 Z1= 53.000 A2=108.000  
 NU( 58, 2) = 0 NU( 38, 2) = 1 Z2 = 45.000  
 A1=127.000 Z1= 47.000 A2=109.000  
 NU( 57, 7) = 1 NU( 39, 7) = 0 Z2 = 44.000  
 A1=127.000 Z1= 48.000 A2=109.000  
 NU( 57, 6) = 1 NU( 39, 6) = 1 Z2 = 43.000  
 A1=127.000 Z1= 49.000 A2=109.000  
 NU( 57, 5) = 1 NU( 39, 5) = 1 Z2 = 42.000  
 A1=127.000 Z1= 50.000 A2=109.000  
 NU( 57, 4) = 1 NU( 39, 4) = 1 Z2 = 41.000  
 A1=127.000 Z1= 51.000 A2=109.000  
 NU( 57, 3) = 1 NU( 39, 3) = 1 Z2 = 40.000  
 A1=127.000 Z1= 52.000 A2=109.000  
 NU( 57, 2) = 1 NU( 39, 2) = 1 Z2 = 45.000  
 A1=126.000 Z1= 47.000 A2=110.000  
 NU( 56, 8) = 1 NU( 40, 8) = 1 Z2 = 44.000  
 A1=126.000 Z1= 48.000 A2=110.000  
 NU( 56, 7) = 1 NU( 40, 7) = 1 Z2 = 43.000  
 A1=126.000 Z1= 49.000 A2=110.000  
 NU( 56, 6) = 1 NU( 40, 6) = 1 Z2 = 42.000  
 A1=126.000 Z1= 50.000 A2=110.000  
 NU( 56, 5) = 1 NU( 40, 5) = 2 Z2 = 41.000  
 A1=126.000 Z1= 51.000 A2=110.000  
 NU( 56, 4) = 1 NU( 40, 4) = 1 Z2 = 40.000  
 A1=126.000 Z1= 52.000 A2=110.000  
 NU( 56, 3) = 0 NU( 40, 3) = 1 Z2 = 46.000  
 A1=125.000 Z1= 46.000 A2=111.000  
 NU( 55, 7) = 1 NU( 41, 7) = 0 Z2 = 45.000  
 A1=125.000 Z1= 47.000 A2=111.000  
 NU( 55, 6) = 1 NU( 41, 6) = 0 Z2 = 44.000  
 A1=125.000 Z1= 48.000 A2=111.000  
 NU( 55, 5) = 1 NU( 41, 5) = 1 Z2 = 43.000  
 A1=125.000 Z1= 49.000 A2=111.000  
 NU( 55, 4) = 2 NU( 41, 4) = 1 Z2 = 42.000  
 A1=125.000 Z1= 50.000 A2=111.000

NU( 55, 3) = 1 NU( 41, 3) = 1 Z2 = 41.000  
 A1=125.000 Z1= 51.000 A2=111.000  
 NU( 55, 2) = 1 NU( 41, 2) = 2 Z2 = 40.000  
 A1=125.000 Z1= 52.000 A2=111.000  
 NU( 55, 1) = 0 NU( 41, 1) = 1 Z2 = 46.000  
 A1=124.000 Z1= 46.000 A2=112.000  
 NU( 54, 9) = 1 NU( 42, 9) = 0 Z2 = 45.000  
 A1=124.000 Z1= 47.000 A2=112.000  
 NU( 54, 8) = 1 NU( 42, 8) = 1 Z2 = 44.000  
 A1=124.000 Z1= 48.000 A2=112.000  
 NU( 54, 7) = 1 NU( 42, 7) = 1 Z2 = 43.000  
 A1=124.000 Z1= 49.000 A2=112.000  
 NU( 54, 6) = 1 NU( 42, 6) = 1 Z2 = 42.000  
 A1=124.000 Z1= 50.000 A2=112.000  
 NU( 54, 5) = 1 NU( 42, 5) = 1 Z2 = 41.000  
 A1=124.000 Z1= 51.000 A2=112.000  
 NU( 54, 4) = 1 NU( 42, 4) = 1 Z2 = 46.000  
 A1=123.000 Z1= 46.000 A2=113.000  
 NU( 53, 7) = 1 NU( 43, 7) = 1 Z2 = 45.000  
 A1=123.000 Z1= 47.000 A2=113.000  
 NU( 53, 6) = 1 NU( 43, 6) = 1 Z2 = 44.000  
 A1=123.000 Z1= 48.000 A2=113.000  
 NU( 53, 5) = 1 NU( 43, 5) = 1 Z2 = 43.000  
 A1=123.000 Z1= 49.000 A2=113.000  
 NU( 53, 4) = 1 NU( 43, 4) = 1 Z2 = 42.000  
 A1=123.000 Z1= 50.000 A2=113.000  
 NU( 53, 3) = 1 NU( 43, 3) = 1 Z2 = 41.000  
 A1=123.000 Z1= 51.000 A2=113.000  
 NU( 53, 2) = 0 NU( 43, 2) = 1 Z2 = 47.000  
 A1=122.000 Z1= 45.000 A2=114.000  
 NU( 52, 8) = 1 NU( 44, 8) = 0 Z2 = 46.000  
 A1=122.000 Z1= 46.000 A2=114.000  
 NU( 52, 7) = 1 NU( 44, 7) = 1 Z2 = 45.000  
 A1=122.000 Z1= 47.000 A2=114.000  
 NU( 52, 6) = 1 NU( 44, 6) = 1 Z2 = 44.000  
 A1=122.000 Z1= 48.000 A2=114.000  
 NU( 52, 5) = 1 NU( 44, 5) = 1 Z2 = 43.000  
 A1=122.000 Z1= 49.000 A2=114.000  
 NU( 52, 4) = 1 NU( 44, 4) = 1 Z2 = 42.000  
 A1=122.000 Z1= 50.000 A2=114.000  
 NU( 52, 3) = 0 NU( 44, 3) = 1 Z2 = 41.000  
 A1=122.000 Z1= 51.000 A2=114.000  
 NU( 52, 2) = 0 NU( 44, 2) = 1 Z2 = 48.000  
 A1=121.000 Z1= 44.000 A2=115.000  
 NU( 51, 8) = 1 NU( 45, 8) = 0 Z2 = 47.000  
 A1=121.000 Z1= 45.000 A2=115.000  
 NU( 51, 7) = 1 NU( 45, 7) = 0 Z2 = 46.000  
 A1=121.000 Z1= 46.000 A2=115.000  
 NU( 51, 6) = 1 NU( 45, 6) = 1 Z2 = 45.000  
 A1=121.000 Z1= 47.000 A2=115.000



NU( 51, 5)= 1 NU( 45, 5)= 1  
 A1=121.000 Z1= 48.000 A2=115.000 Z2= 44.000  
 NU( 51, 4)= 1 NU( 45, 4)= 1  
 A1=121.000 Z1= 49.000 A2=115.000 Z2= 43.000  
 NU( 51, 3)= 1 NU( 45, 3)= 1  
 A1=121.000 Z1= 50.000 A2=115.000 Z2= 42.000  
 NU( 51, 2)= 0 NU( 45, 2)= 1  
 A1=120.000 Z1= 45.000 A2=116.000 Z2= 47.000  
 NU( 50, 8)= 1 NU( 46, 8)= 1  
 A1=120.000 Z1= 46.000 A2=116.000 Z2= 46.000  
 NU( 50, 7)= 1 NU( 46, 7)= 1  
 A1=120.000 Z1= 47.000 A2=116.000 Z2= 45.000  
 NU( 50, 6)= 1 NU( 46, 6)= 1  
 A1=120.000 Z1= 48.000 A2=116.000 Z2= 44.000  
 NU( 50, 5)= 1 NU( 46, 5)= 1  
 A1=120.000 Z1= 49.000 A2=116.000 Z2= 43.000  
 NU( 50, 4)= 1 NU( 46, 4)= 1  
 A1=119.000 Z1= 44.000 A2=117.000 Z2= 48.000  
 NU( 49, 7)= 1 NU( 47, 7)= 0  
 A1=119.000 Z1= 45.000 A2=117.000 Z2= 47.000  
 NU( 49, 6)= 1 NU( 47, 6)= 1  
 A1=119.000 Z1= 46.000 A2=117.000 Z2= 46.000  
 NU( 49, 5)= 1 NU( 47, 5)= 1  
 A1=119.000 Z1= 47.000 A2=117.000 Z2= 45.000  
 NU( 49, 4)= 1 NU( 47, 4)= 1  
 A1=119.000 Z1= 48.000 A2=117.000 Z2= 44.000  
 NU( 49, 3)= 1 NU( 47, 3)= 1  
 A1=119.000 Z1= 49.000 A2=117.000 Z2= 43.000  
 NU( 49, 2)= 0 NU( 47, 2)= 1  
 A1=118.000 Z1= 43.000 A2=118.000 Z2= 49.000  
 NU( 48, 8)= 1 NU( 48, 8)= 1  
 A1=118.000 Z1= 44.000 A2=118.000 Z2= 48.000  
 NU( 48, 7)= 1 NU( 48, 7)= 1  
 A1=118.000 Z1= 45.000 A2=118.000 Z2= 47.000  
 NU( 48, 6)= 2 NU( 48, 6)= 2  
 A1=118.000 Z1= 46.000 A2=118.000 Z2= 46.000  
 NU( 48, 5)= 2 NU( 48, 5)= 2  
 A1=118.000 Z1= 47.000 A2=118.000 Z2= 45.000  
 NU( 48, 4)= 2 NU( 48, 4)= 2  
 A1=118.000 Z1= 48.000 A2=118.000 Z2= 44.000  
 NU( 48, 3)= 1 NU( 48, 3)= 1  
 A1=118.000 Z1= 49.000 A2=118.000 Z2= 43.000  
 NU( 48, 2)= 1 NU( 48, 2)= 1  
 A1=117.000 Z1= 43.000 A2=119.000 Z2= 49.000  
 NU( 47, 8)= 1 NU( 49, 8)= 0  
 A1=117.000 Z1= 44.000 A2=119.000 Z2= 48.000  
 NU( 47, 7)= 1 NU( 49, 7)= 1  
 A1=117.000 Z1= 45.000 A2=119.000 Z2= 47.000  
 NU( 47, 6)= 1 NU( 49, 6)= 1  
 A1=117.000 Z1= 46.000 A2=119.000 Z2= 46.000

NU( 47, 5)= 1 MU( 49, 5)= 1  
 A1=117.000 Z1= 47.000 A2=119.000 Z2= 45.000  
 NU( 47, 4)= 1 MU( 49, 4)= 1  
 A1=117.000 Z1= 48.000 A2=119.000 Z2= 44.000  
 NU( 47, 3)= 0 MU( 49, 3)= 1  
 A1=116.000 Z1= 43.000 A2=120.000 Z2= 49.000  
 NU( 46, 8)= 1 MU( 50, 8)= 1  
 A1=116.000 Z1= 44.000 A2=120.000 Z2= 48.000  
 NU( 46, 7)= 1 MU( 50, 7)= 1  
 A1=116.000 Z1= 45.000 A2=120.000 Z2= 47.000  
 NU( 46, 6)= 1 MU( 50, 6)= 1  
 A1=116.000 Z1= 46.000 A2=120.000 Z2= 46.000  
 NU( 46, 5)= 1 MU( 50, 5)= 1  
 A1=116.000 Z1= 47.000 A2=120.000 Z2= 45.000  
 NU( 46, 4)= 1 MU( 50, 4)= 1  
 A1=115.000 Z1= 42.000 A2=121.000 Z2= 50.000  
 NU( 45, 9)= 1 MU( 51, 9)= 0  
 A1=115.000 Z1= 43.000 A2=121.000 Z2= 49.000  
 NU( 45, 8)= 1 MU( 51, 8)= 1  
 A1=115.000 Z1= 44.000 A2=121.000 Z2= 48.000  
 NU( 45, 7)= 1 MU( 51, 7)= 1  
 A1=115.000 Z1= 45.000 A2=121.000 Z2= 47.000  
 NU( 45, 6)= 1 MU( 51, 6)= 1  
 A1=115.000 Z1= 46.000 A2=121.000 Z2= 46.000  
 NU( 45, 5)= 1 MU( 51, 5)= 1  
 A1=115.000 Z1= 47.000 A2=121.000 Z2= 45.000  
 NU( 45, 4)= 0 MU( 51, 4)= 1  
 A1=115.000 Z1= 48.000 A2=121.000 Z2= 44.000  
 NU( 45, 3)= 0 MU( 51, 3)= 1  
 A1=114.000 Z1= 41.000 A2=122.000 Z2= 51.000  
 NU( 44, 10)= 1 MU( 52, 10)= 0  
 A1=114.000 Z1= 42.000 A2=122.000 Z2= 50.000  
 NU( 44, 9)= 1 MU( 52, 9)= 0  
 A1=114.000 Z1= 43.000 A2=122.000 Z2= 49.000  
 NU( 44, 8)= 1 MU( 52, 8)= 1  
 A1=114.000 Z1= 44.000 A2=122.000 Z2= 48.000  
 NU( 44, 7)= 1 MU( 52, 7)= 1  
 A1=114.000 Z1= 45.000 A2=122.000 Z2= 47.000  
 NU( 44, 6)= 1 MU( 52, 6)= 1  
 A1=114.000 Z1= 46.000 A2=122.000 Z2= 46.000  
 NU( 44, 5)= 1 MU( 52, 5)= 1  
 A1=114.000 Z1= 47.000 A2=122.000 Z2= 45.000  
 NU( 44, 4)= 0 MU( 52, 4)= 1  
 A1=113.000 Z1= 41.000 A2=123.000 Z2= 51.000  
 NU( 43, 9)= 1 MU( 53, 9)= 0  
 A1=113.000 Z1= 42.000 A2=123.000 Z2= 50.000  
 NU( 43, 8)= 1 MU( 53, 8)= 1  
 A1=113.000 Z1= 43.000 A2=123.000 Z2= 49.000  
 NU( 43, 7)= 1 MU( 53, 7)= 1  
 A1=113.000 Z1= 44.000 A2=123.000 Z2= 48.000

NU( 43, 6)= 1 NU( 53, 6)= 1  
 A1=113.000 Z1= 45.000 A2=123.000 Z2= 47.000  
 NU( 43, 5)= 1 NU( 53, 5)= 1  
 A1=113.000 Z1= 46.000 A2=123.000 Z2= 46.000  
 NU( 43, 4)= 1 NU( 53, 4)= 1  
 A1=112.000 Z1= 41.000 A2=124.000 Z2= 51.000  
 NU( 42, 10)= 1 NU( 54, 10)= 1  
 A1=112.000 Z1= 42.000 A2=124.000 Z2= 50.000  
 NU( 42, 9)= 1 NU( 54, 9)= 1  
 A1=112.000 Z1= 43.000 A2=124.000 Z2= 49.000  
 NU( 42, 8)= 1 NU( 54, 8)= 1  
 A1=112.000 Z1= 44.000 A2=124.000 Z2= 48.000  
 NU( 42, 7)= 1 NU( 54, 7)= 1  
 A1=112.000 Z1= 45.000 A2=124.000 Z2= 47.000  
 NU( 42, 6)= 1 NU( 54, 6)= 1  
 A1=112.000 Z1= 46.000 A2=124.000 Z2= 46.000  
 NU( 42, 5)= 0 NU( 54, 5)= 1  
 A1=111.000 Z1= 40.000 A2=125.000 Z2= 52.000  
 NU( 41, 9)= 1 NU( 55, 9)= 0  
 A1=111.000 Z1= 41.000 A2=125.000 Z2= 51.000  
 NU( 41, 8)= 1 NU( 55, 8)= 1  
 A1=111.000 Z1= 42.000 A2=125.000 Z2= 50.000  
 NU( 41, 7)= 1 NU( 55, 7)= 1  
 A1=111.000 Z1= 43.000 A2=125.000 Z2= 49.000  
 NU( 41, 6)= 1 NU( 55, 6)= 1  
 A1=111.000 Z1= 44.000 A2=125.000 Z2= 48.000  
 NU( 41, 5)= 1 NU( 55, 5)= 1  
 A1=111.000 Z1= 45.000 A2=125.000 Z2= 47.000  
 NU( 41, 4)= 0 NU( 55, 4)= 1  
 A1=111.000 Z1= 46.000 A2=125.000 Z2= 46.000  
 NU( 41, 3)= 0 NU( 55, 3)= 1  
 A1=110.000 Z1= 40.000 A2=126.000 Z2= 52.000  
 NU( 40, 9)= 1 NU( 56, 9)= 0  
 A1=110.000 Z1= 41.000 A2=126.000 Z2= 51.000  
 NU( 40, 8)= 1 NU( 56, 8)= 1  
 A1=110.000 Z1= 42.000 A2=126.000 Z2= 50.000  
 NU( 40, 7)= 1 NU( 56, 7)= 1  
 A1=110.000 Z1= 43.000 A2=126.000 Z2= 49.000  
 NU( 40, 6)= 1 NU( 56, 6)= 2  
 A1=110.000 Z1= 44.000 A2=126.000 Z2= 48.000  
 NU( 40, 5)= 1 NU( 56, 5)= 1  
 A1=110.000 Z1= 45.000 A2=126.000 Z2= 47.000  
 NU( 40, 4)= 1 NU( 56, 4)= 1  
 A1=109.000 Z1= 40.000 A2=127.000 Z2= 52.000  
 NU( 39, 8)= 1 NU( 57, 8)= 1  
 A1=109.000 Z1= 41.000 A2=127.000 Z2= 51.000  
 NU( 39, 7)= 2 NU( 57, 7)= 1  
 A1=109.000 Z1= 42.000 A2=127.000 Z2= 50.000  
 NU( 39, 6)= 1 NU( 57, 6)= 1  
 A1=109.000 Z1= 43.000 A2=127.000 Z2= 49.000

NU( 39, 5) = 2 NU( 57, 5) = 1 Z2 = 48.000  
 A1=109.000 Z1= 44.000 A2=127.000  
 NU( 39, 4) = 1 NU( 57, 4) = 1 Z2 = 47.000  
 A1=109.000 Z1= 45.000 A2=127.000  
 NU( 39, 3) = 0 NU( 57, 3) = 1 Z2 = 53.000  
 A1=108.000 Z1= 39.000 A2=128.000  
 NU( 38, 10) = 1 NU( 58, 10) = 0 Z2 = 52.000  
 A1=108.000 Z1= 40.000 A2=128.000  
 NU( 38, 9) = 1 NU( 58, 9) = 1 Z2 = 51.000  
 A1=108.000 Z1= 41.000 A2=128.000  
 NU( 38, 8) = 2 NU( 58, 8) = 1 Z2 = 50.000  
 A1=108.000 Z1= 42.000 A2=128.000  
 NU( 38, 7) = 1 NU( 58, 7) = 1 Z2 = 49.000  
 A1=108.000 Z1= 43.000 A2=128.000  
 NU( 38, 6) = 1 NU( 58, 6) = 1 Z2 = 48.000  
 A1=108.000 Z1= 44.000 A2=128.000  
 NU( 38, 5) = 1 NU( 58, 5) = 1 Z2 = 47.000  
 A1=108.000 Z1= 45.000 A2=128.000  
 NU( 38, 4) = 0 NU( 58, 4) = 1 Z2 = 53.000  
 A1=107.000 Z1= 39.000 A2=129.000  
 NU( 37, 9) = 1 NU( 59, 9) = 0 Z2 = 52.000  
 A1=107.000 Z1= 40.000 A2=129.000  
 NU( 37, 8) = 1 NU( 59, 8) = 1 Z2 = 51.000  
 A1=107.000 Z1= 41.000 A2=129.000  
 NU( 37, 7) = 2 NU( 59, 7) = 2 Z2 = 50.000  
 A1=107.000 Z1= 42.000 A2=129.000  
 NU( 37, 6) = 1 NU( 59, 6) = 1 Z2 = 49.000  
 A1=107.000 Z1= 43.000 A2=129.000  
 NU( 37, 5) = 1 NU( 59, 5) = 1 Z2 = 48.000  
 A1=107.000 Z1= 44.000 A2=129.000  
 NU( 37, 4) = 1 NU( 59, 4) = 1 Z2 = 53.000  
 A1=106.000 Z1= 39.000 A2=130.000  
 NU( 36, 10) = 1 NU( 60, 10) = 1 Z2 = 52.000  
 A1=106.000 Z1= 40.000 A2=130.000  
 NU( 36, 9) = 1 NU( 60, 9) = 1 Z2 = 51.000  
 A1=106.000 Z1= 41.000 A2=130.000  
 NU( 36, 8) = 1 NU( 60, 8) = 1 Z2 = 50.000  
 A1=106.000 Z1= 42.000 A2=130.000  
 NU( 36, 7) = 1 NU( 60, 7) = 1 Z2 = 49.000  
 A1=106.000 Z1= 43.000 A2=130.000  
 NU( 36, 6) = 1 NU( 60, 6) = 2 Z2 = 48.000  
 A1=106.000 Z1= 44.000 A2=130.000  
 NU( 36, 5) = 0 NU( 60, 5) = 1 Z2 = 54.000  
 A1=105.000 Z1= 38.000 A2=131.000  
 NU( 35, 9) = 1 NU( 61, 9) = 0 Z2 = 53.000  
 A1=105.000 Z1= 39.000 A2=131.000  
 NU( 35, 8) = 1 NU( 61, 8) = 1 Z2 = 52.000  
 A1=105.000 Z1= 40.000 A2=131.000  
 NU( 35, 7) = 1 NU( 61, 7) = 1 Z2 = 51.000  
 A1=105.000 Z1= 41.000 A2=131.000

NU( 35, 6)= 1 MU( 61, 6)= 1 Z1= 42.000 A2=131.000 Z2= 50.000  
 A1=105.000 Z1= 1 MU( 61, 5)= 2 Z2= 49.000  
 NU( 35, 5)= 1 MU( 61, 5)= 2 Z2= 49.000  
 A1=105.000 Z1= 43.000 A2=131.000 Z2= 48.000  
 NU( 35, 4)= 1 MU( 61, 4)= 2 Z2= 48.000  
 A1=105.000 Z1= 44.000 A2=131.000 Z2= 48.000  
 NU( 35, 3)= 0 MU( 61, 3)= 1 Z2= 54.000  
 A1=104.000 Z1= 38.000 A2=132.000 Z2= 53.000  
 NU( 34, 9)= 1 MU( 62, 9)= 0 Z2= 53.000  
 A1=104.000 Z1= 39.000 A2=132.000 Z2= 52.000  
 NU( 34, 8)= 1 MU( 62, 8)= 1 Z2= 52.000  
 A1=104.000 Z1= 40.000 A2=132.000 Z2= 51.000  
 NU( 34, 7)= 1 MU( 62, 7)= 2 Z2= 51.000  
 A1=104.000 Z1= 41.000 A2=132.000 Z2= 51.000  
 NU( 34, 6)= 1 MU( 62, 6)= 2 Z2= 50.000  
 A1=104.000 Z1= 42.000 A2=132.000 Z2= 50.000  
 NU( 34, 5)= 1 MU( 62, 5)= 2 Z2= 49.000  
 A1=104.000 Z1= 43.000 A2=132.000 Z2= 49.000  
 NU( 34, 4)= 1 MU( 62, 4)= 1 Z2= 54.000  
 A1=103.000 Z1= 38.000 A2=133.000 Z2= 54.000  
 NU( 33, 8)= 1 MU( 63, 8)= 1 Z2= 53.000  
 A1=103.000 Z1= 39.000 A2=133.000 Z2= 53.000  
 NU( 33, 7)= 1 MU( 63, 7)= 1 Z2= 52.000  
 A1=103.000 Z1= 40.000 A2=133.000 Z2= 52.000  
 NU( 33, 6)= 1 MU( 63, 6)= 2 Z2= 51.000  
 A1=103.000 Z1= 41.000 A2=133.000 Z2= 51.000  
 NU( 33, 5)= 1 MU( 63, 5)= 2 Z2= 50.000  
 A1=103.000 Z1= 42.000 A2=133.000 Z2= 50.000  
 NU( 33, 4)= 1 MU( 63, 4)= 1 Z2= 49.000  
 A1=103.000 Z1= 43.000 A2=133.000 Z2= 49.000  
 NU( 33, 3)= 0 MU( 63, 3)= 1 Z2= 55.000  
 A1=102.000 Z1= 37.000 A2=134.000 Z2= 55.000  
 NU( 32, 10)= 1 MU( 64, 10)= 0 Z2= 54.000  
 A1=102.000 Z1= 38.000 A2=134.000 Z2= 54.000  
 NU( 32, 9)= 1 MU( 64, 9)= 1 Z2= 53.000  
 A1=102.000 Z1= 39.000 A2=134.000 Z2= 53.000  
 NU( 32, 8)= 2 MU( 64, 8)= 1 Z2= 52.000  
 A1=102.000 Z1= 40.000 A2=134.000 Z2= 52.000  
 NU( 32, 7)= 1 MU( 64, 7)= 2 Z2= 51.000  
 A1=102.000 Z1= 41.000 A2=134.000 Z2= 51.000  
 NU( 32, 6)= 1 MU( 64, 6)= 2 Z2= 50.000  
 A1=102.000 Z1= 42.000 A2=134.000 Z2= 50.000  
 NU( 32, 5)= 1 MU( 64, 5)= 2 Z2= 49.000  
 A1=102.000 Z1= 43.000 A2=134.000 Z2= 49.000  
 NU( 32, 4)= 0 MU( 64, 4)= 1 Z2= 55.000  
 A1=101.000 Z1= 37.000 A2=135.000 Z2= 55.000  
 NU( 31, 8)= 1 MU( 65, 8)= 0 Z2= 54.000  
 A1=101.000 Z1= 38.000 A2=135.000 Z2= 54.000  
 NU( 31, 7)= 1 MU( 65, 7)= 1 Z2= 53.000  
 A1=101.000 Z1= 39.000 A2=135.000 Z2= 53.000

NU( 31, 6)= 2 NU( 65, 6)= 1 Z2= 52.000  
 A1=101.000 Z1= 40.000 A2=135.000  
 NU( 31, 5)= 1 NU( 65, 5)= 2 Z2= 51.000  
 A1=101.000 Z1= 41.000 A2=135.000  
 NU( 31, 4)= 1 NU( 65, 4)= 2 Z2= 50.000  
 A1=101.000 Z1= 42.000 A2=135.000  
 NU( 31, 3)= 1 NU( 65, 3)= 1 Z2= 55.000  
 A1=100.000 Z1= 37.000 A2=136.000  
 NU( 30, 8)= 1 NU( 66, 8)= 1 Z2= 54.000  
 A1=100.000 Z1= 38.000 A2=136.000  
 NU( 30, 7)= 1 NU( 66, 7)= 1 Z2= 53.000  
 A1=100.000 Z1= 39.000 A2=136.000  
 NU( 30, 6)= 1 NU( 66, 6)= 2 Z2= 52.000  
 A1=100.000 Z1= 40.000 A2=136.000  
 NU( 30, 5)= 1 NU( 66, 5)= 2 Z2= 51.000  
 A1=100.000 Z1= 41.000 A2=136.000  
 NU( 30, 4)= 1 NU( 66, 4)= 1 Z2= 50.000  
 A1=100.000 Z1= 42.000 A2=136.000  
 NU( 30, 3)= 0 NU( 66, 3)= 1 Z2= 56.000  
 A1= 99.000 Z1= 36.000 A2=137.000  
 NU( 29, 9)= 1 NU( 67, 9)= 0 Z2= 55.000  
 A1= 99.000 Z1= 37.000 A2=137.000  
 NU( 29, 8)= 1 NU( 67, 8)= 1 Z2= 54.000  
 A1= 99.000 Z1= 38.000 A2=137.000  
 NU( 29, 7)= 1 NU( 67, 7)= 1 Z2= 53.000  
 A1= 99.000 Z1= 39.000 A2=137.000  
 NU( 29, 6)= 1 NU( 67, 6)= 2 Z2= 52.000  
 A1= 99.000 Z1= 40.000 A2=137.000  
 NU( 29, 5)= 1 NU( 67, 5)= 2 Z2= 51.000  
 A1= 99.000 Z1= 41.000 A2=137.000  
 NU( 29, 4)= 0 NU( 67, 4)= 2 Z2= 50.000  
 A1= 99.000 Z1= 42.000 A2=137.000  
 NU( 29, 3)= 0 NU( 67, 3)= 1 Z2= 56.000  
 A1= 98.000 Z1= 36.000 A2=138.000  
 NU( 28, 9)= 1 NU( 68, 9)= 0 Z2= 55.000  
 A1= 98.000 Z1= 37.000 A2=138.000  
 NU( 28, 8)= 1 NU( 68, 8)= 1 Z2= 54.000  
 A1= 98.000 Z1= 38.000 A2=138.000  
 NU( 28, 7)= 1 NU( 68, 7)= 2 Z2= 53.000  
 A1= 98.000 Z1= 39.000 A2=138.000  
 NU( 28, 6)= 1 NU( 68, 6)= 2 Z2= 52.000  
 A1= 98.000 Z1= 40.000 A2=138.000  
 NU( 28, 5)= 1 NU( 68, 5)= 2 Z2= 51.000  
 A1= 98.000 Z1= 41.000 A2=138.000  
 NU( 28, 4)= 1 NU( 68, 4)= 1 Z2= 56.000  
 A1= 97.000 Z1= 36.000 A2=139.000  
 NU( 27, 7)= 1 NU( 69, 7)= 1 Z2= 55.000  
 A1= 97.000 Z1= 37.000 A2=139.000  
 NU( 27, 6)= 1 NU( 69, 6)= 2 Z2= 54.000  
 A1= 97.000 Z1= 38.000 A2=139.000

NU( 27, 5) = 1 NU( 69, 5) = 2 Z2= 53.000  
 A1= 97.000 Z1= 39.000 A2=139.000  
 NU( 27, 4) = 1 NU( 69, 4) = 1 Z2= 52.000  
 A1= 97.000 Z1= 40.000 A2=139.000  
 NU( 27, 3) = 1 NU( 69, 3) = 1 Z2= 51.000  
 A1= 97.000 Z1= 41.000 A2=139.000  
 NU( 27, 2) = 0 NU( 69, 2) = 2 Z2= 57.000  
 A1= 96.000 Z1= 35.000 A2=140.000  
 NU( 25, 10) = 1 NU( 70, 10) = 0 Z2= 56.000  
 A1= 96.000 Z1= 36.000 A2=140.000  
 NU( 26, 9) = 1 NU( 70, 9) = 1 Z2= 55.000  
 A1= 96.000 Z1= 37.000 A2=140.000  
 NU( 26, 8) = 1 NU( 70, 8) = 2 Z2= 54.000  
 A1= 96.000 Z1= 38.000 A2=140.000  
 NU( 26, 7) = 1 NU( 70, 7) = 2 Z2= 53.000  
 A1= 96.000 Z1= 39.000 A2=140.000  
 NU( 26, 6) = 1 NU( 70, 6) = 2 Z2= 52.000  
 A1= 96.000 Z1= 40.000 A2=140.000  
 NU( 26, 5) = 0 NU( 70, 5) = 2 Z2= 51.000  
 A1= 96.000 Z1= 41.000 A2=140.000  
 NU( 26, 4) = 0 NU( 70, 4) = 1 Z2= 57.000  
 A1= 95.000 Z1= 35.000 A2=141.000  
 NU( 25, 8) = 0 NU( 71, 8) = 1 Z2= 56.000  
 A1= 95.000 Z1= 36.000 A2=141.000  
 NU( 25, 7) = 1 NU( 71, 7) = 1 Z2= 55.000  
 A1= 95.000 Z1= 37.000 A2=141.000  
 NU( 25, 6) = 1 NU( 71, 6) = 2 Z2= 54.000  
 A1= 95.000 Z1= 38.000 A2=141.000  
 NU( 25, 5) = 1 NU( 71, 5) = 2 Z2= 53.000  
 A1= 95.000 Z1= 39.000 A2=141.000  
 NU( 25, 4) = 0 NU( 71, 4) = 2 Z2= 52.000  
 A1= 95.000 Z1= 40.000 A2=141.000  
 NU( 25, 3) = 0 NU( 71, 3) = 1 Z2= 57.000  
 A1= 94.000 Z1= 35.000 A2=142.000  
 NU( 24, 8) = 1 NU( 72, 8) = 1 Z2= 56.000  
 A1= 94.000 Z1= 36.000 A2=142.000  
 NU( 24, 7) = 1 NU( 72, 7) = 1 Z2= 55.000  
 A1= 94.000 Z1= 37.000 A2=142.000  
 NU( 24, 6) = 1 NU( 72, 6) = 2 Z2= 54.000  
 A1= 94.000 Z1= 38.000 A2=142.000  
 NU( 24, 5) = 1 NU( 72, 5) = 2 Z2= 53.000  
 A1= 94.000 Z1= 39.000 A2=142.000  
 NU( 24, 4) = 1 NU( 72, 4) = 2 Z2= 52.000  
 A1= 94.000 Z1= 40.000 A2=142.000  
 NU( 24, 3) = 0 NU( 72, 3) = 1 Z2= 58.000  
 A1= 93.000 Z1= 34.000 A2=143.000  
 NU( 23, 8) = 1 NU( 73, 8) = 1 Z2= 57.000  
 A1= 93.000 Z1= 35.000 A2=143.000  
 NU( 23, 7) = 1 NU( 73, 7) = 1 Z2= 56.000  
 A1= 93.000 Z1= 36.000 A2=143.000

NU( 23, 6)= 1 NU( 73, 6)= 1  
 A1= 93.000 Z1= 37.000 A2=143.000 Z2= 55.000  
 NU( 23, 5)= 1 NU( 73, 5)= 2  
 A1= 93.000 Z1= 38.000 A2=143.000 Z2= 54.000  
 NU( 23, 4)= 1 NU( 73, 4)= 1  
 A1= 93.000 Z1= 39.000 A2=143.000 Z2= 53.000  
 NU( 23, 3)= 0 NU( 73, 3)= 2  
 A1= 93.000 Z1= 40.000 A2=143.000 Z2= 52.000  
 NU( 23, 2)= 0 NU( 73, 2)= 1  
 A1= 92.000 Z1= 34.000 A2=144.000 Z2= 58.000  
 NU( 22, 9)= 0 NU( 74, 9)= 1  
 A1= 92.000 Z1= 35.000 A2=144.000 Z2= 57.000  
 NU( 22, 8)= 1 NU( 74, 8)= 1  
 A1= 92.000 Z1= 36.000 A2=144.000 Z2= 56.000  
 NU( 22, 7)= 1 NU( 74, 7)= 2  
 A1= 92.000 Z1= 37.000 A2=144.000 Z2= 55.000  
 NU( 22, 6)= 1 NU( 74, 6)= 2  
 A1= 92.000 Z1= 38.000 A2=144.000 Z2= 54.000  
 NU( 22, 5)= 0 NU( 74, 5)= 2  
 A1= 92.000 Z1= 39.000 A2=144.000 Z2= 53.000  
 NU( 22, 4)= 0 NU( 74, 4)= 1  
 A1= 91.000 Z1= 34.000 A2=145.000 Z2= 58.000  
 NU( 21, 7)= 1 NU( 75, 7)= 1  
 A1= 91.000 Z1= 35.000 A2=145.000 Z2= 57.000  
 NU( 21, 6)= 1 NU( 75, 6)= 1  
 A1= 91.000 Z1= 36.000 A2=145.000 Z2= 56.000  
 NU( 21, 5)= 1 NU( 75, 5)= 2  
 A1= 91.000 Z1= 37.000 A2=145.000 Z2= 55.000  
 NU( 21, 4)= 0 NU( 75, 4)= 1  
 A1= 91.000 Z1= 38.000 A2=145.000 Z2= 54.000  
 NU( 21, 3)= 0 NU( 75, 3)= 1  
 A1= 90.000 Z1= 33.000 A2=146.000 Z2= 59.000  
 NU( 20, 8)= 1 NU( 76, 8)= 1  
 A1= 90.000 Z1= 34.000 A2=146.000 Z2= 58.000  
 NU( 20, 7)= 0 NU( 76, 7)= 1  
 A1= 90.000 Z1= 35.000 A2=146.000 Z2= 57.000  
 NU( 20, 6)= 1 NU( 76, 6)= 1  
 A1= 90.000 Z1= 36.000 A2=146.000 Z2= 56.000  
 NU( 20, 5)= 1 NU( 76, 5)= 2  
 A1= 90.000 Z1= 37.000 A2=146.000 Z2= 55.000  
 NU( 20, 4)= 1 NU( 76, 4)= 2  
 A1= 90.000 Z1= 38.000 A2=146.000 Z2= 54.000  
 NU( 20, 3)= 0 NU( 76, 3)= 1  
 A1= 89.000 Z1= 33.000 A2=147.000 Z2= 59.000  
 NU( 19, 7)= 0 NU( 77, 7)= 1  
 A1= 89.000 Z1= 34.000 A2=147.000 Z2= 58.000  
 NU( 19, 6)= 1 NU( 77, 6)= 1  
 A1= 89.000 Z1= 35.000 A2=147.000 Z2= 57.000  
 NU( 19, 5)= 1 NU( 77, 5)= 2  
 A1= 89.000 Z1= 36.000 A2=147.000 Z2= 56.000



NU( 19, 4)= 1 NU( 77, 4)= 1  
 A1= 89.000 Z1= 37.000 A2=147.000 Z2= 55.000  
 NU( 19, 3)= 0 NU( 77, 3)= 1  
 A1= 89.000 Z1= 38.000 A2=147.000 Z2= 54.000  
 NU( 19, 2)= 0 NU( 77, 2)= 1  
 A1= 88.000 Z1= 33.000 A2=148.000 Z2= 59.000  
 NU( 18, 6)= 1 NU( 78, 6)= 1  
 A1= 88.000 Z1= 34.000 A2=148.000 Z2= 58.000  
 NU( 18, 5)= 1 NU( 78, 5)= 2  
 A1= 88.000 Z1= 35.000 A2=148.000 Z2= 57.000  
 NU( 18, 4)= 1 NU( 78, 4)= 1  
 A1= 88.000 Z1= 36.000 A2=148.000 Z2= 56.000  
 NU( 18, 3)= 0 NU( 78, 3)= 2  
 A1= 88.000 Z1= 37.000 A2=148.000 Z2= 55.000  
 NU( 18, 2)= 0 NU( 78, 2)= 1  
 A1= 87.000 Z1= 32.000 A2=149.000 Z2= 60.000  
 NU( 17, 7)= 1 NU( 79, 7)= 1  
 A1= 87.000 Z1= 33.000 A2=149.000 Z2= 59.000  
 NU( 17, 6)= 1 NU( 79, 6)= 1  
 A1= 87.000 Z1= 34.000 A2=149.000 Z2= 58.000  
 NU( 17, 5)= 1 NU( 79, 5)= 1  
 A1= 87.000 Z1= 35.000 A2=149.000 Z2= 57.000  
 NU( 17, 4)= 0 NU( 79, 4)= 2  
 A1= 87.000 Z1= 36.000 A2=149.000 Z2= 56.000  
 NU( 17, 3)= 0 NU( 79, 3)= 1  
 A1= 86.000 Z1= 31.000 A2=150.000 Z2= 61.000  
 NU( 16, 8)= 1 NU( 80, 8)= 0  
 A1= 86.000 Z1= 32.000 A2=150.000 Z2= 60.000  
 NU( 16, 7)= 0 NU( 80, 7)= 1  
 A1= 86.000 Z1= 33.000 A2=150.000 Z2= 59.000  
 NU( 16, 6)= 1 NU( 80, 6)= 1  
 A1= 86.000 Z1= 34.000 A2=150.000 Z2= 58.000  
 NU( 16, 5)= 0 NU( 80, 5)= 1  
 A1= 86.000 Z1= 35.000 A2=150.000 Z2= 57.000  
 NU( 16, 4)= 1 NU( 80, 4)= 1  
 A1= 86.000 Z1= 36.000 A2=150.000 Z2= 56.000  
 NU( 16, 3)= 0 NU( 80, 3)= 1  
 A1= 85.000 Z1= 32.000 A2=151.000 Z2= 60.000  
 NU( 15, 6)= 1 NU( 81, 6)= 1  
 A1= 85.000 Z1= 33.000 A2=151.000 Z2= 59.000  
 NU( 15, 5)= 1 NU( 81, 5)= 2  
 A1= 85.000 Z1= 34.000 A2=151.000 Z2= 58.000  
 NU( 15, 4)= 1 NU( 81, 4)= 1  
 A1= 85.000 Z1= 35.000 A2=151.000 Z2= 57.000  
 NU( 15, 3)= 0 NU( 81, 3)= 1  
 A1= 85.000 Z1= 36.000 A2=151.000 Z2= 56.000  
 NU( 15, 2)= 0 NU( 81, 2)= 1  
 A1= 84.000 Z1= 31.000 A2=152.000 Z2= 61.000  
 NU( 14, 8)= 1 NU( 82, 8)= 1  
 A1= 84.000 Z1= 32.000 A2=152.000 Z2= 60.000

NU( 14, 7)= 0 NU( 82, 7)= 1 Z2= 59.000  
 A1= 84.000 Z1= 33.000 A2=152.000  
 NU( 14, 6)= 1 NU( 82, 6)= 1 Z2= 58.000  
 A1= 84.000 Z1= 34.000 A2=152.000  
 NU( 14, 5)= 0 NU( 82, 5)= 1 Z2= 57.000  
 A1= 84.000 Z1= 35.000 A2=152.000  
 NU( 14, 4)= 0 NU( 82, 4)= 1 Z2= 62.000  
 A1= 83.000 Z1= 30.000 A2=153.000  
 NU( 13, 7)= 1 NU( 83, 7)= 0 Z2= 61.000  
 A1= 83.000 Z1= 31.000 A2=153.000  
 NU( 13, 6)= 0 NU( 83, 6)= 1 Z2= 60.000  
 A1= 83.000 Z1= 32.000 A2=153.000  
 NU( 13, 5)= 1 NU( 83, 5)= 1 Z2= 59.000  
 A1= 83.000 Z1= 33.000 A2=153.000  
 NU( 13, 4)= 0 NU( 83, 4)= 1 Z2= 58.000  
 A1= 83.000 Z1= 34.000 A2=153.000  
 NU( 13, 3)= 0 NU( 83, 3)= 1 Z2= 61.000  
 A1= 82.000 Z1= 31.000 A2=154.000  
 NU( 12, 6)= 1 NU( 84, 6)= 1 Z2= 60.000  
 A1= 82.000 Z1= 32.000 A2=154.000  
 NU( 12, 5)= 0 NU( 84, 5)= 1 Z2= 59.000  
 A1= 82.000 Z1= 33.000 A2=154.000  
 NU( 12, 4)= 0 NU( 84, 4)= 1 Z2= 58.000  
 A1= 82.000 Z1= 34.000 A2=154.000  
 NU( 12, 3)= 0 NU( 84, 3)= 1 Z2= 62.000  
 A1= 81.000 Z1= 30.000 A2=155.000  
 NU( 11, 6)= 1 NU( 85, 6)= 1 Z2= 61.000  
 A1= 81.000 Z1= 31.000 A2=155.000  
 NU( 11, 5)= 0 NU( 85, 5)= 1 Z2= 60.000  
 A1= 81.000 Z1= 32.000 A2=155.000  
 NU( 11, 4)= 0 NU( 85, 4)= 1 Z2= 59.000  
 A1= 81.000 Z1= 33.000 A2=155.000  
 NU( 11, 3)= 0 NU( 85, 3)= 1 Z2= 62.000  
 A1= 80.000 Z1= 30.000 A2=156.000  
 NU( 10, 7)= 0 NU( 86, 7)= 1 Z2= 61.000  
 A1= 80.000 Z1= 31.000 A2=156.000  
 NU( 10, 6)= 1 NU( 86, 6)= 1 Z2= 60.000  
 A1= 80.000 Z1= 32.000 A2=156.000  
 NU( 10, 5)= 0 NU( 86, 5)= 1 Z2= 59.000  
 A1= 80.000 Z1= 33.000 A2=156.000  
 NU( 10, 4)= 0 NU( 86, 4)= 1 Z2= 62.000  
 A1= 79.000 Z1= 30.000 A2=157.000  
 NU( 9, 6)= 0 NU( 87, 6)= 1 Z2= 61.000  
 A1= 79.000 Z1= 31.000 A2=157.000  
 NU( 9, 5)= 0 NU( 87, 5)= 1 Z2= 60.000  
 A1= 79.000 Z1= 32.000 A2=157.000  
 NU( 9, 4)= 0 NU( 87, 4)= 1 Z2= 63.000  
 A1= 78.000 Z1= 29.000 A2=158.000  
 NU( 8, 8)= 0 NU( 88, 8)= 1 Z2= 62.000  
 A1= 78.000 Z1= 30.000 A2=158.000

NU( 8, 7)= 0 NU( 88, 7)= 1  
 A1= 78.000 Z1= 31.000 A2=158.000 Z2= 61.000  
 NU( 8, 6)= 0 NU( 88, 6)= 1  
 A1= 78.000 Z1= 32.000 A2=158.000 Z2= 60.000  
 NU( 8, 5)= 0 NU( 88, 5)= 1  
 A1= 76.000 Z1= 29.000 A2=160.000 Z2= 63.000  
 NU( 7, 6)= 0 NU( 89, 6)= 1  
 A1= 76.000 Z1= 30.000 A2=160.000 Z2= 62.000  
 NU( 7, 5)= 0 NU( 89, 5)= 1  
 A1= 76.000 Z1= 31.000 A2=160.000 Z2= 61.000  
 NU( 7, 4)= 0 NU( 89, 4)= 1  
 A1= 75.000 Z1= 30.000 A2=161.000 Z2= 62.000  
 NU( 6, 5)= 0 NU( 90, 5)= 1  
 A1= 74.000 Z1= 29.000 A2=162.000 Z2= 63.000  
 NU( 5, 5)= 0 NU( 91, 5)= 1  
 A1= 71.000 Z1= 28.000 A2=165.000 Z2= 64.000  
 NU( 1, 4)= 0 NU( 95, 4)= 1