

AD-A155 609

THE INFLUENCE OF OIL CONTAMINATION ON THE NUCLEATE
POOL-BOILING BEHAVIOR O. (U) NAVAL POSTGRADUATE SCHOOL
MONTEREY CA J T REILLY MAR 85 NPS69-85-003

1/2

UNCLASSIFIED

F/G 13/1

NL

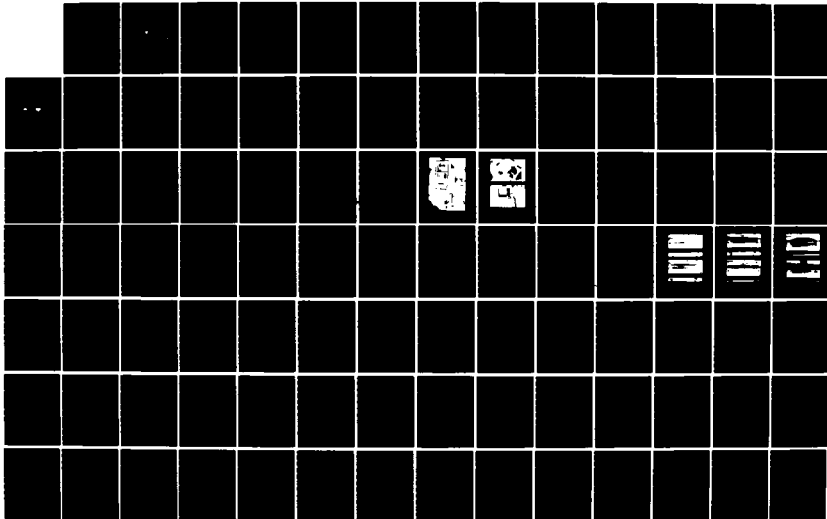

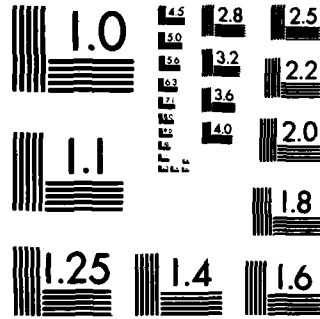

MICROCOPY RESOLUTION TEST CHART
NATIONAL BUREAU OF STANDARDS-1963-A

2

NAVAL POSTGRADUATE SCHOOL Monterey, California

AD-A155 609



DTIC
ELECTE
JUL 1 1985
S B D

THESIS

THE INFLUENCE OF OIL CONTAMINATION ON
THE NUCLEATE POOL-BOILING BEHAVIOR OF
R-114 FROM A STRUCTURED SURFACE

James T. Reilly
March 1985

Thesis Advisor: P. J. Marto

Approved for public release; distribution unlimited

Prepared for:

David W. Taylor Naval Ship Research
and Development Center
Annapolis, Maryland

85 06 17 065

DTIC FILE COPY

NAVAL POSTGRADUATE SCHOOL
Monterey, California

Commodore R. H. Shumaker
Superintendent

David A. Schrady
Provost

This thesis prepared in conjunction with research supported in part by David W. Taylor Naval Ship Research and Development Center under work request N00167-85-WR5-0083.

Reproduction of all or part of this report is authorized.

Released as a
Technical Report by:



John M. Dyer
Dean of Science and Engineering

UNCLASSIFIED

SECURITY CLASSIFICATION OF THIS PAGE (When Data Entered)

REPORT DOCUMENTATION PAGE		READ INSTRUCTIONS BEFORE COMPLETING FORM
1. REPORT NUMBER NPS69-85-003	2. GOVT ACCESSION NO.	3. RECIPIENT'S CATALOG NUMBER
4. TITLE (and Subtitle) The Influence of Oil Contamination on the Nucleate Pool-Boiling Behavior of R-114 from a Structured Surface		5. TYPE OF REPORT & PERIOD COVERED Master's Thesis March 1985
		6. PERFORMING ORG. REPORT NUMBER
7. AUTHOR(s) James T. Reilly		8. CONTRACT OR GRANT NUMBER(s)
9. PERFORMING ORGANIZATION NAME AND ADDRESS Naval Postgraduate School Monterey, California 93940		10. PROGRAM ELEMENT, PROJECT, TASK AREA & WORK UNIT NUMBERS N00167-85-WR5-0083
11. CONTROLLING OFFICE NAME AND ADDRESS David W. Taylor Naval Ship Research and Development Center Annapolis, Maryland 21402		12. REPORT DATE March 1985
		13. NUMBER OF PAGES 122
14. MONITORING AGENCY NAME & ADDRESS (if different from Controlling Office)		15. SECURITY CLASS. (of this report) Unclassified
		15a. DECLASSIFICATION/DOWNGRADING SCHEDULE
16. DISTRIBUTION STATEMENT (of this Report) Approved for public release; distribution unlimited		
17. DISTRIBUTION STATEMENT (of the abstract entered in Block 20, if different from Report)		
18. SUPPLEMENTARY NOTES		
19. KEY WORDS (Continue on reverse side if necessary and identify by block number) Nucleate Pool-Boiling, R-114, R-114-oil mixtures, Structured Surface, High Flux Coating, Heat-transfer enhancement		
20. ABSTRACT (Continue on reverse side if necessary and identify by block number) The external nucleate pool-boiling heat-transfer coefficient of a horizontal smooth copper tube in R-114-oil mixtures (0 to 10 percent oil) was measured for heat fluxes from 1 to 100 kW/m ² at two different saturation temperatures (-2.2 °C and 6.7 °C). A copper-nickel tube coated with the Union Carbic "High Flux" coating was similarly tested. The High Flux coating was found to improve the heat-transfer coefficient by at least a factor of 7 in oil-free R-114. Oil resulted in about a 20 percent reduction		

DD FORM 1 JAN 73 1473

EDITION OF 1 NOV 68 IS OBSOLETE
S/N 0102-LF-014-6601

UNCLASSIFIED

1 SECURITY CLASSIFICATION OF THIS PAGE (When Data Entered)

#20 ABSTRACT (Continued)

of the heat-transfer coefficient of the High Flux surface at heat fluxes less than 30 kW/m² and up to an 80 percent reduction at heat fluxes above 30 kW/m² with greater than 6 percent oil. Under all conditions, the High Flux coated tube outperformed the smooth copper tube.



Accession For	
NTIS GRA&I	<input checked="" type="checkbox"/>
DTIC TAB	<input type="checkbox"/>
Unannounced	<input type="checkbox"/>
Justification	
By	
Distribution/	
Availability Codes	
Dist	Avail and/or Special
A-1	

Approved for public release; distribution is unlimited.

The Influence of Oil Contamination on
the Nucleate Pool-Boiling Behavior of
R-114 from a Structured Surface

by

James T. Reilly
Lieutenant, United States Navy
B.S., U.S. Naval Academy, 1978

Submitted in partial fulfillment of the
requirements for the degree of

MASTER OF SCIENCE IN MECHANICAL ENGINEERING

from the

NAVAL POSTGRADUATE SCHOOL
March 1985

Author:



James T. Reilly

Approved by:

P. J. Marito, Thesis Advisor

A. S. Wanniarachchi, Co-Advisor

P. J. Marito, Chairman,
Department of Mechanical Engineering

John N. Dyer,
Dean of Science and Engineering

(34 11)

ABSTRACT

→ The external nucleate pool-boiling heat-transfer coefficient of a horizontal smooth copper tube in R-114-oil mixtures (0 to 10 percent oil) was measured for heat fluxes from 1 to 100 kW/m² at two different saturation temperatures (-2.2 °C and 6.7 °C). A copper-nickel tube coated with the Union Carbide "High Flux" coating was similarly tested. The High Flux coating was found to improve the heat-transfer coefficient by at least a factor of 7 in oil-free R-114. Oil resulted in about a 20 percent reduction of the heat-transfer coefficient of the High Flux surface at heat fluxes less than 30 kW/m² and up to an 80 percent reduction at heat fluxes above 30 kW/m² with greater than 6 percent oil. Under all conditions, the High Flux coated tube outperformed the smooth copper tube.

*Results - heat transfer
coefficient, Porosity-coating*

TABLE OF CONTENTS

I.	INTRODUCTION	10
	A. BACKGROUND	10
	B. THESIS OBJECTIVES	12
II.	REVIEW OF REFRIGERANT-OIL MIXTURE BEHAVIOR	13
	A. NUCLEATE BOILING OF REFRIGERANT-OIL MIXTURES FROM SMOOTH TUBES	13
	1. Physical Properties	13
	2. Saturation Temperature	20
	3. Tube Diameter	21
	4. Surface Condition	23
	5. Hydrostatic Effect	23
	B. NUCLEATE BOILING OF REFRIGERANT-OIL MIXTURES FROM ENHANCED SURFACES	23
	1. Fins and Surfaces with Reentrant Cavities	24
	2. Porous Coatings	27
III.	DESCRIPTION OF EXPERIMENTAL APPARATUS	30
	A. OVERALL APPARATUS	30
	B. OIL SAMPLING APPARATUS	34
	C. BOILING TUBE CONSTRUCTION	35
	1. Short Tubes	35
	2. Long Tube	38
	D. DATA ACQUISITION AND REDUCTION	40
	E. COMPUTER-CONTROLLED VALVE	42
IV.	EXPERIMENTAL PROCEDURES	45
	A. INSTALLATION OF TUBE IN APPARATUS	45
	B. GENERAL OPERATION	46

C.	SAMPLING OIL	50
V.	SYSTEM OPERATICN AND PROBLEMS	54
A.	CIRCUMFERENTIAL WALL TEMPERATURE VARIATION	54
B.	AXIAL TEMPERATURE VARIATION OF LONG TUBES	57
C.	COMPUTER-CONTROLLED VALVE	61
VI.	RESULTS AND DISCUSSION	64
A.	BOILING PERFORMANCE OF SMOOTH TUBE	64
B.	BOILING PERFORMANCE OF HIGH FLUX SURFACE	68
C.	COMPARISON OF HIGH FLUX TO SMOOTH TUBE BOILING PERFORMANCE	73
D.	EFFECT OF SATURATION TEMPERATURE ON BOILING PERFORMANCE	76
E.	LOCAL OIL SAMPLING EFFORTS	77
VII.	CCNCLUSIONS AND RECOMMENDATIONS	81
A.	CONCLUSIONS	81
B.	RECOMMENDATIONS	82
APPENDIX A:	THERMOCOUPLE CALIBRATION	84
APPENDIX B:	DATA REDUCTION PROGRAM	88
APPENDIX C:	COMPUTER-CONTROLLED VALVE PROGRAM	109
APPENDIX D:	EXAMPLES OF REPRESENTATIVE DATA RUNS	112
APPENDIX E:	UNCERTAINTY ANALYSIS	114
LIST OF REFERENCES	119
INITIAL DISTRIBUTION LIST	122

LIST OF TABLES

1.	Summary of Short Tube Assembly Methods	38
2.	HP-3497A Channel Allocations	42
3.	Summary of Data Runs	47
4.	Configuration of SYS-2A I/O Channels	109
5.	Uncertainty Analysis Terms Using 8 Thermocouples	116
6.	Uncertainty Analysis Terms Using Center 4 Thermocouples	118

LIST OF FIGURES

1.1	Schematic and Scanning Electron Micrograph (500x) of High Flux Surface	11
2.1	Effect of Oil on Boiling Coefficient of R-114 (from Ref. 6)	14
2.2	Variation of Heat-Transfer Coefficient of R-114-Oil Mixtures (from Ref. 13)	15
2.3	Surface-Tension Variation of R-114-Oil Mixtures (from Ref. 6)	17
2.4	Oil Concentration Gradient in a Bubble in Refrigerant-Oil Mixtures (from Ref. 11)	19
2.5	Effect of Saturation Temperature on R-114-Oil Mixtures (from Ref. 6)	22
2.6	Reentrant Cavity Geometry Factors	25
2.7	Surface Details of Gewa-T and Thermoexcel-E Reentrant Surfaces	26
2.8	Comparison of R-11 Boiling Performance from Various Commercial Surfaces (from Ref. 4)	28
3.1	Schematic of Experimental Apparatus	31
3.2	Photograph of Experimental Apparatus	32
3.3	Photographs of Computer-Controlled-Valve Equipment	33
3.4	Oil Sampling Apparatus	36
3.5	Sectional Views of Short Boiling Tube	37
3.6	Sectional View of Long Boiling Tube	39
3.7	Long Tube Thermocouple Channels	41
4.1	Photographs of Boiling and Foaming at 0 and 1 Percent Oil	50
4.2	Photographs of Boiling and Foaming at 3 Percent Oil	51

4.3	Photographs of Boiling and Foaming at 10 Percent Oil	52
5.1	Time Dependency of the Measured Heat-Transfer Coefficient in Press-Fit Tubes	56
5.2	Comparison of Solid and Soft-Soldered Short Tube Heat-Transfer Coefficients	58
5.3	Axial Temperature Variation of Smooth Tube	59
5.4	Axial Temperature Variation of High Flux Tube	60
5.5	System Response to a Transient with Computer-Contrcled Valve	63
6.1	Heat-Transfer Performance of Smooth Tube	65
6.2	Boiling Heat-Transfer Coefficient of Smooth Tube	67
6.3	Relative Effect of Oil on Smooth Tube Boiling Heat-Transfer Performance	69
6.4	Heat-Transfer Performance of High Flux Surface	70
6.5	Boiling Heat-Transfer Coefficient of High Flux Surface	72
6.6	Relative Effect of Oil on High Flux Boiling Heat-Transfer Performance	74
6.7	Comparison of High Flux and Smooth Tube Boiling Heat-Transfer Performance	75
6.8	Relative Improvement of High Flux Surface over Smooth Tube versus Oil	77
6.9	Effect of Saturation Temperature on Boiling Heat-Transfer Coefficient	78
6.10	Effect of Oil on Variation of Boiling Heat-Transfer Coefficient with Saturation Temperature	79
A.1	Thermocouple Discrepancy Correction	86

I. INTRODUCTION

A. BACKGROUND

The U.S. Navy currently uses refrigerant R-114 in centrifugal chilled-water air-conditioning plants aboard submarines and surface ships. The Navy hopes to reduce the size of these units and increase their performance by using enhanced evaporator and condenser surfaces. An experiment by Arai et al. [Ref. 1] produced a prototype 200-Ton R-12 centrifugal water chiller that was 28 percent shorter in length and had a 50-70 percent improvement in the overall heat-transfer coefficient by employing the enhanced surface "Thermoexcel E" made by the Hitachi Company. Comparisons of various enhanced commercial tubes by Yilmaz and Westwater [Ref. 2], Marto and Lepere [Ref. 3], and Carnavos [Ref. 4] for various refrigerants other than R-114 indicated that a porous-coating-enhanced surface, such as Union Carbide's "High Flux," will exhibit the best boiling heat-transfer performance in a pure refrigerant.

The High Flux surface (see Figure 1.1) consists of a sintered metallic matrix bonded to a metallic substrate. The surface is produced by coating a smooth tube with a binder-solvent mixture and then applying a mixture of metal and braze alloy powder; the tube is placed in a furnace to evaporate the solvent, binder, and melt braze alloy thus forming a porous structure having multiple reentrant cavities to enhance nucleation. [Ref. 5]

Since the High Flux surface will be employed in a refrigeration unit using an oil-lubricated, hermetically-sealed, compressor, some amount of oil is always present in the evaporator. Studies by Henrici and Hesse [Ref. 6] for

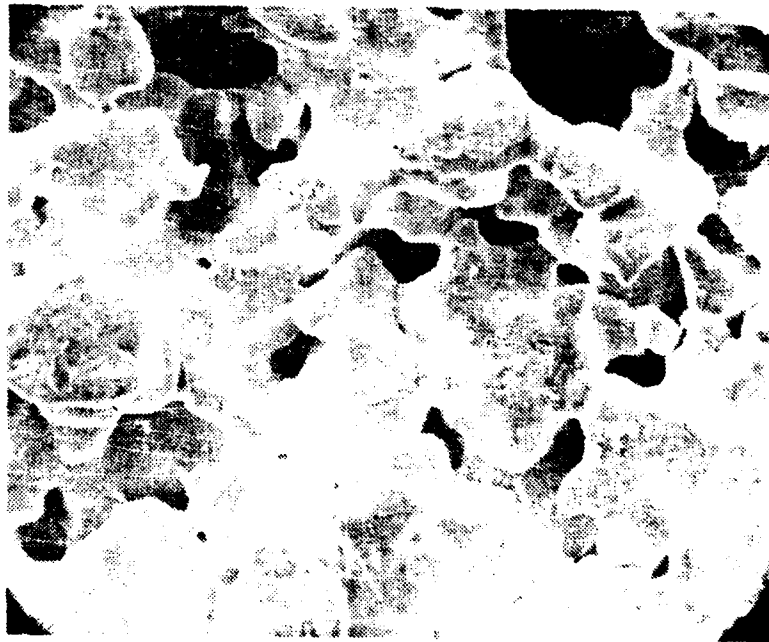
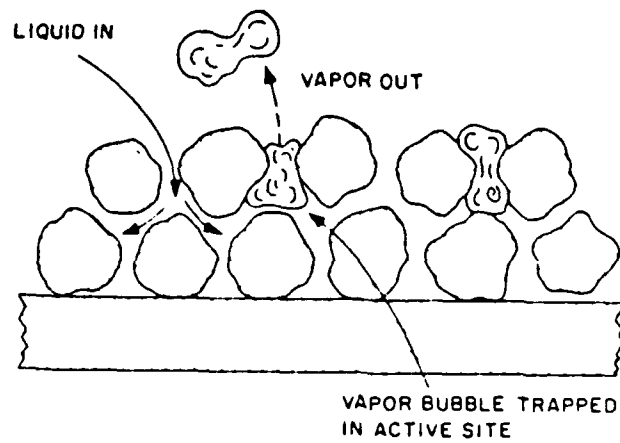

Figure 1.1. Schematic and Scanning Electron Micrograph (500x) of High Flux Surface.

smooth tubes and Stephan [Ref. 7] for the Gewa-T surface (manufactured by the Wieland Company) in R-114-oil mixtures indicate that the heat-transfer coefficient of enhanced surfaces can be significantly altered by oil.

Experimental data showing the effect of oil concentration on the heat-transfer coefficient of the High Flux surface in R-114 are lacking, thus motivating the present investigation. This investigation was funded by the David W. Taylor Naval Ship Research and Development Center. Details of the experimental apparatus are described by Karasabun [Ref. 8]. The smooth copper tubes were supplied by the Wieland Company. The High Flux coated copper-nickel tubes were supplied by the Union Carbide Corporation.

B. THESIS OBJECTIVES

The objectives of this thesis are:

1. Take boiling data on a smooth tube in R-114 with and without oil for comparison with the data of other researchers, and to provide baseline data for evaluating the boiling performance of the High Flux tube.
2. Take boiling data on a High Flux tube for various oil concentrations (0 to 10 percent by mass).
3. Study the effect of saturation temperature on the R-114 boiling behavior.
4. Attempt to sample oil locally in the near vicinity of a tube to investigate the possibility of an oil concentration gradient around the tube during operation.

II. REVIEW OF REFRIGERANT-OIL MIXTURE BEHAVIOR

A. NUCLEATE BOILING OF REFRIGERANT-OIL MIXTURES FROM SMOOTH TUBES

In 1963, Stephan [Ref. 9] published a milestone paper on the influence of oil on the boiling heat transfer of R-12. The effects he noted have been observed in most refrigerants, including R-114. In 1972, Henrici and Hesse [Ref. 6] updated Stephan's work for R-114-oil mixtures boiling from a smooth copper tube. Figures 2.1 and 2.2 summarize Henrici and Hesse's results. Figure 2.1 shows that oil generally lowers the heat-transfer coefficient, and that at high heat fluxes and high oil concentrations (10 percent), the effect grows more pronounced (slope decreases). Figure 2.2 shows that at some oil/heat flux combinations, the heat-transfer coefficient may actually be improved by the addition of oil. Chongrungreong and Sauer [Ref. 10] suggest that the heat-transfer behavior of refrigerant-oil mixtures can be attributed to 5 major factors: 1) the physical properties of the refrigerant-oil mixture, 2) the saturation temperature (or boiling pressure), 3) the tube diameter, 4) the surface condition of the tube (roughness), and 5) the hydrostatic liquid head above the tube.

1. Physical Properties

Refrigerant-oil mixtures have significantly different physical properties than pure refrigerants. Jensen and Jackman [Ref. 11] report that density and specific heat behave ideally in refrigerant-oil mixtures, but that viscosity and surface tension do not. Ideal behavior of refrigerant-oil mixture density and specific

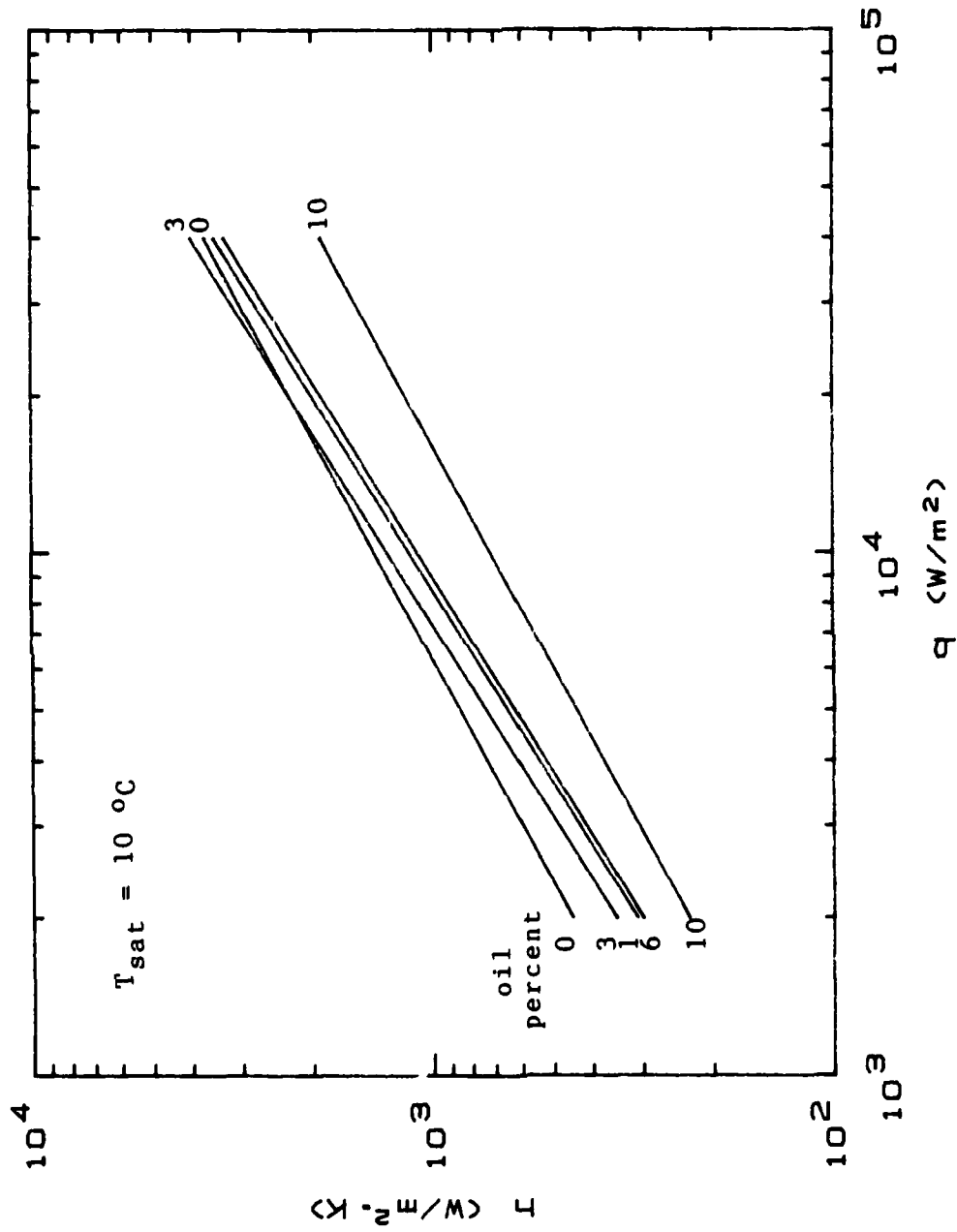

Figure 2.1. Effect of Oil on Boiling Coefficient of R-114 (from Ref. 6).

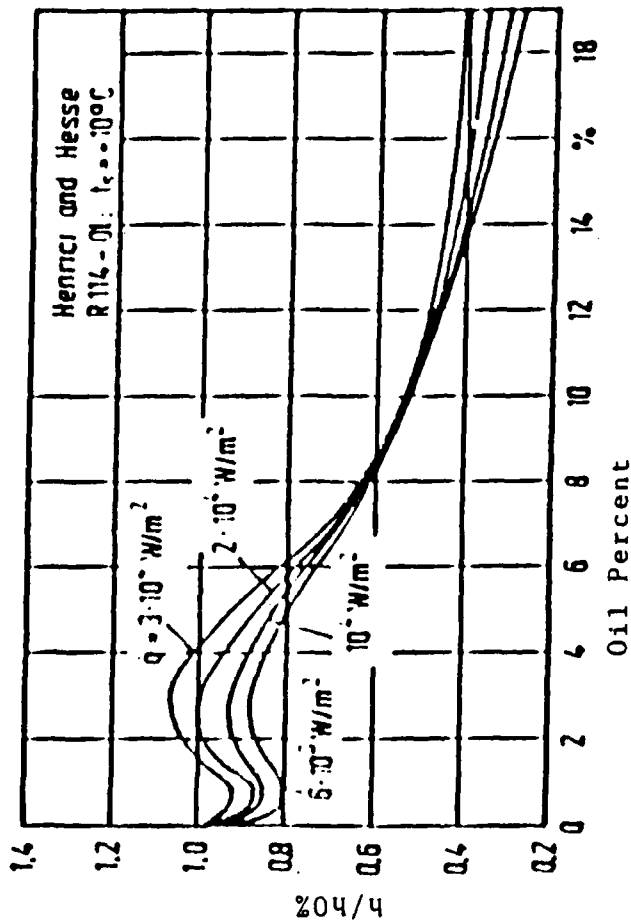

Figure 2.2 Variation of Heat-Transfer Coefficient of R-114-Oil Mixtures (from Ref. 13).

heat does not mean linear behavior. The governing equations are:

$$\frac{1}{\rho_m} = \frac{C}{\rho_{ol}} + \frac{1-C}{\rho_{rl}} \quad (2.1)$$

and

$$c_{pm} = (1-C)c_{prl} + Cc_{pol} \quad (2.2)$$

where

subscripts:

ρ = density	l = liquid
C = oil concentration	m = mixture
c_p = specific heat	o = oil
	r = refrigerant

Jensen and Jackman report that current refrigerant-oil mixture viscosity equations substantially underpredicted their experimental data. No predictive equation has been suggested for the surface tension of refrigerant-oil mixtures, though Jensen and Jackman developed a correlation for R-113-oil mixtures.

Henrici and Hesse [Ref. 6] experimentally determined the surface tension for the R-114-oil mixtures that they used in their 1971 experiment. As shown in Figure 2.3, the surface tension of the mixture first decreased up to an oil concentration of 2.5 percent, and then increased continuously with increasing oil concentration. This type of non-linear behavior makes explaining the change in heat-transfer coefficient of refrigerant-oil mixtures, due to the changing physical properties of these mixtures, both difficult, and

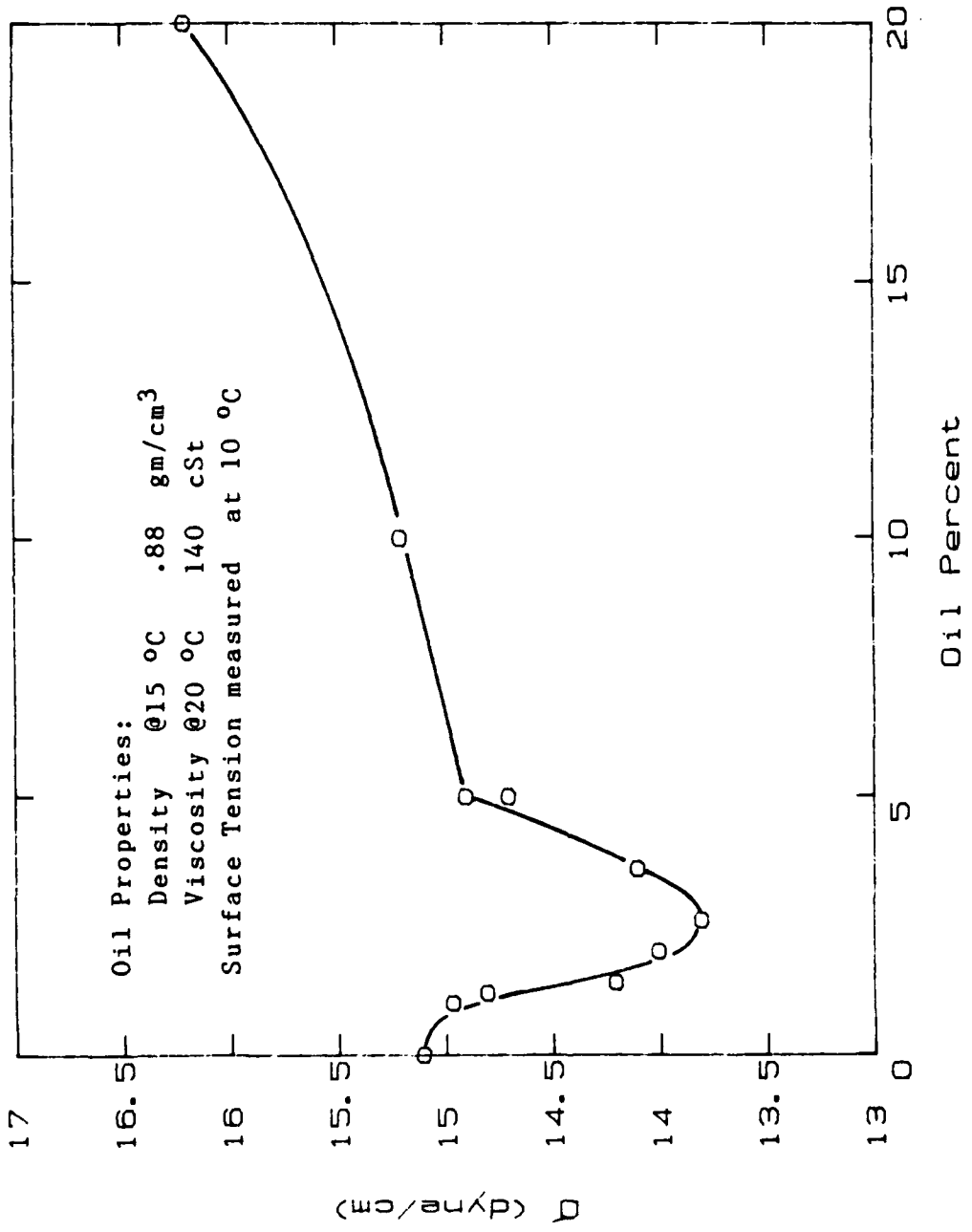

Figure 2.3 Surface-Tension Variation of k-114-oil Mixtures (from Ref. 6).

possibly non-general. The behavior of refrigerant-oil mixtures is specific to the particular mixture components, and may be dependent upon the kind of oil being used. Some qualitative consequences of adding oil to a refrigerant, however, can be noted.

The most observable result of adding oil to refrigerants is foaming. Oil concentrations above 1 percent result in significant amounts of foaming from nucleate boiling. The foam bubbles form because the R-114 in the R-114-oil mixture is more volatile than oil and vaporizes first, creating a gas bubble surrounded by an oil-rich layer (see Figure 2.4). Since the bubbles are coated with oil film with a higher surface tension than the bulk liquid and have lower density, they rise to the top of the liquid. Because of their surface tension, the bubbles build up on the liquid surface to produce a foam layer.

This foaming action, which is most pronounced between 1-10 percent oil concentration [Ref. 6], may affect the heat transfer of tube bundles significantly. For single tubes, it is the oil concentration gradient which would seem to play the major role, since the foam rises away from the tube surface and could only interact with the tube as it sweeps by it from the bottom to the top of the tube.

The general decrease in the heat-transfer coefficient upon adding oil to pure refrigerants (recall Figure 2.1) is subject to many explanations. Thome [Ref. 14], in an extensive review of the literature, reports that the first explanation for the decrease in the heat-transfer coefficient of mixtures was presented by Van Wijk et al. in 1956. The effect was explained as being the result of the evaporation of the more-volatile components, leaving an oil-rich layer with a higher local boiling point, which increases the amount of superheat required to continue vaporization and bubble growth, thus reducing the

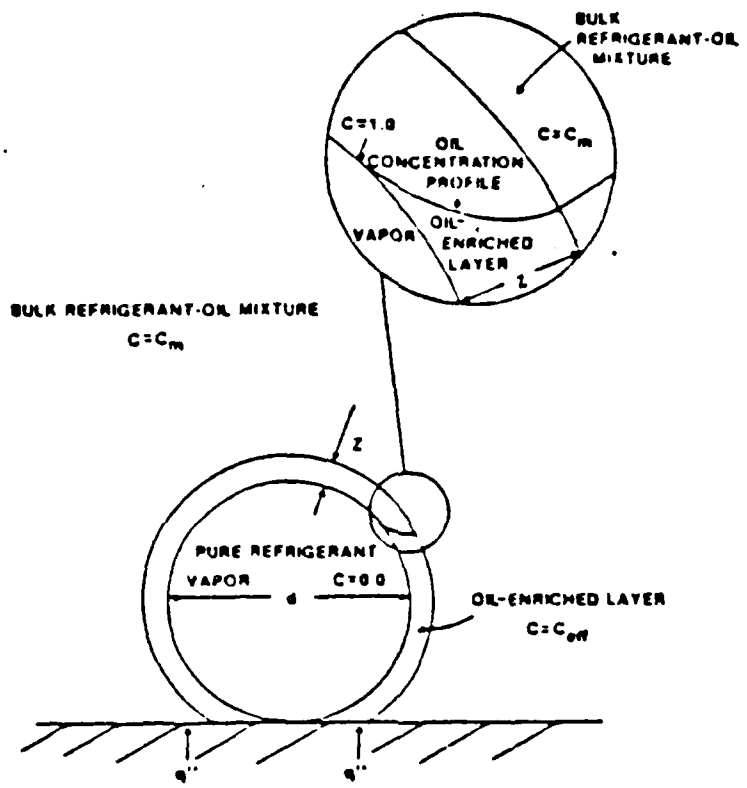

Idealized model of bubble growth in refrigerant-oil mixture

Figure 2.4 Oil Concentration Gradient in a Bubble in Refrigerant-Oil Mixtures (from Ref. 11).

heat-transfer coefficient. Stephan and Preusser [Ref. 12] demonstrated conclusively that the work of formation of bubbles in a mixture is greater than in an equivalent pure fluid. They concluded that the mixture heat-transfer coefficient is lower than for the equivalent pure fluid because of the resulting decrease in the bubble population. Any variation from a decreasing mixture heat-transfer coefficient (like Henrici and Hesse show in Figure 2.2) is attributed by Stephan [Ref. 13] to the non-linear variation of the physical properties. Stephan proposes that the plot of surface tension (Figure 2.3), along with thermal-property variations, accounts for the anomalous rise in the heat-transfer coefficient between 3-6 percent oil concentration. Chongrongeong and Sauer [Ref. 10] state that it is the rate of heat diffusion, governed by the thermal properties of the oil-rich layer, that limits the bubble growth and that the surface-tension effects are negligible.

Thome [Ref. 14] proposes that all of the above factors, as well as the viscosity variation, are important in explaining the rise in the heat-transfer coefficient for some refrigerant-oil mixture and heat-flux combinations.

In summary, all researchers agree that the physical and thermal properties of a refrigerant-oil mixture are important factors in explaining the heat-transfer behavior of mixtures.

2. Saturation Temperature

It has long been noted that increased saturation temperature (i.e., increased boiling pressure) increases the boiling heat-transfer coefficient of surfaces in refrigerant-oil mixtures. In 1963, Stephan [Ref. 9] found that at high oil concentrations, the heat-transfer coefficient of refrigerant-oil mixtures becomes constant with respect to the saturation temperature. Stephan proposed

that this is because the addition of oil to a refrigerant introduces a large diffusion resistance, and that since the velocity of diffusion is almost independent of temperature, so should the heat-transfer coefficient become independent of temperature at high oil concentration. Figure 2.5 shows Henrici and Hesse's data on the effect of oil and saturation temperature in R-114. With no oil, the effect of raising the saturation temperature is seen to be a rise in the heat-transfer coefficient. With oil, raising the saturation temperature is seen to cause a slight drop in the heat-transfer coefficient. This effect has not been explained yet.

3. Tube Diameter

Cornwell, Schuller, and Einarsson [Ref. 15] found that for smooth tube diameters from 6 mm to 30 mm, the nucleate pool boiling heat-transfer coefficient in pure refrigerants falls with increasing diameter. The effect of tube diameter was correlated by:

$$\text{Nu} = C \text{Re}^{2/3} \quad (2.3)$$

where

$$\text{Re} = \frac{q D}{h_{fg} \mu}$$

$$\text{Nu} = \frac{h D}{k}$$

$C = 150$ for refrigerants

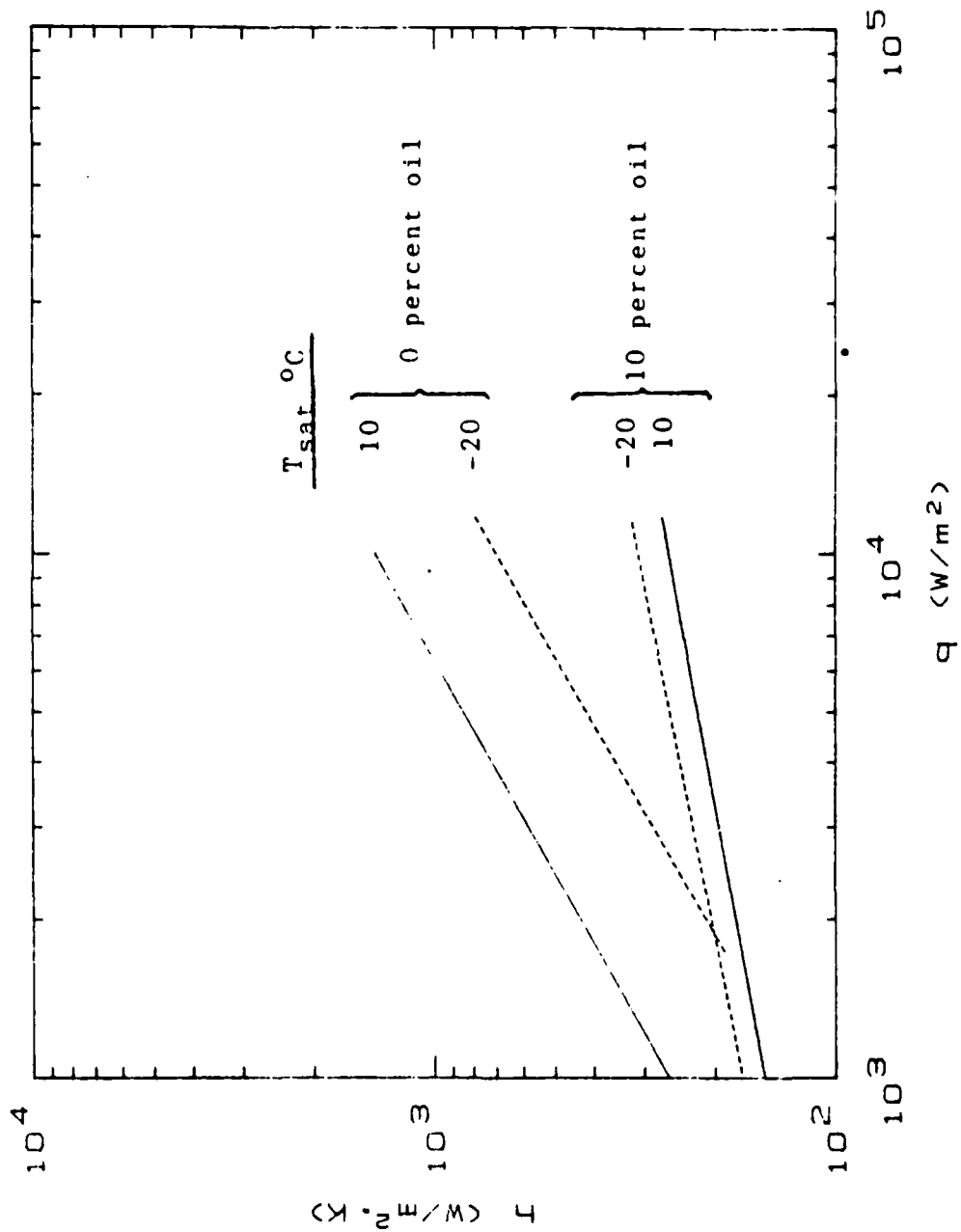

Figure 2.5 Effect of Saturation Temperature
on R-114-Oil Mixtures (from Ref. 6).

Since equation (2.3) depends on physical parameters, the effect of oil could be significant. No known measurements of the effect of tube diameter in refrigerant-oil mixtures have, as yet, been performed.

4. Surface Condition

Several researchers [Ref. 16, 17, 18] have investigated the effects of surface roughness on the heat transfer of pure refrigerants. As surface roughness increases, the heat-transfer coefficient was found to increase due to increased nucleation. Nishikawa [Ref. 18] reported the effect of a variety of surface roughnesses in pure R-114 over a range of pressures from 0.294 MPa (42 psi) to 2.94 MPa (420 psi).

5. Hydrostatic Effect

The liquid column above the boiling surface may generate large static pressures which will increase the boiling point. For R-114 at 0 °C (32 °F), a 0.3 m (1 ft) liquid head will raise the saturation temperature about 5 °C (9 °F). In large machines, this may be a significant effect. However, for small experimental apparatuses, the effect is negligible.

B. NUCLEATE BOILING OF REFRIGERANT-OIL MIXTURES FROM ENHANCED SURFACES

Webb [Ref. 19], in an extensive review of the evolution of enhanced surface geometries, notes that the ability of roughness to improve nucleate boiling performance has been known for over 50 years. However, it was not until 1968 that the first commercial enhanced surface was patented [Ref. 20]. Since then, the number of commercial enhanced surfaces has dramatically increased as the understanding of

their design and operation has grown. Of the many possible methods for heat-transfer enhancement, two areas are currently being commercially developed: 1) fins and surfaces with reentrant cavities, and 2) porous coatings.

1. Fins and Surfaces with Reentrant Cavities

The ability of surface abrasion, open grooves, and fins to improve the heat-transfer performance of a smooth surface was first studied in the 1930's. The main difficulty with using surface abrasion to improve the heat-transfer performance is that fouling of the surface eventually returns the performance to that of a non-abraded surface. Studies in the 1950's and 1960's centered on fins. Recent comparative studies for refrigerants by Carnavos [Ref. 4] and Yilmaz and Westwater [Ref. 2] found that fins and grooves result in a 50-100 percent permanent improvement in the heat-transfer performance compared to a smooth plain tube in the same refrigerant. Webb [Ref. 19], in his literature review, describes how researchers in the early 1960's found methods to improve the performance of fins by creating reentrant cavities on their surfaces. Reentrant cavities, such as shown in Figure 2.6, act as very stable nucleation sites and thereby enhance the heat-transfer performance. For a cavity to function as a nucleation site and remain active, even after the surface is subcooled, the mouth diameter (D) must fall within a critical range. Also, the cavity must have a reentrant shape with a maximum reentrant angle (θ). The optimum mouth diameter (D) and reentrant angle (θ) are functions of the fluid properties.

The Gewa-T surface, patented in 1979 (manufactured by the Wieland Company), and the Thermoexcel-E surface, patented in 1980 (manufactured by the Hitachi Company), are two commercial surfaces which use modified fin shapes to form the necessary reentrant cavities. Figure 2.7 shows the

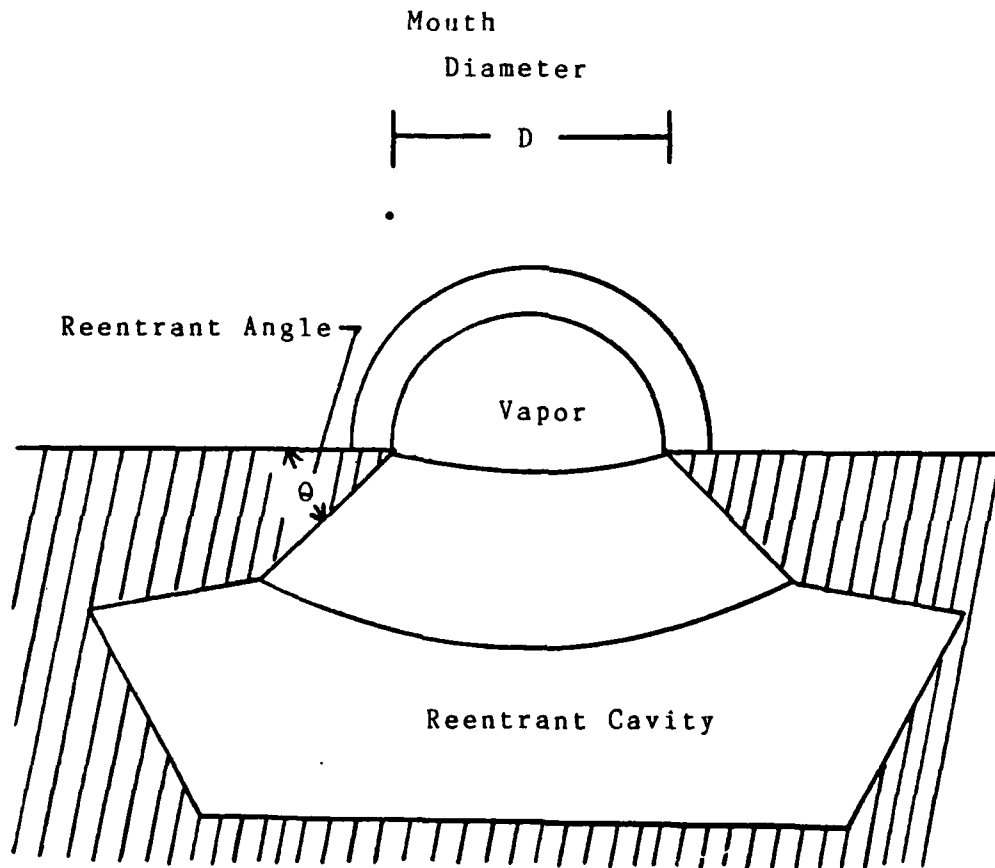
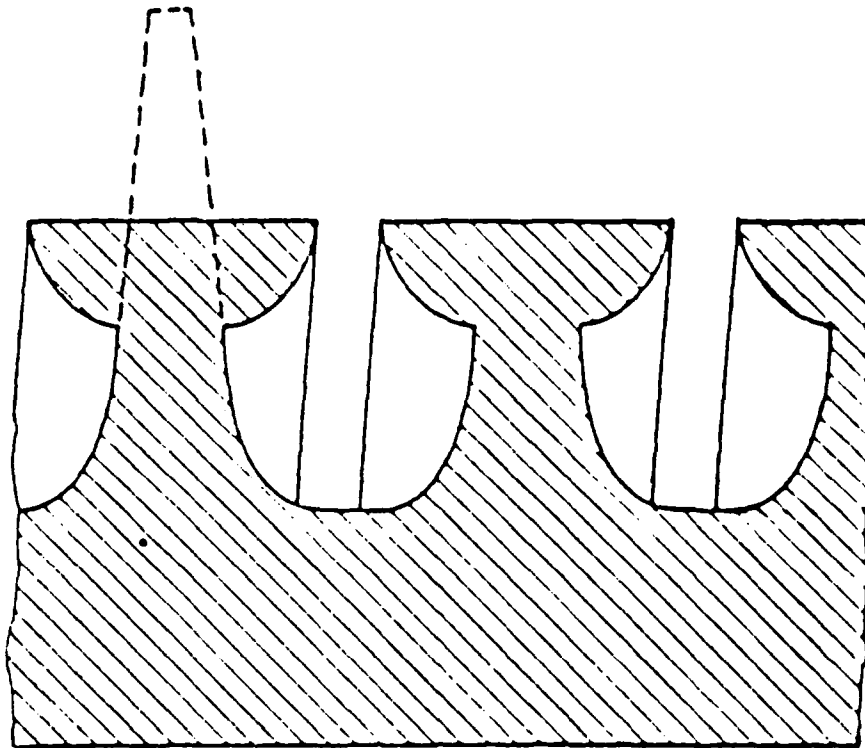
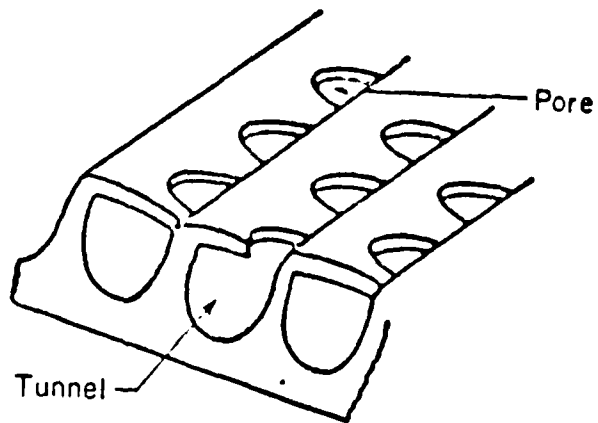

Figure 2.6 Reentrant Cavity Geometry Factors.



(a) Schematic cross section of the Gewa-T surface



(b) Schematic view of the Thermoexcel-E surface

Figure 2.7 Surface Details of Gewa-T and Thermoexcel-E Reentrant Surfaces.

details of these tube surfaces. Carnavos [Ref. 4] found that in pure R-11, the Gewa-T surface outperformed a plain tube by 100-200 percent and the Thermoexcel-E surface outperformed a plain tube by 300-400 percent. Curves 1-5 of Figure 2.8 show the relative improvement in the boiling heat-transfer performance of R-11 that can be achieved by using mechanically produced reentrant cavities. Work continues to optimize these types of surfaces for the various refrigerants in use commercially. Both tubes have been tested in refrigerant-oil mixtures and did not show a significant decrease in performance [Ref. 1 and 7]. The cost of these surfaces is not significantly higher than for smooth plain tubes, and the performance improvement is dramatic.

2. Porous Coatings

The second major type of enhanced surface is the porous boiling surface. Webb [Ref. 19] details the various production improvements and coating variations that have been made to the original 1968 patent by Milton of Union Carbide. The key to the performance of the porous coatings is their small reentrant cavities, which are interconnected by substrate tunnels. The particles used to make the coatings are usually copper or aluminum. According to Webb, researchers have found that the critical variable is the pore size rather than the particle size. Large pores are required for fluids with high surface tension and high thermal conductivity. Small pores are optimum for fluids with low surface tension and low thermal conductivity (like refrigerants). Curve 6 of Figure 2.8 shows the relative performance of the High Flux surface to finned tubes and mechanically produced reentrant surfaces. Carnavos [Ref. 4] found the High Flux surface to be 700-800 percent better than a smooth tube in R-11. No known studies have been

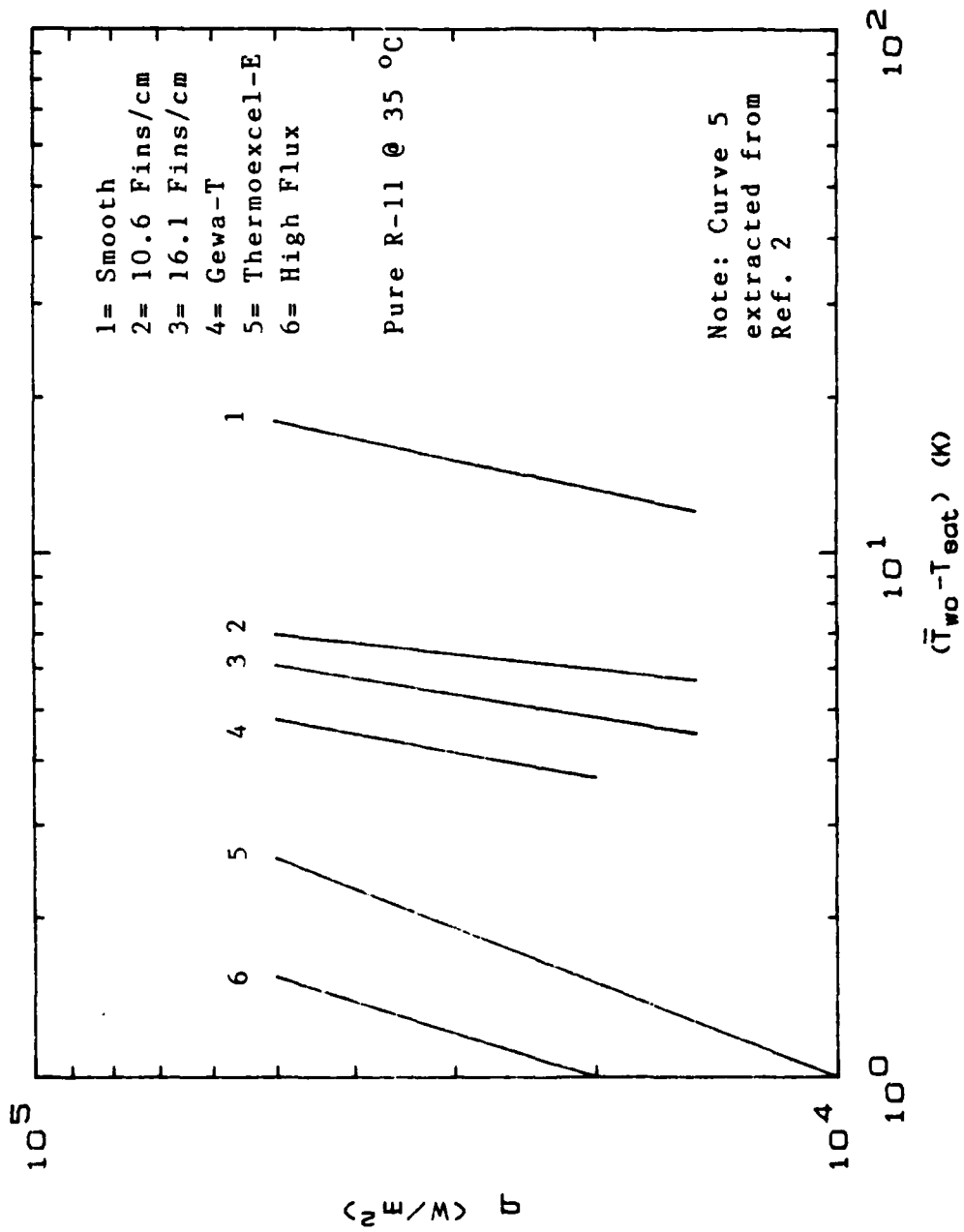

Figure 2.8 Comparison of R-11 Boiling Performance from Various Commercial Surfaces (from Ref. 4).

published on the performance of porous coatings in refrigerant-oil mixtures. Some studies of the heat-transfer performance of porous coatings in pure R-114 and refrigerant-oil mixtures have been made by Union Carbide, but their results are not found in the open literature.

III. DESCRIPTION OF EXPERIMENTAL APPARATUS

A. OVERALL APPARATUS

An overall schematic of the experimental apparatus is shown in Figure 3.1, and a photograph is shown in Figure 3.2. Karasabun [Ref. 8] describes the design, construction, and operation of the apparatus in detail.

The apparatus consists of two Pyrex-glass tees. Liquid R-114 is boiled in glass tee (1) and is condensed in glass tee (2). Gravity drains the condensate from the condenser back to the boiling section. A water-ethylene-glycol mixture at -17°C (1°F) is pumped through the condenser cooling coil via a computer-controlled valve (VC) to condense the R-114 vapor. The sump (7) that supplies the water-ethylene-glycol mixture is cooled by a 1/2-Ton, R-12 air-conditioning plant.

Valve VC controls the R-114 liquid temperature and pressure. Figure 3.3 is a photograph of valve VC and the computer-controlled motor that operated VC. Opening VC causes more R-114 to condense and lowers the system pressure. Also, it returns more subcooled liquid to the boiling section which lowers the bulk liquid temperature. Since data at many heat fluxes was desired for a constant temperature, it can be seen that changing the heat flux without adjusting VC would change the system pressure and temperature. A computer-controlled valve was thought to be the best way to rapidly return the system to the desired saturation temperature following a heat flux change. Sections III.E and IV.D describe in more detail the computer-controlled valve and the operation of the system with the computer-controlled valve in use.

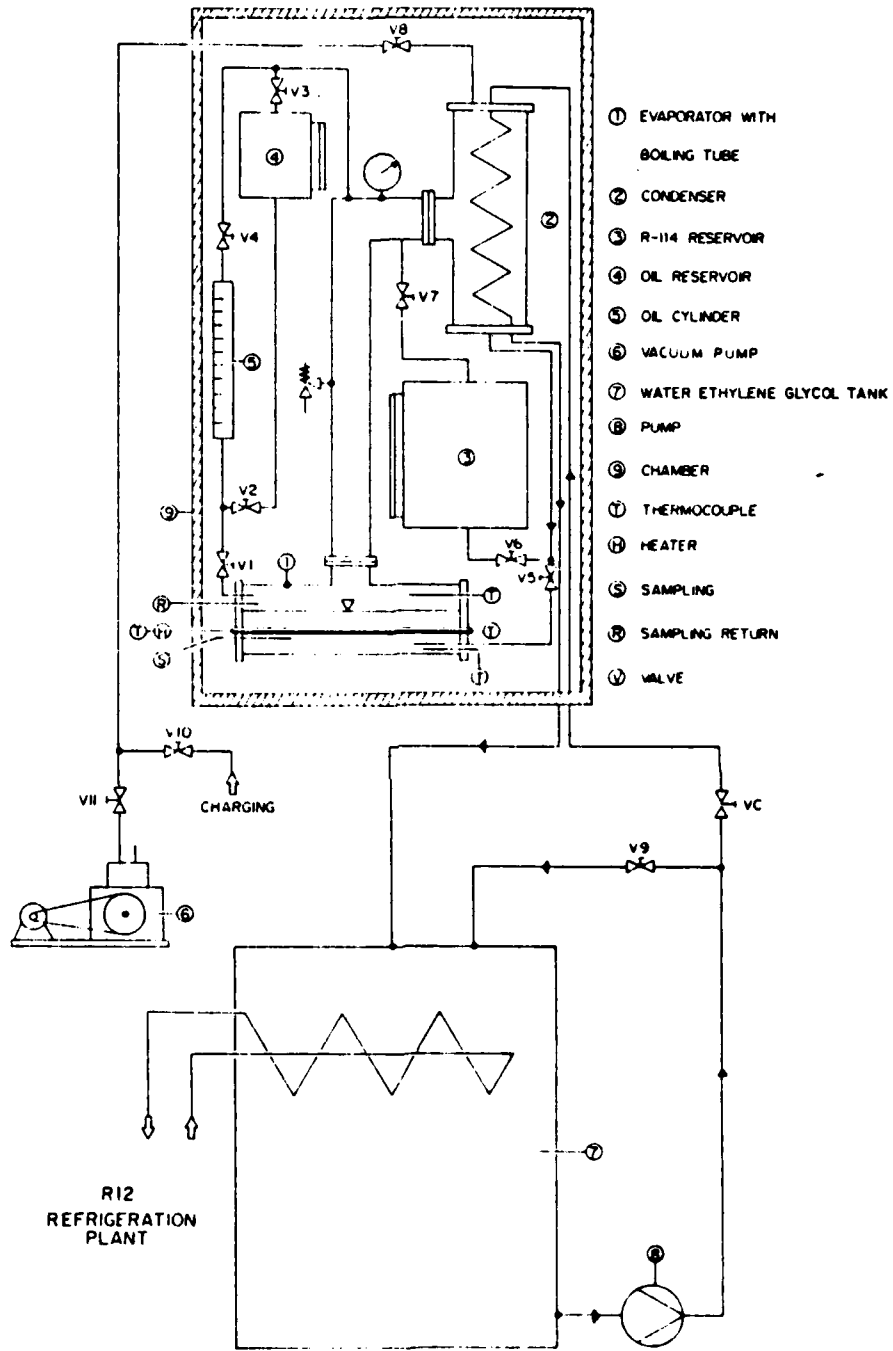

Figure 3.1 Schematic of Experimental Apparatus.

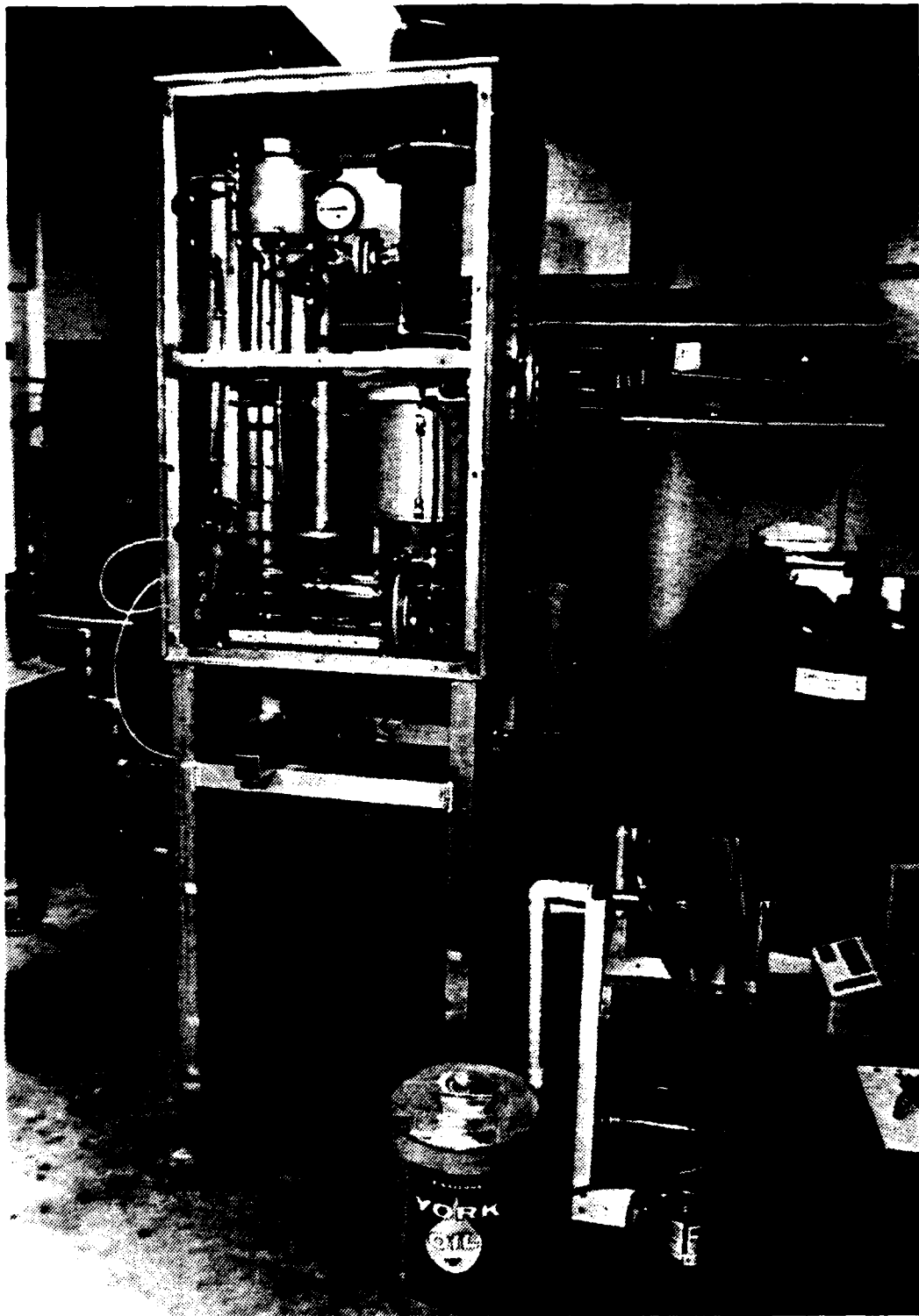
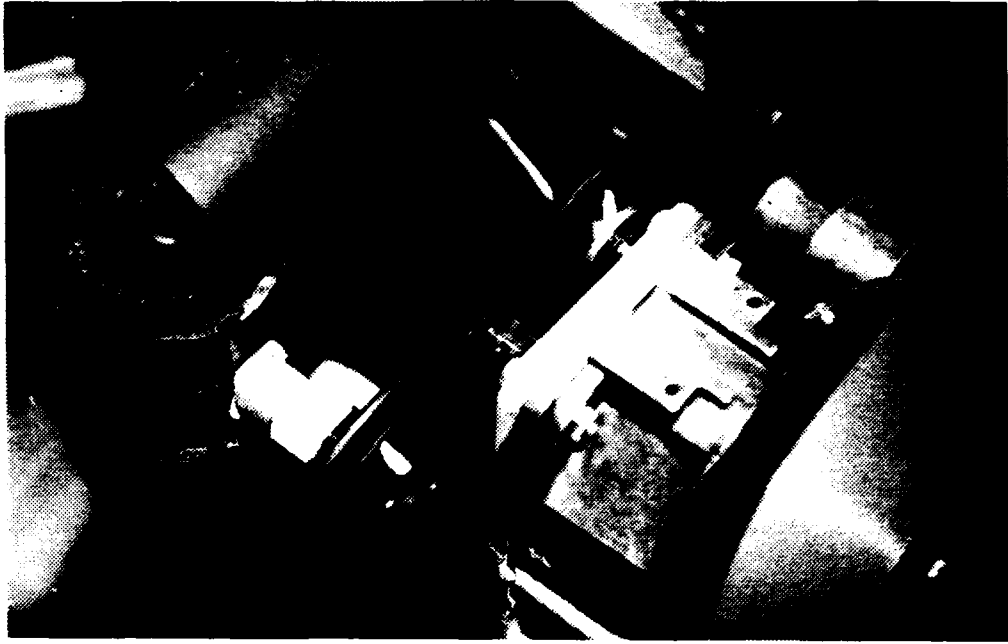

Figure 3.2 Photograph of Experimental Apparatus.



(a) Computer-Controlled Valve.



(b) Computer for Computer-Controlled Valve.

Figure 3.3 Photographs of Computer-Controlled-Valve Equipment.

Oil was added to the liquid R-114 by draining it from a glass oil cylinder (5). The oil cylinder was refilled as needed through valve V-2 from the oil reservoir (4).

Two configurations of boiling tubes were tested. Short boiling tubes were tested to determine the correct assembly procedure to obtain data on the normal 431.8 mm (17 in.) long boiling tubes. The short tubes were cheaper to make, thus more debugging attempts could be made by testing them. Section III.C describes the details of the construction of the short and long test tubes.

B. OIL SAMPLING APPARATUS

Following all data runs, an attempt was made to sample the local oil concentration in the vicinity of a boiling tube. Figure 3.4 shows the oil sampling apparatus. By opening valves S-1, S-2, and S-4, the probe line could be purged, trapping a sample inside a flexible silicon tube that was 30.5 mm (12 in.) long with a 3.16 mm (1/8 in.) inside diameter using pinch clamps. By weighing the sample tube and then boiling off the R-114 leaving behind the oil, the mass percent of oil in the R-114-oil mixture was determined. The mass fraction of oil was calculated by:

$$\text{Mass Fraction} = \frac{m_3 - m_1}{m_2 - m_1} \quad (3.1)$$

where

m_1 = mass of sample line

m_2 = mass of sample line + R-114 + oil

m_3 = mass of sample line + oil (after boiling off R-114)

A Precisa Model 80 electronic mass balance was used to weigh the samples. The Precisa Model 80 is accurate to ± 0.0001 g.

C. BOILING TUBE CONSTRUCTION

1. Short Tubes

Figure 3.5 shows the design of the short tubes. The short tubes were 15.9 mm (5/8 in.) in outer diameter, 12.7 mm (1/2 in.) in inside diameter, and 203.2 mm (8 in.) in length. The short tubes extended 152.4 mm (6 in.) into the liquid R-114 from the left end flange. A 25.4 mm (1 in.) long epoxy plug insulated the right end of the tube. A 1 mm (0.04 in.) thick copper disk behind the epoxy plug was soft soldered in place to act as a pressure barrier. The short tubes were heated by a 500-Watt 240-Volt stainless-steel cartridge heater. The heater was 6.35 mm (1/4 in.) in outer diameter and 101.6 mm (4 in.) in length.

The first short tube was made from thick-walled copper tubing. This tube was solid oxygen-free, high conductivity (OFHC) copper. Four 1.2 mm (3/64 in.) diameter holes were drilled into the wall of this tube at a diameter of 12.7 mm (1/2 in.) for thermocouple channels. Since this tube was solid, and had no sleeve interface, it did not have an interface resistance. Consequently, it was the reference tube against which all other tubes were compared to determine the amount of contact resistance they had.

Six other short tubes were made. Five were made of soft copper tubing and had sleeves inserted into the tube as indicated in Table 1. Soft soldering of the sleeves to the tubes was determined to yield negligible contact resistance by comparison with the solid tube. The last short tube (7) was made of 90-10 copper-nickel and was coated with High Flux over the active 101.6 mm (4 in.) long section. This

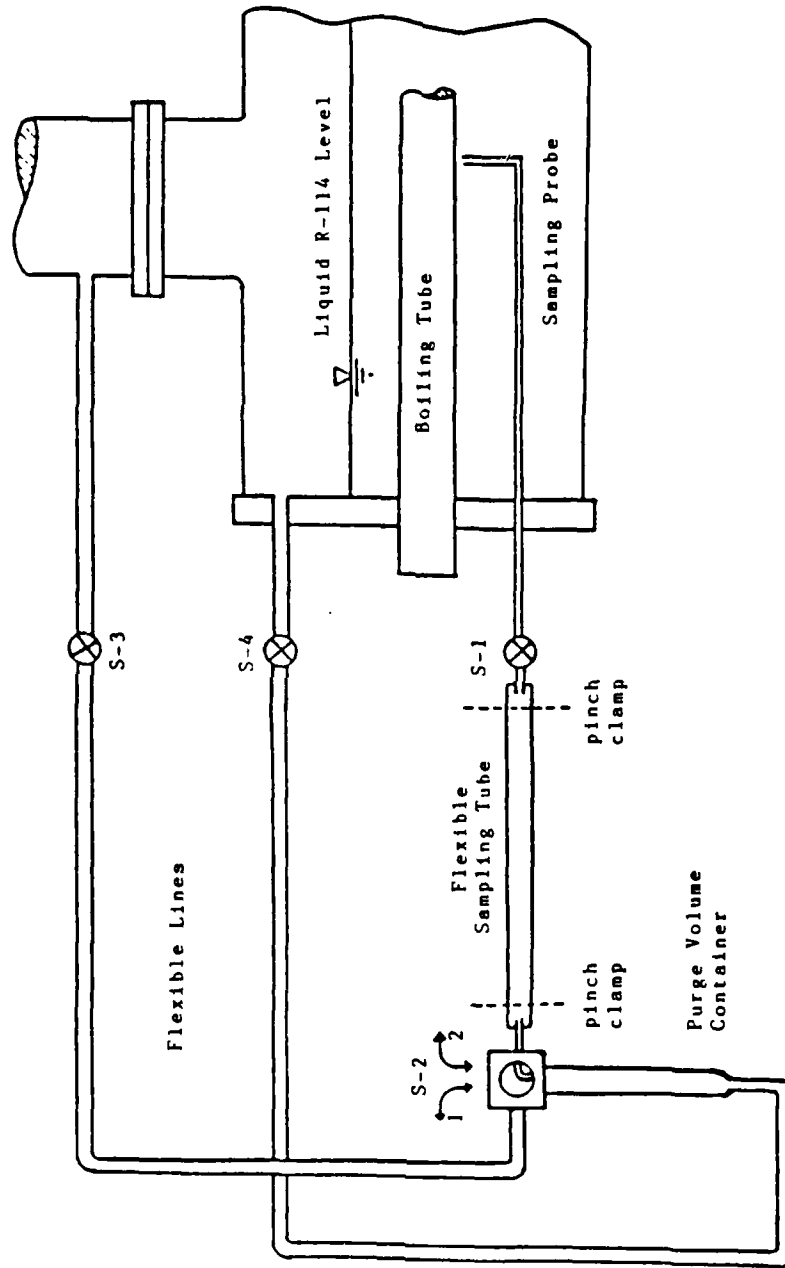
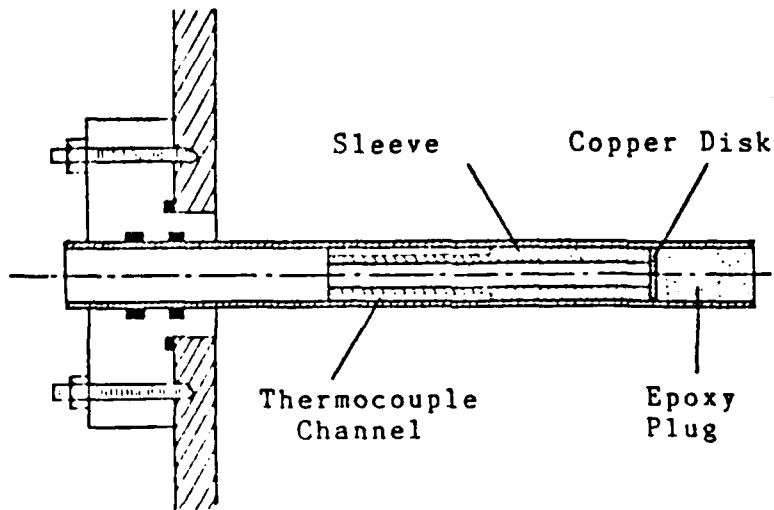
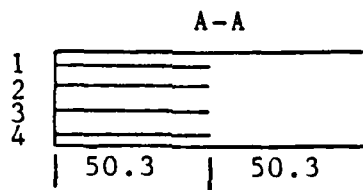

Figure 3.4 Oil Sampling Apparatus.



(a) Sectional view of short tube.



(b) Thermocouple sleeve unwrapped (at section A-A) to show the relative locations of the thermocouple channels (all dimensions in millimeters).

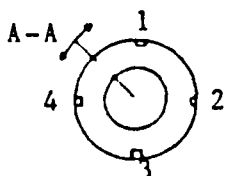

(c) Left-end view of the short tube.

Figure 3.5 Sectional Views of Short Boiling Tube.

tube tested the compatibility of the soft-solder-assembly method with the copper-nickel tube and High Flux coating. Section V.A describes the results of data taken on the short tubes and the selection of the soft-solder method of assembly for the long tubes.

TABLE 1
Summary of Short Tube Assembly Methods

Tube	Surface	Remarks
1	Smooth	Solid, thick-walled tube (reference)
2	Smooth	Slide-fit (0.005 in. clearance)
3	Smooth	Slide-fit (0.002 in. clearance)
4	Smooth	Press-fit (0.004 in. interference)
5	Smooth	Press-fit (0.006 in. interference)
6	Smooth	Soft-soldered
7	High Flux	Soft-soldered

2. Long Tube

Figure 3.6 shows the design of the long boiling tubes. These boiling tubes were 15.9 mm (5/8 in.) in outer diameter, 12.7 mm (1/2 in.) in inside diameter and 431.8 mm (17 in.) in length. The center 203.2 mm (8 in.) was the active test section. For the copper-nickel tube, the center section was the only portion of the tube that was coated with High Flux. The remaining 114.3 mm (4.5 in.) on either side of the center section were smooth and unheated, and did not nucleate under any heat flux or oil condition. Karasabun [Ref. 8] describes how these end-surfaces were treated by the data-reduction program as an extended fin from the center section and how their heat loss was accounted for.

The center section was heated by a 1000-watt 240-volt stainless-steel cartridge heater. The heater was 6.35 mm (1/4 in.) in outer diameter and 203.2 mm (8 in.) in length. The heater was surrounded by a copper sleeve with

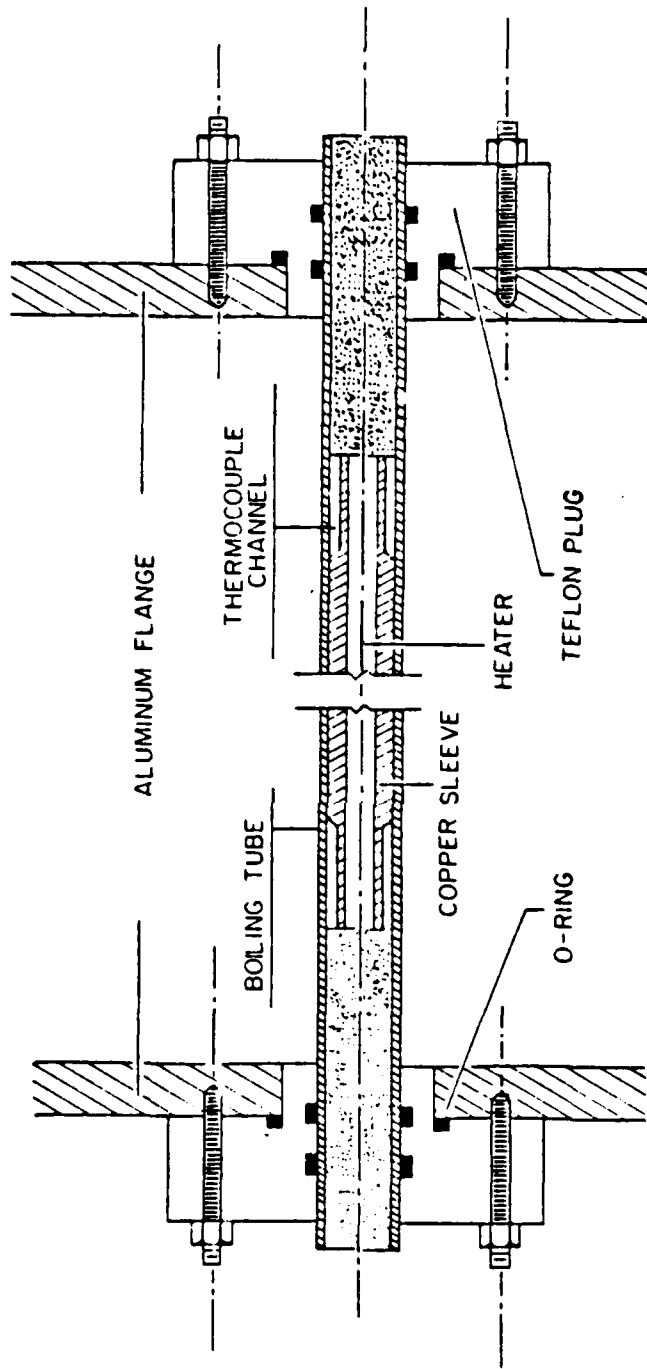

Figure 3.6 Sectional View of Long Boiling Tube.

eight 1.3 mm by 1.3 mm (0.050 in. by 0.050 in.) thermocouple channels in them. Figure 3.7 shows the details of the channel layout. The thermocouple hot junctions were welded to the sleeve. Appendix A describes the calibration of the thermocouples. The channels were oriented to provide both axial and circumferential readings of the tube inner wall temperature. The sleeve was soft soldered to the tube. The data on the short soft-soldered tube closely matched the reference solid-tube data, and the short soft-soldered-tube data matched similiarly with long tube data. The maximum circumferential wall temperature variation in the long smooth tubes was 0.80 K (0.31 °F) at 50 kW/m² compared to a solid tube circumferential variation of 0.34 K (0.61 °F). Section V.A describes in more detail the circumferential variation of temperature that resulted using the various tube construction methods. Some axial temperature variation was experienced in the long tubes, particularly the long High Flux tube. Non-uniform heat generation from the cartridge heater is believed to be responsible for the axial temperature variation. Section V.B descibes in more detail the long tube axial temperature variation.

D. DATA ACQUISITION AND REDUCTION

A Hewlett-Packard 3497A automatic data acquisition/control unit was used to read thermocouple outputs and to read an analog signal representing the current and voltage supplied to the cartridge heater. A Hewlett-Packard 9826A computer unit was used to control the HP-3497A and to analyze and store the data.

Information was entered through the computer keyboard to prompt the HP-3497A to automatically scan each channel. All thermocouple measurements were accomplished by 0.245 mm diameter (30 gage) copper-constantan (type-T) thermocouples.

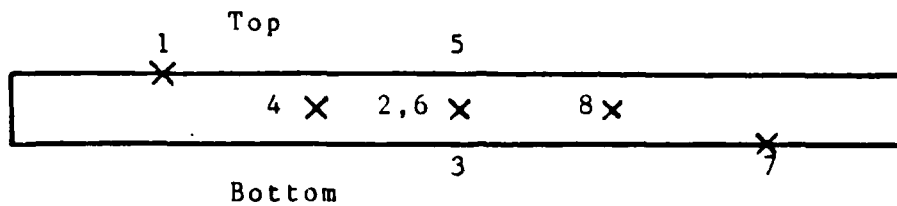

(a) View of the boiling tube thermocouple locations as seen from the front of the experimental apparatus.

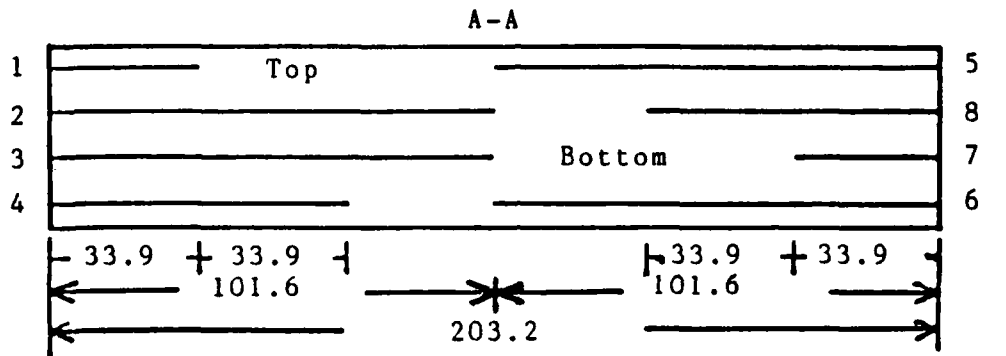

(b) Thermocouple sleeve unwrapped (at section A-A) to show the relative locations of the thermocouple channels (all dimensions in millimeters).

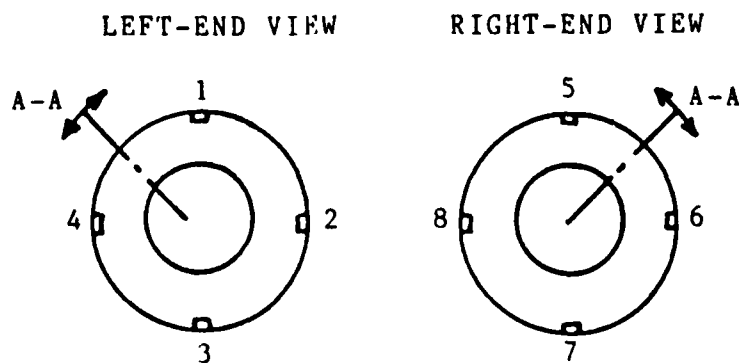

(c) End views of the boiling tube.

Figure 3.7 Long Tube Thermocouple Channels

A power sensing device, described by Karasabun [Ref. 8], converted the AC current and voltage values supplied to the cartridge heater to a 0-5 V analog, DC signal for scanning by the HP-3497A. Table 2 lists the channel allocations in the HP-3497A.

Following data acquisition for each point, results were computed according to the step-wise procedure outlined by Karasabun [Ref. 8], and summarized in Appendix B. Appendix B also includes a complete listing of the data-reduction program (DRP2).

TABLE 2
HP-3497A Channel Allocations

Channel	Purpose
25-32	Tube wall thermocouples (location T(1) to T(8) in long tube, T(5)-T(8) not used in short tubes)
33	Liquid R-114 thermocouple T(9)
34	Backup liquid R-114 thermocouple T(10)
35	R-114 vapor thermocouple T(11)
36	Sump thermocouple T(12)
62	Cartridge heater voltage analog signal
63	Cartridge heater current analog signal

E. COMPUTER-CONTROLLED VALVE

The computer-controlled valve (VC) was a Whitney, screwed bonnet, regulating valve with 3/8 in. Swagelok fittings. The valve travel was 10.5 turns from full shut to full open. The valve handle was replaced by a 101.6 mm (4 in.) hard rubber disk (seen in Figure 3.3) which was rotated by the motor pinion gear.

The computer-controlled motor was a General Electric "Minigear Motor" with a speed of 105.7 rpm and a torque of 3.39 N-m (30 lb-in). The motor direction was controlled by two sets of Crydom solid-state relays that acted to open,

shut, or hold the motor depending on signals from the computer. The computer controlled the amount of time that the valve was moving. Approximately 3 seconds were required for the motor to turn the valve one turn.

The flow through the valve was checked by a flow meter and verified to be approximately linear (1 turn = 10 percent flow) for the flows most often used. The valve position was tracked by a 10-turn potentiometer, which was connected to the computer-controlled motor by another 101.6 mm (4 in.) hard rubber disk driven off the motor pinion gear. Hard rubber disks were used instead of metal gears to avoid damage to the gear teeth during the program debugging stage. The rubber disks allowed sufficient slipping when, for example, the computer sent a valve-open signal even though the valve was fully open.

The R-114 liquid temperature input to the computer was provided by a separate copper-constantan thermocouple installed in the same liquid R-114 thermocouple well that the HP-3497A data acquisition/control unit used. The R-114 thermocouple emf for the computer was amplified by an Omega thermocouple DC millivolt amplifier before input in to the computer. The data acquisition system and the computer-controlled valve system were completely independent systems.

The computer used for the computer-controlled valve was an Octagon Systems SYS-2A microcomputer with an Esprit I terminal connected via an RS-232C serial port. Appendix C lists the control program used. The control program was written in NSC "Tiny EASIC." The control algorithm simulates a proportional-integral-derivative (PID) controller to vary the valve opening and shutting times. In the final program, limits were placed on the numerical value of certain program variables to prevent register overflow, jamming the valve fully open/shut, and to lessen the impact of system noise on the response of the system. NSC Tiny BASIC is limited to

integers from -32000 to 32000 and fractional numbers are truncated. The values of the weighting factors (A,B,C) for the proportional term (E), integral term (I), and derivative term (D) were determined by trial-and-error.

The control algorithm simplifies to the following lines:

```
60 Input required temperature R
230 Read R-114 temperature M
260 Compute error (E), and change in error (D)
262 Add 1 each loop to integral sum (I) if error is positive
264 Add -1 each loop to integral sum (I) if error is negative
400 Valve command  $V = (E/A) + (B * D) + (I/C)$ 
420 If (V>0) then open valve
430 Otherwise shut valve
540 GOTO 230
```

Section V.C describes in detail the system response under this algorithm. Computer control of valve VC was not used during the data taking as originally planned. Section V.C discusses the reasons for this decision.

IV. EXPERIMENTAL PROCEDURES

A. INSTALLATION OF TUBE IN APPARATUS

Prior to installation in the apparatus, the boiling tube surface was cleaned with a 2 percent Nital solution (to remove surface oxidation and oil), rinsed with acetone, and air dried. Short tubes tested with and without the above treatment showed no change in the heat-transfer performance. The treatment was effective in removing the slight surface oxidation present following soft soldering without changing the smooth or High Flux tube performance. Additionally, following testing with oil, a treatment was needed to return the High Flux surface to the "no-oil" condition for further testing.

After installing the tube in the glass tee, the apparatus was evacuated to 29 in. Hg by the portable mechanical vacuum pump (6) shown in Figure 3.1. System pressure was measured by a Marsh pressure gage (30 in. Hg to 150 psi range, ± 2.5 in. Hg and ± 0.5 psi accuracy). The apparatus was left at vacuum for 2 hours to check for leaks prior to each run. No noticeable drop in vacuum was observed within the accuracy of the gage. Next, the system gage pressure was raised to 0.18 MPa (27 psi), the saturation pressure of R-114 at 100°C, by opening valve V7 (see Figure 3.1 for the location of the valves). An Automatic Halogen Leak Detector, TIF 5000, was used to check for R-114 leakage. The sensitivity of this detector is 3 ppm minimum concentration. After pressure equalization with the R-114 reservoir (3), the reservoir drain valve (V6) and condenser return valve (V5) were opened to fill the boiling tee with liquid R-114.

Prior to installation, the left end flange had been scribe marked to indicate the liquid level corresponding to 1600 cc (2500 gm) of liquid R-114 at 21 °C (70 °F). This was the mass of pure R-114 in the apparatus at the beginning of the data runs. The apparatus was now ready for taking data.

B. GENERAL OPERATION

Table 3 lists the 109 data runs accomplished during this thesis effort and their purpose. The data runs were numbered sequentially and preceded by a 2- or 3-letter prefix to indicate the tube type. The tube prefixes were:

SS = Short Solid Tube
HF = High Flux Long Tube
WH = Wieland Hard Copper Long Smooth Tube
SSF = Short Slide-Fit Tube
SPF = Short Press-Fit Tube
SST = Short Soft-Soldered Tube
SHF = Short High Flux Tube

The short tube runs consisted of 6 data points at 6 different heat fluxes (usually 59, 37, 22, 14, 8, and 5 kW/m²). The normal tube runs consisted of at least 7 different heat fluxes with 6 data readings at each heat flux (usually 98, 61, 37, 22, 14, 8, and 5 kW/m²) with some additional low heat fluxes investigated for the 0, 3, and 10 percent oil cases to check for the onset of nucleate boiling and hysteresis in the High Flux surface.

In all cases, the data set was begun by starting the cooling pump (8) and opening valve VC slightly to slowly cool the liquid R-114 to the desired saturation temperature. The R-114 vapor temperature was also monitored and when both liquid and vapor temperatures were stable (usually after 30-45 minutes), the heat flux would be established, the saturation temperature reestablished, and the data acquisition unit was allowed to take data. Usually, the vapor

TABLE 3
Summary of Data Runs

Run No.	Tsat (°C)	No. Pts	Remarks
WH10			Runs WH01 to WH10 taken by Karasabun
SPF11	6.7	3	Debug new tube
SPF12	-2.2	6	press-fit tube 4 (0.004 in. interference)
SPF13	2.2	6	Effect of Tsat
SPF14	6.7	6	Effect of Tsat
SSF15	-2.2	6	Slide-fit tube 2 (0.005 in. clearance)
SSF16	2.2	6	Effect of Tsat
SSF17	6.7	6	Effect of Tsat
SSF18	-2.2	6	Rotate tube 90 degrees
SSF19	2.2	6	Study low heat flux error band
SSF20	-2.2	6	Study high heat flux error band
SSF21	2.2	6	Rotate heater -90 degrees, tube fixed
SSF22	-2.2	6	Shift heater and thermocouples
SSF23	6.7	6	Repeatability
SPF24	-2.2	6	Repeatability
SPF25	2.2	6	Repeatability
SPF26	-2.2	6	Shift heater and thermocouples
SPF27	2.2	6	Clean with Nital, acetone, and air dry
SPF28	6.7	6	Repeatability
SSF29	-2.2	6	Slide-fit tube 3 (0.002 in. clearance)
SSF30	6.7	6	Effect of Tsat
SPF31	-2.2	6	Repeatability
SPF32	2.2	6	Time Variation Study (1 day later)
SPF33	-2.2	6	Effect of Tsat
SPF34	6.7	6	Effect of Tsat
SS35	-2.2	6	Short Solid Tube
SS36	2.2	6	Repeatability
SS37	6.7	6	Effect of Tsat
SPF38	-2.2	6	4 days later
SPF39	2.2	6	Shift heater and thermocouples
SPF40	-2.2	6	7 days later
SPF41	2.2	6	10 days later
SS42	-2.2	6	Time Study Solid Tube (no effect)
SS43	2.2	6	Short soft-soldered tube 6
SST44	-2.2	6	Repeatability
SHF45	-2.2	4	Debug short High Flux tube 7
SHF46	2.2	3	Study T _{vapor} superheat
SHF47	-2.2	7	Repeatability
SHF48	2.2	8	Repeatability
SHF49	-2.2	6	Study hydrostatic head (+1 in. level)
SHF50	2.2	6	-Increase data pts at heat fluxes
SHF51	-2.2	6	-Runs 49-54 form data set
SHF52	2.2	6	-Each run at different heat flux
SHF53	-2.2	6	-Compare with set 55-60
SHF54	2.2	6	End of Set 49-54
SHF55	-2.2	6	Study hydrostatic head (+0.5 in. level)
SHF56	2.2	6	-same as above set 49-54
SHF57	-2.2	6	-same
SHF58	2.2	6	-same
SHF59	-2.2	6	-same
SHF60	2.2	6	End of Set 55-60
SHF61	-2.2	6	Install T _{vapor} radiation shield
SHF62	2.2	6	Study T _{liquid} subcooling
SHF63	-2.2	6	Clean High Flux w/Nital and acetone
SHF64	2.2	6	Repeatability
SHF65	-2.2	6	Repeatability
SHF66	2.2	6	Repeatability
SHF67	-2.2	7	Rotate tube +90 and +180 degrees
SHF68	2.2	6	Repeatability

Table 3

Summary of Data Runs (cont'd)

Run No.	Tsat (°C)	No. Pts	Remarks
SHP 69	-2.2	7	Apply thermal grease to heater (no effect)
SHP 70	-6.7	36	Effect of T _{sat}
SHP 71	-2.2	36	Repeatability
SHP 72	-2.2	36	Debug oil addition (0.2 percent added)
SHP 73	-2.2	36	Remove and clean tube, add 1 percent oil
SHP 74	-2.2	36	2 percent oil
SHP 75	-2.2	36	3 percent oil
SHP 76	-2.2	36	6 percent oil
SHP 77	-2.2	36	10 percent oil
WH 78	-2.2	9	Axial/Circumferential variation study
WH 79	-2.2	42	0 percent oil, decreasing
WH 80	-2.2	11	Rotated tube -90 and -180 degrees
WH 81	-2.2	42	Repeatability (of run WH 79)
WH 82	-2.2	42	0 percent oil, increasing
WH 83	-2.2	38	Repeatability (of run WH 82)
WH 84	-6.7	49	0 percent oil, increasing
WH 85	-2.2	66	0 percent oil, decreasing
WH 86	-2.2	48	1 percent oil, decreasing
WH 87	-6.7	48	1 percent oil, decreasing
WH 88	-2.2	48	2 percent oil, decreasing
WH 89	-6.7	48	2 percent oil, decreasing
WH 90	-2.2	36	3 percent oil, increasing
WH 91	-2.2	48	3 percent oil, decreasing
WH 92	-6.7	48	3 percent oil, decreasing
WH 93	-6.7	48	6 percent oil, decreasing
WH 94	-2.2	48	6 percent oil, decreasing
WH 95	-2.2	61	10 percent oil, increasing
WH 96	-6.7	53	10 percent oil, increasing
WH 97	-2.2	66	10 percent oil, decreasing
WH 98	-2.2	45	Repeatability (of run WH 95)
WH 99	-6.7	66	10 percent oil, decreasing
HF 100	-2.2	66	0 percent oil, increasing
HF 101	-2.2	72	0 percent oil, decreasing
HF 102	-2.2	24	Repeatability (of run HF 100)
HF 103	-6.7	66	0 percent oil, increasing
HF 104	-6.7	69	0 percent oil, decreasing
HF 105	-6.7	56	Repeatability (of run HF 104)
HF 106	-2.2	48	1 percent oil, decreasing
HF 107	-6.7	48	1 percent oil, decreasing
HF 108	-6.7	48	2 percent oil, decreasing
HF 109	-2.2	48	2 percent oil, decreasing
HF 110	-6.7	48	3 percent oil, decreasing
HF 111	-2.2	39	3 percent oil, increasing
HF 112	-2.2	72	3 percent oil, decreasing
HF 113	-2.2	48	6 percent oil, decreasing
HF 114	-6.6	48	6 percent oil, decreasing
HF 115	-2.2	48	10 percent oil, increasing
HF 116	-2.2	72	10 percent oil, decreasing
HF 117	-6.7	72	10 percent oil, decreasing
HF 118	-6.7	48	10 percent oil, increasing
SPF 119	-2.2	36	Complete study of time variation SPF

Note: 75 data runs for Computer-Controlled Valve testing not listed.

temperature would read higher, up to 2 K, than the liquid temperature due to the vapor becoming superheated. The apparatus, though cooled by the R-114, was still hot enough (60 °F) to superheat the vapor. Measurements of the liquid temperature, system pressure, and vapor temperature (with vapor probe shielded by a radiation shield) confirmed this. The liquid temperature best indicated the saturation temperature.

The HP-3497A data acquisition unit would scan each channel, compute the heat-transfer coefficient, print the results (an example printout is shown in Appendix D), and store the data on the floppy disk.

Following the taking of all data points, the data set was statistically analyzed by subroutine STATS to compute the average heat-transfer coefficient at each heat flux and the standard deviation of the 6 data points for a given heat flux. The standard deviation of the 6 data points was usually 0.5 percent for the heat flux and 1-2 percent for the heat-transfer coefficient.

After all data sets at a given oil concentration were complete, oil was added via valve V1. The oil immediately dissolved in the R-114. No carryover to the condenser was noted except for several small drops at 10 percent oil and the highest heat flux during the last few data sets. Foaming occurred with the addition of oil, and increased with both increasing heat flux and increasing oil concentration. Figure 4.1 to 4.3 show photographs at heat fluxes of 30 kW/m² and 98 kW/m² for oil concentrations of 0, 3, and 10 percent. When oil addition was not taking place, the oil cylinder and reservoir were isolated from the apparatus by valves V3 and V4 to minimize R-114 absorption by the oil.

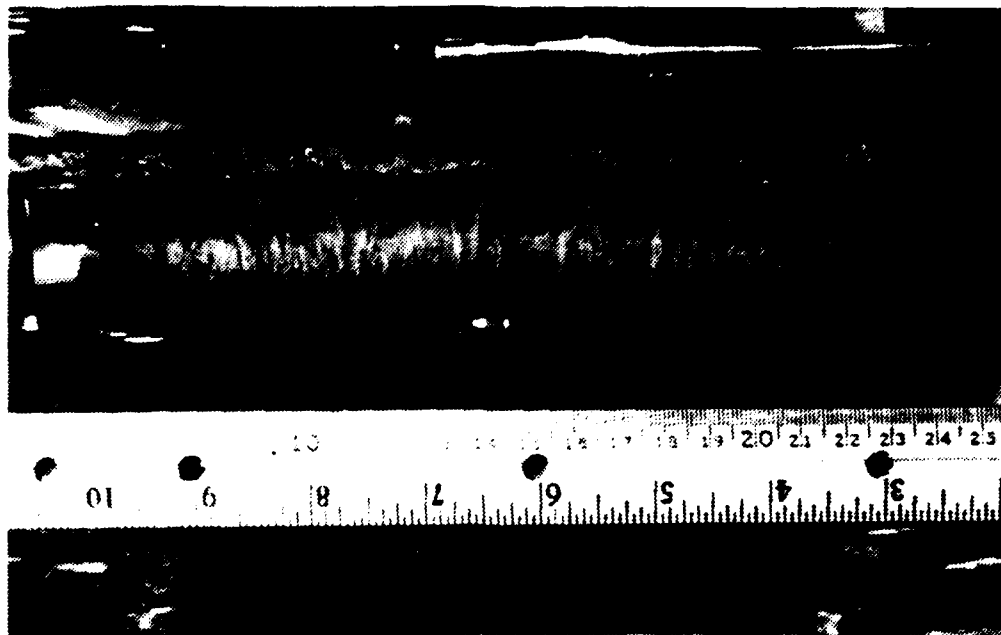

(a) 0 percent oil at 100 kW/m^2 . No Foaming.

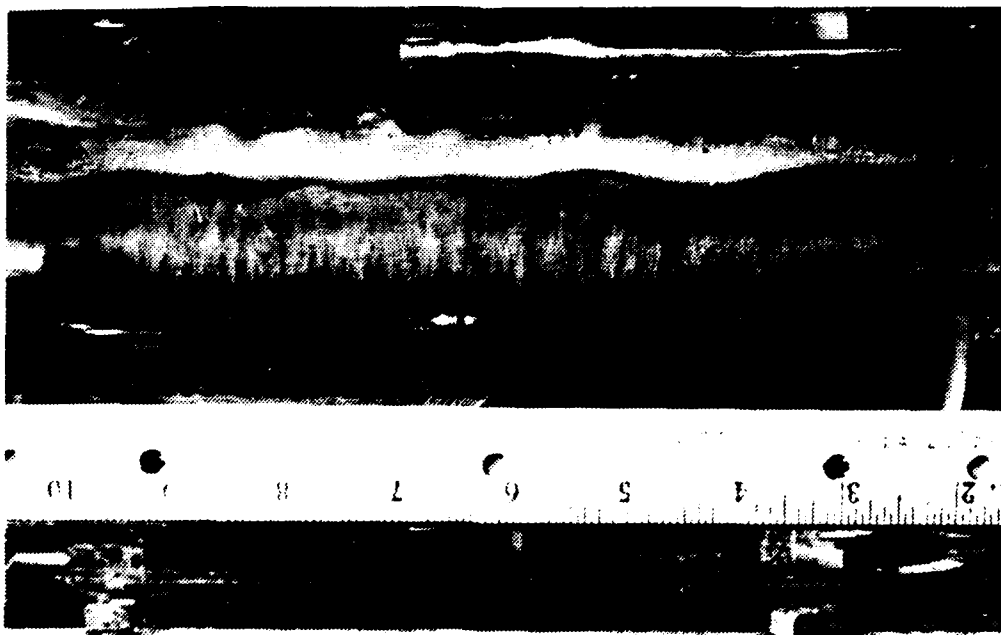

(b) 1 percent oil at 100 kW/m^2 . Foaming begins to appear.

Figure 4.1 Photographs of Boiling and Foaming
at 0 and 1 Percent Oil.

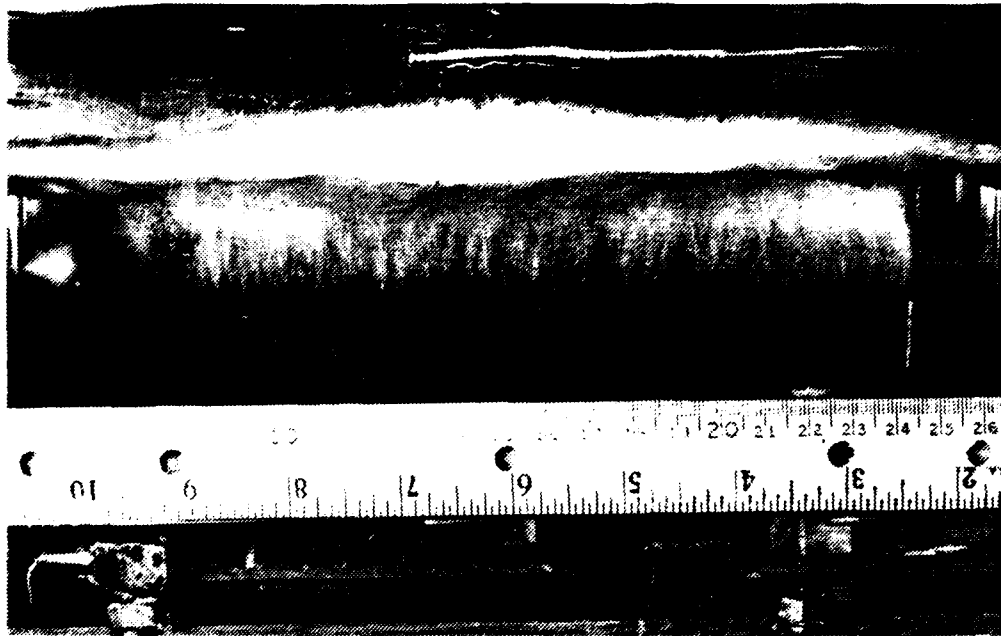

(a) 3 percent oil at 37 kW/m^2 .

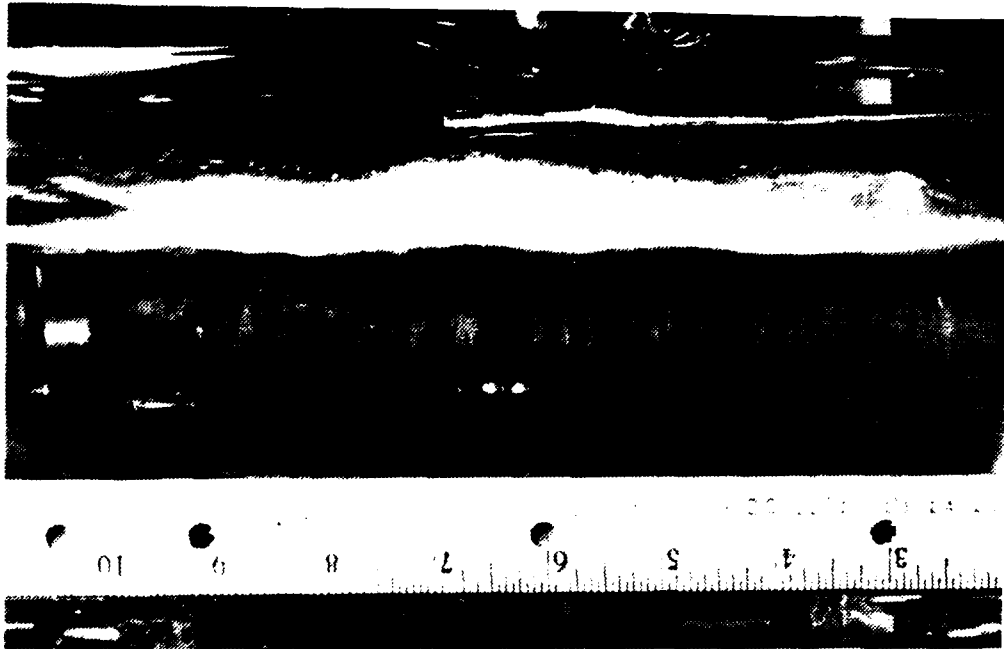

(b) 3 percent oil at 100 kW/m^2 .

Figure 4.2 Photographs of Boiling and Foaming
at 3 Percent Oil.



(a) 10 percent oil at 37 kW/m^2 .

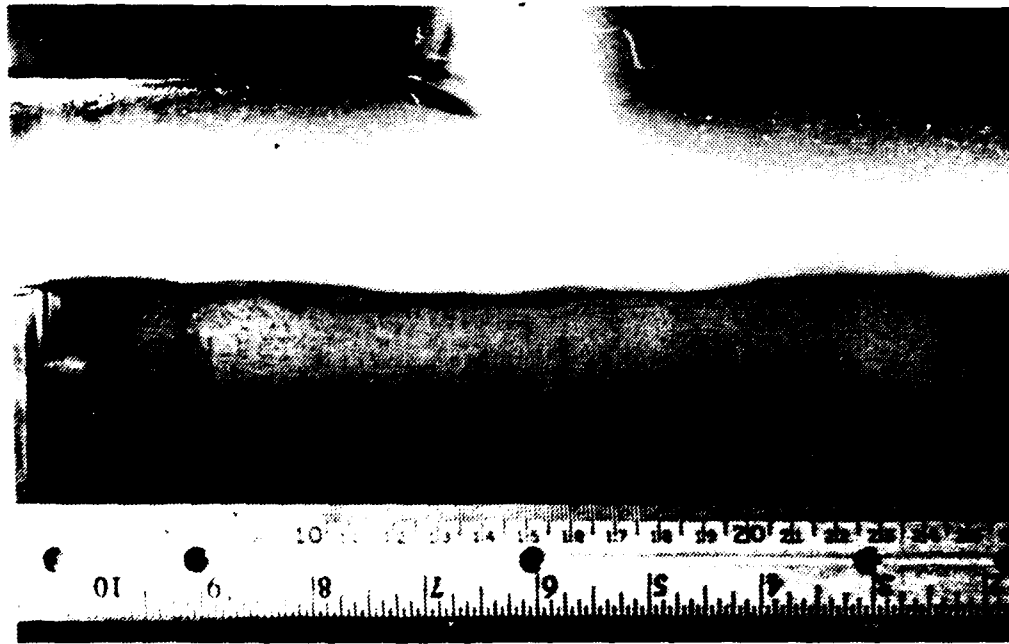

(b) 10 percent oil at 100 kW/m^2 .

Figure 4.3 Photographs of Boiling and Foaming
at 10 Percent Oil.

C. SAMPLING OIL

Oil sampling was done at room temperature to prevent the temperature of the sampling lines from boiling off the R-114 and yielding false readings. The sampling procedure used was:

1. Weigh the empty flexible sample tubing and pinch clamps. Connect them to the sampling apparatus.
2. Open S-1, S-4, and set S-2 to position 2 to provide a purge path for the sample flow.
3. Lower the sample container to a height below the level of the R-114 glass tee.
4. After purging the sample probe and lines, use pinch clamps to isolate the 304.8 mm (12 in.) flexible sample tubing and trap a sample. Shut S-1 and switch S-2 to position 1.
5. Disconnect the flexible sample tubing and immerse it in ice to lower its internal pressure below atmospheric pressure.
6. Open S-3 to provide a vent for the purge container and pour the purge volume back into the boiling tee by lifting it to a height so that it flows by gravity.
7. Weigh the sample line (the mass balance used was accurate to ± 0.0001 g).
8. Open a pinch clamp and allow air to warm the sample line and evaporate off the liquid R-114. Keep the sample line on the mass balance to collect any drops of oil that may splatter as the liquid R-114 evaporates.
9. After allowing several hours for the R-114 to evaporate, reweigh the flexible sample tubing.
10. Calculate the mass percent of oil using equation (3.1).

V. SYSTEM OPERATION AND PROBLEMS

A. CIRCUMFERENTIAL WALL TEMPERATURE VARIATION

Following the construction of the solid, thick-walled, reference tube, an investigation was begun to develop an assembly method which would result in negligible contact resistance between the inner tube wall and the copper sleeve, and yield data comparable to that for the solid tube.

Short slide-fit tubes 2 and 3 (see Table 1) had sleeves that could be slid into the test tube with tube 3 having a tighter clearance. The slide-fit tubes exhibited a circumferential wall temperature variation of 7-14 K at 50 kW/m² in pure R-114 boiling at -2.2 °C. This variation matched data on a similar long tube (with slide-fit sleeve) tested by Karasabun [Ref. 8]. Tube 2 had an average wall temperature of 33 °C and tube 3 had an average wall temperature of 25 °C at 50 kW/m². The tighter clearance of tube 3 resulted in a lower contact resistance, and the wall temperature subsequently dropped. The short solid tube under similar conditions exhibited a 0.34 K circumferential wall temperature variation and an average wall temperature of only 10.7 °C. Sauer et al. [Ref. 21], with a similar experimental apparatus, used a mechanically-press-fitted brass sleeve for obtaining data. Tubes 4 and 5 had copper sleeves that were mechanically cold pressed into the tube. The diametral interference was 0.01 mm (0.0004 in.) for tube 4 and 0.015 mm (0.0006 in.) for tube 5. The interface pressure obtained was calculated to be 15.2 MPa (2200 psi) for tube 4 and 22.8 MPa (3300 psi) for tube 5. During pressing, the sleeves were lubricated with glycerin (C₃H₈O₃) a

high-thermal-conductivity compound that, according to Incropera and Dewitt [Ref. 22], should result in a 10-100 times reduction in the contact resistance when combined with the contact pressures mentioned above.

Tubes 4 and 5 had circumferential wall temperature variations of 0.9-1.5 K with an average wall temperature of 16.2 °C for tube 4 and 14.7 °C for tube 5 during initial testing. However, with time, the circumferential wall temperature variation grew to 5-8 K and the average wall temperature increased to about 28 °C for both tubes. The resulting drop in heat-transfer performance is shown in Figure 5.1. This result is believed to be due to the phenomenon referred to as "stress relaxation."

Stress relaxation is a form of creep. The Metals Handbook [Ref. 23] notes that copper alloys easily undergo a decrease in stress resulting from transformation of elastic strain into plastic strain in a constrained solid. The phenomena occurs even at relatively low operating temperatures (at 25 °C, an 80 percent drop in stress can occur in 200 hours), and is of most concern in applications like press-fits and solderless wrapped copper connectors. The time-dependent data of Figure 5.1 appears to be the result of a dropping press-fit interface pressure yielding a higher contact resistance, higher inner wall temperatures, and lower heat-transfer coefficients.

Stephan and Mitrovic [Ref. 7] used a combination of mechanically press-fit and soft-soldered inner sleeves to obtain data on the Gewa-T surface in R-114. Soft-soldering was initially overlooked by this experimenter because the normal heating method used is an oxy-acetylene torch on the tube surface. The flame temperatures of an oxy-acetylene torch are above 800 °C (1500 °F). The resulting oxidation and heat damage (the High Flux coating melts at 800 °C) to the High Flux surface was unacceptable. Tests showed

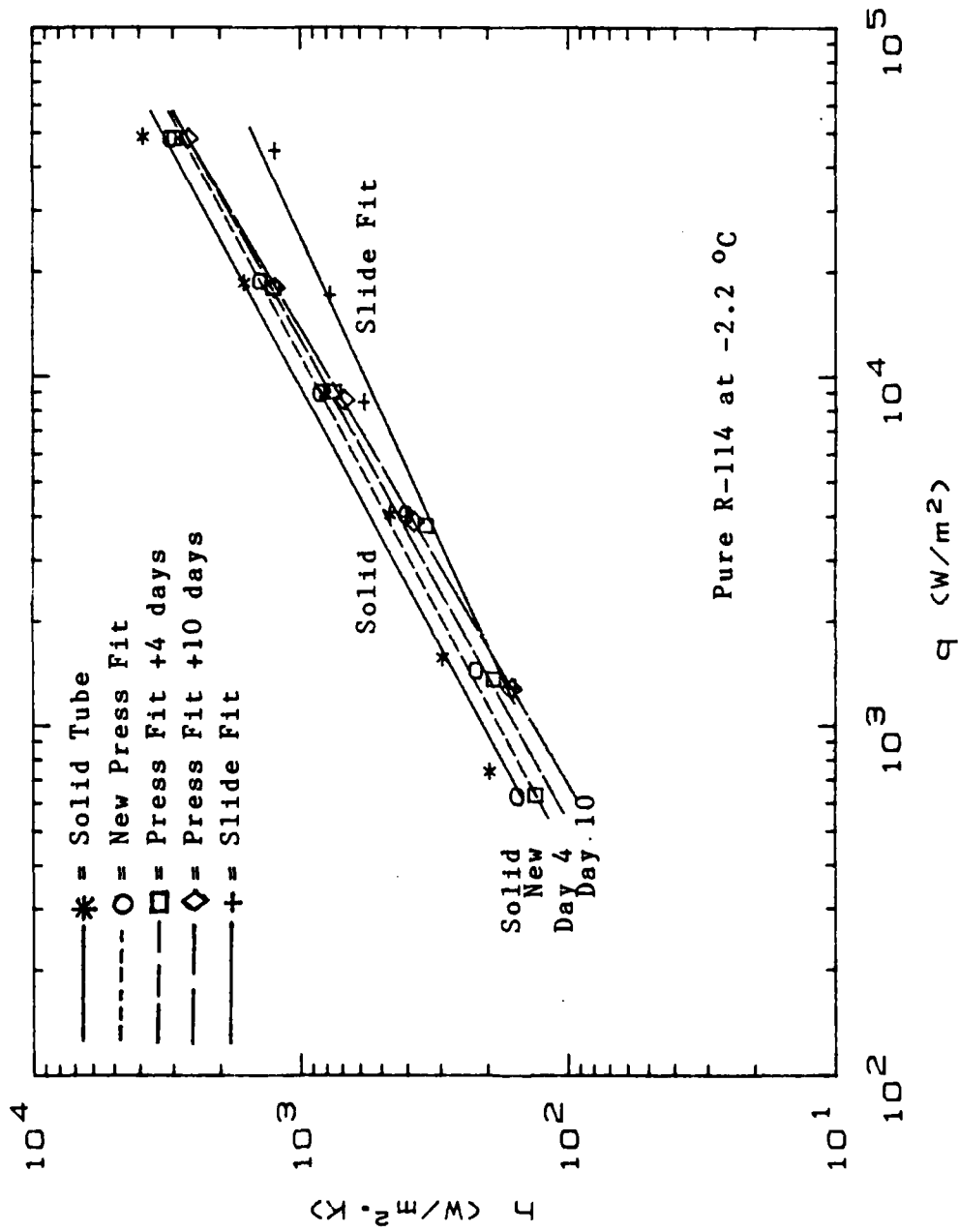

Figure 5.1 Time Dependency of the Measured Heat-Transfer Coefficient in Press-Fit Tubes.

however, that the inner cartridge heater could be used to apply a controlled amount of heat to melt a low temperature (melting point 160 °C) solder, while closely monitoring the tube temperature using the sleeve thermocouples. This method was used to produce soft-soldered short tube 6 which showed circumferential wall temperature variations of 0.8 K and an average wall temperature of 11.5 °C at 50 kW/m². Figure 5.2 compares the results of the soft-soldered and solid tubes. The agreement between the tubes is excellent. The long boiling tubes matched the short soft-soldered data very closely.

Tests made by rotating the test tubes 90 degrees and 180 degrees showed that the slight circumferential wall temperature variation of these tubes was due to the surface characteristics of the boiling tube rather than due to the thermocouples. Thermocouples located near more active nucleation sites of the smooth and High Flux surfaces had slightly lower local wall temperatures. The 0.8 K circumferential wall temperature variation that resulted from soft-soldering the sleeves of the tubes is much smaller than the 11 K variation reported by Sauer et al. [Ref. 21], and is about the same as the 1 K variation reported by Stephan and Mitrovic [Ref. 7].

B. AXIAL TEMPERATURE VARIATION OF LONG TUBES

Karasabun [Ref. 8] reported an axial temperature variation of about 20 K along the inner wall of his slide-fitted sleeve. Stephan and Mitrovic [Ref. 7] reported an axial temperature variation of 1 K along the sleeve they used. The long soft-soldered tubes tested in this experiment exhibited an axial temperature distribution that varied with heat flux. Figures 5.3 and 5.4 show the axial temperature distribution as a function of position along the boiling

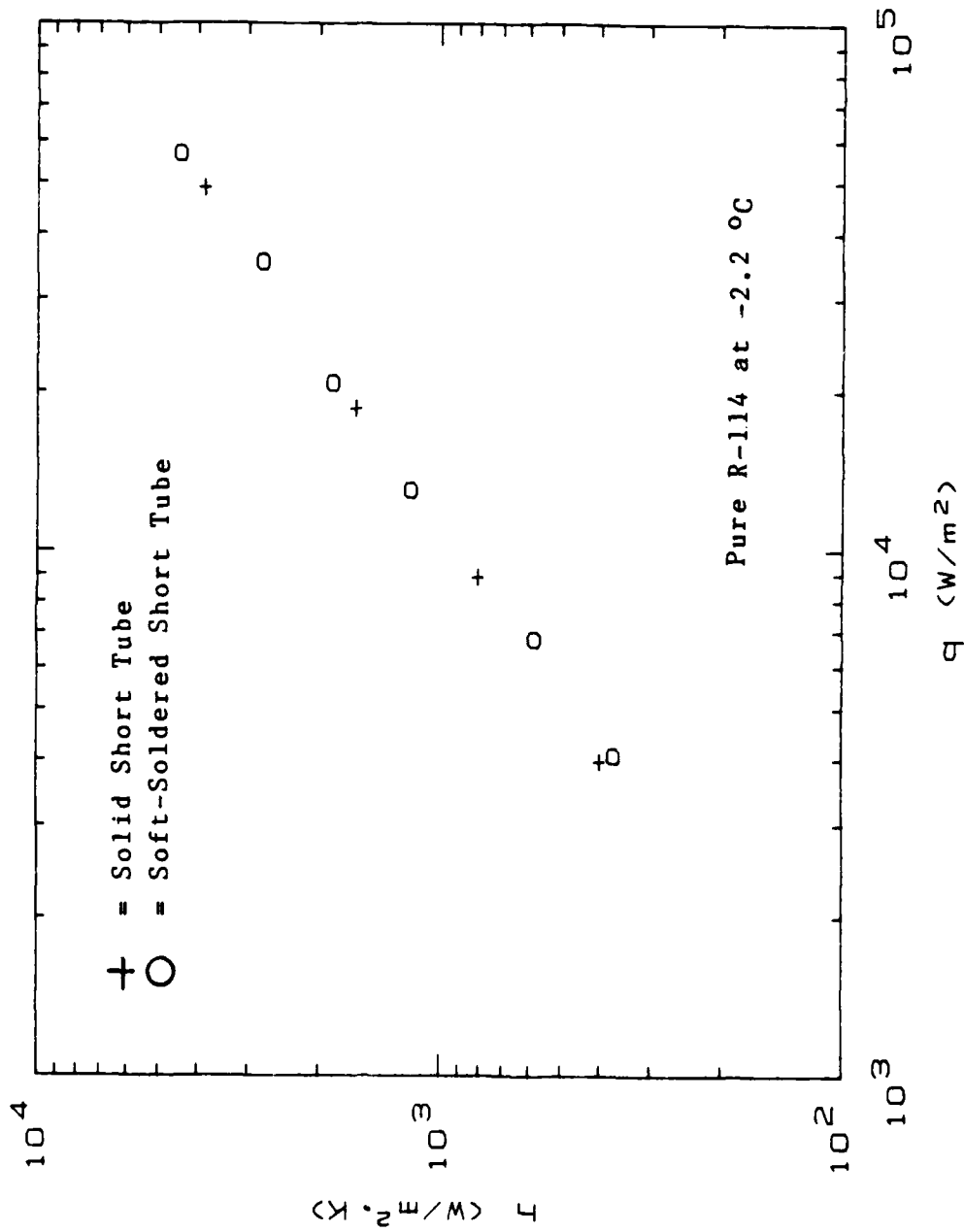

Figure 5.2 Comparison of Solid and Soft-Soldered Short Tube Heat-Transfer Coefficients.

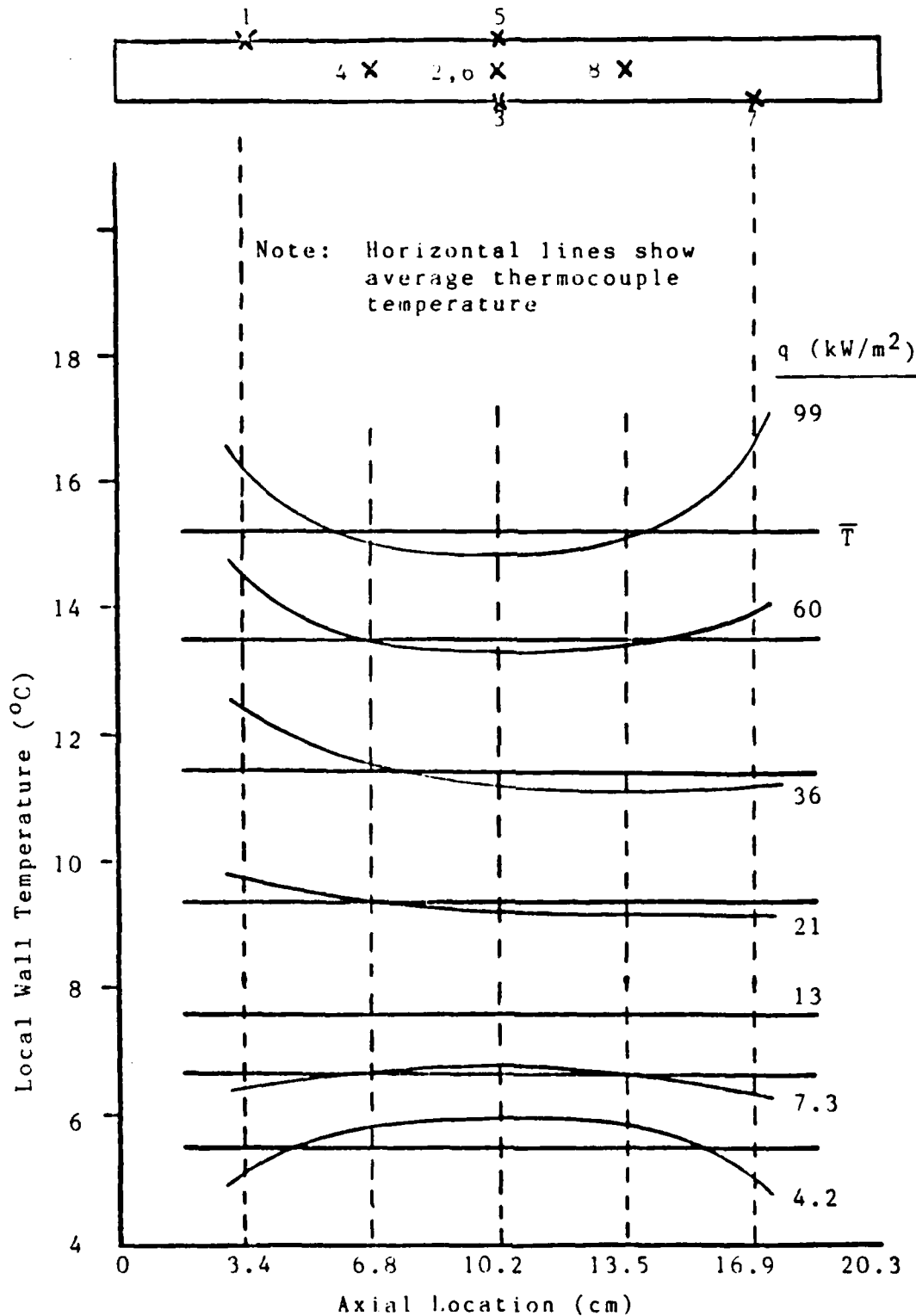

Figure 5.3 Axial Temperature Variation of Smooth Tube.

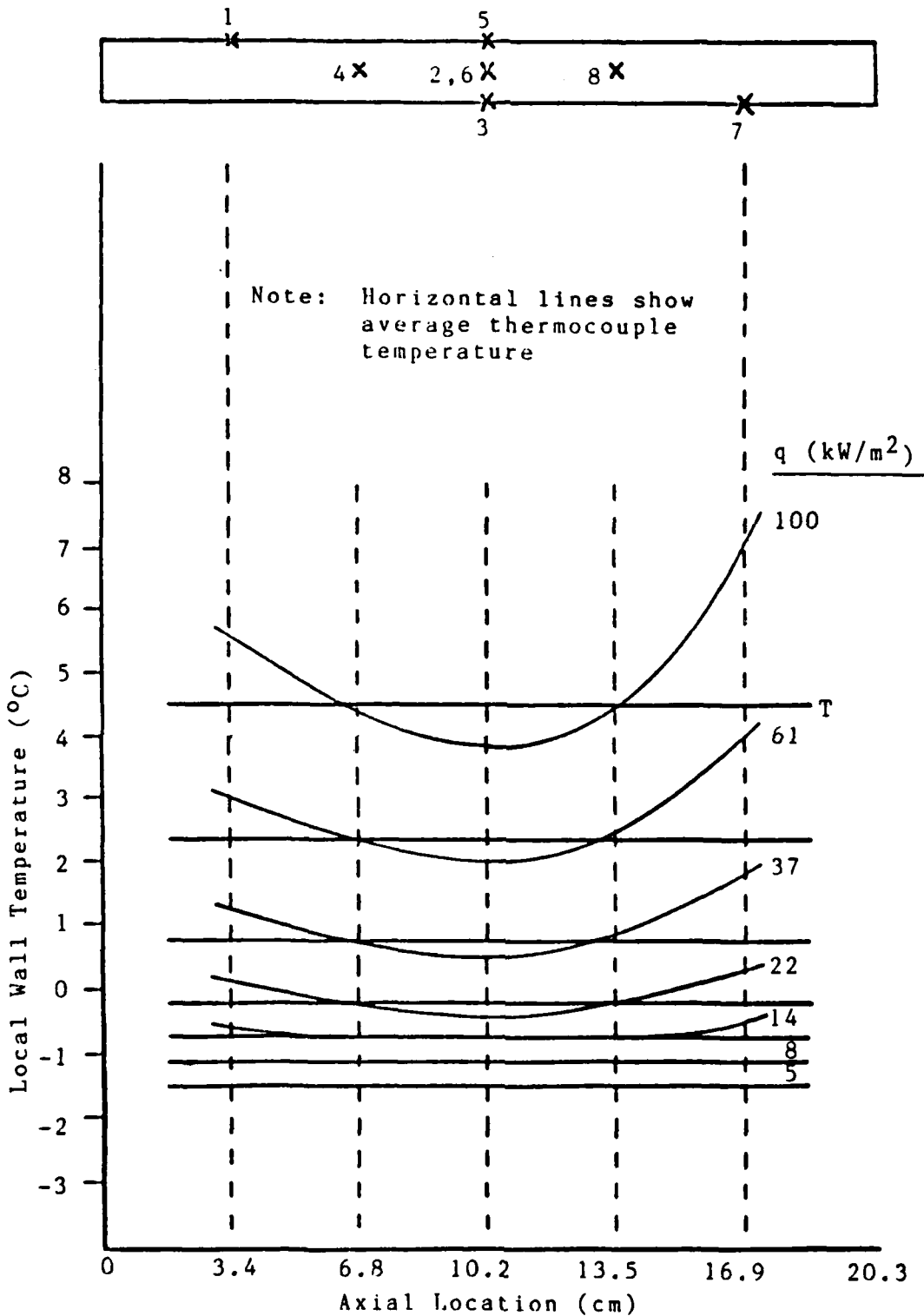

Figure 5.4 Axial Temperature Variation of High Flux Tube.

surface for the smooth tube and High Flux tube respectively. The variation at 20 kW/m^2 (the heat flux at which Stephan and Mitrovic cite their 1 K variation) is less than 1 K for both tubes. The maximum axial temperature variation is 3 K for the High Flux surface at 98 kW/m^2 .

The cartridge heaters used were precision-wound, ceramic-core, magnesium-oxide-insulated, Incoloy-sheathed WATLOW FIREROD heaters. The heaters had 6.35 mm (0.25 in.) long lava-rock plugs at either end of the heater that reduced the actual heating length on each end. The heaters were initially believed to generate a uniform heat flux at all power settings, but the axial wall temperature data indicate the heat generation varied with the power level.

Since the axial temperature distribution was fairly linear over most practical heat fluxes (less than 37 kW/m^2), the arithmetic average of all 8 wall thermocouples was used to compute the heat-transfer coefficient. This results in slightly lower heat-transfer coefficients and is a conservative estimate of the performance of the High Flux surface. Appendix E analyzes the resulting error in the heat-transfer coefficient from using the arithmetic average for calculating the heat-transfer coefficient.

C. COMPUTER-CONTROLLED VALVE

Figure 5.5 shows the system response to closing valve VC manually and the improved response of the system when using the computer-controlled valve. By correctly cycling the valve between open and shut, the system saturation temperature could rapidly be changed. Establishing a stable equilibrium temperature after a large valve movement was, however, difficult during the initial testing of the apparatus. The extensive trial-and-error testing for the correct weighting factors of the proportional, integral, and

derivative terms resulted in a large data base concerning the saturated system operating characteristics and a large amount of practice for the operator in manual control of valve VC following unsuccessful computer-controlled transients.

Manual operation of valve VC was done in conjunction with the section of the data-reduction program (lines 1890 to 2485 of program DRF2 listed in Appendix B) that monitored the saturation temperature and the rate of change of saturation temperature continuously. It was found that, because of the better temperature resolution of the HP-3497A data acquisition unit, with manual operation and a trained operator, temperature transients could be maintained within ± 0.02 K. This was a much tighter control band than was possible with the computer-controlled valve because of the poor resolution of its temperature sensing input from the Omega thermocouple DC millivolt amplifier. Additionally, after much practice and experience, the manual method was found to be as fast as, or faster than the use of computer-controlled valve.

To obtain the highest accuracy data in the shortest period of time, computer-control of valve VC was abandoned. Section VII.B includes recommendations for further improvements to the computer control system to restore its usefulness.

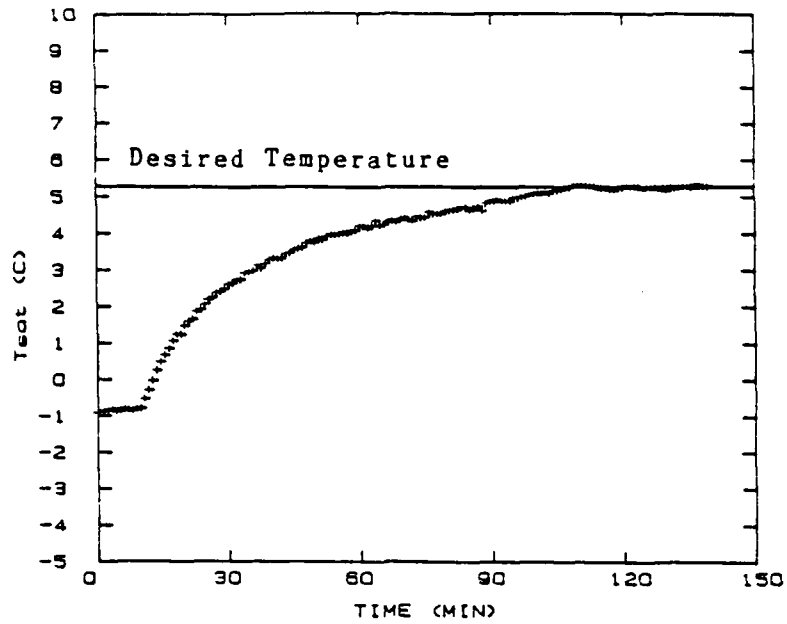

(a) Natural system response to shutting valve VC to cause a desired increase in system temperature.

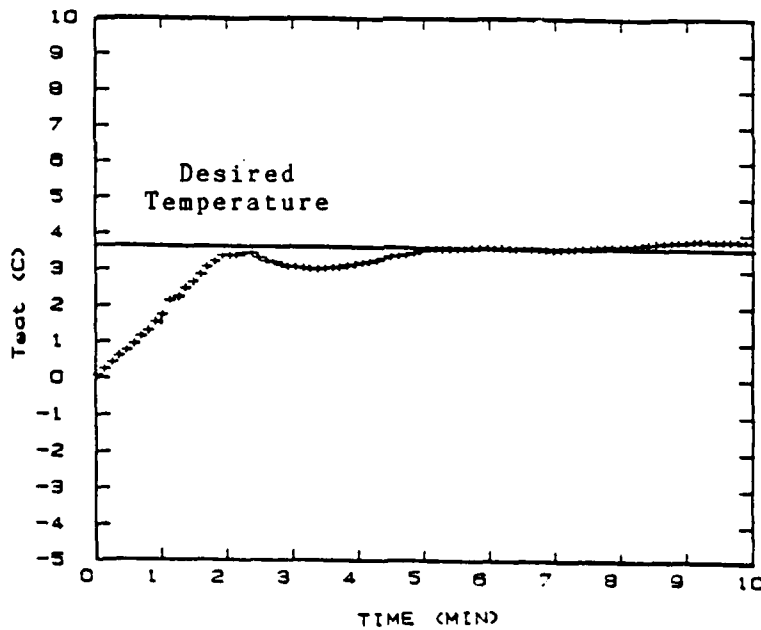

(b) Improvement in system response time using computer control of valve VC to reach a desired temperature (note the different time scale).

Figure 5.5 System Response to a Transient with Computer-Controlled Valve.

VI. RESULTS AND DISCUSSION

A. BOILING PERFORMANCE OF SMOOTH TUBE

Figure 6.1 shows the nucleate pool-boiling performance of the smooth copper tube in R-114. The behavior with no oil represents typical nucleate pool-boiling performance. From point A to point B, a continuous increase in wall superheat ($\bar{T}_{wo} - T_{sat}$) is observed when heat flux is increased. No bubbles were observed in this region of the curve as this region represents natural convection. At point B, incipient nucleate boiling occurs. From point B to point C (or C' for 10 percent oil), a reduction in wall superheat is observed while the heat flux is continuously increased. This region is known as the mixed-boiling region, where transition from natural convection to nucleate pool boiling takes place. In this region, the heated portion of the tube began to activate an increasing number of nucleation sites, while the unheated ends showed no bubbles. In fact, the unheated ends underwent only natural convection, due to axial conduction of heat along the tube wall, at all heat fluxes. The transition from natural convection to nucleate boiling occurred rapidly when there was no oil present. The surface would burst into nucleate boiling in less than a second after the first nucleation site became active. At point C (or C'), all the available nucleation sites were apparently active. After point C, the wall superheat again increases with increasing heat flux as shown in region C-D. In region C-D, no new nucleation sites were seen to become active. Instead, the bubble departure rate increased. When the heat flux is decreased after having established complete nucleate boiling, the curve follows a

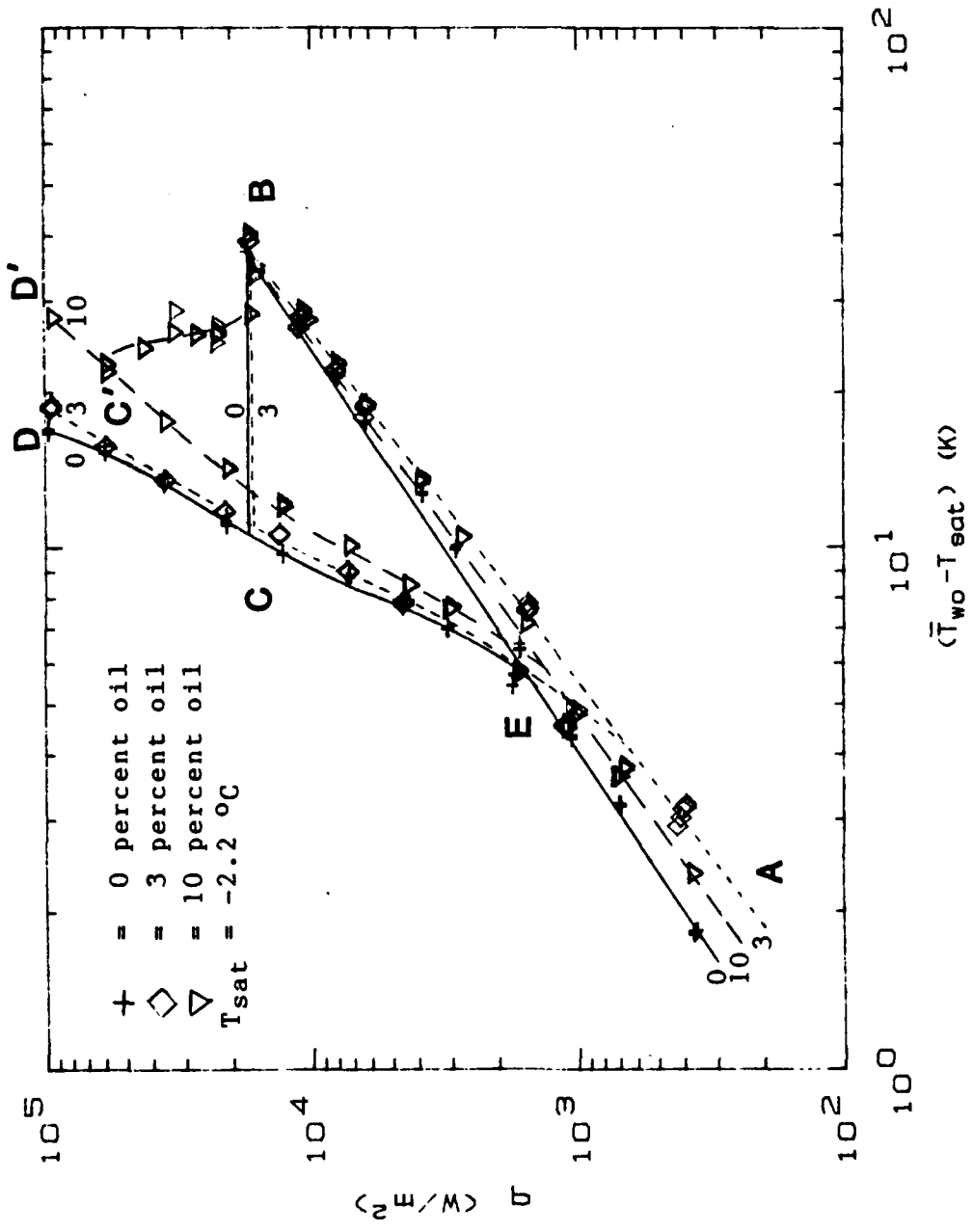

Figure 6.1 Heat-Transfer Performance of Smooth Tube.

different path (point D to point E). The existence of stable nucleation sites, which remain active over a wide range of heat fluxes, results in better heat-transfer performance than in natural convection, resulting in a lower wall superheat.

The effect of adding oil is, according to Stephan [Ref. 9], to introduce a mass diffusion resistance and lower the heat-transfer coefficient. As seen in Figure 6.1, in region A-B, both the 3 and 10 percent curves were lower than the 0 percent oil curve. The 3 percent oil curve is lower than the 10 percent oil curve probably because of the non-linear physical property variations of refrigerant-oil mixtures. The non-linear variation of surface tension (see Figure 2.3) would not seem to be responsible for this anomaly. The curves in region A-B support the contentions of Chongrungeong and Sauer [Ref. 10] and Thome [Ref. 14] that the non-linear variation of physical properties of refrigerant-oil mixtures, other than surface tension, explains the heat-transfer behavior of refrigerant-oil mixtures. The effect of adding 10 percent oil was to delay the transition to complete nucleate boiling on the tube. With 10 percent oil, the surface developed patches of nucleation sites that spread slowly with increasing heat flux, until they covered the entire surface (point C'). Region D-E (or D'-E) shows that oil increased the wall superheat slightly for 3 percent oil and significantly for 10 percent oil. Again, this agrees with the concept of an increased mass diffusion resistance by the addition of oil.

Figure 6.2 shows the heat-transfer coefficient of the smooth tube in R-114-oil mixtures as a function of heat flux. The curves show the heat-transfer coefficient of the smooth tube in region D-E, after complete nucleate boiling has been initiated. The effect of adding less than 6 percent oil is seen to be small (about a 10 percent

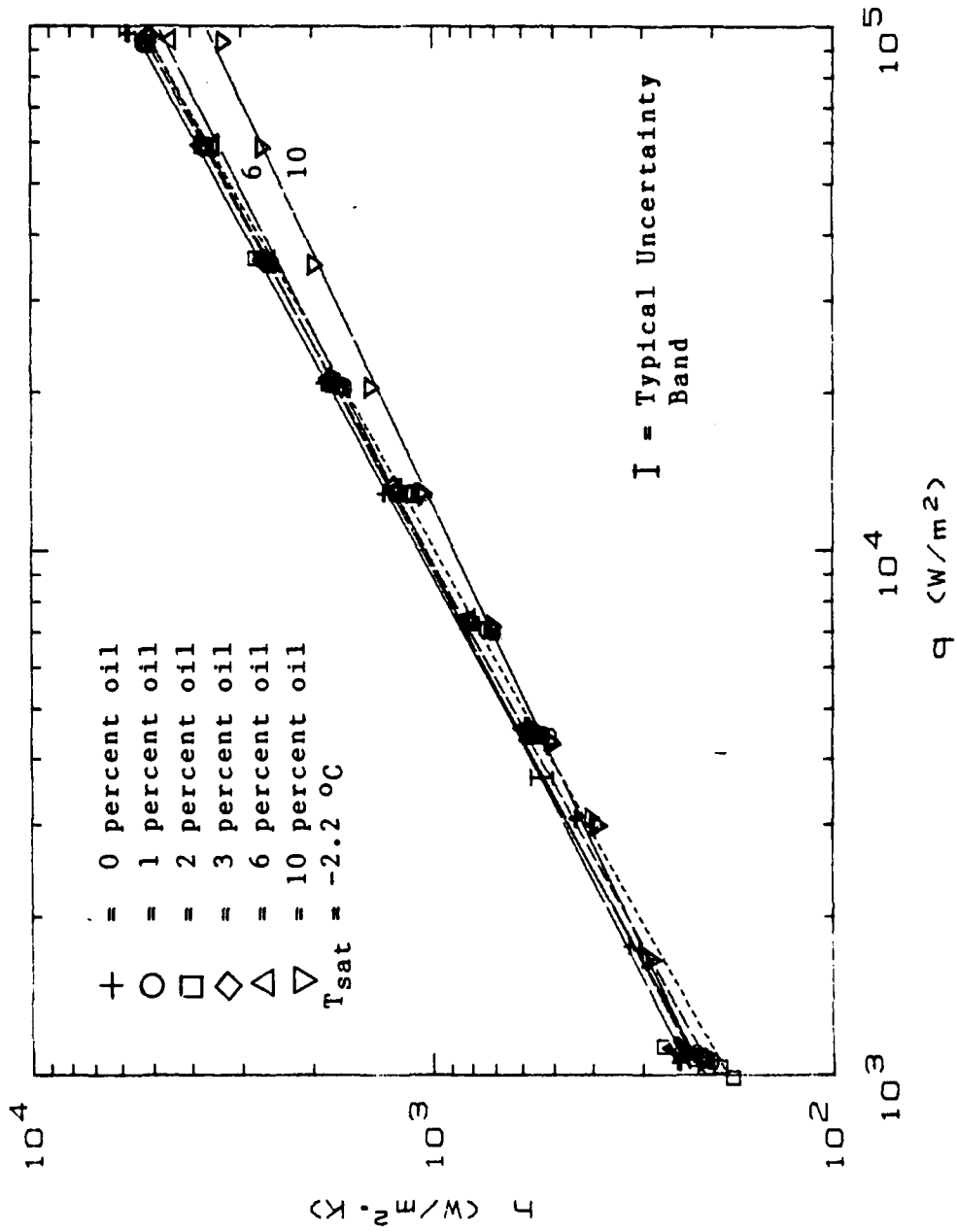

Figure 6.2 Boiling Heat-Transfer Coefficient of Smooth Tube.

reduction in the heat-transfer coefficient). However, an oil concentration of 10 percent causes a more significant drop in the heat-transfer coefficient (from 0 to 35 percent depending on the heat flux).

Figure 6.3 shows more easily the degradation that oil causes in the boiling heat-transfer performance of the smooth tube. This figure plots the heat-transfer coefficient of the smooth tube relative to the heat-transfer coefficient in pure R-114 as a function of oil concentration. The effect of oil can be seen to depend also on the heat flux. Oil can be seen to generally degrade the performance of the smooth tube, except at heat fluxes less than 5 kW/m^2 and oil concentrations between 2 and 8 percent. This behavior was also seen by Henrici and Hesse (see Figure 2.2). Since this curve shows the heat-transfer performance in region D-E, with complete nucleate boiling, the non-linear variation of the physical properties of refrigerant-oil mixtures, including surface tension, again probably accounts for this anomalous behavior. Since no measurements of the physical properties of the R-114-oil mixture were made during this investigation, any possible non-linear property variations of the mixture used are unknown, requiring future work.

B. BOILING PERFORMANCE OF HIGH FLUX SURFACE

Figure 6.4 shows the nucleate pool-boiling performance of the High Flux surface in R-114-oil mixtures. The small magnitude of the wall superheats obtained during nucleate boiling should especially be noted. The High Flux surface in pure R-114 showed typical natural-convection region (A-B) behavior. The incipient point (B) occurred at much lower heat fluxes and superheats than for the smooth tube as shown earlier. The transition to nucleate boiling (B-C) was

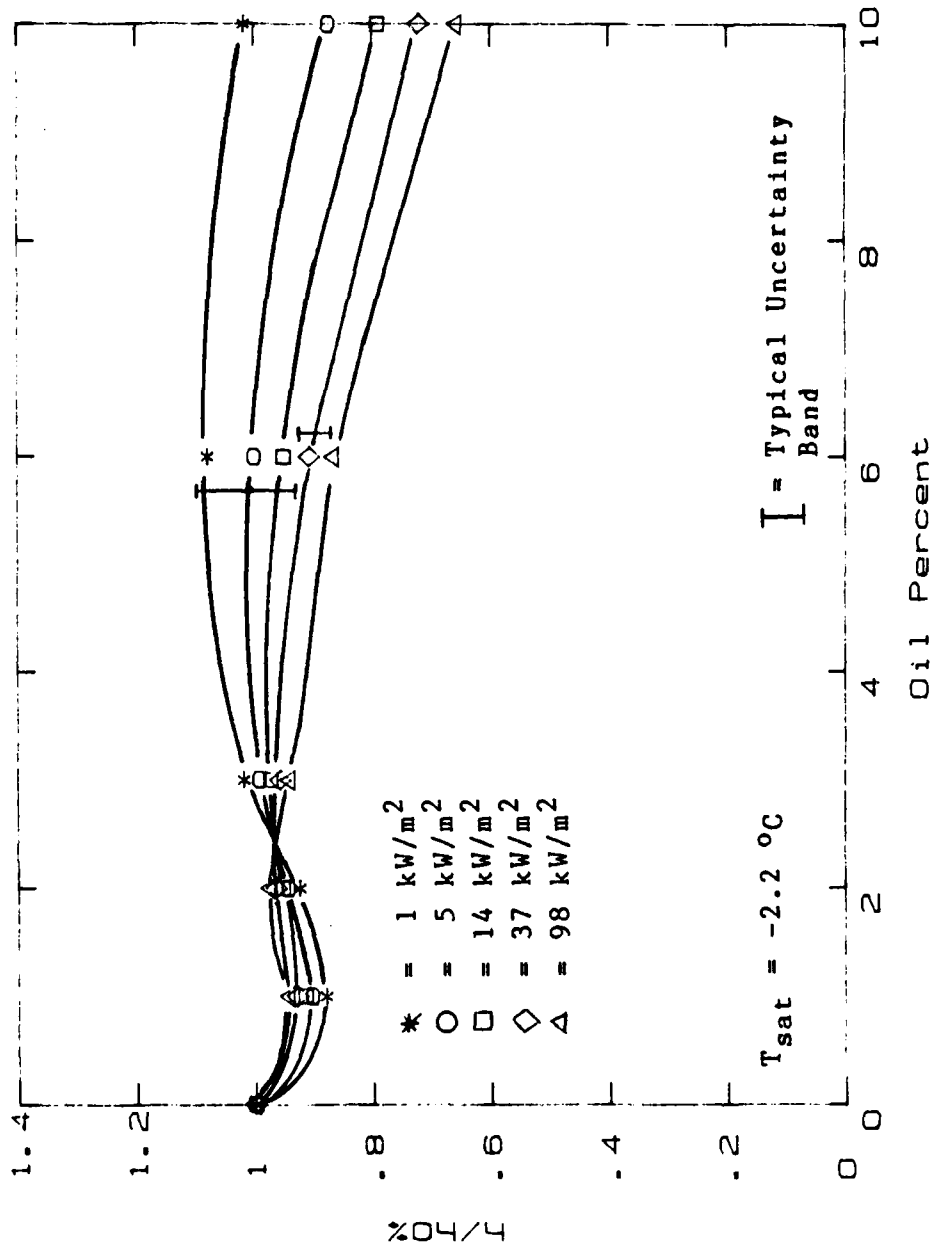

Figure 6.3 Relative Effect of Oil on Smooth Tube Boiling Heat-Transfer Performance.

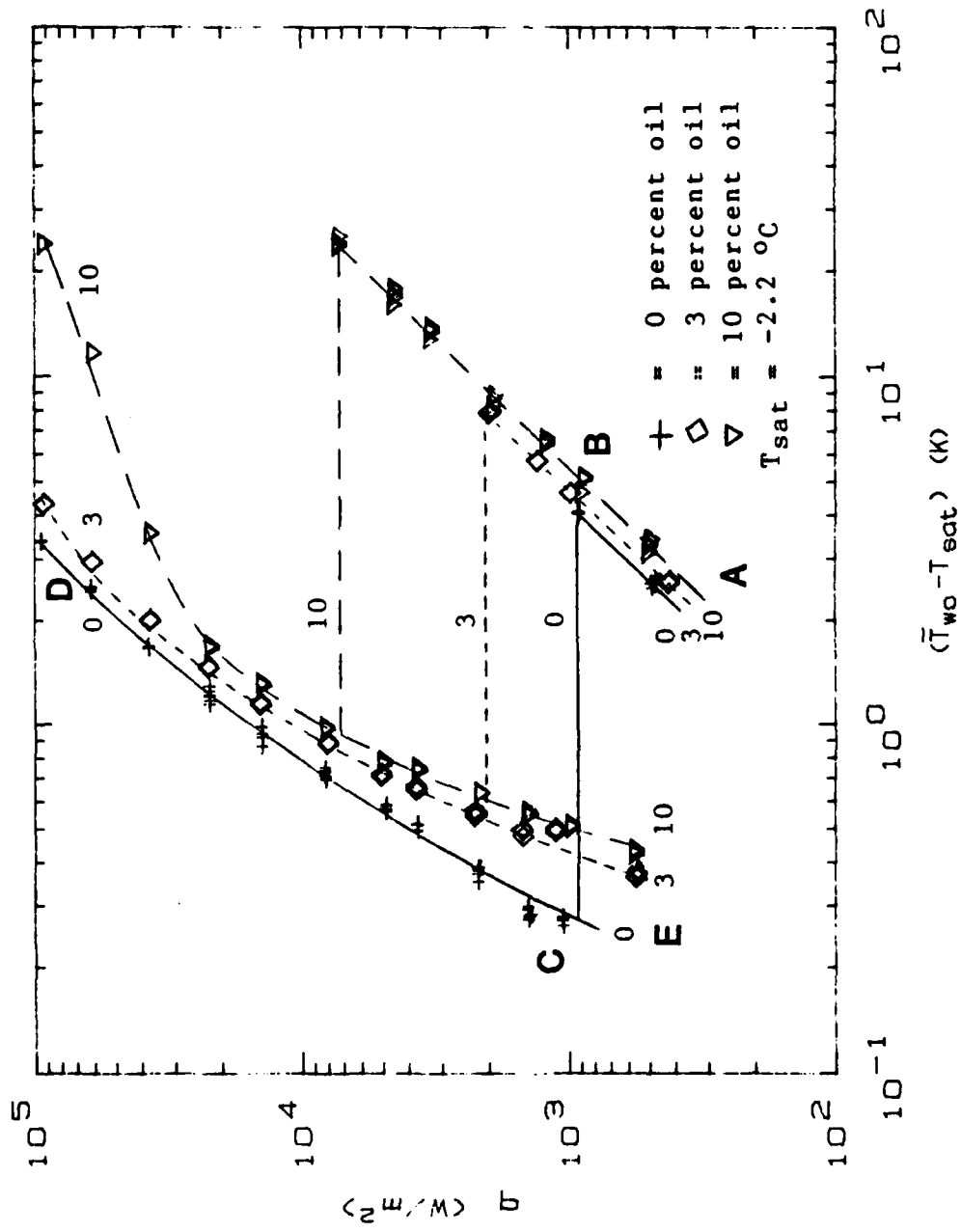

Figure 6.4 Heat-Transfer Performance of High Flux Surface.

similar to the smooth tube, occurring very rapidly (less than 1 second). Nucleate boiling from the High Flux surface results in a drop of the wall superheat by about a factor of 10. This is due to the extremely high density of nucleation sites present on the High Flux surface. From the low heat fluxes (1-10 kW/m²) at which the transition to nucleate boiling occurs, it can be seen that the High Flux coating also assists in the activation of stable nucleation sites.

Adding oil to the High Flux surface appears to delay the onset of nucleate boiling (point B wall superheat increases with increasing oil concentration). However, the transition to nucleate boiling still occurred very rapidly, even at 10 percent oil. The rapid transition to nucleate boiling (less than 1 second) on the High Flux surface is probably due to the interconnected cavities which can assist in nucleating the entire surface once a single site becomes initially active. Oil is unlikely to inhibit this characteristic of the High Flux surface though it apparently delays the initial activation of the first nucleation site. As seen in region D-E, for heat fluxes less than 37 kW/m², the effect of adding oil to the High Flux surface, once it has been nucleating fully, is to cause about a 30 percent increase in the wall superheat. At heat fluxes in excess of 37 kW/m² and at 10 percent oil, the wall superheat increased dramatically. As seen in Figure 6.1, the wall superheat at a heat flux of 98 kW/m² and 10 percent oil is about the same for both the smooth tube and High Flux surface.

Figure 6.5 shows the heat-transfer coefficient of the High Flux surface as a function of heat flux for various oil concentrations. Again, oil is seen to degrade the nucleate pool-boiling heat-transfer performance.

Air-conditioning plants typically operate in the heat flux range of 10 to 40 kW/m² with less than 1 percent oil. In this region of practical interest, the boiling

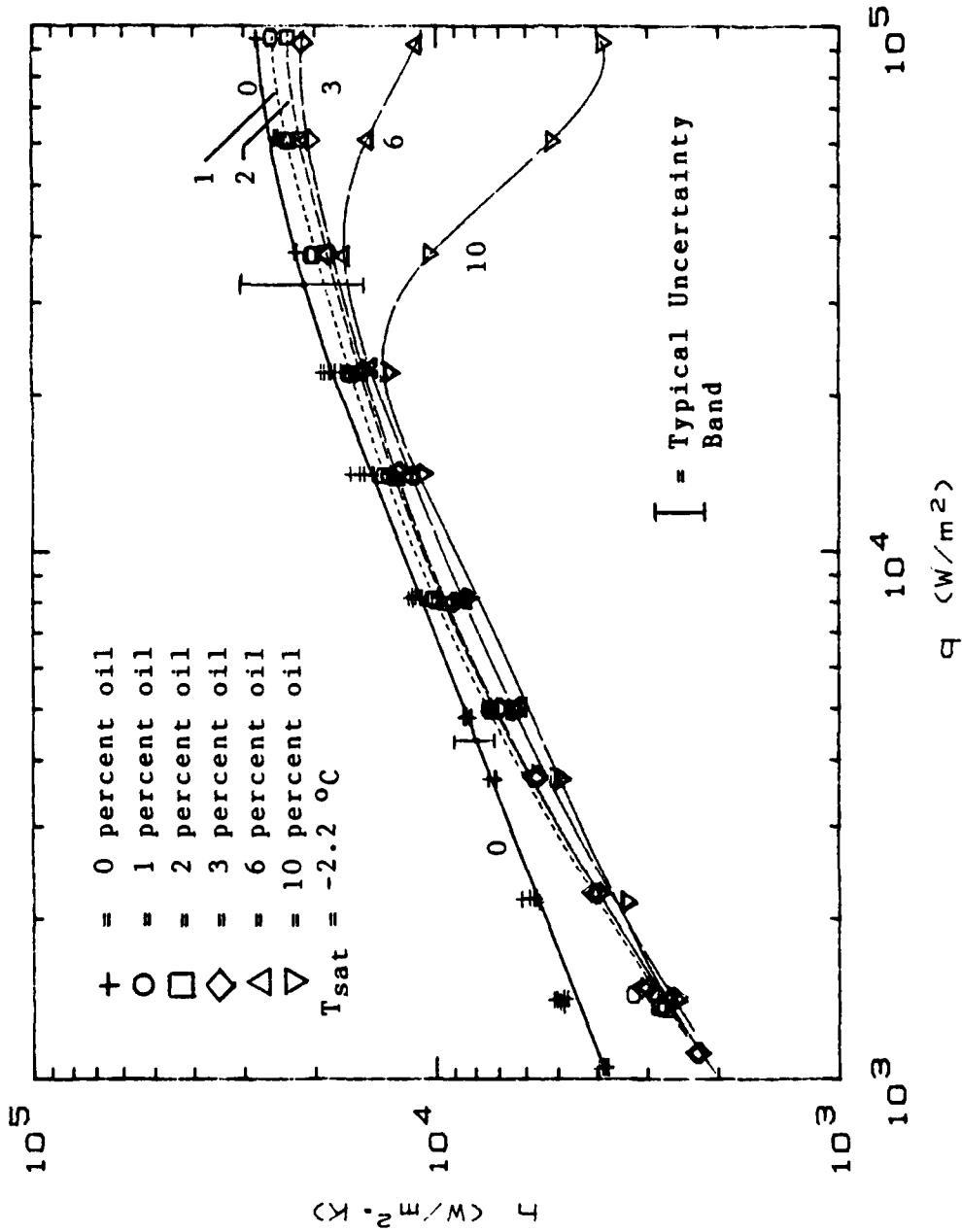

Figure 6.5 Boiling Heat-Transfer Coefficient of High Flux Surface.

heat-transfer coefficient of the High Flux surface is about 10 times better than a smooth tube. Also, it experiences only a 20 percent drop in the boiling heat-transfer coefficient with the addition of oil (1 to 10 percent). This is seen clearly in Figure 6.6 which plots the heat-transfer coefficient, relative to the heat-transfer coefficient for 0 percent oil, as a function of oil concentration. From 1 to 10 percent oil at a heat flux of 14 kW/m^2 , the heat-transfer coefficient is about 80 percent of the no-oil heat-transfer coefficient.

Figure 6.6 also shows that the oil-caused degradation of performance on the High Flux surface is nearly independent of oil concentration at practical heat fluxes. Only at a heat flux of 98 kW/m^2 and 6-10 percent oil, does the High Flux surface experience significant performance degradation. At high heat fluxes and oil concentrations, the effect of oil may be to "clog" the interconnecting cavities of the High Flux surface due to boiling off of the R-114. Clogging the R-114 surface with oil would prevent replenishment of the nucleation sites with R-114 liquid, preventing the nucleation process and leading to higher superheats. The time-dependent behavior of the High Flux surface in high oil concentrations and at high heat fluxes was not studied in this experiment.

C. COMPARISON OF HIGH FLUX TO SMOOTH TUBE BOILING PERFORMANCE

Figure 6.7 shows the heat-transfer performance of both the High Flux surface and the smooth tube as a function of heat flux. Again, the 7-10 times improvement in the heat-transfer coefficient by the High Flux surface is easily seen. At extremely high heat flux and high oil combinations, the High Flux surface performs only slightly better than the smooth tube.

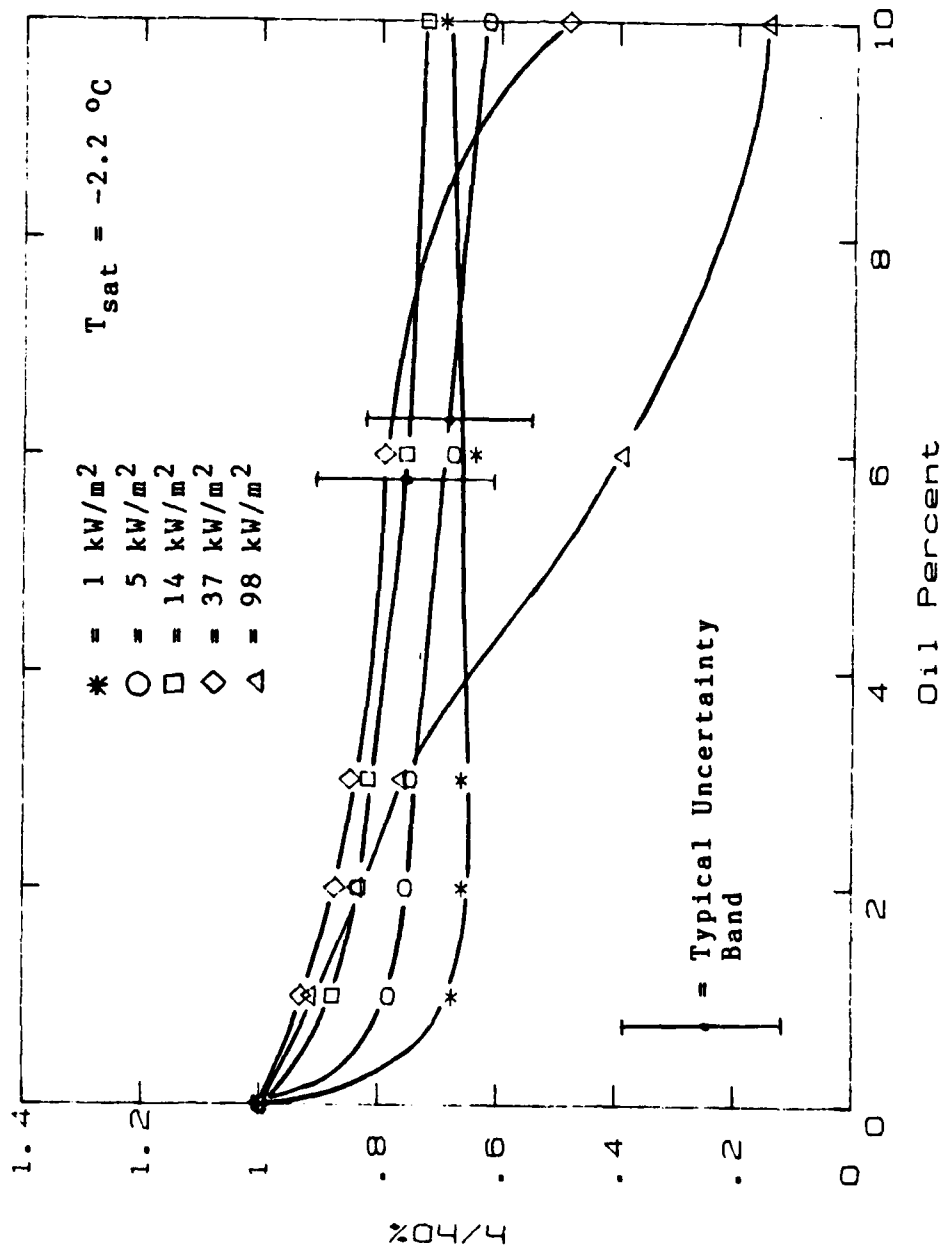

Figure 6.6 Relative Effect of Oil on High Flux Boiling Heat-Transfer Performance.

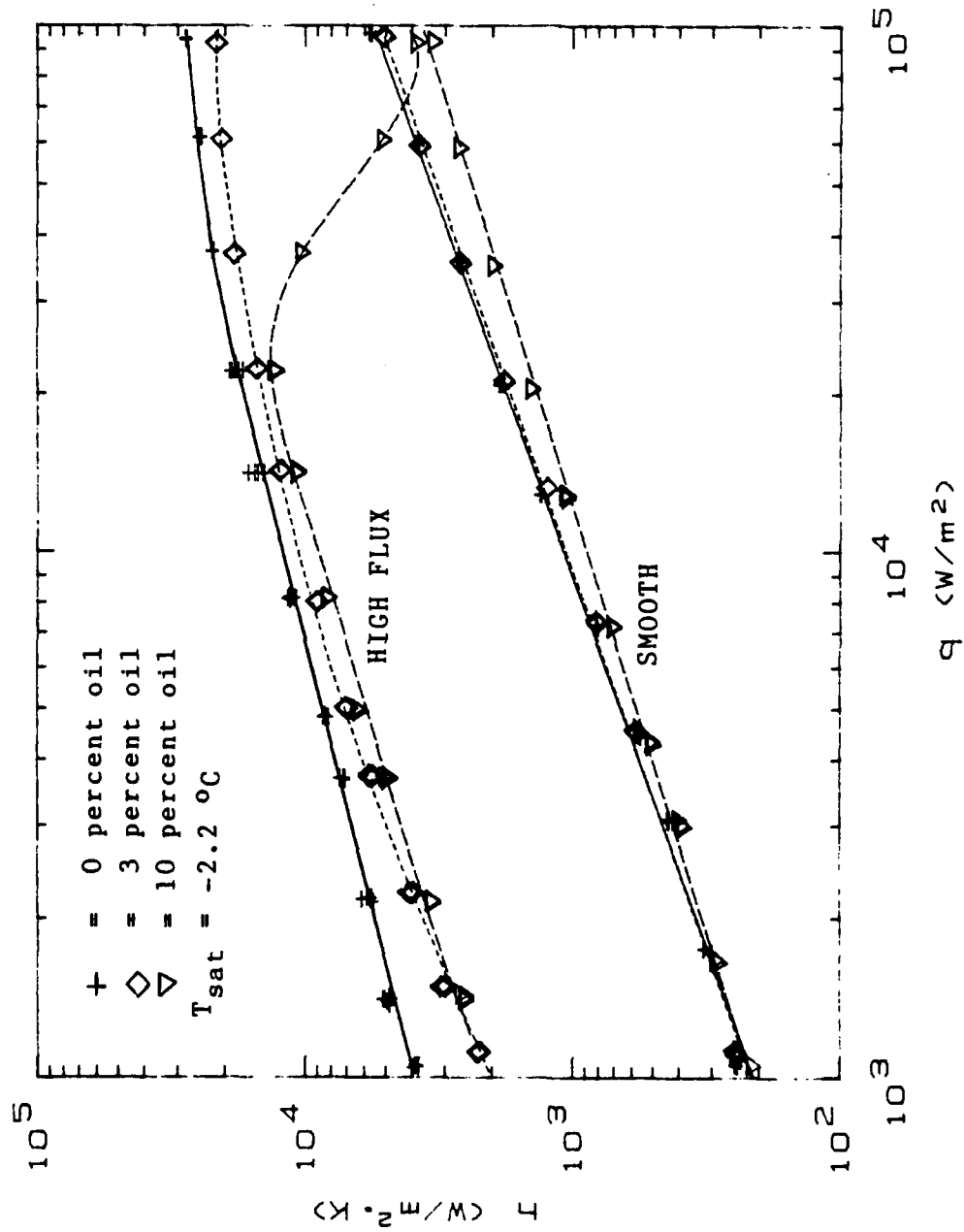

Figure 6.7. Comparison of High Flux and Smooth Tube Boiling Heat-transfer performance.

Figure 6.7 also shows that the heat-transfer curves of the High Flux surface and the smooth tube are not parallel. At low heat fluxes, the High Flux surface is more effective, in comparison to the smooth tube, in enhancing nucleation than at moderate heat fluxes. At high heat fluxes, the performance of the High Flux coating begins to converge toward the smooth-tube curve because the surface became vapor blanketed. This is expected since both tubes should perform about the same when they are completely vapor blanketed.

Figure 6.8 shows the relative improvement of the High Flux surface over the smooth tube as a function of oil concentration. For the heat fluxes of practical interest in air-conditioning plants, the High Flux surface is 7-10 times better than the smooth tube.

D. EFFECT OF SATURATION TEMPERATURE ON BOILING PERFORMANCE

As reported by Stephan [Ref. 9], the effect of increasing the saturation temperature for both the smooth tube and High Flux surface was increased heat-transfer performance. Figure 6.9 shows the improvement in heat-transfer performance in pure R-114 achieved by raising the saturation temperature from -2.2°C (28°F) to 6.7°C (44°F). At high heat fluxes, little improvement is seen in the High Flux surface performance because the surface is nearly vapor blanketed with bubbles.

Figure 6.10 shows the effect of saturation temperature on R-114-oil mixtures. Increased saturation temperature is again seen to improve the performance of the High Flux surface as well as the smooth tube, even with 10 percent oil. This is consistent with the no-oil results, but contradicts Henrici and Hesse's data (see Figure 2.5).

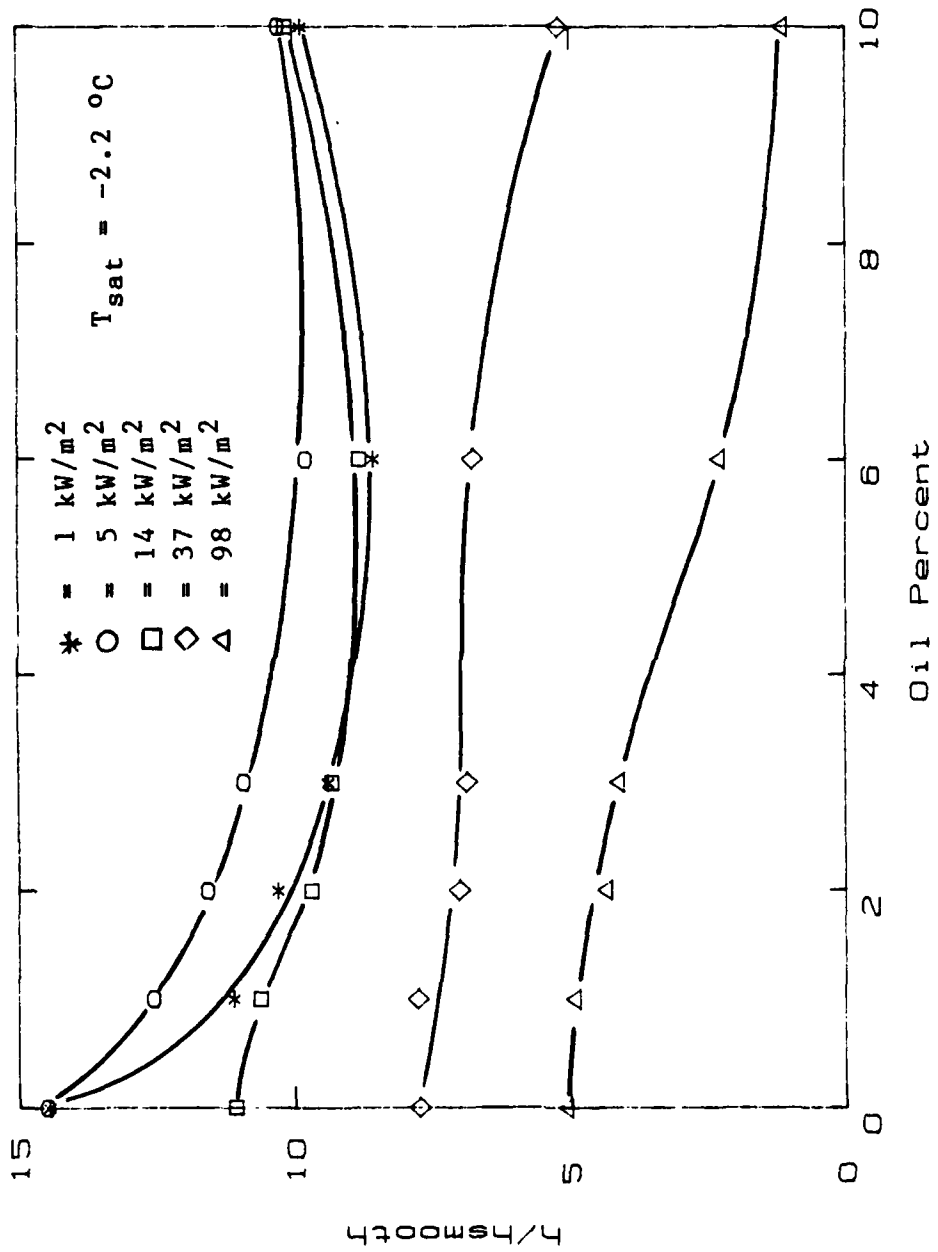

Figure 6.8 Relative Improvement of High Flux Surface over Smooth Tube versus Oil.

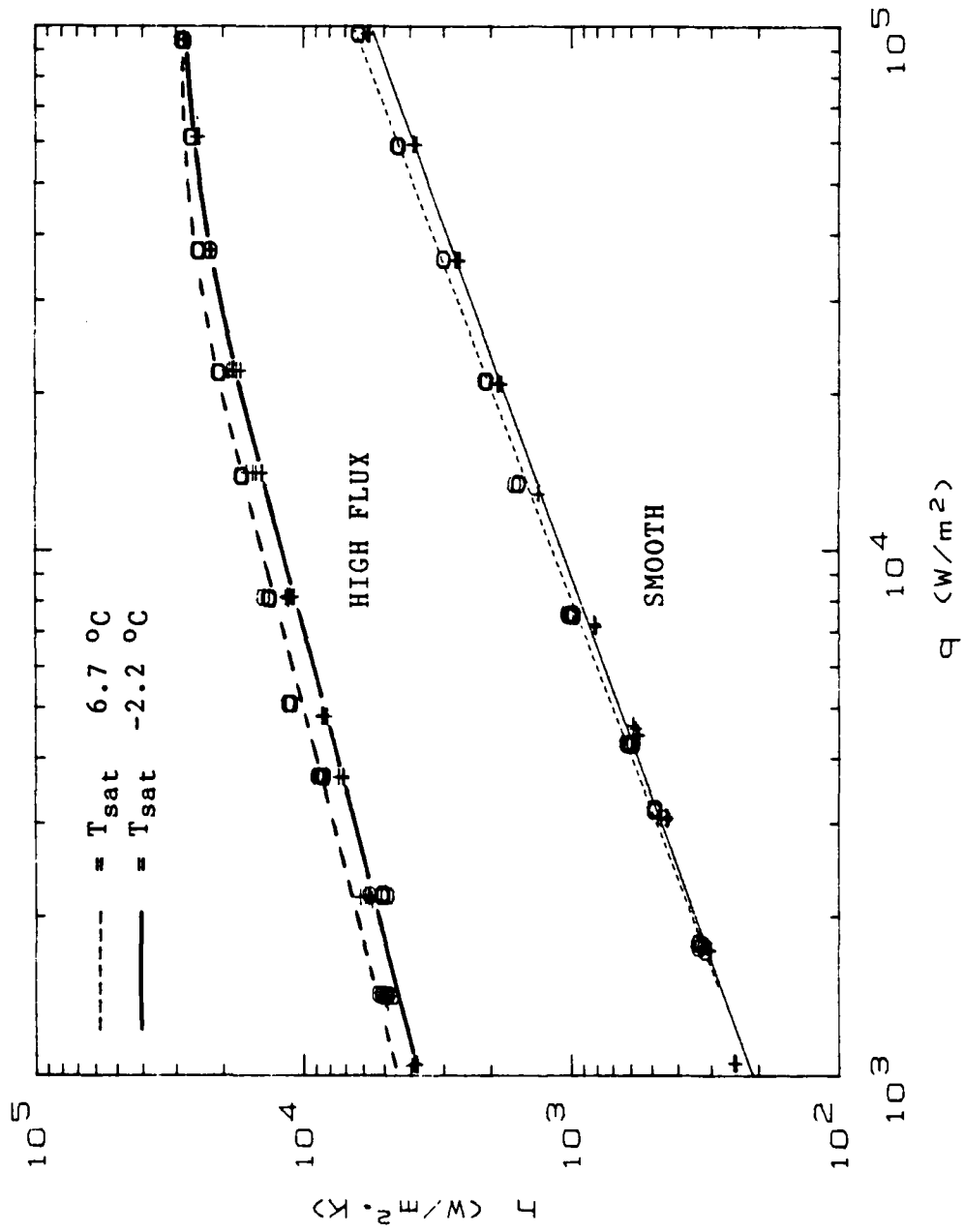

Figure 6.9 Effect of Saturation Temperature on Boiling Heat-Transfer Coefficient.

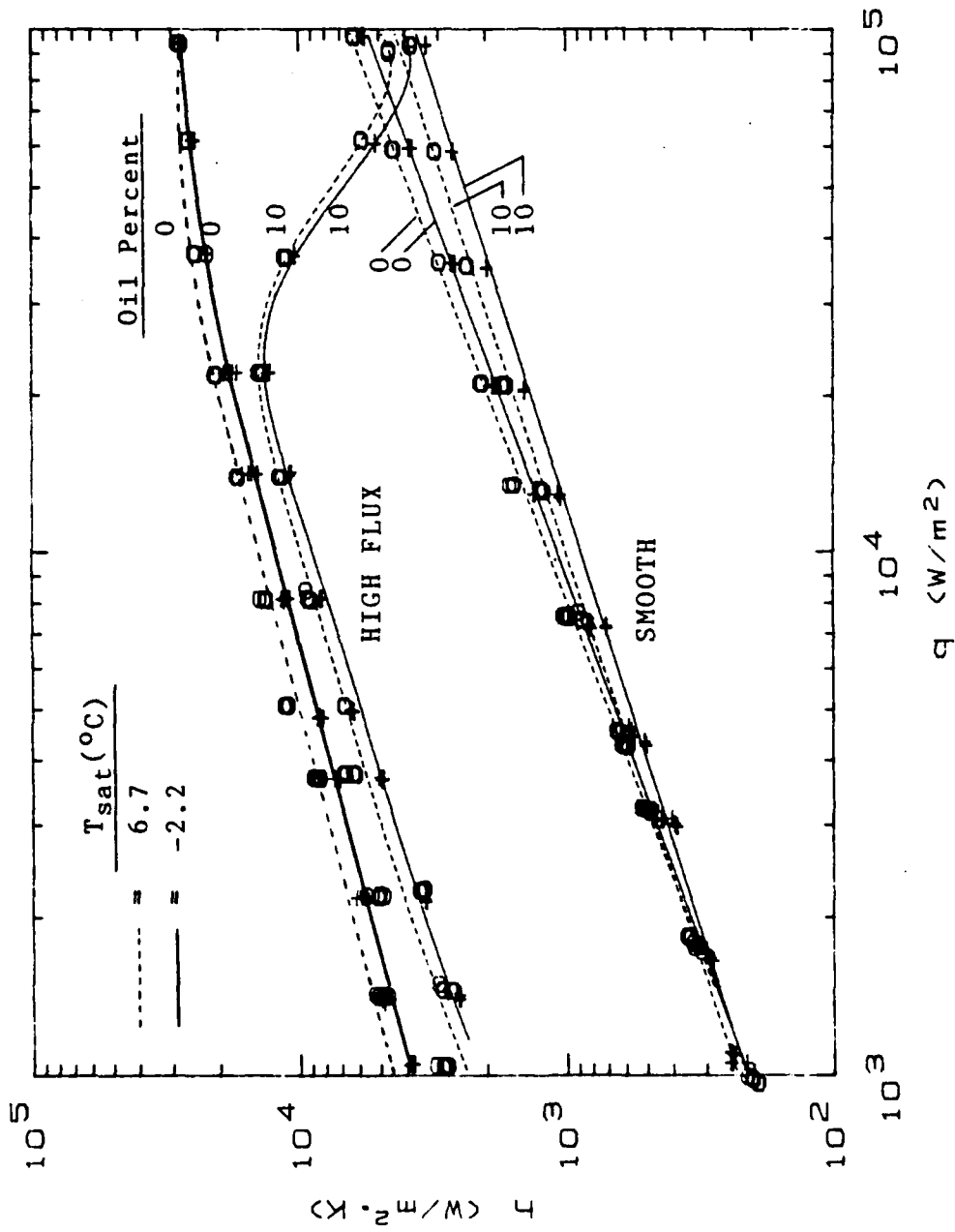

Figure 6.10 Effect of Oil on Variation of Boiling Heat-Transfer Coefficient with Saturation Temperature.

E. LOCAL OIL SAMPLING EFFORTS

The results of the attempt to sample oil locally near the boiling tube were inconclusive. The method outlined in Section IV.C did not produce either repeatable or accurate results. Checks of the sampling method were made by sampling the bulk liquid with 0 and 10 percent oil at zero heat flux. The 0 percent oil check yielded oil concentrations from 0 to 2 percent. The 10 percent oil check yielded oil sample concentrations from 5 to 25 percent.

Further refinements to the sampling apparatus are needed to permit an accurate local sample of oil in the vicinity of a boiling tube. Section VII.B contains recommendations to improve the sampling apparatus.

VII. CONCLUSIONS AND RECOMMENDATIONS

A. CONCLUSIONS

1. In pure R-114, the pool-boiling heat-transfer coefficient of the High Flux surface is about 10 times larger than that of a smooth tube.
2. The High Flux surface began nucleate boiling at low heat fluxes, about 1 kW/m^2 , compared to a heat flux of about 10 kW/m^2 for the smooth tube.
3. Oil delayed the onset of nucleate boiling with the High Flux surface.
4. Oil resulted in about a 20 percent reduction in the heat-transfer coefficient of the High Flux surface for most practical heat flux (less than 37 kW/m^2) and oil combinations (less than 6 percent).
5. At heat fluxes of 98 kW/m^2 and greater than 6 percent oil, the performance of the High Flux surface degraded by as much as 80 percent. The performance of the High Flux surface was little better than the smooth tube at 98 kW/m^2 and 10 percent oil.
6. The boiling heat-transfer coefficient of the High Flux surface was about 7 times better than that of a smooth tube for oil concentrations from 1 to 10 percent over the range of heat fluxes employed in air-conditioning plants ($10\text{-}40 \text{ kW/m}^2$).
7. The boiling heat-transfer coefficient of both the High Flux surface and the smooth tube increased with increasing saturation temperature. The improvement decreased at high heat fluxes for the High Flux surface due to vapor blanketing of the surface.

8. Local oil sample results were not accurate or repeatable enough to determine if a variation in the local oil concentration occurs near a boiling tube.

B. RECOMMENDATIONS

1. The present cartridge heaters should be replaced with more reliable heaters that will produce a uniform heat flux axially at all heat loads.
2. A solid copper tube should be coated with High Flux and tested. Due to the very small superheats of the High Flux surface, even a small amount of contact resistance could affect the data at low heat fluxes.
3. The physical properties of the R-114-oil mixtures tested should be measured to obtain information to better explain the reasons for the heat-transfer performance of both the High Flux surface and the smooth tube. Particularly, the anomalous rise in heat-transfer performance of smooth tubes when 1 to 6 percent oil is present in R-114 should be studied.
4. A secondary heater should be installed in the boiling section to keep the total heat input constant. The heat input to the secondary heater should be increased when the heat input to the boiling tube is decreased and vice versa. This modification will maintain a constant heat load on the condenser and eliminate the need to operate valve VC, except to set the saturation temperature at the beginning of a run. Alternately, the effort to computer control valve VC should continue by obtaining an accurate thermistor with a high temperature resolution for use with the SYS-2A microcomputer. Improved temperature resolution would allow the computer-controlled valve to operate properly and free the operator from the demands of manual control of valve VC.

5. The performance of a bundle of High Flux-coated tubes in R-114-oil mixtures should be studied.
6. Data should be obtained on the High Flux surface over a wider range of temperatures and with oils of varying viscosities.
7. The High Flux surface should be tested for time-dependent heat-transfer performance by taking data periodically over a long time during boiling.
8. A small oil sample container with valves and a vent line should be manufactured. The flexible tubing and pinch clamps used in this experiment did not properly hold or vent the sample.

APPENDIX A
THERMOCOUPLE CALIBRATION

Karasabun [Ref. 8] describes the thermocouple calibration equipment in detail. Two thermocouples were calibrated. One was made from wire at the beginning of the roll, the other from the end of the roll, following the making of all thermocouples used in the apparatus and tests.

Essentially, the manufacturer-supplied calibration equation for the thermocouple wire, a seventh order polynomial, was corrected slightly by adding to it a second order curve fit of the variation of the manufacturer's computed temperature for a given emf from a known set of reference temperatures (measured using a Hewlett-Packard 2804A quartz thermometer with a temperature resolution of ± 0.0001 K and accuracy of ± 0.03 K).

The manufacturer's emf to temperature conversion equation is:

$$T = a_0 + a_1 E + a_2 E^2 + a_3 E^3 + a_4 E^4 + a_5 E^5 + a_6 E^6 + a_7 E^7 \quad (\text{A.1})$$

where

T = temperature ($^{\circ}\text{C}$)
a₀ = 0.100860910
a₁ = 25727.94369
a₂ = -767345.8295
a₃ = 78025595.81
a₄ = -9247486589
a₅ = 6.97688E+11
a₆ = -2.66192E+13
a₇ = 3.94078E+14
E = thermocouple reading (volts)

Figure A.1 shows the quartz thermometer reading minus the thermocouple readings (discrepancy) versus temperature. The two thermocouples agreed to within 0.05 K of each other and the manufacturer's seventh-order polynomial needed about a 0.1 K increase to more accurately convert the emf's to the true temperature. The correcting second-order polynomial was:

$$DCP = b_0 + b_1 T + b_2 T^2 \quad (A.2)$$

where

DCP = discrepancy (K)
 $b_0 = 8.6268968E-2$
 $b_1 = 3.7619902E-3$
 $b_2 = -5.0689259E-5$
T = thermocouple reading
(from equation A.1) ($^{\circ}C$)

Thus, the temperatures computed by the data-reduction program (DRP2) were emf's converted to temperature by equation A.1 with corrections for that temperature computed by equation A.2 added to the temperature to get the true temperature.

Since the data-reduction program utilized differences between thermocouples in all computations, such as wall temperature minus saturation temperature, the corrections above were necessary only for the computation of items dependent on the absolute temperature, like the fluid properties. Appendix E describes in detail the uncertainty analysis and the effect of wall temperature variation on the computation of the heat-transfer coefficient. Thermocouple

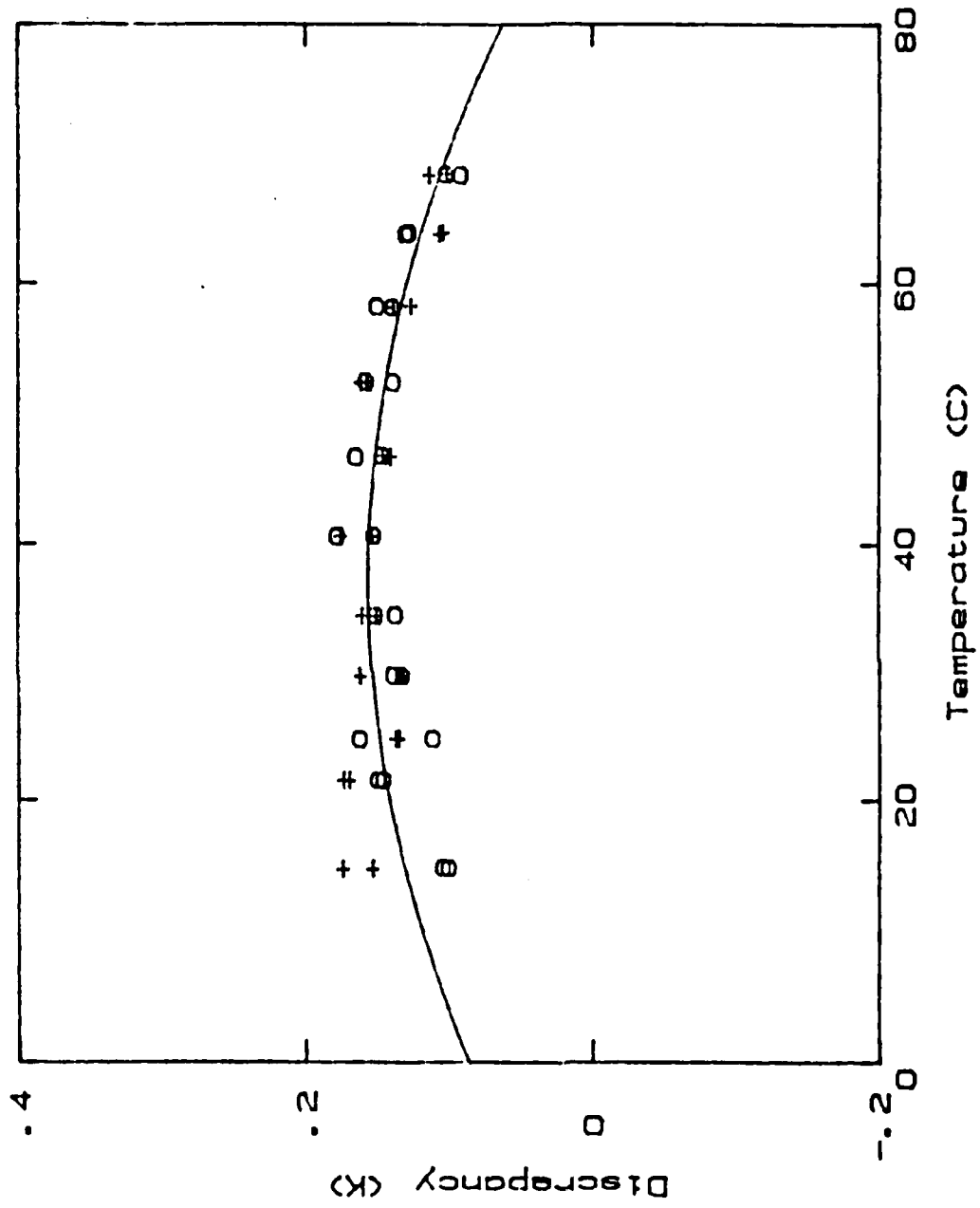

Figure A.1 Thermocouple Discrepancy Correction.

variations of the soft-soldered tubes were most likely due to a slight amount of contact resistance and to the surface characteristics of the tubes tested, since data runs involving shifting the wall thermocouples did not affect the data.

APPENDIX B
DATA REDUCTION PROGRAM

The data reduction program below consists of the following sections:

Main Program - Menu of subprogram options
Sub Main - Take data or reprocess data
Sub Plot - Plot data on log-log scale
Sub Poly - Compute least-squares curve fit of data
Sub Plin - Plot data on linear-linear scale
Sub Stats - Compute average and standard deviation of data

Subprogram Main consists of the following steps:

1. Create data file for data and plot points.
2. Select tube type.
3. Monitor heat flux or saturation temperature to establish steady-state conditions.
4. Scan all channels listed in Table 2 and save in data file.
5. Convert raw emf's to temperatures, current, and voltage.
6. Compute the heat-transfer rate for the cartridge heater.
7. Compute the average wall temperature, the wall superheat, and the film temperature.
8. Compute the physical properties of R-114 using given correlations at film temperature.
9. Compute the natural-convection heat-transfer coefficient of R-114 for the non-boiling ends of the test tube.
10. Compute the heat loss from the non-boiling ends.

11. Calculate the corrected heat flux from the test tube to the liquid R-114.
12. Calculate the boiling heat-transfer coefficient of the R-114 from the test tube.
13. Print data. Store heat flux and wall superheat values in plot file.

The following is a listing of the complete data reduction program (DRP2) written in Basic 3.0 for the Hewlett-Packard 9826 computer.

```

1000: FILE NAME: DRP2
1005: DATE: October 19, 1984
1010: REVISED: March 10, 1985
1015:
1020: BEEP
1025: PRINTER IS 1
1030: PRINT USING "4X "Select option:"
1035: PRINT USING "6X ""Plotting data on re-processing previous data""
1040: PRINT USING "6X ""Plotting data on Log-Log ""
1045: PRINT USING "6X ""Plotting data on Linear""
1050: PRINT USING "6X ""Make cross-plot coefft file""
1055: INPUT Id0
1060: IF Id0=0 THEN CALL Main
1065: IF Id0=1 THEN CALL Plot
1070: IF Id0=2 THEN CALL Plot
1075: IF Id0=3 THEN CALL Coef
1080: END
1095: SUB Main
1096: DIM C(6), D(7), L(4)
1095: DIM Exp(12), I(12), D1(6), D2(6), D3(6), D4(6), L(6), Lnd(6), K(4)(6)
1100: DATA 0.1403609, 25.27, 94369, 767745, 8295, 70025595, 81
1105: DATA -9247406549, 5.97564E+11, 2.66197E+13, 1.94078E+14
1110: READ C(4)
1115: PRINT#15: "W"
1120: CLNR 709
1125: BEEP
1130: INPUT "ENTER MONTH, DATE AND TIME (MM:DD:HH:MM:SS)"; Dates
1135: OUTPUT 709: "10:00:00:00:00"
1140: OUTPUT 709: "10"
1145: ENTER 709: Dates$
1150: PRINT
1155: PRINT " Month, date and time: "; Dates$
1160: PRINT
1165: PRINT USING "10X ""Program name: DRP2""
1170: BEEP
1175: INPUT "ENTER DISK NUMBER"; In
1180: PRINT USING "16X ""Disk number: "" ZZ""In
1185: BEEP
1190: INPUT "ENTER INPUT MODE (0=3054A, 1=FILE)"; In
1195: BEEP
1200: INPUT "ENTER THERMOCOUPLE TYPE (0=NEW, 1=OLD)"; In
1205: IF In=0 THEN
1210: BEEP
1215: INPUT "GIVE A NAME FOR THE RAW DATA FILE"; D2, file$
1220: PRINT USING "16X ""New file name: "" ZZ""D2, file$
1225: BEEP
1230: INPUT "INPUT SIZE OF FILE (KB)"; Size1
1235: CREATE BVAL D2, file$, Size1
1240: ASSIGN @file2 TO D2, file$
1245:
1250: DIMMY FILE @file1, @file2, @file3
1255: D1, file$, "DIMMY"
1260: CREATE BVAL D1, file$, Size1
1265: ASSIGN @file1 TO D1, file$
1270: OUTPUT @file1: Dates$

```

Copy available to DTIC does not
 permit fully legible reproduction

```

1275 BEEP
1280 INPUT "GIVE A NAME FOR THE PLOT FILE" P_files$
1285 BEEP
1290 INPUT "INPUT SIZE OF FILE BOAT" Size2
1295 CREATE BOAT P_files$ Size2
1300 ASSIGN @Plot TO P_files$
1305 BEEP
1310 INPUT "ENTER NUMBER OF DEFECTIVE TCS (0=DEFAULT)" Ldtc
1315 IF Ldtc=0 THEN
1320 Ldtc1=0
1325 Ldtc2=0
1330 PRINT USING "16X,""No defective TCs exist""
1335 END IF
1340 IF Ldtc=1 THEN
1345 BEEP
1350 INPUT "ENTER DEFECTIVE TC LOCATION" Ldtc1
1355 PRINT USING "16X,""TC is defective at location "" ,D"iLdtc1
1360 Ldtc2=0
1365 END IF
1370 IF Ldtc=2 THEN
1375 BEEP
1380 INPUT "ENTER DEFECTIVE TC LOCATIONS" Ldtc1,Ldtc2
1385 PRINT USING "16X,""TC are defective at locations "" ,D,4X,D"iLdtc1,Ldtc2
1390 END IF
1395 IF Ldtc>2 THEN
1400 BEEP
1405 PRINTER IS 1
1410 BEEP
1415 PRINT "INVALID ENTRY"
1420 PRINTER IS 701
1425 GOTO 1305
1430 END IF
1435 OUTPUT @File1:Ldtc1 Ldtc2
1440 In=1 option
1445 ELSE
1450 BEEP
1455 INPUT "GIVE THE NAME OF THE EXISTING DATA FILE" D2_files$
1460 PRINT USING "16X,""Old file name: "" ,14A"iD2_files$
1465 ASSIGN @File2 TO D2_files$
1470 ENTER @File2:Nrun
1475 ENTER @File2:Dold$
1480 BEEP
1485 INPUT "GIVE A NAME FOR PLOT FILE" P_files$
1490 BEEP
1495 INPUT "INPUT SIZE OF FILE BOAT" Size2
1500 CREATE BOAT P_files$ Size2
1505 ASSIGN @Plot TO P_files$
1510 PRINT USING "16X,""This data set taken on : "" ,14A"iDold$
1515 ENTER @File2:Ldtc1,Ldtc2
1520 IF Ldtc1=0 OR Ldtc2=0 THEN
1525 PRINT USING "16X,""Thermocouples were defective at locations: "" ,2(30,4X)"i
Ldtc1,Ldtc2
1530 END IF
1535 ENTER @File2:Itt
1540 END IF
1545 PRINTER IS 1
1550 IF In=0 THEN
1555 BEEP
1560 PRINT USING "14X,""Select tube type""
1565 PRINT USING "16X,""0=Smooth 4 inch Ref""
1570 PRINT USING "16X,""1=Smooth 4 inch Cu (Fress/Slide)""
1575 PRINT USING "16X,""2=Soft Solder 4 inch Cu""
1580 PRINT USING "16X,""3=Soft Solder 4 inch HIGH FLUX""
1585 PRINT USING "16X,""4=Wieland Hard 8 inch""
1590 PRINT USING "16X,""5=HIGH FLUX 8 inch""
1595 PRINT USING "16X,""6=GERM K 19 Print""
1600 INPUT Itt
1605 IF Itt=5 THEN
1610 BEEP
1615 PRINT "INVALID ENTRY"
1620 GOTO 1560
1625 END IF
1630 OUTPUT @File1:Itt
1635 END IF
1640 PRINTER IS 701
1645 PRINT USING "16X,""Tube Type: "" ,D"iItt

```

```

1650 BEEP
1655 INPUT "ENTER OUTPUT VERSION (0=LONG,1=SHORT,2=NONE)" : Iv
1660
1665 D1=Diameter at thermocouple positions
1670 DATA .0111125,.0111125,.0111125,.0129540,.012446,.0129540,.0100965
1675 READ Dia(+ )
1680 D1=Dia(I1t)
1685
1690 D2=Diameter of test section to the base of fins
1695 DATA .015875,.015875,.015875,.015824,.015875,.015824,.01270
1700 READ D2a(+ )
1705 D2=D2a(I1t)
1710
1715 D1=Inside diameter of unenhanced ends
1720 DATA .0127,.0127,.0127,.0122,.0127,.0132,.0111125
1725 READ Dia(+ )
1730 D1=Dia(I1t)
1735
1740 Dc=Outside diameter of unenhanced ends
1745 DATA .015875,.015875,.015875,.015824,.015875,.015824,.01270
1750 READ Dca(+ )
1755 Dc=Dca(I1t)
1760
1765 L=Length of enhanced surface
1770 DATA .1016,.1016,.1016,.1016,.2032,.2032,.2032
1775 READ La(+ )
1780 L=La(I1t)
1785
1790 Lu=Length of unenhanced surface at the ends
1795 DATA .0254,.0254,.0254,.0254,.0762,.0762,.0762
1800 READ Lu(+ )
1805 Lu=Lu(I1t)
1810
1815 Kcu=Thermal Conductivity of tube
1820 DATA 398.344,344.45,344.45,344
1825 READ Kcu(+ )
1830 Kcu=Kcu(I1t)
1835 A=PI*(Dc/2-D1/2)/4
1840 P=PI*Dc
1845 J=1
1850 S=0
1855 Sx=0
1860 Sy=0
1865 Sz=0
1870 Repeat: 1
1875 IF Iw=0 THEN
1880 ON KEY 0,15 RECOVER 1870
1885 PRINTER IS 1
1890 PRINT USING "4X, " "SELECT OPTION"
1895 PRINT USING "6X, " "TAKE DATA"
1900 PRINT USING "6X, " "SET HEAT FLUX"
1905 PRINT USING "6X, " "SET Tsat"
1910 PRINT USING "4X, " "NOTE: KEY 0 = ESCAPE"
1915 BEEP
1920 INPUT Idc
1925 IF Idc=0 THEN 2495
1930
1935 LOOP TO SET HEAT FLUX
1940 IF Idc=1 THEN
1945 OUTPUT 709: "APR AF62 ALSO RMS"
1950 BEEP
1955 INPUT "ENTER DESIRED Qdot: Qdotd" : Qdotd
1960 PRINT USING "4X, " "DESIRED Qdot ACTUAL Qdot"
1965 Err=1000
1970 FOR I=1 TO 2
1975 OUTPUT 709: "AS SA"

```

Copy available to DTIC does not
 permit fully legible reproduction

```

1980 Sum=0
1985 FOR J1=1 TO 5
1990 ENTER 709: E
1995 Sum=Sum+E
2000 NEXT J1
2005 IF I=1 THEN Volt=Sum*5
2010 IF I=2 THEN Amp=E
2015 NEXT I
2020 Aadd=Volt*Amp/(PI*02*L)
2025 IF ABS(Aadd-Qadd) Err THEN
2030 IF Aadd Qadd THEN
2035 BEEP 4000 .2
2040 BEEP 4000 .2
2045 BEEP 4000 .2
2050 ELSE
2055 BEEP 250 .2
2060 BEEP 250 .2
2065 BEEP 250 .2
2070 END IF
2075 PRINT USING "4X MZ.30F.2X MZ.30E":Qadd,Aadd
2080 WAIT 2
2085 GOTO 1970
2090 ELSE
2095 BEEP
2100 PRINT USING "4X MZ.30F.2X MZ.30E":Qadd,Aadd
2105 Err=500
2110 WAIT 2
2115 GOTO 1970
2120 END IF
2125 END IF
2130
2135 LOOP TO SET Tset
2140 IF Ido=2 THEN
2145 BEEP
2150 INPUT "ENTER DESIRED Tset":D1id
2155 PRINT USING "4X.":D1set A1set Rate Tv Rate""
2160 D1d=0
2165 D1c=0
2170 OUTPUT 709:"AR AF33 AL25 PR5"
2175 FOR I=1 TO 3
2180 Sum=0
2185 OUTPUT 709:"AS SA"
2190 FOR J1=1 TO 2
2195 ENTER 709:E1id
2200 Sum=Sum+E1id
2205 NEXT J1
2210 E1id=Sum/2
2215 T1d=PI*Sum*(E1id)
2220 IF I=1 THEN A1id=T1d
2225 IF I=2 THEN T1=T1d
2230 NEXT I
2235 IF ABS(A1id-Q1id)>.2 THEN
2240 IF A1id-Q1id THEN
2245 BEEP 4000 .2
2250 BEEP 4000 .2
2255 BEEP 4000 .2
2260 ELSE
2265 BEEP 250 .2
2270 BEEP 250 .2
2275 BEEP 250 .2
2280 END IF
2285 Err1=A1id-D1d
2290 D1d=A1id
2295 Err2=T1-D1c
2300 D1c=T1
2305 PRINT USING "4X 5:000.00 1X 12:011d A1id Err1 Tv Err2

```

Copy available to DMC does not
 permit fully legible reproduction

```

2310 WAIT 2
2315 GOTO 2170
2320 ELSE
2325 IF ABS(Atld-D1ld) .1 THEN
2330 IF Atld-D1ld THEN
2335 BEEP 3000 .12
2340 BEEP 3000 .12
2345 ELSE
2350 BEEP 800 .12
2355 BEEP 800 .12
2360 END IF
2365 Err1=Atld-D1d1
2370 D1d1=Atld
2375 Err2=Ty-D1d2
2380 D1d2=Ty
2385 PRINT USING "4X.5(MOD.00.1X)":D1d1,Atld,Err1,Ty,Err2
2390 WAIT 2
2395 GOTO 2170
2400 ELSE
2405 BEEP
2410 Err1=Atld-D1d1
2415 D1d1=Atld
2420 Err2=Ty-D1d2
2425 D1d2=Ty
2430 PRINT USING "4X.5(MOD.00.1X)":D1d1,Atld,Err1,Ty,Err2
2435 WAIT 2
2440 GOTO 2170
2445 END IF
2450 END IF
2455 END IF
2460 ERROR TRAP FOR Ids OUT OF BOUNDS
2465 IF Ids < 2 THEN
2470 BEEP
2475 GOTO 1990
2480 END IF
2485
2490 TAKE DATA IF In=0 LOOP
2495 BEEP
2500 INPUT "ENTER BULK OIL XT Bon
2505 OUTPUT 709:AR AF05 AL05 URS"
2510 FOR I=1 TO 12
2515 OUTPUT 709:AS SA"
2520 Sum=0
2525 FOR J=1 TO 2
2530 ENTER 709:IE
2535 Sum=Sum+E
2540 NEXT J
2545 E=Sum/2
2550 NEXT I
2555 OUTPUT 709:AR AF02 AL02 URS"
2560 FOR I=1 TO 2
2565 OUTPUT 709:AS SA"
2570 Sum=0
2575 FOR J=1 TO 2
2580 ENTER 709:IE
2585 Sum=Sum+E
2590 NEXT J
2595 IF I=1 THEN In=Sum/2
2600 IF I=2 THEN In=Sum/2
2605 NEXT I
2610 GOTO
2615 ENTER AF1e:Bon In:05 E=Sum/2
2620 END IF
2625
2630 CONVERT ANSWERS TO TEMP AND CURRENT
2635 Goto

```

Copy available to DTIC does not
 permit fully legible reproduction

```

2640 FOR I=1 TO 12
2645 IF Idtc=0 THEN
2650 IF I=Ldte1 OR I=Ldte2 THEN
2655 T(I)=-99.99
2660 GOTO 2710
2665 END IF
2670 END IF
2675 IF I=4 THEN
2680 IF I>4 AND I<9 THEN
2685 T(I)=-99.99
2690 GOTO 2710
2695 END IF
2700 END IF
2705 T(I)=FNTrav(Emf(I))
2710 NEXT I
2715 IF I=4 THEN
2720 FOR I=1 TO 4
2725 IF I=Ldte1 OR I=Ldte2 THEN
2730 Two=Two
2735 ELSE
2740 Two=Two+T(I)
2745 END IF
2750 NEXT I
2755 Two=Two/(4-Idtc)
2760 ELSE
2765 FOR I=1 TO 8
2770 IF I=Ldte1 OR I=Ldte2 THEN
2775 Two=Two
2780 ELSE
2785 Two=Two+T(I)
2790 END IF
2795 NEXT I
2800 Two=Two/(8-Idtc)
2805 END IF
2810 Tld=Tld
2815 Tld=Tld+Two
2820 T=T(I)
2825 IF I=3 THEN
2830 Tld=-99.99
2835 T=Tld*(10)+T(I)*2
2840 END IF
2845 Tsum=T(I)
2850 Amp=I
2855 Amp=Amp+25
2860 Q=Q+I*Amp
2865 IF I=8 THEN
2870 Prog=Prog+Two
2875 ELSE
2880 Prog=Prog+T(I)
2885 END IF
2890
2895
2900
2905
2910
2915
2920
2925
2930
2935
2940
2945
2950
2955
2960
2965
2970
2975
2980
2985
2990
2995
3000
3005
3010
3015
3020
3025
3030
3035
3040
3045
3050
3055
3060
3065
3070
3075
3080
3085
3090
3095
3100
3105
3110
3115
3120
3125
3130
3135
3140
3145
3150
3155
3160
3165
3170
3175
3180
3185
3190
3195
3200
3205
3210
3215
3220
3225
3230
3235
3240
3245
3250
3255
3260
3265
3270
3275
3280
3285
3290
3295
3300
3305
3310
3315
3320
3325
3330
3335
3340
3345
3350
3355
3360
3365
3370
3375
3380
3385
3390
3395
3400
3405
3410
3415
3420
3425
3430
3435
3440
3445
3450
3455
3460
3465
3470
3475
3480
3485
3490
3495
3500
3505
3510
3515
3520
3525
3530
3535
3540
3545
3550
3555
3560
3565
3570
3575
3580
3585
3590
3595
3600
3605
3610
3615
3620
3625
3630
3635
3640
3645
3650
3655
3660
3665
3670
3675
3680
3685
3690
3695
3700
3705
3710
3715
3720
3725
3730
3735
3740
3745
3750
3755
3760
3765
3770
3775
3780
3785
3790
3795
3800
3805
3810
3815
3820
3825
3830
3835
3840
3845
3850
3855
3860
3865
3870
3875
3880
3885
3890
3895
3900
3905
3910
3915
3920
3925
3930
3935
3940
3945
3950
3955
3960
3965
3970
3975
3980
3985
3990
3995
4000
4005
4010
4015
4020
4025
4030
4035
4040
4045
4050
4055
4060
4065
4070
4075
4080
4085
4090
4095
4100
4105
4110
4115
4120
4125
4130
4135
4140
4145
4150
4155
4160
4165
4170
4175
4180
4185
4190
4195
4200
4205
4210
4215
4220
4225
4230
4235
4240
4245
4250
4255
4260
4265
4270
4275
4280
4285
4290
4295
4300
4305
4310
4315
4320
4325
4330
4335
4340
4345
4350
4355
4360
4365
4370
4375
4380
4385
4390
4395
4400
4405
4410
4415
4420
4425
4430
4435
4440
4445
4450
4455
4460
4465
4470
4475
4480
4485
4490
4495
4500
4505
4510
4515
4520
4525
4530
4535
4540
4545
4550
4555
4560
4565
4570
4575
4580
4585
4590
4595
4600
4605
4610
4615
4620
4625
4630
4635
4640
4645
4650
4655
4660
4665
4670
4675
4680
4685
4690
4695
4700
4705
4710
4715
4720
4725
4730
4735
4740
4745
4750
4755
4760
4765
4770
4775
4780
4785
4790
4795
4800
4805
4810
4815
4820
4825
4830
4835
4840
4845
4850
4855
4860
4865
4870
4875
4880
4885
4890
4895
4900
4905
4910
4915
4920
4925
4930
4935
4940
4945
4950
4955
4960
4965
4970
4975
4980
4985
4990
4995
5000
5005
5010
5015
5020
5025
5030
5035
5040
5045
5050
5055
5060
5065
5070
5075
5080
5085
5090
5095
5100
5105
5110
5115
5120
5125
5130
5135
5140
5145
5150
5155
5160
5165
5170
5175
5180
5185
5190
5195
5200
5205
5210
5215
5220
5225
5230
5235
5240
5245
5250
5255
5260
5265
5270
5275
5280
5285
5290
5295
5300
5305
5310
5315
5320
5325
5330
5335
5340
5345
5350
5355
5360
5365
5370
5375
5380
5385
5390
5395
5400
5405
5410
5415
5420
5425
5430
5435
5440
5445
5450
5455
5460
5465
5470
5475
5480
5485
5490
5495
5500
5505
5510
5515
5520
5525
5530
5535
5540
5545
5550
5555
5560
5565
5570
5575
5580
5585
5590
5595
5600
5605
5610
5615
5620
5625
5630
5635
5640
5645
5650
5655
5660
5665
5670
5675
5680
5685
5690
5695
5700
5705
5710
5715
5720
5725
5730
5735
5740
5745
5750
5755
5760
5765
5770
5775
5780
5785
5790
5795
5800
5805
5810
5815
5820
5825
5830
5835
5840
5845
5850
5855
5860
5865
5870
5875
5880
5885
5890
5895
5900
5905
5910
5915
5920
5925
5930
5935
5940
5945
5950
5955
5960
5965
5970
5975
5980
5985
5990
5995
6000
6005
6010
6015
6020
6025
6030
6035
6040
6045
6050
6055
6060
6065
6070
6075
6080
6085
6090
6095
6100
6105
6110
6115
6120
6125
6130
6135
6140
6145
6150
6155
6160
6165
6170
6175
6180
6185
6190
6195
6200
6205
6210
6215
6220
6225
6230
6235
6240
6245
6250
6255
6260
6265
6270
6275
6280
6285
6290
6295
6300
6305
6310
6315
6320
6325
6330
6335
6340
6345
6350
6355
6360
6365
6370
6375
6380
6385
6390
6395
6400
6405
6410
6415
6420
6425
6430
6435
6440
6445
6450
6455
6460
6465
6470
6475
6480
6485
6490
6495
6500
6505
6510
6515
6520
6525
6530
6535
6540
6545
6550
6555
6560
6565
6570
6575
6580
6585
6590
6595
6600
6605
6610
6615
6620
6625
6630
6635
6640
6645
6650
6655
6660
6665
6670
6675
6680
6685
6690
6695
6700
6705
6710
6715
6720
6725
6730
6735
6740
6745
6750
6755
6760
6765
6770
6775
6780
6785
6790
6795
6800
6805
6810
6815
6820
6825
6830
6835
6840
6845
6850
6855
6860
6865
6870
6875
6880
6885
6890
6895
6900
6905
6910
6915
6920
6925
6930
6935
6940
6945
6950
6955
6960
6965
6970
6975
6980
6985
6990
6995
7000
7005
7010
7015
7020
7025
7030
7035
7040
7045
7050
7055
7060
7065
7070
7075
7080
7085
7090
7095
7100
7105
7110
7115
7120
7125
7130
7135
7140
7145
7150
7155
7160
7165
7170
7175
7180
7185
7190
7195
7200
7205
7210
7215
7220
7225
7230
7235
7240
7245
7250
7255
7260
7265
7270
7275
7280
7285
7290
7295
7300
7305
7310
7315
7320
7325
7330
7335
7340
7345
7350
7355
7360
7365
7370
7375
7380
7385
7390
7395
7400
7405
7410
7415
7420
7425
7430
7435
7440
7445
7450
7455
7460
7465
7470
7475
7480
7485
7490
7495
7500
7505
7510
7515
7520
7525
7530
7535
7540
7545
7550
7555
7560
7565
7570
7575
7580
7585
7590
7595
7600
7605
7610
7615
7620
7625
7630
7635
7640
7645
7650
7655
7660
7665
7670
7675
7680
7685
7690
7695
7700
7705
7710
7715
7720
7725
7730
7735
7740
7745
7750
7755
7760
7765
7770
7775
7780
7785
7790
7795
7800
7805
7810
7815
7820
7825
7830
7835
7840
7845
7850
7855
7860
7865
7870
7875
7880
7885
7890
7895
7900
7905
7910
7915
7920
7925
7930
7935
7940
7945
7950
7955
7960
7965
7970
7975
7980
7985
7990
7995
8000
8005
8010
8015
8020
8025
8030
8035
8040
8045
8050
8055
8060
8065
8070
8075
8080
8085
8090
8095
8100
8105
8110
8115
8120
8125
8130
8135
8140
8145
8150
8155
8160
8165
8170
8175
8180
8185
8190
8195
8200
8205
8210
8215
8220
8225
8230
8235
8240
8245
8250
8255
8260
8265
8270
8275
8280
8285
8290
8295
8300
8305
8310
8315
8320
8325
8330
8335
8340
8345
8350
8355
8360
8365
8370
8375
8380
8385
8390
8395
8400
8405
8410
8415
8420
8425
8430
8435
8440
8445
8450
8455
8460
8465
8470
8475
8480
8485
8490
8495
8500
8505
8510
8515
8520
8525
8530
8535
8540
8545
8550
8555
8560
8565
8570
8575
8580
8585
8590
8595
8600
8605
8610
8615
8620
8625
8630
8635
8640
8645
8650
8655
8660
8665
8670
8675
8680
8685
8690
8695
8700
8705
8710
8715
8720
8725
8730
8735
8740
8745
8750
8755
8760
8765
8770
8775
8780
8785
8790
8795
8800
8805
8810
8815
8820
8825
8830
8835
8840
8845
8850
8855
8860
8865
8870
8875
8880
8885
8890
8895
8900
8905
8910
8915
8920
8925
8930
8935
8940
8945
8950
8955
8960
8965
8970
8975
8980
8985
8990
8995
9000
9005
9010
9015
9020
9025
9030
9035
9040
9045
9050
9055
9060
9065
9070
9075
9080
9085
9090
9095
9100
9105
9110
9115
9120
9125
9130
9135
9140
9145
9150
9155
9160
9165
9170
9175
9180
9185
9190
9195
9200
9205
9210
9215
9220
9225
9230
9235
9240
9245
9250
9255
9260
9265
9270
9275
9280
9285
9290
9295
9300
9305
9310
9315
9320
9325
9330
9335
9340
9345
9350
9355
9360
9365
9370
9375
9380
9385
9390
9395
9400
9405
9410
9415
9420
9425
9430
9435
9440
9445
9450
9455
9460
9465
9470
9475
9480
9485
9490
9495
9500
9505
9510
9515
9520
9525
9530
9535
9540
9545
9550
9555
9560
9565
9570
9575
9580
9585
9590
9595
9600
9605
9610
9615
9620
9625
9630
9635
9640
9645
9650
9655
9660
9665
9670
9675
9680
9685
9690
9695
9700
9705
9710
9715
9720
9725
9730
9735
9740
9745
9750
9755
9760
9765
9770
9775
9780
9785
9790
9795
9800
9805
9810
9815
9820
9825
9830
9835
9840
9845
9850
9855
9860
9865
9870
9875
9880
9885
9890
9895
9900
9905
9910
9915
9920
9925
9930
9935
9940
9945
9950
9955
9960
9965
9970
9975
9980
9985
9990
9995

```

Copy available to JPLS only for
power only hardware production

AD-A155 609

THE INFLUENCE OF OIL CONTAMINATION ON THE NUCLEATE
POOL-BOILING BEHAVIOR O. (U) NAVAL POSTGRADUATE SCHOOL
MONTEREY CA J T REILLY MAR 85 NP569-85-003

2/2

UNCLASSIFIED

F/G 13/1

NL

		END

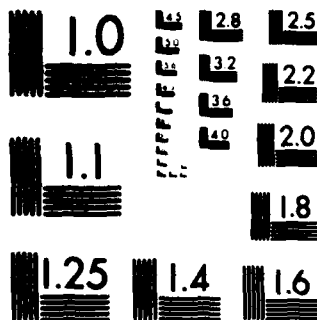

MICROCOPY RESOLUTION TEST CHART
NATIONAL BUREAU OF STANDARDS-1963-A

```

2970 Co=FNCb(Tfilm)
2975 Beta=FNBeta(Tfilm)
2980 Ni=Mu/Rho
2985 Alpha=K/(Rho*Co)
2990 Fr=Ni/Alpha
2995 Psat=FNPsat(Tfd)
3000
3005 COMPUTE NATURAL-CONVECTIVE HEAT-TRANSFER COEFFICIENT
3010 FOR UNENHANCED END(S)
3015 Hbar=190
3020 Fe=(Hbar+P*(Kcu*A))**.5*Lu
3025 Tanh=FNtanh(Fe)
3030 Theta=Thetab*Tanh/Fe
3035 X=(9.81*Beta*Thetab*Do*.3*Tanh/(Fe*Ni*Alpha)).16667
3040 Yy=(1+(.559/Pr)**(.9/16))*.8/27
3045 Hbarc=K/Do*(.6+.387*X**.25)/(1+.95/X**.15)**.25
3050 IF ABS((Hbar-Hbarc)/Hbarc)>.001 THEN
3055 Hbar=(Hbar+Hbarc)*.5
3060 GOTO 3020
3065 END IF
3070
3075 COMPUTE HEAT LOSS RATE THROUGH UNENHANCED END(S)
3080 Ql=(Hbar+P*Kcu*A).5*Thetab*Tanh
3085 Qc=Ql+Ql
3090 As=PI*Do*L
3095
3100 COMPUTE ACTUAL HEAT FLUX AND BOILING COEFFICIENT
3105 Qda=Qc/As
3110 Htube=Qda/Thetab
3115
3120 RECORD TIME OF DATA TAKING
3125 IF Im=0 THEN
3130 OUTPUT T09,T10
3135 ENTER T09,T10,13
3140 END IF
3145
3150 OUTPUT DATA TO PRINTER
3155 PRINTER IS ON
3160 IF Im=0 THEN
3165 PRINT
3170 PRINT USING "10X,""Data Set Number = ",D00,2X,"Bull",O11,X," ",D00,0,5X,1
3175 PRINT
3180 PRINT USING "10X,""TC No: 1 2 3 4 5 6 7
3185 PRINT
3190 PRINT USING "10X,""Temp: ",8(1X,MOD,00)";T(1),T(2),T(3),T(4),T(5),T(6),T(
3195 PRINT USING "10X,""Tm: ",11(1d,11(1d,2 1(1d,Psat Tsump""
3200 PRINT USING "10X,""T(1),T(2),T(3),T(4),T(5),T(6),T(7),T(8)
3205 PRINT USING "10X,""T(1),T(2),T(3),T(4),T(5),T(6),T(7),T(8),T(9),T(10),T(11),T(12),T(13),T(14),T(15),T(16),T(17),T(18),T(19),T(20),T(21),T(22),T(23),T(24),T(25),T(26),T(27),T(28),T(29),T(30),T(31),T(32),T(33),T(34),T(35),T(36),T(37),T(38),T(39),T(40),T(41),T(42),T(43),T(44),T(45),T(46),T(47),T(48),T(49),T(50),T(51),T(52),T(53),T(54),T(55),T(56),T(57),T(58),T(59),T(60),T(61),T(62),T(63),T(64),T(65),T(66),T(67),T(68),T(69),T(70),T(71),T(72),T(73),T(74),T(75),T(76),T(77),T(78),T(79),T(80),T(81),T(82),T(83),T(84),T(85),T(86),T(87),T(88),T(89),T(90),T(91),T(92),T(93),T(94),T(95),T(96),T(97),T(98),T(99),T(100)
3210 PRINT
3215 IF Im=1 THEN
3220 IF J=1 THEN
3225 PRINT
3230 PRINT USING "10X,""Run No: O11, Tsat Htube Qda Thetab""
3235 END IF
3240 PRINT USING "10X,""D: 4X,DD,2X,MOD,00,3(1X,MZ,3DE)";J,Bop,Tfd,Htube,Qda,Thetab
3245 END IF
3250 IF Im=0 THEN
3255 BEEP
3260 INPUT TOK TO STORE THIS DATA SET (KEY Q=N)?"
3265 END IF
3270 IF OI=1 OR Im=1 THEN J=J+1

```

Copy available to DTIC does not permit fully legible reproduction

```

3275 IF OI=1 AND Im=0 THEN OUTPUT @File1:Boo Told$ Emf(*),Vr,Ir
3280 IF Im=1 OR OI=1 THEN OUTPUT @Plot:Qdn,Theta
3285 IF Im=0 THEN
3290 BEEP
3295 INPUT "WILL THERE BE ANOTHER RUN (1=Y,0=N)?" Go_on
3300 Nrun=Nrun+1
3305 IF Go_on=1 THEN 3320
3310 IF Go_on=1 THEN Repeat
3315 ELSE
3320 IF J=Nrun+1 THEN Repeat
3325 END IF
3330 IF Im=0 THEN
3335 BEEP
3340 PRINT USING "10x,"NOTE: "0.22," data runs were stored in file "10A"J-
1,02_file$
3345 ASSIGN @file1 TO *
3350 OUTPUT @file2:Nrun-1
3355 ASSIGN @file1 TO D1_file$
3360 ENTER @file1:Date$ ,I:dtc1,dtc2,ltt
3365 OUTPUT @file2:Date$ ,I:dtc1,dtc2,ltt
3370 FOR I=1 TO Nrun-1
3375 ENTER @file1:Boo Told$ Emf(*),Vr,Ir
3380 OUTPUT @file2:Boo Told$ Emf(*),Vr,Ir
3385 NEXT I
3390 ASSIGN @file1 TO *
3395 PURGE "DUMMY"
3400 END IF
3405 BEEP
3410 PRINT USING "10x,"NOTE: "0.22," X-Y pairs were stored in plot data file
"10A"J-1_P1_file$
3415 ASSIGN @file1 TO *
3420 ASSIGN @Plot TO *
3425 CALL Stats
3430 BEEP
3435 INPUT "LIKE TO PLOT DATA (1=Y,0=N)?" OI
3440 IF OI=1 THEN
3445 CALL Plot
3450 END IF
3455 GOTO 3460
3460
3465 CURVE FITS OF PROPERTY FUNCTIONS
3470 DEF FNCo(C)
3475 OMC COPPER 250 TO 300 K
3480 T1=1+273.15 IC TO K
3485 K=4.74E-11IC+0
3490 RETURN K
3495 FNEND
3500 DEF FNmu(C)
3505 170 TO 350 K CURVE FIT OF VISCOSITY
3510 T1=1+273.15 IC TO K
3515 Mu=EXP(-4.4636+(1011.47-T1)/1.0E-3)
3520 RETURN Mu
3525 FNEND
3530 DEF FNCo(C)
3535 180 TO 400 K CURVE FIT OF Co
3540 T1=1+273.15 IC TO K
3545 Co=-.40189+1.65007E-3*(11.51494E-6+T1)-6.67853E-10*(T1-3)
3550 Co=Co+1000
3555 RETURN Co
3560 FNEND
3565 DEF FNrho(C)
3570 T1=1+273.15 IC TO K
3575 x=-1+1.8*(1+753.95)/T1 TO R
3580 R=16.32+51.146414*x-(1.71+16.419015*x+17.476028*x+.51+1.119828*x-2)
3585 R=-R+.002423
3590 RETURN R

```

Copy available to DTIC does not
 permit fully legible reproduction

```

3595 FNEED
3600 DEF FNPr(T)
3605 Pr=FNCo(T)+FNHu(T)/FNK(T)
3610 RETURN Pr
3615 FNEED
3620 DEF FNK(T)
3625 T=.360 K WITH T IN C
3630 K=.071-.000261*T
3635 RETURN K
3640 FNEED
3645 DEF FNTanh(X)
3650 P=EXP(X)
3655 Q=1/P
3660 Tanh=(P-Q)/(P+Q)
3665 RETURN Tanh
3670 FNEED
3675 DEF FNT/2v(U)
3680 COM /Cv/ C(7),Ical
3685 T=C(0)
3690 FOR I=1 TO 7
3695 T=T+C(I)*U*I
3700 NEXT I
3705 IF Ical=1 THEN
3710 T=T-6.7422934E-2+T*(9.0277043E-3-T*(9.3259917E-5))
3715 ELSE
3720 T=T*0.626897E-2+T*(3.76199E-3-T*5.0689259E-5)
3725 END IF
3730 RETURN T
3735 FNEED
3740 DEF FNBeta(T)
3745 Rco=FNrho(T*.1)
3750 Row=FNrho(T-.1)
3755 Beta= 2/(Rco+Row)*(Rco-Row)/.2
3760 RETURN Beta
3765 FNEED
3770 DEF FNf(tw,tl)
3775 Tf=tw*(tw+tl)/2
3780 RETURN Tf
3785 FNEED
3790 DEF FNPsat(Tc)
3795 @ TO 80 deg F CURVE FIT OF Psat
3800 Tf=.8*Tc+.32
3805 Pa=5.945525*Tf*(.153520P2)+Tf*(1.4840763E-3+Tf*9.6150671E-6)
3810 Pp=Pa-14.7
3815 IF Pp > 0 THEN P = PPSIG, -in Hg
3820 Psat=Pp
3825 ELSE
3830 Psat=Pp+29.92-14.7
3835 END IF
3840 RETURN Psat
3845 FNEED
3850 SUB Pint
3855 COM /Cv/ A(10 10) C(10) B(4),Nop,Iprnt,Opp,Ilog
3860 INTEGER Is
3865 PRINTER IS 1
3870 BEP
3875 INPUT "LIVE DEFAULT VALUES FOR PLOT (Y,N)?",Isv
3880 BEP
3885 PRINT USING "X" "Select Option:"
3890 PRINT USING "X" "a versus delta-T"
3895 PRINT USING "X" "b versus delta-T"
3900 PRINT USING "X" "c versus a"
3905 INPUT Opp
3910 BEP
3915 INPUT "SELECT UNITS (A-S)=ENGLISH" Iun
3920 PRINTER IS 705

```

Copy available to DTIC does not permit fully legible reproduction

```

3925 IF (dy>.1) THEN
3930 BEEP
3935 INPUT "ENTER NUMBER OF CYCLES FOR X-AXIS",Cx
3940 BEEP
3945 INPUT "ENTER NUMBER OF CYCLES FOR Y-AXIS",Cy
3950 BEEP
3955 INPUT "ENTER MIN X-VALUE (MULTIPLE OF 10)",Xmin
3960 BEEP
3965 INPUT "ENTER MIN Y-VALUE (MULTIPLE OF 10)",Ymin
3970 ELSE
3975 IF Doo=0 THEN
3980 Cy=3
3985 Cx=3
3990 Xmin=.1
3995 Ymin=100
4000 END IF
4005 IF Doo=1 THEN
4010 Cy=3
4015 Cx=3
4020 Xmin=.1
4025 Ymin=100
4030 END IF
4035 IF Doo=2 THEN
4040 Cy=3
4045 Cx=2
4050 Xmin=1000
4055 Ymin=100
4060 END IF
4065 END IF
4070 BEEP
4075 PRINT "IN:SP1:IP 7300,2200,8300,5800:"
4080 PRINT "SC 0,100 0,100:TI 2,0:"
4085 SF:=100/Cx
4090 SFY:=100/Cy
4095 PRINT "PU 0,0 PD"
4100 Nn=9
4105 FOR I=1 TO Cx+1
4110 Yt=Ymin+10*(I-1)
4115 IF I=Cx+1 THEN Nn=1
4120 FOR J=1 TO Nn
4125 IF I=1 THEN PRINT "TI 2 0"
4130 IF J=2 THEN PRINT "TI 1 0"
4135 Xa=Xt+I
4140 X=LG(Xa/Ymin)*SF
4145 PRINT "PA IX," 0: XT,"
4150 NEXT J
4155 NEXT I
4160 PRINT "PA 100 0:PU:"
4165 PRINT "PU PA 0,0 PD"
4170 Nn=9
4175 FOR I=1 TO Cy+1
4180 Ya=Ymin+10*(I-1)
4185 IF I=Cy+1 THEN Nn=1
4190 FOR J=1 TO Nn
4195 IF I=1 THEN PRINT "TI 2 0"
4200 IF J=2 THEN PRINT "TI 1 0"
4205 Xa=Xt+I
4210 Y=LG(Ya/Ymin)*SFy
4215 PRINT "PA 0 TY,"YT"
4220 NEXT J
4225 NEXT I
4230 PRINT "PA 0 100 TI 0 0"
4235 Nn=9
4240 FOR I=1 TO Cx+1
4245 Yt=Ymin+10*(I-1)
4250 IF I=Cx+1 THEN Nn=1

```

Copy available to DTIC does not
 permit fully legible reproduction

```

4255 FOR J=1 TO Nn
4260 IF J=1 THEN PRINT "TL 0 2"
4265 IF J=1 THEN PRINT "TL 0 1"
4270 Xa=Xat+J
4275 X=LG(Xa/Xmin)*Sfx
4280 PRINT "PA",X,"",100," XT"
4285 NEXT J
4290 NEXT I
4295 PRINT "PA 100,100 PU PA 100,0 PD"
4300 Nn=9
4305 FOR I=1 TO Cy+1
4310 Yat=Ymin+10*(I-1)
4315 IF I=Cy+1 THEN Nn=1
4320 FOR J=1 TO Nn
4325 IF J=1 THEN PRINT "TL 0 2"
4330 IF J=1 THEN PRINT "TL 0 1"
4335 Ya=Yat+J
4340 Y=LG(Ya/Ymin)*Sfy
4345 PRINT "PD PA 100," Y,""/I"
4350 NEXT J
4355 NEXT I
4360 PRINT "PA 100,100 PU"
4365 PRINT "PA 0 -2 SR 1.5 2"
4370 I=LG(Xmin)
4375 FOR I=1 TO C+1
4380 Xa=Xmin+10*(I-1)
4385 X=LG(Xa/Xmin)*Sfx
4390 PRINT "PA",X,"",0t"
4395 IF I=0 THEN PRINT "CP -2,-2:LB10:PR -2,2:LB"i1i1""
4400 IF I=0 THEN PRINT "CP -2,-2:LB10:PR 0,2:LB"i1i1""
4405 I=I+1
4410 NEXT I
4415 PRINT "PU PA 0,0"
4420 I=LG(Ymin)
4425 YI=10
4430 FOR I=1 TO Cy+1
4435 Ya=Ymin+10*(I-1)
4440 Y=LG(Ya/Ymin)*Sfy
4445 PRINT "PA 0," Y,""
4450 PRINT "CP -4,-.25:LB10:PR -2,2:LB"i1i1""
4455 I=I+1
4460 NEXT I
4465 BEEP
4470 INPUT "WANT USE DEFALT LABELS (1-Y 0-N)?",Id1
4475 IF Id1=1 THEN
4480 BEEP
4485 INPUT "ENTER X-LABEL",Xlabels
4490 BEEP
4495 INPUT "ENTER Y-LABEL",Ylabels
4500 END IF
4505 IF Ono=2 THEN
4510 PRINT "SR 1,2:PU PA 40 -14t"
4515 PRINT "LB1:PR -1.6,3 TD PR 1,2,0 PU:PR .5,-4:LBw1:PR .5,1t"
4520 PRINT "LB-Y:PR .5,-1:LBw1:PR .5,1t"
4525 IF Iun=0 THEN
4530 PRINT "(L) (K)"
4535 ELSE
4540 PRINT "(R) (F)"
4545 END IF
4550 END IF
4555 IF Ono=2 THEN
4560 IF Iun=0 THEN
4565 PRINT "SR 1.5,2:PU PA 40 -14:LB (W)w1:PR 1,1.5:PR 0.5,1:LB2:SR 1.5,2:PR
0.5,-1:LB"
4570 ELSE
4575 PRINT "SR 1.5,2:PU PA 24 -14:LB (B)w1:PR .5,1.5:LB:PR .5,-.5t"

```

Copy available to DTIC does not permit fully legible reproduction

```

4580 PRINT "LBft:PR .5,1:SR 1,1.5:LB2:SR 1.5,2:PR .5,-1:LB1:"
4595 END IF
4590 END IF
4595 IF Opo=0 THEN
4600 IF Iun=0 THEN
4605 PRINT "SR 1.5,2:PU PA -12,40:DI 0,1:LBa (W/m:PR -1,0.5:SR 1,1.5:LB2:SR 1
.5,2:PR 1,.5:LB)"
4610 ELSE
4615 PRINT "SR 1.5,2:PU PA -12,32:DI 0,1:LBq (Btu/h:PR -1.5,.5:LB.iPR .5,.5:"
4620 PRINT "LBft:SR 1,1.5:PR -1,.5:LB2:PR 1,.5:SR 1.5,2:LB)"
4625 END IF
4630 END IF
4635 IF Opo=0 THEN
4640 IF Iun=0 THEN
4645 PRINT "SR 1.5,2:PU PA -12,38:DI 0,1:LBh (W/m:PR -1,.5:SR 1,1.5:LB2:SR 1.
5,2:PR .5,.5:"
4650 PRINT "LB.iPR .5,0:LBK)"
4655 ELSE
4660 PRINT "SR 1.5,2:PU PA -12,20:DI 0,1:LBh (Btu/h:PR -1.5,.5:LB.iPR .5,.5:"
4665 PRINT "LBft:SR 1,1.5:SR 1,1.5:LB2:SR 1.5,2:PR .5,.5:LB.iPR .5,.5:LBf)"
4670 END IF
4675 END IF
4680 IF Idl=0 THEN
4685 PRINT "SR 1.5,2:PU PA 50,-16 CP *-1:EN(X:label$)/2:*0:LB*i:label$:"
4690 PRINT "PA -14,50 CP 0,*-1:EN(Y:label$)/2*5/6:*DI 0,1:LB*i:label$:"
4695 PRINT "CP 0.0 DI"
4700 END IF
4705 Iun=0
4710 Repeat:1
4715 Yll=-1.E+6
4720 Xul=-1.E+6
4725 Icn=0
4730 BEEP
4735 INPUT "WANT TO PLOT DATA FROM A FILE (1=Y,0=N)?",Ok
4740 IF Ok=1 THEN
4745 BEEP
4750 INPUT "ENTER THE NAME OF THE DATA FILE" O_file$
4755 ASSIGN O_file TO O_file$
4760 BEEP
4765 BEEP
4770 INPUT "ENTER THE BEGINNING RUN NUMBER",Md
4775 BEEP
4780 INPUT "ENTER THE NUMBER OF X-Y PAIRS STORED",Npairs
4785 BEEP
4790 INPUT "CONNECT DATA WITH LINE (1=Y,0=N)?",Icl
4795 BEEP
4800 PRINTER IS 1
4805 PRINT USING "4X," "Select a symbol:"
4810 PRINT USING "6X," "1 Star 2 Plus sign"
4815 PRINT USING "6X," "3 Circle 4 Square"
4820 PRINT USING "6X," "5 Rhombus"
4825 PRINT USING "6X," "6 Right-side-up triangle"
4830 PRINT USING "6X," "7 Up-side-down triangle"
4835 INPUT Sym
4840 PRINTER IS 705
4845 PRINT "PU DI"
4850 IF Sym=1 THEN PRINT "SM+"
4855 IF Sym=2 THEN PRINT "SM+"
4860 IF Sym=3 THEN PRINT "SMo"
4865 IF Md=1 THEN
4870 FOR I=1 TO (Md-1)
4875 ENTER O_file:Ys,Xs
4880 NEXT I
4885 END IF
4890 FOR I=1 TO Npairs
4895 ENTER O_file:Ys,Xs

```

Copy available to DTIC does not
 permit fully legible reproduction

```

4900 IF Opo=1 THEN Ya=Ya/Xa
4905 IF Opo=2 THEN
4910 Q=Ya
4915 Ya=Ya/Xa
4920 Ka=Q
4925 END IF
4930 IF Xa<X11 THEN X11=Xa
4935 IF Xa>Xul THEN Xul=Xa
4940 IF Iun=1 THEN
4945 IF Opo<2 THEN Xa=Xa+1.8
4950 IF Opo>0 THEN Ya=Ya*.1761
4955 IF Opo=0 THEN Ya=Ya*.317
4960 IF Opo=2 THEN Xa=Xa*.317
4965 END IF
4970 X=L6T(Xa/Xmin)*Sfa
4975 Y=L6T(Ya/Ymin)*Sfy
4980 IF Sym=3 THEN PRINT "SM"
4985 IF Sym=4 THEN PRINT "SR 1.4,2.4"
4990 IF Icl=0 THEN
4995 PRINT "PA",X,Y,""
5000 ELSE
5005 PRINT "PA",X,Y,"PD"
5010 END IF
5015 IF Sym=3 THEN PRINT "SR 1.2,1.6"
5020 IF Sym=4 THEN PRINT "UC2 .4,99,0,-8,-4,0,0,8,4,01"
5025 IF Sym=5 THEN PRINT "UC3 0,99,-3,-6,-3,6,3,6,3,-61"
5030 IF Sym=6 THEN PRINT "UC0 5,3,99,3,-8,-6,0,3,01"
5035 IF Sym=7 THEN PRINT "UC0,-5,3,99,-3,8,6,0,-3,-01"
5040 NEXT I
5045 PRINT "PU"
5050 BEEP
5055 ASSIGN #File TO *
5060 X11=X11/1.2
5065 Xul=Xul*1.2
5070 GOTO 8040
5075 END IF
5080 PRINT "PU SM"
5085 BEEP
5090 INPUT "WANT TO PLOT A POLYNOMIAL (1=Y,0=N)?" ,Go_on
5095 IF Go_on=1 THEN
5100 BEEP
5105 PRINTER IS I
5110 PRINT USING "4X,""Select line type: ""
5115 PRINT USING "6X ""0 Solid line""
5120 PRINT USING "6X ""1 Dashed""
5125 PRINT USING "6X ""2...5 Longer line - dash""
5130 INPUT Ion
5135 PRINTER IS 705
5140 BEEP
5145 INPUT "SELECT (0=LIN,1=LOG(X,Y))" ,Ilog
5150 Ibrnt=1
5155 CALL Poly
5160 FOR X:=0 TO Cx STEP Cx/200
5165 Xa=Xmin+10*X-
5170 IF Xa < X11 OR Xa > Xul THEN 5300
5175 Icn=Icn+1
5180 Pu=0
5185 IF Icn=1 THEN Idf=Icn MOD 2
5190 IF Icn=2 THEN Idf=Icn MOD 4
5195 IF Icn=3 THEN Idf=Icn MOD 8
5200 IF Icn=4 THEN Idf=Icn MOD 16
5205 IF Icn=5 THEN Idf=Icn MOD 32
5210 IF Idf=1 THEN Pu=1
5215 IF Opo=0 THEN Ya=FNPoly(Xa)
5220 IF Opo=2 AND Ilog=0 THEN Ya=Xa/FNPoly(Xa)
5225 IF Opo=2 AND Ilog=1 THEN Ia=FNPoly(Xa)

```

Copy available to DTIC does not
 permit fully legible reproduction

```

5230 IF Ooo=1 THEN Ya=FNPolv(Xa)/Xa
5235 IF Ya=Ymin THEN 5300
5240 IF Iun=1 THEN
5245 IF Ooo=2 THEN Xa=Xa+.1
5250 IF Ooo>0 THEN Ya=Ya+.1761
5255 IF Ooo=0 THEN Ya=Ya+.317
5260 IF Ooo=2 THEN Xa=Xa+.317
5265 END IF
5270 Y=L6T(Ya/Ymin)*57y
5275 X=L6T(Xa/Xmin)*57x
5280 IF Y<0 THEN Y=0
5285 IF Y>100 THEN GOTO 5300
5290 IF Pu=0 THEN PRINT "FA" X,Y,"PU"
5295 IF Pu=1 THEN PRINT "PA" X,Y,"PU"
5300 NEXT Xa
5305 PRINT "PU"
5310 END IF
5315 BEEP
5320 INPUT "WANT TO QUIT (I=Y,0=N)",Iqt
5325 IF Iqt=1 THEN 5335
5330 GOTO 4715
5335 PRINT "PU PA 0.0 SP0"
5340 SUBEND
5345 DEF FNHsmooth(X,Bop,Isat)
5350 DIM A(5),B(5),C(5),D(5)
5355 DATA .20526,.25322,.319048,.55322,.79909 1.00250
5360 DATA .74515,.72992,.73197,.71225,.68472,.64197
5365 DATA .41092,.17726,.25142,.54806,.81916,1.0845
5370 DATA .71403,.72913,.77565,.696691,.665867,.61889
5375 READ A(*),B(*),C(*),D(*)
5380 IF Bop=6 THEN I=6op
5385 IF Bop=6 THEN I=4
5390 IF Bop=10 THEN I=5
5395 IF Isat=1 THEN
5400 Hs=EXP(A(I)+B(I)*LOG(X))
5405 ELSE
5410 Hs=EXP(C(I)+D(I)*LOG(X))
5415 END IF
5420 RETURN Hs
5425 FNEND
5430 DEF FNPolv(X)
5435 COM /Cply/ A(10,10),C(10),B(4),Nop,Iarnt,Ooo,Ilog
5440 X1=x
5445 Poly=0(0)
5450 FOR I=1 TO Nop
5455 IF Ilog=1 THEN X1=L06(X)
5460 Poly=Poly+B(I)*X1^I
5465 NEXT I
5470 IF Ilog=1 THEN Poly=EXP(Poly)
5475 RETURN Poly
5480 FNEND
5485 SUB Poly
5490 DIM R(10),S(10),Sy(12),Sx(12),Yx(100),Yv(100)
5495 COM /Cply/ A(10,10),C(10),B(4),N,Iarnt,Ooo,Ilog
5500 COM /X-vy/ Yv(5),Yv(5)
5505 FOR I=0 TO 4
5510 B(I)=0
5515 NEXT I
5520 BEEP
5525 INPUT "SELECT (0=FILE,1=KEYBOARD,2=PROGRAM)",Im
5530 Im=Im+1
5535 BEEP
5540 INPUT "ENTER NUMBER OF X-Y PAIRS",No
5545 IF Im=1 THEN
5550 BEEP
5555 INPUT "ENTER DATA FILE NAME",D file$

```

Copy available to DTIC does not
 permit fully legible reproduction

```

5560 BEEP
5565 INPUT "LIKE TO EXCLUDE DATA PAIRS (I=Y,0=N)?" ,Ied
5570 IF Ied=1 THEN
5575 BEEP
5580 INPUT "ENTER NUMBER OF PAIRS TO BE EXCLUDED" ,Ipe
5585 END IF
5590 ASSIGN @file TO D_file#
5595 ELSE
5600 BEEP
5605 INPUT "WANT TO CREATE A DATA FILE (I=Y,0=N)?" ,Yes
5610 IF Yes=1 THEN
5615 BEEP
5620 INPUT "GIVE A NAME FOR DATA FILE" ,D_file#
5625 CREATE @DAT D_file# S
5630 ASSIGN @file TO D_file#
5635 END IF
5640 END IF
5645 BEEP
5650 INPUT "ENTER THE ORDER OF POLYNOMIAL" ,N
5655 FOR I=0 TO N+2
5660 Sy(I)=0
5665 Sx(I)=0
5670 NEXT I
5675 IF Ied=1 AND Im=1 THEN
5680 FOR I=1 TO Ipe
5685 ENTER @file: X,Y
5690 NEXT I
5695 END IF
5700 FOR I=1 TO No
5705 IF Im=1 THEN
5710 IF Ooo=2 THEN ENTER @file: X,Y
5715 IF Ooo=2 THEN ENTER @file: Y,X
5720 IF Ilog=1 THEN
5725 X=X/Y
5730 X=LOG(X)
5735 Y=LOG(X)
5740 END IF
5745 END IF
5750 IF Im=2 THEN
5755 BEEP
5760 INPUT "ENTER NEXT X-Y PAIR" ,X,Y
5765 IF Yes=1 THEN OUTPUT @file: X,Y
5770 END IF
5775 IF Im=3 THEN
5780 X=(I)=X
5785 Y=(I)=Y
5790 ELSE
5795 X=Xo(I-1)
5800 Y=Yo(I-1)
5805 END IF
5810 R(0)=Y
5815 Sy(0)=Sy(0)+Y
5820 S(1)=X
5825 Sx(1)=Sx(1)+X
5830 FOR J=1 TO N
5835 R(J)=R(J-1)+X
5840 Sy(J)=Sy(J)+R(J)
5845 NEXT J
5850 FOR J=2 TO N+2
5855 S(J)=S(J-1)+X
5860 Sx(J)=Sx(J)+S(J)
5865 NEXT J
5870 NEXT I
5875 IF Yes=1 AND Im=2 THEN
5880 BEEP
5885 PRINT USING "12X,00,," X-Y pairs were stored in file " ,I0A" ,No,D_file#

```

Copy available to DTIC does not
 permit fully legible reproduction

```

5890 END IF
5895 Sx(0)=No
5900 FOR I=0 TO N
5905 C(I)=Sy(I)
5910 FOR J=0 TO N
5915 A(I,J)=Sx(I+J)
5920 NEXT J
5925 NEXT I
5930 FOR I=0 TO N-1
5935 CALL Divide(I)
5940 CALL Subtract(I+1)
5945 NEXT I
5950 B(N)=C(N)/A(N,N)
5955 FOR I=0 TO N-1
5960 B(N-1-I)=C(N-1-I)
5965 FOR J=0 TO I
5970 B(N-1-I)=B(N-1-I)-A(N-1-I,N-J)*B(N-J)
5975 NEXT J
5980 B(N-1-I)=B(N-1-I)/A(N-1-I,N-1-I)
5985 NEXT I
5990 'PRINTER IS 701
5995 'PRINT B(*)
6000 'PRINTER IS 705
6005 IF Iornt=0 THEN
6010 PRINT USING "12X,""EXPONENT COEFFICIENT""
6015 FOR I=0 TO N
6020 PRINT USING "15X,DD.5X,MD.7DE" I,B(I)
6025 NEXT I
6030 PRINT " "
6035 PRINT USING "12X,""DATA POINT X Y Y(CALCULATED) DISCR
EFANCY""
6040 FOR I=1 TO No
6045 Yc=B(0)
6050 FOR J=1 TO N
6055 Yc=Yc+B(J)*Xs(I)^J
6060 NEXT J
6065 D=Yy(I)-Yc
6070 PRINT USING "15X,3D.4X.4(MD.5DE,IX)" I,Xs(I),Yy(I),Yc,D
6075 NEXT I
6080 END IF
6085 ASSIGN #File TO *
6090 SUBFND
6095 SUB Divide(M)
6100 COM /Cp1v/ A(10,10),C(10),B(4),N,Iornt,0oo,1log
6105 FOR I=M TO N
6110 Ao=A(I,M)
6115 FOR J=M TO N
6120 A(I,J)=A(I,J)/Ao
6125 NEXT J
6130 C(I)=C(I)/Ao
6135 NEXT I
6140 SUBEND
6145 SUB Subtract(I)
6150 COM /Cp1v/ A(10,10),C(10),B(4),N,Iornt,0oo,1log
6155 FOR I=K TO N
6160 FOR J=K-1 TO N
6165 A(I,J)=A(K-1,J)-A(I,J)
6170 NEXT J
6175 C(I)=C(K-1)-C(I)
6180 NEXT I
6185 SUBFND
6190 SUB File
6195 COM /Cp1v/ A(10,10),C(10),B(4),N,Iornt,0oo,1log
6200 COM /Xsvv/ Xs(5),Ys(5)
6205 PRINTER IS 705
6210 BEEP

```

Copy available to DTIC does not
presume fully legible reproduction

```

6215 INPUT "SELECT (0=h/h0% same tube,1=h(HF)/h(sm)),Irt
6220 BEEP
6225 INPUT "WHICH Tset (1=6.7,0=-2.2)",Isat
6230 Xmin=0
6235 Xmax=10
6240 Xstep=2
6245 IF Irt=0 THEN
6250 Ymin=0
6255 Ymax=1.4
6260 Ystep=.2
6265 ELSE
6270 Ymin=0
6275 Ymax=15
6280 Ystep=5
6285 END IF
6290 BEEP
6295 PRINT "IN:SP:IP 2300,2200,8300,6800:"
6300 PRINT "SC 0,100,0,100:TL 2 0:"
6305 Sfx=100/(Xmax-Xmin)
6310 Sfy=100/(Ymax-Ymin)
6315 PRINT "PU 0.0 PD"
6320 FOR Xa=Xmin TO Xmax STEP Xstep
6325 X=(Xa-Xmin)*Sfx
6330 PRINT "PA"X,".0:XT:"
6335 NEXT Xa
6340 PRINT "PA 100,0:PU:"
6345 PRINT "PU PA 0.0 PD"
6350 FOR Ya=Ymin TO Ymax STEP Ystep
6355 Y=(Ya-Ymin)*Sfy
6360 PRINT "PA 0.":Y,"-YT"
6365 NEXT Ya
6370 PRINT "PA 0,100 IL 0 2"
6375 FOR Xa=Xmin TO Xmax STEP Xstep
6380 X=(Xa-Xmin)*Sfx
6385 PRINT "PA"X,".100:XT"
6390 NEXT Xa
6395 PRINT "PA 100,100 PU PA 100 0 PD"
6400 FOR Ya=Ymin TO Ymax STEP Ystep
6405 Y=(Ya-Ymin)*Sfy
6410 PRINT "PD PA 100,"Y,"YT"
6415 NEXT Ya
6420 PRINT "PA 100,100 FU"
6425 PRINT "PA 0,-2 SR 1.5,2"
6430 FOR Xa=Xmin TO Xmax STEP Xstep
6435 X=(Xa-Xmin)*Sfx
6440 PRINT "PA"X,".0:"
6445 PRINT "CP -2,-1:LB"Xa:"
6450 NEXT Xa
6455 PRINT "PU PA 0,0"
6460 FOR Ya=Ymin TO Ymax STEP Ystep
6465 IF ABS(Ya) > 1.E-5 THEN Ya=0
6470 Y=(Ya-Ymin)*Sfy
6475 PRINT "PA 0,"Y,""
6480 PRINT "CP -4,-.25:LB"Y:""
6485 NEXT Ya
6490 Xlabel$="Oil Percent"
6495 IF Irt=0 THEN
6500 Ylabel$="h/h0%"
6505 ELSE
6510 Ylabel$="h/hsmooth"
6515 END IF
6520 PRINT "SR 1.5 2:PU PA 50 -10 CP"LEN(Xlabel$)/2:"0:LB"Xlabel$:"
6525 PRINT "PA -11.50 CP 0.":LEN(Ylabel$)/2:5:6:"0:LB"Ylabel$:"
6530 PRINT "CP 0 0"
6535 Ion=0
6540 BEEP

```

Copy available to DTIC does not
 permit fully legible reproduction

```

6545 INPUT "WANT TO PLOT DATA FROM A FILE (i=y,0=N)?" ,Olo
6550 Icn=0
6555 IF Olo=1 THEN
6560 BEEP
6565 INPUT "ENTER THE NAME OF THE DATA FILE" ,D_files
6570 BEEP
6575 INPUT "SELECT (0=LINEAR, 1=LOG(X,Y))" ,Ilog
6580 ASSIGN @file TO D_files
6585 BEEP
6590 INPUT "ENTER THE BEGINNING RUN NUMBER" ,Md
6595 BEEP
6600 INPUT "ENTER THE NUMBER OF X-Y PAIRS STORED" ,Npairs
6605 BEEP
6610 INPUT "ENTER DESIRED HEAT FLUX" ,Q
6615 BEEP
6620 PRINTER IS 1
6625 PRINT USING "4X," "Select a symbol:"
6630 PRINT USING "4X," "1 Star 2 Plus sign"
6635 PRINT USING "4X," "3 Circle 4 Square"
6640 PRINT USING "4X," "5 Rombus"
6645 PRINT USING "4X," "6 Right-side-up triangle"
6650 PRINT USING "4X," "7 Up-side-down triangle"
6655 INPUT Sym
6660 PRINTER IS 705
6665 PRINT "PU 01"
6670 IF Sym=1 THEN PRINT "SM+"
6675 IF Sym=2 THEN PRINT "SM+"
6680 IF Sym=3 THEN PRINT "SMo"
6685 Nn=4
6690 IF Ilog=1 THEN Nn=1
6695 IF Md=1 THEN
6700 FOR I=1 TO (Md-1)
6705 ENTER @file,Xa,Ya
6710 NEXT I
6715 END IF
6720 Q1=Q
6725 IF Ilog=1 THEN Q=LOG(Q)
6730 FOR I=1 TO Npairs
6735 ENTER @file,Xa,B(*)
6740 Ya=B(0)
6745 FOR K=1 TO Nn
6750 Ya=Ya+B(K)*Q*K
6755 NEXT K
6760 IF Ilog=1 THEN Ya=EXP(Ya)
6765 IF Ilog=0 THEN Ya=Q1/Ya
6770 IF Int=0 THEN
6775 IF Xa=0 THEN
6780 Ya=Ya
6785 Ya=1
6790 ELSE
6795 Ya=Ya/Ya
6800 END IF
6805 ELSE
6810 Hsm=FNHsmooth(0,Xa,[sat])
6815 Ya=Ya/Hsm
6820 END IF
6825 Xc(I-1)=Xa
6830 Yc(I-1)=Ya
6835 Xc=(Xa-Xmin)+Sfx
6840 Yc=(Ya-Ymin)+Sfy
6845 IF Sym=3 THEN PRINT "SM"
6850 IF Sym=4 THEN PRINT "SR 1,4,2,4"
6855 PRINT "PA" X,Y,""
6860 IF Sym=3 THEN PRINT "SR 1,2,1,6"
6865 IF Sym=4 THEN PRINT "UC2,4,99 0,-0,-4,0,0,8,4,0,1"
6870 IF Sym=5 THEN PRINT "UC3 0,99,-3,-6,-3,6,3,-6,1"

```



```

6875 IF Sym=6 THEN PRINT "UC0,5.3,99,3,-8,-6,0,3,8r"
6880 IF Sym=7 THEN PRINT "UC0,-5.3,99,-3,8,6,0,-3,-8r"
6885 NEXT I
6890 BEEP
6895 ASSIGN @File TO *
6900 END IF
6905 PRINT "PU SM"
6910 BEEP
6915 INPUT "WANT TO PLOT A POLYNOMIAL (I=Y,0=N)?",Otp
6920 IF Otp=1 THEN
6925 BEEP
6930 INPUT "SELECT (0=LINEAR,1=LOG(X,Y))",Ilog
6935 Iornt=1
6940 CALL Poly
6945 FOR Xa=Xmin TO Xmax STEP Xstep/25
6950 Icn=Icn+1
6955 Ya=FNPoly(Xa)
6960 Y=(Ya-Ymin)*Sfy
6965 X=(Xa-Xmin)*Sfx
6970 IF Y<0 THEN Y=0
6975 IF Y 100 THEN GOTO 7025
6980 Pu=0
6985 IF Icn=1 THEN Idf=Icn MOD 2
6990 IF Icn=2 THEN Idf=Icn MOD 4
6995 IF Icn=3 THEN Idf=Icn MOD 8
7000 IF Icn=4 THEN Idf=Icn MOD 16
7005 IF Icn=5 THEN Idf=Icn MOD 32
7010 IF Idf=1 THEN Pu=1
7015 IF Pu=0 THEN PRINT "PA",X,Y,"PD"
7020 IF Pu=1 THEN PRINT "PA",X,Y,"PU"
7025 NEXT Xa
7030 PRINT "PU"
7035 Ipn=Ipn+1
7040 GOTO 6540
7045 END IF
7050 BEEP
7055 INPUT "WANT TO QUIT (I=Y,0=N)?",Iquit
7060 IF Iquit=1 THEN 7070
7065 GOTO 6540
7070 PRINT "PU SP0"
7075 SUBEND
7080 SUB Stats
7085 PRINTER IS 701
7090 J=0
7095 K=0
7100 BEEP
7105 INPUT "PLOT FILE TO ANALYZE?",File$
7110 ASSIGN @File TO File$
7115 BEEP
7120 INPUT "LAST RUN No?(0=QUIT)",Nn
7125 IF Nn=0 THEN 7305
7130 Nn=Nn-J
7135 Sv=0
7140 Sv=0
7145 Sz=0
7150 Sx=s=0
7155 Svs=0
7160 Szs=0
7165 FOR I=1 TO Nn
7170 J=J+1
7175 ENTER @File:0,T
7180 H=Q/T
7185 Sx=Sx+0
7190 Sx=Sx+Q^2
7195 Sy=Sy+T
7200 Svs=Svs+T^2

```

```

7205 Sz=Sz+H
7210 Szs=Szs+H^2
7215 NEXT I
7220 Qave=Sx/Nn
7225 Tave=Sy/Nn
7230 Have=Sz/Nn
7235 Sdevq=SQR(ABS((Nn*S_s-Sx^2)/(Nn*(Nn-1))))
7240 Sdevt=SQR(ABS((Nn*Sy-Sy^2)/(Nn*(Nn-1))))
7245 Sdevh=SQR(ABS((Nn*Szs-Sz^2)/(Nn*(Nn-1))))
7250 Sh=100*Sdevh/Have
7255 Sq=100*Sdevq/Qave
7260 St=100*Sdevt/Tave
7265 IF K=I THEN 7295
7270 PRINT
7275 PRINT USING "11X,""DATA FILE:"",I4A":File#
7280 PRINT
7285 PRINT USING "11X,""RIN Htuba SdevH Qdo SdevQ Thetab SdevT""
7290 K=I
7295 PRINT USING "11X,DD,2(2X,D.30E,1X,3D.2D),2X,DD.3D,1X,3D.2D":J,Have,Sh,Qave,
,Sq,Tave,St
7300 GOTO 7115
7305 ASSIGN @File1 TO *
7310 PRINTER IS 1
7315 SUBEND
7320 SUB Coef
7325 COM /Cply/ A(10,10),C(10),B(4),N,Iprnt,Qoo,Ilog
7330 BEEP
7335 INPUT "GIVE A NAME FOR CROSS-PLOT FILE",Cof#
7340 CREATE @DAT Cof#,2
7345 ASSIGN @File TO Cof#
7350 BEEP
7355 INPUT "SELECT (0=LINEAR,1=LOG(X,Y))",Ilog
7360 BEEP
7365 INPUT "ENTER OIL PERCENT (-)=STOP",Bop
7370 IF Bop=0 THEN 7390
7375 CALL Poly
7380 OUTPUT @File:Bop,B(*)
7385 GOTO 7360
7390 ASSIGN @File TO *
7395 SUBEND

```

Copy available to DTIC does not
 permit fully legible reproduction

APPENDIX C
COMPUTER-CONTROLLED VALVE PROGRAM

The computer-controlled valve was controlled by an Octagon Systems SYS-2A microcontroller. The SYS-2A is a complete computer system on a single card and requires only a 5 volt supply for operation. The SYS-2A has provisions for 4, 2.5 volt A/D data inputs and 8 high current digital outputs. The card was configured as shown in Table 4 below.

TABLE 4
Configuration of SYS-2A I/O Channels

Data Input Channel	Purpose
@#A10 = 8	Valve position
@#A10 = 9	Liquid R-114 Temperature
Data Output Channel	Purpose
@#A00	Shut Valve Relay (0=stop, 1=shut)
@#A01	Open Valve Relay (0=stop, 1=open)

The proportional-integral-derivative control program below was written in NSC "tiny BASIC." The SYS-2A microcontroller operator's manual includes an appendix of tiny BASIC commands. Remarks are provided below that were not in the actual program (to minimize execution time) for clarity. The program was stored in EEPROM added to the card after program debugging was complete.

```

10 Let A=15:Let B=5:Let C=10:Let F=0:Let I=0 Initialize
15 Let @#A00=0:Let @#A01=0 Stop Valve
20 Print"Set Constants(1=Y,0=N)?:Input Q
30 If (Q=0) then GOTO 60
40 Print"A,B,C,G?:Input H,J,K,L
50 Let A=H:Let B=J:Let C=K:Let G=L
60 Print"Input Desired Temp(-1=End)":Input R Enter Temp

```

```

70 Let @#A10=9:Delay 2:Let M=16*@#A11+@#A12/16 Read Channel 9
80 Let @#A10=8:Delay 2:Let P=16*@#A11+@#A12/16 Read Channel 8
90 Print"Temp=",M,"Pos=",P
100 If(R<0)then GOTO 800 Exit Program
200 Let @#A10=8:Delay 2:Let P=16*@#A11+@#A12/16 Read Channel 8
210 Let S=0 Ave 10 Readings
220 For N=1 to 10 Step 1
230 Let @#A10=9:Delay 2:Let M=16*@#A11+@#A12/16 Read Temp
240 Let E=M-R:Let S=S+E Error;average
250 Next N
260 Let E=S:Let D=S-F:Let F=E Error;Derivative
262 If(E<0)then I=I-1 Integral
264 If(E>0)then I=I+1 Integral
266 If(I<-31000)then I=-31000 Binary Limit
268 If(I>31000)then I=31000 Binary Limit
270 Print"M=",M,"E=",E,"D=",D,"I=",I
300 If(E<-1000)then GOTO 600 Control Band
310 If(E>2000)then GOTO 700 Control Band
400 Let V= (E/A) + (B*D) + (I/C) PID Value
410 Print"V=",V,"ET=",E/A,"DT=",B*D,"IT=",I/C Debug Tool
420 If(V>0)then GOTO 500 Above Desired
430 Let V=V*(-1)*G Shut Faster
440 If(V<1)then V=1 Check
450 If(V>1040)then V=0 Delay Function limited 1-1040 entry
460 If(P<150)then V=15 Slow Valve near end of travel
465 If(P<50)then V=10
470 If(P<20)then GOTO 200 End of Travel Limit
480 Let @#A00=1:Delay(V):Let @#A00=0 Shut Variable Time
490 GOTO 200
500 If(P<2500)then GOTO 200 End of Travel Limit
510 If(V<1)then V=1 Check
520 If(V>1040)then V=0 Delay Function limited 1-1040 entry
530 Let @#A01=1:Delay(V):Let @#A01=0 Open Variable Time
540 GOTO 200
600 If(P<20)then GOTO 200 End of Travel Limit

```

```
610 Print"600 Loop"           Out of Bound Warning
620 Let V=0                   Max valve shutting speed
630 If(P<250)then V=50       Slow near end of travel limit
640 If(P<150)then V=15
645 If(P<50)then V=10
650 Let @#A00=1:Delay(V):Let @#A00=0           Shut Valve Fully
660 Let @#A10=8:Delay 2:Let P=16*@#A11+@#A12/16 Read Channel 8
670 GOTO 600
700 If(P>2500)then GOTO 200 End of Travel Limit
710 Print"700 Loop"           Out of Bound Warning
720 Let @#A01=1:Delay 0:Let @#A01=1           Open Valve Fully
730 Let @#A10=8:Delay 2:Let P=16*@#A11+@#A12/16 Read Channel 8
740 GOTO 700
800 END
```

APPENDIX D

EXAMPLES OF REPRESENTATIVE DATA RUNS

The two printouts below are samples of the output of DRP2. The first printout (WH79) is for the smooth tube at high heat flux with 0 percent oil. The second printout (HF101) is for the High Flux tube under similiar conditions.

Month, date and time :03:25:10:02:18

NOTE: Program name : DRP2
Disk number = 02
Old file name: WH79
This data set taken on : 02:10:12:50:15
Tube Type: 4

Data Set Number = 1 Bulk Oil % = 0.0 02:10:13:16:18

TC No:	1	2	3	4	5	6	7	8
Temp :	16.42	14.69	14.61	15.00	14.67	14.91	16.79	14.74
Twa	Tliad	Tliad2	Tvaor	Psat	Tsumo			
15.23	-2.26	-2.20	-.63	-6.31	-17.7			
Thetab	Htube	Qdo						
16.935	5.704E+03	9.660E+04						

Data Set Number = 2 Bulk Oil % = 0.0 02:10:13:19:35

TC No:	1	2	3	4	5	6	7	8
Temp :	16.48	14.60	14.54	14.93	14.52	14.74	16.69	14.67
Twa	Tliad	Tliad2	Tvaor	Psat	Tsumo			
15.15	-2.27	-2.10	-1.44	-6.32	-17.1			
Thetab	Htube	Qdo						
16.866	5.745E+03	9.689E+04						

Data Set Number = 3 Bulk Oil % = 0.0 02:10:13:19:56

TC No:	1	2	3	4	5	6	7	8
Temp :	16.48	14.56	14.52	14.95	14.50	14.67	16.62	14.67
Twa	Tliad	Tliad2	Tvaor	Psat	Tsumo			
15.12	-2.27	-2.13	-1.51	-6.32	-17.0			
Thetab	Htube	Qdo						
16.840	5.760E+03	9.701E+04						

NOTE: 03 X-Y pairs were stored in plot data file PWH79

DATA FILE:PWH79

RUN	Htube	SdevH	Qdo	SdevQ	Thetab	SdevT
3	5.736E+03	.51	9.683E+04	.22	16.800	.29

Month, date and time :03:25:10:03:26

NOTE: Program name : DRP2
Disk number = 02
Old file name: HF101
This data set taken on : 02:16:19:06:52
Tube Type: 5

Data Set Number = 1 Bulk Oil X = 0.0 02:16:19:31:02

TC No:	1	2	3	4	5	6	7	8
Temp :	5.52	2.63	3.76	4.57	3.93	4.52	7.31	4.17
Twa	Tliqd	Tliqd2	Tvapr	Psat	Tsump			
4.55	-2.14	-1.07	.37	-6.20	-15.7			
Thetab	Htube	Qdp						
3.370	2.801E+04	9.440E+04						

Data Set Number = 2 Bulk Oil X = 0.0 02:16:19:31:16

TC No:	1	2	3	4	5	6	7	8
Temp :	5.54	2.65	3.76	4.57	3.93	4.53	7.31	4.18
Twa	Tliqd	Tliqd2	Tvapr	Psat	Tsump			
4.56	-2.14	-1.90	.32	-6.20	-15.6			
Thetab	Htube	Qdp						
3.379	2.792E+04	9.433E+04						

Data Set Number = 3 Bulk Oil X = 0.0 02:16:19:31:27

TC No:	1	2	3	4	5	6	7	8
Temp :	5.55	2.63	3.76	4.57	3.93	4.53	7.31	4.17
Twa	Tliqd	Tliqd2	Tvapr	Psat	Tsump			
4.56	-2.14	-1.91	.26	-6.20	-15.5			
Thetab	Htube	Qdp						
3.369	2.807E+04	9.456E+04						

NOTE: 03 X-Y pairs were stored in plot data file PHF101

DATA FILE:PHF101

RUN	Htube	SdevH	Qdp	SdevQ	Thetab	SdevT
3	2.800E+04	.27	9.443E+04	.12	3.373	.16

APPENDIX E
UNCERTAINTY ANALYSIS

The uncertainty of the heat-transfer coefficient at 37 kW/m² and 5 kW/m² of runs WH79 and HF101 are analyzed below. The analysis is based on the Kline-McClintock [Ref. 24] method of uncertainty analysis.

The heat-transfer coefficient is:

$$h = \frac{q_c}{\bar{T}_{wo} - T_{sat}} \quad (E.1)$$

and

$$\bar{T}_{wo} - T_{sat} = \bar{T}_{wi} - \frac{Q_c \ln(D_2/D_1)}{2 \pi k L} - T_{sat} \quad (E.2)$$

where

- h = heat-transfer coefficient
- q_c = heat flux corrected for end losses
- \bar{T}_{wo} = average outer wall temperature
- T_{sat} = saturation temperature
- \bar{T}_{wi} = average inner wall temperature
- Q_c = heat input corrected for end losses
- D₂ = outer wall diameter of tube
- D₁ = inner wall diameter of tube
- k = thermal conductivity of wall
- L = length of heated surface

let

$$F = \frac{Q_c \ln(D_2/D_1)}{2 \pi k L} \quad (E.3)$$

According to Kline and McClintock, the uncertainty in the heat-transfer coefficient is:

$$\frac{\delta h}{h} = \left[\left(\frac{\delta q_c}{q_c} \right)^2 + \left(\frac{\delta \bar{T}_{wi}}{\bar{T}_{wo} - T_{sat}} \right)^2 + \right. \quad (E.4)$$

$$\left. \left(\frac{\delta F}{\bar{T}_{wo} - T_{sat}} \right)^2 + \left(\frac{\delta T_{sat}}{\bar{T}_{wo} - T_{sat}} \right)^2 \right]^{1/2}$$

by neglecting the error from the logarithmic term, because it is small compared to the other terms, the uncertainty of the Fourier term (F) can be estimated as:

$$\delta F = F \left[\left(\frac{\delta Q_c}{Q_c} \right)^2 + \left(\frac{\delta k}{k} \right)^2 + \left(\frac{\delta L}{L} \right)^2 \right]^{1/2} \quad (E.5)$$

and

$$Q_c = q_c \pi D_2 L \quad (E.6)$$

which has an uncertainty of

$$\frac{\delta Q_c}{Q_c} = \left[\left(\frac{\delta q_c}{q_c} \right)^2 + \left(\frac{\delta D_2}{D_2} \right)^2 + \left(\frac{\delta L}{L} \right)^2 \right]^{1/2} \quad (E.7)$$

Table 5 lists the various terms of equations (E.1) through (E.7) assuming all 8 wall thermocouples are used to get the average wall temperature \bar{T}_{wi} . The data-reduction program (DRP2) used this method to calculate the heat-transfer

TABLE 5
Uncertainty Analysis Terms Using 8 Thermocouples

File Heat Flux	WH79 37 kW/m ²	WH79 5 kW/m ²	HF101 37 kW/m ²	HF101 5 kW/m ²
$\frac{\delta q_c}{q_c}$	0.007	0.009	0.006	0.007
$\frac{\delta k}{k}$	0.15	0.15	0.33	0.33
$\frac{\delta L}{L}$	0.0005	0.0005	0.0005	0.0005
F term (°C)	0.201	0.024	1.316	0.170
δF (°C)	0.030	0.004	0.434	0.056
\bar{T}_{wi} (°C)	11.46	5.63	0.79	-1.43
T_{sat} (°C)	-2.21	-2.23	-2.21	-2.18
$\frac{\delta \bar{T}_{wi}}{T_{wo} - T_{sat}}$	0.032	0.073	0.290	0.126
$\frac{\delta F}{T_{wo} - T_{sat}}$	0.002	0.0005	0.259	0.097
$\frac{\delta T_{sat}}{T_{wo} - T_{sat}}$	0.003	0.008	0.015	0.019
$\frac{\delta q_c}{q_c}$	0.003	0.007	0.008	0.003
$\frac{\delta h}{h}$	0.032	0.074	0.389	0.160
h (W/m ² K)	2660	540	22300	8400

coefficient. Table 6 lists the same terms assuming only the center 4 wall thermocouples (2, 3, 5, and 6) are used to calculate the heat-transfer coefficient. Comparing Tables 5 and 6 shows the effect of the axial and circumferential wall temperature distributions on the uncertainty of the heat-transfer coefficient.

The constraining error of the smooth tube is the uncertainty in the wall temperature. Removing the effect of the axial wall temperature distribution reduces the uncertainty by 1 percent. The large wall superheat of the smooth tube contributes to the small magnitude of the uncertainty terms. The constraining error of the High Flux tube is also the uncertainty in the wall temperature, but the uncertainty of the thermal conductivity (part of the F term) is about the same magnitude as results in the larger overall uncertainty of the High Flux data. The small wall superheats of the High Flux tube also amplify the magnitudes of uncertainty terms. Removing the effect of the axial wall temperature distribution makes the uncertainty in the thermal conductivity of the copper-nickel High Flux tube the constraining uncertainty. The axial temperature distribution is responsible for about 25 percent of the wall uncertainty term, but again the combined effect of the uncertainty of the thermal conductivity, and low wall superheats, does not make it wholly responsible for the large uncertainty of the High Flux data. More accurate data could be obtained on the High Flux surface by using a solid copper tube without a large uncertainty in the wall resistance or an axial wall temperature variation.

TABLE 6
Uncertainty Analysis Terms Using Center 4 Thermocouples

File Heat Flux	WH79 37 kW/m ²	WH79 5 kW/m ²	HF101 37 kW/m ²	HF101 5 kW/m ²
$\frac{\delta Q_c}{Q_c}$	0.007	0.009	0.006	0.007
$\frac{\delta k}{k}$	0.15	0.15	0.33	0.33
$\frac{\delta L}{L}$	0.0005	0.0005	0.0005	0.0005
F term (°C)	0.201	0.024	1.316	0.170
δF (°C)	0.030	0.004	0.434	0.056
\bar{T}_{wi} (°C)	11.34	5.80	0.44	-1.49
T_{sat} (°C)	-2.21	-2.23	-2.21	-2.18
$\frac{\delta \bar{T}_{wi}}{T_{wo} - T_{sat}}$	0.015	0.063	0.213	0.097
$\frac{\delta F}{T_{wo} - T_{sat}}$	0.002	0.0004	0.325	0.108
$\frac{\delta T_{sat}}{T_{wo} - T_{sat}}$	0.003	0.008	0.019	0.021
$\frac{\delta q_c}{q_c}$	0.003	0.007	0.008	0.003
$\frac{\delta h}{h}$	0.016	0.064	0.389	0.146
h (W/m ² K)	2690	530	27800	9280

LIST OF REFERENCES

1. Arai, N., Fukushima, T., Arai, A., Nakajima, T., Fujie, K., Nakayama, Y., "Heat Transfer Tubes Enhancing Boiling and Condensation in Heat Exchangers of a Refrigerating Machine," ASHRAE Transactions, vol. 83, part 2, 1977, pp. 58-70.
2. Yilmaz, S., and Westwater, J. W., "Effects of Commercial Enhanced Surfaces on the Boiling Heat Transfer Curve," ASME Publication, 1981, pp. 73-92.
3. Marto, P. J., and Lepere, V. J., "Pool Boiling Heat Transfer from Enhanced Surfaces to Dielectric Fluids," Journal of Heat Transfer, vol. 104, May 1982, pp. 292-299.
4. Carnavos, T. C., "An Experimental Study: Pool Boiling R-11 with Augmented Tubes," Advances in Enhanced Heat Transfer, ed. R. L. Webb et al., ASME Publications, 1981, pp. 103-108.
5. Grant, A. C., Porous Metallic Layer Formation, U.S. Patent 4064914, December 27, 1977.
6. Henrici, H. and Hesse, G., "Untersuchungen über den Wärmeübergang beim Verdampfen von R114 und R114-Ol-Gemischen an einem horizontalen Glattrohr," Kaltechnik-Klimatisierung, vol. 23, 1971, pp. 54-58.
7. Stephan, K., and Mitrovic, J., "Heat Transfer in Natural Convective Boiling of Refrigerants and Refrigerant-Oil Mixtures in Bundles of T-Shaped Finned Tubes," Advances in Enhanced Heat Transfer, ed. R. L. Webb et al., ASME Publication, 1981, pp. 131-146.
8. Karasabun, M., An Experimental Apparatus to Study Nucleate Pool Boiling of R-114 and Oil Mixtures, M.S. Thesis, Naval Postgraduate School, Monterey, California, 1984.
9. Stephan, K., "Influence of Oil on Heat Transfer of Boiling Freon 12 and Freon 22," Proceedings of the XI International Congress of Refrigeration, vol. 1, 1963, pp. 369-379.
10. Chongrungreong, S., and Sauer, H. J., Jr., "Nucleate Boiling Performance of Refrigerants and Refrigerant-Oil Mixtures," Journal of Heat Transfer, vol. 102, November 1980, pp. 701-705.

11. Jensen, M. K., and Jackman, D. L., "Prediction of Nucleate Pool Boiling Heat Transfer Coefficients of Refrigerant-Oil Mixtures," J. of Heat Transfer, vol. 106, 1984, pp. 184-190.
12. Stephan, K., and Preusser, P., "Heat Transfer in Natural Convection Boiling of Polynary Mixtures," Proceedings of the Sixth International Heat Transfer Conference, Toronto, vol. 1, 1978, pp. 187-192.
13. Stephan, K., "Heat Transfer in Boiling of Mixtures," Proceedings of the Seventh International Heat Transfer Conference, Munich, vol. 1, 1982, pp. 59-81.
14. Thome, J. R., "Boiling of Multicomponent Liquid Mixtures," Advances in Heat Transfer, vol. 16, ed. J. P. Hartnett and T. F. Irvine, Jr., Academic Press, Inc., 1984, pp. 60-153.
15. Cornwell, K., Schuller, R. B., Einarsson, J. G., "The Influence of Diameter on the Nucleate Boiling Outside Tube," Proceeding of the Seventh International Heat Transfer Conference, München, vol. 4, 1982, pp. 47-53.
16. Happel, O., "Heat Transfer during Boiling of Binary Mixtures in the Nucleate and Film Boiling Ranges," Heat Transfer in Boiling, ed. E. Hahne and U. Grigull, Hemisphere Publishing, Washington, D.C., 1977, pp. 207-216.
17. Hesse, G., "Heat Transfer in Nucleate Boiling, Maximum Heat Flux and Transition Boiling," International Journal of Heat and Mass Transfer, vol. 16, 1973, pp. 1611-1627.
18. Nishikawa, K., Fujita, Y., Ohta, H., and Hidaka, S., "Effect of the Surface Roughness on the Nucleate Boiling Heat Transfer over the wide Range of Pressure," Proceedings of the Seventh International Heat Transfer Conference, Munich, vol. 4, 1982, pp. 61-66.
19. Webb, R. L., "The Evolution of Enhanced Surface Geometries for Nucleate Boiling," Heat Transfer Engineering, vol. 2, nos. 3-4, 1981, pp. 46-69.
20. Milton, R. M., Heat Exchange System, U.S. Patent 3384154, May 21, 1968.
21. Sauer, H. J., Gibson, R. K., and Chongrungreong, S., "Influence of Oil on the Nucleate Boiling of Refrigerants," Proceedings from the Sixth International Heat Transfer Conference, Toronto, vol. 1, 1978, pp. 181-186.

22. Incropera, F. P., and DeWitt, D. P., Fundamentals of Heat Transfer, John Wiley and Sons, Inc., New York, 1981, p. 72.
23. Boyer, H. E. and Gall, T. L., ed., Metals Handbook-Desk Edition, American Society of Metals, Metals Park Ohio, 1985, pp. 7.33-7.34.
24. Kline, S. J., and McClintock, F. A., "Describing Uncertainties in Single-Sample Experiments," Mechanical Engineering, January 1953, p. 3.

INITIAL DISTRIBUTION LIST

		No.	Copies
1.	Library Code 0142 Naval Postgraduate School Monterey, California 93943		2
2.	Defense Technical Information Center Cameron Station Alexandria, Virginia 22314		2
3.	Department Chairman, Code 69 Department of Mechanical Engineering Naval Postgraduate School Monterey, California 93943		1
4.	Professor Paul J. Marto, Code 69Mx Department of Mechanical Engineering Naval Postgraduate School Monterey, California 93943		2
5.	Dr. A. S. Wanniarachchi, Code 69Wa Department of Mechanical Engineering Naval Postgraduate School Monterey, California 93943		1
6.	Dr. B. H. Hwang, Code 2722V David W. Taylor Naval Ship Research and Development Center Annapolis, MD 21402		1
7.	Mr. R. Helmick, Code 2745 David W. Taylor Naval Ship Research and Development Center Annapolis, MD 21402		1
8.	Itjg Mustafa Karasabun Merkez Mah. Nazikoglu Sok. No 3, D 6 Golcuk - KOCAELI TURKEY		1
9.	It James Reilly 1260 N. Edgemont St. La Habra, California 90631		2
10.	Mr. Fred Weyler Wieland-America Inc. 22201 Ventura Blvd. Woodland Hills, CA 91364		1
11.	Mr. Elias Ragi Union Carbide Corporation E. O. Box 44 Tonawanda, N.Y. 14151		1

END

FILMED

7-85

DTIC