

2

TECHNICAL REPORT HL-84-10

DIMENSIONS FOR SAFE AND EFFICIENT DEEP-DRAFT NAVIGATION CHANNELS

Hydraulic Model Investigation

by

Herman O. Turner, Jr.

Hydraulics Laboratory

DEPARTMENT OF THE ARMY
Waterways Experiment Station, Corps of Engineers
PO Box 631
Vicksburg, Mississippi 39180-0631



DTIC
ELECTE
MAR 25 1985

S
B

December 1984
Final Report

Approved For Public Release, Distribution Unlimited

Prepared for

DEPARTMENT OF THE ARMY
US Army Corps of Engineers
Washington, DC 20314-1000

85 03 11 084



US Army Corps
of Engineers



AD-A151 619



HYDRAULICS



LABORATORY

DTIC FILE COPY

Destroy this report when no longer needed. Do not return
it to the originator.

The findings in this report are not to be construed as an official
Department of the Army position unless so designated
by other authorized documents.

The contents of this report are not to be used for
advertising, publication, or promotional purposes.
Citation of trade names does not constitute an
official endorsement or approval of the use of
such commercial products.

Unclassified

SECURITY CLASSIFICATION OF THIS PAGE (When Data Entered)

REPORT DOCUMENTATION PAGE		READ INSTRUCTIONS BEFORE COMPLETING FORM	
1. REPORT NUMBER Technical Report HL-84-10	2. GOVT ACCESSION NO. <i>AD-A131 619</i>	REGIMENT'S CATALOG NUMBER	
4. TITLE (and Subtitle) DIMENSIONS FOR SAFE AND EFFICIENT DEEP-DRAFT NAVIGATION CHANNELS; Hydraulic Model Investigation		5. TYPE OF REPORT & PERIOD COVERED Final report	
		6. PERFORMING ORG. REPORT NUMBER	
7. AUTHOR(s) Herman O. Turner, Jr.		8. CONTRACT OR GRANT NUMBER(s)	
9. PERFORMING ORGANIZATION NAME AND ADDRESS US Army Engineer Waterways Experiment Station Hydraulics Laboratory PO Box 631, Vicksburg, Mississippi 39180-0631		10. PROGRAM ELEMENT, PROJECT, TASK AREA & WORK UNIT NUMBERS	
11. CONTROLLING OFFICE NAME AND ADDRESS DEPARTMENT OF THE ARMY US Army Corps of Engineers Washington, DC 20314-1000		12. REPORT DATE December 1984	
		13. NUMBER OF PAGES 39	
14. MONITORING AGENCY NAME & ADDRESS (if different from Controlling Office)		15. SECURITY CLASS. (of this report) Unclassified	
		15a. DECLASSIFICATION/DOWNGRADING SCHEDULE	
16. DISTRIBUTION STATEMENT (of this Report) Approved for public release; distribution unlimited.			
17. DISTRIBUTION STATEMENT (of the abstract entered in Block 20, if different from Report)			
18. SUPPLEMENTARY NOTES Available from National Technical Information Service, 5285 Port Royal Road, Springfield, Virginia 22161.			
19. KEY WORDS (Continue on reverse side if necessary and identify by block number) Channels (Hydraulic engineering)--Design and construction (LC) Hydraulic models (LC) Inland navigation (LC) Ships--Maneuverability (LC) Waterways (LC)			
20. ABSTRACT (Continue on reverse side if necessary and identify by block number) The object of this research was to determine if the existing criteria for design of deep-draft navigation channels are adequate and to refine these cri- teria if possible. This study utilized free-running, remote-controlled model ships at a scale of 1:100 in order to examine deep-draft navigation channel design methods. The tanker class of ships was used in the testing program because of the wide beam and slow response to rudder commands. The scale effects of the 1:100-scale model were overcome by adjusting the model rudder (Continued)			

DD FORM 1 JAN 73 1473

EDITION OF 1 NOV 65 IS OBSOLETE

Unclassified

SECURITY CLASSIFICATION OF THIS PAGE (When Data Entered)

Unclassified

SECURITY CLASSIFICATION OF THIS PAGE(When Data Entered)

20. ABSTRACT (Continued).

until prototype performance was obtained. Prototype test results were used to make these adjustments.

The model ships were equipped with a video camera and telemetry instrumentation. A video camera was mounted in the pilot house area and provided visual cues needed for the model pilot. In addition to the video image, ship performance data concerning rudder angle, shaft rpm, and heading were also transmitted. These data were recorded and plotted.

The straight reach tests were conducted at a depth to draft ratio of 1.2. The channel width dimension was narrowed until an unsafe condition existed. Results of the model tests for both one-way and two-way traffic indicated that the existing design criteria for design of channel dimensions for ideal conditions are conservative. However, the model indicated that only a slight reduction in channel widths (approximately 10 percent) could be made. Considering the potential damage that could result if accidents occur, especially with two-way traffic, some additional safety factors should be allowed. Because of model scale effects and inaccuracies in the facility, it does not appear prudent to revise the design criteria based on the results of this study.

Unclassified

SECURITY CLASSIFICATION OF THIS PAGE(When Data Entered)

PREFACE

The study reported herein was conducted under the sponsorship of the Office, Chief of Engineers (OCE), US Army, as Civil Works Investigation Work Unit 31072, in the Navigation Hydraulics Research Program. Technical monitors of this program during the course of the investigation and the preparation and publication of this report were Messrs. S. B. Powell and B. L. McCartney (OCE). The study was authorized in FY 75.

Tests were conducted in the Hydraulics Laboratory of the US Army Engineer Waterways Experiment Station (WES) under the general supervision of Messrs. H. B. Simmons, Chief of the Hydraulics Laboratory, and J. L. Grace, Jr., Chief of the Hydraulic Structures Division, and under the direct supervision of Mr. G. A. Pickering, Chief of the Locks and Conduits Branch. Tests were conducted by Messrs. J. E. Myrick, E. A. Graves, Jr., J. H. Riley, and H. O. Turner, Jr. This report was prepared by Mr. Turner.

Commanders and Directors of WES during the conduct of the study and the preparation and publication of this report were COL G. H. Hilt, CE, COL John L. Cannon, CE, COL Nelson P. Conover, CE, COL Tilford C. Creel, CE, and COL Robert C. Lee, CE. Technical Director was Mr. F. R. Brown.

Accession For	
NTIS	<input checked="" type="checkbox"/>
DTIC	<input type="checkbox"/>
Unannounced	<input type="checkbox"/>
J. 1000	
By	
Distribution/	
Availability Code	
Dist	Avail and/or Special
A-1	



CONTENTS

	<u>Page</u>
PREFACE	1
CONVERSION FACTORS, US CUSTOMARY TO METRIC (SI) UNITS OF MEASUREMENTS	3
PART I: INTRODUCTION	4
Background	4
Purpose for Research	5
PART II: THE MODELS	7
Description of Test Facility	7
Scale Effect Test Models	7
Scale Relations	7
PART III: TESTS AND RESULTS	13
Scale Effects Tests	13
Squat and Trim Tests	19
Channel Tests	23
PART IV: DISCUSSION	36
REFERENCES	39

CONVERSION FACTORS, US CUSTOMARY TO METRIC (SI)
UNITS OF MEASUREMENTS

US customary units of measurement used in this report can be converted to metric (SI) units as follows:

<u>Multiply</u>	<u>By</u>	<u>To Obtain</u>
feet	0.3048	metres
inches	25.4	millimetres
knots (international)	0.514444	metres per second
tons (2,000 lb, mass)	907.1847	kilograms

DIMENSIONS FOR SAFE AND EFFICIENT DEEP-DRAFT

NAVIGATION CHANNELS

Hydraulic Model Investigation

PART I: INTRODUCTION

Background

1. Present deep-draft navigation channel design criteria used in the United States were formulated in 1965 (Wicker 1965) and used the 1948 tests on the Panama Canal sea-level project (Garthune et al. 1948) as a basis. The criteria are based on providing safe margins for a typical design ship and are presented in Figure 1. The width allowance is from 2.8 to 5.0 times the design ship's beam for one-way traffic and 5.2 to 8.0 times the beam for

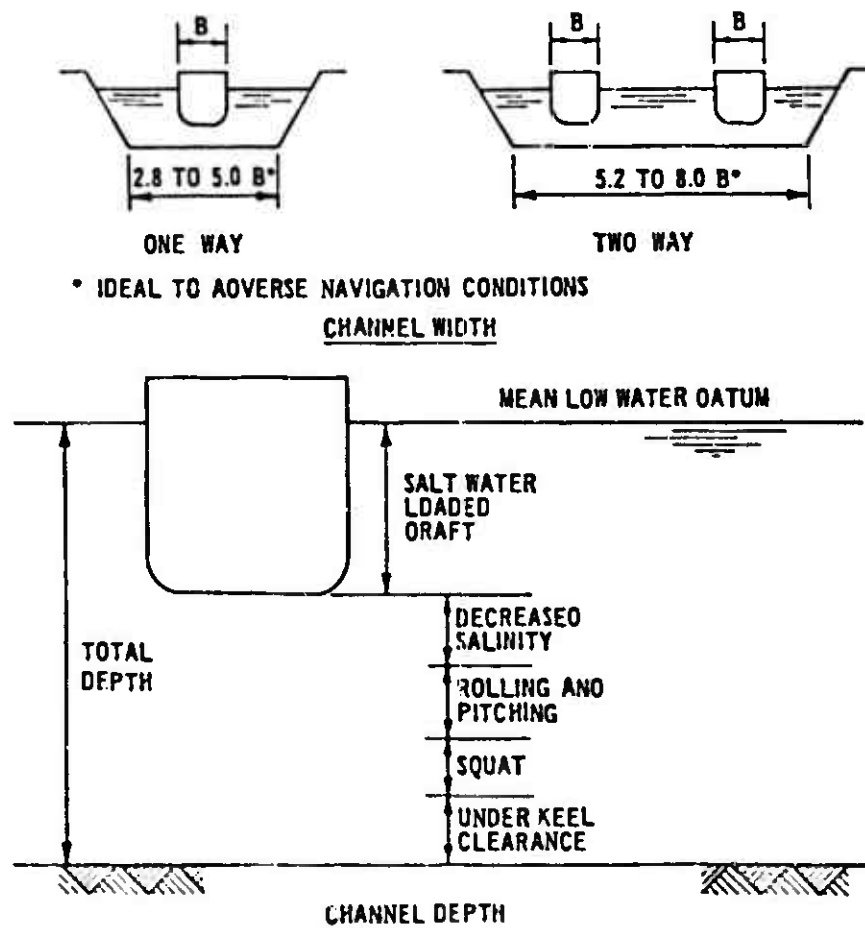

Figure 1. Present channel design criteria

two-way traffic. The width criteria depend on judgment factors relative to design ship controllability, strength of yawing forces, quality of navigation aids, type of channel, and bank orientation. The depth allowance is the sum of ship draft, salinity effects, wave action, squat, and under-keel clearance.

2. Use of the present criteria has led to a wide range in channel dimensions of existing waterways. A review of several typical navigation channels showed a wide variation of dimensions that were not attributable to vessel sizes or operating conditions. Oversized channels require excessive construction and maintenance dredging costs, while undersize channels may be unsafe for navigation or require such slow ship speeds and careful operation as to inhibit maritime commerce. Either situation is undesirable.

Purpose for Research

3. The design of navigation channels is influenced by many factors (Kray 1973). Some of the principal factors are listed in Figure 2 and

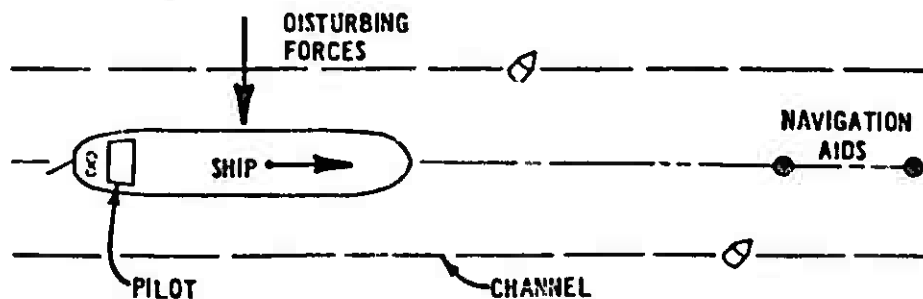

- PILOTING ASPECTS
SKILL, DILIGENCE, TRAINING, KNOWLEDGE
- NAVIGATION/INFORMATION AIDS
ACCURACY, RADAR AND DECCA, METEO/HYDRO
- ENVIRONMENTAL FACTORS
WIND, WAVE, CURRENT, VISIBILITY, TRAFFIC
- CHANNEL PROPERTIES
TYPE, LAYOUT, CRITICAL MANEUVERS
- SHIP FACTORS
TYPE, SIZE, SPEED, RUDDER

Figure 2. Factors influencing channel dimensions

include: ship dimensions, ship-power-to-weight ratio, ship rudder and propeller assemblies, type of traffic (i.e., one way, two way, overtaking), ship speed, pilot ability, and environmental conditions (i.e., wind, waves, fog).

The problem of navigation channel design is made more complex by the interaction of the many variables.

4. A physical model was considered the best method to determine the minimum dimensions of navigation channels compatible with safe and efficient navigation. The objective of the model study was focused on the improvement of navigation channel design methods and not on the study of ship maneuverability improvements. The model ships were used as a means to evaluate the channels being tested.

PART II: THE MODELS

Description of Test Facility

5. The research program was conducted primarily at an undistorted scale of 1:100 in a facility that reproduced two straight reaches of navigation channel with a typical bend in the middle and a turning basin at either end (Figure 3). The straight lengths of navigation channel were about 17,000 ft* (prototype) with a width of up to 1,500 ft. Revisions were made to the model channel width by remolding the model channel side slopes and the model depth was adjusted by varying the water level. Current velocities were simulated by circulating flow with a pumping system. A flowmeter was used to measure the amount of discharge.

6. Tests were conducted with free-running, remote-controlled model ships (Figure 4). A video camera was mounted on the model ship in the area of the pilot house (Figure 5), and the video image was projected to a remote area so that the model pilot's visual cues were similar to those of the prototype. A telemetry system on board the ship transmitted the ship's heading, rudder angle, and shaft rpm to this remote area for use by the pilot (Figure 6). This information was also recorded as a function of time for each test. Different sizes of model ships were used so that different dimensionless parameters (channel width to ship beam, channel depth to ship draft, etc.) could be easily tested without a great number of changes in the channel dimensions.

Scale Effect Test Models

7. Several tests to study scale effects of the 1:100-scale model ships were conducted with larger scale models of the same ship (1:50 scale (Figure 7) and 1:25 scale (Figure 8)). These tests were conducted in Brown's Lake (Figure 9) at the US Army Engineer Waterways Experiment Station (WES).

Scale Relations

8. The accepted equations for hydraulic similitude based on the

* A table of factors for converting US customary units of measurement to metric (SI) units is presented on page 3.

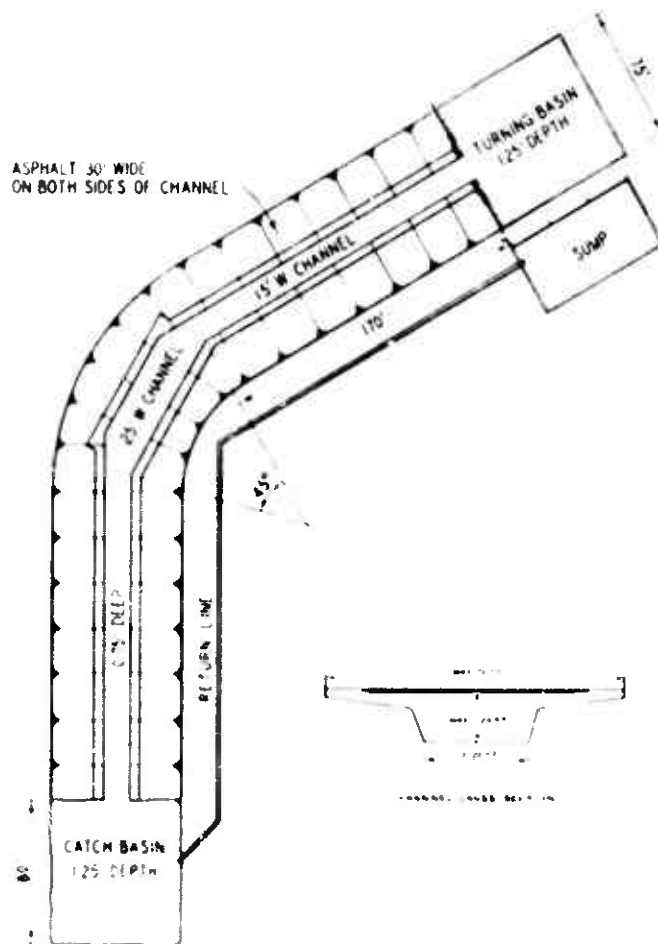

Figure 3. Deep-draft navigation channel dimensions research facility

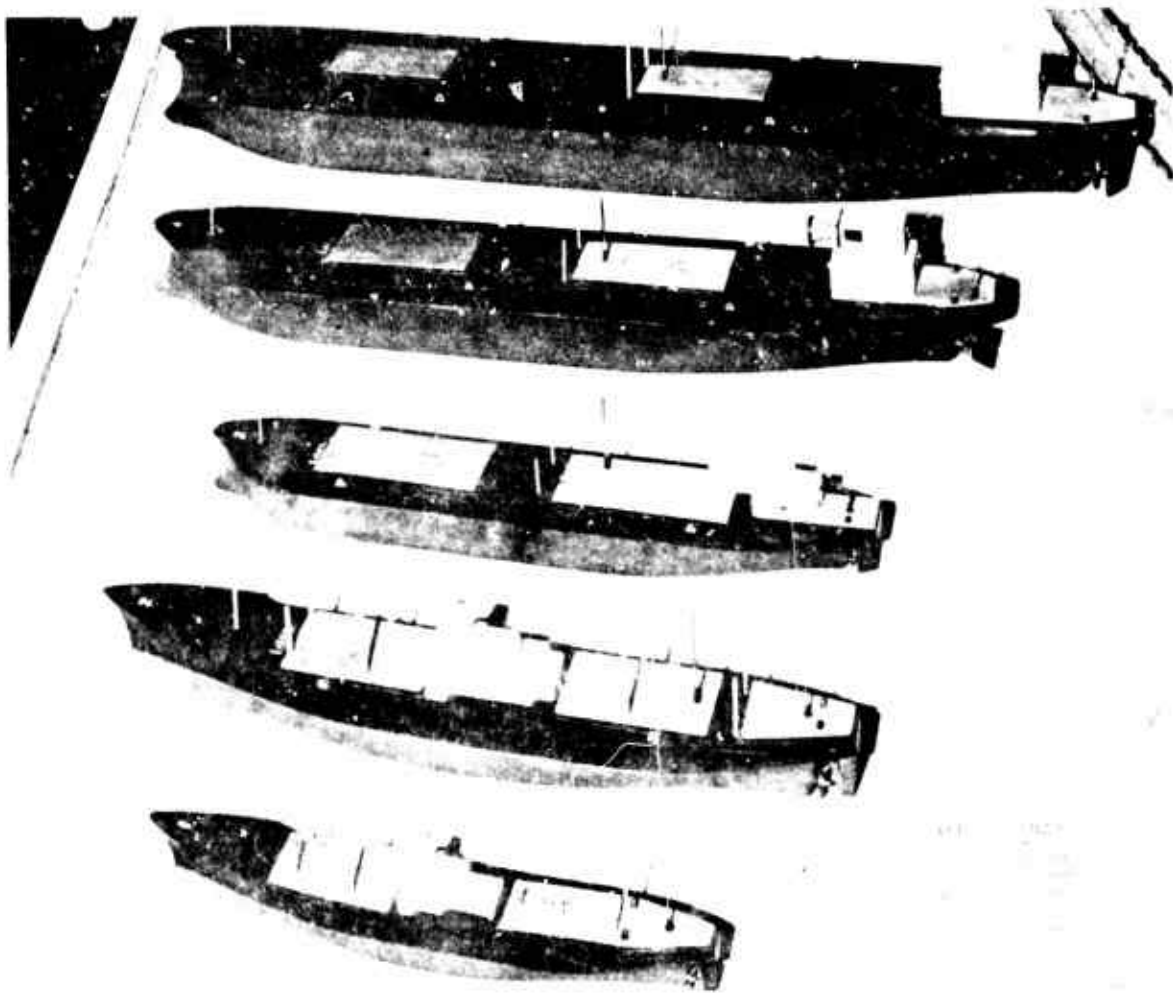

Figure 4. 1:100-scale model ships

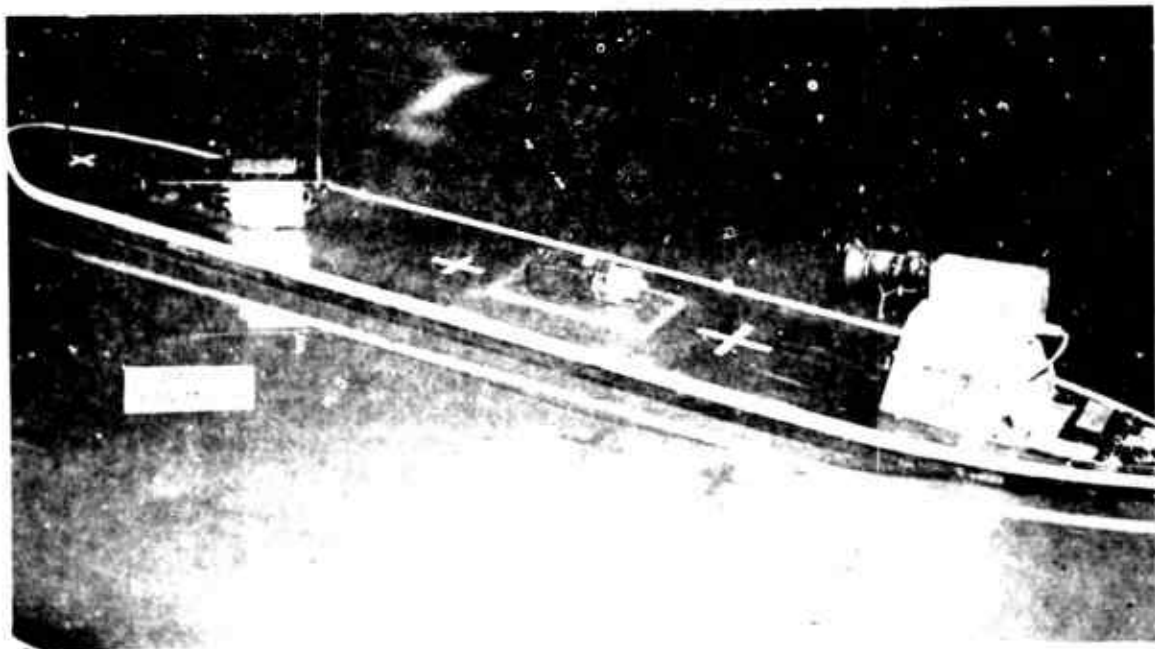

Figure 5. Model ship instrumentation

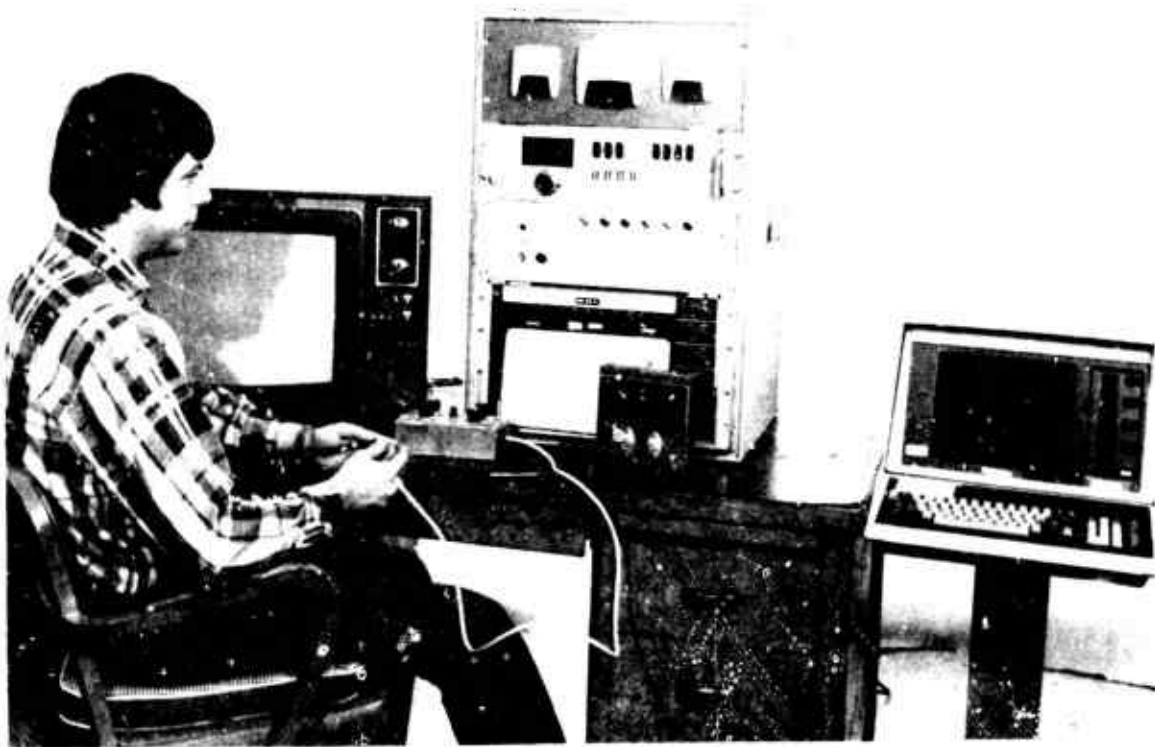

Figure 6. Model ship pilot house



Figure 7. 1:50-scale model tanker

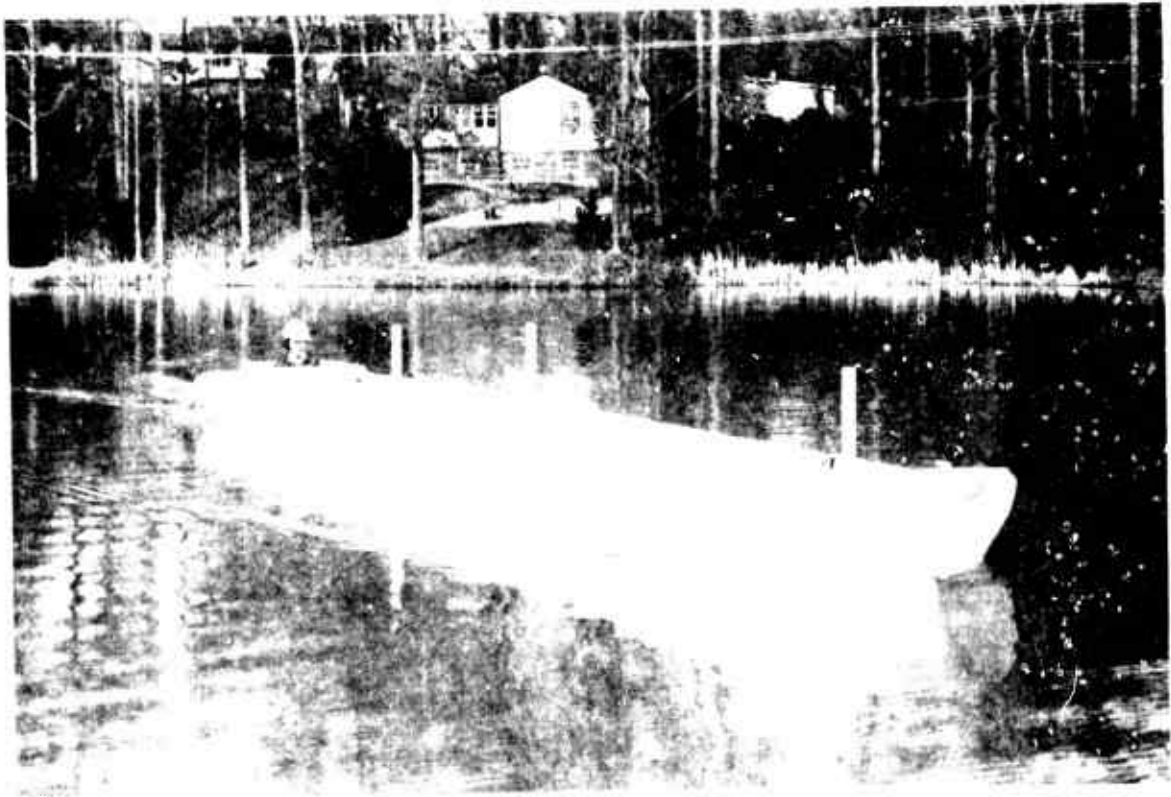

Figure 8. 1:75 scale model Tanker



Figure 9. 1:75 scale model Tanker

Froudian relations, which assume gravity to be the dominant force, were used to express mathematical relations between dimensions and hydraulic quantities of the model and the prototype. General relations for the transference of model data to prototype equivalents are as follows:

<u>Dimension</u>	<u>Ratio</u>	<u>Scale Relations</u>		
Length	L_r	1:25	1:50	1:100
Area	$A_r = L_r^2$	1:625	1:2,500	1:10,000
Weight	$W_r = L_r^3$	1:15,625	1:125,000	1:1,000,000
Velocity	$V_r = L_r^{1/2}$	1:5	1:7.7071	1:10
Time	$T_r = L_r^{1/2}$	1:5	1:7.7071	1:10

PART III: TESTS AND RESULTS

Scale Effects Tests

Model tests

9. As previously stated, the established criteria for hydraulic similitude based on Froude's law were used to express the mathematical relations between the dimensions and hydraulic quantities of the model and prototype. Results obtained from prototype and 1:100-scale model tests can differ significantly because of the different frictional form resistances of real and model ships that are partly dependent on the ship Reynolds number. Therefore some adjustment to the 1:100-scale model ships must be made to accurately reproduce prototype behavior. The relative effect of model scale on drag coefficient is shown in Figure 10. In order for these 1:100-scale model ships

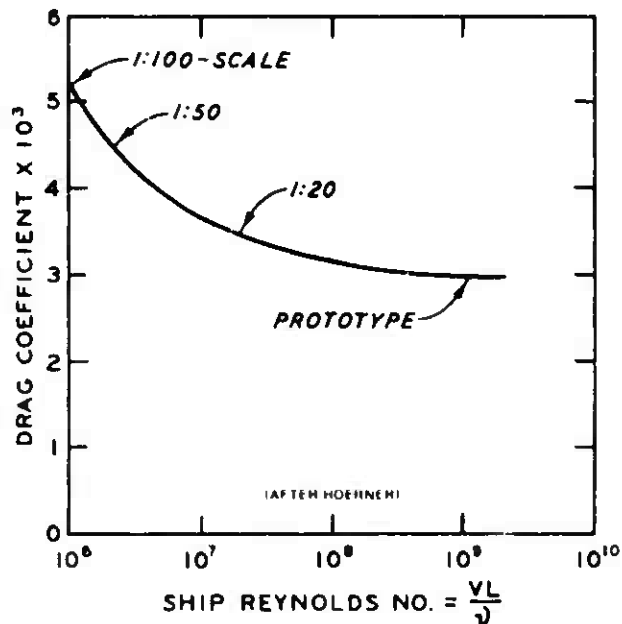

Figure 10. Effect of scale on drag

to achieve the appropriate speed, a greater propeller thrust must be applied. This additional thrust acts to increase the slipstream velocity past the rudder. Since rudder effectiveness increases with the velocity of flow past it, the model will respond quicker than the prototype. Several test techniques or adjustments can be made to the model to overcome this deficiency and are explained in the following paragraphs.

10. The surface friction of the model ship hull can be reduced by adding long-chain polymers to the water. Long-chain polymers are a class of chemical compounds that can be used to alter the viscosity of water. Although this method has been used in related studies, it was not considered reliable or practical for this study as model tests do not result in reproducible data because of chemical decomposition of the compounds with time.

11. The size of the model ship's rudder can be reduced so that the prototype response to a given rudder command is reproduced. This adjustment is satisfactory for open sea or large channel-to-ship-dimension ratios, but the interaction between the ship's rudder and channel boundaries is such that erroneous test results could be produced in confined waters.

12. Wind propellers can be installed on top of the ship to provide additional thrust to overcome the greater model drag.

13. The angle of attack of the model rudder can be adjusted to produce the desired prototype results. An example of this approach is that for a given ship speed, 10-deg rudder response in the model could be equivalent to 20-deg response in the prototype. This method was selected over the others as being more adaptable to changes in the testing program.

14. In the early planning stages of this project, a literature search showed that no prototype tests had been conducted with a ship of the size being used at channel-depth-to-ship-draft (H/T) ratios less than 1.5. In order to evaluate the scale effects and the amount of rudder adjustment needed on the 1:100-scale model, two larger scale ships (1:25 and 1:50) were constructed. A tanker ship was selected for these geosim tests because of the wide beam and the slow response to rudder commands. Previous hydraulic model studies (Figure 10) have shown that ship performance with a 1:25-scale model is within 10 percent of the prototype performance. The larger ships were constructed using the same basic hull lines as one of the 1:100-scale model ships (265,000-deadweight-ton (dwt) tanker). Dimensions of this ship are shown below along with those of the ESSO OSAKA for general comparison.

	<u>Model</u>	<u>ESSO OSAKA</u>
Length	1,085 ft	1,066.3 ft
Beam	170 ft	173.9 ft
Draft	65 ft	72.3 ft
Displacement	265,000 dwt	278,000 dwt

Tests with the 1:25- and 1:50-scale models were conducted in Brown's Lake at WES. The depth of the lake was much greater than needed and yielded a depth-to-draft ratio comparable to deepwater open-sea conditions which was not useful in studying bottom or bank effects on the test ship. A shallower testing facility was needed to obtain the necessary information. Since a shallower testing facility was not available, the 1:100-scale model was to be adjusted to reproduce the performance of the 1:25-scale model at the deep-draft condition. To accomplish this, tests were conducted with the 1:100-scale model in an existing flume so that depth-to-draft ratios similar to those obtained in the lake with the 1:25-scale ship could be obtained.

Prototype tests

15. Prototype maneuvering trials of the 278,000-dwt tanker ESSO OSAKA were made in 1977. These trials addressed the effects of water depth, ship speed, and propeller rpm on turning circles, Z-maneuvers, and accelerating turns. The depth-to-draft ratios tested were 1.2, 1.5, and 4.2 (Crane 1979).

16. The circle test and Z-maneuver results at a depth-to-draft ratio of 1.2 were used to adjust the 1:100-scale model to obtain prototype responses. The specific tests used for the scale adjustment were:

<u>Test</u>	<u>Velocity</u>	<u>H/T</u>
35-deg right circle	7.2 knots	1.2
20-deg Z-maneuver	7.3 knots	1.2
10-deg Z-maneuver	7.1 knots	1.2

A direct comparison of these specific tests was not possible due to model facility limitation. A modified testing procedure called the initial turn test was selected in order to overcome the space limitations and give a better comparison of results based on channel operating procedures which do not permit a ship to circle or zigzag (Z-maneuver) down the channel.

17. The initial turn test concentrates on the initial change of heading that occurs after the rudder command is given. These tests are compared on the length of time required for the heading change to equal the rudder angle. Figure 11 shows an example of the initial turn analysis on prototype data. The initial turn analysis can be performed on both the circle test and

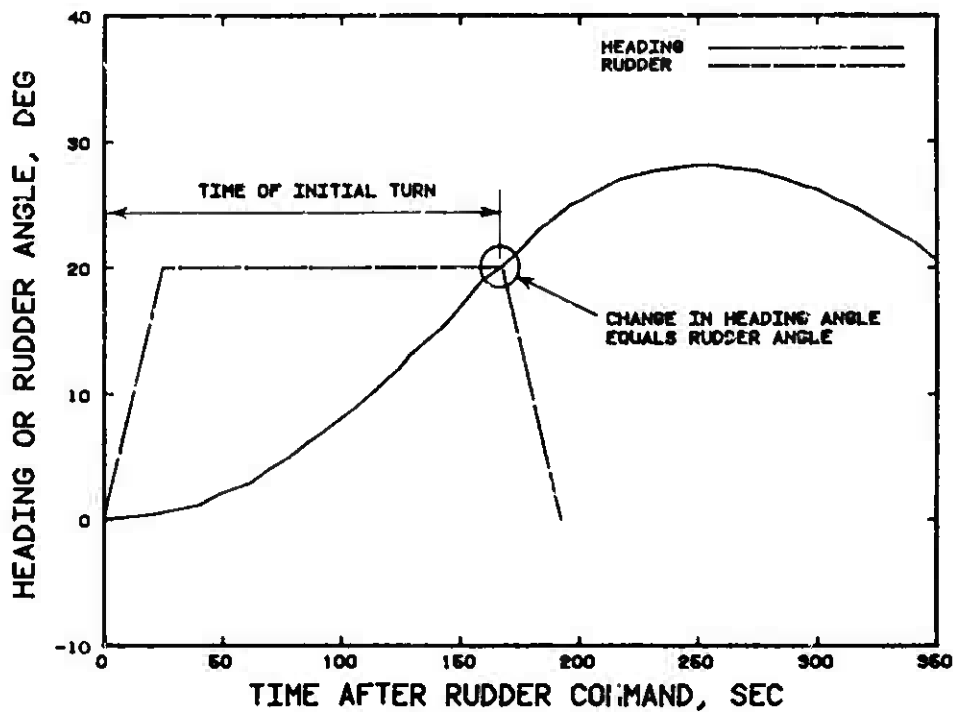
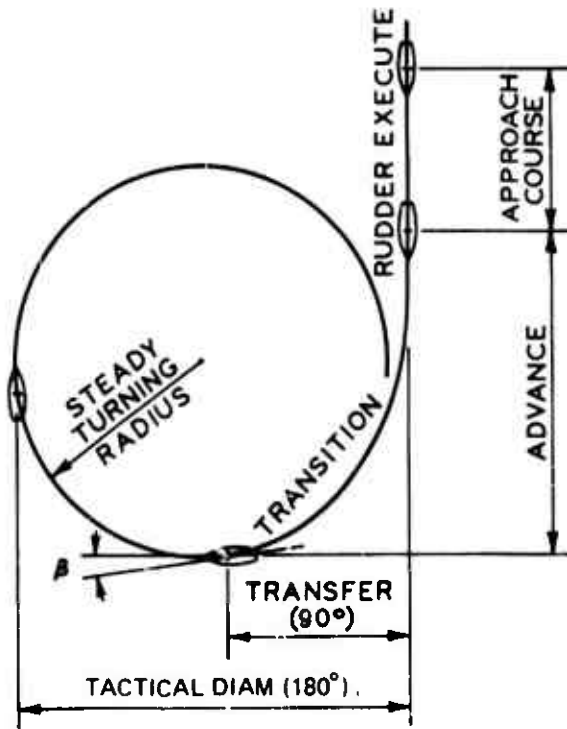

Figure 11. Initial turn analysis

Z-maneuver (Figure 12). Since the 1:100-scale model reacts faster than the prototype, the amount of rudder angle was reduced until the initial turn times were equal. Figure 13a shows how the model for a 35-deg prototype rudder angle adjustment was made. The time scale is in model units and prototype units are obtained by multiplying by a factor of 10. The model rudder angle was reduced from 35 deg in 5-deg steps until the appropriate time was reached. The model time required to achieve a 35-deg change in heading for each model rudder angle is plotted in Figure 13a. For this example, the prototype time is 209 sec (20.9-sec model). The intercept point occurs at approximately 20-deg model rudder angle. The end result of Figure 13a shows that a 20-deg model rudder angle will give the same response as a 35-deg prototype rudder angle. The same procedure was used to analyze the 20-deg (Figure 13b) and 10-deg (Figure 13c) data. The model data tests were conducted according to prototype conditions of depth, draft, and velocity. The intercept points of Figures 13a-13c were used to develop Figure 13d, which shows the scale effects according to the initial turn analysis.

18. Hydronautics Ship Model Basin (HSMB) of Laurel, Maryland, has compiled a computer model of the ESSO OSAKA based on prototype and captive model



CIRCLE TEST

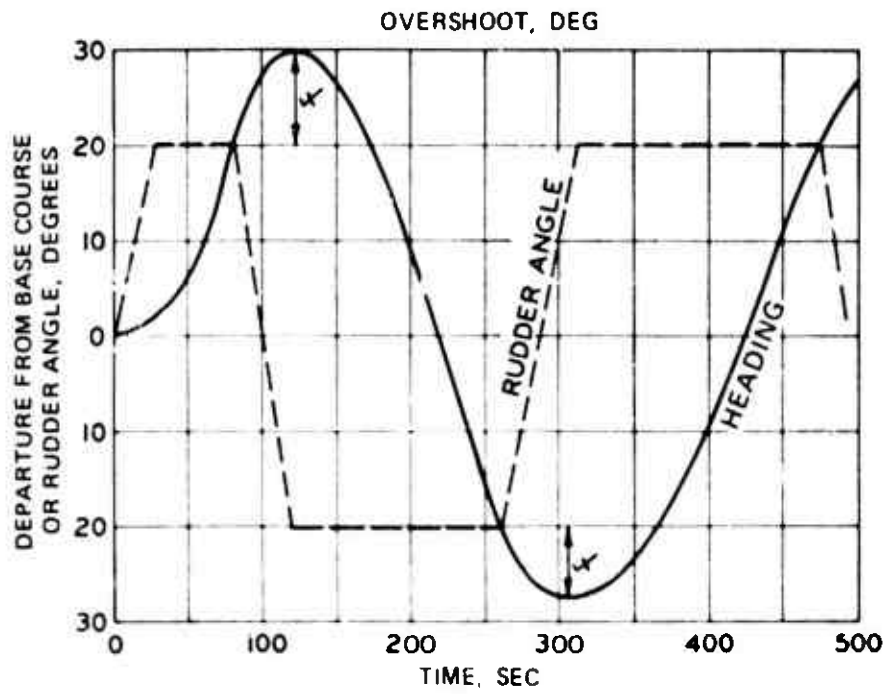

ZIGZAG TEST

Figure 12. Ship maneuverability tests

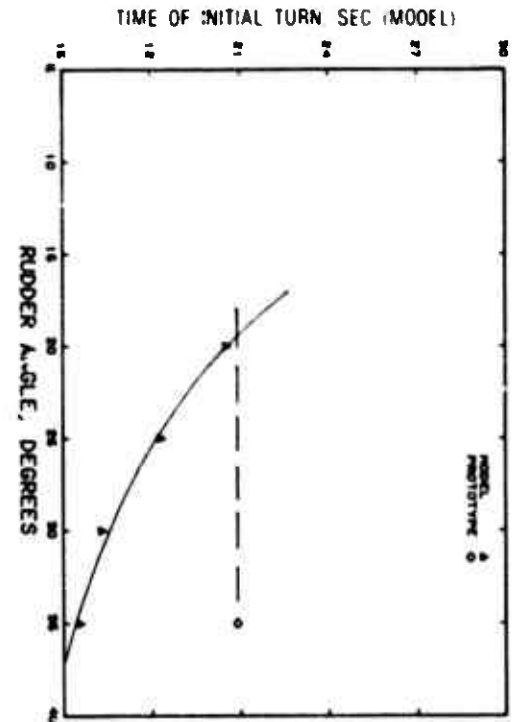

a. 35-deg rudder

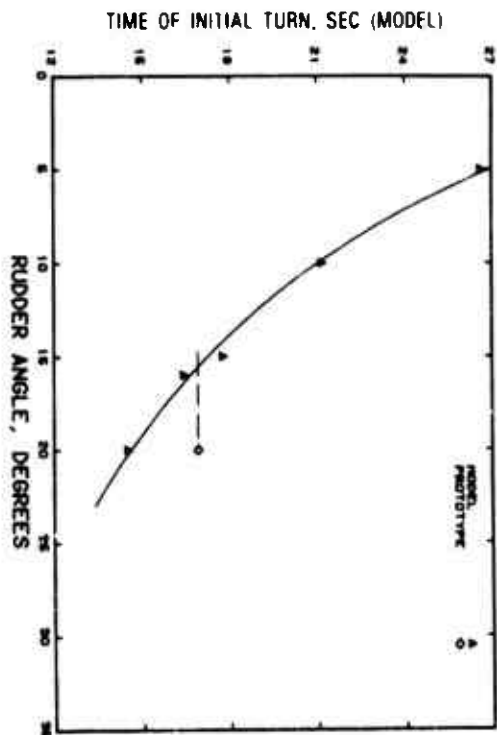

b. 20-deg rudder

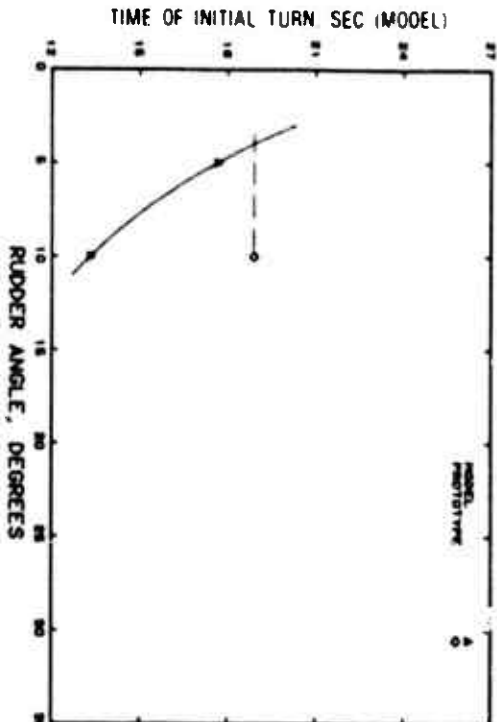

c. 10-deg rudder

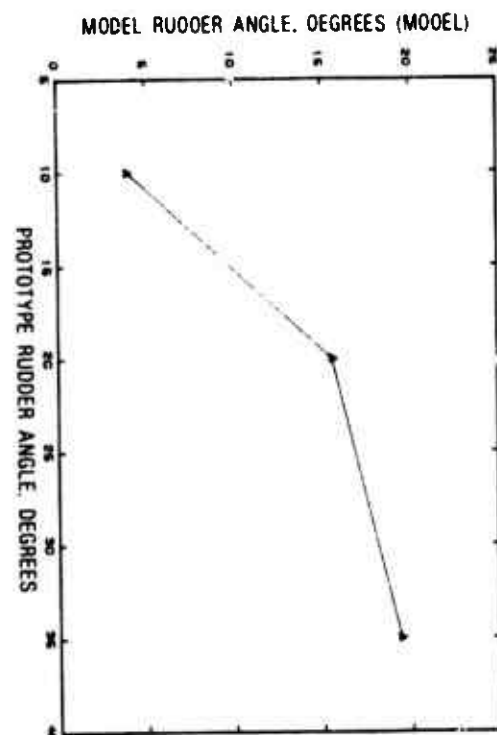

d. Scale effects

Figure 13. Initial turn adjustment, model and prototype, $H/T = 1.2$

results (Hydronautics 1979). This computer model was considered to be another source of prototype data and was used in the scale effects analysis.

19. An initial turn analysis was made on the HSMB math model using prototype conditions as input. A comparison of prototype and math model results for rudder angles of 20 deg and 10 deg is shown in Figures 14a and 14b, respectively. The 35-deg rudder angle results were identical for prototype and math model (Figure 13a). The intercept points of Figures 13a, 14a, and 14b were plotted and are presented in Figure 14c, which shows a comparison of the model scale effects according to the initial turn analysis of both prototype and math model data. The two sources of "prototype" data differ greatly at the 20-deg rudder angle and cannot be explained at this time. The 20-deg rudder angle is considered significant as ship pilots prefer not to use more than 20-deg rudder when making a channel passage.* Safety is the basic reason for limiting the rudder angle as a ship may not be able to safely recover once a high rate of turn is established in a channel environment. Based on the results shown in Figure 14c, a rudder angle of 10 deg in the model was selected as giving the same initial turn result as 20-deg rudder angle in the prototype. This adjustment is conservative when compared with the prototype result at 20-deg rudder angle. In this case, more emphasis was given to the math model results. On the other hand, the adjustments indicated by the math and physical models were almost identical for both the 10- and 35-deg rudders. The scale adjustment described above was only used for the tanker which was the primary test vehicle. The tanker was chosen as the primary test vehicle because of its slow response to rudder commands. Navigation channels designed for the slow-responding tankers would be safe for the better performing cargo and mariner ships.

Squat and Trim Tests

Testing procedure

20. Tests were conducted to determine the amount of ship squat and trim for various ship velocities with the 265,000-dwt tanker. There was no flow in the model channel. This was accomplished by placing two paper cards

* Personal conversations with Houston Ship Channel and Columbia River pilots, 1977.

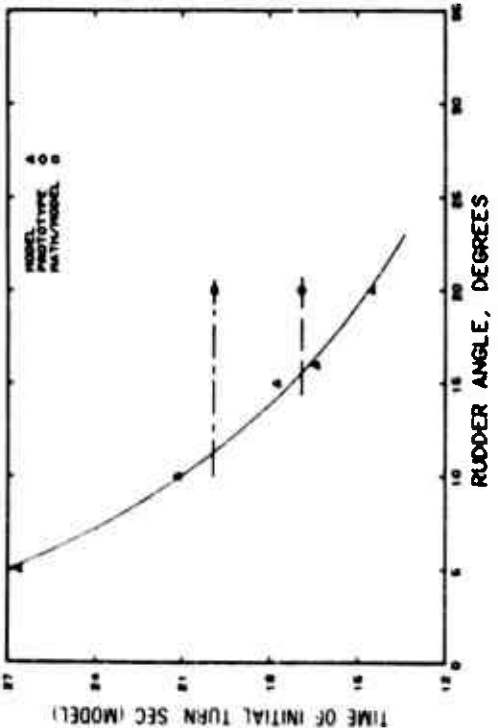

a. 20-deg rudder

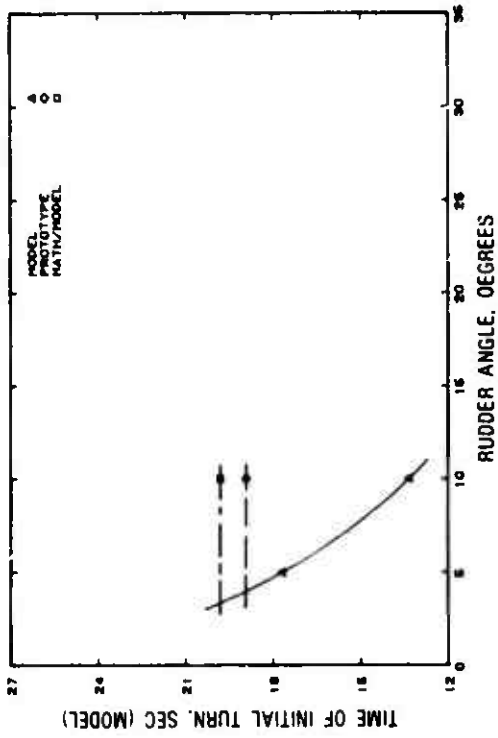

b. 10-deg rudder

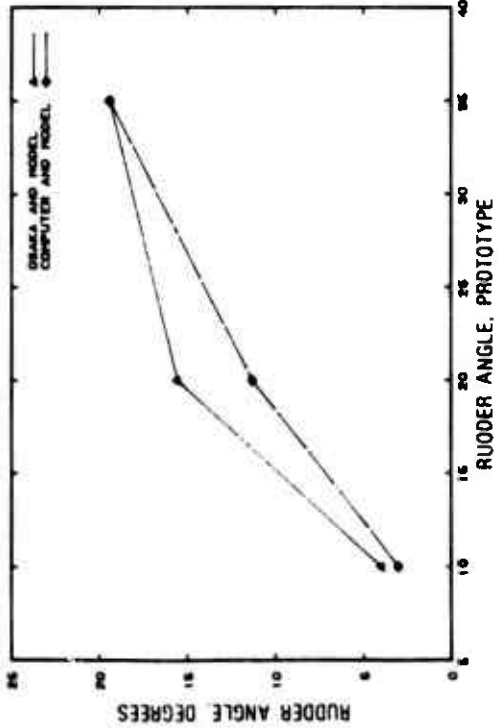

c. Scale effects

Figure 14. Initial turn comparison, model, prototype, and math model, $H/T = 1.2$

on the model ship near the stern and bow. A constant elevation bracket which contained a marker was placed at the side of the channel. A mark representing essentially the static water level on the hull was made on each paper card by running the model ship at a very slow speed (approximately 2 knots) past the constant elevation bracket. All measurements were referenced from this mark. Additional marks were then obtained with the ship traveling at various speeds. The difference in the elevation of the marks was used to compute the squat and trim. An autopilot system allowed the model ship to follow the center of the channel within 3 in. (25 ft prototype).

21. The ship model used for the squat tests was a 1:100-scale model of a 265,000-dwt tanker. The prototype dimensions of this ship are given in the tabulation on page 14. The velocity of the model was regulated by setting the shaft rpm at a desired value. For each channel condition, shaft rpm values of 600, 900, 1,200, and 1,400 were used. These rpm values propelled the model ship at equivalent prototype speeds of between 6 and 15 knots.

22. The channel-width-to-ship-beam ratio (W/B) was changed by moving sheet-metal channel boundaries to the proper location. Values of the W/B ratio tested were 5.76, 3.0, and 1.5. The sheet-metal boundaries were constructed to simulate natural channel boundaries with side slopes of 1V on 5H. These boundaries were submerged for all the tests (Figure 3b). The channel-depth-to-ship-draft ratios tested were 1.5 and 1.2. The H/T values refer to the static depth to draft condition and not a value caused by the resulting squat. Only two (initial and verification) runs were made for each test condition. H/T values of less than 1.2 could not be tested accurately because of the uneven concrete bottom in the model facility.

Effects of depth and width

23. Effects of changes in W/B and H/T were observed on the measured values of ship velocity, squat, and trim. The plotted data were compared on the basis of equal depth-to-draft ratios and data trends caused by changes in the channel-width-to-ship-beam ratio are shown.

24. Figure 15 shows the effects of changes in W/B ratios on the velocity of the ship. As shown in Figure 15a ($H/T = 1.2$), W/B ratios of 3.0 and 5.76 follow about the same curve. A W/B ratio of 1. has more confinement in the channel and follows a lower velocity curve. Figure 15b ($H/T = 1.5$) has a greater under-keel clearance and does not show the trends of Figure 15a ($H/T = 1.2$). The velocity curve values of Figure 15b ($H/T = 1.5$) are

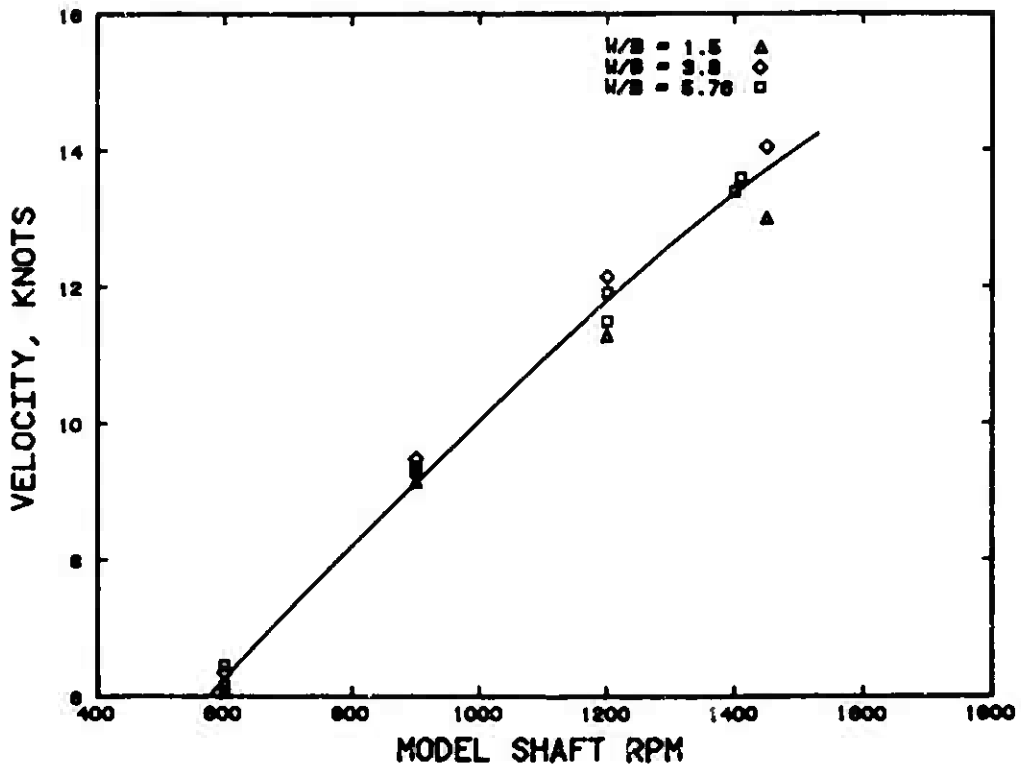

a. $H/T = 1.2$

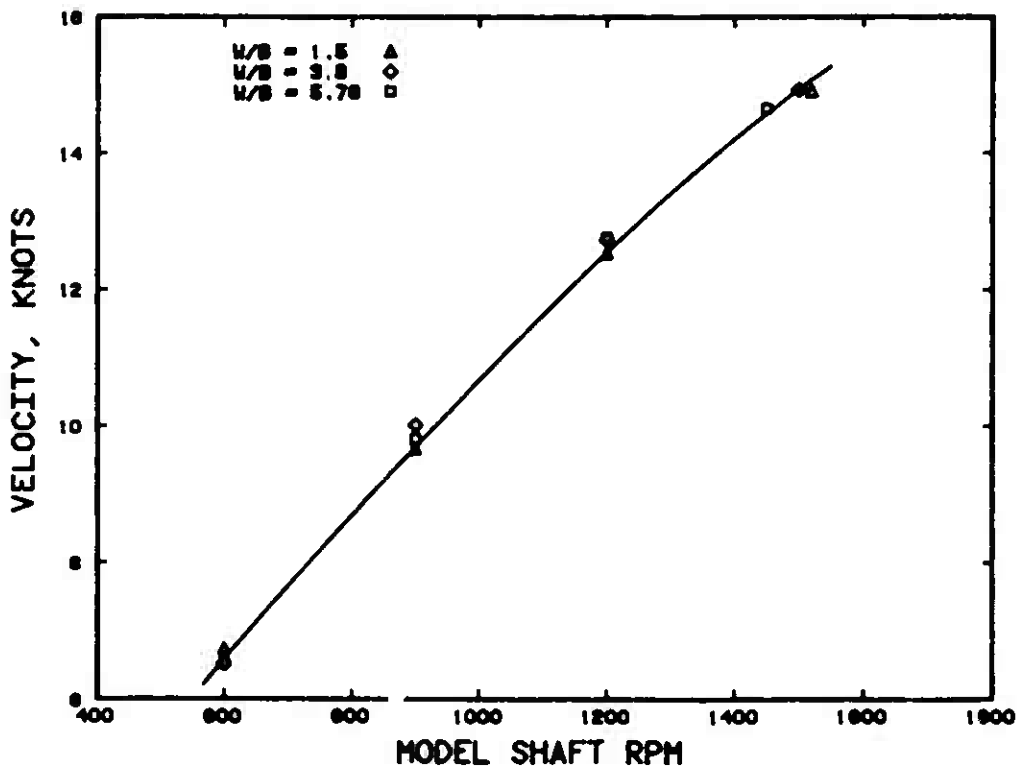

b. $H/T = 1.5$

Figure 15. Shaft rpm versus velocity

consistently higher than those in Figure 15a ($H/T = 1.2$) by about 5 to 10 percent.

25. Overall trends from Figures 15a and 15b show that higher ship velocities are obtained when the under-keel clearance is greater. Changes in the W/B ratio do not affect the velocity when the H/T ratio is 1.5. For $H/T = 1.2$, however, ship velocities increase somewhat with decreasing W/B .

Squat

26. Figures 16a ($H/T = 1.2$) and 16b ($H/T = 1.5$) show the velocity of the ship plotted against the measured midbody squat. According to the data, the W/B ratio does not have much influence on squat. Comparison of Figures 16a and 16b reveals that a greater amount of squat will be experienced at the lower depth-to-draft ratio ($H/T = 1.2$) for a given ship velocity. The data trends of Figures 16a and 16b indicate that the ship squat is a function of velocity and the H/T ratio but is not influenced much by the W/B ratio.

Trim angle

27. Figure 17 shows the trim angles calculated from the test data. The results are scattered and do not indicate a direct correlation with H/T and W/B ratios. An overall trend shows that the trim angle does increase with velocity.

Channel Tests

28. As previously stated, the object of the research was to determine the minimum channel dimensions compatible with safe and efficient navigation. To accomplish this, tests were conducted with various channel dimensions and ship sizes. The channels tested did not represent any particular prototype channel but were based on a typical dredged channel in a natural waterway (Figure 3). The side slopes of the channel were molded to 1V and 5H. The model channel represented an ideal condition. In reality, most channels will have irregularities that could cause turbulence, crosscurrents, etc.; however, it is difficult to reproduce this type of channel and still retain the general dimensionless parameter desired.

29. Channel markers were placed in the channel about 4,000 ft apart in a staggered arrangement to define the bottom width. The test facility had a water supply system that allowed tests to be conducted with currents up to about 10 knots, depending on the width of the channel. Most of the tests were

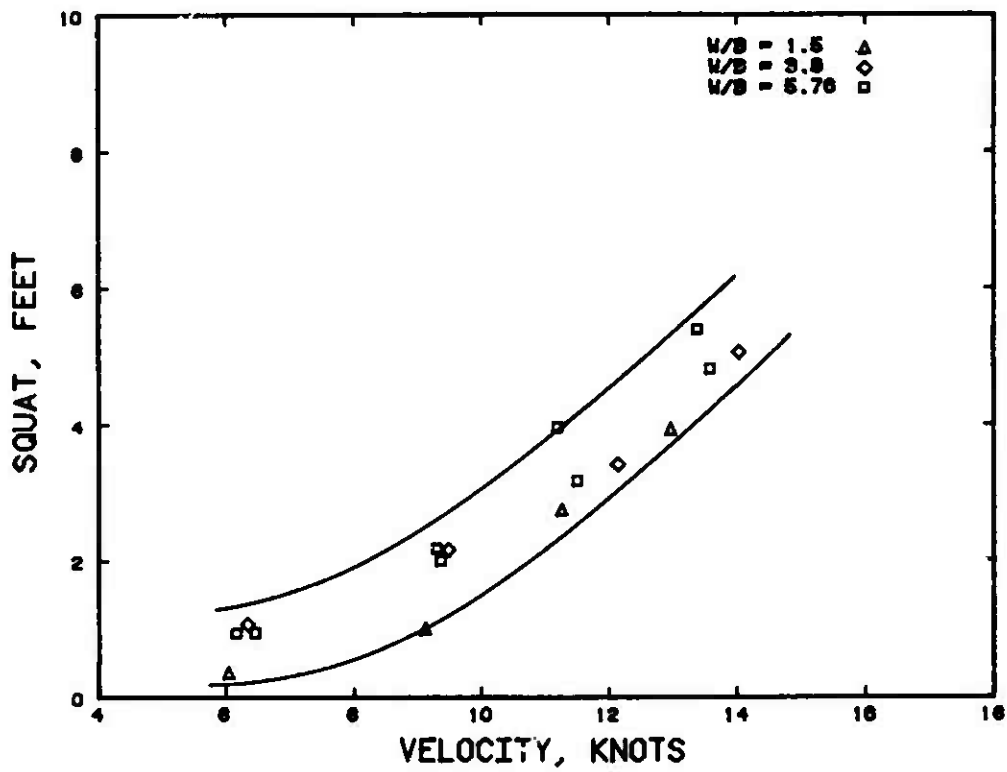

a. $H/T = 1.2$

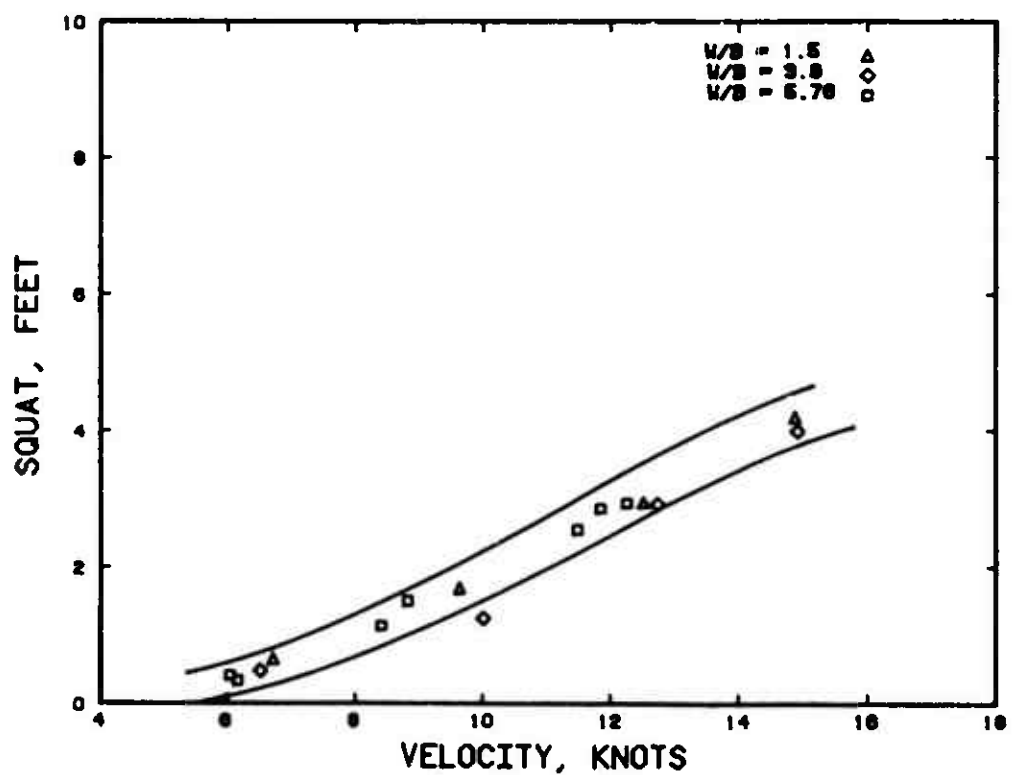

b. $H/T = 1.5$

Figure 16. Velocity versus squat

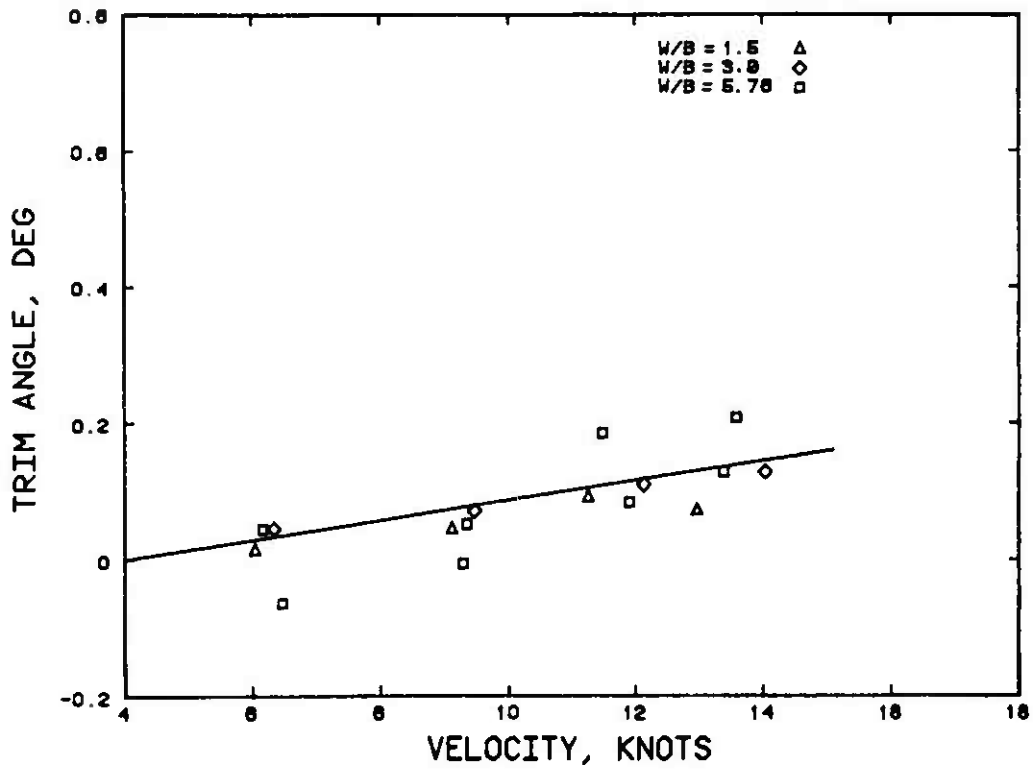

a. H/T = 1.2

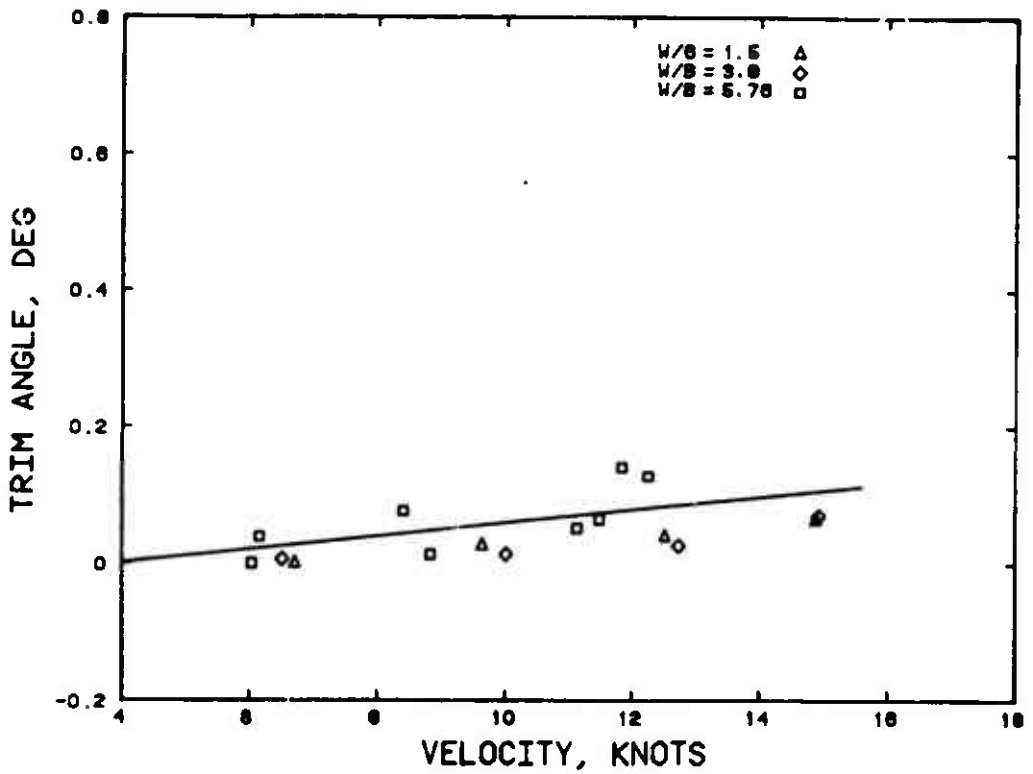

b. H/T = 1.5

Figure 17. Velocity versus trim angle

conducted with tankers because this type of ship is less maneuverable than other types of ships. For example, a channel designed for a tanker can easily be navigated with a container or mariner type ship of equal dimensions.

30. Instrumentation onboard consisted of a telemetry system, gyro-compass, and video camera. The telemetry system transmitted the ship's heading, rudder angle, shaft rpm, and video image. The video camera was mounted in the pilothouse area and was aimed over the bow of the model ship.

31. For a specific test, the W/B ratio was set by constructing the channel boundaries at the desired position and the model channel was flooded to a level that reproduced the proper H/T ratio. During a test, the model ship was operated in the same manner as a prototype ship. A helmsman controlled the rudder angle and shaft rpm by remote control. Commands were given by a pilot who observes the vessel's direction on the video monitor. Instrumentation readouts of rudder angle, shaft rpm, and heading angle allowed the pilot to monitor the ship's performance. This scenario provided the major elements of a pilot house environment. Time-based data consisting of ship speed, rudder angle, and ship heading were collected during each test.

32. Based upon the prototype and math model scale effects tests, the model ship's rudder was adjusted to give the proper prototype ship response. Since ship pilots try to limit the ship's rudder angle to 20 deg during a channel passage, as previously stated, the model ship's rudder was limited to 10 deg. Data from each test were analyzed to determine if the run was safe or unsafe for that particular testing condition. The run was considered unsafe if an excessive amount of rudder was required to successfully navigate the channel or if the model ship came too close to either the side or bottom of the channel. Approximately 40 runs were made with each test condition (each combination of H/T, W/B, and ship speed). If all of the runs were safe, the channel was considered to be safe; if any of the runs were unsafe the channel design was considered unsafe, unless the cause of the unsafe run was attributed to some uncontrollable factor such as malfunction of the model controls. This model test technique was similar to that described by Bindel (1960). Tests were conducted by experienced engineers and technicians who spent much time becoming familiar with the model ships and conducting practice runs. It is considered that their piloting skills were equivalent to those of an experienced ship's pilot.

One-way traffic

33. This phase of the testing program concentrated on one-way traffic in a straight reach. The test ship was a 1:100-scale model of a 265,000-dwt tanker described in the tabulation on page 14. Other types of ships such as cargo and mariner can safely navigate a waterway designed for tankers due to better controllability factors inherent with these types of ships.

34. The H/T ratio used in these tests was 1.2. This value was selected due to reduced controllability of the ship at this condition and variations in the model test facility flow prevented using a lower value. The variations in the slab elevation caused the H/T ratio to vary from 1.15 to 1.25. Prototype ships will operate with a H/T ratio as low as the tide permits.

35. Typical ship speeds of 3, 5, and 7 knots were used in these tests. A design ship speed of greater than 7 knots in a natural waterway was not considered practical due to increased hydrodynamic effects. These effects include squat and bank suction which influence the overall safety of the waterway. Ships traveling at these higher speeds also generate more waves which contribute to bank erosion problems.

36. Failure in these tests was a qualitative standard based upon whether or not the 1:100-scale model ship could safely travel the channel without striking the bank or without using too much rudder angle. In the straight reach, W/B ratios of 2.25 and 2.50 were tested. A high degree of failure was experienced with the W/B of 2.25 (Figure 18). The W/B ratio of 2.50 was found to be safe for ideal conditions of slack water and no wind. A cross section of this channel is shown in Figure 19. Figure 20 shows that the test ship was able to safely transmit the channel without using too much rudder angle or striking the bank. The ship speed had very little effect on maneuverability as would be expected in the ideal channel. A speed of about 3 knots was required to maintain good controllability of the ship. A minimum W/B ratio of 2.8 is recommended in the present design criteria (Figure 21). These design criteria assume that the design vessel has very good controllability and there are no crosscurrents, crosswinds, or waves. Thus the W/B ratio of 2.5 is slightly less than the design criteria presently being used for ideal navigation conditions. Considering the scale effects on bank suction, the accuracy of the scale model tests, and the controlled environmental factors in the model, the values are considered very close and no changes in the present criteria are recommended.

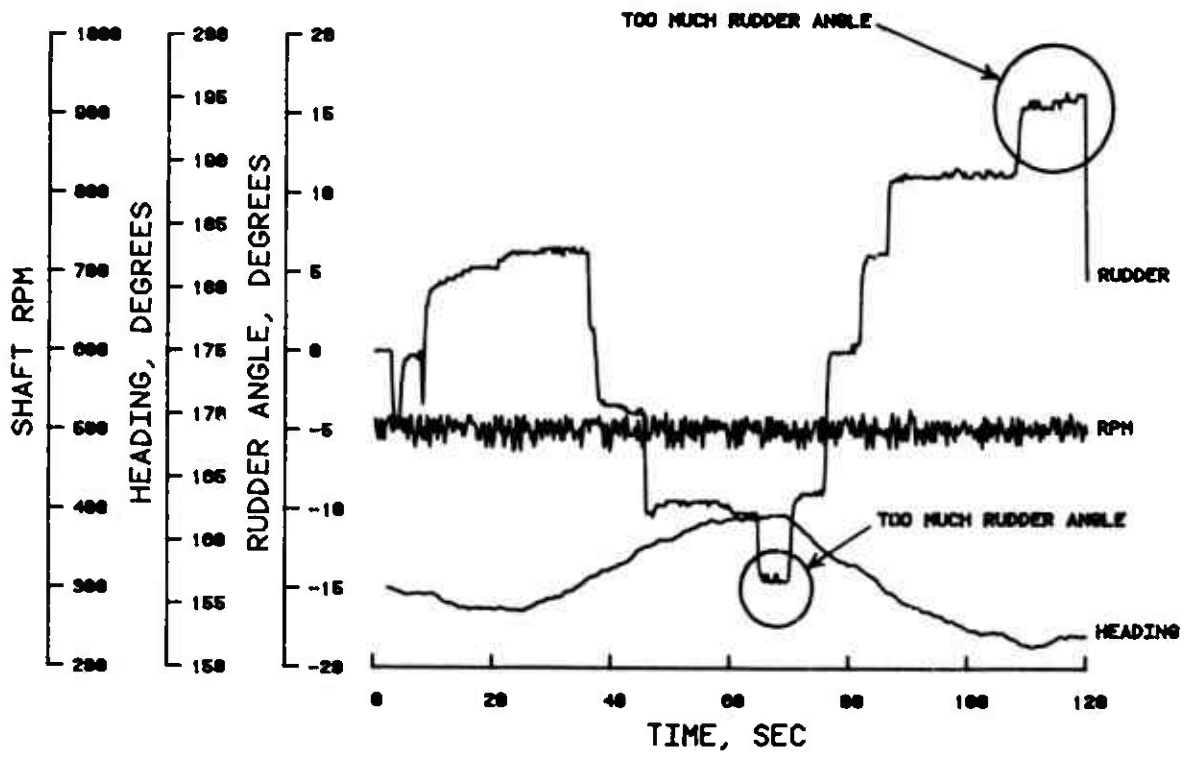

Figure 18. Model ship data--failure; $W/B = 2.25$, $H/T = 1.2$

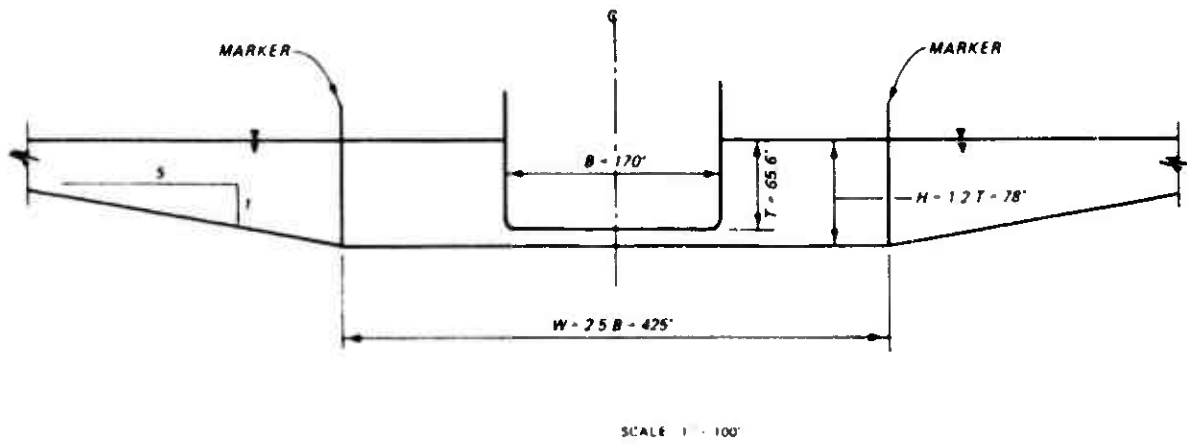

Figure 19. Channel cross section tested for one-way traffic

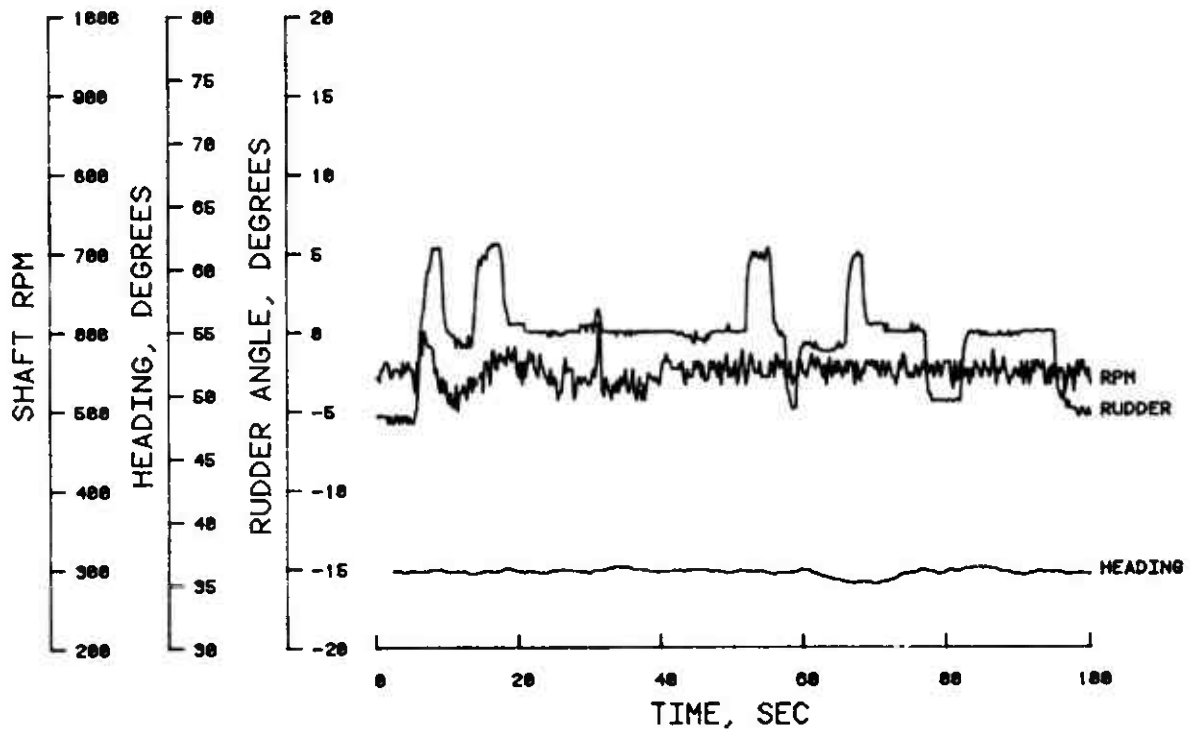

Figure 20. Model ship data--safe transit; $W/B = 2.50$, $H/T = 1.2$

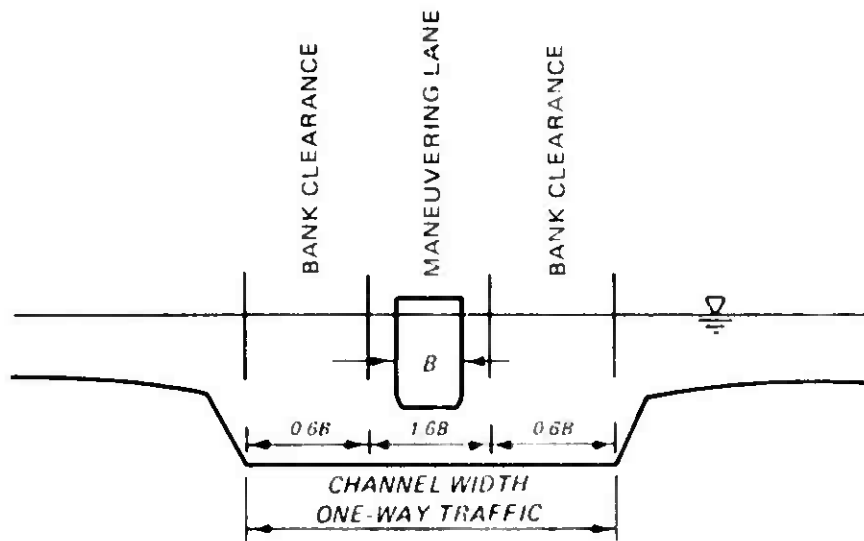

Figure 21. Existing design criteria for channel width with one-way traffic, very good vessel controllability, no cross-currents, no crosswinds, and no waves (EM 1110-2-1613, Figure 7-1)

37. Tests were conducted with currents up to about 4 knots in the channel. Since the channel cross section was uniform throughout the entire length of the channel, the only effect of the current was to change the shaft rpm required to maintain a constant speed. Inconsistencies in the channel cross section could, and probably will, exist in prototype channels. This will cause current velocities to vary in the channel, resulting in more adverse navigation conditions and thus requiring wider channels. Since each prototype channel is unique, good engineering judgment or site-specific model studies will be required to determine the amount of additional width required for these currents.

Bendway tests

38. Failure in these tests was also a qualitative standard based upon whether or not the 1:100-scale model ship could safely approach the bend, maneuver the bend, and recover to exit without striking the bank or without using too much rudder angle. The bendway tests involved a typical 30-deg cut-off bend. The testing conditions were $H/T = 1.2$, no current, and little or no wind. The width of the bend (W_b) was varied to allow for more area in the turn (Figure 22).

39. An initial width-of-bend-to-ship-beam (W_b/B) ratio of 3.5 and W/B of 2.50 quickly proved to be unsafe (Figure 23). This unsafe condition was based upon the qualitative criteria established in the model scale adjustments procedure. The main area of difficulty under these conditions was experienced in recovering from the turning effects of the ship in order to safely navigate the exit channel.

40. The W_b/B ratio was increased to 4.5. Under these conditions ($W/B = 2.5$, $W_b/B = 4.5$), the model ship was able to enter the bend, make the turn, and safely recover (Figure 24). These dimensions allowed the model ship operator more area in which to make rudder and course corrections during the turn. Translating the W_b/B ratio to a function of channel width (W) reveals that the width of the channel bend should be 180 percent of the channel width. As with the straight reach tests, the bendway tests were conducted under ideal conditions (no currents or wind). A more comprehensive study of bends will be conducted at a later date.

Two-way traffic

41. In this series of tests, two radio-controlled free-running model tankers were used. The 1:100-scale 265,000-dwt tanker was used in the same

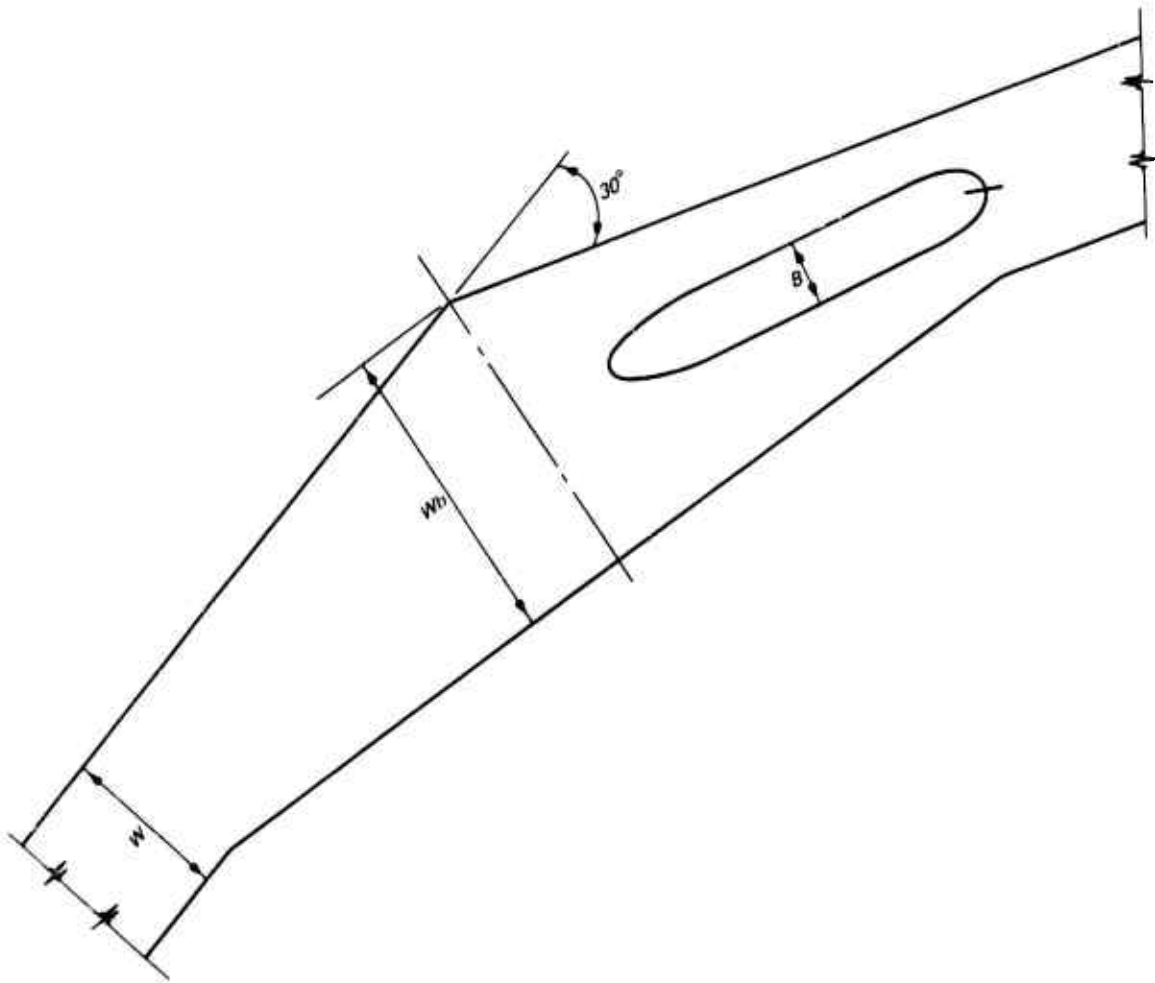

Figure 22. Channel bendway drawing

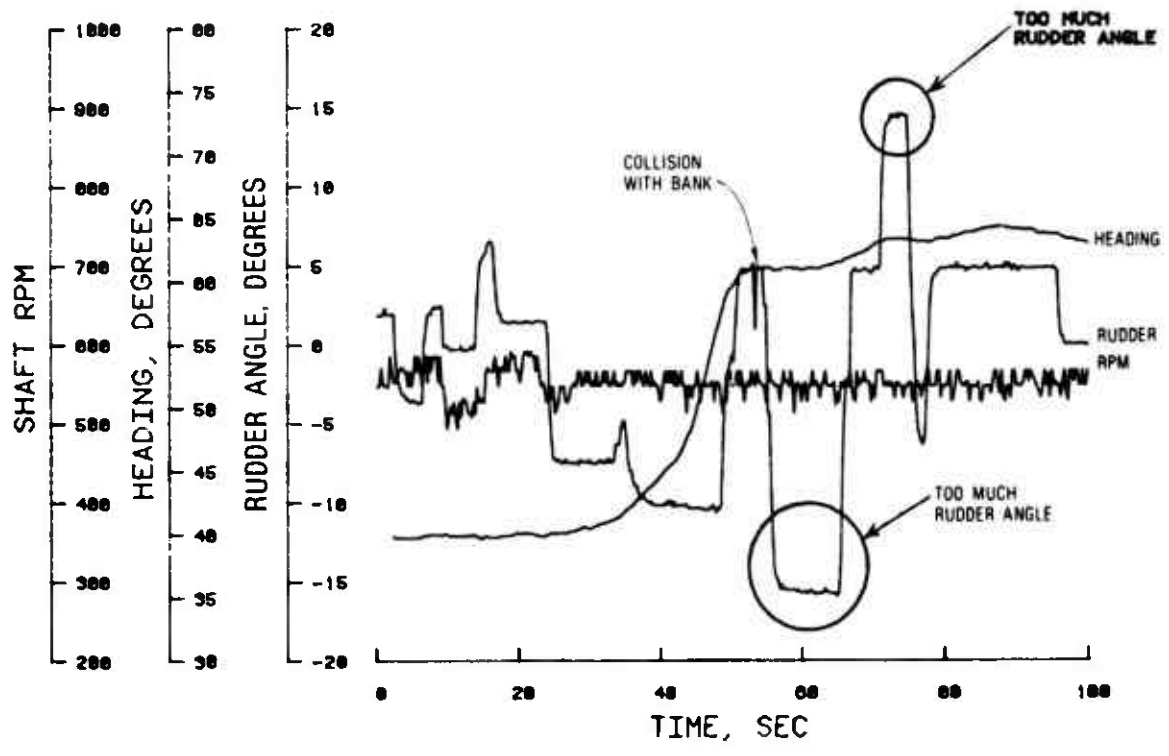

Figure 23. 30-deg bendway data; $W_b/B = 3.5$,
 $W/B = 2.5$, $H/T = 1.2$

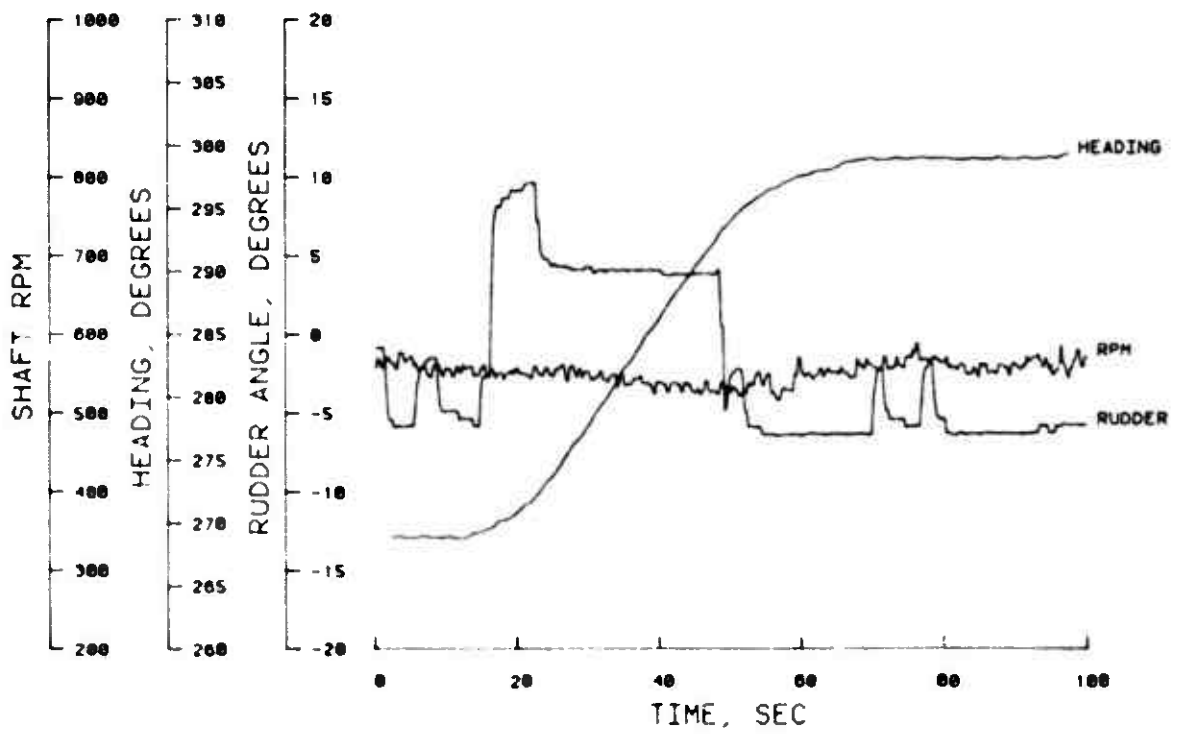
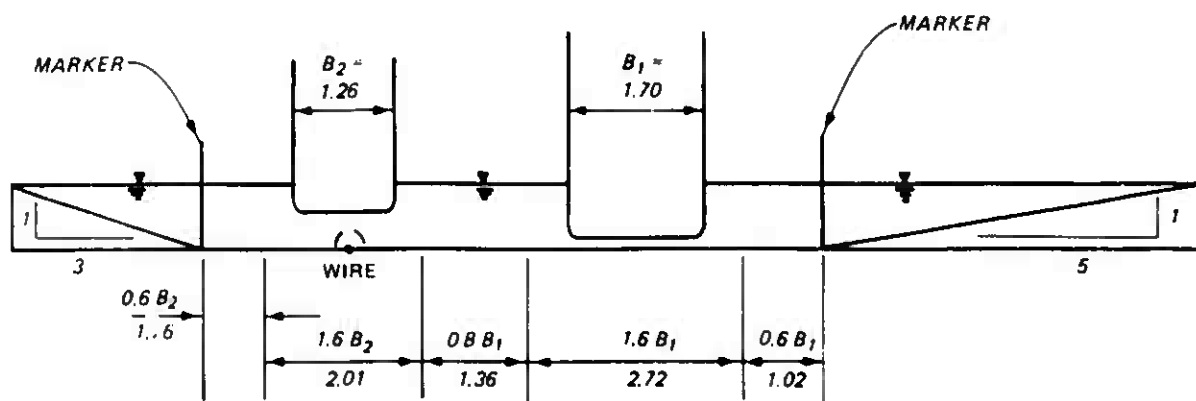

Figure 24. 30-deg bendway data; $W_b/B = 4.5$,
 $W/B = 2.5$, $H/T = 1.2$

manner as the one-way traffic tests. The 1:100-scale 108,000-dwt tanker was equipped with an autopilot system which allowed it to follow a straight line course.

42. The autopilot system used in this study was a wire guided system. A wire was placed on the bottom of the channel in the desired path of ship travel (Figure 25). The system was capable of maneuvering a model ship within



SCALE: 1" = 200'

Figure 25. Channel cross section tested for two-way traffic

the capabilities of the ship. A small amount of alternating electrical current was passed through the wire which established a magnetic field. Three sensing coils on the ship, two detector and one reference, detected the magnetic field. When the ship was too far off course, the detector coil at the greater angle with the wire broke more lines of flux and yielded the greater voltage. The associated electronics adjusted the ship's rudder so that the output voltages of the coils were balanced. This system allowed the ship to track the wire within 3 in. (25 ft prototype). The rudder angle was not limited to any maximum value and was totally controlled by the autopilot system. Only the speed of the vessel was controlled by the manual radio controlled system. The speed of this ship was noted and no other data were recorded.

43. The 265,000-dwt model was remotely piloted as in other tests and the usual data were monitored and recorded. In operating this ship, the operator would aim the ship at range markers located at the end of the test section. Marker buoys were placed to define the channel boundaries.

44. The width of the test channel was set according to current criteria (Figure 26). The channel width consists of maneuvering lanes for each ship,

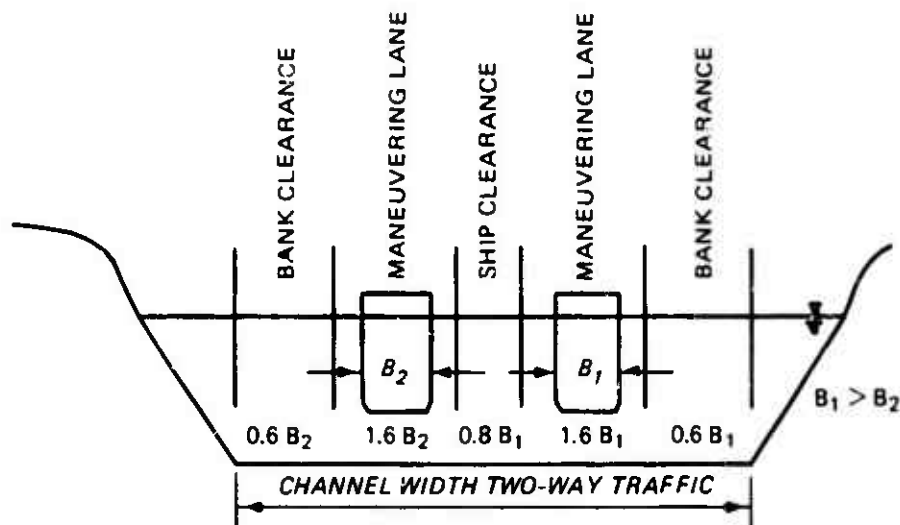

Figure 26. Existing design criteria for channel width with two-way traffic, very good vessel controllability, no crosscurrents, no crosswinds, and no waves (EM 1110-2-1613, Figure 7-1)

bank clearances, and a clearance lane between ships. These design criteria assume that the design vessels have very good controllability and there are no crosscurrents, crosswinds, or waves which would cause the vessels to yaw.

45. Hydrodynamic forces were not measured during a test; such forces are better studied in captive model studies. The heading data give an indication of the bow wave and suction effects that do occur. Figure 27 shows what generally happens when two ships pass each other. The heading angle of this plot shows how the bow waves combine to push each vessel's bow slightly away from the oncoming vessel. The suction effect takes over when the two ships are alongside each other. This suction draws the ships closer together and moves the stern of each ship toward the center of the channel. Just after the ships have passed, the bow of each ship will tend to follow the other ship's wake. The magnitude of this phenomenon increases as the path distance decreases. Vessels passing within one ship beam will experience more of the effect than those passing at a two ship-beam distance. Diligent pilots will take these factors into consideration when a meeting situation arises and avoid the negative aspects by using rudder and engine commands. With the 1:100-scale models, the distance between the meeting ships was difficult to

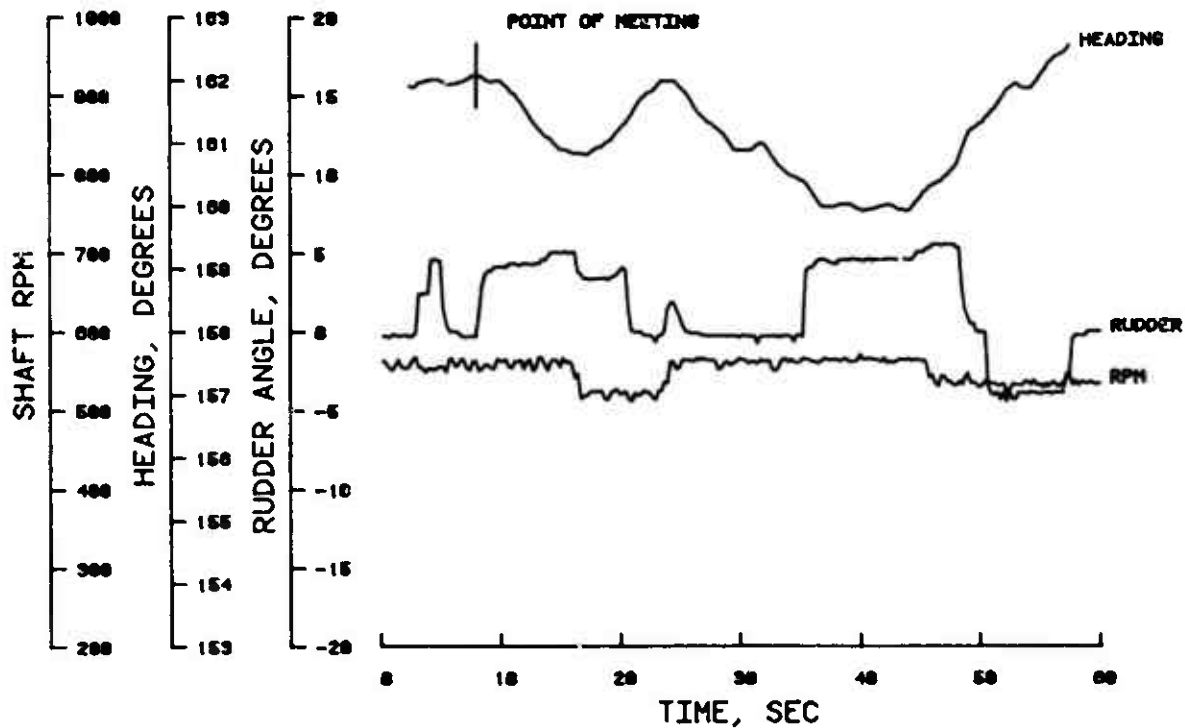

Figure 27. Two-way traffic data

establish due to autopilot accuracy and depth perception limitations of the video monitor.

46. Numerous tests were conducted with the channel width established according to the existing design criteria for two-way traffic (Figure 25). All runs were considered safe and the existing design criteria for ideal conditions are considered adequate. Although several successful runs were made with the clearance lane between ships reduced, several of these runs involved close encounters of the ships. Because of the safety factors required due to greater potential for accidents with two-way traffic, reducing the channel width to less than the existing criteria is not recommended.

PART IV: DISCUSSION

47. The criteria used by the Corps of Engineers for design of deep-draft navigation channels are based on providing for safe and efficient navigation while minimizing the amount of dredging necessary to maintain these channels. These criteria are based on tests conducted in the Panama Canal many years ago, experience in the field, and engineering judgment. The channel width is predicated on the beam of a selected design ship and other factors, such as controllability of the vessels, whether one-way or two-way traffic will be allowed, and forces caused by winds and currents. Channel depth is determined by the draft of the design vessel and other factors such as squat, sinkage, wave conditions, required under-keel clearance, and nature of the channel bottom material. The object of this research was to determine if the existing design criteria are adequate and to refine these criteria if possible.

48. Most of the research was conducted with a tanker as the design vessel since this type of ship has a wide beam and is slow to respond to rudder commands. Most of the data obtained were for ideal navigation conditions (no currents, waves, or wind). In the initial stages of the research program, plans were made to determine the effect of ship speed on channel parameters so that the channel dimensions could be optimized economically from a transportation time/cost standpoint. However, it soon became apparent that the ship speed had very little effect on the required channel width as long as ideal navigation conditions were used, and the shaft rpm were high enough to permit control of the vessel. Thus the vessel speed was not found to be a factor in channel width design, although several runs were made at different speeds during each series of tests.

49. In testing of models at a scale as small as 1:100, much care must be taken to assure that as many of the scale effects as possible are eliminated. Frictional resistance and form resistance between model and prototype are different. A larger propeller slipstream velocity past the rudder increases the rudder effectiveness, causing the model to respond quicker than the prototype. Adjustments were made to the rudder angle in the model to overcome this problem. Results of prototype tests were used to make these adjustments.

50. In a 1:100-scale model the time distortion is 1 to 10. Although

the time distortion was built into the model ships, i.e., the time required to move the rudder from one position to another was properly simulated, the time distortion could affect the response times of the pilot. Also, the model pilot usually can see much more of the channel through a bird's eye view when operating from the model bank. This was eliminated by placing a video camera on the model ship and piloting from the view on a television screen; however, depth perception in the model is then less than that in the prototype. Channel markers and range poles help to eliminate this shortcoming in the model. Also, the model pilots rode on several prototype ships and made video recordings of the view from the pilot house. Through the use of this experience, the model pilots were able to educate themselves as to real life situations in the pilot house. By thoroughly familiarizing themselves with both the prototype and model operations, it was concluded that the model piloting was very similar to the prototype.

51. Results of the model tests for both one-way and two-way traffic indicated that the existing design criteria for design of channel dimensions for ideal conditions are conservative. However, the model indicated that only a slight reduction in channel widths (approximately 10 percent) could be made. Considering the potential damage that could result if accidents occur, especially with two-way traffic, some additional safety factors should be allowed. Because of model scale effects and inaccuracies in the facility, it does not appear prudent to revise the design criteria based on the results of this study.

52. Tests with currents in the model indicate that this has very little effect on navigation in straight channels as long as the channel cross section is uniform. There are many environmental factors such as fog, crosscurrents, wind, etc., that will require additional channel width. Since these factors are unique to each prototype channel, the increased channel dimensions required to permit safe navigation under these environmental conditions must be determined by good engineering judgment gained through past experience and discussions with local pilots or by site-specific model or simulator studies.

53. Much useful information was gained concerning the use of scaled ship models in this study. The capabilities to adjust the rudder angle for simulation of prototype maneuverability, the development of instrumentation for obtaining the required data from the model ships, the use of video cameras to simulate the view of a prototype pilot, and the experience gained by the

model operators will be valuable assets in future studies. Also, the knowledge gained with respect to the type of information that can be obtained from this type of model for site-specific channel design will be very valuable. For example, with the site-specific channel configuration and currents reproduced in a model, and possibly other environmental factors, tests could easily be conducted to determine the required channel dimensions.

54. Tests are presently under way to determine the amount of channel bend widening required to safely navigate bends of various degrees. These tests are being conducted with both slack water and various current velocities.

REFERENCES

- Bindel, S. G. 1960 (Oct). "Experiments on Ship Maneuverability in Canals as Carried Out in the Paris Model Basin," First Symposium on Ship Maneuverability, Report 1461, David Taylor Model Basin, Bethesda, Md.
- Crane, C. L., Jr. 1979 (Jan). "Maneuvering Trials of the 278,000 DWT ESSO OSAKA in Shallow and Deep Waters," Report No. EII.4TM.79, Exxon International Co., Florham Park, N. J.
- Garthune, R. S., et al. 1948 (Aug). "The Performance of Model Ships in Restricted Channels in Relation to Design of a Ship Channel," Report 601, David Taylor Model Basin, Bethesda, Md.
- Hoerner, Sighard F. 1958. "Fluid-Dynamic Drag," published by the author. Hydronautics Computer Model, Hydronautics Inc., Laurel, Md., 1979.
- Kray, C. J. 1973 (Feb). "Design of Ship Channels and Maneuvering Areas," Journal, Waterways, Harbors, and Coastal Engineering Division, American Society of Civil Engineers, Vol 99, No. WW1, pp 89-110.
- Office, Chief of Engineers, Department of the Army. 1983 (8 Apr). "Hydraulic Design of Deep-Draft Navigation Projects," EM 1110-2-1613, Washington, DC.
- Wicker, C. F., ed. 1965 (May). "Evaluation of Present State of Knowledge of Factors Affecting Tidal Hydraulics and Related Phenomena," Committee on Tidal Hydraulics Report No. 3, US Army Engineer Waterways Experiment Station, Vicksburg, Miss.