

4



USAAEFA PROJECT NO. 82-07

AIRWORTHINESS AND FLIGHT CHARACTERISTICS TEST (A&FC) OF THE CH-47D HELICOPTER

USAAEFA
AD-A151 380

GARY L. BENDER
PROJECT OFFICER

PATRICK J. SULLIVAN
CW3, AV
PROJECT PILOT

GEORGE M. YAMAKAWA
PROJECT ENGINEER

ROBERT D. ROBBINS
PROJECT PILOT

MICHAEL K. HERBST
PROJECT ENGINEER

ROBERT A. WILLIAMS
CW4, AV
PROJECT PILOT

FEBRUARY 1984

FINAL REPORT

DTIC
SELECTED
MAR 19 1985
S E D

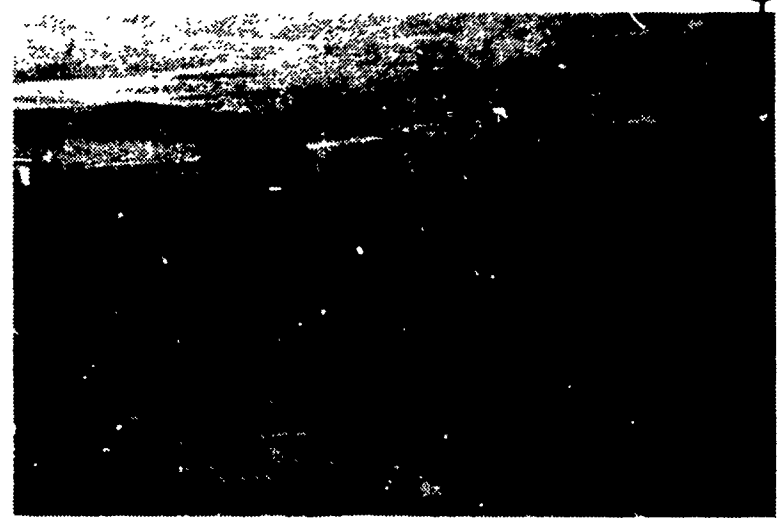

DTIC FILE COPY

APPROVED FOR PUBLIC RELEASE, DISTRIBUTION UNLIMITED.

UNITED STATES ARMY AVIATION ENGINEERING FLIGHT ACTIVITY
EDWARDS AIR FORCE BASE, CALIFORNIA 93523

85 03 07 205

DISCLAIMER NOTICE

The findings of this report are not to be construed as an official Department of the Army position unless so designated by other authorized documents.

DISPOSITION INSTRUCTIONS

Destroy this report when it is no longer needed. Do not return it to the originator.

TRADE NAMES

The use of trade names in this report does not constitute an official endorsement or approval of the use of the commercial hardware and software.

UNCLASSIFIED

SECURITY CLASSIFICATION OF THIS PAGE (When Data Entered)

REPORT DOCUMENTATION PAGE		READ INSTRUCTIONS BEFORE COMPLETING FORM
1. REPORT NUMBER USAAEFA PROJECT NO. 82-07	2. GOV'T ACCESSION NO. A151 380	3. RECIPIENT'S CATALOG NUMBER
4. TITLE (and Subtitle) AIRWORTHINESS & FLIGHT CHARACTERISTICS TEST (A&FC) OF THE CH-47D HELICOPTER		5. TYPE OF REPORT & PERIOD COVERED 25 JAN - 13 DEC 1983 FINAL
7. AUTHOR(s) GARY L. BENDER PATRICK J. SULLIVAN GEORGE M. YAMAKAWA ROBERT D. ROBBINS MICHAEL K. HERBST ROBERT A. WILLIAMS		6. PERFORMING ORG. REPORT NUMBER
9. PERFORMING ORGANIZATION NAME AND ADDRESS US ARMY AVN ENGINEERING FLIGHT ACTIVITY EDWARDS AIR FORCE BASE, CA 93523		8. CONTRACT OR GRANT NUMBER(s)
11. CONTROLLING OFFICE NAME AND ADDRESS US ARMY AVIATION SYSTEMS COMMAND (PROV) 4300 GOODFELLOW BOULEVARD ST. LOUIS, MO 63120		10. PROGRAM ELEMENT, PROJECT, TASK AREA & WORK UNIT NUMBERS 19-2-BK225-04-19-EC
14. MONITORING AGENCY NAME & ADDRESS (If different from Controlling Office)		12. REPORT DATE FEBRUARY 1984
		13. NUMBER OF PAGES 246
		15. SECURITY CLASS. (of this report) UNCLASSIFIED
		15a. DECLASSIFICATION/DOWNGRADING SCHEDULE
16. DISTRIBUTION STATEMENT (of this Report) Approved for public release; distribution unlimited.		
17. DISTRIBUTION STATEMENT (of the abstract entered in Block 20, if different from Report)		
18. SUPPLEMENTARY NOTES		
19. KEY WORDS (Continue on reverse side if necessary and identify by block number) Airworthiness & Flight Characteristics Test CH-47D Helicopter Performance Handling Qualities		
20. ABSTRACT (Continue on reverse side if necessary and identify by block number) An Airworthiness and Flight Characteristics Test of the Boeing Vertol CH-47D helicopter (USA S/N 81-23383) was conducted by the US Army Aviation Engineering Flight Activity. The test was conducted at St. Paul, Minnesota (elevation 704 feet), Edwards Air Force Base (elevation 2302 feet), Bishop (elevation 4120 feet), and Coyote Flats (elevation 9980 feet), California. A total of 148.8 hours (105.4 productive hours) were flown between 25 January and 13 December 1983. Hover, level flight, and autorotational descent performance		

DD FORM 1 JAN 73 1473 EDITION OF 1 NOV 65 IS OBSOLETE

UNCLASSIFIED

SECURITY CLASSIFICATION OF THIS PAGE (When Data Entered)

(Cont.)

UNCLASSIFIED

SECURITY CLASSIFICATION OF THIS PAGE(When Data Entered)

tests were conducted. Handling qualities tests included static and dynamic stability, maneuvering stability, takeoff and landing characteristics, power management, simulated systems failures, simulated Instrument Meteorological Conditions flight evaluation, and vibration evaluation. Cockpit and subsystem evaluations were also made. The CH-47D exceeded those performance requirements of the Prime Item Development Specification which were evaluated during this test. The Advanced Flight Control System heading select capability and the pressure refueling capability were found to be enhancing characteristics of the aircraft. Three significant shortcomings were found: the poor engine governing system which allows large rotor speed excursions with changes in power setting or airspeed, the high level of cockpit vibrations at and above cruise airspeeds, and an easily excited three-axis airframe oscillation during high power conditions at light gross weight.

Accession For	
NTIS GRA&I	<input checked="" type="checkbox"/>
DTIC TAB	<input type="checkbox"/>
Unannounced	<input type="checkbox"/>
Justification	
By _____	
Distribution/	
Availability Codes	
Dist	Avail and/or Special
A-1	



UNCLASSIFIED

SECURITY CLASSIFICATION OF THIS PAGE(When Data Entered)

1



DEPARTMENT OF THE ARMY
HEADQUARTERS, US ARMY AVIATION SYSTEMS COMMAND
4300 GOODFELLOW BOULEVARD, ST. LOUIS, MO 63120

REPLY TO
ATTENTION OF

DRSAV-E

SUBJECT: Directorate for Engineering Position on the Final Report of USAAEFA
Project No. 82-07, Airworthiness and Flight Characteristics Test
(A&FC) of the CH-47D Aircraft

SEE DISTRIBUTION

1. The purpose of this letter is to establish the Directorate for Engineering position on the subject report. The objectives of this A&FC test were to obtain helicopter performance and handling qualities data for the CH-47D Operators' Manual and to determine compliance with the CH-47D Prime Item Development Specification (PIDS).

2. This Directorate agrees with the report conclusions and recommendations, with the exceptions identified herein. Conclusions and recommendations are discussed by paragraph as indicated.

a. Paragraph 94a. The engine governing system on the CH-47 helicopter with the T55 series engines is sensitive to N_1 and N_2 system rigging and inherently allows rotor speed excursions. The rotor speed excursions are the result of the engine fuel control tolerances and the slope in the feedback system to the fuel control. Previous investigations on the YCH-47D and the CH-47C with the T55-L-712 engines and fiberglass rotor blades indicated that the power management was sensitive to the fuel control rigging. The approved ECPs, D001 Improved N_2 Control Box, D036 Alternate N_1 System (Logic) and D050 Engine Control (N_1) Link Mod should provide improved governing characteristics, but primarily for reliability reasons. Although undesirable, the rotor speed excursions are considered acceptable.

b. Paragraph 94b. The high level of cockpit vibrations at and above cruise airspeed is a shortcoming. However, attenuation of the cockpit vibrations is not planned due to the limited mission profile time spent above cruise airspeed, the weight penalty and the complexity of attenuation systems.

c. Paragraph 94c. Boeing Vertol investigated the easily excited three axis aircraft oscillations. Modifications were made to the AFCS to alleviate structural problems associated with the oscillations. While the AFCS modifications solved the structural problem, the oscillations still exist. The oscillations are most pronounced during high power maneuvers at light gross weight. Since this condition is an infrequent occurrence and not a deficiency and further design changes may not be productive, this shortcoming is considered acceptable.

d. Paragraph 94d. The lack of an aircraft intercom ON/OFF capability is a shortcoming. However, the intercom system is standard GFE which is used Army wide and no modifications are planned for the CH-47D.

DRSAV-E

SUBJECT: Directorate for Engineering Position on the Final Report of USAAEFA
Project No. 82-07, Airworthiness and Flight Characteristics Test
(A&FC) of the CH-47D Aircraft

e. Paragraph 94e. The excessive rate of engine torque increase following a failure of the CCDA is not considered a shortcoming. The CCDA failure mode performs per the specification requirements. The probability of encountering a failure of the CCDA is remote and, when it occurs, it will result in a transient torque or temperature limit exceedence which is controllable. No design changes are planned due to the low probability of occurrence and cost impact of a redesign.

f. Paragraph 94f. Agree with the shortcoming relative to the barometric or radar altitude hold feature. No design changes are planned for the CH-47D since the copilot can operate the switch with relative ease and the pilot can operate the system with the thrust control rod release.

g. Paragraph 94g. A helicopter internal cargo handling system product improvement proposal has been approved and is scheduled for FY85 implementation. This action should correct the lack of provisions for easy loading and unloading.

h. Paragraph 94h. The uncommanded pitch oscillations during two wheel taxi is a shortcoming. Changes to the Operator's Manual have been implemented which allow the pilot to turn off the AFCS to eliminate the pitch oscillations.

i. Paragraph 94i. The unconventional position/nomenclature of the VHF AM/FM radio sets is considered a nuisance rather than a shortcoming. It is impractical and too costly to change the design.

j. Paragraph 94j. The engine torque fluctuations in smooth air with the barometric altitude hold feature engaged is not considered a shortcoming unless the associated torque fluctuations in and of themselves create a flying qualities problem and that seems not to be the case as is evidenced by the first sentence of paragraph 87. Corrective action does not appear to be warranted.

k. Paragraph 94k. The lack of independent course deviation indicators for each pilot is peculiar to the test aircraft. Fielded CH-47D aircraft have course deviation indicators for both the pilot and copilot.

l. Paragraph 94l. The restricted field-of-view from the crew chief position fore and aft cargo hooks during tandem rigged load operations has been demonstrated satisfactorily during testing at Fort Rucker. The crew chief is required to wear a monkey harness while leaning through the cargo hatch to observe the external load. There are no planned design changes.

m. Paragraph 94m. The lack of gunner seats for the M24 armament subsystem is a shortcoming. An ECP submitted by Boeing Vertol in 1969 to add gunner seats was rejected because the seat would block an emergency exit, would not allow proper operation of the gun, and be cost ineffective.

DRSAV-E

SUBJECT: Directorate for Engineering Position on the Final Report of USAAEFA
Project No. 82-07, Airworthiness and Flight Characteristics Test
(A&FC) of the CH-47D Aircraft

n. Paragraph 94n. Water leaking into the cockpit during flight in rain is a shortcoming. Field experience has not indicated this is a problem. However, field experience will be followed closely to determine if this problem develops.

o. Paragraph 94o. The inability to ground taxi with power steering while performing other cockpit tasks is a shortcoming. However, a design change is too costly and the current system is considered acceptable.

p. Paragraph 94p. The shortcoming associated with the pilot's restricted field-of-view of the turn and slip indicator should be corrected with ECP 027 (NVG Mod).

q. Paragraph 94q. A PIP is being submitted for FY 87 to remedy the lack of an external load weight measuring system.

r. Paragraph 94r. The inability of the Doppler Navigation Set to display distance and ground speed in units of nautical miles is a shortcoming. The equipment is GFE and no design changes are planned.

s. Paragraph 94s. The readability of the longitudinal stick position indicator at night should be improved with ECP 027 (NVG Mod).

t. Paragraph 94t. ECP 035 (NVG Mod) extends the glare shield which should improve the readability of the caution panel segment lights.

u. Paragraph 94u. The susceptibility of the longitudinal stick position indicator to damage is a shortcoming. The indicator was added after the cockpit design was frozen and is too costly to change.

v. Paragraph 94v. The obstructed field-of-view of the forward end of the longitudinal stick position indicator is a shortcoming but no design changes are planned.

w. Paragraph 94w. The uncomfortable pilot/copilot seat is a shortcoming. However, to change the seat design is cost prohibitive.

x. Paragraph 95. The shortcomings should be corrected as soon as practicable except as noted herein.

y. Paragraph 96. Release of flight controls would be required even if engage/disengage switches were relocated unless placed on the cyclic or collective. Such a change is cost prohibitive and is not considered warranted.

DRSAV-E

SUBJECT: Directorate for Engineering Position on the Final Report of USAAEFA
Project No. 82-07, Airworthiness and Flight Characteristics Test
(A&FC) of the CH-47D Aircraft

3. The CH-47D helicopter is considered qualified based on all the testing accomplished by AEFA and the contractor. Any expansion of the gross weight, center of gravity limits or incorporation of additional subsystems will require further flight testing to substantiate airworthiness.

FOR THE COMMANDER:

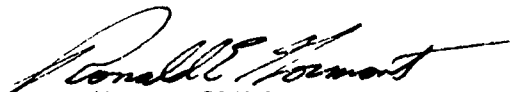

RONALD E. GORMONT
Acting Director of Engineering

TABLE OF CONTENTS

	<u>Page</u>
INTRODUCTION	
Background.....	1
Test Objectives.....	1
Description.....	1
Test Scope.....	1
Test Methodology.....	2
RESULTS AND DISCUSSION	
General.....	3
Performance.....	3
General... ..	3
Hover Performance.....	3
Level Flight Performance.....	5
Autorotational Descent Performance.....	5
Mission Performance.....	10
Handling Qualities.....	10
General.....	10
Flight Control System Mechanical Characteristics..	12
Control Positions in Trimmed Forward Flight.....	13
Static Longitudinal Stability.....	13
Static Lateral-Directional Stability.....	15
Maneuvering Stability.....	18
Dynamic Stability.....	18
Longitudinal Short Term Response.....	18
Three Axis Oscillation.....	20
Longitudinal Long Term Response.....	20
Lateral-Directional Response.....	21
Single AFCS.....	21
AFCS Off.....	22
Ground Handling Characteristics.....	22
Takeoff and Landing Characteristics.....	24
Slope Operation Characteristics.....	24
Power Management.....	25
Mission Maneuvering Characteristics.....	26
Aircraft System Failures.....	26
Simulated Single Engine Failures.....	26
Advanced Flight Control System Failure.....	27
Vibrations.....	29
Instrument Meteorological Conditions (IMC) Flight	
Evaluation.....	31
Cockpit and Cabin Evaluation.....	33
General.....	33
Ingress/Egress.....	33

Cockpit Seats.....	33
Cockpit Leaks.....	33
Caution Panel.....	34
Cargo Loading.....	34
Crew Restraint.....	34
Longitudinal Stick Position Indicator.....	34
Pilot's Turn and Slip Indicator.....	35
Subsystems Tests.....	35
Pitot-Static System.....	35
Interphone System.....	36
Cargo Hook System.....	36
Advanced Flight Control System Altitude Hold.....	37
Doppler Navigation Set.....	38
In-Flight Engine Starts.....	38
Pressure Refueling System.....	39

CONCLUSIONS

General.....	40
Enhancing Characteristics.....	40
Shortcomings.....	40

RECOMMENDATIONS.....	43
----------------------	----

APPENDIXES

A. References.....	44
B. Aircraft Description.....	46
C. Instrumentation.....	67
D. Test Techniques and Data Analysis Methods.....	71
E. Test Data.....	80
F. Equipment Performance Reports.....	232

DISTRIBUTION

INTRODUCTION

BACKGROUND

1. The Boeing Vertol Company (BV) designed, fabricated and completed the necessary qualification of modernized components that upgraded previous Model CH-47 helicopters to the YCH-47D. BV conducted flight testing of the YCH-47D in accordance with the Airworthiness Qualification Specification, BV Document No. 0210-10925-1. Additionally, the US Army Aviation Engineering Flight Activity (USAAEFA) conducted two Preliminary Airworthiness Evaluations (PAE) (refs 1 and 2, app A), climatic laboratory tests (ref 3), and icing tests (ref 4). The US Army Aviation Research and Development Command (AVRADCOM) tasked USAAEFA to conduct an Airworthiness and Flight Characteristics Test (A&FC) of the production CH-47D (ref 5) to verify compliance with the requirements of the Prime Item Development Specification (PIDS) for the Model CH-47D helicopter (ref 6) and obtain detailed flight test data for the operator's manual (ref 7).

TEST OBJECTIVES

2. The objectives of the CH-47D A&FC were to determine contractual compliance with selected portions of the PIDS and to obtain detailed flying qualities and performance data for the operator's manual.

DESCRIPTION

3. The CH-47D is a modernized version of previous model CH-47 tandem-rotor helicopters designed to provide air transportation for general cargo and troops within the combat area. A detailed description of the CH-47D is contained in the operator's manual, the PIDS, and in appendix B. Aircraft serial number 81-23383 was used for this evaluation.

TEST SCOPE

4. The A&FC tests were conducted in 132 flights for a total of 148.8 hours, of which 105.4 were productive. Testing was conducted in St. Paul, Minnesota (elevation 704 feet), Edwards Air Force Base (elevation 2302 feet), Bishop (elevation 4120 feet) and Coyote Flats (elevation 9980 feet), California. Tests were flown between 25 January and 13 December 1983. Instrumentation was installed and maintained by BV. Data reduction and aircraft maintenance were the responsibility of USAAEFA. The tests were conducted in accordance with the test plan (ref 8, app A) and

within the flight restrictions contained in the operator's manual and the airworthiness release (ref 9). Handling qualities results were compared to the requirements of the PIDS. Sufficient performance data were gathered to check the guarantees in the PIDS and to generate the performance section of the operator's manual.

5. Performance testing was conducted over a wide range of weights, altitudes, temperatures, and rotor speeds as presented in applicable sections of this report. Handling qualities were conducted at two target gross weights (41,000 and 50,000 pounds). At 41,000 pounds both forward and aft longitudinal center of gravity locations were tested. A rotor speed of 100% (225 rpm) was used for all handling qualities testing. Further handling qualities test conditions are presented in the applicable sections of this report.

TEST METHODOLOGY

6. The test techniques utilized were standard engineering flight test techniques (refs 10 and 11) and are briefly described in appendix D. Qualitative ratings of the handling qualities were based on the Handling Qualities Rating Scale (HORS) contained in appendix D. Vibration levels were qualitatively evaluated using the Vibration Rating Scale (VRS) contained in appendix D.

7. Data were recorded by hand, on magnetic tape onboard the aircraft, and via telemetry to the Real Time Data Acquisition and Processing System (RDAPS). A detailed listing of parameters is contained in appendix C.

RESULTS AND DISCUSSION

GENERAL

8. Performance and handling qualities tests were conducted at high-altitude and low-altitude test sites. Tests were conducted to determine the hover, level flight, and autorotational descent performance of the CH-47D helicopter. Handling qualities were evaluated at 41,000 lb and 50,000 lb. At 41,000 lb both forward and aft longitudinal center of gravity (cg) locations were tested. The CH-47D exceeded the hover, maximum level flight speed, and the mission III range performance requirements of the PIDS. The pressure refueling and AFCS heading select capabilities were found to be enhancing features of the aircraft. No deficiencies and 25 shortcomings were found. The most significant shortcoming was the engine speed governing system which allowed large rotor speed excursions with changes in power setting or airspeed. Also significant were the high level of cockpit vibrations at and above cruise airspeed, and the easily excited three-axis aircraft oscillation caused by differential rotor torque oscillations.

PERFORMANCE

General

9. Tests were conducted to determine the hover, level flight, and autorotational descent performance of the CH-47D helicopter. This information was then used analytically to determine compliance with certain portions of the PIDS. The performance requirements in the PIDS (ref 6, app A) were verified using the power required information determined during this test and power available obtained from the Lycoming computer program number LS 19.31.51.13 dated June 1983 using installation losses from BV document number D210-11920-1 dated 9 June 1982. The CH-47D exceeded the hover, maximum level flight speed, and the mission III range performance requirements of the PIDS.

Hover Performance

10. Hover performance tests were conducted at the conditions presented in table 1. The tethered hover method described in appendix D was used. Results are presented in figures 1 through 10, appendix E.

11. The aircraft is able to hover out-of-ground effect (OGE) at 53,950 pounds at sea level on a standard day using maximum continuous power on both engines. This performance exceeds the PIDS guarantee of 50,000 pounds by 7.9%.

Table 1. Hover Performance Test Conditions

Wheel Height (ft)	Pressure Altitude Range (ft)	Referred Rotor Speed Range (RPM)
5	2060 4120 - 4140 9700	212 - 227 214 - 229 219 - 234
10	2060 9700	214 - 229 219 - 234
20	2060	215 - 230
50	2120 4000 - 4020 9540	216 - 232 225 - 229 219 - 232
100	9540	217 - 233
150	560 2060 4100 - 4400 9620 - 9900	230 - 250 220 - 237 212 - 233 215 - 234

Level Flight Performance

12. Level flight performance tests were conducted at the conditions shown in table 2. The method of test is described in appendix D. Figures 13, 14, 18, 19, 29 and 30, appendix E present nondimensional data gathered at three values of referred rotor speed (215, 225, and 245 rpm). Range summaries are presented in figures 11 and 12. Figures 15 through 17, 20 through 28, and 31 through 33 present the dimensional level flight performance data gathered during this test.

13. Figure 1 presents level flight performance calculated at the PIDS guarantee conditions. The PIDS specifies a maximum level flight airspeed of 155 knots true airspeed (KTAS) at sea level standard day conditions. The actual performance (162.5 KTAS) exceeds this guarantee by 7.5 KTAS. The YCH-47D PAE testing (ref 1) found only 157.5 KTAS capability. The difference between PAE and A&FC results is primarily caused by increased power available rather than decreased drag since the previous test. During the PAE the Lycoming Engine Specification No. 124.53, dated 19 November 1975, was used to determine power available. The current power available data is based on a 1983 Lycoming computer program (see para 9). This later program specifies a higher maximum continuous power rating. Figure 2 presents level flight data at a thrust coefficient of 0.0055 and at three values of referred rotor speed. As can be seen in the figure, the highest referred rotor speed significantly degraded the level flight performance.

Autorotational Descent Performance

14. Autorotational descent performance data were obtained at gross weights of 33,720 and 47,880 pounds at approximately 100% rotor speed. Data were obtained by stabilizing in autorotational descents at incremental airspeeds between 50 and 120 knots calibrated airspeed (KCAS). The rotor speed for minimum rate of descent was obtained by stabilizing at various autorotational rotor speeds while maintaining approximate minimum rate of descent airspeed. The data are presented in table 3 and figures 34 through 36, appendix E.

FIGURE 1
 LEVEL FLIGHT PERFORMANCE
 CH47D USA S/N 81-23383
 LYCOMING T55-L-712 S/N 71224 & 71226

GROSS WEIGHT (LB)	LONGITUDINAL CG LOCATION (FS)	PRESSURE ALTITUDE (FT)	OAT (DEG C)	ROTOR SPEED (RPM)	CT
33000	330.1 (MID)	ZERO	15.0	225	0.004915

- NOTES:
1. $N/\sqrt{\theta} = 225.0$ RPM.
 2. BALL-CENTERED FLIGHT.
 3. SHP REQUIRED OBTAINED FROM FIG. 18 AND 19, APPENDIX E.
 4. SHP AVAILABLE OBTAINED FROM ENGINE MODEL SPECIFICATION T55-L-712 FILE NO. 19.31.51.13 DATED 27 JUNE 1983.

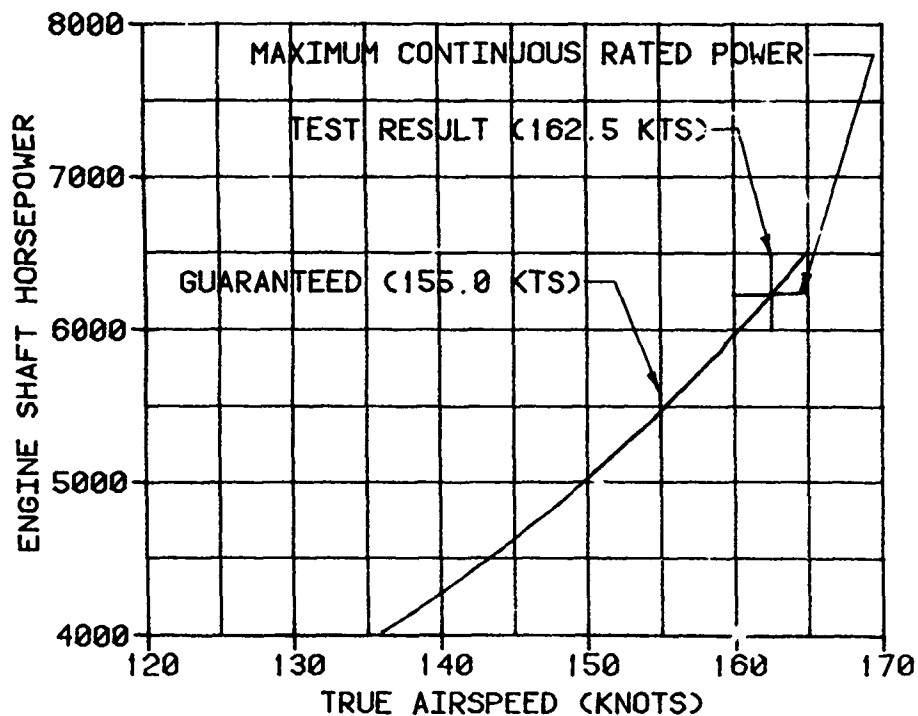

FIGURE 2
 ROTOR SPEED EFFECTS ON LEVEL FLIGHT PERFORMANCE
 CH-47D USA S/N 81-23383
 CT = 0.0055

NOTE: CURVES OBTAINED FROM FIGS. 13, 14, 18, 19,
 29 AND 30, APPENDIX E.

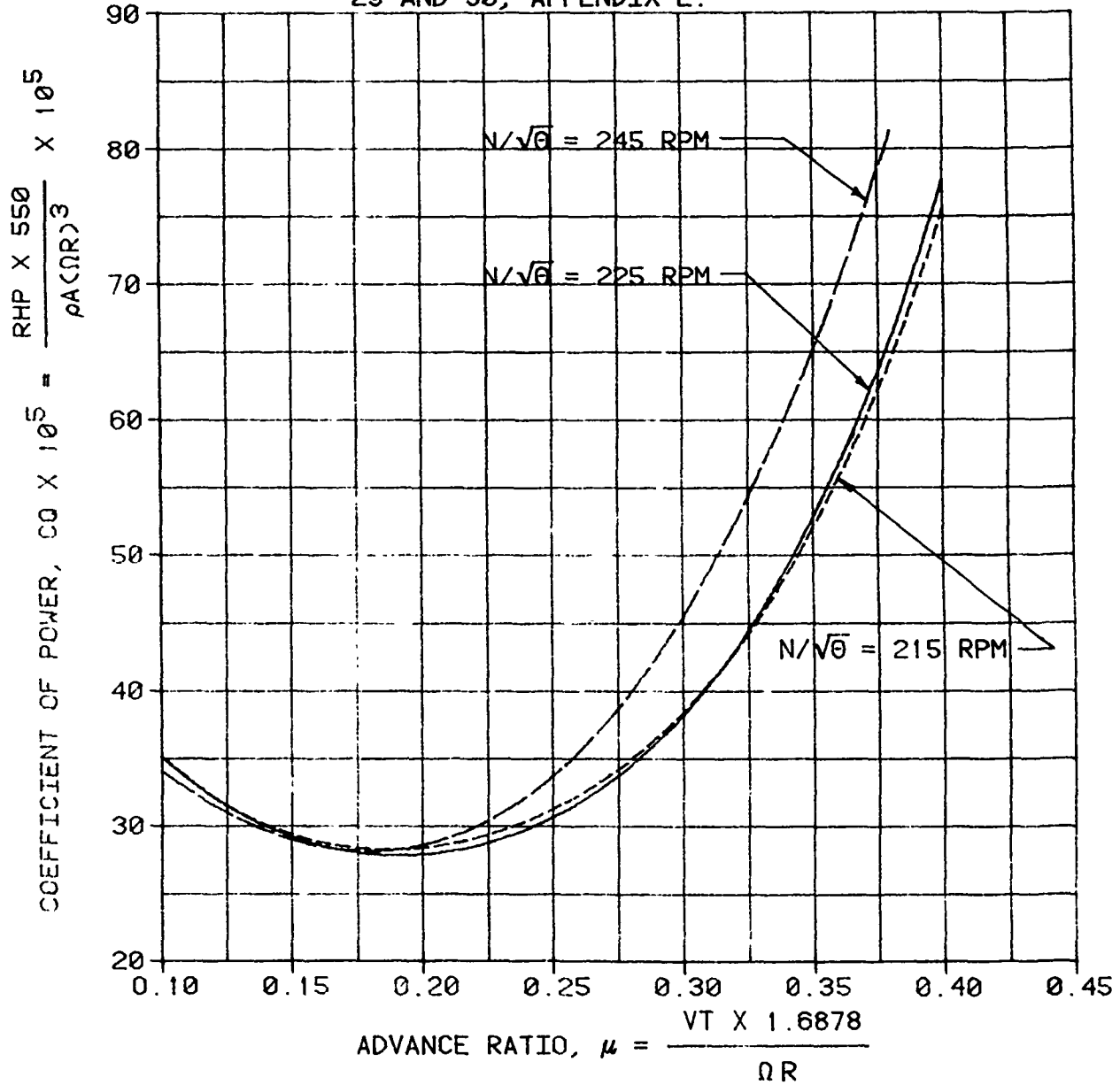

Table 2. Level Flight Performance Test Conditions

Average Gross Weight (lb)	Average Longitudinal Center of Gravity Location (FS)	Average Density Altitude (ft)	Average OAT (Deg C)	Average Referred Rotor Speed	Average Thrust Coefficient	Aircraft Configuration
31,180	330.3 (MID)	3620	25.0	214.3	0.005506	Clean
33,360	329.7 (MID)	8590	17.5	215.1	0.006984	
46,510	330.7 (MID)	6480	21.5	214.6	0.009039	
31,350	330.6 (MID)	1950	1.3	224.8	0.004988	Clean
33,710	331.3 (MID)	4870	6.5	224.3	0.006014	
33,760	331.2 (MID)	9720	6.0	224.5	0.006994	
42,530	328.1 (MID)	6010	5.0	224.9	0.007856	
48,300	329.7 (MID)	6510	7.0	225.1	0.008977	
49,180	329.7 (MID)	8490	-1.0	225.3	0.009985	
31,090	330.7 (MID)	4810	-11.5	244.5	0.004981	Clean
44,140	329.4 (MID)	3750	-17.0	245.0	0.006969	
49,040	329.6 (MID)	8720	-16.5	244.8	0.009013	
38,080	329.5 (MID)	5270	0.0	224.9	0.007003	Ramp Down
30,950	342.3 (AFT)	1560	5.0	224.7	0.005001	Clean
31,970	320.2 (FWD)	850	8.5	224.5	0.005013	Clean

Figure 3. Mission III Performance

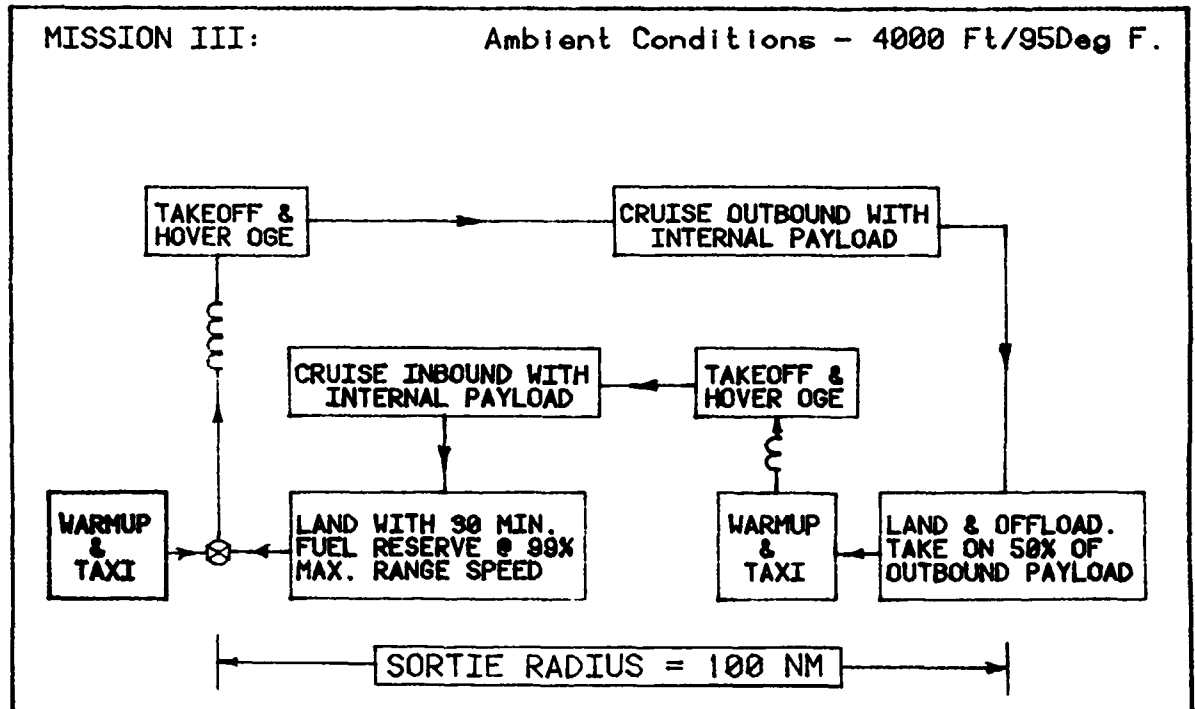

Table 3. Autorotational Descent Performance

Average Gross Weight (pounds)	Minimum Rate of Descent Airspeed (KCAS)	Minimum Rate of Descent Rotor Speed (rpm)	Maximum Glide Distance Airspeed (KCAS)
33,720	76	Not determined	106
47,880	90	224	111

15. The autorotational rate of descent was 2300 to 2500 feet per minute (fpm) at the minimum rate of descent airspeeds and approximately 2700 fpm at the maximum glide distance airspeeds. Desired rotor speed in stabilized autorotation was maintained ± 2 rpm with moderate effort (HQRS 4) at airspeeds above 70 KCAS. Rotor speed control was extremely difficult at lower airspeeds. The autorotational glide distance charts and recommended rotor speed in the operator's manual are sufficiently accurate for operational use. The autorotational descent performance is satisfactory.

Mission Performance

16. The mission III performance requirements of reference 6 are shown in figure 3. Table 4 shows a comparison of the PIDS guaranteed mission III performance to the actual mission III performance. The actual fuel reserve remaining at the end of the mission III profile is 1331 pounds which exceeds the required 1219 pounds. The mission III performance of the CH-47D exceeds the requirement of the PIDS.

HANDLING QUALITIES

General

17. Handling qualities of the CH-47D were evaluated at 41,000 lb and 50,000 lb. At 41,000 lb, both forward and aft longitudinal cg locations were tested. All tests were flown at a mid lateral cg location. Unless otherwise noted, the aircraft was tested with the heading select and altitude hold modes of the AFCS disengaged. The single-point pressure refueling and AFCS heading select capabilities were found to be enhancing features of the aircraft. No deficiencies and 25 shortcomings were found. The most significant shortcoming was the engine speed governing

Table 4. Mission III Performance

Item	PIDS Guarantee		Actual Performance	
	Gross Weight (lb)	Fuel Remaining (lb)	Gross Weight (lb)	Fuel Remaining (lb)
Engine Start	44,000	5239	44,000	5239
Engine warmup and taxi	43,916	5155	43,916	5155
Cruise outbound 100 NM	41,814	3053	41,901	3140
Land and offload 50% of load	34,450	3053	34,537	3140
Engine start, warmup, taxi	34,366	2969	34,453	3056
Cruise inbound 100 NM	32,616	1219	32,728	1331

NOTE: Pressure altitude = 4000 feet, air temperature = 95 degrees F

system which allowed large rotor speed excursion with changes in power setting or airspeed. Also significant were cockpit vibration levels at and above cruise airspeeds, and the easily-excited three-axis aircraft oscillation caused by differential rotor mast torque oscillations.

Flight Control System Mechanical Characteristics

18. Control forces were measured on the ground with the rotors static and external units furnishing AC electrical power and utility hydraulic pressure. The number 1 and 2 power transfer units provided flight control hydraulic pressure. Control forces were measured with a calibrated hand held force gauge, and were qualitatively confirmed in flight. AFCS was off, and control centering was engaged during all ground measurements. The data are presented in figures 37 through 40, appendix E.

19. The longitudinal cyclic control was trimmed to the neutral position (marked N) on the longitudinal cyclic stick position indicator. The longitudinal breakout plus friction force was 2.5 pounds for both forward and aft displacement. The force gradient for the first inch of travel from trim, both fore and aft, was at least equal to the breakout plus friction force. The forward and aft longitudinal stick force gradients were always positive (increasing force for increasing displacement from trim) and approximately 1.0 pound per inch forward and aft. The gradients were essentially linear, the control force for maximum displacement was approximately 10 pounds for forward travel and 9 pounds for aft travel. Longitudinal cyclic trim freeplay was less than 0.1 inch. The longitudinal cyclic control force characteristics are satisfactory.

20. The lateral breakout plus friction force was 2.5 pounds for right displacement and 2.1 pounds for left displacement. The lateral force gradients left and right were approximately 1.2 pounds per inch with no objectionable discontinuities. Control force for maximum displacement was approximately 9 pounds left and right. Trim freeplay was less than 0.1 inch. The lateral control force characteristics are satisfactory.

21. The directional breakout plus friction force was approximately 6 pounds for left displacement and 7 pounds for right displacement. The force gradients were approximately 6 pounds per inch left and right with no objectionable discontinuities. Trim freeplay was less than 0.1 inch. Control force for maximum displacement was approximately 30 pounds left and right. The directional control force characteristics are satisfactory.

22. The thrust control force characteristics were evaluated with the Thrust Control Brake switch taped depressed, so that the thrust control magnetic brake was disengaged. The breakout plus friction was approximately 4.5 pounds when started from the ground detent and moved upward and 1.5 pounds when started from the full up position and moved downward. At the ground detent position, approximately 1.4 inches above full down, a spring opposes downward movement of the thrust control. From the ground detent downward breakout plus friction force was 9.0 pounds. The force gradient was approximately 3 pounds per inch, and control force for full down displacement was approximately 15 pounds. Since all static measurements were taken with the thrust control rod magnetic brake switch depressed, the in-flight values were increased by the amount of magnetic brake force when the switch was not depressed. This combined force provided adequate in-flight thrust control force characteristics. The thrust control force characteristics are satisfactory.

Control Positions in Trimmed Forward Flight

23. Trim flight control positions were evaluated with both AFCS systems on in conjunction with the level flight performance tests at the conditions specified in table 2. Representative data from light and heavy gross weights with forward and aft centers of gravity are presented in figures 41 through 44. The longitudinal control position gradient with airspeed was conventional in that increased forward control position was required to trim at increased airspeeds. The gradient was approximately one inch of longitudinal stick displacement per 80 KCAS and was essentially linear. Lateral control trim changes were less than 3/4 inch; however, more lateral control trim variation occurred with airspeed changes at the heavier gross weights than at the lighter gross weights. Directional control trim changes were negligible (less than 1/4 inch displacement throughout the airspeed range tested). Pitch attitude remained essentially constant from the minimum airspeed tested through 90 KCAS. The pitch attitude became more nose-down as airspeed increased above 90 KCAS. Nose-down attitudes of 8 degrees were observed at the maximum level flight speeds tested. Longitudinal, lateral, and directional control position variation with cg location and gross weight were insignificant. Pitch attitude changes with collective inputs were negligible with both AFCS systems operating. The trim control position characteristics of the CH-47D are satisfactory.

Static Longitudinal Stability

24. Static longitudinal stability characteristics were evaluated at the conditions listed in table 5. The helicopter was stabil-

Table 5. Static Longitudinal Stability Test Conditions

Average Gross Weight (lb)	Average Longitudinal Center of Gravity (FS)	Average Density Altitude (ft)	Average OAT (Deg C)	Trim Calibrated Airspeed (kt)	Flight Condition	AFCS ¹ Condition
40,620 to 41,860	312.7 (fwd) to 312.8 (fwd)	4580 to 5040	16.5 to 17.0	74 130	Level	A
				93	Climb Descent	
41,020 to 42,800	318.5 (fwd) to 318.8 (fwd)	4780 to 5460	23.0 to 24.0	74 88 129	Level	A, B and C
38,820 to 40,900	318.7 (fwd) to 318.8 (fwd)	4940 to 5460	20.0 to 23.5	94 to 97	Climb	A, B and C
40,820 to 42,520	318.5 (fwd) to 318.7 (fwd)	4720 to 5740	18.5 to 20.5	94 to 95	Descent	A, B and C
41,380 to 42,760	345.0 (aft) to 346.0 (aft)	4820 to 5420	20.5 to 21.0	73 130	Level	A
				94	Climb Descent	
41,620 to 42,960	337.0 (aft) to 337.7 (aft)	4800 to 5240	18.5 to 25.0	73 93 129	Level	A, B and C
40,200 to 41,700	337.9 (aft) to 338.9 (aft)	4960 to 5520	18.0 to 22.5	90 to 95	Climb	A, B and C
39,500 to 39,980	338.7 (aft) to 339.4 (aft)	4880 to 5440	17.5 to 22.0	92 to 94	Descent	A, B and C
48,840 to 51,040	331.5 (aft) to 332.3 (aft)	4880 to 5200	26.0 to 27.0	74 88 and 110	Level	A, B and C
47,680 to 48,420	332.4 (aft) to 332.6 (aft)	5000 to 5520	25.5 to 26.5	94	Climb	A, B and C
48,220 to 49,380	331.5 (aft) to 331.9 (aft)	5400 to 5540	22.5	93 to 94	Descent	A, B and C

NOTE: A = Both systems on, B = System No. 2 on, C = Both systems off

ized in ball-centered flight at the desired trim airspeed and flight condition. The thrust control was held fixed while airspeed was varied ± 20 knots about trim in 5-knot increments. Representative test results are shown in figures 45 through 68, appendix E.

25. Dual AFCS static longitudinal stability, as indicated by the variation of longitudinal cyclic control position with airspeed, was positive (forward longitudinal cyclic control position at airspeeds greater than trim). There were some nonlinearities at airspeed variations greater than 10 knots from trim, but this did not degrade the helicopter handling qualities. Control force cues of longitudinal cyclic control displacement from trim were adequate. Static longitudinal stability characteristics were essentially the same during climb, descent and autorotation. The maximum variation of lateral cyclic control position and directional pedal control position with airspeed about trim were approximately 0.4 inches and presented no problems in control of the helicopter. Pitch attitude remained essentially unchanged from the trim value. Desired cruise airspeed was easily maintained within ± 2 knots indicated airspeed (KIAS) in smooth air with no pilot compensation (HORS 2). The dual AFCS static longitudinal stability characteristics are satisfactory.

26. Single AFCS static longitudinal stability was essentially neutral at approximately maximum endurance airspeed (73 KCAS) in level flight as airspeed was decreased from trim airspeed. Otherwise single AFCS static longitudinal stability was similar to dual AFCS static longitudinal stability. Maximum endurance airspeed was easily maintained within ± 3 KIAS with single AFCS by making small $\pm 1/4$ inch longitudinal cyclic control inputs approximately every 5 seconds (HORS 4). The single AFCS static longitudinal stability characteristics are acceptable for a degraded mode and are satisfactory.

27. AFCS off static longitudinal stability was negative at approximately maximum endurance airspeed (73 KCAS) and negative to neutral at cruise airspeed (129 KCAS). Maximum endurance airspeed could be maintained within ± 5 KIAS with AFCS off only with considerable effort by making large ($\pm 1/2$ inch) longitudinal cyclic control inputs approximately every 5 seconds (HORS 7). The helicopter was controllable with both AFCS off. The AFCS off static longitudinal stability characteristics are acceptable for a dual failure degraded mode.

Static Lateral-Directional Stability

28. Static lateral-directional stability characteristics were evaluated at the conditions listed in table 6. The helicopter

Table 6. Static Lateral-Directional Test Conditions

Gross Weight (lb)	Longitudinal Center of Gravity (FS)	Density Altitude (ft)	OAT (Deg C)	Trim Calibrated Airspeed (kt)	Flight Condition	AFCs ¹ Condition
38,680 to 39,980	312.5 (fwd) to 312.7 (fwd)	4640 to 5280	17.0 to 17.5	73 to 129	Level Climb Descent	A
				94		
40,560 to 42,540	318.3 (fwd) to 318.6 (fwd)	4780 to 5400	23.0 to 24.5	74 to 111 to 129	Level	A, B and C
38,840 to 40,140	318.6 (fwd) to 318.8 (fwd)	5060 to 5760	18.5 to 23.5	93 to 95	Climb	A, B and C
40,860 to 42,280	318.5 (fwd) to 318.7 (fwd)	5180 to 5380	18.5 to 19.5	94 to 95	Descent	A, B and C
39,780 to 40,980	346.3 (aft) to 347.2 (aft)	4700 to 5360	20.0 to 21.0	73 to 129	Level Climb Descent	A
				94		
41,080 to 42,980	336.9 (aft) to 338.0 (aft)	4620 to 5080	22.0 to 22.5	72 to 113 to 129	Level	A, B and C
39,940 to 42,140	337.5 (aft) to 338.9 (aft)	5140 to 6100	22.5 to 23.5	93 to 95	Climb	A, B and C
39,260 to 39,980	338.7 (aft) to 339.4 (aft)	5480 to 5640	23.0	93 to 95	Descent	A, B and C
47,200 to 50,400	331.0 (aft) to 332.0 (aft)	4700 to 5640	22.5 to 27.5	112 to 119	Level	A, B, C and D
				72 to 74		
47,820 to 48,920	331.7 (aft) to 332.0 (aft)	5160 to 5520	27.0 to 27.5	94 to 95	Climb	A, B and C

was stabilized in ball-centered flight at the desired trim airspeed and flight condition. The thrust control was held fixed and sideslip angle was varied in approximately 5-degree increments (left and right) while maintaining constant rotor speed and airspeed. Representative test results are shown in figures 69 through 93, appendix E.

29. Dual and single AFCS static lateral-directional stability characteristics were nearly identical. Static directional stability, as indicated by the variation of directional control position with sideslip angle, was positive (left pedal for right sideslip angles) and essentially linear. Directional control position variation with sideslip had nearly the same gradient for all dual and single AFCS forward flight conditions tested. Dihedral effect, as indicated by the variation of lateral cyclic control position with sideslip angle, was positive (left cyclic control for left sideslips) and essentially linear. The gradient of lateral cyclic control position with sideslip angle was primarily affected by airspeed. For a given sideslip angle, increased lateral cyclic control displacement from trim position was required as airspeed increased. Roll attitude variation with sideslip angle was minimal at best endurance airspeed. Sideforce cues in uncoordinated flight were not discernable at bank angles less than $\pm 3^\circ$, which equated to sideslip angles of approximately 15° left or right at 73 KCAS. The bank angle gradient with sideslip increased as airspeed or engine torque increased. Longitudinal cyclic control trim changes during steady heading sideslips were not objectionable and were characterized by a slight requirement for aft longitudinal cyclic control as sideslip was increased left or right. Directional control force was the first cue to the pilot of an out of trim condition. Sideforces were not a good cue to out-of-trim conditions except in high power climbs or high speed flight. However, pilot workload required to maintain coordinated flight with dual or single AFCS was quite low. The heading and bank angle hold features of the AFCS were disengaged during steady heading sideslip maneuvers because the lateral cyclic and directional pedals controls are out of the trim detent positions. During cruise flight, with the controls in the detent positions, the aircraft trim condition could be maintained within $\pm 3^\circ$ of heading or bank angle, and $\pm 1/2$ ball width with no pilot compensation (HORS 2). Dual and single AFCS static lateral-directional stability characteristics are satisfactory.

30. AFCS off static directional stability was essentially neutral in level flight (no directional pedal control position variation with sideslip angles) and was neutral to positive in climbs and neutral to negative in descents. AFCS off dihedral effect was

the same as during dual or single AFCS flight. The requirement for aft longitudinal control increased during AFCS off flight as left sideslip increased to a maximum of about 1.3 inches aft during partial power descents at 95 KCAS and 28° left sideslip. Some slight forward or aft longitudinal cyclic control was required for right sideslips with AFCS off. Roll attitude variation with sideslip angle was essentially the same as during AFCS on flight. The weak sideforce cues and lack of directional pedal control force cues in an out of trim condition greatly increased pilot workload during AFCS off flight, although aircraft control could be maintained. Extensive pilot effort was required to maintain coordinated forward flight within 1 ball width (HORS 7). AFCS off static lateral-directional stability characteristics are acceptable for a dual failure degraded mode.

Maneuvering Stability

31. Maneuvering stability was evaluated at 73 KCAS, approximately 50,000 pounds gross weight and mid cg by establishing the trim condition of level, coordinated flight and then incrementally increasing load factor by increasing bank angle while holding airspeed and thrust control position constant (fig. 94, app E). Maneuvering stability was also qualitatively evaluated during mission maneuvers and during pullups and pushovers. Maneuvering stability, as indicated by the variation of longitudinal cyclic control position with normal load factor was negative (forward cyclic control as normal load factor increased). Normal acceleration was easily controlled (± 0.1 g) during pull-up and push-over maneuvers. Airspeed in turns up to the maximum bank angles was easily maintained within ± 3 knots (HORS 3). The maneuvering stability characteristics did not degrade the mission capability of the CH-47D. The maneuvering stability characteristics are satisfactory for the CH-47D mission.

Dynamic Stability

32. Dynamic stability characteristics were evaluated at the conditions listed in table 7. The helicopter short-term response was investigated in all axes in forward flight and hover. Long-term response, lateral-directional dynamic characteristics, adverse yaw, and spiral stability were evaluated in forward flight. Representative time histories are shown in figures 95 through 103, appendix E.

Longitudinal Short Term Response:

33. Short-term response was evaluated in hover and forward flight by using mechanical fixtures to introduce longitudinal and

Table 7. Dynamic Stability Test Conditions¹

Average Gross Weight (lb)	Average Longitudinal Center of Gravity (FS)	Average Density Altitude (ft)	Average OAT (Deg C)	Calibrated Trim Airspeed (kt)	Flight Condition	Type Test ²
42,740	318.3 (FWD)	5,560	18.0	0	Hover	A
39,220	318.6 (FWD)	11,560	11.0	0	Hover	A
40,840	318.7 (FWD)	6,740	20.5	95	Climb Descent	A A
				75 130	Level Level	A & B A & B
42,960	337.1 (AFT)	5,520	15.0	0	Hover	A
40,880	338.3 (AFT)	11,340	4.0	0	Hover	A
40,200	347.0 (AFT)	5,900	25.5	95	Climb Descent	A A
				75 130	Level Level	A & B A & B
51,160	330.9 (MID)	3,780	24.0	0	Hover	A
48,740	331.7 (MID)	6,080	27.0	95	Climb Descent	A A
				75 130	Level Level	A & B A & B

NOTES:

¹AFCS both ON, both OFF and one system OFF.

²Type of Test: A = Longitudinal and directional pulse inputs, lateral doublet inputs; B = Longitudinal long-period stability and spiral stability tests.

directional control pulse inputs and lateral control doublet inputs. The flight controls were then held in the trim position until helicopter response was completely damped or recovery was necessary. Three axis coupled helicopter response was excited after control inputs in one axis and is discussed separately in paragraph 34. Helicopter short-term response was heavily damped and essentially deadbeat in pitch. A maximum of two overshoots were observed in roll and yaw. The helicopter returned to a trimmed attitude following the control input. The helicopter was easily maneuvered to a desired attitude, and exhibited adequate controllability. The dynamic short-term response characteristics are satisfactory.

Three Axis Oscillation:

34. The CH-47D exhibited a differential torque oscillation between the forward and aft rotor shafts which exceeded their endurance limit. The oscillation appeared in flight as a 3 axis corkscrew motion with a period of about 0.8 seconds. The three axis oscillation was driven by the pitch AFCS and was easily excited in light turbulence or in calm air with small abrupt cyclic inputs. The amplitude of the oscillation was greatest during high power maneuvers at light gross weight. The problem was documented early in the A&FC program and resulted in the test aircraft being bailed back to BV to conduct a flight test program designed to alleviate the structural problems with minimal handling qualities degradation. The aircraft was evaluated with modifications to the AFCS. The final configuration reduced the AFCS pitch rate gain from 10.3 to 8.9 inches of equivalent stick per radian per second and the pitch rate washout time constant from 0.050 seconds to 0.042 seconds. This new production AFCS configuration appeared to solve the structural problem although the oscillation still exists and significantly degrades the handling qualities, particularly in high power maneuvers at light gross weights. The typical response is lightly damped with 3 to 4 overshoots. The flight crew experiences lateral body motion which is quite uncomfortable even when experienced over a short duration. This three-axis oscillation is further discussed in a previous report (ref 16, app A). The easily excited three axis oscillation is a shortcoming.

Longitudinal Long Term Response:

35. The dual AFCS long-term response was evaluated in forward flight by displacing the longitudinal cyclic control to decelerate the helicopter 10 KIAS below trim airspeed, then returning the longitudinal cyclic control to the trim position. Helicopter response was essentially deadbeat. The helicopter returned to

the original trim airspeed in 30 to 60 seconds with no detectable overshoots. The dual AFCS long-term response characteristics are satisfactory.

Lateral-Directional Response:

36. Dual AFCS lateral-directional dynamic characteristics were evaluated following release from steady heading sideslips. Helicopter response was damped, with a maximum of two overshoots observed at 73 KCAS. Response at 127 KCAS was essentially deadbeat. The helicopter maintained the existing bank angle or heading when the controls were returned to the trim detent position and yaw and roll rates were less than 1.5 degrees per second. Except for the three axis oscillation motion noted in paragraph 34, no handling qualities problems were noted during flight in moderate turbulence. The lateral-directional dynamic characteristics are satisfactory.

37. Adverse yaw was evaluated during cyclic only turns. A slight amount of adverse yaw, approximately 1 degree opposite heading change, was detected during rapid entry cyclic only left or right turns. The adverse yaw was not noticeable to the pilot, and no directional pedal control input was required to bank the helicopter into a turn. The adverse yaw characteristics are satisfactory.

38. Spiral stability was evaluated in forward flight by establishing a left or right 5° bank angle with directional pedal control only, then returning the pedals to the original trim position. Spiral stability, as indicated by the tendency of the helicopter to return to a level roll attitude, was positive. The helicopter returned to a level roll attitude at approximately the same rate that the pedals were returned to the trim position. The spiral stability characteristics are satisfactory.

Single AFCS:

39. Single AFCS dynamic stability characteristics were essentially the same as dual AFCS, except that a pitch oscillation was noted at heavy gross weight, high speed, high altitude or high power forward flight. At approximately 50,000 pounds gross weight, 120 KTAS in level flight, or 75 KCAS during intermediate rated power (IRP) climb, a pitch oscillation was easily excited. The amplitude was ±1 to 2 degrees pitch attitude change with a 6 to 8 second period. Airspeed was maintained within ±2 KIAS with controls fixed. The pitch oscillation was lightly to neutrally damped, and was excited by a longitudinal pulse control input or by turbulence. The oscillation caused a slight increase in crew fatigue but did not significantly degrade the mission

capabilities of the helicopter. The single AFCS dynamic stability characteristics are satisfactory. The following note should be added to the operator's manual.

NOTE

During single AFCS operation at heavy gross weight and high speed, high altitude or high power, small pitch oscillations may occur and are normal.

AFCS Off:

40. AFCS off dynamic stability characteristics were evaluated in forward flight and hover. Helicopter responses to any control input were aperiodic and divergent in pitch and yaw. Helicopter control was difficult and required large control inputs (± 1 inch) every 5 seconds to maintain airspeed ± 10 KTAS and heading and sideslip ± 5 degrees (HORS 7). The AFCS off dynamic stability characteristics permitted safe flight and landing under VFR conditions, and were acceptable for a dual failure degraded mode. The AFCS off dynamic stability characteristics are satisfactory.

Ground Handling Characteristics

41. Taxiing with power steering required two pilots. One pilot operated the flight controls while the other pilot operated the wheel brakes and steering control knob. The steering control knob was spring loaded to the zero turn position and could not be released in turns. This prevented either pilot from performing other necessary tasks such as copying instrument clearances or tuning radios while the helicopter was being taxied. This problem was reported on previous model Chinooks (ref 12). The inability to ground taxi with power steering while performing other cockpit tasks is a shortcoming.

42. Ground handling characteristics were evaluated during four wheel taxi at gross weights ranging from 24,200 to 52,000 pounds. The aircraft was easy to maneuver using the power steering system. Reducing rotor speed to minimum heep was effective in preventing the aircraft from becoming light on the aft gear when operating at light gross weights. Excessive braking was required to maintain a normal taxi speed with the thrust control at the ground detent position. The taxi speed was controlled without excessive braking under these conditions by positioning the thrust control below the ground detent. The forward and aft rotor droop stops were instrumented to illuminate a caution light in the cockpit if

droop stop pounding was imminent (blade flapping within 1.5 degrees of droop stop contact). The impending droop stop contact caution light did not illuminate with the thrust control full down and the cyclic and pedals moved through their ground limit range. (0.75 inches right or left of neutral for directional pedals, 2 inches longitudinally aft and 1 inch laterally right or left of neutral for the cyclic). The four wheel taxi characteristics of the CH-47D are satisfactory. The operator's manual limitation "minimum thrust control position not below the ground detent during ground maneuvers" should be rewritten as follows "At light gross weights it may be necessary to lower the thrust control below the ground detent to maintain a reasonable taxi speed".

43. The two wheel taxi characteristics were also evaluated at 25,500 pounds and 35,500 pounds gross weight. Fixed longitudinal cyclic positions from 1/2 inch to 2 inches aft were used to place weight on the aft gear while thrust control was varied to control pitch attitude and forward or rearward taxi speed. One inch aft cyclic appeared to be the optimum longitudinal control position while performing two wheel taxi. The longitudinal cyclic trim (LCT) actuators programmed from GND position to fully retracted as the thrust control position was changed or wind gusts affected the aircraft causing it to become light on the aft gear. This caused uncommanded pitch changes of ± 3 degrees and required continuous thrust control inputs to maintain the pitch attitude within ± 1 degree and a constant taxi speed (HORS 6). Manually positioning the LCT's to the ground position reduced the amplitude of the uncommanded pitch changes approximately 50% making the two-wheel taxi task slightly less difficult (HORS 5). The uncommanded pitch changes were further reduced by selecting single AFCS. Proximity switches (squat switches) located on both of the aft landing gear were activated when weight was on the gear causing the AFCS pitch gain to be reduced by half and the LCT actuators to program to the GND position. The No. 1 AFCS was controlled by the proximity switch on the left aft gear and the No. 2 AFCS was independently controlled by the proximity switch on the right aft gear. Either proximity switch controlled both forward and aft LCT actuators. In crosswind, the uncommanded pitch changes were reduced only when the AFCS corresponding to the downwind side was selected. With sufficient weight on either aft gear, the proximity switch on that gear closed reducing the pitch gain of the respective AFCS to half of the inflight pitch gain. The upwind gear proximity switch appeared to be more susceptible to cycling (opening and closing) because the weight on that gear was less than the downwind gear. This caused the upwind side AFCS pitch gain to cycle from full to half which may induce some of the uncommanded pitch changes. The uncommanded pitch oscillations during two wheel taxi is a shortcoming. Due to

the complexity of determining which AFCS should be disabled while performing the two wheel taxi with constantly changing relative wind directions during turns, this procedure should not be used to reduce the pitch instability. The LCT's should be placed in MANUAL and programmed to the GND position while performing two wheel taxi if pitch oscillations are encountered.

Takeoff and Landing Characteristics

44. Takeoff and landing characteristics were evaluated throughout the A&FC tests. Vertical takeoffs to a hover and to forward flight, vertical landings from a hover, and rolling takeoffs and run-on landings were performed. The aircraft was stable during all the takeoff maneuvers and landings from a hover with no unusual flight characteristics. The run-on landing handling qualities were acceptable, although pilot workload increased during the ground roll termination phase. The running landings were performed with the longitudinal cyclic positioned as necessary to establish the appropriate deceleration and landing attitude. The aircraft pitch attitude was easier to control using approximately one inch aft cyclic during the ground roll phase of the landing. After touchdown on the aft gear the landing roll was aerodynamically slowed to a stop by applying thrust and maintaining approximately a 10° nose high pitch attitude. Pitch oscillations of ±1 degree occurred while slowing to a stop as the weight on the aft gear caused the proximity switches to open and close thus extending and retracting the LCT actuators (paragraph 43). Although this pitching characteristic after touchdown in a running landing increased the pilot workload it was of short duration and the aircraft was easy to transition from two wheel to four wheel taxi. The takeoff and landing characteristics of the CH-47D are satisfactory.

Slope Operation Characteristics

45. Slope operation characteristics were qualitatively evaluated at approximately 31,000 pounds gross weight in winds less than 5 knots. Aircraft attitude while on the slope was determined from the production attitude indicator. Aircraft attitude was 8° for nose-up or nose-down slope and 13° for cross slope operations. The AFCS CYCLIC TRIM was set to AUTO, and the parking brake was set. Slope landing techniques used were described in the operator's manual (ref 7). Nose up-slope landings and takeoffs were easily performed with no sliding of the landing gear after touchdown and required a forward cyclic control input of about 1/2 inch coordinated with thrust control application to lower or raise the aft gear (HORS 3). Nose downslope landing and takeoff required an aft cyclic control input of about 1 inch and more

positive thrust control application when lowering or raising the forward gear to prevent the helicopter from sliding downslope (HORS 4). The LCT cycling between ground and retract position caused pitch attitude oscillations during cross slope landings and takeoffs when both aft gear were on the ground. Cross slope landings and takeoffs with no pitch attitude oscillations were performed by coordinating one inch aft cyclic input with thrust control application after both aft gear were on the ground (HORS 4). No ground resonance tendencies were encountered during slope operations. Droop stop pounding was momentarily encountered during a cross slope landing, but was eliminated after the flight controls were repositioned. The slope landing characteristics are satisfactory.

Power Management

46. The engine governing characteristics were evaluated in hover and forward flight. Pilot qualitative comments were made using the aircraft's production rotor speed indicator. Representative time histories of transient and static rotor speed variations during power changes are presented in figures 104 through 107. Typical transient rotor speed droop characteristics during a vertical takeoff to a 10 foot hover at 35,090 pounds gross weight are shown in figures 93 and 94. Using a typical thrust application rate (ground detent position to the thrust position required for a stabilized hover in 4 seconds) resulted in a rotor speed transient droop of 7 rpm. A 2.5 second thrust application time increased the transient droop to 15 rpm. Similar transient rotor speed droop occurs during termination of an approach to a hover and recovery from low power/high rates of descent.

47. A normal rate thrust increase from 40 to 90 percent dual engine torque in forward flight at a constant airspeed (fig. 106) resulted in a rotor speed static droop of 2 rpm. A corresponding thrust decrease (fig. 107) produced a 2 rpm static increase.

48. Engine governing was also evaluated by performing accelerations and decelerations from 30 to 140 KIAS with a constant thrust setting. A static one rpm increase in rotor speed occurred for every 30 knots increase in airspeed; likewise, during the deceleration a one rpm decrease occurred per 30 knot decrease in airspeed. During a typical takeoff, as thrust was increased and takeoff acceleration began, rotor speed was readjusted to recover from static and transient droop. As the aircraft accelerated the rotor speed increased above 100 percent and had to be reduced if the rotor speed was allowed to increase more than 1 percent (2.5 rpm) the vibration levels increase significantly. The rotor speed was usually adjusted 3 to 4 times during this

maneuver. Engine torque splits reported in reference 1, appendix A were observed but were of less magnitude than previously noted. Pilot workload in nearly all flight regimes was significantly increased because of the poor engine speed governing system. The poor engine governing system which allows large rotor speed excursions with changes in power setting or airspeed is a shortcoming.

Mission Maneuvering Characteristics

49. Mission maneuvers performed included internal and external loads, and terrain flight. The maneuvers are described in the Cargo Helicopter Aircrew Training Manual (ref 13). Loads consisted of internal lead ballast, 4000 pound and 19,000 pound tandem rigged external loads. With the helicopter oriented into the wind, desired altitude and position over the load were easily maintained within ± 1 foot with minimal control inputs (HORS 3) allowing for rapid load hookup. An initial tendency to enter a low amplitude ($\pm 2^\circ$ roll attitude) lateral PIO was easily compensated for by releasing the centering device release switch on the cyclic grip to engage attitude hold. Pilot workload increased slightly during hookup in a gusty 15 knot right crosswind. Frequent, small ($\pm 1/4$ inch) cyclic and thrust control inputs were required to maintain precise hover altitude and positions (± 1 foot) (HORS 5). The radar altitude hold mode of the AFCS was not used. Crewmember interphone transmissions frequently prevented the copilot from monitoring outside radio calls during hookup because of the inability to disable the ICS (para 81). Lateral-directional oscillations during high power climbs and accelerations were easily excited by turbulence (para 34). The oscillations were uncomfortable, increased pilot workload, but did not degrade external load stability. Poor power management characteristics significantly increased pilot workload during terrain flight maneuvers (paras 46 through 48). No other handling qualities or load stabilization problems were encountered during these tests. The cruise guide indicator (CGI) was an excellent pilot reference when approaching high rotor system loads. The mean CGI value increased at extreme aft cg, or as gross weight, density altitude, airspeed, turbulence, maneuver severity, or normal acceleration increased. Except as indicated above, the mission maneuvering characteristics of the CH-47D are satisfactory.

Aircraft System Failures

Simulated Single Engine Failures:

50. Simulated single engine failures were evaluated at 47,400 pounds average gross weight at 75 and 120 KCAS in level

flight. Representative time histories are presented in figures 108 and 109. The engine failure was simulated by moving one engine condition lever from the "FLIGHT" to the "GROUND" position and delaying for a specified time prior to lowering the thrust control. A simulated engine failure at 73 KCAS in level flight resulted in rotor speed decaying to 211 rpm (94%) using a 2 second delay. At 120 KCAS the rotor rpm decayed to 213 rpm (95%) using a 1 second delay. The simulated engine failures were easily detected by change in engine and transmission noise, split in engine torques, and decreased rotor rpm. No unusual attitude changes or control forces were observed during the simulated engine failures and subsequent transition to partial power descent. The single engine failure characteristics of the CH-47D are satisfactory.

Advanced Flight Control System Failure:

51. AFCS failures were evaluated at the conditions listed in table 7. The AFCS failures were simulated using an AFCS pulser/failure box provided by BV. The helicopter was stabilized at the desired trim condition, the failure introduced, and recovery initiated when aircraft rates were completely damped or became excessive. The failures were introduced to a single AFCS system while operating dual AFCS. Representative time histories are shown in figures 110 through 116.

52. AFCS Actuator: AFCS actuator failures caused one AFCS actuator of the integrated lower control actuator (ILCA) to extend to full authority. Pitch AFCS actuator failures caused a 2 to 4 degree pitch attitude change in one second, then a return to trim attitude about three seconds after the failure. Maximum pitch rate was about 3 degrees per second. Roll AFCS actuator failure resulted in up to a 12° roll attitude change about 4 seconds after failure, then a return toward trimmed attitude. Maximum roll rate was about 4 degrees per second. Yaw AFCS actuator failures produced a left or right yaw. Aircraft response to yaw AFCS actuator failure was not repeatable between the two AFCS systems. A typical response was a slowly divergent yaw attitude change with 20° heading change 5 seconds after failure at 72 KCAS. Maximum rate was approximately 8 deg/sec. All AFCS actuator failures either produced very little aircraft attitude change or provided the pilot with adequate warning of the failure and allowed for adequate time, over 3 seconds, before recovery was necessary. The ILCA AFCS actuator failure characteristics are satisfactory.

53. Collective Cockpit Control Driver Actuator (CCDA) Failure: The Collective CCDA moves the cockpit thrust control, when barometric or radar altitude hold is engaged, to maintain altitude.

After the failure was introduced, the thrust control moved up or down from trim at a constant rate of about 0.75 inch per second. The CH-47D does not incorporate an engine overtemperature or transmission overtorque protection system; therefore a CCDA "up" failure may cause an overtemperature or overtorque if not recognized in time by the pilot. Dual engine torque (DEQ) increased at a rate of 20% DEQ per second with 0.8 second time delay after an "up" failure. During cruise flight at 129 KCAS, 41,060 pounds gross weight, 5520 feet density altitude, and 63% DEQ, recovery was initiated 1.6 seconds after failure because of excessive DEQ rate increase. The DEQ increase was the primary pilot warning of collective CCDA "up" failure unless the pilot had his hand on the thrust control to detect the upward movement. At the flight conditions stated above the DEQ transmission torque limit would be exceeded in an estimated 2.8 seconds after failure, or 2.0 seconds after initial warning to the pilot. The excessive rate of dual engine torque increase after collective CCDA failure is a shortcoming.

54. Differential Airspeed Hold (DASH) Actuator Failure: DASH actuator failure caused one section of the DASH actuator to extend or retract at the velocity limit of approximately 0.25 inches equivalent longitudinal stick per second. Aircraft response was nose up or nose down pitch attitude change that either damped to zero pitch rate in about 2 seconds after 5 to 7 degree pitch attitude change, or was divergent at constant pitch acceleration of up to 2.5 deg/sec^2 . The divergent response was uncomfortable because pitch rate continued to increase throughout the maneuver to an estimated 7 deg/sec pitch rate and 12 deg pitch attitude change three seconds after failure. Recovery was easily performed, however, by making a longitudinal cyclic input. Control margins were adequate and no aircraft limitations were exceeded. The DASH actuator failure characteristics are satisfactory.

55. Vertical Gyro Failure: One vertical gyro was failed separately in pitch and roll. Aircraft response to roll failures was similar to the roll AFCS actuators failures. Pitch failure responses were essentially identical to DASH actuator failures, except that rates were approximately 4 deg/sec one second after failure due to AFCS ILCA actuator hardover. Rates then dropped and were essentially the same values as during DASH failures. The initial higher rates were perceived as a slight jolt by the pilots and provided a better warning of the failure without significantly increasing pitch attitude change 3 seconds after failure, when compared to the DASH failures. The Vertical Gyro failure characteristics are satisfactory.

VIBRATIONS

56. Vibrations in the cockpit and cabin areas were evaluated throughout the conduct of the A&FC with a heavy instrumentation package and the BV universal ballast system installed. After all other tests were completed, the aircraft was returned to a production configuration and flights were flown to check compliance with the requirements of the Acceptance Test Procedure (ATP), (ref 14) and of the PIDS, (ref 6). Data were measured by accelerometers and processed by the fast Fourier transform (FFT) method and by the Vibration Amplitude and Direction Indicator (VADI). Appendix D further explains these methods. The VADI was the only processing method available after the instrumentation package had been removed.

57. Figures 117 through 130, appendix E present data processed by the FFT method. Figures 131 through 133 show a comparison of data processed by the two processing methods. Figures 134 through 137 present data processed by the VADI. All the tables also present the pilot's assessment of the cockpit vibration levels expressed as numbers on a rating scale (see appendix D). Table 8 presents the ATP limits.

58. Vertical vibrations at 3/rev and 6/rev in the aircraft cabin increased with airspeed above 110 KCAS (figs. 117 through 121, app E). These vibrations were quite high at typical cruise airspeeds and above. Cockpit vibration levels did not increase as rapidly with airspeed but they did become objectionable at approximately 140 KCAS. The level of cockpit vibrations at cruise airspeed and above is a shortcoming.

59. During A&FC testing, a comparison of the BV VADI to the USAAEFA data system and method of reduction was made. Figures 131, 132, and 133 present data from each system in level flight, climbs, and descents, respectively. The data were gathered at a gross weight approximating that required for the vibration guarantee by the PIDS (ref 6). The USAAEFA data are labeled FFT because of the method of data reduction used. This method results in an average value of the vibration acceleration at each frequency of interest. The VADI system measures acceleration and presents the information in terms of acceleration at frequencies of interest also. However, there are two differences between the VADI and the FFT. One is that the VADI data does not represent an average acceleration but rather the 85 percentile value of the peak acceleration over 20 rotor cycles. The other difference is that the VADI information is presented in percent of the limit specified for that location/direction in the ATP (ref 14). There is little difference between the results from the two

Table 8. Vibration Limits¹

Transducer Location		Transducer Direction	Frequency	ATP ² Limits (g)	PIDS ³ Limits (g)
FS	BL				
50	33 RT	Vertical	1/Rev	0.07	---
50	33 RT	Vertical	3/Rev	0.25	---
95	0	Lateral	3/Rev	0.15	0.20
320	44 LT	Vertical	3/Rev	0.50	---
320	25 LT	Vertical	3/Rev	---	0.20

NOTES:

¹True airspeed = 150 knots

²See reference 14, Appendix A for aircraft configuration

³See reference 6, Appendix A for aircraft configuration

systems. The data in figures 131 through 133 were gathered in very smooth air. The difference between the two systems may increase as the level of turbulence increases.

60. The data in figures 117 through 133 were gathered with the aircraft in a test configuration which may not be representative of CH-47D aircraft in the field. Large, heavy ballast and instrumentation systems were installed which may change the vibration characteristics of the aircraft. However, the comparison of the data systems is valid.

61. The purpose of the ATP is to allow checking of the vibration levels in each production aircraft during the Army acceptance flights without the extensive ballasting which would be required to configure the aircraft as required by the PIDS vibration guarantee. If the aircraft meets the requirements of the ATP, it is assumed that it would also meet the PIDS requirements. In order to see if that assumption is valid, flights were flown in both the ATP and the PIDS configurations. The ballast system and large instrumentation package were removed prior to these flights. The vibration comparison is made on the basis of VADI data only.

62. Figures 134 and 135 present data gathered in level flight at the two configurations. There is little difference in pilot ratings between the configurations, although the data from the heavier PIDS configuration is approximately 10 percentage points higher than the ATP configuration data. Although the CH-47D aircraft met the vibration requirements of the ATP and PIDS configurations at 150 KTAS, the vibration levels at the pilot's station were objectionable and are a shortcoming (see para 58).

63. Figures 136 and 137 present data gathered in descents in the two configurations. The ATP contains no requirements for checking vibration levels in climbs or descents although the PIDS does. The vibration levels in the ATP configuration are higher than in the PIDS configuration in descents.

INSTRUMENT METEOROLOGICAL CONDITIONS (IMC) FLIGHT EVALUATION

64. The IMC evaluation was conducted during ferry flights and approximately 3.8 hours of weather instrument time were flown, including 1 hour in light icing conditions. Procedures used were in accordance with the Operator's Manual (ref 7) and appropriate publications. Generally the CH-47D performed well in IMC with reduced pilot workload when compared to previous model CH-47 aircraft. All instrument tasks could easily be performed to the standards listed in the Aircrew Training Manual (ref 13).

No unusual performance or flying qualities characteristics were noted during IMC flight.

65. The AFCS heading select capability reduced pilot workload and allowed for very accurate course tracking. This was especially apparent when small (2 to 5 degrees), precise heading changes were required such as during instrument landing system (ILS) final approach. The AFCS heading select capability is an enhancing characteristic.

66. The position/nomenclature of the number 1 and number 2 VHF AM/FM Radio Sets (AN/ARC-186) was confusing and increased pilot workload. The confusion arose because the radio sets did not conform to the conventional arrangement of locating the number 1 system on the left and the number 2 system on the right. The number 1 set, located on the right (number 2) side of the console, and connected to the number 1 transmit-receive switches on the interphone control, was easily confused with the number 2 set located on the left (number 1) side of the console which was connected to the number 3 transmit-receive switches. This installation was not as described in the Operator's Manual. This resulted in several occasions of transmitting on the wrong radio, increasing workload for both the pilots and Air Traffic Control (ATC). The unconventional position/nomenclature of the VHF AM/FM Radio Sets is a shortcoming.

67. The Course Deviation Indicator (CDI) of the non-command selected Horizontal Situation Indicator (HSI) was slaved to the course that was set on the command selected HSI in the VOR mode. The copilot, who normally performed navigation duties, was frequently presented with an on-course or off-course indication that did not correspond with the course set on his HSI, or had to take HSI command and disengage heading select. The lack of independent Course Deviation Indicators for each pilot is a shortcoming.

68. Shortcomings observed during other tests which degraded the IMC capability are discussed in other paragraphs and listed below:

- a. The lack of an ICS disable feature (para 83). Crewmember ICS transmissions frequently blocked ATC radio transmissions.
- b. Three-axis oscillations in turbulence (para 34).
- c. The lack of a disable feature for barometric altitude hold mode of the AFCS on the flight control grips (para 86).
- d. Engine torque oscillations in turbulence with BAROALT hold engaged (para 87).

e. Pilot's restricted field-of-view of the turn needle (para 79).

f. Lack of doppler nautical miles per hour groundspeed read-out (para 88).

COCKPIT AND CABIN EVALUATION

General

69. The cockpit and cabin were qualitatively evaluated throughout the test program. The presence of test instrumentation and equipment was considered during the assessment. A night evaluation was not conducted because the test aircraft was not night vision goggle compatible and thus not representative of production CH-47D helicopters. Cockpit arrangement, field-of-view comfort, normal procedures, mission equipment storage space, and readability of gages and notations were satisfactory except as discussed in the following paragraphs.

Ingress/Egress

70. Normal and emergency ingress/egress were evaluated with the engines and rotors static. Normal ingress/egress was degraded slightly from previous model CH-47 helicopters because of the reduced clearance between the overhead switch panel and the center console, but normal ingress/egress provisions were still adequate. The exterior and interior cockpit emergency door jettison handles required 29 pounds of force to operate for emergency egress, as measured 1 inch from the end of the handle. Normal and emergency ingress and egress were satisfactory.

Cockpit Seats

71. The production CH-47D was equipped with the same model pilot/copilot seats as the CH-47C. During long flights, it was found that the seats became very uncomfortable due to "hot spots" and a lack of seat ventilation. The "hot spots" were probably induced by the physical shape of the seat cushions which reduced the normal blood circulation of the body. The discomfort caused by the pilot/copilot seats in the CH-47D is a shortcoming.

Cockpit Leaks

72. Water leaking from the forward pylon area through the overhead switch panel and onto the console was noted during flight through a rain shower, as previously documented (ref 4). The

electrical switches, lights, and engine condition levers were susceptible to short circuits when operating in this environment, and pilot comfort was reduced. The water leaking into the cockpit during flight through rain is a shortcoming.

Caution Panel

73. The light intensity of the caution panel segment legends, when illuminated, was insufficient when exposed to direct sunlight. This made it difficult to determine which caution segments were illuminated and would delay the pilot's reaction to emergency conditions. The lack of readily discernible caution panel segment light in bright sunlight is a shortcoming.

Cargo Loading

74. The cargo compartment and ramp floor described in the Operator's Manual had no provisions (e.g. integral rollers in the floor) for the easy loading and unloading of palletized cargo or bulky, heavy items. A primary mission of the CH-47 is the internal transport of large (approximately 3000 pounds) warhead sections. The warheads are loaded and unloaded by the use of conveyer type steel rollers. Loading takes approximately 30 minutes (ref 15). Other items of bulky cargo must be winched or manhandled onboard. If integral rollers were provided in the cargo compartment and ramp floor, cargo could be loaded and unloaded from the ramp by a forklift, greatly expediting the mission. The lack of provisions for the easy loading and unloading of internal cargo is a shortcoming.

Crew Restraint

75. The armament subsystem M24, described in the Operator's Manual includes M60D machine guns mounted in the cabin door and the cabin escape hatch. The two gunners must stand behind the machine guns during all phases of nap-of-the-earth flight in combat in order to provide suppressive fires. They must also be in good position to view the rotor blades to insure that adequate clearance is maintained. No crew seats were provided to reduce crew fatigue and to provide personnel restraint in the event of a hard landing or crash. The lack of gunner seats is a shortcoming.

Longitudinal Stick Position Indicator

76. The longitudinal stick position indicator is mounted on the right side of the center console and is used by the pilot primarily to monitor longitudinal stick position during ground maneuvers. The indicator consists of a plastic tube etched with

numbers corresponding to inches and a red plastic slider which moves inside the plastic tube. The tip of the slider indicates the longitudinal position of the cyclic. The tube is not protected from contact by the pilot's foot during ingress or egress and is therefore subject to damage. The susceptibility of the longitudinal stick position indicator to damage is a shortcoming.

77. The plastic slider incorporates a red light installed at the tip and the plastic tube has a red light at the lower end for illumination at night. During night flight operations with the cockpit lighting on, the light at the end of the slider and at the lower end of the plastic tube produces a glare within the tube causing the numbers to be unreadable. This renders the indicator virtually unuseable at night. The lack of readability of the longitudinal stick position indicator at night is a shortcoming.

78. The longitudinal stick position indicator is monitored during the flight control travel and hydraulics check to assure that the proper range of longitudinal stick travel exists. The forward 2 1/2 inches of the indicator is blocked from the pilot's view by the cockpit air control handle bracket. The obstructed field-of-view of the forward end of the longitudinal stick position indicator is a shortcoming.

Pilot's Turn and Slip Indicator

79. The pilot's turn and slip indicator is located on the lower right side of the pilot's instrument panel. The housing for the indicator lights are located at the top of the indicator. This housing extends over the face of the indicator blocking the top of the turn needle and the rate of turn symbols from the pilot's view. The pilot is, therefore, unable to determine the aircraft's turn rate which is required during instrument tasks such as holding and approach. The pilot's restricted field-of-view of the turn and slip indicator is a shortcoming.

SUBSYSTEMS TESTS

Pitot-Static System

80. The swiveling head pitot-static boom and standard ship air-speed system were calibrated in level flight using the methods described in appendix D. Additionally, the ship's system was calibrated in climbs and descents using the boom airspeed system as a reference. Checks were also made of the system with bubble windows installed in the second round window opening on each

side of the aircraft (just ahead of the ship's static ports). The boom system was also used as a reference for this calibration. The airspeed calibration data are presented in figures 138 through 140, appendix E.

81. The ship's system airspeed calibration presented in the Operator's Manual was confirmed during the A&FC for airspeeds greater than 70 KIAS. At less than 70 KIAS the position error is greater than that presented in the operator's manual (maximum difference is 4.5 knots at 40 KIAS).

82. The ship's airspeed system has a larger position error when bubble windows are installed just forward of the static ports (see fig. 140, app E). The increased error results in a decrease in indicated airspeed, which could cause the pilot to fly beyond the airspeed limits without realizing it. Altitude errors could not be calculated from the airspeed error because the ship pitot-static system has errors in both total and static pressure measurements. Ship's system indicated airspeed fluctuated ± 5 KIAS with a 2 second period at 70 KCAS in a 2000 fpm climb, and the ship's system altimeter indication fluctuated ± 100 feet with a one second period in a 2000 fpm descent at 70 KCAS. The ship's system vertical speed indicator also fluctuated during partial power descents. IMC flight under these conditions could be hazardous. Because of the adverse effect on the pitot-static system, bubble windows should not be installed in the openings just forward of the static ports.

Interphone System

83. The production CH-47D was equipped with a C-6533/ARC intercommunication control panel (ICP). Because the ICP has no intercom ON/OFF switch, the pilots had to monitor the aircraft intercom at all times. This led to extreme communication problems whenever one pilot had to converse with other members of the flight crew and the other pilot was utilizing the aircraft radios. Several times during the evaluation, radio transmissions from air traffic control were missed or misunderstood because intercom could not be shut off. The lack of an aircraft intercom ON/OFF capability is a shortcoming.

Cargo Hook System

84. The cargo hook system was evaluated with a 20,000 pound load rigged in tandem to the fore and aft cargo hooks and redundant slings to the center hook. The field-of-view from the normal crew chief position of both the fore and aft hooks was poor, as reported previously (ref 1), and could lead to fuselage/load

contact during load hook-up. The poor visibility of the fore and aft cargo hooks during tandem rigged load operations remains a shortcoming.

85. The helicopter had no provisions to directly measure the weight of external loads. External load weight frequently is not known, even by the supported ground unit. Load weight must be known by the pilot for accurate performance planning. This is especially important when conditions are different at the takeoff and landing zones (e.g., landing zone is at a higher altitude than the takeoff zone). The lack of an external load weight measuring system is a shortcoming.

Advanced Flight Control System (AFCS) Altitude Hold

86. The CH-47D AFCS incorporates a barometric (BAROALT) and radar altitude (RADALT) hold feature which can be engaged by the pilot to maintain altitude. Radar altitude hold may be used only during hover operations and barometric altitude hold may be used during forward flight. The desired altitude hold function is activated by depressing the BAROALT ENGAGED or RADALT ENGAGED switch located on the right side of the center console. The systems operate through the No. 1 AFCS computer and sense changes in static air pressure or radar altitude deviations which correspond to altitude changes. Changes in pressure or radar signal produce an error signal which is processed by the AFCS and applied to the CCDA. This actuator drives the thrust control in the direction necessary to null the error signal thereby maintaining a constant pressure or radar altitude depending on which altitude hold function is engaged (BAROALT or RADALT). The CCDA has 100% authority in the thrust axis. The thrust control brake trigger switch on the thrust control rod when depressed places the altitude hold function in a synchronization mode allowing the pilot to change altitude with the thrust control rod. When the thrust control rod trigger is released, the aircraft current pressure or radar altitude is captured and becomes reference altitude for AFCS error signals to maintain that altitude. The pilot must remove his hand from the thrust control rod while reaching for the BARO ALT or RAD ALT switch or request the copilot's assistance when engaging or disengaging the barometric or radar altitude function since the switches are located on the center console. If the pilot elects to disengage the barometric altitude hold function after initiating a descent, he must release the thrust control (thrust control rod trigger) which causes the thrust control to increase attempting to arrest the rate of descent and maintain the altitude at which the thrust control rod trigger was released. The requirement to disengage barometric altitude hold frequently occurs during a descent for approach when the

copilot is making radio calls. The copilot may, therefore, be unable to hear the pilot's request to disengage the barometric altitude hold feature. The requirement for the pilot to release the thrust control or request copilot's assistance to engage or disengage the barometric altitude or radar altitude hold feature is a shortcoming. The barometric altitude and radar altitude engage and disengaged switches should be relocated such that these features may be engaged and disengaged by the pilot without releasing the flight controls.

87. The barometric altitude hold function significantly reduces pilot workload but appears too sensitive to small barometric pressure changes. Two percent engine torque fluctuations occur during level flight in extremely smooth air conditions and altitude is maintained within ± 10 feet. In light turbulence as much as a 10 percent fluctuation were observed. Normal piloting technique to maintain altitude with the BAROALT hold off is to allow altitude variations of ± 50 feet using infrequent small thrust control changes. The system would be adequate if modified to allow greater altitude variation and to minimize the engine torque fluctuations. The engine torque fluctuations in smooth air with the barometric altitude hold feature engaged is a shortcoming.

Doppler Navigation Set

88. During the cockpit evaluation of the Doppler Navigation Set (AN/ASN-128) it was noted that the present doppler configuration only displays distances and ground speeds in kilometers and kilometers/hour respectively. As a result, the pilots must convert distance and ground speed into nautical miles and knots to make the doppler information compatible with sectional aeronautical charts, FLIP manuals and the airspeed indicators. The inability of the Doppler Navigation Set (AN/ASN-128) to display distances and ground speed in units of nautical miles is a shortcoming.

In Flight Engine Starts

89. In flight engine starts were performed on both engines independently at 87 KCAS, and 5000 feet and 10,000 feet density altitude. The desired engine was shut down, power turbine inlet temperature (PTIT) allowed to cool to approximately 150°C , then the engine was restarted using checklist procedures. Hydraulic power was supplied to the respective engine start motor by the transmission mounted utility hydraulic pump. All engine parameters remained within allowable limits during the start sequences. The gas producer speed took slightly longer to reach 10% N_1

speed than during auxiliary power unit (APU) starts, but this was not objectionable. During all engine starts, the engine speed was stabilized at ground idle prior to 45 seconds after the start was initiated. The highest transient PTIT was 700°C when the start switch was selected from START to MOTOR at 400°C. Otherwise, the transient PTIT remained below 600°C, when the start switch was moved from start to motor at 350°C. The inflight engine start characteristics are satisfactory.

Pressure Refueling System

90. The pressure refueling capability allowed for extremely short refueling times at civilian and USAF airfields during cross country flights. Servicing was often completed in ten minutes as compared to a nominal 20 to 30 minute required for single hose, open port refueling. This reduced crewmember exposure time in inclement weather and increased safety and mission capability. The pressure refueling capability is an enhancing characteristic.

CONCLUSIONS

GENERAL

91. The following conclusions were reached upon completion of the CH-47D A&FC:

a. No deficiencies and 25 shortcomings were identified.

b. The CH-47D exceeded the following PIDS performance guarantees:

(1) OGE hover performance at maximum continuous power at sea level, standard day conditions, is 53,950 pounds, which exceeds the 50,000 pound guarantee by 7.9%.

(2) Maximum airspeed in level flight at 33,000 pounds at sea level, standard day conditions, using maximum continuous power is 162.5 knots, true airspeed, which exceeds the 150-knot guarantee by 8.3%.

(3) Mission III performance profile can be accomplished with fuel reserves in excess of that required by the PIDS.

ENHANCING CHARACTERISTICS

92. The AFCS heading select capability is an enhancing characteristic (para 65).

93. The pressure refueling capability is an enhancing characteristic (para 90).

SHORTCOMINGS

94. The following shortcomings (as defined in app D) were identified and are listed in order of importance:

a. The poor engine governing system which allows large rotor speed excursions with change in power setting or airspeed (paras 46, 47, and 48).

b. The high level of cockpit vibrations at and above cruise airspeed (para 58).

c. The easily excited three axis aircraft oscillation (para 34).

d. The lack of an aircraft intercom ON/OFF capability (para 83).

- e. The excessive rate of engine torque increase after collective CCDA failure (para 53).
- f. The requirement for the pilot to release the thrust control or request copilot's assistance to engage or disengage the barometric or radar altitude hold feature (para 86).
- g. The lack of provisions for the easy loading and unloading of internal cargo (para 74).
- h. The uncommanded pitch oscillations during two wheel taxi (para 43).
- i. The unconventional position/nomenclature of the VHF AM/FM radio sets (para 66).
- j. The engine torque fluctuations in smooth air with barometric altitude hold feature engaged (para 87).
- k. The lack of independent Course Deviation Indicators for each pilot (para 67).
- l. The restricted field-of-view from the crew chief position of the fore and aft cargo hooks during tandem rigged load operations (para 84).
- m. The lack of gunner seats for the M24 armament subsystem (para 75).
- n. Water leaking into the cockpit during flight in rain (para 72).
- o. The inability to ground taxi with power steering while performing other cockpit tasks (para 41).
- p. The pilot's restricted field-of-view of the turn and slip indicator (para 79).
- q. The lack of an external load weight measuring system (para 84).
- r. The inability of the Doppler Navigation Set to display distance and ground speeds in units of nautical miles (para 88).
- s. The lack of readability of the longitudinal stick position indicator at night (para 77).
- t. The lack of readily discernable caution panel segment lights in bright sunlight (para 73).

u. The susceptibility of the longitudinal stick position indicator to damage (para 76).

v. The obstructed field-of-view of the forward end of the longitudinal stick position indicator (para 78).

w. The uncomfortable pilot/copilot seats (para 71).

RECOMMENDATIONS

95. The shortcomings listed in paragraph 94 should be corrected as soon as practicable.
96. The barometric altitude and radar altitude engage and disengage switches should be relocated such that these features may be engaged or disengaged by the pilot without releasing the flight control (para 86).
97. The operator's manual (paras 8-27, ref 7, app A) should be changed to eliminate the sentence which reads "This amount of thrust and moderate braking will maintain a reasonable taxi speed". The sentence should be replaced by the following sentence: "At light gross weights, it may be necessary to lower the thrust control rod below the ground detent to maintain a reasonable taxi speed" (para 42).
98. The following sentence should be added to paragraph 8-28 of the operator's manual (ref 7): "The longitudinal cyclic speed trim actuators should be placed in MANUAL mode and programmed to the GRD detent during two wheel taxi" if pitch oscillations are encountered (para 43).
99. The following note should be added to the operator's manual (para 34).

NOTE

During single AFCS operation at heavy gross weight and high speed, high altitude or high power, small pitch oscillations may occur and are normal.

100. Bubble windows should not be installed in the openings just forward of the static air pressure ports (para 82).

APPENDIX A. REFERENCES

1. Final Report, USAAEFA Project No. 79-06, *Preliminary Airworthiness Evaluation (PAE 1) of the YCH-47D Helicopter*, May 1980.
2. Letter, USAAEFA, DAVTE-TI, 31 July 1980, subject: Letter Report, Preliminary Airworthiness Evaluation (PAE) II of the YCH-47D with Modified Advanced Flight Control System (AFCS), USAAEFA Project No. 80-05.
3. Final Report, USAAEFA Project No. 79-13, *Climatic Laboratory Evaluation, YCH-47D Helicopter*, August 1981.
4. Final Report, USAAEFA Project No. 79-07, *Artificial and Natural Icing Test of the YCH-47D*, July 1981.
5. Letter, AVRADCOM, DRDAV-DI, 2 July 1982, subject: Airworthiness and Flight Characteristics (A&FC) Test of the CH-47D.
6. Document, Boeing Vertol Company, No. 145-PJ-8103B, *Prime Item Development Specification for the Model YCH-47D Helicopter*, with revision F, 20 October 1983.
7. Technical Manual, DEPTM 55-1520-240-10, *Operator's Manual, Army Model CH-47D Helicopter*, 10 November 1982.
8. Test Plan, USAAEFA Project No. 82-07, *Airworthiness and Flight Characteristics (A&FC) of the CH-47D*, July 1982.
9. Letter, AVRADCOM, DRDAV-D, 17 December 1982, with revision 5 dated 11 April 1983, subject: Airworthiness Release for Conduct of a Preliminary Airworthiness Evaluation and Airworthiness and Flight Characteristics Test of the CH-47D Helicopter, S/N 81-23383.
10. Flight Test Manual, Naval Air Test Center, FTM No. 102, *Helicopter Performance Testing*, 28 June 1968.
11. Flight Test Manual, Naval Air Test Center, FTM No. 101, *Helicopter Stability and Control*, 10 June 1968.
12. Final Report, USAAEFA Project NO. 66-29, *Airworthiness and Flight Characteristics, CH-47C Helicopter (Chinook), Stability and Control*, March 1972.
13. Training Circular, TCI-139, *Aircrew Training Manual, Cargo Helicopter*, 10 October 1980.
14. Document, Boeing Vertol Company, No. 145-PJ-808-1, revision A, *Flight Test Acceptance Procedure*.

15. Field Manual, FM55-375, *Air Transport Procedures of Pershing Warhead Section in Shipping and Storage Container, M483, by US Army Helicopter*, August 1977.

16. Letter. USAAEFA, DAVTE-TA, 3 May 1983, subject: Report, Preliminary Airworthiness Evaluation (PAE) of the CH-47D at 54,000 Pounds Gross Weight, Project 83-04.

APPENDIX B. AIRCRAFT DESCRIPTION

GENERAL

1. The CH-47D is a twin-turbine engine, tandem rotor helicopter (figs. 1 and 2, and photo 1) designed for internal and external cargo transport during visual and instrument, day and night operations. It is powered by two T55-L-712 turboshaft engines housed in pylons mounted on the aft fuselage. The engines drive tandem, threebladed, fully-articulated, counterrotating rotors. The drive train system consists of two engine transmissions, a combining transmission, and a forward and aft transmission. The combining transmission receives power from the engine transmissions and drives the forward transmission through drive shafting housed in a tunnel along the top of the fuselage. The aft transmission is driven by a drive shaft running from the aft section of the combining transmission. A gas turbine auxiliary power unit mounted in the aft pylon, drives a hydraulic pump and a 20 KVA generator to provide power to the aircraft systems when the rotors are stationary. Fuel is carried in six tanks mounted in pods on the sides of the fuselage. The helicopter is equipped with four nonretractable landing gear with power steering provided by the right aft gear. Entrance to the helicopter is provided through a door located on the forward right side of the cargo compartment or through a hydraulically operated cargo ramp located at the rear of the cargo compartment. The helicopter is equipped with standard tandem rotor cockpit controls and an advanced flight control system (AFCS) described below.

2. The general helicopter arrangement and dimensions are shown in figures 1 and 2. Specifications are given in table 1.

FLIGHT CONTROLS

General

3. The irreversible, electrohydraulic flight control system is powered by two independent hydraulic boost systems, each operating at 3000 psi pressure. Control inputs from the cockpit are transmitted through mechanical linkage to the integrated lower control actuator (ILCA) which then transmits individual axis-oriented control motions to the mechanical mixing units. The mixed outputs are then transmitted through a series of push-pull tubes to the upper dual-boost actuators attached to the forward and aft swashplates.

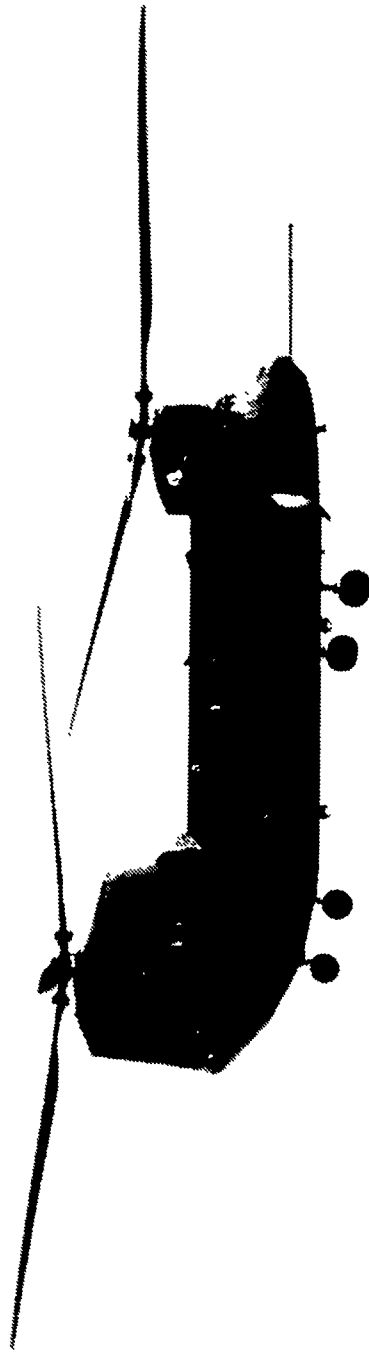
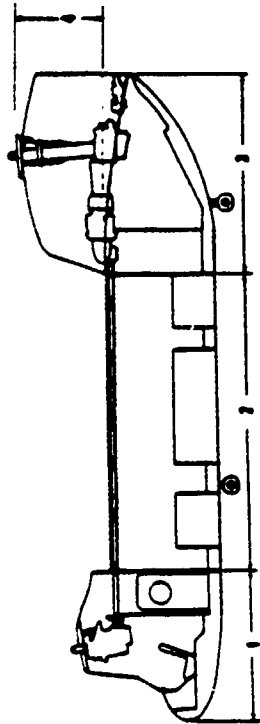

Photo 1. CH-47D Helicopter

- 22. AFT TRANSMISSION
- 23. HYDRAULIC POWER UNITS AND TANKS
- 24. ENGINE AND SCREEN
- 25. RAMP
- 26. STRAKES
- 27. ENGINE TRANSMISSION
- 28. JETTISONABLE CABIN WINDOW (TYPICAL 8 PLACES)
- 29. AFT CARGO HOOK
- 30. LEFT AFT AUXILIARY FUEL TANK
- 31. UTILITY HATCH, CENTER CARGO HOOK
- 32. LEFT MAIN FUEL TANK
- 33. FORWARD CARGO HOOK
- 34. LEFT ELECTRICAL COMPARTMENT
- 35. EXTERNAL POWER RECEPTACLE
- 36. NO. 1 FLIGHT CONTROL HYDRAULIC SYSTEM GROUND TEST CONNECTIONS
- 37. CABIN ESCAPE HATCH
- 38. JETTISONABLE DOOR
- 39. COPILOT'S SEAT
- 40. AFCS PORTS



- 1. FORWARD CABIN SECTION (COCKPIT)
- 2. CABIN FUSELAGE SECTION
- 3. AFT CABIN SECTION
- 4. PYLON SECTION
- 5. PITOT TUBES
- 6. RADAR WARNING ANTENNA
- 7. TRANSPONDER ANTENNA
- 8. CONSOLE
- 9. PILOT'S SEAT
- 10. GLIDE SLOPE ANTENNA
- 11. SPOILERS
- 12. FORWARD TRANSMISSION
- 13. FORWARD ROTOR
- 14. DRIVE SHAFT
- 15. CABIN DOOR
- 16. COMBINING TRANSMISSION
- 17. ENGINE AND COMBINING TRANSMISSION
- 18. OIL COOLER AND DUCT
- 19. AFT ROTOR DRIVE SHAFT
- 20. RADAR WARNING ANTENNA
- 21. AUXILIARY POWER UNIT

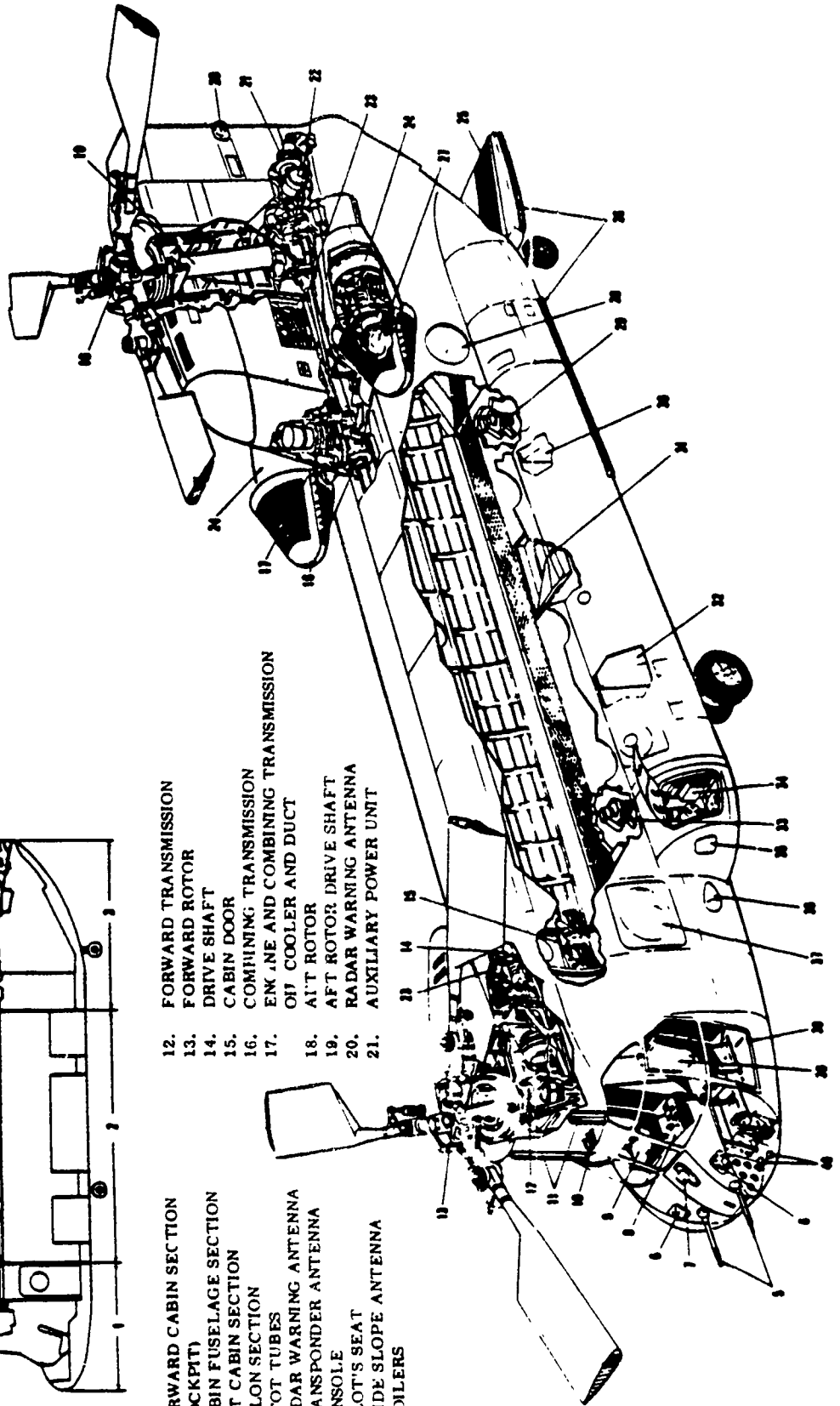

Figure 1. General Arrangement, CH-47D

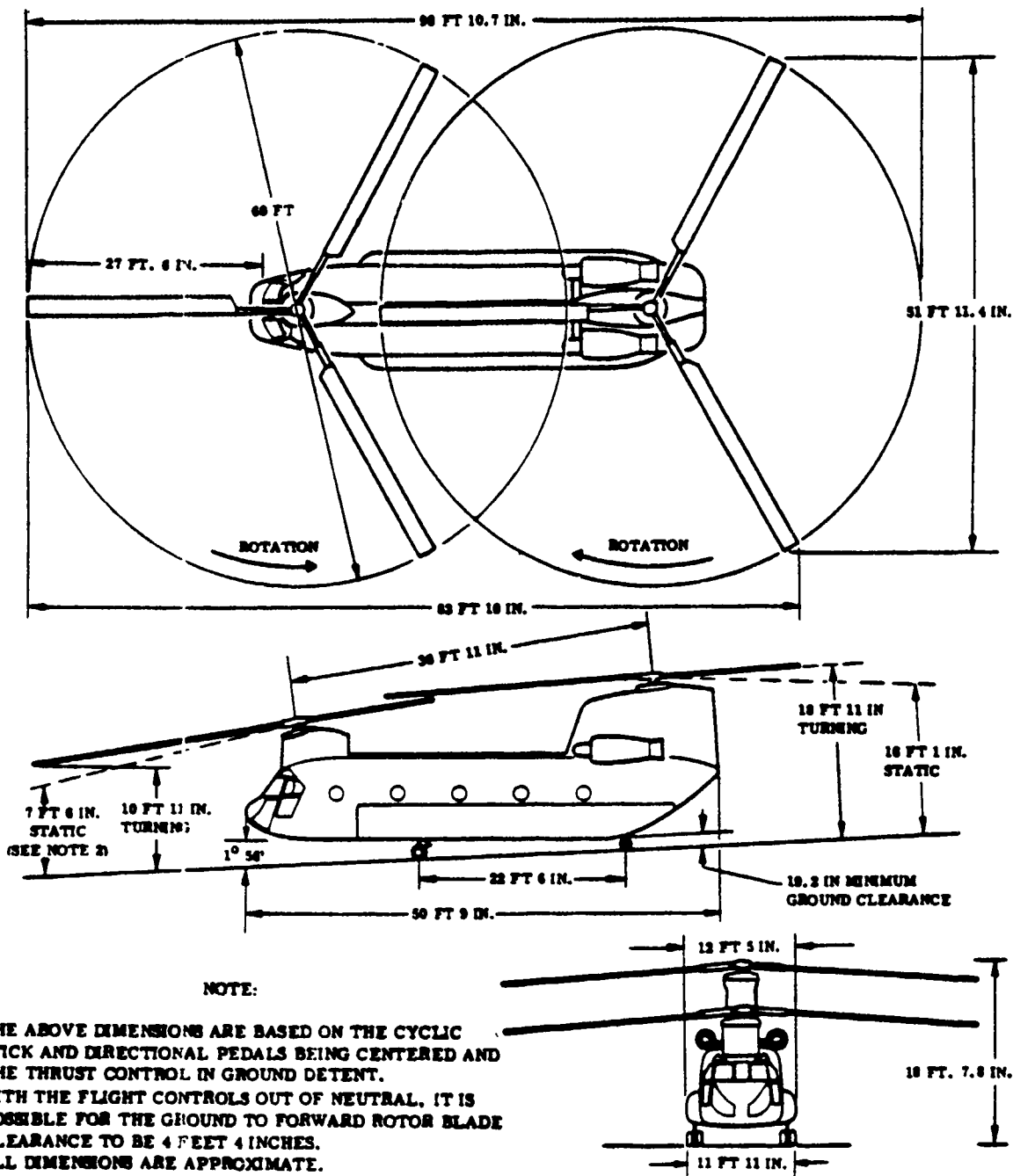

Figure 2. Principal Dimensions CH-47D

Table 1. Specifications - CH-47D Helicopters

	<u>CH-47D</u>
Blade area - each	80 sq ft.
Blade area - total.....	480 sq ft.
Rotor disc area - each.....	2,827 sq ft.
Rotor disc area - total.....	5,655 sq ft.
Airfoil - root (INBD to 85%.....	VR7
Airfoil - tip.....	VR8
Aerodynamic chord length - root and tip.....	32.0 in.
Pitch axis - % of chord.....	25%
Blade pitch range - aft.....	-21.39 to + 39.85
Blade pitch range - fwd.....	-21.39 to + 39.85
Blade twist from C_L of rotor to blade tip.....	12 degrees
Coning stop angle.....	30 degrees
Collective pitch (thrust).....	1 degree - 18 degrees
Rotor disc loading (50,000 gross weight).....	8.84 lb/ft ²
Solidity ratio.....	0.0849
Normal rotor rpm.....	225
Rotor rpm - max. autorotation.....	244
Transmission rating	
Twin engine.....	7500 HP @ 225 RPM
Single engine.....	4600 HP @ 225 RPM
Gear ratio - engine to rotor.....	66.96 to 1
Tip speed - normal.....	707 FPS
Weight empty.....	22,784 lb
Design useful load.....	10,216 lb
Design gross weight.....	33,000 lb
Maximum gross weight.....	50,000 lb
Maximum fuel capacity.....	1030.85 gal.
Engine model designation	LYC T55-L-712
Uninstalled power ratings (sea level standard day)	
Max rated SHP @ 15066 RPM.....	3704 SHP
Max continuous rated SHP @ 15066 RPM.....	2991 SHP
FWD tires.....	8.50-10 III 10 pr.
Aft tires.....	8.50-10 III 10 pr.
Design normal cg location.....	3.1 in FWD
Most FWD cg location (33,000 lb gross weight)...	21.0 in FWD
Most AFT cg location (33,000 lb gross weight)...	12.0 in AFT
Cargo hook locations.....	STA 249, 331 & 409
Cargo compartment - height.....	78 in. Min.
Cargo compartment - width.....	90 in. Min.

NOTE:

All above cg locations are taken from the Datum-Line between rotors
STA 331.0

Advanced Flight Control System (AFCS)

General:

4. Automatic inputs from the AFCS (fig. 3, and tables 2 and 3) enter the flight control system by two means:

a. In series, between the cockpit controls and the rotors, through the ILCA and the differential airspeed hold (DASH). These signals do not move the cockpit controls.

b. In parallel, with the collective controls through a collective drive actuator (CCDA). These signals move the cockpit collective controls.

5. The AFCS provides the following modifications and additions to the stability augmentation system installed in earlier model CH-47 helicopters:

a. Continuous pitch attitude and, in the long-term, airspeed hold referenced to the longitudinal control position throughout the flight envelope.

b. Long-term bank angle and heading hold in level flight and bank angle hold about any stabilized bank angle in turning flight.

c. Vernier beep trim of bank angle and airspeed.

d. Radar and barometric altitude hold.

e. Coupled heading selected through the RMI bug error.

f. Cockpit control position transducers in the longitudinal, lateral, and directional control systems.

g. The mechanical detent switches on the lateral and directional controls have been replaced by electronic signals derived from control position signals supplied to the AFCS.

h. Automatic longitudinal cyclic trim positioning to the ground mode when both aft wheels are on the ground.

Longitudinal Control:

6. As shown in figure 4, pitch rate damping is provided by feeding derived pitch rate into the extensible link of the longitudinal ILCA. The derived pitch rate is obtained by electronically differentiating the vertical gyro pitch attitude

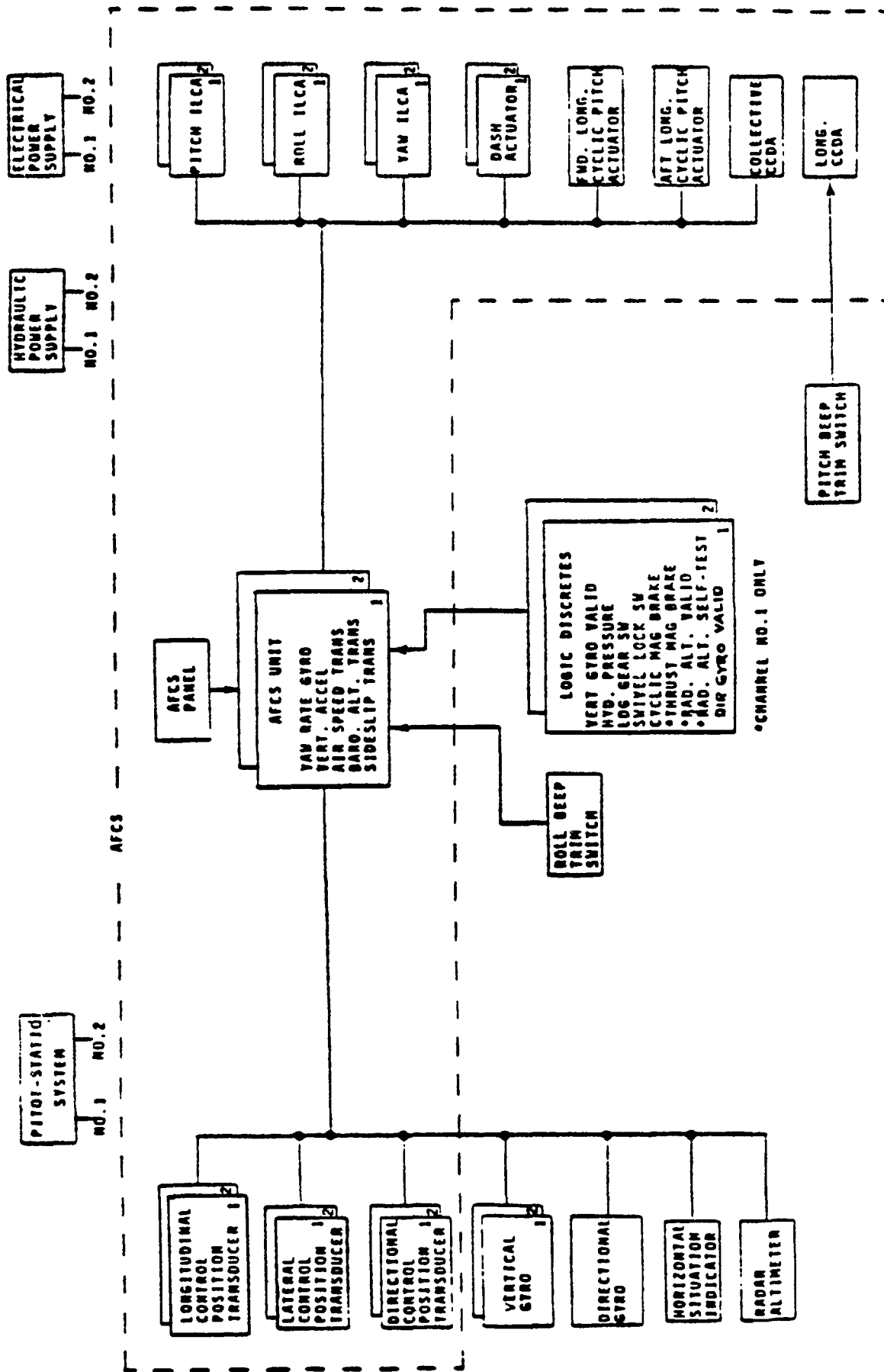

Figure 3. CH-47D AFCS Diagram

Table 2. AFCS Gains and Limits

Symbol	Parameters	Value	Tolerance	Units
K _{DAS}	Dash airspeed gain	0.12	+5%	Inches of Equiv. Cockpit Longitudinal Control kt
K _{DPA}	Dash attitude gain	25.6	+5%	Inches of Equiv. Cockpit Longitudinal Control Radian
K _{DLCV}	Dash longitudinal control (velocity) gain	7.5		Inches of Equiv. Cockpit Longitudinal Control Inch of Cockpit Longitudinal Control
K _{DLCP}	Dash longitudinal control (proportional) gain	1.1		Inches of Equiv. Cockpit Longitudinal Control Inch of Cockpit Longitudinal Control
K _{FCPF}	Forward cyclic pitch function			
K _{CPBA}	Cyclic pitch altitude bias	0.15		Degrees of Cockpit Longitudinal Control 1000 feet
K _{ACPF}	Aft cyclic pitch function			
K _{PR}	Pitch rate gain	8.90		Inches of Equiv. Cockpit Longitudinal Control Radian/sec
K _{RA}	Roll attitude gain	11.0		Inches of Equiv. Cockpit Lateral Control Radian
K _{RAB}	Roll attitude beep gain	0.05		Radians sec
K _{RABO}	Roll attitude beep quickening gain	Zero, but provisions for 0.25 max		Inches of Equiv. Cockpit Lateral Control
K _{RR}	Roll rate gain	5.7		Inches of Equiv. Cockpit Lateral Control Radian/sec
K _{RCP}	Roll control position gain	1.0		Inches of Equiv. Cockpit Lateral Control Inch of Cockpit Lateral Control
K _{HSP}	Heading select function			
K _{RAHS}	Roll attitude-heading select gain	14.3		Inches of Equiv. Cockpit Lateral Control Radian
K _H	Heading gain	8.2		Inches of Equiv. Cockpit Directional Control Radian
K _{RY}	Roll into yaw gain	5.7		Inches of Equiv. Cockpit Lateral Control Radian
K _{SSDF}	Sideslip displacement function			
K _{NA}	Normal acceleration in gain	2.4		Inches of Equiv. Cockpit Collective Control ft/sec ²
K _{AR}	Altitude - radar gain	0.055		Inches of Equiv. Cockpit Collective Control ft
K _{AB}	Altitude - barometric gain	0.024		Inches of Equiv. Cockpit Collective Control ft
K _{PCP}	Pedal control position gain	1.0		Inches of Equiv. Cockpit Directional Control Inch of Pedal
K _{YR}	Yaw rate gain	8.0		Inches of Equiv. Cockpit Directional Control Radian/sec
K _{YRW}	Yaw rate washout gain	1.0 (dimensionless)		
K _{RD}	Roll detent gain	1.0		
K _{RDF}	Roll detent function			
K _{PD}	Pedal detent gain	1.0		
K _{PDF}	Pedal detent function			
K _{SSF}	Sideslip function		+10% of value	
V _{DASH}	Dash longitudinal control velocity limit (dual system)	0.5		Inches of Equiv. Cockpit Longitudinal Control

NOTES:

1 The listed gains are dual system values.

2 One inch of equivalent control means sweepplate(s) movement which equals that produced by one inch of cockpit control movement

Table 3. CH-47D - AFCS Time Constants

Parameters	Symbol	Time Constants (seconds)
Pitch Rate Washout	$T_1 =$	10.0
Lag	$T_2 =$	0.004
Dash Longitudinal Control Lag	$T_3 =$	1.0
Roll Beep Lag	$T_4 =$	0.1
Roll Rate Lag	$T_5 =$	0.016
Roll Attitude Lag	$T_6 =$	0.15
Lateral Control Position Washout	$T_7 =$	3.0
Lag	$T_8 =$	0.8
Yaw Rate Lag	$T_9 =$	0.02
Washout	$T_{10} =$	4.0
Roll into Yaw Lag	$T_{11} =$	4.0
Sideslip Lag	$T_{12} =$	0.25
Heading Lag	$T_{13} =$	0.23
Radar Altitude Lag	$T_{14} =$	0.2
Normal Acceleration Washout	$T_{15} =$	10.0
Normal Acceleration Lag	$T_{16} =$	22.0
CCDA Feedback Lead-Lag	$T_{17} =$	0.06
	$T_{18} =$	0.005
Sin θ Washout	$T_{19} =$	0.042
Sin ϕ Washout	$T_{20} =$	0.05
Pedal Control Position Lag	$T_{21} =$	0.2
CCDA Feedback Washout	$T_{22} =$	10.0
Barometer Lag	$T_{23} =$	0.5
Delta P Lag	$T_{24} =$	0.5

signal and using it along with yaw rate and roll attitude to calculate the body axis pitch rate. The signal is conditioned by a lag to filter noise and a washout to prevent saturation during turns.

7. By summation of aircraft pitch attitude, airspeed, and longitudinal control position, the DASH system actuator provides pitch attitude and airspeed hold as well as a stable gradient of longitudinal control position versus trim airspeed. Since neither pitch attitude nor airspeed are synchronized, their high gain settings would, if not otherwise modified, require very large longitudinal control displacements to oppose their effects. The incorporation of a longitudinal control position transducer acts as a pseudo synchronizer and cancels out most of the airspeed and attitude signal so that the trim control travel over the allowable operating speed range is approximately 2-1/2 inches.

Lateral Control:

8. A block diagram of the lateral control system is shown in figure 5. Rate damping is provided by feeding derived roll rate into the extensible link of the lateral ILCA. The derived roll rate is obtained by electronically differentiating the vertical gyro roll attitude signal. The signal is shaped by a lag to filter noise. A lateral control position transducer opposes the rate gyro signals so that the high stability of the roll AFCS does not degrade lateral maneuverability. Summation of the derived rate signal and the control position signal produces a roll-rate response which is proportional to control displacement. Long-term hold of trim bank attitude is provided by bank-angle inputs from a vertical gyro. Bank angle error signals from the vertical gyro are used to produce corrective control motions through the extensible link of the roll ILCA. When the pilot displaces the lateral control out of the detent position during maneuvering, the trim bank angle error is continuously synchronized to zero. When the pilot returns the control to the detent position and the aircraft roll rate is less than 1.5 degrees per second, the synchronizer switch opens and the system holds the aircraft at the bank angle stored at the synchronizer output. Vernier beep trim of bank attitude is produced by operation of the lateral beep trim switch. Operation of the lateral beep trim switch adjusts the trim bank angle stored at the synchronizer.

9. A selectable turn coupler mode is available for automatic control of heading. In this mode, the vertical gyro bank angle signal and the heading command from the pilot's directional indicator are fed to the extensible link of the lateral ILCA. The system commands a standard rate turn to the commanded heading

and then holds the commanded heading. Bank angle is limited to 20 degrees maximum. During this mode of flight, the normal bank angle and heading hold error signals are synchronized to zero.

Directional Control:

10. As shown in figure 6, yaw rate damping is provided by feeding a signal obtained from a yaw gyro to the extensible link of the directional ILCA. At speeds above 40 knots indicated airspeed (KIAS), the yaw rate signal is washed out to prevent saturation and miscoordination in turns. The yaw rate signal is changed between the two states in 5 to 7 seconds when transitioning through 40 knots. The derived roll rate is lagged and fed into the yaw ILCA to provide automatic turn coordination. Static directional stability is artificially enhanced by sidestick pressure transducer signals. Inputs from the pedal position transducer opposes the yaw feedback signals so that the high stability does not degrade directional maneuverability.

11. Heading hold is maintained by comparing a signal from the directional gyro to a reference heading and feeding the heading error into the extensible link on the directional ILCA. At all speeds the heading reference is synchronized to the existing directional gyro signal whenever the cyclic control centering button is depressed or the pedals moved out of detent. When the pilot releases the control centering button or returns the pedals to detent and the absolute value of yaw rate becomes less than 1.5 degrees per second, the heading reference locks onto and holds the existing aircraft heading. At speeds above 40 KIAS, the synchronization of heading reference also takes place whenever the lateral control is moved out of detent to permit stick-only turns. When the lateral control is returned to detent and bank angle becomes less than 1.5 degrees, the heading reference again locks onto and holds the existing heading. Finally, the heading reference is synchronized whenever the turn coupler mode is selected.

12. Since both AFCS boxes use the signal from the same directional gyro, the signals are electronically limited to half authority, thereby making the gyro failure mode no worse than a single extensible link hardover.

Thrust Control:

13. Altitude hold (fig. 7) is accomplished by comparing the altitude sensor signal to a reference altitude and feeding the error to the CCDA. The CCDA moves the cockpit control to maintain the reference altitude. At any time the altitude hold is turned

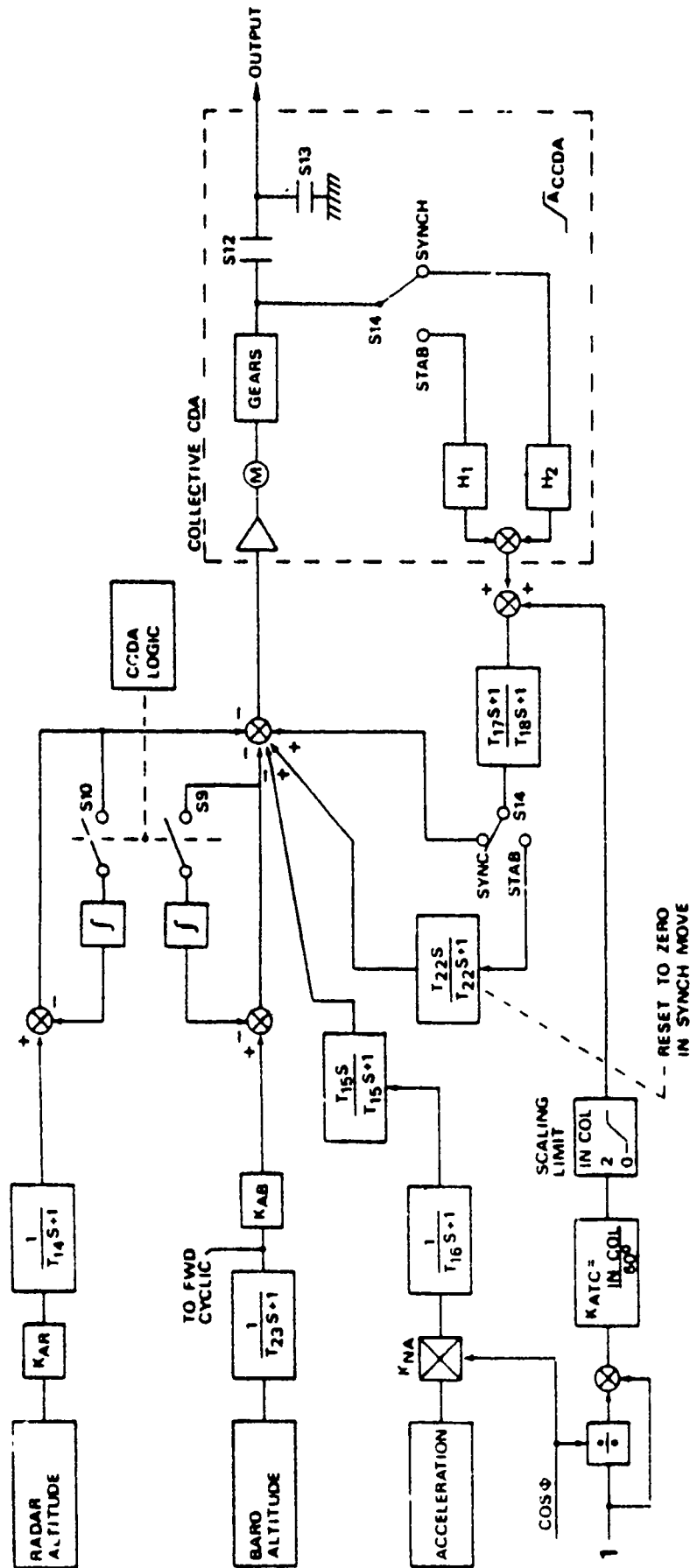

NOTE: + sign at servo causes CCW rotation of CCDA.
See table 2 for values of authorities and limits.

Figure 7. Collective Control Loops

off or the thrust brake trigger is depressed, the reference altitude is continually synchronized to the altitude sensor signal. When the altitude hold is engaged and the thrust brake trigger is released, the reference altitude locks onto and holds the value on the altitude sensor at that time. The altitude sensor is either the barometer altitude sensor or the radar altimeter depending upon the mode selected. A normal accelerometer signal processed by the AFCS provides the required vertical damping. A bank angle signal is used to offset the normal accelerometer and provide the collective command required to maintain altitude in the turn.

Longitudinal Cyclic Trim:

14. The longitudinal cyclic pitch (fig. 8) is automatically programmed with indicated airspeed providing the cyclic trim switch on the AFCS panel is in AUTO. Below 60 knots indicated airspeed (KIAS) the forward and aft rotor tilt is constant at 1.2 degrees and 3.25 degrees aft, respectively. From 60 KIAS to 150 KIAS, the cyclic pitch is increased linearly to 4.0 degrees forward on both rotors. In addition both rotors program with pressure altitude at the rate of 2.0 degrees per 10,000 feet.

15. When both the left and right landing gear switches indicate ground contact has been made the cyclic pitch on both rotors move to zero degrees (ground position) to permit taxi or rotor shutdown.

16. In addition to the AUTO modes above, a manual mode is available as on previous CH-47's. When this mode is selected the cyclic trim can be independently beeped to any desired position.

ROTOR BLADES

17. The fiberglass rotor blades have a 30-foot radius with a 32-inch chord and operate at 225 rpm. The planform is constant-chord between station 97 and the tip; from station 97 inboard it transitions to a circular root end section. The blades have a 12 percent thick VR-7 airfoil out to 85 percent radius, tapering uniformly to an 8 percent thick VR-8 airfoil at the tip.

18. The blades are of fiberglass construction with a nomex honeycomb core (fig. 9). The "D" shaped spar is constructed of fiberglass reinforced composite, terminating at the root end in a "wrap-around" single pin joint. The nose of the spar includes balance weights and provisions for a de-ice heat blanket. Outboard, the spar contains provisions for forward and aft weight fittings. The airfoil trailing aft of the spar is formed from a

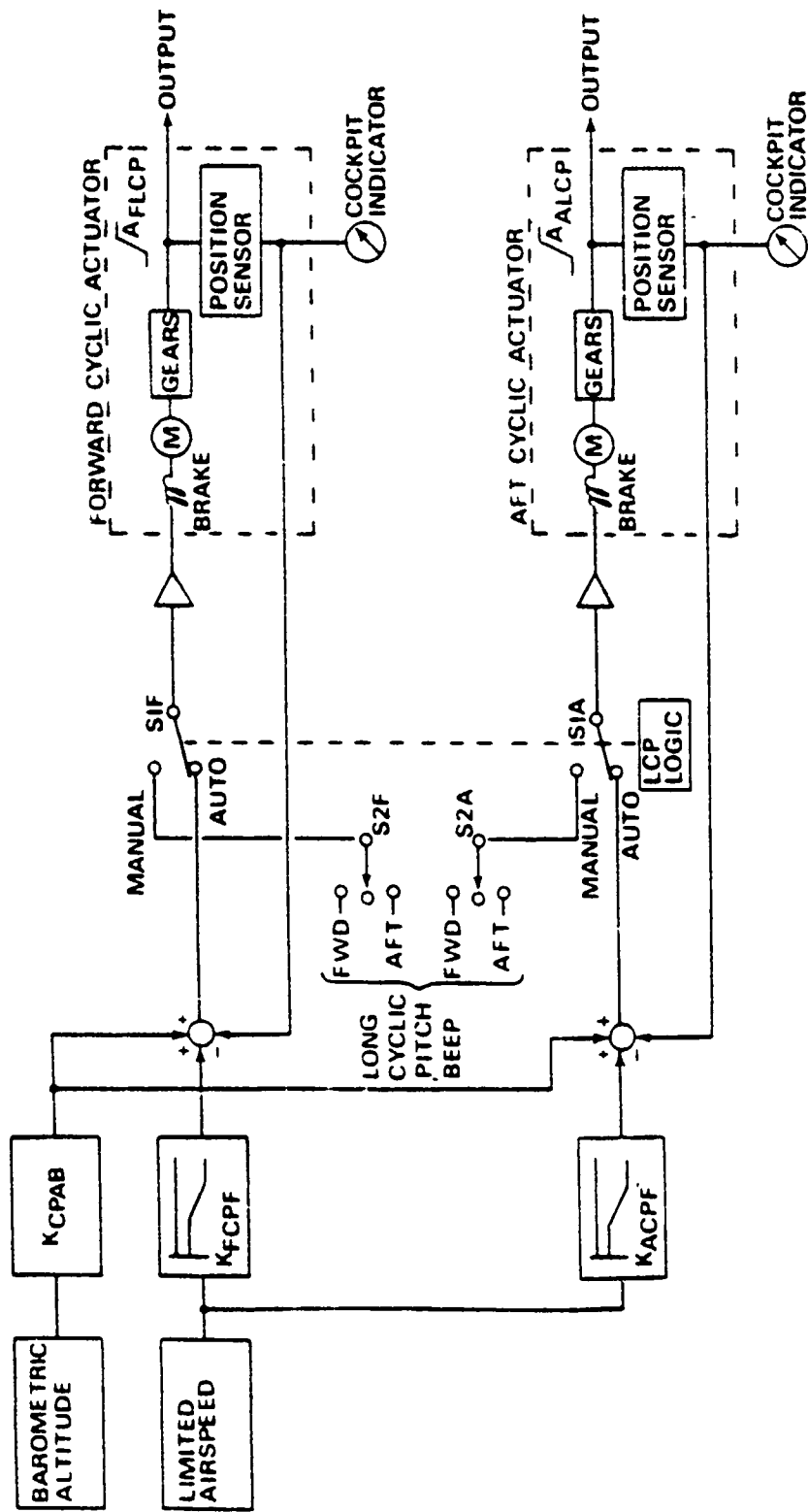

NOTE: + sign at servo input causes the LCP actuators to extend.
 See table 2 for values of authorities and limits

Figure 8. Longitudinal Cyclic Pitch Control Loops

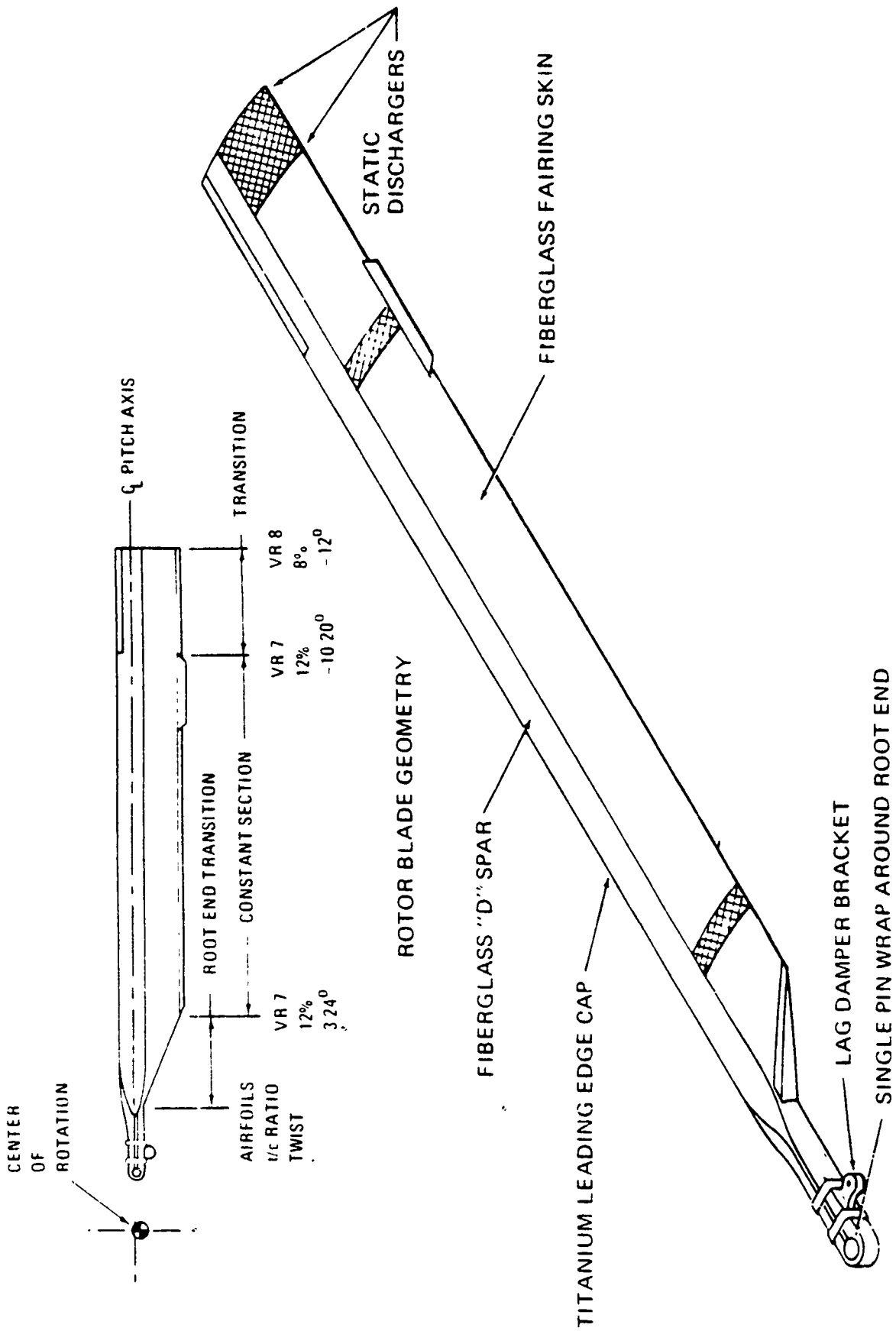

Figure 9. Fiberglass Rotor Blade

banded subassembly of nonmetallic honeycomb core covered with cross-plyed ($\pm 45^\circ$) fiberglass skins. The fiberglass trailing edge member has a built in "cusp" angle. A titanium leading edge cap is incorporated to provide leading edge damage tolerance, erosion protection and lightning protection. A replaceable electro-formed nickel protective cap is installed from the 85 percent radius to the tip.

ENGINES

19. The T55-L-712 engine incorporates improved maintainability and performance capability when compared with earlier T55 models. The engine also has the capability to produce emergency power on pilot demand. The power levels for non-installed, sea level, standard static conditions and 15,066 engine rpm (225 rotor rpm) are presented in table 4 below:

Table 4. T55-L-712 Engine Power Ratings

Emergency power (30 min, cumulative)	4,320 SHP
Maximum power (10 min)	3,704 SHP
Intermediate power (30 min)	3,370 SHP
Maximum continuous power	2,991 SHP

TRANSMISSIONS

20. The CH-47D transmission system includes features that reduce vulnerability and improve reliability. The forward, aft and combiner transmissions include independent lubrication with the forward and aft transmissions having integral cooling blowers and heat exchangers. In addition to the separate oil systems, an auxiliary (redundant) source of lubrication, capable of maintaining safe operation for two hours, is provided. The forward, aft, and combiner transmissions are also capable of operating for 30 minutes after loss of both main and auxiliary oil pressure. Increased reliability is incorporated by use of improved materials, increased gearing and bearing capacity, increased bearing life, reduced shaft and spline stress levels and turning of dynamic components to reduce motion amplitudes.

HYDRAULIC SYSTEMS

21. The hydraulic systems consist of dual modularized flight control systems and a modularized utility hydraulic system. Both

flight control systems operate at 3000 psi and separately and independently operate the dual upper control actuators and ILCA's. The systems are modularized (prepackaged hydraulic components having a standard outline) and provide two power control modules, two transmission mounted pumps, two power transfer units and a hydraulic maintenance panel. The utility system provides hydraulic power for both flight and ground utility functions and ground checkout of the flight control system.

ELECTRICAL SYSTEMS

22. The CH-47D electrical system is a first fail-operative, second fail-safe system capable of serving all required electrical loads during flight and ground operation. The primary electrical system is 115/200 volt 400 Hz alternating current. Electrical power is furnished by two AC, oil cooled, brushless, generators mounted on the aft transmission. The APU drives a 20 KVA generator which provides power for ground service and checkout functions. The AC bus system provides electrical isolation of generator outputs. The DC power is supplied by two transformer rectifier units (TRU), each connected to an isolated bus. The TRU's are physically isolated to reduce vulnerability and a bus tie relay automatically connects the two buses together in the event of failure in either unit. The 24 volt 11 ampere hour nickel - cadmium battery is monitored for overtemperature, short or open circuit, or cell imbalance. A battery charger is connected to the battery.

EXTERNAL CARGO SYSTEM

23. The external cargo system consists of three cargo hooks mounted under the aircraft. The center hook has a 26,000 lb capacity while the fore and aft hooks have a combined 25,000 lb capacity (17,000 lb for single forward or aft hook). The system is capable of carrying loads individually or simultaneously on all of the hooks.

FUEL SUPPLY SYSTEM

24. The fuel supply system furnishes fuel to the two engines, the heater, and the APU. Two separate systems, connected by cross feed and a pressure refueling lines are installed. Provisions are available within the cargo compartment for connecting internal ferry fuel tanks to the two fuel systems. Each fuel system consists of three fuel tanks contained in a pod on each side of

the fuselage. The tanks are identified as forward auxiliary, main, and aft auxiliary tanks. During normal operation, with all booster pumps operating, fuel is pumped from the auxiliary tanks into the main tanks, then from the main tanks to the engine. Should a fuel pump fail in an auxiliary tank, the fuel in that tank is not usable. However, should both booster pumps fail in a main tank, fuel will be drawn from the main tank as long as the helicopter is below 6,000 feet pressure altitude. The single point pressure refueling panel and nozzle adapter are on the right side above the forward landing gear.

APPENDIX C. INSTRUMENTATION

1. Test instrumentation was installed, calibrated, and maintained by Boeing Vertol Co. (BV). Data was displayed in the cockpit, recorded on onboard magnetic tape, and relayed via telemetry to the Real Time Data Acquisition and Processing System (RDAPS) facility.

2. Parameters measured during this evaluation were:

- #1 Engine fuel flow (gal/min)
- #1 Engine fuel temperature (deg C)
- #1 Engine fuel totalizer (gal)
- #1 Engine gas generator speed (percent rpm)
- #1 Engine power turbine inlet temperature (deg C)
- #1 Engine torque (percent)
- #2 Engine fuel flow (gal/min)
- #2 Engine fuel temperature (deg C)
- #2 Engine fuel totalizer (gal)
- #2 Engine gas generator speed (percent rpm)
- #2 Engine power turbine inlet temperature (deg C)
- #2 Engine torque (percent)
- Acceleration, lateral, cabin floor FS95 BL0 (g)
- Acceleration, lateral, copilot seat (g)
- Acceleration, lateral, pilot seat (g)
- Acceleration, longitudinal, #1 engine top flange (g)
- Acceleration, longitudinal, copilot seat (g)
- Acceleration, longitudinal, pilot seat (g)
- Acceleration, radial, #1 engine inlet (g)
- Acceleration, vertical, #1 engine rear hoist boss (g)
- Acceleration, vertical, cabin floor, FS320 BL25 left (g)
- Acceleration, vertical, cabin floor, FS320 BL25 right (g)
- Acceleration, vertical, cabin floor, FS320 BL44 left (g)
- Acceleration, vertical, cabin floor, FS440 BL44 left (g)
- Acceleration, vertical, cabin floor, FS482 BL44 left (g)
- Acceleration, vertical, cabin floor, FS50 BL33 left (g)
- Acceleration, vertical, cabin floor, FS50 BL33 right (g)
- Acceleration, vertical, cabin floor, FS95 BL0 (g)
- Acceleration, vertical, copilot seat (g)
- Acceleration, vertical, pilot seat (g)
- Aft rotor 1/rev pulse
- Airspeed, boom system (in-H₂O)
- Airspeed, ship's system (in-H₂O)
- Altitude, boom system (in-Hg)
- Altitude, radar (ft)
- Altitude, ship's system (in-Hg)
- Ambient air temperature (deg C)
- Angle of attack (deg)
- Angle of sideslip (deg)
- Attitude, pitch (deg)

Attitude, roll (deg)
 Attitude, yaw (deg)
 Axial load, #1 engine aft lower link (lb)
 Axial load, #1 engine aft upper link (lb)
 Axial load, #2 engine aft lower link (lb)
 Axial load, #2 engine aft upper link (lb)
 Axial load, aft fixed link (lb)
 Axial load, aft pivoting actuator (lb)
 Axial load, aft pivoting actuator forward lower lug (lb)
 Axial load, aft swiveling actuator (lb)
 Axial load, forward fixed link (lb)
 Axial load, forward pivoting actuator (lb)
 Axial load, forward pivoting actuator aft lower lug (lg)
 Axial load, forward pivoting actuator forward lower lug (lb)
 Axial load, forward swiveling actuator (lb)
 Axial load, vertical aft pivoting actuator aft lower lug (lb)
 Pending moment (0-130), #2 engine aft lower mount (in-lb)
 Bending moment (0-180), #2 engine aft mount (in-lb)
 Bending moment (0-180), aft slider guide (in-lb)
 Bending moment (90-270), #2 engine aft lower mount (in-lb)
 Bending moment (90-270), #2 engine aft mount (in-lb)
 Bending moment (90-270), aft slider guide (in-lb)
 Cruise guide indicator (percent)
 Droop stop contact indicator, aft
 Droop stop contact indicator, forward
 Inlet temperature, #1 hydraulic reservoir (deg C)
 Outlet temperature, #1 hydraulic reservoir (deg C)
 Position, #1 pitch SCAS actuator (in.)
 Position, #1 roll SCAS actuator (in.)
 Position, #1 yaw SCAS actuator (in.)
 Position, aft cyclic trim actuator position (deg)
 Position, aft pivoting actuator (in.)
 Position, collective control (in. from full down)
 Position, directional control (in. from full left)
 Position, forward cyclic trim actuator (deg)
 Position, forward pivoting actuator (in.)
 Position, lateral control (in. from full left)
 Position, longitudinal control (in. from full forward)
 Rate, pitch (deg/sec)
 Rate, roll (deg/sec)
 Rate, yaw (deg/sec)
 Rotor speed, coarse scale (rpm)
 Rotor speed, sensitive scale (rpm)
 Tension, forward transmission upper cover (psi)
 Tether cable angle, lateral (deg)
 Tether cable angle, longitudinal (deg)
 Tether cable axial load (lb)
 Time code

Torque, aft rotor shaft (in-lb)
Torque, forward rotor shaft (in-lb)

FIGURE A
BOOM SYSTEM AIRSPEED CALIBRATION
CH-47D USA S/N 81-23383

SYMBOL	AVG GROSS WEIGHT (LB)	AVG LONGITUDINAL CG LOCATION (FS)	AVG DENSITY ALTITUDE (FEET)	AVG OAT (DEG C)	AVG ROTOR SPEED (RPM)	TEST METHOD
□	40560	338.3 (AFT)	3400	20.5	225	GRD SPD
○	30240	330.9 (MID)	2660	14.0	224	GRD SPD
△	34580	331.2 (MID)	4600	14.0	225	T28 PACE
+	33020	329.5 (FWD)	2780	13.0	225	TWR FLYBY

CORR TO BE ADDED (KNOTS)

20
15
10
5
0

160

NOT FOR HANDBOOK USE

140

120

100

80

60

40

20

CALIBRATED AIRSPEED (KNOTS)

LINE OF ZERO ERROR

20 40 60 80 100 120 140 160

BOOM SYSTEM INDICATED AIRSPEED (KNOTS)

APPENDIX D. TEST TECHNIQUES AND DATA ANALYSIS METHODS

PERFORMANCE

General

Nondimensional Coefficients:

1. The nondimensional coefficients listed below were used to generalize the hover and level flight data obtained during this evaluation.

a. Coefficient of torque:

$$C_Q = \frac{\text{RHP} \times 550}{\rho A (\Omega R)^3} \quad (1)$$

b. Coefficient of thrust:

$$C_T = \frac{\text{GW}}{\rho A (\Omega R)^2} = \frac{\text{GW}/\delta}{\rho_0 A (\Omega R/\sqrt{\theta})^2} \quad (2)$$

c. Advance ratio:

$$\mu = \frac{1.6878 V_T + \Omega R}{a} \quad (3)$$

d. Advancing blade tip mach number (M_{tip}):

$$M_{tip} = \frac{1.6878 V_T + (\Omega R)}{a} = \frac{1.6878 V_T/\sqrt{\theta} + (\Omega R/\sqrt{\theta})}{1116.45} \quad (4)$$

Where:

RHP = Calculated from equation 8, paragraph 2

550 = Conversion factor (ft-lb/sec/shp)

ρ = Air density (slug/ft³)

ρ_0 = Air density at sea level 15°C (slug/ft³) (0.0023769)

A = Main rotor disc area (ft²) (5655 ft²)

$$\Omega/\sqrt{\theta} = \text{Referred rotor angular velocity} = \frac{\pi}{30} \times \frac{N}{\sqrt{\theta}}$$

R = Rotor radius = 30 ft

N = Rotor rotational speed, RPM

GW = Aircraft gross weight (lb)

δ = Air pressure ratio

V_T = True airspeed (kt)

$V_T/\sqrt{\theta}$ = Referred true airspeed

a = Speed of sound (ft/sec, = $1116.45\sqrt{\theta}$)

1.6878 = Conversion factor (ft/sec/kt)

$$\theta = \text{Temperature ratio} = \frac{(\text{OAT} + 273.15)}{288.15} \quad (5)$$

OAT = Free air temperature

The following constants may be used at 100% rotor speed:

$$\Omega_R = 706.9 \text{ (ft/sec)}$$

$$A(\Omega_R)^2 = 2.8254 \times 10^9 \text{ (ft}^2\text{/sec}^2\text{)}$$

$$A(\Omega_R)^3 = 1.9972 \times 10^{12} \text{ (ft}^3\text{/sec}^3\text{)}$$

Power Determination

2. Power output of the T55-L-712 engines were determined by measuring the engine output shaft torque and the main rotor speed and using the following equation:

$$\text{SHP} = \frac{\Omega G O}{550} \quad (6)$$

where:

Ω = Rotor speed (rad/sec)

G = Engine to rotor gear ratio = 66.96

O = Engine output shaft torque (ft-lb)

The engine torque measuring system was dynamically calibrated by Lycoming in an engine test cell. Rotor shaft torques were also measured and the horsepower being transmitted to the rotors was calculated from the following equation:

$$\text{RHP} = \frac{\Omega(Q_{\text{MRF}} + Q_{\text{MRR}})}{550} \quad (7)$$

where:

Q_{MRF} = Torque on the forward rotor shaft (ft-lb)

Q_{MRR} = Torque on the aft rotor shaft (ft-lb)

The following empirical relationship between RHP and SHP was determined from flight test data.

$$\text{RHP} = 1.010084 \times \text{SHP} - 390.25 \quad (8)$$

Engine output shaft torque was also calculated from fuel flow using a BV-supplied method. This method produced inconsistent results. All engine shaft horsepower data presented in this report were calculated from engine torque measurements.

Airspeed Calibration

3. The test boom and standard ship's pitot-static systems were calibrated. Three methods were used for these calibrations: the pace method (using a T-28 pace aircraft); the ground speed course method; and the tower flyby (or altitude depression) method. The pace method involved flying the CH-47D in formation with a T-28 aircraft, and using the calibrated T-28 pitot-static system as an airspeed reference. For the ground speed course method, the CH-47D was flown over a measured, straight course marked on the ground. The aircraft was flown at constant indicated airspeeds for two passes over the course on reciprocal headings. True airspeed for each direction was calculated from the time and distance and the two airspeeds were averaged. Calibrated airspeed was calculated from the average true airspeed and the air pressure and temperature and was used as a reference. The third method (altitude depression) required flying the aircraft past a tower at incremental indicated airspeeds. On each pass, readings of indicated airspeed and altitude were taken onboard the aircraft at the same time readings were taken in the tower of pressure altitude and aircraft height above (or below) the tower. In this manner, the static pressure position error was determined

as a function of airspeed. By assuming no pitot (total pressure) error, the airspeed position error was calculated from the static pressure error. This method worked well for the test boom system but gave inconsistent results for the ship's system, apparently because the ship's system has an error in the total pressure measurement (pitot error). The boom airspeed calibration is presented in figure A, appendix C.

Hover Performance

4. Hover performance was obtained both iGE and OGE by the tethered hover technique. All hover tests were conducted in winds of less than 3 knots. Atmospheric pressure, temperature, and wind velocity were recorded from a ground weather station. The hover tests consisted of tethering the helicopter to the ground with a cable and load cell, and stabilizing at predesignated rotor speeds and power settings. The power setting was varied to obtain increments of cable tension from minimum to the maximum allowed by the airworthiness release, and three rotor speeds were used.

5. To obtain dimensional performance information from the non-dimensional plots in figures 6 through 10, appendix E, the transmission losses must be applied to the data. For example, to calculate the gross weight at which the aircraft will hover at a given pressure altitude and outside air temperature, the following procedures must be used: (a) determine the total engine horsepower available (SHP) at those conditions from the engine specification, (b) calculate the horsepower delivered to the rotors (RHP) using equation 7, paragraph 2 (c) calculate C_Q using equation 1, paragraph 1, (d) find C_T from the appropriate performance curve (figs. 6 through 10, app E), and (e) calculate gross weight using equation 2, paragraph 1.

Level Flight Performance

6. Level flight performance was determined using the referred gross weight, referred rotor speed method. Each speed-power polar was flown maintaining a constant referred gross weight (W/δ) and referred rotor speed ($N/\sqrt{\theta}$) in ball-centered flight. A constant W/δ was maintained by increasing altitude as the aircraft gross weight decreased due to fuel burnoff. Rotor speed was adjusted to maintain a constant $N/\sqrt{\theta}$ as the outside air temperature changed.

7. The raw data were reduced to nondimensional terms of C_Q , C_T , and μ . No correction was made for the drag of the test airspeed boom nor instrumentation on the rotor heads. As in hover performance, the transmission losses must be accounted for using equation 8, paragraph 2 when converting nondimensional data to dimensional terms.

Autorotational Descent Performance

8. Autorotational descent performance data were acquired at incremental airspeeds with constant rotor speed and incremental rotor speeds with constant airspeed. The tapeline rates of descent were calculated by the expression:

$$\text{R/D tapeline} = \frac{dH_P}{dt} \times \frac{T_t}{T_S} \quad (9)$$

Where:

R/D tapeline = Tapeline rate of descent (ft/sec)

$\frac{dH_P}{dt}$ - Change in pressure altitude per given time (ft/sec)

T_t = Test ambient air temperature (°K)

T_S = Standard ambient air temperature (°K)

HANDLING QUALITIES

Control Positions in Trimmed Forward Flight

9. Control positions and aircraft attitudes as functions of airspeed were determined during level flight performance.

Static Longitudinal Stability

10. The static longitudinal stability tests were accomplished by establishing the trim condition in ball-centered flight and then varying control positions to obtain airspeed changes about the trim airspeed with collective control held fixed at the trim value. The airspeed range of interest was approximately ± 20 knots from trim. Altitude was allowed to vary as required during the test. One or both AFCS systems were turned off during some of the tests.

Static Lateral-Directional Stability

11. These tests were conducted by establishing the trim condition and then varying sideslip angle incrementally up to the pre-established limits. During each test, collective control position, airspeed, and aircraft ground track were held constant and altitude allowed to vary as required. One or both AFCS systems were turned off during some of the tests.

Maneuvering Stability

12. This test was accomplished by establishing the trim condition and then incrementally increasing load factor by increasing roll attitude (in both directions) while holding airspeed and collective control position constant and allowing altitude to vary as necessary.

Dynamic Stability

13. Dynamic longitudinal and lateral-directional stability were qualitatively evaluated to determine both the short- and long-period characteristics. The short-period response was evaluated by use of longitudinal, lateral, and directional pulse or doublet inputs and by releases from a steady-heading sideslip. The long-period dynamic response was evaluated longitudinally by slowly returning the flight controls to trim position following a decrease of 10 knots indicated airspeed (KIAS) from the trim airspeed.

Vibrations

14. Two methods were used to obtain and analyze vibration data. In one method, the output of vibration accelerometers at selected locations in the aircraft were recorded on magnetic tape onboard the aircraft. These data were then reduced using a fast Fourier transform method to obtain average vibration amplitudes as a function of frequency. Amplitude at main rotor harmonic frequencies were then determined. In the other method, the output of the accelerometers went to a vibration amplitude and direction indicator (VADI) developed by BV. The VADI has a dial indicator which reads percent of the PIDS limit for the location, direction and harmonic selected. The PIDS specifies that vibration data at certain aircraft locations, in certain directions and at certain rotor harmonic frequencies, when analyzed over 20 rotor cycles, shall contain amplitude peaks, 85% of which are less than a given limit. The VADI data processing includes the 85% requirement.

DEFINITIONS

Qualitative Rating Scales

15. A Handling Qualities Rating Scale was used to augment pilot comments and is presented as figure A. The Vibration Rating Scale (VRS) was used to augment pilot comments on vibrations and is presented in figure B.

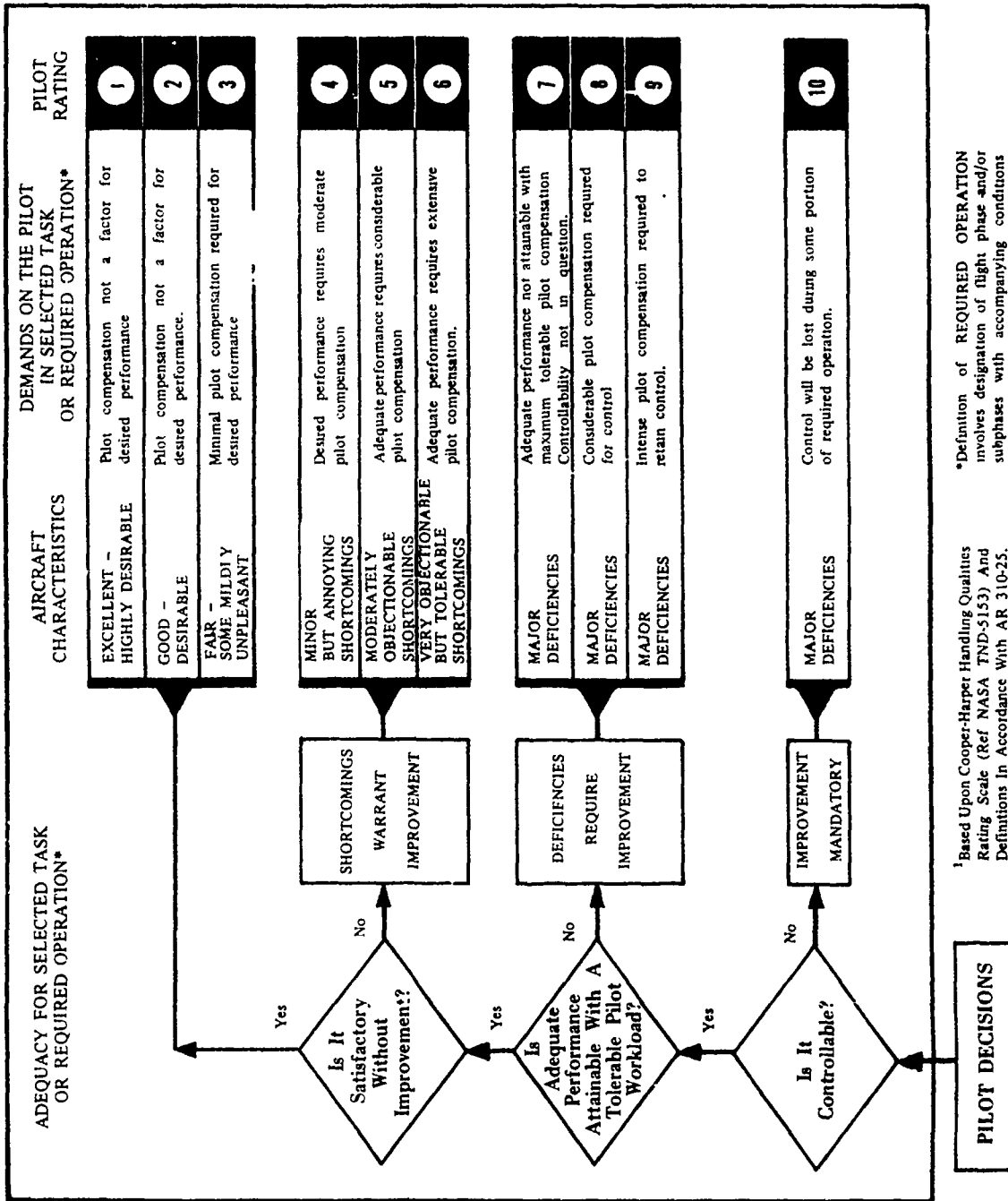

*Definition of REQUIRED OPERATION involves designation of flight phase and/or subphases with accompanying conditions

†Based Upon Cooper-Harper Handling Qualities Rating Scale (Ref NASA TND-5153) And Definitions In Accordance With AR 310-25.

Figure A. Handling Qualities Rating Scale

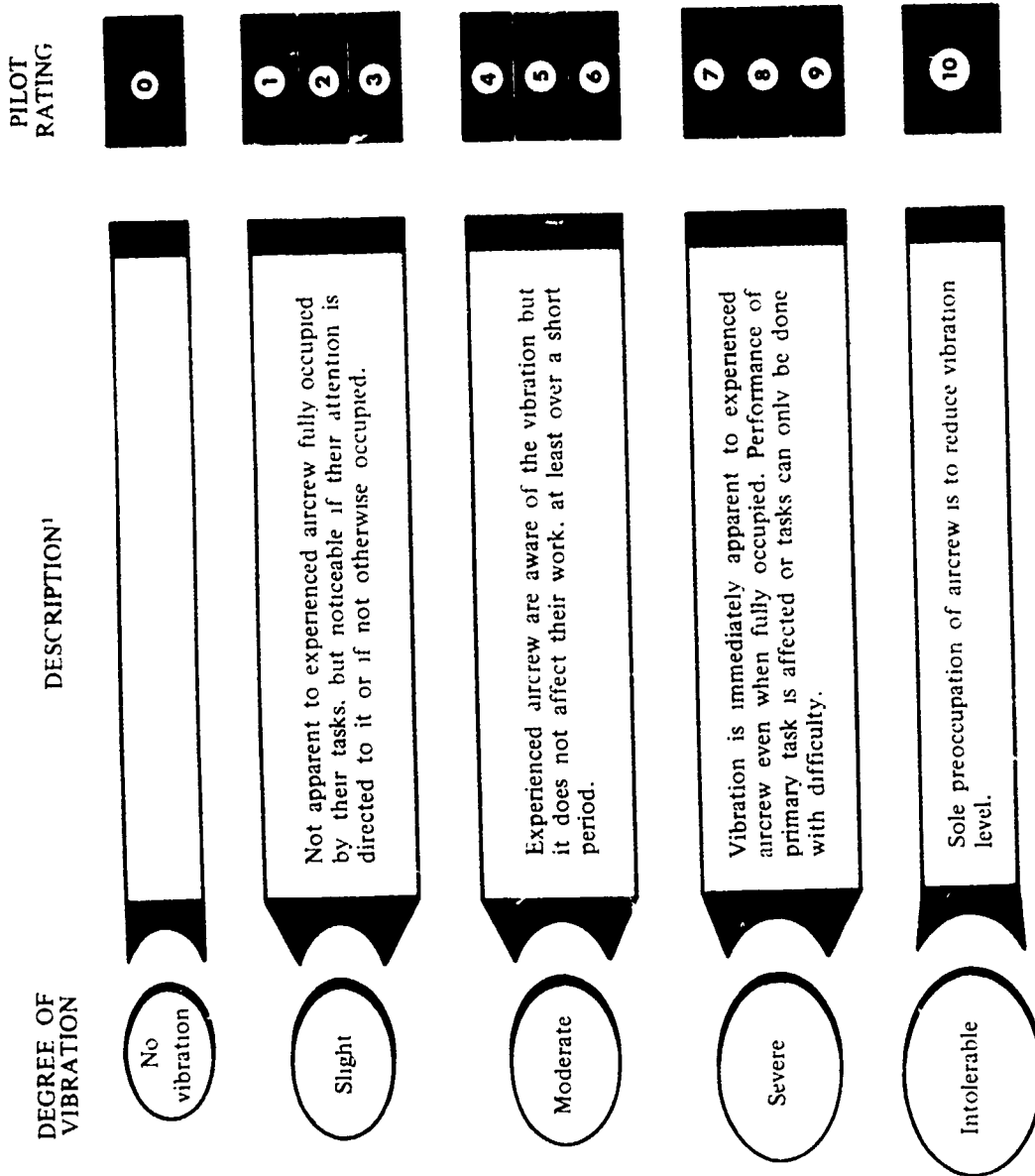

¹ Based upon the Subjective Vibration Assessment Scale developed by the Aeroplane and Armament Experimental Establishment, Boscombe Down, England.

Figure 3. Vibration Rating Scale

Shortcoming

16. A shortcoming is defined as an imperfection or malfunction occurring during the life cycle of equipment which must be reported and which should be corrected to increase efficiency and to render the equipment completely serviceable. It will not cause an immediate breakdown, jeopardize safe operation, or materially reduce the usability of the material or end product.

APPENDIX E. TEST DATA

INDEX

<u>Figure</u>	<u>Figure No.</u>
Hover Summary	1 through 5
Nondimensional Hover Performance	6 through 10
Range Summary	11 and 12
Level Flight Performance	13 through 33
Autorotational Descent Performance	34 through 36
Control System Characteristics	37 through 40
Control Positions in Trimmed Forward Flight	41 through 44
Static Longitudinal Stability	45 through 68
Static Lateral-Directional Stability	69 through 93
Maneuvering Stability	94
Dynamic Stability	95 through 103
Power Management	104 through 107
Single Engine Failures	108 and 109
System Failures	110 and 116
Vibration Characteristics	117 through 137
Airspeed Calibration	138 through 140
Engine Power Available	141 through 145
Engine Characteristics	146 through 151

FIGURE 1
5-FOOT HOVER CAPABILITY
CH-47D USA S/N 81-23383
ROTOR SPEED = 225 RPM
WINDS LESS THAN 3 KNOTS
MAXIMUM RATED POWER (10-MINUTE LIMIT)

NOTE: CURVES DERIVED FROM FIGURE 6

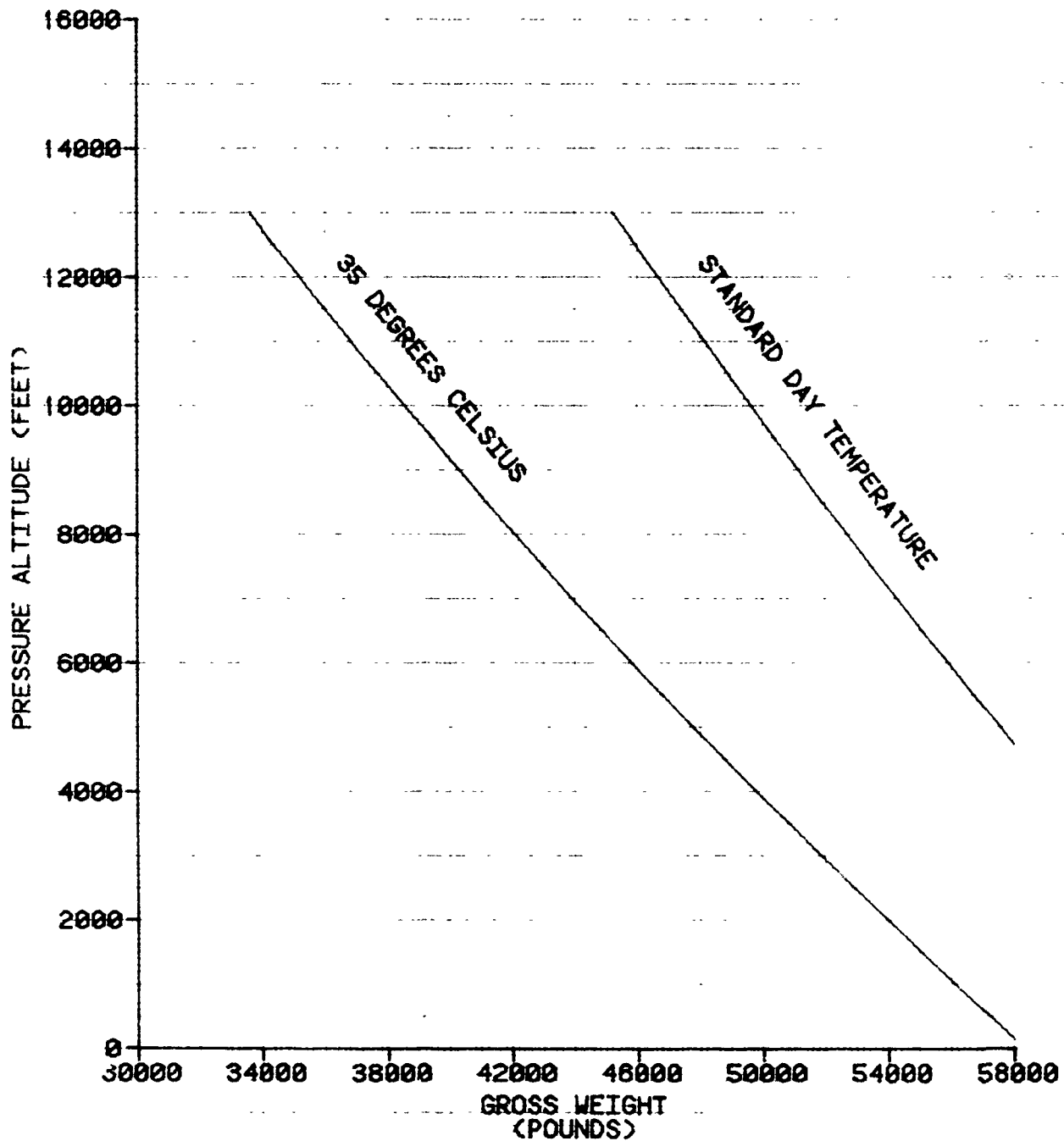

FIGURE 2
10-FOOT HOVER CAPABILITY
CH-47D USA S/N 81-23383
ROTOR SPEED = 225 RPM
WINDS LESS THAN 3 KNOTS
MAXIMUM RATED POWER (10-MINUTE LIMIT)

NOTE: CURVES DERIVED FROM FIGURE 7

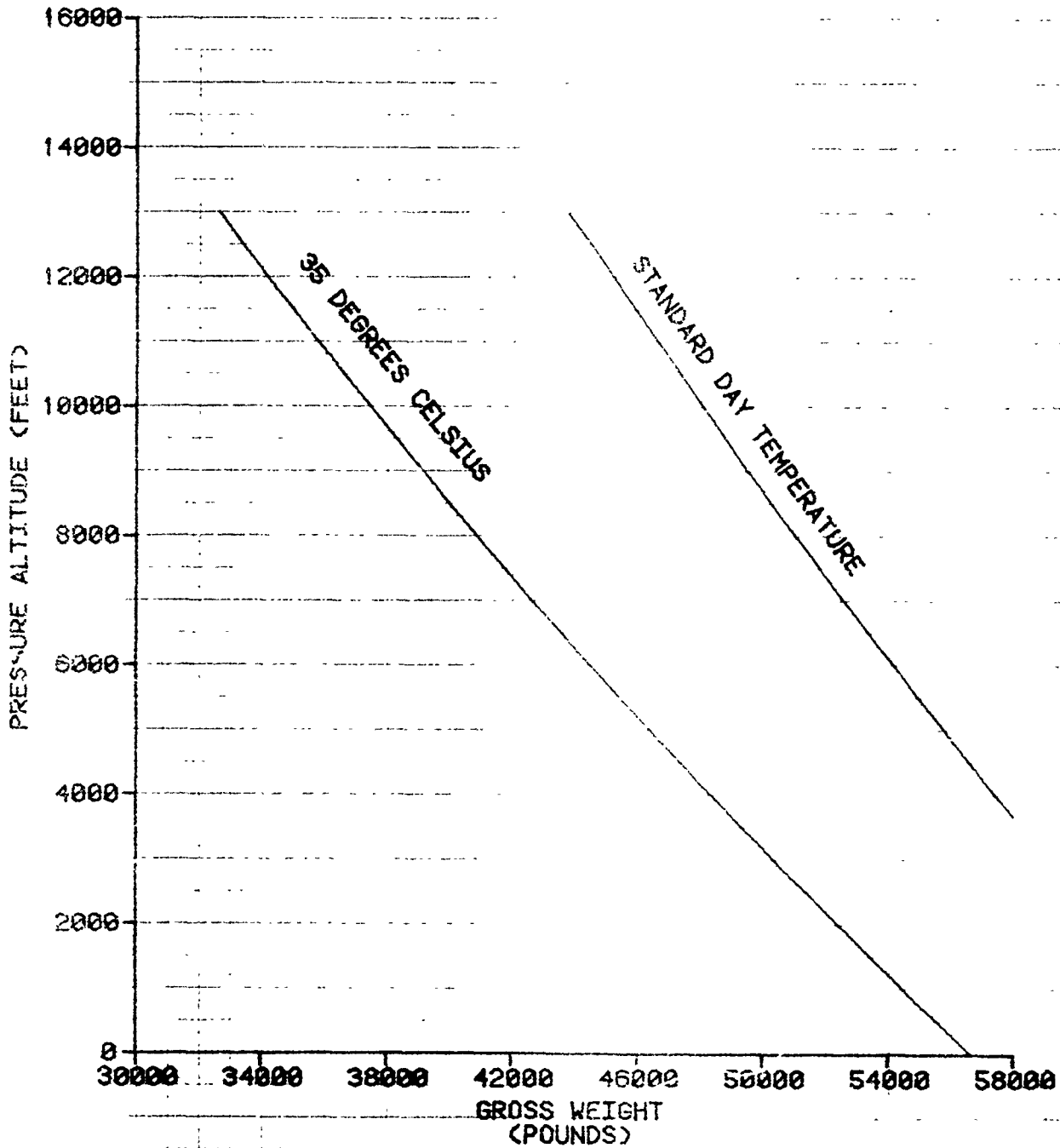

FIGURE 3
20-FOOT HOVER CAPABILITY
CH-47D USA S/N 81-23383
ROTOR SPEED = 225 RPM
WINDS LESS THAN 3 KNOTS
MAXIMUM RATED POWER (10-MINUTE LIMIT)

NOTE: CURVES DERIVED FROM FIGURE 8

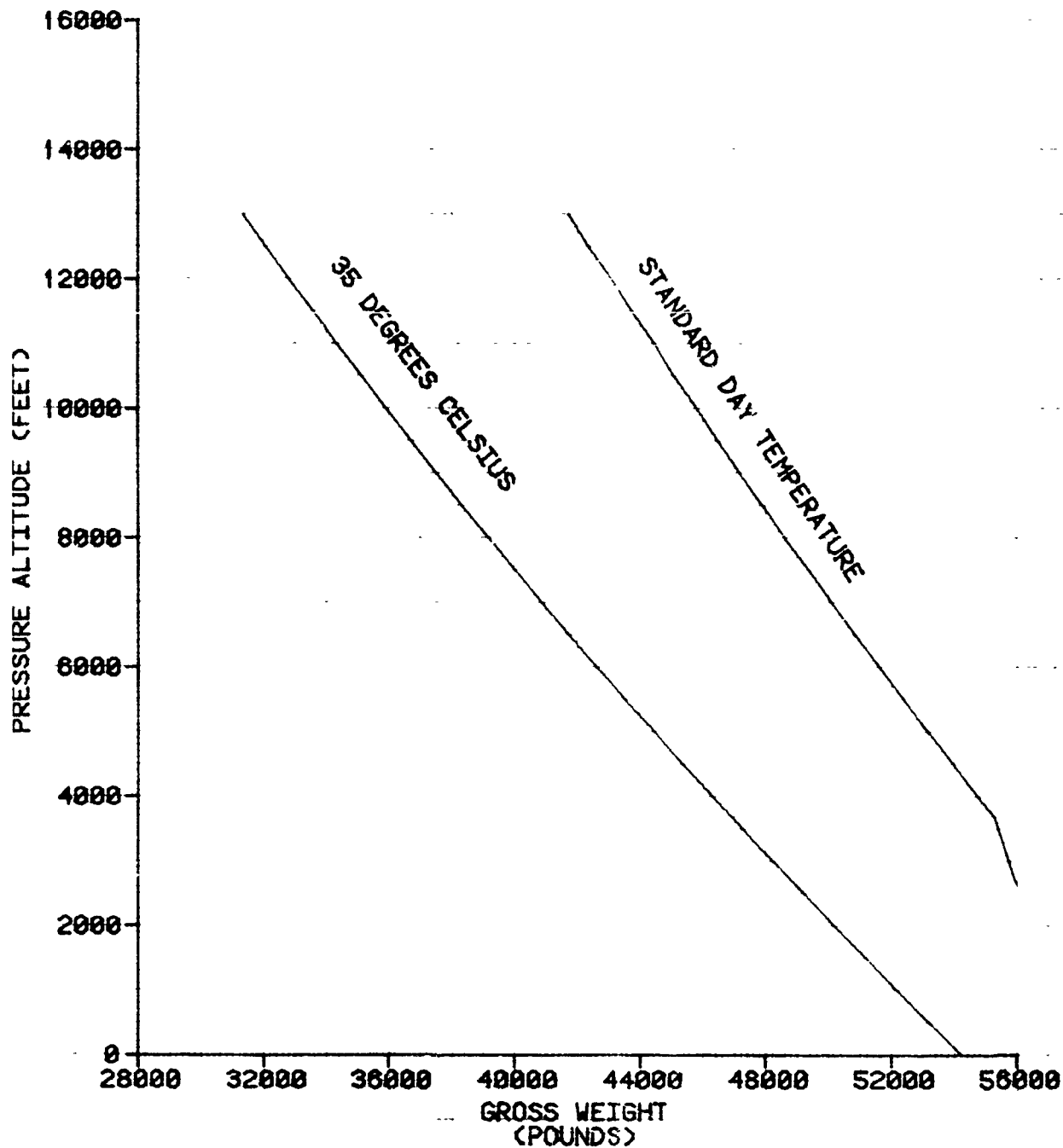

FIGURE 4
50-FOOT HOVER CAPABILITY
CH-47D USA S/N 81-23383
ROTOR SPEED = 225 RPM
WINDS LESS THAN 3 KNOTS
MAXIMUM RATED POWER (10-MINUTE LIMIT)

NOTE: CURVES DERIVED FROM FIGURE 9

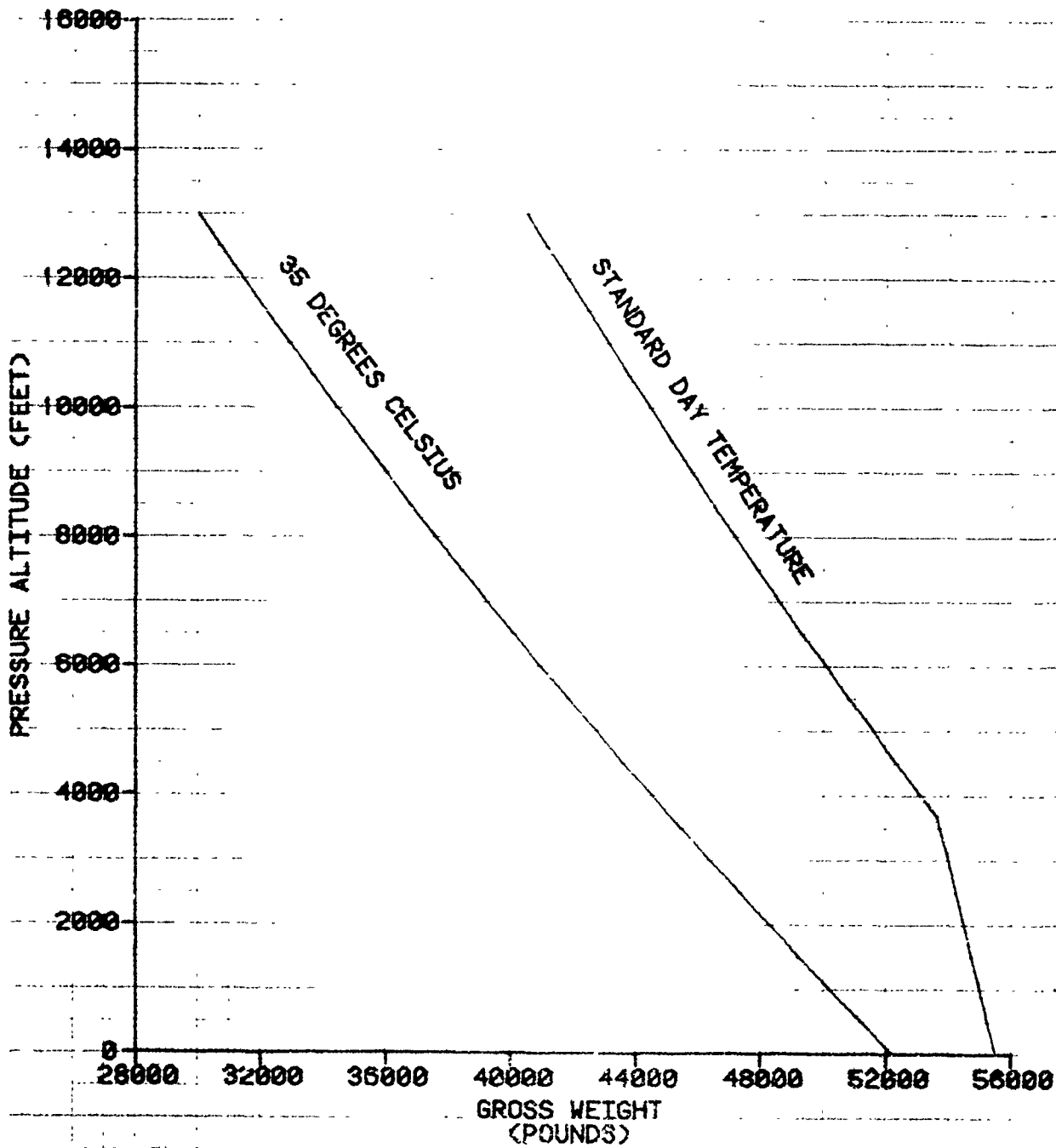

FIGURE 5
DGE HOVER CAPABILITY
CH-47D USA S/N 81-23383
ROTOR SPEED = 225 RPM
WINDS LESS THAN 3 KNOTS

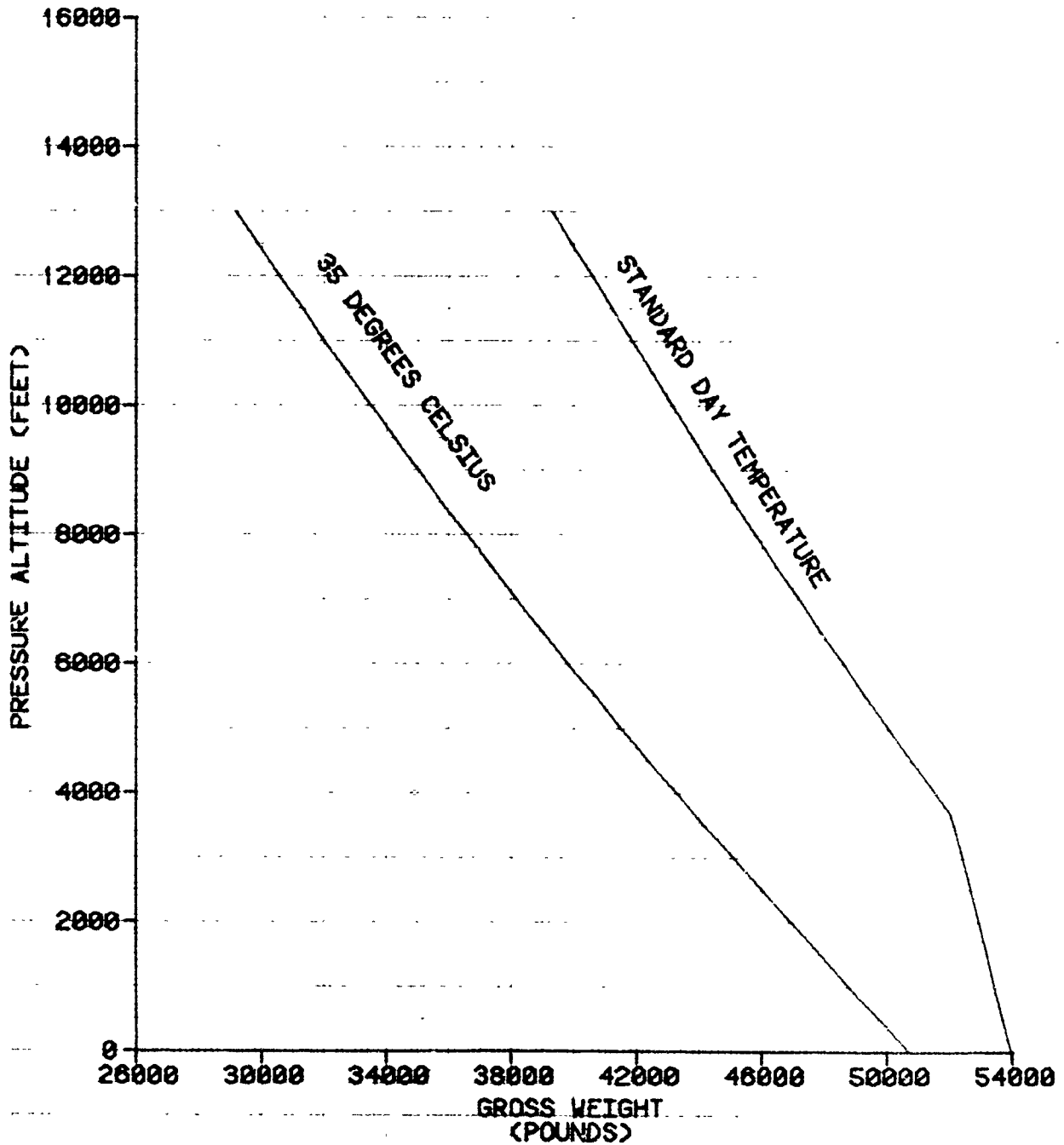

FIGURE 7
 NONDIMENSIONAL HOVER PERFORMANCE
 CH-47D USA S/N 81-23383
 18-FOOT WHEEL HEIGHT
 LYCOMING T55-L-712 S/N 71224 & 71226
 WINDS LESS THAN 3 KNOTS

SYMBOL	AVG ROTOR SPEED (RPM)	AVG PRESSURE ALTITUDE (FEET)	AVG OAT (DEG C)	AVG REF ROTOR SPEED (RPM)
□	231	2000	18.6	220
○	227	2000	18.5	226
△	210	2000	20.0	214
+	231	9700	7.6	224
◇	222	9700	8.6	224
■	217	9700	8.6	219

NOTE: $C_T = 50 + 31 C_P$
 WHEELS: B0 - 81-23383-1
 B1 - 0-75433
 B2 - 19-1-35

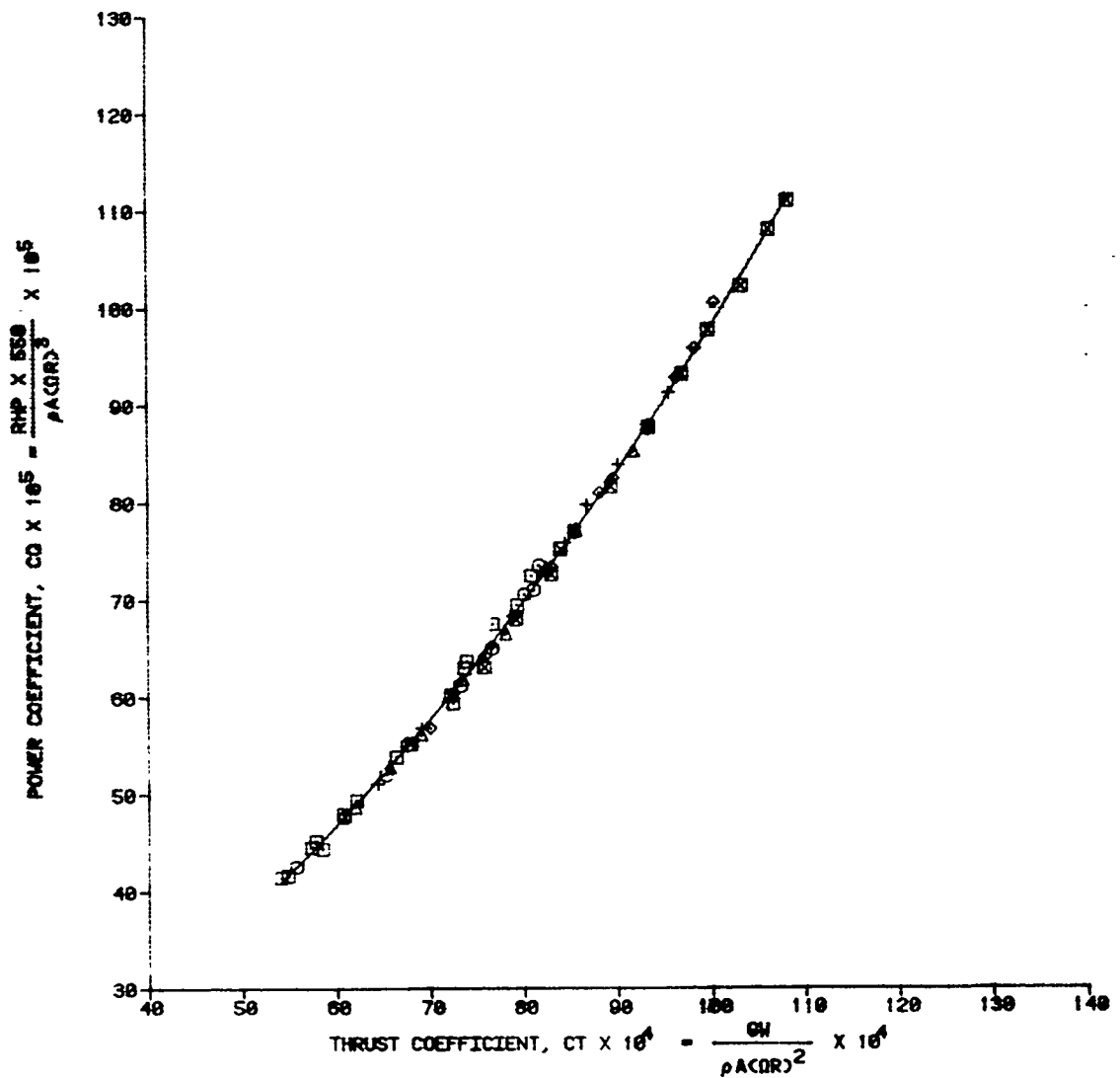

FIGURE 8
 NONDIMENSIONAL HOVER PERFORMANCE
 CH-47D USA S/N 81-23383
 28-FOOT WHEEL HEIGHT
 LYCONING T55-L-712 S/N 71224 & 71226
 WINDS LESS THAN 3 KNOTS

SYMBOL	AVG ROTOR SPEED (RPM)	AVG PRESSURE ALTITUDE (FEET)	AVG OAT (DEG C)	AVG REF ROTOR SPEED (RPM)
B	231	2000	17.8	230
O	222	2000	17.6	220
A	218	2000	17.5	215

NOTE: $C_Q = B_0 + B_1 C_T^{2/3} + B_2 C_T^3$
 WHERE $B_0 = 1.32122E-4$
 $B_1 = 0.63040$
 $B_2 = 304.795$

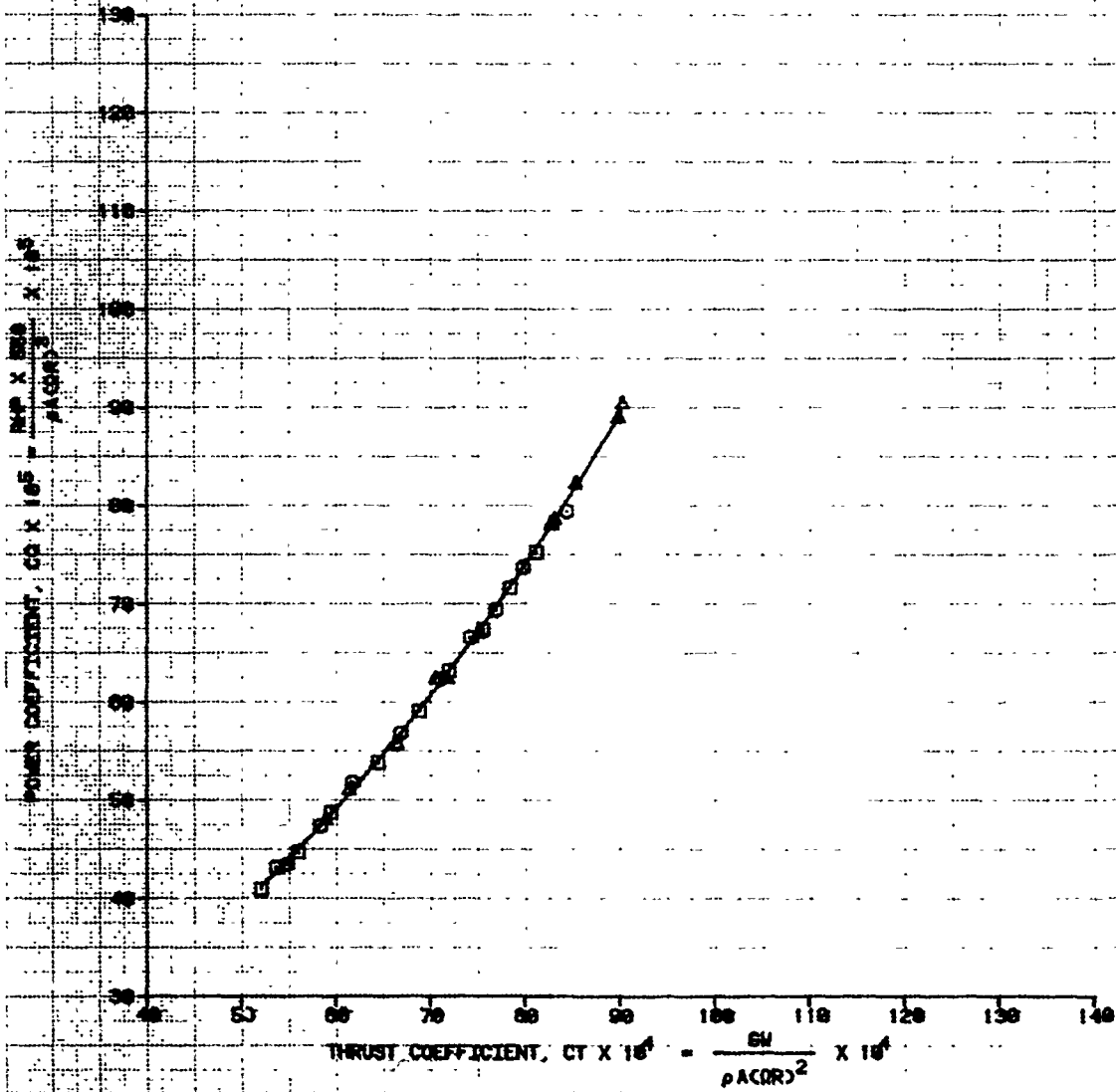

FIGURE 9
 NONDIMENSIONAL HOVER PERFORMANCE
 CH-47D USA S/N 81-23983
 50-FOOT WHEEL HEIGHT
 LYCOMING T55-L-712 S/N 71224 & 71226
 WINDS LESS THAN 3 KNOTS

SYMBOL	AVG ROTOR SPEED (RPM)	AVG PRESSURE ALTITUDE (FEET)	AVG OAT (DEG C)	AVG REF ROTOR SPEED (RPM)
□	231	2120	16.0	232
+	224	2120	16.0	225
○	216	2120	16.0	217
×	231	4820	16.0	232
△	220	4800	16.0	221
◇	227	6540	16.0	228
●	216	6540	7.0	217

NOTE: $C_T = B_0 + B_1 C_T^{2/3} + B_2 C_T^4$

WHERE $B_0 = 6.83E13F^{-5}$
 $B_1 = 0.95E83$
 $B_2 = 7.169994$

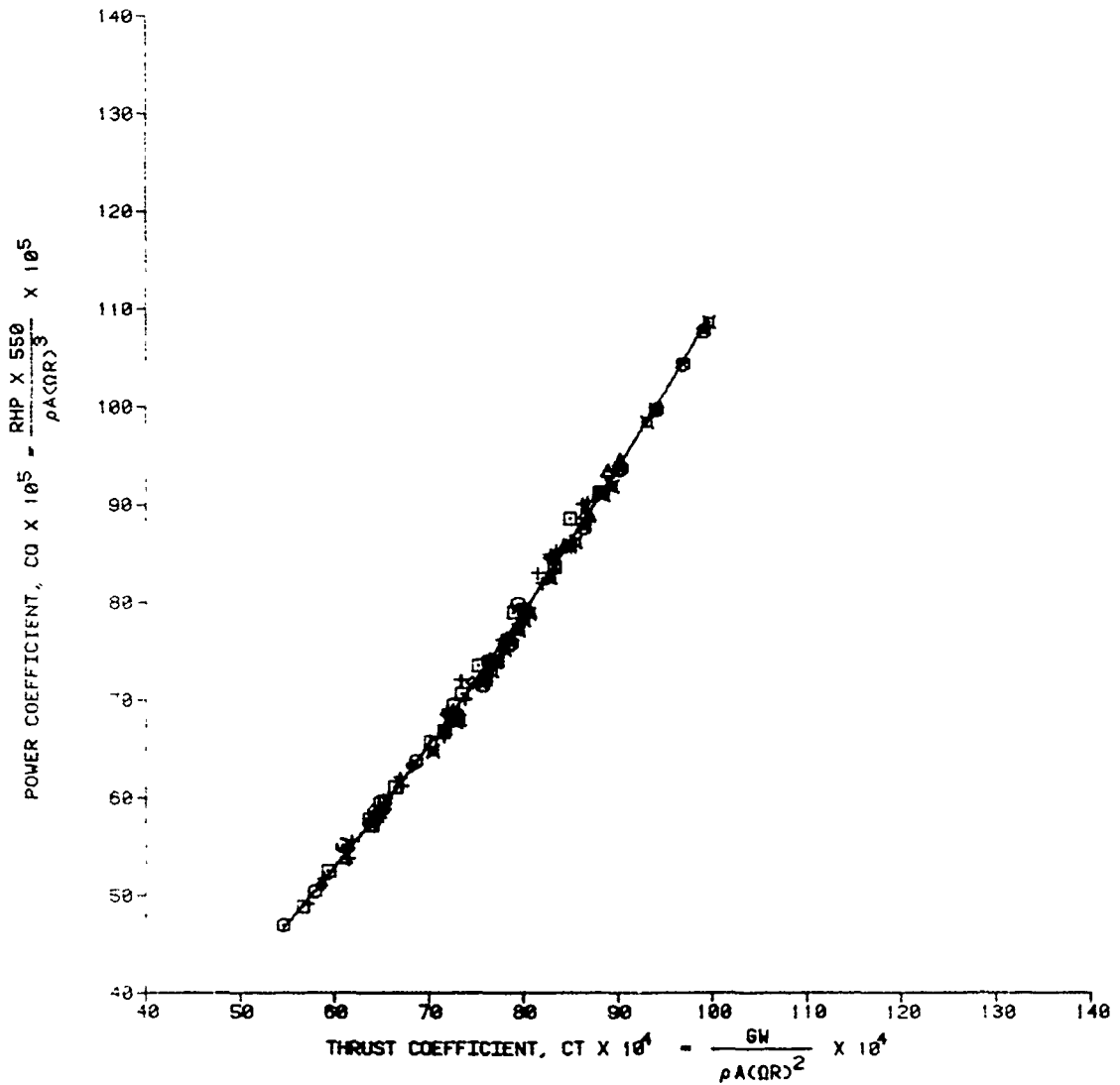

FIGURE 11
 RANGE SUMMARY
 CH-47D USA S/N 81-23383
 STANDARD DAY
 ROTOR SPEED = 225 RPM

- NOTES:
1. SHP REQUIRED OBTAINED FROM FIGS. 18, 19, 29 AND 30.
 2. SHP AVAILABLE AND FUEL FLOW OBTAINED FROM ENGINE MODEL SPECIFICATION T55-L-712 FILE NO. 19.31.51.13 DATED 27 JUNE 1983.
 3. SOLID LINES DENOTE DATA AT 0.99 MAX. NAMPP.
 4. DASH LINES DENOTE DATA AT MAXIMUM CONTINUOUS RATED POWER LIMIT.
 5. DATA REPRESENTS CALCULATED VALUES AND DOES NOT REFLECT CRUISE GUIDE INDICATOR LIMIT OR VIBRATION TOLERANCE LIMIT.
 6. BALL CENTERED FLIGHT.

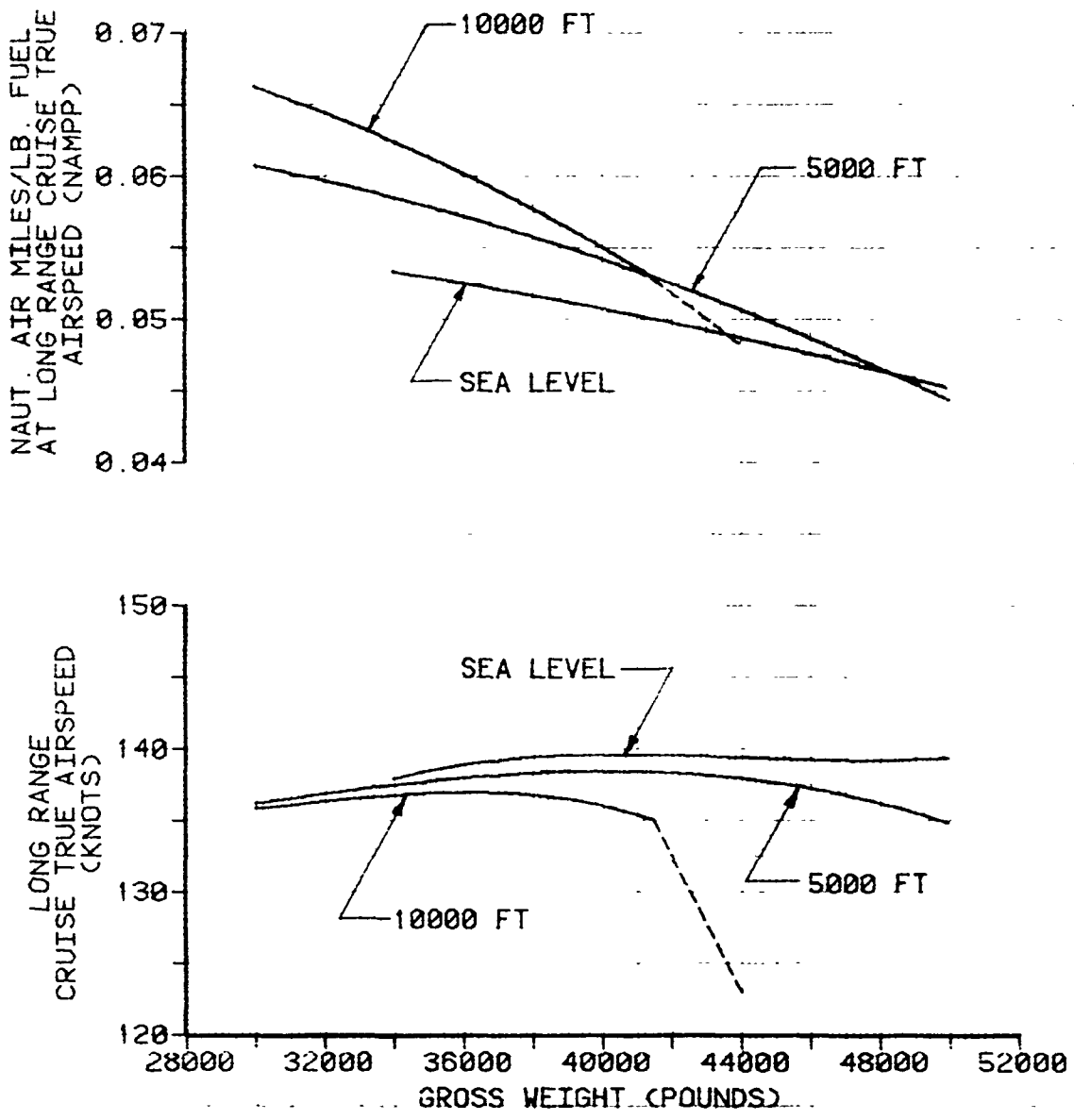

FIGURE 12
 RANGE SUMMARY
 CH-47D USA S/N 81-23383
 35 DEG C DAY
 ROTOR SPEED = 225 RPM

- NOTES: 1. SHP REQUIRED OBTAINED FROM FIGS. 13, 14, 18 AND 19.
 2. SHP AVAILABLE AND FUEL FLOW OBTAINED FROM ENGINE MODEL SPECIFICATION T55-L-712 FILE NO. 19.31.51.13 DATED 27 JUNE 1983.
 3. SOLID LINES DENOTE DATA AT 0.99 MAX. NAMPP.
 4. DASH LINES DENOTE DATA AT MAXIMUM CONTINUOUS RATED POWER LIMIT.
 5. DATA REPRESENTS CALCULATED VALUES AND DOES NOT REFLECT CRUISE GUIDE INDICATOR LIMIT OR VIBRATION TOLERANCE LIMIT.
 6. BALL-CENTERED FLIGHT.

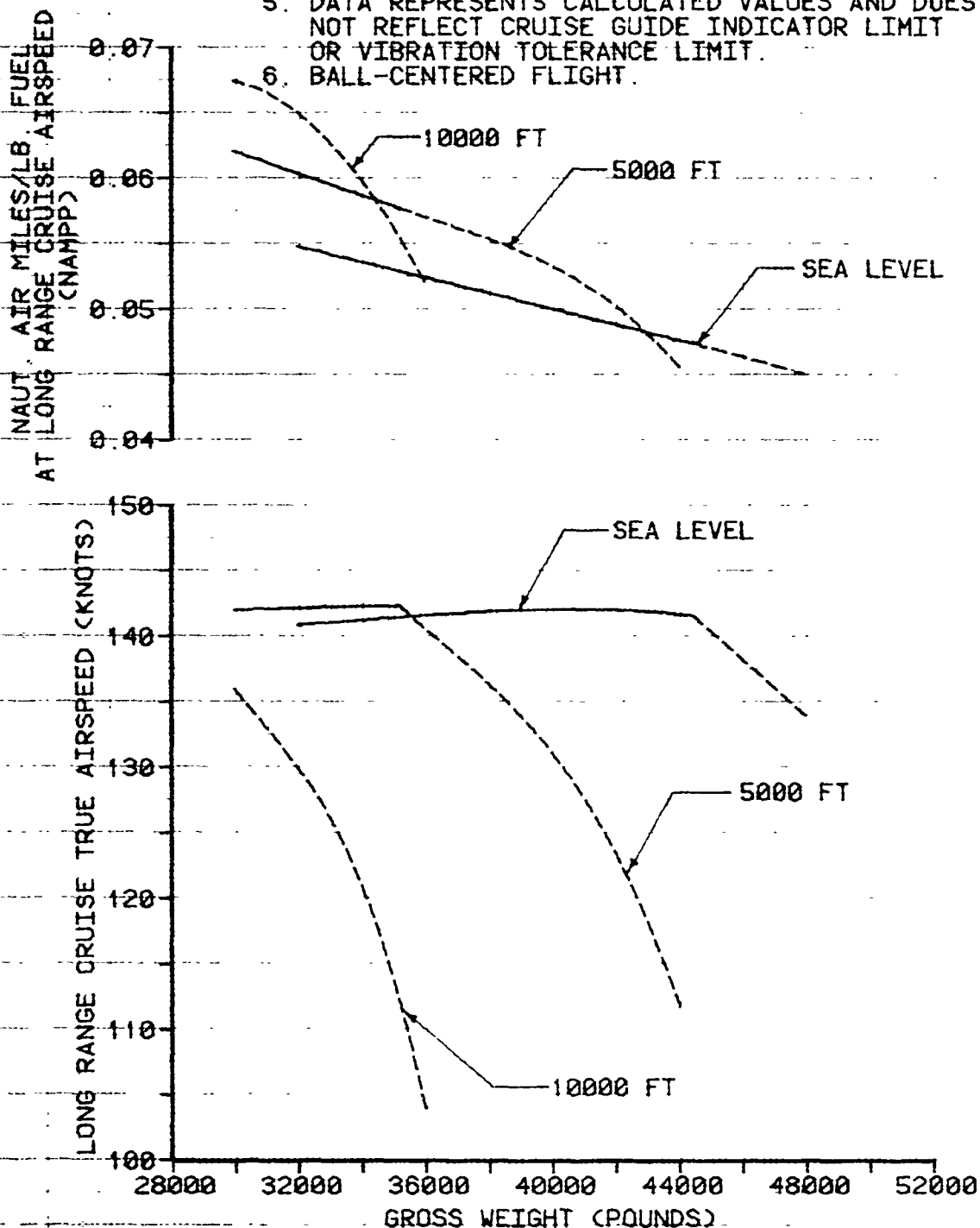

FIGURE 13
 NONDIMENSIONAL LEVEL FLIGHT PERFORMANCE
 CH-47D USA S/N 81-23383
 $N/\sqrt{\theta} = 214.7$ RPM
 LONG. CG = FS 330.2(MID)

- NOTES: 1. CURVES DERIVED FROM FIGS 15 THROUGH 17.
 2. BALL-CENTERED FLIGHT

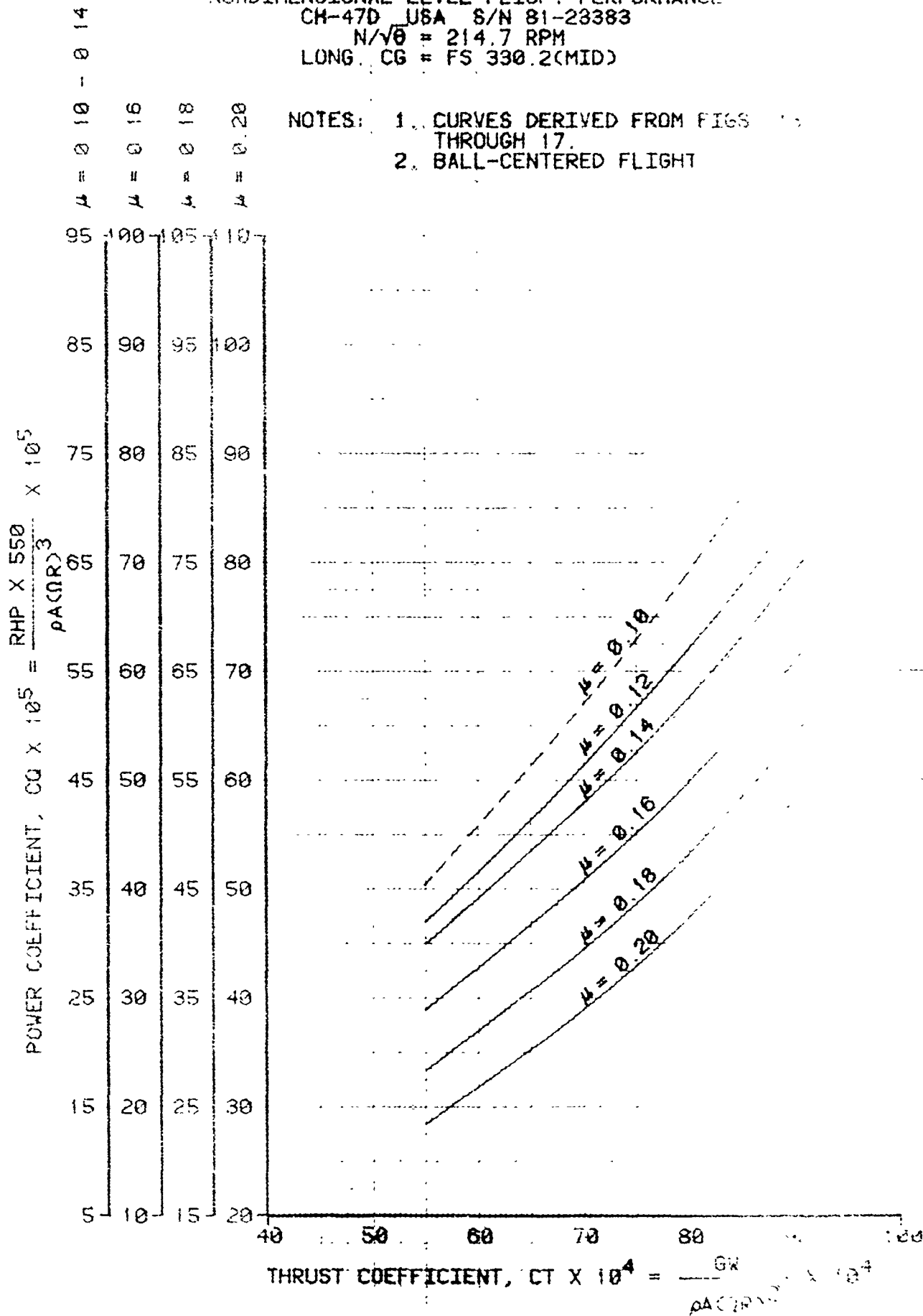

FIGURE 14
 NONDIMENSIONAL LEVEL FLIGHT PERFORMANCE
 CH-47D USA S/N 81-23383
 N/V6 = 214.7 RPM
 LONG CG = FS 330.2(MID)

NOTES: 1. CURVES DERIVED FROM FIGS. 15 THROUGH 17.
 2. BALL-CENTERED FLIGHT.

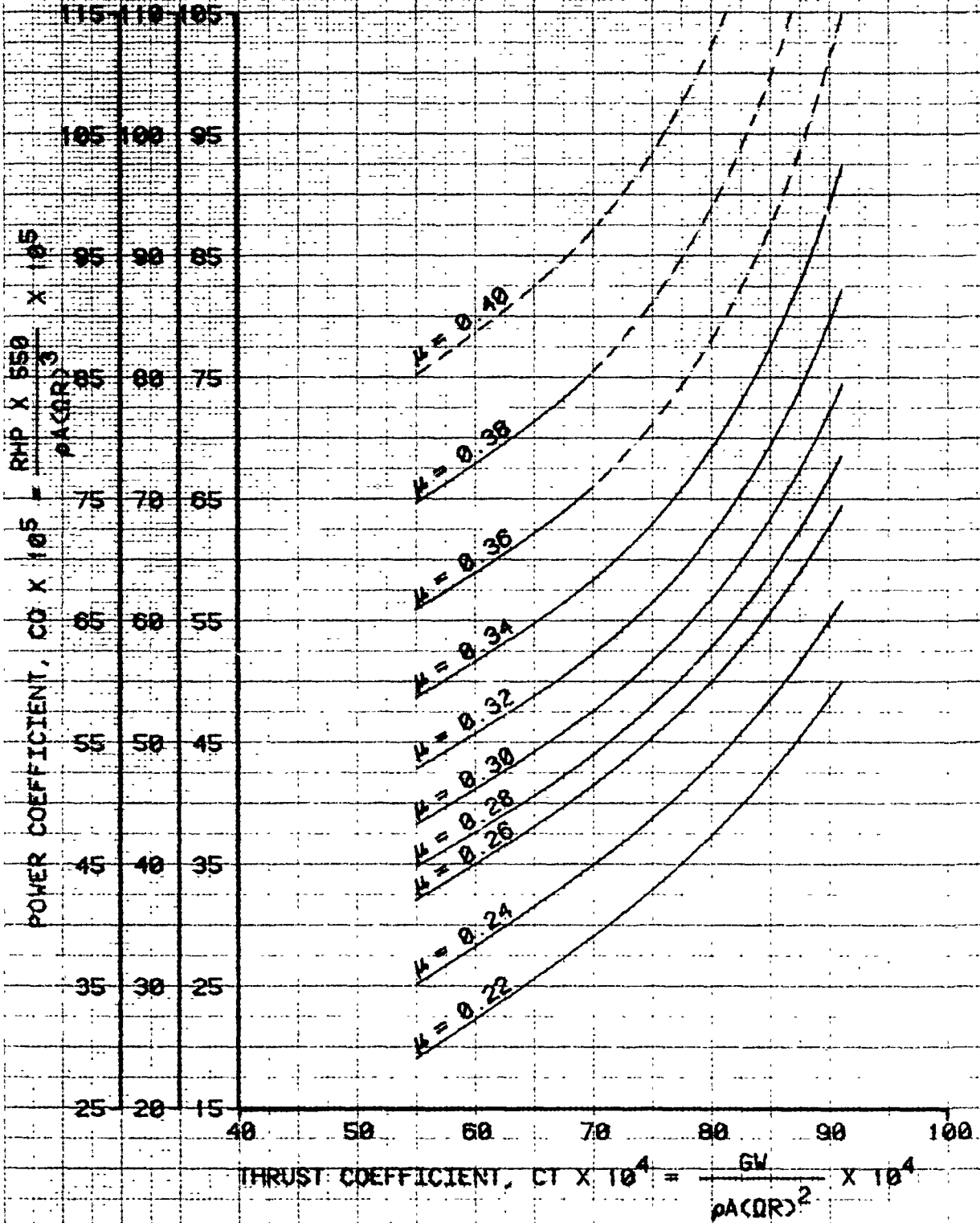

FIGURE 15
LEVEL FLIGHT PERFORMANCE
 CH47D USA S/N 81-23383
 LYCOMING T55-L-712 S/N 71224 & 71226

AVG GROSS WEIGHT (LB)	AVG LONGITUDINAL CG LOCATION (F/S)	AVG DENSITY ALTITUDE (FT)	AVG OAT (DEG C)	AVG ROTOR SPEED (RPM)	AVG CT
31180	330.3(MID)	3620	25.0	218	0.005506

- NOTES: 1. $N/\sqrt{\sigma} = 214.3$ RPM.
 2. BALL-CENTERED FLIGHT.

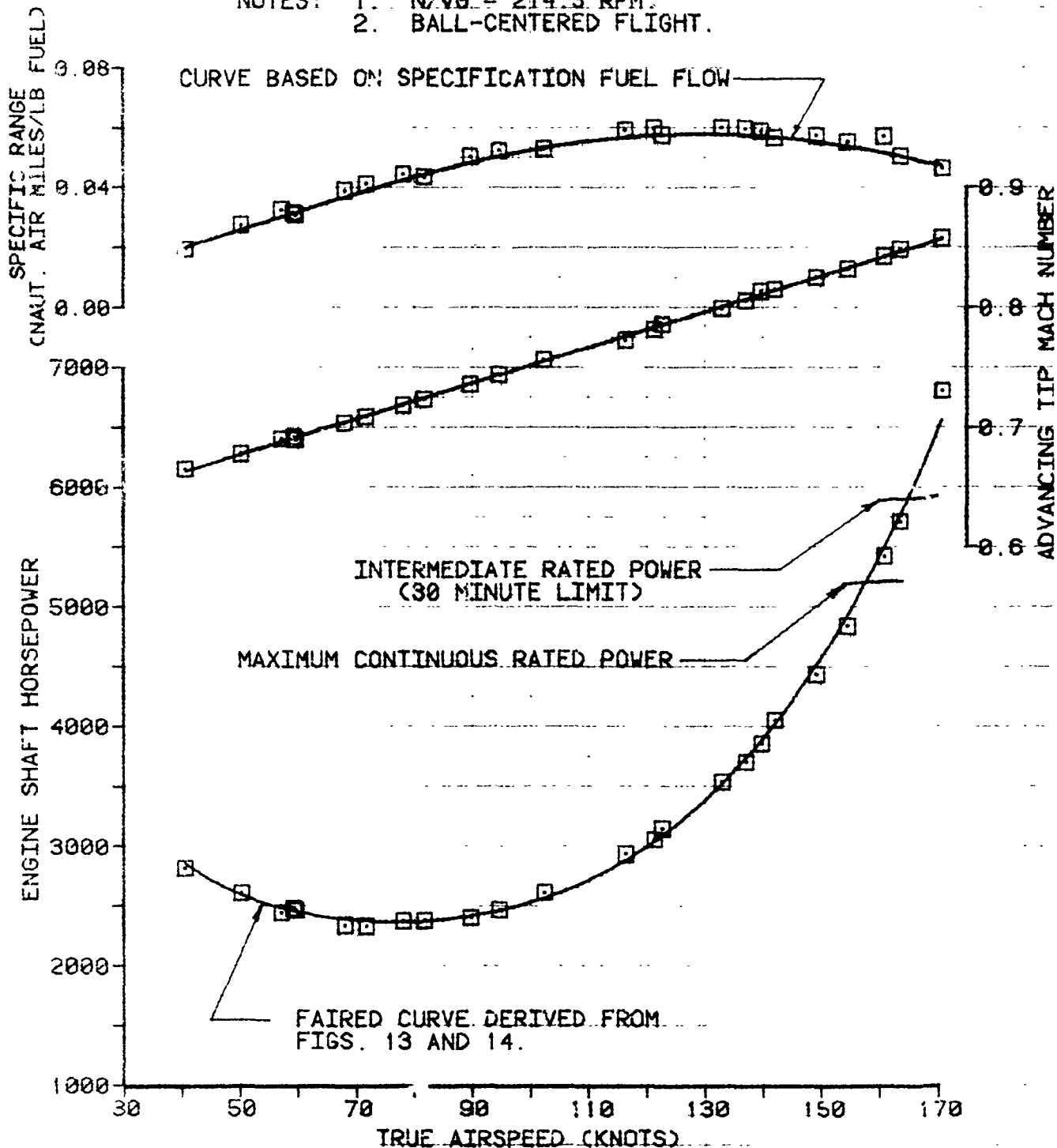

FIGURE 10
LEVEL FLIGHT PERFORMANCE
 CH47D USA S/N 81-23383
 LYCOMING T55-L-712 S/N 71224 & 71226

AVG GROSS WEIGHT (LB)	AVG LONGITUDINAL CG LOCATION (FS)	AVG DENSITY ALTITUDE (FT)	AVG OAT (DEG C)	AVG ROTOR SPEED (RPM)	AVG CT
33360	929.7(MID)	8500	17.5	210	0.006984

NOTES: 1. $N/\sqrt{\sigma} = 215.1$ RPM
 2. BALL-CENTERED FLIGHT.

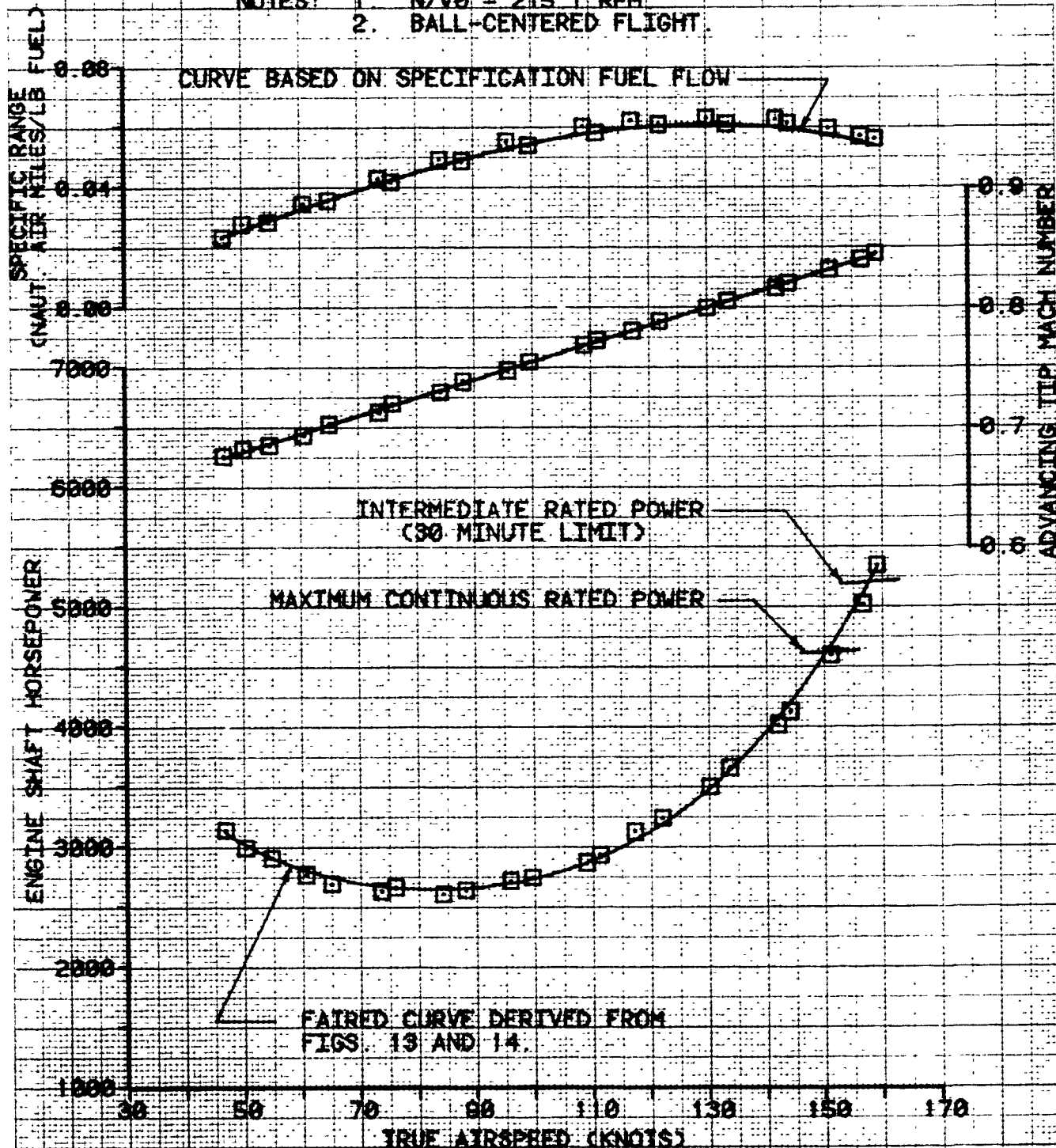

FIGURE 17
 LEVEL FLIGHT PERFORMANCE
 CH47D USA S/N 81-23383
 LYCOMING T55-L-712 S/N 71224 & 71226

AVG GROSS WEIGHT (LB)	AVG LONGITUDINAL CG LOCATION (FSS)	AVG DENSITY ALTITUDE (FT)	AVG OAT (DEG C)	AVG ROTOR SPEED (RPM)	AVG CT
46510	330.7(MID)	6480	21.5	217	0.000039

- NOTES: 1. $N/\sqrt{\sigma} = 214.6$ RPM.
 2. BALL-CENTERED FLIGHT.

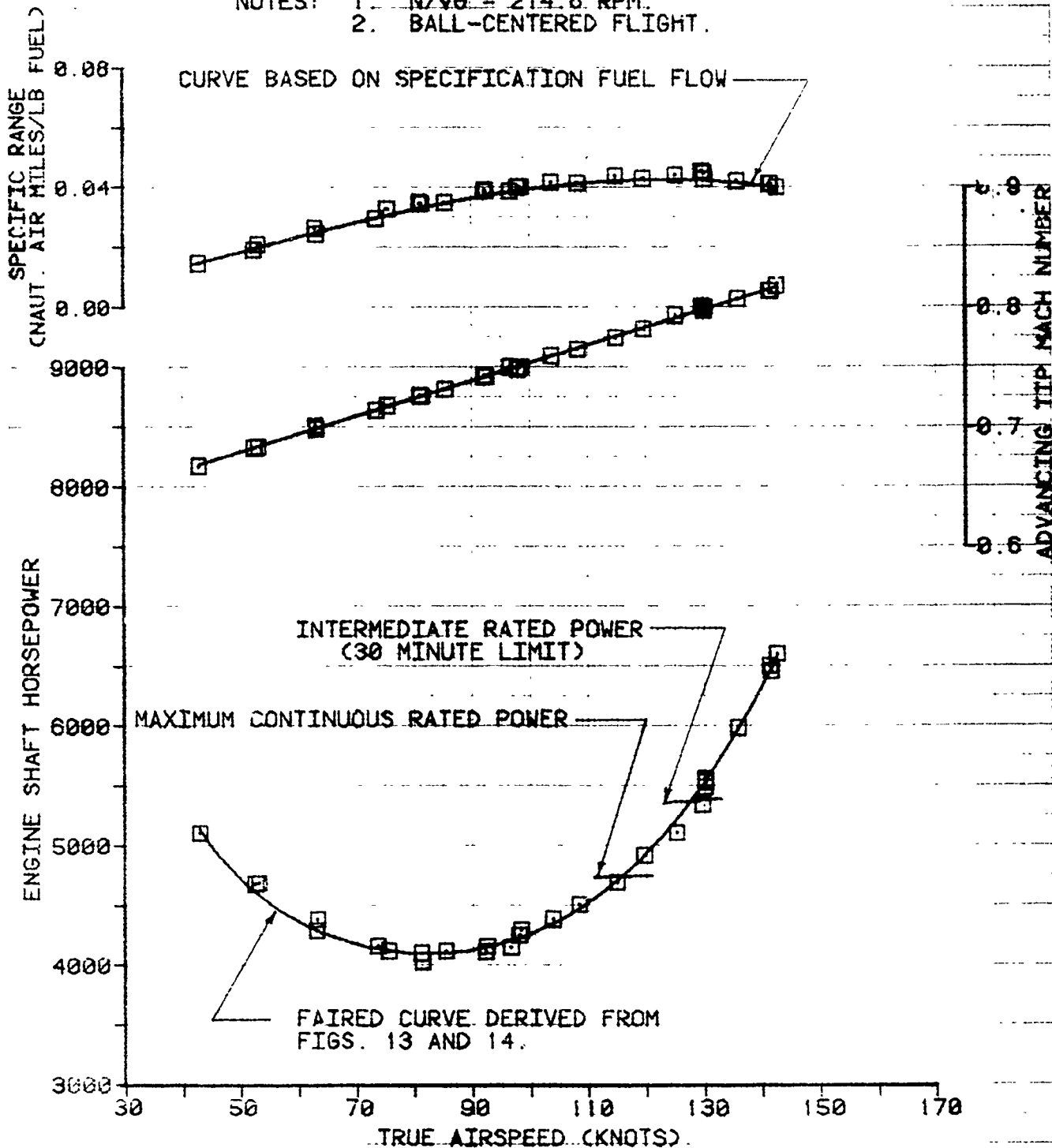

FIGURE 18
 NONDIMENSIONAL LEVEL FLIGHT PERFORMANCE
 CH-47D USA S/N 81-28383
 $N/\sqrt{\sigma} = 224.8$ RPM
 LONG. CG = FS 390.1 (MID)

NOTES: 1. CURVES DERIVED FROM FIGS. 20 THROUGH 25.
 2. BALL-CENTERED FLIGHT.

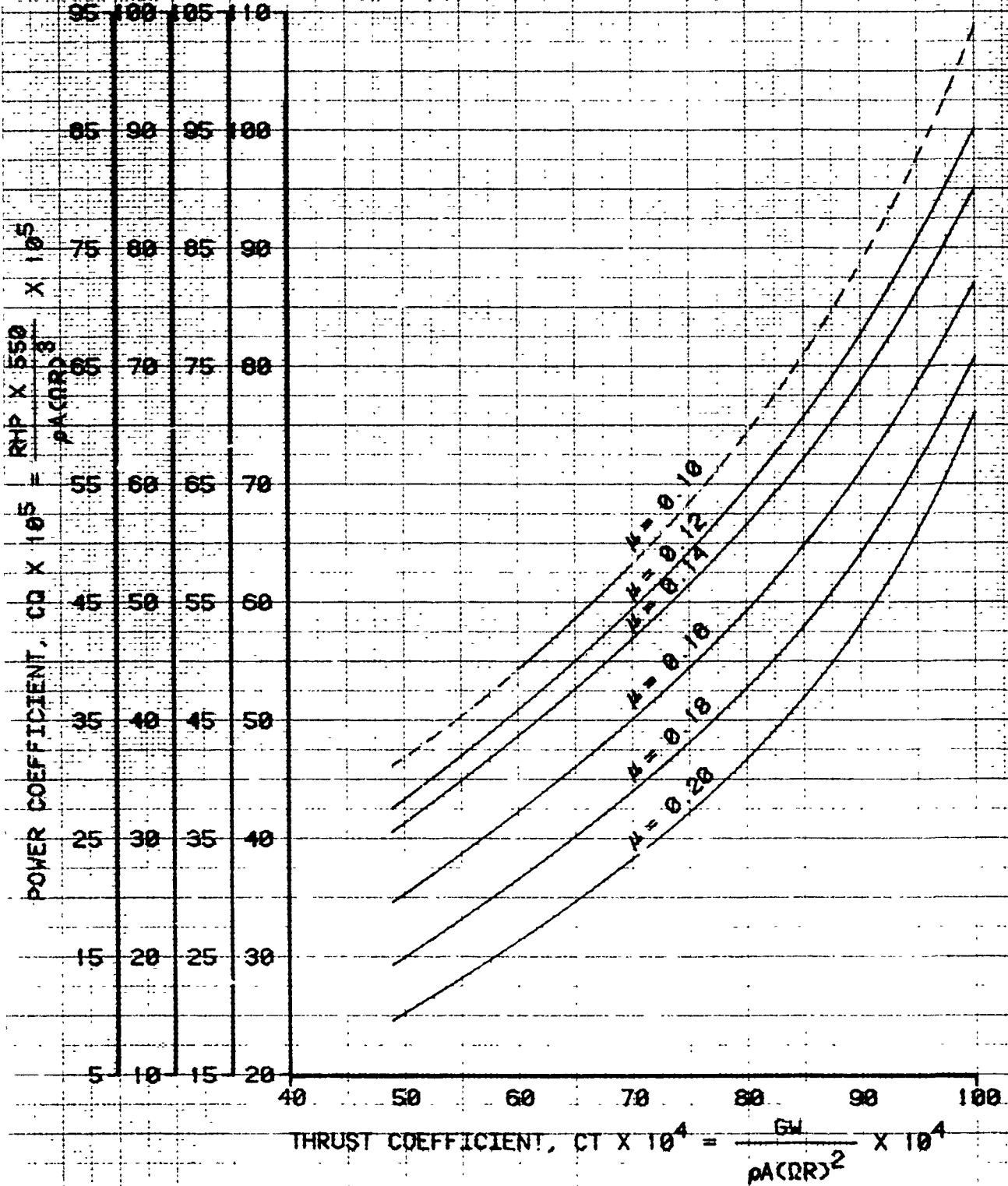

FIGURE 19
 NONDIMENSIONAL LEVEL FLIGHT PERFORMANCE
 CH-47D USA S/N 81-23383
 $N/\sqrt{g} = 224.8$ RPM
 LONG. CG = FS 330.1 (MID)

- NOTES: 1. CURVES DERIVED FROM FIGS. 20 THROUGH 25.
 2. BALL-CENTERED FLIGHT.

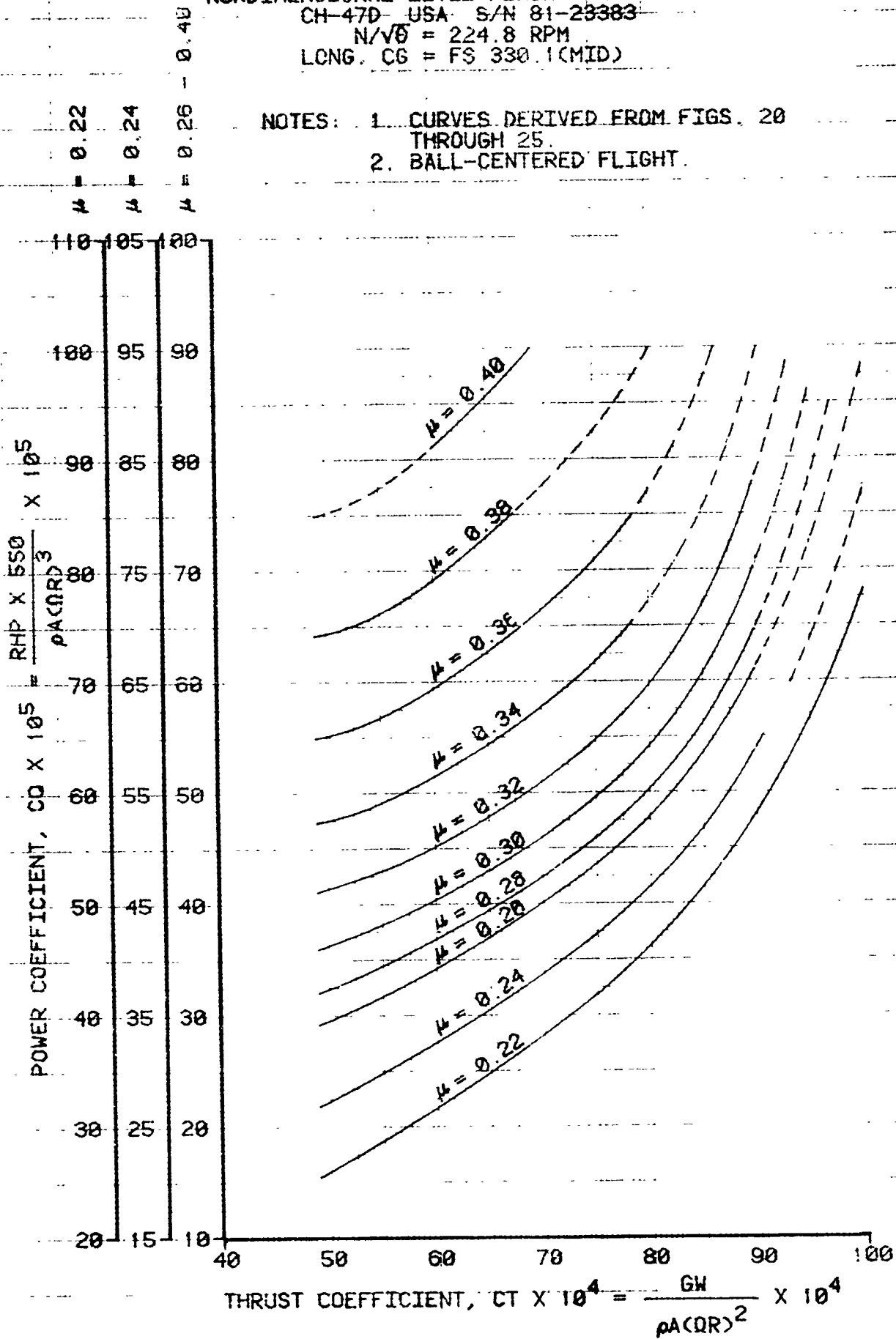

FIGURE 20
 LEVEL FLIGHT PERFORMANCE
 CH47D USA S/N 81-23383
 LYCOMING T55-L-712 S/N 71224 & 71226

AVG GROSS WEIGHT (LB)	AVG LONGITUDINAL CG LOCATION (FS)	AVG DENSITY ALTITUDE (FT)	AVG OAT (DEG C)	AVG ROTOR SPEED (RPM)	AVG CT
31350	930.6 (MID)	1950	13.0	224	0.004988

- NOTES: 1. $N/\sqrt{\sigma} = 224.8$ RPM.
 2. BALL-CENTERED FLIGHT.

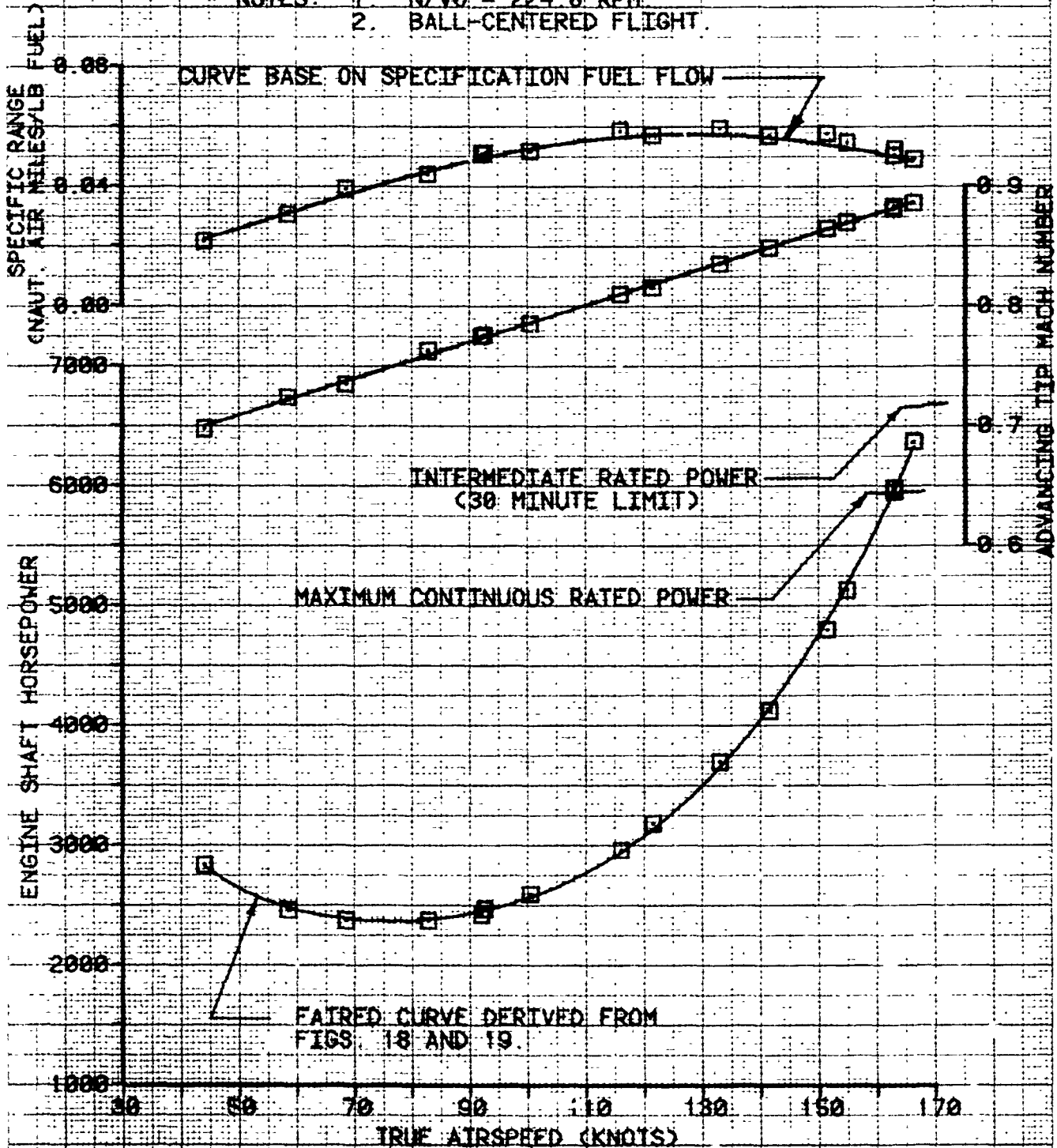

FIGURE 21
 LEVEL FLIGHT PERFORMANCE
 CH47D USA S/N 81-23383
 LYCOMING T55-L-712 S/N 71224 & 71226

AVG GROSS WEIGHT (LB)	AVG LONGITUDINAL CG LOCATION (FS)	AVG DENSITY ALTITUDE (FT)	AVG OAT (DEG C)	AVG ROTOR SPEED (CRPM)	AVG CT
33710	331.3(MID)	4870	6.5	221	0.006014

- NOTES: 1. $N/\sqrt{\delta} = 224.3$ RPM
 2. BALL-CENTERED FLIGHT.

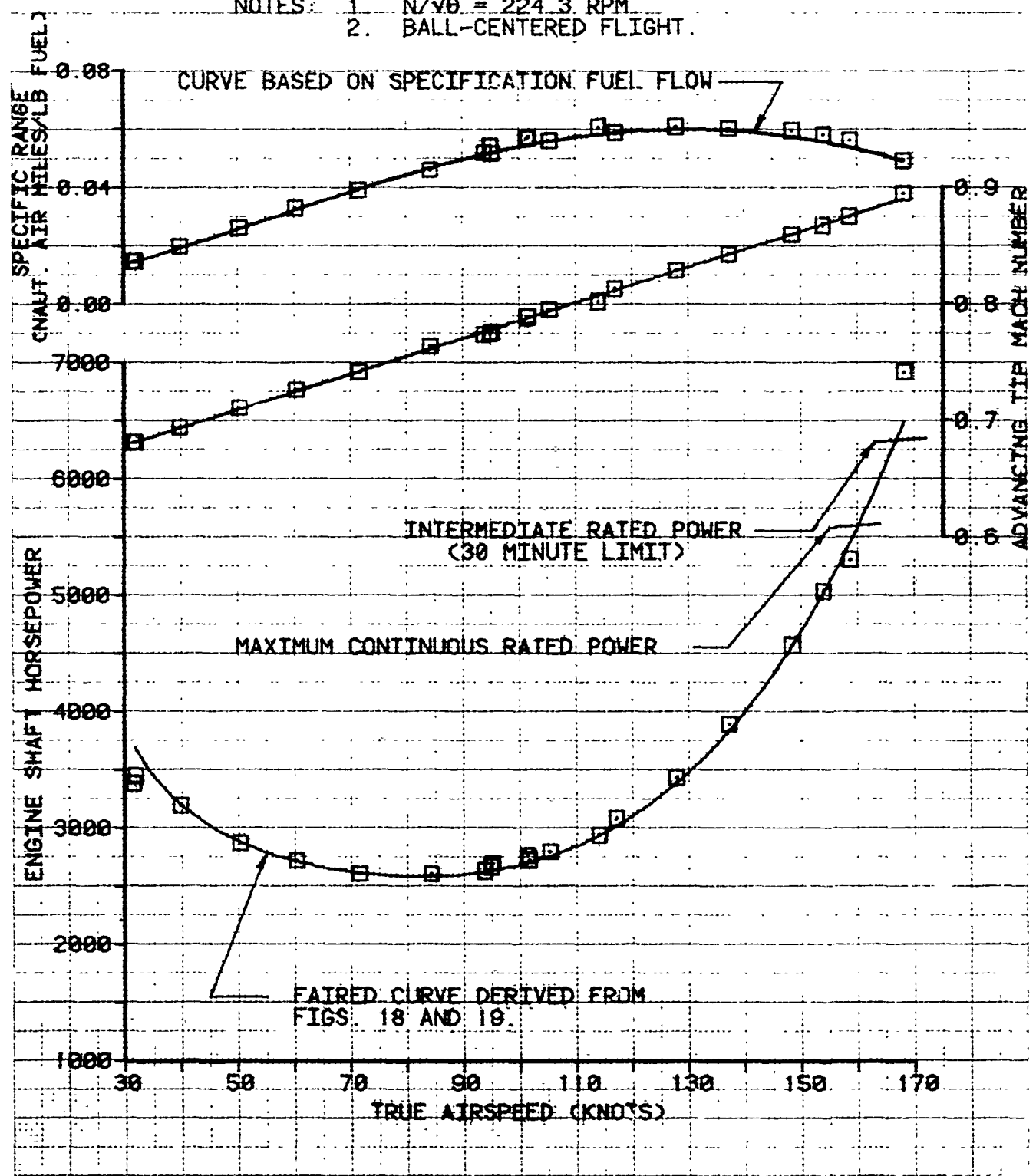

FIGURE 22
LEVEL FLIGHT PERFORMANCE
 CH-47D USA S/N 81-23383
 LYCOMING T55-L-712 S/N 71224 & 71226

AVG GROSS WEIGHT (LBS)	AVG LONGITUDINAL CG LOCATION (CFS)	AVG DENSITY ALTITUDE (FT)	AVG OAT (DEG C)	AVG ROTOR SPEED (RPM)	AVG CT
33760	331.2 (MID)	9720	6.0	221	0.000994

NOTES: 1. $N/\sqrt{\sigma} = 224.5$ RPM
 2. BALL-CENTERED FLIGHT.

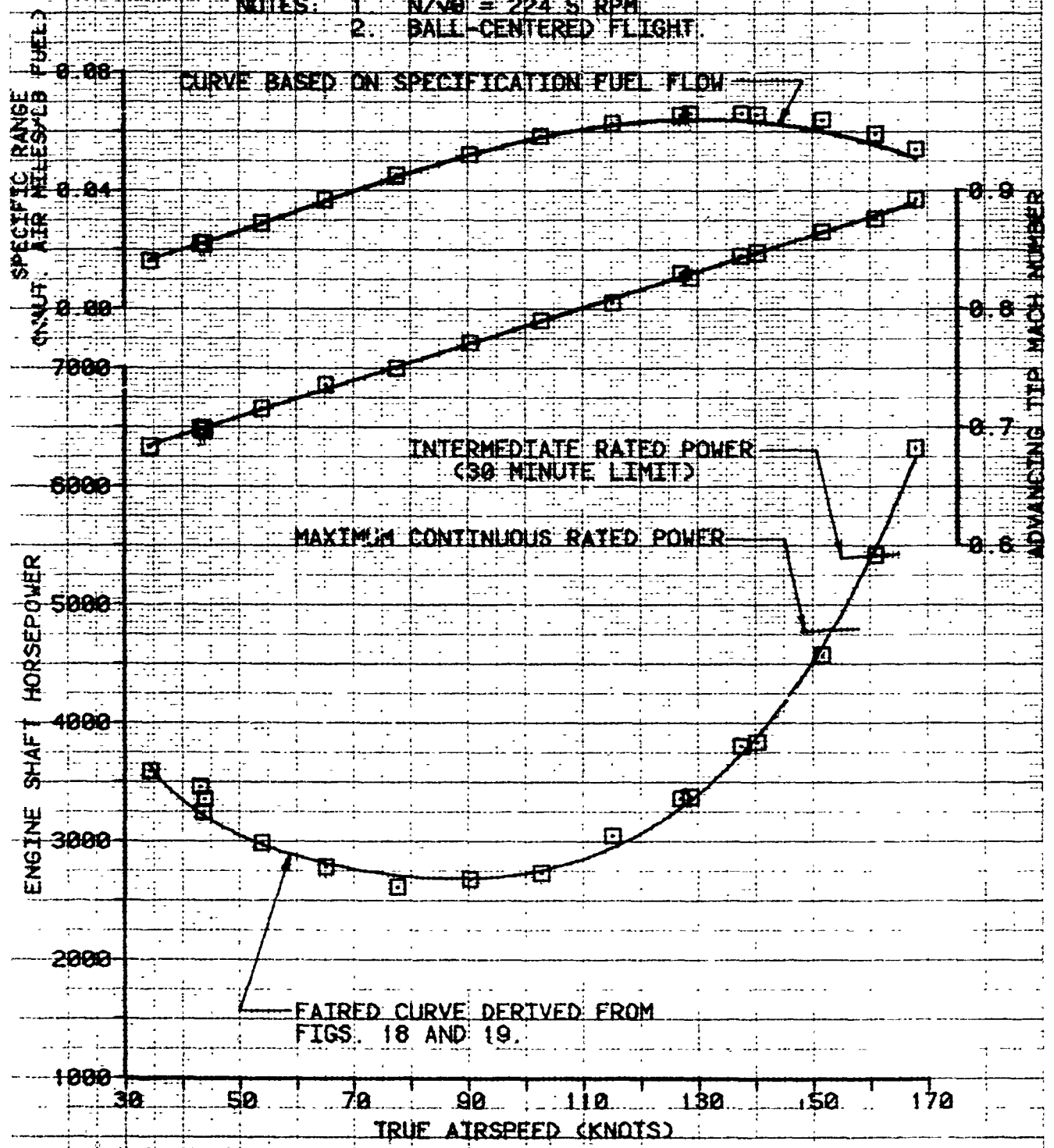

FIGURE 23
LEVEL FLIGHT PERFORMANCE
 CH47D USA S/N 81-23383
 LYCOMING T55-L-712 S/N 71224 & 71226

AVG GROSS WEIGHT (LB)	AVG LONGITUDINAL CG LOCATION (FS)	AVG DENSITY ALTITUDE (FT)	AVG OAT (DEG C)	AVG ROTOR SPEED (RPM)	AVG CT
42500	328.1 (MID)	0010	5.0	221	0.007850

NOTES: 1. N/VG = 224.9 RPM
 2. BALL-CENTERED FLIGHT.

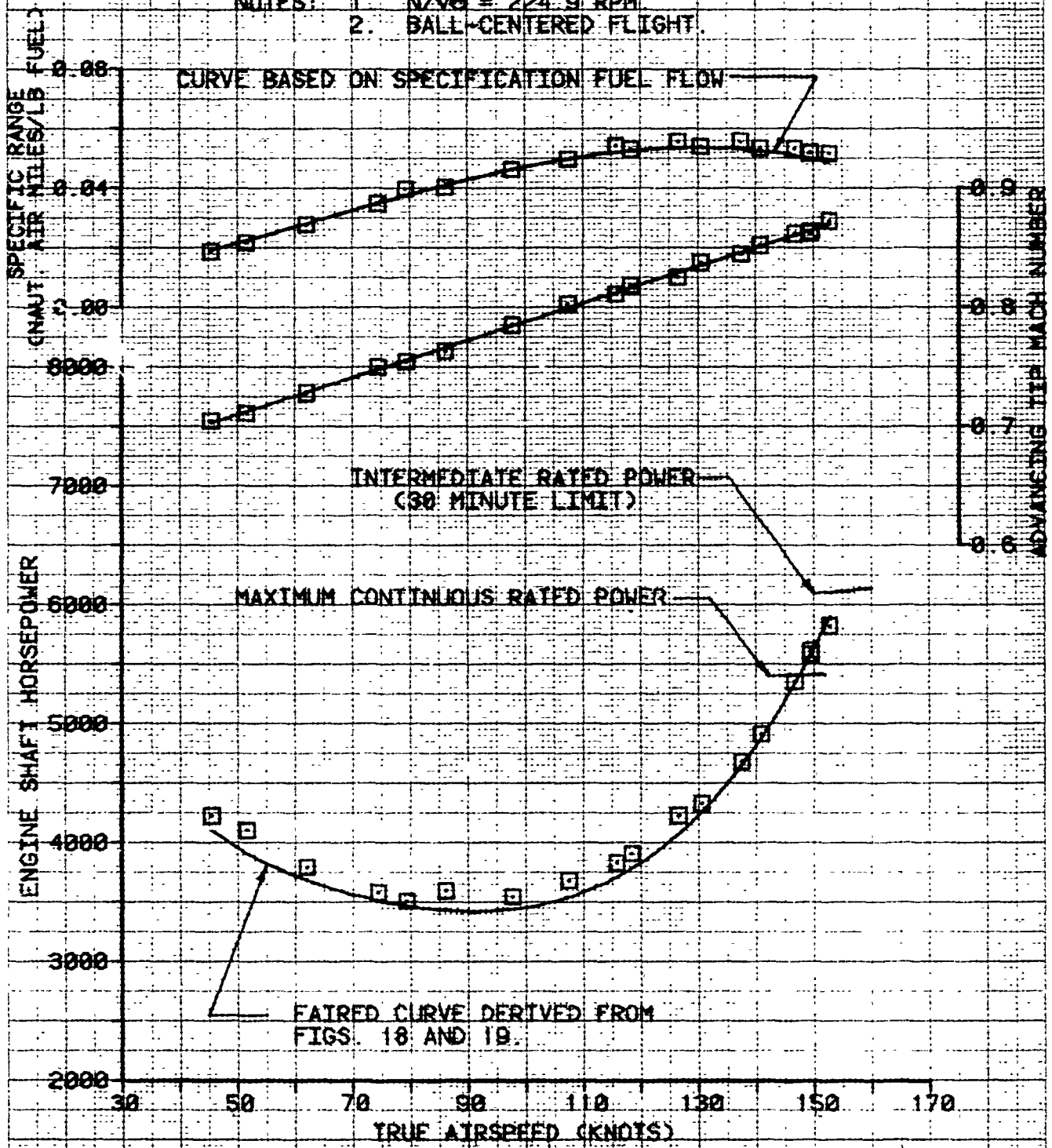

FIGURE 24
LEVEL FLIGHT PERFORMANCE
 CH47D USA S/N 61-23983
 LYCOMING T55-L-712 S/N 71224 & 71226

AVG GROSS WEIGHT (LB)	AVG LONGITUDINAL CG LOCATION (FSD)	AVG DENSITY ALTITUDE (FT)	AVG OAT (DEG C)	AVG ROTOR SPEED (RPM)	AVG CT
48300	329.7 (MID)	6510	7.0	222	0.006977

- NOTES: 1. $N/V_0 = 225.1$ RPM
 2. BALL-CENTERED FLIGHT.

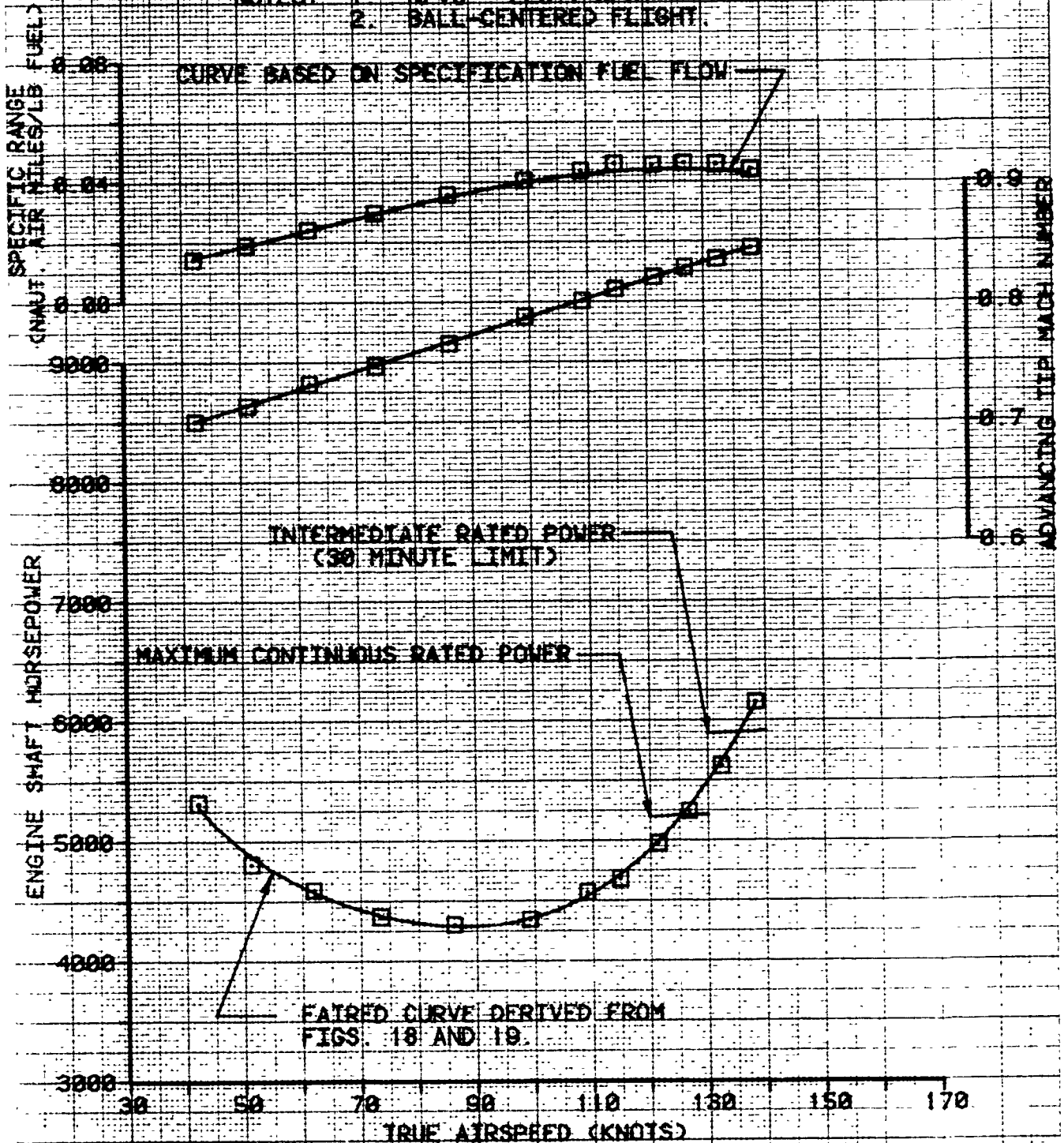

FIGURE 25
LEVEL FLIGHT PERFORMANCE
 CH47D USA S/N 81-23383
 LYCOMING T55-L-712 S/N 71224 & 71226

AVG GROSS WEIGHT (LB)	AVG LONGITUDINAL CG LOCATION (FS)	AVG DENSITY ALTITUDE (FT)	AVG OAT (DEG C)	AVG ROTOR SPEED (RPM)	AVG CT
40180	320.7(MID)	8490	-1.0	219	0.009985

NOTES: 1. $N/\sqrt{\sigma} = 225.3$ RPM
 2. BALL-CENTERED FLIGHT.

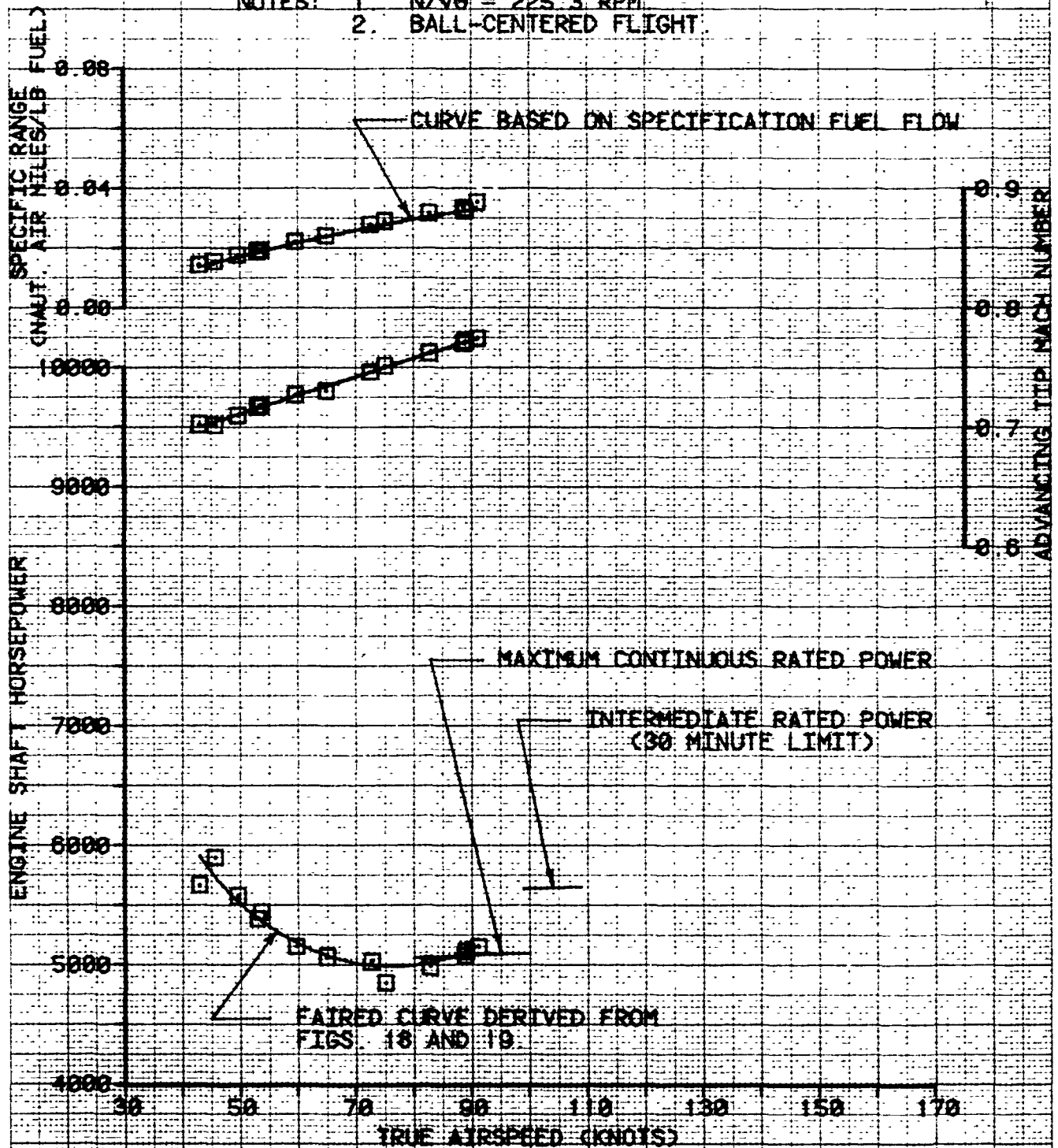

FIGURE 26
LEVEL FLIGHT PERFORMANCE
 CH47D USA S/N 81-23983
 LYCOMING T55-L-712 S/N 71224 & 71226

AVG GROSS WEIGHT (LB)	AVG LONGITUDINAL CG LOCATION (CFS)	AVG DENSITY ALTITUDE (FT)	AVG OAT (DEG C)	AVG ROTOR SPEED (RPM)	AVG CT
20250	342.9(AFT)	1500	5.5	221	0.005001

- NOTES: 1. $N/\sqrt{\sigma} = 224.7$ RPM
 2. BALL-CENTERED FLIGHT.
 3. AFT CG CONFIGURATION.

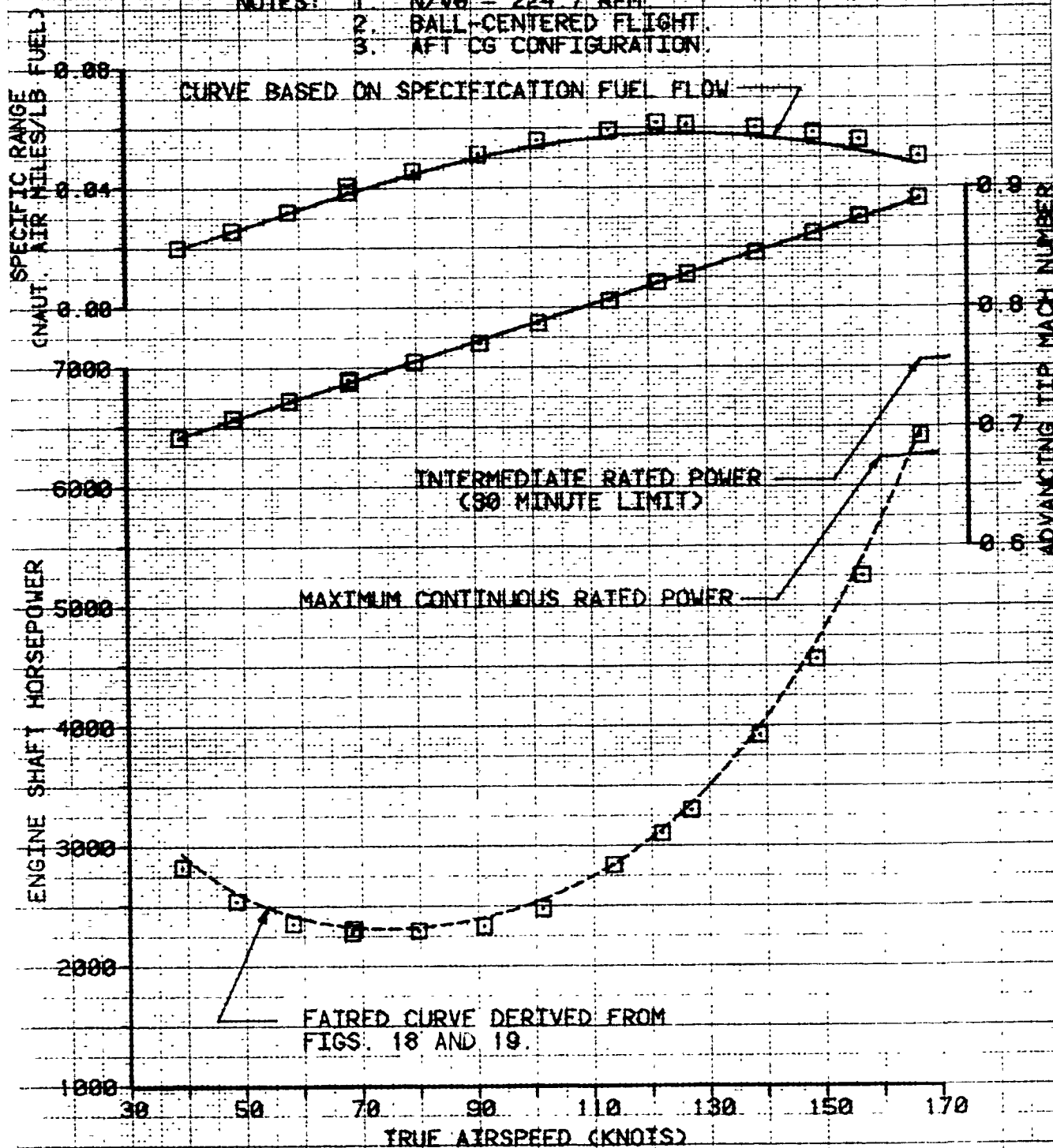

FIGURE 27
LEVEL FLIGHT PERFORMANCE
 CH47D USA S/N 81-23383
 LYCOMING T55-L-712 S/N 71224 & 71226

AVG GROSS WEIGHT (LB)	AVG LONGITUDINAL CG LOCATION (FS)	AVG DENSITY ALTITUDE (FT)	AVG OAT (DEG C)	AVG ROTOR SPEED (RPM)	AVG CT
31970	320.2(FWD)	850	8.5	222	0.005013

- NOTES: 1. $N/\sqrt{\sigma} = 224.5$ RPM.
 2. BALL-CENTERED FLIGHT.
 3. FWD CG CONFIGURATION.

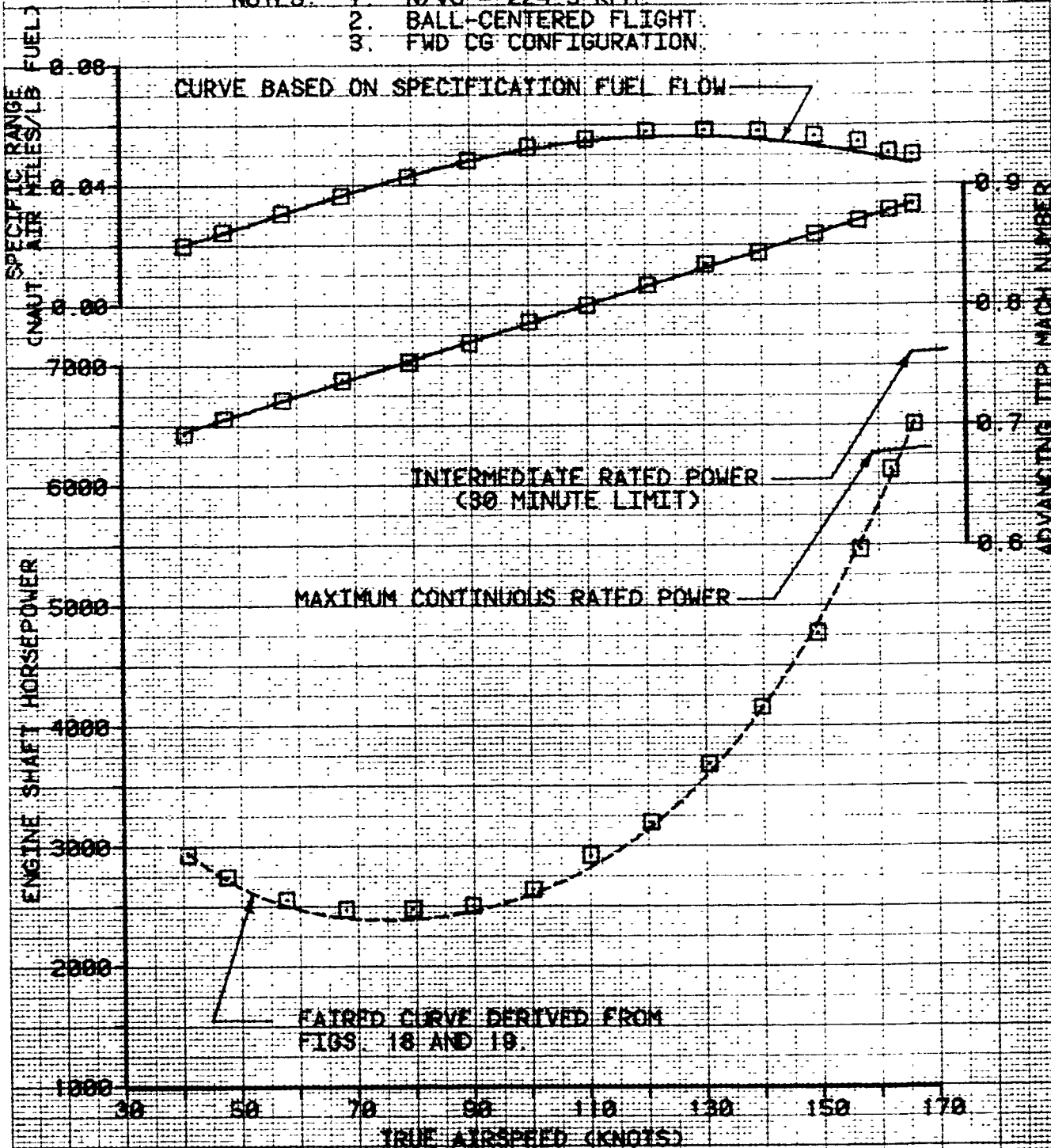

FIGURE 28
LEVEL FLIGHT PERFORMANCE
 CH47D USA S/N 81-29383
 LYCOMING T55-L-712 S/N 71224 & 71226

AVG GROSS WEIGHT (LB)	AVG LONGITUDINAL CG LOCATION (F/S)	AVG DENSITY ALTITUDE (FT)	AVG OAT (DEG C)	AVG ROTOR SPEED (RPM)	AVG CT
30000	329.5 (MID)	5270	0.0	219	0.007003

- NOTES: 1. $N/\sqrt{\sigma} = 224.9$ RPM
 2. BALL-CENTERED FLIGHT
 3. RAMP DOWN CONFIGURATION

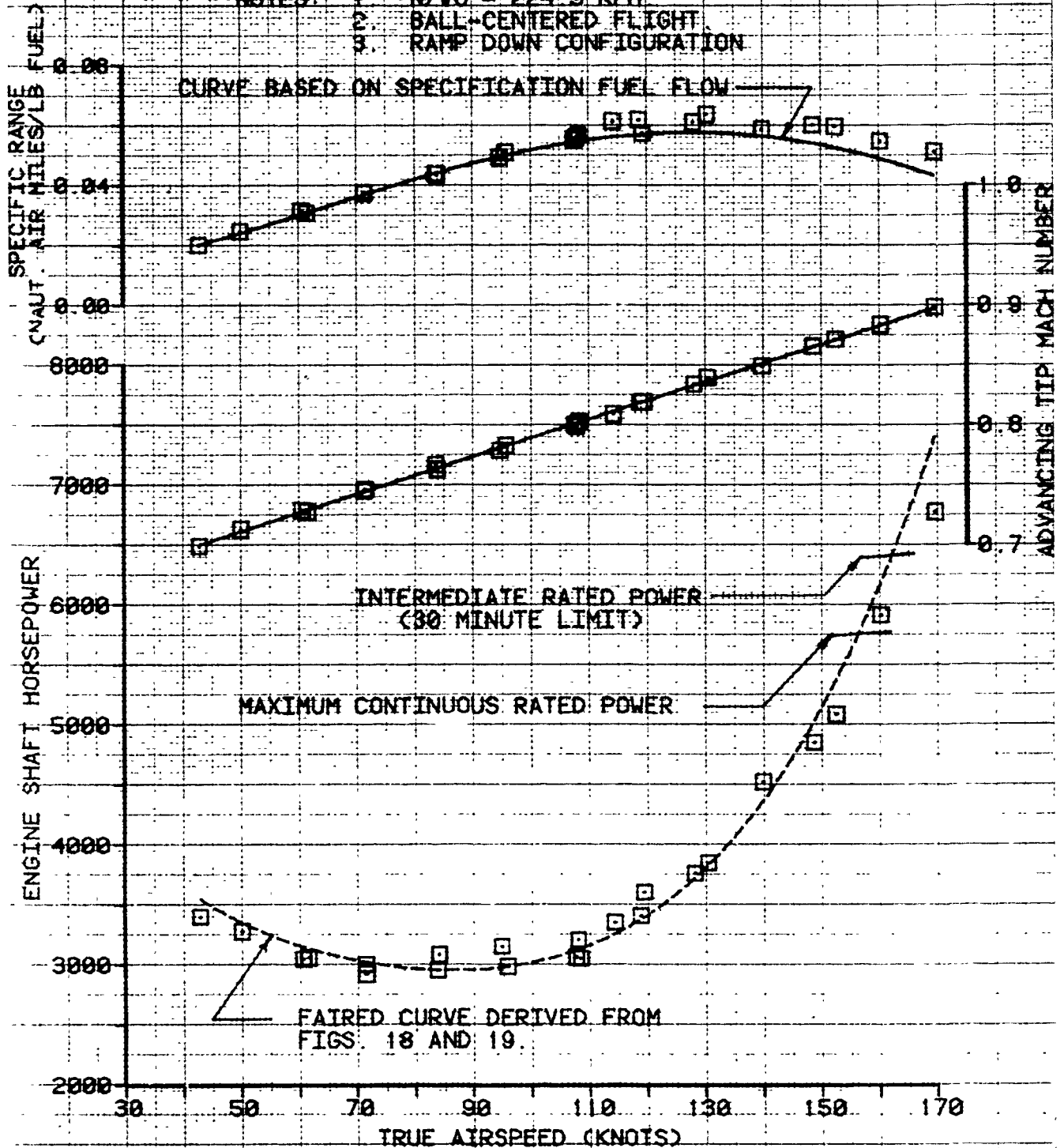

FIGURE 29
 NONDIMENSIONAL LEVEL FLIGHT PERFORMANCE
 CH-47D USA S/N 81-23383
 $N/\sqrt{\theta} = 244.8 \text{ RPM}$
 LONG. CG = FS 329.9(MID)

- NOTES: 1. CURVES DERIVED FROM FIGS. 31 THROUGH 33.
 2. BALL-CENTERED FLIGHT

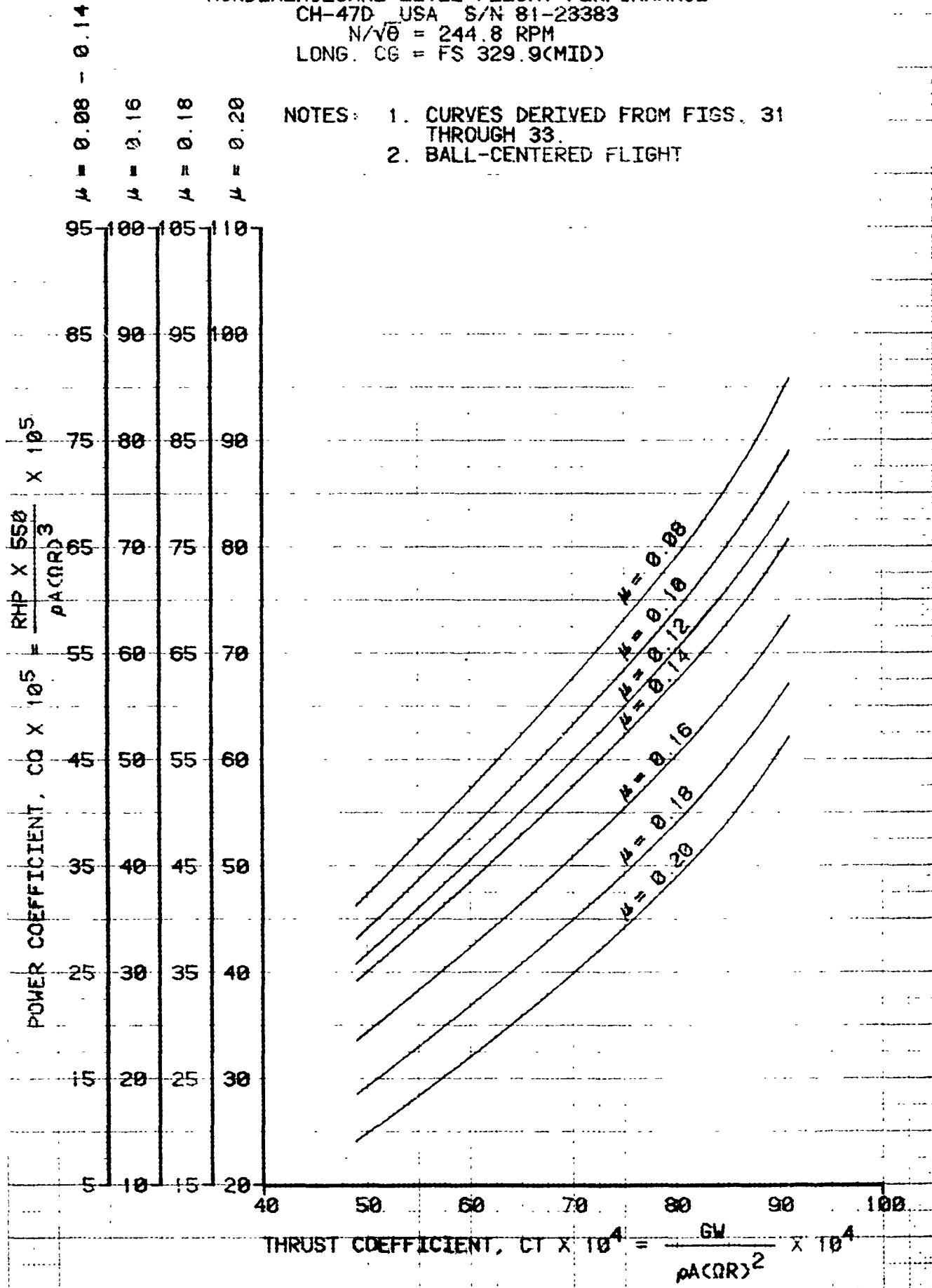

FIGURE 30
 NONDIMENSIONAL LEVEL FLIGHT PERFORMANCE
 CH-47D USA S/N 81-29383
 $N/\sqrt{\sigma} = 244.8$ RPH
 LONG CG = FS 329.9 (MID)

NOTES: 1. CURVES DERIVED FROM FIGS 31 THROUGH 33.
 2. BALL-CENTERED FLIGHT.

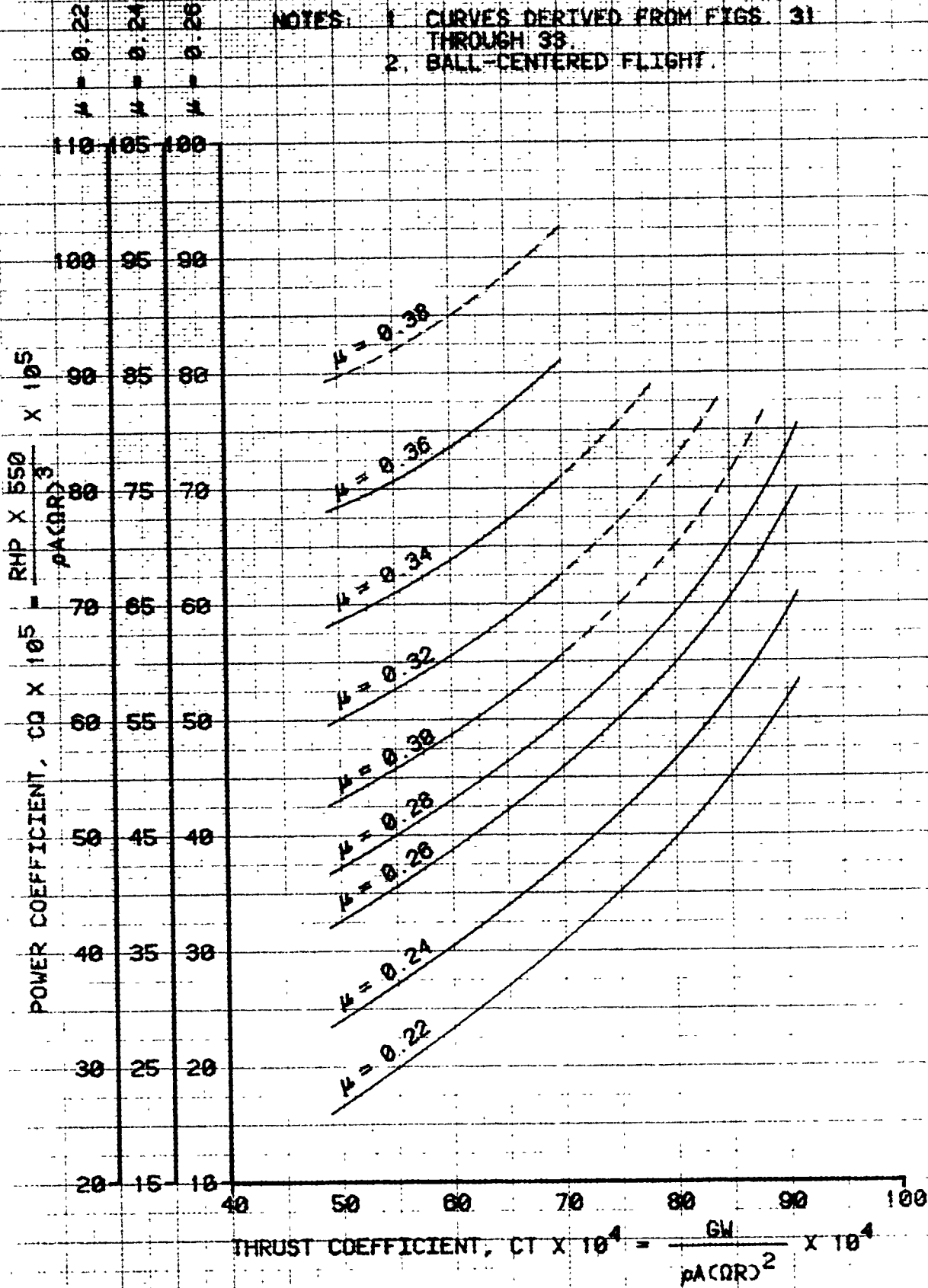

FIGURE 31
LEVEL FLIGHT PERFORMANCE
 CH47D USA S/N 81-23383
 LYCOMING T55-L-712 S/N 71224 & 71226

AVG GROSS WEIGHT (LB)	AVG LONGITUDINAL CG LOCATION (FS)	AVG DENSITY ALTITUDE (FT)	AVG OAT (DEG C)	AVG ROTOR SPEED (RPM)	AVG CT
31090	330.7(MID)	4910	-11.5	233	0.004961

NOTES: 1. $N/\sqrt{\sigma} = 244.5$ RPM
 2. BALL-CENTERED FLIGHT.

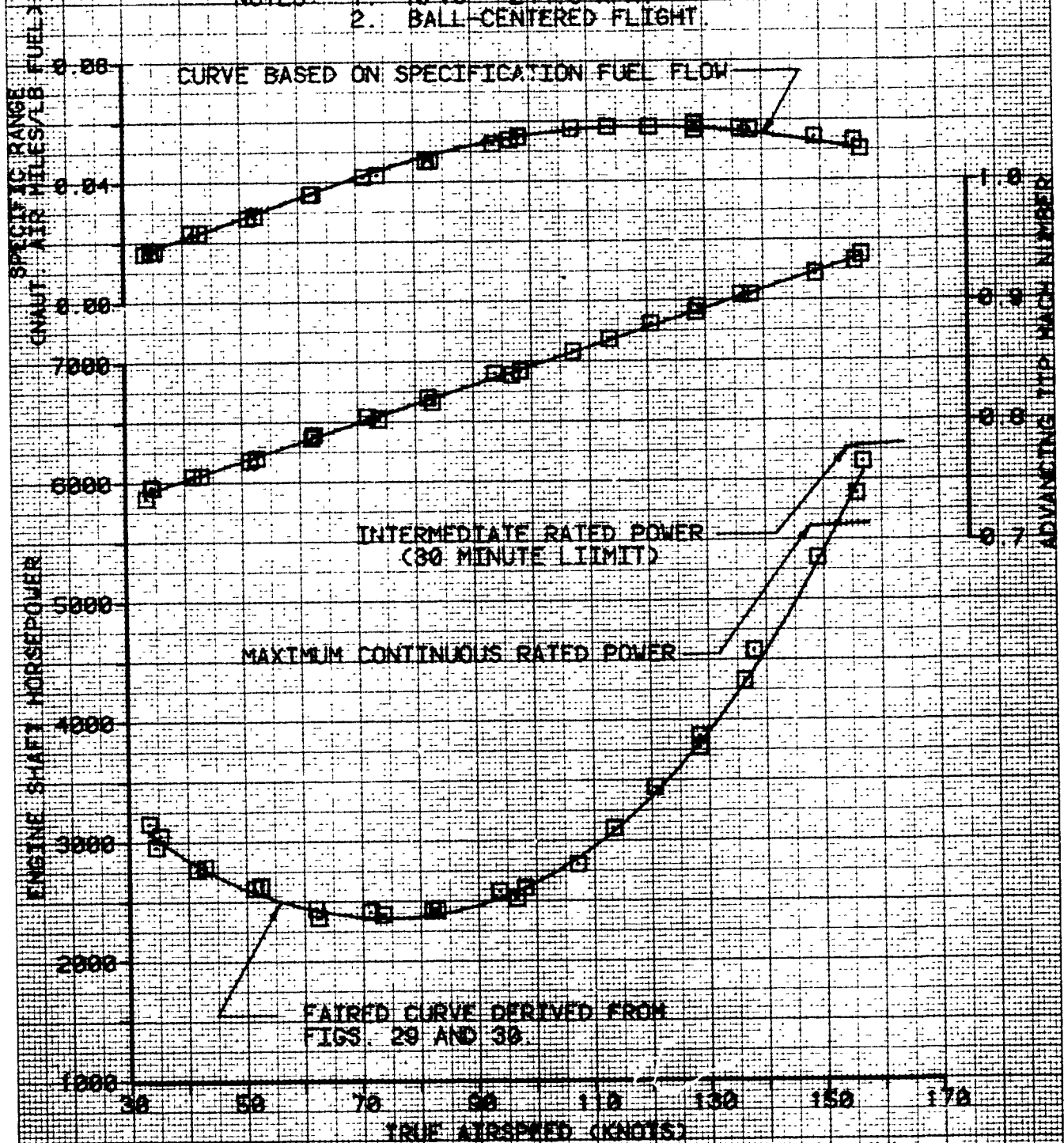

FIGURE 32
LEVEL FLIGHT PERFORMANCE
 CH-7D USA S/N 81-29383
 LYCOMING T55-L-712 S/N 71224 & 71226

AVG GROSS WEIGHT (LB)	AVG LONGITUDINAL CG LOCATION (FS)	AVG DENSITY ALTITUDE (FT)	AVG OAT (DEG C)	AVG ROTOR SPEED (RPM)	AVG CT
44140	320.4 (MID)	3750	-17.0	231	0.006969

NOTES: 1. $N/\sqrt{\sigma} = 245.0$ RPM
 2. BALL-CENTERED FLIGHT.

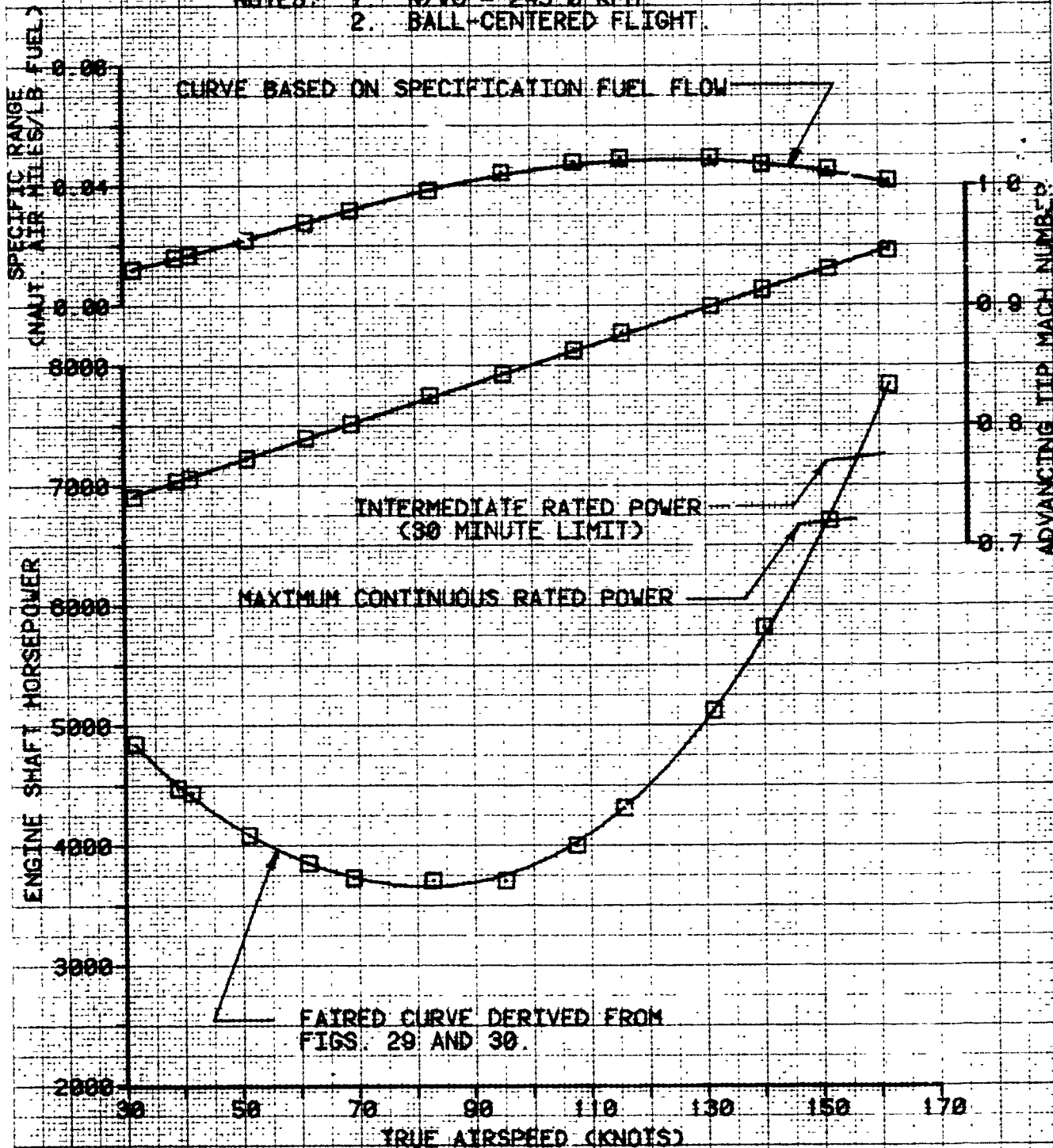

FIGURE 33
LEVEL FLIGHT PERFORMANCE
 CH47D USA S/N 81-23383
 LYCOMING T55-L-712 S/N 71224 & 71226

AVG GROSS WEIGHT (LB)	AVG LONGITUDINAL CG LOCATION (FSS)	AVG DENSITY ALTITUDE (FT)	AVG OAT (DEG C)	AVG ROTOR SPEED (RPM)	AVG CT
49040	329.6(MID)	6720	-10.5	231	0.009013

NOTES: 1. N/V6 = 244.8 RPM.
 2. BALL-CENTERED FLIGHT.

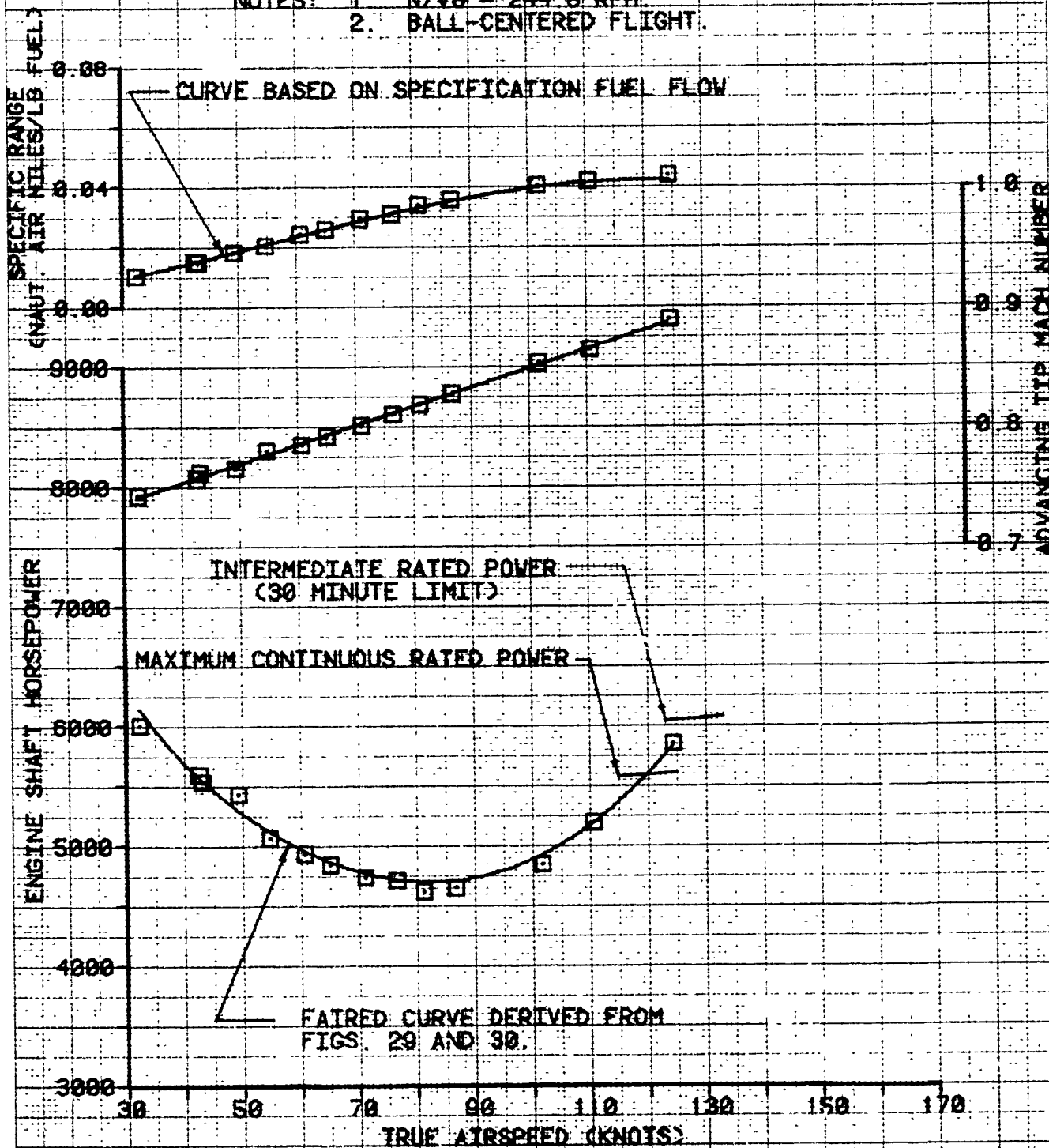

FIGURE 34
 AUTOROTATIONAL DESCENT PERFORMANCE
 CH-47D USA S/N 81-23383

AVG GROSS WEIGHT (LB)	AVG LONGITUDINAL CG LOCATION (F5)	AVG DENSITY ALTITUDE (FEET)	AVG OAT (DEG C)	AVG ROTOR SPEED (RPM)
33720	330.3 (MID)	6480	17.0	224

NOTE: 1 BALL CENTERED FLIGHT

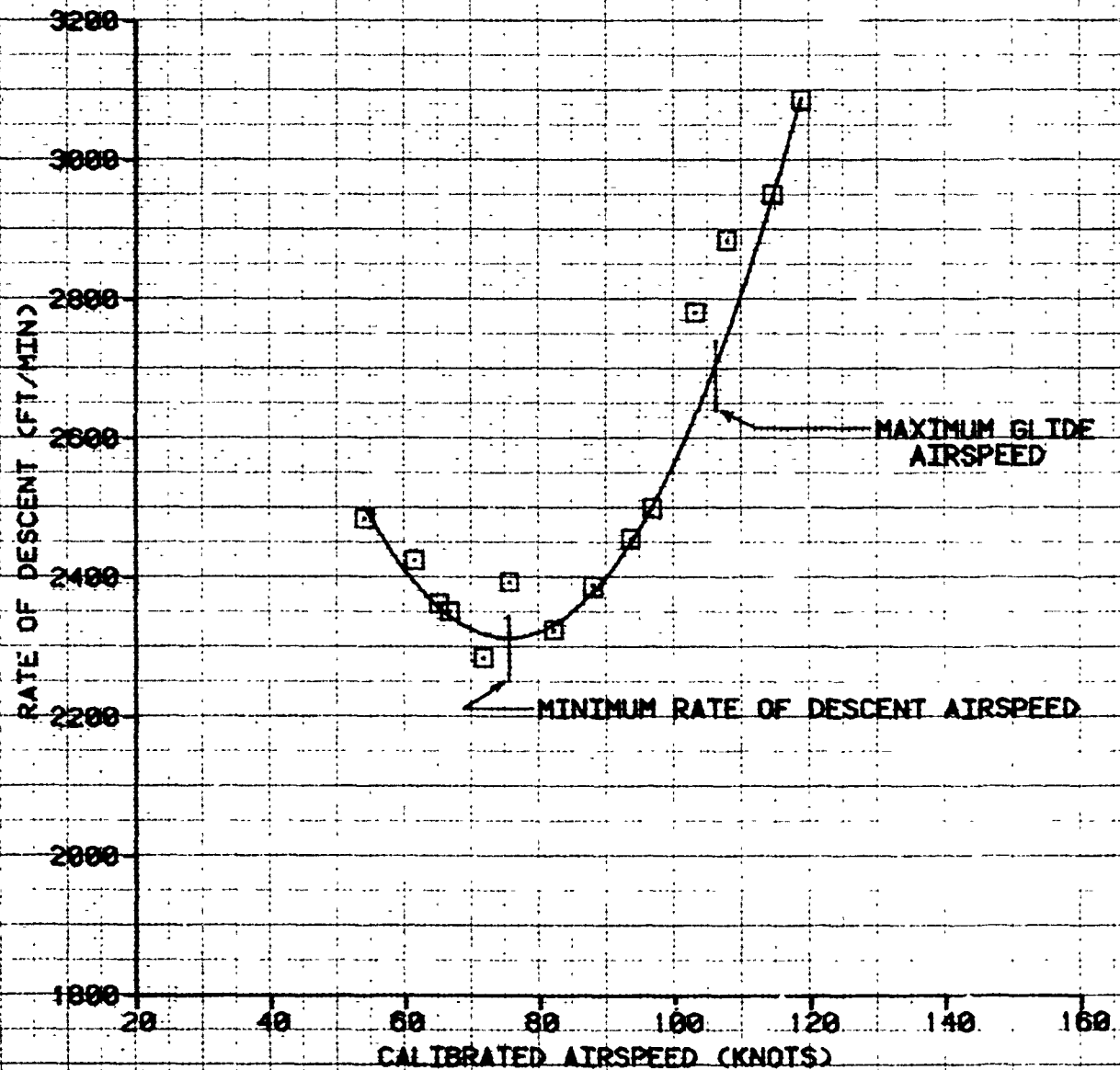

FIGURE 35
 AUTOROTATIONAL DESCENT PERFORMANCE
 CH-47D USA S/N 81-23383

AVG GROSS WEIGHT (LB)	AVG LONGITUDINAL CG LOCATION (FS)	AVG DENSITY ALTITUDE (FEET)	AVG OAT (DEG C)	AVG ROTOR SPEED (RPM)
47880	331.6 (MID)	7620	21.5	225

NOTE: 1. BALL CENTERED FLIGHT

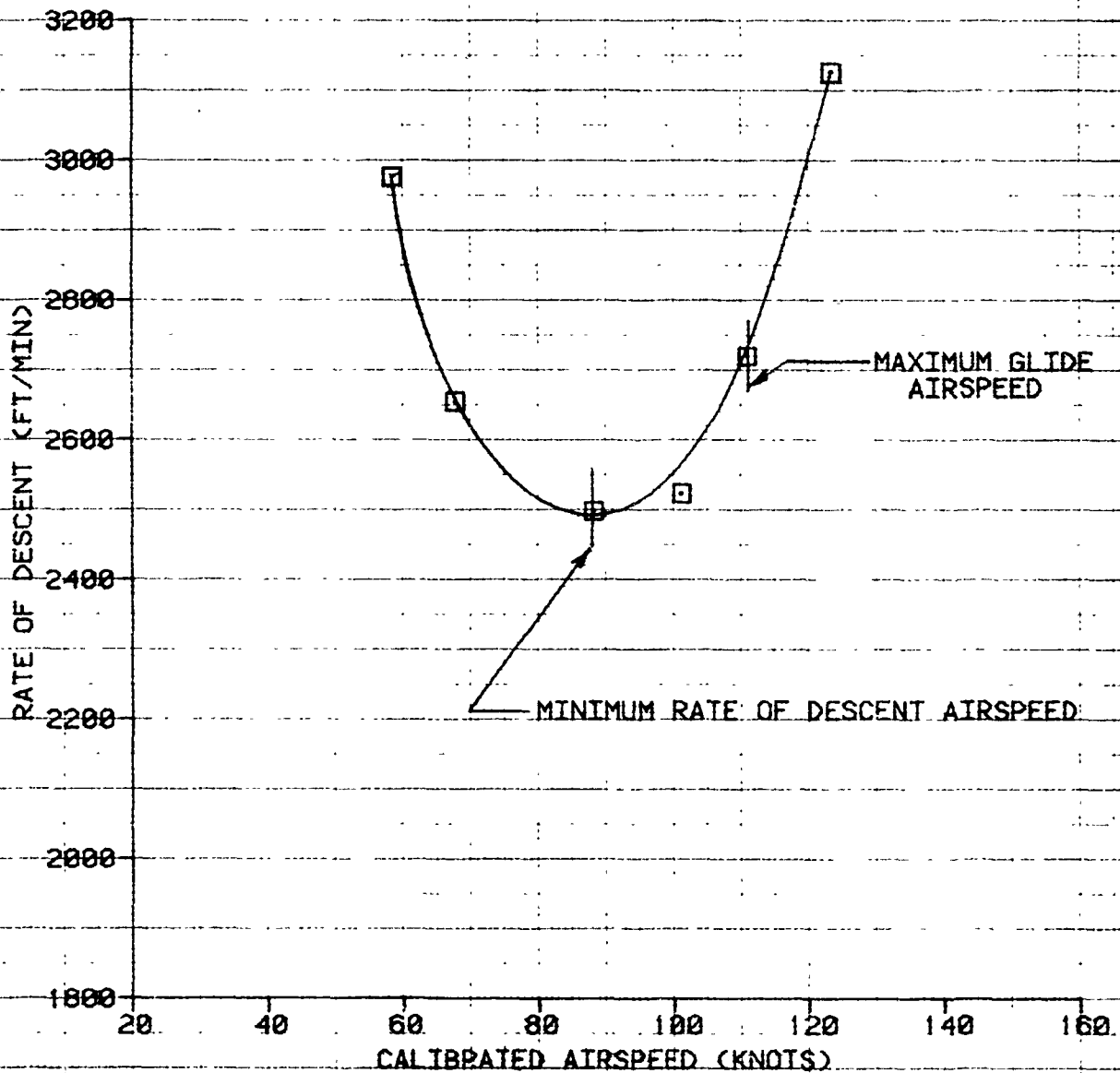

FIGURE 36
AUTOROTATIONAL DESCENT PERFORMANCE
 CH-47D USA S/N 81-23383

Avg Gross Weight (LB)	Avg Longitudinal CG Location (Ft)	Avg Density Altitude (Feet)	Avg OAT (Deg C)	Avg Calibrated Airspeed (Kts)
47140	331.9 (MID)	7580	22.8	90

NOTE: 1 BALL CENTERED FLIGHT

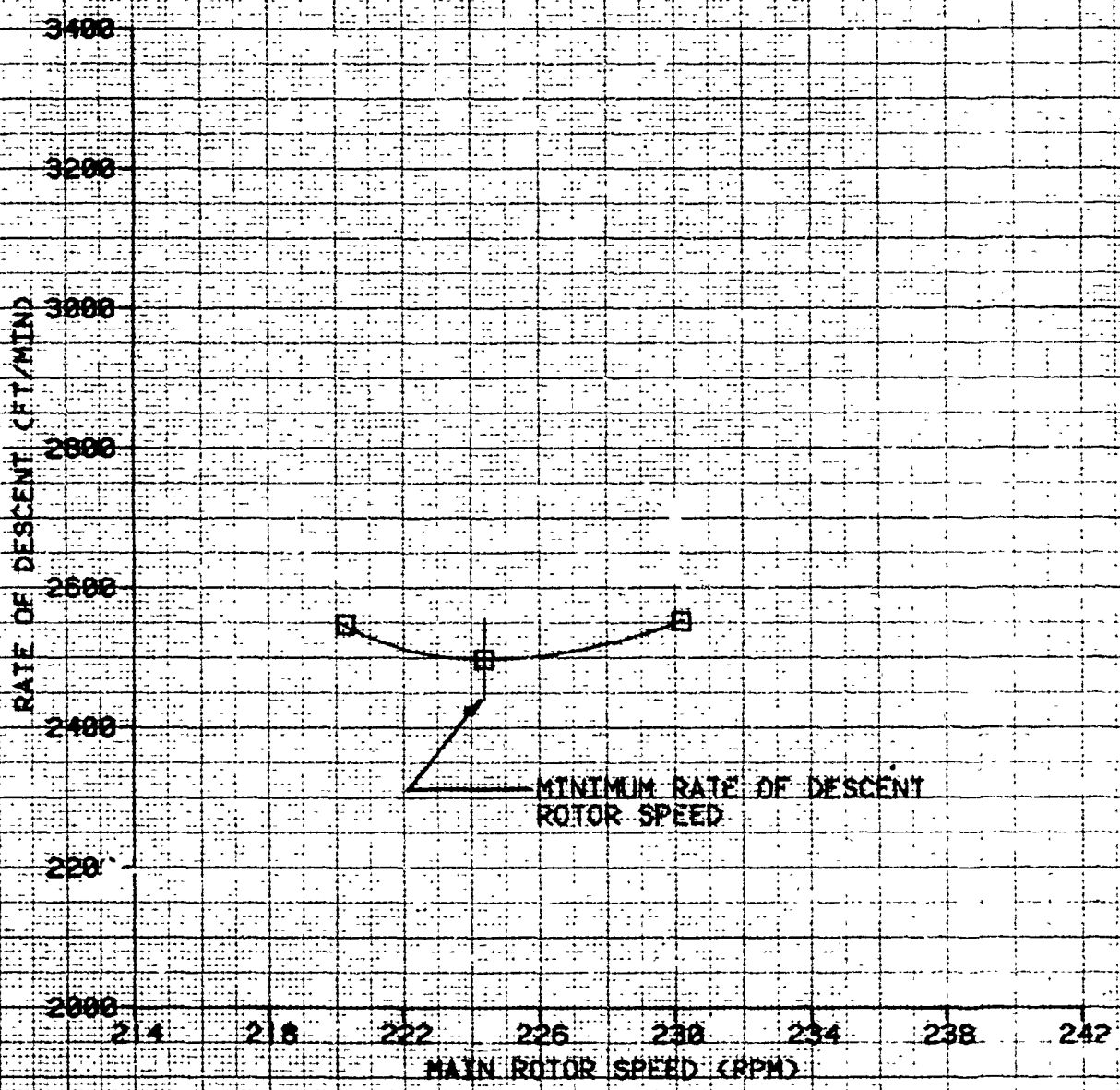

FIGURE 37
 LONGITUDINAL CYCLIC POSITION VS FORCE
 CH-47D USA S/N 81-23383

- NOTES: 1. TEST CONDUCTED ON GROUND WITH GPU SUPPLYING PRESSURE TO BOTH POWER TRANSFER UNITS
 2. TOTAL LONGITUDINAL CONTROL TRAVEL=15.0 INCHES
 3. CONTROL CENTERING ON

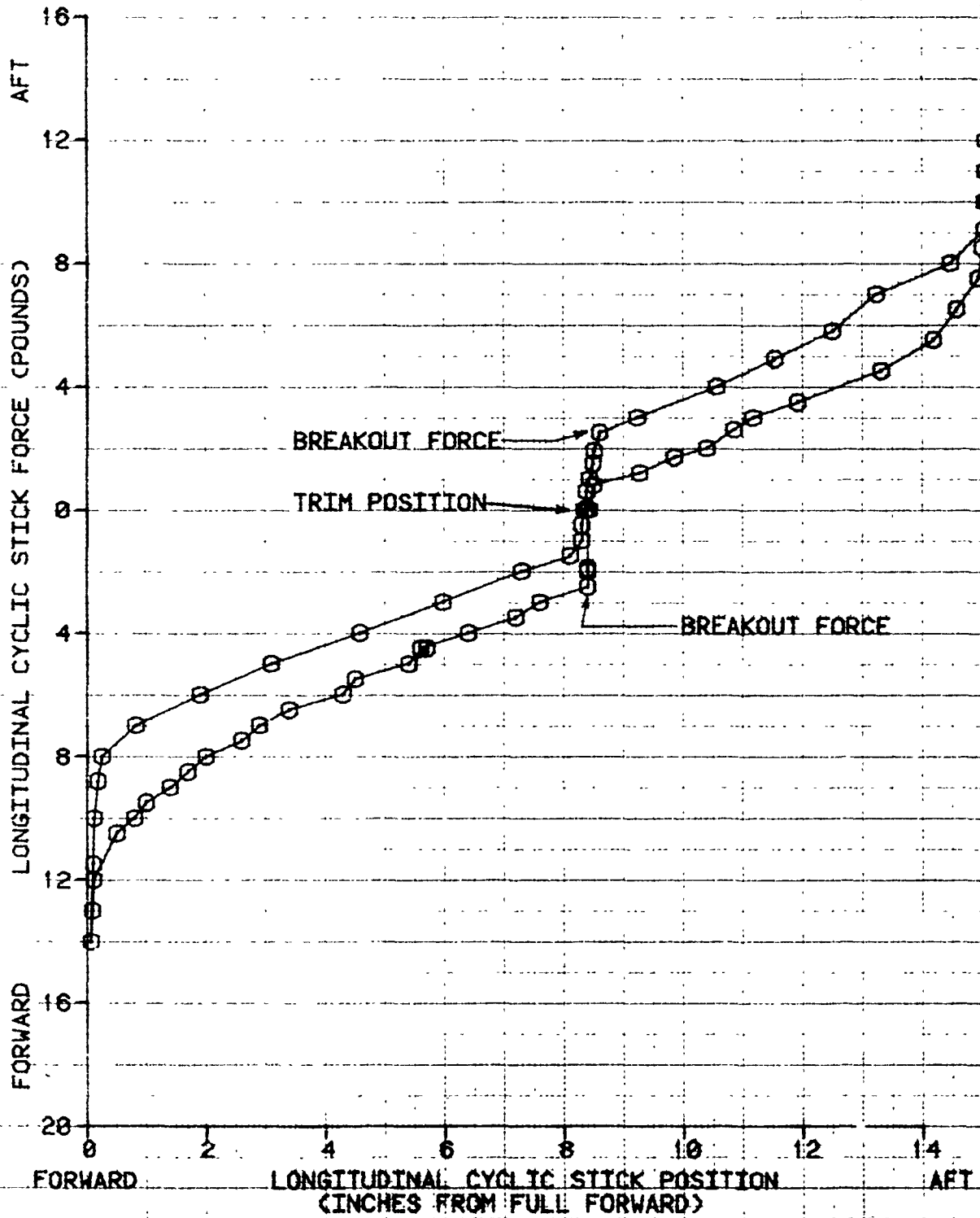

FIGURE 38
 LATERAL CYCLIC POSITION VS FORCE
 CH 47D USA S/N 81-23383

- NOTES: 1. TEST CONDUCTED ON GROUND WITH GPU SUPPLYING
 PRESSURE TO BOTH POWER TRANSFER UNITS
 2. TOTAL LATERAL CONTROL TRAVEL=10.7 INCHES
 3. CONTROL CENTERING ON

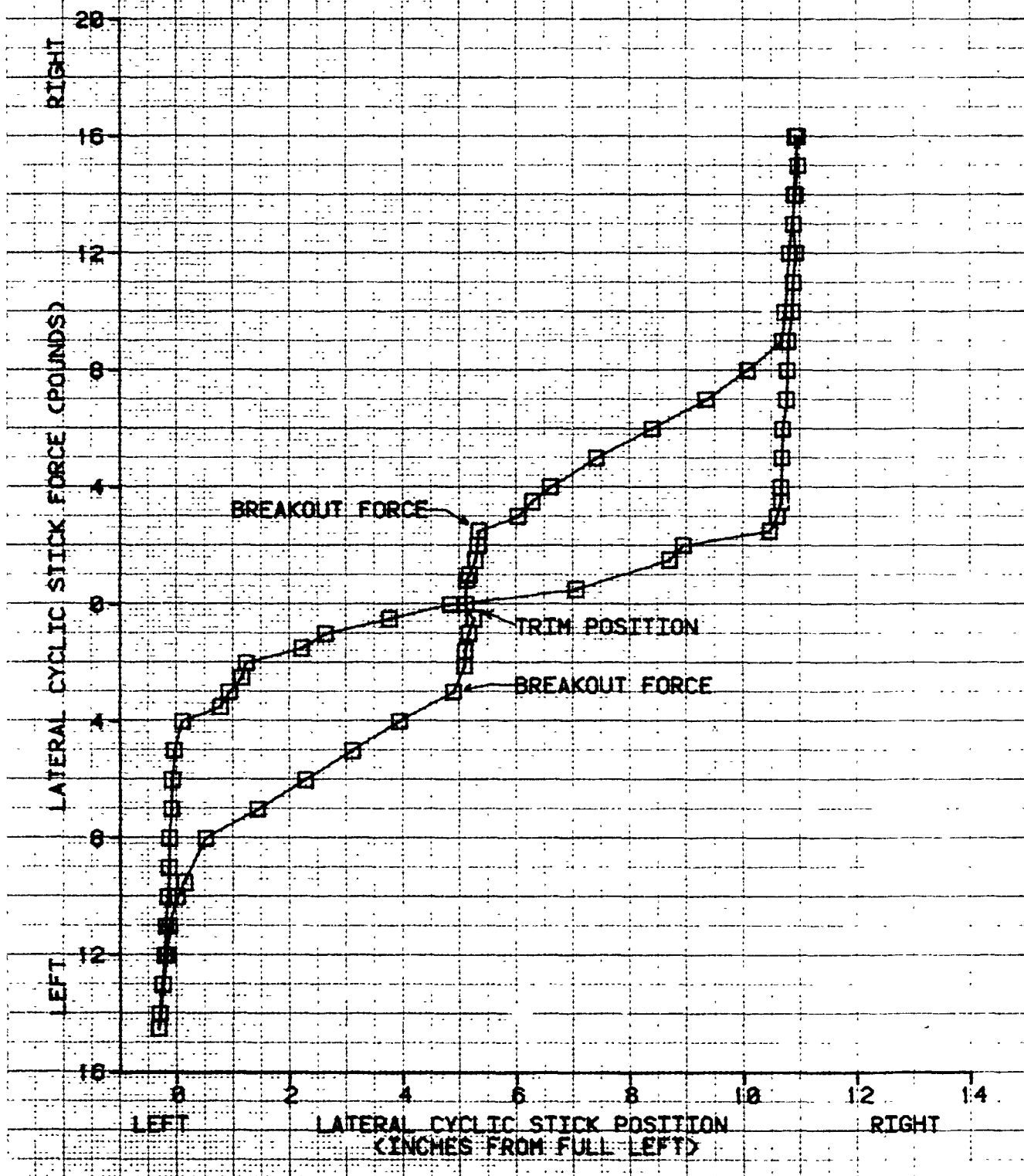

FIGURE 39
 DIRECTIONAL CONTROL POSITION VS FORCE
 CH-47D USA S/N 81-23383

- NOTES: 1. TEST CONDUCTED ON GROUND WITH GPU SUPPLYING PRESSURE TO BOTH POWER TRANSFER UNITS
 2. TOTAL DIRECTIONAL CONTROL TRAVEL=9.1 INCHES
 3. CONTROL CENTERING ON

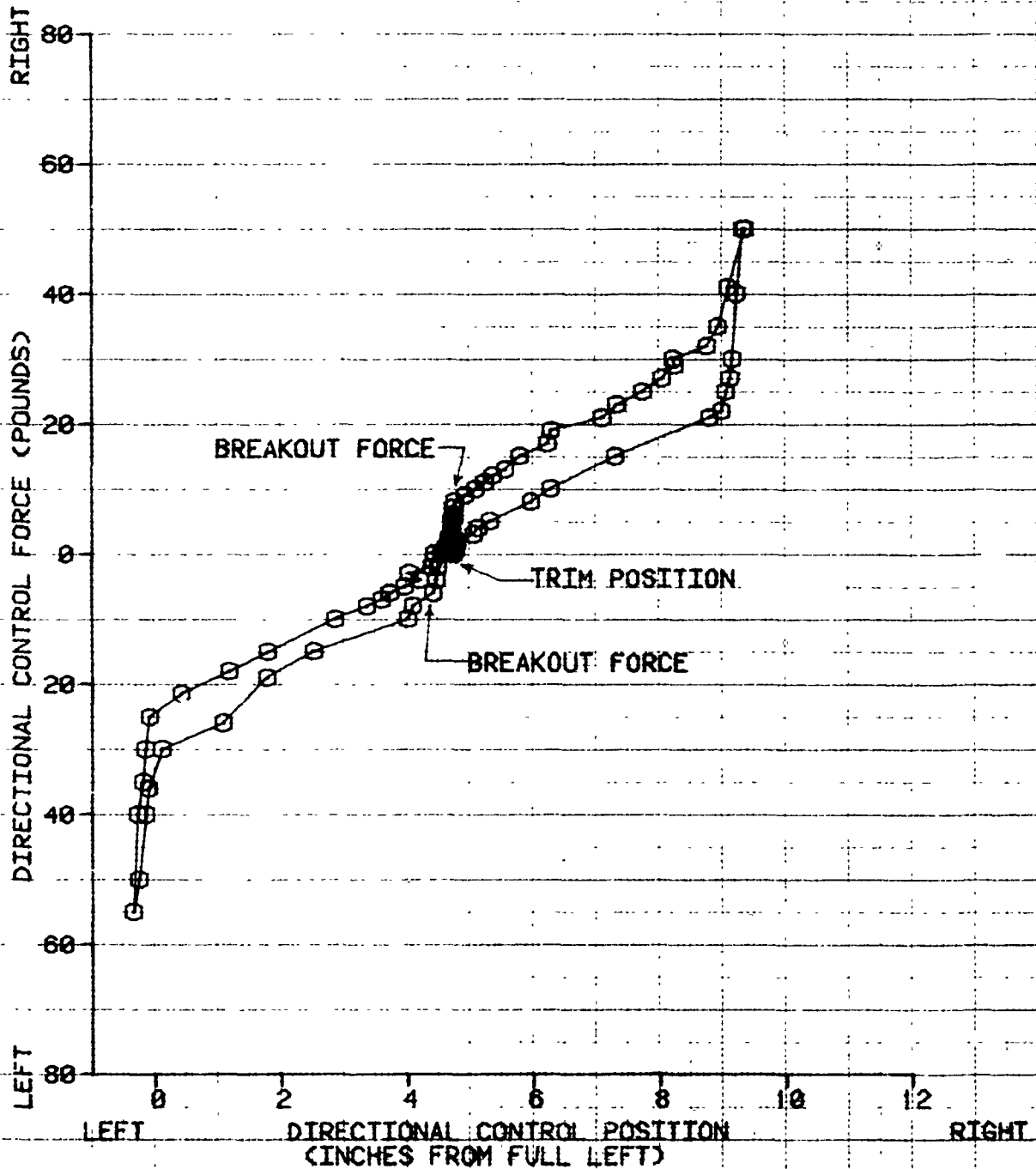

FIGURE 40
THRUST CONTROL POSITION VS FORCE
CH-47D USA S/N 81-23383

- NOTES: 1. TEST CONDUCTED ON GROUND WITH GPU SUPPLYING PRESSURE TO BOTH POWER TRANSFER UNITS
2. TOTAL THRUST CONTROL TRAVEL=9.1 INCHES
3. THRUST CONTROL BRAKE TRIGGER DEPRESSED
4. THRUST CONTROL DETENT AT 1.4 INCHES FROM FULL DOWN

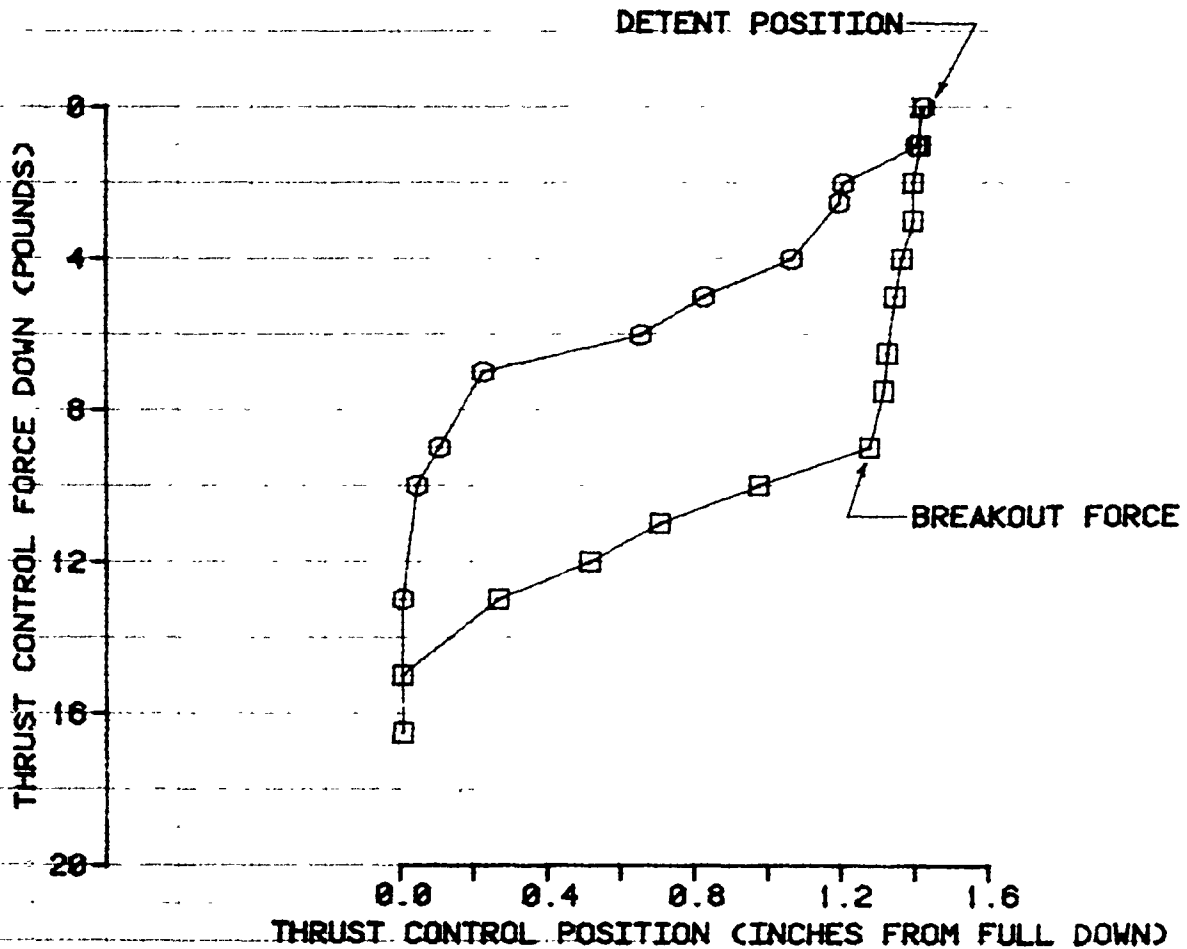

FIGURE 41
CONTROL POSITIONS IN TRIMMED FORWARD FLIGHT
CH-47D USA S/N 81-23383

SYMBOL	AVG GROSS WEIGHT (LB)	AVG LONGITUDINAL CG LOCATION (FS)	AVG DENSITY ALTITUDE (FEET)	AVG OAT (DEG C)	AVG ROTOR SPEED (RPM)	FLIGHT CONDITION
□	31960	320.2 (FWD)	840	8.5	222	LEVEL

NOTES: 1. BALL CENTERED FLIGHT
 2. BOTH AFCS ON

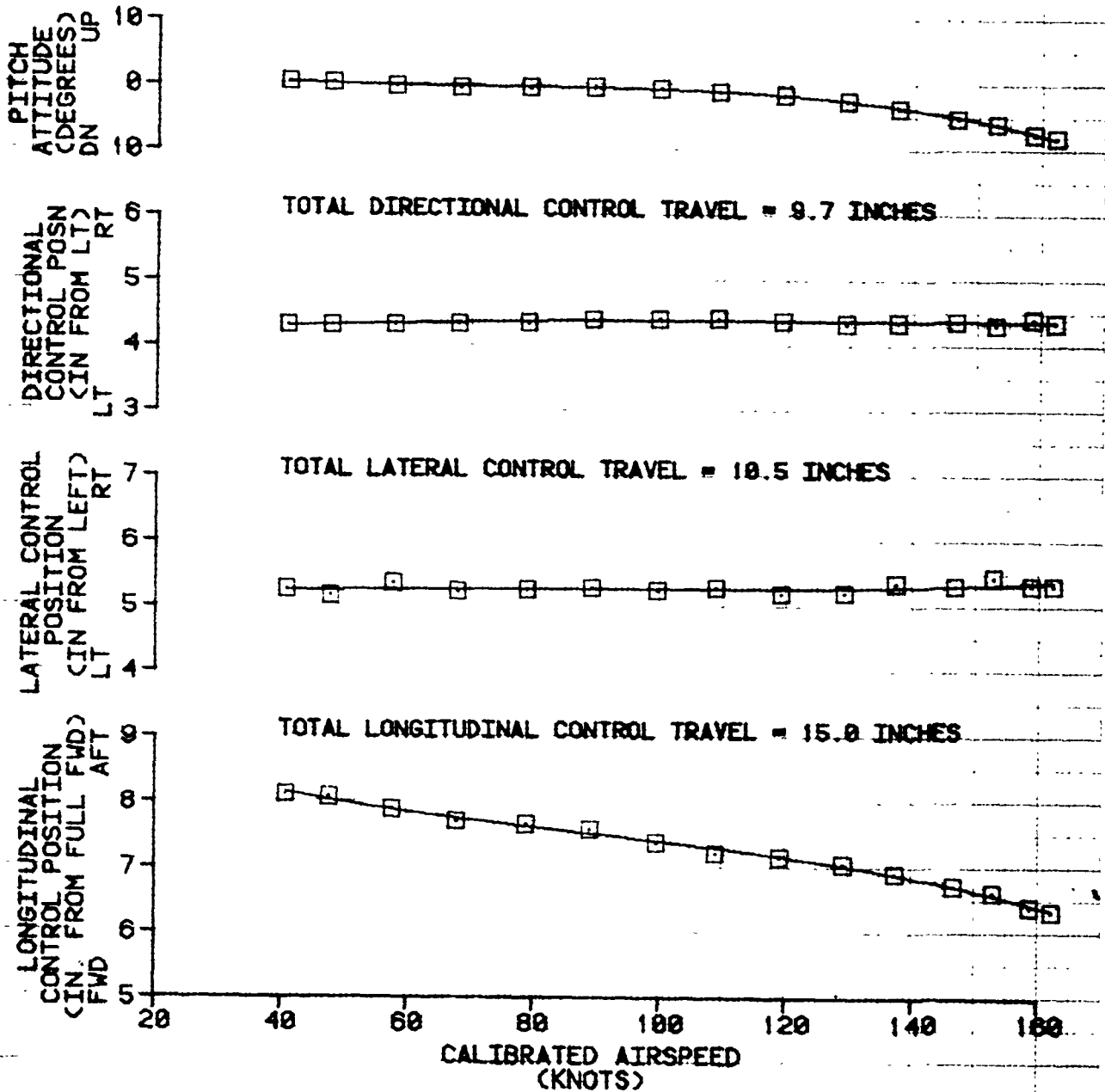

FIGURE 42
CONTROL POSITIONS IN TRIMMED FORWARD FLIGHT
CH-47D USA S/N 81-29383

SYMBOL	AVG GROSS WEIGHT (LB)	AVG LONGITUDINAL CG LOCATION (FS)	AVG DENSITY ALTITUDE (FEET)	AVG OAT (DEG C)	AVG ROTOR SPEED (RPM)	FLIGHT CONDITION
□	30000	310.1 (FWD)	8000	17.5	225	LEVEL

NOTES: 1. BALL CENTERED FLIGHT
2. BOTH AFCS ON

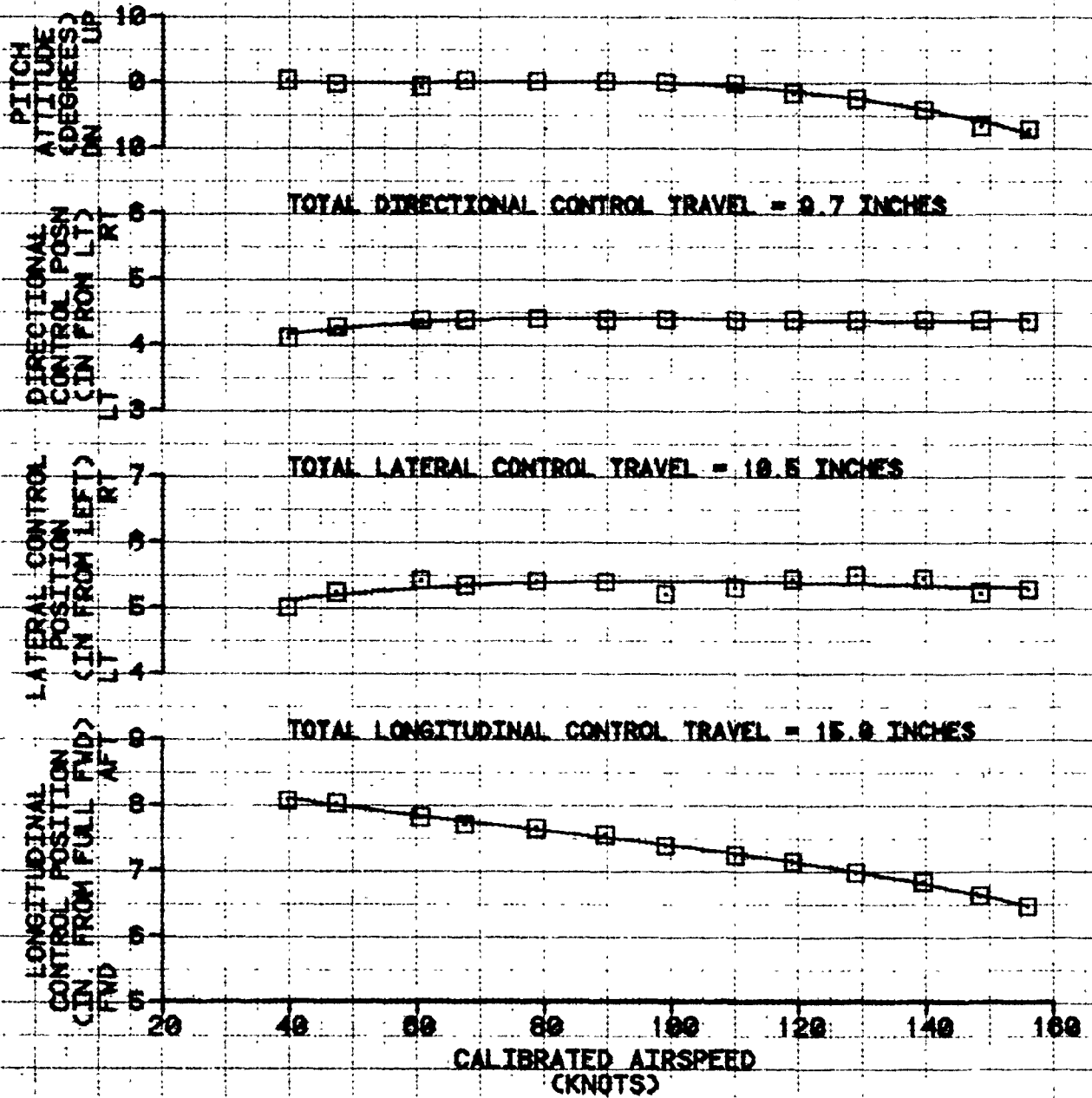

FIGURE 43
CONTROL POSITIONS IN TRIMMED FORWARD FLIGHT
CH-47D USA S/N 81-23383

SYMBOL	AVG GROSS WEIGHT (LB)	AVG LONGITUDINAL CG LOCATION (FS)	AVG DENSITY ALTITUDE (FEET)	AVG OAT (DEG C)	AVG ROTOR SPEED (RPM)	FLIGHT CONDITION
□	31280	342.0 (AFT)	2020	4.5	222	LEVEL

NOTES: 1. BALL CENTERED FLIGHT
 2. BOTH AFCS ON

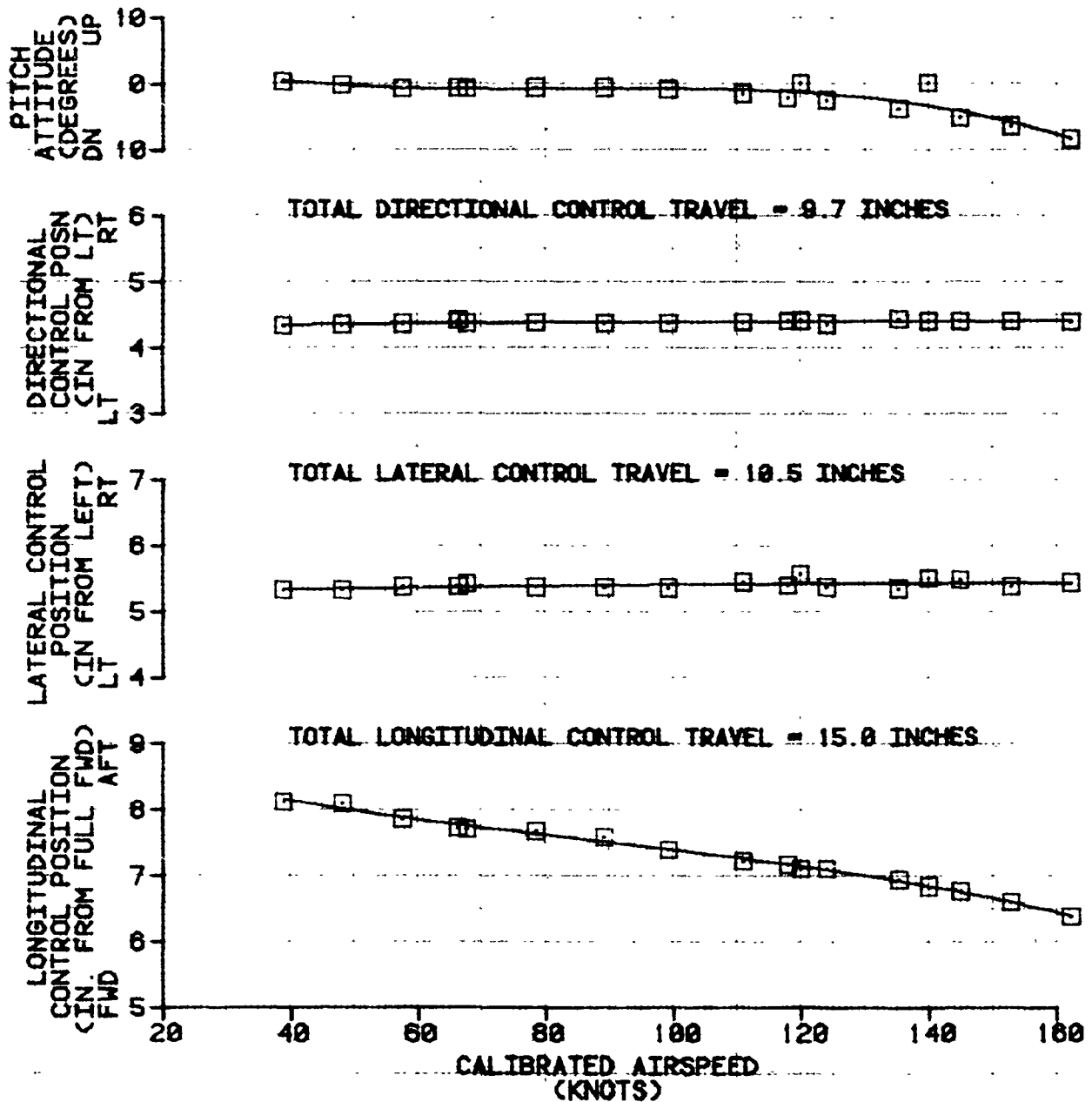

FIGURE 44
CONTROL POSITIONS IN TRIMMED FORWARD FLIGHT
 CH-47D USA S/N 81-28383

SYMBOL	AVG GROSS WEIGHT (LB)	AVG LONGITUDINAL CG LOCATION (FSD)	AVG DENSITY ALTITUDE (FEET)	AVG DAT (DEG C)	AVG ROTOR SPEED (RPM)	FLIGHT CONDITION
B	50000	331.8 (AFT)	5240	28.5	225	LEVEL

NOTES: 1. BALL CENTERED FLIGHT
 2. BOTH APCs ON

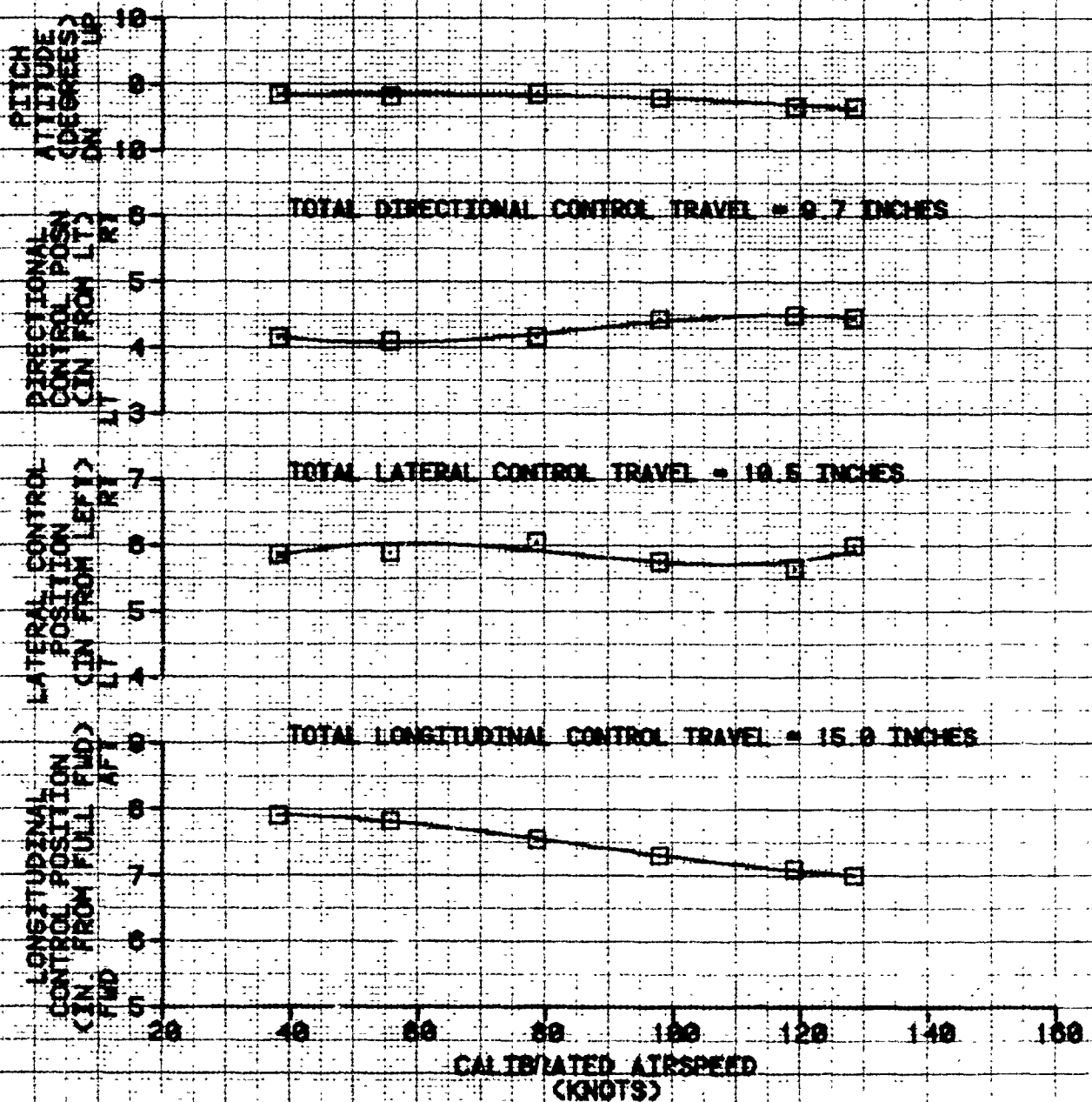

FIGURE 45
STATIC LONGITUDINAL STABILITY
CH-47D USA S/N 81-23383

AVG GROSS WEIGHT (LB)	AVG LONGITUDINAL CG LOCATION (FS)	AVG DENSITY ALTITUDE (FEET)	AVG OAT (DEG C)	AVG ROTOR SPEED (RPM)	FLIGHT CONDITION
41800	912.8 (FWD)	4500	10.5	225	LEVEL

- NOTES: 1. SHADED SYMBOLS DENOTE TRIM
 2. BOTH AFCS ON

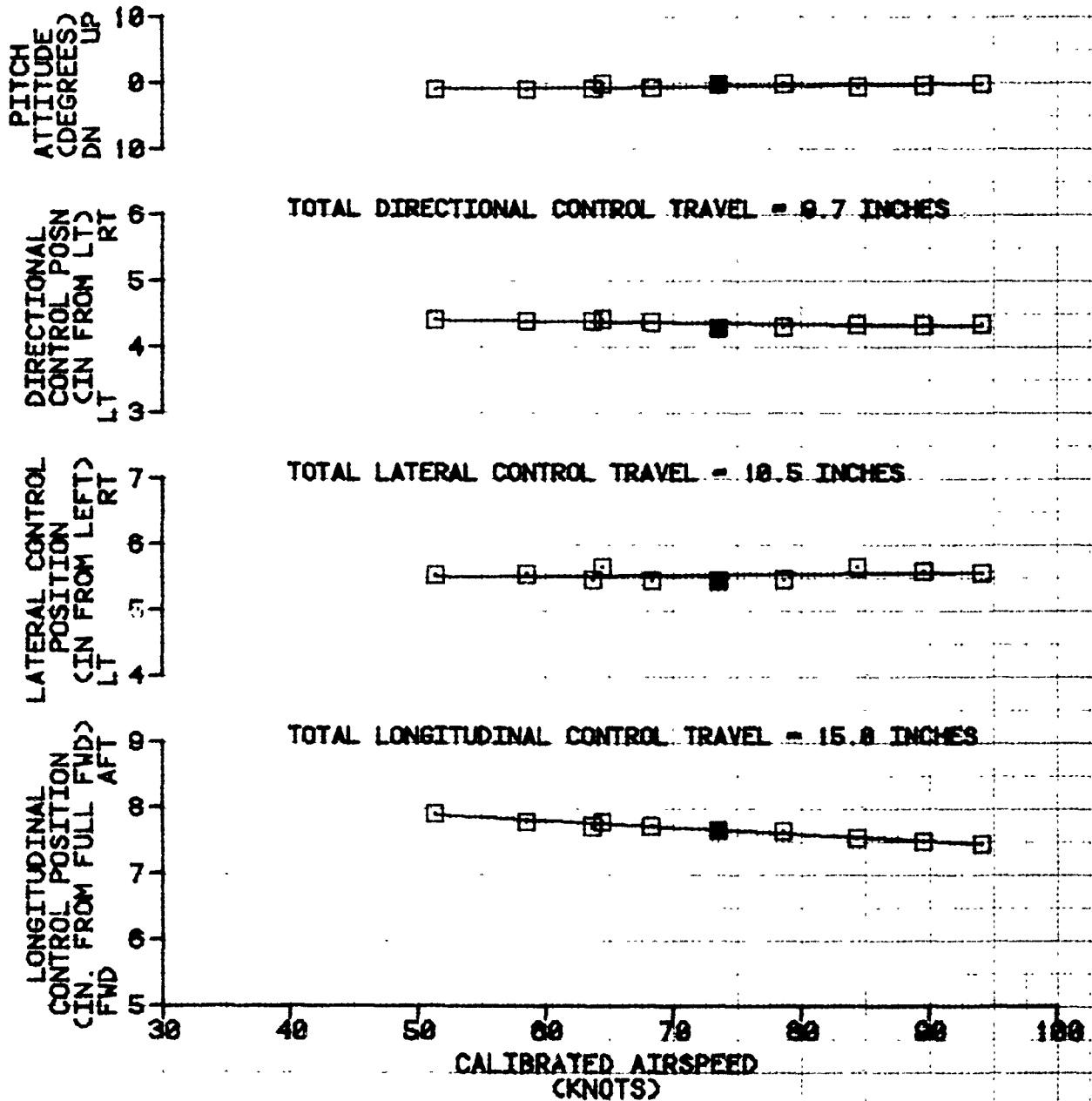

FIGURE 46
STATIC LONGITUDINAL STABILITY
CH-47D USA S/N 81-23383

AVG GROSS WEIGHT (LB)	AVG LONGITUDINAL CG LOCATION (FSD)	AVG DENSITY ALTITUDE (FEET)	AVG OAT (DEG C)	AVG ROTOR SPEED (RPM)	FLIGHT CONDITION
41448	312.8 (FWD)	4980	18.5	224	LEVEL

- NOTES: 1. SHADED SYMBOLS DENOTE TRIM
 2. BOTH AFCS ON

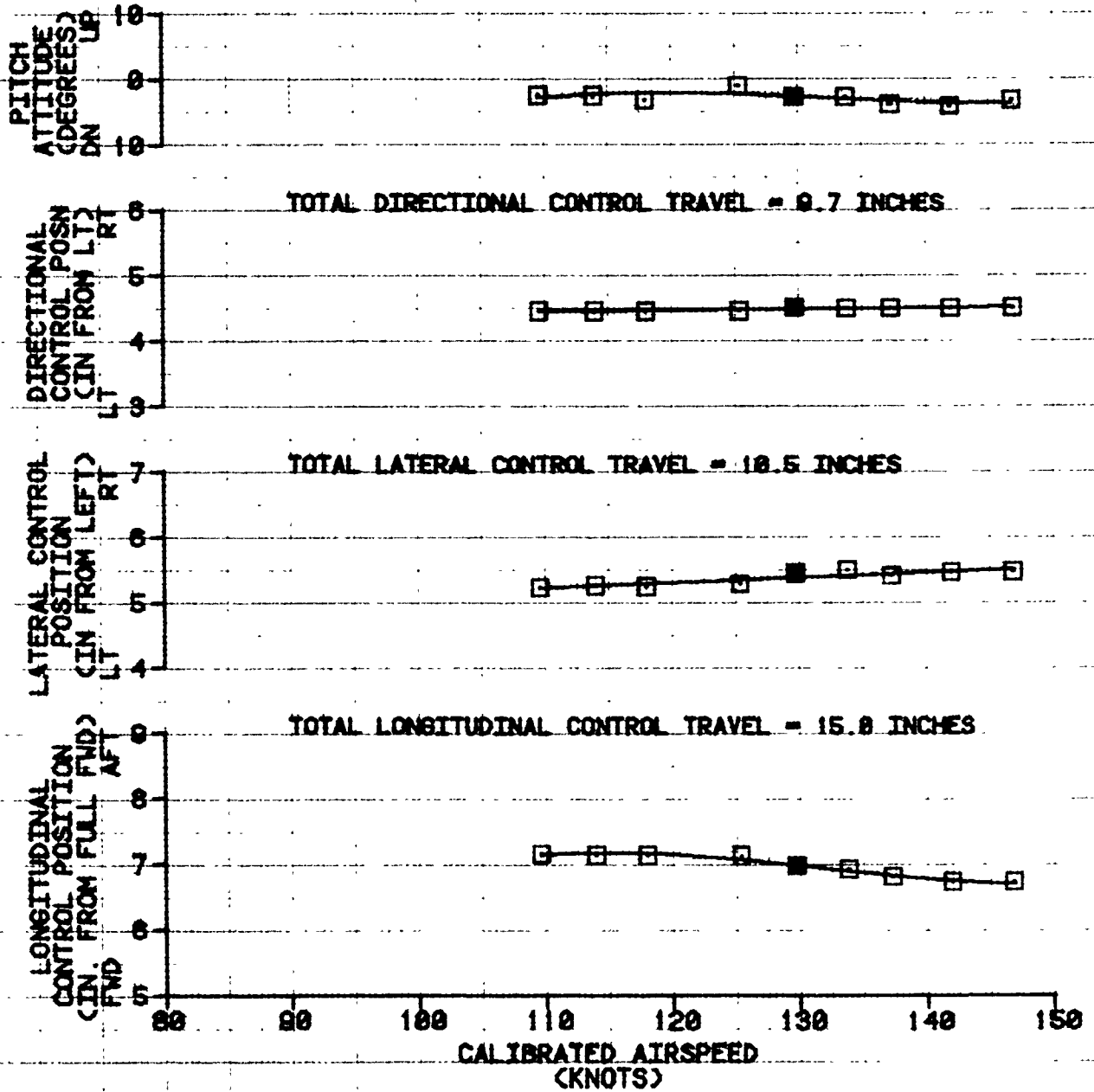

FIGURE 47
STATIC LONGITUDINAL STABILITY
CH-47D USA S/N 81-23383

AVG GROSS WEIGHT (LB)	AVG LONGITUDINAL CG LOCATION (FS)	AVG DENSITY ALTITUDE (FEET)	AVG OAT (DEG C)	AVG ROTOR SPEED (RPM)	FLIGHT CONDITION
48620	312.7 (FWD)	4760	17.0	225	CLIMB

- NOTES: 1. SHADED SYMBOLS DENOTE TRIM
 2. BOTH AFCS ON
 3. ENGINE TORQUE DURING CLIMB = 55 PERCENT

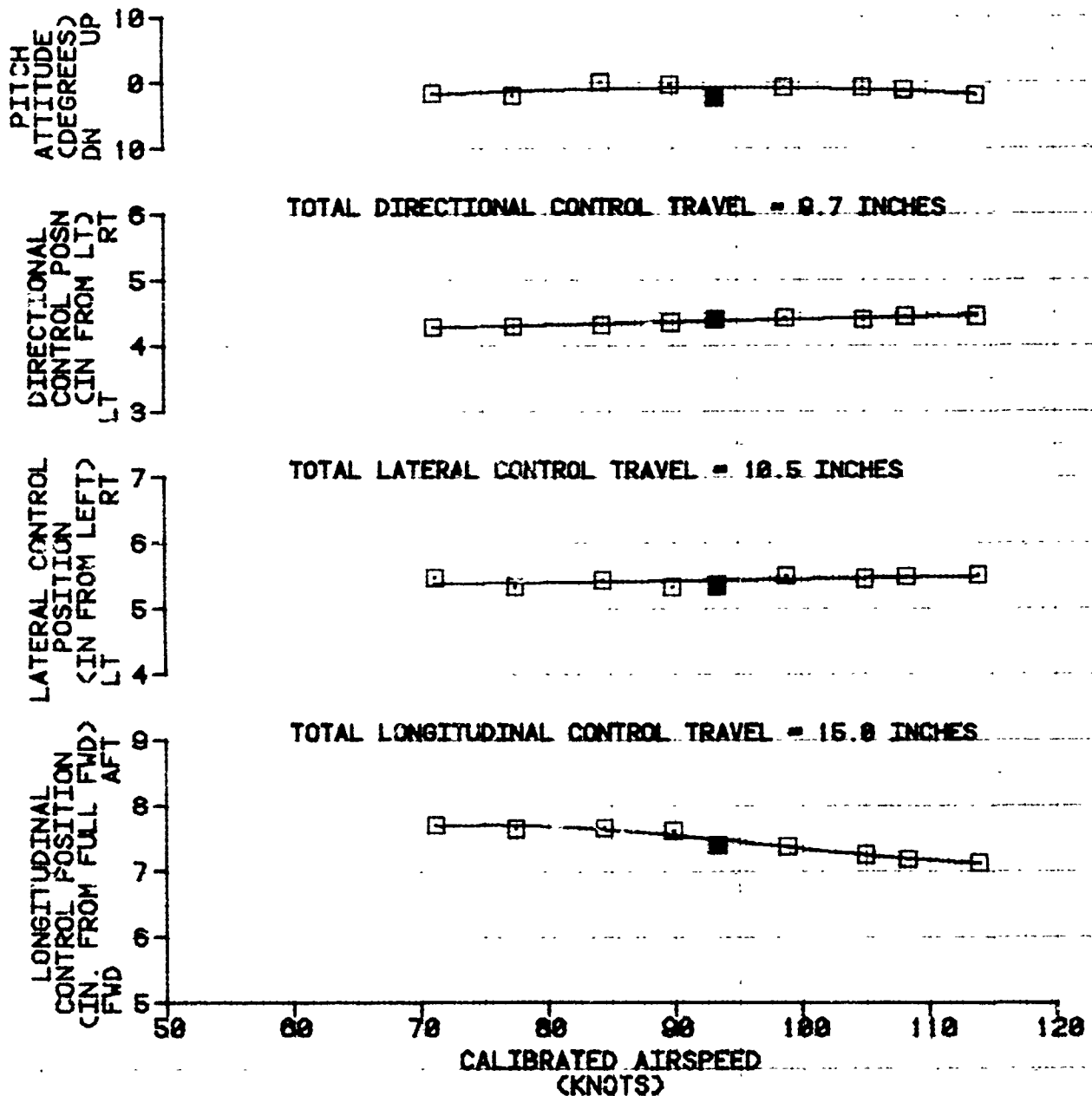

FIGURE 48
STATIC LONGITUDINAL STABILITY
OH-47D USA S/N 81-25363

AVG GROSS WEIGHT (LBS)	AVG LONGITUDINAL CG LOCATION (FWD)	AVG DENSITY ALTITUDE (FEET)	AVG CAT (DEG C)	AVG ROTOR SPEED (RPM)	FLIGHT CONDITION
41800	312.7 (FWD)	5840	17.0	225	DESCENT

- NOTES: 1. SHADED SYMBOLS DENOTE TRIM
 2. BOTH ARCS ON
 3. ENGINE TORQUE DURING DESCENT = 30 PERCENT

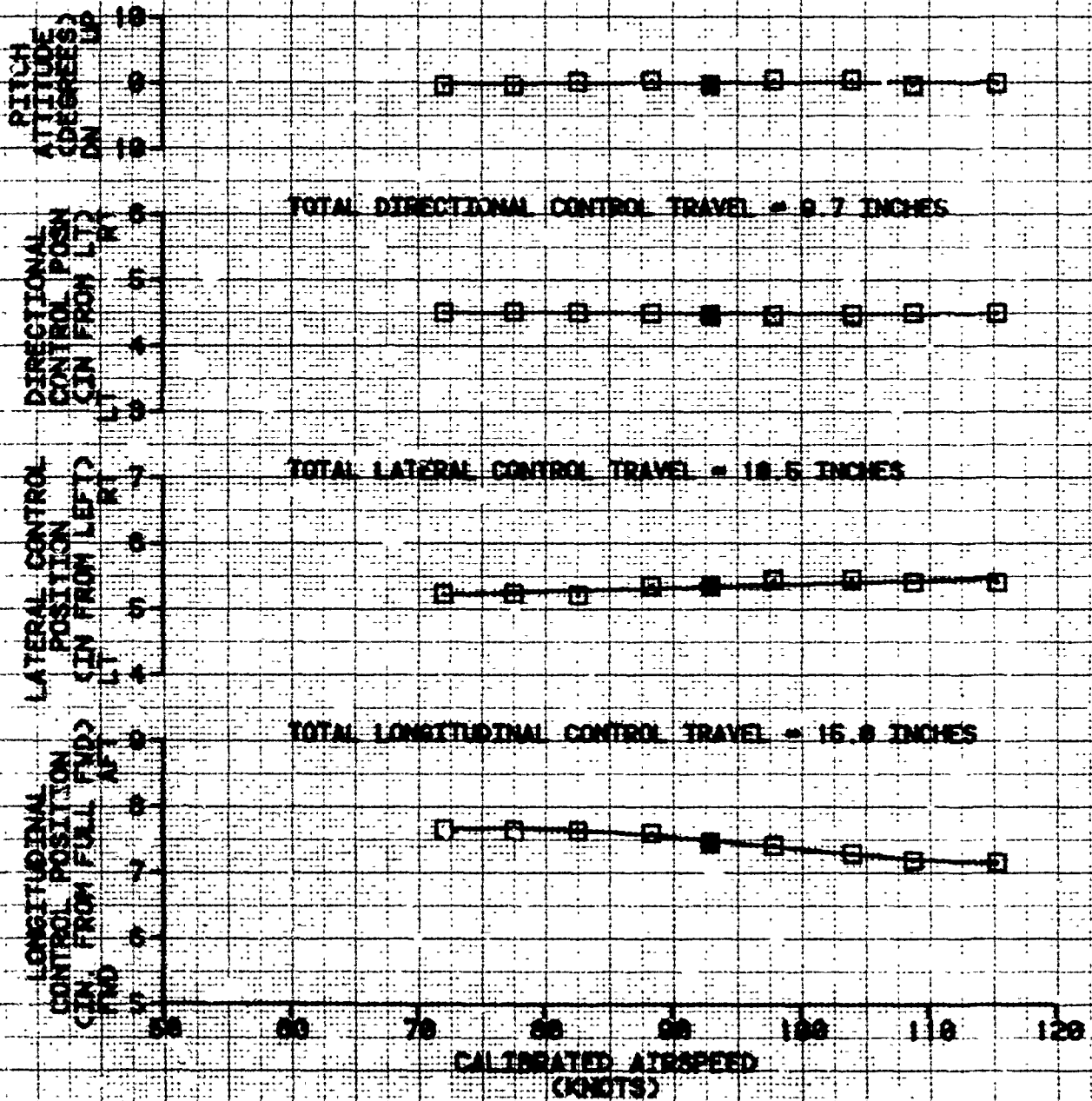

FIGURE 40
STATIC LONGITUDINAL STABILITY
CH-47D USA S/N 81-23383

GT WEIGHT (LB)	AVG LONGITUDINAL CG LOCATION (FS)	AVG DENSITY ALTITUDE (FEET)	AVG PAT (DEG C)	AVG ROTOR SPEED (RPM)	FLIGHT CONDITION
42760	346.8 (AFT)	4820	20.6	226	LEVEL

NOTE: 1. SHADED SYMBOLS DENOTE TRIM
 2. BOTH AFCS ON

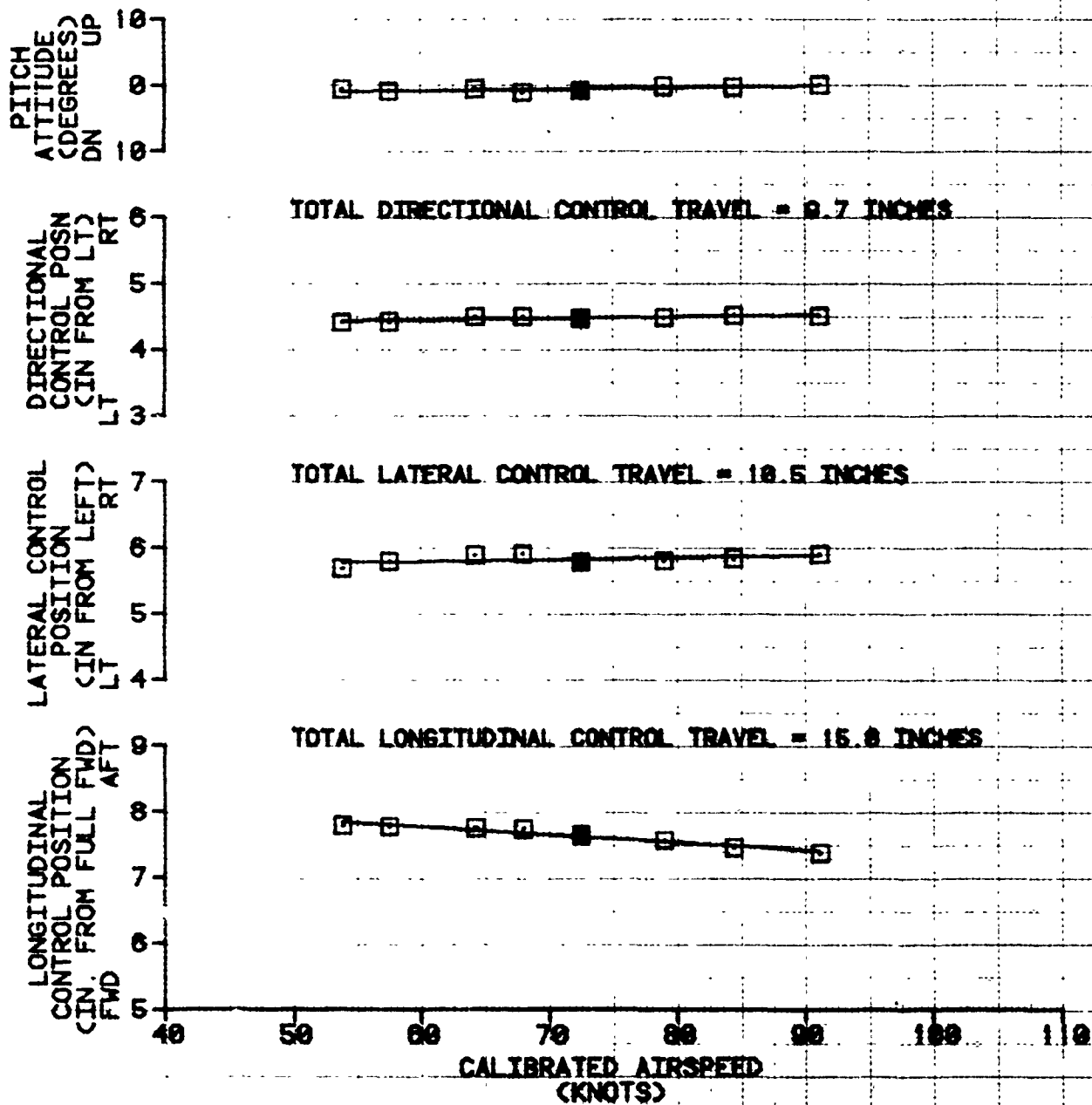

FIGURE 58
STATIC LONGITUDINAL STABILITY
CH-47D USA S/N 81-23363

AVG GROSS WEIGHT (LBS)	AVG LONGITUDINAL CG LOCATION (FUS) (IN)	AVG DENSITY ALTITUDE (FEET)	AVG OAT (DEG C)	AVG ROTOR SPEED (RPM)	FLIGHT CONDITION
42000	346.3 (AFT)	5340	21.8	224	LEVEL

NOTE 1. SHADED SYMBOLS DENOTE TRIM
 2. BOTH AFCS ON

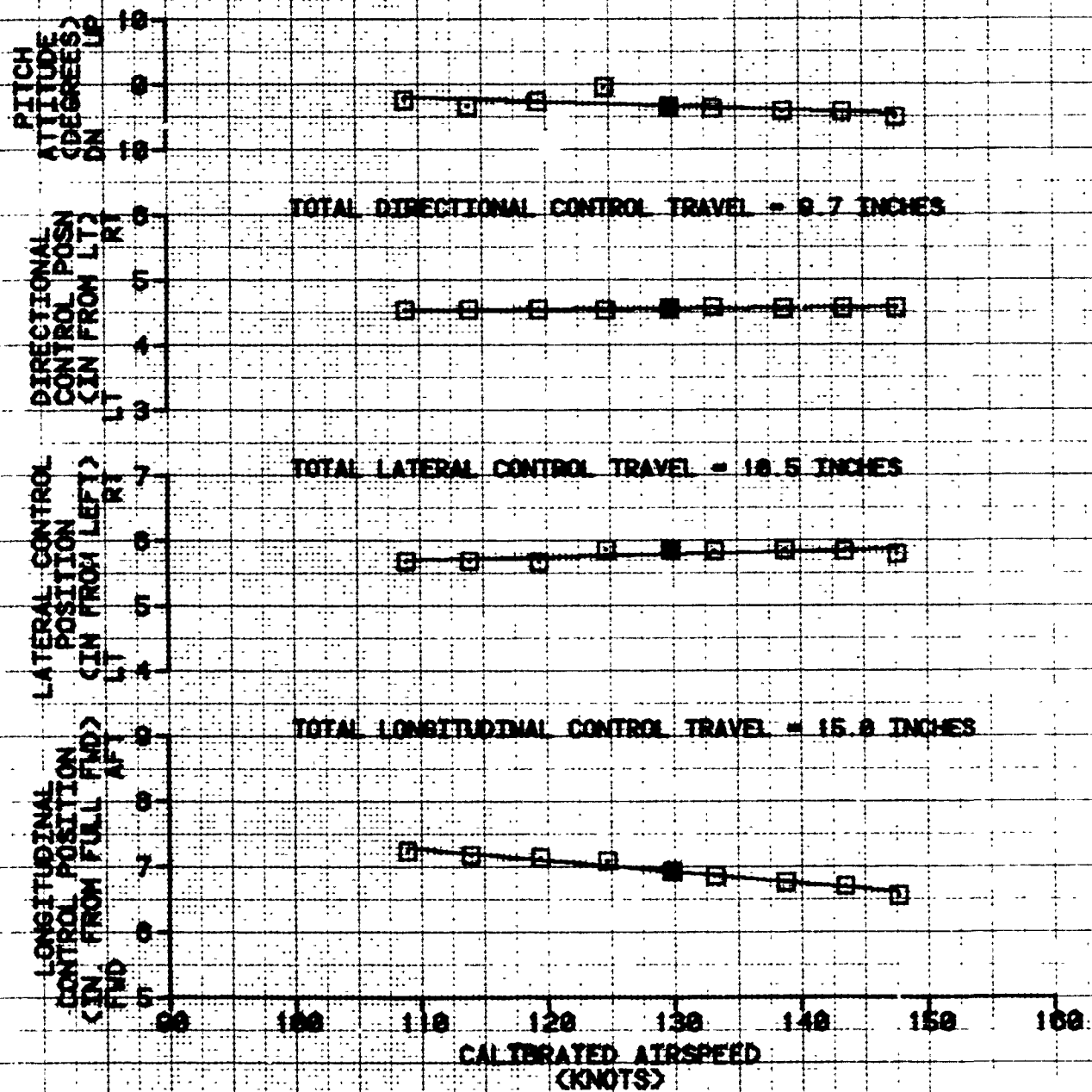
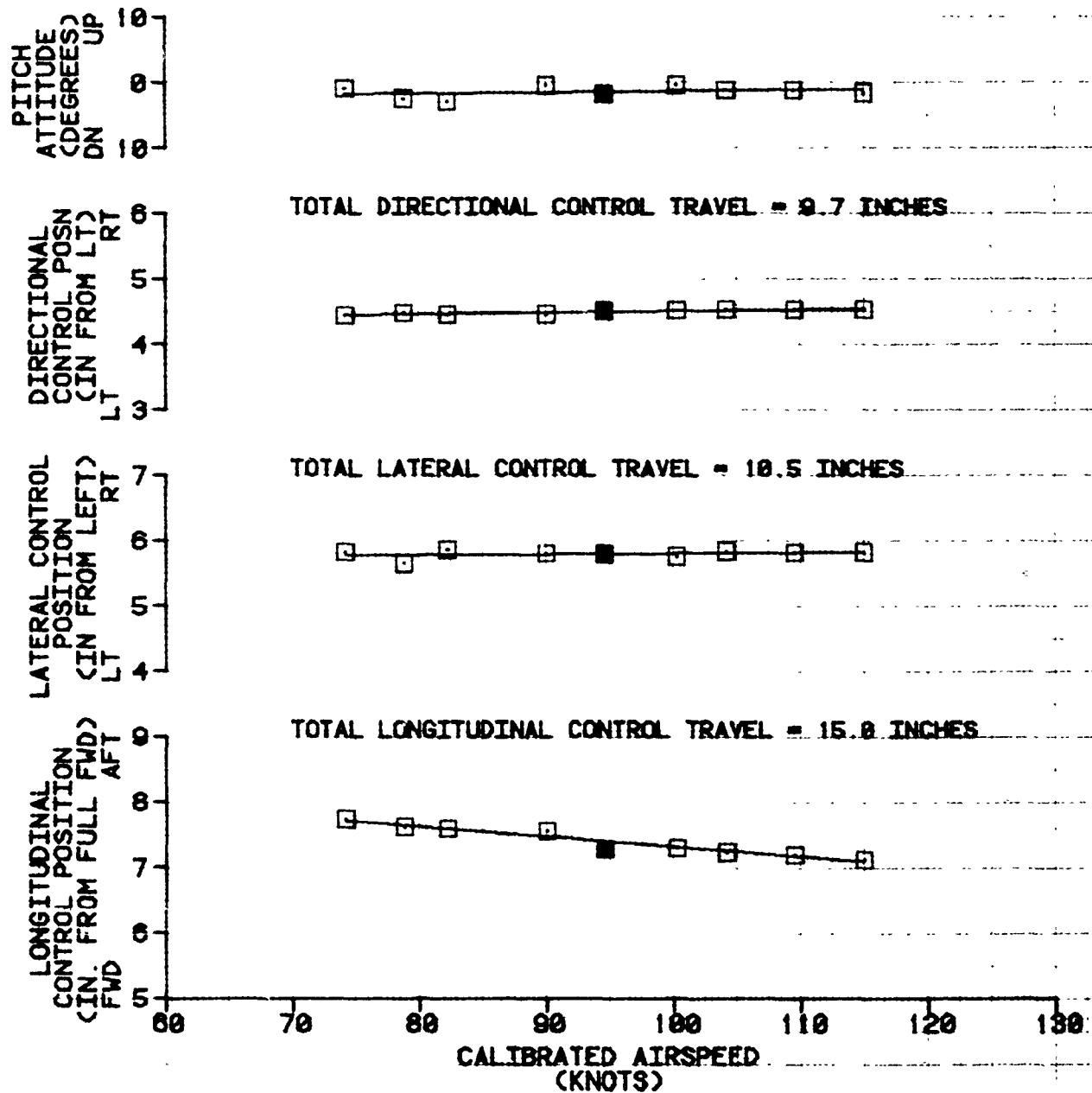

FIGURE 51
 STATIC LONGITUDINAL STABILITY
 CH-47D USA S/N 81-23383

AVG GROSS WEIGHT (LB)	AVG LONGITUDINAL CG LOCATION (FS)	AVG DENSITY ALTITUDE (FEET)	AVG OAT (DEG C)	AVG ROTOR SPEED (RPM)	FLIGHT CONDITION
41820	345.7 (AFT)	5220	21.0	225	CLIMB

- NOTE: 1. SHADED SYMBOLS DENOTE TRIM
 2. BOTH AFCS ON
 3. ENGINE TORQUE DURING CLIMB = 61 PERCENT



**FIGURE 52
STATIC LONGITUDINAL STABILITY
CH-47D USA S/N 81-23383**

AVG GROSS WEIGHT (LB)	AVG LONGITUDINAL CG LOCATION (FS)	AVG DENSITY ALTITUDE (FEET)	AVG OAT (DEG C)	AVG ROTOR SPEED (RPM)	FLIGHT CONDITION
41300	346.8 (AFT)	5420	20.5	253	DESCENT

- NOTE: 1. SHADED SYMBOLS DENOTE TRIM
 2. BOTH AFCS ON
 3. ENGINE TORQUE DURING DESCENT = 36 PERCENT

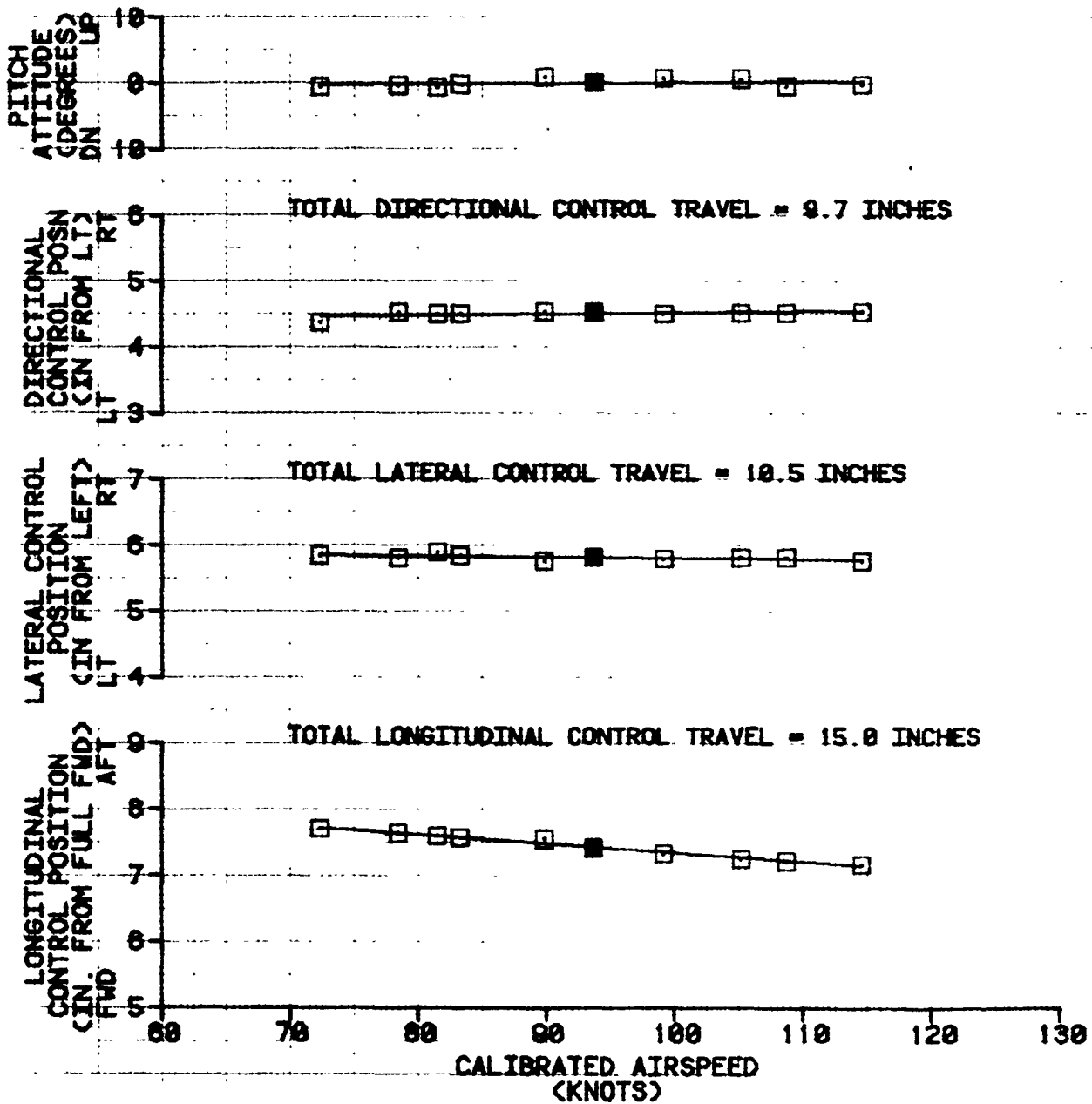

FIGURE 53
 STATIC LONGITUDINAL STABILITY
 CH-47D USA S/N 81-23383

SYMBOL	AVG GROSS WEIGHT (LB)	AVG LONGITUDINAL CG LOCATION (FS)	AVG DENSITY ALTITUDE (FEET)	AVG OAT (DEG C)	AVG ROTOR SPEED (RPM)	FLIGHT CONDITION
□	51040	331.5(AFT)	5000	26.5	225	LEVEL

- NOTES: 1. SHADED SYMBOLS DENOTE TRIM
 2. BOTH AFCS SYSTEMS ON

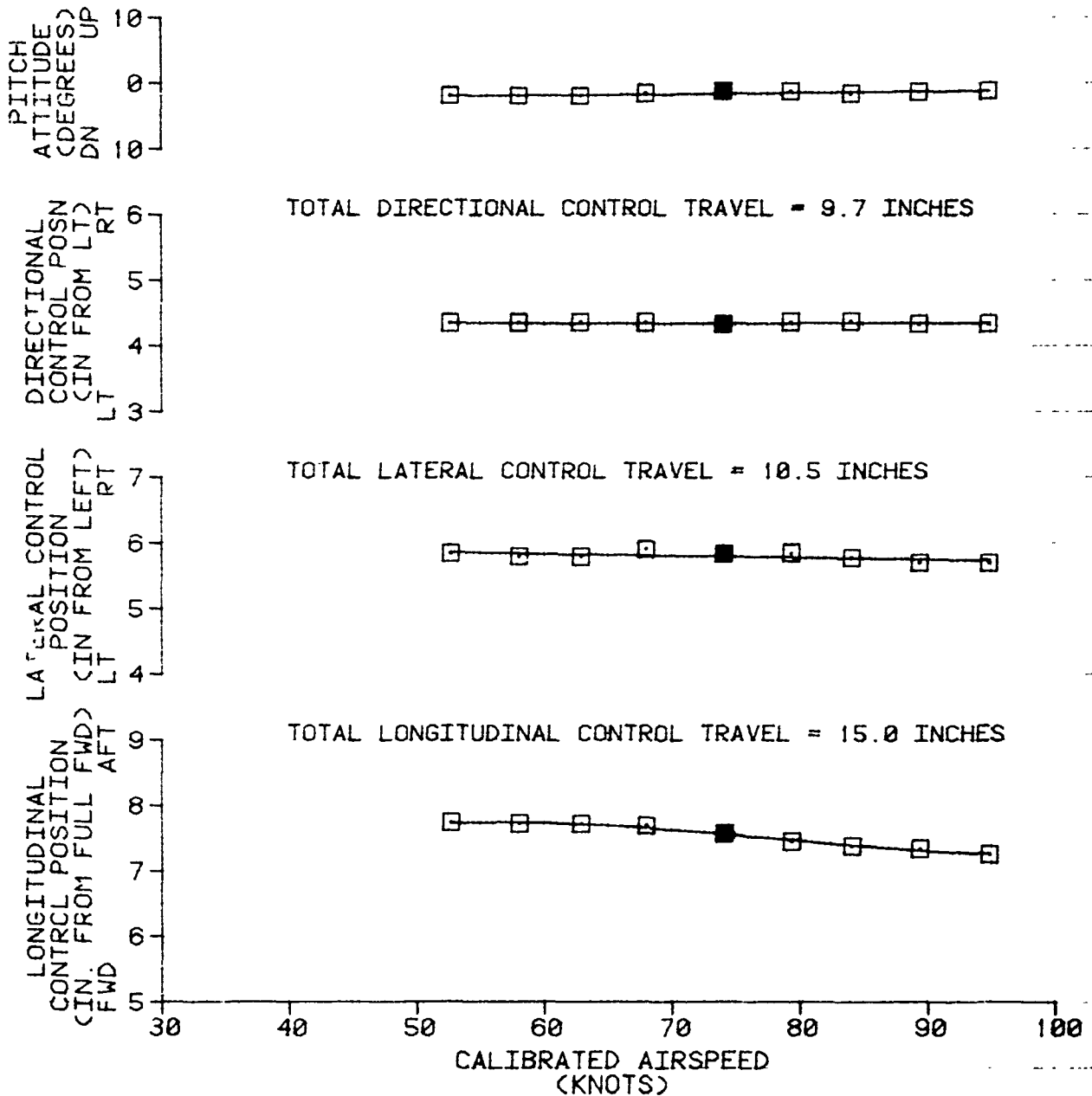

FIGURE 54
 STATIC LONGITUDINAL STABILITY
 CH-47D USA S/N 81-23383

SYMBOL	AVG GROSS WEIGHT (LB)	AVG LONGITUDINAL CG LOCATION (F/S)	AVG DENSITY ALTITUDE (FEET)	AVG OAT (DEG C)	AVG ROTOR SPEED (RPM)	FLIGHT CONDITION
□	48420	332.4(CAFT)	5100	25.5	225	CLIMB

- NOTES: 1. SHADED SYMBOLS DENOTE TRIM
 2. BOTH AFCS SYSTEMS ON
 3. ENGINE TORQUE DURING CLIMBS = 68 PERCENT

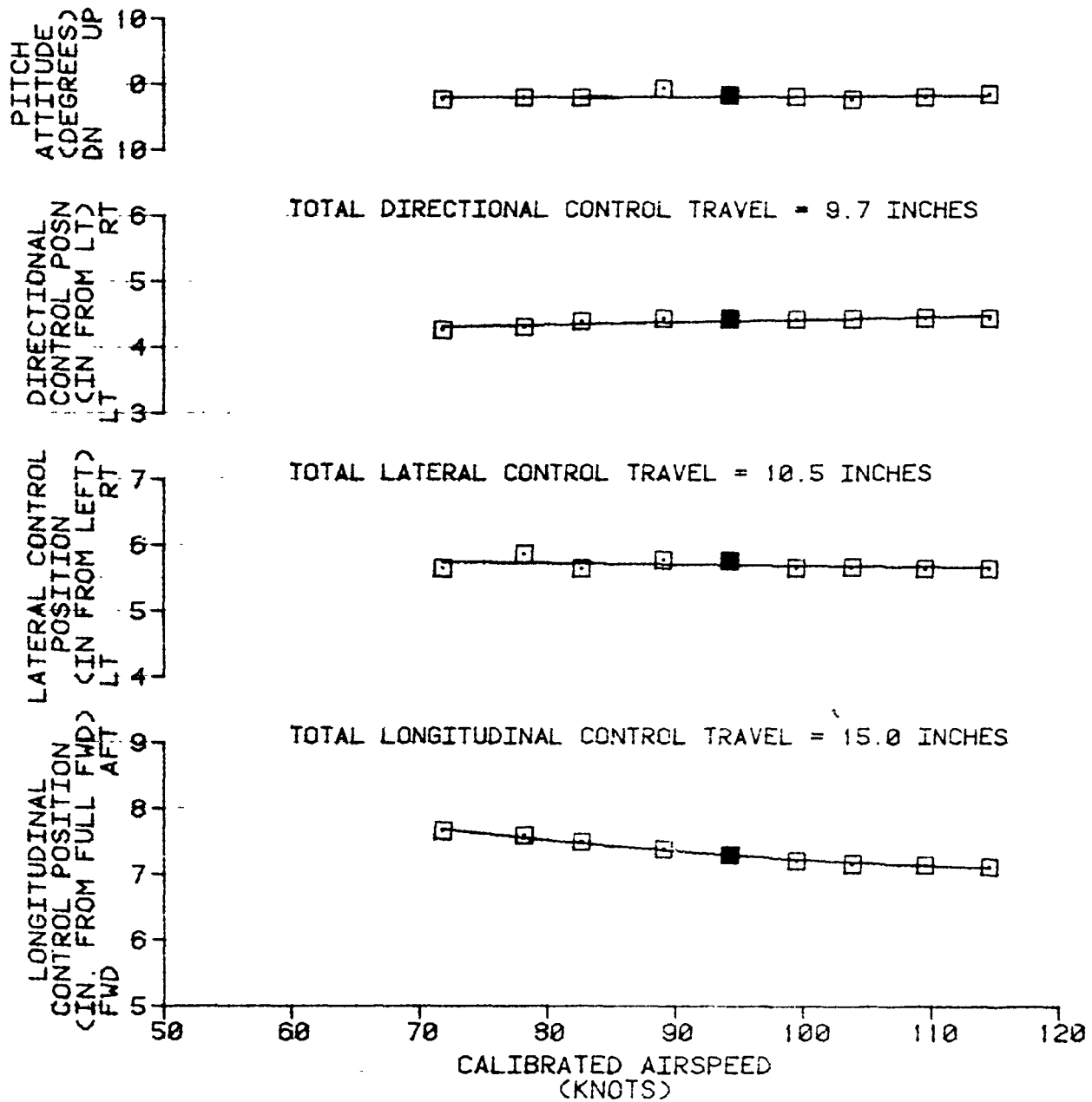

FIGURE 55
STATIC LONGITUDINAL STABILITY
CH-47D USA S/N 81-23383

AVG GROSS WEIGHT (LB)	AVG LONGITUDINAL CG LOCATION (FS)	AVG DENSITY ALTITUDE (FEET)	AVG OAT (DEG C)	AVG ROTOR SPEED (RPM)	FLIGHT CONDITION
49388	331.5 (AFT)	5400	22.5	224	DESCENT

- NOTE: 1. SHADED SYMBOLS DENOTE TRIM
 2. BOTH AFCS OFF
 3. ENGINE TORQUE DURING DESCENT = 48 PERCENT

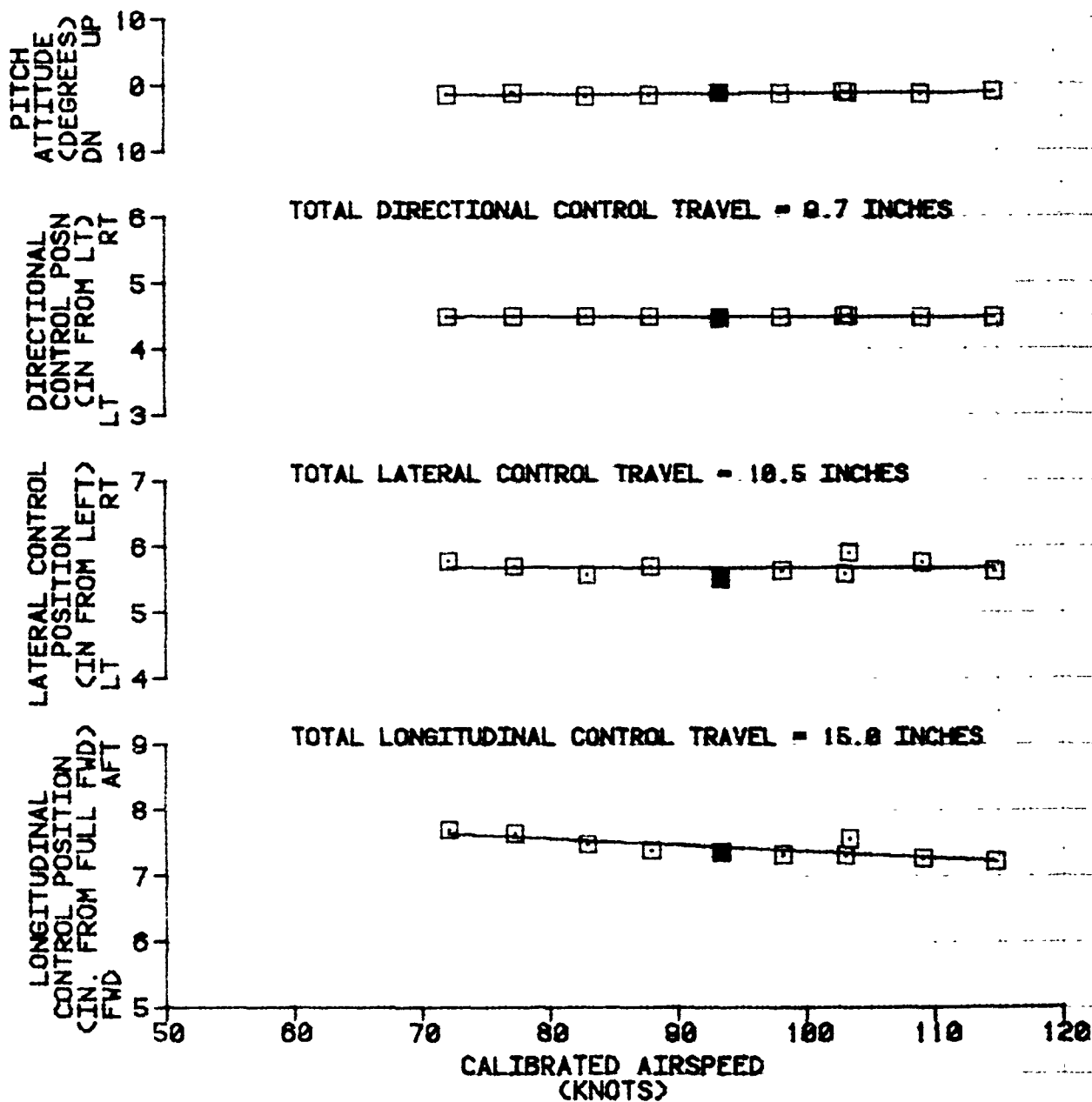

FIGURE 56
 STATIC LONGITUDINAL STABILITY
 CH-47D USA S/N 81-23383

SYMBOL	AVG GROSS WEIGHT (LB)	AVG LONGITUDINAL CG LOCATION (F/S)	AVG DENSITY ALTITUDE (FEET)	AVG OAT (DEG C)	AVG ROTOR SPEED (RPM)	FLIGHT CONDITION
□	49780	331.9(AFT)	4980	26.0	224	LEVEL

NOTES: 1. SHADED SYMBOLS DENOTE TRIM
 2. BOTH AFCS SYSTEMS ON

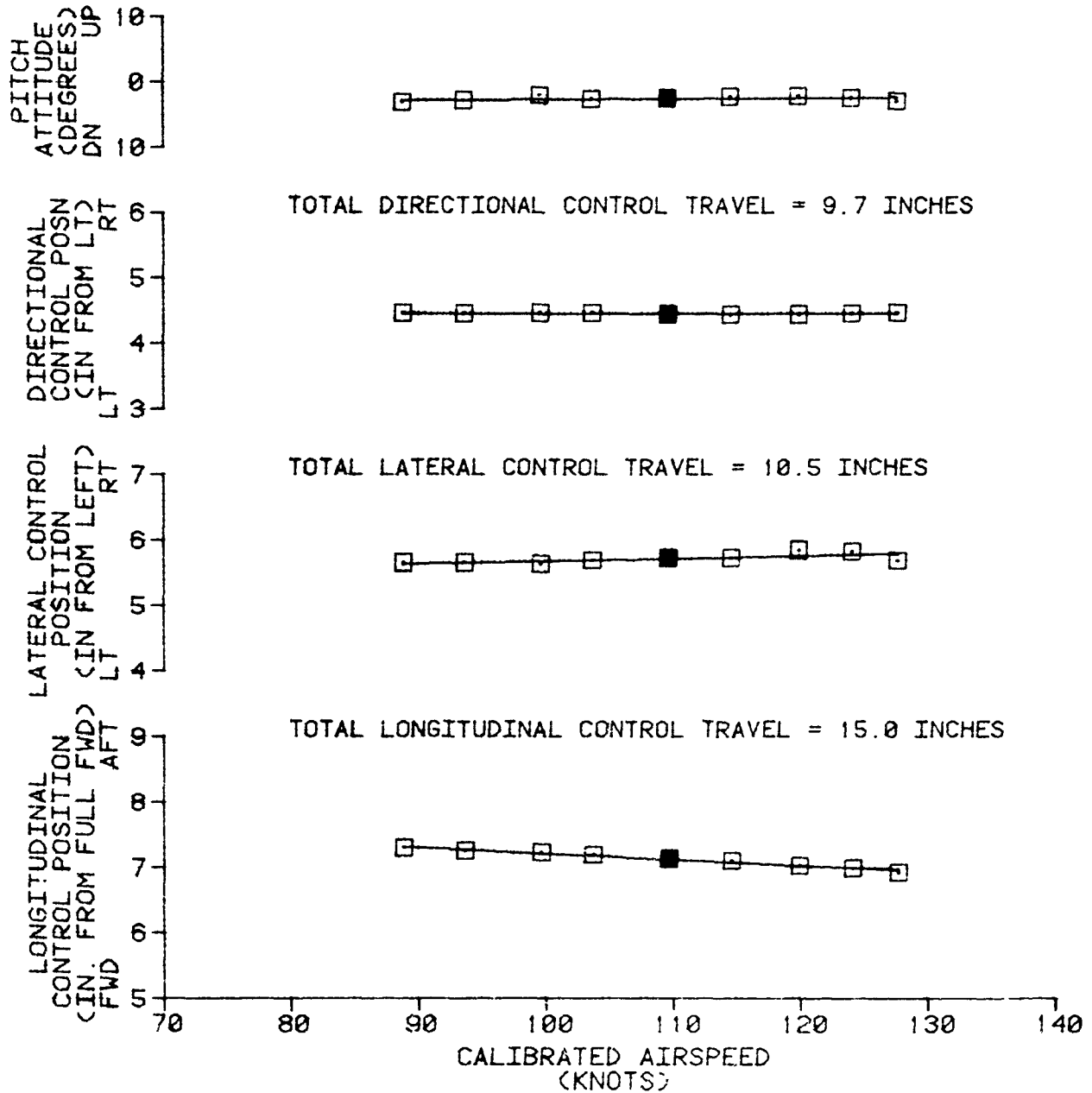

FIGURE 57
STATIC LONGITUDINAL STABILITY
CH-47D USA S/N 81-23383

AVG GROSS WEIGHT (LB)	AVG LONGITUDINAL CG LOCATION (FS)	AVG DENSITY ALTITUDE (FEET)	AVG OAT (DEG C)	AVG ROTOR SPEED (RPM)	FLIGHT CONDITION
42500	318.5 (FWD)	4900	24.0	225	LEVEL

- NOTES: 1. SHADED SYMBOLS DENOTE TRIM
 2. NUMBER ONE AFCS OFF

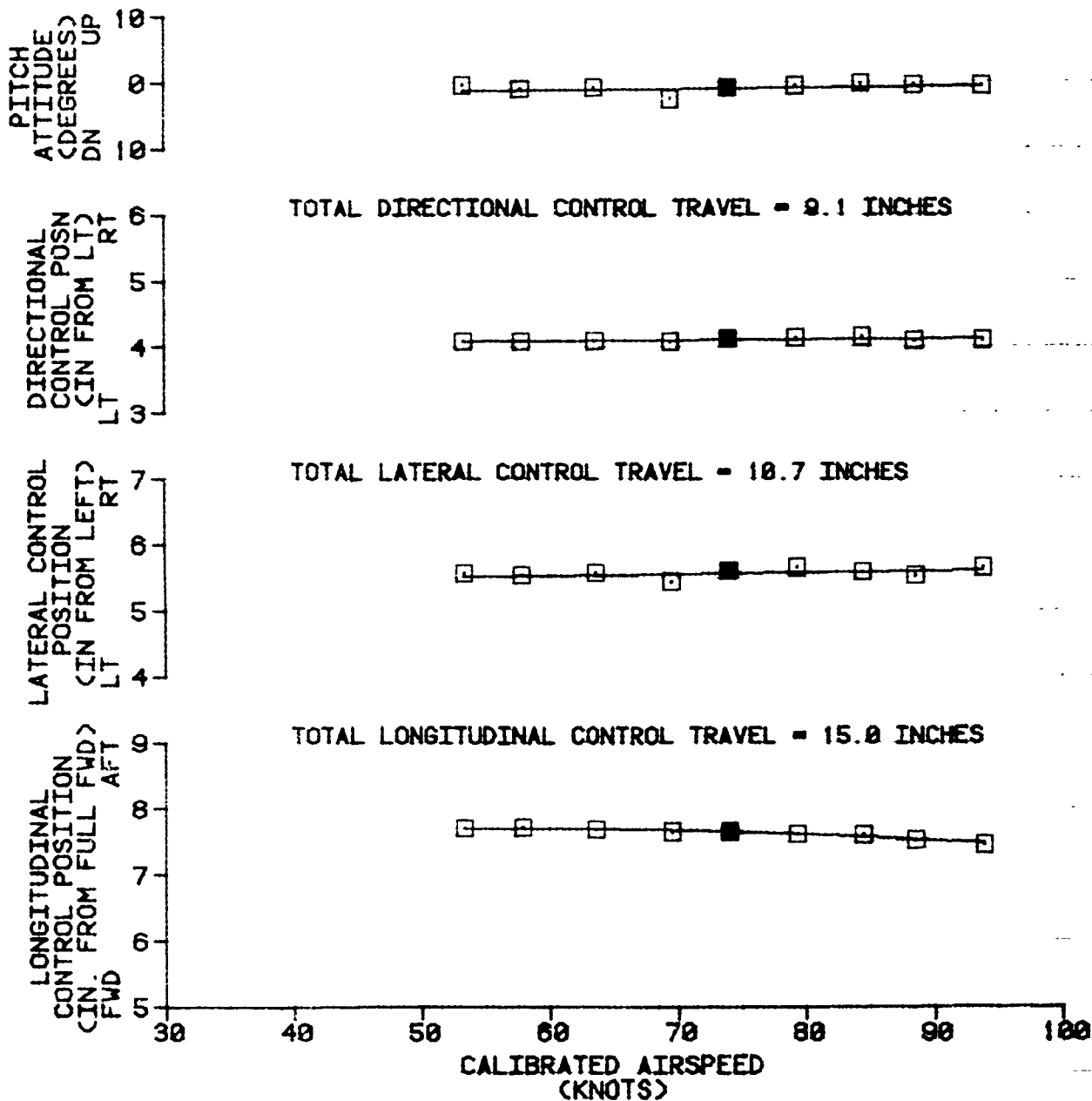

FIGURE 58
STATIC LONGITUDINAL STABILITY
CH-47D USA S/N 81-23383

AVG GROSS WEIGHT (LB)	AVG LONGITUDINAL CG LOCATION (FWS)	AVG DENSITY ALTITUDE (FEET)	AVG OAT (DEG C)	AVG ROTOR SPEED (RPM)	FLIGHT CONDITION
41300	310.8 (FWD)	4820	28.8	226	LEVEL

NOTES: 1. SHADED SYMBOLS DENOTE TRIM
 2. NUMBER ONE AFCS OFF

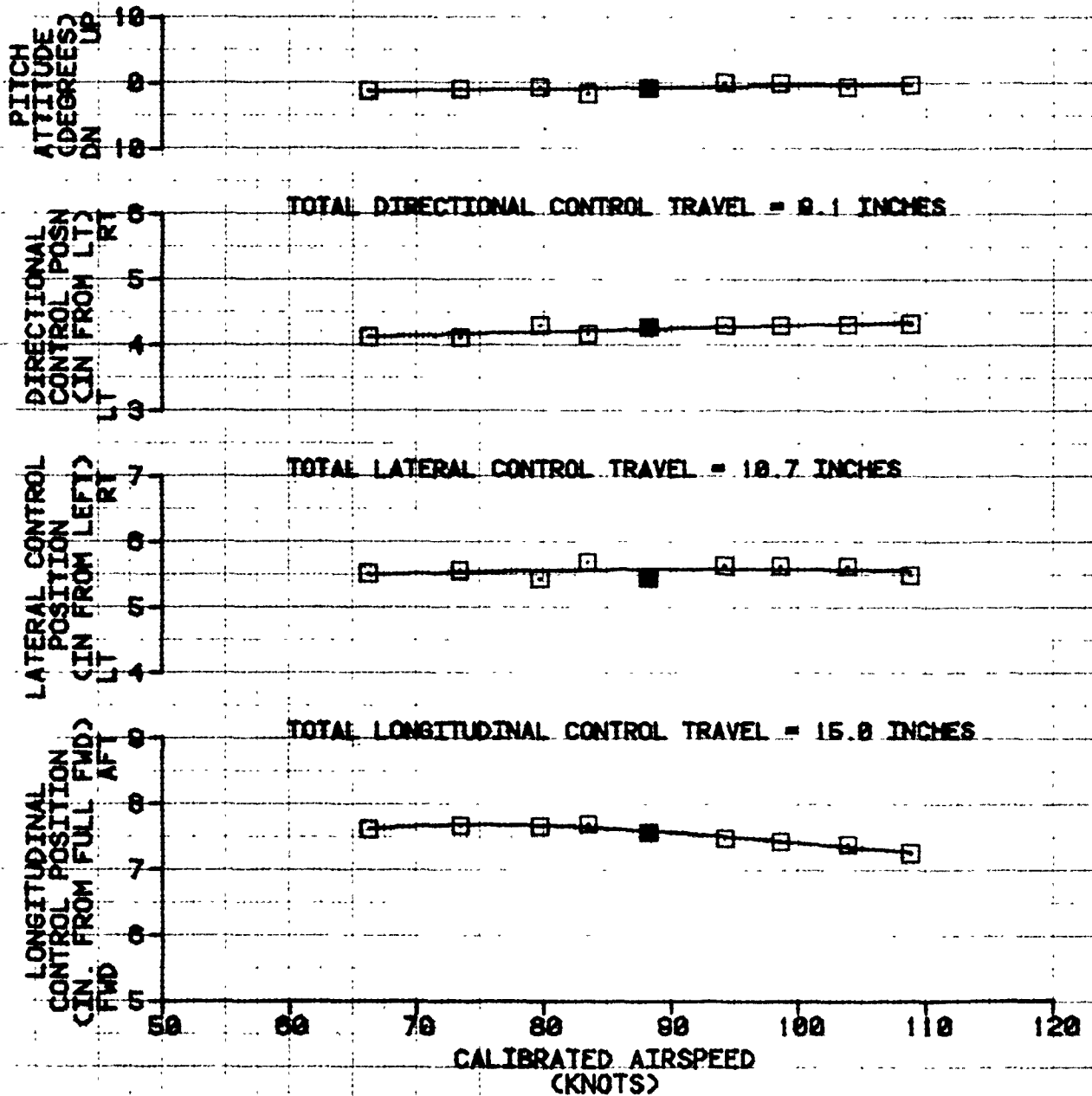

FIGURE 59
STATIC LONGITUDINAL STABILITY
CH-47D USA S/N 81-23383

AVG GROSS WEIGHT (LB)	AVG LONGITUDINAL CG LOCATION (FS)	AVG DENSITY ALTITUDE (FEET)	AVG OAT (DEG C)	AVG ROTOR SPEED (RPM)	FLIGHT CONDITION
42540	337.2 (AFT)	5220	18.5	225	LEVEL

- NOTE: 1. SHADED SYMBOLS DENOTE TRIM
 2. NUMBER ONE AFCS OFF

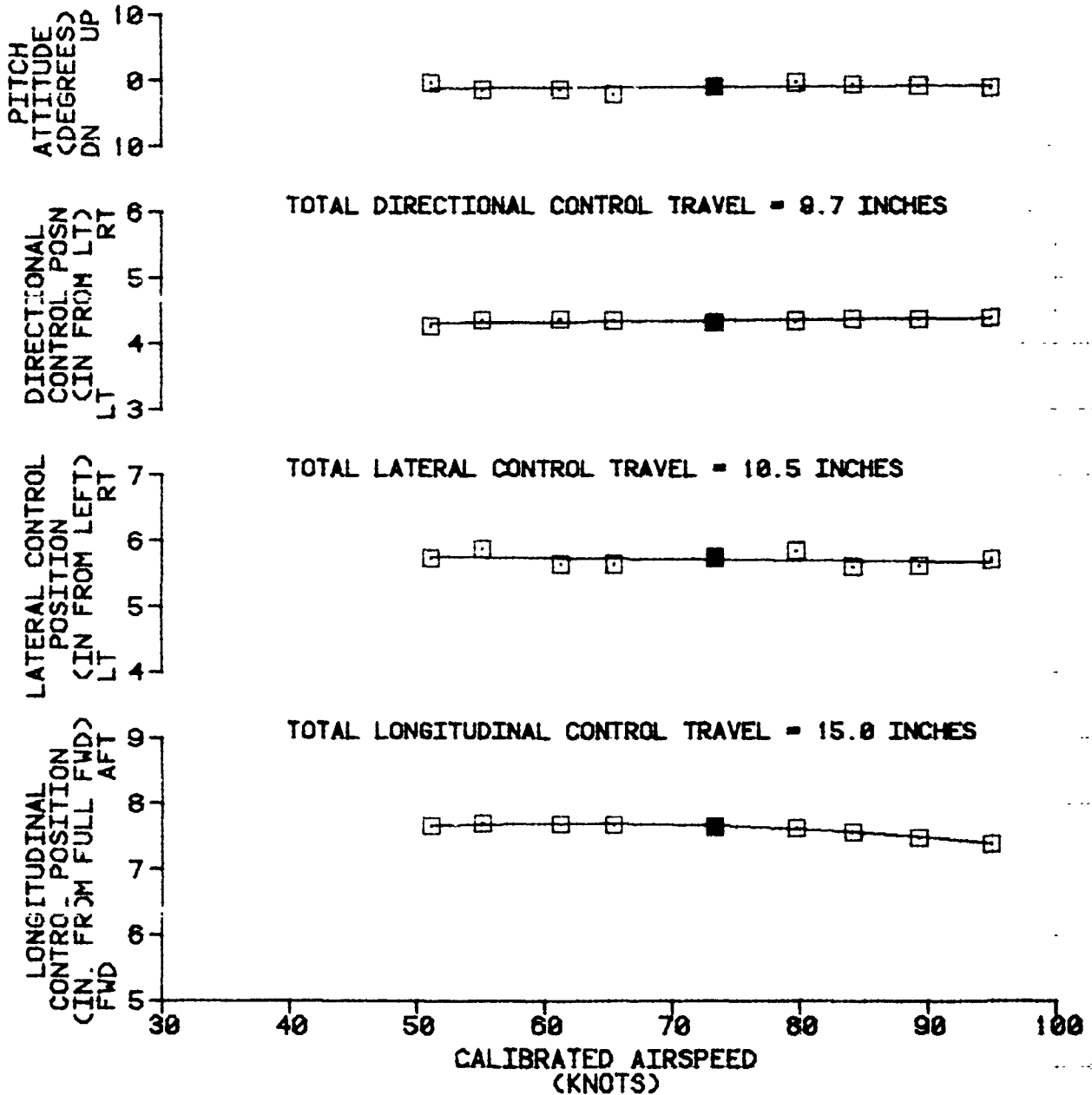

FIGURE 80
STATIC LONGITUDINAL STABILITY
CH-47D USA S/N 81-23383

AVG GROSS WEIGHT (LB)	AVG LONGITUDINAL CG LOCATION (FS)	AVG DENSITY ALTITUDE (FEET)	AVG OAT (DEG C)	AVG ROTOR SPEED (RPM)	FLIGHT CONDITION
42728	337.4 (AFT)	4800	21.5	224	LEVEL

- NOTES: 1. SHADED SYMBOLS DENOTE TRIM
 2. NUMBER ONE AFCS OFF

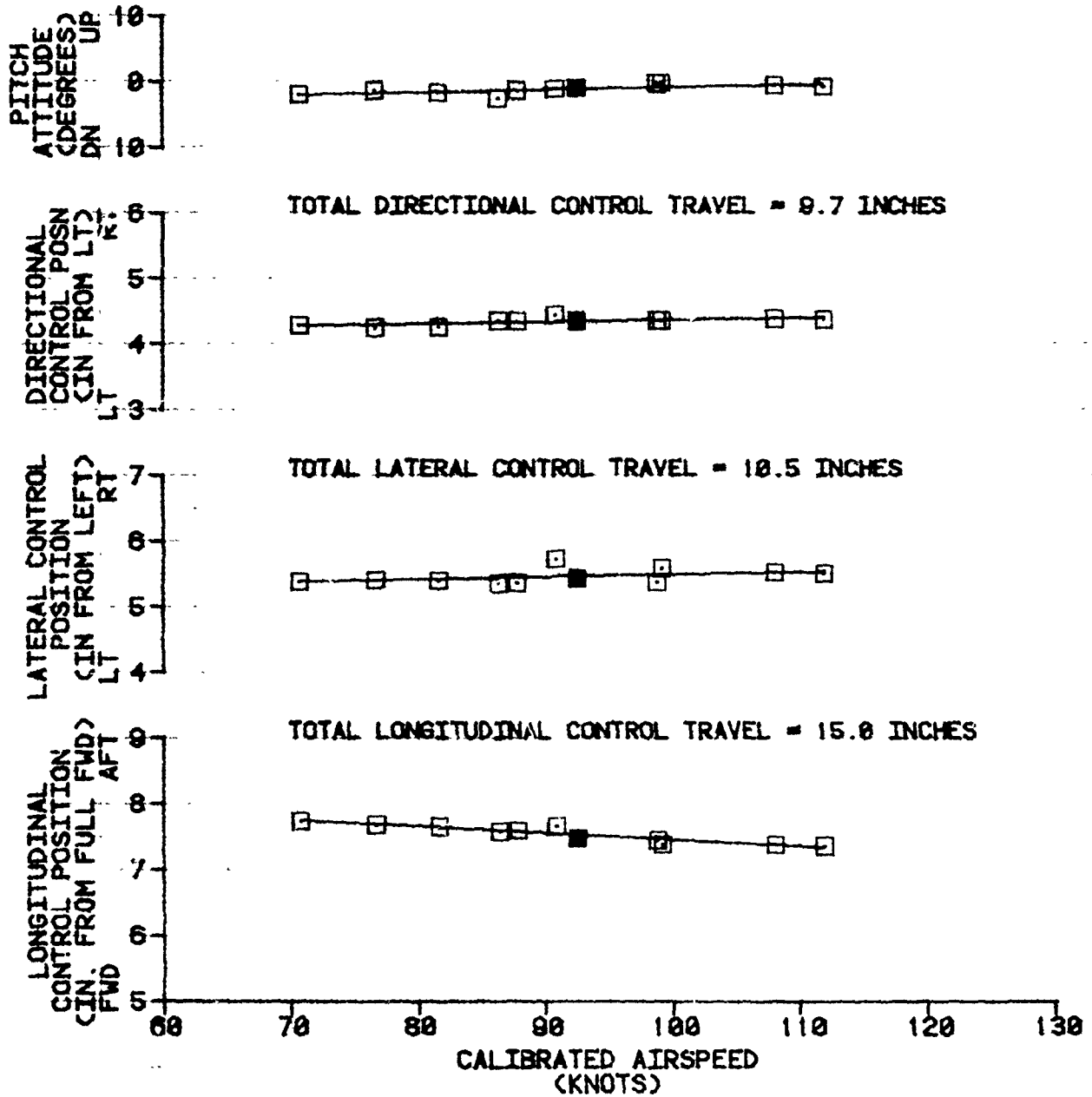

FIGURE 61
 STATIC LONGITUDINAL STABILITY
 CH-47D USA S/N 81-23383

SYMBOL	AVG GROSS WEIGHT (LB)	AVG LONGITUDINAL CG LOCATION (F/S)	AVG DENSITY ALTITUDE (FEET)	AVG OAT (DEG C)	AVG ROTOR SPEED (RPM)	FLIGHT CONDITION
□	50660	331.6(AFT)	5200	27.0	225	LEVEL

- NOTES: 1. SHADED SYMBOLS DENOTE TRIM
 2. NUMBER ONE AFCS SYSTEM OFF

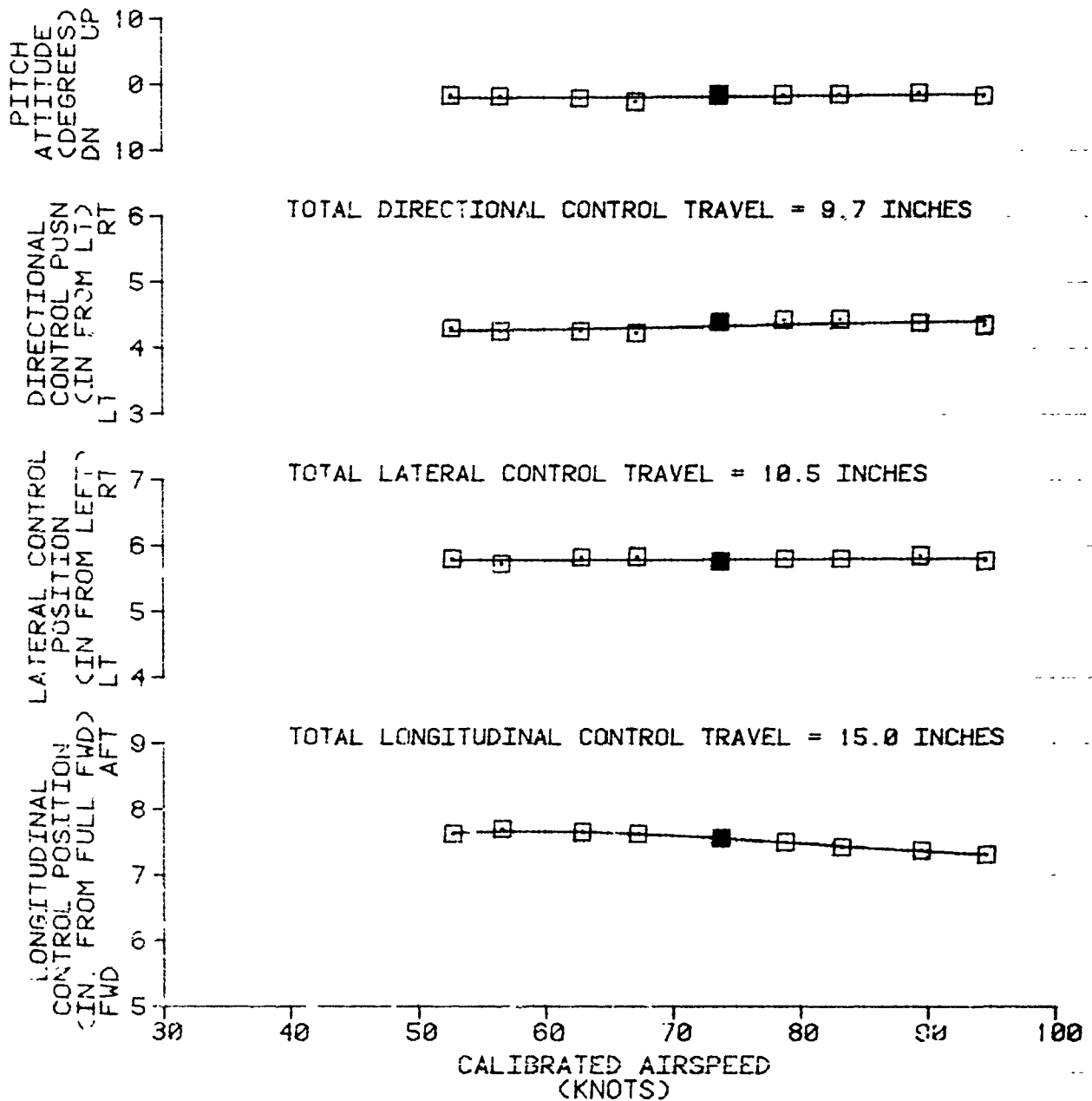

FIGURE 62
 STATIC LONGITUDINAL STABILITY
 CH-47D USA S/N 81-23383

SYMBOL	AVG GROSS WEIGHT (LB)	AVG LONGITUDINAL CG LOCATION (FWS)	AVG DENSITY ALTITUDE (FEET)	AVG OAT (DEG C)	AVG ROTOR SPEED (RPM)	FLIGHT CONDITION
□	49400	332.1(AFT)	4800	26.0	225	LEVEL

NOTES: 1. SHADED SYMBOLS DENOTE TRIM
 2. NUMBER ONE AFCS SYSTEM OFF

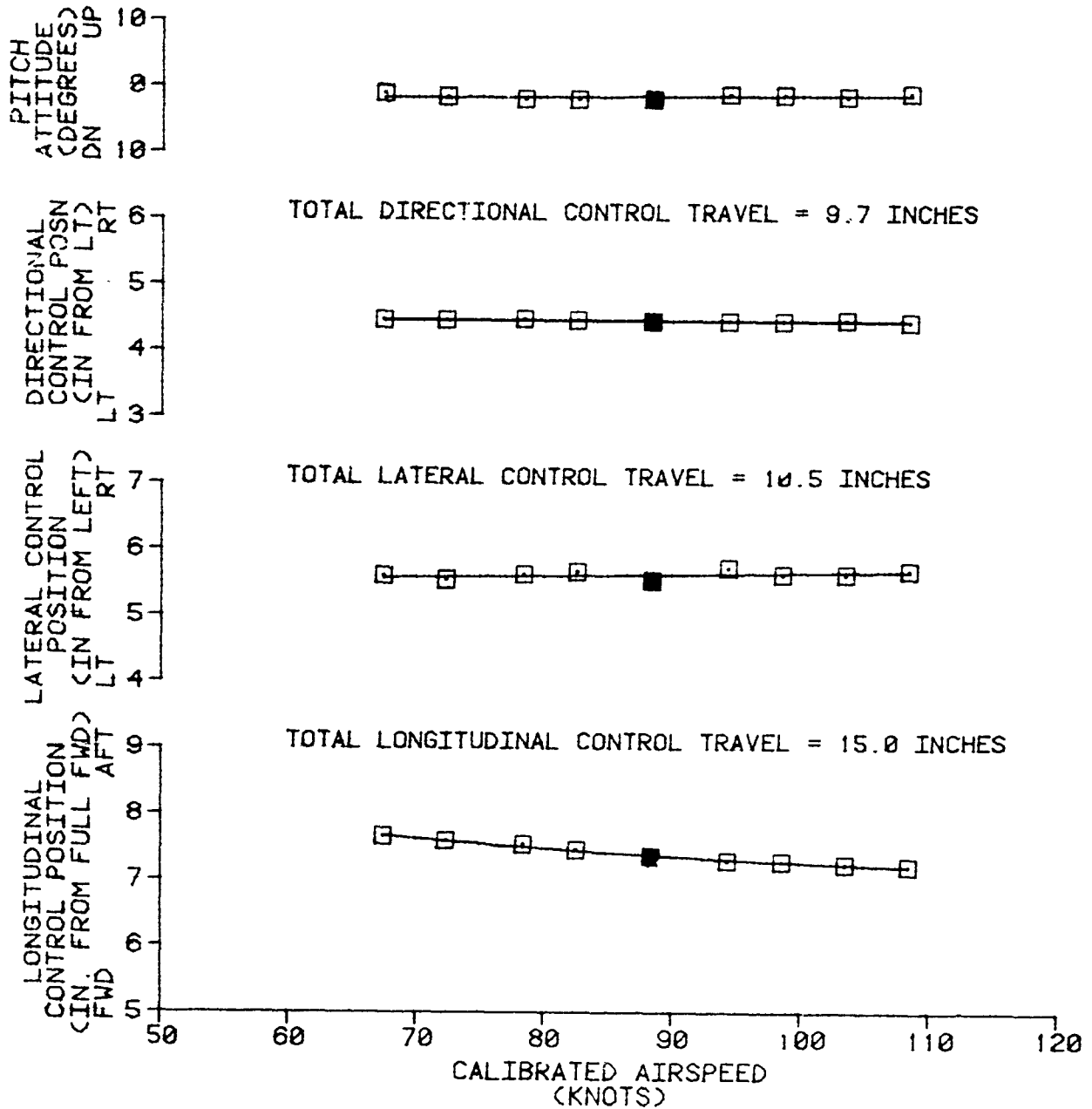

FIGURE 83
STATIC LONGITUDINAL STABILITY
CH-47D USA S/N 81-23383

AVG GROSS WEIGHT (LB)	AVG LONGITUDINAL CG LOCATION (FS)	AVG DENSITY ALTITUDE (FEET)	AVG OAT (DEG C)	AVG ROTOR SPEED (RPM)	FLIGHT CONDITION
42180	318.5 (FWD)	5228	23.5	226	LEVEL

- NOTES: 1. SHADED SYMBOLS DENOTE TRIM
 2. BOTH AFCS OFF

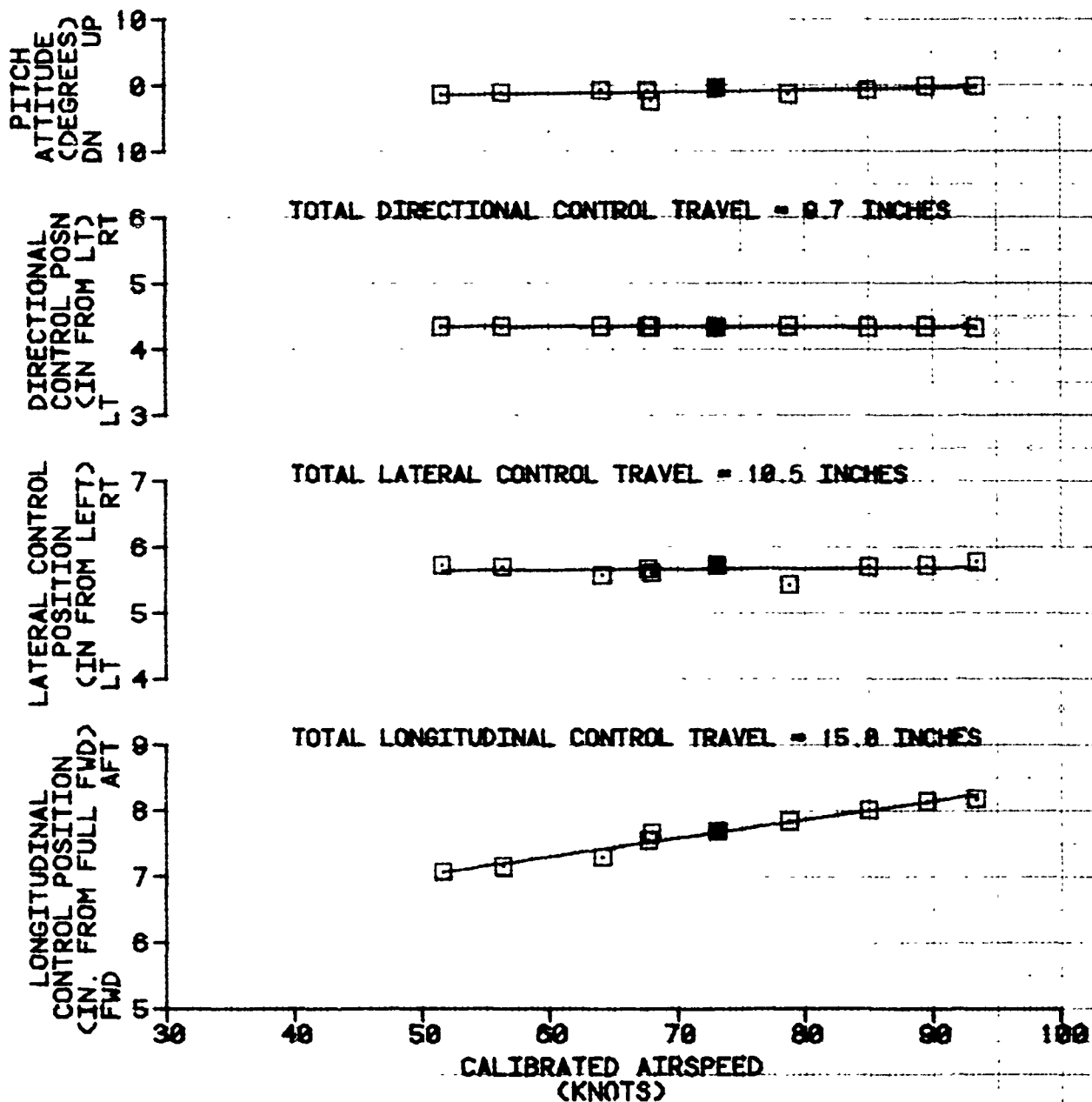

FIGURE 64
STATIC LONGITUDINAL STABILITY
CH-47D USA S/N 81-23383

AVG GROSS WEIGHT (LB)	AVG LONGITUDINAL CG LOCATION (FS)	AVG DENSITY ALTITUDE (FEET)	AVG OAT (DEG C)	AVG ROTOR SPEED (RPM)	FLIGHT CONDITION LEVEL
41828	318.6 (FWD)	5428	23.8	225	LEVEL

NOTES: 1. SHADED SYMBOLS DENOTE TRIM
 2. BOTH AFCS OFF

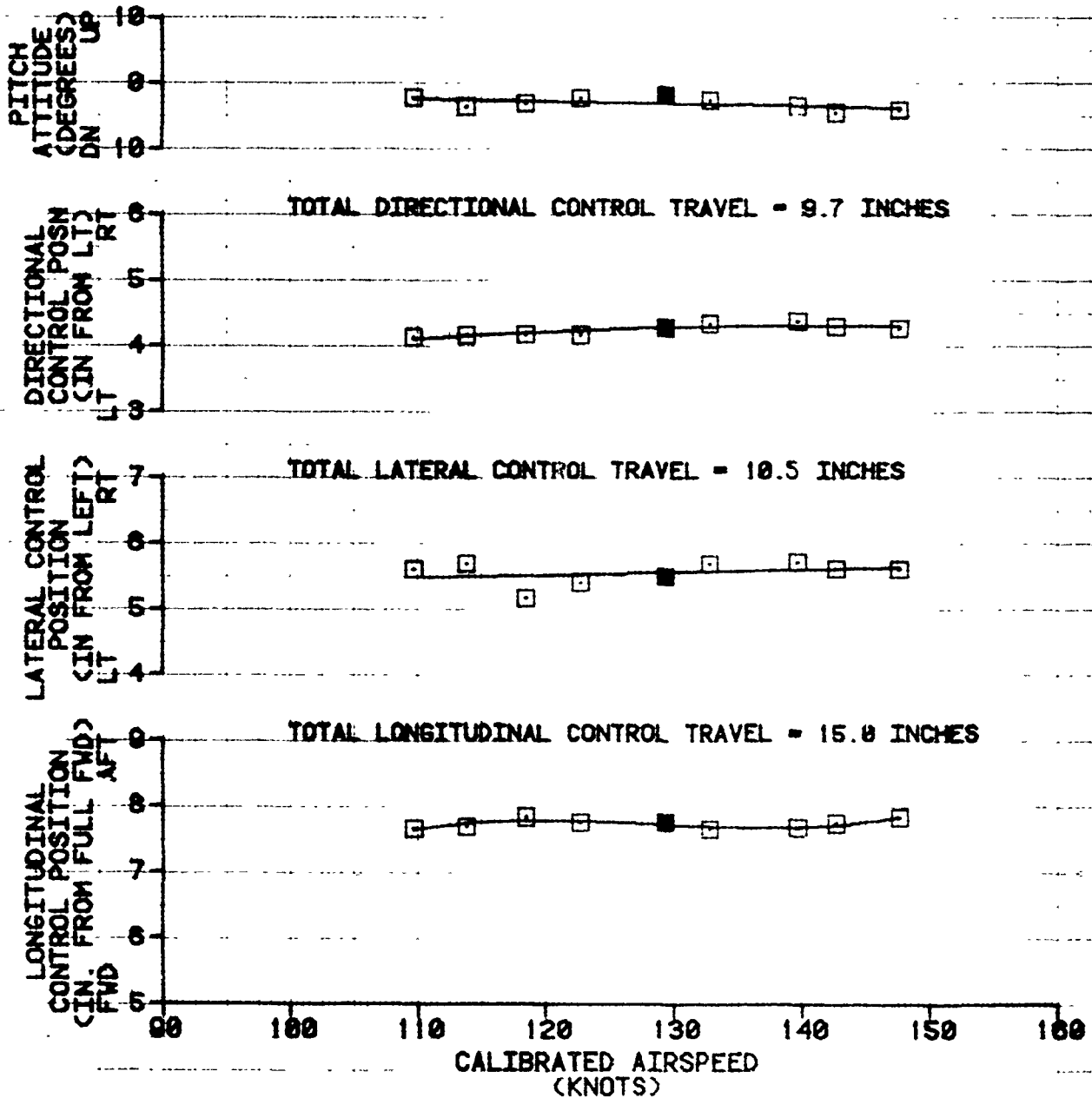

FIGURE 65
STATIC LONGITUDINAL STABILITY
CH-47D USA S/N 81-23383

AVG GROSS WEIGHT (LB)	AVG LONGITUDINAL CG LOCATION (FS)	AVG DENSITY ALTITUDE (FEET)	AVG OAT (DEG C)	AVG ROTOR SPEED (RPM)	FLIGHT CONDITION
42020	337.4(AFT)	4800	19.0	225	LEVEL

NOTE: 1. SHADED SYMBOLS DENOTE TRIM
 2. BOTH AFCS OFF

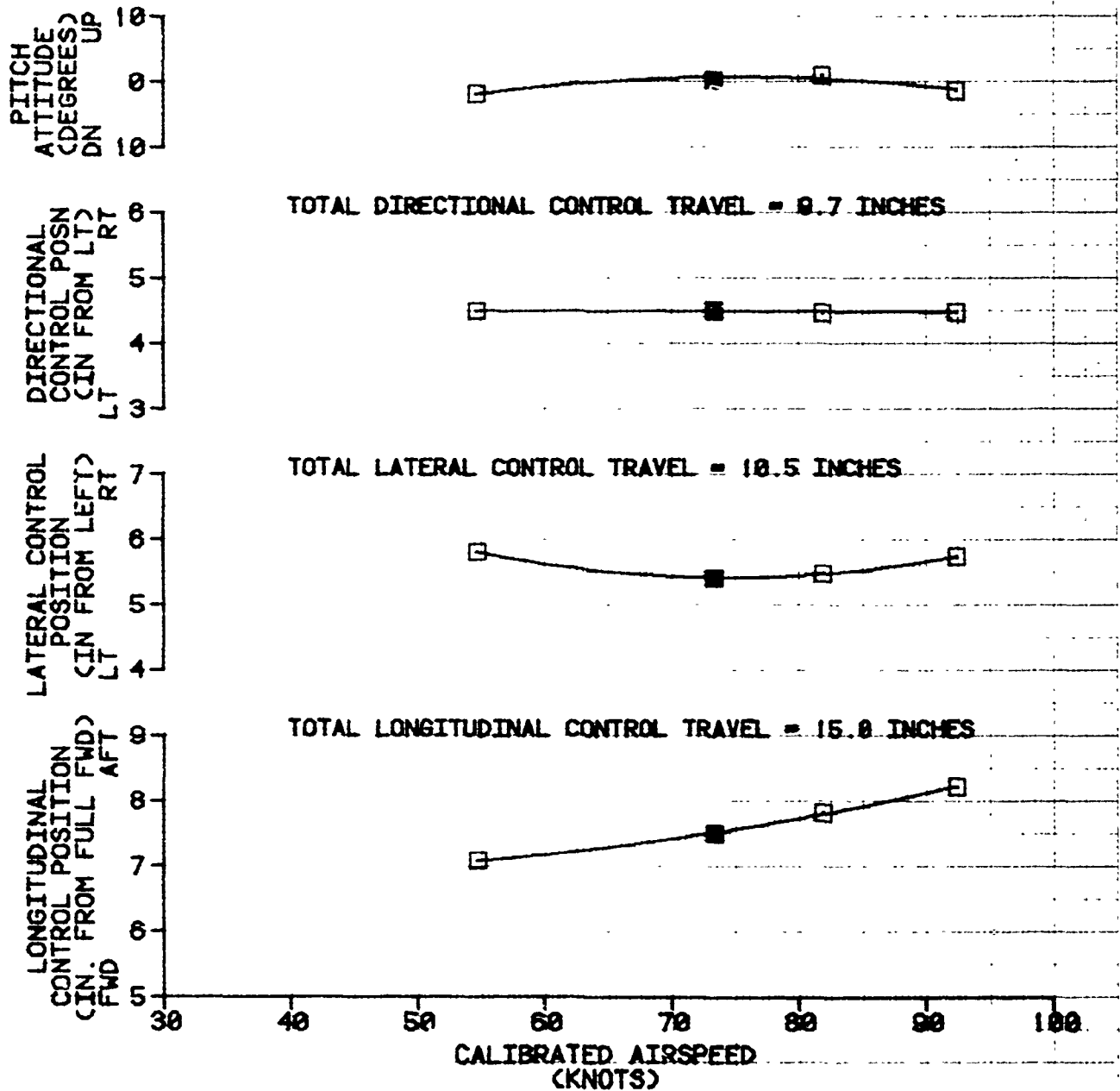

FIGURE 66
STATIC LONGITUDINAL STABILITY
CH-47D USA S/N 81-23383

AVG GROSS WEIGHT (LB)	AVG LONGITUDINAL CG LOCATION (FS)	AVG DENSITY ALTITUDE (FEET)	AVG OAT (DEG C)	AVG ROTOR SPEED (RPM)	FLIGHT CONDITION
42120	337.7 (AFT)	4880	21.5	225	LEVEL

NOTES: 1. SHADED SYMBOLS DENOTE TRIM
 2. BOTH AFCS OFF

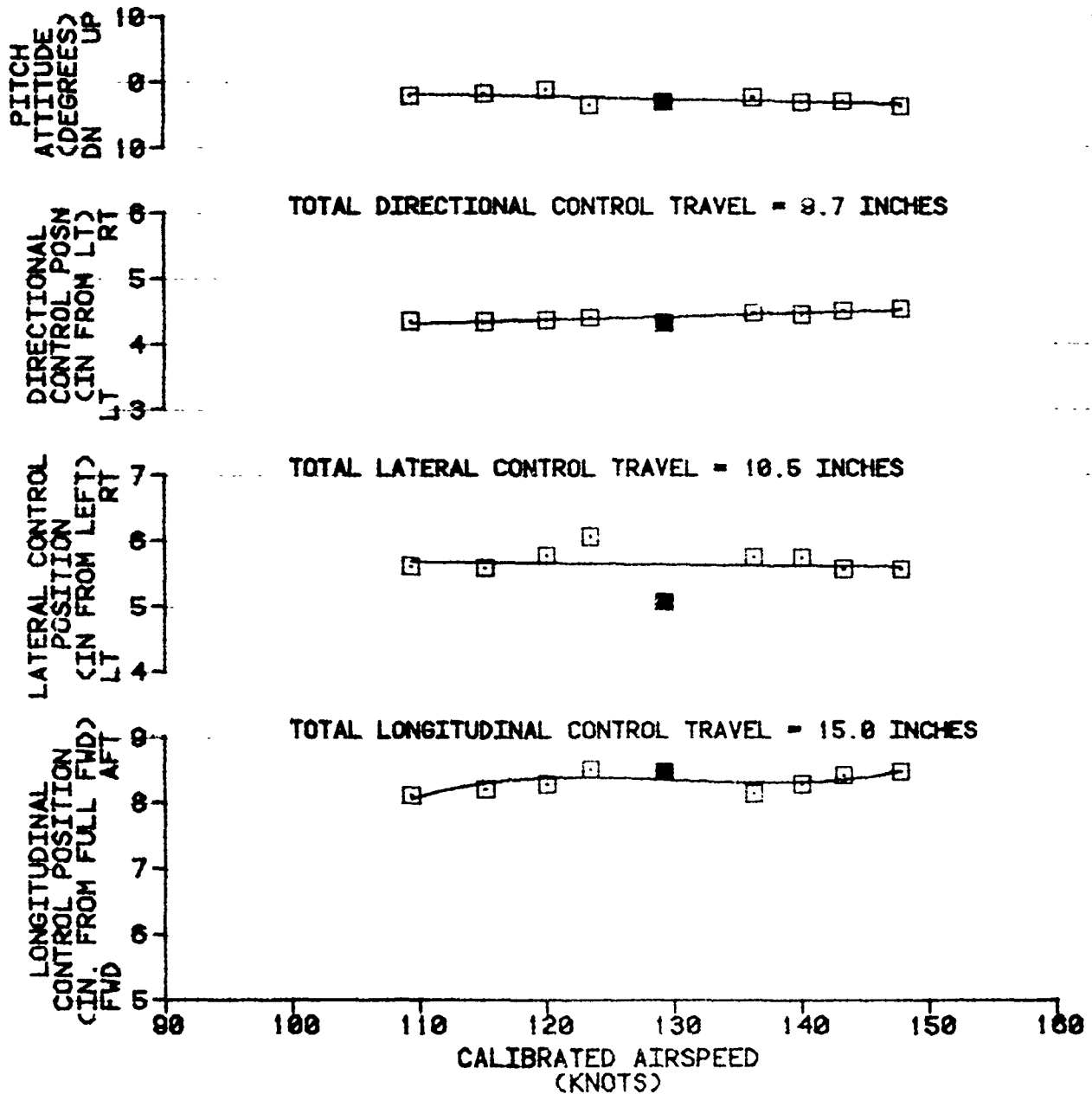

FIGURE 67
 STATIC LONGITUDINAL STABILITY
 CH-47D USA S/N 81-23383

SYMBOL	AVG GROSS WEIGHT (LB)	AVG LONGITUDINAL CG LOCATION (FS)	AVG DENSITY ALTITUDE (FEET)	AVG OAT (DEG C)	AVG ROTOR SPEED (RPM)	FLIGHT CONDITION
□	50240	331.8(AFT)	5000	26.5	225	LEVEL

- NOTES: 1. SHADED SYMBOLS DENOTE TRIM
 2. BOTH AFCS SYSTEMS OFF

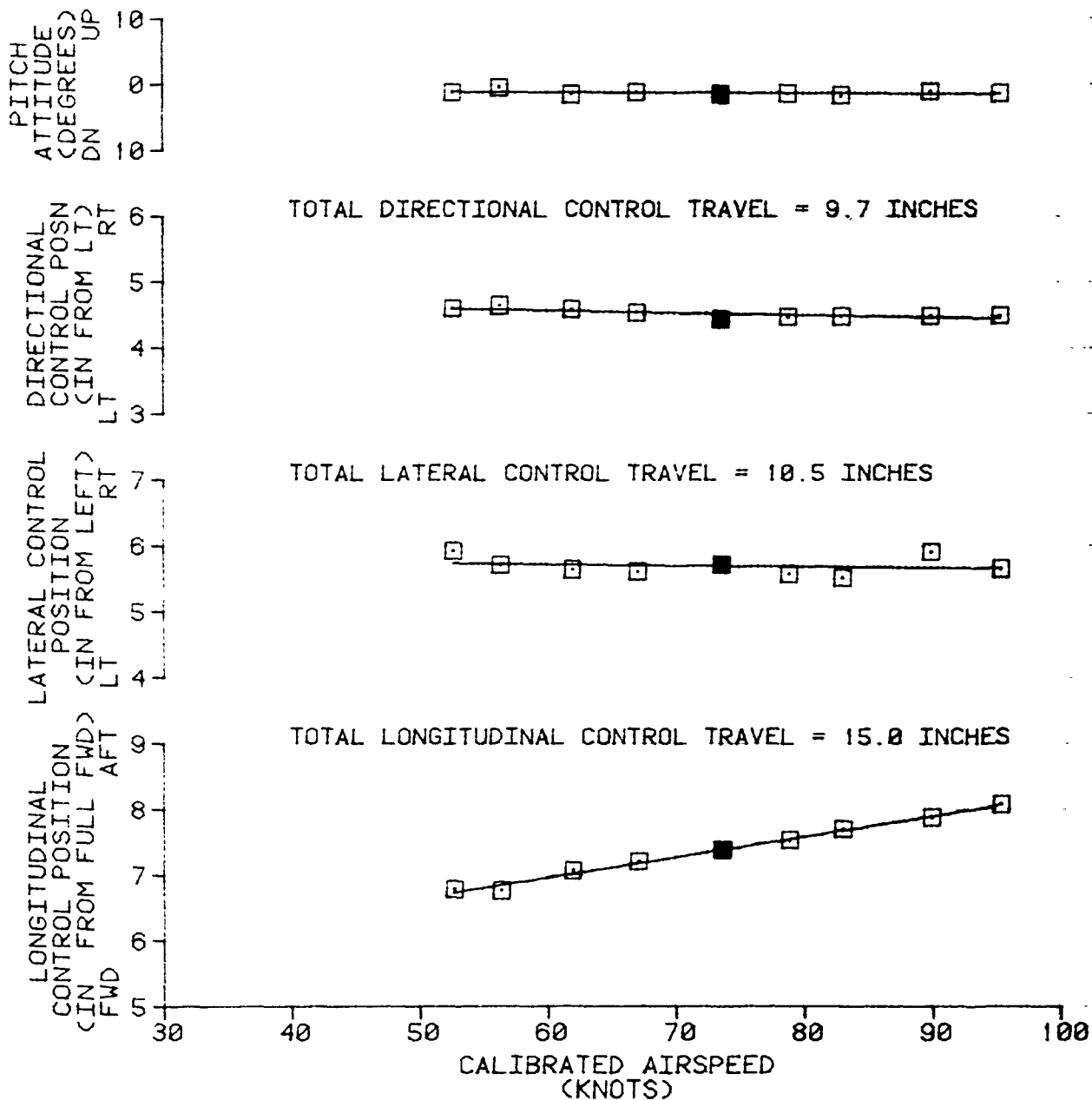

FIGURE 68
 STATIC LONGITUDINAL STABILITY
 CH-47D USA S/N 81-23383

SYMBOL	AVG GROSS WEIGHT (LB)	AVG LONGITUDINAL CG LOCATION (F/S)	AVG DENSITY ALTITUDE (FEET)	AVG OAT (DEG C)	AVG ROTOR SPEED (RPM)	FLIGHT CONDITION
□	48840	332.3(AFT)	5160	26.5	225	LEVEL

- NOTES: 1. SHADED SYMBOLS DENOTE TRIM
 2. BOTH AFCS SYSTEMS OFF

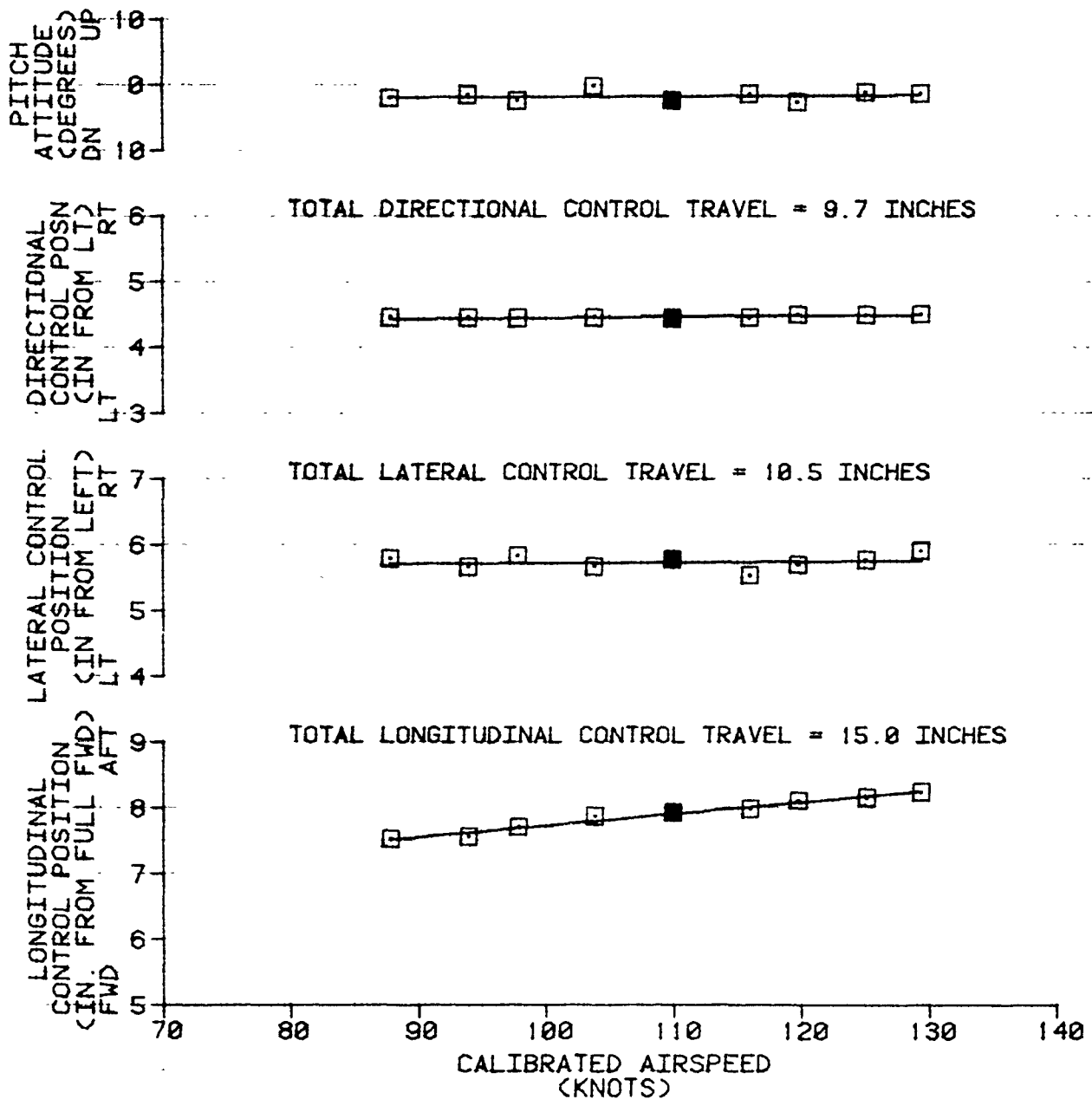

FIGURE 69
 STATIC LATERAL-DIRECTIONAL STABILITY
 CH-47D USA S/N 81-23383

AVG GROSS WEIGHT (LB)	AVG LONG CG LOCATION (FS)	AVG DENSITY ALTITUDE (FT)	AVG OAT (DEG C)	AVG ROTOR SPEED (RPM)	TRIM CALIB AIRSPEED (KT)	FLIGHT CONDITION
39900	912.7 (FWD)	5240	17.5	224	73	LEVEL

NOTES: 1. SHADED SYMBOLS DENOTE TRIM
 2. BOTH AFCS ON

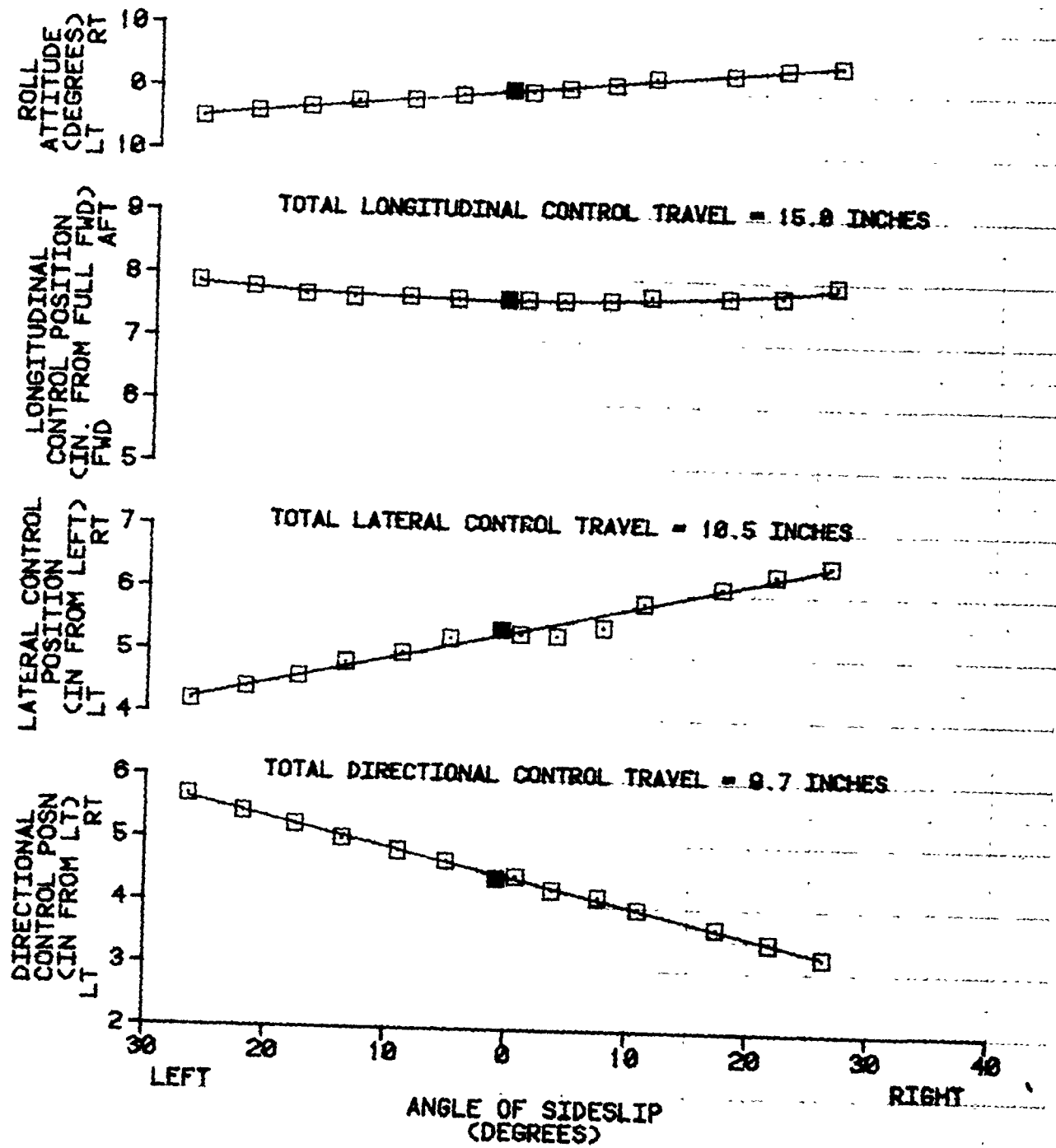

FIGURE 70
STATIC LATERAL-DIRECTIONAL STABILITY
CH-47D USA S/N 81-23383

AVG GROSS WEIGHT (LB)	AVG LONG CG LOCATION (FS)	AVG DENSITY ALTITUDE (FT)	AVG OAT (DEG C)	AVG ROTOR SPEED (RPM)	TRIM CALIB AIRSPEED (KT)	FLIGHT CONDITION
39448	312.8 (FWD)	4848	17.8	224	129	LEVEL

NOTES: 1. SHADED SYMBOLS DENOTE TRIM
 2. BOTH AFCS ON

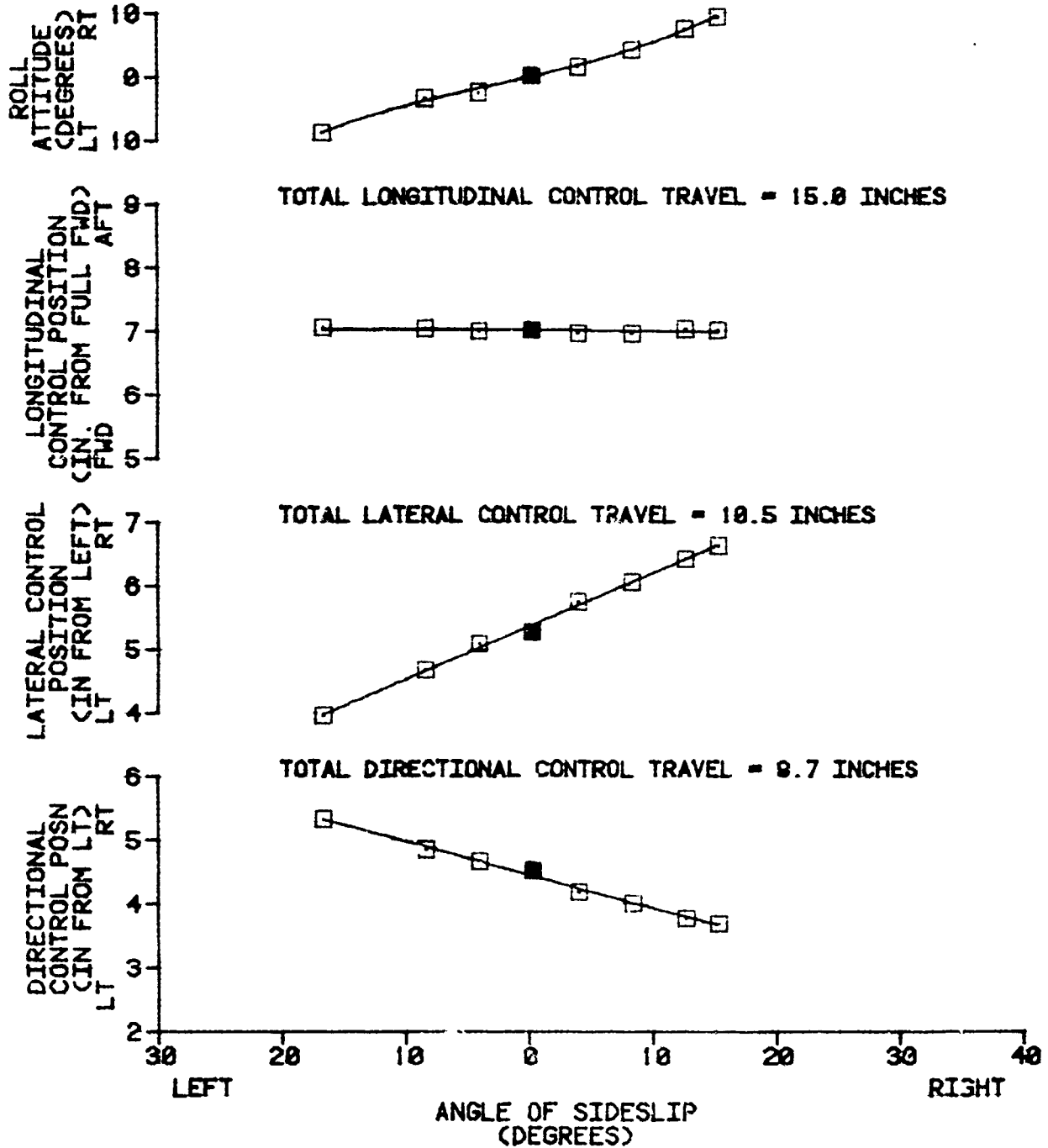

FIGURE 71
STATIC LATERAL-DIRECTIONAL STABILITY
CH-47D USA S/N 81-23383

AVG GROSS WEIGHT (LB)	AVG LONG CG LOCATION (FS)	AVG DENSITY ALTITUDE (FT)	AVG OAT (DEG C)	AVG ROTOR SPEED (RPM)	TRIM CALIB AIRSPEED (KT)	FLIGHT CONDITION
40140	318.7 (FWD)	5580	18.5	225	95	CLIMB

- NOTES: 1. SHADED SYMBOLS DENOTE TRIM
 2. BOTH AFCS ON
 3. ENGINE TORQUE DURING CLIMB = 93 PERCENT

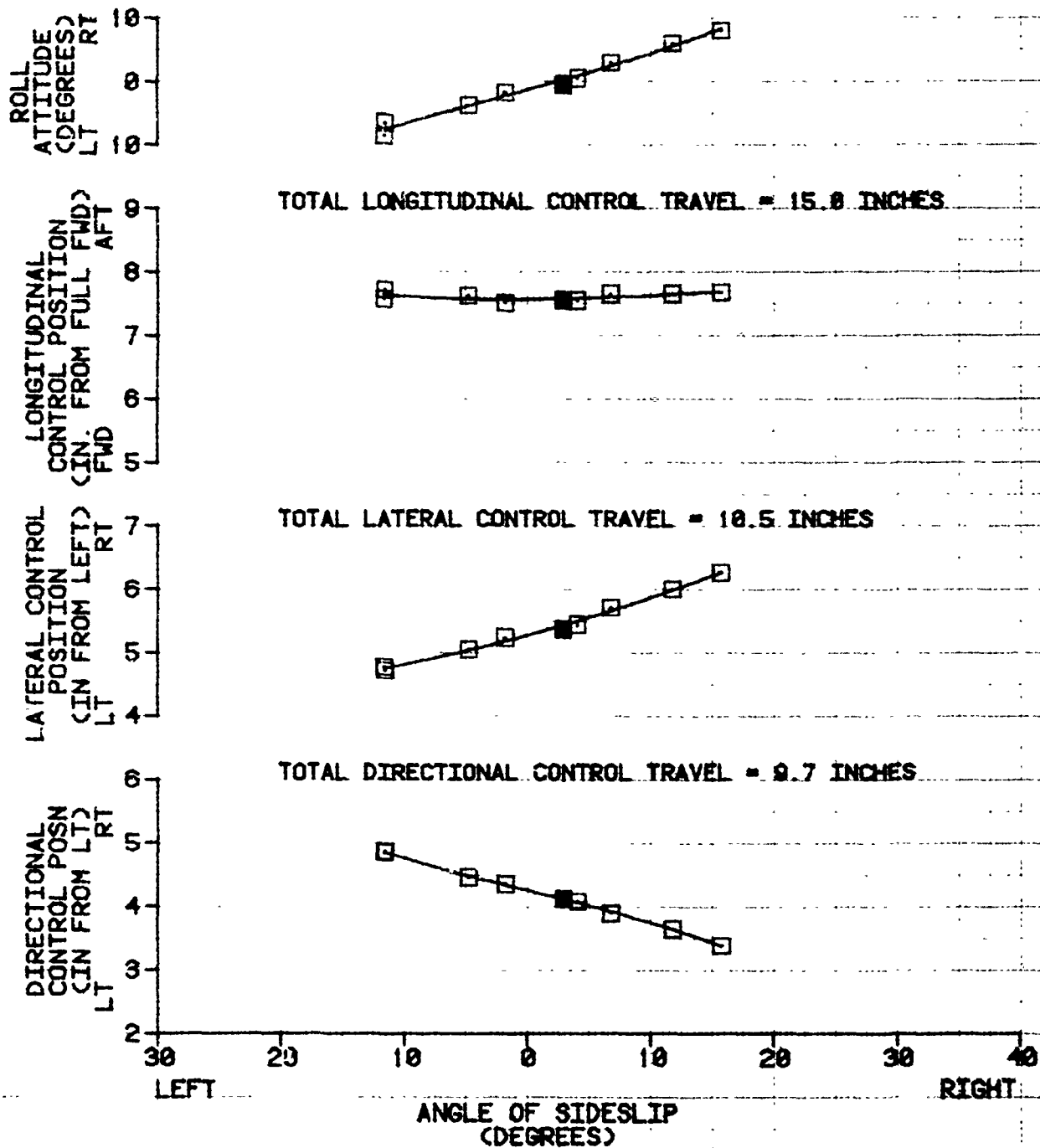

FIGURE 72
STATIC LATERAL-DIRECTIONAL STABILITY
CH-47D USA S/N 81-23383

AVG GROSS WEIGHT (LB)	AVG LONG CG LOCATION (FS)	AVG DENSITY ALTITUDE (FT)	AVG OAT (DEG C)	AVG ROTOR SPEED (RPM)	TRIM CALIB AIRSPEED (KT)	FLIGHT CONDITION
38800	312.5 (FWD)	5280	17.0	224	94	DESCENT

- NOTES: 1. SHADED SYMBOLS DENOTE TRIM
 2. BOTH AFCS ON
 3. ENGINE TORQUE DURING DESCENT = 35 PERCENT

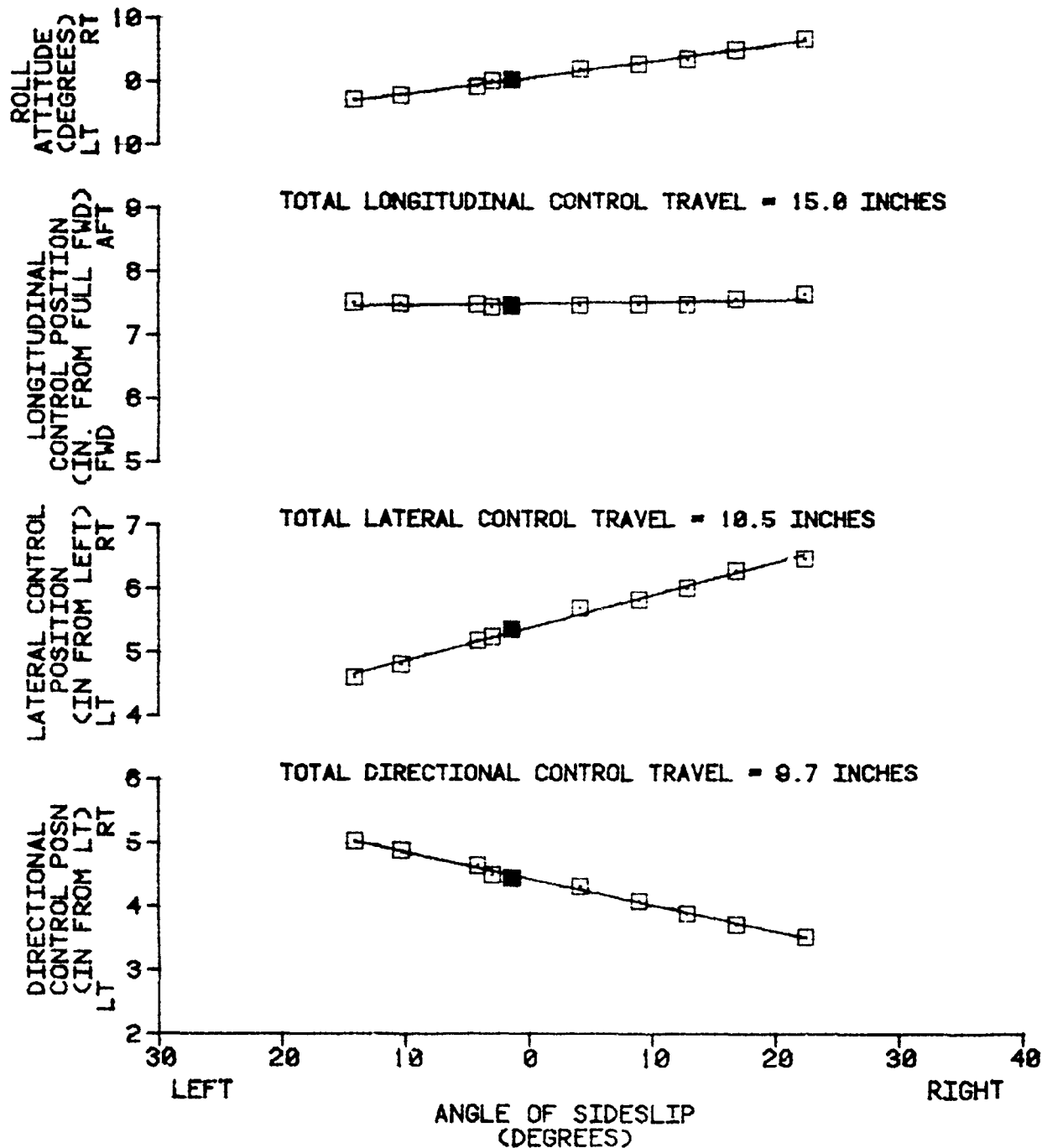

FIGURE 73
STATIC LATERAL-DIRECTIONAL STABILITY
CH-47D USA S/N 81-23383

AVG GROSS WEIGHT (LB)	AVG LONG CG LOCATION (FS)	AVG DENSITY ALTITUDE (FT)	AVG OAT (DEG C)	AVG ROTOR SPEED (RPM)	TRIM CALIB AIRSPEED (KT)	FLIGHT CONDITION
39360	318.8 (FWD)	5820	10.0	224	94	AUTOROTATION

NOTES: 1. SHADED SYMBOLS DENOTE TRIM
 2. BOTH AFCS ON

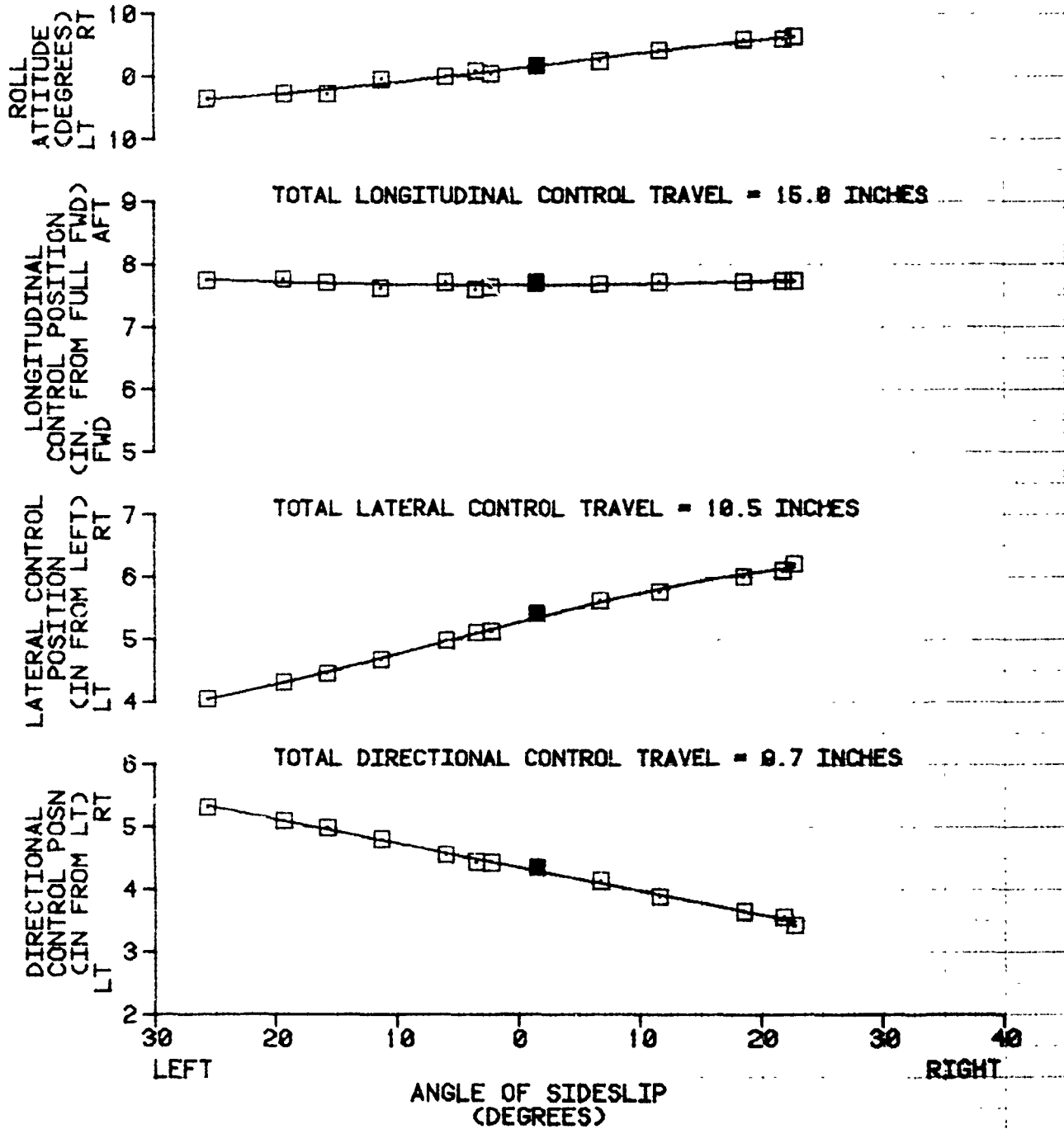

FIGURE 74
STATIC LATERAL-DIRECTIONAL STABILITY
CH-47D USA S/N 81-23383

AVG GROSS WEIGHT (LB)	AVG LONG CG LOCATION (FS)	AVG DENSITY ALTITUDE (FT)	AVG GAT (DEG C)	AVG ROTOR SPEED (RPM)	TRIM CALIB AIRSPEED (KT)	FLIGHT CONDITION
46980	346.3 (AFT)	5100	21.0	226	73	LEVEL

NOTES: 1. SHADED SYMBOLS DENOTE TRIM
 2. BOTH AFCS ON

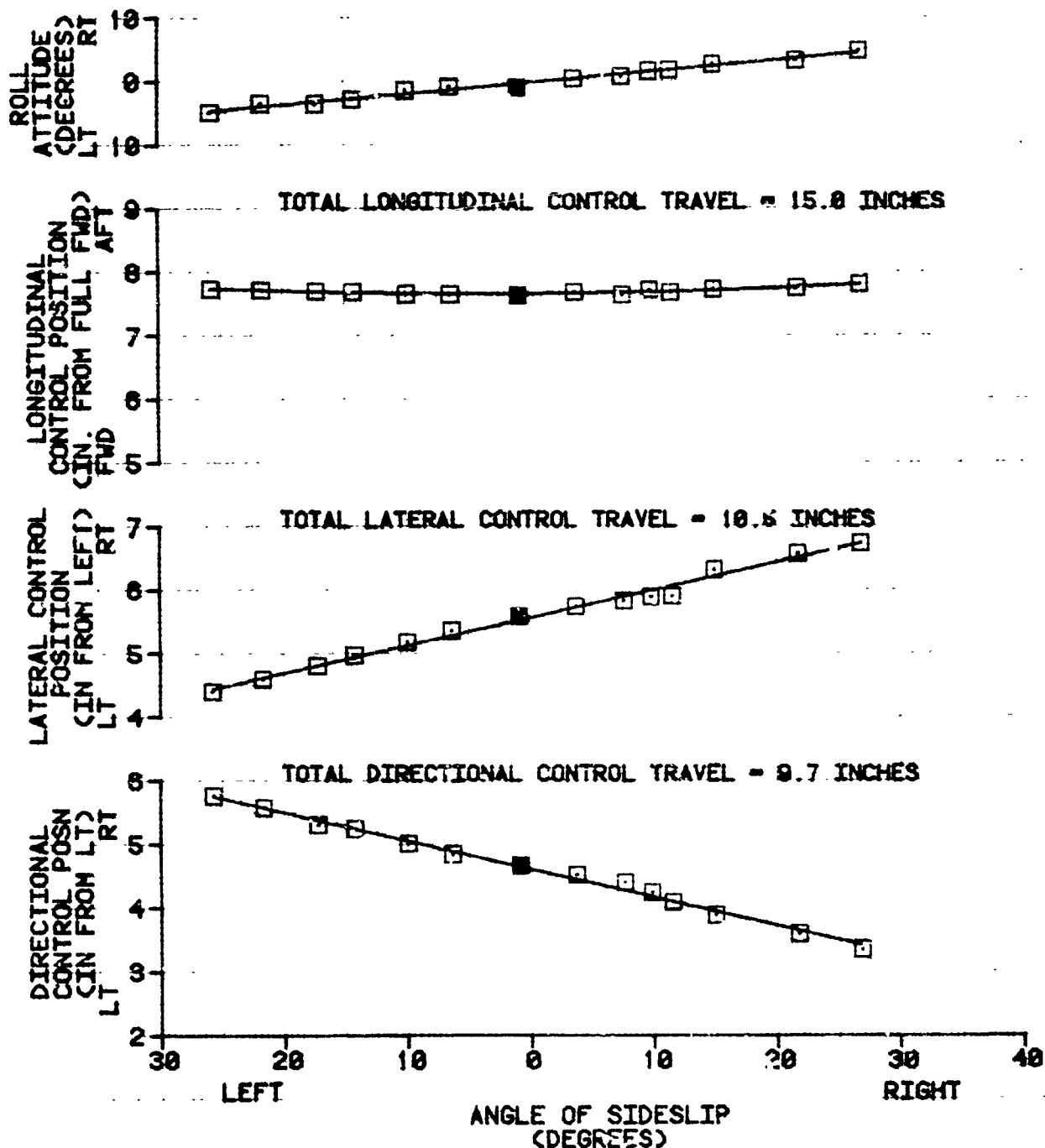
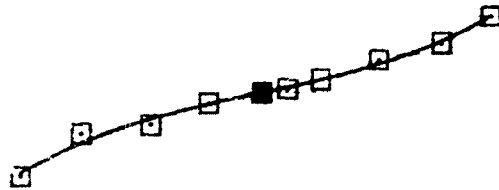

FIGURE 75
STATIC LATERAL-DIRECTIONAL STABILITY
CH-47D USA S/N 81-23383

AVG GROSS WEIGHT (LB)	AVG LONG CG LOCATION (FS)	AVG DENSITY ALTITUDE (FT)	AVG OAT (DEG C)	AVG ROTOR SPEED (RPM)	TRIM CALIB AIRSPEED (KT)	FLIGHT CONDITION
40500	346.7 (AFT)	4700	21.0	225	120	LEVEL

NOTES: 1. SHADED SYMBOLS DENOTE TRIM
 2. BOTH AFCS ON

ROLL ATTITUDE (DEGREES)
 RT
 LT



TOTAL LONGITUDINAL CONTROL TRAVEL = 15.0 INCHES

LONGITUDINAL CONTROL POSITION (IN. FROM FULL FWD)
 FWD
 AFT



TOTAL LATERAL CONTROL TRAVEL = 10.5 INCHES

LATERAL CONTROL POSITION (IN FROM LEFT)
 RT
 LT

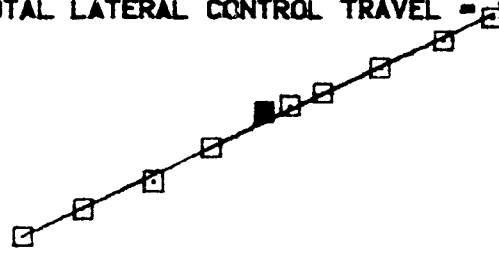

TOTAL DIRECTIONAL CONTROL TRAVEL = 9.7 INCHES

DIRECTIONAL CONTROL POSN (IN FROM LT)
 RT
 LT

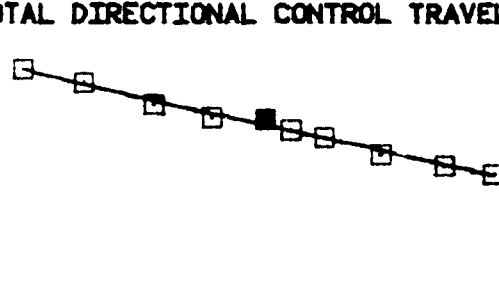

LEFT

ANGLE OF SIDESLIP (DEGREES)

RIGHT

FIGURE 76
STATIC LATERAL-DIRECTIONAL STABILITY
CH-47D USA S/N 81-23383

AVG GROSS WEIGHT (LB)	AVG LONG CG LOCATION (FS)	AVG DENSITY ALTITUDE (FT)	AVG OAT (DEG C)	AVG ROTOR SPEED (RPM)	TRIM CALIB AIRSPEED (KT)	FLIGHT CONDITION
39940	338.9 (AFT)	8109	23.5	224	94	CLIMB

- NOTES: 1. SHADED SYMBOLS DENOTE TRIM
 2. BOTH AFCS ON
 3. ENGINE TORQUE DURING CLIMB = 85 PERCENT

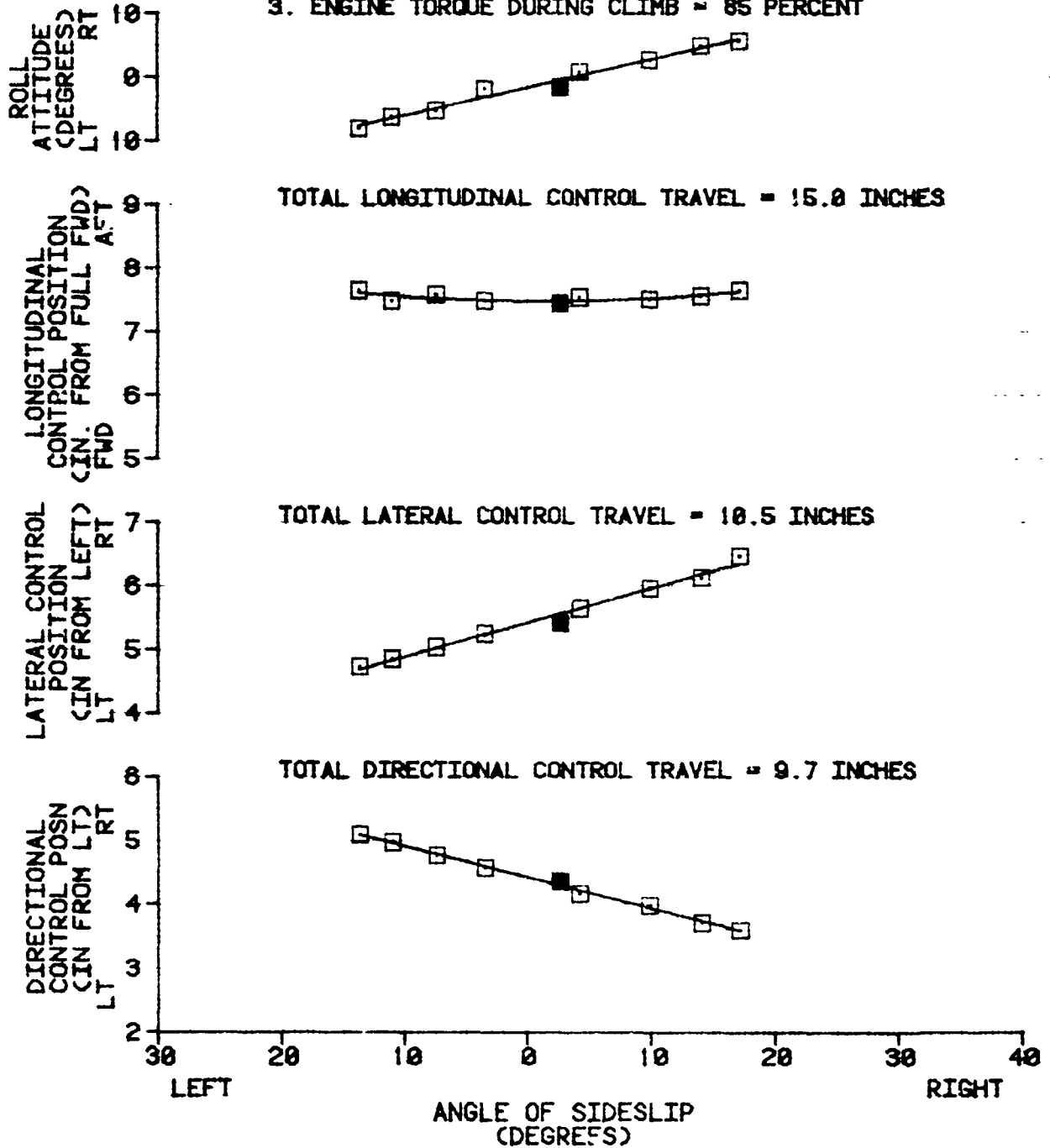

FIGURE 77
STATIC LATERAL-DIRECTIONAL STABILITY
CH-47D USA S/N 81-23383

AVG GROSS WEIGHT (LB)	AVG LONG CG LOCATION (FWS)	AVG DENSITY ALTITUDE (FT)	AVG OAT (DEG C)	AVG ROTOR SPEED (RPM)	TRIM CALIB AIRSPEED (KT)	FLIGHT CONDITION
39780	347.2 (AFT)	5000	20.0	224	94	DESCENT

- NOTES: 1. SHADED SYMBOLS DENOTE TRIM
 2. BOTH AFCS ON
 3. ENGINE TORQUE DURING DESCENT = 36 PERCENT

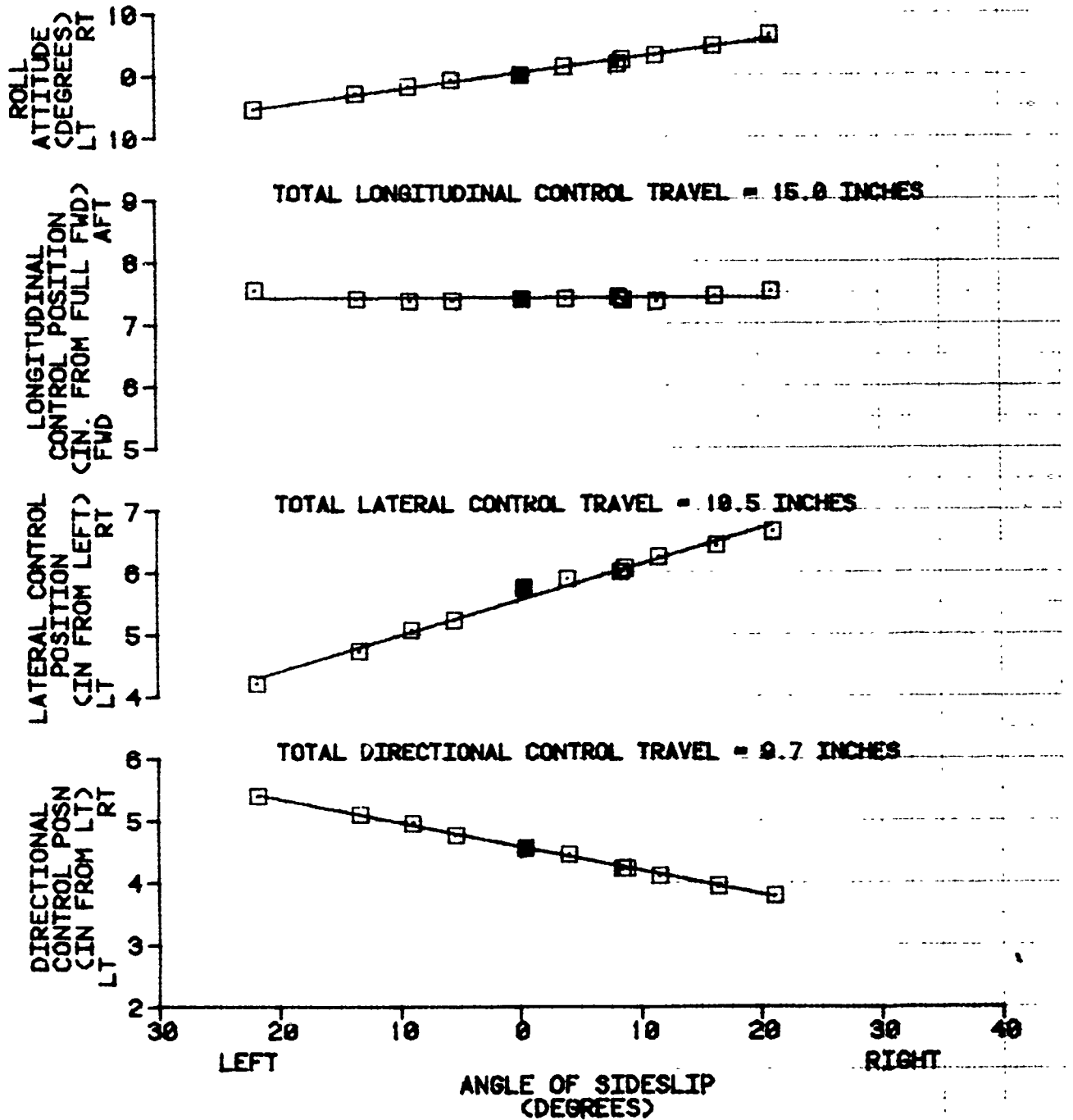

FIGURE 78
STATIC LATERAL-DIRECTIONAL STABILITY
CH-47D USA S/N 81-23383

AVG GROSS WEIGHT (LB)	AVG LONG CG LOCATION (FS)	AVG DENSITY ALTITUDE (FT)	AVG OAT (DEG C)	AVG ROTOR SPEED (RPM)	TRIM CALIB AIRSPEED (KT)	FLIGHT CONDITION
47640	332.0 (AFT)	5640	22.5	224	72	LEVEL

NOTES: 1. SHADED SYMBOLS DENOTE TRIM
 2. BOTH AFCS ON

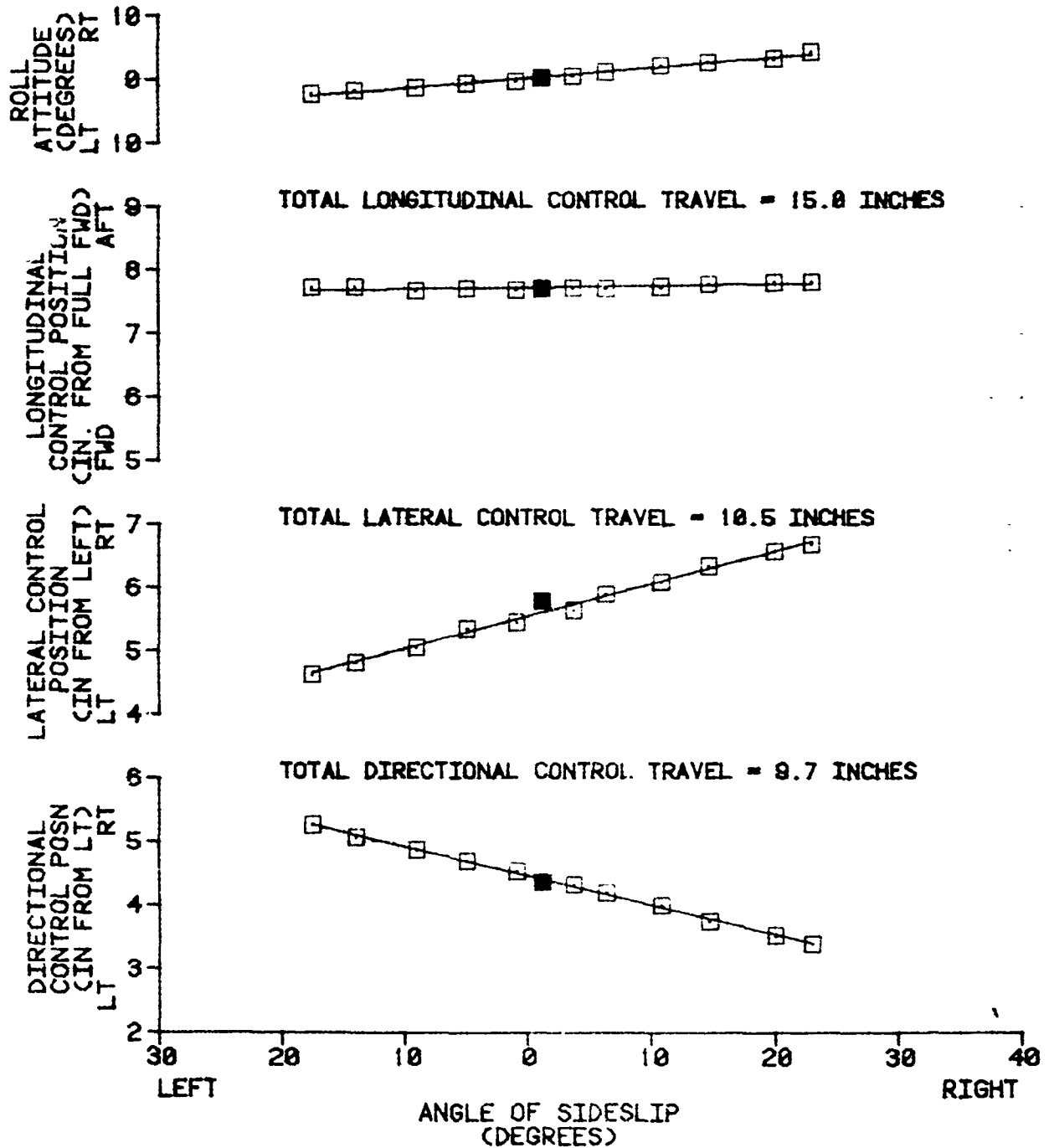

FIGURE 79
 STATIC LATERAL-DIRECTIONAL STABILITY
 CH-47D USA S/N 81-23383

AVG GROSS WEIGHT (LB)	AVG LONG CG LOCATION (FS)	AVG DENSITY ALTITUDE (FT)	AVG OAT (DEG C)	AVG ROTOR SPEED (RPM)	TRIM CALIB AIRSPEED (KT)	FLIGHT CONDITION
50400	331 2 (AFT)	4840	26.0	225	119	LEVEL

NOTES 1 SHADED SYMBOLS DENOTE TRIM
 2 BOTH AFCS ON

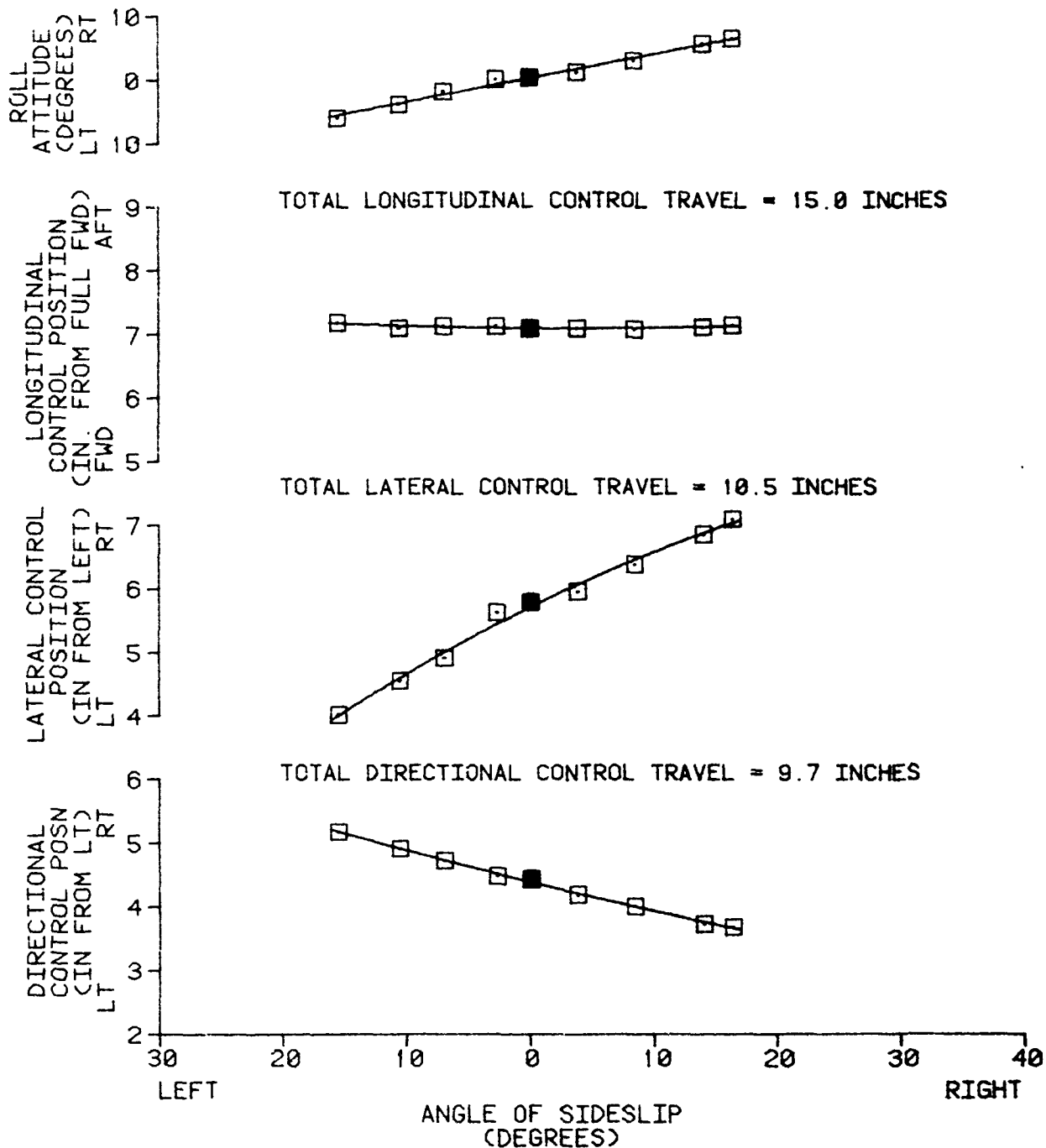

FIGURE 80
STATIC LATERAL-DIRECTIONAL STABILITY
CH-47D USA S/N 81-23383

AVG GROSS WEIGHT (LB)	AVG LONG CG LOCATION (FS)	AVG DENSITY ALTITUDE (FT)	AVG OAT (DEG C)	AVG ROTOR SPEED (RPM)	TRIM CALIB AIRSPEED (KT)	FLIGHT CONDITION
42120	318.4 (FWD)	4840	23.5	225	74	LEVEL

NOTES: 1. SHADED SYMBOLS DENOTE TRIM
 2. NUMBER ONE AFCS OFF

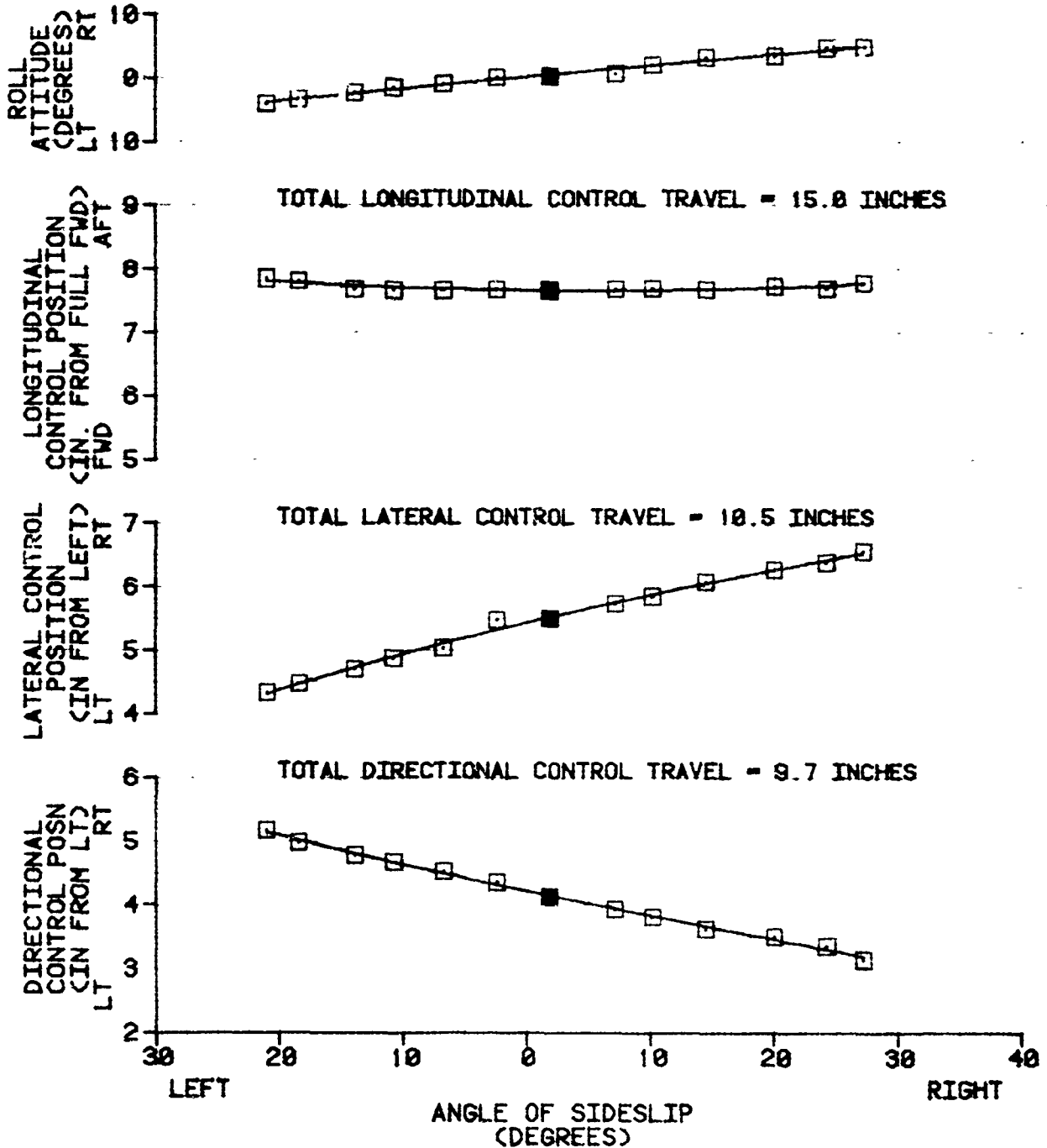

FIGURE 81
STATIC LATERAL-DIRECTIONAL STABILITY
CH-47D USA S/N 81-23383

AVG GROSS WEIGHT (LB)	AVG LONG CG LOCATION (FS)	AVG DENSITY ALTITUDE (FT)	AVG OAT (DEG C)	AVG ROTOR SPEED (RPM)	TRIM CALIB AIRSPEED (KT)	FLIGHT CONDITION
40560	318.6 (FWD)	5400	24.5	224	111	LEVEL

NOTES: 1. SHADED SYMBOLS DENOTE TRIM
 2. NUMBER ONE AFCS OFF

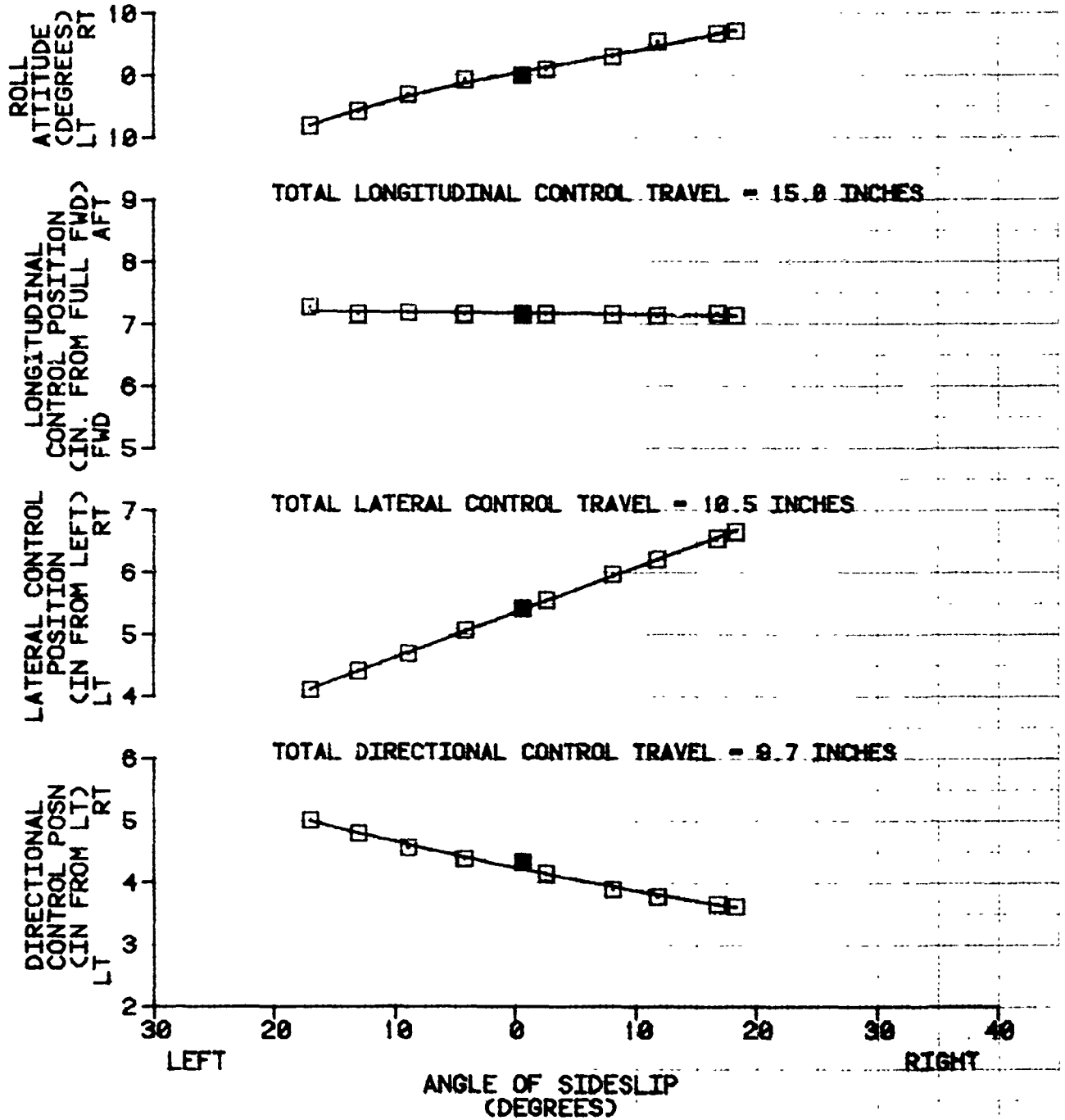

FIGURE 82
STATIC LATERAL-DIRECTIONAL STABILITY
CH-47D USA S/N 81-23383

AVG GROSS WEIGHT (LB)	AVG LONG CG LOCATION (FS)	AVG DENSITY ALTITUDE (FT)	AVG OAT (DEG C)	AVG ROTOR SPEED (RPM)	TRIM CALIB AIRSPEED (KT)	FLIGHT CONDITION
42168	337.5 (AFT)	4768	22.5	225	73	LEVEL

NOTES: 1. SHADED SYMBOLS DENOTE TRIM
 2. NUMBER ONE AFCS OFF

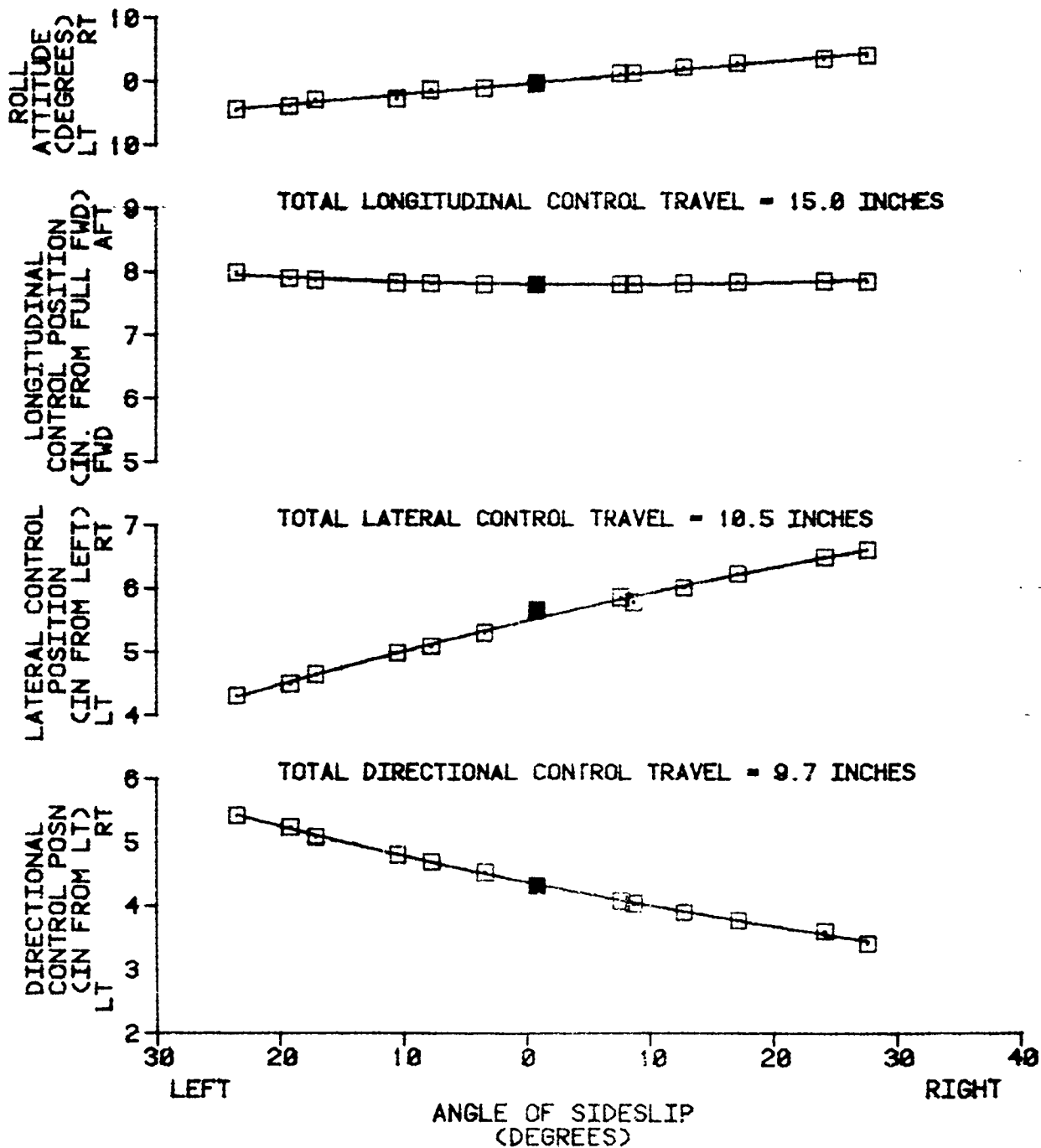

FIGURE 83
STATIC LATERAL-DIRECTIONAL STABILITY
CH-47D USA S/N 81-23383

AVG GROSS WEIGHT (LB)	AVG LONG CG LOCATION (FS)	AVG DENSITY ALTITUDE (FT)	AVG OAT (DEG C)	AVG ROTOR SPEED (RPM)	TRIM CALIB AIRSPEED (KT)	FLIGHT CONDITION
42980	336.9 (AFT)	4620	22.0	227	113	LEVEL

- NOTES: 1. SHADED SYMBOLS DENOTE TRIM
 2. NUMBER ONE AFCS OFF

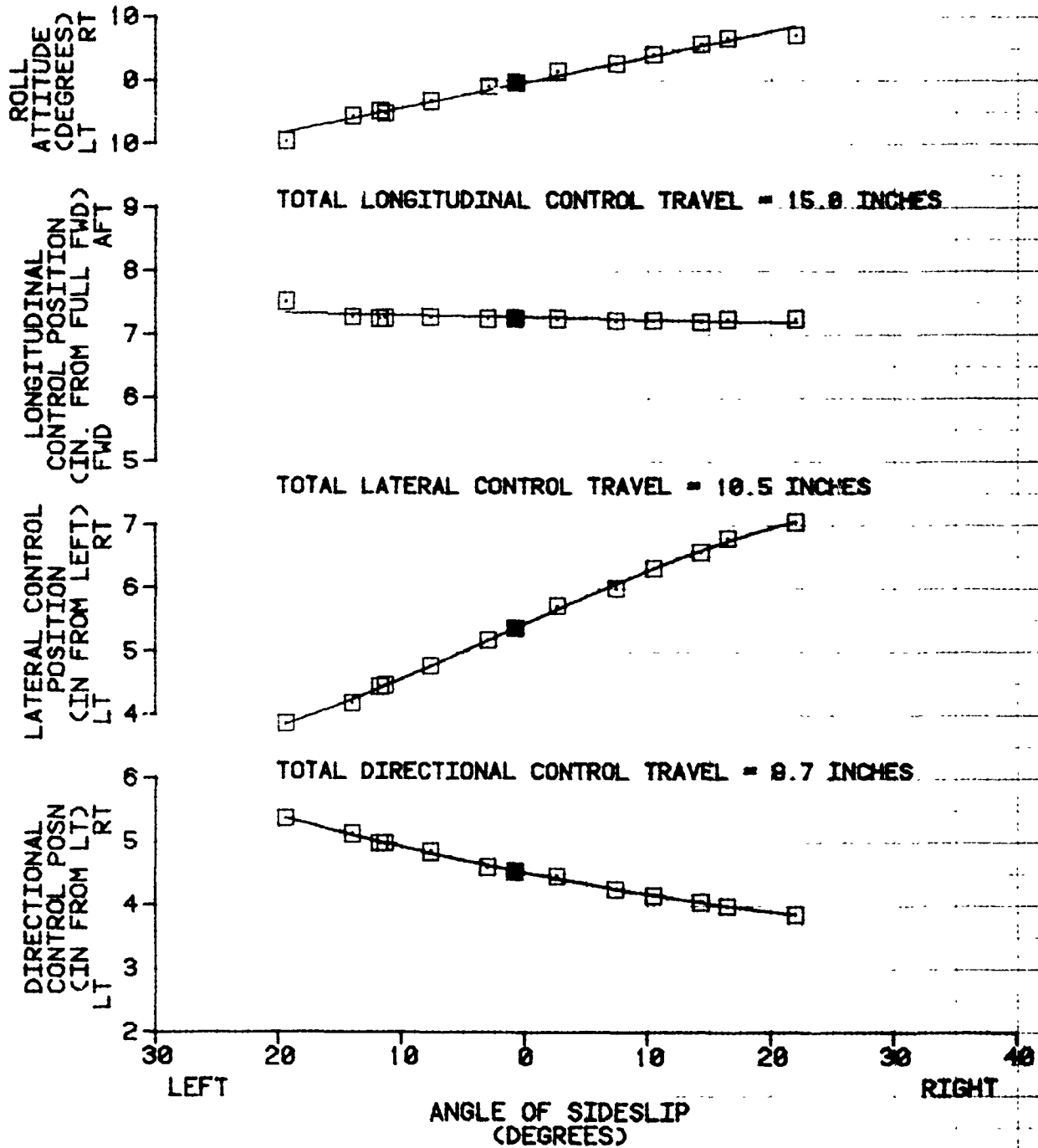

FIGURE 84
STATIC LATERAL-DIRECTIONAL STABILITY
CH-47D USA S/N 81-23383

AVG GROSS WEIGHT (LB)	AVG LONG CG LOCATION (FS)	AVG DENSITY ALTITUDE (FT)	AVG OAT (DEG C)	AVG ROTOR SPEED (RPM)	TRIM CALIB AIRSPEED (KT)	FLIGHT CONDITION
47200	332.2 (AFT)	5500	23.0	225	72	LEVEL

NOTES: 1. SHADED SYMBOLS DENOTE TRIM
 2. NUMBER ONE AFCS OFF

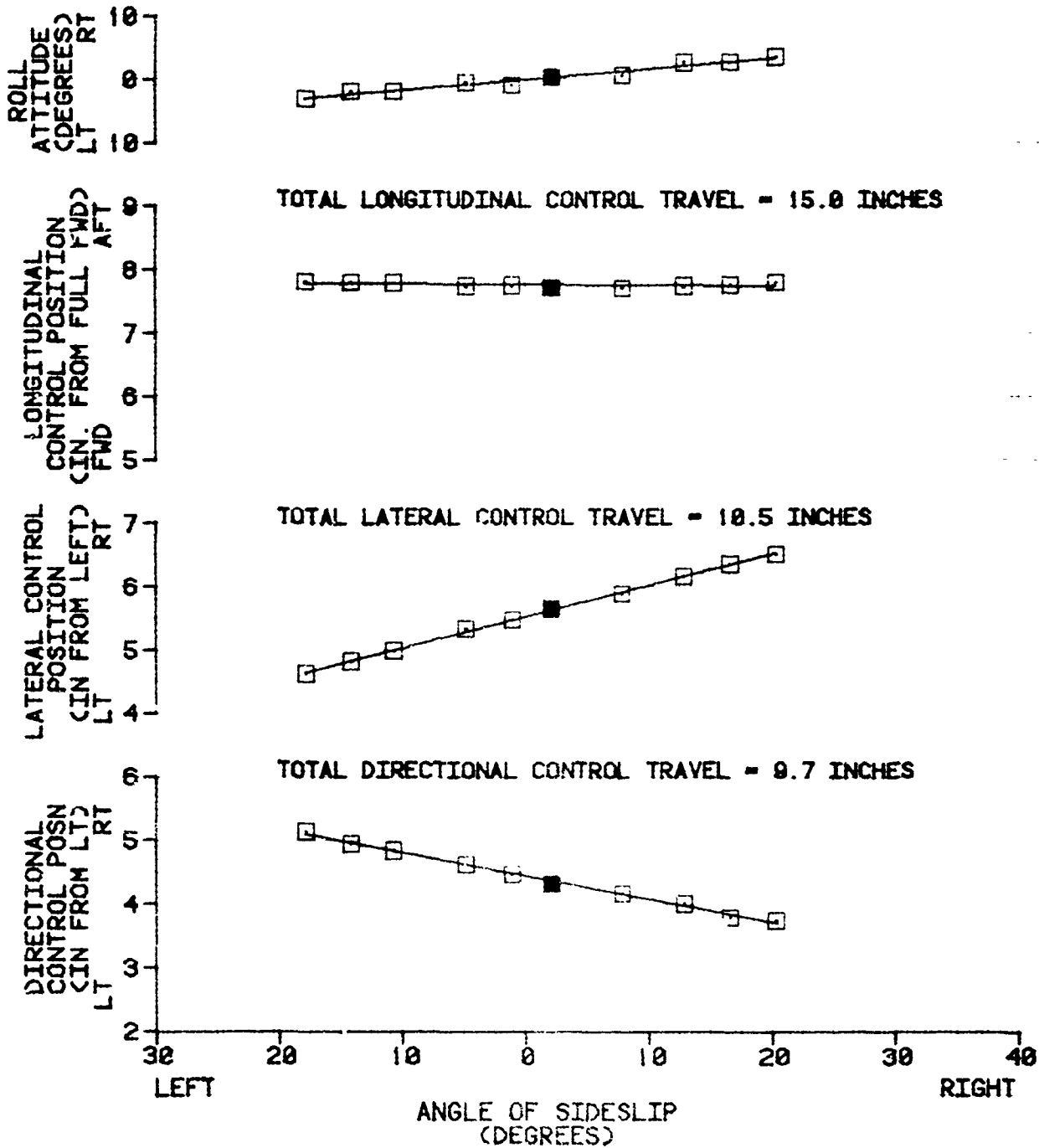

FIGURE 85
STATIC LATERAL-DIRECTIONAL STABILITY
CH-47D USA S/N 81-23383

AVG GROSS WEIGHT (LB)	AVG LONG CG LOCATION (FS)	AVG DENSITY ALTITUDE (FT)	AVG OAT (DEG C)	AVG ROTOR SPEED (RPM)	TRIM CALIB AIRSPEED (KT)	FLIGHT CONDITION
49960	331.3 (AFT)	4700	26.0	225	112	LEVEL

- NOTES: 1. SHADED SYMBOLS DENOTE TRIM
 2. NUMBER TWO AFCS OFF

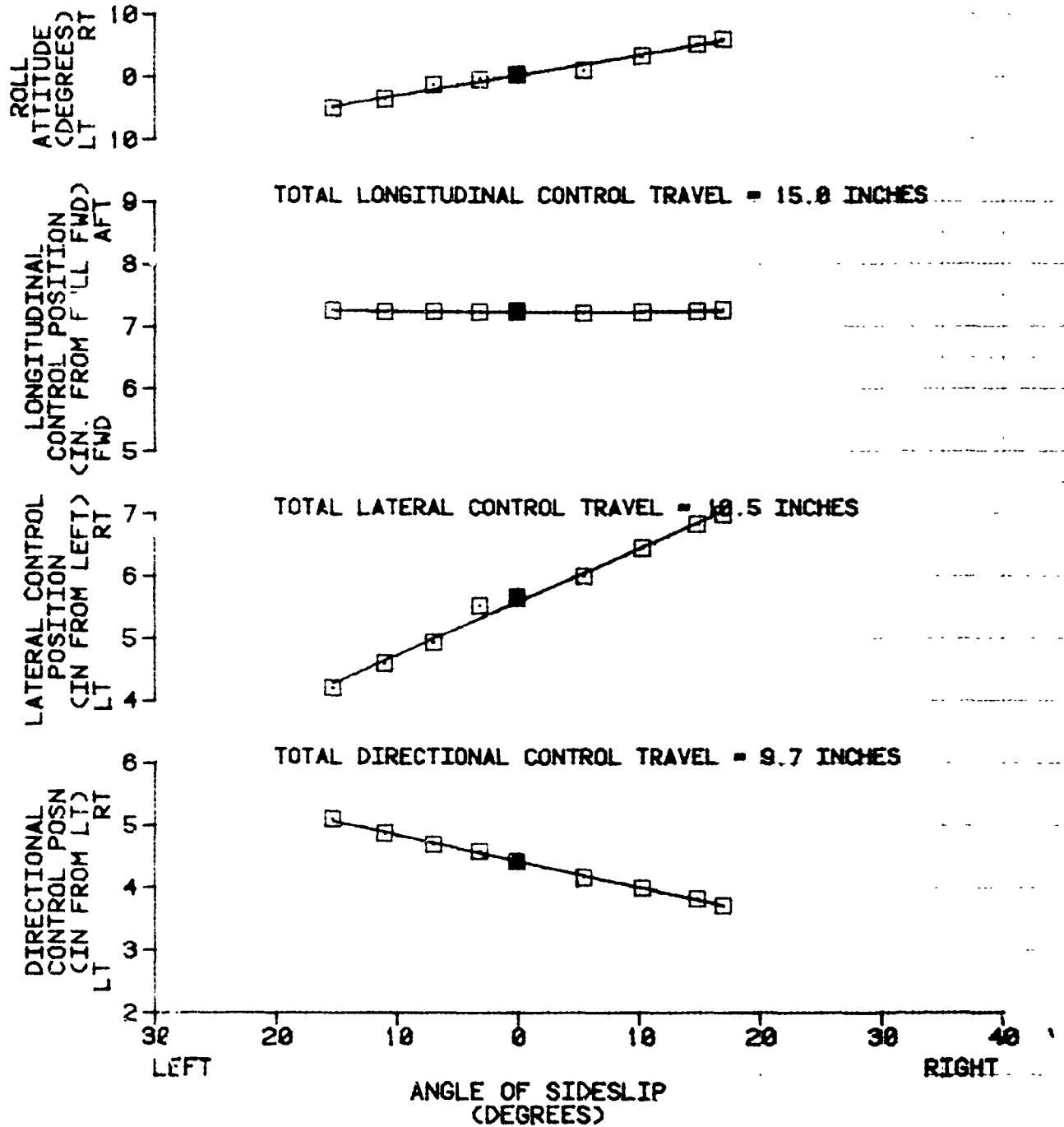

FIGURE 86
STATIC LATERAL-DIRECTIONAL STABILITY
CH-47D USA S/N 81-23383

AVG GROSS WEIGHT (LB)	AVG LONG CG LOCATION (FS)	AVG DENSITY ALTITUDE (FT)	AVG OAT (DEG C)	AVG ROTOR SPEED (RPM)	TRIM CALIB AIRSPEED (KT)	FLIGHT CONDITION
41760	318.4 (FWD)	4780	23.5	224	74	LEVEL

NOTES: 1. SHADED SYMBOLS DENOTE TRIM
 2. BOTH AFCS OFF

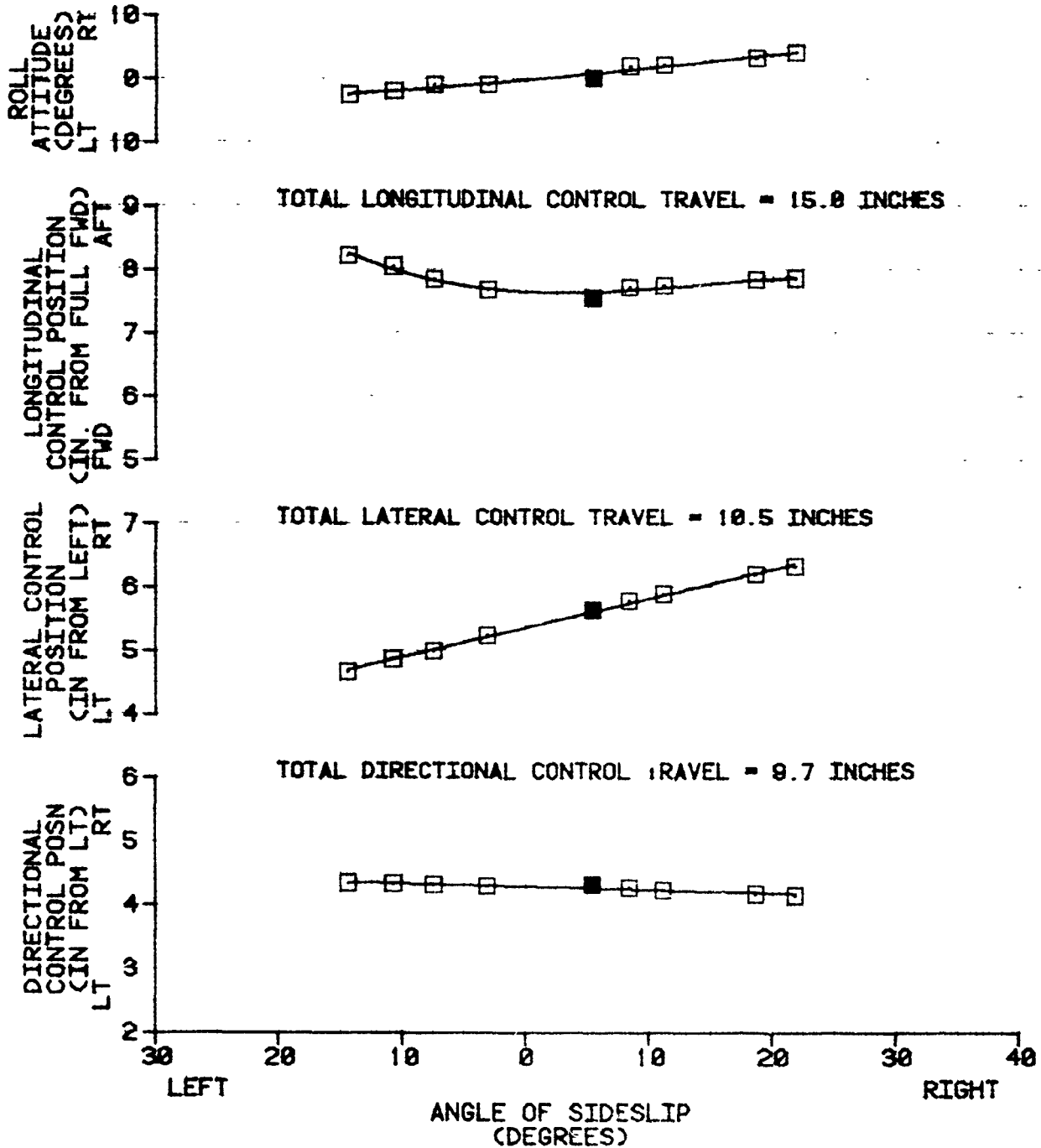

FIGURE 87
STATIC LATERAL-DIRECTIONAL STABILITY
CH-47D USA S/N 81-23383

AVG GROSS WEIGHT (LB)	AVG LONG CG LOCATION (FS)	AVG DENSITY ALTITUDE (FT)	AVG OAT (DEG C)	AVG ROTOR SPEED (RPM)	TRIM CALIB AIRSPEED (KT)	FLIGHT CONDITION
40920	318.5 (FWD)	4940	23.0	225	120	LEVEL

NOTES: 1. SHADED SYMBOLS DENOTE TRIM
 2. BOTH AFCS OFF

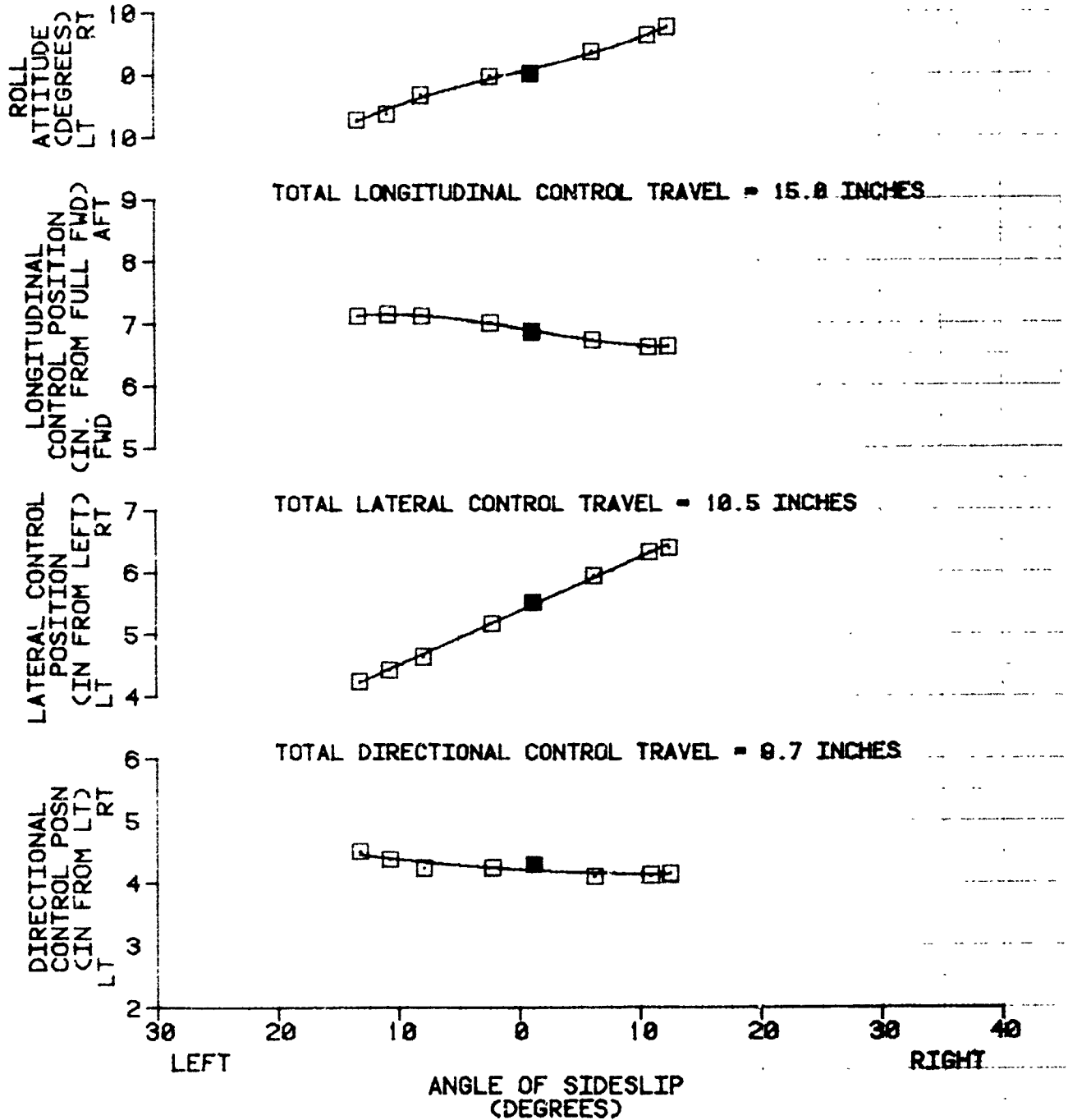

FIGURE 88
STATIC LATERAL-DIRECTIONAL STABILITY
CH-47D USA S/N 81-23383

AVG GROSS WEIGHT (LB)	AVG LONG CG LOCATION (FWS)	AVG DENSITY ALTITUDE (FT)	AVG OAT (DEG C)	AVG ROTOR SPEED (RPM)	TRIM CALIB AIRSPEED (KT)	FLIGHT CONDITION
41620	337.8 (AFT)	4960	22.0	225	71	LEVEL

NOTES: 1. SHADED SYMBOLS DENOTE TRIM
 2. BOTH AFCS OFF

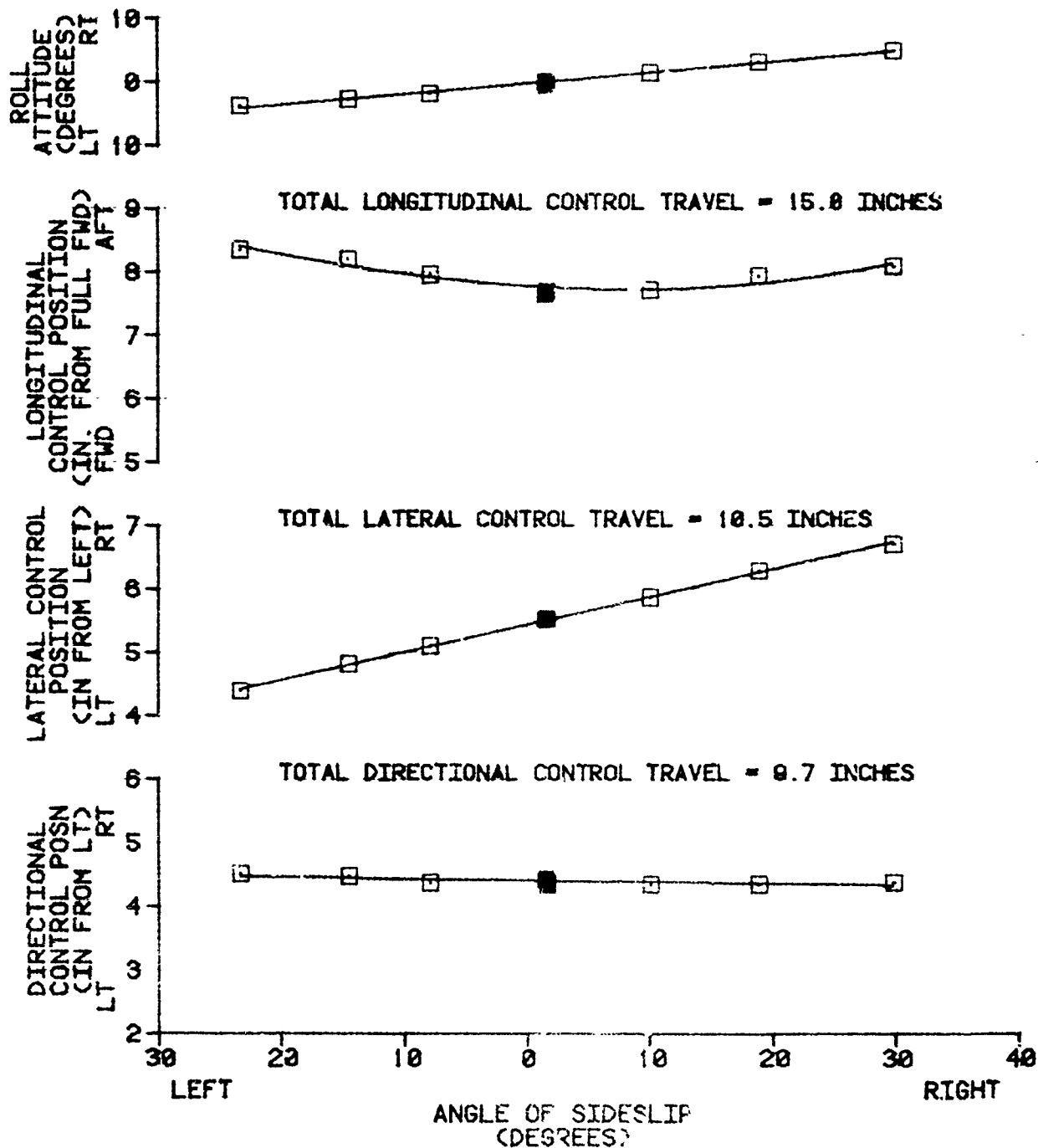

FIGURE 89
STATIC LATERAL-DIRECTIONAL STABILITY
CH-47D USA S/N 81-23383

AVG GROSS WEIGHT (LB)	AVG LONG CG LOCATION (FS)	AVG DENSITY ALTITUDE (FT)	AVG OAT (DEG C)	AVG ROTOR SPEED (RPM)	TRIM CALIB AIRSPEED (KT)	FLIGHT CONDITION
42500	337.2 (AFT)	5040	22.0	224	130	LEVEL

NOTES: 1. SHADED SYMBOLS DENOTE TRIM
 2. BOTH AFCS OFF

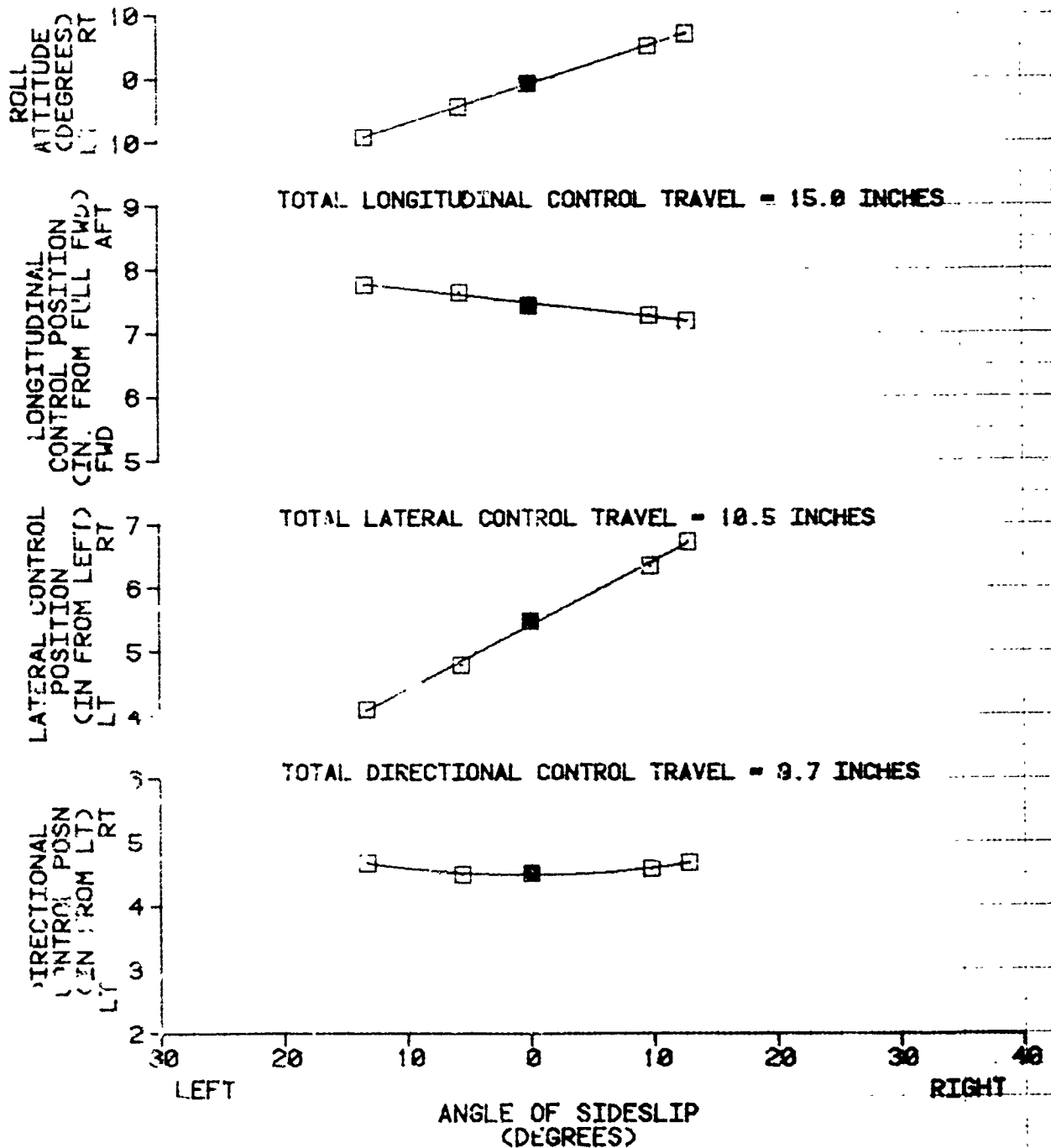

FIGURE 80
 STATIC LATERAL-DIRECTIONAL STABILITY
 CH-47D USA S/N 81-23383

AVG GROSS WEIGHT (LB)	AVG LONG CG LOCATION (FS)	AVG DENSITY ALTITUDE (FT)	AVG OAT (DEG C)	AVG ROTOR SPEED (RPM)	TRIM CALIB AIRSPEED (KT)	FLIGHT CONDITION
51000	331.0 (AFT)	5000	27.5	225	74	LEVEL

NOTES: 1. SHADED SYMBOLS DENOTE TRIM
 2. BOTH AFCS OFF

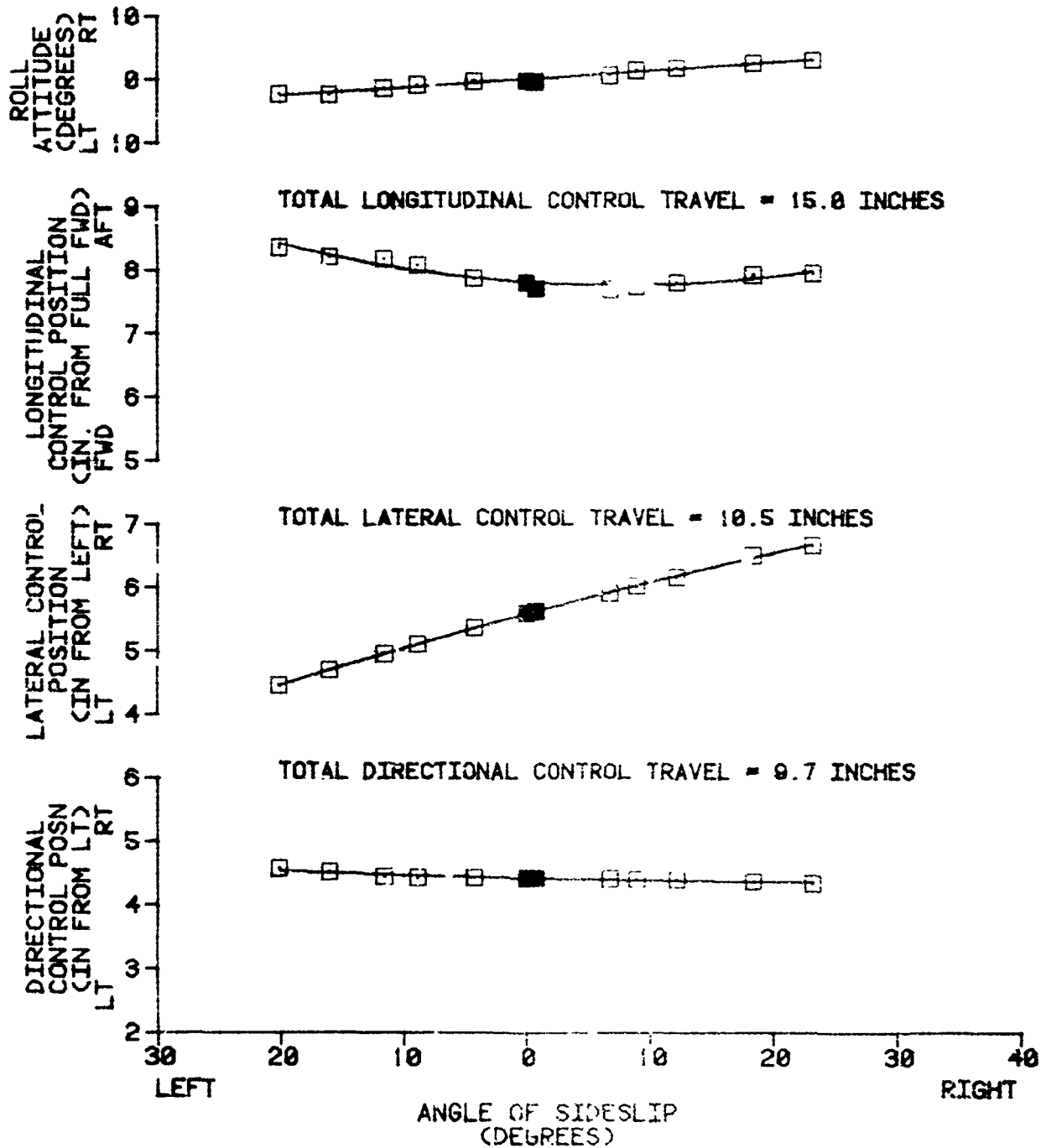

FIGURE 91
 STATIC LATERAL-DIRECTIONAL STABILITY
 CH-47D USA S/N 81-23383

AVG GROSS WEIGHT (LB)	AVG LONG CG LOCATION (FS)	AVG DENSITY ALTITUDE (FT)	AVG OAT (DEG C)	AVG ROTOR SPEED (RPM)	TRIM CALIB AIRSPEED (KT)	FLIGHT CONDITION
49420	331.5 (AFT)	4820	26.0	224	119	LEVEL

NOTES: 1. SHADED SYMBOLS DENOTE TRIM
 2. BOTH AFCS OFF

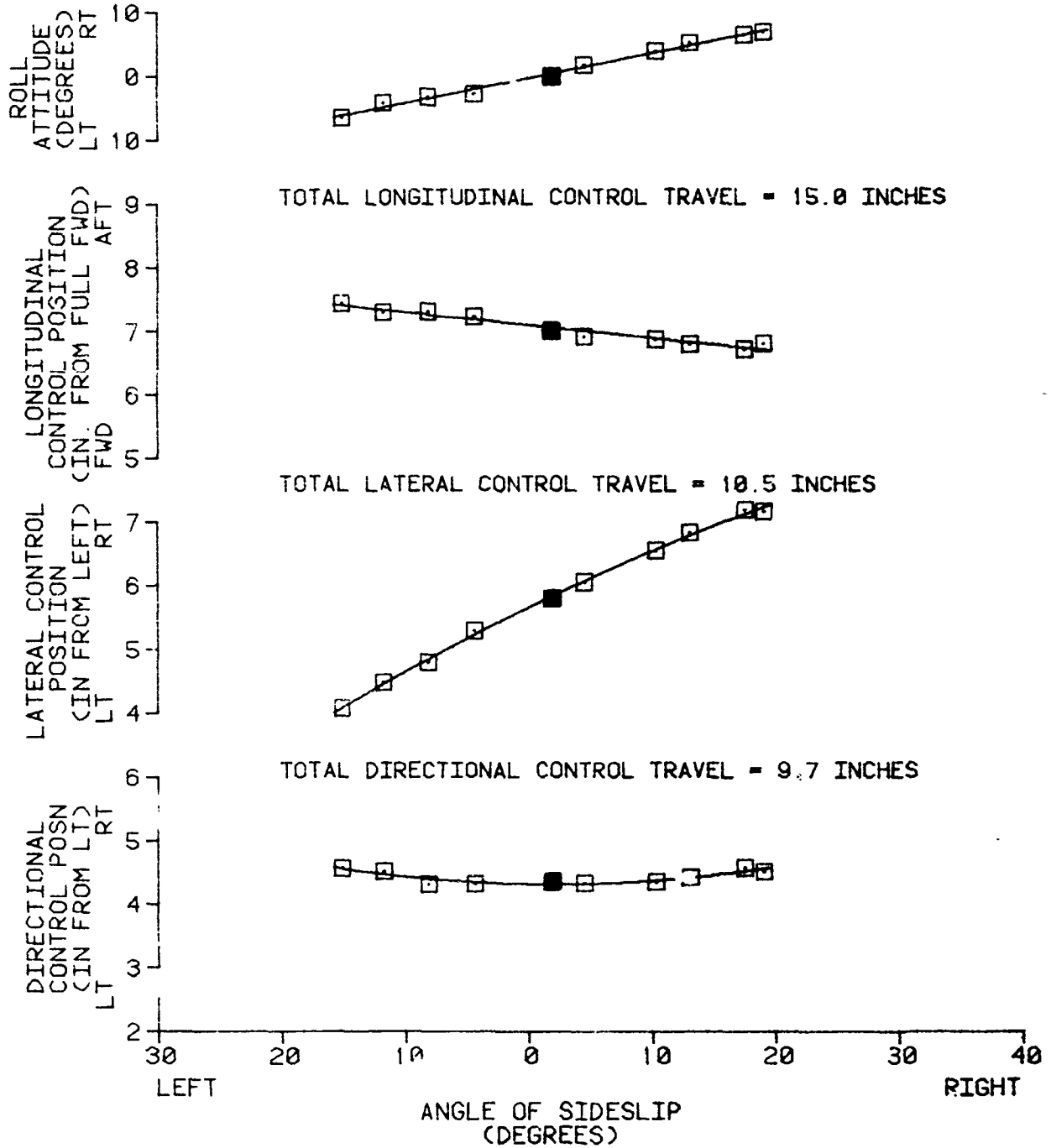

FIGURE 92
 STATIC LATERAL-DIRECTIONAL STABILITY
 CH-47D USA S/N 81-23383

SYMBOL	AVG GROSS WEIGHT (LB)	AVG LONG CG LOCATION (FWS)	AVG DENSITY ALTITUDE (FT)	AVG OAT (DEG C)	AVG ROTOR SPEED (RPM)	TRIM CALIB AIRSPEED (KT)	FLIGHT CONDITION
□	40480	338.4 (AFT)	5740	23.0	223	93	CLIMB

- NOTES: 1. BOTH AFCS SYSTEMS OFF
 2. SHADED SYMBOLS DENOTE TRIM
 3. ENGINE TORQUE DURING CLIMBS = 86 PERCENT

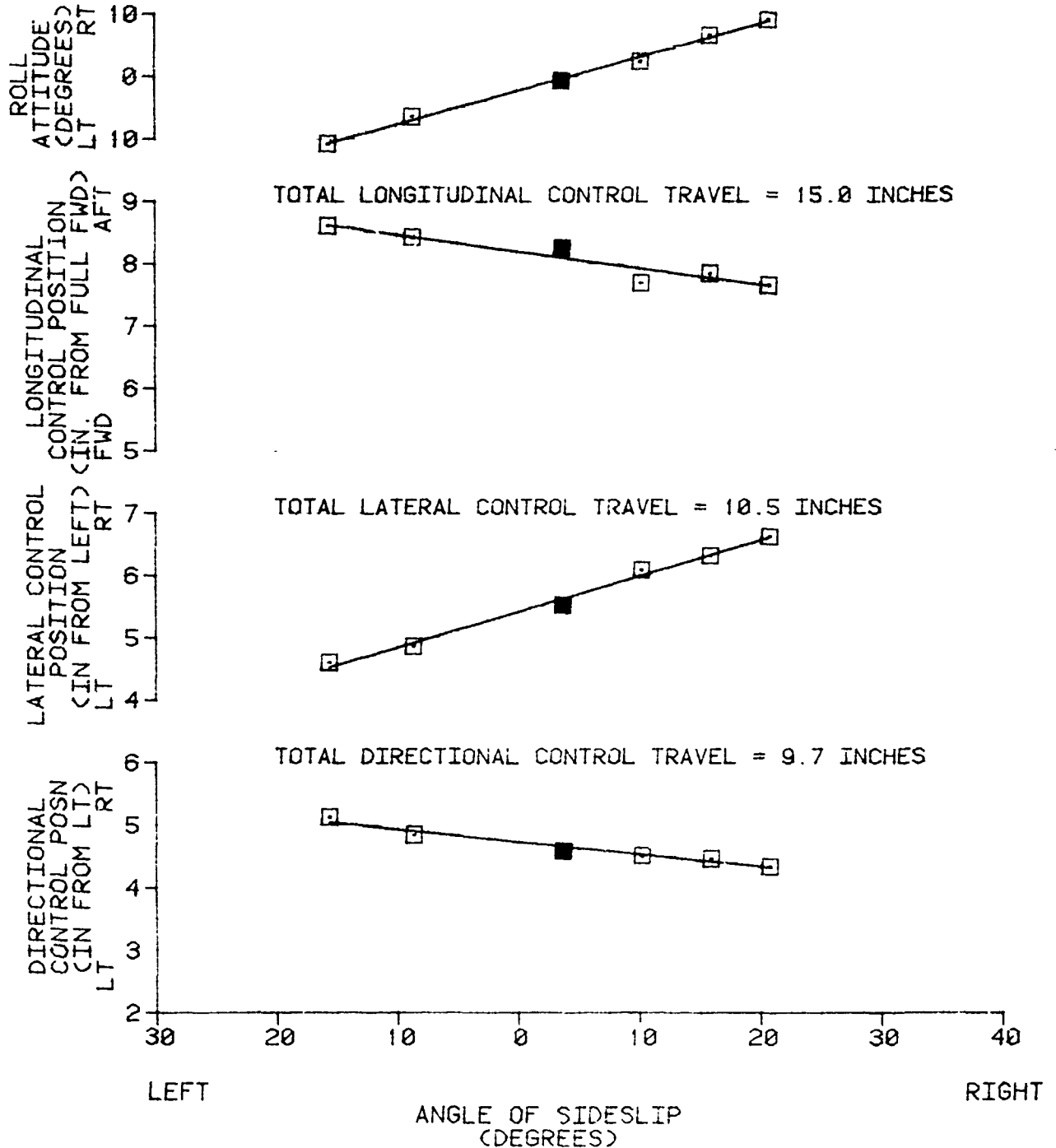

FIGURE 93
 STATIC LATERAL-DIRECTIONAL STABILITY
 CH-47D USA S/N 81-23383

SYMBOL	AVG GROSS WEIGHT (LB)	AVG LONG CG LOCATION (FS)	AVG DENSITY ALTITUDE (FT)	AVG OAT (DEG C)	AVG ROTOR SPEED (RPM)	TRIM CALIB AIRSPEED (KT)	FLIGHT CONDITION
□	39360	339.1 (AFT)	5480	23 0	225	95	DESCENT

- NOTES: 1. BOTH AFCS SYSTEMS OFF
 2. SHADED SYMBOLS DENOTE TRIM
 3. ENGINE TORQUE DURING DESCENTS = 32 PERCENT.

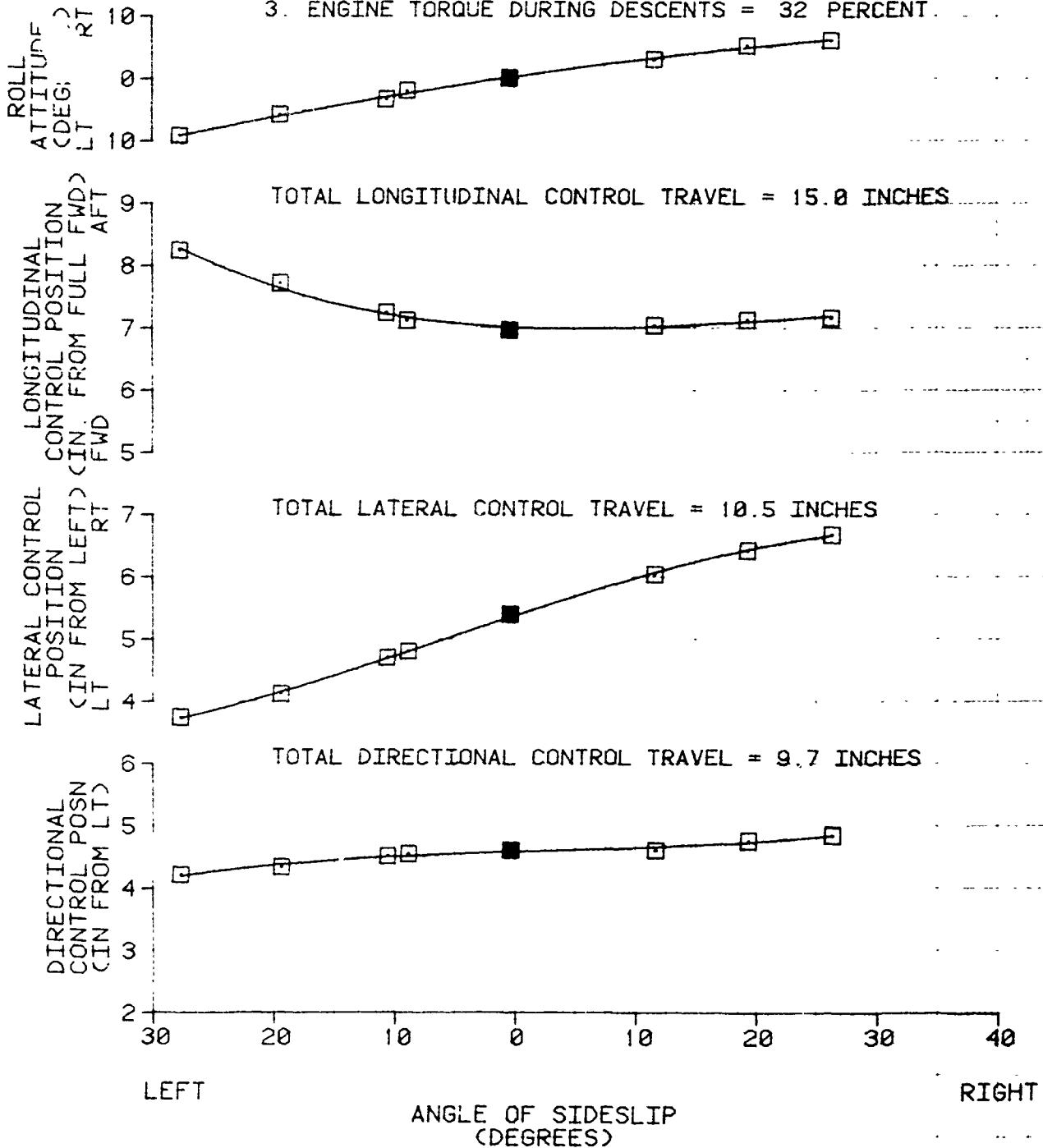

FIGURE 94
 MANEUVERING STABILITY
 CH-47D USA S/N 81-23383

SYM	AVG GROSS WEIGHT (LB)	AVG LONGITUDINAL CG LOCATION (F/S)	AVG DENSITY ALTITUDE (FEET)	AVG OAT (DEG C)	AVG ROTOR SPEED (RPM)	TRIM CALIBRATED AIRSPEED (KNOTS)	FLIGHT CONDITION
☐	51120	330.6 (MID)	6360	25.0	225	73	RIGHT TURN
○	50480	330.8 (MID)	6380	25.0	225	73	LEFT TURN

- NOTES: 1. BOTH AFCS ON
 2. BALL-CENTERED FLIGHT
 3. SHADED SYMBOLS DENOTE TRIM

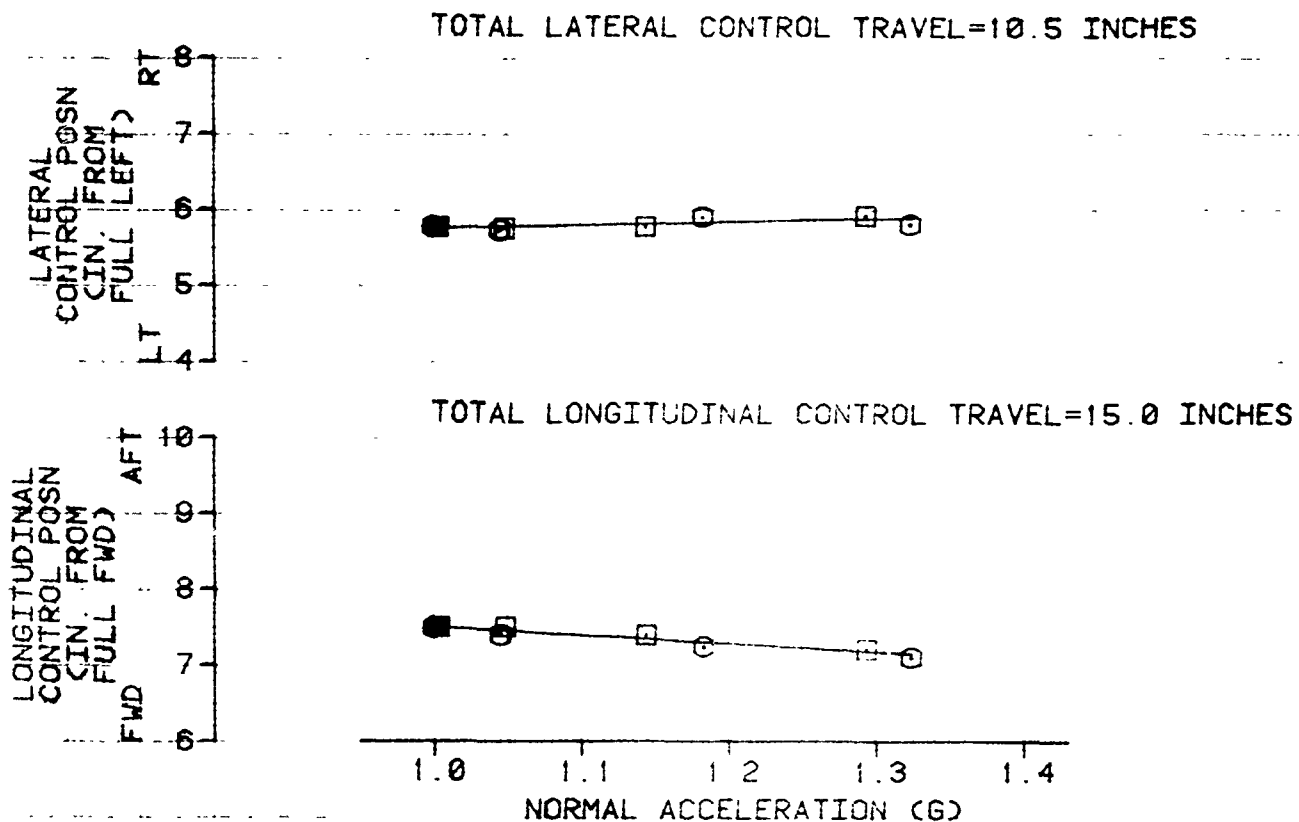

FIGURE 95
 LONGITUDINAL PULSE INPUT
 CH-47D USA S/N 81-29383

AVG GROSS WEIGHT (LB) 42000 337 2(AFT)
 AVG LONG CG LOCATION (F/S) 28 0
 AVG DENSITY ALTITUDE (FT) 3700
 AVG ROTOR SPEED (RPM) 225
 TRIM FLIGHT CONDITION OGE HOVER
 AFGS CONDITION BOTH SYSTEMS ON

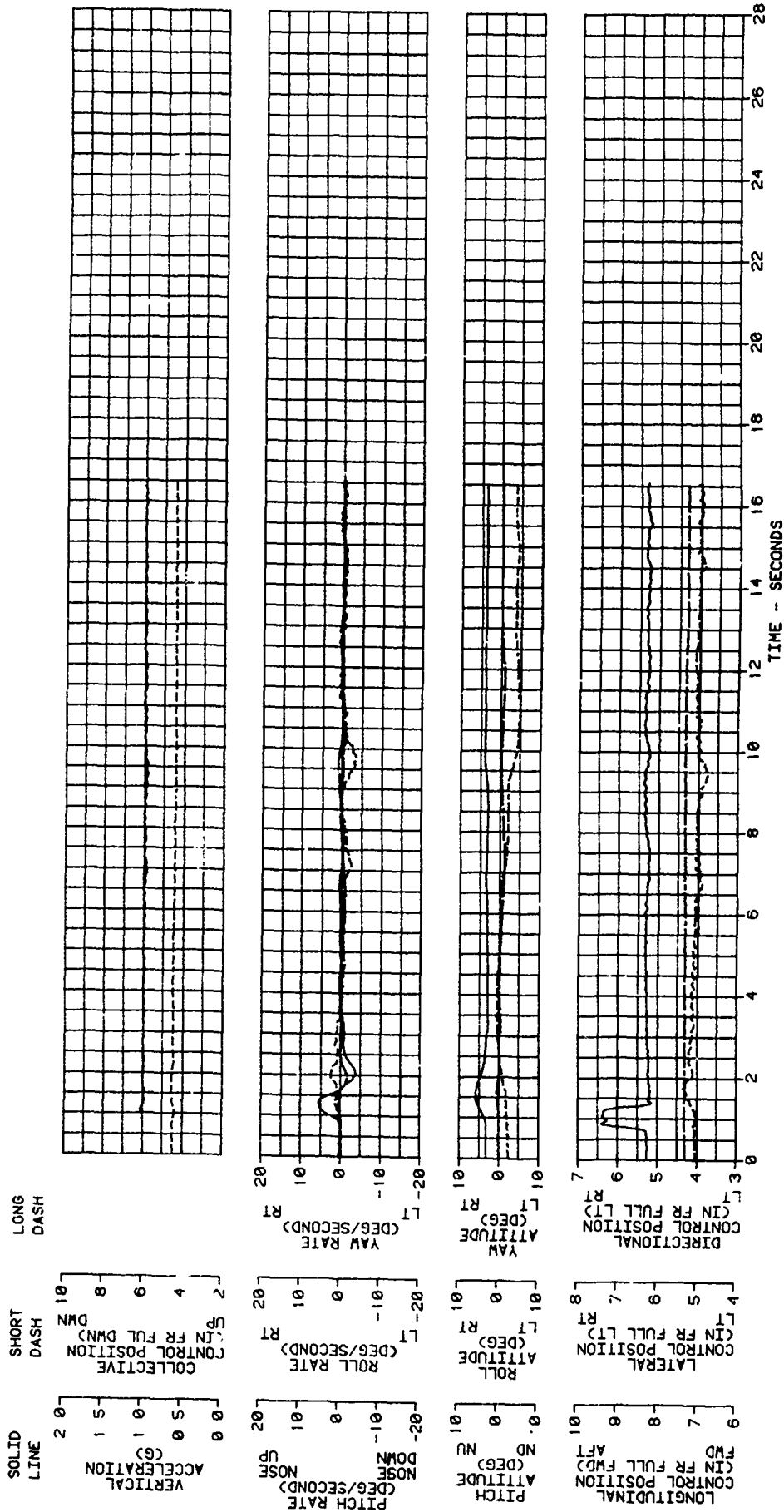

FIGURE 96
LATERAL DOUBLET
CH-47D USA S/N 81-23383

AVG GROSS HEIGHT (CLB) 42880
AVG LONG CG LOCATION (FSS) 337 3(AFT)
AVG DENSITY ALTITUDE (FT) 1660
AVG ROTOR SPEED (SRPM) 225
AVG OAT (DEG C) 20.0
TRIM FLIGHT CONDITION 0GE HOVER
AFCS CONDITION BOTH SYSTEMS ON

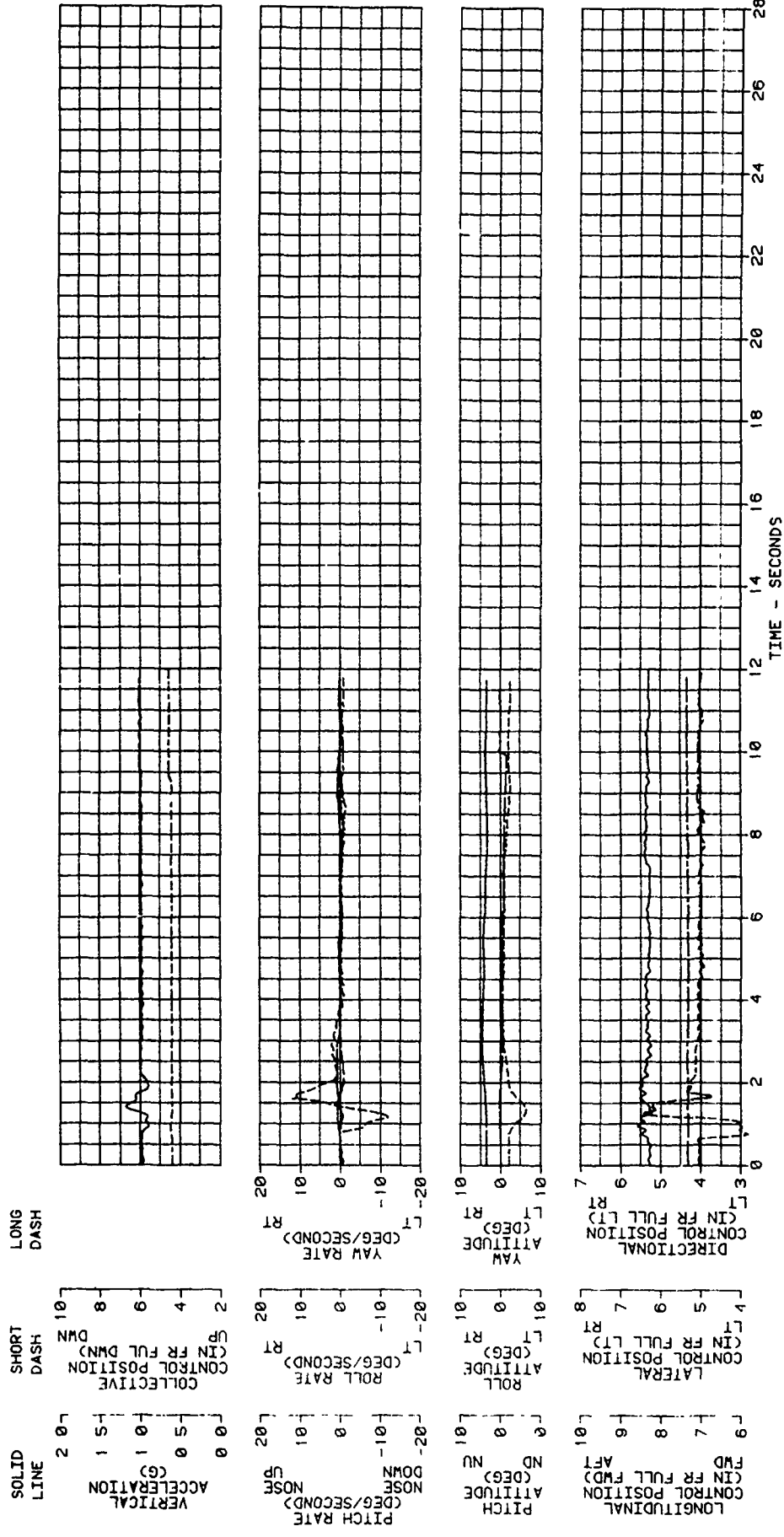

FIGURE 97
 DIRECTIONAL CONTROL PULSE INPUT
 CH-47D USA S/N 81-23383

AVG GROSS WEIGHT (LBS) 42780
 AVG LONG CG LOCATION (IN) 337
 AVG DI'ITY ALTITUDE (FT) 3680
 AVG ROTOR SPEED (RPM) 225
 TRIM FLIGHT CONDITION OGE HOVER
 AFCS CONDITION BOTH SYSTEMS ON

LONG DASH

SHORT DASH

SOLID LINE

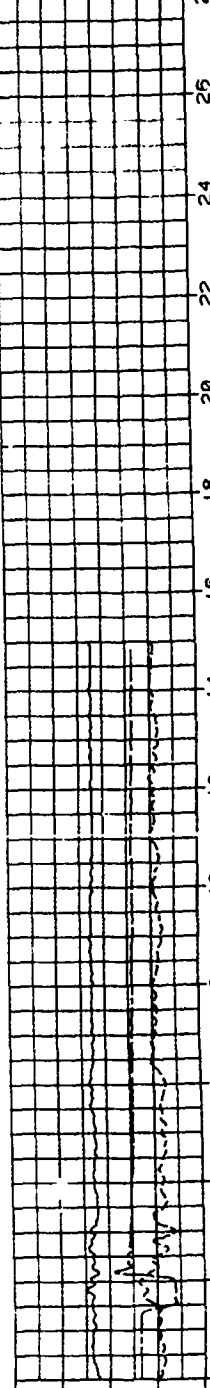
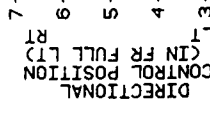
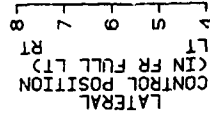
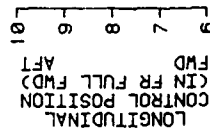
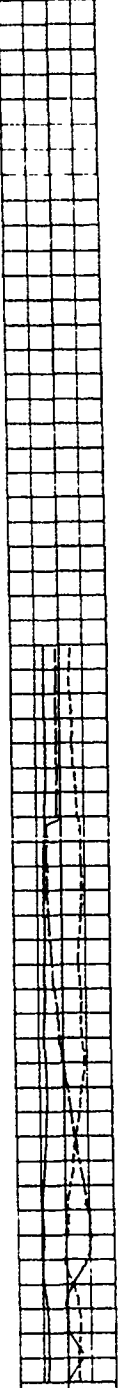
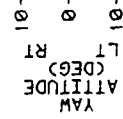
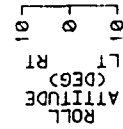
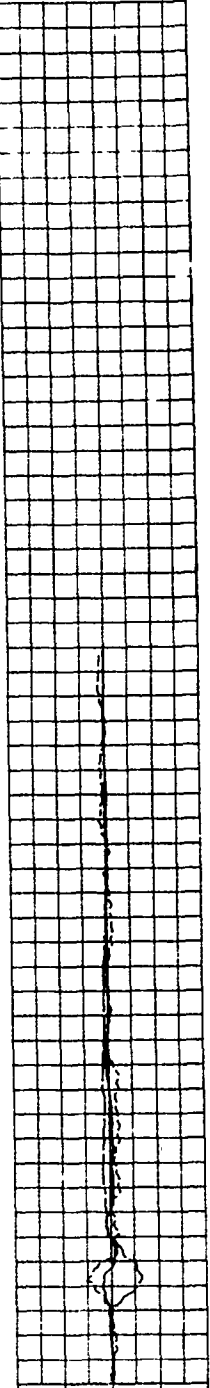
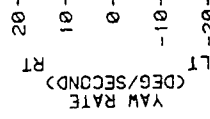
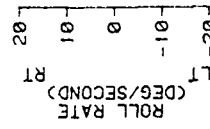
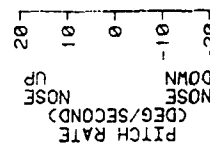
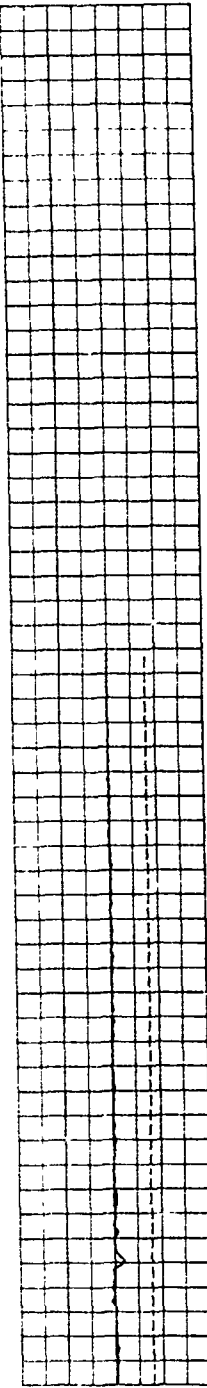
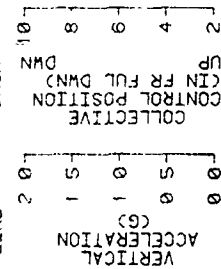

TIME - SECONDS

FIGURE 98
 LONGITUDINAL PULSE INPUT
 CH-47D USA S/N 81-23383

AVG GROSS WEIGHT (CLB) 40500
 AVG LONG CG LOCATION (FWS) 338.6(AFT)
 AVG DENSITY ALTITUDE (FT) 5960
 AVG OAT (DEG C) 24.0
 AVG ROTOR SPEED (RPM) 226
 TRIM CALIB AIRSPEED (KTS) 127
 TRIM FLIGHT CONDITION LEVEL BOTH SYSTEMS ON
 AFCS CONDITION

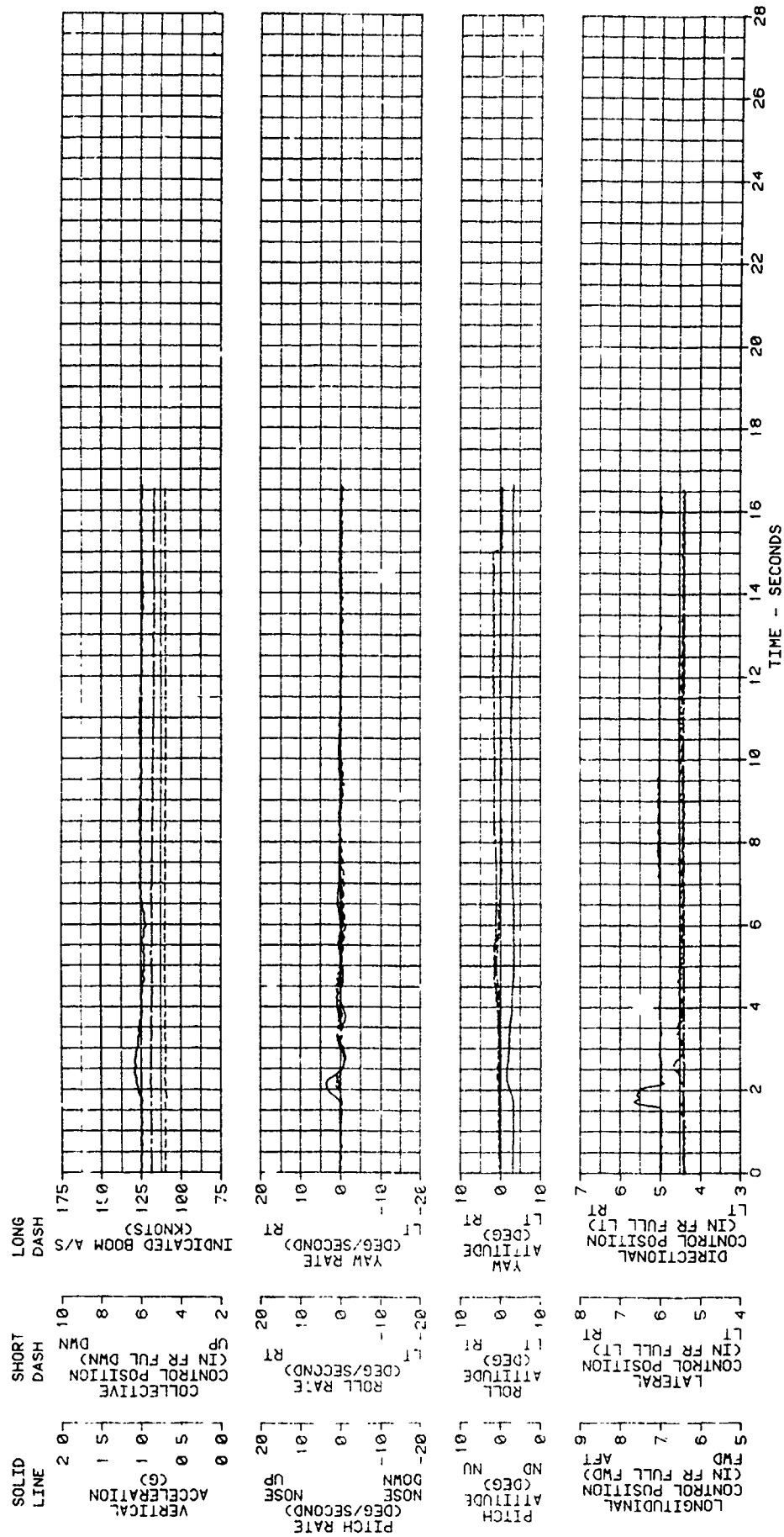

FIGURE 99
LATERAL DOUBLET
CH-47D USA S/N 81-23383

AVG GROSS WEIGHT (L.B) 40920
 AVG LONG CG LOCATION (F.S) 338 7(AFT)
 AVG DENSITY ALTITUDE (FT) 6000
 AVG ROTOR SPEED (RPM) 226
 AVG OAT (DEG C) 24 0
 TRIM CALIB AIRSPEED (KTS) 129
 TRIM FLIGHT CONDITION LEVEL
 AFCS CONDITION BOTH SYSTEMS ON

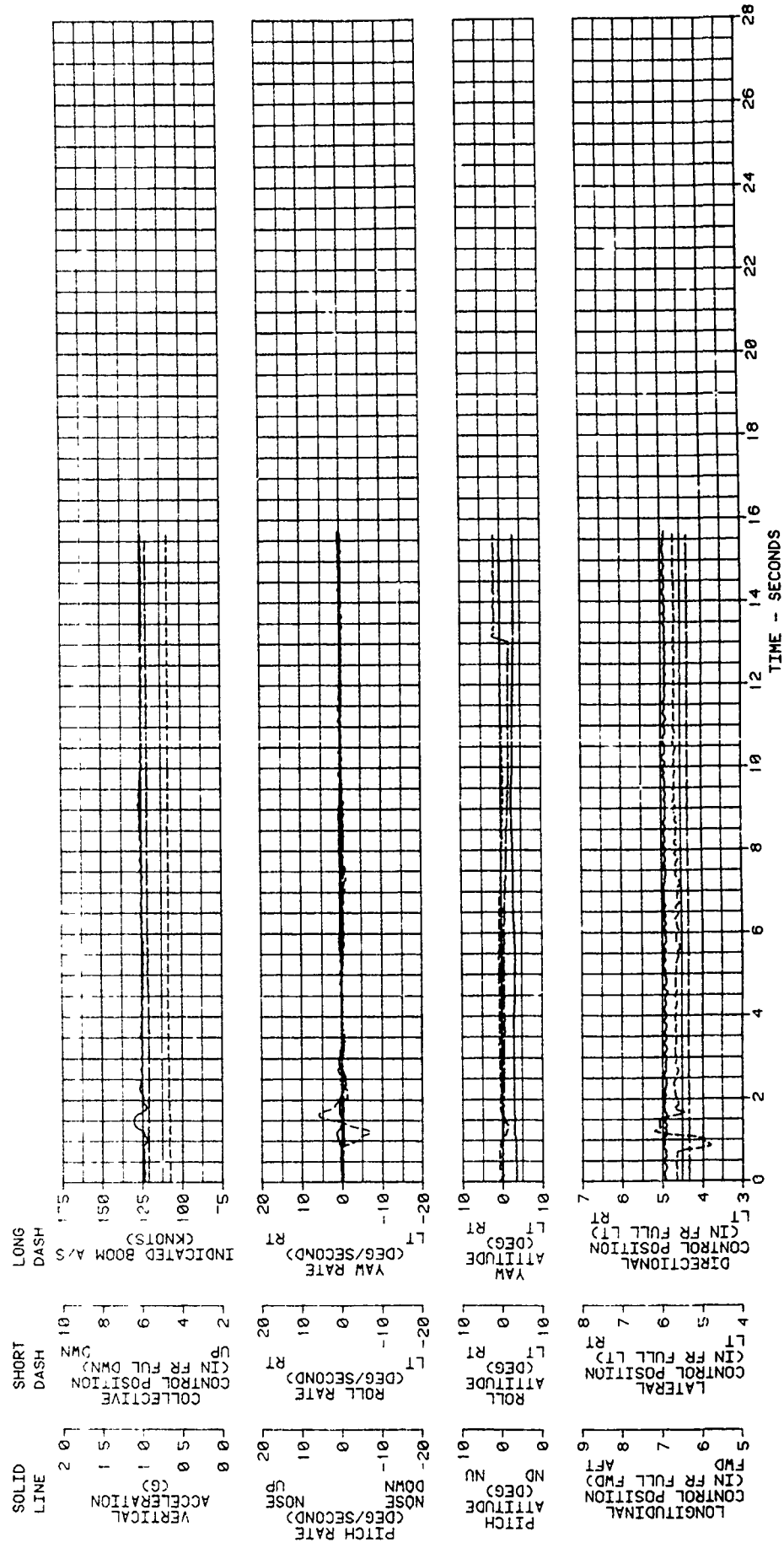

FIGURE 100
 DIRECTIONAL CONTROL PULSE INPUT
 CR-47D USA S/N 81-23383

AVG GROSS WEIGHT (LB) 40180
 AVG LONG CG LOCATION (CFS) 338.8
 AVG DENSITY ALTITUDE (FT) 5740
 AVG ROTOR SPEED (RPM) 227
 AVG OAT (DEG C) 23.5
 TRIM CALIB AIRSPEED (KTS) 129
 TRIM FLIGHT CONDITION LEVEL
 AFCS CONDITION BOTH SYSTEMS ON

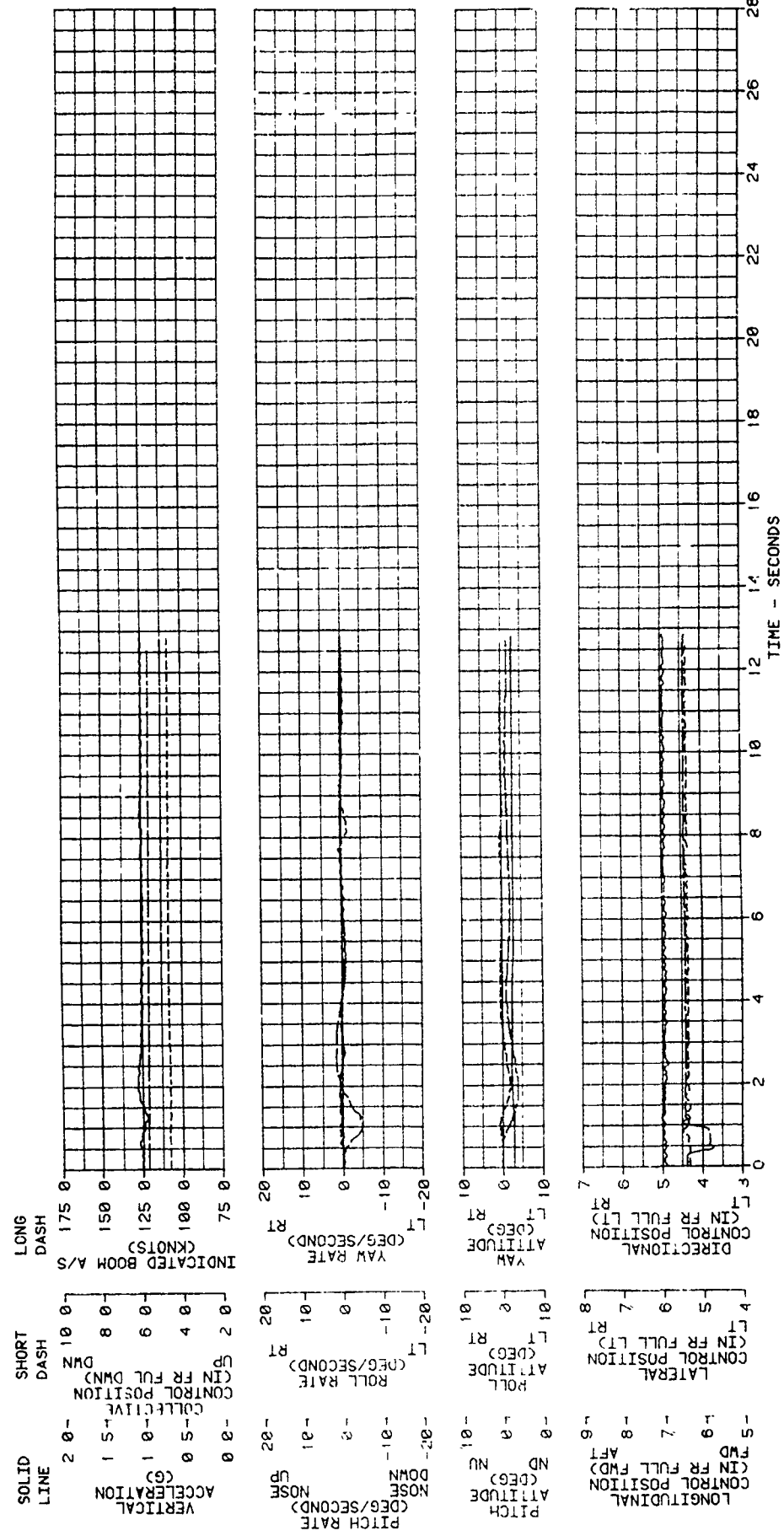

FIGURE 101
 LONGITUDINAL PULSE INPUT
 CH-47D USA S/N 81-23383

AVG GROSS WEIGHT (LBS) 40000
 AVG LONG CG LOCATION (FSS) 338 (KAFT)
 AVG DENSITY ALTITUDE (FT) 6220
 AVG OAT (DEG C) 25 0
 AVG ROTOR SPEED (RPM) 226
 TRIM CALIB AIRSPEED (KKT) 110
 TRIM FLIGHT CONDITION LEVEL
 AFCS CONDITION #1 SYSTEM OFF

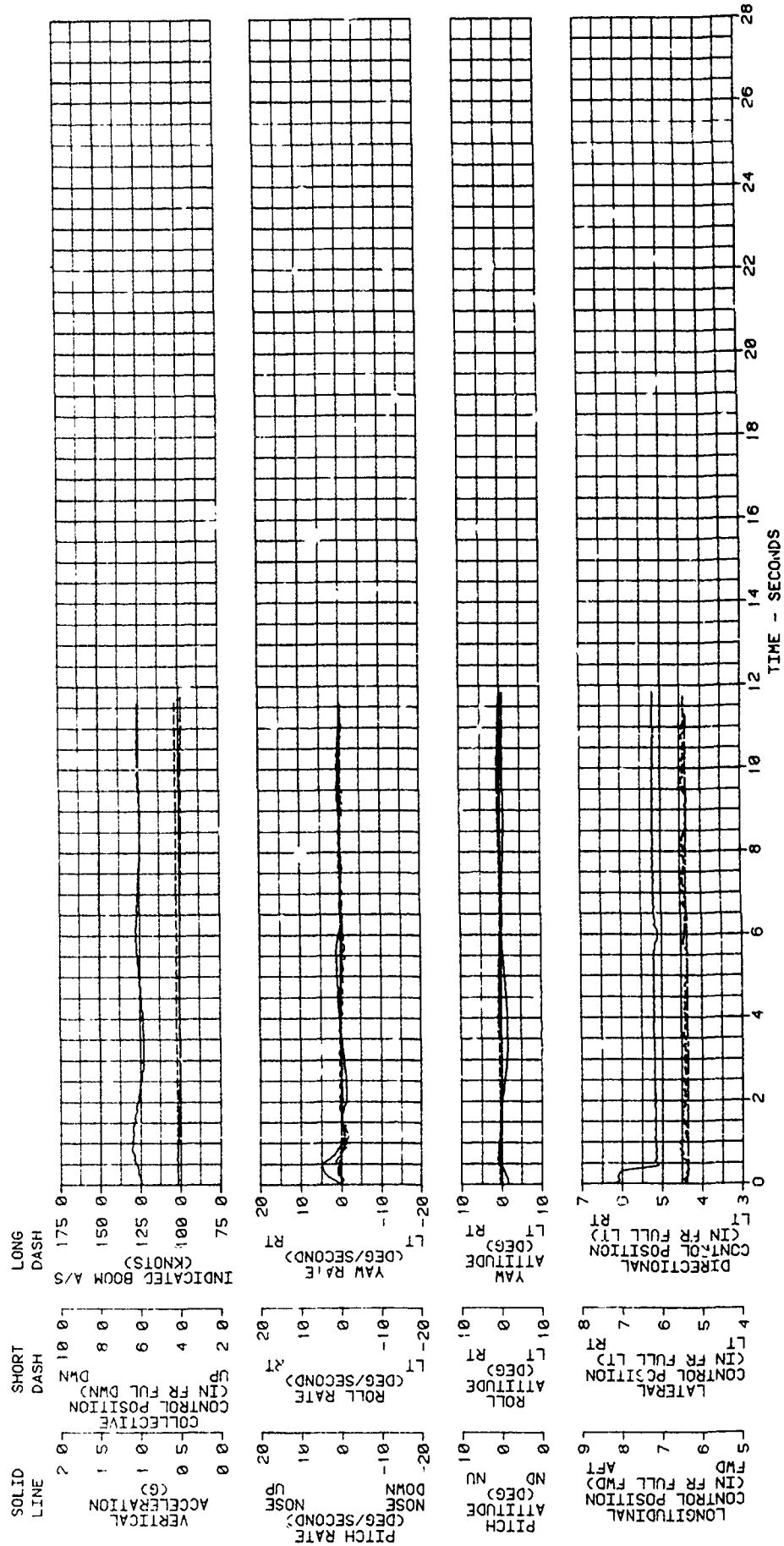

FIGURE 102
LONG TERM RESPONSE
CH-47D USA S/N 81-23383

AVG GROSS WEIGHT (LB) 39780
AVG LONG CG LOCATION (FSS) 338 BK(AFT)
AVG DENSITY ALTITUDE (FT) 6160
AVG ROTOR SPEED (RPM) 225
AVG DAT (DEG C) 24 0
TRIM CALIB AIRSPEED (KT) 88
TRIM FLIGHT CONDITION LEVEL
AFCS CONDITION #1 SYSTEM OFF

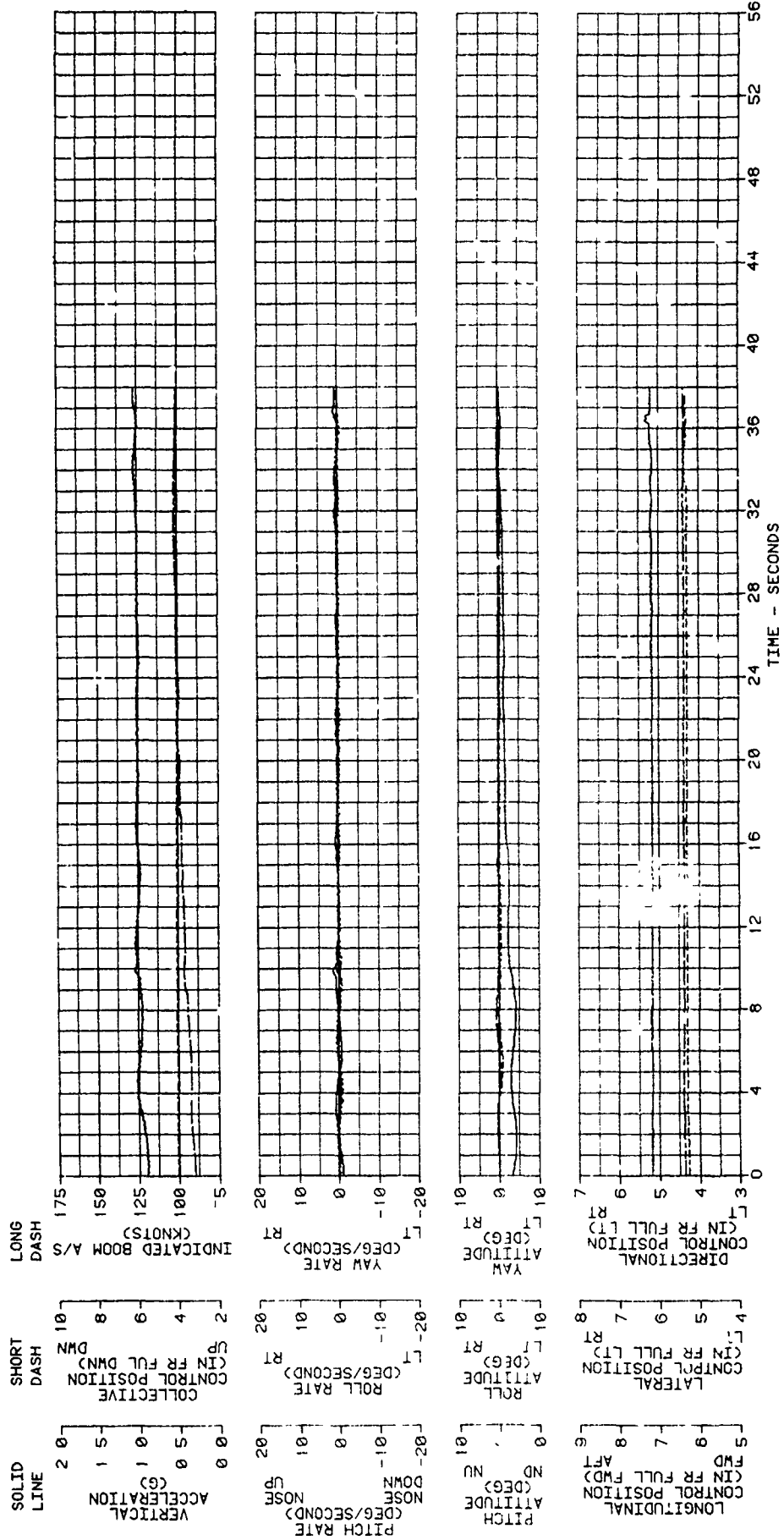

FIGURE 103
LONG TERM RESPONSE
CH-47D USA S/N 81-23383

AVG GROSS WEIGHT (LB)	38640	AVG LONG CG LOCATION (CFS)	339	AVG DENSITY ALTITUDE (FT)	6440	AVG ROTOR SPEED (CRPM)	227	TRIM CALIB AIRSPEED (KTS)	128	AFCS CONDITION	BOTH SYSTEMS ON
AVG LONG CG LOCATION (CFS)	339	AVG DENSITY ALTITUDE (FT)	6440	AVG ROTOR SPEED (CRPM)	227	TRIM CALIB AIRSPEED (KTS)	128	TRIM FLIGHT CONDITION LEVEL	128	AFCS CONDITION	BOTH SYSTEMS ON

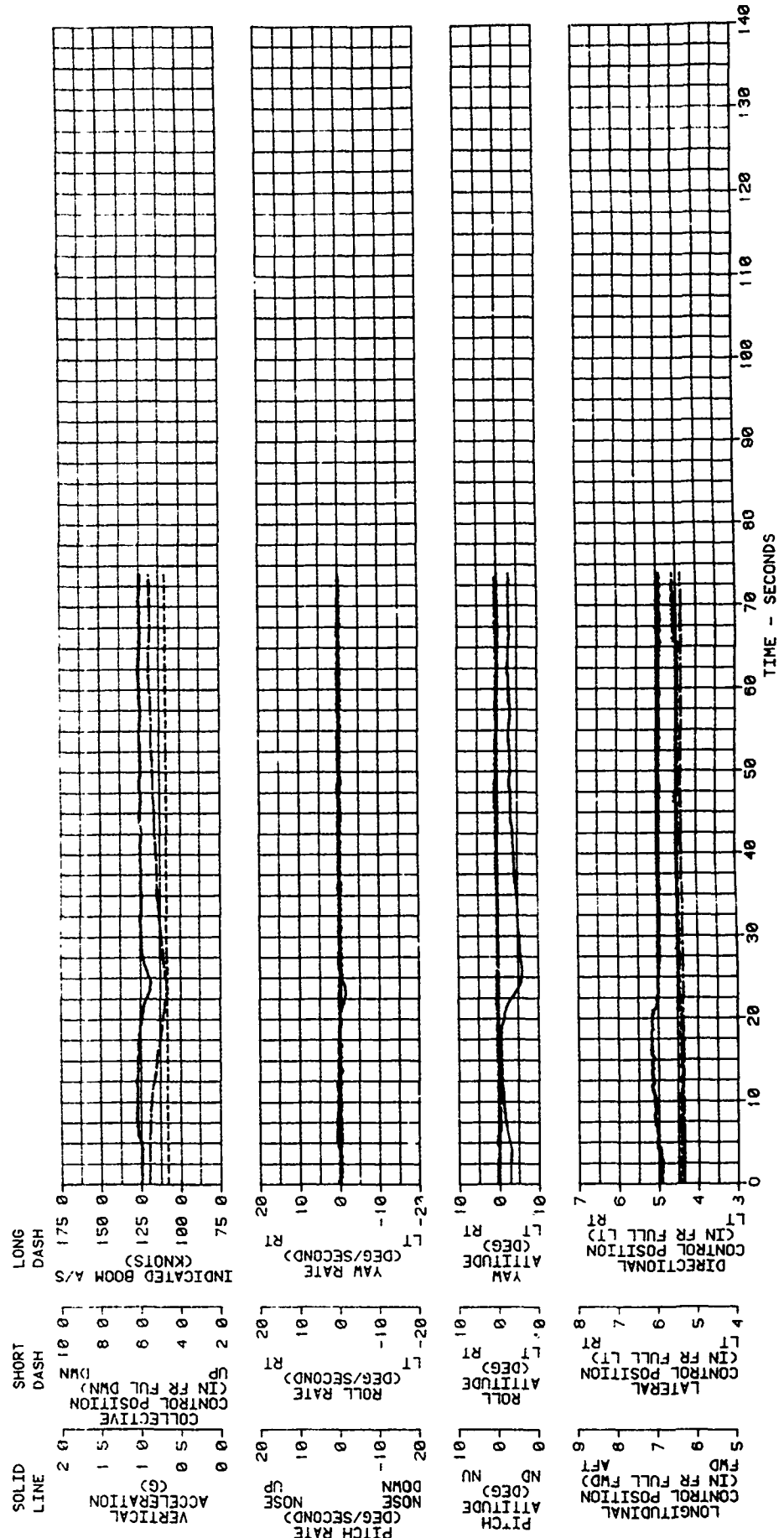

FIGURE 104
 RESPONSE TO COLLECTIVE RAMP INPUT
 CH-47D USA S/N 01-23383

AVG GRSS WEIGHT (LBS)	AVG LONG CG LOCATION (FWS)	AVG DENSITY ALTITUDE (FT)	AVG OAT (DEG C)	AVG ROTOR SPEED (RPM)	TRIM FLIGHT CONDITION	AFCS CONDITION
35120	331.1 (MID)	3560	22.8	223	TAKEOFF TO HOVER	BOTH ON

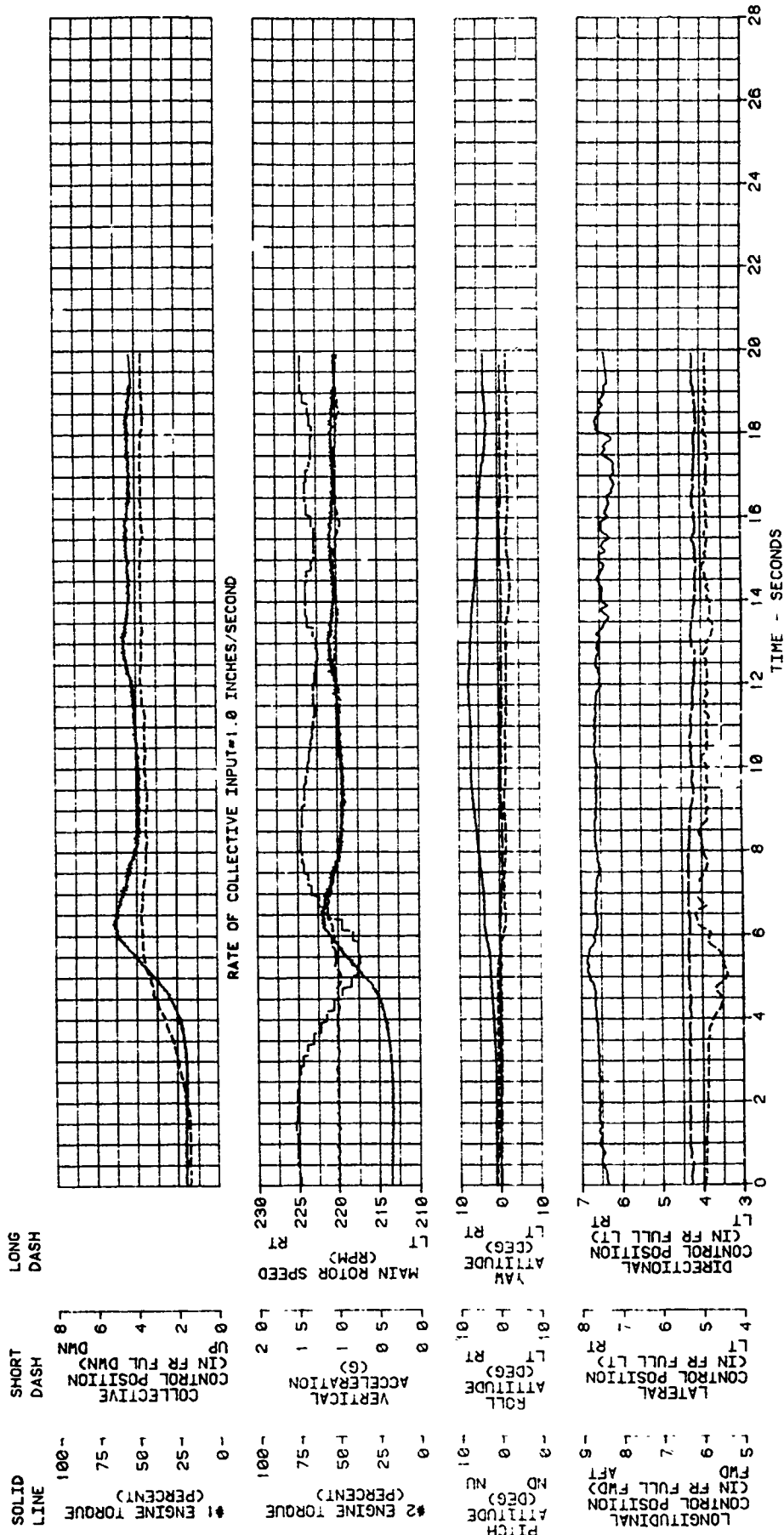

FIGURE 105
RESPONSE TO COLLECTIVE RAMP INPUT
CH-47D USA S/N 81-23383

AVG GROSS WEIGHT (LB)	35060	AVG LONG CG LOCATION (FS)	331 (MID)	AVG DENSITY ALTITUDE (FT)	3580	AVG OAT (DEG C)	22.0	AVG ROTOR SPEED (RPM)	223	TRIM FLIGHT CONDITION	TAKEOFF	AFCS CONDITION	BOTH ON
											TO HOVER		

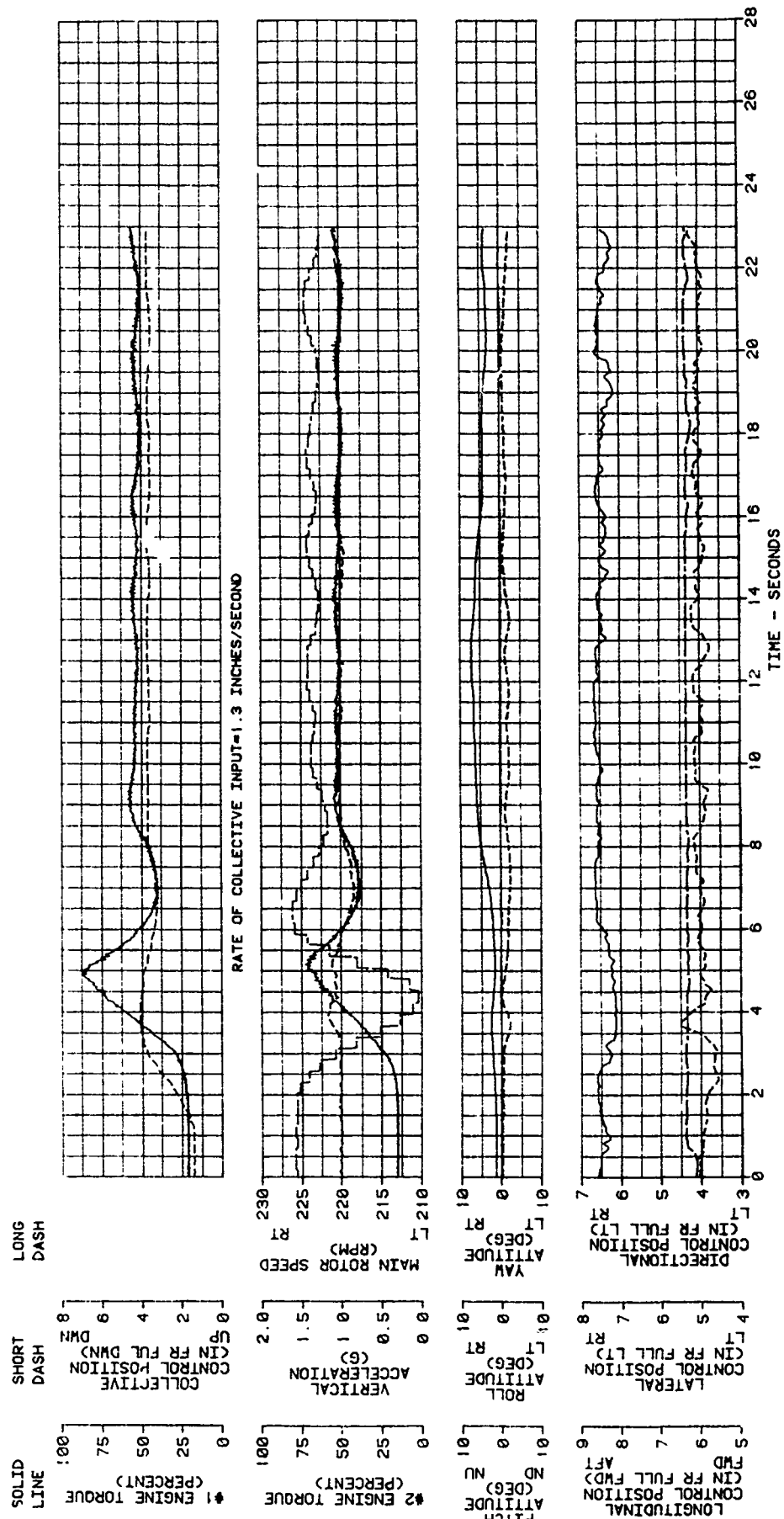

FIGURE 106
 RESPONSE TO COLLECTIVE RAMP INPUT
 CH-47D USA S/N 81-23363

AVG GROSS WEIGHT (LBS) 33828
 AVG LONG CG LOCATION (F9) 331.7<MID>
 AVG DENSITY ALTITUDE (FT) 6496
 AVG ROTOR SPEED (RPM) 226
 TRIM CALLER AIRSPEED (KTS) 78
 TRIM FLIGHT CONDITION LEVEL
 AFCS CONDITION BOTH ON

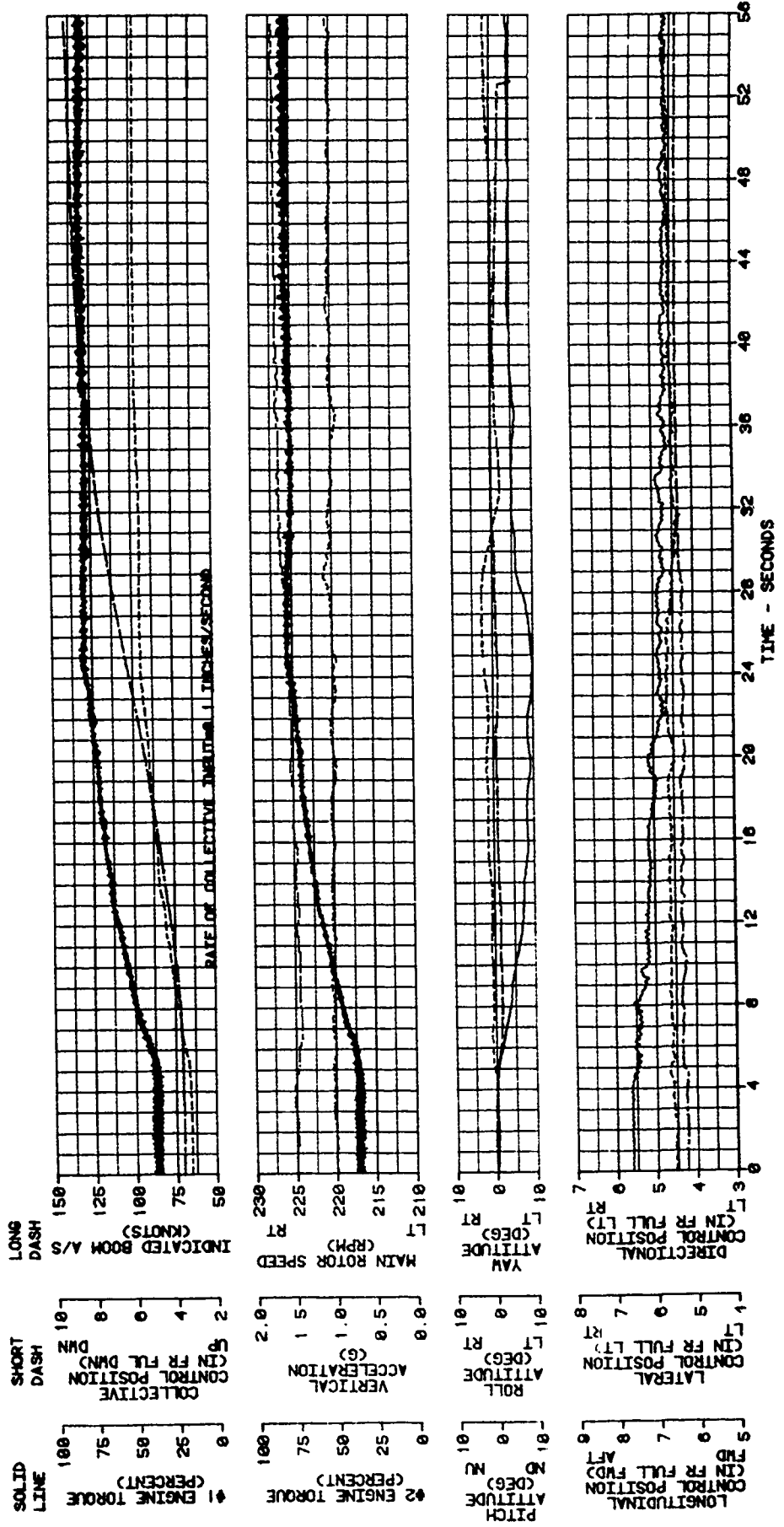

FIGURE 107
 RESPONSE TO COLLECTIVE RAMP INPUT
 CH-47D USA S/N 81-23963

AVG GROSS WEIGHT (LB)	53840	AVG LONG CG LOCATION (FSS)	331.7(MID)	AVG DENSITY ALTITUDE (FT)	6320	AVG OAT (DEG C)	24.0	AVG ROTOR SPEED (RPM)	223	TRIM CALIB AIRSPEED (KT)	148	TRIM FLIGHT CONDITION	LEVEL	AFCS CONDITION	BOTH ON
-----------------------	-------	----------------------------	------------	---------------------------	------	-----------------	------	-----------------------	-----	--------------------------	-----	-----------------------	-------	----------------	---------

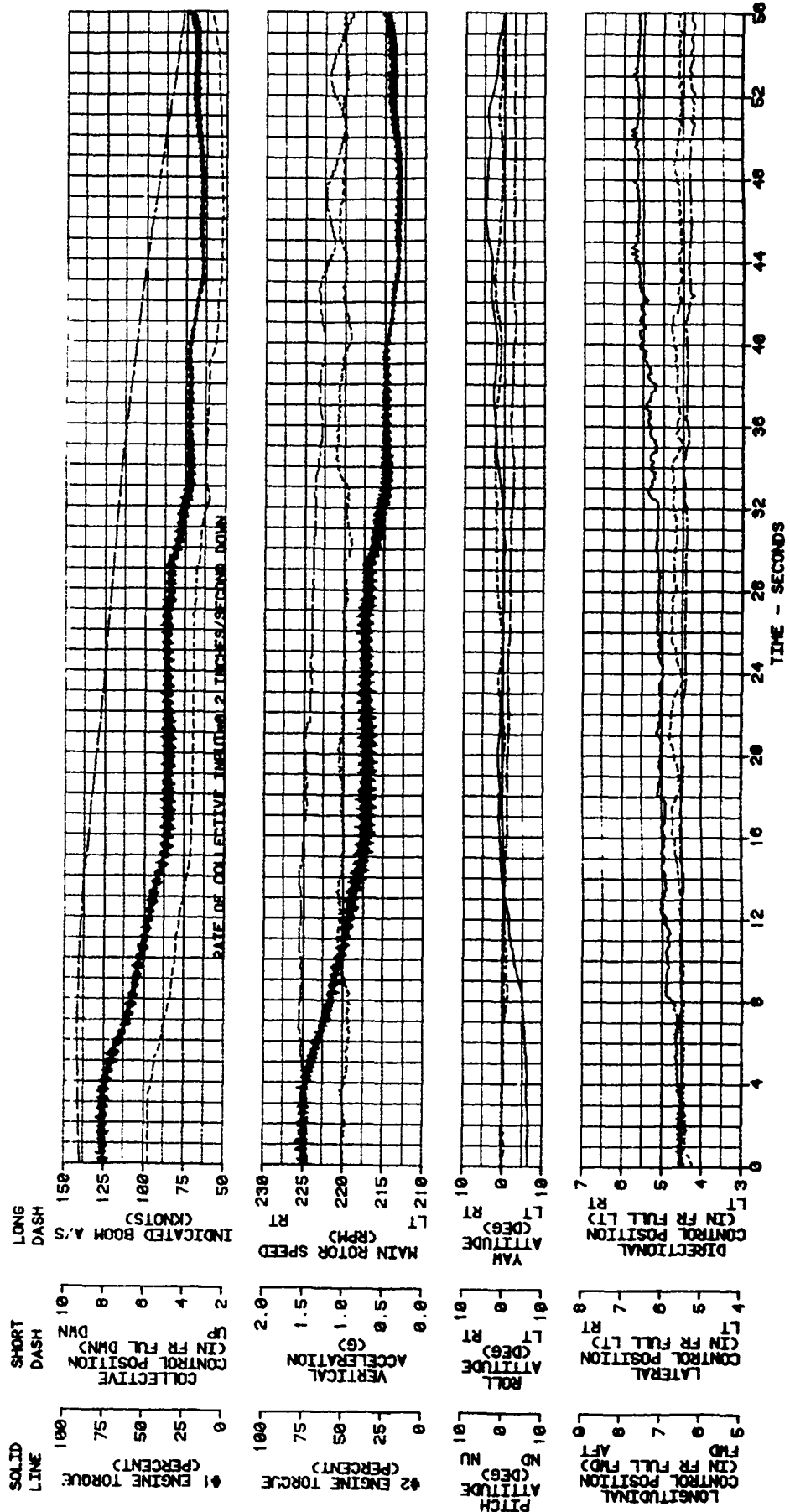

FIGURE 108
SIMULATED SINGLE ENGINE FAILURES
CH-47D USA S/N 81-23383

AVG GROSS WEIGHT (LBS)	47540	AVG LONG CG LOCATION (FWS)	332.0	AVG DENSITY ALTITUDE (FT)	7480	AVG OAT (DEG C)	28.5	AVG ROTOR SPEED (CRPH)	221	TRIM CALIB AIRSPEED (KT)	73	TRIM FLIGHT CONDITION	LEVEL	AFCS CONDITION	BOTH ON
------------------------	-------	----------------------------	-------	---------------------------	------	-----------------	------	------------------------	-----	--------------------------	----	-----------------------	-------	----------------	---------

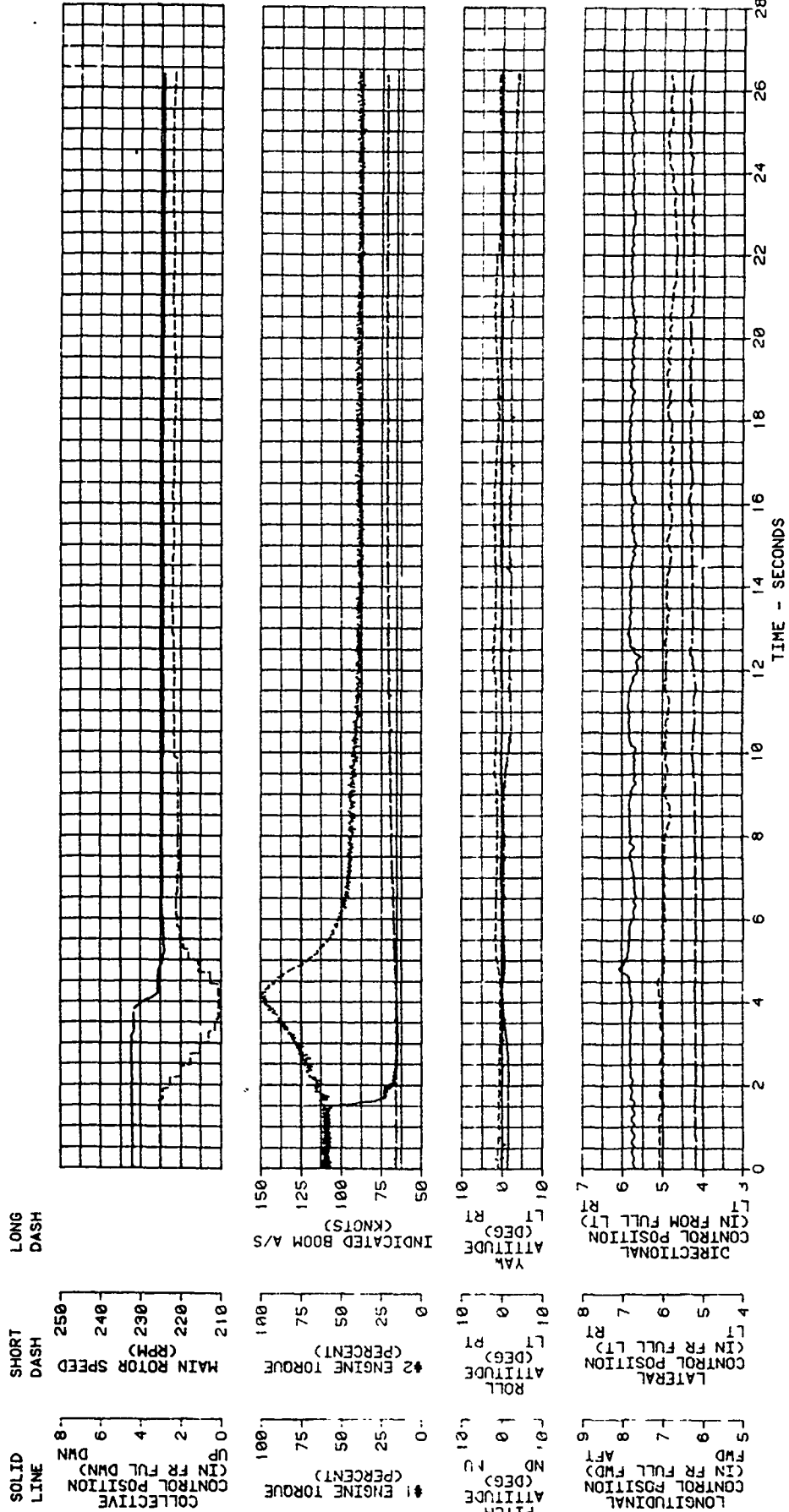

FIGURE 109
SIMULATED SINGLE ENGINE FAILURES
CH-47D USA S/N 81-23383

AVG GROSS WEIGHT (CLB)	47180	AVG LONG CG LOCATION (FSS)	332.1	AVG DENSITY ALTITUDE (FT)	7320	AVG ROTOR SPEED (CRPM)	221	TRIM CALIB AIRSPEED (K.T)	120	TRIM FLIGHT CONDITION	LEVEL	AFCS CONDITION	BOTH ON
------------------------	-------	----------------------------	-------	---------------------------	------	------------------------	-----	---------------------------	-----	-----------------------	-------	----------------	---------

SOLID LINE
LONG DASH

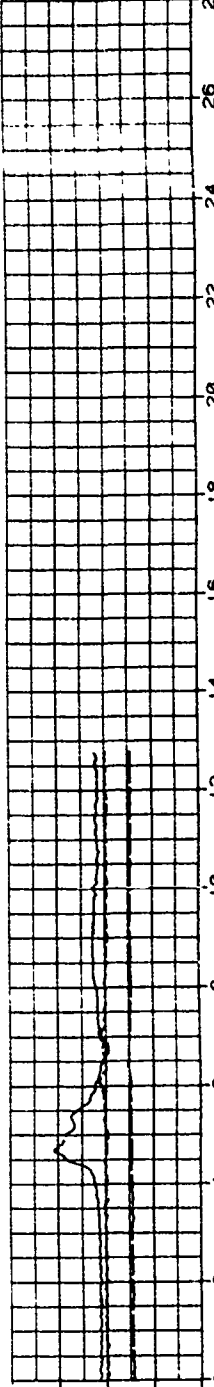
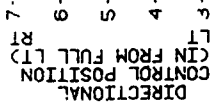
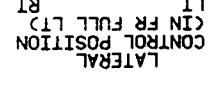
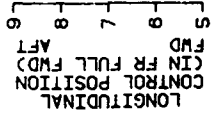
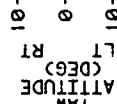
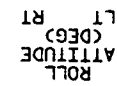
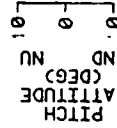
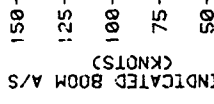
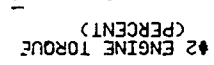
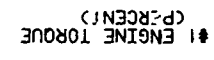
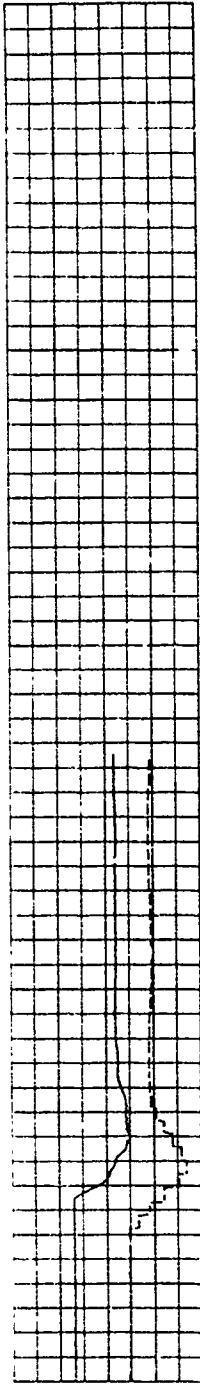
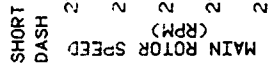
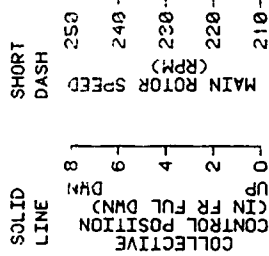

FIGURE 110
 PITCH AFCS ACTUATOR FAILURE
 CH-47D USA S/N 81-23383

AVG GROSS WEIGHT (LB) 38640
 AVG LONG CG LOCATION (FWS) 348 (CAFT)
 AVG DENSITY ALTITUDE (FT) 5860
 AVG QAY (DEG C) 24 S
 AVG SPEED (SRPH) 225
 TRIM CALIB AIRSPEED (KT) 120
 TRIM FLIGHT CONDITION LEVEL
 AFCS CONDITION BOTH SYSTEMS ON

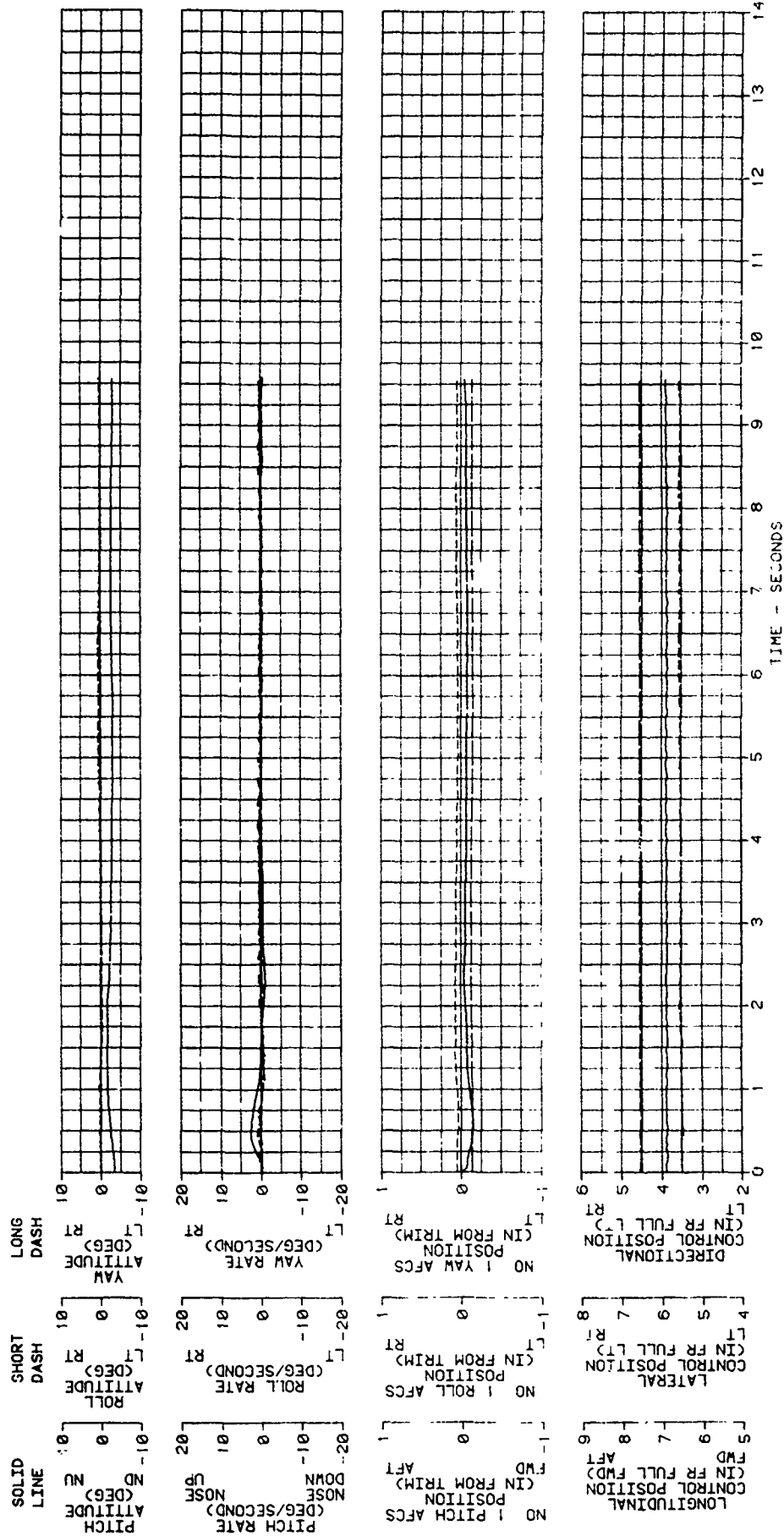

FIGURE 111
 ROLL AFCS ACTUATOR FAILURE
 CH-47D USA S/N 81-23383

AVG GROSS WEIGHT (LB)	38540	AVG LONG CG LOCATION (F)	348 (CAFT)	AVG DENSITY ALTITUDE (FT)	5840	AVG OAT (DEG C)	24.0	AVG ROTOR SPEED (RPM)	225	TRIM CALIB AIRSPEED (KT)	131	TRIM FLIGHT CONDITION	LEVEL	AFCS CONDITION	BOTH SYSTEMS ON
-----------------------	-------	--------------------------	------------	---------------------------	------	-----------------	------	-----------------------	-----	--------------------------	-----	-----------------------	-------	----------------	-----------------

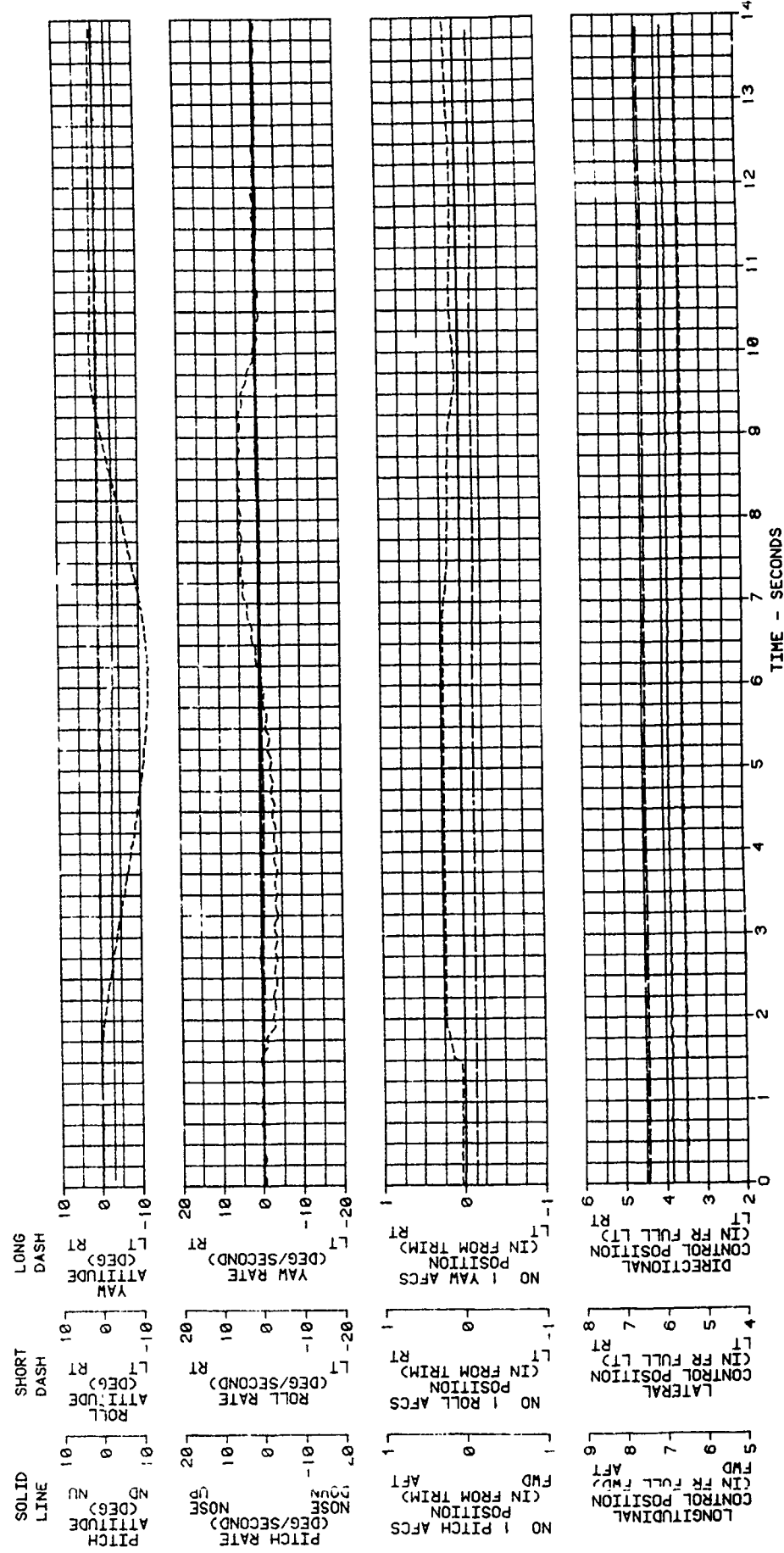

FIGURE 112
YAH AFCS ACTUATOR FAILURE
CH-47D USA S/N 81-23383

AVG GROSS HEIGHT (CLB) 38460
AVG LONG CG LOCATION (CFS) 348 2(AFT)
AVG DENSITY ALTITUDE (FT) 5000
AVG OAT (DEG C) 24.0
AVG ROTOR SPEED (RPM) 225
TRIM CALIB AIRSPEED (KT) 130
TRIM FLIGHT CONDITION LEVEL
AFCS CONDITION BOTH SYSTEMS ON

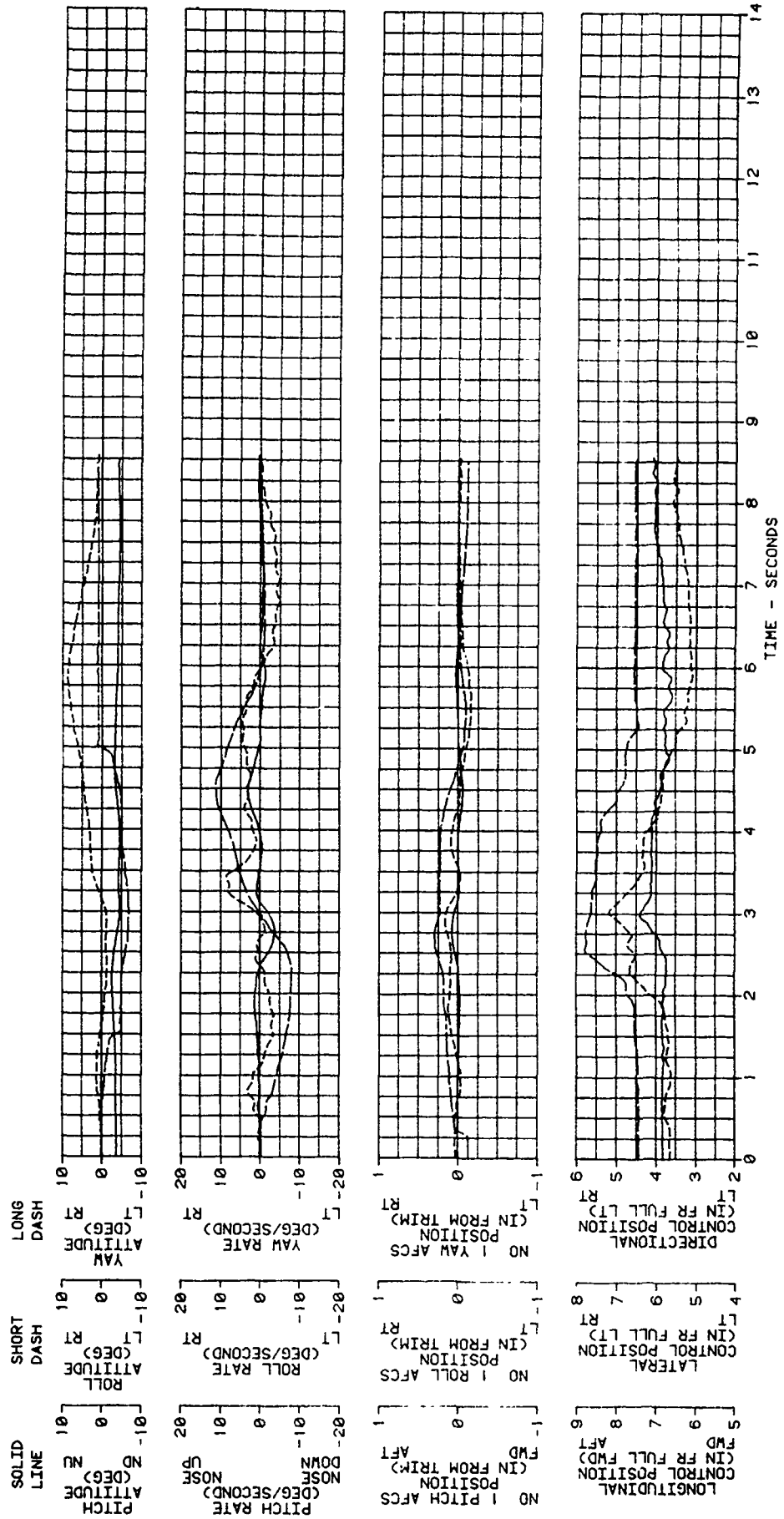

FIGURE 113
DASH FAILURE
CH-47D USA S/N 81-29383

AVG GROSS WEIGHT (LB) 38200
AVG LONG CG LOCATION (FWS) 348 (CAFT)
AVG DENSITY ALTITUDE (FT) 5800
AVG OAT (DEG C) 25.0
AVG ROTOR SPEED (CRPM) 225
TRIM CALIB AIRSPEED (KTS) 128
TRIM FLIGHT CONDITION LEVEL
AFCS CONDITION BOTH SYSTEMS ON

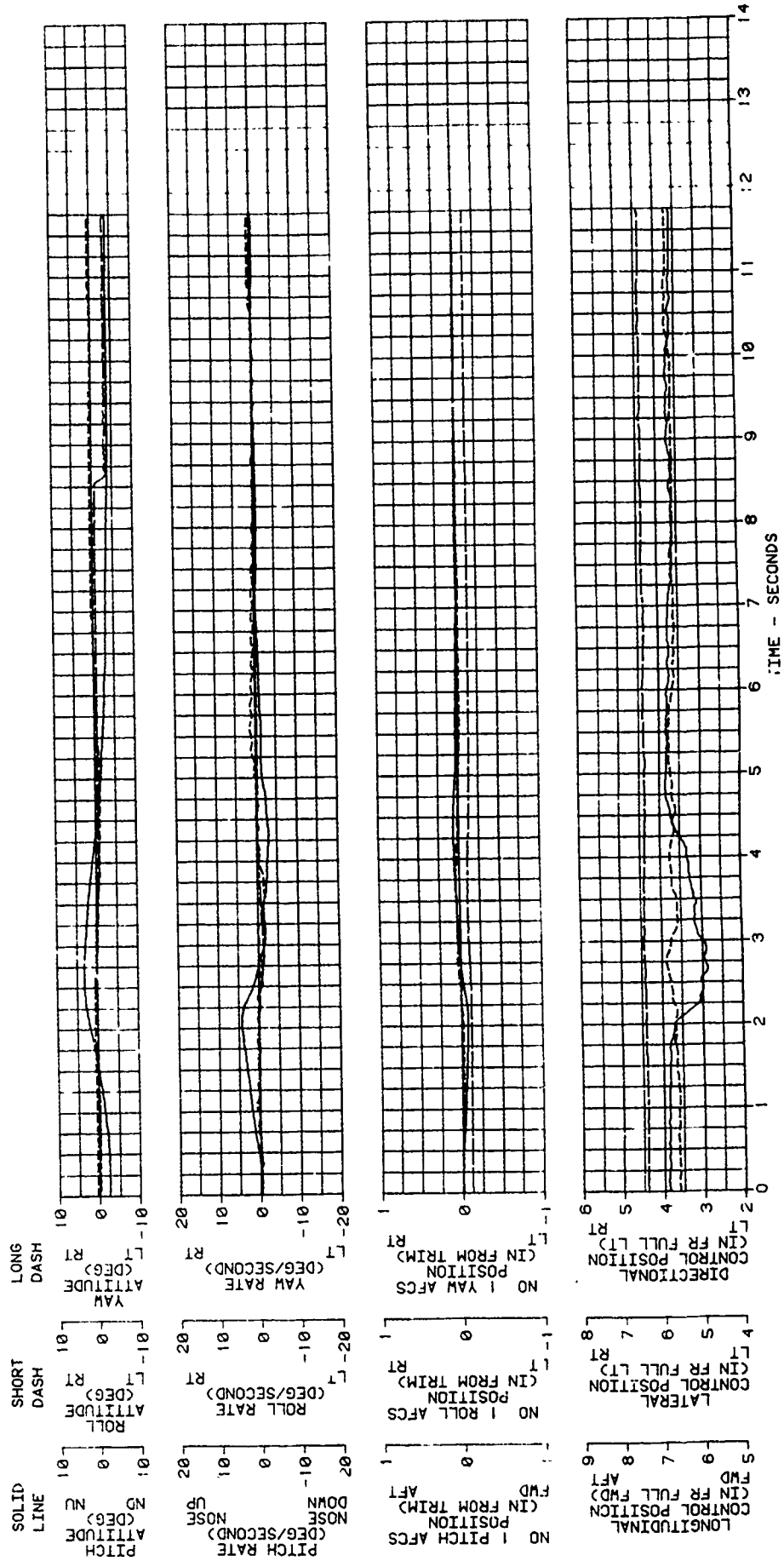

FIGURE 114
 PITCH GYRO FAILURE
 CH-47D USA S/N 81-23383

AVG GROSS WEIGHT (LB) 38080
 AVG LONG CG LOCATION (FSS) 348.5(AFT)
 AVG DENSITY ALTITUDE (FT) 5740
 AVG OAT (DEG C) 25.0
 AVG ROTOR SPEED (CRPM) 224
 TRIM CALIB AIRSPEED (KTS) 127
 TRIM FLIGHT CONDITION LEVEL
 AFCS CONDITION BOTH SYSTEMS ON

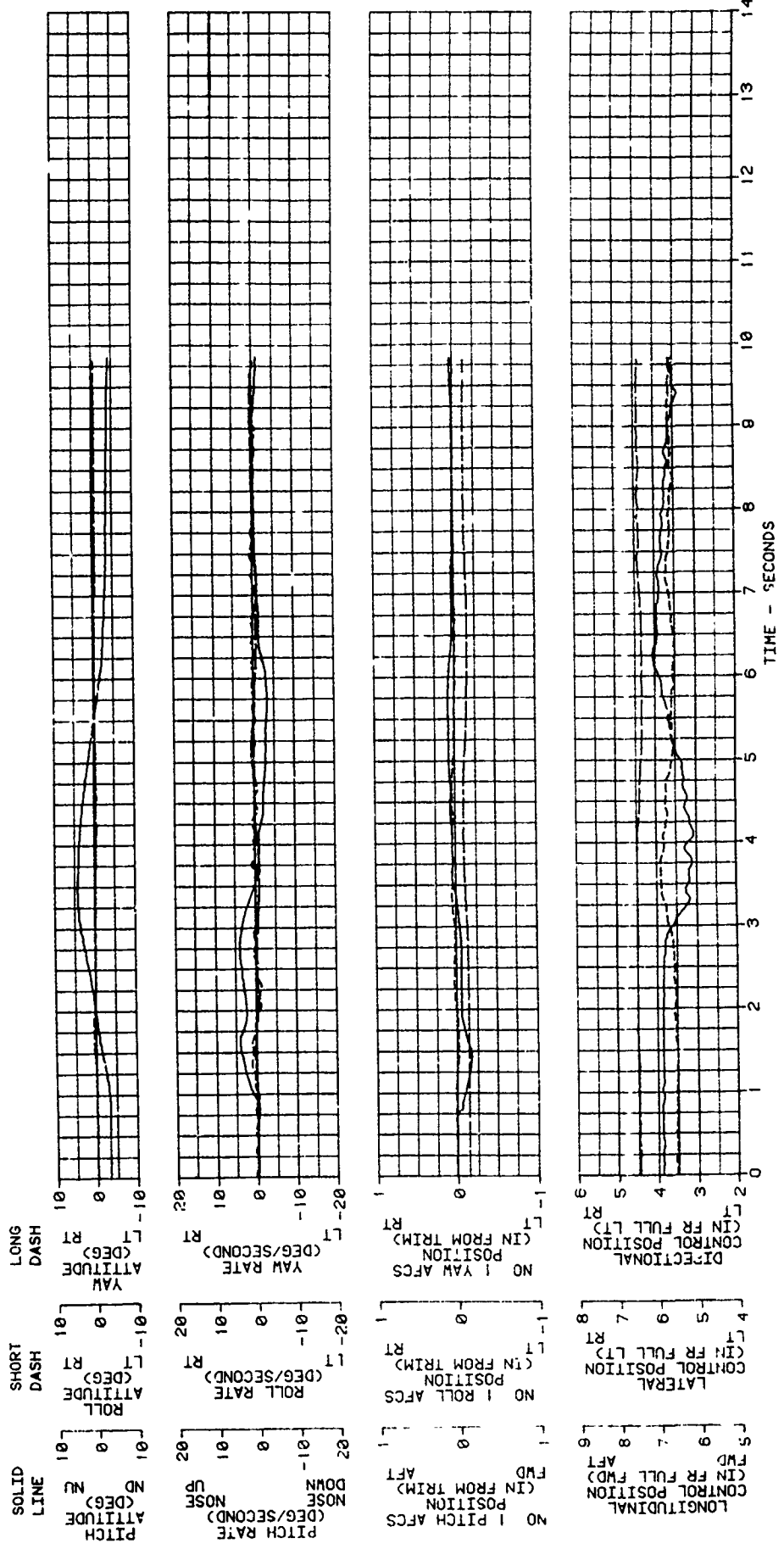

FIGURE 115
ROLL GYRO FAILURE
CH-47D USA S/N 81-23383

AVG GROSS WEIGHT (LB) 37900
AVG LONG CG LOCATION (FWS) 348 (CAFT)
AVG DENSITY ALTITUDE (FT) 5700
AVG OAT (DEG C) 25.0
AVG ROTOR SPEED (CRPM) 225
TRIM CALIB AIRSPEED (KT) 128
TRIM FLIGHT CONDITION LEVEL
AFCS CONDITION BOTH SYSTEMS ON

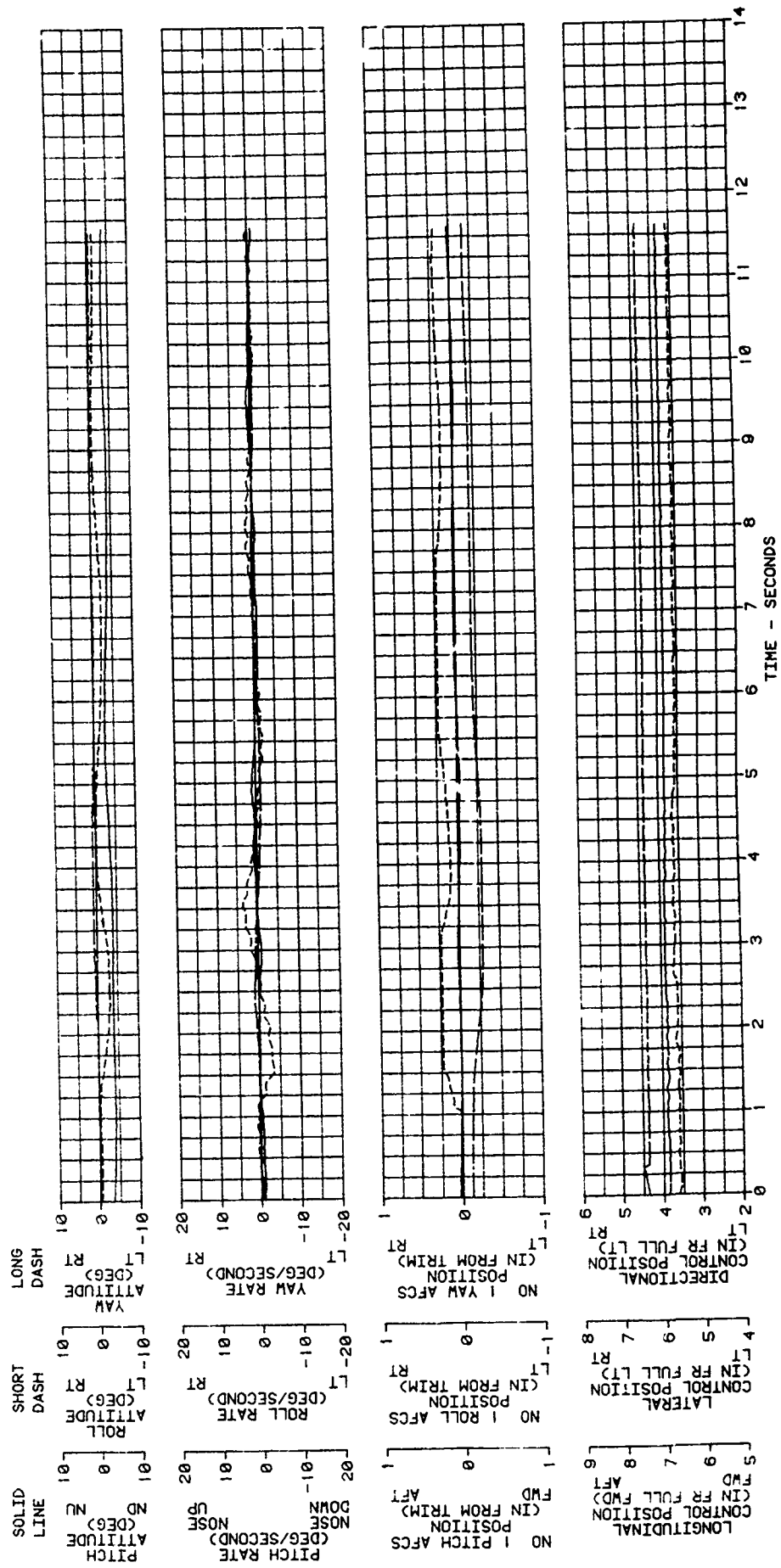

FIGURE 116
CCDA FAILURE
CH-47D USA S/N 81-23383

AVG GROSS WEIGHT (CLB) 41000
 AVG LONG CG LOCATION (CFS) 317 (CFWD)
 AVG DENSITY ALTITUDE (FT) 5820
 AVG OAT (DEG C) 18.5
 AVG ROTOR SPEED (RPM) 224
 TRIM CALIB AIRSPEED (KT) 120
 TRIM FLIGHT CONDITION LEVEL
 AFCS CONDITION BCTH ON

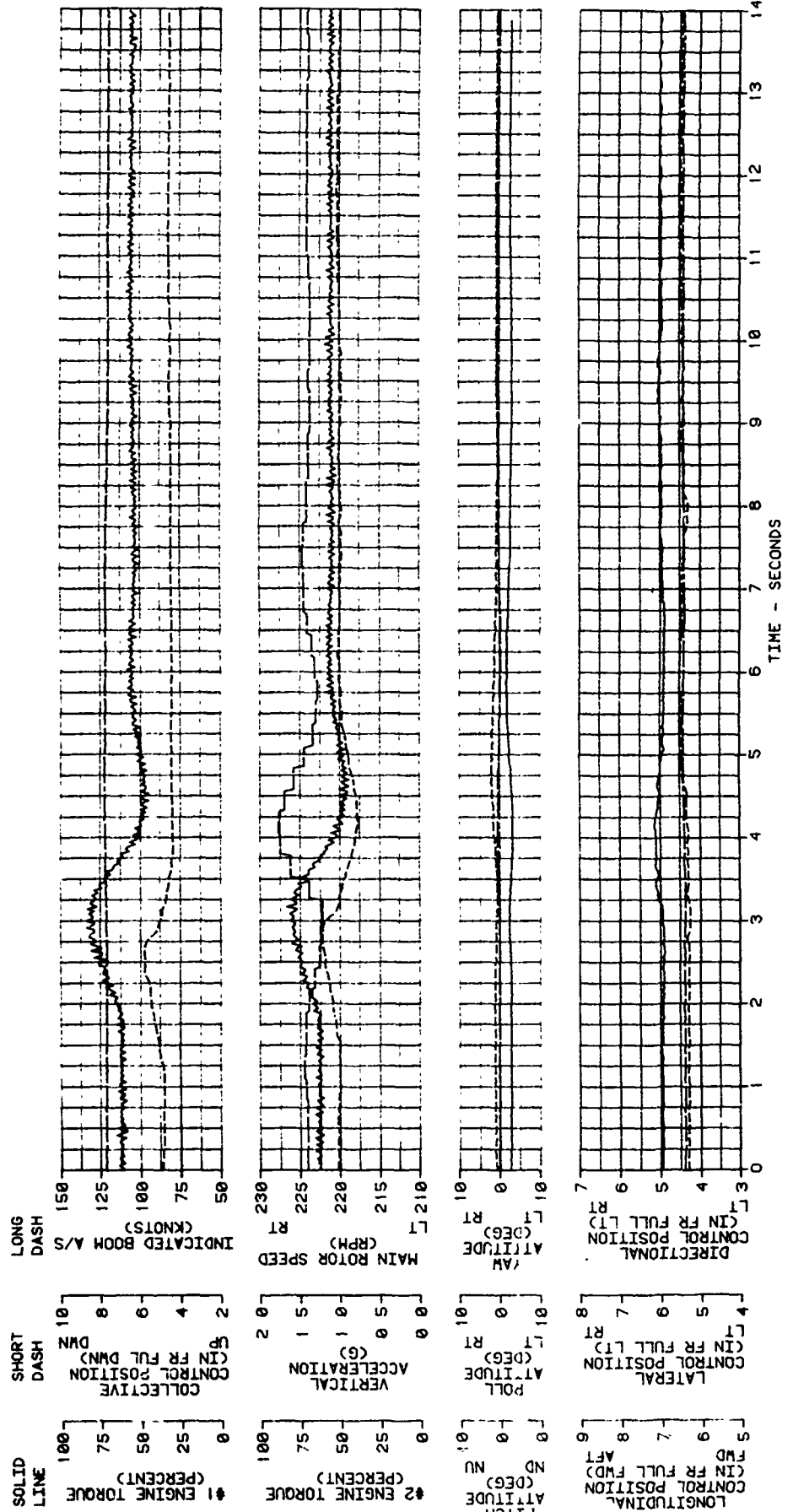

FIGURE 117
 VIBRATION CHARACTERISTICS
 CH-47D USA S/N 81-23383

VERTICAL VIBRATION AT FS 440 BL 44 LEFT

SYM	AVG GROSS WEIGHT (LB)	AVG LONGITUDINAL CG LOCATION (FS)	AVG DENSITY ALTITUDE (FEET)	AVG OAT (DEG C)	AVG ROTOR SPEED (RPM)	FLIGHT CONDITION
⊙	34,140	330 9 (MID)	2850	20.0	225	LEVEL
⊠	41,140	350 1 (MID)	1620	18.0	225	LEVEL

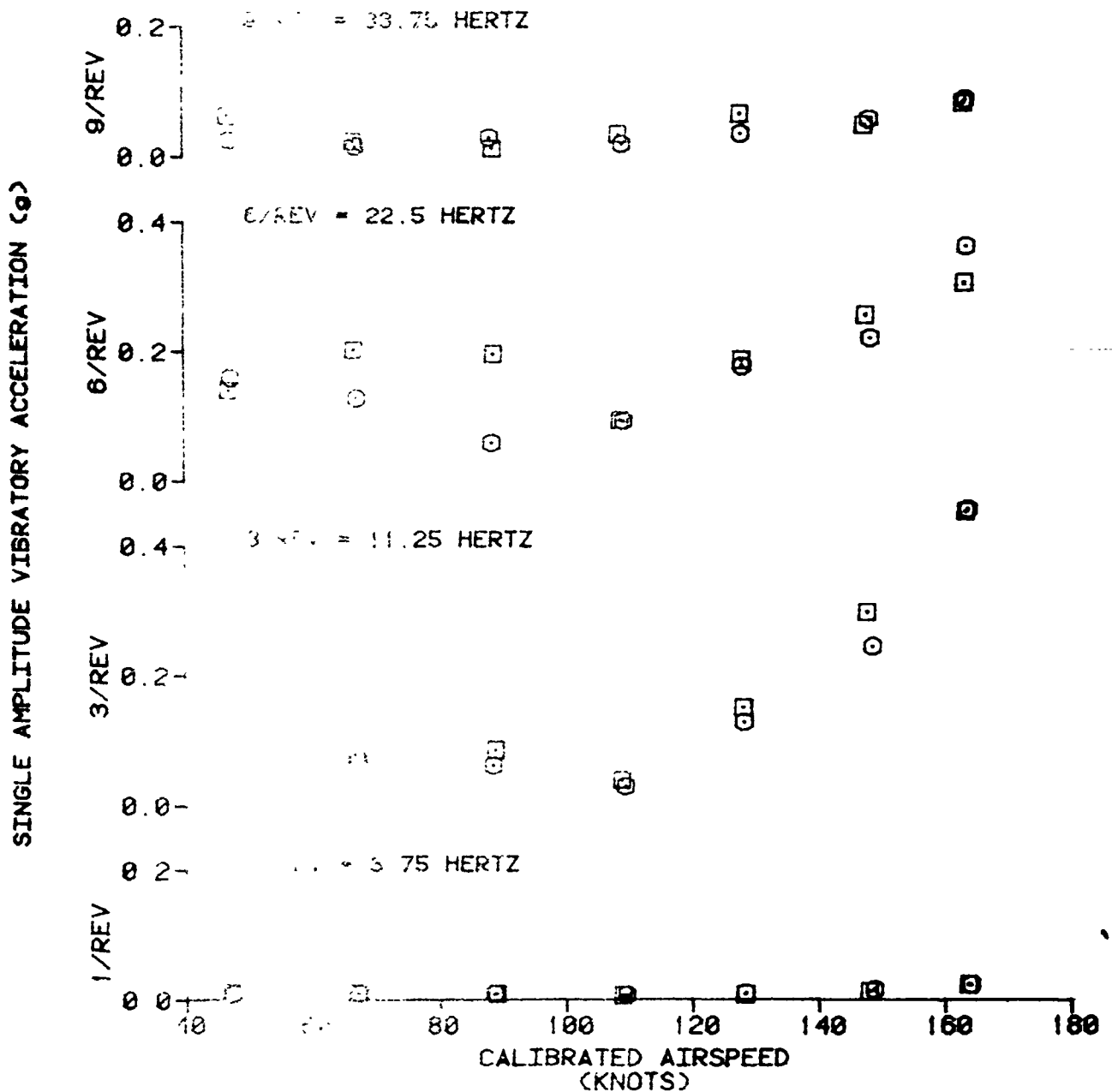

FIGURE 118
VIBRATION CHARACTERISTICS
CH-47D USA S/N 81-23383
VERTICAL VIBRATION AT FS 482 BL 44 LEFT

SYM	AVG GROSS WEIGHT (LB)	AVG LONGITUDINAL CG LOCATION (FS)	AVG DENSITY ALTITUDE (FEET)	AVG OAT (DEG C)	AVG ROTOR SPEED (RPM)	FLIGHT CONDITION
⊙	34140	330.9 (MID)	2850	20.0	225	LEVEL
⊠	41200	330.1 (MID)	1620	18.0	225	LEVEL

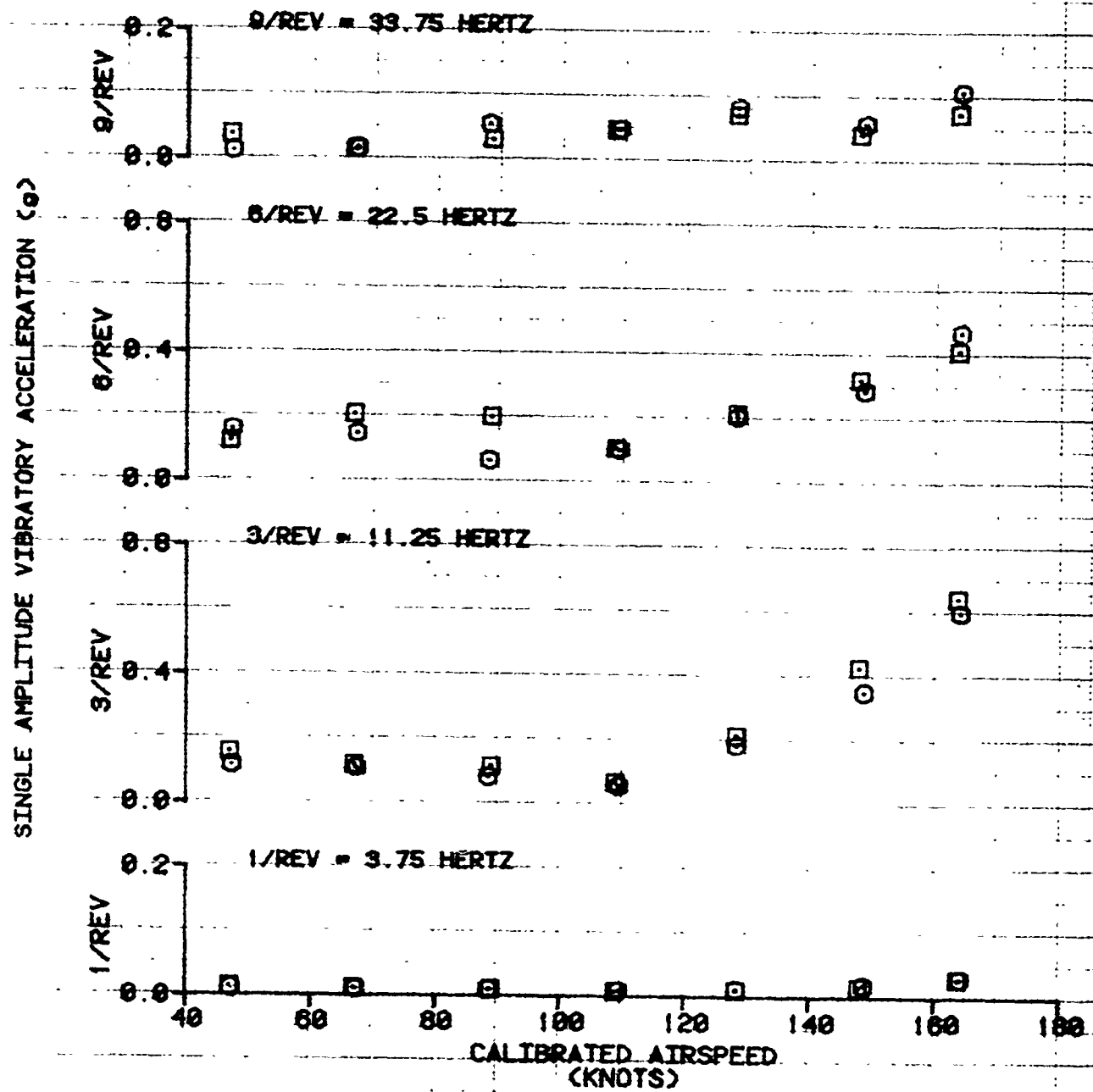

FIGURE 119

VIBRATION CHARACTERISTICS
CH-47D USA S/N 81-23383

VERTICAL VIBRATION AT FS 320 BL 44 LEFT

SYM	AVG GROSS WEIGHT (LB)	AVG LONGITUDINAL CG LOCATION (FS)	AVG DENSITY ALTITUDE (FEET)	AVG OAT (DEG C)	AVG ROTOR SPEED (RPM)	FLIGHT CONDITION
⊙	34140	330.9(MID)	2850	20.0	225	LEVEL
⊠	41200	330.1(MID)	1620	18.0	225	LEVEL

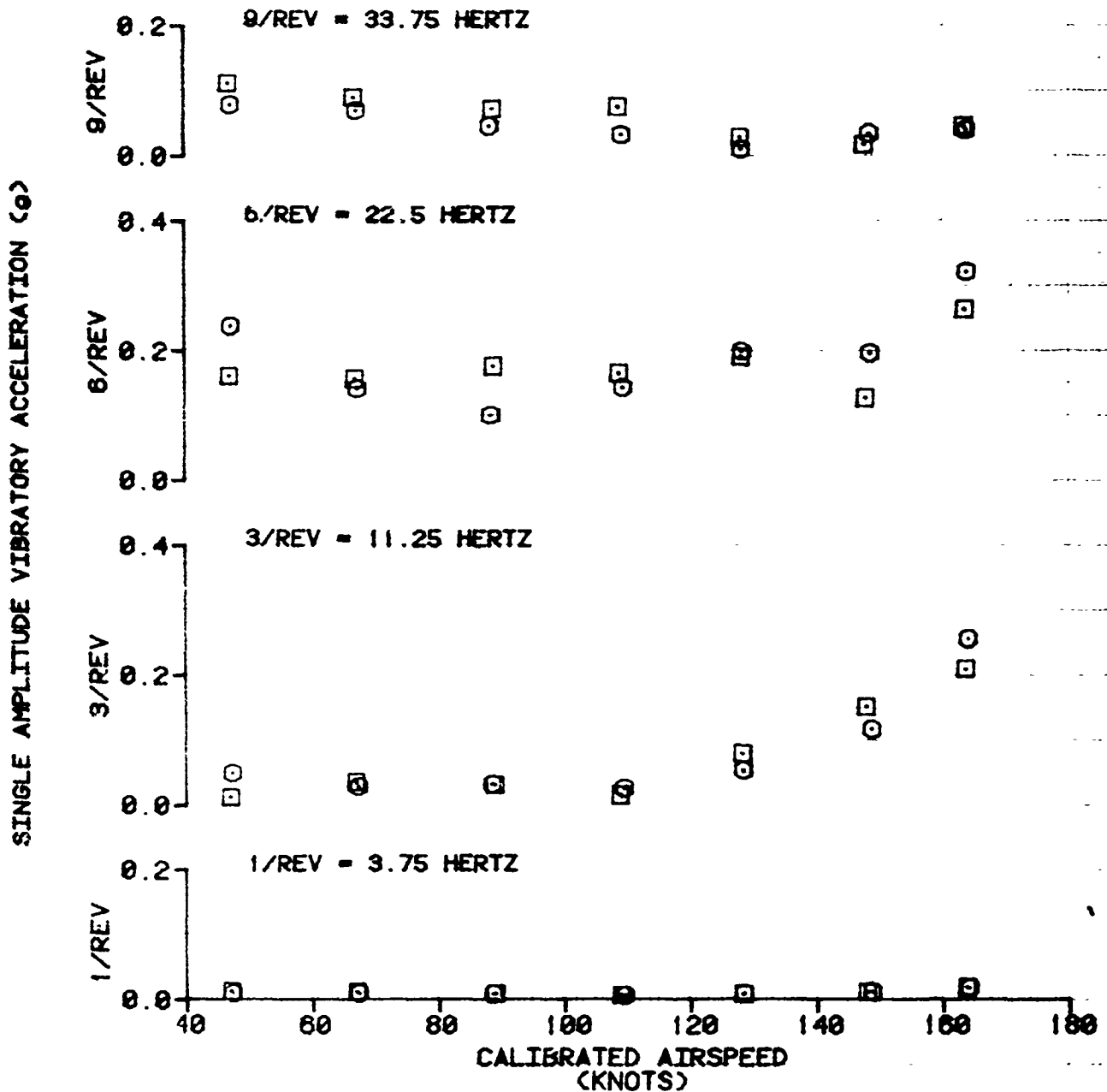

FIGURE 120
 VIBRATION CHARACTERISTICS
 CH-47D USA S/N 81-23383

VERTICAL VIBRATION AT FS 320 BL 25 RIGHT

SYM	AVG GROSS WEIGHT (LB)	AVG LONGITUDINAL CG LOCATION (FS)	AVG DENSITY ALTITUDE (FEET)	AVG OAT (DEG C)	AVG ROTOR SPEED (RPM)	FLIGHT CONDITION
⊙	34140	330.9(MID)	2850	29.0	225	LEVEL
⊠	41200	332.1(MID)	1920	18.0	225	LEVEL

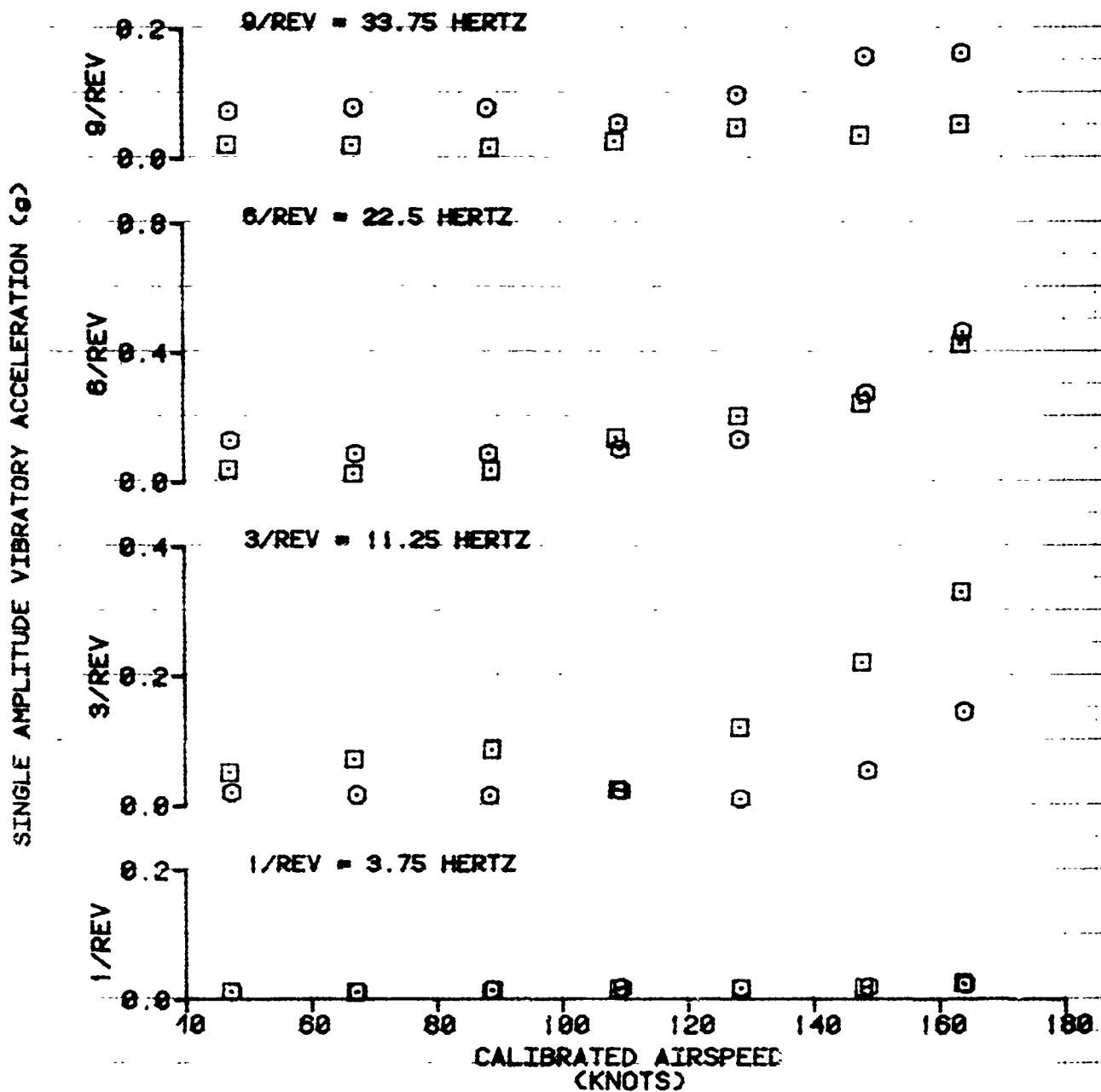

FIGURE 121

VIBRATION CHARACTERISTICS
CH-47D USA S/N 81-23383

VERTICAL VIBRATION AT FS 320 BL 25 LEFT

SYM	AVG GROSS WEIGHT (LB)	AVG LONGITUDINAL CG LOCATION (FS)	AVG DENSITY ALTITUDE (FEET)	AVG OAT (DEG C)	AVG ROTOR SPEED (RPM)	FLIGHT CONDITION
⊙	34140	330.9(MID)	2850	29.0	225	LEVEL
⊠	41200	330.1(MID)	1620	18.0	225	LEVEL

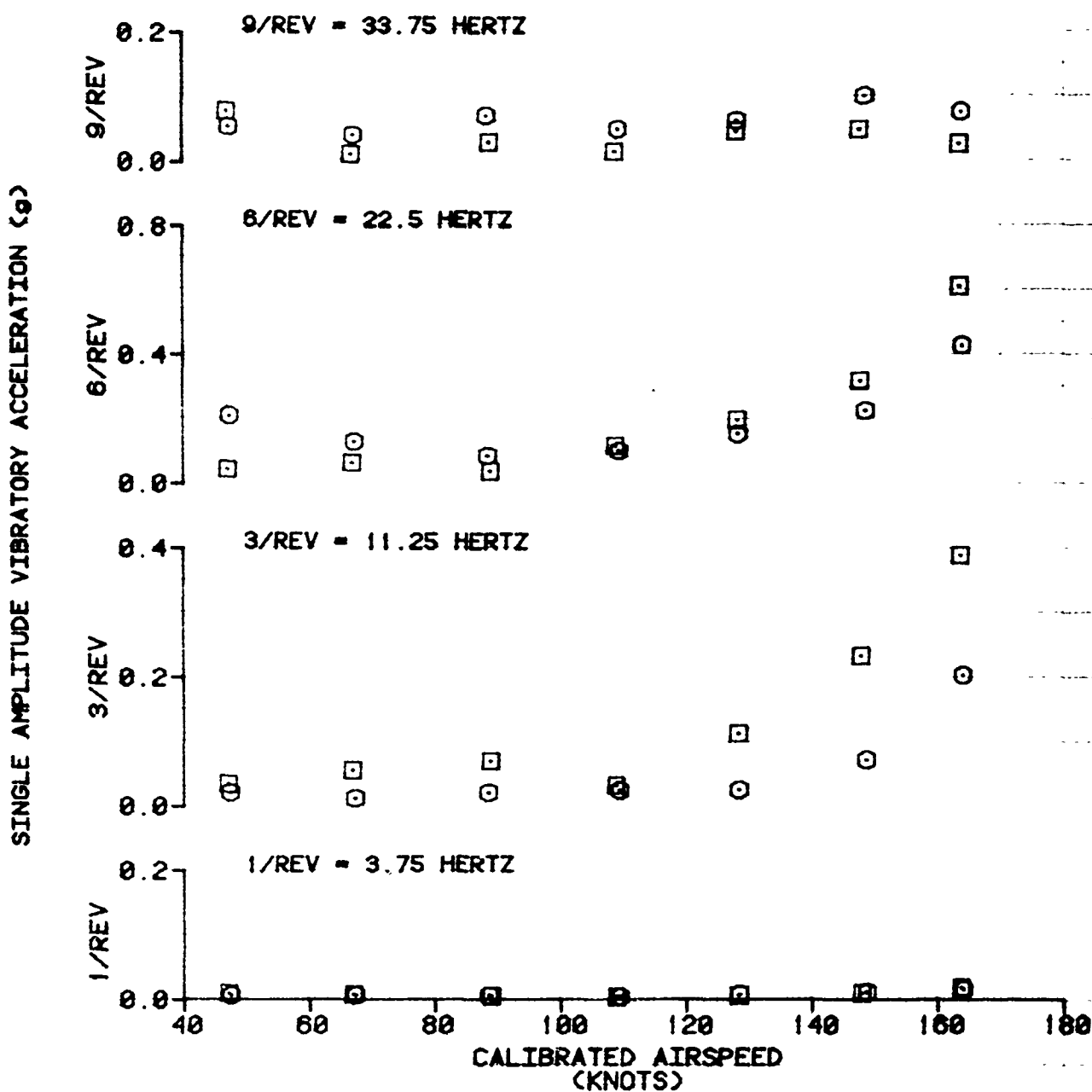

FIGURE 122
 VIBRATION CHARACTERISTICS
 CH-47D USA S/N 81-29383

LONGITUDINAL VIBRATION AT COPILOT SEAT

SYM	AVG GROSS WEIGHT (LB)	AVG LONGITUDINAL CG LOCATION (FS)	AVG DENSITY ALTITUDE (FEET)	AVG OAT (DEG C)	AVG ROTOR SPEED (RPM)	FLIGHT CONDITION
⊙	34140	330.9(MID)	2650	20.0	225	LEVEL
⊠	41200	330.1(MID)	1620	18.0	225	LEVEL

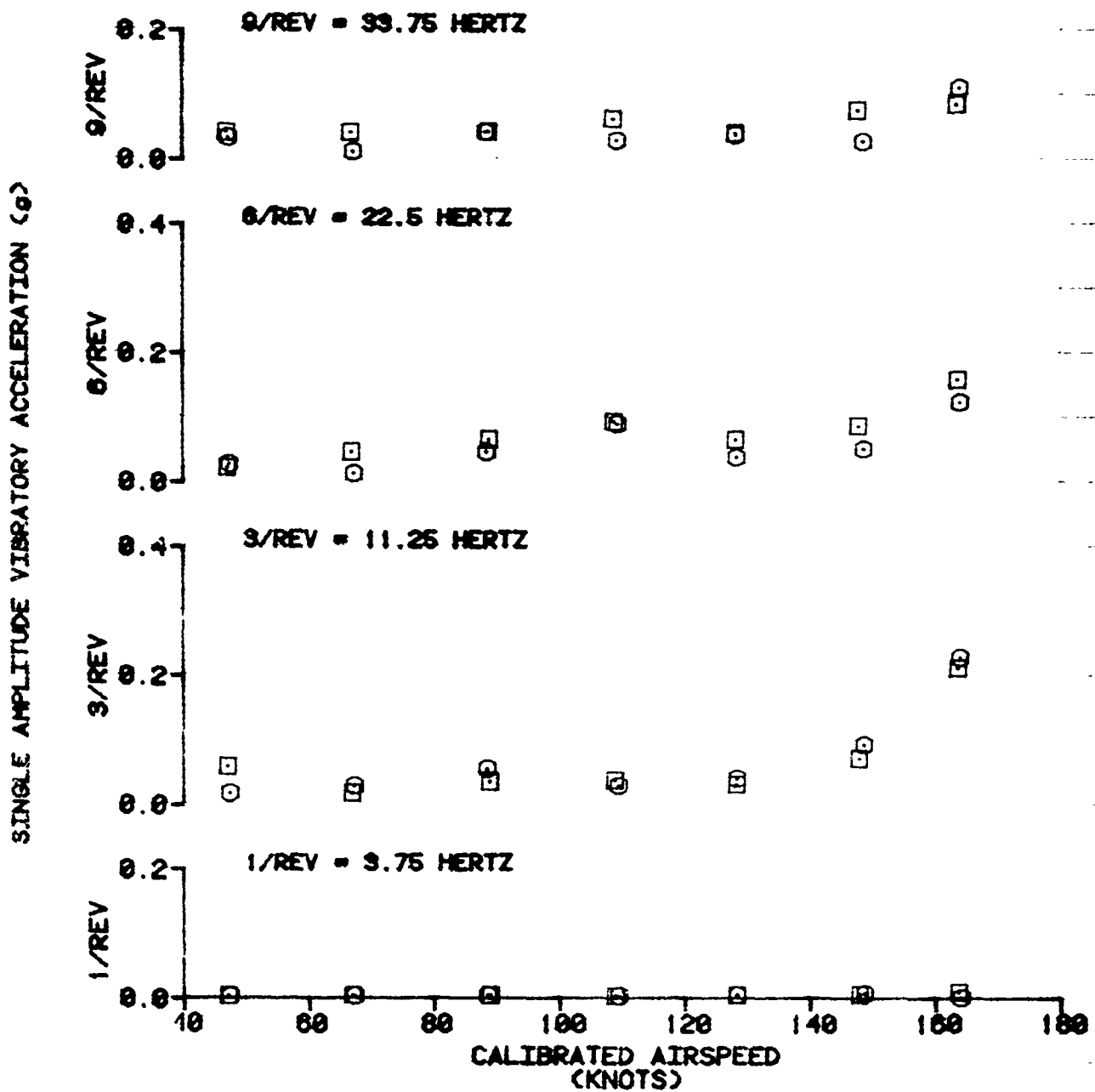

FIGURE 123
 VIBRATION CHARACTERISTICS
 CH-47D USA S/N 81-23383
 VERTICAL VIBRATION AT COPILOT SEAT

SYM	AVG GROSS WEIGHT (LB)	AVG LONGITUDINAL CG LOCATION (FS)	AVG DENSITY ALTITUDE (FEET)	AVG OAT (DEG C)	AVG ROTOR SPEED (RPM)	FLIGHT CONDITION
⊙	34140	930.9 (MID)	2650	20.0	225	LEVEL
⊠	41200	930.1 (MID)	1020	18.0	225	LEVEL

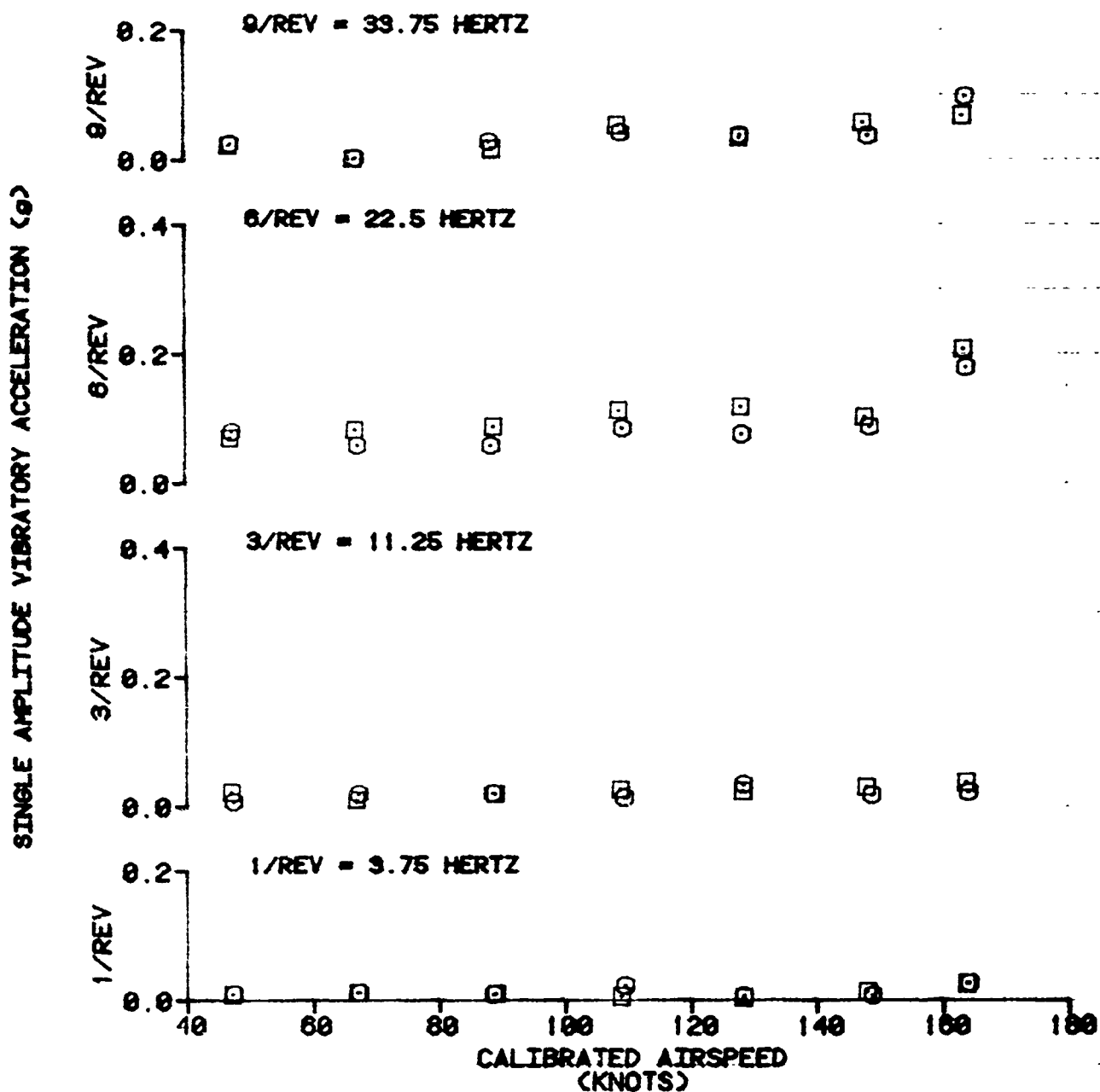

FIGURE 124

VIBRATION CHARACTERISTICS
CH-47D USA S/N 81-29389

LONGITUDINAL VIBRATION AT PILOT SEAT

SYN	AVG GROSS WEIGHT (LB)	AVG LONGITUDINAL CG LOCATION (FS)	AVG DENSITY ALTITUDE (FEET)	AVG OAT (DEG C)	AVG ROTOR SPEED (RPM)	FLIGHT CONDITION
⊙	34140	330.9 (MID)	2050	20.0	225	LEVEL
⊠	41200	330.1 (MID)	1020	18.0	225	LEVEL

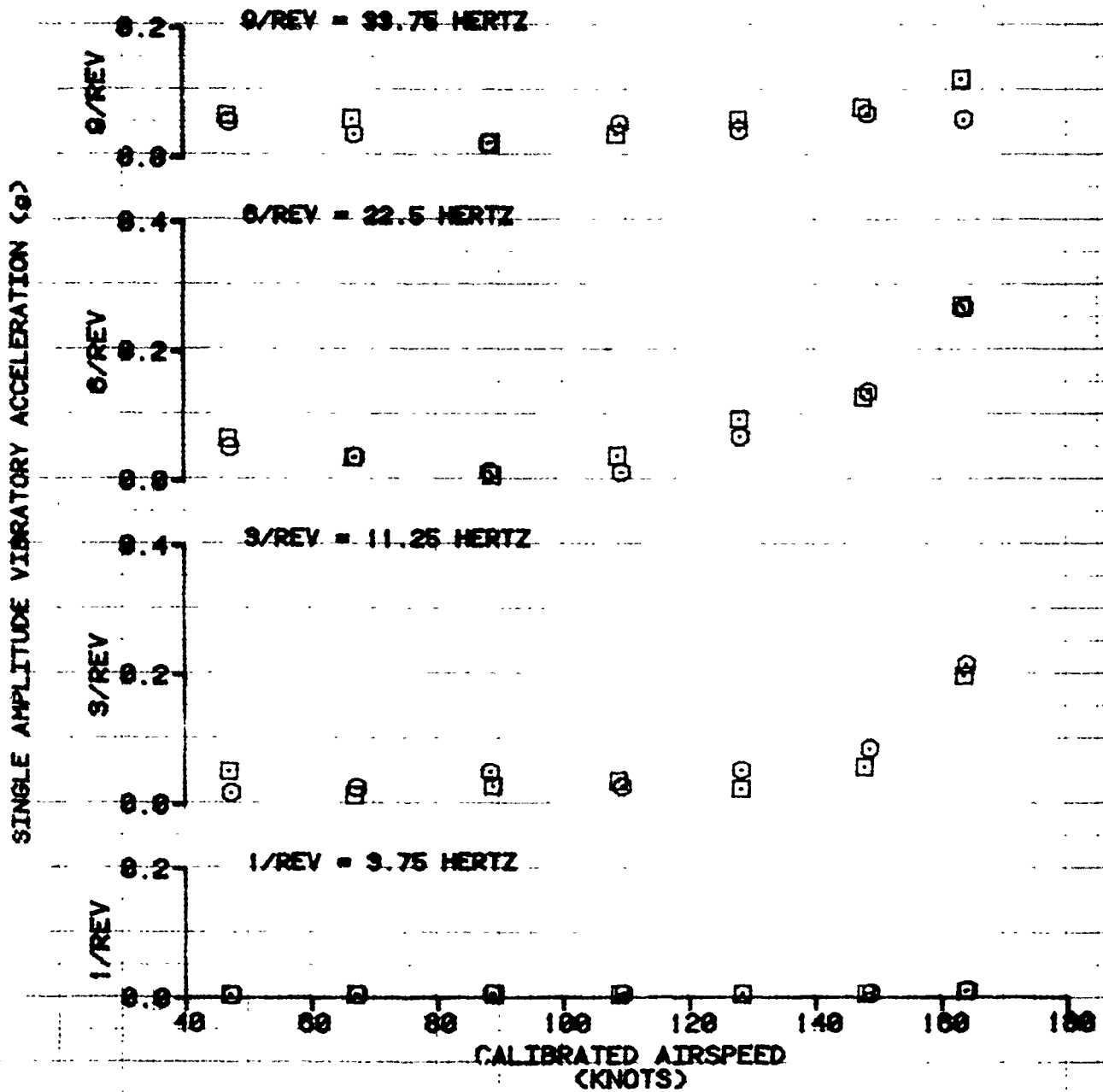

FIGURE 125
 VIBRATION CHARACTERISTICS
 CH-47D USA S/N 81-23383
 LATERAL VIBRATION AT PILOT SEAT

SYM	AVG GROSS WEIGHT (LB)	AVG LONGITUDINAL CG LOCATION (FS)	AVG DENSITY ALTITUDE (FEET)	AVG OAT (DEG C)	AVG ROTOR SPEED (RPM)	FLIGHT CONDITION
⊙	34140	330.9(MID)	2850	20.0	225	LEVEL
⊠	41200	330.1(MID)	1620	18.0	225	LEVEL

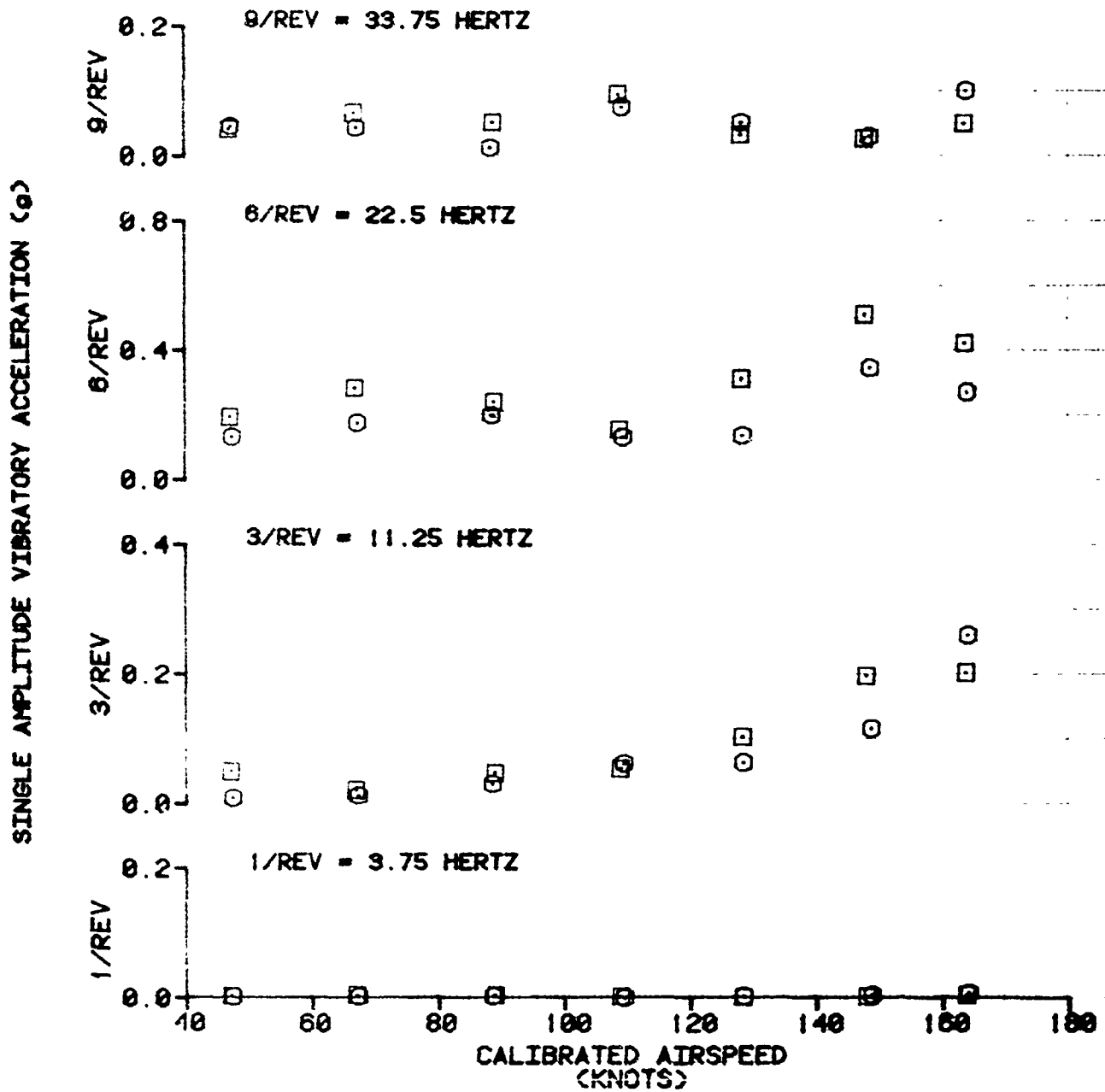

FIGURE 126
VIBRATION CHARACTERISTICS
CH-47D USA S/N 81-23383
VERTICAL VIBRATION AT PILOT SEAT

SYM	AVG GROSS WEIGHT (LB)	AVG LONGITUDINAL CG LOCATION (FS)	AVG DENSITY ALTITUDE (FEET)	AVG OAT (DEG C)	AVG ROTOR SPEED (RPM)	FLIGHT CONDITION
⊙	34148	339.9 (MED)	2858	29.0	225	LEVEL
⊠	41280	339.1 (MED)	1628	18.0	225	LEVEL

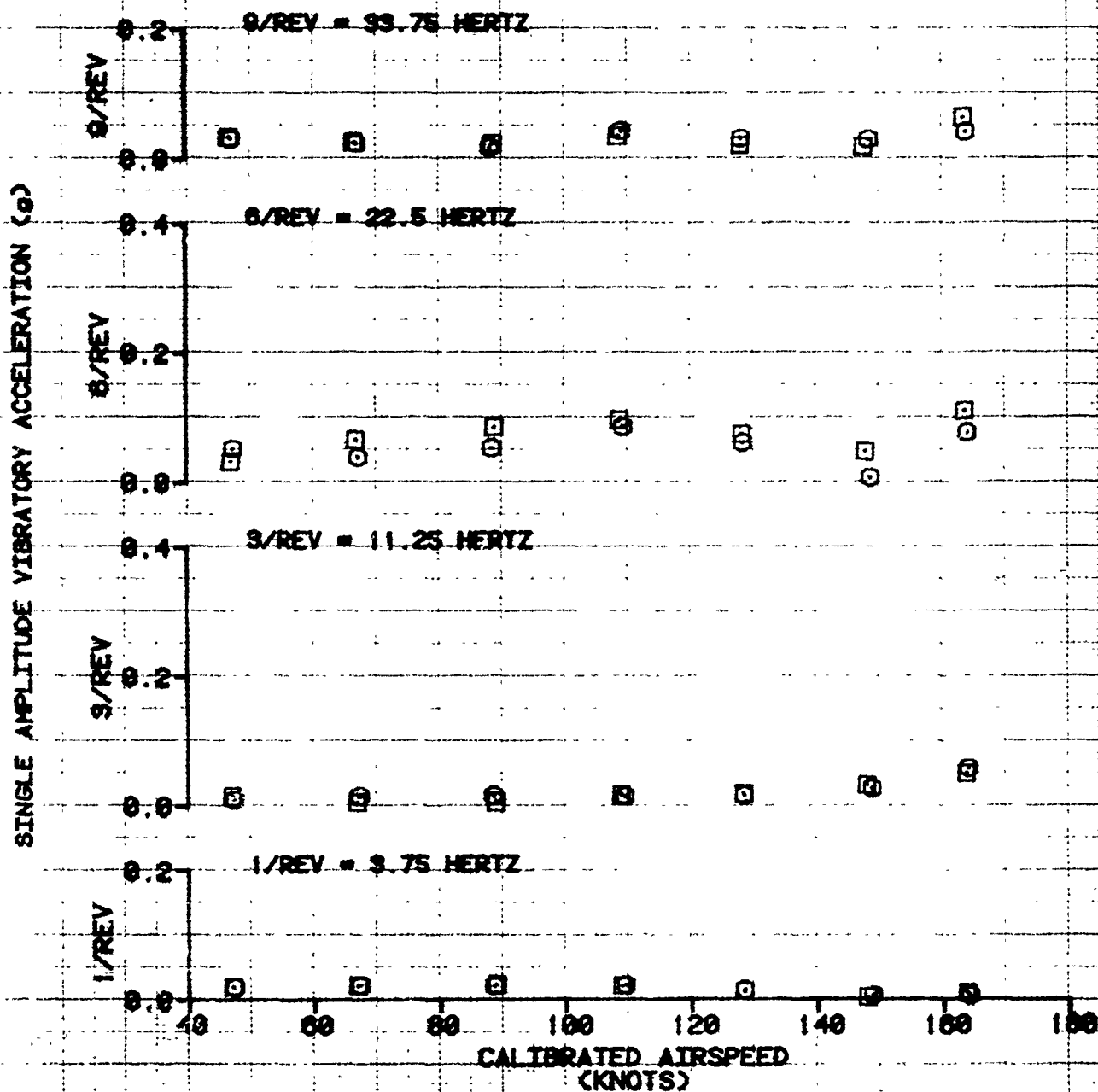

FIGURE 127
 VIBRATION CHARACTERISTICS
 CH-47D USA S/N 81-23383
 LATERAL VIBRATION AT FS 95 BL 0

SYM	AVG GROSS WEIGHT (LB)	AVG LONGITUDINAL CG LOCATION (FS)	AVG DENSITY ALTITUDE (FEET)	AVG OAT (DEG C)	AVG ROTOR SPEED (RPM)	FLIGHT CONDITION
⊙	34140	330.9(MID)	2850	29.0	225	LEVEL
⊠	41200	330.1(MID)	1620	18.0	225	LEVEL

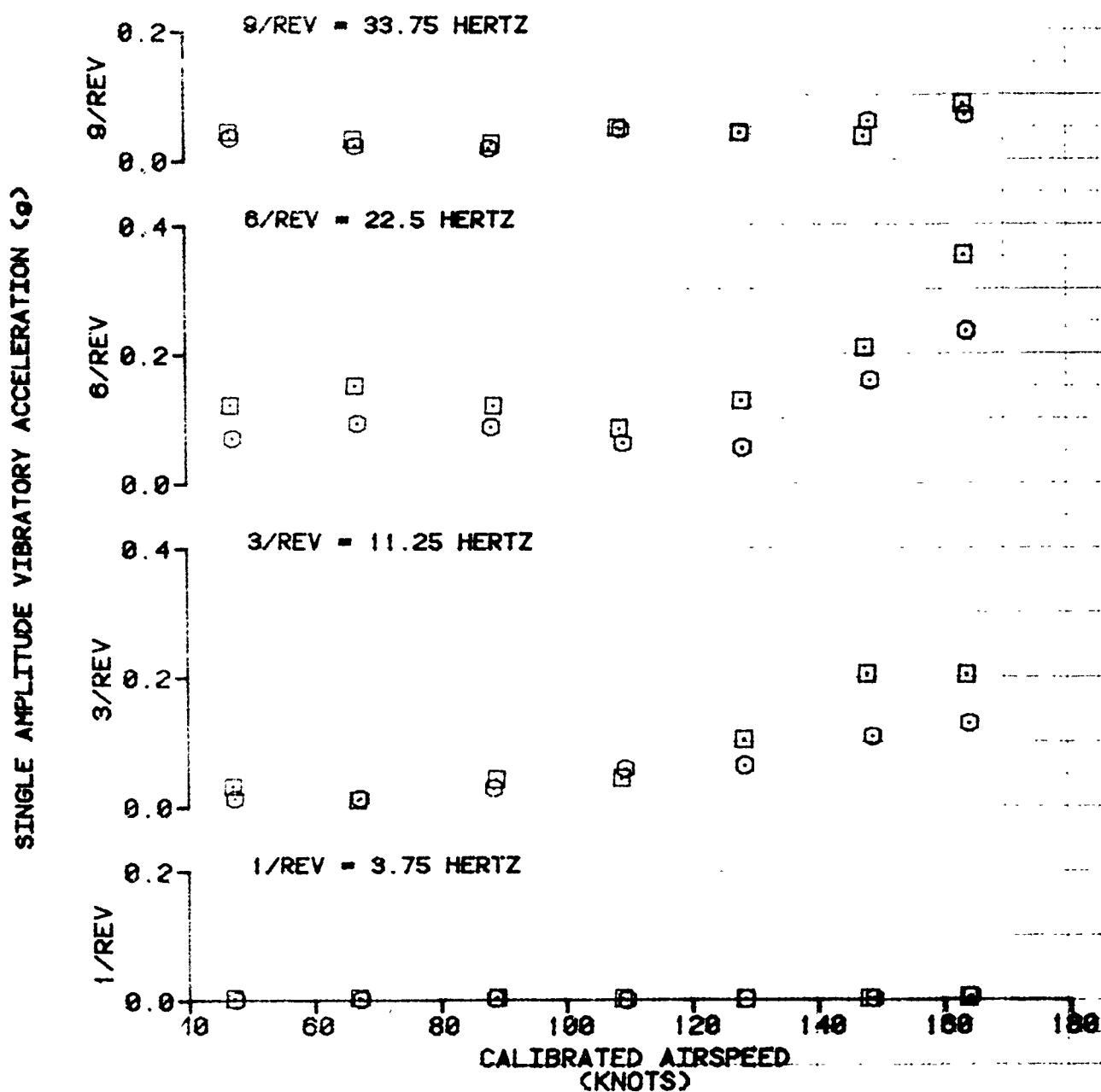

FIGURE 128

VIBRATION CHARACTERISTICS
 CH-47D USA S/N 81-23383

VERTICAL VIBRATION AT FS 95 BL 0

SYM	AVG GROSS WEIGHT (LB)	AVG LONGITUDINAL CG LOCATION (FS)	AVG DENSITY ALTITUDE (FEET)	AVG OAT (DEG C)	AVG ROTOR SPEED (RPM)	FLIGHT CONDITION
⊙	34140	330.9(MID)	2650	20.0	225	LEVEL
⊠	41200	330.1(MID)	1620	18.0	225	LEVEL

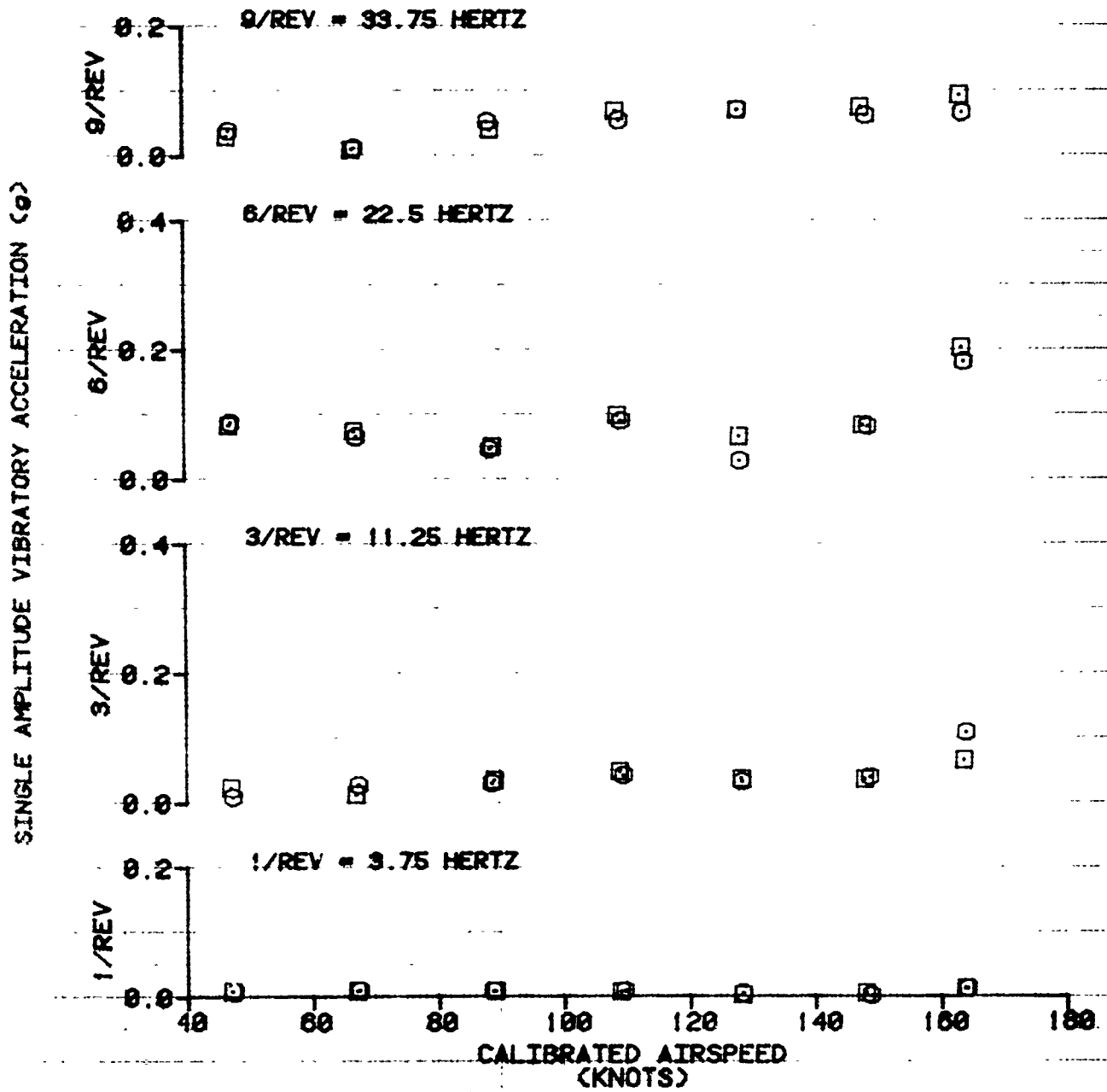

FIGURE 129
 VIBRATION CHARACTERISTICS
 CH-47D USA S/N 81-23383
 VERTICAL VIBRATION AT FS 50 BL 33 RIGHT

SYM	AVG GROSS WEIGHT (LB)	AVG LONGITUDINAL CG LOCATION (FS)	AVG DENSITY ALTITUDE (FEET)	AVG OAT (DEG C)	AVG ROTOR SPEED (RPM)	FLIGHT CONDITION
⊙	3140	330.9(MID)	2850	20.0	225	LEVEL
⊠	41200	330.1(MID)	1620	18.0	225	LEVEL

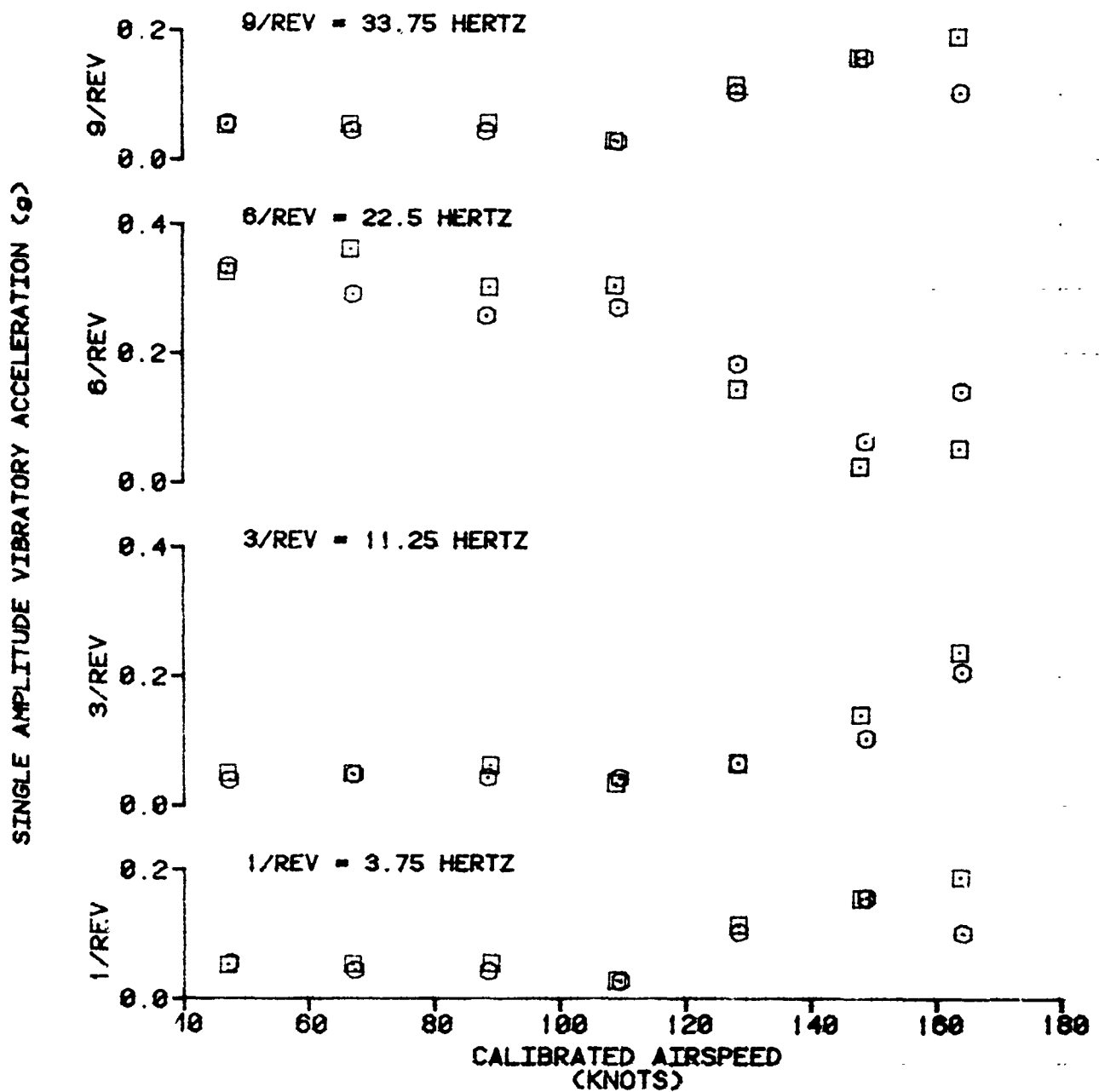

FIGURE 130
 VIBRATION CHARACTERISTICS
 CH-47D USA S/N 81-23383

VERTICAL VIBRATION AT FS 58 BL 33 LEFT

SYM	AVG GROSS WEIGHT (LB)	AVG LONGITUDINAL CG LOCATION (FS)	AVG DENSITY ALTITUDE (FEET)	AVG OAT (DEG C)	AVG ROTOR SPEED (RPM)	FLIGHT CONDITION
⊙	34140	330.9(MID)	2850	20.0	225	LEVEL
⊠	41200	330.1(MID)	1620	18.0	225	LEVEL

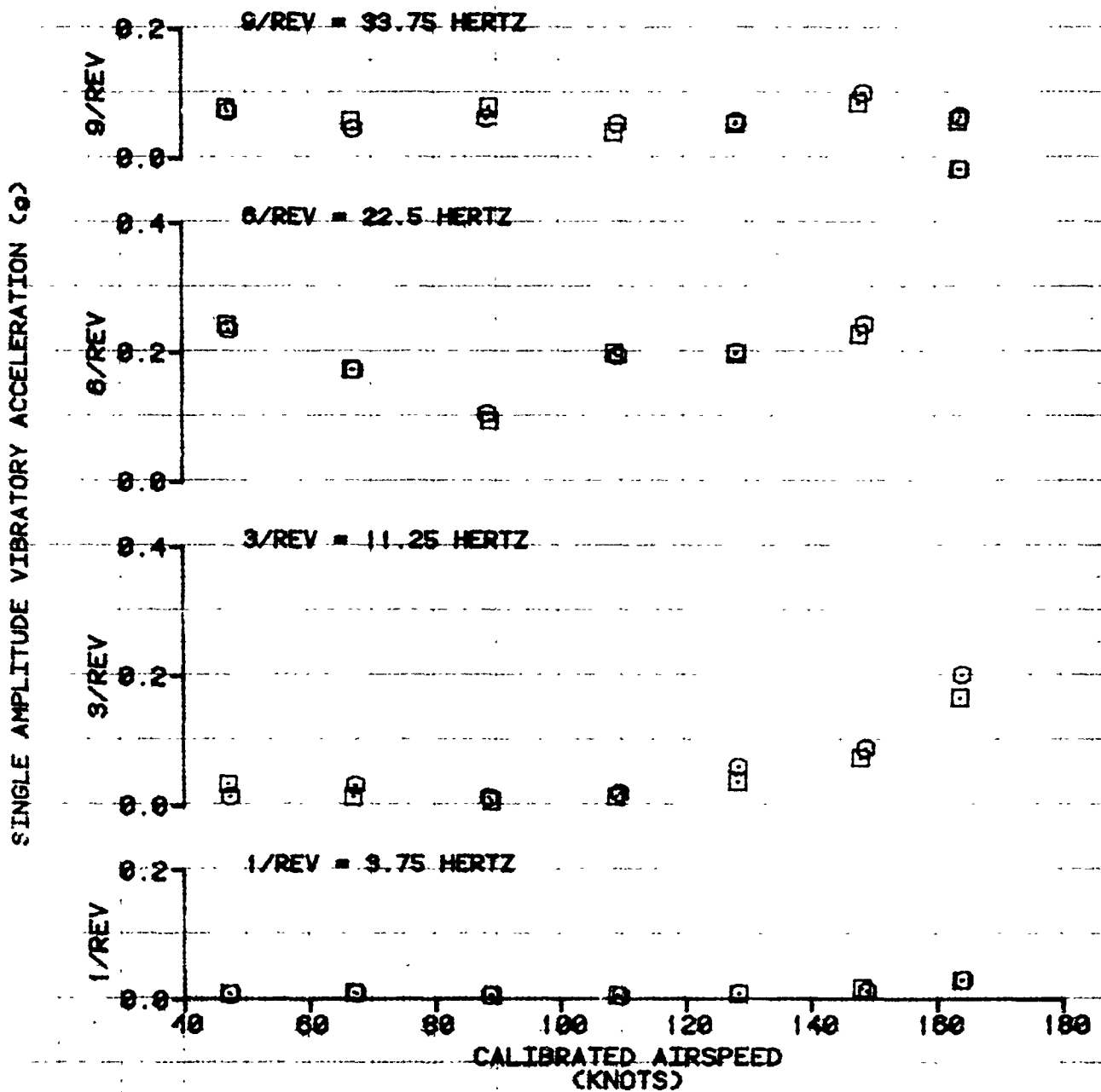

Figure 131. Level Flight Vibration Comparison¹

True Airspeed	1/Rev Vertical Vib. at FS 50 BL 33 Right		3/Rev Vertical Vib. at FS 50 BL 33 Right		3/Rev Lateral Vib. at FS 95 BL 0		3/Rev Vertical Vib. at FS 320 BL 44 Left		Pilot Ratings (VRS) ⁴			
	VADI ²		VADI		VADI		VADI					
	(%)	(g)	(%)	(g)	(%)	(g)	(%)	(g)				
33.5	32	0.022	0.013	0.075	0.056	<30	<0.450	0.017	<30	<0.150	0.040	3
43.5	30	0.021	0.019	<30	0.037	<30	<0.450	0.023	<30	<0.150	0.027	3
52.0	33	0.023	0.018	<30	0.024	<30	<0.450	0.007	<30	<0.150	0.019	3
62.0	38	0.027	0.023	<30	0.026	<30	<0.450	0.006	<30	<0.150	0.021	3
72.5	38	0.027	0.023	<30	0.042	<30	<0.450	0.016	<30	<0.150	0.022	3
85.0	39	0.027	0.022	30	0.052	<30	<0.450	0.022	<30	<0.150	0.025	2
96.5	38	0.027	0.021	<30	0.046	<30	<0.450	0.031	<30	<0.150	0.025	3
107.0	37	0.026	0.022	<30	0.052	42	0.063	0.058	<30	<0.150	0.025	3
118.5	38	0.027	0.024	<30	0.038	32	0.048	0.056	<30	<0.150	0.024	3
128.0	38	0.027	0.024	<30	0.039	38	0.057	0.066	<30	<0.150	0.044	3
140.0	32	0.022	0.019	30	0.055	54	0.081	0.091	<30	<0.150	0.069	3
150.0	30	0.021	0.017	34	0.085	68	0.102	0.100	<30	<0.150	0.099	4
150.5	<30	<0.021	---	45	0.113	65	0.098	---	30	0.150	---	5
171.0	<30	<0.021	0.011	90	0.225	95	0.143	0.134	48	0.240	0.225	6
180.0	<30	<0.021	0.008	107	0.268	105	0.158	0.167	50	0.250	0.236	7

NOTES:

- ¹Gross weight = 34,600 lb, Longitudinal Center of Gravity = FS 329.9 (MID), Density Altitude = 4880 ft, Free Air Temperature = 17.5 Deg C, Rotor Speed = 225 rpm, Ballast and Instrumentation Systems Installed.
- ²VADI = Vibration Amplitude and Direction Indicator, reading in percent of limit in Acceptance Test Procedure.
- ³FFT = Fast Fourier Transform method of processing
- ⁴VRS = Vibration Rating Scale

Figure 132. Climbing Flight Vibration Comparison¹

True Airspeed (knots)	1/Rev Vertical Vib. at FS 50 BL 33 Right		3/Rev Vertical Vib. at FS 50 BL 33 Right		3/Rev Lateral Vib. at FS 95 BL 0		3/Rev Vertical Vib. at FS 320 BL 44 Left		Pilot Ratings (VRS) ⁴					
	VADI ²		VADI		VADI		VADI							
	(%)	(g)	(%)	(g)	(%)	(g)	(%)	(g)						
33.5	32	0.022	<30	<0.075	0.041	<30	<0.045	<30	<0.150	0.041	<30	<0.150	0.041	3
42.5	34	0.024	<30	<0.075	0.042	<30	<0.045	<30	<0.150	0.026	<30	<0.150	0.035	3
52.0	38	0.027	<30	<0.075	0.036	<30	<0.045	<30	<0.150	0.013	<30	<0.150	0.033	3
62.0	40	0.028	<30	<0.075	0.040	<30	<0.045	<30	<0.150	0.015	<30	<0.150	0.034	3
73.5	40	0.028	<30	<0.075	0.038	<30	<0.045	<30	<0.150	0.016	<30	<0.150	0.032	3
86.0	38	0.027	<30	<0.075	0.037	<30	<0.045	<30	<0.150	0.014	<30	<0.150	0.027	3
97.0	38	0.027	<30	<0.075	0.042	<30	<0.045	<30	<0.150	0.035	<30	<0.150	0.027	3
107.0	38	0.027	<30	<0.075	0.028	30	0.045	30	<0.150	0.047	<30	<0.150	0.012	3
119.0	40	0.028	<30	<0.075	0.019	35	0.053	35	<0.150	0.050	<30	<0.150	0.025	2
128.5	37	0.026	<30	<0.075	0.033	41	0.062	41	<0.150	0.067	<30	<0.150	0.048	3
140.0	35	0.025	<30	<0.075	---	48	0.072	48	<0.150	---	<30	<0.150	---	4
148.5	30	0.021	34	0.085	0.074	45	0.068	45	<0.150	0.079	<30	<0.150	0.105	4
160.0	<30	<0.021	45	0.113	0.128	72	0.108	72	0.185	0.103	37	0.185	0.181	5
168.5	<30	<0.021	90	0.225	0.219	106	0.159	106	0.300	0.156	60	0.300	0.274	8

NOTES:

- 1Gross weight = 33,560 lb, Longitudinal Center of Gravity = FS 330.4 (MID), Density Altitude = 4880 ft, Free Air Temperature = 17.0 Deg C, Rotor Speed = 225 rpm, Ballast and Instrumentation Systems Installed.
- 2VADI = Vibration Amplitude and Direction Indicator, reading in percent of limit in Acceptance Test Procedure.
- 3FFT = Fast Fourier Transform method of processing
- 4VRS = Vibration Rating Scale

Figure 133. Descending Flight Vibration Comparison¹

True Airspeed	1/Rev Vertical Vib. at FS 50 BL 33 Right		3/Rev Vertical Vib. at FS 50 BL 33 Right		3/Rev Lateral Vib. at FS 95 BL 0		3/Rev Vertical Vib. at FS 320 BL 44 Left		Pilot Ratings			
	VADI2		VADI		VADI		VADI					
	(%)	(g)	(%)	(g)	(%)	(g)	(%)	(g)				
30.0	35	0.025	0.021	0.113	0.094	<30	0.045	0.050	<30	<0.150	0.122	4
41.0	32	0.022	0.021	0.075	0.058	32	0.048	0.037	<30	<0.150	0.062	3
49.0	40	0.028	0.024	0.100	0.093	42	0.063	0.072	<30	<0.150	0.088	4
60.5	38	0.027	0.023	0.075	0.081	38	0.057	0.058	<30	<0.150	0.082	3
72.0	32	0.022	0.020	0.105	0.011	40	0.060	0.070	<30	<0.150	0.087	3
83.0	42	0.029	0.026	0.075	0.078	44	0.066	0.067	<30	<0.150	0.070	4
94.5	40	0.028	0.025	0.088	0.094	58	0.087	0.087	<30	<0.150	0.075	4
107.0	38	0.027	0.024	0.080	0.078	58	0.087	0.086	<30	<0.150	0.055	4
116.5	35	0.025	0.023	<0.075	0.064	60	0.090	0.088	<30	<0.150	0.045	3
130.0	32	0.022	0.019	0.075	0.071	55	0.083	0.091	<30	<0.150	0.056	3
138.5	30	0.021	0.017	0.075	0.067	60	0.090	0.095	<30	<0.150	0.079	3
148.5	30	0.021	0.017	0.095	0.093	91	0.137	0.124	<30	<0.150	0.102	4
158.5	<30	<0.021	0.006	0.130	0.124	85	0.128	0.127	30	0.150	0.132	5
170.0	<30	<0.021	0.004	0.195	0.193	88	0.132	0.132	43	0.215	0.194	6

NOTES:

¹Gross weight = 33,320 lb, Longitudinal Center of Gravity = FS 330.5 (MID), Density Altitude = 4640 ft,

Free Air Temperature = 17.0 Deg C, Rotor Speed = 225 rpm, Ballast and Instrumentation Systems Installed.

²VADI = Vibration Amplitude and Direction Indicator, reading in percent of limit in Acceptance Test Procedure.

³FFT = Fast Fourier Transform method of processing

⁴VRS = Vibration Rating Scale

Figure 134. Level Flight Vibration Data (ATP Configuration)¹

True Airspeed (knots)	1/Rev Vertical Vib. at				3/Rev Vertical Vib. at				3/Rev Lateral Vib. at			3/Rev Vertical Vib. at			Pilot Rating (VRS) ²			
	FS	50	BL	33	Lt	FS	50	BL	33	LT	FS	95	BL	0		FS	320	BL
	(%)				(%)				(%)			(%)						
54.5	32				<30				<30			<30			2			
69.5	30				30				<30			<30			2			
86.5	32				30				30			<30			3			
106.0	30				30				38			<30			3			
125.0	30				30				40			<30			4			
140.0	<30				35				55			30			5			
145.0	<30				45				55			35			6			
149.0	<30				62				52			45			7			
156.5	<30				75				70			52			8			

NOTES:

¹Gross Weight = 29,340 lb, Longitudinal Center of Gravity = FS 331.8 (MTD), Density Altitude = 2260 ft, Free Air Temperature = 9.5 Deg C, Rotor Speed = 225 rpm, Ballast and Instrumentation Systems removed, all readings from the Vibration Amplitude and Direction Indicator (VADI) in percent of limit in Acceptance Test Procedure.

²VRS = Vibration Rating Scale (see encl 2)

Figure 135. Level Flight Vibration Data (PIDS Configuration)¹

True Airspeed (knots)	1/Rev Vertical Vib. at FS 50 BL 33 Lt (%)	3/Rev Vertical Vib. at FS 50 BL 33 LT (%)	3/Rev Lateral Vib. at FS 95 BL 0 (%)	3/Rev Vertical Vib. at FS 320 BL 44 LT (%)	Pilot Rating (VRS) ²
53.5	32	<30	<30	<30	3
69.0	32	<30	<30	<30	3
86.0	30	<30	<30	<30	2
104.5	32	<30	<30	<30	4
123.5	30	<30	33	<30	4
140.0	30	43	55	30	5
143.5	<30	45	63	30	6
150.0	<30	65	85	40	7
154.0	<30	85	80	43	8

NOTES:

¹Gross Weight = 36,780 lb, Longitudinal Center of Gravity = FS 327.3 (MID), Density Altitude = 1640 ft, Free Air Temperature = 4.5 Deg C, Rotor Speed = 225 rpm, Ballast and Instrumentation Systems removed, all readings from the Vibration Amplitude and Direction Indicator (VADI) in percent of limit in Acceptance Test Procedure.

²VRS = Vibration Rating Scale (see encl 2)

Figure 136. Descending Flight Vibration Data (ATP Configuration)¹

Descent Rate (ft/min)	True Airspeed (knots)	1/Rev Vertical Vib. at FS 50 BL 33 Lt (%)	3/Rev Vertical Vib. at FS 50 BL 33 LT (%)	3/Rev Lateral Vib. at FS 95 BL 0 (%)	3/Rev Vertical Vib. at FS 320 BL 44 LT (%)	Pilot Rating (VRS) ²
500 fpm	70.0	35	38	62	30	4
1000 fpm	70.0	35	50	85	33	4
1500 fpm	70.0	40	60	105	35	5
500 fpm	106.0	30	40	58	<30	4
1000 fpm	110.0	30	35	80	<30	5
1500 fpm	107.0	30	45	105	<30	6

NOTES:

¹Gross Weight = 29,360 lb, Longitudinal Center of Gravity = FS 332.4 (MID), Density Altitude = 2760 ft, Free Air Temperature = 8.0 Deg C, Rotor Speed = 225 rpm, Ballast and Instrumentation Systems removed, all readings from the Vibration Amplitude and Direction Indicator (VADI) in percent of limit in Acceptance Test Procedure.

²VRS = Vibration Rating Scale (see encl 2)

Figure 137. Descending Flight Vibration Data (PIDS Configuration)¹

Descent Rate (ft/min)	True Airspeed (knots)	1/Rev Vertical Vib. at FS 50 BL 33 Lt (%)	3/Rev Vertical Vib. at FS 50 BL 33 LT (%)	3/Rev Lateral Vib. at FS 95 BL 0 (%)	3/Rev Vertical Vib. at FS 320 BL 44 LT (%)	Pilot Rating (VRS) ²
500 fpm	70.0	35	34	38	<30	4
1000 fpm	69.0	33	38	40	30	4
1500 fpm	69.0	40	40	90	35	5
500 fpm	105.0	30	35	50	<30	4
1000 fpm	105.0	32	40	55	<30	5
1500 fpm	105.0	34	50	60	<30	5

NOTES:

¹Gross Weight = 35,700 lb, Longitudinal Center of Gravity = FS 327.7 (MTD), Density Altitude = 2020 ft, Free Air Temperature = 6.0 Deg C, Rotor Speed = 225 rpm, Ballast and Instrumentation Systems removed, all readings from the Vibration Amplitude and Direction Indicator (VADI) in percent of limit in Acceptance Test Procedure.

²VRS = Vibration Rating Scale (see encl 2)

FIGURE 138
SHIPS SYSTEM AIRSPEED CALIBRATION IN LEVEL FLIGHT
CH-47D USA S/N 81-23383

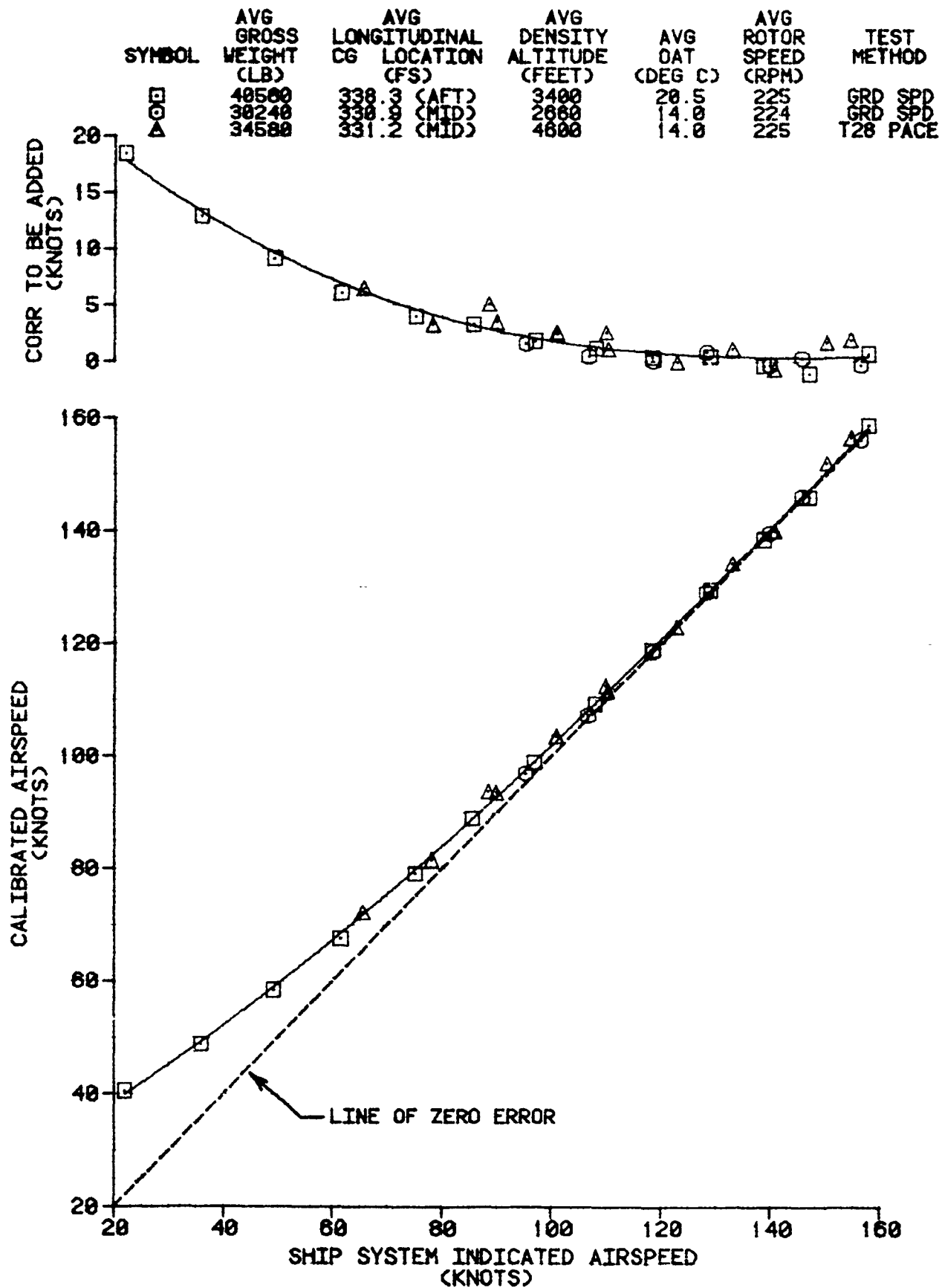

FIGURE 139
SHIPS SYSTEM AIRSPEED CALIBRATION
CH-47D USA S/N 81-23383

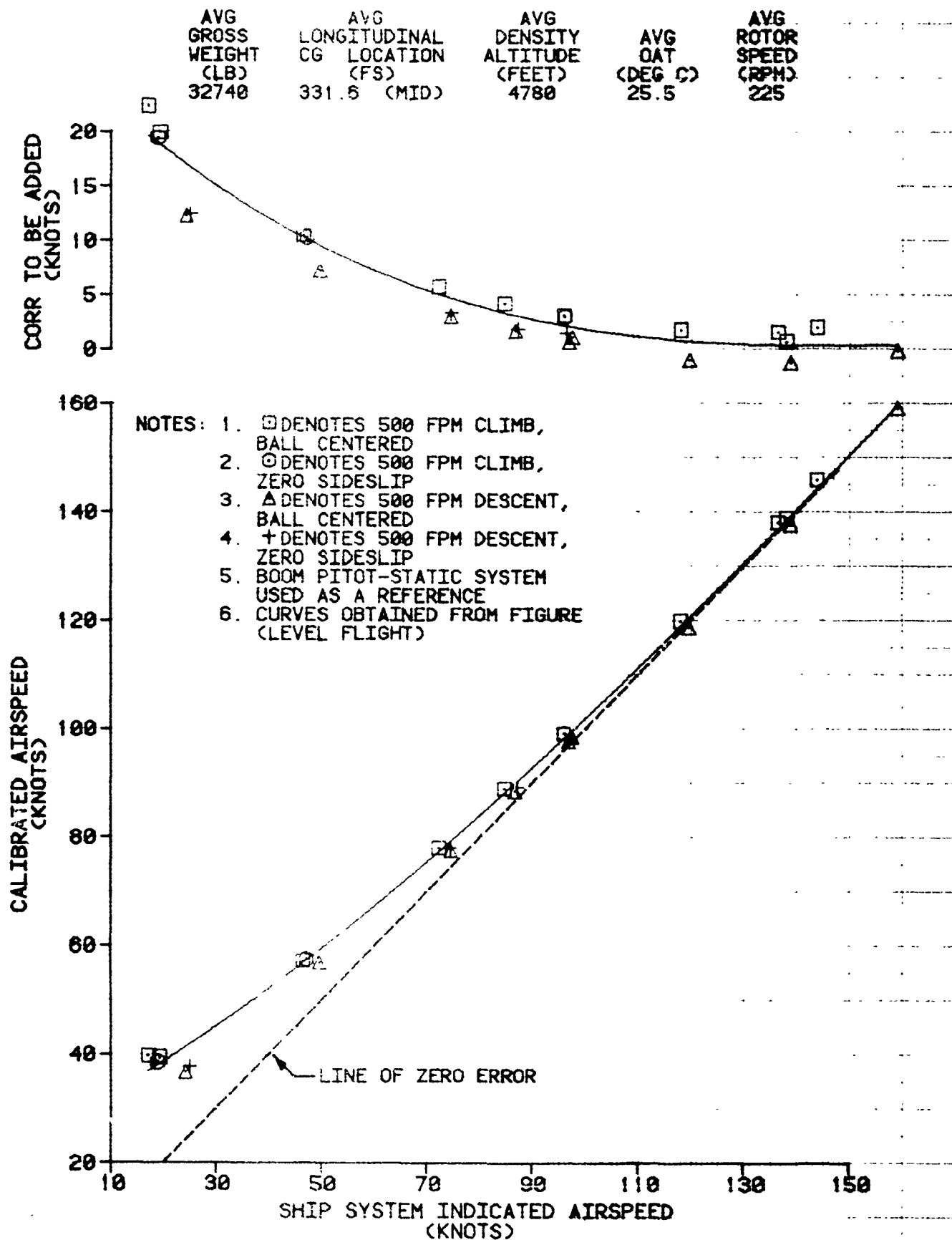

FIGURE 140
SHIPS SYSTEM AIRSPEED CALIBRATION
 CH-47D USA S/N 81-23383
 BUBBLE WINDOWS INSTALLED

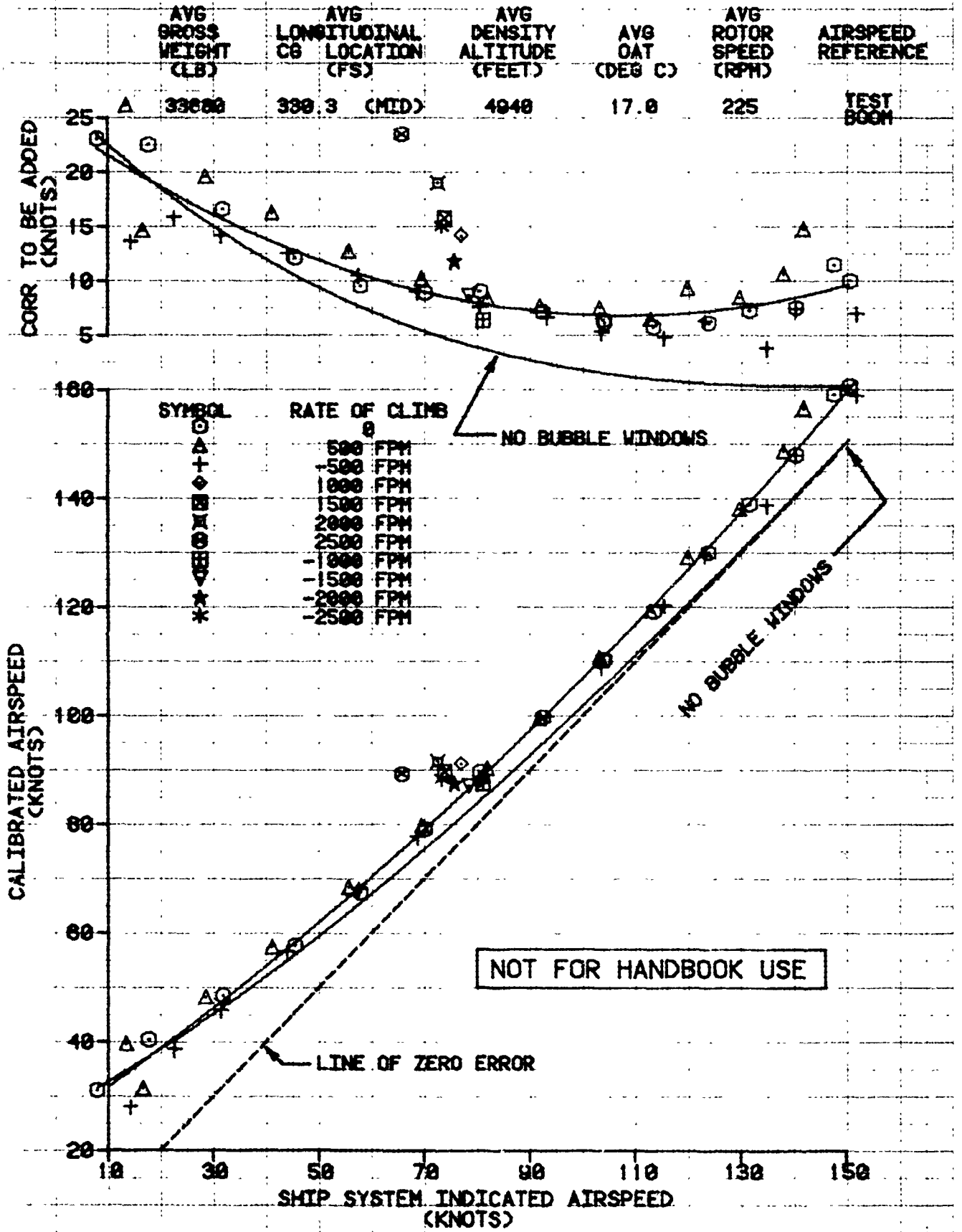

FIGURE 141
 SHAFT HORSEPOWER AVAILABLE
 CH-47D
 MAXIMUM CONTINUOUS POWER
 ENGINE SPEED 15066 RPM (225 RPM)

- NOTES:
1. STATIC CONDITIONS
 2. AIR BLEED: ZERO
 3. HP EXTRACTION ZERO
 4. INLET TEMPERATURE RISE: ZERO
 5. ANTI-ICE OFF
 6. CH-47D PRESSURE LOSS: REFERENCE BY DOCUMENT NUMBER D210-11920-1 DATED JUNE 9, 1982
 7. BASED ON AVCO LYCOMING ENGINE MODEL SPECIFICATION T55-L-712 FILE NO. 19.31.51.13 DATED JUNE 27, 1983

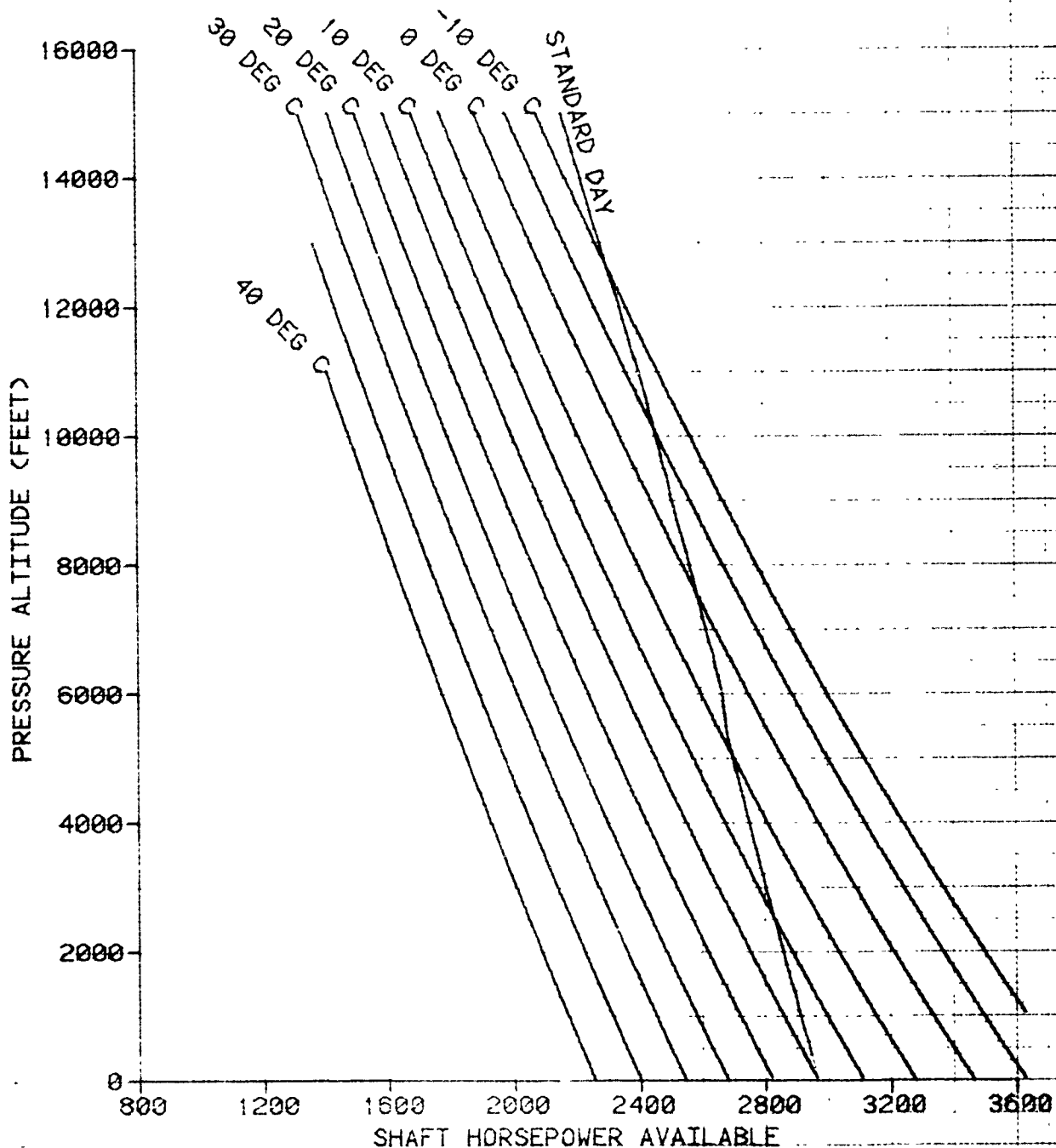

FIGURE 142
SHAFT HORSEPOWER AVAILABLE
CH-47D

INTERMEDIATE RATED POWER (30 MINUTE LIMIT)
ENGINE SPEED 15066 RPM (225 RPM)

- NOTES:
1. STATIC CONDITIONS
 2. AIR BLEED: ZERO
 3. HP EXTRACTION: ZERO
 4. INLET TEMPERATURE RISE: ZERO
 5. ANTI-ICE OFF
 6. CH-47D PRESSURE LOSS: REFERENCE BY DOCUMENT NUMBER D210-11920-1 DATED JUNE 9, 1982
 7. BASED ON AVCO LYCOMING ENGINE MODEL SPECIFICATION T55-L-712 FILE NO. 19-31-51-13 DATED JUNE 27, 1983

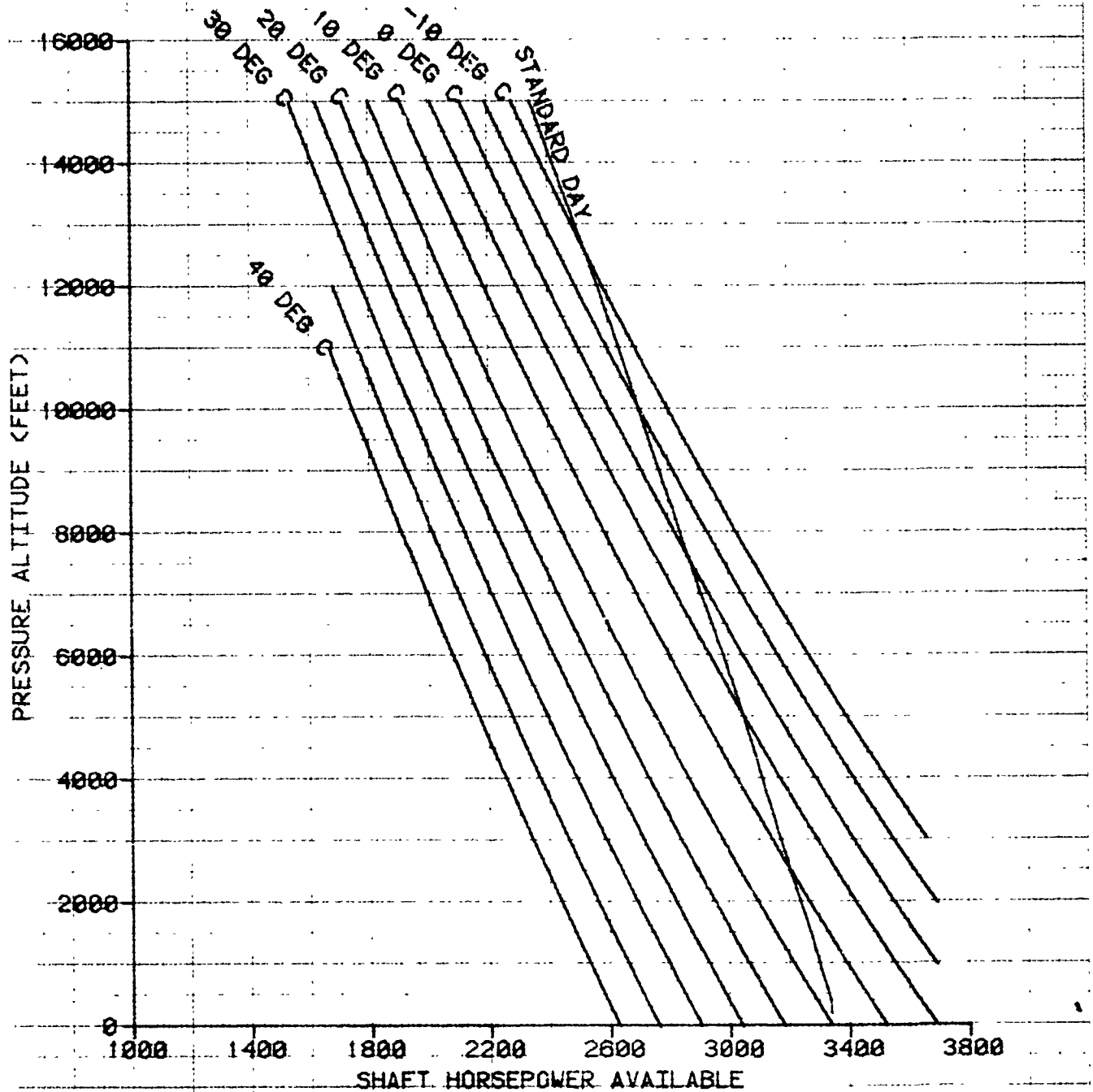

FIGURE 143
 SHAFT HORSEPOWER AVAILABLE
 CH-47D
 MAXIMUM RATED POWER (10 MINUTE LIMIT)
 ENGINE SPEED 5066 RPM (225 RPM)

- NOTES:
1. STATIC CONDITIONS
 2. AIR BLEED: ZERO
 3. HP EXTRACTION: ZERO
 4. INLET TEMPERATURE RISE: ZERO
 5. ANTI-ICE OFF
 6. CH-47D PRESSURE LOSS: REFERENCE BY DOCUMENT NUMBER D210-11920-1 DATED JUNE 9, 1982
 7. BASED ON AVCO LYCOMING ENGINE MODEL SPECIFICATION T55-L-712 FILE NO. 19.31.51.13 DATED JUNE 27, 1983

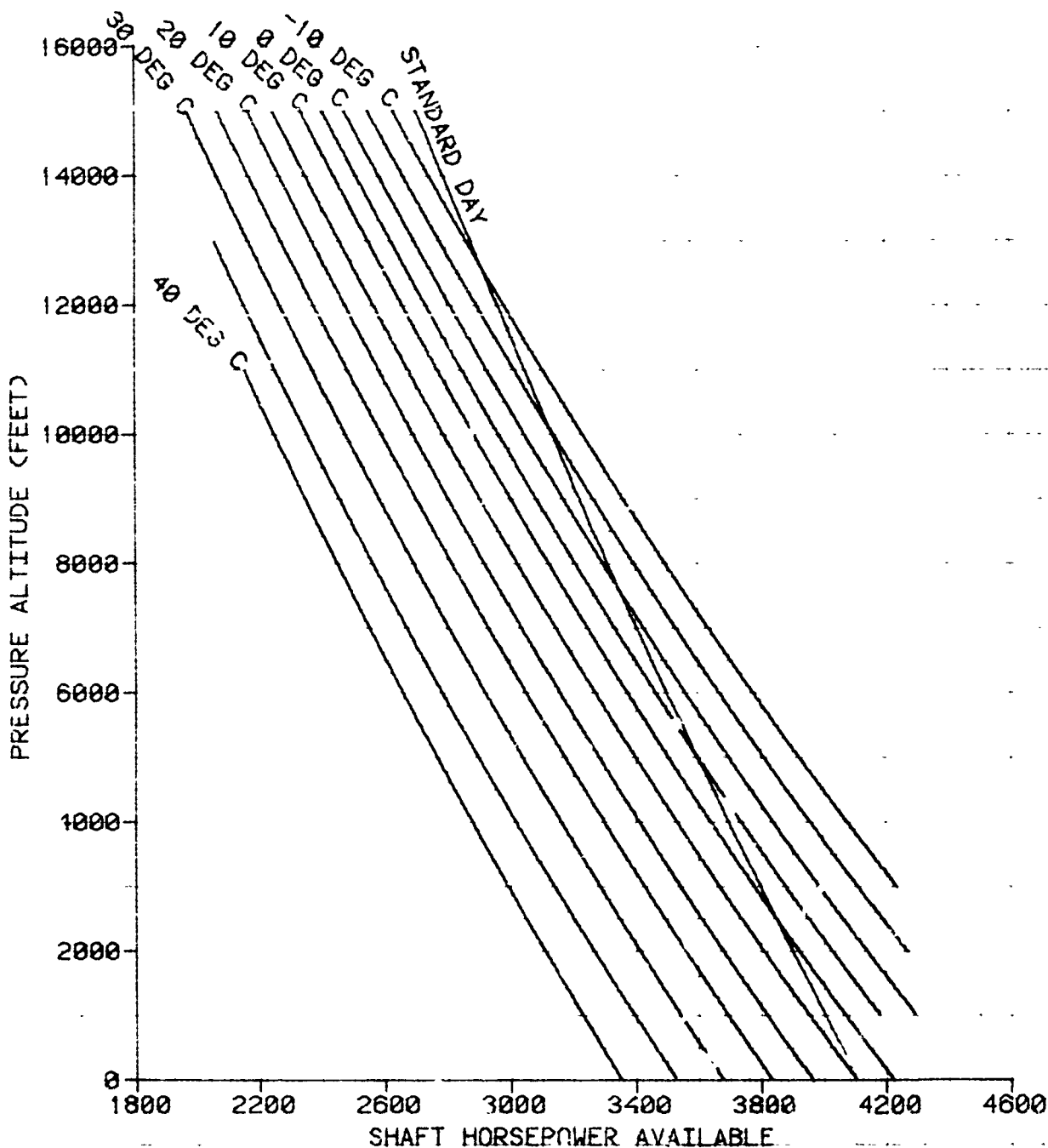

FIGURE 144
 SHAFT HORSEPOWER AVAILABLE
 CH-47D
 EMERGENCY RATED POWER
 ENGINE SPEED 15066 RPM (225 RPM)

- NOTES:
1. STATIC CONDITIONS
 2. AIR BLEED: ZERO
 3. HP EXTRACTION: ZERO
 4. INLET TEMPERATURE RISE: ZERO
 5. ANTI-ICE OFF
 6. CH-47D PRESSURE LOSS: REFERENCE BY DOCUMENT NUMBER D210-11920-1 DATED JUNE 9, 1982
 7. BASED ON AVCO LYCOMING ENGINE MODEL SPECIFICATION T55-L-712 FILE NO. 19.31.51.13 DATED JUNE 27, 1983

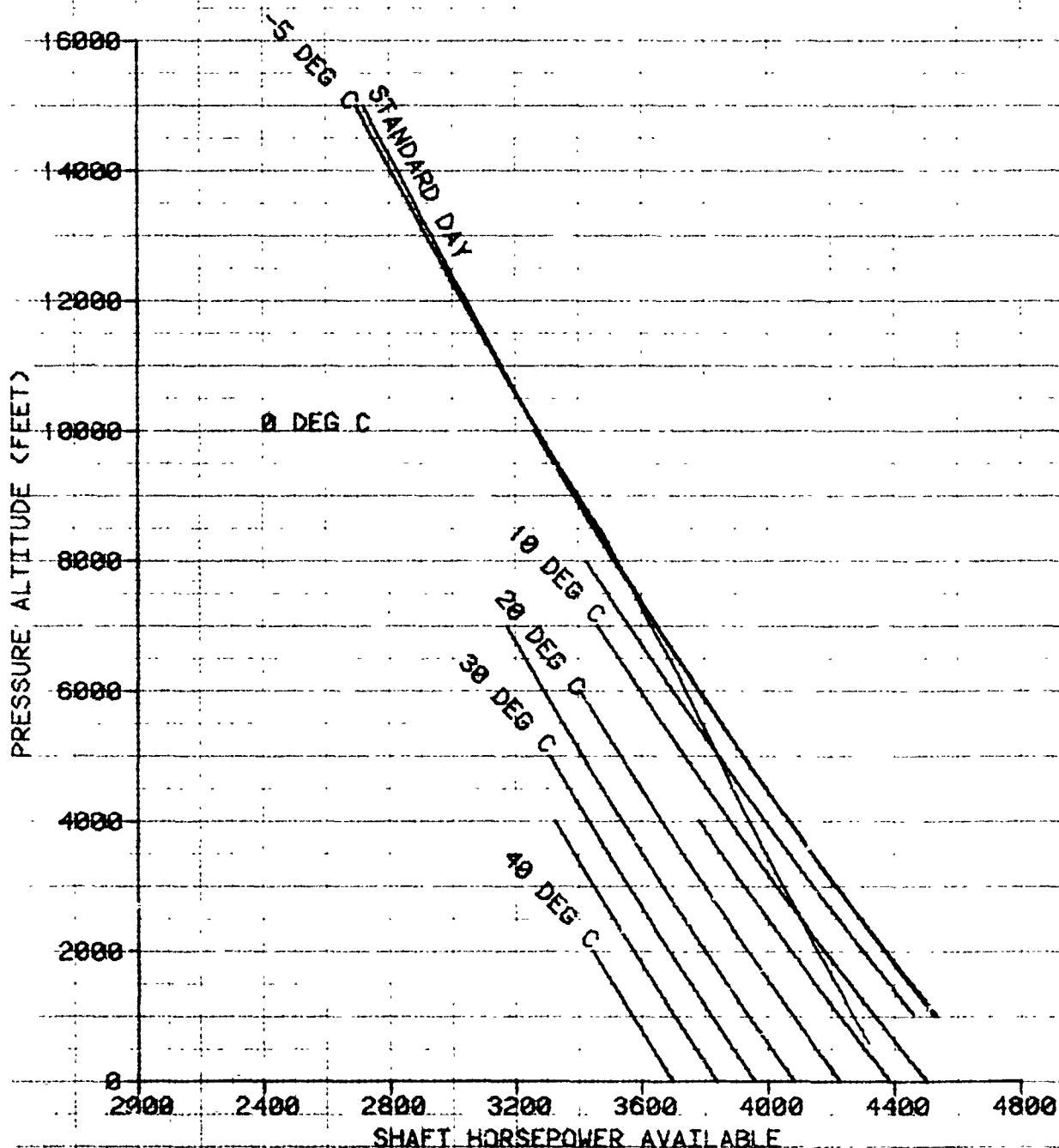

FIGURE 145
 FUEL FLOW
 CH-47D USA S/N 81-23383
 STANDARD DAY CONDITIONS
 ENGINE SPEED = 15066 RPM (225 RPM)

- NOTES:
1. STATIC CONDITIONS
 2. AIR BLEED: ZERO
 3. HP EXTRACTION: ZERO
 4. INLET TEMPERATURE RISE: ZERO
 5. ANTI-ICE OFF
 6. CH-47D PRESSURE LOSS: REFERENCE BY DOCUMENT NUMBER D210-11920-1 DATED JUNE 9, 1982
 7. BASED ON AVCO LYCOMING ENGINE MODEL SPECIFICATION T55-L-712 FILE NO. 19.31.51.13 DATED JUNE 27, 1983

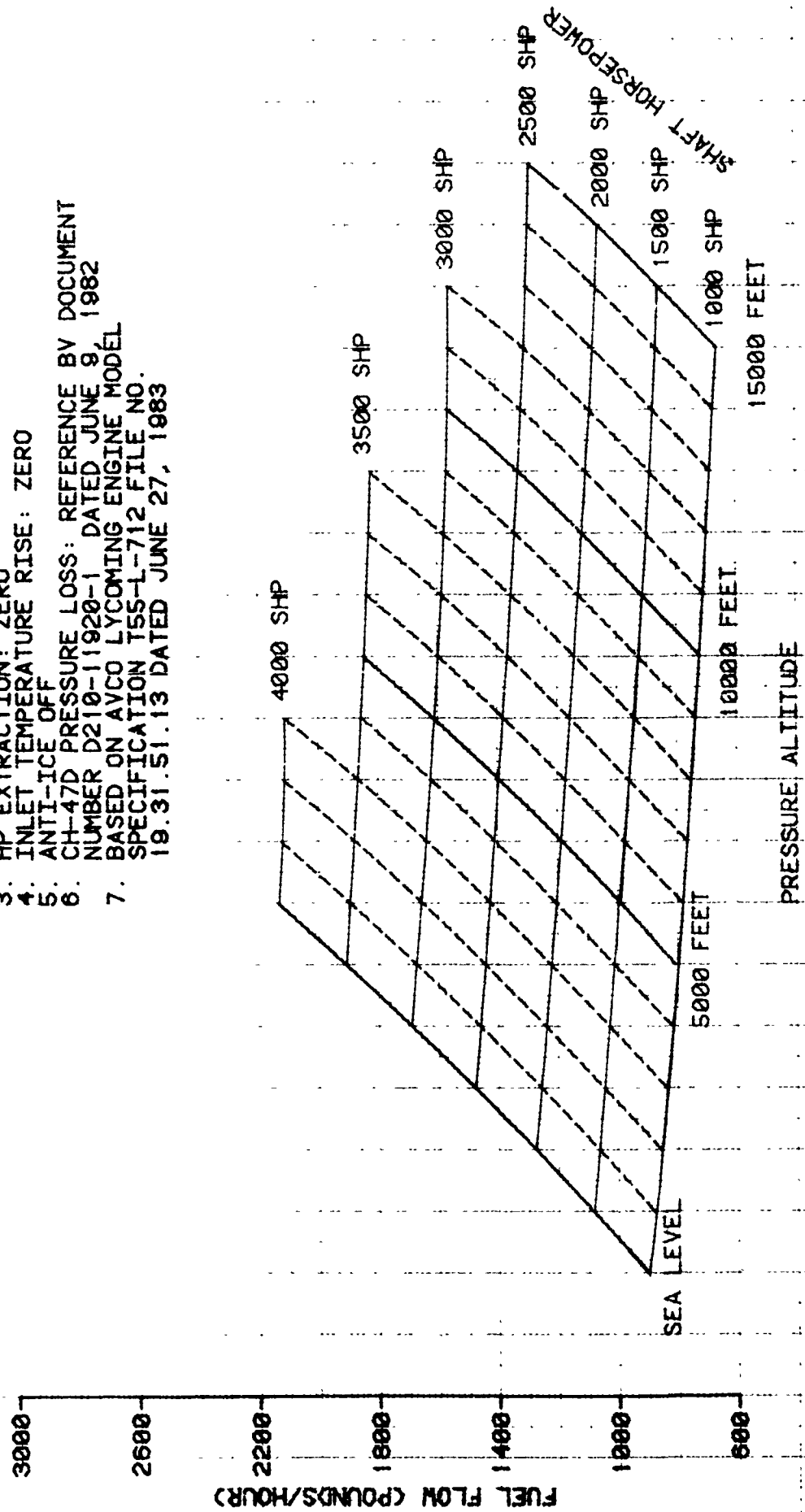

FIGURE 146
 ENGINE CHARACTERISTICS
 CH-47D USA S/N 81-23383
 LYCOMING T55-L-712 S/N 71224

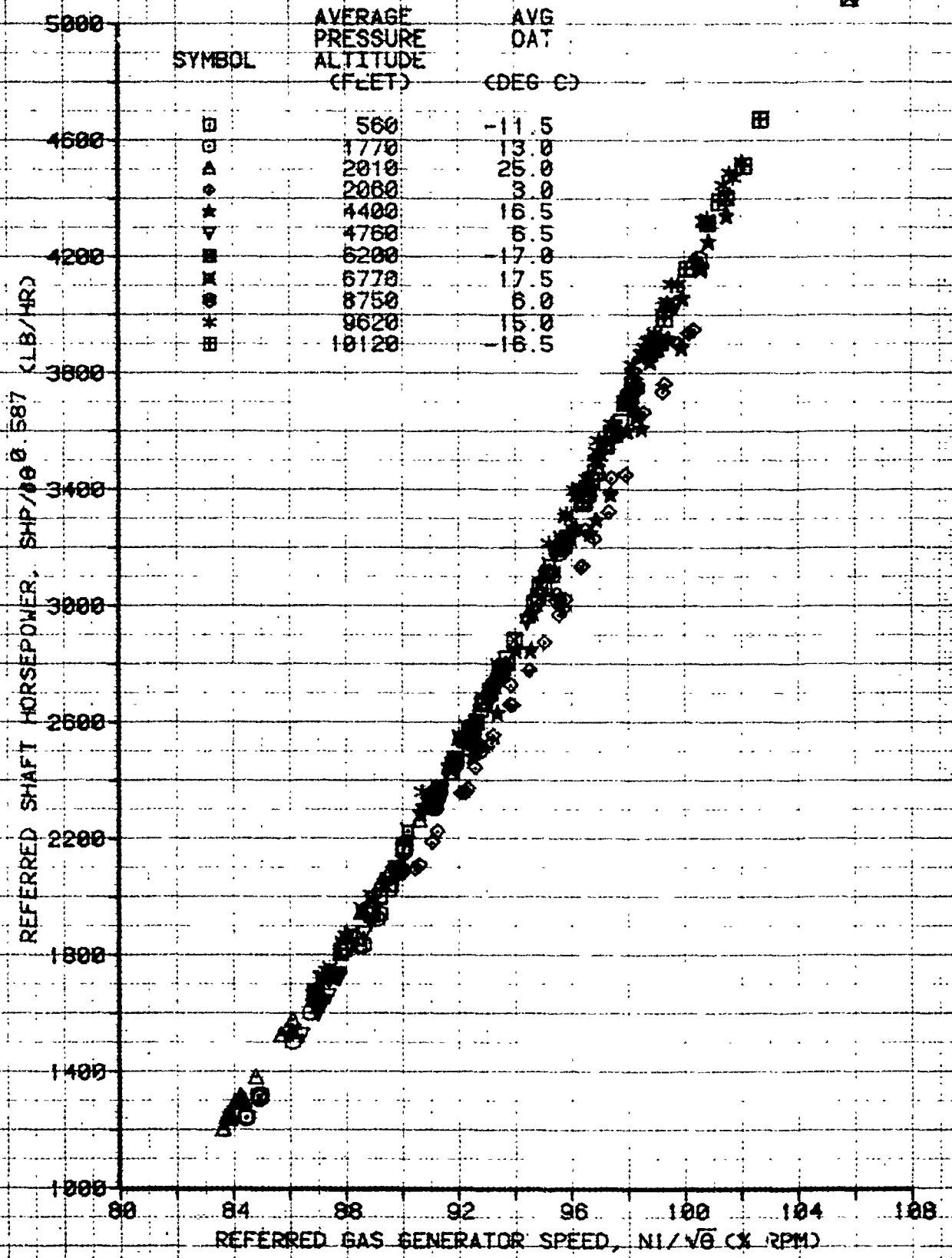

FIGURE 147
 ENGINE CHARACTERISTICS
 CH-47D USA S/N 81-23383
 LYCOMING T55-L-712 S/N 71224

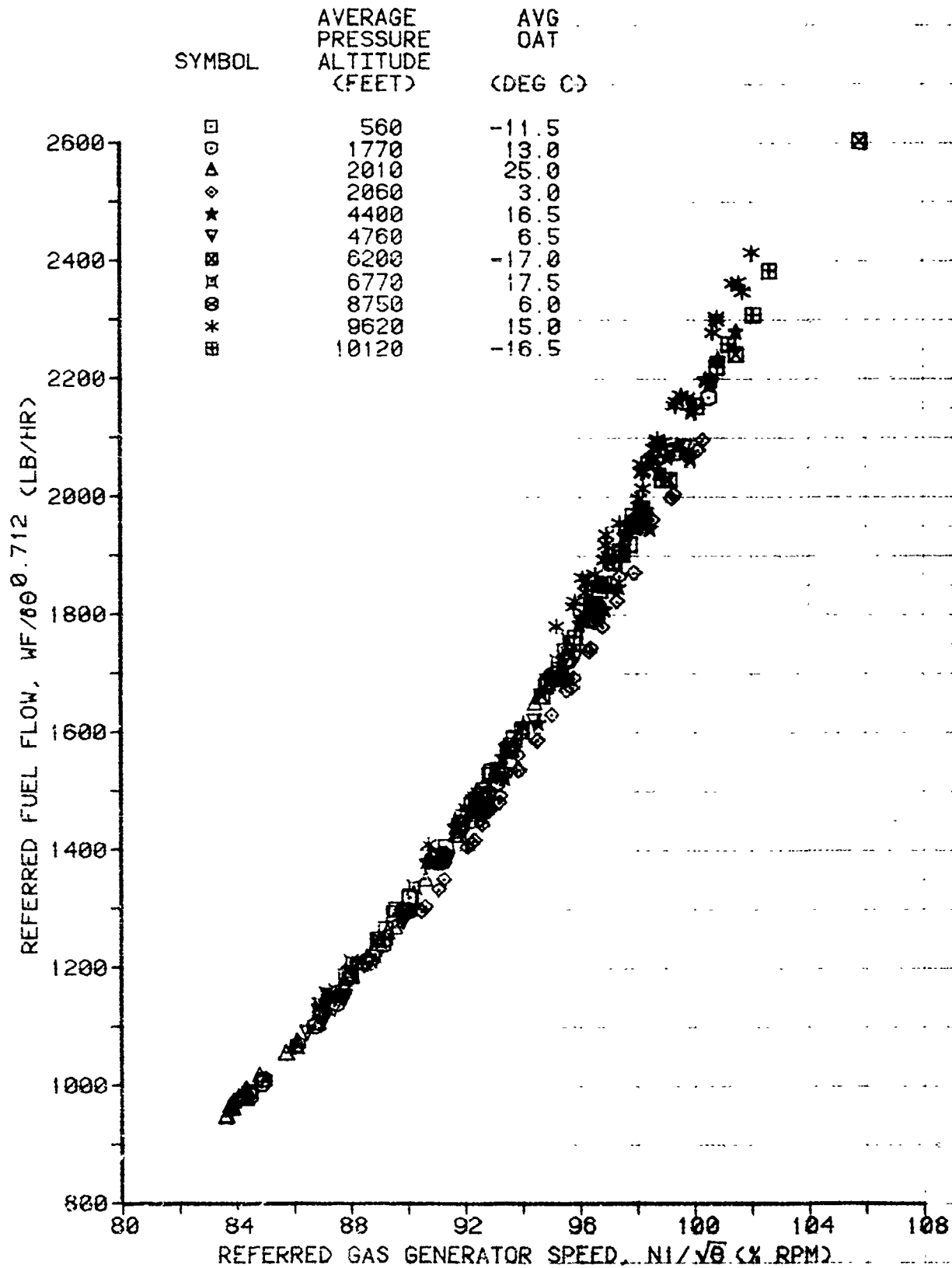

FIGURE 148
 ENGINE CHARACTERISTICS
 CH-47D USA S/N 81-23383
 LYCOMING T55-L-712 S/N 71224

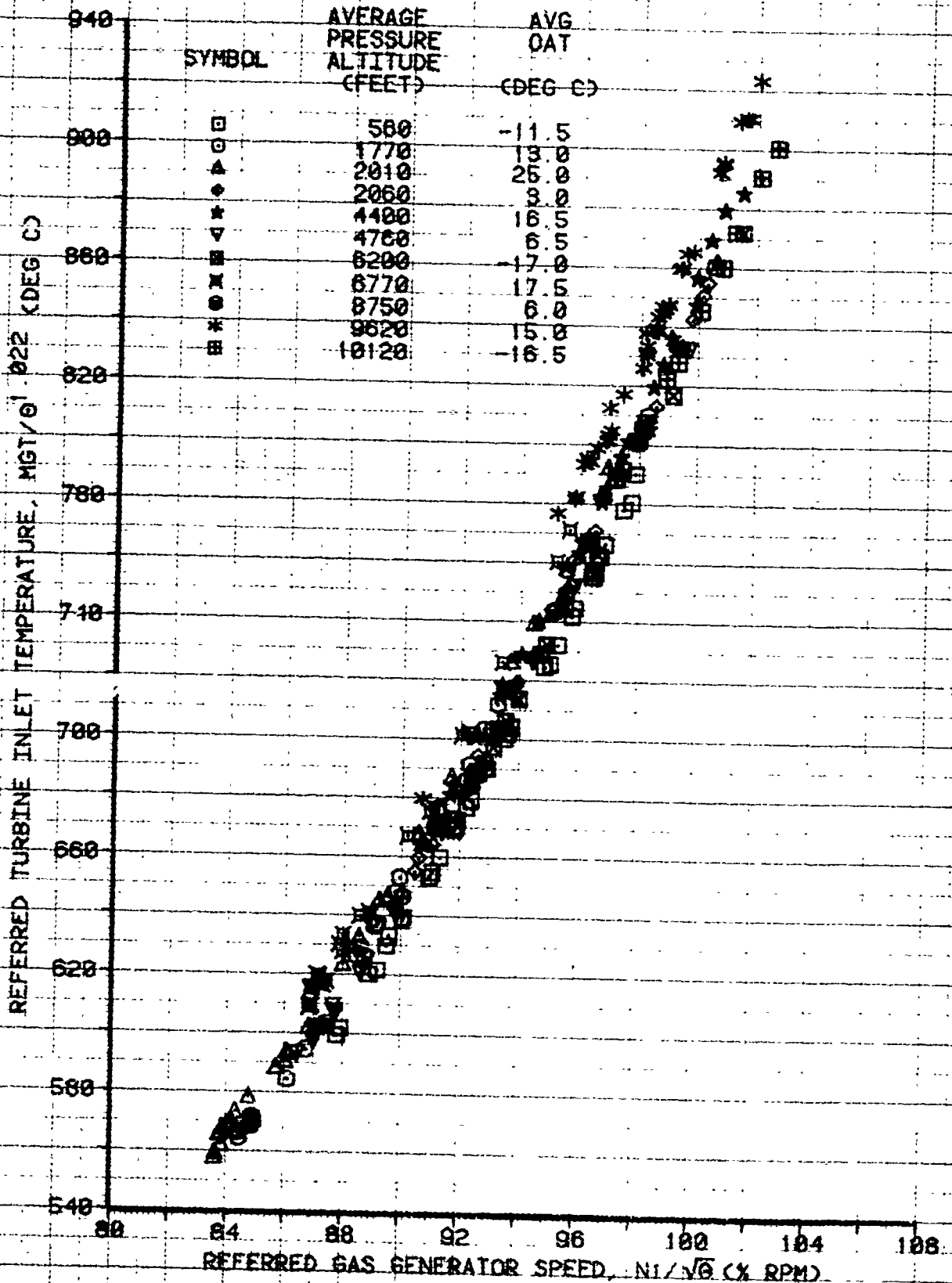

FIGURE 149
 ENGINE CHARACTERISTICS
 CH-47D USA S/N 81-23383
 LYCOMING T55-L-712 S/N 71226

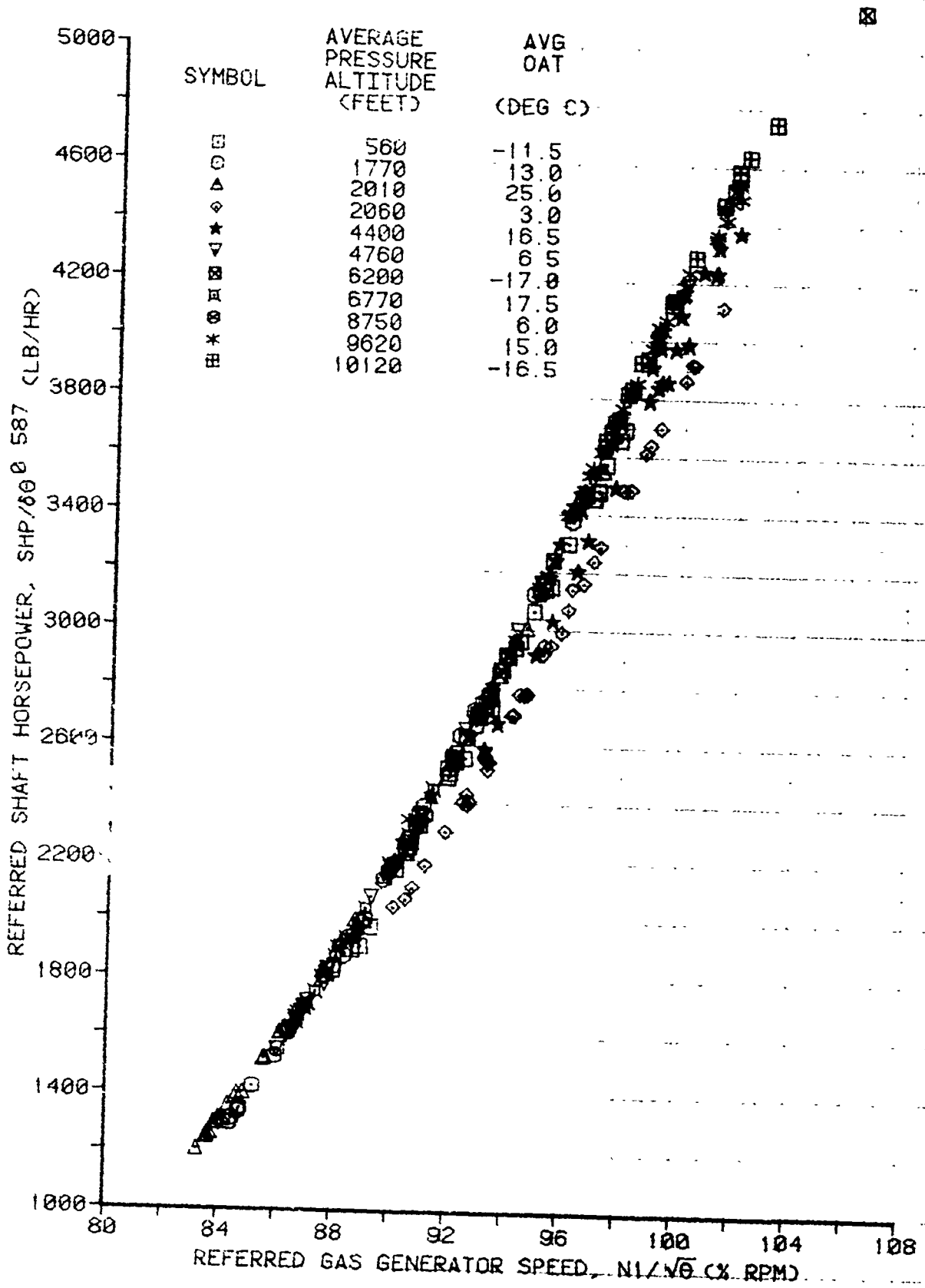

FIGURE 150
 ENGINE CHARACTERISTICS
 CH-47D USA S/N 81-23383
 LYCOMING T55-L-712 S/N 71226

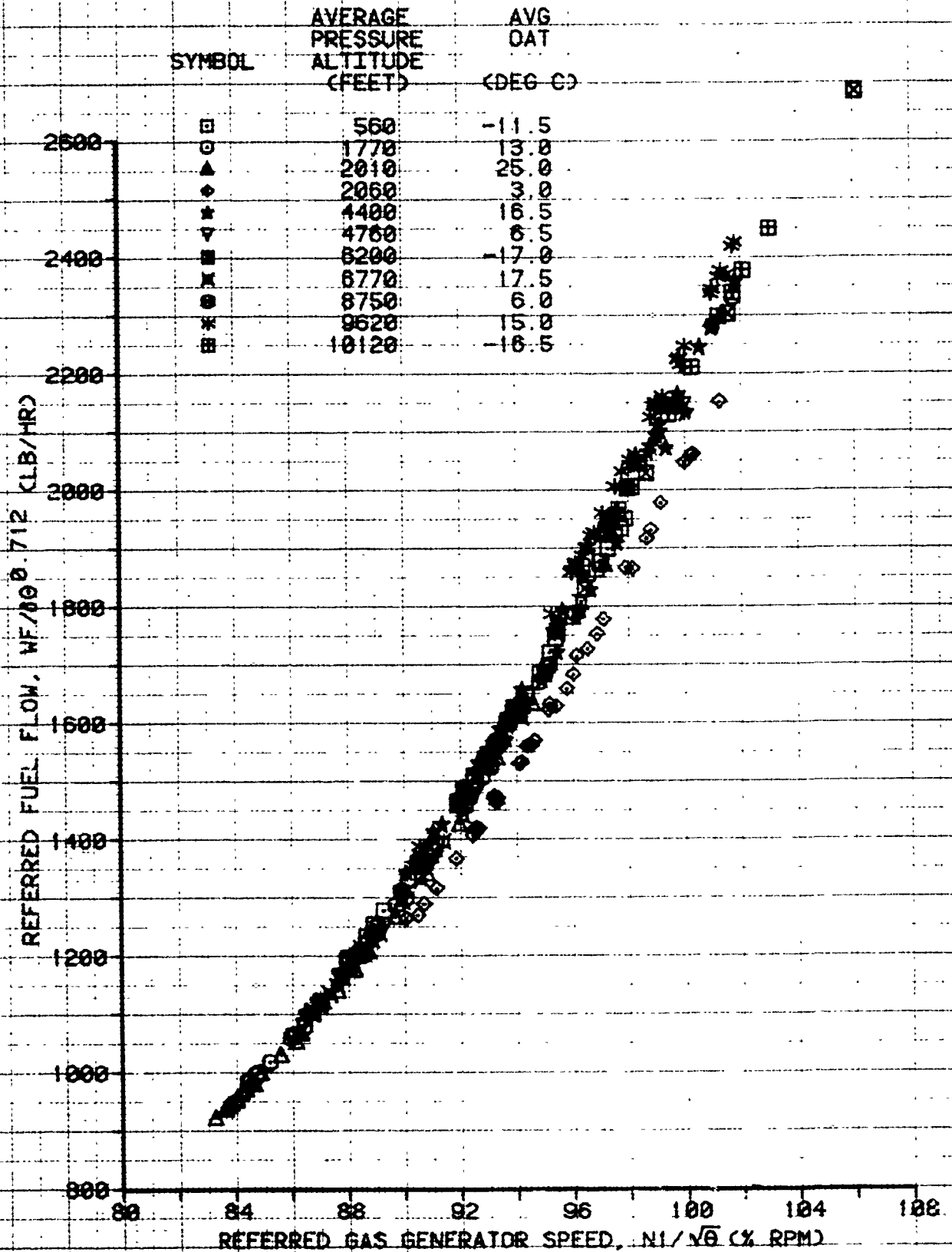
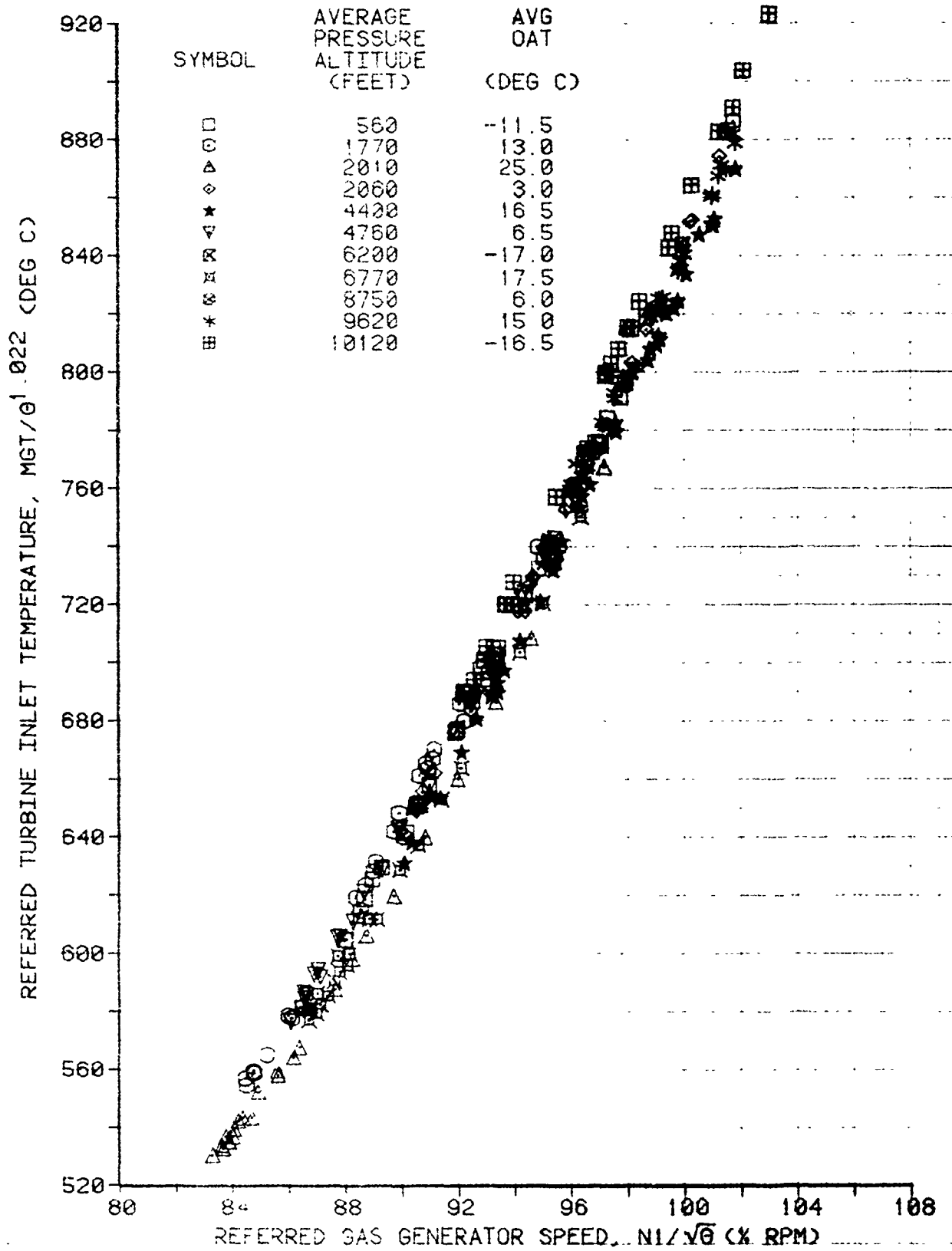

FIGURE 151
 ENGINE CHARACTERISTICS
 CH-47D USA S/N 81-23383
 LYCOMING T55-L-712 S/N 71226



APPENDIX F. EQUIPMENT PERFORMANCE REPORTS

The following Equipment Performance Reports (EPR) were submitted during the CH-47D A&FC test.

<u>EPR No.</u>	<u>Date</u>	<u>Description</u>
82-07-1	20 Jan 83	Broken wire to transmission chip detector
82-07-2	28 Jan 83	Damage to rotor blade tip cover
82-07-3	29 Jan 83	Hydraulic leak on #2 Power Transfer Unit
82-07-4	12 Apr 83	Damage to forward drive shaft cover
82-07-5	14 Jun 83	Failure of hydraulic hand pump
82-07-6	14 Jun 83	Loss of torque on combiner transmission right hand aft mounting bolt
82-07-7	14 Jun 83	Same subject as 82-07-6
82-07-8	14 Jun 83	Tear in rubber covering of rotor root end
82-07-9	14 Jun 83	Bearing freeplay in walking beam at FS 401
82-07-10	4 Aug 83	Blade lag damper bushing disengaged
82-07-11	4 Aug 83	Rivet popping and cracking of skin support structure
82-07-12	4 Aug 83	Aft rain shield chafes upper pylon
82-07-13	10 Aug 83	Bearing came loose from aft right landing gear drag link
82-07-14	11 Oct 83	Fuel line leak left engine
82-07-15	11 Oct 83	Failure of valve solenoid cartridge #1 PTU
82-07-16	11 Oct 83	Failure of N2 actuator #2 engine
82-07-17	18 Oct 83	Broken ground wires top side, aft rotor

DISTRIBUTION

HODA (DALO-SMM, DALO-AV, DALO-RO, DAMO-HRS, DAMA-PPM-T, DAMA-RA, DAMA-WSA, DACA-FA)	8
US Army Materiel Command (AMCDE-SA, AMCOA-E, AMCDE-I, AMCDE-P, AMCOA-SA, AMCSM-WA AMCOA-ST)	7
US Army Training and Doctrine Command (ATTG-U, ATCD-T, ATCD-ET, ATCD-R)	4
US Army Aviation Systems Command (AMSAV-ED, AMSAV-EI, AMSAV-EL, AMSAV-EA, AMSAV-EP, AMSAV-ES, AMSAV-O, AMSAV-MC, AMSAV-ME)	11
US Army Test and Evaluation Command (DRSTE-CT-A, DRSTE-TO-O)	2
US Army Logistics Evaluation Agency (DALO-LEI)	1
US Army Materiel Systems Analysis Agency (DRXSY-R, DRXSY-MP)	2
US Army Operational Test and Evaluation Agency (CSTE-ASD-E)	1
US Army Armor Center (ATZK-CD-TE)	1
US Army Aviation Center (ATZO-D-T, ATZO-TSM-A, ATZO-TSM-S, ATZO-TSM-II)	4
US Army Combined Arms Center (ATZLCA-DM)	1
US Army Safety Center (IGAR-TA, IGAR-Library)	2
US Army Research and Technology Laboratories (AVSCOM) (SAVDL-AS, SAVDL-POM (Library))	2
US Army Research and Technology Laboratories/Applied Technology Laboratory (SAVDL-ATL-D, SAVDL-Library)	2
US Army Research and Technology Laboratories/Aeromechanics Laboratory (AVSCOM) (SAVDL-AL-D)	1

US Army Research and Technology Laboratories/Proplusion	
Laboratory (AVSCOM) (SAVDL-PL-D)	1
Defense Technical Information Center (DDR)	12
US Military Academy, Department of Mechanics	
(Aero Group Director)	1
MTMC-TEA (MTT-TRC)	1
ASD/AFXT, ASD/ENF	2
US Naval Post Graduate School, Department Aero Engineering	1
(Professor Donald Layton)	
Assistant Technical Director for Projects, Code: CT-24	
(Mr. Joseph Dunn)	2
6520 Test Group (ENML/Stop 238)	1
Commander, Naval Air Systems Command (AIR 5115B, AIR 5301)	3
Project Manager, CH-47 Modernization Program (DRCPM-CH47M)	5
Boeing Vertol Company (Charles McCall M/S P32-52)	3
Avco Lycoming	3