

MICROCOPY RESOLUTION TEST CHART  
NATIONAL BUREAU OF STANDARDS-1963-A

2

# NAVAL POSTGRADUATE SCHOOL

Monterey, California



AD-A151 282

DTIC  
SELECTE  
MAR 18 1985  
S \* D  
A

## THESIS

AN APPARATUS FOR SIZING PARTICULATE  
MATTER IN SOLID ROCKET MOTORS

by

Robert Kelly Harris

June 1984

Thesis Advisor:

D. W. Netzer

DTIC FILE COPY

Approved for public release; distribution unlimited.

85 03 08 037

UNCLASSIFIED

SECURITY CLASSIFICATION OF THIS PAGE (When Data Entered)

REPORT DOCUMENTATION PAGE		READ INSTRUCTIONS BEFORE COMPLETING FORM
1. REPORT NUMBER	2. GOVT ACCESSION NO.	3. RECIPIENT'S CATALOG NUMBER
4. TITLE (and Subtitle) An Apparatus for Sizing Particulate Matter in Solid Rocket Motors		5. TYPE OF REPORT & PERIOD COVERED Master's Thesis June 1984
		6. PERFORMING ORG. REPORT NUMBER
7. AUTHOR(s) Robert Kelly Harris		8. CONTRACT OR GRANT NUMBER(s)
9. PERFORMING ORGANIZATION NAME AND ADDRESS Naval Postgraduate School Monterey, California 93943		10. PROGRAM ELEMENT, PROJECT, TASK AREA & WORK UNIT NUMBERS F04611-84-X-0009
11. CONTROLLING OFFICE NAME AND ADDRESS Air Force Rocket Propulsion Laboratory Edwards, California 93523		12. REPORT DATE June 1984
		13. NUMBER OF PAGES 87
14. MONITORING AGENCY NAME & ADDRESS (if different from Controlling Office)		15. SECURITY CLASS. (of this report) UNCLASSIFIED
		15a. DECLASSIFICATION/DOWNGRADING SCHEDULE
16. DISTRIBUTION STATEMENT (of this Report)  Approved for public release; distribution unlimited.		
17. DISTRIBUTION STATEMENT (of the abstract entered in Block 20, if different from Report)		
18. SUPPLEMENTARY NOTES		
19. KEY WORDS (Continue on reverse side if necessary and identify by block number)  Light Scattering      Photodiode Array Diffraction              Solid Propellants Polydispersion		
20. ABSTRACT (Continue on reverse side if necessary and identify by block number)  A light scattering apparatus to measure particle size ( $D_{32}$ ) in a solid rocket motor was improved. Multiple consecutive scans of two photodiode arrays were accomplished with a pacing circuit and added memory. The device was calibrated using various suspended particle samples and found to make accurate measurements. <i>Additional keywords: theses, data acquisition, data reduction, diffraction, polydispersion, solid propellants, computer programs.</i>		

DD FORM 1473 1 JAN 73

EDITION OF 1 NOV 68 IS OBSOLETE  
S/N 0102-LF-014-6601

UNCLASSIFIED  
1 SECURITY CLASSIFICATION OF THIS PAGE (When Data Entered)

Approved for public release; distribution unlimited.

An Apparatus for Sizing Particulate  
Matter in Solid Rocket Motors

by

Robert Kelly Harris  
B.S., Central Washington University, 1979

Submitted in partial fulfillment of the  
requirements for the degree of

MASTER OF SCIENCE IN AERONAUTICAL ENGINEERING

from the

NAVAL POSTGRADUATE SCHOOL  
June 1984

Author:

*Robert Kelly Harris*  
\_\_\_\_\_

Approved by:

\_\_\_\_\_ Thesis Advisor  
*Donald R. Taylor*  
\_\_\_\_\_ Chairman, Department of Aeronautics

*M. Dyer*  
\_\_\_\_\_ Dean of Science and Engineering



TABLE OF CONTENTS

I. INTRODUCTION . . . . . 9

II. THEORETICAL BACKGROUND . . . . . 12

    A. GENERAL DISCUSSION . . . . . 12

    B. APPLICATION TO LARGE PARTICLES . . . . . 13

    C. RESTRICTIONS AND SOURCES OF ERROR . . . . . 16

III. EXPERIMENTAL APPARATUS . . . . . 18

IV. DATA ACQUISITION SYSTEM . . . . . 21

    A. NEW CONTROLLER . . . . . 21

    B. MODIFICATIONS . . . . . 22

    C. PACING AND MEMORY CONTROL CIRCUITS . . . . . 22

V. DATA REDUCTION . . . . . 26

VI. CALIBRATION AND EVALUATION . . . . . 29

    A. IMPROVEMENTS . . . . . 29

    B. RESULTS . . . . . 30

VII. CONCLUSIONS AND RECOMMENDATIONS . . . . . 34

APPENDIX A: PROGRAM LISTINGS . . . . . 65

LIST OF REFERENCES . . . . . 85

INITIAL DISTRIBUTION LIST . . . . . 87

LIST OF TABLES

1. DATA ACQUISITION SYSTEM MANUALS . . . . . 35  
2. CALIBRATION RESULTS . . . . . 36



LIST OF FIGURES

1.	Photographs of Light Scattering Apparatus . . . . .	37
2.	Schematic of Light Scattering Apparatus . . . . .	38
3.	Flow Chart for Program "ACQDTA" . . . . .	39
4.	Schematic of Data Acquisition System . . . . .	40
5.	Timing Diagram for Data Acquisition System . . . . .	41
6.	Schematic of Pacing Circuit for Data Acquisition . . . . .	42
7.	Flow Chart for Program "RDC" . . . . .	43
8.	Comparison of Two Geometries for Light Scattering Measurements . . . . .	45
9.	37-44 Micron Glass Using No Beam Stop . . . . .	46
10.	37-44 Micron Glass Using Beam Stop . . . . .	47
11.	53-63 Micron Glass Showing Diffraction Rings . . . . .	48
12.	1-37 Micron Glass, High Concentration . . . . .	49
13.	1-37 Micron Glass, Low Concentration . . . . .	50
14.	50 Micron Aluminum Oxide, High Concentration . . . . .	51
15.	50 Micron Aluminum Oxide, Low Concentration . . . . .	52
16.	25 Micron Aluminum Oxide, High Concentration . . . . .	53
17.	25 Micron Aluminum Oxide, Low Concentration . . . . .	54
18.	5 Micron Polystyrene, Curve Fit . . . . .	55
19.	5 Micron Polystyrene, Two Angle Method . . . . .	56
20.	10 Micron Polystyrene, Curve Fit . . . . .	57
21.	10 Micron Polystyrene, Two Angle Method . . . . .	58

22.	20 Micron Polystyrene, Curve Fit . . . . .	59
23.	20 Micron Polystyrene, Two Angle Method . . . . .	60
24.	SEM Photographs of Aluminum Oxide . . . . .	61
25.	SEM Photographs of Glass Spheres . . . . .	62
26.	SEM Photographs of Glass and Polystyrene Spheres . .	63
27.	SEM Photographs of Polystyrene Spheres . . . . .	64

#### ACKNOWLEDGMENT

It has been my privilege to work with the staff of the Department of Aeronautics. I am grateful to them all for the help and friendship they gave me. Professor D. W. Netzer made it a pleasure to work and study at the Combustion Lab. Thanks also to Mark Nelson of NASA Jet Propulsion Lab. and Ken Graham of China Lake Naval Weapons Test Center for getting me started on the HP 9836 Computer.

## I. INTRODUCTION

Performance prediction codes for solid rocket motors model two phase flow losses as functions of particle size. In addition, particle size within the grain port strongly affects the damping of combustion pressure oscillations. At present these models are based on particle size data from collected exhaust samples [Ref. 1]. However, particle size varies with position in the motor and other parameters (pressure, propellant formulation, nozzle design, etc.). Therefore, experiments to determine how particle size varies in the actual flow environment of the motor (i.e., across the nozzle) are needed to validate the models for two phase flow losses. Cramer [Ref. 2] and Karagounis [Ref. 3] provide a good summary of the subject and the Naval Postgraduate School Combustion Laboratory effort to obtain particle size data across the exhaust nozzle of a solid rocket motor.

The method used in this continuing effort was the diffractively scattered light technique. The diffraction patterns of light scattered by particles are analyzed to determine the volume to surface mean diameter [Refs. 4 through 11]. This method has the disadvantages that size distributions cannot be easily determined and particles larger than some threshold size will not be detected due to the exceedingly small angles as which they scatter light. However, it has the advantage

that it is non-intrusive and in theory can be used in the internal motor environment.

Use of this method for particle sizing in solid rocket motors at the Naval Postgraduate School Combustion Laboratory was begun by Karagounis [Ref. 3]. The apparatus was subsequently redesigned and the data acquisition equipment upgraded with the introduction of the Hewlett Packard 3054A data acquisition system with an HP 85 as the controlling computer [Ref. 12]. The investigation by Cramer and Hansen followed and showed that propellant composition can limit the application of the technique. Large particulate combustion products in the flow made particle size data difficult to obtain. This was especially true if only one measurement of the scattering profile was made during a test firing.

To address this problem in the present study several improvements were made. A cleaner burning propellant was obtained to reduce char agglomerates in the exhaust products. A more statistically valid data sample (multiple measurements during a single test) was made possible with added memory in the data acquisition equipment and a pacing circuit which allowed full use of this memory. Data reduction was also improved with a Hewlett Packard 9836S computer combined with a more recently developed approach to particle sizing presented by Buchele [Ref. 13]. This method is discussed later in depth.

The focus of this thesis project was the following:

- (1) Implement the HP 9836S as the system controller.
- (2) Expand the multiprogrammer memory in order to obtain up to eight consecutive scans of the diode arrays during a test firing.
- (3) Improve data reduction techniques by the method of Buchele [Ref. 13].
- (4) Modify the apparatus and experimental procedures to improve the angular resolution and to reduce extraneous light.
- (5) Certify the proper functioning and accuracy of the apparatus prior to actual motor testing.

## II. THEORETICAL BACKGROUND

### A. GENERAL DISCUSSION

The completely general theory of scattering was developed by Mie and is presented by Van de Hulst [Ref. 14]. The light scattering characteristics for spherical particles of any size are fully described in a mathematical format. The Mie scattering functions contain Legendre polynomials and spherical Bessel functions and fully treat the phenomena of reflection, refraction, diffraction, and extinction. The full theory is most often applied when particle size is approximately the same as the wavelength of the incident light. Van de Hulst [Ref. 14] calls this the regime of Anomalous Scattering.

For particle sizes much smaller than the wavelength of light the Mie equations simplify to a form which is more dependent on the index of refraction of the particles and less dependent on particle size. This is called Rayleigh Scattering.

The study of particle size behavior in solid propellant rockets mainly covers sizes much greater than the wavelength of light. Scattering by large particles such as these is described adequately by Fraunhofer diffraction.

## B. APPLICATION TO LARGER PARTICLES

The ringed diffraction pattern generated by a hole in a mask, or a number of particles of the same size is described by the equation:

$$I(\theta) = \left[ \frac{2J_1(\alpha\theta)}{\alpha\theta} \right]^2$$

where:

$I(\theta)$  describes the relative intensity of the scattered light at an angle theta ( $\theta$ )

$J_1(\alpha\theta)$  is the Bessel function of the first kind

$\alpha = \frac{\pi D}{\lambda}$  is the particle size parameter for diameter  $D$  and wavelength of light lambda ( $\lambda$ ).

Measuring the particle size for a monodispersion can be accomplished by measuring the angular position of a dark or bright ring in the diffraction pattern. For a dark ring the zero of the Bessel function corresponding to the ring is set equal to  $(\alpha\theta)$  and particle size is determined directly [Ref. 5]. For bright rings one sets  $(\alpha\theta)$  equal to the corresponding maximum of the Bessel function and solves for the diameter.

The above method is not used for polydispersions since the discrete rings are not observed. However, Dobbins, et al. [Ref. 5] introduced a significant improvement in the diffractively scattered light method of particle sizing. They found that although the method was not directly able to



determine distributions of sizes, the volume to surface mean diameter defined by

$$D_{32} = \frac{\int_0^{\infty} N_r(D) D^3 dD}{\int_0^{\infty} N_r(D) D^2 dD} \quad (1)$$

where:

$N_r(D)$  is a distribution function describing the proportion of particles with diameter (D) in the sample, could be accurately measured.

A curve for sizing polydispersions was presented which was used by Cramer and Hansen [Refs. 2, 12].

Two phase flow losses are often calculated in terms of  $D_{43}$ . If the distribution of sizes in the polydispersion is well behaved then  $D_{32}$  and other diameters such as  $D_{43}$  can be easily related [Ref. 15]. Reference 5 reported that very small particles in the distribution have a minor influence on the scattering profile. This makes the measurement technique promising for the two phase flow loss study since very small particles do not contribute significantly to these losses and so are of less interest.

Roberts and Webb [Ref. 6] essentially confirmed the conclusions of Reference 5 and presented a similar curve for use in sizing.

More recently, Buchele [Ref. 13] gives a good summary of experimental techniques for particle sizing by measuring

diffracted light. One point of interest in his report is that he represents the scattering profile of a polydispersion with a function which closely approximates the curves of References 5 and 6.

$$I_n(\theta) = \text{EXP} - (.57\alpha\theta)^2$$

This function from Reference 13 and the curve from Reference 5 were both used in the present study to evaluate the apparatus to be used with solid propellant rocket motors.

An additional detail of measuring scattering profiles is covered by Van de Hulst [Ref. 14]. The wavelength of light used in the scattering calculations depends on the index of refraction of the medium containing the particles. The wavelength used in all calculations must be:

$$\lambda = \frac{\lambda_0}{M}$$

where:

$\lambda_0$  is the wavelength of light in a vacuum and,  
M is the refractive index of the medium with respect to a vacuum.

Thus, the size parameter ( $\alpha$ ) becomes:

$$\alpha = \frac{\pi DM}{\lambda_0}$$

and the beam spread parameter becomes:

$$(\alpha\tilde{\epsilon}) = \frac{-DM\tilde{\epsilon}}{\lambda_0}$$

Another consideration is presented by Gumprecht and Slipevich [Ref. 4]. Light scattered by particles in a medium is refracted as it crosses each interface of the container holding the medium. This is discussed further in the section on calibration and evaluation of the apparatus.

Additional complications arise with the full treatment of the index of refraction of the particles with respect to the medium. But, for Fraunhofer diffraction alone this aspect can be neglected.

#### C. RESTRICTIONS AND SOURCES OF ERROR

Some restrictions on use of the method are described by Dobbins, et al. [Ref. 5] and were satisfied as described by Cramer [Ref. 2]. These are related to the size of particles, the distance to the detector, and some phenomenon covered in the rigorous Mie theory.

One must keep in mind also that the curves developed for polydispersions are based on the Upper Limit Distribution Function of Mugele and Evans [Ref. 7]. This means that no particles with size greater than approximately ten times the mean should be in the sample [Ref. 13]. This appears to be a mild restriction. Van de Hulst [Ref. 14] describes the criteria for single scattering and a simple test to verify

it. In general, as long as the scattered intensity is proportional to the number of particles the mathematics remain simple.

Sources of error of the diffractively scattered light method are covered by Buchele [Ref. 13] and are presented here.

- (1) Inaccuracy of angular measurement or the limited ability to resolve small angles and,
- (2) Inaccuracy of the intensity measurement due to extraneous light.

Extraneous light includes all light other than scattered light from the particles. Some examples are scattering from an aperture or dirty test section windows. Refraction of the beam due to gas density gradients and image point broadening from turbulence are others. Laser speckle is also extraneous light.

The sources of error addressed in this investigation are discussed in the related portions of the paper.

### III. EXPERIMENTAL APPARATUS

A photograph of the apparatus is presented in Figure 1. A schematic is presented in Figure 2. The light scattering equipment was mounted on two optical benches. Components for measurements in the exhaust plane were mounted on one bench. The other bench held the equipment associated with the motor cavity. The light source was an eight (8) milliwatt Helium Neon laser mounted on the exhaust bench. A collimated beam was required so a spatial filter/collimator was used. A modification to this collimator is discussed later in this section. The collimated beam passed through a cube beam splitter and the second beam was diverted to a 90 degree prism on the other bench. The original beam continued through the motor exhaust plane. The other beam was routed through the nitrogen-purged glass windows in the motor housing.

Each beam was then intercepted by a physical stop located in front of its set of receiving optics. The further the stop was placed from the test section, the smaller the angle at which scattered light could be measured. In this apparatus, the stops were placed approximately 30.5 centimeters from the exit plane of the test section. This allowed a minimum angle of approximately .008 radians to be measured. Light scattered at angles greater than this was

not intercepted and continued past the edges of the stop. The stop served to keep the transmitted beam out of the measuring optics and thus reduce extraneous light. The stops also improved optics alignment. This is discussed under calibration and evaluation of the apparatus.

The scattered light passed through a narrow pass filter which admitted only light of the Helium Neon frequency. This filter served to reduce extraneous light from the external surroundings.

An objective lens of 50 centimeter focal length was located behind the narrow pass filter. This lens imaged onto a photodiode array the scattering profile of the particles in the test section. The shadow of the beam stop was also imaged since the stop was between the test section and the objective lens. This was a limitation which is discussed under calibration and evaluation.

The photodiode arrays were the same units used by Cramer and Hansen [Refs. 2,12]. Each array contained 1024 silicon photodiodes on a single chip with 25 micron spacing. The accompanying circuits provided a sampled and held output which was essentially analog except for switching transients. At the end of each diode scan there was a delay before the next scan. During this delay the diodes were reset and allowed to measure the intensity of the scattering profile again. The scanning of the diode array repeated continuously. The

actual sampling time of the array was about 34 milliseconds with a delay between scans of about 6 milliseconds.

The 50 centimeter focal length of the objective lens combined with the dimensions of the diode array provided a half angle field of view of about 3 degrees for mediums of refractive index near one. The effective field of view was reduced to about 2.3 degrees for calibrations when the refractive index of a Plexiglas container and water was taken into account.

The laser beam collimator mentioned previously at first produced a beam one centimeter in diameter. A lens in the collimator was changed to reduce the beam diameter for several reasons. Extraneous light would be generated if a large beam impinged on the aperture of the motor test section window. Also, if the aft beam was larger than the motor exhaust jet it would be refracted in the density (and refractive index) gradient between the exhaust and air.

The last part of the apparatus was the rocket motor itself. It was the one used by Cramer and Hansen [Refs. 2,12] and in the present study served only for aligning the optics.

#### IV. DATA ACQUISITION SYSTEM

##### A. NEW CONTROLLER

Hansen [Ref. 12] describes the major components of the Hewlett Packard 3054A data acquisition system. A list of the manuals relevant to this study is in Table 1. The HP 85 computer used by Hansen and Cramer was replaced with an HP 9836S as system controller. This newer computer has far more capability than the HP 85, including a choice of more powerful operating systems. The system used for this study was Basic Extended 2.1.

The data acquisition program written by Hansen needed minor modification to acquire multiple consecutive scans of the photodiodes. Some different I/O commands such as those which transfer data to the disk were also incorporated. The revised version of this program is listed in Appendix A. A general flow chart is presented in Figure 3.

The 9836S has two internal disk drives which were used to store the data after acquisition. The data from both diode arrays was stored in the same file. The eight (8) scans of the motor cavity were first, followed by the four (4) exhaust scans.



## B. MODIFICATIONS

The memory capacity of the Multiprogrammer unit was increased so that multiple consecutive scans of the diode arrays could be recorded during a motor firing. This would provide a more statistically valid measurement of particle size. Fluctuations of scattered light intensity for a polydispersion need to be integrated over time or averaged to provide a more appropriate measurement.

In order to fully use the memory added and make data management easier the data acquisition system needed to be modified. The memory consisted of three (3) cards, each with a capacity of 4096 values. The fact that this was a multiple of 1024 (the exact number of photodiodes) meant that the idle period between scans needed to be excluded from the data. If this was not done, one (1) less scan per card would have been acquired and locating the scans in the overall block of memory would have been more difficult.

It was also necessary to chain two of the memory cards together in a way which would allow one card to be filled and then the other. A schematic of the data acquisition system is presented in Figure 4.

## C. PACING AND MEMORY CONTROL CIRCUITS

The timing clock and blanking pulse of the photodiode circuitry provided the means for pacing data acquisition.

Specific results of the modifications were:

- (1) Memory space was fully utilized and management of the multiple scans made easier.
- (2) A/D conversions of the data were made exactly when a diode's output was on line and steady. Thus, the analog filter used in the previous study was no longer needed to suppress the switching spikes on the data line.

The following is a description of the signals and circuits used to modify the data acquisition system. All voltage levels were TTL. A timing diagram in Figure 5 shows the relations between signals. A schematic of the circuit is presented in Figure 6.

The clock pulse was a positive going spike at a frequency of about 30 KHz. This clock controlled all circuits of the photodiodes. It ran continuously, even during the blank period between scans when the diode output was clamped at zero volts.

The blanking pulse was a signal which fell to zero at the beginning of each scan. It then went positive at the end of the scan and remained high until the next scan began.

The clock pulse was used to drive a pulse shaper (monostable multivibrator). This ensured that the voltage levels through the rest of the circuit would not accidentally fall below the TTL threshold. The pulse width of the shaper was adjusted so that the negative going edge of each pulse

would occur after the switching transient on the data line had decayed. This negative going edge would eventually trigger the A/D converter to store the output of each diode.

The blanking pulse was inverted and connected to an AND gate along with the pulse shaper output. The output of this AND gate is shown in Figure 5 as the pulse shaper signal held low between scans of the diode array. This was the basic signal which paced data acquisition.

This basic trigger signal was connected to an AND gate along with the output of the Multiprogrammers Timer Pacer card. In this way the trigger would not reach the A/D until the Timer Pacer output a pulse. This enabling pulse from the Timer Pacer was at least as long as the time for eight scans of a diode array.

The controller programed the Timer Pacer to produce the pulse when the Timer Pacer received a trigger from the blanking pulse. In this way, data acquisition began at the start of a scan and no data was taken during the time between scans.

The circuit to chain the memory cards together was basically an OR gate used as a negative logic AND gate. The end of conversion ( $\overline{\text{EOC}}$ ) signal of the A/D and the ( $\overline{\text{FULL}}$ ) signal of one memory card were connected to the gate. When both signals went low the second card was then able to store data from the A/D. This arrangement is shown in the schematic of

the data acquisition system in Figure 4. The automatic lock-out feature of the memory cards when full, and the relatively slow rate of data throughput made it unnecessary to control other handshake lines [memory card manual, Table 1].

The circuit was designed to handle four (4) memory cards, so no modification will be necessary if one more card is added to the system. This would provide an additional four scans of the exhaust beam.

## V. DATA REDUCTION

The data reduction programs written by Hansen were not used for this study. The new computer lended itself to another approach. Its memory capacity made it unnecessary to chain programs together and polynomial curve fitting was eliminated in favor of interactive graphics. Avoiding polynomial fits preserved the nature of the raw data so that one had a better feel for the parameters. The data reduction program "RDC" is listed in Appendix A. Figure 7 is a general flow chart for the program.

The following is a description of the program. The user was first prompted for values needed to analyze a given data set. For example, the wavelength of the laser used and the index of refraction of the medium must be known for any data set. Next, one had the choice of reducing raw data scans or reviewing a reduced data file. For raw data one chose either the exhaust or motor cavity beam data.

Raw data was plotted on the CRT and any obviously erroneous scans were excluded from further reduction. The valid scans were averaged to obtain a mean scattering profile. The mean intensity profile taken before particles were introduced was then subtracted from that taken with particles present.

This corrected for the characteristics of individual photodiodes and extraneous light which was independent of the particles.

A symmetric moving-average-type of digital filter was then applied to the profile to achieve some smoothing. This type of digital filter was chosen for simplicity and because it does not have the phase lag of analog filters [Ref. 16]. Preserving the phase of the data was necessary to retain angular resolution. Another advantage of filtering in the software rather than hardware was that raw data files remained unmolested.

The scattering profile was then analyzed using interactive graphics. If earlier, one chosen to review a reduced file, program execution began here.

One had to normalize a scattering profile in order to compare it to the theoretical curves for polydispersions. The scattered intensity on the centerline of the beam was the correct value to use for normalization but was unmeasurable due to the beam's presence.

The other unknown was, of course, the particle size. These two variables (centerline intensity for the measured profile and  $D_{32}$  for the theoretical profile of normalized intensity vs.  $(\theta_1)$ ) were adjusted using interactive graphics until the curve for polydispersions coincided with the data. In this way the mean diameter of particles was determined.

The second reduction technique used was the direct application of the method presented by Buchele [Ref. 13]. The equation for the polydispersion curve:

$$I_n(\theta) = \text{EXP} - (.57 \alpha \theta)^2$$

was applied at two points of the scattering profile. This gave:

$$I_2/I_1 = \text{EXP} -D^2 [(\theta_2^2 - \theta_1^2) (.57 \pi/\lambda)^2]$$

Solving this for the diameter gave:

$$D = [-L_n(I_2/I_1) (\lambda/.57\pi)^2 / (\theta_2^2 - \theta_1^2)]^{1/2}$$

The computer would sweep through the data using many values of theta1 ( $\theta_1$ ) along with several angle ratios to determine theta2 ( $\theta_2$ ). The results were presented graphically as particle size vs. theta1 for each angle ratio ( $\theta_2/\theta_1$ ).

In actual practice the range of useable angles depends on the apparatus, and the quality of the data. Therefore, in order to interpret the results one must have previously inspected the data. The interactive graphics routine was well suited to this and provided a hard copy for inspection.

After reducing a set of raw data the mean scattering profile was stored on disk for later review.

## VI. CALIBRATION AND EVALUATION

### A. IMPROVEMENTS

The geometry of the apparatus used in the investigation by Cramer and Hansen is compared with that of this study in Figure 8. In the previous study the transmitted beam was allowed to enter the receiving optics. The beam was focused off the diode array a few millimeters from the first diode. This was necessary to avoid damaging the diodes but introduced some uncertainty in angle measurements. The intense image of the beam along with scattered light from the receiving optics produced a high level of extraneous light. In the present study, stops were used to intercept the beam before reaching the receiving optics. These stops provided several advantages. A high intensity beam could be used while producing little extraneous light. Optics alignment was also improved. This reduced error in angle measurement. Alignment was accomplished using a neutral density filter to reduce beam intensity and protect the diodes. A schematic of the apparatus is in Figure 2. The laser, collimator, beam splitter and prism were positioned so that the beams passed through the appropriate measurement areas. The narrow pass filter and imaging lens were then positioned so that the beam entered on the centerline. The



photodiode array was then moved using a three-axis micrometer so that the focused beam fell on the first diode. The beam stops were then put in place and the neutral density filter removed. In this way measurements commenced exactly from the optical axis of the beam.

Procedures were also refined to account for the bending of light rays as they passed through the walls of the particle container. As noted earlier, the index of refraction of the container and the medium containing particles affects scattering measurements. A Plexiglas box held the particle samples and a magnetic stirrer kept the samples suspended in water. The index of refraction of the Plexiglas and water combination was measured using a simple technique. A microscope was used to measure the ratio of actual depth to apparent depth for Plexiglas and water. The index of refraction was determined to be 1.39. This value was applied to the data to convert the measured scattering profile to that actually produced in the medium containing the particles.

## B. RESULTS

Calibration results are summarized in Table 2. Initial tests were done with two samples which were basically mono-dispersions of large particles. Figure 9 shows the measured profile of scattered light for glass spheres ranging from

37 to 44 microns in diameter. This profile was obtained by placing the focussed beam just far enough from the first diode to avoid saturation with no particles present. The diodes located at angles less than about .01 radians saturated. The first bright ring for particles of about 40 micron diameter was visible near .02 radians. Figure 10 shows a profile for the same particles, illustrating use of the beam stops to avoid diode saturation and improve angle measurements. In this case, the first diode was located exactly on the centerline of the beam as discussed above.

Results for a sample of 53 to 63 micron glass spheres are shown in Figure 11. The center lobe was nearly completely missed but the first two bright rings were seen near .014 and .022 radians. The first two dark rings near .01 and .019 radians were also seen. The method described earlier of setting the beam spread parameter ( $\alpha\theta$ ) equal to the zeroes and maximums of  $J_1(\alpha\theta)$  was used to calculate a size of about 58 microns. Also shown in Figure 11 is the theoretical profile for a polydispersion with  $D_{32} = 54$  microns.

Various polydispersions of either glass spheres or aluminum oxide powder were then tested. These polydispersions consisted of fairly large particles. Results are shown in Figures 12 through 17. These tests showed that the apparatus

had two distinct modes of operation. If the particle concentration was very high, or if large particles dominated the polydispersion, many of the diodes at the smaller angles would saturate. This left only the data at larger angles useable. When many diodes saturated, the theoretical curve given by Dobbins, et al., was used to determine size. This was done because this curve was valid for the larger angles and lower relative intensities. The curve from Buchele [Ref. 13] was not valid for values of the beam spread parameter greater than three (3).

For low particle concentrations and/or small particles the data proved more accurate at the smaller angles. If no diodes were seen to saturate then one knew the measurement was in the higher intensity part of the center lobe. Here the curve given by Buchele was quite satisfactory for sizing.

The smallest particles tested were five, ten, and twenty micron polystyrene spheres. The bright rings for these particles occurred at angles too large for the apparatus to measure. For these samples the diodes did not saturate. Both the Gaussian curve fit and the two angle method were used to obtain  $D_{32}$ . These results were especially consistent. It should be noted that the two-angle method uses the equation for the Gaussian. If the measured profile matched the Gaussian exactly, then  $D_{32}$  would be the same for any  $(\theta_1)$  and angle ratio  $(\theta_2/\theta_1)$  employed. Some variations in

calculated  $D_{32}$  due to the imperfect fit are obvious in Figures 19, 21 and 23.

A scanning electron microscope was used to photograph the types of particles tested. These photographs are shown in Figures 24 through 27. Equation (1) was used along with these photographs to calculate some of the values of  $D_{32}$  in Table II. Calculations of  $D_{32}$  for the polystyrene were arrived at using the manufacturers data on size distributions. The photographs generally confirm the validity of the technique.

## VII. CONCLUSIONS AND RECOMMENDATIONS

The results of the calibration tests showed that the apparatus is capable of accurately measuring mean particle size for a broad range of mean diameters. It was found that the technique was most accurate if the theoretical profile fit or the two-angle method were applied at the smallest possible scattering angles.

The rocket exhaust is likely to attenuate the beam somewhat, reducing the problems related to diode saturation at small scattering angles. Thus, measurements should be possible using the high intensity part of the center lobe. This should make data reduction less ambiguous. Actual testing should begin with measurements at the exhaust plane of the motor. These should be compared with collected exhaust samples to validate the use of the apparatus in an actual motor environment. Measurements in the motor cavity would then be interpreted based on the correlation between exhaust samples and exhaust measurements.

It is also recommended that the index of refraction of the combustion gases be investigated. A literature search for an estimate of the index of refraction would probably be satisfactory.

TABLE I

ELECTRONICS MANUALS

1. HP Memory Cards Model 6970B Operating Manual
2. HP Timer Pacer Card Model 69737A Operating Manual
3. HP Analog to Digital Converter Card Model 69736A  
Operating Manual
4. HP Users Guide, "Using the 9826 and 9836 Computers with  
the 6942A Multiprogrammer"
5. Basic Language Reference Guide with Extensions 2.0 for  
Series 200 Computers

TABLE II. CALIBRATION RESULTS

Particle Material	Particle Size microns	Equation (1) Calculated $D_{32}$ microns	Scattering Measurement $D_{32}$ microns	Error microns
Polystyrene	3 to 6	4.7 **	4.5	.5
Polystyrene	6 to 16	10.2 **	7.9	2.3
Polystyrene	15 to 30	21.6 **	21	.6
Glass	37 to 44	38. *	40	2.
Glass	53 to 63	54. *	54 to 58	0 to 4
Glass	1 to 37	25. *	28 to 30	3 to 5
Aluminum Oxide	≈ 25	see Fig. 24	28	-----
Aluminum Oxide	≈ 50	see Fig. 24	45	-----

\* From SEM Photos      \*\* From Manufacturers Data

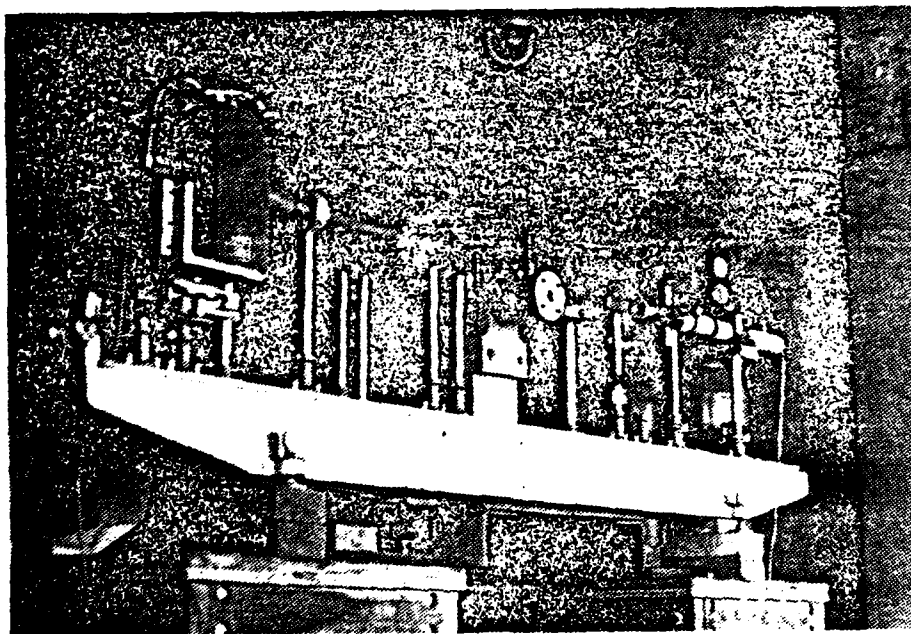
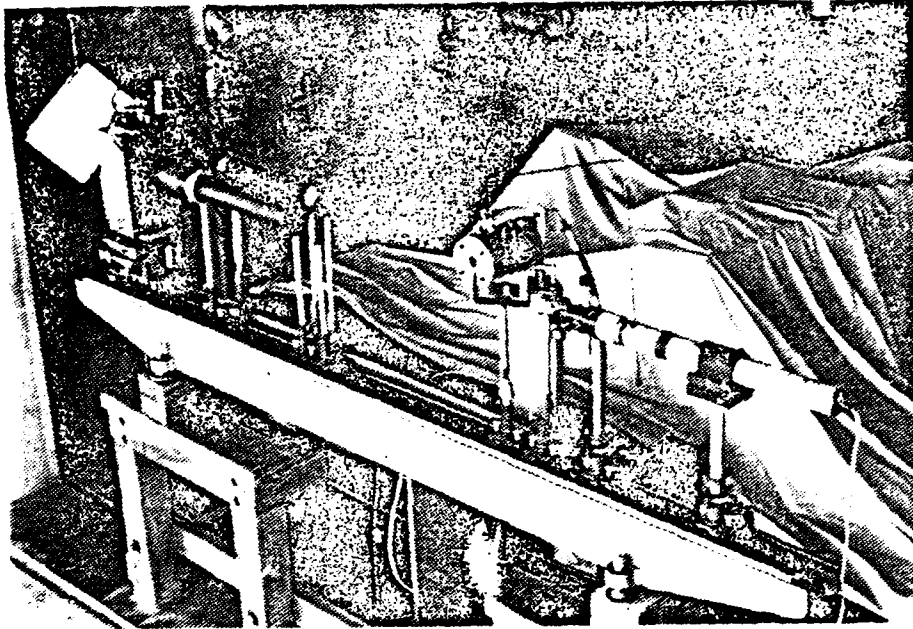

Figure 1. Photographs of Light Scattering Apparatus



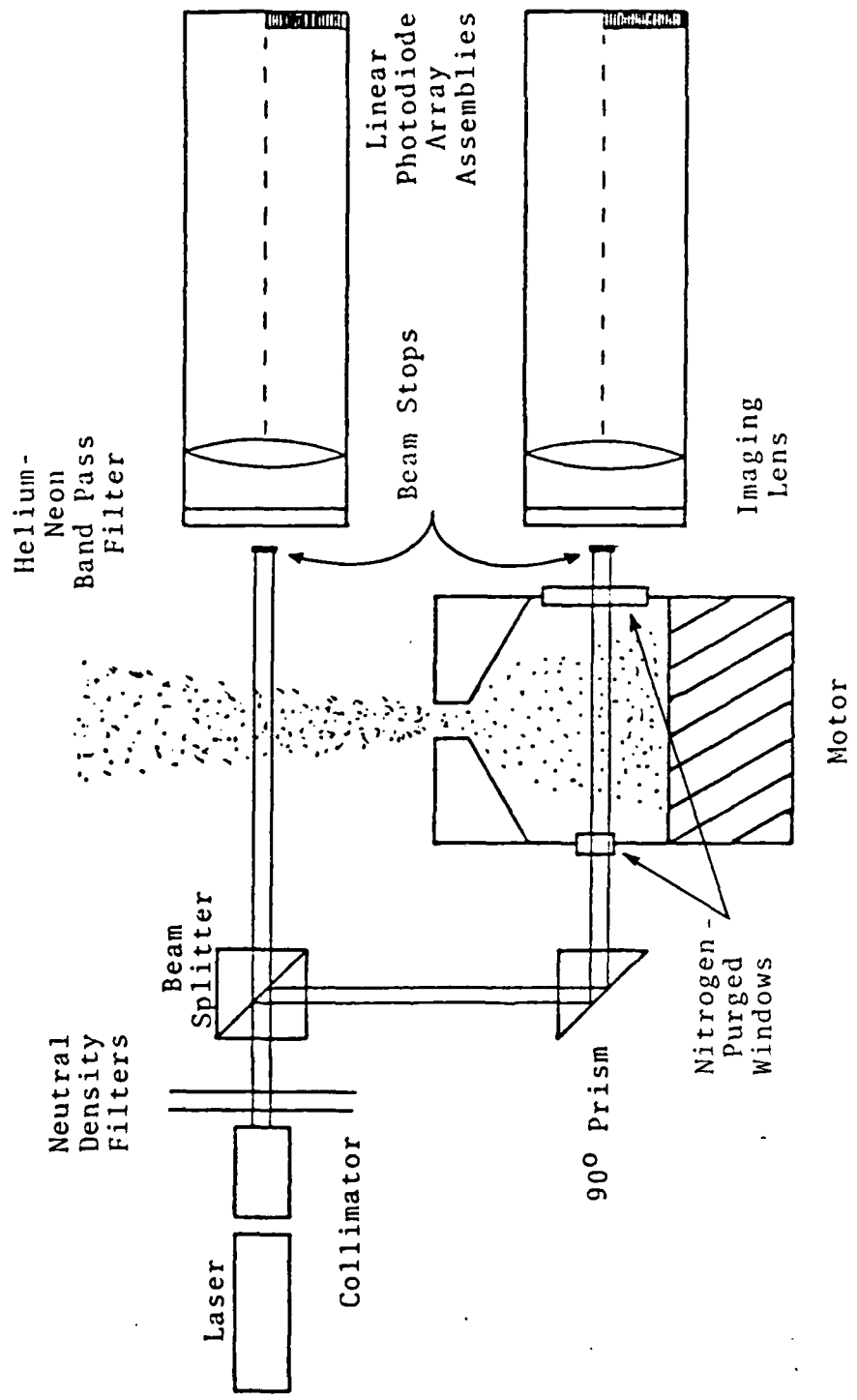

Figure 2. Schematic of Light Scattering Apparatus.

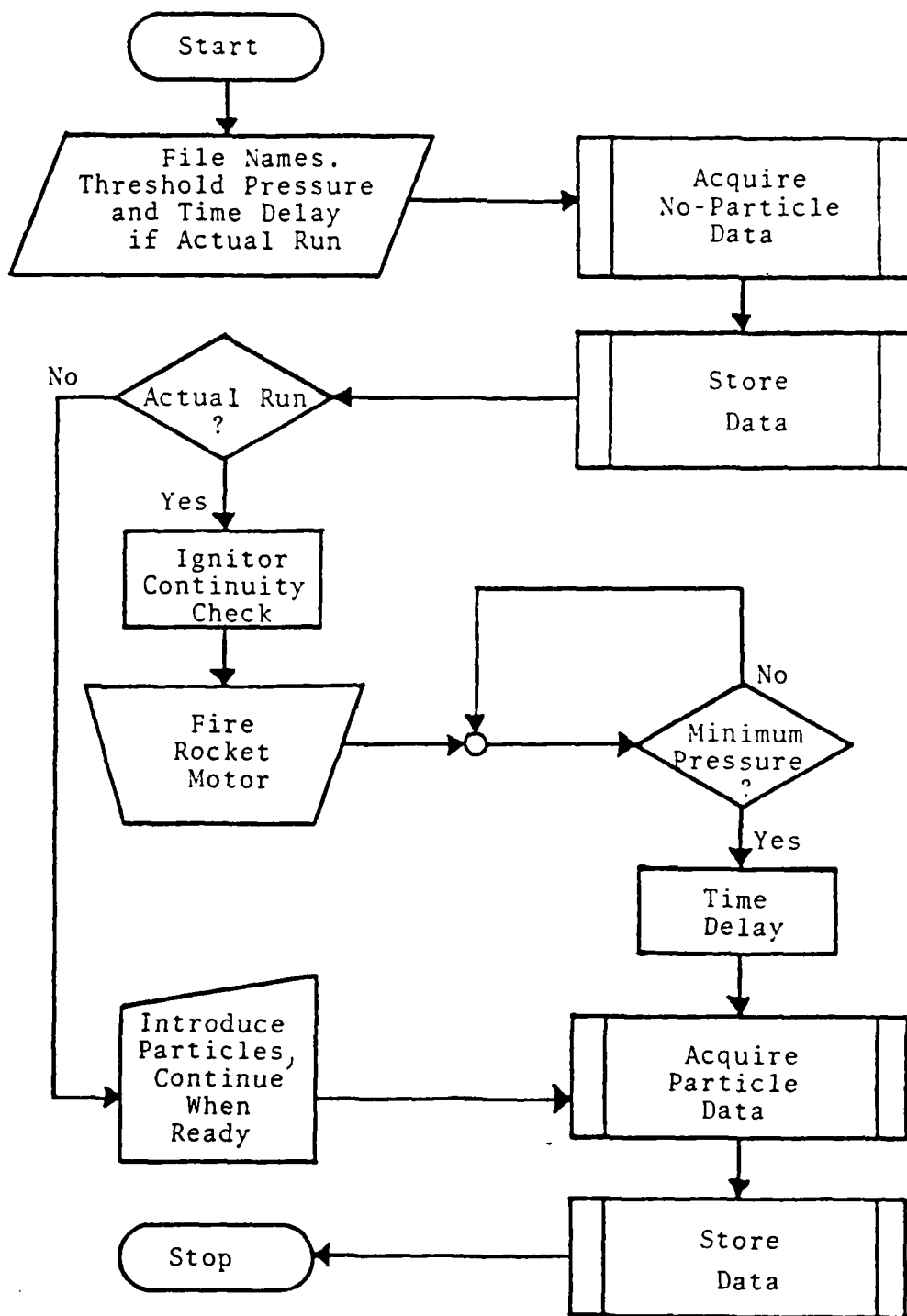

Figure 3. Flow Chart for Program "ACQDTA".

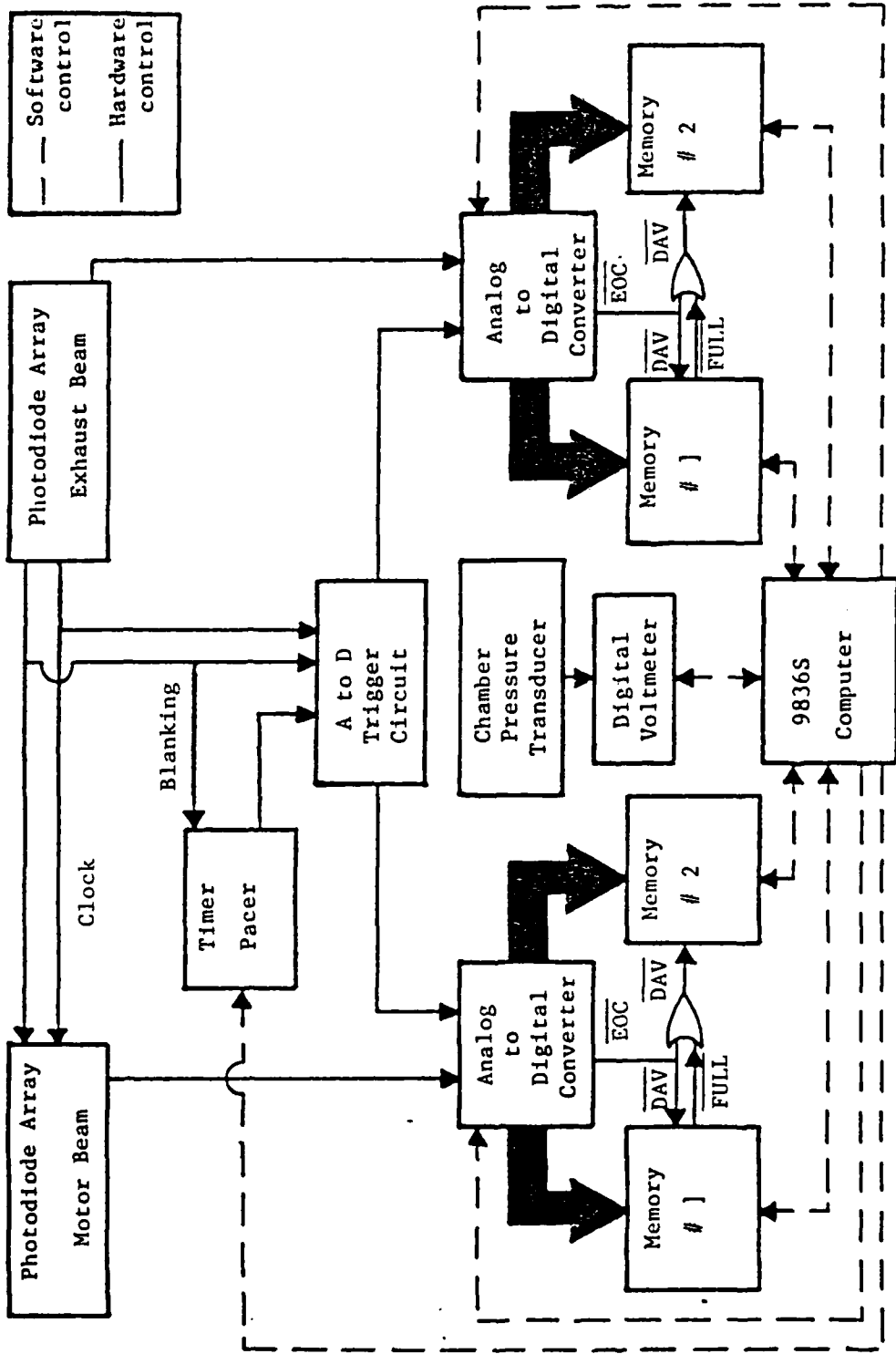

Figure 4. Schematic of Data Acquisition System.

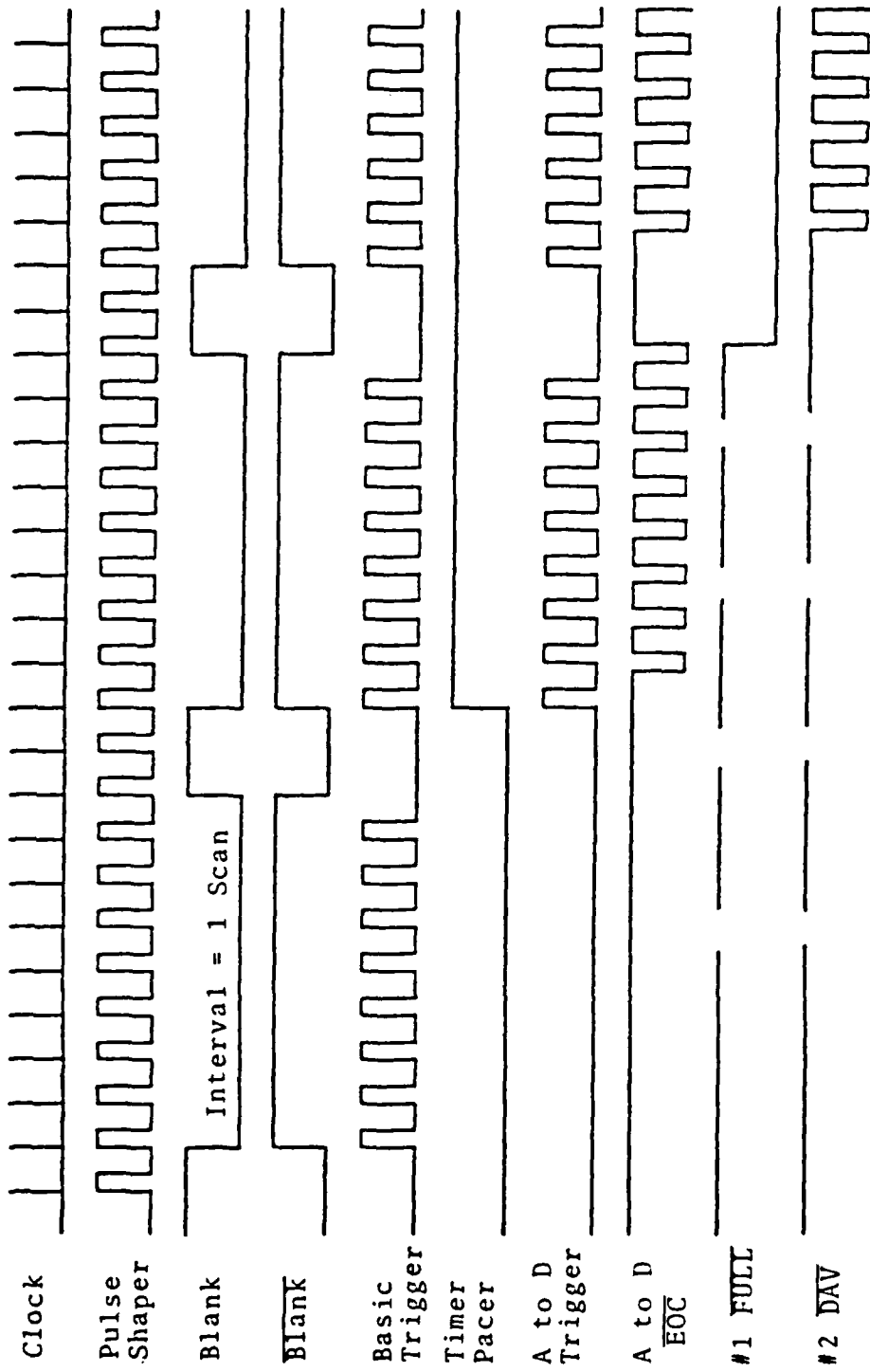

Figure 5. Timing Diagram for Data Acquisition.

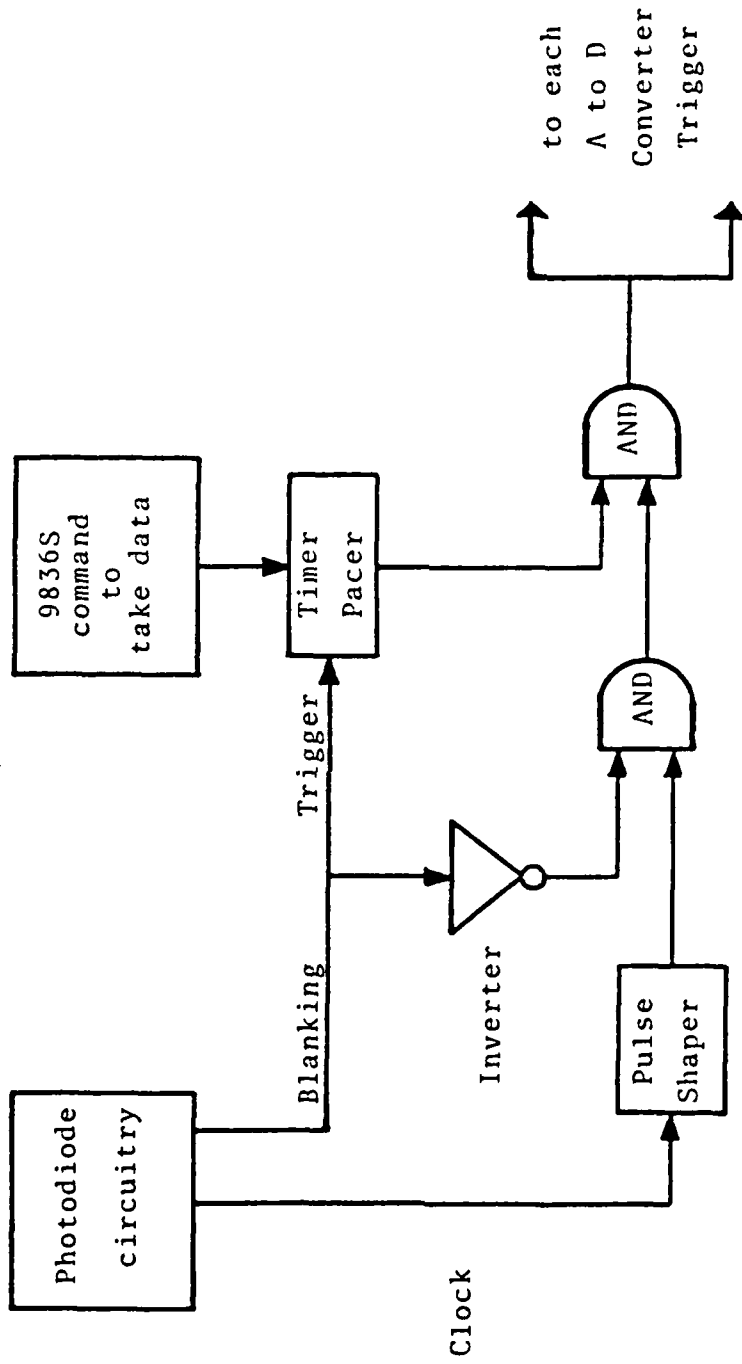

Figure 6. Schematic of Pacing Circuit for Data Acquisition.

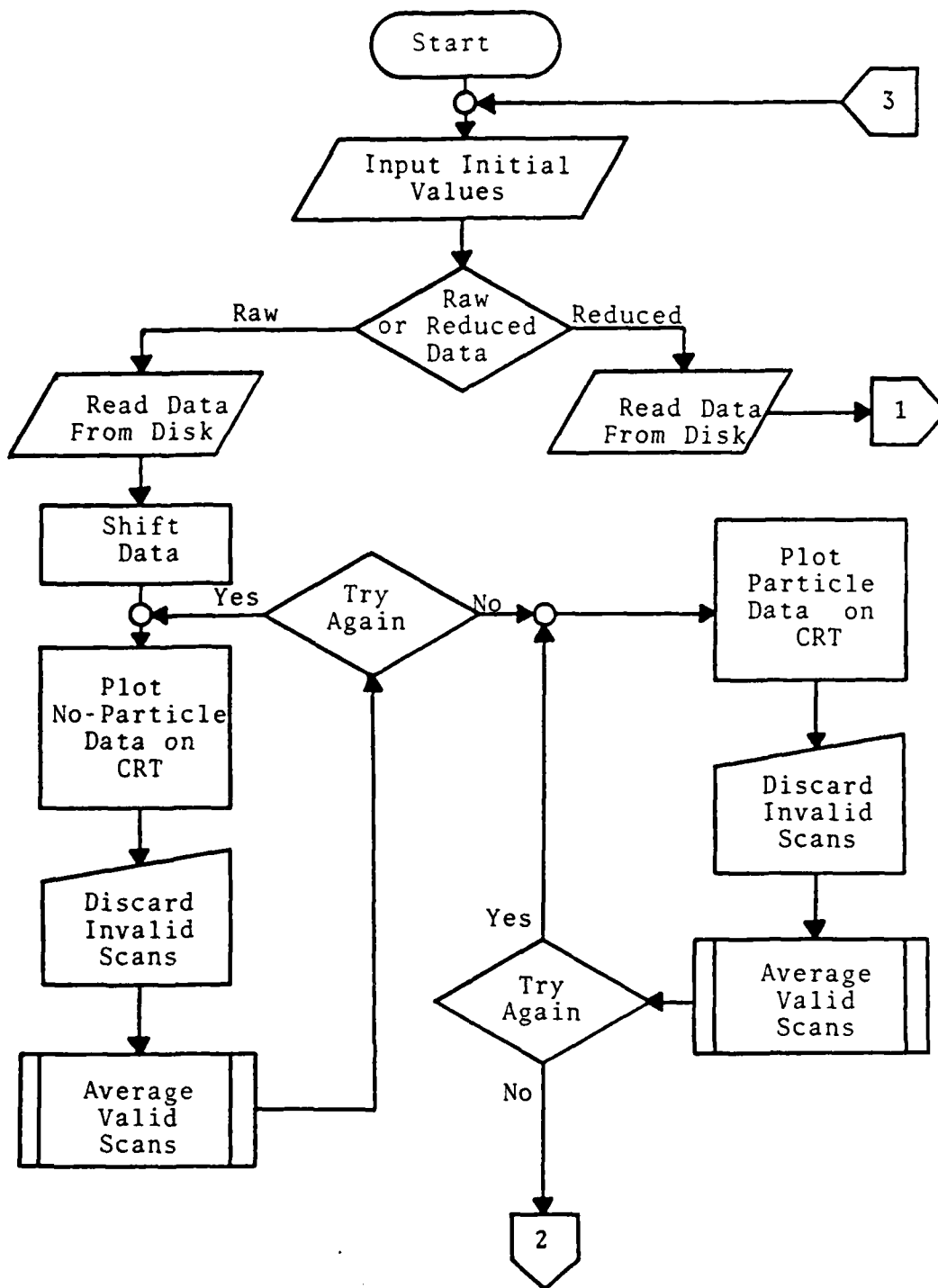

Figure 7. Flow Chart for Program "RDC".

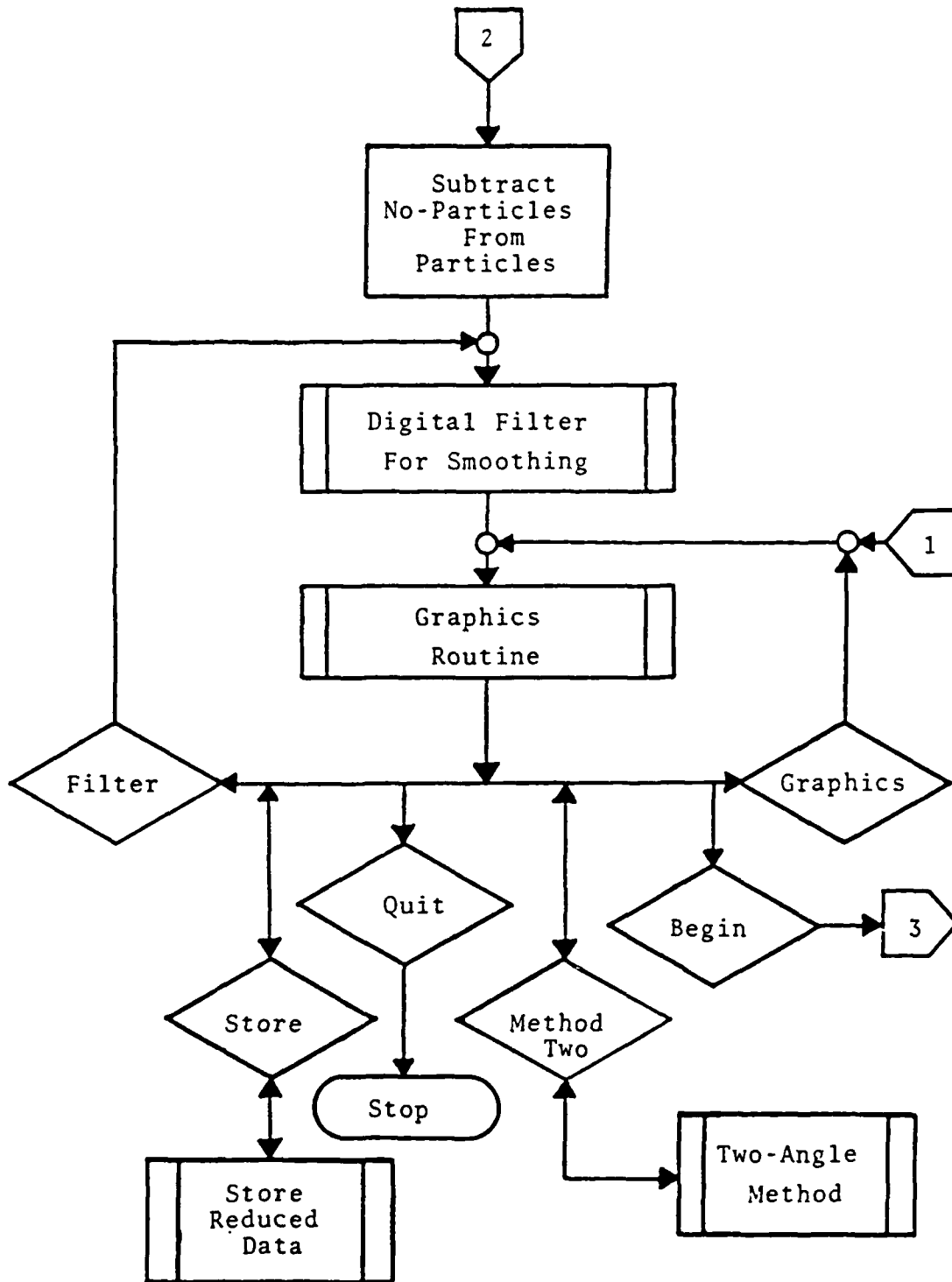

Figure 7. (Continued) Flow Chart for Program "RDC".

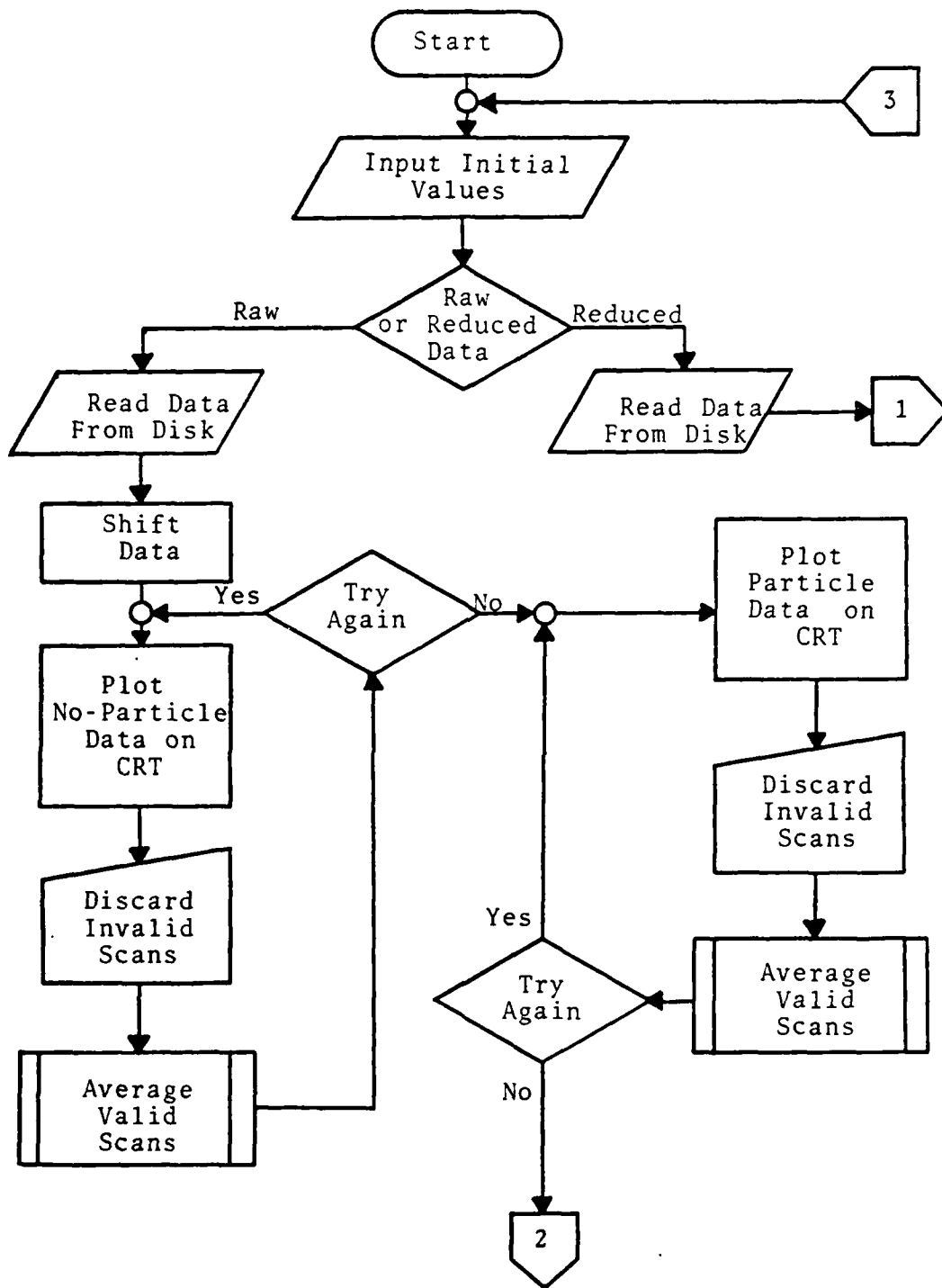

Figure 7. Flow Chart for Program "RDC".



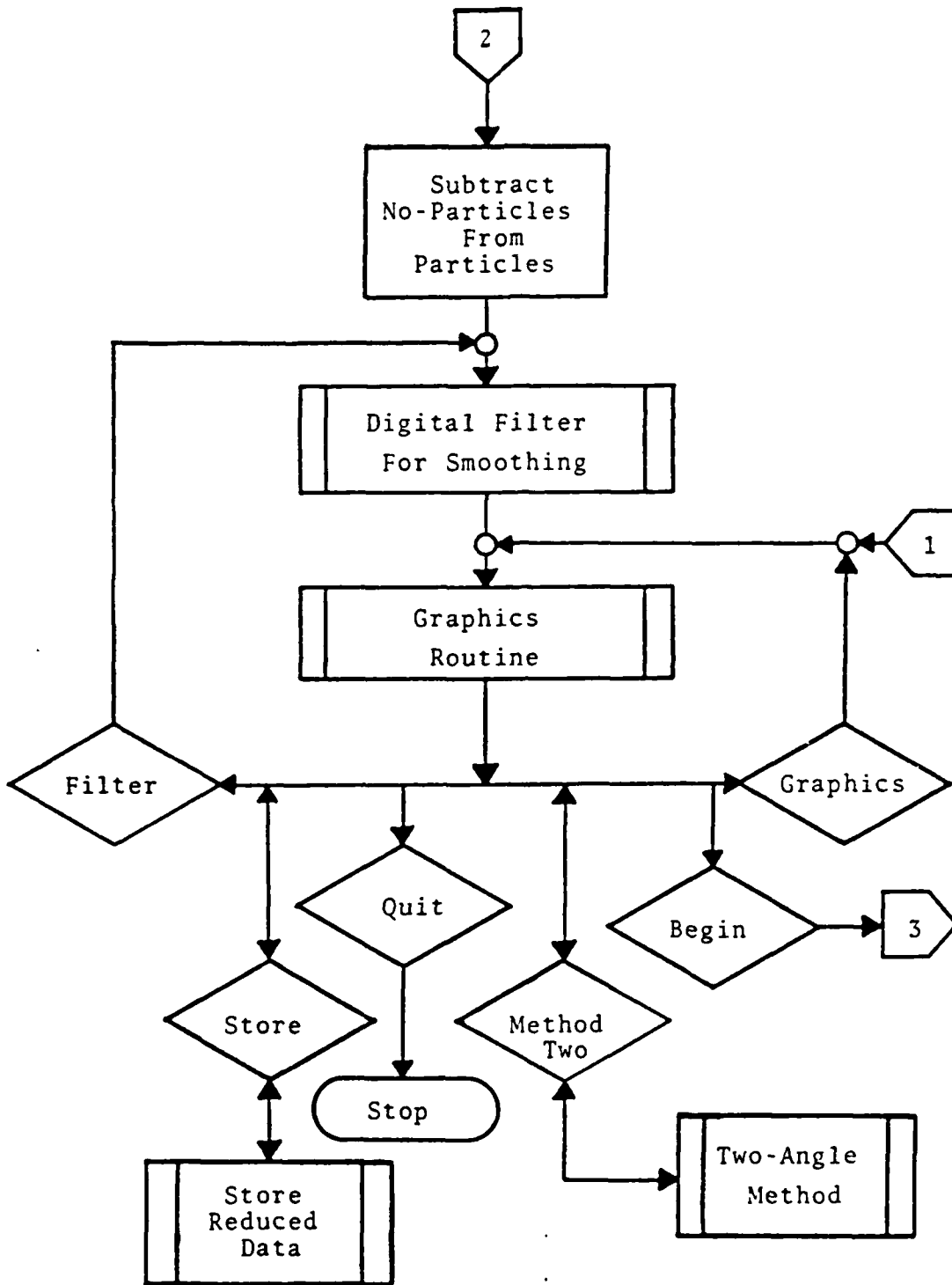

Figure 7. (Continued) Flow Chart for Program "RDC".

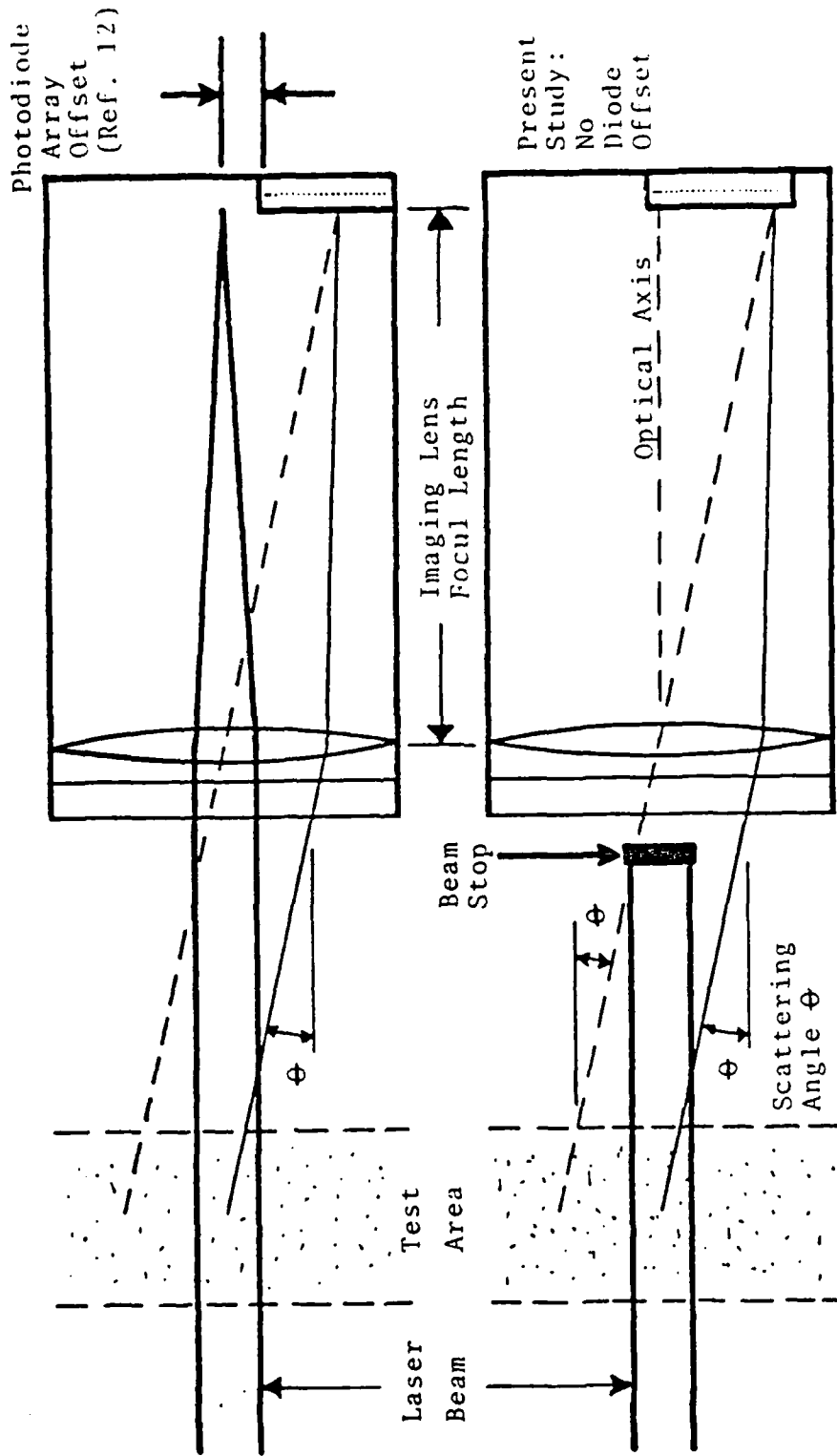

Figure 8. Comparison of Two Geometries for Light Scattering Measurements.

# CURVE FIT RESULTS INTENSITY VS. THETA

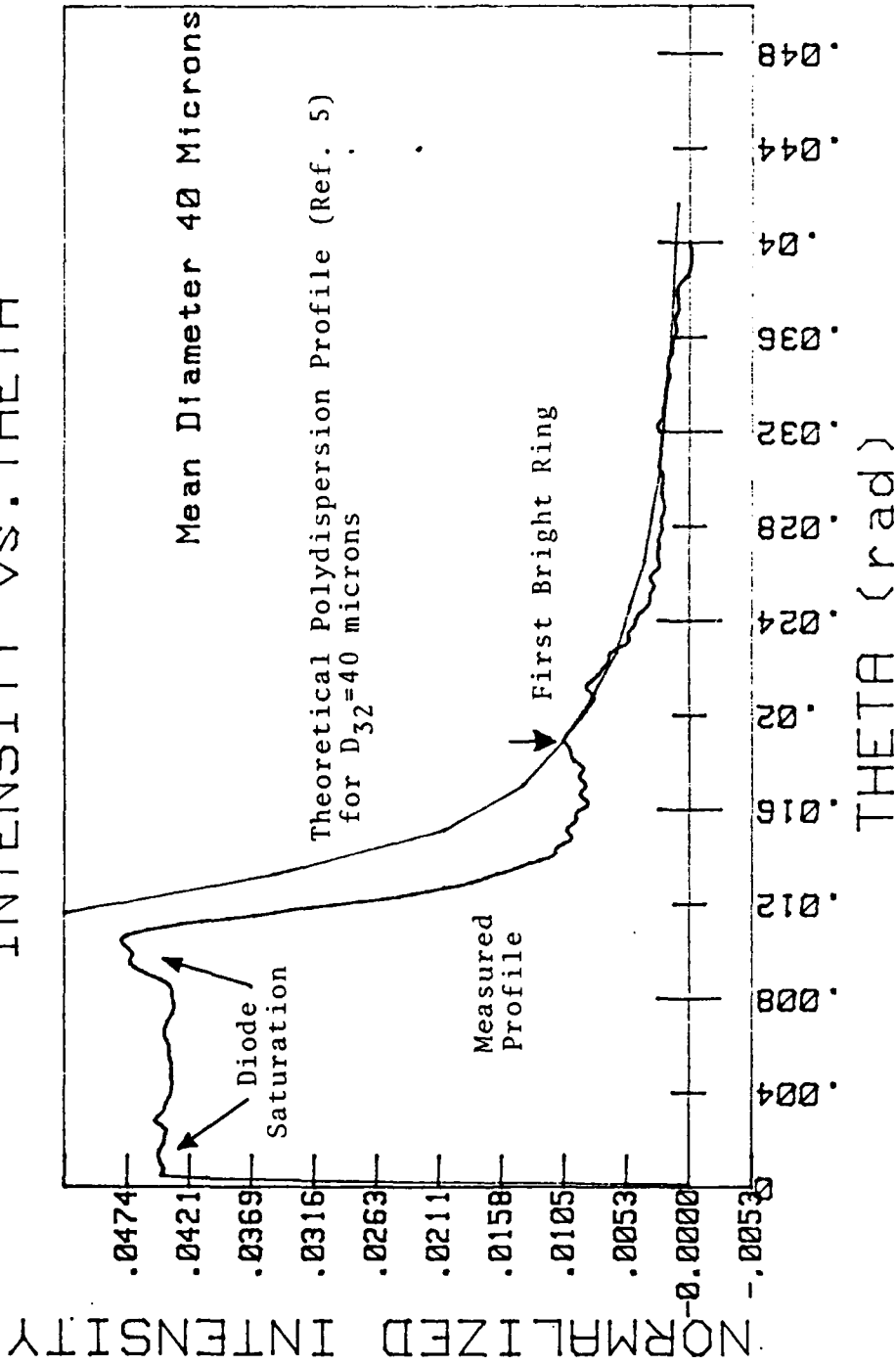

Figure 9. 37-44 Micron Glass Spheres Using No Beam Stop.

# CURVE FIT RESULTS INTENSITY VS. THETA

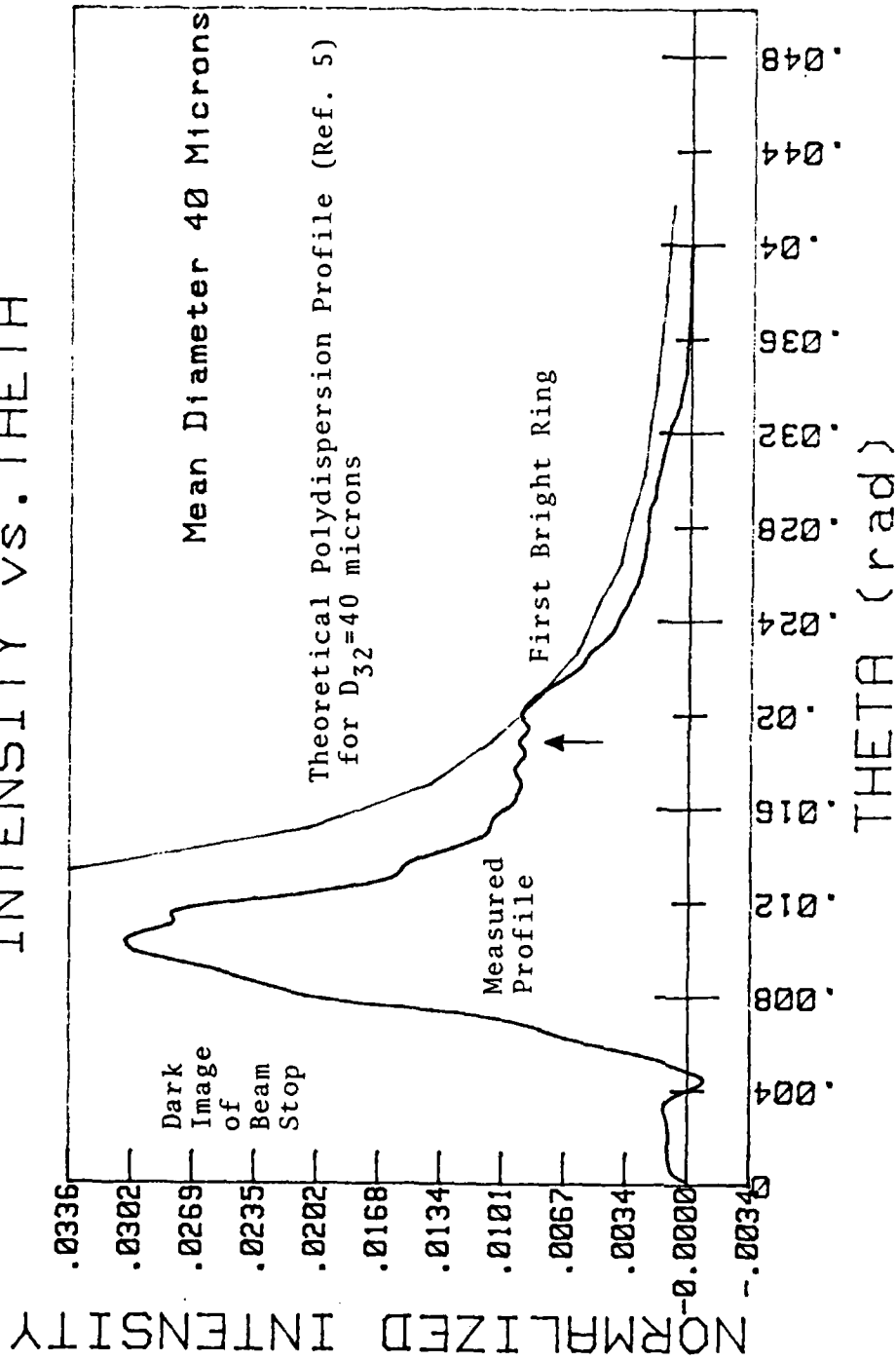

Figure 10. 37-44 Micron Glass Spheres Using Beam Stop.

# CURVE FIT RESULTS INTENSITY VS. THETA

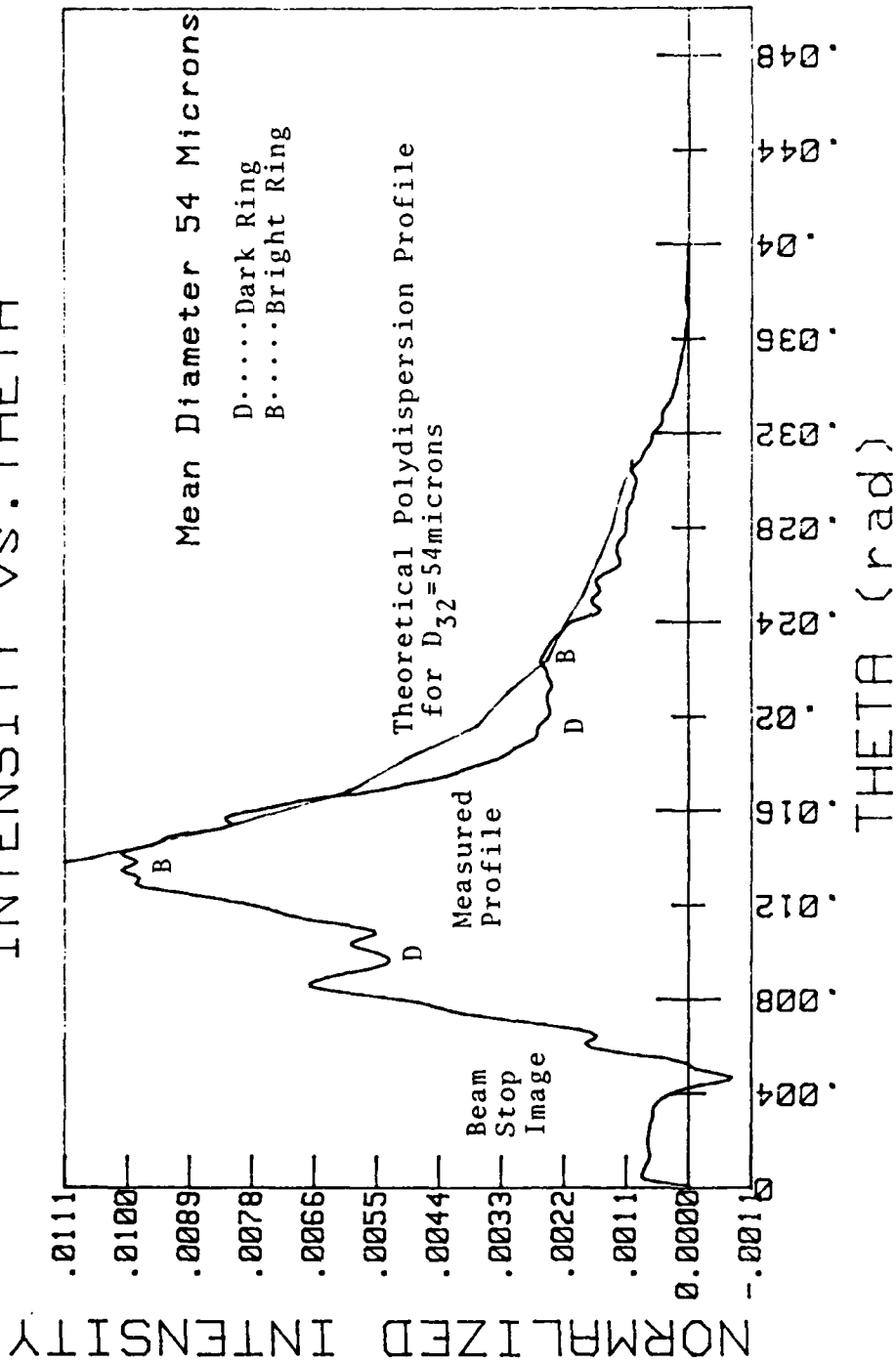

Figure 11. 53-63 Micron Glass Spheres Showing Diffraction Rings.

# CURVE FIT RESULTS INTENSITY VS. THETA

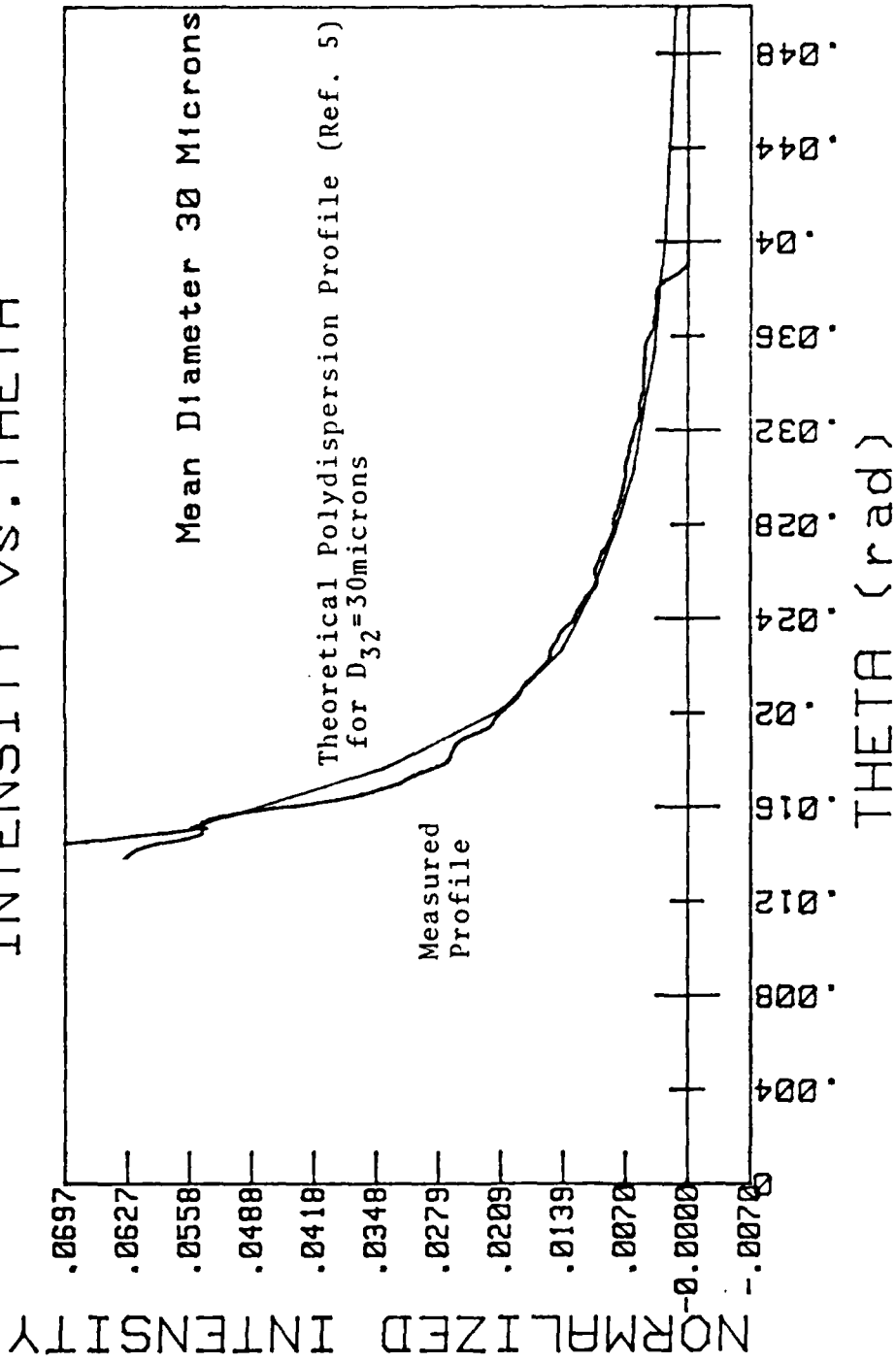

Figure 12. 1-37 Micron Glass Spheres, High Concentration.

# CURVE FIT RESULTS INTENSITY vs. THETA

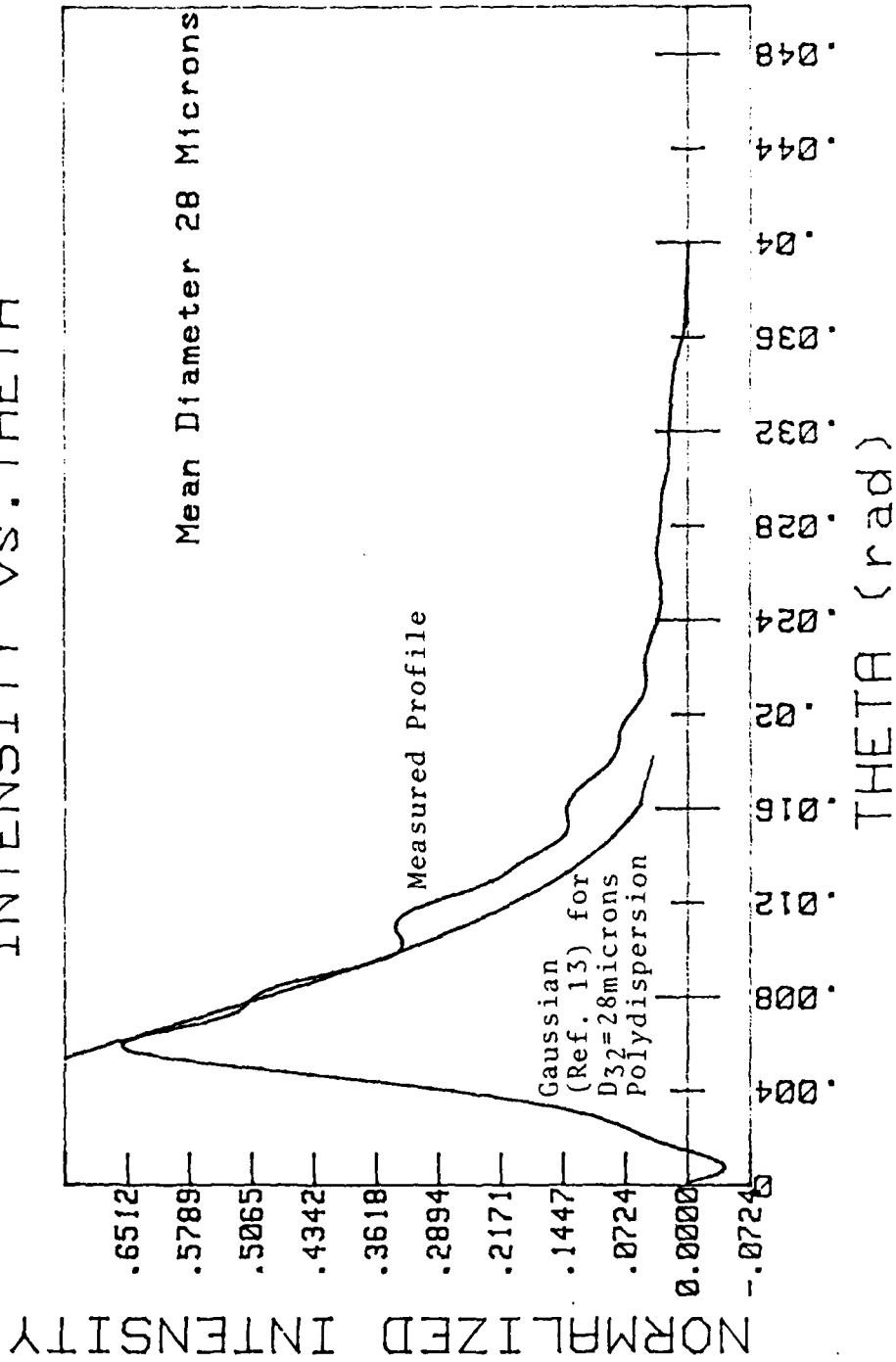

Figure 13. 1-37 Micron Glass Spheres, Low Concentration.

# CURVE FIT RESULTS INTENSITY VS. THETA

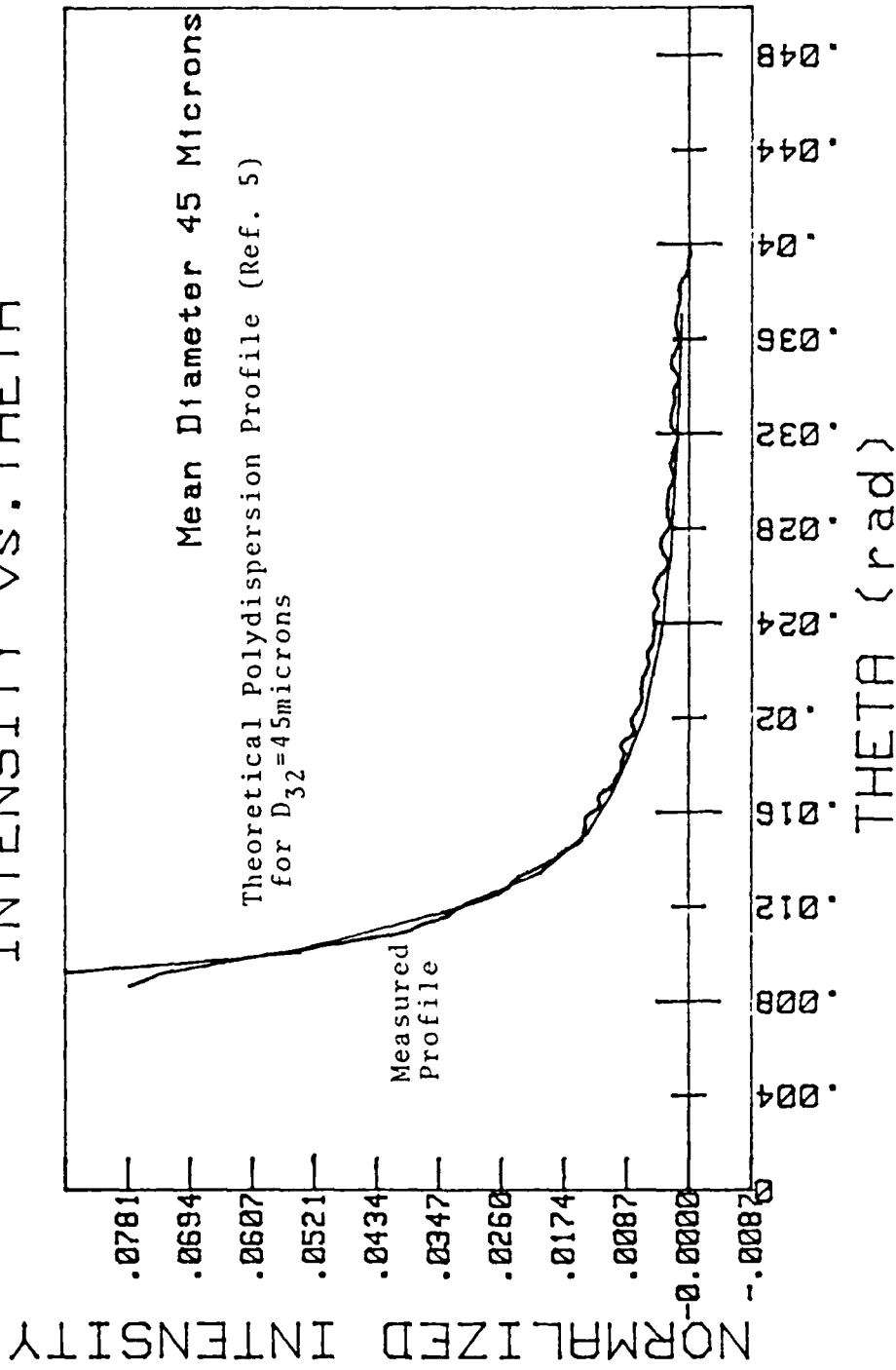

Figure 14. 50 Micron Aluminum Oxide, High Concentration.



# CURVE FIT RESULTS INTENSITY vs. THETA

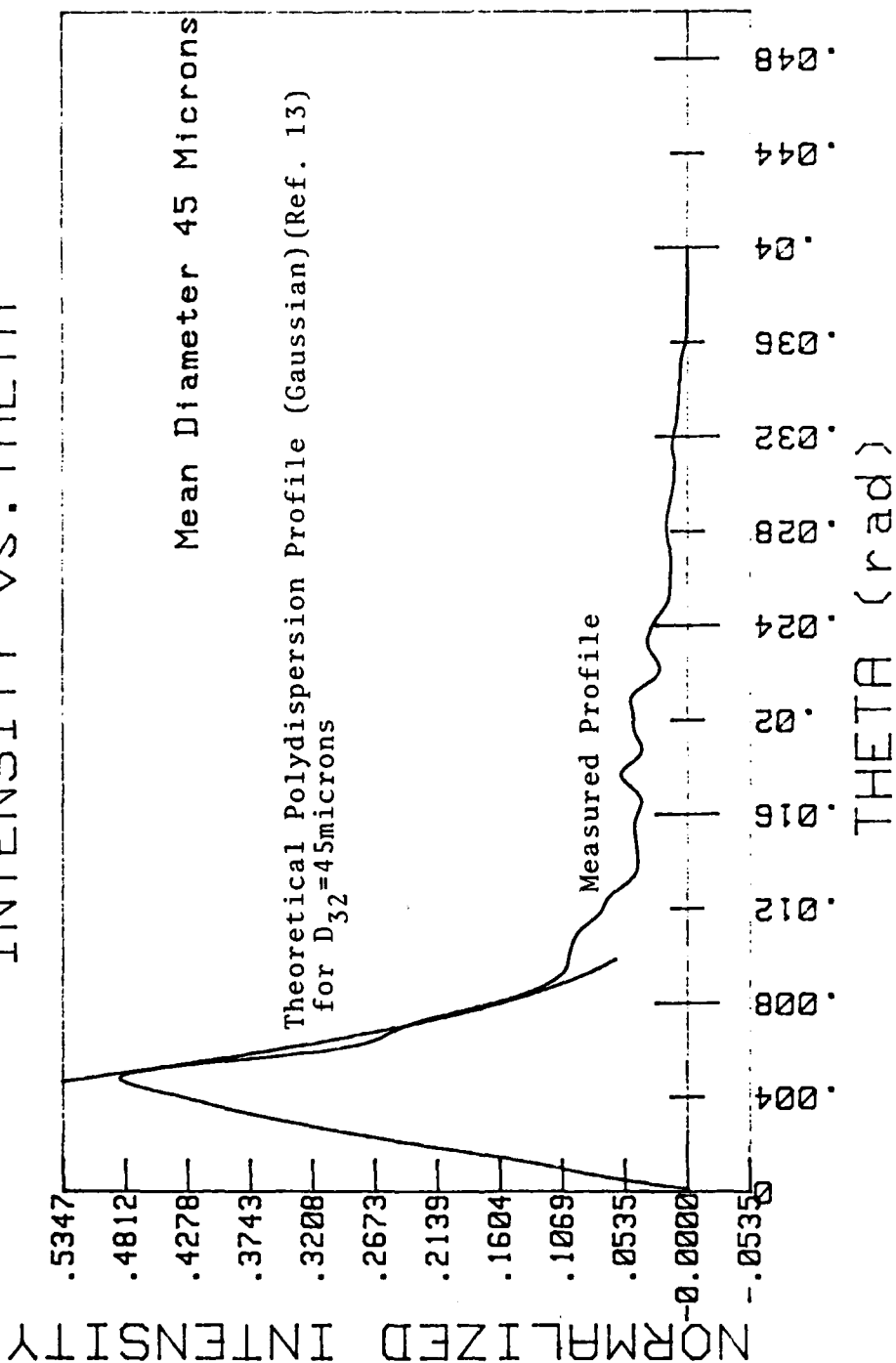

Figure 15. 50 Micron Aluminum Oxide, Low Concentration.

# CURVE FIT RESULTS INTENSITY VS. THETA

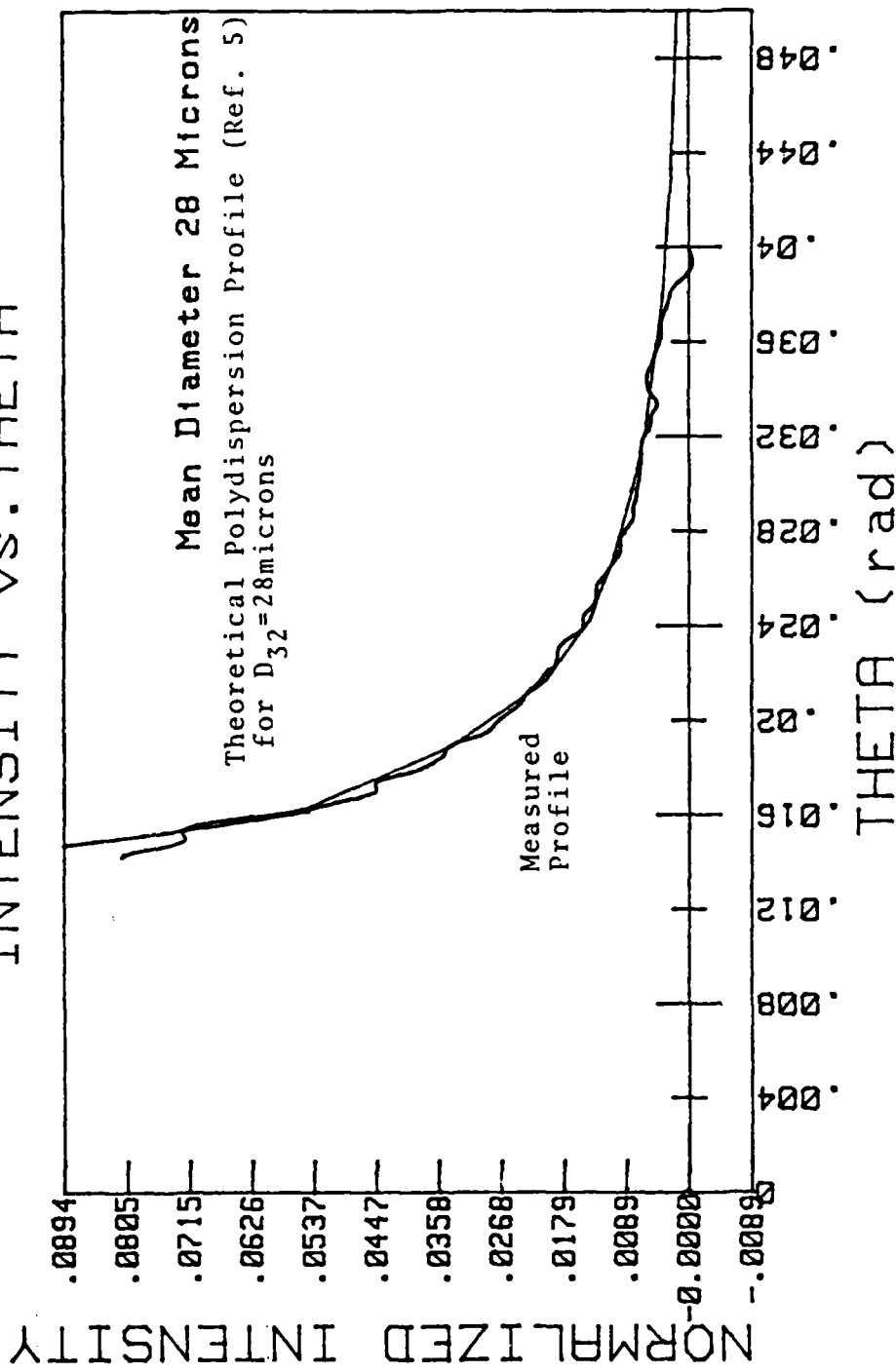

Figure 16. 25 Micron Aluminum Oxide, High Concentration.

# CURVE FIT RESULTS INTENSITY vs. THETA

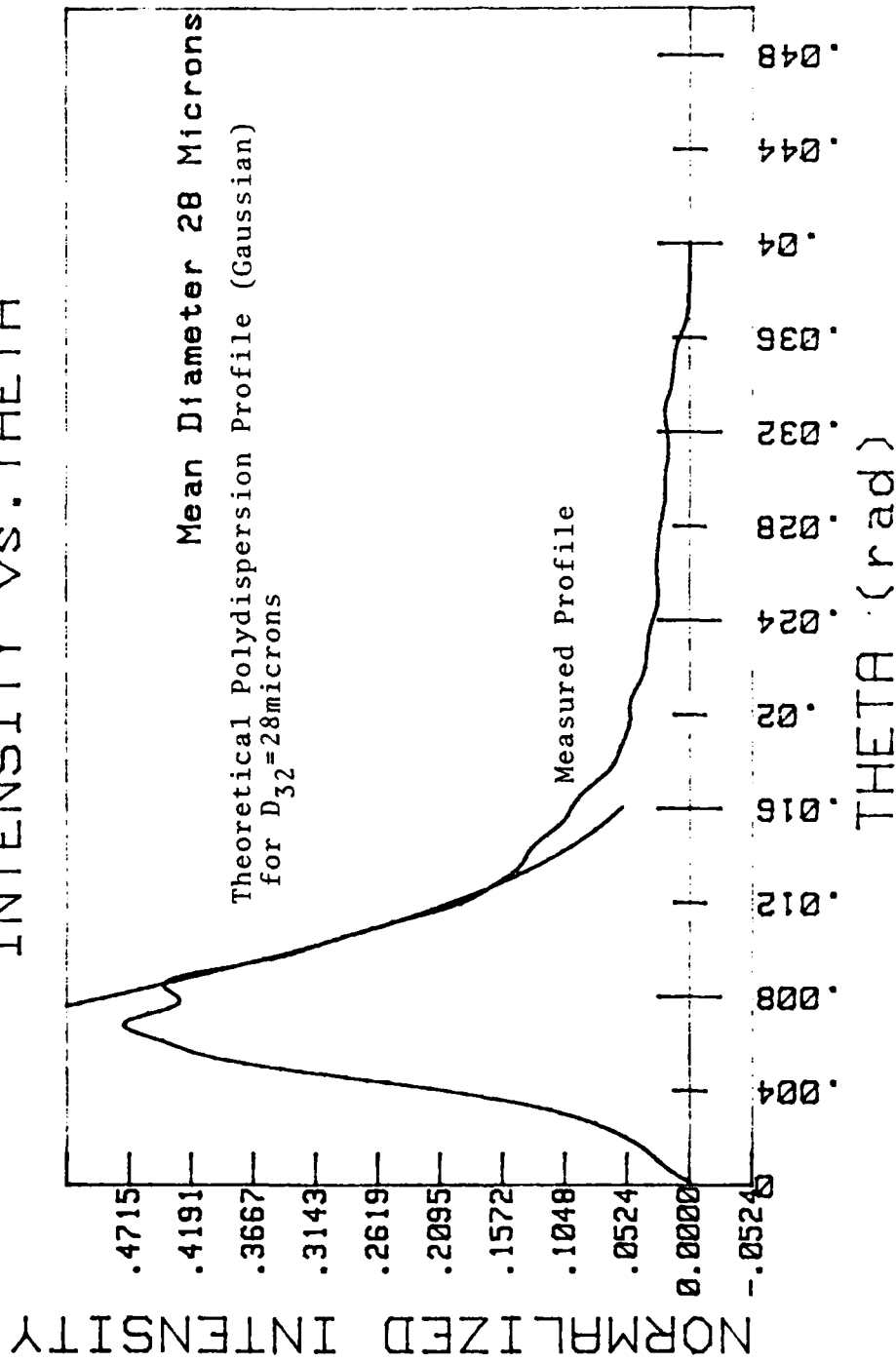

Figure 17. 25 Micron Aluminum Oxide, Low Concentration.

# CURVE FIT RESULTS INTENSITY vs. THETA

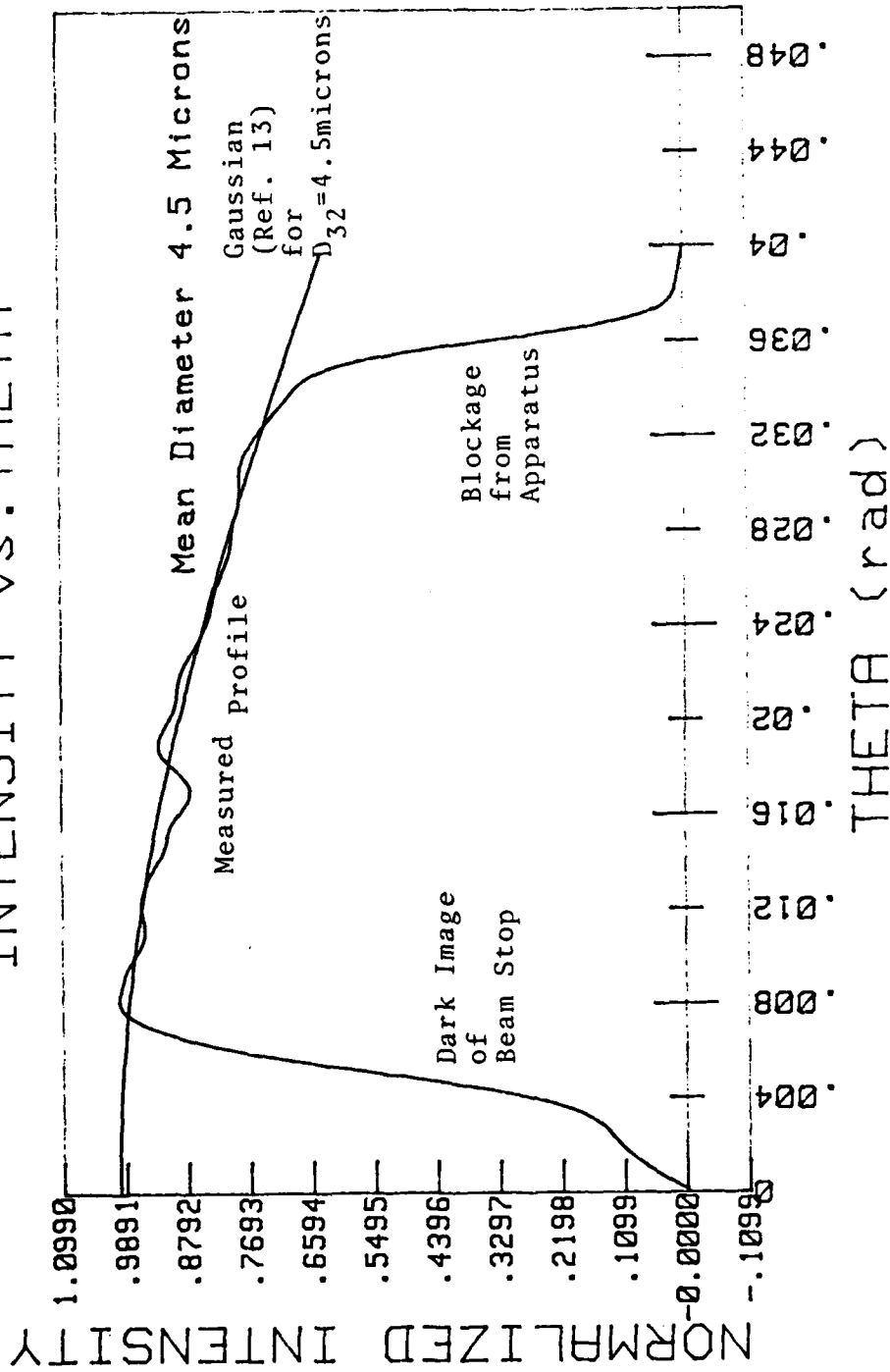

Figure 18. 5 Micron Polystyrene, Curve Fit.

# TWO-ANGLE METHOD For Various Angle Ratios

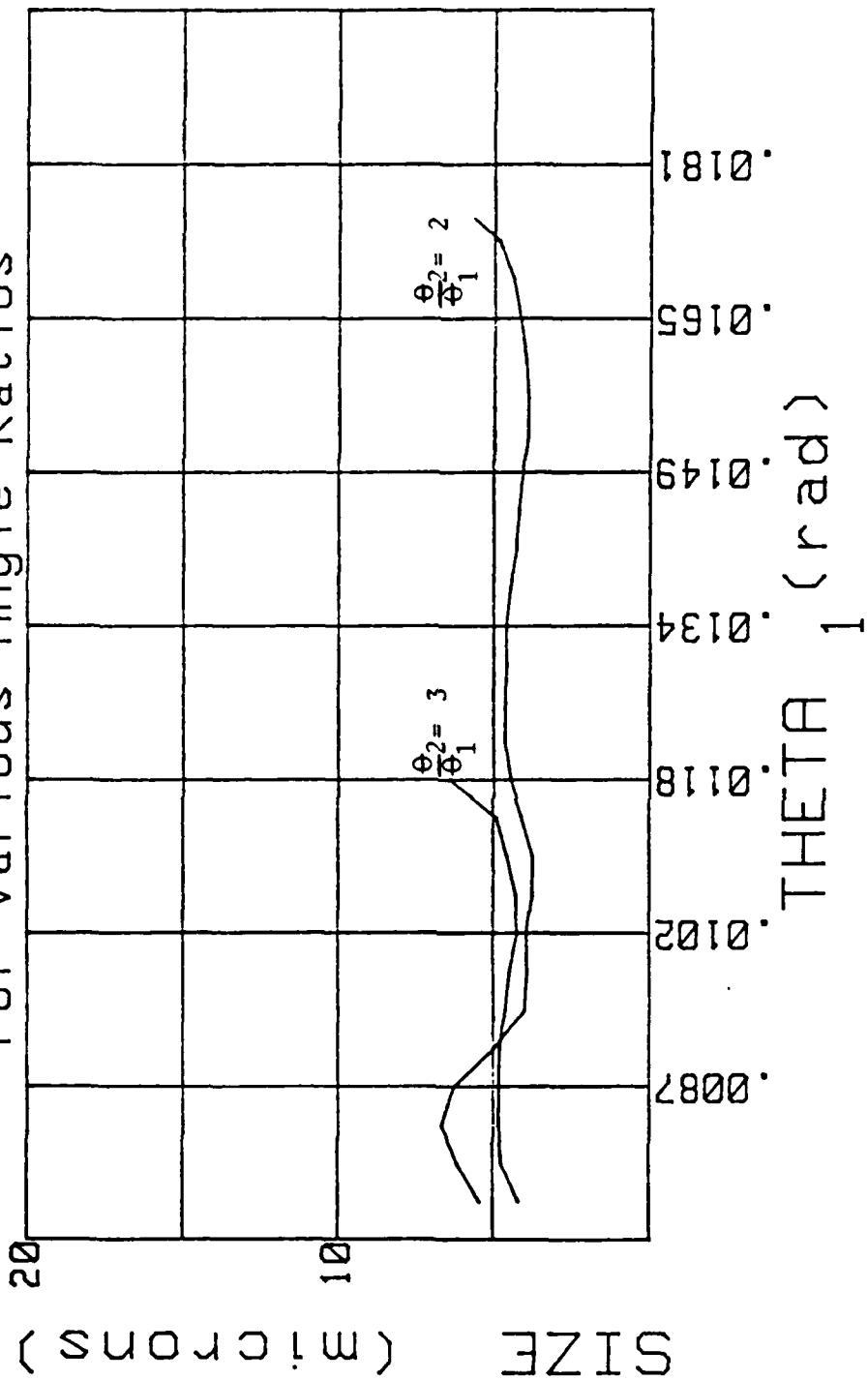

Figure 19. 5 Micron Polystyrene, Two Angle Method [Ref. 13].

# CURVE FIT RESULTS INTENSITY VS. THETA

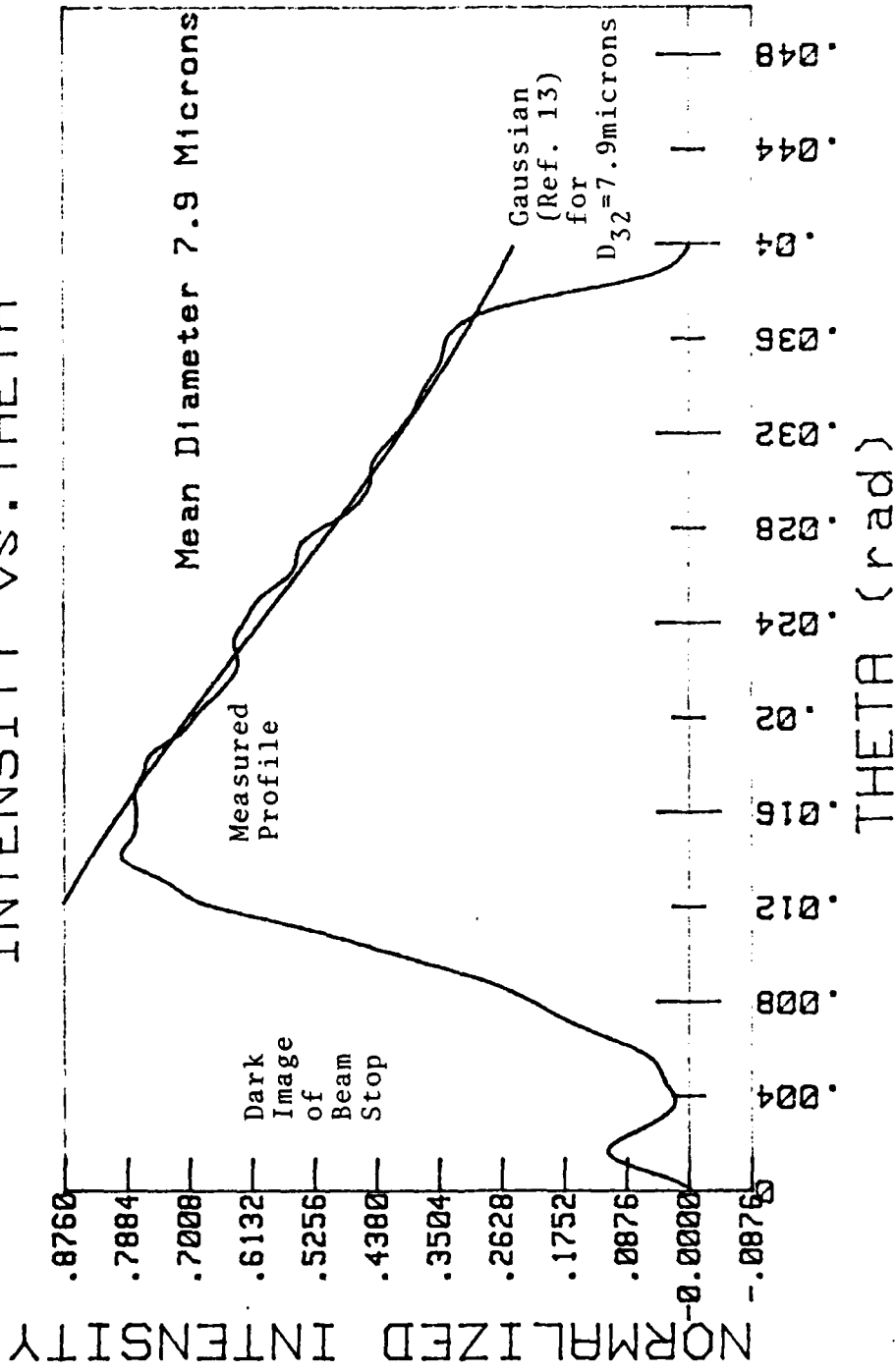

Figure 20. 10 Micron Polystyrene, Curve Fit.

# TWO-ANGLE METHOD For Various Angle Ratios

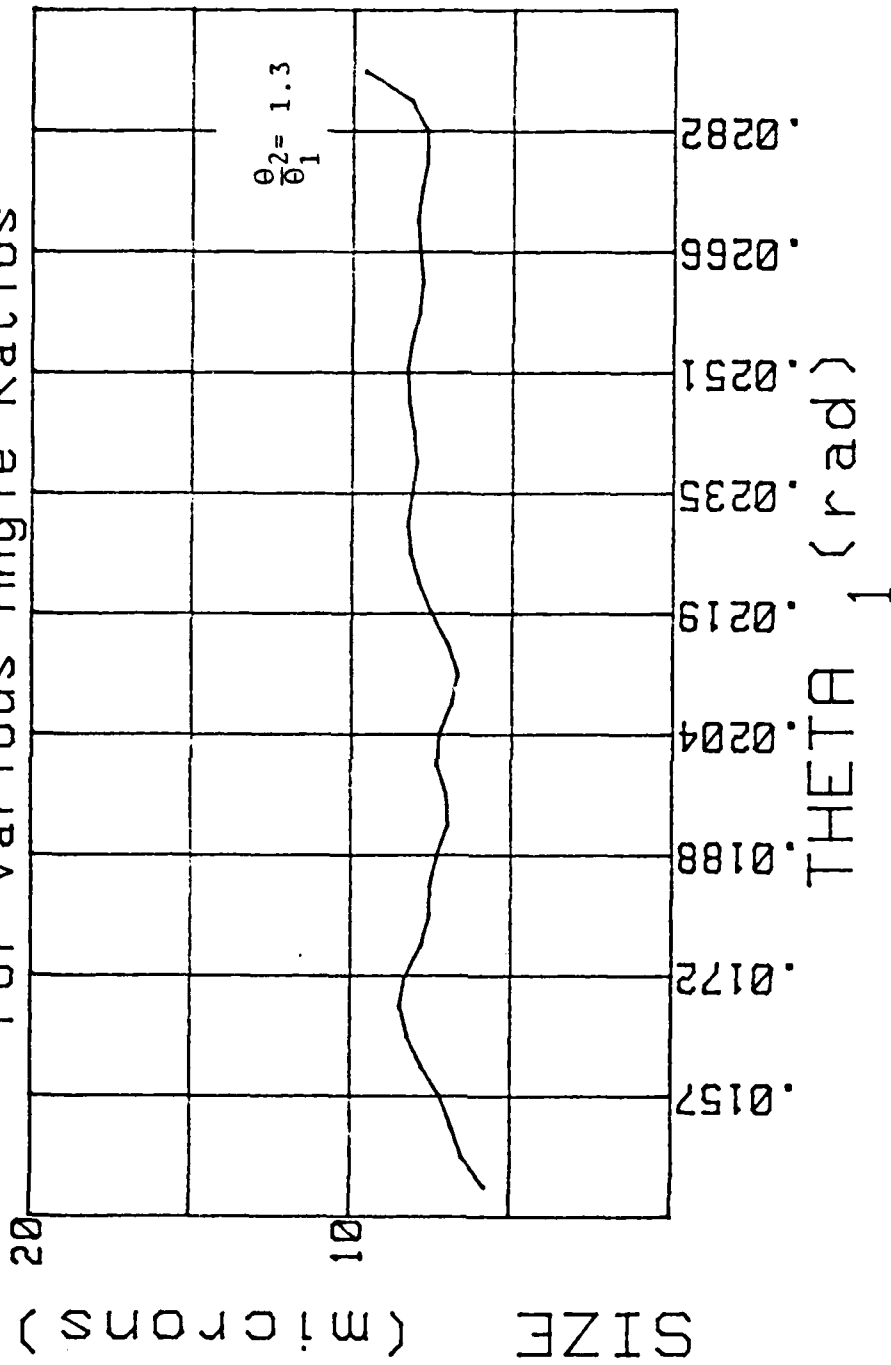

Figure 21. 10 Micron Polystyrene, Two Angle Method [Ref. 13].

# CURVE FIT RESULTS INTENSITY VS. THETA

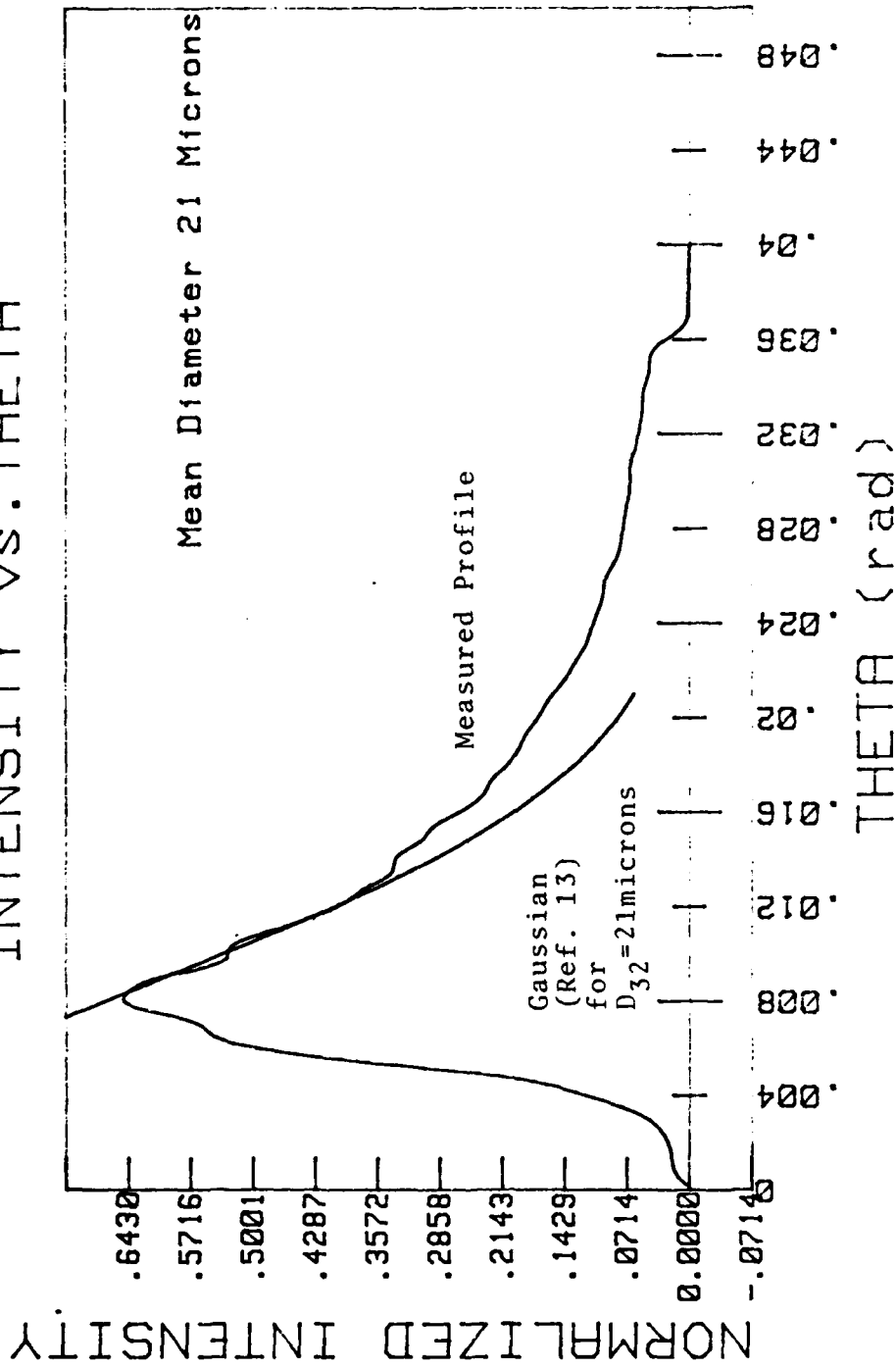

Figure 22. 20 Micron Polystyrene, Curve Fit.



# TWO-ANGLE METHOD For Various Angle Ratios

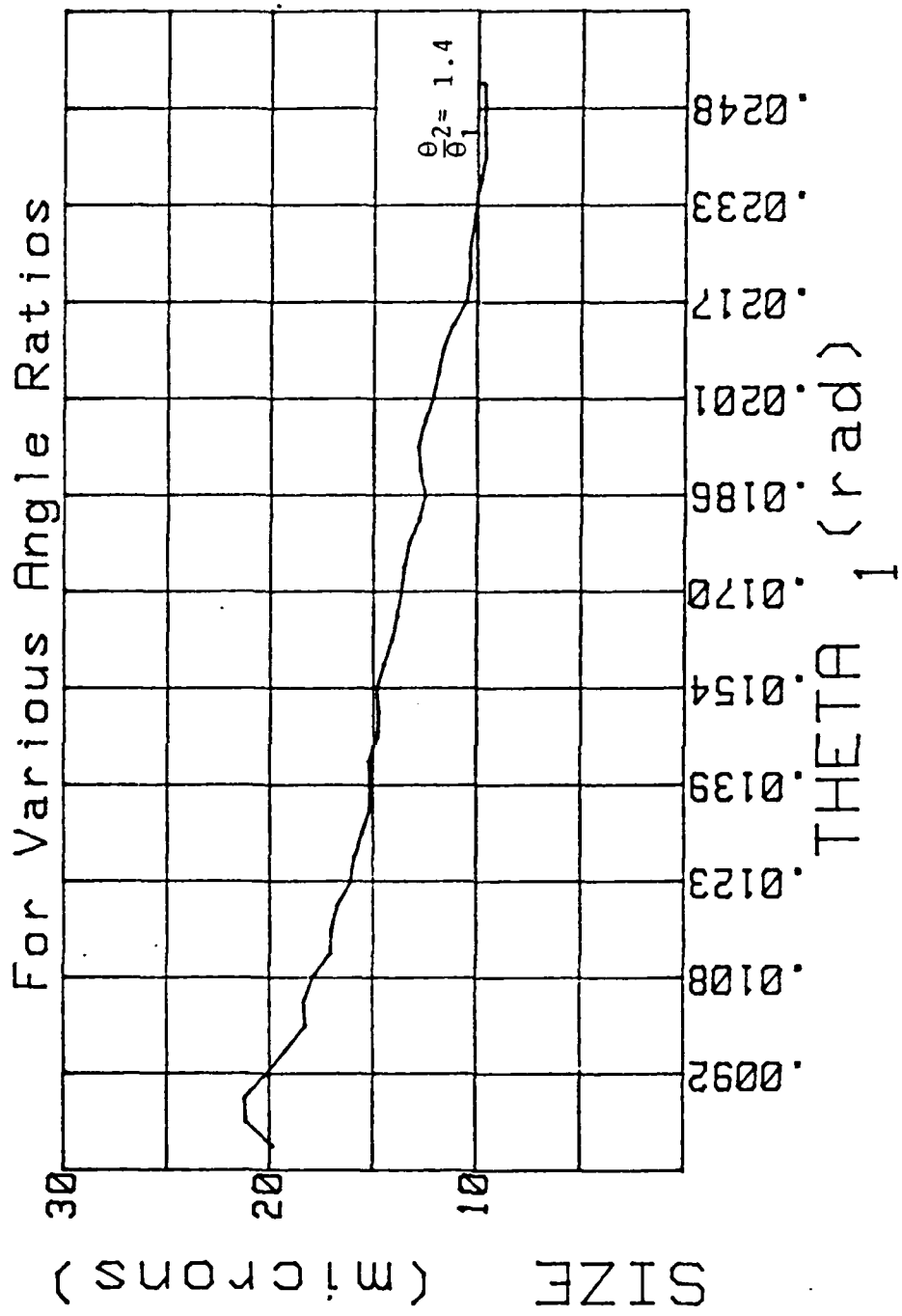
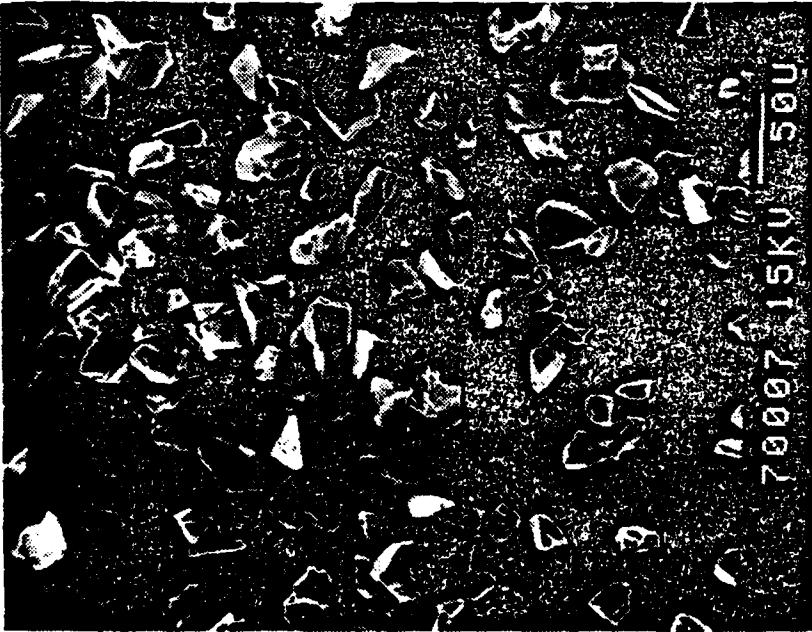

Figure 23. 20 Micron Polystyrene, Two Angle Method [Ref. 13].



50micron Aluminum Oxide



25micron Aluminum Oxide

Figure 24. SEM Photographs of Aluminum Oxide.

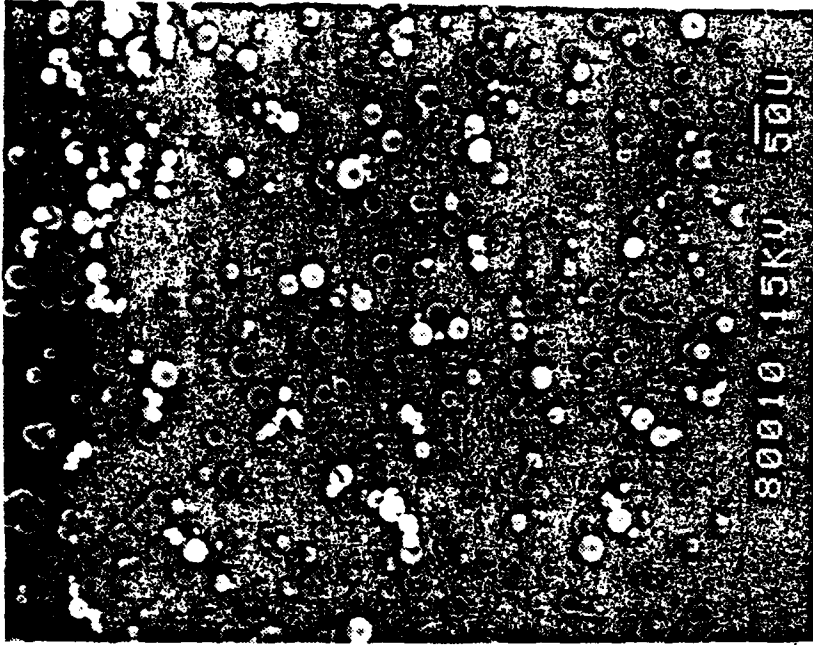

1 to 37micron Glass  
 $D_{32} = 25$

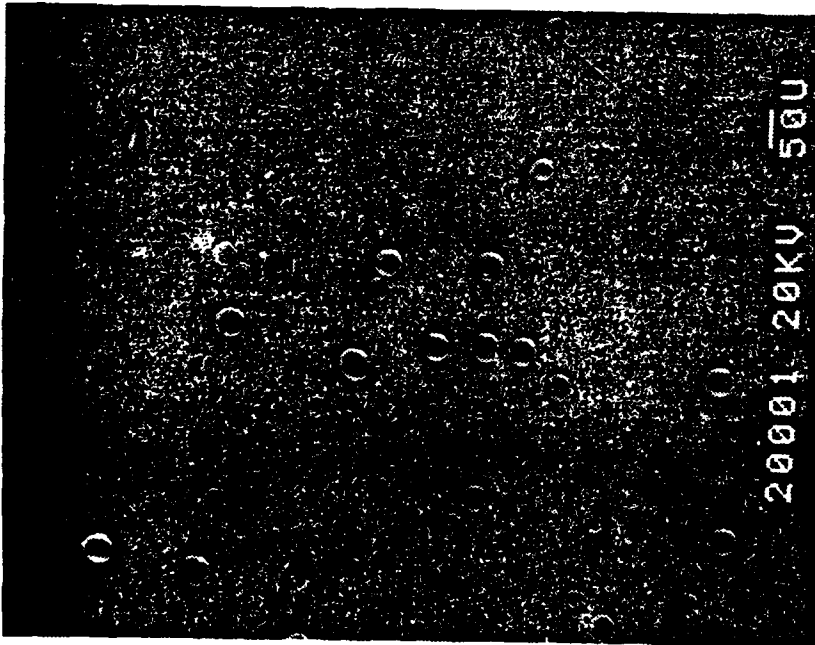

37 to 44micron Glass  
 $D_{32} = 38$

Figure 25. SEM Photographs of Glass Spheres.

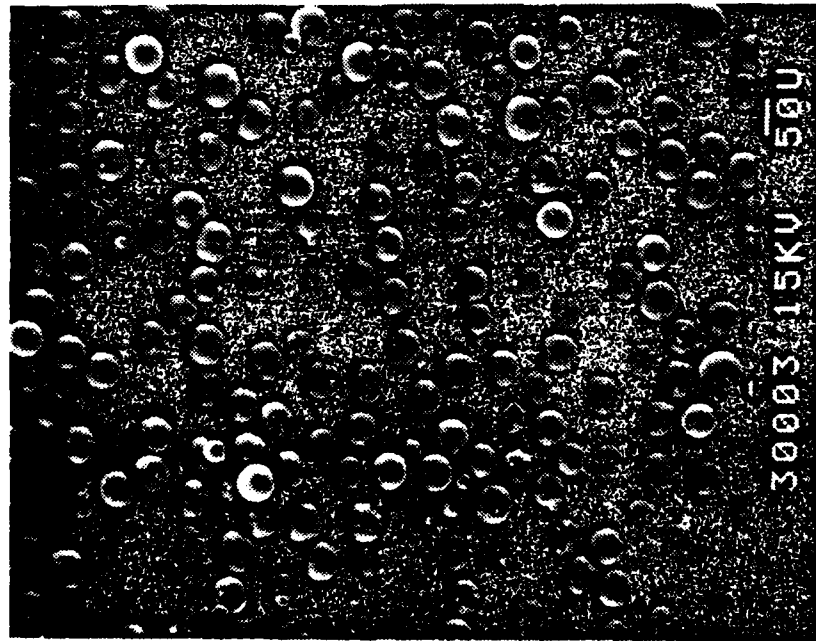

53 to 63micron Glass  
 $D_{32} = 54$

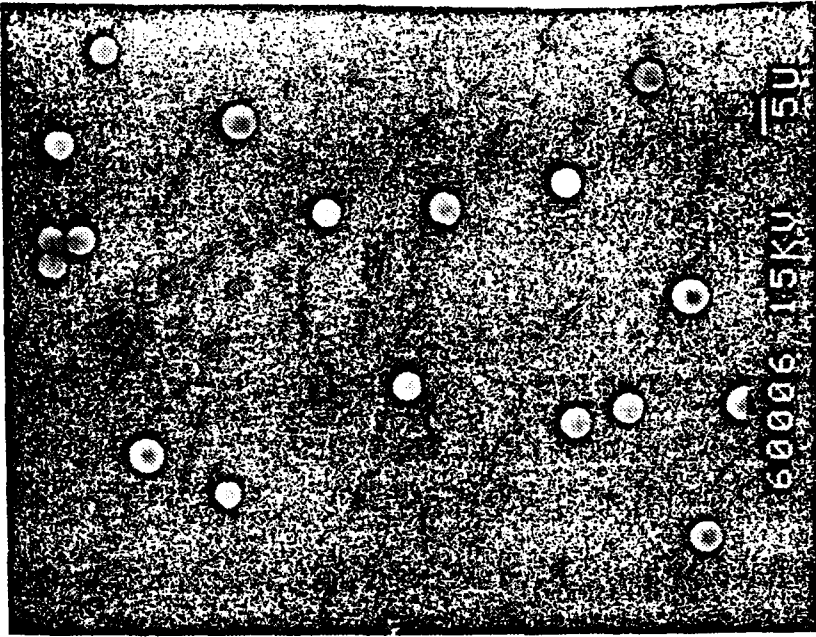

5micron Polystyrene  
 $D_{32} = 4.7$

Figure 26. SEM Photographs of Glass and Polystyrene Spheres.

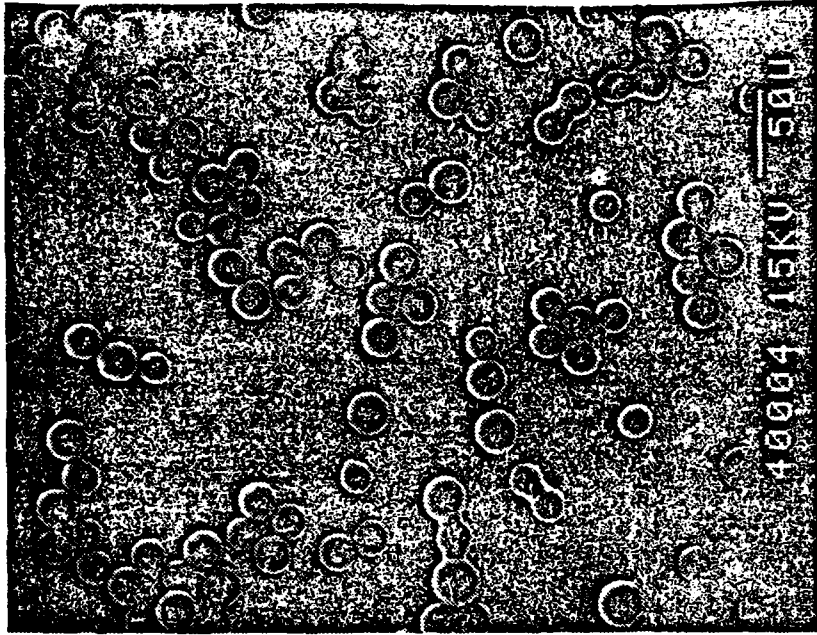

20micron Polystyrene  
 $D_{32} = 21.6$

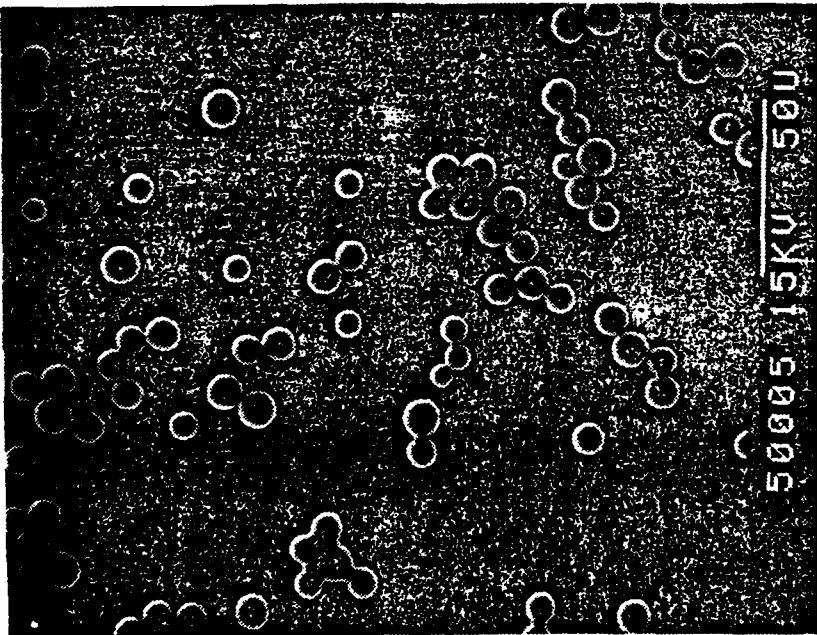

10micron Polystyrene  
 $D_{32} = 10.2$

Figure 27. SEM Photographs of Polystyrene Spheres.

APPENDIX A

PROGRAM LISTINGS

```

10 !***** ACQDTA : FOR 9836S *****
20 !***** ACQUIRES MULTIPLE SCANS OF BOTH DIODE ARRAYS *****
30 !***** AND STORES THEM ON DISK *****
40 !***** BERT HANSEN, KEN GRAHAM, KELLY HARRIS 1984 *****
50 OPTION BASE 1
60 COM Q1$(12),Q2$(12),T1$(20),D1$(12),D2$(12),Address(4),E(4096)
70 COM A(1024) BUFFER,B(4096) BUFFER,C(4096) BUFFER,D(4096) BUFFER
80 OUTPUT 709;"AR" !ANALOG RESET
90 ASSIGN @Multi10 TO 72310 !CLEARS THE WAKE-UP SERVICE REQUEST
100 ENTER @Multi10;Qq1,Qq2,Qq3,Qq4,Qq5,Qq6 !OF THE MULTIPROGRAMMER
110 MAT Address= (0)
120 ENABLE INTR 7
130 CLEAR 722
140 PRINT USING "3/"
150 PRINT "ENTER THE FILENAMES OF THE DATA FILES TO BE CREATED (e.g. RAW1,RAW2
) "
160 PRINT " 12 CHARACTERS MAXIMUM, EACH"
170 PRINT USING "/"
180 PRINT " AN EMPTY DISK MUST BE IN THE LEFT DISK DRIVE "
190 PRINT ""
200 PRINT " THE DATA FILES WILL NEARLY FILL A DISK"
210 PRINT USING "/"
220 MASS STORAGE IS ":INTERNAL,4,0" ! CHANGE THIS LATER IF NECESSARY
230 INPUT " INPUT FILE NAMES NOW - (FILENAME1,FILENAME2) ",D1$,D2$
240 M5=1024
250 Zz$=":INTERNAL,4,1" ! STRING INDICATES MASS STORAGE
260 CREATE BDAT D1&Zz$,6144,16 ! 12 SCANS OF 1024 @ 2*8 BYTES PER RECORD
270 CREATE BDAT D2&Zz$,6144,16 ! 1024*12/2=NUMBER OF RECORDS=6144)
280 PRINT USING "e"
290 PRINT " DATA WILL BE STORED ON DISKETTE WITH FOLLOWING FILE NAMES:"
300 PRINT USING "///"
310 PRINT " NO PARTICLES ---- FILENAME = ";D1$
320 PRINT " PARTICLES ----- FILENAME = ";D2$
330 PRINT USING "///"
340 PRINT " IS THIS A CALIBRATION ? ENTER ' Y ' IF YES "
350 PRINT " ANYTHING ELSE IF NO "
360 INPUT R$
370 PRINT USING "///"
380 PRINT " BE SURE LASER IS ON"
390 PRINT " PRESS [CONTINUE] WHEN READY"
400 PAUSE

```

```

410 IF R8="Y" THEN 470
420 PRINT USING "e"
430 INPUT "ENTER THE THRESHOLD PRESSURE TO TRIGGER THE DEVICES (psi)",S8
440 INPUT "ENTER TIME DELAY FROM THRESHOLD PRESSURE (sec)",T8
450 !          TIMES ARE INTERPRETED BY THE COMPUTER IN SECONDS DOWN TO .001
460 V0=S8/151.5          ! CALIBRATION OF PRESSURE TRANSDUCER
470 D3=D1$          ! NO-PARTICLES STRING NAME
480 GOSUB Multiprog
490 GOSUB Storedata
500 IF R8="Y" THEN 1000
510 !*****
520 Contcheck:          !Continuity checking
530 OUTPUT 709;"AC20"          !CONNECT 3456A DVM TO IGNITION FIRING LINE
540 LOCAL LOCKOUT 7          !KEEPS OPR. FROM SWITCHING FRONT PANEL TO LOCAL
550 R7=225          ! IN THOUSANDS OF OHMS
560 OUTPUT 722;"HSM002SW2S01L1S0F4R1T3QX1"          !RESISTANCE MEASUREMENT
570 ! H RESETS DVM;SM002 SETS SERVICE REQUEST MASK WHERE 002 IS OCTAL REP. OF
580 ! THE SERIAL POLL MASK BYTE;SW2 TELLS WHICH TERMINAL SWITCH IS USED;S01
590 ! SYSTEM OUTPUT MODE ON - WAITS FOR CONTROLLER TO HANDSHAKE;L1 LOAD
600 ! INTERNAL MEMORY ON;S0-FUNCTION SHIFT OFF;F4-TWO WIRE CONNECTION TO DVM
610 ! R1-AUTORANGING;T3-SINGLE TRIGGER;Q-LOAD INTERNAL MEMORY OFF;X1-EXECUTE
620 ! STORED PROGRAM.
630 GOSUB Reading
640 R9=V
650 IF R8(R7 THEN GOTO Ok
660 !*****CONTINUITY CHECK*****
670 PRINT USING "e"
680 PRINT "CONTINUITY CHECK BAD!!!!"
690 PRINT "RECHECK BEFORE PROCEEDING. WHEN CHECKED, PRESS [CONTINUE]"
700 BEEP 3000,.3
710 WAIT .1
720 BEEP 100,1.0
730 PAUSE
740 GOTO Contcheck
750 Ok:PRINT USING "e"
760 DISP "          CONTINUITY CHECK IS O.K."
770 PRINT "          BE SURE NITROGEN IS ON"
780 OUTPUT 709;"AC21"          !CONNECT DVM FOR IGNITOR VOLTAGE MEASUREMENT
790 PRINT "          DVM CONNECTED TO FIRE SWITCH"
800 PRINT USING "/"
810 PRINT "BE SURE VISICORDER IS SET UP TO RUN ON PROPER SCALE WITH LAMP ON."
820 PRINT USING "/"
830 OUTPUT 722;"HSM002SW2Z0S01L1FL0.01STIS0F1R1T3Q"          ! VOLTAGE ON IGNITER
840 DISP "          STANDING BY FOR IGNITION"
850 PRINT "          STANDING BY FOR IGNITION"
860 BEEP 2000,.1
870 OUTPUT 722;"X1"          !VOLTMETER TRIGGER
880 GOSUB Reading          !READS VOLTMETER
890 R9=ABS(V)
900 IF R9(10 THEN GOTO 870          ! 12 VOLTS ON IGNITOR

```

```

910 00=TIMEDATE          ! USES COMPUTER CLOCK TO GET ELAPSED TIMES
920 OUTPUT 709;"AC22"    ! CONNECT PRESSURE REDUCER TO DVM
930 OUTPUT 723;"X1"      ! TRIGGER VOLTMETER
940 GOSUB Reading
950 R9=ABS(V)
960 IF R9<V0 THEN GOTO 930      ! THRESHOLD PRESSURE
970 WAIT T8                ! TIME DELAY
980 01=TIMEDATE
990 IF R$(0)*Y" THEN 1060      ! IF ACTUAL RUN THEN SKIP SOME LINES
1000 !                      FOR CALIBRATIONS INTRODUCE PARTICLES AND THEN CONTINUE
1010 PRINT CHR$(12)
1020 PRINT USING "////////"
1030 PRINT "              INTRODUCE PARTICLES THEN PRESS KEY # 9 TO TAKE DATA"
1040 ON KEY 9 LABEL " TAKE DATA" GOTO 1060
1050 Standby: GOTO Standby
1060 GOSUB Multiprog          ! TAKE PARTICLE DATA
1070 LOCAL 7
1080 D3%=D2%                !PARTICLE DATA FILE NAME
1090 GOSUB Storedata
1100 PRINT "      ELAPSED TIME:      FIRE TO MULTIPROGRAMMER CALL = ":01-00
1110 PRINT "      ELAPSED TIME:      FIRE TO MEMORY INTERRUPT   = ":02-00
1120 PRINT "      DATA STORED ON DISK WITH FILENAMES (";D1%;") AND (";D2%;")"
1130 GOTO End
1140 Multiprog: !
1150 OUTPUT 723;"CC,2,3,12,13T"
1160 OUTPUT 723;"CC,5,6,9,10T" !CLEARS THE ARM,BUSY AND EOP OF MEMORY CARDS
1170 OUTPUT 723;"CC,1,4,11T"  !CLEARS SAME FOR A TO D'S AND TIMER PACER
1180 OUTPUT 723;"SF,2,3,1,.001,12,T" ! THE (1) IS 2'S COMPLIMENT BINARY
1190 OUTPUT 723;"SF,5,3,1,.001,12,T" ! THE .001 IS THE LEAST SIGNIFICANT BIT
1200 OUTPUT 723;"SF,9,3,1,.001,12,T" ! THE 12 IS FOR 12 BIT WORD SIZE
1210 OUTPUT 723;"SF,12,3,1,.001,12,T" ! SINCE THE A TO D IS 12 BIT
1220 OUTPUT 723;"WF,3,1023T,WF,6,4095T"
1230 OUTPUT 723;"WF,10,4095T,WF,13,4095T"
1240 ! SETS REFERENCE WORD FOR WHEN TO STOP TAKING DATA AND GENERATE INTERRUPT
1250 OUTPUT 723;"WF,2.1,1T,WF,5.1,1T,WF,9.1,1T,WF,12.1,1T" !SETS FIFO MODE
1260 OUTPUT 723;"WF,3.1,0T,WF,3.2,0T,WF,3.3,0T,WF,13.1,0T,WF,13.2,0T,WF,13.3,0T"
.
1270 OUTPUT 723;"WF,6.1,0T,WF,6.2,0T,WF,6.3,0T,WF,10.1,0T,WF,10.2,0T,WF,10.3,0T"
.
1280 ! SETS COUNTER AND POINTERS OF 2ND MEMORY CARD IN EACH PAIR TO 0
1290 OUTPUT 723;"AC,3T,AC,6T,AC,10T,AC,13T"!ARMS CARDS WHICH GENERATE INTERRUPT
1300 OUTPUT 723;"WF,4.2,0T,WF,4,1ST" ! TIMER PACER GIVES 1 PULSE OF 1 SEC WHEN
1310 ! TRIGGERED BY THE BLANKING PULSE (PLENTY OF TIME FOR 8 SCANS)
1320 WAIT 2
1330 K=SPOLL(723)          !WAIT FOR MEM INTERRUPT
1340 IF K(>64 THEN GOTO 1330
1350 OUTPUT 723;"WF,4.2,1T" ! MAY BE UNNECESSARY TO ALTER TIMER PACER SINCE
1360 ! MEMORY CARDS HAVE AUTOMATIC LOCKOUT BUT FOR NOW WE WILL DO IT
1370 02=TIMEDATE
1380 ON ERROR GOTO Err_trap ! NEEDED TO READ ARMED CARD INTERRUPT LIST
1390 SEND 7;UNL MLA TALK 23 SEC 12 ! SPECIFICALLY ASKS FOR INTERRUPT LIST

```



```

1400 Var_read: ENTER 7,Address(*)           !READ WHICH CARDS INTERRUPTED
1410 Memcards: PRINT *                     MEMORY CARDS WHICH GENERATED INTERRUPTS ARE *
1420 PRINT *                               SLOTS# = *;Address(*)
1430 MAT Address= (0)
1440 OFF ERROR
1450 OUTPUT 723;"DC,3,6,13,10T"           !DISSARM MEM CARDS
1460 OUTPUT 723;"MI,2,1024T"             ! SET UP CARD TO BE READ
1470 ENTER 72305;A(*)                     ! GETS DATA FROM 1024 MEMORY BOARD
1480 OUTPUT 723;"MI,5,4096T"
1490 ENTER 72305;B(*)                     ! GETS DATA FROM 4096 MEMORY BOARD
1500 PRINT *                               EXHAUST DATA ENTERED*
1510 OUTPUT 723;"MI,12,4096T"
1520 ENTER 72305;C(*)
1530 OUTPUT 723;"MI,9,4096T"
1540 ENTER 72305;D(*)
1550 ENABLE INTR 7;8
1560 PRINT *                               MOTOR DATA ENTERED*
1570 MAT A= (-1)*A                         ! THE 1024 CARD IS INCLUDED BUT NOT SAVED. IT DIDN'T
1580 MAT B= (-1)*B                         ! PERFORM WELL. COULD BE REPLACED BY A 4096 CARD.
1590 MAT C= (-1)*C
1600 MAT D= (-1)*D                         ! DIODE VOLTAGES ARE NEGATIVE SO SIGNS ARE CHANGED
1610 RETURN
1620 Storedata: !
1630 ASSIGN @Diskfile TO D3%&Zz%
1640 ASSIGN @Buff1 TO BUFFER C(*)           ! MOTOR CAVITY 4 SCANS
1650 ASSIGN @Buff2 TO BUFFER D(*)           ! MOTOR CAVITY 4 SCANS
1660 ASSIGN @Buff3 TO BUFFER B(*)           ! EXHAUST 4 SCANS
1670 CONTROL @Buff1,3;1,32768,1           !SETS BUFFER POINTERS TO FULL
1680 CONTROL @Buff2,3;1,32767,1           !INTERFACE REGISTERS SECTION OF
1690 CONTROL @Buff3,3;1,32767,1           !LANGUAGE MANUAL
1700 TRANSFER @Buff1 TO @Diskfile          ! ORDER OF DATA ON THE DISK IS
1710 WAIT FOR EOT @Diskfile               ! MOTOR CAVITY--8 SCANS
1720 TRANSFER @Buff2 TO @Diskfile         ! EXHAUST -- 4 SCANS
1730 WAIT FOR EOT @Diskfile               !WAIT BECAUSE OVERLAPPING
1740 TRANSFER @Buff3 TO @Diskfile         !TRANSFERS ARE NOT WANTED
1750 WAIT FOR EOT @Diskfile
1760 ASSIGN @Diskfile TO *                 !CLOSE I / O PATHS
1770 ASSIGN @Buff1 TO *
1780 ASSIGN @Buff2 TO *
1790 ASSIGN @Buff3 TO *
1800 RETURN
1810 Reading: !
1820 STATUS 7,1;A0                         !CHECKING STATUS BEFORE READING
1830 ENTER 722;V                           !VOLTMETER IS A FORMALITY TO
1840 ENABLE INTR 7;8                       !CLEAR THE SERVICE REQUEST
1850 RETURN
1860 Err_trap: IF ERRN=159 AND ERRL(Var_read) THEN Memcards
1870 PRINT ERRN%                            !EVEN IF THE ERROR WAS NOT THE ONE PLANNED
1880 GOTO Memcards                          !FOR PROGRAM EXECUTION CONTINUES
1890 End: END

```

```

10 !*****
20 !*****          RDC          *****
30 !*****          PLOTS RAW DATA *****
40 !*****          AVERAGES     *****
50 !*****          FILTERS      *****
60 !*****          DETERMINES MEAN DIAMETER *****
70 !*****          BY INTERACTIVE GRAPHICS *****
80 !*****          AND THE TWO-ANGLE METHOD *****
90 !*****          Robert Kelly Harris *****
100 !*****          1984         *****
110 !*****
120 OPTION BASE 1
130 COM /Hrdgaus/ Av2(1024)
140 COM /Gauss/ T1(1024),G(1024),L
150 COM /Max/ M7,M5,Xt,Yt,Xm,Ym
160 COM /Readata/ B,P,H,Q3$(20),Q4$(20),Zz$(20),Y1(8192) BUFFER,Y2(8192) BUFFE
R
170 COM /Two/ Av1(1024),M,M1,F
180 DIM Scans(8),X(1024)
190 COM /Plots/ P1$(20),P2$(20),P3$(20),P4$(20)
200 INTEGER Graf(1:12480) BUFFER
210 Choose: PRINT CHR$(12)
220 Old=0
230 PRINT " TO LOOK AT ANY DATA FILE THE PROGRAM NEEDS SOME STARTING INFORMATI
ON"
240 PRINT ""
250 PRINT "          TO ACCOUNT FOR THE CHANGE IN WAVELENGTH IN THE MEDIUM"
260 PRINT ""
270 PRINT "          ENTER THE INDEX OF REFRACTION OF THE MEDIUM"
280 PRINT ""
290 PRINT "          WATER = 1.33"
300 PRINT "          AIR = 1.0"
310 PRINT "          ESTIMATE OF EXHAUST = 1.1"
320 BEEP
330 INPUT "          THIS VALUE ADJUSTS THE COMPARISON CURVE TO THE MEDIUM",M1
340 PRINT CHR$(12)
350 PRINT "          TO ACCOUNT FOR REFRACTION OF LIGHT AT BOUNDARIES BETWEEN"
360 PRINT ""
370 PRINT "          THE MEDIUM AND AIR YOU MUST ENTER THE INDEX OF REFRACTION "
380 PRINT ""

```

```

390 PRINT *      OF THE COMBINATION OF THE MEDIUM AND ITS BOUNDARY*
400 PRINT **
410 PRINT *      THIS VALUE IS APPLIED DIRECTLY TO THE DATA*
420 PRINT **
430 PRINT *      AIR=1.0          PLEXIGLASS & WATER = 1.39*
440 PRINT **
450 PRINT *ESTIMATE OF MOTOR CAVITY COMBUSTION PRODUCTS & WINDOW = 1.22*
460 PRINT **
470 PRINT *      ESTIMATE OF ROCKET EXHAUST = 1.1 OR 1.0*
480 INPUT M
490 PRINT CHR$(12)
500 INPUT *      ENTER LASER WAVELENGTH (HeNe=.6328,Ar=.488)*,L
510 INPUT *ENTER THE DESIRED PLOTTING INTERVAL OF DIODE ARRAY (2,4,6)*,H
520 F=460          !MM FOCUL LENGTH OF OBJECTIVE LENS
530 Diode=.025    !MM DIODE SPACING MAY BE .03
540   FOR I=0 TO 1023
550     X(I+1)=I+1          !CREATE AN ARRAY OF DIODE NUMBERS
560     T1(I+1)=(I*Diode)/(F*M) !CREATE AN ARRAY OF THETA
570   NEXT I
580 PRINT CHR$(12)
590 CALL Display1(Old)    !JUST PRINTS INITIAL REMARKS ON CRT
600 IF Old THEN CALL Review(Av1(*)) !THESE TWO LINES ALLOW FOR
610 IF Old THEN GOTO Gauss !REVIEWING REDUCED DATA FILES
620 BEEP
630 INPUT *      INPUT TWO FILENAMES NOW (NO-PART ,PART)*,Q3$,Q4$
640 INPUT *      ENTER '1' FOR MOTOR   '2' FOR EXHAUST*,P
650 Zz$=":INTERNAL,4,1"    ! USES LEFT DISK DRIVE FOR RAW DATA FILES
660 CALL Readdata
670 CALL Shift
680 BEEP
690 Screen: !
700 PRINT CHR$(12)        !CLEARS SCREEN
710 P1$="VOLTAGE"
720 P2$="DIODE NUMBER"   ! STRINGS FOR PLOTS
730 P3$="VOLTAGE vs. DIODE"
740 P4$="RAW DATA"
750 MS=1024
760 Xt=64                ! SET UP VALUES FOR PLOTS
770 Yt=.04
780 Xm=4
790 Ym=5
800 CALL Plot(Y2(*))     ! DRAWS AXES ,ETC...
810 GSTORE Graf(*)      ! STORES GRAPHICS DISLAY JUST MADE
820 CALL Dataplot(B,Y1(*),H) !PLOT NO-PARTICLES DATA
830 PRINT *              NO-PARTICLES PLOTTED*
840 PRINT **
850 PRINT *              HOW MANY SCANS SEEM TO BE GOOD ?*
860 INPUT J

```

```

370 PRINT ""
380 PRINT "          WHICH SCANS ARE GOOD ?...ie...1,2,4,5,7,INCLUDE LAST CO
MMA"          !LAST COMMA IS REQUIRED OR YOU HAVE TO HIT CONT.. TWICE
890 INPUT Scans(*)
900 PRINT CHR$(12)
910 PRINT USING "/////////"
920 PRINT "          AVERAGING THE SELECTED SCANS"
930 GRAPHICS OFF
940 CALL Average(J,Scans(*),Y1(*),Av1(*))
950 PRINT USING "e"
960 GLOAD Graf(*)          !LOADS GRAPHICS ARRAY RATHER THAN WASTE TIME RE-DRAWING
970 GRAPHICS ON
980 CALL Result(Av1(*),X(*),H)          ! PLOTS 1024 ELEMENT ARRAYS
990 PRINT USING "/"
1000 PRINT "          Average Intensity No-Particles"
1010 ON KEY 0 LABEL "AVERAGE1" GOTO Screen
1020 ON KEY 1 LABEL "PLOT-PARTICLES" GOTO 1060
1030 PRINT "          PRESS KEY # 0 TO RE-AVERAGE OR # 1 TO CONTINUE"
1040 Standby:          ! MANUAL CALLS THIS INTERRUPT DRIVEN PROGRAMMING
1050          GOTO Standby          ! LOOPS, WAITING FOR USER TO DECIDE
1060 PRINT USING "e"
1070 OFF KEY 1          !HELPS AVOID CONFUSION BY CLEARING THAT BOX
1080 CALL Dataplot(B,Y2(*),H)          !PLOT PARTICLES DATA
1090 PRINT USING "/"
1100 PRINT "          PARTICLE DATA PLOTTED"
1110 PRINT "          FOR A HARD COPY OF THIS RAW DATA PRESS KEY # 6"
1120 PRINT " "
1130 PRINT "          OR          TO CONTINUE PRESS KEY # 1"
1140 ON KEY 6 LABEL "HARD & RAW" GOTO Raw
1150 ON KEY 1 LABEL "CONTINUE " GOTO Select
1160 GOTO Standby
1170 Raw: CALL Plot(Y2(*),1)          ! THE ONE (1) IS AN OPTIONAL PARAMETER
1180 CALL Dataplot(B,Y2(*),H)          ! WHICH IS USED TO GET HARD COPIES
1190 Select:!
1200          OFF KEY 6
1210          OFF KEY 1
1220 PRINT CHR$(12)
1230 PRINT USING "/////////"
1240 PRINT "          HOW MANY SCANS SEEM TO BE GOOD ?"
1250 INPUT J
1260 PRINT "          WHICH SCANS ARE GOOD ?...ie...1,2,4,5,7,INCLUDE
LAST COMMA"
1270 INPUT Scans(*)
1280 PRINT CHR$(12)
1290 PRINT USING "/////////"
1300 GRAPHICS OFF
1310 PRINT "          AVERAGING THE SELECTED SCANS"
1320 CALL Average(J,Scans(*),Y2(*),Av2(*))
1330 PRINT USING "e"
1340 P4%="AVERAGED SCANS"

```

```

1350 CALL Plot(Av2(*))
1360 GRAPHICS ON
1370 GSTORE Graf(*)
1380 CALL Result(Av2(*),X(*),H)
1390 PRINT USING "//"
1400 PRINT "                                     Average Scattered Intensity"
1410 ON KEY 2 LABEL "AVERAGE2" GOTO 1080
1420 ON KEY 3 LABEL "SUBTRACT" GOTO 1450
1430 PRINT "                                     HIT KEY # 2 TO RE-AVERAGE OR KEY # 3 TO
CONTINUE"
1440 GOTO Standby
1450 PRINT USING "0"
1460 OFF KEY 3
1470 MAT Av1= Av2-Av1                                     !SUBTRACTS NO-PARTICLES FROM PARTICLES
1480 GLOAD Graf(*)
1490 CALL Result(Av1(*),X(*),H)
1500 PRINT USING "///"
1510 PRINT "                                     Plot of the Difference Between Particles and N
o-Particles"
1520 PRINT "                                     KEY # 6 FOR HARD COPY"
1530 PRINT "                                     KEY # 1 TO CONTINUE "
1540 ON KEY 6 LABEL " HARD AVERAGE" GOTO 1570
1550 ON KEY 1 LABEL " FILTER " GOTO 1600
1560 GOTO Standby
1570 CALL Plot(Av1(*),1)
1580 CALL Result(Av1(*),X(*),H)
1590 PLOTTER IS 3,"INTERNAL"
1600 PRINT USING "//"
1610 PRINT "                                     ENTER THE NUMBER OF TIMES YOU WISH TO APPLY"
1620 PRINT "                                     THE DIGITAL FILTER FOR SMOOTHING"
1630 PRINT "                                     EXAMPLE***** 10"
1640 PRINT "                                     TAKES ABOUT 1.5 MINUTES"
1650 INPUT "                                     ZERO IS ALSO ACCEPTABLE",Fil
1660 IF Fil=0 THEN Gauss
1670 P4$="FILTERED DATA"
1680 CALL Filter(Av1(*),Fil)
1690 PRINT CHR$(12)
1700 CALL Plot(Av1(*))
1710 IF 01d THEN MAT X= T1
1720 CALL Result(Av1(*),X(*),H)
1730 PRINT "                                     Plot of the Difference Between Particles and N
o-Particles"
1740 PRINT "                                     AFTER APPLICATION OF A DIGITAL FIL
TER"
1750 PRINT "                                     for a HARD COPY "
1760 PRINT "                                     PREPARE the PLOTTER and"
1770 PRINT "                                     PRESS KEY # 8"
1780 PRINT "                                     OR"
1790 PRINT "                                     PRESS KEY # 9 TO NORMALIZE"
1800 ON KEY 8 LABEL "HARD FILTERED" GOTO 1830
1810 ON KEY 9 LABEL " NORMALIZE " GOTO Gauss

```

```

1820 GOTO Standby
1830 CALL Plot(Av1(*),!) ! The ! is for hard copy
1840 CALL Result(Av1(*),X(*),H)
1850 OFF KEY 8
1860 Gauss: OFF KEY 2 !KEY 1 OPTION IS STILL VALID
1870 OFF KEY 8
1880 ON KEY 1 LABEL " FILTER " GOTO 1600 ! ALLOWS ONE TO SMOOTH OLD DATA
1890 ! WHEN REVIEWING REDUCED FILES
1900 PRINT CHR$(12)
1910 !Av2 Array is Normalized BUT Av1(*) is Still Saved For Re-work if Needed
1920 MAT Av2= Av1 ! TO BEGIN WITH THE ARRAY IS ASSUMED TO BE NORMALIZED
1930 ! AND THE USER CHANGES THIS WITH INTERACTIVE GRAPHICS
1940 ! IN THE SUBROUTINE "Compare"
1950 P1$="NORMALIZED INTENSITY"
1960 P2$="THETA (rad)" !STRINGS FOR PLOTS
1970 P3$="INTENSITY vs.THETA"
1980 P4$="CURVE FIT RESULTS"
1990 M5=.05 !SET UP VALUES
2000 Xt=.004 !FOR PLOTS
2010 Yt=.1
2020 Xm=2
2030 Ym=2
2040 CALL Plot(Av2(*))
2050 CALL Result(Av2(*),T1(*),H) !PLOT OF NORMALIZED INTENSITY vs. THETA
2060 GSTORE Graf(*) ! SAVES THE SCREEN IMAGE
2070 CALL Compare(Av1(*),H,M,M1,Graf(*))
2080 GRAPHICS OFF
2090 ON KEY 4 LABEL "OTHER ARRAY" GOTO Choose
2100 ON KEY 5 LABEL " TWO-ANGLE" GOTO Buchele
2110 ON KEY 9 LABEL " NORMALIZE" GOTO Gauss
2120 ON KEY 6 LABEL "STORE DATA" GOTO Storedata
2130 ON KEY 7 LABEL " QUIT " GOTO Quit
2140 CALL Menu1 ! PRINTS OPTIONS ON THE SCREEN
2150 GOTO Standby
2160 Buchele: !
2170 CALL Twoangle
2180 CALL Menu1
2190 GOTO Standby
2200 Storedata:!
2210 CALL Store
2220 CALL Menu1
2230 GOTO Standby
2240 Quit: !
2250 END
2260 SUB Average(J,Scans(*),Y(*),Av(*)) !AVERAGES SELECTED SCANS
2270 MAT Av= (0) !INITIALIZES THE ARRAY LOCAL TO THIS ROUTINE
2280 FOR I=1 TO J STEP 1
2290 K=(Scans(I)-1)*1024+1 ! THIS COUNTER IS THE BEGINNING
2300 L=Scans(I)*1024 ! AND THIS ONE THE END OF BLOCKS
2310 FOR I1=K TO L ! OF 1024 IN THE OVERALL DATA

```

```

2320             I2=I1-K+1           ! THIS COUNTER IS ALWAYS BETWEEN
2330             Av(I2)=Av(I2)+Y(I1) ! 1 AND 1024
2340             NEXT I1
2350             NEXT I
2360             MAT Av= Av/(J)       !*****THE AVERAGE*****!
2370             SUBEND
2380             SUB Dataplot(B,Y(*),H) !B IS 4 OR 8(THE NUMBER OF SCANS)
2390             COM /Max/ M7,M5,Xt,Yt,Xn,Yn
2400             LDIR 0
2410             LORG 4
2420             FOR J=1 TO B         !EACH SCAN
2430             MOVE 500+J*50,M7-.05 ! SEE NEXT LINE
2440             LABEL J;             ! HELPS KEEP TRACK OF EACH SCAN AS IT APPEARS
2450             LINE TYPE 1
2460             K=(J-1)*1024+1      !BEGINNING OF EACH SCAN AND
2470             L=J*1024            !THE END WITHIN THE TOTAL BLOCK
2480             MOVE 1,Y(K)         ! MOVE TO THE FIRST POINT
2490             FOR I=K TO L STEP H
2500             X=I-K+1             ! THIS GIVES 1 TO 1024 FOR ABSCISSA
2510             PLOT X,Y(I)
2520             NEXT I
2530             NEXT J
2540             PENUP
2550             SUBEND
2560             SUB Result(Iav(*),D(*),H) !THE AVERAGE INTENSITY IS PLOTTED
2570             CLIP ON
2580             MOVE D(1),Iav(1)
2590             FOR I=1 TO 1024 STEP H
2600             DRAW D(I),Iav(I)
2610             NEXT I
2620             PENUP
2630             SUBEND
2640             SUB Plot(Y(*),OPTIONAL Hard) !IF THE OPTIONAL(Hard)IS RECEIVED
2650             COM /Max/ M7,M5,Xt,Yt,Xn,Yn !THE FIGURE GOES TO THE PLOTTER
2660             COM /Plots/ P1$(20),P2$(20),P3$(20),P4$(20)
2670             M7=MAX(Y(*))*1.1      ! A SCALING VARIABLE
2680             M6=.1*M7              ! ANOTHER SCALING VARIABLE
2690             PRINT **
2700             GINIT                 !GINIT IS JUST GOOD PRACTICE SO YOU KNOW
2710                                 !WHERE YOU ARE BEGINNING
2720             SELECT NPAR           !THIS DETECTS IF THE HARD COPY IS DESIRED
2730             CASE 1                !IT COULD BE DONE WITH IF THEN LOGIC
2740             PLOTTER IS 3,"INTERNAL" !BUT IS PRESENTED FOR FAMILIARIZATION
2750             CASE 2                !SINCE IT IS MORE POWERFUL IN COMPLEX
2760             PLOTTER IS 705,"HPGL" !SITUATIONS
2770             END SELECT
2780             GRAPHICS ON           ! TO BE ABLE TO SEE THE PLOT
2790             CSIZE 5,.6
2800             DEG
2810             LDIR 0

```

```

2820 LORG 5
2830 MOVE 75,95
2840 LABEL USING "K";P4$
2850 MOVE 75,90
2860 LABEL P3$
2870 MOVE 75,20
2880 LABEL P2$
2890 LDIR 90
2900 MOVE 18,60
2910 LABEL P1$
2920 VIEWPORT 30,125,30,85          ! SCREEN UNITS FOR MARGINS
2930 FRAME                          ! DRAWS A BOX
2940 WINDOW 0,M5,-M6,M7            ! EXTENT OF X AND Y
2950 AXES Xt,M6,0,0,Xn,1,5
2960 LDIR 0
2970 CSIZE 3,.5
2980 LORG 8
2990 CLIP OFF
3000   FOR I=-M6 TO M7 STEP M7/10    !NUMBER THE Y AXIS
3010     MOVE 0,I
3020     LABEL USING "#,M0.DDDD";I
3030     NEXT I
3040 CSIZE 3,.6
3050 LDIR 90
3060   LORG 8
3070   FOR I=0 TO M5 STEP Xt        !NUMBER THE X AXIS
3080     MOVE I,-M6
3090     LABEL USING "#,X";I
3100     NEXT I
3110   PENUP
3120 SUREND
3130   SUB Compare(Av1(*),H,M,M1,INTEGER Graf(*))
3140   COM /Gauss/ T1(*),G(*),L
3150   COM /Hrdgaus/ Av2(*)
3160   COM /Max/ M7,M5,Xt,Yt,Xn,Yn
3170   DIM T(1:1024),At(1:17),Dobbins(1:17),Tld(1:17)
3180   DATA 3.,3.5,4.,4.5,5.,5.5,6.,6.5,7.,7.5,8.,8.5,9.,9.5,10.,10.5,11.
3190   DATA .0556,.085,.0206,.014,.0106,.0081,.00605,.005,.00374,.0032,.00248,
.0022,.00185,.0016,.00135,.0012,.001
3200   READ At(*)
3210   READ Dobbins(*)
3220   OFF KEY                        !GETS RID OF ALL LABELS ON KEYS
3230   ON KEY 3 LABEL "MENUE" GOTO Subexit
3240   PLOTTER IS 3,"INTERNAL"        ! IN CASE A HARD COPY WAS JUST MADE
3250   Hard=0                          ! (0) SO ONE DOESN'T EXIT TOO SOON
3260   Centerline=1                    ! THE INITIAL NORMALIZING VALUE
3270   D=20.                            ! INITIAL PATICLE MEAN DIAMETER IN MICRONS
3280 Change: CSIZE 4,.6
3290   PRINT USING "////////"

```



```

3300 PRINT *                                STAND BY FOR CURVE*
3310 MOVE 0,1
3320 CLIP ON
3330 Con=PI*D*M1/L                          !A CONSTANT
3340 FOR I=1 TO 1024 STEP H
3350 T(I)=T1(I)*Con                          !Theta-bar for some Dbar(note M1)
3360 G(I)=EXP(-((.57*T(I))^2))              !Gaussian curve for this Dbar
3370 IF T(I)>3.0 THEN 3400                   !GAUSSIAN NO GOOD FOR Theta-bar>3
3380 DRAW T1(I),G(I)                         !Gaussian curve vs. theta
3390 NEXT I
3400 MAT Tld= At/(Con)                       !THETA FOR POINTS ON DOBBINS'CUR
VE
3410 FOR I=1 TO 17
3420 DRAW Tld(I),Dobbins(I)
3430 NEXT I
3440 PENUP
3450 IF Hard THEN SUBEXIT                     !EXITS ROUTINE IF A HARD COPY WAS JUST MADE
3460 PRINT USING "/////////"
3470 PRINT *                                USE THE KNOB TO VARY THE PARTICLE
SIZE*
3480 PRINT *                                OR HIT KEY # 6 FOR HARD COPY*
3490 PRINT * *
3500 PRINT *                                KEY # 9 ALLOWS YOU TO*
3510 PRINT *                                RE-NORMALIZE*
3520 PRINT * *
3530 PRINT *                                HIT KEY # 3 TO GET OUT*
3540 PRINT USING "/////////"
3550 ON KEY 6 LABEL "HARD COPY" GOTO Hardgauss
3560 ON KEY 9 LABEL "NORMALIZE" GOTO Divide
3570 ON KNOB .05 GOTO Pulse                  !(.05) IS TIME INTERVAL IN WHICH
3580 Wait: GOTO Wait                          ! PULSES FROM THE KNOB ARE
3590 Pulse: PRINT USING "P"                  ! COUNTED AND THIS NUMBER IS
3600 Strng1$="Mean Diameter *              ! USED BY THE INTERACTIVE
3610 Strng2$=" Microns"                    ! GRAPHICS TO VARY THE PARTICLE
3620 Count=KNOB*                             ! SIZE AND PLOT THE ASSOCIATED
3630 D=DROUND(D+Count/15,2)                ! GAUSSIAN APPROXIMATIONS OF
3640 GLOAD Graf(*)                          ! SCATTERING PROFILES
3650 LDIR 0
3660 LORG 8
3670 MOVE M5,.8*M7
3680 LABEL Strng1$&VAL$(D)&Strng2$
3690 GOTO Change
3700 Hardgauss: !
3710 PRINT *                                PREPARE the PLOTTER*
3720 PRINT *                                PRESS CONTINUE for *
3730 PRINT *                                HARD COPY*
3740 PAUSE
3750 Hard=1                                  ! SO THAT SUBEXIT OCCURS AFTER HARD COPY
3760 CALL Plot(Av2(*),1)                    ! 1**HARD COPY
3770 CALL Result(Av2(*),T1(*),H)

```

```

3780 PRINT USING "0"
3790 LORG 8
3800 MOVE M5,.8*M7
3810 LDIR 0
3820 LABEL Strng1$&VAL$(D)&Strng2$
3830 MOVE 0,1
3840 GOTO Change
3850 Divide:
3860 PEN -1 !ERASES LAST PLOT
3870 MOVE 0,0
3880 FOR I=1 TO 1024 STEP H
3890 DRAW T1(I),Av2(I)
3900 NEXT I
3910 PRINT CHR$(12)
3920 PRINT USING "/////"
3930 PRINT "
3940 PRINT "
3950 PRINT "
3960 ON KEY 4 LABEL " RE-PLOT" GOTO Replot
3970 ON KNOB .05 GOTO Vary
3980 GOTO Wait
3990 Vary:PRINT CHR$(12)
4000 PEN -1 !ERASES LAST PLOT
4010 MOVE 0,0
4020 FOR I=1 TO 1024 STEP H
4030 DRAW T1(I),Av2(I)
4040 NEXT I
4050 PEN 1
4060 C2=KNOBX
4070 Centerline=Centerline+C2/120 !KNOB USED TO VARY NORMALIZING VALUE
4080 MAT Av2= Av1/(Centerline) !NEW NORMALIZED DATA ARRAY
4090 GOTO 3870 !PLOTS THE NEW NORMALIZED ARRAY
4100 Replot: !
4110 PRINT CHR$(12)
4120 CALL Plot(Av2(*))
4130 CALL Result(Av2(*),T1(*),H)
4140 GSTORE Graf(*)
4150 GOTO Change
4160 Subexit: !
4170 SUBEND
4180 SUB Menu1
4190 PRINT USING "0"
4200 PRINT "
4210 PRINT "*****"
4220 PRINT "
4230 PRINT "*****"
4240 PRINT "
4250 PRINT "
4260 PRINT "
4270 PRINT "*****"
YOU CAN RE-NORMALIZE"
YOU CAN RE-AVERAGE (New Data Only)"
PRESS KEY 4 TO LOOK AT OTHER DATA"
OLD OR NEW "
MOTOR / EXHAUST"

```

```

4280 PRINT " PRESS KEY # 5 "
4290 PRINT " FOR THE ' TWO-ANGLE ' METHOD"
4300 PRINT " OF PARTICLE SIZING"
4310 PRINT "*****"
4320 PRINT " TO STORE THE REDUCED DATA PRESS KEY # 6 "
4330 PRINT "*****"
4340 PRINT " TO END THIS SESSION PRESS KEY # 7"
4350 SUBEND
4360 SUB Display1(Old)
4370 PRINT " TO REDUCE NEW DATA PRESS KEY # 1"
4380 PRINT ""
4390 PRINT " TO REVIEW PREVIOUSLY REDUCED DATA PRESS KEY # 2"
4400 PRINT " "
4410 ON KEY 1 LABEL " NEW DATA" GOTO New
4420 ON KEY 2 LABEL " OLD DATA" GOTO Review
4430 Wait: GOTO Wait
4440 New: PRINT CHR$(12)
4450 PRINT " PUT THE DISK IN THE LEFT DRIVE IF IT IS NOT ALREADY"
4460 PRINT ""
4470 PRINT " ENTER THE NAMES OF THE FIRST AND SECOND FILES."
4480 PRINT ""
4490 PRINT " EACH FILE HAS DATA FROM BOTH DIODE ARRAYS."
4500 PRINT ""
4510 PRINT " FIRST IS NO-PARTICLES & NEXT IS PARTICLES ----D1$,D2$"
4520 PRINT ""
4530 Old=0
4540 SUBEXIT
4550 Review: Old=1 !THIS VARIABLE IS PASSED TO THE MAIN PROGRAM TO INDICATE
4560 !THAT THE DATA TO BE READ IS ONE (1) SCAN AND THAT
4570 !THE AVERAGING ROUTINES WILL NOT BE USED
4580 SUBEND
4590 SUB Readata
4600 COM /Readata/ B,P,H,Q3$(20),Q4$(20),Zz$(20),Y1(*) BUFFER,Y2(*) BUFFER
4610 Xyz=1 ! FILE POINTER VARIABLE
4620 B=8 ! NUMBER OF SCANS IN MOTOR DATA
4630 R1=65536 !NUMBER OF BYTES OF MOTOR DATA
4640 IF P=2 THEN Xyz=4097 !RECORD # WHERE EXHAUST DATA BEGINS
4650 IF P=2 THEN R1=32768 !NUMBER OF BYTES OF EXHAUST DATA
4660 IF P=2 THEN B=4 !NUMBER OF SCANS IN EXHAUST DATA
4670 PRINT " "
4680 PRINT " READING DATA FROM FILE ON DISK"
4690 ASSIGN @Disk1 TO Q3&&Zz$
4700 ASSIGN @Disk2 TO Q4&&Zz$ !OPEN I/O PATHS
4710 ASSIGN @Buff1 TO BUFFER Y1(*)
4720 ASSIGN @Buff2 TO BUFFER Y2(*)
4730 CONTROL @Disk1,5;Xyz
4740 TRANSFER @Disk1 TO @Buff1;COUNT R1 !READS NO-PARTICLE DATA
4750 WAIT FOR EOT @Disk1 ! NOT AN OVERLAPPING TRANSFER
4760 CONTROL @Disk2,5;Xyz !Xyz SETS DISK FILE POINTER TO
4770 !EITHER MOTOR OR EXHAUST DATA

```

```

4780     TRANSFER @Disk2 TO @Buff2;COUNT R1           !READS PARTICLE DATA
4790     WAIT FOR EOT @Disk2
4800     ASSIGN @Disk1 TO *
4810     ASSIGN @Disk2 TO *           !JUST GOOD PRACTICE TO CLOSE
4820     ASSIGN @Buff1 TO *           !I/O PATHS
4830     ASSIGN @Buff2 TO *
4840     SUBEND
4850     SUB Plot2(E,D(*),X)
4860         DIM Title1$(25),Theta$(20)
4870         GINIT
4880         IF X=1 THEN PLOTTER IS 705,"HPGL"
4890         DEG                               !DEGREES for LABEL DIRECTION
4900         GRAPHICS ON
4910         VIEWPORT 35,125,30,85
4920         Max=10*INT((MAX(D(*))+10)/10)
4930         WINDOW D(1,2),D(E,2),0,Max
4940         G=(D(E,2)-D(1,2))/(E-1)*4       !AN X GRID LINE EVERY 4th POINT
4950         F=(INT(E/4)-1)*4
4960         IF F=0 THEN F=4
4970         CLIP D(4,2)-G,D(F,2)+2*G,0,Max   !MAKES GRID UNIFORM
4980         GRID G,5,D(4,2)-G,0
4990         CLIP OFF
5000         LORC 8
5010         LDIR 90
5020         CSIZE 4,.5
5030         FOR I=4 TO E STEP 4             !PUTS NUMBERS ON X AXIS
5040             MOVE D(I,2),0
5050             LABEL USING ".DDDD";D(I,2)
5060         NEXT I
5070         LDIR 0
5080         LORC 8
5090         FOR I=10 TO Max STEP 10        !NUMBER Y AXIS
5100             MOVE D(4,2)-G,I
5110             LABEL USING "#,K";I
5120         NEXT I
5130         CSIZE 6,.6
5140         Title$="TWO-ANGLE METHOD"
5150         Title1$="For Various Angle Ratios" !STRINGS FOR PLOTS
5160         Size$="SIZE (microns)"
5170         Theta$="THETA (rad)"
5180         Sub$="1"
5190         LDIR 90
5200         LORC 5
5210         B=D(4,2)-G-(D(E,2)-D(1,2))/10
5220         MOVE B,Max/2
5230         LABEL Size$
5240         LDIR 0
5250         A=(D(E,2)+D(1,2))/2
5260         MOVE A,-Max/4
5270         LABEL Theta$

```

```

5280   LORG 3
5290   MOVE A,-Max/4
5300   LABEL Sub$
5310   LORG 5
5320   MOVE A,Max*1.15
5330   LABEL Title$
5340   CSIZE 4.5
5350   MOVE A,Max*1.05
5360   LABEL Title1$
5370   PENUP
5380 SUBEND
5390 SUB Distribution(D(*),Tratio,E)
5400   LINE TYPE 1
5410   CLIP ON
5420   Tratio=VAL$(Tratio)                ! ANGLE RATIO
5430   MOVE D(1,2),D(1,1)
5440   FOR I=1 TO E
5450       DRAW D(I,2),D(I,1)
5460   NEXT I
5470   LORG 4
5480   LINE TYPE 1
5490   CSIZE 4,.3
5500   MOVE D(I-1,2),D(I-1,1)+2
5510   LABEL Tratio$
5520   PENUP
5530 SUBEND
5540 SUB Twoangle
5550 !*****
5560 !*****          SUBPROGRAM 'TWOANGLE'          *****
5570 !*****          PARTICLE SIZING BY          *****
5580 !*****          MEASURING THE RATIO          *****
5590 !*****          OF INTENSITY AT          *****
5600 !*****          TWO ANGLES          *****
5610 !*****
5620 OPTION BASE 1
5630 COM /Two/ Av1(1024),M,M1,F
5640 COM /Gauss/ T1(1024),G(1024),L
5650                                     !THE GAUSS IS NOT USED HERE
5660 DIM D(200,2)                       !BUT THE COM BLOCK HAS THETA
5670 PRINT CHR$(12)                       !AND WAVELENGTH
5680 PRINT USING "////////"
5690 PRINT " THIS SUBPROGRAM USES THE TWO-ANGLE METHOD DESCRIBED BY BUCHELE"
5700 PRINT " "
5710 PRINT " TO CALCULATE PATICLE SIZE FOR VARIOUS ANGLE RATIOS AND ANGLES."
5720 PRINT " "
5730 PRINT " IT IS HOPED THAT THE CURVES WHICH RESULT WILL SHOW "
5740 PRINT " "
5750 PRINT " WHICH SIZE IS THE MOST PROBABLE."
5760 PRINT " "
5770 PRINT "AFTER NOTING FROM THE RAW DATA WHICH ANGLES CONTAIN THE CENTER LOBE"

```

```

5720 PRINT **
5790 PRINT *   ENTER*****THE SMALLEST USEABLE ANGLE,*
5800 PRINT *   THE SMALLEST ANGLE RATIO,AND*
5810 PRINT *   THE STEP SIZE BETWEEN ANGLE RAIOS*
5820 PRINT *   YOU WISH TO EXPLORE*
5830 PRINT *   EXAMPLE*****.012,1.2,.4*
5840 INPUT * ENTER   thetal,theta-ratio,theta-step*,Q,A,B
5850   OFF KEY
5860   X=0           !GRAPH WILL APPEAR ON SCREEN
5870 Begin:        !RUNNING CONTINUES HERE WHEN A HARD COPY IS DESIRED
5880   !Van De Hulst and Gumprech & Sleepevich explain that the change in
5890   !wavelength of the beam is accounted for by dividing by the index
5900   !of refraction of the medium. *****L=M/L *****
5910 C=(L/M1/.57/PI)^2   !-----see page 15 of nasa tech paper 2156
5920 FOR N=1 TO 1024   !to see this is a convenient constant
5930   IF Q<T1(N) THEN 5950   !FINDS POSITION OF MINIMUM ANLGE
5940 NEXT N
5950 FOR Tratio=A TO 3 STEP B   !VARIOUS ANGLE RATIOS
5960   FOR J=N TO 1010/Tratio STEP 10   !SETS THE RANGE OF POSSIBLE
5970   ! ANGLES (THETA 1)
5980     Thta1=T1(J)
5990     Thta2=T1(J*Tratio)   ! THETA 2
6000     Deltatheta=Thta2^2-Thta1^2
6010     I1=0
6020     I2=0
6030     FOR I=J-5 TO J+5   !THESE 2 LOOPS AVERAGE A FEW
6040       I1=I1+Av1(I)   !INTENSITIES IN THE HOPE
6050     NEXT I   !OF A STEADIER CALCULATION
6060       I1=I1/11
6070     FOR I=INT(J*Tratio-5) TO INT(J*Tratio+5)
6080       I2=I2+Av1(I)   ! DONE HERE FOR THETA2 FOR
6090     NEXT I   ! THE GIVEN ANGLE RATIO
6100       I2=I2/11
6110     E=(J-N)/10+1   !THIS IS A COUNTER FOR THE ARRAY CONTAINING
6120     !PARTICLE SIZE AND THETA1 FOR THE GIVEN
6130     !ANGLE RATIO
6140     IF I1(I2 OR I1=0 OR I2<=0 THEN D(E,1)=0 !ALLOWANCE FOR IF THE DATA
6150     IF I1(I2 OR I1=0 OR I2<=0 THEN GOTO Xcomp !IS NOT WELL BEHAVED
6160     D(E,1)=SQR(-C/Deltatheta*LOG(I2/I1))   !TWO ANGLE METHOD
6170     !VALUE OF DIAMETER based on INTENSITY RATIO
6180     !For a given ANGLE RATIO and ANGLE THETA1
6190 Xcomp: D(E,2)=Thta1
6200     Spar=PI*D(E,1)*M1/L   !THIS IS PI*D/LAMBDA -- THE SIZE PARAMETER
6210     Tbar=Spar*Thta2   !THETA BAR FOR THE LARGER ANGLE
6220     IF Tbar>3 THEN J=1010/Tratio   !THIS ENDS THE DO LOOP FOR THIS
6230     IF E=1 AND Tbar>3 THEN 6330   !ANGLE RATIO SINCE THE GAUSSIAN
6240 !the above line ends all calculation if   !IS NOT VALID WHEN Tbar > 3
6250 !the first element (E=1)failed the test
6260     NEXT J
6270     ! FIRST TIME THROUGH-- D HAS THE MOST ELEMENTS IT WILL HAVE

```

```

6280          ! SO SET UP THE GRAPH USING D's PRESENT PARAMETERS
6290 PRINT CHR$(12)
6300     IF Tratio=A THEN CALL Plot2(E,D(*),X)
6310     CALL Distribution(D(*),Tratio,E)
6320 NEXT Tratio
6330     ON KEY 2 LABEL "HARD COPY" GOTO Hard
6340     ON KEY 3 LABEL "MENU " GOTO Subexit
6350 PRINT USING "/////"
6360 PRINT "
6370 PRINT "
6380 Standby:GOTO Standby
6390 Hard:X=1
6400     GOTO Begin
6410 Subexit: GINIT
6420     GRAPHICS OFF
6430 SUBEND
6440 SUB Shift
6450 COM /Readata/ B,P,H,Q3$(20),Q4$(20),Zz$(20),Y1(*) BUFFER,Y2(*) BUFFER
6460 DIM E(1:9192)
6470 PRINT CHR$(12)
6480 PRINT USING "/////////"
6490 PRINT " RAW DATA IS BEING SHIFTED TO CORRECT FOR SMALL GAPS BETWEEN SCANS"
6500 PRINT ""
6510 PRINT "
6520     ! BE PATIENT, IT'S A LONG SET OF DO-LOOPS"
6530     ! THERE ARE SOME SMALL GAPS BETWEEN SCANS AND THIS SUBROUTINE
6540     ! SHIFTS THE DATA SO THAT THE FIRST DIODE DATA POINT IS MOVED
6550     ! TO THE VERY BEGINNING OF ITS 1024 BLOCK IN THE OVERALL ARRAY
6560     ! .THE FIRST SET IS RIGHT ON, THE NEXT IS ONE OFF,THE THIRD IS
6570     ! TWO OFF ,,SO FORTH. THIS MAY NOT MATTER WITH OUR RESOLUTION
6580     ! AND IS PROBABLY DUE TO THE MEMORY CARD CYCLING AT THE END OF
6590     ! SOME SCANS. SEE THE CIRCUIT TIMING DIAGRAM IN THE THESIS.
6590     SELECT B
6600     CASE 4             !EXHAUST DATA HAS 4 SCANS
6610         M=3
6620     CASE 8             !MOTOR DATA HAS 8 SCANS
6630         M=7
6640     END SELECT
6650     FOR K=1 TO 2
6660     IF K=1 THEN MAT E= Y1             !OPPERATES ON NO-PARTICLE AND PARTICLE SETS
6670     IF K=2 THEN MAT E= Y2
6680         FOR J=0 TO M
6690             IF M=7 AND J(=3 THEN 6800 !One 4096 Block Doesn't Need Shifting
6700             FOR I=(J)*1024+1 TO (J+1)*1024             !BLOCKS OF 1024
6710                 IF M=3 THEN L=I+J             !Array B Has the worst
6720                 !Problem With Shifting Data
6730                 IF M=7 THEN L=I+1             !Array D is Always off by one
6740                 IF ' .J+1)*1024 THEN L=(J+1)*1024
6750             !JUST TO AVOID PROGRAMMING ERROR AT THE END OF THE ARRAY
6760             E(I)=E(L)             !THIS SHIFTS THE DATA
6770             !DEPENDING ON 'L',ARRIVED AT

```

```

6780                                     !BY OBSERVING RAW DATA
6790             NEXT I
6800             NEXT J
6810             IF K=1 THEN MAT Y1= E
6820             IF K=2 THEN MAT Y2= E
6830 NEXT K
6840 SUBEND
6850 SUB Store      ! THE LARGE ARRAY CONTAINING MULTIPLE SCANS HAS BEEN REDUCED
6860                ! TO A MEAN SCATTERING PROFILE BY AVERAGING AND FILTERING. IF
6870                ! YOU FEEL THAT STORING THIS DATA IS NECESSARY THIS ROUTINE
6880                ! DOES IT. IT SAVES DISK SPACE TO STORE THE RESULTS THEN
6890                ! ELIMINATE THE RAW DATA IF YOU FEEL CONFIDENT THAT THE
6900                ! REDUCTION IS THE BEST THAT CAN BE. IN OTHER WORDS,
6910                ! DO NOT PURGE A RAW DATA FILE UNLESS YOU ARE ABSOLUTELY SURE
6920                ! YOU WON'T WANT TO REDUCE IT AGAIN.
6930 COM /Hrdgaus/ Av2(*)                !Av2(*) IS THE REDUCED DATA
6940 DIM Data(1:1024) BUFFER              !BUFFER USED TO TRANSFER TO DISK
6950 MAT Data= Av2
6960 PRINT CHR$(12)
6970 PRINT USING "//////"
6980 PRINT "  A SUGGESTED METHOD OF NAMING REDUCED DATA FILES IS AS FOLLOWS"
6990 PRINT "  M-----MOTOR BEAM"
7000 PRINT "  X-----EXHAUST BEAM"
7010 PRINT "  C-----CALIBRATION , IF NO 'C' THEN AN ACTUAL FIRING IS ASSUMED"
7020 PRINT "  G-----GLASS BEADS "
7030 PRINT "                IF NO 'C' THEN 'G' STANDS FOR 'GAP' PROPELLANT"
7040 PRINT "  A-----ALUMINUM OXIDE"
7050 PRINT "  PPP----CHAMBER PRESSURE FOR RUN OR OTHER...(NOZZLE TYPE)"
7060 PRINT "                PARTICLE SIZE FOR CALIBRATION"
7070 PRINT "  MMDD---MONTH, DAY OF RUN OR CALIBRATION"
7080 PRINT ""
7090 PRINT "                EXAMPLE:  MCA125JN12"
7100 PRINT ""
7110 PRINT "  MOTOR BEAM CALIBRATION USING ALUMINUM OXIDE FROM 1 TO 25 MICRONS"
7120 PRINT "  ON JUNE 12"
7130 PRINT "                EXAMPLE:  XG550AU10"
7140 PRINT ""
7150 PRINT "  EXHAUST BEAM DATA FOR GAP PROPELLANT AT 550 psi ON AUGUST 10"
7160 PRINT "                PLACE A DISK IN THE RIGHT HAND DRIVE"
7170 PRINT "  ENTER THE FILENAME YOU WISH TO USE FOR THIS REDUCED DATA"
7180 INPUT A$
7190 CREATE BDAT A$,512,16
7200 ASSIGN @Disk TO A$
7210 ASSIGN @Buff TO BUFFER Data(*)
7220 CONTROL @Buff,3;1,8192,1                !BUFFER IS FULL
7230 TRANSFER @Buff TO @Disk;COUNT 8192
7240 WAIT FOR EOT @Disk
7250 ASSIGN @Buff TO *
7260 ASSIGN @Disk TO *
7270 SUBEND

```



```

7280 SUB Review(Avl(*))
7290 DIM Data(1:1024) BUFFER
7300 PRINT " EACH REDUCED FILE CONTAINS ONE SCAN ONLY. YOU MUST KNOW IF IT"
7310 PRINT "      IS EXHAUST , MOTOR CAVITY , OR CALIBRATION DATA."
7320 PRINT ""
7330 PRINT " THE DISK WITH THE REDUCED FILE SHOULD BE IN THE RIGHT-HAND DRIVE"
7340 PRINT ""
7350 PRINT "      ENTER THE FILENAME OF THE REDUCED DATA"
7360 PRINT "      TO BE REVIEWED"
7370 PRINT ""
7380 INPUT A$
7390 ASSIGN @Disk TO A$
7400 ASSIGN @Buff TO BUFFER Data(*)
7410 CONTROL @Disk,5;1
7420 CONTROL @Buff,3;1,0,1           !THIS IS AN EMPTY BUFFER
7430 TRANSFER @Disk TO @Buff;COUNT 8192      !1024*8=NUMBER OF BYTES
7440 WAIT FOR EOT @Disk
7450 ASSIGN @Disk TO *
7460 ASSIGN @Buff TO *
7470 MAT Avl= Data
7480 SUBEND
7490 SUB Filter(A(*),Fil)
7500 DIM E(1:1024)
7510 PRINT CHR$(12)
7520 PRINT USING "////////"
7530 PRINT "      FILTERING THE SCATTERING PROFILE"
7540     FOR J=1 TO Fil
7550         FOR I=1 TO 1014
7560             B=I+1           !THIS IS A Symetric Moving Average
7570             C=I+2           !TYPE OF DIGITAL FILTER. EACH
7580             D=I+3           !DATA POINT IS EQUALLY WEIGHTED
7590             F=I+4           !IN THIS CASE BUT THIS CAN BE
7600             G=I+5           !CHANGED IF ONE DETERMINES THAT
7610             H=I+6           !FEWER POINTS WITH UNEQUAL WEIGHTS
7620             K=I+7           !WOULD BE FASTER OR GIVE BETTER
7630             L=I+8           !RESULTS. THIS TYPE OF FILTER WAS
7640             N=I+9           !USED SINCE IT INTRODUCES NO PHASE
7650             P=I+10          !LAG      (Anqular Resolution).
7660     E(G)=(A(I)+A(B)+A(C)+A(D)+A(F)+A(G)+A(H)+A(K)+A(L)+A(N)+A(P))/11
7670         NEXT I
7680     MAT A= E
7690     NEXT J
7700 SUBEND

```

## LIST OF REFERENCES

1. Hermsen, R. W., Aluminum Oxide Particle Size for Solid Rocket Motor Performance Prediction, AIAA Paper 81-0035, American Institute of Aeronautics and Astronautics, New York, New York, January 1981.
2. Cramer, R., Particle Size Determination in Small Solid Propellant Rocket Motors Using Light Scattering Method, M. S. Thesis, Naval Postgraduate School, Monterey, California, October 1982.
3. Karagounis, S. G., An Investigation of Particulate Behavior in Solid Propellant Rocket Motors, Engineer Thesis, Naval Postgraduate School, Monterey, California, 1981.
4. Gumprecht, R. O. and Sliepcevich, C. M., "Scattering of Light by Large Spherical Particles," Journal of Physical Chemistry, v. 57, pp. 90-94, January 1953.
5. Dobbins, R. A., Crocco, L. and Glassman, I., "Measurement of Mean Particle Sizes of Sprays from Diffractively Scattered Light," AIAA Journal, v. 1, no. 8, pp. 1882-1886, 1963.
6. Roberts, J. H. and Webb, M. J., "Measurements of Droplet Size for Wide Range Particle Distributions," AIAA Journal, v. 2, no. 3, pp. 583, 585, 1964.
7. Mugele, R. A. and Evans, H. D., "Droplet Size Distribution in Sprays," Industrial and Engineering Chemistry, v. 43, pp. 1317-1324, 1951.
8. Dobbins, R. A. and Jizmagian, G. S., "Optical Scattering Cross Sections for Polydispersions of Dielectric Spheres," Journal of the Optical Society of America, v. 56, no. 10, pp. 1345, 1350, 1966.
9. Dobbins, R. A. and Jizmagian, G. S., "Particle Size Measurements Based on Use of Mean Scattering Cross Sections," Journal of the Optical Society of America, v. 56, no. 10, pp. 1351-1354, 1966.
10. Hodkinson, J. R., "Particle Sizing by Means of the Forward Scattering Lobe," Applied Optics, v. 5, no. 5, pp. 839, 844, 1966.

11. Powell, E. A., Cassanova, R. A., Bankston, C. P. and Zinn, B. I., "Combustion Generated Smoke Diagnostics by Means of Optical Measurement Techniques," AIAA 14th Aerospace Sciences Meeting, AIAA Paper No. 76-67, January 1976.
12. Hansen, B. J., Automatic Control and Data Acquisition System for Combustion Laboratory Applications, Engineer Thesis, Naval Postgraduate School, Monterey, October 1982.
13. NASA Technical Paper 2156, Particle Sizing by Measurement of Forward Scattered Light at Two Angles, by Donald R. Buchele, May 1983.
14. Van de Hulst, H. C., Light-Scattering by Small Particles, John Wiley and Sons, Inc., New York, 1957.
15. Stokham, J. D., Fochtman, E. G., Particle Size Analysis, Anarbor Science Publishers, Inc., 1979.
16. Koopmans, L. H., The Spectral Analysis of Time Series, Academic Press, New York, p. 171, 1974.

INITIAL DISTRIBUTION LIST

	No. Copies
1. Defense Technical Information Center Cameron Station Alexandria, Virginia 22314	2
2. Library, Code 0142 Naval Postgraduate School Monterey, California 93943	2
3. Department Chairman, Code 67 Department of Aeronautics Naval Postgraduate School Monterey, California 93943	1
4. Professor D. W. Netzer, Code 67Nt Department of Aeronautics Naval Postgraduate School Monterey, California 93943	2
5. Mr. R. K. Harris 615 East Richmond Dayton, Washington 99328	5
6. Commander, Code 3891 Naval Weapons Center China Lake, California 93555 Attn: K. Graham	1
7. M. D. Nelson, MS 185 Jet Propulsion Laboratory 4800 Oak Grove Drive Pasadena, California 91109	1
8. Director Turbopropulsion Laboratory, Code 67Sf Department of Aeronautics Naval Postgraduate School Monterey, California 93943	5

**END**

**FILMED**

**4-85**

**DTIC**