

AD-A151 160

A USER'S GUIDE TO ISRP: THE INTERACTIVE SURVEY
REDUCTION PROGRAM(U) COASTAL ENGINEERING RESEARCH
CENTER YICKSBURG MS W BIRKEMEIER NOV 84 CERC-IR-84-1
F/G 9/2

1/2

UNCLASSIFIED

NL



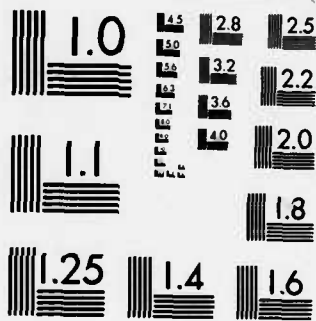

MICROCOPY RESOLUTION TEST CHART
NATIONAL BUREAU OF STANDARDS-1963-A

4

INSTRUCTION REPORT CERC-84-1

A USER'S GUIDE TO ISRP: THE INTERACTIVE SURVEY REDUCTION PROGRAM

by

William Birkemeier

Coastal Engineering Research Center

DEPARTMENT OF THE ARMY

Waterways Experiment Station, Corps of Engineers
PO Box 631, Vicksburg, Mississippi 39180-0631



US Army Corps
of Engineers

AD-A151 160

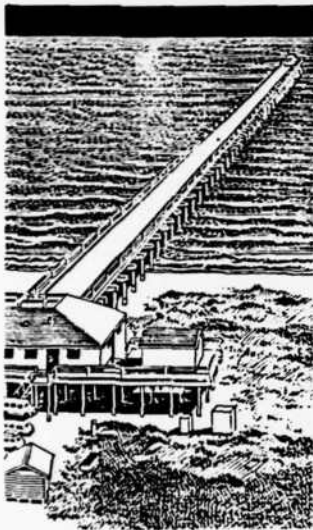

DTIC
ELECTE
MAR 14 1985
S B D

November 1984

Final Report

Approved For Public Release; Distribution Unlimited

DTIC FILE COPY

Prepared for
DEPARTMENT OF THE ARMY
US Army Corps of Engineers
Washington, DC 20314-1000

85 03 06 009



**Destroy this report when no longer needed. Do not return
it to the originator.**

**The findings in this report are not to be construed as an official
Department of the Army position unless so designated
by other authorized documents.**

**The contents of this report are not to be used for
advertising, publication, or promotional purposes.
Citation of trade names does not constitute an
official endorsement or approval of the use of
such commercial products.**

Unclassified

SECURITY CLASSIFICATION OF THIS PAGE (When Date Entered)

REPORT DOCUMENTATION PAGE		READ INSTRUCTIONS BEFORE COMPLETING FORM
1. REPORT NUMBER Instruction Report CERC-84-1	2. GOVT ACCESSION NO. AD-A151160	3. RECIPIENT'S CATALOG NUMBER
4. TITLE (and Subtitle) A USER'S GUIDE TO ISRP: THE INTERACTIVE SURVEY REDUCTION PROGRAM		5. TYPE OF REPORT & PERIOD COVERED Final report
7. AUTHOR(s) William Birkemeier		6. PERFORMING ORG. REPORT NUMBER
9. PERFORMING ORGANIZATION NAME AND ADDRESS US Army Engineer Waterways Experiment Station Coastal Engineering Research Center PO Box 631, Vicksburg, Mississippi 39180-0631		8. CONTRACT OR GRANT NUMBER(s)
11. CONTROLLING OFFICE NAME AND ADDRESS DEPARTMENT OF THE ARMY US Army Corps of Engineers Washington, DC 20314-1000		10. PROGRAM ELEMENT, PROJECT, TASK AREA & WORK UNIT NUMBERS
14. MONITORING AGENCY NAME & ADDRESS (if different from Controlling Office)		12. REPORT DATE November 1984
		13. NUMBER OF PAGES 114
		15. SECURITY CLASS. (of this report) Unclassified
16. DISTRIBUTION STATEMENT (of this Report) Approved for public release; distribution unlimited.		15a. DECLASSIFICATION/DOWNGRADING SCHEDULE
17. DISTRIBUTION STATEMENT (of the abstract entered in Block 20, if different from Report)		
18. SUPPLEMENTARY NOTES Available from National Technical Information Service, 5285 Port Royal Road, Springfield, Virginia 22161.		
19. KEY WORDS (Continue on reverse side if necessary and identify by block number) Computer programs--Handbooks, manuals, etc. (LC) Beaches--Data processing (LC) Interactive Survey Reduction Program (ISRP) (WES) ISRP (Computer program)--Handbooks, manuals, etc. (LC)		
20. ABSTRACT (Continue on reverse side if necessary and identify by block number) This report describes the capabilities and use of the Interactive Survey Reduction Program (ISRP). ISRP is a FORTRAN program which permits interactive reduction, editing, and plotting of field survey notes and the correction of previously entered data. The primary output from ISRP is a two-dimensional distance offshore and elevation data file compatible with the Beach Profile and Analysis System (BPAS) program developed by CERC (see CERC TR 82-1). (Continued)		

DD FORM 1 JAN 73 1473 EDITION OF 1 NOV 65 IS OBSOLETE

Unclassified

SECURITY CLASSIFICATION OF THIS PAGE (When Date Entered)

Unclassified

SECURITY CLASSIFICATION OF THIS PAGE(When Data Entered)

20. ABSTRACT (Continued).

→ The BPAS includes six modules for use in editing, analyzing, and plotting beach profile data; it provides a powerful tool for studying beach profile changes.

Because the data format created by ISRP is sufficiently general, anyone processing most kinds of beach and nearshore survey data will find ISRP useful.

This report includes detailed discussions of each ISRP option.

Appendices A-D contain an option summary, a sample run, a discussion of program mechanics, and installation-specific instructions for executing ISRP.

The ISRP program is not included in this report but is available from the Engineer Computer Program Library, US Army Engineer Waterways Experiment Station, Vicksburg, Miss. ↗

Unclassified

SECURITY CLASSIFICATION OF THIS PAGE(When Data Entered)

PREFACE

This report was prepared at the Coastal Engineering Research Center (CERC) of the U. S. Army Engineer Waterways Experiment Station (WES) as part of the Storm Erosion Studies Work Unit, Shore Protection and Restoration Program, Coastal Engineering Area, Civil Works Research and Development. Technical Monitors from the Office, Chief of Engineers, were Mr. John H. Lockhart, Jr. and Mr. John G. Housley.

The Interactive Survey Reduction Program (ISRP) was developed by Mr. William Birkemeier at CERC's Field Research Facility (FRF) to fulfill a specific need for the efficient entry and analysis of beach and nearshore survey data. Over a period of 3 years, it has been tested, enhanced, and sufficiently generalized to be useful to any coastal surveyor.

This report was prepared by Mr. William Birkemeier, Hydraulic Engineer, under the supervision of Mr. Curt Mason, Chief, Field Research Facility, Dr. James Houston, Chief, Research Division, and Dr. Robert W. Whalin, Chief, CERC. Mrs. Mary Cialone, Mrs. Harriet Klein, Mr. Michael Leffler, Miss Rebecca Savage, and Mr. Francis Sargent contributed to either the development and testing of ISRP or the preparation of this report.

Commander and Director of WES upon publication of this report was COL Robert C. Lee, CE. Mr. F. R. Brown was Technical Director.

Accession For	
NTIS GRA&I	<input checked="" type="checkbox"/>
DTIC TAB	<input type="checkbox"/>
Unannounced	<input type="checkbox"/>
Justification	
By _____	
Distribution/	
Availability Codes	
Dist	Avail and/or Special
A-1	



CONTENTS

	<u>Page</u>
PREFACE	1
PART I: INTRODUCTION	4
PART II: GENERAL PROGRAM STRUCTURE AND USE	7
PART III: TWO-DIMENSIONAL DATA ENTRY, OUTPUT, AND FILE MANAGEMENT	11
Data Input and Output Formats	12
Raw Data Entry Options	18
Option ND: ISRP initialization for data entry	19
Option HI: Check or change of instrument height and location	21
Option KD: Known data entry	22
Option MD: Level and tape survey data entry	23
Option ST: Stadia survey data entry	25
Option HS: Half stadia data entry	27
Option TP: Turning points	28
Option A1: EDM, theodolite data entry	30
Option FD: Fathometer data entry	32
Option RD: Data recovery	35
Options R2D, OUT, LI: Reading In and Outputting Data	36
Option R2D: Reading in processed data	37
Option LI: Listing data on the input file	43
Option OUT: Outputting data	44
PART IV: DATA EDITING, PLOTTING, MANIPULATING, AND OTHER OPTIONS	45
Option CD: Correction, Addition, and Deletion of Individual Points	46
Option CHG: Changing, Dropping, and Switching Groups of Points	47
Change 1--Add a constant correction	48
Change 2--Add a graduated correction	49
Change 3--Multiply a correction	50
Change 4--Switch coordinates	51
Change 5--Delete points	52
Option CO: Unit Conversion	53
Option ED: Data Editing	54
Option END: Terminating ISRP	56
Option HC: Modifying the Profile Header Data	57
Option HELP	58
Option LD: Data Listing	59
Option PLT: Data Plotting	60
Option RST: Resetting Options	64
Option SA: Data Saving	65
Option SD: Data Sorting	66
Option VC: Computing Volume Changes	67
PART V: THREE-DIMENSIONAL DATA PROCESSING	71
3-D Data Format	72
Option ND: Initialization of 3-D Data Entry	73
Option KD: Known 3-D Data Entry	74

Options MD, ST, HS, FD: Level and Tape, Stadia, and Fathometer Data Entry	75
Option A1: EDM, Theodolite Data Entry	76
Option RD: Data Recovery	77
Option R2D: Reading 2-D Data	78
Option R3D: Reading 3-D Data	79
Option OUT: Writing Out Data	80
PART VI: EXECUTING PROGRAM ISRP	81
How ISRP Works	82
What to Do if the Program Suddenly Terminates	84
Planning Your ISRP Run	85
PART VII: SUMMARY	87
REFERENCES	88
APPENDIX A: QUICK-LOOK OPTION SUMMARY (OPTION HELP)	A1
APPENDIX B: SAMPLE ISRP RUN	B1
APPENDIX C: UNDERSTANDING AND MODIFYING ISRP	C1
Adding a New Survey Procedure	C3
To Change or Add an Input or Output Format.	C4
To Modify the Plotting Subroutine	C5
Data Comparison	C5
FORTRAN Read and Write Units.	C6
Units of the Data	C6
How the Program Restart Works	C7
Option Deletion	C7
APPENDIX D: INSTALLATION-SPECIFIC INSTRUCTIONS	D1

A USER'S GUIDE TO ISRP:
THE INTERACTIVE SURVEY REDUCTION PROGRAM

PART I: INTRODUCTION

1. This report describes the capabilities and use of the Interactive Survey Reduction Program (ISRP) developed at the Coastal Engineering Research Center (CERC), U. S. Army Engineer Waterways Experiment Station. This FORTRAN program permits interactive reduction, editing, and plotting of field survey notes and the correction of previously entered data. The primary output from ISRP is a two-dimensional (2-D) data (distance offshore and elevation) file compatible with the Beach Profile Analysis System (BPAS) developed by CERC and published by Fleming and Lawler (1982). The BPAS includes six modules for use in editing, analyzing, and plotting beach profile data. The system provides a powerful tool for the coastal researcher or engineer studying beach profile changes.

2. Three-dimensional (3-D) data (distance offshore and alongshore and elevation) which retain the exact alongshore position of each survey point can also be processed. These data are useful as input to contour or perspective plotting routines and for computing areal changes. Since it is assumed that most users will be interested in only 2-D processing, it will be presented first. Three-dimensional processing is discussed in Part V.

3. Though ISRP is designed as a complement to BPAS, it is not necessary to use BPAS to take advantage of ISRP. In fact, the format of the output file produced by ISRP is a compact way to store data and can be used as input to any beach profile analysis program. Moreover, it is fairly easy to modify ISRP to produce any output format the user desires.

4. Figure 1 shows a typical beach profile (or cross section) and identifies the coordinate system and definitions used by ISRP. Beach survey data usually consist of a number of repetitive "surveys" of a number of "profile lines" located on a beach or "locality." Each survey of a profile line will be called a "profile-survey" since it can be referenced by the profile number and repetitive survey number. Survey points along a profile are referenced by their sequential point index numbers and by their X, Y, and Z coordinates (distance alongshore and offshore and depth), respectively.

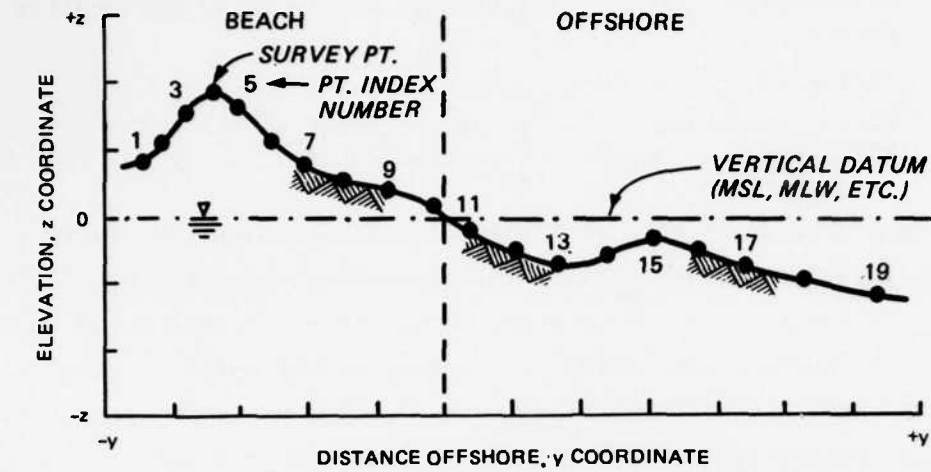

PROFILE LINE CROSS SECTION

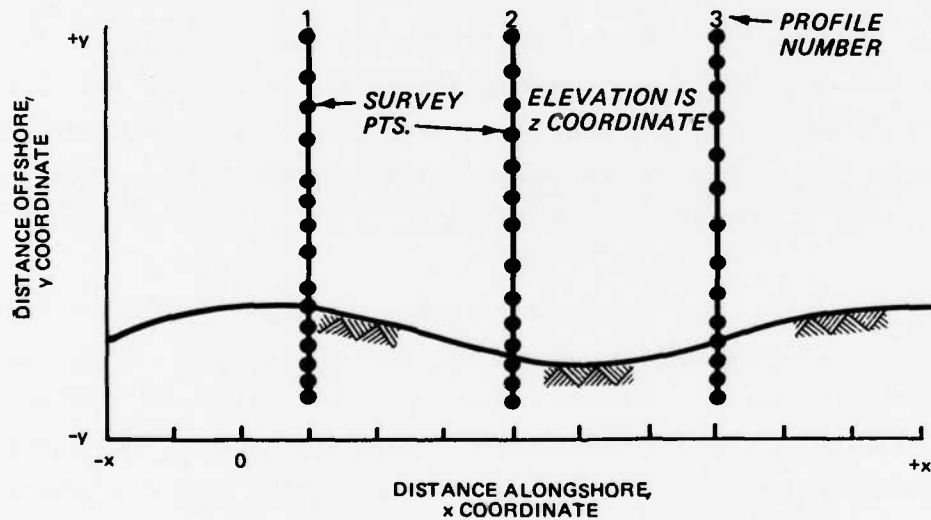

SHORELINE PLAN VIEW

Figure 1. Profile line definition sketch.

5. The normal procedure for preparing data for analysis by BPAS includes the following steps:
 - a. Calculator reduction of the field notes to Y-Z data pairs.
 - b. Hand transfer of the data from the fieldbook to a keypunch form.
 - c. Keypunching of the coding form into BPAS EDIT1 format.

- d. Processing of EDIT1 cards through module EDIT1 to identify errors.
- e. Correction of errors.
- f. Final processing of EDIT1 cards through module EDIT2 to produce EDIT2 cards or magnetic format output for use by the BPAS analysis routines.

6. This procedure is both costly and inefficient and frequently results in errors not being identified until later processing and plotting. ISRP replaces steps a through e, and it is possible to produce either EDIT1 cards or to go directly to EDIT2 format cards or magnetic format output. Since the program edits the data, allows corrections, and plots each survey against data from a previous survey (if available), the possibility of errors is greatly reduced. The actual time to do all this is not much longer than for entering all the raw data into a calculator. Actual costs for running the program are more than equally offset by time savings and by the high quality of the resulting data.

7. This user's guide contains six parts plus four appendices. Part II describes the general flow of the program, its capabilities, and the various options. Part III describes the 2-D data entry, output routines, and file management options. Part IV discusses the data editing, plotting, and manipulation options. Part V describes the 3-D data options. Part VI discusses use of ISRP.

8. Appendix A is a quick-reference option summary. Appendix B is a sample ISRP run which combines use of many of the ISRP options. Programmers will appreciate Appendix C, which discusses the mechanics of the ISRP program and includes information for developing and adding new options. Appendix D includes installation-specific instructions for executing ISRP. A general description of ISRP is available during program execution. The program is available in either tape or hard copy form from the Engineer Computer Program Library, U. S. Army Engineer Waterways Experiment Station, Vicksburg, Miss. 39180.

PART II. GENERAL PROGRAM STRUCTURE AND USE

9. Since ISRP queries the user for required information, actual execution of the program is fairly easy. Some knowledge of the basic structure of the program will help to use it efficiently and to minimize execution errors. Of primary importance is understanding that ISRP processes one survey of one profile at a time. This one profile is said to be in "program control." Profile data may be read in from a previously generated file or can be hand entered via the terminal. Once the data are under program control, they can be edited, plotted, listed, converted to different units, or changed. Once all manipulations have been completed and the user is satisfied with the data, it is then written to an output file. At the user's option, the program will also merge newly entered data with the data from previous surveys (see option R2D for details). Doing so permits new data to be compared to the previous surveys and for a final complete output file to be created. It is not necessary to always create an output file. A valid use of ISRP is simply to read, display, and examine existing data.

10. All data processing is performed by interactively executing the various ISRP options listed in Table 1 (this table is available at any time during execution as option OPT). These options will be discussed in detail in the appropriate sections. In addition, capsule summaries of each option are available using option HELP (see Appendix A for the complete HELP listing). Each option is executed by entering the appropriate code after the OPT CODE prompt. Most options can be executed in any order, though ISRP will not allow an improper sequence. For instance, option LD, which lists some or all of the entered data, and PLT, which plots the data, can be repeatedly executed as data are being entered. However, ISRP requires that the data be either edited (option ED) or plotted before option OUT can be used to send the data to the output file. Similarly, the program prints a warning when the user attempts to begin processing a new profile before writing the previous one to the output file.

11. The approximately 5,500-line ISRP program was originally developed on a CDC Cyber computer using FORTRAN V. Though it requires 140,000 OCTAL 60-bit words of core, the program is configured for a minimum word size of 24 bits. ISRP-generated plots require either Tektronix Advanced Graphing and Terminal Control System (AGIITCS) or Corps of Engineers Graphics Compatibility

Table 1
Option Code List (Option OPT)

AVAILABLE OPTIONS

RAW DATA ENTRY

A1 EDM, THEODOLITE DATA
FD FATHOMETER DATA, (ALLOWS MIXED MEASUREMENT UNITS)
HI CHECK OR ENTER INST. HEIGHT AND LOCATION
HS HALF STADIA DATA
KD KNOWN DATA ENTRY - Y, Z, (X)
MD LEVEL AND TAPE SURVEYS (MEASURED DISTANCES)
ND NEW DATA, INITIALIZE FOR DATA ENTRY
RD RECALL ENTERED DATA FROM SCRATCH FILE (TAPE10)
ST STADIA SURVEY DATA
TP TURNING POINTS

INPUT AND OUTPUT OPTIONS

LI LIST PROFILE HEADER INFO ON FILE TAPE7
OUT WRITE 2-D BPAS DATA TO TAPES, 3-D TO TAPES (IF 3-D MODE)
R2D READ BPAS FORMAT 2-D DATA FROM INPUT FILE (TAPE?)
R3D READ 3-D FORMAT DATA FROM FILE TAPE12

DATA MODIFICATION AND OTHER OPTIONS

CD CORRECT, DELETE, ADD SINGLE POINTS
CHG CHANGE, DELETE, SWITCH GROUPS OF POINTS
CO CONVERT FT. TO M. OR M. TO FT.
ED EDIT DATA IN PROGRAM CONTROL
END TERMINATE ISRP
HC CHANGE THE PROFILE HEADER INFO.
HELP PRINT DESCRIPTIONS OF EACH OPTION
LD LIST DATA IN PROGRAM CONTROL
OPT LIST OPTION CODES
PLT PLOT SINGLE OR COMPARISON PROFILE CROSS-SECTIONS
RST RESET SPECIFIC OPTIONS
SA SAVE DATA FOR USE IN COMPARISONS
SD SORT DATA BY OFFSHORE DISTANCE (AFTER EDITING)
UC COMPUTE PROFILE CHANGES, PUT OUTPUT ON TAPE14

TO TERMINATE DATA ENTRY, TYPE 0 0 0'S AFTER = PROMPT
YOU CAN SEPARATE MULTIPLE DATA ENTRIES WITH COMMAS OR BLANKS
DECIMAL POINTS ARE OPTIONAL, USE WHEN NEEDED

OPT. CODE-

System (GSC) software (refer to Appendix C). Normal use of the program is with a Tektronix 4014 or similar graphics terminal with hard-copy capability (a nongraphics terminal may also be used). In order to allow easy additions and changes, the program has a simple structure: it consists of a main program and a series of subroutines, with each subroutine executing one of the interactive options.

12. Basic questions and instructions which are required by the program are asked at the beginning of program execution and during the first call to many options. During subsequent calls to the same options, only critical information is requested thus streamlining program execution considerably. If initial responses to an option were incorrect or needed to be changed, options can be independently "reset" using option RST, and then reexecuted.

13. Most questions require either a Y or N response (for Yes or No) or request data entry. Characters other than Y or N will not terminate the program but will result in normal or default program execution. Depending on the computer being used, the response to a question will be either on the same line as the question or the next line (with or without a special prompt character).

14. In all examples used in this guide, user input appears below the question except after an equals sign prompt, when it appears on the same line. Both situations are illustrated in Figure 2.

```

OPT. CODE-
R3D
DATA TO BE READ IN FT OR M?-
User input → N
ENTER PROFILE, SURVEY-
188 30

ENTER - DIST EL (0,0 TO END)
9- 650 -10
10- 710 -13.27
11- 800 -15.69
12- 850 -20.2
13- 0,0
    }
    User input
Equals signs →

```

Figure 2. Display of user input

15. Data entry usually follows a minus or equals sign prompt. Data entry must be numeric; decimals are required only when needed, and multiple entries on a single input line should be separated by a space or comma. When more than one entry is requested (for instance, a distance and an elevation

value), the program will wait, even after a carriage return, until the proper number of values has been entered. If more values than required are entered, the additional values may be used by the next program read statement; therefore, the user should be aware of entering data properly. If an error is encountered, the option should be exited and the data listed (option LD) and corrected if necessary (option CD).

16. Because the ISRP options permit virtually any entry to be corrected, there should be no reason to deliberately terminate program execution. If an incorrect entry is made or an incorrect option is called, continue executing the option (even with incorrect responses), then reexecute the option with correct responses or select the proper option.

17. Should an unexpected termination occur, ISRP also permits a smooth restart which under most circumstances will prevent the loss of hand entered data and have little impact on the final output data file (see Part VI).

PART III: TWO-DIMENSIONAL DATA ENTRY, OUTPUT, AND FILE MANAGEMENT

18. This is probably the most important part of the ISRP Guide since it describes the various options for reading or entering data into the program, for writing data out, and for managing the input and output files. The part is divided into three sections: the first addresses the input and output data formats, the second discusses the entry and reduction of field survey notes, and the third addresses reading in and outputting processed data. Data read into or output from ISRP can be in either BPAS EDIT1 or EDIT2 card images or in the variable-length record of EDIT2 magnetic medium format. These formats will be discussed in detail below. ISRP requires a number of files for reading in and outputting data. FORTRAN write and read statements use units 7, 8, and 10, with file names which will be referred to as TAPE7, TAPE8, and TAPE10, respectively.

Data Input and Output Formats

19. The primary output of ISRP is a file of reduced distance elevation data which is ready for analysis. Usually, it is desirable to merge the profiles entered from a new survey into the data collected during earlier surveys. Occasionally, the user may want to adjust data entered during a previous survey or to correct an earlier error. In any case, the user wants to end up with an output file which includes the new or corrected data and the previous data, all properly sorted. All this can be done using ISRP. An understanding of how this is done is necessary to ensure both that data are not inadvertently lost and that the final output file is properly organized.

20. In its present configuration, ISRP can read and write 2-D data in the three formats recognized by BPAS. Routines could be added to process data in other formats using the guidance in Appendix C. The three BPAS formats are: EDIT1 cards, EDIT2 cards, and EDIT2 magnetic media format. Note that use of the words cards only indicates an 80-character record and that ISRP actually manipulates computer files of card "images." Each of these formats is specified in Tables 2, 3, and 4, respectively (samples are shown in Figures 3-5), and include the following information:

- a. A two-character locality code which identifies the beach being surveyed.
- b. A three-digit profile number which identifies the profile (or range) surveyed.
- c. A four-digit survey number which identifies the repetitive surveys of the profiles.
- d. A six-digit survey date in the order of year, month, day.
- e. A five-digit 24-hour time.
- f. The distance and elevation pairs for the profile (without decimal points).

21. There are differences in the formats due to their different purposes. EDIT1 cards are used for raw data entry into BPAS, and their format is most complete, including both the units of the data and a vertical datum code. They are designed to be typed onto keypunch cards and scanned for keypunch and data errors through BPAS module EDIT1. EDIT1 cards or card images must be converted to either of the EDIT2 formats before the data can be processed through the BPAS analysis routines.

22. Since use of ISRP eliminates keypunch and data errors, use of the

Table 2

BPAS EDIT1 Card Image Format

Character Position	Entry Description	Entry Format
<u>First Card in Each Record</u>		
1-2	Locality code	A2
3-5	Profile line number	I3
6-9	Survey identification number	I2
10-11	Card number (01)	I2
12-13	Number of cards needed to complete the record	I2
14-15	Year survey was performed	I2
16-17	Month survey was performed	I2
18-19	Day survey was performed	I2
20	Blank	IX
21-23	Hour survey was performed	I4
24-25	Minute survey was performed	I2
26	(Input) vertical datum code	A1
27-28	Two-character abbreviation for units of measurement in which input data are recorded (FT, M, etc.)	A2
29,30	Blank	2X
31-35	Distance coordinate	I5
36-40	Corresponding elevation coordinate	I5
41-45	Distance coordinate	I5
46-50	Corresponding elevation coordinate	I5
51-55	Distance coordinate	I5
56-60	Corresponding elevation coordinate	I5
61-65	Distance coordinate	I5
67-70	Corresponding elevation coordinate	I5
71-75	Distance coordinate	I5
76-80	Corresponding elevation coordinate	I5

Second and Following Cards in Each Record

Data in columns 1-13, except card number, remain unchanged.

Distance and elevation coordinates begin in column 21 and end in column 80.

No decimals are entered; the position of the decimal is defined on a user-supplied option card.

39	25	5	1	5791020	14002FT	+	0+	122+	10+	131+	20+	152+	30+	195+	40+	215	
39	25	5	2	5													
39	25	5	3	5													
39	25	5	4	5													
39	25	5	5	5													
39	25	5	6	1	5791020	13002FT	+	0+	130+	10+	125+	20+	127+	30+	142+	40+	157
39	25	5	7	5													
39	25	5	8	5													
39	25	5	9	5													
39	25	5	0	5													
39	25	5	1	6791019	11202FT	+	0+	148+	5+	182+	20+	177+	40+	176+	60+	169	
39	25	5	2	6													
39	25	5	3	6													
39	25	5	4	6													
39	25	5	5	6													
39	25	5	6	6													
39	25	5	7	6													
39	25	5	8	6													
39	25	5	9	6													
39	25	5	0	6													
39	25	5	1	5791019	14322FT	+	0+	119+	20+	127+	40+	134+	60+	141+	80+	145	
39	25	5	2	5													
39	25	5	3	5													
39	25	5	4	5													
39	25	5	5	5													
39	25	5	6	1	5791019	15442FT	+	0+	128+	10+	142+	20+	145+	30+	149+	40+	163
39	70	5	2	6													
39	70	5	3	6													
39	70	5	4	6													
39	70	5	5	6													
39	70	5	6	6													
39	70	5	7	6													
39	70	5	8	6													
39	70	5	9	6													
39	70	5	0	6													
39	70	5	1	5791020	10002FT	+	10+	115+	30+	119+	50+	123+	70+	133+	90+	147	
39	70	5	2	5													
39	70	5	3	5													
39	70	5	4	5													
39	70	5	5	5													
39	70	5	6	1	5791020	11202FT	+	0+	133+	20+	132+	40+	133+	60+	138+	80+	145
39	70	5	7	5													
39	70	5	8	5													
39	70	5	9	5													
39	70	5	0	5													

Figure 3. Sample of BPAS EDIT1 card

Table 3
BPAS EDIT2 Card Image Format

First Card in Each Record

Character Position	Entry Description	Entry Format
1-2	Locality code	A2
3-5	Profile line number	I3
6-9	Survey identification number	I4
10	Card number (1)	A1
11-16	Date of survey	3I2
17-21	Time of survey	I5
22-24	Number of coordinate pairs in the survey record	I3
25-29	Minimum elevation this record	I5
30-40	Blank	11X
41-80	First four distance, elevation coordinate pairs; five columns each coordinate; no decimals	8I5

Continuation cards

1-9	Same as for first card	
10	Card number (2-9, then A-Z)	
11-80	Seven distance, elevation coordinate pairs; five positions each coordinate	14I5

If there are exactly four coordinate pairs (first card only needed, filled to Column 80), the second and last card in the record must be a blank card.

39 25	51701020	1408	27	-2				0	122	10	131	20	152	30	195
39 25	52	40	215	45	211	50	193	60	153	70	99	80	100	90	96
39 25	53	100	92	103	92	115	62	120	60	130	48	140	44	150	37
39 25	54	160	30	170	24	180	19	190	14	200	10	210	6	220	4
39 25	55	230	1	240	-2										
39 25	61791020	1308	29	-5				0	130	10	125	20	127	30	142
39 25	62	40	157	50	127	60	183	70	180	80	173	90	172	100	179
39 25	63	110	178	120	172	130	157	136	144	140	122	150	115	160	111
39 25	64	170	92	180	80	190	69	200	62	210	55	220	51	230	43
39 25	65	240	32	250	20	260	8	270	-5						
39 25	81791019	1120	32	-3				0	148	5	182	20	177	40	176
39 25	82	60	160	80	176	100	191	120	194	140	200	150	217	170	209
39 25	83	177	208	180	236	105	234	190	218	200	182	210	159	215	140
39 25	84	230	123	250	102	260	94	270	91	280	85	290	73	300	62
39 25	85	310	55	320	40	330	39	340	28	350	18	360	8	370	-3
39 25	111791019	1432	29	-37				0	119	20	127	40	134	60	141
39 25	112	80	145	100	149	110	160	120	166	130	175	140	186	150	197
39 25	113	170	195	190	172	205	157	210	139	230	105	250	83	260	73
39 25	114	270	71	280	68	290	60	300	47	310	35	320	25	330	14
39 25	115	340	1	350	-11	360	-22	380	-37						
39 58	81010717	1200	50	-320				155	198	168	205	183	169	194	154
39 58	82	210	153	222	134	245	104	262	93	275	80	290	71	308	59
39 58	83	335	34	339	37	379	0	409	-30	439	-62	462	-98	489	-100
39 58	84	505	-110	524	-110	572	-111	609	-83	643	-61	683	-54	726	-58
39 58	85	019	-81	904	-99	967	-112	1051	-125	1170	-135	1274	-141	1388	-149
39 58	86	1504	-158	1624	-167	1761	-179	1927	-192	2126	-208	2241	-217	2387	-225
39 58	87	2567	-239	2710	-247	2846	-254	3020	-265	3149	-273	3295	-280	3421	-290
39 58	88	3539	-295	3660	-301	3787	-306	3934	-320						
39 58	111010823	1600	43	-208				169	205	181	172	194	155	214	164
39 58	112	224	133	240	113	249	100	284	63	328	31	362	-1	382	-27
39 58	113	408	-38	431	-50	466	-68	490	-85	513	-98	544	-100	568	-101
39 58	114	591	-102	608	-106	636	-109	663	-116	698	-115	726	-115	751	-103
39 58	115	775	-99	797	-79	833	-71	908	-82	961	-104	1003	-113	1046	-129
39 58	116	1106	-128	1183	-134	1263	-140	1341	-148	1418	-153	1512	-160	1609	-167
39 50	117	1684	-175	1790	-184	1932	-194	2100	-208						
39 58	131011104	1545	43	-292				170	201	192	157	218	146	246	99
39 58	132	268	74	282	59	306	42	352	20	390	-10	404	-29	442	-41
39 58	133	495	-66	520	-83	548	-114	572	-116	609	-120	645	-125	686	-119
39 58	134	720	-105	771	-87	816	-85	879	-90	946	-85	1017	-80	1086	-101
39 58	135	1179	-125	1277	-140	1371	-151	1484	-162	1616	-174	1730	-183	1841	-190
39 58	136	2022	-205	2195	-217	2346	-220	2500	-237	2663	-246	2814	-254	2988	-267
39 50	137	3136	-271	3252	-292										

Figure 4. Sample of BPAS EDIT2 card

Table 4
 BPAS EDIT2 Magnetic Media Format

Character Position	Entry Description	Entry Format
1-2	Locality code	A2
3-5	Profile line number	I3
6-9	Survey identification number	I4
10-15	Date of survey	3I2
16-20	Number of coordinate pairs in the record	I3
24-28	Minimum elevation on the record	I5
29-35	Blank	7X

The distance and elevation coordinate pairs follow from position 36 on, five positions per coordinate, no decimals. 15

```

39 1 1740500 1400 11- 20      + 0+ 143+ 18+ 205+ 29+ 248+ 40+ 193+ 53+ 152+ 76
+ 100+ 100+ 75+ 125+ 56+ 150+ 30+ 165+ 10+ 186- 20
39 1 2740603 1100 9- 25      + 0+ 141+ 16+ 193+ 29+ 246+ 41+ 190+ 59+ 132+ 92
+ 83+ 130+ 63+ 185+ 29+ 189- 25
39 1 3740701 1100 10- 35     + 0+ 140+ 16+ 198+ 29+ 246+ 41+ 182+ 62+ 126+ 90
+ 83+ 100+ 78+ 118+ 68+ 168+ 9+ 200- 35
39 1 4740805 1300 10- 30     + 0+ 141+ 16+ 194+ 29+ 247+ 41+ 190+ 59+ 130+ 92
+ 111+ 134+ 73+ 184+ 23+ 200+ 11+ 236- 30
39 2 1740506 1300 14- 20     + 0+ 118+ 25+ 128+ 35+ 135+ 50+ 177+ 65+ 200+ 72
+ 173+ 81+ 138+ 100+ 110+ 125+ 92+ 150+ 78+ 175+ 58+ 200
39 2 2740603 1100 11- 20     + 0+ 118+ 32+ 132+ 48+ 170+ 61+ 201+ 67+ 202+ 78
+ 145+ 93+ 116+ 129+ 89+ 148+ 65+ 185+ 21+ 226- 20
39 2 3740701 1100 13- 34     + 0+ 117+ 32+ 132+ 48+ 171+ 60+ 211+ 68+ 196+ 78
+ 155+ 93+ 118+ 100+ 106+ 129+ 84+ 168+ 69+ 200+ 26+ 226
39 3 1740506 1300 15- 20     + 0+ 130+ 25+ 133+ 40+ 157+ 50+ 185+ 72+ 178+ 100
+ 176+ 122+ 144+ 148+ 101+ 175+ 91+ 200+ 82+ 225+ 64+ 250
39 3 2740603 1100 15- 35     + 0+ 125+ 20+ 126+ 35+ 146+ 50+ 186+ 77+ 171+ 100
+ 174+ 118+ 161+ 139+ 118+ 154+ 99+ 180+ 93+ 200+ 80+ 214
39 4 1740500 1500 15- 20     + 0+ 160+ 25+ 166+ 50+ 163+ 71+ 197+ 81+ 224+ 100
+ 212+ 125+ 189+ 139+ 203+ 153+ 175+ 175+ 132+ 200+ 94+ 225
39 4 2740603 1200 16- 35     + 0+ 158+ 22+ 166+ 41+ 158+ 54+ 163+ 72+ 197+ 82
+ 227+ 100+ 213+ 120+ 193+ 133+ 190+ 140+ 203+ 160+ 165+ 186
  
```

Figure 5. Sample of BPAS EDIT2 magnetic media format

EDIT1 card format is not required. ISRP can be used to correct EDIT1 data and to prepare it for processing by BPAS module EDIT1.

23. The magnetic media EDIT2 format differs from the EDIT2 card format in that all the survey points are put on one long variable-length record (up to 1035 characters). This format provides more compact data storage and is recommended for use with very large data files. EDIT2 cards fit an 80-column format and contain an extra column for storing a card number (1-9, A-Z).

Important: ISRP is configured to normally handle only 100 survey points per profile. An attempt to enter more results in an error message. More points can be entered if the dimensions are changed within the program itself (see Appendix C).

24. Use of either EDIT2 format is at the user's discretion. Note that EDIT2 magnetic media format files can have too many characters per line to be processed by the Editor system on some computers (an Editor is a system program for creating and changing program and data files).

25. Since the EDIT2 formats do not include information about vertical datum, types of units, and decimal places, this and other information, including details about the data in the file, are stored on a "header card." The format of the header card is given in Table 5, and a sample in Figure 6. This card, which is produced by BPAS module EDIT2, contains such details about the data as the range of dates and the maximum number of data points for any profile. The header record is placed in front of the EDIT2 format data. In the case of magnetic media format, the header record is followed by an End Of Record (EOR) and an End Of Filemark (EOF). There is normally not an EOR, EOF after the header record when EDIT2 cards are produced or read by BPAS.

26. Using option R2D, ISRP can read (from TAPE7) and write (to TAPE8) EDIT2 format data with or without a header record according to the following rules:

- a. An EOR, EOF must separate the header record from the data if EDIT2 magnetic media format data are being read from the input file (TAPE7). The EOR, EOF is optional with EDIT2 cards.
- b. ISRP can transfer the header record from the input to the output file and can update it. Since ISRP cannot scan the output file, it is up to the user to ensure that the updates are correct.
- c. A header record can be placed on the output file only if one exists on the input file. ISRP cannot create a header record.
- d. An EOR, EOF will separate the header record from the data on the

output file (TAPE8) with magnetic format data, but is optional with EDIT2 card data.

By using ISRP to maintain the header record on the data file, a special run of the BPAS EDIT2 module, normally required to update a header record, can be avoided.

Table 5
Format of The BPAS Header Record

Character Position	Entry Description	Entry Format
1-2	00	2X
3-5	Lowest profile line number in data file	I3
6-9	Lowest survey identification number in data file	I4
10-12	Highest profile line number in the data file	I3
13-16	Highest survey identification in the data file	I4
17-19	Maximum number coordinate pairs required to define any one survey	I3
20	Number of places to the right of the decimal for the distance coordinates	I1
21	Number of places to the right of the decimal for the elevation coordinates	I1
22-23	Two-character abbreviation for units of measurement in which the data are recorded	A2
24-27	Four-character acronym describing the vertical datum to which the data are referenced	A4
28-49	Range of dates covered by the data	2(3I2,I5)
50-80	Thirty-one-character description of the data	31A1

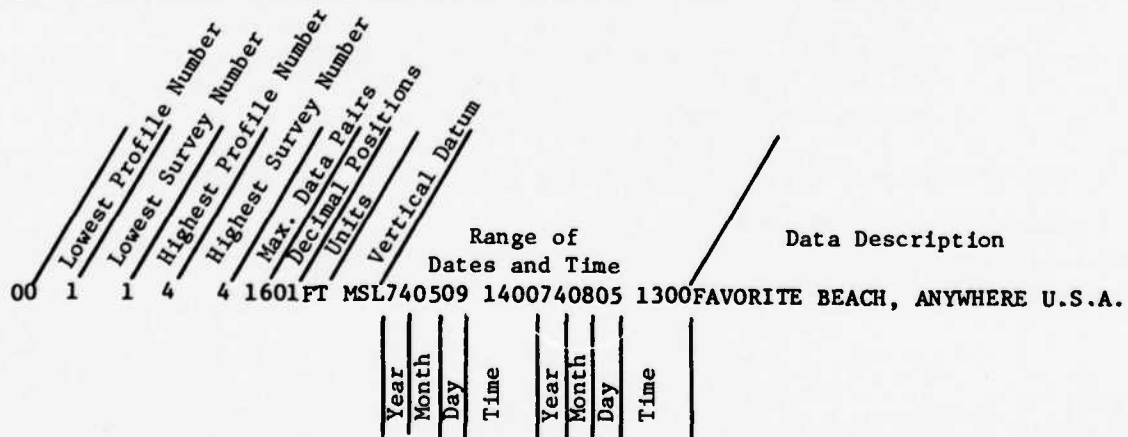

Figure 6. Sample header record

Raw Data Entry Options

27. ISRP was designed to be used by the field surveyor to reduce field notes. It therefore attempts to combine the flexibility of a calculator with the power of a computer. For example, it permits the user to recompute, delete, or change erroneous points as they are encountered and does not add a new data point to its memory until instructed by the user to do so. Table 1 lists the options and survey methods available for processing raw data. Additional options for different methods can easily be developed.

28. For example, an ISRP option could read from an input file data automatically recorded by an electronic total station. Such an option has been developed for use with the Zeiss Elta-2 total station used to survey with CERC's Coastal Research Amphibious Buggy (CRAB) (see Birkemeier 1982). Guidelines for developing new options are given in Appendix C.

29. All raw data entry options have the following things in common:

- a. Option ND (New Data; see paragraphs 31-33) must be executed in order to initialize ISRP for new data entry.
- b. Each option prompts the user for data with an equals sign; to exit the option, enter a series of 0's equal to the number of data values being entered. As each point is entered, it is sequentially numbered with a "point index" beginning at 1.
- c. The various options may be mixed. For example, one survey may contain some stadia data, some taped distances, and some previously computed data. Use the appropriate option for each method as it is needed.
- d. Data may be entered in any order, though use of either ascending or descending order is preferred. Data may be sorted later using option SD.
- e. In order to reduce the possibility of losing entered data due to a program or system failure, each of the entry routines writes the data to a "scratch" file (TAPE10) as it is being entered. TAPE10 can then be used as input to the program during a restart of ISRP. Refer to option RD for details.

30. Appendix B includes a detailed sample ISRP run which combines use of a number of entry options.

Option ND: ISRP
initialization for data entry

31. Option ND (New Data) must be called before data can be entered. This option resets the point index counter; determines the profile number, survey number, date, time, input units; and, if required, computes the instrument height (HI) and the distance along the profile to the instrument. If the HI and the instrument distance are known, they can be entered directly. Incorrect entries made in option ND can be corrected using options HC and HI. Option ND can be reset using option RST.

32. Figure 7 illustrates three different uses of option ND. Figure 7a is for stadia data. When processing stadia, a positive (Y) response to the "stadia data?" question sets ISRP up for measuring distances relative to the instrument position. The position of the instrument along the profile is computed in option ND by directly entering the distance or by entering the actual stadia readings (note that when ISRP asks for stadia data, it expects the original stadia readings; if the distances are already reduced, the data should be treated as having "measured distances"). When reducing the original stadia readings, option ND checks the stadia data for errors as described under option ST. ISRP uses a stadia multiplier of 100 and an instrument focal length of 1.20 ft.* These can be changed during the first use of option ND.

33. Figure 7b illustrates use of option ND with level and tape data. Fewer questions are asked during the subsequent calls to option ND, as shown in Figure 7c. Note also that in the Figure 7c example, computation of the instrument height was not required since entry options ST (stadia data), MD (measured data), or HS (half stadia data) were not used.

* To convert from feet to meters (SI), multiply by 0.3048.

```

OPT. CODE-
ND
ENTER LOCALITY CODE (2 CHARACTER)-
39
INPUT UNITS IN FT OK?-
Y
STADIA SURVEYS?-
Y
STADIA MULTIPLIER= 100.00 FOCAL LENGTH= 1.20 FT. OK?-
Y
ENTER DATE (YRMDA) AND SURVEY NUMBER-
830417 25
ENTER PROFILE AND 24 HOUR TIME-
169 1235
USING OPTIONS ND, ST, OR HS TO ENTER DATA?-
Y
IS HI AND DIST. TO INST. KNOWN?-
N
ENTER BM ELEV-
11.79
ENTER BACKSIGHT-
4.145
ENTER DIST. TO POINT FROM WHICH INST LOC. WAS DETERMINED-
182.48
WAS STADIA USED TO MEAS. INST LOC.?-
Y
ENTER US AND LS-
4.25 4.05
HI= 15.835 FT THE INST DIST = 204.68 FT
OPT. CODE-

```

a. Use of option ND with stadia data

```

OPT. CODE-
ND
ENTER LOCALITY CODE (2 CHARACTER)-
HI
INPUT UNITS IN FT OK?-
Y
STADIA SURVEYS?-
N
ENTER DATE (YRMDA) AND SURVEY NUMBER-
830412, 89
ENTER PROFILE AND 24 HOUR TIME-
57 1400
USING OPTIONS ND, ST, OR HS TO ENTER DATA?-
Y
IS HI KNOWN?-
N
ENTER BM ELEV-
16.57
ENTER BACKSIGHT-
4.35
ENTER STARTING DISTANCE-
84
HI= 20.920 FT STARTING DISTANCE= 84.00 FT
OPT. CODE-

```

b. Use of option ND with level and tape data

```

OPT. CODE-
ND
NEW DATE OR SURVEY?-
Y
ENTER DATE (YRMDA) AND SURVEY NUMBER-
830211, 230
ENTER PROFILE AND 24 HOUR TIME-
45, 1330
USING OPTIONS ND, ST, OR HS TO ENTER DATA?-
N
OPT. CODE-

```

c. Use of option ND when HI does not need to be computed

Figure 7. Three uses for option ND

Option HI: Check or change of instrument height and location

34. Option HI (Height of the Instrument) can be used at any time to either check the HI and instrument location being used or to change it. It will not compute a new HI; that must be done using Option TP (see paragraph 45). Figure 8 illustrates use of option HI.

```
OPT. CODE-  
  HI  
HI- 15.935 FT  THE INST DIST.- 204.68 FT  
DO YOU WANT TO CHANGE IT?-  
  Y  
ENTER NEW HI AND INST DIST. -  
  20.0 200.0  
OPT. CODE-
```

Figure 8. Use of option HI (stadia data)

Option KD: Known data entry

35. Data already reduced to Y, Z coordinate pairs can be entered using option KD (Known Data). Since some users may prefer entering either the distance or the elevation first, the order of entry can be set during the first use of the option. To exit option KD, enter a 0,0. Figure 9 illustrates option KD. Because no computations are performed, entered data are immediately added to the profile being processed.

```
OPT. CODE-  
  KD  
KNOWN DATA, FORMAT = DIST EL OK?-  
Y  
ENTER - DIST EL (0,0 TO END)  
 9-   650 -10  
10-   710 -13.27  
11-   800 -15.69  
12-   850 -20.2  
13-    0 0  
OPT. CODE-
```

Figure 9. Use of option KD

Option MD: Level and
tape survey data entry

36. A common beach survey method uses a tape to measure distances and a surveying level to determine elevation. Elevations and distances are measured relative to a baseline or permanent monument located at the landward end of the profile. For each survey point, the field notes consist of (a) a distance along the profile relative to a monument (or, if mixed with stadia data, to the instrument location) and (b) a "foresight" (FS) reading of the level rod, which has to be subtracted from the instrument height. These types of data can be handled by option MD (Measured Distances). Data entry follows the printing of the point index and an equals sign prompt. Data may be entered with either the distance or the foresight entered first, and the user is given the option of previewing and verifying every computed data point before it is actually included in the profile being processed.

37. During stadia surveys, the program queries the user as to whether each data point is either landward or seaward of the instrument. The question is repeated until all points are seaward. Figures 10a and 10b illustrate, respectively, calls to option MD for distances measured relative to the monument and relative to the instrument. Option MD is exited by entering 0,0.

```
OPT. CODE-  
  MD  
MEASURED DATA ENTRY, ORDER = DIST FS OK?-  
I>N  
DO YOU WANT TO SEE AND VERIFY CALCULATED VALUES?-  
  Y  
ENTER - FS DIST (0,0 TO END)  
  1= 2.5 14  
- Y= 98.00 Z= 18.42 OK?-  
  Y  
  2= 5.6 25.9  
- Y= 109.90 Z= 15.32 OK?-  
  Y  
  3= 7.8, 75.9  
- Y= 159.90 Z= 13.12 OK?-  
  Y  
  4= 0,0  
OPT. CODE~
```

Figure 10a. Use of option MD to enter level and tape data, with distances measured relative to the benchmark; e.g., where HI = 20.92 ft and the starting distance = 84.00 ft

```

OPT. CODE-
  MD
MEASURED DATA ENTRY, ORDER = DIST FS OK?-
Y
DO YOU WANT TO SEE AND VERIFY CALCULATED VALUES?-
Y
ENTER - DIST FS (0,0 TO END)
4= 120 17.5
- Y= 320.00 Z= 2.50 OK?~
Y
5= 150 18.75
- Y= 350.00 Z= 1.25 OK?~
Y
6= 200 22.06
- Y= 400.00 Z= -2.06 OK?~
N
6= 200 22.60
- Y= 400.00 Z= -2.60 OK?~
Y
7= 0 0
OPT. CODE-

```

Figure 10b. Use of option MD to enter tape and level data relative to the instrument; e.g., where HI = 20,000 ft the instrument distance = 200.00 ft

Option ST: Stadia survey data entry

38. In stadia surveying, three rod readings are made at each survey point and recorded in the field book (Birkemeier 1981). The center reading or foresight is used to compute the elevation, and the outer two readings give the distance from the instrument to the survey point. Because three readings are made and because the outer readings must be read to an accuracy of ± 0.01 ft or better in order to determine distances to ± 1 ft, there is greater chance for distance errors in stadia surveying.

39. Option ST (Stadia) can reduce stadia data obtained using either a level or a transit (with the vertical angle set at 90 degrees). In its present form, option ST cannot reduce stadia data where a vertical angle is also read (however, a modification to process the vertical angle could be made).

40. Though stadia data may be more error prone than other methods, the three readings do provide a built-in check. If the level rod is held reasonably vertical, the difference between the upper stadia reading (US) and the foresight reading (FS) should equal, or nearly equal, the difference between the FS and the lower stadia reading (LS), or

$$US - FS = FS - LS \quad (1)$$

rewritten

$$US - 2FS + LS = \epsilon = 0 \quad (2)$$

41. In actual practice, because the readings are made to ± 0.01 ft, a reasonable value of ϵ is less than about 0.02 ft. Option ST computes equation 2 and, when the computed value of ϵ (called the "error-check accuracy" by ISRP) exceeds 0.02 ft (or a value set by the user), signals the possibility that one or all of the readings may be in error and indicates how much by printing ϵ .

42. Option ST will also recompute the data three ways, each time dropping one of the three values and using the other two. With this information and the distances to adjacent points, the skilled user can decide if the data were properly collected or if one reading is bad. On entering option ST, the user is asked if he wants to adjust the error check accuracy. Once this is done, the user has only to enter each FS, US, and LS. If the computed ϵ is

small, the resultant Y and Z coordinates are computed and displayed and the user is asked if the point is okay. A positive response adds the point to the profile. If ϵ is large, the value of ϵ is printed and the user is asked if the point should be recomputed. Even if the point is not recomputed, the user is asked whether to use it as is. A negative response causes the entered data to be ignored. Points can be computed repeatedly until the user is satisfied. To use one of the recomputed points, it must be manually entered using option KD. Since stadia measurements are made relative to the instrument location, option ST must be told when points are landward or seaward of the instrument. The program queries the user as to whether each point is landward of the instrument. This question is repeated until a negative response is given indicating that all remaining points are seaward.

43. Use of option ST is shown in Figure 11. This example shows the shift from landward to seaward and recomputation of suspect readings. Option ST is exited by entering 0,0,0.

```

OPT. CODE-
ST
STADIA DATA - DEFAULT ERROR CHECK = .02 OK?-
Y
STADIA ENTRY, FORMAT = FS US LS (0,0,0 TO END)
IS NEXT POINT LANDWARD OF INST?-
Y
1= 4.15 4.25 4.05
- Y= 178.80 Z= 15.85 OK?-
Y
LANDWARD STILL?-
N
2= 12.66 12.86 12.46
- Y= 241.20 Z= 7.34 OK?-
Y
3= 14.43 15.05 13.86
ERROR CHECK = .050 WANT ME TO RECOMPUTE IT ?-
Y
PRESENTLY Y= 320.20 Z= 5.57
ASSUMING GOOD FS AND ONE BAD STADIA
Y= 325.20 (US) OR 315.20 (LS) Z= 5.57
ASSUMING WRONG FS GOOD STADIA
Y= 320.20 Z= 5.55
USE POINT AS IS?-
N
RE-ENTER STADIA OR USE OPTION KD TO ENTER
POINT AS COMPUTED ABOVE.
3= 14.43 15 13.86
- Y= 315.20 Z= 5.57 OK?-
Y
4= 0 0 0
OPT. CODE-

```

Figure 11. Use of option ST to enter stadia data; e.g., where HI = 20.000 ft and the instrument distance = 200.00 ft. Note recomputation of erroneous point and subsequent correction

Option HS: Half stadia data entry

44. Though it is of questionable accuracy, occasionally only two level rod readings are made, usually the foresight and lower stadia. This type of data can be processed using option HS (Half Stadia). Since only two readings are made, no accuracy check is made and all distances are assumed to be seaward of the instrument. Refer to Figure 12 for an example. Note that option HS assumes that earlier calls have been made to option ST. To exit option HS, enter 0,0.

```
OPT. CODE-  
  HS  
HALF STADIA ENTRY, FORMAT - FS LS(OR US) 0,0 TO EXIT  
  7= 22 23.6  
- Y= 501.20 Z= -2.00  
  8= 25 27.2  
- Y= 641.20 Z= -5.00  
  9= 0 0  
OPT. CODE-
```

Figure 12. Use of option HS (distance relative to instrument at 200 ft)

Option TP: Turning points

45. During either a level and tape or stadia survey, it is often necessary to reestablish the location and height of the instrument by using a Turning Point (TP). The primary difference between the two methods is that the new location of the instrument is not important in level and tape surveying; only the elevation is. Figures 13a, 13b, and 13c illustrate three different uses of option TP. Note that the turning point does not need to be a point on the profile line. If it is a survey point, then it must be the point last entered before use of option TP. When stadia data are used, they are checked for errors as described in the section on option ST.

```
OPT. CODE-
  TP
IS TURNING POINT ALSO A SURVEY POINT?-
  Y
HAS POINT BEEN ENTERED?-
  Y
ENTER BACKSIGHT-
  5.4
WAS STADIA USED TO MEAS. INST LOC.?-
  Y
ENTER US AND LS-
  5.6,5.2
HI= 10.800 FT THE INST DIST = 266.20 FT
OPT. CODE-
```

Figure 13a. Use of option TP to compute a turning point using the last entered survey point and stadia readings

```
OPT. CODE-
  TP
IS TURNING POINT ALSO A SURVEY POINT?-
  N
ENTER FS AND BS TO TURNING POINT (NO DIST.)-
  10.3 2.65
NEW HI= 13.270 FT
```

Figure 13b. Use of option TP to compute a turning point with level and tape surveying. Only the foresight (FS) to the TP and the backsight (BS) need be entered

```

OPT. CODE-
  TP
IS TURNING POINT ALSO A SURVEY POINT?-
  N
WAS STADIA USED TO COMPUTE DISTANCE?-
  Y
ENTER FS,US,LS TO TP.-
  10.10.25,9.75
IS TP SEAWARD OF CURRENT INST POSITION?-
  Y
ENTER BACKSIGHT-
  3.5
WAS STADIA USED TO MEAS. INST LOC.?-
  Y
ENTER US AND LS-
  3.6,3.4
HI= 13.500 FT THE INST DIST = 272.40 FT
OPT. CODE-

```

Figure 13c. Use of option TP to compute a turning point with stadia data where the TP is not a survey point

Option A1: EDM, theodolite data entry

46. Users who have an EDM (electronic distance meter) or total station such as a Hewlett Packard 3810 can use option A1 (One Angle) for data entry. These data consist of (a) a distance from the instrument to the survey point (RANGE), (b) the difference in elevation between the height of the instrument and the height of the prism rod (DELZ), and (c) a horizontal angle measured from some reference direction (ANG). Data resulting from this type of data collection are usually in three dimensions but can be processed in two dimensions if the alongshore coordinate is not important.

47. Because the instrument location is determined by a procedure slightly different from the other procedures, it is computed in option A1, not by option ND (see Part V). During its first use, option A1 asks for the horizontal coordinates for the instrument and the backsight reading of the monument. It then requests the X, Y, Z coordinates of the monument and the prism height used to measure the backsight. In order to establish the proper orientation of the instrument, the direction of rotation of the instrument from the backsight must be entered. To allow for a change in prism height, a new prism height can be entered.

48. The user is then asked to enter the data. If all the points are on the same line and the horizontal angles all equal 0, then a shorthand entry of just the RANGE and DELZ can be used. Otherwise, the user needs to enter the RANGE, DELZ, and ANG. The angle should be entered in a format of DD.MMSS where D is degrees, M is minutes, and S is seconds. The computer calculates and displays the X, Y, and Z coordinates. The point is added to the profile data upon a "Y" response to the computer's "OK?" prompt. Data entry continues until an appropriate number of 0's is entered. An example of the use of option A1 is shown in Figure 14. Note that option A1 does not compensate for either the effects of refraction or earth curvature.

```

OPT. CODE-
A1
THIS ROUTINE REDUCES TO X,Y,Z COORD
DATA CONSISTING OF RANGE, DELTA ELEV, AND HORIZ-ANG.
YOU MUST KNOW THE Y,Z,X COORDINATES OF THE
BENCHMARK AND THE Y,X,COORDINATES OF THE INSTRUMENT.
OPTION A1 DOES NOT COMPENSATE FOR EARTH RADIUS OR
REFRACTION EFFECTS.

ENTER INST. X,Y, AND BS-
0.120,1.5
ENTER INSTRUMENT X,Y,Z,PRISM HEIGHT-
0.0,15.5,6.0
HI= 20.00
ENTER POSITIVE ROTATION FROM BS (R)IGHT OR (L)EFT-
R
NEW PRISM HEIGHT?
N

ALL H-ANGLES=0?-
Y
ENTER RANGE,EL
1= 14.3 -2.9
Y,X,Z= 134.30 0.00 11.10 OK?-
Y
2= 31.1 -4.1
Y,X,Z= 151.10 0.00 9.90 OK?-
Y
3= 60.3 -7
Y,X,Z= 180.30 0.00 7.00 OK?-
Y
4= 100 -15
Y,X,Z= 220.00 0.00 -1.00 OK?-
N
4= 100 -15.5
Y,X,Z= 220.00 0.00 -2.50 OK?-
Y
5= 0.0
OPT. CODE-

```

Figure 14. Use of option A1 to reduce EDM data

Option FD: Fathometer data entry

49. Fathometer surveying usually consists of distance data measured relative to a point on the profile and a depth which requires a tide correction. Because of different fathometer and ranging equipment, a combination of measurement units may be used. For instance, the distance from the monument to a ranging device might be measured in feet while the actual range data are collected in meters. These types of data can be processed by option FD (Fathometer Data).

50. Option FD has two data entry methods. Given a starting distance and a distance increment, the option will generate distances at equal (or standard) increments at which depths should be entered. This is followed by a request for data at user-specified (nonstandard) distances.

51. The option first asks for the measurement units of the distances, depths, distance correction, and tide correction. The distance correction is a distance to be added to all distances in order to adjust them to the baseline. Similarly, the tide correction is added to each depth.

52. The option next requests the tide and distance corrections and the distance increment. The distance increment should be entered in the desired input units as established in option ND (see paragraphs 31-33). If a 0 distance increment is entered, standard interval data entry is skipped. New tide and distance corrections can be entered during each use of option FD.

53. If using standard interval entry, the starting measured distance (excluding the distance correction) is entered. Option FD then prints each distance relative to the benchmark in desired units and relative to the distance correction in measurement units. The user enters only the measured depths (with sign). After the first point, all subsequent distances are in even multiples of the distance increment (for example, 377, 400, 450, 500, 550). To exit standard interval entry, enter a 0.

54. Nonstandard data entry requires only the entry of the measured distance and corresponding fathometer reading (with sign). To exit, enter a 0,0. Note that because of the data conversions, option FD does not print the reduced distance and elevation pairs. Use option LD (see paragraph 97) to list the data and option SD (see paragraph 108) to sort them (if needed) after exiting option FD.

55. Option FD provides a powerful tool for processing survey data which combine a normal beach survey with an overlapping fathometer survey. Use

options ND, MD (see paragraphs 36-37), and ST (see paragraphs 38-43) to enter the beach survey data, followed by option FD for the offshore data.

56. A sample use of option FD is shown in Figure 15. In this example, distances are being measured by a ranging device in meters, though the final data will be in feet. The ranging device was set on the profile line 100 m from the monument, and the elevation of the tide during the survey was +1 ft above datum. The first data point is 22.5 m from the ranging station. Four points are entered using a standard distance interval of 50 ft.

OPT. CODE-

FD

THIS OPTION ACCEPTS FATHOMETER AND DIST. DATA GIVEN A START DISTANCE AND AN INCREMENT. IT WILL FIRST GENERATE DISTANCES FOR DATA ENTRY. THIS IS FOLLOWED BY AN OPPORTUNITY TO ENTER DATA FOR ANY DISTANCE. IT WILL ACCEPT DATA IN MIXED UNITS AND CHANGE THEM TO FT

A FULL EXPLANATION IS AVAILABLE IN THE USER MANUAL OR THROUGH OPTION HELP.

DO YOU WANT TO CONTINUE?-

y

DISTANCES MEASURED IN M OK?-

y

DISTANCE CORRECTION IN FT OK?-

N

DEPTHS MEASURED IN FT OK?-

y

TIDE CORRECTION IN FT OK?-

y

ENTER TIDE CORRECTION AS THE AMOUNT TO BE ADDED TO DEPTH READINGS IN FT-

1.0

ENTER DISTANCE CORRECTION TO BE ADDED TO ALL DISTANCES IN M -

100

ENTER DISTANCE INCREMENT IN FT-

50

ENTER START DISTANCE IN M -

22.5

Y = DISTANCE FROM THE BENCHMARK

Y1= DISTANCE FROM MEASUREMENT POINT

ENTER NEGATIVE FATHOMETER READING,
ENTER 999 TO DELETE DISTANCE (0 TO EXIT)

POINT Y(FT) Y1(M) Z(FT)

47	401.00	22.50	.	-15
48	450.00	37.16	.	-22
49	500.00	52.40	.	-30
50	550.00	67.64	.	-35
51	600.00	82.88	.	0

ANY DATA AT SPECIFIC DISTANCES?-

y

ENTER DISTANCE IN M DEPTH IN FT (0 0 TO EXIT)

51-	95	-40
52-	105	-47.5
53-	0	0

OPT. CODE-

Listing of entered data

I	Y	Z
47	401.00	-14.00
48	450.00	-21.00
49	500.00	-29.00
50	550.00	-34.00
51	639.76	-39.00
52	672.57	-46.50

Figure 15. Use of option FD with both standard interval and specific distance entries

Option RD: Data recovery

57. In order to prevent the loss of data entered through the terminal into ISRP due to a program or system malfunction, data are written to a scratch output file (TAPE10) as they are entered. Possible causes of a malfunction are system crashes or a program execution error. Upon reexecution of program, the last profile being processed can be recalled from TAPE10 using option RD (Recall Data).

58. Data are written to TAPE10 by all the data entry options and when previously processed data are read in using options R2D and R3D (see paragraphs 62-75 and 125 and paragraph 131). TAPE10 is also updated each time the data being processed are sorted (option SD; see paragraph 108) or corrected (option CD; see paragraphs 80-81).

59. Global changes to all or some points on the profile using option CHG (see paragraphs 82-84) are not updated on TAPE10. This permits the data to be temporarily changed and examined. If the change is incorrect, the original data can be recalled during program execution using option RD.

60. Only one profile is stored on TAPE10 at a time. Every call of option ND, R2D, or R3D rewinds TAPE10 and prepares it for the next profile line to be processed. Figure 16 illustrates the use of option RD. More information on restarting ISRP is also given in the discussion of option R2D and in Part VI.

```
OPT. CODE-  
RD  
27 DATA POINTS HAVE BEEN READ FROM TAPE10  
LOCALITY-39 PROFILE- 25 SURVEY NO.- 5  
DATE- 791020 TIME- 1408  
DATA IN (FT)  
  
OPT. CODE-
```

Figure 16. Use of option RD to recover data previously entered

Options R2D, OUT, LI: Reading In and Outputting Data

61. This section discusses the routines for reading in previously processed 2-D data, for summarizing the information on the input file (TAPE7), and for outputting entered data to the output file (TAPE8). These routines are the most elaborate ones in the ISRP package because they include a number of checks on the user to ensure that the data are properly processed and that the user has not made an error (such as starting to process a new profile before the data from the previous one were output). Unfortunately, these same features also increase the cost of using ISRP, particularly with large input data files. In order to keep track of the data ISRP uses a number of scratch files (see Appendix C), which are read and reread along with the input data file. Thus, as the size of the input data file increases, so do ISRP costs, and users may want to separate large data files into smaller parts.

Option R2D: Reading in processed data

62. Option R2D (Read 2-D Data) allows the user to bring into program control a specific profile-survey in any of the three BPAS formats from input file TAPE7. In addition, option R2D will, at the user's request, transfer un-requested data from the input directly to the output file. By judiciously reading data into ISRP using option R2D and entering new data through the data entry options, it is easy both to comparison-plot new and old surveys and to produce a fully merged, properly sorted output file. Option R2D also allows ISRP to be restarted after a program interrupt without affecting the status of the output file.

63. Though option R2D has been designed to be easily used, some explanation of the general program flow and capabilities is helpful. During the first use of option R2D, the user must answer a series of questions describing the input file (type of format, number of decimal places, presence of a header record, etc.). The user is also asked if data which are not specifically requested are to be transferred to the output file (TAPE8); positive response to this question sets up a program-wide flag which helps ensure that all data are properly transferred. Some basic rules about data transfer are:

- a. Data are transferred to the output file in the order in which they appear on the input file.
- b. Because of the above, data must be requested in sequence from the input file (this does not require the input data to be sorted).
- c. All data which precede a user-requested profile-survey are automatically transferred to the output file.
- d. If data are being transferred, ISRP forces the format of the input and output files to be identical. Though ISRP will permit a format change, that requires bringing each profile-survey into program control and individually writing it out in the new format using option OUT (see paragraphs 77-78).

64. Since it is expected that the user may accidentally request non-existent data or data out of order, option R2D creates a lookup table of the profiles, surveys, and dates on the input file. Some or all of this table can be listed during the first use of option R2D or using option LI (see paragraph 76) at any time after the first use of R2D.

65. This table is scanned by option R2D each time data are read, and the user is alerted if data were requested out of order (and were, therefore, already transferred) or if the requested data are not on the input file. In

either case, the user is allowed to continue by requesting a different profile and survey number.

66. When the requested data are found on the input file, data preceding them are automatically transferred to the output file and the requested data are brought into program control where they can be manipulated, plotted, or dropped (by starting to process a new survey). If the user wants to keep the data once he is finished with them (even if no changes were made), the data in program control must be written to the output file using option OUT. Not doing so results in a warning to the user. On exiting ISRP (using option END; see paragraph 95), any unrequested data remaining on the input file are automatically transferred to the output file. Figure 17 schematically illustrates how data are transferred from the input to the output file and brought into program control. If the user does not elect to transfer data to the output file, then data may be read repeatedly and in any order from the input file.

67. On the first call to R2D, the user is given instructions for use of the option and asked if he wants to read data. A negative response exits the option. After a positive response, the user is asked to specify the BPAS format of the input file (using number code 1 to 3), whether data are to be transferred to the output file, and whether there is a header record on the input file. A positive response to the header questions results in printing of the header information and a series of questions concerning transferring and updating the header record. The user is allowed to update only the maximum number of profiles, the maximum number of surveys, the date and time of the last survey, and the maximum number of points for any survey. (Note that BPAS does not require the maximum number of points to be exact, but it must equal or exceed the true maximum.)

68. If the input data do not have a header record, the user must specify the input units (FT or M) and the number of distance (Y) and elevation (Z) decimal places to use if other than the default values of 0 and 1, respectively, for data in feet (1 and 2 decimal places for metric data). The user is then asked if he wants a summary of the input data. A positive response automatically calls option LI.

69. Once all the preliminary questions are answered (and during all subsequent calls to option R2D), the user is requested to enter the profile and survey numbers of the data to be read in. If data are requested out of

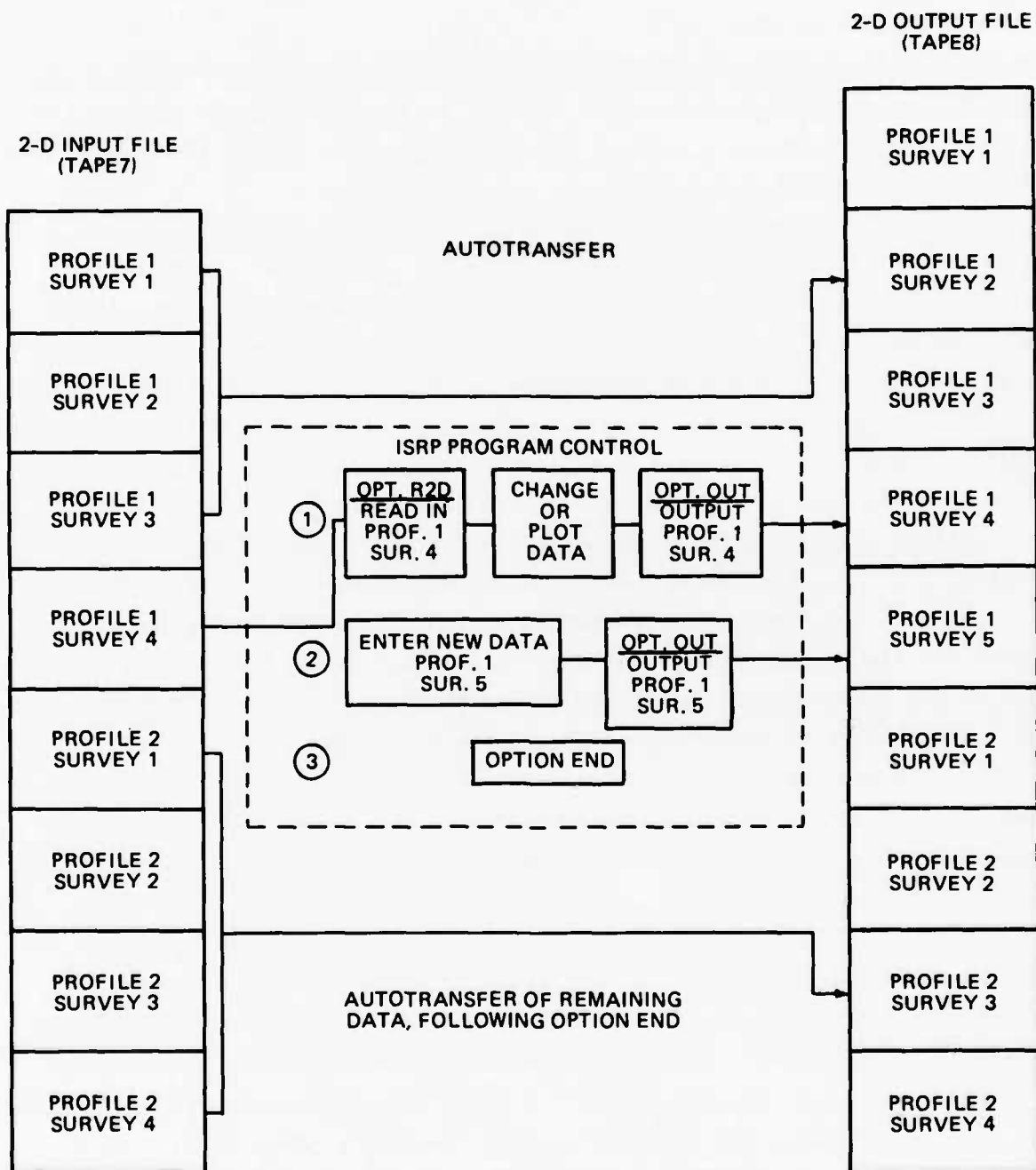

Figure 17. Schematic of automatic data transfer. Step ①--Use R2D to read in profile 1 survey 4; surveys 1, 2, and 3 of profile 1 are transferred; option OUT is used to add profile 1 survey 4 to the output file. Step ②--Survey 5 of profile 1 is entered and added to output file. Step ③--option END causes the remaining data on the input file to be moved to the output file

sequence and are being autotransferred, the user is alerted and is allowed to continue processing other data.

Important: If an error is made in requesting data, the best procedure is to complete the ISRP run, and to reexecute ISRP by first making the output file of the first run the input file of the second run (ISRP prints this suggestion should the situation occur).

70. ISRP assumes that the data being read in are free of keypunch errors. It will try to read through bad data but may produce questionable results. Use the BPAS edit routines for more thorough editing. Note that when data are read in, a copy of the data is also written to the scratch file (TAPE10) from which it can be recalled using option RD (see paragraphs 57-60).

71. Though option R2D is more complex than other ISRP options, after a couple of runs the user should find that it is easy to use and that it supplies adequate warnings so that problems can be avoided. Figure 18 illustrates the reading of EDIT2 cards with data transfer, while Figure 19 shows input of EDIT2 magnetic media data with a header record with data transfer.

72. In the event of an unexpected program interrupt during execution, option R2D can be used during a restart to maintain proper bookkeeping of the data on the output file. This is of considerable importance if data are automatically being transferred from the input to the output files.

73. Before restarting ISRP, do not perform any operations on the 2-D output file (TAPE8) since it contains good data generated before the program interrupt. This will also ensure that the file pointer is properly positioned at the bottom of the file.

74. When restarting ISRP, use either option RD or R2D as the first option. During the first use of R2D following the restart, the program will acknowledge the restart and, if transferring data, will print the profile and survey of the last data read from the input file (TAPE7). The user is asked if these data were written to the output file, and the program is restarted. The user is then asked for the next profile and survey number to be read in (enter 0,0 to exit). Since the restarting feature is an important ISRP capability, it is discussed further in Part VI.

75. ISRP determines that the program is being restarted by reading the lookup table of the data on the input file. This lookup table is written to FORTRAN Unit 13 and exists as a "local" or "working" file, which under normal program termination is returned and does not exist. In the event that the

```

OPT. CODE-
R2
THIS ROUTINE BRINGS INTO PROGRAM CONTROL A SPECIFIC
PROFILE-SURVEY FROM TAPE7. IT CAN ALSO CONTROL THE
TRANSFER OF DATA FROM TAPE7 TO TAPES. SEE OPTION
HELP OR THE USERS MANUAL FOR SPECIFIC INSTRUCTIONS.

DO YOU WANT TO READ DATA?-
Y
AVAILABLE INPUT FORMATS
1 - EDIT1 CARDS
2 - EDIT2 CARDS
3 - EDIT2 MAGNETIC MEDIA

ENTER CODE-
2
TRANSFER DATA TO TAPES?-
Y
HEADER RECORD ON TAPE7?-
N
ASSUMED INPUT UNITS ARE FT OK?-
Y
INPUT DECIMAL PLACES ARE Y(0),Z(1) OK?-
Y
THERE ARE 15 PROFILE-SURVEYS ON TAPE7
DO YOU WANT SUMMARY OF DATA ON TAPE7?-
N
ENTER PROFILE AND SURVEY NUMBERS (0,0 TO EXIT)-
25 5
27 POINTS READ FOR PROFILE 25 SURVEY 5
OPT. CODE-

```

Figure 18. Use of option R2D to read BPAS EDIT2 format data. Note that data are being transferred to the output file (TAPE8)

```

OPT. CODE-
R2D
THIS ROUTINE BRINGS INTO PROGRAM CONTROL A SPECIFIC
PROFILE-SURVEY FROM TAPE7. IT CAN ALSO CONTROL THE
TRANSFER OF DATA FROM TAPE7 TO TAPES. SEE OPTION
HELP OR THE USERS MANUAL FOR SPECIFIC INSTRUCTIONS.

DO YOU WANT TO READ DATA?-
Y
AVAILABLE INPUT FORMATS
1 - EDIT1 CARDS
2 - EDIT2 CARDS
3 - EDIT2 MAGNETIC MEDIA

ENTER CODE-
3
TRANSFER DATA TO TAPES?-
Y
HEADER RECORD ON TAPE7?-
Y
HEADER RECORD SUMMARY
NO. OF PROFILES = 4
NO. OF SURVEYS = 4
NO. OF POINTS = 16
FIRST DATE = 740500 1400
LAST DATE = 740805 1300

WRITE HEADER TO TAPES?-
Y
DO YOU WANT TO UPDATE THE HEADER RECORD?-
Y
ENTER-NEW MAX PROF, MAX SURU-
4,5
ENTER-NEW LAST DATE, LAST TIME-
830312,1230
MAX PTS PER PROFILE = 16 CHANGE?-
Y
ENTER MAX PTS.-
35
THERE ARE 11 PROFILE-SURVEYS ON TAPE7
DO YOU WANT SUMMARY OF DATA ON TAPE7?-
N
ENTER PROFILE AND SURVEY NUMBERS (0,0 TO EXIT)-
3,1
15 POINTS READ FOR PROFILE 3 SURVEY 1
OPT. CODE-

```

Figure 19. Use of option R2D to read EDIT2 magnetic media data with a header record and transfer of data to the output file (TAPE8)

user wants to begin ISRP from scratch without the restart procedure, this local file (usually called TAPE13) must be eliminated before reexecution.

Option LI: Listing
data on the input file

76. As mentioned before, ISRP permits the user to scan the data stored on the input file (TAPE7) using option LI (List Intput) either during the first execution of option R2D or at any time during a run. Option LI lists the profile number, survey number, date, and number of data points for each profile-survey on the input file in the order in which they appear. All the data may be listed, or the user may list the heading information from selected profiles or surveys. The listing always starts at the beginning of the file. Forty lines are listed, followed by a question asking whether to list the next 40 lines. Figure 20 is an example of two calls to option LI, one to list all the data in a file and one to list a specific profile.

```

OPT. CODE-
LI
THIS ROUTINE LISTS THE HEADER INFO. FROM
EACH OF THE 15 PROFILE-SURVEYS ON TAPE7
YOU CAN SELECT LISTING BY ENTERING-
A-LIST ALL          P-SINGLE PROFILE
S-SINGLE SURVEY    N-NO LISTING
ENTER CODE-
A
PROFILE SURVEY  DATE  DATA PTS.
-----
25      5  791000    27
25      6  791020    29
25      8  791019    32
25     11  791019    29
58      8  810717    50
58     11  810823    43
58     13  811104    43
58     14  811117    48
59     15  820105    48
59     16  820200    40
59     17  820318    37
60      8  820421    39
60      9  820602    43
188     51  811110    45
188     52  811116    46
OPT. CODE-

```

```

OPT. CODE-
LI
THIS ROUTINE LISTS THE HEADER INFO. FROM
EACH OF THE 15 PROFILE-SURVEYS ON TAPE7
YOU CAN SELECT LISTING BY ENTERING-
A-LIST ALL          P-SINGLE PROFILE
S-SINGLE SURVEY    N-NO LISTING
ENTER CODE-
P
ENTER PROFILE NUMBER-
25
PROFILE SURVEY  DATE  DATA PTS.
-----
25      5  791020    27
25      6  791020    29
25      8  791019    32
25     11  791019    29
OPT. CODE-

```

Figure 20. Two calls to option LI to summarize the data on the input file

Option OUT: Outputting data

77. The final step in data entry is to write the entered data to the output file (TAPE8) using option OUT (Output). Any of the three BPAS formats can be output, though the output format is forced to agree with the input if data are being transferred. ISRP's internal flags require that data be edited (option ED) or plotted (option PLT) before being output. ISRP also ensures that data entered or read in are output before option ND can be called or new data can be read in.

78. If the output format of the data is not set by a previous call to R2D, the user is asked in the first call to OUT to give details of the output file, including format and decimal places. If EDIT1 or EDIT2 cards are being output, the user is asked if printing is desired. A positive response results in a listing of the card images at the terminal. This 80-column listing can provide a convenient temporary record of the data until a more complete listing can be generated. If a negative response to the printing question is given during the first use of option OUT, the program asks "EVER?" A second negative response suppresses the printing question during all subsequent uses of option OUT. To ensure that data are in correct order, option OUT first sorts it by ascending distances. Figure 21 illustrates use of option OUT to create EDIT2 card images.

```
OPT. CODE-
OUT
AVAILABLE OUTPUT FORMATS
1 - EDIT1 CARDS
2 - EDIT2 CARDS
3 - EDIT2 MAGNETIC MEDIA
ENTER CODE-
2
OUTPUT DECIMAL PLACES ARE Y(1),Z(2) OK?-
Y
PRINTING?-
Y
39188 301830328 1000 42 -790          527 653 552 686 576 672 599 585
39188 302 636 440 683 358 721 317 836 215 972 92 1117 -96 1168 -210
39188 303 1250 -223 1302 -138 1544 -143 1769 -173 1994 -218 2189 -222 2416 -299
39188 304 2566 -396 2886 -450 3074 -469 3310 -470 3553 -461 3754 -449 3966 -425
39188 305 4261 -408 4562 -418 4836 -449 5100 -484 5388 -523 5634 -558 5881 -588
39188 306 6174 -624 6465 -650 6747 -674 7012 -694 7280 -714 7547 -736 7834 -749
39188 307 8134 -769 8427 -783 8593 -790
7 CARDS WRITTEN TO TAPES
```

Figure 21. Use of option OUT to produce EDIT2 card images

PART IV: DATA EDITING, PLOTTING, MANIPULATING, AND OTHER OPTIONS

79. ISRP includes 14 options (listed in Table 1) for checking, displaying, and changing profile data brought into program control. They permit unit conversion, sorting, data deletion, insertion, and changing. Each of the routines can be called at any time during program execution. Collectively, they provide a powerful tool for data correction since the data may be repeatedly plotted and corrected until errors are removed. Descriptions of these options follow alphabetically but can be executed in any order and repeatedly.

Option CD: Correction, Addition, and Deletion of Individual Points

80. Option CD (Correct Data) can be used to modify specific data values identified by their point index. To change a previously entered value, the user is directed to enter the point index of the incorrect value and the correct Y and Z values. To delete data, the point index is entered along with 999,999. Additional data may be added at the same time by entering the next higher point index and the appropriate Y and Z values. Points may be changed or added in any order. Since added points are automatically sorted into the other data, option CD provides a convenient way to insert points (points may also be added using option KD; see paragraph 35).

81. To exit option CD, enter a response of 0,0,0 after the equals sign prompt. An example of option CD use is given in Figure 22. Note that the survey points are renumbered on exiting and that, since changes have been made, the data must be edited or plotted before they can be written to the output file. Option CD also updates the scratch file (TAPE10).

```

OPT. CODE-
  CD
TO CHANGE OR ADD DATA
ENTER THE POINT INDEX AND THE NEW Y AND Z VALUES
TO DROP A POINT ENTER INDEX AND 999 999

ENTER 0,0,0 TO EXIT
LAST INDEX = 22      UNITS =FT
. 7 200 -19.2
. 12 145 4.4
. 50 250 -1.2
. 40 20 15.0
. 0 0 0
OPT. CODE-

```

DATA BEFORE			DATA AFTER		
I	Y	Z	I	Y	Z
1	45.00	21.10	1	20.00	15.00
2	50.00	19.30	2	45.00	21.10
3	60.00	15.30	3	50.00	19.30
4	70.00	9.90	4	60.00	15.30
5	80.00	10.00	5	70.00	9.90
6	90.00	9.60	6	80.00	10.00
7	100.00	9.20	7	90.00	9.60
8	103.00	9.20	8	200.00	-19.20
9	115.00	6.20	9	103.00	9.20
10	120.00	6.00	10	115.00	6.20
11	130.00	4.80	11	120.00	6.00
12	140.00	4.40	12	130.00	4.80
13	150.00	3.70	13	145.00	4.40
14	160.00	3.00	14	150.00	3.70
15	170.00	2.40	15	160.00	3.00
16	180.00	1.90	16	170.00	2.40
17	190.00	1.40	17	180.00	1.90
18	200.00	1.00	18	190.00	1.40
19	210.00	.60	19	200.00	1.00
20	220.00	.40	20	210.00	.60
21	230.00	.10	21	220.00	.40
22	240.00	-.20	22	230.00	.10
			23	240.00	-.20
			24	250.00	-1.20

Figure 22. Use of option CD to change specified data points

Option CHG: Changing, Dropping, and
Switching Groups of Points

82. It is not uncommon for a surveying error to affect a number of successive points, such as occurs when an incorrect benchmark elevation was used or when an instrument was out of level. It is also not unusual to have mistakenly entered the distance and elevations in the wrong order or to have neglected the location of the decimal place. These and other errors can be corrected with option CHG (CHAnGe).

83. The points to be modified can be specified by either the first and last point indices or by distance along the profile. When using distance entries, it is not necessary to enter the exact starting and ending distances to be changed, only distances which lie between the correct and incorrect data. The entire profile can be modified by entering a range of point indices equal to or greater than the true number of points, or distances in excess of the true starting and ending distances.

84. Option CHG permits five different types of changes, which are selected from the menu below:

- | | |
|------------------------------|------------------------|
| 1-ADD A CONSTANT CORRECTION | 4-SWITCH COORDINATES |
| 2-ADD A GRADUATED CORRECTION | 5-DELETE POINTS |
| 3-MULTIPLY A CORRECTION | 0-NO CORRECTION (EXIT) |

Change 1--Add a constant correction

85. To add a constant correction, the user is requested to enter a correction for each coordinate. Enter a 0 correction for coordinates not to be changed. An additive correction is shown in Figure 23.

OPT. CODE-
CHG
THIS OPTION CORRECTS, DROPS, OR SWITCHES
GROUPS OF DATA POINTS.
THE FOLLOWING CHANGES CAN BE MADE (0 TO EXIT)
1-ADD A CONSTANT CORRECTION 4-SWITCH COORDINATES
2-ADD A GRADUATED CORRECTION 5-DELETE POINTS
3-MULTIPLY A CORRECTION 6-NO CORRECTION (EXIT)

ENTER CODE-
1
DO YOU WANT TO CHANGE BY-
1-POINT INDICES 2-Y DISTANCE ?-
1
ENTER FIRST AND LAST POINT INDICES-
1, 15
ENTER CORRECTIONS OF 0 FOR COORDINATES NOT BEING CHANGED
ENTER HORIZ. AND VERT. CORRECTION-
100 10
15 POINTS HAVE BEEN CHANGED FROM Y= 0.00 FT TO 120.00 FT
OPT. CODE-

DATA BEFORE			DATA AFTER		
I	Y	Z	I	Y	Z
1	0.00	12.20	1	100.00	22.20
2	10.00	13.10	2	110.00	23.10
3	20.00	15.20	3	120.00	25.20
4	30.00	19.50	4	130.00	29.50
5	40.00	21.50	5	140.00	31.50
6	45.00	21.10	6	145.00	31.10
7	50.00	19.30	7	150.00	29.30
8	60.00	15.30	8	160.00	25.30
9	70.00	9.90	9	170.00	19.90
10	80.00	10.00	10	180.00	20.00
11	90.00	9.60	11	190.00	19.60
12	100.00	9.20	12	200.00	19.20
13	103.00	9.20	13	203.00	19.20
14	115.00	6.20	14	215.00	16.20
15	120.00	6.00	15	220.00	16.00

Figure 23. Example of an additive correction

Change 2--Add a graduated correction

86. A graduated correction is required to adjust the data for an instrument which is discovered to be out of level. A graduated correction can be added to the data by specifying the change in Z, the corresponding change in Y, and the distance at which the correction is 0 (usually the instrument location). A graduated correction is shown in Figure 24.

OPT. CODE-
 CHG
 THIS OPTION CORRECTS, DROPS, OR SWITCHES
 GROUPS OF DATA POINTS.

THE FOLLOWING CHANGES CAN BE MADE (0 TO EXIT)
 1-ADD A CONSTANT CORRECTION 4-SWITCH COORDINATES
 2-ADD A GRADUATED CORRECTION 5-DELETE POINTS
 3-MULTIPLY A CORRECTION 0-NO CORRECTION (EXIT)

ENTER CODE-
 2
 DO YOU WANT TO CHANGE BY-
 1-POINT INDICES 2-Y DISTANCE ?-
 1
 ENTER FIRST AND LAST POINT INDICES-
 1,15

FOR A GRADUATED CORRECTION OF DEPTH BASED ON
 Y DISTANCE. YOU MUST ENTER THE SLOPE OF THE CORRECTION
 AS THE CHANGE IN Z (DZ), THE CHANGE IN Y (DY) AND THE
 STARTING Y DISTANCE OF THE CORRECTION. TO EXIT ENTER 0,0,0

ENTER DZ,DY, AND DIST.-
 10,100,20
 15 POINTS HAVE BEEN CHANGED FROM Y- 0.00 FT TO 120.00 FT
 OPT. CODE-

DATA BEFORE			DATA AFTER		
I	Y	Z	I	Y	Z
1	0.00	12.20	1	0.00	14.20
2	10.00	13.10	2	10.00	14.10
3	20.00	15.20	3	20.00	15.20
4	30.00	19.50	4	30.00	20.50
5	40.00	21.50	5	40.00	23.50
6	45.00	21.10	6	45.00	23.60
7	50.00	19.30	7	50.00	22.30
8	60.00	15.30	8	60.00	19.30
9	70.00	9.90	9	70.00	14.90
10	80.00	10.00	10	80.00	16.00
11	90.00	9.50	11	90.00	16.60
12	100.00	9.20	12	100.00	17.20
13	103.00	9.20	13	103.00	17.50
14	115.00	6.20	14	115.00	15.70
15	120.00	6.00	15	120.00	16.00

Figure 24. Example of a graduated correction

Change 3--Multiply a correction

87. A constant correction can be multiplied into the data by specifying corrections for each coordinate. Enter a 0 or a 1 for coordinates not being changed. This procedure can correct for sign or decimal place errors and will allow data collected in mixed units to be properly converted. An example of a multiplication correction is shown in Figure 25.

OPT. CODE-
 CHG
 THIS OPTION CORRECTS, DROPS, OR SWITCHES
 GROUPS OF DATA POINTS.

THE FOLLOWING CHANGES CAN BE MADE (0 TO EXIT)
 1-ADD A CONSTANT CORRECTION 4-SWITCH COORDINATES
 2-ADD A GRADUATED CORRECTION 5-DELETE POINTS
 3-MULTIPLY A CORRECTION 0-NO CORRECTION (EXIT)

ENTER CODE-
 3
 DO YOU WANT TO CHANGE BY-
 1-POINT INDICES 2-Y DISTANCE ?-
 1
 ENTER FIRST AND LAST POINT INDICES-
 1,15
 ENTER CORRECTIONS OF 0 FOR COORDINATES NOT BEING CHANGED
 ENTER HORIZ. AND VERT. CORRECTION-
 10,0
 15 POINTS HAVE BEEN CHANGED FROM Y- 0.00 FT TO 120.00 FT
 OPT. CODE-

DATA BEFORE

I	Y	Z
1	0.00	12.20
2	10.00	13.10
3	20.00	15.20
4	30.00	19.50
5	40.00	21.50
6	45.00	21.10
7	50.00	19.30
8	60.00	15.30
9	70.00	9.90
10	80.00	10.00
11	90.00	9.60
12	100.00	9.20
13	103.00	9.20
14	115.00	6.20
15	120.00	6.00

DATA AFTER

I	Y	Z
1	0.00	12.20
2	100.00	13.10
3	200.00	15.20
4	300.00	19.50
5	400.00	21.50
6	450.00	21.10
7	500.00	19.30
8	600.00	15.30
9	700.00	9.90
10	800.00	10.00
11	900.00	9.60
12	1000.00	9.20
13	1030.00	9.20
14	1150.00	6.20
15	1200.00	6.00

Figure 25. Example of multiplication correction

Change 4--Switch coordinates

88. Option CHG can correct data which were accidentally entered in the wrong order. An example of this option is shown in Figure 26.

```
TR
OPT. CODE-
  CHG
THIS OPTION CORRECTS, DROPS, OR SWITCHES
GROUPS OF DATA POINTS.

THE FOLLOWING CHANGES CAN BE MADE (0 TO EXIT)
  1-ADD A CONSTANT CORRECTION      4-SWITCH COORDINATES
  2-ADD A GRADUATED CORRECTION    5-DELETE POINTS
  3-MULTIPLY A CORRECTION          0-NO CORRECTION (EXIT)

ENTER CODE-
  4
DO YOU WANT TO CHANGE BY-
1-POINT INDICES  2-Y DISTANCE ?-
  1
ENTER FIRST AND LAST POINT INDICES-
  1,15
15 POINTS HAVE BEEN CHANGED FROM Y-      0.00 FT TO      120.00 FT
OPT. CODE-
```

DATA BEFORE

I	Y	Z
1	0.00	12.20
2	10.00	13.10
3	20.00	15.20
4	30.00	19.50
5	40.00	21.50
6	45.00	21.10
7	50.00	19.30
8	60.00	15.30
9	70.00	9.90
10	80.00	10.00
11	90.00	9.60
12	100.00	9.20
13	103.00	9.20
14	115.00	6.20
15	120.00	6.00

DATA AFTER

I	Y	Z
1	12.20	0.00
2	13.10	10.00
3	15.20	20.00
4	19.50	30.00
5	21.50	40.00
6	21.10	45.00
7	19.30	50.00
8	15.30	60.00
9	9.90	70.00
10	10.00	80.00
11	9.60	90.00
12	9.20	100.00
13	9.20	103.00
14	6.20	115.00
15	6.00	120.00

Figure 26. Example of column switching

Change 5--Delete points

89. To delete a group of points, the user has only to select the delete points code and specify the points. An example is shown in Figure 27.

OPT. CODE-
CHG
THIS OPTION CORRECTS, DROPS, OR SWITCHES
GROUPS OF DATA POINTS.

THE FOLLOWING CHANGES CAN BE MADE (0 TO EXIT)
1-ADD A CONSTANT CORRECTION 4-SWITCH COORDINATES
2-ADD A GRADUATED CORRECTION 5-DELETE POINTS
3-MULTIPLY A CORRECTION 0-NO CORRECTION (EXIT)

ENTER CODE-
5
DO YOU WANT TO CHANGE BY-
1-POINT INDICES 2-Y DISTANCE ?-
2
ENTER FIRST AND LAST DISTANCES -
0,40
5 POINTS HAVE BEEN CHANGED FROM Y- 0.00 FT TO 40.00 FT
OPT. CODE-

DATA BEFORE			DATA AFTER		
I	Y	Z	I	Y	Z
1	0.00	12.20	1	45.00	21.10
2	10.00	13.10	2	50.00	19.30
3	20.00	15.20	3	60.00	15.30
4	30.00	19.50	4	70.00	9.90
5	40.00	21.50	5	80.00	10.00
6	45.00	21.10	6	90.00	9.60
7	50.00	19.30	7	100.00	9.20
8	60.00	15.30	8	103.00	9.20
9	70.00	9.90	9	115.00	6.20
10	80.00	10.00	10	120.00	6.00
11	90.00	9.60			
12	100.00	9.20			
13	103.00	9.20			
14	115.00	6.20			
15	120.00	6.00			

Figure 27. Example of delete points option

90. Changes made using option CHG do not cause the scratch file (TAPE10) to be updated. This feature allows temporary changes to be made and tested. If an incorrect change is made, the user can recall the original unchanged data using option RD.

Option C0: Unit Conversion

91. Though most use of ISRP will probably be with English units, the program includes considerable flexibility for converting from English units to metric, and vice versa. The data in program control can be converted, as shown in Figure 28, using option C0 (Convert). Note that this does not affect the units of the data coming into the program through the data entry routines since their units are automatically reset with option ND. A problem will occur if for some reason a user who was entering data in feet converted the data to metric and then tried to add additional data in feet. The user should either enter the additional data in meters or, better still, convert the data back to feet with another call to option C0 before continuing. Option C0 also converts the instrument height and location and, if required, converts data saved with option SA (see paragraphs 106-108).

```
OPT. CODE-  
  C0  
  46 Pts CONVERTED TO (M )  
OPT. CODE-
```

Figure 28. Use of option C0

Option ED: Data Editing

92. Before entered data can be either sorted or written to the output file, ISRP requires the user to either plot the data or to call option ED to check the data. Option ED checks for the following three things:

- a. A spike caused by an elevation change greater than 5 ft (2 m, if processing metric data) between adjacent points.
- b. A jump in the data caused by a change in distance greater than 75 ft (25 m).
- c. Nonascending distances between successive points, indicating either a point out of order or an improper distance entry.

93. The spike and jump checks can be changed during the first use of option ED to suit the user's needs: for instance, a longer jump check might be more reasonable if data points are normally surveyed at wider spacings. To change these checks at a later time, reset option ED using option RST (see paragraphs 104-105).

94. Data may be arranged in either ascending or descending order before using option ED. Once called, option ED scans the data for suspected errors and prints out the first ten erroneous points. The program then asks the user if more errors should be listed. A total number of errors is given on completion of the option. Once option ED has been called, option SD (see paragraph 109) can be used to sort the data (if required), and options CD (see paragraphs 80-81) or CHG (see paragraphs 82-90) should be used to correct any errors. Figure 29 illustrates a sample option ED call. It is not necessary for the user to actually correct the errors identified by option ED before he can use option OUT (see paragraphs 77-78) to output the data, and option OUT will sort it.

OPT. CODE-

^{ED}
THIS ROUTINE CHECKS FOR THE FOLLOWING ERRORS

ELEV. SPIKES =5.0 FT
DISTANCES BETWEEN POINTS .GT. 75.0 FT
NON-ASCENDING DISTANCES

DO YOU WANT TO CHANGE TOLERANCES?-

N		POINT 1 (FT)		POINT 2 (FT)		ERROR
POINT INDICES		-Y-	-Z-	-Y-	-Z-	
1	2	20.00	15.00	45.00	21.10	ELEV. DIFF. OF 6.10
4	5	60.00	15.30	70.00	9.00	ELEV. DIFF. OF 5.40
7	8	90.00	9.60	200.00	-19.20	ELEV. DIFF. OF 28.80
7	8	90.00	9.60	200.00	-19.20	DIST. DIFF. OF 110.00
8	9	200.00	-19.20	103.00	9.20	ELEV. DIFF. OF 28.40
8	9	200.00	-19.20	103.00	9.20	NON-ASCENDING DISTANCES

4 SUSPECTED ERRORS
USE OPTIONS CD,SD,CHG OR HC IF CORRECTIONS ARE NEEDED
OPT. CODE-

Figure 29. Use of option ED to scan data for errors

Option END: Terminating ISRP

95. To exit ISRP, the user enters "END" after the option code prompt. Any data on the input file that remain to be transferred are placed on the output file, and the program stops. If the user forgets to output the last entered data, a message appears and the OPT CODE prompt returns, allowing a final call to option OUT.

Option HC: Modifying the Profile Header Data

96. Each profile-survey is identified by a locality code, profile number, survey number, date, and time. These parameters can be changed using option HC (Header Change). Option HC also permits the units of the data to be changed without actually changing the values. An example of the use of HC is shown in Figure 30. Each item of information can be changed, in any order, using the code numbers 1 to 6. After completing the changes, the user enters the number 7 to exit the option. Changes made with option HC are not put on the scratch file (TAPE10).

```
OPT. CODE-
HC
TO CHANGE HEADING INFO. ENTER CODE AS FOLLOWS
1-LOCALITY 5-TIME
2-PROFILE 6-UNITS
3-SURVEY
4-DATE 7-EXIT OPTION

ENTER CODE-
1
LOCALITY?-
HI
ENTER CODE-
2
PROFILE?-
123
ENTER CODE-
7
OPT. CODE-
```

Figure 30. Use of option HC to change the heading information

Option HELP

97. Option HELP prints short descriptions of each option. Descriptions for any number of options can be listed during a single use of option HELP. An example use of option HELP is given in Figure 31. A complete listing of HELP output is given in Appendix A.

```
OPT. CODE-  
HELP  
SHORT DESCRIPTIONS OF THE FOLLOWING OPTIONS CAN  
BE PRINTED  
A1  CD  CHG  CO  ED  
FD  HC  HI  HS  KD  
LD  LI  MD  ND  OUT  
PLT RD  RST R2D R3D  
SA  SD  ST  TP  UC  
  
ENTER OPTION (E TO EXIT)-  
CD  
  
USE OPTION CD TO CORRECT, CHANGE, DELETE, OR  
ADD DATA. POINTS ARE SPECIFIED BY THEIR INDEX VALUE. UP  
TO 25 POINTS CAN BE ADDED AT A TIME, BUT USE OF KD IS RE-  
COMMENDED. OPTION CD WILL SORT ADDED POINTS INTO THE  
DATA.  
ENTER OPTION (E TO EXIT)-  
E  
  
OPT. CODE-
```

Figure 31. Use of option HELP

Option LD: Data Listing

98. At any time during use of ISRP, the data in program control can be listed using option LD (List Data). When executed, this option lists the header information, the units being used, and the number of data points in the survey. Then the user is queried as to what points to list. The user may list all or some of the data by giving the first and last point index numbers. A sample execution of LD is shown in Figure 32. Note that it is often useful to use option LD before correcting or changing data since it prints the index numbers of each survey point; these numbers are required by the data modification options.

```
OPT. CODE-
LD
LOCAL PROFILE SURVEY DATE TIME POINTS UNITS
39 25 5 791020 1408 27 FT
LIST ALL?-
N
ENTER INDEX OF FIRST AND LAST PTS (0,0 TO EXIT)-
1,15 y 2
1 0.00 12.20
2 10.00 13.10
3 20.00 15.20
4 30.00 19.50
5 40.00 21.50
6 45.00 21.10
7 50.00 19.30
8 60.00 15.30
9 70.00 9.00
10 80.00 10.00
11 90.00 9.60
12 100.00 9.20
13 103.00 9.20
14 115.00 6.20
15 120.00 6.00
OPT. CODE-
```

Figure 32. Use of option LD to list data

Option PLT: Data Plotting

99. ISRP includes a fairly sophisticated routine for displaying cross-section plots of the data using option PLT (PLoT). The option was designed for use on Tektronix graphics equipment but should be adaptable to other devices (see Appendix C). Option PLT can plot the data at any scale and can overplot two surveys. During the first call to PLT, the user is asked a series of questions that establish the plot characteristics. Should these change during the run, option PLT can be reset using option RST (see paragraphs 104-105). Figure 33 shows a sample plot of a single survey and defines the various plot specifications.

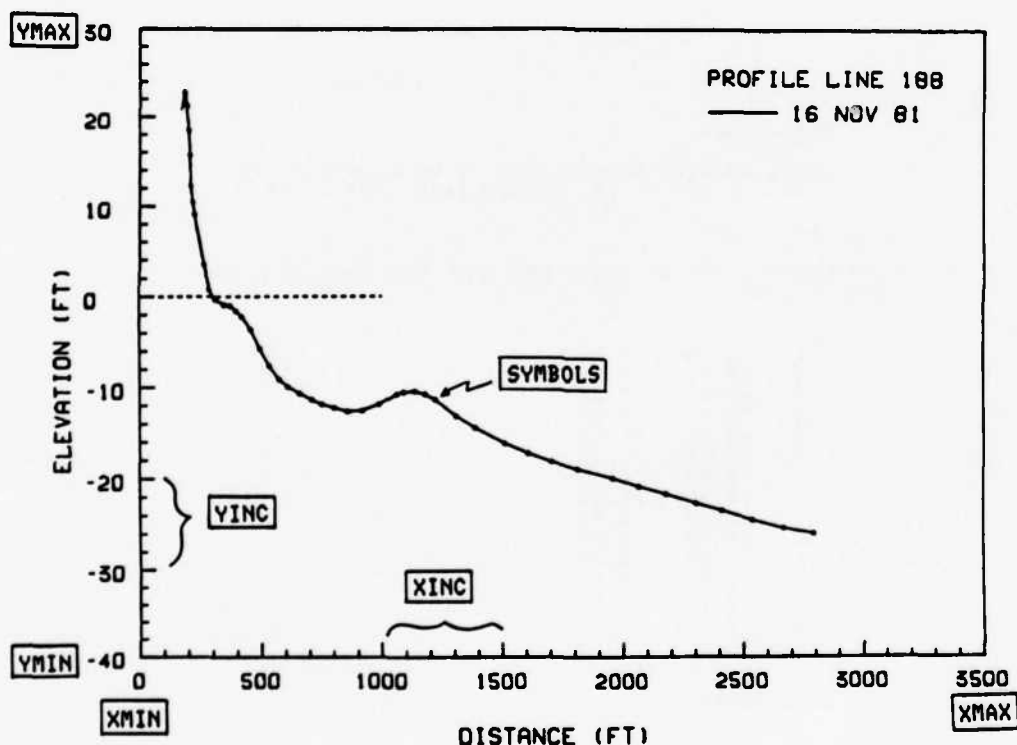

Figure 33. Sample of single survey plot

100. On entering PLT, the user is first asked the following questions:
- a. The baud rate being used.
 - b. Whether to use the default axis specifications of: feet or meters (see below):

		<u>Feet</u>	<u>Meters</u>
X-AXIS	XMIN	0	0
	XMAX	3500	1000
	XINC	500	200
Y-AXIS	YMIN	-40	-10
	YMAX	30	10
	YINC	10	2.5

- c. The plot specifications to use if not the default ones.
- d. Whether or not to use either the default specifications or the user-defined ones for all plots.
- e. Whether to plot single surveys or to compare surveys.
- f. Whether to include symbols on one or both lines.

After each plot is generated, the program pauses until any character is entered.

101. Each user answer is followed by an "always" question; the answer will permit the permanent setting of a particular plot specification. All specifications can be reset to their initial settings using option RST. If using the default plot specifications, option PLT will sense the units of the data being plotted and automatically shift from the default English to the metric axis. This is a useful feature where the user is processing data in feet but wants to create metric plots (or vice versa). Use of option PLT to create Figure 33 is given in Figure 34.

```

OPT. CODE-
  PLT
HIT 'RETURN' AFTER MENU SELECTION TO BEGIN PLOT
PROGRAM RINGS BELL/PAUSES WHEN FINISHED PLOT
MAKE COPY THEN/OR HIT 'RETURN' TO CONTINUE

BAUD RATE SET AT 120 CPS, OK?-
  Y
DEFAULT PLOT?-
  Y
ALWAYS?-
  N
SELECT PLOT TYPE • 1-SINGLE, 2-COMPARISON -
  1
ALWAYS?-
  N
SYMBOLS?-
  Y
ALWAYS?-
  N

```

Figure 34. Plot commands used to create Figure 33

102. Figure 35 is an example of the use of option PLT to compare two different surveys and to change the axis to enlarge the beach area. The resulting plot is shown in Figure 36.

```

OPT. CODE-
  PLT
DEFAULT PLOT?-
  N
ENTER XMIN,XMAX,XINC-
  0,1500,500
ENTER YMIN,YMAX,YINC-
  -20,20,5
USE THESE ALWAYS?-
  Y
SELECT PLOT TYPE = 1-SINGLE, 2-COMPARISON -
  2
ALWAYS?-
  Y
SYMBOLS ON WHICH LINES
0-NONE, 1-LINE 1, 2-LINE 2, 3-BOTH ?-
  0
ALWAYS?-
  Y

```

Figure 35. Use of option PLT to compare two surveys and to enlarge the beach region

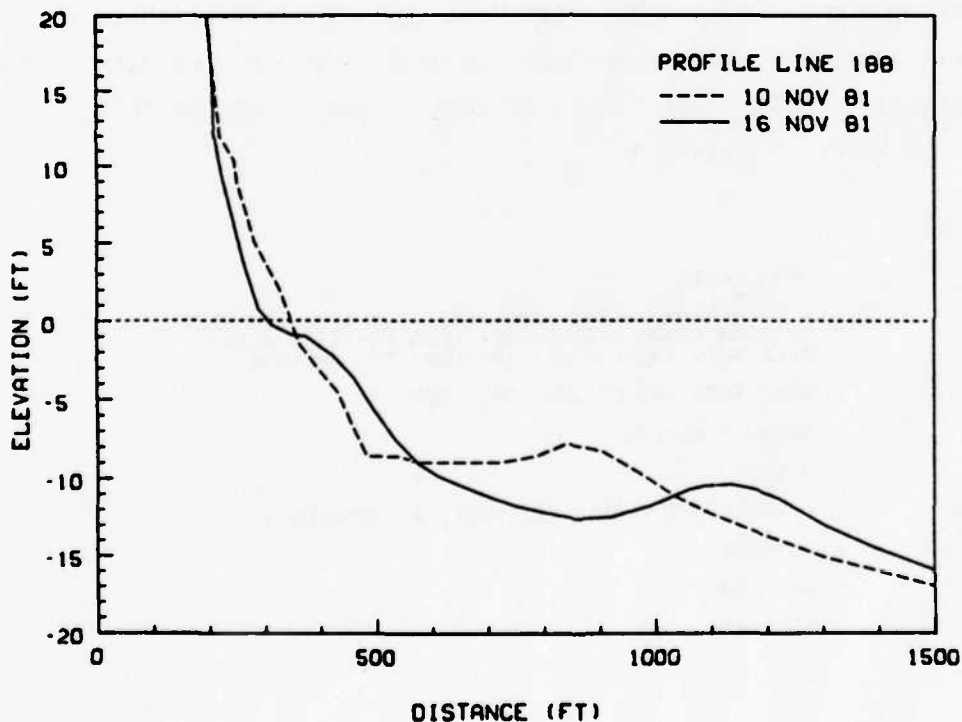

Figure 36. Plot resulting from commands used in Figure 35

103. Plotting the data is the single best way to edit and check them,

particularly if a new survey can be compared to a previous one. Therefore, it is suggested that all data be plotted before writing them to the output file. Use of symbols will aid in identifying specific points which may be in error, but will increase the time required to draw the plot.

Option RST: Resetting Options

104. ISRP streamlines itself by asking basic questions and setting flags during the first use of many of the options. To avoid having to re-execute ISRP if an entry error is made during the first use of an option, ISRP allows a number of options to be re-initialized using option RST (ReSeT).

105. Options A1, CD, ED, FD, KD, MD, ND, ST, OUT, and PLT can be reset. Only one option can be reset with each use of RST. When resetting option ND, be sure that any data in program control have been written to the output file first; not doing so could result in lost data. Figure 37 illustrates use of option RST.

```
OPT. CODE-  
RST  
YOU MAY RESET OPTIONS  
A1, CD, ED, FD, KD, MD, ND, ST, OUT, AND PLT  
ENTER OPTION (E TO EXIT)-  
PLT
```

Figure 37. Use of option RST to reset
option PLT

Option SA: Data Saving

106. Option SA (SAve Data) stores any profile-survey brought into program control for later comparison with any other profile-survey. Option SA must be used prior to use of option VC, which computes volume changes, and prior to comparison plotting. A natural use of this feature is to compare newly entered data with an earlier survey. To do so, use the following procedure:

- a. Option R2D to read in the earlier survey.
- b. Option SA to save the data and, if transferring data, to call option OUT to write the saved survey to the output file.
- c. Option ND and others to input the new survey data.
- d. Option PLT or VC to compare the new and saved surveys.
- e. Option ED to edit the new data.
- f. Option OUT to output the new data.

107. Repeating these steps for each profile line of a new survey will produce useful comparisons and a final combined output file.

108. By appropriately using option SA to save specific surveys, it is possible to compare virtually any combination of profiles or surveys. Data may be saved in either feet or meters, since option CO (see paragraph 91) will convert both the saved data and the data in program control. Note that there is no way to access or change saved data after a new profile-survey is brought into program control. When newly entered, changed, or read-in data are saved, option SA asks if the user wants to output the data. A positive response causes option OUT to be called. Figure 38 illustrates two uses of option SA, one with newly entered data and one without.

```
OPT. CODE-  
SA  
DATA SAVED  
WANT TO OUTPUT DATA?-  
Y
```

```
OPT. CODE-  
SA  
DATA SAVED
```

Figure 38. Use of option SA

Option SD: Data Sorting

109. Though it is not recommended, data may be entered in any order and sorted by Y distance using option SD (Sort Data). Because a data point out of order may also be a distance error, the edit option ED must be called prior to sorting. Option SD is able to correctly sort data at scarps (vertical cuts in the beach identified by two different elevations at exactly the same distance) by determining if the data are ascending or descending and then adding 0.001 units to the seaward point. As Figure 39 shows, there are no user entries to option SD. To ensure that the data are in correct order, option OUT automatically calls option SD, prior to outputting data.

```
OPT. CODE-  
  SD  
  24 DATA PAIRS READ AND SORTED  
OPT. CODE-
```

Figure 39. Use of option SD

Option VC: Computing Volume Changes

110. One way of examining profile changes is to compute changes in profile volume (volume is defined as cross-sectional area multiplied by a unit width, 1 ft or 1 m, of beach). Volume changes can be used to determine the effect of a benchmark or tide correction error, or to indicate movement of sediment on the profile. Option VC (Volume Change) computes a number of volumetric quantities, the movement of the shoreline (vertical datum intercept), and the elevation and change in elevation at any distance.

111. Option VC computes cross-section areas using vertical slices as shown in Figure 40. The slices are distributed only over the region which

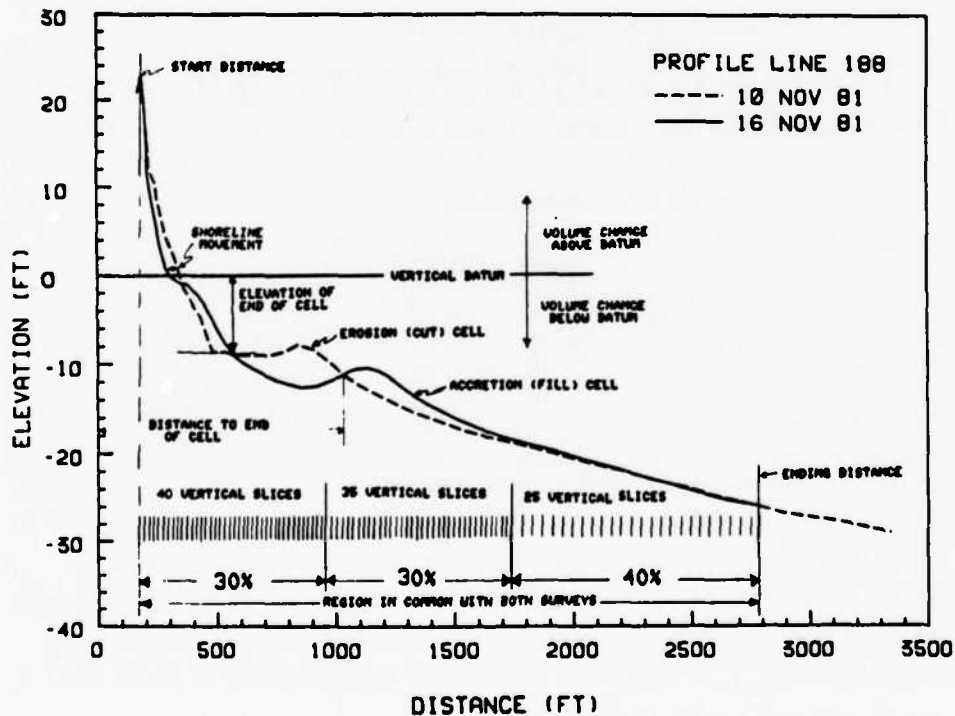

Figure 40. Definition of parameters used by option VC

is common to both surveys being compared. The number of slices equals the maximum number of survey points allowed by ISRP (100). In order to increase the resolution of the computation near the shore where profiles are more complex, the slices are distributed according to the following scheme:

- a. Forty percent of the slices cover the first 30 percent of the region being compared.
- b. Thirty-five percent of the slices cover the next 30 percent of the region.
- c. Twenty-five percent of the slices cover the outer 40 percent of the region.

This simple scheme should give adequate coverage for any profiles which can be adequately described with 100 points or less.

112. The option VC table corresponding to Figure 40 is shown in Figure 41.

OPT. CODE-
VC

ANALYSIS OF PROFILE CHANGES

BETWEEN PROFILE 188 ON 811110 AND PROFILE 188 ON 811116
STARTING DISTANCE- 183.00 FT ENDING DISTANCE - 2791.00 FT
THE SHORELINE CHANGED -40.67 FT FROM 347.17 FT TO 306.50 FT

- CUT/FILL COMPUTATION -

CELL	DISTANCE TO END FT	ELEVATION OF END PT FT	CELL VOLUME YD3/FT	CELL THICKNESS FT	PROFILE CUM.VOL. YD3/FT	PROFILE GROSS UOL YD3/FT
1	203.21	11.37	.14	.19	.14	.14
2	356.79	-.83	-15.57	-2.74	-15.43	15.71
3	571.81	-8.47	14.48	1.82	-.94	30.19
4	1034.76	-11.02	-44.46	-2.59	-45.40	74.65
5	2376.67	-23.26	41.93	.84	-3.47	116.59
6	2751.64	-25.53	-1.74	-.13	-5.21	118.33
END	2791.00	-25.95	.07	.05	-5.14	118.39

VOLUME CHANGE ABOVE DATUM- -14.55 YD3/FT
VOLUME CHANGE BELOW DATUM- 9.41 YD3/FT

WANT TO COMPUTE ELEVATIONS FOR SPECIFIC DISTANCES?-

Y
ENTER DISTANCE IN FT (0 TO EXIT)-

1900
ELEV. CHANGED .31 FT FROM -19.80 FT ON 811110 TO -19.50 FT ON 811116

ENTER DISTANCE IN FT (0 TO EXIT)-

400
ELEV. CHANGED 1.58 FT FROM -3.22 FT ON 811110 TO -1.65 FT ON 811116

ENTER DISTANCE IN FT (0 TO EXIT)-

0
OPT. CODE-

Figure 41. Option VC table for data shown in Figure 40

It includes (a) the limits of the region being compared and (b) the position and horizontal movement of the shoreline. In addition, volume changes are computed by option VC in terms of cut (erosion) and fill (accretion) cell quantities. For each cell, the following quantities are computed:

- a. Distance to the end. The distance along the profile to the seaward end of each cell.
- b. Elevation of end. The elevation at the seaward end of each cell except for the END point, which is the average elevation of the two surveys.
- c. Cell volume. The volume of the cell.
- d. Cell thickness. The average height of the cell computed as the cell volume divided by the cell length.
- e. Profile cumulative volume. The total sum of all preceding cells or the "net volume change."
- f. Profile gross volume. The sum of the absolute values of all preceding cells. This value is useful as an indicator of overall profile change.

Option VC also computes the net volume change both above and below the vertical datum.

113. After ISRP prints the cut/fill table, the user can specify distances at which the elevation and change in elevation will be computed. This can be very useful in determining the magnitude of a suspected benchmark elevation error.

114. Note that option VC has the following limitations:

- a. The region being compared varies with each combination of two surveys; therefore, be cautious in comparing different computations.
- b. Option VC requires that both surveys reach the vertical datum. It will extrapolate the intercept if the user requests it (see Figure 42), but the results may be questionable.
- c. Profile data being compared must be in proper ascending order prior to using option VC.

115. All option VC output is written both to the user's terminal and to a local file called TAPE14 which can be routed to a high-speed printer following the ISRP run.

OPT. CODE-
 UC
 SURVEY ON 811116 REACHED ONLY .70 FT
 WANT ME TO EXTRAPOLATE?-
 Y

 ANALYSIS OF PROFILE CHANGES

BETWEEN PROFILE 188 ON 811110 AND PROFILE 188 ON 811116
 STARTING DISTANCE- 183.00 FT ENDING DISTANCE - 295.25 FT
 THE SHORELINE CHANGED -51.92 FT FROM 347.17 FT TO 295.25 FT

- CUT/FILL COMPUTATION -

CELL	DISTANCE TO END FT	ELEVATION OF END PT FT	CELL VOLUME YD3/FT	CELL THICKNESS FT	PROFILE CUM.VOL. YD3/FT	PROFILE GROSS VOL YD3/FT
1	195.58	20.16	.09	.18	.09	.09
2	196.50	19.97	-.00	-.02	.08	.09
3	203.29	17.23	.05	.20	.14	.14
END	295.25	2.05	-11.19	-3.28	-11.05	11.32

VOLUME CHANGE ABOVE DATUM- -15.00 YD3/FT
 WANT TO COMPUTE ELEVATIONS FOR SPECIFIC DISTANCES?-
 N
 OPT. CODE-

Figure 42. Use of option VC to extrapolate vertical datum when one survey was incomplete

PART V: THREE-DIMENSIONAL DATA PROCESSING

116. For users interested in including the alongshore coordinates (X) with their data, ISRP includes a 3-D mode which can be set by a positive response to the "3-D DATA?" question asked at the start of each ISRP run. Doing so includes the X dimension in many of the options, includes 3-D output in the OUT option, and permits data to be read into program control in the 3-D format. It also allows shore-parallel lines to be processed. Part V describes the additional options and the minor modifications to the 2-D options.

117. The original purpose of ISRP's 3-D capability was to produce a file of easily readable data for input to a 3-D contour plotting routine. It has been designed to complement the 2-D format data.

118. In its present configuration, true 3-D data can be entered only through option KD or A1 (after calling option ND to initialize data entry). Options MD, ST, HS, and FD will also work using a constant X-value which is entered in option ND. Other options could be easily developed to handle 3-D data collected using other survey methods.

119. A unique feature of ISRP is its ability to handle and plot shore-parallel lines (constant Y, changing X values; see Figure 1). To process a shore-parallel line, the user need only add 1000 to the profile number when it is entered through option ND. This acts as a flag for the program during processing but is subtracted when the data are output.

120. ISRP is less sophisticated in its handling of 3-D data than of 2-D data. There is no automatic transfer of data from the 3-D input file (TAPE12) to the 3-D output file (TAPE9). Option R3D rewinds the input file each time that data are read from it; consequently, the data may be requested in any order from the input file, and there is no requirement for the input file to be sorted. It is not an efficient data handler and was designed to handle only one or a few surveys at a time; users with large 3-D files may want to add a 3-D format to option R2D (see paragraphs 62-75 and 124; Appendix C). Since there is no automated transfer of 3-D data, the user must transfer each profile survey from the input to the output file by bringing each survey into program control and then writing it to the output file; this, too, is a laborious procedure when processing a large file. It may be more efficient to use ISRP only to create, display, and manipulate the 3-D data and to use the computer's EDITOR system to merge the new or corrected 3-D data with the old.

Of course, all the 2-D options, including the generation of a 2-D output file, continue to operate in the 3-D mode. It is even possible to create a 3-D file from a 2-D file since, in the 3-D mode, ISRP will ask for a constant X-distance for each profile survey read in from the 2-D input file.

3-D Data Format

121. Only one 3-D format is recognized by ISRP. It is a simple format utilizing the profile heading information from the BPAS formats, but it includes only one survey point per line. The format, given in Table 6 and shown in Figure 43, is the same for English or metric units and uses three decimal places for each coordinate. This format can be changed by changing only four lines of ISRP code: the read statement and format in option R3D (see paragraph 130) (subroutine READ3D) and the write statement and format in option OUT (subroutine OUT). Note that neither the units of the data nor the vertical datum are specified in the 3-D format.

Table 6
Format of the 3-D Data File

<u>Character Position</u>	<u>Entry Description</u>	<u>Entry Format</u>
1-2	Locality code	A2
3-5	Profile number	I3
6-9	Survey number	I4
10,11	Year	I2
12,13	Month	I2
14,15	Day	I2
16-20	Time	I5
21-23	Card number	I3
24-34	Y-coordinate	F11.3
35-45	X-coordinate	F11.3
46-56	Z-coordinate	F11.3

```

39 58 14811117 1330 1 128.000 3300.000 19.200
39 58 14811117 1330 2 155.000 3300.000 19.600
39 58 14811117 1330 3 169.000 3300.000 19.800
39 58 14811117 1330 4 170.000 3300.000 20.300
39 58 14811117 1330 5 181.000 3300.000 17.300
39 58 14811117 1330 6 192.000 3300.000 15.800
39 58 14811117 1330 7 203.000 3300.000 15.600
39 58 14811117 1330 8 214.000 3300.000 16.500
39 58 14811117 1330 9 221.000 3300.000 12.900
39 58 14811117 1330 10 236.000 3300.000 10.800
39 58 14811117 1330 11 251.000 3300.000 9.100
39 58 14811117 1330 12 253.000 3300.000 9.200
39 58 14811117 1330 13 282.000 3300.000 7.600
39 58 14811117 1330 14 311.000 3300.000 4.900
39 58 14811117 1330 15 350.000 3300.000 1.400
39 58 14811117 1330 16 369.000 3300.000 -2.000
39 58 14811117 1330 17 398.000 3300.000 -3.200

```

Figure 43. Sample of 3-D Data

Option ND: Initialization of 3-D Data Entry

122. Use of option *ND* for 3-D data is the same as for 2-D. Option *ND* will ask for a constant X-distance for the profile being entered. This is used by options *MD*, *ST*, *HS*, *FD*, and *R2D* to generate a constant X-coordinate and by option *LD* to compute an "off-line" distance equal to the difference between the actual X-coordinate and the assumed or constant value.

Option KD: Known 3-D Data Entry

123. The use of option KD for 3-D data is similar to 2-D; the user simply enters each data point in Y, Z, X order (to change this order, a simple program change has to be made to subroutine KNOWN). To exit the option, enter 0,0,0.

Options MD, ST, HS, FD: Level and Tape, Stadia, and Fathometer Data Entry

124. The only difference between these options in the 2-D and 3-D modes is that a constant X-value is defined for each point as it is entered. The user is unaware of this, and data entry is the same as described in Part III.

Option A1: EDM, Theodolite Data Entry

125. Option A1 is the same for either 2-D or 3-D data entry.

Option RD: Data Recovery

126. As in the 2-D mode, options ND, KD, ST, HS, CD, HI, FD, R2D, R3D, and A1 all write 3-D data to scratch file TAPE10 as it is entered. This file can be read using option RD.

Option R2D: Reading 2-D Data

127. It is possible to read in data from the 2-D input file during a 3-D run. Some reasons for doing so are to create a 3-D file from a 2-D one, or to comparison-plot data in a 3-D file against data in a 2-D file. In 3-D mode, option R2D asks for an alongshore distance for each profile read from the input file (TAPE7).

Option R3D: Reading 3-D Data

128. Option R3D (Read 3-D Data) will read a specified profile-survey from input file TAPE12. Data on TAPE12 may be accessed in any order. Input data may be read in units of feet or meters. Figure 44 illustrates use of option R3D.

```
OPT. CODE-  
R3D  
DATA TO BE READ IN FT OR M?-  
M  
ENTER PROFILE,SURVEY-  
188 30  
42 POINTS READ IN M FOR LINE 188, SURVEY 30  
OPT. CODE-
```

Figure 44. Use of option R3D

Option OUT: Writing Out Data

129. Option OUT is used to output both 2-D data (as described in paragraphs 77-78) and 3-D data; the 2-D data are written to file TAPE8, while the 3-D data are written to TAPE9. Option OUT allows output of the 3-D data to be automatically converted to units different from the 2-D data units. During the first call to OUT, the user is asked "METRIC 3-D DATA?-" if the data are in feet, or "ENGLISH 3-D DATA?" if the data are in meters. A positive response will result in a converted 3-D file. After the data are output, the number of survey points written to TAPE9 is printed. Figure 45 illustrates the 3-D version of option OUT.

```
OPT. CODE-
OUT
AVAILABLE OUTPUT FORMATS
 1 - EDIT1 CARDS
 2 - EDIT2 CARDS
 3 - EDIT2 MAGNETIC MEDIA
ENTER CODE-
 1
DO YOU WANT TO SEE DATUM CODES?-
N
ENTER DATUM CODE-
 2
OUTPUT DECIMAL PLACES ARE Y(0),Z(1) OK?-
Y
PRINTING?-
N
EVER?-
N
 8 CARDS WRITTEN TO TAPES

ALL SURVEYS TO BE WRITTEN TO THE 3-D OUTPUT FILE?-
N
ENTER NUMBER OF ONLY SURVEY TO BE 3-D OUTPUT-
 30
METRIC 3-D DATA?-
Y
 42 POINTS WRITTEN TO TAPES

OPT. CODE-
```

Figure 45. Example of 3-D version of option OUT. Note that only survey 30 is to be output to the 3-D output file (TAPE9)

PART VI: EXECUTING PROGRAM ISRP

130. This part describes the functioning of ISRP, how to execute the program, and how to make the best use of its options. Though the actual details of execution will differ among computer systems (see Appendix D), the basic steps will be the same. ISRP was developed and tested on a Tektronix 4014 graphics terminal and on an Execuport terminal connected to a Tektronix 4662 flatbed plotter. The program should work on almost any terminal, though the plotting option requires both a hardware graphics capability and incorporation of the appropriate plotting software in subroutine IPLOT of ISRP (see Appendix C). Since ISRP prints lots of messages, use of a baud rate of 120 cps (characters per second) or higher is recommended.

How ISRP Works

131. This section describes and reviews the general use of ISRP to read, enter, manipulate, and ultimately output a profile-survey. A schematic diagram of ISRP is shown in Figure 46. This diagram also reveals the complexity of the file management handled by ISRP.

132. Basically, data are entered or read into program control from the input side of Figure 46. Once in program control, data can be modified, displayed, and compared. Once the user is satisfied, the data can be transferred to the output file in the desired format, using option OUT. Data may be either (a) read into program control using options R2D or R3D or (b) hand-entered through the terminal, using option ND followed by any combination of options A1, FD, HI, KD, MD, ST, HS, or TP. Once in program control, data can be plotted with option PLT, listed with option LD, and edited using option ED. Errors can be fixed using the correction options CD, CHG, and SD. Modification options can be used in any order, but either option ED or PLT must be used prior to outputting the data.

133. If the user attempts to begin processing a new profile-survey before outputting the previous one, the following warning appears:

("HAVE YOU WRITTEN YOUR DATA TO A FILE?")

Anything but a positive response will return the user to the OPT CODE prompt in order to use option OUT. A positive response indicates that the data in program control have been output or are deliberately not going to be output.

134. For volume or plot comparisons, the user must first use option SA to save a survey for later comparison to itself or to any other survey brought into program control. Use option PLT for comparison plots and option VC for volume changes. Tabular output from option VC is also written to output file TAPE14 for later routing to a high-speed printer.

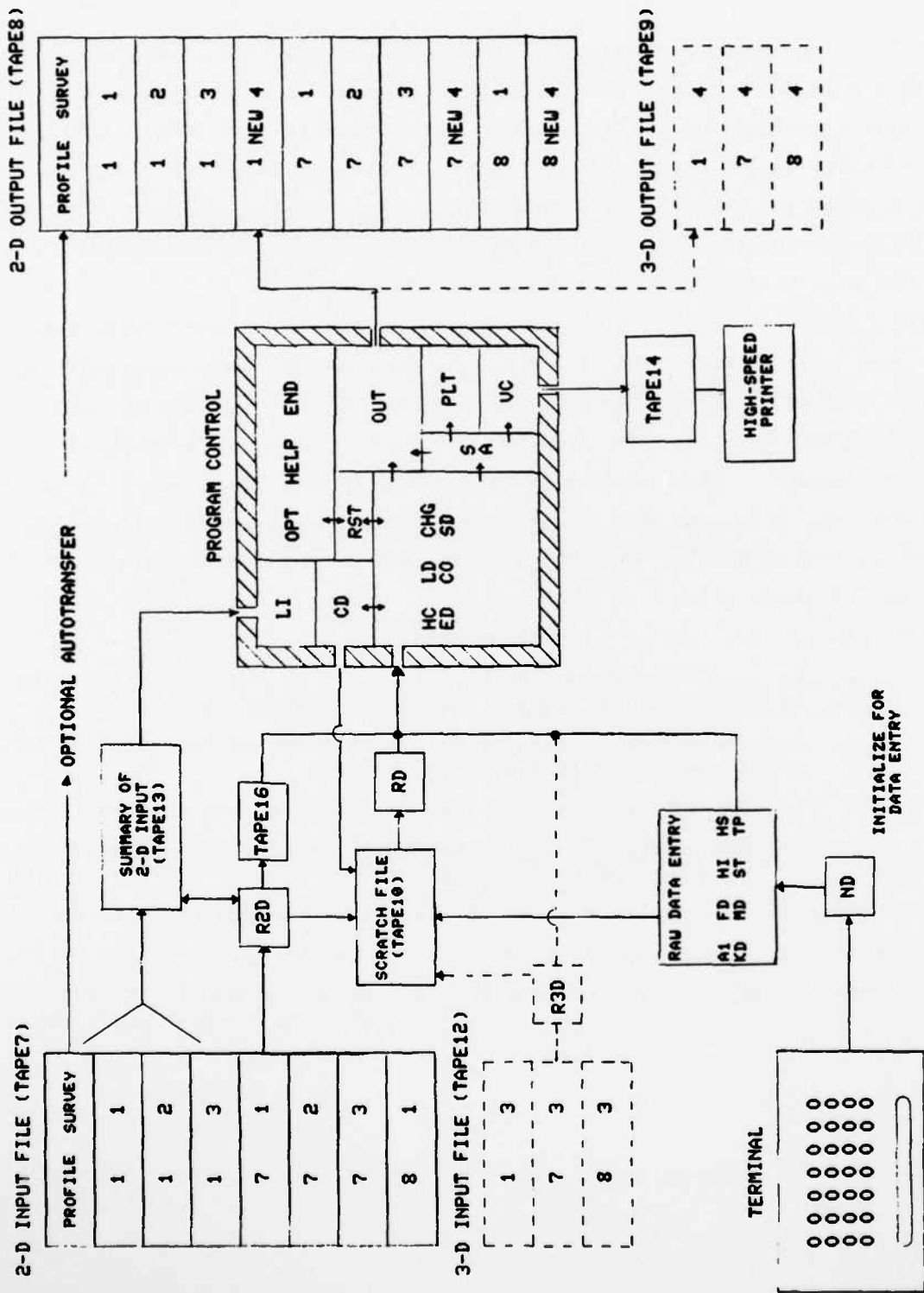

Figure 46. Schematic diagram of ISRP

What to Do If the Program Suddenly Terminates

135. Since an ISRP session could be quite lengthy and expensive, ISRP has been designed to prevent the inadvertent loss of data due to a user error or a computer malfunction. It does this using files TAPE10, TAPE13, and TAPE16 shown in Figure 46. All data either read or hand-entered into program control are automatically written to file TAPE10, as are modifications made with option CD. Should the program terminate, reexecute the program and use option RD to recall the last profile processed during the first run.

136. Option RD can also be used during program execution, after option CHG has been used to make changes, to recall data as they were originally input.

137. After an unexpected program termination, ISRP is able to properly keep track of the data transfer from the 2-D input file (TAPE7) to the 2-D output file (TAPE8). This is done by using TAPE13, which contains a table of all the data on TAPE7, and TAPE16, which holds the heading information of the last data read from TAPE7. Fortunately, the user need not concern himself with either of these files.

138. To restart ISRP, follow these instructions:

- a. Do not rewind or do any manipulations to the 2-D output file after the ISRP crash and before the restart.
- b. Reexecute ISRP, beginning with either option RD or option R2D, according to the following guidelines:
 - (1) Use option RD if the last data entered had not been output.
 - (2) Use option R2D if the next data to be processed must be read in from the 2-D input file.

139. This should result in a smooth restart of the program with no loss of data. Note that if the program crashes during use of option OUT or option R2D, questionable results may occur and the data should be carefully examined.

Planning Your ISRP Run

140. Since normal execution of ISRP consists of repeating a series of option calls for a number of profile lines, it is useful to outline the required sequence of options. A sample diagram is shown in Figure 47.

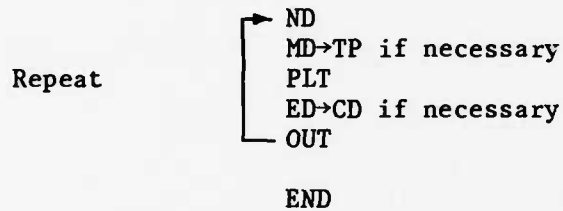

Figure 47. Outline of sample option sequence

This sequence does the following:

- a. Option ND initializes ISRP for data entry.
- b. Option MD allows level and tape data entry, with use of option TP for the turning points.
- c. Option PLT plots the entered line (optional).
- d. Option ED edits the data. If the plot or the edit indicates problems, then option CD can be used to correct the data. Other options such as LD, CHG, etc., can also be used.
- e. Option OUT outputs the data.

141. Occasionally, a user may simply want to comparison-plot the data on the input file without making any changes, adding data, or creating an output file. Such a sequence is shown below in Figure 48.

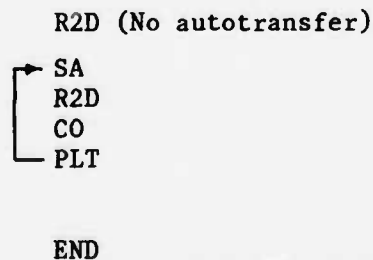

Figure 48. Outline of options for comparison plot

This sequence also converts the data to different units. The first step reads in the first survey to be compared. Option SA is then used to store it. The

next three steps read the second survey, convert it and the stored data, and plot the comparison.

142. The cycle is repeated by storing the second survey and reading in a third one. If an error in the data is encountered, the other ISRP options can be used to fix it and the plot can be rerun.

143. Figure 49 illustrates a typical use of ISRP: to enter new data, compare it to previous data, and merge all the data.

```
→ R2D - with autotransfer
  SA→OUT

  ND
  ST, MD, TP, FD, etc.
  ED
  PLT
  LD
  OUT

  END
```

Figure 49. Typical
ISRP sequence

This option sequence is begun by reading the previous survey from the input file, storing it, and writing it to the output file by a call to OUT (allowed from option SA). New data collected using stadia surveying and other methods are then entered by first using option ND. The data are edited, plotted, and listed before being output. Again, should problems be encountered, the other options are available for use. The sequence is repeated by reading the previous survey for the next profile to be processed from the input file.

PART VII: SUMMARY

144. ISRP is an easy-to-use interactive FORTRAN program for entering, editing, and processing beach and nearshore survey data. Use of ISRP can greatly improve the speed of data reduction and the quality of processed survey data. Input to ISRP can be anything from raw field survey notes to previously processed data. Its primary output is a file of formatted data that can be used as input to other analysis programs, such as the Beach Profile Analysis System (BPAS) also developed by CERC. Though ISRP is a logical complement to BPAS for creating and preprocessing BPAS data files, the ISRP output format can easily be used by other programs.

145. The user interacts with ISRP on a computer terminal by answering various questions, selecting which of the ISRP options to use, and entering data. The different ISRP options allow data to be entered, manipulated, listed, changed, edited, and output. The program also has options for data conversion, cross-section plotting, and computing volume and shoreline changes between surveys. Internal checks and frequent messages keep the user from making mistakes which might result in lost or incorrect data. Additional information, including descriptions of available options, is interactively available to the user through the HELP option.

146. ISRP users should employ this manual to familiarize themselves with ISRP's capabilities, options, and data formats. First-time users will find it helpful to diagram the options they plan to use before each session (sample diagrams are given in Part VI). Advanced users and programmers will find Appendix C useful in understanding how ISRP works and how it can be modified.

REFERENCES

Birkemeier, W. A. 1981. "Fast, Accurate Two-Person Beach Surveys," CERC Coastal Engineering Technical Aid 81-11, US Army Engineer Waterways Experiment Station, Vicksburg, Miss.

_____. 1982. "Surf Zone Surveying with the CRAB and a Total Station," Proceedings of the US Army, Corps of Engineers Survey Requirements Meeting, US Army Engineer Waterways Experiment Station, April 1982.

Fleming, M. V., and Lawler, T. S. 1982. "Beach Profile Analysis System (BPAS)," CERC Technical Report 82-1, Volumes 1-8, US Army Engineer Waterways Experiment Station, Vicksburg, Miss.

APPENDIX A: QUICK-LOOK OPTION SUMMARY (OPTION HELP)

A1 EDM, THEODOLITE DATA

OPTION A1 IS USED TO ENTER DATA COLLECTED WITH AN EDM, CONSISTING OF A RANGE, HORIZONTAL ANGLE, AND A DIFFERENCE IN ELEVATION. USE OPTION NO TO ENTER THE PROFILE INFORMATION, BUT USE OPTION A1 TO COMPUTE THE INSTRUMENT HEIGHT AND LOCATION. REQUIRED STATIONING INPUT ARE THE X, Y, Z, COORDINATES OF THE BENCHMARK, THE X, Y OF THE INSTRUMENT, A PRISM HEIGHT, BACKSIGHT, AND THE DIRECTION OF POSITIVE ROTATION. TWO ENTRY FORMATS ARE AVAILABLE INCLUDING A SHORT ONE IF ALL HORIZONTAL ANGLES EQUAL ZERO. EACH POINT ENTERED IS REDUCED, PRINTED, AND MUST BE VERIFIED BEFORE IT IS ADDED TO THE DATA. OPTION A1 DOES NOT COMPENSATE FOR EARTH CURVATURE OR REFRACTION EFFECTS.

CD CORRECT, DELETE, ADD SINGLE POINTS

USE OPTION CD TO CORRECT, CHANGE, DELETE, OR ADD DATA. POINTS ARE SPECIFIED BY THEIR INDEX VALUE. UP TO 25 POINTS CAN BE ADDED AT A TIME, BUT USE OF KO IS RECOMMENDED. OPTION CD WILL SORT ADDED POINTS INTO THE DATA.

CHG CHANGE, DELETE, SWITCH GROUPS OF POINTS

GROUPS OF ADJACENT POINTS CAN BE MODIFIED WITH OPTION CHG. POINTS MAY BE SPECIFIED BY POINT INDEX OR BY DISTANCE. ANY COORDINATE Y, Z, (X) MAY BE CHANGED, OR POINTS MAY BE DROPPED. COORDINATES MAY ALSO BE SWITCHED. THIS FEATURE IS USEFUL IF DISTANCES AND ELEVATIONS WERE ENTERED IN THE WRONG ORDER.

POINTS MAY BE ADJUSTED BY ADDITION OR MULTIPLICATION OF SPECIFIC COORDINATES BY A CONSTANT. A MULTIPLICATION CORRECTION IS USEFUL IF ONE COORDINATE IS MEASURED IN DIFFERENT UNITS THAN THE OTHER ONES OR TO MOVE A DECIMAL PLACE.

IT IS ALSO POSSIBLE TO ADD A GRADUATED DEPTH CORRECTION BASED ON THE Y DISTANCE, USEFUL FOR CORRECTING DATA COLLECTED WITH AN OUT-OF-LEVEL INSTRUMENT. THE USER MUST ENTER THE CHANGE IN ELEV.(OZ) AND IN DIST.(OY) AND THE Y DISTANCE AT WHICH THE CORRECTION EQUALLED 0 (USUALLY THE LOCATION OF THE INSTRUMENT).

CO CONVERT FT. TO M. OR M. TO FT.

OPTION CO CONVERTS THE DATA IN PROGRAM CONTROL AND, IF NEEDED, DATA WHICH HAVE BEEN SAVED WITH OPTION SA FROM FEET TO METERS OR METERS TO FEET. NOTE THAT REPEATED USE OF CO COULD AFFECT THE PRECISION OF THE DATA DUE TO ROUNDING ERRORS.

ED EDIT DATA IN PROGRAM CONTROL

OPTION ED SCANS THE DATA FOR THE FOLLOWING
TYPES OF ERRORS

NONASCENDING DISTANCES
ELEVATION SPIKES
DISTANCE JUMPS

JUMP AND SPIKE TOLERANCES CAN BE CHANGED BY THE USER. ED PRINTS 10 ERRORS, STOPS, AND ASKS IF MORE WISH TO BE SEEN. IF NOT, A TOTAL NUMBER OF ERRORS IS PRINTED. OPTION ED (OR OPTION PLT) MUST BE CALLED BEFORE DATA MAY BE SORTED OR OUTPUT. USE OPTIONS CD, CHG, SD, AND HC TO MAKE CORRECTIONS IF NEEDED. THE DATA DO NOT HAVE TO BE CORRECTED PRIOR TO OUTPUTTING IT. NOR DO DATA HAVE TO BE SORTED SINCE OPTION OUT WILL SORT IT.

FD FATHOMETER DATA (ALLOWS MIXED MEASUREMENT UNITS)

OPTION FD ACCEPTS ELEVATION AND DISTANCE DATA IN SIMILAR OR MIXED UNITS, AND IT WILL ALLOW EACH COORDINATE TO BE ADJUSTED BY A CONSTANT VALUE WHICH CAN ALSO BE IN DIFFERENT UNITS OF MEASUREMENT. THE OPTION WAS ORIGINALLY DESIGNED FOR THE REDUCTION OF FATHOMETER DATA WITH DISTANCES MEASURED IN METERS RELATIVE TO A DISTANCE ALONG THE PROFILE MEASURED IN FEET.

THE USER IS REQUIRED FIRST TO DEFINE ALL THE UNITS OF MEASUREMENT, A DISTANCE INCREMENT USED FOR INTERNALLY GENERATING DISTANCES, A TIDE CORRECTION, AND A DISTANCE CORRECTION. ONCE A STARTING DISTANCE IS ENTERED, THE PROGRAM GENERATES AND PRINTS EQUALLY SPACED DISTANCES RELATIVE TO THE BASELINE. THE USER ONLY ENTERS THE APPROPRIATE DEPTH (INCLUDING THE SIGN). TO EXIT THIS STANDARD INCREMENT ENTRY, ENTER A 0.

THE OPTION THEN ALLOWS THE ENTRY OF DATA AT SPECIFIC DISTANCES RELATIVE TO THE DISTANCE CORRECTION. ENTER A 0,0 TO EXIT THE OPTION.

ALL DATA ARE PROPERLY CONVERTED TO THE DESIRED UNITS WHEN OPTION FD IS EXITED. BECAUSE OF THE UNIT CONVERSIONS, REDUCED DATA ARE NOT PRINTED AT THE TERMINAL. USE OPTION LD TO LIST THE DATA AND OPTION SD TO SORT IT.

HC CHANGE THE PROFILE HEADER INFO.

OPTION HC IS USED TO CHANGE THE PROFILE INFORMATION. ANY OR ALL OF THE FOLLOWING CAN BE CHANGED

LOCALITY	DATE
PROFILE	TIME
SURVEY	

HC ALSO ALLOWS THE UNITS LABEL TO BE CHANGED WITHOUT ACTUALLY CONVERTING THE DATA.

HELP PRINT DESCRIPTIONS OF EACH OPTION

SHORT DESCRIPTIONS OF THE FOLLOWING OPTIONS CAN
BE PRINTED

A1	CD	CHG	CO	ED
FD	HC	HI	HS	KD
LD	LI	ND	ND	OUT
PLT	RD	RST	R2D	R3D
SA	SD	ST	TP	VC

HI CHECK OR ENTER INST. HEIGHT AND LOCATION

OPTION HI CAN BE USED AT ANY TIME TO CHECK OR
CHANGE THE INSTRUMENT HEIGHT OR LOCATION. USE OPTION TP
OR ND TO COMPUTE A NEW HI.

HS HALF STADIA DATA

OPTION HS IS USED FOR REDUCING STADIA DATA
WHEN ONLY TWO OF THE THREE STADIA READINGS ARE AVAILABLE.
NO ACCURACY CHECK IS MADE, AND ALL DISTANCES ARE ASSUMED
TO BE SEAWARD OF THE INSTRUMENT.

KD KNOWN DATA ENTRY - Y,Z, (X)

OPTION KD IS USED TO ENTER DATA WITH KNOWN
Y,Z,(X) COORDINATES. ORDER OF ENTRY FOR 2-D DATA IS
USER SPECIFIED.

LD LIST DATA IN PROGRAM CONTROL

OPTION LD LISTS THE DATA IN PROGRAM CONTROL.
ALL OR SOME OF THE POINTS MAY BE LISTED. POINTS ARE
SELECTED BY SPECIFYING THE POINT INDICES.

LI LIST PROFILE HEADER INFO ON FILE TAPE7

OPTION LI LISTS THE PROFILE HEADINGS OF THE
DATA ON THE 2-D INPUT FILE. IT TELLS HOW MANY PROFILE
SURVEYS THERE ARE AND ALLOWS ALL OR SOME OF THE DATA TO
BE LISTED. SINGLE PROFILES OR SURVEYS CAN BE LISTED.
ONLY ONE LISTING IS MADE DURING EACH USE OF LI.

MD LEVEL AND TAPE SURVEYS (MEASURED DISTANCES)

OPTION MD IS USED TO REDUCE FIELD DATA COLLECTED WITH A LEVEL AND TAPE. DATA ENTRY CONSISTS OF A DISTANCE AND A FORESIGHT. ORDER OF ENTRY IS USER SPECIFIED. USER ALSO SPECIFIES IF REDUCED VALUES ARE TO BE PRINTED AND VERIFIED AFTER EACH ENTRY. DISTANCES MAY BE RELATIVE TO A BENCHMARK OR TO THE INSTRUMENT. OPTION MD MUST BE USED FIRST TO COMPUTE THE INSTRUMENT HI AND STARTING DISTANCE. USE OPTION TP TO COMPUTE TURNING POINTS.

ND NEW DATA, INITIALIZE FOR DATA ENTRY

OPTION ND MUST BE CALLED TO INITIALIZE ISRP FOR EACH NEW PROFILE TO BE ENTERED. IT IS USED TO ENTER THE SURVEY NUMBER, DATE, AND TIME AND, IF REQUIRED, TO COMPUTE THE LOCATION AND HEIGHT OF THE INSTRUMENT. OPTION ND IS NOT USED BEFORE READING DATA ALREADY IN BPAS FORMAT.

OUT WRITE 2-D BPAS DATA TO TAPE8, 3-D TO TAPE9 (IF 3-D MODE)

OPTION OUT IS USED TO OUTPUT TO THE OUTPUT FILE (TAPE8) THE DATA IN PROGRAM CONTROL. OUTPUT FORMAT IS USER SELECTABLE AS ONE OF THE THREE BPAS FORMATS. USER MAY SELECT TERMINAL PRINTING OF THE OUTPUT.

IN ADDITION IF 3-D DATA ARE BEING PROCESSED, A 3-D OUTPUT FILE (TAPE9) IS CREATED. IF AUTO TRANSFER IS SELECTED, THE OUTPUT FORMAT IS PRESET. USER MAY OUTPUT 3-D DATA IN DIFFERENT UNITS THAN THE 2-D DATA AND MAY SELECT 3-D OUTPUT OF A SINGLE SURVEY NUMBER IF DESIRED. NOTE THAT OPTION OUT SORTS NEWLY ENTERED OR CHANGED DATA BEFORE IT IS OUTPUT TO ENSURE THAT IT IS IN CORRECT ORDER.

PLT PLOT SINGLE OR COMPARISON PROFILE CROSS SECTIONS

OPTION PLT PLOTS THE DATA IN PROGRAM CONTROL. IT CAN ALSO PLOT COMPARISONS OF TWO SURVEYS. COMPARISONS ARE PLOTTED BY FIRST USING OPTION SA TO SAVE A PROFILE IN PROGRAM CONTROL FOR LATER COMPARISON. AFTER ANOTHER PROFILE IS READ OR ENTERED THEY BOTH CAN BE PLOTTED USING OPTION PLT.

THE USER MAY USE DEFAULT PLOT SPECIFICATIONS OR ENTER NEW ONES. SYMBOLS MAY ALSO BE INCLUDED. BY SETTING DIFFERENT PLOT SPECIFICATIONS, IT IS POSSIBLE TO ZOOM IN ON ANY PART OF THE PLOT. PLOTS MAY BE REPEATED AS OFTEN AS NEEDED.

USE OPTION RST TO RESET PREVIOUSLY DEFINED PLOT AXES. REFER TO USER'S MANUAL FOR DETAILS.

AD-A151 160

A USER'S GUIDE TO ISRP: THE INTERACTIVE SURVEY
REDUCTION PROGRAM(U) COASTAL ENGINEERING RESEARCH
CENTER VICKSBURG MS W BIRKEMEIER NOV 84 CERC-IR-84-1

2/2

UNCLASSIFIED

F/G 9/2

NL

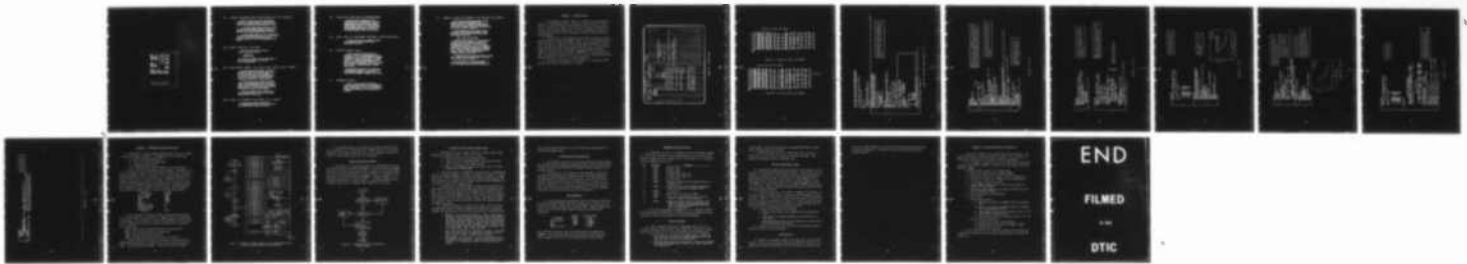

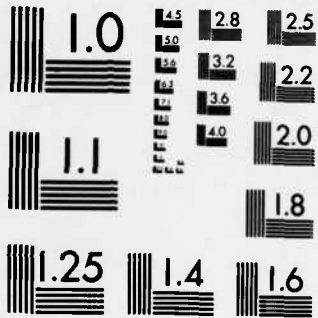

MICROCOPY RESOLUTION TEST CHART
NATIONAL BUREAU OF STANDARDS-1963-A

RD RECALL ENTERED DATA FROM SCRATCH FILE (TAPE10)

OPTION RD IS USED IN THE FOLLOWING TWO CIRCUMSTANCES TO RECALL DATA TO PROGRAM CONTROL. IT READS FROM FILE TAPE10 WHICH IS CREATED OR UPDATED DURING THE ISRP SESSION. NOTE THAT TAPE10 STORES ONLY ONE PROFILE-SURVEY AT A TIME.

1) FOLLOWING A PROGRAM CRASH, OPTION RD WILL RECOVER DATA WHICH WERE EITHER ENTERED THROUGH THE TERMINAL OR WHICH WERE READ IN USING OPTIONS-ND AND A1,FD,HI,HS,KD,MD, RZD,R3D,ST,TP OR DATA WHICH WERE MODIFIED WITH OPTION CD

2) DURING PROGRAM EXECUTION TO RECALL TO PROGRAM CONTROL THE PROFILE-SURVEY BEING PROCESSED AS IT WAS PRIOR TO USING OPTION CHG. THIS FEATURE ALLOWS CHANGES TO BE MADE AND TESTED REPEATEDLY, AN AID IN FIXING BENCHMARK AND OTHER ERRORS.

RST RESET SPECIFIC OPTIONS

OPTION RST ALLOWS THE FOLLOWING OPTIONS TO BE RESET TO THEIR INITIAL STATE

KD,MD,CD,ED,RZ,
ST,ND,OUT,FA,PLT

THIS IS USEFUL IF AN INCORRECT ENTRY WAS MADE DURING THE FIRST USE OF THESE OPTIONS. AFTER RESETTING, SELECT THE DESIRED OPTION.

R2D READ BPAS FORMAT 2-D DATA FROM INPUT FILE (TAPE7)

OPTION R2D ALLOWS THE USER TO READ IN 2-D FORMAT BPAS DATA FOR COMPARISON OR CORRECTION. INPUT DATA ARE READ FROM FILE TAPE7 IN ANY OF THE BPAS FORMATS, (EDIT1 OR EDIT2 CARD IMAGES, OR EDIT2 MAGNETIC MEDIA) TAPE7 DOES NOT HAVE TO HAVE A BPAS HEADER RECORD, BUT IF IT DOES, IT CAN BE CHANGED. THE USER IS ASKED FOR DETAILS ABOUT THE DATA (UNITS, DECIMAL PLACES, ETC.).

AT THE USERS OPTION, DATA NOT BROUGHT INTO PROGRAM CONTROL MAY BE AUTOTRANSFERRED TO THE 2-D OUTPUT FILE (TAPE8). THIS FEATURE ALLOWS NEW DATA TO BE ENTERED AND PROPERLY MERGED WITH THE OLDER SURVEYS INTO A FINAL COMPLETED OUTPUT FILE. DURING THE FIRST USE OF R2D, A LIST OF THE DATA ON THE INPUT FILE MAY BE OBTAINED.

DATA READ INTO PROGRAM CONTROL ARE SPECIFIED BY PROFILE AND SURVEY NUMBERS. SEE THE ISRP USERS MANUAL FOR FURTHER DETAILS OF THIS OPTION.

R3D READ 3-D FORMAT DATA FROM FILE TAPE12

OPTION R3D READS A SPECIFIC PROFILE-SURVEY IN 3-D FORMAT DATA FROM INPUT FILE TAPE12. DATA MAY BE READ IN ANY ORDER AND IN EITHER FEET OR METERS.

SA SAVE DATA FOR USE IN COMPARISONS

OPTION SA IS USED TO SAVE DATA THAT ARE IN PROGRAM CONTROL FOR LATER COMPARISON (VC OR PLT) WITH OTHER DATA WHICH WILL BE READ (R2D,R3D) OR ENTERED. COMPARISONS MAY BE MADE BETWEEN DIFFERENT SURVEYS OR BETWEEN DIFFERENT PROFILES. IF THE DATA BEING SAVED ARE NEWLY ENTERED (AND EDITED) OR IF DATA ARE BEING AUTOTRANSFERRED FROM THE INPUT TO THE OUTPUT FILE, THEN OPTION SA INCLUDES A PROMPT TO CALL OPTION OUT.

SD SORT DATA BY OFFSHORE DISTANCE (AFTER EDITING)

OPTION SD SORTS THE DATA BY INCREASING Y DISTANCE NEWLY ENTERED DATA MUST BE EDITED OR PLOTTED BEFORE OPTION SD WILL WORK.

ST STADIA SURVEY DATA

OPTION ST IS USED TO REDUCE STADIA DATA CONSISTING OF A FORESIGHT (FS), UPPER STADIA (US), AND LOWER STADIA (LS). THE THREE MEASUREMENTS ARE EVALUATED BY COMPARING THE QUANTITY $((US-FS)-(FS-LS))$ TO AN ERROR ACCURACY OF 0.02 (THIS VALUE CAN BE RESET BY THE USER). OPTION ST WILL RECOMPUTE BAD MEASUREMENTS 3 WAYS ASSUMING ONE OF THE THREE READINGS IS IN ERROR. AFTER EACH POINT IS COMPUTED, THE USER MUST ACCEPT IT BEFORE IT IS ADDED TO THE DATA. RECOMPUTED DATA MUST BE ENTERED USING OPTION KD.

OPTION ND MUST BE USED PRIOR TO ST TO COMPUTE THE INSTRUMENT HEIGHT AND LOCATION. ST ADDS ALL DISTANCES TO THE INSTRUMENT DISTANCE. THE USER IS ASKED WHETHER POINTS ARE LANDWARD OR SEAWARD OF THE INSTRUMENT.

TP TURNING POINTS

OPTION TP IS USED TO COMPUTE TURNING POINTS FOR STADIA OR LEVEL AND TAPE DATA. IF THE TURNING POINT IS ALSO A SURVEY POINT, THEN IT MUST BE FIRST ENTERED USING A DATA ENTRY OPTION. SINCE FOR LEVEL AND TAPE DATA, DISTANCE IS NOT REQUIRED, ONLY THE FS AND BS NEED TO BE ENTERED.

VC COMPUTE PROFILE CHANGES, PUT OUTPUT ON TAPE14

OPTION VC COMPUTES THE VOLUME AND SHORELINE CHANGES BETWEEN THE DATA IN PROGRAM CONTROL AND DATA STORED WITH OPTION SA. THE COMPARISON IS MADE ONLY FOR DISTANCES COMMON TO BOTH SURVEYS. THE OUTPUT INCLUDES THE LIMITS OF THIS REGION, THE CHANGE IN SHORELINE POSITION, AND A TABLE OF CUT AND FILL QUANTITIES.

THIS TABLE COMPUTES THE LIMITS, AVERAGE THICKNESS, AND VOLUME OF EACH ACCRETION AND EROSION CELL. IT ALSO GIVES CUMULATIVE NET AND GROSS PROFILE VOLUME CHANGES. GROSS CHANGES ARE DEFINED AS

$$\text{GROSS} = \text{ACCRETION} + \text{ABS(EROSION)}$$

THE COMPUTATIONS ARE BASED ON A LINEAR DIGITIZATION OF THE ACTUAL DATA INTO 110 INCREMENTS. A VARIABLE-WIDTH INTERVAL IS USED IN ORDER TO GIVE GREATER DETAIL TO THE LANDWARD END OF THE PROFILE. CUT AND FILL VOLUMES ARE COMPUTED BASED ON VERTICAL SLICES. THIS IS USEFUL FOR OFFSHORE DATA BUT USUALLY NOT FOR BEACH DATA. ACCORDINGLY, OPTION VC WILL ONLY PROCESS DATA WHICH REACH THE VERTICAL DATUM. OPTION VC WILL PERMIT EXTRAPOLATION TO THE DATUM INTERCEPT IF DESIRED. THE OPTION ALSO COMPUTES THE CHANGE ABOVE AND BELOW THE DATUM.

AT THE USER'S OPTION, THE ELEVATION AND CHANGE IN ELEVATION CAN BE COMPUTED AT USER-SPECIFIED DISTANCES. THIS CAN BE USEFUL IN COMPUTING VERTICAL CHANGES.

OUTPUT FROM OPTION VC IS ALSO WRITTEN TO OUTPUT FILE -TAPE14- WHICH CAN BE SENT TO A HIGH-SPEED PRINTER. SEE THE USER'S MANUAL FOR DETAILS ABOUT THIS USEFUL OPTION

APPENDIX B: SAMPLE ISRP RUN

1. This appendix includes a sample use of ISRP to enter some new data, compare it to the previous survey, and merge it with existing data. While this is a typical use of ISRP, it does not fully illustrate the flexibility and power of the various ISRP options. Users are encouraged to explore all the ISRP options, both to develop confidence in them and to gain experience with the program.

2. The data used in the example are actual beach survey data collected using the method described by Birkemeier (1981). The actual fieldbook page is shown in Figure B1. These data, which include some known distance elevation pairs, some level and tape data, and some stadia data, are to be entered and merged into the input file of BPAS EDIT2 card image format data shown in Figure B2. This file must be attached to FORTRAN Unit 7 prior to executing ISRP. Two-dimensional output which is written to Unit 8 by ISRP must be saved following execution. This file is listed in Figure B3.

3. Note that for the purpose of this example, user responses to ISRP questions are clearly indicated by a **- prompt.

PROFILE 16	ANDRITE BEACH	1930	STADIA		
STA	BS	EL	FS	RANGE	STADIA
G.M.	8.95	7.75		400	9.27
	HT			400	8.64
1	16.73	7.4		426	
2		9.6		447	
3		12.0		468	
4		11.7		464.20	0
5		7.55	9.18	469.85	5.65'
6		3.99	12.74	533.4	69.2'
7		2.03	14.70	595.4	131.2'
8		0.76	15.97	661.4	16.95
9		0.23	16.50	685.4	14.99
10		-0.12	16.85	715.4	17.60
					15.40
					18.10
					16.60
					5

PH SMITH
K JOHN

KNOWN POINTS ON
BOARDS WALK

INST LOCATION

DISTANCES MEASURED FROM INST

UPPER STADIA READING

LOWER STADIA READING

DATA COMPUTED BY
ISRA ARE IDENTIFIED
BY DARK BOX

Figure B1. Fieldbook page

Original 2-D input file (TAPE7)

11	16	261771127	1435	15	-2			400	74	426	96	447	120	468	117	
11	16	262	471	76	475	80	478	73	488	68	515	59	554	49	593	32
11	16	263	634	21	673	13	715	6	756	-2						
11	17	251771110	1340	16	-10				428	97	458	112	470	109	482	107
11	17	252	485	105	489	94	497	100	504	102	512	105	515	97	526	79
11	17	253	527	64	561	31	605	13	667	0	713	-10				
11	17	261771127	1515	16	5				482	107	486	102	489	95	494	99
11	17	262	498	101	507	103	511	104	514	99	516	107	517	101	524	91
11	17	263	535	70	536	57	568	27	605	16	643	5				
11	17	281771221	1045	15	-4				482	107	489	97	491	97	500	101
11	17	282	511	104	514	98	517	96	517	82	518	70	522	66	524	62
11	17	283	549	34	589	12	626	2	655	-4						
11	18	261771127	1530	16	-2				550	91	626	95	679	100	712	99
11	18	262	738	102	766	100	782	101	790	101	801	98	801	72	811	68
11	18	263	814	63	840	43	878	27	904	17	943	-2				

E01.
E)

Figure B2. Original 2-D input file (TAPE7)

Final 2-D output file (TAPE8)

11	16	261771127	1435	15	-2			400	74	426	96	447	120	468	117		
11	16	262	471	76	475	80	478	73	488	68	515	59	554	49	593	32	
11	16	263	634	21	673	13	715	6	756	-2							
11	16	281771222	1430	10	-1				400	74	426	96	447	120	468	117	added data
11	16	282	470	75	533	40	595	20	661	8	685	2	715	-1			
11	17	251771110	1340	16	-10				428	97	458	112	470	109	482	107	
11	17	252	485	105	489	94	497	100	504	102	512	105	515	97	526	79	
11	17	253	527	64	561	31	605	13	667	0	713	-10					
11	17	261771127	1515	16	5				482	107	486	102	489	95	494	99	
11	17	262	498	101	507	103	511	104	514	99	516	107	517	101	524	91	
11	17	263	535	70	536	57	568	27	605	16	643	5					
11	17	281771221	1045	15	-4				482	107	489	97	491	97	500	101	
11	17	282	511	104	514	98	517	96	517	82	518	70	522	66	524	62	
11	17	283	549	34	589	12	626	2	655	-4							
11	18	261771127	1530	16	-2				550	91	626	95	679	100	712	99	
11	18	262	738	102	766	100	782	101	790	101	801	98	801	72	811	68	
11	18	263	814	63	840	43	878	27	904	17	943	-2					

E01.
E)

Figure B3. Final 2-D output file (TAPE8)

THIS IS ISRP, THE INTERACTIVE SURVEY REDUCTION PROGRAM
AS OF 12 JULY 1983, CONTACT BILL BIRKEMEIER 919-261-3511.

THIS VERSION ALLOWS 110 DATA PAIRS PER PROFILE.

WANT A GENERAL DESCRIPTION?

88- N

3-D SURVEYS?

88- N

USE OPTION OPT TO LIST OPTIONS.

OPTION HELP FOR OPTION DESCRIPTIONS.

OPT. CODE-

88- R THIS ROUTINE BRINGS INTO PROGRAM CONTROL A SPECIFIC
PROFILE-SURVEY FROM TAPE7. IT CAN ALSO CONTROL THE
TRANSFER OF DATA FROM TAPE7 TO TAPE8. SEE OPTION
HELP OR THE USERS MANUAL FOR SPECIFIC INSTRUCTIONS.

DO YOU WANT TO READ DATA?

88- Y

AVAILABLE INPUT FORMATS

1 - EDIT1 CARDS

2 - EDIT2 CARDS

3 - EDIT2 MAGNETIC MEDIA

ENTER CODE-

88- 2

TRANSFER UNREQUESTED DATA TO THE 2-D OUTPUT FILE?

88- Y

HEADER RECORD ON TAPE7? Select transfer

88- N

ASSUMED INPUT UNITS ARE FT OK?

88- Y

INPUT DECIMAL PLACES ARE Y(0),Z(1) OK?

88- Y

THERE ARE 5 PROFILE-SURVEYS ON TAPE7

DO YOU WANT SUMMARY OF DATA ON TAPE7? "Yes" response calls option LI

88- Y

THIS ROUTINE LISTS THE HEADER INFO. FROM
EACH OF THE 5 PROFILE-SURVEYS ON TAPE7

YOU CAN SELECT LISTING BY ENTERING-

A-LIST ALL

S-SINGLE SURVEY

P-SINGLE PROFILE

N-NO LISTING

ENTER CODE-

88- A

PROFILE SURVEY DATE

15 26 771127

17 26 771110

17 26 771127

17 26 771127

18 26 771127

88- 16 26

ENTER PROFILE AND SURVEY NUMBERS (0,0 TO EXIT)-

88- 16 26

15 POINTS READ FOR PROFILE 16 SURVEY 26

Request survey 26 of profile 16

LI

Note only first two letters of option code are required (R2=R2D)

Use Option R2D to read in last survey of
profile 16 and to select autotransfer of
data from the 2-D input to the 2-D output
file.

R2D

Figure B4. Annotated sample output (1 of 7)

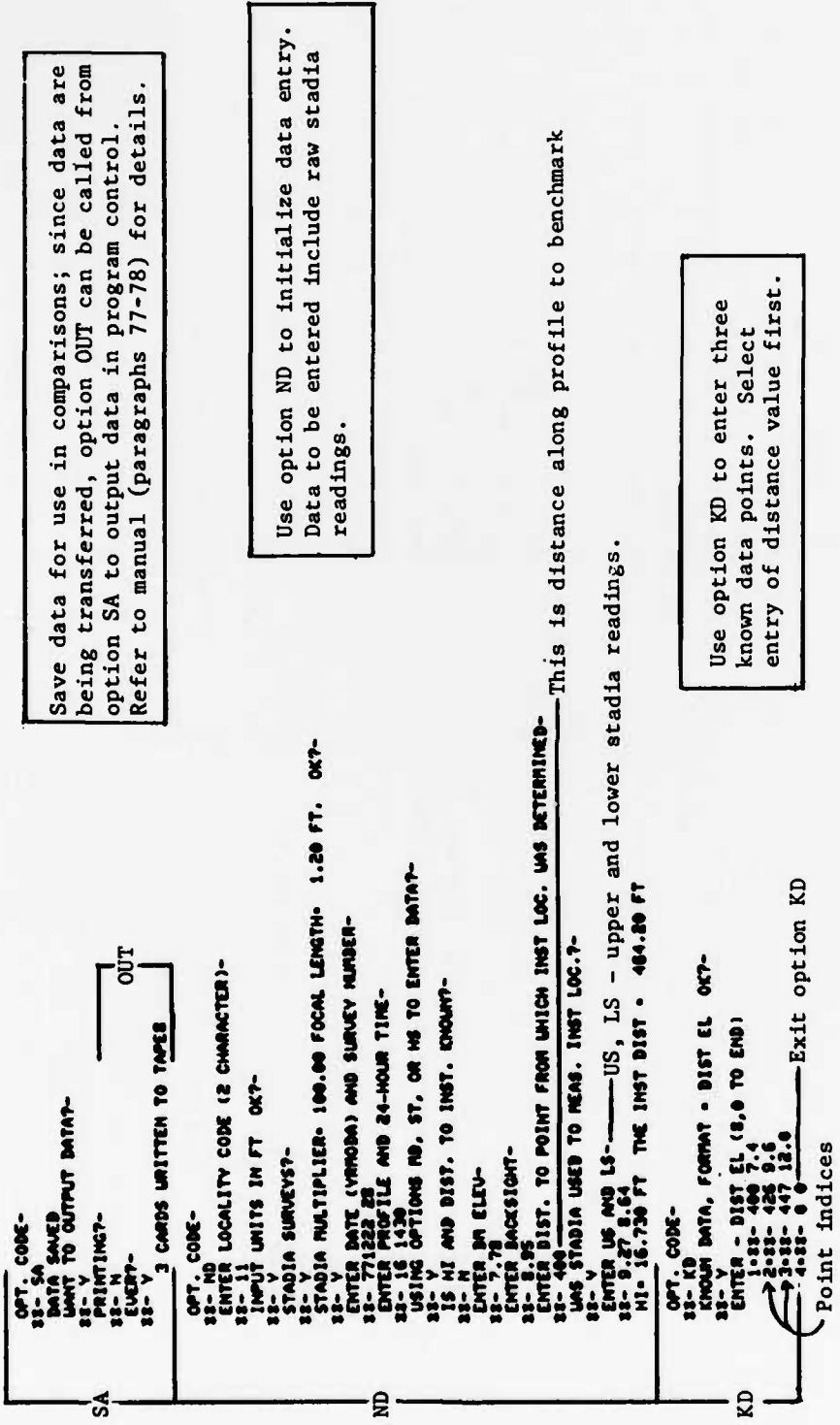

Save data for use in comparisons; since data are being transferred, option OUT can be called from option SA to output data in program control. Refer to manual (paragraphs 77-78) for details.

Use option ND to initialize data entry. Data to be entered include raw stadia readings.

This is distance along profile to benchmark

Use option KD to enter three known data points. Select entry of distance value first.

Figure B4. (2 of 7)

```

OPT. CODE-
32- MD MEASURED DATA ENTRY, ORDER - DIST FS OK?-
32- M DO YOU WANT TO SEE AND VERIFY CALCULATED VALUES?-
32- N ENTER - FS DIST (0.0 TO END) FS = Foresight
IS NEXT POINT LANDWARD OF INST.?-
32- N 4-22- 9.18 5.65
5-22- 12.74 69.2
6-22- 14.7 131.2
7-22- 0 0 Exit option MD

```

Use option MD to enter level and tape data--assumed to be measured relative to instrument, as are stadia data.

```

OPT. CODE-
32- ST STADIA DATA - DEFAULT ERROR CHECK - .02 OK?-
32- V STADIA ENTRY, FORMAT - FS US LS (0.0,0 TO END)
7-22- 15.97 16.95 14.99
V= 661.40 Z= .76 OK?-
8-22- 16.5 17.6 15.4
V= 689.40 Z= .23 OK?-
9-22- 16.85 18.1 16.6
ERROR CHECK- 1.000 WANT ME TO RECOMPUTE IT ?-
32- V PRESENTLY V= 615.40 Z= -.12
ASSUMING GOOD FS AND ONE BAD STADIA
V= 715.40 (US) OR 515.40 (LS) Z= -.12
ASSUMING WRONG FS GOOD STADIA
V= 615.40 Z= -.62
USE POINT AS IS?-
32- N RE-ENTER STADIA OR USE OPTION KD TO ENTER
POINT AS COMPUTED ABOVE.
9-22- 16.85 18.1 15.6 Re-enter correct readings
V= 715.40 Z= -.12 OK?-
10-22- 0 0 0 Exit option ST

```

Use option ST to reduce stadia readings. Refer to manual (paragraphs 40-42) for explanation of error-check value.

Automatic recomputation of suspected erroneous point

Use option LD to list the data in program control.

```

OPT. CODE-
88- LD
LOCAL PROFILE SURVEY DATE TIME POINTS UNITS
11 16 20 771222 1430 9 FT
MI= 16.73 FT THE INST. DIST.= 464.20 FT
LIST ALL? (0 TO EXIT)-
88- Y Y Z
1 400.00 7.40
2 425.00 9.60
3 447.00 12.00
4 469.85 7.56
5 533.48 3.09
6 595.48 2.03
7 661.48 .76
8 685.48 .23
9 715.48 -.12
  
```

```

OPT. CODE-
88- PL
HIT 'RETURN' AFTER MENU SELECTION TO BEGIN PLOT
PROGRAM RINGS BELL/PAUSES WHEN FINISHED PLOT
PAGE COPY THEN/OR HIT 'RETURN' TO CONTINUE
88- Y GAUG RATE SET AT 120 CPS, OK?-
DEFAULT PLOT?- Do not use default plot
88- M ENTER XMIN, YMAX, XINC-
88- 300 800 100
88- -5 20 5
USE THESE ALWAYS?-
88- M SELECT PLOT TYPE = 1-SINGLE, 2-COMPARISON -
88- 2 ALWAYS?-
88- M SYMBOLS ON WHICH LINES
88- 2 0-NONE, 1-LINE 1, 2-LINE 2, 3-BOTH 7-
88- 2 ALWAYS?-
88- Y
  
```

Use option PLT to plot the data.

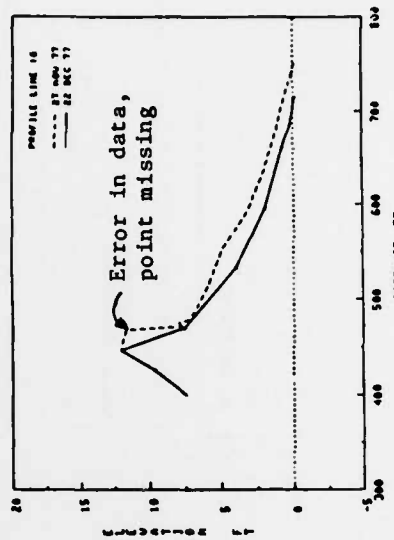

Plot Resulting From Option PLT

Figure B4. (4 of 7)

Since plot identified an error, use option KD to enter missing point (could also use option CD). Note that it is out of order.

Use option ED to edit the data--this is required before data can be sorted or output.

Use SD to sort the data.

Use PLT to replot the data. Note that because of preceding responses to "always" questions, some questions are repeated from first use of PLT.

```

OPT. CODE-
KD  33- KD
    ENTER - DIST EL (0.0 TO END)
    10-33- 468 11.7
    11-33- 0
    OPT. CODE-
ED  33- ED
    THIS ROUTINE CHECKS FOR THE FOLLOWING ERRORS
    ELEV. SPIKES -5.0 FT
    DISTANCES BETWEEN POINTS .GT. 75.0 FT
    NON-ASCENDING DISTANCES
    DO YOU WANT TO CHANGE TOLERANCES?-
    POINT  POINT 1 (FT)  POINT 2 (FT)  ERROR
    INDICES  -Y-      -Z-
    9 10 715.40  -.12  468.00  11.70  ELEV. DIFF. OF 11.82
    9 10 715.40  -.12  468.00  11.70  NON-ASCENDING DISTANCES
    USE OPTIONS CD,SD,CHG OR MC IF CORRECTIONS ARE NEEDED
    OPT. CODE-
SD  33- SD
    10 DATA PAIRS READ AND SORTED
    OPT. CODE-
PLT 33- PL
     DEFAULT PLOT?-
    33- N
     ENTER XMIN, XMAX, XINC-
    33- 300 800 100
     ENTER YMIN, YMAX, YINC-
    33- 0 20 5
     USE THESE ALWAYS?-
    33- Y
     SELECT PLOT TYPE - 1-SINGLE, 2-COMPARISON -
    33- 2
     ALWAYS?-
    33- N
  
```

Error is due to point out of order

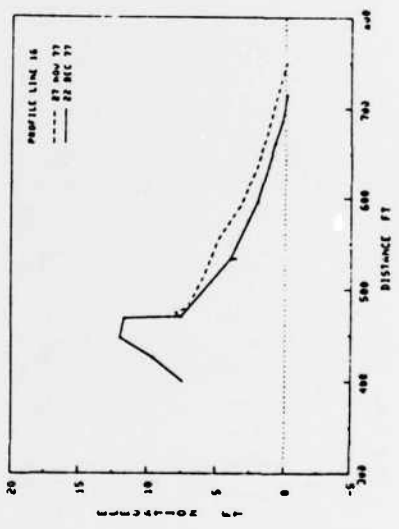

Final Plot Generated

Figure B4. (5 of 7)

OPT. CODE-
 88- LD
 LOCAL PROFILE SURVEY DATE TIME POINTS UNITS
 11 16 28 771822 1436 10 FT
 MI= 16.73 FT THE INST. DIST.= 464.80 FT
 LIST ALL? (0 TO EXIT)-

Use option LD to list final data.

88- Y V Z
 1 400.00 7.40
 2 425.00 9.60
 3 447.00 12.00
 4 468.00 11.70
 5 469.05 7.55
 6 533.48 3.98
 7 595.48 2.83
 8 661.48 .75
 9 685.48 .23
 10 715.48 -.12

OPT. CODE-
 88- UC

ANALYSIS OF PROFILE CHANGES

 BETWEEN PROFILE 16 ON 771127 AND PROFILE 16 ON 771222
 STARTING DISTANCE. 400.00 FT ENDING DISTANCE. 715.48 FT
 THE SHORELINE CHANGED -40.64 FT FROM 745.75 FT TO 705.11 FT

- CUT/FILL COMPUTATION -

CELL DISTANCE ELEVATION CELL CELL PROFILE
 TO END OF END PT VOLUME THICKNESS CUR.VOL. GROSS VOL
 FT FT V03/FT FT V03/FT V03/FT
 END 715.48 .24 -8.53 -.73 -8.53 8.53
 VOLUME CHANGE ABOVE DATUM- -8.99 V03/FT
 VOLUME CHANGE BELOW DATUM- .37 V03/FT

Use option VC to compute volume and elevation changes (note duplicate table is also written to Unit 14 for off-line printing).

WANT TO COMPUTE ELEVATIONS FOR SPECIFIC DISTANCES?
 88- Y

ENTER DISTANCE IN FT (0 TO EXIT)-
 88- 500
 ELEV. CHANGED -.54 FT FROM 6.40 FT ON 771127 TO 5.86 FT ON 771222
 ENTER DISTANCE IN FT (0 TO EXIT)-
 88- 700
 ELEV. CHANGED -.79 FT FROM .85 FT ON 771127 TO .06 FT ON 771222
 ENTER DISTANCE IN FT (0 TO EXIT)-
 88- 0 Exit option

Figure B4. (6 of 7)

```

OPT. CODE-
IS- OUT
PRINTING?
11 16 281771822 1430 10 -1
11 16 282 478 75 533 40 595
11 2 CARDS WRITTEN TO TAPES

```

```

400 74 426 95 447 120 468 117
20 681 8 686 2 715 -1

```

Use option OUT to
output the data.

The user can proceed at this point to next
profile to be processed or can terminate
ISRP session by entering END (as shown).

```

OPT. CODE-
IS- END
DATA BEING TRANSFERRED TO TAPES

```

Figure B4. (7 of 7)

APPENDIX C: UNDERSTANDING AND MODIFYING ISRP

1. Though ISRP is a general beach-surveying program, there are a number of reasons for wanting to modify it. The primary ones are the following:

- a. To add a new surveying procedure.
- b. To add a new input and output format.
- c. To change plotting software.
- d. To remove questions always answered with the same response.

2. Each of these will be discussed in this appendix. The general structure of the program, along with subroutine names, is illustrated in Figure C1. The primary purpose of each of the options is to create and manipulate the survey data stored in the Y, Z, and X data arrays. A maximum of 100 points is allowed, and warnings are printed if an attempt is made to exceed this limit. This limit may be changed by changing the dimensions of the common statements and by changing the value of MAXPT in the main program. Other information about the data in program control is stored in the following variables:

<u>Information</u>	<u>Variable</u>
Profile number	I PROF
Survey number	I SUR
Date	I DATE
Time	I TIME
Locality	I LOC
Number of points	I
Instrument height	HI
Distance to the instrument	DINST

3. Other important variables and flags are passed between subroutines with common statements and are defined in a comment section at the beginning of the program. Of the variables in common, ICHK and MOVE have special significance. ICHK tracks the status of the data in program control according to the following code:

ICHK=0 Initial value, assumes new data are not being entered.

ICHK=1 Data have been written to the output file.

ICHK=2 Data have been edited or plotted.

ICHK=3 New data have been entered or data were corrected.

4. Options which allow new data to be entered or corrected always set ICHK=3 which forces the user to use option ED or PLT before the data can be output. Options ED and PLT set ICHK=2. A final call to OUT sets ICHK=1.

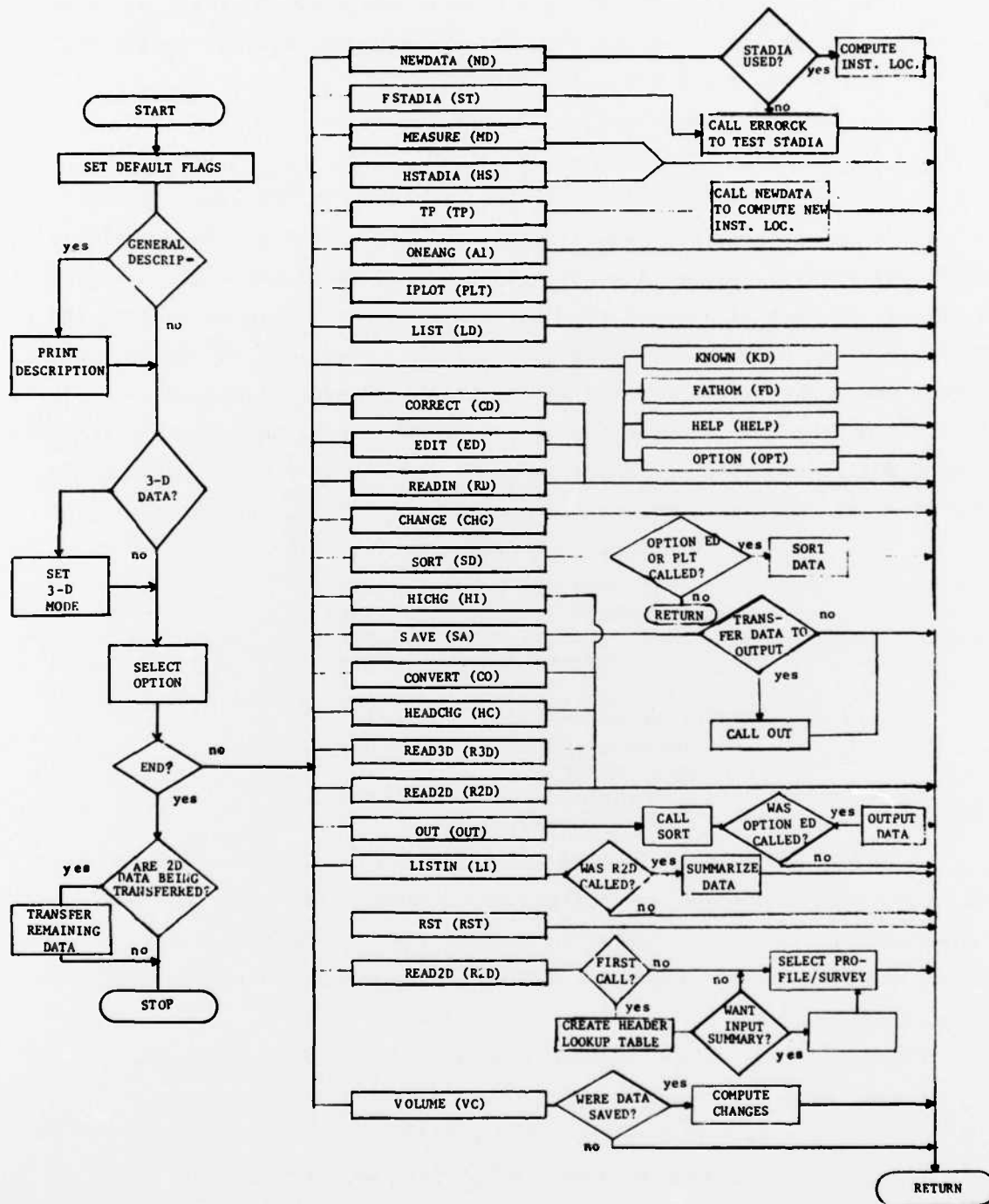

Figure C1. Schematic of ISRP program structure showing subroutines and their respective options (in parentheses)

5. Variable MOVE controls the automatic data transfer from the 2-D input to the output file. The default value is MOVE=0, which is set in the main program and which indicates that data are not to be transferred. MOVE is set equal to 2 in option R2D if data are to be transferred.

Adding a New Survey Procedure

6. The addition of a new survey procedure is straightforward and can be patterned after option A1 (subroutine ONEANG) or option MD (subroutine MEASURE). The primary difference between these is that A1 computes the instrument height and location in subroutine ONEANG, while option MD uses the instrument location determined using option ND (subroutine NEWDATA). A general schematic for an additional survey method is shown in Figure C2. This method assumes that the instrument location is to be computed (and recomputed) in the option.

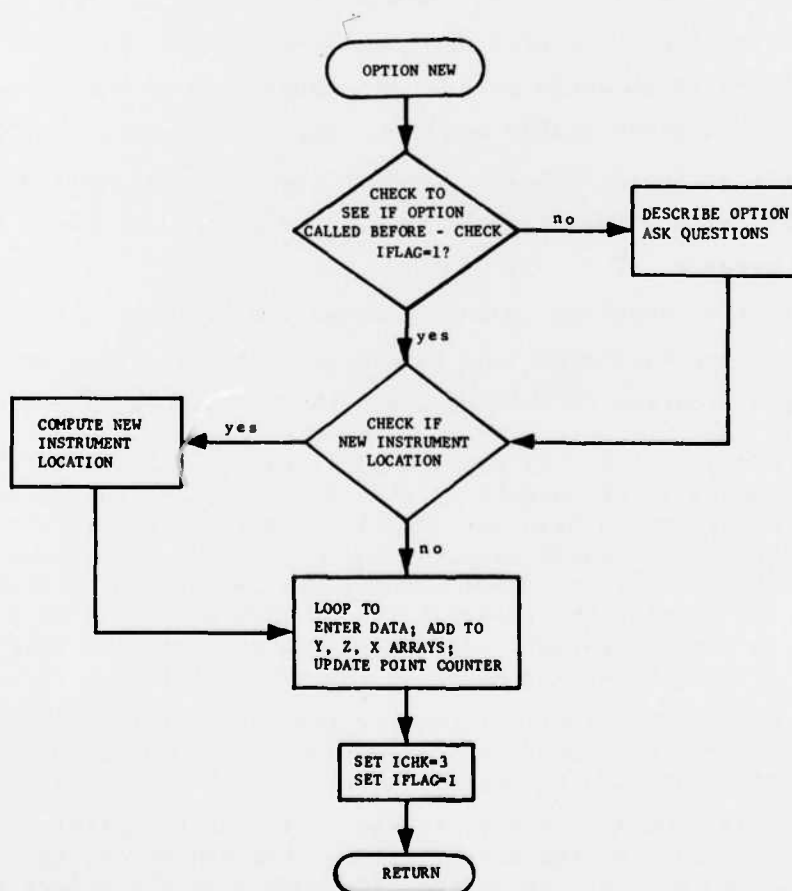

Figure C2. Suggested flowchart of new survey method option

To Change or Add an Input or Output Format

7. Depending on the user's intent, there are a number of ways to make ISRP process a different format. They are as follows:

- a. Add new routines for data input and output.
- b. Change one of the three BPAS formats to the desired format.
- c. Add a new format to those handled by ISRP.
- d. Write a short program to convert the data to one of the BPAS formats prior to using ISRP.

8. The last procedure is probably the easiest and most straightforward, and it is strongly recommended. Procedure a, though fairly simple, is undesirable since it does not maintain the unique data transfer capabilities of ISRP. These procedures are similar to the 3-D input routine (subroutine READ3D) and the 3-D part of option OUT (subroutine OUT).

9. Changing one of the BPAS formats is probably the most logical approach since it requires basically changing read and write statements and formats. The sections which would have to be changed can be found in the main program and in subroutines READ2D and OUT. These routines are well commented, and it should not be too difficult to make a change. Any additional information required by the new format would have to be placed in common statements throughout the program.

10. Another alternative is to add a new 2-D format. This can be done through modifications to subroutines READ2D (option R2D), OUT, and the main program. The modification to each of these three routines is described below:

- a. READ2D. A fairly complex modification. Add a fourth format in the table of formats so that JIN=4 denotes that a new format is being used. Also set JOUT=4 if data are being autotransferred. Use either existing questions or add new ones to obtain details about the input data. Modify the section which scans the data and creates the lookup table on TAPE13. Add a section to read in the new format. Add an output statement so unrequested data are automatically moved to the output file.
- b. OUT. Add a fourth format to the table of formats so that JOUT=4 denotes the new format. Add additional questions as needed. Add a section to output the data in the new format.
- c. MAIN PROGRAM. Add a section to transfer remaining data from the input to the output file. This can be easily done using an A1 format for the appropriate number of characters in each record.

All of the sections discussed above are well labeled in the program and are identified by comment cards.

To Modify the Plotting Subroutine

11. Two different versions of the plotting subroutine have been written, one using the Tektronix Advanced Graphing and Terminal Control System (AGIITCS) software and one using the Army Corps of Engineers Graphics Compatibility System (GCS) software.

12. Users wanting to use different plotting software can develop the required plotting subroutine by changing the code in the IPLOT subroutine. The IPLOT subroutine is divided into two sections: the first section asks questions about the details of the plot (whether one or two lines are to be plotted, if symbols are to be used, etc.); the second section does the plotting. Only the second section must be changed, and it is clearly commented, explaining at each step what part of the plot is being done.

Data Comparison

13. The data comparisons performed by option PLT (subroutine IPLOT) and VC (subroutine VOLUME) compare the data in program control (arrays Y, Z, and X) with data stored using option SA (subroutine SAVE). Subroutine SAVE copies the data into the YOLD and ZOLD arrays and stores the following other information:

<u>Variable</u>	<u>Variable Name</u>	<u>Saved Variable Name</u>
Profile number	I PROF	T IPOLD
Date	I DATE	T IDTEOLD
Units	I UNIT	T IOLDU
Number of points	I	T IOLD

The stored data are passed to the various subroutines with common block "OLDDATA." Data once saved cannot be recalled; however, they continue to exist in program control until a new profile-survey is read or entered.

FORTRAN Read and Write Units

14. ISRP makes use of up to 10 different internal files during a typical run. These files are used to input and output data and to keep track of the automatic transfer from the 2-D input file to the 2-D output file. The tabulation below summarizes these files.

<u>Unit</u>	<u>File Name</u>	<u>Purpose</u>
5	TAPE5	Terminal entry
6	TAPE6	Terminal output
7	TAPE7	2-D BPAS format input file
8	TAPE8	2-D BPAS format output file
9	TAPE9	3-D output file
10	TAPE10	Scratch file used to avoid losing data due to a program crash
11	TAPE11	Used by the Corps Graphic Compatibility System (GCS) plot version of subroutine IPLOT
12	TAPE12	3-D input file
13	TAPE13	Lookup table of the data on TAPE7
14	TAPE14	Copy of all output from option VC; should be routed to a printer after execution
16	TAPE16	Scratch tape which is used in conjunction with TAPE13 to provide a smooth program recovery after an unsuspected program interrupt (used only with autotransfer)

15. Use of file name TAPE7 for FORTRAN Unit 7 is a convention required by the system used to develop ISRP. Continued use of this convention is suggested since these files are referred to in many ISRP messages.

Units of the Data

16. ISRP's flexibility with units of measurement (FT or M) is controlled by variables IUNIT and IUIN. Both variables are characters of format A2 and can equal "FT" or "M_". The two variables have the following uses:

- a. IUNIT (the units of the data in program control). These are set initially to FT but can be changed with options CO or HC. Data are output according to variable IUNIT.
- b. IUIN (the units of the data being input). This is set in option ND (subroutine NEWDATA) and is used to reset IUNIT during each use of option ND.

Variable IUNIT is also reset with each use of options R2D and R3D, allowing data in different units to be read in.

17. Option OUT checks the value of IUNIT before data are output to ensure that it is the same as the value for the first data output. This prevents the accidental output of mixed-unit data.

How the Program Restart Works

18. Because use of ISRP requires long sessions on the computer, the possibility of an unexpected program termination exists. This can have grave consequences in terms of lost or missing data, particularly when data are being autotransferred from the input to the output file (see paragraphs 62-76). Except under certain situations, ISRP is able to correctly restart by using file TAPE13 and, if autotransferring data, file TAPE16 (FORTRAN read and write units 13 and 16). These are defined as scratch files and are released following normal program termination.

19. During the first use of option R2D, it attempts to read TAPE13; if the option finds that TAPE13 exists, it then knows that the program is being restarted. TAPE16 is a one-line file that includes the profile and survey number of the last data read from the 2-D input file. Once the restart has been detected and TAPE16 has been read, the program is restarted and data may continue to be read and autotransferred from the input file.

20. A proper restart requires the following:

- a. That all output buffers were flushed when the program terminated.
- b. That output files TAPE8 and TAPE9 were not rewound prior to restarting.
- c. That the termination did not occur during use of options OUT or R2D (though results may be okay).

21. Though the restart procedure should work on any computer system, it should be tested on any new installation.

Option Deletion

22. Because of the length of ISRP, the user may wish to delete unused options. This can be easily done by deleting the subroutine, the call to the subroutine, and the line referring to the deleted option in the options list.

All calls to option subroutines are made from the main program (with the exceptions noted in Figure C1). You might also want to drop the deleted options from RST and HELP.

APPENDIX D: INSTALLATION-SPECIFIC INSTRUCTIONS

1. Actual use of ISRP will vary slightly with each installation. This appendix addresses the execution procedure in general. Once a procedure is established, a description of it should be added to this appendix.

2. For convenience, store the source code for ISRP under a recognizable file name such as ISRPS or ISRPSOU. Similarly, store the compiled code under ISRPLGO or ISRPRUN.

3. Program execution requires the following steps:

- a. Request the compiled version of ISRP (ISRPRUN).
- b. Attach the 2-D input file to TAPE7 (or unit 7)**optional**.
- c. Attach the 3-D input file to TAPE12 (or unit 12)**optional**.
- d. If necessary, extend the time limit.
- e. Connect TAPE5 and TAPE6 (Units 5 and 6) to the terminal for terminal input and output.
- f. Ensure that output buffers will be properly flushed if the program unexpectedly terminates.
- g. Attach and load the plotting software.
- h. Execute ISRP.
- i. After normal execution:
 - (1) Make the 2-D output file (TAPE8 or Unit 8) a permanent file.
 - (2) Make the 3-D output file (TAPE9 or Unit 9) a permanent file (if processing 3-D data).
 - (3) Route TAPE14 (or Unit 14) to a printer to print out volume change tables **optional**.
 - (4) Return TAPE10, TAPE13, and TAPE16 (or Units 10, 13, 16).
- j. After an abnormal termination,
 - (1) Do not make the output files permanent.
 - (2) Do not rewind either output file (TAPE8 or TAPE9).
 - (3) Do not return any files.

4. All of the above steps can usually be combined into an easy-to-use procedure which requires the user to specify only the names of the input and output files.

END

FILMED

4-85

DTIC