

AD-A142 584

HOUSATONIC RIVER BASIN WATERBURY CONNECTICUT EAST
MOUNTAIN RESERVOIR DAM..(U) CORPS OF ENGINEERS WALTHAM
MA NEW ENGLAND DIV DEC 79

1/1

UNCLASSIFIED

F/G 13/13

NL

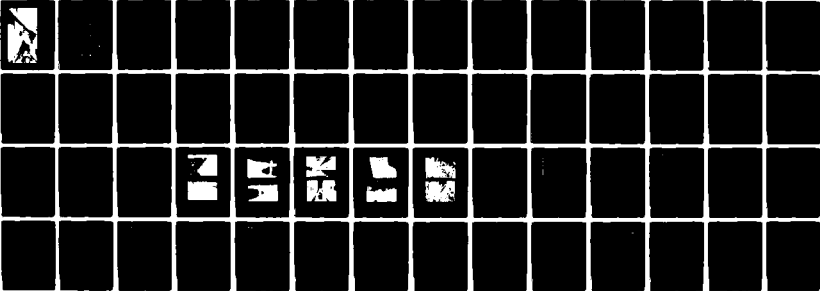

END
DATE
FILMED
8-84
DTIC

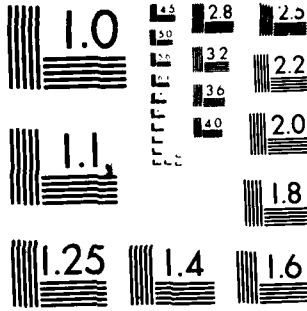

MICROCOPY RESOLUTION TEST CHART
NATIONAL BUREAU OF STANDARDS-1963-A

(1)

HOUSATONIC RIVER BASIN

WATERBURY, CONNECTICUT

**EAST MOUNTAIN RESERVOIR DAM
CT 00032**

AD-A142 584

**PHASE I INSPECTION REPORT
NATIONAL DAM INSPECTION PROGRAM**



DTIC
ELECT
JUL 2 1984
S
A

**DEPARTMENT OF THE ARMY
NEW ENGLAND DIVISION, CORPS OF ENGINEERS
WALTHAM, MASS. 02154**

DECEMBER, 1979

This document has been approved
for public release and sale; its
distribution is unlimited.

DTIC FILE COPY

84 06 29 072

~~CLASSIFIED~~

SECURITY CLASSIFICATION OF THIS PAGE (When Data Entered)

REPORT DOCUMENTATION PAGE		READ INSTRUCTIONS BEFORE COMPLETING FORM
1. REPORT NUMBER CT. 00032	2. GOVT ACCESSION NO. AM2584	3. RECIPIENT'S CATALOG NUMBER
4. TITLE (and Subtitle) East Mountain Reservoir Dam Housatonic River Basin, Waterbury, Conn. NATIONAL PROGRAM FOR INSPECTION OF NON-FEDERAL DAMS		5. TYPE OF REPORT & PERIOD COVERED INSPECTION REPORT
7. AUTHOR(s) U.S. ARMY CORPS OF ENGINEERS NEW ENGLAND DIVISION		6. PERFORMING ORG. REPORT NUMBER
9. PERFORMING ORGANIZATION NAME AND ADDRESS		8. CONTRACT OR GRANT NUMBER(s)
11. CONTROLLING OFFICE NAME AND ADDRESS DEPT. OF THE ARMY, CORPS OF ENGINEERS NEW ENGLAND DIVISION, NEDED 424 TRAPELO ROAD, WALTHAM, MA. 02254		10. PROGRAM ELEMENT, PROJECT, TASK AREA & WORK UNIT NUMBERS
14. MONITORING AGENCY NAME & ADDRESS (if different from Controlling Office)		12. REPORT DATE December 1979
		13. NUMBER OF PAGES 75
		15. SECURITY CLASS. (of this report) UNCLASSIFIED
		15a. DECLASSIFICATION/DOWNGRADING SCHEDULE
16. DISTRIBUTION STATEMENT (of this Report) APPROVAL FOR PUBLIC RELEASE: DISTRIBUTION UNLIMITED		
17. DISTRIBUTION STATEMENT (of the abstract entered in Block 20, if different from Report)		
18. SUPPLEMENTARY NOTES Cover program reads: Phase I Inspection Report, National Dam Inspection Program; however, the official title of the program is: National Program for Inspection of Non-Federal Dams; use cover date for date of report.		
19. KEY WORDS (Continue on reverse side if necessary and identify by block number) DAMS, INSPECTION, DAM SAFETY, Waterbury, Conn. East Mountain Reservoir Dam Housatonic River Basin		
20. ABSTRACT (Continue on reverse side if necessary and identify by block number) The dam, built in the late 1800's, consists of an earthfill embankment with a concrete corewall and two gate gouses. The dam is 400+ ft. long and 12 ft. wide at the top. The upstream slope is riprapped to the top of the dam and the downstream slope is covered with grass and has two 12 ft. wide berms at elevations 683.8 and 673.8. The top of the dam has a crushed stone cover and at elevation 694.3 is 35 ft. above the streambed of East Mountain Brook. A concrete corewall extends 375 ft. along the axis of the dam with the top of the corewall 2.5 ft. below the dam crest or at elevation 691.8. There are two gate houses, the service gate house downstream toe of the dam. The drain gate house contains the valves for the low level drain outlet.		



DEPARTMENT OF THE ARMY
NEW ENGLAND DIVISION, CORPS OF ENGINEERS
424 TRAPELO ROAD
WALTHAM, MASSACHUSETTS 02154

REPLY TO
ATTENTION OF:

NEDED-E

JUL 29 1980

Honorable Ella T. Grasso
Governor of the State of Connecticut
State Capitol
Hartford, Connecticut 06115

Dear Governor Grasso:

Inclosed is a copy of the East Mountain Reservoir Dam Phase I Inspection Report, which was prepared under the National Program for Inspection of Non-Federal Dams. The report is based upon a visual inspection, a review of past performance, and a preliminary hydrological analysis. A brief assessment is included at the beginning of the report.

The preliminary hydrologic analysis has indicated that the spillway capacity for the East Mountain Reservoir Dam would likely be exceeded by floods greater than 3 percent of the Probable Maximum Flood (PMF), the test flood for spillway adequacy. Our screening criteria specifies that a dam of this class which does not have sufficient spillway capacity to discharge fifty percent of the PMF, should be adjudged as having a seriously inadequate spillway and the dam assessed as unsafe, non-emergency, until more detailed studies prove otherwise or corrective measures are completed.

The term "unsafe" applied to a dam because of an inadequate spillway does not indicate the same degree of emergency as that term would if applied because of structural deficiency. It does indicate, however, that a severe storm may cause overtopping and possible failure of the dam, with significant damage and potential loss of life downstream.

It is recommended that within twelve months from the date of this report the owner of the dam engage the services of a professional or consulting engineer to determine by more sophisticated methods and procedures the magnitude of the spillway deficiency. Based on this determination, appropriate remedial mitigating measures should be designed and completed within 24 months of this date of notification. In the interim a detailed emergency operation plan and warning system should be promptly developed. During periods of unusually heavy precipitation, round-the-clock surveillance should be provided.

HOUSATONIC RIVER BASIN

WATERBURY, CONNECTICUT

**EAST MOUNTAIN RESERVOIR DAM
CT 00032**

PHASE I INSPECTION REPORT
NATIONAL DAM INSPECTION PROGRAM



DEPARTMENT OF THE ARMY
NEW ENGLAND DIVISION, CORPS OF ENGINEERS
WALTHAM, MASS. 02154

DECEMBER, 1979

BRIEF ASSESSMENT

PHASE I INSPECTION REPORT

NATIONAL PROGRAM OF INSPECTION OF DAMS

Name of Dam: EAST MOUNTAIN RESERVOIR DAM
Inventory Number: CT 00032
State Located: CONNECTICUT
County Located: NEW HAVEN
Town Located: WATERBURY
Stream: EAST MOUNTAIN BROOK
Owner: WATER DEPARTMENT, CITY OF WATERBURY
Date of Inspection: NOVEMBER 7, 1979
Inspection Team: PETER M. HEYNEN, P.E.
MIRON PETROVSKY
HECTOR MORENO, P.E.
JAY COSTELLO

The dam, built in the late 1800's, consists of an earthfill embankment with a concrete corewall and two gate houses. The dam is 400+ feet long and 12 feet wide at the top. The upstream slope is riprapped to the top of the dam and the downstream slope is covered with grass and has two 12 foot wide berms at elevations 683.8 and 673.8. The top of the dam has a crushed stone cover and at elevation 694.3 is 35 feet above the streambed of East Mountain Brook. A concrete corewall extends 375 feet along the axis of the dam with the top of the corewall 2.5 feet below the dam crest or at elevation 691.8. There are two gate houses, the service gate house at the right upstream end of the dam and the drain gate house at the downstream toe of the dam. The drain gate house contains the valves for the low-level drain outlet and the service gate house contains the facilities for an abandoned water supply line. There is no spillway or any other operational outlet facility other than the low-level outlet.

The overall condition of the project appears to be good, however there are areas requiring maintenance and monitoring. No evidence of instability was observed in the dam or appurtenant structures. Based upon the visual inspection at the site, past performance and the lack of a spillway at the dam, the project is judged to be in fair condition.

In accordance with the Army Corps of Engineers' Guidelines for size (small) and hazard (high) classification for the dam, the test flood may be considered in the range from one-half the Probable Maximum Flood ($\frac{1}{2}$ PMF) to the Probable Maximum Flood (PMF). The test flood for East Mountain Reservoir Dam is considered to be equivalent to the PMF. Peak inflow to the reservoir at the PMF is 1400 cfs; peak outflow, assuming a normal pool elevation of 691.0, is 910 cfs with the dam overtopped 0.9 feet. The low-level outlet has a capacity of 28 cfs with the reservoir level to the top of the dam, which is 3% of the routed test flood outflow.

It is recommended that the owner retain the services of a registered professional engineer to perform a more detailed hydraulic/hydrologic analysis to determine the adequacy of the project discharge. Other recommendations include inspection of the low-level outlet for seepage, gating the outlet upstream, and identification of the origin and significance of flow from the 6 inch pipe in the discharge channel.

The above recommendations and further remedial measures which are discussed in Section 7, should be instituted within 1 year of the owner's receipt of this report.



Peter M. Heynen, P.E.
Project Manager
Cahn Engineers, Inc.

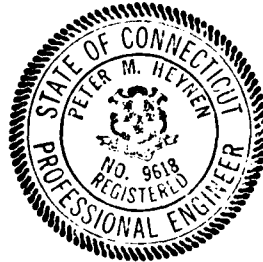



Edgar B. Vinal, Jr., P.E.
Senior Vice President
Cahn Engineers, Inc.

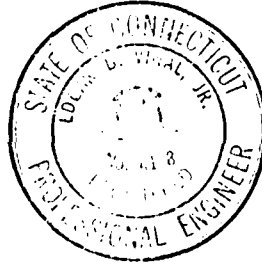

This Phase I Inspection Report on East Mountain Reservoir Dam has been reviewed by the undersigned Review Board members. In our opinion, the reported findings, conclusions, and recommendations are consistent with the Recommended Guidelines for Safety Inspection of Dams, and with good engineering judgment and practice, and is hereby submitted for approval.

Carney M. Terzian

CARNEY M. TERZIAN, MEMBER
Design Branch
Engineering Division

Richard J. DiBuono

RICHARD DIBUONO, MEMBER
Water Control Branch
Engineering Division

Aramast Mahtesian

ARAMAST MAHTESIAN, CHAIRMAN
Geotechnical Engineering Branch
Engineering Division

APPROVAL RECOMMENDED:

Joe B. Fryar

JOE B. FRYAR
Chief, Engineering Division

PREFACE

This report is prepared under guidance contained in the Recommended Guidelines for Safety Inspection of Dams, for Phase I Investigations. Copies of these guidelines may be obtained from the Office of Chief of Engineers, Washington, D.C. 20314. The purpose of a Phase I Investigation is to identify expeditiously those dams which may pose hazards to human life or property. The assessment of the general condition of the dam is based upon available data and visual inspection. Detailed investigation, and analyses involving topographic mapping, subsurface investigations, testing, and detailed computational evaluations are beyond the scope of a Phase I Investigation; however, the investigation is intended to identify any need for such studies.

In reviewing this report, it should be realized that the reported condition of the dam is based on observations of field conditions at the time of inspection along with data available to the inspection team. In cases where the reservoir was lowered or drained prior to inspection, such action, while improving the stability and safety of the dam, removes the normal load on the structure and may obscure certain conditions which might otherwise be detectable if inspected under the normal operating environment of the structure.

It is important to note that the condition of a dam depends on numerous and constantly changing internal and external conditions, and is evolutionary in nature. It would be incorrect to assume that the present condition of the dam would necessarily represent the condition of the dam at some point in the future. Only through continued care and inspection can there be any chance that unsafe conditions will be detected.

Phase I inspections are not intended to provide detailed hydrologic and hydraulic analyses. In accordance with the established Guidelines, the Spillway Test Flood is based on the estimated "Probable Maximum Flood" for the region (greatest reasonably possible storm runoff), or fractions thereof. Because of the magnitude and rarity of such a storm event, a finding that a spillway will not pass the test flood should not be interpreted as necessarily posing a highly inadequate condition. The test flood provides a measure of relative spillway capacity and serves as an aid in determining the need for more detailed hydrologic and hydraulic studies, considering the size of the dam, its general condition and the downstream damage potential.

The Phase I Investigation does not include an assessment of the need for fences, gates, no-trespassing signs, repairs to existing fences and railings and other items which may be needed to minimize trespass and provide greater security for the facility and safety to the public. An evaluation of the project for compliance with OSHA rules and regulations is also excluded.

TABLE OF CONTENTS

	<u>Page</u>
Letter of Transmittal	
Brief Assessment	i, ii
Review Board Signature Page	iii
Preface	iv
Table of Contents	v-vii
Overview Photo	viii
Location Map	ix
SECTION 1: PROJECT INFORMATION	
1.1 <u>General</u>	1-1
a. Authority	
b. Purpose of Inspection Program	
c. Scope of Inspection Program	
1.2 <u>Description of Project</u>	1-2
a. Location	
b. Description of Dam and Appurtenances	
c. Size Classification	
d. Hazard Classification	
e. Ownership	
f. Operator	
g. Purpose of Dam	
h. Design and Construction History	
i. Normal Operational Procedures	
1.3 <u>Pertinent Data</u>	1-3
a. Drainage Area	
b. Discharge at Damsite	
c. Elevations	
d. Reservoir	
e. Storage	
f. Reservoir Surface	
g. Dam	
h. Diversion and Regulatory Tunnel	
i. Spillway	
j. Regulating Outlets	
SECTION 2: ENGINEERING DATA	
2.1 <u>Design</u>	2-1
a. Available Data	
b. Design Features	
c. Design Data	

2.2	<u>Construction</u>	2-1
	a. Available Data	
	b. Construction Considerations	
2.3	<u>Operations</u>	2-1
2.4	<u>Evaluation</u>	2-1
	a. Availability	
	b. Adequacy	
	c. Validity	
 SECTION 3: VISUAL INSPECTION		
3.1	<u>Findings</u>	3-1
	a. General	
	b. Dam	
	c. Appurtenant Structures	
	d. Reservoir Area	
	e. Downstream Channel	
3.2	<u>Evaluation</u>	3-2
 SECTION 4: OPERATIONAL PROCEDURES		
4.1	<u>Regulating Procedures</u>	4-1
4.2	<u>Maintenance of Dam</u>	4-1
4.3	<u>Maintenance of Operating Facilities</u> ..	4-1
4.4	<u>Description of Any Warning System in Effect</u>	4-1
4.5	<u>Evaluation</u>	4-1
 SECTION 5: HYDRAULIC/HYDROLOGIC		
5.1	<u>Evaluation of Features</u>	5-1
	a. General	
	b. Design Data	
	c. Experience Data	
	d. Visual Observations	
	e. Test Flood Analysis	
	f. Dam Failure Analysis	
 SECTION 6: STRUCTURAL STABILITY		
6.1	<u>Evaluation of Structural Stability</u> ...	6-1
	a. Visual Observations	
	b. Design and Construction Data	
	c. Operating Records	
	d. Post Construction Changes	
	e. Seismic Stability	

SECTION 7: ASSESSMENT, RECOMMENDATIONS & REMEDIAL MEASURES

7.1	<u>Dam Assessment</u>	7-1
	a. Condition	
	b. Adequacy of Information	
	c. Urgency	
7.2	<u>Recommendations</u>	7-1
7.3	<u>Remedial Measures</u>	7-2
	a. Operation and Maintenance Procedures	
7.4	<u>Alternatives</u>	7-2

APPENDICES

		<u>Page</u>
APPENDIX A:	<u>INSPECTION CHECKLIST</u>	A-1 to A-5
APPENDIX B:	<u>ENGINEERING DATA AND CORRESPONDENCE</u>	
	Dam Plan, Profile and Sections	Sheet B-1
	List of Existing Plans	B-1
	Summary of Data and Correspondence	B-2
	Data and Correspondence	B-3
APPENDIX C:	<u>DETAIL PHOTOGRAPHS</u>	
	Photograph Location Plan	Sheet C-1
	Photographs	C-1 to C-5
APPENDIX D:	<u>HYDRAULIC/HYDROLOGIC COMPUTATIONS</u>	
	Drainage Area Map	Sheet D-1
	Computations	D-1 to D-9
	Preliminary Guidance for Estimating Maximum Probable Discharges	i to viii
APPENDIX E:	<u>INFORMATION AS CONTAINED IN THE NATIONAL INVENTORY OF DAMS</u>	E-1



OVERVIEW PHOTO
(November 1979)

US ARMY ENGINEER DIV NEW ENGLAND
CORPS OF ENGINEERS
WALTHAM, MASS

CAHN ENGINEERS INC.
WALLINGFORD, CONN
ENGINEER

NATIONAL PROGRAM OF
INSPECTION OF
NON-FED DAMS

East Mountain Reservoir Dam
EAST MOUNTAIN BROOK

Waterbury
CONNECTICUT

DATE Dec 1979
CE #27 660 KE
PAGE VIII

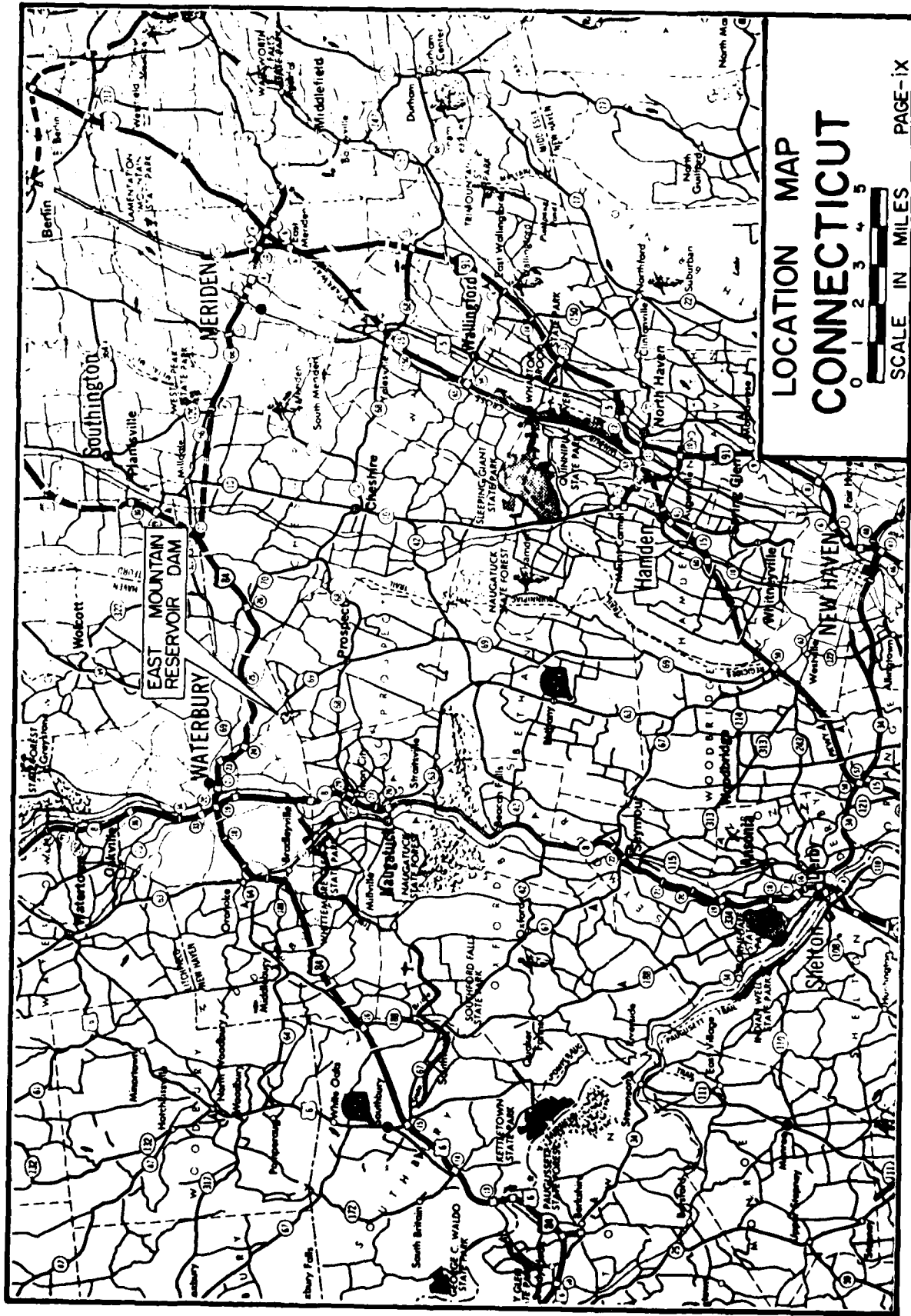

LOCATION MAP
CONNECTICUT

SCALE IN MILES



PHASE I INSPECTION REPORT
EAST MOUNTAIN RESERVOIR DAM
SECTION I - PROJECT INFORMATION

1.1 GENERAL

a. Authority - Public Law 92-367, August 8, 1972, authorized the Secretary of the Army, through the Corps of Engineers, to initiate a National Program of Dam Inspection throughout the United States. The New England Division of the Corps of Engineers has been assigned the responsibility of supervising the inspection of dams within the New England Region. Cahn Engineers, Inc. has been retained by the New England Division to inspect and report on selected dams in the State of Connecticut. Authorization and notice to proceed were issued to Cahn Engineers, Inc. under a letter of October 15, 1979 from William E. Hodgson, Jr. Colonel, Corps of Engineers. Contract No. DACW 33-79-C-0059 has been assigned by the Corps of Engineers for this work.

b. Purpose of Inspection Program - The purposes of the program are to:

1. Perform technical inspection and evaluation of non-federal dams to identify conditions requiring correction in a timely manner by non-federal interests.
2. Encourage and prepare the States to quickly initiate effective dam inspection programs for non-federal dam.
3. To update, verify and complete the National Inventory of Dams.

c. Scope of Inspection Program - The scope of this Phase I inspection report includes:

1. Gathering, reviewing and presenting all available data as can be obtained from the owners, previous owners, the state and other associated parties.
2. A field inspection of the facility detailing the visual condition of the dam, embankments and appurtenant structures.
3. Computations concerning the hydraulics and hydrology of the facility and its relationship to the calculated flood through the existing spillway.
4. An assessment of the condition of the facility and corrective measures required.

It should be noted that this report does not pass judgement on the safety or stability of the dam other than on a visual basis. The inspection is to identify those features of the dam which need corrective action and/or further study.

1.2 DESCRIPTION OF PROJECT

a. Location - The dam is located on East Mountain Brook in a rural area of the City of Waterbury, County of New Haven, State of Connecticut. The dam is shown on the Waterbury USGS Quadrangle Map having coordinates latitude N 41° 31.7' and longitude W 73° 00.3'.

b. Description of Dam and Appurtenances - The dam is 400+ feet long, 35 feet high and 12 feet wide at the top. The upstream slope is inclined at 2 horizontal to 1 vertical and has a dumped riprap protection to the top of the dam. There are two 12 foot wide berms on the downstream slope, one at elevation 683.8 and one at 673.8. The downstream slope is grass covered and has an inclination of 2 horizontal to 1 vertical above the upper berm, 2.5 horizontal to 1 vertical above the lower berm, and 3 horizontal to 1 vertical at the toe. The top of the dam is covered with crushed stone and has a maximum elevation of 694.3. The concrete corewall is 375 feet long and has a top elevation of 691.8. The corewall is 37+ feet high, 2.5 feet below the crest of the dam, 3.5 feet wide at the base, and 16 inches wide at the top (See Sheet B-1).

The dam has two gate houses, a drain gate house and a service gate house. The drain gate house, which is located at the downstream toe of the dam, houses two 16 inch control valves which are situated one behind the other on the 16 inch low-level outlet pipe. The service gate house is located at the right upstream end of the dam and has two low-level intake valves, two upper level intake valves, two 14 inch outlet valves to the water supply lines and two waste water outlet valves (See page B-4).

The inlet structure for the low-level outlet pipe is located 85+ feet upstream from the crest of the dam. The pipe is a 20 inch concrete lined pipe (inlet invert elevation 663.5) that extends from the inlet structure to the corewall, where it reduces to a 16 inch cast iron pipe before continuing to the drain gate house (See Sheet B-1). This 20/16 inch pipe terminates at a stone and mortar masonry headwall (invert elevation 661.1) just downstream from the gate house. From the headwall, a stone and mortar masonry discharge channel extends 65+ feet to a 36 inch reinforced concrete pipe culvert under Route 69. This discharge channel is 6+ feet wide and has a 6 inch cast iron pipe protruding from the right wall approximately 18 feet from the drain gate house. The exact direction and use for this pipe was not determined. No spillway section exists at the dam.

c. Size Classification - SMALL - The dam impounds 540 acre-feet of water with the reservoir level at the top of the dam, which at elevation 694.3, is 35 feet above the streambed of East Mountain Brook. According to the Recommended Guidelines, a dam with this height and storage capacity is classified as small in size.

d. Hazard Classification - HIGH - If the dam were to be breached, there is potential for loss of life and extensive property damage at several private residences, a church, a school and an apartment complex, all of which are directly downstream and across Route 69 from the dam.

There were two cases of possible failure considered. One, if the highway embankment at the base of the dam fails along with the breach of the dam, and the other by overtopping of this embankment upon failure of the dam. If the highway embankment fails, the resulting outflow will be 31,000 cfs and the water level will rise 15+ feet, or to a depth of 5 feet above Route 69. If the highway embankment does not fail, the peak failure outflow will be 18,000 cfs with the water level rising to a depth 10 feet above Route 69. In either case, a breach of the dam would inundate structures at the initial impact area as well as present a danger to structures all along East Mountain Brook and Route 69 downstream from the dam.

e. Ownership - Water Department, City of Waterbury
21 East Aurora Street
Waterbury, Conn.
Mr. Leonard Assard (203) - 283-9139

f. Operator - Ben Ebner (Superintendent of Water)
(203) 574-8251

g. Purpose of Dam - The dam was originally built to supplement water supply storage capacity for the City of Waterbury. However, the facilities at the dam for drawing water have been abandoned since 1955 and the reservoir is now used only as a recreational facility.

h. Design and Construction History - The following information is believed to be accurate based on the plans and correspondence available. The original dam was constructed in the late 1800's and was a smaller earthfill embankment than the existing dam. The dam was reconstructed to its present configuration in 1921. At this time the dam was raised 2.5 feet, the downstream slope was flattened, and a concrete corewall and two new gate houses were added. This addition to the dam was engineered by the Waterbury Bureau of Engineering.

i. Normal Operational Procedures - The dam is no longer used as an operational water supply facility. The valves at the service gate house are closed and have not been operated since 1955, and it was reported by the owner that "it would take at least a week to get it operational." The owner also reported that a set of blow-off valves were installed on the supply lines about 500 feet downstream so the pipes can be checked for leakage periodically. The two valves at the drain gate house are located one just behind the other with the upstream valve maintained in an open position and the downstream valve used to control flow. The water level is normally maintained at elevation 691.0 but is lowered in anticipation of storms and during the winter to prevent vandalism to the service gate house.

1.3 PERTINENT DATA

a. Drainage Area - .57 square miles of highly developed rolling terrain which is about 40% open.

b. Discharge at Damsite - Discharge is through the 16 inch low-level outlet at the drain gate house.

1. Outlet works (conduits):

20 inch pipe to corewall,
16 inch pipe from corewall to
drain gate house outlet,
16 inch outlet invert
el. 661.1:

28 cfs @ 32 feet of head

2-14 inch supply lines
from service gate house:

Unknown

2. Maximum known flood @ damsite: Unknown

3. Ungated spillway capacity
@ top of dam: N/A

4. Ungated spillway capacity
@ test flood: N/A

5. Gated spillway capacity
@ normal pool: N/A

6. Gated spillway capacity
@ test flood: N/A

7. Total spillway capacity
@ test flood: N/A

8. Total project discharge @
test flood el. 695.2: 910 cfs

c. Elevations (National Geodetic Vertical Datum)

1. Streambed @ toe of dam: 660+

2. Maximum tailwater: N/A

3. Upstream portal invert
diversion tunnel: N/A

4. Recreation pool: 691.0

5. Water supply pool: N/A

6. Spillway crest: N/A

7. Design surcharge
(original design): Unknown

8. Top of dam: 694.3

9. Test flood surcharge: 695.2

d. Reservoir

1. Length of maximum pool: 3000 ft.
2. Length of recreation pool: 2800 ft.
3. Length of flood control pool: N/A

e. Storage

1. Recreation pool: 420 acre-ft.
2. Flood control pool: N/A
3. Water supply pool: N/A
4. Top of dam: 580 acre-ft.
5. Test flood pool: 630 acre-ft.

f. Reservoir Surface

1. Recreation pool: 36 acres
2. Flood control pool: N/A
3. Water supply pool: N/A
4. Top of dam: 46 acres
5. Test flood pool: 50 acres

g. Dam

1. Type: Earthfill embankment
2. Length: 400 ft.
3. Height: 35 ft.
4. Top width: 12 ft.
5. Size slopes: 2H to 1V Upstream
2-3H to 1V Downstream
6. Zoning: N/A
7. Impervious core: Concrete corewall
8. Cutoff: N/A
9. Grout curtain: N/A
10. Other: N/A

h. Diversion and Regulatory Tunnel - N/A

i. Spillway - N/A

j. Regulating Outlets - 20 inch concrete lined inlet pipe to corewall, reducing to a 16 inch cast iron pipe to drain gate house outlet.

1. Invert: 661.1 (downstream)
2. Size: 20/16 inch
3. Description: 20/16 inch outlet pipe valved at draingate house
4. Control mechanism: 2 - 16 inch cast iron valves in series and controlled by two hand operated gate stands
5. Other: 2 - abandoned 14" supply lines from service gate house.

SECTION 2: ENGINEERING DATA

2.1 DESIGN

a. Available Data - The available data consists of drawings showing the reconstruction of the dam in 1921. The drawings were done by the Bureau of Engineering, Waterbury, Connecticut. Also available is an Inventory Data sheet from the Connecticut Department of Environmental Protection.

b. Design Features - The drawings and data indicate the design features stated previously in this report.

c. Design Data - There are no engineering values, assumptions, test results or calculations available for the original construction or subsequent reconstruction of the dam in 1921.

2.2 CONSTRUCTION

a. Available Data - There are no as-built drawings or construction inspection records available for either the original dam or for the reconstruction to its present configuration.

b. Construction Considerations - No information was available.

2.3 OPERATIONS

Lake level readings are not taken at any specified interval. According to the owner, the dam has never been overtopped. No formal operations records are known to exist.

2.4 EVALUATION

a. Availability - Existing data was provided by the owner and the Connecticut Department of Environmental Protection. The owner made the project available for visual inspection.

b. Adequacy - The limited amount of detailed engineering data available was generally inadequate to perform an in-depth assessment of the dam, therefore, the assessment of this dam must be based on visual inspection, performance history, hydraulic computations of spillway capacity and approximate hydrologic judgments.

c. Validity - A comparison of record data and visual observation reveals no significant discrepancies in the record data.

SECTION 3: VISUAL INSPECTION

3.1 FINDINGS

a. General - The general condition of the project is fair. The inspection revealed areas requiring maintenance, monitoring and repair. The reservoir level was at elevation 691.5 or 2.8 feet below the top of the dam at the time of the inspection. There is no spillway at the dam.

b. Dam

Crest - The crest appears to be in good condition (Photo 1). No cracks, erosion or depressions were observed on the crest.

Upstream Slope - The dumped riprap on the upstream slope appeared to be in good condition (Photo 1) except for the left side of the dam where there is a visible erosion zone with no riprap (Photo 4). The stone wall along the left shore is in poor condition with several areas deteriorating and stones falling into the reservoir.

Downstream Slope - The downstream slope and berms are well maintained and in good condition (Photo 2). No cracks, sloughing, seepage or wet areas were observed at the downstream slope or toe of the dam.

Seepage was found at a large gulley further downstream below East Mountain Road (Photo 10). The seep is located about 200 feet downstream from the left end of the dam crest and is lower in elevation than the toe of the dam. The flow from the seep was 3 to 4 gallons per minute (gpm) and water was clear. The origin of the source for this seep was not determined.

c. Appurtenant Structures - The abandoned service gate house located at the right upstream side of the dam (Photo 1) is in good condition. Some spalling of the concrete on the northern corner of the gate house was observed. An examination of the inside of the concrete chamber did not reveal any leaks through the concrete walls.

The concrete and brick drain gate house at the downstream toe is in good condition (Photos 2 and 5). No damage to the concrete or seepage through the concrete chamber walls was noted. The valve stem at the upstream side of the gate house is leaking. Water from this leak was flowing out to the discharge channel through a 4 inch tile drain pipe at a rate of 1 to 2 gpm.

The stone masonry outlet headwall for the drain gate house and the stone masonry walls for the discharge channel are in satisfactory condition. There is some minor damage at the mortar joint around the 16 inch outlet pipe (Photo 7). Several vertical transverse cracks were noted in the stone masonry walls of the discharge channel. The openings of these cracks are 1/16 to 1/8 inches (Photo 8).

There are a number of seepage spots on the right wall of the discharge channel approximately 10 to 12 feet from the outlet (Photo 8). The outlet for a 6 inch metal pipe is located on the right wall of the discharge channel approximately 16 feet downstream from the outlet headwall (Photos 5 and 6). The origin of this pipe was not determined and the rate of flow from this pipe was 6+ gpm.

Debris was observed on the floor of the discharge channel including stones, tree branches and a piece of a metal pipe (Photos 5 and 6). The concrete headwalls of the 36 inch culvert under Route 69 appear to be in good condition (Photos 6 and 9). No cracks or concrete spalling was observed.

d. Reservoir Area - The area surrounding the reservoir is substantially developed and about 40% open. Route 69 runs along the eastern shore of the reservoir adjacent to the dam. There are several erosion zones along this portion of the shore where the masonry retaining walls constructed for bank reinforcing are cracked and falling into disrepair.

e. Downstream channel - The downstream channel of the dam is the streambed of East Mountain Brook. This area is a heavily developed residential area.

3.2 EVALUATION

Based upon the visual inspection, the project is assessed as being generally in fair condition. The following features which could influence the future condition and/or stability of the project were identified:

1. There is no spillway at the dam.
2. Loss of riprap on the upstream slope of the dam could lead to erosion in these areas.
3. Seepage through the dam and/or its foundation can potentially increase in flow, leading to instability of the dam and appurtenant structures.
4. Debris on the floor of the discharge channel could block the 36 inch culvert under Route 69.
5. Damaged riprap along the right shore of the reservoir adjacent to the dam and erosion of the right shore itself could increase erosion at the dam.

SECTION 4: OPERATIONAL PROCEDURES

4.1 REGULATING PROCEDURES

The valve at the downstream side of the drain gate house is opened as needed to regulate flow through the 16 inch outlet pipe and maintain the reservoir at elevation 691.0. The service gate house is no longer in operation and the valves at the gate house have been closed with blow-off valves installed on the supply lines 500 to 1000 feet downstream to check for seepage in the lines. Lake level readings are not taken at any specific intervals.

4.2 MAINTENANCE OF DAM

The grass and brush is cut once a month during the warmer seasons. There is no formal inspection schedule. Maintenance and repairs are done by the town of Waterbury.

4.3 MAINTENANCE OF OPERATING FACILITIES

There is no formal schedule for maintenance inspection or repair of the operation facilities.

4.4 DESCRIPTION OF ANY FORMAL WARNING IN EFFECT

No formal warning system is known to be in effect.

4.5 EVALUATION

The maintenance and operation procedures for the dam are generally good, however there are areas requiring improvement. A formal program of operation and maintenance procedures should be implemented, including documentation to provide complete records for future reference. Also, a formal warning system should be developed and implemented within the time period indicated in Section 7.1c. Recommended operation and maintenance improvements are presented in Section 7.

SECTION 5: HYDRAULIC/HYDROLOGIC

5.1 EVALUATION OF FEATURES

a. General - The dam is an earthfill embankment with no spillway section. The available storage (assuming normal pool elevation of 691.0) will reduce the Probable Maximum Flood (PMF) from 1400 cfs to 910 cfs (a 35% reduction) and the 1/2 PMF from 700 cfs to 270 cfs (a 61% reduction). The watershed is 0.6 square miles of highly developed rolling terrain which is about 40% open.

b. Design Data - No computations could be found for the original dam construction or subsequent reconstruction in 1921.

c. Experience Data - No information was found to indicate there have been any serious problems at the dam, and it was reported that the dam has not been overtopped.

d. Visual Observations - The dam appears to be well maintained and the appurtenant structures are in good condition. No spillway section exists at the dam.

e. Test Flood Analysis - Based upon the Army Corps of Engineers' "Preliminary Guidance for Estimating Maximum Probable Discharge", dated March 1978, the watershed area (0.6 square miles) and the watershed classification (rolling), a Probable Maximum Flood of 1400 cfs, or 2000 cfs per square mile, is expected at the dam site. In accordance with the Army Corps' guidelines for size (small) and hazard (high) classification of the dam, the test flood may be considered in the range from $\frac{1}{2}$ PMF to the PMF. The test flood for East Mountain Reservoir Dam is considered to be equivalent to the PMF.

Peak inflow to the reservoir at the PMF is 1400 cfs (Appendix D-1) and the peak outflow is 910 cfs (assuming normal pool at 691.0) with the dam overtopped 0.9 feet (Appendix D-5). The discharge capacity of the low-level drain pipe (reservoir level to top of dam) is estimated at 28 cfs, or 3% of the routed test flood outflow. This capacity is not included in the peak outflow computations. At the $\frac{1}{2}$ PMF, peak inflow to the reservoir is 700 cfs and the peak outflow is 270 cfs with the dam overtopped 0.4 feet to elevation 694.7.

f. Dam Failure Analysis - The dam failure analysis is based on the April 1978 "Rule of Thumb Guidance for Downstream Dam Failure Hydrographs". Discharge prior to failure of the dam is considered to be only the flow from the 20/16 inch low-level drain pipe. The increase in the water level at the initial impact area would depend on whether the Route 69 embankment remains intact or fails following breach of the dam. If the road embankment holds, peak failure outflow would be about 18,000 cfs and the road would be overtopped by some 10 feet. If the road embankment fails, peak failure outflow would be about 31,000 cfs and the water level at Route 69 would rise 15+ feet or to a level about 5 feet above the original elevation of the road surface. In either case, however, at least four types of structures (houses, school, church and apartment building) at the initial impact area would be inundated by some 5 to 10 feet.

SECTION 6: STRUCTURAL STABILITY

6.1 EVALUATION OF STRUCTURAL STABILITY

a. Visual Observations - The visual inspection did not reveal any indications of stability problems. There are areas of seepage, masonry and riprap deterioration, and erosion as described in Section 3, however they are not considered stability concerns at the present time.

b. Design and Construction Data - There is not enough design and construction data available to permit an in-depth assessment of the structural stability of the dam.

c. Operating Records - The operating records do not include any indications of instability of the dam since its construction in the late 1800's.

d. Post Construction Changes - In 1921, the dam underwent a complete reconstruction which included:

1. Raising the dam 2.5 feet.
2. Concrete corewall installation.
3. New service and drain gate house construction. The service gate house was closed in 1955 and is not operational at the present time.

e. Seismic Stability - The project is in Seismic Zone 1 and according to the Recommended Guidelines, need not to be evaluated for seismic stability.

SECTION 7: ASSESSMENT, RECOMMENDATIONS AND REMEDIAL MEASURES

7.1 PROJECT ASSESSMENT

a. Condition - Based upon the visual inspection of the site and past performance, the dam appears to be in good condition. However, because there is no spillway at the dam, the overall project is considered to be in fair condition. No evidence of structural instability was observed in the dam or appurtenant structures. The dam embankment is generally in good condition with minor areas of concern which require maintenance and monitoring.

Based upon the Army Corps of Engineers' "Preliminary Guidance for Estimating Maximum Probable Discharge" dated March, 1978 and hydraulic/hydrologic computations, peak inflow to the reservoir is 1,400 cfs and peak outflow is 910 cfs (assuming normal pool at elevation 691.0) with the dam overtopped 0.9 feet.

b. Adequacy of Information - The information available is such that an assessment of the condition and stability of the project must be based solely on visual inspection, past performance of the project, and sound engineering judgement.

c. Urgency - It is recommended that the measures presented in Section 7.2 and 7.3 be implemented within one year of the owner's receipt of this report.

7.2 RECOMMENDATION

It is recommended that further studies be made by a registered professional engineer qualified in dam design and inspection pertaining to the following:

1. A detailed hydraulic/hydrologic analysis to determine the adequacy of the existing outlet facilities. Included in this analysis should be the effect of the abandoned service gate house and the effect of maintaining a lower reservoir level on the performance of the project during test flood conditions. Recommendations, including spillway type and test flood for spillway design, should be made by the engineer and implemented by the owner.
2. Inspection of the low-level drain pipe for possible seepage.
3. Gating the low-level drain pipe upstream of the dam so as to eliminate pressures in the pipe within the embankment.
4. A comprehensive program of inspection of the dam. Items of particular importance are as follows:
 - (a) The existence, location and condition of the toe drain system of the dam. This study should include identification of the origin and significance of seepage flowing from the 6 inch pipe at the right side of the discharge channel (See Photo 6).

- (b) The origin and significance of seepage at the gulley below East Mountain Road.

7.3 REMEDIAL MEASURES

a. Operation and Maintenance Procedures - The following measures should be undertaken within the time period indicated in Section 7.1c and continued on a regular basis.

1. Round-the-clock surveillance should be provided by the owner during periods of heavy precipitation and high project discharge. The owner should develop a downstream warning system in case of emergencies at the dam.
2. A formal program of operation and maintenance procedures should be instituted and fully documented to provide accurate records for future reference.
3. A comprehensive program of inspection by a registered professional engineer qualified in dam inspection should be instituted on a biennial basis.
4. Areas exposed by loss of riprap on the upstream slope of the dam and at the right bank of the reservoir adjacent to the dam, as well as the stone wall at the left side of the reservoir should be repaired to prevent erosion in the future.
5. The mortar joints of the stone masonry walls at the discharge channel and the damaged masonry of the outlet headwall at the low-level drain pipe should be sealed so as to prevent further deterioration and seepage in these areas.
6. Any debris on the floor of the discharge channel and in the 36 inch concrete culvert should be removed.
7. Flow through the 6 inch pipe, seepage and wet areas on the right wall of the discharge channel, and the seepage at the large gulley below East Mountain road should be monitored periodically to measure any changes in the seepage flow.
8. The leaking valve stem at the drain gate house should be repaired or replaced.
9. The cutting of grass and brush on the crest, slopes and toe of the dam should be continued as part of the routine maintenance procedure.

7.4 ALTERNATIVES

This study has identified no practical alternatives to the above recommendations.

APPENDIX A

INSPECTION CHECKLIST

VISUAL INSPECTION CHECK LIST
PARTY ORGANIZATION

PROJECT EAST MOUNTAIN
RESERVOIR DAM

DATE: NOVEMBER 7, 1979

TIME: 9:00 A.M. - 1:00 P.M.

WEATHER: CLOUDY, 50°F

W.S. ELEV. 691.5 U.S. - DN.S

PARTY:

INITIALS:

DISCIPLINE:

1. <u>PETER M. HEYDEN</u>	<u>PMH</u>	<u>Project Manager</u>
2. <u>MIRON PETROVSKY</u>	<u>MP</u>	<u>Sr. Geotech. Engr.</u>
3. <u>JAY COSTELLO</u>	<u>JC</u>	<u>Project Engineer</u>
4. <u>HECTOR MORENO</u>	<u>HM</u>	<u>Chief Hydraul. Engr.</u>
5. _____	_____	_____
6. _____	_____	_____

PROJECT FEATURE

INSPECTED BY

REMARKS

1. <u>EARTH EMBANKMENT</u>	<u>PMH, MP, JC, HM</u>	
2. <u>DRAIN GATEHOUSE</u>	<u>MP, JC</u>	
3. <u>LOW-LEVEL OUTLET</u>	<u>PMH, MP, JC, HM</u>	
4. <u>SERVICE GATEHOUSE</u>	<u>MP, JC</u>	
5. _____		
6. _____		
7. _____		
8. _____		
9. _____		
10. _____		
11. _____		
12. _____		

PERIODIC INSPECTION CHECK LIST

Page A-2

PROJECT EAST MOUNTAIN RESERVOIR DAM

DATE Nov. 7, 1979

PROJECT FEATURE EARTH EMBANKMENT

BY PMH, MP, JC, HM

AREA EVALUATED	CONDITION
<u>DAM EMBANKMENT</u>	
Crest Elevation	694.3
Current Pool Elevation	691.5
Maximum Impoundment to Date	UNKNOWN
Surface Cracks	NONE OBSERVED
Pavement Condition	GRAVEL & Sand, NO EROSION
Movement or Settlement of Crest	NONE OBSERVED
Lateral Movement	NONE OBSERVED
Vertical Alignment	APPEARS GOOD
Horizontal Alignment	GOOD
Condition at Abutment and at Concrete Structures	GOOD
Indications of Movement of Structural Items on Slopes	NONE OBSERVED
Trespassing on Slopes	NONE OBSERVED
Sloughing or Erosion of Slopes or Abutments	SOME EROSION ON LEFT EMBANKMENT
Rock Slope Protection-Riprap Failures	EROSION ON RIGHT SHORE, DEGRADATION OF LEFT SHORE STONE WALL.
Unusual Movement or Cracking at or Near Toes	SEEPAGE SOURCE AT D/S BEHIND EAST MOUNTAIN RD.
Unusual Embankment or Downstream Seepage	NONE OBSERVED
Piping or Boils	NONE OBSERVED
Foundation Drainage Features	UNKNOWN
Toe Drains	6" MET. DRAIN OUTLET AT RIGHT WALL OF DISCHARGE CHANNEL W/FLOW: 6gpm
Instrumentation System	N/A

PERIODIC INSPECTION CHECK LIST

Page A-3

PROJECT EAST MOUNTAIN RESERVOIR DAM

DATE Nov. 7, 1979

PROJECT FEATURE DRAIN GATEHOUSE

BY MP, JC

AREA EVALUATED	CONDITION
<u>OUTLET WORKS-CONTROL TOWER</u>	
a) <u>Concrete and Structural</u>	
General Condition	GOOD
Condition of Joints	
Spalling	NONE OBSERVED
Visible Reinforcing	
Rusting or Staining of Concrete	
Any Seepage or Efflorescence	
Joint Alignment	NONE OBSERVED
Unusual Seepage or Leakage in Gate Chamber	FLOW FROM 4" TILE DRAIN PIPE
Cracks	NONE OBSERVED
Rusting or Corrosion of Steel	SOME
b) <u>Mechanical and Electrical</u>	
Air Vents	
Float Wells	
Crane Hoist	N/A
Elevator	
Hydraulic System	
Service Gates	TWO 16" VALVES, OPERABLE; LEAK FROM STEM OF U/S VALVE
Emergency Gates	
Lightning Protection System	
Emergency Power System	N/A
Wiring and Lighting System	

PERIODIC INSPECTION CHECK LIST

Page A-4

PROJECT EAST MOUNTAIN RESERVOIR DAM

DATE Nov. 7, 1979

PROJECT FEATURE LOW-LEVEL OUTLET

BY PMH, MP, JC, HM

AREA EVALUATED	CONDITION
<p>OUTLET WORKS-OUTLET STRUCTURE AND OUTLET CHANNEL</p>	<p>MORTAR MASONRY WITH CONCRETE COPING</p>
<p>General Condition of Concrete</p>	<p>GOOD TO FAIR</p>
<p>Rust or Staining</p>	<p>NONE OBSERVED</p>
<p>Spalling</p>	<p>SEVERAL CRACKS IN CONCRETE</p>
<p>Erosion or Cavitation</p>	<p>SOME EROSION</p>
<p>Visible Reinforcing</p>	<p>NONE OBSERVED</p>
<p>Any Seepage or Efflorescence</p>	<p>TWO SEEPS THROUGH MORTAR JOINTS ON RIGHT TRAINING WALL</p>
<p>Condition at Joints</p>	<p>N/A</p>
<p>Drain Holes</p>	<p>SEE P. A-2</p>
<p>Channel</p>	<p>SOME TREES</p>
<p>Loose Rock or Trees Overhanging Channel</p>	<p>MANY STONES, PIECE OF MET. PIPE ON CHANNEL FLOOR</p>
<p>Condition of Discharge Channel</p>	<p></p>

PERIODIC INSPECTION CHECK LIST

Page A-5

PROJECT EAST MOUNTAIN RESERVOIR DAM

DATE Nov. 7, 1979

PROJECT FEATURE SERVICE GATEHOUSE

BY MP, JC

AREA EVALUATED	CONDITION
<u>OUTLET WORKS-CONTROL TOWER</u>	
a) <u>Concrete and Structural</u>	
General Condition	SOME VANDALISM. WINDOW IS OUT
Condition of Joints	UNKNOWN
Spalling	SOME, NORTHWEST SIDE
Visible Reinforcing	
Rusting or Staining of Concrete	
Any Seepage or Efflorescence	NONE OBSERVED
Joint Alignment	
Unusual Seepage or Leaks in Gate Chamber	
Cracks	
Rusting or Corrosion of Steel	SOME
b) <u>Mechanical and Electrical</u>	
Air Vents	
Float Wells	
Crane Hoist	N/A
Elevator	
Hydraulic System	
Service Gates	8 VALVES, NOT OPERABLE
Emergency Gates	
Lightning Protection System	N/A
Emergency Power System	
Wiring and Lighting System	

APPENDIX B

ENGINEERING DATA AND CORRESPONDENCE

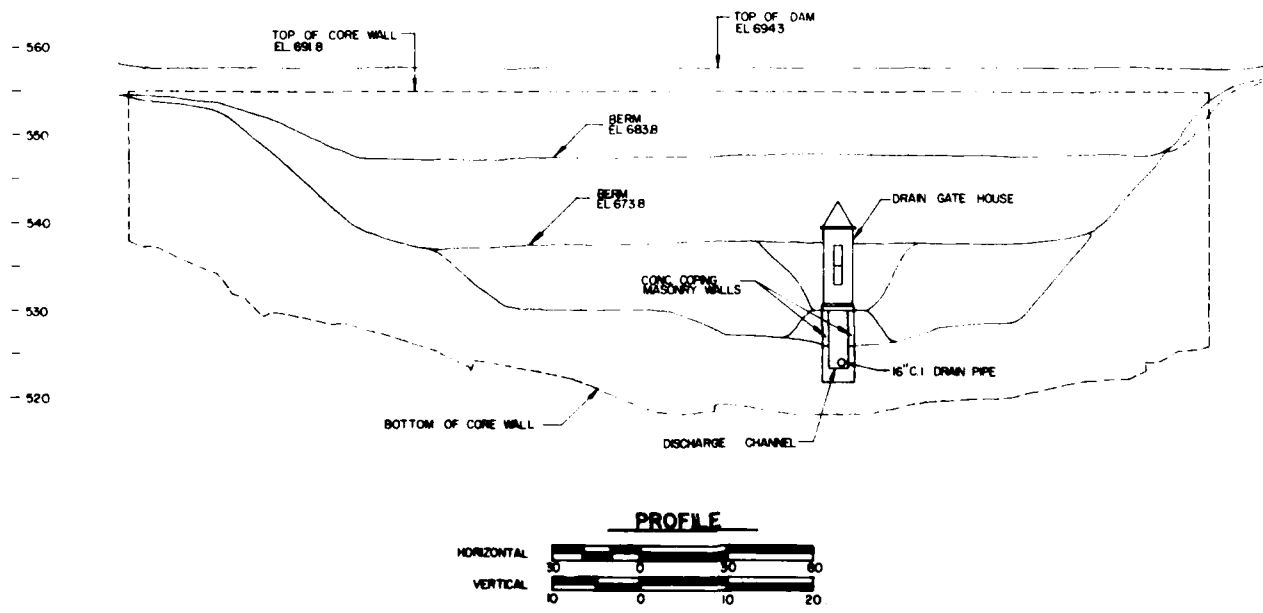
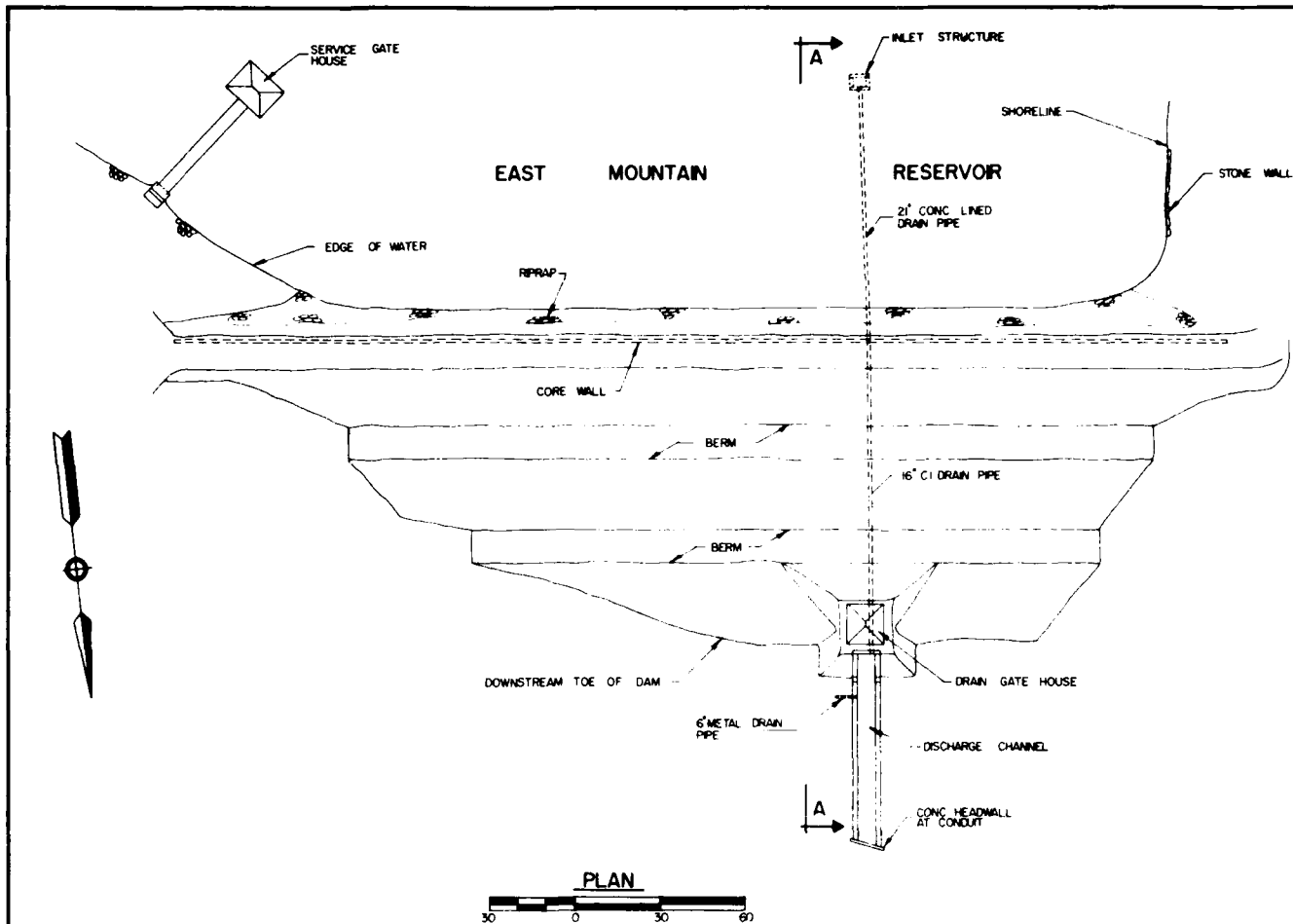

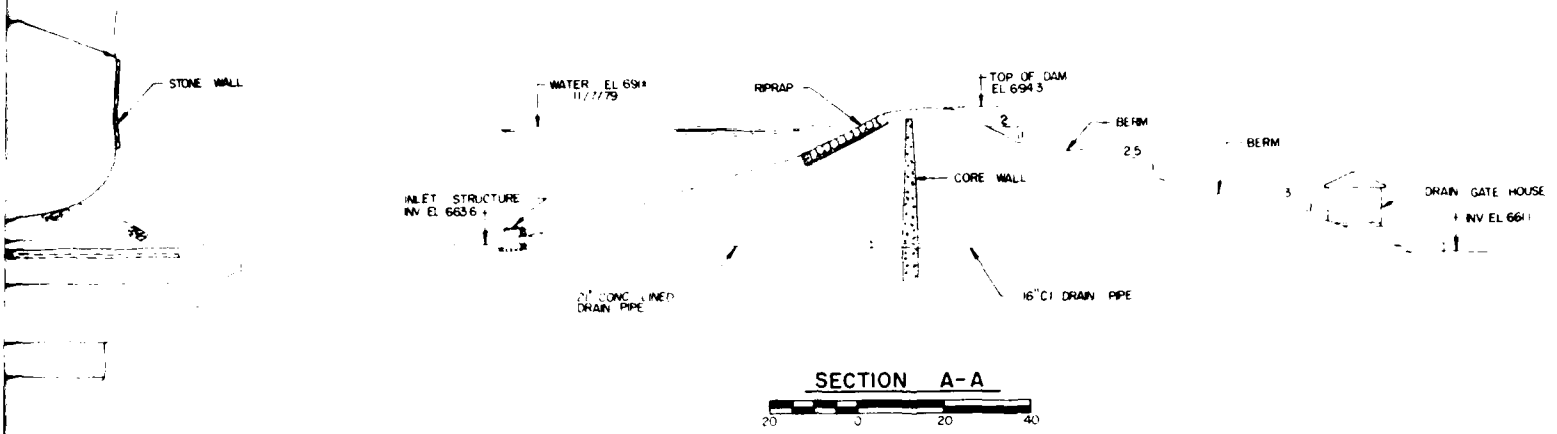

NOTES

- 1 THIS PLAN WAS COMPILED FROM EXISTING PLANS FOR RECONSTRUCTION OF EAST MOUNTAIN DAM BY BUREAU OF ENGINEERING WATERBURY CONN. DATED NOVEMBER 1921.
- 2 NOT ALL TOPOGRAPHIC AND/OR STRUCTURAL FEATURES ARE NECESSARILY IDENTIFIED ON THIS PLAN.
- 3 ALL ELEVATIONS ARE NGVD
NGVD WATERBURY DATUM +136.8

CAHN ENGINEERS INC WALLINGFORD, CONNECTICUT ENGINEER	U.S. ARMY ENGINEER DIV NEW ENGLAND CORPS OF ENGINEERS WALTHAM, MASS
NATIONAL PROGRAM OF INSPECTION OF NON-FED DAMS	
PLAN PROFILE AND SECTION	
EAST MOUNTAIN RESERVOIR DAM	
EAST MOUNTAIN BROOK WATERBURY, CONNECTICUT	
DRAWN BY H. N.	CHECKED BY [Signature]
APPROVED BY [Signature]	SCALE AS NOTED
DATE NOV 1979	SHEET B-1

EAST MOUNTAIN RESERVOIR DAM

EXISTING PLANS

"Reconstruction of East Mountain Dam"
Bureau of Engineering,
Waterbury, Conn.
November 1921
2 sheets plus X-sect. every 25 feet

SUMMARY OF DATA AND CORRESPONDENCE

<u>DATE</u>	<u>TO</u>	<u>FROM</u>	<u>SUBJECT</u>	<u>PAGE</u>
June 5, 1964	File	Connecticut Water Resources Commission for Supervision of Dams	Inventory Data	B-2
Dec. 18, 1979	File	Cahn Engineers, Inc.	Schematic of outlet facilities	B-4

No. WB-5

WATER RESOURCES COMMISSION
SUPERVISION OF DAMS
INVENTORY DATA

4.
CT 32

Inventoried
By WPS

Long. 73-00-20
Lat. 41-31-43

Date 5 JUNE 1964

Name of Dam or Pond EAST MOUNTAIN RESERVOIR

Code No. N19.2 MD 2.7 BV 0.2 U0.7

Nearest Street Location ROUTE 69

Town WATERBURY

U.S.G.S. Quad. WATERBURY

Name of Stream UNNAMED

Owner City of Waterbury

Address _____

012
1173

Pond Used For WATER SUPPLY DA 0575M

Dimensions of Pond: Width 1000 FEET Length 2000 FEET Area ³⁵50 ACRES

Total Length of Dam 350 FEET Length of Spillway 24" PIPE (6.2')

Location of Spillway WEST END OF DAM

Height of Pond Above Stream Bed 25 FEET

Height of Embankment Above Spillway 4 FEET

Type of Spillway Construction 24" PIPE THROUGH DAM

Type of Dike Construction EARTH

Downstream Conditions CULVERT UNDER ROUTE 69

Summary of File Data _____

Remarks _____

Would Failure Cause Damage? YES

Class B
B-3

Project East Mountain Reservoir Dam Sheet 1 of 1

Computed By Jay A. Costello Checked By _____ Date 12/19/79

Field Book Ref. _____ Other Refs. _____ Revisions _____

Diagram of Approximate valve layout

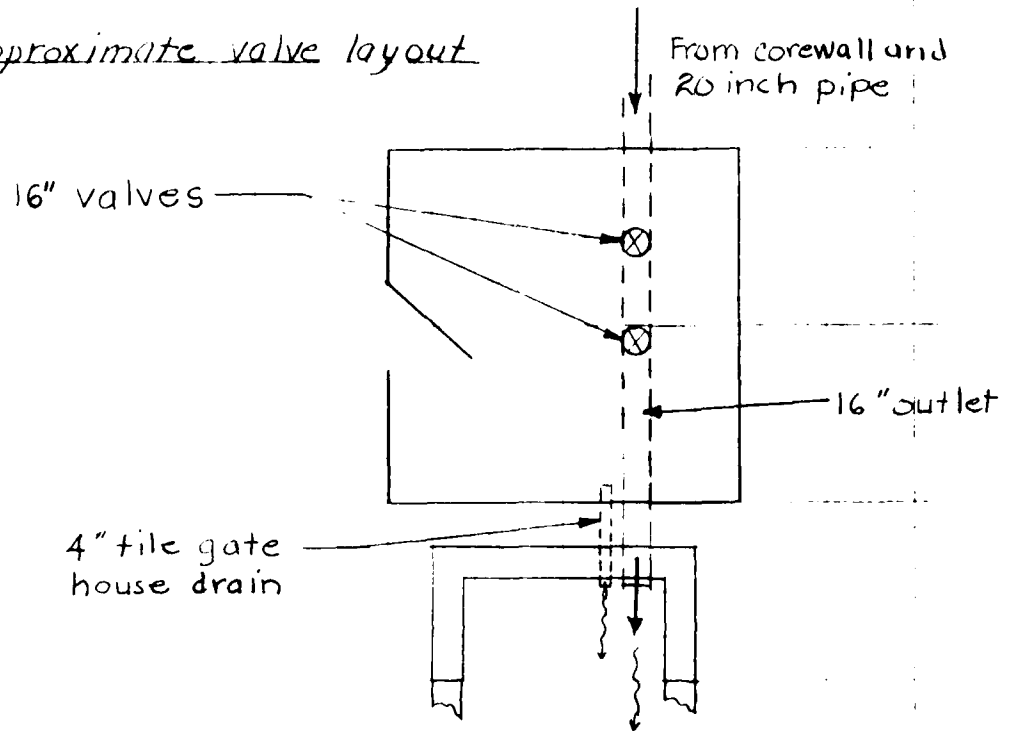

Drain Gate House

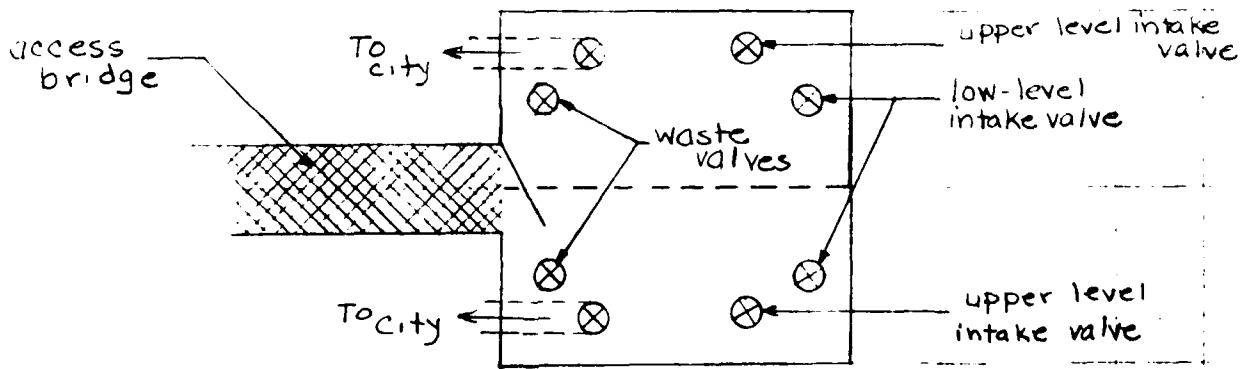

Service Gate House

APPENDIX C

DETAIL PHOTOGRAPHS

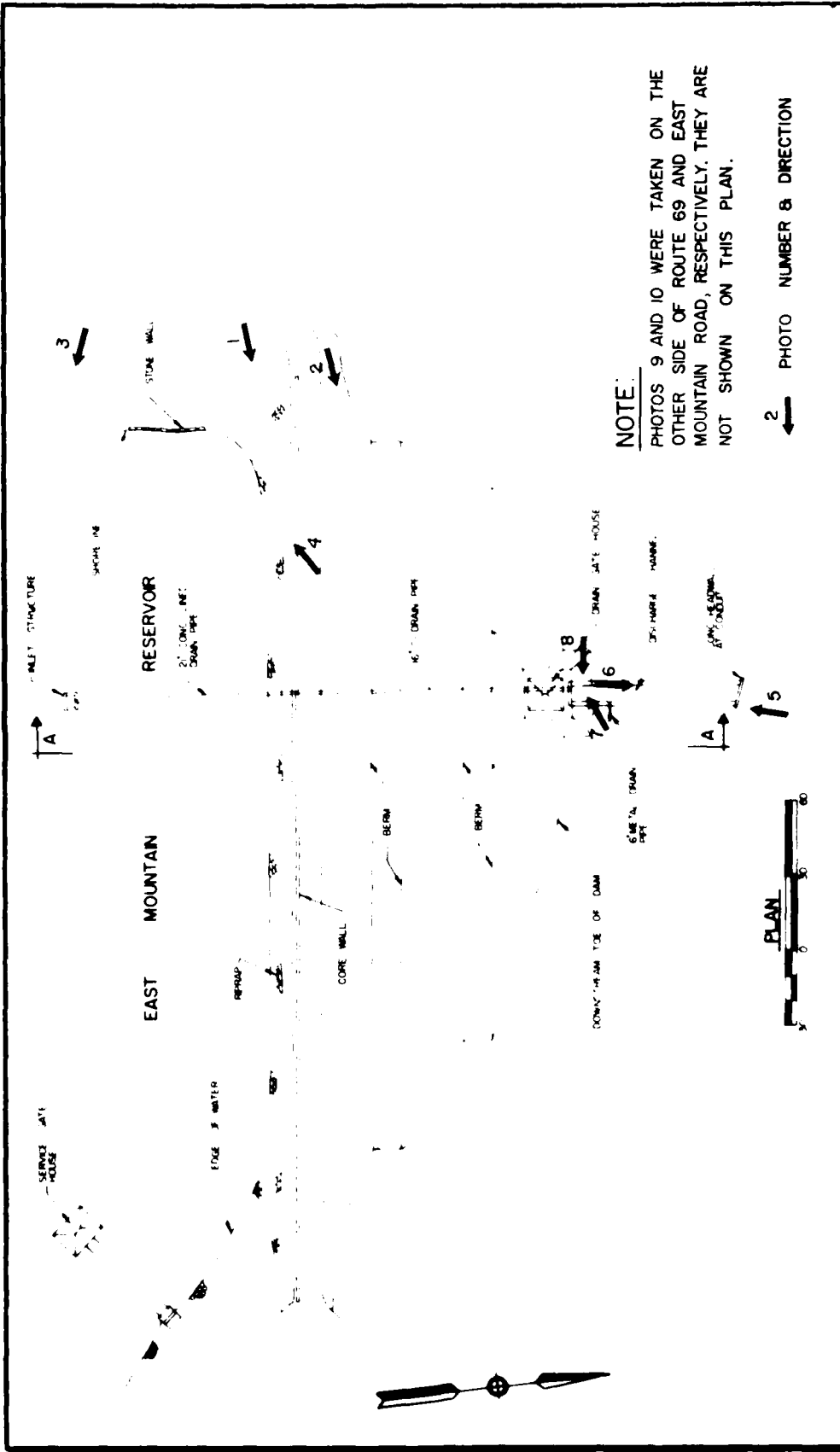

NOTE:
 PHOTOS 9 AND 10 WERE TAKEN ON THE OTHER SIDE OF ROUTE 69 AND EAST MOUNTAIN ROAD, RESPECTIVELY. THEY ARE NOT SHOWN ON THIS PLAN.

2 PHOTO NUMBER & DIRECTION

PHOTO LOCATION PLAN
 EAST MOUNTAIN RESERVOIR DAM
 SHEET C-1



Photo 1 - Crest and upstream slope from left abutment



Photo 2 - Downstream slope and drain gate house.

US ARMY ENGINEER DIV. NEW ENGLAND
CORPS OF ENGINEERS
WALTHAM, MASS

CAHN ENGINEERS INC.
WALLINGFORD, CONN.
ENGINEER

NATIONAL PROGRAM OF
INSPECTION OF
NON-FED. DAMS

East Mountain Reservoir Dam
East Mountain Brook
Waterbury, Connecticut
CE # 27 660 KE
DATE Nov '79 PAGE C-1



Photo 3 - Right shore of reservoir adjacent to dam

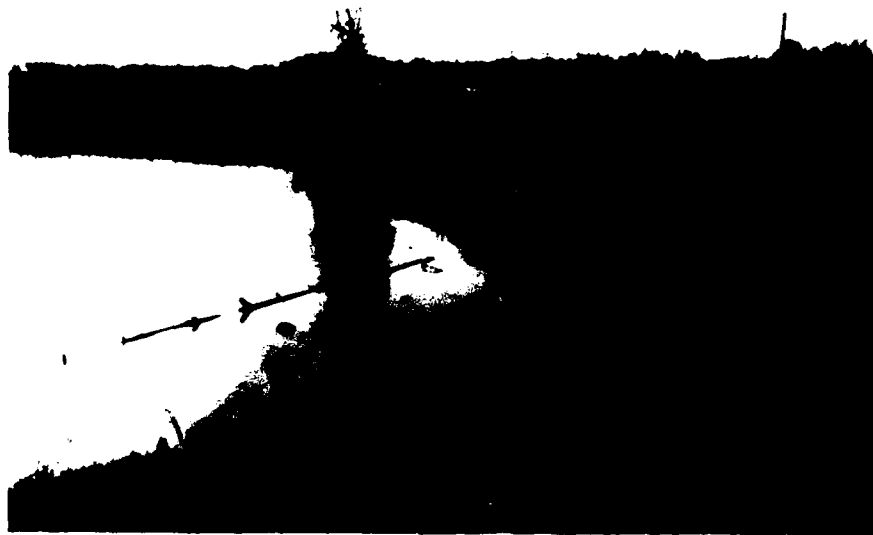

Photo 4 - Left shore of reservoir and left abutment of dam

US ARMY ENGINEER DIV. NEW ENGLAND CORPS OF ENGINEERS WALTHAM, MASS	NATIONAL PROGRAM OF	East Mountain Reservoir Dam
CAHN ENGINEERS INC. WALLINGFORD, CONN. ENGINEER	INSPECTION OF NON-FED. DAMS	East Mountain Brook
		Waterbury, Connecticut
		CE #27 660 KE
		DATE Nov '79 PAGE C-2

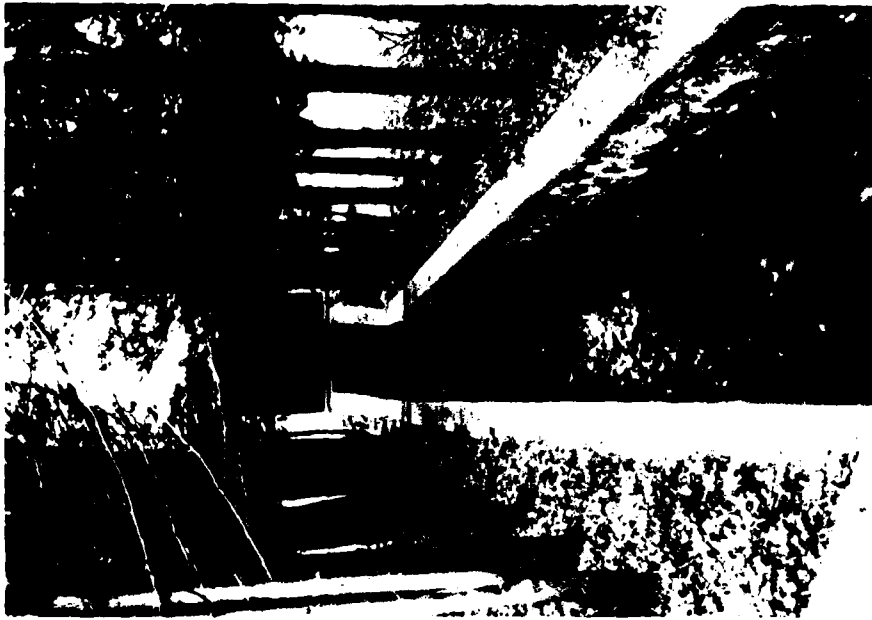

Photo 5 - Drain gate house and discharge channel

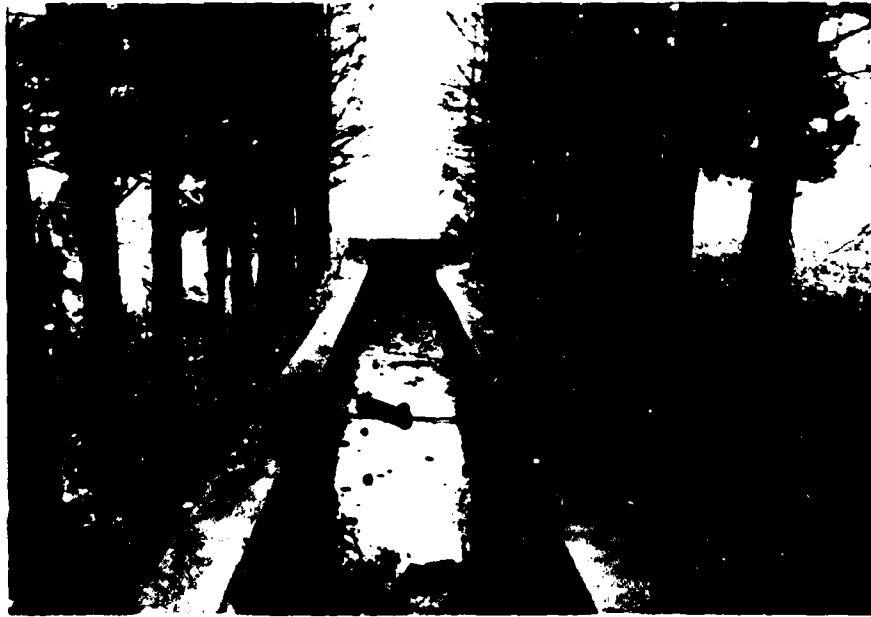

Photo 6 - Discharge channel and culvert inlet. Note discharge from 6 inch pipe at right side of channel.

US ARMY ENGINEER DIV. NEW ENGLAND
CORPS OF ENGINEERS
WALTHAM, MASS

CAHN ENGINEERS INC.
WALLINGFORD, CONN.
ENGINEER

NATIONAL PROGRAM OF
INSPECTION OF
NON-FED. DAMS

East Mountain Reservoir Dam
East Mountain Brook
Waterbury, Connecticut
CE #27 660 KE
DATE Nov '79 PAGE C-3



Photo 7 - Cast iron low-level outlet, masonry outlet structure and tile gate house drain pipe.



Photo 8 - Seepage through right wall of discharge channel

US ARMY ENGINEER DIV. NEW ENGLAND
CORPS OF ENGINEERS
WALTHAM, MASS

CAMN ENGINEERS INC.
WALLINGFORD, CONN.
ENGINEER

NATIONAL PROGRAM OF
INSPECTION OF
NON-FED. DAMS

East Mountain Reservoir Dam
East Mountain Brook
Waterbury, Connecticut
CE # 27 660 KE
DATE Nov '79 PAGE C-4



Photo 9 - Culvert outlet at downstream side of Route 69.



Photo 10 - Seepage source at large gully downstream of East Mountain Road

US ARMY ENGINEER DIV. NEW ENGLAND
CORPS OF ENGINEERS
WALTHAM, MASS

CAHN ENGINEERS INC.
WALLINGFORD, CONN.
ENGINEER

NATIONAL PROGRAM OF
INSPECTION OF
NON-FED. DAMS

East Mountain Reservoir Dam
East Mountain Brook
Waterbury, Connecticut
CE # 27 660 KE
DATE Nov '79 PAGE C-5

APPENDIX D
HYDRAULICS/HYDROLOGIC COMPUTATIONS

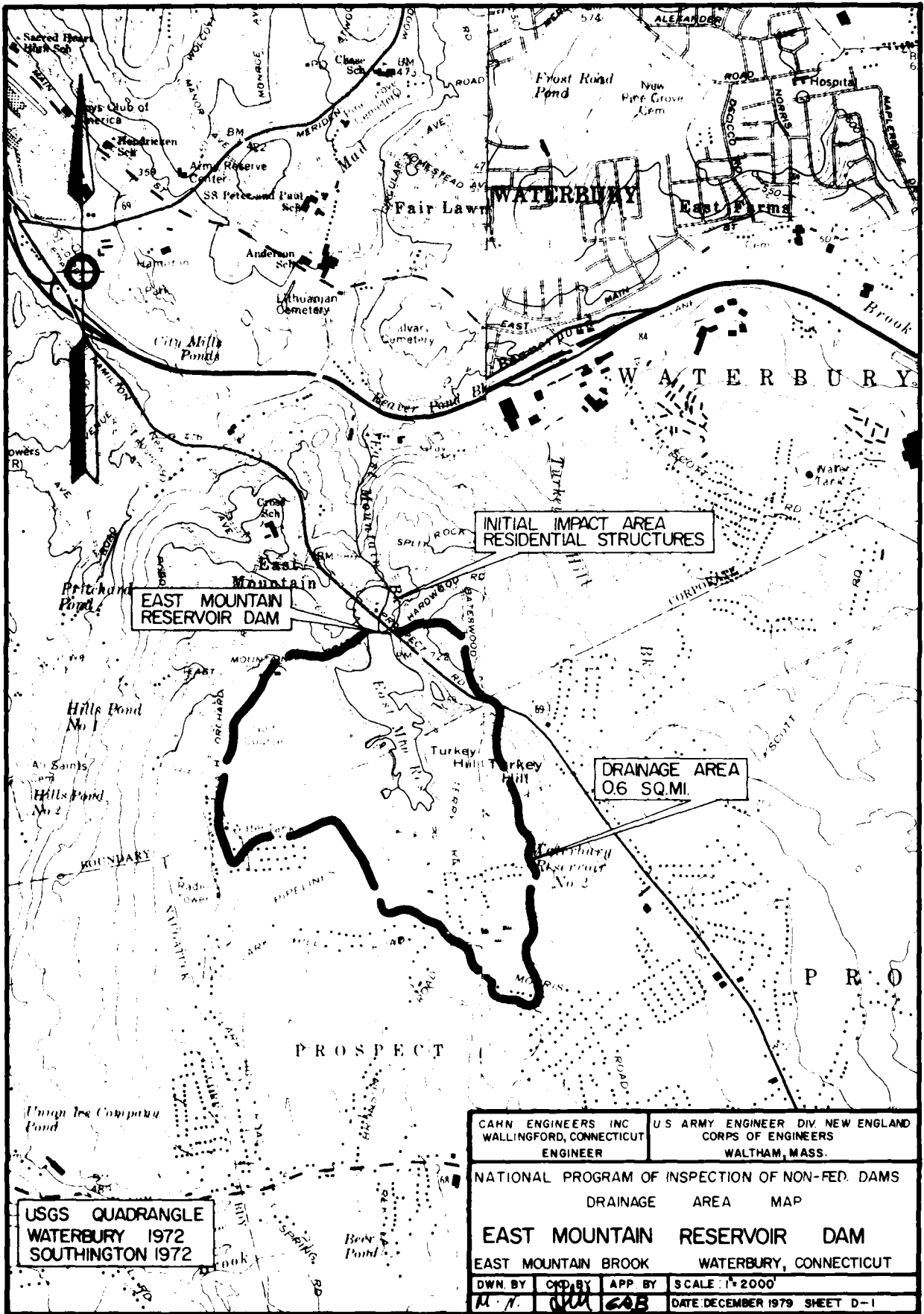

USGS QUADRANGLE
 WATERBURY 1972
 SOUTHWINGTON 1972

CAHN ENGINEERS INC WALLINGFORD, CONNECTICUT ENGINEER		US ARMY ENGINEER DIV. NEW ENGLAND CORPS OF ENGINEERS WALTHAM, MASS.	
NATIONAL PROGRAM OF INSPECTION OF NON-FED. DAMS			
DRAINAGE AREA MAP			
EAST MOUNTAIN RESERVOIR DAM		EAST MOUNTAIN BROOK WATERBURY, CONNECTICUT	
DWN. BY	CHK. BY	APP. BY	SCALE 1"=2000'
M. N.	W. J.	G. B.	DATE: DECEMBER 1979 SHEET D-1

Project NON-FEDERAL DAMS INSPECTION Sheet D-1 of 9
Computed By R.R. JAHN Checked By [Signature] Date 11/06/72
Field Book Ref _____ Other Refs. CE # 27 660 HB Revisions _____

HYDROLOGIC/HYDRAULIC INSPECTION

EAST MOUNTAIN RESERVOIR DAM, WATERBURY, VT.

I) PERFORMANCE AT PEAK FLOOD CONDITIONS

1) PROBABLE MAXIMUM FLOOD (PMF)

a) WATERSHED CLASSIFIED AS ROLLING

b) WATERSHED AREA D.A. = 0.57 SQ. MI.

NOTE: FROM CONN. DEP., BULLETIN No. 1, 1972, (GAZETTEER OF NATURAL DRAINAGE AREAS, PG 64)

c) PEAK FLOOD (FROM MED. AGE GUIDELINES - GUIDE CURVES FOR PMF)

$$1) \text{ PMF} = 2500 \frac{\text{CFS}}{\text{SQ. MI.}} \times 0.57 \text{ SQ. MI.} = 1400 \text{ CFS}$$

$$2) \text{ } 1/2 \text{ PMF} = 700 \text{ CFS}$$

d) SURCHARGE AT PEAK FLOOD (PMF AND 1/2 PMF)

a) OUTFLOW RATING CURVE

1) SPILLWAY

EAST MOUNTAIN RESERVOIR DOES NOT HAVE A SPILLWAY. INFLOWS ARE DISCHARGED THROUGH (1) 10' OF 16" CI AND (2) 90' OF 20" CI PIPE TO A DOWNSTREAM CHANNEL. (EAST MOUNTAIN BR. #1) (SEE NOTE PAGE D-3)

2) RATING CURVE FOR SURCHARGES OVERTOPPING THE DAM

EAST MOUNTAIN RESERVOIR DAM IS AN EARTH EMBANKMENT (1) 400' LONG (2) 12' WIDE AT THE CREST (3) 694.3 MSL. THE 1/5 = 1/5

Cahn Engineers Inc.

Consulting Engineers

Project NON-FEDERAL DAMS INSPECTION

Sheet D-2 of 9

Computed By R.R. WAHN

Checked By [Signature]

Date 11/06/19

Field Book Ref _____

Other Refs. CE # 27 660 HB

Revisions _____

E. MOUNTAIN RESERVOIR DAM

2. CONT'D) OUTFLOW RATING CURVE

FACES SLOPE 2' TO 1'

ASSUME $C = 2.7$ FOR FLOWS OVER TOP OF DAM & ADJACENT TERRAIN

ASSUME EQUIVALENT FLOWS FOR THE SLOPING PORTIONS OF THE SIDES OF THE DAM AS FOLLOWS: (SEE OVERFLOW SECTION BELOW)

RIGHT SIDE OF DAM (NOTE TOP OF DAM USED AS DATUM)

$$\text{ROAD, } Q_R \approx \frac{2}{3}(2.7)(17)(H)^{5/2} = 31(H)^{5/2}$$

LEFT SHOULDER OF DAM

$$\begin{aligned} \text{TERRAIN, } Q_T &= \frac{2}{3}(2.7)(27)(H)^{5/2} = 48.6H^{5/2} && \text{FOR } H \leq 3.7 \\ Q_T' &= \frac{2}{3}(2.7)(100)(H-0.9)^{3/2} = 270(H-0.9)^{3/2} && \text{FOR } H > 3.7 \end{aligned}$$

$$Q_T = \frac{2}{3}(2.7)(40)(H-3.7)^{5/2} = 72(H-3.7)^{5/2}$$

DAM & FLAT TERRAIN TO RIGHT OF DAM: $Q_{PT} = 2.7(363)H^{3/2} = 980H^{3/2}$
THE TOTAL OVERFLOW RATING CURVE CAN BE APPROXIMATED BY

$$Q \approx 980H^{3/2} + 31H^{5/2} + (Q_T \text{ OR } Q_T') + 72(H-3.7)^{5/2}$$

THE OUTFLOW CURVE IS PLOTTED ON THE NEXT PAGE

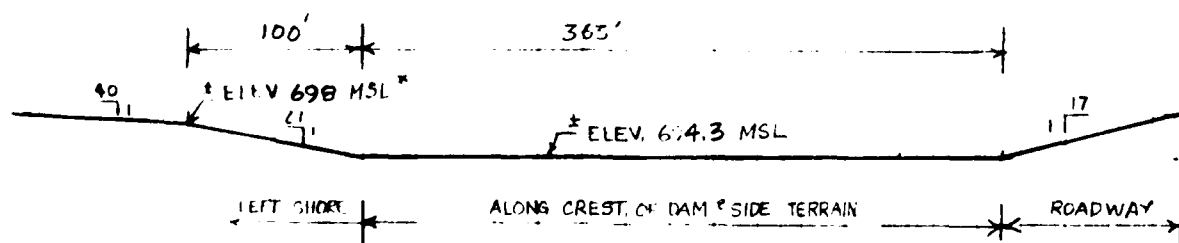

EAST MOUNTAIN DAM OVERFLOW SECTION

* THE MSL DATUM IS EQUIVALENT TO THE NGVD DATUM

Project NON FEDERAL DAM INSPECTION

Sheet D-3 of 2

Computed By K.R. JAHN

Checked By [Signature]

Date 11/06/79

Field Book Ref _____

Other Refs. CE # 27 660 HB

Revisions _____

EAST MOUNTAIN RESERVOIR

2) CONT'D) OUTFLOW RATING CURVE

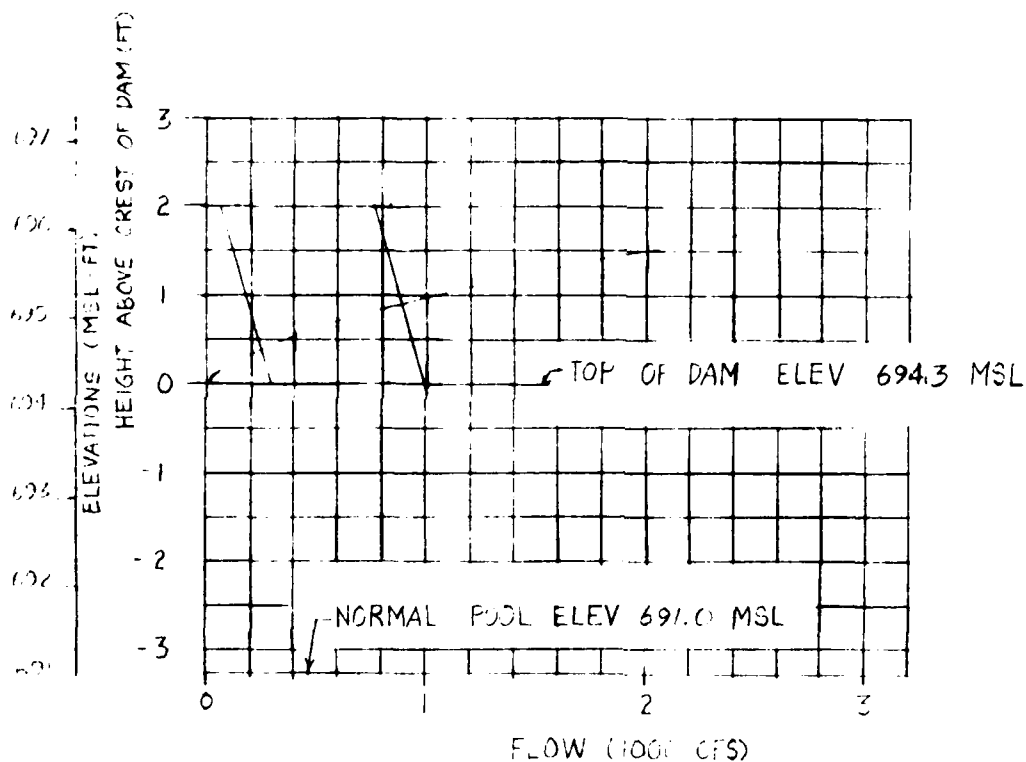

EAST MOUNTAIN RESERVOIR HAS 110' OF 16" PIPE AND 90' OF 10" PIPE (VALVED) WHICH IS USED TO MAINTAIN NORMAL POOL LEVEL AT (+) ELEV. 691' MSL. THE CAPACITY OF THE PIPE UNDER A FULL HEAD OF (+) 32', (TOP OF DAM (+) ELEV 694.3 - E. OUTLET (+) ELEV 662 MSL) IS ESTIMATED AT (+) 28 CFS. THIS FLOW HAS BEEN NEGLECTED FROM COMPUTATIONS OF RATING CURVE.

NOTE: AVAILABLE EAST MOUNTAIN RESERVOIR DAM DRAWINGS ARE ON CITY OF WATERBURY DATUM, THEREFORE CONVERSION TO MSL DATUM HAS BEEN MADE AS FOLLOWS:

MSL (USGS DATUM) \approx CITY OF WATERBURY DATUM + 136.75

(SAY 136.8)

Cahn Engineers Inc.

Consulting Engineers

Project NON-FEDERAL DAMS INSPECTION

Sheet D-4 of 9

Computed By R.R. JAHN

Checked By [Signature]

Date 11/06/71

Field Book Ref _____

Other Refs. CE # 27 660 HB

Revisions _____

EAST MOUNTAIN RESERVOIR DAM

2 CONT'D) OUTFLOW RATING CURVE

1) SURCHARGE HEIGHT TO PASS PEAK INFLOWS (Q_p & Q_p')

1) @ Q_p & PMF ≈ 1400 CFS, $H_s \approx 1.2'$ OR, (+) 4.5' ABOVE NORMAL POOL^(*)

2) @ Q_p' $\approx 1/2$ PMF ≈ 700 CFS, $H_s' \approx 0.8'$ OK, (+) 4.1' ABOVE NORMAL POOL^(*)

2) EFFECT OF SURCHARGE STORAGE ON PEAK OUTFLOWS

1) AVG LAKE AREA WITHIN EXPECTED SURCHARGE

1) LAKE AREA AT NORMAL POOL (+) 3.3' BELOW TOP OF DAM
(ASSUMED TO BE (+) ELEV 691 MSL) $A_{3.3} = 36.0$ AC

2) AREA AT CONTOUR 700 MSL* $A_{700} = 65.0$ AC

3) AREA AT CONTOUR 710 MSL* $A_{710} = 79.0$ AC

2) AVG. AREA WITHIN EXPECTED SURCHARGE $A = 36.0 + \frac{4(29)}{9} \approx 49$ AC

* NOTE: AREAS FROM USGS WATERBURY, CONN. QUAD. SHEET

3) WATERSHED AREA D.A. ≈ 0.57 SQ. MI. (SEE PS. 1)

4) DISCHARGE Q_p AT VARIOUS HYPOTHETICAL SURCHARGES (ABOVE TOP OF DAM)^(*)

* ($H_{ws} = 3.3$) $H = 0'$ $Y = 3.3 \times 49 = 160$ AC-FE $S = 160 / (0.57 \times 53.3) = 5.32'$

* ($H_{ws} = 5.3$) $H = 2'$ $Y = 5.3 \times 49 = 260$ AC FE $S = 260 / (0.57 \times 53.3) = 8.50$

FROM APPROXIMATE ROUTING NED-ACE GUIDELINES AND 12" MAXIMUM PROBABLE R.O. IN NEW ENGLAND

$Q_p \approx Q_p' (1.5/1.9)$ AND FOR 1/2 PMF $Q_p' = Q_p (1 - 0.25)$

*) NOTE: ADD 3.3' TO SURCHARGE ABOVE TOP OF DAM (H) TO OBTAIN SURCHARGES ABOVE NORMAL POOL (H_{ws})

Project NON - FEDERAL DAMS INSPECTION Sheet D-5 of 2
Computed By R.K. JAHN Checked By [Signature] Date 11/26/79
Field Book Ref _____ Other Refs CE # 27 660 HB Revisions _____

LAST MOUNTAIN RESERVOIR DAM

2. CONT'D) EFFECT OF SURCHARGE AREA ON PEAK OUTFLOWS

1. FOR HYPOTHETICAL SURCHARGES (ABOVE TOP OF DAM)

$$(H_{ws} = 0) \quad H = -3.3' \quad Q_p \approx 1400 \text{ CFS} \quad Q_{p2}' \approx 700 \text{ CFS}$$

$$(H_{ws} = 3.3) \quad H = 0 \quad Q_p \approx 1000 \text{ CFS} \quad Q_{p2}' \approx 310 \text{ CFS}$$

$$(H_{ws} = 5.3) \quad H = 2' \quad Q_p \approx 770 \text{ CFS} \quad Q_{p2}' \approx 69 \text{ CFS}$$

3) PEAK OUTFLOWS

USING NEW AEC GUIDELINES "SURCHARGE STORAGE ROUTING" ALTERNATE METHOD (SEE RATING CURVE BS D-5)

$$Q_{p3} \approx 910 \text{ CFS} \quad H_3 \approx 0.9'$$

$$Q_{p3}' \approx 270 \text{ CFS} \quad H_3 \approx 0.4'$$

Cahn Engineers Inc.

Consulting Engineers

Project NON-FEDERAL DAMS INSPECTION Sheet D-6 of 9
Computed By R.R. JAIN Checked By [Signature] Date 11/05/79
Field Book Ref _____ Other Refs. CL # 27 660 HB Revisions _____

EAST MOUNTAIN RESERVOIR DAM

1) DOWNSTREAM FAILURE HAZARD

a) POTENTIAL IMPACT AREAS

IF FAILURE OCCURS, THE FLOOD WOULD BREACH OR TRAVEL OVER CONN. RTE. 69, A MAJOR SECONDARY HIGHWAY. IMMEDIATELY D/S FROM THE RESERVOIR ARE PRIVATE RESIDENCES, A SCHOOL, A CHURCH, AND AN APARTMENT HOUSE, ALL WHICH HAVE FIRST FLOORS WITHIN 4' OF THE ROAD SURFACE.

2) FAILURE AT EAST MOUNTAIN RESERVOIR

a) BREACH WIDTH:

i) HEIGHT OF DAM

TOP OF DAM (+) ELEV 694.3 MSL

D/S OUTLET CHANNEL (+) 659.8' MSL

∴ H = 34.5', SAY 35'

ii) MID-HEIGHT (+) ELEV 677' MSL $(694.3 - \frac{35}{2} = 676.8 \text{ SAY } 677 \text{ MSL})$

iii) APPROXIMATE MID-HEIGHT LENGTH $L \approx 230'$ (SEE FIELD MEASURE 10/79)

iv) BREACH WIDTH (SEE NED-ACE D/S DAM FAILURE GUIDELINES)

$$W = 0.40 * 230 = 92' \quad \text{ASSUME } W_b = 90'$$

b) PEAK FAILURE OUTFLOW (Q_p)

ASSUME SURCHARGE TO TOP OF DAM AT TIME OF FAILURE (ELEV. 694.3 MSL)

i) CONN RTE 69 ROAD EMBANKMENT CROSSES THE D/S CHANNEL APPROXIMATELY 100' D/S FROM THE 16" DRAIN OUTLET. THE ROAD SLOPES TO A LOW POINT OF (+) 670 MSL AT THE INTERSECTION OF RTE 69

Project NON-FEDERAL DAMS INSPECTION Sheet D-7 of 9
Computed By R.R. SAHN Checked By JLL Date 11/20/79
Field Book Ref. _____ Other Refs. CE # 27660 HB Revisions _____

EAST MOUNTAIN RESERVOIR DAM

26- CONT'D) PEAK FAILURE OUTFLOW

AND EAST MOUNTAIN ROAD. THE 36" RCP CULVERT UNDER ROUTE 69 WOULD BE INADEQUATE THE FLOW AND Q_p WOULD POOL BETWEEN THE DAM AND RTE 69 TO (+) ELEV 670 BEFORE OVERTOPPING THE ROAD.

(1) TWO D/S FAILURE CONDITIONS MAY BE CONSIDERED :

a) IF THE ROAD EMBANKMENT FAILS, THE FLOOD DEPTH IMMEDIATELY BELOW THE DAM WOULD BE APPROXIMATED BY :

i) $Y_0 = 35'$ (HEIGHT OF DAM)

ii) $Q_b = 3/27 W_b \sqrt{g} Y_0^{3/2} \approx 31,300$ CFS

iii) $Y = 0.44 Y_0 \approx 15.4$ (SAY 5' ABOVE THE ROAD)

b) IF THE ROAD IS OVERTOPPED WITHOUT FAILURE, THE FLOOD DEPTH IMMEDIATELY D/S FROM THE DAM WOULD BE APPROXIMATED BY :

i) $Y_0 = 24'$ (TOP OF DAM (+) 694.3 - TOP OF ROAD (+) 670')

ii) $Q_b \approx 3/27 W_b \sqrt{g} Y_0^{3/2} \approx 17,800$ CFS

iii) $Y = 0.44 Y_0 \approx 10.4'$ (SAY 10' ABOVE THE ROAD)

iii) NO SIGNIFICANT DEPTH OF FLOW IS EXPECTED D/S BEFORE FAILURE.

Cahn Engineers Inc.

Consulting Engineers

Project NON FEDERAL DAMS INSPECTION

Sheet D-8 of 2

Computed By R.K. JAIN

Checked By [Signature]

Date 11/6/11

Field Book Ref _____

Other Refs. CE # 27660 HB

Revisions _____

EAST MOUNTAIN RESERVOIR DAM

III) SELECTION OF TEST FLOOD

1) CLASSIFICATION OF DAM ACCORDING TO NED-ACE GUIDELINES

a) SIZE : * STORAGE ≈ 580 ^{Ac-Ft} (50 < S < 1000 ^{Ac-Ft})
* HEIGHT $\approx 35'$ (25 < H < 40 ^{Ft})

*NOTE: STORAGE (SEE PG D-9), HEIGHT (SEE PG D-6)

A. SIZE CLASSIFICATION SMALL

b) HAZARD POTENTIAL - AS A RESULT OF THE D/S FAILURE ANALYSIS AND INVIEW OF THE IMPACT THAT THE FAILURE OF THE DAM MAY HAVE ON THE IMMEDIATE IMPACT AREA, THE EAST MOUNTAIN RESERVOIR DAM IS CLASSIFIED AS HAVING :

HAZARD CLASSIFICATION : HIGH

c) TEST FLOOD = PMF = 1400 CFS

IV) SUMMARY AND CONCLUSIONS

1) TEST FLOOD = PMF = 1400 CFS

(PARALLEL COMPUTATIONS HAVE BEEN MADE FOR 1/2 PMF ≈ 700 CFS AND ARE ALSO SUMMARIZED BELOW.

2) PERFORMANCE AT PEAK FLOOD CONDITIONS

a) PEAK INFLOWS $Q_p = \text{PMF} = 1400$ ^{CFS} $Q_p' = 1/2 \text{ PMF} = 700$ ^{CFS}

b) PEAK OUTFLOWS $Q_p \approx 910$ ^{CFS} $Q_p' \approx 270$ ^{CFS}

Project NON FEDERAL DAMS INSPECTION Sheet D-9 of 9
Computed By R.R. LAHN Checked By HLL Date 11/06/79
Field Book Ref. _____ Other Refs. CE # 27 660 HB Revisions _____

EAST MOUNTAIN RESERVOIR DAM

II CONT'D) SUMMARY AND CONCLUSIONS

AT TEST FLOOD, $Q_R = PMF$, THE DAM IS GOING TO BE OVERTOPPED BY $(+)0.9'$ (ELEV 695.2' MSL), AND A $Q_R = 1/2 PMF$, THE DAM WILL BE OVERTOPPED $(+)0.4'$ (ELEV 694.7 MSL)

THE 36" RCP CULVERT UNDER RTE 69 IS INADEQUATE TO PASS THE FLOODS. IF THE DAM FAILS, PONDING WILL OCCUR BETWEEN EAST MOUNTAIN DAM AND THE ROUTE 69 ROAD EMBANKMENT, WITH THE RESULTING OVERFLOW RUNNING ALONG AND OVER CONN ROUTE 69.

3) CONDITIONS AT THE IMMEDIATE IMPACT AREA ARE SUMMARIZED AS FOLLOWS

a) IF THE RTE 69 EMBANKMENT FAILS:

- a) PEAK FAILURE OUTFLOW $Q_R \approx 31,300$ CFS
- b) FLOOD DEPTH IMMEDIATELY AFTER FAILURE $Y \approx 15'$ ($(+)5'$ ABOVE RTE 69 ELEV)
- c) RAISE IN STAGE AFTER FAILURE $\Delta Y \approx 15'$

b) IF RTE 69 IS OVERTOPPED WITHOUT FAILING

- a) PEAK FAILURE OUTFLOW $Q_R \approx 17,800$ CFS
- b) FLOOD DEPTH IMMEDIATELY AFTER FAILURE $Y \approx 10'$ ($(+)10'$ ABOVE RTE 69 ELEV)
- c) RAISE IN STAGE AFTER FAILURE $\Delta Y \approx 10'$

NOTE: STORAGE AT NORMAL POOL ELEVATION $(+)691'$ MSL IS 137 MG OR
 $(+)420$ $A_c \cdot FL$ MAXIMUM STORAGE = $420 + 3.3 \times 49$ A_c (S.A.)
 ≈ 580 $A_c \cdot FL$

PRELIMINARY GUIDANCE
FOR ESTIMATING
MAXIMUM PROBABLE DISCHARGES
IN
PHASE I DAM SAFETY
INVESTIGATIONS

New England Division
Corps of Engineers

March 1978

MAXIMUM PROBABLE FLOOD INFLOWS
NED RESERVOIRS

<u>Project</u>	<u>Q</u> (cfs)	<u>D.A.</u> (sq. mi.)	<u>MPF</u> cfs/sq. mi.
1. Hall Meadow Brook	26,600	17.2	1,546
2. East Branch	15,500	9.25	1,675
3. Thomaston	158,000	97.2	1,625
4. Northfield Brook	9,000	5.7	1,580
5. Black Rock	35,000	20.4	1,715
6. Hancock Brook	20,700	12.0	1,725
7. Hop Brook	26,400	16.4	1,610
8. Tully	47,000	50.0	940
9. Barre Falls	61,000	55.0	1,109
10. Conant Brook	11,900	7.8	1,525
11. Knightville	160,000	162.0	987
12. Littleville	98,000	52.3	1,870
13. Colebrook River	165,000	118.0	1,400
14. Mad River	30,000	18.2	1,650
15. Sucker Brook	6,500	3.43	1,895
16. Union Village	110,000	126.0	873
17. North Hartland	199,000	220.0	904
18. North Springfield	157,000	158.0	994
19. Ball Mountain	190,000	172.0	1,105
20. Townshend	228,000	106.0(278 total)	820
21. Surry Mountain	63,000	100.0	630
22. Otter Brook	45,000	47.0	957
23. Birch Hill	88,500	175.0	505
24. East Brimfield	73,900	67.5	1,095
25. Westville	38,400	99.5(32 net)	1,200
26. West Thompson	85,000	173.5(74 net)	1,150
27. Hodges Village	35,600	31.1	1,145
28. Buffumville	36,500	26.5	1,377
29. Mansfield Hollow	125,000	159.0	786
30. West Hill	26,000	28.0	928
31. Franklin Falls	210,000	1000.0	210
32. Blackwater	66,500	128.0	520
33. Hopkinton	135,000	426.0	316
34. Everett	68,000	64.0	1,062
35. MacDowell	36,300	44.0	825

MAXIMUM PROBABLE FLOWS
BASED ON TWICE THE
STANDARD PROJECT FLOOD
(Flat and Coastal Areas)

<u>River</u>	<u>SPF</u> (cfs)	<u>D.A.</u> (sq. mi.)	<u>MPF</u> (cfs/sq. mi.)
1. Pawtuxet River	19,000	200	190
2. Mill River (R.I.)	8,500	34	500
3. Peters River (R.I.)	3,200	13	490
4. Kettle Brook	8,000	30	530
5. Sudbury River.	11,700	86	270
6. Indian Brook (Hopk.)	1,000	5.9	340
7. Charles River.	6,000	184	65
8. Blackstone River.	43,000	416	200
9. Quinebaug River	55,000	331	330

ESTIMATING EFFECT OF SURCHARGE STORAGE ON MAXIMUM PROBABLE DISCHARGES

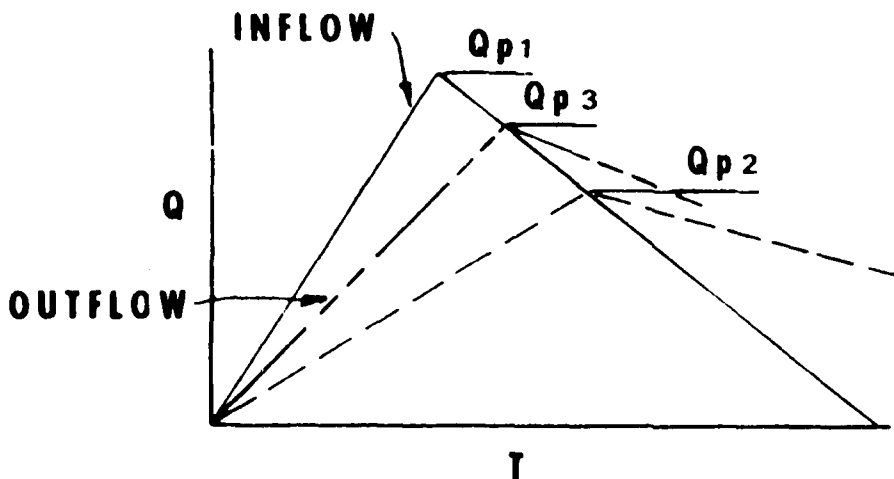

STEP 1: Determine Peak Inflow (Q_{p1}) from Guide Curves.

STEP 2: a. Determine Surcharge Height To Pass " Q_{p1} ".

b. Determine Volume of Surcharge ($STOR_1$) In Inches of Runoff.

c. Maximum Probable Flood Runoff In New England equals Approx. 19", Therefore:

$$Q_{p2} = Q_{p1} \times \left(1 - \frac{STOR_1}{19}\right)$$

STEP 3: a. Determine Surcharge Height and " $STOR_2$ " To Pass " Q_{p2} "

b. Average " $STOR_1$ " and " $STOR_2$ " and Determine Average Surcharge and Resulting Peak Outflow " Q_{p3} ".

MAXIMUM PROBABLE FLOOD PEAK FLOW RATES

x 5 - NED DAM IDENTIFICATION
 ⊗ 7' - TWICE SPF AT INDICATED SITES
 DEC. 1977

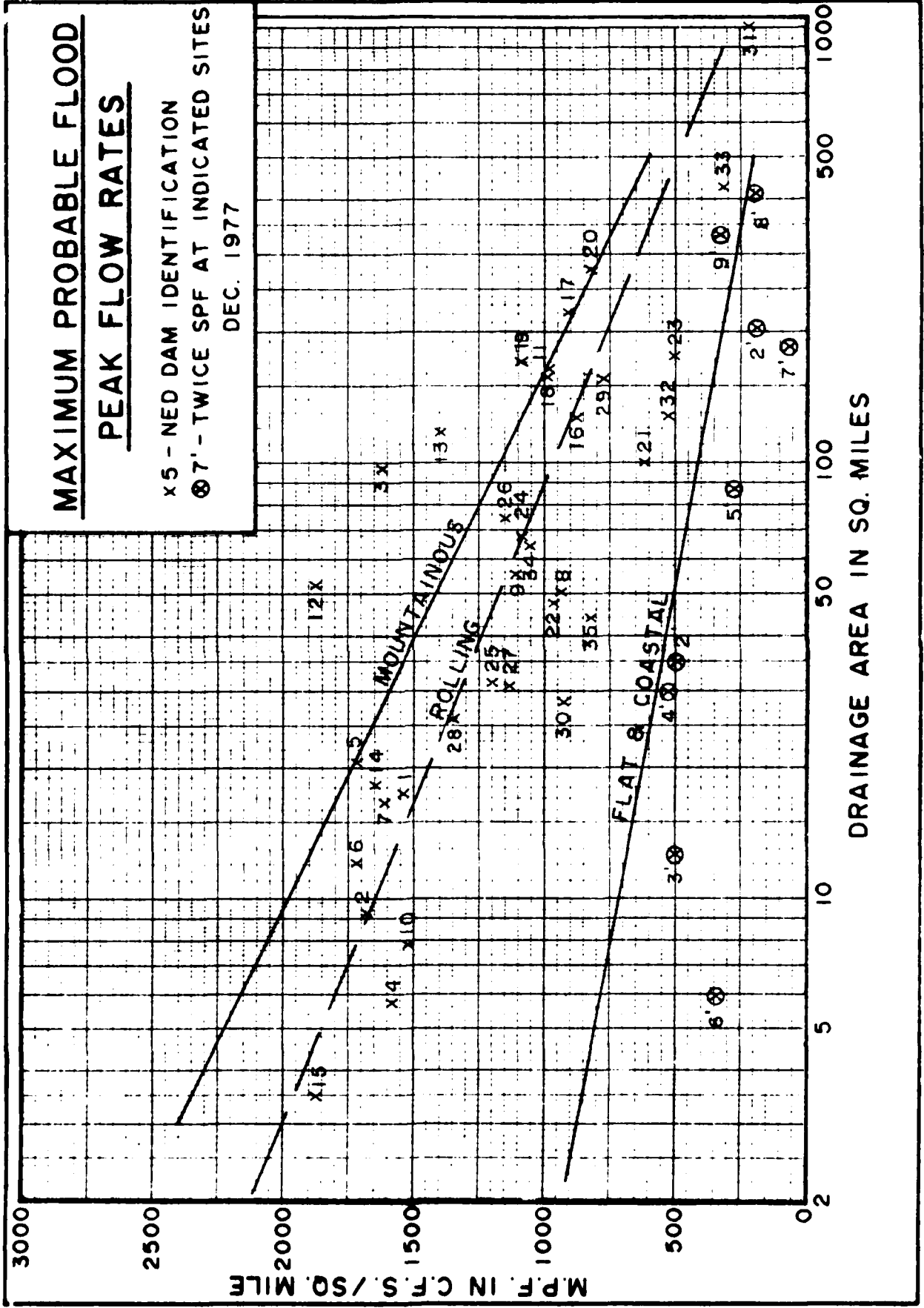

SURCHARGE STORAGE ROUTING SUPPLEMENT

**STEP 3: a. Determine Surcharge Height and
"STOR₂" To Pass "Q_{p2}"**

**b. Avg "STOR₁" and "STOR₂" and
Compute "Q_{p3}".**

**c. If Surcharge Height for Q_{p3} and
"STOR_{AVG}" agree O.K. If Not:**

**STEP 4: a. Determine Surcharge Height and
"STOR₃" To Pass "Q_{p3}"**

**b. Avg. "Old STOR_{AVG}" and "STOR₃"
and Compute "Q_{p4}"**

**c. Surcharge Height for Q_{p4} and
"New STOR_{AVG}" should Agree
closely**

SURCHARGE STORAGE ROUTING ALTERNATE

$$Q_{p2} = Q_{p1} \times \left(1 - \frac{\text{STOR}}{19} \right)$$

$$Q_{p2} = Q_{p1} - Q_{p1} \left(\frac{\text{STOR}}{19} \right)$$

FOR KNOWN Q_{p1} AND 19" R.O.

Q_{p2}
=====
=====

STOR
=====
=====

EL.
=====
=====

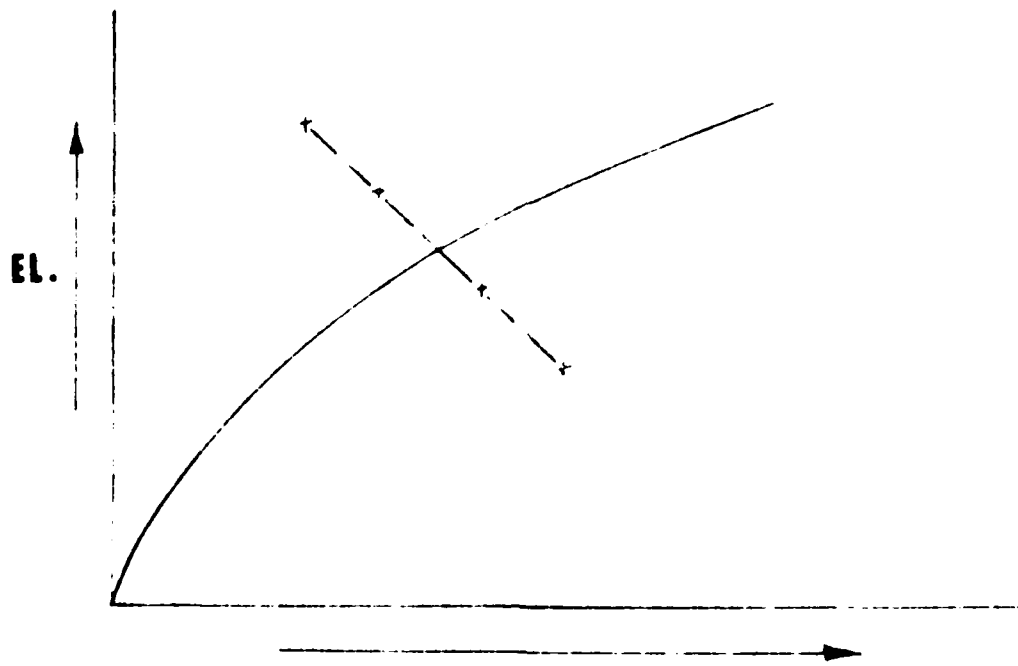

"RULE OF THUMB" GUIDANCE FOR ESTIMATING DOWNSTREAM DAM FAILURE HYDROGRAPHS

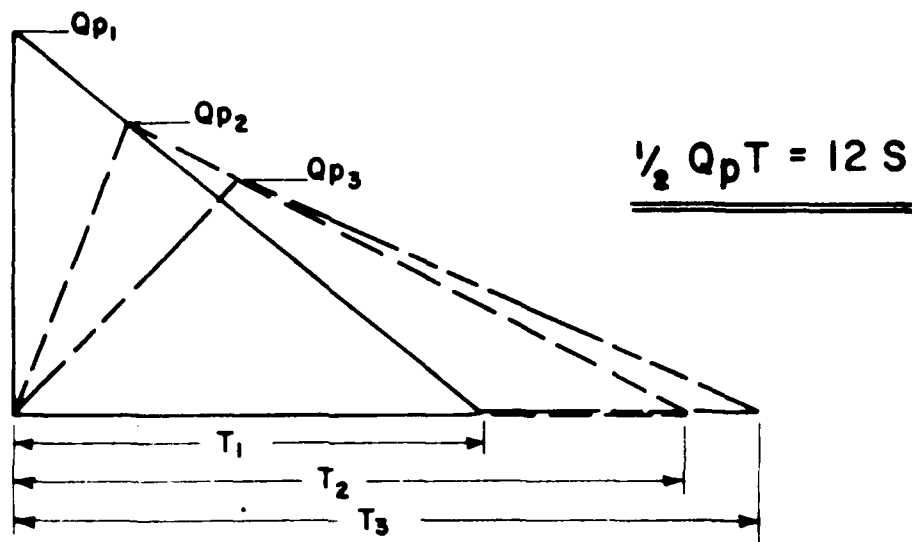

STEP 1: DETERMINE OR ESTIMATE RESERVOIR STORAGE (S) IN AC-FT AT TIME OF FAILURE.

STEP 2: DETERMINE PEAK FAILURE OUTFLOW (Q_{p1}).

$$Q_{p1} = \frac{8}{27} W_b \sqrt{g} Y_0^{3/2}$$

W_b = BREACH WIDTH - SUGGEST VALUE NOT GREATER THAN 40' OF DAM LENGTH ACROSS RIVER AT MID HEIGHT.

Y_0 = TOTAL HEIGHT FROM RIVER BED TO POOL LEVEL AT FAILURE.

STEP 3: USING USGS TOPO OR OTHER DATA, DEVELOP REPRESENTATIVE STAGE-DISCHARGE RATING FOR SELECTED DOWNSTREAM RIVER REACH.

STEP 4: ESTIMATE REACH OUTFLOW (Q_{p2}) USING FOLLOWING ITERATION.

A. APPLY Q_{p1} TO STAGE RATING, DETERMINE STAGE AND ACCOMPANYING VOLUME (V_1) IN REACH IN AC-FT. (NOTE: IF V_1 EXCEEDS 1/2 OF S, SELECT SHORTER REACH.)

B. DETERMINE TRIAL Q_{p2} .

$$Q_{p2}(\text{TRIAL}) = Q_{p1} \left(1 - \frac{V_1}{S}\right)$$

C. COMPUTE V_2 USING Q_{p2} (TRIAL).

D. AVERAGE V_1 AND V_2 AND COMPUTE Q_{p2} .

$$Q_{p2} = Q_{p1} \left(1 - \frac{V_{\text{avg}}}{S}\right)$$

STEP 5: FOR SUCCEEDING REACHES REPEAT STEPS 3 AND 4.

APRIL 1978

APPENDIX E

**INFORMATION AS CONTAINED IN THE
NATIONAL INVENTORY OF DAMS**



INVENTORY OF DAMS IN THE UNITED STATES

IDENTITY NUMBER	32	DIVISION	16
STATE	CT	COUNTY	05
CONGR DIST		CONGR DIST	
NAME		EAST MOUNTAIN RESERVOIR DAM	
LATITUDE (NORTH)	4131.7	LONGITUDE (WEST)	7300.3
REPORT DATE DAY	01	REPORT DATE MO	3
REPORT DATE YR	01	REPORT DATE YR	DEC 79

POPULAR NAME	EAST MOUNTAIN RESERVOIR		
REGION	RIVER OR STREAM	NEAREST DOWNSTREAM CITY - TOWN - VILLAGE	DIST FROM DAM (MI.)
CT 10	EAST MOUNTAIN BROOK	WATERBURY	3
POPULATION	107400		

TYPE OF DAM	YEAR COMPLETED	PURPOSES	SURFACE ELEVATION		HYDRAULIC HEIGHT	IMPOUNDING CAPACITIES	DIST OWN	FED R	PRV	FED	SCS	A	VER	DATE
			FEET	FEET										
WEGC	1971	R	35	35	35	580	420	N	N	N	N	N	N	N

REMARKS

DATE IS APPROXIMATE

U.S. HAS LENGTH	TYPE	WIDTH	MAXIMUM DISCHARGE	VOLUME OF DAM	POWER CAPACITY	NAVIGATION LOCKS
1	W	100	100	100	100	100

OWNER	ENGINEERING BY	CONSTRUCTION BY
CITY OF WATERBURY	NOT KNOWN	NOT KNOWN

DESIGN	CONSTRUCTION	OPERATION	MAINTENANCE
CT WATER RESOURCES	CT WATER RESOURCES	CT WATER RESOURCES	CT WATER RESOURCES

INSPECTION BY	INSPECTION DATE	AUTHORITY FOR INSPECTION
CAMP ENGINEERS INC	07 NOV 79	PL 92-347

REMARKS