

AD-A142 124

DEVELOPMENT OF A MICROPROCESSOR BASED AUDIOMETER FOR  
THRESHOLD SHIFT STUDIES(U) ARMY AEROMEDICAL RESEARCH  
LAB FORT RUCKER AL B T NOZO ET AL. MAR 84 USAARL-84-7

1/1

UNCLASSIFIED

F/G 6/16

NL

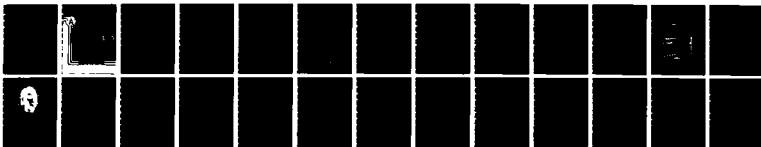

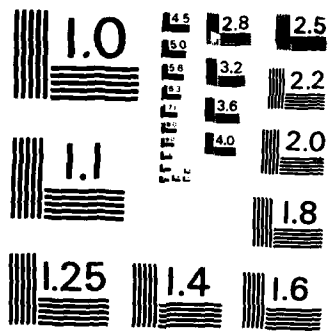

MICROCOPY RESOLUTION TEST CHART  
NATIONAL BUREAU OF STANDARDS-1963-A

12

USAARL REPORT NO. 84-7



# DEVELOPMENT OF A MICROPROCESSOR BASED AUDIOMETER FOR THRESHOLD SHIFT STUDIES

AD-A142 124

By  
Ben T. Mozo  
James H. Patterson, Jr.  
Ron Marrow  
MAJ William R. Nelson  
SFC IIIa M. Lomba-Gautler  
SP5 Dennis L. Curd

DTIC  
ELECTE  
JUN 15 1984  
S B

SENSORY RESEARCH DIVISION

March 1984

U.S. ARMY AEROMEDICAL RESEARCH LABORATORY  
FORT RUCKER, ALABAMA 36362

DTIC FILE COPY

84 06 15 008

# USAARL

NOTICE

Qualified Requesters

Qualified requesters may obtain copies from the Defense Technical Information Center, Cameron Station, Alexandria, Virginia, 22314. Orders will be expedited if placed through the librarian or other person designated to request documents from the Defense Technical Information Center.

Change of Address

Organizations receiving reports from the US Army Aeromedical Research Laboratory on automatic mailing lists should confirm correct address when corresponding about laboratory reports.

Disposition

Destroy this report when it is no longer needed. Do not return it to the originator.

Disclaimer

The views, opinions, and/or findings contained in this report are those of the authors and should not be construed as an official Department of the Army position, policy, or decision, unless so designated by other official documentation. Citation of trade names in this report does not constitute an official Department of the Army endorsement or approval of the use of such commercial items.

Human Use

Human subjects participated in these studies after giving free and informed voluntary consent. Investigators adhered to AR 70-25 and USAMRDC Reg 70-25 on Use of Volunteers in Research.

Reviewed:

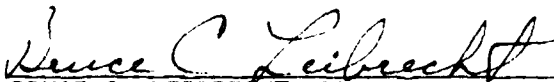
  
BRUCE C. LEIBRECHT, Ph.D.  
MAJ, MS  
Director, Sensory Research Division

Released for Publication:

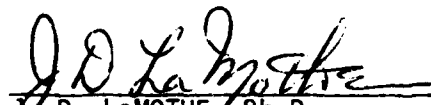
  
J. D. LaMOTHE, Ph.D.  
LTC, MS  
Chairman, Scientific Review  
Committee

  
DUDLEY R. PRICE  
Colonel, MC, SFS  
Commanding

UNCLASSIFIED

SECURITY CLASSIFICATION OF THIS PAGE (When Data Entered)

REPORT DOCUMENTATION PAGE		READ INSTRUCTIONS BEFORE COMPLETING FORM
1. REPORT NUMBER USAARL Report No. 84- 7	2. GOVT ACCESSION NO. AD-A141 124	3. RECIPIENT'S CATALOG NUMBER
4. TITLE (and Subtitle) Development of a Microprocessor Based Audiometer For Threshold Shift Studies		5. TYPE OF REPORT & PERIOD COVERED
		6. PERFORMING ORG. REPORT NUMBER
7. AUTHOR(s) Ben T. Mozo, James H. Patterson, Jr., Ron Marrow, MAJ William R. Nelson, SFC Ilia M. Lomba-Gautier, and SP5 Dennis L. Curd		8. CONTRACT OR GRANT NUMBER(s)
9. PERFORMING ORGANIZATION NAME AND ADDRESS Sensory Research Division US Army Aeromedical Research Laboratory Fort Rucker, AL 36362		10. PROGRAM ELEMENT, PROJECT, TASK AREA & WORK UNIT NUMBERS DA Project 3E162777A878 AA 136
11. CONTROLLING OFFICE NAME AND ADDRESS US Army Medical Research and Development Command Fort Detrick Frederick, MD 21701		12. REPORT DATE March 1984
		13. NUMBER OF PAGES 21
14. MONITORING AGENCY NAME & ADDRESS (if different from Controlling Office)		15. SECURITY CLASS. (of this report)  Unclassified
		15a. DECLASSIFICATION/DOWNGRADING SCHEDULE
16. DISTRIBUTION STATEMENT (of this Report) Approved for public release; distribution unlimited		
17. DISTRIBUTION STATEMENT (of the abstract entered in Block 20, if different from Report)		
18. SUPPLEMENTARY NOTES		
19. KEY WORDS (Continue on reverse side if necessary and identify by block number) Acoustics Audiometry Hearing Threshold Shifts Microprocessor		
20. ABSTRACT (Continue on reverse side if necessary and identify by block number) See reverse.		

UNCLASSIFIED

SECURITY CLASSIFICATION OF THIS PAGE(When Data Entered)

20. ABSTRACT. In order to permit the collection of data on hearing threshold shift resulting from firing Army weapons, a multichannel microprocessor-controlled audiometer was developed. The system features four synchronized channels for determining hearing thresholds by a fixed frequency, fix test-time Von Bekesy tracking method. Nonstandard, noise excluding headsets were developed as part of the system. Biological calibration of the system was accomplished by comparison to a clinical audiometer and a validation test was completed to demonstrate system accuracy and reliability. The results indicate the system is as accurate as, and more reliable than, the clinical audiometer.

UNCLASSIFIED

SECURITY CLASSIFICATION OF THIS PAGE(When Data Entered)

## ACKNOWLEDGEMENTS

The authors would like to express appreciation to Mr. Keith Zienert for assistance in the construction of the microprocessor audiometer, Ms. Linda Barlow for data analysis and collation, and Ms. Phyllis Burns for assistance in the preparation of the final report.

Accession For	
NTIS GRA&I	<input checked="" type="checkbox"/>
DTIC TAB	<input type="checkbox"/>
Unannounced	<input type="checkbox"/>
Justification	
By	
Distribution/	
Availability Codes	
Dist	Avail and/or Special
A-1	



TABLE OF CONTENTS

	PAGE NO.
List of Figures . . . . .	2
List of Tables . . . . .	2
Introduction . . . . .	3
Methods and Materials. . . . .	4
Results and Discussion . . . . .	10
References . . . . .	16
Appendix	
A. List of Equipment Manufacturers. . . . .	17



## LIST OF FIGURES

FIGURE NO.		PAGE NO.
1	Block Diagram of Multichannel, Microprocessor Controlled Audiometer (MCA). . . . .	4
2	Photograph of Microprocessor Controlled Audiometer System. . . . .	6
3	Components of the Audiometric Headsets . . . . .	8
4	Assembled Audiometric Headset. . . . .	9

## LIST OF TABLES

TABLE NO.		PAGE NO.
1	Ambient Noise Octave Band Levels (dB SPL) in Three Audiometric Rooms used for Biological Calibration of MCA Headphones . . . . .	10
2	Sound Pressure Level in dB SPL at 0 dB HTL for Four Channels of the USAARL Microprocessor Controlled Audiometer (MCA). . . . .	11
3	Mean and Standard Deviation of Hearing Thresholds in dB HTL Determined Using a Grason-Stadler 1701 Audiometer and the USAARL Microprocessor Controlled Audio- meter (MCA). . . . .	13
4	Standard Deviations and Range of Hearing Thresholds in dB HTL for Seven Listeners Determined Using a Grason-Stadler 1701 and the USAARL Microprocessor Controlled Audiometer (MCA) (Page 1). . . . .	14
4	Standard Deviations and Range of Hearing Thresholds in dB HTL for Seven Listeners Determined Using a Grason-Stadler 1701 and the USAARL Microprocessor Controlled Audiometer (MCA) (Page 2). . . . .	15

## INTRODUCTION

In preparation for the field study to determine the adequacy of hearing protection for use with the M198, 155mm howitzer, a special purpose, multi-channel audiometer was developed. The development of the audiometer was initiated in December 1976 in preparation for a "quick fix" for the M198 blast overpressure problem. Between 1976 and 1980, there were numerous delays in executing the "quick fix." During this time, the original audiometer was constructed and the system underwent several modifications which altered its final capabilities. This report documents the development of the audiometer and its calibration.

The design characteristics of the special purpose audiometer were determined primarily by the operational requirement to measure auditory thresholds (audiograms) before and after exposure to weapons noise in a field setting. These audiograms had to be determined quickly, accurately, and reliably with minimally trained volunteers.

A modified Von Bekesy tracking procedure (Von Bekesy, 1947) was selected for this purpose. The procedure was based on testing discrete frequencies for a fixed length of time. This would permit the calculation of time between the noise exposure and the testing of each frequency. The system had to have a wide dynamic range to be capable of determining thresholds which were 20 to 30 dB better than normal and thresholds which were temporarily elevated well above normal. The original design requirement for six people to be tested simultaneously was later reduced to four people. In addition, noise excluding headphones were required to permit audiometric testing under adverse environmental noise conditions.

With these design characteristics established, a search for a commercially available unit was undertaken. None could be found which met all requirements. In-house development then was initiated utilizing available audio components to the maximum extent possible. The requirement for six channels, fixed time of testing each frequency, and use by minimally-trained individuals suggested that a microprocessor control system with digitally controlled attenuators and data collection capability would be most suitable. This also established the possibility of automatic data transfers to desk top calculators for rapid data analysis. This latter capability was added after the initial system fabrication. No satisfactory noise-excluding headphones could be identified which would yield acceptable noise reduction at the subject's ear. Therefore, standard audiometric headphones were mounted in good hearing protective earmuffs to meet this requirement.

An attempt was made during the development process to maintain maximum flexibility of the microprocessor control over the hardware components of the system. This flexibility was accomplished by insuring the system's ability to be modified by changing software. Various audiometric and analysis procedures could be implemented without a requirement for direct engineering support.

Once the system was fabricated, it was subjected to a series of comparison tests in the laboratory and in the USAARL Mobile Audiometric Test Trailer to determine its performance as compared to a high quality clinical audiometer. Since the headphones could not be calibrated by standard methods (due to the nonstandard mounting), a biological calibration factor was developed and validated by these comparison tests.

#### METHODS AND MATERIALS

A block diagram of the multichannel microprocessor controlled audiometer is shown in Figure 1. The system is comprised of two parts; (1) stimulus generation, and (2) control and data processing. Each channel of the audiometer includes a programmable attenuator, step attenuator, 1-watt power amplifier, earphones, and response switch. These items are shown on the

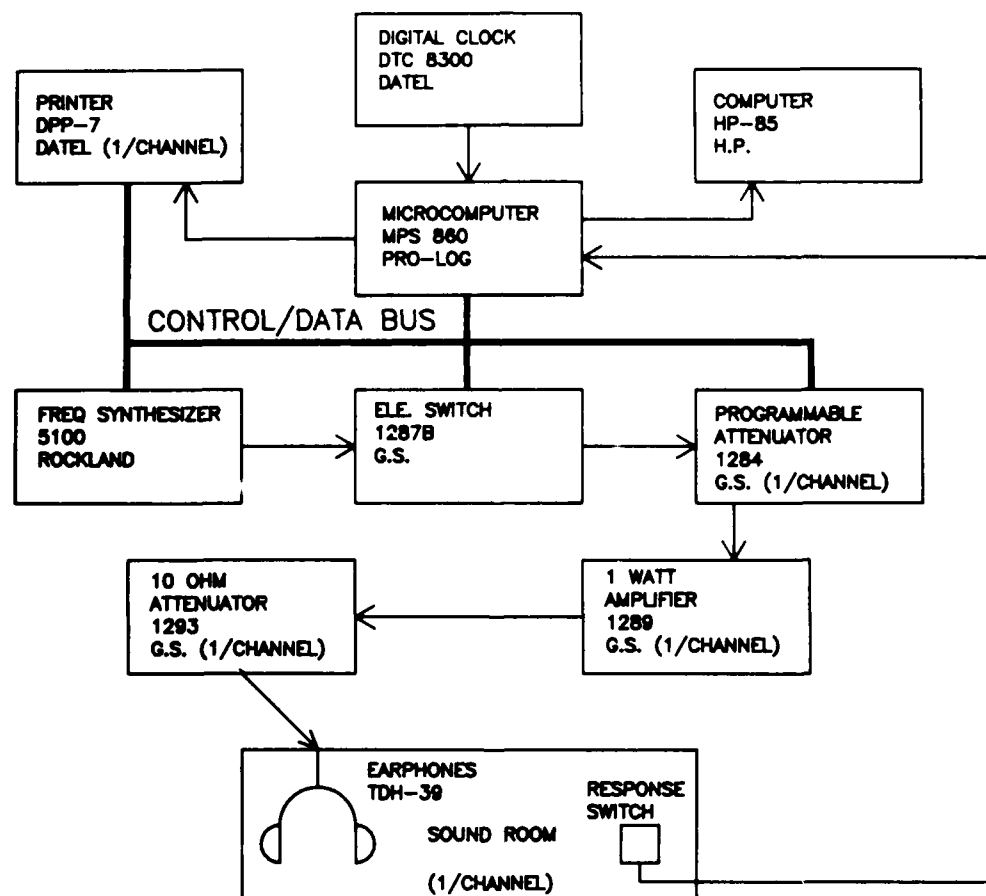

FIGURE 1. Block Diagram of Multichannel, Microprocessor Controlled Audiometer (MCA).

block diagram for a single channel. The remainder of the components are common to all channels. The system utilizes a hex keyboard for the operator to enter data or control the audiometer. The audiometer is designed for 6-channel operation; however, the USAARL mobile audiometric trailer limits the system to four channels.

The frequency synthesizer is controlled by the microprocessor to produce the stimuli for the audiometer. The frequency, order of frequency, and number of frequencies are stored in memory and may be modified. The frequencies presently used range from 500 Hz to 8 kHz with a presentation order of 2K, 4K, 6K, 3K, 8K, 2K, 1K, and 500 Hz. The test signal produced by the synthesizer is input to the electronic switch where it is pulsed with a microprocessor-controlled period of 350 ms. The electronic switch is adjusted to provide a 25 ms rise and fall time gate on the stimuli to eliminate audible clicks. The output of the electronic switch is input to the programmable attenuator of each channel.

Each programmable attenuator is capable of controlling the stimulus level over a range of 128 dB in 0.5 dB increments. An increment of 2 dB was considered adequate for the threshold determination accuracy required for weapons field studies. The attenuator is a binary weighted system where the  $2^n$  result is the attenuation in dB. A 6-bit up/down counter, with the stages of the counter attached to corresponding stages of the attenuator, is used to control the attenuator setting. The up/down control of the counter is directly related to the subject response switch. If the subject hears the tone and presses the switch, then the up/down control is set for up count and when the clock pulse is received from the microprocessor the attenuator increases its attenuation by 2 dB. The up/down counter may be preset to any value by the microprocessor. The state of the up/down counter is capable of being read by the microprocessor.

After output from the programmable attenuator, the signal is amplified by the 1-watt amplifier, then passes through the 10 ohm step attenuator to the Telephonics\* TDH-49 earphones which are worn by the test subject. The step attenuator may be adjusted over a range of 100 dB in 5 dB increments. In this application the step attenuator is used to decrease the system noise level at the earphones, and also to provide the experimenter with a means of checking listener reliability. Figure 2 shows the completely assembled audiometer rack, mounted and ready for use.

The threshold determination procedure uses the tracking method (Von Bekesy, 1947). The threshold determination for a particular frequency consists of four segments. The first segment provides the listener with two pulses of the stimulus at a level approximately 40 dB above hearing threshold. This alerts the listener that a test trial is beginning and provides him with a cue as to the sound of the stimulus. The second segment is the beginning of

---

\*See Appendix A

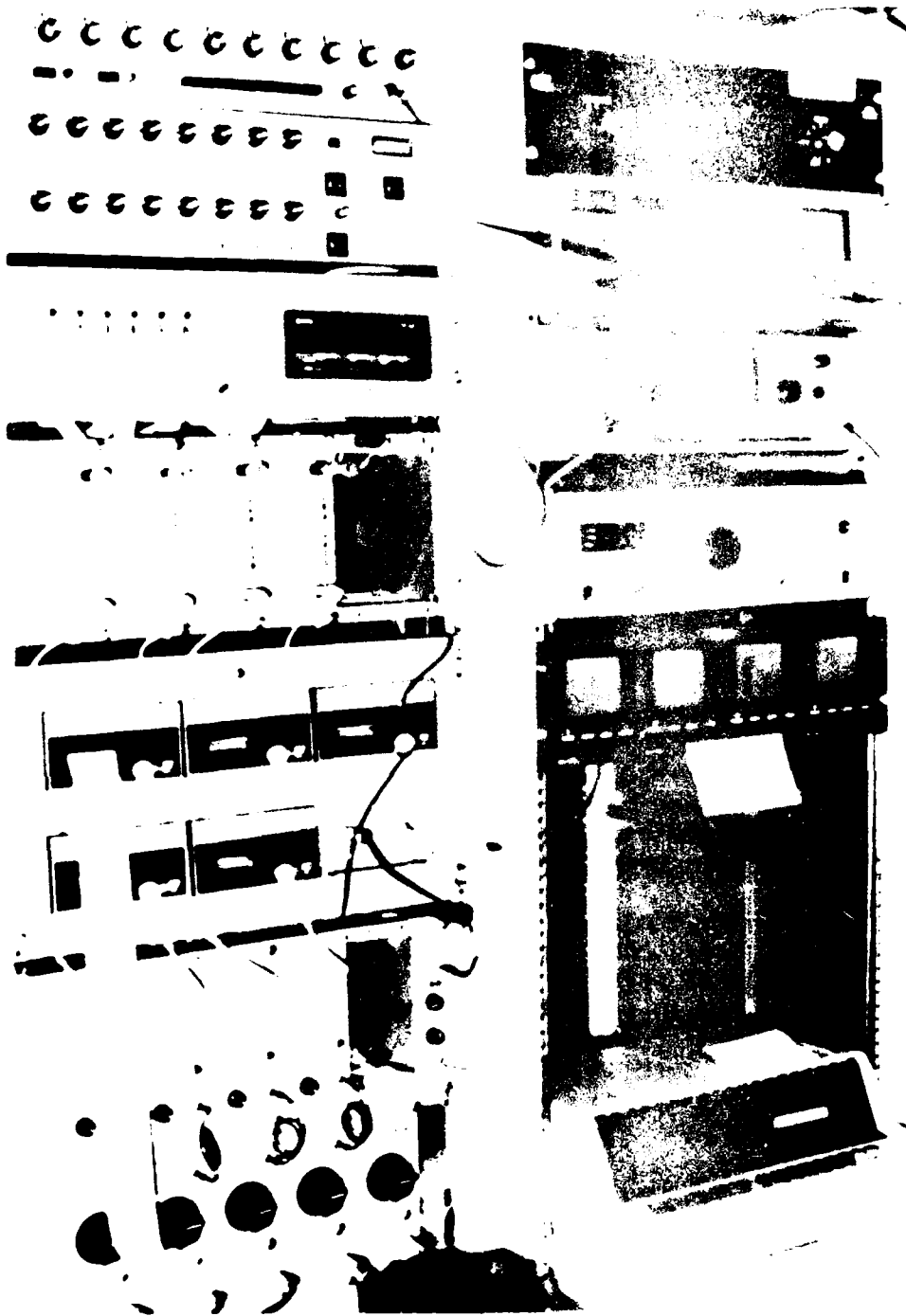

FIGURE 2. Photograph of Microprocessor Controlled Audiometer System.

the threshold tracking task. The level of the stimulus begins at approximately 10 dB Hearing Threshold Level (HTL) and is controlled by the listener through the hand switch. This segment presents 16 tone pulses (approximately 5.6 sec) to allow the listener to converge to his threshold before data are collected. The third segment, consisting of 48 pulses (16.8 sec), involves the collection of threshold data. Each time the response switch state changes during the tracking process the attenuator value is read and stored by the microprocessor. The fourth segment is the development of the mean attenuator value which is translated into HTL and printed. This process is completed for all frequencies and for both the left and right ears.

Data are output to either the Datel\* printer or the Hewlett-Packard\* HP-85 computer. If the printer is used, prior to each test frequency the subject's identification number, the date, the test frequency, and the start time for that test frequency are printed. During the test each time the microprocessor detects a change of state for the subjects response switch, the value of the programmable attenuator (corrected for HTL) is printed. After the test frequency is completed, the total number of switch state changes and the mean attenuator value (corrected for HTL) are printed. If the HP-85 is used, the programmable attenuator value at switch state change time is displayed on the CRT at the end of the test frequency. When the subject has completed the entire audiogram, all data may be stored on cassette tape for later analysis.

The headsets used in this application were designed and built using "off-the-shelf" components of proven quality (Figure 3). The transducers were matched pairs of TDH-49 earphones purchased specifically for this project. They were enclosed in earmuffs obtained through the federal supply system (National Stock Number 4240-00-759-3290). Installation of the earphones was accomplished by drilling 1/4" holes through the walls of the earcups. Rubber grommets were inserted and Belden\* 8411 coaxial cable was passed through the grommets to the TDH-49 earphones. The opposite ends of the cable were terminated with a standard stereo phone jack. The cables were approximately 6 feet long to allow mobility for the earphone wearer.

The original foam material from inside the earcups was removed and used as a pattern to cut new inserts to go in the cups. The new inserts were made from 3/4" thick open cell foam polyester with a specific density of 2.25 ± 0.5 lbs/cu ft.

The earphones were centered in the earcups and held in place with specially-built retainers made of Plexiglas. The retainers were backed with a very thin sheet of polyester foam to prevent direct contact with the earphones. The earphones and retainers were covered with a 3/8" sheet of open cell polyester foam. The original ear seals were used, as were the suspension systems and head cushions.

Right and left earphones were connected to the stereo phone jack in a predetermined fashion and labeled by placing tape on the right cup to ensure that the subjects always placed the right and left earphones on the correct ear. Figure 4 shows the assembled headset unit.

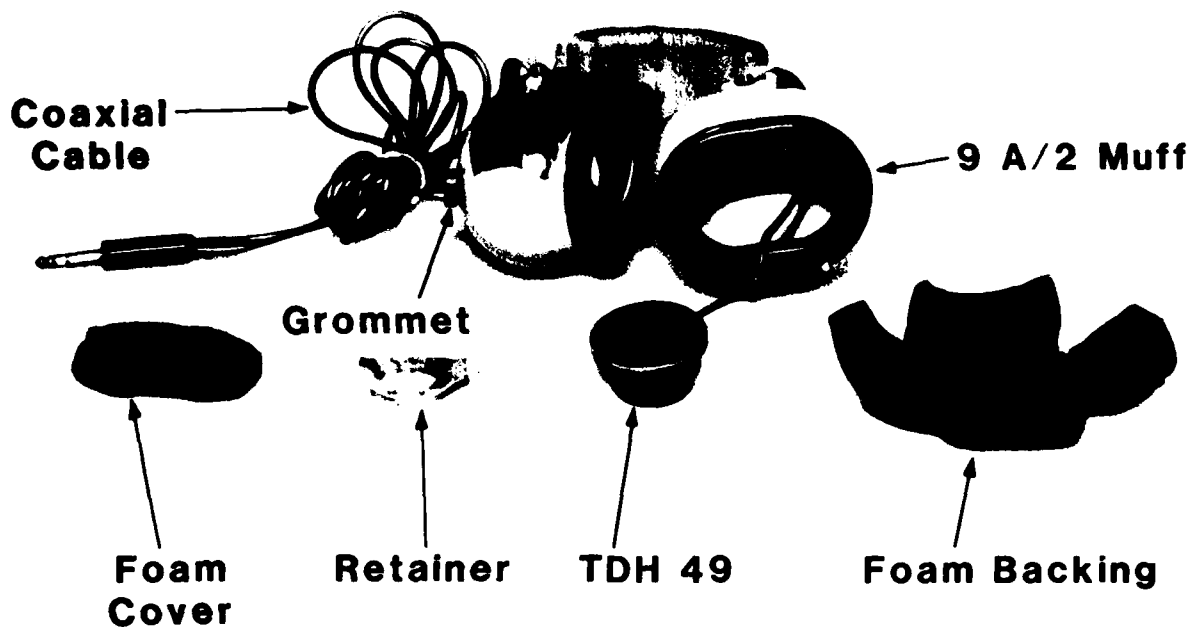

FIGURE 3. Components of the Audiometric Headsets.

Acoustic calibration of the headsets was accomplished using a Bruel and Kjaer (B&K)\* type 4153 artificial ear fitted with a flat plate adapter. A B&K type 4134 microphone was used with the coupler and a type 2619 preamplifier connected to a model 227 multiplexer amplifier. The sound pressure levels were read on a B&K Model 2606 measuring amplifier with external filter type 1618. The measurement system was calibrated with a B&K type 4220 piston phone prior to the calibration of the headsets. The headphone acoustic calibration was accomplished by setting the audiometer to provide an output of 67.5 dB SPL at 1000 Hz measured at the right earphone. The output at all test frequencies was measured at both earphones with this attenuator setting held constant.

Since the nonstandard mountings of the headphones precluded calibration by standard methods, a biological calibration was performed. This was done



FIGURE 4. Assembled Audiometric Headset.

in two phases. First, the threshold was measured on a group of four listeners (Group 1) using a Grason-Stadler\* 1701 audiometer and the new audiometer. These listeners were not screened for normal hearing (some did have a high frequency hearing loss.) The GS-1701 audiometer was calibrated to the manufacturer's specifications in accordance with American National Standards Institute (ANSI) S3.6 (1969).

Audiograms were repeated five times for each listener on each system. The new audiometer thresholds were in values of attenuation. This first phase was



used to derive a conversion table which was incorporated in the audiometric program to convert these threshold attenuation values to estimates of hearing Threshold Level (HTL). The second phase of biological calibration involved the comparison of HTLs measured on the Grason-Stadler 1701 and on the new audiometer. This comparison was accomplished in the USAARL mobile audiometric trailer.

Ten listeners (Group 2) produced three audiograms each on each audiometer. These listeners were selected for normal hearing in accordance with ANSI S3.19 (1974). Three of these listeners produced six additional audiograms for a total of nine audiograms on each audiometer. Table 1 contains the ambient noise levels in the laboratory audiometric room and in the mobile audiometric facility used for the biological calibrations.

TABLE 1  
 AMBIENT NOISE OCTAVE BAND LEVELS (dB SPL) IN THREE AUDIOMETRIC ROOMS  
 USED FOR BIOLOGICAL CALIBRATION OF MCA HEADPHONES

Octave Band Center in Hertz	Mobile Room 1	Mobile Room 2	Laboratory Room
31.5	33	32	34
63	26	30	31
125	21	11	14
250	14	6	12
500	5	5	12
1K	5	5	11
2K	6	6	11
4K	6	7	11
8K	6	6	10
16K	14	9	10

#### RESULTS AND DISCUSSION

Table 2 contains the estimated Sound Pressure Levels (SPL) at HTL of zero, as derived from the initial biological calibration and the flat plate calibration. For comparison, the SPL values at audiometric zero provided by Grason-Stadler (1971) are included also. The sound pressure levels of the MCA headphones agree with the reference levels of the Grason-Stadler 1701 except at 8.0 kHz.

TABLE 2

SOUND PRESSURE LEVEL IN dB SPL AT 0 dB HTL FOR FOUR CHANNELS OF THE  
USAARL MICROPROCESSOR CONTROLLED AUDIOMETER (MCA)

	Frequency in kHz													
	Right Ear					Left Ear								
	.5	1.0	2.0	3.0	4.0	6.0	8.0	.5	1.0	2.0	3.0	4.0	6.0	8.0
GS 1701 Calibration SPL*	13.5	7.5	11.0	9.5	10.5	13.5	13.0	13.5	7.5	11.0	9.5	10.5	13.5	13.0
MCA Channel 1	12.1	8.5	10.4	8.8	7.5	13.3	19.1	11.2	6.4	10.6	9.5	9.0	12.6	18.4
MCA Channel 2	14.9	8.5	10.1	9.3	9.1	12.9	22.0	16	9.9	10.3	7.8	6.2	13.7	19.7
MCA Channel 3	15.7	8.5	9.9	8.8	8.9	13.4	20.9	14.6	8.9	10.9	9.1	9.5	14.3	22.4
MCA Channel 4	14.7	8.5	11.6	11.1	12.3	15.0	23.8	13.9	7.9	11.4	9.5	8.3	14.5	21.7

\*Source: Grason-Stadler, a GR Company. 1971. *1701 Audiometer Instruction Manual*. Concord, Massachusetts: Grason-Stadler Company, Inc.

Table 3 contains a summary of the second phase of biological calibration. The mean and standard deviation of threshold obtained on the Grason-Stadler 1701 and the new audiometer are shown for the ten Group 2 listeners tested three times each. These results give an indication of the accuracy of the MCA compared to the standard audiometer. With the exception of 6.0 kHz in the right ear, the agreement is within the tolerances specified in ANSI S3.6 (1969).

The reliability of the MCA can be estimated from measures of variability of the individual audiograms. Because of individual differences in threshold between listeners, the results of the nine repeated audiograms on the three Group 2 listeners and the five repeated audiograms of the four Group 1 listeners were used to compute standard deviations and range of thresholds for each listener on each audiometer. These results are presented in Table 4. These standard deviations and ranges give an indication of the relative reliability of the two audiometers. As can be seen, for most listeners at most frequencies there is little difference between the reliability of the two audiometers. However, at some frequencies (especially the higher ones), the MCA is clearly more reliable than the clinical audiometer. This is probably a result of the difficulty of obtaining a consistent earphone placement with the clinical audiometer and standard headphones. The superior reliability of the MCA system is particularly important for threshold shift studies since individual audiograms must be used without retesting or averaging to improve reliability.

TABLE 3

MEAN AND STANDARD DEVIATION OF HEARING THRESHOLDS IN dB HTL DETERMINED USING A GRASON-STADLER 1701  
 AUDIOMETER AND THE USAARL MICROPROCESSOR CONTROLLED AUDIOMETER (MCA)\*

SYSTEM	Frequency in kHz													
	Right Ear					Left Ear								
	.5	1.0	2.0	3.0	4.0	6.0	8.0	.5	1.0	2.0	3.0	4.0	6.0	8.0
GS 1701	Mean	.9	1.1	-1.2	-1.7	-1.1	7.0	.3	.6	1.2	1.5	3.3	9.0	7.3
	S.D.	4.9	7.0	7.2	5.3	5.9	7.9	4.2	6.2	7.3	6.0	9.3	11.7	8.5
MCA	Mean	-.5	-.5	-1.8	-4.3	-2.0	.1	2.4	.4	-2.7	-3.8	-.3	5.8	7.3
	S.D.	4.0	6.5	8.2	6.8	5.0	6.0	7.0	7.0	10.2	4.9	9.6	7.6	8.9

\*Based on 10 listeners (Group 2) repeated 3 times each on each system.

TABLE 4

## STANDARD DEVIATIONS AND RANGE OF HEARING THRESHOLDS IN dB HTL FOR SEVEN LISTENERS DETERMINED USING A GRASON-STADLER 1701 AND THE USAARL MICROPROCESSOR CONTROLLED AUDIOMETER (MCA)

LISTENER	SYSTEM	Frequency in kHz													
		Right Ear					Left Ear								
		.5	1.0	2.0	3.0	4.0	6.0	8.0	.5	1.0	2.0	3.0	4.0	6.0	8.0
MN*	GS 1701	S.D. Range	1.5 3.0	2.9 8.0	1.4 3.0	.7 2.0	2.4 6.0	2.8 16.0	5.8 6.0	2.5 4.0	1.3 3.0	1.6 4.0	2.5 6.0	2.3 5.0	11.0 28.0
	MCA	S.D. Range	1.7 4.0	2.6 7.0	1.0 2.0	.7 2.0	1.9 5.0	2.2 5.0	2.6 6.0	2.7 6.0	.9 2.0	2.1 5.0	1.5 4.0	1.3 3.0	2.9 7.0
RM*	GS 1701	S.D. Range	3.0 7.0	2.6 7.0	2.1 5.0	2.3 6.0	3.2 8.0	2.5 6.0	5.9 15.0	3.8 9.0	1.5 4.0	1.5 4.0	6.1 14.0	3.7 9.0	7.4 16.0
	MCA	S.D. Range	4.1 10.0	2.1 5.0	1.5 3.0	2.2 5.0	2.2 5.0	1.9 4.0	1.3 3.0	1.8 4.0	2.7 7.0	1.3 3.0	2.0 5.0	2.4 6.0	4.3 10.0
BM*	GS 1701	S.D. Range	3.1 8.0	3.4 8.0	3.4 8.0	2.3 6.0	3.3 8.0	3.3 8.0	2.2 5.0	2.2 6.0	2.8 6.0	2.2 6.0	4.3 11.0	4.8 11.0	4.4 11.0
	MCA	S.D. Range	2.1 5.0	2.3 6.0	2.5 7.0	2.2 5.0	1.9 5.0	2.4 6.0	3.1 6.0	1.6 4.0	2.1 5.0	2.5 6.0	1.1 4.0	1.9 5.0	1.1 3.0
JP*	GS 1701	S.D. Range	.9 2.0	1.1 3.0	3.0 8.0	1.9 5.0	1.3 3.0	3.5 9.0	4.4 12.0	1.9 5.0	2.9 8.0	3.3 7.0	1.0 2.0	2.9 7.0	1.8 4.0
	MCA	S.D. Range	1.7 4.0	2.2 6.0	1.5 3.0	2.6 7.0	1.3 3.0	2.5 6.0	4.9 12.0	2.9 7.0	.8 2.0	2.9 7.0	2.4 6.0	1.0 2.0	1.5 4.0

\*Testing was conducted using Group 1 listeners 5 times each.

\*\*Testing was conducted using Group 2 listeners 9 times each.

TABLE CONTINUED  
ON NEXT PAGE

TABLE 4 (CONTINUED)

LISTENER	SYSTEM	Frequency in KHz														
		Right Ear					Left Ear									
		.5	1.0	2.0	3.0	4.0	6.0	8.0	.5	1.0	2.0	3.0	4.0	6.0	8.0	
SE**	GS 1701	S.D.	1.9	2.6	2.1	1.6	3.5	3.2	4.8	3.8	1.6	1.8	6.8	3.0	3.1	2.5
		Range	5.3	8.5	6.4	4.4	8.9	11.1	14.3	11.5	5.5	6.1	23.2	7.2	10.6	7.4
	MCA	S.D.	2.2	2.5	2.1	2.4	2.3	3.6	3.8	2.2	1.6	3.1	2.1	2.4	2.0	2.5
		Range	7.0	8.0	7.0	8.0	6.0	10.0	11.0	6.0	5.0	9.0	6.0	7.0	6.0	7.0
LP**	GS 1701	S.D.	5.4	1.9	1.7	1.9	2.3	3.1	4.2	3.8	3.2	3.2	3.5	2.7	3.7	4.5
		Range	17.6	5.3	5.1	5.6	6.6	9.2	10.4	12.5	10.0	9.5	10.2	7.8	11.6	11.4
	MCA	S.D.	.7	1.7	2.9	2.4	1.7	2.4	3.0	1.1	2.1	3.7	2.1	2.2	1.1	1.8
		Range	2.0	5.0	7.0	8.0	5.0	7.0	9.0	4.0	6.0	10.0	7.0	6.0	3.0	5.0
SH**	GS 1701	S.D.	6.9	2.4	4.2	5.7	5.3	4.3	4.4	3.7	4.4	2.9	2.5	2.9	4.1	2.8
		Range	21.0	7.1	13.0	17.5	15.3	14.9	12.7	11.8	14.8	7.7	6.4	9.7	11.0	8.9
	MCA	S.D.	4.0	2.4	4.4	2.4	2.9	1.8	2.4	1.1	1.5	1.4	1.2	1.0	1.9	2.0
		Range	11.0	8.0	12.0	6.0	9.0	6.0	7.0	4.0	5.0	4.0	4.0	3.0	5.0	6.0

\* Testing was conducted using Group 1 listeners 5 times each.

\*\* Testing was conducted using Group 2 listeners 9 times each.

## REFERENCES

- American National Standards Institute, 1969. *American National Standard Specifications for Audiometers*. New York: American National Standards Institute. ANSI S3.6-1969.
- American National Standards Institute, 1974. *Method for the Measurement of Real-Ear Protection of Hearing Protectors and Physical Attenuation of Earmuffs*. New York: American Institute of Physics. ANSI S3.19-1974.
- Grason-Stadler, a GR Company. 1971. *1701 Audiometer Instruction Manual*. Concord Massachusetts: Grason-Stadler Company, Incorporated.
- Von Bekesy, G. 1947. A New Audiometer. *Acta Oto-Laryngologica*. Volume 35: 411-422.

DISTRIBUTION

Defense Technical Information Center Cameron Station Alexandria, VA 22314	(12)	Aeromechanics Laboratory US Army Research & Technology Labs Ames Research Center, M/S 215-1 Moffett Field, CA 94035	(1)
Under Secretary of Defense for Research and Engineering ATTN: Military Assistant for Medical and Life Sciences Washington, DC 20301	(1)	Sixth United States Army ATTN: SMA Presidio of San Francisco, California 94129	(1)
Uniformed Services University of the Health Sciences 4301 Jones Bridge Road Bethesda, MD 20014	(1)	Director Army Audiology & Speech Center Walter Reed Army Medical Center Forest Glen Section, Bldg 156 Washington, DC 20012	(1)
Commander US Army Medical Research and Development Command ATTN: SGRD-RMS/Ms. Madigan Fort Detrick Frederick, MD 21701	(5)	Harry Diamond Laboratories Scientific & Technical Information Offices 2800 Powder Mill Road Adelphi, MD 20783	(1)
Redstone Scientific Information Center ATTN: DRDMI-TBD US Army Missile R&D Command Redstone ARsenal, AL 35809	(1)	US Army Ordnance Center & School Library, Bldg 3071 ATTN: ATSL-UOSL Aberdeen Proving Ground, MD 21005	(1)
US Army Yuma Proving Ground Technical Library Yuma, AZ 85364	(1)	US Army Environmental Hygiene Agency Library, Bldg E2100 Aberdeen Proving Ground, MD 21010	(1)
US Army Aviation Engineering Flight Activity ATTN: DAVTE-M ( Technical Library) Edwards AFB, CA 93523	(1)	Technical Library Chemical Systems Laboratory Aberdeen Proving Ground, MD 21010	(1)
US Army Combat Developments Experimentation Command Technical Library HQ, USACDEC Box 22 Fort Ord, CA 93941	(1)	US Army Materiel Systems Analysis Agency ATTN: Reports Distribution Aberdeen Proving Ground, MD 21005	(1)



Commander US Army Medical Research Institute of Chemical Defense Aberdeen Proving Ground, MD 21010	(1)	US Army Field Artillery School Library Snow Hall, Room 16 Fort Sill, OK 73503	(1)
Commander Naval Air Development Center ATTN: Code 6022 (Mr. Brindle) Warminster, PA 18974	(1)	US Army Dugway Proving Ground Technical Library Bldg 5330 Dugway, UT 84022	(1)
Director Ballistic Research Laboratory ATTN: DRDAR-TSB-S (STINFO) Aberdeen Proving Ground, MD 21005	(2)	US Army Materiel Development. & Readiness Command ATTN: DRCSG 5001 Eisenhower Avenue Alexandria, VA 22333	(1)
US Army Research & Development Technical Support Activity Fort Monmouth, NJ 07703	(1)	US Army Foreign Science & Technology Center ATTN: DRXST-ISI 220 7th St., NE Charlottesville, VA 22901	(1)
Commander/Director US Army Combat Surveillance & Target Acquisition Laboratory ATTN: DELCS-D Fort Monmouth, NJ 07703	(1)	Commander US Army Training and Doctrine Command ATTN: ATCD Fort Monroe, VA 23651	(2)
US Army Avionics R&D Activity ATTN: DAVAA-O Fort Monmouth, NJ 07703	(1)	Commander US Army Training and Doctrine Command ATTN: Surgeon Fort Monroe, VA 23651	(1)
US Army White Sands Missile Range Technical Library Division White Sands Missile Range New Mexico 88002	(1)	US Army Research & Technology Labs Structures Laboratory Library NASA Langley Research Center Mail Stop 266 Hampton, VA 23665	(1)
Chief Benet Weapons Laboratory LCWSL, USA ARRADCOM ATTN: DRDAR-LCB-TL Watervliet Arsenal Watervliet, NY 12189	(1)	Commander 10th Medical Laboratory ATTN: DEHE (Audiologist) APO New York 09180	(1)
US Army Research & Technology Labs Propulsion Laboratory MS 77-5 NASA Lewis Research Center Cleveland, OH 44135	(1)	Commander US Army Natick R&D Laboratories ATTN: Technical Librarian Natick, MA 01760	(1)

Commander US Army Troop Support & Aviation Materiel Readiness Command ATTN: DRSTS-W St. Louis, MO 63102	(1)	US Air Force Armament Development & Test Center Technical Library Eglin AFB, FL 32542	(1)
Commander US Army Aviation R&D Command ATTN: DRDAV-E 4300 Goodfellow Blvd St. Louis, MO 63166	(1)	US Air Force Institute of Technology (AFIT/LDE) Bldg 640, Area B Wright-Patterson AFB, OH 45433	(1)
Director US Army Human Engineering Laboratory ATTN: Technical Library Aberdeen Proving Ground, MD 21005	(1)	US Air Force Aerospace Medical Division School of Aerospace Medicine Aeromedical Library/TSK-4 Brooks AFB, TX 78235	(1)
Commander US Army Aviation R&D Command ATTN: Library 4300 Goodfellow Blvd St. Louis, MO 63166	(1)	Director of Professional Services Office of The Surgeon General Department of the Air Force Washington, DC 20314	(1)
Commander US Army Health Services Command ATTN: Library Fort Sam Houston, TX 78234	(1)	Human Engineering Division Air Force Aerospace Medical Research Laboratory ATTN: Technical Librarian Wright-Patterson AFB, OH 45433	(1)
Commandant US Army Academy of Health Sciences ATTN: Library Fort Sam Houston, TX 78234	(1)	US Navy Naval Weapons Center Technical Library Division Code 2333 China Lake, CA 93555	(1)
Commander US Army Airmobility Laboratory ATTN: Library Fort Eustis, VA 23604	(1)	US Navy Naval Aerospace Medical Institute Library Bldg 1953, Code 012 Pensacola, FL 32508	(1)
Air University Library (AUL/LSE) Maxwell AFB, AL 36112	(1)	US Navy Naval Submarine Medical Research Lab Medical Library, Naval Submarine Base Box 900 Groton, CT 06340	(1)
US Air Force Flight Test Center Technical Library, Stop 238 Edwards AFB, CA 93523	(1)	Staff Officer, Aerospace Medicine RAF Staff British Embassy 3100 Massachusetts Avenue, NW Washington, DC 20008	(1)
Colonel Stanley C. Knapp US Central Command CCSG MacDill AFB, FL 33608	(1)		

Director Naval Biosciences Laboratory Naval Supply Center, Bldg 844 Oakland, CA 94625	(1)	Commanding Officer Naval Biodynamics Laboratory P.O. Box 29407 New Orleans, LA 70189	(1)
Naval Air Systems Command Technical Library AIR 950D RM 278 Jefferson Plaza II Department of the Navy Washington, DC 20361	(1)	FAA Civil Aeromedical Institute ATTN: Library Box 25082 Oklahoma City, OK 73125	(1)
US Navy Naval Research Laboratory Library Code 1433 Washington, DC 20375	(1)	Department of Defence R.A.N. Research Laboratory P.O. Box 706 Darlinghurst, N.S.W. 2010 Australia	(1)
US Navy Naval Air Development Center Technical Information Division Technical Support Department Warminster, PA 18974	(1)	Canadian Society of Avn Med c/o Academy of Medicine, Toronto ATTN: Ms. Carmen King 288 Bloor Street West Toronto, Ontario M5S 1V8	(1)
Human Factors Engineering Division Aircraft & Crew Systems Technology Directorate Naval Air Development Center Warminster, PA 18974	(1)	COL F. Cadigan DAO-AMLOUS B Box 36, US Embassy FPO New York 09510	(1)
US Navy Naval Research Laboratory Library Shock & Vibration Information Center Code 8404 Washington, DC 20375	(1)	Officer Commanding School of Opnl & Aerospace Medicine DCIEM PO Box 2000 1133 Sheppard Avenue West Downsview, Ontario M3M 3B9 Canada	(1)
Director of Biological & Medical Sciences Division Office of Naval Research 800 N. Quincy Street Arlington, VA 22217	(1)	Dr. E. Hendler Code 6003 Naval Air Development Center Warminster, PA 18974	(1)
Commanding Officer Naval Medical R&D Command National Naval Medical Center Bethesda, MD 20014	(1)	Commander US Army Transportation School ATTN: ATSP-TD-ST Fort Eustis, VA 23604	(1)
Commander Naval Air Development Center Biophysics Laboratory ATTN: George Kydd Code 60B1 Warminster, PA 18974	(1)	National Defence Headquarters 101 Colonel By Drive Ottawa, Ontario K1A 0K2 Canada ATTN: DPM	(1)

Commanding Officer  
404 Maritime Training Squadron  
Canadian Forces Base Greenwood  
Greenwood, N.S. BOP 1N0  
Canada  
ATTN: Aeromedical Training Unit  
WO P. Handy or Capt  
S. Olsen (1)

Canadian Forces Medical Liaison  
Officer  
Canadian Defence Liaison Staff  
2450 Massachusetts Ave, NW  
Washington, DC 20008 (1)

Canadian Airline Pilot's Assn  
MAJ J. Soutendam (Ret)  
1300 Steeles Avenue East  
Brampton, Ontario L6T 1A2  
Canada (1)

END

FILMED

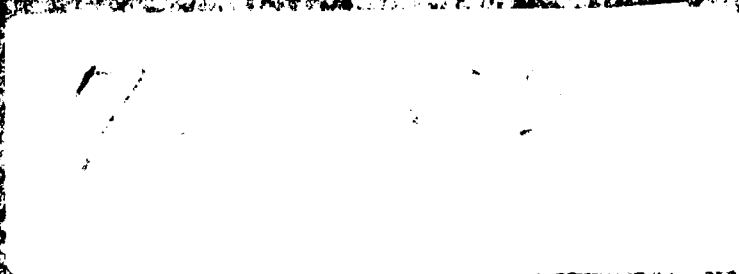

DTIC