

AD-A137 524

MECHANICAL SYSTEMS CONDITIONING MONITORING TECHNOLOGY
WORKING GROUP REPOR. (U) INSTITUTE FOR DEFENSE ANALYSES
ALEXANDRIA VA SCIENCE AND TECH. P HOWARD AUG 83

1/6

UNCLASSIFIED

IDA-D-36 IDA/HQ-83-25899 MDA903-79-C-0018 F/G 15/3

NL

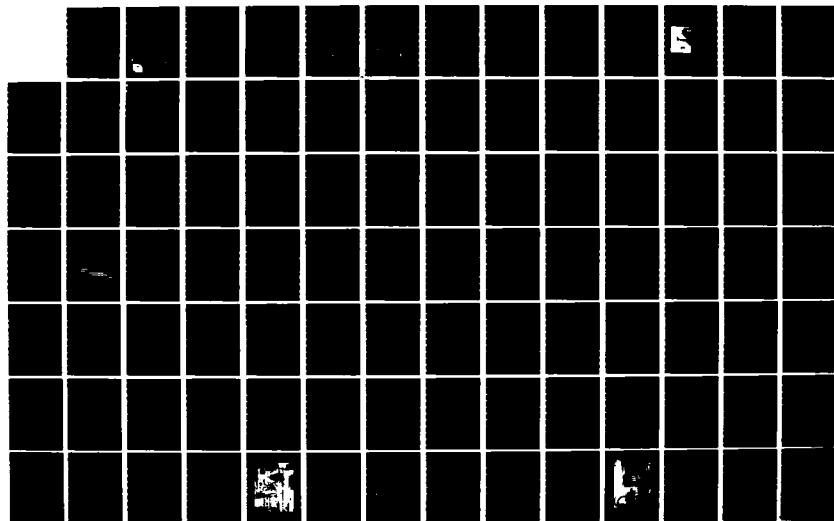

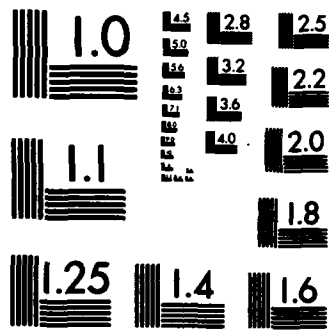

MICROCOPY RESOLUTION TEST CHART
 NATIONAL BUREAU OF STANDARDS-1963-A

2

ADA137524

IDA RECORD DOCUMENT D-36

MECHANICAL SYSTEMS CONDITIONING
MONITORING TECHNOLOGY
WORKING GROUP REPORT
(IDA/OSD R&M STUDY)

Paul Howard
TEDECO
Working Group Chairman

August 1983

The views expressed within this document are those of the working group only. Publication of this document does not indicate endorsement by IDA, its staff, or its sponsoring agencies.

DTIC FILE COPY

Prepared for
Office of the Under Secretary of Defense for Research and Engineering
and
Office of the Assistant Secretary of Defense
(Manpower, Reserve Affairs and Logistics)

DTIC
ELECTRONIC
FEB 01 1984
E



INSTITUTE FOR DEFENSE ANALYSES
SCIENCE AND TECHNOLOGY DIVISION

This document has been approved for public release and sales in distribution is unlimited.

84 01 31 037

The work reported in this document was conducted under contract MDA 903 79 C 0018 for the Department of Defense. The publication of this IDA Record Document does not indicate endorsement by the Department of Defense, nor should the contents be construed as reflecting the official position of that agency.

Approved for public release; distribution unlimited.

UNCLASSIFIED

SECURITY CLASSIFICATION OF THIS PAGE (When Data Entered)

REPORT DOCUMENTATION PAGE		READ INSTRUCTIONS BEFORE COMPLETING FORM
1. REPORT NUMBER	2. GOVT ACCESSION NO.	3. RECIPIENT'S CATALOG NUMBER
	ADA137 524	
4. TITLE (and Subtitle) Mechanical Systems Conditioning Monitoring Technology Working Group Report (IDA/OSD R&M Study)		5. TYPE OF REPORT & PERIOD COVERED Final July 1982 - August 1983
		6. PERFORMING ORG. REPORT NUMBER IDA Record Document D-36
7. AUTHOR(s) Paul Howard, TEDECO Working Group Chairman		8. CONTRACT OR GRANT NUMBER(s) MDA 903 79 C 0018
9. PERFORMING ORGANIZATION NAME AND ADDRESS Institute for Defense Analyses 1801 N. Beauregard Street Alexandria, VA 22311		10. PROGRAM ELEMENT, PROJECT, TASK AREA & WORK UNIT NUMBERS Task T-2-126
11. CONTROLLING OFFICE NAME AND ADDRESS Office of the Assistant Secretary of Defense (MRA&L), The Pentagon Washington, D.C. 20301		12. REPORT DATE August 1983
		13. NUMBER OF PAGES 550
14. MONITORING AGENCY NAME & ADDRESS (if different from Controlling Office) DoD-IDA Management Office 1801 N. Beauregard Street Alexandria, VA 22311		15. SECURITY CLASS. (of this report) UNCLASSIFIED
		16. DECLASSIFICATION/DOWNGRADING SCHEDULE N/A
16. DISTRIBUTION STATEMENT (of this Report) Approved for public release; distribution unlimited.		
17. DISTRIBUTION STATEMENT (of the abstract entered in Block 20, if different from Report) None		
18. SUPPLEMENTARY NOTES N/A		
19. KEY WORDS (Continue on reverse side if necessary and identify by block number) Reliability, Maintainability, Readiness, mechanical system condition monitoring, oil debris, diagnostics, vibration, signature analysis, fiber optics, engine diagnostics, shipboard machinery, electrostatic pulse, chip detector		
20. ABSTRACT (Continue on reverse side if necessary and identify by block number) This document records the activities and presents the findings of the Mechanical Systems Conditioning Monitoring Technology Working Group part of the IDA/OSD Reliability and Maintainability Study, conducted during the period from July 1982 through August 1983.		

IDA RECORD DOCUMENT D-36

**MECHANICAL SYSTEMS CONDITIONING
MONITORING TECHNOLOGY
WORKING GROUP REPORT
(IDA/OSD R&M STUDY)**

**Paul Howard
TEDECO
Working Group Chairman**

August 1983



Accession For	
NTIS GRA&I	<input checked="" type="checkbox"/>
DTIC TAB	<input type="checkbox"/>
Unannounced	<input type="checkbox"/>
Justification	
By	
Distribution/	
Availability Codes	
Dist	Avail and/or Special
A-1	



**INSTITUTE FOR DEFENSE ANALYSES
SCIENCE AND TECHNOLOGY DIVISION
1801 N. Beauregard Street, Alexandria, Virginia 22311
Contract MDA 903 79 C 0018
Task T-2-126**

RELIABILITY AND MAINTAINABILITY STUDY

— REPORT STRUCTURE —

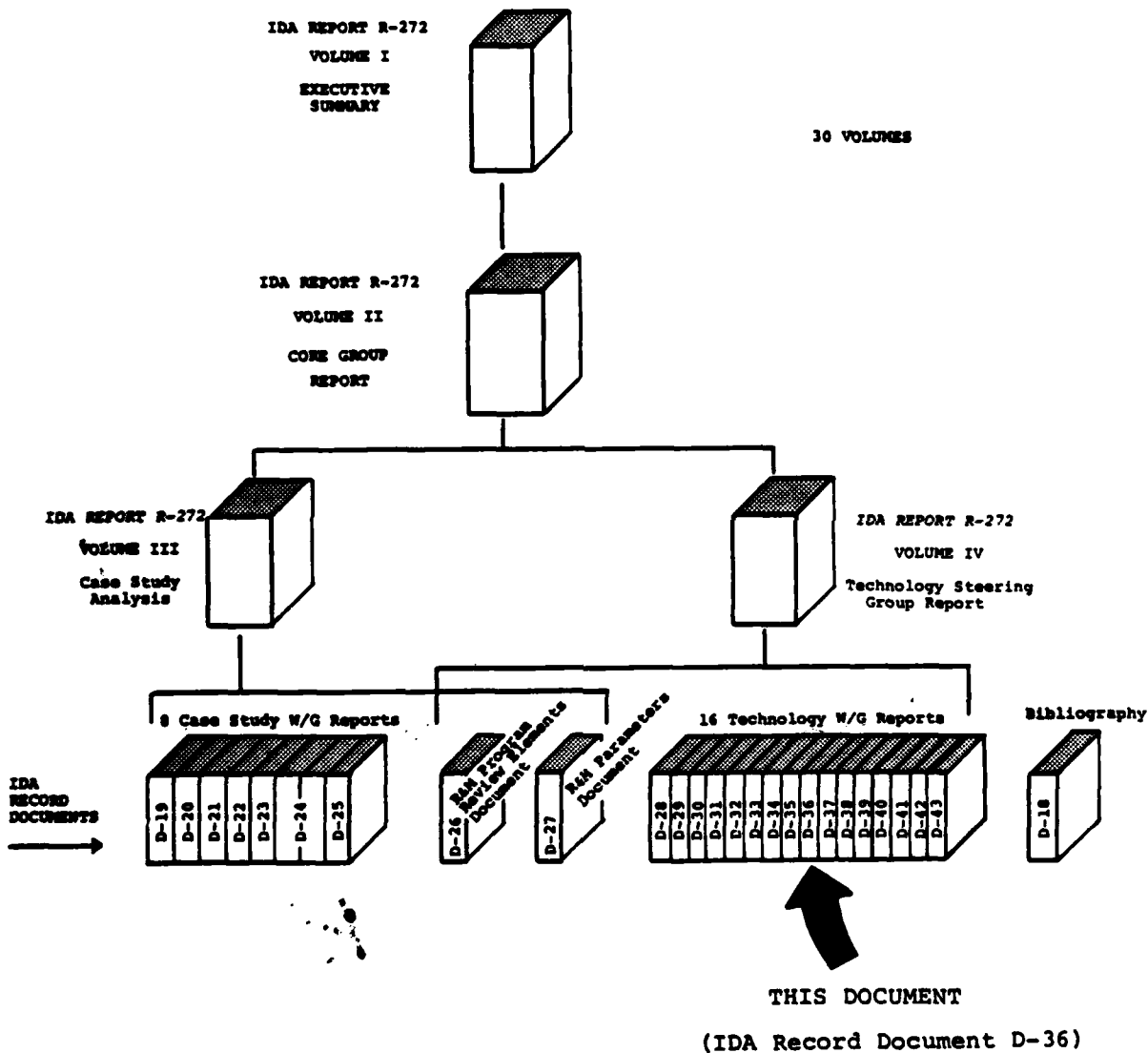

PREFACE

As a result of the 1981 Defense Science Board Summer Study on Operational Readiness, Task Order T-2-126 was generated to look at potential steps toward improving the Material Readiness Posture of DoD (Short Title: R&M Study). This task order was structured to address the improvement of R&M and readiness through innovative program structuring and applications of new and advancing technology. Volume I summarizes the total study activity. Volume II integrates analysis relative to Volume III, program structuring aspects, and Volume IV, new and advancing technology aspects.

The objective of this study as defined by the task order is:

"Identify and provide support for high payoff actions which the DoD can take to improve the military system design, development and support process so as to provide quantum improvement in R&M and readiness through innovative uses of advancing technology and program structure."

The scope of this study as defined by the task order is:

To (1) identify high-payoff areas where the DoD could improve current system design, development program structure and system support policies, with the objective of enhancing peacetime availability of major weapons systems and the potential to make a rapid transition to high wartime activity rates, to sustain such rates and to do so with the most economical use of scarce resources possible, (2) assess the impact of advancing technology on the recommended approaches and guidelines, and (3) evaluate the potential and recommend strategies that might result in quantum increases in R&M or readiness through innovative uses of advancing technology.

The approach taken for the study was focused on producing meaningful implementable recommendations substantiated by quantitative data with implementation plans and vehicles to be provided where practical. To accomplish this, emphasis was placed upon the elucidation and integration of the expert knowledge and experience of engineers, developers, managers, testers and users involved with the complete acquisition cycle of weapons systems programs as well as upon supporting analysis. A search was conducted through major industrial companies, a director was selected and the following general plan was adopted.

General Study Plan

- Vol. III ● Select, analyze and review existing successful program
- Vol. IV ● Analyze and review related new and advanced technology
- Vol. II (● Analyze and integrate review results
(● Develop, coordinate and refine new concepts
- Vol. I ● Present new concepts to DoD with implementation plan and recommendations for application.

The approach to implementing the plan was based on an executive council core group for organization, analysis, integration and continuity; making extensive use of working groups, heavy military and industry involvement and participation, and coordination and refinement through joint industry/service analysis and review. Overall study organization is shown in Fig. P-1.

The basic technology study approach was to build a foundation for analysis and to analyze areas of technology to surface: technology available today which might be applied more broadly; technology which requires demonstration to finalize and reduce risk; and technology which requires action today to provide reliable and maintainable systems in the future. Program structuring implications were also considered. Tools used to accomplish

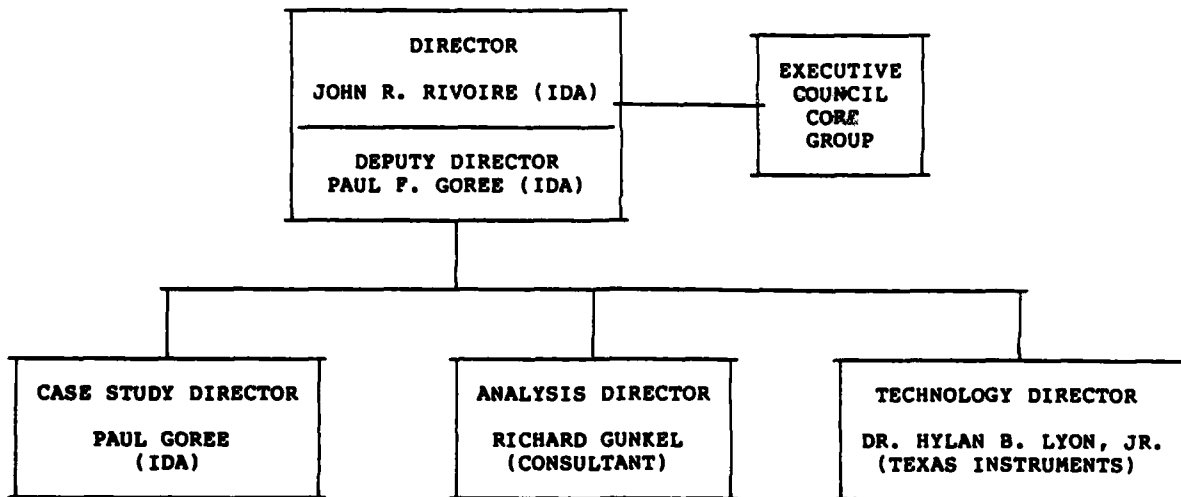

FIGURE P-1. Study Organization

this were existing documents, reports and study efforts such as the Militarily Critical Technologies List. To accomplish the technology studies, sixteen working groups were formed and the organization shown in Fig. P-2 was established.

This document records the activities and findings of the Technology Working Group for the specific technology as indicated in Fig. P-2. The views expressed within this document are those of the working group only. Publication of this document does not indicate endorsement by IDA, its staff, or its sponsoring agencies.

Without the detailed efforts, energies, patience and candidness of those intimately involved in the technologies studied, this technology study effort would not have been possible within the time and resources available.

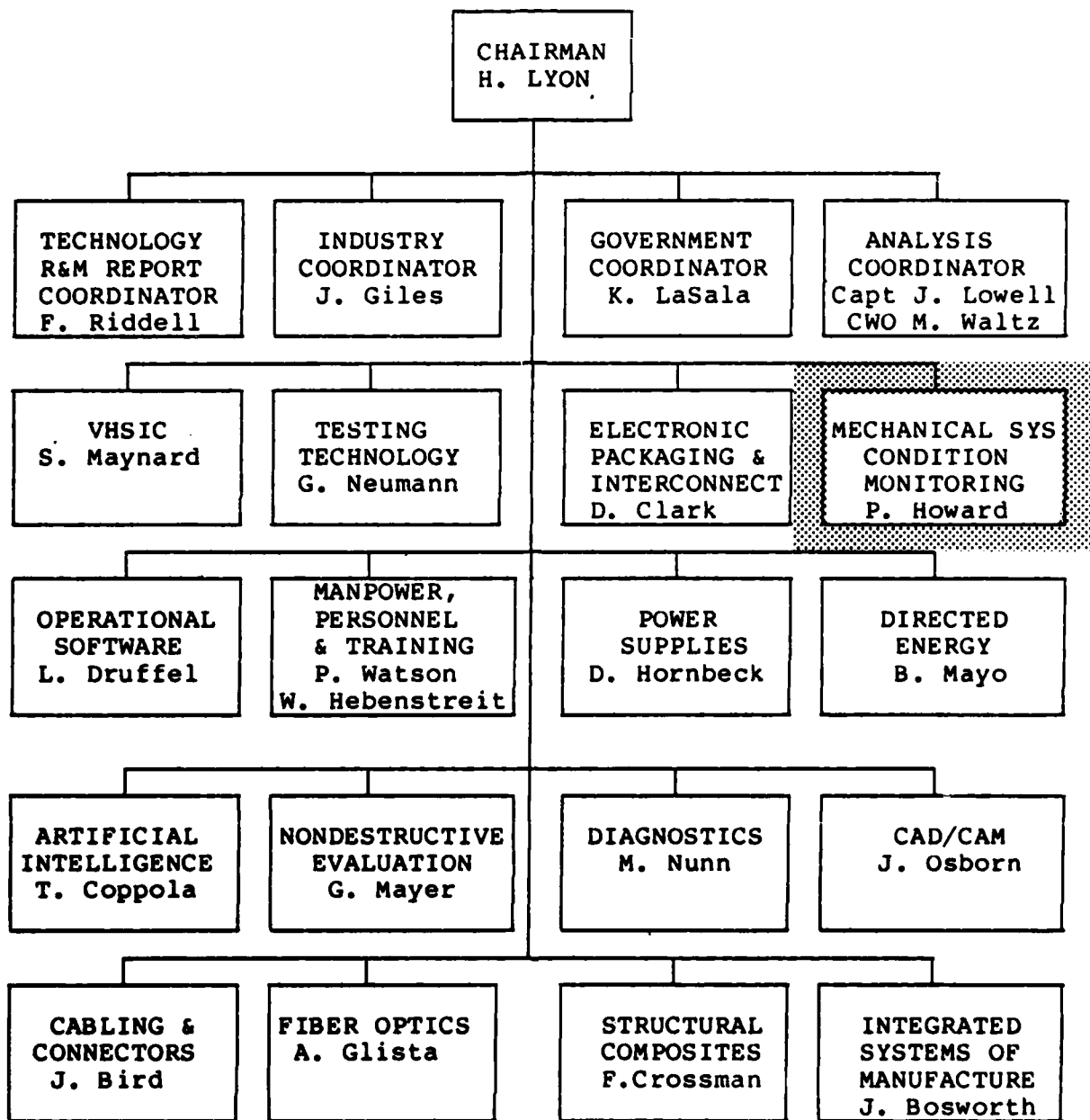

FIGURE P-2. Technology Study Organization

MECHANICAL SYSTEMS CONDITION MONITORING

WORKING GROUP

FINAL REPORT

JULY 1983

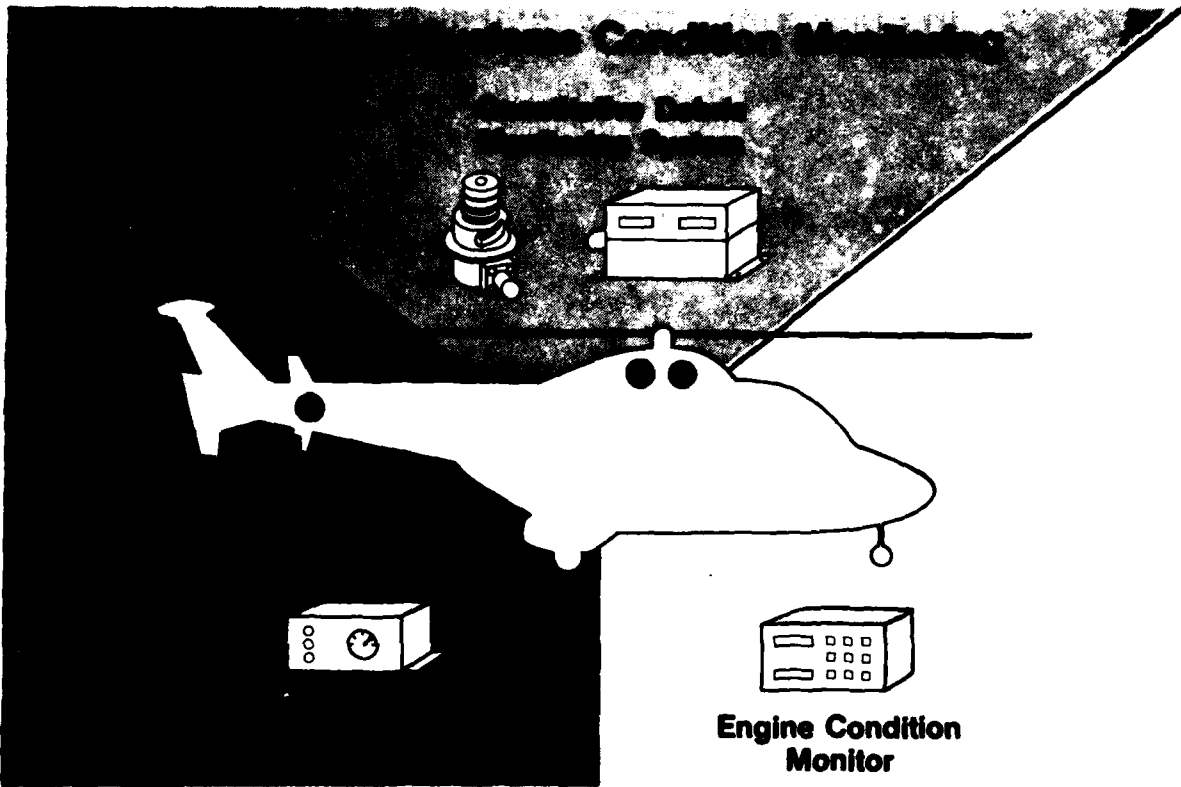

OSD/IDA R&M STUDY

TASK ORDER: MDA903 79 C 0018: T-2-126

The views expressed herein are those of the working group only. Publication of this document does not indicate endorsement by IDA, its staff, or its sponsoring agencies.

58/2-1

MECHANICAL SYSTEMS CONDITION MONITORING

WORKING GROUP MEMBERSHIP

Chairman: Paul Howard TEDECO
TEDECO
24 E. Glenolden Avenue
Glenolden, PA 19036

Mike Green USAF/ASD
Code ASD/YZL
Wright Patterson AFB
Ohio 45433

Andy Hess USNAVY/NASC
Naval Air Systems Command
AIR 53632G
Room 854 JP #2
Washington, DC 20361

Wayne Hudgins USARMY/AVRADCOM/ATL
Applied Technology Lab.
US Army Research &
Technology Labs.
AVRADCOM
Ft. Eustis, VA 23602

Dick Lee USARMY/JOAP
JOAP-TSC
Building 780
Pensacola Naval Air Station
Pensacola, FL 32508

Al Lemanski SIKORSKY
Sikorsky Aircraft
120 North Main Street
Stratford, CT 06602

Robert Stenberg USARMY/AVRADCOM
US Army Aviation Research
& Development Command
Attn: DRDAV-DP
4300 Goodfellow Boulevard
St. Louis, MO 63120

"When you can measure what you are speaking about and express it in numbers, you know something about it; but when you cannot, your knowledge is of a meagre and unsatisfactory kind."

-- Lord Kelvin
(1824-1907)

47/15-1

ACKNOWLEDGMENT

The Mechanical Systems Condition Monitoring Working Group is grateful to the following participating organizations for providing personnel and technology data to this aspect of the OSD/IDA R&M Study. Without their support the effort would not have been possible.

Bendix Energy Control Division
David W. Taylor Naval Ship R&D Center
Joint Oil Analysis Program
LSI Avionics Systems Corp.
Mechanical Technology, Inc.
Northrop Corp. Electronics Division
Technical Development Co.
United Technology Research Center/Hamilton Standard
United Technology/Sikorsky Aircraft
U.S. Air Force Aeronautical Systems Division
U.S. Army AVRADCOM
U.S. Army AVRADCOM-ATL
U.S. Naval Air Systems Command
Vibro-Meter Corp.

Paul L. Howard, Chairman
Mike Green
Andy Hess
Wayne Hudgins
Dick Lee
Al Lemanski
Bob Stenberg

MECHANICAL SYSTEMS CONDITION MONITORING

STATEMENT OF PURPOSE

STUDY OBJECTIVE

- Identify and provide support for high-payoff actions which the DoD can take to improve the military system design, development and support process so as to provide quantum improvements in R&M readiness through innovative uses of advancing technology and program structure

STUDY APPROACH

- Select, analyze and review existing successful programs
- Analyze and review related new and advancing technology
- Analyze and integrate review results
- Develop, coordinate and refine new concept(s)
- Present new concept(s) to DoD with recommendations for implementation

47/15-3

TABLE OF CONTENTS

MSCM WORKING GROUP MEMBERSHIP iii

ACKNOWLEDGMENT vii

STATEMENT OF PURPOSE ix

I. EXECUTIVE SUMMARY I-1

 Mechanical Systems Condition Monitoring
 Technology--What is it? I-13

II. MSCM STUDY APPROACH II-1

 Current Technology Applications II-1

 New Technology Assessment II-2

 Program Case Studies--Lessons Learned II-2

III. R&M IMPROVEMENT PROPOSALS III-1

 Introduction III-1

 Oil Debris Diagnostic System (ODDS)
 for Helicopter Propulsion Systems III-3

 Cost Savings Summary III-8

 Engine Condition Monitoring System Application
 Proposal III-15

 A-7E Engine Monitoring System (EMS) Program III-19

 Cost Benefit Support Data III-23

IV. MSCM TECHNOLOGY ASSESSMENT IV-1

MSCM R&D PROGRAM RECOMMENDATIONS IV-13
David Taylor Naval Ship R&D Center IV-17
Lear-Siegler, Inc. IV-47
Mechanical Technology, Inc. IV-63
Northrop Electronics Division IV-67
United Technology, Inc. IV-119
Vibro-Meter Corp. IV-139

V. MSCM PROGRAM CASE STUDIES AND LESSONS LEARNED V-1

Engine Monitoring Lessons Learned V-6
Assessment of Air Force Engine Monitoring V-9
Conclusion V-12
Programmatic Recommendations V-13
Draft Charter--Engine Condition Monitoring Group V-15

APPENDIX A--TECHNOLOGY ASSESSMENT PRESENTATIONS
AND PROPOSALS

UT/Hamilton Standard A-5
Mechanical Technology, Inc. A-35
David Taylor NSR&DC A-105
Northrop A-131
Bendix A-215
Vibro-Meter Corp. A-247

APPENDIX B--SAE TURBINE DIAGNOSTICS SUMMARY
SAE-AIR-1828

I. EXECUTIVE SUMMARY

I. EXECUTIVE SUMMARY

Propulsion, transmission and structural aspects of current weapon systems can be significant contributors to the readiness or lack of readiness of these systems. The Mechanical Systems Condition Monitoring working group has now concentrated on the key technology area of condition monitoring of the major mechanical portions of these weapon systems, turbine engine and power transmissions, and has formulated specific R&M improvement proposals within the guidelines and goals of the R&M Study.

Because of the potential for high payoffs, turbine engine condition monitoring and engine and transmission failure detection and prognosis technology were the major areas of study concentration. It is possible that a similar concentration in the structural area could yield comparable results for future systems.

The MSCM study approach addressed three facets of the task:

- (1) Determination of current technology to current program marriages where near in, high payoff R&M improvements could be achieved with modest investment.
- (2) Determination of developmental or emerging technologies that if expeditiously developed and applied could provide quantum improvement in readiness.
- (3) Determination from MSCM-oriented program case studies of the programmatic changes that could result in significant positive R&M inputs.

Figure I-1 illustrates the MSCM study approach and serves as a guide for locating the detailed back-up data for each study area.

The principal mechanical systems condition monitoring study findings are:

- High R&M payoff MSCM technology currently exists and is under-utilized.
 - Fine filtration
 - Engine condition monitoring
 - Quantitative lube oil on-board debris monitoring
 - Vibration and shock pulse analysis
- R&M improvements are possible on current, emerging, and new weapon systems from MSCM technology:
 - Helicopter
 - Fighter aircraft
- New technology is emerging which, if implemented, will increase R&M payoffs on future systems:
 - Transmission condition monitoring system
 - High temperature turbine engine internal vibration sensor
 - Aircraft structural integrity tracking and prognostic program
 - M-1 tank mechanical condition monitoring system
 - Electrostatic engine wear monitor
 - Fiber-optic bearing condition monitor
 - Ultrasonic lube oil small wear particle sensor
- R&M improvements from MSCM programmatic changes
 - MSCM visibility early in development
 - Engine condition monitoring needs tri-service coordinated emphasis
 - MSCM standards/design guidelines.

These findings lead to several recommended high R&M payoff actions in the three MSCM study areas.

1. Current Technology/Current Program Proposals

Two current technology applications to existing weapons systems are proposed as a means of realizing near-in R&M improvements. As a second phase, fourteen technology R&D programs were developed and ranked in three priority categories: (1) Those with near-term R&M payoff, (2) those with payoff on future programs, and (3) those with R&M benefits apparent but needing an application program to better define the magnitude of payoff.

Realization of these R&M improvements in terms of readiness as well as return on investment requires program funding. The favorable cash flow analyses notwithstanding, front-end investment is required. While reprogramming of a weapon system's current funds has been a somewhat traditional approach to funding of changes, it can be quite ineffective on R&M improvements because of the disproportionate current emphasis of performance over R&M considerations and the classic shortage of funding for even the most crucial changes that exists on many (especially fully deployed) weapon systems. One of the primary findings of this study is the advisability of a separate funding path for the proposed MSCM R&M improvements, especially in the case of the two current technology application programs proposed.

The programs proposed to provide near-in benefits of the application of current MSCM techniques to deployed weapon systems will also serve as technology demonstrators for the extension of the technology and R&M benefits to similar current or follow-on weapons.

- (a) Helicopter fleet availability for current and future can be improved by 4.5 percent through the application of fine filtration and improved oil debris diagnostics to the engine and transmission lubrication systems. Overall operational readiness can be improved by 0.2 percent. For the

current UH-1/AH-1 4,000 aircraft fleet, this proposed change results in annual maintenance and spares savings of \$7 million, a 10-year ROI of 6:1, and a break-even point of 20 months. Extension of this technology to the UH-60 and AH-64 weapon systems is also highly recommended to enhance the R&M of these systems.

- (b) Extension of the trial lot A-7E Engine Condition Monitoring System to the total A7-E fleet and transition of this proven technology to the F-14A could produce as much as 35 percent availability increase primarily through reduction in unnecessary engine removals. On the A-7E test fleet a 2.8:1 reduction of total maintenance man hour per flight hour was demonstrated. A reduction of 6:1 was achieved in Level 2 maintenance man hours per flight hour, illustrating the further benefit of accomplishing more of the remaining required maintenance at the flight line rather than at the second level. Extension of this technology to the F-14, especially the re-engined version, is highly recommended.

2. MSCM Technology Development

New technology exists which can fill the current gaps in engine and transmission condition monitoring coverage and can provide LCC savings in excess of \$1.6 billion on current and developmental weapon systems.

Technology or application holes exist in current MSCM coverage of the condition monitoring task for turbine engines and transmissions. Some of these holes can be eliminated simply by applying currently proven technology such as turbine engine

condition monitoring, shock pulse analysis, and quantitative oil debris monitoring more extensively. Some of these holes require the further focused development of technologies such as vibration analysis and advanced gearbox diagnostics.

Figure I-2 broadly illustrates the potential and existing coverage of these broad technology areas.

The assessment of MSCM technology involved extensive review of current development efforts of six industrial operations and one military research center. This comprehensive review of current state-of-the-art resulted in fourteen technology development and demonstration proposals focused on the goals of eliminating the current MSCM technology gaps and providing high payoffs in the R&M of current and future weapon systems. These proposals are summarized in Fig. I-3 and detailed in later sections of this report. It is a goal of the MSCM portion of the R&M study to effect changes in R&M through application of these individual developments to current and emerging weapon systems. To this end, a continuing effort focused on contractor/program office implementation of these proposals is intended--the result of this effort should be change and R&M improvement, not study and recommendation.

To establish action emphasis in the technology development area, the fourteen proposed programs were prioritized in three categories based on potential for R&M improvement, existence of a weapon system program that could benefit, and return on investment. Figure I-4 summarizes this.

3. Development Program Changes in the MSCM Area

Programmatic changes are indicated in the area of enhancing MSCM visibility early in the system development effort rather than as a remedial addition to an ailing system. Engine condition

monitoring should be coordinated between the three Services. MSCM Guidelines and Standards are required across the Services on current and new programs.

The MSCM working group is composed of aircraft industry, diagnostic industry, and tri-Service personnel specializing in R&M and MSCM technology. We have drawn new technology presentations from seven industry and government laboratory participants. While the MSCM study has not been exhaustive, it has been thorough in the aspects covered, and has produced tangible results and achievements toward the goal of improving R&M through innovative application of MSCM technology.

Extensive industry support in the form of technical data and technical presentations was received. This resource information is included in Appendix A. Additionally, SAE Document AIR-1828, a definitive resource on oil condition monitoring technology and current system usage, has been included as Appendix B.

Current trends toward RCM demand an increased emphasis on this kind of technology and, indeed, depend for their success on the prudent application of MSCM.

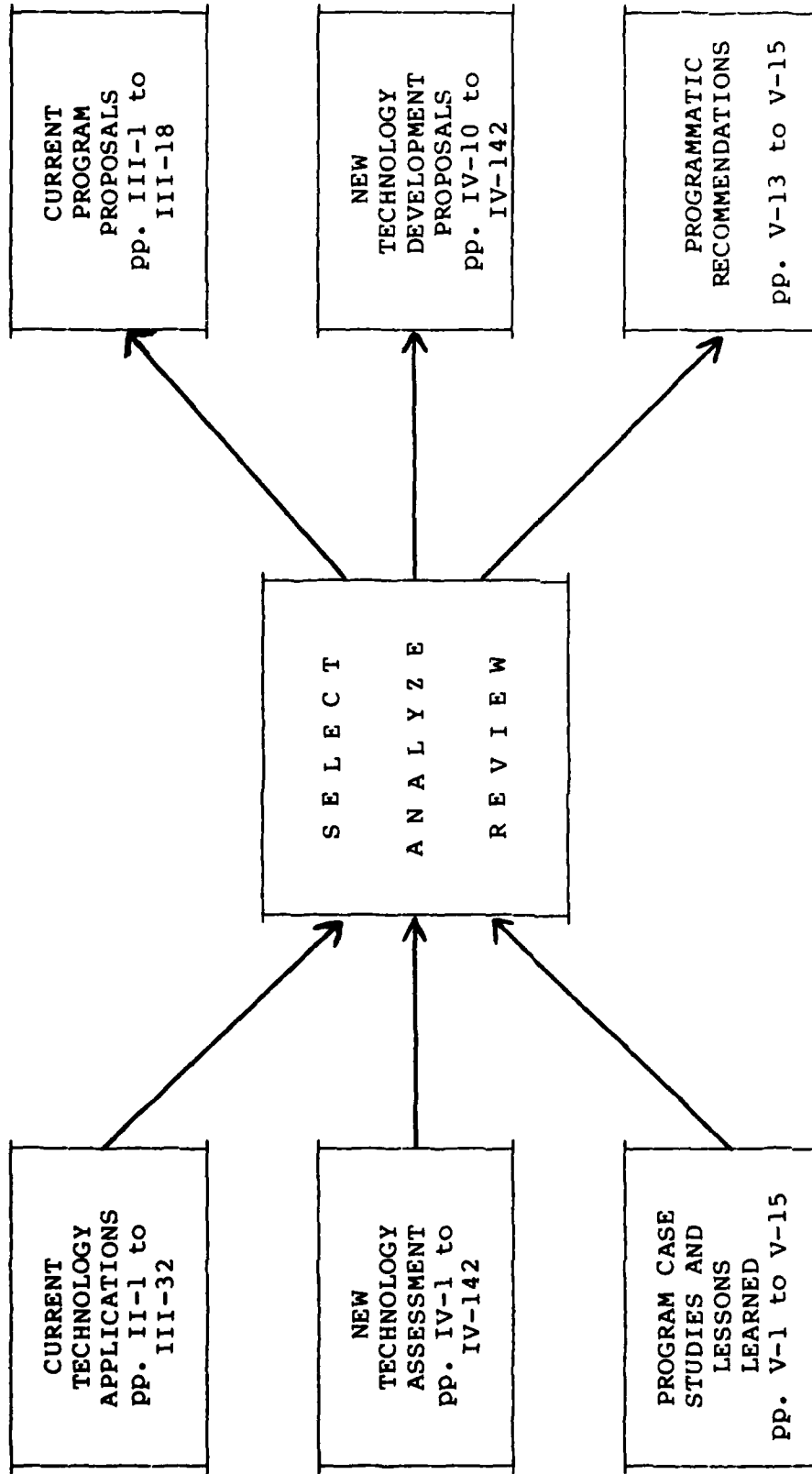

FIGURE I-1. MSCM Study Flow Chart Approach and Results

TECHNOLOGY (COVERAGE AREA)	CAPABILITY PARAMETER				DEGRADATION PROGNOSIS
	FAULT DETECTION	FAULT ISOLATION	MAJOR FAILURE DETECTION		
1. Turbine Engine Condition Monitoring (Engine)	Yes	Some	Yes	Yes	Yes
2. Vibration Analysis (Engine & Transmission)	Some	Some	Yes	Needs Development	Needs Development
3. Shock Pulse Analysis (Transmission Bearings and Gears)	Some	Some	Some	Needs Development	Needs Development
4. Quantitative Oil Debris Monitoring (Engine and Transmission Bearings and Gears)	Most	Some	Yes	Yes	Yes
5. Gearbox Diagnostics (Total Gearbox)	Potentially Yes	Potentially Yes	Yes	Potentially Yes	Potentially Yes

FIGURE I-2. MSCM Technology Coverage

ORGANIZATION	PROPOSED PROGRAM	BENEFITS	R&D FUNDING REQUIRED	PROGRAM PERFORMANCE (MONTHS)
United Technology Research Center/ Hamilton Standard/ Sikorsky Aircraft (UTRC/HS/SA)	1. Integrated Black Hawk Helicopter Transmission Monitoring System 2. Electrostatic Engine Condition Monitor for A-6/J52	<ul style="list-style-type: none"> • Reduced Mission Aborts (\$20M savings) • Increased System Availability (\$105M savings) • Reduced Unscheduled Engine Removals • Extend Major Component Repair Interval • Extend Hot Section Inspection Interval (A-6 Savings--\$9.3M plus \$6.3M annually) Fleet Implementation.	\$2M*	24 mos*
*Note: Cost and schedule do not include Fleet Implementation.				
Mechanical Technology, Inc. (MTI)	M-1 Tank Monitoring System	<ul style="list-style-type: none"> • Reduced Life Cycle Costs (\$135M savings) 	\$700K	18 mos
David Taylor Naval Ship Research & Development Center (DTNSR&DC)	Extend AVLD to Tri-Service Develop Fiber Optic Bearing Monitor UltraSonic Wear Particle Sensor Integrated Shipboard Machinery Monitoring System	<ul style="list-style-type: none"> • \$20 M/yr savings in unnecessary valve replacement • Reduced Mtn & Downtime Costs • Detect Failures • Reduced Secondary Damage • Reduced Support Costs (LCC) (\$50M per ship) 	\$400K \$2.6M \$4M \$33M	- 48 mos 60 mos 60 mos

FIGURE I-3. Summary of Program Proposals

ORGANIZATION	PROPOSED PROGRAM	BENEFITS	R&D FUNDING REQUIRED	PROGRAM PERFORMANCE (MONTHS)
Northrop Electronics Division (NED)	<ol style="list-style-type: none"> 1. F-14/TF30 TEMS Technology Demonstration Pgm. 2. F-16/F100 TEMS Technology Demonstration Pgm. 3. T-38 Structural Tracking Technology Demonstration Pgm. 4. Diagnostic Technology Advancement Program (Engine Structure) 	<ul style="list-style-type: none"> • Common Structural and Engine Monitoring System (software change only) • Increased R.M.A. • LCC Reduction A-10 Savings \$464M. 	\$3.3M (Approx.--- to be defined by more detailed definition of program scope)	15 mos to 24 mos
Lear-Siegler, Inc. (LSI)	EDS R&M Capabilities Demonstration on F-15 or F-16 F100 Engine	<ul style="list-style-type: none"> • Reduce unnecessary Engine Removals • Implement RCM • Reduce LCC--Analysis Shows F-15 LCC Savings of \$500M 	\$25M	36 mos
BENDIX	NO PROGRAM PROPOSED	-----	----	----
VIBRO-METER Corp. (VM)	<ol style="list-style-type: none"> 1. High Temp (900°F) Proximity Probe for Rotating Shaft Diagnostics 2. Engine-Mounted/Fuel-Cooled Vibration Analyzer 3. Gearbox Extension of Technology Developed in (2.) 	<ul style="list-style-type: none"> • Failure Diagnostics Technology Improvement • Aircraft Engine Shaft/Bearing Diagnosis Improvement 	\$1.55M (Retention of Commercial Rights Requested)	24 mos

FIGURE I-3. Summary of Program Proposals (cont'd)

<p align="center"><u>PRIORITY 1</u></p> <p align="center">(PROGRAMS RECOMMENDED FOR IMMEDIATE ACTION)</p>	<p align="center"><u>PRIORITY 2</u></p> <p align="center">(PROGRAMS RECOMMENDED FOR IMMEDIATE REVIEW FOR POSSIBLE DEVELOPMENT WITH BENEFITS FOR FUTURE PROGRAMS)</p>	<p align="center"><u>PRIORITY 3</u></p> <p align="center">(PROGRAMS NEEDING SPECIFIC WEAPON SYSTEM APPLICATION BENEFIT ANALYSES PRIOR TO DEVELOPMENT)</p>
<ul style="list-style-type: none"> • T-38 Structural Tracking Technology Demonstration Program (NED) • Diagnostic Technology Advancement Program-- Engine Structure (NED) • Integrated Blackhawk Helicopter Transmission Monitoring System (UTC) • High Temperature Proximity Probe (900°F)--Engine Rotating Shaft Diagnostics (VM) • M-1 Tank Monitoring System (MTI) • F-16/F-100 TEMS Technology Demonstration Program (NED & LSI) 	<ul style="list-style-type: none"> • Development of Fiber-Optic Bearing Monitor (DTNSRDC) • Ultrasonic Wear Particle Sensor (DTNSRDC) • F-14/TF30 TEMS Technology Demonstration Program (NED) • Electrostatic Engine Monitor (UTC) 	<ul style="list-style-type: none"> • Extend Acoustic Valve Leak Detector to Tri-Service (DTNSRDC) • Integrated Shipboard Machinery Monitoring System (DTNSRDC) • Engine-Mounted/Fuel-Cooled Vibration Analyzer (VM) • Gearbox Extension of Diagnostic Technology (VM)

FIGURE I-4. Prioritization Categories for MSCM R&M Improvement Proposals

MECHANICAL SYSTEMS CONDITION MONITORING TECHNOLOGY--
WHAT IS IT?

The mechanical system aspects of current weapon systems, while leading contributors to R&M levels, are not monitored to an extent even comparable to the electronics on these weapons systems. The propulsion system on the F-15C, for example, accounts for 21 percent of the mean time between maintenance (MTBM), and is nearly twice as significant as the next nearest contributor (the fire control radar).

The mechanical system aspects of current weapons systems include propulsion, power transmission, structure and auxiliary systems (such as hydraulic controls). Clearly, all mechanical systems are not equally significant contributors to the R&M level achieved and, therefore, not all are candidates for improvements that can lead to quantum changes in R&M. To address the major issue of the present R&M Study, two key areas were selected for the MSCM concentration because they appear to offer the most potential for high payoff.

Turbine engines and transmissions were selected with areas of application including tanks, fixed wing aircraft, and helicopters. For these mechanical systems several condition monitoring disciplines apply.

Turbine engine performance is monitored by measuring primary engine parameters such as speed, fuel flow, gas temperature and pressure, determining engine operating performance and comparing that to standards to indicate off-nominal or subnormal performance. A computer program, specific to each engine, is used to translate engine parameter values to engine performance figures. The strength of this diagnostic is its ability to indicate degradation and to a large extent isolate the source permitting measurement of remaining component life.

47/11

Components within turbine engines and transmissions may be monitored by measurement and signature analysis of vibration. This technology, while involving considerable complexity, can isolate damage to given components, track damage growth, and predict failure. With the advent of "expert computers" (artificial intelligence), this technology can come of age.

Quantitative debris monitoring systems for ferrous debris detection in the lubricating oil systems of turbine engines and transmissions provide damage detection and growth measurement data for ferrous oil-wetted components (bearings and gears). Debris size and rate of generation are direct measures of the onset of, seriousness of, and rate of progression of damage. This technology is developed, applied to commercial turbine engines and gearboxes, and is capable of translating the savings in spares and unnecessary component removals achieved there directly to comparable military equipment.

MSCM, then, combines the elements of measurement of performance and detection of damage with the possibilities of prognostics to eliminate unnecessary and premature removals. New technology, proven technology, and demonstrated results of the application of the technology indicate that R&M benefits are achievable if the technology is applied to current and future military systems.

II. MSCM STUDY APPROACH

II. MSCM STUDY APPROACH

The approach taken by the MSCM group was generally parallel with that of the entire R&M Study and was consistent with the overall study objective to identify and provide support for high-payoff actions which the DoD can take to improve the military systems design, development and support process so as to provide quantum improvements in R&M (readiness) through innovative uses of advancing technology and program structure.

The MSCM effort consisted of three tasks:

- (1) Current technology applications reviews
- (2) New technology assessment
- (3) Program case studies--lessons learned.

The issues addressed include:

- Can MSCM increase operational readiness through preventive maintenance actions at reasonable costs?
- Are MSCM techniques being properly utilized to the proper extent through R&M logistics analysis?

CURRENT TECHNOLOGY APPLICATIONS

In this task the approach was to select, analyze, and review existing successful programs where MSCM is applied to determine how these techniques can be effectively applied to other existing weapons systems and provide near-in high-payoff results in system operational readiness or substantial reductions in system operating costs, with a minimum of development investment and risk.

47/12-1

NEW TECHNOLOGY ASSESSMENT

The approach taken in this task was to contact the MSCM industrial community and arrange briefings and reports on their technology thrusts containing:

- Brief description of the MSCM technology
- Recommended application of the technology
- Anticipated R&M benefits--tangible and justified
- Resource required/source/development schedule.

Excellent presentations were received, analyzed, and reviewed relative to new and advancing technology, R&M improvement targets, benefits, cost and schedule of proposed programs.

PROGRAM CASE STUDIES--LESSONS LEARNED

Our approach to case studies was to task group members to thoroughly review various engine programs from a single perspective, MSCM, and ask the following basic questions:

- Was MSCM considered early in the development program? If so, how implemented?
- Was MSCM considered only after development or production? If so, how implemented?
- If MSCM was implemented at some time, what was the motivation?

Along with the research into the programs, lessons learned on good program features were to be captured and listed.

The goal here was to look at programs which were in various phases of acquisition and present the results in tabular form

47/12-2

for comparison. This procedure was intended to determine what had been done correctly in successful programs and could be extended to new development programs.

47/12-3

II-3

III. R&M IMPROVEMENT PROPOSALS

III. R&M IMPROVEMENT PROPOSALS

INTRODUCTION

Significant gains can be made in improving weapon systems' reliability and maintainability by applying proven diagnostic technology to new systems. This study has identified two potential high-payoff actions which, if implemented, will result in increases in system operational readiness and substantial reductions in system operating costs. The recommendations of this study group are that propulsion system full flow debris monitoring and fine filtration be applied to the UH-1/AH-1 helicopters and that the A-7E in-flight engine condition monitoring system (IECMS) be extended to the F-14 aircraft. Both of these diagnostic systems have undergone extensive development and operational flight testing and have demonstrated successful operation and reliability improvements.

The helicopter oil-wetted component Oil Debris Diagnostics System (ODDS) and filtration system was designed to reliably detect failures, reduce the high rate of false and nuisance chip light indications, and help reduce no-fault removals of oil-wetted components while improving component life and extending the useful life of the lubricating oil. Over 70,000 flight hours on 50 UH-1H helicopters have demonstrated that ODDS meets these goals.

The A-7E IECMS provides engine monitoring capabilities such as automatic fault detection/isolation component life usage tracking and cockpit warnings of impending catastrophic failures. The system, even though designed for the A-7E, can

be applied to other aircraft/engine applications. A-7E IECMS-equipped aircraft have had no engine-caused aircraft losses and a reduction in maintenance man hours per flight hour.

The following proposals provide a brief description of the technology, the new application, and a quantitative assessment of the benefits gained from implementing the technology including a return on investment evaluation.

OIL DEBRIS DIAGNOSTIC SYSTEM (ODDS)
FOR HELICOPTER PROPULSION SYSTEMS

DESCRIPTION:

An advanced oil debris discrimination and filtration system has been developed which extends component life, permits full implementation of on-condition maintenance, and provides quantum improvement in operational readiness.

The system has been developed for the UH-1/AH-1 helicopters, but has potential for broad application to turbine engines and drives in other helicopters, fixed-wing aircraft and surface vehicles.

The system is composed of an ultrafine (3-micron) filter unit and advanced full-flow chip detectors for the engine and main transmission, and discriminating chip detectors for the gearboxes without recirculating oil systems.

PROPOSAL:

Incorporate this system on current UH-1 and AH-1 aircraft on a high priority basis.

RECOMMENDATIONS:

1. Extend the application of the system to the UH-60, AH-64, CH-47, CH-53 and OH-58 helicopters.
2. Apply the technology to the engines and systems of other high performance military systems, such as F-15 airframe mounted gearbox, LACV 30, M-1 engine, LM-2500, and T-56 gearbox.

3. Require the application of this technology to all future turbine engine and mechanical drive development programs.

BENEFITS:

- Reduction F.A.R. 48% reduction
- Increase oil change interval 3:1 increase on transmission
10:1 on engine
- Increase filter change interval 3:1 increase
- Increase MTBR 20% above currently improved MTBR
- Reduction in MMH requirements 72,800 MMH/yr

INTANGIBLES:

- Increased component life due to finer filtration will result in reduction in spares cost and logistics burden due to a gradual increase in mean time between removal (MTBR)
- Reduction in consumables
- Improved mission reliability
- Improved safety.

RESULTS:

- Permits on-condition maintenance
- Increases operational readiness
- Increases mission reliability

COST/BENEFIT ANALYSIS (UH-1 fleet):

- \$7M annual cost savings
- Payback 1.7 year
- 10-year ROI = 5.86:1

PROPOSED PROGRAM (UH-1 fleet retrofit):

- Cost: \$12.5M
- Performance period: 3 years

PROGRAM COST

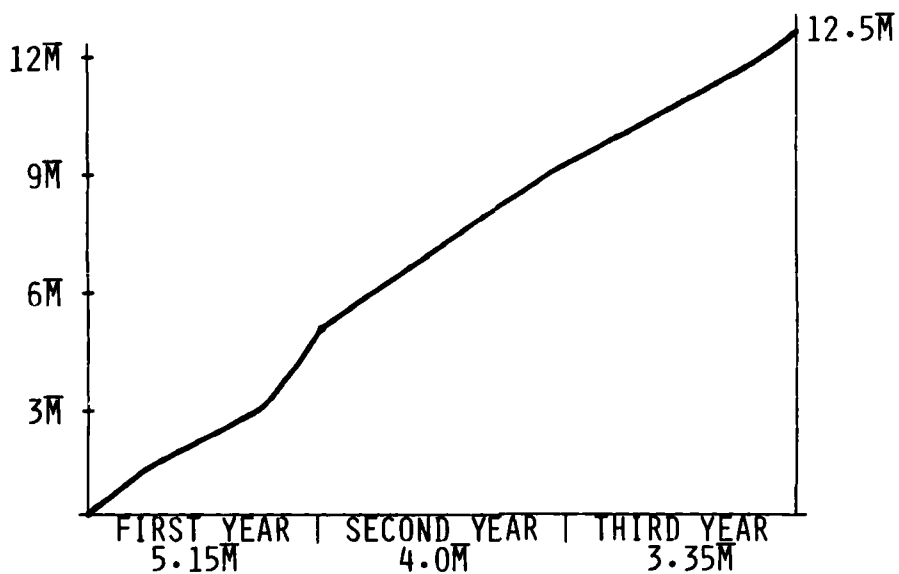

PROGRAM SCHEDULE

	FIRST YEAR	SECOND YEAR	THIRD YEAR
TOOLING	████████████████		
DESIGN	██████████		
PRODUCTION		██	
INSTALLATION		██	
SPARES			██████████

47/2-4
2/16-1

FULL-FLOW DEBRIS MONITORING AND FINE FILTRATION

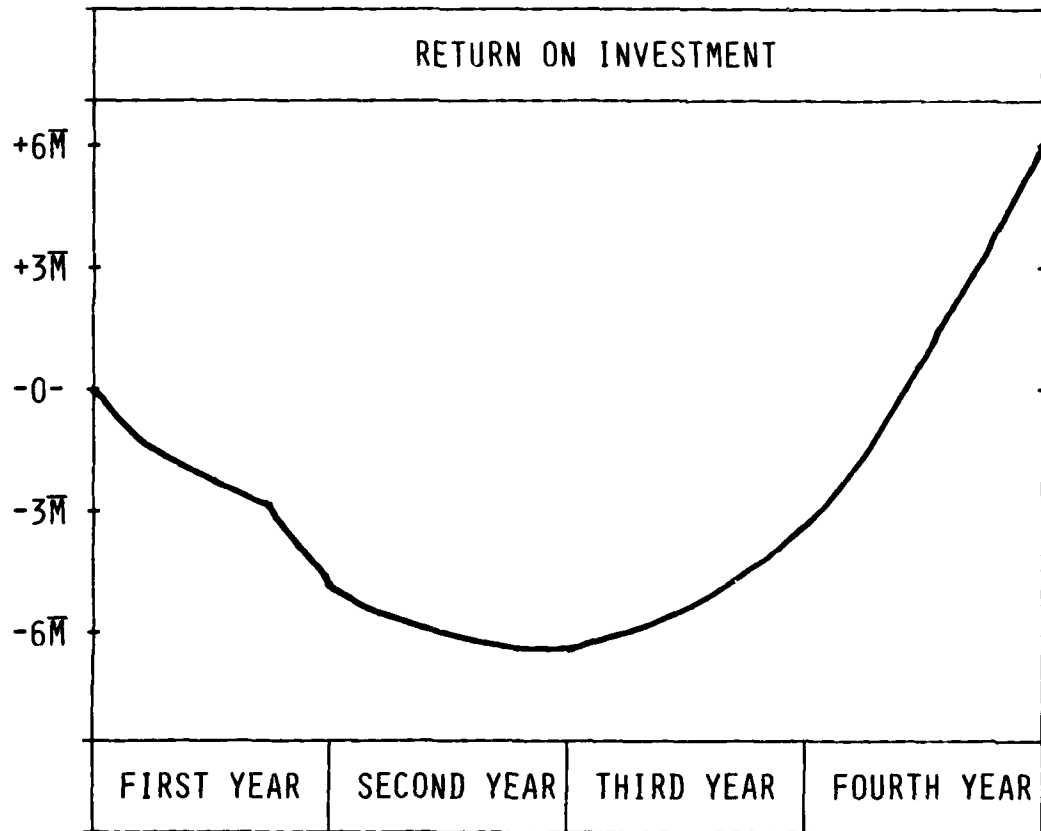

47/2-5
2/16-1

OIL DEBRIS DIAGNOSTIC SYSTEM (ODDS)

COST SAVINGS SUMMARY

<u>Item</u>	<u>Cost Saved</u>	<u>Aircraft Hours Saved</u>
1. Removal of TBO from trans- mission	\$2,665,680	6,240
2. On-condition filter element replacement	65,880	2,034
3. Oil samples not required	1,626,660	27,111
4. Reduction in precautionary landings	2,294,260	27,336
5. System drain and flush	93,975	1,790
6. No-fault removals, engine and transmission	82,466	1,045
7. Reduction in spares cost	176,840	-0-
Totals	\$7,005,761	65,546

Intangible benefits not included in savings analysis are: yearly cost savings during wartime of \$14 million per year, reduction in consumables, maintenance burden, and unscheduled maintenance. ODDS provides for increases in mission reliability, aircraft availability, and improved safety.

The following cost savings and OR rate improvement analysis are based on the ODDS fleet of 4,000 UH/AH-1 helicopters. The

average flight hours per year for this fleet is assumed to be 800,000. Various assumptions have been made in the following analysis; these are denoted by an asterisk (*). All assumptions are believed to be conservative and are used where specific values are not known. Other statistical data are presented and the source of these data are shown by subscripts 1, 2, 3, etc.

It may be noted that aircraft hours used in the following analysis do not include the wartime role of these helicopters. Based on projected wartime usage the cost savings and increased OR shown would more than double. Considering the above scenario, the OR rate improvement is:

$$\frac{65,546}{35,040,000} = 0.19\%$$

1. Remove TBO from transmission when ODDS are installed:

MTBR will increase from the current 1,250₁ to 2,000* hours,

Therefore: $\frac{800,000}{2,000} = 400$ trans. OH/yr. (new system)

$\frac{800,000}{1,250} = 640$ trans. OH/yr. (old system)

Results in 240 less trans. OH/yr. x \$9107₂ = cost saved = \$2,184,000

Field labor to remove and replace 240 trans. =
 \$30₃ per hr. x 60₁ MMH x 240 = \$432,000

Cost to ship 240 trans = 240 x \$162* = \$38,880

30* gal fuel MOC x 240 = 7,200 gal @ \$1.50 = \$10,800

Total saved = \$2,665,680

26₁ aircraft hours required for all removal and replacement, and includes 30 min. MOC

26 x 240 = 6,240 aircraft hrs.

<u>Subscripts:</u>	1 SDC	3 AVRADCOM	5 Ft Rucker Test
	2 CCAD	4 SS	6 MERSA

83/27-2

2. Filter element replacement for the ODDS is on-condition:

Std. system $\frac{800,000}{150 \text{ hrs}} = 5,400$ replacements/year

Replacement cost for std. filter = 5,400 x \$12 ea = \$64,800

3-micron filter (2)*** $\frac{800,000}{1,200} = 1,332$ x \$45 ea = \$59,940

5400 - 1332 = 4068 less changes per year with ODDS.

Labor to change filter: 4,068 x 1/2* hr x \$30 = \$61,020

1/2 hr x 4,068 = 2,034 hrs. The aircraft is not available.

Total saved = \$65,880

*** Requires 2 engine and transmission

3. ODDS does not require oil samples:

Current engine: $\frac{800,000}{12} = 66,666$ samples

Current transmission: $\frac{800,000}{25} = 32,000$ samples

Current 90° gearbox: $\frac{800,000}{25} = 32,000$ samples

Current 42° gearbox: $\frac{800,000}{25} = 32,000$ samples

Total samples std. system = 162,666

162,666 samples at \$5₆ = \$813,220 total lab. cost

Field labor 10* min./sample: 27,111 hrs x \$30 = \$813,330

Aircraft not available = 27,111 hrs.

Total saved: \$1,626,660

4. Precautionary landings reduced by ODDS:

3.635 less chip lights/1,000 flt hrs.

49% of landings are off-site and require 14 hrs to recover

51% of landings are on-site and require 5 hrs to recover

49% x 3.63 = 1.7787/1,000 less recoveries off-site

51% x 3.63 = 1.8513/1,000 less recoveries on-site

1.7787 x 800 x 14 hrs = 19,921 aircraft not available

1.8513 x 800 x 5 hrs = 7,405 aircraft not available

Total hours aircraft not available = 27,326 hrs

Cost: 800 x 1.7787 x \$1,300*/recovery = \$1,849,848

800 x 1.8513 x 5 hrs x 2 MMH x \$30 = 444,312

Total saved = \$2,294,260

5. Flush and drain from special oil samples and component removals:

a. Special oil samples = 1/1,000 hrs of operation*

2 acft hrs reqd per operation

2 x 800 = 1,600 acft hrs

Cost: 2 MMH x \$30 x 800 = \$48,000

Fuel cost for MOC after flush and drain

30 gal x \$1.50 x 800 = \$36,000

b. Components removed for contamination

Engine removed for oil contamination per yr = 59₂

Transmission removed for oil contamination per yr = 36*

Total = 89 components removed for contamination

95 x 30 gal x \$1.50 = \$4,275 Fuel for MOC

c. ODDS does not require system FLUSH after component replacement

95 components replaced @ 2 acft hrs
for flushing = 190 hrs.

$$190 \text{ hrs} \times \$30 = \$5,700$$

$$\text{Total saved} = \$48,000 + \$36,000 + \$4,275 + 5,700 = \underline{\$93,975}$$

6. No-fault removal engine and transmission:

Engine 9/yr₂; trans. 10/yr*

50 MMH hrs required to remove and replace engine

60 MMH hrs required to remove and replace transmission

110 MMH hrs = 55 acft hrs (MMH includes 2 men)

$$55 \times 19 = 1,045 \text{ acft hrs total}$$

Cost: Engine 50 MMH x \$30 x 9 = \$13,500

Trans 60 MMH x \$30 x 10 = \$18,000

Shipping engine: \$194 x 9 = \$1,746

Shipping transmission: \$162 x 10 = \$1,620

Depot labor (engine): 120 MMH* x 30 x 9 = \$32,400

Depot parts (engine): \$200* x 9 = \$1,800

Depot labor (trans.): 40 MMH* x 30 x 10 = \$12,000

Depot parts (trans.): \$140 x 10 = \$1,400

Total saved = \$82,466

7. Reduction in spares cost engine transmission: 10%

$$\text{Eng OH/yr} = \frac{800,000}{950} = 842$$

$$\text{Trans OH/yr} = \frac{800,000}{1,250} = 640$$

Eng. spares cost = $\$200^* \times 842 - \$168,400 \times 10\% = \$16,840$

Trans. spares cost =

$\$2,500^* \times 640 = 1,600,000 \times 10\% = \$160,000$

Total saved = \$176,840

ANNEX 1

CHIP LIGHT FREQUENCY - UH-1H

	<u>Standard Aircraft</u>	<u>Modified Aircraft</u>
T-53 engine	.00125	.00333*
42° gearbox	.00250	.00002
90° gearbox	.00250	.00002
Main transmission	.00133	.00058
TOTALS	.00758	.00395

48% reduction in chip lights with modified system

*Latest design indicates .00222.

ENGINE CONDITION MONITORING SYSTEM
APPLICATION PROPOSAL

DESCRIPTION:

An engine life usage/condition monitoring system has been developed which permits on-condition maintenance, and provides a quantum improvement in operational readiness.

The system provides continuous monitoring of aircraft engine sensors for airborne and ground data analysis which has been successfully demonstrated for over 50,000 hours of fleet operation.

The key elements of the system allow for existing engine sensors to measure parameters of performance and performance degradation through computation and data storage combined with software which translates sensor outputs to performance indicators.

PROPOSAL:

Retrofit the complete A-7E Navy aircraft fleet, and extend the application of the A-7E IECMS to the F-14A.

RECOMMENDATION:

Specify the IECMS functional capabilities for all new aircraft engines including AV8-B, VTX, and JVX.

A7E DEMONSTRATED RESULTS:

- A-7E IECMS EXPERIENCE
 - No engine-caused aircraft losses in 50,000 flt hrs versus fleet average (last 2 years) of 15,000-20,000 flt hrs/engine caused aircraft losses
 - 2.8 to 1 reduction of total engine maintenance man hrs per flt hr
 - 6 to 1 reduction in level 2 maintenance man hr/flt hr
 - 40 percent reduction in total engine removal rate. Estimated VA-46 and VA-72 maintenance cost savings due to reduced engine removals in 1980 alone was \$2.1M
 - Reduced unsubstantiated component removals--45 percent reduction in 1 year (10,500 flt hrs)
 - 3-4 year LCC payback (without aircraft saves) based on LCC analysis.

APPLICATION BENEFITS:

- Improved aircraft readiness--increased engine availability
- Improved safety--early detection and reduced aborts
- Reduced spares support--increased component life usage, reduce no-fault removals, and secondary damage
- Improved maintenance--automated diagnostics and trouble-shooting
- Improved engine logistic management--parts tracking, product support programs and design inputs
- Reduced fuel requirement--decreased trim time and effective trouble shooting.

47/3-2

3/14-1

RESULTS:

- Increases operational readiness
- Increases mission reliability
- Reduces maintenance burdens

COST/BENEFITS

- F-18 IECMS
 - G.E. projected life cycle saving of \$270K per engine due to life usage monitoring for 2,000 to 3,000 engine fleet--\$540M LCC saving
 - Demonstrated improved troubleshooting efficiency
 - Demonstrated quick response to new fleet problems-- IECMS diagnosed compressor blade failure cause and provide early cockpit warning fix.
- F-14 EMS Application
 - Reduction of engine MMH/FH
 - Reduced engine removal rate
 - Reduced unnecessary component removal
 - Eliminate need to procure redundant aircraft fatigue monitoring system
 - Early LCC payback

ESTIMATED COST OF IMPLEMENTATION PROGRAM:

- A-7E EMS Retrofit Program (OSIP-in process)
 - Over 300 aircraft/400 engines
 - Unit cost per aircraft \$100K
 - \$35-40M Total

47/3-3

3/14-1

- F-14 EMS Application
 - All aircraft (production)
 - Include aircraft fatigue monitoring capability
 - Unit cost per aircraft \$100K
 - \$80 - \$100M total.

A-7E ENGINE MONITORING SYSTEM (EMS) PROGRAM

1. The A-7E Engine Monitoring System (EMS) Program, originally called the Inflight Engine Condition Monitoring System (IECMS), was started in 1971 with fabrication and test of a prototype system developed to reduce engine-caused aircraft losses. The EMS retains all the functional capabilities and benefits of the older IECMS while improving system reliability at reduced costs and complexity. The EMS is designed to provide for early detection of TF41 engine malfunctions and to reduce the maintenance time associated with troubleshooting engine discrepancies. The EMS also provides the engine component life usage tracking and performance degradation trending data required to support the "on-condition" maintenance aspects of the CNO directed Engine Analytical Maintenance Program (EAMP).

2. Both the EMS and the IECMS consists of (1) a set of engine and airframe sensors, (2) a set of avionics equipment for continually monitoring sensed parameters and recording data when required, (3) cockpit warning lights for alerting the pilot to potentially catastrophic engine problems, and (4) a ground processing station for automated and detailed analysis of recorded data. Reliability and affordability considerations have led to the development of a lower cost and less complex version of the EMS. This recently refined version of the EMS uses fewer engine parameters and takes advantage of current avionics micro-processor technology to significantly reduce system cost and improve reliability over the originally IECMS.

3. The A-7E IECMS has undergone a long history of evaluation test and fleet operational usage. A TECHEVAL was followed by a fleet operational evaluation. Update (pilot production) units were subsequently incorporated into all VA-46/72 aircraft

for extended operational assessment and software refinement. To date the system has accumulated over 50,000 operational flight hours on five carrier deployments and has been extremely well received by user activities. The system has proven to be a highly useful maintenance tool, significantly reducing the maintenance man-hours required for troubleshooting, reducing aircraft downtime, increasing aircraft availability and determining the need for unscheduled maintenance. NARF Jacksonville analysis has shown that, from July to December 1978, the IECMS equipped A-7E squadrons exhibited a decrease in maintenance man-hours per flight hour on the order of 2.8 to 1 when compared with two other non-IECMS A-7E squadrons similarly deployed. This same analysis also showed that the IECMS equipped aircraft flew more hours and proportionately shifted their level of repair actions to lower maintenance levels than the average A-7E squadrons. Additionally, the IECMS equipped engines experienced a reduced material cost per repair action, a situation reflecting the capability to decrease secondary damages through early problem detection. Operational experience with the IECMS has continuously exhibited an increase in time between engine removals when compared with the fleet average and has generated several documented squadron reports of IECMS indications averting a safety-of-flight incident or possible aircraft loss. One evaluation of IECMS equipped squadrons documented a 65 percent reduction in premature and a 45 percent reduction in total engine removal rates.

4. All deficiencies identified in early IECMS testing have been addressed and fixes implemented in the EMS design. The IECMS is currently deployed with VA-46/72 and all reports indicate the system is continuing to meet its performance goals. Continued user recommendations to implement the system fleet wide have resulted in OPNAV support of a retrofit A-7E EMS program. The EMS is currently being procured as a fleet-wide OSIP retrofit program.

5. The fleet experience with the A-7E IECMS is being used in the F/A-18 aircraft IECMS program. The A-7E EMS avionics have been designed to support an engine monitoring requirement on another aircraft type. The F-14A aircraft and TF30 engine particularly can use the benefits afforded by implementation of engine monitoring. The A-7E EMS avionics could be used with minimum hardware changes to implement engine monitoring on the F-14A aircraft.

F-18 IECMS DEMONSTRATED ENGINE DEVELOPMENT BENEFITS

Early testing of the F404 engine on the F-18 provided a good example of the value of an EMS applied during engine development.

The F404 engine used in the F-18 aircraft has experienced a hardware failure that demonstrates both the benefits and flexibility of an EMS on new aircraft. Every F404 powered F-18 aircraft has an Inflight Engine Condition Monitoring System (IECMS). Early in the fleet introduction phase of the F-18 aircraft program, several F404 engines experienced inflight failures of 4th stage compressor blades. These failures caused internal FOD, compressor stalls and significant secondary engine damage. To troubleshoot and define the cause of this type of engine failure would normally require an exhaustive contractor engineering investigation backed up by much costly ground and flight testing to verify the cause. All this investigation would have normally taken a great deal of time and money. Instead, since each F-18 has an IECMS, data was recorded that led to a timely definition of the cause of the blade failure. The IECMS data showed that the engine T₁ sensor was failing intermittently. Failure of the T₁ signal impacts the engine in two detrimental ways. First, failure of the T₁ signal causes the engine control to mis-position the fan guide vanes which leads to resonance fluctuations, and, eventually,

failure of the 4th stage compressor blades. A T₁ sensor failure also causes other engine anomalies even when there is no danger of compressor blade failure. These anomalies involve the engine control unit and manifest themselves in compressor stalls and/or afterburner blowouts.

The proposed fix to the 4th stage compressor blade problem is to both re-design the engine T₁ sensor and to "beef up" the compressor blade. Both of these hardware "fixes" are long lead time to fleetwide implementation. The short term solution to this problem involved an IECMS software change. An IECMS software algorithm was quickly developed and implemented that not only recognizes intermittent T₁ sensor failures but also warns the pilot inflight. This new T₁ sensor failure software has been implemented at minimum cost and time and has already "saved" several engines from blade failures.

A-7E ENGINE MONITOR SYSTEM

COST BENEFIT

SUPPORT DATA

47/2-12

III-23

SQUADRON ACCEPTANCE

CO, VA-72 - SEPT '79

"IT IS MY BELIEF THAT FLIGHT SAFETY, OPERATIONAL READINESS, AND COST SAVINGS IN THE OUT-YEARS WILL INCREASE GREATLY BY PROVIDING IECMS FOR ALL A7E AIRCRAFT."

CO, VA-46 - SEPT '79

"IECMS CAN BE USED AS A TOOL FOR EARLY DETECTION/EVALUATION OF ENGINE MALFUNCTIONS. IT IS A USEFUL TOOL FOR TROUBLESHOOTING, REDUCING AIRCRAFT DOWN TIME, INCREASING AIRCRAFT AVAILABILITY, AND IN DETERMINING THE NEED FOR UNSCHEDULED MAINTENANCE."

"IECMS DECREASES OPERATING COSTS THROUGH MORE ACCURATE TROUBLESHOOTING."

COMNAVAIRLANT - DEC '79

"IT IS APPARENT THAT THE SYSTEM CAN AND DOES PROVIDE DIRECT INDICATION OF ENGINE HEALTH, PERFORMANCE TRENDING, AND PROVIDES IMPROVED ACCURACY IN TRIM ADJUSTMENT. A CORRECTLY MAINTAINED, EFFICIENTLY OPERATING ENGINE PROVIDES FAR MORE ASSURANCE OF A SAFE RETURN THAN DOES A PILOT WARNING SYSTEM.

" - - - THE TIME HAS COME TO RETROFIT IECMS TO THE REST OF THE ATLANTIC A7E COMMUNITY."

SQUADRON ACCEPTANCE (CONT)

CO, VA-46 - JULY '80

"THE IMMEDIATE AND PRECISE ANALYSIS OF ENGINE HEALTH AVAILABLE THROUGH IECMS CONTINUES TO BE THE SALIENT STRENGTH OF THE SYSTEM, AND OF INMEASURABLE VALUE IN ASSET CONSERVATION. ACCUMULATION OF ENGINE COMPONENT STRESS DATA AS A BASE FOR TRANSITION TO ON-CONDITION MAINTENANCE IS ALSO OF GREAT IMPORTANCE. RETROFIT OF IECMS INTO ALL A7E AIRCRAFT CONTINUES TO BE MOST STRONGLY RECOMMENDED.

COMCARAIRWING ONE - JAN '81

"LOSS OF THIS VALUABLE SYSTEM (IECMS) WILL DEGRADE SAFETY AND SIGNIFICANTLY INCREASE ENGINE RELATED MAINTENANCE MANHOURS IN BOTH A7E SQUADRONS."

"RECOMMEND IECMS SYSTEM/SUPPORT BE MAINTAINED ON ALL VA-46 AND VA-72 AIRCRAFT UNTIL REPLACED BY EMS."

MAINTENANCE MAN HOUR REDUCTION

NARFJAX SPEED LETTER - JUNE '79

"FROM THE DATA PROVIDED, IECMS EQUIPPED ENGINES EXHIBIT
A DECREASE IN MAINTENANCE MANHOURS PER FLIGHT HOUR ON THE
ORDER OF 2.8:1."

S.T. ARMSTRONG
BY DIRECTION

IECMS NON-IECMS COMPARISON

APR - SEP 78

OCT - DEC 78

JUL - DEC 78

DEPLOYED/ASHORE	DEPLOYED 6 MO		ASHORE 3 MO DEPLOYED 3 MO		DEPLOYED		DEPLOYED
	IECMS	NON-IECMS	IECMS	NON-IECMS	IECMS	NON-IECMS	
ACTIVITIES	VA-46 VA-72	VA-37 VA-105	VA-46 VA-72	VA-37 VA-105	VA-46 VA-72	VA-37 VA-105	VA-97 VA-27
AIRCRAFT INVENTORY FLIGHT HOURS	24.1 8,690.0	22.0 5,316.0	24.3 3,979.0	23.0 2,656.0	23.0 2,656.0	23.0 2,656.0	22.8 3,226.0
HOURS IN READINESS REPORTING STATUS	104,127.0	95,230.0	52,530.0	49,627.0	52,530.0	49,627.0	98,875.0
NOT OPERATIONALLY READY	10,716.4	5,434.0	7,118.1	3,994.9	7,118.1	3,994.9	1,693.8
KORU	1,541.2	1,645.7	1,067.0	1,086.1	1,067.0	1,086.1	1,066.5
NORS	9,175.2	3,788.3	6,051.1	2,908.8	6,051.1	2,908.8	627.3
MAINTENANCE MANHOURS	2,666.7	4,913.7	1,288.1	2,151.2	1,288.1	2,151.2	4,617.6
PSH/PL - 1	2,512.7	2,924.7	1,234.1	1,646.2	1,234.1	1,646.2	3,486.1
PSH/PL - 2	154	1,989.0	54.0	505.0	54.0	505.0	1,131.5
MAINTENANCE ACTIONS VERIFIED FAILURES	76 16	71 24	37 5	30 12	37 5	30 12	89 37
MAINTENANCE MANHOUR PER FLIGHT HOUR (ALL)	.306	.924	.323	.809	.323	.809	.883
MAINTENANCE LEVEL-1	.289	.550	.310	.619	.310	.619	.667
MAINTENANCE LEVEL-2	.017	.374	.013	.190	.013	.190	.216

ENCLOSURE (1)

ENGINE REMOVAL RATE REDUCTION

	<u>ALL CAUSES</u>	<u>PREMATURE</u>
● VA-46 AND VA-72 ENGINE REMOVAL RATE (REMOVALS PER 1000 HRS)	2.9	1.3
● FLEET AVERAGE	4.9	2.9
● PER CENT REDUCTION	40%	65%

ESTIMATED VA-46 AND VA-72 MAINTENANCE COST SAVINGS DUE TO REDUCED
ENGINE REMOVALS ALONE IN 1980 WAS \$2.1 MILLION.

TF41 COMPONENT REMOVAL SUMMARY

<u>COMPONENT</u>	<u>VA-46/72 REMOVALS</u>	<u>FLEET AVERAGE</u>	<u>*REMOVALS SAVED</u>	<u>\$ SAVED</u>
MAIN FUEL CONTROL	2	7	5	60,000
HP FUEL PUMP	0	4	4	48,000
AIRFLOW CONTROL REGULATOR	0	3	3	30,000
EXCITER	2	4	2	6,000
MANUAL FUEL CONTROL	0	2	2	20,000
OIL PUMP	0	1	1	6,000
PERMANENT MAGNET GENERATOR	2	2	0	0
RELAY BOX	1	0	(1)	(3,000)
TEMPERATURE LIMITER AMPLIFIER	10	8	(2)	(20,000)
				<u>\$147,000</u>

• ABOVE DATA BASED ON 10,500 FLIGHT HOURS IN CY 1980.

• ALL VA-46 AND VA-72 REMOVALS HAVE BEEN SUBSTANTIATED.

EMS ENGINE (ACCESSORIES) ANALYSIS

09-Feb-81

BUNO 1 160552
 ENGINE MODEL 1 TF41A
 DASH NUMBER 1 402B

ENGINE SERIAL NUMBER 1 0141996

10:34

REPORTING CUSTODIAN 1 09058

NOMENCLATURE	PART NUMBER	SERIAL #	ENG RUN TIME	FLT/HR USAGE	FLT/HR LIMIT	FLT/HR REMAIN	EMS PARAM	CURRENT CYCLES	EMS LIMIT	PRED FM REMAIN
VANE, MP1 TURBINE	6889420	NONE	230.7	205.9	450.0	244.1	TSC	3359.6	13500.0	386.3
BLADE, MP1 TURBINE (FORGED)	6869795	NONE	838.7	750.9	1000.0	249.1	TSC	14804.6	30000.0	578.9
SPACER, MPC 9-10	6866679	HC023	986.2	868.9	1500.0	631.1	NH	1327.0	2700.0	762.8
BLADE, MP2 TURBINE	6869079	NONE	230.7	205.9	1000.0	794.1	TSC	3359.6	30000.0	1014.9
WHEEL, MP1 TURBINE	6860027	10720	1478.7	1262.9	2500.0	1237.1	NH	2036.2	4500.0	1368.8
WHEEL, MP2 TURBINE	6861135	MY14597	928.7	822.9	2500.0	1677.1	NH	1244.2	4500.0	1808.8
WHEEL, LP2 COMPRESSOR	6866245	MM10695	2037.4	1709.9	5000.0	3290.1	NL	5022.6	9600.0	1430.4
BLADE, LP1 COMPRESSOR	6869628	NONE	1824.9	1539.9	7500.0	5960.1	NL	4478.6	24000.0	6100.4
WHEEL, MP5 COMPRESSOR	6888463	670CAM	1247.4	1077.9	8000.0	6922.1	NH	1703.2	14400.0	7053.8
WHEEL, MP6 COMPRESSOR	6888464	401CAM	1247.4	1077.9	8000.0	6922.1	NH	1703.2	14400.0	7053.8
BLADE, LP2 COMPRESSOR	6866282	NONE	2537.4	2109.9	10000.0	7890.1	NL	6302.6	32000.0	8030.4
WHEEL, MP8 COMPRESSOR	6888466	914RH	1247.4	1077.9	9000.0	7922.1	NH	1703.2	16200.0	8053.8
WHEEL, MP11 COMPRESSOR	6860859	111GP	1997.4	1677.9	10000.0	8322.1	NH	2783.2	18000.0	8453.8
BLADE, LP3 COMPRESSOR	6866286	NONE	1787.4	1509.9	10000.0	8490.1	NL	4382.6	32000.0	8630.4
BEARING MP THRUST	6863739	K391	1592.4	1353.9	10000.0	8646.1	NH	2200.0	18000.0	8777.8
SLEEVE, MP TURBINE	6889625	KK12830	1478.7	1262.9	10000.0	8737.1	NH	2036.2	18000.0	8868.8
WHEEL, MP4 COMPRESSOR	6888462	510CAS	1247.4	1077.9	10000.0	8922.1	NH	1703.2	18000.0	9053.8
WHEEL, MP7 COMPRESSOR	6888465	436RH	1247.4	1077.9	10000.0	8922.1	NH	1703.2	18000.0	9053.8
WHEEL, MP9 COMPRESSOR	6888467	726EAA	1247.4	1077.9	10000.0	8922.1	NH	1703.2	18000.0	9053.8
WHEEL, MP3 COMPRESSOR	6888461	871CAS	1247.4	1077.9	13000.0	11922.1	NH	1703.2	23400.0	12053.8
WHEEL, MP2 COMPRESSOR	6888460	222CAM	1718.7	1454.9	14000.0	12545.1	NH	2381.8	25200.0	12676.8
WHEEL, MP10 COMPRESSOR	6888468	561EAB	1247.4	1077.9	20000.0	18922.1	NH	1703.2	36000.0	19053.8

LOW CYCLE FATIGUE RESULTS

- PRESENT TF41 LIFE LIMITS BASED ON 1.8 N_H CYCLES AND 3.2 N_L CYCLES PER FLIGHT HOUR
- IECMS DATA AS TRANSFERRED TO CAMS INDICATES ACTUAL CYCLES OF .85 N_H AND 1.01 N_L CYCLES PER FLIGHT HOUR
- LIFE USAGE TRACKING WITH ACTUAL CYCLES REPRESENTS A POTENTIAL LIFE INCREASE OF:
 - 65 PERCENT - LP
 - 50 PERCENT - HP
- DIRECT PERCENTAGE REDUCTION OF SPARE LIFE LIMITED COMPONENTS (COMPRESSOR AND TURBINE DISCS AND BLADES)

EMS FLEET INCORPORATION LIFE CYCLE COST STUDY

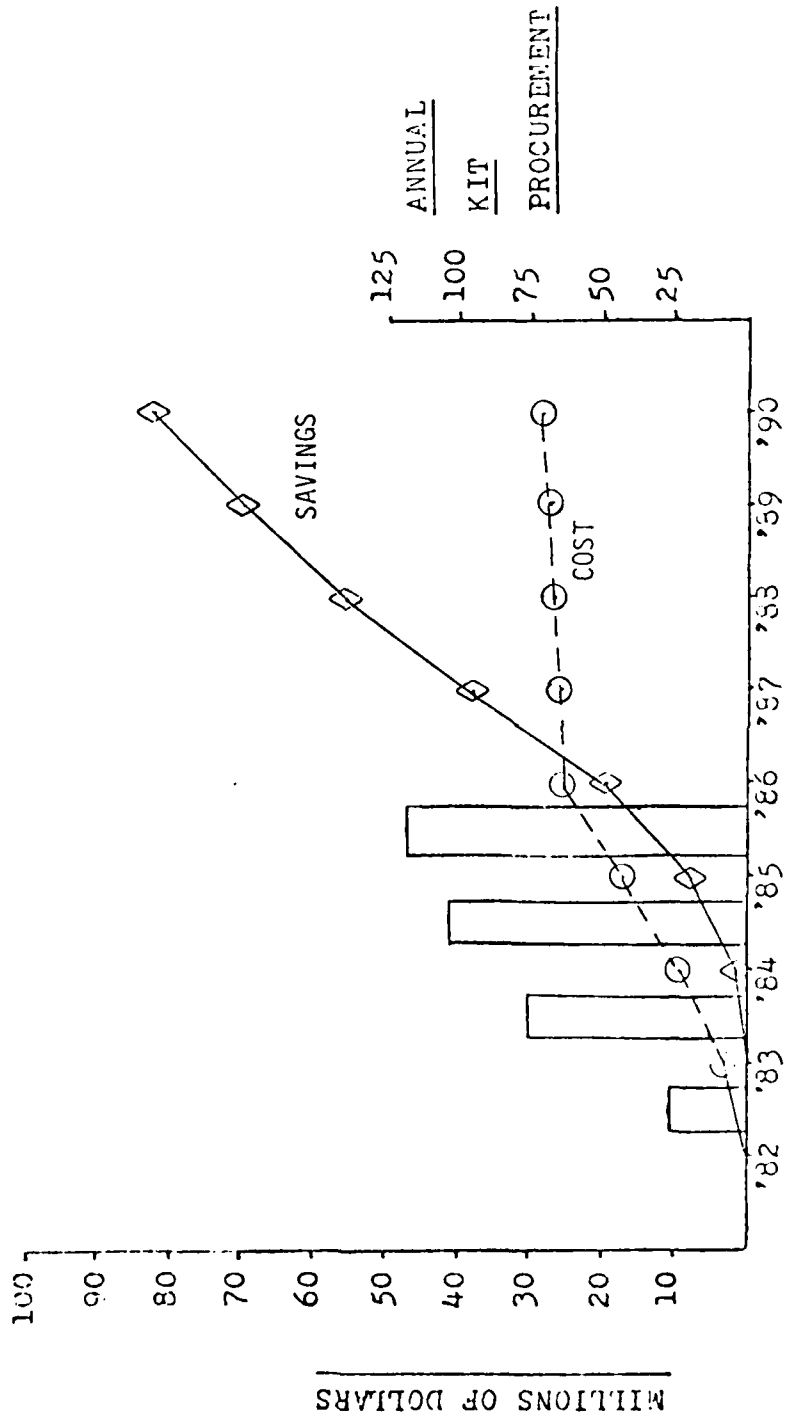

IV. MSCM TECHNOLOGY ASSESSMENT AND R&D RECOMMENDATIONS

IV. MSCM TECHNOLOGY ASSESSMENT AND R&D RECOMMENDATIONS

IV. MSCM TECHNOLOGY ASSESSMENT

Significant technological advances in the field of mechanical systems condition monitoring stimulated this committee to pursue a review of current industry and military research programs. As with engine condition monitoring, previous oil-wetted component condition monitoring techniques and procedures are inadequate to properly and reliably detect and diagnose component condition. Current SOAP and chip detection systems do not address all of the failure modes and have not proven to be totally effective due to application considerations and equipment limitations. As an example, Fig. IV-1 summarizes the main points of a recent Army Aviation mechanical systems diagnostics review of currently-applied techniques, their discrepancies, and improvement areas indicated. The MSCM technology assessment was undertaken to identify ways to fill perceived gaps in condition monitoring technology and identify technology improvement areas.

Letters of invitation (Fig. IV-2) were sent to eight manufacturers and one military research center. Each letter detailed our tasking and laid the ground rules for a 2-hour presentation period by each group. The response to our invitations was admirable (see Table IV-1). We received two days (11 January and 15 February) of excellent presentations covering a wide spectrum of hardware and software programs. Refining the presentation material to determine the best technology candidates led to the assessments which follow (see Table IV-2).

The proposals received for new technology development are well-defined in technology content but somewhat less precise in the program cost and return on investment areas. Refinement of these aspects requires a closer definition of program scope, ground rules and implementation plan for each of the technologies

than was possible in the time available. The purpose of this part of the MSCM effort is to bring up these promising technologies that have apparent R&M benefit potential and match the appropriate program and OSD people with the contractor technology sources. To this end, the level of detail in the proposals should suffice. It is recognized that implementation requires further detailed program/equipment definition.

Our general response to the reviews was that equipment manufacturers seemed most often to specialize in a single aspect of monitoring, software houses are catching up with microprocessor implementation of diagnostics, and service programs are still very protective and parochial. The essence of this is unanimous agreement that monitoring can provide the traditionally missing information necessary for life usage monitoring and early detection and prognosis of mechanical failures.

In addition to the corporate proposals we have evaluated, there are three other technological areas that are under development and have shown potential benefit and require final development and application consideration:

- Vibration monitoring needs further development and a strong push for integration into the overall monitoring discipline.
- Quantitative oil debris monitoring appears ready for wide application. It is receiving acceptance by foreign helicopter and commercial aircraft manufacturers but needs strong advocacy for U.S. military systems to allow the same R&M benefits to be realized.
- Shock pulse technology has demonstrated preliminary savings of 35 percent of repair costs in transmissions and reductions in no fault found actions.

OSD advocacy for new weapon systems application of these technologies is recommended. These technologies need integration with automated data processing equipment and application engineering for the specifics of each system. They are cornerstone technologies for inflight mechanical system condition monitoring, failure warning, and prognosis.

We are firm in our belief that low risk technology is available and the specific programs we are recommending can indeed provide a quantum improvement in the readiness of high performance weapon systems.

OSD advocacy for new weapon systems application of these technologies is recommended. These technologies need integration with automated data processing equipment and application engineering for the specifics of each system. They are cornerstone technologies for inflight mechanical system condition monitoring, failure warning, and prognosis.

We are firm in our belief that low risk technology is available and the specific programs we are recommending can indeed provide a quantum improvement in the readiness of high performance weapon systems.

<p>A. CURRENTLY APPLIED MECHANICAL AND LUBRICANT CONDITION MONITORING TECHNIQUES:</p>		
<p><u>1. ON-BOARD MONITORING</u></p> <ul style="list-style-type: none"> • Chip Detectors • Oil Sensors <ul style="list-style-type: none"> - Temperature - Pressure • Crew Sensed 	<p><u>2. GROUND SUPPORT</u></p> <ul style="list-style-type: none"> • Crew Inspection • Maintenance Inspection • SOAP 	
<p>B. OBSERVED DISCREPANCIES WITH EXISTING TECHNIQUES</p>		
<p style="text-align: center;"><u>ON-BOARD (IN FLIGHT)</u></p>		
<p><u>1. CHIP DETECTORS</u></p> <ul style="list-style-type: none"> • Placement • Sensitivity • Nuisance Indications • Interpretation 	<p><u>2. OIL SENSORS</u></p> <ul style="list-style-type: none"> • Non-Specific • Nuisance Indications 	<p><u>3. CREW SENSED</u></p> <ul style="list-style-type: none"> • Training/ Experience • Non-Specific • No Equipment
<p style="text-align: center;"><u>GROUND SUPPORT</u></p>		
<p><u>1. CREW INSPECTION</u></p> <ul style="list-style-type: none"> • Training • Experience • Equipment Lack 	<p><u>2. MAINT. INSPECTION</u></p> <ul style="list-style-type: none"> • Training • Experience • Equipment Lack 	<p><u>3. SOAP</u></p> <ul style="list-style-type: none"> • Particle Size • Concentration • Sampling • Filtration • Time Lags for Results
<p>C. RECOMMENDED IMPROVEMENTS IN DIAGNOSTICS</p>		
<p><u>1. OIL ANALYSIS PROGRAM</u></p> <ul style="list-style-type: none"> • Ferrography • Microscopy (Filter and Chip Detector Debris Analysis) • Water 	<p><u>2. CREW AND MAINTENANCE</u></p> <ul style="list-style-type: none"> • Training in Debris Collection and Evaluation • Vibration* 	<p><u>3. ON BOARD</u></p> <ul style="list-style-type: none"> • Improved Filtration (3μ) • Full Flow Debris Discrimination Chip Detectors
<p>*Long-term development of a piece of ATE required.</p>		

FIGURE IV-1. Mechanical Systems Diagnosis for Army Aviation--Now and Future

January 14, 1983

Dear Mr. -----:

As part of the OSD/IDA R&M Study commissioned by the attached Task Order No. MDA903 79 C 0018: T-2-126, new technology is being reviewed in the area of Mechanical Systems Condition Monitoring of turbine engines, transmissions, and structures. Technology that, if developed and applied, could provide quantum improvements in weapon system R&M is of specific interest to the study group. The MSCM report to the study Core Group and OSD will include key technology development recommendations based on these technology reviews.

We believe that your organization may be performing R&D programs which relate to the requirements of our study, and invite a representative to present pertinent aspects of your MSCM work to the MSCM Work Group of the R&M Study on February 15, 1983, from 3:00 p.m.-5:00 p.m. The briefing will be conducted at the Institute for Defense Analyses, 1801 N. Beauregard Street, Alexandria, VA 22311 (map attached).

We would appreciate the briefing being made in a viewfoil format with a copy of the viewfoils (no proprietary data, please) being supplied for use by the MSCM Work Group in preparing later briefings and reports.

Our report format requirements can best be met by briefings that have the following content:

- (a) Brief description of the MSCM technology.
- (b) Recommended application of the technology.
- (c) Anticipated R&M benefits--tangible and justified.
- (d) Resource required/source/development schedule.

FIGURE IV-2. Sample letter of invitation to manufacturers and military research center (continued on next page)

Mr. -----
January 14, 1983
Page Two

The subject of the briefing should be limited to Mechanical System Condition Monitoring technology, and the length of the briefing should be limited to 1 hr 45 mins including Q&A. While backup data and reports may be submitted, we request no hardware demonstrations be planned. For our planning purposes I would like to have an outline of your presentation (agenda) two weeks in advance.

In order that we may make arrangements for your visit, please forward the names and organizational affiliations or titles of the attendees to Anthea DeV Vaughan at 703-845-2370. Security clearances should be called in to the IDA Security Office at 703-845-2183, with confirmation following by mail. Unclassified briefings are desirable.

Thank you for your consideration of this request; we are looking forward to an interesting briefing.

Please call me if you need any further information. I can be reached at 215-583-9400 or 703-845-2370.

Sincerely,

Paul L. Howard
Chairman, MSCM

Attachments:

- (1) Task Order
- (2) IDA map

PLH:amd
37/45-2

cc: Mr. Martin A. Meth
Mr. George Mayer
Mr. John Rivoire
Dr. Hylan B. Lyon, Jr.

FIGURE IV-2 (cont'd)

47/5-2

TABLE IV-1. TECHNOLOGY REVIEW CONTACTS SUMMARY

ORGANIZATION	MSCM TECHNOLOGIES	IMPROVEMENT TARGET
United Technology Research Center/Hamilton Standard/Sikorsky Aircraft (UTRC/HS/SA)	<ul style="list-style-type: none"> ● Electrostatic Pulse Analysis Classifier ● Pattern Recognition ● Laser Vibration Sensor ● Airborne Transmission Monitoring System 	<ul style="list-style-type: none"> ● Reduced Mission Aborts ● Increased System Availability
Mechanical Technology, Inc. (MTI)	<ul style="list-style-type: none"> ● Intelligent Microprocessor-based Monitoring System ● Vibration Signature Analysis 	<ul style="list-style-type: none"> ● Reduced Reworks ● Reduced Logistics Tail (increased readiness)
David Taylor Naval Ship R&D Center (DTNSR&DC)	<ul style="list-style-type: none"> ● Acoustic Valve Leak Detector ● Fiber Optic Rearing Monitor ● Ultrasonic Wear Particle Sensor ● Integrated Shipboard Machinery Monitoring System 	<ul style="list-style-type: none"> ● Reduced Troubleshooting Downtime and Associated Costs
Northrop Electronics Division (NED)	<ul style="list-style-type: none"> ● Airborne Engine Monitoring System ● A/C Structural Tracking System 	<ul style="list-style-type: none"> ● Reduced Mission Aborts ● Increased System Availability ● Reduced Fuel Consumption (Cost)

(continued)

TABLE IV-1 (continued)

ORGANIZATION	MSCM TECHNOLOGIES	IMPROVEMENT TARGET
Lear-Siegler, Inc. (LSI)	<ul style="list-style-type: none"> ● F100 Engine Diagnostic System 	<ul style="list-style-type: none"> ● Reduced Mission Aborts ● Increased System Availability ● Improved Trim and Trouble-shooting Procedures (i.e., Reduced Cost)
BENDIX	<ul style="list-style-type: none"> ● Propulsion Multiplexer ● Pressure Transducer 	<ul style="list-style-type: none"> ● Reduced O&S Costs ● Improved Sensor Reliability ● Increased Reliability of Monitoring Systems
VIBRO-METER Corp. (VM)	<ul style="list-style-type: none"> ● Piezo-Electric Transducers ● Vibrational Data Processing (Digital Output Technique) 	<ul style="list-style-type: none"> ● Optimizing Data Acquisition and Extraction

ACRONYMS:

- UTRC -- United Technology Research Center
- HS -- Hamilton Standard
- SA -- Sikorsky Aircraft
- MTI -- Mechanical Technology, Inc.
- DTNSRDC -- David W. Taylor Naval Ship Research & Development Center
- NED -- Northrop Electronics Division
- LSI -- Lear Siegler, Inc.
- VM -- Vibro-Meter, Inc.

INVITED BUT DECLINED: Hughes Aircraft Company
Garrett Air Research Manufacturing Company

TABLE IV-2. SUMMARY OF PROGRAM PROPOSALS

ORGANIZATION	PROPOSED PROGRAM	BENEFITS	R&D FUNDING REQUIRED	PROGRAM PERFORMANCE (MONTHS)
United Technology Research Center/ Hamilton Standard/ Sikorsky Aircraft (UTRC/HS/SA)	1. Integrated Black Hawk Helicopter Transmission Monitoring System 2. Electrostatic Engine Condition Monitor for A-6/J52	<ul style="list-style-type: none"> • Reduced Mission Aborts (\$20M savings) • Increased System Availability (\$105M savings) • Reduced Unscheduled Engine Removals • Extend Major Component Repair Interval • Extend Hot Section Inspection Interval (A-6 Savings--\$9.3M plus \$6.3M annually) Fleet Implementation.	\$2M*	24 mos*
*Note: Cost and schedule do not include Fleet Implementation.				
Mechanical Technology, Inc. (MTI)	M-1 Tank Monitoring System	<ul style="list-style-type: none"> • Reduced Life Cycle Costs (\$135M savings) 	\$700K	18 mos
David Taylor Naval Ship Research & Development Center (DTNSR&DC)	Extend AVLD to Tri-Service Develop Fiber Optic Bearing Monitor UltraSonic Wear Particle Sensor Integrated Shipboard Machinery Monitoring System	<ul style="list-style-type: none"> • \$20 M/yr savings in unnecessary valve replacement • Reduced Mtn & Downtime Costs • Detect Failures • Reduced Secondary Damage • Reduced Support Costs (LCC) (\$50M per ship) 	\$400K \$2.6M \$4M \$33M	- 48 mos 60 mos 60 mos

TABLE IV-2 (continued)

ORGANIZATION	PROPOSED PROGRAM	BENEFITS	R&D FUNDING REQUIRED	PROGRAM PERFORMANCE (MONTHS)
Northrop Electronics Division (NED)	<ol style="list-style-type: none"> 1. F-14/TF30 TEMS Technology Demonstration Pgm. 2. F-16/F100 TEMS Technology Demonstration Pgm. 3. T-38 Structural Tracking Technology Demonstration Pgm. 4. Diagnostic Technology Advancement Program (Engine Structure) 	<ul style="list-style-type: none"> • Common Structural and Engine Monitoring System (software change only) • Increased R.M.A. • LCC Reduction • A-10 Savings \$464M. 	\$3.3M (Approx.-- to be defined by more detailed definition of program scope)	15 mos to 24 mos
Lear-Siegler, Inc. (LSI)	EDS R&M Capabilities Demonstration on F-15 or F-16 F100 Engine	<ul style="list-style-type: none"> • Reduce unnecessary Engine Removals • Implement RCM • Reduce LCC--Analysis Shows F-15 LCC Savings of \$500M 	\$25M	36 mos
BENDIX	NO PROGRAM PROPOSED	-----	----	-----
VIBRO-METER Corp. (VM)	<ol style="list-style-type: none"> 1. High Temp (900°F) Proximity Probe for Rotating Shaft Diagnostics 2. Engine-Mounted/Fuel-Cooled Vibration Analyzer 3. Gearbox Extension of Technology Developed in (2.) 	<ul style="list-style-type: none"> • Failure Diagnostics Technology Improvement • Aircraft Engine Shaft/Bearing Diagnosis Improvement 	\$1.55M (Retention of Commercial Rights Requested)	24 mos

MSCM R&D PROGRAM RECOMMENDATIONS

This committee has prioritized the preceding proposals into three groups. Prioritization was guided by perceived near-term availability and quantum improvements in R&M.

The Priority 1 programs recommended for immediate action are:

- T-38 Structured Tracking Technology Demonstration Program (NED)
- Diagnostic Technology Advancement Program--Engine Structured (NED)
- Integrated Black Hawk Helicopter Transmission Monitoring System (UTRC)
- High Temperature Proximity Probe 900°F--Engine Rotating Shaft Diagnostics (VM)
- M-1 Tank Monitoring System (MTI)
- F-16/F-100 TEMS Technology Demonstration Program (NED & LSI).

The Priority 2 programs recommended for immediate review for possible development with benefits for future programs:

- Development of Fiber Optic Bearing Monitor (DTNSRDC)
- UltraSonic Wear Particle Sensor (DTNSRDC)
- F-14/TF30 TEMS Technology Demonstration Program (NED)
- Electrostatic Engine Monitor (UTRC).

47/14-1

3/14-1

In the third category we have placed programs we feel may have less immediate and undetermined future benefit. These programs need specified weapon system application benefit analyses:

- Extend Acoustic Valve Leak Detector to Tri-Service (DTNSRDC)
- Integrated Shipboard Machinery Monitoring System (DTNSRDC)
- Engine-Mounted/Fuel-Cooled Vibration Analyzer (VM)
- Gearbox Extension of Diagnostic Technology (VM).

The following section includes the details of the basic proposals previously reviewed and ranked. They are succinct and lack the full justification package required to implement them. This was done to avoid unnecessary expense being incurred by the industries that responded and because more definition of scope and planning is necessary mutually between the industry proposing the technology and the program which would potentially apply the technology.

Sufficient detail is presented to provide a tangible benefits overview and a description of the technology itself. Costs and schedules are somewhat less precise.

The proposals are grouped by company alphabetically. For clarity the MSCM recommended priority (MSCM-1, MSCM-2, MSCM-3) has been added to the individual proposal description.

47/14-2

3/14-1

MSCM R&D PROGRAM RECOMMENDATIONS

TABLE OF CONTENTS

David Taylor Naval Ship R&D Center	IV-17
Lear Siegler, Inc.	IV-47
Mechanical Technology, Inc.	IV-63
Northrop Electronics Division	IV-67
United Technology Research & Development Center	IV-119
Vibro-Meter Corp.	IV-139

DAVID TAYLOR NAVAL SHIP RESEARCH

AND DEVELOPMENT CENTER

IV-17

ACOUSTIC VALVE LEAK DETECTOR
DESCRIPTION

The Acoustic Valve Leak Detector (AVLD) is a portable, nonintrusive instrument developed by the David Taylor Naval Ship R&D Center in response to a requirement for an instrument which would reduce the need for opening piping systems to inspect valves. The AVLD listens for the ultrasonic acoustic emissions characteristic of internal valve leakage.

Types of fluids to which the instrument has been successfully applied include steam, water, hydraulic oil and high-pressure air. Since the transducers are attached to the outside of the valves, the time and expense of dismantling the valves or removing them from the system are eliminated.

Savings have resulted from its ability to detect small leaks before they become large enough to necessitate more expensive repair procedures. The AVLD has proven effective for troubleshooting by identifying the leaking valves in parallel arrangements where it is not normally possible to determine which valve is leaking, and it has been used by naval shipyards to identify ship valves requiring repair during scheduled overhauls.

We recommend that the Tri-Services stay with portable diagnostic instrumentation unless the need for permanently mounted valve monitoring equipment is better established. The cost benefits in the Navy program have been substantial (\$20M/year) even with applications limited to combatant ships. The extension of this technology to Tri-Services could be implemented by establishing a Tri-Services team to identify specific applications. DTNSRDC, if tasked, would function as a Navy representative on this team and will in any event act as technical consultants.



• FEET SUPPORT

• ACOUSTIC
VALVE LEAK
DETECTOR

• \$1M SAVINGS ON CUMULATIVE

INSIDE

LEAKAGE RATE VS. SIGNAL AMPLITUDE AT 175 KHZ
(2 INCH VALUE, 4000 PSID)

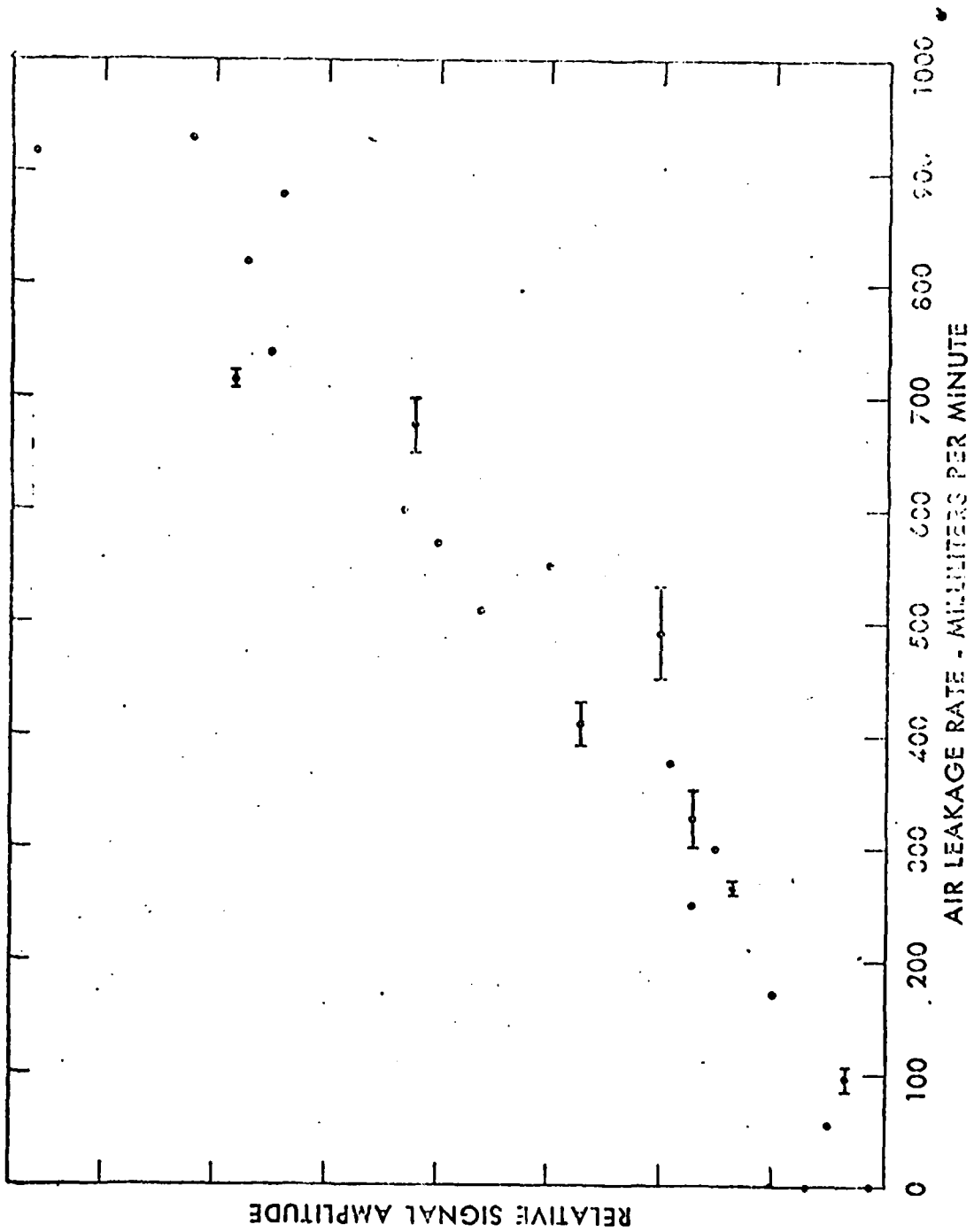



SHIPBOARD MACHINERY MONITORING

COST BENEFITS - AVLD

\$20M ESTIMATED FOR FY 81

BASED ON:

- SUBSTANTIAL CUTS IN VALVE WORK PACKAGE (ON USS JOHN F. KENNEDY, USS RATHBURN, USS PAUL FOSTER, USS INDEPENDENCE, USS LEAHY, USS LUCE, USS BAINBRIDGE, MOST ATLANTIC BASED FBM SUBMARINES)

DOES NOT INCLUDE:

- OCCASIONAL SHORTENING OF THE OVERHAUL PERIOD FOR FBM SUBMARINES OR SURFACE SHIPS
- SUBSTANTIAL FUEL SAVINGS RESULTING FROM TIGHTER SHIPBOARD STEAM PLANTS
- FLEET EMERGENCIES - E.G. NOT BEING ABLE TO LAUNCH



SHIPBOARD MACHINERY MONITORING

RECOMMENDATION — AVLD

APPLY PRESENT PORTABLE DIAGNOSTIC TECHNOLOGY TO TRI-SERVICE

- OSD — ESTABLISH TRI-SERVICE TEAM
 - PLAN SPECIFIC SERVICE APPLICATION
 - ESTIMATE MANPOWER AND COST FOR TRAINING, LOGISTICS AND PRODUCTION
 - \$350K
- DTNSRDC
 - CONSULT WITH OSD
 - TECHNOLOGY TRANSFER
 - \$50K

FIBER OPTIC BEARING MONITOR
DESCRIPTION

Based on the concept of measuring deflections of a bearing outer race, direct measurements of bearing condition and operational performance are obtained. A portable instrument is used to check the installation of a bearing system. A permanently machine mounted system is used to monitor in-service bearing condition. Bearing noise levels, defect factors, and temperatures are continuously sampled, trended, compared to limits, and coupled to an alarm system for warning of impending problems/failures.

THE FIBER OPTIC METHOD FOR BEARING CONDITION MONITORING

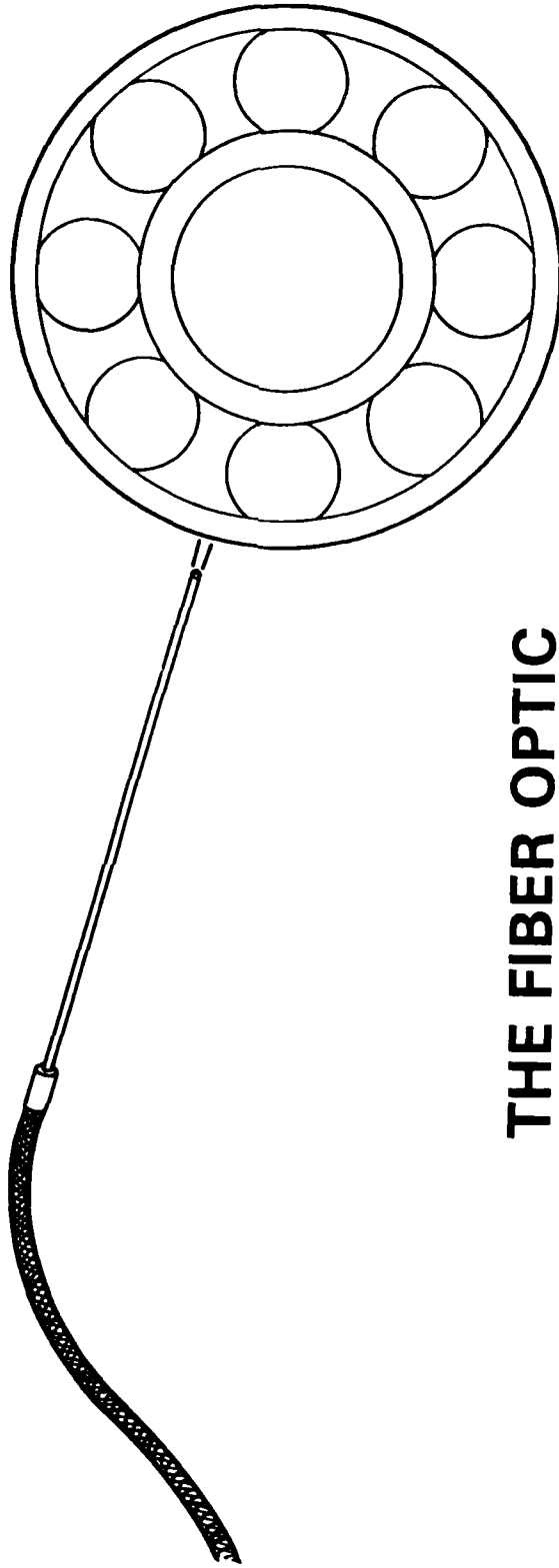

THE FIBER OPTIC
METHOD

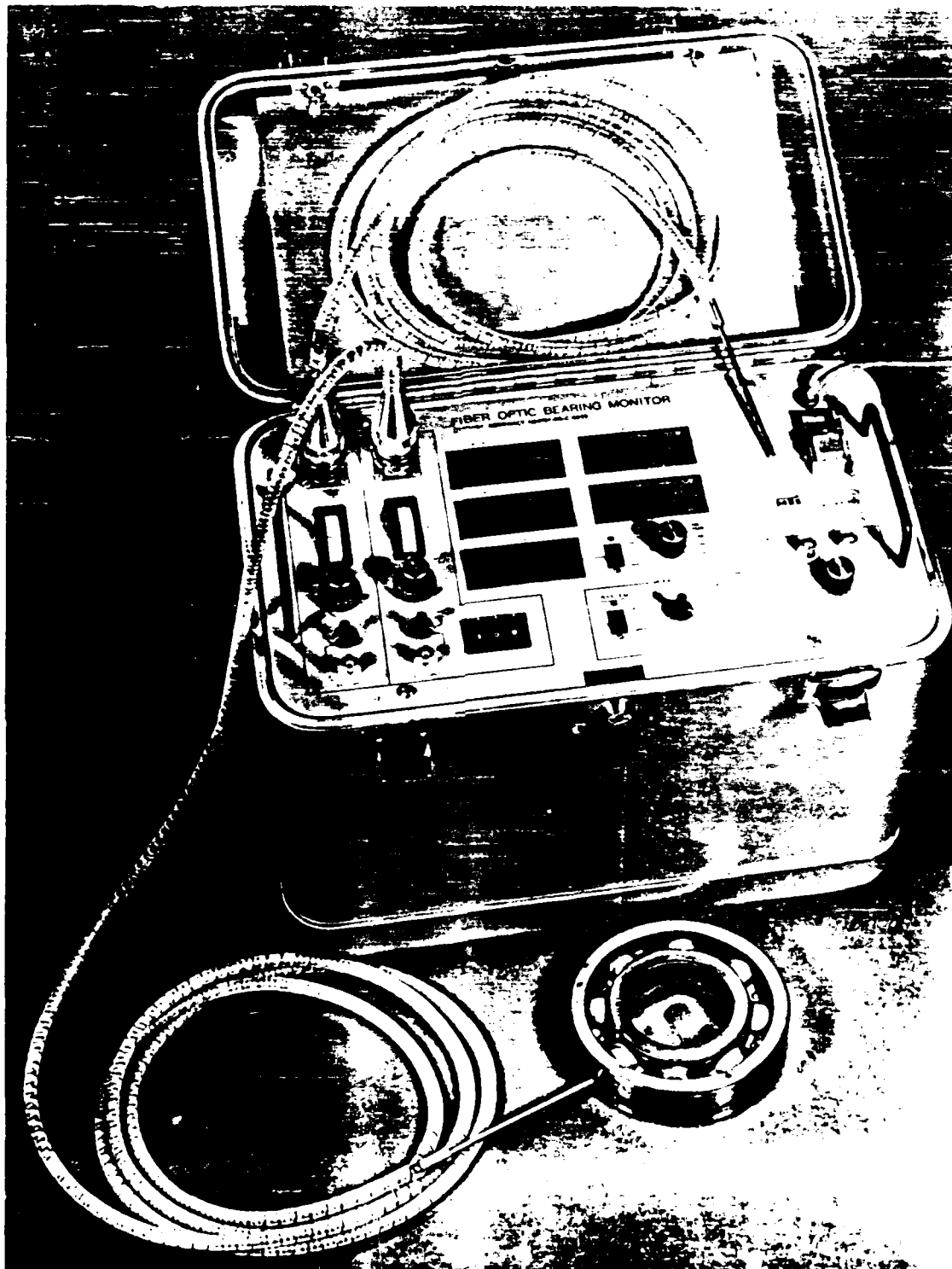

MACHINE MOUNTED BEARING MONITOR

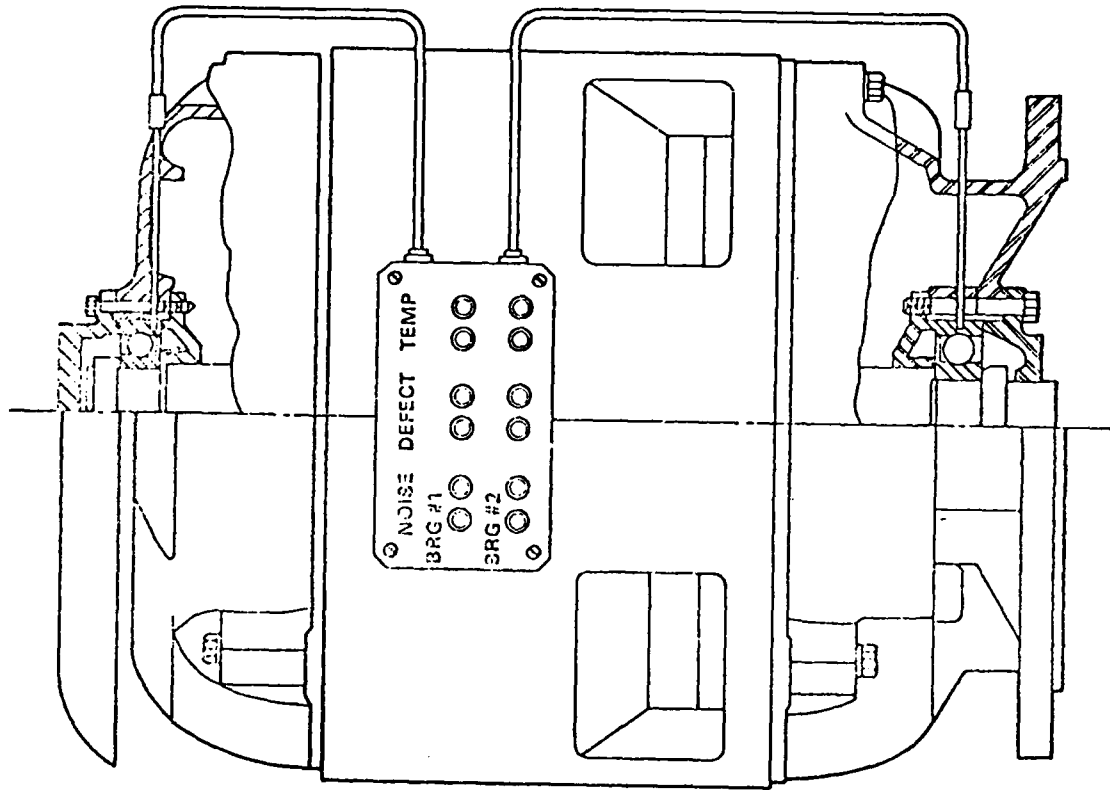

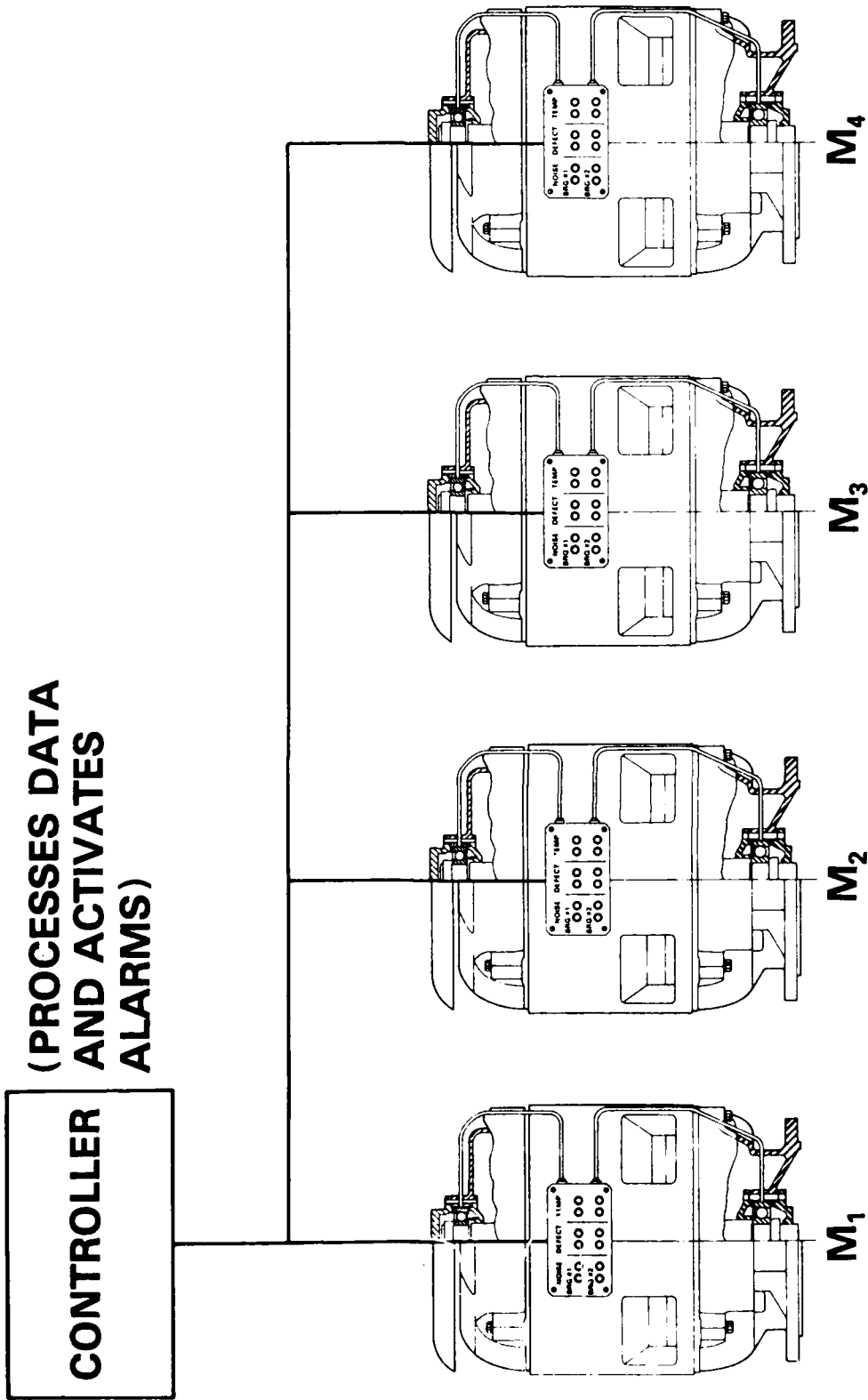

FIBER OPTIC BEARING MONITORING

CURRENT USAGE

- NAVAL SHIPBOARD AUXILIARY MACHINERY
- BALL BEARINGS - 3600 RPM

RECOMMENDED APPLICATIONS

- ALL ROTATING MACHINERY - AUXILIARIES,
TURBINES, ETC
- ALL BALL AND ROLLER BEARINGS

AD-A137 524

MECHANICAL SYSTEMS CONDITIONING MONITORING TECHNOLOGY
WORKING GROUP REPOR. (U) INSTITUTE FOR DEFENSE ANALYSES
ALEXANDRIA VA SCIENCE AND TECH. P HOWARD AUG 83

2/6

UNCLASSIFIED

IDA-D-36 IDA/HQ-83-25899 MDA903-79-C-0018 F/G 15/3

NL

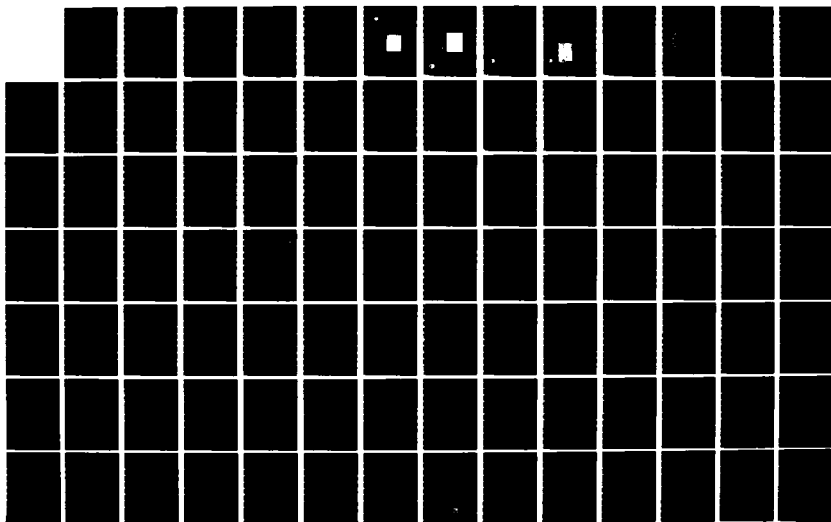

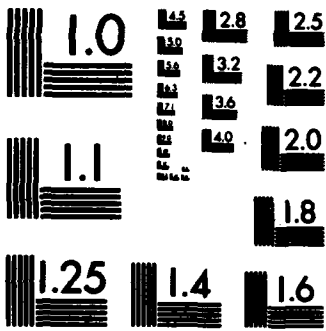

MICROCOPY RESOLUTION TEST CHART
 NATIONAL BUREAU OF STANDARDS-1963-A

BENEFITS OF THE FIBER OPTIC BEARING MONITORING SYSTEM

- PROVIDES POSITIVE IDENTIFICATION OF GOOD/BAD BEARINGS
- ENSURES A HIGH DEGREE OF SAFETY
- AVOIDS UNNECESSARY BEARING CHANGES
- AVOIDS THE INTRODUCTION OF DEFECTS CAUSED BY TIME-BASED OVERHAULS
- PREVENTS CATASTROPHIC DAMAGE
- INCREASES BEARING SERVICE LIFE
- IMPROVES MACHINERY RELIABILITY, REPAIRABILITY AND AVAILABILITY
- REDUCES MAINTENANCE COSTS
- REDUCES DOWNTIME COSTS

BEARING MONITOR DEVELOPMENT

EVENTS	FY 84				FY 85				FY 86				FY 87			
	1ST QTR	2ND QTR	3RD QTR	4TH QTR	1ST QTR	2ND QTR	3RD QTR	4TH QTR	1	2	3	4	1	2	3	4
CONTRACTING	A	A	A	A	A											
COST EFFECTIVENESS STUDY	D → FAB → C → L															
BEARING MONITORING																
SENSOR (PROTOTYPE)																
SENSOR (PPM)																
SMART MONITOR (PPM)																
ALARM (PPM)																
TECHEVAL																
OPEVAL																
APPROVAL FOR FULL PRODUCTION																
RESOURCE SUMMARY																
TEST ARTICLES																
MEET RDT & E SUPPORT																
INSTALL/REMOVE REQUIREMENT																
PERSONNEL																
PERSONNEL TRAINING																
FUNDING ANALYSIS																
REQ'D \$K																
6.2/6.3																
IN/OUT HOUSE																

A - AWARD
 C - CONTRACT DELIVERY
 FAB - FABRICATE
 L - LAB TEST
 I - INSTALL SYSTEM
 PPM - PILOT PRODUCTION MODEL
 T - TRAIN SHIP'S FORCE

**ULTRASONIC WEAR PARTICLE SENSOR
DESCRIPTION**

The David Taylor Naval Ship R&D Center is developing the Ultrasonic Wear Particle Sensor (UWPS) as an on-line and portable oil debris monitor for shipboard machinery systems. The UWPS is an active ultrasonic sensor which irradiates oil lines and counts echoes from entrained wear particles larger than seven micrometers in diameter. Future capabilities in order of descending development difficulty are size ranging, clamp-on transducers, and composition and shape information.

Wear particle monitoring by the UWPS will be used to determine internal wear rates of shipboard machinery. Measurement capabilities will be similar to chip detectors, ferrographs, and emission spectrometers. Applications will include engines, transmissions, gear boxes, hydraulic systems, and other lubricating systems.

Ultimate benefits will provide early detection of impending catastrophic failure, reduction of secondary failures, reduction of troubleshooting time, reduction of wear rates, and extension of overhaul times.

The UWPS is presently in 6.2 development. Increasing the funding would decrease the time required to develop an instrument applicable to shipboard and Tri-Service use. Transition to 6.3 development is currently planned for FY 85 but could occur by the end of FY 83 with a wetted transducer model. Level of investment needed for the Navy program is \$4M over five years for exploratory development, advanced development, validation and verification.

Enclosure (3)



SHIPBOARD MACHINERY MONITORING

ULTRASONIC WEAR PARTICLE SENSOR OBJECTIVE

DESIGN AND CONSTRUCT AN ON-LINE AND PORTABLE WEAR PARTICLE SENSOR FOR SHIPBOARD HYDRAULIC AND LUBRICATING SYSTEMS, USING ULTRASONICS TO DETECT PARTICLE:

- NUMBERS
- SIZE
- COMPOSITION
- SHAPE



SHIPBOARD MACHINERY MONITORING

ULTRASONIC WEAR PARTICLE SENSOR **CUTTING WEAR PARTICLES**



Fig. 1.2.6 S.E.M. 225X |—100 μ m—|

**REF: BOWEN AND WESTCOTT, "WEAR PARTICLE ATLAS,"
FOXBORO FOR NAEC, JULY 1976**



SHIPBOARD MACHINERY MONITORING

ULTRASONIC WEAR PARTICLE SENSOR SLIDING WEAR PARTICLES

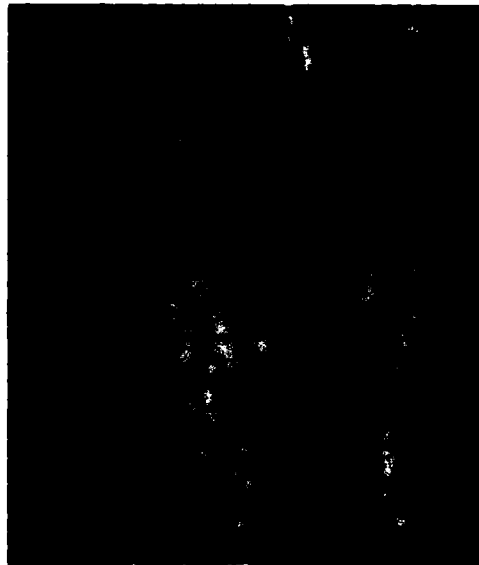

Fig. 1.5.2 Opt. M. 450X |——50µm——|

REF: BOWEN AND WESTCOTT, "WEAR PARTICLE ATLAS,"
FOXBORO FOR NAEC, JULY 1976



ELECTRICAL MACHINERY AND POWER DISTRIBUTION

SF 43-431

PE 62543N

ULTRASONIC WEAR PARTICLE DETECTOR

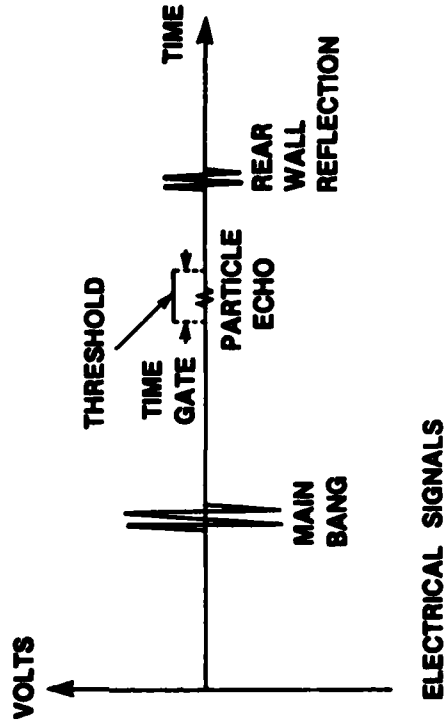
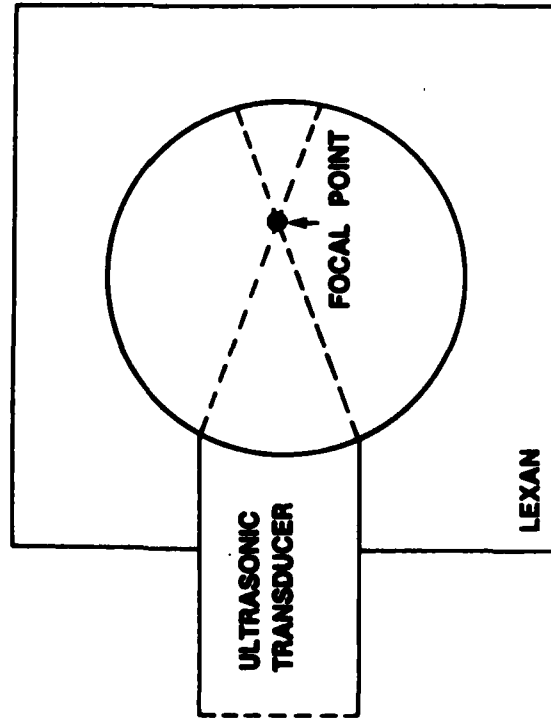



ELECTRICAL MACHINERY AND POWER DISTRIBUTION

SF 43-431

PE 62543N

ULTRASONIC WEAR PARTICLE DETECTOR

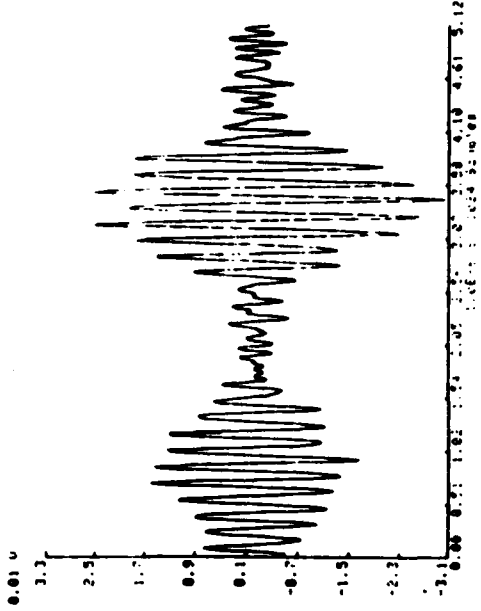
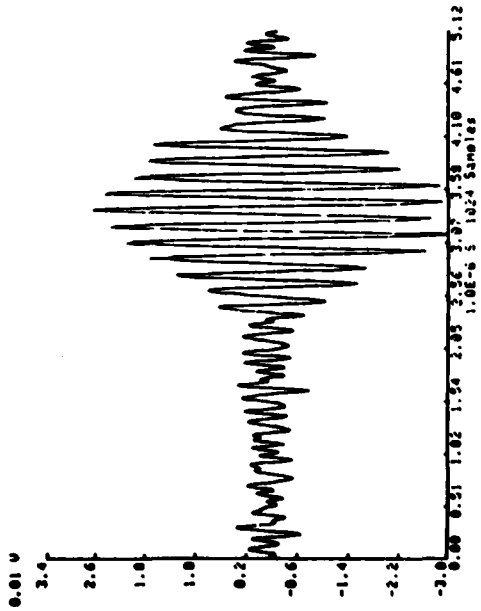
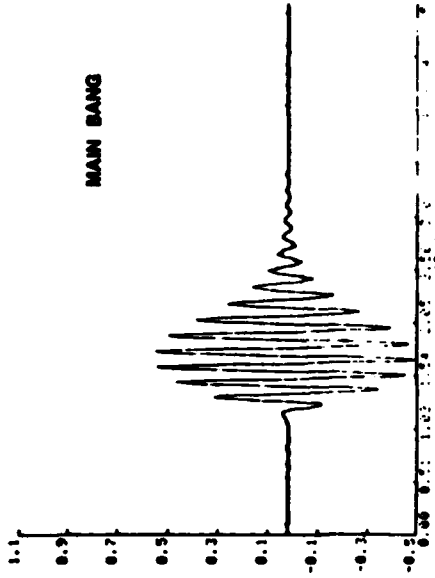
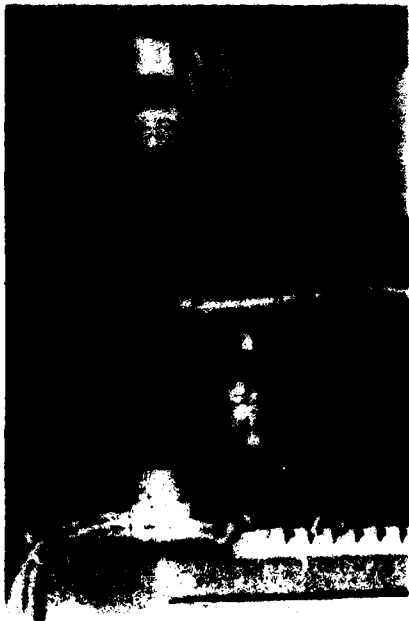

ULTRASONIC PARTICLE COUNT CUMULATIVE DISTRIBUTION
 CONCENTRATION 1000 GL EDS PER 100 ML OIL

DT JRDG
 CODE 2732

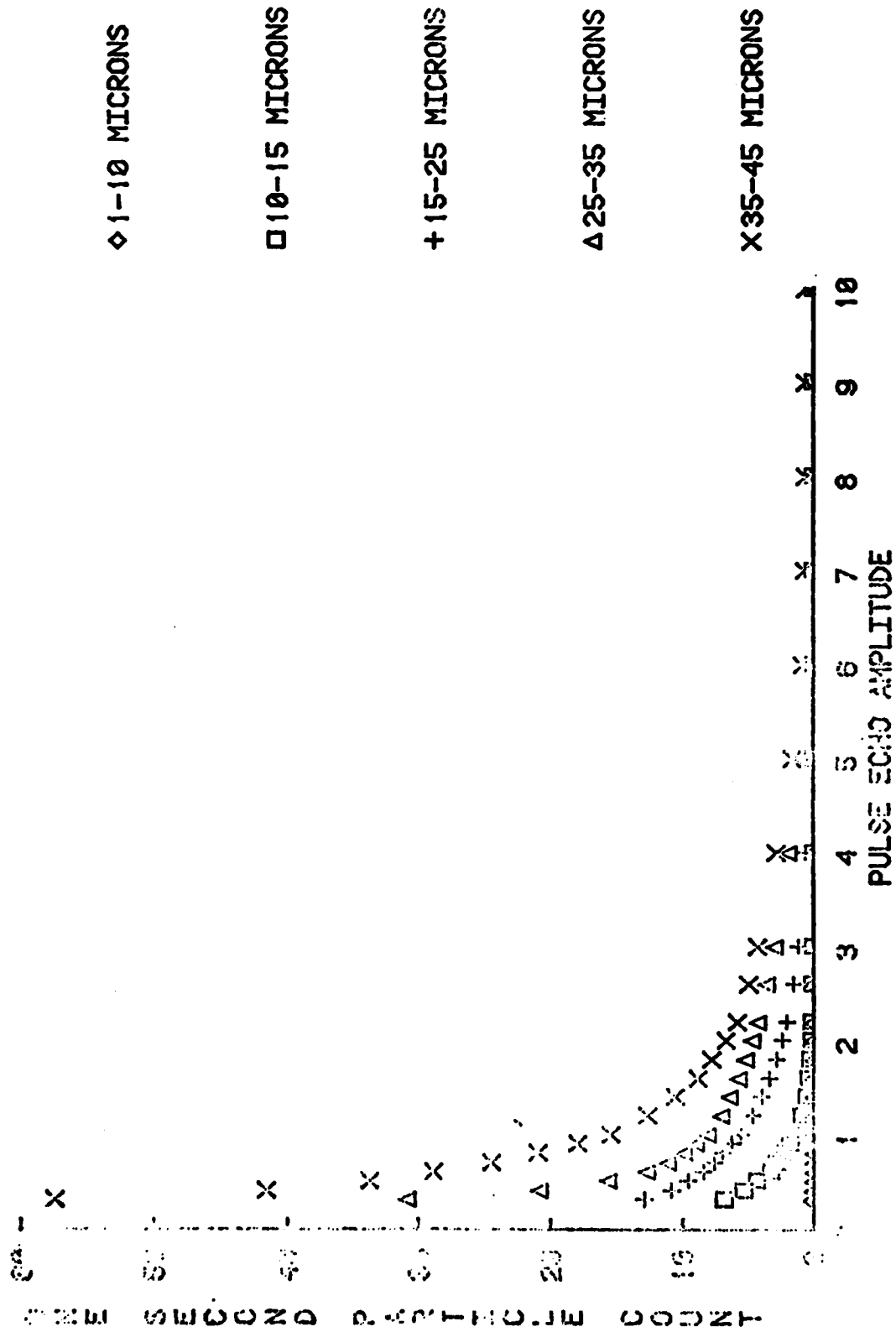



SHIPBOARD MACHINERY MONITORING

ULTRASONIC WEAR PARTICLE SENSOR

BENEFITS

APPLICATIONS

- ENGINES
- TRANSMISSIONS
- GEAR BOXES
- HYDRAULIC SYSTEMS
- LUBRICATING SYSTEMS

PAYOFF:

- REDUCE TROUBLESHOOTING TIME
- DETECT IMPENDING CATASTROPHIC FAILURE
- EXTEND OVERHAUL PERIODS
- REDUCE SECONDARY FAILURE DAMAGE
- REDUCE WEAR RATE (VIA ADJUSTMENTS AND OIL CHANGES)

MSCM - 3

I. RELATED PROGRAMS:

- A. BOILER IMPROVEMENT PROGRAM** -
examines the state-of-the-art for flaw location and sizing.
Developing new instrument for fleet use.
- B. PIPING SYSTEM CONDITION MONITORING PROGRAM** -
examines the state-of-the-art for predicting remaining useful
life for lagged and unlaged piping systems using "clamp-on" technology.
- C. PUMP CONDITION MONITORING PROGRAM** -
examines the state-of-the-art for pump performance measurement
and expected useful life prediction using "Clamp-on" technology.
- D. ACOUSTIC IMAGING PROGRAM** -
examines the state-of-the-art for "clamp-on" examination of machinery
and piping systems, especially complex geometries.
- E. DEEP OCEAN COMPONENTS PROGRAM** -
continuous on-line monitoring/control and data collection
at remote sites. (time, temperature, flow, current, voltage, heat transfer)
- F. TANK LEVEL INDICATOR PROGRAM** -
Continuous tank level measurement using time domain reflectometry;
No moving parts; Measures multi-fluid tanks simultaneously with a
single probe (e.g. compensated fuel oil/seawater tanks)

EXECUTIVE SUMMARY
FOR
INTEGRATED SHIPBOARD MACHINERY
MONITORING SYSTEM PRESENTATION

I. Statement of Problem.

As shipboard propulsion and auxiliary machinery become more diverse and complex, their operation, maintenance, and performance monitoring have become more difficult and costly. These activities, which are relatively labor intense, demand personnel with high skill levels. However, the availability and retainability of people with requisite skills have decreased. In the face of the growing sophistication of hostile weapons systems and the need to counter this technological threat, the trend to increasing ship system complexity and support costs will continue unabated. Further, the manpower availability and retention outlook is unlikely to improve. Development of a standardized, integrated shipboard machinery monitoring system to provide machinery plant status, level of performance, failure detection and prediction, and determination of maintenance requirements has potential for alleviating this situation, thereby enhancing fleet readiness.

The current shipboard maintenance procedure is based upon a planned maintenance system which details the various work tasks to be performed, their frequency, the number of hours allocated to each task, and the spare parts required. Also, each corrective maintenance action is reported through the Maintenance, Material and Management (3-M) System to keep a complete maintenance history of the ships.

This method of ship maintenance relies upon time-based, open-and-inspect procedures which do not account for variations in wear of identical equipments. Each open-and-inspect procedure increases the chance of future failure of the equipment due to improper reassembling procedure. The 3-M reporting procedure, a basis for maintenance scheduling, has been found to be of little value in keeping Navy ships in a high state of readiness and in minimizing maintenance costs! Several analyses of actual Navy maintenance data have emphasized the need to improve Navy ships maintenance methods; and consequently, reduce the frequency of failure and the amount of maintenance required.

II. Program Objective and System Development Goals.

A. Primary Objective. The objective of this program is to develop an automated prototype system for monitoring the performance of shipboard machinery and predicting impending machinery failures with enough leadtime to improve maintenance planning and allocation at all levels (shipboard, tender or ashore). For the purpose of this system development program, shipboard machinery is comprised of propulsion systems and auxiliary machinery equipment.

B. Benefits and Expected Payoffs. A significant goal of the integrated shipboard monitoring system would be the reorientation of machinery maintenance from reliance on reactive or scheduled modes to a mode based on reliable prediction. It would:

1. Enhance ship readiness with more timely detection of machinery performance degradation.
 - o Increase equipment availability/readiness by 20% or more.
2. Provide the technology to implement an improved maintenance mode, Reliability Centered Maintenance, performed only on-condition.
 - o Reduce maintenance actions by 35% or more.
3. Extend testing, fault isolation and analytical methods beyond practical limits of manual methods (especially with low skill-level personnel).
 - o Reduce good parts removal by 30% or more.
4. Improve continuity of operations and reduce machinery downtime.
 - o Extend life of purchased equipment by 10% or more.
5. Reduce time and manpower necessary to test and maintain complex machinery.
 - o Reduce manhours expended for inspection and repair by 20% or more
6. Reduce logistic support costs through early detection and identification of faults at lower levels of repair.
 - o Reduce spares provisioning by 20% or more.

Increased machinery system availability/survivability can be attained for integrated shipboard propulsion and auxiliary machinery through the judicious application of advanced control, monitoring, processing and distribution technologies: (1) distributed architecture and micro-processor based control systems, (2) automatic fault prediction, isolation and prognosis techniques, (3) shipboard data multiplex systems and (4) the use of standard electronic modules (SEMs) and general purpose controllers (GPC).

III. Program Plan.

The integrated shipboard machinery monitoring system development program is divided into two phases (Phase I: Testing Technology Development and Phase II: System Development Evaluation).

1. Phase I will analyze machinery failure modes and develop the analytical methods to determine machinery sensing requirements for five candidate machinery systems: a controllable reversible pitch propeller hydraulic system; a medium speed diesel engine; an air compressor system; an air conditioning plant; and a distillation plant. The failure analysis will be performed on data obtained from maintenance records and performance specifications for each selected machinery system. Various forms of analysis, including mathematical modeling and simulation, will be used to determine appropriate monitoring techniques for failure detection

and prediction. In addition to analysis of individual machinery items, a system failure mode analysis will be used to ascertain failures which could be detected or predicted more efficiently through systemic monitoring. From the failure analysis, sensing parameters for individual machinery items will be determined. These parameters will be used to select sensors and sensing techniques already available, or as the basis for developing innovative sensing capability. Since the ultimate use of sensed data will affect sensor selection and placement, determination of sensing parameters will consider the full range of utility expected from the data (e.g., command information, machinery plant control, machinery condition status).

2. Phase II is the system development and evaluation phase. A system architecture will be established and hardware/software requirements will be specified. On this basis, equipment and software will be procured or developed. This phase will also include checkout of sub-element sensing techniques using actual machinery and sensing hardware. A model system will be assembled and used for demonstration, technical evaluation, and concept validation on a land based test facility (LBTF). Additionally, a prototype system will be procured and subjected to shipboard evaluation while operated by Navy personnel. The LBTF and shipboard evaluations of the model monitoring system will lead to the design of a total ship machinery monitoring system.

LEAR SIEGLER, INC.

IV-47



AVIONIC SYSTEMS CORP.
A SUBSIDIARY OF LEAR SIEGLER, INC.

2 March 1983

Institute for Defense Analyses
Science and Technology Division
1801 N. Beauregard Street
Alexandria, Virginia 22311

Attention: Mr. Paul L. Howard
Chairman, MSCM

Subject: Task Order MDA903-79-C-0018:T-2-126
R & M Study

Reference: LSI/ASC Presentation at IDA to the MSCM
Working Group 15 February 1983

Gentlemen:

This letter proposal is in response to a verbal suggestion made by members of the MSCM Working Group at the close of the referenced presentation made by representatives of LSI Avionic Systems Corporation (LSI/ASC), a Subsidiary of Lear Siegler, Inc.

BACKGROUND

Over the last decade, several engine monitoring systems have been built and tested. Two of these for USAF are the F-15/F100 Engine Diagnostic System and the A-10/TF34 Turbine Engine Monitoring System.

The F100 EDS was flight tested at Langley Air Force Base for a period of about one year. The five instrumented aircraft have since been de-modified.

A similar program was conducted at Myrtle Beach AFB on the A-10/TF34 TEMS. Currently, an expanded Squadron Level Test is in progress at Barksdale AFB with additional plans for a fleet-wide retrofit.

It is our understanding that similar expanded programs are not planned for the F100 engine although there are over 2500 engines in inventory used on both the F-15 and F-16 first line USAF fighter aircraft. In addition both of these aircraft are in service by a number of United States allies.

IV-49

2 March 1983

Page 2

THE PROBLEM

The F100 Engine installed in the F-15 and F-16 is a complex, high performance, high technology engine which is necessary to support the Air Force Mission. It has been stated in the Press and debated in the Congress that the initial costs for the F100 engine plus overhaul and maintenance are very high. The limited flight test program at Langley AFB demonstrated that the F100 EDS could:

1. Save engines
2. Facilitate anticipatory maintenance
3. Prevent misdirected maintenance
4. Eliminate human error in time and cycle data collection
5. Through its flexibility, take on changes and new requirements
6. Support CIP
7. Save Man-hours and other costs
8. Improve operational readiness
9. Provide other Logistics Savings

RECOMMENDATIONS

The F100 EDS should be incorporated in the F-15 (or the F-16) on a squadron level (or wing level) to fully demonstrate and quantify its R & M capabilities.

Based on these results, the total system should be optimized for all users prior to fleet-wide introduction.

PROPOSED PROGRAM

PHASE I: Study program to optimize the system for use by maintenance personnel. This will include elimination of unnecessary parameters, addition of new parameters and modification of the software aimed at fault isolation. This should take maximum advantage of past and current efforts and particularly those that have been accomplished by Pratt & Whitney under their on-going Component Improvement Program. Three months.

2 March 1983

Page 3

PROPOSED PROGRAM (cont'd)

- PHASE II: Equipment fabrication, software changes and ground test. This includes twenty-three ship-sets airborne equipment and three each Diagnostic Display Units and Data Collection Units along with necessary support and test equipment. Eighteen months.
- PHASE III: Aircraft installation and check-out. Three months.
- PHASE IV: Software verification and modification under operational conditions including check-out of Air Force maintenance personnel on system operation. Six months.
- PHASE V: Flight test program conducted primarily by Air Force personnel with contractor support. Twelve months.
- PHASE VI: Evaluation of results and recommendations for future action. Three months.

If done sequentially these six Phases encompass 45 months. However, with some logical overlap, Phases I thru IV could be reduced from 30 to 24 months and in less than 36 months the preliminary results would allow future action planning.

COST

It is estimated that the cost for this six phase program would be approximately \$25 million dollars with about \$20 million devoted to the first three phases. Assuming the program is conducted on an F-15 squadron, about 35-40% of the total cost is estimated to be Program Management, aircraft modifications, engine kits and general support by McDonnell Aircraft Company and Pratt & Whitney.

BENEFITS

Extensive life cycle cost studies have been conducted on the F100 EDS and should be available if desired through ASD/YZ. Their results have been positive and it is not our intent to repeat them.

LSI/ASC believes that the real results will not be known unless determined in actual practice and that is the basis for this proposal.

LSI AVIONIC SYSTEMS CORP.

2 March 1983

Page 4

BENEFITS (cont'd)

The proposed cost for the squadron level test can be equated to about 10 spare engines and is less than one half of one percent of the value of the 2500 plus engines in inventory. Seemingly a modest cost to prove unequivocally that engine diagnostics/engine monitoring can be a cost effective R & M tool. Saving one F-15 that might be lost due to in-flight engine problems would represent a 100% return on investment.

Perhaps one of the biggest arguments rests within the Air Force itself where this type of system will probably be included on all future aircraft/engines. It seems reasonable that our current weapons systems deserve the same consideration.

LSI Avionic Systems Corporation sincerely appreciates the invitation and opportunity to present background on the EDS at the referenced meeting and to submit the above information relative to further evaluation of the Program.

Very truly yours,

LSI AVIONIC SYSTEMS CORPORATION



Walter M. Sherwood
Director - Marketing

WMS:AMC

A LIFE CYCLE COST ANALYSIS OF THE PROPOSED ENGINE

DIAGNOSTIC SYSTEM FOR THE F100 ENGINE

BY

**LT SHARON BINNINGS
F-15 SYSTEM PROGRAM OFFICE**

**CAPT KENNETH ECHOLS
F-16 SYSTEM PROGRAM OFFICE**

19 MAY 1977

IV-53

SUMMARY

This study represents a six week joint F-15 and F-16 System Program Office effort to quantify the anticipated Life Cycle Cost (LCC) savings associated with the incorporation of the Engine Diagnostic System (EDS) on the F100 engine. Numerous inputs, including previous studies and current operational data were analyzed and will be described in the body of the report.

The EDS LCC is composed of several major areas. Savings were calculated in Unscheduled Engine Removal Cost, Fuel Usage Cost, Spare Engine Cost, and Secondary Damage. A cost increase was calculated in System Support Cost. All costs were calculated in constant 77 dollars for the baseline without EDS and compared to the costs with EDS. The total LCC with the EDS breaks out as follows:

Unscheduled Engine Removal Cost	(\$450,058,128)
Fuel Usage Cost	(\$264,435,647)
Spare Engine Cost	(\$ 18,780,000)
System Support Cost	\$ 5,354,995
Secondary Damage	(\$ 84,800,000)
Total LCC Savings	(\$812,718,780)
Total EDS Program Cost	\$276,500,000
Net EDS LCC Savings	(\$536,218,780)

INTRODUCTION

The attached report documents a Life Cycle Cost (LCC) analysis of the Engine Diagnostic System (EDS) proposed for the F100 engine for use on both the F-15 and F-16 aircrafts. The analysis is a joint effort conducted by the F-15 and F-16 System Program Offices (SPOs) and represents a six week effort. Both AFLC and TAC representatives have been briefed and concur with the factors used in the analysis.

BACKGROUND

An LCC analysis on the EDS was submitted by AFLC/AFSC in November 1976. AF/ACMC in performing an analysis of that study questioned several of the basic assumptions it had made. AFLC refuted ACMC's comments, with the end result being an Air Staff tasking msg (242225Z Feb 77) to AFLC/CV, AFSC/CV, and TAC/CV. Referenced message tasks AFSC to take the lead in performing a new EDS study, addressing the differences among the analyses and reconciling fuel consumption rates and depot maintenance costs per flying hour with the AFSC January 77 submittal of Operation and Support (O&S) cost goals for the F-15 and F-16.

TOTAL EDS PROGRAM COSTS

The total EDS program costs are as estimated by the program manager.

These costs in FY77 dollars in millions are as follows:

F-15 Flight Demonstration	9.7
Redesign	2.6
Qualification Testing	2.5
F-16 Flight Evaluation	1.0
F-15 Production/Retrofit	131.1
F-16 Production/Retrofit	<u>129.6</u>
Total Program Cost	276.5

For the LCC analysis, these program costs were broken down into costs per year in both constant 77 dollars and Then Year dollars. These yearly totals were then added to the EDS alternative yearly costs to be compared with the baseline without EDS.

TOTAL EDS LCC SAVINGS

The total EDS LCC savings was calculated by subtracting the cost of the alternative with EDS from the baseline cost without EDS for each of the major areas addressed. The net LCC savings is the total savings minus the total EDS program cost.

Unscheduled engine removal cost reflected a savings of \$450,058,128 with the EDS; \$264,435,647 was saved in fuel usage. The F-16 spare engine procurement was reduced by ten engines, saving \$18,780,000. \$3,260,000 was saved in support equipment acquisition for the F-16, but the Operational Support Cost of the EDS itself, as compared to the EHR, was an increase of \$8,614,995. The result being a net increase of \$5,354,995 for system support. Secondary damage savings of \$84,800,000 were estimated by AFLC.

Total EDS LCC savings, totaling all the areas discussed above, are \$812,718,780. Subtracting EDS Program Costs of \$276,500,000, the net LCC savings for the EDS is \$536,218,780.

PREVIOUS EDS ANALYSES

In November 1976, AFLC/AFSC submitted an LCC study of the EDS to Air Staff. The two major areas of savings in the study were depot repair and fuel usage. Total fuel usage, both air and ground, was estimated to be reduced by the EDS by 10%. For the depot savings, an estimated 30% of projected F-15 depot support would be reduced because of increased fault isolation, improved forecasting capability, and reduced premature removals. This depot savings was ratioed for the F-16 application. The total LCC savings for the EDS was stated at \$923.9M in FY77 dollars.

AF/ACMC questioned several of the assumptions used in that study and performed its own analysis in January 1977. APMC estimated a reduction of ground fuel usage of 25% with the EDS. They also used the same 30% reduction in depot costs, but used much lower projected depot support costs. Their total LCC savings for the EDS was stated at \$193M in FY77 dollars.

This study addresses specific ground run fuel reductions and specific changes in the unscheduled engine removal scenario, relating to both base and depot support. Its projected total LCC savings is \$812M in FY77 dollars.

OPERATION AND SUPPORT COST GOALS

The AFSC January 1977 O&S cost goals are Pentagon inputs based on AFR 173-10 methodology and corrected and coordinated by the using activities. These goals address total weapon system support costs for the mature weapon system. Costs used in this study do not specifically relate to the factors used for the O&S cost goals and are not intended to alter these factors in any way.

The depot cost factors used for the F-15 and F-16 total systems for O&S cost goals are \$392/FH and \$199/FH, respectively. The depot costs used in this study relate only to the portions of engine depot maintenance which the EDS will affect. These costs do not depict total depot costs for the F100. The depot costs addressed in the study equate to \$86/FH.

This study only addresses partial fuel usage for the F-15 and F-16, again not relating directly to the O&S cost goal factors. Fuel savings in the study are based on three specific types of ground runs which the EDS can affect. This fuel usage equates to \$160/FH. The O&S cost goal factors for total fuel usage for the F-15 and F-16 are \$531/FH and \$325/FH respectively.

ECONOMIC PRESENTATION

The LCC study was accomplished using constant 77 dollars. Total LCC for the baseline, without EDS, was calculated by year based on the projected yearly flying hours and procurement schedules for the F-15 and F-16. The total LCC for the alternative being considered, with the EDS, was also calculated by year, based on the same flying hours and procurement schedules, altered for the projected procurement and retrofit of the EDS system. The entire study covers the development, acquisition, and operation of the EDS from 1978 through 1996.

Each yearly cost for both the baseline and the EDS alternative was multiplied by escalation rates taken from the F-15 SPO June 1976 Escalation Study, equating to approximately 4 1/2% a year. The result being that the yearly totals were then expressed in Then Year dollars.

Each escalated cost by year was then multiplied times its appropriate discounting rate (equating to 10% a year) as outlined on page 12 of AFR 178-1, Attachment 2, dated 28 December 1973. The discounted total LCC for the EDS alternative was then subtracted from the discounted baseline LCC. The resultant net savings is \$327,257,555.

MECHANICAL TECHNOLOGY, INC.

IV-63

1/31/83

M-1 TANK MECHANICAL SYSTEM CONDITION
MONITORING AND DIAGNOSTIC SYSTEM

M S C M - 1

Technology

Embedded intelligence; machinery monitoring system utilizing state-of-the-art vibration signature analysis.

Description

A compact system capable of detecting and diagnosing mechanical problems based on vibration, speed and load parameters. The signals would provide real-time operation as well as equipment maintenance directives for key power train components. The system has continuous multi-channel vibration monitoring for warning and alarm indication. The system will retain data for mechanical system mission analyses and maintenance action.

Benefits

- o increased weapons system mission reliability
- o continuous drive train condition monitoring
- o provide failure evaluation data
- o eliminate unjustified equipment rework
- o accurately monitor field degradation and damage
- o provide realistic maintenance procedures
- o increased combat readiness by reducing the logistics tail

Background and Related Technology

- o Inflight Engine Monitoring System (IECMS) evaluates the condition of TF41 turbine engines aboard A7 aircraft.
- o Turbine Engine Monitoring System (TEMS) is being implemented by the U. S. Air Force to determine the condition of TF34 engines on A10 aircraft and will help dictate maintenance procedures.
- o U. S. Air Force program for Automated Vibration Diagnostic (AVID) Systems for detecting engine mechanical problems. Mechanical Technology Inc. is the prime contractor.

Investment

- o Prototype system development cost \$900,000
- o Production unit cost approximately - \$12-15,000 per unit.
- o Levelized payback less than one year.
- o Estimate that \$275 million would be saved over the first five year period.
- o An ROI of 600% based on operating and maintenance savings over five years.

NORTHROP ELECTRONICS DIVISION

IV-67

DIAGNOSTIC TECHNOLOGY PROPOSALS

1. F-14/TF30 TURBINE ENGINE MONITORING SYSTEM (TEMS) TECHNOLOGY APPLICATION/DEMONSTRATION PROGRAM
2. F-16/F100 TURBINE ENGINE MONITORING SYSTEM (TEMS) TECHNOLOGY APPLICATION/DEMONSTRATION PROGRAM
3. T-38 STRUCTURAL TRACKING TECHNOLOGY APPLICATION/DEMONSTRATION PROGRAM
4. DIAGNOSTIC TECHNOLOGY GENERAL ADVANCEMENTS (A-10 TEST VEHICLE)

INTRODUCTION

The Northrop Corporation, Electronics Division (NED) is submitting four proposals for Diagnostics Technology Application/Demonstration Programs as a responsive follow-up of recommendations made to and requested by the Institute for Defense Analyses (IDA) in a briefing to the Mechanical System Condition Monitoring Study Group on 15 February 1983.

The briefing afforded an opportunity to present an overview and insight into Northrop intensive involvement in developing and implementing diagnostic technology in major weapon systems over the past decade with specific emphasis directed to Engine and Structural Monitoring Systems.

Presented herein are briefs of the proposed programs which address the stated objectives of the I.D.A. and in turn the goals expressed for the O.S.D. inspired Study for "quantum improvements in reliability and maintainability (R&M) through innovative use of advancing technology".

The Northrop proposals are structured to permit DoD/IDA selection(s) for implementation action on discrete programs and respective elements thereof with clearly defined goals, task definitions and methodology, scope of effort, and recommended contractual interfaces.

To provide realism to the results and expectations, the proposals specifically identify the major Weapon System on which the technology can be demonstrated in near term with the accompanying rationale for the selection timeliness.

While specific in Navy and Air Force Weapon Systems identified (F-14, F-16, T-38) as the demonstration test vehicles, there is definite cross pollination of the technology among numerous related current weapon systems and the element of influence on emerging or future programs, e.g., the Advanced Tactical Fighter (ATF), an objective of the DSD/IDA Study

The importance of applied System Engineering disciplines and resources at this juncture, to measure and assess the effectiveness of engine and structural monitoring technology cannot be overstated.

It should be noted that considerable Northrop Independent Research and Development (I.R.&D.) and contractually funded efforts have been performed over an extended period of time to reach the current status.

The timeliness of the I.D.A. interest and the candidate program selections phased activity offer unusual opportunities for both technical and cost effectiveness. Hence, only a fraction of the costs normally required to meet the proposed program's objectives are needed. The O.S.D./I.D.A. Study recommendations and initiative implementation of advancing technology programs will enable formulation of system support policy and direction to the Services and to demonstrate advocacy.

**SUMMARY - PROPOSED DIAGNOSIS TECHNOLOGY ADVANCEMENT PROGRAMS
HIGH PAYOFF YIELD CANDIDATES**

PROPOSAL NO.	TITLE	CONTRACTING AGENCY	CONTRACTORS	EST. DURATION	EST. RESOURCES	REMARKS
1.	F-14/TF30 TEMS APPLICATION/DEMO. PROGRAM	NADC	GRUMMAN, NORTHROP ELECTRONICS	16 MONTHS	TBD	PIGGYBACK W/ PENDING F-14 PMS PROGRAM
2.	F-16/F100 TEMS APPLICATION/DEMO.	AFSC/ ASD SPO	G.D./F.W., NORTHROP & AEDC	20 MONTHS	TBD	CURRENT STATE-OF-ART TECHNOLOGY FOR F100 DIAGNOSTIC FUNCTIONS
3.	STRUCTURAL TRACKING TECHNOLOGY (T-38 TEST CANDIDATE)	SA-ALC	NORTHROP CORPORATION (NED/NAD)	18 MONTHS	TBD	HOLLOMAN AFB-TAC LEAD-IN FIGHTER PROGRAM
4.	DIAGNOSTIC TECHNOLOGY GENERAL ADVANCEMENTS (A-10 TEST VEHICLE)	SA-ALC ASD/ENF	NORTHROP & G.E.	24 MONTHS	TBD	DEVELOPMENTS APPLICABLE TO R.M.A. DoD GOALS TO BE SUBMITTED ON EXPRESSION OF IDA INTEREST
	<p>NOTE: FROM UPON I.D.A. EXPRESSION OF INTEREST AND RESOLUTION OF PROGRAM SCOPE, AND INTERFACES.</p>					

A-10A LIFE CYCLE COST BENEFIT EXAMPLE
FMC RATE INCREASE ONLY

- CONSERVATIVE 5% INCREASE IN FMC STATUS GENERATES 165,000 ADDITIONAL FLEET F.Hs EQUIVALENT TO TWO (2) 18 A/C A-10 SQUADRONS DURING 15 YR LIFE CYCLE

COST AVOIDANCE FY 1982 \$*

(1) A/C ACQUISITION - 36 A/C @	9.0M EACH	\$324M
(2) SQUADRONS EQUIPMENT ELIMINATION	90.0M/S	180M
(3) A/C LCC MODIFICATIONS	8.5M EACH	17M
(4) PERSONNEL FOR 2 ADDITIONAL SQUADRONS	82.5M EACH	165M
(5) PERSONNEL SUPPORT FOR ABOVE	73.5M EACH	147M
			<hr/>
	LCC AVOIDANCE	\$833M

LCC EXPENDITURES FOR INCREASED UTILIZATION OF A-10 TEMS-EQUIPPED FLEET

(1) OPERATION COST INCREASE (FUEL, BASE LABOR, BASE MAINTENANCE SUPPLIES, SPARES, DEPOT MAINTENANCE)	165,000 F.H x \$1834/F.H	\$303M
(2) TOTAL COST OF TEMS FOR FLEET (ACQUISITION, INSTALLATION, & SUPPORT)		66M

NET LCC SAVINGS \$833M - \$369M = \$464M

*APR 173-13 FEB 1982

47/22-5

CONCLUSIONS

- WORKING EXISTING AIRCRAFT HARDER WITHIN CAPABILITIES HAS HIGH PAYOFF
 - TAC FMC STANDARD FOR A-10 65%
 - ACHIEVED FMC = 52%
- A 13%
- 5% INCREASE IN FMC IS CONSERVATIVE FOR ENGINES ALONE--CAN BE DEMONSTRATED
(-- FACTORS IDENTIFIED AND APPARENT EVEN DURING INITIAL EXPERIENCE)
 - NO CHANGE IN SQUADRON MANNING LEVEL ANTICIPATED (NO REDUCTION)
TEMS PERMITS GREATER EFFICIENCY FROM EXISTING PERSONNEL
AS A/C ARE PUMPED HARDER--GREATER COMBINED UTILIZATION
 - ANALYSIS NEGLECTS SURGE INCREASE CAPABILITY
 - SAVINGS/EXPENDITURE DISTRIBUTION:
AFLC SPENDS MORE FOR OPERATIONS ... AFSC AVOIDS INITIAL COSTS

NORTHROP

OPERATING AND SUPPORT COST FACTORS*
(IN 1982 DOLLARS)

	A-10A	F-16A
FUEL (\$1.31 PER GALLON) (\$/FH)	773	1,005
BASE LABOR (MMH/FH x \$25) (\$/FH)**	380	623
BASE MAINTENANCE SUPPLIES (\$/FH)	158	178
REPLENISHMENT SPARES (\$/FH)	278	551
DEPOT MAINTENANCE (\$/FH)	245	455
SUB TOTAL	1,834	3,212
BASE MAINTENANCE SUPPLIES (\$/PAA/YEAR)	18,100	10,500
DEPOT MAINTENANCE (\$/PAA/YEAR)	30,000	43,000
SUPPORT EQUIP REPLACEMENT (\$/PAA/YEAR)	15,700	39,900

• EXCLUDES PAY AND ALLOWANCES OF PILOTS/BOS/OTHER SQUADRON PERSONNEL, REPLACEMENT TRAINING, AND OTHER MISCELLANEOUS O&S COSTS

* AFR 173-13, FEB. 1982 EXCEPT FOR BASE LABOR

** INCLUDING GENERAL SUPPORT: A-10A = 15.2, F-16A = 24.9 MMH/FH

NORTHROP ELECTRONICS DIVISION
PROPOSAL NO. 1

TITLE: F-14/TF30 TURBINE ENGINE MONITORING SYSTEM (TEMS)
TECHNOLOGY APPLICATION/DEMONSTRATION PROGRAM
(ESCALATION FROM PLANNED DEDICATED F-14
FATIGUE MONITORING SYSTEM ONLY)

OBJECTIVE:

Demonstrate the inherent capability of Northrop qualified state-of-art technology to perform prescribed engine diagnostic functions for dual TF30 engines integral with the same equipment currently pending for the F-14 structural Fatigue Monitoring System (FMS), as a cost effective combination for significant improvement in reliability, maintainability and availability of the weapon system.

TECHNOLOGY:

Grumman Aerospace Corporation (GAC) specifications for advanced technology micro-processor-oriented hardware to acquire and process data related solely to the FMS requirement has been released with USN approval. Involved are two airborne items of equipment and two ground support items, all of which contain the same electronic elements as the Northrop TEMS AN/USQ-85 comprising the total system. Northrop equipment was designed with the dual capability of handling both engine health monitoring and structural fatigue tracking in a single cost effective configuration designated as STEMS. For economic reasons, the Northrop proposal for the F-14 FMS function only does not delete the engine-related additional signal conditioning capacity and flexibility nor alter memory size and computer speed. With hardware relatively unaffected, the principal differences are in software modules for FMS unique data and its fracture mechanics computations/presentations vs. engine gas path thermodynamic technology and its algorithms, or the composite. The equipment installation in the aircraft remains unchanged. To accommodate the added engine diagnostics for the TF30's entails only additional engine-mounted sensors and associated cabling. As indicated, the equipment for airborne display, data recovery, storage, presentation and printout is identical.

SCOPE

Concurrent with the F-14 FMS program, Northrop proposes a DoD directed effort to encompass engine diagnostics, all with the equipment for early demonstration (1st quarter of 1984).

GOAL

Demonstration of the STEMS configuration in F-14 test aircraft with evaluation results in time to permit incorporation of the dual function system at the outset of planned F-14 retrofit.

CONTRACTUAL CONSIDERATION

Grumman Aerospace Corporation, as the F-14 weapon system contractor and prime contractor for the pending FMS addition, should have the contract awarded for the combination STEMS with differential costs provided. The Northrop unique equipment design permits a two-phase contractual effort, without penalty, thus allowing the FMS program to begin prior to the DoD/USN authorization for follow-on.

SCHEDULE

Normal TEMS/STEMS hardware lead time independent of unique software generation/validation is seventeen months. Northrop is consigning preproduction hardware, its own asset equipment, in 8 months ARO, which would be unaffected by the proposed change. Total program span will increase approximately 3-6 months, depending on go-ahead authorization.

FUNDING REQUIREMENT (ROM)

To be coordinated with GAC and Northrop Electronics.

F-14/TF30 TEMS TECHNOLOGY APPLICATION/DEMONSTRATION VEHICLE
PROPOSAL NO. 1 HIGHLIGHTS

- MAJOR WEAPON SYSTEM HIGH PAYOFF APPLICATION
- DEMONSTRATION OF FEASIBILITY AND PRACTICALITY
(COMMON STRUCTURAL AND ENGINE MONITORING SYSTEM)
- ESCALATION FROM SINGLE PURPOSE AIRFRAME FATIGUE MONITORING SYSTEM (FMS)
(PHASE IN ON NON-INTERFERENCE BASIS)
- COORDINATED ADD-ON FUNCTION TO PROGRAMMED F-14 FMS
(INCORPORATION AND PIGGYBACK TEST EVALUATION)
- HARDWARE INSTALLATION IN THE ONLY LIMITED AVAILABLE F-14 SPACE
- HARDWARE CONSIGNED AT NO COST TO PROGRAM UNCHANGED AND MEETS
G.A.C. SPECIFICATIONS

F-14/TF30 TEMS TECHNOLOGY APPLICATION/DEMONSTRATION VEHICLE
PROPOSAL NO. 1 HIGHLIGHTS (CONTINUED)

- TECHNOLOGY OBJECTIVE -- INCREASED WEAPON SYSTEM R.M.A. RATE
- REINFORCES GENERIC HARDWARE CHARACTERISTICS FOR STILL ANOTHER
DoD ENGINE
- RESULTS APPLICABLE TO F/FB111 SERIES AIRCRAFT.
- NEAR-TERM CONFIRMATION OF UNIQUE SOFTWARE FEATURES INCLUDING
ENGINE STRUCTURAL INTEGRITY/DURABILITY PARAMETERS
- PROGRAM DURATION 15 MONTHS, INCLUDING 3 MONTHS FLIGHT TEST
- PROPOSED PRIME CONTRACTOR - GRUMMAN AEROSPACE CORPORATION (NADC)
SUBCONTRACTOR - NORTHROP ELECTRONICS DIVISION

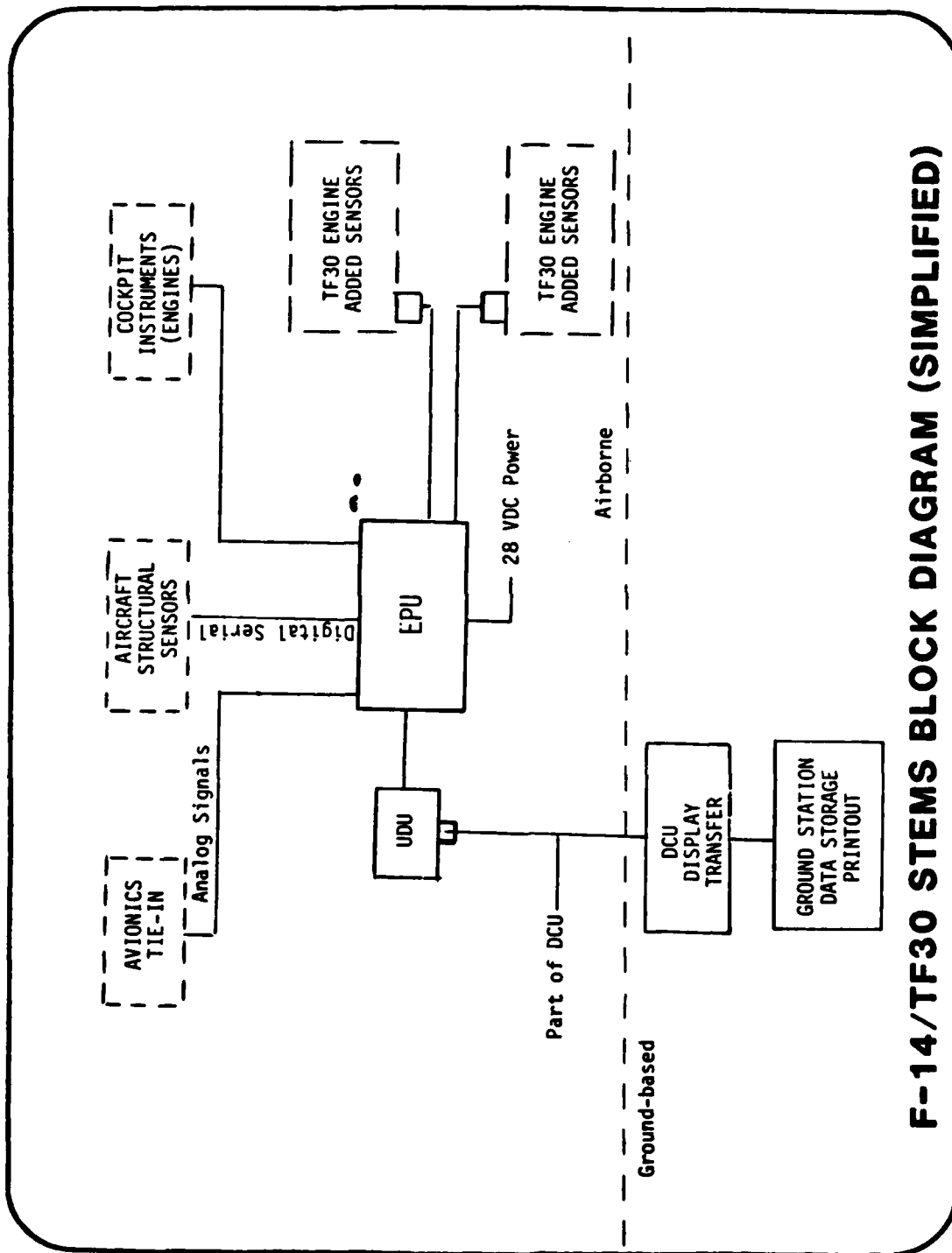

F-14/TF30 STEMS BLOCK DIAGRAM (SIMPLIFIED)

NORTHROP
Electronics Division

V3308

NORTHROP ELECTRONICS DIVISION
PROPOSAL NO. 2

TITLE: F-16/F100 TURBINE ENGINE MONITORING SYSTEM (TEMS)
TECHNOLOGY APPLICATION/DEMONSTRATION PROGRAM

OBJECTIVE:

Demonstrate the feasibility and applicability of state-of-art developed TEMS technology to make a significant improvement in reliability, maintainability and availability (RMA) on the F-16 aircraft.

TECHNOLOGY:

Lightweight, miniature airborne microprocessor-oriented diagnostic equipment is now available in U.S. inventory, designed to provide continuous monitoring and on-board diagnostic analysis of sophisticated military engines (e.g., TF34-CFM56, F404) with capability to handle the F100. Airborne data processing permits real time indication of selected impending problems (events) amenable to pilot response for safety as well as provide post-flight data, including key parameters trending for maintenance decisions. Precise knowledge of engine mechanical condition and performance criteria permits maintenance on an as need basis or at opportunistic times to maximize the Fully Mission Capable (FMC) rate.

PROPOSAL RATIONALE:

TEMS equipment not available at start of F-16 program. F-15/F100 engine diagnostics program originally destined for F-16 has concluded without success and redesign requires protracted development. New RDT&E requires an 8-year cycle. TEMS AN/USQ-85 qualified hardware available for near term feasibility demonstration.

IMPLEMENTATION:

TEMS system hardware, both airborne and supporting ground equipment, can be diverted from government inventory or furnished by Northrop. No equipment design-development or modification anticipated to accommodate proposed F100 engine parameters and functions. No known physical constraints to installation in F-16, using equipment location currently occupied by MXU553 Recorder/Multiplexer for ASIP function, obviated by TEMS. Limited number of added engine mounted sensors required to meet the high payoff proposed system specifics; existing aircraft and engine sensor directly apply. Principal task is system engineering and software unique to the F-16 selected functions.

SCOPE:

F-16/F100 TEMS Application/Configuration Study, verification in engine test cell at Arnold Engineering Development Center (AEDC) and confirmation in one TAC operated F-16 aircraft, on a nondedicated basis. Program characterization is no frills class II modification, essential documentation only, and TAC evaluation to a coordinated test plan.

A simplified TEMS configuration using qualified hardware with selected high payoff RMA functions as opposed to all possible diagnostic functions. Also, prudent use of proven technique in incremental functional growth through software executive control and software modular concept.

GOAL:

Early demonstration of AN/USQ-85 feasibility for F-16 as a potential candidate for a squadron evaluation upon successful completion of proposed technology application.

CONTRACTUAL CONSIDERATIONS:

Hq. USAF direction to Air Force Systems Command (AFSC) to authorize TEMS Technology Demonstration Program on condition of Hq. TAC expression of interest and support for one assigned test aircraft. F100-200 instrumented engine(s) in operational test scheduled at AEDC cells through 1984. (16 hours/week). Recommend ASD F-16 SPO funding for General Dynamics (GD/FW) TEMS installation (Class II Flight Test Only Basis) with installation in field at TAC base using instrumented engine identical to AEDC configuration (including same sensors). Proposed program would permit direct correlation of test cell and flight test data.

Northrop contractual interfaces to be resolved in favor of maximized program success at lowest cost.

Estimated test cell operation (piggyback arrangement) - one month. Duration of flight test - three months to initial evaluation milestone with option for extension.

Two part Program Plan with

Part I Application Engineering Study and Test Cell Verification

Part II F-16 Flight Test Confirmation/Demonstration

Estimated Program Cost \$ _____

F-16/F100 TEMS TECHNOLOGY APPLICATION/DEMONSTRATION PROGRAM

PROPOSAL NO. 2 HIGHLIGHTS

- MAJOR WEAPON SYSTEM HIGH PAYOFF APPLICATION
- DEMONSTRATION OF EXISTING TECHNOLOGY DIAGNOSTIC EFFECTIVENESS FOR F-100 (POTENTIAL DoD/USAF POTENTIAL IMPLEMENTATION OPTION)
- TECHNOLOGY OBJECTIVE - INCREASED WEAPON SYSTEM RELIABILITY AND AVAILABILITY
 - EMPHASIS ON FLIGHT SAFETY
 - AIRBORNE DIAGNOSTIC ANALYSIS FOR REAL TIME WARNING OPTION
 - DYNAMIC DATA ACQUISITION, PROCESSING AND INFORMATION MANAGEMENT
- DEMONSTRATION OF HIGH RATIO EFFECTIVENESS VS. COMPLEXITY CONFIGURATION
- DEMONSTRATION OF COMPATIBILITY WITH SEVERE F-16 INSTALLATION CONSTRAINTS
- CONFIRMATION OF F-100/TEMS FUNCTIONAL COMPATIBILITY IN AEDC TEST CELL (PIGGYBACK OPERATION)
(FULLY INSTRUMENTED F-100-PW-200 AVAILABLE FOR AEDC TEST THRU CY 1984)
- NORTHROP SYSTEM HARDWARE AVAILABLE ON PRIORITY BASIS;
SOFTWARE DEVELOPMENT AND IMPLEMENTATION BY AEDC/NORTHROP/G.D., F.W.

F-16/F100 TEMS TECHNOLOGY APPLICATION/DEMONSTRATION PROGRAM

PROPOSAL NO. 2 HIGHLIGHTS (CONTINUED)

- VERIFICATION/EVALUATION IN ONE F-16 AIRCRAFT - (TAC ASSIGNED AND OPERATED)
(CONDUCTED TO APPROVED FLIGHT TEST PLAN)
- PROGRAM EMPHASIS DIRECTED TO DIAGNOSTIC TECHNOLOGY YIELD
- F-16 CLASS II MODIFICATION BY G.D./F.W. (FLIGHT TEST DEPARTMENT) AT TAC BASE
- MINIMAL DOCUMENTATION - NO FRILLS PROGRAM FOR TECHNOLOGY EVALUATION
- TWO PART PROGRAM, EACH WITH DISCRETE SELF-CONTAINED OBJECTIVES
 - PART I - SYSTEM ENGINEERING AND TEST CELL VERIFICATION - 10 MONTHS
 - PART II - FLIGHT TEST VERIFICATION/EVALUATION - 3 MONTHS
- CONTRACTUAL INTERFACES TO BE ESTABLISHED (NORTHROP, G.D./F.W., AEDC)

PROPOSED F100 TEMS FUNCTIONS

- PRE-TAKEOFF THRUST NORMALCY INDICATION (COCKPIT DISPLAY)
- INFLIGHT WARNING TIE-IN (2-3 PARAMETERS ON SELECTED BASIS)
- STALL STAGNATION DETECTION AND HIGH RESOLUTION DATA PRESENTATION
- SELECTED INFLIGHT EVENTS DATA ACQUISITION - APPROXIMATELY 6 (NO/NO-GO STATUS INDICATION)
- TRIM/PERFORMANCE EQUATIONS - 2 (POST FLIGHT TRENDING)
- ENGINE USAGE DATA - (L.C.F. AND ENGINE HISTORY RECORDING FUNCTIONS)
- SIMPLIFIED 'WINDOWS' DATA FRAMES - (2) TRENDING
- PILOT SELECTED DATA FRAMES ACQUISITION/PRESENTATION

WHY STEMS FOR F-16?

- NO HARDWARE DEVELOPMENT
- QUALIFIED AN/USQ-85 EQUIPMENT IN USAF INVENTORY
- COMBINATION STRUCTURES TRACKING & ENGINE MONITORING
PERMITS MXU 553 EQUIPMENT DELETION -- PROVIDES INSTALLATION SPACE
- COMPATIBILITY WITH STRINGENT F-16 INSTALLATION CONSTRAINTS
(WEIGHT/SPACE/POWER)
- SIZED TO F100 SINGLE-ENGINE DIAGNOSTIC REQUIREMENTS

IV-88

NORTHROP
Electronics Division
V83-4

NORTHROP ELECTRONICS DIVISION
PROPOSAL NO. 3

TITLE: T-38 STRUCTURAL TRACKING TECHNOLOGY APPLICATION/
DEMONSTRATION PROGRAM

OBJECTIVE:

Demonstrate the feasibility and technical approach of the Northrop Structural Tracking System (STEMS) to measure the operational usage of the T-38 aircraft selected as a demonstration candidate. The program encompasses the development of the appropriate computer programs, equipment installation, and flight test on a single aircraft.

TECHNOLOGY APPLICATION RATIONALE:

The T-38 was designed for basic pilot training in advanced supersonic aircraft. While it is currently being used in this role, it is also used in the much more severe Lead-In Fighter (LIF) and Dissimilar Air Combat Training (DACT). To assess the effect of these severe usages on the service life of the T-38, the Air Force has equipped 129 T-38's in the LIF squadrons with mechanical strain recorders (MSR) and 10 aircraft with multi-channel tape recorders. The remaining 800 T-38's in the Air Training Command and DACT do not have any type of recorder!

A number of problems have plagued the recording systems on LIF aircraft. These include a very poor return of usable data due to faulty installation of the MSR's, magnetic tape handling problems, and sensor failures. A change in the usage of the T-38's in the Air Training Command has been identified, and the Air Force would like to equip selected aircraft with a recorder system to measure this change. However, it will be several years before MXU-553 tape recorders are available, and in light of the experience with these systems on the LIF aircraft, their value to TAC and ATC is doubtful.

As an alternative, Northrop proposes using the STEMS as a flight data recorder/analyzer. The STEMS Electronic Processor Unit will accept all sensors currently used with the MXU-553 recorder, including:

Vertical and Lateral Accelerations	Altitude
Roll, Yaw, and Pitch Rate	Airspeed
Rudder, Flap, and Elevator Position	Strain
Takeoff and Landing	Events

The onboard microprocessor will monitor these signals for peaks and valleys and store a frame of data containing all of the information when either a peak or valley occurs and perform prescribed airborne computations for post flight review and transmission to an analysis center.

SCOPE:

Develop the structural tracking subsystem to STEMS on a single T-38 aircraft. Northrop can provide the necessary hardware, software, installation support, and technical services required for this demonstration program.

GOAL:

Demonstrate STEMS technology on the T-38 aircraft. Show that the STEMS equipment can provide greater operational usage information currently provided by the MXU-553 recorder, with considerably lower maintenance due to the higher reliability of modern solid state electronics and compressed time for availability.

CONTRACTUAL CONSIDERATIONS:

It is proposed that Northrop Electronics Division be the prime contractor for this program, with San Antonio Air Logistics Center as the program monitor. Northrop will consign the necessary hardware for the duration of the program and charge only for technical services required.

SCHEDULE:

The duration of this program will be 1.3 years. Approximately nine months of initial development will be required. Hardware will be available for installation in the 2nd quarter of 1984. Following this installation, a six-month flight evaluation program is recommended.

STRUCTURAL TRACKING TECHNOLOGY PROBLEM

- CURRENT TREND TO MISAPPLY EMERGING MICROPROCESSOR CAPABILITY ORIENTED TO IMPROVED DATA ACQUISITION AND STORAGE MEDIA FOR CONVENTIONAL POST FLIGHT PROCESSING, COMPUTATION, ANALYSIS AND PRESENTATION AS AN OVERLAY NOT AN ADVANCEMENT
 - RESISTS AIRBORNE COMPUTATION IN OPERATIONAL ENVIRONMENTS
 - MINIMIZES CRACK GROWTH FRACTURE MECHANICS EFFECTIVENESS
 - PRECLUDES QUANTUM IMPROVEMENT WITH REDUCED RESOURCES
- ADVANCED HARDWARE IS MERELY THE TOOL;
ANALYTICAL TECHNIQUES AND INNOVATIVE SOFTWARE ARE THE KEYS!
- DoD SPONSORED DEMONSTRATION OF TECHNOLOGY PROPER IMPLEMENTAL ESSENTIAL

T-38 STRUCTURAL TRACKING TECHNOLOGY APPLICATION/
DEMONSTRATION PROGRAM

- T-38 AIRCRAFT SELECTED AS CANDIDATE VEHICLE REQUIRING USAGE SPECTRA MODERNIZATION
(OPERATION FAR EXCEEDS DESIGN CRITERIA AND SERVICE LIFE)
- DEMONSTRATED SOLUTION APPLIES TO OTHER DoD AIRCRAFT
- EXISTING TECHNIQUES AND EQUIPMENT GROSSLY INADEQUATE TO YIELD REQUIRED DATA
 - BEST CONVENTIONAL RECORDERS OBSOLETE AND UNRELIABLE
 - LIMITED QUALITY DATA AND LONG DELAYS IN ACCESS TO EVEN RAW DATA
 - LARGE INVESTMENTS IN FLEET SERVICE LIFE EXTENSION IN JEOPARDY
- ADVANCED STRUCTURAL INTEGRITY PROGRAMS DEMAND GENERIC SOLUTION FOR INVENTORY AIR
 - 900 T-38 AIRCRAFT FLEET EFFECTIVE USAGE INSIGHT A KEY EXAMPLE)
- DoD MUST TAKE LEAD IN CONFIRMING AND UTILIZING NEW TECHNOLOGY EFFECTIVENESS
(MULTI SERVICE POTENTIAL)

PROPOSAL NO. 3 HIGHLIGHTS

PROPOSAL OBJECTIVE:

DEMONSTRATED FEASIBILITY OF MODERN TECHNICAL APPROACH WITH COMPUTATIONAL CAPACITY FOR AIRBORNE CRACK GROWTH ANALYSIS AND LOADS/ENVIRONMENTAL SPECTRAL SURVEY DATA AS A QUANTUM IMPROVEMENT IN INFORMATION MANAGEMENT

T-38 AIRCRAFT SELECTION:

- REPRESENTATIVE OF "TACTICAL" AIRCRAFT SEVERE USAGE SPECTRA
- MOST STRINGENT INSTALLATION CONSTRAINTS - WT./POWER/VOLUME
- COINCIDES WITH CONSIDERATION FOR FLEET SERVICE LIFE EXTENSION TO YEAR 2010
- ECONOMICS - COMPLETE DAMAGE TOLERANCE ASSESSMENT (DTA) DATA AVAILABLE

PROPOSAL NO. 3 HIGHLIGHTS

- MAKE AVAILABLE AN/USQ-85 EQUIPMENT SET ON PRIORITY BASIS
- INSTALL STEMS HARDWARE IN ONE T-38 TACTICAL OPERATED AIRCRAFT AT HOLLOWMAN AFB
 - LEAD IN FIGHTER (LIF) AIRCRAFT OR
 - DISSIMILAR AIR COMBAT TRAINING (DACT) AIRCRAFT
- TEST AIRCRAFT CONFIGURED FOR MXC-553 RECORDER USAGE AND INSTRUMENTATION
- DEVELOP APPROPRIATE STEMS SOFTWARE PROGRAM AND INCORPORATE/VALIDATE
- USE AS DoD SHOWCASE FOR MODERN INDIVIDUAL AIRCRAFT TRACKING (IAT) INCLUDING CRACK GROWTH INDEX AT MULTIPLE FATIGUE CRITICAL LOCATIONS (FCLs)
- GENERATE COMPARATIVE DATA - TECHNICAL AND ECONOMICS EFFECTIVE
- PROGRAM DURATION - 18 MONTHS TOTAL
 - 12 MONTHS SYSTEM AND APPLICATION ENGINEERING INCLUDING INSTALLATION
 - 6 MONTHS FLIGHT TEST EVALUATION
- CONTRACTURAL - NORTHROP CORPORATION, ELECTRONICS DIVISION
UNDER CONTRACT FROM SAN ANTONIO AIR LOGISTICS CENTER

NORTHROP
Electronics Division

PROPOSAL NO. 3 HIGHLIGHTS

- MAKE AVAILABLE AN/USQ-85 EQUIPMENT SET ON PRIORITY BASIS
- INSTALL STEMS HARDWARE IN ONE T-38 TACTICAL OPERATED AIRCRAFT AT HOLLOWAN AFB
 - LEAD IN FIGHTER (LIF) AIRCRAFT OR
 - DISSIMILAR AIR COMBAT TRAINING (DACT) AIRCRAFT
- TEST AIRCRAFT CONFIGURED FOR MXC-553 RECORDER USAGE AND INSTRUMENTATION
- DEVELOP APPROPRIATE STEMS SOFTWARE PROGRAM AND INCORPORATE/VALIDATE
- USE AS DoD SHOWCASE FOR MODERN INDIVIDUAL AIRCRAFT TRACKING (IAT) INCLUDING CRACK GROWTH INDEX AT MULTIPLE FATIGUE CRITICAL LOCATIONS (FCLs)
- GENERATE COMPARATIVE DATA - TECHNICAL AND ECONOMICS EFFECTIVE
- PROGRAM DURATION - 18 MONTHS TOTAL
 - 12 MONTHS SYSTEM AND APPLICATION ENGINEERING INCLUDING INSTALLATION
 - 6 MONTHS FLIGHT TEST EVALUATION
- CONTRACTURAL - NORTHROP CORPORATION, ELECTRONICS DIVISION
UNDER CONTRACT FROM SAN ANTONIO AIR LOGISTICS CENTER

NORTHROP
Electronics Division

NORTHROP ELECTRONICS DIVISION
PROPOSAL NO. 4

TITLE: DIAGNOSTIC TECHNOLOGY GENERAL ADVANCEMENTS

SCOPE:

Development Engineering to be demonstrated and evaluated on A-10 test aircraft equipped with STEMS, on a non-interference basis.

TECHNOLOGY EXAMPLES:

1. Gross extension of engine structural fatigue parameters/environmental monitoring. Extrapolation of USAF ENSIP Program with more advanced fracture mechanics criteria. Objective: To maximize hard time designation of critical engine components in R.C.M. concept. (A high payoff prospect applicable to modern turbine engine durability assessment and usage correlation).
2. New advanced engine sensors application for use in conjunction with TEMS (e.g., turbine blade temperature sensor - pyrometer).
3. Demonstration of "accident investigation data recorder" remote solid state crash survivable memory unit with optimized software algorithms which grossly depart from TS0-C51A commercial concept as intelligent 'logic' for accident/incident significance. To interface directly with STEMS having all engines conditions, structural integrity, dynamic environment, control surfaces positions and with added signals from key airframe systems such as hydraulics, flight controls and electrical system. Could be two step demonstration. Step 1. Remote memory unit with convention housing and Step 2. With protective construction/material techniques qualified for crash environment.
4. Critical maintenance/status data of Weapon System transmitted by airborne data link and voice transmission to maximize surge rate.

4. (continued)

Special emphasis on data implying ability to perform next mission from forward operation locations (FOL) with critical systems requiring special level of repair facilitation.

Candidate Weapon Systems:

- o A-10A, in E.O.T. locations
- o S-3A on small carriers
- o Lamps from destroyer fantail operations
 - on anti-submarine missions
- o EA6B on surveillance mission

PROPOSAL NO. 4 HIGHLIGHTS
DIAGNOSTIC TECHNOLOGY GENERAL ADVANCEMENTS

- OBJECTIVE -- DoD RESOURCES TO ADVOCATE SIGNIFICANT TECHNOLOGY
(HIGH PAYOFF DIAGNOSTIC FUNCTIONS EVALUATION)
- A-10 TEMS-EQUIPPED AIRCRAFT SELECTED ONLY AS COST EFFECTIVE TEST VEHICLE
- TECHNOLOGY ADVANCEMENTS SELECTED TO APPLY TO MULTIPLE DoD AIRCRAFT
(R&D "TOOL" FOR REALISTIC DEMONSTRATION TO SERVICES)
- PROGRESSIVE TIME-PHASED SERIES OF SPECIFIC APPROVED PROJECTS & MILESTONES
- TF34 ENGINE STRUCTURAL INTEGRITY PROGRAM GROSS EXTENSION
EXAMPLE OF ENORMOUS POTENTIAL TO APPLY FRACTURE MECHANICS ENGINEERING
TO HOT SECTION ANALYSIS FOR SAFE EXTENDED FIRST TIME REPLACEMENT
- CONTRACTUAL ARRANGEMENTS -- JOINT AFSC/AFLC RESPONSIBILITY
ADDERS TO EXISTING SA-ALC CONTRACT FOR USE BY TRI-SERVICES

STEMS TECHNOLOGY GROWTH PROSPECT

- CRASH RECORDER OPTION -- STEMS SURVIVABLE DATA UNIT
 - TEMS HARDWARE COMMONALITY FOR CURRENT & REPLACEMENT ENGINES
 - F-16/F100 & F110 APPLICATION
 - F-14/TF30 & F110 APPLICATION
- } EXAMPLES
- STANDARDIZED DATA COLLECTION (UNIT) -- MULTIPLE PROGRAMS
 - A/C SYSTEM MAINTENANCE PANEL BIT STATUS MONITOR - E.G., AVIONICS
(INCREMENT SCOPE INCREASE FOR INFORMATION MANAGEMENT)

10 MARCH 1983

IMPLEMENTATION PLANS
DIAGNOSTIC TECHNOLOGY PROPOSALS
FOR
IMPROVED WEAPON SYSTEM RELIABILITY AND MAINTAINABILITY

SUBMITTED TO
INSTITUTE FOR DEFENSE ANALYSES
I.D.A.
SCIENCE AND TECHNOLOGY DIVISION
MECHANICAL SYSTEM CONDITION MONITORING GROUP

PREPARED BY
NORTHROP ELECTRONICS DIVISION
DIAGNOSTIC SYSTEMS SECTION

PROGRAM IMPLEMENTATION PLANS

INTRODUCTION

This section provides the anatomy of implementation plans for four programs proposed to the Institute for Defense Analyses in support of the I.D.A. Study of Available Diagnostic Technology to provide quantum improvements in Reliability and Maintainability (R&M) for major weapon systems.

Individual implementation plans for each program are presented in bullet form statements which delineate the fundamentals of proposed conduct and the prime tasks and organizations to achieve the objectives with credibility.

Foremost, Northrop proposes an integrated team effort of associated contractors and government agencies having the composite resources to insure overall success through total access to the technical disciplines and criteria, including the specialized facilities to perform elements of the selected programs.

These are namely the weapon system prime contractors, Grumman and General Dynamics for the F-14 and F-16 respectively, the engine prime contractor, Pratt and Whitney for both the TF30 and F100 engines, and especially the outstanding government agencies for engine development and testing, Arnold Engineering Development Center (AEDC) and the Naval Air Propulsion Test Center (NAPTC) for the F100 and TF30 engines respectively.

As a Diagnostic technology prime contractor Northrop Electronics Division has had extensive experience with the interfaces involved. Of paramount importance is the need to delineate and control the scope of participation and support from respective team members to insure program objectivity and the spirit of streamlined no-frills implementation as intended. There must be a team leader with demonstrated advocacy to diagnostics and the program commitments with respect to performance, cost and schedule. Northrop is prepared to assume a lead role in the implementation process. Contracted arrangements by the government will be the key.

The proposed F-14 and F-16 TEMS Diagnostic Technology Application/Demonstration implementation plans feature a program management technique which provides high visibility of progress and early assessment of the prospect for end result success. Each of the programs are divided into two self-contained phase entities. Phase I entails an Engineering Study to formulate and establish the baseline system configuration and provide the definition of physical interfaces and the functions to be mechanized. This enables the clarification of algorithms and the development of software, the key technical discipline in view of the advanced status of the hardware. Installation and test of the system in an engine test cell under controlled operational conditions including dynamic ambient ranges, completes the Plan I evaluation process. Sensor and diagnostic hardware compatibility are then confirmed. Most important the results provides a self-contained accomplishment to evaluate the proposed technology capabilities relative to the I.D.A. Study expectations.

Phase II involves installation, calibration, checkout and validation in the respective weapon systems, clearly showing the physical as well as functional interfaces with the airframe systems and the human operators. For example, there must be proof that the stringent constraints posed by the F-14 and F-16 with respect to electrical power, weight, and space are satisfied and that the prospect of future implementation in the Weapon System is both feasible and practical. Of course the Information Management Engineering aspects of the diagnostics technology has real world significance in the Phase II flight test.

Significantly, the structuring of the two phases as entities provided the maximum visibility and control of the program with options to the government based on meeting performance objectives.

Program number 3 involves Advanced Structural Tracking Technology Application/ Demonstration using the T-38 Lead-in Fighter (LIF) as an ideal demonstration vehicle. Unlike the foregoing program implementation plan, all of the resources and disciplines necessary to perform the totality of the effort resides in the Northrop Corporation Electronics and Aircraft Divisions. The Electronics Division is the prime mover in the application of airborne microprocessor oriented equipment applied to structural tracking and inflight crack growth analytical techniques - as mechanized in STEMS. The Aircraft Division, as the prime contractor for the T-38 of course has complete array of fracture mechanics engineering talent and the Corporate repository of loads spectra, fatigue critical locations, mission design criteria and the current operational utilization of the T-38 aircraft beyond original expectations.

Of course there exists the historical data for comparison as well as the T-38 Damage Tolerance Assessment (DTA) data bank. An extraordinary transfer of knowledge is in the prospect, valued at tenfold the proposed contract value. This program, if recommended by the I.D.A. and authorized by the DoD, will extend and optimize the tracking technology techniques beyond current mechanizations to the extent that time and funds permit.

With respect to the implementation plan for program 4, Northrop proposes to utilize this in-being dedicated A-10/TF34 STEMS system as an airborne laboratory for rapid reaction technical investigations for the Services. There is a favorable interest from the AFSC/ASD organization seeking correlation of data involving engine durability parameters in general, and the TF34 engine as a model.

**PROPOSED TEAM ARRANGEMENTS
IDA TECHNOLOGY PROGRAMS**

PROGRAM	TEAM MEMBERS							GOV'T AGENCY
	N.E.D.	G.A.C.	G.D./ F.W.	AEDC/ ARO	NAPTC	P&W	N.A.D.	
NO. 1 F-14/TF30 TEMS	✓	✓	-	-	✓	✓	-	NADC
NO. 2 F-16/F100 TEMS	✓	-	✓	✓	-	✓	-	AFSC
NO. 3 T-38 STEMS	✓	-	-	-	-	-	✓	AFLC
NO. 4 GENERAL TECHNOLOGY (A-10 TEST VEHICLE)	✓	-	-	-	-	-	-	AFLC

NORTHROP
Electronics Division

V83-30

IDA PROPOSAL NO. 1 IMPLEMENTATION PLAN FUNDAMENTALS

- STRUCTURED FOR TWO DISCRETE PHASES
 - PHASE I - CONFIGURATION ESTABLISHMENT ENGINEERING STUDY AND TEST DEMONSTRATION
 - PHASE II - F-14 A/C FLIGHT TEST VALIDATION -- "PIGGYBACK" EXTENSION OF FMS PROGRAM
- PHASE I IS STAND ALONE PROGRAM WITH PROGRESSION TO PHASE II CAPABILITY
- PHASE I CONDUCT AT NAPTC; PHASE II AT GAC TEST SITE
- HARDWARE CONFIGURATION TO MEET GAC SPECS & F-14 UNIQUE MOUNTING ARRANGEMENT
- DELIVERED HARDWARE WILL BE PRIOR AIRWORTHINESS TESTED
(F-14 OPERATIONAL ENVIRONMENT)

PROPOSAL NO. 1 IMPLEMENTATION PLAN (Cont.)

- TEMS TESTS CONDUCTED ON NONINTERFERENCE BASIS WITH ON-GOING ACTIVITY AND NOT SOLE COST BEARING
- NAPTIC TECHNICAL SUPPORT TO NAD WITH P&W CONSULTATION ROLE TO FORMULATE TEMS SYSTEM CONFIGURATION FOR HIGH PAYOFF FUNCTIONS
- PROGRAM OBJECTIVE IS TECHNOLOGY APPLICATION FEASIBILITY/PRACTICALITY; (HIGH YIELD EFFECTIVENESS VS. COMPLEXITY RATIO) SYSTEM OPTIMIZATION OR MAXIMIZATION BEYOND PROGRAM SCOPE
- CONFIGURATION CONTROL DOCUMENT (CCD) TO BE PREPARED AT STUDY CONCLUSION
 - HARDWARE INTERFACE CONTROL
 - SELECTED FUNCTIONS AND ALGORITHMS DEFINITION
- ONLY DOCUMENTATION NECESSARY FOR INTENDED FUNCTIONS TO BE PREPARED AND IN CONTRACTOR FORMAT
- AVAILABLE APPLICABLE TEMS DOCUMENTATION TO BE FURNISHED W/O COSTS

PROPOSAL NO. 1 IMPLEMENTATION PLAN (Cont.)

- INSTRUMENTATION MOD TO TEST CELL ENGINES BY NAPTC;
CLASS II MOD TO A/C BY GAC
- NAPTC/GAC/NED JOINT SYSTEM ENGINEERING RESPONSIBILITY
CONSISTENT WITH OBJECTIVES & ROLES
- NAPTC TO PROCURE & INSTALL ADDED SENSORS & FABRICATE INTERCONNECT HARNESS
- SYSTEM HARDWARE CONSIGNMENT BY NED FOR TEST PROGRAM DURATION
FOR PROGRAM FLEXIBILITY & COST REDUCTION
 - NO HARDWARE INVESTMENT BY GOVERNMENT FOR ONE-SHOT DEMONSTRATION
 - AVOIDANCE OF S.E. & ILS COSTS
 - ABILITY TO INCORPORATE SOFTWARE CHANGES W/O FORMAL PAPER HANDLING
- PROGRAM DURATION & MILESTONES
(TO BE DELINEATED IN PROGRAM PLAN COORDINATED BY TEAM MEMBERS)
COORDINATED BY TEAM MEMBERS

IDA PROPOSAL NO. 1 IMPLEMENTATION PLAN CONTRACTUAL CONSIDERATIONS

- FOCUS ON SYSTEM ENGINEERING TO APPLY EXISTING TECHNOLOGY
(NO HARDWARE DEVELOPMENT COSTS)
- TEAM MEMBERS SELECTED FOR COMPOSITE RESOURCES FOR SUCCESS
- NO TEST CELL OPERATIONS COSTS TO BE BORNE BY PROGRAM
- SUBSTANTIAL SAVINGS THROUGH INTEGRATION WITH GAC FMS PROGRAM
(PIGGYBACK FLIGHT TEST ON NONINTERFERENCE BASIS)
- PROGRAM LOW TECHNICAL/PERFORMANCE RISKS BY REALISTIC GOALS
- CONFIRMATION AT OUTSET OF SCOPE & CONTRACTUAL INTERFACES
- TYPE OF CONTRACT TO MAXIMIZE EFFICIENCY -- OPTIONAL

IV-109

NORTHROP
Electronics Division
V83-27

IDA PROPOSAL NO. 2

IMPLEMENTATION PLAN FUNDAMENTALS

- STRUCTURED FOR TWO DISCRETE PHASES
- PHASE I - CONFIGURATION ESTABLISHMENT ENGINEERING STUDY
AND TEST CELL DEMONSTRATION
- PHASE II - F-16 A/C FLIGHT TEST VALIDATION/DEMONSTRATION
- PHASE I IS STAND ALONE PROGRAM WITH PROGRESSION TO PHASE II CAPABILITY
- PHASE I CONDUCT AT AEDC; PHASE II BY TAC AT OT&E BASE*
- HARDWARE TO BE STANDARD AN/USQ-85 EQUIPMENT
- AIRWORTHINESS TESTS TO SUPPLEMENT MIL QUAL TEST STATUS
IF REQUIRED FOR F-16 UNIQUE OPERATIONAL ENVIRONMENT

*PREFERENCE TO WEST COAST PROXIMITY LIKE NELLIS AFB FOR RAPID ACCESS

IV-110

IDA PROPOSAL NO. 2 IMPLEMENTATION PLAN (Cont.)

- AEDC/ARO TECHNICAL SUPPORT TO NED WITH P&M CONSULTANT ROLE
TO FORMULATE TEMS SYSTEM CONFIGURATION FOR HIGH PAYOFF FUNCTIONS
- TECHNICAL APPROACH NOT INTENDED TO BE GUIDED BY F-15/F100 EDS CONFIGURATION
BUT LESSONS LEARNED WILL BE APPLIED
- PROGRAM OBJECTIVE IS EXISTING TECHNOLOGY FEASIBILITY/PRACTICALITY DEMO
- SYSTEM OPTIMIZATION & ULTIMATE SOFTWARE DIAGNOSTIC/PROGNOSTIC SOFTWARE
BEYOND SCOPE OF INTENDED PROGRAM, BUT CAN BE ADDRESSED
- CONFIGURATION CONTROL DOCUMENT (CCD) TO BE PREPARED AT STUDY CONCLUSION
 - HARDWARE INTERFACE CONTROL
 - SELECTED FUNCTIONS & ALGORITHMS DEFINITION

IDA PROPOSAL NO. 2 IMPLEMENTATION PLAN (Cont.)

- FUNCTIONAL EMPHASIS DIRECTED TO F-16 UNIQUE OBJECTIVES
(CROSS SECTION OF INHERENT CAPABILITY)
- AVAILABILITY OF APPLICABLE NONPROPRIETARY SOFTWARE ASSUMED
- ACCESS TO BASIC DESIGN CRITERIA ASSUMED FROM GD/FW, P&W AND AEDC
- MODULAR SOFTWARE CONCEPT UNDER EXECUTIVE CONTROL
MAY BE IMPLEMENTED ON PROGRESSIVE BASIS
- ONLY DOCUMENTATION NECESSARY FOR INTENDED FUNCTION TO BE PREPARED
AND IN CONTRACTOR FORMAT
- OTHER APPLICABLE TEMS DOCUMENTATION TO BE FURNISHED W/O COSTS

IDA PROPOSAL NO. 2 IMPLEMENTATION PLAN (Cont.)

- ONE F-16 TEST VEHICLE SELECTED FOR DEMONSTRATION PROGRAM OPERATED BY TAC
(SECOND A/C OPTION ASSUMING EQUIPMENT AVAILABILITY)
- TEST INSTALLATION IN TEST A/C BY GD/FW -- CLASS II MOD
- TEMS ELECTRONIC PROCESSOR UNIT (EPU) INSTALLATION AT CURRENT MXU553 LOCATION
(NO PHYSICAL CONSTRAINTS KNOWN)
- NED WILL CONSIGN TEMS SYSTEM HARDWARE ON NO COST BASIS FOR DURATION OF PROGRAM
- NED WILL PROVIDE ILS TO PROGRAM
- SAME EQUIPMENT WILL BE UTILIZED AT BOTH AEDC & FOR FLIGHT TEST
- INSTRUMENTATION USED ON F100-200 ENGINE AT AEDC CELL & IN F-16 IDENTICAL

IDA PROPOSAL NO 2 IMPLEMENTATION PLAN CONTRACTUAL CONSIDERATIONS

- FOCUS ON SYSTEM ENGINEERING TO APPLY EXISTING TECHNOLOGY
(NO HARDWARE DEVELOPMENT COSTS)
- TEAM MEMBERS SELECTED FOR COMPOSITE RESOURCES FOR SUCCESS
- NO TEST CELL OPERATIONS COST TO BE BORNE BY PROGRAM
(PIGGYBACK ON OTHER AEDC ACTIVITY)
- PROGRAM LOW TECHNICAL/PERFORMANCE RISKS BY REALISTIC GOALS
- FLIGHT TEST A/C KIT HARDWARE & SPARES TO BE FURNISHED
- CONFIRMATION AT OUTSET OF SCOPE & CONTRACTURAL INTERFACES
- TYPE OF CONTRACT TO MAXIMIZE EFFICIENCY -- OPTIONAL

IDA PROPOSAL NO. 3 IMPLEMENTATION PLAN FUNDAMENTALS

- STEMS CONFIGURATION STUDY AND FORMULATION FOLLOWED BY INSTALLATION AND FLIGHT TEST.
- ONE T-38 T.A.C. LEAD-IN-FIGHTER (LIF) A/C STEMS INSTALLATION.
- AIRCRAFT OPERATED BY T.A.C. AT HOLLOMAN A.F.B.
- INSTALLATION, CALIBRATION AND CHECKOUT BY NORTHROP - TURN KEY OPERATION (ON SITE TECHNICAL SUPPORT ON NEED BASIS).
- ELECTRONIC PROCESSOR UNIT (EPU) INSTALLATION IN DORSAL FIN LIMITED AREA.
- INTERMEDIATE MILESTONE FOR SOFTWARE REFINEMENT INCORPORATION.

IV-115

NORTHROP
Electronics Division

V83-31 Pg 1

IDA PROPOSAL NO. 3 IMPLEMENTATION PLAN (Cont.)

- ASSESSMENT OF ADVANCED TECHNOLOGY EFFECTIVENESS AND BENEFITS
(A.F. AND A/C PRIME CONTRACTOR TEAM)
- EXTENSION OF STATE-OF-ART STRUCTURAL FRACTURE MECHANICS INCLUDING
CRACK GROWTH ANALYSES AND AIRBORNE COMPUTER TECHNIQUES.
- OPTIMIZATION OF DATA COMPRESSION AND DATA PRODUCTS PRESENTATION.
- DEVELOPMENT OF T-38 UNIQUE SOFTWARE AND CORRELATION BY LABORATORY
SIMULATION TECHNIQUES.
- DEMONSTRATION OF DATA TRANSMISSION BY MODEM FOR REMOTE ANALYSIS
AND FLIGHT TEST CONDUCT CONTROL EFFICIENCY.
- FLIGHT TEST DURATION COMMENSURATE WITH FUNDING.

IV-116

NORTHROP
Electronics Division

V83-31 Pg 2

IDA PROPOSAL NO. 4 IMPLEMENTATION PLAN FUNDAMENTALS

- USE OF A-10A STEMS EQUIPPED A/C AS GENERIC TEST VEHICLE ONLY.
- IDENTIFICATION OF TECHNOLOGY CHALLENGES REQUIRING SOLUTIONS BY AIRBORNE MICROPROCESSOR TECHNIQUES TO BE EVOLVED, APPLIED, DEMONSTRATED AND EVALUATED USING IN-PLACE SYSTEM CAPABILITY.
- IMPLEMENTATION ARRANGEMENTS ON A CASE-BY-CASE BASIS WITH UNIQUE HARDWARE ADAPTATIONS AND SOFTWARE VARIANCES.
- CORRELATION OF GROUND OPERATIONS WITH FLIGHT TEST ENVIRONMENT.
- CONCEPTS TO BE EVOLVED AND TESTED BY CONTRACTOR(S) AND/OR SERVICE(S) FOR INDEPENDENT OR JOINT INVESTIGATION OF TECHNOLOGY INNOVATIONS TO IMPROVE M.R. & A. OF WEAPON SYSTEMS.

UNITED TECHNOLOGIES RESEARCH CENTER
SIKORSKY AIRCRAFT
HAMILTON STANDARD DIVISION

IV-119

PROPOSALS FOR:

1. Integrated Blackhawk Helicopter Transmission Monitoring System
2. Electrostatic Engine Monitoring System for the A-6/J52

Presented by:

United Technologies Research Center
Sikorsky Aircraft
Hamilton Standard Division

UNITED TECHNOLOGIES CORPORATION

INTRODUCTION

United Technologies is pleased to present two proposals for Mechanical Systems Condition Monitoring programs as requested by the MSCM Committee of the Institute for Defense Analysis. These proposals capsulize the information presented to the MSCM Study Group on 11 January 1983.

The first proposal illustrates specialized test capabilities and system demonstration of an Integrated Blackhawk Helicopter Transmission Monitor. This demonstration program combines the OEM capabilities of Sikorsky Aircraft, the sensor technology of United Technologies Research Center and the mechanical system condition monitoring system hardware capability of Hamilton Standard in a systems approach to automatically detect different types of transmission failure modes in their early stages to provide in-flight warning. The modes of failure to be addressed are either presently "invisible" or those whose detectable threshold results in unacceptable aircraft availability. Thus, the benefits from this monitoring system will be reduced secondary damage and wear, reduced mission aborts and increased system availability.

The second proposal is for an Electrostatic Engine Monitoring System demonstration program for the A-6/J52. The electrostatic monitoring system measures gas path component wear which gives substantially earlier warning of physical deterioration than existing performance parameter measurement. Thus, electrostatics used to further the on-condition maintenance goals of the military can reduce the costs of engine maintenance, increase reliability and reduce the risks of in-flight failures.



East Hartford
Connecticut 06108

SEL: 7618

February 3, 1983

To: Paul L. Howard
Chairman, MSCM

From: J. L. Pratt, Sikorsky Aircraft

Subject: Integrated BlackHawk Helicopter Transmission Monitoring System
Development

References:

- (A) UTC presentation to MSCM working group at IDA on the subject of BlackHawk Condition Monitoring. IDA, Alexandria, VA, January 11, 1983.
- (B) Electrostatic Pulse Analysis Program; Phase 1, F100 Pulse Classifier, P. E. Zwicke, UTRC R82-395794-1, June 1982.
- (C) UH-1H AIDAPS Test Bed Program. Final Technical Report. Hamilton-Standard Division of United Aircraft Corporation. USAAVSCOM Report 72-18, U.S. Army Aviation Systems Command, St. Louis, Missouri, August 1972.

SUMMARY

This letter expands the UTC January 11 presentation on BlackHawk transmission condition monitoring (Ref. A). Our contention is that present helicopter in-flight failure detection systems can be significantly improved through integration of vibration monitoring technology. We have outlined a technical program which, if funded by a government agency, would accelerate the integration of this technology.

BENEFITS OF ADDITIONAL MONITORING

The Sikorsky BlackHawk transmission incorporates the most advanced design and manufacturing standards in the rotary wing industry. Its inherent reliability is due, in part, to a 40 percent reduction in gear train parts. The transmission is, nevertheless, a relatively complex mechanical system having 24 gears, 43 bearings and 4 shafts. To further ensure the reliability of the transmission,

and the availability of the helicopter, on-board failure detection systems (magnetic chip detectors, oil and temperature sensors) and depot level diagnostics (SOAP) are used. While adequate to assure safe transmission operation, the present systems are not able to detect a number of failure modes (fatigue, scuffing, scoring, etc.), nor are they always able to give sufficiently early warning on a developing malfunction to prevent secondary damage to otherwise healthy components. For example, to avoid frequent nuisance indications, chip detectors may employ some mechanism to suppress very small metal particles (i.e., "fuzz burn-off"). On the other hand, large metal pieces (a broken gear tooth) may not be washed into the chip detector. It is highly desirable to develop a monitor to detect such "invisible" failure modes. Recent developments in vibration monitoring, discussed below, indicate that this is now feasible.

The benefits of an integrated BlackHawk transmission monitor are:

- (1) Reduced mission aborts: A \$20M savings in aircraft operation is projected (see Table 1) due to the reduction in false indications caused by present failure detectors. This figure does not include the cost of missions lost that would result from the estimated 1030 annual mission aborts.
- (2) Increased system availability: A potential cost savings of \$105.4M is projected (see Table 2).
- (3) Reduced secondary damage and wear: Because of the high inherent reliability of the BlackHawk gearbox, and its recent deployment, insufficient data exists at present to establish a meaningful estimate of cost savings. Without a monitor system, however, it is certain that many gearbox malfunctions will produce debris that will degrade wear rates in the gearbox and in some cases induce secondary failures.
- (4) Spin-off technology: The development of an integrated BlackHawk transmission monitor will produce spin-off technology benefits for monitoring of other mechanical systems, with similar cost savings. These systems include aircraft gas-turbine engine monitoring, tank engine/drive train diagnostics, and vehicle internal combustion engine diagnostics.

The cost benefits of this spin-off is best illustrated using a typical example. It is projected that in FY '87 the USAF F-15 fleet will fly a total of 204,059 hrs (USAF sources). There are two accessory Drive Gearboxes mounted on the airframe (NSN 2835 01 020 7249 and 2835 01 034 6948). Accessory Drive gearbox flight time is therefore 408,118 hr/yr. Using USAF projected failure data, there would normally be 412 depot returns from all causes. This produces a return rate of 1.0095/1000 gb

hrs. The average cost per return is estimated at \$18,000. An analysis model of projected savings for condition monitoring for civil aircraft has been developed from actual airline experience (a Cost Benefit Analysis Model for Automatic Engine Condition Monitoring on Civil Transport Aircraft - ESP 8213). Adapting this model for F-15 gearbox data will produce a conservative savings estimate. The F-15 gearbox data analyzed by this model indicates a potential savings of approximately \$3 million per year on F-15 AMAD gearboxes.

UNITED TECHNOLOGIES: THE LOGICAL CHOICE

United Technologies Corporation, UTC, has been involved in monitoring system development for many years. Realizing the importance of this technology, UTC is supporting its development with well over \$1M yearly in Corporate funding. Past contract work in this area includes the AIDAPS program (Ref. C). Presently, several different in-house programs involve monitoring of mechanical systems. This work has resulted in new transducer design (particularly laser based systems) and new signal analysis techniques (see "Related Work/Transferrable Technology").

United Technologies has the required combination of technical disciplines to successfully develop the BlackHawk transmission monitor. Sikorsky Aircraft, the BlackHawk designer and manufacturer, will provide detailed failure mode analysis, specialized test capabilities, and monitor system integration. United Technologies Research Center, a leader in the development and application of monitoring technology, will provide the technology base. Hamilton Systems will build the monitoring system hardware, drawing upon its extensive experience in the development of microelectronics based flight systems.

UTC APPROACH VERSUS SPADE PROGRAM

Recently, ATL (Fort Eustis) awarded a \$1.3M contract to develop a small, portable diagnostic analyzer (SPADE) for the UH-1, AH-15, and OH-58 helicopters. The UTC approach differs from the SPADE program in three major areas. First, the SPADE program will produce ground based diagnostic equipment whereas the UTC approach will produce an in-flight monitoring system. Only the UTC approach addresses rapidly propagating failure modes that require immediate pilot action. Second, the SPADE program is specifically aimed at vibration; whereas the UTC approach uses a systems approach, integrating several proven vibration monitoring methods (to identify "invisible" failure modes) with the present detection systems. This systems approach results in more timely and reliable monitoring. Third, the UTC approach incorporates a higher level of automatic information

interpretation. The monitor system will not only detect an abnormal transmission event, but will also identify the faulty component and provide information about the degree of degradation. This high level of information interpretation will minimize pilot work load and reduce cockpit clutter.

UTC TECHNICAL APPROACH

The initial objective is to provide a means of automatically detecting several different types of transmission failure modes in their early stages. The modes of failure addressed are either presently "invisible" or those whose detectable threshold results in unacceptable aircraft availability. The system will be a "smart" monitor that provides in-flight warning for modes whose propagation from detection to unacceptable levels is so short that immediate pilot action is required (e.g., shaft fatigue). The system will also provide post-flight warning for slower propagating modes to improve aircraft availability.

UTC proposes a three-phase program to develop and demonstrate the individual elements of an integrated transmission monitor; which incorporates all present failure detection functions while introducing new monitor functions to address "invisible" modes of failure or to lower the detectable threshold on visible modes.

The requirement for the Phase One Technology demonstrator is limited to a laboratory experimental unit to use during development of the data acquisition and classification techniques. The unit will be used to verify acceptability of the sensor and signal conditioner as well as the accuracy of the classification technique used in the microprocessor.

The unit will consist of two major blocks, the input block and the processor block. The input block will be a single channel P.C. board to facilitate changes of transducer types. The processor block will consist of an 8 bit processor and at least 32K of memory. The operating software and the classification algorithms will be capable of being easily changed to accommodate changes required during the development phase.

Phase I: Technology Demonstrator

Tasks:

- (1) Critical Failure Mode Selection
Select 3 failure modes based on cost payback, speed of propagation and potential for success. These will probably include, early detection of bearing spall, shaft fatigue and gear fatigue.
- (2) Prepare Test Plan

- (3) Select transducer and transducer locations
- (4) Acquire defective components, several grades of each
- (5) Record vibration data
 - (a) Good gearboxes for baseline
 - (b) Several runs for each implant
- (6) Determine signal analysis technique(s) to detect and locate each type of failure mode. Assess the effect of the degree of degradation on the analysis techniques.
- (7) Integrate existing monitoring functions into decision process
- (8) Build microprocessor based demonstrator
- (9) Ground Test the demonstrator

Schedule: 12 months

Approx. Cost: \$750K

Phase II: Prototype Monitor Development

Tasks:

- (1) Build and flight test Phase I demonstrator
(Partial Military Qualification)
- (2) Select 3 additional failure modes
More difficult to monitor modes. May include, cage loss, lube starvation, bearing spin
- (3) Prepare test plan
- (4) Obtain implants
- (5) Verify transducer and locations
- (6) Determine signal analysis techniques
- (7) Expand prototype
- (8) Flight-test prototype
- (9) Develop fleet implementation plan

Schedule: 12 months

Approx. Cost: \$1.25M

Phase III: Fleet Implementation

Tasks:

- (1) Full Military Qualification of Phase II monitor
- (2) Fleet implementation per Phase II Plan

Schedule: 18 months

Approx. Cost: TBD

RELATED WORK/TRANSFERRABLE TECHNOLOGY

The development of an integrated vibration monitoring system for the BlackHawk transmission will benefit from similar automatic diagnostic systems and related technology already developed. Several of these systems are described below.

(1) Electrostatic Pulse Analysis Classifier (ESPA)

The ESPA program is a Joint HS/UTRC/P&WA program to develop a gas turbine engine monitoring and diagnostic method based upon electrostatic pulses in the gas path. An automatic classifier has been developed which detects 24 different engine events (such as blade rub and blade erosion) based upon shape differences in the electrostatic pulses produced by these events (Ref. B). The classifier is being implemented in microprocessor based hardware. The classifier development and implementation procedures are applicable to the vibration monitoring program.

(2) NDE Programs:

Several monitoring and inspection systems developed under contract and in-house have common elements with the vibration monitoring program. Ultrasonics have been used to inspect various gas turbine engine components. Pattern recognition has been used to predict the strength of adhesive bonds, using information extracted from ultrasonic data. Signal Processing and pattern recognition have been applied to Eddy current signals to locate and size various flaws in aircraft structures. Acoustic Emission monitoring is being applied to detect and monitor crack growth in highway bridges. Image processing and understanding is being applied to fluoroscopic images of turbine blades to automatically find various metallurgical flaws.

(3) Laser Vibration Sensor (LVS):

UTRC has developed a LVS for industrial and military monitoring applications. The LVS has already been used to acquire vibration data from helicopter gearboxes. The advantages of the LVS are (1) very high bandwidth (1 to 1MHz), (2) noncontacting, (3) nonresonant, (4) high dynamic range (10^6 G's), (5) surface monitoring capability. Although the LVS is applicable for ground test systems, it is several years away from being applicable for in-flight monitoring. However, the LVS will still play an important role in the technical plan for developing the in-flight system prototype. Specifically, it will be used to scan the gearbox to find the optimum locations for mounting the accelerometers. This is a crucial step in the successful detection of low-energy failure modes.

TABLE 1: REDUCED MISSION ABORTS

1. Fleet Size - 1107 aircraft (latest figure)
2. Usage - 69 hrs/ac-month (specification)
3. False Indications - 2.25/1000 flight hours (estimate)
4. Cost - \$1000/flight hour (approximate)
5. Aircraft Life Cycle - 20 years (estimate)
6. Assumptions:
 - (a) 50% of false indications occur on outbound leg
 - (b) one hour extra flight time per abort
 - (c) 97% monitor efficiency at eliminating aborts due to false indications

TABLE 2: SYSTEM AVAILABILITY

1. Transmission MTBF's 7000 hours: 2 accessory modules
 5000 hours: 2 input modules
 4500 hours: 1 main module
2. Usage - 69 hrs/aircraft-month
3. Fleet size - 1107 aircraft
4. Fleet deployment - 60% small base (< 17 a/c)
 40% large base (> 17 a/c)
5. Small base - 75% spares available in 3 days
 25% spares available in 3 weeks (depot)
Large base - 50% spares available in 3 days
 50% spares available in 3 weeks (depot)
6. 80% monitor efficiency at scheduling removals; thus reducing 3 week waiting period to 2.4 weeks
7. Aircraft cost - \$6.2M

BLACKHAWK TRANSMISSION MONITOR DEVELOPMENT SCHEDULE

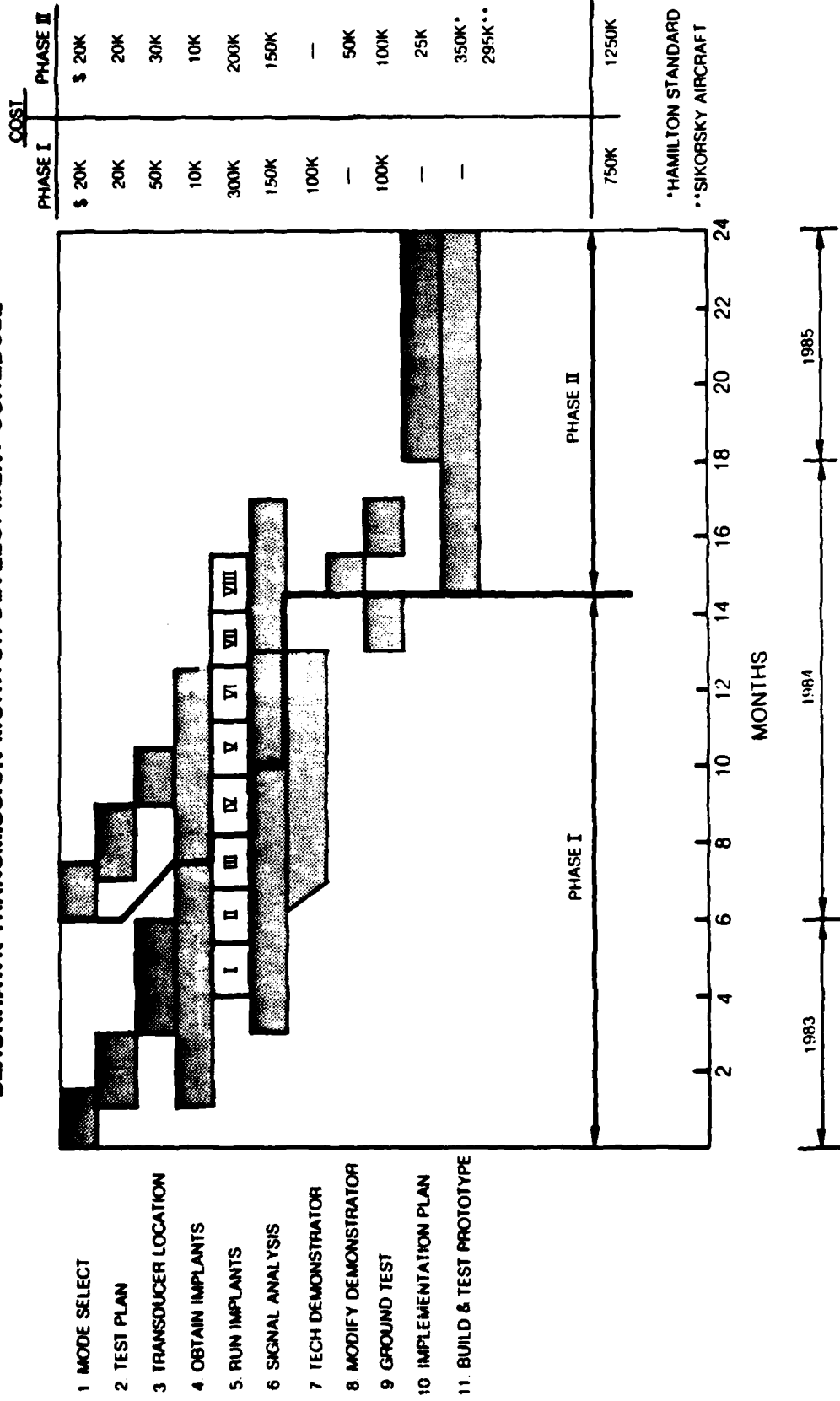

1. MODE SELECT
2. TEST PLAN
3. TRANSDUCER LOCATION
4. OBTAIN IMPLANTS
5. RUN IMPLANTS
6. SIGNAL ANALYSIS
7. TECH DEMONSTRATOR
8. MODIFY DEMONSTRATOR
9. GROUND TEST
10. IMPLEMENTATION PLAN
11. BUILD & TEST PROTOTYPE

UNITED TECHNOLOGIES

United Technologies Research Center

Hamilton Standard

IV-131

March, 1983

HSPC 3S008-2

**ELECTROSTATIC ENGINE
MONITORING SYSTEM
(EEMS)
for the
P&WA J-52 ENGINE**

**Prepared for
Institute for Defense Analysis**



IV-132

1.0 INTRODUCTION

Hamilton Standard is developing a technology called electrostatics to use as a monitoring system for measuring internal component wear in gas turbine engines. This monitoring system is an improvement over current performance monitors because it measures physical deterioration, giving warning substantially before traditional performance parameters are affected. Current programs involve test stand monitoring and technology transfer to transport engine flight monitoring this year. The program suggested here is for flight baselining and demonstration in the Navy attack arena on the J-52 engine in the A-4 and A-6 aircraft.

2.0 ELECTROSTATICS

2.1 Engine Condition Monitoring Using Electrostatics

The Electrostatics method provides a simple, direct measurement of physical deterioration of internal engine components in the gas path, just as SOAP does in the oil system. By observing electrostatic pulses generated in the gas path as a result of component rubbing, chaffing, erosion and burning, electrostatics warns of potential engine performance degradation before it occurs. When this early physical deterioration occurs in the hostile environment of the turbine engine, it results in the discharge of minute particles in the form of ionized clouds or pulses which generate the diagnosable electrostatic charge. The normal (healthy engine) deterioration rate is first established as a function of engine cycling and power and a "baseline" count is established. When this "baseline" is exceeded by a predetermined margin, a warning is given that a "significant abnormal event" has occurred which requires further investigation.

Traditional engine condition monitoring consists of taking performance data from the engine at periodic intervals while operating, converting this data into a form that takes into account various temperatures and pressures, and comparing this data with a baseline curve made at the time the engine was new or recently overhauled. Deviations indicate wear or possible incipient trouble. The inherent problems with this method are the complexity and time involved in analyzing a large quantity of performance data, and the need for performance to begin to deteriorate in order to indicate a problem.

The difference between the two methods is that electrostatics measures physical deterioration prior to its effecting performance, while "conventional" diagnosis relies on early detection of performance degradation regardless of the extent of prior physical deterioration. Measurement of physical deterioration takes the guess work out of gas path monitoring and enables monitoring component wear from its inception, providing the ultimate in trending capability.

The pulses or "charged clouds" are detected by inserting electrostatic probes into the engine's gas path or by encircling the gas path with a capacitively coupled ring probe. As the pulse passes the probe, a time varying voltage is

2.1 (Continued)

produced which can be analyzed and a "signature" developed corresponding to a given deterioration or "wear condition". Fault isolation is therefore possible by analyzing the location of the pulse and the pulse signature. The degree of deterioration can be determined by the number of pulses or pulse rate.

2.2 Present Program

Presently, HSD is using IR&D funds to develop electrostatic technology for both fighter and transport applications. The program in 1982 concentrated on developing baseline data during test cell operations on F100 and TF33 engines. The 1983 objective is to transfer the technology to the flight regime of a transport aircraft because of the lower risk involved in flight demonstration on a transport aircraft vs. a fighter aircraft. Electrostatic data acquisition equipment will be installed on five to eight TF33 engines used on the C141 transport at Charleston AFB as part of a life extension program being conducted by Military Air Lift Command. Development of flight test data on transport type aircraft will allow positive correlation between test stand results and operation of the engine in the flight environment.

2.3 Fighter Attack Application

Hamilton Standard would like to conduct a parallel program on the J52 attack engine to extend the technology into this more severe environment. Once these program objectives are met in the J52 attack application, we anticipate using this "baseline" for extensions to advanced fighter/attack applications.

3.0 PROPOSED PROGRAM

The proposed program will consist of mounting electrostatic data acquisition units on the J52 in the A-4 or A-6 aircraft during a flight test program and analyzing the data gathered to determine the severity of engine component wear. The goals of the program will be to:

1. Develop and demonstrate the technology and hardware for acquiring electrostatic pulses on operational fighter aircraft.
2. Verify and classify the pulse signals generated from the engine component wear.
3. Correlate specific electrostatic pulse data with specific critical component deterioration.

The proposed program will be conducted in two phases:

- I Hardware Design and Construction
- II Data Acquisition and Analysis

Phase I will occur in the first six months of the program, and Phase II will occupy the remaining 12 months.

Phase II will require ground operation to acquire baseline data and a flight program to develop the classification data base. Installation of the equipment on the selected aircraft and ground operation is expected to take about three months of the 12, with flight data acquisition and analysis using the remaining nine months.

The program cost is estimated to be \$950K. A more formal breakdown of the program elements will be made available upon request.

4.0 BENEFIT ANALYSIS

The capability to determine the health of the internal core of a jet engine provides many benefits. Estimations of the potential savings which may accrue with electrostatic condition monitoring have been made using data derived primarily from the Navy 3M (Maintenance and Material Management) system for J-52 P6/8/408 engines. Electrostatics monitoring improvement factors are engineering estimates based primarily on test stand data and airline condition monitoring experience.

Even though this technology will not be confined to the J52, the potential savings on an annual basis for this engine alone using an Electrostatic Engine Monitoring System are substantial. These potential savings result from the reduction in unschedule engine removals, extension of major component repair intervals and extension of hot section inspection intervals. Unscheduled Engine Removals (UERs) are estimated to be reduced by 30% because of the early detection of engine problems resulting in direct savings of \$2.1M per year. This reduced UER rate will in turn require fewer spare engines resulting in a savings of \$3.9M.

Extending the overhaul interval by an estimated 25% from 2500 hours to 3125 hours will result in a direct savings of \$1.85M per year. The reduction in spare engines needed will be from 12 to 10 engines for a savings of \$2.6M.

Adding up the total cost savings from the reduction in UERs and extension of overhaul and hot section inspection intervals are estimated to save \$6.3M per year and \$9.0M one time savings.

The potential savings on this engine alone should justify the funding of a demonstration program. The other fighter attack aircraft potential savings possible using similar programs adds additional justification for funding this program.

ELECTROSTATIC COST/BENEFIT ANALYSIS

• Program length/cost - 18 months /\$950K

<u>Benefit</u>	<u>Annual savings</u>	<u>Spare savings</u>
• Unscheduled engine removal (UER) reduction	\$2.1M	\$3.9M
• Major component repair interval extension	1.85M	2.6M
• Hot section inspection interval extension	2.36M	2.6M
Total savings	\$6.31M	\$9.3M
	annually	

AD-A137 524

MECHANICAL SYSTEMS CONDITIONING MONITORING TECHNOLOGY
WORKING GROUP REPOR. (U) INSTITUTE FOR DEFENSE ANALYSES
ALEXANDRIA VA SCIENCE AND TECH. P HOWARD AUG 83

3/6

UNCLASSIFIED

IDA-D-36 IDA/HQ-83-25899 MDA903-79-C-0018 F/G 15/3

NL

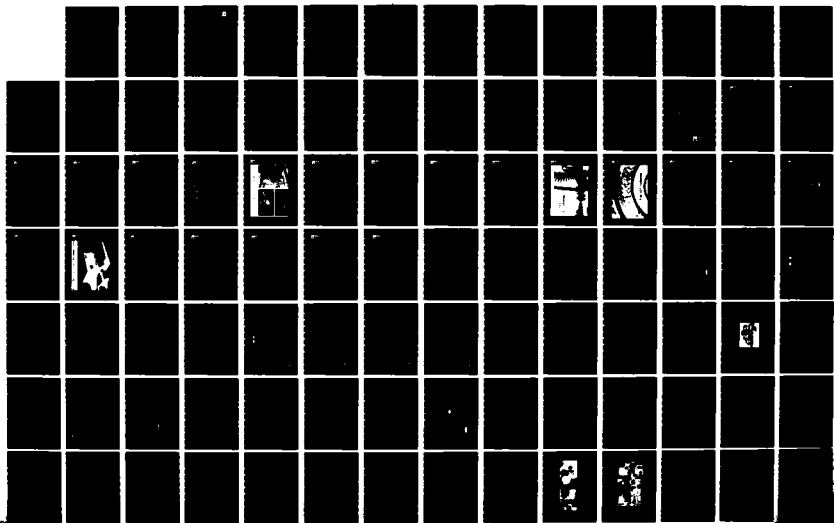

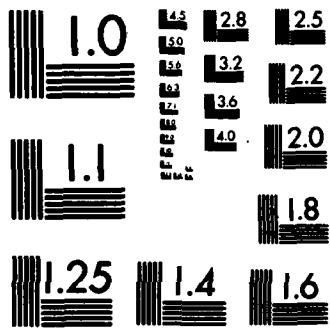

MICROCOPY RESOLUTION TEST CHART
NATIONAL BUREAU OF STANDARDS-1963-A

VIBRO-METER CORP.

IV-139

vibro-meter corp.

22109 South Vermont Avenue, Torrance, California 90502
Headquartered at:
50 Moulton Street, Cambridge, Massachusetts 02238
(Formerly BBN Instruments Corporation)
Phone: (617) 491-0091



Phone: (213) 320-8410
Cable Address: Vibrocal
Telex: 673-528
Telecopier: (213) 328-9621

February 23, 1983

Mr. Paul Howard, Chairman MSCM
Institute for Defense Analyses
Science & Technology Division
1801 N. Beauregard Street
Alexandria, VA 22311

Dear Paul:

Following our presentation to your IDA MSCM committee on February 15th, we have considered in some depth the future direction that our development is taking regarding condition monitoring of turbines and associated mechanical equipment. Our perception of the market, its current requirements and future potential needs, has been utilized on a world-wide basis in outlining our ideas to you as contained herein.

For your information we also indicate our current thinking regarding the budgetary costs of these programs, in 1983 dollars. We would expect that if such developments could be agreed upon then they would take the form of cost plus programs and that the amounts involved would be contributory so as not to put in doubt the "ownership" rights of Vibro-Meter Corporation in the products that may ultimately result from these programs.

<u>Item to be Developed</u>	<u>Budgetary Cost</u>	
1.) High temperature 900° F operation (1000° F survival) proximity probe for general usage on rotating machines.	\$300,000	<u>MSCM - 1</u>
2.) Engine mounted/fuel cooled engine vibration diagnostic system using advanced digital analysis techniques and controlled by micro-processor. This system to include adaptive software and storage of maintenance data in X.Y.Z. format.	\$500,000	<u>MSCM - 3</u>

<u>Item to be Developed</u>	<u>Budgetary Cost</u>
3.) Extension of system outlined in (2) to attain the following additions:	
i) Gear box/transmission monitor	
ii) Temperature, pressure, speed parameters for engine health monitoring	
iii) Software/A.I. to compute engine health algorithms such as low cycle fatigue, creep, thermal fatigue, exceedances	\$750,000

M S C M - 3

Vibro-Meter would propose that this program would be system directed by Vibro-Meter but in active collaboration with rotating machinery/air-frame manufacturer and drawing on the existing expertise of Bolt Beranek and Newman (previous owners of the instrument division that Vibro-Meter has acquired) in the field of computer software and artificial intelligence.

We hope that this proposal will meet with your approval. We are available to meet with you or other members of your committee, at your convenience, to further discuss this matter if you should feel that we may be of assistance.

Yours sincerely,

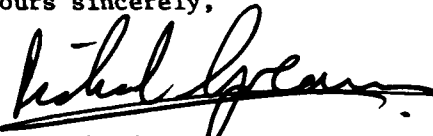

Dr. Richard W. Greaves
President

RWG/lb

V. MSCM CASE STUDIES/PROGRAMATIC RECOMMENDATIONS

V. MSCM PROGRAM CASE STUDIES AND LESSONS LEARNED

One of the key questions addressed by this committee was: "How do you successfully get MSCM considerations incorporated into a program early on and infuse new technology in less than the evidently traditional eight years?" As background, we reviewed several development programs (primarily engine) to determine when MSCM was considered, how it was integrated into the system design, how MSCM effectiveness was measured, and how observed failures/malfunctions occurred versus the predictions made during the FMEA and RCMA. Of most interest were programs with successful track records and proof of benefits. What was found, most often, was a consistent lack of mechanical systems condition monitoring beyond time/cycle counting and oil sampling until a problem caused economic or mission performance problems. Then the resultant solution was aimed at a particular problem and not the mechanical system as a whole. The LM2500 ship engine diagnostic system (Navy) proved to be exceptional in the sense that more diagnostic and prognostic complexity was initially designed in than was finally found to be necessary. A beneficial simplification in diagnostic systems was attainable because, unlike aircraft turbine engines, the LM2500 is operated at a fraction of its rating (less stress). The LM2500 is typical in that it was in late development before the subject of diagnostics was addressed.

In some cases program controls in the MSCM area were absent and decisions were deferred to the contractor. It appears nearly axiomatic in a program to identify problems, generate solutions to them individually, and then turn over system support and management to the user command. One general observation in this area is that military managers on time-limited tours of duty do not appear motivated through performance ratings or

career intentions to promote reliability and maintainability, at least from an MSCM perspective.

Table V-1 lists the three basic questions asked for each program. Through these questions we hoped to discern the thought process and timing for the consideration of MSCM application. Table V-2 lists the responses received. In general, there was little effort toward early incorporation of MSCM; we found retrofit activities for all but the newest engines. This late incorporation of MSCM negates many of the LCC benefits that come with front-ended incorporation.

Also included are lessons learned from the engine monitoring experiences and an assessment of USAF programs.

TABLE V-1. BASIC QUESTIONS ASKED FOR EACH PROGRAM

ASSUMPTION:

Early incorporation of MSCM requirements in engine development programs yields the highest payoff and maximum benefits for reliability and maintainability. To be effective MSCM must be applied from the user's perspective and benefits measured from that perspective.

FOR EACH ENGINE:

1. Was MSCM requirement recognized early in the development program.
 - 1a. If yes, what was done?
2. Was MSCM requirement recognized after engine development? Production?
 - 2a. If yes, what was done?
3. If MSCM was implemented, what was the motivation?

TABLE V-2. QUESTIONS RELATED TO MSCM CONSIDERATIONS IN ENGINE PROGRAMS

ENGINES	QUESTION NO. (From Table I)		
	1.	2.	3.
	1a.	2a.	
F100/F-15, F-16	No	Yes (Prod)	EDS, PATTS BLEATS, AGEETS
TF34/A-10	No	Yes (Prod)	A-10/TEMS
F101/B-1B	Yes	-	-
F108/KC-135	No	Yes (Dev)	Add-On Adapted A-10/TEMS
F109/T-46A	Yes	-	-
ATF F100 DEEC & F110	Yes	-	-
			Low Availability High MTRR High CND Eng Complexity RCM In-Flight Anomalies Maintenance Concept Parts Life Track FCMP Parts Life Track Performance RCM RCM Engine Diag. Past Performance Logistics

(continued)

ATF -- Advanced Tactical Fighter
 EHR -- Events History Recorder
 OAP -- Oil Analysis Program
 ETTR -- Elapsed Time Temp Rec
 CITS -- Central Integrated Test Subsys.
 EDS -- Engine Diagnostics System

PATTS -- Programmed Automated Trim & Test Sys.
 BLEATS -- Base Level Engine Automated Test System
 AGEETS -- Automated Ground Engine Test System
 TEMS -- Turbine Engine Monitoring System
 FCMP -- Engine Condition Monitoring Program

TABLE V-2 (continued)

ENGINES	QUESTION NO. (From Table I)		
	1.	2.	3.
T700/ UH-60 AAH LAMPS	No Cycle Counter Chip Detectors	No	NA
T53/UH/AH-1	No Chip Detectors	No	NA
T55/CH-47	No Chip Detectors	No	NA
T63/OH-58 OH-6	No Chip Detectors	No	NA
T58/S-61	No Chip Detectors	No	NA
T64/CH-53	No Chip Detectors	No	NA
LY1100/M-1 Tank	No None	Yes (Prod)	Reliability Experience
TF41/A-7E	No Filter & P Button Chip Detectors	Yes (Prod)	In-Flight Anomalies Maintenance Improvements Performance
LM2500/Ship	No --	Yes (Modified Production Engine)	On Condition Maintenance (Long Mission Time)

ENGINE MONITORING LESSONS LEARNED

1. From the review of various engine monitoring systems approaches, it becomes obvious that because of the many available options, future planners must ask questions which include: "What is the management/decision system informational requirement to produce on-condition capability at the lowest life cycle cost? Should the information be presented on-board or off-board? Or a combination of both? When and where will the information be integrated into the operational environment? How much monitoring is enough?" Proper focus of engine monitoring development efforts to meet the requirements for engine usage, engine parts tracking, fault detection and isolation, and engine performance trending necessary for reliability centered maintenance can be achieved only when correct answers to these questions are established.
2. Retrofitting engine monitoring systems for either the gas path or major mechanical components can be very expensive and payback is not realized in the short term. Every attempt should be made to use existing or standard hardware to perform the monitoring function as well as the data extraction and subsequent processing.
3. The overall driver in establishing an engine maintenance concept, of which engine monitoring is a key element, is to minimize maintenance manhours per operating or flying hour. Don't build or buy monitoring equipment that defeats that purpose.

4. An engine condition and mechanical systems condition monitoring on each engine is necessary for full implementation of reliability centered maintenance on engines.
5. The overwhelming demand for the highest possible performance technology can provide has led to a situation where reliability has been sought and improved only after entry into service. Very severe economic penalties in terms of cost, maintenance manhours and materials are being realized in falling mission readiness.
6. Centralizing most of the engine monitoring activities at an operating base shortens communication links and ensures that the engineering feedback and data collection come together as quickly as possible. This close communication is essential for software evolution and final development.
7. A substantial portion of engine maintenance is spent on investigations in which no defect is found. This means that maintenance decisions are being made without proper or any illuminating data. In addition, under similar conditions, different decisions are being made. It is, therefore, in the best interests of DoD and the engine contractor that the engine contractor be prime for the development of engine monitoring systems.
8. In terms of the total aircraft systems maintenance, the engine accounts for 10 percent or less of the manhours expended. What is important is the significance of the failures to flight safety and mission readiness.

47/8-7

2/18-1

9. Even though reliability centered maintenance has been implemented within the Air Force, the whole engine work unit code still appears very high in the ranking of engine maintenance codes and the preponderance of the whole engine occurrences are listed as no-defects-found. Just looking at removals, one can see that 64 percent of all removals are still unscheduled and attributed to mechanical failures. The Air Force isn't meeting the goals of RCM.

10. Many engine mishaps are caused by foreign object damage. Engine monitoring is not much help in this area.

ASSESSMENT OF AIR FORCE ENGINE MONITORING

Engine Condition Monitoring in the Air Force is currently undergoing change. Of the current inventory engines, none has an automated engine monitoring system (or, in the case of C-5A MADARS, one that is relied upon for decisional support). The majority of engines are manually tracked, timed metered through mechanical indicators and performance trended through crew observation. The Spectrometric Oil Analysis Program is deeply entrenched and relied upon heavily by the AF maintenance community. Changing all of this is the introduction of the A-10 Turbine Engine Monitoring System which will automatically monitor mechanical and gas path performance of the TF-34 engine. This system is also being applied to the F100 engine for re-engined KC-135s. An automated ground engine test system (AGETS) is near production to automate engine test, trim, and trouble shooting for the F100 engine. The F101 engine for the B-1B is nearing production and will be monitored by the Central Integrated Test Subsystem. These very near term programs will move the Air Force from manual to stand alone (separate from other aircraft systems) automatic data collection and monitoring of engines.

Hand in hand with these evolutionary changes is the change to the engine data handling system. Heretofore manual data transcribed from form to form to punch card to magnetic tape has been batch loaded to base level computers and virtually lost to base technicians because of long processing delays and extensive errors. The Air force is currently implementing an operator interactive on-line system that transfers data electronically and allows flexible graphics at base level for manipulation by engine technicians. This step into smart processing complements the move to automatic data collection on-board the aircraft and

helps illuminate the results of the data collection to the people who need to make decisions.

Because of the new accessibility to near real time, in-flight data, AF designers are recognizing the need to link the reliability centered maintenance analysis with design of the monitoring system. This step makes it possible to move from a reactionary style of designing to monitor known problems to a clear trend of designing for flexibility to support decisions that must be made in different wartime and peacetime scenarios. This is strongly evidenced in the F110, F100-PW-200 competition fighter engine programs. In each of these programs a concerted effort is being made to integrate the monitoring function within the electronic engine control and access the information it generates through the aircraft multiplex bus. This opens many new decision possibilities during flight, certification runs and trouble-shooting.

In addition, a great deal of effort is being expended by the Air Force standardizing the support equipment used to handle the data generated by these different systems.

The Air Force will not attempt to apply the advanced, automatic monitoring methods to the older inventory engines. Their sophistication is low and a great deal of experience already exists and resides in their respective technical manuals. It is also just as apparent that while the AF has specific plans for engine systems to be produced in the late 1980s-early 1990s, little or no research is being done to further the evolution of engine monitoring. The current Advanced Propulsion Monitoring System being studied by the AF Propulsion Laboratory is in real danger of being caught by the systems under design for the F110, F100-PW-220 engines.

The evolution the AF has experienced is depicted in the following chart.

47/8-10

2/18-1

ENGINE MONITORING CAPABILITY

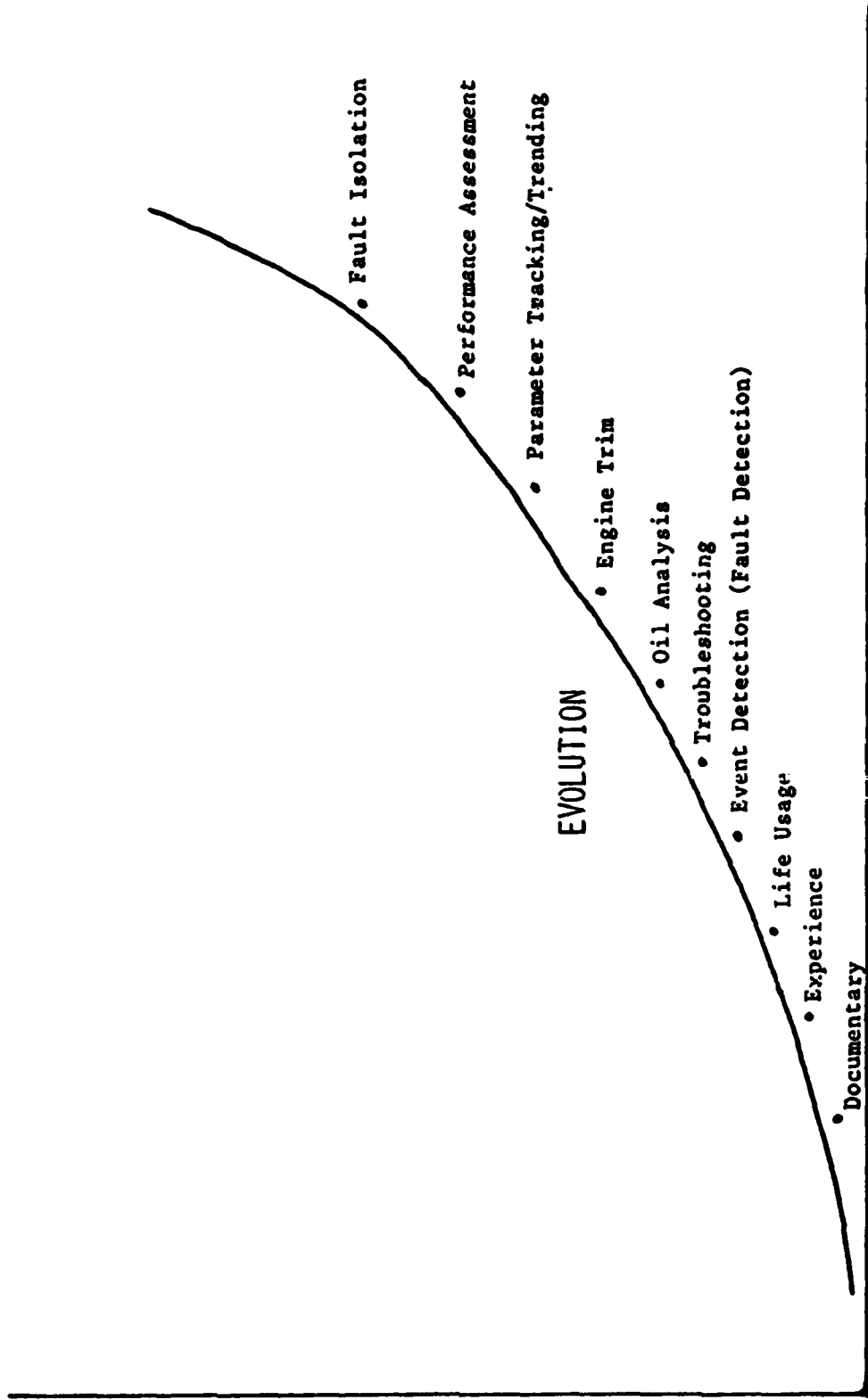

ENGINE DIAGNOSTIC SPECTRUM

CONCLUSION

Based on the above matrix the Air Force has fully realized the importance of MSCM in all of their engine programs. The success stems from their single point engine management approach. The Army and Navy could benefit from this, focusing the aircraft engine development production and operation under the responsibility of a single System Program Office (SPO).

PROGRAMMATIC RECOMMENDATIONS

1. The military has not done a good job of recognizing and telling industry exactly what it wants when MSCM is required. A key example of this is the proliferation of redundant engine condition monitoring development projects that has occurred. To correct this situation we recommend the formation of a DoD Engine Condition Monitoring Group. It shall be chaired by a DoD representative and include members from each of the Services and from industry. The primary responsibility of this group is to infuse into future engine programs what has to be done to maximize readiness and minimize LCC through the use of MSCM technology and innovative analysis techniques. This group should be tasked with recommending policy and giving technological direction to industry. Its business will be to tell what and when aspects of MSCM need to be injected. A draft charter for the Engine Condition Monitoring Group follows.

2. All military engine and drive system development programs shall have specific requirements for mechanical systems condition monitoring (MSCM). The requirement shall be further amplified in the RCMA so that diagnostic solutions to findings in the FMEA are implemented using MSCM techniques and equipment.

3. Army (DARCOM) and Navy (AIR) should extract the management of engines from airframe management offices and form one organization with the principal responsibility to develop and acquire engines for that Service using as a pattern the organization of the USAF Engine/Propulsion SPO (ASD/YZ).

DRAFT CHARTER--ENGINE CONDITION MONITORING GROUP

To establish an OSD-directed tri-Service/industry engine condition monitoring effort that will:

- Maintain current definition of the technology in engine monitoring.
- Coordinate the technology activities and engine monitoring programs conducted by the Army, Navy, Air Force.
- Sponsor an annual technology exchange and program guidance meeting on engine monitoring topics.
- Publish an annual report including the minutes of the Tri-Service meeting for distribution to industry.
- Make recommendations to key program management personnel on the benefits, general trends, new technology, and specific programs involving engine monitoring to encourage transfer-of-technology and standardization in engine monitoring.
- Generate design/performance requirement standards and guidelines for engine condition monitoring.
- Ensure that engine condition monitoring is established as a front-end requirement for all new engines and incorporated into existing programs as practical.

47/10-1

2/17-1

VI. APPENDICES

APPENDIX A
TECHNOLOGY ASSESSMENT
PRESENTATIONS

R&M STUDY MECHANICAL SYSTEMS CONDITION MONITORING

TENTATIVE AGENDA
JANUARY 11-12, 1983

TUESDAY, 11 JANUARY 1983

9:30-10:00 MSCM WORKING GROUP MEETING

10:00-12:00 UNITED TECHNOLOGY RESEARCH CENTER/HAMILTON STANDARD
(10:00-10:30 SYSTEM REQUIREMENTS, JOE PRATT
[SIKORSKY])
10:30-11:15 VIBRATION MONITORING, PHIL ZWICKE
[UNITED TECHNOLOGY RESEARCH CENTER]
11:15-11:45 MECHANICAL SYSTEMS CONDITION MONITORING,
PAUL HOAR [UT RESEARCH CENTER/HAMILTON
STANDARD])

12:00- 1:00 LUNCH

1:00- 3:00 MECHANICAL TECHNOLOGY, INC.
1. BRIEF INTRODUCTION OF MTI
2. OVERVIEW OF THE MTI STUDY AREA
3. VIBRATION AS AN INDICATOR OF MACHINERY PROBLEMS
4. A CURRENT MILITARY PROGRAM FOR AUTOMATED VIBRATION
DIAGNOSTICS
5. MTI STUDY AREA--ENGINE MONITORING AND DIAGNOSTICS
SYSTEMS FOR GAS TURBINE VEHICLES
6. INVESTMENT INFORMATION
7. SUMMARY

PRESENTERS:

LARRY LAGACE
RICHARD A. RIO
FLOYD YOUNG

3:00- 5:00 DAVID W. TAYLOR NAVAL SHIP R&D CENTER
1. GENERAL INTRODUCTION
2. EXISTING WORK
3. MACHINERY MONITORING PROPOSAL
4. RESOURCES/COST ESTIMATES

PRESENTERS: HANK WHITESEL
JOE DICKEY
WILL ANDERSON
HANK HEGNER

WEDNESDAY, 12 JANUARY 1983

8:30- 4:00 MSCM WORKING GROUP MEETING
1. CHAIRMAN'S BRIEFING
• OSD/IDA R&M ACTIVITIES
• TECHNOLOGY ASSESSMENT ACTIVITIES
• FEBRUARY TECHNOLOGY ASSESSMENT
ACTIVITIES AND SCHEDULE
2. TECHNOLOGY ASSESSMENT REVIEWS--CONCLUSIONS
3. REPORT INPUT REVIEWS
4. PROGRAM MANAGEMENT PROPOSAL REVIEWS

R&M STUDY MECHANICAL SYSTEMS CONDITION MONITORING
INSTITUTE FOR DEFENSE ANALYSES, ALEXANDRIA, VA
FEBRUARY 15-17, 1983

TENTATIVE AGENDA

TUESDAY, 14 FEBRUARY, 1983 (COMMONS ROOM)

8:00 A.M.-10:00 A.M. NORTHROP CORP. ELECTRONICS DIVISION
PRESENTATION
SPEAKER: ALVIN R. VOGEL

10:00 A.M.-12:00 NOON LSI AVIONICS SYSTEMS CORP.
SPEAKERS: PHILIP DARO
WALTER SHERWOOD
GEORGE BOONE
F-100 ENGINE DIAGNOSTIC SYSTEM
- RESULTS AND FINDINGS
- CONCLUSIONS AND RECOMMENDATIONS

1:00 P.M.- 3:00 P.M. BENDIX ENERGY CONTROL DIVISION
SPEAKERS: JACK WETZEL
JOSEPH BLUISH
TED REILLY

3:00 P.M.- 5:00 P.M. VIBRO-METER CORP.
SPEAKERS: DR. RICHARD GREAVES
MERVIN FLOYD
TOM MACALUSO
CARL NICOLINO

1. INTRODUCTION TO VIBRO-METER
 - PRODUCTS
 - LOCATION
 - PRESENT STATUS
2. ENGINE VIBRATION MONITORING SYSTEMS
 - ACCELEROMETERS
 - CONNECTORS AND CABLES
 - ELECTRONICS
3. OBJECTIVES OF AN EVM
 - APPLICATION
4. USE OF DATA
 - BENEFITS
5. FUTURE DEVELOPMENTS
6. CONCLUSION

43/32
2/14/83

UTR&DC
AND
HAMILTON STANDARD

March, 1983

HSPC 3S008-2

**ELECTROSTATIC ENGINE
MONITORING SYSTEM
(EEMS)**

for the

P&WA J-52 ENGINE

**Prepared for
Institute for Defense Analysis**



TABLE OF CONTENTS

	<u>Page</u>
1.0 INTRODUCTION	1
2.0 ELECTROSTATICS	2
2.1 Engine Condition Monitoring Using Electrostatics	2
2.2 Benefits of Electrostatics	3
3.0 MONITORING PROGRAMS	7
3.1 Background	7
3.2 Present Program	8
4.0 PROPOSED PROGRAM	12
4.1 Program Tasks	13
4.2 Electrostatic Engine Monitoring System (EEMS)	13
5.0 BENEFIT ANALYSIS	17
5.1 Analysis Methodology	18

LIST OF FIGURES

Figure No.

- | | |
|---|---|
| 1 | Electrostatics Wear Monitor |
| 2 | Electrostatic Probes |
| 3 | TF-33 Turbine Wheel Misalignment |
| 4 | TF-33 Turbine Erosion |
| 5 | Electrostatic Engine Mointoring System (EEMS) |
| 6 | Electrostatic Pulse Analyzer (ESPA) |



HSPC 3S008-2

1.0 INTRODUCTION

Hamilton Standard is developing a technology called electrostatics to use as a monitoring system for measuring internal component wear in gas turbine engines. The Electrostatic monitoring system is an improvement over current performance monitors because it measures physical deterioration giving warning substantially before traditional performance parameters are affected. Current program involve test stand monitoring and technology transfer to transport engine flight monitoring this year. The program suggested here is for flight baselining and demonstration in the Navy attack arena on the J-52 engine in the A-4 and A-6 aircraft. A formal proposal on this program can be presented upon request.

2.0 ELECTROSTATICS

2.1 Engine Condition Monitoring Using Electrostatics

The Electrostatics method (*) provides a simple, direct measurement of physical deterioration of internal engine components in the gas path, just as SOAP does in the oil system. By observing electrostatic pulses generated in the gas path as a result of component rubbing, chaffing, erosion and burning, electrostatics warns of potential engine performance degradation before it occurs. This early physical deterioration normally occurs in the hostile environment of the turbine engine and results in minute particles which form ionized clouds or pulses which generate the diagnosable electrostatic charge. The normal (healthy engine) deterioration rate is established as a function of engine cycling and power and a "baseline" count is established. When this "baseline" is exceeded by a predetermined margin, a warning is given that a "significant abnormal event" has occurred which requires further investigation.

Traditional engine condition monitoring consists of taking performance data from the engine at periodic intervals while operating, converting this data into a form that takes into account various temperatures and pressures and comparing this data with a baseline curve made at the time the engine was new or recently overhauled. Deviations indicate wear or possible incipient trouble. The inherent problems with this method are the complexity and time involved in analyzing a large quantity of performance data, and the need for performance to begin to deteriorate in order to indicate a problem.

The difference between the two methods is that electrostatics measures physical deterioration prior to its effecting performance, while "conventional" diagnosis relies on early detection of performance degradation regardless of the extent of prior physical deterioration. Measurement of physical deterioration takes the guesswork out of gas path monitoring and enables monitoring component wear from its inception, providing the ultimate in trending capability.

(*)Patents pending-UTC

2.1 (Continued)

The pulses or "charged clouds" are detected by inserting electrostatic probes into the engine's gas path or by encircling the gas path with a capacitively coupled ring probe as shown in Figures 1 and 2. As the pulse passes the probe, a time varying voltage is produced which can be analyzed and a "signature" developed corresponding to a given deterioration or "wear condition". Fault isolation is therefore possible by analyzing the location of the pulse and the pulse signature. The degree of deterioration can be determined by the number of pulses or "pulse rate".

2.2 Benefits Of Electrostatics

The projected benefits of Electrostatic Engine Monitoring include reduced risk with increased reliability and maintainability. The traditional Life Consumed versus Operating Time graph has been used for years to illustrate that Engine Condition Monitoring can reduce the costs of engine and aircraft maintenance, increase reliability, improve safety, reduce the risks of in-flight failures and thus save dollars.

Some of the specific benefits that electrostatics can provide are outlined in the following paragraphs.

Engine Wear Monitor

Since electrostatics monitors actual deterioration of the internal components, normal wear may be determined and maintenance scheduled based on wear rate in the true on-condition monitoring sense. Thus, a reduction in unscheduled maintenance, unscheduled engine removals and extension of inspection intervals can result because of advanced warning of abnormal wear conditions. Additionally, the pulse shapes (signatures) resulting from different engine wear situations vary from component to component so fault isolation to component level is possible. Thus, go/no-go and fault isolation information will be available with this technology.

ELECTROSTATIC Wear Monitor

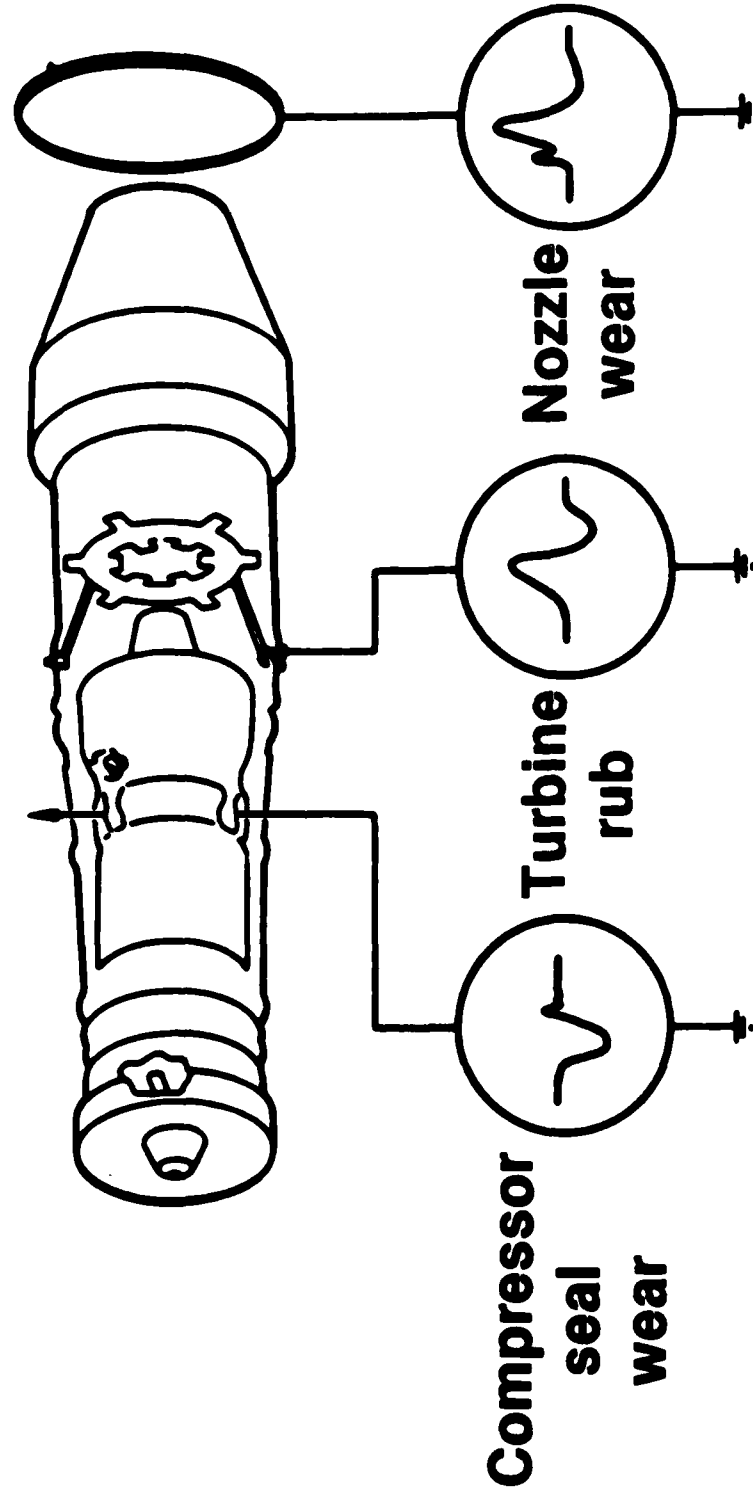

FIGURE 1



ELECTROSTATIC PROBES

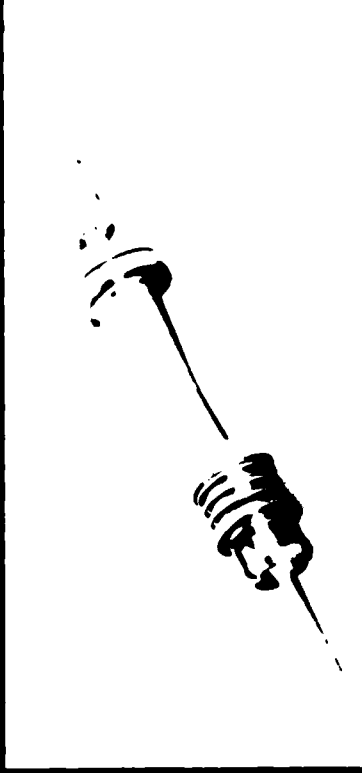
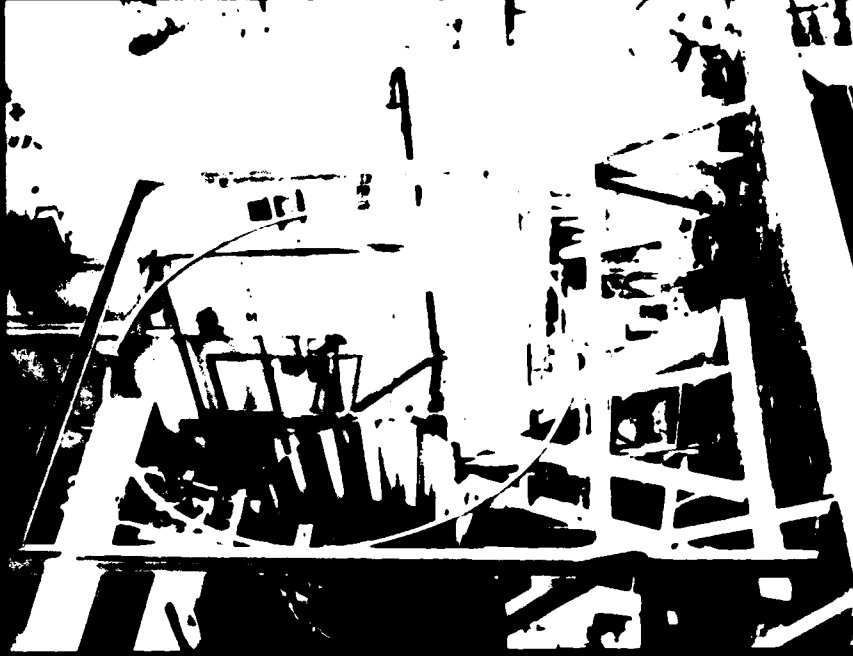

FIGURE 2



HSPC 3S008-2

2.2 (Continued)

Safety and Survivability

Not only is primary deterioration measurable with electrostatics, but secondary damage may be detectable as well. If a component rub or erosion condition reaches a severe level, larger particles of material travel back through the gas path resulting in measurable secondary damage. Thus, if foreign objects or a projectile is introduced into the gas path, the severity and duration of the damage is detectable. Having information on the severity of battle damage is a benefit which is planned for the future.

Reliability & Maintainability

As electrostatics become an integral part of the maintenance methodology, the ability to fault isolate and predict abnormal wear conditions will improve causing a decrease in unscheduled maintenance and an improvement in the preventative maintenance performed in scheduled maintenance. The increase in predictive maintenance will increase reliability and maintainability with a resultant increase in availability.



3.0 MONITORING PROGRAMS

3.1 Background

Hamilton Standard Division of United Technologies has been developing monitoring systems for more than 20 years. The technology advances which have been implemented by HSD have paralleled and complemented philosophical and technological changes in military and commercial maintenance programs.

In the early 1960's, the normal maintenance approach was for "hard time" replacement of parts. Engine parameters were just beginning to be monitored, primarily during required trim runs after maintenance. HSD provided equipment to facilitate trimming and engine parameter monitoring. These early units were strictly data gathering devices with limited or no automatic analyzing capability.

As maintenance philosophies changed in the 1970's, primarily in the commercial fleets, to "repair only on deterioration", a requirement for more sophisticated monitoring capability, both on the ground and in the air, was seen. HSD provided the latest equipment in such programs as AIDS, PETTS and AIDAPS that was more accurate and included more sophisticated diagnostic capability. Computers were used to accomplish, in real time, those analytical procedures formerly requiring a large fixed computer at the depot. On-board monitoring systems are now being used on many of the world's largest airlines and substantial financial benefits and much improved dispatch reliability have been proven.

To maintain this position in the forefront of engine condition monitoring, HSD continuously pursues an aggressive program of internal R&D with maximum use of the resources available to UTC. Development programs to improve the state-of-the-art in condition monitoring and diagnostics are planned in conjunction with engine development programs of Pratt & Whitney Aircraft (P&WA). The analytical basis of the diagnostic programs is developed using the expertise of the UTC Research Center, a world leader in signal analysis techniques.



HSPC 3S008-2

3.1 (Continued)

The recent rapid advances in both sensor technology and microprocessor power provides an opportunity to again make a quantum improvement in early detection and repair of jet engine deterioration. With the experience of HSD and the extensive resources available within UTC, we are currently in an excellent position to advance engine condition monitoring technology.

3.2 Present Program

Presently, HSD is using IR&D funds to develop electrostatic technology for both fighter and transport applications. The program in 1982 concentrated on developing baseline data during test cell operations on F100 and TF33 engines. The 1983 objective is to transfer the technology to the flight regime of a transport aircraft because of the lower risk involved in flight demonstration on a transport aircraft versus a fighter aircraft. Installation of electrostatic data acquisition equipment is presently being pursued on five to eight TF33 engines used on the C141 transport at Charleston AFB as part of a life extension program being conducted by Military Air Lift Command. Development of flight test data on transport type aircraft will allow positive correlation between test stand results and operation of the engine in the flight environment.

The initial evaluation of the technology has been on the F100 engine built by P&WA. Data has been taken during test stand runs using ground equipment and is being used in developing the expertise necessary to produce a signal classification system for the F100 engine. Correlation between specific features of the electrostatic pulse and various engine problems are being demonstrated for the F100 engine. The pulse definition work is a program identified as "Phase I, F100 Pulse Classifier", P. E. Zwicke, UTRC R82-395794-1, June 1982, which is being conducted at UTRC. Using the data developed from the UTRC effort, a computer driven analyzer is being developed to provide real time analysis of engine condition.



3.2 (Continued)

A program to develop TF33 baseline data has been in progress since 1982. On August 16, 1982, a TF33 engine S/N P659710 with 10,410 hours TSO was removed from a C141 aircraft and run in the test cell at Charleston AFB for low oil pressure problems. The electrostatic pulse count recorded by the Hamilton Standard Data Acquisition Unit indicated 51 positive and 46 negative counts, far exceeding the pulse count for a nominal TF33 engine. The engine was removed from service and disassembled. The findings after tear-down showing first stage inlet nozzle guide vane deterioration, turbine shroud shingling and turbine seal damage are illustrated in Figures 3 and 4.

The 1983 effort includes the generation of suitable test plans and the acquisition of appropriate flight test data. The TF-33 Program will demonstrate electrostatic applicability to an engine in the transport category. Development of flight test data on transport type aircraft will allow positive correlation between test stand results and engine operation in the flight environment. Data acquisition will be accomplished on five to eight flight units which will be installed on TF33 engines used on the C141 transport at Charleston AFB as a part of a life extension program being conducted by Military Air Lift Command.

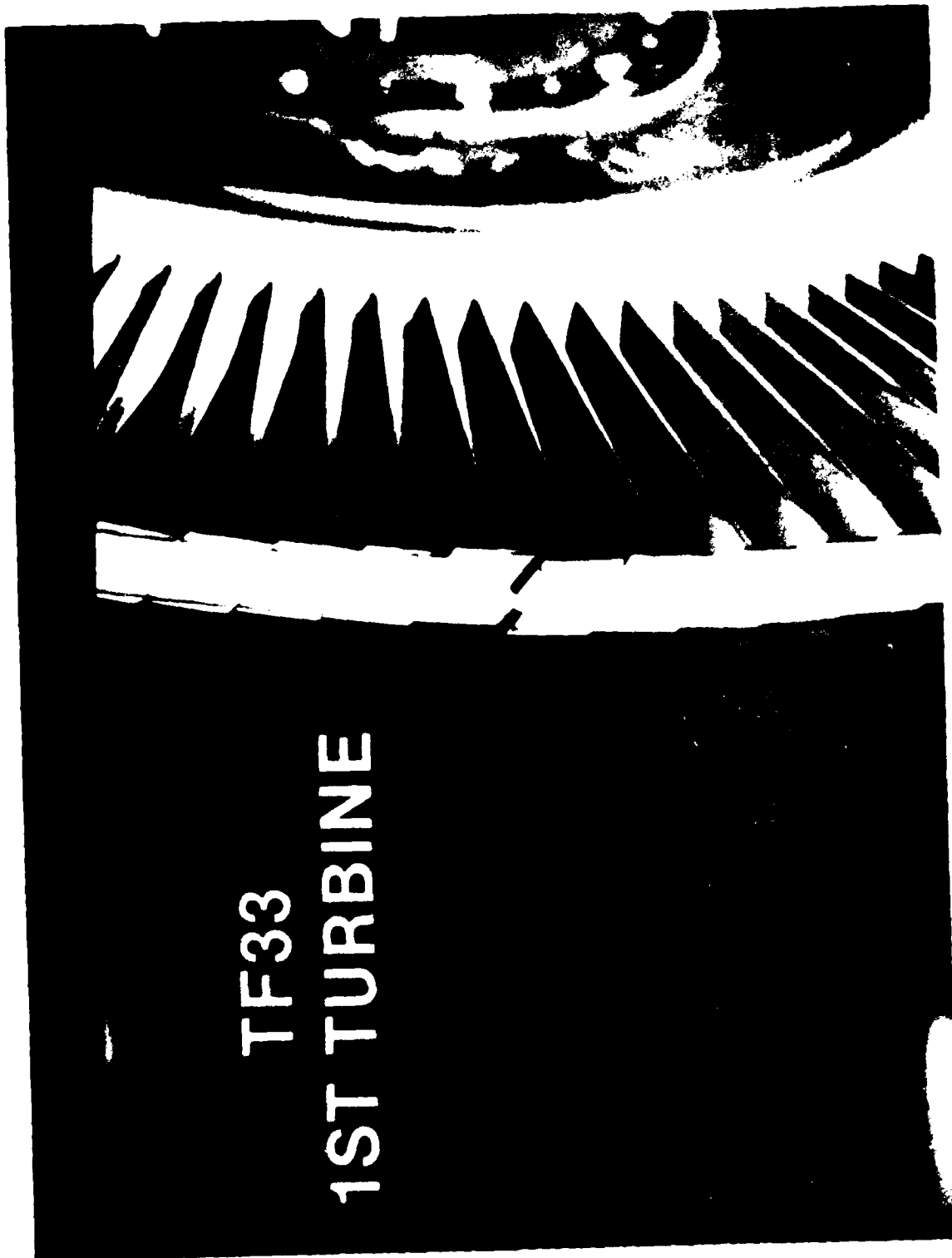

FIGURE 3



FIGURE 4



4.0 PROPOSED PROGRAM

Hamilton Standard would like to conduct a parallel program on the J52 attack engine to extend the technology into this more severe environment. Once these program objectives are met in the J52 attack application, we anticipate using this "baseline" for extensions to more advanced fighter/attack applications.

The proposed program will consist of mounting electrostatic data acquisition units on the J52 in the A-4 or A-6 aircraft during a flight test program and analyzing the data gathered to determine the severity of engine component wear. The goals of the program will be to:

1. Develop and demonstrate the technology and hardware for acquiring electrostatic pulses on operational fighter aircraft.
2. Verify and classify the pulse signals generated from the engine component wear.
3. Correlate specific electrostatic pulse data with specific critical component deterioration.

The proposed program will be conducted in two phases:

- I. Hardware Design and Construction
- II. Data Acquisition and Analysis

Phase I will occur in the first six months of the program, and Phase II will occupy the remaining 12 months.

Phase II will require ground operation to acquire baseline data and a flight program to develop the classification data base. Installation of the equipment on the selected aircraft and ground operation is expected to take about three months of the 12, with flight data acquisition and analysis using the remaining nine months.

The program cost is estimated to be \$950K. A more formal breakdown of the program elements will be made available upon request.

4.1 Program Tasks

The tasks to be performed in this program are:

- 1) Determine critical component criteria
- 2) Determine DAU and probe mounting
- 3) Design and build DAU
- 4) Design, build and qualify probes
- 5) Prepare test plan
- 6) Support data acquisition activities
- 7) Analyze data
- 8) Develop preliminary classifier
- 9) Evaluate classifier results against engine condition
- 10) Evaluate degradation thresholds

4.2 Electrostatic Engine Monitoring System (EEMS)

There are four (4) specific pieces of hardware required to implement an electrostatic monitoring program as shown in Figure 5. The status panel is (TBD) but is planned to offer cockpit information in the future.

- Engine Mounted Probes
- Data Acquisition Unit (DAU)
- Transfer Unit (TU)
- Electro static Pulse Analyser (ESPA)

The TU and ESPA are common to all engines with minor software changes required to accommodate various engine/aircraft combinations. The Probes and DAU are designed and qualified for the particular application desired.

Probes

The electrostatic probes will be developed using the existing probes in the engine and modifying them to monitor the pulses. The modification basically consists of electrically isolating the protruding portion of the probe from the case of the engine and attaching a lead wire to the isolated section.

ELECTROSTATIC ENGINE MONITORING SYSTEM (EEMS)

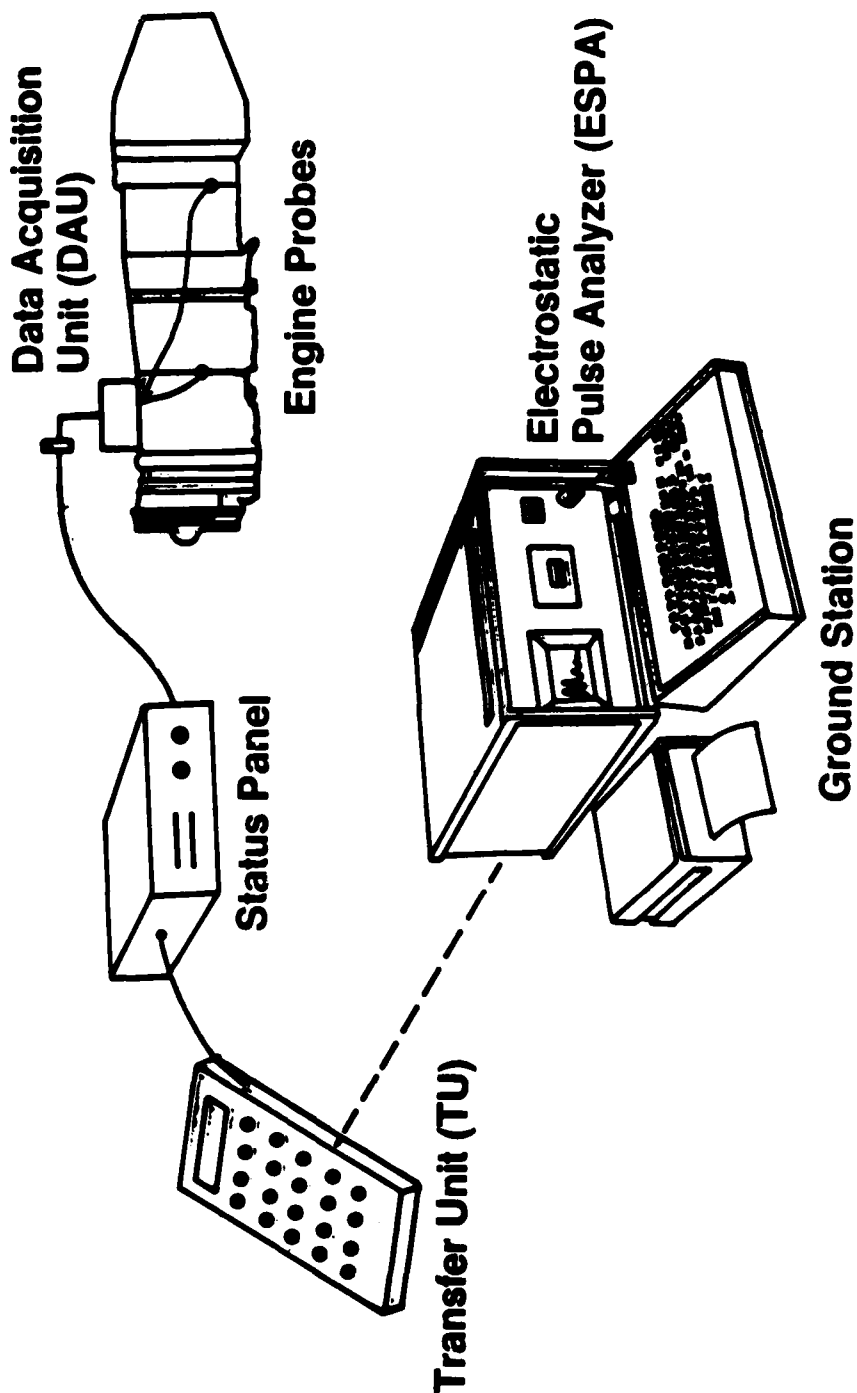

FIGURE 5

4.2 (Continued)

DAU

The DAU will be designed for the aircraft/engine combination selected. The unit will be a small closed box mounted on the engine in a convenient location. The unit will be constructed to withstand the normal environmental conditions in the engine compartment in a relatively cool area forward of the diffuser. It will be capable of recording at least three electrostatic probes, rotor speed and EGT. It will be designed to operate independent of the pilot's control and will turn on and off using the engine RPM as a control signal. Power will be supplied by the on-board power system. The memory will be non-volatile so that all recorded information will be maintained after engine shutdown.

TU

The Transfer Unit will be a small hand-held device which is used by the flight line personnel to extract the recorded data from the engine mounted Data Acquisition Unit (DAU). It is designed to interface with a connector placed in an easily accessible area on the engine and to cause the DAU to dump the contents of its memory into the memory of the TU. This data is then transferred into the analyzer located in a nearby area. The TU will be available to the crew chief of the program aircraft and will be battery powered and simple to operate. A readout of the number of pulses for each flight will be included on the TU for manual recording of engine condition by the flight line personnel.

ESPA

The Electrostatic Pulse Analyzer (ESPA), shown in Figure 6, is designed to provide a means of digitizing, monitoring and analyzing pulses detected by the electrostatic probes. The unit normally located in an engine test facility consists of a five inch CRT display, a digital cassette mechanism, a alpha-numeric keyboard with all hardware and software to enable the system to condition, digitize, record, analyze and display a pulse signature. The Analyzer is contained in a standard 19-inch rack suitable for standard cabinet mounting. This unit will take the signals from the Transfer Unit (TU) and provide the analysis power required for the development phase of the program. The goal will be to develop the technology to provide in-aircraft analysis of the pulse significance for pilot warning and flight line maintenance uses.



**UNITED
TECHNOLOGIES**
HAMILTON
STANDARD

HSPC 3S008-2

ELECTROSTATIC PULSE ANALYZER

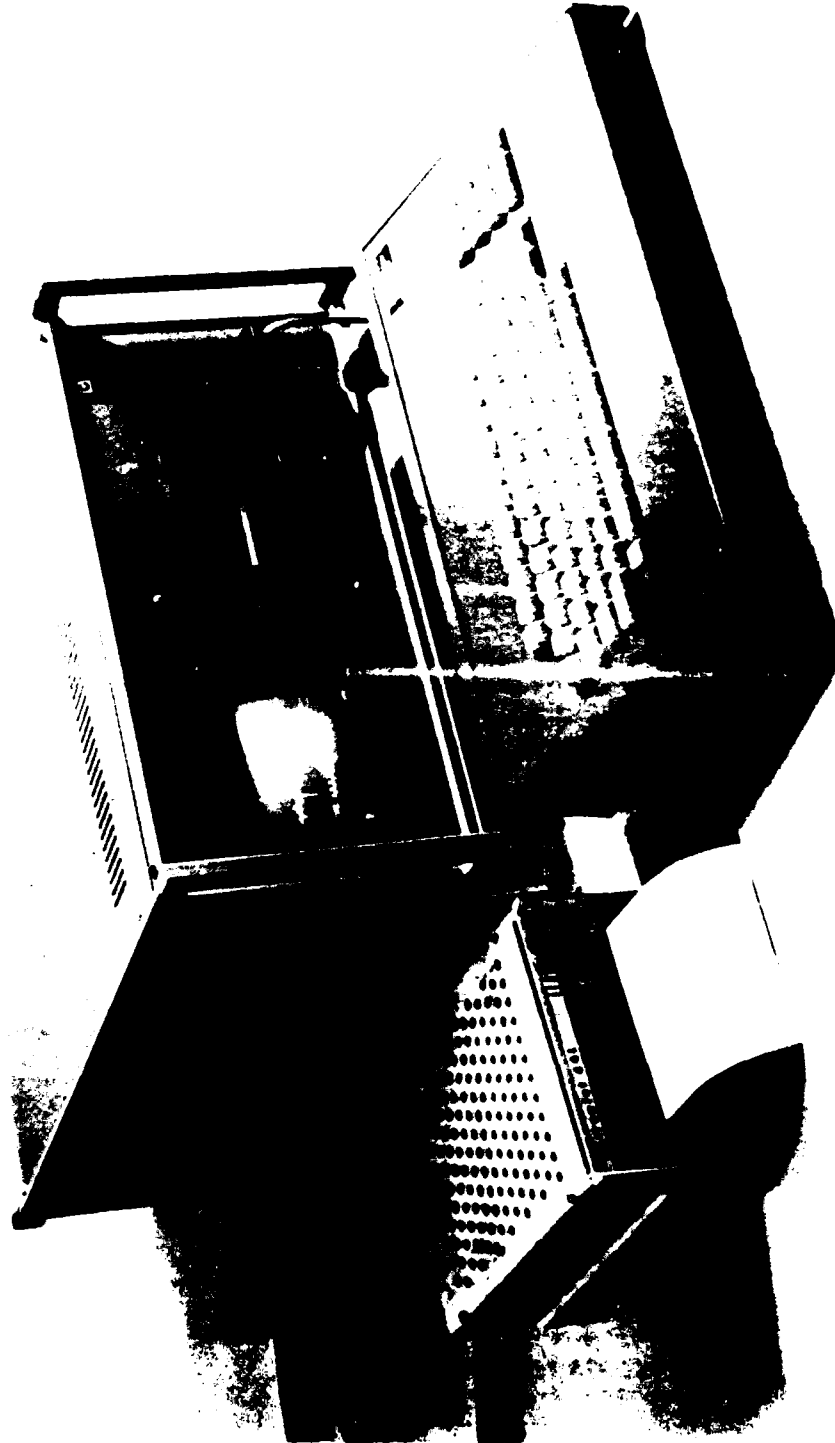

FIGURE 6



HSPC 3S008-2

5.0 BENEFIT ANALYSIS

The capability to determine the health of the internal core of a jet engine provides many benefits. Estimations of the potential savings which may accrue with electrostatic condition monitoring have been made using data derived primarily from the Navy 3M (Maintenance and Material Management) system for J-52 P6/8/408 engines. Electrostatics monitoring improvement factors are engineering estimates based primarily on test stand data and airline condition monitoring experience.

Even though this technology will not be confined to the J52, the potential savings on an annual basis for this engine alone using an Electrostatic Engine Monitoring System are substantial. The potential savings result from the reduction in unschedule engine removals, extension of major component repair intervals and extension of hot section inspection intervals. Unschedule Engine Removals (UERs) are estimated to be reduced by 30% because of the early detection of engine problems resulting in direct savings of \$2.1M per year. The reduced UER rate will in turn require fewer spare engines resulting in a savings of \$3.9M.

Extending the major component repair interval by an estimated 25% from 2500 hours to 3125 hours will result in a direct savings of \$1.85M per year. The reduction in spare engines needed will be from 12 to 10 engines for a savings of \$2.6M.



HSPC 3S008-2

5.0 BENEFIT ANALYSIS (Cont'd)

Extension of the hot Section inspection intervals will provide a direct savings of \$2.36M yearly and a reduction of requirements for 2 spare engines for a one-time savings of \$2.6M.

Adding up the total cost savings from the reduction in UERs and extension of overhaul and hot section inspection intervals are estimated to save \$6.3M per year and \$9.0M one time savings.

The potential savings on this engine alone should justify the funding of a demonstration program. The other fighter attack aircraft potential savings possible using similar programs adds additional justification for funding this program.



5.1 Analysis Methodology

The following illustrates the methods for arriving at the potential savings discussed.

Data Base

- 1) Engine Flying Hours (EFH)

P6/8	360,000/yr	(NAVAIR)
P408	95,000/yr	(NAVAIR)

- 2) **Unscheduled Engine Removals (UER)**
 - o UER Rate:

P6/8	.63/1000 EFH	(3M)
P408	1.15/1000 EFH	(3M)

 - o UER's chargeable to internal engine components monitored by electrostatics: 58% of total (Aircraft Engine Maintenance System) (AEMS)

 - o Direct UER cost 10K/eng (P&WA-GPD)

 - o UER Turn Around Time (TAT) four days (P&WA-GPD)

- 3) **Major Component Repair Interval**
 - o Time Between Major Component Repair

2500 hours	(P&WA-GPD)
------------	------------

 - o Cost of Overhaul

\$50K	(P&WA-GPD)
-------	------------

 - o TAT of Overhaul

52 days	(P&WA-GPD)
---------	------------

- 4) **Hot Section Inspection**
 - o Time Between Inspection (TBI)

P6/8	750 hours	(3M)
P408	500 hours	(3M)

 - o Hot Section TAT

5 day	(P&WA-GPD)
-------	------------



5.1 (Continued)

Direct Savings Calculation

1) UER

- a) Total UER/yr = UER rate x EFH = 722 eng/yr
- b) UER's chargeable to monitored components
Total UER/yr x .58 = 419 engines
- c) Direct cost of chargeable UER's
419 eng/yr x \$10K/eng = \$4190K/yr
- d) Fifty percent of chargeable UERs saved with electrostatic monitoring
(eng. est.)\$4190K/yr x .5 = \$2.1 M/yr.

2) Repair Extension

- a) Total repair/yr. = EFH/yr - TBO = 192 eng./yr.
- b) Total direct cost of repair = eng. /yr x cost/eng = \$9100K/yr.
- c) Electrostatic monitoring will allow 25% extension of repair time (eng. est.)
- d) Engines/yr. with extended TBO = 145 eng/yr.
- e) New cost 145 x 50K = \$7,250K/yr.
- f) Yearly savings \$9100K - \$7250 K = \$1.85 M/yr.

3) Hot Section Inspection Extension

- a) Total hot section inspection EFH - TBI = 670 eng./yr.
- b) Total cost cost of inspection x # of eng. = \$13,400 K/yr.
- c) Electrostatic monitoring will allow 25% extension of hot section inspection time (eng. est.)
- d) Eng./yr. with extended inspection time = 552 eng/yr.
- e) New cost 552 x 50K = \$11,040 K/yr.
- f) Savings/yr = \$13,400 K - \$11,040 K = \$2.36 M/yr.

TOTAL DIRECT COST SAVINGS/YR.	\$2.1 M
	1.85 M
	<u>2.36 M</u>
	\$6.31 M/yr.



HSPC 3S008-2

5.1 (Continued)

One Time Savings Calculations

1) UER

- a) 419 UERs/yr. para 1.C
- b) Total days used $419 \times \text{TAT} (4) = 1676$ days
- c) Five day week @ 52 weeks = 52 weeks = 260 days
- d) $1676 - 260 = 6.45$ therefore six spares required to cover
- e) fifty percent fewer engines required with electrostatic monitoring -
eng. @ \$1.3 M (P&WA-GPD) = \$3.9 M savings

2) Repair

- a) Eng. required to cover repair non-electrostatics:
 $182 \times 52 (\text{TAT}) - 260 = 12$ eng.
- b) Eng. required to cover repair with electrostatics:
 $145 \times 52 - 260 = 10$ eng.
- Savings 2 eng. @ \$1.3 M = \$2.6 M

3) Hot Section Inspection

- a) Eng. required to cover hot section inspection without electrostatics
 $.670 \times 5 (\text{TAT}) - 260 = 12$
- b) Eng. required to cover hot section inspection with electrostatics
 $552 \times 5 - 260 = 10$
- Savings 2 eng. @ \$1.3 M = \$2.6 M

Total one time savings = \$9.3 M

RELATED WORK/TRANSFERRABLE TECHNOLOGY

The development of an integrated vibration monitoring system for the BlackHawk transmission will benefit from similar automatic diagnostic systems and related technology already developed. Several of these systems are described below.

(1) Electrostatic Pulse Analysis Classifier (ESPA)

The ESPA program is a Joint HS/UTRC/P&WA program to develop a gas turbine engine monitoring and diagnostic method based upon electrostatic pulses in the gas path. An automatic classifier has been developed which detects 24 different engine events (such as blade rub and blade erosion) based upon shape differences in the electrostatic pulses produced by these events (Ref. B). The classifier is being implemented in microprocessor based hardware. The classifier development and implementation procedures are applicable to the vibration monitoring program.

(2) NDE Programs:

Several monitoring and inspection systems developed under contract and in-house have common elements with the vibration monitoring program. Ultrasonics have been used to inspect various gas turbine engine components. Pattern recognition has been used to predict the strength of adhesive bonds, using information extracted from ultrasonic data. Signal Processing and pattern recognition have been applied to Eddy current signals to locate and size various flaws in aircraft structures. Acoustic Emission monitoring is being applied to detect and monitor crack growth in highway bridges. Image processing and understanding is being applied to fluoroscopic images of turbine blades to automatically find various metallurgical flaws.

(3) Laser Vibration Sensor (LVS):

UTRC has developed a LVS for industrial and military monitoring applications. The LVS has already been used to acquire vibration data from helicopter gearboxes. The advantages of the LVS are (1) very high bandwidth (1 to 1MHz), (2) noncontacting, (3) nonresonant, (4) high dynamic range (10^6 G's), (5) surface monitoring capability. Although the LVS is applicable for ground test systems, it is several years away from being applicable for in-flight monitoring. However, the LVS will still play an important role in the technical plan for developing the in-flight system prototype. Specifically, it will be used to scan the gearbox to find the optimum locations for mounting the accelerometers. This is a crucial step in the successful detection of low-energy failure-modes.

TABLE 1: REDUCED MISSION ABORTS

1. Fleet Size - 1107 aircraft (latest figure)
2. Usage - 69 hrs/ac-month (specification)
3. False Indications - 2.25/1000 flight hours (estimate)
4. Cost - \$1000/flight hour (approximate)
5. Aircraft Life Cycle - 20 years (estimate)
6. Assumptions:
 - (a) 50% of false indications occur on outbound leg
 - (b) one hour extra flight time per abort
 - (c) 97% monitor efficiency at eliminating aborts due to false indications

TABLE 2: SYSTEM AVAILABILITY

1. Transmission MTBF's 7000 hours: 2 accessory modules
 5000 hours: 2 input modules
 4500 hours: 1 main module
2. Usage - 69 hrs/aircraft-month
3. Fleet size - 1107 aircraft
4. Fleet deployment - 60% small base (< 17 a/c)
 40% large base (> 17 a/c)
5. Small base - 75% spares available in 3 days
 25% spares available in 3 weeks (depot)
Large base - 50% spares available in 3 days
 50% spares available in 3 weeks (depot)
6. 80% monitor efficiency at scheduling removals; thus reducing 3 week waiting
period to 2.4 weeks
7. Aircraft cost - \$6.2M

BLACKHAWK TRANSMISSION MONITOR DEVELOPMENT SCHEDULE

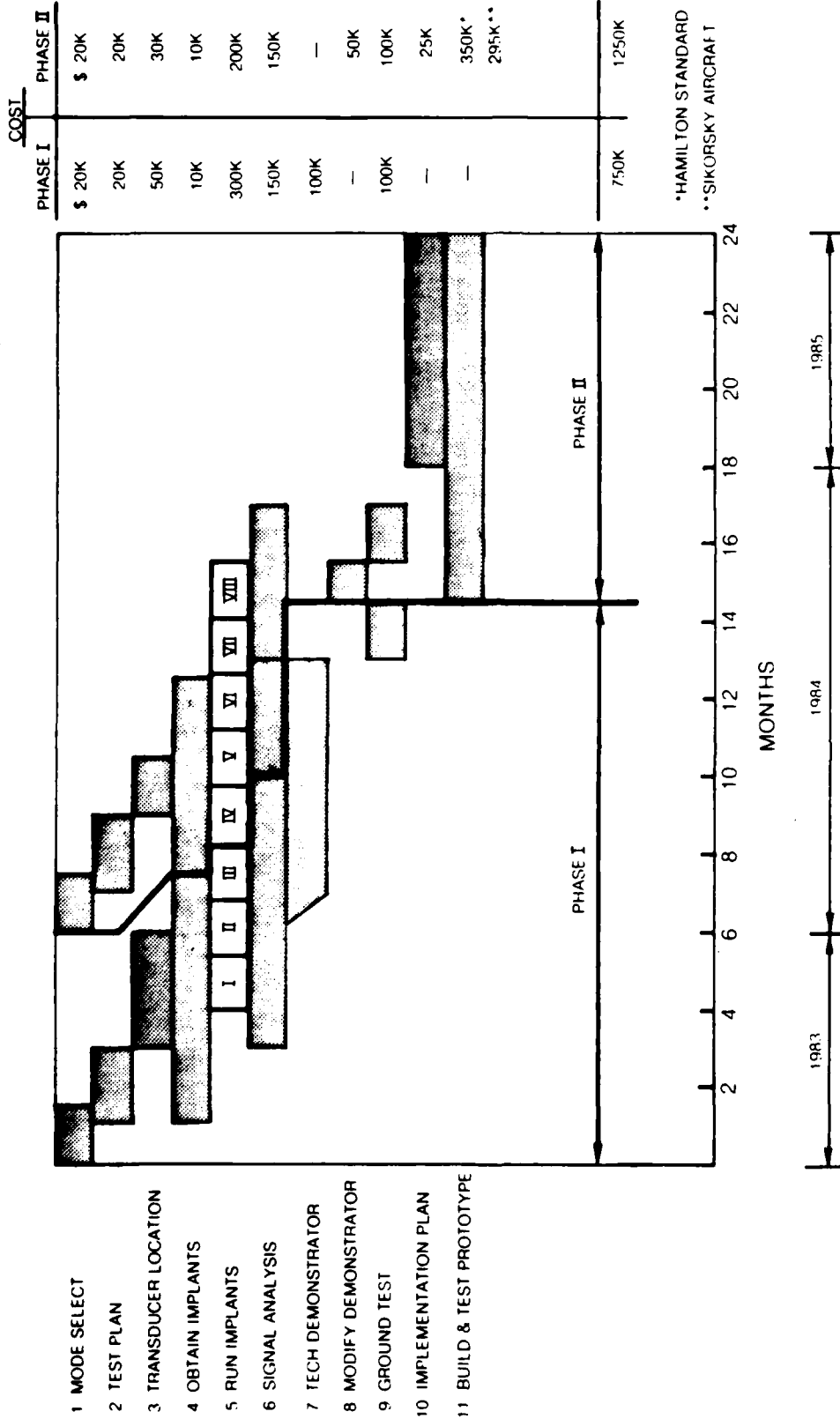

MECHANICAL TECHNOLOGY, INCORPORATED

**OSD/IDA R&M Study Briefing for the
Mechanical Systems Condition Monitoring
Working Group**

by

Richard A. Rio



Mechanical Technology
incorporated

Briefing Outline

- Background on Mechanical Technology Incorporated
- Overview of the MTI Study Area
- Vibration as an Indicator of Machine Problems
- A Current Military Program in Automated Vibration Diagnostics
- MTI Study Area for Tank Monitoring Systems

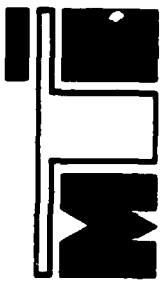

OBJECTIVE

To develop a science-based,
growth enterprise built on the
profitable manufacture and sale
of products and services

Industry through Science and Innovation



STAFF GROWTH

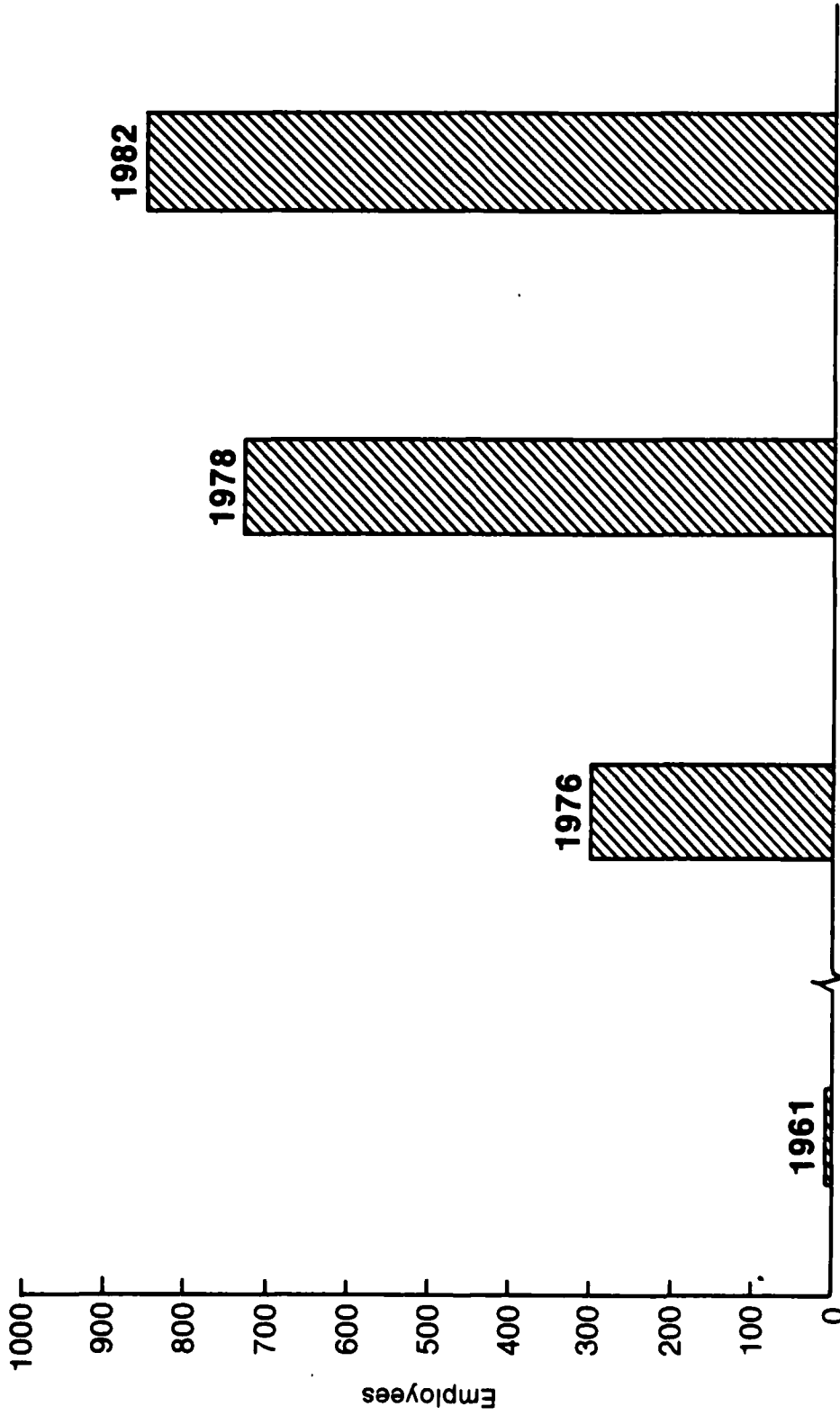

**MECHANICAL
TECHNOLOGY
INCORPORATED**
822016(A)

MTI Growth

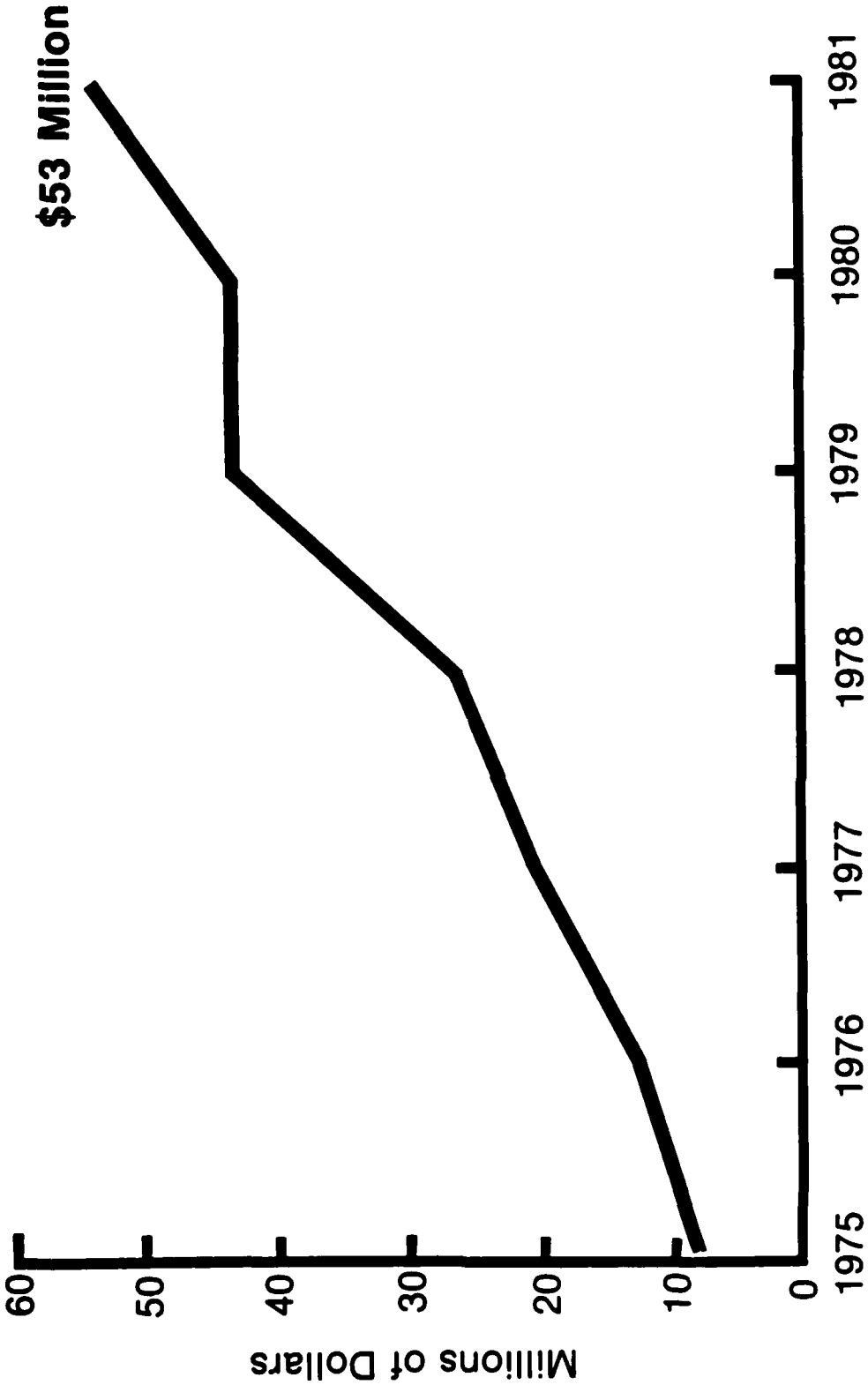

**MECHANICAL
TECHNOLOGY
INCORPORATED**
793182(a)

Mechanical Technology Incorporated Corporate Structure

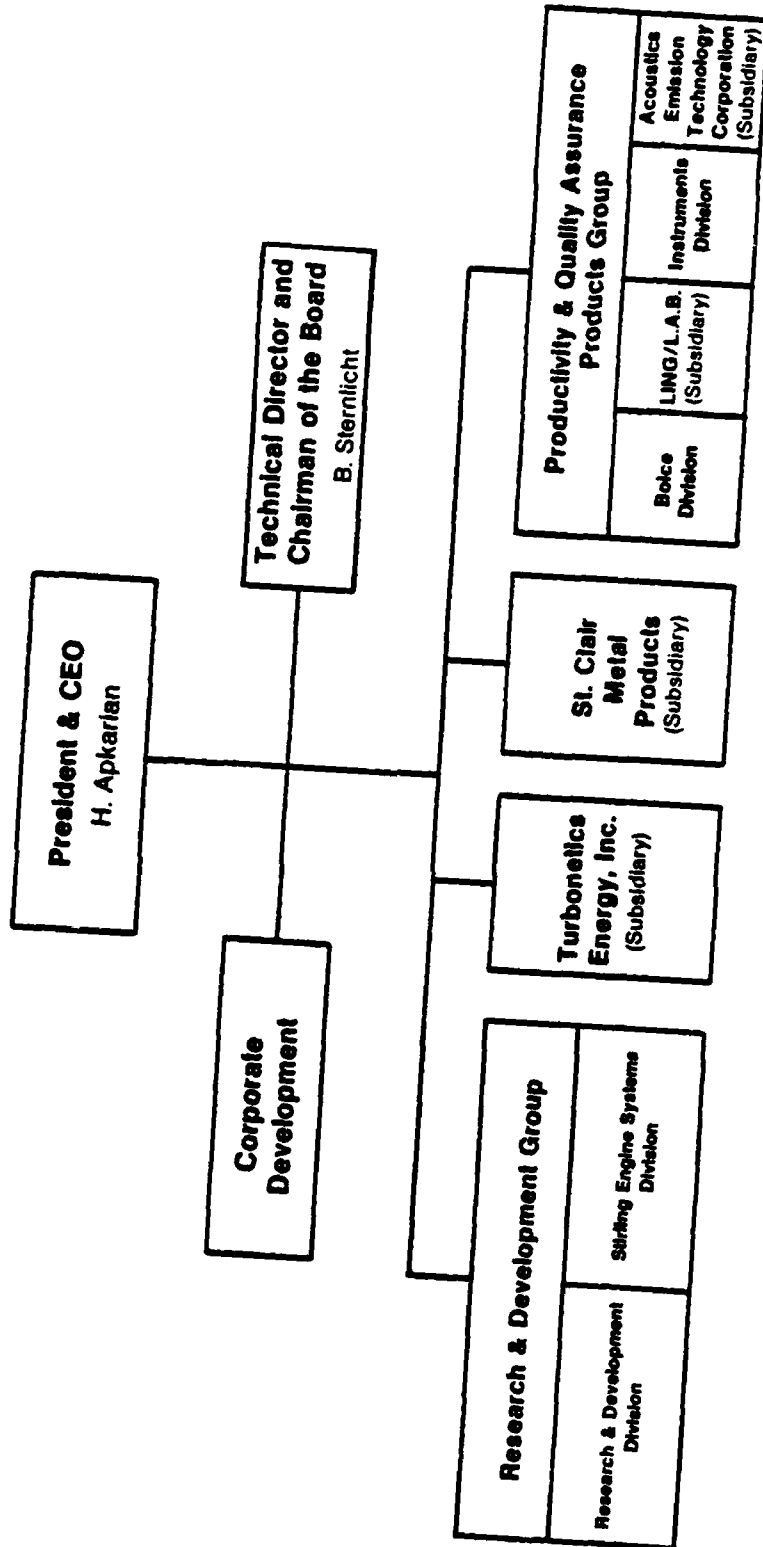

MTI Where We Are

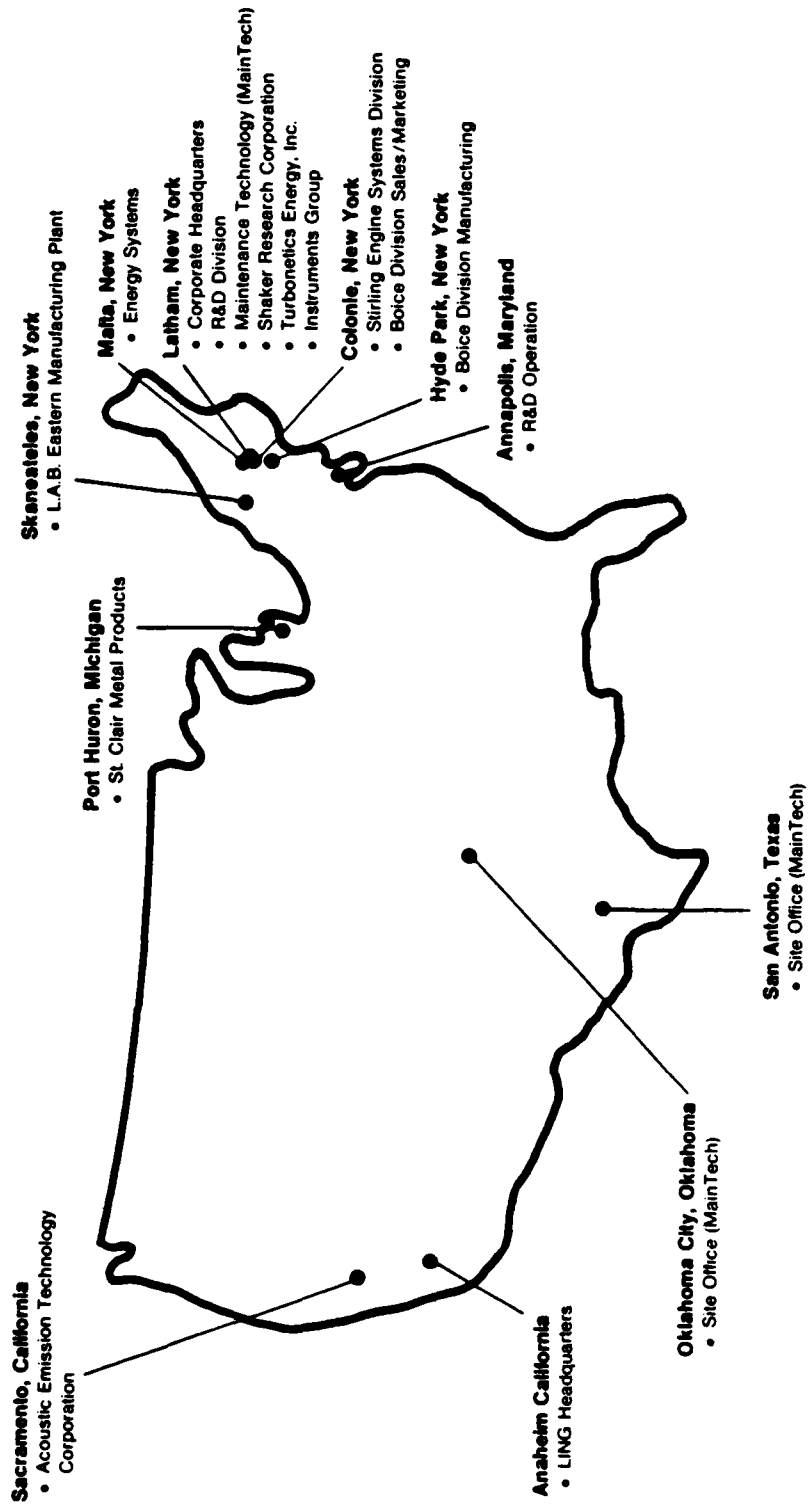

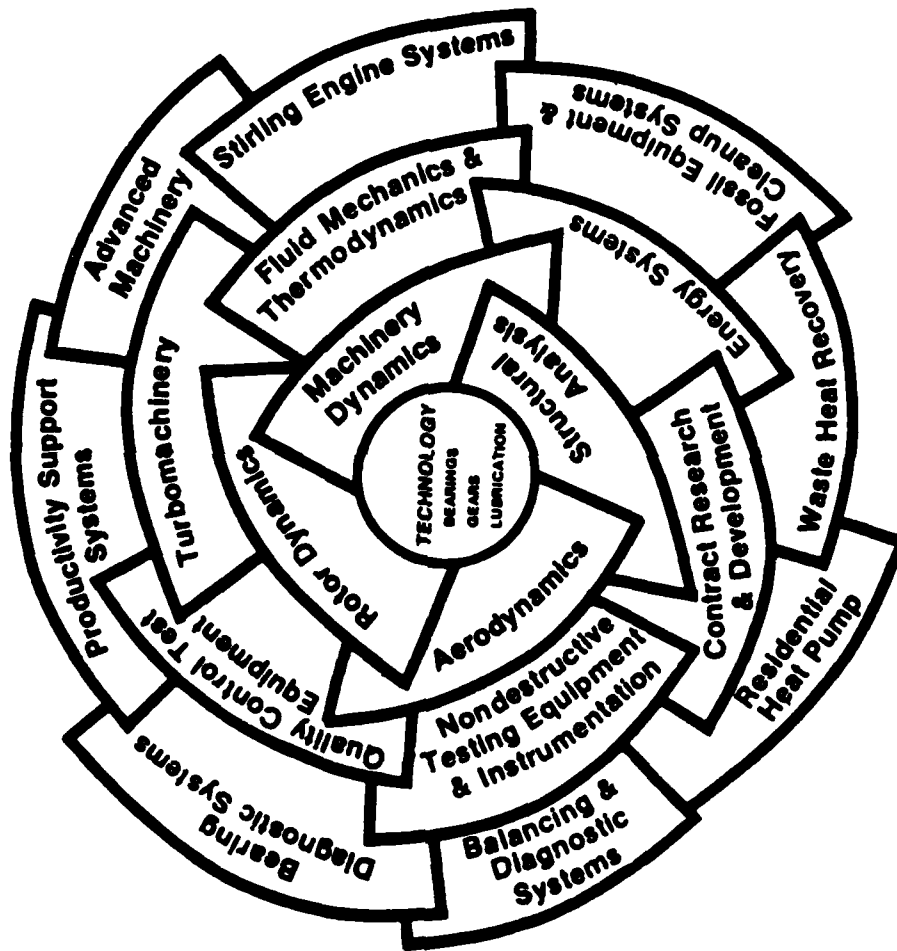

Maintenance Technology Division

Charter:

To Transfer Current Technology
to the Maintenance Arena

MainTech Evolution

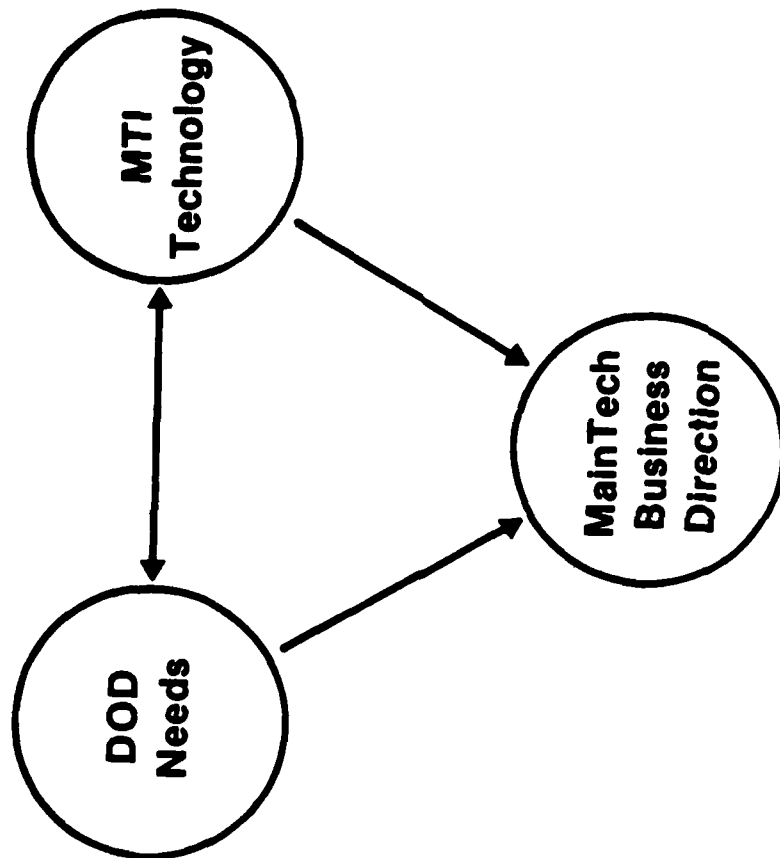

Maintenance Technology Activity

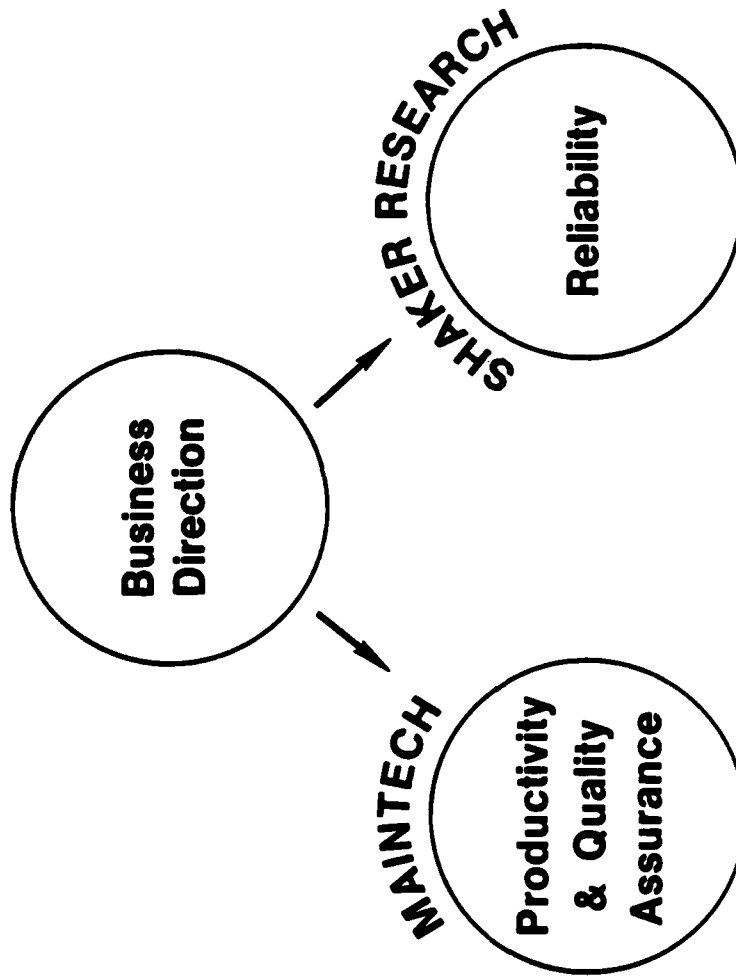

- ◆ Automated Systems for
 - Test
 - Inspection
 - Component Evaluation
 - Machinery Diagnostics
- Intelligent Monitoring Systems
- Field Troubleshooting Services
- Unique Monitoring DAS
 - Remote
 - Dynamic Data Analysis

Areas of Expertise

- **Rotating Machinery and Performance Condition Monitoring**
- **Testing, Diagnostics, Inspection, and Analysis**
- **Automated Systems**
- **Total System Integration**
- **Adaptable to Existing Processes and Procedures**

Relevant MTI Resources

- **Engine Experience**
- **Machinery Diagnostics**
- **Computer Controls and Communications**
- **Inspection and Gaging Systems**
- **Personnel Familiar with Maintenance Procedures**

MTI Study Area

- **Category**
 - Advancing Technologies for New Applications

- **Technology**
 - Intelligent Microprocessor-Based Monitoring System for Continuous Machinery Surveillance with Fault Detection, Diagnostics, and Prognostics

MTI Study Area

- **Application**
 - Gas-Turbine-Powered Vehicles Where R&M Is Crucial for Weapons System Effectiveness

- **Example**
 - General Dynamics M-1 Tank: Ground-Based Vehicles Have Less Space and Weight Restrictions, More Complex Drive Train Over Flight Aircraft and More Severe Environmental Effects

Vibration is an Indicator of Machine Problems

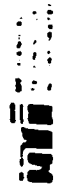
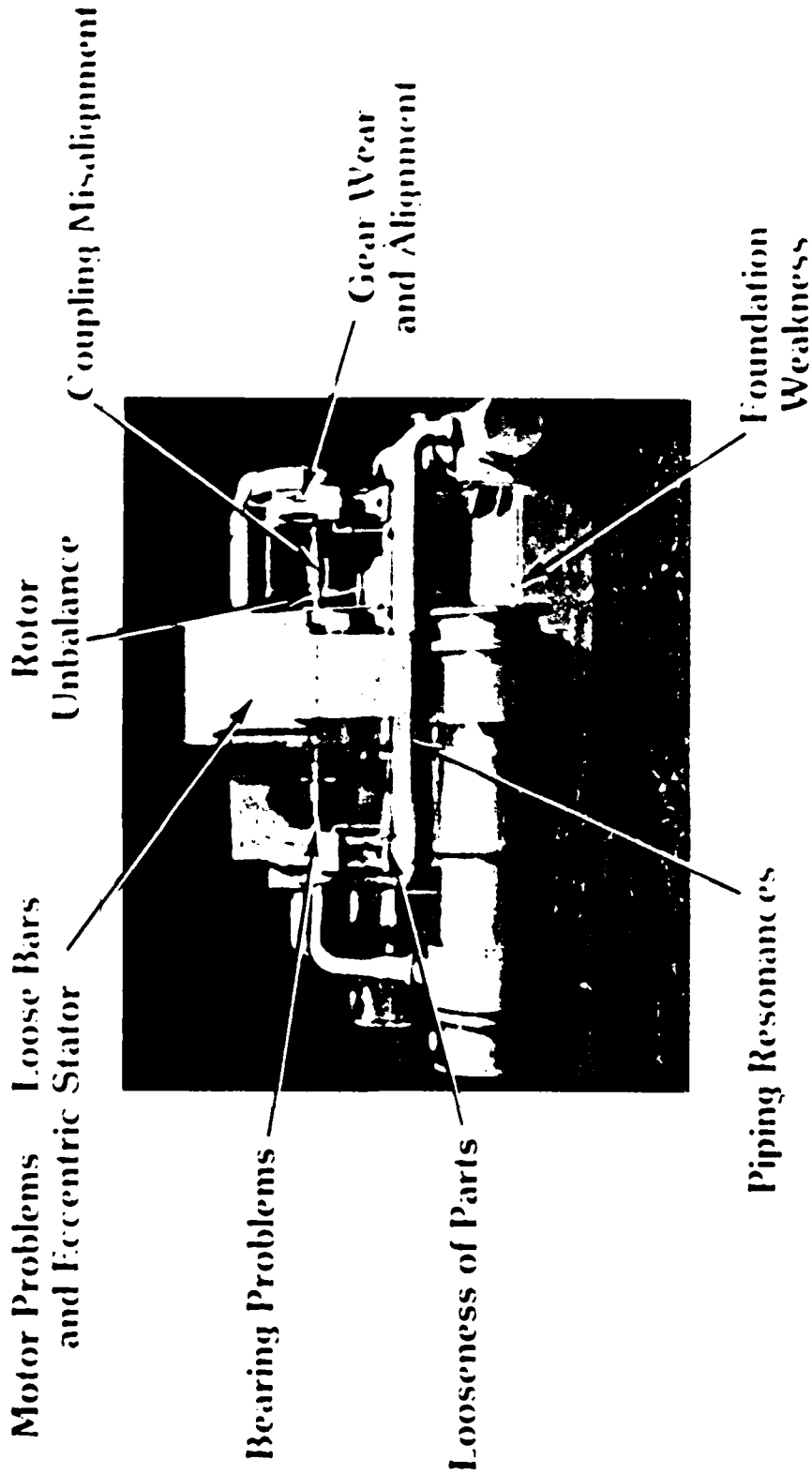

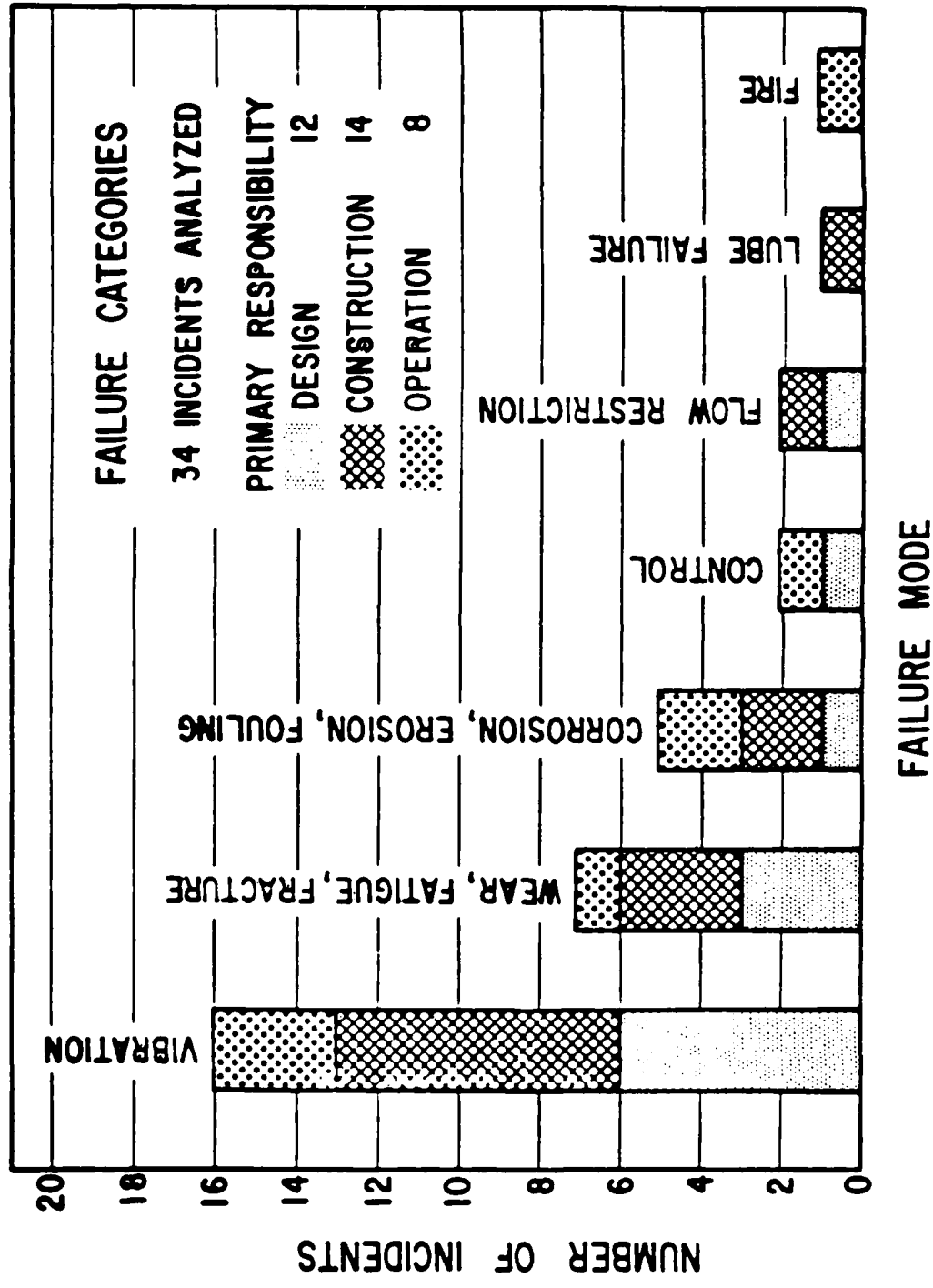

Using Vibrations Management as an Aid to Machine Maintenance

- Understand Vibrations
- Use Basic Vibration Measurements to Assess General Health and to Detect Problems
- Pinpoint Problem Areas by Analyzing Vibration Characteristics
 - Frequency
 - Direction
 - Location
 - Phase

SIGNATURE ANALYSIS

TYPES OF INFORMATION OBTAINED

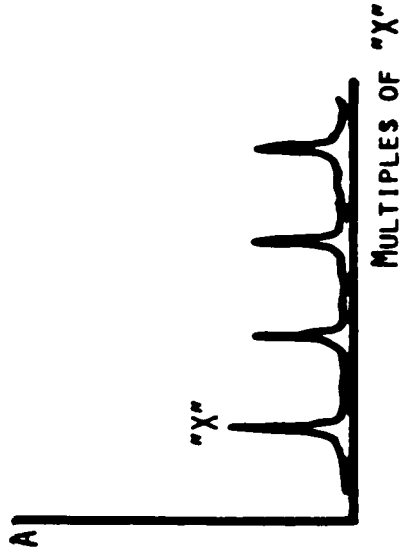
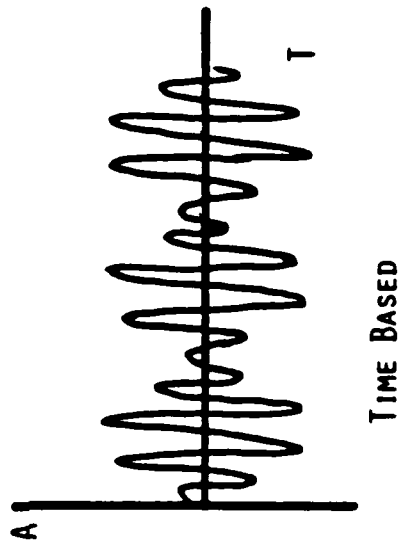
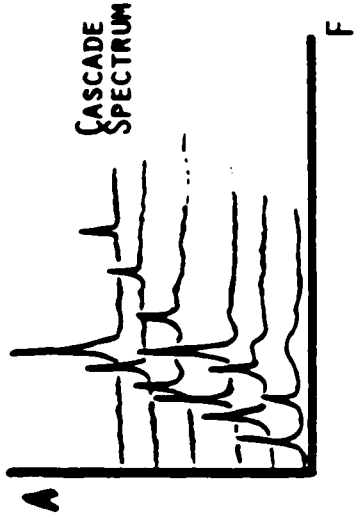
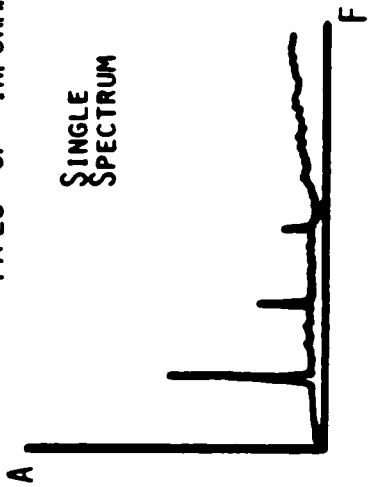

MECHANICAL TECHNOLOGY INCORPORATED

Demodulation

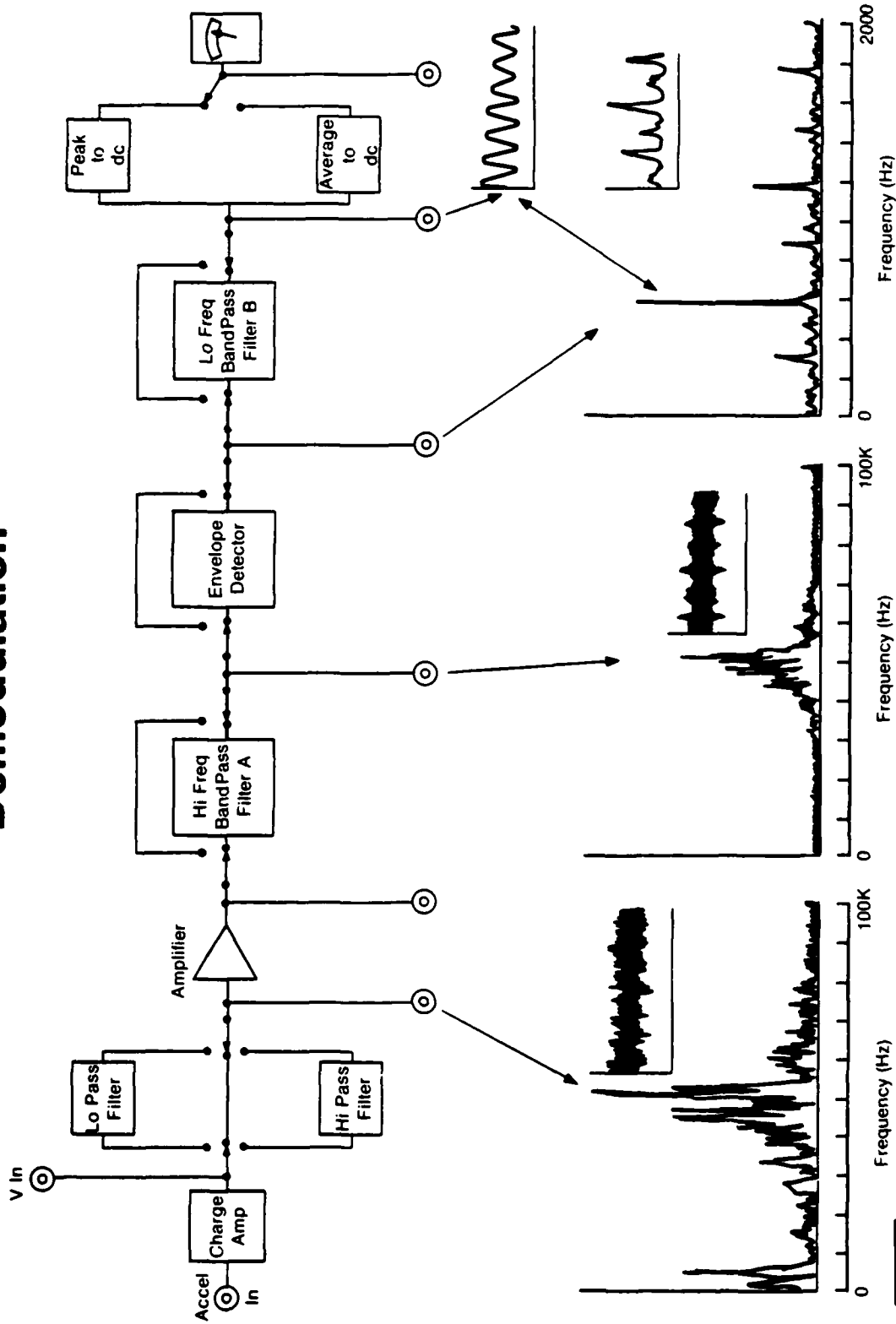

The Process of Equipment Fault Diagnosis

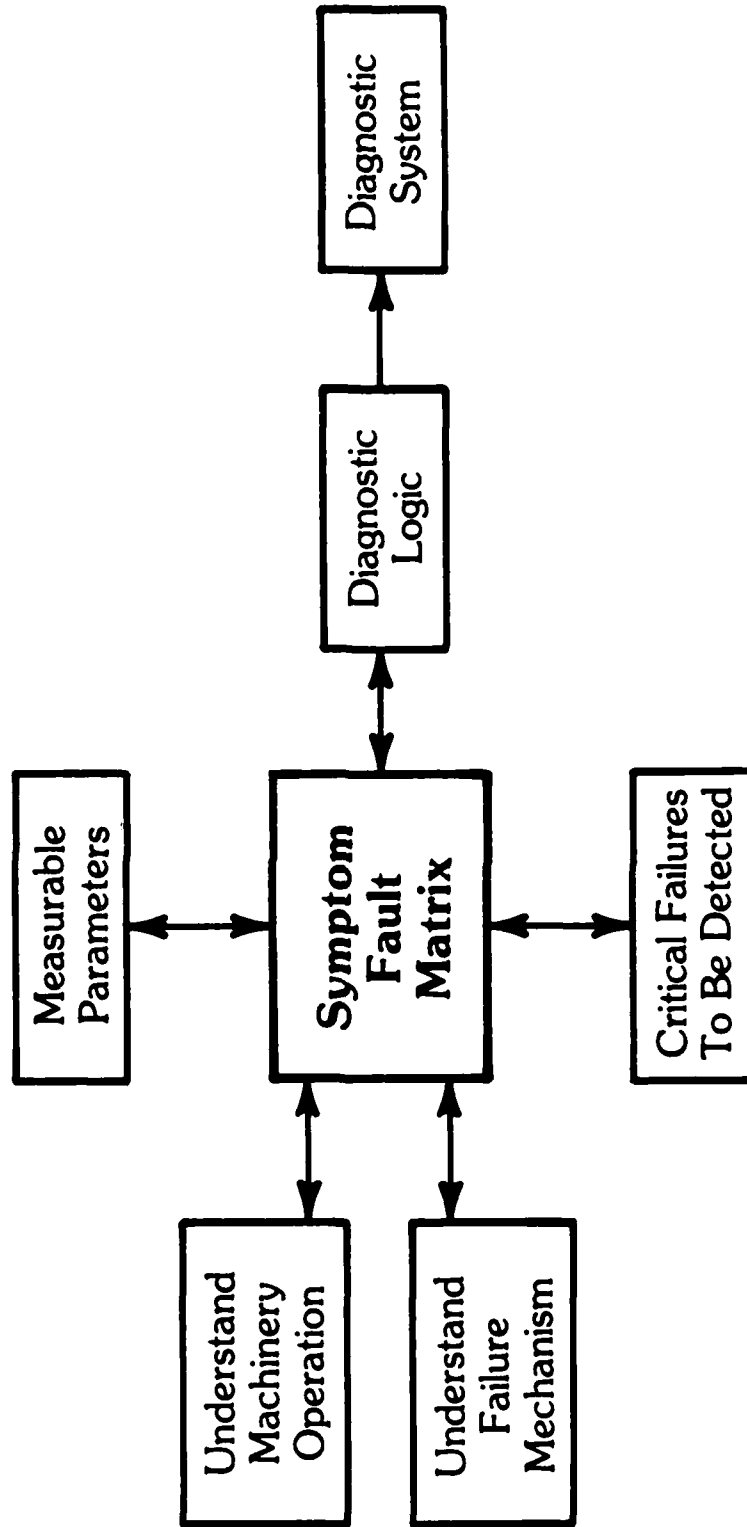

MECHANICAL PROBLEMS INDICATED BY MODULATED VIBRATION SIGNALS

<u>MECHANICAL PROBLEM</u>	<u>DIAGNOSTIC INDICATOR</u>
GEAR INACCURACIES	AMPLITUDE MODULATION OF GEAR-MESH FREQUENCY (F_G)
GEAR DAMAGE	AM MODULATION F_G
GEAR RUNOUT	AM MODULATION F_G
HELICOPTER GEAR NOISE	EVIDENCE OF STRONG MODULATION PRODUCTS
RUNOUT OF CENTRIFUGAL OR AXIAL COMPRESSOR IMPELLER	BLADE-PASSING FREQUENCY MODULATED AT ONCE-PER-REVOLUTION AS FUNCTION OF TIP-TO-SHROUD CLEARANCE VARIATIONS
BALL BEARING DEFECTS	BALL OR RACE RESONANT FREQUENCY AMPLITUDE-MODULATED AT BALL PASS FREQUENCY
DIESEL VALVE TIMING	VALVE IMPACT RESONANCE MODULATED BY OPENING/CLOSING RATE
I.C. ENGINE MAIN BEARING RUB	STRUCTURAL RESONANT FREQUENCY MODULATED AT IMPACT OR ROTATIONAL FREQUENCY
HIGH SPEED GEAR TOOTH	FREQUENCY MODULATION (MANY SIDEBANDS) NEAR F_G

Periodic Data Showing Deterioration of Compressor Gearbox

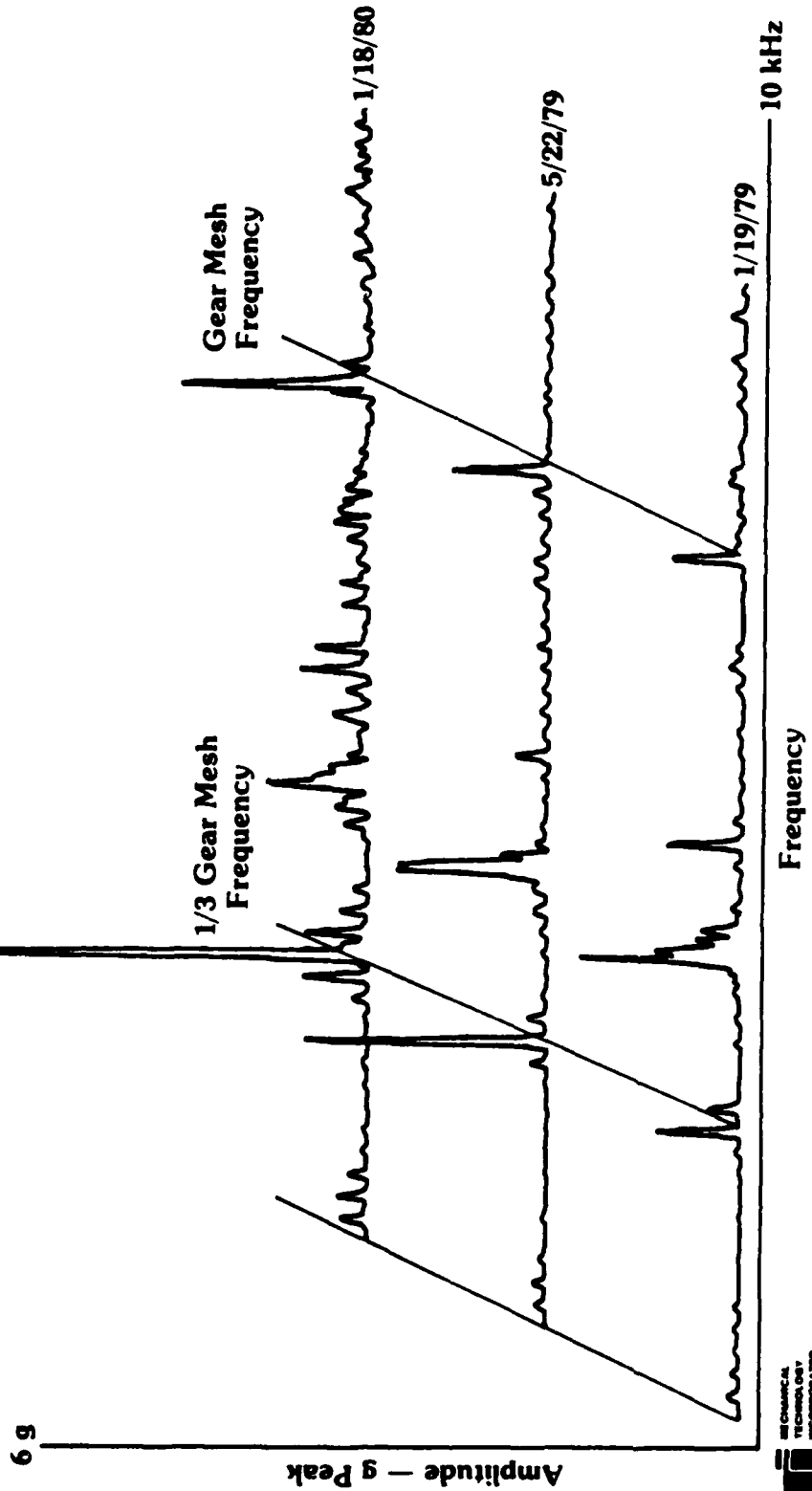

MECHANICAL
TECHNOLOGY
INCORPORATED
811481

Onset of Subsynchronous Instability in High-Pressure Centrifugal Compressor

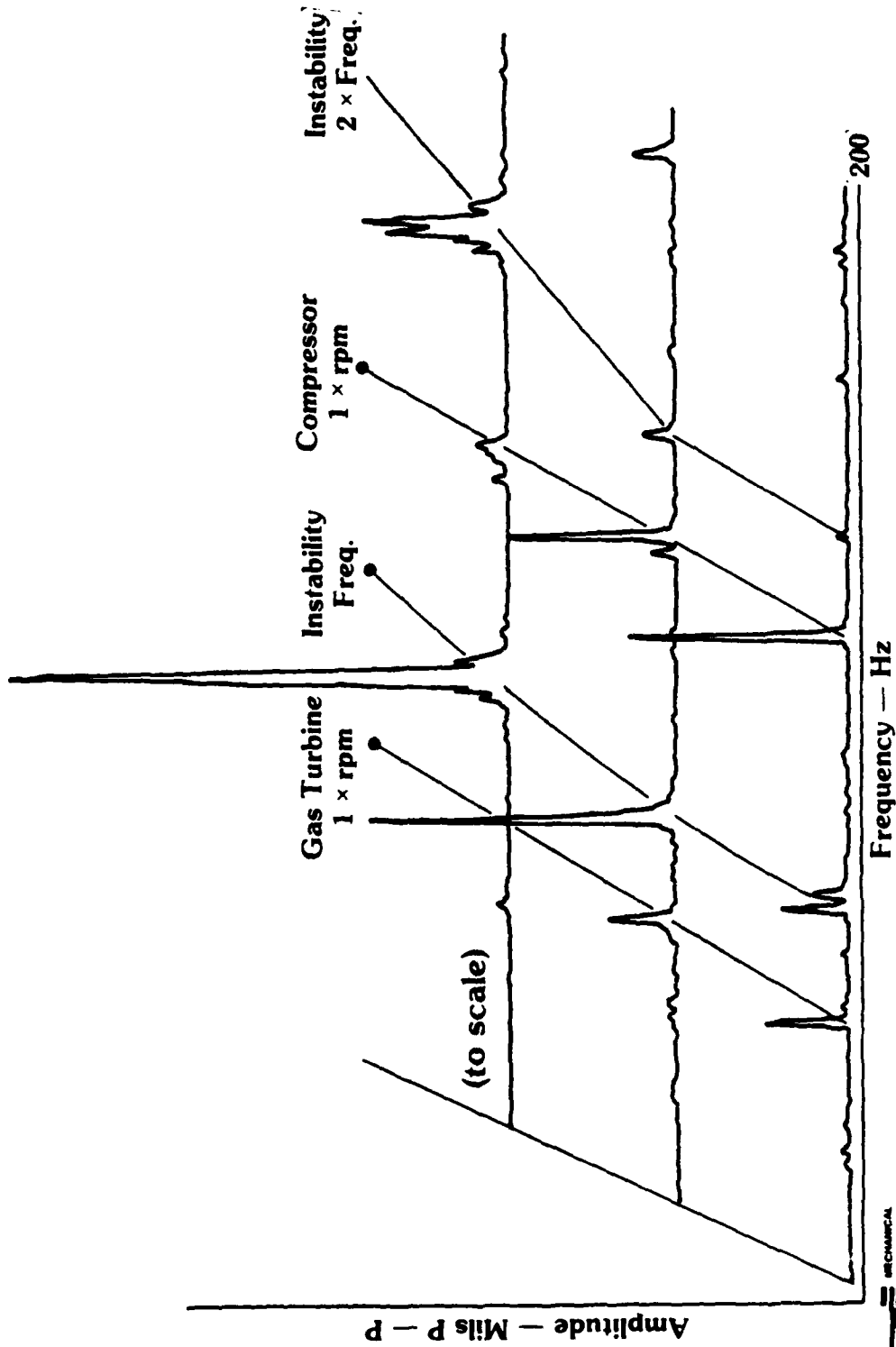

MECHANICAL
TECHNOLOGY
INCORPORATED
801495

AUTOMATED VIBRATION DIAGNOSTIC SYSTEM



AVID™ SYSTEM



Mechanical Technology Incorporated

Field Check

Test

Engine Rework Cycle

Mission

Assembly

MTI AVID™ System Background

- **APL Contract**
 - MTI Investigated the Vibration Characteristics of the Jet Engines in the Air Force Inventory
- **PRAM Contract**
 - MTI Developed and Successfully Demonstrated a Jet Engine Diagnostic System for the TF30 Engine
 - The TF30 System Has Been in Operation by Air Force Personnel Since July 1979
- **AFLC Contract**
 - MTI is Developing a Jet Engine Diagnostic System for Kelly AFB, Texas,, and Tinker AFB, Oklahoma

ENGINE 1 RECORD 4, V, PROBE, N, TRACKING

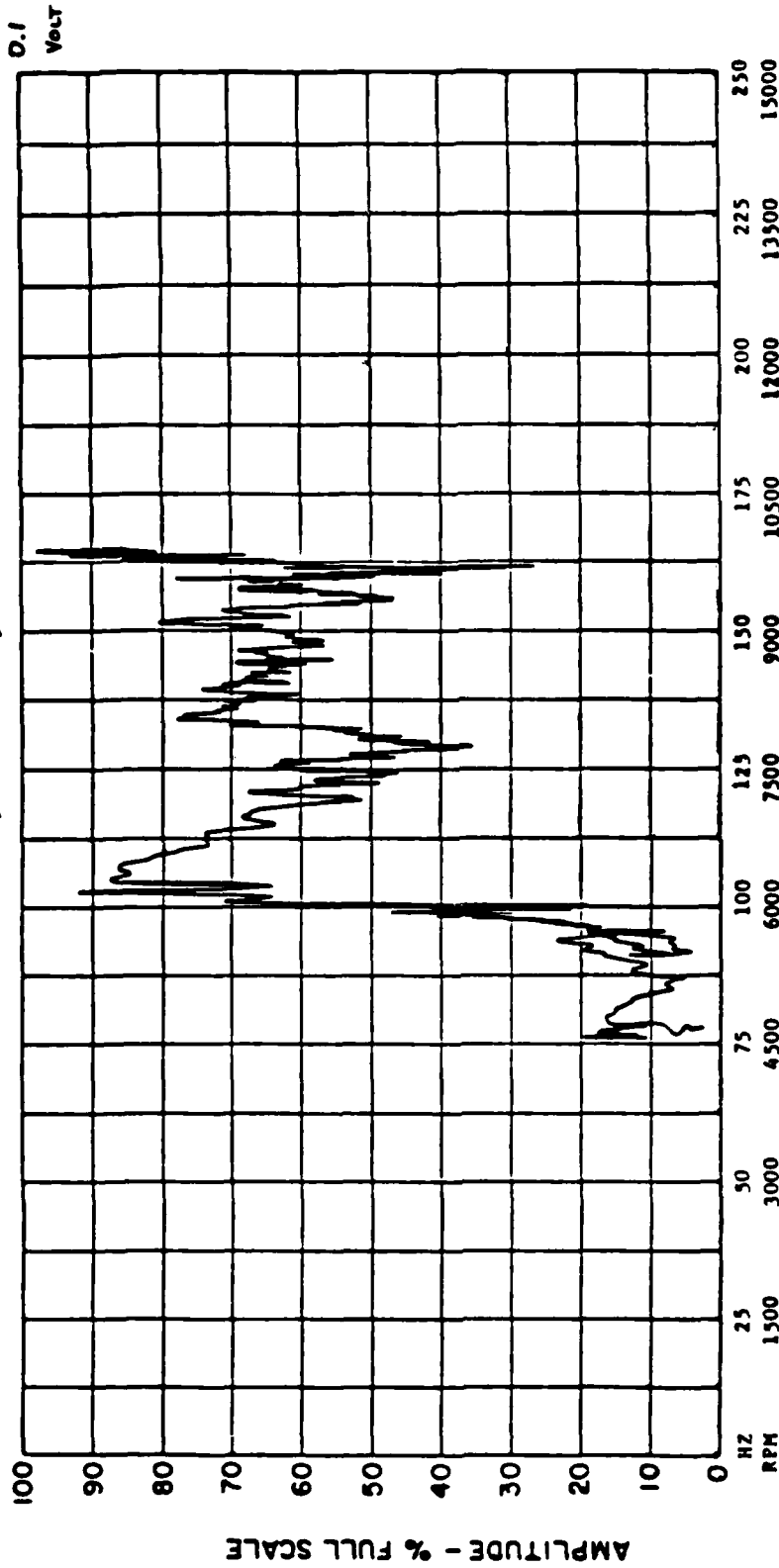

MECHANICAL
TECHNOLOGY
CORPORATION
83732

MTI DIAGNOSTIC SYSTEM
AMPLITUDE VS. TIME

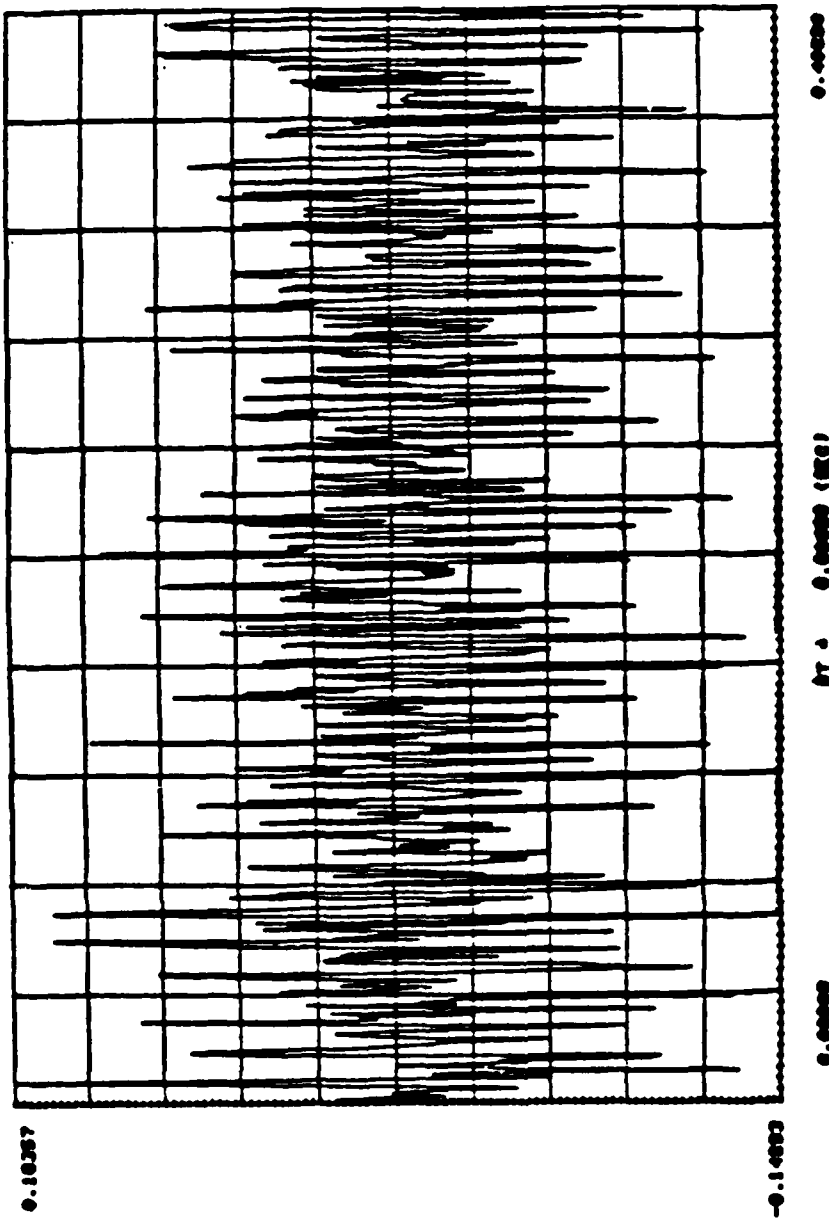

A M P L I T U D E

Figure 12

MECHANICAL
TECHNOLOGY
INCORPORATED

83731

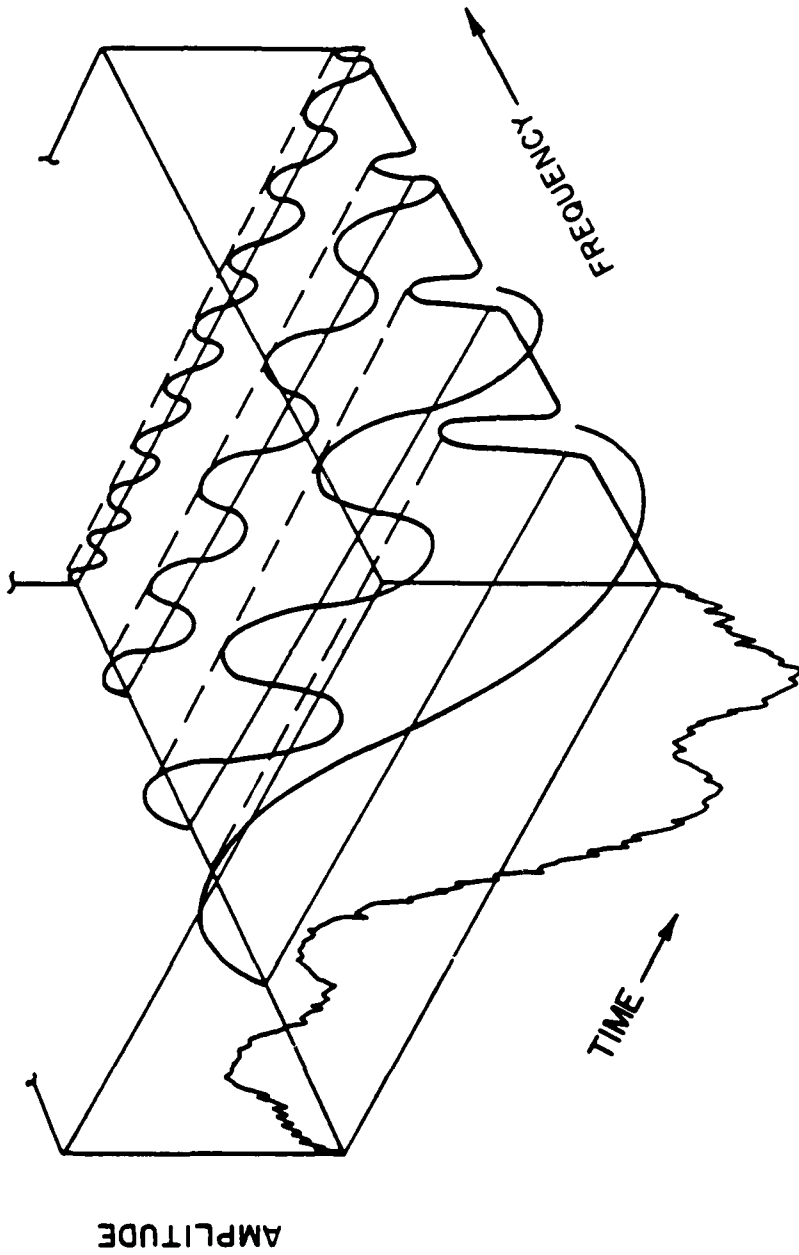

ENGINE 1
V1 PROBE 98.8% N2 MILITARY

MTE DIAGNOSTIC SYSTEM
AMPLITUDE VS. FREQUENCY

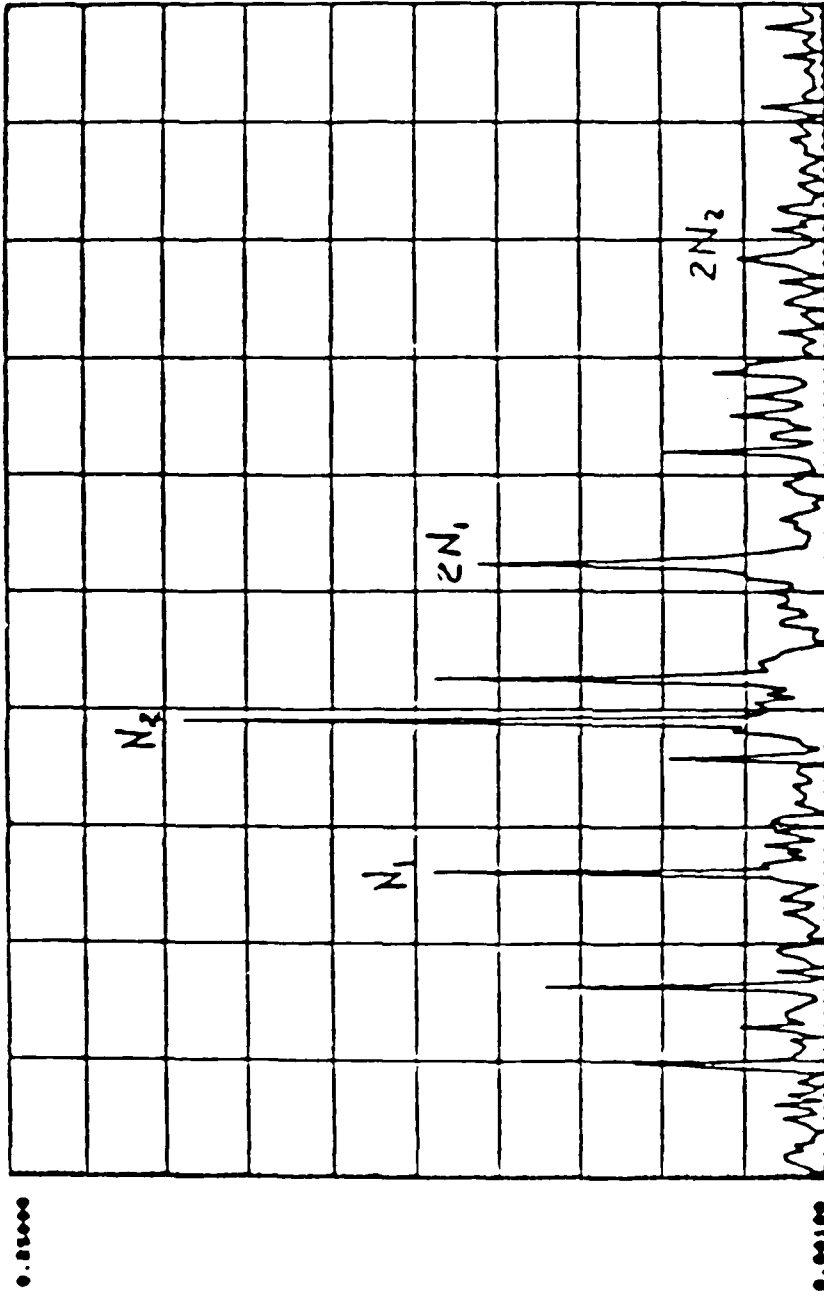

A M P L I T U D E

A-68



TEST CELL ACTIVITY SUMMARY

DECEMBER 1975 THRU NOVEMBER 1976
(OCTOBER 1976 DATA NOT AVAILABLE)

<u>TOTAL ENGINES THRU TEST CELL</u>	<u>FIRST TIME SUCCESSFUL</u>	<u>TOTAL REWORK</u>
1,550	749	801

J-57, J-75, TF-30, TF-33, TF-41

TF-30 SUMMARY

<u>TOTAL</u>	<u>FIRST TIME SUCCESSFUL</u>	<u>TF-30 REWORK</u>
374	205	169

45 ENGINES PRODUCED: 169 TEST CELL OCCUPANCIES

AVERAGE - 3.76

TF-30 PAYOFF

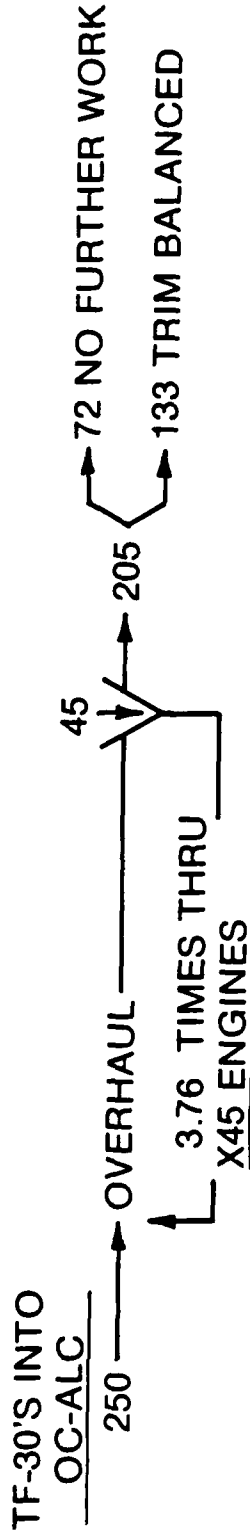

169 TEST CELL OCCUPANCIES (94 FOR VIBRATION)

A-71

<u>DIAGNOSTICS</u>	<u>FUEL SAVINGS</u>	<u>PRODUCTION CAPACITY</u>
NR. TCO'S 169	FUEL/TRIM BAL. 538g	TRIM BALANCE 7-8 HRS.
AVG. COST/TCO 5K	FUEL/AUTO. TR. BAL -102g	AUTO TR. BAL 1 HR:20 MIN.
COST OF TCO'S \$845K	FUEL SAVED/ATB 436g	TIME SAVED/ATB 5 HRS.
REDUCE TIMES THRU 60%	NUMBER ATB'S (EST) 227	5 HRS. X 133 ENG. =665 HRS.
SAVINGS \$507K	FUEL SAVED 98,972g	INCR. TCO CAPY. 665 HRS.

IMPLEMENTATION PAYOFF AT OC-ALC

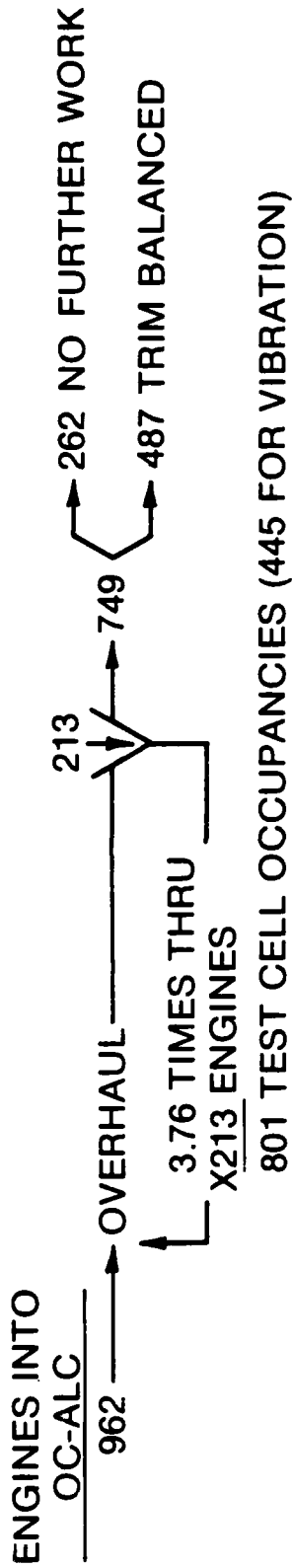

A-72

DIAGNOSTICS

FUEL SAVINGS

PRODUCTION CAPACITY

NR. TCO'S	801	FUEL/TRIM BAL.	538g	TRIM BALANCE	7-8 HRS.
AVG. COST/TCO	5K	FUEL/AUTO. TRIM BAL	-102g	AUTO. TR. BAL.	-1 HR:20 MIN.
COST OF TCO'S	4.00M	FUEL SAVED/ATB	436g	TIME SAVED/ATB	5 HRS.
REDUCE TIMES THRU	60%	EST. NR. ATB'S	932	5 HRS. X 487 ENG.	=2435 HRS.
SAVINGS	<u>\$2.40M</u>	FUEL SAVED	<u>406,350g</u>	INCR. TCO CAPY.	<u>2435 HRS.</u>

RETURN ON INVESTMENT
AT OC-ALC

DIAGNOSTICS —	= \$2,400,000
FUEL SAVINGS — 406,350 GAL X\$.67/GAL	= \$ 270,000
PRODUCTION CAPACITY — 2435TCO HRS.X4.5 X\$16 ⁰⁰ /HR.	= \$ <u>175,000</u>
SAVINGS BASED ON 11 MOS.	\$ 2,845,000
ADJUSTMENT FOR 12 MOS.	<u>258,000</u>
ANNUAL COST SAVINGS	\$ 3,103,000

UPDATED (1980) ECONOMIC ANALYSIS USAF AVID™ SYSTEMS

— SUMMARY —

SAVINGS AREA	\$ SAVED/YR (MILLIONS)
DIAGNOSTICS	\$3.44
FUEL	0.70
TEST CELL CAPACITY	0.49
PRODUCTION CAPACITY	1.82
	<hr/>
	\$6.45 MILLION
	SAVINGS/YR
	BOTH ALC'S

INTANGIBLES

- ENERGY SAVINGS
- INCREASED READINESS/FLEET UTILIZATION
- TOOLS FOR ASSESSING MAINTENANCE PROCEDURES
- INCREASED DEPOT MAINTENANCE CAPABILITY FOR POTENTIAL PEAK REQUIREMENT

MTI AVID™ System Features

- **Quick and Accurate Trim Balancing**
- **Identification of Vibration Related Malfunctions**
- **Engineering Resource Data**
- **Archive Capability**
- **Group Capabilities for**
 - Performance Diagnostics
 - Closed-Loop Operation
 - Communication with Portable Test Cells

USAF AVID™ System Program

- **Improve and Install Jet Engine Diagnostic Systems**
 - In Eight Additional Test Cells at Oklahoma City
 - In Ten Test Cells at San Antonio
- **Expand the System to All Engine Types**
- **Provide Engineering Support and Maintenance**

A-76

 **MECHANICAL
TECHNOLOGY
INCORPORATED**
803433

MTI AVID™ System

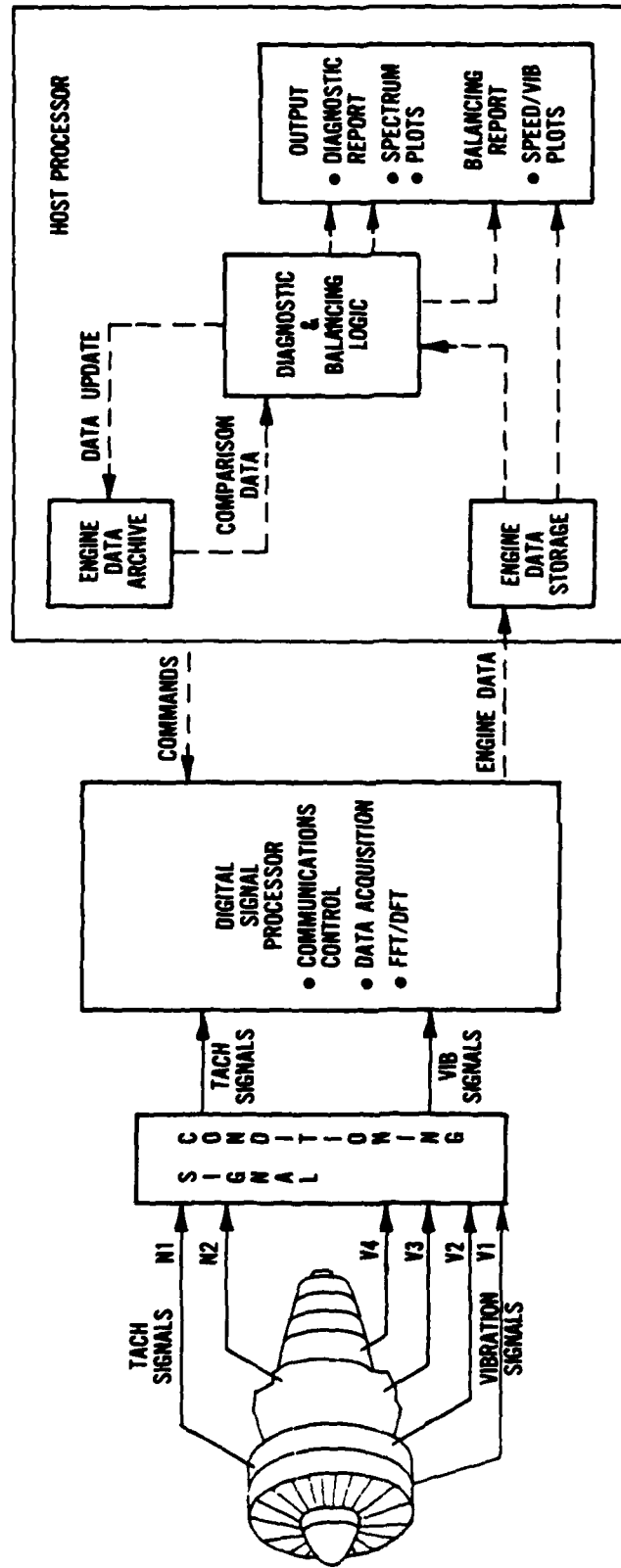

— ANALOG SIGNALS
 - - - DIGITAL SIGNALS

MECHANICAL
 TECHNOLOGY
 INCORPORATED
 883-444

Automatic Vibration Diagnostic Systems for the Air Force

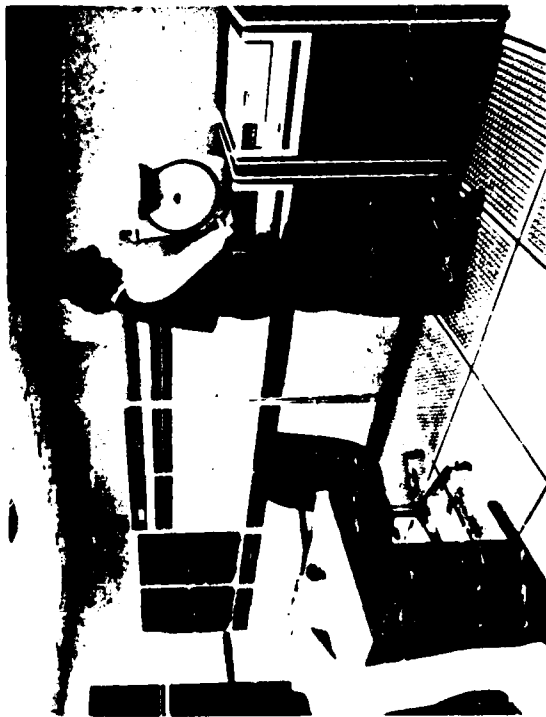

DS7760

HTI-21115



COMPOSITE AND SYNCHRONOUS VIBRATION
AMPLITUDE VS N1 ROTOR SPEED

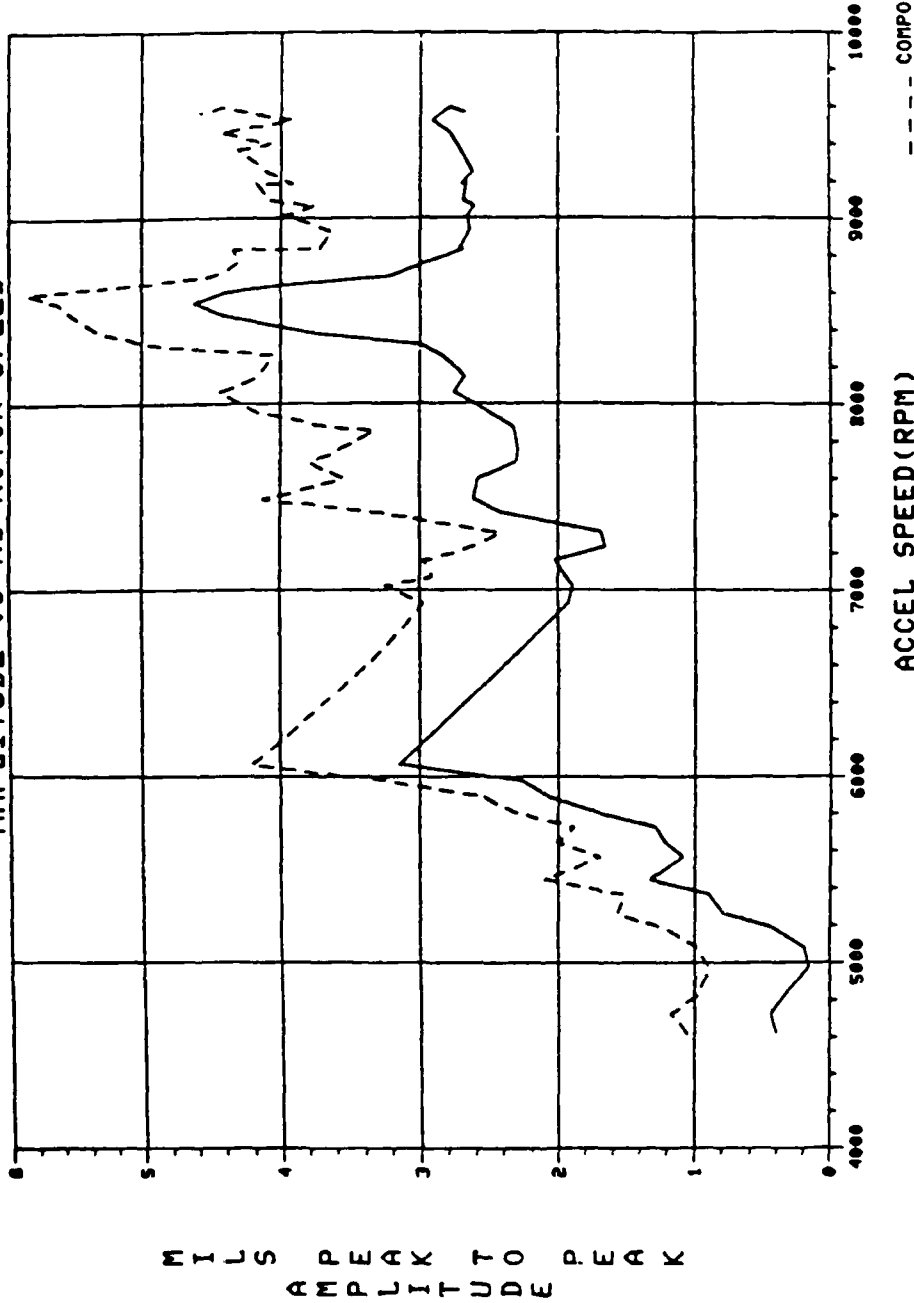

M I L S
A M P L I T U D E
P E A K

ACCEL SPEED (RPM) --- COMPOSITE

PROBE NUMBER	1	TACH NO	1
ENGINE TYPE	TF30 P3	TEST CELL	11
ENG SERIAL NO	659144	DATE/TIME	24-MAR-81 14103119
MAX SYNC AMP, SPD	4.61	MAX COMP AMP, SPD	5.87
			8603.

BALANCING WEIGHT DISTRIBUTION FOR PLANE: FRONT COMPRESSOR

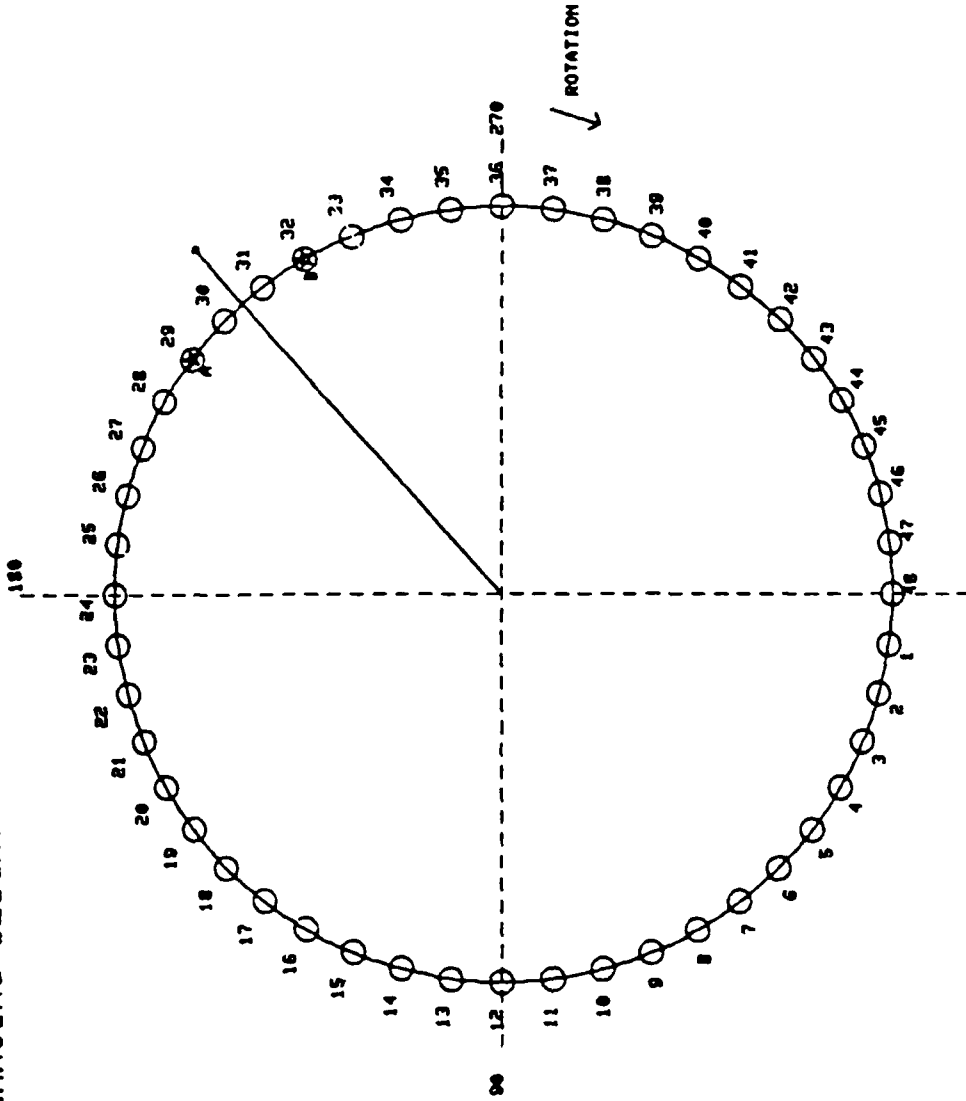

VECTOR: 1.9602/IN @ 228.75 DEG

ENGINE TYPE	TF30P3	WEIGHT: A	1.00	B	1.00
ENG SERIAL NO	659144	(OZ/IN) C		D	
TEST CELL	11	E		F	
DATE/TIME	03/24/81 12:30	G		H	

TF-30P3 HIGH VIBRATION POINT DIAGNOSTIC SUMMARY

TEST CELL: 11 DATE: 3/24/81
 SERIAL NO.: 659144 MTI SEQ. NO.: 911
 THROTTLE: 94% N1: 9378 RPM N2: 13857 RPM

THE FOLLOWING ITEMS HAVE BEEN DIAGNOSED TO BE POSSIBLE CAUSES OF THE HIGH VIBRATIONS OBSERVED IN THIS ENGINE

FACTOR	WEIGHT
<input type="checkbox"/> LOW ROTOR COMPRESSOR UNBALANCE	45
<input type="checkbox"/> LOW ROTOR TURBINE UNBALANCE	16
<input type="checkbox"/> ACCESSORY GROUP THREE	10
<input type="checkbox"/> LOW ROTOR MISALIGNMENT	9
<input type="checkbox"/> HIGH ROTOR COMPRESSOR UNBALANCE	8
<input type="checkbox"/> HIGH ROTOR TURBINE UNBALANCE	6
<input type="checkbox"/> ACCESSORY GROUP FOUR	4
<input type="checkbox"/> SEAL RUB OR BEARING	3

AD-A137 524

MECHANICAL SYSTEMS CONDITIONING MONITORING TECHNOLOGY
WORKING GROUP REPORT (U) INSTITUTE FOR DEFENSE ANALYSES
ALEXANDRIA VA SCIENCE AND TECH. P HOWARD AUG 83
IDA-D-36 IDA/HQ-83-25899 NDA903-79-C-0018 F/G 15/3

4/6

UNCLASSIFIED

NL

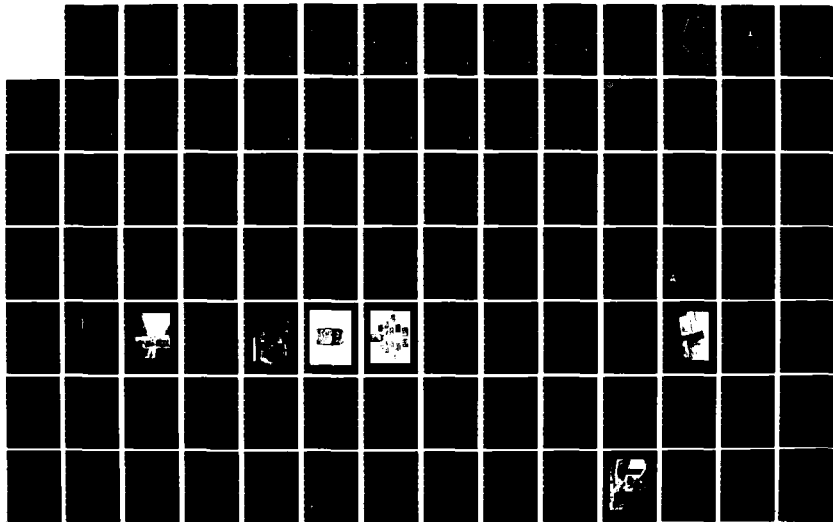

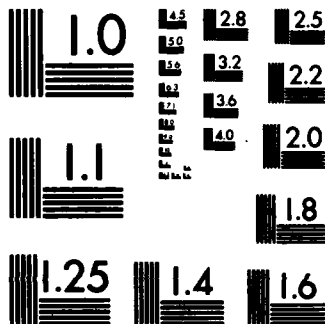

MICROCOPY RESOLUTION TEST CHART
NATIONAL BUREAU OF STANDARDS-1963-A



SPEED

FREQUENCY SPECTRUM

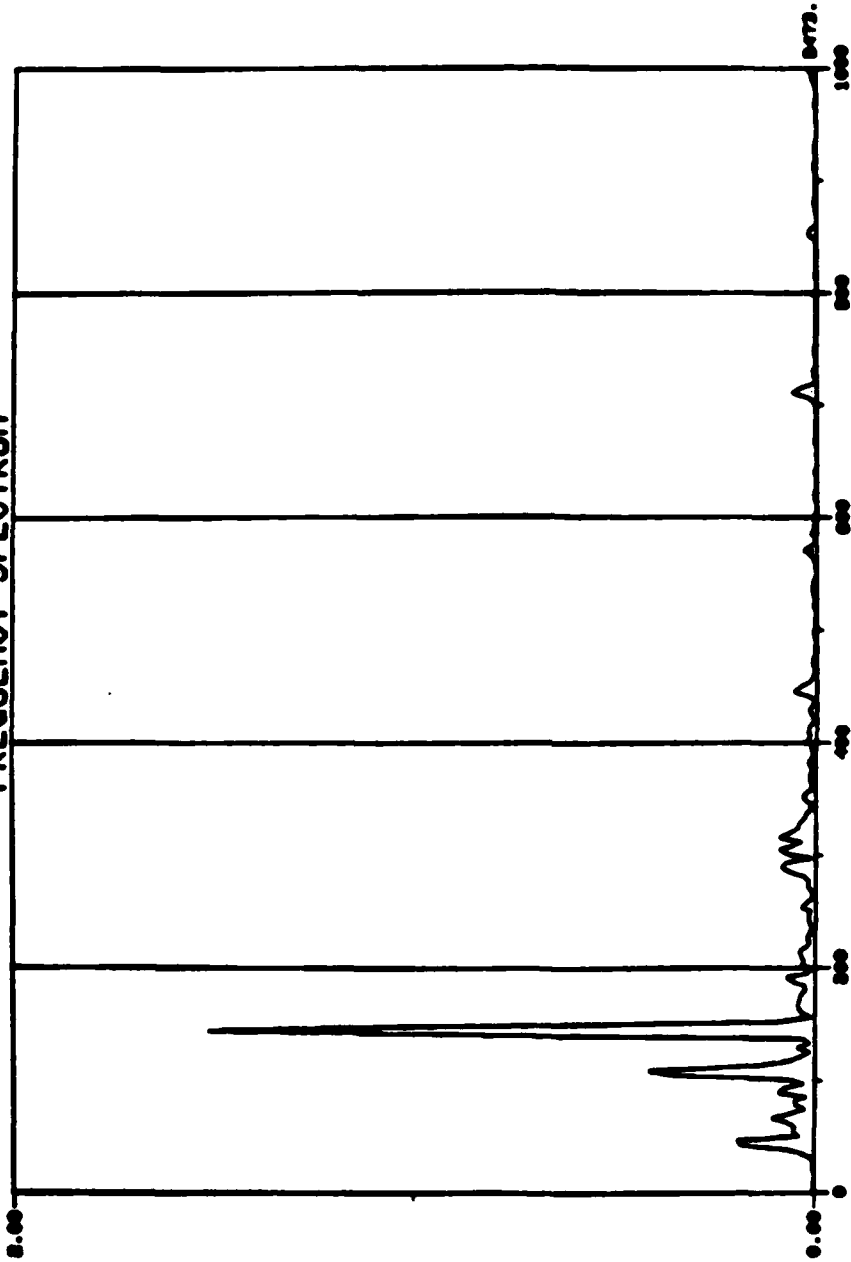

M I L S
A P E A K
L I T U D E
P E A K

FREQUENCY (HZ)

PROBE NUMBER	U1	DATE/TIME	24-NOV-81	14104120
ENGINE TYPE	TF30 P3	M1 FREQ(HZ)	141	
ENG SERIAL NO	659144	M2 FREQ(HZ)	219	
TEST CELL	11			



83720

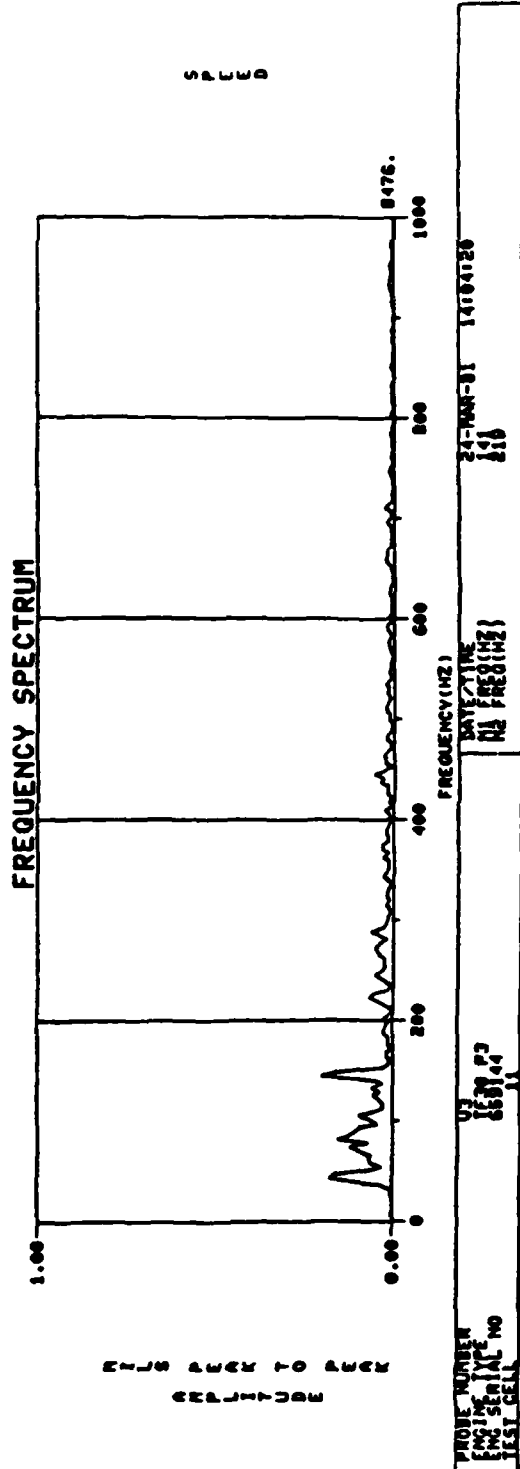
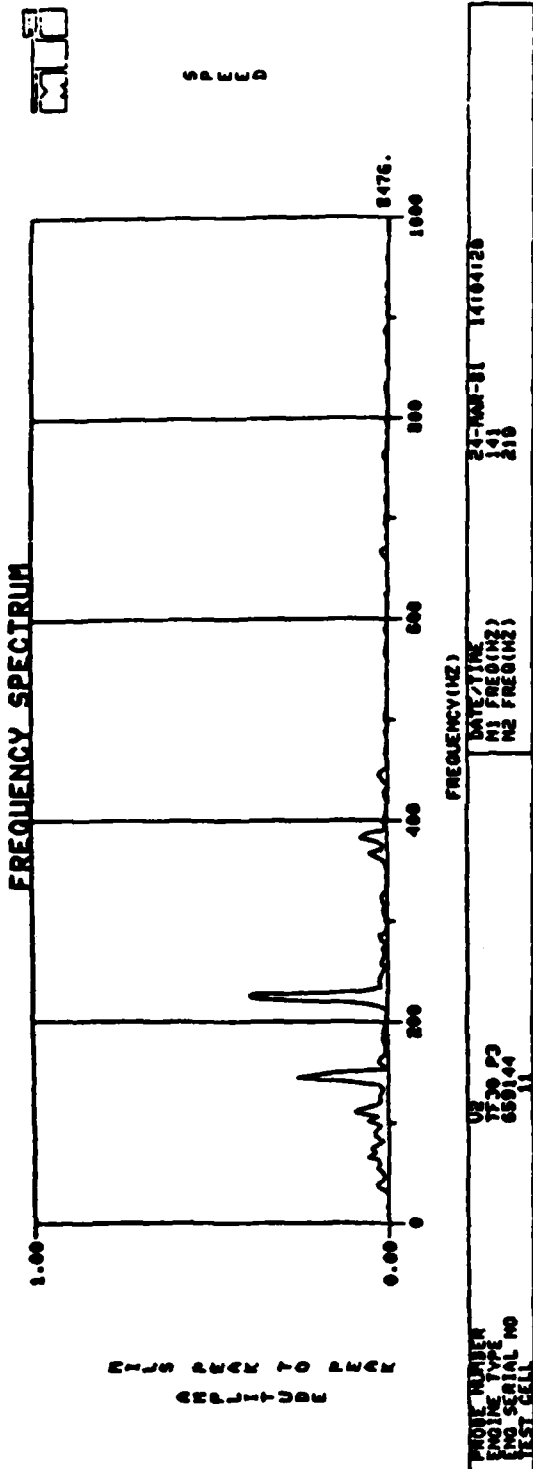

**AUTOMATIC TRIM BALANCING AND DIAGNOSTIC SYSTEM
DATA HANDLING FOR THE AIR LOGISTIC CENTERS**

- STORED SIGNATURE ON REJECTED ENGINES (ANY CAUSE)
- STORED SIGNATURE OF AVERAGE ENGINES
 - OVERALL VIBRATION
 - N₁ & N₂ vs SPEED
 - SPECTRAL PLOTS
 - 6 MONTH SAMPLING (CONTINUOUS UPDATING)
- TRACK ENGINE SERIAL NUMBERS FOR SHORT TERM
 - IDENTIFY REPEAT REJECTS
 - COMPILE ENGINE CORRECTIVE MAINTENANCE HISTORY
- 6 MONTH RETRIEVAL OF GOOD ENGINE DATA
 - OVERALL VIBRATION
 - N₁ & N₂ vs SPEED
 - RETRIEVE DATA ON INSTALLED REJECTS

AVID Benefits

- **Reduced Engine Reject Rate**
- **Increased Engine Throughput**
- **Reduced Overhaul Cost and Fuel Utilization**
- **Maximized Use of Existing Facilities**
- **Increased Availability of Engines**
- **Reduced Logistics Tail**

MTI Study Area

Significant R&M Can Be Achieved with an Engine Monitoring System for the General Dynamics M-1 Tank

A-87



Engine Maintenance Concepts Are Changing

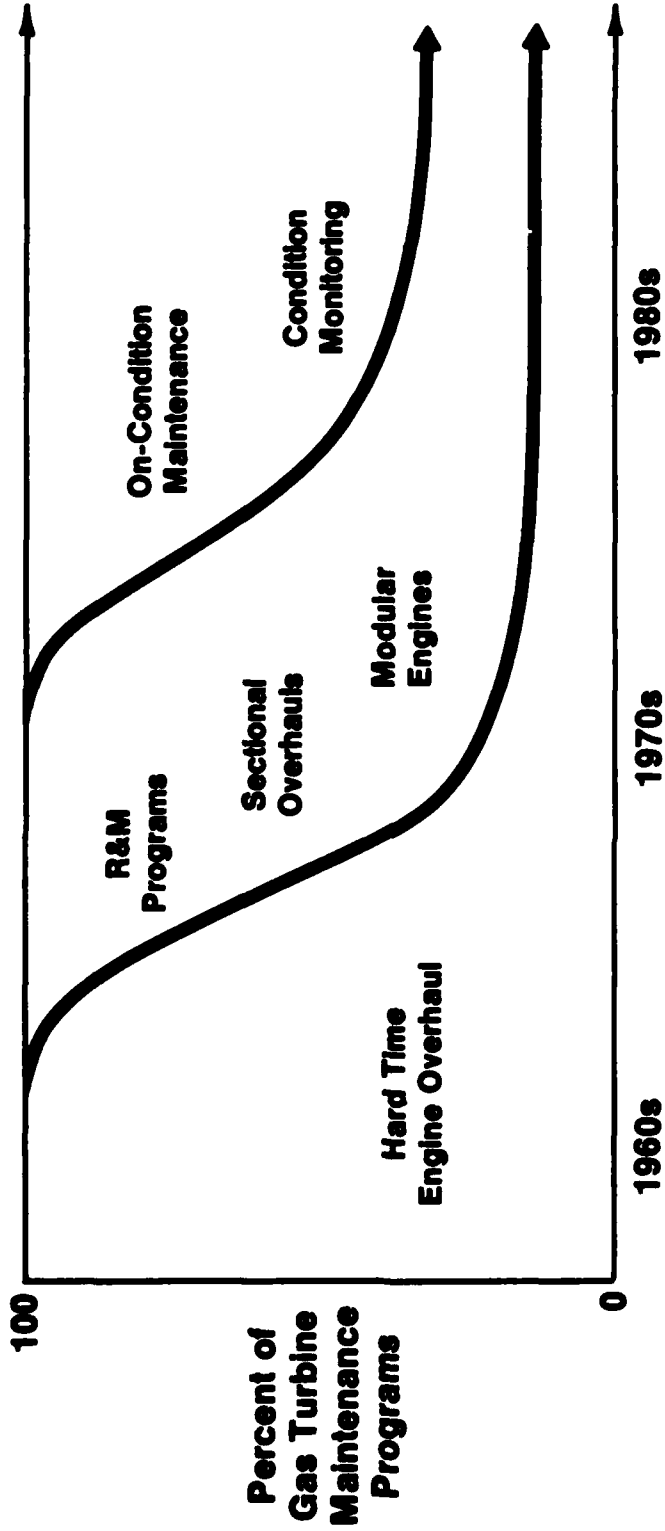

Percent of Gas Turbine Maintenance Programs



Why?

**On-Condition Maintenance (OCM)
Reduces Risk . . . Increases R&M
Saves \$\$**

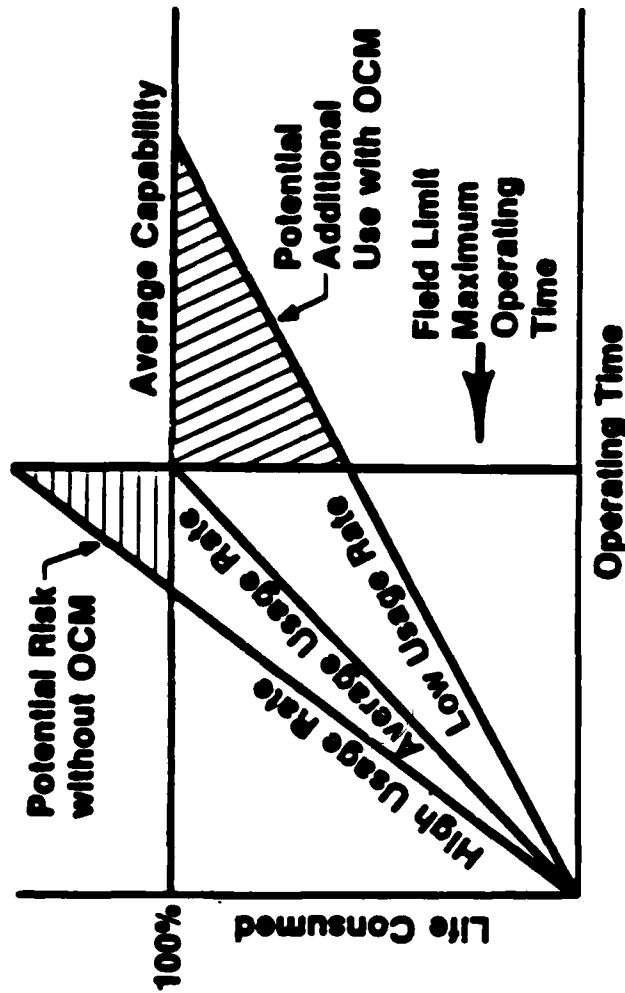

Engine Health Indicators

— Integration Requirements —

- Usage Factors
 - Time
 - Cycles
- Event / Exceedance Detection
- Vibration
- Performance Monitoring / Trending
- Oil Analysis
- Maintenance History
- Configuration Status



Total System Viewpoint

Who Does What?

How Much is Enough?

Goal

**Maximum System
Effectiveness**

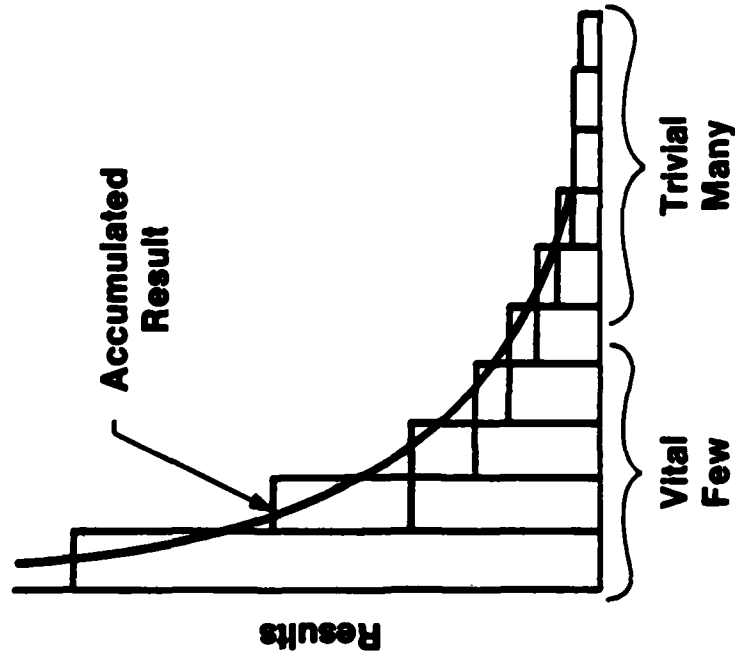

MTI
MECHANICAL
TECHNOLOGY
INCORPORATED
811899

Engine Monitoring System (EMS)

Overview

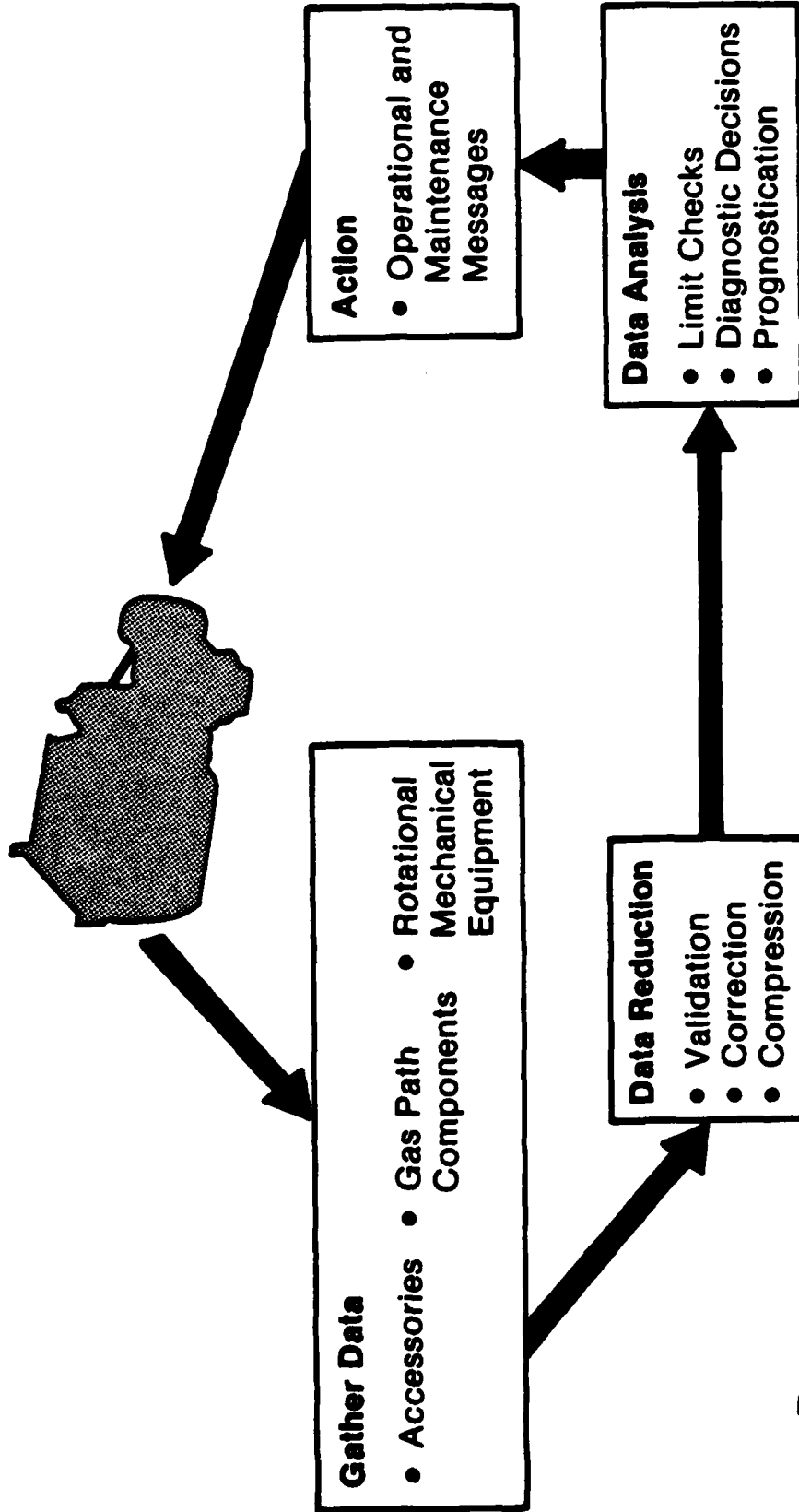

Basic Purpose of EMS

Provide a Data Base from Which to:

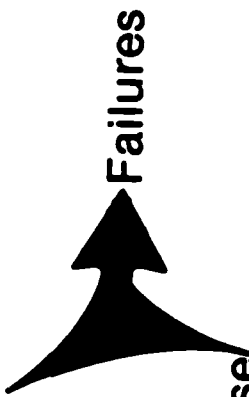
- Predict
 - Detect
 - Diagnose
- 
- Failures

MECHANICAL
TECHNOLOGY
INCORPORATED
811894

Elements of System Effectiveness

System Effectiveness

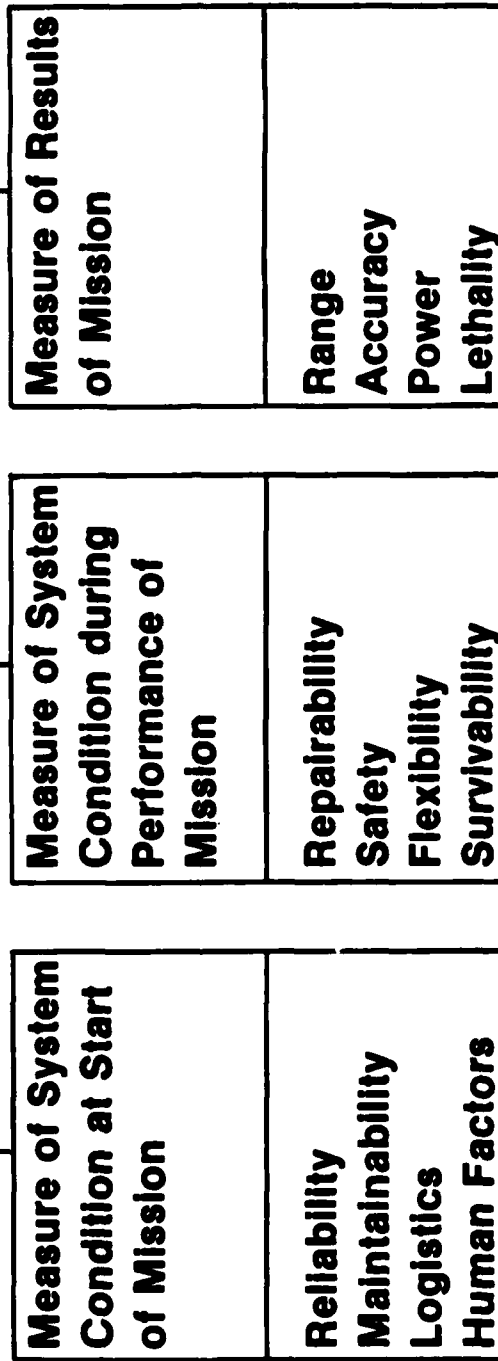

M MECHANICAL
TECHNOLOGY
INCORPORATED
811902

Engine Monitoring System (EMS)

Hardware Approach

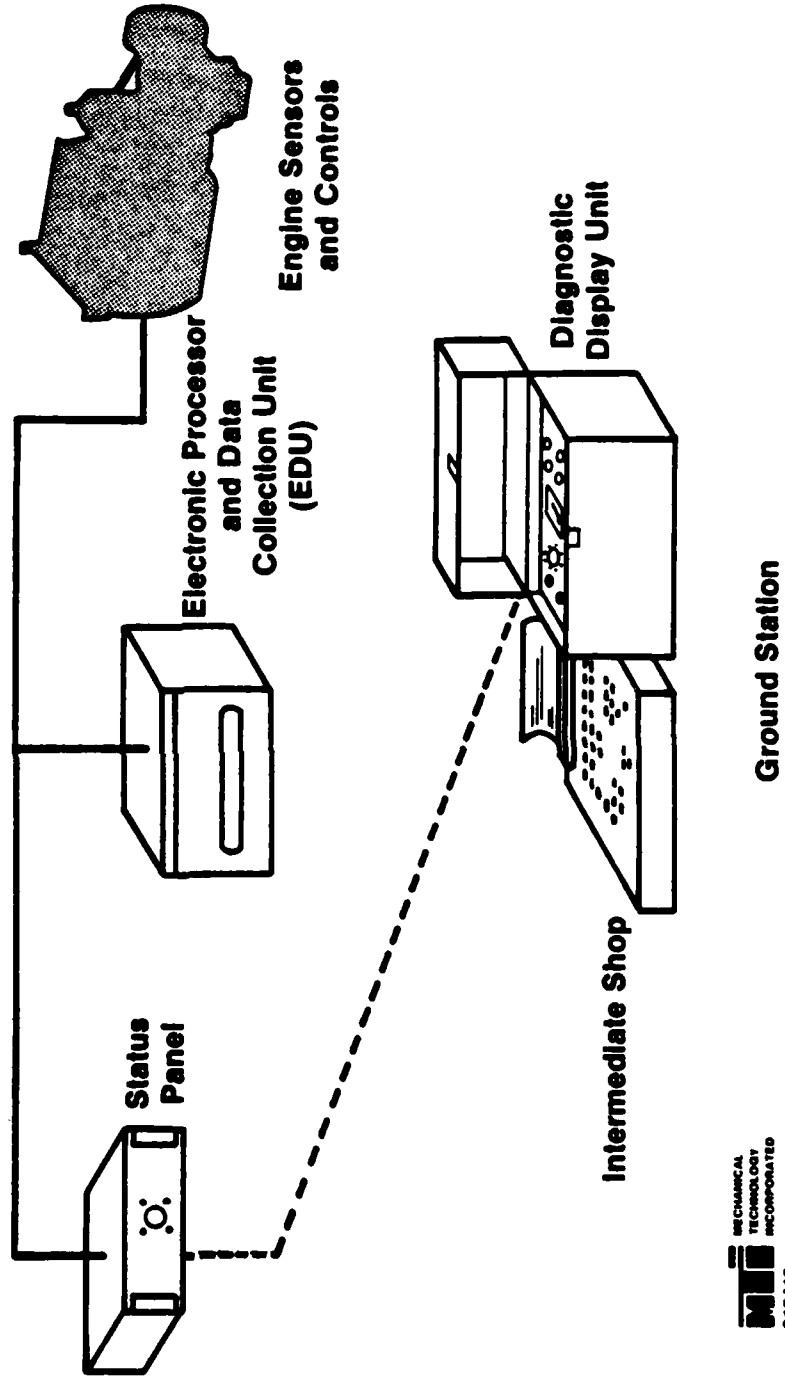

ME
MECHANICAL
TECHNOLOGY
INCORPORATED
872418

On-Board Diagnostic System

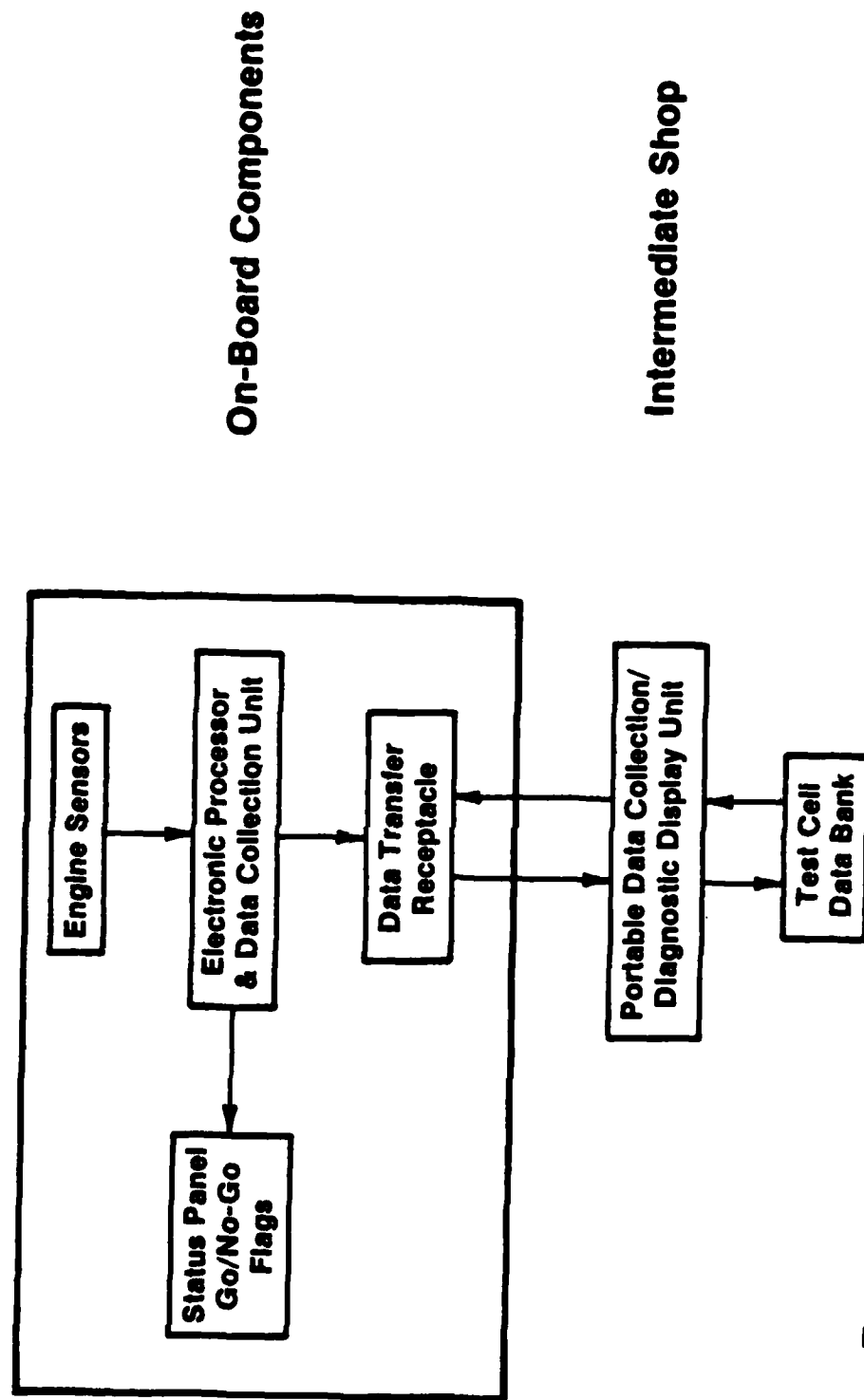

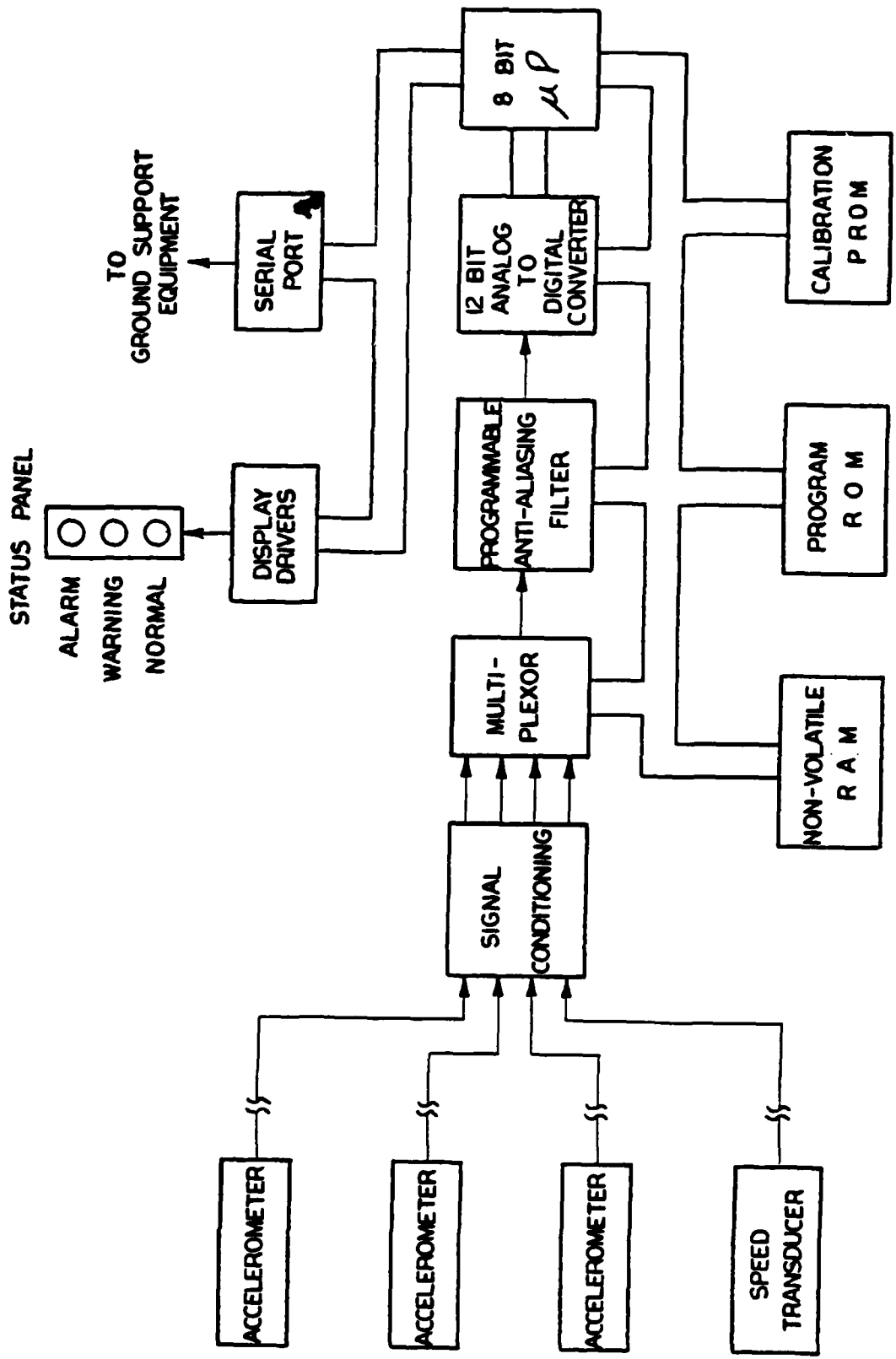

GENERAL DYNAMICS M-1 TANK MONITORING AND DIAGNOSTIC SYSTEM

ENGINE MONITORING SYSTEM

Program Approach

- Machinery Analysis
 - Failure Modes
 - Sensor Requirements
- Engine Data Analysis
 - Vibration Recordings
 - In-House Data Reduction
- Conceptual Design
 - Feasibility
 - Return on Investment
- System Design
- System Demonstration
- System Acquisition

ENGINE MONITORING SYSTEM

Functional Operation

I. Alarm Mode

- Continuous Monitoring of Each Sensor
- Transient Filtering
- Alarm, Warning Levels Function of Speed or Load
- Alert Operator of Over Level(s)

ENGINE MONITORING SYSTEM

Functional Operation

II. Data Acquisition Mode

- Acquire New Data as Function of Speed Range Change or Load Range Change
- Store Raw Data
- Produce Frequency Data
- Retain First and Last for Each Window
 - Raw Data
 - Frequency Data
 - Time of Occurrence
 - Load / Speed
- Intermediate Shop Analysis
 - Amplitude Trending
 - Excitation Frequencies
 - Diagnostics
 - Maintenance Actions

ENGINE MONITORING SYSTEM

Financial Assumptions

Capital Equipment Cost:

- 3000 M-1 Tanks Plus 25% Spares = 3750 Drivetrains
- Engine and Drivetrain Cost = \$450,000 (15% of system)

Investment Cost:

- EMS Development Program = \$700,000 over 18 months
- EMS Acquisition Costs = \$12,000 each
1000 units/yr = 3000 total

Return:

- Eliminate 15% of Spares
with Reduced Logistics Tail = 112 x \$450,000 = \$50.4 Million
- Reduce Life-Cycle Cost by 10%
with Condition Monitoring = \$135 Million

ENGINE MONITORING SYSTEM

Return on Investment

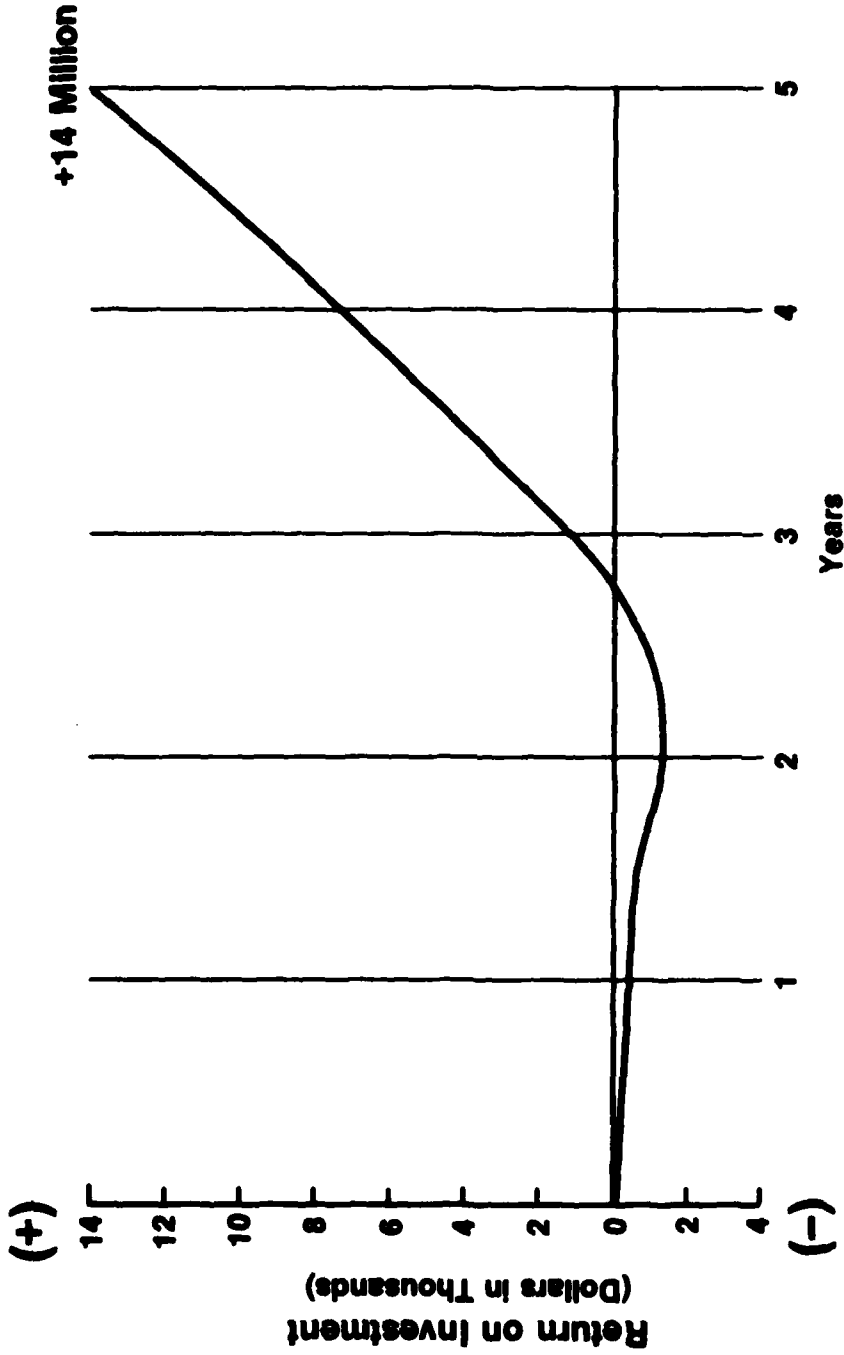

ENGINE MONITORING SYSTEM

Summary

- Can Provide Indications of Drivetrain Health
 - Engine
 - Gearbox
 - Transmission
- Design/Operation Feedback
 - Improve System Quality
 - Identify Avoidance Areas
- Eliminate “Check — No Defect”
- Reduced Logistics Tail
 - Fewer Spares
 - Quick Depot Turnaround
 - Identify Field-Level Maintenance
- Increased Mission
 - Effectiveness
 - Reliability
 - Availability

DTNSR&DC

A-105



DEPARTMENT OF THE NAVY

DAVID W. TAYLOR NAVAL SHIP RESEARCH
AND DEVELOPMENT CENTER

HEADQUARTERS
BETHESDA, MARYLAND 20084

ANNAPOLIS LABORATORY
ANNAPOLIS, MD 21402

CARDEROCK LABORATORY
BETHESDA, MD 20084

IN FILE REFER TO:

2732:JWD

3900

1 0 FEB 1983

Dr. Paul M. Howard
Chairman, MSCM
Institute for Defense Analyses
Science and Technology Division
1801 N. Beauregard Street
Alexandria, Virginia 22311

Dear Dr. Howard:

We appreciate your continued interest in the technology advances which we have been developing at the David Taylor Naval Ship Research and Development Center.

Per your request, we are forwarding a refined version of the material which we presented to the Mechanical Systems Condition Monitoring Working Group on 11 January 1983. The four enclosures describing recommended development plans are:

1. The extension of Acoustic Valve Leak Detector technology to Tri-Services applications.
2. The development of Fiber Optic Bearing Monitoring technology and its extension to Tri-Services use.
3. The development of an on-line and portable Ultrasonic Wear Particle Sensor.
4. The development of an Integrated Shipboard Machinery Monitoring System.

Original viewgraph packages of the four enclosures will be forwarded to you under separate cover due to their bulk. We hope that this material meets your needs. The Center's point of contact for this effort is Mr. Henry Whitesel who will be glad to answer any questions. Mr. Whitesel may be contacted at the following: commercial 301-267-2163 or Autovon 281-2163.

Sincerely yours,

W. C. DIETZ
Head, Propulsion and
Auxiliary Systems Dept.

Enclosures

**INTEGRATED
SHIPBOARD MACHINERY
MONITORING**

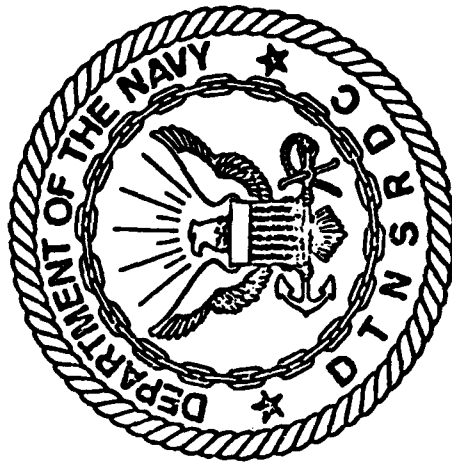

**DAVID TAYLOR
NAVAL SHIP RESEARCH &
DEVELOPMENT CENTER
(DTNSRDC)**



MISSION

**DAVID TAYLOR NAVAL SHIP R&D CENTER
NAVY'S PRINCIPAL RDT&E CENTER FOR NAVAL
VEHICLES INCLUDING SHIPBOARD MACHINERY**

**PROPULSION AND AUXILIARY SYSTEMS
DEPARTMENT**

**ONLY NAVAL ORGANIZATION WHOSE PRIMARY
MISSION IS DEVELOPMENT OF NAVAL MACHINERY
(NON-NUCLEAR PROPULSION AND AUXILIARY
MACHINERY SYSTEMS AND EQUIPMENT)**

SHIPBOARD MACHINERY MONITORING



R & D PROGRAM OBJECTIVE

DEVELOP PROPULSION & AUXILIARY MACHINERY

MONITORING CAPABILITY TO:

- ASCERTAIN MACHINERY PLANT STATUS
- IDENTIFY PERFORMANCE LEVELS
- DETECT DEGRADING SYSTEM PERFORMANCE
- PREDICT IMPENDING FAILURES
- ISOLATE FAULTS
- PREDICT MAINTENANCE REQUIREMENTS

TO SUPPORT NAVY REQUIREMENTS FOR:

- IMPROVING SHIP READINESS
- MAINTENANCE REDUCTION
- SHIP AUTOMATION
- MANNING REDUCTION

SHIPBOARD MACHINERY MONITORING



WHY MACHINERY MONITORING

- MAINTENANCE IS LARGELY MANUAL & LABOR INTENSIVE
- MAINTENANCE LOAD IS DRIVEN BY SCHEDULES OR REACTION TO MALFUNCTIONS
- LOGISTIC SUPPORT COSTS ARE INCREASING
- MAINTENANCE SKILL REQUIREMENTS ARE INCREASING
- SKILLS AVAILABILITY & RETAINABILITY ARE DECREASING
- SCHEDULED MAINTENANCE INCLUDES MUCH UNNECESSARY WORK
- MALFUNCTIONS ARE OFTEN CAUSED BY SCHEDULED MAINTENANCE ACTIONS

SHIPBOARD MACHINERY MONITORING



POTENTIAL IMPACT

- INCREASE EQUIPMENT AVAILABILITY/READINESS BY 20%
OR MORE
- REDUCE MAINTENANCE ACTIONS BY 35%
OR MORE
- REDUCE INSPECTION & REPAIR MANHOURS BY 20%
OR MORE
- REDUCE GOOD PART REMOVAL BY 30%
OR MORE
- EXTEND EQUIPMENT LIFE BY 10%
OR MORE
- REDUCE SPARES PROVISIONING BY 20%
OR MORE



SHIPBOARD MACHINERY MONITORING

INDUSTRY/JOINT SERVICES AUTOMATIC TEST PROJECT R&M BENEFITS STUDY, FF1052 CLASS

SAVINGS IN MAINTENANCE MANHOURS WITH MACHINERY MONITORING SYSTEM	27%	
TOTAL LIFE CYCLE COST SAVINGS PER FF1052 CLASS SHIP (INCLUDES BOTH MAINTENANCE AND PERSONNEL)		\$35M \$50M



SHIPBOARD MACHINERY MONITORING

PRIMARY MISSION CRITICAL MACHINERY FAILURES, FY 82

ITEM	NO. OF FAILURES	ITEM	NO. OF FAILURES
1. BOILERS	87	8. MOTOR- GENERA- TORS	11
2. TURBINES	55	9. SHIP/BOAT PROP. GMP	11
3. ENGINES	47	10. CONDEN- SORS	11
4. PUMPS	41	11. GEARS	10
5. VALVES	34		
6. DISTILLING PLANTS (EVAP.)	16		
7. MOTORS	15		

FOR OFFICIAL USE ONLY

THIS DOCUMENT IS SUBJECT TO SPECIAL EXPORT CONTROLS AND EACH TRANSMITTAL TO FOREIGN GOVERNMENTS OR FOREIGN NATIONALS MAY BE MADE ONLY WITH PRIOR APPROVAL OF THE CHIEF OF NAVAL OPERATIONS.



SHIPBOARD MACHINERY MONITORING

SUMMARY OF BOILER PLANT MACHINERY MONITORING OUTPUT VARIABLES

MAIN TURBINE

14 VARIABLES INCLUDING SHAFT
HORSEPOWER, TORQUE AND SPEED,
STEAM FLOW, AND MECHANICAL AND
THERMAL EFFICIENCIES

BOILER

18 VARIABLES INCLUDING STEAM
AND COMBUSTION EFFICIENCIES, AIR
AND FUEL FLOW, SUPER HEATER
STEAM FLOW, PRESSURE, AND
TEMPERATURES

TURBO GENERATORS

10 VARIABLES INCLUDING MECHANICAL AND THERMAL EFFICIENCIES
KILOWATT OUTPUT, AND STEAM
FLOW

MAIN FEED PUMPS

12 VARIABLES INCLUDING MECHANICAL AND THERMAL EFFICIENCIES,
WATER FLOW, AND STEAM FLOW

FORCED DRAFT BLOWERS

12 VARIABLES INCLUDING MECHANICAL AND THERMAL EFFICIENCIES,
AIRFLOW, AND STEAM FLOW



TYPICAL PROBLEM AREAS IN AUXILIARY MACHINERY

INTERNAL WEAR

DEFECTIVE HEAD GASKET

WORN VALVES

WORN PISTONS

OVERHEATING

WORN RINGS

BAD CONTROL VALVE

CLOGGED OR DIRTY STRAINER

WORN SUCTION VALVE

WORN DISCHARGE VALVE

CONTAMINATED OIL SUPPLY

CONTAMINATED FREON SUPPLY

MOTOR FAILURE

REDUCED CHILLED WATER

PUMP PERFORMANCE

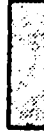

WEAR



BEARING



LEAKS

SHIPBOARD MACHINERY MONITORING



COMMERCIAL SHIP SYSTEMS

- HYDE PRODUCTS
 - STEERING GEAR DIAGNOSTICS
- MARINE ELECTRIC RPD
 - MERPD PROPULSION MACHINERY MONITORING
 - RTD-TM-10 MACHINERY TEMP/POWER/EFFICIENCY
- MARCON SYSTEMS
 - PMS 6000 TUGBOAT MACHINERY MONITORING
- NATIONAL MARINE SERVICE
 - DIESEL ENGINE MONITORING
- MEGA SYSTEMS
 - SEAMATIC II FUEL MANAGEMENT MONITORING
- SPERRY SYSTEMS
 - DIESEL, GENERATOR, BLOWER, AIR COMPRESSOR MONITORING
- ULTRA PRODUCTS SYSTEMS
 - POWER PLANT EFFICIENCY MONITORING



SHIPBOARD MACHINERY MONITORING

SYSTEMS TO BE INVESTIGATED

- DIESEL ENGINES
- AIR CONDITIONING PLANT
- AIR COMPRESSOR
- DISTILLING PLANT
- HYDRAULICS (CRP)
-
- GAS TURBINES



SHIPBOARD MACHINERY MONITORING

INFORMATION FLOW

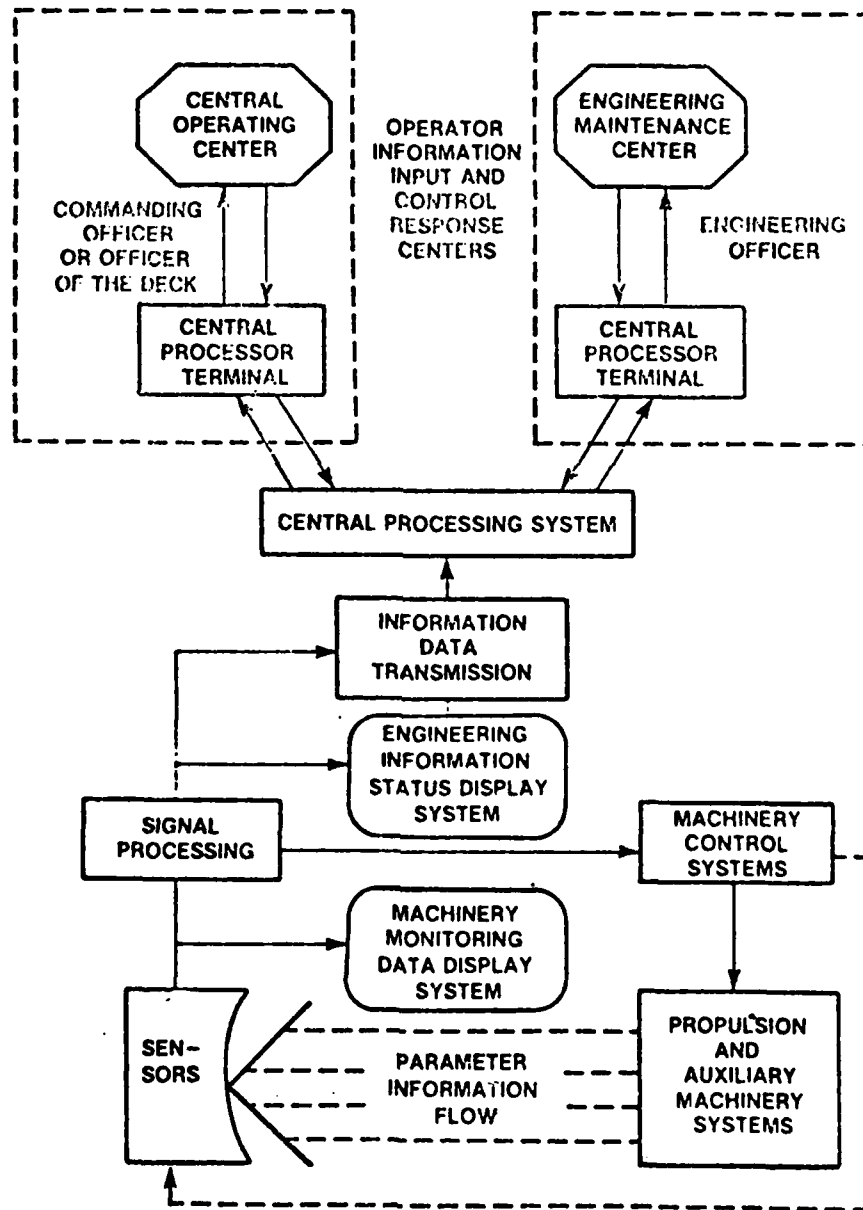

SHIPBOARD MACHINERY MONITORING



SYSTEM ARCHITECTURE

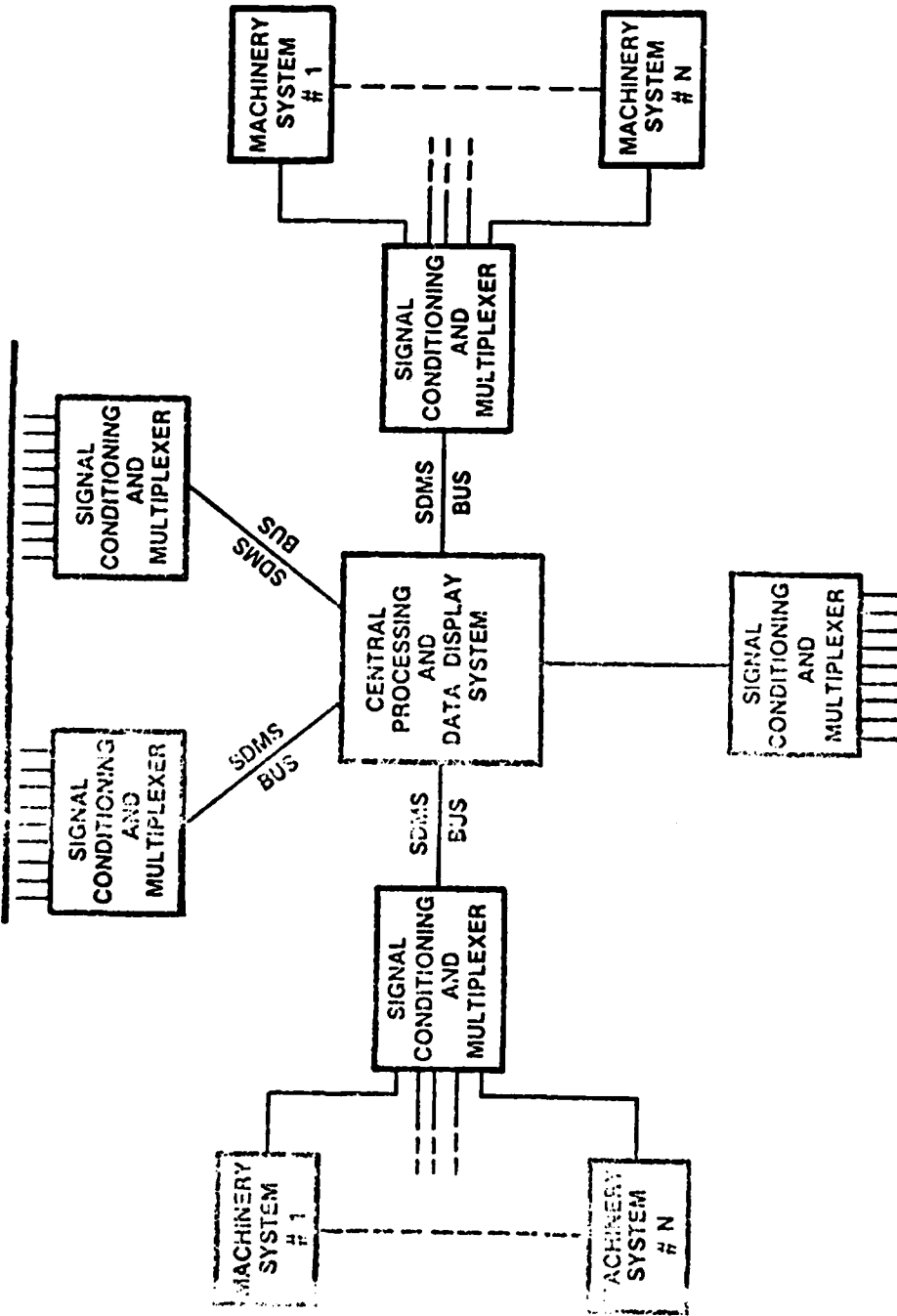



TESTING TECHNOLOGY DEVELOPMENT (PHASE I)

FAILURE MODE ANALYSIS

- CATEGORIZE MACHINERY FAILURE MODES
- RANK SEVERITY AND FREQUENCY
- DERIVE MACHINERY PARAMETERS INDICATIVE OF FAILURE

DETERMINE CONDITION/PERFORMANCE SENSOR REQUIREMENTS

- DEFINE SENSOR FAMILY FOR CANDIDATE SYSTEMS
- IDENTIFY SENSOR PERFORMANCE REQUIREMENTS
- IDENTIFY EXISTING SENSOR SUITABILITY

DEVELOP FAILURE DETECTION/PREDICTION SOFTWARE ALGORITHMS

- DEVELOP ALGORITHMS TO ASSESS CONDITION AND TRENDS
OF MACHINERY PERFORMANCE

SENSOR DEVELOPMENT & QUALIFICATION

- DEVELOP AND/OR MILITARIZE REQUIRED SENSORS



SYSTEM DEVELOPMENT & EVALUATION (PHASE II)

DESIGN MONITORING SYSTEM

- CONTRACTOR SUPPORT
- IN-HOUSE INTEGRATION

PROCURE SYSTEM HARDWARE

- PURCHASE HARDWARE
- DESIGN LBTM

DEVELOP MONITORING SYSTEM SOFTWARE

- CONTRACTOR DEVELOPMENT
- IN-HOUSE INTEGRATION

INSTALL HARDWARE IN LBTM & EVALUATE

- FAULT IMPLEMENTATION
- SENSOR/SOFTWARE EVALUATION
- SYSTEM REFINEMENT

INSTALL HARDWARE ON TEST VEHICLE & EVALUATE

- OPERATIONAL EVALUATION
- SYSTEM REFINEMENT

DESIGN HANDBOOK



SHIPBOARD MACHINERY MONITORING

MILESTONE	FY-1	FY-2	FY-3	FY-4	FY-5
HASE I TESTING TECHNOLOGY DEV. FAILURE MODE ANALYSIS DETERMINE CONDITION/PERFORMANCE SENSOR REQUIREMENTS DEVELOP FAILURE DETECTION/ PREDICTION SOFTWARE ALGORITHM SENSOR DEVELOPMENT & QUALIFICATION	○	—▲	—▲	—▲	—▲
HASE II SYSTEM DEVELOPMENT & EVALUATION DESIGN MONITORING SYSTEM PROCURE SYSTEM HARDWARE DEVELOP MONITORING SYSTEM SOFTWARE INSTALL HARDWARE IN LBIM & EVALUATE INSTALL HARDWARE ON TEST VEHICLE & EVALUATE DESIGN HANDBOOK	○	—▲	○—▲	○—▲	○—▲
FUNDING REQUIRED \$M	4	8	14	4	3
IN-HOUSE	1	4	5	3	2
CONTRACTORS	3	4	9	1	1



COST JUSTIFICATION

• PROGRAM COSTS AND CONTRACTOR PARTICIPATION BASED ON UPDATE OF DETAILED FORMAL PROGRAM PLANNING & PROPOSAL EFFORTS OVER PAST 8 YEARS. i.e.

• U.S. NAVY TEST TECHNOLOGY RDT&E PLAN, REV V 1982 (NAVELEX
CST)

• REPORT OF INDUSTRY ADHOC AUTOMATIC TEST EQUIPMENT PROJECT FOR THE NAVY APRIL 1977 (AEROSPACE INDUSTRIES ASSOC, ELECTRONIC INDUSTRIES ASSOC, NATIONAL SECURITY INDUSTRIAL ASSOC, WESTERN ELECTRONIC MFGS ASSOC, SHIPBUILDERS COUNCIL OF AMERICA)

• INDUSTRY/JOINT SERVICES AUTOMATIC TEST PROJECT FINAL REPORT JUNE 1980

• REPORT ON NAVY ISSUES CONCERNING AUTOMATIC TEST, MONITORING AND DIAGNOSTIC SYSTEMS AND EQUIPMENT FOR ASN(R&D) FEB 1976

• NAVSEA 6.3 PROGRAM MASTER TECHNICAL PLAN, 1 OCTOBER 1979, "SHIPBOARD MACHINERY PERFORMANCE MONITORING SYSTEM"

SHIPBOARD MACHINERY MONITORING



PAYOFF

- ENHANCED SHIP READINESS
 - TIMELY DETECTION OF MACHINERY PERFORMANCE DEGRADATION
 - REDUCED DOWN TIME
 - PROJECTION OF MACHINERY SYSTEM CAPABILITY
- REDUCED LOGISTIC SUPPORT COSTS
 - EARLY DETECTION & IDENTIFICATION OF FAULTS AT LOWER LEVEL OF REPAIR
 - MAINTENANCE ON DEMAND RATHER THAN CALENDAR SCHEDULING
 - REDUCED TIME TO TEST & MAINTAIN COMPLEX EQUIPMENT
 - MAINTENANCE SCHEDULING & RECORDING CAPABILITY
 - BETTER UTILIZATION OF MANPOWER

SHIPBOARD MACHINERY MONITORING



TECHNICAL RISKS

- RELIABILITY AND MAINTAINABILITY OF MONITORING SYSTEM
- ABILITY TO ACHIEVE HIGH CONFIDENCE PROGNOSTIC CAPABILITY
- SUCCESSFUL INTEGRATION WITH OTHER SYSTEMS
- SENSOR DEVELOPMENT AND IMPLEMENTATION COSTS



SHIPBOARD MACHINERY MONITORING

PROJECT ORGANIZATION

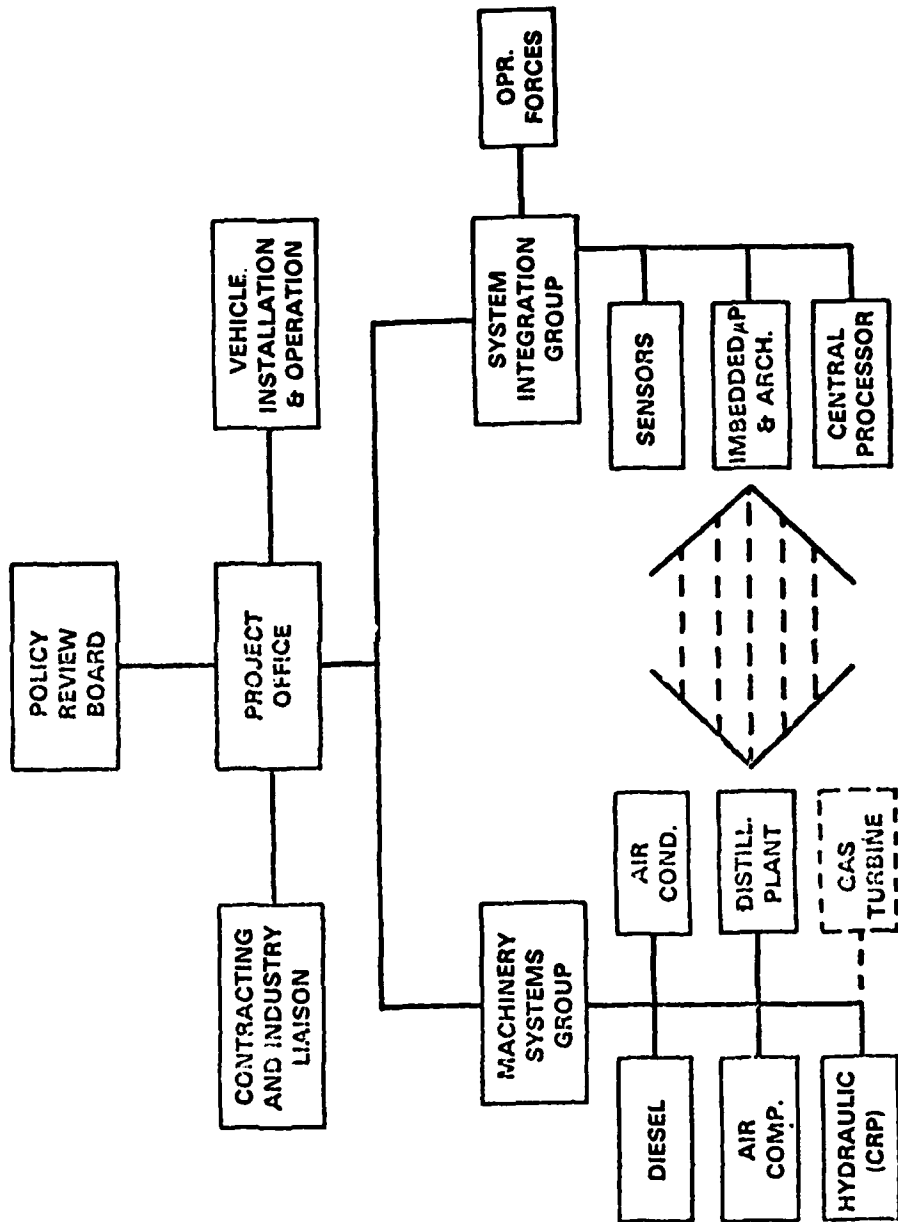

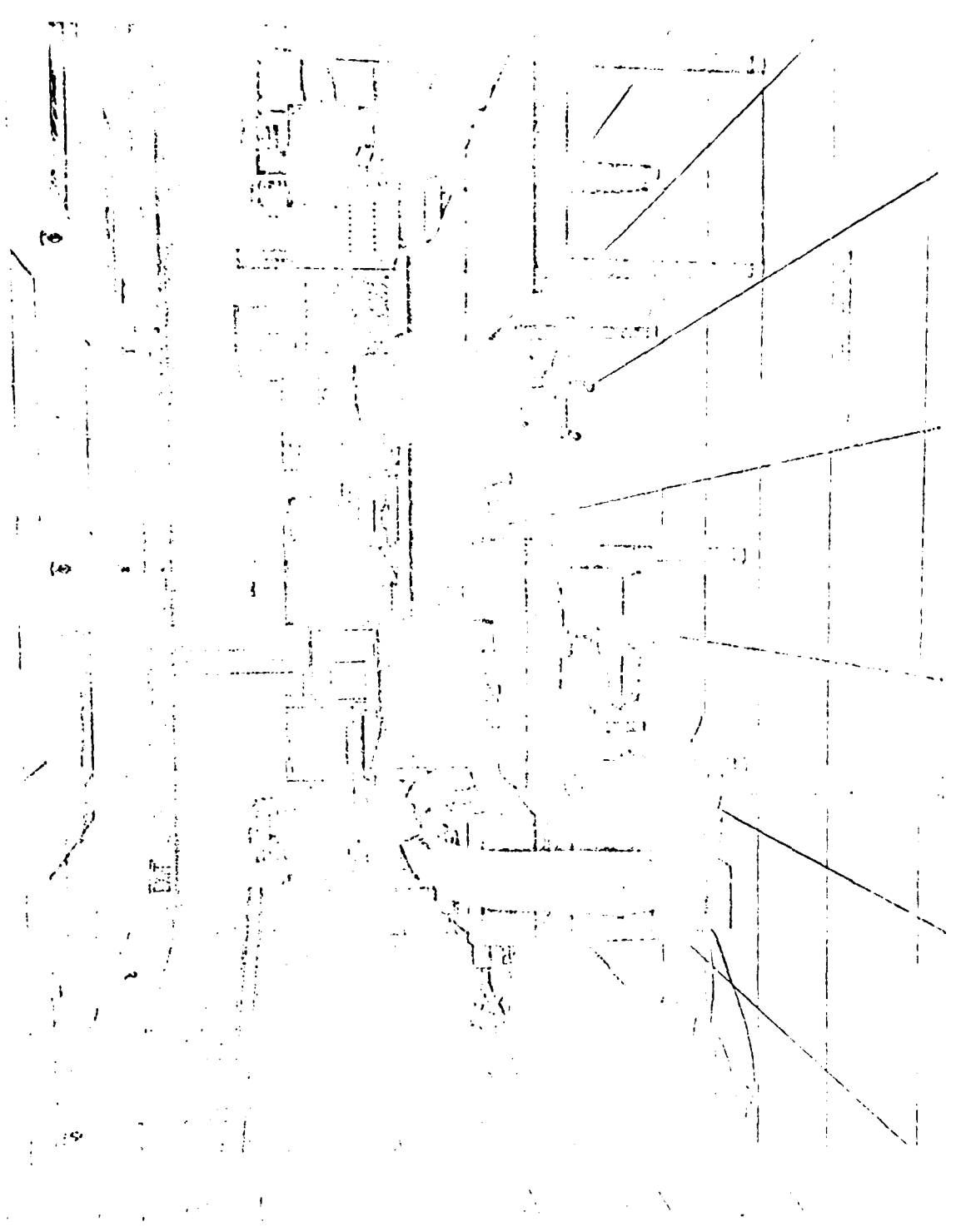

A-128



SHIPBOARD MACHINERY MONITORING

SUMMARY

DTNSRDC PROPOSES AND SUPPORTS DEVELOPMENT OF
AN INTEGRATED SHIPBOARD MACHINERY MONITORING
SYSTEM

RESULTING IN

- BROAD-FOCUS SYSTEM
- STANDARDIZATION (SOFTWARE AND HARDWARE)
- LOWER DEVELOPMENT COST
- ON BOARD FAILURE DETECTION/PREDICTION CAPABILITY

WITH BENEFITS

- IMPROVE SHIP READINESS
- REDUCE MAINTENANCE BURDEN
- REDUCE MANNING REQUIREMENTS

NORTHROP ELECTRONICS DIVISION

A-131

**TURBINE ENGINE
& AIRCRAFT STRUCTURAL MONITORING
TECHNOLOGY / APPLICATION
AT NORTHROP**

**PRESENTED TO
INSTITUTE FOR DEFENSE ANALYSES
SCIENCE AND TECHNOLOGY DIVISION**

15 FEBRUARY 1983

BY

NORTHROP ELECTRONICS DIVISION

76932

NORTHROP
Electronics Division

**SCOPE LIMITED TO DIAGNOSTIC TECHNOLOGY APPLICATION
AT NORTHROP ELECTRONICS DIVISION**

- **WHAT HAS BEEN DONE**
- **WHAT IS BEING DONE**
- **WHAT COULD BE DONE TO MAXIMIZE
IMPLEMENTATION PAYOFFS**

76933

NORTHROP
Electronics Division

PRESENTATION OUTLINE

- **OVERVIEW OF NORTHROP'S ACTIVITIES**
- **DESCRIPTION OF THE TECHNOLOGY**
- **APPLICATION OF THE TECHNOLOGY**
- **R&M BENEFITS**
- **RECOMMENDATIONS / SUMMARY**

76934

NORTHROP
Electronics Division

STEMS — WHAT IS IT?

- AIRBORNE DIAGNOSTIC SYSTEM OPERATING IN DYNAMIC ENVIRONMENT
- COMPRISED OF TWO FUNCTIONAL SUBSYSTEMS, SEPARATE OR INTEGRATED
 - TURBINE ENGINE MONITORING SUBSYSTEM = TEMS
 - AIRCRAFT STRUCTURAL TRACKING SUBSYSTEM = STEMS
- UTILIZING COOPERATIVE AIRBORNE & GROUND-BASED HARDWARE IN CONJUNCTION WITH EXISTING & ADDED SENSORS
- CONTROLLED BY COMMON FIRMWARE & SPECIFIC / UNIQUE SOFTWARE
- TO PROCESS & PRESENT TIMELY INFORMATION FOR R&M DECISION MAKING AT MOST FORWARD OPERATING LOCATION

HISTORY

- NORTHROP CONCEPT FORMULATION & DEVELOPMENT (I.R. & D) 1967 — 1971
 - T-38 TEMS MULTI-PHASE DEMONSTRATION PROGRAM 1972 — 1977
 - A-10 TEMS APPLICATION SERVICE EVALUATION PROGRAM 1977 — 1979
 - A-10 TEMS INTEGRATED STRUCTURAL TRACKING SYSTEM 1978 — 1982
- THREE PHASE PROGRAM
- TRANSITION-TO-PRODUCTION (T.T.P) PROGRAM 1979 — 1981
 - KC135R/CFM56 TEMS APPLICATION PROGRAM 1982 — 1983
 - INITIAL PRODUCTION AWARDS 1982 — 1983

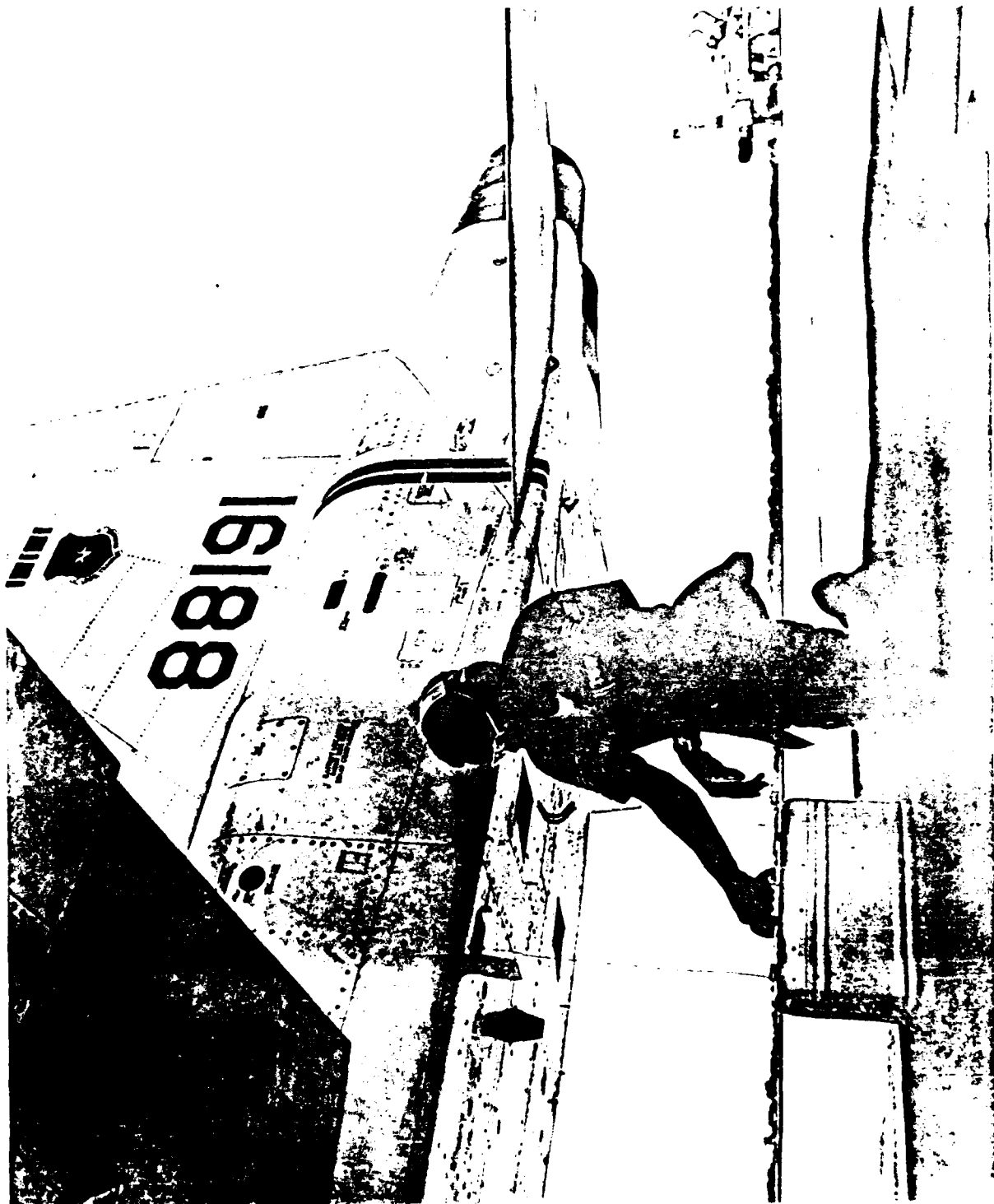

A-138

CURRENT STATUS

- **A-10 STEMS SQUADRON INTEGRATION PROGRAM IN PROCESS**
- **KC135R / CFM56 TEMS APPLICATION PROGRAM IN FLT TEST
(INITIAL PRODUCTION LOTS AUTHORIZED)**
- **F-20 STEMS DEMONSTRATION PROGRAM IN PROCESS**
- **F-14 STEMS COMPETITION IN PROCESS**

76937

NORTHROP
Electronics Division

TECHNOLOGY DESCRIPTION

NORTHROP
Electronics Division

76938

STEMS APPLICATION PRIME DISCIPLINES

- **SYSTEM ENGINEERING**
- **DIGITAL & ANALOG ELECTRONICS**
- **PROPULSION THERMODYNAMICS**
- **FATIGUE & FRACTURE MECHANICS**
- **COMPUTER SOFTWARE DEVELOPMENT**
- **INSTRUMENTATION ENGINEERING**
- **SIMULATION & TEST ENGINEERING**
- **RELIABILITY / MAINTAINABILITY ENGINEERING**
- **INFORMATION ENGINEERING**

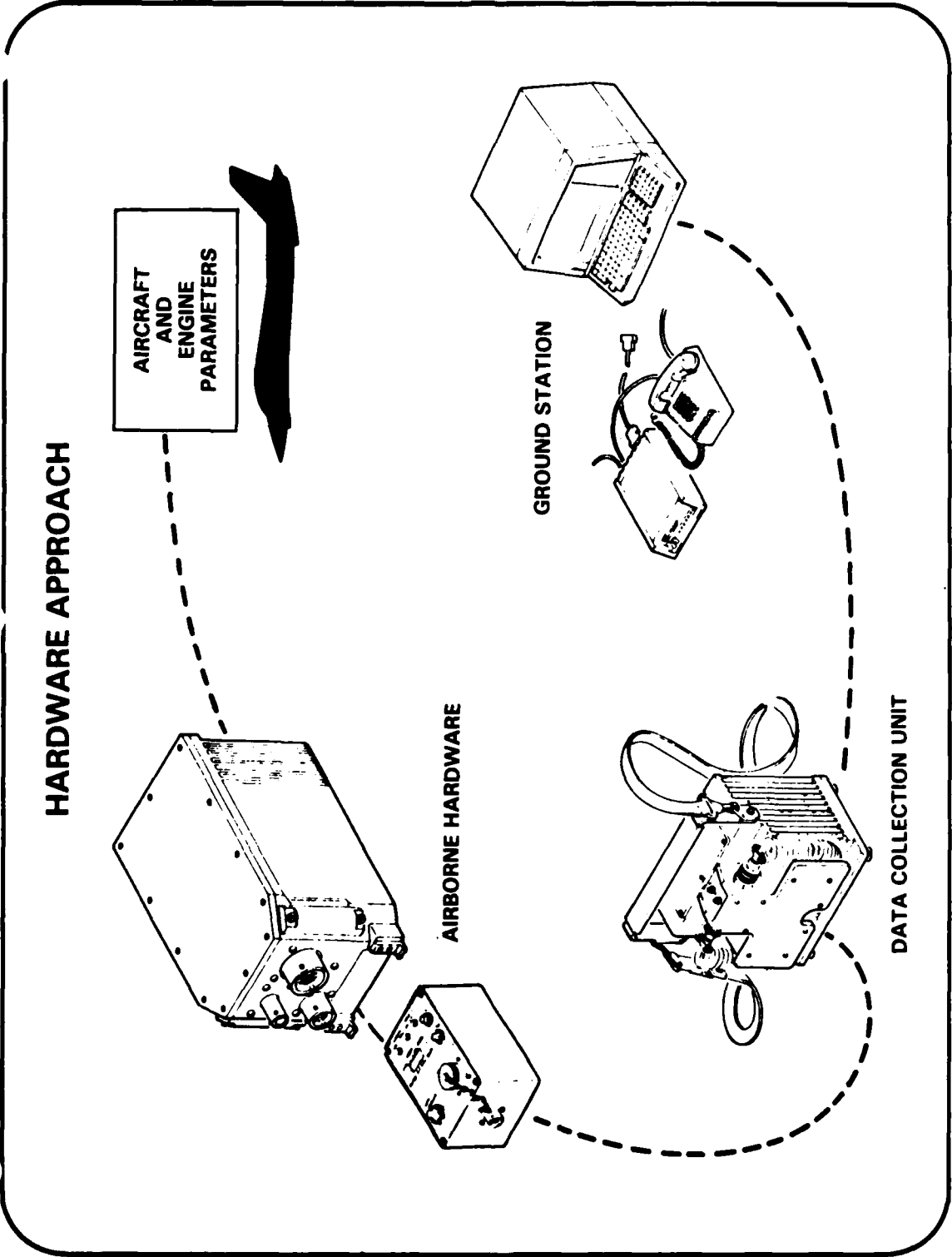



A-143

SYSTEM TECHNOLOGY

- MODULAR, STATE-OF-ART DIGITAL ELECTRONICS
 - DIGITAL PROCESSOR — MULTI TASK INTERRUPT MECHANIZATION
 - HIGH CAPACITY SOLID STATE MEMORY (PROM & RAM)
 - MULTIPLEXED LARGE ARRAY SIGNAL CONDITIONING — GENERIC MATRIX
 - RS 232 COMMUNICATION & MIL-STD-1553 PROVISIONS
- MODULAR UNIQUE SOFTWARE (MACHINE LANGUAGE)
 - EQUATIONS POLYNOMIAL FORM, LINE OR CURVE FITTING
 - DATA SUPPRESSION & COMPRESSION TECHNIQUES
 - TRIM & PERFORMANCE EQUATIONS & TRENDING
 - DOCUMENTARY DATA & 'EVENTS' ACQUISITION
 - ALGORITHMS TRANSFORMING DATA TO DECISIONAL INFORMATION
- GROUND-BASED, STATE-OF-ART INFORMATION MANAGEMENT / COMMUNICATION
 - DATA MENUS, DISPLAYS, PRINTOUTS & TRANSMISSION

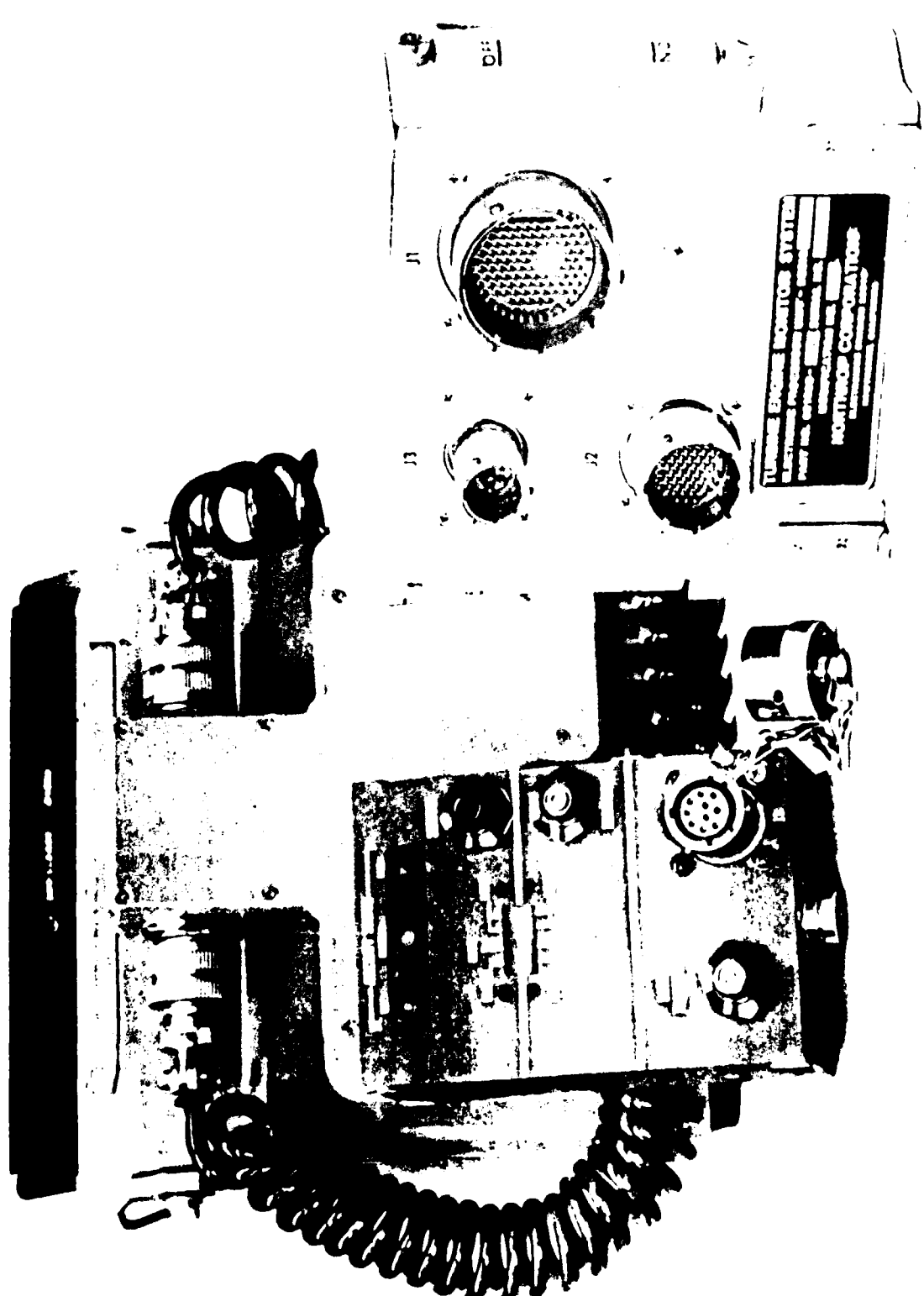

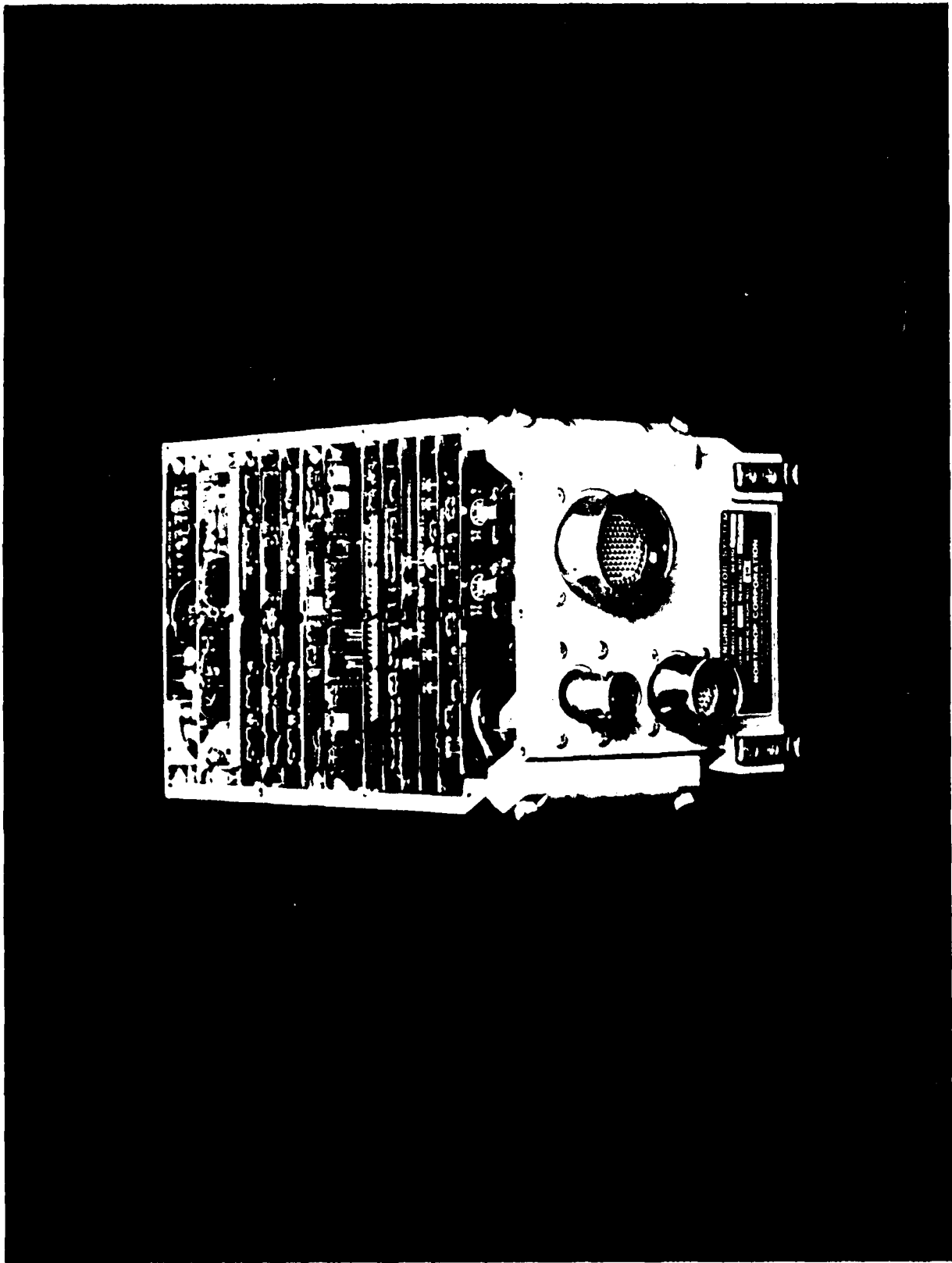

A-146

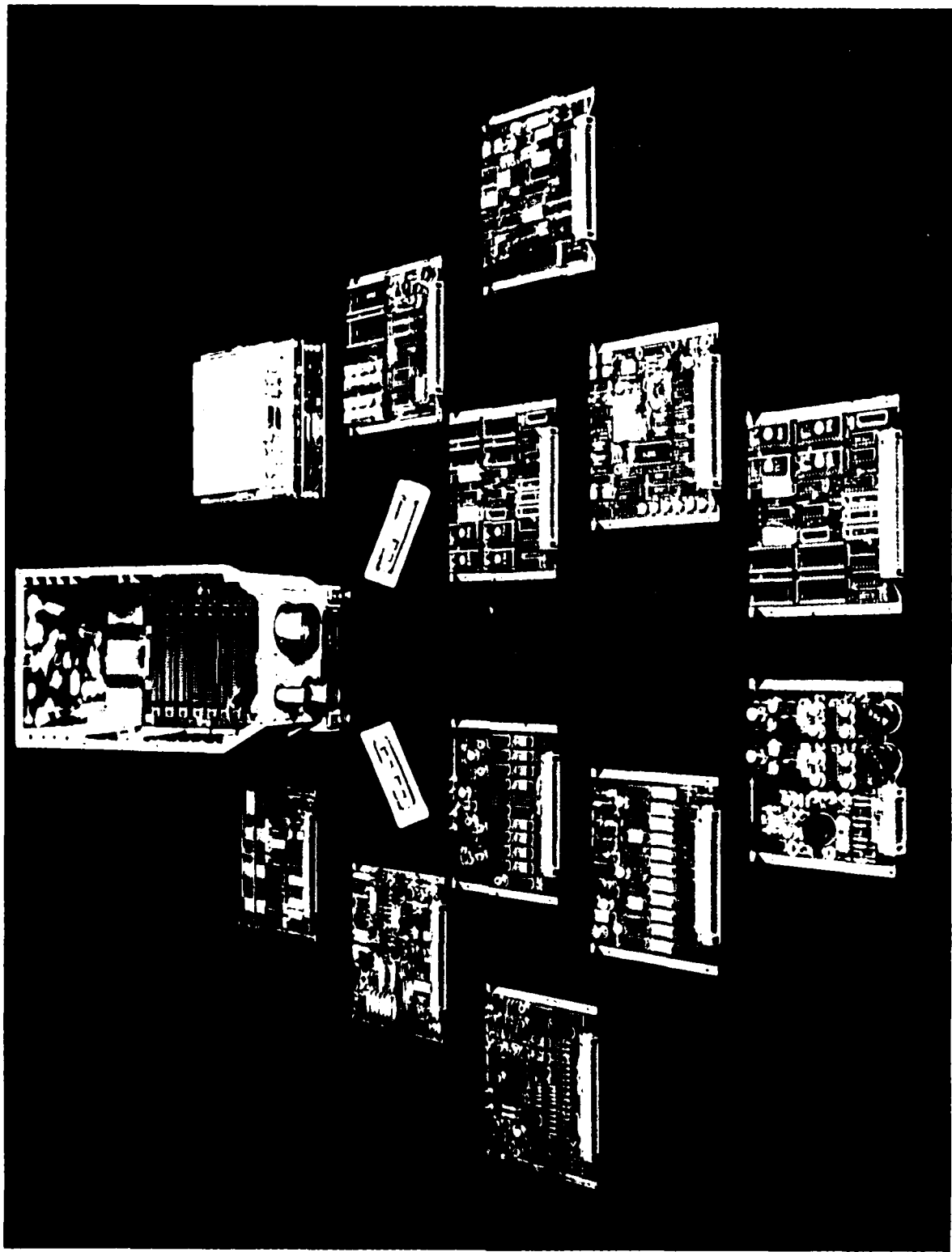

A-147

ELECTRONIC PROCESSOR UNIT EPU CP 1481 / USQ85

FUNCTION — ONBOARD MICROPROCESSOR PERFORMS SIGNAL CONDITIONING, DATA PROCESSING AND STORAGE.

BRIEF SPECIFICATION

VOLUME: 0.18 CU. FT.
SIZE: 9.5" L x 6.0" W x 5.5" H
WEIGHT: 10 POUNDS MAXIMUM
POWER: EXTERNAL 20 WATTS
28 VOLTS DC
MEMORY: PROM 32,768 8-BIT WORDS
RAM 32,768 8-BIT WORDS
EXPANSION TO 128K
8-BIT WORDS
BIT: FOR MALFUNCTION OF EPU
ENVIRONMENT: MIL-E-5400 CLASS 2
SERVICE LIFE: 20,000 HOURS
MTBF: 3000 HOURS
MTTR: 1.0 HOURS
RESOLUTION: 12 BITS BINARY

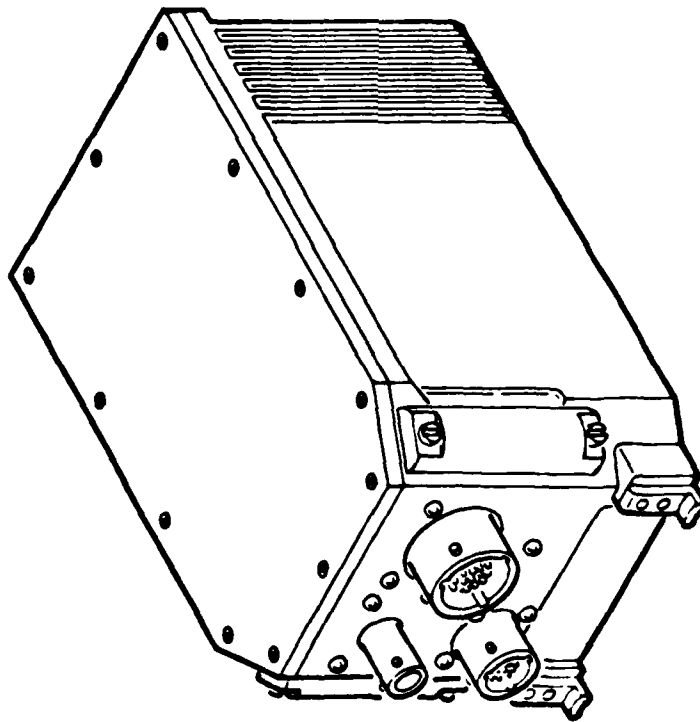

A-148

76941

NORTHROP
Electronics Division

**UMBILICAL DISPLAY UNIT
UDU
J 3784 / USQ85**

**FUNCTION — PROVIDE CONVENIENT
ACCESS TO EPU FOR DATA TRANSFER
AND AIRCRAFT STATUS.**

BRIEF SPECIFICATION

**VOLUME: 0.02 CU. FT.
SIZE: 4.9" L X 3.9" W X 1.8" D
WEIGHT: 1.75 POUNDS
POWER: EXTERNAL 12 WATTS AT
28 VOLTS DC
ENVIRONMENT: MIL-E-5400 CLASS 2
SERVICE LIFE: 20,000 HOURS
MTBF: 10,000 HOURS
MTRR: 1.0 HOURS**

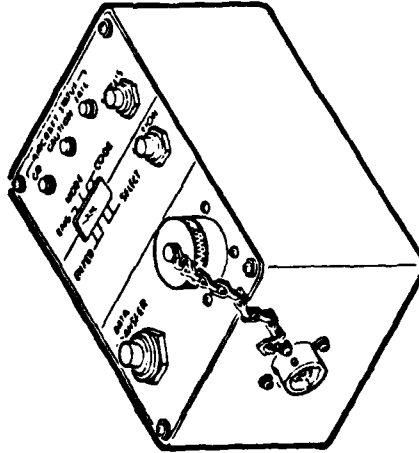

A-149

NORTHROP
Electronics Division

76942

**DATA COLLECTION UNIT
DCU
MU 718 / USQ85**

FUNCTION - TRANSFER DATA FROM EPU TO
GROUND STATION.

BRIEF SPECIFICATION

VOLUME: 0.32 CU. FT.
SIZE: 6.5"L x 10"W x 8.5"H
WEIGHT: 10.5 POUNDS MAXIMUM
POWER: EXTERNAL 15 WATTS
28 VOLTS DC
INTEGRAL BATTERY POWER PACK
OPTION

MEMORY: PROM 2048 8-BIT WORDS
RAM 65536 8-BIT WORDS
GROWTH OPTION - 192K
FOR MALFUNCTION OF EPU

BIT: ENVIRONMENT: MIL-T-28800 CLASS 3
SERVICE LIFE: 20,000 HOURS
MTBF: 5000 HOURS
MTTR: 1.0 HOURS

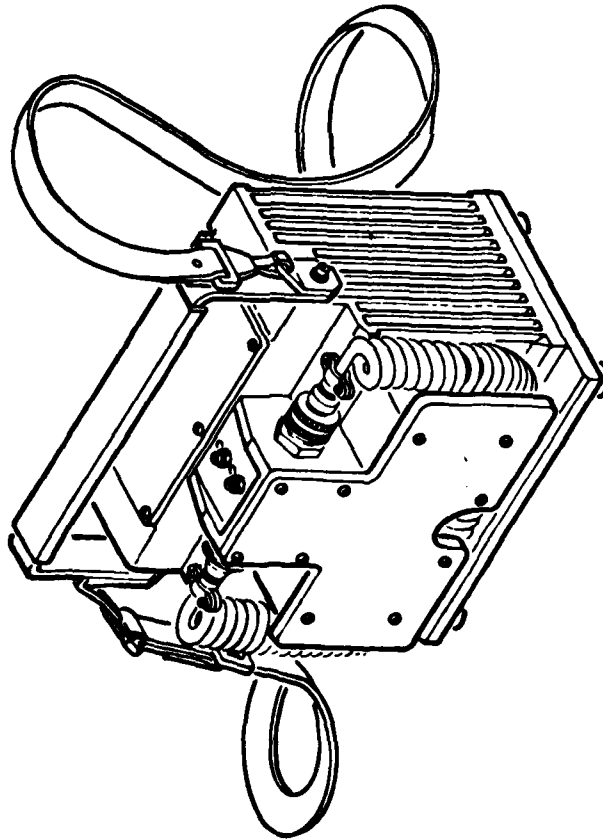

76943

NORTHROP
Electronics Division

**STEMS
DEPLOYABLE INFORMATION STATUS CENTER
(DISC)**

- **INTEGRATED MINIATURE FUNCTIONAL ELEMENTS**
 - **VIDEO — GRAPHICS CRT — 12"**
 - **DATA STORAGE — DUAL FLOPPY DISKETTES — 5 1/4" 360 K BYTES**
 - **HARD DISC (WINCHESTER) — 5 M BYTES**
 - **INTEGRAL KEYBOARD WITH MICROPROCESSOR**
 - **PRINTER — FULL SIZE DOT MATRIX GRAPHICS**
 - **MODEM — 1200 BAUD TRANSMISSION RATE**



A-152

APPLICATION OF THE TECHNOLOGY

NORTHROP
Electronics Division

76946

TEMS FUNCTIONS

MAINTENANCE / LOGISTICS

- ACQUIRE / AUTOMATE DATA SUFFICIENT AND NECESSARY FOR RCM IMPLEMENTATION
- MONITOR / DETECT / DIAGNOSE ENGINE DEGRADATIONS AND FAULTS — TRENDING
- VALIDATE CORRECTIVE MAINTENANCE ACTIONS INCLUDING FCFs
- TRACK / RECORD ENGINE USAGE AND LIFE LIMITED PARTS
(INCLUDING ENGINE MODULES AND CONFIGURATION CONTROL DATA)
- PROVIDE MAINTENANCE INFORMATION MANAGEMENT SYSTEM DATA

OPERATIONS / SAFETY

- DISPLAY ENGINES READINESS STATUS — ON-BOARD
PREFLIGHT / THRU-FLIGHT / POST FLIGHT MISSION ELEMENTS
- ALERT AIRCREW OF POTENTIAL SAFETY-RELATED PROBLEMS

76947

NORTHROP
Electronics Division

DATA FRAME ACQUISITION SCOPE

- **AUTOMATIC DATA FRAMES – STABILIZED CONDITIONS
(ENGINE PERFORMANCE TRENDING)**
- **DETECTED EVENTS FRAMES – OUT OF LIMIT CONDITIONS
(WITH COMPREHENSIVE CORRELATING DATA)**
- **AIRBORNE REAL TIME COMPUTATIONS UNDER DYNAMIC CONDITIONS
(COCKPIT WARNING OPTION)**
- **DIAGNOSTIC INDICATORS TO CORRELATE TO HANDBOOK**
- **LIFE USAGE FACTORS – TIME KEEPING & CYCLE COUNTING
(STRUCTURAL INTEGRITY PROGRAM & PARTS LIFE TRACKING DATA)**

**TEMS SOFTWARE SPECIAL MODULES
(EXAMPLES)**

- **AUTOMATED SENSOR CALIBRATION**
- **ENGINE EQUILIBRIUM LOGIC**
- **OPERATIONAL ENVIRONMENT LIMITS**
- **CONTROL SCHEDULES & PERFORMANCE LIMITS / CHARACTERISTICS**
- **DATA VALIDITY TESTING**
- **'SPECIAL' EVENTS HIGH RESOLUTION DATA FRAMES**
- **DATA PLOTTING ROUTINES**
- **DATA TRANSFER 'HANDSHAKE'**

INPUT PARAMETER SCOPE*

- TEMPERATURES — AMB / GAS PATH / FLUID
- PRESSURES — AMB / GAS PATH / FLUID
(TOTAL / STATIC / DIFFERENTIAL)
- POSITION / DISPLACEMENT SIGNALS
- FLOWS — AIR / FUEL / OIL
- ROTATIONAL SPEEDS —
- FLUCTUATIONS — TEMP / PRESS / POSITION / FLOW / SPEED
- VIBRATIONS — ACCELERATION / VELOCITY / DISPLACEMENT
(1 / REV & BROADBAND)
- DISCRETE ELECTRICAL SIGNALS — MULTIPLE COMBINATIONS
— VOLTAGE EXCITATION & LEVELS
(SWITCHES / SELSYNS / HI-LEVEL DC ANALOG / VARIABLE FREQ.)
- DIGITAL COUNTS — INDIVIDUAL & CUMULATIVE
- AIRFRAME DYNAMICS & ATTITUDE
- TIME — INCREMENTAL & CUMULATIVE

*BUFFERED / CONDITIONED / MULTIPLEXED SIGNAL CAPACITY > 70 INPUTS

76951

NORTHROP
Electronics Division

ENGINE MONITORING SUBSYSTEM FUNCTIONS (TYPICAL)

- **THRUST — PRE-TAKEOFF DISPLAY**
- **TRIM STATUS (DECK & AIRBORNE VERIFICATION)**
- **CONTROL SCHEDULES MONITORING (CVV, N1, N2, FTIT, AJ)**
- **AUGMENTOR SYSTEM NORMALCY**
- **VIBRATION LEVELS MATRIX**
- **ENGINE STABILITY MONITORING**
- **STALL DETECTION**
- **LUBE SYSTEM NORMALCY TRENDING**
- **FUEL SYSTEM NORMALCY**
- **ENGINE TIME-TEMP COUNTING (ENGINE DURABILITY ASSESSMENT)**
- **PROGRAMMED 'EVENT' MONITORING**
- **KEY ENGINE PERFORMANCE MONITORING**

TEMS EXPERIENCE EXAMPLES

- ISOLATION OF FAULT TO T5 (EGT) AMPLIFIER
AS OPPOSED TO MAIN FUEL CONTROL (MFC)
- IMPROPER THROTTLE RIGGINGS
RESULTING IN POWER LIMITATION OR INCOMPLETE SHUTDOWN
- THRUST DEGRADATIONS PRECISE VALUES – COMP. CONTAMINATION BY
GUNFIRE
(AND CHECK OF RESTORATION FOLLOWING WATER WASH)
- VIBRATION DETECTION & COMPRESSOR BALANCE FOLLOWING
REPLACEMENT FOR F.O.D.
- INFLIGHT COMPRESSOR STALL DETECTION (ALL TYPES) & PULSING
MAGNITUDE
(POST-FLIGHT MAINTENANCE AVOIDANCE)

FULL TIME ENGINE TEST CELL IN THE SKY

A-10 TEMS ENGINE STALL DETECTION EXAMPLE

CONDITIONS RECORDED

- ALT - 17105 FT.
- AIRSPEED 254 KCAS
- MACH NO. .525
- OUTSIDE AIR TEMP. -21.1 °C
- NORMAL ACCEL. 4.0 gs
- ANGLE OF ATTACK 23.2 UNITS
- SLATS POSITION EXTENDED
- GUNFIRE NONE

ENGINE DATA RECORDED PRIOR, DURING & POST STALL

- TURBINE TEMP
- COMP INLET TEMP
- POWER LEVEL ANGEL
- VARIABLE GEOMETRY
- FUEL FLOW
- COMP. DISC. PRESS.
- TURB. DISC. PRESS.
- FAN SPEED
- CORE SPEED

- LEFT ENGINE STALL; R.E. O.K.
- CAUSE CONFIRMED BY HIGH RESOLUTION DATA FRAMES
- NO MAINTENANCE ACTION OR TROUBLE SHOOTING REQUIRED

76955

NORTHROP
Electronics Division

**A-10A / TF 34 STALL LOGIC SOFTWARE
(EXAMPLE)**

- **MONITOR COMPRESSOR DISCHARGE PRESSURE (P_{s3}) EACH 10 MSEC**
- **COMPARE P_{s3} VALUE WITH PREVIOUS 0.25 SEC. AVERAGE**
- **DISCERN 50% OR > SUDDEN DROP**
- **CONFIRM WITH FAN SPEED (NF) DROP > 1% WITHIN 0.5 SEC**

ENGINE STALL DATA PRESENTATION
A-10A TEMS EVENT 26 JAN 1983

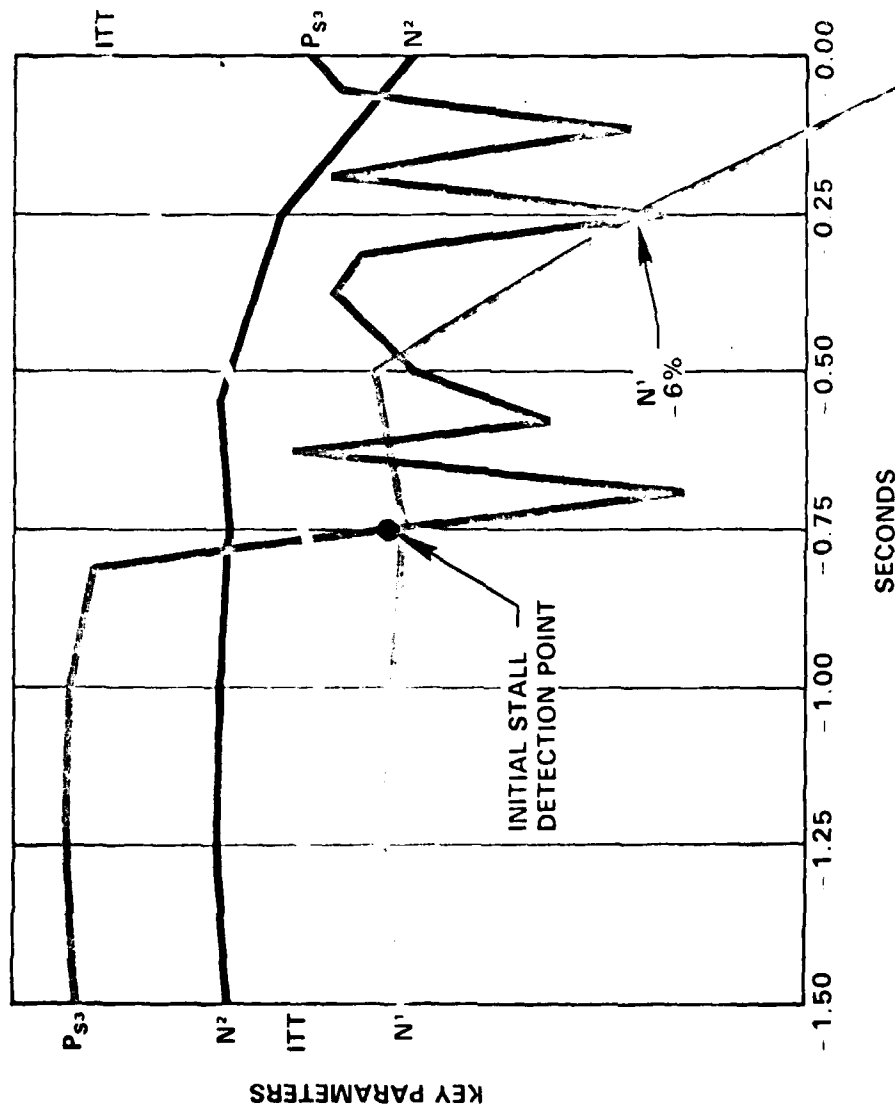

NOTE
 • PLA CONSTANT

76956

NORTHROP
 Electronics Division

STRUCTURAL TRACKING SUBSYSTEM FUNCTIONS

- **INDIVIDUAL AIRCRAFT TRACKING (IAT)**

MONITOR DAMAGE AT FATIGUE CRITICAL LOCATIONS TO:

- **PROVIDE SAFE OPERATIONAL LIFE**
- **DETERMINE INSPECTION AND REPAIR SCHEDULES**
- **SCHEDULE REPLACEMENT PARTS PROCUREMENT**

- **LOADS / ENVIRONMENT SPECTRAL SURVEY (L / ESS)**

GATHER DATA ON FLIGHT LOADS ENCOUNTERED OPERATIONAL AIRCRAFT TO:

- **ESTABLISH OR RE-EVALUATE USAGE SPECTRA**
- **DETERMINE SERVICE LIFE EXPECTANCY**
- **DETERMINE OPERATIONAL LIMITATIONS**
- **DEVELOP DATA FOR IMPROVED STRUCTURAL CRITERIA**

76957

NORTHROP
Electronics Division

A-10 INDIVIDUAL AIRCRAFT TRACKING IMPLEMENTATION

- ON BOARD CYCLE-BY-CYCLE CRACK GROWTH ANALYSIS
 - FIVE AIRFRAME LOCATIONS:
 - INNER WING LOWER COVER
 - OUTER WING LOWER COVER
 - AFT FUSELAGE
 - VERTICAL STABILIZER
 - HORIZONTAL STABILIZER
- MEASURED FLIGHT DATA:
 - VERTICAL ACCELERATION
 - LATERAL ACCELERATION*
 - AIRSPEED
 - FUEL FLOW
- IDENTIFICATION DATA:
 - TIME
 - DATE
 - AIRCRAFT SERIAL NUMBER
 - BASE
 - FLIGHT DURATION
 - MISSION CODE
 - AIRCRAFT WEIGHT
 - STORES CONFIGURATION

* NEW SENSOR

76958

NORTHROP
Electronics Division

STEMS FLIGHT DATA COMPRESSION TECHNIQUE

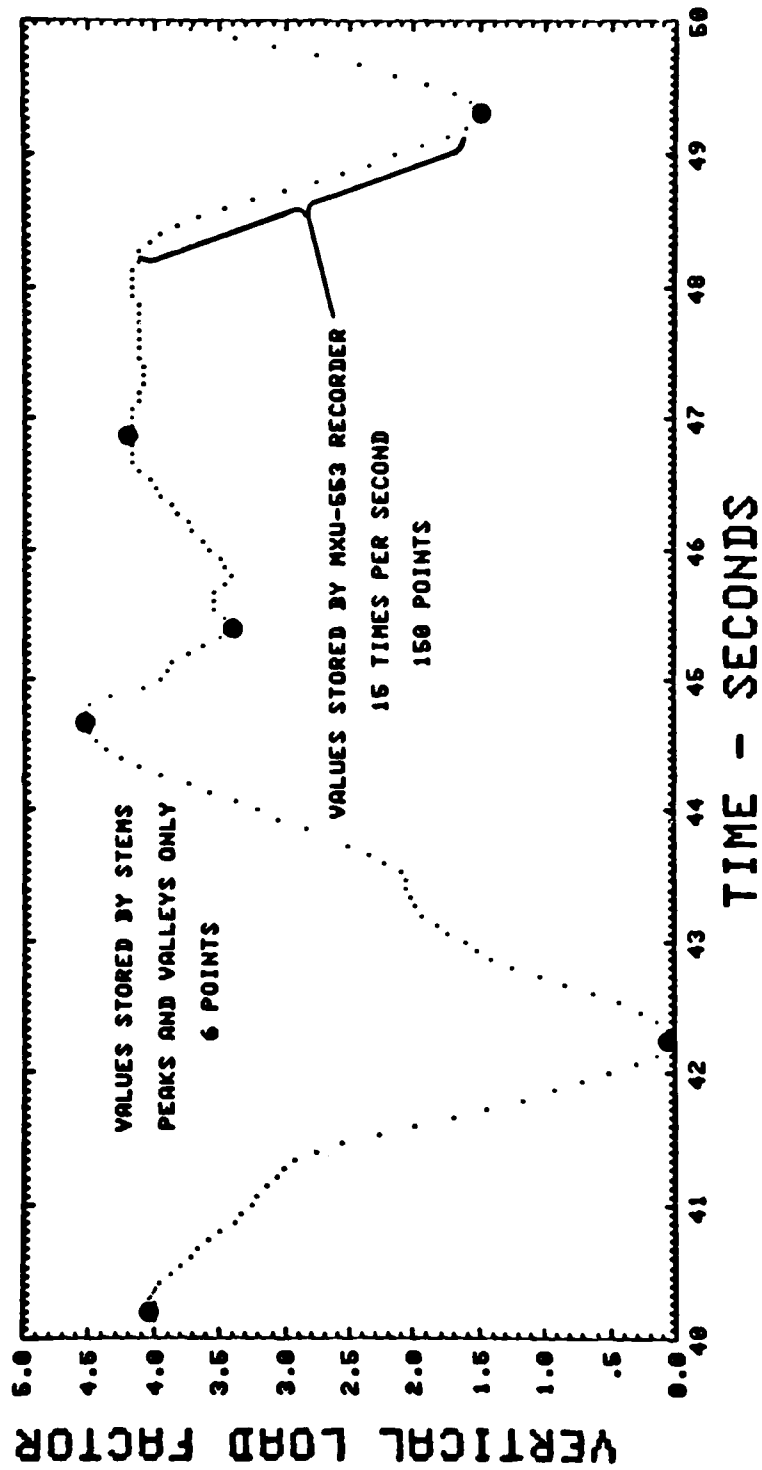

76959

NORTHROP
Electronics Division

STEMS CRACK GROWTH ANALYSIS

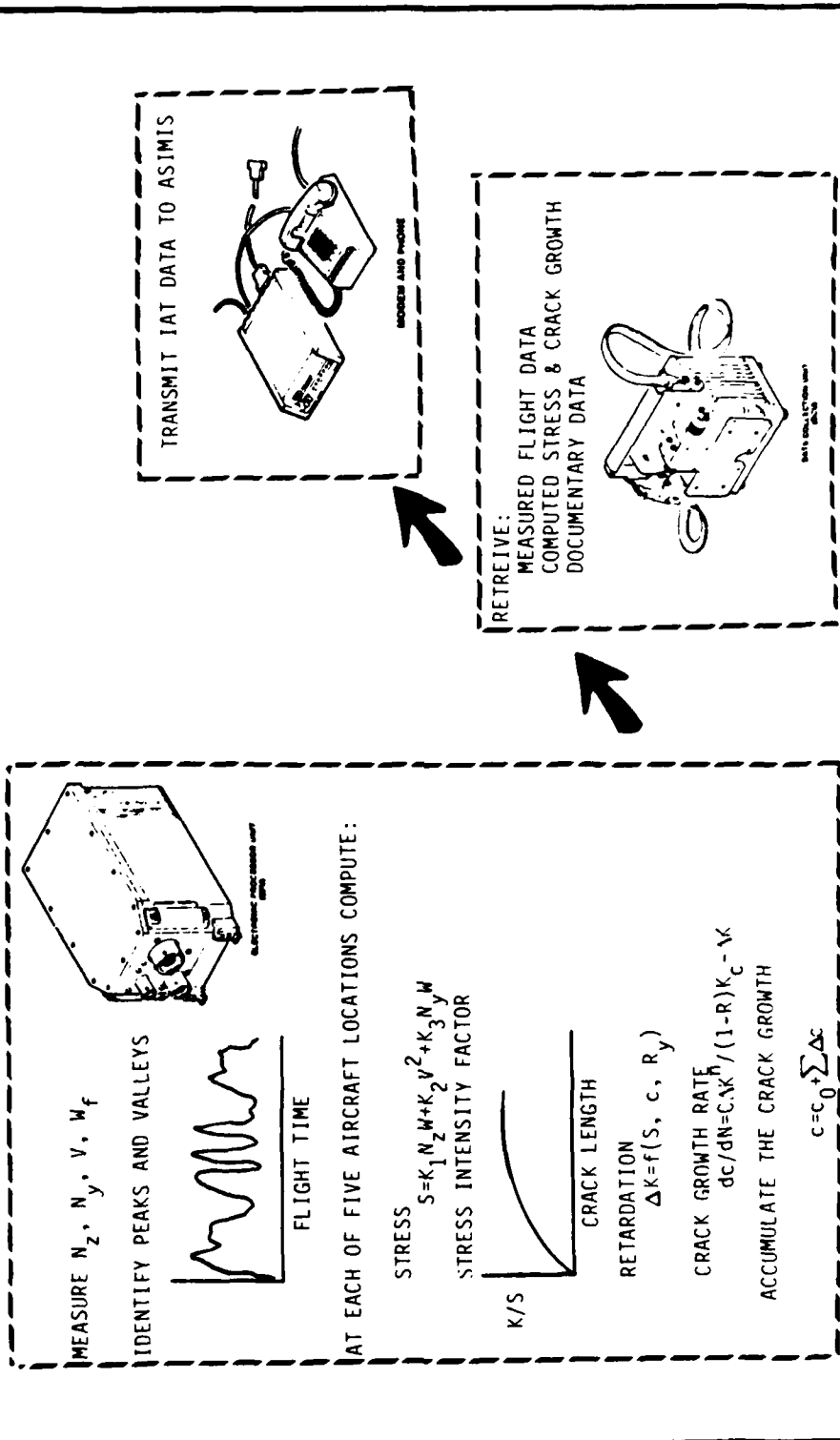

NORTHROP
Electronics Division

76960

A-10 LOAD / ENVIRONMENT SPECTRA SURVEY IMPLEMENTATION

- DETERMINE PEAK AND VALLEYS OF
 - LATERAL ACCELERATION
 - VERTICAL ACCELERATION
 - PITCH ACCELERATION
 - POWER LEVER ANGLE

- FOR EACH PEAK OR VALLEY STORE
 - PEAK CODE
 - WEIGHT
 - FUEL WEIGHT
 - ALTITUDE
 - AIRSPEED
 - LATERAL ACCELERATION
 - VERTICAL ACCELERATION

- IDENTIFICATION DATA
 - TIME
 - DATE
 - AIRCRAFT SERIAL NUMBER
 - BASE
 - FLIGHT DURATION

- ROLL RATE
- PITCH RATE
- YAW RATE

}

*

- ROLL RATE
- PITCH RATE
- YAW RATE
- PITCH ACCELERATION
- POWER LEVER ANGLE POSITION
- TIME
- EVENTS

- MISSION CODE
- AIRCRAFT WEIGHT
- STORES CONFIGURATION

*ONE NEW SENSOR PACKAGE

76961

NORTHROP
Electronics Division

**CONFIGURATION COMPARISON
TEMS TO STEMS
(TYPICAL)**

SYSTEM ELEMENT	TEMS BASELINE	STEMS
<p>ELECTRONIC PROCESSOR UNIT — EPU UMBILICAL DISPLAY UNIT — UDU DATA COLLECTION UNIT — DCU DIAGNOSTIC DISPLAY UNIT — DDU DEPLOYABLE GROUND STATION — DISC AIRFRAME SENSORS ENGINE-MOUNTED SENSORS — ADDED STRUCTURAL TRACKING SENSORS ADDED FIRMWARE INCL. EXECUTIVE ENGINE DIAGNOSTIC SOFTWARE MODULES STRUCTURAL TRACKING SOFTWARE MODULES A / C INSTALLATION PROVISIONS</p>	<p>✓ ✓ ✓ ✓ ✓ ✓ ✓ NOT REQ'D ✓ ✓ NOT REQ'D ✓</p>	<p>ADD 1 RAM MODULE SAME SAME SAME SAME SAME SAME ADD 2 SENSORS SAME SAME ADD EQUIV. 20% TEMS ADD'L CABLING</p>

76962

NORTHROP
Electronics Division

TEMS / STEMS SYSTEM CONFIGURATION COMPLEXITY DISTRIBUTION GENERAL

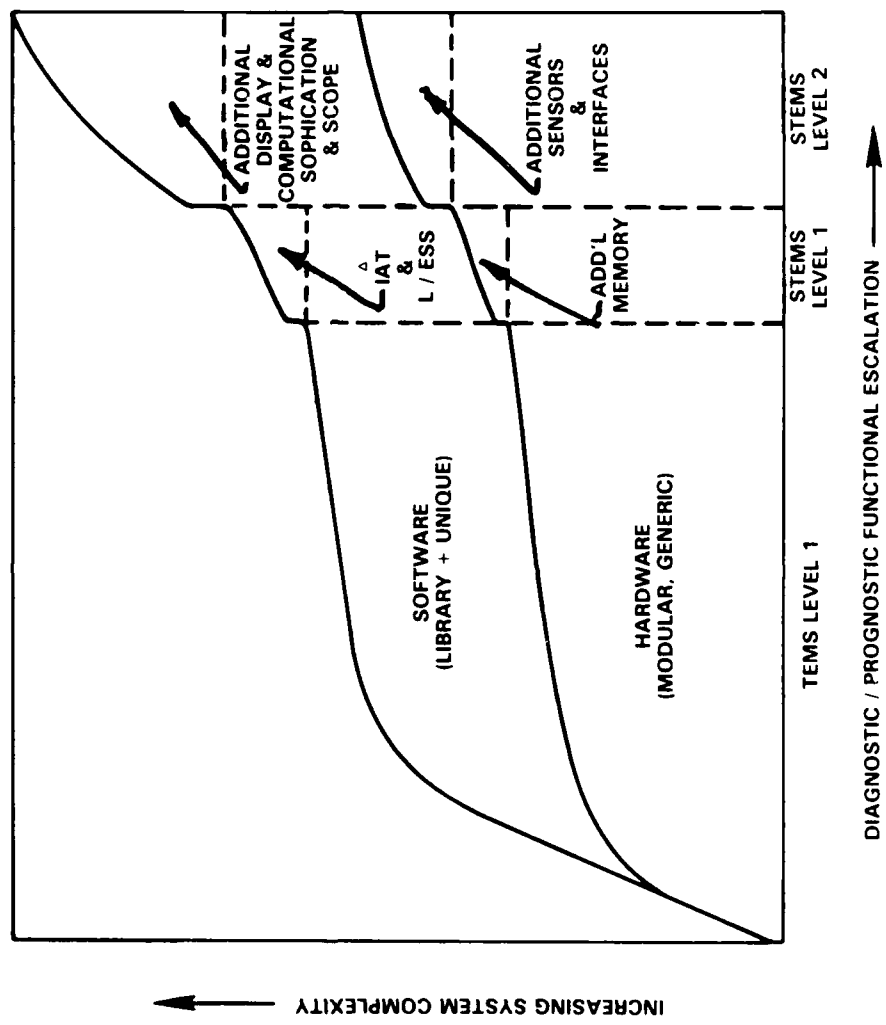

76964

EXISTING TEMS / STEMS IS GENERIC HARDWARE

	A-10A	F-20	KC-135R
ENGINE MONITORING			
● DATA ACQUISITION	✓	✓	✓
● EVENT DETECTION	✓	✓	✓
● USAGE / SEVERITY RECORDING	✓	✓	✓
● ENGINE TRIMMING VERIFICATION	✓	✓	✓
● FAULT ISOLATION (DIRECT OR HANDBOOK)	✓	✓	—
● PERFORMANCE MONITORING (GAS PATH ANALYSIS)	✓	✓	✓
● TRIM & PERF. TRENDING — PROGNOSIS	✓	✓	✓
● STATUS INDICATION (ON-BOARD)	✓	✓	✓
● MAINT. DATA MGMT — INFO PRINTOUT	✓	✓	✓
● REAL TIME DIAGNOSTIC DISPLAY (DDU)	✓	✓	—
● WARRANTY DATA	—	—	✓
STRUCTURES MONITORING			
● IAT / LESS / ENSIP	✓	✓	*

* PENDING

76965

NORTHROP
Electronics Division

**RELIABILITY, MAINTAINABILITY, AVAILABILITY
BENEFITS**

76966

NORTHROP
Electronics Division

ANTICIPATED R.M.A. BENEFITS

- INCREASED FULLY MISSION CAPABLE (FMC) & SORTIE RATES
- PROGRESSION TO RELIABILITY CENTERED MAINTENANCE (RCM) CONCEPT
THE KEY TOOL
- REDUCED FUEL CONSUMPTION — CRITICAL NATIONAL RESOURCE
(FEWER TROUBLESHOOTING GROUND RUNUPS & FUNCTIONAL CHECK FLIGHTS)
- IMPROVED LOGISTICS MANAGEMENT — MODERN INFORMATION
MANAGEMENT

PROMOTES ENORMOUS CONFIDENCE INCREASE IN FMC STATUS

**TEMS LCC BENEFITS
(TACTICAL AIRCRAFT)**

<u>FACTOR</u>	<u>ESTIMATED IMPROVEMENT</u>
● A / C AVAILABILITY (FORCE MULTIPLIER)	5 - 10% INCREASE
● BASE MAINTENANCE LABOR	1.0 MMH / FH REDUCTION
● FUEL CONSUMPTION	30% OF GROUND RUNS ELIMINATED
● A / C ATTRITION	10% IMPROVEMENT - SINGLE ENGINE A / C 5% IMPROVEMENT - DUAL ENGINE A / C
● ENGINE REMOVAL RATE (SHOP VISITS)	25% REDUCTION IN UNSCHEDULED MAINTENANCE (UNWARRANTED REMOVAL)
● SECONDARY DAMAGE (MATERIEL)	15% REDUCTION
● FUNCTIONAL CHECK FLIGHTS (FCFs)	25% REDUCTION
● LOGISTICS MANAGEMENT PAPER HANDLING	33% - 50% REDUCTION



GENERAL ELECTRIC INDEPENDENT ASSESSMENT

- **TEMS AIRCRAFT AVAILABILITY 30% BETTER THAN NON-TEMS**
- **TEMS CAN REPLACE ETTRS, TRIM BOX & VIBRATION ANALYZER**
- **DETECT 75% OF MALFUNCTIONS/SYMPOMS RESULTING IN ON WING ADJUSTMENTS**
- **DETECT/FAULT ISOLATE 34% OF MALFUNCTION SYMPTOMS WHICH RESULT IN UNSCHEDULED LINE REPLACEMENT UNIT REMOVALS**
- **DETECT OR FAULT ISOLATE 25% OF MALFUNCTION SYMPTOMS WHICH RESULT IN UNSCHEDULED SHOP VISITS**

A-174

76968

2495

INCREASED A / C AVAILABILITY COST BENEFIT

A-10 A FORCE MULTIPLIER EXAMPLE

- FLEET SIZE — 733 A / C
- LIFE EXPECTANCY — 15 YEARS
- UTILIZATION
 - PER A / C — 4500 F.H. (BASED ON 25 F.H. / MO)
 - FLEET 3,300,000 F.H.
- ASSUME 5% FMC IMPROVEMENT DUE TO TEMS
- ADDITIONAL F.H.s THAT CAN BE GENERATED BY FLEET — 165,000 F.H.

FORCE MULTIPLIER
EQUIVALENT TO 2 ADD'L 18 A / C SQUADRONS

SUMMARY & RECOMMENDATIONS

NORTHROP
Electronics Division

76972

SUMMARY

- QUALIFIED GENERIC HARDWARE BEING APPLIED
 - NO TECHNOLOGY BARRIERS
- FUTURE REFINEMENTS PROVISIONS FOR INCORPORATION WHEN REQUIRED
 - MIL-STD-1750A COMPUTER
 - MIL-STD-1584A HIGHER ORDER LANGUAGE
 - MIL-STD 1553B COMMUNICATIONS BUS -- IN PROCESS
 - INCREASED MEMORY STORAGE CAPACITY -- IN PROCESS
- TECHNOLOGY DEVELOPMENT PER SE NOT REQ'D; APPLICATION ENGINEERING IS:
 - SYSTEMS ENGINEERING FOR EACH NEW CANDIDATE W.S.
 - UNIQUE / INNOVATIVE SOFTWARE
- HIGHEST PAYOFF IS IN APPLICATION OF MULTI FUNCTIONAL EXISTING TECHNOLOGY BUT PLANS FOR FOLLOW-ON OBSCURE

76973

NORTHROP
Electronics Division

RECOMMENDATIONS

- UPDATE DOD POLICIES & GUIDANCE TO SERVICES ON DIAGNOSTIC APPLICATION
 - ENGINE & STRUCTURES CLARIFICATION
 - INTEGRATED MULTI FUNCTION WHEREVER POSSIBLE
 - DIRECT AGGRESSIVE APPLICATION OF EXISTING TECHNOLOGY / EQUIPMENT *
INDEPENDENT OF LONG TERM UNENDING R&D PROJECTS
 - REALISTIC NEAR TERM IMPLEMENTATION / BENEFITS
 - AVOIDANCE OF REDUNDANCY & PROLIFERATION PROBLEMS
 - INVESTIGATE OTHER POTENTIAL APPLICATIONS
 - ROTARY AS WELL AS FIXED WING TACTICAL A / C
 - SHIPBOARD TURBINE ENGINES
 - TANK TURBINE ENGINE
 - SUBMARINE SYSTEMS
- * STUDY AN / USQ-85 POTENTIAL



STEMS AUTOMATIC INPUT SIMULATOR (A15)

A-179

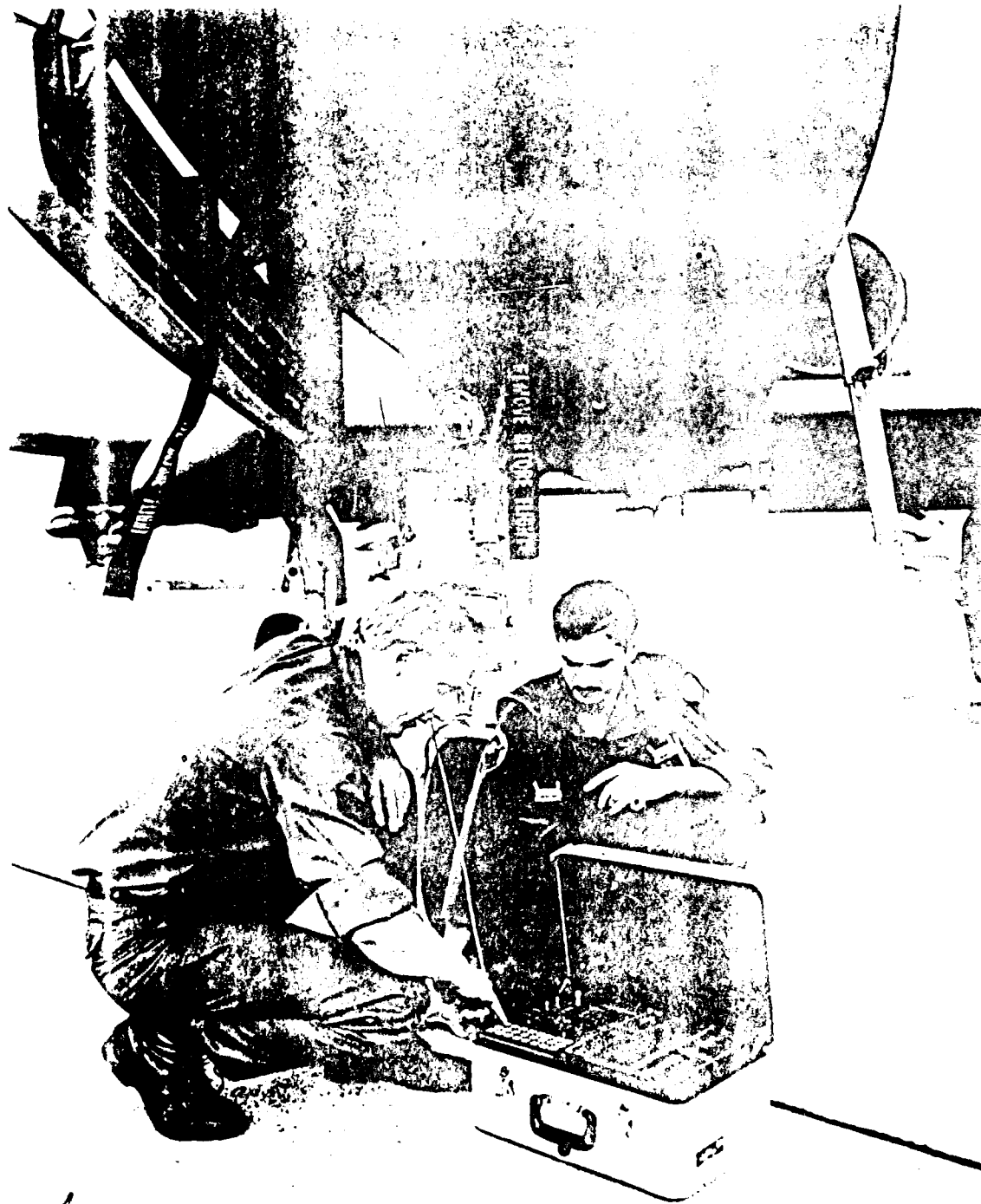

A-180

**USAF SCIENTIFIC ADVISORY BOARD REPORT
JULY 1982**

"IN THE CASE OF TACTICAL AIRCRAFT, THE USE OF AUTOMATED EQUIPMENT, I.E., TURBINE ENGINE MONITORING SYSTEM (TEMS), IS OBLIGATORY."

"PROLIFERATION OF UNIQUE DIAGNOSTIC EQUIPMENT FOR EACH AND EVERY APPLICATION BEARS HARD ON LACK OF SUCCESS OF PREVIOUS PROGRAMS."

"WHILE TEMS CAN BE OF SERVICE TO THE FLIGHT LINE MECHANIC AND THE BASE COMMANDER IN GENERATING INCREASED SORTIES AND DECREASING THE TRAINING REQUIRED BY THE FLIGHT LINE CREWS, IT NEVERTHELESS HAS ITS BIG PAYOFF IN SUPPORTING RELIABILITY CENTERED MAINTENANCE."

LEAR SIEGLER, INC.

A-183

AD-A137 524

MECHANICAL SYSTEMS CONDITIONING MONITORING TECHNOLOGY
WORKING GROUP REPORT (U) INSTITUTE FOR DEFENSE ANALYSES
ALEXANDRIA VA SCIENCE AND TECH. P HOWARD AUG 83

5/6

UNCLASSIFIED

IDA-D-36 IDA/HQ-83-25899 MDA903-79-C-0018

F/G 15/3

NL

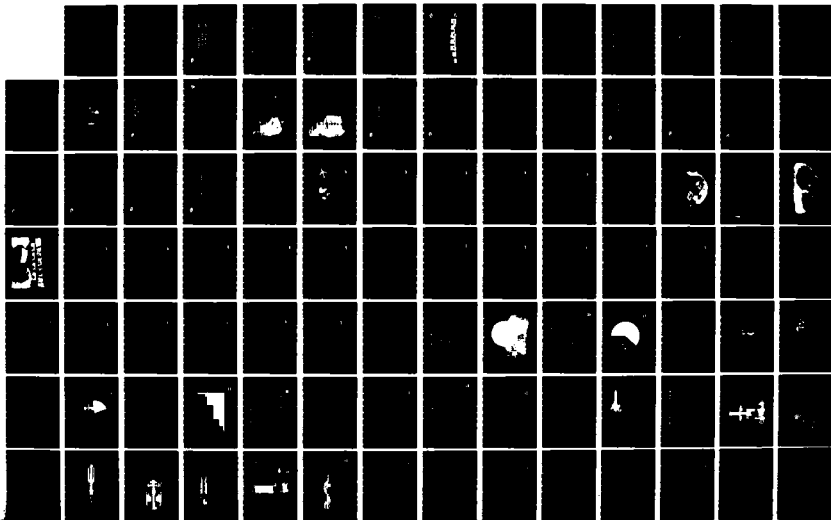

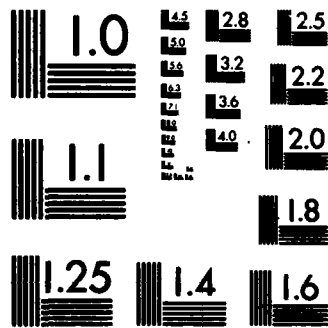

MICROCOPY RESOLUTION TEST CHART
NATIONAL BUREAU OF STANDARDS-1963-A

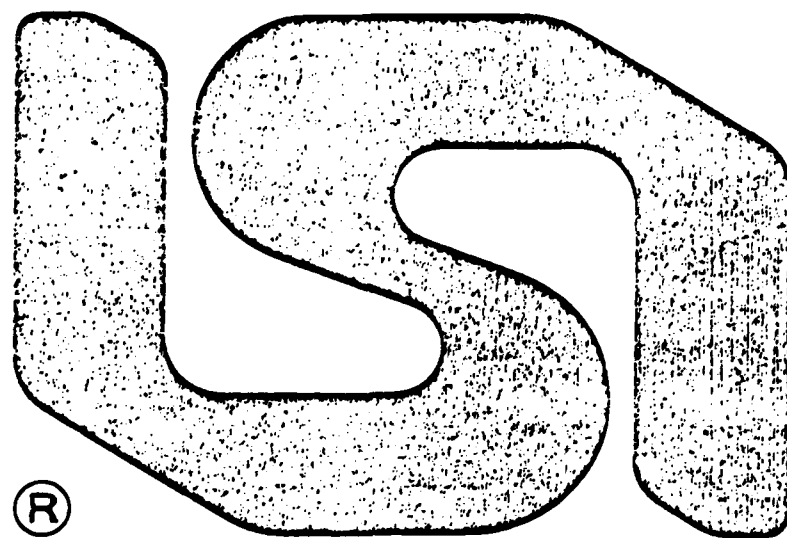

®

LEAR SIEGLER, INC.



LEAR SIEGLER, INC.

Aerospace Group

Santa Monica, Calif.

Astronics Div.

Santa Monica, Calif.

Instrument Div.

Grand Rapids, Mich.

LSI Avionic Systems Corp.

West Caldwell, N.J.

Management Services Div.

Oklahoma City, Okla.

Power Equipment Div.

Maple Heights, Ohio

Romec Div.

Elyria, Ohio

Steinheil - Lear Siegler AG

West Germany

Transport Dynamics Div.

Santa Ana, Calif.

THE WALL STREET JOURNAL.

© 1982 Dow Jones & Company, Inc. All Rights Reserved.

3 ★ ★ ★

Business Bureau

THURSDAY, DECEMBER 9, 1982

PRINCETON, NEW JERSEY

What's News

ig News
ie Angle
he Same

to Find
g Japan,
ade Issues

IBM Case

Business

Supreme Court

Chemical

Shareholders

What's News

Business

THE FOC IN
direct com
and data carr
ications. The s
AT&T to offer i
data services at
overseas. The
RIO General's
New York CK
carries, N.J.

Bradell said i
operating plan i
apped two week
is to lease jets
lated assets fro

Even outside
would leave th
"an enormous
about \$150 bill
large budget C
Lawrence Kuth
the White Hou
ment and Bank

A tax based on gasoline and diesel
traits was tentatively approved by the
Senate finance panel. The proposed in-
crease may be considered by the full
Senate late this week.

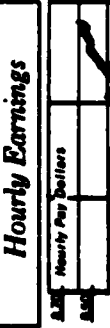

LEAR SIEGLER, INC.

Fiscal 1982 Statistics

Sales
Working Capital
Total Assets

\$1,487,505,000
292,848,000
909,697,000

21,983 Employees In 46 Divisions
14,082,220 Sq. Ft. of Floor Space
22,585 Shareholders
New York Stock Exchange

Business Bulletin

A Special Background Report
On Trends in Industry

matches ar
sis.
te; expecta-
ghee Co., a
hain, says
ead of last
closer to
ident, the
%." People
sarily par-
cles execu
oadway de-
make sure

nds of the
the middle
il for outlet
20% to 25%
& Taylor, a
ciated Dry
very good

his back."
"bet he's
featured in

lammers,
and provide
members of
there is the
le "for lec

tures, editorial meetings or stroking ab-
tractedly." And so it goes: "Items from
Our Catalog" (Avon Books, \$4.95) is a deft
84-page parody of L.L. Bean's popular
mailer. Avon has printed 400,000 copies so
far.

Stocks

Drop i
Many i
And to

Buying
Has
Wait

The New

By
Carolya Ja
has just mad
vest her \$40
account rail
past. "Now i
seems to be
And in Pak
a \$28 blazer
is an engineer
but he forgot
won't cut any
might even c

Mrs. Jacks
fundamental
the developm
egy. "Disinfla
terms of consum
the '80s and
economist at
Cynwyd, Pa.
price-increase'
placed by a
with renewed
Inflation De

Underlying
the sharp drop

Also new in humor at many bookstores is
"Over-Extension University Bulletin" (M.
Evans, \$3.95), a spoof of continuing educa-



LSI/ASC

Major Program/Product Experience

A-6E	Air Data Computer Weapons Management System	F-18	Weapons Management System Communications Control Set
EA-6B	Air Data Computer Course Attitude Director	AV-8B	Weapons Management System Auxiliary CNI Panel
E-2C (C-2)	Air Data Computer Impact Pressure Transducer	Shuttle	Engine Interface Unit FM Signal Processor Ground Command Interface Logic Unit Mission Timer Event Timer
F-4G	Mission Recorder	MK 48 Torpedo	Syncrostepper
F-15	Signal Data Recorder	All USAF Aircraft (Percentage)	Flight Loads Data Acquisition System
F-16	Flight Loads Data Acquisition System		

Universal Locator/Airborne Integrated Data System (ULIDS)

- Health Monitoring and Recording
 - Engines
 - Aircraft Structure
 - Avionics
- Crash Recording
- Master Monitor Display
- Data Bus Multiplexing

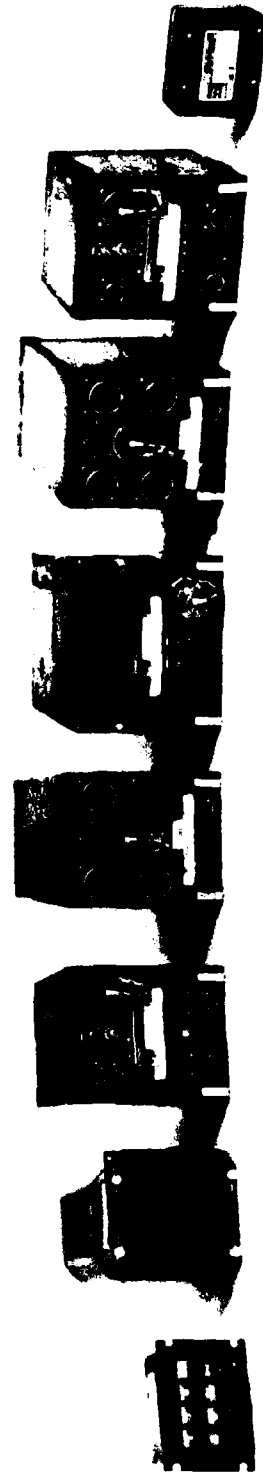

AM/ATQ-8 (U) PLATE

F-15/F100 ENGINE DIAGNOSTIC SYSTEM PROGRAM STRUCTURE

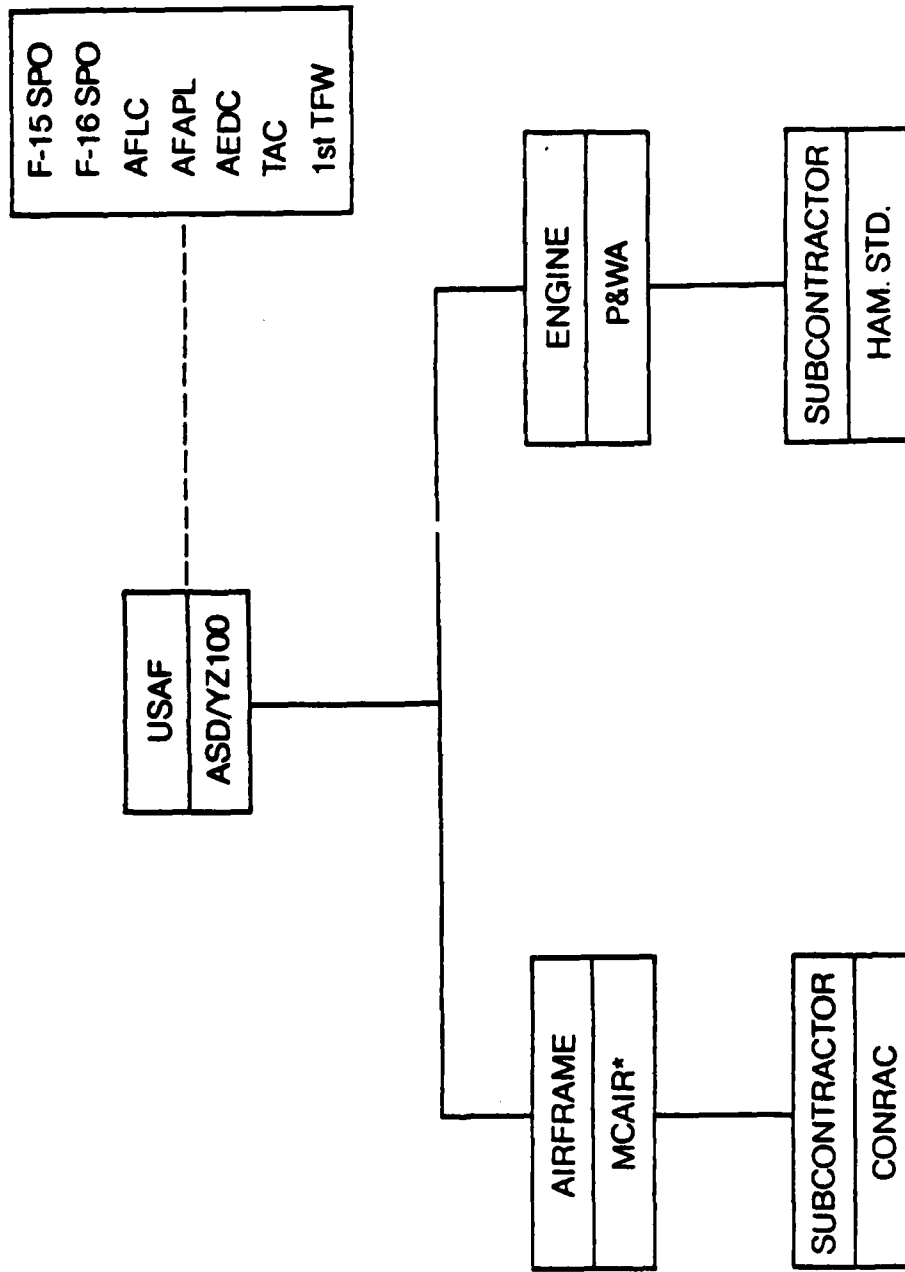

*LEAD CONTRACTOR

F100 EDS SYSTEM FUNCTIONS

- Automate Time/Cycle Data Collection
- Engine Trim
- Event Detection
- Diagnostics
- Automate Trend Data Collection

F100 ENGINE DIAGNOSTIC SYSTEM

- Sensors
- Engine Multiplex Unit (EMUX)
- Data Processor Unit (DPU)
- Diagnostic Display Unit (DDU)
- Data Collection Unit (DCU)
- Cockpit
- EDS Status Panel

ENGINE DIAGNOSTIC SYSTEM

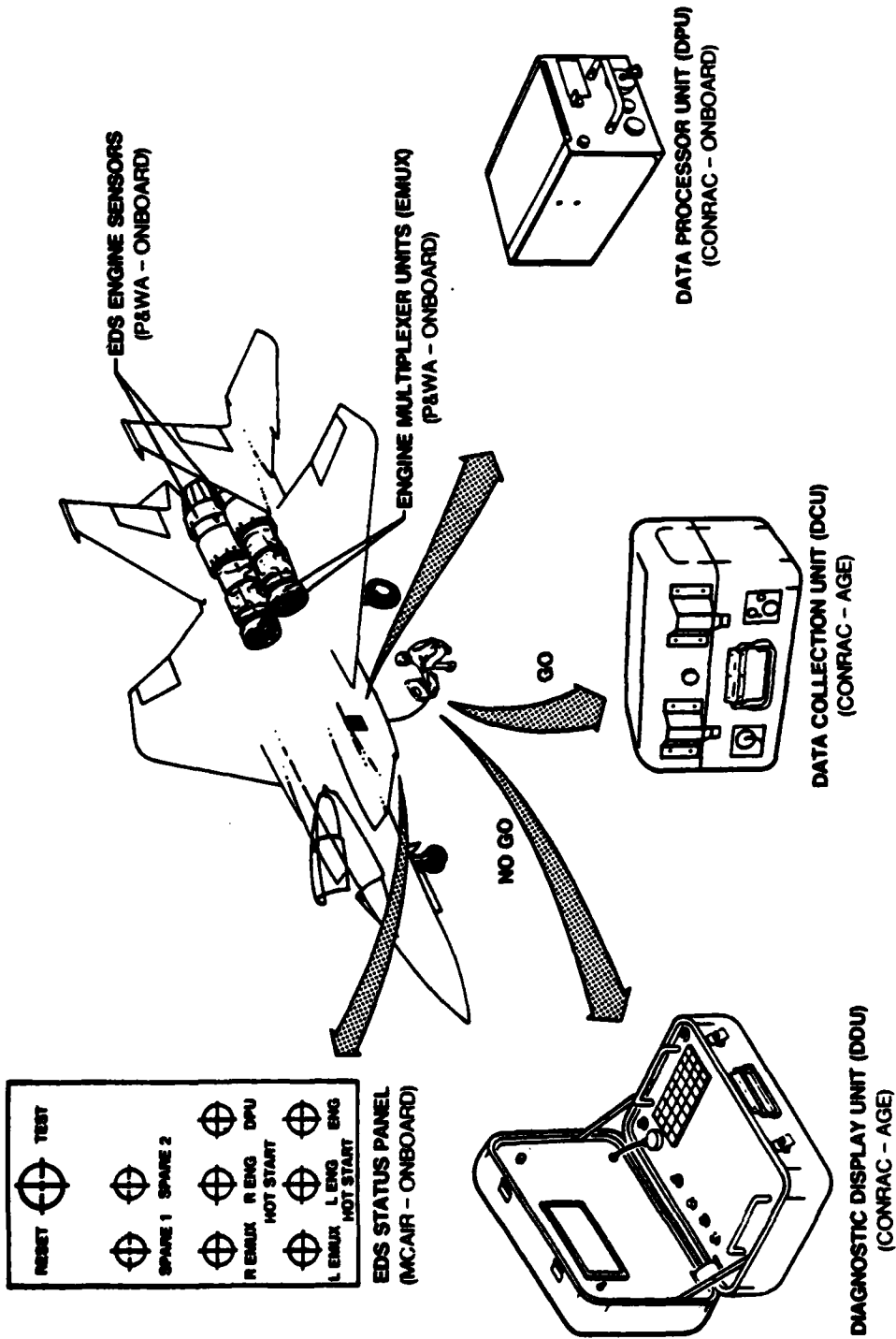

00407

F100 EDS PARAMETER LIST

EIGHTY-FIVE PARAMETERS (F-15)

- **SEVEN AIRFRAME SUPPLIED**
 - **Four Air Data**
 - **Two Fuel Flow**
 - **One Discrete**
- **THIRTY-NINE ENGINE PARAMETERS**
 - **Fifteen Gas Path Pressures, Temperatures, and Rotor Speeds**
 - **Six Variable Geometry and Vibration**
 - **Nine Pressures and Temperatures (Fuel & Lube)**
 - **Nine Discretes**

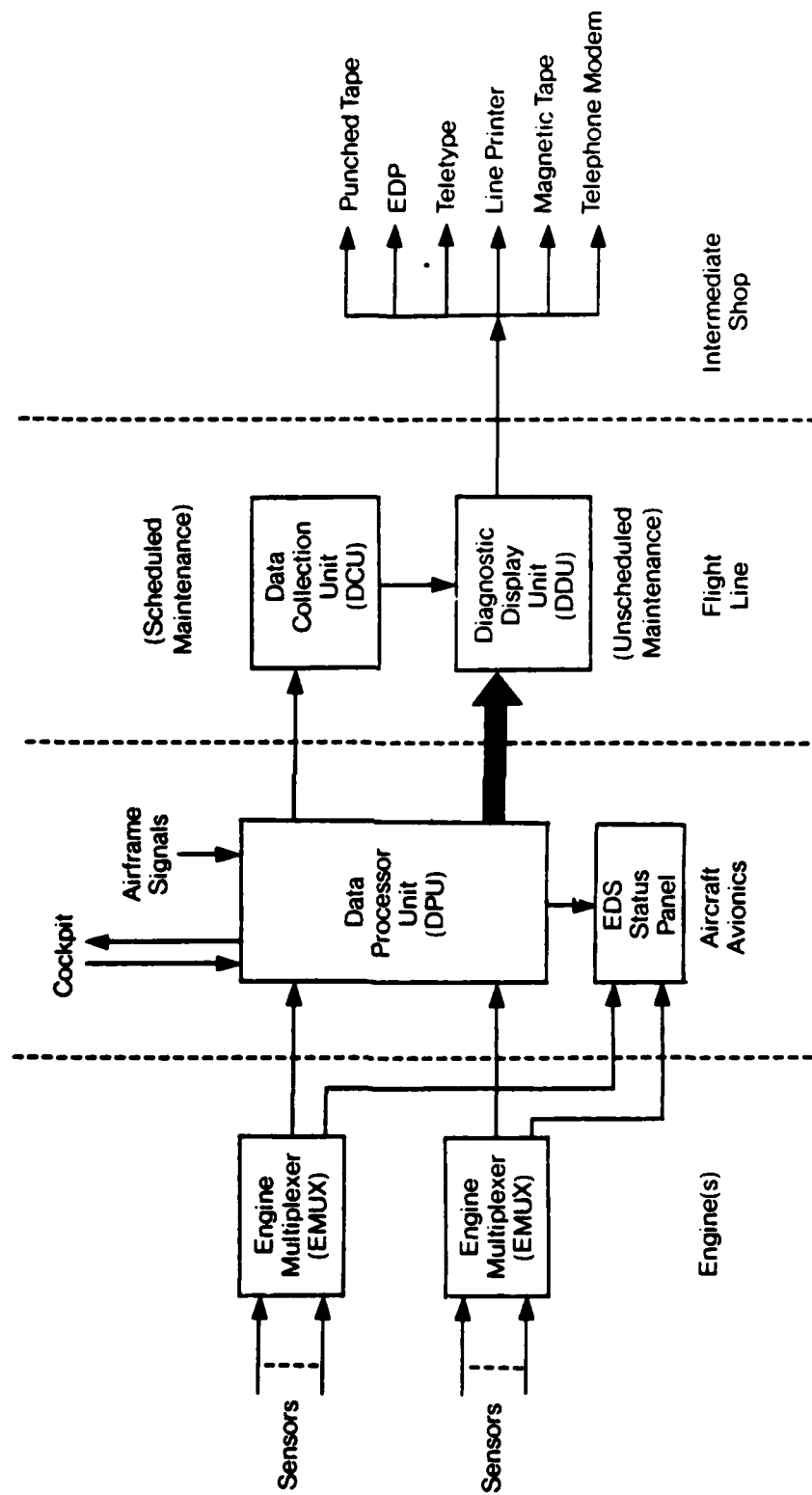

**Engine Diagnostic System
Flow Diagram**

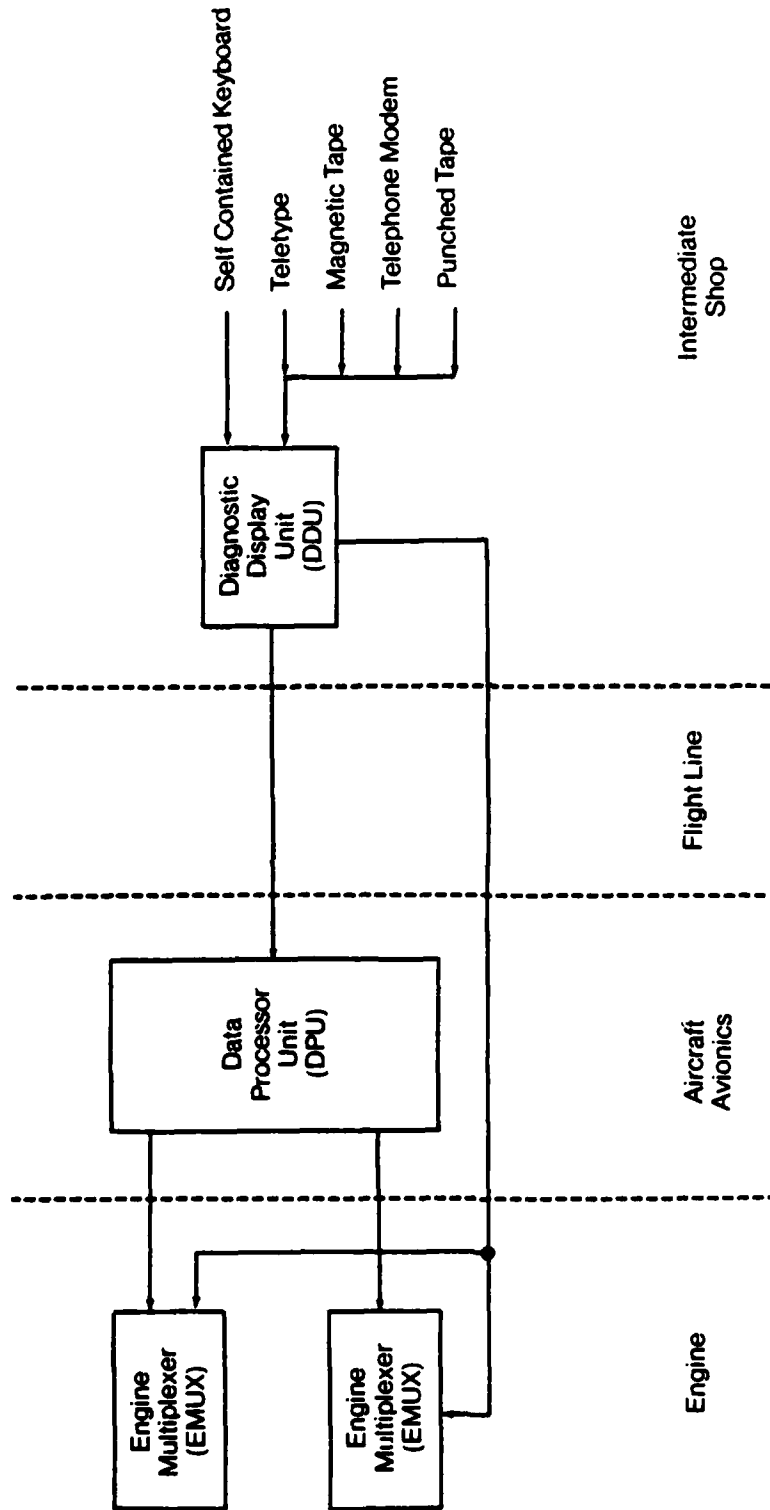

**Engine Diagnostic System
Flow Diagram
(Reprogram DPU or EMUX)**

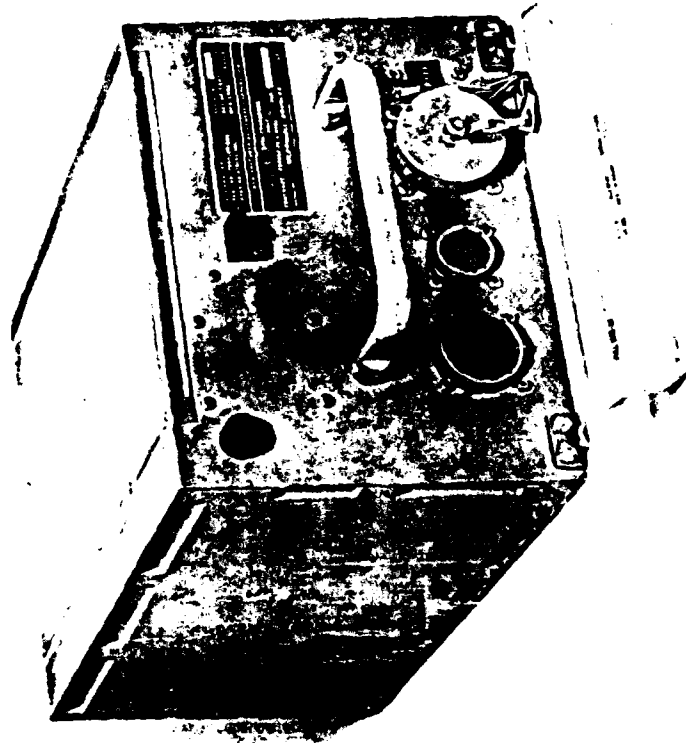

A-198



F100 Engine Diagnostic System

Data Processor Unit

- I/O – Digital
Analog
Discrete
- Microprocessor
- Non-Volatile Memory – 64K x 9
- Data Compression – Store Anomalies
- 85 Parameters
- Sampling Rate – 10 Per Second Per Parameter
- Size – 8W x 11D x 6H
- Weight – 20 Pounds
- Power – 100 Watts



DPU Features

- **Microprocessor Controlled**
 - 8 Bits
 - High Speed MPY/DIV
 - Direct Memory Access
 - Multilevel Maskable Interrupts

- **Core Memory**
 - SEMS-16
 - 64K Words By 9 Bits
 - Reprogrammable

- **Vibration Analysis**
 - Broad Band (50 To 300HZ)
 - Narrow Band (10HZ) Bandwidth
 - 50 To 300HZ Band
 - Proportional To RPM
 - Processor Controlled

- **Automatic Bit**
 - Capability To Fault Isolate To A Replaceable Assembly

Diagnostic Display Unit (DDU)

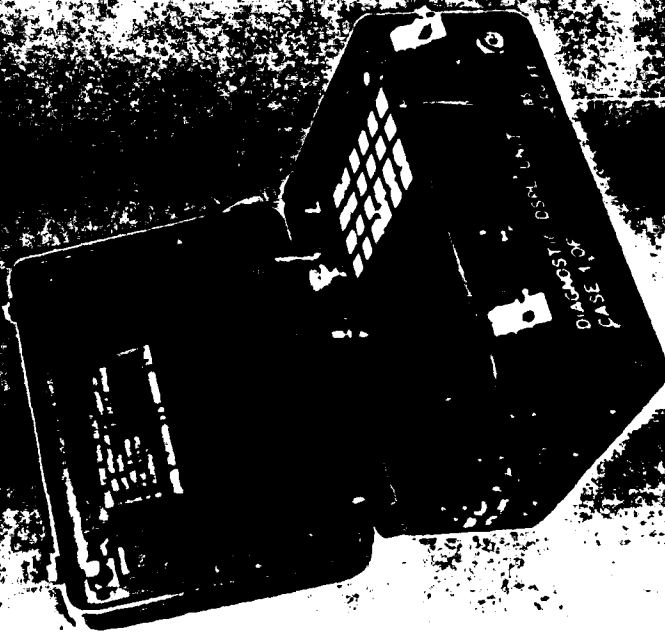

- Weight 45 lb
- Volume 1759 cu in.
- Cooling Internal Fan
- Power Source Battery (Flight Line)
115 VAC (Test Areas and Engine Shop)
- Power Consumption 164 Watts
- Memory 64K x 18 Bit (Core)
- Design MTBF 800 hr
- Features
 - Gas Plasma Display
 - 32 x 8 Characters
 - Ambient Pressure and Temperature Sensors
- External Indicators
 - Elapsed Time
 - Status
 - Battery
 - Data Transfer
 - Memory Remaining
 - Maintenance Advisory
 - BIT Failure
 - EMUX Data
 - 120 Words/Frame
 - 10 Frames/Sec
- Data Processing

Data Collection Unit (DCU)

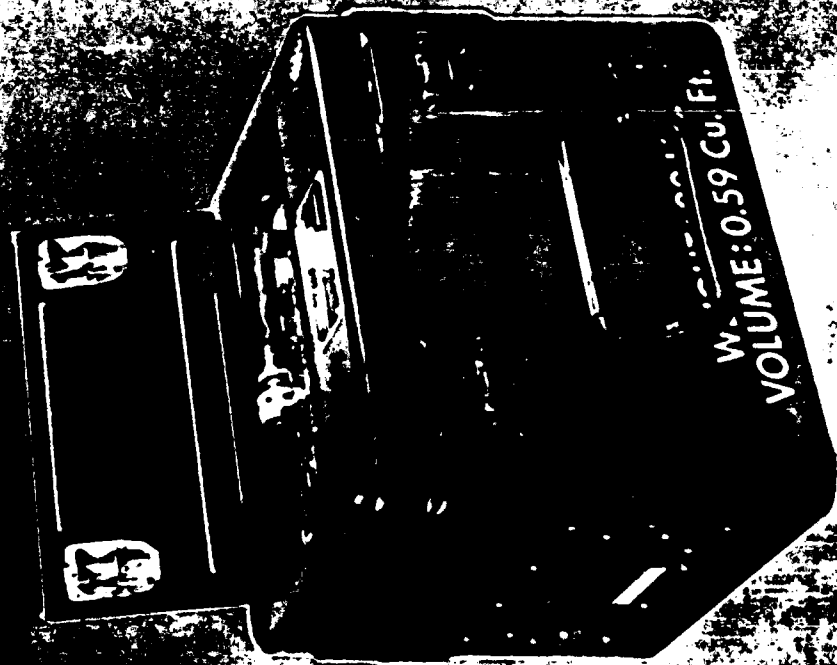

- Weight
- Volume
- Cooling
- Power Source
- Memory
- Design MTBF
- Data Storage
- External Indicators
- 20 lbs
- 0.59 cu. ft.
- None
- Battery
- 32K x 18 Bit (Com)
- 1000 hr
- 10 to 15 Aircraft
- Elapsed Time Status
- Battery
- Data Transfer
- Memory Remaining
- Maintenance Advisory
- BIT Failure



Engine Statistics

- Goal – 3000 Engine Operating Hours
- Total Engine Operating Time
With EDS = 3996 Hours
- Total Engine Flight Time
With EDS = 2579 Hours
- Engine Operating Time –
Excluding Debug Phase = 2490 Hours

(1 September 1980 Thru 15 June 1981)



**EDS Flight Test Program
Hits Detected Per Engine
(10 Jul '80 - 15 Jun '81)**

Events	Engine S/N												Total
	160	311	330	415	470	528	639	694	722	801	907		
Engine					5								5
No-Go			1				1						0
Hot Start													2
O'Speed													12
O Temp													29
Oil Press	2				2	5					3		7
EEC	4		7		9	8			1				29
MFP Fail			2	2	1			1		1			7
Maintenance													
Advisory													
Stall	3		1		1	17	4	10	3	1			40
Spread	67	24	62		12		3	3		2			173
SCAV Press					9								9
Aug B/O M/L			1			3		1					5
RCW	31	16	42	1	6	23	1			8	29		157
VIBS	22	4		11	73	11	7	23	6	2	2		161
Records													
Trend													305
PERF													194

EDS FLIGHT TEST PROGRAM
 MAINTENANCE "SAVES"

<u>ENGINE</u>	<u>PILOT ASSESSMENT</u>	<u>EDS RESULTS</u>
EIGHT ENGINES	PILOT WROTE-UP BOTH OR WRONG ENGINES FOR STALLS OR A/B BLOWOUTS	FOUR INSTANCES - EDS DETECTED PROBLEMS WITH CORRECT ENGINES
311	A/B BLOWOUT ON 311	BLOWOUT FOLLOWED BY STALL - ALSO RCW SCHEDULED EVENT
470	NO COMPLAINTS	REPEATED EEC LEVEL 1 FAULTS. NO COCKPIT WARNING DUE TO SHORTED ODU CABLE
160	NO COMPLAINTS	GEARBOX VIBRATION OVER LIMITS. CORRECTED BY REPLACING PTO SHAFT COUPLING
639	NO COMPLAINTS	RCW EVENTS SHOWED HOT TT2.5 READINGS. FOUND BOROSCOPE PLUG AP2 MISSING

EDS FLIGHT TEST PROGRAM
 POTENTIAL ENGINE "SAVES"

<u>EVENT</u>	<u>ENGINE</u>	<u>PILOT REPORTED</u>	<u>CORRECTIVE ACTION</u>
HI SCAV PRESS	470	NO	VAC CHECK NO. 4 COMPARTMENT FOUND FOREIGN MATERIAL IN OIL SYSTEM
FTIT SPREAD	160 311 330	YES* YES* YES*	RECURRING CONDITION - BOROSCOPE AT 50 HR. INTERVALS TO WATCH FOR TURBINE DETERIORATION
FAILED FTIT PROBES	SEVEN ENGINES	NO	12 PROBES VERIFIED FAILED AND REPLACED
EEC FAULT	330	NO	RELAY FAILURE BLOCKED WARNING TO COCKPIT
OVER TEMP	330	YES	EDS DETECTED MORE SEVERE OVER TEMP THAN REPORTED BY THE PILOT - EEC CHANGED

* DETECTABLE BY PILOT ONLY ON EDS AIRCRAFT



EDS Trim Statistics

- **Five Engines Trimmed by EDS**
- **Trim Set-up Time Reduced Approx. 80%**
- **Trim Run Time Reduced Approx. 30%**
- **Approx. 35% Fewer Events Were Experienced On EDS Trimmed Engines**



System Functions Status

- **Time/Cycle Data Collection**
 - Demonstrated
 - Print Out AFTO 93 Using TTY Interface
- **Engine Trim**
 - Demonstrated
 - On Aircraft
 - On Stand
 - Faster (Real Time) — Saves Fuel
 - Eliminates Human Error
 - Validated By USAF
- **Event Detection**
 - Demonstrated With Confirmed Accuracy
 - Showed Necessary Logic Changes Required
 - Simple Software Implementation
- **Diagnostics**
 - Fully Demonstrated
 - Saves Time — Minimizes Decision Making
- **Trend Data Collection**
 - Demonstrated



Operational Advantages

- **Save Engines**
- **Facilitate Anticipatory Maintenance**
- **Prevent Misdirected Maintenance**
- **Eliminate Human Error Element In T&C Data**
- **Flexibility To Take On Changes And New Requirements**
- **Support CIP**



Additional EDS Capabilities

- **Plug Compatible MIL-STD-1553 (A/B) Interface Boards Currently In Production.**
- **Plug Compatible Memory Modules With Double Capacity Now Available.**
- **Plug Compatible "Parallel Processor" Board To Increase Processing Throughput Now Fully Developed.**
- **Plug Compatible 16 Bit Processor In Development (Breadboarded).**
- **Various Plug Compatible Analog, Digital, And Discrete Interface Boards Currently In Production.**



Technology Developments

- MIL-STD-1750 Computer
- High Order Language
- Memory Technology
- Fiber Optics
- Data Compression
- Advanced Packaging
- Leadless Carrier



EDS Benefits

- Improved Operational Readiness
- On-Condition Vs Scheduled Maintenance
 - Man-Hour And Cost Savings
- Improved “On-Aircraft” Maintenance
 - Fewer Engine Removals
- Trim
 - Reduced Time
 - Fuel Savings
 - Fewer Age Items
 - Increased Accuracy
- Can Be Used To Trim Non-EDS Engines
- Maintenance Management
 - Interface With MMICS And CEMS
 - Logistics Savings



Conclusion

The F-15/F100 EDS Has The Proven Capability To Direct Field Maintenance And Provide Required Logistical Information. It Is Also Capable Of Being Programmed For Use With Other Engines.



Recommendations

EDS Should Be Incorporated In The F-15 Or F-16 On A Squadron Or Wing Level To Fully Demonstrate The R & M Capabilities.

Based On These Results, The Total System Should Be Optimized For All Users Prior To Decision For Fleet-Wide Introduction.

BENDIX

A-215

BENDIX PROPULSION MULTIPLEXER (PMUX)

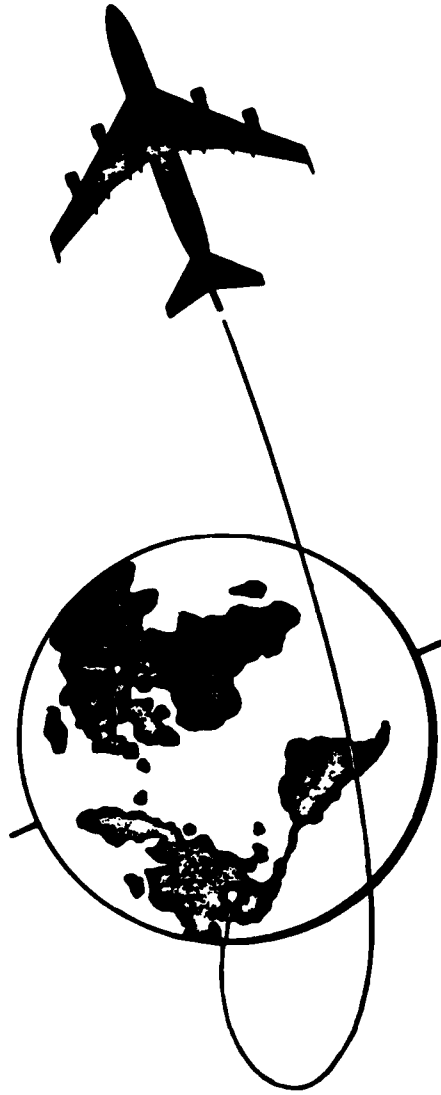

EFFICIENT ENGINE CONDITION MONITORING

A-217

Bendix Energy Controls
Division

FEBRUARY 1983

BRIEFING CONTENTS

- **INTRODUCTION**
 - WHAT IS PMUX**
 - PMUX VALUE IN ENGINE MAINTENANCE**
 - THE 747 - 300 AIDS/PMUX**
- **PMUX PHYSICAL DESCRIPTION**
- **SPECIFICATIONS/CAPABILITIES**
 - PRESSURES**
 - SPEEDS**
 - TEMPERATURES**
 - FUEL FLOW**
- **MONITORING SYSTEM SELF TEST**

PMUX
A DIGITAL ELECTRONIC COMPONENT TO:

- **COLLECT AND CONDITION ENGINE SENSOR SIGNALS**
- **MEASURE ENGINE PRESSURES WITH SELF - CONTAINED SENSORS**
- **CONVERT ANALOG SIGNALS TO DIGITAL FORM**
- **STORE, SORT, IDENTIFY AND SEQUENCE DIGITAL DATA FOR TRANSMISSION**
- **TRANSMIT ENGINE DATA TO AIDS VIA ARINC 429 SERIAL DATA LINK**

ENGINE MONITORING REDUCES MAINTENANCE & OPERATING COSTS

- **ON CONDITION ENGINE MAINTENANCE**
 - **AVOIDS UNNECESSARY ENGINE REMOVALS**
 - **ELIMINATES UNNECESSARY TEST RUNS**
- **MODULAR ENGINE MAINTENANCE**
 - **ONLY FAULTY MODULES REMOVED**
 - **REDUCED SPARES REQUIREMENTS**
- **ENGINE EFFICIENCY MONITORED**
 - **FUEL CONSUMPTION REDUCED**

A-220



**Energy Controls
Division**

PMUX BENEFITS ENGINE MONITORING

- **MORE ACCURATE ENGINE DATA**
 - QUARTZ PRESSURE SENSORS
 - VERNIER SPEED CIRCUIT FOR N1, N2, & WF
 - SIGNAL NOISE REDUCED BY ELIMINATION OF ANALOG SIGNAL TRANSMISSION

- **LOWER WEIGHT ENGINE MONITORING SYSTEM**
 - ARINC 429 BUS REPLACES MULTI-WIRE CABLES (> 100#IN 747)

- **REDUCED ENGINE MONITORING SYSTEM MAINTENANCE COSTS**
 - ELIMINATION OF LARGE CABLES & CONNECTORS
 - BITE IDENTIFIES SENSOR FAILURES
 - BITE IDENTIFIES PMUX FAILURES
 - SIMPLIFIED EMS INSTALLATION

A-221



Energy Controls
Division

A 747 AIDS WITH PMUX

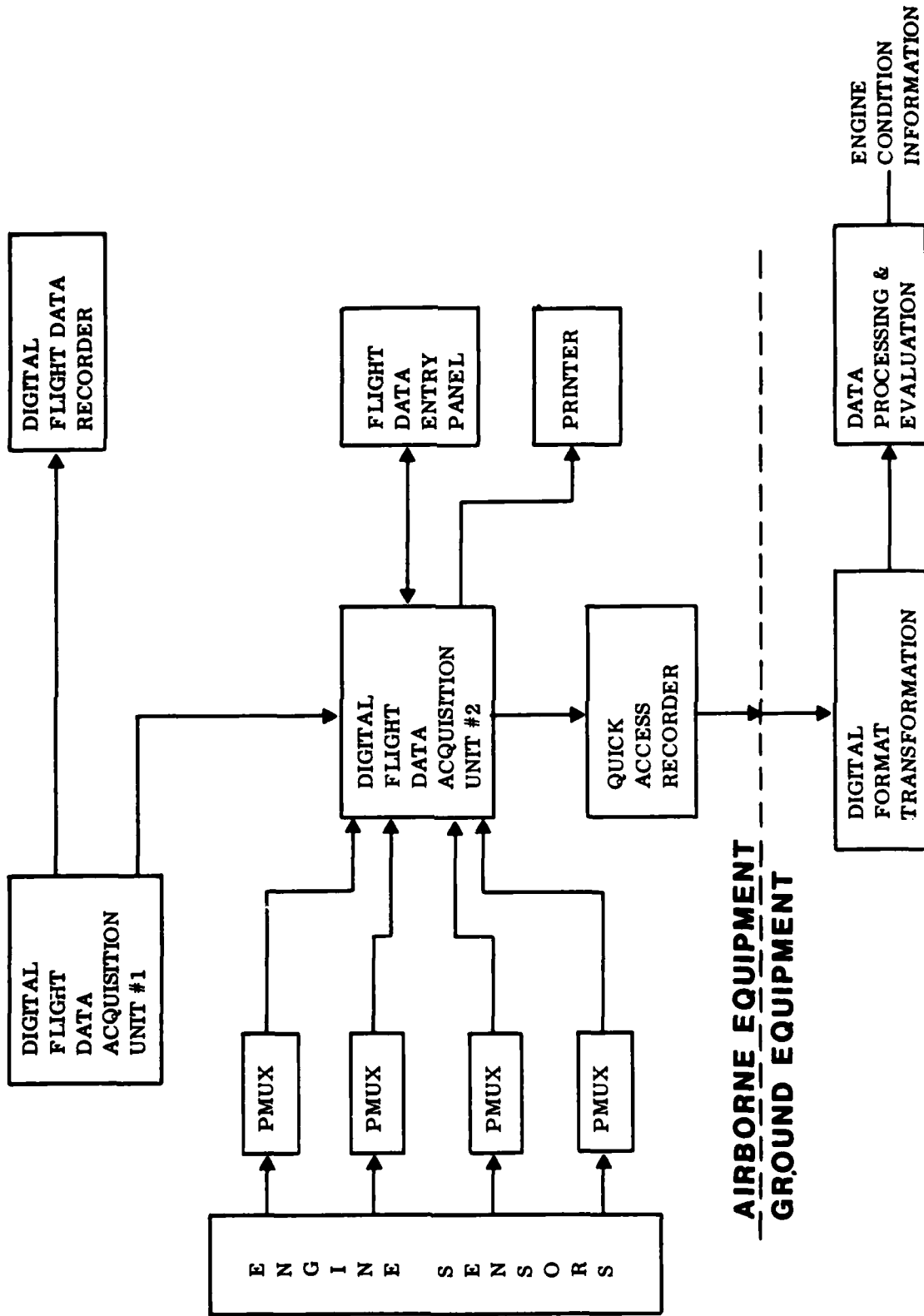

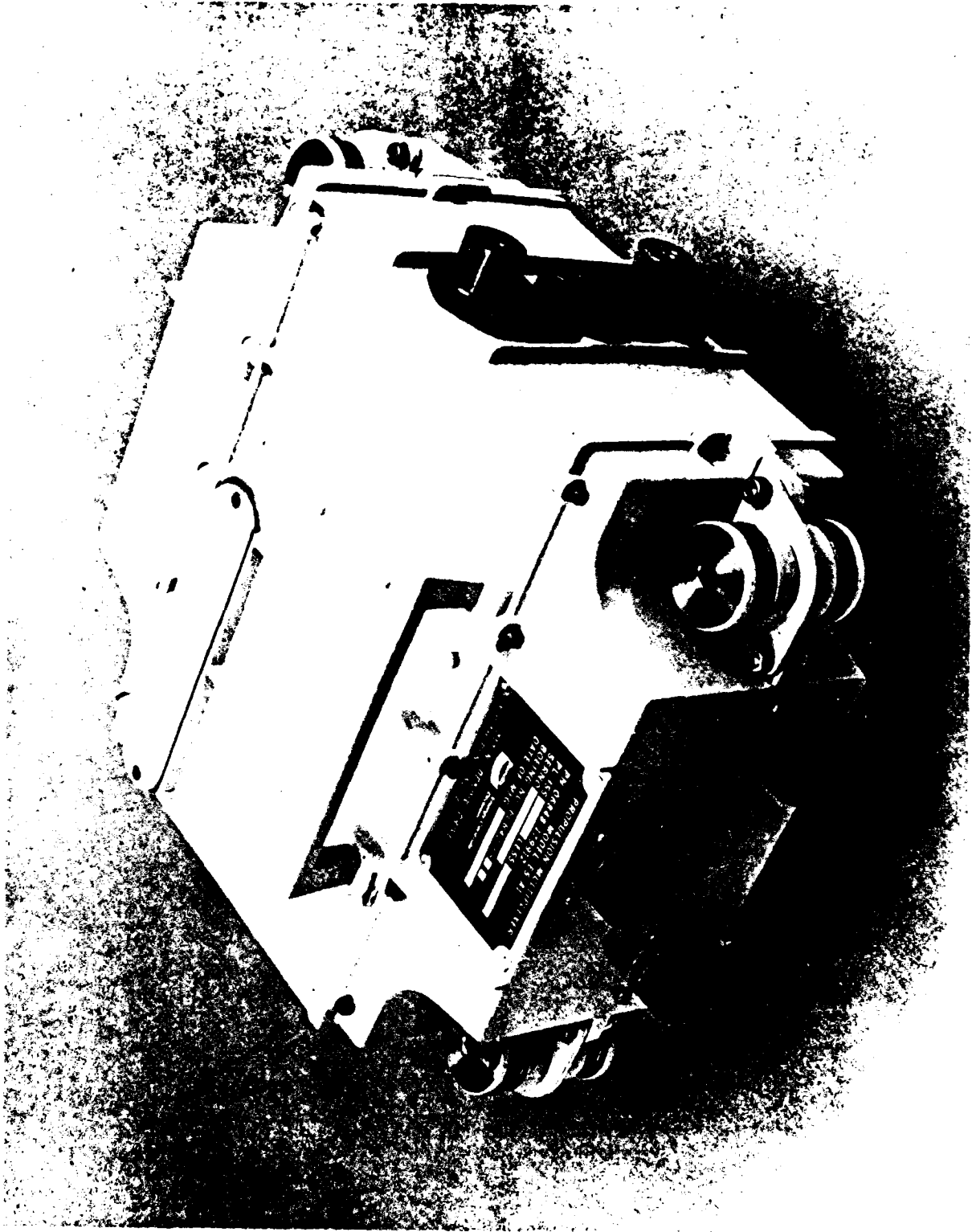

A-223

BENDIX PROPULSION MULTIPLEXER (PMUX)

EXPLODED VIEW

I/O CONNECTOR MODULE ASSEMBLY

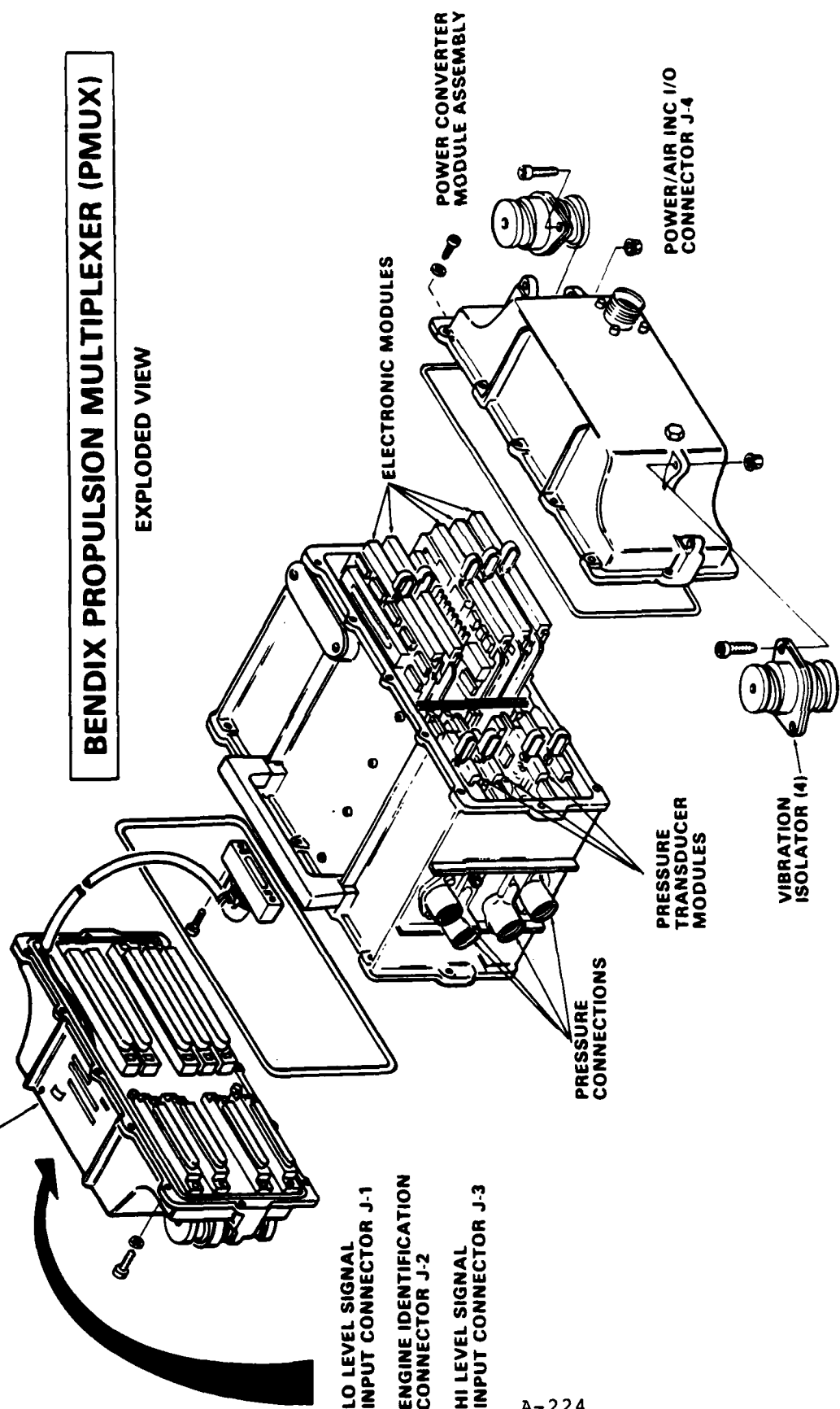

LO LEVEL SIGNAL
INPUT CONNECTOR J-1
ENGINE IDENTIFICATION
CONNECTOR J-2
HI LEVEL SIGNAL
INPUT CONNECTOR J-3

ELECTRONIC MODULES

POWER CONVERTER
MODULE ASSEMBLY

POWER/AIR INC I/O
CONNECTOR J-4

PRESSURE
TRANSDUCER
MODULES

PRESSURE
CONNECTIONS

VIBRATION
ISOLATOR (4)

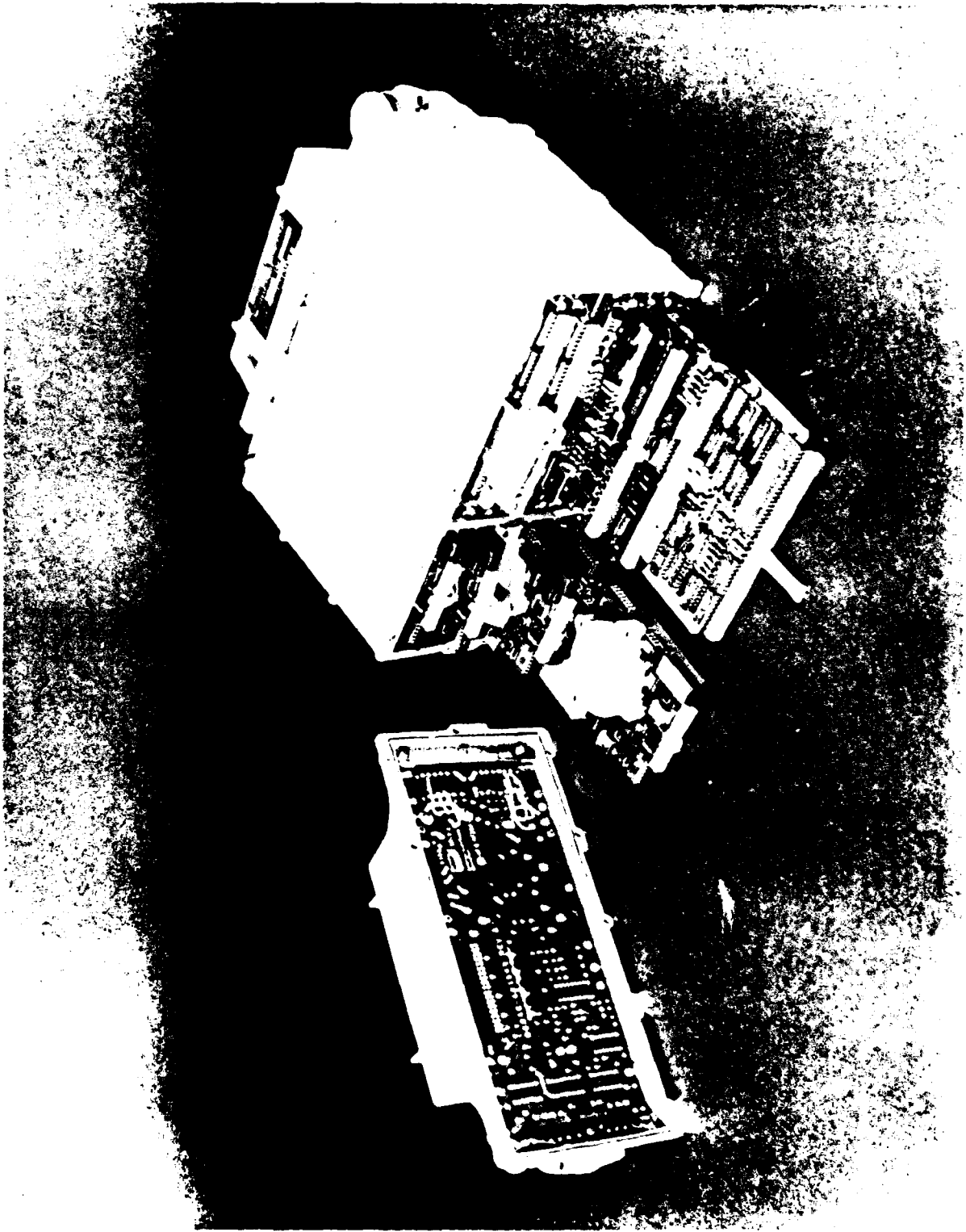

A-225

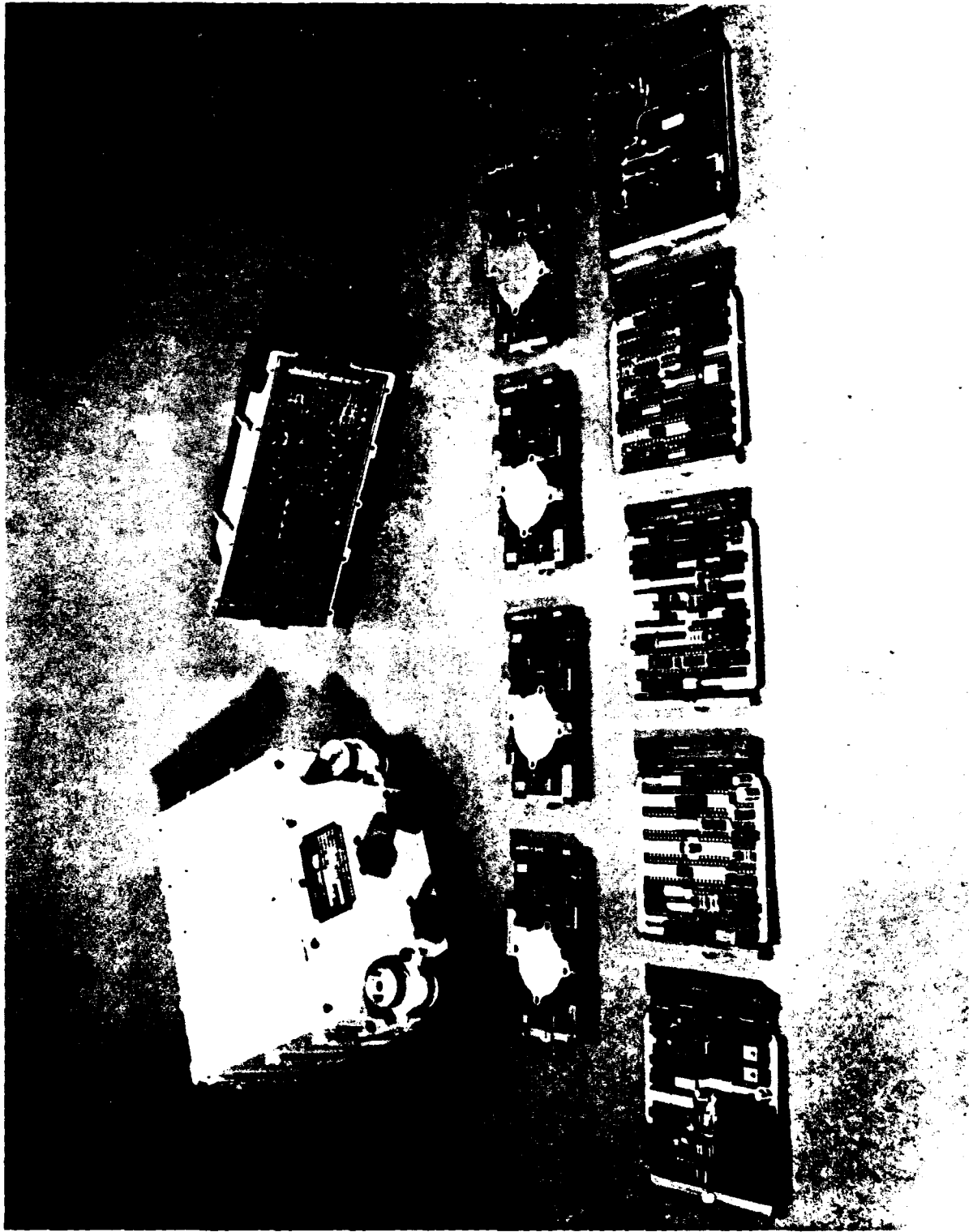

A-226

PMUX MODEL ES-A1 INPUT PARAMETER LISTING

JT9D-7R4G2 ENGINE PARAMETER	SENSOR	OPERATING RANGE	REPEATABILITY & ACCURACY REQ'D
PT2 FAN INLET	QUARTZ	2 TO 30 PSIA	± (.025 PSI + 0.0025 PT)
PT3 EXIT LPC	QUARTZ	2 TO 45 PSIA	± 0.5% OF PT eCRUISE
PS4 EXIT HPC	QUARTZ	2 TO 500 PSIA	± 0.5% OF PT eCRUISE
PT7 EXIT LPT	QUARTZ	2 TO 30 PSIA	± (.025 PSI + 0.0025PT)
• PT5	QUARTZ	2 TO 400 PSIA	± 0.5% OF PT eCRUISE
TT3	T/C CH/AL	-20 TO +160°C	± 2.2°C eCRUISE
TT4.5	T/C CH/AL	-20 TO +610°C	± 2.2°C eCRUISE
EGT	T/C CH/AL	125°C TO 1050°C	± 3.8°C
• EGT (6 EA)	T/C CH/AL	125°C TO 1050°C	± 3.8°C

• PROVISIONS FOR

PMUX MODEL ES-A1 INPUT PARAMETER LISTING (CONTINUED)

<u>JT9D-7R4G2 ENGINE PARAMETER</u>	<u>SENSOR</u>	<u>OPERATING RANGE</u>	<u>REPEATABILITY & ACCURACY REQ'D</u>
N1 LOW ROTOR N2 HIGH ROTOR	TACHOMETER TACHOMETER	1 TO 85 HZ 1 TO 85 HZ	± 0.5% PT ± 0.5% PT
WF FUEL FLOW	MASS FLOWMETER PULSE TIME DIS- PLACEMENT	615 TO 27,000 PPH 8 MS TO 278 MS	± 0.6% PT eCRUISE
SVA STATOR VANE ANGLE	RESOLVER 6.25 VAC, 1000 Hz EXC.	- 40° TO +10°	± 0.3°
3.0 BLD POSITION	LINEAR POSITION SENSOR (POT) + 5 VDC EXC.		± 0.5% FS
HYDRAULIC OIL TEMP	NICKEL TEMP	- 40° TO 300°C	± 1.5°C
8 DISCRETE INPUTS	RELAYS/ SWITCHES		
6 DIGIT ENGINE ID	RESISTOR PLUG CODING		

ACCURACY CAPABILITIES

	REQUIRED	ACHIEVABLE
N1 - LOW PRESSURE ROTOR SPEED	± .5% PT	± .05% PT *
N2 - HI PRESSURE ROTOR SPEED	± .5% PT	± .05% PT *
WF - FUEL FLOW	± .6% PT	± .05% PT *
EGT - EXHAUST GAS TEMPERATURE	± 3.8°C	± 2.8°C
PT3 - LOW PRESSURE COMP.	± .5% PT	± .5% PT *
PS4 - HI PRESSURE COMP.	± .5% PT	± .5% PT *
PT5 - HI PRESSURE TURBINE INLET	± .5% PT	± .5% PT *
PT7 - LOW PRESS. TURBINE DISCHARGE	± 1.6% PT	± .5% PT *
TT3 - LOW PRESSURE COMP. DISCH.	± 2.2°C	± 1.8°C
TT4.5 - HI PRESSURE COMP. EXIT	± 2.2°C	± 2.1°C

* THE ACCURACIES LISTED ARE WORSE CASE AT WORSE CASE CONDITION,
REFER TO CURVES FOR ACCURACIES OVER OPERATING RANGE.



OPERATIONAL FAILURE RATE ES-B1

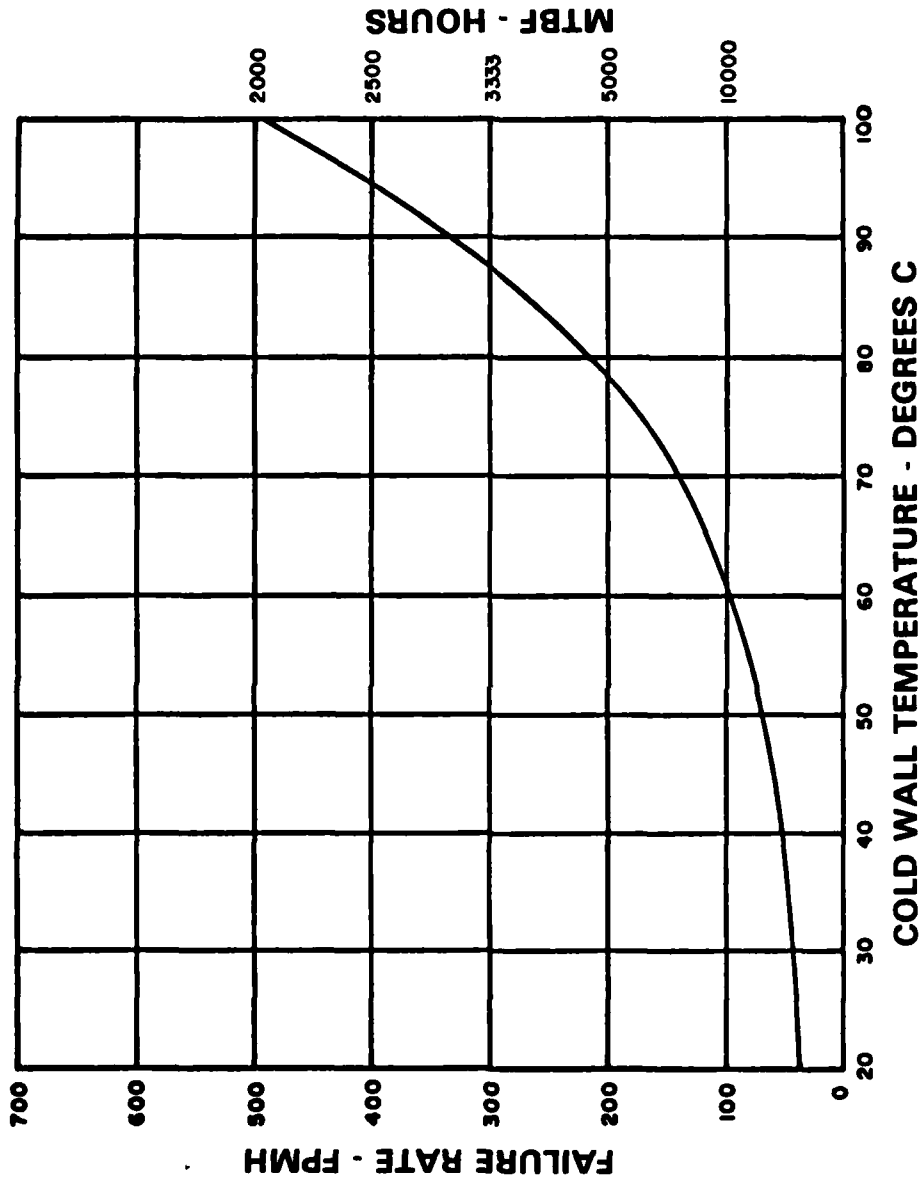

ES-A1 RELIABILITY

70% STD DAY 15% COLD DAY 15% HOT DAY

TIME AVERAGED COLD WALL TEMPERATURE -- 26.8°C

MTBF -- 17,644 HOURS

FAILURE RATE -- 56.67 FPMH

PMUX (ES-A1) BLOCK DIAGRAM

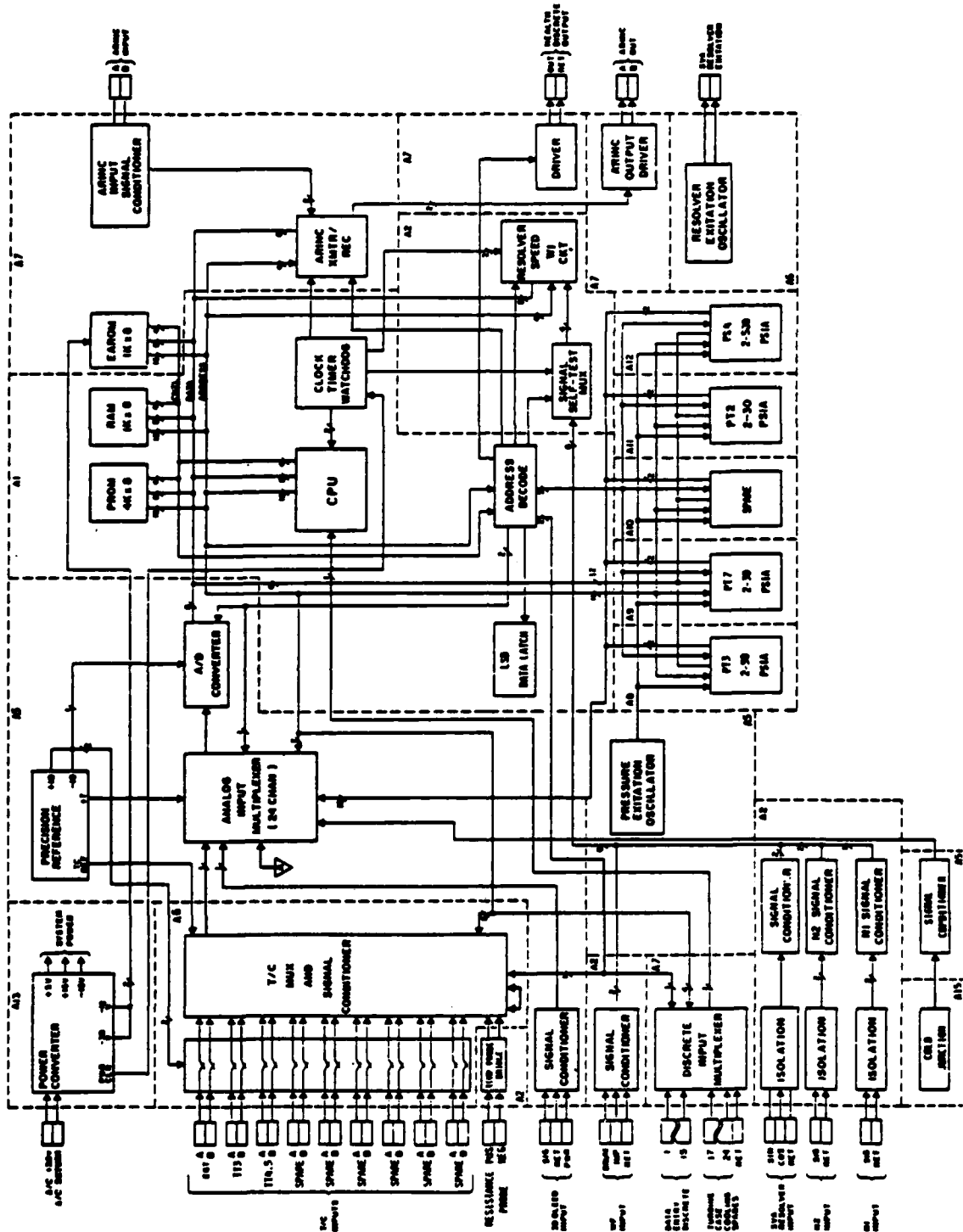

PMUX PRESSURE TRANSDUCERS

PROPRIETARY BENDIX DESIGN

- QUARTZ CAPACITOR SENSOR - HIGHLY STABLE
- CAPACITANCE BRIDGE (INCLUDING SENSOR) IS BALANCED BY CHANGING MULTIPLYING D/A VALUES
- CPU HANDLES BALANCING THE BRIDGE
- CPU READS DIGITAL WORD AND TEMPERATURE, THEN COMPUTES PRESSURE FROM THE CALIBRATION LOOK-UP TABLE
- INTERCHANGEABLE PRESSURE MODULES

A-233

Bendix Energy Controls
Division

PRESSURE SENSOR FEATURES

CHANNEL ACCURACY OF BETTER THAN 1 PERCENT OF POINT

PRESSURE TURNDOWN RATIO OF 100 to 1

OPERATING TEMPERATURE -65°F TO 200°F

REPEATABILITY WITHIN $\pm 1/2$ BIT RESOLUTION

CONSTANT DYNAMIC CHARACTERISTICS OVER THE FULL PRESSURE RANGE

NO SELECT AT TEST COMPONENTS OR TRIM POTENTIOMETERS

PMUX PRESSURE SENSORS

- BENDIX HIGH ACCURACY SENSORS
- USED DURING ENGINE CERTIFICATION OF JT9D 7R4G2 ENGINE
- EXCELLENT PERFORMANCE BEING COMPARED WITH FLIGHT-TEST INSTRUMENTATION
- TYPICAL PERFORMANCE (10-100% RANGE -40.+150°F) 98% READING 0.2% POINT

HANGER CHECK @ 30.20 IN HG *

RANGE	PT2 30 PSI	PT3 50 PSI	PS4 500 PSI	PT7 30 PSI
1	30.194 IN. HG.	14.92 PSI	30.2 IN. HG.	30.206 IN. HG.
2	30.238 IN. HG.	14.83 PSI	30.4 IN. HG.	--
3	30.289 IN. HG.	14.84 PSI	30.1 IN. HG.	30.206 IN. HG.
4	30.222 IN. HG.	14.84 PSI	30.5 IN. HG.	30.226 IN. HG.

* INSTRUMENTATION INTERFACE INCLUDED.

SINGLE CHANNEL PRESSURE TRANSDUCER - BLOCK DIAGRAM

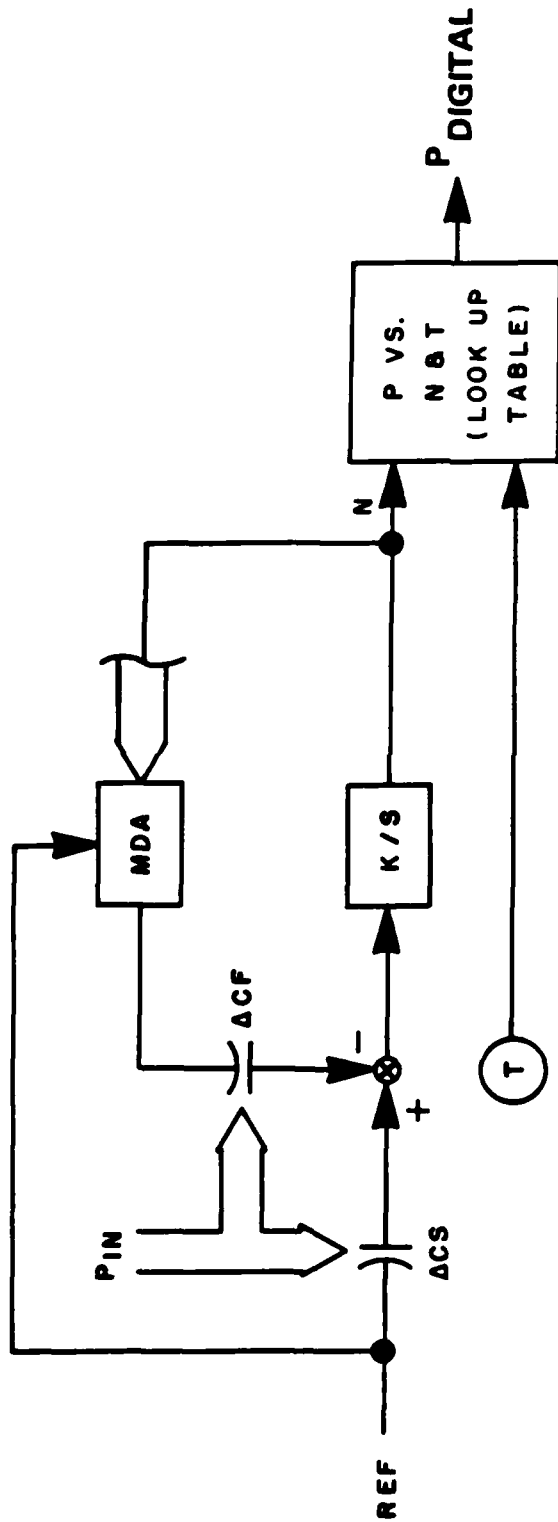

$$\Delta C_S = C_S - C_R$$

$$\Delta C_F = C_{FS} - C_{FR}$$

$$N = \frac{\Delta C_S}{\Delta C_F} \cdot N_{MAX}$$

P DIGITAL f (N & T)

PRESSURE TRANSDUCER ACCURACY

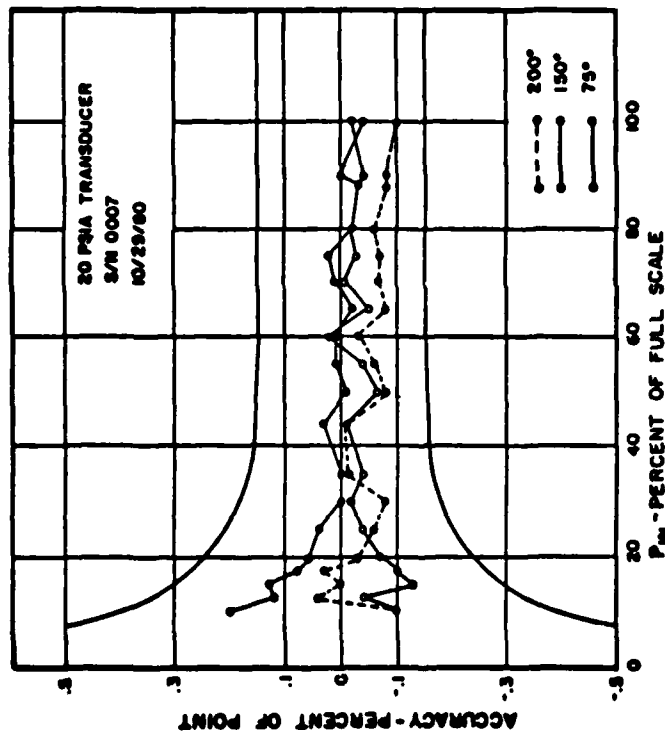
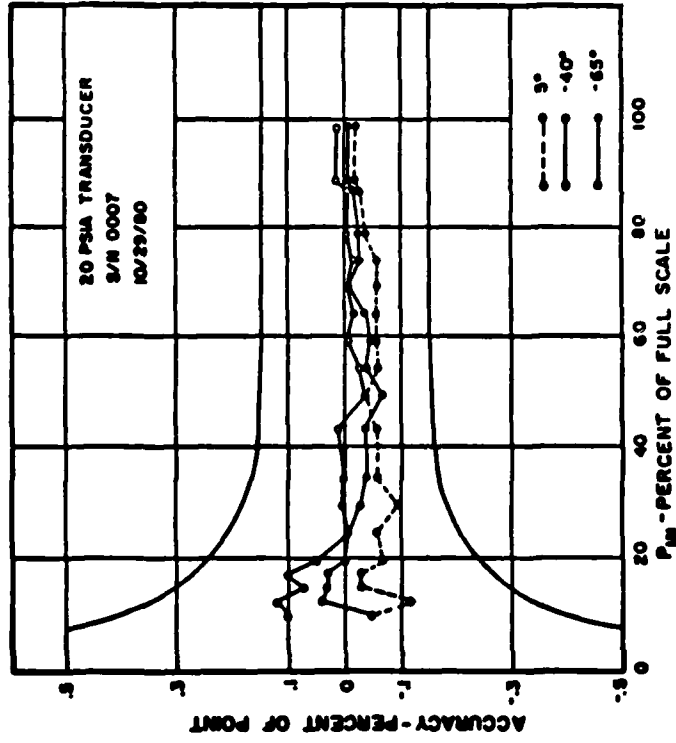

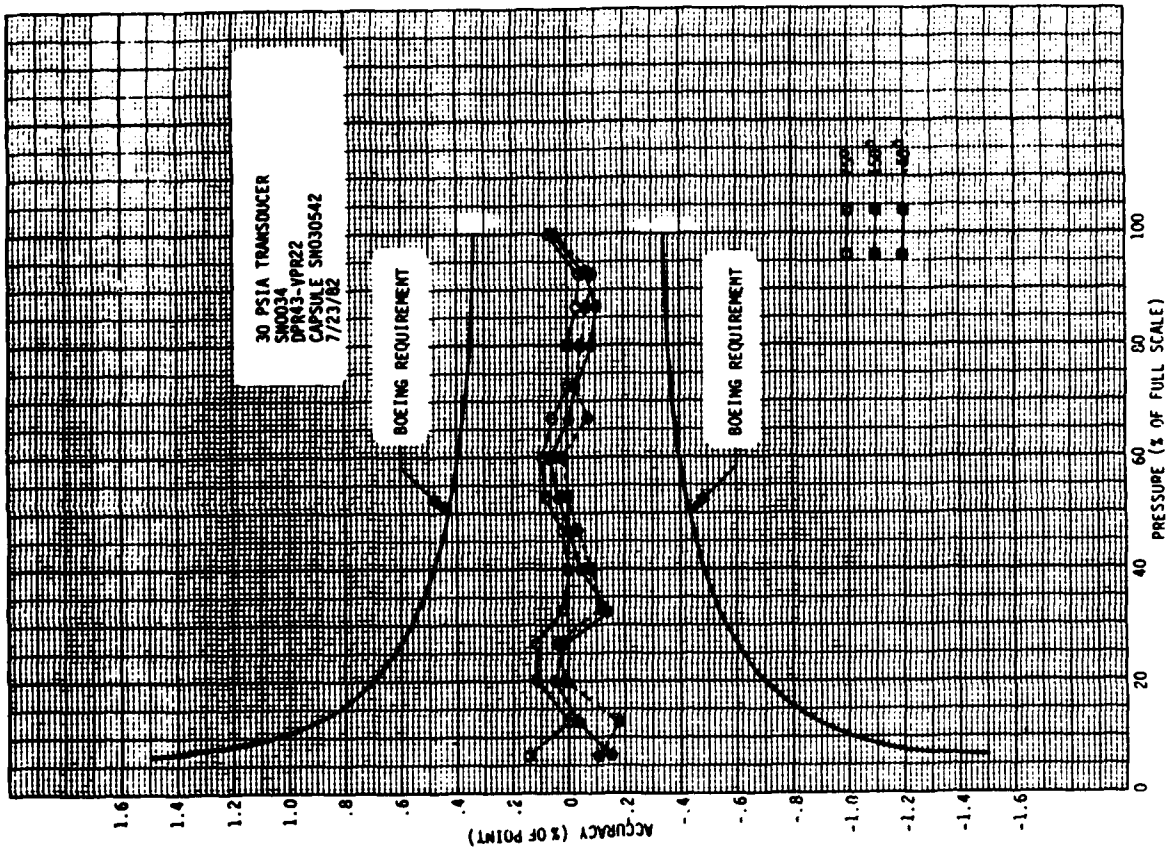

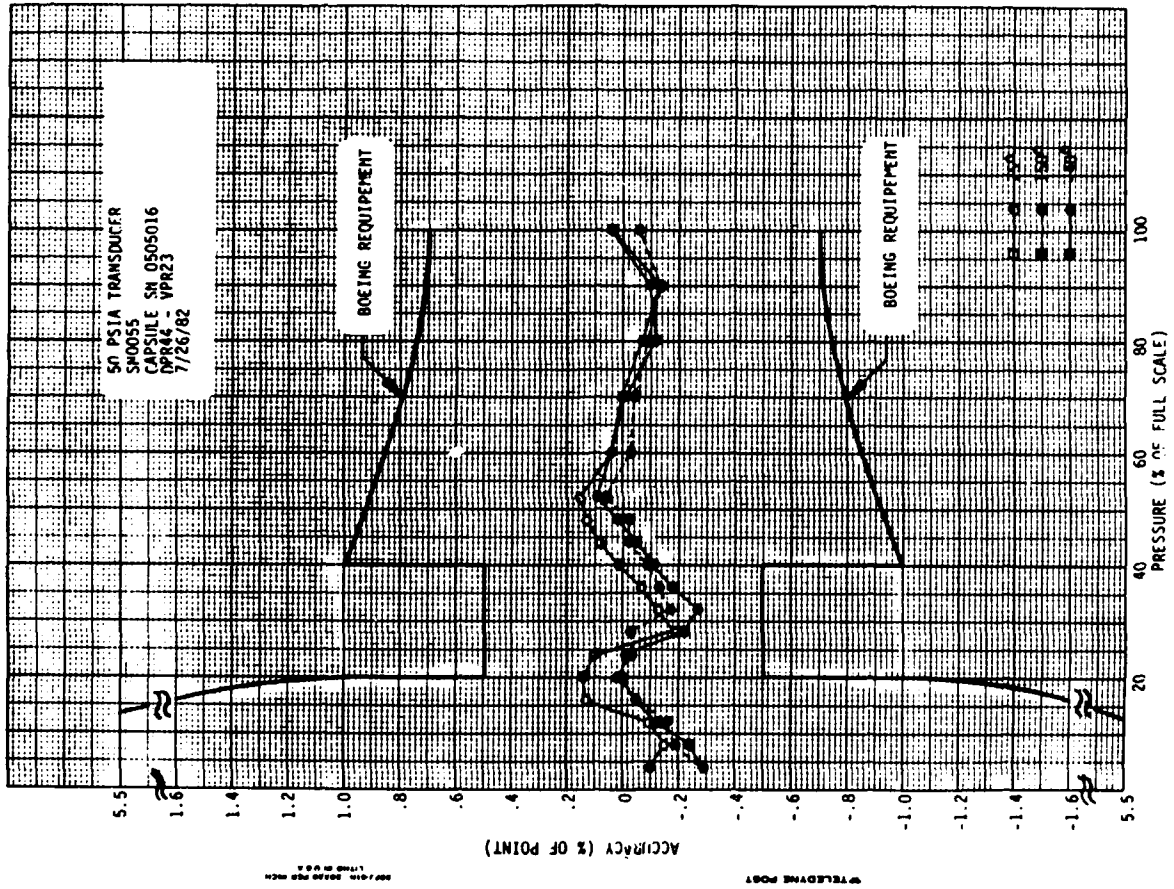

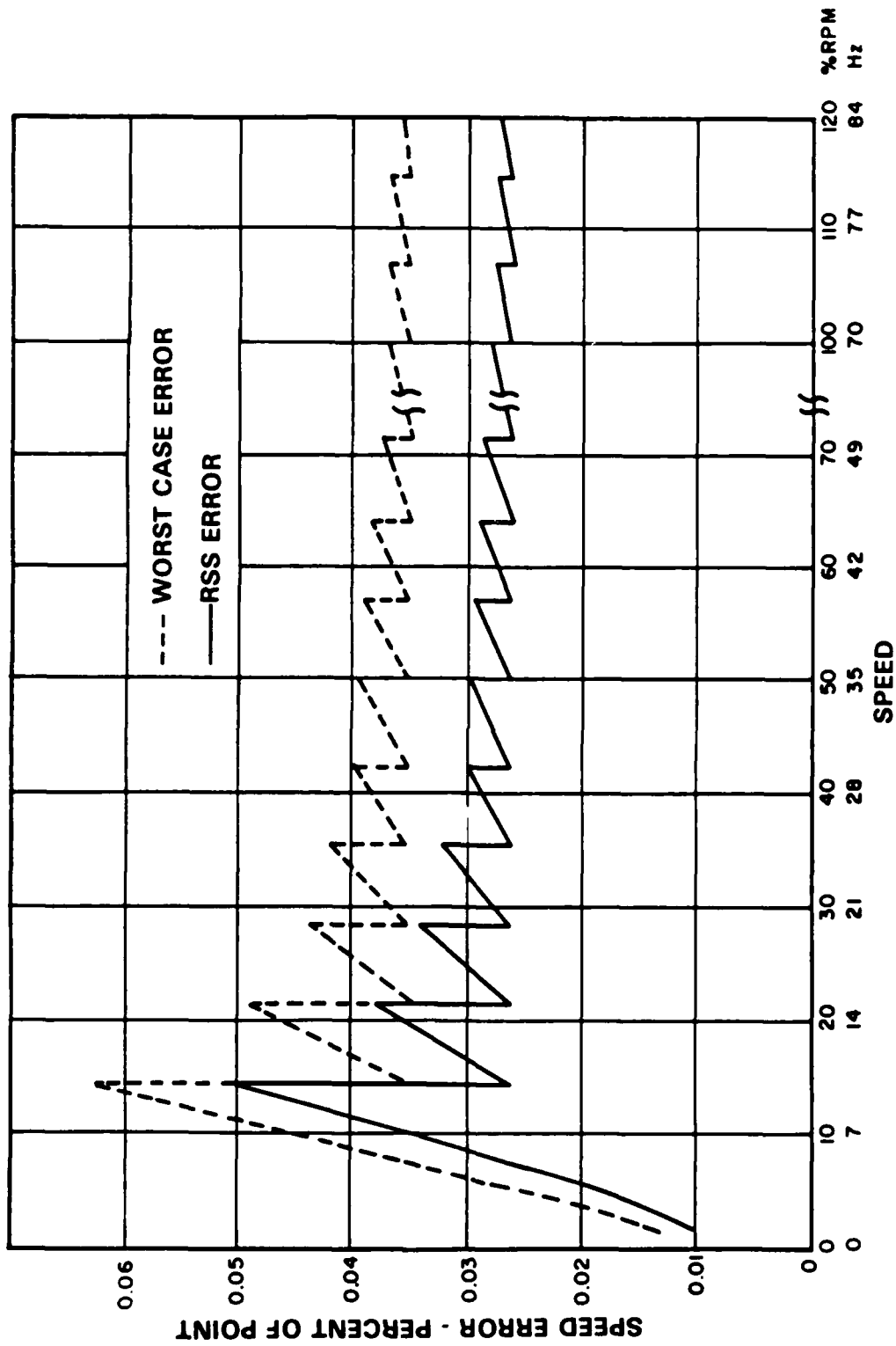

Bendix
Energy Controls
Division

PMUX THERMOCOUPLE INPUTS

- NINE THERMOCOUPLE INPUTS PROVIDED
- ALL INPUTS MULTIPLEXED INTO SINGLE INSTRUMENTATION AMPLIFIER
- ZERO AND REFERENCE SIGNALS PROVIDED FOR GAIN AND OFFSET COMPENSATION
- COLD JUNCTION COMPENSATION FROM SEPARATE SENSOR
- EACH CIRCUIT HAS TRANSIENT PROTECTION AND PASSIVE SIGNAL CONDITIONING
- THREE INPUTS CURRENTLY USED:
 - EGT - +125 TO +150 DEG C RANGE, ± 3.8 DEG C ACCURACY
 - TT3 - 0 TO +160 DEG C RANGE, ± 2.2 DEG C ACCURACY
 - TT4.5 - 0 TO 610 DEG C RANGE, ± 2.2 DEG C ACCURACY
- THERMOCOUPLE LINEARITY CORRECTION PROVIDED BY SOFTWARE TABLE LOOK-UP

PMUX THERMOCOUPLE INPUTS

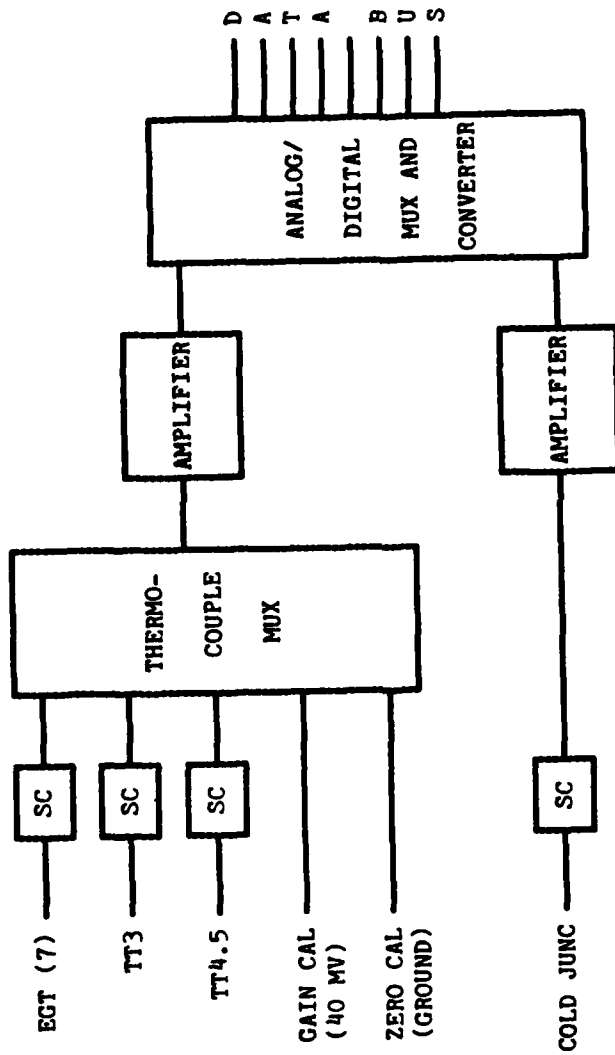

• PMUX THERMOCOUPLE INPUTS

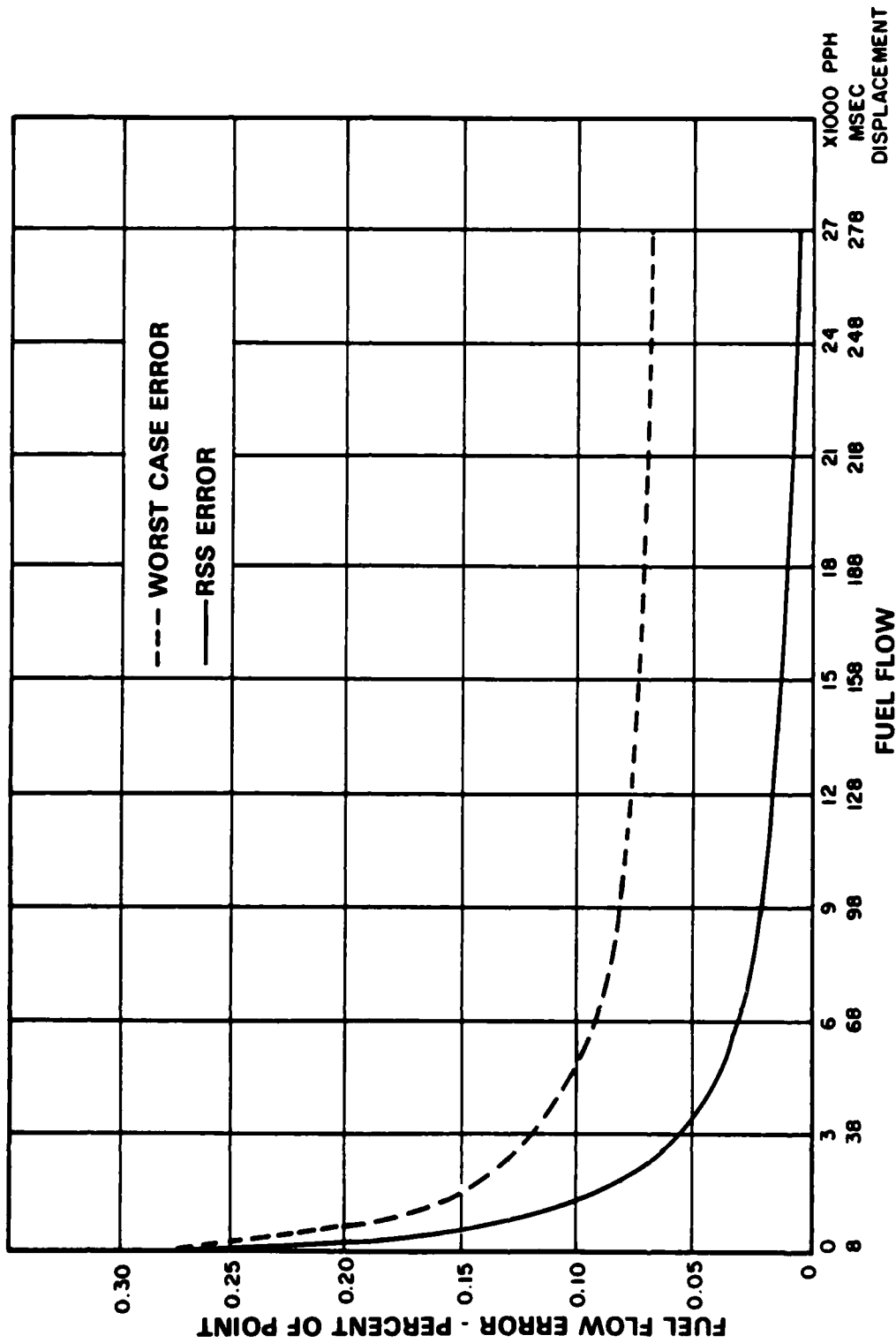

MONITORING SYSTEM SELF-TESTS

SELF-TESTING IS PERFORMED CONTINUOUSLY. TEST RESULTS CAN BE AVAILABLE ON ARINC.

- INPUTS RANGE AND RATE CHECKED BY SOFTWARE**
- SELF-TEST SIGNALS FOR N1, N2, SVA, WF**
- A/D SELF-TEST AND CALIBRATION SIGNALS**
- ROM AND RAM CHECKS**
- WATCHDOG CIRCUITS FOR PROGRAM ITERATION AND CLOCKS**
- ARINC WRAPAROUND**
- POWER CONVERTER FAULT LOGIC**



FAULT READOUT

OPERATIONAL MODE - ONE ARINC ADDRESS DEDICATED TO PMUX HEALTH

TEST MODE - SELECTED BY ARINC INPUT

- ARINC ADDRESS REASSIGNMENT ALLOWS READOUT OF STORED FAULT DATA

A-245



Energy Controls
Division

VIBRO-METER CORP.

A-247

VIBRO-METER



**PIEZOELECTRIC TRANSDUCERS
AND COMPASSONS.
INDUSTRIAL**

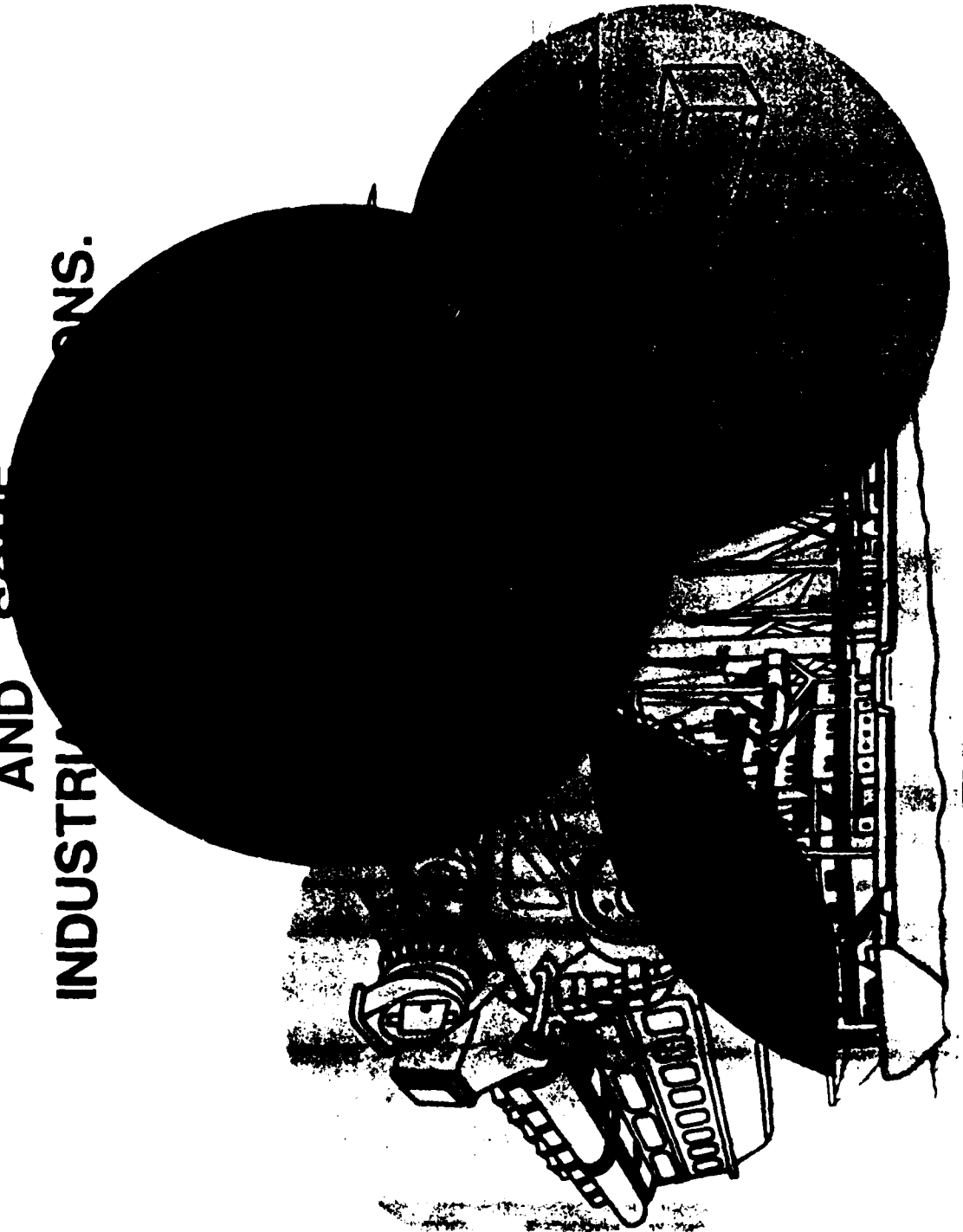

PRODUCT RANGE

- **PIEZO-ELECTRIC TRANSDUCERS**
- **ELECTRONIC PROCESSORS**
- **ELECTRO-MAGNETIC BRAKES**
- **STRAIN GAGE TRANSDUCERS**
- **GROUND SUPPORT EQUIPMENT**

A-251





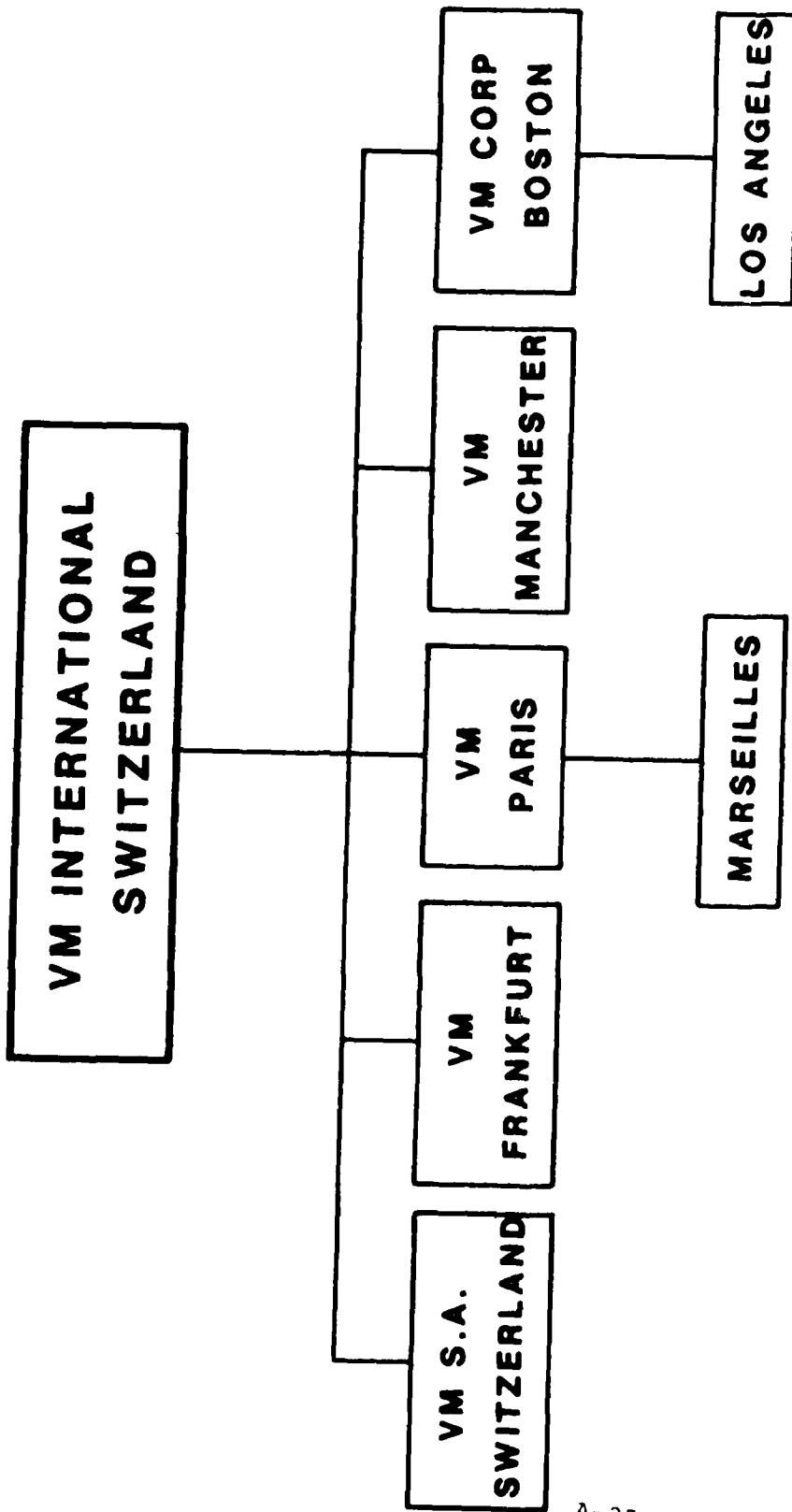

A-253



LOCATION

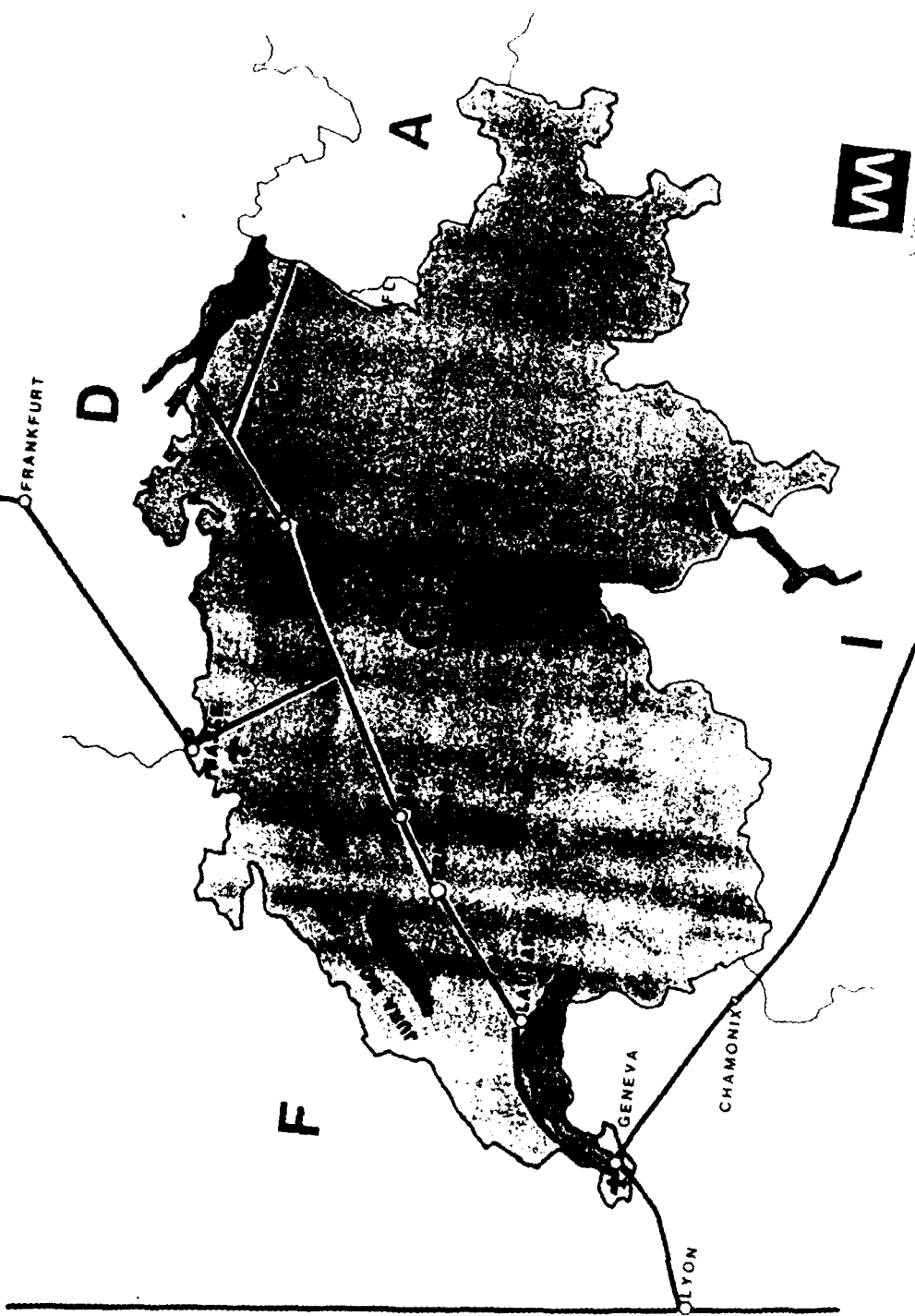

A-254

VM CORP.

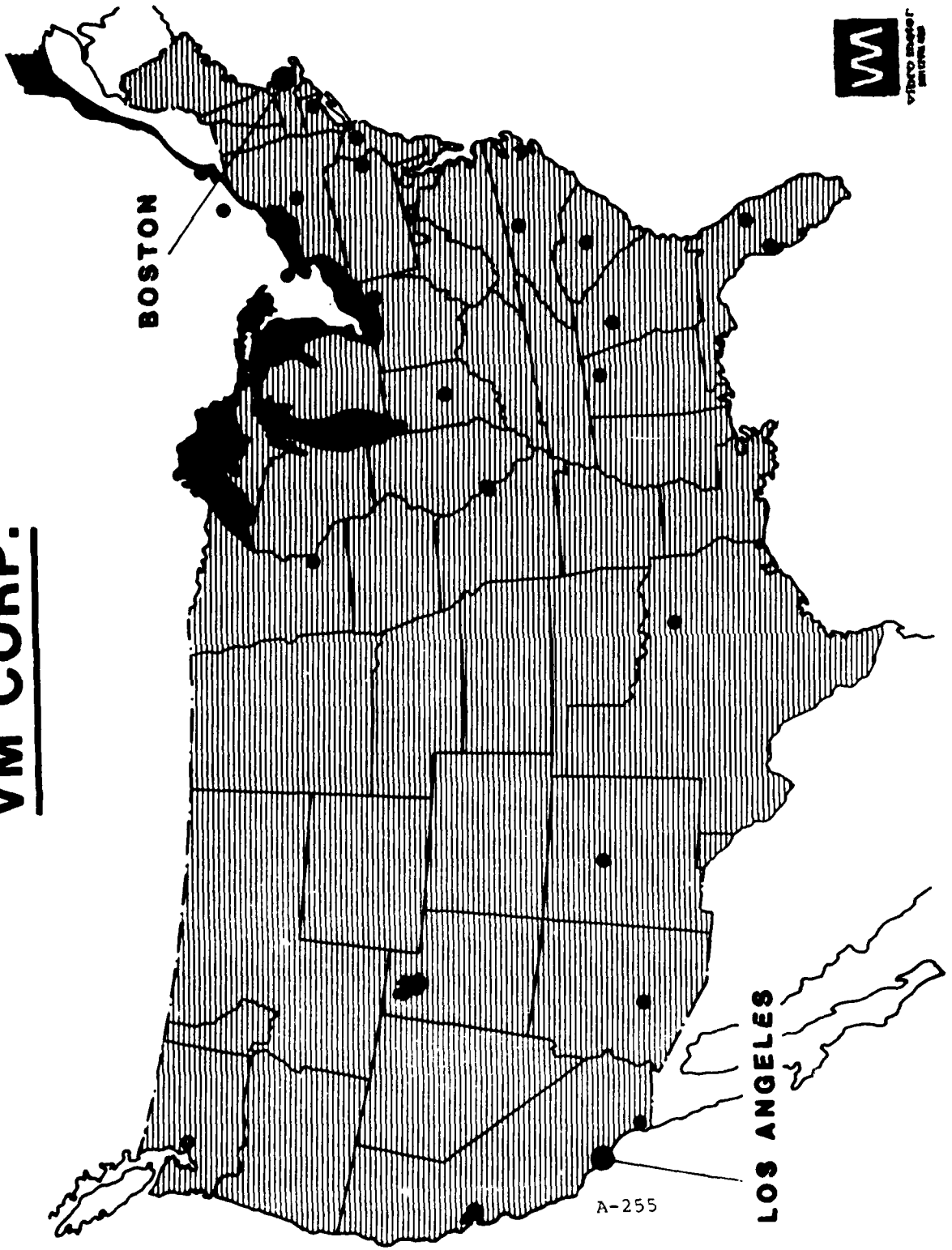

VIDEO MARKET
AND MORE

ORGANIZATION
CHART

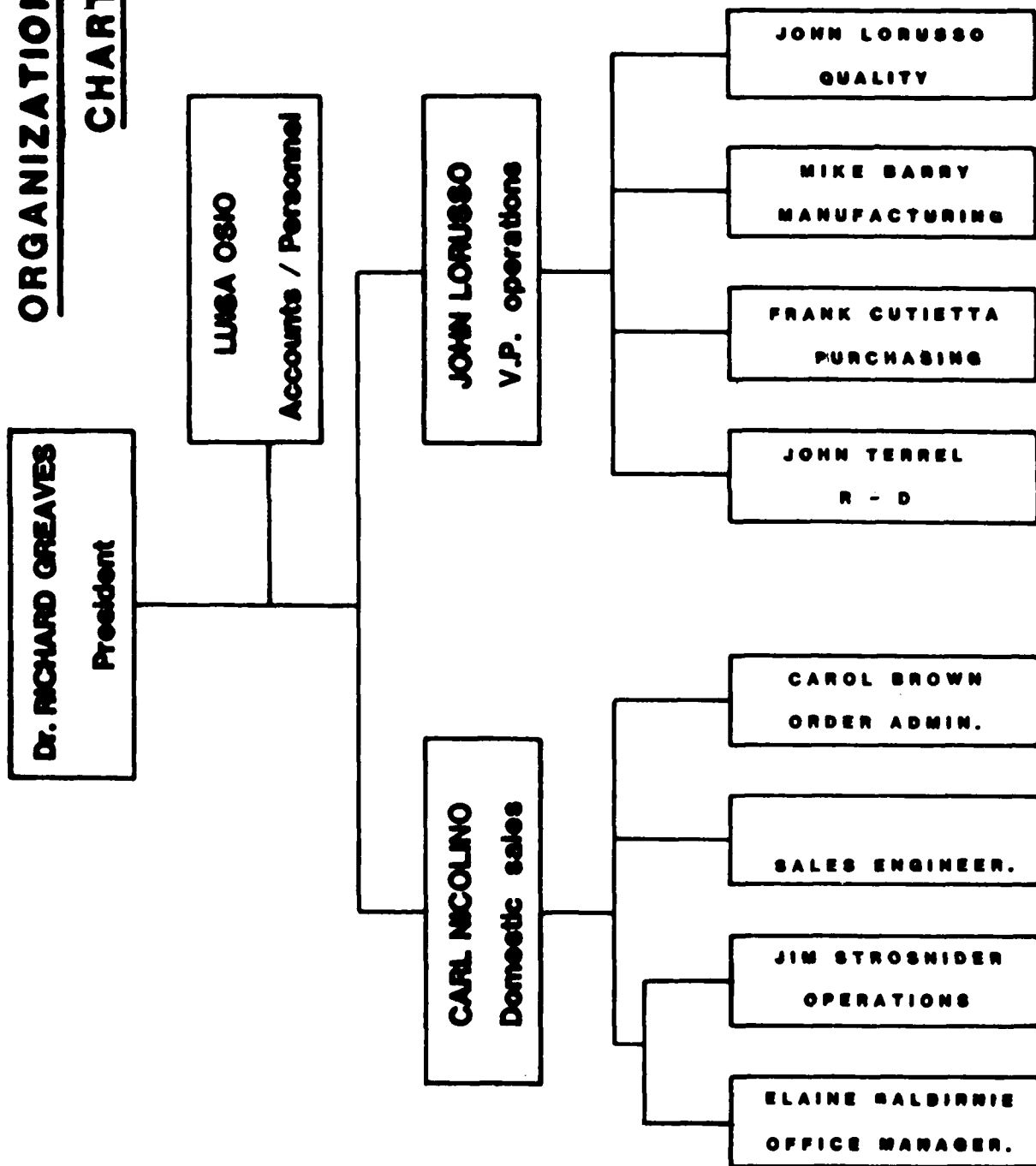

MANPOWER DISTRIBUTION

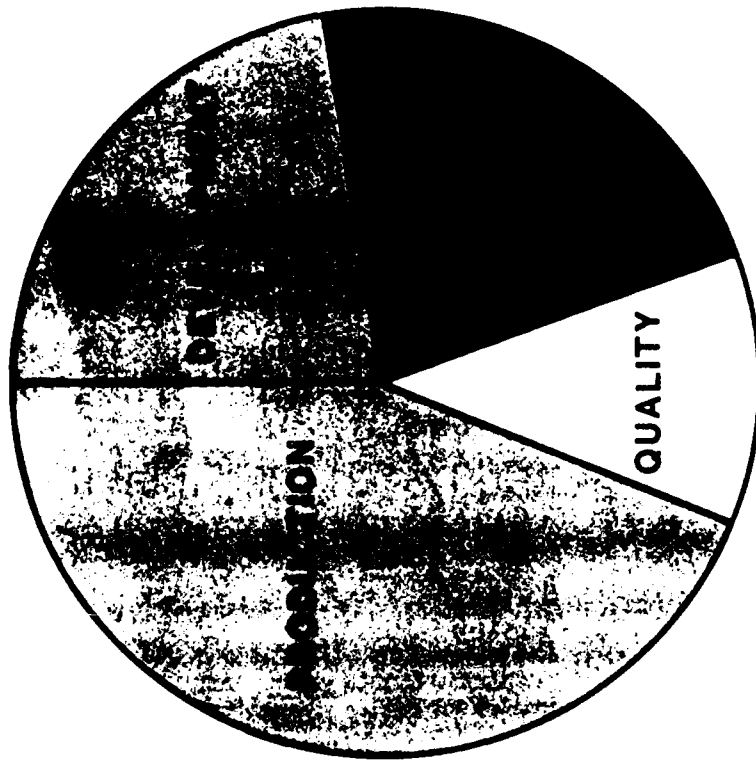

vibro meter. sas
1999

MILESTONES

- 1952 - FOUNDATION OF VIBRO - METER S.A.
- 1967 - FIRST AIRBORNE PIEZOELECTRIC EVM SYSTEM - CV 990
- 1968 - FIRST MAJOR PROGRAM AWARD L-1011
- 1970 - DC 10-30 (KSSU / ATLAS)
- 1972 - A300B
- 1978 - FIRST ROTOR IMBALANCE (TRACKING) EVM-B 747 / RB 211
- 1978 - FIRST MICROPROCESSOR CONTROLLED EVM (SHELL)
- 1979 - FIRST HYBRID MICRO-MINIATURE EVM-MILITARY
- 1979 - CONTRACT AWARD B 767
- 1980 - PATENT AWARD FOR ADVANCED ROTOR IMBALANCE TECHNIQUE
- 1980 - FIRST RELEASE OF MICROPROCESSOR EVM TO LATEST ARINC REQUIREMENTS



GROWTH OF VIBRO-METER

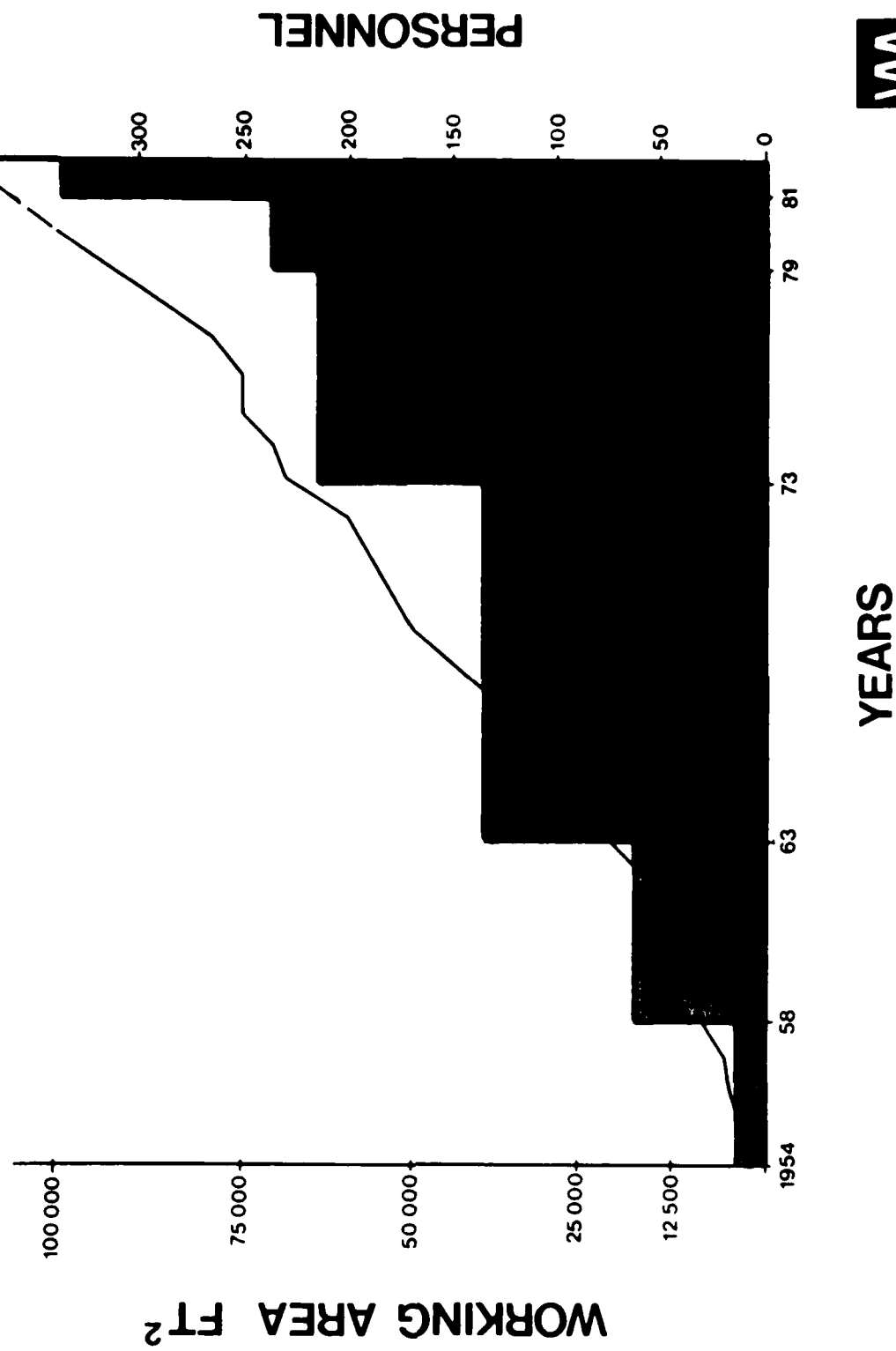

PRESENT STATUS

CIVIL AVIATION

- **87 AIRLINE CUSTOMERS**
- **ALL MAJOR WIDE-BODY JETS
FITTED**
- **ALL CURRENT AND PROJECTED
ENGINES FITTED**



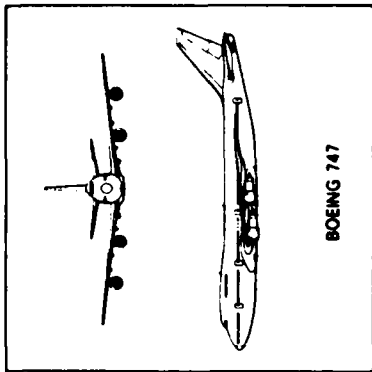

BOEING 747

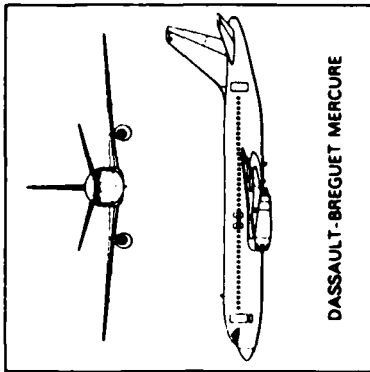

DASSAULT-BREGUET MERCURE

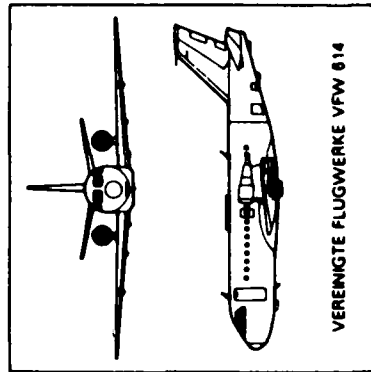

VERENIGTE FLUGWERKE VFW 614

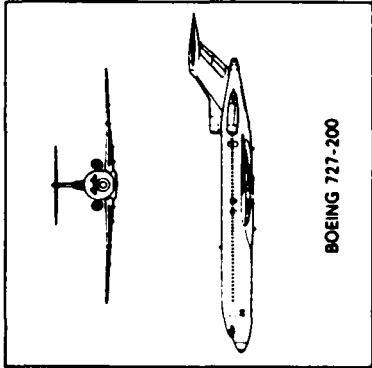

BOEING 727-200

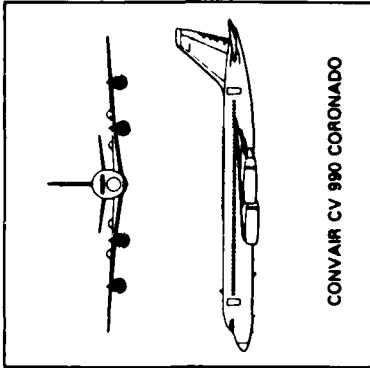

CONVAIR CV 990 CORONADO

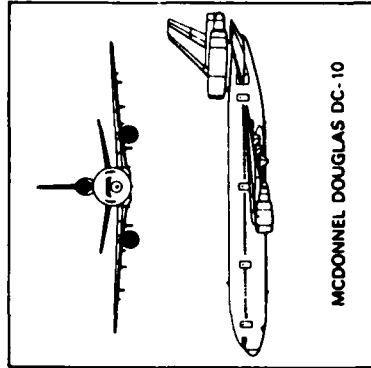

MCDONNELL DOUGLAS DC-10

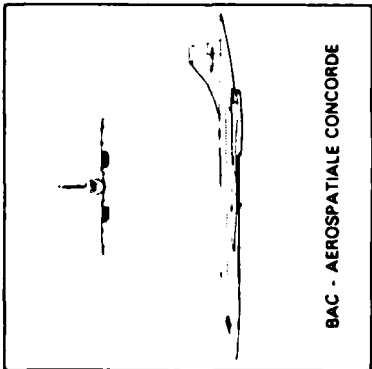

BAC - AEROSPATIALE CONCORDE

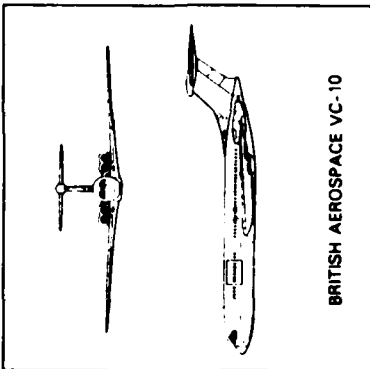

BRITISH AEROSPACE VC-10

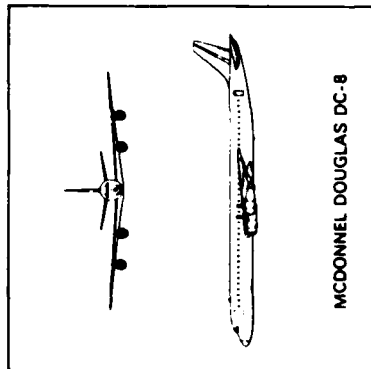

MCDONNELL DOUGLAS DC-8

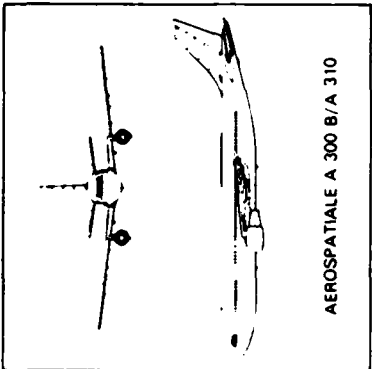

AEROSPATIALE A 300 B/A 310

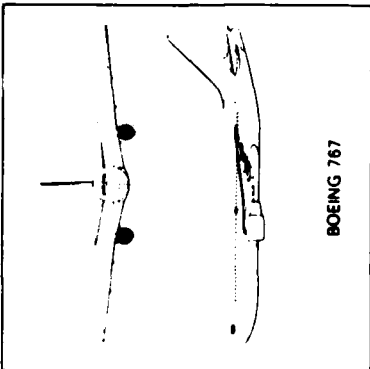

BOEING 767

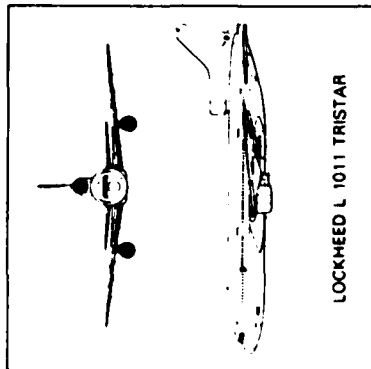

LOCKHEED L 1011 TRISTAR

PRESENT STATUS MILITARY PROGRAMS

- **MRCA-TORNADO**
 -EVM SYSTEM
 -JET PIPE RESONANCE SYSTEM
- **ALPHAJET**
- **MIRAGE-2000/4000**
 SNECMA M53
- **A7 CORSAIR-DDA TF-41**
- **HAWK-ADOUR**
- **CHINOOK**
- **F 404-TEST BEDS RCAF**



**VM
THE PRODUCTS**

INDUSTRIAL

**AVIONICS /
NUCLEAR**



'INDUSTRIAL' PRODUCTS

- MODULAR ELECTRONIC PROCESSORS
- ELECTRO-MAGNETIC BRAKES
- TORQUE/LOAD/PRESSURE/
TRANSDUCERS
- WEIGHING SYSTEMS
- VIBRATION TRANSDUCERS
 - DISPLACEMENT (PROXIMITY)
 - PIEZO ELECTRIC / RESISTIVE
- SPEED PICK-UPS



vibro-meter
sartorius

AVIO / NUCLEAR PRODUCTS

- **SPECIALIST PIEZO ELECTRIC TDR'S**
 - **VIBRATION**
 - **PRESSURE**
- **SPEED/MOTION PICK-UPS**
- **AIRBORNE AND GROUND BASED**
 - ELECTRONIC PROCESSORS /**
 - ANALYSIS SYSTEMS**
- **SUPPORT / TEST EQUIPMENT**

A-265



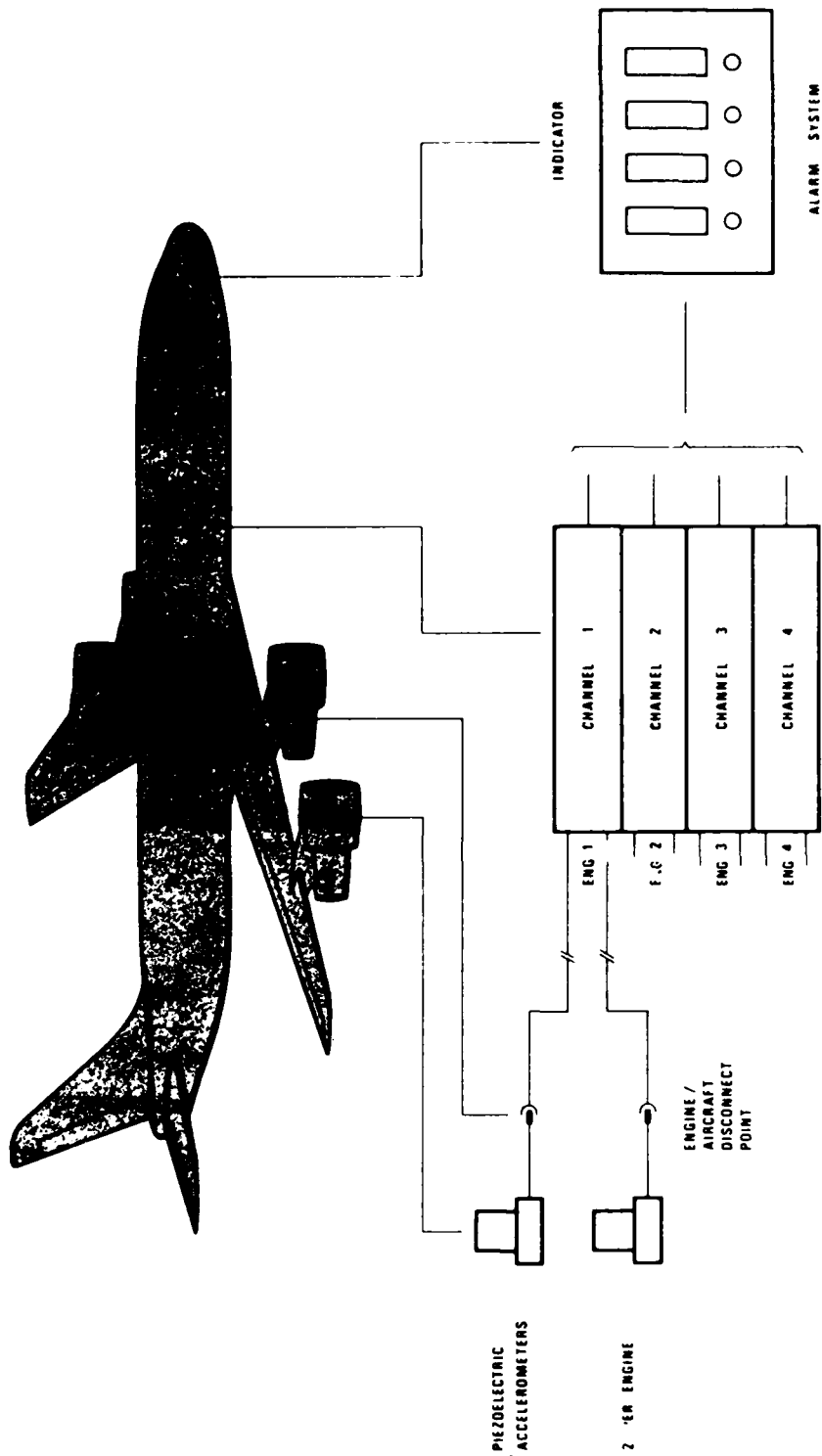

A-266

ENGINE

AIRCRAFT ELECTRONICS BAY

COCKPIT



COMPONENTS OF AN EVM

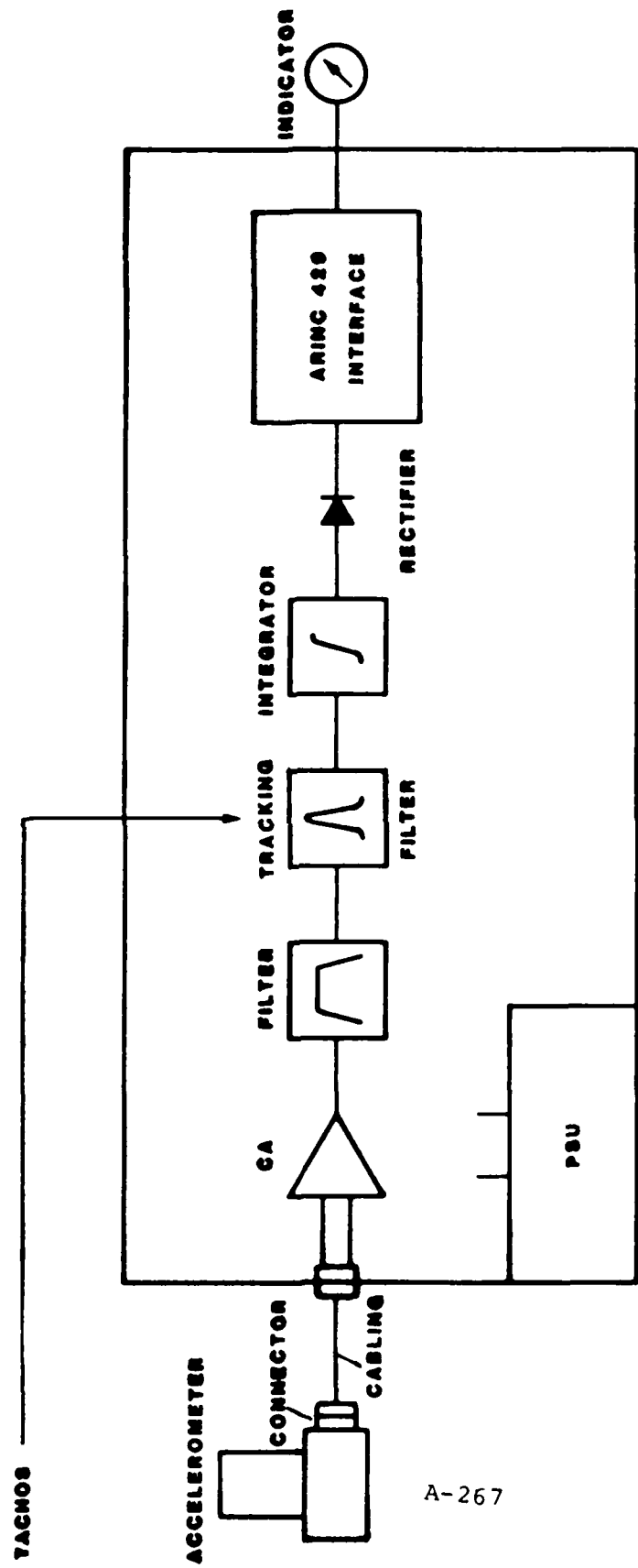

A-267

ELECTRONICS PROCESSOR



COMPRESSION
MODE

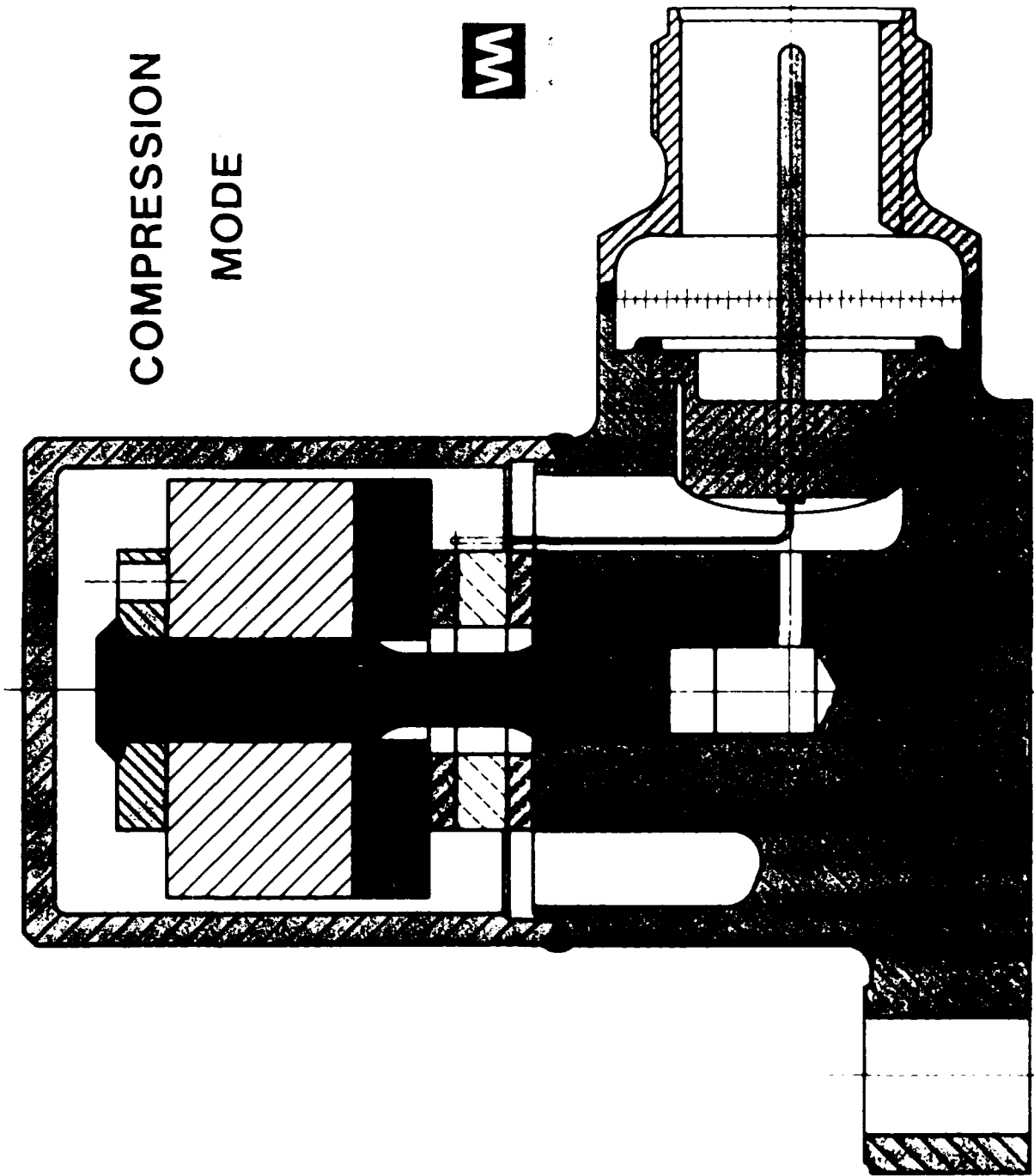

SYMMETRICAL SHEAR

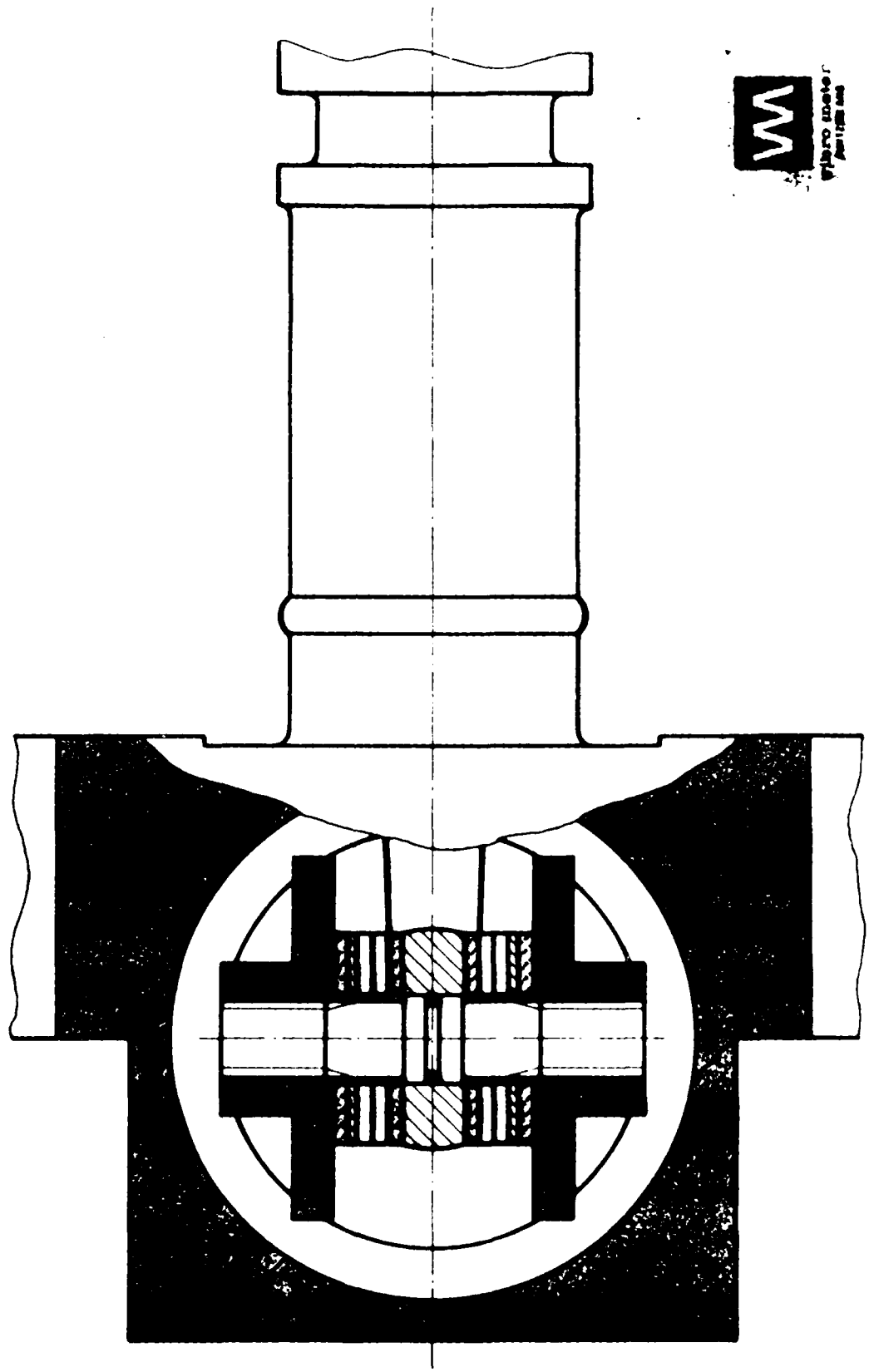

PROBE ACCELEROMETER

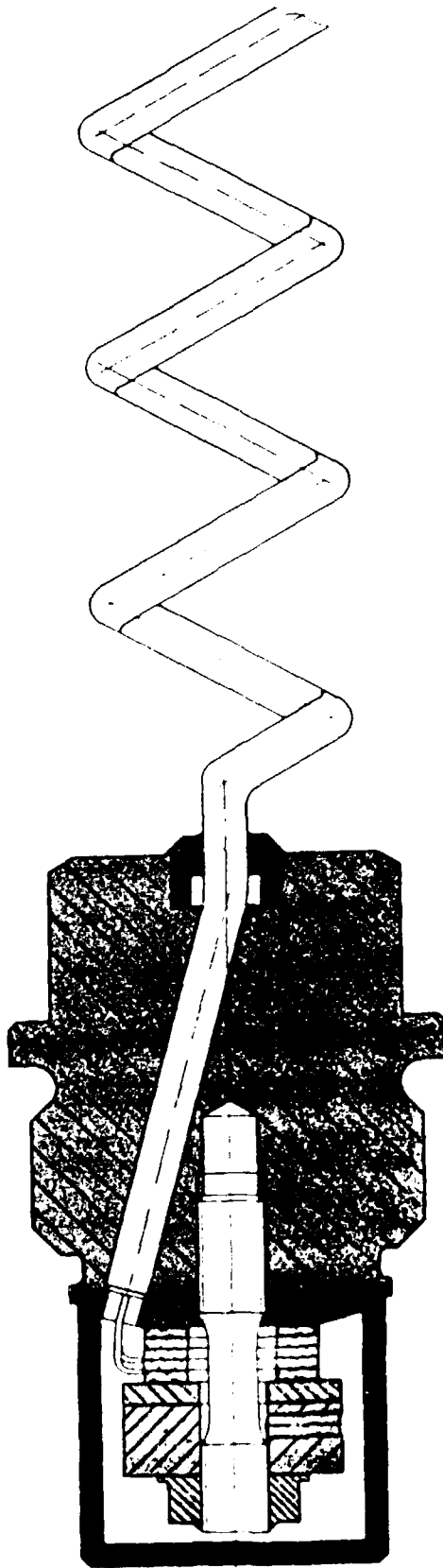

A-270

ACCELEROMETER (BIAXIAL)

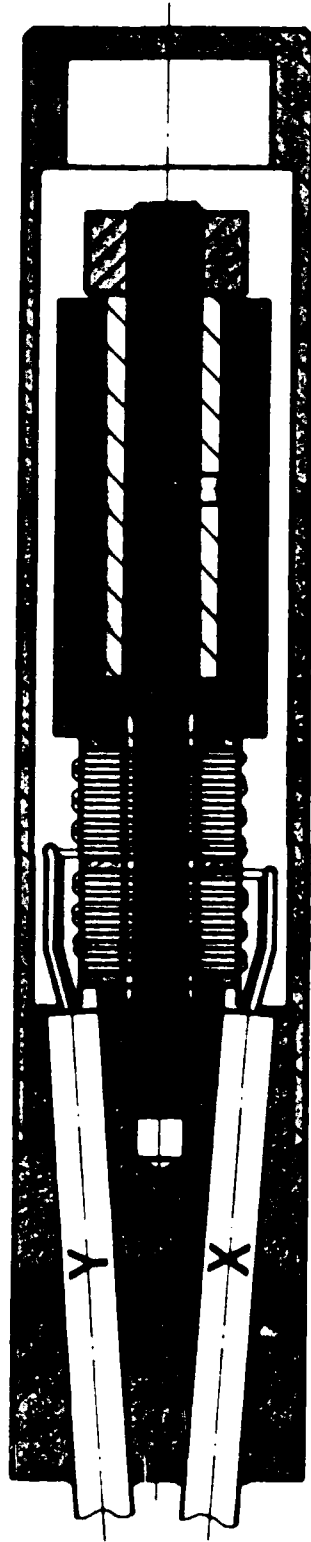

A-271



PRESSURE TRANSDUCER

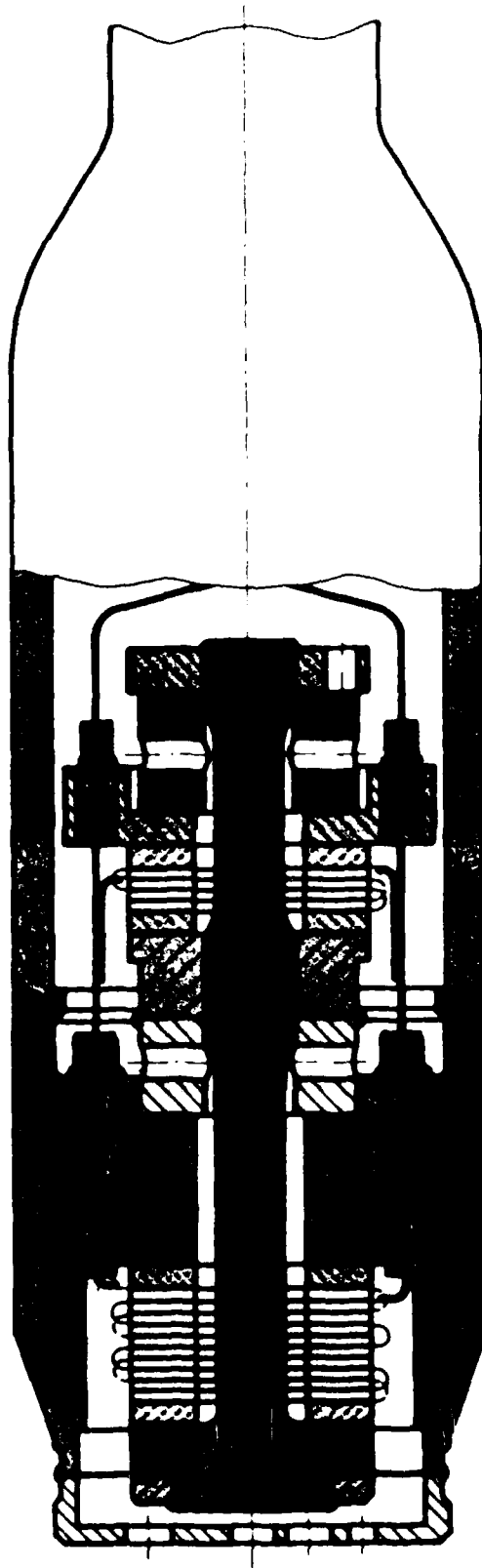

A-272

HIGH TEMPERATURE PROXIMITY PROBE

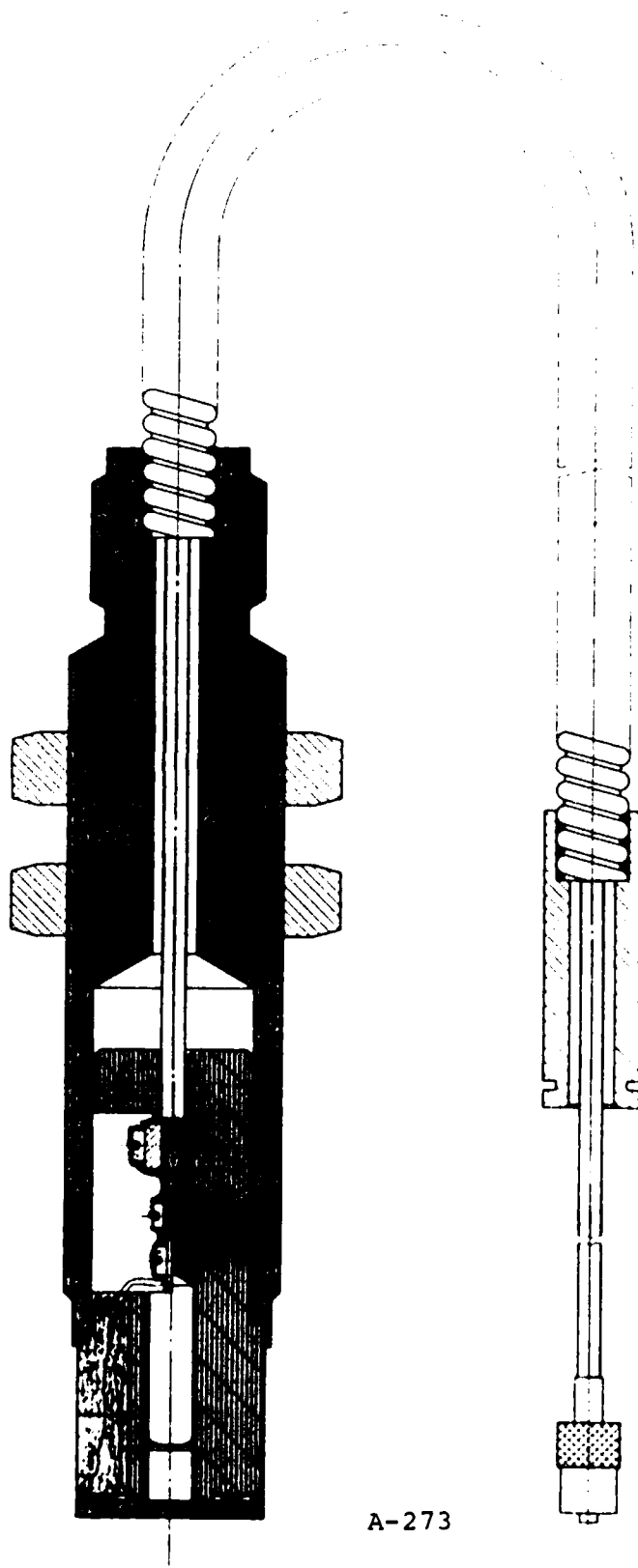

A-273

DOUBLE ELEMENT COMPRESSION MODERATOR

PATENT APPLIED FOR

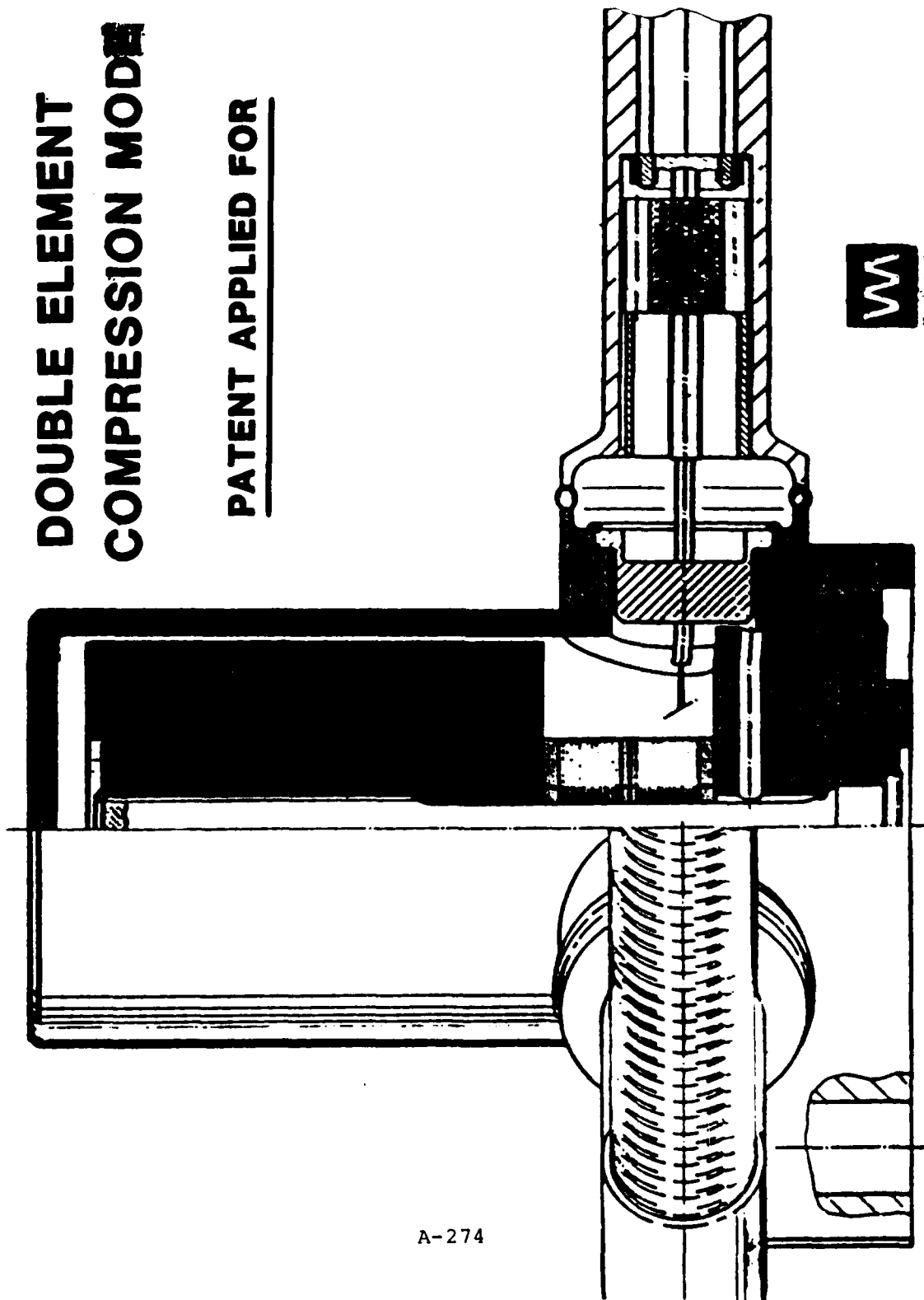

A-274

2-Pole Connector Type CG 505

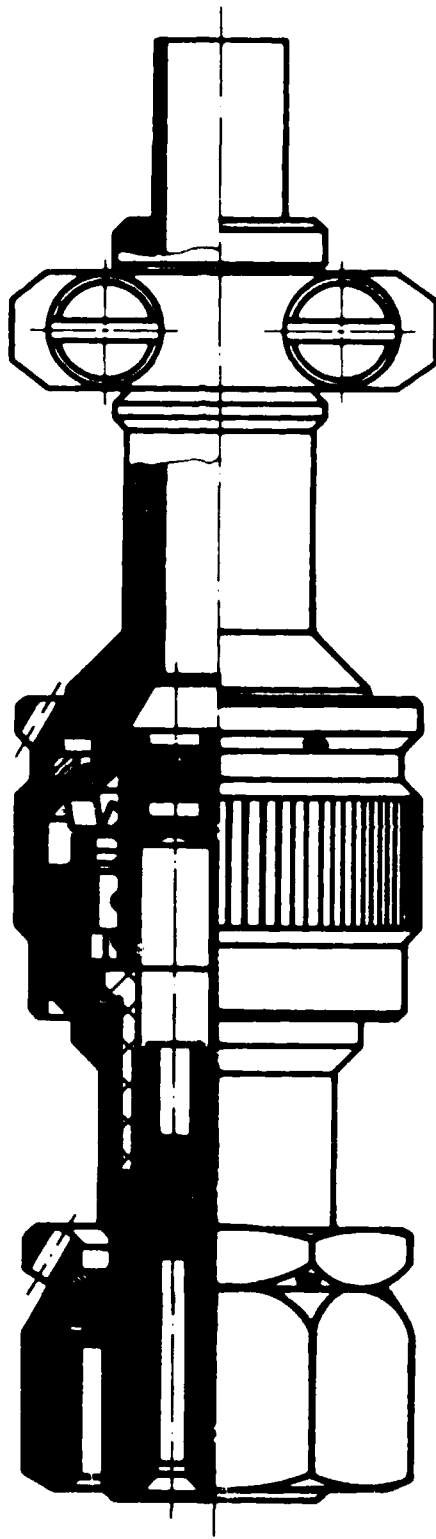

A-275

CABLING

- ALL ENGINE CABLING MUST BE
LO-NOISE TYPE
- CORRECT EARTHING CONFIGURATION
THROUGHOUT SYSTEM IS ESSENTIAL
- CABLE ROUTING / CLIPPING IS CRITICAL

A-276



STATE OF THE ART. 2

- WITH MODERN DIGITAL TECHNOLOGY,
ADVANCED DIAGNOSTIC
TECHNIQUES CAN BE INCORPORATED
INTO EVM SYSTEMS GIVING:
- SUPERIOR DATA INTEGRITY
- QUANTUM JUMP IN RELIABILITY

A-277



SUMMARY

ADVANCES IN TECHNIQUES AND TECHNOLOGY HAVE BROUGHT US TO THE POINT OF RECONSIDERING EVM SYSTEM CONCEPTS AND PHILOSOPHY FROM SQUARE "1"



VIBRATION MONITORING

WHY ?

OBJECTIVES

HOW ?



- ROTATING PARTS VIBRATE
- VIBRATION CAUSES FAILURES
- FAILURES COST MONEY

- VIBRATION ANALYSIS REVEALS SOURCE ,
MAGNITUDE AND PROGRESSION .
- ENABLING : -
- PREVENTIVE ACTION .
- MAINTENANCE PLANNING .



- THIS SAVES MONEY -

OBJECTIVE

• TO PROVIDE A COST EFFECTIVE MEANS
OF RELIABLY AND ACCURATELY MEASURING
VIBRATIONAL DATA AND TO PRESENT IT
IN AN UNAMBIGUOUS MANNER SO AS TO :

1. IMPROVE FLIGHT SAFETY
2. REDUCE MAINTENANCE TIME
AND COST

A-281



HOW ? I

**1. DETERMINE AREAS OF INTEREST
AND INSTALL ACCELEROMETERS**

**2. DETERMINE NATURE OF PROBLEM
AND DEFINE THE APPROPRIATE
ANALYSIS TECHNIQUE FOR**

PROCESSING DATA



HOW ? II

- ITEM 1 REQUIRES COOPERATION
BETWEEN SYSTEM SUPPLIER AND
ENGINE / AIRFRAME MANUFACTURER
AT THE DESIGN / DEVELOPMENT STAGE
- E.G. SITING OF INTERNAL
ACCELEROMETERS AND
INTERPRETATION OF DATA



AD-A137 524

MECHANICAL SYSTEMS CONDITIONING MONITORING TECHNOLOGY
WORKING GROUP REPOR. (U) INSTITUTE FOR DEFENSE ANALYSES
ALEXANDRIA VA SCIENCE AND TECH. P HOWARD AUG 83

6/6

UNCLASSIFIED

IDA-D-36

IDA/HQ-83-25899

MDA903-79-C-0018

F/G 15/3

NL

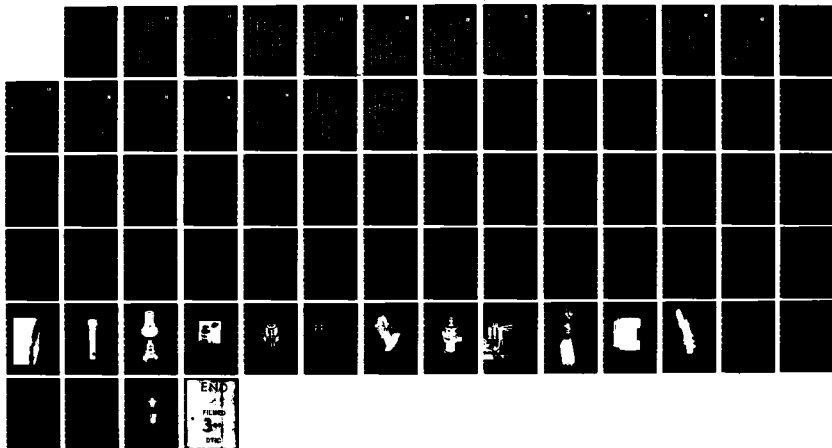

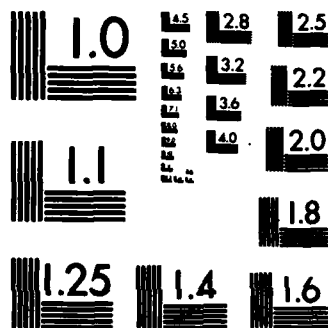

MICROCOPY RESOLUTION TEST CHART
 NATIONAL BUREAU OF STANDARDS-1963-A

HOW ? III

- **ITEM 2 REQUIRES CLOSE LIAISON
BETWEEN SYSTEM SUPPLIER,
MANUFACTURER(S) AND END
USERS TO ENSURE OPTIMUM
COST EFFECTIVENESS**

HOW ? IV

- IT IS ESSENTIAL THAT
FULL SYSTEM RESPONSIBILITY
IS PLACED UPON THE
EVM SYSTEM SUPPLIER

A-285



**• IN A RETROFIT SITUATION
ON EXISTING EQUIPMENT
THE EXPERTISE OF THE
SYSTEM SUPPLIER IS
OF PRIME IMPORTANCE**

WHAT IS POSSIBLE ?

- SHORT TERM

- LONG TERM



**RELIABLE AND ACCURATE DETECTION
OF VIBRATION, AT SOURCE, IS NO
LONGER A PROBLEM.
ATTENTION CAN NOW BE FOCUSED
ON OPTIMIZING MEANS OF EXTRACTING
DATA RELATED TO ENGINE HEALTH
AND PRESENTING IT IN THE MOST
APPROPRIATE MANNER.**



- **THE NEW GENERATION OF EVM SYSTEMS WILL HAVE THE SIGNAL PROCESSOR CONTROLLED BY ONE OR MORE DIGITAL MICROPROCESSORS**
- **THEIR FUNCTION/SEQUENCE OF OPERATION WILL ALMOST ENTIRELY BE DETERMINED BY "SOFTWARE" (COMPUTER PROGRAM)**
- **GIVEN THE BASIC CONCEPT OF "COMPUTER" CONTROL, VARIOUS DIAGNOSTIC TECHNIQUES BECOME AVAILABLE**



TYPICAL DIAGNOSTIC TECHNIQUES

- NUMERIC TRACKING FILTERS
- MONOLITHIC SWITCHED
CAPACITOR FILTERS
- FAST FOURIER TRANSFORM (FFT)
- COMB FILTERS

A-290



OVERALL CONCEPT

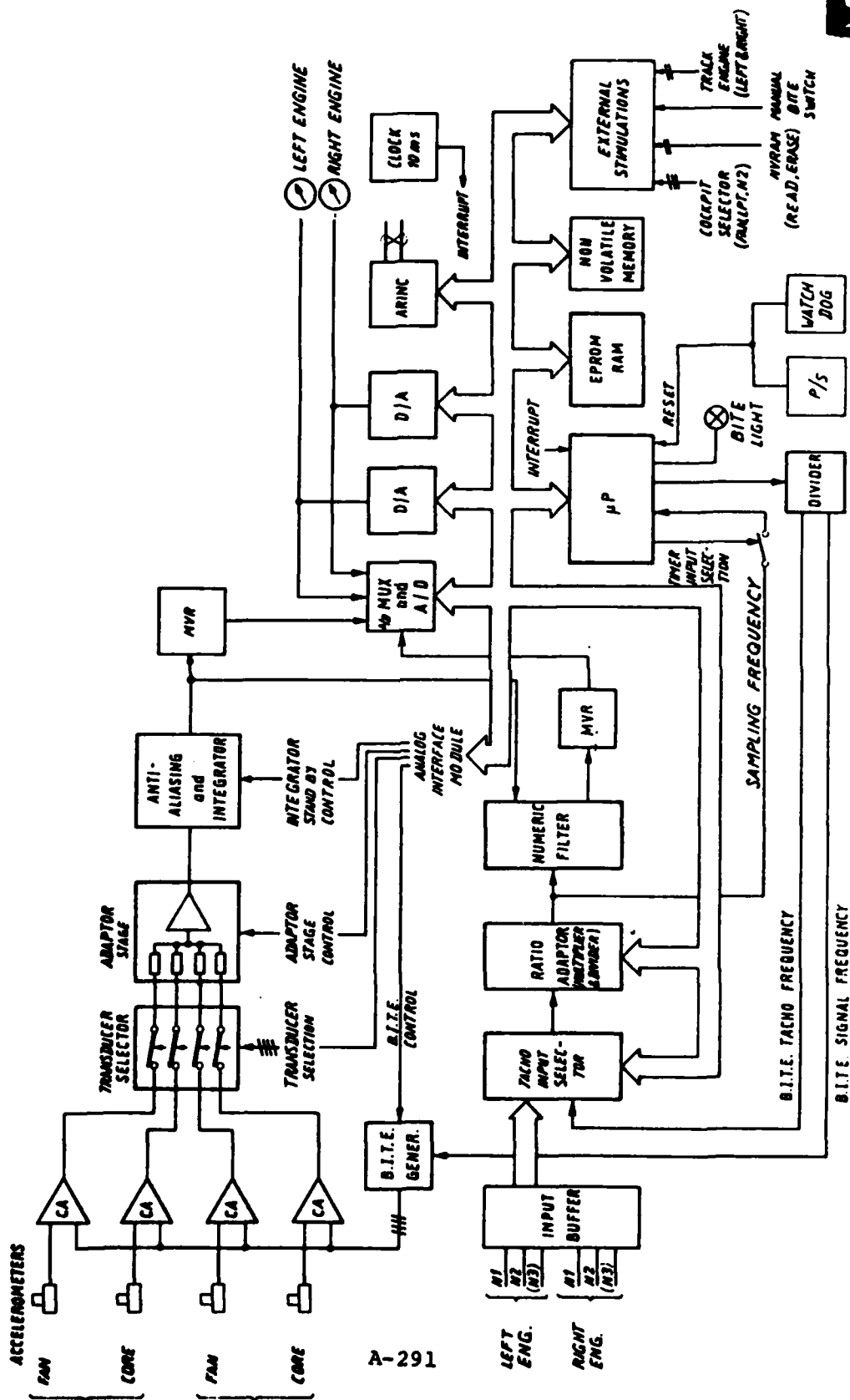

A-291



VIBENT SYSTEMS
SWITZERLAND

REAL TIME EXECUTIVE CONTROL FLOW GRAPH

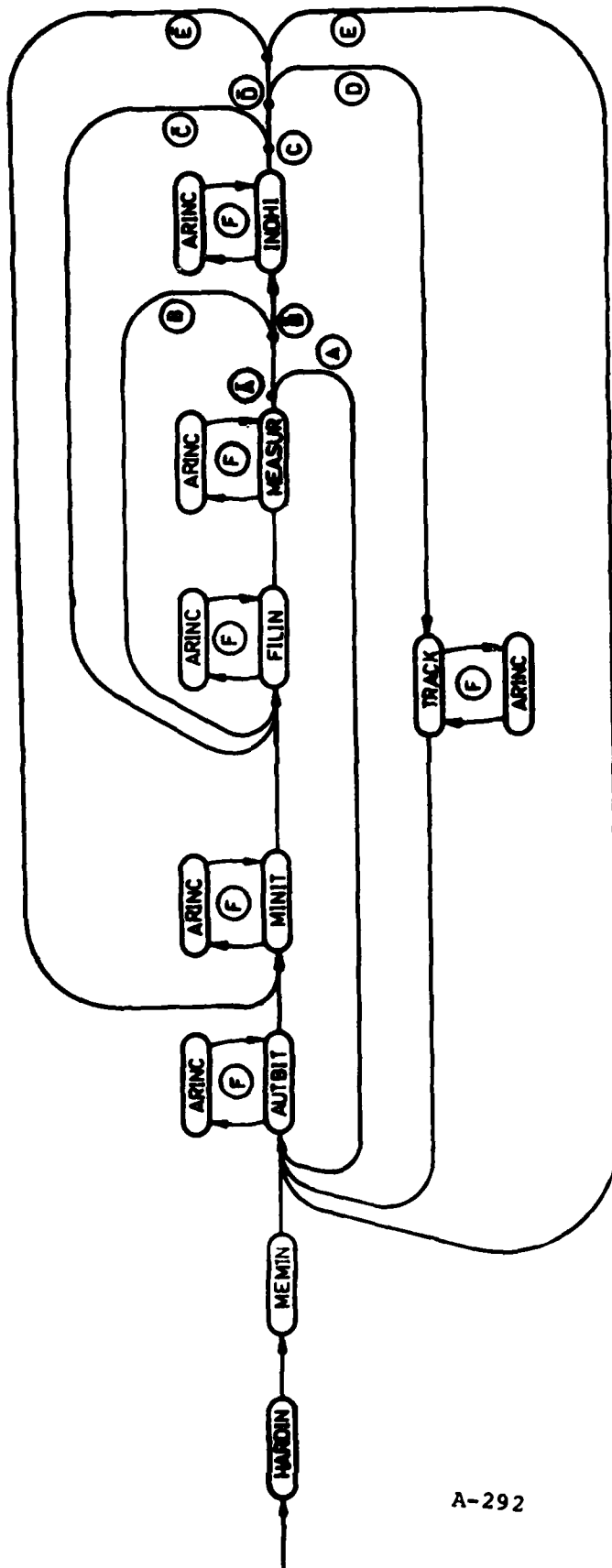

- (A) : EXTERNAL STIMULATION (MANUAL BITE, READ NVRAM, ERASE NVRAM) REQUEST
- (B) : MEASUREMENT FOR FAN, LPT AND N2
- (C) : COMPLETE MEASUREMENT CYCLE PERFORMED
- (D) : FOR MAINTENANCE PURPOSES, A "TRACK ENGINE" HAS BEEN REQUESTED
- (E) : AFTER 32 MEASUREMENTS OF BOTH RIGHT AND LEFT ENGINES, AN AUTOMATIC SYSTEM CHECK SHALL BE PERFORMED BY THE AUTOBIT MODULE
- (F) : EVERY IONS AN ARINC WORD IS SENT



**• ANY SYSTEM BASED ON THESE PRINCIPLES
CAN BE MADE AVAILABLE IN A RELATIVELY
SHORT TIMESCALE**

• LONGER SCALE OBJECTIVES:

- ADAPTIVE PROGRAMMING**
- EXTENDED MEMORY CAPACITIES**
- EXTENSION OF MONITORING COVERAGE**
- INCLUSION OF OTHER PARAMETERS**

A-293



WE HAVE THE DATA .

NOW WHAT ?

A-294



USE OF DATA

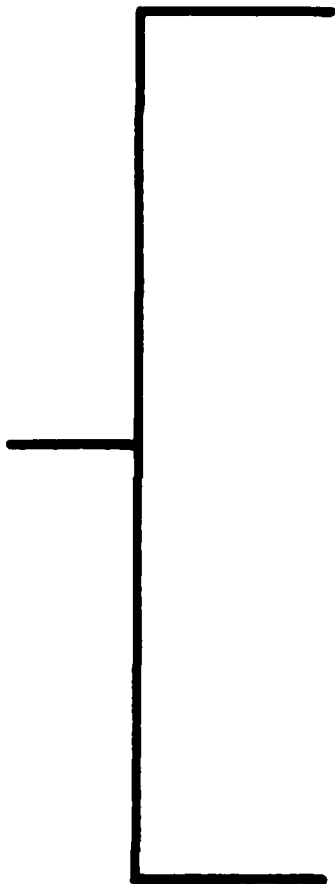

REAL TIME

OFF-LINE

A-295

MAINTENANCE

**• CLEAR, UNAMBIGUOUS
INSTRUCTION ON
NEED TO KNOW BASIS**

**• NORMAL DATA
• SPECIAL OCCURENCES**



REAL TIME

- DISPLAYS PRIMARILY ASSOCIATED WITH
 - SAFETY ITEMS
 - ITEMS REQUIRING INTERVENTION
- DISPLAY SHOULD INDICATE
 - MAGNITUDE OF PROBLEM
 - RECOMMENDED ACTION

MAINTENANCE

- **STORAGE OF ALL AREAS OF INTEREST THAT HAVE BEEN DETERMINED TO BE RELEVANT TO ENGINE HEALTH**
- **INDICATION OF EXCEEDANCE AND STORAGE OF SUPPLEMENTARY DATA LEADING TO PREVENTIVE MAINTENANCE**
- **"NORMAL" ENVELOPE LEADING TO STORAGE IN DATA BANK**



TIME / CYCLES

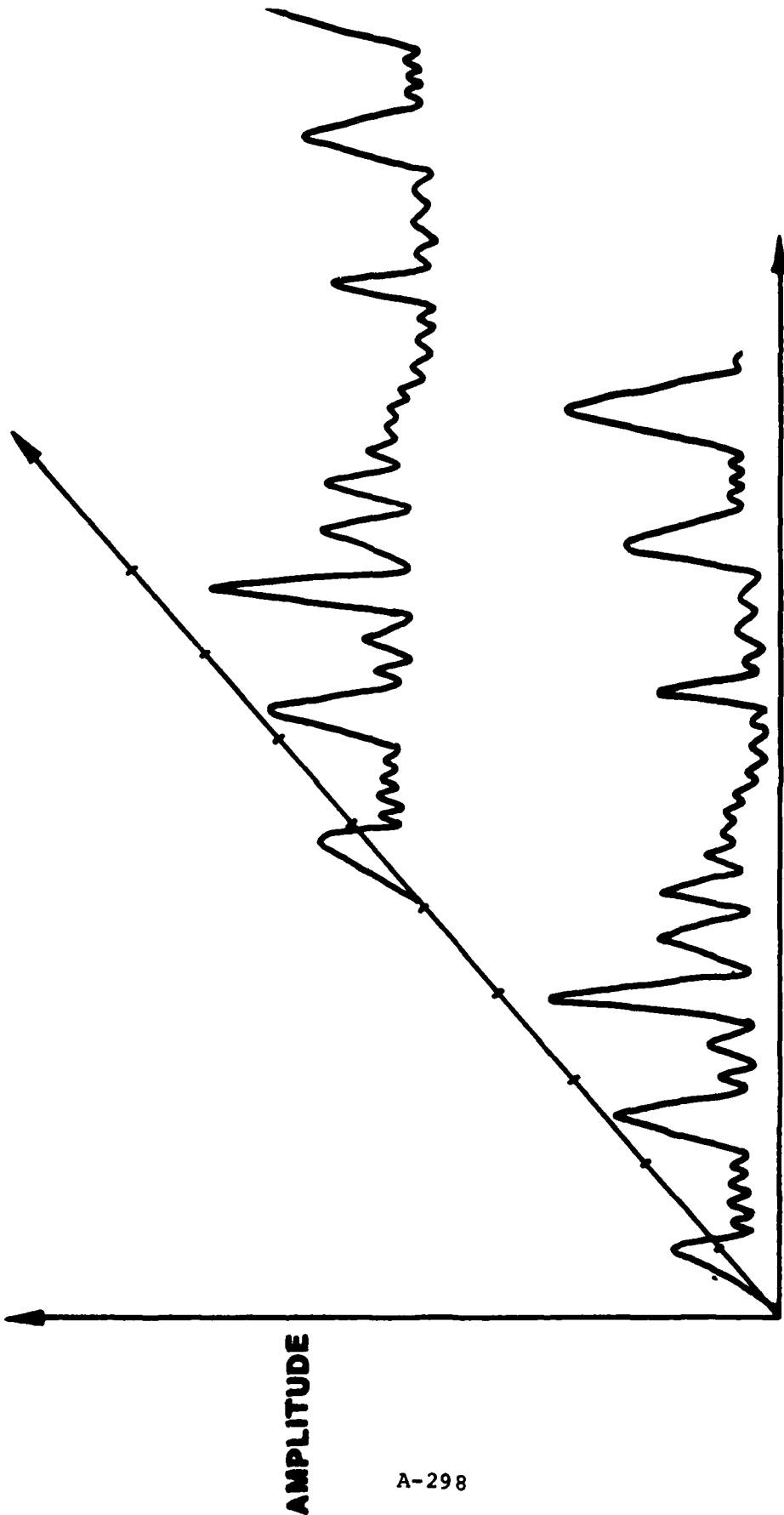

AMPLITUDE

A-298

FREQUENCY



SUGGESTIONS I

- THE EXPERIENCE AND 'KNOW HOW' IS AVAILABLE TO DO A LONG OVERDUE EVM JOB ON HELICOPTERS
- THE CIVIL HELICOPTER MARKET IS THE MOST RAPIDLY EXPANDING AVIATION MARKET . THEY ARE INTERESTED.
- CIVILIAN DEVELOPMENT PROGRAMS ARE SLOW. A MILITARY FUNDED COOPERATIVE PROGRAM WOULD BE FASTER AND COSTS COULD BE OFFSET BY COMMERCIAL SALES



SUGGESTIONS II

- THE FOREGOING APPLIES TO ALL FORMS OF
 - ROTATING MACHINERY
 - STRUCTURES
 - NUCLEAR REACTOR INTERNALS
 - STEAM GENERATORS
- INDUSTRY IMPETUS IS REQUIRED TO ENABLE ESSENTIAL SYSTEMS OF THIS TYPE TO BE REALISED WITH
 - LO COST
 - LO WEIGHT AND SIZE
 - HI RELIABILITY
 - HI INTEGRITY



CONCLUSIONS 1

**. A RANGE OF GROUND BASED SYSTEMS IS,
OR WILL SHORTLY, BE AVAILABLE TO COVER
MOST VIBRATION MONITORING AND
DIAGNOSTIC REQUIREMENTS OF TODAY**

CONCLUSIONS 2

**SUCCESSFUL VIBRATION MONITORING
REQUIRES A HIGH DEGREE OF
TECHNICAL EXPERTISE AND EXPERIENCE**

**IT IS LOGICAL THAT EVM SYSTEMS SHOULD
EXPAND TO INCLUDE
OTHER HEALTH/LIFE PARAMETERS**

APPENDIX B

SAE TURBINE DIAGNOSTICS

SUMMARY

SAE-AIR-1828

FINAL DRAFT

February 1, 1983

AIR 1828

**GUIDE TO OIL SYSTEM MONITORING
IN AIRCRAFT GAS TURBINE ENGINES**

B-3

GUIDE TO OIL SYSTEM MONITORING
IN AIRCRAFT GAS TURBINE ENGINES

TABLE OF CONTENTS

<u>Paragraph</u>	<u>Page Number</u>
1. PURPOSE	1
2. INTRODUCTION	1
3. HISTORY	1
4. BENEFITS	3
4.1 Reliability/Availability	3
4.2 Reduced Cost of Ownership	3
4.3 Product Assurance and Verification	4
4.4 Safety	4
5. OIL SYSTEM OPERATION MONITORING	4
5.1 Oil Pressure	4
5.2 Oil Temperature	5
5.3 Oil Quantity	5
5.4 Filter Bypass Indicator	6
6. OIL DEBRIS MONITORING	6
6.1 On Aircraft Debris Monitoring	9
6.1.1 Established Techniques	9
6.1.1.1 Magnetic Chip Collector	9
6.1.1.2 Electric Chip Detector	11
6.1.1.3 Pulsed Electric Chip Detector	12
6.1.1.4 Screen-Type Full-Flow Debris Monitor	12
6.1.2 Experimental Techniques	13
6.1.2.1 Centrifugal Debris Separator	13
6.1.2.2 Quantitative Debris Monitor	13
6.1.2.3 Electro-Optical Debris Monitor	14
6.1.2.4 Inductive Debris Monitor	14
6.1.2.5 Indicating Screen	14
6.1.2.6 X-Ray Fluorescence Monitor	14
6.1.2.7 On-Line Ferrograph	15
6.1.2.8 Degaussing Chip Detector	15
6.1.2.9 Capacitative Debris Monitor	15

<u>Paragraph</u>	<u>Page Number</u>
6.2 Off-Aircraft Debris Monitoring	15
6.2.1 Spectrometric Oil Analysis (SOAP)	15
6.2.2 Quantification and Analysis of Debris from Magnetic Chip Collectors	19
6.2.3 Filter Analysis	19
6.2.4 Ferrography	20
6.2.5 Colorimetric Oil Analysis	21
6.2.6 Radioactive Tagging	22
6.2.7 X-Ray Spectrophotometer	22
6.2.8 Scanning Electron Microscope (SEM)	22
 7. OIL CONDITION MONITORING	 23
7.1 Physical/Chemical Properties	23
7.2 Complete Oil Breakdown Analyzer (COBRA)	23
7.3 Total Acid Number Kit (TAN Kit)	23
 8. GENERAL REQUIREMENTS	 23
 9. OIL SYSTEM CONSIDERATIONS FOR DEBRIS MONITORING	 24
9.1 Sensor Integration into the Oil System	25
9.2 Oil System Layout for Optimum Prognostic and Cost Effectiveness	26
9.3 Oil Debris Monitoring and Filtration	26
 REFERENCES	 27
 BIBLIOGRAPHY	 28
 ILLUSTRATIONS	

<u>Figure</u>	<u>Title</u>	<u>Section</u>
1	Oil System Monitoring In Aircraft Gas Turbine Engines	2
2	Life Cycle Cost For Oil Monitoring Systems	4.2
3	Thermal Resistance Sensor	5.2
4	Oil Quantity Sensor	5.3
5	Magnetic Chip Collector With Self-Closing Valve	6.1.1.1
6	Debris From Engine Failure	6.1.1.1
7	Electric Chip Detector	6.1.1.2
8	Maintenance Manual Excerpt For Chip Detector Debris Interpretation	6.1.1.2
9	Pulsed Electric Chip Detector System	6.1.1.3
10	Screen-Type Full-Flow Debris Monitor	6.1.1.4

<u>Figure</u>	<u>Title</u>	<u>Section</u>
11	Centrifugal Debris Separator With Oil System Deaeration Capability	6.1.2.1
12	Quantitative Debris Monitor	6.1.2.2
13	Electro-Optical Debris Monitor	6.1.2.3
14	Indicating Screen Debris Monitor	6.1.2.5
15	Airline SOAP Sampling Method	6.2.1
16	U.S. Military SOAP Sampling Method	6.2.1
17	Factors Influencing Debris Detection	9.1
18	Capture Efficiencies For Debris Particles	9.1
19	Oil Sampling Valve	9.2

PREPARED BY

SAE E-32 COMMITTEE

AIRCRAFT GAS TURBINE ENGINE MONITORING

All SAE documents are reviewed every five years. The Committee would appreciate any comments or input the reader might have which would make the document more usable in the future.

1. **PURPOSE:** The purpose of this AIR is to provide information and guidance for the selection and use of oil system monitoring devices and methods.

This Aerospace Information Report (AIR) is intended to be used as a technical guide. It is not intended to be used as a standard or legal document.

2. **INTRODUCTION:** Oil system monitoring for gas turbine engines can be classified into three types of activities:
 - oil system operation monitoring (monitoring the oil system for proper operation);
 - oil debris monitoring (monitoring the condition of oil-wetted engine components via the oil system);
 - oil condition monitoring (monitoring the condition of the oil itself).

Figure 1 shows schematically the techniques and hardware used for these three types of activities.

Further classifications are useful with respect to whether these techniques are established or still under development and whether they involve on-aircraft equipment only or whether they require off-aircraft equipment or facilities. Figure 1 also indicates these classifications.

Oil system monitoring is one of the methods which constitute an engine monitoring system, as discussed in ARP 1587 "Aircraft Gas Turbine Engine Monitoring System Guide". Frequently, oil system monitoring data are complimentary to information obtained from other components of the EMS. This is especially true for vibration monitoring.

For on-aircraft debris monitoring methods, proper integration of the sensor(s) into the oil system is essential and can determine their success or failure. Further, both on-aircraft and off-aircraft debris monitoring methods are affected by the degree of oil filtration. This document therefore addresses both sensor integration where applicable and the interaction of debris monitoring and oil filtration.

The scope of this document is limited to those inspection and analysis methods and devices which can be considered appropriate for routine maintenance.

3. **HISTORY:** Oil system operation monitoring by means of pressure, temperature and oil quantity constitutes the earliest form of oil system monitoring in aircraft engines. Later, filter bypass indicators were added to alert maintenance crews to clogged filters.

Wear debris monitoring goes back to the periodic checking of filters, pump inlet screens and magnetic drain plugs in reciprocating engines. By the early 1950's, some airlines had developed successful systems for monitoring piston, piston ring and main journal bearing condition on radial aircraft engines, using such methods.

The introduction of gas turbine engines with their high speed ball and roller bearings brought new failure modes with high secondary damage potential. The airlines successfully applied the earlier techniques to these engines. They developed a method consisting of regular removal of the screen-type oil filters, back flushing them and visually analyzing their content in terms of quantity, size, shape, color and material.¹⁾ Experience obtained from previous cases was used to estimate the likelihood and severity of failures and to aid in the decision to remove the engine. Even today, regular filter inspection is used by some users and is a valuable source of additional information when other methods provide ambiguous indications of incipient failure.

The second generation of gas turbine engines was already equipped with magnetic chip collectors with automatic shut-off valves to retain the oil and simplify routine inspection. Sophisticated oil debris monitoring methods have since been built around this principle.

The U.S. military environment is less conducive to techniques involving a considerable degree of judgment. Thus, in the early 1960's, electric chip detectors began to replace the magnetic chip collectors in U.S. military engines. In Europe, however, magnetic chip collectors are still in wide use today in military, as well as commercial aircraft.

Filter checks, magnetic chip collectors and electric chip detectors are effective in detecting debris larger than about 50 microns. For the quantitative assessment of finer debris (smaller than 10 microns), the U.S. military developed the Spectrometric Oil Analysis Program (SOAP). The origins of this technique go back to condition monitoring efforts on railroad diesel engines in the 1940's. Today, it is in wide use by most military services and many airlines throughout the world. The U.S. military has standardized the required hardware and procedures through its Joint Oil Analysis Program (JOAP), using atomic absorption and emission spectrography.

During the last decade, growing emphasis on reduced cost of ownership, on-condition maintenance and automated engine monitoring has stimulated the development of new oil debris monitoring and assessment technologies.

A number of on-aircraft debris monitors, some of them based on sophisticated physical principles, are being offered and have

been or are being evaluated by various engine manufacturers and users. At the same time, improved oil filtration with its well-established benefit of longer component life may reduce the effectiveness of some off-aircraft debris monitoring techniques and may stimulate the development of more sensitive instruments and methods for off-aircraft wear debris analysis and characterization.

4. **BENEFITS:** The benefits which can result from oil system monitoring include increased reliability/availability, reduced cost of ownership, improved product assurance and enhanced safety.
 - 4.1 **Reliability/Availability:** Oil system components (including the oil-wetted components of the engine itself) are generally maintained "on condition". An oil system monitoring method with good prognostic capability can therefore improve operational readiness, removal scheduling and engine management and enhance mission reliability and equipment availability.
 - 4.2 **Reduced Cost Of Ownership:** An oil system monitoring method with good prognostic and diagnostic performance can provide information for trade-off decisions between aircraft availability and cost of secondary damage. Cost of ownership for the aircraft and fleet size can then be minimized. This requires a substantial amount of experience concerning failure modes and progression rates. This experience, in turn, can be obtained from effective oil system monitoring.

Reliable oil system monitoring methods can reduce cost of ownership also by permitting extensions in time between overhaul or by helping to eliminate scheduled overhauls entirely. Further, they can help to reduce unnecessary removals and secondary damage of actual failures by initiating prompt maintenance action. An effective system will also help in minimizing in-flight shutdowns.

A cost/benefit evaluation criterion for oil system monitoring is life cycle cost (LCC). An objective of LCC trade-off analyses is to maximize return on investment (ROI) by addressing projected cost benefit (Ref. ARP 1587, Aircraft Gas Turbine Engine Monitoring System Guide, Section 6.4, Cost Benefit Analysis).

The acquisition costs of many oil system monitoring devices are relatively low compared to the engine components they are intended to protect. The cost/benefit ratio is therefore generally favorable, especially for large engines. However, maintenance, inspection, logistics and support personnel requirements can be dominant contributors to life cycle costs and must be taken into account (see figure 2).

The cost/benefit ratio of oil debris monitoring methods varies greatly from engine model to engine model, even within the same performance class. This is due to the fact that the mean time

between oil wetted component failures depends on loads, speeds, lubrication conditions and number of components, all of which can vary from design to design. In a given engine model, oil wetted component defects may be a relatively frequent occurrence and an effective debris monitoring system can contribute significant cost savings. This is especially true in the early years after service introduction. In engine models where this is not the case, an expensive oil debris monitoring system or program may not be justified. Nevertheless, the general trend towards higher oil system component loads, operating temperatures, lower weight and on-condition maintenance continues to drive the development of debris monitoring methods with improved failure detection, prognostic and diagnostic capability.

- 4.3 Product Assurance and Verification: Oil system monitoring provides product assurance by being an integral part of engine maintenance and inspection procedures and policies.

Bearings misaligned during assembly and similar build defects are frequently detected during engine acceptance test, run-in or initial operation by proper oil system monitoring. Oil system monitoring also plays an important role during engine development for verification of bearing life and heat transfer calculations.

- 4.4 Safety: Since bearing or gear malfunctions can lead to loss of engine power, oil system monitoring can contribute to flight safety. This is especially true for single-engine aircraft, including helicopters. In aircraft of this type, effective oil monitoring is therefore especially important.

5. OIL SYSTEM OPERATION MONITORING

- 5.1 Oil Pressure: Monitoring engine oil pressure provides indication of proper oil system operation and is used to detect abnormal conditions. High oil pressure can be caused by clogged oil jets and filters or by pressure regulator malfunction. Low oil pressure can be the result of leaks, broken lines, pump failure (partial or complete), low oil level, or pressure relief valve malfunction.

In most aircraft, oil pressure is monitored continuously by means of pressure transducers installed on the high-pressure side of the lubrication system. These transducers are connected to cockpit instruments and can be interfaced with on-aircraft engine monitoring systems.

Transducer selection should address environment, linearity, repeatability, hysteresis, resolution, temperature errors, calibration errors, reliability and mechanical/electrical interface requirements. The environmental parameters include temperature, vibration and shock, acoustic noise and conducted and radiated EMI (electromagnetic interference).

There are a variety of pressure transducer technologies available on the market. These include strain gage, capacitive, inductive, potentiometric, piezoresistive and digital types. These pressure transducers are all passive, as they require an input excitation voltage.

In addition to pressure transducers for continuous oil pressure indication, most aircraft gas turbine engines are provided with a low-pressure switch to alert the crew to a critical engine condition. Federal Airworthiness Requirements (ref. FAR items 23.1305, 25.1305, 27.1305 and 29.1307) require a low oil pressure warning and/or an oil pressure indicator, depending on the type of aircraft. The British Civil Airworthiness Requirements have similar provisions. An oil pressure indicator is also required by applicable specifications for U.S. military engines.

- 5.2 Oil Temperature: In conjunction with other oil system parameters, high oil temperature may indicate and help isolate engine subsystem malfunction. If oil temperature is sensed at the scavenge side, extreme bearing distress or hot section seal leakage may be detected. If the sensor is located downstream of the oil cooler, its clogging may lead to an over-temperature indication. However, slow or small changes cannot be determined in advance of a real problem. This is due to the wide range of independent variables that affect system temperature levels. These variables include fuel temperature to the engine (if used for oil system heat sink), ambient air temperature (if air/oil cooling is used), altitude and Mach No. No simple diagnostic set of limits can be derived for multiple sensing or single sensing locations. Sensing multiple temperatures with an on-board computer would provide excellent diagnostics but would probably not be cost effective.

In general, oil temperature is sensed by thermal resistance sensors which produce a change in electrical resistance with respect to temperature (figure 3). Resistance temperature sensors are generally of the metallic type. The resistance from the temperature sensor is measured in some form of Wheatstone bridge. Due to non-linearity and lower accuracy, thermistor temperature sensors are generally not used for oil system monitoring.

- 5.3 Oil Quantity: Monitoring oil quantity and oil added can provide information about excessive oil consumption, oil system leakage or fuel contamination. Most engine oil tanks are equipped with sight gauges or simple dipsticks for pre or post flight oil level checking. Some commercial and some military engines also have oil quantity transducers. These transducers are usually of the mechanical float/reed-switch, capacitance or thermistor types which can operate in this high-temperature environment. There are single point (low level) switches (figure 4) as well as multi-level transducers for in-flight cockpit or maintenance panel read out.

5.4 Filter Bypass Indicator: Since a clogged oil filter would otherwise lead to oil starvation, gas turbine engine filters have bypass valves which open under increased differential pressure. Most filters have provisions to indicate this condition externally by means of a mechanical or electrical bypass indicator. An impending bypass indicator is required by the FAR (ref. items 23.1019, 25.1019, 27.1019, 29.1019 and 33.71) and is also required by the U.S. military (MIL-E-8593). The impending bypass indicator is set below the bypass cracking pressure, since the oil wetted components can be damaged by recirculating debris if the engine is operated with a bypassing filter. A thermal lockout prevents indication due to cold oil.

The mechanical indicators are pop-up buttons and can often only be inspected by removing cowlings, etc. The electrical bypass switch permits cockpit indication.

6. OIL DEBRIS MONITORING: In addition to its function as a lubricating and cooling fluid, the oil serves as a transport medium for the debris generated by the rolling and sliding surfaces which are subject to wear. Wear, accelerated wear, incipient failure and failure involves the removal of material, although at different rates. The debris generated in these processes contains valuable and detailed information about the condition of the wear surfaces. This forms the basis for engine monitoring via the oil system (oil debris monitoring).

Parameters by which the debris can be assessed include quantity, rate of production, material, particle shape, size, size distribution and color. The various debris monitoring methods generally differ with respect to the parameters which are observed and the range in which they are measured. Depending on the failure mode, debris production may increase dramatically in one size range but not in another. As a result, the individual debris monitoring methods are said to be effective in detecting some incipient failure modes but not necessarily others.

The major concern of engine oil debris monitoring is the prompt detection of failure modes with rapid progression, particularly those with short time to onset of significant secondary engine damage.

In selecting the debris detection method(s) for the engine monitoring system, it is necessary to determine: 1) the types of potential failure modes, 2) their criticality vs. their probability, 3) the required detection point (timeliness) and 4) cost effectiveness.

The failure mode assessment should include consideration of wear and failure mechanisms and of the materials of critical oil-wetted engine components.

Wear and failure mechanisms are a result of lubrication and load conditions and of the mechanical design characteristics of engine components. Under full-film elastohydrodynamic (EHL) lubrication conditions, where the film thickness is large compared to the average surface roughness, the predominant failure mode of rolling-contact bearings is spalling or macropitting induced by surface fatigue.²⁾ This process produces mostly large debris particles with a typical size range from 100 to 1000 micron. In the boundary lubricated and mixed-mode (partial EHL) regimes, where asperity contact occurs, the debris particles are of smaller size (<100 micron). Under such lubrication conditions, abrasive or rubbing-type accelerated wear modes are more common. Bearing skidding can occur when bearing loads are light. It produces very small debris particles (<25 micron) and can progress rapidly when bearing surface speeds are high.

Wear modes with slow progression rates usually do not lead to engine failure by themselves. However, they can initiate secondary modes with faster progression rates. For example, a bearing surface damaged by corrosion can begin to spall eventually. Detection of this secondary mode which progresses at a faster rate then becomes essential.

Sudden failures of oil wetted components caused by fatigue cracking, such as gear tooth or bearing race fracture, are not normally detectable by any of the methods described in this AIR. Their failure modes produce little or no debris prior to component disintegration. However, this type of failure is extremely rare in a production engine and can be prevented by proper design and quality assurance.

In gas turbine engines, main shaft bearings are the most critical oil wetted components. Less critical are accessory gear box bearings and gears. In turboshaft and turboprop engines, planetary reduction gear components are also critical. Today, main shaft bearings are generally made from double vacuum-remelted steel with high amounts of tungsten and molybdenum. Cages are also generally made from steel and silver plated. Gear box bearings may contain bronze cages, as do main shaft bearings of many older engines. In the future, bearings in some engines may be made from ceramic materials.

An effective oil debris monitoring system should therefore, as a minimum, respond to the presence of bearing-type (ferrous) particles in the oil system. It should also have trending capability in order to differentiate progressive from non-critical conditions.

The oil debris monitoring methods currently in use or under development can be divided into on-aircraft and off-aircraft debris monitoring techniques. This classification is useful since the two categories have entirely different hardware and logistics requirements.

On-aircraft debris monitoring techniques are based on sensors or debris collectors which are permanently installed in the engine lubrication system. They can be augmented by off-aircraft analysis of the collected debris. Sensors may further require signal conditioners, cockpit readouts and/or interface hardware with engine monitoring systems.

The main advantages of on-aircraft debris monitoring methods are fast response and minimal logistics requirements. This category includes the following well-established devices in use on current production engines:

- . magnetic chip collector
- . electric chip detector
- . pulsed electric chip detector
- . screen-type full-flow debris monitor

In addition, a variety of devices have been or are currently being developed without, so far, having been included on production engines. Most of these devices have the additional advantage that they can be interfaced with an on-aircraft engine monitoring system:

- . centrifugal debris separator
- . quantitative debris monitor
- . electro-optical debris monitor
- . inductive debris monitor
- . indicating screen
- . X-ray fluorescence monitor
- . on-line ferrograph
- . degaussing chip detector
- . capacitance debris monitor

Due to complexity, cost and weight, some of these devices are currently only suited for test stand use during engine development. However, they are included in this AIR since they may eventually be refined for on-aircraft use.

Off-aircraft debris monitoring techniques involve the regular removal of oil samples or collected debris from the engine and their subsequent analysis in a laboratory or by means of some other ground service equipment. The advantage of these techniques is generally that the more sophisticated instruments used provide more information. These techniques include:

- . spectrometric oil analysis procedure (SOAP)
- . quantification and analysis of debris
 - from magnetic chip collectors
- . filter analysis
- . ferrography
- . scanning electron microscope
- . colorimetric oil analysis
- . radioactive tagging
- . X-ray spectrophotometer
- . scanning electron microscope (SEM)

The most widely used debris monitoring methods and the respective particle size ranges in which they are most effective are:

Magnetic chip collectors	50 to >1000 microns
Electric chip detectors	50 to >1000 microns
Ferrography	1 to 100 microns
SOAP	<10 microns

For failure modes which produce debris in more than one of these size ranges, the user can therefore obtain corroborating information from two or three different techniques. This is useful since it aids in the removal decision.

There are, however, failure modes which produce only large or only small particles or in which small particles are generated much later than large particles and vice-versa. An example is surface fatigue (spalling) which generates few, large particles and becomes detectable by SOAP only, if at all, at an advanced stage when some of the large debris has been ground up into smaller particles. It is therefore important to understand that the user, in collaboration with the engine manufacturer, must decide how to compliment the on-aircraft debris monitoring devices usually found on the engine as standard equipment with other techniques to suit his special requirements.

6.1 On-Aircraft Debris Monitoring

6.1.1 Established Techniques

6.1.1.1 Magnetic Chip Collector: Also referred to as magnetic plugs or magnetic chip detectors, these devices have been used in gas turbine engines since the late 1950's. They are usually installed in main or individual scavenge lines and accessory or reduction gear boxes. If located below the oil reservoir level, they should have self-closing valves which permit the inspection of the magnetic probe without the need to drain the oil (figure 5). Most of today's units have high-reliability quick-disconnect locks which eliminate the need for tools or lock wiring. Rare-earth magnets are used increasingly to enhance magnetic strength and chip capture efficiency.

The period between inspections of the magnetic chip collector(s) of an engine should be in relation to its known failure modes. Intervals vary widely, but are generally 25 to 50 hours where chip collectors are used as primary failure detection devices. If a problem exists, more frequent inspections (even daily or after each flight) may be justified for a short period of time. Inspection intervals can be extended as experience is gained and the engine matures.

Optimum location for at least the most critical units would be underneath a separate access door or near the oil filter or pressure fill fitting so that they can be inspected without opening of engine cowlings. Partly due to poor accessibility on some engines, a number of airlines check magnetic chip collectors only during B-checks (typically 125 hours) or after high-iron SOAP readings when an incipient failure is suspected.

The engine maintenance manual should include good illustrations of typical debris (see figure 6 for an example), together with guidelines relating debris particle size and quantity to likely failure mode and severity. This enhances the effectiveness of magnetic chip collectors considerably, since maintenance personnel can compare appearance and quantity of collected debris with a standard. However, removal decisions are more accurate if maintenance personnel is experienced in debris interpretation (especially concerning the engine model in question and its predominant failure modes) or can get support from a laboratory facility.

The proper location of magnetic chip detectors within the lubrication system is essential to high chip capture efficiency. Magnetic chip collectors should therefore be located in well-designed "pockets" or inside full-flow debris separators. This is discussed more fully in section 9. Since magnetic chip collectors are relatively inexpensive, they can be installed cost effectively in different parts of the engine, such as individual scavenge lines and accessory or reduction gear boxes. This makes failure isolation possible and can help reduce overhaul costs.

Sophisticated and very effective oil debris monitoring methods have been developed around magnetic chip collectors.^{1), 7)} They involve recording, retention and quantification of collected debris for trending and analytical techniques for diagnosis and fault isolation. These techniques are more fully described in section 6.2.2.

Magnetic chip collectors are most effective for the detection of failure modes involving the production of large magnetic particles (100 microns and larger) such as surface fatigue spalling of bearings, gears and pump elements. If well integrated into the lubrication system so that debris capture efficiency is high, they can also be used to detect failure modes which produce smaller debris (bearing skidding, gear and pump scoring, spline wear and rotating bearing races). Failures of bronze bearing cages have been detected when sufficiently far advanced to induce skidding of bearing elements and generation of magnetic debris.

6.1.1.2 **Electric Chip Detector:** Electric chip detectors are essentially magnetic chip collectors with electric continuity indication capability. They are used in many U.S. engines and are required for military turbojet and turbofan engines by MIL-E-50070 and for turboshaft and turboprop engines by MIL-E-8593A. In Europe magnetic chip collectors (see section 6.1.1.1) are more widely used than electric chip detectors.

Two types of electric chip detectors are in use: chip detectors with connectors for remote indication and chip detectors with touch-to-test terminals for ground check-out with an ohmmeter or continuity tester.

Remotely indicating chip detectors are usually wired to cockpit indicators. Their main advantages are immediate response and absence of scheduled inspections. To simplify visual inspection after a chip light occurrence, self-closing oil shut-off valves are usually incorporated. This type of chip detector is used in most U.S.-designed helicopter engines, some single-engine aircraft with gas turbine engines and some military long-range patrol aircraft.

Chip detectors for ground check-out are used in many U.S. military propulsion engines. Continuity checks must be carried out at frequent intervals (10 flight hours or less). After deposition of debris, the contact resistance increases steadily due to the action of hot oil. This has been confirmed by washing a chip detector loaded with debris and reinstalling it into an engine. In order to obviate the need for frequent checks, the chip detector can be wired to an indicator with a lock-on feature. This can be located on a maintenance panel.

The chip sensitive area of an electric chip detector consists of two electrodes and a magnet to attract magnetic debris (figure 7). The electrodes are bridged if enough debris has accumulated, either in the form of a few large particles or many smaller ones. The spacing between these electrodes is generally .045 to .150 inches wide. It depends on engine size (considerations are rotating component rpm and size of wear surfaces), quality of oil filtration (good filtration permits smaller gap spacing) and criticality of failure mode. Optimum gap spacing may be .060 to .075 inches (1500 to 1900 microns). This size gap will indicate when only a few spalling flakes are captured. This is especially important if debris transport within the lube system is not very effective or where a bearing failure progresses rapidly to secondary engine damage.

Where provisions are made to ensure good debris transport and effective debris deposition on the chip gap, electric

chip detectors are effective indicators of incipient failure. They are especially effective for surface fatigue-type failures which generate particles larger than 100 micron in size.

As in the case of magnetic chip collectors, engine maintenance manuals should contain good instructions for debris interpretation (see figure 8 for an example). This aids in the removal decision.

A serious draw back of electric chip detectors is that they have no trending capability and, if wired to a cockpit indicator, can cause false alarms. They are therefore not well suited to being interfaced with engine monitoring systems (EMS).

False alarms are mainly caused by background debris and by electrical problems. They can be reduced by improved oil filtration and cleanliness during engine build-up to reduce background contamination and use of state-of-the-art connectors to eliminate electrical problems.

- 6.1.1.3 Pulsed Electric Chip Detector: In lubrication systems with conventional filtration levels (coarser than 15 microns), false chip indications of electric chip detectors are predominantly caused by build up of fine, non-significant wear debris on the chip detector. These can be suppressed by delivering a current pulse from a capacitor to the chip detector, melting the fine debris.

This does not affect significant, failure-related debris which has a larger cross section. The current pulse can be initiated automatically when the gap is bridged or manually by the pilot after the chip light illumination. Figure 9 shows a pilot-initiated system for helicopter cockpit installation. Due to their simplicity and success in dealing with false indications of this type, these systems have found acceptance in helicopter engines, although their main area of application to date is in helicopter transmissions. Since production of fine debris at an increased rate can signify bearing failure, a pilot-initiated system provides earlier warning and permits limited trending. For automatically initiated systems, such trending is also possible if the current pulses are recorded by mechanical counters or an EMS.

- 6.1.1.4 Screen-Type Full-Flow Debris Monitor: In engines of older design, the chip detectors are installed in scavenge lines or accessory gear boxes with no provision to capture the debris other than by magnetic attraction and sedimentation. In such installations, most of the debris bypasses the chip detector and finds its way into the oil filter. This can cause delayed or unreliable failure detection.

A full-flow debris monitor is designed to scan the entire scavenge flow. This enhances failure detection efficiency substantially.³⁾ Figure 9 shows a screen-type full-flow debris monitor for a modern turboshaft engine. The screen can be removed for cleaning. Located inside is an electric chip detector. The screen openings are on the order of 500 microns, giving the device a capture efficiency of 100% for particles above that size. Such units are also in use with self-closing valves and with separate housings for installation in external oil lines. They can function as scavenge pump inlet screens.

6.1.2 Experimental Techniques

- 6.1.2.1 Centrifugal Debris Separator: A full-flow debris monitor without screen is shown in figure 11. Its tangential inlet nozzle creates an internal vortex which separates the entrained debris effectively down to about 100 microns with acceptable pressure drops.⁴⁾

The unit is intended for installation on the pressure side of the scavenge pump. The debris sensor can consist of a magnetic chip collector, electric chip detector or other debris-sensitive device. The unit operates best in well-filtered oil systems. An additional advantage is its ability to de-aerate the oil by means of a separate air exit nozzle. This feature is optional, however.

- 6.1.2.2 Quantitative Debris Monitor: Two of the most characteristic parameters for detection of an incipient failure are the rate of debris production and particle size range. Trending these parameters permits detection with high reliability and can help in determining how long the engine can be used safely.

Figure 12 shows a quantitative debris monitoring system consisting of a sensor and signal conditioner. This system provides real-time signals in response to the arrival of discrete magnetic particles whose mass are in excess of the detection threshold of the device.

The sensor can be installed in a screen-type full-flow housing (see section 6.1.1.4) or centrifugal debris separator (see section 6.1.2.1) to enhance capture efficiency. It collects the debris particles for visual inspection like a magnetic chip collector and also has a self-closing valve. The signal conditioner can record discrete particle arrivals on a mechanical counter and differentiate them into two size ranges. It also has TTL- or CMOS-compatible output options for the two size ranges for interfacing with engine monitoring systems (EMS) or event recorders. A BITE feature is included.

A substantial advantage of the quantitative debris monitor is that its output signal can be trended. This provides prognostic information about oil wetted component condition.

This system has undergone successful engine test cell and bearing test rig evaluation. It is especially effective for surface-fatigue type failure modes.

- 6.1.2.3 Electro-Optical Debris Monitor: Under evaluation for a period of years, the unit shown in figure 13 optically scans the oil flow for entrained debris and oil condition. Metallic particles entrained in the lubricant scatter the light from an infrared light source. The scattered light is detected by a phototransistor and related to particle concentration. Attenuation is also determined and related to oil condition. The system is most sensitive for particles below ten microns. It is therefore effective for failure modes involving the production of large quantities of fine particles. Since the device is sensitive to entrained air, it should be located on the pressure side of the oil system, after the oil has been deaerated in the reservoir. The unit also requires a signal conditioner which is not shown in figure 13.
- 6.1.2.4 Inductive Debris Monitor: This device consists essentially of two coils which enclose two sections of the oil scavenge line. One coil is for reference. A large particle entrained in the oil induces a voltage pulse in the unit which is amplified and counted. The system has been undergoing evaluation for a number of years and at least one engine company has reported good results on a bearing test stand.
- 6.1.2.5 Indicating Screen: Based on a patented weave of conducting wire and insulating spacer rods, a screen made from this material becomes a directly indicating full-flow debris monitor. It is unaffected by fine wear debris. The minimum particle size threshold is determined by the smallest screen openings which can be achieved in production. Figure 14 illustrates a unit designed for installation in an external scavenge line.
- 6.1.2.6 X-Ray Fluorescence Monitor: Under development since the mid 1960's, the system employs radioisotope excited X-ray fluorescence (XRF). A small radioactive source is used to excite metal atoms suspended in the oil as wear debris to emit characteristic X-rays. The X-rays pass through an X-ray transparent window out of the flow chamber and are detected by a gas-filled proportional counter and signal conditioner and are used to provide an in-line measure of wear metal quantity. The sensitivity of the unit is currently at the ± 3 ppm level but is expected to be improved.

The use of an X-ray monitoring system using a radioisotope excitation source on board aircraft is limited due to current shielding technology. It may require compliance with safety regulations relative to the storage, use and disposal of the radioactive material.

- 6.1.2.7 On-Line Ferrograph: The principle of ferrography, described in section 6.2, has been used to develop a real-time device suitable for installation in engine lubrication systems. The unit samples the oil stream and measures the concentration of two size ranges of magnetic particles by depositing them on a surface effect capacitive sensor in a high-gradient magnetic field. Installation guidelines must be followed to ensure delivery of a hot, representative oil sample to the sensor. A signal conditioner is also required. As currently configured, the unit is designed for stationary applications and engine test stand operation only.
- 6.1.2.8 Degaussing Chip Detector: An electric chip detector with the capability to demagnetize itself after particle capture would give multiple indications in response to continuing debris production. Two devices of this type have been proposed. The first is a chip detector with electromagnet, rather than a permanent magnet. When a particle bridges the chip gap, an external signal conditioner shuts off the DC current to the electromagnet and turns on a decaying AC current to demagnetize the pole shoes. After the particle drops off, the DC current is turned on again. The second unit has a permanent rare-earth magnet but an additional electromagnet is used to impose an opposite magnetic field on it for a short period of time, thus making it effectively non-magnetic. The high remanence of the rare earth magnet restores the permanent field after the electromagnet has been turned off.
- 6.1.2.9 Capacitive Debris Monitor: During the U.S. Army AIDAPS (Automatic Inspection, Diagnostic and Prognostic System) program, a unit was evaluated which sensed capacitatively the amount of debris deposited between two electrodes by means of a vortex.⁵⁾ Although the unit was found to have mechanical problems which precluded its evaluation, the principle may be promising.

6.2 Off-Aircraft Debris Monitoring

- 6.2.1 Spectrometric Oil Analysis Program (SOAP): Spectrometric Oil Analysis is the most widely used off-aircraft oil monitoring method. The procedure requires that a small oil sample be taken from the engine and transmitted to a specially equipped laboratory for analysis where the suspended metal particle content is determined spectrographically in parts per million. The results are then interpreted and put into a form that may be used for determining required maintenance action.

The technique relies on the fact that oil wetted components, under certain conditions of accelerated wear, produce larger-than-normal quantities of fine wear particles which are carried away by the oil. This leads to an increase in wear particle concentration in the oil.

The spectrographic analysis involves determination of the light spectrum generated by the oil sample as it is burned. Trace element content is determined by the frequency and intensity of the resultant spectral lines. Two approaches are commonly employed: atomic emission and atomic absorption spectroscopy.

Atomic emission spectroscopy uses a high voltage arc to burn a small portion of the oil sample and measures the resultant light intensity in specific narrow frequency ranges utilizing a diffraction grating and photo multiplier tubes. These are located at points where specific spectral lines of interest are projected. The results can be printed out directly by a computer connected to the instrument. Samples can be processed quickly, and this method is therefore the most common.

Atomic absorption spectroscopy measures the absorption of specific light frequencies associated with trace elements of interest. High-intensity light is passed through a flame (usually fueled by an air-acetylene or oxygen-acetylene mixture) into which the suitably diluted oil sample is aspirated. The light source is monochromatic and associated with the element of interest. Free atoms of that element in the flame absorb the incident light to a degree proportional to the amount of trace element present, with the remaining light being transmitted through the flame and measured electronically. The test is then repeated, utilizing different light sources for each element. Atomic absorption spectroscopy is more sensitive than atomic emission spectroscopy but is more time consuming.

The upper limit of particle size which can be detected is in the 5 to 8 micron range for the emission spectrograph and somewhat less for the absorption spectrograph. SOA is therefore suited to those types of accelerated wear modes which produce large quantities of fine particles, such as fretting, bearing skidding, cage rubbing, gear scuffing and bearing race rotation. It is not very effective for fatigue-type failure modes (spalling, pitting and cracking) where small particulate generation is not significant.

A critical requirement for the successful application of Spectrometric Oil Analysis to engine oil monitoring is careful and consistent oil sampling methodology. Representative oil samples, taken with clean sampling equipment, must be taken sufficiently often to allow meaningful data trending.

Sampling intervals vary from as short as one sample per flight on some military applications, to more than 50 flight hours on some commercial aircraft programs. In general, the interval is established by economic, operational and previous failure history considerations for the engine being monitored. For example, a joint European airline consortium has established and proven the effectiveness of an 80-flight-hour sampling interval.

Oil samples taken must be representative of the circulated oil in order for the analysis to be valid. The most common method used by airlines involves samples taken through a filler port with a sampling tube extended to the center of the oil tank (figure 15). The U.S. military services, through their Joint Oil Analysis Program (JOAP), have developed two standard sampling kits for all military equipment in the program. They consist of a 17 ml glass bottle and polyethylene tubes in two different lengths. Sampling is performed from the oil reservoir or through chip detector valves (figure 16).

It is recommended that samples be taken no more than 15 to 30 minutes after engine shutdown to minimize settling of wear particles of interest. Samples should not be taken through the tank drain fitting, since unrepresentative sediment concentration may exist at this point. Oil samples should be taken in roughly similar locations and at established times after shutdown to assure maximum consistency. Sample tube and container cleanliness is also very important. Contamination in the sampling equipment can produce erroneous analyses and lead to unnecessary maintenance actions.

Modern spectrographic instruments provide the capability of analysing at least 20 different elements. However, the majority of SOA programs limit analysis to 6-9 of the most common elements found in lube systems. The detection limit depends on the nature of the instrument and on the vaporization temperature of the element of interest. For example, the detection limit for iron in an emission spectrograph is approximately 3 ppm, and in an absorption spectrograph 0.1 ppm.

Some of the more common elements detectable with routine sampling and their significance are:

- . Iron - possible wear in gears, splines, bearing races and/or rolling elements
- . Molybdenum - possible wear in bearing elements made from high-temperature, high-strength steel such as M50
- . Aluminum - possible wear of some gear cases, shims and spacers
- . Copper - possible wear in alloyed components of bronze, for example, bearing cages
- . Silver - possible wear in plated parts such as bearing cages
- . Titanium - possible wear in bearing hubs

The instruments are calibrated for each element with commercially available standards.

Depending on the result of the analysis in parts per million, further action is triggered either by exceedances in wear metal concentration or in rate of concentration. Thresholds are set on the basis of large sample populations from engines considered to be operating normally, recommendations from the engine manufacturer, metallurgical information concerning engine components, from other engine models of similar design and from correlation with inspection results after removals. Rate of concentration is a more significant parameter than concentration itself since it relates directly to rate of wear-metal production.⁶⁾ In engines with significant oil consumption, oil replenishment must be taken into consideration to obtain meaningful results. However, in large, dispersed fleets this may be difficult to accomplish.

Despite the complete quantification of the data, their interpretation is somewhat subjective and requires experience and communication between laboratory and maintenance personnel. Concentration or rate-of-concentration exceedances usually lead to resampling to confirm or disprove abnormal readings. If readings are confirmed, additional maintenance actions such as inspection of chip detectors, screens and filters, are usually recommended. Previous maintenance actions or special conditions affecting the engine need to be considered. The sample also can be filtered and the residue examined microscopically to determine if larger debris is present to confirm an incipient failure.

Typical wear metal patterns can be used for failure isolation if certain engine components have characteristic compositions. Reference 6 describes a method to identify debris sources in terms of characteristic wear metal concentration rates. This system is used by the French Air Force.

Spectrometric oil analysis programs have been applied widely to both military and commercial gas turbine engines. The disadvantages of the technique are high initial equipment cost, the logistics of application (especially the time delay between sampling and maintenance action), the high requirement for sample cleanliness and integrity and the limited effectiveness for fatigue-type failures. An additional disadvantage is its current inability to work in oil systems that have very fine filtration (see section 9.3).

Important advantages are the ability to quantify and trend data easily and to detect the presence of various types of wear metals, including non-ferrous, and of foreign contaminants in the lubrication system.

6.2.2 Quantification and Analysis of Debris from Magnetic Chip Collectors: Some non-U.S. airlines and military services have developed sophisticated and effective failure detection, prognostication and isolation systems based on magnetic chip collectors.^{1), 7)} The magnetic probes (such as the one shown in figure 6) are removed from the engine at regular intervals, typically every 25 or 50 hours, and replaced with clean spares.

An initial assessment of the severity of contamination, if any, is made on the flight line. The probes are then sent to a laboratory for cleaning, visual inspection under a 20X microscope and classification, recording and archiving of the collected debris. The amount of debris can be measured with an inductive instrument called debris tester. The reading can be trended and compared to preset rate thresholds. This provides a more objective basis than mere visual observation. The predominant failure modes of a given engine model are usually recognizable to experienced personnel by shape, size and quantity of the debris. As an incipient failure develops, the inspection interval is reduced until the engine is removed with the certainty that a problem exists. If a scanning electron microscope with energy dispersive capability is available, debris material can be identified. This aids in diagnosis and fault isolation.

This system is particularly effective for engines with lubrication systems specifically designed for optimum oil debris monitoring. This depends on number, location and capture efficiency of the magnetic chip collectors (see section 9). Ideally, each bearing return line and gear box should be equipped with a magnetic chip collector for fault isolation.

Although U.S. airlines do not sample and replace chip collectors routinely, many of them perform regular routine checks and use them for failure verification when other indications of incipient failure exist.

6.2.3 Filter Analysis: A quick visual assessment of the debris content of the oil filter is often performed in an attempt to verify SOAP or chip detector indications. This is especially applicable to engines in which chip detector installations have low capture efficiencies. However, so-called "educated filter checks" have been used by some airlines for many years.¹⁾ This involves the careful backwashing or disassembly of the filter element and subsequent microscopic analysis of the debris collected on a piece of filter paper. Prognostic information can be obtained by analyzing size, size distribution, quantity, color and shape of the debris. Previous experience is used to judge the severity of a progressing failure.

6.2.4 **Ferrography:** Under development during the last several years, ferrography is both a laboratory technique for the microscopic classification of wear debris suspended in oil samples and a method to quantify the data in a simple way for working use. As is the case with magnetic chip collectors, the visual analysis of the debris requires skill and training; as with SOAP, sample cleanliness and sampling method are critical.

The technique depends on magnetic precipitation of ferrous particles. It is most sensitive to particles which lie between 1 and 100 microns. This range overlaps that of SOAP at the small end and of magnetic chip collectors at the large end and the technique therefore has high potential.

There are two types of ferrograph, the Direct Reader (DR) and the analytical ferrograph.

In the DR ferrograph the oil sample, diluted with a solvent, is passed through a sloping glass tube which is positioned above the poles of a magnet. The downward velocity of a ferrous particle in the magnetic field is approximately proportional to the square of its size. Hence, there is a maximum distance that can be travelled by a particle of a given size. Particles become deposited on the wall of the tube graded according to size. The amount of debris is measured optically at two positions, namely at a "large" position (D_L) and a "small" position (D_S). These two readings are related to wear particle concentrations and may be combined to give a severity of wear index. There are several different forms of this index, such as:

$$\begin{aligned} &D_L \\ &D_L (D_L - D_S) \\ &D_L^2 - D_S^2 \\ &\frac{(D_L - D_S)}{(D_L + D_S)} \end{aligned}$$

The user may determine which form is most suitable to his needs.

In the analytical ferrograph, an oil sample is caused to flow over a glass or plastic substrate in the presence of a strong magnetic field gradient which pulls the particles to the substrate. The oil is then washed away with a solvent, leaving the particles clean, aligned, and fixed to the substrate surface. The resulting particle display (ferrogram) is a permanent record. When non-ferrous metal particles are present in the oil they are usually magnetic enough to separate, especially when they were generated in

a ferrous/non-ferrous interface. Contamination particles, both organic and inorganic, can also be separated. For example, this technique is widely used for contamination studies in hydraulic systems. The ferrous metals can be differentiated into broad alloy classes by their temper color. The shape and morphology of the particles reveal the mode of wear, such as wear, scuffing, corrosion or lack of lubrication. A special microscope/camera system called a Ferroscope is available which has a number of features to permit rapid analysis of the ferrograms.

Both DR and analytical ferrograph have been used to monitor the health of several different types of machinery. It appears that the most satisfactory method is to use the DR ferrograph to monitor the severity of wear index and when this or its rate of increase becomes large, the analytical ferrograph can be used to determine the type of wear.

As is the case with SOAP, special consideration must be given to sample integrity. Since the wear particles addressed by Ferrography are larger than those for SOAP, settling is an even more important consideration in obtaining representative wear particle distributions. The method also is not as effective for fatigue-type failures as it is for abrasive-type accelerated wear modes and is interfered with by fine filtration.

6.2.5 Colorimetric Oil Analysis: Colorimetric Oil Analysis was developed and used for monitoring iron and copper in turbine lubricants by the Australian Defense Standards Laboratory during the late 1960's. This technique involves the analysis of the wear metal by acid extraction from the lubricant, buffering of the extraction solution and subsequent chelation with an appropriate indicator to produce a colored metal complex. The concentration of each wear metal is determined by measuring the intensity of the color formed and comparison with standard calibration data.

Using this approach, the U.S. Air Force has developed a Colorimetric Oil Analysis Kit for measuring the iron concentration in lubricating oils. It is designed for use at remote locations where spectrometric oil analysis is not available. This kit weights 25 pounds and requires an analysis time of approximately 10 minutes. The colorimeter reads directly in parts per million iron. The wear metal guidelines and threshold values required for the evaluation of the data are the same as those established for the atomic absorption spectrometer.

Development of a Colorimetric Oil Analysis Kit for titanium has recently been completed using the same principle as that for the iron kit. These two kits are being developed into one Colorimetric Oil Analysis Kit.

6.2.6 Radioactive Tagging: Since the early 1960's, various radioactive techniques have been investigated and applied to test systems for measuring bearing wear and the monitoring of wear debris in the lubrication system. These techniques have good sensitivities and repeatable wear measurements but utilized radiation levels which are unacceptable for turbine engine monitoring. The practical constraints of radioactive tagging of turbine engine mainshaft bearings includes consideration of safety, handling and maintenance procedures.

A safe low level radiation technique for the detection of wear occurring with mainshaft bearings has been developed and demonstrated, using high speed cylindrical roller bearings in a test rig. Iron-55 is employed as the active tag and is obtained through the neutron irradiation of the bearing rollers. Iron-55 provides low radiation levels, long half-life and homogeneity of the isotope in the rollers. The low level of radiation in the tagged wear particles requires the separation of the wear debris from the oil by filtration or some other means. Testing shows that the tagging method would provide a means of identifying tagged roller wear at the ± 0.5 part per million level in a 5 gallon capacity test system. Radioactive tagging techniques would be most suited for identifying abnormal wear occurring with a critical or problem related mainshaft bearing.

6.2.7 X-Ray Spectrophotometer: This instrument, which may be available in materials laboratories of major airlines, military services and engine manufacturers and in commercial metallurgical laboratories, permits determination of material composition of debris particles. In an evacuated chamber, debris particles are irradiated by an X-ray tube. Their atoms emit secondary X-rays with characteristic energies. The intensity of this emission is proportional to the amount of the element present in the sample. In this way, alloys can be identified precisely. However, if the sample contains particles of different materials, the resulting spectrum is a mixture of the spectra of the individual particles and must be interpreted.

6.2.8 Scanning Electron Microscope (SEM): This instrument is also only available in well-equipped materials laboratories. It permits viewing of individual debris particles at great magnification. This can provide information about the process of their generation and, therefore, about the failure or wear mode which produced them. Energy-dispersive X-ray analysis (EDAX) provides spectra of secondary X-rays emitted by the SEM sample which are characteristic for a given element. Individual alloys can therefore be identified precisely. The advantage of the EDAX over the X-ray spectrophotometer is that it can determine the composition of individual debris particles.

7. OIL CONDITION MONITORING:

- 7.1 Physical/Chemical Properties: Physical/chemical property analysis of used oil can provide information about the condition of the oil as well as certain engine malfunctions.

The rate and degree of oil degradation in a turbine engine is dependent on aeration, temperature, oil consumption, oil system capacity and oil formulation. For normally operating engines, the rate and degree of oil degradation are low and are compensated by oil consumption and replenishment. Changes in engine operating condition resulting in higher aeration (increased oxygen availability) or higher oil temperature such as seal wear can cause a significant increase in the rate of oil degradation. Tests for oxidation, additive depletion, solids content, fuel dilution, viscosity and total acid number can be performed in the laboratory to determine lubricant serviceability. However, they are rarely performed routinely in the field because they are equipment and labor intensive.

- 7.2 Complete Oil Breakdown Analyzer (COBRA): The COBRA instrument is under development by the U.S. Air Force to routinely determine oil quality. Increased degradation produces changes in the electrochemical properties of the oil which is measured by the instrument.

The COBRA instrument measures 10 x 5 x 5 inches, weighs 8 pounds and is battery powered. After the instrument is calibrated, obtaining a COBRA measurement, including data recording, takes approximately one minute and requires only two drops of the lubricant. The small test volume permits use of residual SOAP samples thus eliminating the cost and time required for separate oil sampling. The COBRA instrument is intended to extend oil change intervals, i.e. to change oil "on condition" rather than at fixed intervals.

- 7.3 Total Acid Number Kit (TAN Kit): The TAN kit was developed for the U.S. Navy as a field go/no-go determination of the acidity of MIL-L-23699 lubricating oil. The Naval Air Propulsion Center (NAPC) established a TAN of 2.0 mg koh/gram as the maximum at which MIL-L-23699 oil should be used.

The TAN kit, composed of a bottle of acetone solution neutralized to pH 7.0 and a vial of aqueous sodium hydroxide reacts with a 5.0 ml volume of sample oil to produce a color change that indicates either a "go" (<2.0 TAN) or "no-go" (\geq 2.0 TAN) condition.

8. GENERAL REQUIREMENTS: The design and use of oil system monitoring should consider the following factors:

- . life cycle cost (including inspection and support requirements)
- . type and criticality of oil wetted component wear and failure modes

- . detection and fault isolation capability
- . engine modularity
- . debris transport within the oil system
- . degree of oil filtration
- . qualitative and quantitative criteria for engine or module removal
- . human factors
- . maintenance crew training
- . coordination and participation of equipment suppliers, engine and aircraft manufacturers and users
- . documentation (i.e. manuals)

For on-aircraft oil debris monitoring methods, the following additional considerations apply:

- . sensor integration into the oil system environment
- . weight and reliability of on-aircraft equipment, including wiring, connectors, and signal conditioners
- . accessibility
- . inspection and/or cleaning requirements
- . location of fault annunciators (cockpit or maintenance panel)
- . interfaces
- . BITE

Additional considerations unique to off-aircraft oil debris monitoring methods are:

- . sampling provisions and equipment
- . sampling frequency
- . response time
- . cost of laboratory and support equipment and personnel
- . logistics
- . oil consumption and replenishment
- . calibration requirements

The guidelines of ARP 1587 (Aircraft Gas Turbine Engine Monitoring System Guide) also should be reviewed and applied to ensure that oil system monitoring is effectively integrated into the overall engine monitoring system.

9. OIL SYSTEM CONSIDERATIONS FOR ON-AIRCRAFT DEBRIS MONITORING:
All on-aircraft debris monitors, whether in production or experimental, rely on the debris transport characteristics of the oil system. Most respond to debris in a size range considerably larger than the separation capability of the oil filter and are therefore installed upstream of the filter. Some of the experimental sensors listed in section 6.1.2 contain electronics and are not suitable for installation on the hot scavenge side where

oil temperatures can exceed 200°C (400°F). The proper understanding of the capabilities and limitations of the debris sensor is essential to its effective operation.

- 9.1 Sensor Integration Into The Oil System: The probability of detecting an incipient failure increases with the amount of debris available to the sensor. Figure 17 shows a section of a typical engine oil system schematic with a debris generating site, pump screen, scavenge pump and debris sensor to illustrate this relationship. The debris available for detection at the sensor site depends on the transport efficiency of the oil system.

As figure 17 illustrates, the debris transport efficiency η_T determines what fraction of the debris generated by the source arrives at the sensor location. It depends on oil system layout, fluid velocity and particle size. For example, the scavenge system shown in figure 17 traps all particles larger than the openings of the pump screen. Its η_T for this size range is therefore equal to zero. Additionally, in an actual lubrication system, particles can stick to cavity walls or can be trapped in corners.

The debris capture efficiency η_C applies to sensors which capture the debris for failure detection (e.g. magnetic chip collectors, electric chip detectors). It is a function of sensor characteristics, particle size, fluid velocity and the design of the cavity in which the sensor is located.

The debris indication efficiency η_I represents the sensitivity of the sensor and system to a particle of given size and material.

The overall debris detection probability is given by

$$\eta_D = \eta_T \eta_C \eta_I$$

and corresponds to the fraction of particles indicated versus those which are generated at the site.

Effective diagnostic capability requires optimizing these quantities during oil system design and development and, if possible, measuring them through oil system rig testing. If the debris transport and/or capture efficiencies are low, as is the case in many older engines, the sensitivity η_I of the sensor must be high to compensate for it. This, in turn, makes the system more susceptible to false alarms. Even then, incipient failures which release only a few large particles (e.g. gear tooth fracture) may not be detected.

Debris capture efficiency is enhanced by passing the entire oil flow through the debris monitor (full flow debris monitoring) and by including positive means to separate the debris from the oil. As examples, figure 18 shows a variety of scavenge line installations of chip collectors and electric chip detectors with their respective capture efficiencies at comparable flow rates.

9.2 Oil System Layout For Optimum Prognostic And Cost Effectiveness:

The requirement to detect more failure modes with greater reliability increases sensor and system cost. At the same time, the requirement for fault isolation to an engine module or bearing set requires multiple sensor locations. For cost effectiveness, the functions of failure detection (requiring one sophisticated sensor and in-flight signal processing capability) and isolation (requiring several sensors for ground checkout only) can be separated. This "Master/Slave" system is incorporated in figure 1. A high-performance full-flow debris monitor ("Master") is installed in the main scavenge line. For the purpose of failure isolation, additional probes ("Slaves") are located in each of the bearing return lines and in the accessory gear box. These can consist of simple magnetic chip collectors whose capture efficiency is kept low so as not to interfere with the operation of the master detector.

For off-aircraft debris monitoring, the oil system must have provisions for oil sampling. Although samples are generally taken from the reservoir, some military engines have oil sampling valves (figure 19) which permit removal of samples from a line rather than from the oil reservoir. This enhances sample repeatability but increases sampling cost due to reduced hardware standardization.

9.3 Oil Debris Monitoring And Filtration: The benefits of improved filtration for longer bearing life are well-established^{8), 9)} and widely accepted. For this reason, there is an increasing trend to use finer filters on aircraft gas turbine engines. At least one modern turboshaft engine, the T-700, incorporates an ultrafine filter with a rating of 3 micron absolute. Field experience with this engine has demonstrated that SOAP becomes ineffective at these filtration levels. The engine incorporates a screen-type full-flow debris monitor which is very effective.

The trend towards finer filtration is expected to increase the number of engines in the field for which traditional off-aircraft debris monitoring, such as SOAP, is ineffective. This should stimulate the development of more sensitive off-aircraft monitoring methods. Among on-aircraft monitoring systems, it should favor those which have "single-pass" capability, i.e. which do not require debris enrichment of the oil through recirculation. Since fine filtration removes most of the recirculating background debris, magnetic chip collectors, electric chip detectors and quantitative debris sensors benefit from this trend.

REFERENCES:

1. R. C. Hunter: Engine Failure Prediction Techniques, Aircraft Engineering, March 1975.
2. P. Cooper: Wear Debris Monitoring of Rolling Bearings, RHP Bearing Research Centre, Newark Notts NG24 2JF, U.K., March 1982.
3. T. Tauber: Full-Flow Oil Debris Monitoring In Gas Turbine Engines, ASME Paper No. 81-GT-60, March 1981.
4. T. Tauber, S. D'Ambrosia, F. Rudbarg: A Lube System Diagnostic Monitor With Deaeration Capability, ASME Paper No. 82-GT-79, April 1982.
5. Automatic Inspection, Diagnostic and Prognostic System (AIDAPS), Test Cell Data Collection and Technical Support - Final Report. Bell Helicopter Company Report No. 699-099-038, August 1977.
6. D. Lotan: Spectrometric Oil Analysis - Use and Interpretation of Data, SAE Publication 720303, 1972.
7. Oil System Debris Assessment. Rolls Royce Publication TSD 7001, Derby, U.K.
8. S. H. Loewenthal, D. W. Moyer: Filtration Effects on Ball Bearing Life and Condition in a Contaminated Lubricant, ASME Paper No. 78-Lub-34, June 1978.
9. S. H. Loewenthal, D. W. Moyer, W. M. Needelman: Effects of Ultra-Clean and Centrifugal Filtration on Rolling-Element Bearing Life, ASME Paper No. 81-Lub-35, March 1981.

BIBLIOGRAPHY:

ARP 1587, Aircraft Gas Turbine Engine Monitoring System Guide, SAE, April 1981.

National Bureau of Standards Publication NBSIR 73-252 (Proceedings of the 18th Meeting of the Mechanical Failures Prevention Group, Gaithersburg, Maryland, 1972).

National Bureau of Standards Special Publication 436 (Proceedings of the 22nd Meeting of the Mechanical Failures Prevention Group, Anaheim, California, 1975).

National Bureau of Standards Special Publication 494 (Proceedings of the 26th Meeting of the Mechanical Failures Prevention Group, Chicago, Illinois, 1977).

National Bureau of Standards Special Publication 547 (Proceedings of the 28th Meeting of the Mechanical Failures Prevention Group, San Antonio, Texas, 1978).

National Bureau of Standards Special Publication 622 (Proceedings of the 32nd Meeting of the Mechanical Failures Prevention Group, Santa Monica, California, 1980).

Sawyer's Turbomachinery Maintenance Handbook, Volume III: Support Services & Equipment, Turbomachinery International Publications, Norwalk, Connecticut, 1980.

Tribology 1978-Materials Performance and Conservation. Proceedings - University College of Swansea Conference, 3-4 April 1978. Institution of Mechanical Engineers, London, 1978.

R. A. Collacott: Mechanical Fault-Diagnosis and Condition Monitoring. Chapman & Hall, London; John Wiley & Sons, New York.

Ferrogaphy. Proceedings - Symposium Organized by the Condition Monitoring R&D Group of The British Institute of Non-Destructive Testing, October 1979.

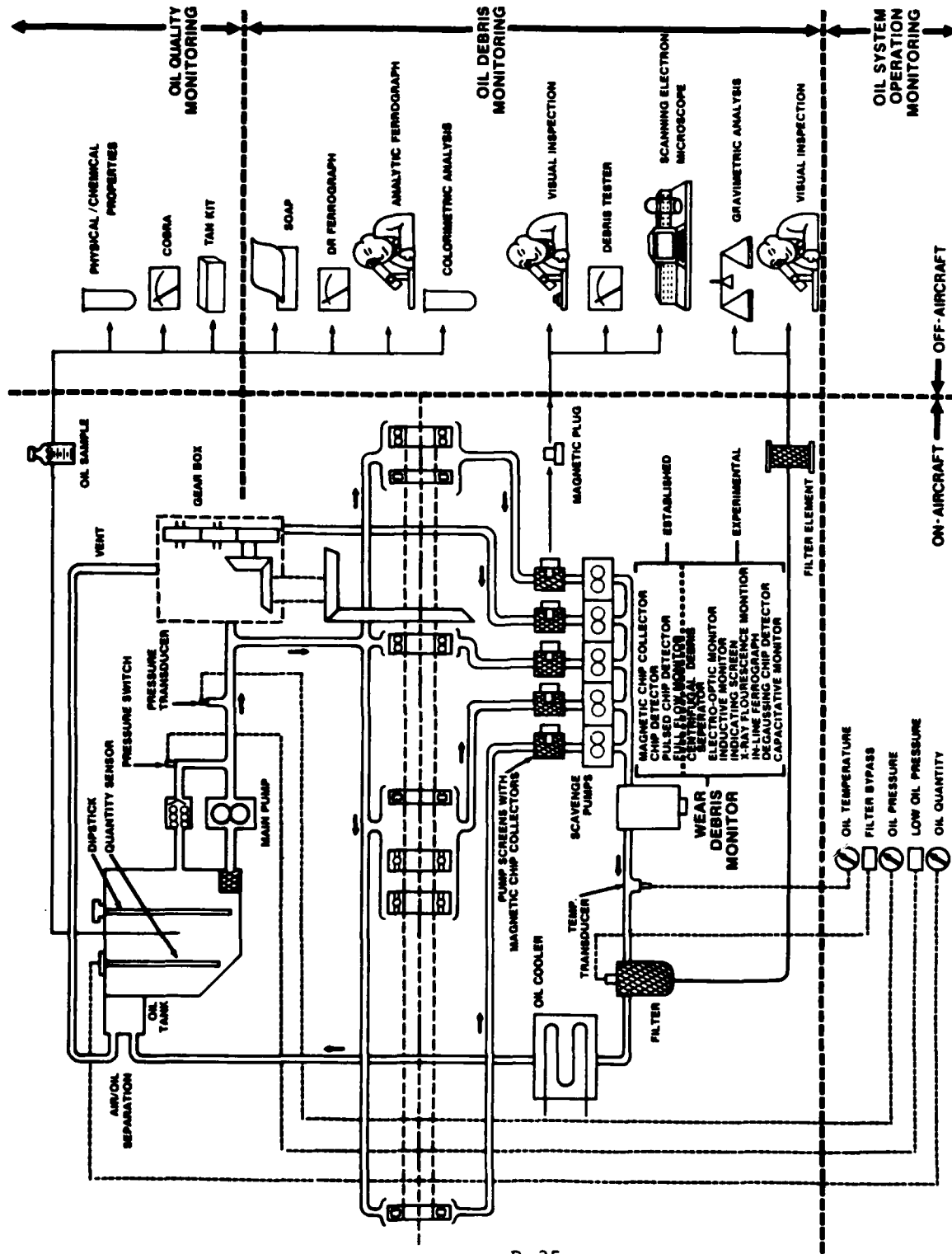

FIGURE 1. OIL SYSTEM MONITORING IN AIRCRAFT GAS TURBINE ENGINES

LCC = RDT & E + Acquisition + Operational and Support
Development Procurement Maintenance
Spares Inspection
Laboratory Logistics
Facilities Support Personnel

Fig.2 Life Cycle Cost for Oil Monitoring Systems



Fig.3 Thermal Resistance Sensor



Fig.4 Oil Quantity Sensor

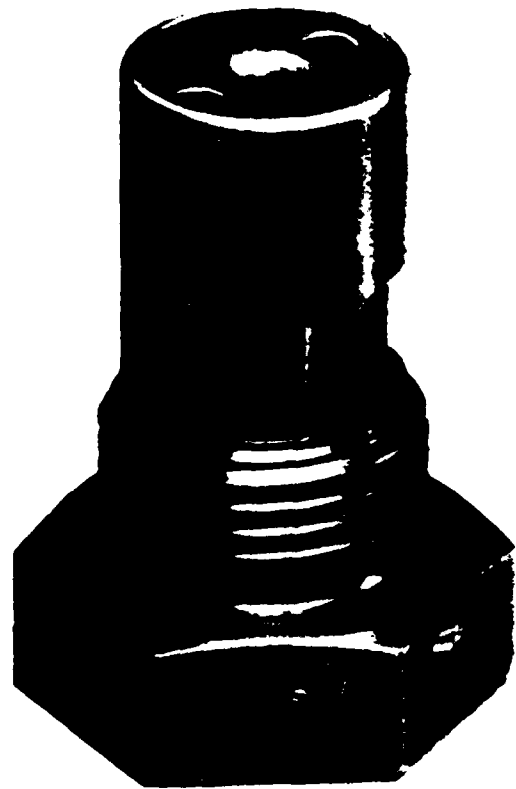

Fig.5 Magnetic Chip Collector with Self-Closing Valve



Fig.6 Debris from Engine Failure

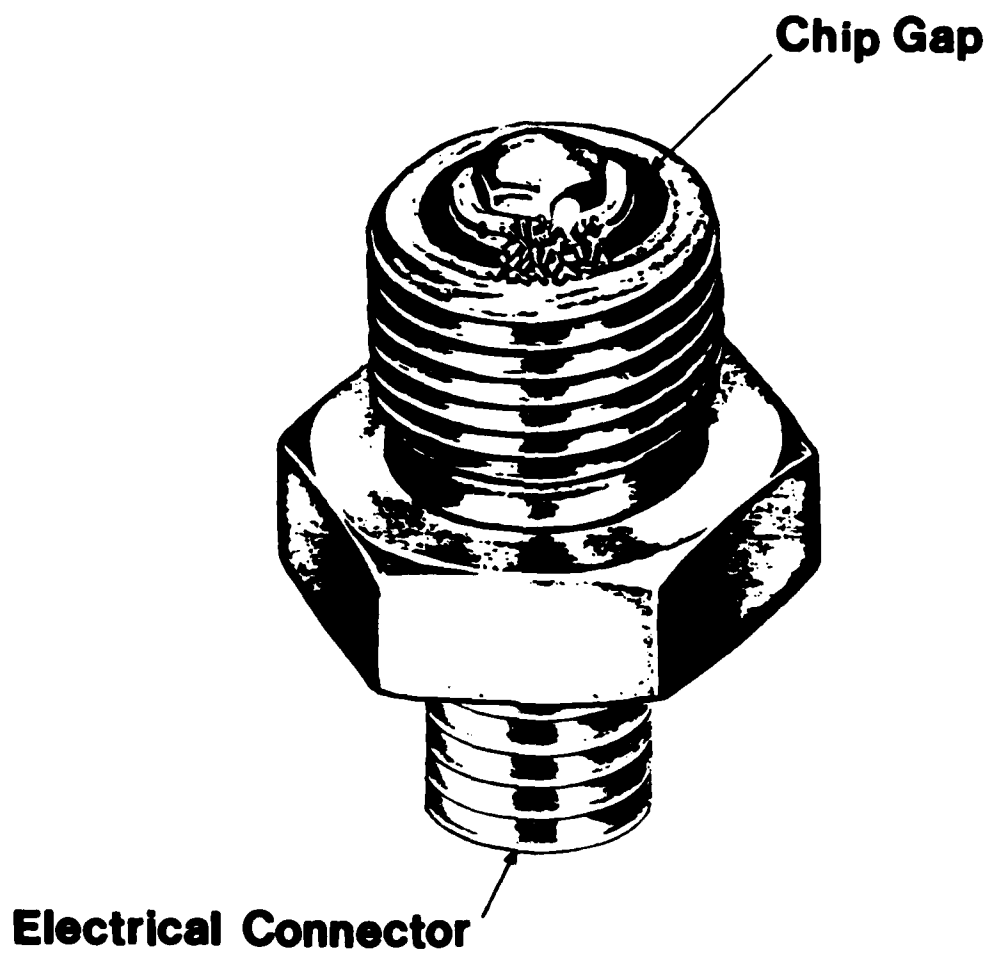

Fig.7 Electric Chip Detector

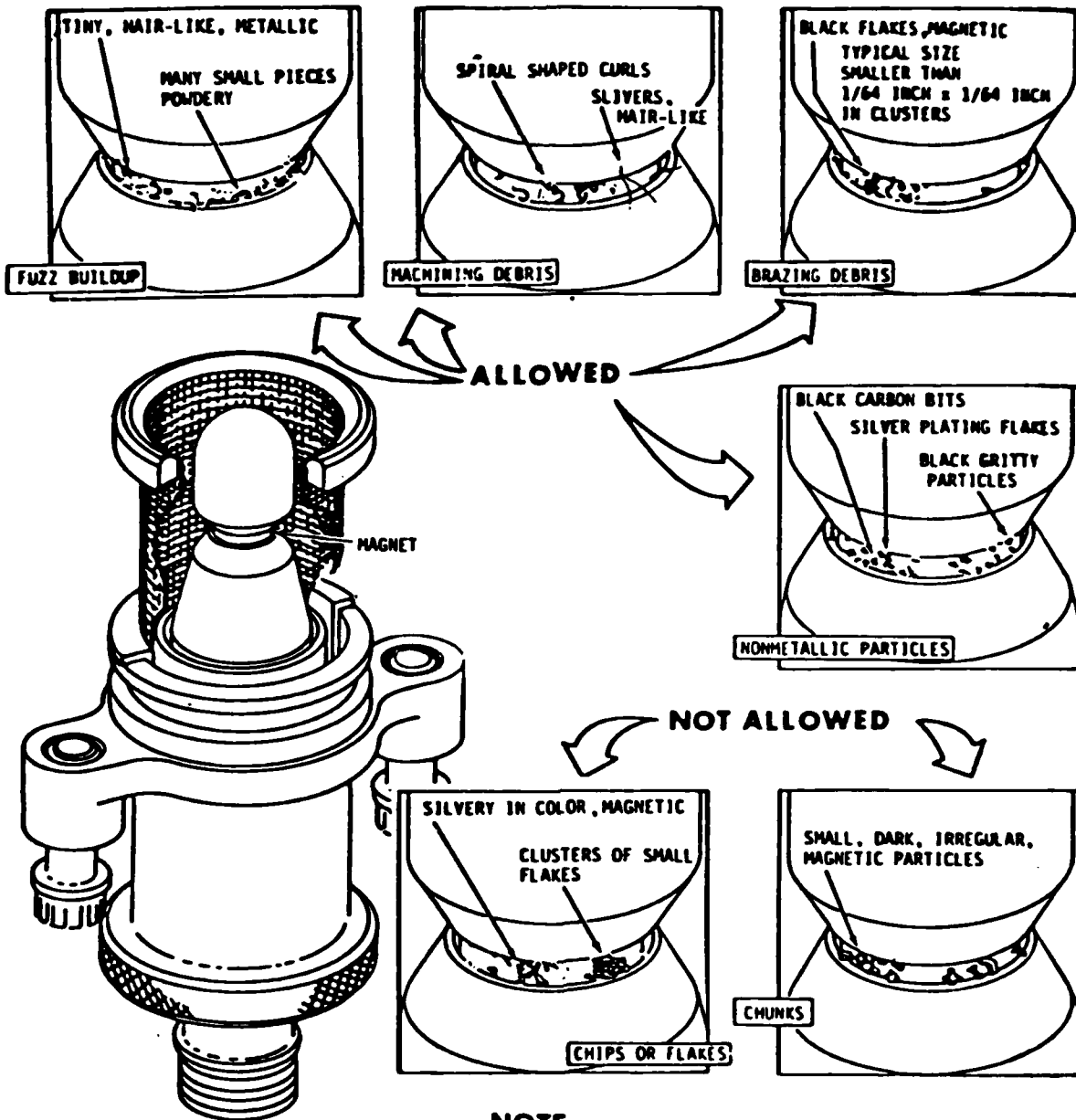

Fig.8 Maintenance Manual Excerpt For Chip Detector Debris Interpretation

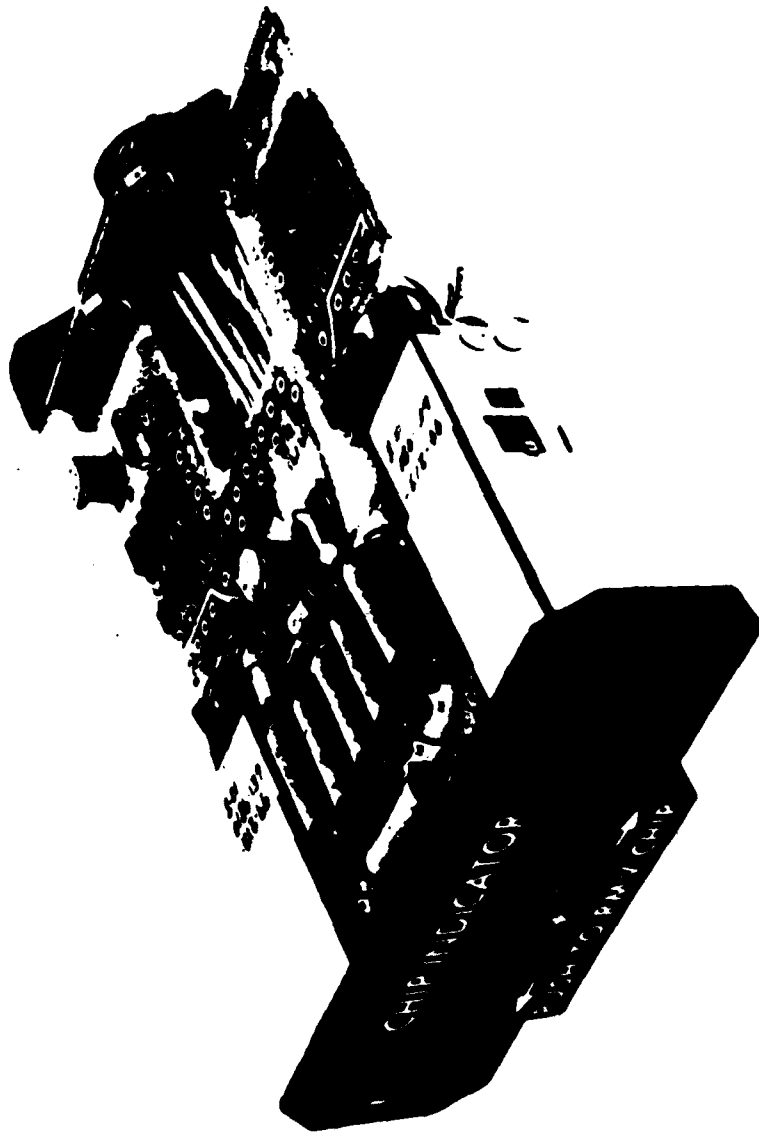

Fig.9 Pulsed Electric Chip Detector System

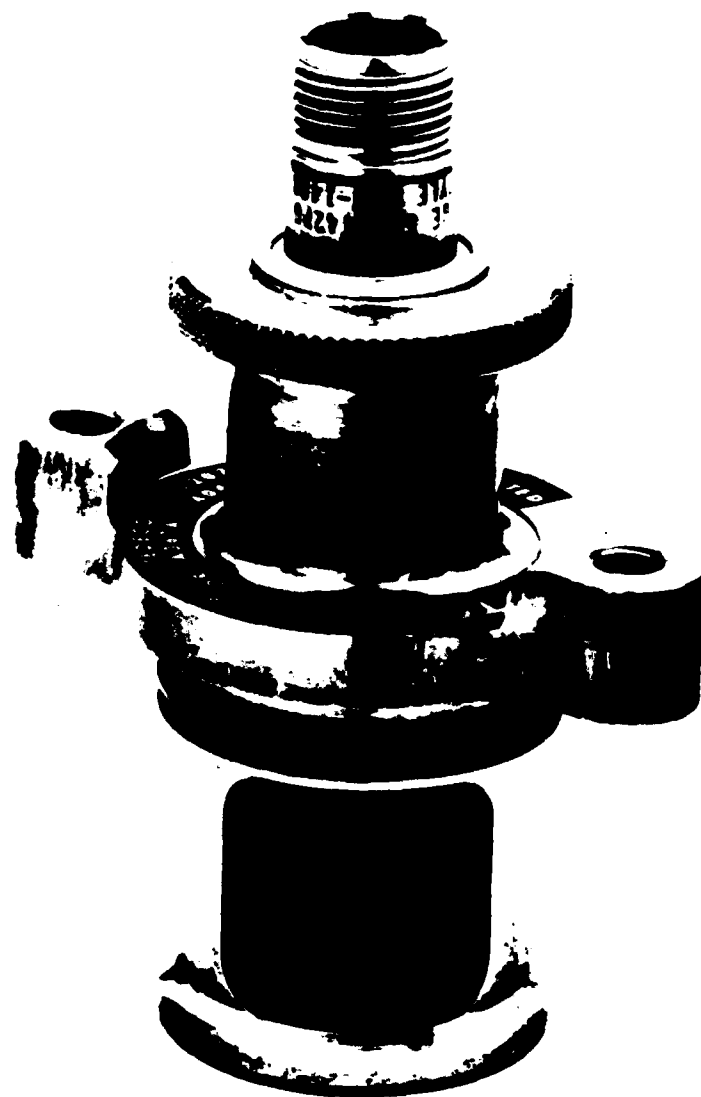

Fig.10 Screen-Type Full-Flow Debris Monitor

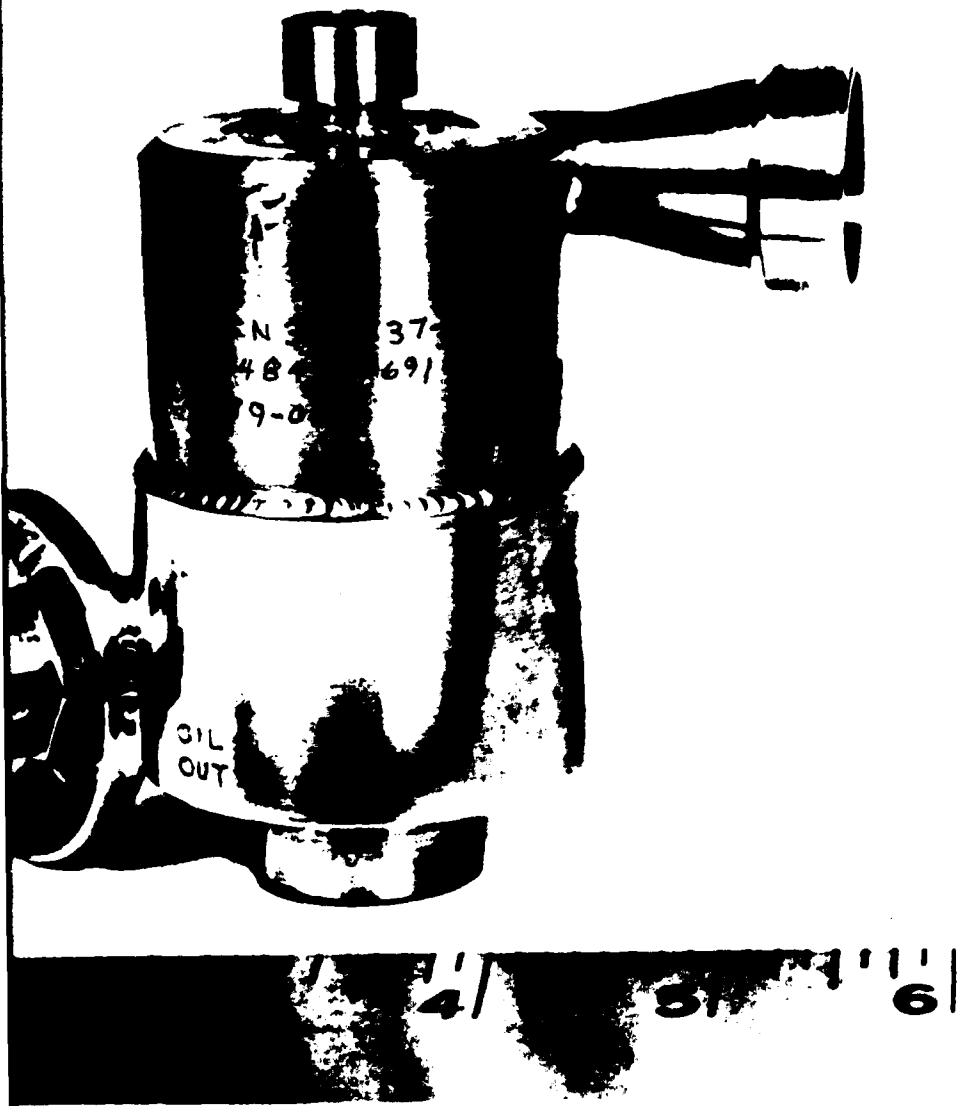
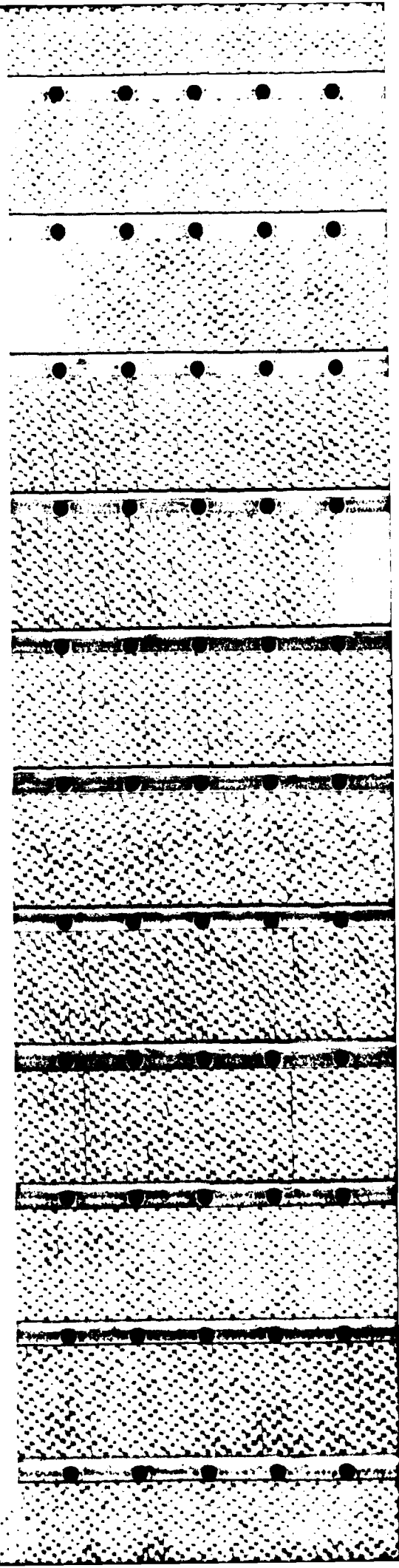

Fig. 11 Centrifugal Debris Separator With Oil System Deaeration Capability

B-45



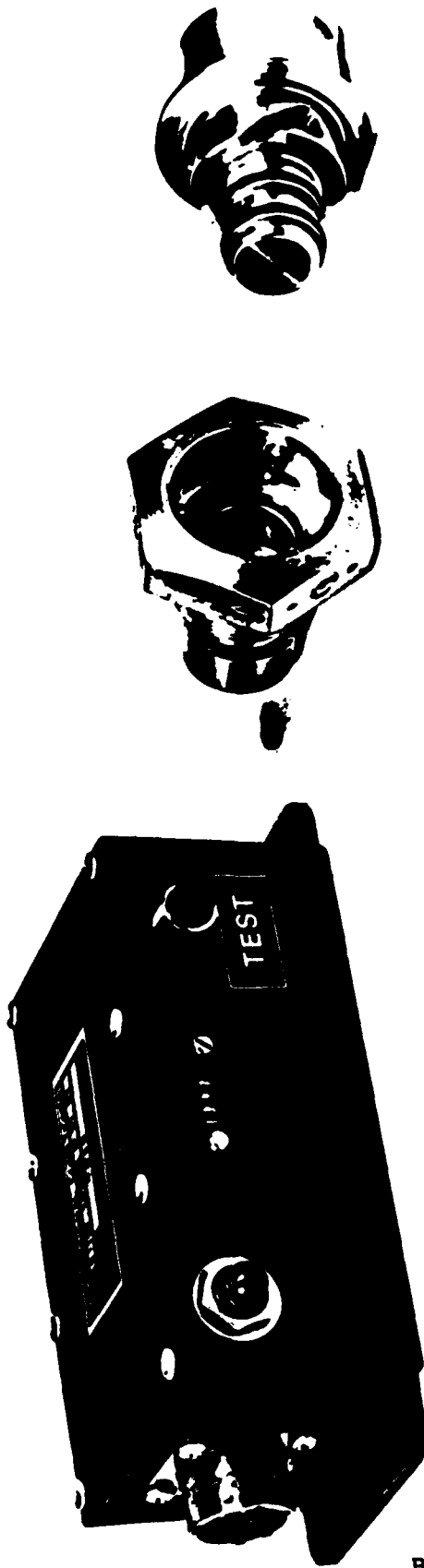

Fig.12 Quantitative Debris Monitor

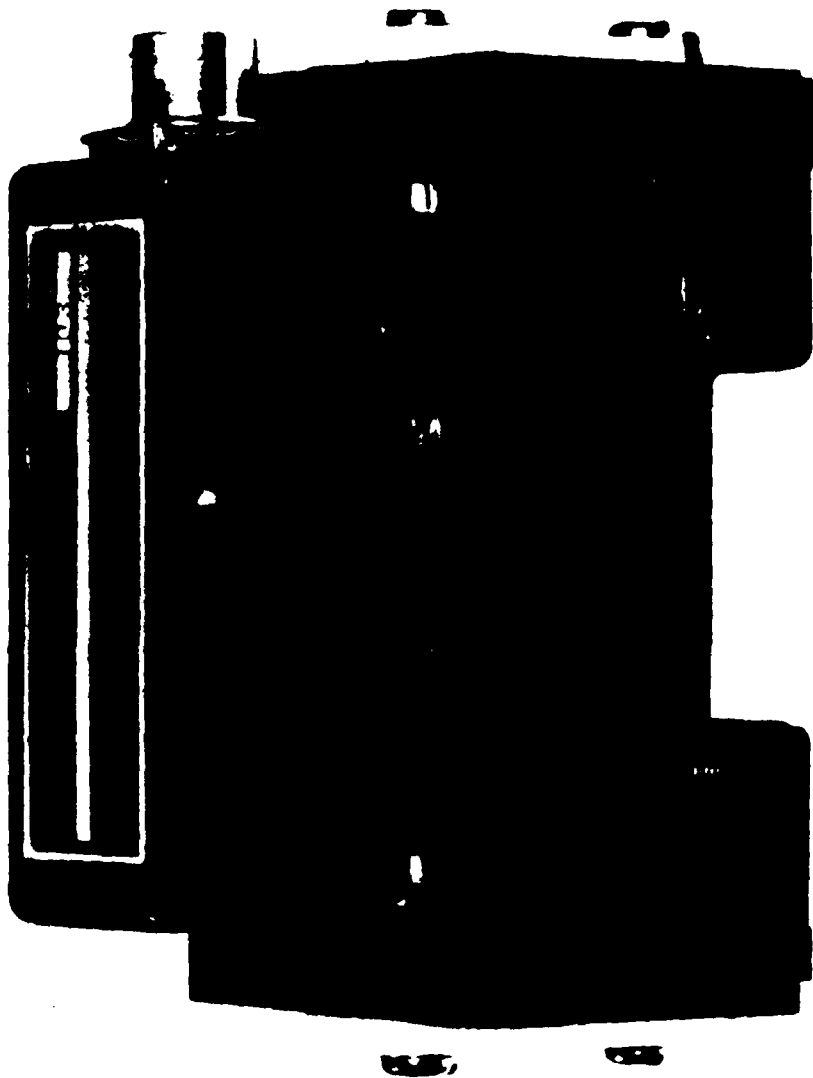
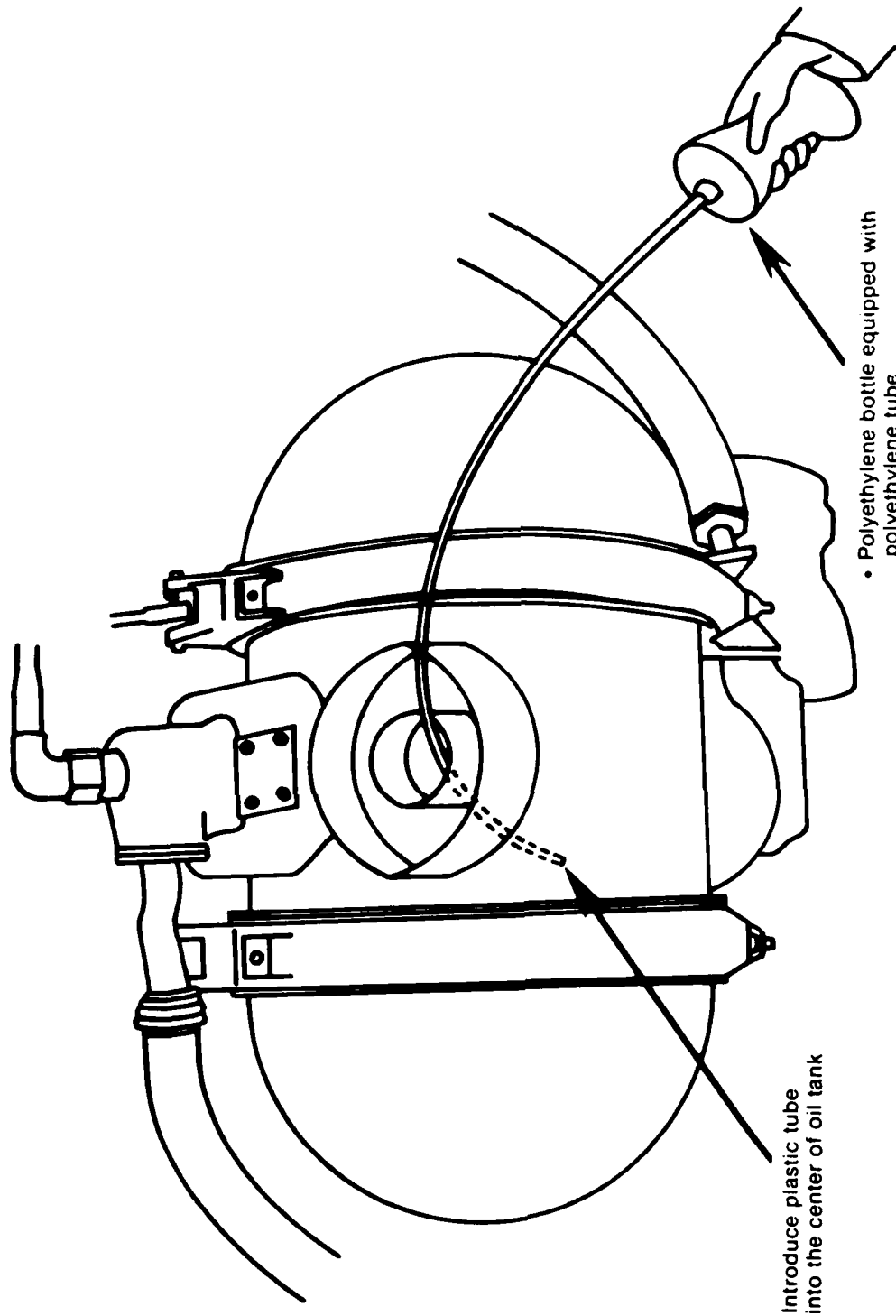

Fig.13 Electro-Optical Debris Monitor



Fig.14 Indicating Screen Debris Monitor



- Polyethylene bottle equipped with polyethylene tube
- 250 ccm contents - Fill to 100 ccm
- Dispose of the tube after use - Stop bottle
- Inscribe S/N of A/C engine, position and date on bottle

Introduce plastic tube into the center of oil tank

Fig.15 Airline SOAP Sampling Method

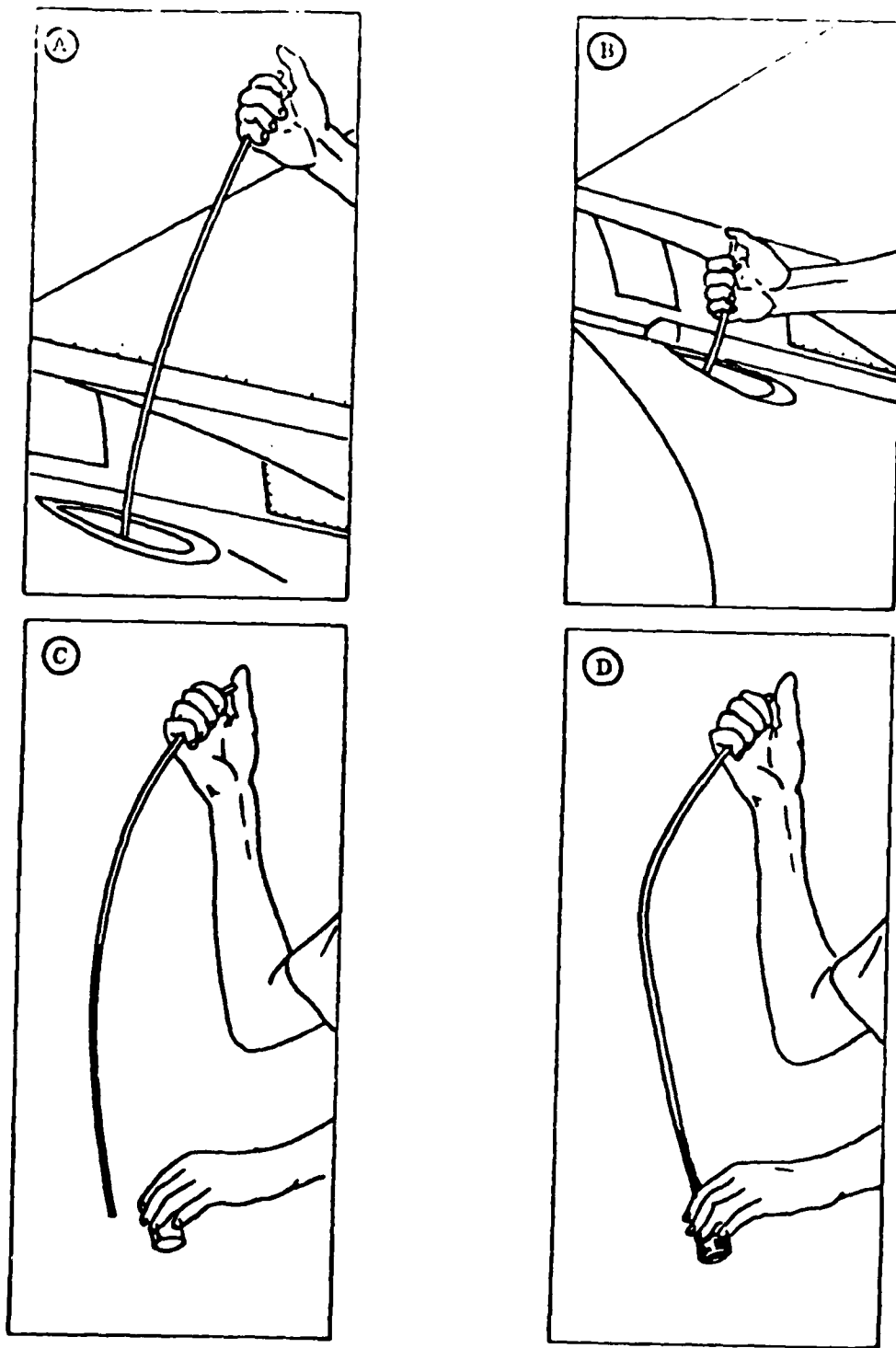
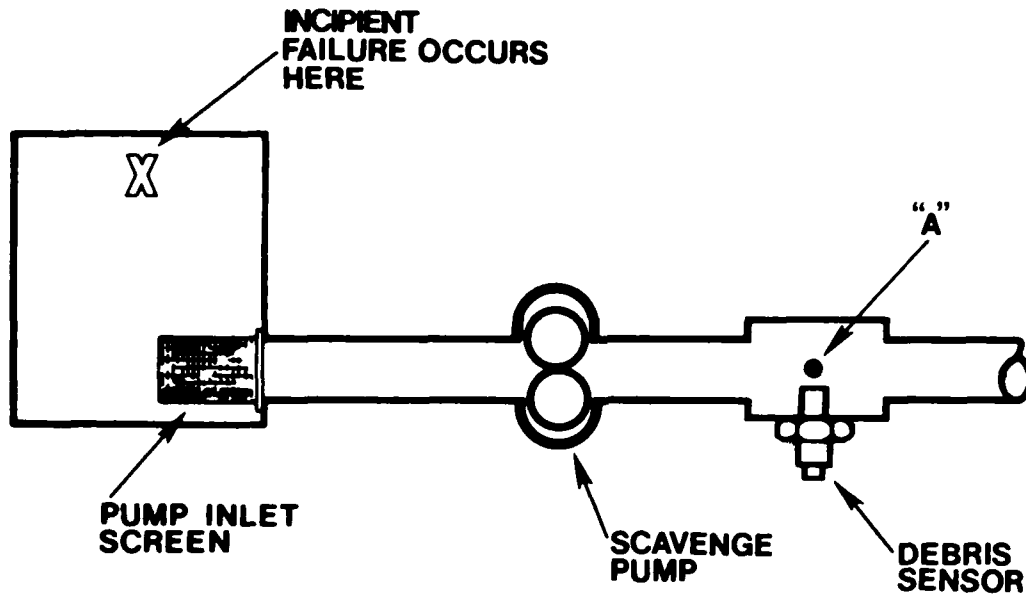

Fig.16 U.S. Military SOAP Sampling Method



TRANSPORT EFFICIENCY

$$\eta_t = \frac{\text{PARTICLES TO POINT "A"}}{\text{PARTICLES GENERATED}}$$

CAPTURE EFFICIENCY

$$\eta_c = \frac{\text{PARTICLES ON DEBRIS SENSOR}}{\text{PARTICLES TO POINT "A"}}$$

INDICATION EFFICIENCY

$$\eta_i = \frac{\text{PARTICLES INDICATED}}{\text{PARTICLES ON DEBRIS SENSOR}}$$

DEBRIS DETECTION PROBABILITY

$$\eta_d \cdot \eta_t \cdot \eta_c \cdot \eta_i = \frac{\text{PARTICLES INDICATED}}{\text{PARTICLES GENERATED}}$$

Fig.17 Factors Influencing Debris Detection

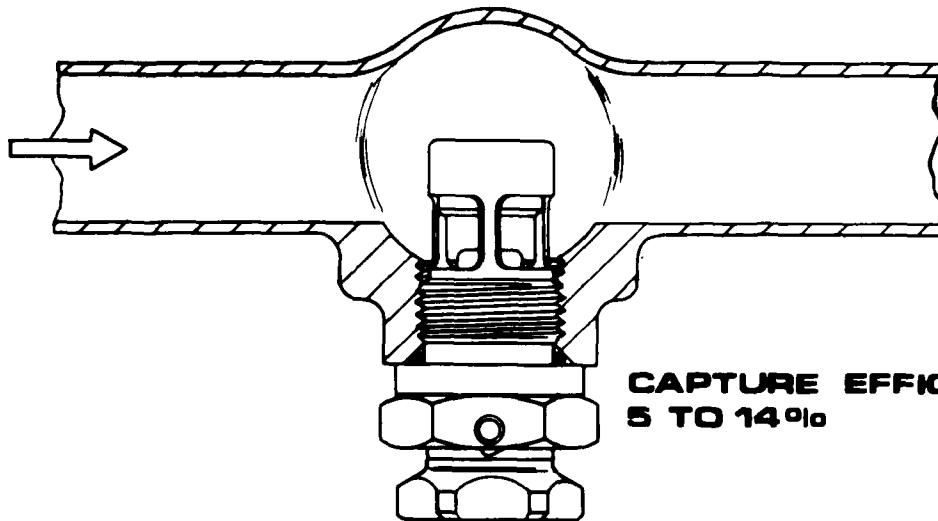

**CAPTURE EFFICIENCY
5 TO 14%**

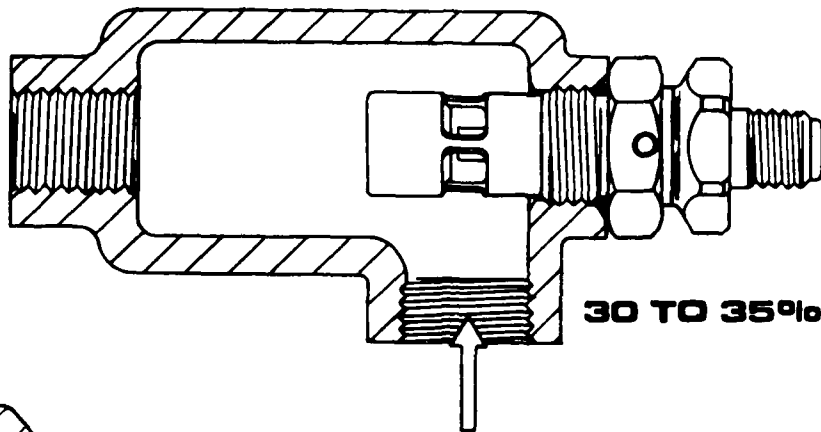

30 TO 35%

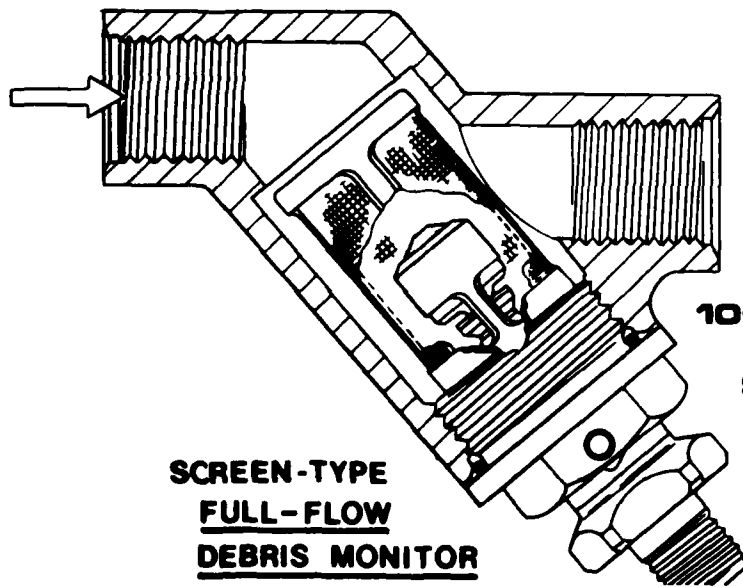

**100% (PARTICLES
LARGER THAN
SCREEN MESH)**

**SCREEN-TYPE
FULL-FLOW
DEBRIS MONITOR**

B-52

Fig.18 Capture Efficiencies for Debris Particles

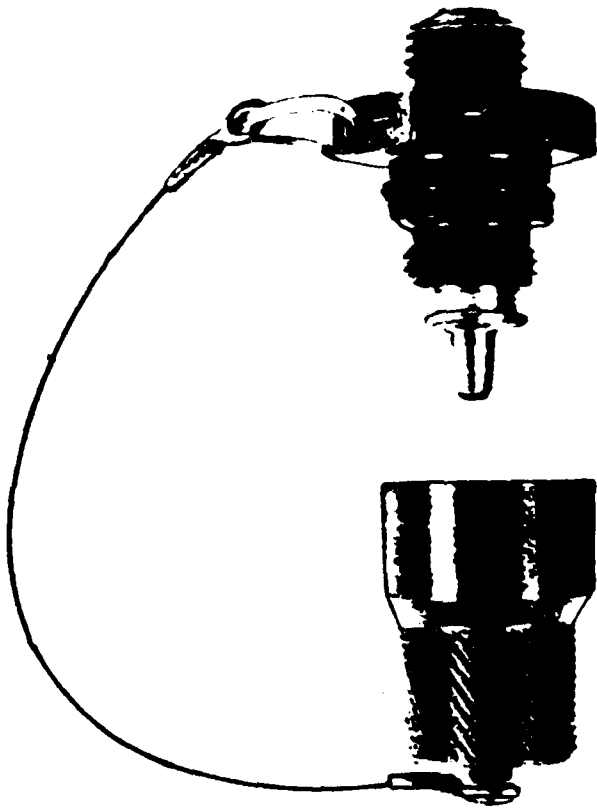

Fig.19 Oil Sampling Valve

END

FILMED

3-84

DTIC