

AD-A135 696

GETAWAY: A MODEL FOR PARAMETRIC STUDIES IN THE AREA OF
BASE ESCAPE SURVIV. (U) AIR FORCE INST OF TECH
WRIGHT-PATTERSON AFB OH SCHOOL OF ENGI.

1/2

UNCLASSIFIED

D F MACGHEE ETAL. MAR 83 AFIT/GST/PH/83M-3 F/G 1/3

NL

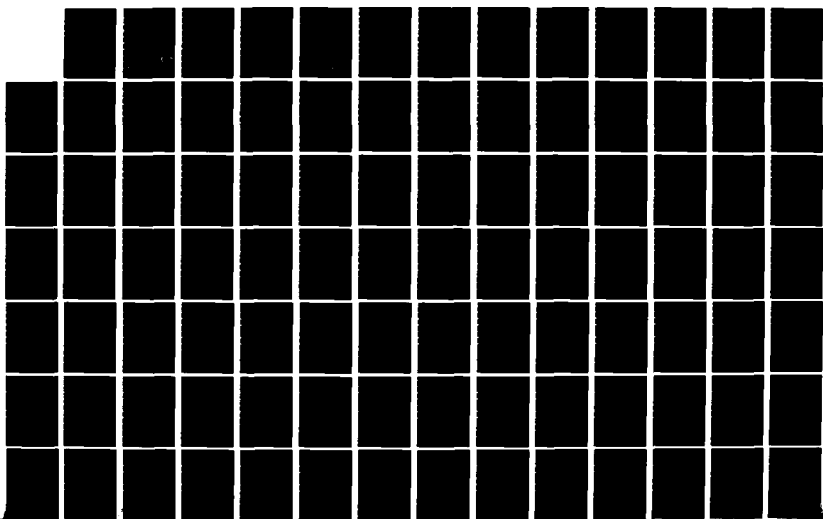

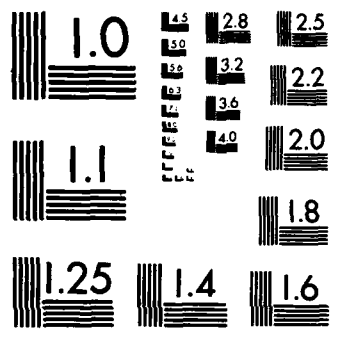

MICROCOPY RESOLUTION TEST CHART
NATIONAL BUREAU OF STANDARDS-1963-A

1

AD-A135696

"GETAWAY,"
A MODEL FOR PARAMETRIC STUDIES
IN THE AREA OF
BASE ESCAPE SURVIVABILITY

THESIS

AFIT/GST/PH/83M-3 David F. MacGhee Jr.
Maj USAF

Charles P. Williams
Capt USAF

DTIC
ELECTE
DEC 12 1983
S
B

DTIC FILE COPY

Approved for public release: distribution unlimited

83 12 12 069

AFIT/GST/PH/83M-3

"GETAWAY,"
A MODEL FOR PARAMETRIC
STUDIES IN THE AREA OF
BASE ESCAPE SURVIVABILITY

THESIS

Presented to the Faculty of the School of Engineering
of the Air Force Institute of Technology
Air University
in Partial Fulfillment of the
Requirements for the Degree of
Master of Science

by

David F. MacGhee Jr., M.S.
Major USAF

and

Charles P. Williams, B.A.
Capt USAF

Graduate Strategic and Tactical Sciences
March 1983

Contents

	<u>Page</u>
Acknowledgements	iii
List of Figures	iv
List of Tables	v
Abstract	vi
I. Introduction	1
Statement of the Problem	2
II. Background	6
Survivability Analysis	6
"Cookie Cutter" Vulnerability Envelopes	8
Monte Carlo Simulation	12
Current Models	13
QUANTA	13
FLEE	16
III. GETAWAY	18
The Direct Encounter Approach	18
Implementation of GETAWAY	21
Definitions	22
Assumptions	23
Location of Escaping Aircraft and Threat Detonations	24
Aircraft Location	24
Attack Pattern	25
Computation of Weapon Effect Intensities	27
Blast (Overpressure/Gust)	28
Thermal	28
Radiation	31
Determination of Probability of Survival	33
Log-Normal Damage Functions	33
Individual Aircraft and Fleet Survivability	35
IV. Example Demonstration	38
Parametric Problem	38
Results	39

	<u>Page</u>
V. Model Analysis	42
Verification	42
Validation	43
Sensitivity Analysis	53
VI. Conclusion	56
Recommendations	57
References	60
Vitae	62
Appendix A. User's Guide	A-1
Section I	A-1
Introduction	A-1
Parameter Definitions and Defaults	A-2
Procedures	A-6
Step-by-Step Example	A-12
Section II	A-18
Glossary of Variables	A-18
Flow Charts	A-28
Program Listing	A-34
Appendix B. Horizons Technology Inc.	B-1
Appendix C. Circular Quadrature Scheme	C-1
Appendix D. Validation Data	D-1
Appendix E. Log-Normal Damage Functions	E-1

Accession For	
NTIS GFA&I	<input checked="" type="checkbox"/>
DTIC TAB	<input type="checkbox"/>
Unannounced	<input type="checkbox"/>
Justification	
By _____	
Distribution/ _____	
Availability Codes	
Dist	Avail and/or Special
A-1	



Acknowledgements

The authors thank their thesis committee (Col. Donald Stevens, Lt. Col. Robert Davie, Lt. Col. James Bexfield, Mr. Dudley Ward and Mr. Bill Lyons). Their expertise in the areas the research effort encompassed and their guidance, motivation, and patience made this effort possible. A special thanks to Tammy Jones for her expertise which made this thesis a professional product.

Major Dave MacGhee's wife, Kathy, and daughter, Ann; Captain Chuck William's wife, Janet, and children, Nathaniel and Ben, were instrumental in completing this thesis. Their support, understanding, and love during many trying times will always be appreciated.

List of Figures

<u>Figure</u>		<u>Page</u>
1	Basic Components of Base Escape Survivability Analysis	7
2	Aircraft Survivability Envelopes and Base Escape Circle	8
3	QUANTA Attack Areas	14
4	Standard Base With Escape Route	26
5	Attack Pattern by Algorithm for Three Detonations (LAFD Past Turn Point)	27
6	Peak Overpressure from a One (1) kt Free Air Burst in a Standard Sea Level Atmosphere .	29
7	Peak Overpressures at the Surface for a One (1) kt Burst Over a Near-Ideal Surface, High Overpressure Region	30
8	Normalized Thermal Power and Energy for an Airburst below 100,000 Feet	32
9	Homogeneous ANISIN Curve Fit	33
10	Cumulative Log-Normal Damage Function	34
11	Ten Cell Model	35
12	Average Fleet Survivability for 14 Aircraft, 20 Bursts	40
13	Aircraft #7, Survivability Plot	40
A-1	3-Dimensional Array Indexing	A-18
C-1	GETAWAY Ten Cell Model	C-3

List of Tables

<u>Table</u>		<u>Page</u>
I	Current Survivability Models	3
II	Escape, Threat, and Hardness Parameters . .	21
III	Parameter Values	38
IV	Thermal Reflectivity	39
V	Time Comparison	44
VI	Validation Results Average Fleet Probability of Survival . . .	45
VII	Model Differences	46
VIII	ANOVA for Predicted Survivability	50
IX	Pairwise Comparisons - Predicted Surviv- ability Matched Pairs t-Statistic	50
X	ANOVA for Change in Survivability	51
XI	Pairwise Comparisons - Change in Surviv- ability Matched Pairs t-Statistic	52
A-I	GETAWAY Parameters	A-2
A-II	Parameter Abbreviations and Default Values .	A-5
A-III	Default Departure Profiles	A-6
C-I	Ten Cell Model Effective Cell Center Points	C-7
D-I	Validation Results	D-1

Abstract

GETAWAY, a base escape nuclear survivability model specifically designed for parametric studies, is presented. GETAWAY computes the probability of survival for an alert force escaping from a single base under SLBM attack. Parametric studies of 20 escape, threat, and hardness parameters are possible. Nuclear blast, thermal, and prompt radiation intensities are computed and aircraft survivability is derived from cumulative log-normal damage functions of weapon effect intensity. GETAWAY is shown to be an effective alternative to current predictive models for conducting parametric analysis. Its advantages over current base escape survivability models are speed, cost effectiveness, and interactive capabilities while providing parametric results highly comparable to alternative models. GETAWAY's methodology could also be applied to ICBM, naval, or ground force nuclear survivability analyses. A User's Guide, Example Session, and Program Listing are provided as appendices.

"GETAWAY," A MODEL FOR PARAMETRIC
STUDIES IN THE AREA OF BASE
ESCAPE SURVIVABILITY

I. Introduction

This study is concerned with calculating the nuclear survivability of strategic aircraft which have experienced blast, thermal, and radiation effects from a detonating warhead during a surprise submarine launched ballistic missile (SLBM) attack. The bomber and tanker alert force forms the air breathing leg of the United States TRIAD of strategic nuclear deterrence. The survivability of this force in the face of a SLBM attack is critical to maintaining deterrence by preventing any enemy from conducting a disarming first attack (Ref 1:1-11).

Air Force Regulation 80-38, Management of the Air Force Survivability Program, recognizes the importance of being able to assess alert force survivability and places responsibility for developing analytical techniques for survivability and vulnerability (S/V) assessment on Air Force Systems Command (AFSC) (Ref 2:5). The survivability/vulnerability branch of Aeronautical Systems Division (ASD/ENFTV) is the office with primary responsibility for conducting nuclear S/V aircraft analyses for ASD. This

office performs extensive studies in the area of alert force survivability. Much of their work centers on developing hardness requirements for new and existing aircraft weapon systems with particular emphasis on base escape survivability (Ref 3).

One particularly important task performed by ENFTV is developing hardness specifications which take into account both the projected SLBM threat and a wide range of base escape tactics. In order to accomplish this task, extensive parametric studies must be conducted using a survivability model. These studies evaluate alert force base escape probability of survival while varying hardness specifications, threat scenarios, and base escape tactics.

There are many survivability models currently being used for predicting base escape survivability (see Table I). ASD/ENFTV currently uses two primary models, FLEE and QUANTA, to conduct base escape survivability studies. FLEE uses a Monte Carlo simulation approach to determine probability of survival while QUANTA uses an analytical approach based on vulnerability envelopes (cookie cutter).

Statement of the Problem. FLEE and QUANTA have certain drawbacks when used for parametric base escape probability of survival studies (Ref 5,6). The models are difficult to use and interpret for parametric analysis, probably because neither model was developed specifically for conducting parametric studies. In addition, both models exclude some weapon effect damage mechanisms of

TABLE I

Current Survivability Models

NAME	DEVELOPER/ AGENCY	THREAT EFFECTS	METHODOLOGY	RESULTS
FLEE	BDM Corp./ AFTEC	Overpressure Thermal Radiation	Monte Carlo Single base	Probability of exceeding spec- ified hardness limits
QUANTA	AFWL	Overpressure Thermal	Cookie cutter envelopes Multiple bases	% Surviving (Optimizes weapon allocation)
FLUSH	ASD	Overpressure Gust Thermal	Monte Carlo Multiple bases	% Surviving
SIMPLS	General Research Corp.	Overpressure Gust Thermal	Monte Carlo and Cookie cutter envelopes Multiple bases	% Surviving
BASEM	ANSER/ Hq USAF	Overpressure Gust Thermal	Cookie cutter envelopes Multiple bases	% Surviving
STRAT SURVIVOR	SA/ Hq USAF	Overpressure Thermal	Monte Carlo and Cookie cutter envelopes Multiple bases	% Surviving

interest. The approaches taken by each model require significant computer time to make a single survivability prediction, causing parametric studies to be costly and time-consuming. The Background Section contains a detailed description of FLEE and QUANTA and their respective disadvantages.

ASD/ENFTV needs a base escape survivability model developed specifically for parametric studies. It should be straightforward to use, easy to interpret, and capable of being run from an interactive computer terminal. Results should be provided quickly and in a format which emphasizes the parametric nature of the studies. The model should consider all blast, thermal, and radiation effects of concern in base escape analysis and must be economical to use so that cost considerations will not limit its utility. Finally, the parametric results from the model must be comparable to those obtained from QUANTA and FLEE.

The remainder of this report begins with a background on base escape survivability analysis which discusses current approaches and reviews QUANTA and FLEE, the models used by ASD. The background is followed by a description of the approach and implementation of GETAWAY, the parametric base escape survivability model developed during this thesis effort. GETAWAY is then applied to an example parametric study to demonstrate its capabilities. The report finishes with an analysis of the model and a conclu-

sion with recommendations for application and further study.

II. Background

Survivability Analysis

There are three basic components involved in any survivability analysis. They are the mission, the threat, and the mission/threat interaction. For an alert force base escape survivability analysis, the mission of interest is the base escape phase of the overall alert force mission. The threat is an SLBM nuclear attack. The mission/threat interaction occurs when each aircraft actually experiences the blast, thermal, and radiation effects of a detonating warhead. The specific mission, threat, and mission/threat interaction are defined in this study by the parameters in Figure 1. A parametric base escape survivability model must permit variation of each of these parameters.

The mission component is defined by the five parameters listed in Figure 1. All five parameters influence where each escaping aircraft is located when each threat weapon detonates. Much like the mission component, the threat component parameters listed in Figure 1 (except for yield) deal with when and where the warheads detonate. The interaction component is where the mission component encounters the threat component and the outcome, probability of survival, is determined. Weapon effect intensities (see Figure 1) at the aircraft depend on yield and relative position of the aircraft to the detonation. Air-

craft hardness, defined as the aircraft's ability to withstand damage from nuclear effects (Ref 4:25), is the listed interaction parameter which is determined by aircraft design. Probability of survival is the outcome of the encounter of weapon effects intensities with aircraft hardness. There are currently two basic approaches to determining the probability of survival: vulnerability envelopes ("cookie cutter") and Monte Carlo simulation.

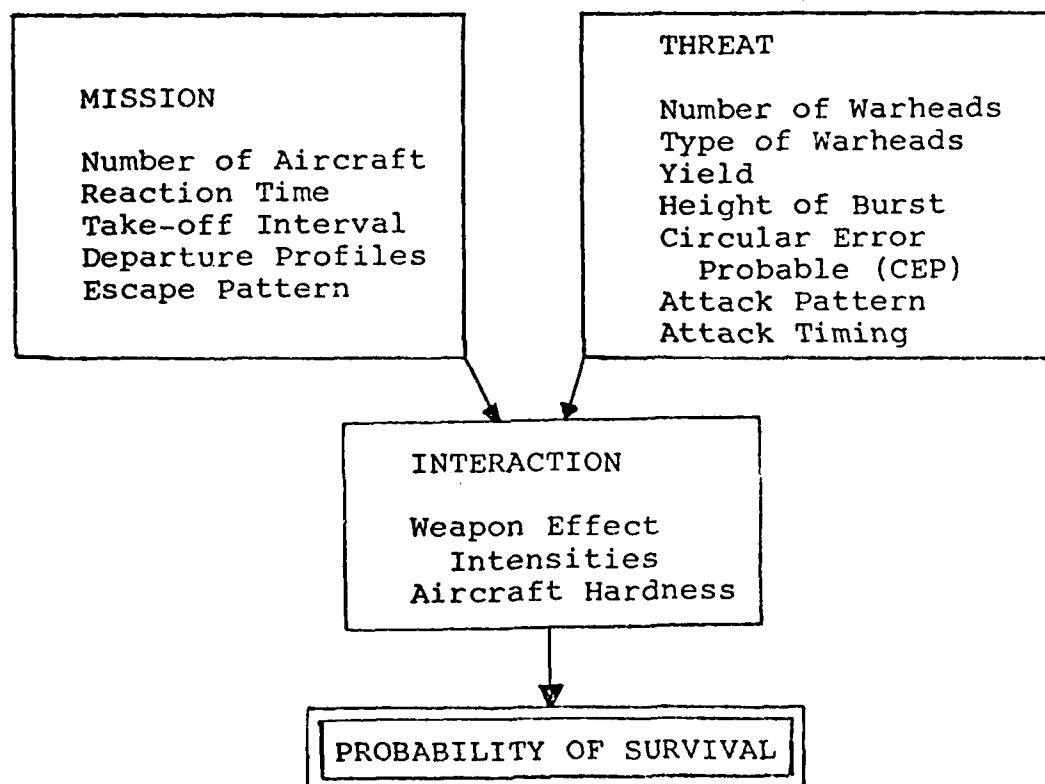

Figure 1. Basic Components of Base Escape Survivability Analysis

"Cookie Cutter" Vulnerability Envelopes

The most frequently employed technique for determining probability of survival is the cookie cutter or vulnerability envelope. This technique is described in the Handbook for Analysis of Nuclear Weapon Effects on Aircraft, Volume I. In general, as illustrated in Figure 2, a three dimensional vulnerability envelope around each aircraft is determined for each encountered threat (Ref 4:27). Any threat detonation inside this vulnerability envelope results in loss of the aircraft, and for a detonation outside the envelope, the aircraft is considered safe.

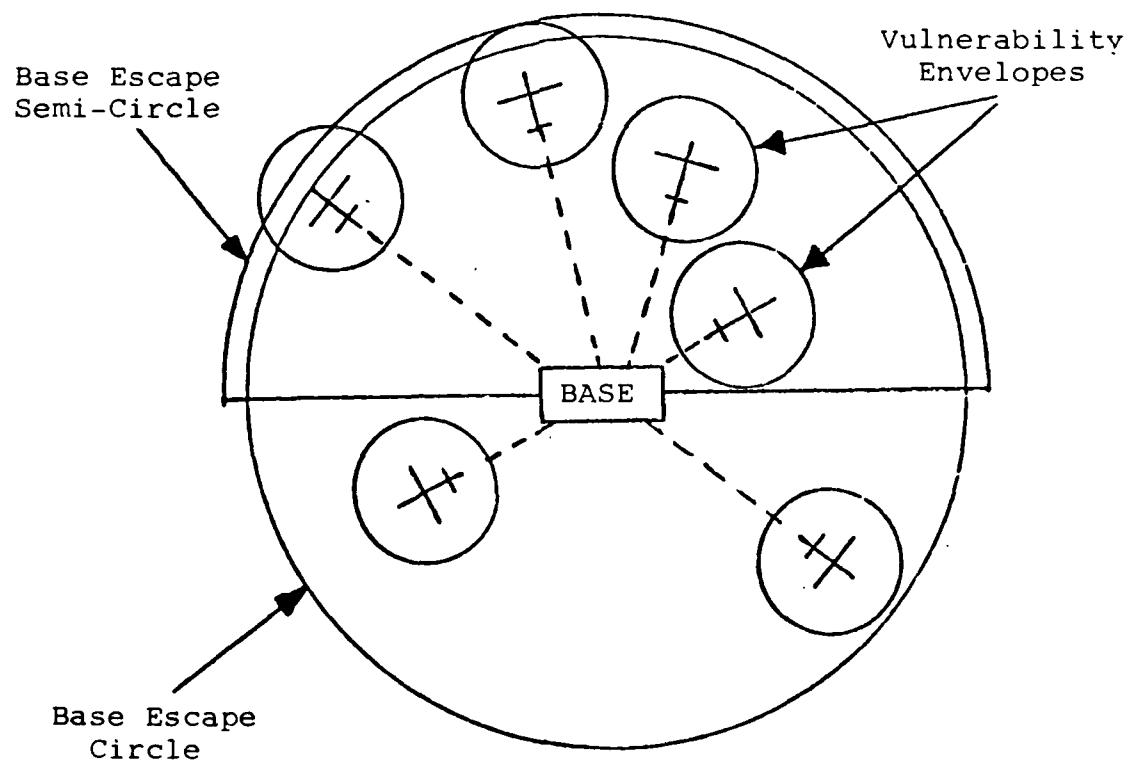

Figure 2. Aircraft Survivability Envelopes and Base Escape Circle

By assuming that the escaping aircraft are randomly distributed in the large base escape circle around the base in Figure 2, with no overlap of vulnerability areas, and by assuming the detonations are also randomly distributed in the circle, the probability of survival (P_s) for each burst is calculated by the following equation:

$$P_s = 1 - \frac{\text{Total of vulnerability areas}}{\text{Area of escape circle}} \quad (1)$$

The vulnerability approach depends heavily on how the size of the "cookie cutter" envelopes are determined. Specific hardness levels in terms sure-safe and sure-kill are the major factors used to determine the envelope size. Sure-safe is that level of intensity for each threat effect (blast, thermal, and radiation) below which no degradation in the aircraft capability occurs. Sure-kill is defined as that level of weapon effect intensity above which catastrophic damage and immediate loss of the aircraft occurs (Ref 4:25). For example, an aircraft might be specified as hardened to an overpressure of 2 p.s.i. sure-safe and 5 p.s.i. sure-kill for the overpressure blast effect.

The size of the vulnerability envelope is determined after the threat yield and height of burst have been specified and after the aircraft altitude, speed, and sure-safe hardness levels are defined. Sure-safe rather than sure-kill hardness levels are most often used to reflect

the conservative nature of survivability analysis. Procedures outlined in the Handbook for Analysis of Nuclear Effects on Aircraft are used to calculate the ranges at which each specified sure-safe effect intensity (blast, thermal, and radiation) is encountered. The procedure selects the greatest range, which corresponds to the most critical effect, to establish the size of the sure-safe envelope around each aircraft.

Determining the size of the base escape circle is also an important part of the cookie cutter approach. Since the aircraft are assumed to be uniformly distributed in the circle, the radius of the circle is usually defined as the range of the farthest escaping aircraft at detonation time. Since alert force aircraft are usually restricted to a northerly departure to be able to complete their missions, the escape circle may be taken as only half that depicted in Figure 2. This reduces the calculated probability of survival significantly, and tempers the assumption that the aircraft are equally distributed in the area.

The vulnerability envelope approach could easily be applied to a model specifically designed for parametric analysis. It is conceptually simple and is a traditional approach well understood by ASD/ENFTV and others in the nuclear survivability community. However, it has certain drawbacks as an approach for parametric analysis.

One disadvantage is that construction of the cookie

cutter envelopes is complicated and time-consuming. Although depicted as circles in Figure 2, this is an over-simplification since an aircraft's vulnerability to a weapon effect is not necessarily symmetrical. For example, an aircraft can generally survive the gust from a fore or aft detonation better than from the side (Ref 4). In addition, determining the vulnerability ranges must be done iteratively, varying weapon effect intensities until the critical range is found. These calculations require substantial amounts of computer time, making parametric studies a lengthy process.

A more subtle disadvantage involves the cookie cutter technique of using only sure-safe or sure-kill hardness levels to determine the size of the envelopes. It is physically unrealistic to assume that a detonation just inside the envelope will result in complete loss of the aircraft while a detonation just outside the envelope results in complete escape (Ref 4:3). The vulnerability envelope approach does not address the probability of surviving intensities somewhere between sure-safe and sure-kill. This inability is a severe limitation when conducting parametric studies where the resultant change in survivability for a small change in one parameter can go from zero to one so easily. The second basic approach to determining probability of survival is based on Monte Carlo simulation.

Monte Carlo Simulation

Monte Carlo simulation is well suited to base escape survivability analysis since it can model any physical problem as closely as the physical situation and the input variables are known. In this approach, all the parameters listed in Figure 1 are treated as random variables, and the outcomes of repeated encounters are averaged. The values of the parameters for each encounter are chosen randomly from specified distributions. Distributions are chosen which best, or most conveniently describe each parameter based on our knowledge of the physical situation (for example, circular normal for CEP). The final answer, after repeated simulations, yields an average probability of survival. Confidence in this average will increase with the number of iterations of the simulation. Of course, this confidence relies to a great extent on the analysts' belief that the distributions chosen to represent all the model parameters are accurate representations of reality. Such beliefs are hard to support when so little empirical data relating to nuclear survivability exists.

Although Monte Carlo simulation could provide meaningful results for base escape survivability analysis, the approach is not well suited for parametric studies. Such studies would involve excessive computer time since Monte Carlo needs significant time to compute a single answer and parametric analysis requires many answers for

comparison over a range of parameter values. Additionally, comparison of simulation results for parametric analysis is often questionable because of the variance induced by the simulation itself. Monte Carlo simulation can often produce quite different results from the same sets of inputs. Although such variance can be dealt with, it generally means more computer time and less confidence in the conclusions of the analysis.

Current Models

ASD/ENFTV currently uses two models, QUANTA and FLEE, to conduct aircraft base escape survivability analysis. QUANTA uses the vulnerability envelope approach discussed above and FLEE is a Monte Carlo simulation model. This subsection examines these two models and discusses their major shortcomings when used for conducting parametric base escape analysis.

QUANTA. QUANTA is an analytical model which optimizes an SLBM attack on any number of alert force bases. It uses the vulnerability envelope approach to determining probability of survival and applies a LaGrange optimization technique to minimize the probability of survival of all aircraft at all the bases considered. It does have the capability to consider a single base with a single type of aircraft. This single base mode is most often used to conduct parametric studies of the type discussed in this report.

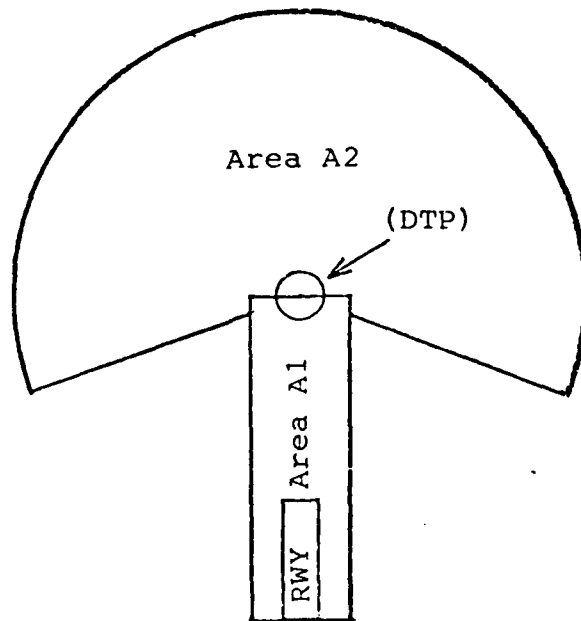

Figure 3. QUANTA Attack Areas

When used in the single base mode, all warheads are allocated between two areas around the base as shown in Figure 3. Area A1 is a corridor between the brake release point and the departure turn point (DTP). Area A2 is a pie shaped sector centered at the DTP. The radius of A2 is determined by the maximum range of any escaping aircraft based on escape timing. The pie sector limits are based on planned aircraft escape routing. QUANTA assumes the enemy has perfect knowledge of escape timing and routing. It uses this knowledge to determine the number of aircraft in each of the two areas during the attack and

minimizes probability of survival in each area by allocating an optimum distribution of warheads between the two areas. This optimization is accomplished using a LaGrangian technique along with probability of survival calculations based on the concept of ratios of areas as illustrated in Equation (1). For final results, QUANTA computes the expected number of aircraft surviving as the average fleet probability of survival. To conduct parametric studies, the value of one input parameter can be changed from run to run to study the effect of the changes on average fleet survivability.

When applied to parametric studies, QUANTA suffers from all the disadvantages of the vulnerability envelope approach discussed in the previous section. In addition, it has some further drawbacks of its own. First, QUANTA only deals with overpressure and thermal damage mechanisms. This excludes gust and radiation weapon effects which are of interest in base escape survivability analysis and precludes any parametric analysis in these areas. Second, the optimization aspects of QUANTA tend to obscure changes in survivability when varying parameters involved with escape timing and routing. Real gains in survivability due to increased aircraft performance or increased readiness may be hidden from analysis with QUANTA because it optimizes with perfect enemy knowledge. Finally, since a separate run is required for each change in the value of a

parameter being studied, a full parametric study requires numerous separate runs after which the results must be compiled and analyzed by hand. Consequently, conducting parametric studies with QUANTA can be a cumbersome and time-consuming task since it was not designed with parametric studies in mind.

FLEE. FLEE is a full Monte Carlo simulation model used by ASD/ENFTV for base escape survivability analysis. It simulates an SLBM attack on a single aircraft alert base and tabulates the number of times each aircraft exceeds specified levels of nuclear overpressure, thermal, and radiation effects (does not treat gust). By replicating a simulation a number of times for a given attack scenario, the probability of each aircraft exceeding the specified hardness levels is computed as the percentage of the replications in which the levels were exceeded. Nearly all input parameters listed in Figure 1 can be defined by distributions chosen by the analyst, including escape timing, routing, and attack pattern. No assumptions about enemy knowledge are made unless they are reflected in the way these distributions are chosen. Probability of survival is still based on the cookie cutter concept since no distribution of survival between specified hardness levels is included.

As discussed in the previous section, Monte Carlo simulation has drawbacks when applied to parametric

analysis. FLEE is no exception. In addition, one aspect of FLEE makes it unusually difficult to use for any type of base escape survivability analysis. The results reported by FLEE are extremely difficult to interpret. The primary statistic reported after a number of simulations is the probability of each individual aircraft exceeding the specified hardness levels entered as input parameters. Also reported are probabilities of exceeding several combinations of these hardness levels. The different combinations included are not described in a clear manner. This leads to great confusion as to the significance of the results because FLEE does not actually compute individual aircraft or average fleet probability of survival. These statistics can be computed by hand from the output results of FLEE, but it requires substantial expertise to identify which FLEE results should be used for which desired probabilities of survival. To do this by hand for a full parametric analysis would require substantial time, making FLEE impractical as a tool for conducting parametric base escape survivability analysis.

III. GETAWAY

The preceding sections have documented the difficulties of using the vulnerability envelope approach of QUANTA or the Monte Carlo approach of FLEE to conduct parametric studies in the area of base escape survivability. This section describes the direct encounter approach used in "GETAWAY," summarizes its advantages for conducting parametric studies, and provides a detailed description of the implementation of GETAWAY.

The Direct Encounter Approach

GETAWAY, the parametric base escape survivability model developed in this thesis, uses what the authors call the direct encounter approach to determine aircraft base escape survivability. In the direct encounter approach, all mission, threat, and hardness parameters as listed in Figure 1 are fully specified for the scenario to be studied. This full specification of scenario parameters is used to compute all nuclear blast, thermal, and radiation weapon effect intensities encountered by each aircraft during the SLBM attack. The probability of each aircraft surviving each effect encountered is determined by using probability of survival functions (damage functions) which are cumulative log-normal functions of weapon effect intensity. Hardness parameters of sure-safe and sure-kill for each weapon effect are used to define these damage functions. The probability of an individual

aircraft surviving the attack is simply the product of the probabilities that it survived each effect encountered. Average fleet probability of survival is determined by finding the expected proportion of the fleet surviving the entire attack.

The direct encounter approach has several advantages as a tool for parametric studies when compared to the vulnerability envelope and Monte Carlo approaches described earlier. First, this approach is quick and simple. For a fully specified set of scenario parameters, probability of survival can be quickly calculated by one run of a direct encounter model. To conduct a parametric study, the value of one parameter is easily changed for another direct encounter evaluation and results can be easily compared from run to run. Second, during a parametric study, the full effect of changing the parameter value is evident and is not confounded with random effects of a simulation. This confounding can easily occur with the Monte Carlo approach. Third, the relative impact of each weapon effect on survivability is readily available since probability of surviving each effect has already been determined. This information is of particular value when conducting parametric studies for aircraft design purposes but is not available when using the vulnerability envelope or the Monte Carlo approach. Finally, by using a distribution of survivability between sure-safe and sure-kill instead of the cookie cutter concept employed by the

vulnerability envelope approach, small parametric changes in survivability are more easily detected and analyzed. This enhances the power of the direct encounter approach as a tool for conducting parametric base escape survivability analysis.

The one outstanding disadvantage of the direct encounter approach is that it lacks the predictive fidelity of the other two approaches. This is because it depends on an "average encounter" and takes no account of any variability associated with the scenario parameters as does the Monte Carlo approach. Nor does the direct encounter approach use the established concepts of vulnerable areas and vulnerable volumes to determine probability of survival as does the vulnerability envelope approach. This disadvantage is not as great as it may seem if this approach is used only for parametric studies where the differential effect of changing parameter values is the object of study rather than the actual predicted probability of survival. However, even in parametric studies, the predicted probability of survival should be reasonably comparable to results obtained from the higher fidelity approaches. This comparability is examined further in Section V. The next subsection gives a detailed description of how the direct encounter approach is implemented in GETAWAY.

Implementation of "GETAWAY"

The background section of this report pointed out the three components of a base escape survivability analysis, the mission, the threat, and the mission/threat interaction (see Figure 1). GETAWAY models a base escape scenario from launch of the first SLBM to detonation of the last warhead. The scenario is specified by 20 escape, threat, and hardness parameters, as outlined in Table II. GETAWAY is specifically designed to study these parameters and the differential effect they have on alert force survivability. The model is implemented in three steps. First, each aircraft is located in its escape sequence as each incoming warhead detonates. Second, the weapon effect intensities are computed at the aircraft, and third, the probability that each aircraft survives each detonation is determined and average fleet survivability is computed. After defining the major terms and discussing the pertinent assumptions, this subsection describes how GETAWAY performs these three steps.

TABLE II
Escape, Threat, and Hardness Parameters

Escape Parameters	Threat Parameters	Hardness Parameters
Number of aircraft Reaction time Escape sector width Take-off interval Departure profile Distance to turn point	Missile flight time Number of bursts Detonation interval Yield Height of burst Circular error probable Type warhead	Overpressure Gust Thermal fluence Tissue dose Equipment dose Equipment dose rate Neutron fluence

Definitions

The following definitions are provided to clarify the exact meaning of each parameter used in GETAWAY:

- Number of Aircraft: Number of aircraft on alert, ready for immediate launch.
- Reaction Time: The time from the first missile launch, "breakwater," to the first aircraft take-off. This time includes warning and crew reaction time.
- Escape Sector: A sector centered at the turn point containing all escaping aircraft past the turn point.
- Take-off Interval: The time interval between escaping aircraft.
- Departure Profile: A time/range/altitude description of aircraft position given for discrete time increments after take-off. Example -- 120 seconds/5 nautical miles/5,000 feet.
- Distance to Turn Point: Distance from brake release point to departure turn point.
- Missile Flight Time: Time from "breakwater" to detonation of the first warhead.
- Number of Warheads/Bursts: The number of warheads targeted at the alert force base.
- Detonation Interval: Time between warhead detonations.
- Yield: Warhead yield.
- Height of Burst (HOB): Distance above ground (sea level) that warhead detonates.
- Delivery Error: The accuracy associated with the warheads, specified in nautical miles, circular error probable (CEP).
- Warhead Radiation Type: Warhead type -- fission or thermonuclear.
- Overpressure Hardness: Sure-safe (SS) and sure-kill (SK) in pounds per square inch (psi) overpressure.

- Gust Hardness: Sure-safe and sure-kill in feet per second (fps) side gust at sea level.
- Thermal Fluence Hardness: Sure-safe and sure-kill thermal fluence in calories per square centimeters (cal/cm²).
- Tissue Dose Hardness: Sure-safe and sure-kill prompt gamma and neutron dose in rads-tissue.
- Equipment Dose Hardness: Sure-safe and sure-kill prompt gamma and neutron dose in rads-silicon.
- Equipment Dose Rate Hardness: Sure-safe and sure-kill gamma dose rate in rads-silicon per second (rads-sil/sec).
- Neutron Fluence Hardness: Sure-safe and sure-kill neutron fluence in neutrons per square centimeters (n¹/cm²).

Assumptions

In order for the model to be conceptually simple, easy to use, and economical, it was necessary to make the following assumptions. These assumptions may appear to be over-simplifications, but they enhance the usefulness of the model for parametric studies.

1. The model assumes a single base at sea level elevation. Relative distance between this single base and the submarine launched missiles along with the missile trajectory is modeled simply by stipulating missile flight time.

Example: Enemy submarine shooting flat trajectories would be modeled by short missile flight time chosen by the user.

2. Survivability is assumed to be a function of only those effects under consideration -- blast, thermal, and radiation. The effects of nuclear cloud encounter, electromagnetic pulse (EMP), dust, and fallout are not

treated in this study. Also, synergistic effects are not considered.

3. Each aircraft is viewed as a system with an overall hardness level for each effect. Subsystem vulnerability is not explicitly considered.
4. Aircraft and aircrew reliability in the attack environment is not considered in survivability determinations.
5. All the warheads are assumed to be of the same type. Although independently targetable, the warheads have identical yields, HOBs, CEPs, and radiation output.
6. All thermal reflection and absorption from cloud and ground are neglected. Atmospheric conditions are considered to be standard day and a constant atmospheric thermal transmission factor is used in thermal calculations.
7. An optimum attack scenario is always selected based on the assumption that the enemy has full knowledge of reaction time, take-off direction, departure turn point locations, and escape route pattern.

Location of Escaping Aircraft and Threat Detonations

During each run of GETAWAY, each aircraft is flown out a standard departure route from a standard base on a selected time/range/altitude profile. As each weapon detonates, every aircraft is spatially located relative to the departure turn point. The attack pattern is also defined relative to the turn point, which allows the distance from detonation to aircraft to be computed.

Aircraft Location. The aircraft location at detonation time is a direct function of time of flight at detonation (determined by all the timing parameters) and

the route flown. For blast effects, the aircraft are located at time of shock arrival instead of time of detonation. The standard route is depicted in Figure 4 where distance to turn point (DTTP) is a specified parameter, and aircraft turn angles are computed by an algorithm which spaces the aircraft evenly through the escape sector.

A semi-circular escape route pattern was chosen as a default pattern for GETAWAY. This is believed to be more realistic than the traditional approach which uses a full circle, since alert force aircraft are generally restricted to a northerly departure heading to be able to complete their missions. The user has the option of choosing any sector size. Figure 4 depicts a North-South runway which was chosen as the standard base with a fixed north take-off. Choosing this standard base configuration corresponds to the assumption of enemy knowledge of the active runway, turn point location, and escape sector pattern, and eliminates the base and runway configuration as a variable in the model.

Attack Pattern. The attack pattern is determined by an algorithm which depends on the number of bursts, the size of the escape sector, and the positions of the first aircraft at last detonation (FALD) and the last aircraft at first detonation (LAFD). If the LAFD is not past the turn point, the algorithm determines the number of aircraft between the brake release point and the turn point and allocates one weapon per aircraft in an evenly spaced

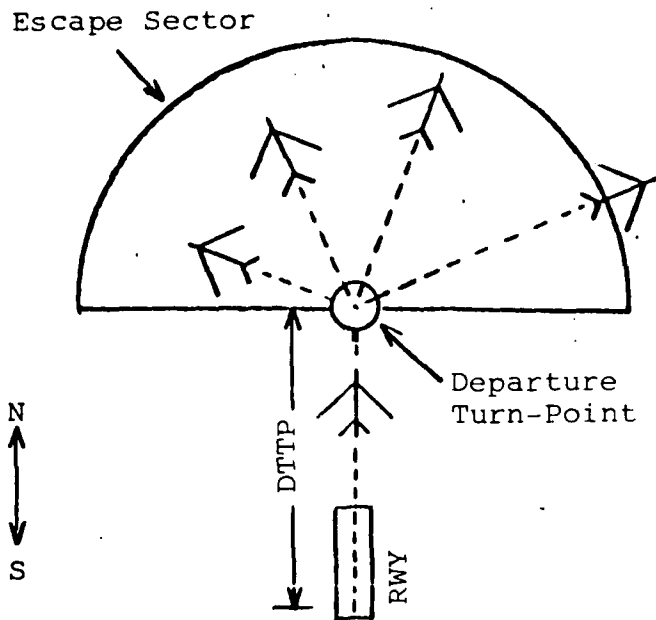
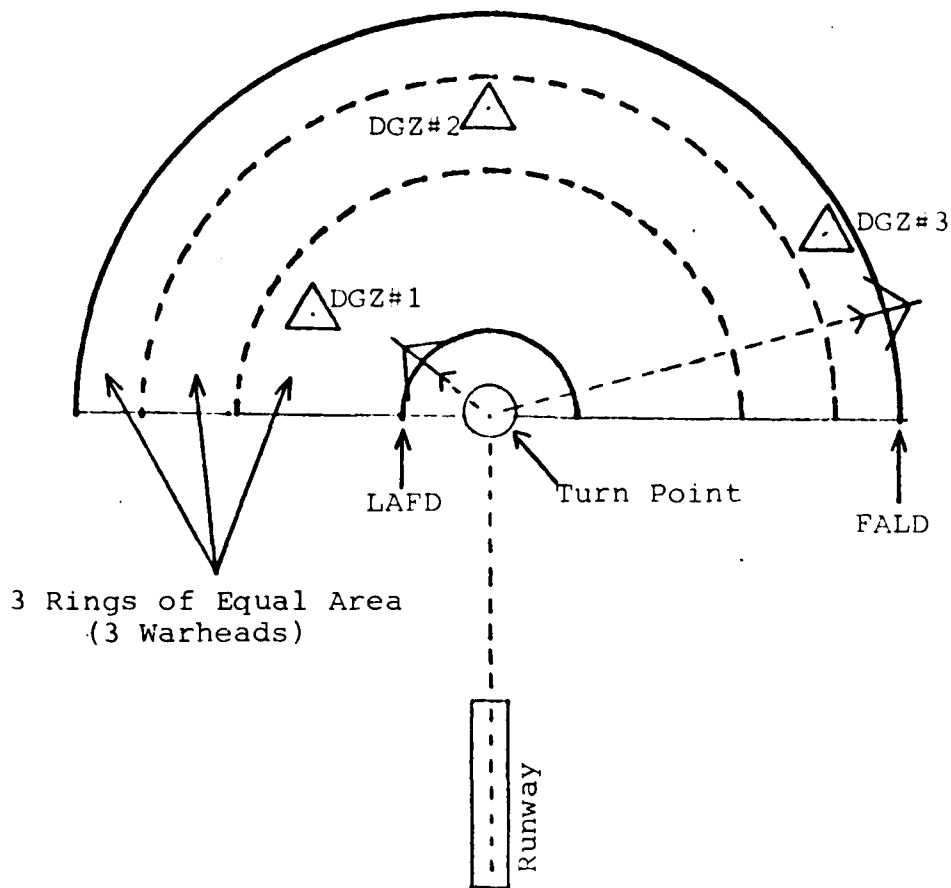

Figure 4. Standard Base With Escape Route

pattern between the turn point and the runway. The remaining weapons are evenly spaced in the escape sector between the turn point and the FALD. If the LAFD is past the turn point, all weapons are evenly spaced in the annulus in the sector between LAFD and FALD. This even spacing is determined by cutting the annulus into rings of equal area and then placing one weapon in each ring, spaced by angle in the sector, similar to the aircraft turn angle algorithm (see Figure 5). This even spacing gives the attack pattern the characteristics of the traditional, evenly distributed attack assumed by the vulnerability



FALD = First Aircraft at Last Detonation
 LAFD = Last Aircraft at First Detonation

Figure 5. Attack Pattern by Algorithm
 for Three Detonations (LAFD Past Turn Point)

envelope approach discussed in the background section.

Computation of Weapon Effect Intensities

After the aircraft and detonations are located at
 detonation time (shock arrival time for blast effects),

GETAWAY computes the blast, thermal, and radiation effect intensities actually experienced by each aircraft.

Blast (Overpressure/Gust). Overpressure at the aircraft is computed using empirical formulas derived by Horizons Technology, Inc. (Ref 7). These formulas are empirical fits to nuclear blast curves contained in Capabilities of Nuclear Weapons EM-1 (see Figures 6 and 7) and calculate overpressure both in and out of the mach stem. A summary of the HTI equations is contained in Appendix B. The goodness of fit of these formulas has been verified by Potochi (Ref 9).

Shock wave gust velocity is computed directly from overpressure using the Rankine-Hugoniot relations (Ref 10: 56-58). Next, the shock gust and aircraft velocity vectors are resolved to obtain side gust experienced by the aircraft at altitude. Finally, this side gust at altitude is converted to side gust at sea level relative to constant dynamic pressure (Ref 11:9-14).

Thermal. Thermal fluence (cal/cm²) perpendicular to the aircraft fuselage is computed using the following equation:

$$F = \frac{S\tau \cos\theta}{4\pi R^2} \quad (2)$$

where:

- S = Thermal energy transmitted
- θ = Fuselage incidence angle
- τ = Atmospheric transmittance factor
- R = Slant range from detonation to aircraft

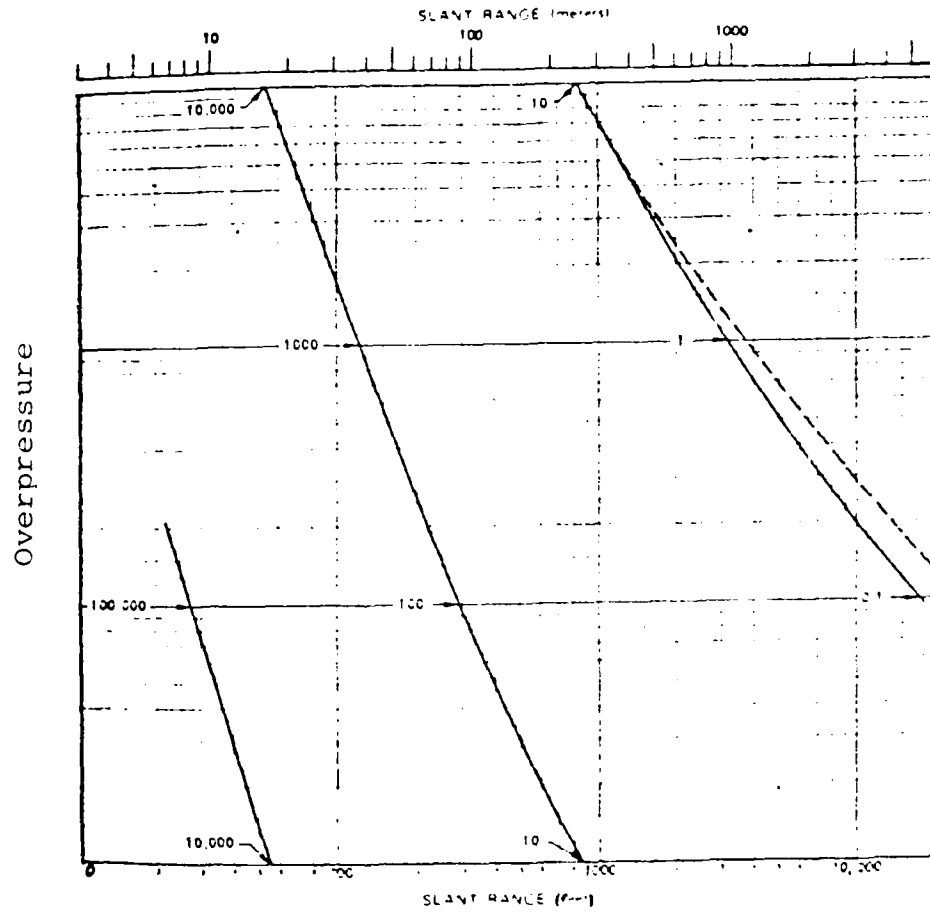

Figure 6. Peak Overpressure from a One (1) kt Free Air Burst in a Standard Sea Level Atmosphere (Ref 8:17)

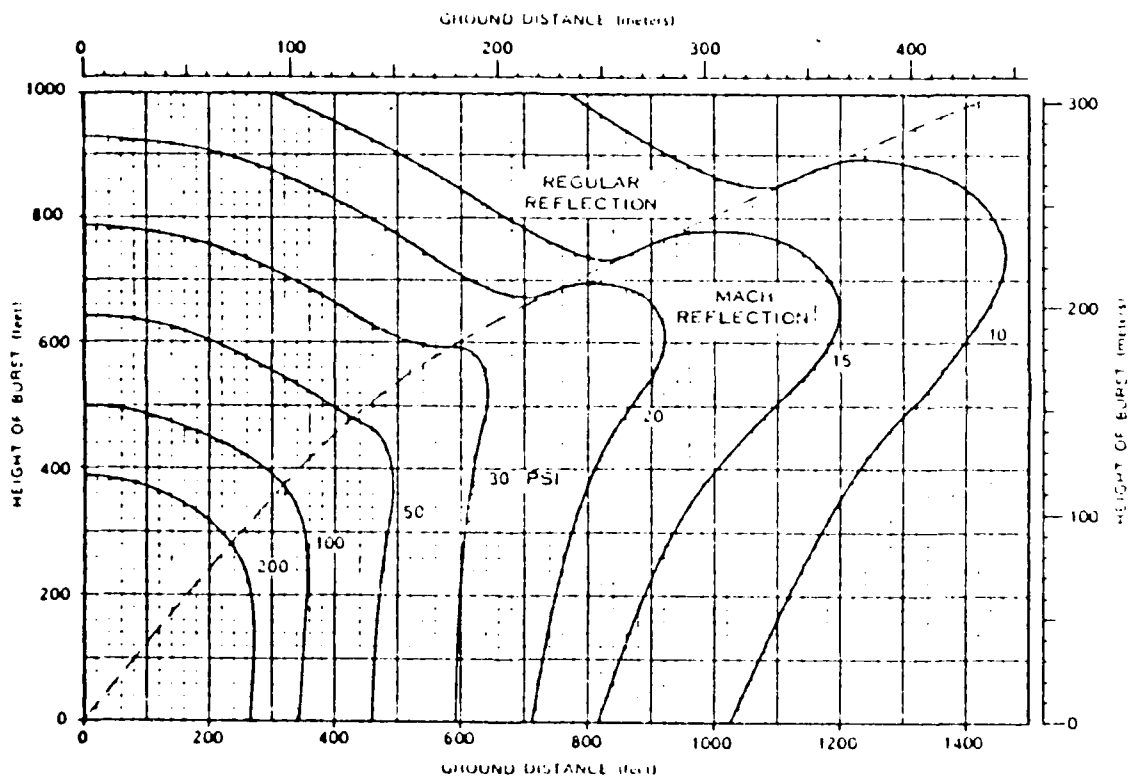

Figure 7. Peak Overpressures at the Surface
 for a One (1) kt Burst Over a
 Near-Ideal Surface,
 High Overpressure Region
 (Ref 8:22)

This equation accounts for the total thermal energy and for atmospheric attenuation, but neglects the reality that the aircraft moves over the time period of thermal transmittance. GETAWAY solves this problem by numerically integrating the time derivative of equation (2) over the effective time of thermal transmittance. That is:

$$F = \int_T \frac{\dot{S}(t) \tau \cos(\theta(t))}{4\pi R(t)^2} dt \quad (3)$$

where:

$\dot{S}(t)$ = Thermal power as a function of time
 $\theta(t)$ = θ as a function of time
 $R(t)$ = Range as a function of time
 T = Effective time of thermal transmittance

Figure 8 is the basis for the numerical integration where T is taken at $t/t_{\max} = 10$, the normalized time period where 80% of the thermal energy has been transmitted. GETAWAY performs a trapezoidal integration of equation (3) over the ten time intervals indicated in Figure 8 to obtain the cumulative cal/cm² incident on the aircraft fuselage.

Radiation. GETAWAY computes four radiation effects at each aircraft from each burst:

- Prompt neutron and gamma tissue dose (rads tissue)
- Prompt neutron and gamma equipment dose (rads silicon)
- Prompt gamma equipment dose rate (rads-silicon/sec)
- Prompt neutron fluence (on^1/cm^2)

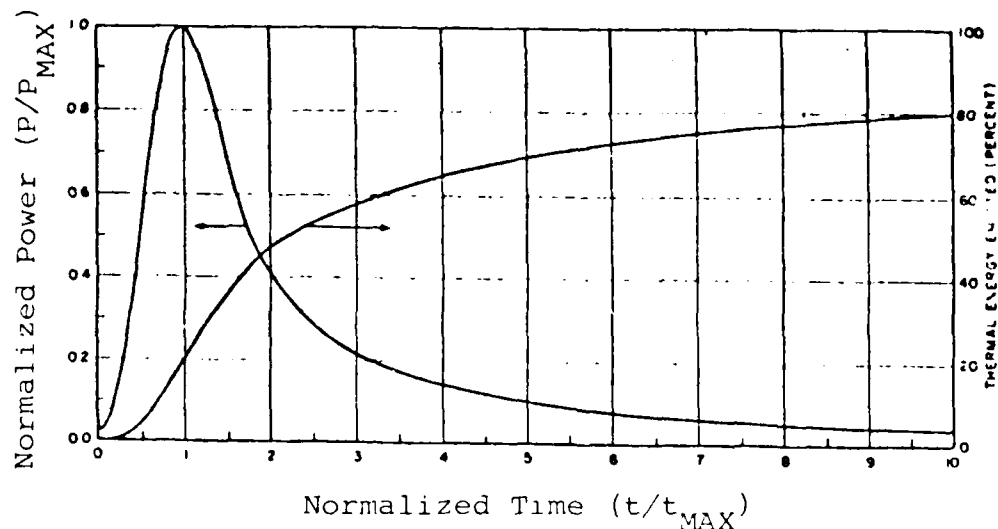

Figure 8. Normalized Thermal Power and Energy
for an Airburst below 100,000 Feet
(Ref 10:311)

These doses, rates, and fluences are computed from empirical fits to one-dimensional homogeneous air transport data generated from mass integral scaling of ANISIN transport results (Ref 12:28). The fit equations are of the form:

$$\ln(4\pi R^2 \text{Dose}) = A+Bx+Cx^2+Dx^{3/2}+Ex^{1/2}+Fx^{1/3}+G \ln x \quad (4)$$

where x is the atmospheric mass integral in gm/cm^2 between the weapon and the aircraft (distance R). The coefficients A through G fit the equation to the specified radiation effect for the selected radiation source. GETAWAY uses coefficients for two unclassified fission and thermo-nuclear sources provided by Harry L. Murphy of Air Force Weapons Laboratory and used in FLEE, a Monte Carlo base escape model (Ref 5). Figure 9 is an example of a homogeneous ANISIN fit produced by the above equation (Ref 12:55).

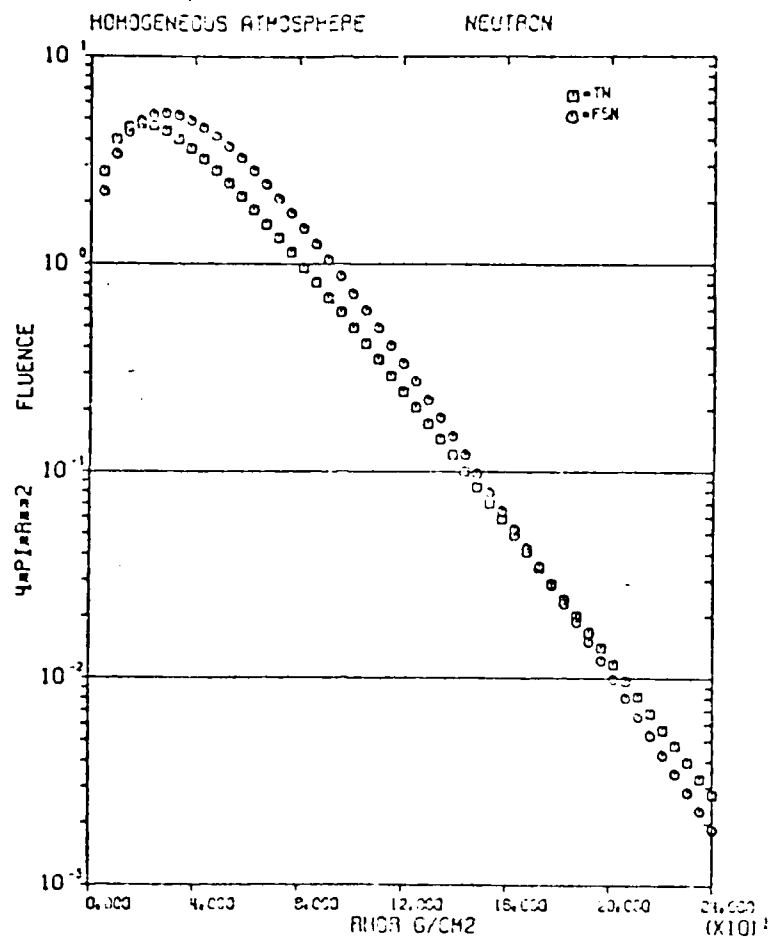

Figure 9. Homogeneous ANISIN Curve Fit (Ref 12)

Determination of Probability of Survival

After computing the blast, thermal, and radiation intensities experienced by each aircraft, GETAWAY uses log-normal damage functions to compute probability of survival for each effect encountered. These probabilities are compounded to obtain individual aircraft and average fleet probabilities of survival.

Log-Normal Damage Function. GETAWAY uses log-normal damage functions where a weapon effect intensity equal to

sure-safe is defined as $P_s = .98$ and a weapon effect intensity equal to sure-kill is defined as $P_s = .02$ (see Figure 10). The application of log-normal damage functions to nuclear weapon effects is based on reliability theory and is substantiated in a study by Kelley (Ref 13:1). Sure-safe and sure-kill values for each weapon effect are input parameters in GETAWAY, and they are used directly to define the damage functions each time an attack is modeled. All probability of survival calculations begin by using these damage functions to calculate the probability of one aircraft surviving the weapon effect intensity experienced from one detonation.

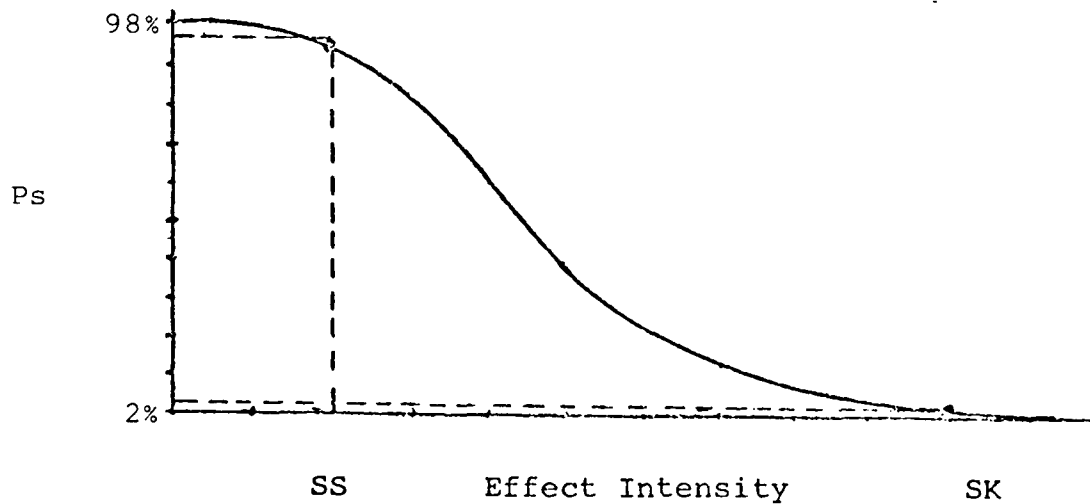

Figure 10. Cumulative Log-Normal
Damage Function
(See Appendix E)

Individual Aircraft and Fleet Survivability. GETAWAY

uses a ten cell circular normal quadrature scheme to include the uncertainty of detonation position (CEP) in the determination of probability of survival. Each incoming warhead is modeled as ten detonations, with one detonation occurring at each effective cell center point of the ten cell model (see Figure 11). The effective cell center point is defined as the expected value (average) of (ρ, θ) for each cell such that the probability of hitting in any of the ten cells is equally likely (0.1). The polar coordinates of each effective cell center point are determined by a circular normal quadrature scheme discussed in Appendix C.

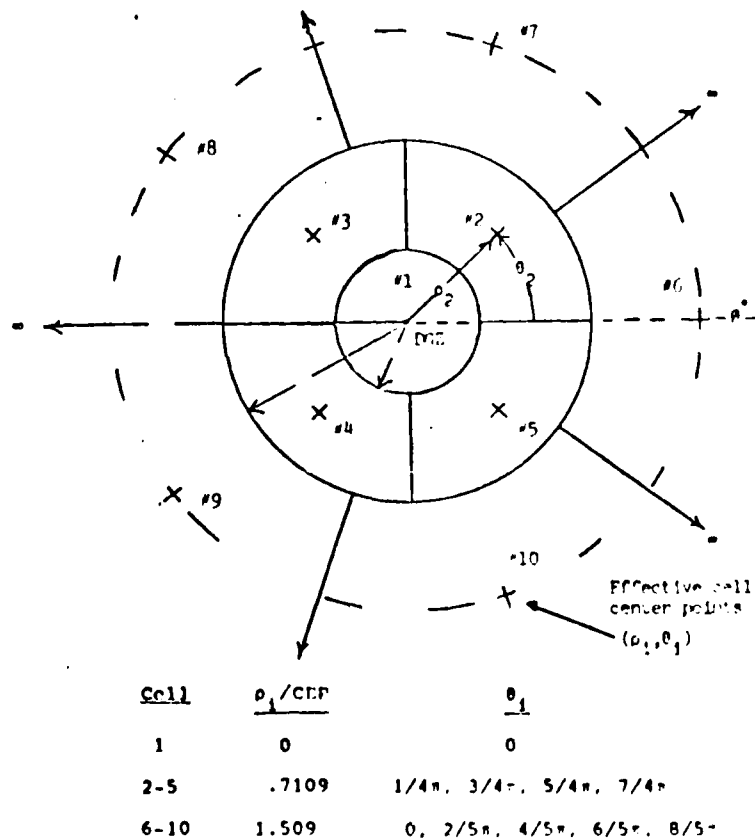

Figure 11. Ten Cell Model

GETAWAY then treats each weapon as ten detonations, and averages (finds the expected value of) the probability of surviving each of the ten detonations to calculate the probability of one aircraft surviving the effects from the one weapon. The probability of surviving one of the ten equally likely detonations is simply the product of the probabilities of surviving each effect, derived from the log-normal damage functions. Mathematically, the probability that aircraft i survives weapon j is:

$$\begin{aligned}
 P_{s_{i,j}} &= \sum_{k=1}^{10} P(\text{impact in cell } k) P(\text{survive/impact cell } k) \\
 &= \frac{1}{10} \sum_{k=1}^{10} \left(\prod_{h=1}^7 P_{se_{k,h}} \right) \quad (5) \\
 &\quad \text{(cells) (effects)}
 \end{aligned}$$

where $P_{se_{k,h}}$ is the probability of surviving effect h from a detonation in cell k . The P_{se} 's are derived from the log-normal damage functions after computing weapon effect intensities for a detonation at the corresponding cell center.

The probability of aircraft i surviving all weapons j is the product of surviving each of B weapons:

$$P_{s_i} = \prod_{j=1}^B P_{s_{i,j}} \quad (6)$$

The average fleet survivability, P_{s_f} , is calculated by averaging the survivability, P_{s_i} , of all N aircraft:

$$P_{s_f} = \frac{\text{Exp \# Survive}}{\text{Total \# Aircraft}} = \frac{\sum_{i=1}^N P_{s_i}}{N} \quad (7)$$

P_{s_f} is the expected percentage of the fleet surviving the entire attack.

GETAWAY also calculates aircraft and fleet probability of surviving each weapon effect. These Pe_s values are calculated in the same manner as for the combined effects $P_{s_{i,j}}$ discussed above. For each weapon effect e, average fleet survivability is:

$$Pe_{s_f} = \frac{1}{N} \sum_{i=1}^N \prod_{j=1}^B \left(\frac{1}{10} \sum_{k=1}^{10} P_{se_{k,e}} \right) \quad (8)$$

aircraft weapons cells

The individual effect Pe_s values are useful for assessment during parametric studies, but they should not be used when assessing overall fleet survivability, since the average fleet survivability is not the product of the average Pe_s for each effect. This caution also extends to using individual effect Pe_s values when assessing overall survivability for a single aircraft since the individual effect Pe_s values are averaged over ten cells when $Pe_{s_{i,j}}$ is computed.

IV. Example Demonstration

The Survivability/Vulnerability Branch of Aeronautical Systems Division was interested in studying the effect of thermal reflectivity on alert force aircraft during a base escape scenario. They provided us with the following parametric problem.

Parametric Problem

What benefit (in terms of P_s) would be derived from an increase in thermal reflectivity on the fuselage of an escaping aircraft? The study was conducted using the following set of parameters (see Table III).

TABLE III
Parameter Values

Escape		Threat	
Number of Aircraft	14	Missile Flight Time	500 sec
Reaction Time	300 ₀ sec	Number of Bursts	20
Escape Sector	180 ^o	Detonation Interval	8 sec
Take-off Interval	12 sec	Yield	250 KT
Profile	Medium	Height of Burst	2000 ft
Distance to Turn Point	5 NM	Circular Error	1.0 NM
		Probable	
		Type of Weapon	Thermonuclear
Hardness			
	<u>SS</u>	UNDER STUDY	<u>SK</u>
THERMAL (cal/cm ²)			
Overpressure	1.5 psi		5.0 psi
Gust	50 fps		160 fps
Tissue Dose	10 rads-tissue		50 rads-tissue
Equipment Dose	2.00E + 03 rads-silicon		5.00E + 03 rads-silicon
Gamma Dose Rate	1.00E + 06 rads-silicon		1.00E + 08 rads-sil/sec
Neutron Fluence	1.00E + 06 ₀ n ¹ /cm ²		1.00E + 12 ₀ n ¹ /cm ²

The area of interest was an increase in thermal reflectivity up to .65. Given an initial thermal hardness of 20 cal/cm², this corresponds to an increase in thermal hardness from 20 to 57.1 cal/cm² as illustrated in Table IV.

TABLE IV
Thermal Reflectivity

Increase of Thermal Reflectivity	Cal/cm ²
0	20
.1	22.2
.2	25.0
.	.
.	.
.	.
.	.
.	.
.	.
.65	57.1

GETAWAY was run using the parameters listed in Table III. Thermal sure-kill was varied from 20 to 60 cal/cm² while sure-safe was held constant at 20 cal/cm².

Results

The results of the study are depicted below. Figure 12 displays the average fleet probability of survival (P_s) results and Figure 13 shows the effect on P_s for aircraft #7, selected from the fleet as a representative aircraft.

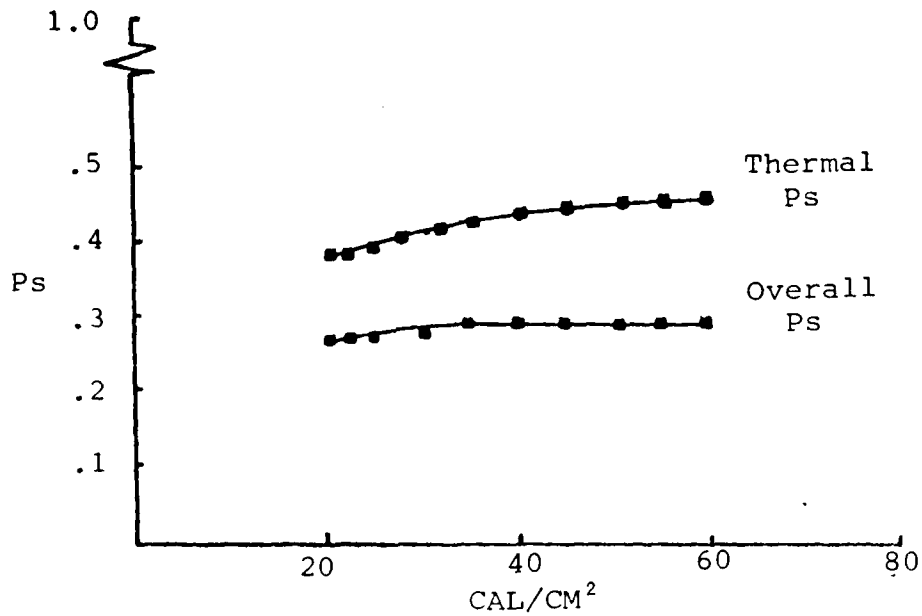

Figure 12. Average Fleet Survivability For 14 Aircraft, 20 Bursts

(For a thermal reflectivity increase of 20 to 60 cal/cm² sure-kill, the overall P_s increases from .27 to .29 and thermal survivability increases from .38 to .47.)

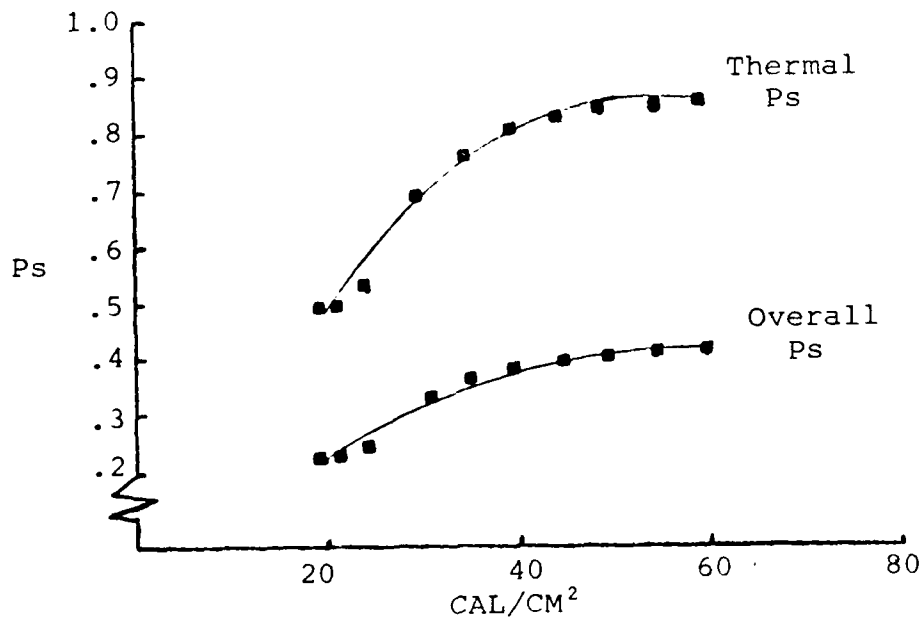

Figure 13. Aircraft #7, Survivability Plot

(For a thermal reflectivity increase of 20 to 60 cal/cm² sure-kill, the overall P_s increases from .24 to .41 and thermal survivability increases from .50 to .86.)

Overall fleet probability of survival (P_s) increased from .27 to .29 (+ .02) when thermal reflectivity was increased by a factor of .1 to .65. However, the average survivability for thermal increased from .38 to .47 (+ .19). The difference between the increase in overall survivability and thermal survivability (.02 versus .19), illustrates the importance of balanced hardness in aircraft design. Similar results are depicted in Figure 13 for aircraft #7.

For this particular scenario, the results suggest that an increase in fuselage thermal reflectivity is not warranted, unless other hardness characteristics are increased in a balanced manner.

V. Model Analysis

A substantial effort was made to verify that GETAWAY functioned as planned, to validate its utility as a parametric base escape survivability model, and to analyze its sensitivity to the model parameters.

Verification

GETAWAY consists of 47 sub-programs; 28 associated with the interactive input, output, and decision structures and 19 associated with the scenario modeling and the determination of probability of survival. The operation of the interactive routines was verified by exercising all user options and by ensuring that input, output, and program operations were consistent with the options selected. The scenario modeling and survivability routines were verified as they were developed. Some of the weapon effect routines had been written as part of class work at AFIT and had already been verified with an established validation case. All other routines were checked by hand calculations.

The final verification phase was accomplished after all the routines were assembled in the program. One complete run of GETAWAY was made which listed all aircraft and weapon location data, weapon effect intensities, and probability of survival results. This listing was used to verify that GETAWAY in its final form, performed as expected.

Validation

GETAWAY was validated by investigating how well it satisfied the criteria for solution to the problem as presented in the introduction. That is, the new model was to be easy to use, economical in terms of cost and time, and was to provide parametric results reasonably comparable to current models used by ASD/ENFTV.

GETAWAY was developed specifically to make parametric base escape survivability analyses easy to perform. Its success in this area is best judged by ASD/ENFTV's reaction to their initial hands on experience. We provided a preliminary copy of GETAWAY to ASD/ENFTV during model development to obtain their comments. Their reaction was very favorable. They also provided some suggestions to further enhance the usability of the program. These suggestions have been incorporated into the final version of GETAWAY.

Another objective of GETAWAY was to reduce the time and cost involved in conducting parametric studies. Table V presents a comparison of the CPU time and turnaround time required by GETAWAY, FLEE, and QUANTA to conduct the parametric study discussed in the previous section.

TABLE V
Time Comparison

MODEL	CPU (Cost)	TURNAROUND
GETAWAY	20 seconds	15 minutes
FLEE	3600 seconds	24 hours
QUANTA	200 seconds	24 hours

The times for FLEE and QUANTA are estimates based on other validation runs since the actual study was not performed with FLEE or QUANTA. By considering cost proportional to CPU time, it is easy to see GETAWAY's success at reducing the cost of parametric studies. The reduction in turnaround time is also quite evident. This is mostly a function of GETAWAY's interactive capability, since both FLEE and QUANTA are restricted to "late night runs" at the ASD installation because of CPU time and core memory requirements. These benefits of cost and time reduction would be meaningless unless the probability of survival results from GETAWAY compared favorably to results from FLEE and QUANTA.

To demonstrate this comparability of GETAWAY to QUANTA and FLEE, we performed an experiment involving average fleet base escape probability of survival. Twenty scenarios were chosen at random from a realistic range of input parameters and all three models were used to evaluate

average fleet probability of survival for each of the twenty scenarios. Then, for each scenario, a separate input parameter was selected, its value was arbitrarily changed, and fleet survivability was again evaluated by each model. The parameters being changed for each scenario were selected to enhance the comparison of parametric results as discussed in the next paragraph. The probability results predicted for the original scenarios and the projected change in survivability for the parameter changes are summarized in Table VI.

TABLE VI
Validation Results
Average Fleet Probability of Survival

Predicted Survivability				Change in Survivability		
*Scenario #/ Parameter Changed	QUANTA	FLEE	GETAWAY	QUANTA	FLEE	GETAWAY
1/HOB	.56	.71	.61	+.05	+.03	+.02
2/OP	.70	.86	.70	-.35	-.35	-.19
3/THRML	.75	.93	.73	-.06	-.16	-.03
4/RT	.70	.84	.77	-.10	-.06	-.03
5/DOI	.89	.94	.98	+.03	0.00	0.00
6/THRML	.95	.96	1.00	-.10	-.09	-.08
7/OP	.58	.79	.65	+.26	+.07	+.21
8/DTPP	.09	.63	.19	+.23	+.02	+.50
9/TOI	.07	.58	.51	0.00	-.13	-.30
10/NOAC	.40	.70	.40	-.09	-.08	-.01
11/SECT	0.00	.13	.22	0.00	+.28	0.00
12/YLD	.27	.64	.71	+.35	+.21	+.16
13/NPRO	.38	.64	.79	+.10	+.03	+.02
14/OP	.84	.92	.94	-.24	-.09	-.16
15/HOB	.31	.40	.56	-.02	-.03	-.08
16/RT	.26	.60	.23	+.09	+.05	+.10
17/TOI	.69	.91	.93	-.23	-.03	-.54
18/THRML	.27	.55	.43	0.00	0.00	-.01
19/OP	.01	.68	.21	+.11	+.15	+.30
20/DOI	.22	.54	.21	+.08	+.28	+.09

*See Appendix A, Table A-II, for parameter abbreviations.
See Appendix D for a full description of scenarios #1-20.

Table VII highlights the different aspects of GETAWAY, FLEE, and QUANTA which had to be accounted for in order to make the results of the comparisons as meaningful as possible.

TABLE VII
Model Differences

Aspect	GETAWAY	QUANTA	FLEE
Methodology	Analytical	Analytical	Simulation
Damage Functions	Log-Normal	Cookie Cutter	Cookie Cutter
Radiation	Yes	No	Yes
CEP	Yes	No	Yes

First, an attempt was made to reduce the variance in the simulation results of FLEE so that they would represent an accurate average, bracketed by as small a confidence interval as possible. This was done by fixing as constants as many parameters as possible for all the evaluations. For example, even though reaction timing and take-off interval can be stipulated as random variables in FLEE, they were input as constants equal to the expected value for each particular scenario. Aircraft turn angle and attack pattern were the only parameters treated as random variables. These were defined by uniform distributions with minimum and maximum values corresponding to appropriate

scenario parameters. Additionally, FLEE was run for 100 replications for each scenario to reduce the confidence intervals around the reported average fleet probability of survival. Second, GETAWAY was run in a cookie cutter mode which disregarded the log-normal damage functions so that GETAWAY results would be consistent with the cookie cutter methodologies of both QUANTA and FLEE. Finally, the parameters being changed for each scenario to perform the parametric comparisons were selected such that each parameter capable of being studied by all three models was changed at least once. Hardness and timing parameters were changed for several scenarios because these areas are of current interest in parametric studies. For example, for scenario #1, height of burst (HOB) was changed from 2000 to 1000 feet, for scenario #2, overpressure hardness (OP) was changed from 3.2 to 1.0 p.s.i., and so on. Radiation parameters and CEP were not selected to be changed since all three models are not capable of including these parameters. Radiation calculations were suppressed for all evaluations in GETAWAY and FLEE. Appendix D contains a full description of the scenarios, the parameter value changes made on each scenario, and full results from all 40 evaluations for all three models.

To validate GETAWAY as a useful tool for parametric base escape survivability analysis, we previously stated that it was necessary to demonstrate that results from GETAWAY are reasonably comparable to results obtained from

QUANTA and FLEE. A review of Table VI reveals a wide difference in the "Predicted Survivability" results from the three models, but shows a closer agreement in the "Change in Survivability" results. These results represent actual differences between the three models since GETAWAY and QUANTA are analytical models which produce expected value results. However, are these differences large enough to invalidate GETAWAY as a parametric tool?

We realized that standard statistical techniques could not be used to draw statistical conclusions about this question of comparability. This is because the results obtained from the experiment for the most part are analytical and non-stochastic in nature. The differences indicated in this data represent actual differences in the models.

However, because of a lack of a more accepted method of comparing results from analytical models, we used a Complete Block Design ANOVA and a Matched Pairs t-Statistic to give us some means of comparing results from the three models. This was done realizing that the statistics from these two approaches would only give us an indication about the size of the differences in model results for our specific sample and could not be used as statistical evidence about the comparability of the models in general.

As long as this limitation is recognized, a CBD-ANOVA model can give us an indication about how significant the actual differences in the models are. By sampling over a

range of randomly selected scenarios and then using the Complete Block Design to block out the differences in the results attributable to the scenarios, the F statistic from the ANOVA model:

$$F = \frac{\text{Mean Square Model Effects}}{\text{Mean Square Error}} \quad (10)$$

can be used to characterize the significance of the differences of the three models' effects on predicting average fleet probability of survival and on projecting parametric changes in survivability. Furthermore, a Matched Pairs t-Statistic can also be used to make pairwise comparisons (Ref 15:466) between the models, as long as the same non-stochastic realization is made.

Table VIII summarizes the CBD-ANOVA for the "Predicted Survivability" results and indicates a significant difference between the three models. A Matched Pairs t-Statistic comparison was performed to evaluate the pairwise differences in the models for "Predicted Survivability". The results summarized in Table IX indicate a significant difference between all pairwise comparisons, highlighting the largest difference between QUANTA and FLEE and the smallest difference between FLEE and GETAWAY.

TABLE VIII
ANOVA for Predicted Survivability

Source of Variation	Sum of Squares	Degrees of Freedom	Mean Square	F	Significance of F
Models (Main Effects)	.631	2	.316	21.24	.001
Scenarios (Block Effects)	3.472	19	.183	12.30	.001
Error	.565	38	.015		
Total	4.668	59			

TABLE IX
Pairwise Comparisons - Predicted Survivability
Matched Pairs t-Statistic

Comparison	t-Statistic	$t_{.025,19}$	Results
QUANTA vs FLEE	6.5	> 2.09	Significant Difference (.00001)
GETAWAY vs QUANTA	3.7	> 2.09	Significant Difference (.0005)
GETAWAY vs FLEE	2.5	> 2.09	Significant Difference (.02)

(Note: t-Statistic(X1 vs X2): $D_i = X1_i - X2_i; t = \frac{\bar{D}}{S_D/\sqrt{n}}$)

The ANOVA analysis of the "Change in Survivability" results is presented in Table X. There is a striking difference between these ANOVA results and those for the "Predicted Survivability" data. The "Change in Survivability" ANOVA gives a significant indication of no difference in the three models when used for projecting parametric changes in average fleet survivability. This is strong evidence for GETAWAY's utility as a parametric tool for base escape survivability analysis since the results indicate a high comparability between parametric results from the three models.

TABLE X
ANOVA for Change in Survivability

Source of Variation	Sum of Squares	Degrees of Freedom	Mean Square	F	Significance of F
Models (Main Effects)	.001	2	.000	.024	.976
Scenarios (Block Effects)	1.377	19	.073	5.18	.001
Error	.482	38	.013		
Total	1.860	59			

Although not needed to establish comparability, the Matched Pairs t-Statistic comparisons summarized in Table XI add strength to the appearance of no difference between the models when used for parametric projections and highlight

the smallest difference between QUANTA and FLEE and the largest (but still small) difference between GETAWAY and QUANTA.

TABLE XI
 Pairwise Comparisons - Change in Survivability
 Matched Pairs t-Statistic

Comparison	t-Statistic	$t_{.025,19}$	Results
QUANTA vs FLEE	.001	2.09	No Significant Difference (.999)
GETAWAY vs QUANTA	.24	2.09	No Significant Difference (.8)
GETAWAY vs FLEE	.16	2.09	No Significant Difference (.85)

In summary, we can conclude that parametric results from GETAWAY appear highly comparable to parametric results from QUANTA and FLEE; however, predictive results do not appear reasonably comparable between any of the three models. This conclusion substantiates GETAWAY's intended utility as a tool for parametric base escape survivability analyses and emphasizes that for predictive purposes, the higher fidelity approaches of vulnerability envelopes used in QUANTA or Monte Carlo simulation used in FLEE are probably more appropriate.

Sensitivity Analysis

Although the statistical analysis helped evaluate the differences between GETAWAY, FLEE, and QUANTA, it did not explain why some of the more extreme results indicated on both sides of Table VI occurred. By examining the results in light of the scenarios, some trends in both the "Predicted Survivability" and "Change in Survivability" results are evident.

Scenarios numbered 8, 9, 10, 12, 13, 16, 19, and 20 show the greatest variance in the "Predicted Survivability". A review of these scenarios reveals that they all involved combinations of distance to turn point and reaction timing which trapped a large portion of the escaping aircraft between the base and the turn point. Under these conditions, FLEE predicted a much higher probability of survival than QUANTA and GETAWAY. This was because the uniform random attack pattern used in FLEE for the comparison runs takes no account of the number of aircraft between the base and the turn point whereas, both QUANTA and GETAWAY optimize the attack on this area if timing suggests a large number of aircraft are between the base and the turn point. Differences between QUANTA and GETAWAY during this situation are attributable to QUANTA's optimization routine which is more effective than GETAWAY's targeting algorithm. The scenarios with the most comparable results (#1, 2, 4, 5, 6, 14) were generally well balanced in respect to number of aircraft past the turn point, aircraft to warhead

ratio, and aircraft spacing.

Scenarios numbered 8, 9, 11, and 17 show the largest differences in "Change in Survivability" results. Again, these scenarios all involved the majority of aircraft inside the turn point and a parameter value being changed which affected the targeting algorithm, such as distance to turn point, reaction timing, sector width, or aircraft spacing. Conversely, for those scenarios where hardness and threat parameters were changed, the "Change in Survivability" results projected by the three models were highly comparable, regardless of the attack pattern.

In general, for balanced scenarios (majority of aircraft past the turn point, a nearly one-to-one aircraft to warhead ratio, and normal aircraft spacing), the "Predicted Survivability" results from GETAWAY, QUANTA, and FLEE can be very comparable. Additionally, projected "Change in Survivability" results should be highly comparable between the three models except in certain scenarios which accentuate the different attack pattern algorithms used in GETAWAY, QUANTA, and FLEE.

Of course, these conclusions are based on a somewhat limited sample size and limited range of scenarios. Resources did not permit increasing the number of runs of QUANTA and FLEE much beyond the 40 replications required for this analysis. As GETAWAY is used for parametric studies, the nature of these sensitivities will become more apparent. Additional sensitivity analysis could be

performed if comparability between GETAWAY and either QUANTA or FLEE became more of a critical issue. This analysis has been concerned with validating GETAWAY as a new tool for conducting parametric base escape survivability analysis which gives results reasonably comparable to current models. The utility of GETAWAY as such a tool has been clearly demonstrated.

VI. Conclusion

The objective of this thesis was to develop a base escape survivability model specifically designed for conducting parametric studies. These studies should evaluate alert force base escape survivability while varying parameters in the areas of hardness specifications, threat scenarios, and base escape tactics. The new base escape survivability model was not to be a replacement for pre-launch survivability models currently being used by ASD/ENFTV. Instead, the model was meant to solve some of the problems of usability and economy associated with the current models when conducting parametric analyses.

GETAWAY satisfies the above stated objectives. It is an effective model for conducting parametric base escape survivability analyses. Although it may lack the predictive fidelity of current models which use cookie cutter vulnerability envelopes or Monte Carlo simulation, GETAWAY is an excellent alternative for parametric analyses because it provides parametric results highly comparable to the current models while reducing cost, increasing speed and enhancing usability. GETAWAY is particularly useful for assessing the balance of aircraft hardness in respect to the separate nuclear blast, thermal, and radiation weapon effects.

Recommendations

The direct encounter approach of GETAWAY computes weapon effect intensities at each aircraft and derives aircraft probability of survival from cumulative log-normal damage functions. Although this approach is applied to base escape survivability under SLBM attack, it could have much broader application in many areas of nuclear survivability analysis. In particular, the methodology of GETAWAY could easily be adapted to base escape under ICBM attack, ICBM survivability, or naval and ground forces survivability.

This study pointed out the differences of GETAWAY when compared to QUANTA and FLEE when used to predict average fleet base escape survivability. It identified some scenario-based sensitivities which affect this comparison of survivability predictions and demonstrated that for a narrow range of balanced scenarios, the comparison of prediction results was quite good. We suggest further study in this area if predictive results more comparable to one of the other two models are of interest. Such a study could further identify the sensitivities involved and suggest changes to GETAWAY's methodology that would expand the range of scenarios over which comparable results could be attained.

Another area for further development has been suggested by ASD/ENFTV. There is interest in studying what effect the assumption of enemy knowledge of escape timing

and routing has on predicted survivability. Specifically, they are interested in answering questions about the effect on predicted survivability when the enemy misjudges actual timing and routing parameters. GETAWAY could be modified to address these questions by adding additional parameters to the model. Although this would add to the memory requirements which are already near the interactive limit on the CYBER computer system, some of the interactive input/output options could be discarded or optimized to make room for the additional parameters and associated routines.

As noted above, GETAWAY is currently near the interactive central memory limit. Additionally, the interactive time limit is occasionally exceeded for lengthy parametric studies with large numbers of aircraft and warheads. Significant work could be done to reduce the size and time requirements of GETAWAY by optimizing the FORTRAN code. In its present form, GETAWAY was written to cover a wide range of options and much of the FORTRAN code was developed with readability rather than efficiency in mind. By reducing the time and memory requirements, GETAWAY could be implemented on a wider range of computers, including micro-computers. This could greatly expand application of GETAWAY to other areas of parametric survivability analysis.

One possible area for reducing GETAWAY's time and memory requirements would be to study the effect of remov-

ing the ten cell quadrature scheme from the model. This method of modeling delivery error (warhead CEP) requires significant run time since it replicates each warhead ten times. Delivery error considerations may not be critical to survivability analyses when studying area type targets as represented by an escaping fleet of aircraft. However, if GETAWAY's methodology were applied to point targets, such as ICBMs as discussed above, the manner in which delivery error is modeled would be much more relevant to the predicted survivability output.

One major asset of GETAWAY is its usability. It was developed to be used by analysts with limited experience in computer operations and a wide range of base escape survivability experience. The interactive capabilities of the model are aimed towards eliminating input errors and giving the operator ample opportunity to review the model parameters and scenario before the survivability runs are made. We realize this approach may be frustrating for those more experienced in computer model operations and an attempt was made to include as many options as possible; however, we were limited by the maximum core memory available. As a further refinement of GETAWAY, we suggest that each user modify the interactive aspects to best suit his needs.

References

1. AFM 1-1. Functions and Basic Doctrine of the United States Air Force. Washington, D. C.: HQ USAF/XOX, February 1979.
2. AFR 80-38. Management of the Air Force Survivability Program. Washington, D. C.: HQ USAF/RDQPN, September 1973.
3. Ward, Dudley C., Technical Representative, Survivability/Vulnerability Branch, Aeronautical Systems Division (personal interviews). Wright Patterson AFB, Ohio, 1982.
4. Defense Nuclear Agency. Handbook for Analysis of Nuclear Weapon Effects on Aircraft, Vol. I. Washington, D. C., 1976. (AD BO 12992L).
5. BDM Corporation. FLEE. 2 Users and Analyst Manual, BDM/TAC-77-54-TR-R1. Kirtland AFB, NM: Air Force Test and Evaluation Center, 12 February 1978.
6. QUANTA Users Manual. AFWL-TR-79-193. Kirtland AFB, NM: Air Force Weapons Laboratory, 1980.
7. Horizons Technology, Inc., Nuclear Weapons Effects Programs, HTI-78-R-109, 8 December 1978.
8. Donlan, Phillip J., Capabilities of Nuclear Weapons, SR1, DNA EM-1, 1 July 1972.
9. Potochi, Mark L. Evaluation of Five Nuclear Weapons Effects Programs Developed by HTI MS Thesis. AD A106388. Air Force Institute of Technology, Wright-Patterson Air Force Base, Ohio, March, 1981.
10. Glasstone, Samuel and Phillip J. Dolan. The Effects of Nuclear Weapons, Third Edition. Washington, D. C., U. S. Government Printing Office, 1977.
11. Patrick, Rayford P. Nuclear Hardness and Base Escape, Engineering Report No. S-112. Omaha, Nebraska: HQ SAC, 31 March 1981.
12. Kaman Sciences Corporation. High Altitude Atmospheric Radiation Transport Calculations. AFWL-TR-76-142. Kirtland AFB, NM: Air Force Weapons Laboratory, August 1976.

13. Kelley, C. Stuart. Distribution of Nuclear Damage Probability with Distance, HDL-TR-1866. Adelphi, Md.: Harry Diamonds Laboratories, August 1978.
14. Montgomery, Douglas C. Design and Analysis of Experiments. New York, New York: John Wiley and Sons, 1976.
15. Neter, John and William Wasserman. Applied Linear Statistical Models. Homewood, Illinois: Richard D. Irwin, Inc., 1974.
16. Abramowitz, Milton. Handbook of Mathematical Functions. Washington, D. C.: United States Government Printing Office 1964.

VITA

David F. MacGhee Jr. was born on 10 January, 1948 in Washington, D. C. He graduated from George C. Marshall High School in Falls Church, Virginia in 1966 and attended the United States Air Force Academy from which he received the degree of Bachelor of Science, International Affairs in June 1970. He completed pilot training and received his wings in July 1971. He has flown the T-38, F-111A, F-111F, the British Jaguar GR-1, and F-111E during his operational assignments in Texas, Nevada, and England. He served as the 20 Tactical Fighter Wing Mission Director until entering the School of Engineering, Air Force Institute of Technology, in August 1981.

Permanent address: 7303 Gordons Road
Falls Church, Virginia 22043

VITA

Charles P. Williams was born on 19 July 1948 in Denver, Colorado. He graduated from Littleton High School, Colorado, in 1966 and after four years in the United States Navy he attended the University of Colorado from which he received the degree of Bachelor of Arts, Mathematics, in 1974. Upon graduation, he received his commission in the United States Air Force through Officer Training School. After completing navigator training and receiving his wings in 1975, he served as a B-52 navigator/bombardier in the 337th Heavy Bombardment Squadron, Dyess Air Force Base, Texas until entering the School of Engineering, Air Force Institute of Technology, in August 1981.

Permanent address: 8152 West Quarto Drive
Littleton, Colorado 80123

Appendix A. User's Guide

Section I

Introduction. GETAWAY models an SLBM attack on a single strategic alert base and determines individual aircraft and average fleet probability of survival. It simulates the attack from the first SLBM launch to detonation of the last incoming warhead. As each warhead detonates, all aircraft are located and nuclear blast, thermal, and prompt radiation effects are calculated.

The probability of each aircraft surviving each weapon effect encountered during the attack is determined by comparing weapon effect intensities with cumulative log-normal damage functions defined by sure-safe and sure-kill specifications of aircraft hardness. The probability of each aircraft surviving the entire attack is calculated as the product of the probabilities of surviving all weapon effects encountered. Average fleet probability of survival is determined by using each aircraft's probability of survival to calculate the expected number of aircraft surviving.

The purpose of this User's Guide is to assist the GETAWAY user in performing parametric analysis of base escape survivability when varying 20 escape, threat, and hardness parameters (see Table A-I). The methodology of GETAWAY is described in the main report to which this guide is an appendix. That report points out GETAWAY's

TABLE A-I
GETAWAY Parameters

Escape Parameters	Threat Parameters	Hardness Parameters
#1 Number of Aircraft #2 Reaction Time #3 Escape Sector Width #4 Take-off Interval #5 Escape Profile Number #6 Distance to Turn Point	#7 Missile Flight Time #8 Number of Bursts #9 Detonation Interval #10 Yield #11 Height of Burst #12 Circular Error Probable #13 Type of Warhead	#14 Overpressure #15 Side Gust at Sea Level #16 Thermal Fluence #17 Tissue Dose #18 Silicon Dose #19 Gamma Dose Rate #20 Neutron Fluence

limitations as a model for predicting base escape survivability and establishes its capabilities as a tool for parametric studies. This guide assumes the user is familiar with the main report.

GETAWAY is written in ANSI Standard FORTRAN 77 and is currently implemented on the CDC CYBER 750. It compiles and loads under INTERCOM Version 5.0 with 56200_g core memory required. It is intended as a fully interactive program but can be run as a batch job with some difficulty.

Parameter Definitions and Default Values. GETAWAY is designed specifically as an interactive program which allows the analyst to study the parametric effect that changes in the model parameters have on alert force base escape survivability.

There are 20 parameters under control of the user.

They are in three general categories:

Escape parameters
Threat parameters
Hardness parameters

These 20 parameters, their abbreviations, and the default values for the initial scenario are outlined in Table A-II. The 20 parameters are fully defined below. Table A-III contains the time, range, and altitude description of the four default departure profiles available in GETAWAY.

THERE ARE 6 ESCAPE PARAMETERS

- #1 NUMBER OF AIRCRAFT (1 TO 20)
NUMBER OF A SINGLE TYPE AIRCRAFT ON FULL ALERT STATUS
AT THE SINGLE ESCAPE BASE
- #2 REACTION TIME (SEC)
TIME FROM 1ST SLBM BREAKWATER TO THE 1ST AIRCRAFT
RELEASING BRAKES FOR TAKEOFF
- #3 ESCAPE SECTOR WIDTH(DEG)
WIDTH OF THE ESCAPE SECTOR CENTERED AT THE TURN POINT.
- #4 TAKE-OFF INTERVAL (SEC)
CONSTANT TIME INTERVAL BETWEEN LAUNCHING
ALERT AIRCRAFT AFTER FIRST AIRCRAFT TAKES OFF
- #5 ESCAPE PROFILE(#1-4:DEFAULT,#5&6:USERS)
A TIME/DISTANCE/ALTITUDE PROFILE FLOWN BY ALL AIRCRAFT
AFTER TAKE-OFF. THE VALUE OF THIS PARAMETER (NPRO)
SELECTS WHICH OF 6 POSSIBLE PROFILES IS FLOWN.
REFER TO THE USERS MANUAL PG. XX FOR SPECIFIC
VALUES OF THE POINTS ON THE PROFILES.
- #6 DISTANCE TO TURN POINT (NM.)
DISTANCE FROM BRAKE RELEASE POINT TO DEPARTURE TURN POINT

THERE ARE 7 THREAT PARAMETERS

- #7 MISSILE FLIGHT TIME (SEC)
TIME FROM FIRST SLBM LAUNCH TO FIRST DETONATING WARHEAD
- #8 NUMBER OF BURSTS (1 TO 20)
NUMBER OF WARHEADS TARGETED AT THE ESCAPING AIRCRAFT
- #9 DETONATION INTERVAL (SEC)
FIXED TIME BETWEEN DETONATING WARHEADS
- #10 YIELD (KT)
EACH WARHEAD HAS IDENTICAL YIELD
- #11 HEIGHT OF BURST (FEET MSL)
EACH WARHEAD DETONATES AT IDENTICAL ALTITUDE ABOVE SEA LEVEL
- #12 DELIVERY ERROR - CEP (NM)
ACCURACY OF WARHEAD DELIVERY ON DESIGNATED AIMPOINT
- #13 RADIATION TYPE (1=FISSION , 2=TN)
TYPE OF WARHEAD: 1 = FISSION
2 = THERMONUCLEAR

THERE ARE 7 HARDNESS PARAMETERS

- #14 OVERPRESSURE HARDNESS SPECIFICATION
SURE-SAFE(SS) & SURE-KILL(SK) A/C HARDNESS TO OVERPRESSURE
- #15 GUST HARDNESS SPECIFICATIONS
SURE-SAFE(SS) & SURE-KILL(SK) AIRCRAFT HARDNESS TO GUST
SPECIFIED IN FEET PER SECOND SIDE GUST AT SEA LEVEL ALTITUDE
- #16 THERMAL HARDNESS SPECIFICATIONS
SURE-SAFE(SS) & SURE-KILL(SK) AIRCRAFT HARDNESS TO
THERMAL RADIATION FLUENCE IN CALORIES PER SQUARE CENTIMETER
- #17 AIRCREW RADIATION HARDNESS SPECIFICATIONS
SURE-SAFE(SS) & SURE-KILL(SK) AIRCREW HARDNESS TO GAMMA AND
NEUTRON TOTAL RADS-TISSUE DOSE
- #18 EQUIPMENT RADIATION HARDNESS SPECIFICATIONS
SURE-SAFE(SS) & SURE-KILL(SK) ELECTRONIC EQUIPMENT HARDNESS
TO GAMMA AND NEUTRON RADIATION IN TOTAL RADS-SILICON
- #19 EQUIPMENT DOSE RATE HARDNESS SPECIFICATIONS
SURE-SAFE(SS) & SURE-KILL(SK) ELECTRONIC HARDNESS TO GAMMA
DOSE RATE IN RADS-SILICON PER SECOND
- #20 AIRCRAFT NEUTRON FLUENCE HARDNESS SPECIFICATIONS
SURE-SAFE(SS) & SURE-KILL(SK) AIRCRAFT HARDNESS TO NEUTRON
FLUENCE IN NUETRONS PER SQUARE CENTIMETER

TABLE A-II.- PARAMETER ABBREVIATIONS AND DEFAULT VALUES

ABBREVIATIONS:

PSTUDY - CURRENT PARAMETER UNDER STUDY

ESCAPE PARAMETERS #1 - #6

- #1-NOAC - NUMBER OF AIRCRAFT(1-20)
- #2-RT - REACTION TIME(0-900 SEC)
- #3-SECT - ESCAPE SECTOR WIDTH(0-360 DEG)
- #4-TOI - TAKE OFF INTERVAL(0-300 SEC)
- #5-NPRO - PROFILE NUMBER(#1-4:DEFAULT, #5&6:USERS)
- #6-DTTP - DISTANCE TO TURN POINT(0-20 NM.)

THREAT PARAMETERS #7 - #13

- #7-MFT - MISSILE FLIGHT TIME(0-900 SEC)
- #8-NB - NUMBER OF BURSTS(1-20)
- #9-DOI - DETONATION INTERVAL(0-120 SEC)
- #10-YLD - YIELD(1-10000 KT)
- #11-HOB - HEIGHT OF BURST(0-90000 FEET)
- #12-CEP - CIRCULAR ERROR PROBABLE(0-5 N.M.)
- #13-ITYPE - TYPE WARHEAD(1:FISSION, 2:THERMONUCLEAR)

HARDNESS PARAMETERS #14 - #20

- #14-OP - OVERPRESSURE(0-20 PSI)
- #15-GUST - FT/SEC SIDE GUST AT S.L.(0-500 FPS)
- #16-THRML - THERMAL FLUENCE(0-1000 CAL/CM2)
- #17-TIS - TISSUE DOSE(0-5000 RADS-TISSUE)
- #18-SIL - SILICON DOSE(0-1E+9 RADS-SILICON)
- #19-GDOT - GAMMA DOSE RATE(0-1E+12 RADS-SIL/SEC)
- #20-NFLU - NEUTRON FLUENCE(0-1E+20 N/CM2)

DEFAULT VALUES :

ESCAPE PARAMETERS #1-6 :

#1-NOAC	#2-RT	#3-SECT	#4-TOI	#5-NPRO	#6-DTTP
6.0	300.0	180.0	12.0	3.0	5.0

THREAT PARAMETERS #7-13 :

#7-MFT	#8-NB	#9-DOI	#10-YLD	#11-HOB	#12-CEP	#13-ITYPE
500.0	8.0	8.0	250.0	2000.0	1.0	2.0

HARDNESS PARAMETERS #14-20 :

#14-OP	#15-GUST	#16-THRML	#17-TIS	#18-SIL	#19-GDOT	#20-NFLU
SS 1.5	50.00	20.00	10.00	2.00E+03	1.00E+06	1.00E+06
SK 5.0	160.00	120.00	50.00	5.00E+03	1.00E+08	1.00E+12

TABLE A-III

Default Departure Profiles

TIME (SEC)	RANGE (N.M.)	ALTITUDE (FEET)	TIME (SEC)	RANGE (N.M.)	ALTITUDE (FEET)
Profile #1 - Slow			Profile #2 - Medium		
0	0	0	0	0	0
90	3.75	750	90	3.2	600
120	5.0	1000	120	5.3	2300
210	10.0	1400	150	7.0	3500
240	12.5	2600	180	9.0	5600
270	15.0	3000	210	12.0	6000
300	17.5	3020	240	14.8	6000
330	19.8	4000	270	18.0	6000
360	22.5	4600	300	22.0	6000
Profile #3 - Fast			Profile #4 - Hyper		
0	0	0	0	0	0
90	3.5	800	150	12.0	300
120	5.5	2900	180	17.0	5500
150	8.0	5200	210	22.0	11000
180	11.0	6000	240	27.0	16500
210	14.3	6000	270	32.0	22000
240	17.8	6000	300	37.0	27500
270	21.5	6000	330	42.0	30000
300	25.0	6000	360	47.0	35500
330	29.0	6000	390	52.0	40000
			420	57.0	40000
			450	62.0	40000

Procedures. Section II of this appendix contains the logic flow diagram for the GETAWAY executive routine. There are several user decision points as the program progresses which affect how the input, output, and survivability analysis are performed. The next subsection of

this guide gives a step-by-step example of the operation of GETAWAY. This subsection provides an explanation of the major decision options available to the user. Once GETAWAY begins, the user guides the parametric analysis by choosing from the options as presented below.

DO YOU WANT TO SUPPRESS ALL RADIATION CALCULATIONS? (Y/N)?

Y - Probability of survival for all radiation effects will be set equal to one (1) and radiation calculations will not be performed.

N - All prompt radiation effects are calculated and their effects on aircraft survivability are accounted for.

YOU NOW HAVE YOUR CHOICE OF 3 METHODS OF ENTERING THE INITIAL SET OF PARAMETERS:

- 1 - REVIEW ALL PARAMETER DEFINITIONS AND MAKE CHANGES AS YOU GO.
- 2 - SKIP THE DEFINITIONS AND MAKE A FEW CAREFUL CHANGES TO THE CURRENT(DEFAULT) VALUES.
- 3 - MAKE A SERIES OF QUICK CHANGES BY PARAMETER # FOR AS MANY AS YOU DESIRE.

NOW ENTER YOUR CHOICE (#1-3) FROM THE MENU ABOVE ?

- 1 - Designed for the first time GETAWAY user. Each parameter is defined with allowable ranges and default values. User is given opportunity to set the value of each parameter as they are reviewed.
- 2 - Designed for the user familiar with GETAWAY but requiring the option to review definitions, labels, and current values as the initial scenario values are set.
- 3 - Designed for the frequent GETAWAY user. Allows rapid entry of any number of parameters by parameter number with no definition, label, range, or current value review.

NOTE: A review of all parameter values is made after exercising any of the three above options, including an opportunity to make last minute changes.

 CURRENT PARAMETER VALUES #1 TO 20 : (SEE USER MANUAL PG. ZZ)
 ESCAPE PARAMETERS #1-6 : (FOR PARAMETER ABBREVIATIONS)
 #1-NOAC #2-RT #3-SECT #4-TOI #5-NPRO #6-DTTP
 6.0 300.0 180.0 12.0 3.0 5.0
 THREAT PARAMETERS #7-13 :
 #7-MFT #8-NB #9-DOI #10-YLD #11-HOB #12-CEP #13-ITYPE
 500.0 8.0 8.0 250.0 2000.0 1.0 2.0
 HARDNESS PARAMETERS #14-20 :
 #14-OP #15-GUST #16-THRML #17-TIS #18-SIL #19-GDOT #20-NFLU
 SS 1.5 50.00 20.00 10.00 2.00E+03 1.00E+06 1.00E+06
 SK 5.0 160.00 120.00 50.00 5.00E+03 1.00E+08 1.00E+12

ALL 20 PARAMETERS AND THEIR CURRENT VALUES ARE REVIEWED ABOVE.
 DO YOU WISH TO MAKE ANY FURTHER CHANGES
 BEFORE THE INITIAL RUN? (Y/N)?

Y - Last chance to change any parameters before initial
 scenario run.

N - Ready for initial run.

WOULD YOU LIKE TO SEE A MORE DETAILED REPORT
 OF SURVIVABILITY BY INDIVIDUAL AIRCRAFT? (Y/N)?

Y - Displays Ps for all aircraft for the run just completed.
 See the example output below.

N - Program proceeds to routine for choosing a parameter
 to study or to making the next change to the value of
 the current parameter under study.

SURVIVABILITY RESULTS BY AIRCRAFT FOR RUN # 1

PS RESULTS FOR 6 INDIVIDUAL A/C ON RUN # 1									
0	A/C#	OP	GUST	THRML	TIS	SIL	GDOT	NFLU	- TOTAL
	1	.99	.99	.96	.83	1.00	1.00	.86	.67
	2	.45	.32	.69	.57	1.00	.97	.56	.03
	3	.83	.83	1.00	1.00	1.00	1.00	.98	.68
	4	.99	.99	1.00	1.00	1.00	1.00	1.00	.99
	5	1.00	1.00	1.00	1.00	1.00	1.00	1.00	1.00
	6	1.00	1.00	1.00	1.00	1.00	1.00	1.00	1.00

WOULD YOU LIKE TO REVIEW PS RESULTS FOR A PARTICULAR AIRCRAFT FOR ALL RUNS ON THE CURRENT PARAMETER? (Y/N)?

Y - Displays Ps for the chosen aircraft for all runs with the current parameter under study. ("Y" should not be selected when reviewing initial run.)

N - Program proceeds to choices for the next run.

ENTER THE A/C # YOU ARE INTERESTED IN REVIEWING?
(1 TO 6) ?

Choose the particular aircraft by number.

PS RESULTS FOR A/C # 3 OVER 6 RUNS
WITH PSTUDY= #11 HEIGHT OF BURST (FEET MSL)

PSTUDY	OPRES	GUST	THRML	TDOSE	SDOSE	GDOT	N-FLU	- TOTAL
0.	.83	.83	1.00	1.00	1.00	1.00	.98	.68
1.000E+03	.63	.63	1.00	1.00	1.00	1.00	.98	.39
2.000E+03	.70	.53	1.00	1.00	1.00	1.00	.97	.36
3.000E+03	.89	.81	1.00	1.00	1.00	1.00	.96	.68
4.000E+03	.88	.87	1.00	.99	1.00	1.00	.95	.72
5.000E+03	.87	.87	1.00	.98	1.00	1.00	.94	.69

WOULD YOU LIKE TO REVIEW SOME OTHER AIRCRAFT'S PROBABILITY OF SURVIVAL(PS) OVER ALL RUNS? (Y/N)?

Y - Provides opportunity to review some other single aircraft's Ps for all runs with current parameter under study as in example above

N - Program proceeds to choices for next run.

YOU HAVE JUST REVIEWED THE RESULTS OF AN INITIAL RUN
(OR HAVE COMPLETED THE STUDY OF ONE PARAMETER) AND IT
IS NOW TIME TO CHOOSE ONE OF THE 20 PARAMETERS TO STUDY
THE EFFECT OF CHANGING THAT PARAMETER HAS ON THE ALERT
FORCE SURVIVABILITY UNDER SLBM ATTACK
THERE ARE THREE GROUPS OF PARAMETERS:

- 1= ESCAPE PARAMETERS
- 2= THREAT PARAMETERS
- 3= HARDNESS PARAMETERS

WHICH GROUP CONTAINS THE PARAMETER YOU ARE
INTERESTED IN STUDYING? (ENTER 1, 2, OR 3) ?

User chooses the parameter group; then a list of that group
with current values is displayed. User has opportunity to
have the definition of any parameter displayed before
making choice of parameter to study.

NOW ENTER THE NUMBER OF THE PARAMETER
YOU WANT TO STUDY. (1 TO 20) ?

User chooses the parameter to be studied.

WOULD YOU LIKE TO ENTER A FULL SET OF CHANGES
AND GET ONE FINAL REPORT RATHER THAN
MAKE THE CHANGES AND GET RESULTS AS YOU GO? (Y/N)?

- Y - Program proceeds to a routine which lets user enter a
series of new values for the parameter under study.
- N - Program proceeds to let user make changes to the
parameter under study one at a time with full review
of results of each run between changes.

DO YOU WISH TO CHANGE THE VALUE OF THE CURRENT PARAMETER UNDER STUDY AND MAKE ANOTHER RUN? (Y/N)?

Y - Program goes to change routine and lets user select another value for the current parameter under study to assess the effect the change has on Ps.

N - Program proceeds to the next question listed below.

DO YOU WISH TO STUDY THE EFFECTS ON SURVIVABILITY OF CHANGING SOME OTHER PARAMETER? (Y/N)?

Y - User may now begin a completely new study.

N - Ends this session of GETAWAY.

DO YOU WANT TO START WITH A NEW INITIAL SET OF PARAMETERS RATHER THAN THE CURRENT SET? (Y/N)?

Y - Gives user the chance to set an entire new scenario with the three option initial set procedure described above.

N - The initial scenario from the previous study is used. Program proceeds to routine which lets user choose a parameter to study.

Step-by-Step Example.

WELCOME TO GETAWAY

GETAWAY IS A BASE ESCAPE SURVIVABILITY MODEL DESIGNED SPECIFICALLY FOR PARAMETRIC STUDIES. THE SCENARIO MODELED REPRESENTS UP TO 20 AIRCRAFT ESCAPING FROM A SINGLE ALERT BASE UNDER SLBM ATTACK.

THERE ARE 20 INPUT PARAMETERS IN 3 GENERAL GROUPS:

ESCAPE PARAMETERS
THREAT PARAMETERS
HARDNESS PARAMETERS

AFTER CHOOSING AN INITIAL SET OF PARAMETERS, PROBABILITY OF SURVIVAL FOR THE ESCAPING ALERT FORCE AIRCRAFT UNDER SLBM ATTACK WILL BE COMPUTED AND DISPLAYED.

THEN YOU WILL BE GIVEN A CHANCE TO CHOOSE AND CHANGE THE INPUT PARAMETERS ONE AT A TIME TO STUDY THE DIFFERENTIAL EFFECT OF THE CHANGES ON ALERT FORCE SURVIVABILITY..

ENTER ANY CHARACTER TO CONTINUE C

BECAUSE THIS IS A PARAMETRIC MODEL, THE SURVIVABILITY RESULTS SHOULD NOT BE USED AS ABSOLUTE PREDICTIONS OF SURVIVABILITY. HIGHER FIDELITY MODELS (FLEE,QUANTA) ARE AVAILABLE TO PREDICT ALERT FORCE PRE-LAUNCH SURVIVABILITY. GETAWAY SHOULD BE USED WHEN PARAMETRIC RESULTS ARE OF INTEREST.

ALTHOUGH NOT MANDATORY, WE SUGGEST YOU HAVE A COPY OF THE GETAWAY USERS MANUAL AT HAND WHEN USING THIS PROGRAM. IF YOU HAVE ANY QUESTIONS DURING THE OPERATION OF GETAWAY, THE USERS MANUAL WILL AID IN AVOIDING DIFFICULTIES.

IF AT ANYTIME YOU WISH TO ABORT THE PRESENT OPERATIONS, ENTER --999-- FOR A CURRENT NUMERICAL REQUEST OR ENTER -AAA- FOR A CURRENT CHARACTER REQUEST.

YOU MAY NOW ENTER A NAME TO IDENTIFY THIS SESSION .

ENTER SESSION NAME: 1 TO 20 CHARACTERS (AAA TO ABORT) ?
STEP-BY-STEP

DO YOU WANT TO SUPPRESS ALL RADIATION CALCULATIONS? (Y/N)? N

YOU NOW HAVE YOUR CHOICE OF 3 METHODS OF ENTERING
THE INITIAL SET OF PARAMETERS:

- 1 - REVIEW ALL PARAMETER DEFINITIONS AND
MAKE CHANGES AS YOU GO.
- 2 - SKIP THE DEFINITIONS AND MAKE A FEW
CAREFUL CHANGES TO THE CURRENT(DEFAULT) VALUES.
- 3 - MAKE A SERIES OF QUICK CHANGES BY
PARAMETER # FOR AS MANY AS YOU DESIRE.

NOW ENTER YOUR CHOICE (#1-3) FROM THE MENU ABOVE ? 2

CURRENT PARAMETER VALUES #1 TO 20 : (SEE USER MANUAL PG. ZZ)
ESCAPE PARAMETERS #1-6 : (FOR PARAMETER ABBREVIATIONS)

#1-NOAC	#2-RT	#3-SECT	#4-TOI	#5-NPRO	#6-DITP
6.0	300.0	180.0	12.0	3.0	5.0

THREAT PARAMETERS #7-13 :

#7-MFT	#8-NB	#9-DOI	#10-YLD	#11-HOB	#12-CEP	#13-ITYPE
500.0	8.0	8.0	250.0	2000.0	1.0	2.0

HARDNESS PARAMETERS #14-20 :

#14-OP	#15-GUST	#16-THRML	#17-TIS	#18-SIL	#19-GDOT	#20-NFLU
SS 1.5	50.00	20.00	10.00	2.00E+03	1.00E+06	1.00E+06
SK 5.0	160.00	120.00	50.00	5.00E+03	1.00E+08	1.00E+12

ALL 20 PARAMETERS AND THEIR CURRENT VALUES ARE REVIEWED ABOVE.
DO YOU WISH TO MAKE ANY FURTHER CHANGES
BEFORE THE INITIAL RUN? (Y/N)? Y

ENTER THE PARAMETER # YOU WANT TO CHANGE (#1 TO 20)
ENTER ZERO (0) IF FINISHED CHANGING PARAMETERS
? 11

YOU NOW HAVE THE OPPORTUNITY TO CHANGE PARAMETER #11
PARAMETER #11 IS HEIGHT OF BURST (FEET MSL)
THIS IS CHANGE # 0
THE CURRENT VALUE IS: 2000.00
PREVIOUS VALUES RUN ARE(NONE IF CHANGE #0):
NOW ENTER A NEW VALUE FOR HEIGHT OF BURST (FEET MSL)
0.0

HEIGHT OF BURST (FEET MSL) IS NOW= 0.00

ARE YOU SATISFIED WITH THIS CHANGE? (Y/N)? Y

ENTER THE PARAMETER # YOU WANT TO CHANGE (#1 TO 20)
ENTER ZERO (0) IF FINISHED CHANGING PARAMETERS
? 0

CURRENT PARAMETER VALUES #1 TO 20 : (SEE USER MANUAL PG. ZZ)
 ESCAPE PARAMETERS #1-6 : (FOR PARAMETER ABBREVIATIONS)
 #1-NOAC #2-RT #3-SECT #4-TOI #5-NPRO #6-DTTP
 6.0 300.0 180.0 12.0 3.0 5.0

THREAT PARAMETERS #7-13 :
 #7-MFT #8-NB #9-DOI #10-YLD #11-HOB #12-CEP #13-ITYPE
 500.0 8.0 8.0 250.0 0.0 1.0 2.0

HARDNESS PARAMETERS #14-20 :
 #14-OP #15-GUST #16-THRML #17-TIS #18-SIL #19-GDOT #20-NFLU
 SS 1.5 50.00 20.00 10.00 2.00E+03 1.00E+06 1.00E+06
 SK 5.0 160.00 120.00 50.00 5.00E+03 1.00E+08 1.00E+12

ALL 20 PARAMETERS AND THEIR CURRENT VALUES ARE REVIEWED ABOVE.
 DO YOU WISH TO MAKE ANY FURTHER CHANGES
 BEFORE THE INITIAL RUN? (Y/N)? N

PS RUN IN PROGRESS -- STANDBY FOR RESULTS

AVERAGE FLEET SURVIVABILITY FOR RUNS #1 TO # 1

AVERAGE FLEET SURVIVABILITY FOR 6 AIRCRAFT - LISTED 1ST RUN TO LATEST
 PSTUDY OP GUST THRML TIS SIL GDOT NFLU -TOTAL # SV
 0. .88 .86 .94 .90 1.00 1.00 .90 .73 4.37

WOULD YOU LIKE TO SEE A MORE DETAILED REPORT
 OF SURVIVABILITY BY INDIVIDUAL AIRCRAFT? (Y/N)? Y

SURVIVABILITY RESULTS BY AIRCRAFT FOR RUN # 1

PS RESULTS FOR 6 INDIVIDUAL A/C ON RUN # 1

A/C#	OP	GUST	THRML	TIS	SIL	GDOT	NFLU	- TOTAL
1	.99	.99	.96	.83	1.00	1.00	.86	.67
2	.45	.32	.69	.57	1.00	.97	.56	.03
3	.83	.83	1.00	1.00	1.00	1.00	.98	.68
4	.99	.99	1.00	1.00	1.00	1.00	1.00	.99
5	1.00	1.00	1.00	1.00	1.00	1.00	1.00	1.00
6	1.00	1.00	1.00	1.00	1.00	1.00	1.00	1.00

FLEET AVG .88 .86 .94 .90 1.00 1.00 .90 .73

WOULD YOU LIKE TO REVIEW PS RESULTS FOR A PARTICULAR
 AIRCRAFT FOR ALL RUNS ON THE CURRENT PARAMETER? (Y/N)? N

YOU HAVE JUST REVIEWED THE RESULTS OF AN INITIAL RUN
(OR HAVE COMPLETED THE STUDY OF ONE PARAMETER) AND IT
IS NOW TIME TO CHOOSE ONE OF THE 20 PARAMETERS TO STUDY
THE EFFECT OF CHANGING THAT PARAMETER HAS ON THE ALERT
FORCE SURVIVABILITY UNDER SLBM ATTACK
THERE ARE THREE GROUPS OF PARAMETERS:

- 1= ESCAPE PARAMETERS
- 2= THREAT PARAMETERS
- 3= HARDNESS PARAMETERS

WHICH GROUP CONTAINS THE PARAMETER YOU ARE
INTERESTED IN STUDYING? (ENTER 1, 2, OR 3) ? 2

**** THREAT PARAMETERS ****

# 7	MISSILE FLIGHT TIME (SEC)	500.0
# 8	NUMBER OF BURSTS (1 TO 20)	8.000
# 9	DETONATION INTERVAL (SEC)	8.000
#10	YIELD (KT)	250.0
#11	HEIGHT OF BURST (FEET MSL)	0.
#12	DELIVERY ERROR - CEP (NM)	1.000
#13	RADIATION TYPE (1=FISSION , 2=TN)	2.000

THE PARAMETERS FROM THE GROUP YOU HAVE CHOSEN ARE REVIEWED ABOVE

WOULD YOU LIKE TO REVIEW THE DEFINITION OF
ANY OF THE ABOVE PARAMETERS
BEFORE MAKING YOUR CHOICE? (Y/N)? N

NOW ENTER THE NUMBER OF THE PARAMETER
YOU WANT TO STUDY. (1 TO 20) ? 11

WOULD YOU LIKE TO ENTER A FULL SET OF CHANGES
AND GET ONE FINAL REPORT RATHER THAN
MAKE THE CHANGES AND GET RESULTS AS YOU GO? (Y/N)? Y

NOW ENTER THE NUMBER OF TIMES THE PARAMETER IS TO BE CHANGED (1-19) ?
IN OTHER WORDS, HOW MANY DIFFERENT RUNS ARE TO BE MADE (1-19) ? 5
ENTER THE PARAMETER CHANGES ONE AT A TIME
NEXT VALUE FOR - HEIGHT OF BURST (FEET MSL)
FOR RUN #1 VALUE= ? 1000

PS RUN IN PROGRESS -- STANDBY FOR RESULTS

NEXT VALUE FOR - HEIGHT OF BURST (FEET MSL)
FOR RUN #2 VALUE= ? 2000

PS RUN IN PROGRESS -- STANDBY FOR RESULTS

NEXT VALUE FOR - HEIGHT OF BURST (FEET MSL)
FOR RUN #3 VALUE= ? 3000

PS RUN IN PROGRESS -- STANDBY FOR RESULTS

NEXT VALUE FOR - HEIGHT OF BURST (FEET MSL)
FOR RUN #4 VALUE= ? 4000

PS RUN IN PROGRESS -- STANDBY FOR RESULTS

NEXT VALUE FOR - HEIGHT OF BURST (FEET MSL)
FOR RUN #5 VALUE= ? 5000

PS RUN IN PROGRESS -- STANDBY FOR RESULTS

AVERAGE FLEET SURVIVABILITY FOR RUNS #1 TO # 6

AVERAGE FLEET SURVIVABILITY FOR 6 AIRCRAFT - LISTED 1ST RUN TO LATEST
PARAMETER UNDER STUDY(PSTUDY) IS #11 HEIGHT OF BURST (FEET MSL)

PSTUDY	OP	GUST	THRML	TIS	SIL	GDOT	NFLU	-TOTAL	# SV
0.	.88	.86	.94	.90	1.00	1.00	.90	.73	4.37
1.000E+03	.79	.78	.93	.88	1.00	.98	.88	.65	3.89
2.000E+03	.83	.75	.92	.87	1.00	.97	.87	.62	3.74
3.000E+03	.89	.83	.92	.86	1.00	.95	.86	.69	4.13
4.000E+03	.88	.85	.91	.86	.98	.94	.85	.71	4.24
5.000E+03	.88	.85	.91	.86	.98	.93	.84	.70	4.20

WOULD YOU LIKE TO SEE A MORE DETAILED REPORT
OF SURVIVABILITY BY INDIVIDUAL AIRCRAFT? (Y/N)? Y

SURVIVABILITY RESULTS BY AIRCRAFT FOR RUN # 6

PS RESULTS FOR 6 INDIVIDUAL A/C ON RUN # 6
PSTUDY=#11 HEIGHT OF BURST (FEET MSL) = 5000.0

A/C#	OP	GUST	THRML	TIS	SIL	GDOT	NFLU	- TOTAL
1	.98	.98	.94	.81	1.00	.92	.75	.51
2	.41	.23	.55	.35	.85	.66	.36	.00
3	.87	.87	1.00	.98	1.00	1.00	.94	.69
4	1.00	1.00	1.00	1.00	1.00	1.00	1.00	1.00
5	1.00	1.00	1.00	1.00	1.00	1.00	1.00	1.00
6	1.00	1.00	1.00	1.00	1.00	1.00	1.00	1.00
FLEET AVG	.88	.85	.91	.86	.98	.93	.84	.70

WOULD YOU LIKE TO REVIEW PS RESULTS FOR A PARTICULAR
AIRCRAFT FOR ALL RUNS ON THE CURRENT PARAMETER? (Y/N)? Y

ENTER THE A/C # YOU ARE INTERESTED IN REVIEWING?
(1 TO 6) ? 3

PS RESULTS FOR A/C # 3 OVER 6 RUNS
WITH PSTUDY= #11 HEIGHT OF BURST (FEET MSL)

PSTUDY	OPRES	GUST	THRML	TDOSE	SDOSE	GDOT	N-FLU	TOTAL
0.	.83	.83	1.00	1.00	1.00	1.00	.98	.68
1.000E+03	.63	.63	1.00	1.00	1.00	1.00	.98	.39
2.000E+03	.70	.53	1.00	1.00	1.00	1.00	.97	.36
3.000E+03	.89	.81	1.00	1.00	1.00	1.00	.96	.68
4.000E+03	.88	.87	1.00	.99	1.00	1.00	.95	.72
5.000E+03	.87	.87	1.00	.98	1.00	1.00	.94	.69

WOULD YOU LIKE TO REVIEW SOME OTHER AIRCRAFT'S
PROBABILITY OF SURVIVAL(PS) OVER ALL RUNS? (Y/N)? N

DO YOU WISH TO CHANGE THE VALUE OF THE CURRENT PARAMETER
UNDER STUDY AND MAKE ANOTHER RUN? (Y/N)? N

DO YOU WISH TO STUDY THE EFFECTS ON SURVIVABILITY OF
CHANGING SOME OTHER PARAMETER? (Y/N)? N

THIS CONCLUDES "GETAWAY" SESSION NAMED STEP-BY-STEP

REMEMBER, THE PROBABILITY OF SURVIVAL RESULTS FROM THESE
RUNS ARE MEANT TO BE USED FOR PARAMETRIC ANALYSIS AND
NOT FOR PREDICTING ALERT FORCE SURVIVABILITY.
A RECORD OF THIS SESSIONS OUTPUT RESULTS IS ON
TAPE13. YOU SHOULD STORE TAPE13 OR ROUTE IT TO A
PRINTER FOR FURTHER REFERENCE BEFORE LOGGING OUT.
GOODBYE AND STOP BACK AGAIN SOON !!!!

Section II

Glossary of Variables. This glossary is arranged by subprogram in the order in which they appear in the listing. All COMMON block variables are defined first and are not repeated for the subprogram in which they appear. To find the definition of a variable that is not in a common block, find the glossary for the subprogram in which the variable appears. Variables are listed in the order in which they appear in the subprogram. Figure A-1 is an illustration of the order of three dimensional array indexing used in GETAWAY.

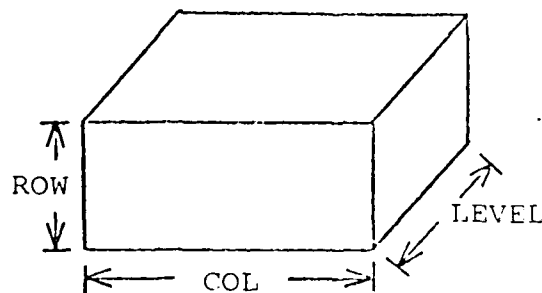

Figure A-1. 3-Dimensional Array Indexing
ARRAY (level, row, col)

```
COMMON//CELL(20,11,8),PS(21,21,8),OLD(20,2),HISTRY(20,21,8)
```

```
CELL(20,11,8) - Ps results for 10 cell model for  
                1-20 a/c.  
A(20,11,8)     Row 11 contains 10 cell average.  
                Col 8 contains Ps for all 7 weapon  
                effects.  
                Col 1-7 contain Ps for each weapon  
                effect.
```

PS(21,21,8) - Probability of survival array for
1-20 a/c & 1-20 warheads.
B(21,21,8) Level 21 contains Ps for entire
attack.
Row 21 contains average fleet Ps.
Col 1-7 contain Ps for each effect -
Col 8 for all effects.

OLD(20,2) Stores values of the current parameter
under study (IPUS) for 1-20 runs for
each study.

HISTORY(20,21,8) Ps results for 1-20 runs. Stores
level 21 from array PS.

COMMON/PARAM/PAR(27)

PAR(27) - Character array containing labels for parameters #1-20. Hardness parameters (#14-20) are labeled in pairs of SS and SK.
For example: PAR(14)=Overpressure - SS
PAR(15)=Overpressure - SK

COMMON/ESCPAR/RT, SECT, TOI, NOAC, DTTP, NP(6), PROFIL(6, 20, 3), TURN(20)

RT - Reaction time (sec)
SECT - Escape sector width (deg)
TOI - Take-off interval (sec)
NOAC - Number of aircraft
NPRO - Current profile number
DTTP - Distance to turn point (NM)
NP(6) - Number of points describing each of 6 profiles
PROFIL(6, 20, 3) - 6 departure profiles with up to 20 points each. Each point contains time(sec)/range(NM)/altitude(feet)
TURN(20) - Aircraft turn angle at departure turn point for 1-20 aircraft

COMMON/THTPAR/MFT, NB, DOI, BRHO(20), BPHI(20), YLD, HOX, CEP, ITYPE

MFT - Missile flight time (sec)
NB - Number of warheads
DOI - Warhead detonation interval (sec)
BRHO(20) - Warhead aimpoint distance measured from departure turn point
BPHI(20) - Warhead aimpoint angle measured from reference radial(0 deg = rwy to turn point)
YLD - Warhead yield in kilotons
HOX - Height of burst (feet)
CEP - Warhead delivery error (NM)
ITYPE - Warhead radiation type: 1 = fission
2 = thermonuclear

COMMON/HRDPAR/OP(2), GUST(2), HEAT(2), TIS(2), SIL(2), DOSE(2), FLU(2)

OP(2) - Overpressure hardness SS & SK (psi)
GUST(2) - Side gust hardness SS & SK (fps @ sea level)
HEAT(2) - Thermal fluence hardness SS & SK (cal/cm²)

TIS(2) - Tissue dose hardness SS & SK (rads-tissue)
SIL(2) - Equipment dose hardness SS & SK (rad-silicon)
DOSE(2) - Gamma dose rate hardness SS & SK (rads-sil/sec)
FLU(2) - Neutron fluence hardness SS & SK (n/cm²)

COMMON/ACPOS/YIELD,HOB,HAC,X,V0

YIELD - Weapon yield in kilotons
HOB - Height of burst in meters
HAC - Height of aircraft in meters
X - Aircraft distance from turn point in meters
V0 - Speed of aircraft in meters/sec

COMMON/REFAMB/RPRES,RDEN,RTEMP,RSSO
COMMON/TGTAMB/TPRES,TDEN,TTEMP,TSSO
COMMON/BSTAMB/BPRES,BDEN,BTEMP,BSSO
(sea level, target, and burst altitude ambient air data)

R/T/BPRES - air pressure (psi)
R/T/BDEN - air density (Kg/m³)
R/T/BTEMP - air temperature (deg Kelvin)
R/T/BSSO - speed of sound (m/sec)

PROGRAM GETWAY

NAME - Character variable with session name
RADOUT - Logical flag: TRUE = suppress radiation
N - Run number
IPUS - Index number of current parameter under study

SUBROUTINE SET

MENU - SET option #1, 2, or 3
NFP - Index number of last parameter
NHP - Number of hardness parameters
H & I - Index number of parameter being set

SUBROUTINE STEP

I - Index number of first parameter to be defined
J - Index number of last parameter to be defined

SUBROUTINE CHOOSE

H & J - Index number (1-3) of parameter group
H & K - Index number (1-20) of parameter
chosen for definition
H & IPUS - Index number (1-20) of parameter
chosen for study
L - Indexing variable to convert hardness
index (14-20) to (14-27) for pairs of
SS & SK

SUBROUTINE RNGCHK

I - Parameter index number
V - Parameter value
RANGES(20,2) - Lower and upper bounds for 20 parameters

SUBROUTINE CHANGE

I - Parameter index number
N - Current run number
VALNEW - New value for parameter #I
SS - New sure-safe value
SK - New sure-kill value
L - Indexing variable to convert hardness
index (14-20) to (14-27) for pairs of
SS & SK

SUBROUTINE NEWPRO

N - Index number of profile (1-6) to be
changed or defined
H & J & NC - Index number of profile point being
changed
H & NP(N) - Number of points in the profile
H & L - Number of new points to be added to
profile

SUBROUTINE RUN

L - Index for warhead number
TB - Time from 1st aircraft brake release to
detonation of warhead #L
N - Index for aircraft number
TN - Time from brake release of aircraft #N
to detonation of warhead #L
RADOUT - Flag: TRUE = suppress radiation

SUBROUTINE TURNS

SECTR - Escape sector width in radians
SLICE - An equal interval of SECTR, one for each a/c
SECBD - Lower boundary of escape sector

SUBROUTINE PATTERN

NBL - Number of warheads remaining to be allocated
FIRST - Flight time of 1st aircraft at last detonation
TLAST - Flight time of last aircraft at first detonation
RNGF - Range of 1st aircraft at last detonation
RNGL - Range of last aircraft at 1st detonation
STEP - Distance increment for warhead aimpoint allocation
V - Average aircraft speed to profile point #3
TTTP - Average flight time to turn point
NBTP - Expected number of aircraft between base and turn point
SECTR - Escape sector width in radians
SECBD - Lower boundary of escape sector
SLICE - An equal interval of SECTR, one for each warhead allocated to escape sector
RSTRT - Range from turn point to aimpoint of first warhead allocated to escape sector
RTOT - Total range from inner to outer ring of attack annulus
RO - Lower range bound of ring of equal area
RI - Upper range bound of ring of equal area
NSTRT - Index number of 1st warhead allocated to escape sector

SUBROUTINE LOCATE

TN - Time from brake release for aircraft being located
POINT(2) - Array holding interpolated data
IFIND - Index variable used during search
FACD - Denominator of interpolation factor
FACN - Numerator of interpolation factor
FACTOR - Interpolation factor
TOP - Upper value of interpolation
BOT - Lower value of interpolation

SUBROUTINE BANG

N - Index number of aircraft in escape sequence
BRO - Aimpoint(DGZ) distance from turn point
BFI - Aimpoint(DGZ) angle from turn point
outbound radial
RADOUT - Flag: TRUE = suppress radiation
BPI - BFI adjusted for aircraft #N turn angle
RHO - Effective cell center point distance
from DGZ
THETA - Effective cell center point angle from
DGZ
I - Cell number index

SUBROUTINE EFFECT

ESCAPE - Flag: TRUE = aircraft escapes blast effects
RADOUT - Flag: TRUE - suppress radiation
RHO - Effective cell center distance from DGZ
THETA - Effective cell center angle from DGZ
FGR - Final ground range detonation to a/c
FSSR - Final scaled slant range detonation to
a/c
FX - Final distance from turn point
OVPPFS - Overpressure at the aircraft
DENSITY - Shock wave density at the aircraft
WIND - Shock gust velocity at the aircraft
GST - Side gust at aircraft (fps @ sea level)
H - Thermal fluence at aircraft
T - Tissue dose
S - Equipment dose
D - Gamma dose rate
F - Neutron fluence

SUBROUTINE CHASE

RHO -	Detonation distance from DGZ
THETA -	Detonation angle from DGZ
FGR -	Final ground range from burst
FSSR -	Final scaled slant range
FX -	Final distance from turn point
ESCAPE -	Flag: TRUE = a/c escapes blast effects
FACTOR -	Yield & altitude scaling factor
SX -	Scaled distance from turn point
SVO -	Scaled aircraft velocity
COSTHA -	Cosine of THETA
SZSQ -	Scaled altitude difference squared
SRHO -	Scaled RHO
TGS -	Guess of time of flight since burst
DIFOLD -	Last difference between TGS and shock arrival time
SFX -	Scaled distance from turn point at time TGS
SGRSQ -	Scaled ground range squared
STA -	Scaled time of arrival of shock
DIENFW -	Difference between present TGS & STA
BSTSE -	Final unscaled slant range to burst
TIMFAC -	Time scaling factor
TARV -	Final unscaled time of arrival

SUBROUTINE BLAST

FGR -	Final ground range
FSSR -	Final slant range
OVPRES -	Overpressure at aircraft
DENSTY -	Shock wave density at aircraft
WIND -	Shock gust velocity at aircraft
FACTOR -	Yield scaling factor
SHOB -	Scaled height of burst
SHAC -	Scaled height of aircraft
SGRNG -	Scaled ground range
C -	Constant for height of triple point calculations
SOTP -	Scaled origin of triple point
SHOTP -	Scaled height of triple point
LGS -	$\ln(.001 * FSSR)$, computation constant
ROVPR -	1 kt free air overpressure
BSTOP -	Overpressure at burst altitude
A -	Ledsham-Pike Alpha factor
SR1 -	Slant range from burst to foot of mach stem
Z -	$\text{Log}(SR1)$, computational constant
SND -	Sine of angle delta in mach stem triangle
CSD -	Cosine of angle delta in mach stem triangle
OP9-OPZ-OPA -	Parts of mach stem overpressure fit equation

AD-A135 696

GETAWAY: A MODEL FOR PARAMETRIC STUDIES IN THE AREA OF
BASE ESCAPE SURVIV. (U) AIR FORCE INST OF TECH
WRIGHT-PATTERSON AFB OH SCHOOL OF ENGI.

2/2

UNCLASSIFIED

D F MACGHEE ETAL. MAR 83 AFIT/GST/PH/83M-3 F/G 1/3

NL

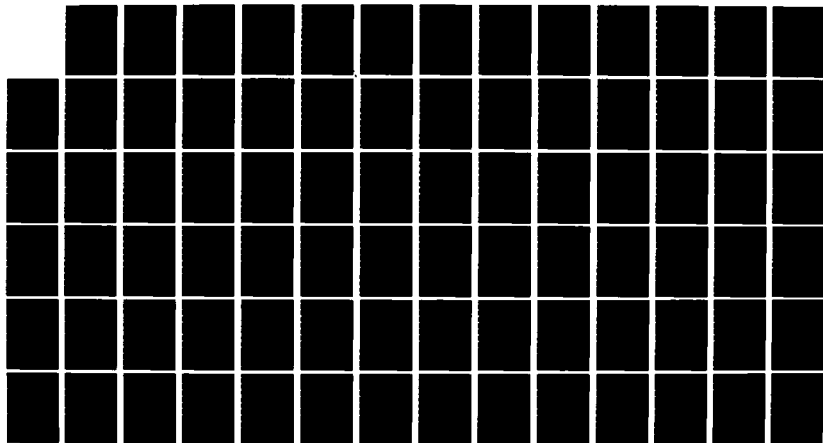

5440

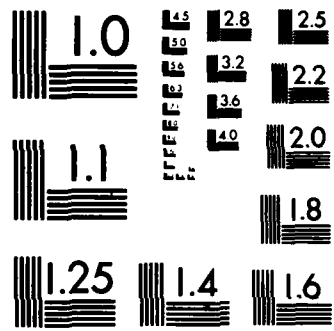

MICROCOPY RESOLUTION TEST CHART
NATIONAL BUREAU OF STANDARDS-1963-A

FUNCTION PRBSVL

S & SS -	Sure-safe hardness level of effect
K & SK -	Sure-kill hardness level of effect
EFF -	Intensity level experienced of effect
ALPHA -	Mean of underlying normal distribution
BETA -	Std. deviation of underlying normal distribution
ZS & Z	Std. normal EFF
A -	Empirical fit to std. normal distribution

SUBROUTINE TRNSLT

RHO -	Detonation range from DGZ
THETA -	Detonation angle from DGZ
BRHO -	DGZ range from turn point
BPHI -	DGZ angle from turn point
XO -	X component of BRHO & BPHI
YO -	Y component of BRHO & BPHI
XX -	X component of new RHO & THETA
YX -	Y component of new RHO & THETA

SUBROUTINE SGUST

RHO - Detonation range from DGZ
THETA - Detonation angle from DGZ
FX - Final distance from turn point
D - Shock wave density at aircraft
U1 - Shock wave gust at aircraft
GF - Sea level equivalent side gust at a/c
THETAG - Local copy of THETA
GR - Ground range from burst
COSW - Cosine of angle between velocity & ground vectors
SINPHI - Sine of angle between gust & vertical
V3 - Local side gust at aircraft
Q - Dynamic side pressure
P - Overpressure at sea level for constant Q

SUBROUTINE THERML

RHO - Detonation range from DGZ
THETA - Detonation angle from DGZ
HEAT - Total thermal fluence perpendicular to fuselage
INT/INT1/INT2 - Variables used for trapazoidal integration
S(10) - Array of normalized power levels from Figure 8
Ratio - Factor for computing SMAX & TMAX
SMAX - Maximum thermal power
TMAX - Time of maximum power
TAU - Atmospheric transmission factor (.8)
B - Constant in thermal equation
Z / XO / Z1 - Legs of triangle to compute COSE
T - Cumulative time increment
SR - Slant range burst to aircraft
COSE - Cosine of incidence angle

SUBROUTINE RADIAT

RHO - Detonation range from DGZ
THETA - Detonation angle from DGZ
TIS - Tissue dose at aircraft
SIL - Equipment dose at aircraft
DOSE - Gamma dose rate at aircraft
FLU - Neutron fluence at aircraft
Z - Altitude difference from burst to aircraft
SR - Slant range burst to aircraft
MI - Air mass integral in gm/cm²
ALT - Altitude in meters
STEP - Integration increment
AREA - Integral sum
DEN - Air density at ALT
Remainder of variables in RADIAT come from routines written by H. L. Murphy, AFWL

Flow Charts. This subsection contains the logic flow diagrams for GETAWAY's executive routine (Part I and Part II) and the main survivability routines -- RUN, BANG, and EFFECT. All other subroutines are simple structures and are fully documented in the program listing.

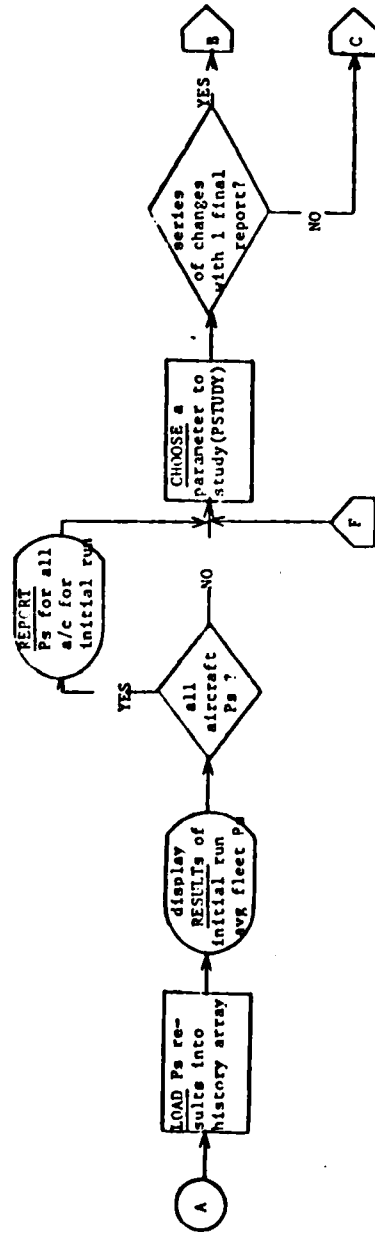
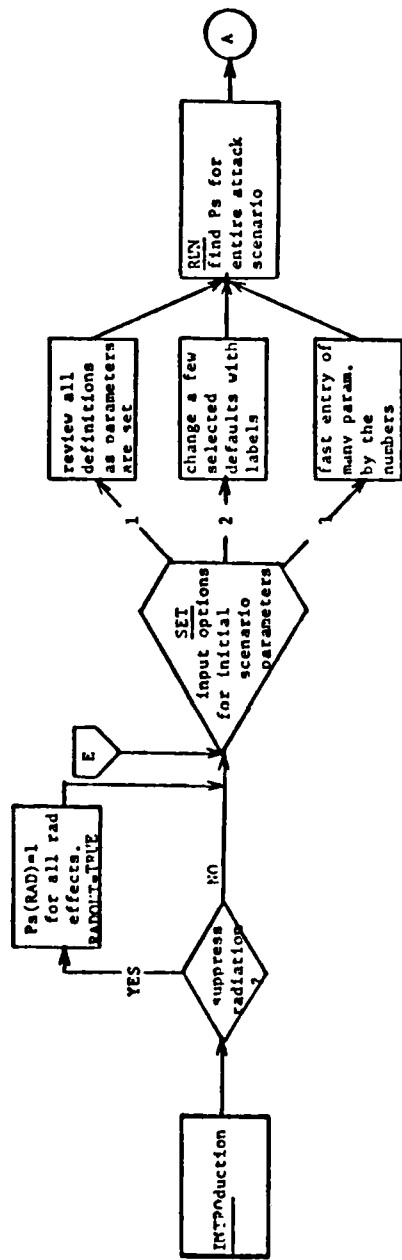

GETAWAY Executive Routine Part I

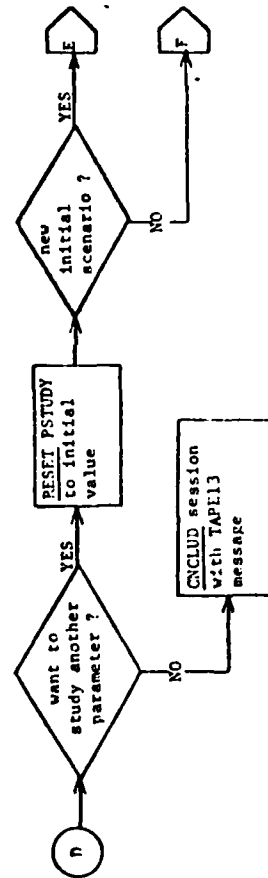
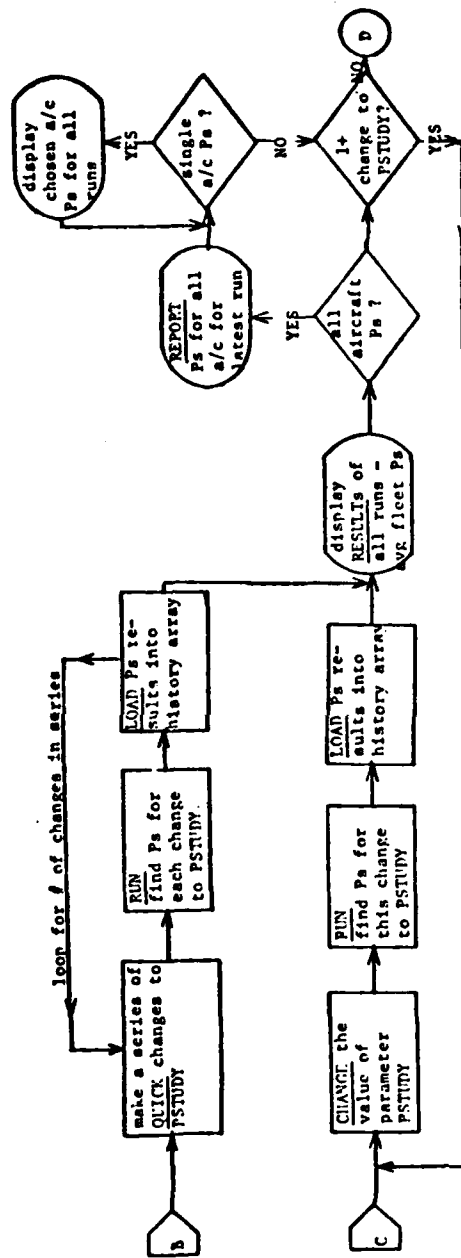

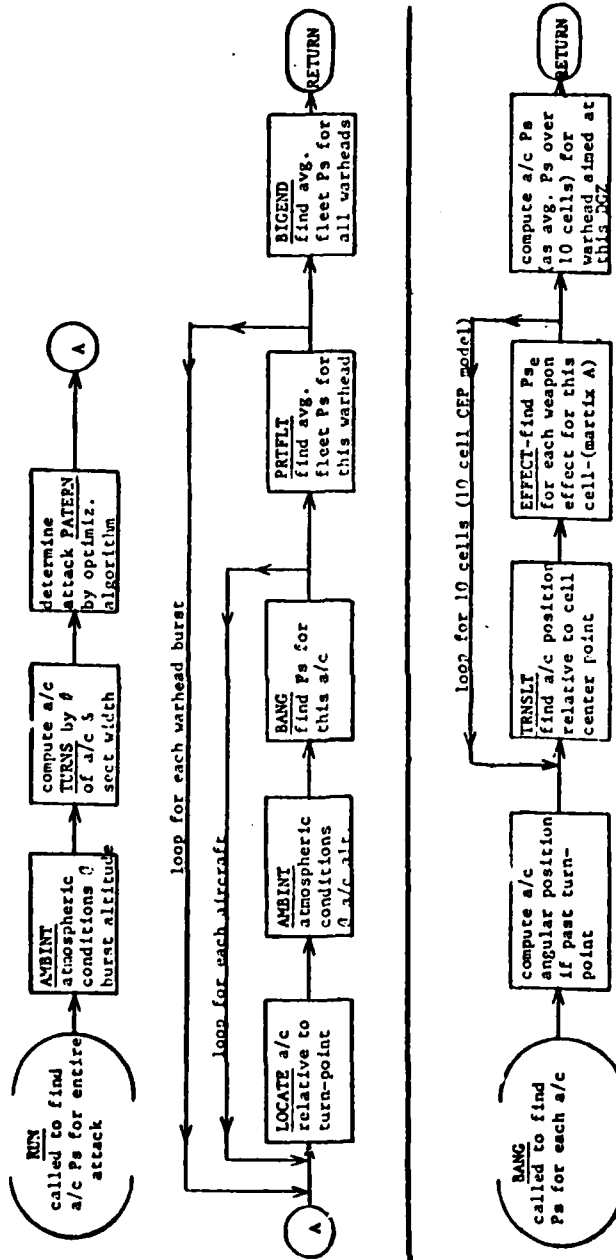

GETAWAY's Main Survivability Routines --
 RUN and BANG

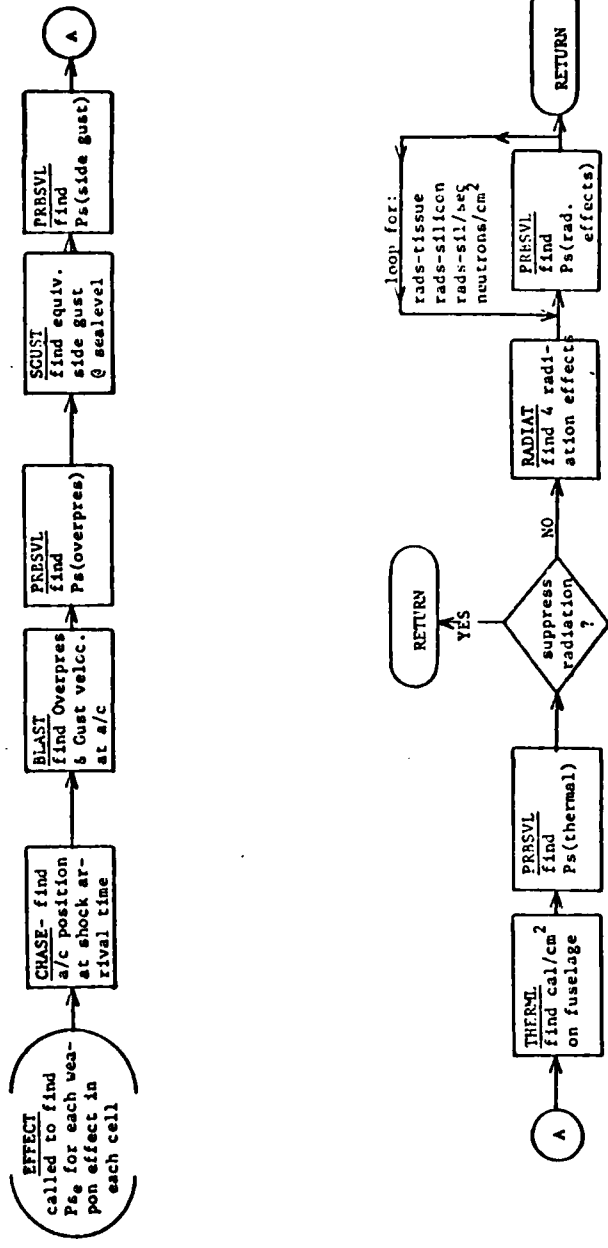

GETAWAY's Main Survivability Routines --
EFFECT

Program Listing. This subsection contains a complete listing of GETAWAY. It consists of the main program, GETWAY, and 46 subprograms as indexed below:

<u>Subprogram</u>	<u>Page</u>	<u>Subprogram</u>	<u>Page</u>
GETWAY	1	RUN	33
INTRO	3	AMBINT	34
SET	4	URNS	34
STEP	5	PATERN	35
READIN	6	LOCATE	36
LIST	7	BANG	37
DEFINE	8	TRNSLT	38
CHOOSE	11	EFFECT	38
STORE	12	CHASE	39
QUICK	14	BLAST	40
RESET	15	SGUST	42
CHANGE	16	THERML	43
RNGCHK	18	RADIAT	44
RNGOUT	18	TRANSF	45
SSWARN	18	BLOCK DATA NGXCON	46
NEWPRO	19	PRBSVL	47
ASK	21	ATANME	47
CHECKN	22	PRTFLT	48
ABORT	22	BIGEND	48
PVAL	23		
BLOCK DATA FLYOUT	25		
BLOCK DATA DEFALT	26		
LOAD	27		
RESULT	28		
REPORT	29		
HEADER	31		
CNCLUD	32		
RDONES	32		

PROGRAM GETWAY

```
*****
* THIS IS THE EXECUTIVE PROGRAM FOR "GETAWAY" - AN INTERACTIVE
* BASE ESCAPE SURVIVABILITY MODEL DEVELOPED SPECIFICALLY FOR
* PARAMETRIC STUDIES IN THE AREAS OF BASE ESCAPE TACTICS AND
* AIRCRAFT HARDNESS CRITERIA UNDER VARIOUS ATTACK SCENARIOS
*****
* WRITTEN BY CAPT CHARLES P. WILLIAMS AND
* MAJ DAVID F. MACGHEE
*****
* IN PARTIAL FULLFILLMENT OF MASTERS OF SCIENCE DEGREE REQUIREMENTS
* AT THE AIR FORCE INSTITUTE OF TECHNOLOGY - MARCH 1983
*****
REAL PS(21,21,8),MFT,OLD(20,2),HISTRY(20,21,8),CELL(20,11,8)
CHARACTER NAME*20
LOGICAL ASK,RADOUT
CHARACTER PAR*40
COMMON//CELL,PS,OLD,HISTRY
COMMON/PARAM/PAR(27)
COMMON/ESCPAR/RT,SECT,TOI,NOAC,
+NPRO,DTTP,NP(6),PROFIL(6,20,3),TURN(20)
COMMON/THTPAR/MFT,NB,DOI,BRHO(20),BPHI(20),YLD,HOX,CEP,ITYPE
COMMON/HRDPAR/OP(2),GUST(2),HEAT(2),TIS(2),SIL(2),DOSE(2),FLU(2)
SAVE
* INTRODUCE USER TO "GETAWAY" - WHAT IT IS & WHAT IT ISN'T
CALL INTRO (NAME)
* CHECK IF RADIATION CALCULATIONS ARE TO BE SUPPRESSED
100 RADOUT=.FALSE.
IF(ASK(17)) THEN
RADOUT=.TRUE.
CALL RDONES
ENDIF
* INITIALIZE ESCAPE, THREAT, & HARDNESS PARAMETERS
CALL SET(RADOUT)
* SIMULATE ATTACK & ESCAPE - CALCULATE ALERT FORCE SURVIVABILITY
* (PS) FOR INITIAL SET OF PARAMETERS
CALL RUN(RADOUT)
* DISPLAY PS RESULTS OVERALL AND BY WEAPON EFFECT
N=1
IPUS=0
CALL LOAD(PS,IPUS,N,HISTRY,OLD)
CALL RESULT (PS,IPUS,N,HISTRY,OLD)
* CHECK IF DETAILED PS RESULTS BY A/C ARE OF INTEREST
IF(ASK(1)) CALL REPORT(PS,IPUS,N,"HISTRY,OLD)
* CHOOSE ONE OF THE 20 PARAMETERS TO STUDY
200 CALL CHOOSE (IPUS,OLD,RADOUT)
N=1
* MAKE A REQUESTED CHANGE IN THE PARAMETER UNDER STUDY (IPUS)
* SELECT OPTION TO MAKE CHANGES IN SERIES OR AS-YOU-GO
IF(ASK(14)) THEN
CALL QUICK(IPUS,N,RADOUT)
GO TO 69
ENDIF
300 CALL CHANGE (IPUS,N,OLD)
```

```

* RE-SIMULATE ATTACK & ESCAPE - CALCULATE PS WITH NEW VALUE OF IPUS      *
  CALL RUN(RADOUT)                                                         *
* DISPLAY PS RESULTS FOR INITIAL PARAMETER SET AND FOR EACH/ALL          *
* CHANGES TO PARAMETER UNDER STUDY (IPUS)                               *
  N=N+1                                                                     *
  CALL LOAD(PS,IPUS,N,HISTRY,OLD)                                          *
69  CALL RESULT (PS,IPUS,N,HISTRY,OLD)                                     *
* DISPLAY MORE DETAILED RESULTS BY A/C IF DESIRED                         *
  IF(ASK(1)) CALL REPORT(PS,IPUS,N,HISTRY,OLD)                             *
* LOOP TO CHANGE IPUS AGAIN IF DESIRED                                    *
  IF(ASK(2)) GO TO 300                                                       *
* DETERMINE IF USER WANTS TO STUDY ANOTHER PARAMETER , AND              *
* IF SO, WHETHER A NEW INITIAL SET OF PARAMETERS IS DESIRED             *
  IF(ASK(3)) THEN                                                            *
    CALL RESET(IPUS,OLD)                                                    *
    IF(ASK(4)) GO TO 100                                                    *
    CALL HEADER(1)                                                           *
    GO TO 200                                                                *
  ENDIF                                                                      *
* CONCLUDE THE SESSION WITH MESSAGES ABOUT OUTPUT FILE AND              *
* FINAL WARNING ABOUT PARAMETRIC VS PREDICTIVE NATURE OF "GETAWAY"      *
  CALL CNCLUD(NAME)                                                         *
*** END GETWAY ***                                                         *
  END                                                                       *

```

```

SUBROUTINE INTRO (NAME)
*****
* INTRODUCES USER TO "GETAWAY" AND OUTLINES
* HOW IT SHOULD AND SHOULD NOT BE USED
*****
CHARACTER NAME*20,CNT*1
LOGICAL ASK
10 PRINT 100
PRINT 150
150 FORMAT(/' ENTER ANY CHARACTER TO CONTINUE'/)
READ(*,'(A1)')CNT
PRINT 200
100 FORMAT(///' WELCOME TO GETAWAY'///' GETAWAY IS A BASE ESCAPE ',
+' SURVIVABILITY MODEL DESIGNED SPECIFICALLY'/' FOR',
+' PARAMETRIC STUDIES. THE SCENARIO MODELED REPRESENTS UP 20'/
+' AIRCRAFT ESCAPING FROM A SINGLE ALERT BASE UNDER SLBM AT 1000 K.'/'
+' THERE ARE 20 INPUT PARAMETERS IN 3 GENERAL GROUPS:/'
+' ESCAPE PARAMETERS'/'
+' THREAT PARAMETERS'/'
+' HARDNESS PARAMETERS'/'
+' AFTER CHOOSING AN INITIAL SET OF PARAMETERS, PROBABILITY
+' OF SURVIVAL FOR THE ESCAPING ALERT FORCE AIRCRAFT UNDER '/'
+' SLBM ATTACK WILL BE COMPUTED AND DISPLAYED.'/'
+' THEN YOU WILL BE GIVEN A CHANCE TO CHOOSE AND CHANGE THE '/'
+' INPUT PARAMETERS ONE AT A TIME TO STUDY THE DIFFERENTIAL '/'
+' EFFECT OF THE CHANGES ON ALERT FORCE SURVIVABILITY.'/)
200 FORMAT(/' BECAUSE THIS IS A PARAMETRIC MODEL, '/'
+' THE SURVIVABILITY RESULTS SHOULD NOT BE USED'/'
+' AS ABSOLUTE PREDICTIONS OF SURVIVABILITY. HIGHER FIDELITY'/'
+' MODELS (FLEE,QUANTA) ARE AVAILABLE TO PREDICT ALERT FORCE'/'
+' PRE-LAUNCH SURVIVABILITY. GETAWAY SHOULD BE USED WHEN '/'
+' PARAMETRIC RESULTS ARE OF INTEREST.'/'
+' ALTHOUGH NOT MANDATORY, WE SUGGEST YOU HAVE A COPY'/'
+' OF THE GETAWAY USERS MANUAL AT HAND WHEN USING THIS PROGRAM.'/'
+' IF YOU HAVE ANY QUESTIONS DURING THE OPERATION OF GETAWAY, '/'
+' THE USERS MANUAL WILL AID IN AVOIDING DIFFICULTIES.'/'
+' IF AT ANYTIME YOU WISH TO ABORT THE PRESENT OPERATIONS, '/'
+' ENTER -999- FOR A CURRENT NUMERICAL REQUEST OR'/'
+' ENTER -AAA- FOR A CURRENT CHARACTER REQUEST.'/'
+' YOU MAY NOW ENTER A NAME TO IDENTIFY THIS SESSION .'/'
+' ENTER SESSION NAME: 1 TO 20 CHARACTERS ( AAA TO ABORT) ?'///)
READ(*,'(A20)') NAME
IF(NAME.EQ.'AAA') CALL ABORT
WRITE(13,300) NAME
300 FORMAT('1 THIS IS THE SUMMARY FILE OF "GETAWAY" RESULTS',
+' FOR THE RUN NAMED'/'
+' 0',30X,A20/'0')
WRITE(13,100)
WRITE(13,200)
RETURN
***END INTRO***
END

```

```

SUBROUTINE SET(RADOUT)
*****
* INITIALIZES THE 20 PARAMETERS - USER MAY CHOOSE FROM DEFAULTS
* OR ROLL THEIR OWN
*****
LOGICAL ASK,CHECKN,RADOUT
REAL MFT
CHARACTER PAR*40
COMMON/PARAM/PAR(27)
COMMON/ESCPAR/RT,SECT,TOI,NOAC,
+NPRO,DTPP,NP(6),PROFIL(6,20,3),TURN(20)
COMMON/THTPAR/MFT,NB,DOI,BRHO(20),BPHI(20),YLD,HOX,CEP,ITYPE
COMMON/HRDPAR/OP(2),GUST(2),HEAT(2),TIS(2),SIL(2),DOSE(2),FLU(2)
SAVE
PRINT 100
100 FORMAT(/' YOU NOW HAVE YOUR CHOICE OF 3 METHODS OF ENTERING'/
+' THE INITIAL SET OF PARAMETERS: '//
+5X,'1 - REVIEW ALL PARAMETER DEFINITIONS AND'/
+9X,'MAKE CHANGES AS YOU GO.'/
+5X,'2 - SKIP THE DEFINITIONS AND MAKE A FEW'/
+9X,'CAREFUL CHANGES TO THE CURRENT(DEFAULT) VALUES.'/
+5X,'3 - MAKE A SERIES OF QUICK CHANGES BY'/
+9X,'PARAMETER # FOR AS MANY AS YOU DESIRE.'/
+' NOW ENTER YOUR CHOICE (#1-3) FROM THE MENU ABOVE ? ')
READ*,MENU
GO TO (1,5,3),MENU
3 CALL READIN
GO TO 5
1 PRINT*,'THERE ARE 6 ESCAPE PARAMETERS'
CALL LIST(1)
CALL STEP(1,6)
PRINT*,'THERE ARE 7 THREAT PARAMETERS'
CALL LIST(2)
CALL STEP(7,13)
NFP=20
NHP=7
IF(RADOUT) THEN
    NHP=3
    NFP=16
ENDIF
PRINT*,'THERE ARE ',NHP,' HARDNESS PARAMETERS'
CALL LIST(NHP)
CALL STEP(14,NFP)

```



```

* REVIEW INITIAL PARAMETER SET AND MAKE LAST MINUTE CHANGES      *
5   CALL HEADER(1)                                               *
20  IF(ASK(7)) THEN                                             *
25  PRINT*, 'ENTER THE PARAMETER # YOU WANT TO CHANGE (#1 TO 20) ' *
    PRINT*, 'ENTER ZERO (0) IF FINISHED CHANGING PARAMETERS'   *
    PRINT*, '?'                                                 *
    PRINT*                                                       *
    READ*,H                                                       *
    IF(CHECKN(H)) CALL ABORT                                     *
    IF(H.EQ.0) GO TO 5                                          *
    I=NINT(H)                                                   *
    CALL CHANGE(I,0,I)                                         *
    GO TO 25                                                    *
    ENDIF                                                       *
    RETURN                                                      *
*** END SET ***                                               *
    END                                                         *

```

```

SUBROUTINE STEP(I,J)                                           *
*****                                                         *
*DEFINES PARAMETERS I TO J AND CALLS FOR CHANGE                *
*TO CURRENT CLASS IF REQUESTED.                               *
*****                                                         *
    LOGICAL ASK                                               *
    REAL MFT                                                  *
    CHARACTER PAR*40                                          *
    COMMON/PARAM/PAR(27)                                     *
    COMMON/ESCPAR/RT,SECT,TOI,NOAC,                          *
+NPRO,DTTP,NP(6),PROFIL(6,20,3),TURN(20)                    *
    COMMON/THTPAR/MFT,NB,DOI,BRHO(20),BPHI(20),YLD,HOX,CEP,ITYPE *
    COMMON/HRDPAR/OP(2),GUST(2),HEAT(2),TIS(2),SIL(2),DOSE(2),FLU(2) *
    SAVE                                                       *
    DO 10 K=I,J                                               *
        CALL DEFINE(K)                                       *
        IF(ASK(6)) CALL CHANGE(K,0,K)                       *
10   CONTINUE                                                *
    RETURN                                                    *
*** END STEP ***                                             *
    END                                                         *

```

```

SUBROUTINE READIN
*****
* ALLOWS USER TO MAKE A QUICK SERIES OF PARAMETER CHANGES
* DURING THE INITIAL SET-UP OF A "GETAWAY" SESSION
*****
LOGICAL RNGCHK,CHECKN
PRINT 100
100 FORMAT(/' YOU MAY NOW ENTER A SERIES OF PARAMETER CHANGES.'/
+' ENTER THE PARAMETER NUMBER FOLLOWED BY THE VALUE.'/
+' IF A HARDNESS PARAMETER(#14-20), YOU MUST ENTER 2'/
+' VALUES AFTER THE PARAMETER NUMBER (SS & SK).'/
+' IF YOU SET 5 OR 6 FOR PARAMETER #5, YOU WILL BE SENT'/
+' TO A PROFILE ENTRY ROUTINE BEFORE CONTINUING.'/
+' ENTER A ZERO (0) TO FINISH THE SERIES.'/
+' IT IS NOT NECESSARY TO CHANGE ALL PARAMETERS,/'
+' NOR MUST THEY BE CHANGED IN ORDER. '//
+' NOW BEGIN YOUR SERIES OF ENTRIES - '/
+' USE A CARRIAGE RETURN AFTER EACH NUMBER ENTERED'/)
10 PRINT*, 'ENTER PARAMETER NUMBER = ? '
11 READ*,I
IF(I.EQ.0) RETURN
IF(CHECKN(FLOAT(I))) CALL ABORT
IF(I.LT.0.OR.I.GT.20) THEN
PRINT*, 'PARAM # OUT OF RANGE - TRY AGAIN !'
GO TO 10
ENDIF
IF(I.GT.13) THEN
PRINT*, 'SS= ? '
READ*,V1
PRINT*, 'SK = ? '
READ*,V2
IF(CHECKN(V1).OR.CHECKN(V2)) CALL ABORT
IF(RNGCHK(I,V1).OR.RNGCHK(I,V2)) GO TO 99
IF(V2.LT.V1) THEN
PRINT*, 'SS .GT. SK - NOT ACCEPTED! - TRY AGAIN!'
GO TO 10
ENDIF
L=2*I-14
CALL STORE(L,V1)
CALL STORE(L+1,V2)
GO TO 10
ENDIF
PRINT*, 'VALUE = ? '
READ*,V1
IF(CHECKN(V1)) CALL ABORT
IF(RNGCHK(I,V1)) GO TO 99
CALL STORE(I,V1)
IF(I.EQ.5.AND.(V1.EQ.5.OR.V1.EQ.6)) CALL NEWPRO(NINT(V1))
GO TO 10
99 CALL RNGOUT(I)
GO TO 10
*** END READIN ***
END

```

```

SUBROUTINE LIST(I)
*****
* LISTS PARAMETERS BY GROUPS WITH CURRENT VALUES
*   I=1 : ESCAPE PARAMETERS #1-5
*   I=2 : THREAT PARAMETERS #6-13
*   I=3 : HARDNESS PARAMETERS #14-20 (OR #14-16 IF RADOUT)
*****
REAL MFT
CHARACTER PAR*40
COMMON/PARAM/PAR(27)
COMMON/ESCPAR/RT,SECT,TOI,NOAC,
+NP,DTTP,NP(6),PROFIL(6,20,3),TURN(20)
COMMON/THTPAR/MFT,NB,DOI,BRHO(20),BPHI(20),YLD,HOX,CEP,ITYPE
COMMON/HRDPAR/OP(2),GUST(2),HEAT(2),TIS(2),SIL(2),DOSE(2),FLU(2)
SAVE
GO TO (1,2,3,7,7,7,7),I
1 PRINT*, '**** ESCAPE PARAMETERS ****'
  I=1
  J=6
  GO TO 30
2 PRINT*, '**** THREAT PARAMETERS ****'
  I=7
  J=13
  GO TO 30
3 I=14
  J=16
  GO TO 8
7 I=14
  J=20
8 PRINT*, '**** HARDNESS PARAMETERS ****'
  PRINT*, '      SS=SURE-SAFE SK=SURE-KILL'
  GO TO 50
30 DO 40 K=I,J
    PRINT 100,K,PAR(K),PVAL(K)
100 FORMAT(2X,'#',I2,5X,A40,5X,1PG15.4)
40 CONTINUE
  PRINT*, ' '
  RETURN
50 DO 60 K=I,J
    L=K+K-14
    PRINT 200,K,PAR(L),PVAL(L),PAR(L+1),PVAL(L+1)
200 FORMAT(2X,'#',I2,5X,A40,5X,1PG15.5/10X,A40,5X,1PG15.5)
60 CONTINUE
  PRINT*, ' '
  RETURN
*** END LIST ***
END

```

```

SUBROUTINE DEFINE (I)
*****
* DEFINES INPUT PARAMETER I , I= 1 TO 20
*****
      CHARACTER PAR*40
      COMMON/PARAM/PAR(27)
      GO TO (1,2,3,4,5,6,7,8,9,10,11,12,13,14,15,16,17,18,19,20),I
1      PRINT 100,PAR(1),PVAL(1)
100     FORMAT(' #1',5X,A40/
+ ' NUMBER OF A SINGLE TYPE AIRCRAFT ON FULL ALERT STATUS' /
+ ' AT THE SINGLE ESCAPE BASE' /
+ ' RANGE: 1 TO 20' /
+ ' PRESENT VALUE: NOAC= ',F4.0)
      PRINT*, ' '
      RETURN
2      PRINT 200,PAR(2),PVAL(2)
200     FORMAT(' #2',5X,A40/
+ ' TIME FROM 1ST SLBM BREAKWATER TO THE 1ST AIRCRAFT' /
+ ' RELEASING BRAKES FOR TAKEOFF' /
+ ' RANGE: 0 TO 900 SEC' /
+ ' PRESENT VALUE: RT= ',F6.1,' SEC')
      PRINT*, ' '
      RETURN
3      PRINT300, PAR(3),PVAL(3)
300     FORMAT(' #3',5X,A40/
+ ' WIDTH OF THE ESCAPE SECTOR CENTERED AT THE TURN POINT.' /
+ ' RANGE: 0 TO 360 DEG' /
+ ' PRESENT VALUE: SECT= ',F6.1,' DEG')
      PRINT*, ' '
      RETURN
4      PRINT 400, PAR(4),PVAL(4)
400     FORMAT(' #4',5X,A40/
+ ' CONSTANT TIME INTERVAL BETWEEN LAUNCHING' /
+ ' ALERT AIRCRAFT AFTER FIRST AIRCRAFT TAKES OFF' /
+ ' RANGE: 0 TO 300 SEC' /
+ ' PRESENT VALUE: TOI= ',F6.1,' SEC')
      PRINT*, ' '
      RETURN
5      PRINT 500, PAR(5),PVAL(5)
500     FORMAT(' #5',5X,A40/
+ ' A TIME/DISTANCE/ALTITUDE PROFILE FLOWN BY ALL AIRCRAFT' /
+ ' AFTER TAKE-OFF. THE VALUE OF THIS PARAMETER (NPRO)' /
+ ' SELECTS WHICH OF 6 POSSIBLE PROFILES IS FLOWN.' /
+ ' REFER TO THE USERS MANUAL PG. XX FOR SPECIFIC' /
+ ' VALUES OF THE POINTS ON THE PROFILES.' /
+ ' RANGE: #1 TO #6 - #1 = SLOW' /
+ '                   #2 = MEDIUM' /
+ '                   #3 = FAST' /
+ '                   #4 = HYPER' /
+ '                   #5 & #6 = USER DEFINED' /
+ ' PRESENT PROFILE: NPRO= ',F4.0)
      PRINT*, ' '
      RETURN

```

```

6      PRINT 600,PAR(6),PVAL(6)
600    FORMAT(  #6  ,5X,A40/
+  DISTANCE FROM BRAKE RELEASE POINT TO DEPARTURE TURN POINT  /
+  RANGE: 0 TO 20 NM.  /
+  PRESENT VALUE: DTP=  ,F6.1,  NM.  )
      PRINT*,  ' '
      RETURN
7      PRINT 700, PAR(7),PVAL(7)
700    FORMAT(  #7  ,5X,A40/
+  TIME FROM FIRST SLBM LAUNCH TO FIRST DETONATING WARHEAD  /
+  RANGE: 0 TO 900 SEC  /
+  PRESENT VALUE: MFT=  ,F6.1,  SEC  )
      PRINT*,  ' '
      RETURN
8      PRINT 800, PAR(8),PVAL(8)
800    FORMAT(  #8  ,5X,A40/
+  NUMBER OF WARHEADS TARGETED AT THE ESCAPING AIRCRAFT  /
+  RANGE: 1 TO 20 BURSTS  /
+  PRESENT VALUE: NB=  ,F4.0,  BURSTS  )
      PRINT*,  ' '
      RETURN
9      PRINT 900, PAR(9),PVAL(9)
900    FORMAT(  #9  ,5X,A40/
+  FIXED TIME BETWEEN DETONATING WARHEADS  /
+  RANGE: 0 TO 120 SEC  /
+  PRESENT VALUE: DOI=  ,F6.1,  SEC  )
      PRINT*,  ' '
      RETURN
10     PRINT 1000, PAR(10),PVAL(10)
1000   FORMAT(  #10  ,5X,A40/
+  EACH WARHEAD HAS IDENTICAL YIELD  /
+  RANGE: 1 TO 10000 KILOTONS  /
+  PRESENT VALUE: YLD=  ,F7.0,  KT  )
      PRINT*,  ' '
      RETURN
11     PRINT 1100, PAR(11),PVAL(11)
1100   FORMAT(  #11  ,5X,A40/
+  EACH WARHEAD DETONATES AT IDENTICAL ALTITUDE ABOVE SEALEVEL  /
+  RANGE: 0 TO 90000 FEET MSL  /
+  PRESENT VALUE: HOB=  ,F8.0,  FEET  )
      PRINT*,  ' '
      RETURN
12     PRINT 1200, PAR(12),PVAL(12)
1200   FORMAT(  #12  ,5X,A40/
+  ACCURACY OF WARHEAD DELIVERY ON DESIGNATED AIMPOINT  /
+  RANGE: 0 TO 5 NAUTICAL MILES(NM)  /
+  PRESENT VALUE: CEP=  ,F4.2,  NM  )
      PRINT*,  ' '
      RETURN
13     PRINT 1300, PAR(13),PVAL(13)
1300   FORMAT(  #13  ,5X,A40/
+  TYPE OF WARHEAD: 1 = FISSION  /
+                   2 = THERMONUCLEAR  /
+  PRESENT SELECTION: ITYPE=  ,F4.0)
      PRINT*,  ' '
      RETURN

```

```

14 PRINT 1400, PVAL(14),PVAL(15) *
1400 FORMAT( #14 OVERPRESSURE HARDNESS SPECIFICATION / *
+ SURE-SAFE(SS) & SURE-KILL(SK) A/C HARDNESS TO OVERPRESSURE / *
+ RANGE: 0 TO 20 PSI / *
+ PRESENT VALUE: SS= ,F4.1, PSI / *
+ SK= ,F4.1, PSI / *
GO TO 99 *
15 PRINT 1500, PVAL(16),PVAL(17) *
1500 FORMAT( #15 GUST HARDNESS SPECIFICATIONS / *
+ SURE-SAFE(SS) & SURE-KILL(SK) AIRCRAFT HARDNESS TO GUST / *
+ SPECIFIED IN FEET PER SECOND SIDE GUST AT SEALEVEL ALTITUDE / *
+ RANGE: 0 TO 500 FPS @ SL / *
+ PRESENT VALUE: SS= ,F6.1, FPS / *
+ SK= ,F6.1, FPS / *
GO TO 99 *
16 PRINT 1600, PVAL(18),PVAL(19) *
1600 FORMAT( #16 THERMAL HARDNESS SPECIFICATIONS / *
+ SURE-SAFE(SS) & SURE-KILL(SK) AIRCRAFT HARDNESS TO / *
+ THERMAL RADIATION FLUENCE IN CALORIES PER SQUARE CENTIMETER / *
+ RANGE: 0 TO 1000 CAL/CM2 / *
+ PRESENT VALUES: SS= ,F6.1, CAL/CM2 / *
+ SK= ,F6.1, CAL/CM2 / *
GO TO 99 *
17 PRINT 1700, PVAL(20),PVAL(21) *
1700 FORMAT( #17 AIRCREW RADIATION HARDNESS SPECIFICATIONS / *
+ SURE-SAFE(SS) & SURE-KILL(SK) AIRCREW HARDNESS TO GAMMA AND / *
+ NEUTRON TOTAL RADS-TISSUE DOSE / *
+ RANGE: 0 TO 5000 RADS-TISSUE / *
+ PRESENT VALUES: SS= ,F7.1, RADS-TIS / *
+ SK= ,F7.1, RADS-TIS / *
GO TO 99 *
18 PRINT 1800, PVAL(22),PVAL(23) *
1800 FORMAT( #18 EQUIPMENT RADIATION HARDNESS SPECIFICATIONS / *
+ SURE-SAFE(SS) & SURE-KILL(SK) ELECTRONIC EQUIPMENT HARDNESS / *
+ TO GAMMA AND NEUTRON RADIATION IN TOTAL RADS-SILICON / *
+ RANGE: 0 TO 1E+9 RADS-SILICON / *
+ PRESENT VALUES: SS= ,1PG15.3, RADS-SIL / *
+ SK= ,1PG15.3, RADS-SIL / *
GO TO 99 *
19 PRINT 1900, PVAL(24),PVAL(25) *
1900 FORMAT( #19 EQUIPMENT DOSE RATE HARDNESS SPECIFICATIONS / *
+ SURE-SAFE(SS) & SURE-KILL(SK) ELECTRONIC HARDNESS TO GAMMA / *
+ DOSE RATE IN RADS-SILICON PER SECOND / *
+ RANGE: 0 TO 1E+12 RADS-SIL/SEC / *
+ PRESENT VALUE: SS= ,1PG15.3, RADS-SIL/SEC / *
+ SK= ,1PG15.3, RADS-SIL/SEC / *
GO TO 99 *
20 PRINT 2000, PVAL(26),PVAL(27) *
2000 FORMAT( #20 AIRCRAFT NEUTRON FLUENCE HARDNESS SPECIFICATIONS / *
+ SURE-SAFE(SS) & SURE-KILL(SK) AIRCRAFT HARDNESS TO NEUTRON / *
+ FLUENCE IN NUETRONS PER SQUARE CENTIMETER / *
+ RANGE: 0 TO 1E+20 N/CM2 / *
+ PRESENT VALUES: SS= ,1PG15.3, N/CM2 / *
+ SK= ,1PG15.3, N/CM2 / *
99 RETURN *
*** END DEFINE *** *
END *

```

```

SUBROUTINE CHOOSE(IPUS,OLD,RADOUT)
*****
* ALLOWS USER TO CHOOSE ONE OF THE 20 PARAMETERS FOR STUDY.
* IPUS IS RETURNED AS THE CHOICE
*****
LOGICAL ASK,CHECKN,RADOUT
REAL OLD(20,2)
PRINT 100
100 FORMAT(' YOU HAVE JUST REVIEWED THE RESULTS OF AN INITIAL RUN'/
+ ' (OR HAVE COMPLETED THE STUDY OF ONE PARAMETER) AND IT'/
+ ' IS NOW TIME TO CHOOSE ONE OF THE 20 PARAMETERS TO STUDY'/
+ ' THE EFFECT OF CHANGING THAT PARAMETER HAS ON THE ALERT '/
+ ' FORCE SURVIVABILITY UNDER SLBM ATTACK')
10 PRINT 200
200 FORMAT(' THERE ARE THREE GROUPS OF PARAMETERS: '/
+ ' 1= ESCAPE PARAMETERS'/
+ ' 2= THREAT PARAMETERS'/
+ ' 3= HARDNESS PARAMETERS'//
+ ' WHICH GROUP CONTAINS THE PARAMETER YOU ARE'/
+ ' INTERESTED IN STUDYING? (ENTER 1, 2, OR 3) ?')
PRINT*
PRINT*
READ*,H
IF(CHECKN(H)) CALL ABORT
J=NINT(H)
IF(J.LT.1.OR.J.GT.3) THEN
PRINT*, 'YOU MUST CHOOSE 1,2, OR 3 - YOU ENTERED',J
GO TO 10
ENDIF
20 IF(J.EQ.3.AND..NOT.RADOUT) J=7
CALL LIST(J)
PRINT 300
300 FORMAT(' THE PARAMETERS FROM THE GROUP YOU HAVE CHOSEN ARE ',
+ ' REVIEWED ABOVE')
* CHECK IF USER WANTS FURTHER DEFINITIONS
30 IF(ASK(13)) THEN
PRINT*, 'WHICH ONE? (ENTER THE PARAMETER NUMBER) ?'
PRINT*
PRINT*
READ*,H
IF(CHECKN(H)) CALL ABORT
K=NINT(H)
IF(K.LT.1.OR.K.GT.20) THEN
PRINT*, 'YOU MUST CHOOSE A NUMBER BETWEEN 1 & 20'
GO TO 10
ENDIF
CALL DEFINE(K)
GO TO 30
ENDIF
ENDIF

```

```

* FINALLY CHOOSE THE PARAMETER UNDER STUDY (IPUS)
40 PRINT*, "NOW ENTER THE NUMBER OF THE PARAMETER"
PRINT*, "YOU WANT TO STUDY. (1 TO 20) ?"
READ*, H
IF(CHECKN(H)) CALL ABORT
IPUS=NINT(H)
IF(IPUS.LT.0.OR.IPUS.GT.20) THEN
PRINT*, "YOU MUST CHOOSE A PARAMETER NUMBER FROM 1 TO 20"
GO TO 40
ENDIF
* STORE CURRENT VALUE OF IPUS IN OLD ARRAY
L=IPUS
IF(L.GT.13) THEN
L=L+L-14
OLD(1,2)=PVAL(L+1)
ENDIF
OLD(1,1)=PVAL(L)
RETURN
*** END CHOOSE ***
END

```

```

SUBROUTINE STORE(I,V)
*****
* STORES NEW VALUE V IN PARAMETER #I
*****
REAL MFT
COMMON/ESCPAR/RT,SECT,TOI,NOAC,
+NPRO,DTTP,NP(6),PROFIL(6,20,3),TURN(20)
COMMON/THTPAR/MFT,NB,DOI,BRHO(20),BPHI(20),YLD,HOX,CEP,ITYPE
COMMON/HRDPAR/OP(2),GUST(2),HEAT(2),TIS(2),SIL(2),DOSE(2),FLU(2)
SAVE
GO TO(1,2,3,4,5,6,7,8,9,10,11,12,13,14,15
+,16,17,18,19,20,21,22,23,24,25,26,27),I
1 NOAC=NINT(V)
RETURN
2 RT=V
RETURN
3 SECT=V
RETURN
4 TOI=V
RETURN
5 NPRO=NINT(V)
RETURN
6 DTTP=V
RETURN
7 MFT=V
RETURN
8 NB=NINT(V)
RETURN

```



```

9      DOI=V
      RETURN
10     YLD=V
      RETURN
11     HOX=V
      RETURN
12     CEP=V
      RETURN
13     ITYPE=NINT(V)
      RETURN
14     OP(1)=V
      RETURN
15     OP(2)=V
      RETURN
16     GUST(1)=V
      RETURN
17     GUST(2)=V
      RETURN
18     HEAT(1)=V
      RETURN
19     HEAT(2)=V
      RETURN
20     TIS(1)=V
      RETURN
21     TIS(2)=V
      RETURN
22     SIL(1)=V
      RETURN
23     SIL(2)=V
      RETURN
24     DOSE(1)=V
      RETURN
25     DOSE(2)=V
      RETURN
26     FLU(1)=V
      RETURN
27     FLU(2)=V
      RETURN
*** END STORE ***
      END

```

```

SUBROUTINE QUICK(IPUS,N,RADOUT)
*****
* READS A SERIES OF PARAMETER CHANGES TO BE ACCOMPLISHED
* AND MAKES THE RUNS BEFORE PRESENTING ANY RESULTS
*****
REAL PS(21,21,8),MFT,OLD(20,2),HISTRY(20,21,8),CELL(20,11,8)
LOGICAL ASK,RADOUT,CHECKN,RNGCHK
CHARACTER PAR*40
COMMON//CELL,PS,OLD,HISTRY
COMMON/PARAM/PAR(27)
COMMON/ESCPAR/RT,SECT,TOI,NOAC,
+NPRO,DTP,NP(6),PROFIL(6,20,3),TURN(20)
COMMON/THTPAR/MFT,NB,DOI,BRHO(20),BPHI(20),YLD,HOX,CEP,ITYPE
COMMON/HRDPAR/OP(2),GUST(2),HEAT(2),TIS(2),SIL(2),DOSE(2),FLU(2)
SAVE
IF(N.NE.1) RETURN
10 PRINT*, 'NOW ENTER THE NUMBER OF TIMES THE PARAMETER ',
+'IS TO BE CHANGED (1-19) ?'
PRINT*, 'IN OTHER WORDS, HOW MANY DIFFERENT RUNS ARE ',
+'TO BE MADE (1-19) ?'
READ*,I
IF(CHECKN(FLOAT(I))) CALL ABORT
IF(I.LT.1.OR.I.GT.19) THEN
PRINT*, '# OF RUNS OUT OF RANGE (1-19) - TRY AGAIN !'
GO TO 10
ENDIF
L=IPUS
PRINT*, 'ENTER THE PARAMETER CHANGES ONE AT A TIME'
IF(L.GT.13) THEN
L=2*L-14
DO 20 K=1,I
PRINT 200,PAR(L)
200 FORMAT(' NEXT VALUE FOR - ',A34)
25 PRINT*, 'FOR RUN #',K,' SS= ? '
READ*,V1
PRINT*, 'SK= ? '
READ*,V2
IF(CHECKN(V1).OR.CHECKN(V2)) CALL ABORT
IF(RNGCHK(IPUS,V1).OR.RNGCHK(IPUS,V2)) THEN
CALL RNGOUT(IPUS)
GO TO 25
ENDIF
IF(V2.LT.V1) THEN
PRINT*, ' SS .GT. SK - TRY AGAIN!'
GO TO 25
ENDIF
CALL STORE(L,V1)
CALL STORE(L+1,V2)
CALL RUN(RADOUT)
N=N+1
CALL LOAD(PS,IPUS,N,HISTRY,OLD)
20 CONTINUE

```

```

ELSE
  DO 30 K=1,I
    PRINT 200,PAR(L)
    PRINT*, 'FOR RUN #',K, ' VALUE= ? '
    READ*,V1
    IF(CHECKN(V1)) CALL ABORT
    IF(RNGCHK(IPUS,V1)) THEN
      CALL RNGOUT(IPUS)
      GO TO 35
    ENDIF
    CALL STORE(L,V1)
    CALL RUN(RADOUT)
    N=N+1
    CALL LOAD(PS,IPUS,N,HISTRY,OLD)
30  CONTINUE
  ENDIF
  RETURN
*** END QUICK ***
END

```

```

SUBROUTINE RESET(IPUS,OLD)
*****
* RESETS THE VALUE OF THE CURRENT PARAMETER UNDER STUDY(IPUS)
* TO THE INITIAL SET VALUE BEFORE PROCEEDING WITH THE
* STUDY OF ANOTHER PARAMETER
*****
  REAL OLD(20,2)
  L=IPUS
  IF(L.GT.13) THEN
    L=2*L-14
    CALL STORE(L+1,OLD(1,2))
  ENDIF
  CALL STORE(L,OLD(1,1))
  RETURN
*** END RESET ***
END

```

```

SUBROUTINE CHANGE(I,N,OLD)
*****
* ALLOWS USER TO CHANGE THE VALUE OF PARAMETERS DURING
* INITIAL SET-UP AND DURING PARAMETRIC STUDIES WHERE PARAMETER "I"
* CAN BE CHANGED UP TO 20 TIMES. PAST VALUES OF I ARE STORED IN OLD
*****
REAL MFT,OLD(20,2)
CHARACTER PAR*40
LOGICAL ASK,CHECKN,RNGCHK
COMMON/PARAM/PAR(27)
COMMON/ESCPAR/RT,SECT,TOI,NOAC,
+NPPO,DTPP,NP(6),PROFIL(6,20,3),TURN(20)
COMMON/THTPAR/MFT,NB,DOI,BRHO(20),BPHI(20),YLD,HOX,CEP,ITYPE
COMMON/HRDPAR/OP(2),GUST(2),HEAT(2),TIS(2),SIL(2),DOSE(2),FLU(2)
SAVE
* START THE COUNT OVER IF MORE THAN 19 CHANGES HAVE BEEN MADE
IF(N.GT.19) N=N-19
PRINT 50,I
50 FORMAT(' YOU NOW HAVE THE OPPORTUNITY TO CHANGE PARAMETER #',I2)
* BRANCH IF I IS A HARDNESS PARAMETER
IF(I.GT.13) GO TO 14
* PERFORM CHANGE FOR ESCAPE OR THREAT PARAMETER
5 PRINT 100,I,PAR(I)
100 FORMAT(' PARAMETER #',I2,' IS ',A40)
PRINT 200,N,PVAL(I)
200 FORMAT(' THIS IS CHANGE #',I2/
+' THE CURRENT VALUE IS: ',F8.2/
+' PREVIOUS VALUES RUN ARE(NONE IF CHANGE #0): ')
DO 10 J=1,N
PRINT 300,J,OLD(J,1)
300 FORMAT(' RUN #',I2,' VALUE= ',F8.2)
10 CONTINUE
* READ & STORE THE NEXT VALUE OF THE PARAMETER
15 PRINT 400,PAR(I)
400 FORMAT(' NOW ENTER A NEW VALUE FOR ',A40, '//, '?' )
READ*,VALNEW
IF(CHECKN(VALNEW)) CALL ABORT
IF(RNGCHK(I,VALNEW)) THEN
CALL RNGOUT(I)
GO TO 5
ENDIF
* CHECK IF USER DEFINED PROFILE IS DESIRED
IV=NINT(VALNEW)
IF(I.EQ.5.AND.(IV.EQ.5.OR.IV.EQ.6.OR.IV.EQ.NINT(PVAL(5))))
+ CALL NEWPRO(IV)
* STORE THE NEW VALUE
CALL STORE(I,VALNEW)
* LAST CHANCE TO ADJUST THE CHANGE BEFORE RUN
PRINT 250,PAR(I),PVAL(I)
250 FORMAT(A40,' IS NOW= ',F8.2)
IF(.NOT.ASK(9)) GO TO 15
RETURN

```

```

* READ & STORE SS & SK FOR HARDNESS PARAMETER CHANGE
14   L=I+I-14
      PRINT 500,I,PAR(L),PVAL(L),PAR(L+1),PVAL(L+1)
500  FORMAT(' PARAMETER #',I2,' IS A HARDNESS PARAMETER'/
+20X,'SS=SURE-SAFE, SK=SURE-KILL'/
+' THE CURRENT VALUES ARE ',A40,1PG15.5/24X,A40,1PG15.5)
      PRINT 600,N
600  FORMAT(' THIS IS CHANGE #',I2/
+' PREVIOUS VALUES ARE: RUN#',I2,'SS',13X,'SK (NONE IF #0)')
      DO 20 J=1,N
          PRINT 700,J,OLD(J,1),OLD(J,2)
700  FORMAT(24X,I2,1PG15.5,1PG15.5)
20   CONTINUE
* READ & STORE NEW SS & SK VALUES
25   DO 30 J=L,L+1
          PRINT 400,PAR(J)
          READ*,VALNEW
          IF(CHECKN(VALNEW)) CALL ABORT
          IF(RNGCHK(I,VALNEW)) THEN
              CALL RNGOUT(I)
              GO TO 14
          ENDIF
          CALL STORE(J,VALNEW)
30   CONTINUE
* CHECK FOR SS>=SK
      SS=PVAL(L)
      SK=PVAL(L+1)
      IF(ABS(SK-SS).LT.(.01)) CALL SSWARN
      IF(SK.LT.SS) THEN
          PRINT*,'YOU HAVE ENTERED A SK VALUE WHICH IS'
          PRINT*,'LESS THAN THE SS VALUE--TRY AGAIN !!'
          GO TO 14
      ENDIF
* LAST CHANCE TO CHANGE BEFORE RUN
      PRINT 800,PAR(L),PVAL(L),PAR(L+1),PVAL(L+1)
800  FORMAT(' THE HARDNESS VALUES ARE NOW AS FOLLOWS'/
+A40,1PG15.5/A40,1PG15.5)
      IF(.NOT.ASK(9)) GO TO 25
      RETURN
*** END CHANGE ***
      END

```

```

      LOGICAL FUNCTION RNGCHK(I,V)
      *****
      * CHECKS IF NUMERICAL VALUE ENTERED FOR PARAMETER VALUE
      * IS WITHIN REASONABLE RANGE DESCRIBED IN DEFINITION
      *****
      REAL RANGES(20,2)
      DATA((RANGES(I,J),J=1,2),I=1,20)/
      +1,20,0,900,0,360,0,300,1,6,0,20,0,900,1,20,0,120,
      +1,10000,0,90000,0,5,1,2,0,20,0,500,0,1000,0,5000,
      +0,1E+9,0,1E+12,0,1E+20/
      RNGCHK=.FALSE.
      IF(V.LT.RANGES(I,1).OR.V.GT.RANGES(I,2)) RNGCHK=.TRUE.
      RETURN
      *** END RNGCHK ***
      END

```

```

      SUBROUTINE RNGOUT(I)
      *****
      * NOTIFIES USER HE/SHE HAS ENTERED A VALUE FOR A PARAMETER
      * WHICH IS OUT OF REASONABLE RANGE FOR PARAMETER I AND
      * DEFINES PARAMETER I
      *****
      PRINT*, 'YOU HAVE ENTERED A VALUE OUT OF THE REASONABLE RANGE'
      PRINT*, 'FOR THE FOLLOWING PARAMETER.'
      PRINT*, 'PLEASE REVIEW THE FOLLOWING DEFINITION AND '
      PRINT*, 'TRY AGAIN - THANK YOU'
      CALL DEFINE(I)
      RETURN
      *** END RNGOUT ***
      END

```

```

      SUBROUTINE SSWARN
      *****
      * WARNS THE USER OF THE CONSEQUENCES OF SETTING SS = SK
      *****
      PRINT 500
      WRITE(13,500)
500  FORMAT('O WARNING - YOU HAVE ENTERED SURE-SAFE AND SURE-KILL'
      + ' HARDNESS VALUES WHICH ARE EQUAL. ALTHOUGH GETAWAY WILL'
      + ' FUNCTION IN THIS COOKIE-CUTTER MODE, DOING SO WILL'
      + ' DEFEAT THE PARAMETRIC VALUE OF THE MODEL WHEN'
      + ' STUDYING SURVIVABILITY OF INDIVIDUAL AIRCRAFT.')
      RETURN
      *** END SSWARN ***
      END

```

```

SUBROUTINE NEWPRO(N)
*****
* ALLOWS USER TO DEFINE HIS/HER OWN DEPARTURE PROFILE IN
* (TIME/RANGE/ALTITUDE)
*****
      REAL MFT
      LOGICAL ASK,CHECKN,RNGCHK
      COMMON/ESCPAR/RT,SECT,TOI,NOAC,
+NPRO,DTTP,NP(6),PROFIL(6,20,3),TURN(20)
      COMMON/THTPAR/MFT,NB,DOI,BRHO(20),BPHI(20),YLD,HOX,CEP,ITYPE
      COMMON/HRDPAR/OP(2),GUST(2),HEAT(2),TIS(2),SIL(2),DOSE(2),FLU(2)
      SAVE
      PRINT 100,N
100  FORMAT(' YOU HAVE ELECTED TO DEFINE YOUR OWN DEPARTURE'/
+ ' PROFILE (TIME/RANGE/ALTITUDE) RATHER THAN USE ONE'/
+ ' OF THE 4 PROFILES PROVIDED AS DEFAULTS'/
+ ' OR YOU WISH TO CHANGE A DEFAULT PROFILE'/
+ ' THIS IS PROFILE #',I2)
      GO TO 25
10   PRINT*, 'ENTER THE NUMBER OF POINTS IN THE PROFILE (2 TO 20) ?'
      J=1
      READ*,H
      IF(CHECKN(H)) CALL ABORT
      NP(N)=NINT(H)
      IF(NP(N).LT.2.OR.NP(N).GT.20) THEN
          PRINT*, 'YOU MAY ONLY HAVE FROM 2 TO 20 POINTS IN'
          PRINT*, 'A PROFILE, YOU HAVE ENTERED',NP(N)
          PRINT*, 'PLEASE TRY AGAIN'
          GO TO 10
      ENDIF
15   DO 20 I=J,NP(N)
          PRINT 200,I
200  FORMAT(' FOR POINT #',I2,' ENTER:')
          PRINT*, 'TIME(SEC)=?'
          READ*,PROFIL(N,I,1)
          PRINT*, 'RANGE(NM.)=?'
          READ*,PROFIL(N,I,2)
          PRINT*, 'ALTITUDE(FEET MSL)=?'
          READ*,PROFIL(N,I,3)
20   CONTINUE
25   PRINT 300,NP(N),N
300  FORMAT(' THERE ARE CURRENTLY ',I2,' POINTS IN PROFILE #',I2/
+ ' WE WILL NOW REVIEW THEM'/
+ /5X,'POINT#',5X,'TIME',5X,'RANGE',5X,'ALTITUDE')
      DO 30 I=1,NP(N)
          PRINT 400,I,(PROFIL(N,I,J),J=1,3)
400  FORMAT(7X,I2,6X,F5.0,2X,F8.2,5X,F8.0)
30   CONTINUE
      PRINT 500
500  FORMAT(' PLEASE REVIEW THE ABOVE LISTING TO INSURE IT'/
+ ' REFLECTS YOUR DESIRED PROFILE.'/
+ ' NO RANGE CHECKING FOR REASONABLE VALUES HAS BEEN'/
+ ' PERFORMED AND THIS IS YOUR LAST CHANCE TO'/
+ ' MAKE CORRECTIONS BEFORE THE NEXT RUN.')
      IF(ASK(10)) GO TO 40
      RETURN

```

```

* THE FOLLOWING CODE MAKES CHANGES TO THE PROFILE
40  IF(ASK(11)) GO TO 10
50  IF(ASK(12)) THEN
      PRINT*, 'HOW MANY NEW POINTS TO BE ADDED TO THE'
      PRINT*, 'PROFILE? (REMEMBER, THE TOTAL CANNOT'
      PRINT*, 'EXCEED 20) ?'
      J=NP(N)+1
      READ*,H
      IF(CHECKN(H)) CALL ABORT
      L=NINT(H)
      IF((NP(N)+L).GT.20) THEN
          PRINT*, 'YOU HAVE EXCEEDED 20 POINTS.'
          PRINT*, 'THERE ARE PRESENTLY', NP(N), ' POINTS'
          PRINT*, 'TRY AGAIN'
          GO TO 50
      ENDIF
      NP(N)=NP(N)+L
      GO TO 15
ENDIF
60  PRINT*, 'YOU MUST WANT TO CHANGE SOME OF THE EXISTING POINTS'
70  PRINT*, 'ENTER WHICH POINT YOU WANT TO CHANGE ?'
      PRINT*, '(ENTER 0 IF FINISHED CHANGING POINTS) ?'
      READ*,H
      IF(CHECKN(H)) CALL ABORT
      NC=NINT(H)
      IF(NC.GT.NP(N).OR.NC.LT.0) THEN
          PRINT*, NC, 'IS NOT ONE OF THE POINTS IN THE PROFILE.'
          PRINT*, 'TRY AGAIN'
          GO TO 70
      ENDIF
      IF(NC.EQ.0) GO TO 25
      PRINT 200, NC
      PRINT*, 'ALL 3 (TIME/RANGE/ALT) IN FREE FIELD FORMAT - ?'
      READ*, (PROFIL(N, NC, I), I=1, 3)
      GO TO 70
*** END NEWPRO ***
      END

```

LOGICAL FUNCTION ASK(I)

```

*****
* POSES AND RETURNS YES/NO ANSWERS TO QUESTIONS FROM ALL ROUTINES.
* ANSWER DEFAULTS TO YES(TRUE) UNLESS A NO("N") IS READ
*****
CHARACTER ANS*1
PRINT*
ASK=.TRUE.
GO TO (1,2,3,4,5,6,7,8,9,10,11,12,13,14,15,16,17),I
1 PRINT*, "WOULD YOU LIKE TO SEE A MORE DETAILED REPORT"
PRINT*, "OF SURVIVABILITY BY INDIVIDUAL AIRCRAFT? (Y/N)?"
GO TO 99
2 PRINT*, "DO YOU WISH TO CHANGE THE VALUE OF THE CURRENT PARAMETER"
PRINT*, "UNDER STUDY AND MAKE ANOTHER RUN? (Y/N)?"
GO TO 99
3 PRINT*, "DO YOU WISH TO STUDY THE EFFECTS ON SURVIVABILITY OF"
PRINT*, "CHANGING SOME OTHER PARAMETER? (Y/N)?"
GO TO 99
4 PRINT*, "DO YOU WANT TO START WITH A NEW INITIAL SET OF"
PRINT*, "PARAMETERS RATHER THAN THE CURRENT SET? (Y/N)?"
GO TO 99
6 PRINT*, "WOULD YOU LIKE TO CHANGE THE ABOVE"
PRINT*, "PARAMETER FROM THE CURRENT VALUE? (Y/N)?"
5 GO TO 99
7 PRINT*, "ALL 20 PARAMETERS AND THEIR CURRENT VALUES ",
+ "ARE REVIEWED ABOVE."
PRINT*, "DO YOU WISH TO MAKE ANY FURTHER CHANGES"
PRINT*, "BEFORE THE INITIAL RUN? (Y/N)?"
GO TO 99
8 PRINT*, "WOULD YOU LIKE TO REVIEW THE DEFINITION"
PRINT*, "OF THIS PARAMETER? (Y/N)?"
GO TO 99
9 PRINT*, "ARE YOU SATISFIED WITH THIS CHANGE? (Y/N)?"
GO TO 99
10 PRINT*, "DO YOU WANT TO MAKE CHANGES IN THE ABOVE PROFILE? (Y/N)?"
GO TO 99
11 PRINT*, "DO YOU WISH TO CHANGE THE ENTIRE PROFILE? (Y/N)?"
GO TO 99
12 PRINT*, "DO YOU WANT TO ADD POINTS TO"
PRINT*, "THE END OF THE PROFILE? (Y/N)?"
GO TO 99
13 PRINT*, "WOULD YOU LIKE TO REVIEW THE DEFINITION OF"
PRINT*, "ANY OF THE ABOVE PARAMETERS"
PRINT*, "BEFORE MAKING YOUR CHOICE? (Y/N)?"
GO TO 99
15 PRINT*, "WOULD YOU LIKE TO REVIEW PS RESULTS FOR A PARTICULAR"
PRINT*, "AIRCRAFT FOR ALL RUNS ON THE CURRENT PARAMETER? (Y/N)?"
GO TO 99
14 PRINT*, "WOULD YOU LIKE TO ENTER A FULL SET OF CHANGES"
PRINT*, "AND GET ONE FINAL REPORT RATHER THAN"
PRINT*, "MAKE THE CHANGES AND GET RESULTS AS YOU GO? (Y/N)?"
GO TO 99

```

```

16  PRINT*, 'WOULD YOU LIKE TO REVIEW SOME OTHER AIRCRAFT'S'
    PRINT*, 'PROBABILITY OF SURVIVAL(PS) OVER ALL RUNS? (Y/N)?'
    GO TO 99
17  PRINT*, 'DO YOU WANT TO SUPPRESS ALL RADIATION CALCULATIONS(Y/N)?'
    GO TO 99
99  PRINT*
    PRINT*
    READ(*, '(A1)') ANS
    IF(ANS.EQ.'A') CALL ABORT
    IF(ANS.EQ.'N') ASK=.FALSE.
    RETURN
*** END ASK ***
END

```

```

          LOGICAL FUNCTION CHECKN(VAL)
*****
* CHECKS VAL FOR USER ABORT -999-
*****
    NUM=NINT(VAL)
    CHECKN=.FALSE.
    IF(NUM.EQ.999) CHECKN=.TRUE.
    RETURN
*** END CHECKN ***
END

```

```

          SUBROUTINE ABORT
*****
* PROVIDES USER WITH ABORT MESSAGE AND STOPS EXECUTION
*****
    PRINT*, 'YOU HAVE ELECTED TO ABORT THIS SESSION OF GETAWAY'
    PRINT*, 'TO BEGIN ANOTHER SESSION, EXECUTE GETAWAY AS BEFORE.'
    CALL CNCLUD(' ABORT ')
    STOP 'USER ABORT'
*** END ABORT ***
END

```

```

FUNCTION PVAL(I)
*****
* RETURNS CURRENT VALUE OF PARAMETER I
*****
REAL MFT
COMMON/ESCPAR/RT,SECT,TOI,NOAC,
+NPRO,DTP,NP(6),PROFIL(6,20,3),TURN(20)
COMMON/THTPAR/MFT,NB,DOI,BRHO(20),BPHI(20),YLD,HOX,CEP,ITYPE
COMMON/HRDPAR/OP(2),GUST(2),HEAT(2),TIS(2),SIL(2),DOSE(2),FLU(2)
SAVE
GO TO (1,2,3,4,5,6,7,8,9,10,11,12,13,14,15
+      ,16,17,18,19,20,21,22,23,24,25,26,27),I
1  PVAL=NOAC
   RETURN
2  PVAL=RT
   RETURN
3  PVAL=SECT
   RETURN
4  PVAL=TOI
   RETURN
5  PVAL=NPRO
   RETURN
6  PVAL=DTP
   RETURN
7  PVAL=MFT
   RETURN
8  PVAL=NB
   RETURN
9  PVAL=DOI
   RETURN
10 PVAL=YLD
   RETURN
11 PVAL=HOX
   RETURN
12 PVAL=CEP
   RETURN
13 PVAL=ITYPE
   RETURN
14 PVAL=OP(1)
   RETURN
15 PVAL=OP(2)
   RETURN
16 PVAL=GUST(1)
   RETURN
17 PVAL=GUST(2)
   RETURN
18 PVAL=HEAT(1)
   RETURN
19 PVAL=HEAT(2)
   RETURN
20 PVAL=TIS(1)
   RETURN
21 PVAL=TIS(2)
   RETURN

```

```
22  PVAL=SIL(1)          *
    RETURN              *
23  PVAL=SIL(2)          *
    RETURN              *
24  PVAL=DOSE(1)        *
    RETURN              *
25  PVAL=DOSE(2)        *
    RETURN              *
26  PVAL=FLU(1)         *
    RETURN              *
27  PVAL=FLU(2)         *
    RETURN              *
*** END PVAL ***      *
    END                  *
```

```

BLOCK DATA FLYOUT
*****
* DATA FOR THE 4 PRE-DEFINED DEPARTURE PROFILES & SEALEVEL AMBIENT
* EACH POINT= TIME,RANGE,ALTITUDE SEC,NAUT MILES,FEET MSL
*****
COMMON/ESCPAR/RT,SECT,TOI,NOAC,
+NPRO,DTTP,NP(6),PROFIL(6,20,3),TURN(20)
COMMON/REFAMB/RPRES,RDEN,RTEMP,RSSO
DATA RPRES,RDEN,RTEMP,RSSO/14.7,1.225,288,340/
** PROFILE #1 - SLOW
DATA((PROFIL(1,I,J),J=1,3),I=1,9)/
+0,0,0, 90,3.75,750,
+120,5,1000, 210,10,1400,
+240,12.5,2600, 270,15,3000,
+300,17.5,3020, 330,19.8,4000,
+360,22.5,4600/
** PROFILE #2 - MEDIUM
DATA((PROFIL(2,I,J),J=1,3),I=1,9)/
+0,0,0, 90,3.2,600,
+120,5.3,2300, 150,7,3500,
+180,9,5600, 210,12,6000,
+240,14.8,6000, 270,18,6000,
+300,22,6000/
** PROFILE #3 - FAST
DATA((PROFIL(3,I,J),J=1,3),I=1,10)/
+0,0,0, 90,3.5,800,
+120,5.5,2900, 150,8,5200,
+180,11,6000, 210,14.3,6000,
+240,17.8,6000, 270,21.5,6000,
+300,25,6000, 330,29,6000/
** PROFILE #4 - HYPER
DATA((PROFIL(4,I,J),J=1,3),I=1,12)/
+0,0,0, 150,12,300,
+180,17,5500, 210,22,11000,
+240,27,16500, 270,32,22000,
+300,37,27500, 330,42,30000,
+360,47,35500, 390,52,40000,
+420,57,40000, 450,62,40000/
** PROFILES #5 & 6 - USER DEFINABLE - SET TO ZEROS
DATA((PROFIL(5,I,J),J=1,3),I=1,20)/60*0/
DATA((PROFIL(6,I,J),J=1,3),I=1,20)/60*0/
** NP FOR ALL 6 PROFILES
DATA(NP(I),I=1,6)/9,9,10,12,2*0/
*** END BLOCK DATA FLYOUT ***
END

```

```

BLOCK DATA DEFALT
*****
** DEFAULT DATA AND STRING LABELS FOR ALL 20 PARAMETERS
*****
REAL MFT
CHARACTER PAR*40
COMMON/PARAM/PAR(27)
COMMON/ESCPAR/RT,SECT,TOI,NOAC,
+NPRO,DTTP,NP(6),PROFIL(6,20,3),TURN(20)
COMMON/THTPAR/MFT,NB,DOI,BRHO(20),BPHI(20),YLD,HOX,CEP,ITYPE
COMMON/HRDPAR/OP(2),GUST(2),HEAT(2),TIS(2),SIL(2),DOSE(2),FLU(2)
DATA (PAR(I),I=1,13)/
+ NUMBER OF AIRCRAFT (1 TO 20)~,
+ REACTION TIME (SEC)~,
+ ESCAPE SECTOR WIDTH(DEG)~,
+ TAKE-OFF INTERVAL (SEC)~,
+ ESCAPE PROFILE(#1-4:DEFAULT,#5&6:USERS)~,
+ DISTANCE TO TURN POINT (NM.)~,
+ MISSILE FLIGHT TIME (SEC)~,
+ NUMBER OF BURSTS (1 TO 20)~,
+ DETONATION INTERVAL (SEC)~,
+ YIELD (KT)~,
+ HEIGHT OF BURST (FEET MSL)~,
+ DELIVERY ERROR - CEP (NM)~,
+ RADIATION TYPE (1=FISSION , 2=TN)~/
DATA(PAR(I),I=14,27)/
+ OVERPRESSURE (PSI) - SS=~,
+ SK=~,
+ GUST (FPS @ SL) - SS=~,
+ SK=~,
+ THERMAL (CAL/CM2) - SS=~,
+ SK=~,
+ TISSUE DOSE (RADS-TISSUE)- SS=~,
+ SK=~,
+ EQUIP DOSE (RADS-SILICON) - SS=~,
+ SK=~,
+ EQUIP DOSE RATE(RADS-SIL/SEC) - SS=~,
+ SK=~,
+ NEUTRON FLUENCE (N/CM2) - SS=~,
+ SK=~/
DATA NOAC,RT,SECT,TOI,NPRO,DTTP/6,300,180,12,3,5/
DATA MFT,NB,DOI,YLD,HOX,CEP,ITYPE/500,8,8,250,2000,1,2/
DATA OP(1),OP(2),GUST(1),GUST(2),HEAT(1),HEAT(2)/
+1.5,5.0,50,160,20,120/
DATA TIS(1),TIS(2),SIL(1),SIL(2),DOSE(1),DOSE(2),FLU(1),FLU(2)/
+10,50,2000,5000,1.0E6,1.0E8,1.0E6,1.0E12/
*** END BLOCK DATA DEFALT ***
END

```

```

SUBROUTINE LOAD(PS,IPUS,N,H,OLD)
*****
* LOADS PS RESULTS INTO HISTORY ARRAY AND OLD VALUE OF IPUS TO OLD
*****
REAL MFT,PS(21,21,8),OLD(20,2),H(20,21,8)
CHARACTER PAR*40
COMMON/PARAM/PAR(27)
COMMON/ESCPAR/RT,SECT,TOI,NOAC,
+NPRO,DTTP,NP(6),PROFIL(6,20,3),TURN(20)
COMMON/THTPAR/MFT,NB,DOI,BRHO(20),BPHI(20),YLD,HOX,CEP,ITYPE
COMMON/HRDPAR/OP(2),GUST(2),HEAT(2),TIS(2),SIL(2),DOSE(2),FLU(2)
SAVE
* LOAD HISTORY ARRAY H WITH THIS RUNS PS
DO 10 J=1,8
DO 20 I=1,NOAC
20      H(N,I,J)=PS(21,I,J)
        H(N,21,J)=PS(21,21,J)
10      CONTINUE
* STORE PRESENT IPUS VALUE IN OLD ARRAY
OLD(N,2)=0.0
IF(N.EQ.1) RETURN
L=IPUS
IF(L.GT.13) THEN
L=2*L-14
OLD(N,2)=PVAL(L+1)
ENDIF
OLD(N,1)=PVAL(L)
RETURN
*** END LOAD ***
END

```

```

SUBROUTINE RESULT(PS,IPUS,N,H,OLD)
*****
* DISPLAYS PS RESULTS FOR ALL RUNS CURRENT PARAMETER UNDER STUDY(PSTUDY)*
* PS RESULTS ARE LISTED FOR ENTIRE FLEET FOR EACH RUN AFTER THE
* CURRENT VALUES OF ALL 20 PARAMETERS ARE DISPLAYED
*****
REAL MFT,PS(21,21,8),OLD(20,2),H(20,21,8)
CHARACTER PAR*40
COMMON/PARAM/PAR(27)
COMMON/ESCPAR/RT,SECT,TOI,NOAC,
+NPRO,DTTP,NP(6),PROFIL(6,20,3),TURN(20)
COMMON/THTPAR/MFT,NB,DOI,BRHO(20),BPHI(20),YLD,HOX,CEP,ITYPE
COMMON/HRDPAR/OP(2),GUST(2),HEAT(2),TIS(2),SIL(2),DOSE(2),FLU(2)
SAVE
* PRINT RESULTS FOR RUNS 1 TO N IN ORDER PRECEDED BY CURRENT PVALS
L=IPUS
IF(L.GT.13) L=2*L-14
PRINT 100,N
WRITE(13,100)N
100 FORMAT(///'1 AVERAGE FLEET SURVIVABILITY FOR RUNS #1 TO #',I2,
+/1X,71('-'))
CALL HEADER(2)
PRINT 200,NOAC
WRITE(13,200) NOAC
200 FORMAT('/' AVERAGE FLEET SURVIVABILITY FOR ',I2,
+' AIRCRAFT - LISTED 1ST RUN TO LATEST')
IF(N.EQ.1) THEN
OLD(1,1)=0.0
GO TO 40
ENDIF
PRINT 300,IPUS,PAR(L)
WRITE(13,300)IPUS,PAR(L)
300 FORMAT(' PARAMETER UNDER STUDY(PSTUDY) IS #',I2,2X,A34)
* LIST THE PS RESULTS FOR RUNS 1 TO N
40 PRINT 400
WRITE(13,400)
400 FORMAT(' PSTUDY',3X,' OP ',2X,' GUST',2X,' THRML',2X,' TIS ',
+2X,' SIL ',2X,' GDOT',2X,' NFLU', ' - ', 'TOTAL',2X,
+'# SV'/1X,4('-'),5X,9(5('-'),2X))
DO 50 I=1,N
PRINT 500,OLD(I,1),(H(I,21,J),J=1,8),(NOAC*H(I,21,8))
WRITE(13,500) OLD(I,1),(H(I,21,J),J=1,8),(NOAC*H(I,21,8))
500 FORMAT(1X,1PG9.3,OP,8(F4.2,3X),F5.2)
IF(IPUS.GT.13) THEN
PRINT 600,OLD(I,2)
WRITE(13,600) OLD(I,2)
600 FORMAT(1X,1PG9.3)
ENDIF
50 CONTINUE
RETURN
*** END RESULT ***
END

```



```

SUBROUTINE REPORT(PS,IPUS,N,H,OLD)
*****
* DISPLAYS PS RESULTS BY INDIVIDUAL A/C FOR USER'S CHOICE
*****
LOGICAL ASK,CHECKN,RNGCHK
REAL MFT,PS(21,21,8),H(20,21,8),OLD(20,2)
CHARACTER PAR*40
COMMON/PARAM/PAR(27)
COMMON/ESCPAR/RT,SECT,TOI,NOAC,
+NPRO,DTP,NP(6),PROFIL(6,20,3),TURN(20)
COMMON/THTPAR/MFT,NB,DOI,BRHO(20),BPHI(20),YLD,HOX,CEP,ITYPE
COMMON/HRDPAR/OP(2),GUST(2),HEAT(2),TIS(2),SIL(2),DOSE(2),FLU(2)
SAVE
* PRINT RESULTS BY INDIV A/C FOR LATEST RUN
PRINT 100,N
WRITE(13,100) N
100 FORMAT(////'1 SURVIVABILITY RESULTS BY AIRCRAFT FOR RUN #',
+I2/1X,71(' '))
CALL HEADER(2)
L=IPUS
IF(L.GT.13) L=2*L-14
PRINT 200,NOAC,N
WRITE(13,200) NOAC,N
200 FORMAT(' PS RESULTS FOR ',I2,' INDIVIDUAL A/C ON RUN #',I2)
IF(N.EQ.1) GO TO 40
PRINT 300,IPUS,PAR(L),OLD(N,1)
WRITE(13,300) IPUS,PAR(L),OLD(N,1)
300 FORMAT(' PSTUDY=#',I2,1X,A40,5X,'=',1PG15.5)
IF(L.GT.13) THEN
PRINT 400,PAR(L+1),OLD(N,2)
WRITE(13,400) PAR(L+1),OLD(N,2)
400 FORMAT(12X,A40,5X,'=',1PG15.5)
ENDIF
40 PRINT 500
WRITE(13,500)
500 FORMAT('0',2X,'A/C#',2X,' OP ',2X,' GUST',2X,' THRML',
+2X,' TIS ',2X,' SIL ',2X,' GDOT',2X,' NFLU ',
+' - ',TOTAL/3X,9(5(' ')),2X))
DO 50 I=1,NOAC
PRINT 600,I,(H(N,I,J),J=1,8)
50 WRITE(13,600) I,(H(N,I,J),J=1,8)
600 FORMAT(4X,I2,4X,8(F4.2,3X))
PRINT 700,(H(N,21,J),J=1,8)
WRITE(13,700) (H(N,21,J),J=1,8)
700 FORMAT(1X,71(' ')/' FLEET AVG',8(F4.2,3X))

```

```

* PRINT PS FOR SELECTED A/C OVER ALL RUNS OF IPUS
IF(.NOT.ASK(15)) RETURN
60 PRINT*, 'ENTER THE A/C # YOU ARE INTERESTED IN REVIEWING?'
PRINT*, '(1 TO ', NOAC, ') ?'
PRINT*
PRINT*
READ*, HM
IF(CHECKN(HM)) CALL ABORT
M=NINT(HM)
IF(M.LT.1.OR.M.GT.NOAC) THEN
PRINT*, 'YOU HAVE CHOSEN A/C# ', M
PRINT*, 'THERE ARE ONLY ', NOAC, ' IN THIS RUN. TRY AGAIN.'
GO TO 60
ENDIF
PRINT 800, M, N, IPUS, PAR(L)
WRITE(13, 800) M, N, IPUS, PAR(L)
800 FORMAT('1', 5X, 'PS RESULTS FOR A/C #', I2, ' OVER ',
+I2, ' RUNS'/' WITH PSTUDY= #', I2, 2X, A34)
PRINT 550
WRITE(13, 550)
550 FORMAT('0', 'PSTUDY', 3X, 'OPRES', 2X, ' GUST', 2X, 'THRML',
+2X, 'TDOSE', 2X, 'SDOSE', 2X, ' GDOT', 2X, 'N-FLU',
+' - ', 'TOTAL'/1X, 4(' '), 5X, 8(5(' '), 2X))
DO 70 I=1, N
PRINT 900, OLD(I, 1), (H(I, M, K), K=1, 8)
WRITE(13, 900) OLD(I, 1), (H(I, M, K), K=1, 8)
900 FORMAT(1X, 1PG9.3, OP, 8(F4.2, 3X))
IF(L.GT.13) THEN
PRINT 1000, OLD(I, 2)
WRITE(13, 1000) OLD(I, 2)
1000 FORMAT(1X, 1PG9.3)
ENDIF
70 CONTINUE
* DISPLAY PS RESULTS FOR OTHER SELECTED A/C
IF(ASK(16)) GO TO 60
RETURN
*** END REPORT ***
END

```

```

SUBROUTINE HEADER(M)
*****
* PRINTS PARAMETERS 1-20 WITH CURRENT VALUES IN ABBREVIATED FORM
* FOR PS RESULTS DISPLAYS IN RESULT & REPORT
*****
COMMON/ESCPAR/RT,SECT,TOI,NOAC,
+NPRO,DTTP,NP(6),PROFIL(6,20,3),TURN(20)
GO TO(1,2),M
1 PRINT 50
50 FORMAT(1X,71('-'))
PRINT 100,(PVAL(I),I=1,13),(PVAL(J),J=14,26,2),
+(PVAL(K),K=15,27,2)
RETURN
2 WRITE(13,100)(PVAL(I),I=1,13),(PVAL(J),J=14,26,2),
+(PVAL(K),K=15,27,2)
100 FORMAT(' ',9X,'CURRENT PARAMETER VALUES #1 TO 20 :',
+' (SEE USER MANUAL PG. 22)'/
+' ESCAPE PARAMETERS #1-6 :',18X,'(FOR PARAMETER ABBREVIATIONS)'/
+' #1-NOAC #2-RT #3-SECT #4-TOI #5-NPRO #6-DTTP'/
+'6(F10.1)/
+' THREAT PARAMETERS #7-13 :'/
+' #7-MFT #8-NB #9-DOI',
+' #10-YLD #11-HOB #12-CEP #13-ITYPE'/
+'7(F10.1)/
+' HARDNESS PARAMETERS #14-20 :'/
+' #14-OP #15-GUST #16-THRML #17-TIS',
+' #18-SIL #19-GDOT #20-NFLU'/
+' SS',F7.1,3(F10.2),3(1PE10.2),OP,/
+' SK',F7.1,3(F10.2),3(1PE10.2)/1X,71('-'))
WRITE(13,300)((PROFIL(NPRO,I,J),J=1,3),I=1,NP(NPRO))
300 FORMAT( 1X,10X,'ESCAPE PROFILE'/11X,14('-')/
+ 1X,'TIME(SEC) ',5X,'RANGE(NM) ',5X,'ALTITUDE(FEET)'/
+1X,10('-'),5X,10('-'),5X,14('-')/
+20(1X,3(F10.1,5X),/))
RETURN
*** END HEADER ***
END

```

```

SUBROUTINE CNCLUD(NAME)
*****
* CONCLUDES THE SESSION WITH PARAMETRIC WARNING AND
* MESSAGE ABOUT ROUTING OUTPUT FILE #13
*****
CHARACTER NAME*20
PRINT 100,NAME
WRITE(13,100) NAME
100 FORMAT('THIS CONCLUDES "GETAWAY" SESSION NAMED ',A20/
+ 1X,60('-')/
+'OREMEMBER, THE PROBABILITY OF SURVIVAL RESULTS FROM THESE'/
+' RUNS ARE MEANT TO BE USED FOR PARAMETRIC ANALYSIS AND'/
+' NOT FOR PREDICTING ALERT FORCE SURVIVABILITY.'/
+' OA RECORD OF THIS SESSIONS OUTPUT RESULTS IS ON'/
+' TAPE13. YOU SHOULD STORE TAPE13 OR ROUTE IT TO A'/
+' PRINTER FOR FURTHER REFERENCE BEFORE LOGGING OUT.'/
+'GOODBYE AND STOP BACK AGAIN SOON !!!')
REWIND (13)
RETURN
*** END CNCLUD ***
END

```

```

SUBROUTINE RDONES
*****
* PLACES PS=1 IN RADIATION RESULTS WHEN RADIATION SUPPRESSED
*****
REAL CELL(20,11,8),PS(21,21,8),OLD(20,2),H(20,21,8)
COMMON//CELL,PS,OLD,H
DO 10 I=1,20
DO 10 J=1,21
DO 10 K=4,7
10 PS(I,J,K)=1.0
*
DO 20 I=1,20
DO 20 J=1,11
DO 20 K=4,7
20 CELL(I,J,K)=1.0
*
RETURN
*** END RDONES ***
END

```

```

SUBROUTINE RUN(RADOUT)
*****
* THIS IS THE MAIN SIMULATION ROUTINE FOR LOCATING AIRCRAFT AND
* DETONATIONS DURING THE ESCAPE SEQUENCE AND DETERMINING
* PROBABILITY OF SURVIVAL FOR THE ESCAPING ALERT FORCE
*****
LOGICAL RADOUT
REAL A(20,11,8), B(21,21,8)
REAL MFT
COMMON//A,B
COMMON/ESCPAR/RT,SECT,TOI,NOAC,
+NPRO,DTTP,NP(6),PROFIL(6,20,3),TURN(20)
COMMON/THTPAR/MFT,NB,DOI,BRHO(20),BPHI(20),YLD,HOX,CEP,ITYPE
COMMON/HRDPAR/OP(2),GUST(2),HEAT(2),TIS(2),SIL(2),DOSE(2),FLU(2)
COMMON/ACPOS/YIELD,HOB,HAC,X,VO
COMMON/REFAMB/RPRES,RDEN,RTEMP,RSSO
COMMON/TGTAMB/TPRES,TDEN,TTEMP,TSSO
COMMON/BSTAMB/BPRES,BDEN,BTEMP,BSSO
SAVE
PRINT*
PRINT*, 'PS RUN IN PROGRESS -- STANDBY FOR RESULTS'
PRINT*
YIELD=YLD
* CONVERT HOB TO METERS
HOB=HOX*0.3048
* INITIALIZE AMBIENT AIR AT BURST ALTITUDE
CALL AMBINT(HOB,BPRES,BDEN,BTEMP,BSSO)
* COMPUTE RANDOM UNIFORM TURN ANGLES FOR AIRCRAFT
CALL TURNS(TURN,NOAC,SECT)
* COMPUTE AND LOAD ATTACK PATTERN
CALL PATERN
* TOP OF LOOP FOR MORE THAN ONE BURST
DO 990 L=1,NB
* * COMPUTE BURST TIME
TB=MFT-RT+(L-1)*DOI
* * TOP OF LOOP FOR EACH AIRCRAFT
DO 600 N=1,NOAC
* * COMPUTE A/C FLIGHT TIME AT BURST
TN=TB-TOI*(N-1)
* * LOCATE AND INTERPOLATE A/C PROFILE DATA FOR TIME "TN"
CALL LOCATE(TN,PROFIL,NP(NPRO),DTTP,NPRO)
* * COMPUTE AMBIENT CONDITIONS AT A/C
CALL AMBINT(HAC,TPRES,TDEN,TTEMP,TSSO)
* * COMPUTE EFFECTS AND PS FOR 10 CELL MODEL
CALL BANG(A,N,BRHO(L),BPHI(L),RADOUT)
600 CONTINUE
* * BOTTOM OF LOOP FOR EACH AIRCRAFT
* ** CALCULATE FINAL SURVIVABILITY MATRIX FOR FLEET FOR EACH BURST
CALL PRTFLT (NOAC,L,A,B)
990 CONTINUE
** BOTTOM OF LOOP FOR MORE THAN ONE BURST
** COMPUTE FINAL MATRIX
CALL BIGEND (B,NB,NOAC)
*** END RUN ***
999 END

```

```

SUBROUTINE AMBINT(ALT,PRESS,DEN,TEMP,SSO)
*****
*THIS SUB CALCULATES AMBIENT DATA GIVEN ALT IN METERS
* DEN= KG/M3 : SSO= M/SEC : PRESS= PSI : TEMP= DEG-K
*****
  IF(ALT.GT.11000.0) THEN
    TEMP=216.0
    PRESS=1.013E5*.224*EXP(-1.582E-4*(ALT-11000.0))
  ELSE
    TEMP=288-.0065*ALT
    PRESS=1.013E5*(TEMP/288)**5.2
  ENDIF
  DEN=.003484*PRESS/TEMP
  SSO=SQRT(1.4*PRESS/DEN)
  PRESS=PRESS/6894.76
*** END AMBINT ***
END

```

```

SUBROUTINE TURNS(TURN,NOAC,SECT)
*****
* COMPUTES A UNIFORM SPACING OF AIRCRAFT TURN ANGLES
* OVER THE ESCAPE SECTOR
*****
  REAL TURN(20)
  PI=3.1415926536
  SECTR=SECT*PI/180
  SLICE=SECTR/NOAC
  SECBD=2*PI-SECTR/2.0
*LOAD THE TURN BETWEEN +/- .5*SECT DEG FOR EACH AIRCRAFT
DO 10 I=1,NOAC
  10   TURN(I)=SECBD+SLICE*(I-.5)
  RETURN
*** END TURNS ***
END

```

```

SUBROUTINE PATERN
*****
* LOADS RANGE AND BEARING OF WARHEAD AIMPOINTS AS DETERMINED
* BY ALGORITHM WHICH SPACES ATTACK BETWEEN 1ST & LAST A/C
*****
REAL MFT
INTEGER IS(17)
COMMON/ESCPAR/RT,SECT,TOI,NOAC,
+NPRO,DTTP,NP(6),PROFIL(6,20,3),TURN(20)
COMMON/THTPAR/MFT,NB,DOI,BRHO(20),BPHI(20),YLD,HOX,CEP,ITYPE
COMMON/ACPOS/YIELD,HOB,HAC,X,VO
SAVE
PI=3.1415926536
NBL=NB
* FIND FLIGHT TIME OF 1ST & LAST A/C AT LAST AND 1ST DETONATION
FIRST=MFT-RT+NB*DOI
TLAST=MFT-RT-TOI*(NOAC-1)
* FIND RANGE OF 1ST & LAST A/C FROM TURN POINT
CALL LOCATE(FIRST,PROFIL,NP(NPRO),DTTP,NPRO)
RNGF=X/1853.0
CALL LOCATE(TLAST,PROFIL,NP(NPRO),DTTP,NPRO)
RNGL=X/1853.0
* ALLOCATE ALL WEAPONS BETWEEN 1ST A/C & BASE IF TP NOT REACHED
IF(RNGF.LE.0.0) THEN
STEP=(DTTP+RNGF)/(NBL)
DO 10 I=1,NBL
BRHO(I)=I*STEP-RNGF
BPHI(I)=PI
10 RETURN
ENDIF
* ALLOCATE 1 BURST/PLANE BETWEEN LAFD AND TURNPOINT
IF(RNGL.LT.0) THEN
V=PROFIL(NPRO,3,2)/PROFIL(NPRO,3,1)
TTTP=-RNGL/V
NBTP=NINT(TTTP/TOI)
IF(NBTP.EQ.0) GO TO 17
STEP=-RNGL/NBTP
DO 15 J=1,NBTP
BRHO(J)=J*STEP
BPHI(J)=PI
15 NBL=NBL-NBTP
IF(NBL.EQ.0) RETURN
ENDIF
* DISTRIBUTE REMAINING BURSTS EVENLY IN ESCAPE SECTOR
17 SECTR=SECT/57.29578
SECBD=2*PI-SECTR/2
FNBL=FLOAT(NBL)
SLICE=SECTR/NBL
SQRTP5=SQRT(.5)
RSTRT=MAX(0.0,RNGL)
RO=RSTRT
RTOT=RNGF-RSTRT
NSTRT=NB-NBL

```

```

* SLICE & DICE THE PIE - BANG! BANG! BANG!
DO 20 I=1,NBL
  RI=RSTRT+RTOT*SQRT(I/FNBL)
  BRHO(NSRST+I)=RO+SQRTP5*(RI-RO)
  RO=RI
  BPHI(NSRST+I)=SECBD+SLICE*(I-.5)
20  CONTINUE
  RETURN
*** END PATERN ***
END

```

```

SUBROUTINE LOCATE(TN,PROFIL,NP,DTTP,NPRO)
*****
** THIS SUB LOCATES A/C AT BURST TIME "TN" AND RETURNS
**DIST/ALT/VEL FROM PROFILE IN X,HAC,VO THRU COMMON/ACPOS/
** ALSO DEFINES TGTAMB ONCE A/C ALTITUDE IS DETERMINED
*****
REAL PROFIL(6,20,3),POINT(2)
COMMON/ACPOS/YIELD,HOB,HAC,X,VO
SAVE
* CHECK A/C OFF GROUND
  IF(TN.LE.0) THEN
    X=-DTTP*1853.0
    HAC=0
    VO=0
    RETURN
  ENDIF
* LOCATE A/C IN PROFILE BY TIME
  IFIND=0
70  IFIND=IFIND+1
  IF(PROFIL(NPRO,IFIND,1).LT.TN.AND.IFIND.LT.NP) GO TO 70
* COMPUTE LINEAR INTERPOLATION FACTOR BETWEEN POINTS ON PROFILE
  FACD=PROFIL(NPRO,IFIND,1)-PROFIL(NPRO,IFIND-1,1)
  FACN=TN-PROFIL(NPRO,IFIND-1,1)
  FACTOR=FACN/FACD
* INTERPOLATE ALT & DIST FLOWN COMPUTE DIST LAST SO THAT
* TOP & BOT CAN BE USED FOR VELOCITY COMPUTATION
  DO 80 K=3,2,-1
    TOP=PROFIL(NPRO,IFIND,K)
    BOT=PROFIL(NPRO,IFIND-1,K)
80  POINT(K-1)=BOT+(TOP-BOT)*FACTOR
  X=(POINT(1)-DTTP)*1853.0
  HAC=POINT(2)*0.3048
  VO=(TOP-BOT)/FACD*1853.0
*** END LOCATE ***
  RETURN
END

```



```

SUBROUTINE BANG(A,N,BRO,BFI,RADOUT)
*****
** THIS SUB STEPS THROUGH THE 10 CELL MODEL FOR THE BURST
** AND THE AIRCRAFT--TRNSLT CONVERTS RHO & THETA FOR
** NON TURN POINT DGZ'S
*****
LOGICAL RADOUT
REAL A(20,11,8),MFT
COMMON/ACPOS/YIELD,HOB,HAC,X,VO
COMMON/REFAMB/RPRES,RDEN,RTEMP,RSSO
COMMON/TGTAMB/TPRES,TDEN,TTEMP,TSSO
COMMON/BSTAMB/BPRES,BDEN,BTEMP,BSSO
COMMON/ESCPAR/RT,SECT,TOI,NOAC,
+NPRO,DTP,NP(6),PROFIL(6,20,3),TURN(20)
COMMON/THTPAR/MFT,NB,DOI,BRHO(20),BPHI(20),YLD,HOX,CEP,ITYPE
COMMON/HRDPAR/OP(2),GUST(2),HEAT(2),TIS(2),SIL(2),DOSE(2),FLU(2)
PI=3.1415926536
*ADJUST BPHI FOR A/C TURN IF BURST OCCURS AFTER TURNPOINT
  BPI=BFI
  IF(X.GT.0.0) BPI=BPI-TURN(N)
* FIRST CELL
  RHO=0
  THETA=0
    CALL TRNSLT(RHO,THETA,BRO,BPI)
    CALL EFFECT(1,RHO,THETA,A,N,RADOUT)
*CELLS 2,3,4,5
  DO 10 I=2,5
    RHO=.7109*CEP
    THETA=PI/4.0+(I-2)*PI/2.0
    CALL TRNSLT(RHO,THETA,BRO,BPI)
    CALL EFFECT(I,RHO,THETA,A,N,RADOUT)
10  CONTINUE
* CELLS 6,7,8,9,10
  DO 20 I=6,10
    RHO=1.509*CEP
    THETA=(I-6)*2*PI/5.0
    CALL TRNSLT(RHO,THETA,BRO,BPI)
    CALL EFFECT(I,RHO,THETA,A,N,RADOUT)
20  CONTINUE
* CALCULATE OVERALL PROBABILITIES IN MATRIX A
* OVERALL (INTERSECTION) PS FOR EACH CELL
  DO 30 I=1,10
    A(N,I,8)=1.0
    DO 30 J=1,7
      A(N,I,8)=A(N,I,8)*A(N,I,J)
30  CONTINUE
* AVERAGE PS FOR 10 CELLS BY EFFECTS AND COMBINED
  DO 40 J=1,8
    A(N,11,J)=0.0
    DO 40 I=1,10
      A(N,11,J)=A(N,11,J)+A(N,I,J)/10.0
40  CONTINUE
*** END BANG ***
END

```

```

SUBROUTINE TRNSLT(RHO,THETA,BRHO,BPHI)
*****
** THIS SUB TRANSLATES ANGLE & DIST RELATIVE TO TARGET
** TO ANGLE & DIST RELATIVE TO TURNPOINT
*****
      IF(BRHO.EQ.0.AND.BPHI.EQ.0) RETURN
      XO=BRHO*COS(BPHI)
      YO=BRHO*SIN(BPHI)
      XX=XO+RHO*COS(THETA)
      YX=YO+RHO*SIN(THETA)
      RHO=SQRT(XX**2+YX**2)
      THETA=ATANME(YX,XX)
*** END TRNSLT ***
      END

```

```

SUBROUTINE EFFECT (I,RHO,THETA,A,N,RADOUT)
*****
*THIS SUB DRIVES THE SEPERATE EFFECTS & PROBABILITY SUBS
* FOR AIRCRAFT N & DETONATION CELL I
*****
      REAL A(20,11,8),MFT
      LOGICAL ESCAPE,RADOUT

      COMMON/ESCPAR/RT,SECT,TOI,NOAC,
+NPRO,DTTP,NP(6),PROFIL(6,20,3),TURN(20)
      COMMON/THTPAR/MFT,NB,DOI,BRHO(20),BPHI(20),YLD,HOX,CEP,ITYPE
      COMMON/HRDPAR/OP(2),GUST(2),HEAT(2),TIS(2),SIL(2),DOSE(2),FLU(2)
      COMMON/ACPOS/YIELD,HOB,HAC,X,VO
      COMMON/REFAMB/RPRES,RDEN,RTEMP,RSSO
      COMMON/TGTAMB/TPRES,TDEN,TTEMP,TSSO
      COMMON/BSTAMB/BPRES,BDEN,BTEMP,BSSO
      SAVE
      RHO=RHO*1853.0
      CALL CHASE (RHO,THETA,FGR,FSSR,FX,ESCAPE)
      IF(ESCAPE) THEN
          A(N,I,1)=1
          A(N,I,2)=1
          GO TO 10
      ENDIF
      CALL BLAST(FGR,FSSR,OVPRES,DENSTY,WIND)
          A(N,I,1)=PRBSVL(OP(1),OP(2),OVPRES)
      CALL SGUST (RHO,THETA,FX,DENSTY,WIND,GST)
          A(N,I,2)=PRBSVL(GUST(1),GUST(2),GST)
10    CALL THERML(RHO,THETA,H)
          A(N,I,3)=PRBSVL(HEAT(1),HEAT(2),H)
      IF(RADOUT) RETURN
      CALL RADIAT(RHO,THETA,T,S,D,F)
          A(N,I,4)=PRBSVL(TIS(1),TIS(2),T)
          A(N,I,5)=PRBSVL(SIL(1),SIL(2),S)
          A(N,I,6)=PRBSVL(DOSE(1),DOSE(2),D)
          A(N,I,7)=PRBSVL(FLU(1),FLU(2),F)
*** END EFFECT ***
      END

```

```

SUBROUTINE CHASE (RHO, THETA, FGR, FSSR, FX, ESCAPE)
*****
* THIS SUB LOCATES A/C POSITION AT TIME OF SHOCK ARRIVAL
*****
* COMMON DATA BLOCKS
COMMON/ACPOS/YIELD, HOB, HAC, X, VO
COMMON/REFAMB/ RPRES, RDEN, RTEMP, RSSO
COMMON/TGTAMB/ TPRES, TDEN, TTEMP, TSSO
COMMON/BSTAMB/ BPRES, BDEN, BTEMP, BSSO
SAVE
LOGICAL ESCAPE
ESCAPE=.FALSE.
FACTOR=(BPRES/ RPRES/YIELD)**(1./3.)
SX=X*FACTOR
SVO=VO*RSSO/BSSO
COSTHA=COS(THETA)
SZSQ=(ABS(HAC-HOB)*FACTOR)**2
SRHO=RHO*FACTOR
TGS=0
DIFOLD=600
10 SFX=SX+SVO*TGS
SGRSQ=SRHO**2+SFX**2-2*SRHO*SFX*COSTHA
FSSR=SQRT(SZSQ+SGRSQ)
STA=(7E-7*FSSR**2.5)/(1+2.5E-4*FSSR**1.5)
DIFNEW=STA-TGS
IF(ABS(DIFNEW).GT.(.001)) THEN
  IF(ABS(DIFNEW).GE.ABS(DIFOLD).OR.FSSR.GT.4E4) THEN
    ESCAPE=.TRUE.
    RETURN
  ENDIF
  TGS=TGS+DIFNEW/2.0
  DIFOLD=DIFNEW
  GO TO 10
ENDIF
*SCALE DIST & TIMES BACK TO BURST
FX=SFX/FACTOR
FGR=SQRT(SGRSQ)/FACTOR
BSTSR=FSSR/FACTOR
TIMFAC=(RTEMP/BTEMP)**.5/FACTOR
TARV=STA*TIMFAC
*** END CHASE ***
END

```

```

SUBROUTINE BLAST (FGR, FSSR, OVPRES, DENSTY, WIND)
*****
* THIS SUB CALCULATES BLAST EFFECTS AT A GIVEN RANGE AND DISTANCE
* FROM THE GIVEN BURST TO THE GIVEN TARGET
*****
COMMON/ACPOS/YIELD, HOB, HAC, X, VO
COMMON/REFAMB/RPRES, RDEN, RTEMP, RSSO
COMMON/TGTAMB/TPRES, TDEN, TTEMP, TSSO
COMMON/BSTAMB/BPRES, BDEN, BTEMP, BSSO
SAVE
REAL LGS
*TEST A/C IN MACH STEM
*SCALE ALL DIST FOR YIELD
  FACTOR=YIELD**(1./3.)
  SHOB=HOB/FACTOR
  SHAC=HAC/FACTOR
  SGRNG=FGR/FACTOR
*COMPUTE SHOTP
  SHOTP=999999
  IF(SHOB.LT.15.) THEN
    SHOB=0.0
    GO TO 20
  ENDIF
  SHOTP= 0
  S=SHOB
  C=.02754+2.524/S+1.085E3/S**2-4.372E4/S**3
  C=C+5.851E5/S**4-2.371E6/S**5
  SOTP=95*(EXP(SHOB/175)-1)
  IF((SGRNG/SOTP).LE.1.0) GO TO 20
  SHOTP=C*SOTP*(SGRNG/SOTP-1)**1.6
*BRANCH ON SHOTP
20  IF(SHAC.GT.SHOTP)THEN
*FREEAIR
*COMPUTE REFERENCE OVERPRESSURE
  LGS=ALOG(FSSR/1000)
  ROVPR=EXP(.19*LGS**2-1.5*LGS-.1)
*SCALE TO BST ALT
  BSTOP=ROVPR*BPRES/RPRES
*LED SHAM PIKE TO A/C ALT
  IF(HAC.NE.HOB)THEN
    IF(FSSR.LE.150)THEN
      A=6.590E-4*FSSR**1.2369
    ELSE
      A=1.106*FSSR**(-.085)-133.2*FSSR**(-1.16)
    ENDIF
  ELSE
    A=0
  ENDIF
  OVPRES=BSTOP*(TPRES/BPRES)**A
ELSE

```

```

*A/C IN MACH STEM
*COMPUTE OVERPRESSURE AT FOOT OF MACH STEM
30  IF(SHOB.EQ.0.0 .OR. SGRNG.LT.FSSR*.7) SGRNG=FSSR
    SR1=SQRT(SHOB**2+SGRNG**2)
    IF(SR1.EQ.0.0) SR1=0.0001
    Z=ALOG(SR1)
    SND=SHOB/SR1
    CSD=SGRNG/SR1
    OP9=.01*EXP(40.3*SR1**(-.295))
    OPZ=.001*EXP(31.3*SR1**(-.2136))
    OPA=OP9-(OP9-OPZ)*CSD**2
    IF(SR1.LE.100.OR.SR1.GT.3500)THEN
        ROVPR=OPA
    ELSE
        A=EXP(.3549*Z**3-6.7133*Z**2+41.468*Z-82.819)
        B=EXP(.25194*Z**4-5.8741*Z**3+50.298*Z**2-185.95*Z+248.8)
        G=EXP(.1826*Z**4-4.36786*Z**3+38.6017*Z**2-149.59*Z+216.26)
        ROVPR=OPA+(CSD**(2*B))*(SND**A)*EXP(G)
    ENDIF
*SCALE OVERPRESSURE UP MACH STEM
OVPRES=ROVPR*TPRES/RPRES
ENDIF
*END MACH STEM CASE
*RANKINE HUGONIOT EFFECTS FROM OVPRES
DENSTY=TDEN*(7*TPRES+6*OVPRES)/(7*TPRES+OVPRES)
SHCSPD=TSSO*SQRT(1+6*OVPRES/7/TPRES)
WIND=5*TSSO*TSSO*OVPRES/7/TPRES/SHCSPD
TEMP=TTEMP*(TPRES+OVPRES)/TPRES*TDEN/DENSTY
DYPRES=2.5*OVPRES**2/(7*TPRES+OVPRES)
*** END BLAST ***
END

```

```

SUBROUTINE SGUST (RHO,THETA,FX,D,U1,GF)
*****
* THIS SUB FINDS SIDE GUST RELATIVE TO CONSTANT "Q" IN F/SEC @ SEALEVEL *
*****
COMMON/ACPOS/YIELD,HOB,HAC,X,VO
COMMON/REFAMB/RPRES,RDEN,RTEMP,RSSO
SAVE
PI=3.1415926536
* COMPUTE SIDE GUST M/SEC AT A/C = V3 BY RESOLVING A/C
* HEADING VECTOR WITH BLAST WIND VECTOR
  THETAG=THETA
  IF(FX.LT.0) THEN
    THETAG=PI-THETAG
    FX=-FX
  ENDIF
  GR=SQRT(RHO**2+FX**2-2*FX*RHO*COS(THETAG))
  IF(FX.EQ.0) FX=1
  IF(GR.EQ.0) GR=1
  COSW=(GR**2+FX**2-RHO**2)/2/GR/FX
  SINPHI=GR/SQRT(GR**2+(HAC-HOB)**2)
  IF(SINPHI.GT.1) SINPHI=1
  IF(ABS(COSW).GT.1.0) COSW=1.0
  V3=U1*SINPHI*SQRT(1-COSW**2)
* TRANSLATE M/SEC AT A/C TO F/SEC AT SEA LEVEL FOR CONSTANT "Q"
  Q=0.5*D*V3**2
* CONVERT NT/M2 TO PSI
  Q=Q*1.45037E-4
  P=(2.0*Q+SQRT(4.0*Q**2+280.0*Q*RPRES))/10.0
  GF=5.0*RSSO*P/(7.0*RPRES*SQRT(1+6.0*P/7.0/RPRES))
  GF=GF*3.2808
*** END SGUST ***
RETURN
END

```

```

SUBROUTINE THERML(RHO,THETA,HEAT)
*****
* THIS SUB FINDS TOTAL THERMAL FLUENCE NORMAL TO A/C FUSELAGE
* FOR A MOVING AIRCRAFT - AN ATMOS TRANS FACTOR OF 0.8 IS ASSUMED
*****
COMMON/ACPOS/YIELD,HOB,HAC,X,VO
COMMON/REFAMB/RPRES,RDEN,RTEMP,RSSO
COMMON/TGTAMB/TPRES,TDEN,TTEMP,TSSO
COMMON/BSTAMB/BPRES,BDEN,BTEMP,BSSO
SAVE
REAL INT,INT1,INT2,S(10)
DATA (S(I),I=1,10)/1.0,.4,.22,.15,.10,.07,.05,.045,.04,.035/
IF(HOB.LE.4572) THEN
    SMAX=1.33E13*YIELD**.56
    TMAX=.0417*YIELD**.44
ELSE
    RATIO=RDEN/BDEN
    SMAX=1.49E13*YIELD**.59/RATIO**.45
    TMAX=.038*YIELD**.44*RATIO**.36
ENDIF
*DEFINE CONSTANTS & INITIALIZE VARIABLES FOR LOOP
PI=3.1415926536
TAU=0.8
B=TAU/4/PI*SMAX*2.38845E-05
Z=ABS(HAC-HOB)
XO=X-RHO*COS(THETA)
Z1SQ=(RHO*SIN(THETA))**2+Z**2
Z1=SQRT(Z1SQ)
INT=0.0
INT1=0.0
* LOOP FOR 10 TMAX'S
DO 10 I=1,10
    T=I*TMAX
    SR=SQRT((XO+T*VO)**2+Z1SQ)
    IF(SR.LE.1.0) SR=1.0
    COSE=Z1/SR
    INT2=.5*COSE/SR**2*S(I)
    INT=INT+INT1+INT2
    INT1=INT2
10 CONTINUE
HEAT=B*INT*TMAX
*** END THERMAL ***
RETURN
END

```

```

SUBROUTINE RADIAT(RHO, THETA, TIS, SIL, DOSE, FLU)
*****
* THIS SUB FINDS PROMPT TISSUE DOSE, EQUIP DOSE, GAMMA DOSE RATE
* AND NUETRON FLUENCE
*****
REAL MI, MFT
COMMON/ACPOS/YIELD, HOB, HAC, X, VO
COMMON/THTPAR/MFT, NB, DOI, BRHO(20), BPHI(20), YLD, HOX, CEP, ITYPE
COMMON /NGX/ NTYPE, DELTA(2), YNEUT(2), YPGAM(2), FFRAC(2), TINNC(7
1,2), TINGC(7,2), TIGGC(7,2), SINNC(7,2), SINGC(7,2), SIGGC(7,2), S
2IGDC(7,2)
DIMENSION GMX(7)
DATA EQCON/1.29E10/
**COMPUTE SLANT RANGE FOR THIS CELL
Z=HAC-HOB
SR=SQRT(Z**2+RHO**2+X**2-2*RHO*X*COS(THETA))
IF(SR.LE.1.0) SR=1.0
IF(SR.LE.1.0) SR=1.0

** COMPUTE MASS INTEGRAL (SIMPSON'S RULE)
CALL AMBINT(HOB, P, DEN, T, S)
IF(Z.LT.100) THEN
MI=DEN*SR/10.0
ELSE
AREA=0.0
ALT=HOB
STEP=Z/100.0
DO 10 I=1,50
AREA=AREA+DEN
ALT=ALT+STEP
CALL AMBINT(ALT, P, DEN, T, S)
AREA=AREA+4*DEN
ALT=ALT+STEP
CALL AMBINT(ALT, P, DEN, T, S)
AREA=AREA+DEN
10 CONTINUE
MI=(SR/Z)*(AREA*STEP/3.0)/10.0
ENDIF

```



```

** COMPUTE FLUENCES & DOSES
*****
* THE FOLLOWING CODE WAS BORROWED FROM FLEE
* ROUTINES BY H. M. MURPHY, JR., AFWL/SATR
*****
C          COMPUTE YIELD AND INVERSE-SQUARE SCALING.
  SCALE=YIELD/(125663.7061*SR**2)
C          LOAD GMX ARRAY WITH FUNCTIONS OF GCM2.
  GMX(2)=AMAX1(MI,0.1)
  GMX(3)=GMX(2)**2
  GMX(4)=GMX(2)**1.5
  GMX(5)=SQRT(GMX(2))
  GMX(6)=GMX(2)**(1./3.)
  GMX(7)=ALOG(GMX(2))
C          COMPUTE PROMPT DOSES.
  RTIN=SCALE*YNEUT(ITYPE)*TRANSF(GMX,TINNC(1,ITYPE))
  RTIG=SCALE*(YNEUT(ITYPE)*TRANSF(GMX,TINGC(1,ITYPE))+YPGAM(ITYPE)*T*
1TRANSF(GMX,TIGGC(1,ITYPE)))
  RSIN=SCALE*YNEUT(ITYPE)*TRANSF(GMX,SINNC(1,ITYPE))
  RSIG=SCALE*(YNEUT(ITYPE)*TRANSF(GMX,SINGC(1,ITYPE))+YPGAM(ITYPE)*T*
1TRANSF(GMX,SIGGC(1,ITYPE)))
  SIEQ=EQCON*RSIN
  GDOT=SCALE*YPGAM(ITYPE)*TRANSF(GMX,SIGDC(1,ITYPE))/DELTA(ITYPE)
  TIS=RTIN+RTIG
  SIL=RSIN+RSIG
  FLU=SIEQ
  DOSE=GDOT
*** END RADIAT ***
  RETURN
  END

```

```

          FUNCTION TRANSF (GMX,CON)
*****
C          EVALUATES 7-CONSTANT 4-PI R**2 TRANSMISSION FUNCTION.
C          ROUTINE BY HARRY M. MURPHY, JR., AFWL/SATR, 14 NOVEMBER 1975.
*****
          DIMENSION GMX(7), CON(7)
C
C          TRANSF IS ZERO FOR DEPTHS GREATER THAN 1000 G/CM2.
1      TRANSF=0.0
      IF (GMX(2).GT.1000.0) GO TO 3
C          EVALUATE 7-CONSTANT TRANSMISSION FUNCTION.
      SUM=CON(1)
      DO 2 I=2,7
      SUM=SUM+GMX(I)*CON(I)
2      CONTINUE
      TRANSF=EXP(SUM)
C
3      RETURN
      END

```

```

BLOCK DATA NGXCON
*****
C THIS IS THE BLOCK DATA ROUTINE FOR NUCRAD.
C ROUTINE BY HARRY M. MURPHY, JR., AFWL/SATR, 14 NOVEMBER 1975.
*****
COMMON /NGX/ NTYPE,DELTA(2),YNEUT(2),YPGAM(2),FFRAC(2),TINNC(7
1,2),TINGC(7,2),TIGGC(7,2),SINNC(7,2),SINGC(7,2),SIGGC(7,2),S
2IGDC(7,2)
C SOURCE TYPE 1 (UNCLASSIFIED FISSION SOURCE.)
DATA DELTA(1)/1.5E-8/
DATA YNEUT(1)/2.5E+23/,YPGAM(1)/2.9E+22/,FFRAC(1)/1.0/
DATA (TINNC(I,1),I=1,7)/-1.69281E+01,-1.96531E-01,-5.36731E-05,4.6*
19734E-03,3.83366E+00,-6.29139E+00,4.12820E-01/
DATA (TINGC(I,1),I=1,7)/-2.24229E+01,-2.25576E-01,-6.68071E-05,5.9*
19840E-03,5.41145E+00,-1.01014E+01,1.84282E+00/
DATA (TIGGC(I,1),I=1,7)/-2.17207E+01,-8.55296E-02,-2.75185E-05,2.3*
12437E-03,6.00888E-01,-4.12358E-01,-9.08753E-02/
DATA (SINNC(I,1),I=1,7)/-2.05631E+01,-1.78533E-01,-4.75672E-05,4.1*
15315E-03,3.45519E+00,-5.76748E+00,3.90241E-01/
DATA (SINGC(I,1),I=1,7)/-2.25158E+01,-2.30191E-01,-6.89943E-05,6.1*
16498E-03,5.46820E+00,-1.00931E+01,1.82683E+00/
DATA (SIGGC(I,1),I=1,7)/-2.14323E+01,-1.32304E-01,-4.84769E-05,3.9*
15806E-03,1.44786E+00,-1.51051E+00,-9.83529E-02/
DATA (SIGDC(I,1),I=1,7)/-2.25454E+01,-2.13344E-02,-5.68538E-06,4.3*
10663E-04,-9.21823E-01,1.76281E+00,-1.83008E-01/
C SOURCE TYPE 2 (UNCLASSIFIED TN SOURCE.)
DATA DELTA(2)/2.0E-8/
DATA YNEUT(2)/8.5E+23/,YPGAM(2)/1.49E+22/,FFRAC(2)/0.5/
DATA (TINNC(I,2),I=1,7)/-2.02007E+01,-8.49185E-02,-1.82948E-05,1.4*
16035E-03,8.58789E-01,-5.63695E-01,-9.75262E-02/
DATA (TINGC(I,2),I=1,7)/-2.52357E+01,-9.01837E-02,-2.76677E-05,2.3*
17863E-03,1.00134E+00,-1.29250E+00,1.00189E+00/
DATA (TIGGC(I,2),I=1,7)/-2.17207E+01,-8.55296E-02,-2.75185E-05,2.3*
12437E-03,6.00888E-01,-4.12358E-01,-9.08753E-02/
DATA (SINNC(I,2),I=1,7)/-2.08778E+01,-9.67196E-02,-1.78261E-05,1.5*
16670E-03,1.76226E+00,-3.13976E+00,2.29852E-01/
DATA (SINGC(I,2),I=1,7)/-2.49561E+01,-1.00256E-01,-3.10245E-05,2.6*
16873E-03,1.29599E+00,-1.84549E+00,1.04914E+00/
DATA (SIGGC(I,2),I=1,7)/-2.14323E+01,-1.32304E-01,-4.84769E-05,3.9*
15806E-03,1.44786E+00,-1.51051E+00,-9.83529E-02/
DATA (SIGDC(I,2),I=1,7)/-2.25454E+01,-2.13344E-02,-5.68538E-06,4.3*
10663E-04,-9.21823E-01,1.76281E+00,-1.83008E-01/
DATA NTYPE/3/
END

```

```

FUNCTION PRBSVL(SS,SK,EFF)
*****
* THIS FUNCTION COMPUTES PROB OF SURVIVAL GIVEN SS
* AND SK LEVELS AND EFFECT LEVEL. THE PROB
* OF SURVIVAL IS FITTED TO A LOG NORMAL DIST
* WITH SS=.02 KILL AND SK=.98 KILL.
*****
REAL K
IF(SS.EQ.SK) THEN
  PRBSVL=1.0
  IF(EFF.GT.SS) PRBSVL=0.0
  RETURN
ENDIF
S=SS
K=SK
IF(S.EQ.0.0) S=.0000001
IF(K.EQ.0.0) K=0.0000001
IF(EFF.EQ.0.0) EFF=0.0000001
S=ABS(S)
K=ABS(K)
EFF=ABS(EFF)
ALPHA=(ALOG(S)+ALOG(K))/2.0
BETA=(ALOG(K)-ALOG(S))/4.108
ZS=(ALOG(EFF)-ALPHA)/BETA
Z=ABS(ZS)
A=(1+.196854*Z+.115194*Z*Z+.000344*Z*Z*Z+.012527*Z*Z*Z*Z)**(-4.0)
IF(ZS.GE.0.0) THEN
  PRBSVL=A/2.0
ELSE
  PRBSVL=1.0-A/2.0
ENDIF
*** END PRBSVL ***
END

```

```

FUNCTION ATANME (Y,X)
*****
** THIS FUNCTION RETURNS THE ANGLE WHOSE TANGENT IS (Y/X).
** THE ANGLE IS ALWAYS GIVEN AS POSITIVE RADIAN WITH QUADRANT
** DETERMINED BY THE SIGN OF X & Y.
*****
PI=3.1415926536
IF(Y.GT.0.AND.X.GT.0) ATANME=ATAN(Y/X)
IF(Y.GT.0.AND.X.LT.0) ATANME=ATAN(Y/X)+PI
IF(Y.LT.0.AND.X.LT.0) ATANME=ATAN(Y/X)+PI
IF(Y.LT.0.AND.X.GT.0) ATANME=ATAN(Y/X)+2*PI
IF(X.EQ.0.AND.Y.GT.0) ATANME=PI/2
IF(X.EQ.0.AND.Y.LT.0) ATANME=3*PI/2
IF(Y.EQ.0.AND.X.GT.0) ATANME=0
IF(Y.EQ.0.AND.X.LT.0) ATANME=PI
IF(X.EQ.0.AND.Y.EQ.0) ATANME=0
*** END ATANME ***
END

```

```

SUBROUTINE PRFTLT (NOAC,L,A,B)
*****
** THIS SUB COMPUTES FLEET S/V MATRIX FOR EACH BURST
*****
REAL A(20,11,8),B(21,21,8)
* PLACE OVERALL PS (ROW 11 MATX-A) FOR EACH A/C IN MTX-B FOR BURST L
DO 60 N=1,NOAC
  B(L,N,8)=1
  DO 60 I=1,7
    B(L,N,I)=A(N,11,I)
    B(L,N,8)=B(L,N,8)*B(L,N,I)
60 CONTINUE
* AVERAGE PS OVER ALL A/C BY 7 EFFECTS AND COMBINED IN ROW 21
DO 66 J=1,8
  B(L,21,J)=0
  DO 66 I=1,NOAC
    B(L,21,J)=B(L,21,J)+B(L,I,J)/NOAC
66 CONTINUE
*** END PRFTLT ***
END

```

```

SUBROUTINE BIGEND (B,NB,NOAC)
*****
** THIS SUB CALCULATES FLEET SURVIVABILITY MATRIX
** FOR EACH/ALL AIRCRAFT FOR ALL ENCOUNTERS
*****
REAL B(21,21,8)
* INTERSECTION(PRODUCT) OF PS AND A/C FOR EACH EFFECT OVER ALL BURSTS
DO 10 K=1,8
  DO 10 J=1,NOAC
    B(21,J,K)=1
    DO 10 I=1,NB
      B(21,J,K)=B(21,J,K)*B(I,J,K)
10 CONTINUE
* NOW TAKE AVERAGE OVER ALL A/C
DO 20 K=1,8
  B(21,21,K)=0
  DO 20 I=1,NOAC
    B(21,21,K)=B(21,21,K)+B(21,I,K)/NOAC
20 CONTINUE
*** END BIGEND ***
END

```

Appendix B. Horizons Technology Inc.

GETAWAY uses the following equations in the computation of shock arrival time, Free Air overpressure and Mach Stem overpressure. These empirical equations were developed by Horizons Technology Incorporated. The Free Air and Mach Stem overpressure equations fit the one kiloton standard (Ref 7:17, 17-5).

Equations

1. Shock front time of arrival is given by

$$SR_1 = SR/Y^{1/3} \quad (B-1)$$

$$t_1 = \frac{(7E-7)SR_1^{3.5}}{SR_1 + (2.5 E-4)SR_1^{2.5}} \quad (B-2)$$

$$t = t_1 Y^{1/3} \quad (B-3)$$

where

SR = slant range (meters) from burst

Y = yield (KT)

SR_1 = scaled slant range (m/KT^{1/3})

t_1 = shock arrival time (seconds) at scaled distance from a 1 KT burst

t = shock arrival time (seconds) from burst of interest

2. Peak Free Air Overpressure

$$\Delta P = \exp \left[0.19 \left(\frac{\ln SR_1}{1000} \right)^2 - 1.5 \frac{\ln SR_1}{1000} - 0.1 \right] \quad (B-4)$$

where

ΔP = peak free air overpressure (psi)

in the range

$$7 \leq SR_1 \leq 10,000 \quad (m/KT^{1/3})$$

3. EQUATIONS

Yield, $Y(KT)$, $0.1 KT < Y \leq 30,000 KT$

Height of Burst, HOB (m)

Ground Range (distance from ground zero), GR(m)

Slant Range, $SR(m) = (HOB^2 + GR^2)^{1/2}$, $20m < SR/Y^{1/3} \leq 2500m$

Angle of Incidence, $\theta = \arctan (HOB/GR)$

Peak Overpressure, Δp (psi), $1 \text{ psi} \leq \Delta p \leq 10,000 \text{ psi}$

$$\text{for } SR < 100Y^{1/3}, \Delta p = \Delta p_1 \quad (B-5)$$

$$\text{for } SR \geq 100Y^{1/3}, \Delta p = \Delta p_1 + \Delta p_2 \quad (B-6)$$

where

$$\Delta p_1 = \Delta p_{90} + \cos^2 \theta (\Delta p_{90} - \Delta p_0) \quad (B-7)$$

$$\Delta p_{90} = .01 \exp (40.2 SR^{-0.295}), \quad (B-8)$$

$$\Delta p_0 = .001 \exp (31.3 SR^{-0.2136}), \quad (B-9)$$

and

$$\Delta p_2 = \cos^{2\beta} \theta \sin^{\alpha} \theta e^{\gamma} \quad (B-10)$$

where

$$\alpha = \exp(.35493x^3 - 6.7133x^2 + 41.468x - 82.819) \quad (B-11)$$

$$\beta = \exp(.25192x^4 - 5.8741x^3 + 50.298x^2 - 185.95x + 248.8) \quad (B-12)$$

$$\gamma = \exp(.1826x^4 - 4.26786x^3 + 38.6017x^2 - 149.59x + 216.26) \quad (B-13)$$

$$x = \ln(SR1/Y^{1/3}) \quad (B-14)$$

There is a slight discontinuity in the equations at $SR = 100Y^{1/3}$ for overpressures in the range of 120 to 315 psi.

Approximate optimum height of burst for

$GR \geq 100Y^{1/3}$ m is:

$$HOB = 10 (GR Y^{1/3})^{1/2} \quad (B-15)$$

Appendix C. Circular Normal Quadrature Scheme

This is a scheme for modeling warhead delivery error in probability of survival computations. The ten cell scheme was developed by Dr. Bridgeman and Dr. Davie at AFIT. The original inspiration for this application comes from a similar 100 cell scheme used for making physical vulnerability calculations as outlined in AP550, Physical Vulnerability Handbook, Nuclear Weapons (U) prepared by the Defense Intelligence Agency.

The development of this scheme begins with the circular normal distribution as applied to delivery error. The probability of a hit within radius r of the aim point given a circular normal distribution of hits with mean equal to zero and the standard deviation equal to sigma (σ) is:

$$P_H(r) = \int_0^{2\pi} \int_0^r \frac{1}{2\pi\sigma^2} e^{-1/2\left(\frac{r}{\sigma}\right)^2} r dr$$

$$P_H(r) = \int_0^r \frac{1}{\sigma^2} e^{-1/2\left(\frac{r}{\sigma}\right)^2} r dr$$

$$P_H(r) = 1 - e^{-1/2\left(\frac{r}{\sigma}\right)^2} \quad (C-1)$$

The standard definition of CEP is that radius r which gives

$$P_H(r) = .5$$

Thus:

$$P_H(\text{CEP}) = 1 - e^{-1/2 \left(\frac{\text{CEP}}{\sigma}\right)^2} = .5$$

$$\text{CEP} = 1.1774\sigma$$

or

$$\sigma = .8493 \text{ CEP}$$

and:

$$P_H(r) = 1 - e^{-1/2 \left(\frac{r}{.8493 \text{ CEP}}\right)^2}$$

$$P_H(r) = 1 - e^{-.693 \left(\frac{r}{\text{CEP}}\right)^2} \quad (\text{C-2})$$

The objective of the quadrature scheme is to represent the above probability distribution by 10 discrete cells with the probability of a hit in any cell equally likely (0.1). This ten cell model is not unique and was chosen based on its convenience and the author's experience that it gives good results. The number of cells and the geometrical arrangement of them in the scheme could be varied in many different ways.

Figure C-1 represents the ten cell model selected for use in GETAWAY.

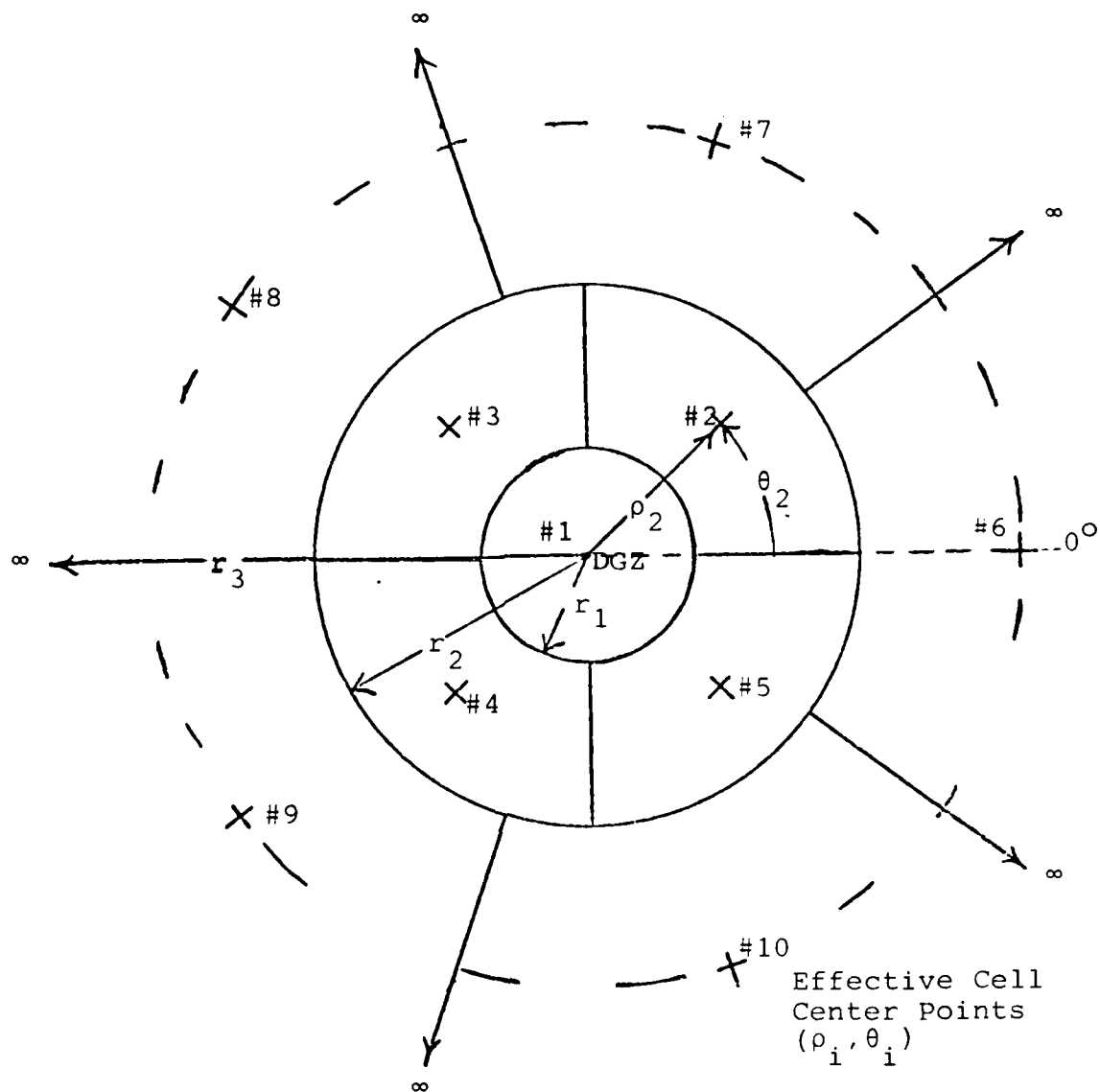

Figure C-1. GETAWAY Ten Cell Model

Our mathematical approach begins by finding r_1 and r_2 such that $P_H(r_1) = .1$, $P_H(r_1, r_2) = .4$ and $P_H(r_2, \infty) = .5$. Equation (C-2) gives $r_1 = .3899\text{CEP}$ and $r_2 = 1.00\text{CEP}$. The angular boundaries of each cell are chosen such that the cells in each ring have equal area, therefore: P_H (any cell) = .1, that is, equally likely.

In order to model the survivability of an aircraft with respect to a warhead aimed at the specified desired ground zero (DGZ, center of cell #1), the expected probability of survival for a detonation in each of the ten equally likely cells is calculated. That is:

$$P_{S_{DGZ}} = \sum_{i=1}^{10} (P_H(\text{cell } i) * P_s(\text{detonation in cell } i))$$

$$P_{S_{DGZ}} = \frac{1}{10} \sum_{i=1}^{10} P_s(\text{cell } i) \quad (C-3)$$

However, to calculate $P_s(\text{cell } i)$, we must stipulate a detonation point in each cell.

(ρ_i, θ_i) is defined as the effective cell center point represented by the expected value of (ρ, θ) in each cell i , $i = 1$ to 10 . This expected value of (ρ, θ) can be viewed as the average impact point in each cell, given the circular normal distribution of impacts and the ten cell model as illustrated in Figure C-1. The average or expected angle of impact (θ_i) is midway between the boundaries of each cell. For example, θ_2 for cell #2 is equal to 45° measured from the reference in Figure C-1. The expected or average impact range in each cell, ρ_i , is somewhat more complicated.

By defining the expected impact range for a cell as the normalized expected value of ρ over the interval of the radial boundaries of the cell (i.e., a weighted average over the interval), ρ_i for the cells in each ring of the ten cell model is derived from:

$$\rho_i = \frac{\int_{r_{i-1}}^{r_i} \rho P_H(\rho) d\rho}{\int_{r_{i-1}}^{r_i} P_H(\rho) d\rho}$$

$$\rho_i = \frac{\int_{r_{i-1}}^{r_i} \rho \frac{1}{\sigma^2} e^{-1/2(\frac{\rho}{\sigma})^2} \rho d\rho}{\int_{r_{i-1}}^{r_i} \frac{1}{\sigma^2} e^{-1/2(\frac{\rho}{\sigma})^2} \rho d\rho} \quad (C-4)$$

where r_{i-1} and r_i are the radial boundaries of each ring and $\sigma = .8493$ CEP.

The design of the ten cell model has already defined the integral in the denominator as $P_H(r_{i-1}, r_i)$ (cumulative probability distribution of ρ between r_{i-1} and r_i as listed in Table C-1). Integration of the numerator can be accomplished by parts as follows:

$$\text{Let } u = \rho \quad \text{If } v = -e^{-1/2(\frac{\rho}{\sigma})^2}$$

$$du = d\rho \quad \text{Then } dv = \frac{1}{\sigma^2} e^{-1/2(\frac{\rho}{\sigma})^2} \rho d\rho$$

Recall

$$\int u dv = uv - \int v du$$

Then:

$$\int_{r_{i-1}}^{r_i} \rho \left(\frac{1}{\sigma^2} e^{-1/2 \left(\frac{\rho}{\sigma} \right)^2} \right) \rho d\rho = \left(\rho \left(-e^{-1/2 \left(\frac{\rho}{\sigma} \right)^2} \right) \right) \Bigg|_{r_{i-1}}^{r_i} - \int_{r_{i-1}}^{r_i} - e^{-1/2 \left(\frac{\rho}{\sigma} \right)^2} d\rho$$

$$= -\rho e^{-1/2 \left(\frac{\rho}{\sigma} \right)^2} \Bigg|_{r_{i-1}}^{r_i} + \sqrt{2\pi} \sigma \int_{r_{i-1}}^{r_i} \frac{1}{\sqrt{2\pi} \sigma} e^{-1/2 \left(\frac{\rho}{\sigma} \right)^2} d\rho$$

The remaining integral is the Standard Normal Probability function (SNF), thus:

$$\rho_i = \frac{-\rho e^{-1/2 \left(\frac{\rho}{\sigma} \right)^2} \Bigg|_{r_{i-1}}^{r_i} + \sqrt{2\pi} \sigma \text{SNF} \Bigg|_{r_{i-1}/\sigma}^{r_i/\sigma}}{P_H(r_{i-1}, r_i)} \quad (C-5)$$

Applying equation (C-5) to the cell boundaries established in the ten cell model gives effective cell center points (ρ_i, θ_i) as summarized in Table C-I.

TABLE C-I

Ten Cell Model Effective Cell Center Points

Ring	Cell	r_i	$P_H(r_{i-1}, r_i)$	ρ_i/CEP	θ_i
1	1	.3899	.1	0	0
2	2, 3, 4, 5	1.0000	.4	.7109	$1/4\pi, 3/4\pi, 5/4\pi, 7/4\pi$
3	6, 7, 8, 9, 10	∞	.5	1.5090	$0, 2/5\pi, 4/5\pi, 6/5\pi, 8/5\pi$

Appendix D. Validation Data

This appendix contains a full description of the scenarios and average fleet survivability results from 40 validation runs used to compare GETAWAY to FLEE and QUANTA. Table D-I is a summary of the predicted survivability and projected changes in survivability obtained on the 40 runs. Each scenario description (#1 through 20) lists the parameter values in abbreviated form, the parameter change made for the parametric run, and the results obtained. Section V of the main report contains a discussion on the significance of these results.

TABLE D-I
Validation Results

Scenario #/ Parameter Changed	Predicted Survivability			Change in Survivability		
	QUANTA	FLEE	GETAWAY	QUANTA	FLEE	GETAWAY
1/HOB	.56	.71	.61	+.05	+.03	+.02
2/OP	.70	.86	.70	-.35	-.35	-.19
3/THRML	.75	.93	.73	-.06	-.16	-.03
4/RT	.70	.84	.77	-.10	-.06	-.03
5/DOI	.89	.94	.98	+.03	0.00	0.00
6/THRML	.95	.96	1.00	-.10	-.09	-.08
7/OP	.58	.79	.65	+.26	+.07	+.21
8/DTTP	.09	.63	.19	+.23	+.02	+.50
9/TOI	.07	.58	.51	0.00	-.13	-.30
10/NOAC	.40	.70	.40	-.09	-.08	-.01
11/SECT	0.00	.13	.22	0.00	+.28	0.00
12/YLD	.27	.64	.71	+.35	+.21	+.16
13/NPRO	.38	.64	.79	+.10	+.03	+.02
14/OP	.84	.92	.94	-.24	-.09	-.16
15/HOB	.31	.40	.56	-.02	-.03	-.08
16/RT	.26	.60	.23	+.09	+.05	+.10
17/TOI	.69	.91	.93	-.23	-.03	-.54
18/THRML	.27	.55	.43	0.00	0.00	-.01
19/OP	.01	.68	.21	+.11	+.15	+.30
20/DOI	.22	.54	.21	+.08	+.08	+.09

AVERAGE FLEET SURVIVABILITY FOR SCENARIO #1

CURRENT PARAMETER VALUES #1 TO 20 : (SEE USER MANUAL PG. 22)
 (FOR PARAMETER ABBREVIATIONS)

ESCAPE PARAMETERS #1-6 :

#1-NOAC	#2-RT	#3-SECT	#4-TOI	#5-NPRO	#6-DTTP
20.0	300.0	180.0	12.0	3.0	5.0

THREAT PARAMETERS #7-13 :

#7-MFT	#8-NB	#9-DOI	#10-YLD	#11-HOB	#12-CEP	#13-ITYPE
590.0	12.0	7.5	250.0	2000.0	1.0	2.0

HARDNESS PARAMETERS #14-20 :

#14-OP	#15-GUST	#16-THRML	#17-TIS	#18-SIL	#19-GDOT	#20-NFLU
SS 2.0	103.00	20.00	10.00	2.00E+03	1.00E+06	1.00E+06
SK 2.0	103.00	20.00	50.00	5.00E+03	1.00E+08	1.00E+12

	QUANTA	FLEE	GETAWAY	
SCENARIO #1	.56	.71	.61	
SCENARIO #1C	<u>.61</u>	<u>.74</u>	<u>.63</u>	HOB 2000 to 1000 feet
Change	.05	.03	.02	

AVERAGE FLEET SURVIVABILITY FOR SCENARIO #2

CURRENT PARAMETER VALUES #1 TO 20 : (SEE USER MANUAL PG. 22)
 (FOR PARAMETER ABBREVIATIONS)

ESCAPE PARAMETERS #1-6 :

#1-NOAC	#2-RT	#3-SECT	#4-TOI	#5-NPRO	#6-DTTP
20.0	300.0	180.0	12.0	3.0	5.0

THREAT PARAMETERS #7-13 :

#7-MFT	#8-NB	#9-DOI	#10-YLD	#11-HOB	#12-CEP	#13-ITYPE
590.0	12.0	7.5	250.0	2000.0	1.0	2.0

HARDNESS PARAMETERS #14-20 :

#14-OP	#15-GUST	#16-THRML	#17-TIS	#18-SIL	#19-GDOT	#20-NFLU
SS 3.2	160.00	50.00	10.00	2.00E+03	1.00E+06	1.00E+06
SK 3.2	160.00	50.00	50.00	5.00E+03	1.00E+08	1.00E+12

	QUANTA	FLEE	GETAWAY	
SCENARIO #2	.70	.86	.70	
SCENARIO #2C	<u>.35</u>	<u>.51</u>	<u>.51</u>	OP 3.2 to 1.5 psi (GUST to 53)
Change	-.35	-.35	-.19	

AVERAGE FLEET SURVIVABILITY FOR SCENARIO #3

CURRENT PARAMETER VALUES #1 TO 20 : (SEE USER MANUAL PG. 22)
 ESCAPE PARAMETERS #1-6 : (FOR PARAMETER ABBREVIATIONS)

#1-NOAC	#2-RT	#3-SECT	#4-TOI	#5-NPRO	#6-DTTP
20.0	300.0	180.0	12.0	3.0	5.0

THREAT PARAMETERS #7-13 :

#7-MFT	#8-NB	#9-DOI	#10-YLD	#11-HOB	#12-CEP	#13-ITYPE
590.0	12.0	7.5	250.0	2000.0	1.0	2.0

HARDNESS PARAMETERS #14-20 :

#14-OP	#15-GUST	#16-THRML	#17-TIS	#18-SIL	#19-GDOT	#20-NFLU
SS 5.0	240.00	120.00	10.00	2.00E+03	1.00E+06	1.00E+06
SK 5.0	240.00	120.00	50.00	5.00E+03	1.00E+08	1.00E+12

	QUANTA	FLEE	GETAWAY	
SCENARIO #3	.75	.93	.73	
SCENARIO #3C	<u>.69</u>	<u>.77</u>	<u>.70</u>	THRML 120 to 20 cal/cm ²
Change	-.06	-.16	-.03	

AVERAGE FLEET SURVIVABILITY FOR SCENARIO #4

CURRENT PARAMETER VALUES #1 TO 20 : (SEE USER MANUAL PG. 22)
 ESCAPE PARAMETERS #1-6 : (FOR PARAMETER ABBREVIATIONS)

#1-NOAC	#2-RT	#3-SECT	#4-TOI	#5-NPRO	#6-DTTP
6.0	300.0	180.0	12.0	3.0	5.0

THREAT PARAMETERS #7-13 :

#7-MFT	#8-NB	#9-DOI	#10-YLD	#11-HOB	#12-CEP	#13-ITYPE
590.0	12.0	7.5	250.0	2000.0	1.0	2.0

HARDNESS PARAMETERS #14-20 :

#14-OP	#15-GUST	#16-THRML	#17-TIS	#18-SIL	#19-GDOT	#20-NFLU
SS 2.0	103.00	20.00	10.00	2.00E+03	1.00E+06	1.00E+06
SK 2.0	103.00	20.00	50.00	5.00E+03	1.00E+08	1.00E+12

	QUANTA	FLEE	GETAWAY	
SCENARIO #4	.70	.84	.77	
SCENARIO #4C	<u>.60</u>	<u>.78</u>	<u>.74</u>	DOI 7.5 to 15 sec
Change	-.10	-.06	-.03	

AVERAGE FLEET SURVIVABILITY FOR SCENARIO #5

CURRENT PARAMETER VALUES #1 TO 20 : (SEE USER MANUAL PG. ZZ)
 ESCAPE PARAMETERS #1-6 : (FOR PARAMETER ABBREVIATIONS)

#1-NOAC	#2-RT	#3-SECT	#4-TOI	#5-NPRO	#6-DTTP
6.0	300.0	180.0	12.0	3.0	5.0

THREAT PARAMETERS #7-13 :

#7-MFT	#8-NB	#9-DOI	#10-YLD	#11-HOB	#12-CEP	#13-ITYPE
590.0	12.0	7.5	250.0	2000.0	1.0	2.0

HARDNESS PARAMETERS #14-20 :

#14-OP	#15-GUST	#16-THRML	#17-TIS	#18-SIL	#19-GDOT	#20-NFLU
SS 3.2	160.00	50.00	10.00	2.00E+03	1.00E+06	1.00E+06
SK 3.2	160.00	50.00	50.00	5.00E+03	1.00E+08	1.00E+12

	QUANTA	FLEE	GETAWAY	
SCENARIO #5	.89	.94	.98	
SCENARIO #5C	<u>.92</u>	<u>.94</u>	<u>.98</u>	RT 300 to 330 sec
Change	.03	.00	.00	

AVERAGE FLEET SURVIVABILITY FOR SCENARIO #6

CURRENT PARAMETER VALUES #1 TO 20 : (SEE USER MANUAL PG. ZZ)
 ESCAPE PARAMETERS #1-6 : (FOR PARAMETER ABBREVIATIONS)

#1-NOAC	#2-RT	#3-SECT	#4-TOI	#5-NPRO	#6-DTTP
6.0	300.0	180.0	12.0	3.0	5.0

THREAT PARAMETERS #7-13 :

#7-MFT	#8-NB	#9-DOI	#10-YLD	#11-HOB	#12-CEP	#13-ITYPE
590.0	12.0	7.5	250.0	2000.0	1.0	2.0

HARDNESS PARAMETERS #14-20 :

#14-OP	#15-GUST	#16-THRML	#17-TIS	#18-SIL	#19-GDOT	#20-NFLU
SS 5.0	240.00	120.00	10.00	2.00E+03	1.00E+06	1.00E+06
SK 5.0	240.00	120.00	50.00	5.00E+03	1.00E+08	1.00E+12

	QUANTA	FLEE	GETAWAY	
SCENARIO #6	.95	.96	1.00	
SCENARIO #6C	<u>.85</u>	<u>.87</u>	<u>.92</u>	THRML 120 to 20 cal/cm ²
Change	-.10	-.09	-.08	

AVERAGE FLEET SURVIVABILITY FOR SCENARIO #7

CURRENT PARAMETER VALUES #1 TO 20 : (SEE USER MANUAL PG. ZZ)
 (FOR PARAMETER ABBREVIATIONS)

ESCAPE PARAMETERS #1-6 :

#1-NOAC	#2-RT	#3-SECT	#4-TOI	#5-NPRO	#6-DTTP
6.0	330.0	180.0	12.0	3.0	5.0

THREAT PARAMETERS #7-13 :

#7-MFT	#8-NB	#9-DOI	#10-YLD	#11-HOB	#12-CEP	#13-ITYPE
590.0	8.0	8.0	250.0	2000.0	1.0	2.0

HARDNESS PARAMETERS #14-20 :

#14-OP	#15-GUST	#16-THRML	#17-TIS	#18-SIL	#19-GDOT	#20-NFLU
SS 1.5	78.00	20.00	10.00	2.00E+03	1.00E+06	1.00E+06
SK 1.5	78.00	20.00	50.00	5.00E+03	1.00E+08	1.00E+12

	QUANTA	FLEE	GETAWAY	
SCENARIO #7	.58	.79	.65	
SCENARIO #7C	<u>.84</u>	<u>.86</u>	<u>.86</u>	OP 1.5 to 4.0 psi (GUST to 195)
Change	.26	.07	.21	

AVERAGE FLEET SURVIVABILITY FOR SCENARIO #8

CURRENT PARAMETER VALUES #1 TO 20 : (SEE USER MANUAL PG. ZZ)
 (FOR PARAMETER ABBREVIATIONS)

ESCAPE PARAMETERS #1-6 :

#1-NOAC	#2-RT	#3-SECT	#4-TOI	#5-NPRO	#6-DTTP
12.0	360.0	250.0	7.0	2.0	9.0

THREAT PARAMETERS #7-13 :

#7-MFT	#8-NB	#9-DOI	#10-YLD	#11-HOB	#12-CEP	#13-ITYPE
590.0	13.0	10.0	800.0	2000.0	1.0	2.0

HARDNESS PARAMETERS #14-20 :

#14-OP	#15-GUST	#16-THRML	#17-TIS	#18-SIL	#19-GDOT	#20-NFLU
SS 2.0	103.00	65.00	10.00	2.00E+03	1.00E+06	1.00E+06
SK 2.0	103.00	65.00	50.00	5.00E+03	1.00E+08	1.00E+12

	QUANTA	FLEE	GETAWAY	
SCENARIO #8	.09	.63	.19	
SCENARIO #8C	<u>.32</u>	<u>.65</u>	<u>.69</u>	DTTP 9 to 3nm
Change	.23	.02	.50	

AVERAGE FLEET SURVIVABILITY FOR SCENARIO #9

CURRENT PARAMETER VALUES #1 TO 20 : (SEE USER MANUAL PG. ZZ)
 ESCAPE PARAMETERS #1-6 : (FOR PARAMETER ABBREVIATIONS)

#1-NOAC	#2-RT	#3-SECT	#4-TOI	#5-NPRO	#6-DTTP		
9.0	265.0	150.0	15.0	1.0	10.0		

THREAT PARAMETERS #7-13 :

#7-MFT	#8-NB	#9-DOI	#10-YLD	#11-HOB	#12-CEP	#13-ITYPE
590.0	15.0	9.0	250.0	2700.0	1.0	2.0

HARDNESS PARAMETERS #14-20 :

#14-OP	#15-GUST	#16-THRML	#17-TIS	#18-SIL	#19-GDOT	#20-NFLU
SS 1.5	75.00	35.00	10.00	2.00E+03	1.00E+06	1.00E+06
SK 1.5	75.00	35.00	50.00	5.00E+03	1.00E+08	1.00E+12

	QUANTA	FLEE	GETAWAY	
SCENARIO #9	.07	.58	.51	
SCENARIO #9C	<u>.07</u>	<u>.45</u>	<u>.21</u>	TOI 15 to 30 sec
Change	0.00	-.13	-.30	

AVERAGE FLEET SURVIVABILITY FOR SCENARIO #10

CURRENT PARAMETER VALUES #1 TO 20 : (SEE USER MANUAL PG. ZZ)
 ESCAPE PARAMETERS #1-6 : (FOR PARAMETER ABBREVIATIONS)

#1-NOAC	#2-RT	#3-SECT	#4-TOI	#5-NPRO	#6-DTTP		
7.0	365.0	100.0	20.0	3.0	8.0		

THREAT PARAMETERS #7-13 :

#7-MFT	#8-NB	#9-DOI	#10-YLD	#11-HOB	#12-CEP	#13-ITYPE
590.0	6.0	5.0	400.0	4500.0	1.0	2.0

HARDNESS PARAMETERS #14-20 :

#14-OP	#15-GUST	#16-THRML	#17-TIS	#18-SIL	#19-GDOT	#20-NFLU
SS 4.5	215.00	55.00	10.00	2.00E+03	1.00E+06	1.00E+06
SK 4.5	215.00	55.00	50.00	5.00E+03	1.00E+08	1.00E+12

	QUANTA	FLEE	GETAWAY	
SCENARIO #10	.40	.70	.40	
SCENARIO #10C	<u>.31</u>	<u>.62</u>	<u>.39</u>	NOAC 7 to 10
Change	-.09	-.08	-.01	

AVERAGE FLEET SURVIVABILITY FOR SCENARIO #11

CURRENT PARAMETER VALUES #1 TO 20 : (SEE USFR MANUAL PG. ZZ)
 (FOR PARAMETER ABBREVIATIONS)

ESCAPE PARAMETERS #1-6 :

#1-NOAC	#2-RT	#3-SECT	#4-TOI	#5-NPRO	#6-DTTP
18.0	330.0	60.0	14.0	3.0	12.0

THREAT PARAMETERS #7-13 :

#7-MFT	#8-NB	#9-DOI	#10-YLD	#11-HOB	#12-CEP	#13-ITYPE
590.0	14.0	20.0	800.0	2500.0	1.0	2.0

HARDNESS PARAMETERS #14-20 :

#14-OP	#15-GUST	#16-THRML	#17-TIS	#18-SIL	#19-GDOT	#20-NFLU
SS 1.0	53.00	30.00	10.00	2.00E+03	1.00E+06	1.00E+06
SK 1.0	53.00	30.00	50.00	5.00E+03	1.00E+08	1.00E+12

	QUANTA	FLEE	GETAWAY	
SCENARIO #11	0.00	.13	.22	
SCENARIO #11C	<u>0.00</u>	<u>.41</u>	<u>.22</u>	SECT 60 to 180 degrees
Change	0.00	.28	0.00	

AVERAGE FLEET SURVIVABILITY FOR SCENARIO #12

CURRENT PARAMETER VALUES #1 TO 20 : (SEE USER MANUAL PG. ZZ)
 (FOR PARAMETER ABBREVIATIONS)

ESCAPE PARAMETERS #1-6 :

#1-NOAC	#2-RT	#3-SECT	#4-TOI	#5-NPRO	#6-DTTP
9.0	340.0	110.0	9.0	1.0	1.0

THREAT PARAMETERS #7-13 :

#7-MFT	#8-NB	#9-DOI	#10-YLD	#11-HOB	#12-CEP	#13-ITYPE
590.0	12.0	15.0	900.0	2500.0	1.0	2.0

HARDNESS PARAMETER #14-20 :

#14-OP	#15-GUST	#16-THRML	#17-TIS	#18-SIL	#19-GDOT	#20-NFLU
SS 4.0	195.00	40.00	10.00	2.00E+03	1.00E+06	1.00E+06
SK 4.0	195.00	40.00	50.00	5.00E+03	1.00E+08	1.00E+12

	QUANTA	FLEE	GETAWAY	
SCENARIO #12	.27	.64	.71	
SCENARIO #12C	<u>.62</u>	<u>.85</u>	<u>.87</u>	YLD 900 to 200 kt
Change	.35	.21	.16	

AVERAGE FLEET SURVIVABILITY FOR SCENARIO #13

CURRENT PARAMETER VALUES #1 TO 20 : (SEE USER MANUAL PG. ZZ)
 (FOR PARAMETER ABBREVIATIONS)

ESCAPE PARAMETERS #1-6 :

#1-NOAC	#2-RT	#3-SECT	#4-TOI	#5-NPRO	#6-DTTP
15.0	210.0	150.0	15.0	2.0	5.0

THREAT PARAMETERS #7-13 :

#7-MFT	#8-NB	#9-DOI	#10-YLD	#11-HOB	#12-CEP	#13-ITYPE
590.0	20.0	11.0	800.0	3000.0	1.0	2.0

HARDNESS PARAMETERS #14-20 :

#14-OP	#15-GUST	#16-THRML	#17-TIS	#18-SIL	#19-GDOT	#20-NFLU
SS 1.5	80.00	30.00	10.00	2.00E+03	1.00E+06	1.00E+06
SK 1.5	80.00	30.00	50.00	5.00E+03	1.00E+08	1.00E+12

	QUANTA	FLEE	GETAWAY	
SCENARIO #13	.38	.64	.79	
SCENARIO #13C	<u>.48</u>	<u>.67</u>	<u>.81</u>	NPRO 2 to 3
Change	.10	.03	.02	

AVERAGE FLEET SURVIVABILITY FOR SCENARIO #14

CURRENT PARAMETER VALUES #1 TO 20 : (SEE USER MANUAL PG. ZZ)
 (FOR PARAMETER ABBREVIATIONS)

ESCAPE PARAMETERS #1-6 :

#1-NOAC	#2-RT	#3-SECT	#4-TOI	#5-NPRO	#6-DTTP
8.0	310.0	155.0	10.0	3.0	2.0

THREAT PARAMETERS #7-13 :

#7-MFT	#8-NB	#9-DOI	#10-YLD	#11-HOB	#12-CEP	#13-ITYPE
590.0	15.0	14.0	400.0	1300.0	1.0	2.0

HARDNESS PARAMETERS #14-20 :

#14-OP	#15-GUST	#16-THRML	#17-TIS	#18-SIL	#19-GDOT	#20-NFLU
SS 3.0	150.00	65.00	10.00	2.00E+03	1.00E+06	1.00E+06
SK 3.0	150.00	65.00	50.00	5.00E+03	1.00E+08	1.00E+12

	QUANTA	FLEE	GETAWAY	
SCENARIO #14	.84	.92	.94	
SCENARIO #14C	<u>.60</u>	<u>.83</u>	<u>.78</u>	OP 3.0 to 1.5 psi (GUST to 78)
Change	-.24	-.09	-.16	

AVERAGE FLEET SURVIVABILITY FOR SCENARIO #15

CURRENT PARAMETER VALUES #1 TO 20 : (SEE USER MANUAL PG. ZZ)
 (FOR PARAMETER ABBREVIATIONS)

ESCAPE PARAMETERS #1-6 :

#1-NOAC	#2-RT	#3-SECT	#4-TOI	#5-NPRO	#6-DTTP
9.0	365.0	325.0	21.0	1.0	2.0

THREAT PARAMETERS #7-13 :

#7-MFT	#8-NB	#9-DOI	#10-YLD	#11-HOB	#12-CEP	#13-ITYPE
590.0	10.0	5.0	350.0	2000.0	1.0	2.0

HARDNESS PARAMETERS #14-20 :

#14-OP	#15-GUST	#16-THRML	#17-TIS	#18-SIL	#19-GDOT	#20-NFLU
SS 2.0	103.00	90.00	10.00	2.00E+03	1.00E+06	1.00E+06
SK 2.0	103.00	90.00	50.00	5.00E+03	1.00E+08	1.00E+12

	QUANTA	FLEE	GETAWAY	
SCENARIO #15	.31	.40	.56	
SCENARIO #15C	<u>.29</u>	<u>.37</u>	<u>.48</u>	HOB 2000 to 3000 feet
Change	-.02	-.03	-.08	

AVERAGE FLEET SURVIVABILITY FOR SCENARIO #16

CURRENT PARAMETER VALUES #1 TO 20 : (SEE USER MANUAL PG. ZZ)
 (FOR PARAMETER ABBREVIATIONS)

ESCAPE PARAMETERS #1-6 :

#1-NOAC	#2-RT	#3-SECT	#4-TOI	#5-NPRO	#6-DTTP
14.0	290.0	95.0	33.0	3.0	11.0

THREAT PARAMETERS #7-13 :

#7-MFT	#8-NB	#9-DOI	#10-YLD	#11-HOB	#12-CEP	#13-ITYPE
590.0	19.0	15.0	250.0	3500.0	1.0	2.0

HARDNESS PARAMETERS #14-20 :

#14-OP	#15-GUST	#16-THRML	#17-TIS	#18-SIL	#19-GDOT	#20-NFLU
SS 2.5	125.00	20.00	10.00	2.00E+03	1.00E+06	1.00E+06
SK 2.5	125.00	20.00	50.00	5.00E+03	1.00E+08	1.00E+12

	QUANTA	FLEE	GETAWAY	
SCENARIO #16	.26	.60	.23	
SCENARIO #16C	<u>.35</u>	<u>.65</u>	<u>.33</u>	RT 290 to 250 sec
Change	.09	.05	.10	

AVERAGE FLEET SURVIVABILITY FOR SCENARIO #17

CURRENT PARAMETER VALUES #1 TO 20 : (SEE USER MANUAL PG. ZZ)
 ESCAPE PARAMETERS #1-6 : (FOR PARAMETER ABBREVIATIONS)

#1-NOAC	#2-RT	#3-SECT	#4-TOI	#5-NPRO	#6-DTTP	
11.0	285.0	210.0	10.0	2.0	9.0	

THREAT PARAMETERS #7-13 :

#7-MFT	#8-NB	#9-DOI	#10-YLD	#11-HOB	#12-CEP	#13-ITYPE
590.0	16.0	19.0	1000.0	2200.0	1.0	2.0

HARDNESS PARAMETERS #14-20 :

#14-OP	#15-GUST	#16-THRML	#17-TIS	#18-SIL	#19-GDOT	#20-NFLU
SS 3.5	175.00	80.00	10.00	2.00E+03	1.00E+06	1.00E+06
SK 3.5	175.00	80.00	50.00	5.00E+03	1.00E+08	1.00E+12

	QUANTA	FLEE	GETAWAY	
SCENARIO #17	.69	.91	.93	
SCENARIO #17C	<u>.46</u>	<u>.88</u>	<u>.39</u>	TOI to 24 sec
Change	-.23	-.03	-.54	

AVERAGE FLEET SURVIVABILITY FOR SCENARIO #18

CURRENT PARAMETER VALUES #1 TO 20 : (SEE USER MANUAL PG. ZZ)
 ESCAPE PARAMETERS #1-6 : (FOR PARAMETER ABBREVIATIONS)

#1-NOAC	#2-RT	#3-SECT	#4-TOI	#5-NPRO	#6-DTTP	
12.0	235.0	350.0	20.0	1.0	10.0	

THREAT PARAMETERS #7-13 :

#7-MFT	#8-NB	#9-DOI	#10-YLD	#11-HOB	#12-CEP	#13-ITYPE
590.0	7.0	9.0	500.0	3000.0	1.0	2.0

HARDNESS PARAMETERS #14-20 :

#14-OP	#15-GUST	#16-THRML	#17-TIS	#18-SIL	#19-GDOT	#20-NFLU
SS 1.0	53.00	40.00	10.00	2.00E+03	1.00E+06	1.00E+06
SK 1.0	53.00	40.00	50.00	5.00E+03	1.00E+08	1.00E+12

	QUANTA	FLEE	GETAWAY	
SCENARIO #18	.27	.55	.43	
SCENARIO #18C	<u>.27</u>	<u>.55</u>	<u>.42</u>	THRML 40 to 20 cal/cm ²
Change	0.00	0.00	-.01	

AVERAGE FLEET SURVIVABILITY FOR SCENARIO #19

CURRENT PARAMETER VALUES #1 TO 20 : (SEE USER MANUAL PG. ZZ)
 (FOR PARAMETER ABBREVIATIONS)

ESCAPE PARAMETERS #1-6 :

#1-NOAC	#2-RT	#3-SECT	#4-TOI	#5-NPRO	#6-DTTP
5.0	350.0	95.0	12.0	1.0	7.0

THREAT PARAMETERS #7-13 :

#7-MFT	#8-NB	#9-DOI	#10-YLD	#11-HOB	#12-CEP	#13-ITYPE
590.0	4.0	22.0	300.0	3000.0	1.0	2.0

HARDNESS PARAMETERS #14-20 :

#14-OP	#15-GUST	#16-THRML	#17-TIS	#18-SIL	#19-GDOT	#20-NFLU
SS 2.0	103.00	100.00	10.00	2.00E+03	1.00E+06	1.00E+06
SK 2.0	103.00	100.00	50.00	5.00E+03	1.00E+08	1.00E+12

	QUANTA	FLEE	GETAWAY	
SCENARIO #19	.01	.68	.21	
SCENARIO #19C	<u>.12</u>	<u>.83</u>	<u>.51</u>	OP 2 to 3 psi (GUST to 150)
Change	.11	.15	.30	

AVERAGE FLEET SURVIVABILITY FOR SCENARIO #20

CURRENT PARAMETER VALUES #1 TO 20 : (SEE USER MANUAL PG. ZZ)
 (FOR PARAMETER ABBREVIATIONS)

ESCAPE PARAMETERS #1-6 :

#1-NOAC	#2-RT	#3-SECT	#4-TOI	#5-NPRO	#6-DTTP
15.0	400.0	90.0	20.0	3.0	4.0

THREAT PARAMETERS #7-13 :

#7-MFT	#8-NB	#9-DOI	#10-YLD	#11-HOB	#12-CEP	#13-ITYPE
590.0	16.0	13.0	250.0	4000.0	1.0	2.0

HARDNESS PARAMETERS #14-20 :

#14-OP	#15-GUST	#16-THRML	#17-TIS	#18-SIL	#19-GDOT	#20-NFLU
SS 3.0	150.00	70.00	10.00	2.00E+03	1.00E+06	1.00E+06
SK 3.0	150.00	70.00	50.00	5.00E+03	1.00E+08	1.00E+12

	QUANTA	FLEE	GETAWAY	
SCENARIO #20	.22	.54	.21	
SCENARIO #20C	<u>.30</u>	<u>.82</u>	<u>.30</u>	DOI 13 to 30 sec
Change	.08	.28	.09	

Appendix E. Log-Normal Damage Functions

This appendix gives details of the log-normal damage functions used in GETAWAY. For each weapon effect, the sure-safe (SS) and sure-kill (SK) hardness specifications are used to define a log-normal damage function of weapon effect intensity such that probability of kill (P_k) at SS intensity equals .02 and P_k (SK) equals .98.

The standard cumulative log-normal distribution function (F) of a random variable X is defined as follows:

$$F(X) = \int_{-\infty}^{\frac{\ln(X) - \mu}{\sigma}} \frac{1}{\sqrt{2\pi}} e^{-1/2y^2} dy$$

where:

$\ln(X)$ is normally distributed with mean μ and standard deviation σ , (i.e. $\ln(X) \sim N(\mu, \sigma)$).

In GETAWAY, the random variable X is taken as weapon effect intensity and F(X) becomes the damage function P_k such that P_k (SS) = .02 and P_k (SK) = .98, that is:

$$P_k(X=SS) = \int_{-\infty}^{\frac{\ln(SS) - \mu}{\sigma}} \frac{1}{\sqrt{2\pi}} e^{-1/2y^2} dy = .02$$

and:

$$P_k (X=SK) = \int_{-\infty}^{\frac{\ln(SK)-\mu}{\sigma}} \frac{1}{\sqrt{2\pi}} e^{-1/2y^2} dy = .98$$

Using Standard Normal tables to evaluate the integrals, we find:

$$\frac{\ln(SS)-\mu}{\sigma} = -2.054$$

and:

$$\frac{\ln(SK)-\mu}{\sigma} = +2.054$$

Solving for μ and σ :

$$\mu = \frac{\ln(SS) + \ln(SK)}{2}$$

$$\sigma = \frac{\ln(SK) - \ln(SS)}{4.108}$$

Therefore, given any sure-safe (SS) and sure-kill (SK) hardness specifications and a weapon effect intensity $X = I$, the probability of kill P_k becomes the cumulative normal function of Z where:

$$z = \frac{\ln(I) - \mu}{\sigma}$$

and μ and σ are defined by SS and SK as described above.

GETAWAY uses an approximation to the cumulative normal distributions to compute P_k as follows:

$$P_k = \begin{cases} 1 - 1/2A & \text{if } z \geq 0 \\ 1/2A & \text{if } z < 0 \end{cases}$$

where:

$$A = (1 + .196854|z| + .115194|z|^2 + .000344|z|^3 + .012527|z|^4)^{-4}$$

(Ref 16:932)

REPORT DOCUMENTATION PAGE	
1. REPORT NUMBER AFIT/GST/PH/83M-3	2. GOVT ACCESSION NO. H/11-11-11
4. TITLE (and Subtitle) "GETAWAY": A Model for Parametric Studies in the Area of Base Escape Survivability	6. PERFORMING ORGANIZATION REPORT NUMBER MS thesis
7. AUTHOR(s) David F. MacGhee, Jr. Charles P. Williams Major USAF Capt USAF	8. CONTROLLING OFFICE NAME AND ADDRESS
9. PERFORMING ORGANIZATION NAME AND ADDRESS Air Force Institute of Technology (AFIT/EN) Wright-Patterson AFB, Ohio 45433	10. PROGRAM ELEMENT, REPORT NUMBER, AND WORK UNIT NUMBER
11. CONTROLLING OFFICE NAME AND ADDRESS	12. REPORT DATE March 1983
	13. NUMBER OF PAGES 170
14. MONITORING AGENCY NAME & ADDRESS (if different from Controlling Office)	15. SECURITY CLASSIFICATION of this Report Unclassified
16. DISTRIBUTION STATEMENT (of this Report) Approved for public release; distribution unlimited.	
17. DISTRIBUTION STATEMENT (of the abstract entered in Block 20, if different from Report)	
18. SUPPLEMENTARY NOTES Approved for public release: IAW AFR 190-17. <i>Lynn E. Wolaver</i> LYNN E. WOLAYER Dean for Research and Professional Development Air Force Institute of Technology (AIC) Wright-Patterson AFB, OH 45433	
19. KEY WORDS (Continue on reverse side if necessary and identify by block number) nuclear survivability analysis QUANTA cookie cutter FLEE vulnerability envelopes base escape survivability model Monte Carlo simulation parametric analysis probability of survival GETAWAY	
20. ABSTRACT (Continue on reverse side if necessary and identify by block number) GETAWAY, a base escape nuclear survivability model specifically designed for parametric studies, is presented. GETAWAY computes the probability of survival for an alert force escaping from a single base under SLBM attack. Parametric studies of 20 escape, threat, and hardness parameters are possible. Nuclear blast, thermal, and prompt radiation intensities are computed and aircraft survivability is derived from cumulative log-normal damage functions of effect intensity. GETAWAY is shown to be an effective	

UNCLASSIFIED

Item 20 (cont'd)

predictive models for conducting parametric analysis. Its advantages over current base escape survivability models are speed, cost effectiveness, and interactive capabilities while providing parametric results highly comparable to alternative models. GETAWAY's methodology could also be applied to ICBM, naval, or ground force nuclear survivability analyses. A User's Guide, Example Session, and Program Listing are provided as appendices.

UNCLASSIFIED

END

FILMED

1-84

DTIC