

AD-A135 409

DAMPING MATERIALS FINITE ELEMENTS AND SPECIAL PROJECTS  
(U) DAYTON UNIV OH RESEARCH INST M RUDDELL ET AL  
DEC 82 UDR-TR-82-110 AFWAL-TR-82-4167 F33615-79-C-5108

1/3

UNCLASSIFIED

F/G 14/2

NL

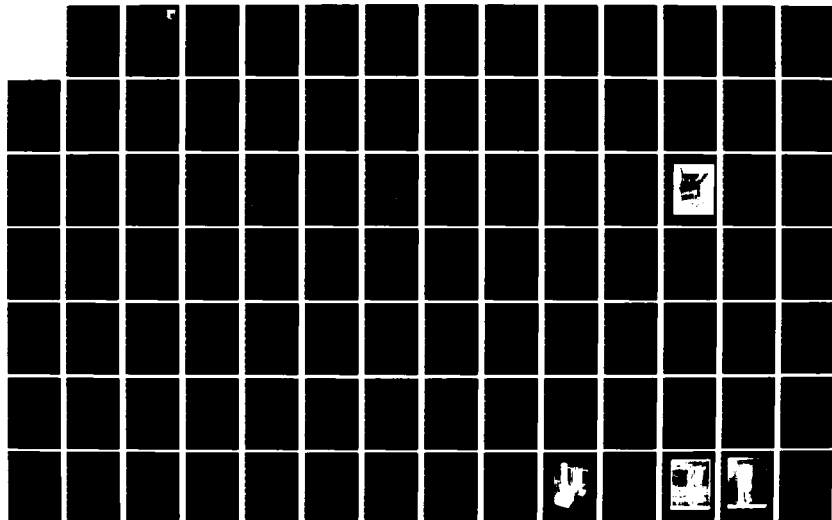

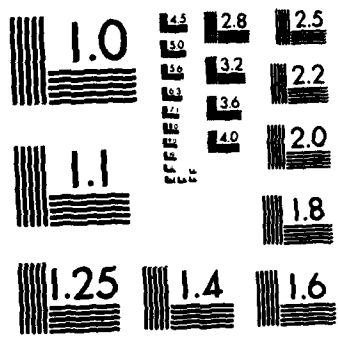

MICROCOPY RESOLUTION TEST CHART  
NATIONAL BUREAU OF STANDARDS-1963-A

12

AFWAL-TR-82-4167

DAMPING MATERIALS, FINITE ELEMENTS AND  
SPECIAL PROJECTS

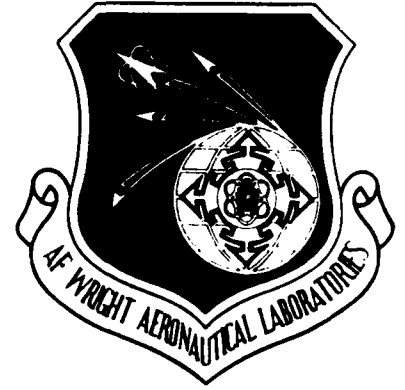

A135409

UNIVERSITY OF DAYTON  
RESEARCH INSTITUTE  
300 COLLEGE PARK AVENUE  
DAYTON, OHIO 45469

DECEMBER 1982

FINAL REPORT FOR PERIOD OCTOBER 1979 - JULY 1982

APPROVED FOR PUBLIC RELEASE; DISTRIBUTION UNLIMITED

MATERIAL LABORATORY  
AIR FORCE WRIGHT AERONAUTICAL LABORATORIES  
AIR FORCE SYSTEMS COMMAND  
WRIGHT-PATTERSON AIR FORCE BASE, OHIO 45433

DTIC  
SERIALIZED  
DEC 0 1983  
E

DTIC FILE COPY

NOTICE

When Government drawings, specifications, or other data are used for any purpose other than in connection with a definitely related Government procurement operation, the United States Government thereby incurs no responsibility nor any obligation whatsoever; and the fact that the government may have formulated, furnished, or in any way supplied the said drawings, specifications, or other data, is not to be regarded by implication or otherwise as in any manner licensing the holder or any other person or corporation, or conveying any rights or permission to manufacture use, or sell any patented invention that may in any way be related thereto.

This report has been reviewed by the Office of Public Affairs (ASD/PA) and is releasable to the National Technical Information Service (NTIS). At NTIS, it will be available to the general public, including foreign nations.

This technical report has been reviewed and is approved for publication.

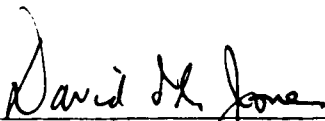
  
\_\_\_\_\_  
DAVID I.G. JONES, Project Engineer  
Metals Behavior Branch  
Metals and Ceramics Division  
Materials Laboratory

  
\_\_\_\_\_  
JOHN P. HENDERSON, Chief  
Metals Behavior Branch  
Metals and Ceramics Division  
Materials Laboratory

FOR THE COMMANDER:

  
\_\_\_\_\_  
LAWRENCE N. HJELM, Asst. Chief  
Metals and Ceramics Division  
Materials Laboratory

"If your address has changed, if you wish to be removed from our mailing list, or if the addressee is no longer employed by your organization please notify AFWAL/MLLN, W-PAFB, OH 45433 to help us maintain a current mailing list".

Copies of this report should not be returned unless return is required by security considerations, contractual obligations, or notice on a specific document.

| REPORT DOCUMENTATION PAGE   |                                      | READ INSTRUCTIONS<br>BEFORE COMPLETING FORM   |
|---|--------------------------------------|---|
| 1. REPORT NUMBER<br>AFWAL-TR-82-4167  | 2. GOVT ACCESSION NO.<br>AD A135 409 | 3. RECIPIENT'S CATALOG NUMBER   |
| 4. TITLE (and Subtitle)<br>DAMPING MATERIALS, FINITE ELEMENTS AND<br>SPECIAL PROJECTS   |                                      | 5. TYPE OF REPORT & PERIOD COVERED<br>Final Report for Period<br>October 1979 - July 1982 |
|   |                                      | 6. PERFORMING ORG. REPORT NUMBER<br>UDR-TR-82-110   |
| 7. AUTHOR(s)<br>Mark Ruddell<br>Philip A. Graf<br>Matthew F. Kluesener  |                                      | 8. CONTRACT OR GRANT NUMBER(s)<br>F33615-79-C-5108  |
| 9. PERFORMING ORGANIZATION NAME AND ADDRESS<br>University of Dayton Research Institute<br>300 College Park Avenue<br>Dayton, Ohio 45469   |                                      | 10. PROGRAM ELEMENT, PROJECT, TASK<br>AREA & WORK UNIT NUMBERS<br>62102F<br>24180312      |
| 11. CONTROLLING OFFICE NAME AND ADDRESS<br>Materials Laboratory (AFWAL/MLLN)<br>Air Force Wright Aeronautical Laboratories (AFSC)<br>Wright-Patterson Air Force Base, Ohio 45433  |                                      | 12. REPORT DATE<br>December 1982  |
| 14. MONITORING AGENCY NAME & ADDRESS (if different from Controlling Office)   |                                      | 13. NUMBER OF PAGES<br>209  |
|   |                                      | 15. SECURITY CLASS. (of this report)<br>Unclassified                                      |
|   |                                      | 15a. DECLASSIFICATION/DOWNGRADING<br>SCHEDULE   |
| 16. DISTRIBUTION STATEMENT (of this Report)<br><br>Approved for public release; distribution unlimited.   |                                      |   |
| 17. DISTRIBUTION STATEMENT (of the abstract entered in Block 20, if different from Report)  |                                      |   |
| 18. SUPPLEMENTARY NOTES   |                                      |   |
| 19. KEY WORDS (Continue on reverse side if necessary and identify by block number)<br>Damping Materials                      Turbine Blades<br>Test Techniques                         Finite Elements<br>Transducers                                Data Reduction   |                                      |   |
| 20. ABSTRACT (Continue on reverse side if necessary and identify by block number)<br>This report denotes work under the subject contract in the area of polymeric and enamel material damping properties measurement, finite element analysis of damped components and some special projects, including state-of-the-art mobility measurement evaluations and development of a unique high temperature, high driving force electro-magnetic transducer. |                                      |   |

## TABLE OF CONTENTS

| SECTION  | PAGE |
|--|------|
| 1  | 1    |
| MATERIALS  | 1    |
| 1.1 POLYMERIC MATERIALS  | 1    |
| 1.1.1 New Materials  | 1    |
| 1.1.2 E·A·R C-1002   | 1    |
| 1.1.3 ISD-110  | 16   |
| 1.1.4 ASTM E-33 Committee Testing  | 16   |
| 1.2 VITREOUS ENAMELS TESTING   | 23   |
| 1.2.1 Determination of Material Properties                                       | 23   |
| 1.2.1.1 High Temperature Enamels Test Apparatus                                  | 24   |
| 1.2.1.2 Beam Testing   | 31   |
| 1.2.1.3 Calculation of Damping Properties  | 43   |
| 1.2.1.4 Material Properties Presentation   | 44   |
| 1.2.1.5 Data Files Maintenance   | 55   |
| 1.2.1.6 Materials Tested   | 62   |
| 1.3 MATERIAL DATA COMPUTER PROGRAMS  | 74   |
| 1.3.1 Vibration Damping Material Property Reduction and Display Computer Program | 74   |
| 1.3.2 Additional Material Computer Programs                                      | 74   |
| 1.4 TESTING OF DAMPED SPACE SHUTTLE TEST BEAMS                                   | 77   |
| 1.5 EXHAUST GAS SIMULATOR (EGS)  | 92   |
| 1.5.1 Background   | 92   |
| 1.5.2 Simulator Design   | 92   |
| 1.5.3 Operation  | 93   |
| 1.5.4 Material Evaluation  | 94   |
| 2  | 98   |
| FINITE ELEMENT ANALYSES AND DEVELOPMENT  | 98   |
| 2.1 FINITE ELEMENT ANALYSIS OF STRUCTURES  | 98   |
| 2.1.1 Damped Skin Stringer Panel   | 98   |
| 2.1.2 Analyses of F100 2nd Stage Turbine Blade                                   | 108  |
| 2.1.2.1 F100 2nd Stage Turbine Blade Models                                      | 108  |
| 2.1.2.2 UDRI Analysis of Damped F100 Turbine Blade                               | 113  |
| 2.1.2.3 Comparison of NASTRAN and MAGNA-D Results                                | 127  |

TABLE OF CONTENTS  
(concluded)

| <u>SECTION</u> |  | <u>PAGE</u> |
|----------------|--|-------------|
|                | 2.2 FINITE ELEMENT PROGRAMMING   | 130         |
| 3              | SPECIAL PROJECTS   | 137         |
|                | 3.1 STRUCTURAL ANALYSIS  | 137         |
|                | 3.2 DDA ELASTOMERIC TOOLING  | 137         |
|                | 3.3 HIGH FORCE, HIGH TEMPERATURE ELECTROMAGNETIC<br>TRANSDUCER DEVELOPMENT | 138         |
|                | 3.3.1 Cooling System   | 141         |
|                | 3.3.1.1 Transducer Connection  | 153         |
|                | 3.3.1.2 Operation  | 155         |
|                | 3.4 DAMPING OF NASA FLUTTER BLADES   | 156         |
|                | 3.5 CHARACTERIZATION OF MAGNETIC TRANSDUCERS                               | 166         |
|                | REFERENCES   | 174         |
| APPENDICES     |  |             |
| A              | DAMPING PROPERTIES OF TWELVE COMMERCIAL MATERIALS                          | 176         |
| B              | TABULAR DATA OF TESTS PERFORMED ON ISD-110                                 | 186         |
| C              | J-85 AFTERBURNER LINER FOLLOW-UP TEST DATA SHEETS                          | 191         |
| D              | MAGNA COMPUTER PROGRAM   | 208         |

|                      |                                     |
|----------------------|-------------------------------------|
| <b>Accession For</b> |                                     |
| NTIS GRA&I           | <input checked="" type="checkbox"/> |
| DTIC TAB             | <input type="checkbox"/>            |
| Unannounced          | <input type="checkbox"/>            |
| Justification        |                                     |
| By _____             |                                     |
| Distribution/        |                                     |
| Availability Codes   |                                     |
| Dist                 | Avail and/or<br>Special             |

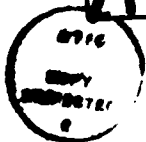

## LIST OF ILLUSTRATIONS

| <u>Figure</u> |  | <u>Page</u> |
|---------------|--|-------------|
| 1.1           | Nomogram for 3M NPE-9047 (NBN-51914-50-2)  | 3           |
| 1.2           | Nomogram for 3M NPE-9046 (NBN-51914-50-8)  | 4           |
| 1.3           | Nomogram for 3M ISD-468  | 5           |
| 1.4           | Nomogram for Soundcoat MN (121580)   | 6           |
| 1.5           | Nomogram for Soundcoat D   | 7           |
| 1.6           | Nomogram for Soundcoat N   | 8           |
| 1.7           | Nomogram for Soundcoat M   | 9           |
| 1.8           | Nomogram for Soundcoat LT  | 10          |
| 1.9           | Nomogram for E•A•R C-1002  | 11          |
| 1.10          | Nomogram for E•A•R C-2003  | 12          |
| 1.11          | Nomogram for UDRI Butyl 268  | 13          |
| 1.12          | Nomogram for UDRI Butyl 268 + 60% Carbon Black   | 14          |
| 1.13          | Nomograph of E•A•R C-1002  | 15          |
| 1.14          | Data from DMA Test of E•A•R C-1002   | 17          |
| 1.15          | 0.005" ISD-110 on 0.060" Aluminum Beams  | 18          |
| 1.16          | 0.058" ISD-110 on 0.068" Stainless Steel Beams   | 19          |
| 1.17          | 0.058" ISD-110 on 0.080" Aluminum Beams  | 20          |
| 1.18          | 0.058" ISD-110, DMA Test   | 21          |
| 1.19          | 0.002" ISD-110, Reovibran Test   | 22          |
| 1.20          | High Temperature Enamels Damping Fixture Number One  | 25          |
| 1.21          | High Temperature Enamels Damping Fixture Number Two  | 26          |
| 1.22          | Schematic of the Enamels Testing Furnace Showing the Locations of the Control and Monitoring Thermocouples | 28          |
| 1.23          | Schematic of the Connection of the Drive Transducer  | 30          |
| 1.24          | Schematic of High Temperature Damping Test Apparatus Cooling System  | 33          |
| 1.25          | Block Diagram of High Temperature Test Apparatus   | 34          |
| 1.26          | Schematic of the Cantilever Beam Test Specimens with Typical Dimensions                                    | 36          |
| 1.27          | Resonant Frequency Versus Temperature Curve of Modes for Bare (Uncoated) Beam.                             | 38          |
| 1.28          | Half-power Bandwidth (Modal Damping) of Each Mode Versus Temperature for Bare (Uncoated) Beam.             | 39          |
| 1.29          | Typical Plot of Coated Beam Center Frequency Versus Temperature  | 41          |



LIST OF ILLUSTRATIONS  
(continued)

| <u>Figure</u> |   | <u>Page</u> |
|---------------|---|-------------|
| 1.30          | Half-power Bandwidth (Modal Damping) Versus Temperature for Coated Beam.                          | 42          |
| 1.31          | Coated Oberst Test Beam.  | 43          |
| 1.32          | Storage Modulus and Loss Modulus Versus Reduced Frequency.  | 45          |
| 1.33          | Storage Modulus and Loss Factor Versus Reduced Frequency.   | 46          |
| 1.34          | Example for Determining Loss Factor and Storage Modulus at 500 Hz and 600°C.                      | 49          |
| 1.35          | Example for Determining Loss Modulus and Storage Modulus at 500 Hz and 600°C.                     | 50          |
| 1.36          | Example for Determining Peak Damping Temperature for 100 and 1,000 Hz.                            | 51          |
| 1.37          | Example for Determining Material Damping Temperature Range at 1,000 Hz.                           | 52          |
| 1.38          | Curve Fit Parameters for Storage Modulus.   | 53          |
| 1.39          | Curve Fit Parameters for Loss Factor.   | 54          |
| 1.40          | Vitreous Enamel Evaluation Sheet.   | 56          |
| 1.41          | Bare Beam Test Data.  | 57          |
| 1.42          | Composite Beam Test Data.   | 58          |
| 1.43          | Reduced Data (Computer Print-Out).  | 59          |
| 1.44          | Reduced Temperature Nomograph with Young's Modulus and Loss Factor Plotted (Computer Print-Out).  | 60          |
| 1.45          | Reduced Temperature Nomograph with Young's Modulus and Loss Modulus Plotted (Computer Print-Out). | 61          |
| 1.46          | Bending Strain Monitoring Circuit.  | 63          |
| 1.47          | Second Bending Mode Responses of Beam 03-06 at 800°F.   | 64          |
| 1.48          | Second Bending Mode Responses of Beam 03-06 at 850°F.   | 64          |
| 1.49          | Second Bending Mode Responses of Beam 03-06 at 900°F.   | 65          |

LIST OF ILLUSTRATIONS  
(continued)

| <u>Figure</u> |  | <u>Page</u> |
|---------------|--|-------------|
| 1.50          | Second Bending Mode Response of Beam 03-06 at 1002°F.  | 65          |
| 1.51          | Second Bending Mode Response of Beam 03-06 at 1053°F.  | 66          |
| 1.52          | Second Bending Mode Response of Beam 03-06 at 1093°F.  | 66          |
| 1.53          | Second Bending Mode Response of Beam 03-06 at 1147°F.  | 67          |
| 1.54(a)       | Reduced Test Data .004 Inch Mag-Spinel, 25mv <sub>rms</sub> Excitation.                        | 68          |
| 1.54(b)       | Loss Modulus-Reduced Frequency Nomograph 0.004 Inch Mag-Spinel 25mv <sub>rms</sub> Excitation. | 68          |
| 1.54(c)       | Loss Factor-Reduced Frequency Nomograph 0.004 Inch Mag-Spinel 25mv <sub>rms</sub> Excitation.  | 68          |
| 1.55(a)       | Reduced Test Data, 0.004 Inch Mag-Spinel, 50mv <sub>rms</sub> Excitation.                      | 69          |
| 1.55(b)       | Loss Modulus-Reduced Frequency Nomograph 0.004 Inch Mag-Spinel 50mv <sub>rms</sub> Excitation. | 69          |
| 1.55(c)       | Loss Factor-Reduced Frequency Nomograph 0.004 Inch Mag-Spinel 50mv <sub>rms</sub> Excitation.  | 69          |
| 1.56(a)       | Reduced Test Data, 0.004 Mag-Spinel 75mv <sub>rms</sub> Excitation.                            | 70          |
| 1.56(b)       | Loss Modulus-Reduced Frequency Nomograph 0.004 Inch Mag-Spinel 75mv <sub>rms</sub> Excitation. | 70          |
| 1.56(c)       | Loss Factor-Reduced Frequency Nomograph 0.004 Inch Mag-Spinel 75mv <sub>rms</sub> Excitation.  | 70          |
| 1.57(a)       | Reduced Test Data, 0.010 Inch Mag-Spinel 25mv <sub>rms</sub> Excitation.                       | 71          |
| 1.57(b)       | Loss Modulus-Reduced Frequency Nomograph 0.010 Inch Mag-Spinel 25mv <sub>rms</sub> Excitation. | 71          |
| 1.57(c)       | Loss Factor-Reduced Frequency Nomograph 0.010 Inch Mag-Spinel 25mv <sub>rms</sub> Excitation.  | 71          |
| 1.58(a)       | Reduced Test Data, 0.010 Inch Mag-Spinel 50mv <sub>rms</sub> Excitation.                       | 72          |
| 1.58(b)       | Loss Modulus-Reduced Frequency Nomograph 0.010 Inch Mag-Spinel 50mv <sub>rms</sub> Excitation. | 72          |

LIST OF ILLUSTRATIONS  
(continued)

| <u>Figure</u>   | <u>Page</u> |
|---|-------------|
| 1.58(c) Loss Factor-Reduced Frequency Nomograph 0.010 Inch<br>Mag-Spinel 50mv <sub>rms</sub> Excitation.      | 72          |
| 1.59(a) Reduced Test Data, 0.010 Inch Mag-Spinel 75mv <sub>rms</sub><br>Excitation.                           | 73          |
| 1.59(b) Loss Factor-Reduced Frequency Nomograph, 0.010 Inch<br>Mag-Spinel 75mv <sub>rms</sub> Excitation.     | 73          |
| 1.60 The Interrelationship Between the Computer Programs<br>"REDUC", "CURVE", "MPROP", and "PREDC".           | 75          |
| 1.61 Test Set-Up for Pin-Free Beam Test.  | 79          |
| 1.62 Modified Space Shuttle Beam Test Fixture Showing<br>Location of Drive Transducer.                        | 81          |
| 1.63 Modified Space Shuttle Beam Test Fixture Showing<br>Location of Response Transducer.                     | 82          |
| 1.64 Temperature Distribution Versus Exhaust Chamber<br>Position for Both Free-Flow and Forced-Draft Exhaust. | 96          |
| 1.65 Schematic Cross-Section of Exhaust Gas Simulator.  | 97          |
| 2.1 Finite Element Model of Stiffened Panel.  | 99          |
| 2.2 Cross-Section of Model.   | 100         |
| 2.3 Mode 1, 1 of Stiffened Panel (48.8 Hz).   | 103         |
| 2.4 Mode 1, 3 of Stiffened Panel (68.9 Hz).   | 104         |
| 2.5 Mode 3, 3 of Stiffened Panel (120.1 Hz).  | 105         |
| 2.6 Mode 1, 5 of Stiffened Panel (149.7 Hz).  | 106         |
| 2.7 Mode 5, 3 of Stiffened Panel (159.2 Hz).  | 107         |
| 2.8 Kielb Model, Which Includes the Platform and Neck.  | 110         |
| 2.9 Pratt and Whitney Model, Which Includes the Platform<br>and Neck But not the Dovetail Section.            | 111         |
| 2.10 The UDRI Model.  | 112         |
| 2.11 Deformed Mode Shapes.  | 115         |
| 2.12 Finite Element Model of Turbine Blade.   | 116         |

LIST OF ILLUSTRATIONS  
(continued)

| <u>Figure</u> |  | <u>Page</u> |
|---------------|--|-------------|
| 2.13          | Receptance Measurement Points.   | 117         |
| 2.14          | Amplitude-Frequency Response (Case 1 and 2).   | 118         |
| 2.15          | Amplitude-Frequency Response (Case 3 and 4).   | 119         |
| 2.16          | Amplitude-Frequency Response (Case 5 and 6).   | 120         |
| 2.17          | Amplitude-Frequency Response (case 7 and 8).   | 121         |
| 2.18          | Comparison of Damped and Undamped Response.  | 123         |
| 2.19          | First Mode Response of Blade with Full Glass Coating at Three Temperatures.            | 123         |
| 2.20          | Loss Modulus and Composite Factor of Blade with Full Glass Coating versus Temperature. | 124         |
| 2.21          | Comparison of Blade with Glass and Blade with Glass and Nickel.                        | 124         |
| 2.22          | First Mode Response of Damped Blade, Rotating and Non-Rotating.                        | 126         |
| 2.23          | Comparison of Results Using Different Element Types to Model the Glass Damping Layer.  | 126         |
| 2.24          | Airfoil Section of Pratt and Whitney Model.  | 129         |
| 2.25          | Successive States of Deformation of a Three-Dimensional Body.                          | 132         |
| 3.1           | Schematic Cross-Section of Transducer Showing Coolant Flow.                            | 140         |
| 3.2           | Magnetic Transducer Body.  | 142         |
| 3.3           | Magnetic Transducer Outer Barrel.  | 143         |
| 3.4           | Magnetic Transducer Coil Form.   | 144         |
| 3.5           | Magnetic Transducer Core Sheet.  | 145         |
| 3.6           | Magnetic Transducer End Cap.   | 146         |
| 3.7           | Magnetic Transducer Hole Spacing Sketch.   | 147         |
| 3.8           | Air Gap Magnetic Intensity Versus D.C. Current in Coil.                                | 148         |

LIST OF ILLUSTRATIONS  
(continued)

| <u>Figure</u> |  | <u>Page</u> |
|---------------|--|-------------|
| 3.9           | Air Gap Magnetic Intensity Versus D.C. Current in Coil.  | 149         |
| 3.10          | Air Gap Magnetic Intensity Versus D.C. Current in Coil.  | 150         |
| 3.11          | Acceleration Response Versus D.C. Bias at a Constant A.C. Drive Level.   | 151         |
| 3.12          | Acceleration Response Versus A.C. Drive Voltage at a D.C. Bias Current.  | 151         |
| 3.13          | Coolant Manifold.  | 152         |
| 3.14          | Schematic of Cooling System.   | 154         |
| 3.15          | NASA Lewis Research Center Facility for Flutter Studies.   | 157         |
| 3.16          | Flutter Blade Test Fixture.  | 158         |
| 3.17          | Undeformed and Mode 1 Shapes of Flutter Blade Showing Point Numbers and X-Y-Z Orientation.   | 159         |
| 3.18          | Modes 2 and 3 of Flutter Blade Superimposed Over Undeformed Shape.   | 160         |
| 3.19          | Modes 4 and 5 of Flutter Blade Superimposed Over Undeformed Shape.   | 161         |
| 3.20          | Modes 6 and 7 of Flutter Blade Superimposed Over Undeformed Shape.   | 162         |
| 3.21          | Comparison of Measured Value of Bare Blade Loss Factor to Value of Loss Factor of Chosen Damping Configuration 0.002 inch ISD 112 and 0.005 inch Aluminum. | 163         |
| 3.22          | Comparison of Measured Value of Bare Blade Loss Factor to Value of Loss Factor of 0.005 inch ISD 112 and 0.005 inch Aluminum Damping Configuration.        | 164         |
| 3.23          | Test Fixture for Measuring the Force-Frequency Relationship of Magnetic Transducers.   | 167         |
| 3.24          | Block Diagram of Constant Current Force Gage Test.   | 168         |
| 3.25          | Block Diagram of Constant Voltage Force Gage Test.   | 168         |
| 3.26          | Force Versus Frequency for First Model 3030 HTB, Constant Voltage, 20V <sub>RMS</sub> .  | 169         |

LIST OF ILLUSTRATION  
(concluded)

| <u>Figure</u> |   | <u>Page</u> |
|---------------|---|-------------|
| 3.27          | Force Versus Frequency for First Model 3030 HTB, Constant Current $0.7\text{mA}_{\text{RMS}}$ .                 | 169         |
| 3.28          | Force Versus Frequency for Second Model 3030 HTB, Constant Voltage, $20\text{V}_{\text{RMS}}$ .                 | 170         |
| 3.29          | Force Versus Frequency for Second Model 3030 HTB, Constant Current, $0.7\text{mA}_{\text{RMS}}$ .               | 170         |
| 3.30          | Force Versus Frequency for Model 3015 HTB, Constant Voltage, $10\text{V}_{\text{RMS}}$ .                        | 171         |
| 3.31          | Force Versus Frequency for Model 3015 HTB, Constant Current, $50\text{mA}_{\text{RMS}}$ .                       | 171         |
| 3.32          | Force Versus Frequency for Original High Temperature Transducer, Constant Voltage, $2.5\text{V}_{\text{RMS}}$ . | 172         |
| 3.33          | Force Versus Frequency for Original High Temperature Transducer, Constant Current, $90\text{mA}_{\text{RMS}}$ . | 172         |
| 3.34          | Force Versus Frequency for New High Temperature Transducer, Constant Voltage, $3\text{V}_{\text{RMS}}$ .        | 173         |
| 3.35          | Force Versus Frequency for New High Temperature Transducer, Constant Current, $15\text{mA}_{\text{RMS}}$ .      | 173         |

## LIST OF TABLES

| <u>TABLE</u> |  | <u>PAGE</u> |
|--------------|--|-------------|
| 1.1          | NEW MATERIALS TESTED   | 2           |
| 1.2          | DAMPING LAYER AND BEAM COMBINATIONS USED TO TEST<br>DAP-1                            | 2           |
| 1.3          | TEMPERATURE DEVIATION OF MONITOR THERMOCOUPLES                                       | 29          |
| 1.4          | LIST OF ELECTRONIC EQUIPMENT   | 32          |
| 1.5          | CAPABILITIES OF MATERIAL EVALUATION AND STRUCTURAL<br>PREDICTION PROGRAMS            | 76          |
| 1.6          | USER PROGRAM MANUALS   | 76          |
| 1.7          | PREDICTED AND MEASURED CENTER FREQUENCIES OF ALUMINUM<br>SHUTTLE BEAM                | 77          |
| 1.8          | CONSTRUCTION OF SHUTTLE TEST BEAMS   | 78          |
| 1.9          | SPACE SHUTTLE TEST BEAM DATA   | 83          |
| 1.10         | COMPLETE SET OF EXPERIMENTS CONDUCTED WITH THE EXHAUST<br>GAS SIMULATOR              | 95          |
| 2.1          | MODES OF UNDAMPED SKIN STRINGER PANEL  | 102         |
| 2.2          | RESULTS FOR UNDAMPED AND DAMPED PANEL  | 109         |
| 2.3          | ANALYSES OF TURBINE BLADE  | 114         |
| 2.4          | COMPARISON OF MAGNA-D AND NASTRAN, FIRST THREE<br>FREQUENCIES OF TURBINE BLADE MODEL | 128         |

SECTION 1  
MATERIALS

1.1 POLYMERIC MATERIALS

1.1.1 New Materials

The dynamic damping properties were determined for eleven commercial materials and two materials compounded by UDRI. The materials are listed in Table 1.1. The materials were tested by the resonant beam technique as discussed in AFWAL-TR-80-4093, "Polymeric Material Testing Procedures to Determine Damping Properties and the Results of Selected Commercial Materials." Nomograms for twelve of the materials are shown in Figures 1.1 through 1.12. Tabular data for these materials are in Appendix A.

One free layer material, DAP-1, (Allforce Acoustics) was difficult to test and the nomograph has not yet been produced. Although the raw data was consistent and believable, the reduced data contained negative and ridiculously high loss factor and modulus values for some points at temperatures above the damping peak. This was initially attributed to improper thickness and stiffness ratios of the composite beam. As a result, DAP-1 was tested in seven different configurations, using both steel and aluminum beams (Table 1.2). However, all of these combinations produced similar results. It is possible that DAP-1 becomes soft enough at temperatures above the damping peak to use in a sandwich configuration.

1.1.2 E·A·R C-1002

A representative of the E·A·R division of the Cabot Corporation questioned the validity and test method used to determine the damping properties of their vinyl-based damping material, C-1002.

C-1002 was tested by UDRI in a free-layer beam configuration because of its relatively high stiffness at room temperature. According to E·A·R, C-1002 should have been tested in a sandwich beam (shear) configuration. The results from the first beam test (Figure 1.13) indicate that near the high end of the test temperature range, the modulus of C-1002 approaches the upper limit for sandwich beam materials (100 MPa, as defined by the ASTM E-33 standard).



TABLE 1.1  
NEW MATERIALS TESTED

| Material                       | Manufacturer        | Test Configuration          |
|--------------------------------|---------------------|-----------------------------|
| NPE-9047                       | 3M                  | Shear (sandwich)            |
| NPE-9046                       | 3M                  | " "                         |
| ISD-468                        | 3M                  | " "                         |
| MN                             | Soundcoat           | " "                         |
| D                              | "                   | " "                         |
| N                              | "                   | " "                         |
| M                              | "                   | " "                         |
| LT                             | "                   | " "                         |
| C-1002                         | E·A·R (Cabot Corp.) | Free Layer (Oberst)         |
| C-2003                         | " " "               | " " "                       |
| DAP-1                          | Allforce Acoustics  | Oberst & Modified<br>Oberst |
| Butyl 268                      | UDRI                | Shear (sandwich)            |
| Butyl 268+<br>60% carbon black | "                   | " "                         |

TABLE 1.2  
DAMPING LAYER AND BEAM COMBINATIONS  
USED TO TEST DAP-1

| <u>DAP-1<br/>Thickness</u> | <u>Beam<br/>Thickness</u> | <u>Beam<br/>Material</u> | <u>Configuration</u> |
|----------------------------|---------------------------|--------------------------|----------------------|
| 0.060-inch                 | 0.080-inch                | Aluminum                 | Oberst               |
| 0.060-inch                 | 0.060-inch                | Aluminum                 | Oberst               |
| 0.060-inch                 | 0.068-inch                | Steel                    | Oberst               |
| 0.060-inch                 | 0.080-inch                | Aluminum                 | Modified Oberst      |
| 0.020-inch                 | 0.080-inch                | Aluminum                 | Oberst               |
| 0.020-inch                 | 0.068-inch                | Steel                    | Oberst               |
| 0.020-inch                 | 0.068-inch                | Steel                    | Modified Oberst      |

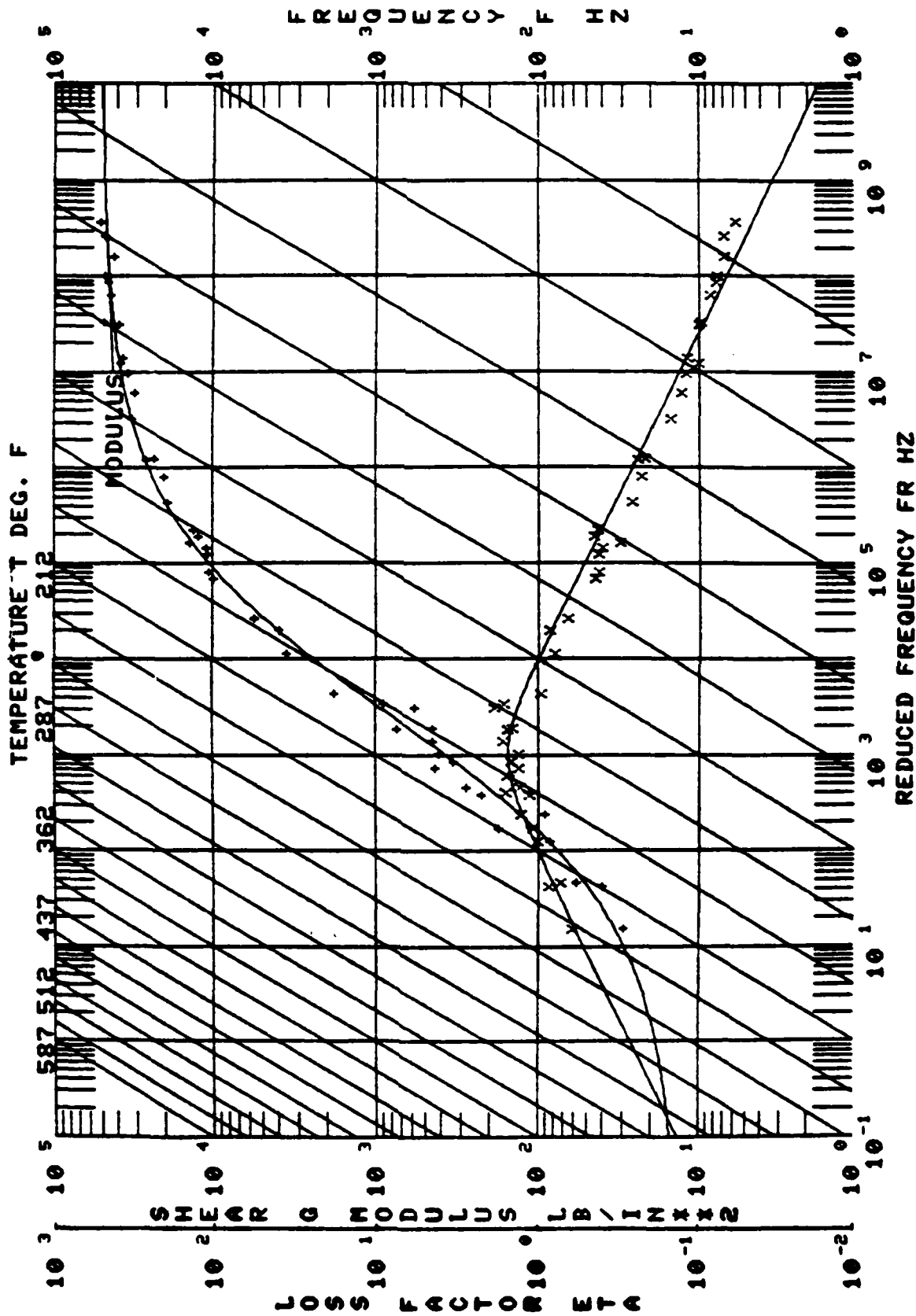

Figure 1.1. Nomogram for 3M NPE-9047 (NBN-51914-50-2).

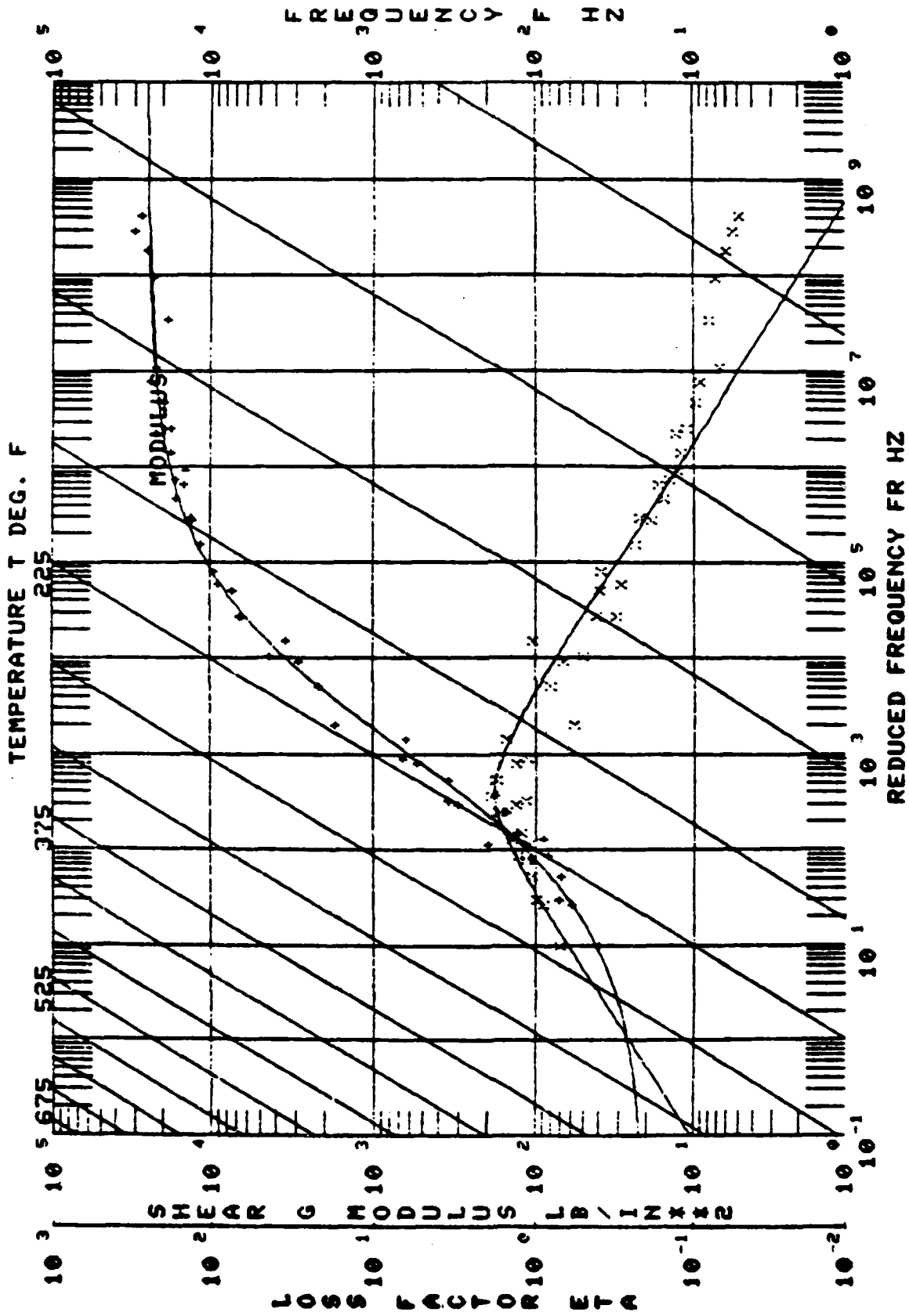

Figure 1.2. Nomogram for 3M NPE-9046 (NBN -51914-50-8).

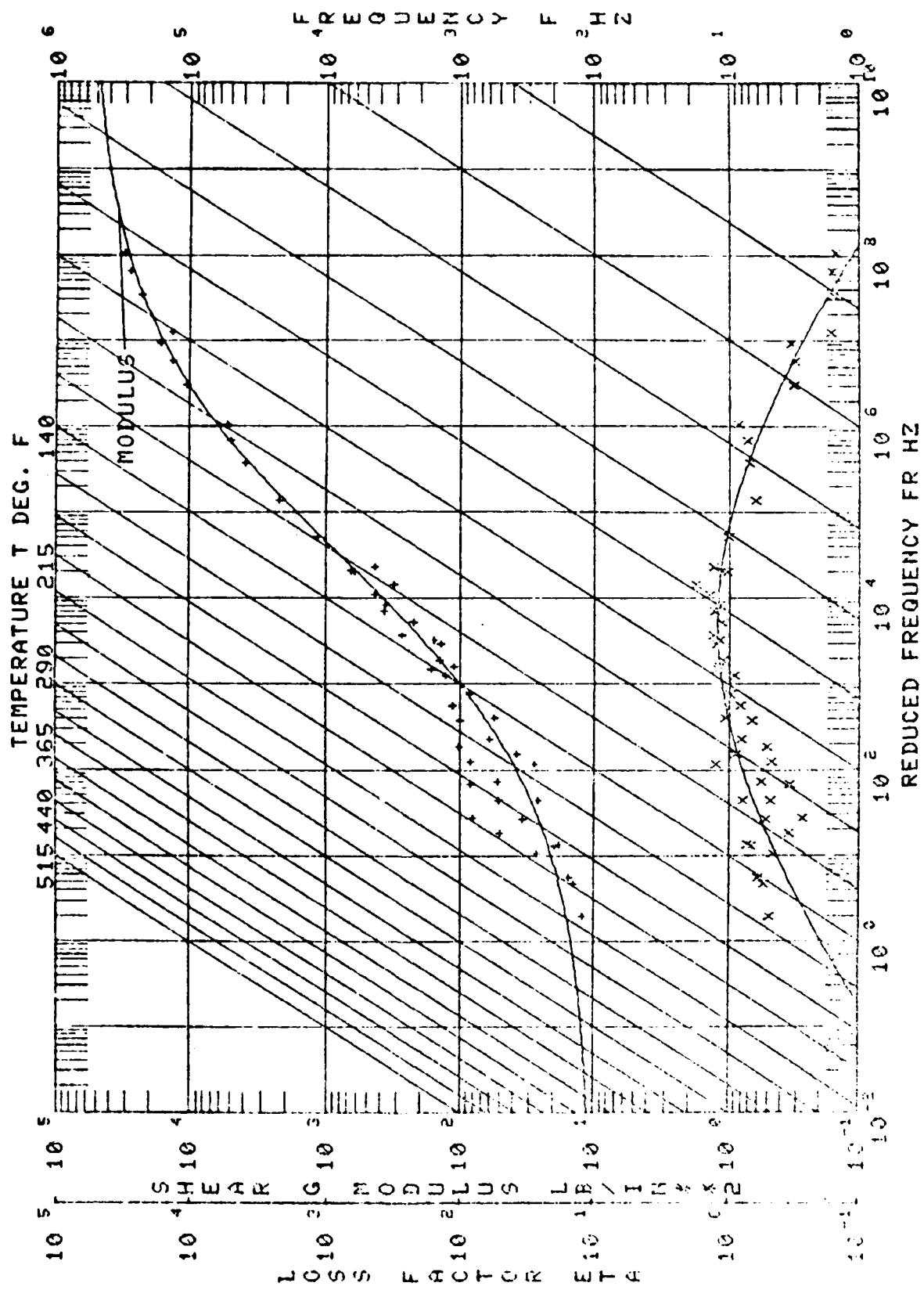

Figure 1.3. Nomogram for 3M ISD-468.

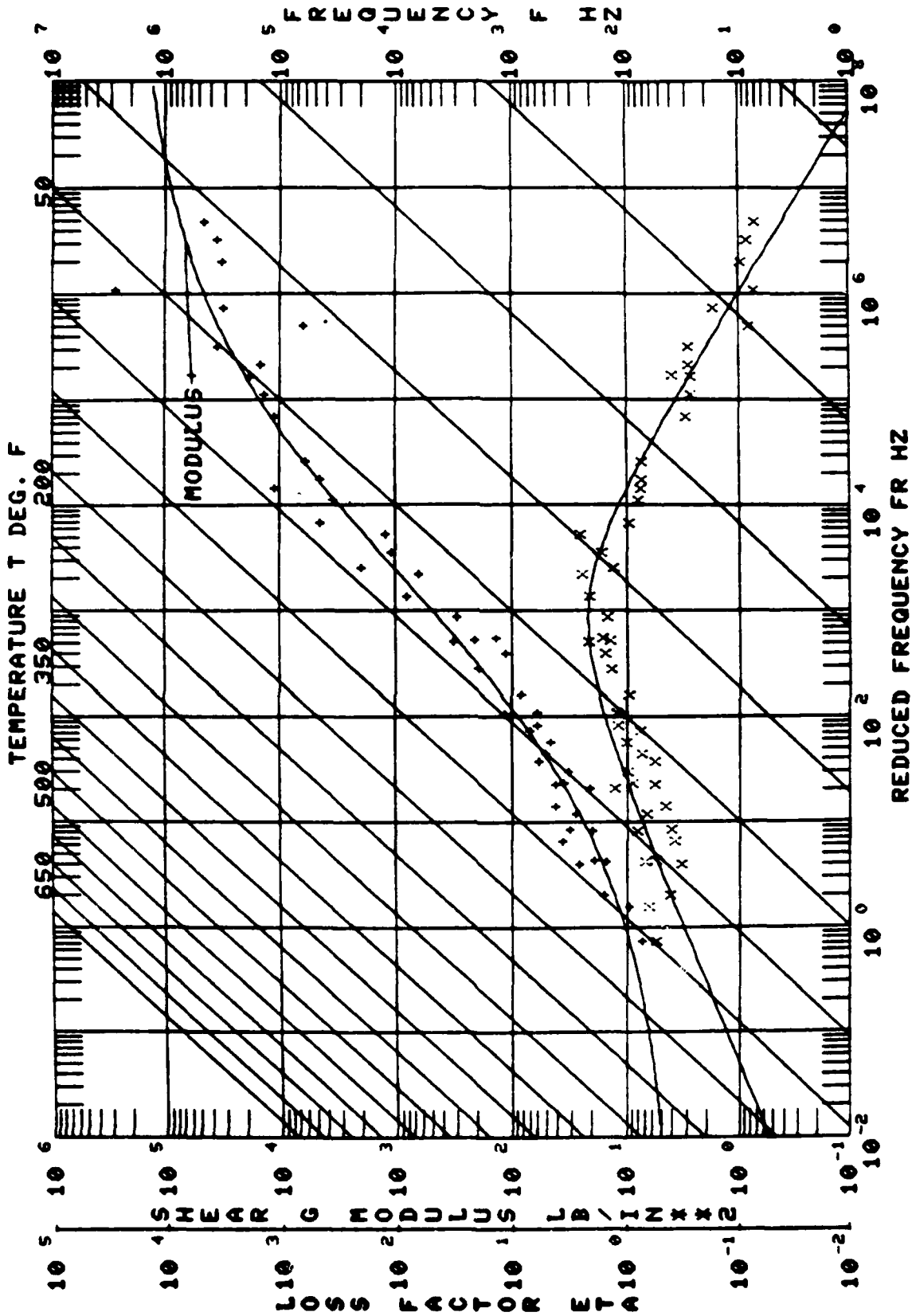

Figure 1.4. Nomogram for Soundcoat MN (121580).

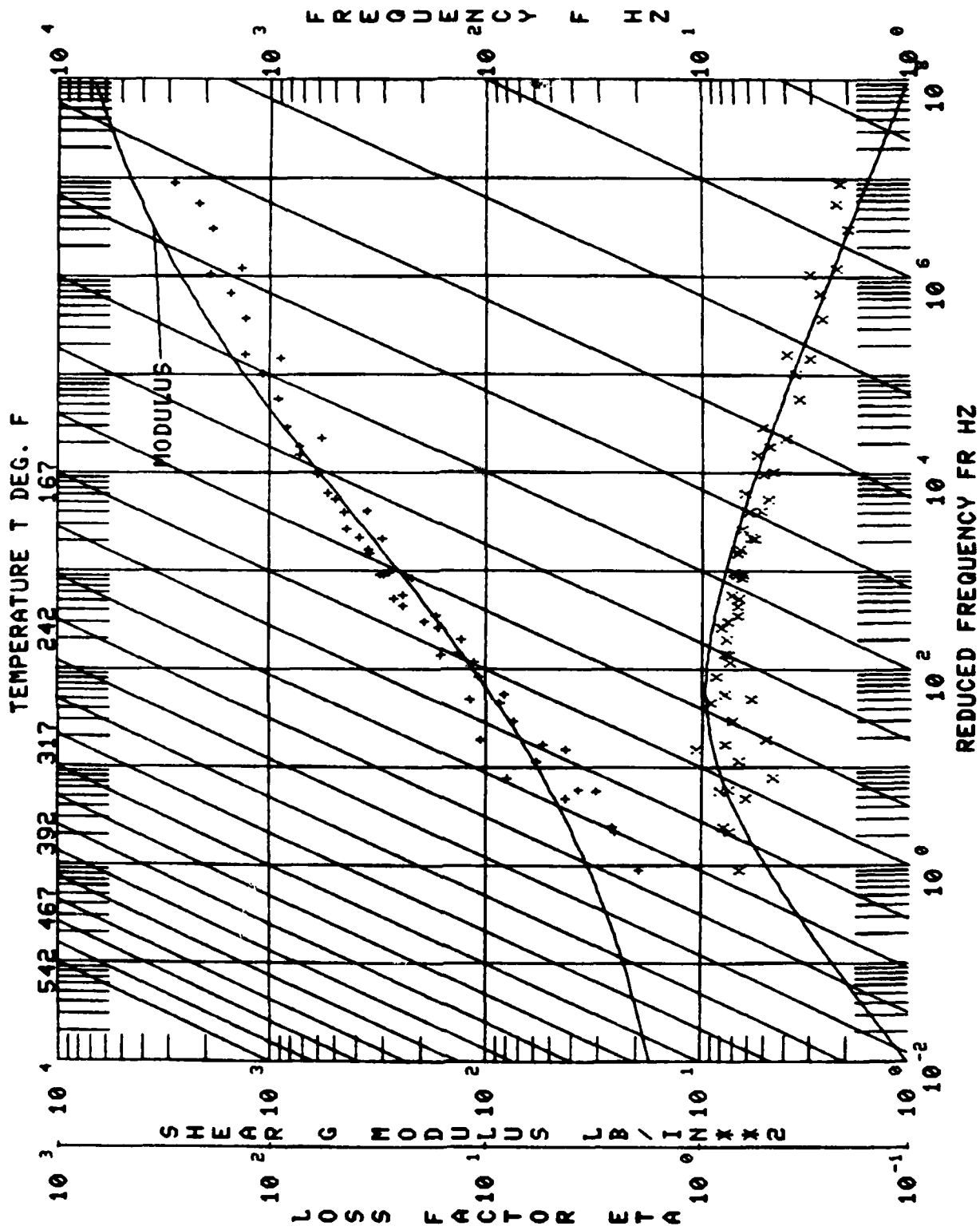

Figure 1.5. Nomogram for Soundcoat D.

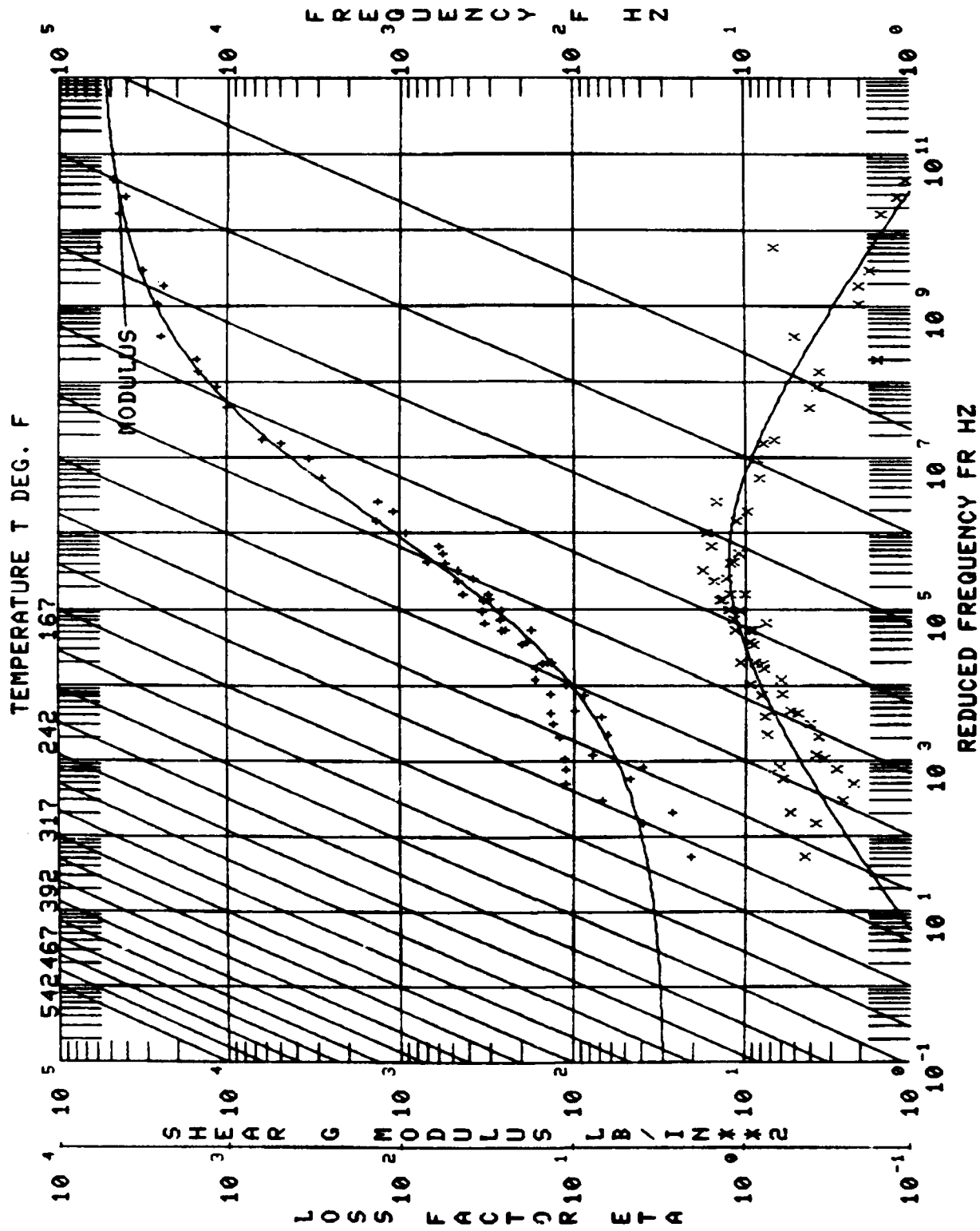

Figure 1.6. Nomogram for Soundcoat N

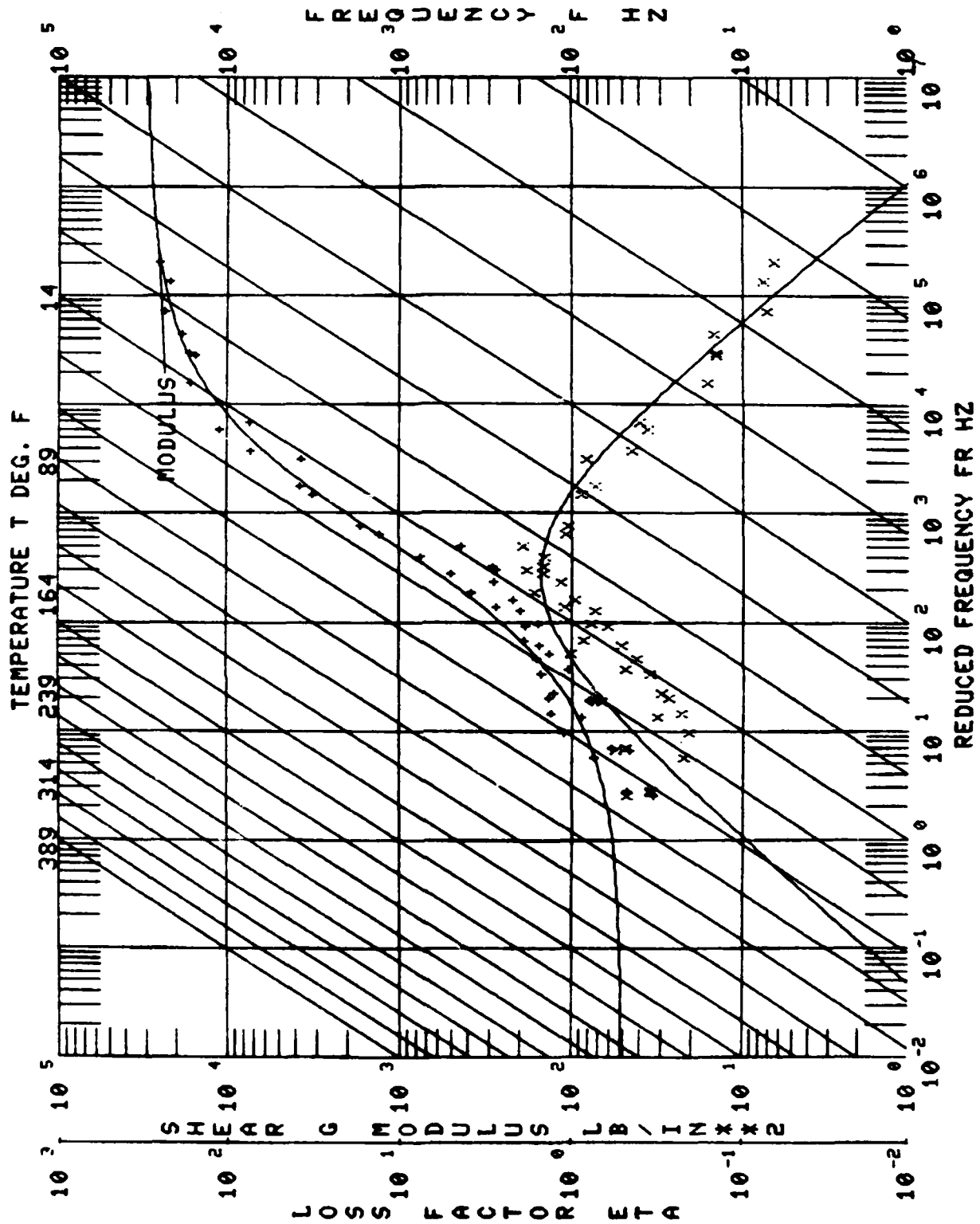

Figure 1.7. Nomogram for Soundcoat M



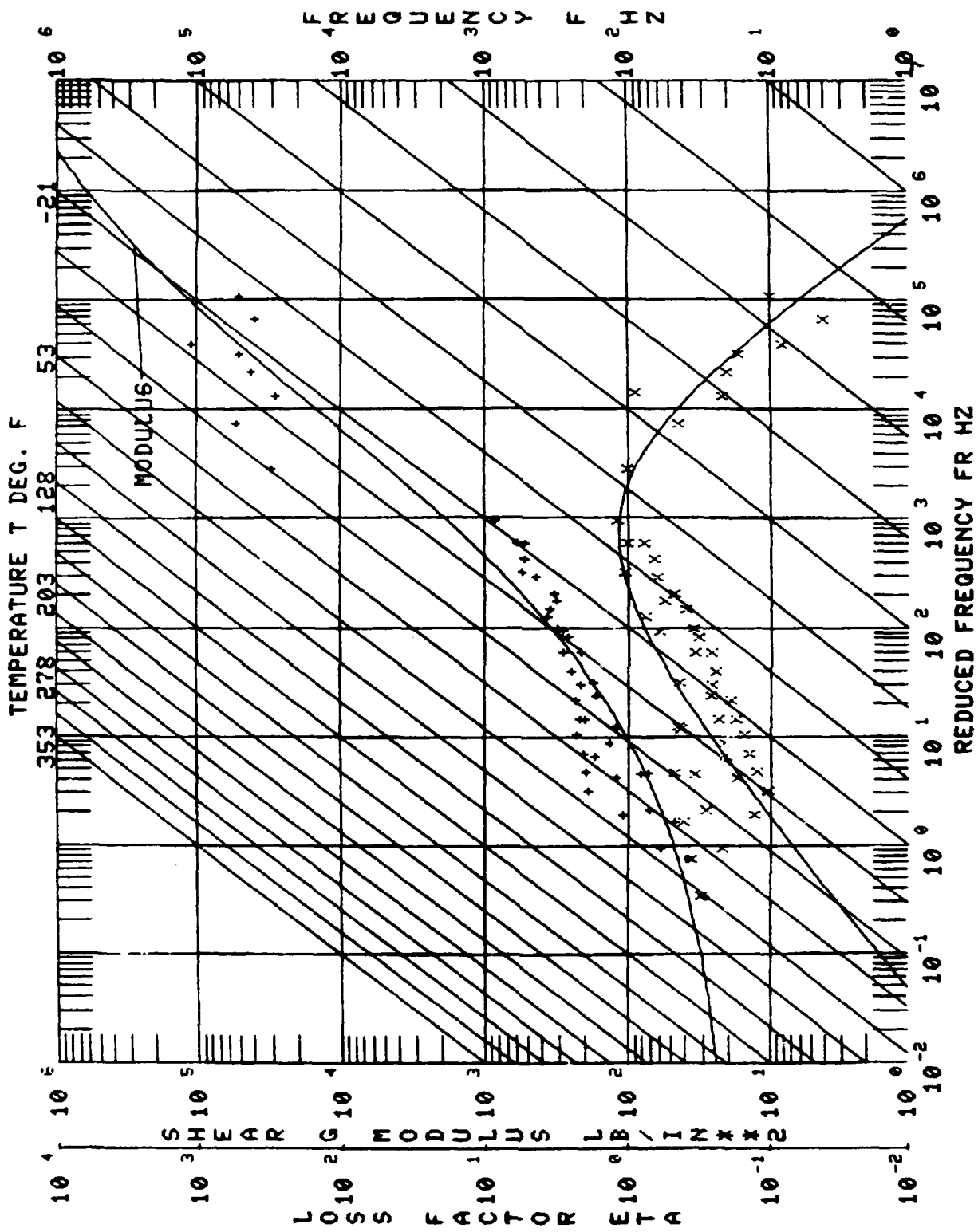

Figure 1.8. Nomogram for Soundcoat LT

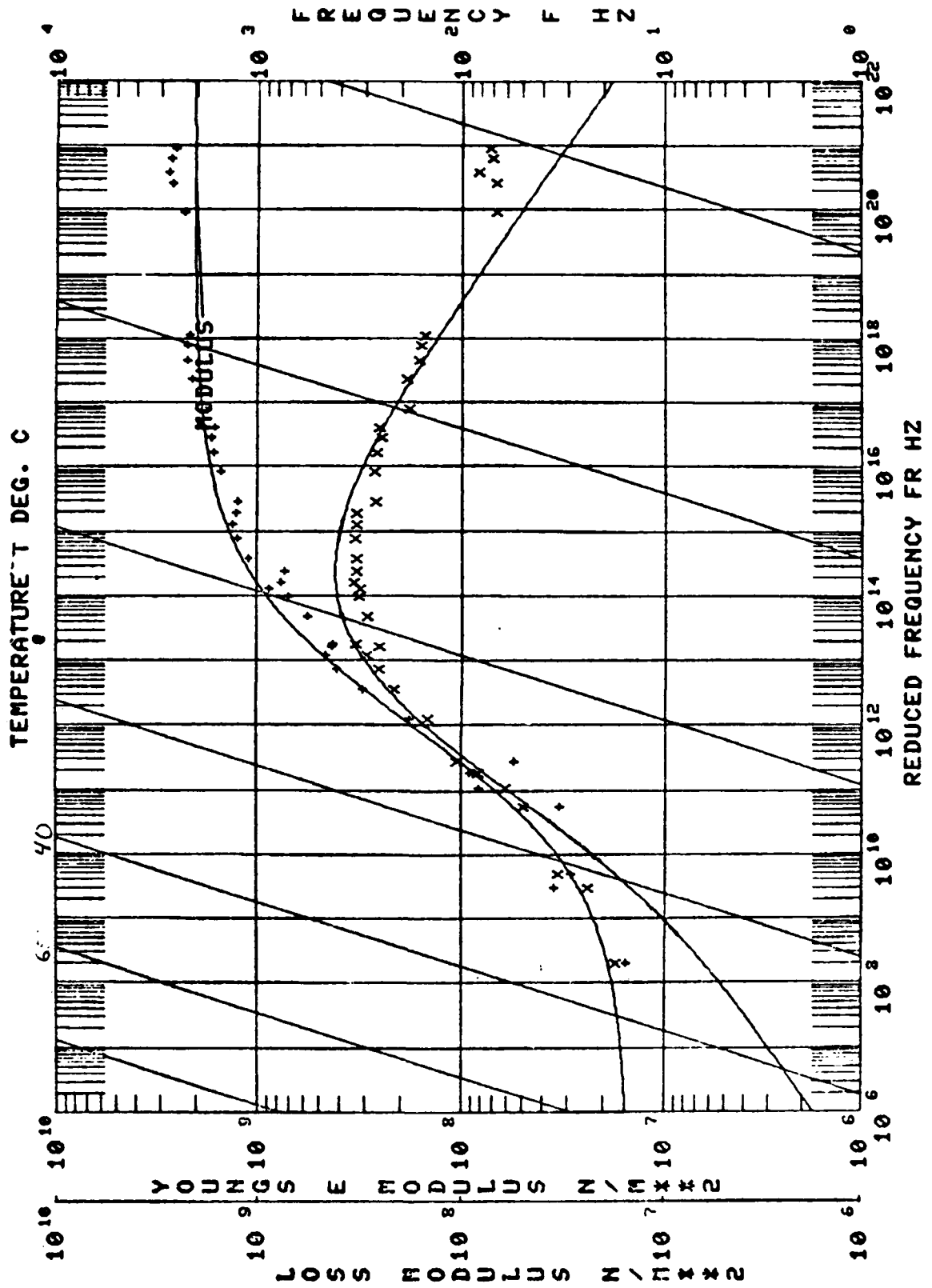

Figure 1.9. Nomogram for E.A.R C-1002

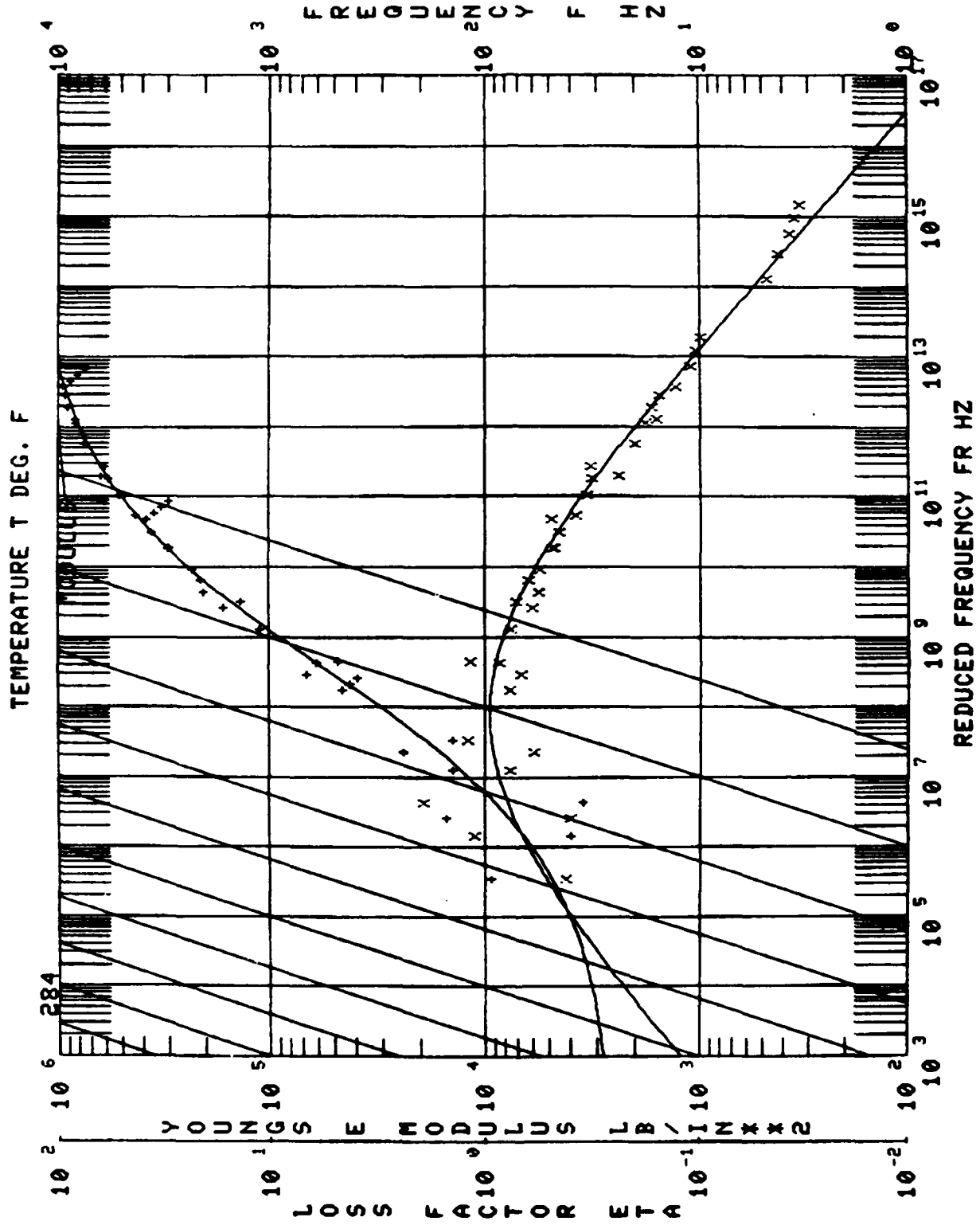

Figure 1.10. Nomogram for E.A.R.C-2003

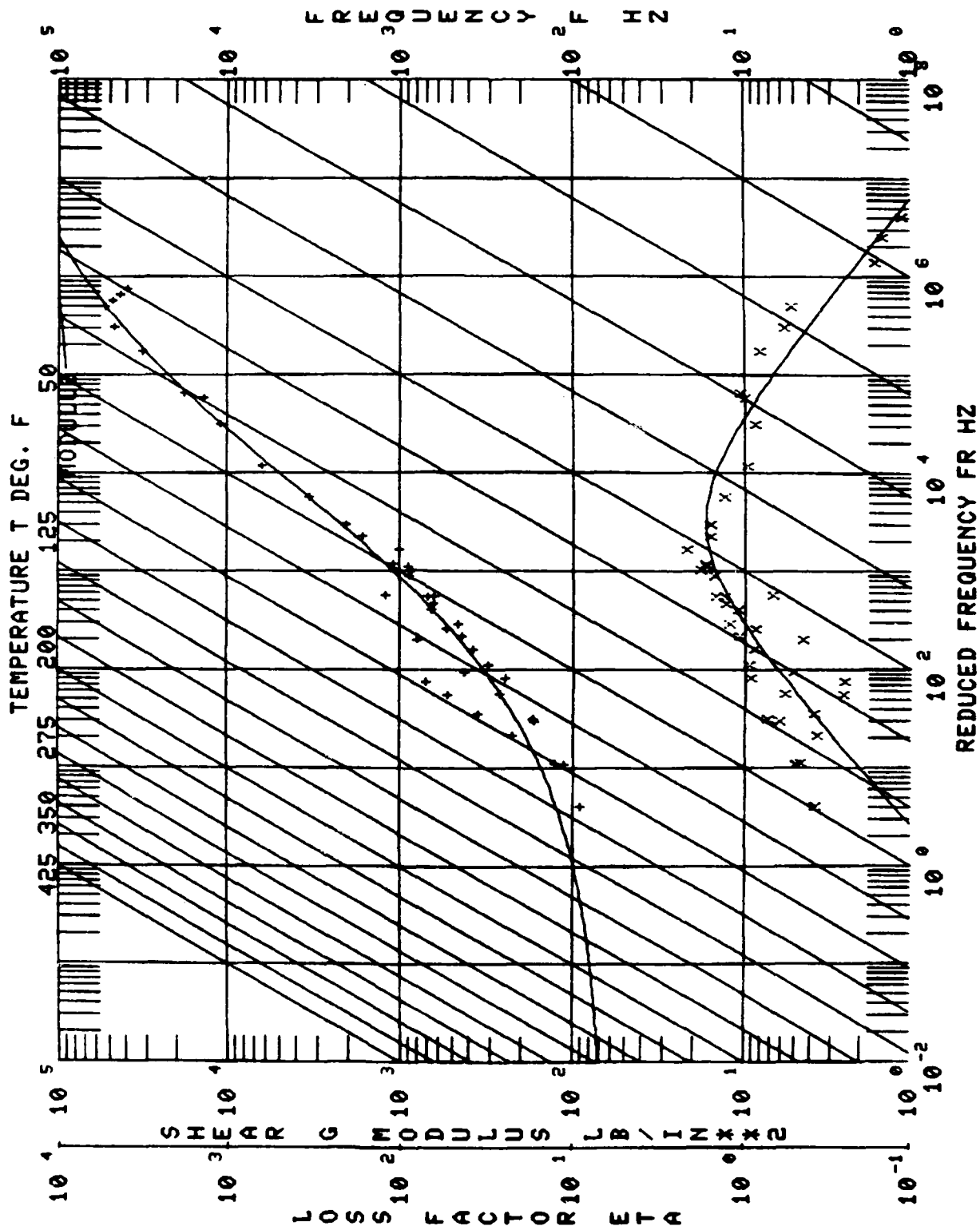

Figure 1.11. Nomogram for UDRI Butyl 268

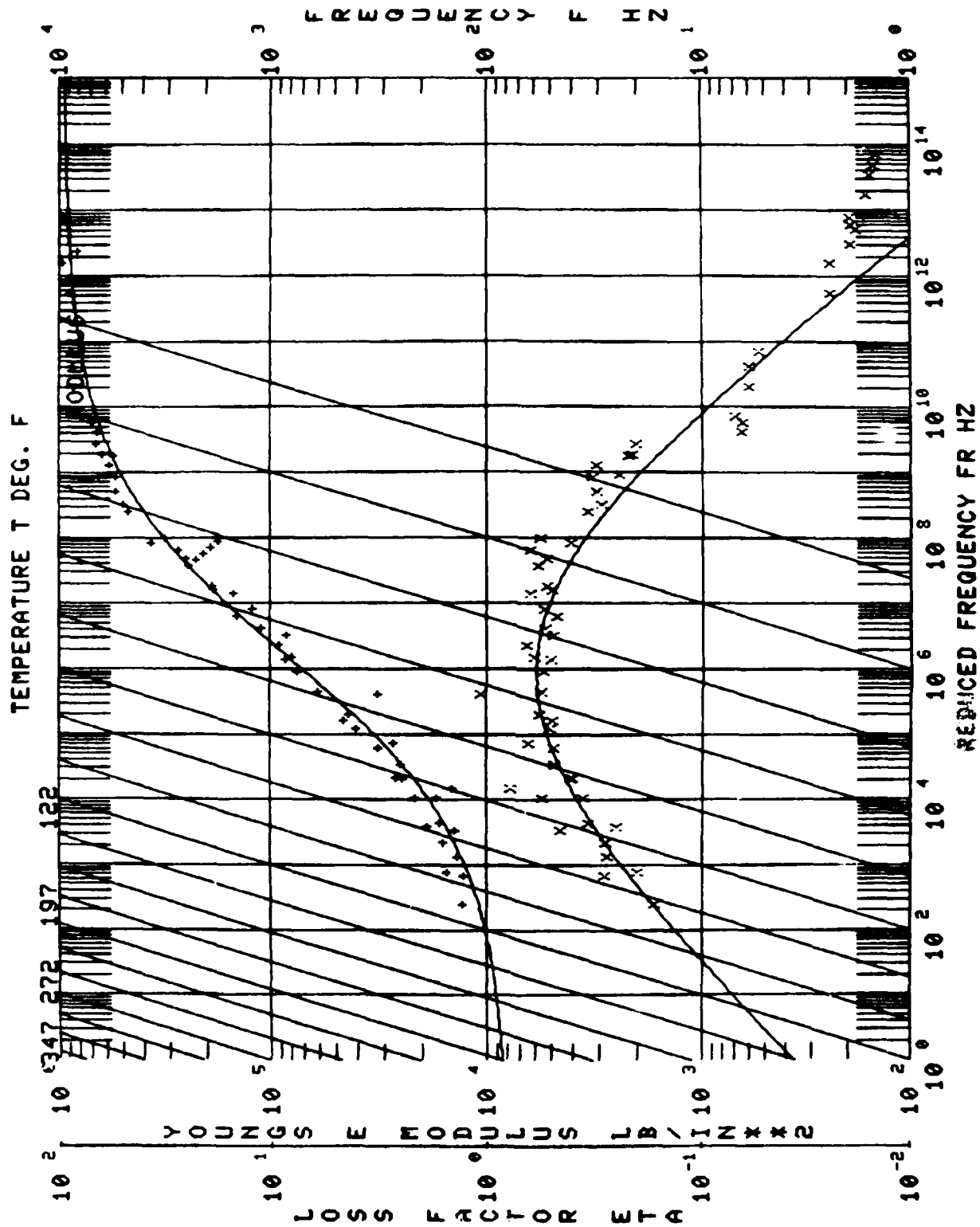

Figure 1.12. Nomogram for UDRI Butyl 268 + 60% Carbon Black

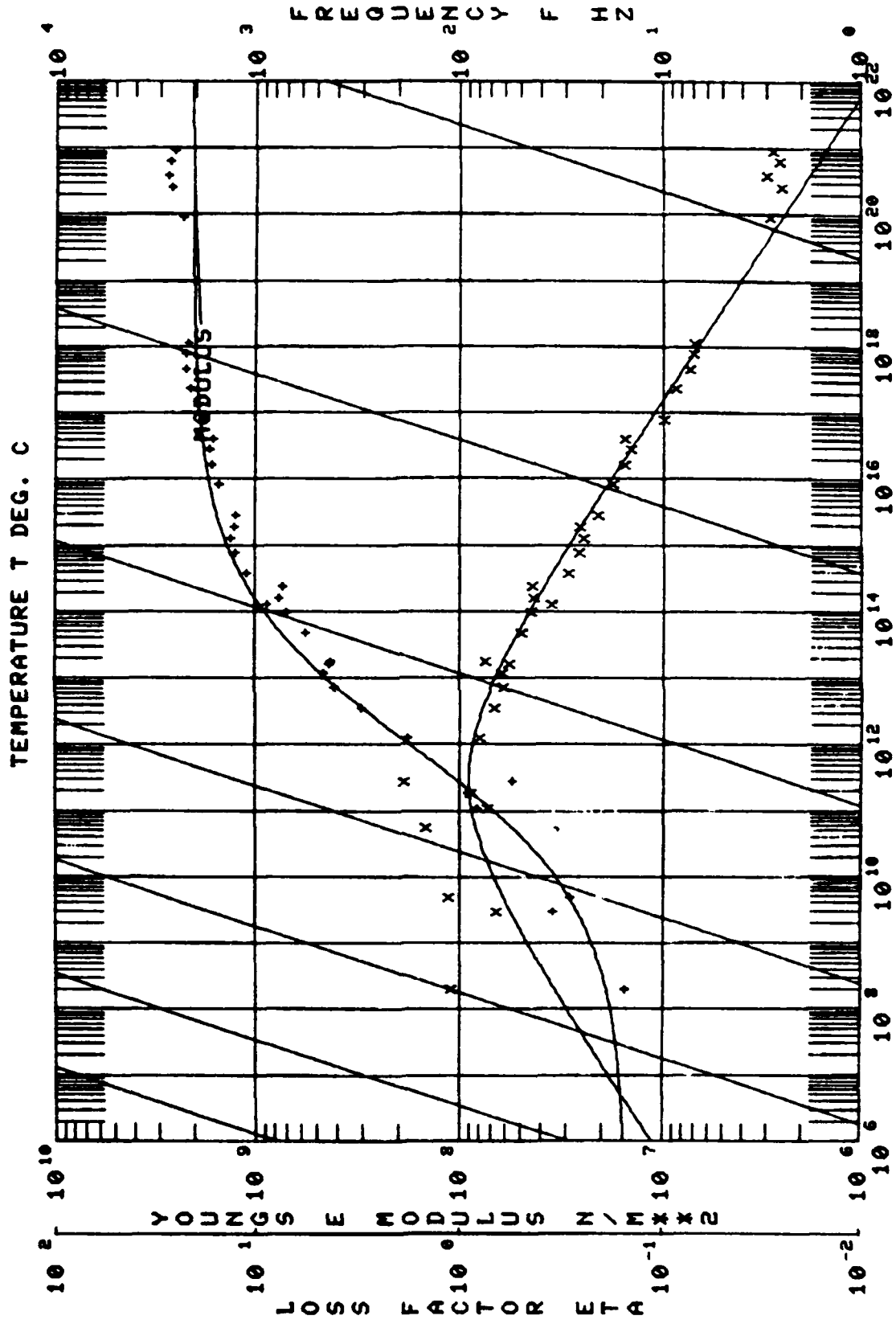

Figure 1.13. Nomograph of E·A·R C-1002.

To verify our beam test, a Dynamic Mechanical Analysis (DMA) was conducted on C-1002 to check the modulus and glass transition temperature. According to the DMA data (Figure 1.14) the glass transition occurred at  $-2^{\circ}\text{C}$  ( $28.4^{\circ}\text{F}$ ), and the modulus drops to 100 MPa at approximately  $-8^{\circ}\text{C}$  ( $17.6^{\circ}\text{F}$ ). The maximum modulus of C-1002 is about 4410 MPa, well above the upper limit for a sandwich beam test. The UDRI feels, therefore, that a free-layer beam test was the proper method of testing E·A·R C-1002.

#### 1.1.3 ISD-110

It was suggested that ISD-110 should be retested in a sandwich beam configuration having a maximum structural loss factor of 0.2. The UDRI was supplied with a sample of 0.058 inch thick ISD-110. Computer predictions based on available beam pairs indicated that the test should be done with 0.068 inch stainless steel beams.

In addition to the stainless steel beam test, ISD-110 was tested on 0.080 inch aluminum beams, the Dynamic Mechanical Analyzer and the Reovibran. Due to the limitations of the Reovibran, the test sample was 0.002 inch thick ISD-110, and from a different batch than that used for the beam and DMA tests.

Figure 1.15 is the nomogram for ISD-110 which is commonly used at UDRI. Figures 1.16 through 1.19 are nomographs of the stainless steel beam, aluminum beam, DMA, and Reovibran tests of ISD-110. All of the nomographs show good correlations between loss factors, but some significant differences in modulus. Tabular data for these materials are in Appendix B.

#### 1.1.4 ASTM E-33 Committee Testing

The UDRI participated in a "round robin" testing program conducted by the ASTM E-33 committee to aid in developing a national standard for evaluating polymeric materials. This involved the characterization of eight bare beams and the evaluation of six materials by the resonant beam technique. Raw data, reduced data, and reduced temperature nomograms were forwarded to the E-33 committee on completion.

E.A.R.C. 1002 MERGE RUN 559 + RUN 608

608  
STORAGE MODULUS □  
LOSS MODULUS ◆

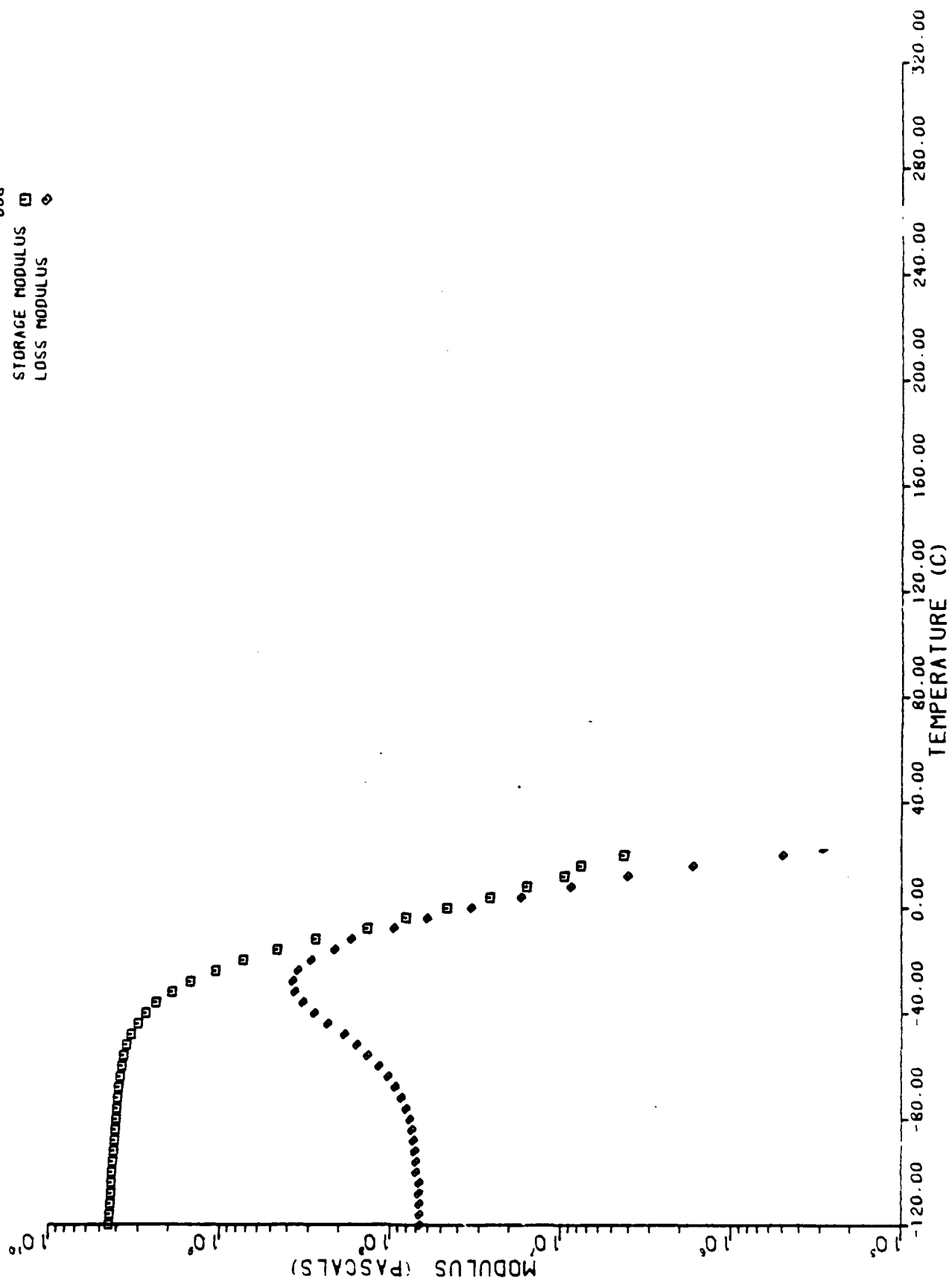

Figure 1.14. Data from DMA Test of E.A.R.C-1002.



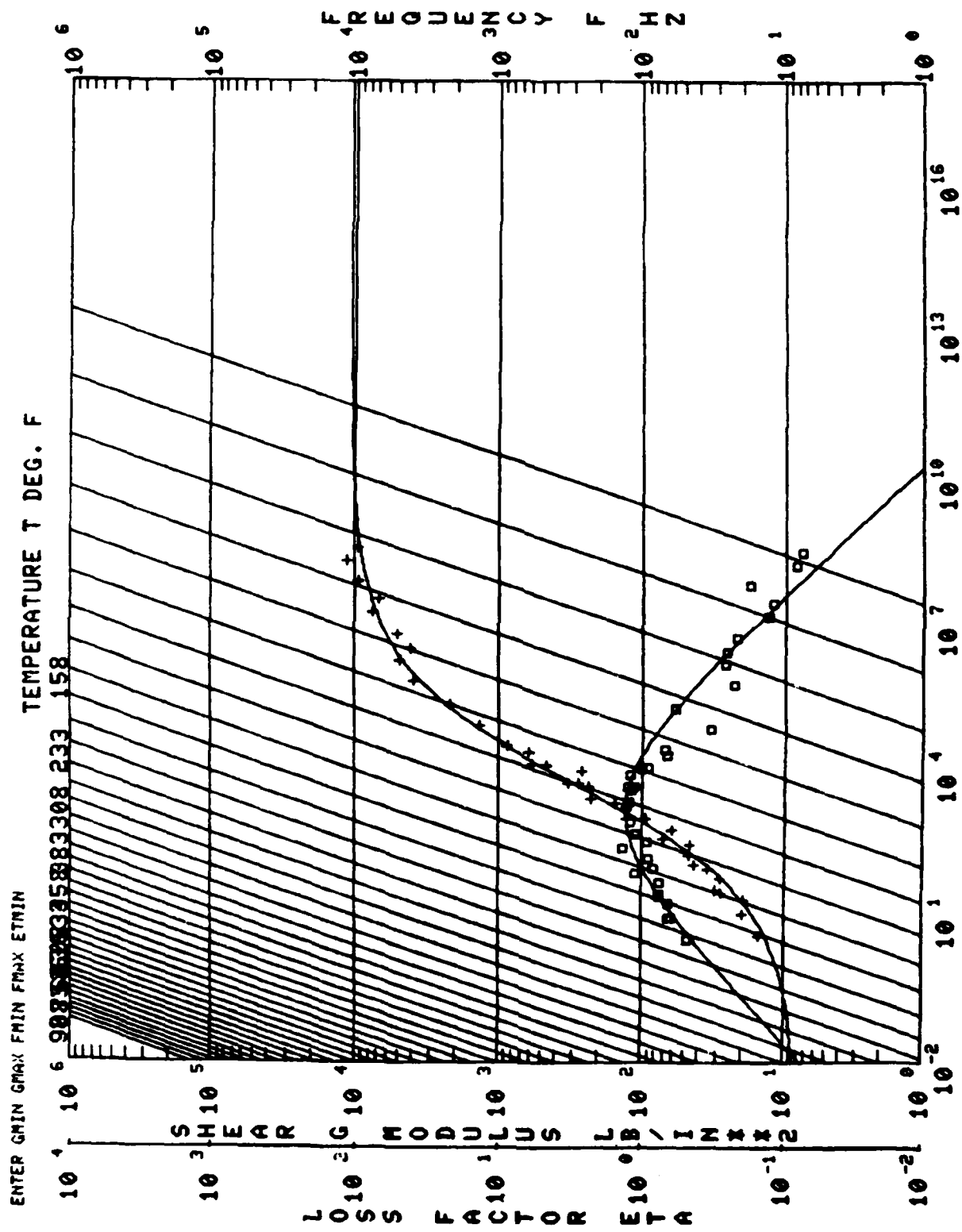

Figure 1.15. 0.005" ISD-110 on 0.060" Aluminum Beams.

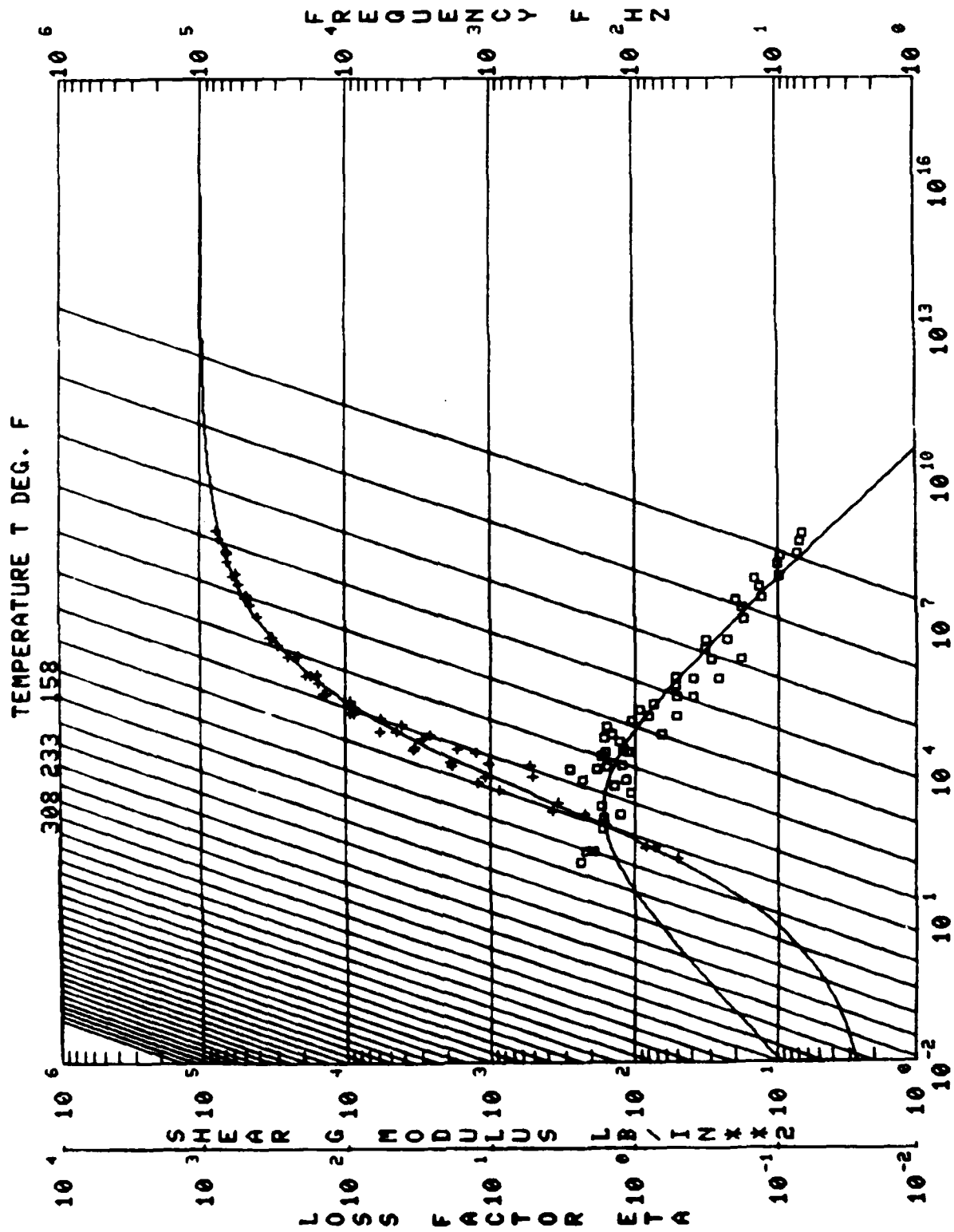

Figure I.16. 0.058" ISD-110 on 0.068" Stainless Steel Beams

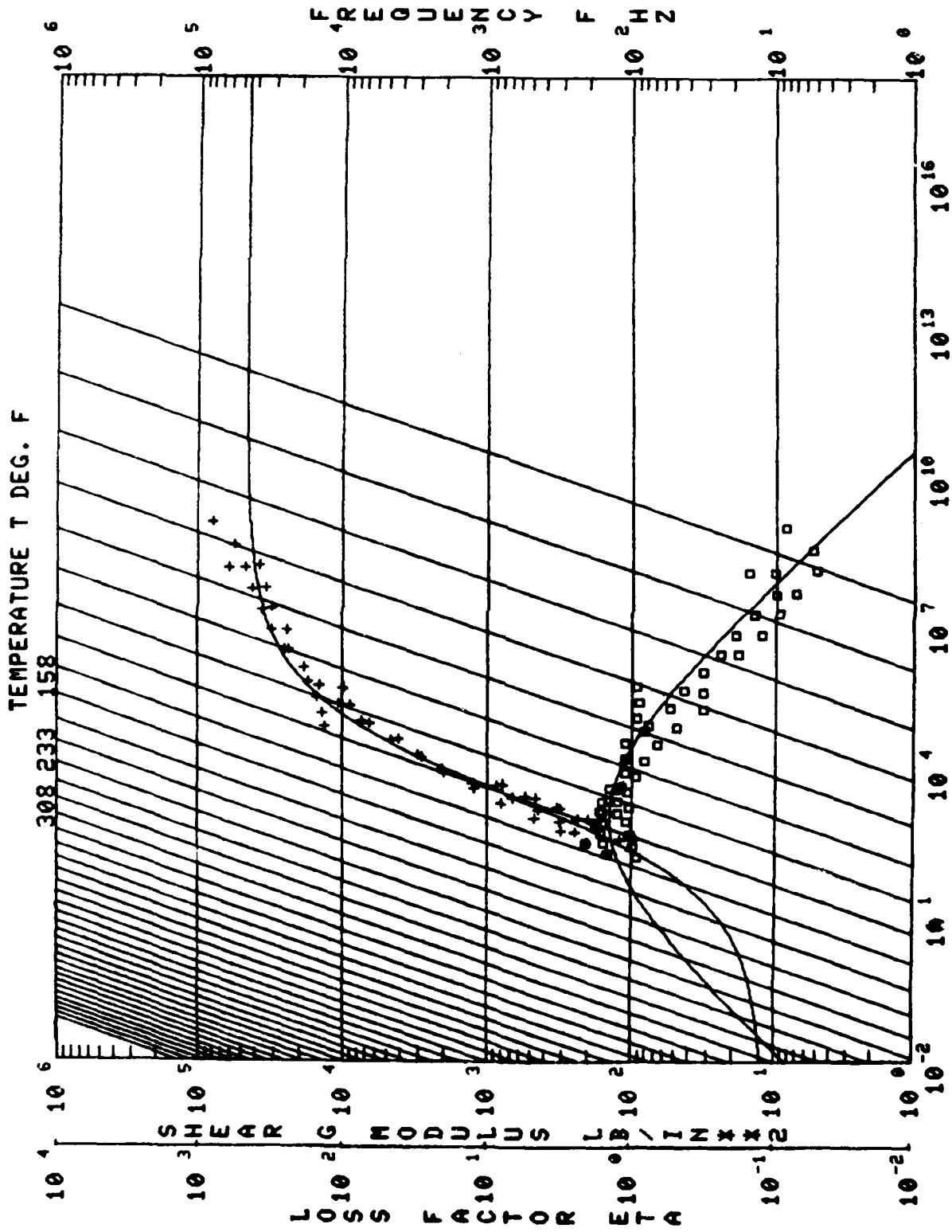

Figure 1.17. 0.058" ISD-110 on 0.080" Aluminum Beams

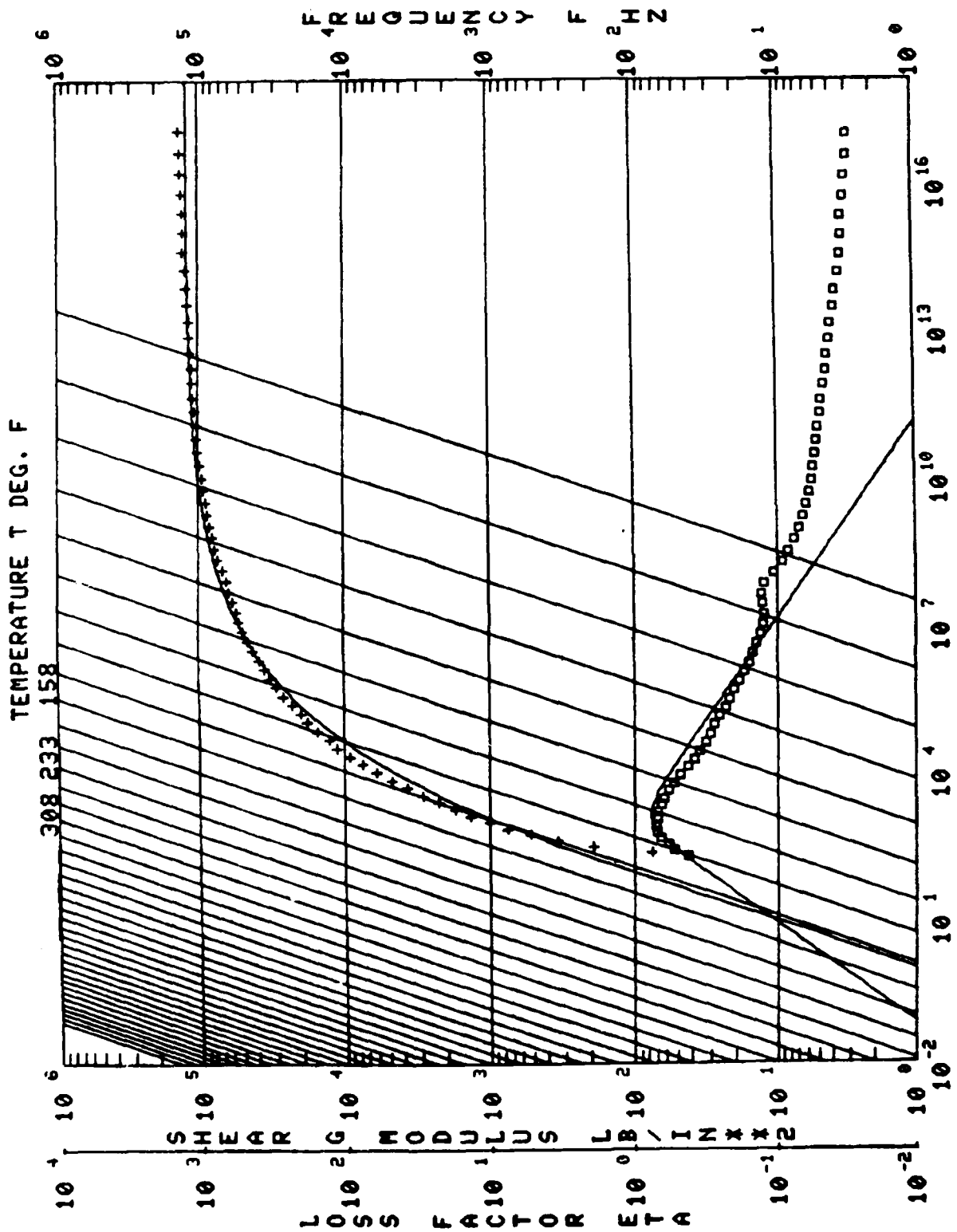

Figure 1.18. 0.058" ISD-110, DMA Test

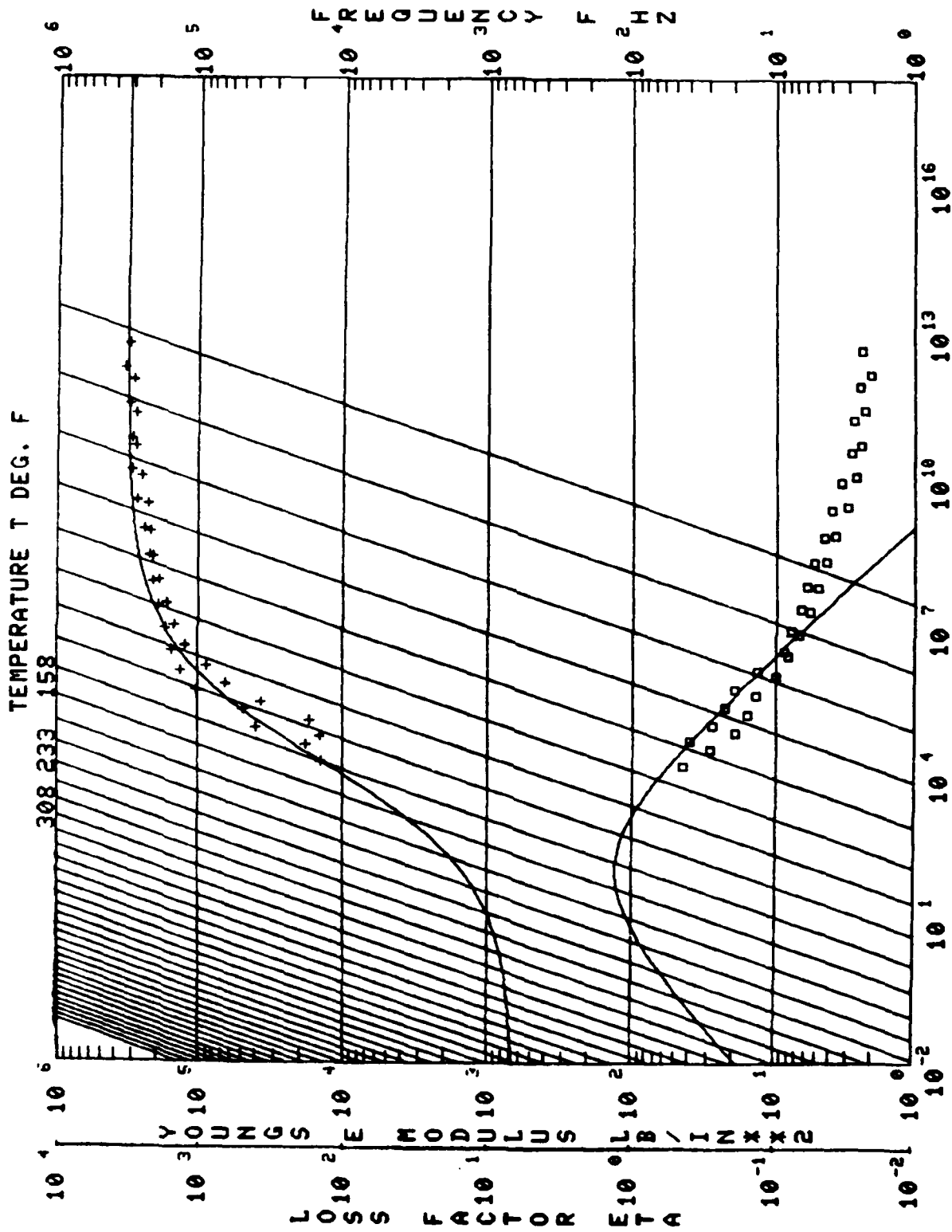

Figure 1.19. 0.002" ISD-110, Reovibrant Test

## 1.2. VITREOUS ENAMELS TESTING

Testing of vitreous enamels was conducted in support of several research and developmental efforts sponsored by AFWAL/MLLN. The testing effort was expended on high temperature characterization of damping properties of a variety of formulations, and the investigation of the effects on some formulations of extended exposure to hostile environments such as jet engine exhaust gases and/or high temperatures.

High temperature characterization was accomplished using the half-power bandwidth method to measure the structural damping of several bending modes, usually the second through sixth, over the appropriate temperature range. The test data were reduced to nomographs of material loss factor, material loss modulus, and Young's modulus versus reduced frequency and temperature using routines documented in Section 1.3.

Environmental exposure studies were conducted in the Exhaust Gas Simulator or high temperature furnaces. Results were evaluated by the half-power bandwidth method, visual inspection, X-ray diffraction, scanning electron microscopy, or optical microscopy as appropriate. This section presents descriptions of the testing facilities used and the procedures followed, and brief discussion of the projects supported.

### 1.2.1. Determination of Material Properties

The definition of vibration damping properties by the Oberst beam testing technique involves four main steps. The damping characteristics of the uncoated beam specimen are determined by the resonant beam technique. After the base line data for the test beam is known, the beam is then coated with the high temperature damping material to be evaluated. The composite beam is then tested to obtain the damping characteristics of the coated specimen. The data from the uncoated and coated beam tests are then combined and entered into a computer program which defines the material's storage modulus, loss modulus, and loss factor of the specific temperatures and modes as determined from the beam tests. A reduced frequency nomograph

is developed from these material properties by means of another computer program. This nomograph displays the vibration damping properties of the materials as a function of temperature and frequency for a temperature and frequency range which extends beyond that of the test data.

#### 1.2.1.1. High Temperature Enamels Test Apparatus

The apparatus used for high temperature characteristics testing consists of a constant pressure cantilever test fixture, a controlled modified tube furnace, an excitation system consisting of an electromagnetic transducer (refrigerant cooled) with its driving and monitoring circuitry, and a response force measuring system.

##### High Temperature Cantilever Test Fixture

The high temperature enamels cantilever test fixture was developed to maintain a constant clamping force on the test specimen as the temperature is varied over the test range, and to transmit the motion of the test specimen to the force gage located outside the high temperature furnace. The high temperature enamels damping fixture number one is illustrated in Figure 1.20. The fixture consists of an isolated table, clamping fixture, force couple, force gage, and air cylinder. The table is a platform mounted to a wooden frame by isolation mounts. A metal plate is attached to the table. The clamping fixture is two blocks machined from Inconel Alloy Number 625. Two bolts machined from Inconel Alloy 625 pass through grooves along the side of the blocks and through the table and are attached to the top of a force link. The test specimen is inserted between the blocks and approximately 50 psi applied to the air cylinder providing a constant clamping force to the root of the specimen. The air cylinder is a major innovation for this system. Any bolting system used to apply clamping pressure lost torque at the higher temperatures. The air cylinder takes into account any thermal expansion and this results in a constant clamping pressure over the entire temperature range. Vibrations in the beam are mechanically transmitted to the force link via the fixture block and bolts. Fixture number two (illustrated in Figure 1.21) is



Figure 1.20. High Temperature Enamels Damping Fixture Number One.



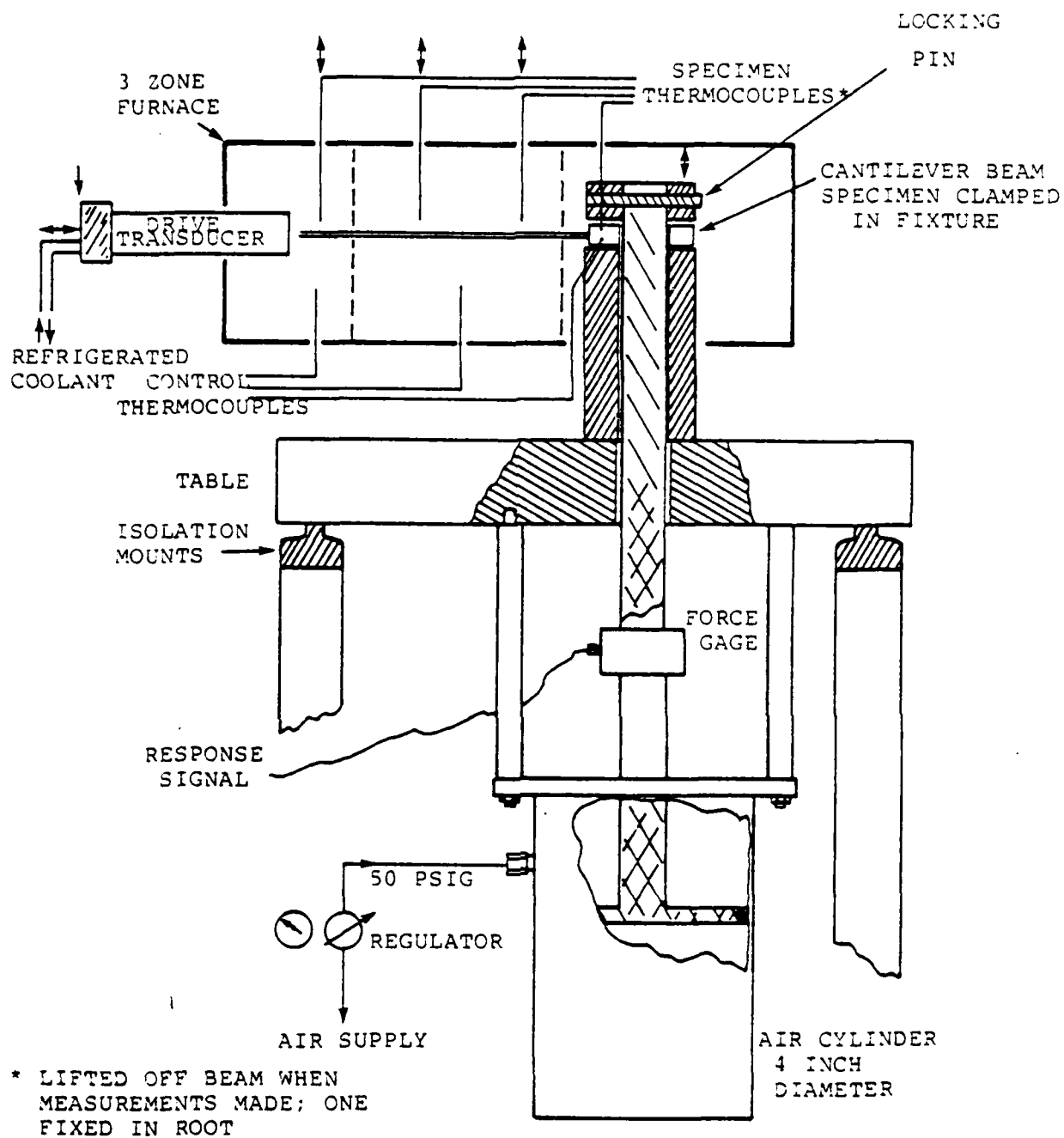

Figure 1.21. High Temperature Enamels Damping Fixture Number Two.

similar, except the blocks and bolts are made of Hastalloy X. Only one bolt is used and it is passed through the center of the block and specimen root. This arrangement reduces background interference as seen by the force link.

#### Temperature Control

To achieve the high temperature necessary for the evaluation of high temperature vibration damping materials, a three-zone tube furnace was modified to accept the enamels test fixture and the electromagnetic drive transducer. Baffles are used to separate the zones for more precise temperature control. The temperature in each zone is independently controlled by a proportional temperature controller. Control thermocouples provide the signals to the proportional controllers. The controllers are manually adjusted to achieve the desired temperature as read on monitoring thermocouples. Figure 1.22 is a schematic of the enamels testing furnace showing the location of the control thermocouples (TM-1, TM-2A, TM-2B, and TC-3). Zone one (fixture end) thermocouples are inserted into holes in the root of the test specimen. Zones two and three control thermocouples are inserted through the bottom of the furnace to about one-half inch below the test specimen. Zones two and three monitoring thermocouples are set down onto the surface of the test specimen measuring the temperature of the enamel coating. The temperature is set and allowed to stabilize. When the temperature is at the desired level, the zone two and zone three monitoring thermocouples are lifted and modal damping data is taken. Even with baffles separating the zones, there is considerable interaction between the zones. To achieve more accurate control of the temperature, two monitoring thermocouples are used in zone two. Table 1.3 shows typical temperature variance between monitoring thermocouples after the temperature is stabilized at the desired temperature. The test temperature is considered stabilized when the variations in Table 1.3 are maintained for three minutes.

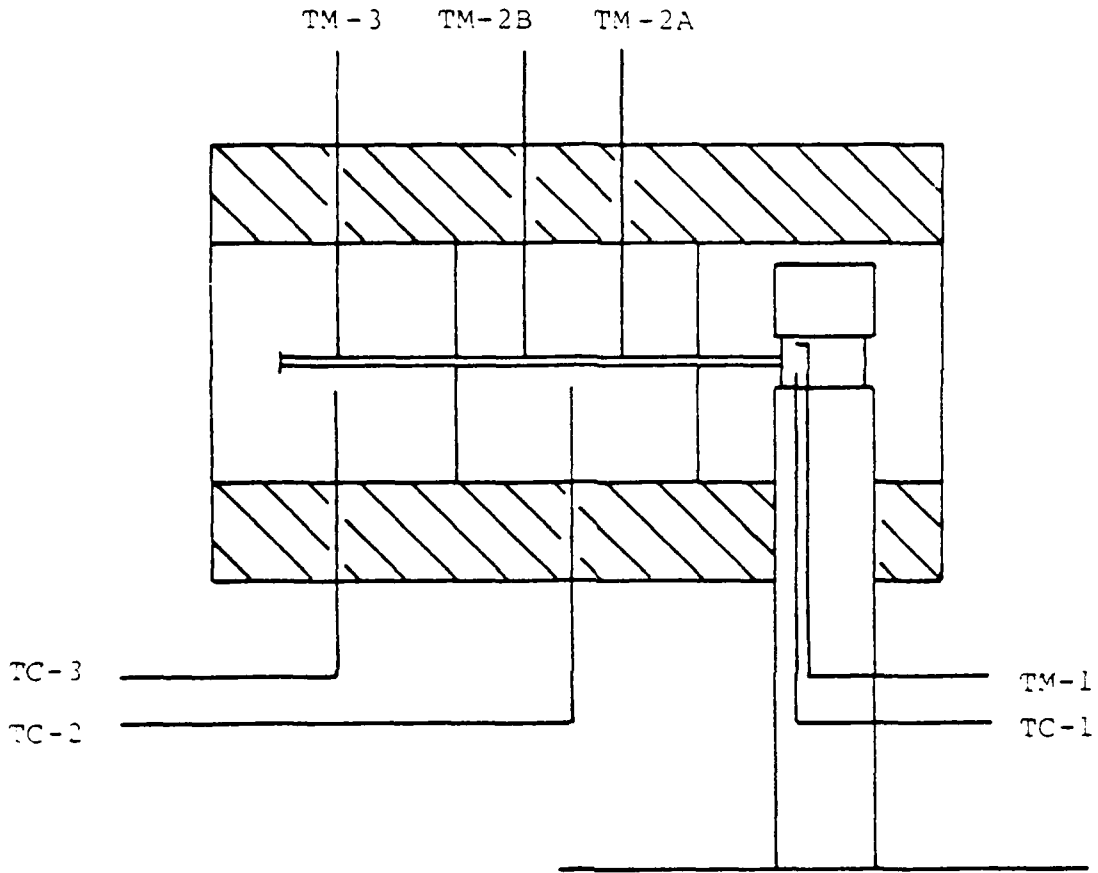

Figure 1.22. Schematic of the Enamels Testing Furnace Showing the Locations of the Control and Monitoring Thermocouples.

TABLE 1.3  
TEMPERATURE DEVIATION OF MONITOR THERMOCOUPLES

| Thermocouple Number | Furnace Zone | Derivation from Set Temperature |
|---------------------|--------------|---------------------------------|
| TM-1                | 1            | 1.7 to 2.8°C                    |
| TM-2A               | 2            | -1.7 to 2.8°C                   |
| TM-2B               | 2            | 1.7 to 2.8°C                    |
| TM-3                | 3            | -2.8 to 3.9°C                   |

Excitation System

Excitation of resonant vibrations in beams in high temperature environments (980°C, 1800°F) requires unique equipment. Because no commercially marketed magnetic transducer capable of operation at these temperatures was available, the UDRI developed and fabricated under a previous contract to AFWAL/MLLN a refrigerant cooled non-contacting electromagnetic transducer.[1] Improvements to the original designs of both the transducer and its cooling system evolved and were implemented during this contractual period.

The transducer body is constructed of mild steel. The end covering the coil and the core is also mild steel but the end cap is non-magnetic stainless steel. A teflon bobbin holds the coil in place. When using this type of transducer, a DC current source is required for the static magnetic field. The required dynamic signal is applied to excite the structure under test. The block diagram in Figure 1.23 shows connection for the transducer.

Standard commercially available electronic equipment is used to produce and monitor the drive transducer input signal. The amplified output of a frequency synthesizer in series with a DC power supply provide the controlled sine power signal which results in the desired magnetic field from the drive transducer. A cobalt disc on the end of the test beam provide the magnetic couple

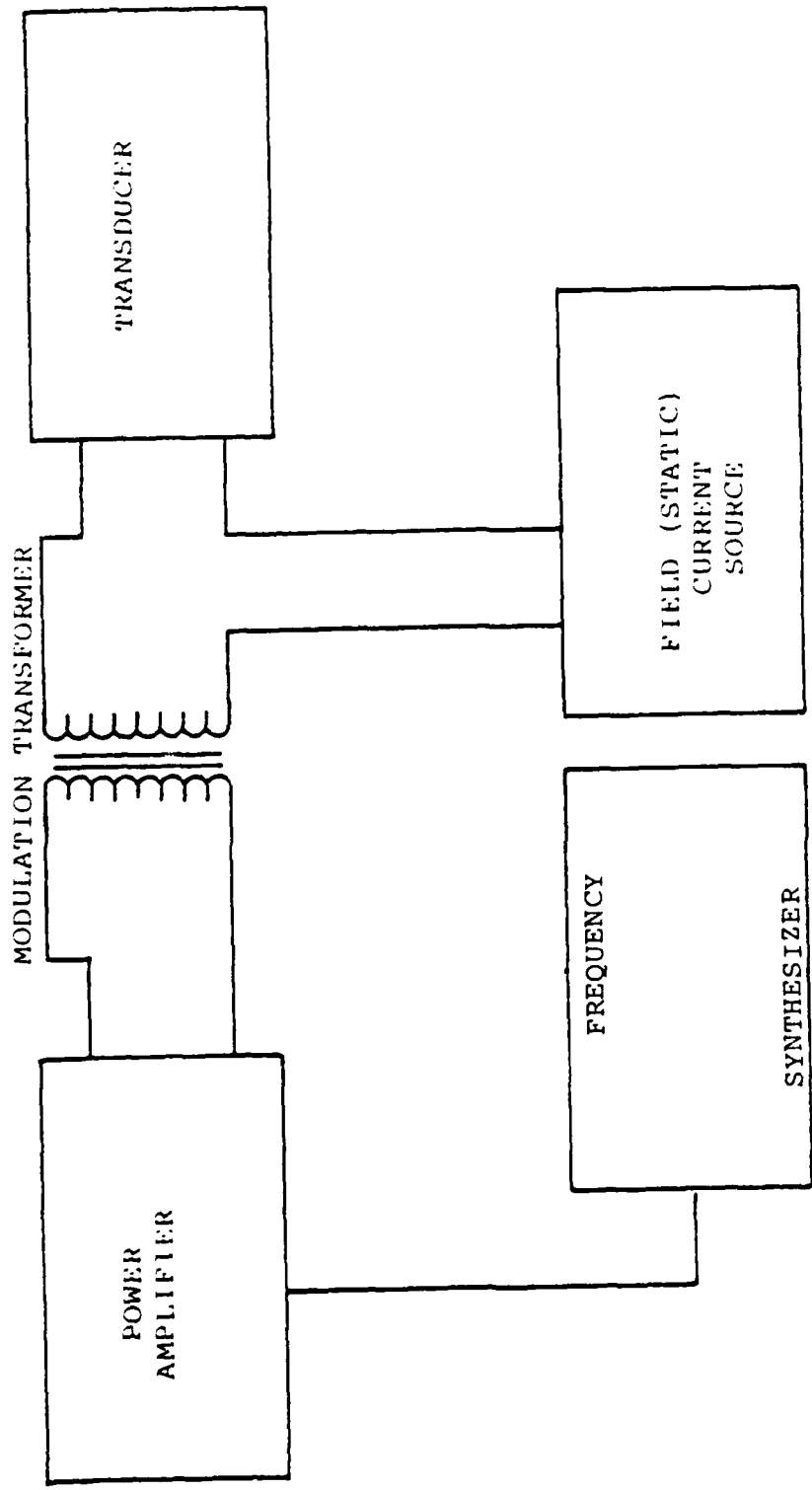

Figure 1.23. Schematic of the Connection of the Drive Transducer.

between the drive transducer and the test beam. By varying the frequency of the synthesizer resonant vibration is induced in the beam.

The equipment used to cool the transducer was in its original form, a 4000 BTU room air conditioner which was modified by replacing the evaporator coil with the transducer. This system operated in satisfactory manner, however, the continuous duty cycle shortened the life of the compressor. The consumer oriented compressor was replaced with a commercial compressor and has operated efficiently since its installation. A schematic of the refrigeration system is presented in Figure 1.24.

#### Force Response Measuring System

The resonant motion induced in the beam is transmitted mechanically through the high temperature cantilever test fixture to a force link. The output of the force link is amplified and provides the signal for the half-power bandwidth measurement needed to determine the material's damping properties. Figure 1.25 is a block diagram of the high temperature testing apparatus and Table 1.4 lists the electronic equipment used in this experimental set-up.

##### 1.2.1.2. Beam Testing

The method for determining the loss factor and complex Young's modulus properties for high temperature free layer materials is the Oberst beam test [2]. The frequency response and modal damping as a function of temperature are measured for each undamped test beam. Accurate measurements of the resonant frequencies are necessary because the material damping properties calculated from experimental measurements are very sensitive to errors in the ratio of the coated beam resonant frequency to the uncoated resonant frequency ( $f_c/f_n$ ), especially for thin coatings.

TABLE 1.4

## LIST OF ELECTRONIC EQUIPMENT

| <u>Description</u>                    | <u>Manufacturer</u> | <u>Model Number</u> |
|---------------------------------------|---------------------|---------------------|
| Oscilloscope                          | Ballantine          | 1066S               |
| Meter, R.M.S.                         | Hewlett-Packard     | 3400A               |
| Amplifier, Power                      | McIntosh            | MC50                |
| Drive Transducer,<br>Freon Cooled     | UDRI fabricated     |                     |
| Refrigeration System,<br>Transducer   | UDRI fabricated     |                     |
| Preamplifier,<br>Precision            | MB Electronics      | N400                |
| Plotter, Graphic<br>X/Y               | Hewlett-Packard     | 7035B               |
| Force Gage, Axial                     | PCB                 | 233A                |
| Power Supply,<br>Current Source       | Harrison            | 6203A               |
| Impedance Transformer,<br>Line Driver | UDRI fabricated     |                     |
| Frequency Synthesizer                 | Hewlett-Packard     | 3325A               |

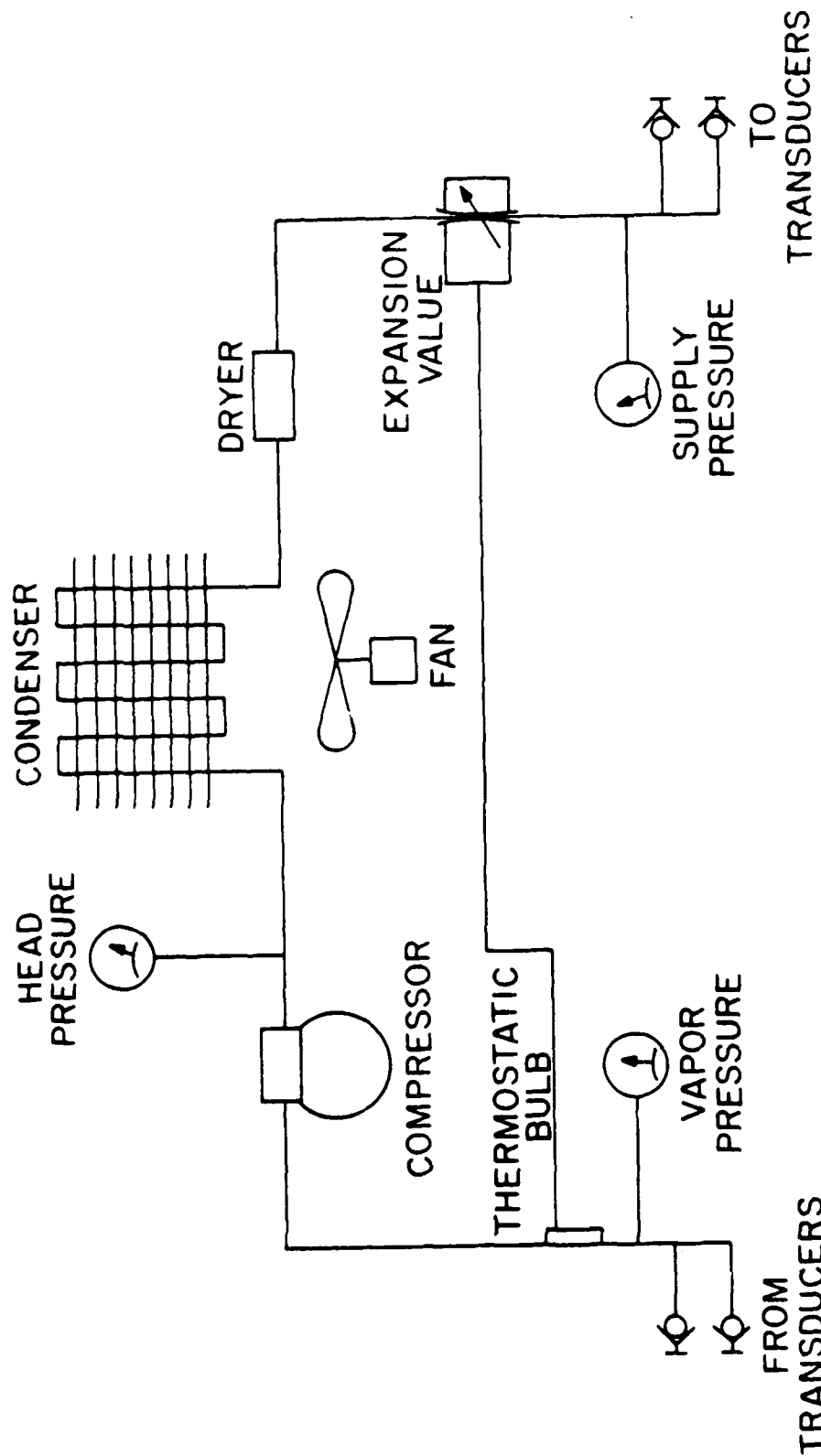
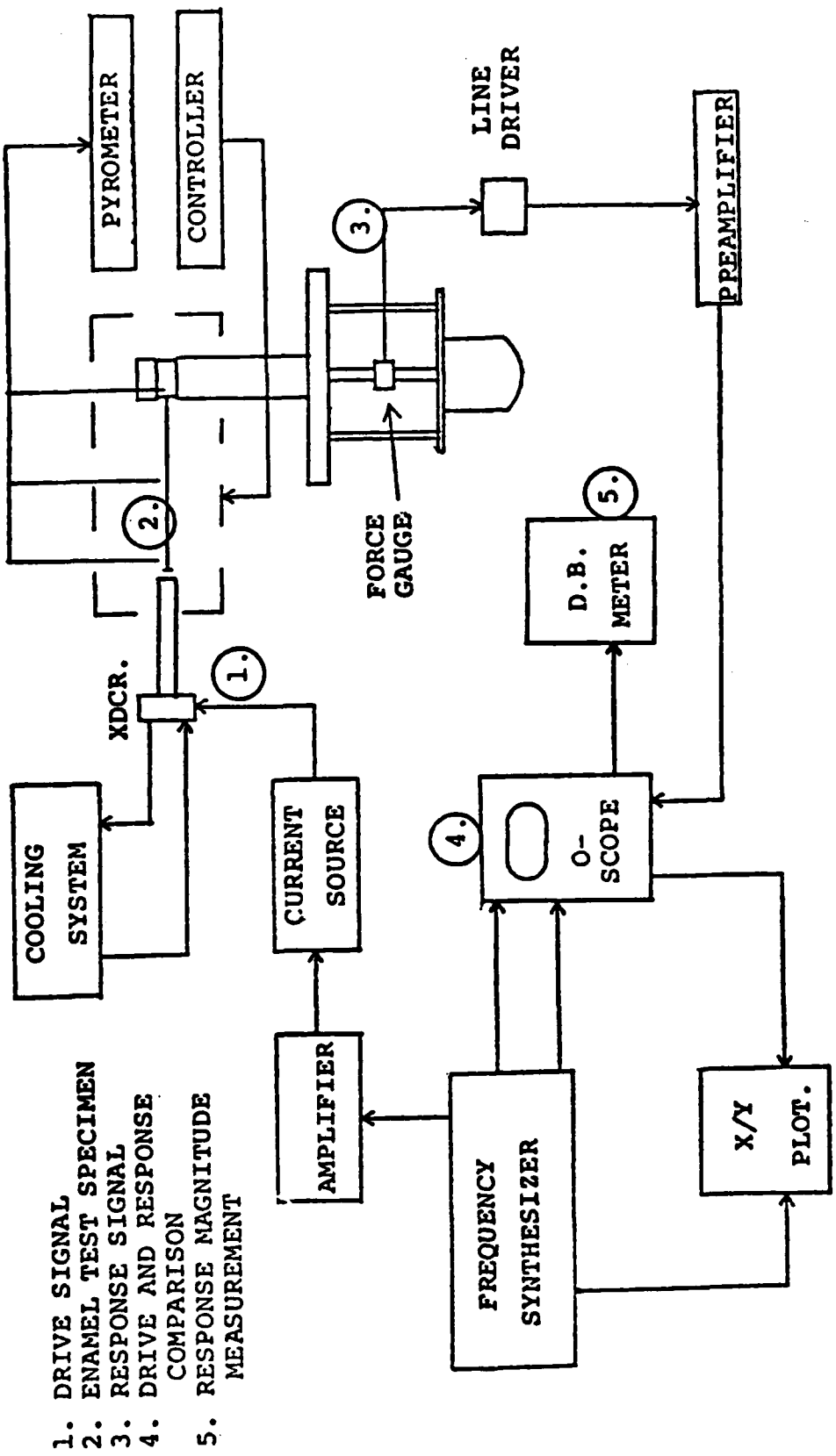

Figure 1.24. Schematic of High Temperature Damping Test Apparatus Cooling System.





- 1. DRIVE SIGNAL
- 2. ENAMEL TEST SPECIMEN
- 3. RESPONSE SIGNAL
- 4. DRIVE AND RESPONSE COMPARISON
- 5. RESPONSE MAGNITUDE MEASUREMENT

Figure 1.25. Block Diagram of High-Temperature Test Apparatus.

### Uncoated Test

The high temperature enamel test specimens are cantilever beams made of either Haynes Alloy Number 188, Hastalloy C, Hastalloy X, or 17-4PH stainless steel Hastalloy X. Figure 1.26 is a schematic of the test specimens with typical dimensions. The top beam is made to be used in test fixture number one, and the bottom in test fixture number two. Both specimens are identical except a one-half inch hole is drilled in the root of the beams to be used in fixture number two. The beams are cut from sheet and machined to the required dimensions. The roots are cut from 0.25 inch Hastalloy X sheets and machined to size. A 0.125 inch hole is drilled into each root to allow the high temperature testing furnace's zone one thermocouples to be inserted into the beam. The roots are then welded onto the top and bottom of the test beam. The beams and roots are welded on three sides to insure adequate clamping. Since Haynes Alloy Number 188 and the Hastalloy alloys are non-magnetic, a high Curie temperature cobalt disc is welded onto the beam to provide a magnetic couple to the electromagnetic drive transducer.

The physical dimensions for the uncoated beam are measured and recorded. To determine the material loss factor and complex Young's modulus, the Oberst equations require the uncoated beam thickness ( $h_b$ ), length ( $l$ ), and density ( $\rho_b$ ). Beam dimensions are illustrated in Figure 1.26.

The cantilever beam test specimen is placed in the apparatus illustrated in Figure 1.21. As mentioned previously, this apparatus compensates for the thermal expansion and high temperature creep of the fixture and ensures a constant clamping pressure over the entire temperature range for which the measurements are obtained.

For the uncoated beams, each beam is stabilized at the highest expected test temperature (usually about 1,000°C) and the resonant frequency and modal damping of the second through sixth modes are measured. The temperature is then reduced in 100°C

COBALT DISC  
0.25 INCH DIAMETER  
0.040 INCH THICK

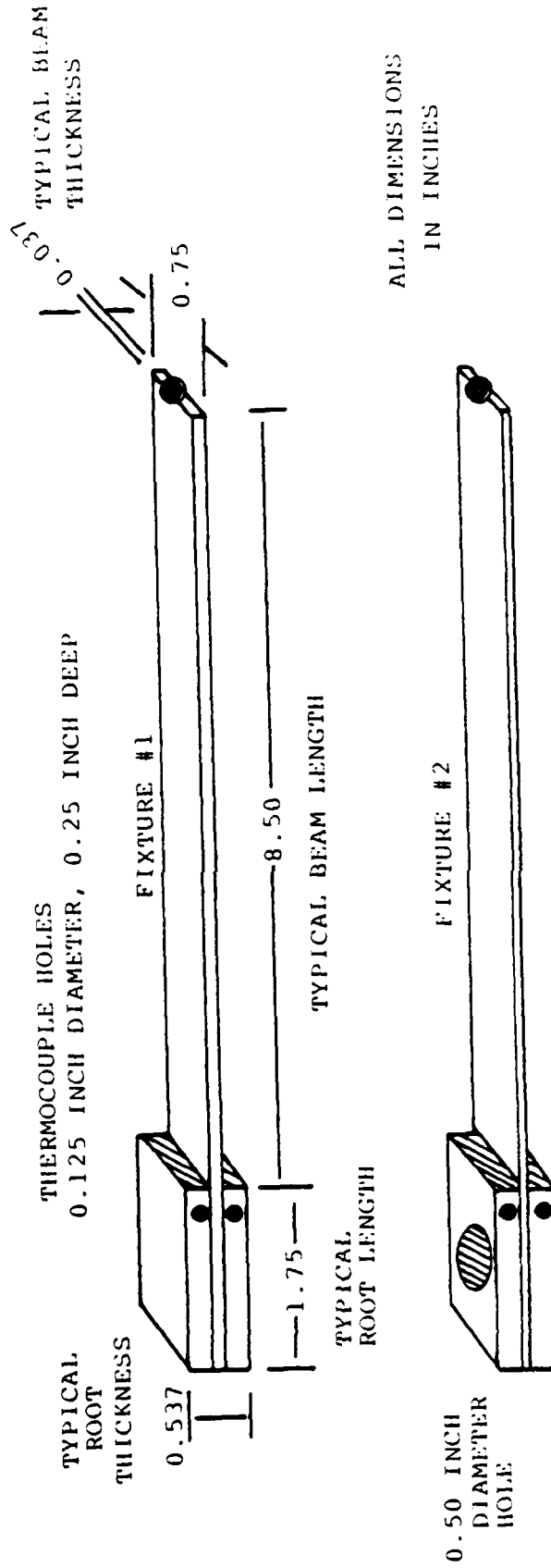

Figure 1.26. Schematic of the Cantilever Beam Test Specimens with Typical Dimensions.

increments, stabilized (refer to Table 1.3), and the response measurements repeated. This procedure is continued to approximately 300°C. The resonant frequency and modal damping versus temperature for each of the modes are then plotted. The resonant frequency versus temperature for each of the modes are then plotted. The resonant frequency versus temperature curve, as illustrated in Figure 1.27, for each of the modes of the uncoated specimens tested is a smooth curve, and accurate resonant frequencies could be picked from this curve for any temperature of interest. The modal damping is determined by measuring the half-power bandwidth of each of the modes ( $\eta = \Delta f_n / f_n$ ) and plotted versus temperature as illustrated in Figure 1.28.

Experience showed it was necessary to heat the specimen to the highest temperature and measure the response of the specimen as it cooled. The resonant frequencies measured on cooling from the highest temperature were higher than the resonant frequencies measured upon heating from room temperature to the highest temperature of interest. Once the specimen was heated to the highest temperature and cooled, the resonant frequencies measured going up in temperature and those measured coming down in temperature were the same, within experimental error, providing the specimen remained in the fixture. Other investigators have also noticed this behavior [3]. It is believed to be caused by the beam "setting in" the fixture and the relief of surface stresses in the beam introduced during fabrication. It is not due to the beam material being annealed. The annealing temperature of the beam material used (Haynes Alloy 188) is greater than 1,100°C.

#### Coated Beam Test

After the uncoated specimen responses are measured, the beam is then coated on one side with a glass. The coated beam is heated to the expected maximum temperature for the particular coating, and the resonant frequencies and modal damping of the second through sixth modes are measured. The temperature is then reduced in steps of 25°C and the response is again measured. If the modal damping decreased upon cooling, the temperature of the speci

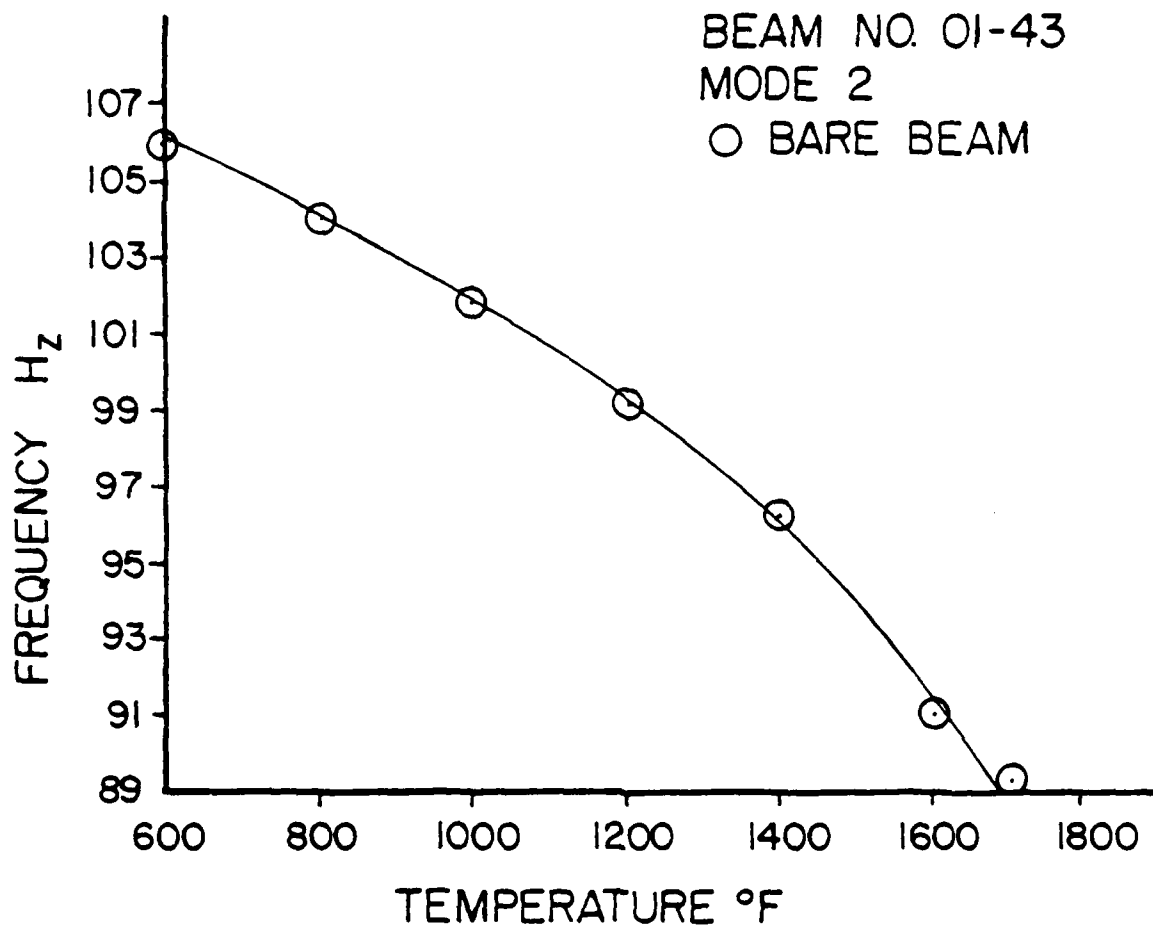

Figure 1.27. Resonant Frequency Versus Temperature Curve of Modes for Bare (Uncoated) Beam.

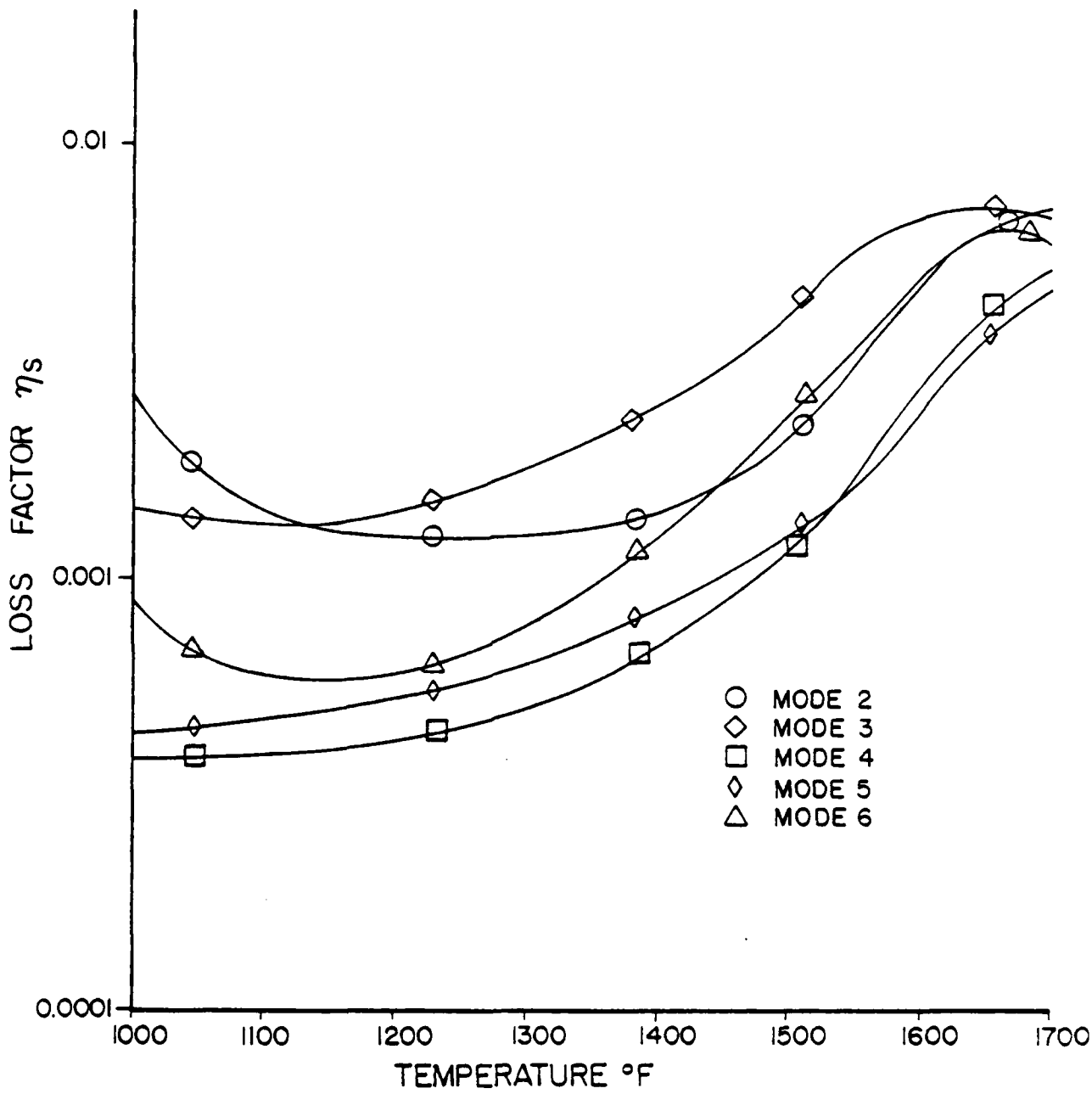

Figure 1.28. Half-power Bandwidth (Modal Damping) of Each Mode Versus Temperature for Bare (Uncoated) Beam.

is increased above the initial test temperature in 25°C increments until the modal damping decreases for two successive increases in temperature. The specimen is then cooled in 25°C steps and new measurements taken. Figure 1.29 is a typical plot of coated beam center frequency versus temperature and Figure 1.30 is a typical plot modal damping versus temperature.

The measurements made upon heating are not used to calculate the damping properties of the coating for the reasons previously mentioned. Another reason is that a glass is sensitive to its previous thermal history, in particular to the rate at which it is cooled from its firing temperature. The specimens tested are fired and then air quenched. This rapid cooling may have caused large residual stresses and some non-equilibrium structure can be frozen in. Heating the glass above its softening temperature and slowly cooling it allows the residual stresses to be relieved and the glass to maintain equilibrium.

The loss factor of the uncoated beam is subtracted from the measured loss factor of the coated beam to obtain a "corrected" modal damping coefficient. Sridharan [3] has shown that for small modal damping

$$\eta_c = \eta_s - \eta_b$$

where

- $\eta_b$  is the modal damping of the uncoated beam;
- $\eta_s$  is the measured modal damping of the coated specimen;
- $\eta^c$  is the modal damping that would have been observed if the uncoated beam damping was zero.

This correction is usually only necessary for temperatures greater than 650°C (1,200°F). The data recorded for each of the modes and temperatures are:

- T - the temperature of the specimen;
- $f_n$  - the resonant frequency for the  $n^{\text{th}}$  mode of the uncoated beam;
- $f_c$  - the resonant frequency for the  $n^{\text{th}}$  mode of the coated beam;

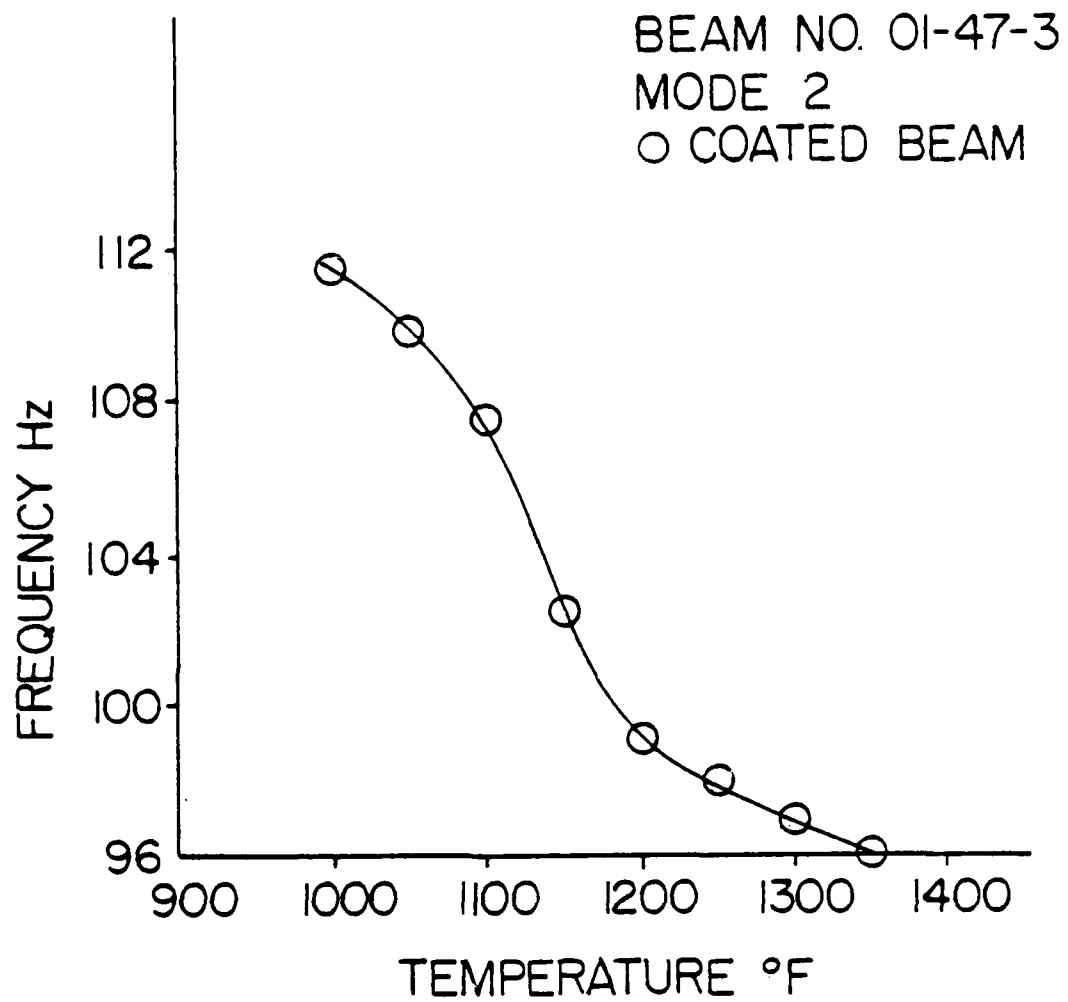

Figure 1.29. Typical Plot of Coated Beam Center Frequency Versus Temperature.



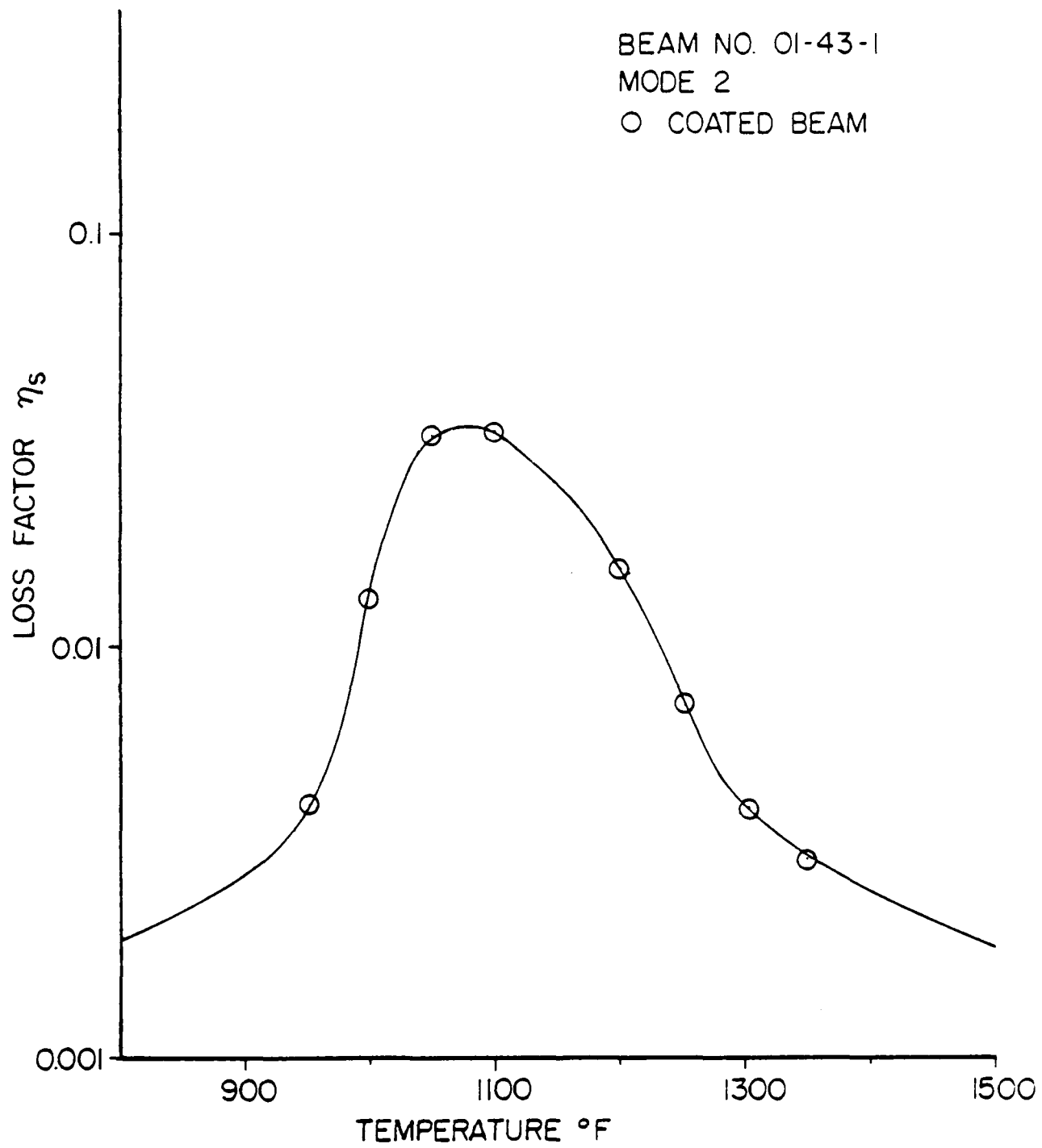

Figure 1.30. Half-power Bandwidth (Modal Damping) Versus Temperature for Coated Beam.

- $\Delta f_n$  - the half-power bandwidth of the  $n^{\text{th}}$  mode of the uncoated beam;
- $\Delta f_c$  - the half-power bandwidth of the  $n^{\text{th}}$  mode of the coated beam;
- $\eta_s$  - modal damping of the  $n^{\text{th}}$  mode of the coated beam;
- $\eta_b$  - modal damping of the  $n^{\text{th}}$  mode of the uncoated beam.

1.2.1.3. Calculation of Damping Properties

The damping characteristics of the coatings are determined by measuring the vibration response of a composite cantilever beam at varying temperatures over a viscoelastic range. It is assumed that the enamel can be treated as a complex quantity

$$E_D^* = E_D' + iE_D'' = E_D (1 + i \eta_D)$$

$$\eta_D = E_D''/E_D'$$

where  $E_D'$  is the storage or Young's modulus of the enamel and  $\eta_D$  is the ratio of the dissipative modulus,  $E_D''$  to the storage modulus.

Consider the metal beam with enamel coating on one side, as shown in Figure 1.31.

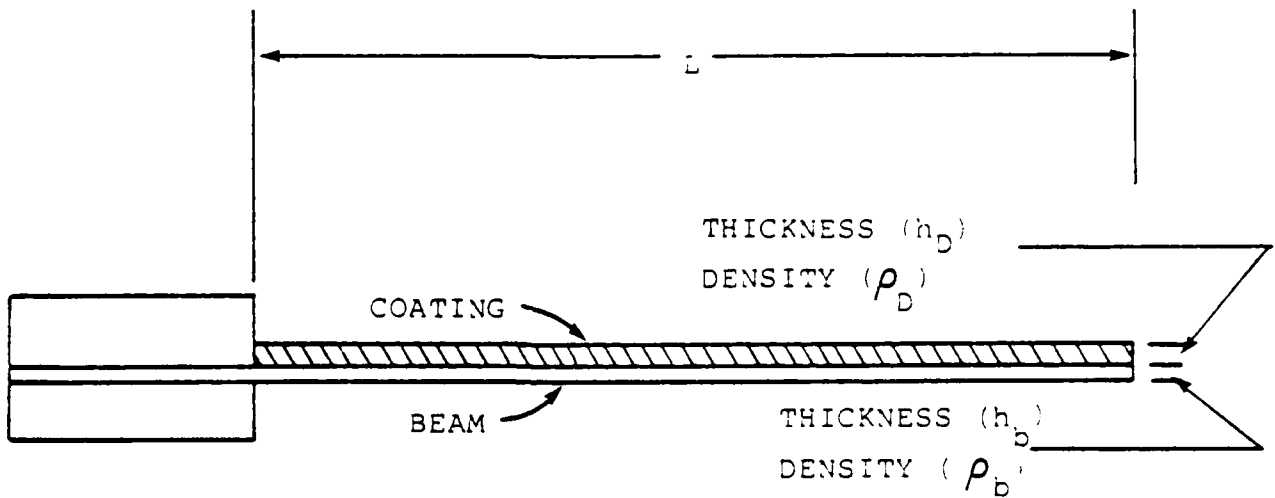

Figure 1.31. Coated Oberst Test Beam.

$\xi_n^4$  = the eigen value corresponding to the  $n^{\text{th}}$  mode and is a constant, determined by the boundary conditions;

$\mu_1 = \rho_1 b h_1$  = the mass per unit length of the metal beam;

$L$  = the length of the beam;

$I = 1/12 b h_1^3$  = the second moment of area of the metal beam about its centerline.

The values of  $\xi_n^4$  for beams with classical boundary conditions are well known and can be found in reference [4]. Thus, from the measured resonant frequencies of the coated and bare beams and the measured composite loss factor, the damping properties of the enamel can be determined as a function of temperature and frequency.

The resonant frequencies and modal damping of five to six modes of the coated beam, covering a frequency range of 100 Hz to 1,500 Hz can usually be measured for each temperature. Thus, the damping properties of the vitreous coating over a decade of frequency at a given temperature can be easily and quickly determined.

#### 1.2.1.4. Material Properties Presentation

A nomograph developed by Jones [5] is used to present both the temperature and frequency dependence of the enamel coating. A computer program developed by King [6], using the technique of Rogers and Nashif [7], is used to plot the properties on the nomograph. There are two graphs for a coating. One plot is the storage modulus and loss modulus versus reduced frequency which is illustrated in Figure 1.32, and the other plot is the storage modulus and loss factor versus reduced frequency which is shown in Figure 1.33. These plots readily illustrate the variation of the damping properties of the material with frequency and temperature.

The plot is read by choosing the temperature of interest and following the oblique temperature isotherm until it intersects the horizontal constant frequency line of interest (frequency is the right vertical axis of the plot).

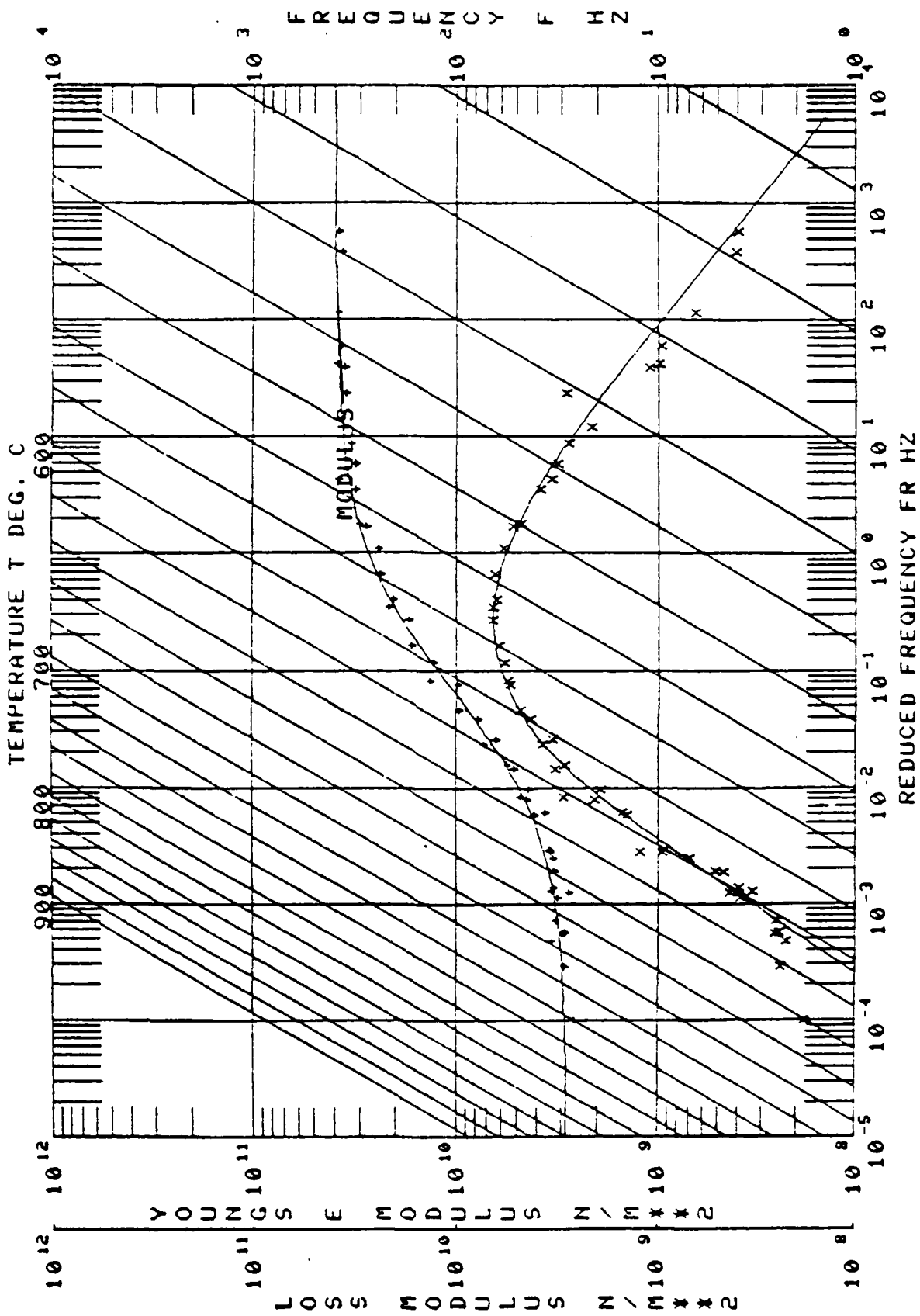

Figure 1.32. Storage Modulus and Loss Modulus Versus Reduced Frequency.

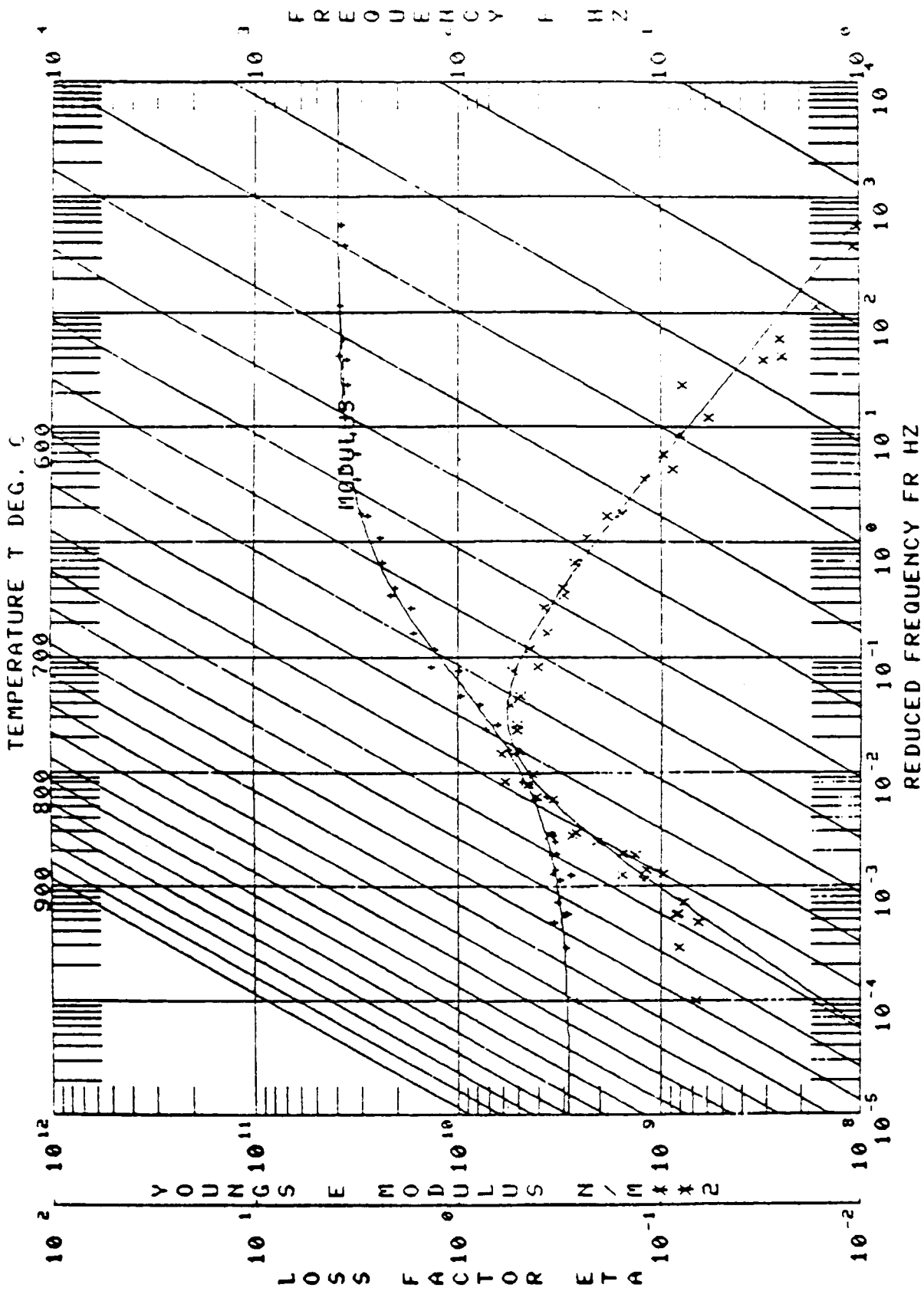

Figure 1.33. Storage Modulus and Loss Factor Versus Reduced Frequency.

The formulas developed by Oberst [2] and used by many other investigators were used to determine the damping properties of the enamel as a function of frequency and temperature. These formulae are:

$$(\omega_n/\omega_{1n})^2 (1+h_D\rho_D/h_1\rho_1) = \frac{1+2(E_D/E_1)(h_D/h_1)A + (E_D/E_1)^2(h_D/h_1)^4}{1 + (E_D/E_1)(h_D/h_1)} \quad (1)$$

and

$$\frac{\eta_D}{\eta_C} = \frac{(E_D/E_1)(h_D/h_1)[2A + 2(E_D/E_1)(h_D/h_1)^3 + (E_D/E_1)^2(h_D/h_1)^4 - 1]}{[1 + (E_D/E_1)(h_D/h_1)][1 + 2A(E_D/E_1)(h_D/h_1) + (E_D/E_1)^2(h_D/h_1)^4]} \quad (2)$$

where

$$A = 2 + 3(h_D/h_1) + 2(h_D/h_1)^2 \quad (3)$$

$\omega_n$  = natural frequency of the  $n^{\text{th}}$  mode of the composite beam,  $2\pi f_n$ , rad/sec;

$\omega_{1n}$  = natural frequency of the  $n^{\text{th}}$  mode of the metal beam,  $2\pi f_{1n}$ , rad/sec;

$h_D$  = thickness of enamel coating applied to composite beam;

$h_1$  = thickness of metal beam;

$\rho_D$  = density of enamel coating;

$\rho_1$  = density of metal beam;

$E_D$  = real part of the modulus of enamel coating;

$E_1$  = Young's modulus of metal beam;

$\eta_C$  = effective loss factor of composite beam;

$\eta_D$  = loss factor of enamel coating.

The quantities of  $h_D$ ,  $h_1$ ,  $\rho_D$ , and  $\rho_1$  are known and are assumed to remain constant with temperature. The parameters  $\omega_n$ ,  $\omega_{1n}$ , and  $\eta_C$  are experimentally measured. The value of  $\eta_D$  is determined from

$$\eta_C = \frac{\Delta\omega_n}{\omega_n} = \frac{\Delta f_c}{f_c} \quad (4)$$

where  $\Delta f_c$  is the bandwidth at the half-power points of the response peak for the  $n^{\text{th}}$  mode. The value of  $E_1$  can be determined from the measured response of the uncoated metal beam using

$$\xi_n^4 = \mu_1 \omega_{1n}^2 L^4 / E_1 I_1 \quad (5)$$

vertical line at that point until it intersects the curve of interest, and read the properties of interest. Figures 1.34 and 1.35 illustrate this method to identify the damping properties at 500 Hz and 600°C. By reversing this process, the temperature of peak damping can be determined as illustrated in Figure 1.36. By defining the effective temperature range of material damping is above 1.707 peak damping (Figure 1.37), a description of the shape of the damping peak can be made. These methods were used to develop the summary of damping properties on the material damping properties evaluation summary sheet used in the data presentation Appendix of this report.

It can easily be seen from the nomographs that the data in this format is amenable to the development of analytical equations which would represent the data. The equations used to fit the material properties are those suggested by Rogers in reference [7].

The ability to represent the dynamic material properties in equation form greatly facilitates the use of this data in analytical structural design. A short discussion of the equations and parameters used in the curve fitting routine follows. More detailed information is in references [6] and [7].

The curves fit to the data on the nomographs were calculated by the computer program previously in this Section. The basic form for these equations are as follows:

Storage Modulus

$$\log_{10}(E'_D) = \log_{10}(M_f) + \frac{2 \log_{10} \left( \frac{M_{rom}}{M_l} \right)}{1 + \left( \frac{f_{rom}}{f_r} \right)^N} \quad (6)$$

where:

- $E'_D$  is the material storage modulus;
- $f_r$  is the reduced frequency;
- $M_{rom}$  is the inflection point of the storage modulus curve as read on the Young's modulus scale;

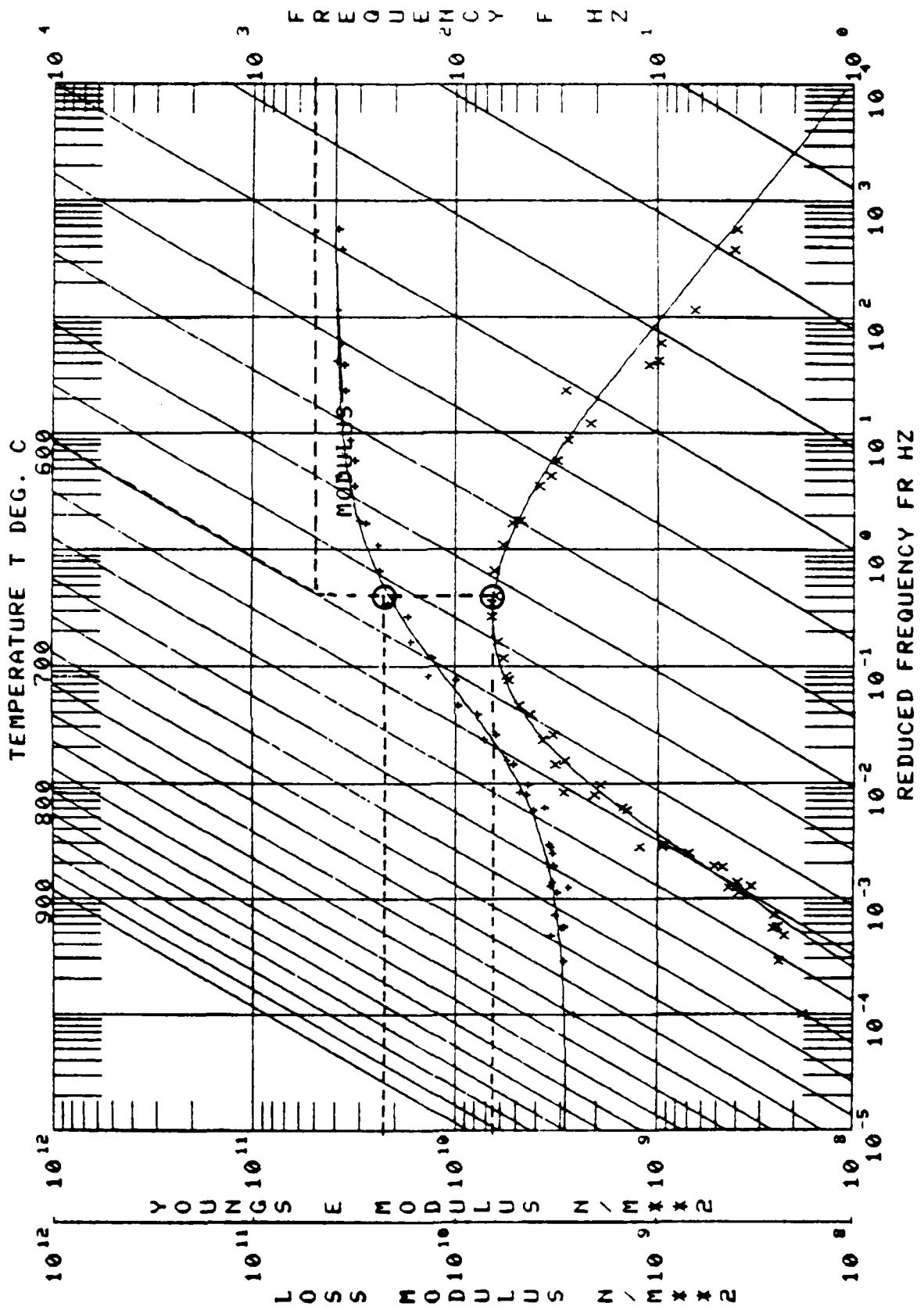

Figure 1.34. Example for Determining Loss Factor and Storage Modulus at 500 Hz and 600°C.



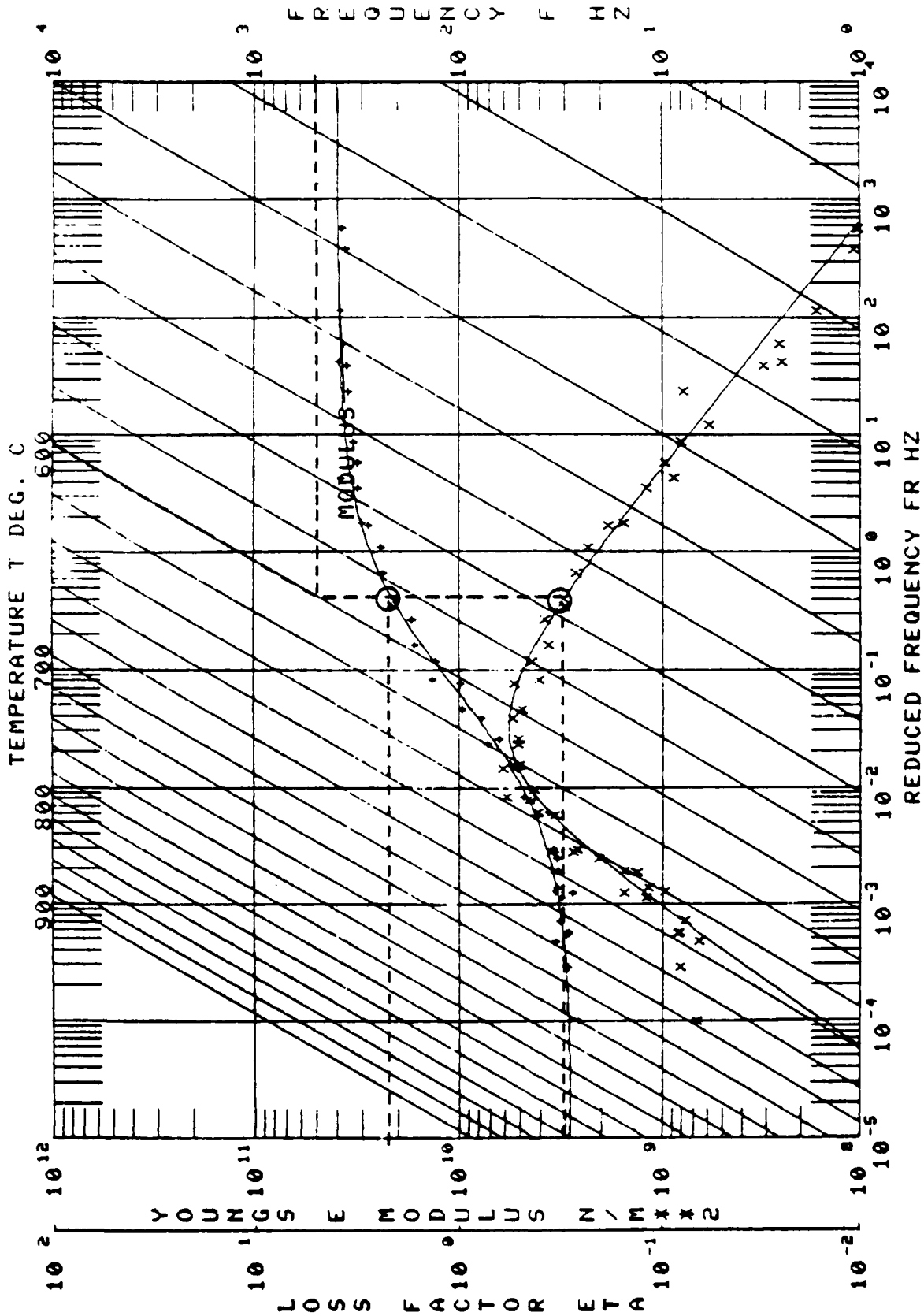

Figure 1.35. Example for Determining Loss Modulus and Storage Modulus at 500 Hz and 600°C.

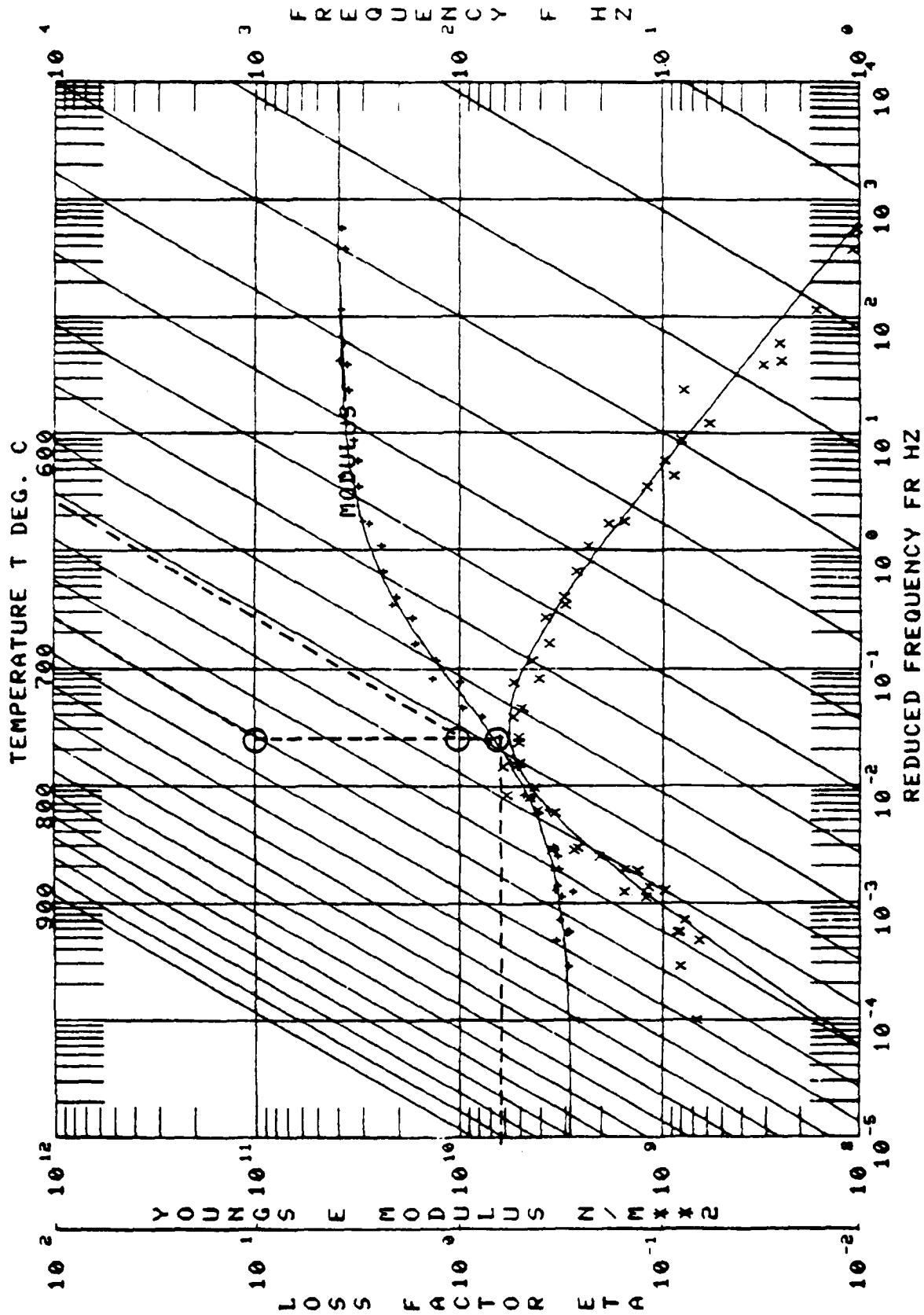

Figure 1.36. Example for Determining Peak Damping Temperature for 100 and 1,000 Hz.

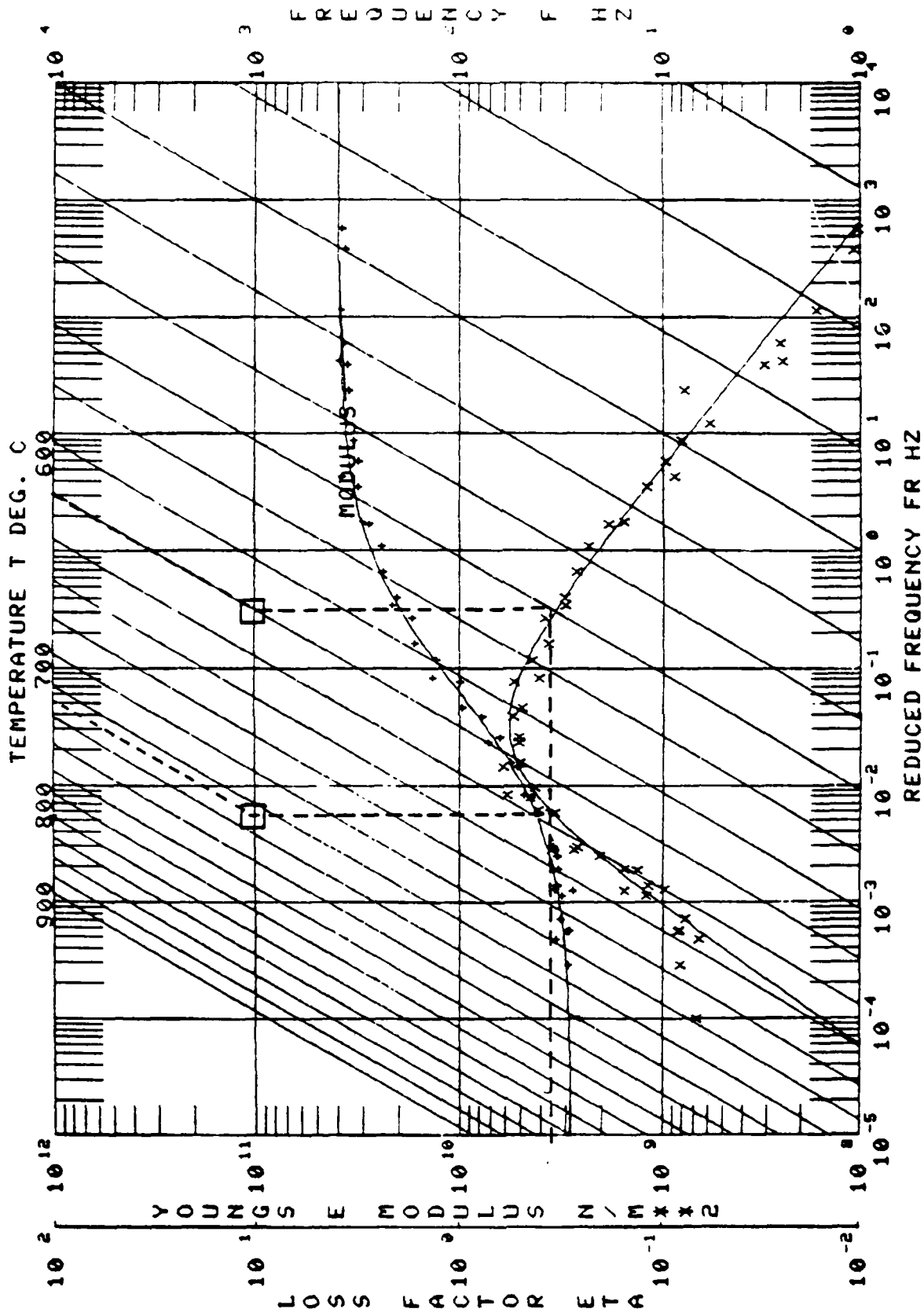

Figure 1.37. Example for Determining Material Damping Temperature Range at 1,000 Hz.

$f_{rom}$  is the reduced frequency value of this inflection point;

$N$  is the slope of the curve at the inflection point;

$M_l$  is the Young's modulus value of the lower horizontal asymptote of this curve.

Figure 1.38 illustrates the curve fit parameters  $M_{rom}$ ,  $f_{rom}$ ,  $N$ , and  $M_l$ .

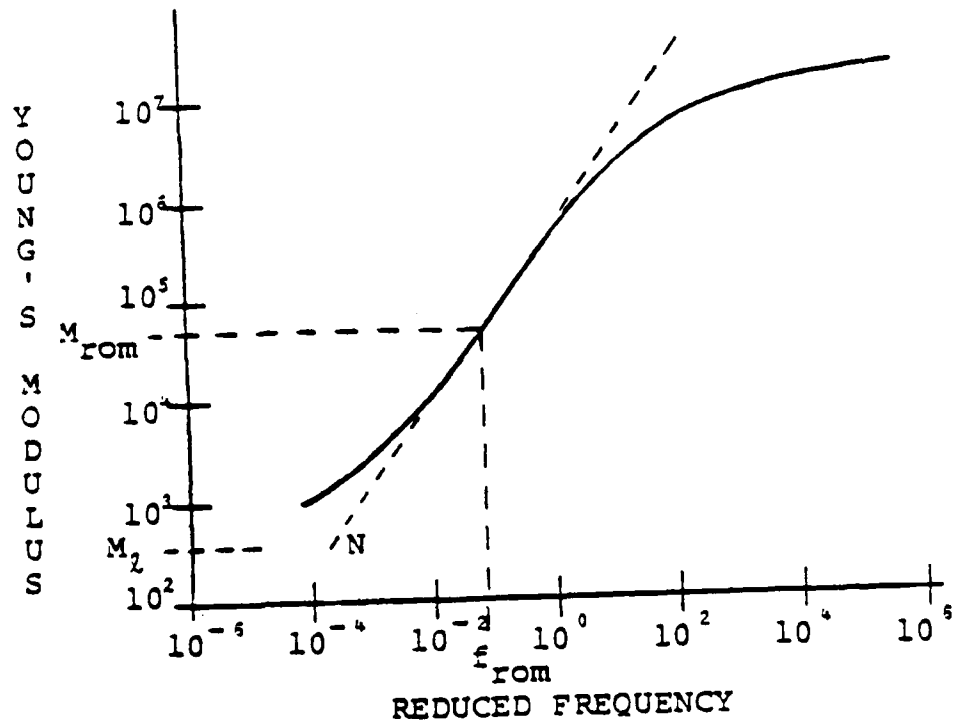

Figure 1.38. Curve Fit Parameters for Storage Modulus.

Loss Factor

$$\log_{10}(n) = \log_{10}(n_{frol}) + \frac{C}{2} \left[ \left( \frac{S_l + S_h}{C} \right) \log_{10} \left( \frac{f_l}{f_{rol}} \right) + (S_l + S_h) \left( 1 - \sqrt{1 + \left( \frac{\log_{10} \left( \frac{f_r}{f_{rol}} \right)}{C} \right)^2} \right) \right] \quad (7)$$

where:

$\eta$  is the loss factor;

$f_r$  is the reduced frequency;

$\eta_{f_{rol}}$  is the loss factor value of the damping peak;

$f_{rol}$  is the reduced frequency value of the damping peak;

$S_l$  is the slope of asymptotic line for low values of reduced frequency;

$S_h$  is the slope of asymptotic line for high values of reduced frequency;

$C$  is a parameter which defines the curvature of the damping peak.

Figure 1.39 illustrates the curve fit parameters  $\eta_{f_{rol}}$ ,  $f_{rol}$ ,  $S_l$ ,  $S_h$ , and  $C$ .

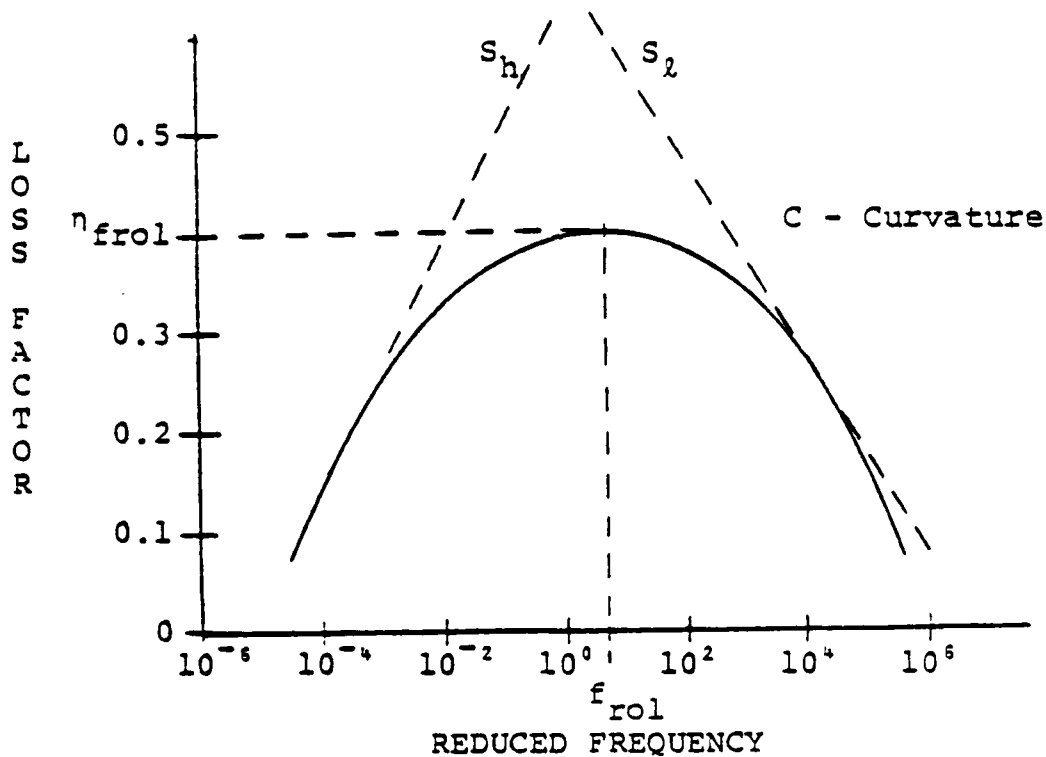

Figure 1.39. Curve Fit Parameters for Loss Factor

The curve fit equations for each material are included in the materials damping properties evaluation summary sheets.

1.2.1.5. Data Files Maintenance

A file of high temperature beam test data compiled between February, 1977 and November, 1979 were completely reorganized and have been updated as additional tests were conducted. The format used to tabulate the results of these enamels tests are shown in Figures 1.40 through 1.45 as follows:

Figure 1.40: A Brief Summary of Each Beam Test

Figure 1.41: Bare Beam Test Data

Figure 1.42: Composite Beam Test Data

Figure 1.43: Reduced Data (Computer Print-out)

Figure 1.44: Reduced Temperature Nomograph with Young's Modulus and Loss Factor Plotted (Computer Print-out)

Figure 1.45: Reduced Temperature Nomograph with Young's Modulus and Loss Modulus Plotted (Computer Print-out)

Material properties of all materials characterized to date are currently available upon request.

A beam test number is assigned to each beam test and includes a two digit beam material code followed by a two digit specimen number and the test run number of this beam. The test run number is a chronological count indicating the number of coated beam tests run on that particular beam. An example of this system follows.

|                   |                 |                   |
|-------------------|-----------------|-------------------|
| <u>01</u>         | <u>01</u>       | <u>-1</u>         |
| Material Code     | Specimen Number | First coated beam |
| Haynes Alloy #188 | First beam made | test of specimen  |
|                   | of Haynes #188  | 01-01             |

The bare beam tests are indicated in the same manner with no test number. The bare beam test number of the beam example above would be 01-01.

The results of the beam tests have been reported in appropriate technical reports. These results are available upon request.

Beam No. 01-48-4

Beam No. 01-48-4

Date: 4/25/79

Damping Material Corning 7570 + 2% Na<sub>2</sub>O + 2% KHCO<sub>3</sub>

Material thickness 0.0186 in. Material Density 0.1876 lb/in<sup>3</sup> Fixture No. 2

Beam Thickness .0371 in. Beam Density 0.33 lb/in<sup>3</sup> Length 8.28 in.

Temperature Test Range: Between 925 °F and 650 °F

Frequency Test Range: Between N/A Hz and N/A Hz

Loss Factor  $\eta_D$ :

|       |         |                     |                           |
|-------|---------|---------------------|---------------------------|
| Peak  | 100 Hz  | $\eta_D$ <u>0.5</u> | Temperature <u>800</u> °F |
|       | 1000 Hz | $\eta_D$ <u>0.5</u> | Temperature <u>842</u> °F |
| Range | 100 Hz  | <u>830</u> °F       | <u>770</u> °F             |
|       | 1000 Hz | <u>860</u> °F       | <u>810</u> °F             |

Complex Modulus:  $E_D^*$

|       |         |                                 |                           |
|-------|---------|---------------------------------|---------------------------|
| Peak  | 100 Hz  | <u>7.2 × 10<sup>6</sup></u> psi | Temperature <u>760</u> °F |
|       | 1000 Hz | <u>7.2 × 10<sup>6</sup></u> psi | Temperature <u>810</u> °F |
| Range | 100 Hz  | <u>820</u> °F                   | <u>740</u> °F             |
|       | 1000 Hz | <u>852</u> °F                   | <u>770</u> °F             |

Vibr 2 Index 70 Cufit Index 119

Project: F107-2

Remarks: Coating smooth and glossy with no visible signs of deterioration  
at completion of test.

Beam No. 01-48-4

Figure 1.40. Vitreous Enamel Evaluation Sheet.

| Temp.       | Mode | $f_C$   | $f_L$   | $f_R$   | $\Delta f$ | $\eta$ |
|-------------|------|---------|---------|---------|------------|--------|
| $^{\circ}F$ |      | Hz      | Hz      | Hz      | Hz         |        |
| 1700        | 2    | 91.32   | 91.02   | 91.66   | .64        | .00701 |
| 1700        | 4    | 504.87  | 503.52  | 506.16  | 2.64       | .00523 |
| 1700        | 5    | 837.31  | 835.14  | 839.00  | 3.86       | .00461 |
| 1700        | 6    | 1253.24 | 1249.93 | 1256.41 | 6.48       | .00517 |
| 1650        | 2    | 91.93   | 91.63   | 92.30   | .67        | .00729 |
| 1650        | 4    | 508.85  | 507.85  | 509.92  | 2.07       | .00407 |
| 1650        | 5    | 843.49  | 841.81  | 844.88  | 3.07       | .00364 |
| 1650        | 6    | 1261.49 | 1258.07 | 1265.05 | 6.98       | .00553 |
| 1600        | 2    | 93.01   | 92.69   | 93.35   | .66        | .00710 |
| 1600        | 4    | 513.40  | 512.77  | 514.08  | 1.31       | .00255 |
| 1600        | 5    | 850.77  | 849.74  | 851.78  | 2.04       | .00240 |
| 1600        | 6    | 1272.71 | 1271.91 | 1274.40 | 2.49       | .00196 |
| 1600        | 2    | 92.94   |         |         |            |        |
| 1600        | 3    | 260.95  |         |         |            |        |
| 1600        | 4    | 512.97  |         |         |            |        |
| 1600        | 5    | 849.68  |         |         |            |        |
| 1600        | 6    | 1272.57 |         |         |            |        |
| 1550        | 2    | 94.01   | 93.73   | 94.27   | .54        | .00574 |
| 1550        | 4    | 517.68  | 517.28  | 518.15  | .88        | .00170 |
| 1550        | 5    | 857.57  | 856.97  | 858.44  | 1.47       | .00171 |
| 1550        | 6    | 1283.32 | 1282.16 | 1284.41 | 2.25       | .00175 |
| 1500        | 2    | 94.73   | 94.55   | 94.95   | .40        | .00422 |
| 1500        | 3    | 265.34  | 265.07  | 265.61  | .54        | .00204 |
| 1500        | 4    | 521.54  | 521.32  | 521.92  | .60        | .00115 |
| 1500        | 5    | 864.06  | 863.55  | 864.62  | 1.07       | .00124 |
| 1500        | 6    | 1293.12 | 1292.28 | 1294.04 | 1.76       | .00136 |
| 1400        | 2    | 96.07   |         |         |            |        |
| 1400        | 3    | 268.96  |         |         |            |        |
| 1400        | 4    | 528.72  |         |         |            |        |
| 1400        | 5    | 875.72  |         |         |            |        |
| 1400        | 6    | 1310.02 |         |         |            |        |
|             |      |         |         |         |            |        |
|             |      |         |         |         |            |        |

Figure 1.41. Bare Beam Test Data.



| Temp. | Mode | $f_c$   | $f_n$   | $f_L$   | $f_R$   | $\Delta f$ | $n_s$  | $n_c$ | ldb |
|-------|------|---------|---------|---------|---------|------------|--------|-------|-----|
| 925   | 2    | 93.39   | 102.18  | 93.29   | 93.53   | .24        | .0026  |       |     |
|       | 3    | 260.45  | 285.60  | 260.06  | 260.87  | .81        | .0031  |       |     |
|       | 4    | 511.48  | 562.90  | 510.44  | 512.52  | 2.08       | .0041  |       |     |
|       | 5    | 843.11  | 932.10  | 840.91  | 845.69  | 4.78       | .0057  |       |     |
|       | 6    | 1257.30 | 1394.90 | 1252.52 | 1263.12 | 10.60      | .0084  |       |     |
| 900   | 2    | 93.66   | 102.44  | 93.51   | 93.81   | .30        | .00033 | .0013 |     |
|       | 3    | 261.34  | 286.35  | 260.79  | 262.07  | 1.28       | .0049  |       |     |
|       | 4    | 513.42  | 564.40  | 511.33  | 515.51  | 4.18       | .0081  |       |     |
|       | 5    | 846.36  | 934.50  | 842.14  | 851.93  | 9.79       | .0116  |       |     |
|       | 6    | 1263.65 | 1398.60 | 1256.23 | 1276.54 | 20.31      | .0161  |       |     |
| 900   | 2    | 93.83   | 102.44  | 93.62   | 93.95   | .33        | .0015  |       |     |
|       | 3    | 261.34  | 286.35  | 260.92  | 261.58  | 1.30       | .0050  |       |     |
|       | 4    | 512.82  | 564.40  | 510.84  | 515.00  | 4.16       | .0081  |       |     |
|       | 5    | 846.51  | 934.50  | 841.32  | 853.46  | 12.14      | .0143  |       |     |
|       | 6    | 1264.88 | 1398.60 | 1253.80 | 1276.25 | 22.45      | .0177  |       |     |
| 875   | 2    | 94.11   | 102.71  | 93.84   | 94.36   | .52        | .0055  |       |     |
|       | 3    | 262.51  | 287.15  | 260.99  | 263.66  | 2.67       | .0102  |       |     |
|       | 4    | 515.82  | 565.60  | 511.31  | 520.64  | 9.33       | .0181  |       |     |
|       | 5    | 855.12  | 937.00  | 843.72  | 868.02  | 24.30      | .0284  |       |     |
|       | 6    | 1279.14 | 1402.00 | 1267.14 | 1286.53 | 38.11      | .0298  |       |     |

Figure 1.42. Composite Beam Test Data.

EXPERIMENTAL CODE 1 70  
 MATERIAL BEAM NO. 01-48  
 MANUFACTURER IN DATA SOURCES  
 AFML UDR1 BEAM COATED ONE SIDE 4/27  
 OTHER 17570 + 2X NA2O + 2X KAC03

| NO. | MODULUS<br>N/MHz <sup>2</sup> | LOSS<br>FACTOR | TEMP.<br>DEC. | FREQ.<br>HZ | MODE<br>NO. | BEAM MOD.<br>N/MHz <sup>2</sup> | COMPOSITE<br>LOSS FAC. | BEAM FREQ.<br>HZ | COMPLEX MOD.<br>N/MHz <sup>2</sup> |
|-----|-------------------------------|----------------|---------------|-------------|-------------|---------------------------------|------------------------|------------------|------------------------------------|
| 1   | 1.85229E+10                   | .1465          | 426.7         | 1416.4      | 6.          | 2.14025E+11                     | .0318                  | 1412.5           | 2.17141E+09                        |
| 2   | 3.62775E+09                   | .2005          | 496.1         | 1257.3      | 6.          | 2.08724E+11                     | .0084                  | 1394.0           | 5.26324E+08                        |
| 3   | 3.61045E+09                   | .1175          | 496.1         | 843.1       | 5.          | 2.07209E+11                     | .0057                  | 1321.1           | 3.58177E+08                        |
| 4   | 6.99005E+09                   | .0208          | 496.1         | 511.5       | 4.          | 2.06412E+11                     | .0041                  | 955.9            | 2.58177E+08                        |
| 5   | 4.38652E+09                   | .0183          | 482.2         | 266.5       | 3.          | 2.05809E+11                     | .0031                  | 285.6            | 2.08030E+08                        |
| 6   | 4.15388E+09                   | .0753          | 482.2         | 97.7        | 2.          | 2.05202E+11                     | .0023                  | 102.4            | 2.18787E+08                        |
| 7   | 3.77388E+09                   | .1371          | 482.2         | 51.3        | 2.          | 2.04606E+11                     | .0019                  | 286.7            | 3.12880E+08                        |
| 8   | 3.25566E+09                   | .2279          | 482.2         | 1846.4      | 4.          | 2.04010E+11                     | .0081                  | 564.7            | 5.15066E+08                        |
| 9   | 2.94341E+09                   | .3471          | 482.2         | 846.4       | 5.          | 2.03414E+11                     | .0116                  | 931.5            | 7.33106E+08                        |
| 10  | 4.21818E+09                   | .4620          | 468.3         | 1279.1      | 6.          | 2.02818E+11                     | .0161                  | 1398.6           | 1.94863E+09                        |
| 11  | 4.22356E+09                   | .4369          | 468.3         | 855.1       | 5.          | 2.02222E+11                     | .0284                  | 1402.0           | 1.94863E+09                        |
| 12  | 4.11645E+09                   | .2840          | 468.3         | 515.8       | 6.          | 2.01626E+11                     | .0181                  | 937.0            | 1.85433E+09                        |
| 13  | 4.28715E+09                   | .1407          | 468.3         | 262.2       | 4.          | 2.01030E+11                     | .0102                  | 555.6            | 1.85433E+09                        |
| 14  | 4.69146E+09                   | .0761          | 468.3         | 94.1        | 3.          | 2.00434E+11                     | .0055                  | 228.7            | 6.28115E+08                        |
| 15  | 4.85578E+09                   | .1617          | 454.4         | 94.1        | 3.          | 2.00838E+11                     | .0055                  | 102.7            | 3.58177E+08                        |
| 16  | 1.49710E+10                   | .2294          | 440.6         | 1383.7      | 6.          | 2.00242E+11                     | .0120                  | 1409.1           | 7.85902E+08                        |
| 17  | 1.00193E+10                   | .4016          | 440.6         | 895.7       | 5.          | 2.00646E+11                     | .0428                  | 1409.1           | 3.43393E+09                        |
| 18  | 8.35547E+09                   | .4903          | 440.6         | 534.8       | 5.          | 2.01050E+11                     | .0550                  | 1003.0           | 4.02414E+09                        |
| 19  | 6.47126E+09                   | .5157          | 440.6         | 268.1       | 4.          | 2.01454E+11                     | .0579                  | 568.7            | 4.02414E+09                        |
| 20  | 6.56706E+09                   | .3726          | 440.6         | 95.0        | 3.          | 2.01858E+11                     | .0493                  | 288.7            | 4.02414E+09                        |
| 21  | 3.8791E+10                    | .0152          | 343.7         | 108.6       | 2.          | 2.02262E+11                     | .0360                  | 109.2            | 3.37770E+09                        |
| 22  | 3.57155E+10                   | .0097          | 343.7         | 108.6       | 2.          | 2.02666E+11                     | .0270                  | 109.2            | 3.37770E+09                        |
| 23  | 1.39311E+10                   | .3338          | 426.7         | 306.6       | 5.          | 2.03070E+11                     | .0026                  | 109.2            | 3.37770E+09                        |
| 24  | 1.41140E+10                   | .3324          | 426.7         | 320.9       | 5.          | 2.03474E+11                     | .0026                  | 294.3            | 2.48011E+08                        |
| 25  | 1.00539E+10                   | .3968          | 426.7         | 557.0       | 4.          | 2.03878E+11                     | .0596                  | 942.8            | 4.69522E+09                        |
| 26  | 1.58110E+10                   | .3008          | 426.7         | 98.5        | 2.          | 2.04282E+11                     | .0548                  | 570.0            | 4.69522E+09                        |
| 27  | 1.93269E+10                   | .2094          | 412.8         | 286.8       | 3.          | 2.04686E+11                     | .0589                  | 109.5            | 3.99886E+09                        |
| 28  | 1.77265E+10                   | .1756          | 412.8         | 576.1       | 3.          | 2.05090E+11                     | .0470                  | 1290.2           | 4.75671E+09                        |
| 29  | 2.2057E+10                    | .0222          | 412.8         | 94.4        | 4.          | 2.05494E+11                     | .0370                  | 104.6            | 4.07377E+09                        |
| 30  | 2.22374E+10                   | .0775          | 398.0         | 145.4       | 5.          | 2.05898E+11                     | .0230                  | 145.0            | 2.11202E+09                        |
| 31  | 2.0847E+10                    | .1089          | 398.0         | 970.7       | 5.          | 2.06302E+11                     | .0230                  | 198.2            | 1.70095E+09                        |
| 32  | 2.07113E+10                   | .1448          | 398.0         | 585.9       | 4.          | 2.06706E+11                     | .0266                  | 522.7            | 3.3610E+09                         |
| 33  | 1.95730E+10                   | .1490          | 398.0         | 295.9       | 3.          | 2.07110E+11                     | .0266                  | 291.0            | 3.02666E+09                        |
| 34  | 2.46712E+10                   | .0415          | 385.0         | 1473.6      | 2.          | 2.07514E+11                     | .0338                  | 1041.0           | 2.91563E+09                        |
| 35  | 2.40522E+10                   | .0404          | 385.0         | 982.3       | 6.          | 2.07918E+11                     | .0308                  | 142.6            | 2.91563E+09                        |
| 36  | 2.39899E+10                   | .0477          | 385.0         | 593.3       | 5.          | 2.08322E+11                     | .0104                  | 955.5            | 1.97278E+09                        |
| 37  | 2.35885E+10                   | .0640          | 385.0         | 301.2       | 4.          | 2.08726E+11                     | .0164                  | 577.4            | 1.15553E+09                        |
| 38  | 2.2021E+10                    | .0795          | 385.0         | 106.7       | 3.          | 2.09130E+11                     | .0195                  | 110.1            | 1.51021E+09                        |
| 39  | 2.33555E+10                   | .0418          | 371.1         | 304.1       | 2.          | 2.09534E+11                     | .0164                  | 110.1            | 1.51021E+09                        |
| 40  | 2.5310E+10                    | .0307          | 371.1         | 109.7       | 2.          | 2.09938E+11                     | .0166                  | 110.1            | 1.51021E+09                        |
| 41  | 2.5310E+10                    | .0307          | 371.1         | 304.1       | 2.          | 2.10342E+11                     | .0166                  | 110.1            | 1.51021E+09                        |
| 42  | 2.5310E+10                    | .0307          | 371.1         | 109.7       | 2.          | 2.10746E+11                     | .0166                  | 110.1            | 1.51021E+09                        |
| 43  | 2.5310E+10                    | .0307          | 371.1         | 304.1       | 2.          | 2.11150E+11                     | .0166                  | 110.1            | 1.51021E+09                        |
| 44  | 2.5310E+10                    | .0307          | 371.1         | 109.7       | 2.          | 2.11554E+11                     | .0166                  | 110.1            | 1.51021E+09                        |
| 45  | 2.5310E+10                    | .0307          | 371.1         | 304.1       | 2.          | 2.11958E+11                     | .0166                  | 110.1            | 1.51021E+09                        |
| 46  | 2.5310E+10                    | .0307          | 371.1         | 109.7       | 2.          | 2.12362E+11                     | .0166                  | 110.1            | 1.51021E+09                        |
| 47  | 2.5310E+10                    | .0307          | 371.1         | 304.1       | 2.          | 2.12766E+11                     | .0166                  | 110.1            | 1.51021E+09                        |
| 48  | 2.5310E+10                    | .0307          | 371.1         | 109.7       | 2.          | 2.13170E+11                     | .0166                  | 110.1            | 1.51021E+09                        |
| 49  | 2.5310E+10                    | .0307          | 371.1         | 304.1       | 2.          | 2.13574E+11                     | .0166                  | 110.1            | 1.51021E+09                        |
| 50  | 2.5310E+10                    | .0307          | 371.1         | 109.7       | 2.          | 2.13978E+11                     | .0166                  | 110.1            | 1.51021E+09                        |
| 51  | 2.5310E+10                    | .0307          | 371.1         | 304.1       | 2.          | 2.14382E+11                     | .0166                  | 110.1            | 1.51021E+09                        |
| 52  | 2.5310E+10                    | .0307          | 371.1         | 109.7       | 2.          | 2.14786E+11                     | .0166                  | 110.1            | 1.51021E+09                        |
| 53  | 2.5310E+10                    | .0307          | 371.1         | 304.1       | 2.          | 2.15190E+11                     | .0166                  | 110.1            | 1.51021E+09                        |
| 54  | 2.5310E+10                    | .0307          | 371.1         | 109.7       | 2.          | 2.15594E+11                     | .0166                  | 110.1            | 1.51021E+09                        |
| 55  | 2.5310E+10                    | .0307          | 371.1         | 304.1       | 2.          | 2.15998E+11                     | .0166                  | 110.1            | 1.51021E+09                        |
| 56  | 2.5310E+10                    | .0307          | 371.1         | 109.7       | 2.          | 2.16402E+11                     | .0166                  | 110.1            | 1.51021E+09                        |
| 57  | 2.5310E+10                    | .0307          | 371.1         | 304.1       | 2.          | 2.16806E+11                     | .0166                  | 110.1            | 1.51021E+09                        |
| 58  | 2.5310E+10                    | .0307          | 371.1         | 109.7       | 2.          | 2.17210E+11                     | .0166                  | 110.1            | 1.51021E+09                        |
| 59  | 2.5310E+10                    | .0307          | 371.1         | 304.1       | 2.          | 2.17614E+11                     | .0166                  | 110.1            | 1.51021E+09                        |
| 60  | 2.5310E+10                    | .0307          | 371.1         | 109.7       | 2.          | 2.18018E+11                     | .0166                  | 110.1            | 1.51021E+09                        |
| 61  | 2.5310E+10                    | .0307          | 371.1         | 304.1       | 2.          | 2.18422E+11                     | .0166                  | 110.1            | 1.51021E+09                        |
| 62  | 2.5310E+10                    | .0307          | 371.1         | 109.7       | 2.          | 2.18826E+11                     | .0166                  | 110.1            | 1.51021E+09                        |
| 63  | 2.5310E+10                    | .0307          | 371.1         | 304.1       | 2.          | 2.19230E+11                     | .0166                  | 110.1            | 1.51021E+09                        |
| 64  | 2.5310E+10                    | .0307          | 371.1         | 109.7       | 2.          | 2.19634E+11                     | .0166                  | 110.1            | 1.51021E+09                        |
| 65  | 2.5310E+10                    | .0307          | 371.1         | 304.1       | 2.          | 2.20038E+11                     | .0166                  | 110.1            | 1.51021E+09                        |
| 66  | 2.5310E+10                    | .0307          | 371.1         | 109.7       | 2.          | 2.20442E+11                     | .0166                  | 110.1            | 1.51021E+09                        |
| 67  | 2.5310E+10                    | .0307          | 371.1         | 304.1       | 2.          | 2.20846E+11                     | .0166                  | 110.1            | 1.51021E+09                        |
| 68  | 2.5310E+10                    | .0307          | 371.1         | 109.7       | 2.          | 2.21250E+11                     | .0166                  | 110.1            | 1.51021E+09                        |
| 69  | 2.5310E+10                    | .0307          | 371.1         | 304.1       | 2.          | 2.21654E+11                     | .0166                  | 110.1            | 1.51021E+09                        |
| 70  | 2.5310E+10                    | .0307          | 371.1         | 109.7       | 2.          | 2.22058E+11                     | .0166                  | 110.1            | 1.51021E+09                        |
| 71  | 2.5310E+10                    | .0307          | 371.1         | 304.1       | 2.          | 2.22462E+11                     | .0166                  | 110.1            | 1.51021E+09                        |
| 72  | 2.5310E+10                    | .0307          | 371.1         | 109.7       | 2.          | 2.22866E+11                     | .0166                  | 110.1            | 1.51021E+09                        |
| 73  | 2.5310E+10                    | .0307          | 371.1         | 304.1       | 2.          | 2.23270E+11                     | .0166                  | 110.1            | 1.51021E+09                        |
| 74  | 2.5310E+10                    | .0307          | 371.1         | 109.7       | 2.          | 2.23674E+11                     | .0166                  | 110.1            | 1.51021E+09                        |
| 75  | 2.5310E+10                    | .0307          | 371.1         | 304.1       | 2.          | 2.24078E+11                     | .0166                  | 110.1            | 1.51021E+09                        |
| 76  | 2.5310E+10                    | .0307          | 371.1         | 109.7       | 2.          | 2.24482E+11                     | .0166                  | 110.1            | 1.51021E+09                        |
| 77  | 2.5310E+10                    | .0307          | 371.1         | 304.1       | 2.          | 2.24886E+11                     | .0166                  | 110.1            | 1.51021E+09                        |
| 78  | 2.5310E+10                    | .0307          | 371.1         | 109.7       | 2.          | 2.25290E+11                     | .0166                  | 110.1            | 1.51021E+09                        |
| 79  | 2.5310E+10                    | .0307          | 371.1         | 304.1       | 2.          | 2.25694E+11                     | .0166                  | 110.1            | 1.51021E+09                        |
| 80  | 2.5310E+10                    | .0307          | 371.1         | 109.7       | 2.          | 2.26098E+11                     | .0166                  | 110.1            | 1.51021E+09                        |
| 81  | 2.5310E+10                    | .0307          | 371.1         | 304.1       | 2.          | 2.26502E+11                     | .0166                  | 110.1            | 1.51021E+09                        |
| 82  | 2.5310E+10                    | .0307          | 371.1         | 109.7       | 2.          | 2.26906E+11                     | .0166                  | 110.1            | 1.51021E+09                        |
| 83  | 2.5310E+10                    | .0307          | 371.1         | 304.1       | 2.          | 2.27310E+11                     | .0166                  | 110.1            | 1.51021E+09                        |
| 84  | 2.5310E+10                    | .0307          | 371.1         | 109.7       | 2.          | 2.27714E+11                     | .0166                  | 110.1            | 1.51021E+09                        |
| 85  | 2.5310E+10                    | .0307          | 371.1         | 304.1       | 2.          | 2.28118E+11                     | .0166                  | 110.1            | 1.51021E+09                        |
| 86  | 2.5310E+10                    | .0307          | 371.1         | 109.7       | 2.          | 2.28522E+11                     | .0166                  | 110.1            | 1.51021E+09                        |
| 87  | 2.5310E+10                    | .0307          | 371.1         | 304.1       | 2.          | 2.28926E+11                     | .0166                  | 110.1            | 1.51021E+09                        |
| 88  | 2.5310E+10                    | .0307          | 371.1         | 109.7       | 2.          | 2.29330E+11                     | .0166                  | 110.1            | 1.51021E+09                        |
| 89  | 2.5310E+10                    | .0307          | 371.1         | 304.1       | 2.          | 2.29734E+11                     | .0166                  | 110.1            | 1.51021E+09                        |
| 90  | 2.5310E+10                    | .0307          | 371.1         | 109.7       | 2.          | 2.30138E+11                     | .0166                  | 110.1            | 1.51021E+09                        |
| 91  | 2.5310E+10                    | .0307          | 371.1         | 304.1       | 2.          | 2.30542E+11                     | .0166                  | 110.1            | 1.51021E+09                        |
| 92  | 2.5310E+10                    | .0307          | 371.1         | 109.7       | 2.          | 2.30946E+11                     | .0166                  | 110.1            | 1.51021E+09                        |
| 93  | 2.5310E+10                    | .0307          | 371.1         | 304.1       | 2.          | 2.31350E+11                     | .0166                  | 110.1            | 1.51021E+09                        |
| 94  | 2.5310E+10                    | .0307          | 371.1         | 109.7       | 2.          | 2.31754E+11                     | .0166                  | 110.1            | 1.51021E+09                        |
| 95  | 2.5310E+10                    | .0307          | 371.1         | 304.1       | 2.          | 2.32158E+11                     | .0166                  | 110.1            | 1.51021E+09                        |
| 96  | 2.5310E+10                    | .0307          | 371.1         | 109.7       | 2.          | 2.32562E+11                     | .0166                  | 110.1            | 1.51021E+09                        |
| 97  | 2.5310E+10                    | .0307          | 371.1         | 304.1       | 2.          | 2.32966E+11                     | .0166                  | 110.1            | 1.51021E+09                        |
| 98  | 2.5310E+10                    | .0307          | 371.1         | 109.7       | 2.          | 2.33370E+11                     | .0166                  | 110.1            | 1.51021E+09                        |
| 99  | 2.5310E+10                    | .0307          | 371.1         | 304.1       | 2.          | 2.33774E+11                     | .0166                  | 110.1            | 1.51021E+09                        |
| 100 | 2.5310E+10                    | .0307          | 371.1         | 109.7       | 2.          | 2.34178E+11                     | .0166                  | 110.1            | 1.51021E+09                        |

Figure 1.43. Reduced Data (Computer Print-Out).

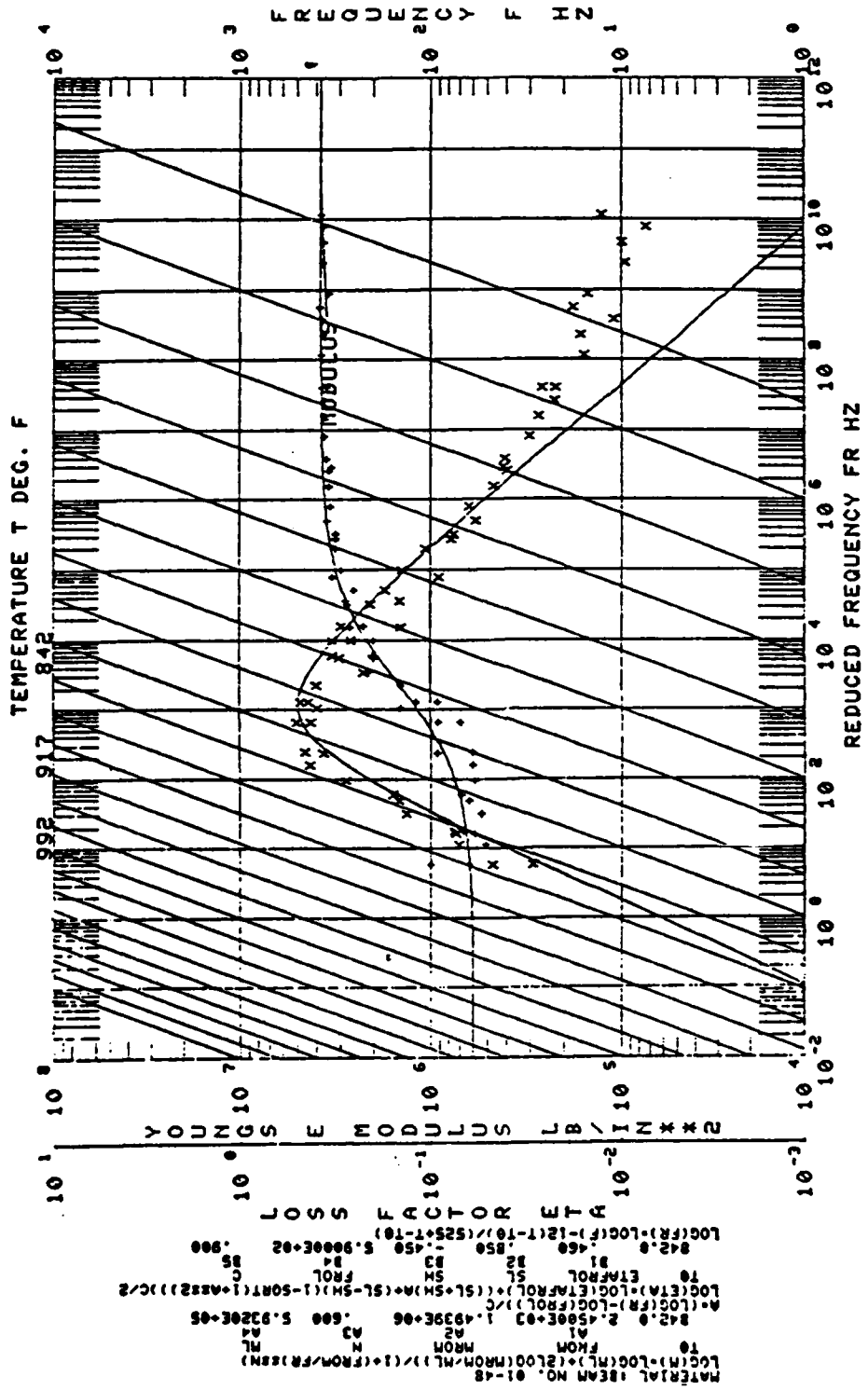

Figure 1.44. Reduced Temperature Nomograph with Young's Modulus and Loss Factor Plotted (Computer Print-Out).

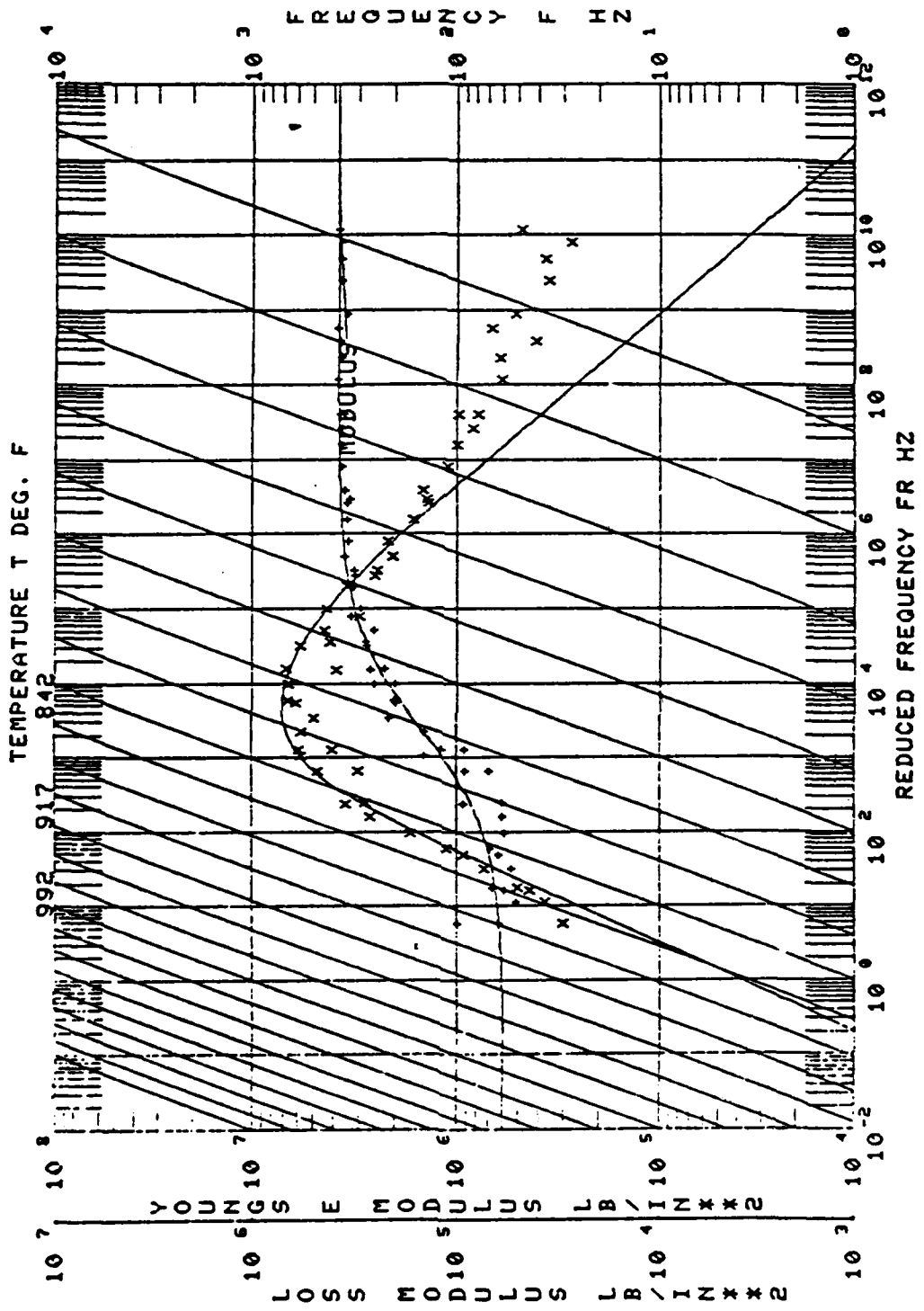

Figure 1.45. Reduced Temperature Nomograph with Young's Modulus and Loss Modulus Plotted (Computer Print-Out).

#### 1.2.1.6. Materials Tested

##### Magnesia-Alumina Spinel

UDRI and Detroit Diesel Allison Division of the General Motors Corporation (DDA), conducted a cooperative effort to characterize a DDA proprietary temperature damping material.

The UDRI supplied two 17-4PH steel beam specimens, serial number 03-05 and 03-06, to DDA for coating. Baseline damping measurements obtained for the second through sixth modes in the 700°F to 1,000°F (371.11°C to 537.78°C) range and the data were stored before the beams were transported to DDA.

The beams were coated with METCO 212-NS Magnesia-Alumina Spinel (Mag-Spinel) and tested at DDA. The procedures and test results were reported by Mr. David R. Oeth, DDA, in a letter report dated 14 March 1981. The coated beams were returned to UDRI for testing at elevated temperatures.

Room temperatures were conducted on the beam using three level of excitation while the force gage output and strain gage output were monitored. The relative outputs were plotted as strain gage output versus force gage output for the lowest four bending modes. It was planned to use these relationships to conduct the high temperature tests at the three desired levels of excitation. The procedures followed during these tests were as previously described with the exception of the strain gage monitoring. The circuit used to monitor bending strain is illustrated in Figure 1.46.

As testing at elevated temperatures commenced it was apparent that the system was not capable of driving the beam at the desired excitation levels. It was decided to drive the system at three levels of excitation; 25, 50, and 75 mv rms output at the frequency synthesizer (1.70, 3.40, and 5.10 volts rms into the transducer).

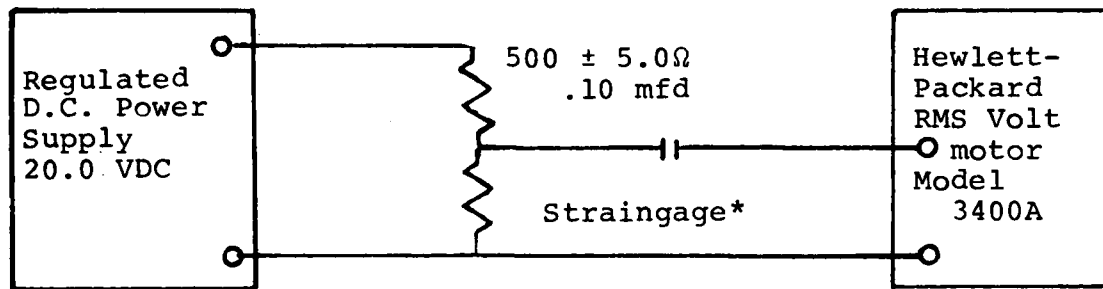

\*Strain gage: M-M type ED-DY-062-AK-350

Figure 1.46. Bending Strain Monitoring Circuit

Sine frequency sweeps of the force gage output at each temperature were recorded for the second bending mode of beam 03-06. These are presented in Figures 1.47 through 1.53. These curves reflect the expected tendency toward increasing asymmetry about the center frequency as the intensity of excitation is increased. The expected decrease in center frequency related to the increased excitation intensity is also demonstrated.

The reduced material properties are presented in Figures 1.54 through 1.59. Curves of loss modulus and loss factor versus temperature and reduced frequency could not be fit to these data as the temperature at which peak damping occurs was not clearly defined. It would appear that the loss factor is fairly constant over a very wide temperature range, certainly over the range at which the 17-4PH stainless steel beams could be tested.

Serious discrepancy was noted between the structural loss factors derived from the room temperature tests and those reported by DDA. These differences have not been reconciled.

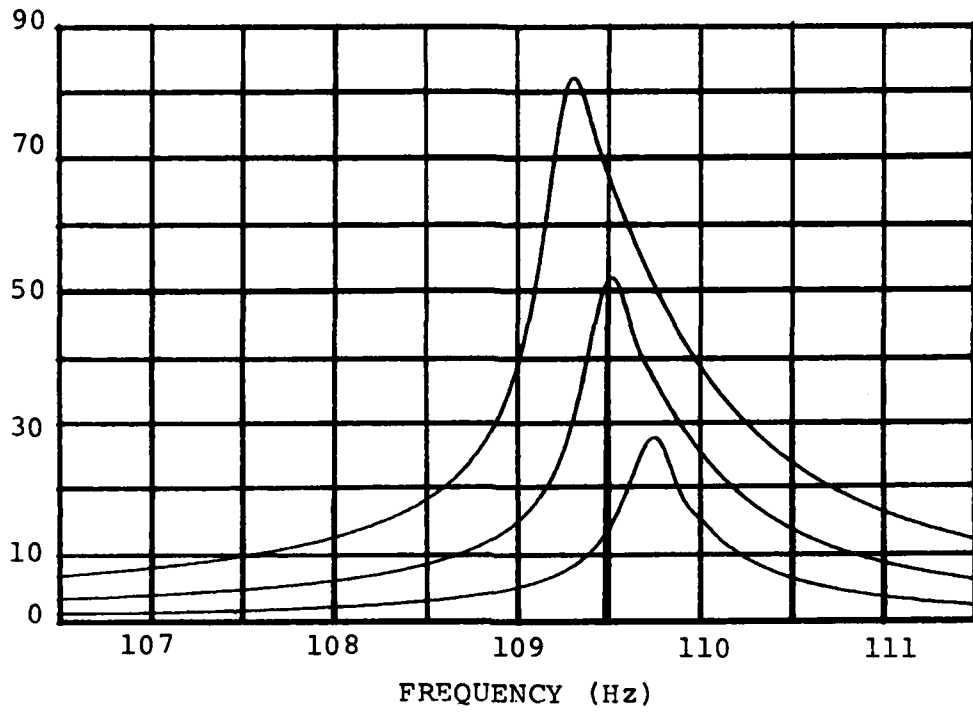

Figure 1.47. Second Bending Mode Responses of Beam 03-06 at 800°F.

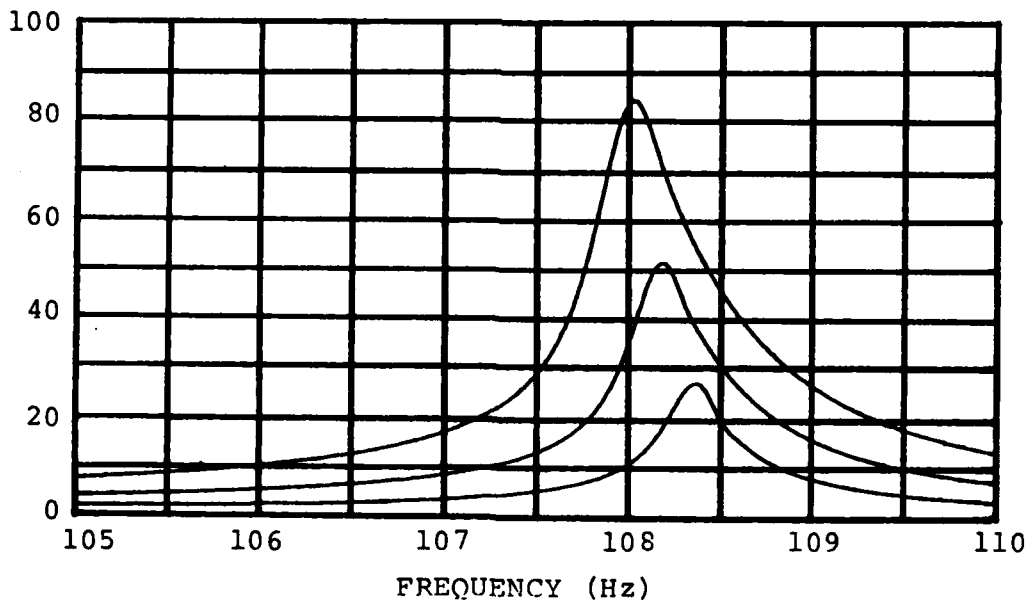

Figure 1.48. Second Bending Mode Responses of Beam 03-06 at 850°F.

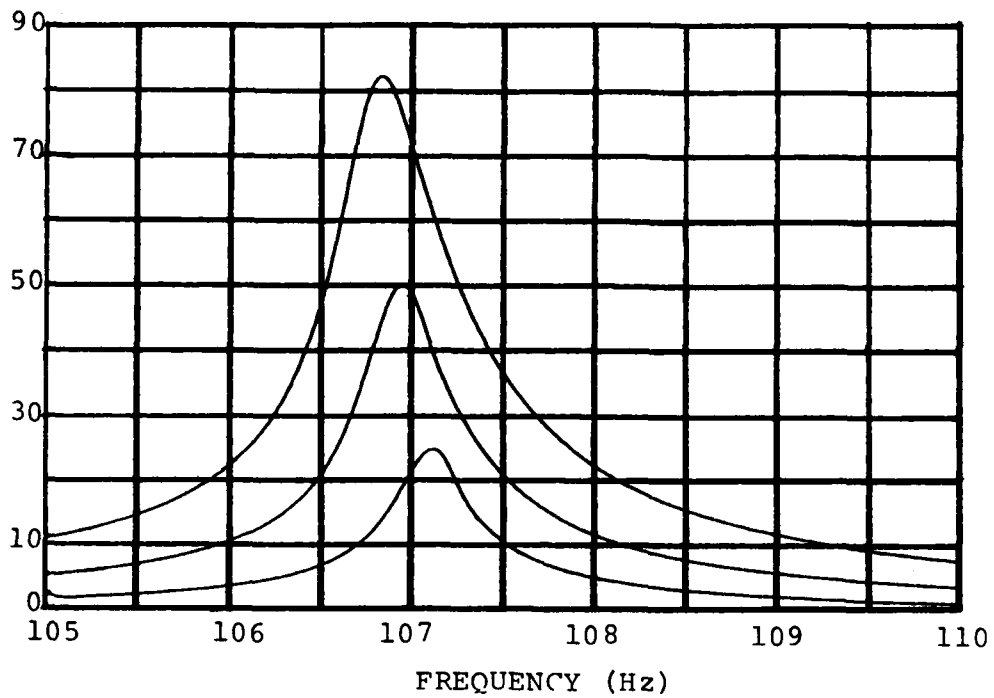

Figure 1.49. Second Bending Mode Responses of Beam 03-06 at 900°F.

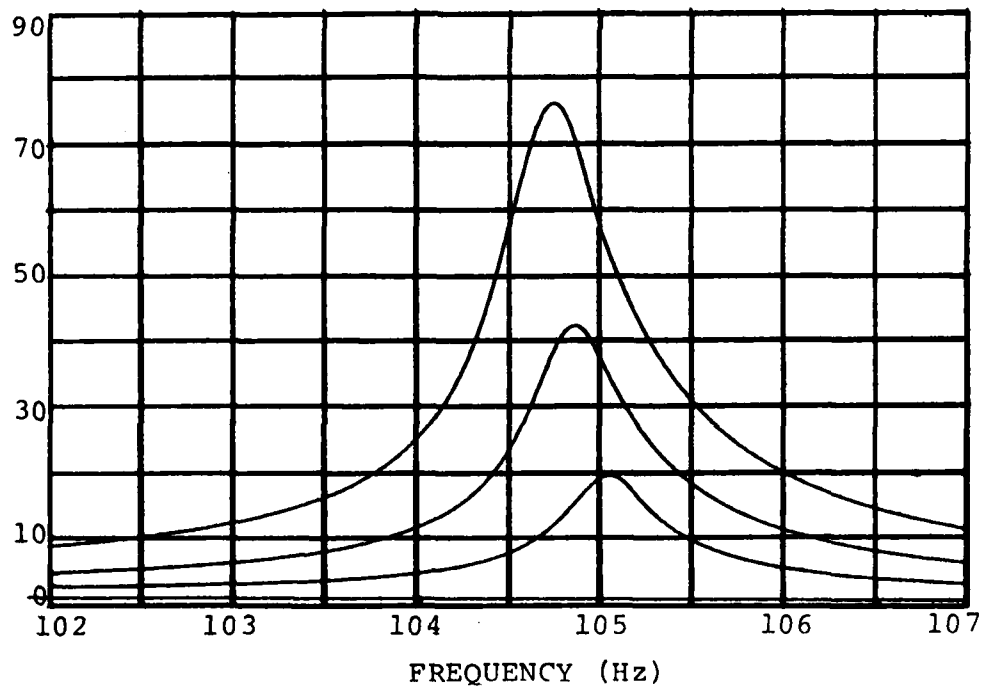

Figure 1.50. Second Bending Mode Response of Beam 03-06 at 1002°F.



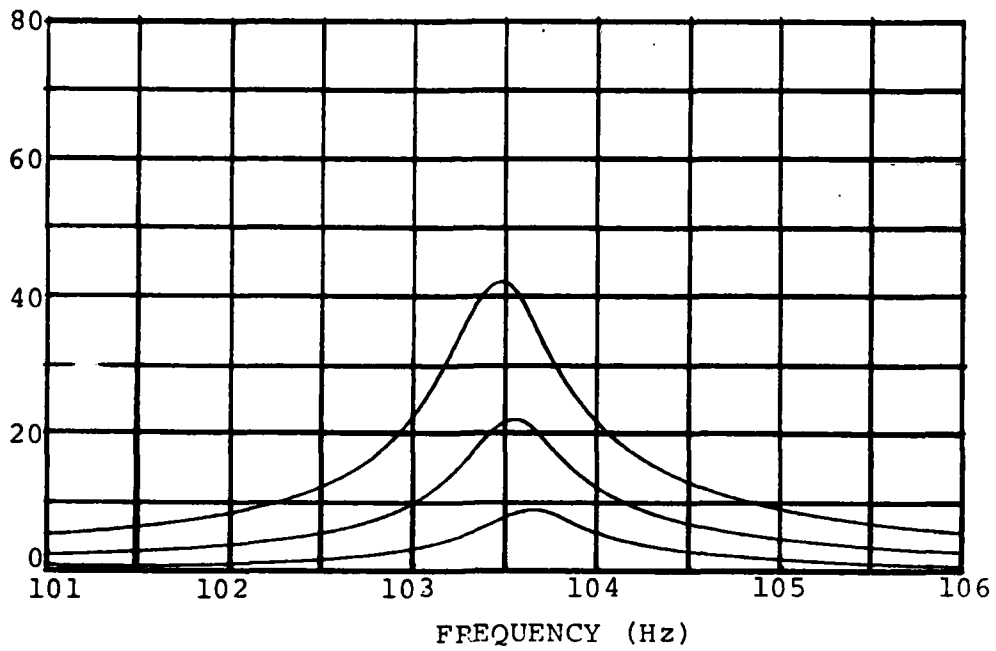

Figure 1.51. Second Bending Mode Responses of Beam 03-06 at 1053°F.

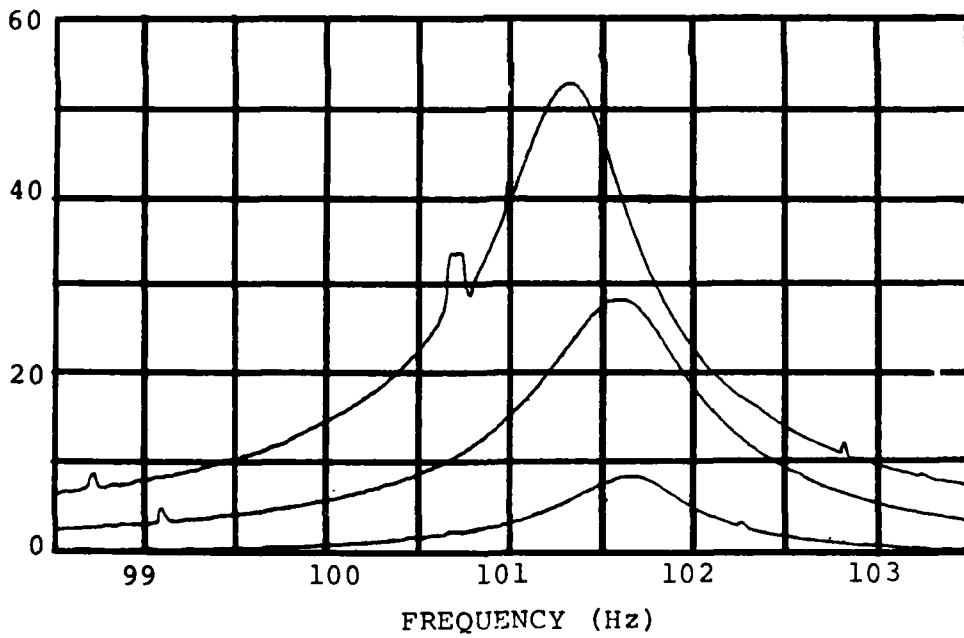

Figure 1.52. Second Bending Mode Responses of Beam 03-06 at 1093°F.

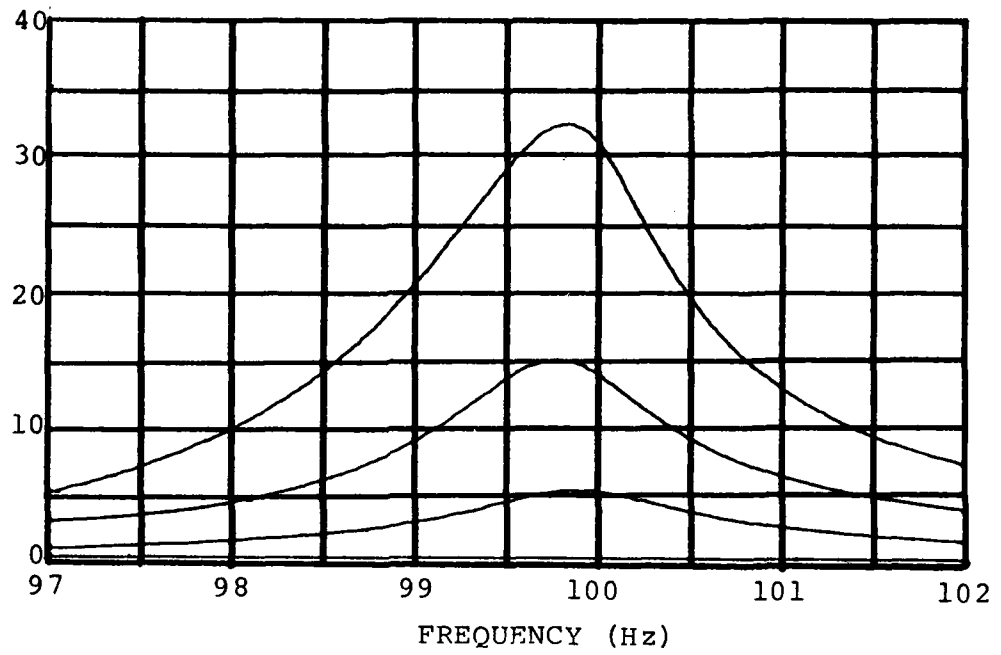

Figure 1.53. Second Bending Mode Responses of Beam 03-06 at 1147°F.

CONFIGURATION TYPE 2  
 DAMPING LAYER THICKNESS .00400 DENSITY 1.0838  
 BEAM LENGTH 8.75000 THICKNESS .04400 DENSIT. .28100

| NO. | MODULUS<br>N/R102 | LOSS<br>FACTOR | TEMP.<br>DEG. C | FREQ.<br>HZ | MODE<br>NO. | BEAM FREQ.<br>HZ | COMPOSITE<br>LOSS FAC. | LOSS MOD.<br>N/R102 |
|-----|-------------------|----------------|-----------------|-------------|-------------|------------------|------------------------|---------------------|
| 1   | 1.5481E+10        | .1749          | 537.8           | 101.1       | 1           | 151834E+11       | .0055                  | 1.51834E+11         |
| 2   | 1.6232E+10        | .1451          | 537.8           | 283.8       | 3           | 1.52230E+11      | .0043                  | 1.52230E+11         |
| 3   | 1.6092E+10        | .1284          | 537.8           | 558.3       | 4           | 1.53362E+11      | .0043                  | 1.53362E+11         |
| 4   | 1.7783E+10        | .1414          | 519.0           | 108.6       | 2           | 1.56139E+11      | .0045                  | 1.56139E+11         |
| 5   | 1.7783E+10        | .0917          | 519.0           | 238.3       | 3           | 1.56798E+11      | .0032                  | 1.56798E+11         |
| 6   | 1.7849E+10        | .0871          | 519.0           | 565.3       | 4           | 1.57248E+11      | .0033                  | 1.57248E+11         |
| 7   | 1.9764E+10        | .0673          | 482.2           | 104.2       | 2           | 1.60957E+11      | .0027                  | 1.60957E+11         |
| 8   | 2.2275E+10        | .0669          | 482.2           | 292.3       | 3           | 1.61944E+11      | .0028                  | 1.61944E+11         |
| 9   | 2.3036E+10        | .0818          | 482.2           | 576.1       | 4           | 1.64389E+11      | .0028                  | 1.64389E+11         |
| 10  | 1.8288E+10        | .0818          | 482.2           | 105.4       | 2           | 1.65358E+11      | .0021                  | 1.65358E+11         |
| 11  | 2.2487E+10        | .0569          | 482.2           | 295.9       | 3           | 1.65870E+11      | .0022                  | 1.65870E+11         |
| 12  | 2.3638E+10        | .0569          | 482.2           | 583.2       | 4           | 1.65870E+11      | .0022                  | 1.65870E+11         |

Figure 1.54(a) Reduced Test Data .004 Inch Mag-Spinel, 25mv rms Excitation.

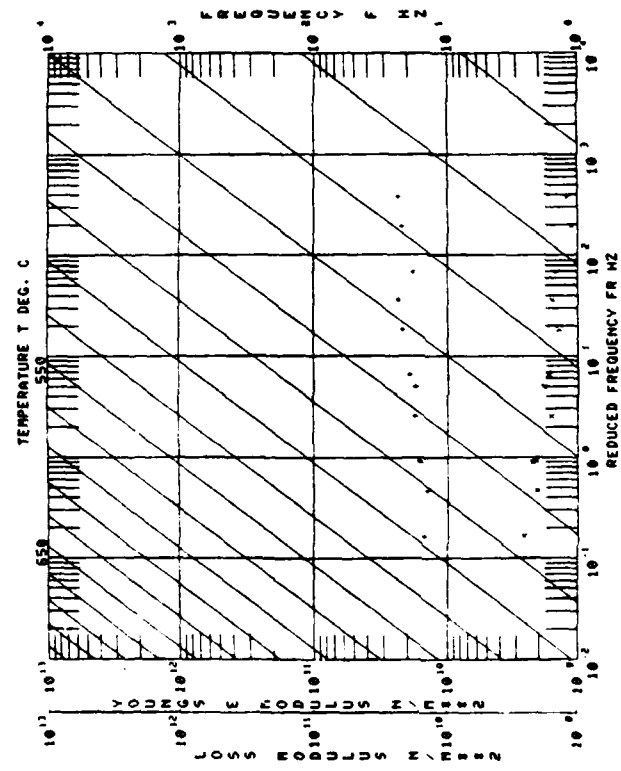

Figure 1.54(b) Loss Modulus-Reduced Frequency Nomograph  
 0.004 Inch Mag-Spinel  
 25mv rms Excitation.

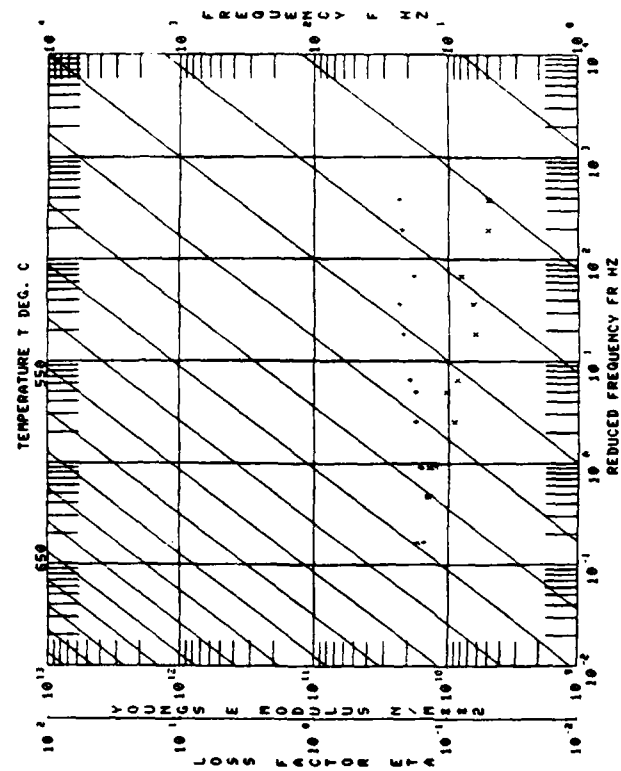

Figure 1.54(c) Loss Factor-Reduced Frequency Nomograph  
 0.004 Inch Mag-Spinel  
 25mv rms Excitation.

CONFIGURATION TYPE 2  
 DAMPING LAYER THICKNESS .00400 DENSITY .10838  
 BEAM LENGTH 8.75000 THICKNESS .04400 DENSITY .28100

| NO. | MODULUS<br>N/IN <sup>2</sup> | LOSS<br>FACTOR | TEMP.<br>DEG. C | FREQ.<br>MC | MODE<br>NO. | BEAM MOD.<br>LOSS FAC. | COMPOSITE<br>LOSS FAC. | BEAM FREQ.<br>HZ | LOSS MOD.<br>N/IN <sup>2</sup> |
|-----|------------------------------|----------------|-----------------|-------------|-------------|------------------------|------------------------|------------------|--------------------------------|
| 1   | 1.72687E+10                  | .1457          | 537.8           | 101.2       | 3           | 1.51634E+11            | .0451                  | 101.2            | 2.51549E+09                    |
| 2   | 1.43373E+10                  | .1278          | 537.8           | 283.7       | 3           | 1.21634E+11            | .0437                  | 284.4            | 1.82141E+09                    |
| 3   | 1.60301E+10                  | .0912          | 537.8           | 553.4       | 4           | 1.51634E+11            | .0431                  | 558.3            | 1.54382E+09                    |
| 4   | 1.58741E+10                  | .1463          | 510.0           | 103.6       | 2           | 1.21634E+11            | .0436                  | 102.7            | 2.22240E+09                    |
| 5   | 1.79251E+10                  | .0825          | 510.0           | 285.3       | 3           | 1.51634E+11            | .0439                  | 285.1            | 1.47940E+09                    |
| 6   | 1.84677E+10                  | .0861          | 510.0           | 562.3       | 4           | 1.57140E+11            | .0434                  | 565.5            | 1.58827E+09                    |
| 7   | 1.81580E+10                  | .1147          | 482.2           | 104.0       | 2           | 1.54457E+11            | .0430                  | 103.9            | 2.08209E+09                    |
| 8   | 2.14328E+10                  | .0691          | 482.2           | 293.0       | 3           | 1.61044E+11            | .0435                  | 291.9            | 1.48449E+09                    |
| 9   | 2.33738E+10                  | .0639          | 482.2           | 575.5       | 2           | 1.51345E+11            | .0432                  | 571.9            | 1.49125E+09                    |
| 10  | 1.65543E+10                  | .1104          | 454.4           | 105.2       | 2           | 1.54368E+11            | .0435                  | 105.3            | 1.66098E+09                    |
| 11  | 2.11994E+10                  | .0536          | 454.4           | 296.5       | 3           | 1.65255E+11            | .0423                  | 295.7            | 1.13676E+09                    |
| 12  | 2.32767E+10                  | .0446          | 454.4           | 583.1       | 4           | 1.65570E+11            | .0419                  | 580.3            | 1.03719E+09                    |

Figure 1.55(a) Reduced Test Data, 0.004 Inch  
 Mag-Spinel, 50mv rms Excitation.

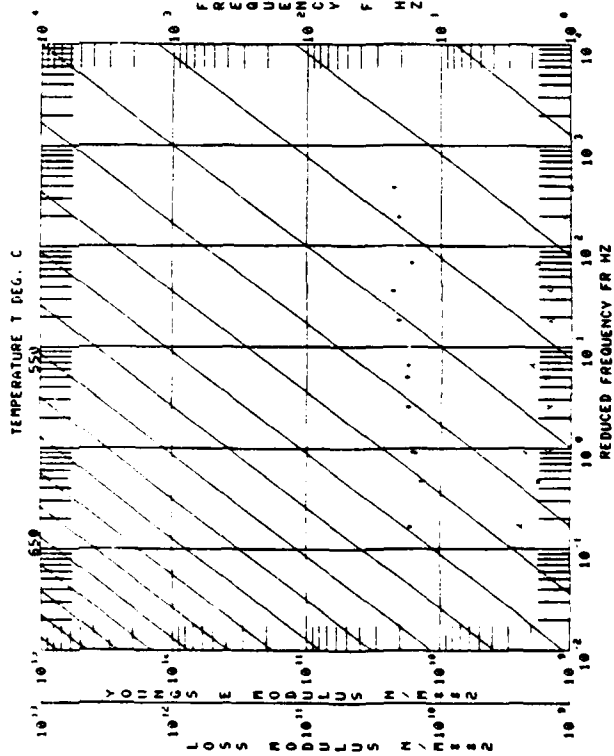

Figure 1.55(b) Loss Modulus-Reduced  
 Frequency Nomograph  
 0.004 Mag-Spinel  
 50mv rms Excitation.

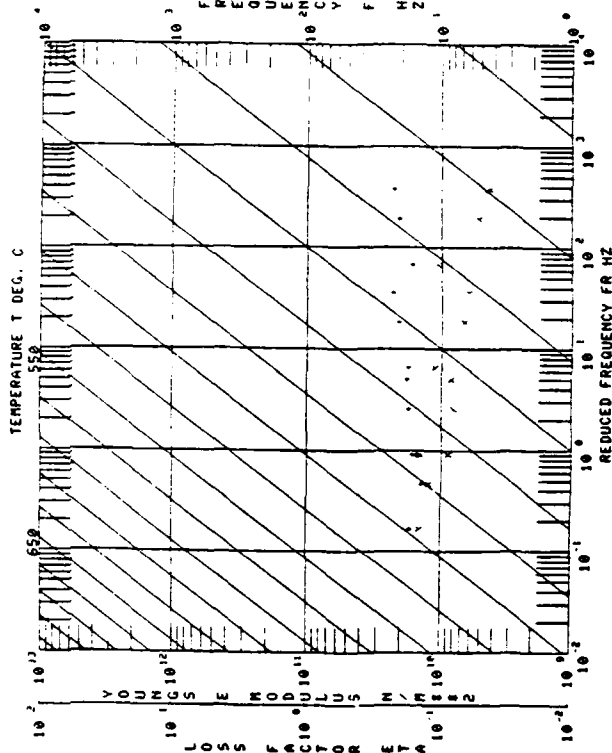

Figure 1.55(c) Loss Factor-Reduced  
 Frequency Nomograph  
 0.004 Mag-Spinel  
 50mv rms Excitation.

CONFIGURATION TYPE 2  
 DAMPING LAYER THICKNESS .00400 DENSITY .10632  
 BEAM LENGTH 8.75000 THICKNESS .04400 DENSITY .28100

| NO. | MODULUS<br>M/MS <sup>2</sup> | LOSS<br>FACTOR | TEMP.<br>DEG. C | FREQ.<br>HZ | MODE<br>NO. | BEAM MOD.<br>N/MS <sup>2</sup> | COMPOSITE<br>LOSS FAC. | BEAM FREQ.<br>HZ | LOSS MOD.<br>M/MS <sup>2</sup> |
|-----|------------------------------|----------------|-----------------|-------------|-------------|--------------------------------|------------------------|------------------|--------------------------------|
| 1   | 1.73342E+10                  | .1480          | 537.8           | 101.3       | 2           | 1.51634E+11                    | .0053                  | 191.2            | 2.55536E+09                    |
| 2   | 1.47375E+10                  | .1304          | 537.8           | 283.9       | 3           | 1.52876E+11                    | .0030                  | 234.4            | 1.92237E+09                    |
| 3   | 1.67204E+10                  | .1190          | 537.8           | 558.3       | 4           | 1.53352E+11                    | .0040                  | 558.3            | 1.90076E+09                    |
| 4   | 1.58241E+10                  | .1554          | 510.0           | 162.6       | 2           | 1.56139E+11                    | .0052                  | 182.7            | 2.62532E+09                    |
| 5   | 1.80238E+10                  | .1017          | 510.0           | 238.3       | 3           | 1.56798E+11                    | .0036                  | 283.1            | 1.83728E+09                    |
| 6   | 1.82618E+10                  | .0757          | 510.0           | 566.1       | 4           | 1.57346E+11                    | .0027                  | 565.5            | 1.38332E+09                    |
| 7   | 1.75592E+10                  | .1206          | 482.2           | 194.0       | 2           | 1.60057E+11                    | .0041                  | 193.9            | 2.13006E+09                    |
| 8   | 2.05880E+10                  | .0768          | 482.2           | 292.8       | 3           | 1.61044E+11                    | .0030                  | 291.9            | 1.58223E+09                    |
| 9   | 2.31817E+10                  | .0667          | 482.2           | 575.7       | 4           | 1.61345E+11                    | .0029                  | 572.6            | 1.54402E+09                    |
| 10  | 1.54190E+10                  | .1339          | 454.4           | 105.1       | 2           | 1.64362E+11                    | .0030                  | 105.3            | 2.06482E+09                    |
| 11  | 1.27472E+10                  | .0655          | 454.4           | 296.2       | 3           | 1.65255E+11                    | .0024                  | 295.7            | 1.29365E+09                    |
| 12  | 2.23360E+10                  | .0039          | 454.4           | 582.6       | 4           | 1.65670E+11                    | .0018                  | 580.3            | 9.73900E+08                    |

Figure 1.56(a) Reduced Test Data, 0.004 Mag-Spinel  
 75mv rms Excitation.

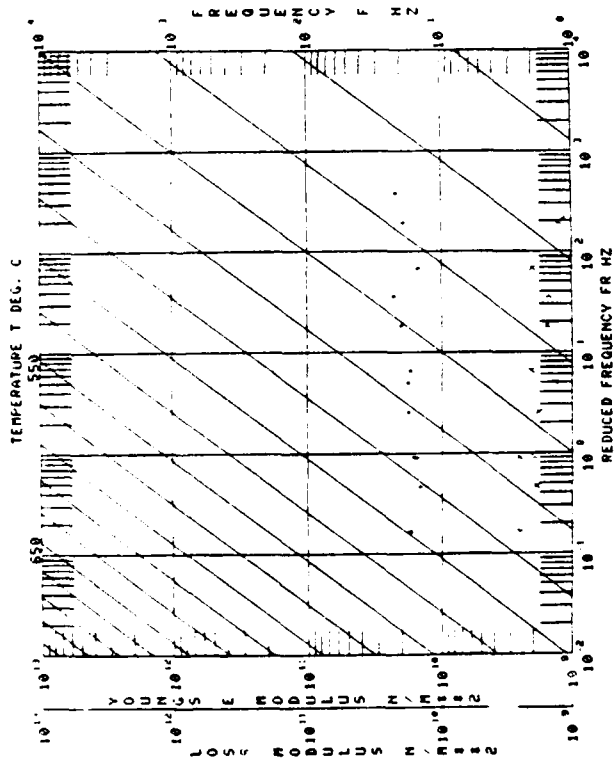

Figure 1.56(b) Loss Modulus-Reduced  
 Frequency Nomograph  
 0.004 Mag-Spinel  
 75mv rms Excitation.

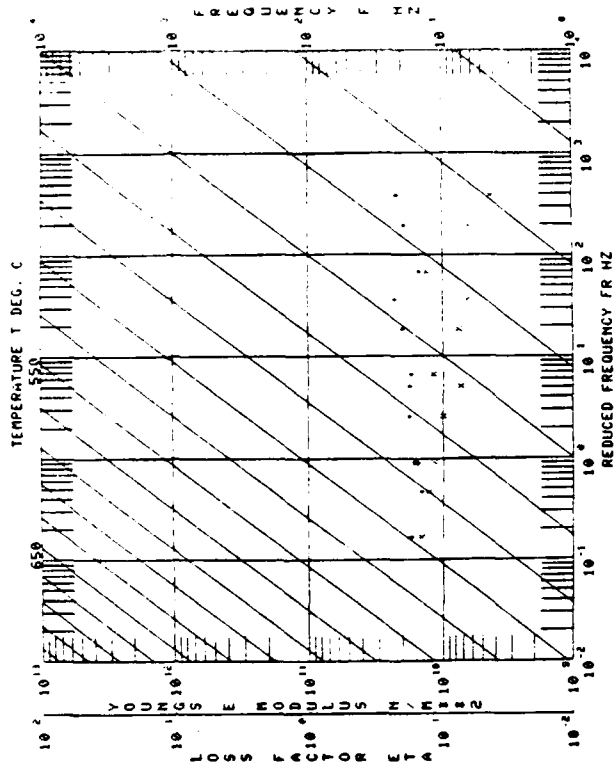

Figure 1.56(c) Loss Factor-Reduced  
 Frequency Nomograph  
 0.004 Mag-Spinel  
 75mv rms Excitation.

CONFIGURATION TYPE 2  
 DAMPING LAYER THICKNESS .01000 DENSITY .16838  
 BEAM WIDTH 8.75000 THICKNESS .24400 DENSITY .28100

| NO. | MODULUS<br>N/IN <sup>2</sup> | LOSS<br>FACTOR | TEMP.<br>DEG. C | FREQ.<br>MC | MODE<br>NO. | BEAM MOD.<br>N/IN <sup>2</sup> | COMPOSITE<br>LOSS FAC. | BEAM FREQ.<br>MC | LOSS MOD.<br>N/IN <sup>2</sup> |
|-----|------------------------------|----------------|-----------------|-------------|-------------|--------------------------------|------------------------|------------------|--------------------------------|
| 1   | 2.86638E+10                  | .0366          | 539.9           | 105.0       | 3           | 1.50932E+11                    | .0047                  | 104.9            | 8.68542E+08                    |
| 2   | 2.85088E+10                  | .0371          | 538.9           | 205.6       | 4           | 1.29932E+11                    | .0059                  | 221.7            | 2.16652E+08                    |
| 3   | 2.82018E+10                  | .0378          | 538.0           | 379.3       | 4           | 1.29932E+11                    | .0059                  | 373.0            | 9.51182E+08                    |
| 4   | 2.78101E+10                  | .0387          | 536.0           | 602.6       | 2           | 1.24107E+11                    | .0073                  | 402.8            | 7.50082E+08                    |
| 5   | 2.73292E+10                  | .0397          | 534.0           | 882.4       | 4           | 1.24107E+11                    | .0073                  | 525.8            | 6.23172E+08                    |
| 6   | 2.68523E+10                  | .0408          | 492.3           | 107.4       | 4           | 1.20625E+11                    | .0078                  | 189.8            | 6.55232E+08                    |
| 7   | 2.63734E+10                  | .0420          | 482.3           | 300.2       | 7           | 1.20625E+11                    | .0078                  | 203.6            | 8.80472E+08                    |
| 8   | 2.58925E+10                  | .0433          | 482.3           | 539.6       | 4           | 1.20625E+11                    | .0078                  | 222.6            | 3.80472E+08                    |
| 9   | 2.54136E+10                  | .0447          | 481.4           | 843.7       | 2           | 1.20625E+11                    | .0078                  | 185.4            | 5.30282E+08                    |
| 10  | 2.49347E+10                  | .0462          | 481.4           | 1188.2      | 2           | 1.20625E+11                    | .0078                  | 205.4            | 3.30282E+08                    |
| 11  | 2.44558E+10                  | .0478          | 481.4           | 1608.5      | 7           | 1.20625E+11                    | .0078                  | 277.9            | 4.30282E+08                    |
| 12  | 2.39769E+10                  | .0495          | 482.7           | 2108.5      | 2           | 1.20625E+11                    | .0078                  | 346.9            | 4.30282E+08                    |
| 13  | 2.34980E+10                  | .0513          | 482.7           | 2693.3      | 2           | 1.20625E+11                    | .0078                  | 428.9            | 3.59132E+08                    |
| 14  | 2.30191E+10                  | .0532          | 482.7           | 3373.3      | 4           | 1.20625E+11                    | .0078                  | 528.3            | 2.48782E+08                    |
| 15  | 2.25402E+10                  | .0552          | 482.7           | 4158.3      | 4           | 1.20625E+11                    | .0078                  | 658.3            | 2.48782E+08                    |

Figure 1.57(a) Reduced Test Data, 0.010 Mag-Spinel  
 25mv rms Excitation.

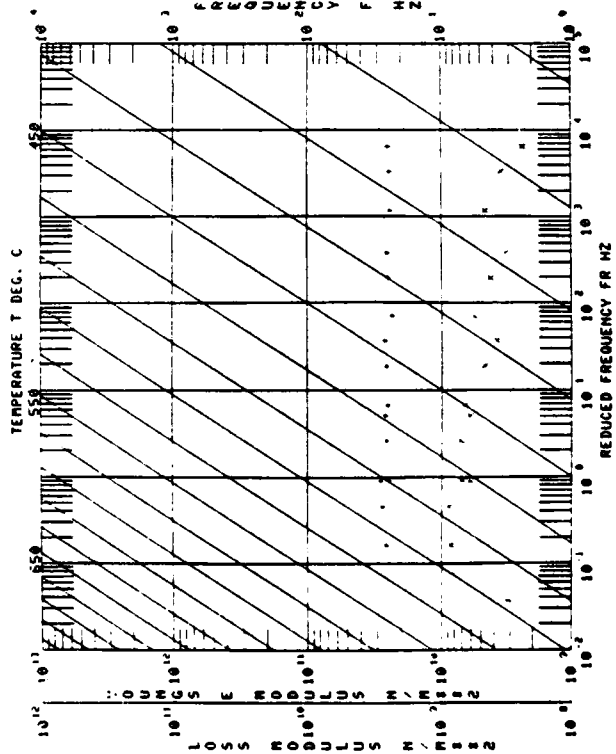

Figure 1.57(b) Loss Modulus-Reduced  
 Frequency Nomograph  
 0.010 Mag-Spinel  
 25mv rms Excitation.

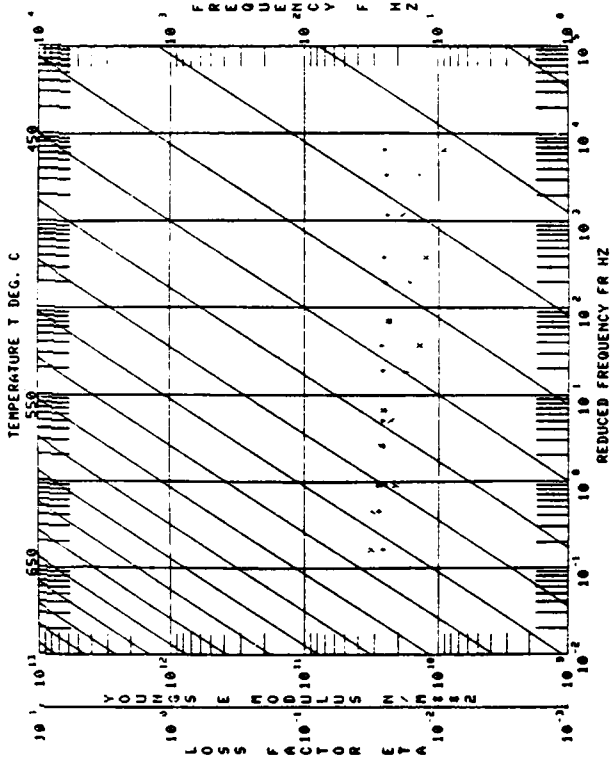

Figure 1.57(c) Loss Factor-Reduced  
 Frequency Nomograph  
 0.010 Mag Spinel  
 25mv rms Excitation.

CONFIGURATION TYPE 2  
 DAMPING LAYER THICKNESS 0.1000 DENSITY 10238  
 BEAM LENGTH 8.75000 SURFACE AREA 0.00000 TEMPERATURE 271000

| NO. | MODULUS<br>N/M <sup>2</sup> | LOSS<br>FACTOR | TEMP<br>DEG. C | FREQ.<br>HZ | PODE<br>NO. | BEAM MOD.<br>N/M <sup>2</sup> | COMPOSITE<br>LOSS FMC | BEAM FREQ.<br>HZ | LOSS MOD.<br>N/M <sup>2</sup> |
|-----|-----------------------------|----------------|----------------|-------------|-------------|-------------------------------|-----------------------|------------------|-------------------------------|
| 1   | 2.61748E+10                 | .0259          | 518.9          | 104.9       | 2.          | 1.50063E+11                   | .0451                 | 109.9            | 9.18761E+08                   |
| 2   | 2.84318E+10                 | .0263          | 518.9          | 294.5       | 3.          | 1.40077E+11                   | .0347                 | 281.7            | 8.76774E+08                   |
| 3   | 2.26019E+10                 | .0245          | 518.9          | 579.2       | 4.          | 1.58470E+11                   | .0033                 | 553.0            | 6.21187E+08                   |
| 4   | 2.20782E+10                 | .0215          | 518.9          | 105.5       | 2.          | 1.54150E+11                   | .0048                 | 102.0            | 8.20103E+08                   |
| 5   | 2.23282E+10                 | .0230          | 518.9          | 206.3       | 3.          | 1.54177E+11                   | .0027                 | 205.6            | 8.24256E+08                   |
| 6   | 2.24597E+10                 | .0249          | 518.9          | 582.3       | 4.          | 1.54645E+11                   | .0041                 | 569.6            | 5.99168E+08                   |
| 7   | 2.55098E+10                 | .0224          | 482.2          | 109.1       | 2.          | 1.58466E+11                   | .0031                 | 292.6            | 7.50990E+08                   |
| 8   | 2.74909E+10                 | .0177          | 482.2          | 303.6       | 4.          | 1.58956E+11                   | .0022                 | 563.4            | 4.24547E+08                   |
| 9   | 2.76575E+10                 | .0178          | 482.2          | 108.1       | 2.          | 1.64604E+11                   | .003E                 | 105.4            | 7.34193E+08                   |
| 10  | 2.55608E+10                 | .0128          | 454.4          | 303.6       | 3.          | 1.67716E+11                   | .0022                 | 294.4            | 4.30046E+08                   |
| 11  | 2.61712E+10                 | .0128          | 454.4          | 596.7       | 4.          | 1.64302E+11                   | .0017                 | 577.9            | 2.34573E+08                   |
| 12  | 2.63282E+10                 | .0250          | 426.7          | 109.4       | 2.          | 1.68798E+11                   | .0033                 | 106.6            | 6.52640E+08                   |
| 13  | 2.58152E+10                 | .0151          | 426.7          | 307.2       | 3.          | 1.68700E+11                   | .0019                 | 298.9            | 3.78781E+08                   |
| 14  | 2.55214E+10                 | .0079          | 426.7          | 603.3       | 4.          | 1.69143E+11                   | .0010                 | 586.3            | 2.00451E+08                   |

Figure 1.58(a) Reduced Test Data, 0.010 Mag-Spinel  
 50mv rms Excitation.

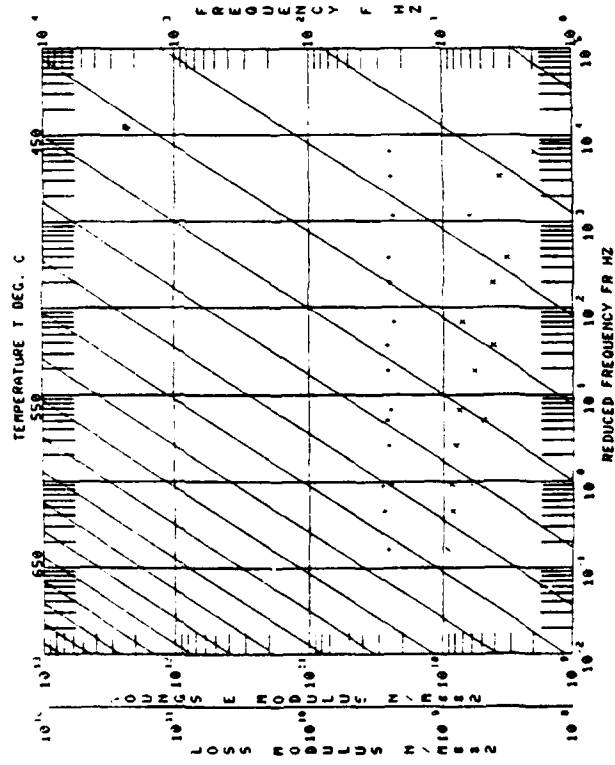

Figure 1.58(b) Loss Modulus-Reduced  
 Frequency Nomograph  
 0.010 Mag-Spinel  
 50mv rms Excitation.

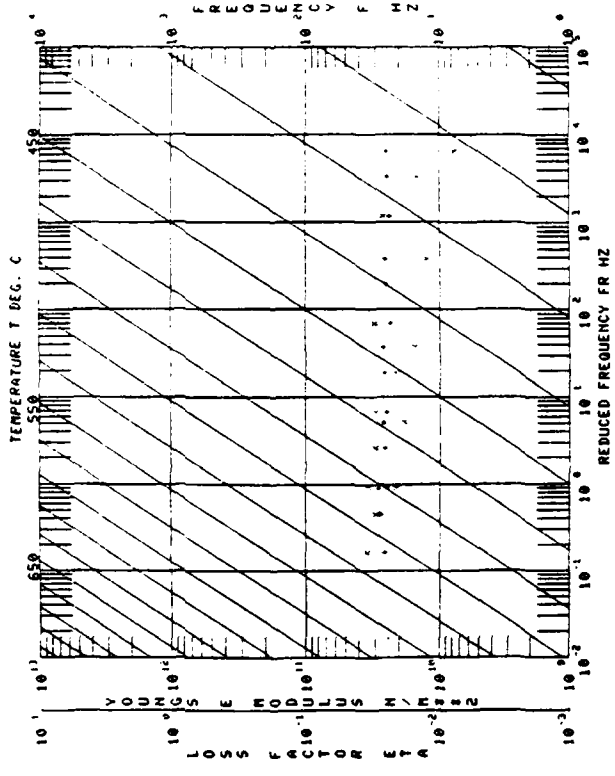

Figure 1.58(c) Loss Factor-Reduced  
 Frequency Nomograph  
 0.010 Mag-Spinel  
 50mv rms Excitation.

CONFIGURATION TYPE 2  
 DAMPING LAYER THICKNESS .0100 DENSITY .10838  
 BEAM LENGTH 8.75000 THICKNESS .04400 DENSITY .28100

| NO. | MODULUS<br>N/MTX2 | LOSS<br>FACTOR | TEMP.<br>DEG. C | FREQ.<br>HZ | MODE<br>NO. | BEAM MOD.<br>N/MTX2 | COMPOSITE<br>LOSS FAC. | BEAM FREQ.<br>HZ | LOSS MOD.<br>N/MTX2 |
|-----|-------------------|----------------|-----------------|-------------|-------------|---------------------|------------------------|------------------|---------------------|
| 1   | 2.55777E+10       | .0444          | 538.9           | 104.7       | 2.          | 1.50963E+11         | .0062                  | 100.9            | 1.13559E+09         |
| 2   | 2.81772E+10       | .0324          | 538.9           | 294.3       | 3.          | 1.49937E+11         | .0049                  | 231.7            | 9.12168E+08         |
| 3   | 2.91379E+10       | .0213          | 538.9           | 579.1       | 4.          | 1.50470E+11         | .0033                  | 553.0            | 6.20863E+08         |
| 4   | 2.61189E+10       | .0308          | 510.0           | 296.2       | 3.          | 1.54117E+11         | .0043                  | 285.6            | 9.04086E+08         |
| 5   | 2.66920E+10       | .0219          | 510.0           | 582.1       | 4.          | 1.54645E+11         | .0031                  | 560.6            | 5.33963E+08         |
| 6   | 2.46857E+10       | .0444          | 482.2           | 105.7       | 2.          | 1.58625E+11         | .0058                  | 103.5            | 1.09693E+09         |
| 7   | 2.83282E+10       | .0233          | 482.2           | 299.9       | 3.          | 1.58486E+11         | .0032                  | 229.6            | 6.12765E+08         |
| 8   | 2.70093E+10       | .0179          | 482.2           | 589.5       | 4.          | 1.58956E+11         | .0025                  | 563.4            | 4.82440E+08         |
| 9   | 2.30942E+10       | .0391          | 454.4           | 107.9       | 3.          | 1.64504E+11         | .0047                  | 105.4            | 9.84007E+08         |
| 10  | 2.5422E+10        | .0200          | 454.4           | 303.4       | 4.          | 1.63716E+11         | .0026                  | 234.4            | 5.07240E+08         |
| 11  | 2.59804E+10       | .0129          | 454.4           | 596.4       | 4.          | 1.64302E+11         | .0017                  | 577.9            | 3.34081E+08         |
| 12  | 2.36409E+10       | .0350          | 426.7           | 106.2       | 3.          | 1.68398E+11         | .0042                  | 106.6            | 8.26959E+08         |
| 13  | 2.4659E+10        | .0177          | 426.7           | 306.9       | 3.          | 1.68760E+11         | .0022                  | 239.9            | 4.37308E+08         |
| 14  | 2.54618E+10       | .0142          | 426.7           | 603.2       | 4.          | 1.69143E+11         | .0013                  | 586.3            | 2.60467E+08         |
| 15  | 2.47766E+10       | .0351          | 510.0           | 105.4       | 2.          | 1.54120E+11         | .0051                  | 102.0            | 9.43278E+08         |

Figure 1.59(a) Reduced Test Data, 0.010 Mag-Spinel  
 75mv<sub>rms</sub> Excitation.

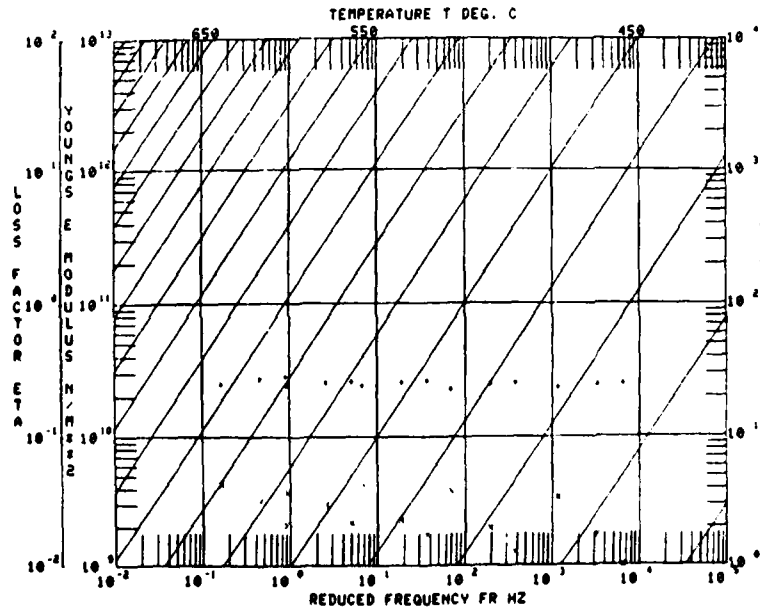

Figure 1.59(b) Loss Factor-Reduced Frequency  
 Nomograph, 0.010 Mag-Spinel  
 75mv<sub>rms</sub> Excitation.



### 1.3. MATERIAL DATA COMPUTER PROGRAMS

#### 1.3.1. Vibration Damping Material Property Reduction and Display Computer Program

The computer programs for determining and displaying the dynamics modulus properties of vibration damping materials have been updated and expanded as required. To keep these programs small enough to run on the Hewlett-Packard 2100 they were subdivided into four stand alone routines as described in Table 1.5 and Figure 1.60.

Figure 1.60 shows the interrelationship between the computer programs "REDUC", "CURVE", "MPROP", and "PREDC", and Table 1.5 lists the input, function, and output of the programs. Beam test data are entered into the data reduction program "REDUC", where material modulus, loss factor, and loss modulus are calculated. The reduced data is stored in a data file on disc where it is accessible by "REDUC" (for data editing and displaying test and/or reduced data), "CURVE", and "MPROP". Reduced data may be plotted on a reduced temperature nomogram, and curves fit to the data in the program "CURVE". Curve parameters are stored in data files on the disk where they are accessible to "CURVE" (for nomogram manipulation), "MPROP", and "PREDC". Program "MPROP" may be used to display the reduced data, nomograms, or material properties at any temperature and frequency. Program "PREDC" may be used to predict the structural dynamics of composite structures. The predictions are based on 4th beam theory.

User manuals with sample input/output for these four manuals are available upon request as listed in Table 1.6.

#### 1.3.2. Additional Material Computer Programs

The following computer programs were developed to operate on the HP2100 minicomputer.

(1) "BECK 1"

"BECK 1" is a computer program written for the 2100 DOS-III System to allow several materials to be plotted in nomogram form on a single nomogram. To accomplish this the temperature scale was converted to temperature relative to  $T(\text{zero})$  e.g.  $T_0 + 10$ .

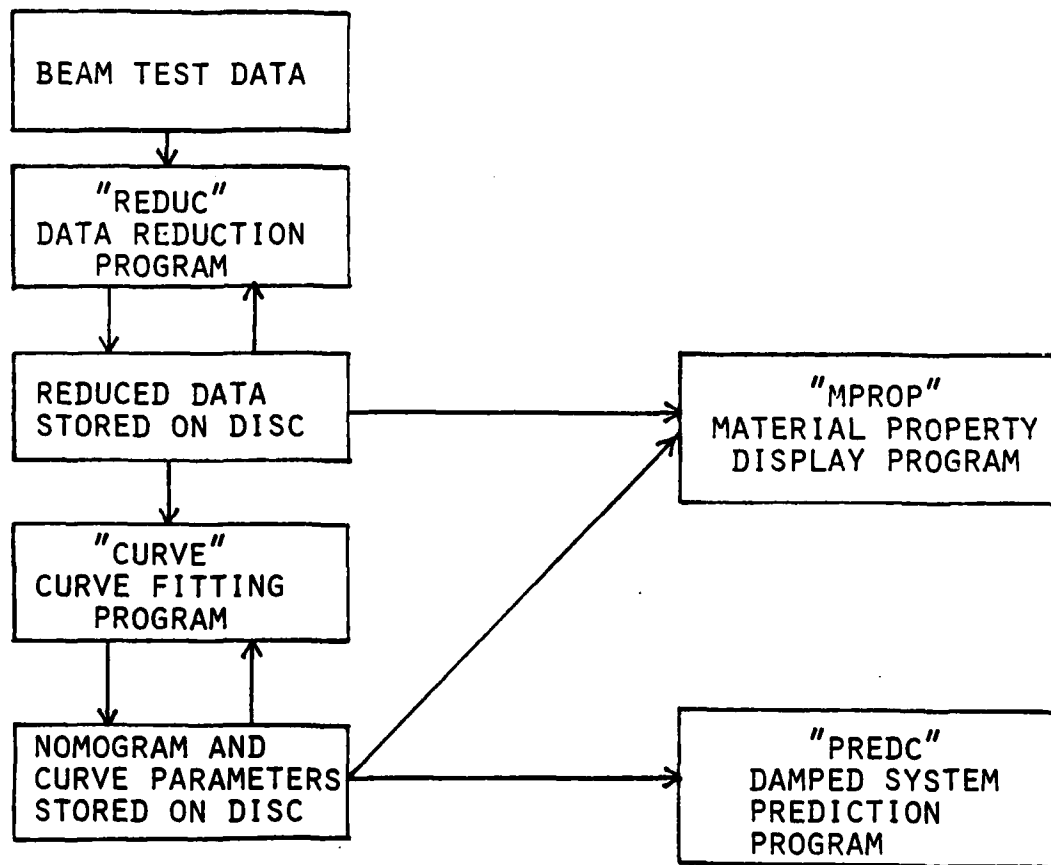

Figure 1.60. The Interrelationship Between the Computer Programs "REDUC", "CURVE", "MPROP" and "PREDC".

(2) "SETT $\phi$ "  
 "SETT $\phi$ " is a program which allows T zero to be defined rapidly. This time for defining the Dynamic Modulus Equations in the "CURVE" program is greatly reduced by running "SETT $\phi$ " before Curve fitting T zero.

(3) "HOP99"  
 "HOP99" allows up to four combinations of material and temperature to be plotted in material loss factor versus frequency form.

TABLE 1.5  
 CAPABILITIES OF MATERIAL EVALUATION AND  
 STRUCTURAL PREDICTION PROGRAMS

| Program | Input   | Function  | Output  |
|---------|---|---|---|
| REDUC   | Damping Material Beam Test Data   | Reduce experimental test data to material properties                            | Material property data for specific temperatures and frequencies; data files VIBE |
| CURVE   | Material property data for specific temperatures and frequencies; data files VIBE           | Develop reduced temperature nomogram material property, and equation parameters | Reduced temperature nomogram and equation parameter; data files VIBR              |
| MPROP   | Reduced temperature nomogram equation parameters; data file VIBR                            | Display material properties in any form   | Material property lists and plots   |
| PREDC   | Reduced temperature nomogram equation parameters, structural configuration; data files VIBR | Predict damping design effectiveness for simple beam and plate structures       | Structural loss factor for various design parameters                              |

TABLE 1.6  
 USER PROGRAM MANUALS

| Program | UDRI-TR Number | Title  |
|---------|----------------|--|
| REDUC   | UDR-TR-82-12   | User Manual with Sample Input/Output for Material Data Reduction Program (REDUC)   |
| CURVE   | UDR-TR-82-13   | User Manual with Sample Input/Output for Material Data Curve Fit Program (CURVE)   |
| MPROP   | UDR-TR-82-14   | User Manual with Sample Input/Output for Material Property Display Program (MPROP) |
| PREDC   | UDR-TR-82-15   | User Manual with Sample Input/Ourput for Damped System Prediction Program (PREDC)  |

#### 1.4 TESTING OF DAMPED SPACE SHUTTLE TEST BEAMS

Several small damped sandwich beams were sent to UDRI to be tested as part of a program to evaluate the effects of the space environment on damping materials. The beams were to be evaluated before being carried aboard the space shuttle, then again after the return. The beams consisted of various combinations of aluminum, graphite-epoxy, and damping materials, as shown in Table 1.8.

The beams were difficult to evaluate because of their small size (3.5 inches long) and poor design (no integral roots, no place to attach roots).

A pin-free test set-up was developed for testing the damped beams. This test set-up is shown in Figure 1.61. The beams are glued to an aluminum rod, which rests on two knife edges. Drive is provided by a noncontacting magnetic transducer at the free end. Initially, the response was measured with an accelerometer, but it was determined that mass loading could be a problem, due to the extremely small size of the beams. To eliminate this problem, the accelerometer was replaced with a non-contacting capacitance probe. Table 1.7.

TABLE 1.7  
PREDICTED AND MEASURED CENTER FREQUENCIES  
OF ALUMINUM SHUTTLE BEAM

| MODE | PREDICTED<br>FREQUENCY | MEASURED FREQUENCY |                |
|------|------------------------|--------------------|----------------|
|      |                        | ACCELEROMETER      | NON-CONTACTING |
| 1    | 539                    | 536                | 540            |
| 2    | 1748                   | 1715               | 1724           |

All of the test beams were characterized at room temperature using the pin-free test system. There are eight damping configurations each with five identical beams. The two most closely matched beams from each group of five were selected for further testing.

TABLE 1.8  
CONSTRUCTION OF SHUTTLE TEST BEAMS

| Beam Material  | Damping Material | Damping Layer Thickness |
|----------------|------------------|-------------------------|
| graphite-epoxy | ISD-113          | 0.002"                  |
| " "            | ISD-113          | 0.010"                  |
| " "            | ISD-112          | 0.002"                  |
| " "            | ISD-110          | 0.010"                  |
| aluminum       | ISD-112          | 0.002"                  |
| "              | ISD-113          | 0.010"                  |
| "              | ISD-110          | 0.010"                  |
| "              | ISD-113          | 0.002"                  |

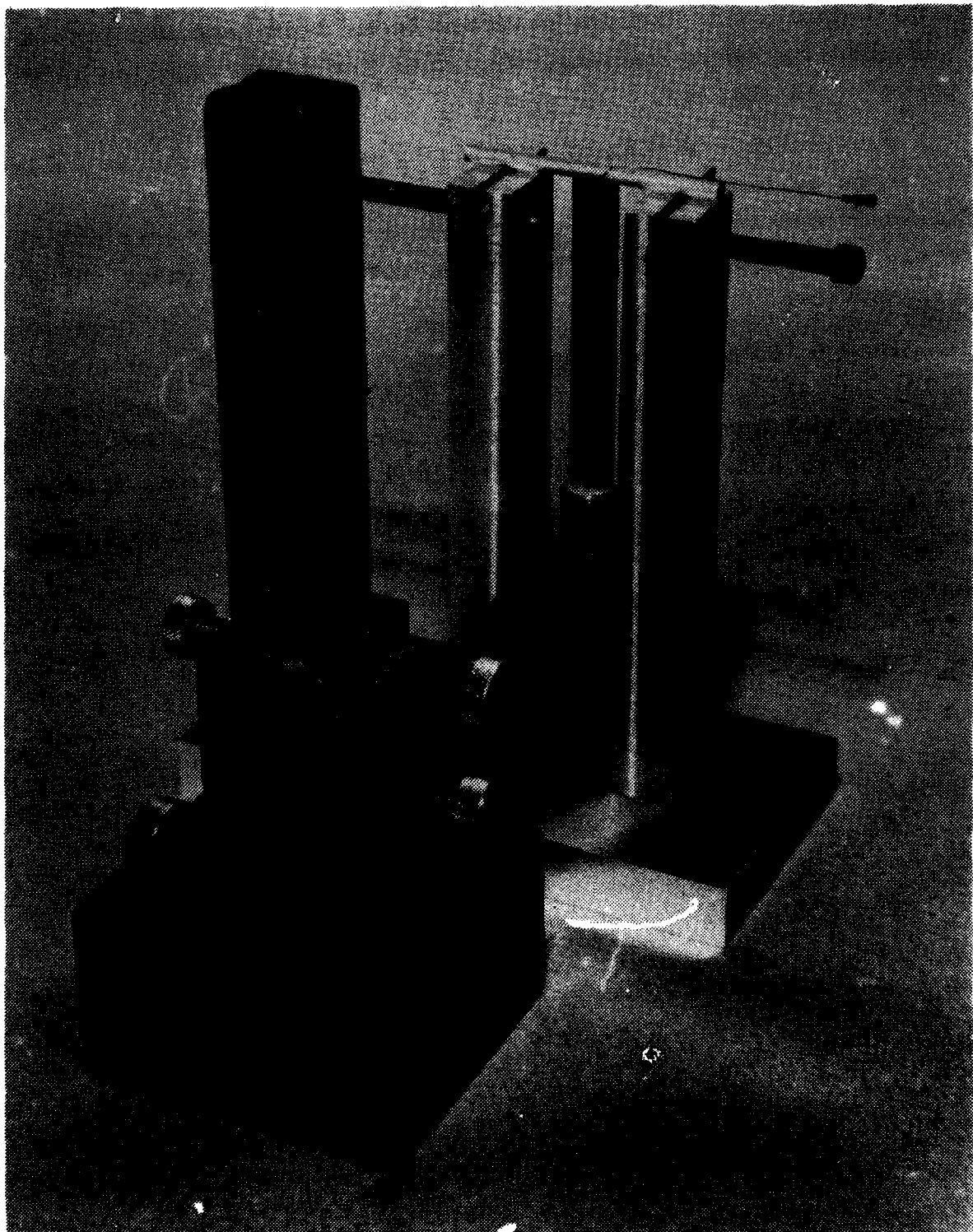

Figure 1.61. Test Set-Up for Pin-Free Beam Test

A computer analysis was performed to determine the temperature of peak damping and the temperatures of 70 percent peak damping, for each configuration. The two selected beams from each was tested at the appropriate three temperatures, then the first beam was retested to check repeatability.

A considerable amount of difficulty was encountered in collecting data caused by transducer positioning. The pin-free test set-up was modified such that the drive and response transducers were mounted directly to the test fixture to ensure more accurate positioning of the transducers.

Although this change helped, it was decided that more accurate data for comparison could be achieved by mounting the beams in a cantilever configuration. This was accomplished by gluing one end of the beam to an aluminum block attached to the vertical support posts of the fixture (Figures 1.62 and 1.63).

The cantilever test configuration greatly increased the repeatability of the data and the signal to noise ratio.

The results of these pre-flight shuttle beam tests are in Table 1.9.

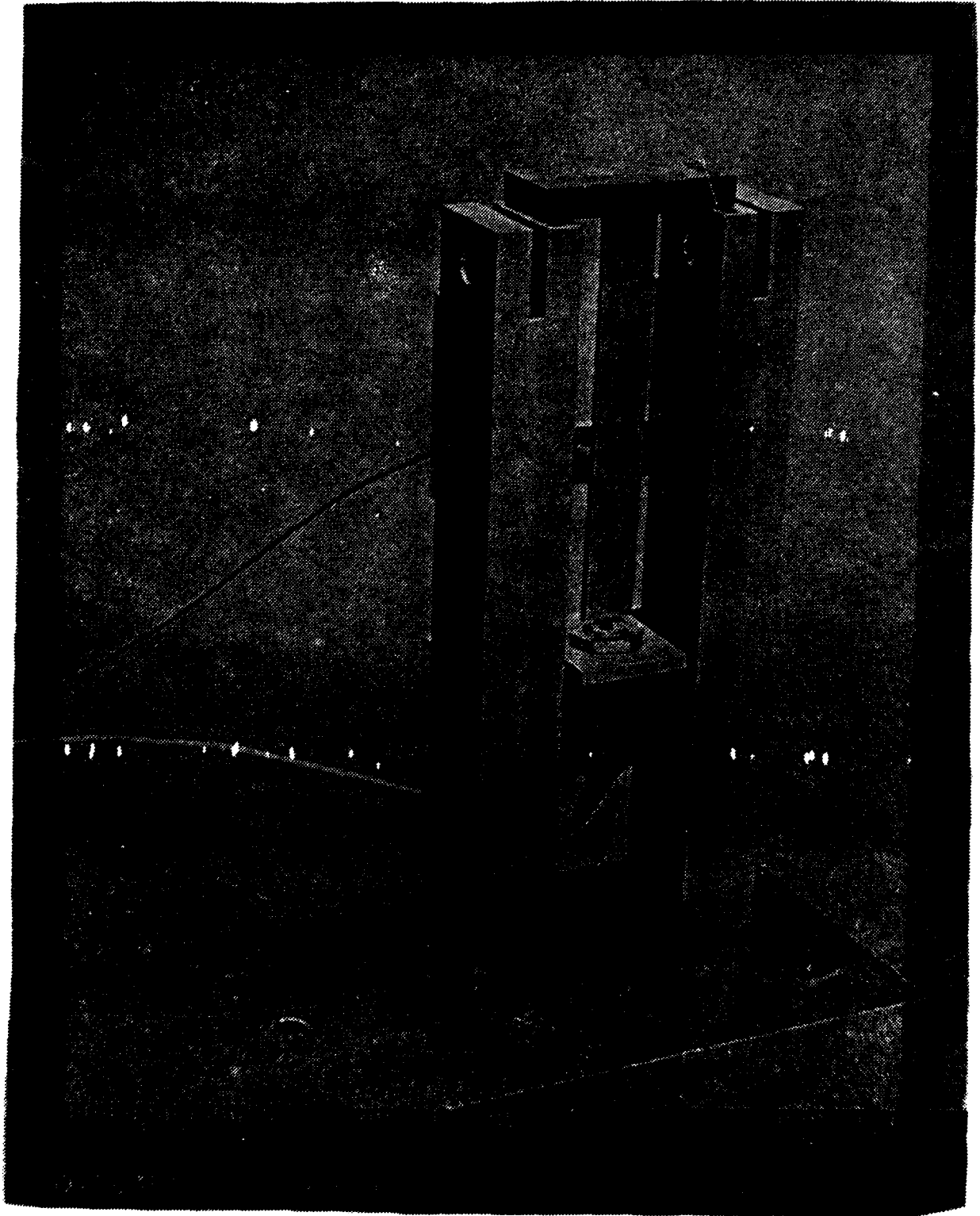

Figure 1.62. Modified Space Shuttle Beam Test Fixture Showing Location of Drive Transducer.



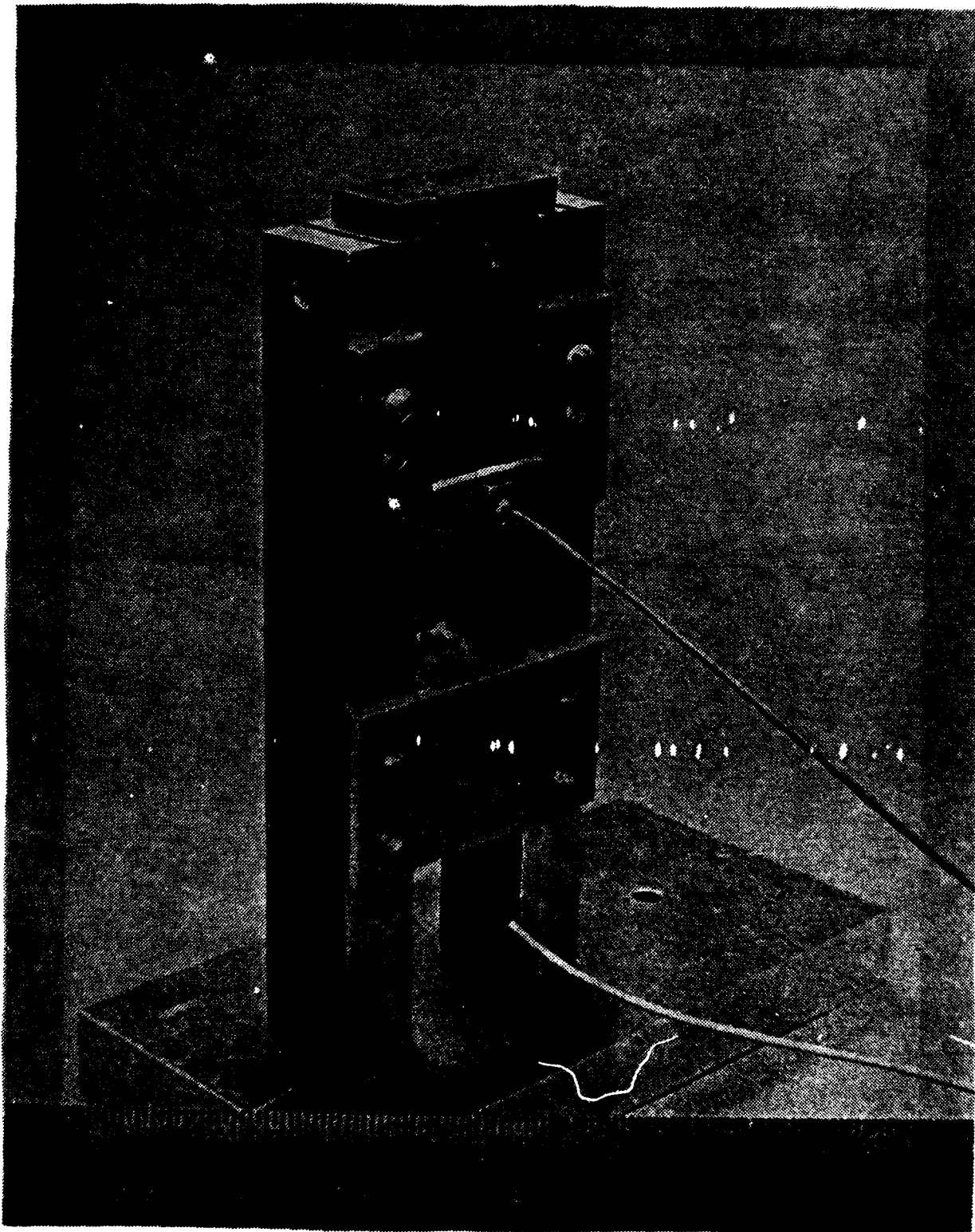

Figure 1.63. Modified Space Shuttle Beam Test Fixture Showing Location of Response Transducer.

TABLE 1.9  
SPACE SHUTTLE TEST BEAM DATA

| Batch I.D.        | Beam No. | °F | Mode   | $f_c$  | $f_L$  | $f_r$  | $\Delta f$ | $\eta$ |
|-------------------|----------|----|--------|--------|--------|--------|------------|--------|
| LDEF-1GE<br>112-2 | 2        | 42 | 1      | 131.5  | 128.2  | 134.5  | 6.3        | .0479  |
|                   |          |    | 2      | 803.3  | 793.8  | 816.2  | 22.4       | .0279  |
|                   |          |    | 3      | 2317.7 | 2310.6 | 2333.9 | 23.3       | .0101  |
|                   |          |    | 4      | 3923.2 | 3902.0 | 3957.5 | 55.5       | .0141  |
| 2                 | 136      | 1  | --     | --     | --     | --     | --         |        |
|                   |          | 2  | 434.1  | 409.5  | 473.9  | 64.4   | .1484      |        |
|                   |          | 3  | 1147.0 | 1072.1 | 1225.7 | 153.6  | .1339      |        |
|                   |          | 4  | 2257.6 | 2248.8 | 2270.2 | 21.4   | .0186      |        |
| 2                 | 70       | 1  | 191.0  | 189.5  | 193.1  | 3.6    | .0188      |        |
|                   |          | 2  | 1240.1 | 1227.1 | 1256.4 | 29.3   | .0236      |        |
|                   |          | 3  | 3347.5 | 3263.9 | 3490.0 | 211.7  | .0637      |        |
| 4                 | 42       | 1  | 133.4  | 131.0  | 135.5  | 4.5    | .0337      |        |
|                   |          | 2  | 803.5  | 794.2  | 829.2  | 35.0   | .0435      |        |
|                   |          | 3  | 2314.4 | 2304.2 | 2331.5 | 27.3   | .0118      |        |
|                   |          | 4  | 3928.7 | 3860.0 | 3952.8 | 92.8   | .0236      |        |
| 4                 | 70       | 1  | 195.3  | 193.5  | 198.4  | 4.9    | .0251      |        |
|                   |          | 2  | 1237.5 | 1222.1 | 1254.4 | 32.3   | .0261      |        |
|                   |          | 3  | 3315.4 | 3220.3 | 3451.5 | 231.2  | .0697      |        |
| 4                 | 88       | 1  | 188    | 186    | 190    | 4.0    | .0213      |        |
|                   |          | 2  | 1210   | 1189   | 1231   | 42     | .0347      |        |
|                   |          | 3  | 3223   | 3099   | 3350   | 251    | .0779      |        |
| 4                 | 136      | 1  | --     | --     | --     | --     | --         |        |
|                   |          | 2  | 443.9  | 406.6  | 475.9  | 69.3   | .1561      |        |
|                   |          | 3  | 1155.0 | 1143.8 | 1221.5 | 77.7   | .0673      |        |
|                   |          | 4  | 2299.2 | 2269.2 | 2310.3 | 41.1   | .0179      |        |
| 1                 | 70       | 1  | 189.6  | 187.3  | 192.2  | 4.9    | .0258      |        |
|                   |          | 2  | 1200.1 | 1186.2 | 1219.0 | 32.8   | .0273      |        |
|                   |          | 3  | 3247.3 | 3161.0 | 3329.6 | 168.6  | .0519      |        |
| 3                 | 70       | 1  | 201.0  | 198.4  | 204.9  | 6.5    | .0323      |        |
|                   |          | 2  | 1242.7 | 1229.5 | 1259.0 | 29.5   | .0237      |        |
|                   |          | 3  | 3323.8 | 3183.4 | 3395.1 | 211.7  | .0637      |        |

AD-A135 409

DAMPING MATERIALS FINITE ELEMENTS AND SPECIAL PROJECTS  
(U) DAYTON UNIV OH RESEARCH INST M RUDDLE ET AL.  
DEC 82 UDR-TR-82-110 AFMAL-TR-82-4167 F33615-79-C-5108

2/3

UNCLASSIFIED

F/G 14/2

NL

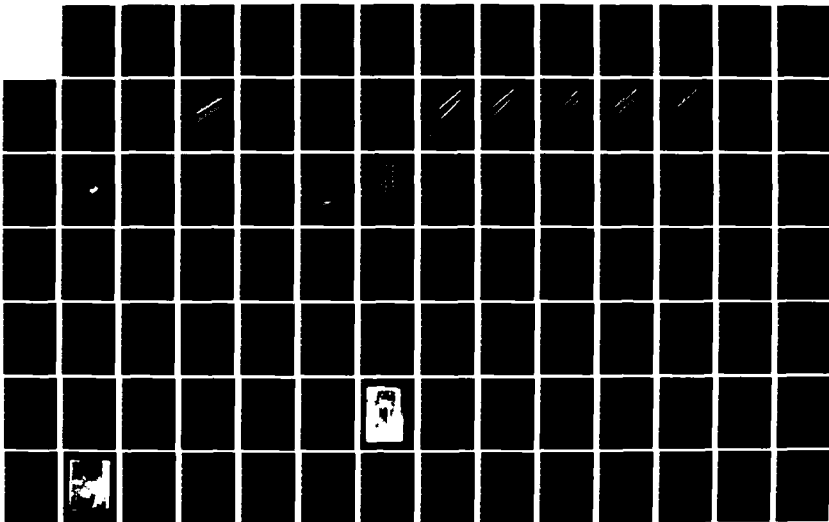

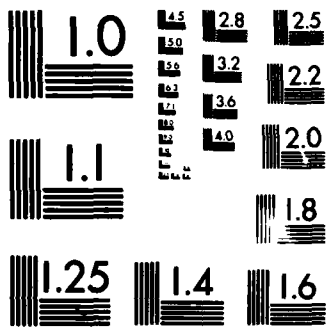

MICROCOPY RESOLUTION TEST CHART  
NATIONAL BUREAU OF STANDARDS-1963-A

TABLE 1.9  
(continued)

| Batch I.D.            | Beam No. | °F  | Mode    | $f_c$   | $f_L$   | $f_r$   | $\Delta f$ | $\eta$ |
|-----------------------|----------|-----|---------|---------|---------|---------|------------|--------|
| LDEF-<br>1GE<br>112-2 | 5        | 70  | 1       | 184.2   | 182.9   | 186.2   | 3.3        | .0179  |
|                       |          |     | 2       | 1226.8  | 1212.5  | 1245.2  | 32.7       | .0267  |
|                       |          |     | 3       | 3278.9  | 3156.6  | 3361.7  | 205.1      | .0625  |
| VEM<br>113<br>010     | 4        | -10 | 1       | 158.76  | 156.7   | 160.83  | 4.13       | .0260  |
|                       |          |     | 2       | 964.69  | 930.23  | 993.54  | 63.31      | .0656  |
|                       |          |     | 3       | 2554.69 | 2414.47 | 2673.33 | 258.86     | .1013  |
|                       |          |     | 4       | 4618.11 | 4227.41 | 4912.65 | 685.24     | .1484  |
| 4                     | 50       | 1   | 103.44  | 91.11   | 131.78  | 40.76   | .3940      |        |
|                       |          | 2   | 494.23  | 440.20  | 534.78  | 94.58   | .1914      |        |
|                       |          | 3   | 1255.87 | 1141.68 | 1396.5  | 254.82  | .2029      |        |
|                       |          | 4   | 2382.47 | 2120.09 | 2560.28 | 440.19  | .1848      |        |
| 4                     | 70       | 1   | 92.1    | 87.8    | 96.5    | 8.7     | .0945      |        |
|                       |          | 2   | 425.3   | 418.8   | 434.9   | 16.1    | .0379      |        |
|                       |          | 3   | 1207.5  | 1164.3  | 1250.3  | 86.0    | .0712      |        |
|                       |          | 4   | 2308.5  | 2233.4  | 2375.6  | 142.2   | .0616      |        |
| 4                     | 160      | 1   | 185.7   | 168.2   | 267.8   | 99.6    | .5363      |        |
|                       |          | 2   | 1208.7  | 1201.4  | 1220.2  | 18.8    | .0306      |        |
|                       |          | 3   | 2148.5  | 2116.9  | 2187.1  | 70.2    | .0328      |        |
| 5                     | -10      | 1   | 157.54  | 155.50  | 160.90  | 5.4     | .0343      |        |
|                       |          | 2   | 900.20  | 834.80  | 939.90  | 105.1   | .1167      |        |
|                       |          | 3   | 2481.65 | 2381.63 | 2598.43 | 216.8   | .1717      |        |
| 5                     | 50       | 1   | 103.69  | 91.93   | 134.34  | 42.41   | .4090      |        |
|                       |          | 2   | 488.50  | 439.34  | 526.37  | 87.03   | .1782      |        |
|                       |          | 3   | 1266.58 | 1151.81 | 1385.24 | 233.43  | .1843      |        |
|                       |          | 4   | 2331.27 | 2091.25 | 2503.39 | 412.14  | .1768      |        |
| 5                     | 70       | 1   | 92.2    | 86.9    | 97.0    | 10.1    | .1095      |        |
|                       |          | 2   | 462.4   | 445.8   | 474.2   | 28.4    | .0614      |        |
|                       |          | 3   | 1214.6  | 1175.6  | 1258.1  | 82.5    | .0680      |        |
|                       |          | 4   | 2299.5  | 2224.1  | 2368.7  | 144.6   | .0628      |        |
| 1                     | 70       | 1   | 73.9    | 67.8    | 89.8    | 22.0    | .2977      |        |
|                       |          | 2   | 418.4   | 394.4   | 447.9   | 53.5    | .1279      |        |
|                       |          | 3   | 1139.3  | 1088.7  | 1189.5  | 100.8   | .0885      |        |
|                       |          | 4   | 2186.6  | 2106.1  | 2259.2  | 153.1   | .0700      |        |

TABLE 1.9  
(continued)

| Batch<br>I.D.      | Beam<br>No. | °F  | Mode | $f_c$  | $f_L$  | $f_r$  | $\Delta f$ | $\eta$ |
|--------------------|-------------|-----|------|--------|--------|--------|------------|--------|
| VEM<br>113<br>010  | 2           | 70  | 1    | 81.0   | 73.9   | 86.7   | 12.8       | .1580  |
|                    |             |     | 2    | 438.2  | 425.5  | 450.3  | 24.8       | .0566  |
|                    |             |     | 3    | 1181.3 | 1127.8 | 1217.3 | 89.5       | .0758  |
|                    |             |     | 4    | 2209.3 | 2136.2 | 2286.3 | 150.1      | .0679  |
|                    | 3           | 70  | 1    | --     | --     | --     | --         | --     |
|                    |             |     | 2    | 435.6  | 412.9  | 462.2  | 49.3       | .1132  |
|                    |             |     | 3    | 1158.1 | 1112.9 | 1205.5 | 92.6       | .0800  |
|                    |             |     | 4    | 2254.9 | 2176.1 | 2335.2 | 159.1      | .0705  |
| VEM<br>112-<br>002 | 3           | 38  | 1    | 133.2  | 131.3  | 135.4  | 4.1        | .0308  |
|                    |             |     | 2    | 776.9  | 681.8  | 811.0  | 129.2      | .1663  |
|                    | 3           | 70  | 1    | 152.5  | 150.2  | 156.0  | 5.8        | .0380  |
|                    |             |     | 2    | 659.5  | 536.3  | 855.5  | 319.2      | .4840  |
|                    |             |     | 3    | 1575.3 | 1248.9 | 1780.2 | 531.3      | .3377  |
|                    | 3           | 138 | 2    | 441.5  | 398.0  | 483.2  | 85.2       | .1930  |
|                    |             |     | 3    | 1200.3 | 1160.4 | 1267.1 | 106.7      | .0889  |
|                    |             |     | 4    | 2246.7 | 2221.5 | 2288.2 | 66.7       | .0297  |
|                    |             |     | 5    | 3739.4 | 3672.4 | 3774.2 | 101.8      | .0272  |
|                    | 5           | 38  | 1    | 127.3  | 124.5  | 129.4  | 4.9        | .0385  |
|                    |             |     | 2    | 768.8  | 740.0  | 793.2  | 53.2       | .0692  |
|                    |             |     | 3    | 2109.2 | 1983.3 | 2188.1 | 204.8      | .0971  |
|                    | 5           | 70  | 1    | 122.0  | 112.6  | 134.2  | 21.6       | .1770  |
|                    |             |     | 2    | 670.6  | 623.2  | 781.4  | 158.2      | .4636  |
|                    |             |     | 3    | 1624.4 | 1398.5 | 1766.8 | 368.3      | .4456  |
|                    | 5           | 88  | 1    | 116.0  | 93.0   | 130.0  | 37.0       | .3190  |
|                    |             |     | 2    | 580.0  | 574.0  | 651.0  | 77.0       | .1328  |
|                    |             |     | 3    | 1510   | 1495   | 1540   | 45         | .0298  |
|                    | 5           | 138 | 2    | 442.4  | 409.7  | 474.7  | 65.0       | .1469  |
|                    |             |     | 3    | 1171.2 | 1109.8 | 1261.6 | 151.8      | .1296  |
|                    |             |     | 4    | 2263.1 | 2242.1 | 2338.9 | 96.8       | .0428  |
|                    |             |     | 5    | 3761.2 | 3701.0 | 3797.9 | 96.9       | .0258  |

TABLE 1.9  
(continued)

| Batch I.D.         | Beam No. | °F  | Mode    | $f_c$  | $f_L$  | $f_r$  | $\Delta f$ | $\eta$ |
|--------------------|----------|-----|---------|--------|--------|--------|------------|--------|
| VEM<br>112-<br>002 | 1        | 70  | 1       | 118.9  | 117.1  | 122.1  | 5.0        | .0421  |
|                    |          |     | 2       | 600.0  | 529.6  | 687.9  | 158.3      | .2638  |
|                    |          |     | 3       | 1550.6 | 1243.5 | 1724.8 | 481.3      | .3104  |
|                    | 2        | 70  | 1       | 140.5  | 131.8  | 151.3  | 19.5       | .1388  |
|                    |          |     | 2       | 672.4  | 553.3  | 795.6  | 242.3      | .3604  |
|                    |          |     | 3       | 1730.5 | 1431.3 | 1964.6 | 533.3      | .3082  |
|                    | 4        | 70  | 1       | 156.4  | 153.9  | 159.0  | 5.1        | .0326  |
|                    |          |     | 2       | 730.5  | 702.4  | 787.7  | 85.3       | .2294  |
|                    |          |     | 3       | 1639.4 | 1455.2 | 1781.2 | 326.0      | .3908  |
| VEM<br>110-<br>010 | 4        | 70  | 1       | 155.7  | 152.1  | 161.3  | 9.2        | .0591  |
|                    |          |     | 2       | 919.8  | 859.7  | 970.9  | 111.2      | .1209  |
|                    |          |     | 3       | 2395.0 | 2214.4 | 2550.4 | 336.0      | .1403  |
|                    | 4        | 78  | 1       | 153.4  | 149.1  | 157.9  | 8.8        | .0574  |
|                    |          |     | 2       | 910.4  | 851.7  | 962.3  | 110.6      | .1215  |
|                    |          |     | 3       | 2355.4 | 2183.4 | 2515.7 | 332.3      | .1411  |
|                    |          |     | 4       | 4024.2 | 3949.5 | 4067.8 | 118.3      | .0294  |
|                    | 4        | 114 | 1       | 94.5   | 92.7   | 99.2   | 6.5        | .0688  |
|                    |          |     | 2       | 690.0  | 678.6  | 749.4  | 70.8       | .1026  |
|                    |          |     | 3       | 1289.8 | 1280.9 | 1330.4 | 49.5       | .0384  |
|                    |          |     | 4       | 2628.7 | 2610.1 | 2682.5 | 72.4       | .0275  |
|                    | 4        | 150 | 3       | 1125.2 | 1119.5 | 1148.2 | 28.7       | .0501  |
| 4                  |          |     | 3623.6  | 3592.7 | 3647.6 | 54.9   | .0298      |        |
| 5                  |          |     | 5622.11 | 5171.8 | 6070.3 | 898.5  | .1598      |        |
| 5                  | 70       | 1   | 151.3   | 148.0  | 156.5  | 8.5    | .0562      |        |
|                    |          | 2   | 902.9   | 858.6  | 969.5  | 110.9  | .1228      |        |
|                    |          | 3   | 2332.5  | 2152.4 | 2486.4 | 334.0  | .1431      |        |
| 5                  | 78       | 1   | 148.4   | 144.2  | 153.1  | 8.9    | .0599      |        |
|                    |          | 2   | 895.5   | 851.6  | 960.7  | 109.1  | .1218      |        |
|                    |          | 3   | 2305.2  | 2127.2 | 2457.2 | 330.0  | .1432      |        |
| 5                  | 150      | 4   | 3809.0  | 3782.5 | 3925.4 | 42.9   | .0221      |        |
|                    |          | 5   | 5577.0  | 4833.4 | 5927.0 | 1093.6 | .1961      |        |

TABLE 1.9  
(continued)

| Batch I.D.               | Beam No. | °F  | Mode   | $f_c$  | $f_L$  | $f_r$  | $\Delta f$ | $\eta$ |
|--------------------------|----------|-----|--------|--------|--------|--------|------------|--------|
| VEM<br>110-<br>010       | 1        | 70  | 1      | 195.2  | 190.4  | 200.8  | 10.4       | .0533  |
|                          |          |     | 2      | 916.4  | 868.7  | 963.5  | 94.8       | .1034  |
|                          |          |     | 3      | 2362.7 | 2187.9 | 2503.2 | 315.3      | .1334  |
|                          | 2        | 70  | 1      | 159.3  | 155.7  | 165.7  | 10.0       | .0628  |
|                          |          |     | 2      | 909.7  | 826.5  | 951.9  | 125.4      | .1378  |
|                          |          |     | 3      | 2391.5 | 2156.6 | 2665.6 | 509.0      | .2128  |
|                          | 3        | 70  | 1      | 167.6  | 162.4  | 175.1  | 12.7       | .0758  |
|                          |          |     | 2      | 919.7  | 868.4  | 965.2  | 96.8       | .1053  |
|                          |          |     | 3      | 2394.5 | 2205.9 | 2526.2 | 320.3      | .1337  |
| LDEF<br>GE<br>110-<br>10 | 2        | 70  | 1      | 218.4  | 216.1  | 221.6  | 5.5        | .0252  |
|                          |          |     | 2      | 1394.8 | 1352.8 | 1440.6 | 87.8       | .0629  |
|                          |          |     | 3      | 3613.8 | 3463.9 | 3742.3 | 278.4      | .0770  |
|                          | 2        | 77  | 1      | 236.9  | 232.9  | 241.8  | 8.9        | .0376  |
|                          |          |     | 2      | 1378.4 | 1335.5 | 1448.5 | 113.0      | .0819  |
|                          |          |     | 3      | 3795.0 | 3748.0 | 3857.9 | 109.9      | .0289  |
|                          | 2        | 152 | 2      | 795.9  | 784.3  | 851.9  | 67.6       | .0849  |
|                          |          |     | 3      | 2203.6 | 2190.7 | 2231.4 | 40.7       | .0185  |
|                          |          |     | 4      | 3628.8 | 3573.8 | 3667.0 | 93.2       | .0257  |
|                          | 4        | 70  | 1      | 210.8  | 207.5  | 214.8  | 7.3        | .0346  |
|                          |          |     | 2      | 1360.1 | 1316.4 | 1433.0 | 116.6      | .0857  |
|                          |          |     | 3      | 3685.7 | 3418.3 | 3802.4 | 384.1      | .1042  |
|                          | 4        | 77  | 1      | 230.6  | 225.6  | 235.7  | 10.1       | .0438  |
|                          |          |     | 2      | 1376.4 | 1338.2 | 1454.6 | 116.4      | .0846  |
|                          |          |     | 3      | 3822.0 | 3760.1 | 3873.6 | 113.5      | .0297  |
|                          | 4        | 114 | 1      | 199.0  | 180.1  | 219.4  | 39.3       | .1975  |
|                          |          |     | 2      | 1081.4 | 941.1  | 1227.6 | 286.5      | .2649  |
|                          |          |     | 3      | 2716.2 | 2693.0 | 2893.6 | 200.6      | .0739  |
| 4                        | 152      | 2   | 784.3  | 779.2  | 842.7  | 63.5   | .0810      |        |
|                          |          | 3   | 2244.9 | 2230.0 | 2263.6 | 33.6   | .0150      |        |
|                          |          | 4   | 3633.4 | 3547.5 | 3687.5 | 140.0  | .0385      |        |



TABLE 1.9  
(continued)

| Batch I.D.                | Beam No. | °F  | Mode   | $f_c$  | $f_L$  | $f_r$  | $\Delta f$ | $\eta$ |
|---------------------------|----------|-----|--------|--------|--------|--------|------------|--------|
| LDEF<br>GE<br>110-<br>10  | 1        | 70  | 1      | 356.0  | 343.4  | 378.1  | 34.7       | .0975  |
|                           |          |     | 2      | 1420.5 | 1357.4 | 1468.5 | 111.1      | .0782  |
|                           |          |     | 3      | 3628.0 | 3458.7 | 3769.8 | 311.1      | .0857  |
|                           | 3        | 70  | 1      | 319.2  | 312.9  | 325.9  | 13.0       | .0407  |
|                           |          |     | 2      | 1408.6 | 1366.9 | 1463.2 | 96.3       | .0684  |
|                           |          |     | 3      | 3663.5 | 3476.3 | 3850.5 | 374.2      | .1021  |
|                           | 5        | 70  | 1      | 227.9  | 215.5  | 249.2  | 33.7       | .1479  |
|                           |          |     | 2      | 1429.8 | 1375.3 | 1473.4 | 98.1       | .0686  |
|                           |          |     | 3      | 3733.0 | 3541.7 | 3839.4 | 297.7      | .0797  |
| LDEF-<br>1GE<br>113<br>10 | 3        | -10 | 1      | 200.5  | 198.2  | 202.8  | 4.6        | .0229  |
|                           |          |     | 2      | 1317.5 | 1289.0 | 1336.1 | 47.1       | .0357  |
|                           |          |     | 3      | 3606.2 | 3520.7 | 3654.1 | 133.4      | .0370  |
|                           |          |     | 4      | 6725.9 | 6522.8 | 6854.0 | 331.2      | .0492  |
|                           | 3        | 48  | 1      | 175.4  | 154.9  | 195.6  | 40.7       | .2320  |
|                           |          |     | 2      | 896.4  | 729.0  | 1094.9 | 365.9      | .4082  |
|                           |          |     | 3      | 2140.7 | 2071.6 | 2331.0 | 259.4      | .2381  |
|                           | 3        | 70  | 1      | 145.5  | 131.9  | 177.5  | 45.6       | .3134  |
|                           |          |     | 2      | 705.1  | 606.9  | 784.5  | 177.6      | .2519  |
|                           |          |     | 3      | 1798.5 | 1654.8 | 2003.5 | 348.7      | .1938  |
|                           |          |     | 4      | 3340.0 | 2910.0 | 3733.0 | 823.0      | .2464  |
|                           | 4        | -10 | 1      | 211.4  | 209.8  | 213.3  | 3.5        | .0165  |
|                           |          |     | 2      | 1442.6 | 1424.1 | 1458.9 | 34.8       | .0241  |
|                           |          |     | 3      | 3819.3 | 3736.6 | 3873.3 | 136.7      | .0358  |
|                           |          |     | 4      | 7112.2 | 6773.8 | 7303.5 | 529.7      | .0745  |
|                           | 4        | 16  | 1      | 224.8  | 221.4  | 228.2  | 6.8        | .0302  |
| 2                         |          |     | 1396.6 | 1355.1 | 1450.7 | 95.6   | .0684      |        |
| 3                         |          |     | 3624.2 | 3449.8 | 3816.6 | 366.8  | .1012      |        |
| 4                         | 48       | 1   | 149.7  | 140.2  | 162.9  | 22.7   | .2980      |        |
|                           |          | 2   | 795.4  | 581.0  | 957.9  | 376.9  | .4738      |        |
|                           |          | 3   | 2048.1 | 1626.3 | 2560.5 | 934.2  | .4561      |        |

TABLE 1.9  
(continued)

| Batch<br>I.D.            | Beam<br>No. | °F | Mode   | $f_c$  | $f_L$  | $f_r$  | $\Delta f$ | $\eta$ |
|--------------------------|-------------|----|--------|--------|--------|--------|------------|--------|
| LDEF<br>1GE<br>113<br>10 | 4           | 70 | 1      | 143.8  | 129.9  | 176.8  | 46.9       | .3261  |
|                          |             |    | 2      | 716.5  | 602.1  | 817.1  | 215.0      | .3001  |
|                          |             |    | 3      | 1809.0 | 1682.4 | 2033.3 | 350.9      | .1939  |
|                          |             |    | 4      | 3404.0 | 3048.7 | 3878.7 | 830.0      | .2438  |
| 1                        | 70          | 1  | 143.0  | 130.4  | 180.7  | 50.3   | .3517      |        |
|                          |             | 2  | 685.1  | 569.0  | 768.9  | 199.9  | .2918      |        |
|                          |             | 3  | 1773.9 | 1541.5 | 1979.1 | 437.6  | .2479      |        |
|                          |             | 4  | 3287.1 | 2806.5 | 3621.3 | 814.8  | .2479      |        |
| 2                        | 70          | 1  | 143.7  | 136.3  | 164.1  | 27.8   | .3802      |        |
|                          |             | 2  | 684.8  | 629.7  | 725.2  | 95.5   | .2741      |        |
|                          |             | 3  | 1749.0 | 1618.8 | 1964.3 | 345.5  | .1975      |        |
|                          |             | 4  | 3413.6 | 3246.8 | 3711.0 | 464.2  | .2672      |        |
| 5                        | 70          | 1  | 145.5  | 130.7  | 189.5  | 58.8   | .4041      |        |
|                          |             | 2  | 713.7  | 596.4  | 804.6  | 208.2  | .2917      |        |
|                          |             | 3  | 1799.1 | 1655.4 | 1990.5 | 335.1  | .1863      |        |
| LDEF-<br>1GE<br>113-2    | 3           | 10 | 1      | 191.4  | 190.2  | 192.5  | 2.3        | .0120  |
|                          |             |    | 2      | 1209.7 | 1194.7 | 1222.0 | 27.3       | .0226  |
|                          |             |    | 3      | 3349.9 | 3298.2 | 3387.2 | 89.0       | .0266  |
|                          |             |    | 4      | 6203.0 | 5969.1 | 6300.5 | 331.4      | .0534  |
| 3                        | 42          | 1  | 164.7  | 163.2  | 166.3  | 3.1    | .0188      |        |
|                          |             | 2  | 1202.0 | 1170.3 | 1213.6 | 43.3   | .0360      |        |
|                          |             | 3  | 3276.9 | 3093.7 | 3419.4 | 325.7  | .0994      |        |
|                          |             | 4  | 6120.2 | 6082.7 | 6159.7 | 77.0   | .0126      |        |
| 3                        | 70          | 1  | 164.8  | 156.5  | 174.9  | 18.4   | .1117      |        |
|                          |             | 2  | 872.1  | 749.4  | 1010.3 | 260.9  | .2992      |        |
|                          |             | 3  | 2323.2 | 2007.5 | 2723.2 | 715.7  | .3081      |        |
| 3                        | 82          | 1  | 162.3  | 154.4  | 178.6  | 24.2   | .1491      |        |
|                          |             | 2  | 842.8  | 742.8  | 950.5  | 207.7  | .2464      |        |
|                          |             | 3  | 2088.3 | 1841.3 | 2377.5 | 536.2  | .2567      |        |

TABLE 1.9  
(continued)

| Batch<br>I.D.           | Beam<br>No. | °F | Mode   | $f_c$  | $f_L$  | $f_r$  | $\Delta f$ | $\eta$ |
|-------------------------|-------------|----|--------|--------|--------|--------|------------|--------|
| LDEF<br>1GE<br>113<br>2 | 4           | 10 | 1      | 183.8  | 182.8  | 185.1  | 2.3        | .0125  |
|                         |             |    | 2      | 1197.5 | 1182.6 | 1207.8 | 25.2       | .0210  |
|                         |             |    | 3      | 3302.0 | 3260.3 | 3328.1 | 67.8       | .0205  |
|                         |             |    | 4      | 6285.9 | 6195.3 | 6397.5 | 202.2      | .0632  |
|                         | 4           | 70 | 1      | 163.4  | 155.6  | 176.7  | 21.1       | .1291  |
|                         |             |    | 2      | 869.4  | 806.8  | 943.2  | 136.4      | .3083  |
|                         |             |    | 3      | 2316.0 | 1997.4 | 2780.3 | 782.9      | .3380  |
|                         | 4           | 82 | 1      | 158.9  | 143.9  | 177.3  | 33.4       | .2102  |
|                         |             |    | 2      | 924.9  | 911.4  | 956.7  | 45.3       | .0963  |
|                         | 1           | 70 | 1      | 163.5  | 155.5  | 192.0  | 36.5       | .2232  |
|                         |             |    | 2      | 868.2  | 739.5  | 989.5  | 250.0      | .2879  |
|                         |             |    | 3      | 2283.8 | 1965.1 | 2838.7 | 873.6      | .3825  |
| 2                       | 70          | 1  | 161.2  | 152.3  | 177.5  | 25.2   | .1563      |        |
|                         |             | 2  | 868.4  | 716.7  | 1023.7 | 307.0  | .3535      |        |
|                         |             | 3  | 2230.4 | 1856.5 | 2570.9 | 714.4  | .3202      |        |
| 5                       | 70          | 1  | 163.0  | 156.4  | 193.5  | 37.1   | .2276      |        |
|                         |             | 2  | 946.5  | 833.8  | 1033.5 | 199.7  | .2109      |        |
|                         |             | 3  | 2480.0 | 2181.9 | 2882.4 | 700.5  | .2824      |        |
| VEM<br>113<br>002       | 1           | 10 | 1      | 133.5  | 132.6  | 134.6  | 2.0        | .0149  |
|                         |             |    | 2      | 850.8  | 842.4  | 857.4  | 15.0       | .0176  |
|                         |             |    | 3      | 2322.7 | 2291.8 | 2353.6 | 61.8       | .0266  |
|                         |             |    | 4      | 4446.0 | 4359.9 | 4519.5 | 159.6      | .0359  |
|                         |             |    | 5      | 7122.4 | 6993.6 | 7337.3 | 343.7      | .0483  |
|                         | 1           | 44 | 1      | 120.9  | 114.4  | 130.1  | 15.7       | .1298  |
|                         |             |    | 2      | 738.9  | 712.0  | 797.4  | 85.4       | .1156  |
|                         |             |    | 3      | 1656.8 | 1407.5 | 1927.5 | 520.0      | .3138  |
|                         | 1           | 70 | 2      | 460.3  | 411.9  | 496.9  | 85.0       | .1847  |
|                         |             |    | 3      | 1266.9 | 1176.1 | 1403.4 | 227.3      | .1794  |
|                         | 1           | 82 | 1      | 67.3   | 96.9   | 119.2  | 22.3       | .2078  |
|                         |             |    | 2      | 546.4  | 471.7  | 662.0  | 190.3      | .3482  |

TABLE 1.9  
(concluded)

| Batch<br>I.D.     | Beam<br>No. | *F | Mode   | $f_c$  | $f_L$  | $f_r$  | $\Delta f$ | $\eta$ |
|-------------------|-------------|----|--------|--------|--------|--------|------------|--------|
| VEM<br>113<br>002 | 2           | 10 | 1      | 134.3  | 133.5  | 135.1  | 1.6        | .0119  |
|                   |             |    | 2      | 836.9  | 827.0  | 843.2  | 16.2       | .0193  |
|                   |             |    | 3      | 2687.7 | 2672.2 | 2701.5 | 29.3       | .0109  |
|                   |             |    | 4      | 4374.2 | 4298.7 | 4400.5 | 101.8      | .0233  |
|                   |             |    | 5      | 7075.5 | 6910.5 | 7237.2 | 326.7      | .0461  |
| 2                 | 70          | 2  | 479.5  | 434.7  | 517.2  | 82.5   | .1721      |        |
|                   |             | 3  | 1282.3 | 1186.6 | 1419.6 | 233.0  | .1817      |        |
| 2                 | 82          | 1  | 118.3  | 108.5  | 129.9  | 21.4   | .1809      |        |
|                   |             | 2  | 599.4  | 533.0  | 720.3  | 187.3  | .3125      |        |
| 3                 | 70          | 1  | 98.9   | 92.6   | 112.8  | 20.2   | .2042      |        |
|                   |             | 2  | 562.5  | 551.6  | 581.8  | 30.2   | .0537      |        |
|                   |             | 3  | 1282.5 | 1192.5 | 1476.2 | 283.7  | .2212      |        |
| 4                 | 70          | 1  | 97.7   | 92.8   | 110.8  | 18.0   | .3621      |        |
|                   |             | 2  | 563.6  | 554.6  | 580.5  | 25.9   | .0459      |        |
|                   |             | 3  | 1213.7 | 1199.2 | 1221.5 | 22.3   | .0184      |        |
| 5                 | 70          | 1  | 98.1   | 86.1   | 124.1  | 38.0   | .3874      |        |
|                   |             | 2  | 419.9  | 405.2  | 464.1  | 58.9   | .1403      |        |
|                   |             | 3  | 1214.9 | 1201.3 | 1342.5 | 141.2  | .1162      |        |

## 1.5 EXHAUST GAS SIMULATOR (EGS)

### 1.5.1. Background

Previous experience indicated that devising a successful vibration damping vitreous enamel treatment for a given application is not really the end of the design process. The material treatment also has to survive the operational environment. The internal jet engine environment is a highly complex one, which includes such factors as temperature distribution variation and chemical reaction between the enamel treatment and exhaust gases, among others. It was therefore decided at the outset of this contract to design a simple jet engine exhaust gas simulator which could create an accurately duplicated chemical-temperature environment for study purposes.

### 1.5.2. Simulator Design

Discussions were held with various parties to develop ideas for the design. A literature review by I. T. Osgerby (AIAA Journal, Vol. 12, No. 6, pp. 743-754, June 1974) of turbine combustor modeling and emissions was most helpful. It was decided that a commercially-available 150,000 B.T.U. forced air combustion fuel oil heater designed for free-air heating of large rooms was ideally suited as a base unit. The similarity to a jet engine combustor was very close; and using JP-5 as the fuel base would not require any significant modifications to the basic unit. A stable temperature profile over a relatively wide range would be possible by constructing a simple tubular exhaust extension. It was also decided that since sulfur is the major known reactant, addition of tertiary-butyldisulfide  $[(CH_3)_3CSSC(CH_3)_3]$  to the JP-5 (mixture of 0.2 cc per 5 gallons of JP-5) would accurately generate the level of sulfur commonly found in operational engine exhausts.

In order to obtain a relative picture of the emissions to be expected with such a combustion mixture, it was decided to first determine the components of JP-5 fuel (although JP-8 could be used, the ready availability of JP-5 rendered its use more practical).

A sample analysis of JP-5 revealed the following components:

- Percent volatile by volume 96%  
Percent other components by volume 4%
- Percent of volatiles by volume:

|                    |       |
|--------------------|-------|
| Parafins           | 45.3% |
| Monocycloparaffins | 37.0% |
| Dicycloparaffins   | 3.1%  |
| Alkylbenzenes      | 8.7%  |
| Indans & tetralins | 3.2%  |
| Napthalenes        | 2.7%  |

### 1.5.3, Operation

Prior to actual use, the simulator emissions were evaluated. The report is summarized as follows:

- Description of emissive device:  
Simulator: jet engine exhaust gas  
Fuel: JP-5 or JP-8  
Additives: Tertiary-butyldisulfide  
Mixture: 0.2 cc per 5 gallons fuel
- Conclusions of emission test  
Particulate emissions significantly below maximum acceptability. Major pollutant: Sulfur 0.4% total  
Exhaust volume  $\approx$  30 cfm (free exhaust conditions)  
B.T.U. output  $\approx$  150,000 (at 250 C.F.M. forced-draft flue exhaust conditions)
- Provisions  
Fuel not to be stored within immediate vicinity  
Approximately 2 C.F.M. fresh air should be provided for each C.F.M. exhaust volume  
CO<sub>2</sub> extinguisher to be provided in close proximity

Initial tests were conducted in free-air conditions behind W-PAFB, building 32. A temperature profile compiled at this time indicated usable temperatures from 1450°F (788°C) to 900°F (482°C)

In the fall of 1979, the Vibration Damping Group moved to a new laboratory on campus at the Kettering Labs building. The exhaust gas simulator was set-up in a small nearby lab room. This room was provided with a 900 C.F.M. exhaust duct which vented to the roof of the building.

Careful studies indicated that the forced draft of the exhaust gases into the duct caused considerable turbulence of the flow within the extension tube "test chamber". This resulted in an unstable temperature distribution. Various alternative ducting

methods were tried until an optimal configuration was devised. A commercially available steel container, approximately 30 inches in diameter, was modified as part of a flue design large enough to reduce the velocity of the forced draft. This then permitted a stable temperature distribution within the chamber ranging from 1330°F (720°C) to 930°F (500°C). With an additional 18-inch extension, temperatures down to 550°F (290°C) were achieved.

#### 1.5.4. Material Evaluation

A data sheet was produced which could be filled out appropriately for each material being evaluated. Provision was made to record material description (including up to 3 overcoats), thermal cycling history, and notes concerning various types of decomposition/degradation, based upon previous experience.

Initial test specimens were materials from the J-85 afterburner liner project, the purpose being to see if the failure condition of the materials exposed to actual exhaust emissions could be duplicated. Also evaluated were "off the shelf" commercial materials, as well as various experimental sulfate materials.

Altogether, the test results were very useful in determining material degradation effects. A total of 16 material exposure tests were conducted in the simulator at various temperatures. A list of the tests are in Table 1.10. The material degradation data sheets for the tests are included, in chronological order, in Appendix C.

TABLE 1.10  
COMPLETE SET OF EXPERIMENTS CONDUCTED WITH THE  
EXHAUST GAS SIMULATOR

| Experiment | Project        | Material    | Exposure<br>°C | Total Time<br>Exposure | Survival |
|------------|----------------|-------------|----------------|------------------------|----------|
| 01         | J-85-Follow-up | J-85-1      | 815            | 8.5 Hours              | NO       |
| 02         | " "            | J-85-2      | 815            | 8.5 "                  | PARTIAL  |
| 03         | " "            | J-85-3      | 815            | 8.5 "                  | NO       |
| 04         | " "            | J-85-4      | 815            | 8.5 "                  | NO       |
| 05         | " "            | J-85-5      | 815            | 8.5 "                  | NO       |
| 06         | Development    | 8871        | 540            | 8.5 "                  |          |
| 07         | "              | 8871 + 3%   | 540            | 8.5 "                  | PARTIAL  |
| 08         | "              | Sulfate 2   | 399            | 2.0 "                  | NO       |
| 09         | "              | Lead 1      | 635            | 28.0 "                 | NO       |
| 010        | "              | Lead 2      | 635            | 28.0 "                 | NO       |
| 011        | J-85-Follow-up | J-85-14     | 675            | 30.0 "                 | YES      |
| 012        | Development    | AMB5        | 630            | 28.0 "                 | PARTIAL  |
| 013        | "              | Sulfate 3   | 399            | 2.0 "                  | NO       |
| 014        | "              | Sulfate S-7 | 399            | 2.0 "                  | NO       |
| 015        | "              | Sulfate S11 | 399            | 2.0 "                  | NO       |
| 016        | "              | Sulfate S11 | 399            | 2.0 "                  | NO       |



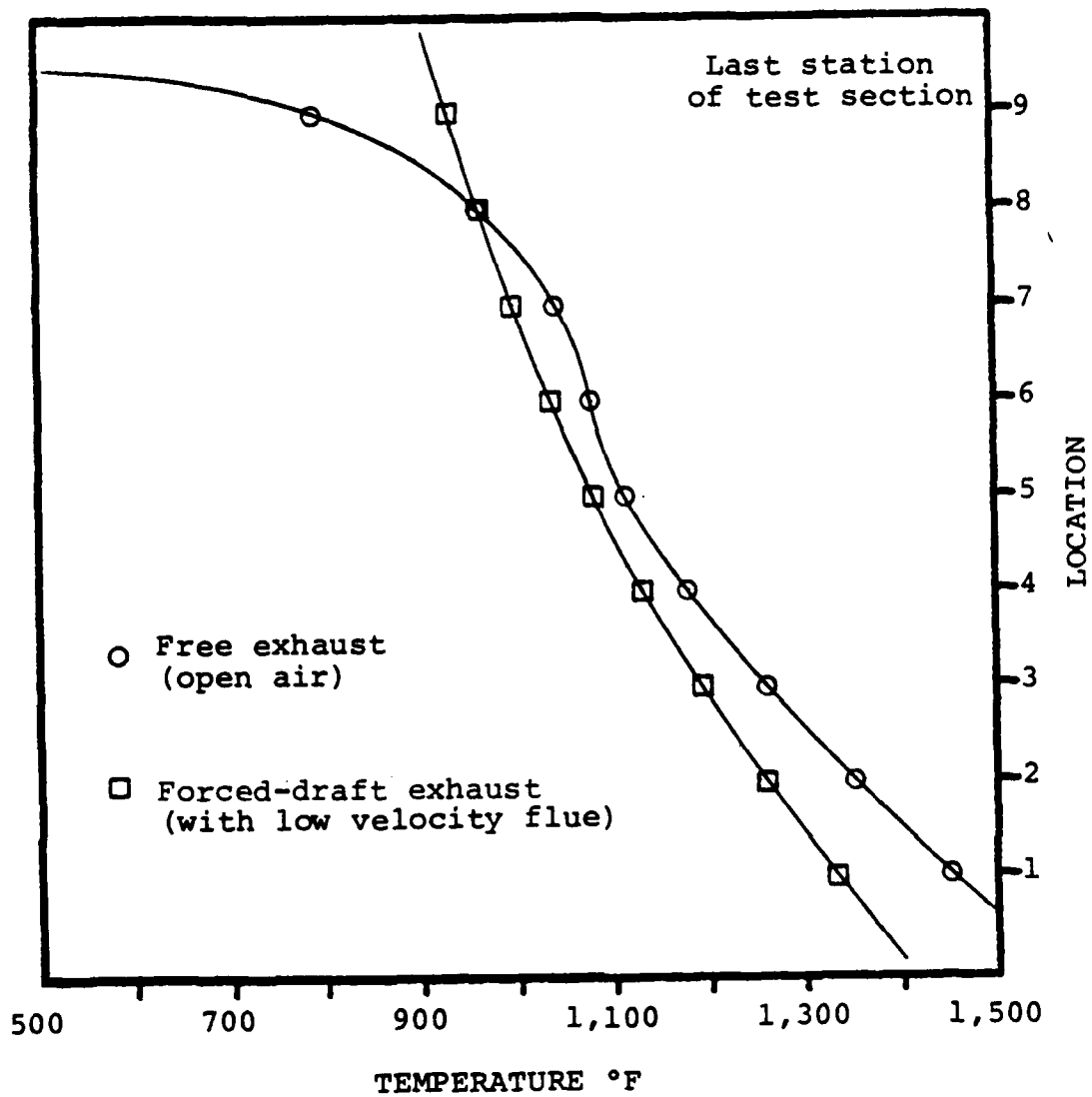
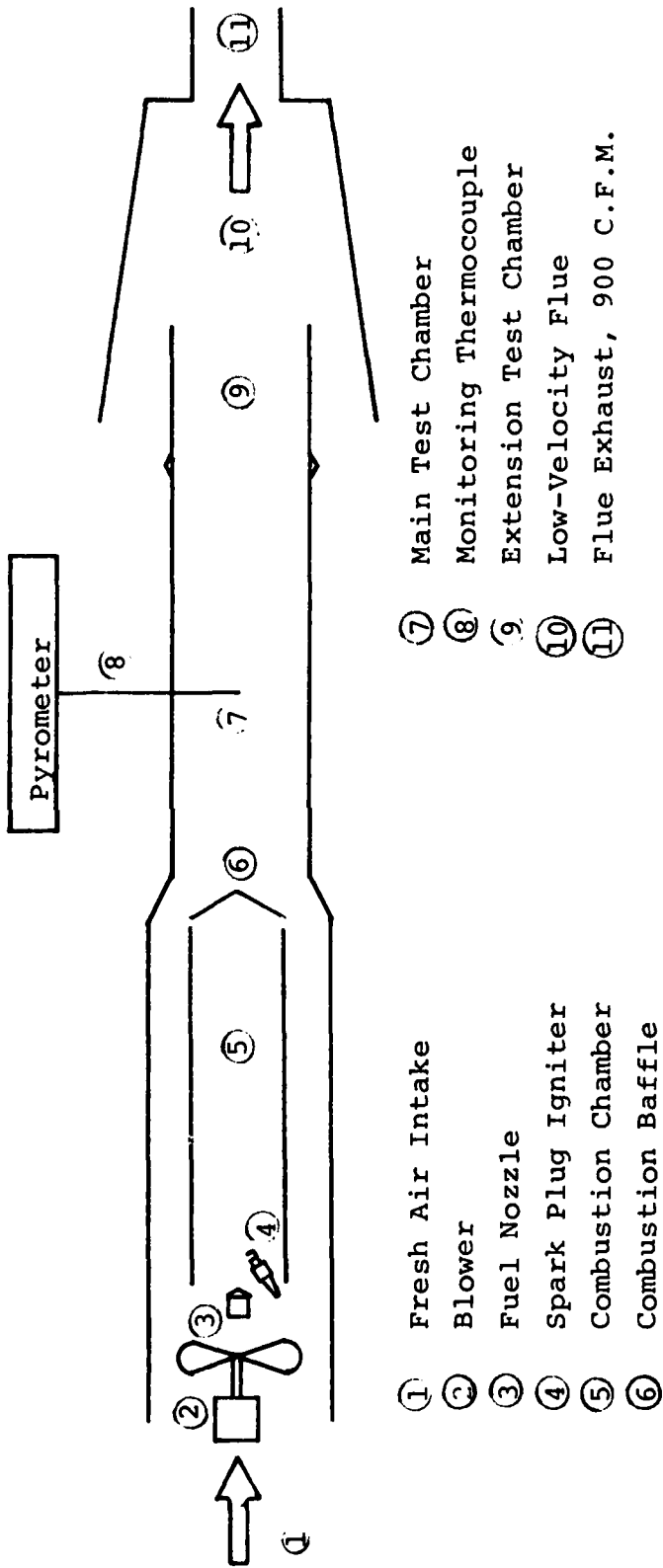

Figure 1.64. Temperature Distribution Versus Exhaust Chamber Position for Both Free-Flow and Forced-Draft Exhaust.



- ① Fresh Air Intake
- ② Blower
- ③ Fuel Nozzle
- ④ Spark Plug Igniter
- ⑤ Combustion Chamber
- ⑥ Combustion Baffle

- ⑦ Main Test Chamber
- ⑧ Monitoring Thermocouple
- ⑨ Extension Test Chamber
- ⑩ Low-Velocity Flue
- ⑪ Flue Exhaust, 900 C.F.M.

Figure 1.65. Schematic Cross-Section of Exhaust Gas Simulator.

SECTION 2  
FINITE ELEMENT ANALYSES AND DEVELOPMENT

2.1 FINITE ELEMENT ANALYSIS OF STRUCTURES

The finite element program developed under this contract was used to analyze several damped and undamped structures. The following paragraphs contain a detailed discussion of those analyses.

2.1.1 Damped Skin Stringer Panel

To gain experience with the newly developed finite element program, an analysis of a skin stringer panel was conducted. The purpose of the investigation was to lower the stresses in the resonant condition by the use of viscoelastic constrained layer damping. The method and analysis are not limited to aircraft fuselage structures, but are also representative of any general class of structures consisting of stiffened skins or panels.

The model of the skin stringer panel shown in Figure 2.1 consisted of 285 elements and 828 nodes, for a total of almost 2,500 degrees of freedom. Symmetric-symmetric boundary conditions were used in the analysis, yielding the symmetric (odd-odd) modes. The cross section of the structure is shown in Figure 2.2. The panel was 1524 mm (60 inches) long by 813 mm (32 inches) wide, with the boundary conditions chosen. The distance between the stiffening ribs is 254 mm (10 inches).

The ribs and damping material layer were modeled with solid elements. In particular, the damping layer is modeled with 8 node solid elements which are shear deformable. It is important that the damping layer is modeled with shear deformable elements since a constrained layer damping treatment dissipates energy through shear deformation. The ribs were modeled with 16 node elements which have midside nodes (but no nodes through the thickness). Both the 8 node solid and the 16 node solid are formulated according to a full three-dimensional theory of elasticity. The constraining layer and panel were modeled with 8 node thin shell elements. The panel, ribs, and constraining layer were aluminum.

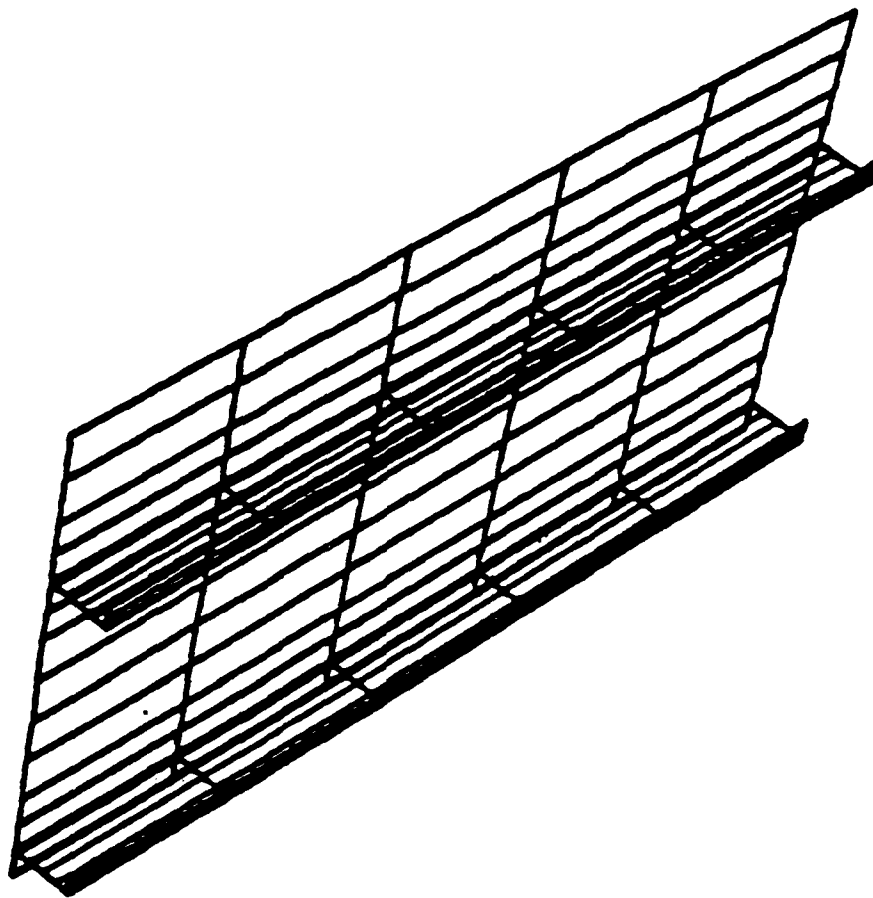

Figure 2.1. Finite Element Model of Stiffened Panel.

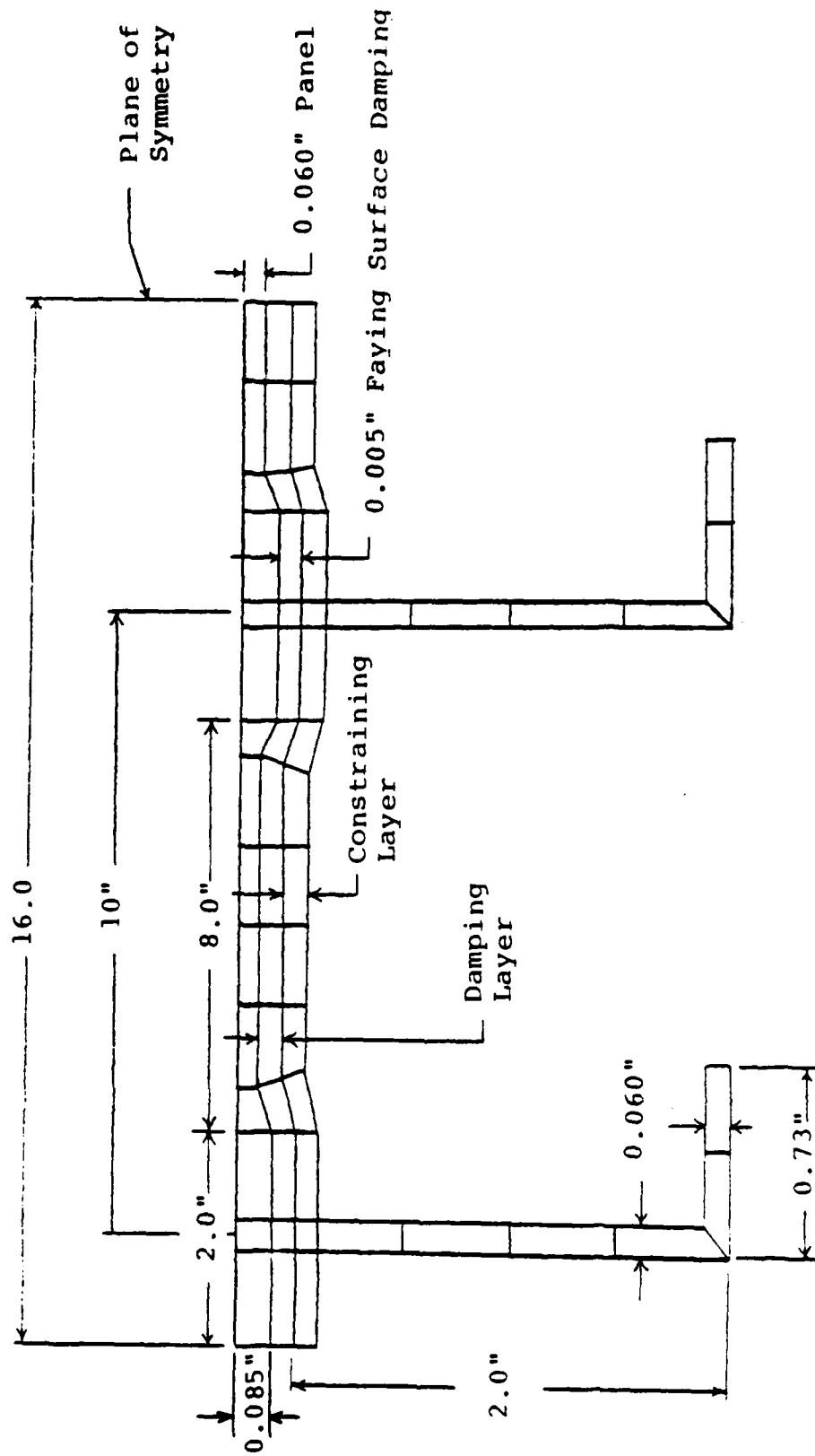

Figure 2.2. Cross-Section of Model.

The stiffeners are 51-mm (2 inches) high, and all sections of the stiffeners are 1.5-mm (0.060 inch) thick. The panel directly under the stiffener web is 2.2-mm (0.085 inch) thick. From this point under the web, the panel tapers to a thickness of 1.5-mm (0.060 inch), in a distance of 25-mm (1-inch). The taper is actually very shallow, and not abrupt as it appears in Figure 2.2. This taper represents a two-step chem-milled panel.

In between the stiffener web and the panel, a very thin element, 0.13-mm (0.005-inch) is incorporated. This element could be used as a faying surface damping treatment. A faying surface damping treatment is a damping layer applied where two surfaces fit together and where relative motion or fretting between the surfaces might occur. For the undamped runs this thin element was given the material properties of aluminum, and it adds little stiffness to the ribs.

In the not too distant past, analysis of skin stringer structures required the use of warping constants to account for the non-uniform torsion that occurs when the stiffening rib is restrained from warping because it is riveted to the skin panel. The non-symmetric ribs displace out of plane when subjected to bending loads that are not applied at the shear center and this in turn induces torsion of the cross-section. These warping constants were needed because the ribs were modeled with one-dimensional beam elements, whose properties were specified by their modulus, moment of inertia, cross-sectional area, and warping constant. However, in the present analysis, the ribs are modeled with 16 node solid elements. The 16 node solid elements encompass the full three-dimensional theory of elasticity with no approximations (other than representing a continuum by a finite number of elements) and hence no special consideration for warping of the ribs is necessary.

In the analysis the "undamped" structure actually included the damping and constraining layers. The stresses for the undamped forced vibration analysis were obtained by giving the damping material a very low loss factor, 0.006, the same loss factor as was used for the aluminum panels and ribs. For the damped force vibration analysis, the damping material was given its normal loss factor of approximately 0.9 at the temperature and frequency of interest, and the stresses were obtained.

The first five modes of the panel for the symmetric-symmetric boundary conditions are listed in Table 2.1 and shown in Figures 2.3 through 2.7. The investigation centered about the third mode, the 3,3 mode at 120.1 Hz, as shown in Figure 2.5.

In the undamped and damped forced vibration analysis, the force was a harmonic pressure loading normal to the surface of the panel. The pressure corresponded to an acoustic sound pressure level of 165 dB. A small amount of inherent damping was included in the base structure (loss factor - 0.006) to simulate actual structural damping and to keep the response at the natural frequency for the undamped case from becoming infinite. The constrained layer damping treatment consists of 0.35-mm (0.014-inch) of 3M Company's ISD 112 damping materials (properties chosen at 29°C(85°F) and 120 Hz and 0.2-mm (0.008-inch) of aluminum constraining layer.

TABLE 2.1  
MODES OF UNDAMPED SKIN STRINGER PANEL

| Mode | Frequency (Hz) |
|------|----------------|
| 1,1  | 48.8           |
| 1,3  | 68.9           |
| 3,3  | 120.1          |
| 1,5  | 149.7          |
| 5,3  | 159.2          |

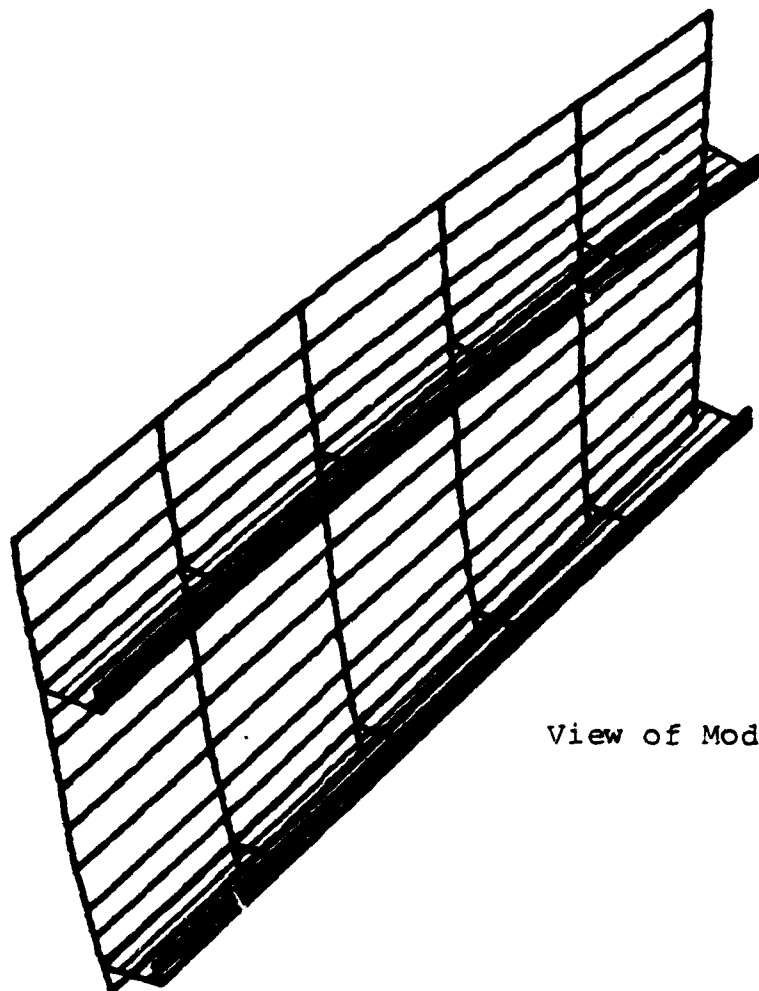

View of Mode 1,1

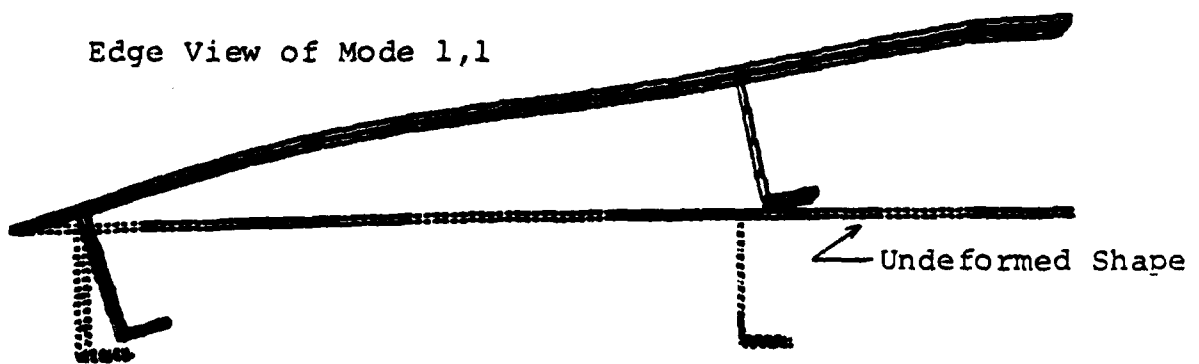

Edge View of Mode 1,1

Undeformed Shape

Figure 2.3. Mode 1,1 of Stiffened Panel (48.8 Hz).



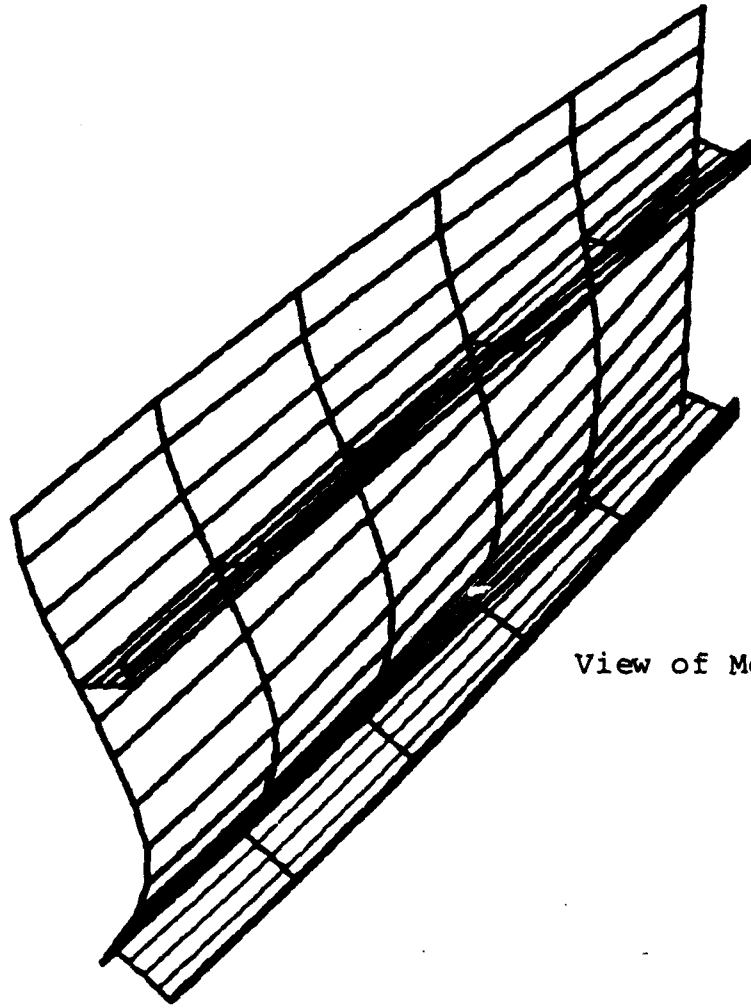

View of Mode 1,3

Edge View of Mode 1,3

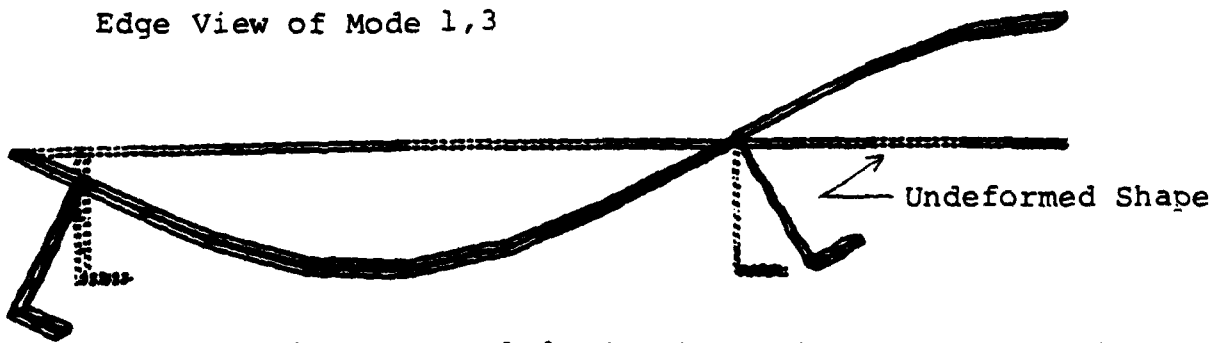
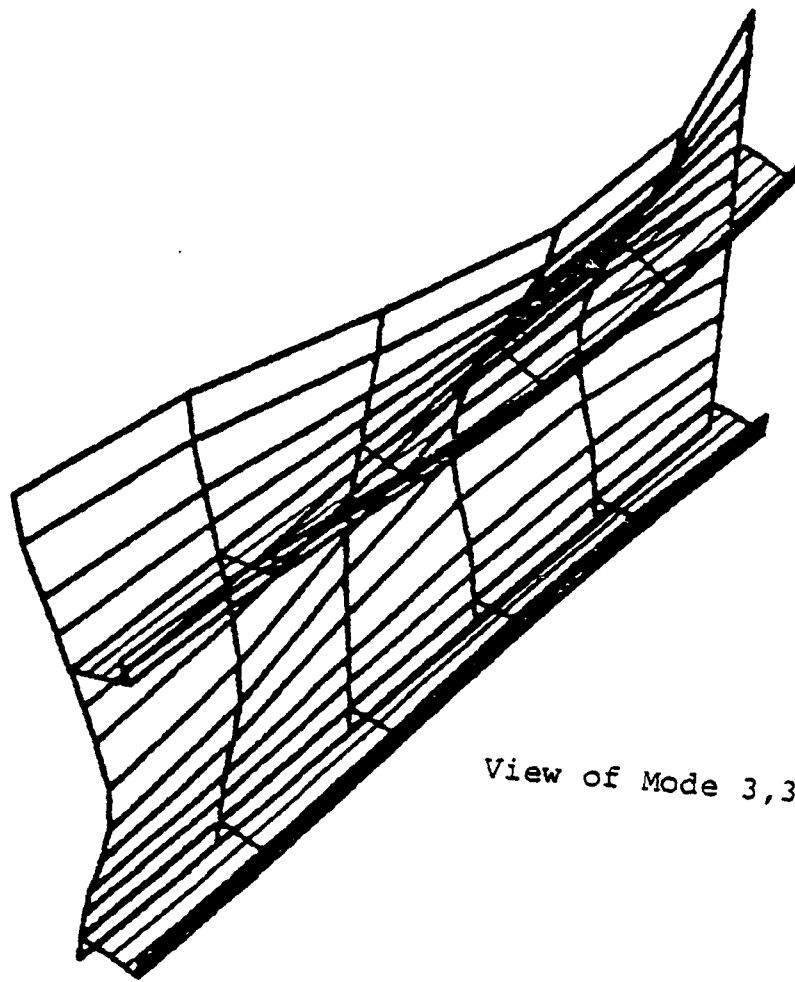

Figure 2.4. Mode 1,3 of Stiffened Panel (68.9 Hz).



View of Mode 3,3

Edge View of Mode 3,3



Undeformed Shape

Figure 2.5. Mode 3,3 of Stiffened Panel (120.1 Hz).

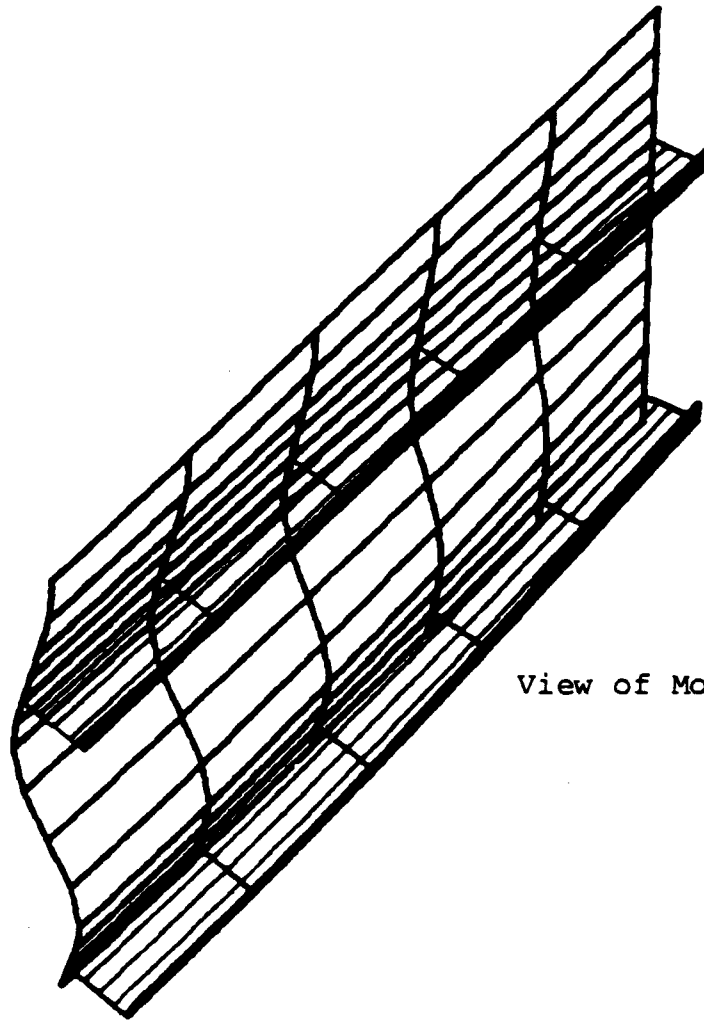

View of Mode 1,5

Edge View of Mode 1,5

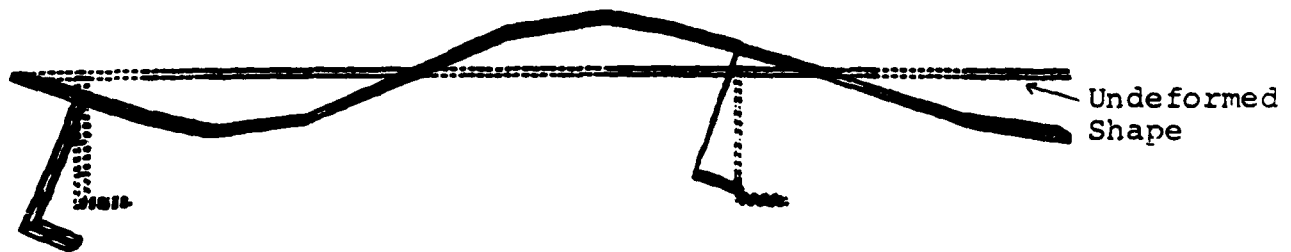
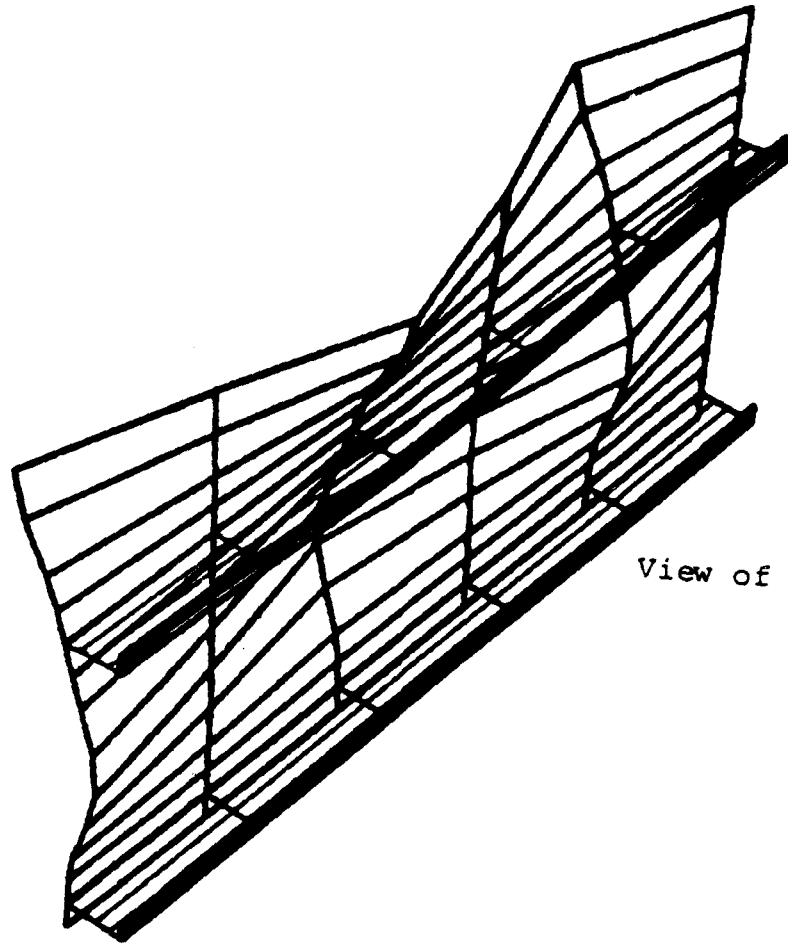

Figure 2.6. Mode 1,5 of Stiffened Panel (149.7 Hz).



View of Mode 5,3

Edge View of Mode 5,3

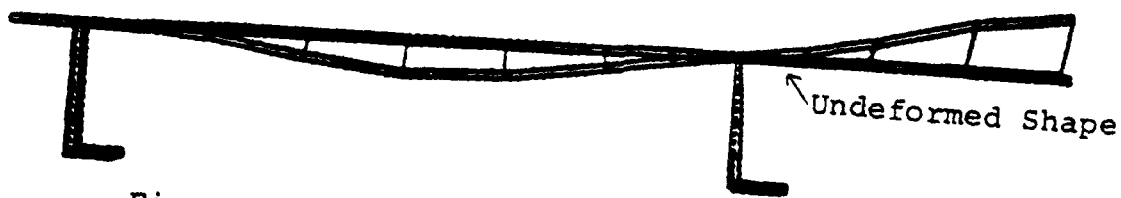

Figure 2.7. Mode 5,3 of Stiffened Panel (159.2 Hz).

The results for the undamped and damped panel are given in Table 2.2. With an inherent loss factor of 0.006, the stress in the undamped panel was 263 MPa (38,000 psi). With the addition of 0.35 mm (0.014 inch) damping layer and a 0.20 mm (0.008 inch) constraining layer, the loss factor increased to 0.029. Stress was reduced by 80 percent to 48.5 MPa (7,030 psi). The addition of the damping treatment represents only a ten percent increase in weight of the structure.

### 2.1.2. Analyses of F100 2nd Stage Turbine Blade

The UDRI analyzed the F100 2nd stage turbine blade with various damping treatments. The following sections discuss various finite element model of the blade, the results of UDRI analyses of the blade and comparison with NASTRAN models of the blade.

#### 2.1.2.1. F100 2nd Stage Turbine Blade Models

During the course of the turbine blade analyses, card decks of the blade model were made available from two different sources. The UDRI then modified one of the models to use in its analyses. The three finite element models of the F100 2nd stage turbine blade are described below. There are (1) the Kielb, Henderson, and Abell NASTRAN model taken from a 14 July 1975 NASTRAN output file (referred to as the Kielb model); (2) the Pratt and Whitney model, which comes from a NASTRAN card deck supplied from Pratt and Whitney through John Ogg (referred to as P&W model); and (3) the University of Dayton Research Institute model (referred to as UDRI model) which was derived from the P&W model.

The Kielb model includes the platform and neck as shown in Figure 2.8. The model does not include the dovetail section.

An input deck was generated from the Kielb run, and was transmitted to Conor Johnson of Anamet Laboratories, California.

The P&W model also includes the platform and neck, but not the dovetail section. The P&W model is shown in Figure 2.9. It can be seen from the figure that there are errors in the card deck supplied to UDRI. The data file for the P&W model was forwarded to Conor Johnson. The UDRI filled in the missing elements on the airfoil section and used this as the basis for the UDRI model, shown in Figure 2.10.

TABLE 2.2

## RESULTS FOR UNDAMPED AND DAMPED PANEL

| Condition  | Frequency<br>(Hz) | Mode | Damping | Stress                     | Percent<br>Stress<br>Reduction | Percent<br>Weight<br>Increase |
|--|-------------------|------|---------|----------------------------|--------------------------------|-------------------------------|
| 1.5-mm (0.060")<br>panel, undamped   | 120.1             | 3,3  | 0.006   | 263 MPa<br>(38,000<br>psi) | 0                              | 0                             |
| 1.5-mm (0.060")<br>panel, 0.35-mm<br>(0.014") damping<br>layer, 0.2-mm<br>(0.008") con-<br>straining layer | 120.3             | 3,3  | 0.029   | 48.5 MPa<br>(7,030<br>psi) | 80                             | 10                            |

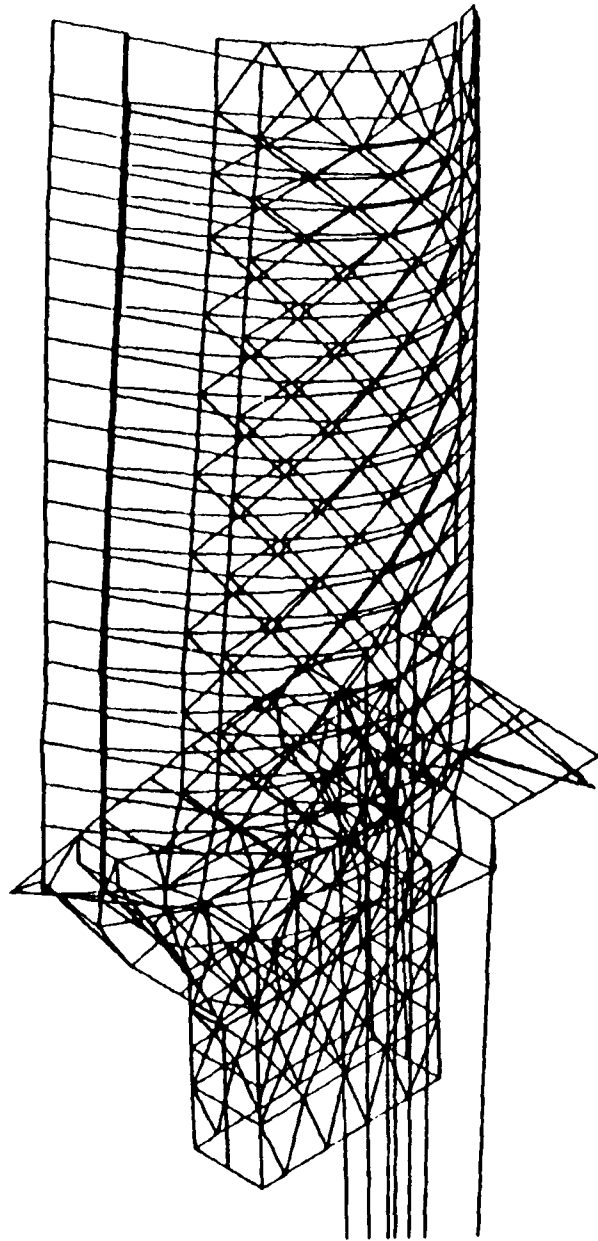

Figure 2.8. Kielb Model, Which Includes the Platform and Neck.

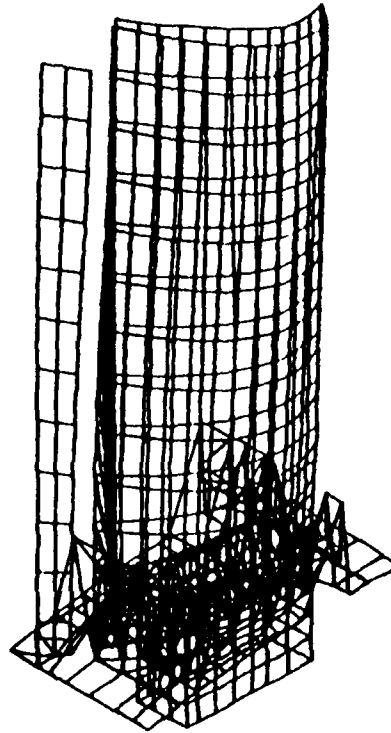

Figure 2.9. Pratt and Whitney Model, Which Includes the Platform and Neck But Not the Dovetail Section.



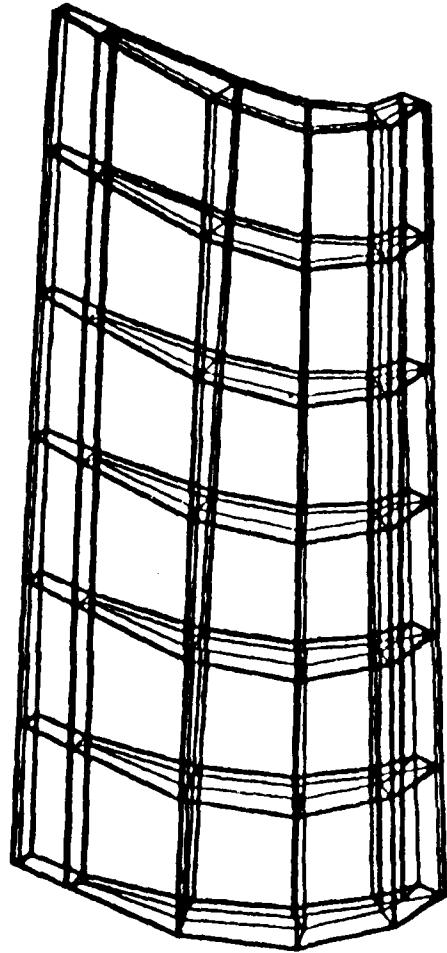

Figure 2.10. The UDRI Model.

#### 2.1.2.2. UDRI Analysis of Damped F100 Turbine Blade

The UDRI conducted an analysis of the F100 2nd stage turbine blade. The analysis consisted of studying the forced harmonic response of the first bending mode of the blade for the following cases: (1) undamped blade; (2) blade with free layer damping treatment; and (3) rotating blade with constrained layer damping treatment. The seven non-rotating cases and the one rotating case are shown in Table 2.3. The first three modes are shown in Figure 2.11.

The model, shown in Figure 2.12, consists of 234 elements. The axial length is divided into six sections, giving 39 elements per section. The cross-section of the blade is also shown in Figure 2.12. The damping treatment consists of a 0.25 mm (0.010 inch) layer of glass covered by a 0.13 mm (0.005 inch) layer of nickel. The glass layer is modeled by twelve elements per section, the nickel by twelve elements per section, and the blade by fifteen elements per section. The platform and root of the blade were not modeled.

The purpose of the forced harmonic response analysis was not to determine absolute stresses and absolute displacements, but was used to show the relative decrease in response with damping as compared to the undamped response, given the same loading condition. This was illustrated by a receptance plots, which were generated by calculating the response at discrete frequencies in the neighborhood of the resonant frequency of interest. From these plots, the half-power bandwidths were determined and structural loss factor computed for that particular mode. Thus, the end results of the forced harmonic response analysis was the structural loss factor. All the receptance plots generated were driving-point measurements, with the load applied at the tip of the blade as shown in Figure 2.13. The eight receptance plots for cases 1 through 8 are shown in Figures 2.14 through 2.17, respectively.

Figure 2.18 shows cases 1, 2, and 3 on the same plot for comparison purposes. Cases 1 and 2 are the undamped blade at room temperature and at 496°C (925°F), respectively. Comparison

TABLE 2.3  
ANALYSES OF TURBINE BLADE

| Case | Description  | First Three Modes (Hz)        | Composite Loss Factor |
|------|--|-------------------------------|-----------------------|
| 1    | Bare, undamped blade, all material properties at room temperature  | 1,085.1<br>1,972.0<br>3,010.4 | 0.002*                |
| 2    | Bare, undamped blade, all material properties at 496°C (925°F)   | 1,002.7<br>1,822.6<br>2,782.0 | 0.002*                |
| 3    | Damped blade, full blade glass coating with nickel overcoat, material properties at 496°C (925°F)  | 1,050.7<br>2,847.4<br>4,032.9 | 0.011                 |
| 4    | Damped blade, full glass coating, all material properties at 496°C (925°F)   | 920.6<br>1,660.8<br>2,845.7   | 0.008                 |
| 5    | Damped blade, full glass coating, all material properties at 427°C (800°F)   | 940.6<br>1,690.7<br>2,917.3   | 0.0022                |
| 6    | Damped blade, full glass coating, all material properties at 538°C (1,000°F)   | 907.3<br>1,641.0<br>2,792.2   | 0.0044                |
| 7    | Damped blade, full blade glass coating with nickel overcoat, all material properties at 496°C (925°F), 7,500 rpm                         | 1,082.4<br>2,870.6<br>4,037.5 | 0.0083**              |
| 8    | Damped blade, full blade coating with nickel overcoat, all material properties at 496°C (925°F), glass layer modeled with solid elements | 1,058.7<br>2,874.5<br>3,999.2 | 0.0122                |

\*blade material is assumed to have an inherent loss factor of 0.002

\*\*the loss factor is approximate because the peak is non-symmetric; loss factor was estimated by using the left side of the peak and multiplying bandwidth by two. Analysis includes blade rotation effects

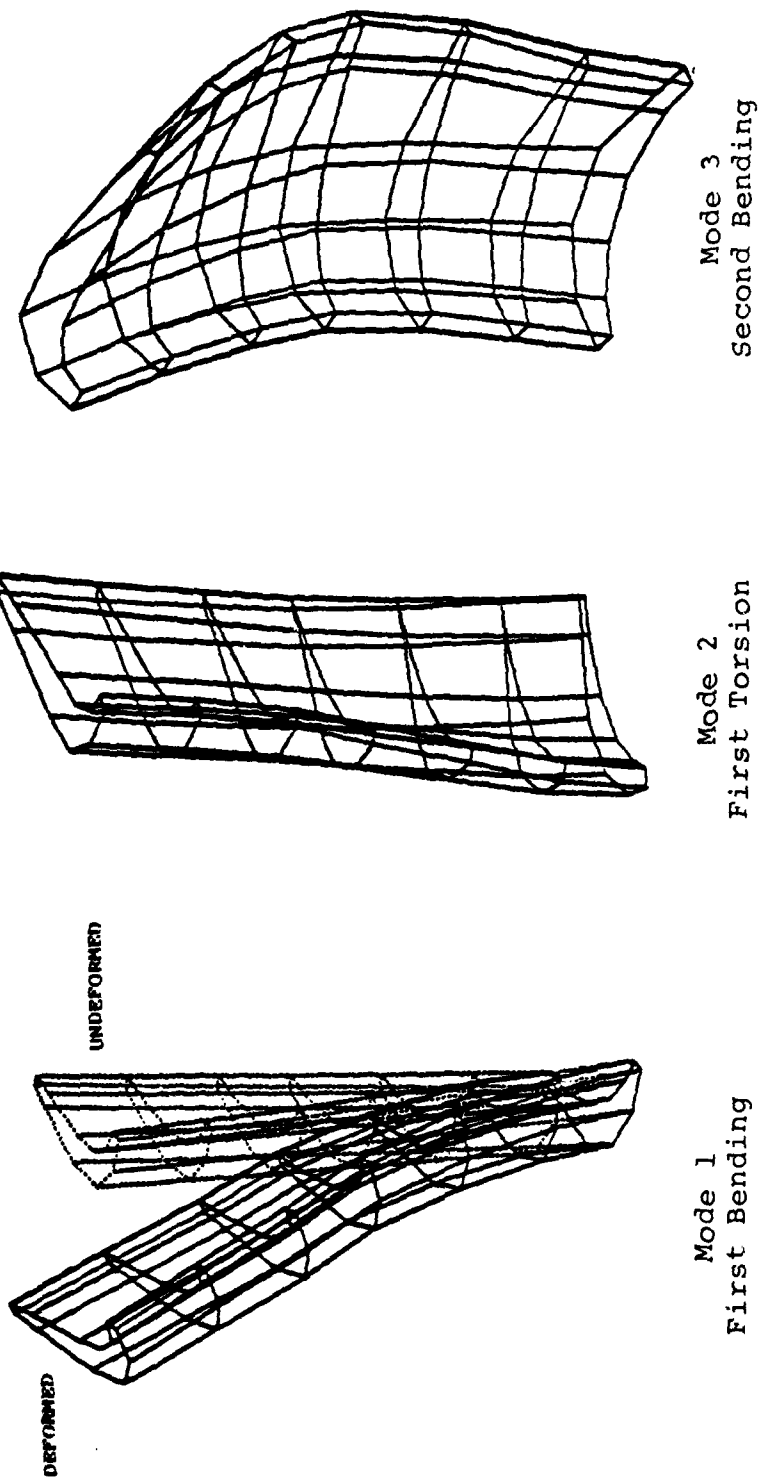
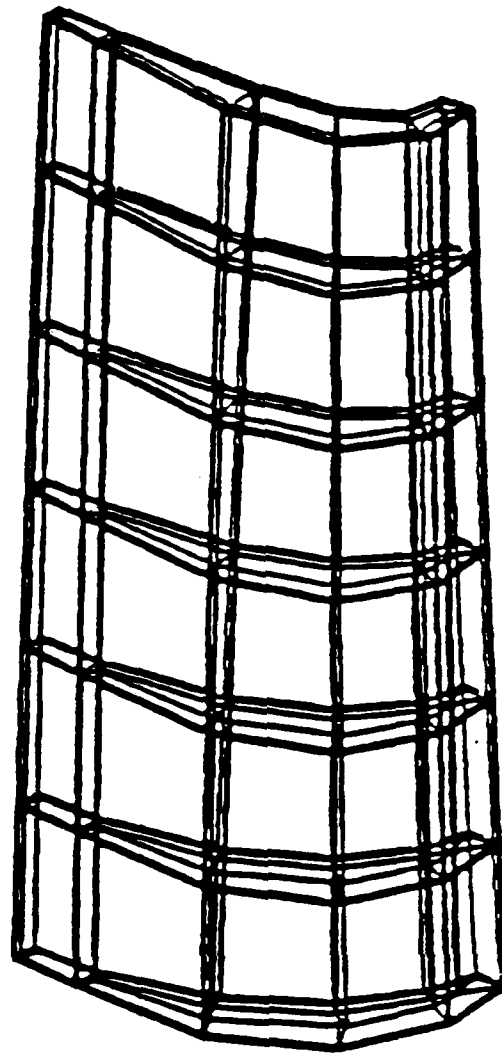
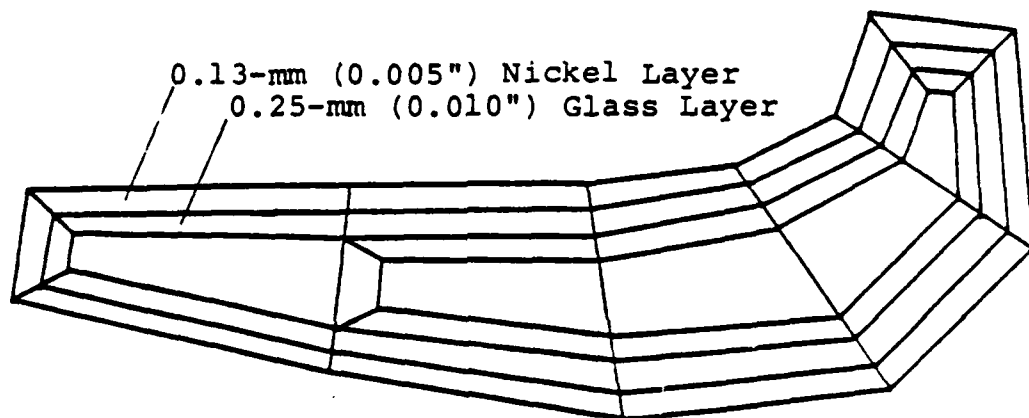

Figure 2.11. Deformed Mode Shapes.



Model of  
Turbine Blade



Cross-section of Turbine Blade

Figure 2.12. Finite Element Model of Turbine Blade.

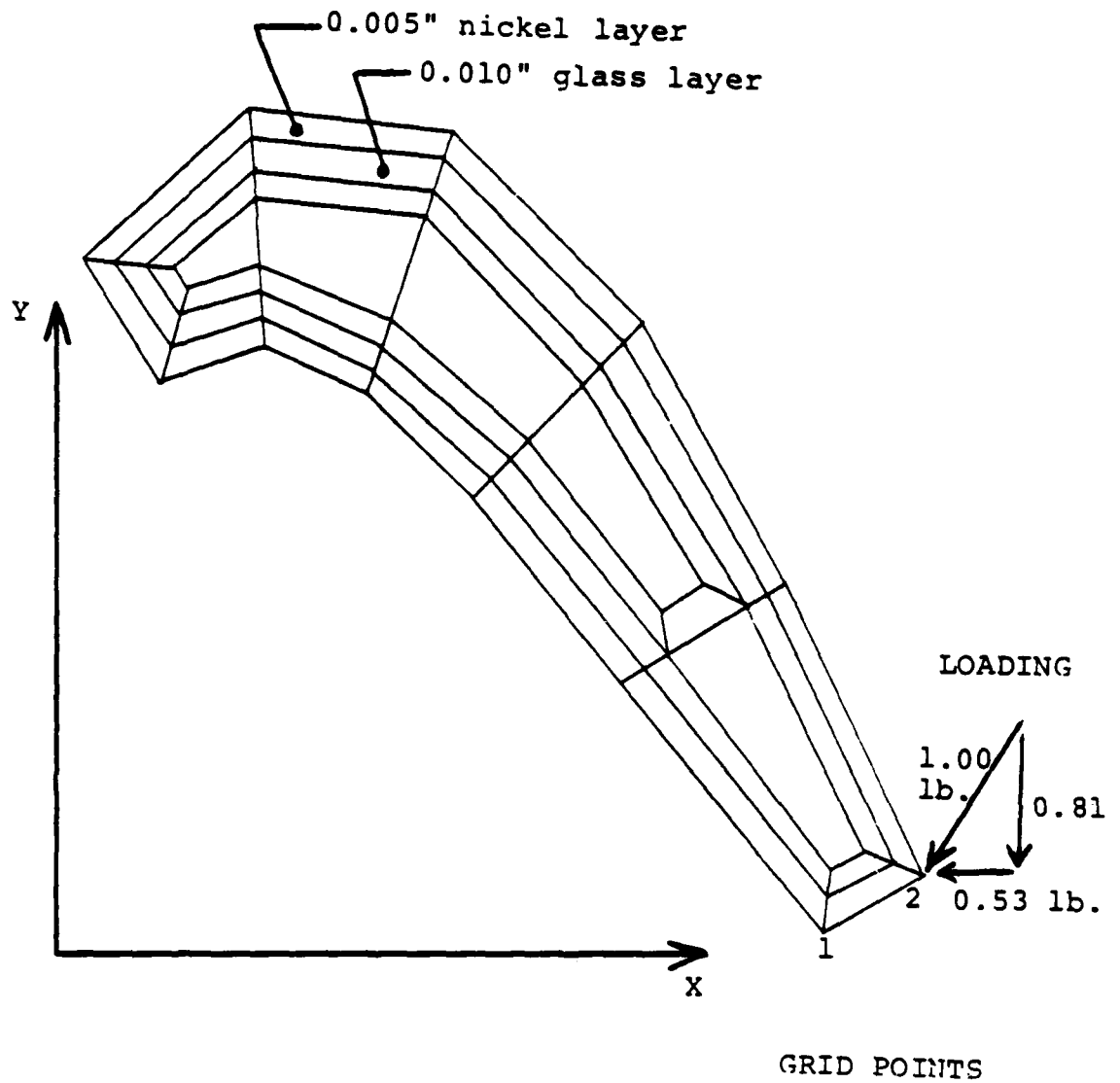
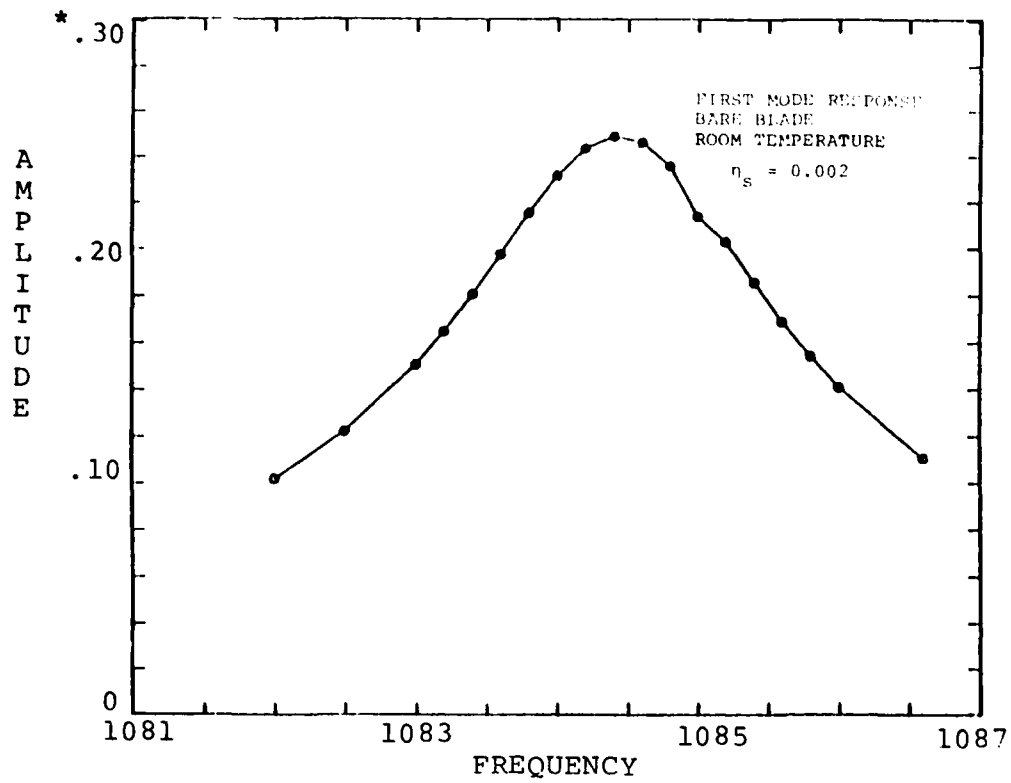
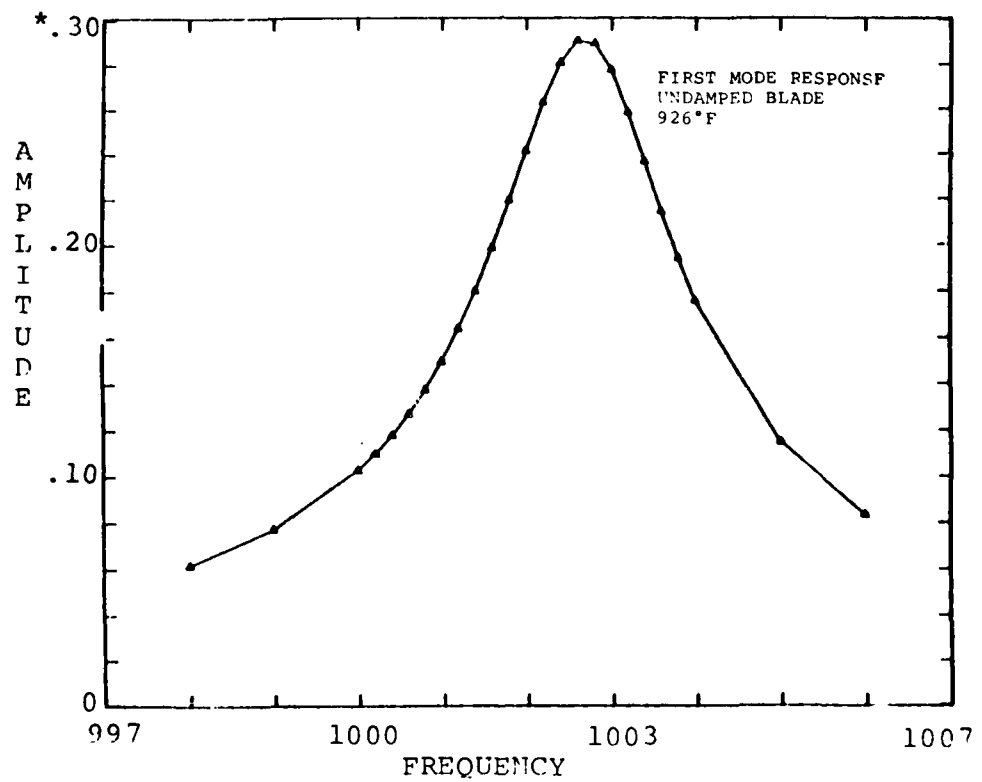

Figure 2.13. Receptance Measurement Points.



(CASE 1)



(CASE 2)

Figure 2.14. Amplitude-Frequency Response.

\*amplitude in inches

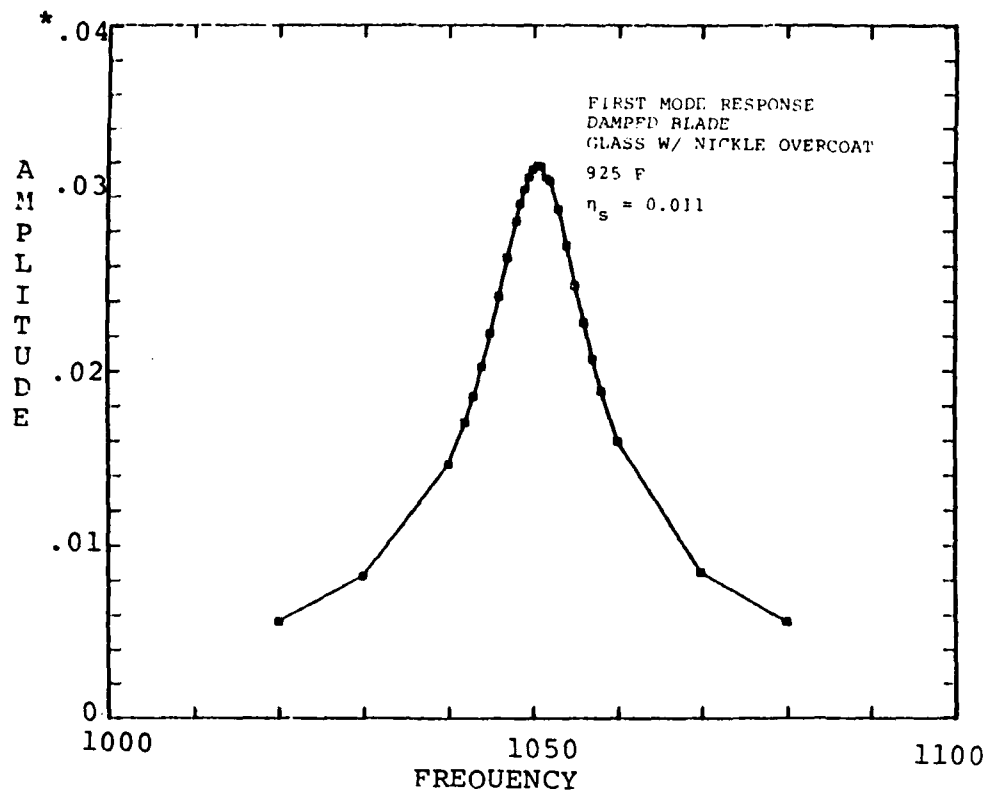

(CASE 3)

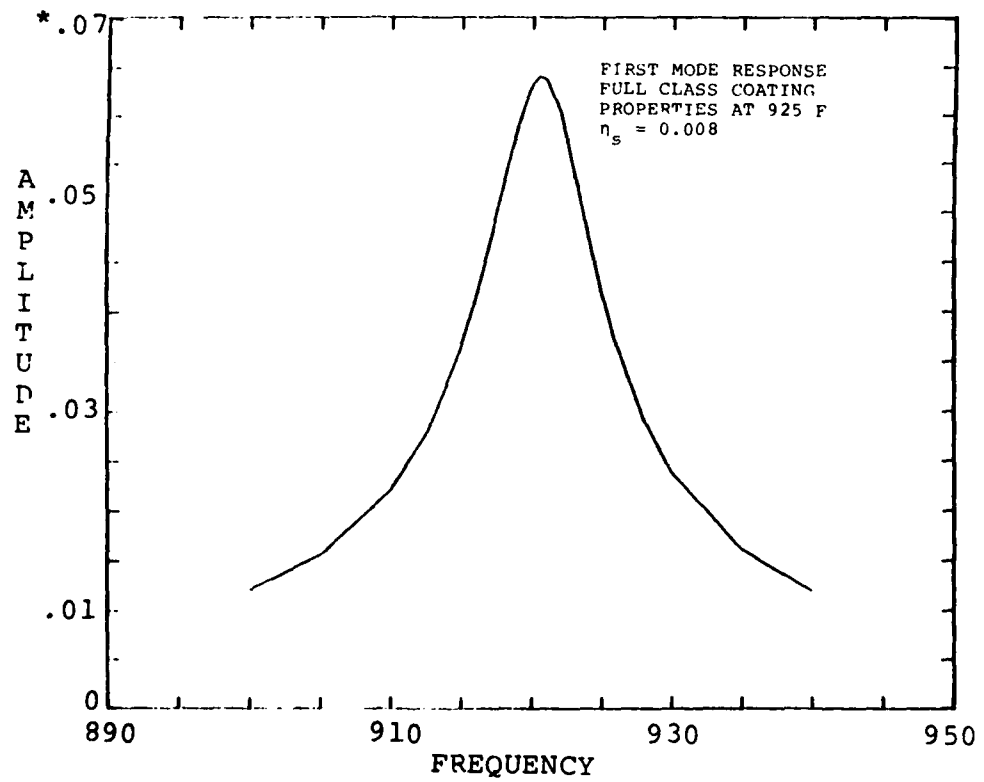

(CASE 4)

Figure 2.15. Amplitude-Frequency Response.

\*amplitude in inches



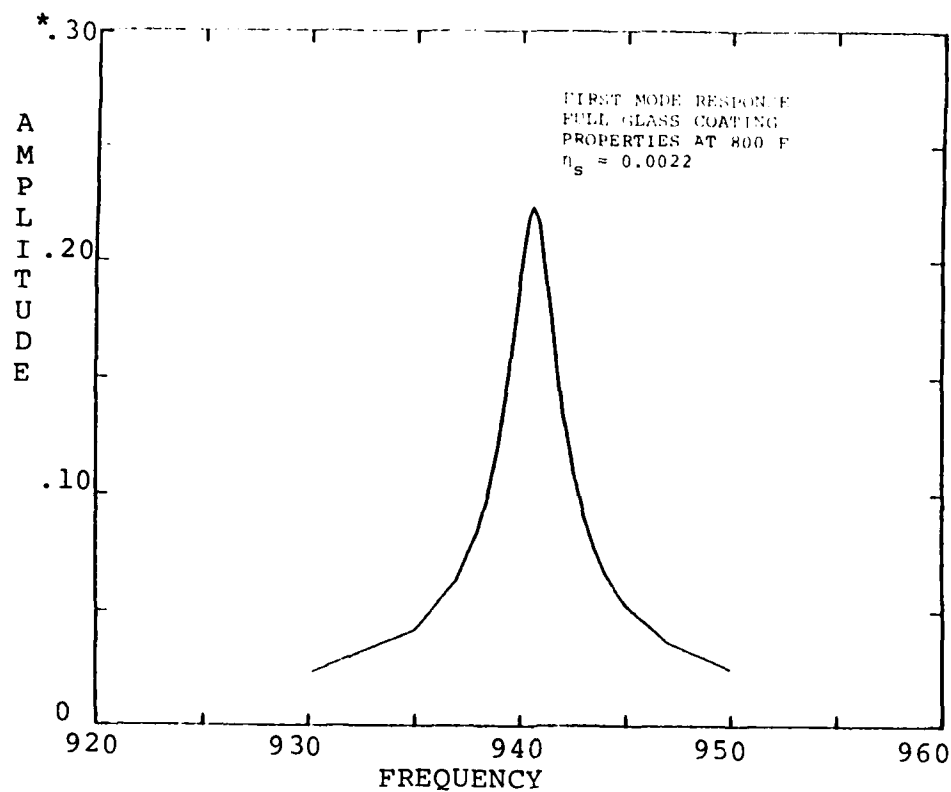

(CASE 5)

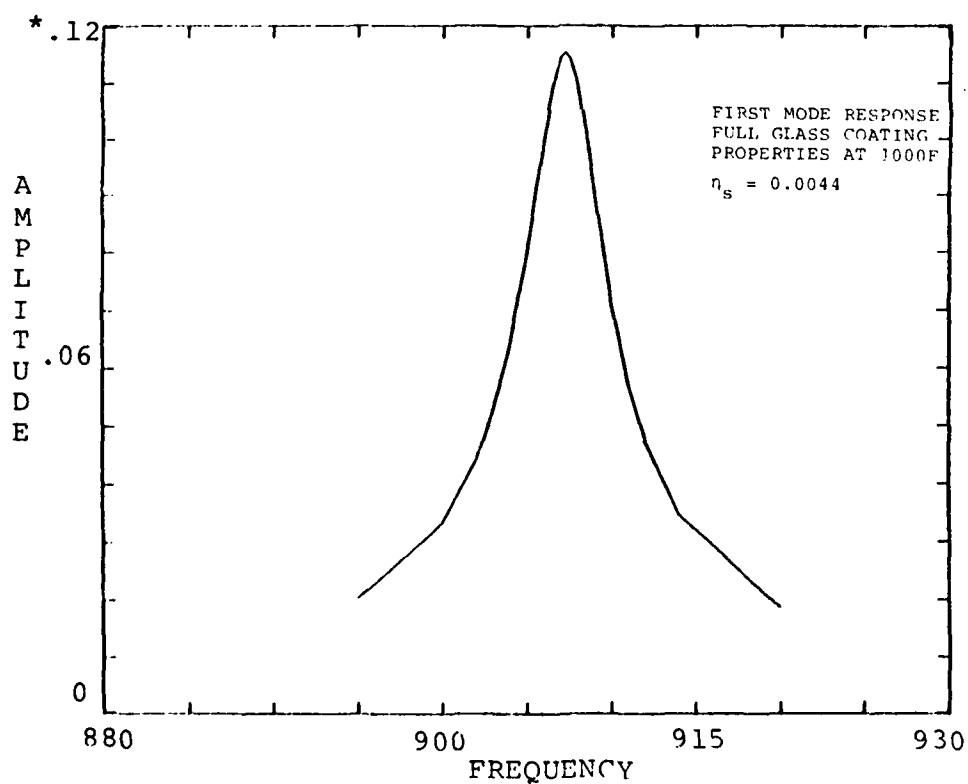

(CASE 6)

Figure 2.16. Amplitude-Frequency Response.

\*amplitude in inches

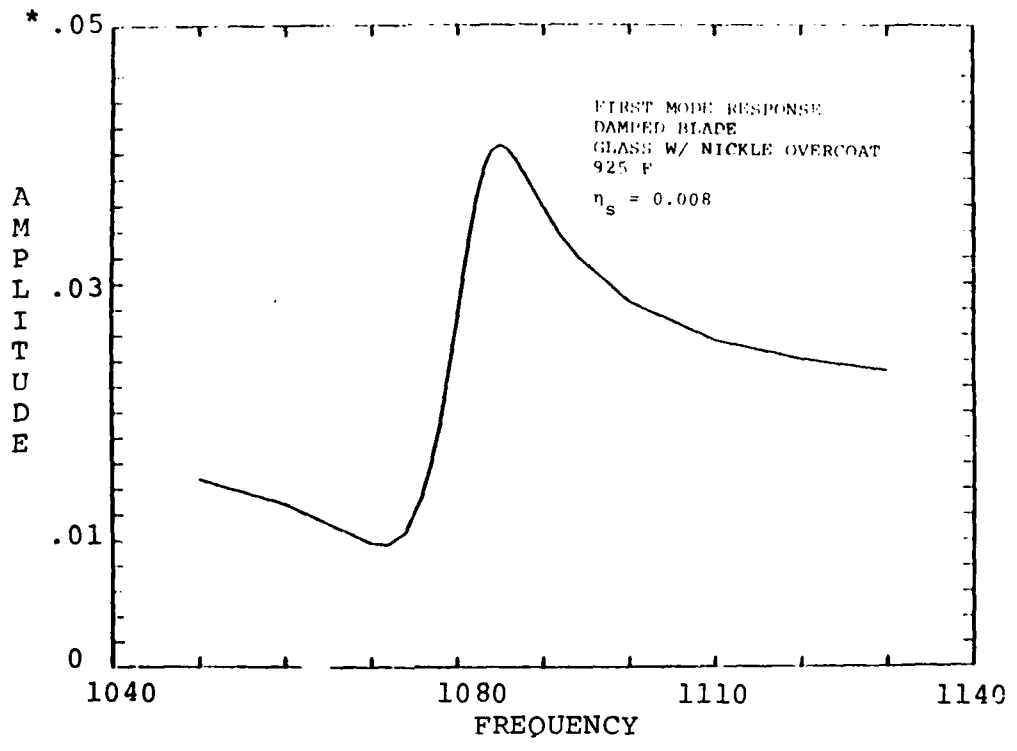

(CASE 7)

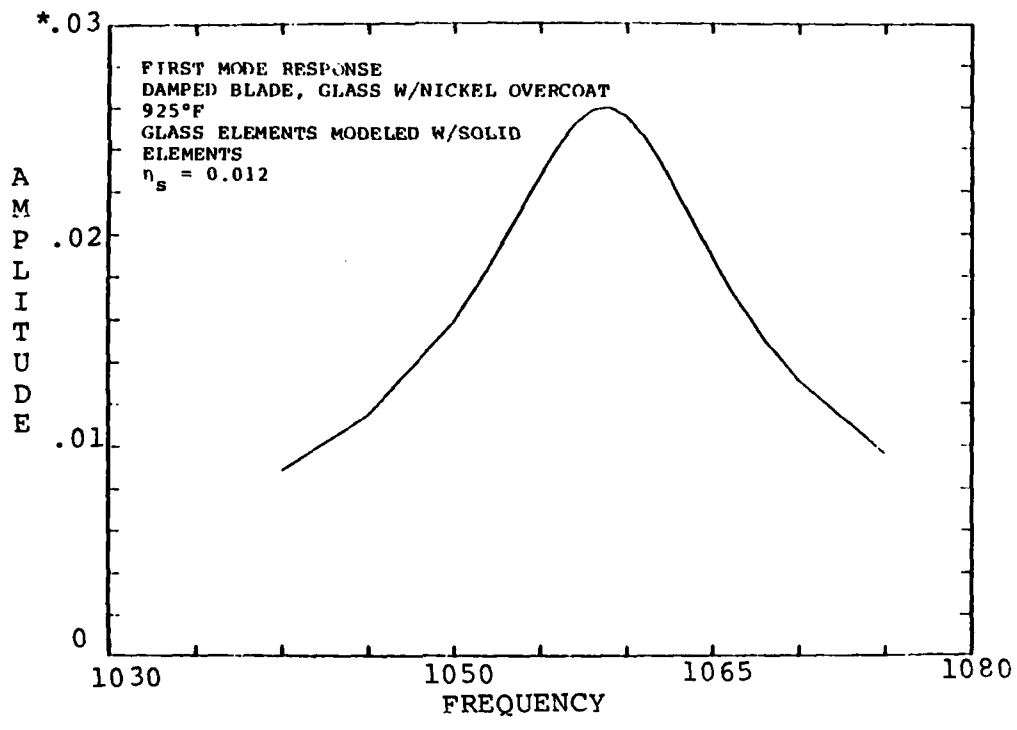

(CASE 8)

Figure 2.17. Amplitude-Frequency Response.  
\*amplitude in inches

of case 3 with case 2 illustrates the increased first mode frequency of the damped blade due primarily to the stiffness of the nickel overcoat. Of course the most obvious feature is the marked decrease in response of the damped blade compared to the undamped blade. The loss factor increased from .002 to .011.

A series of analyses was completed for a non-rotating blade with an 0.25 mm (0.010 inch) glass free layer coating (full blade coverage (at 427, 496, and 538°C (800, 925, and 1,000°F)). The peak structural loss factor occurs at the temperature of 496°C (925°F), at which the loss modulus is also at a maximum. The amplitude-frequency response for the three temperatures is shown in Figure 2.19. This plot shows the reduced response amplitude of the blade at the optimum temperature. The shift in the first mode frequency with temperature can also be seen. The structural loss factors at 427, 496, and 538°C are 0.0022, 0.008, and 0.0044, respectively.

In a structure with a free layer damping treatment, the damping is proportional to the loss modulus. The loss modulus (modulus  $\times$  loss factor) of Corning Glass 8463 versus temperature is shown in Figure 2.20. Superimposed on this graph is the structural loss factor of the blade with full glass coating. This plot shows that the loss factor predicted by the finite element analysis has the same temperature profile as the loss modulus. For a free layer damping application, these are the trends expected. Also shown on this plot is the experimentally measured structural loss factor for a blade with a half-blade glass coating. The peak structural loss factor is high and occurs at a lower temperature.

Figure 2.21 shows case 3 and case 4 together for comparison purpose. The damped blade with glass coating and nickel overcoat exhibits a lower response than the blade with just a glass coating. Case 4 has a lower first mode frequency because the glass coating adds mass to the blade, but contributes very little stiffness since its modulus is an order of magnitude lower than the modulus of the blade material or nickel overcoat.

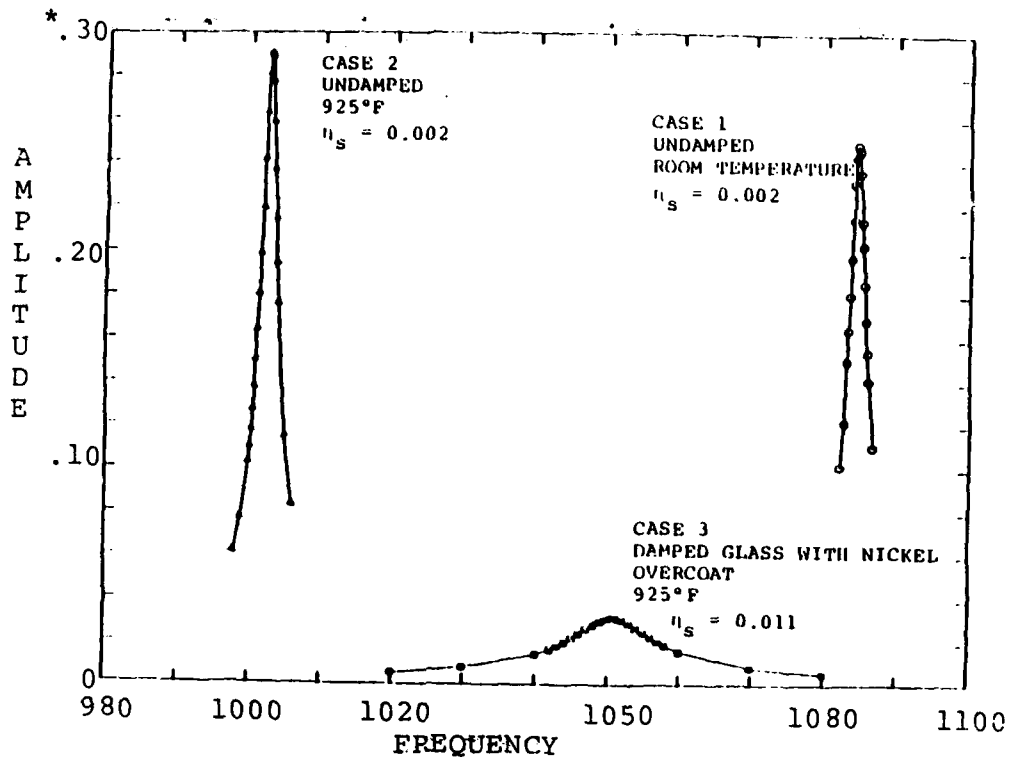

Figure 2.18. Comparison of Damped and Undamped Response.

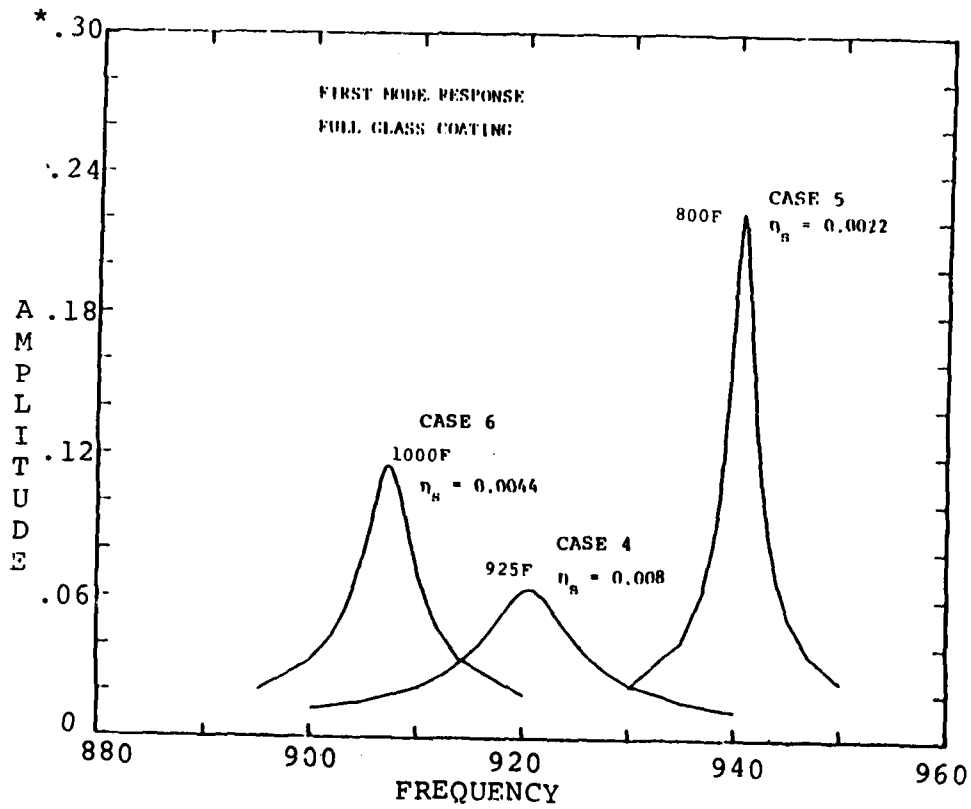

Figure 2.19. First Mode Response of Blade with Full Glass Coating at Three Temperatures.  
\*amplitude in inches

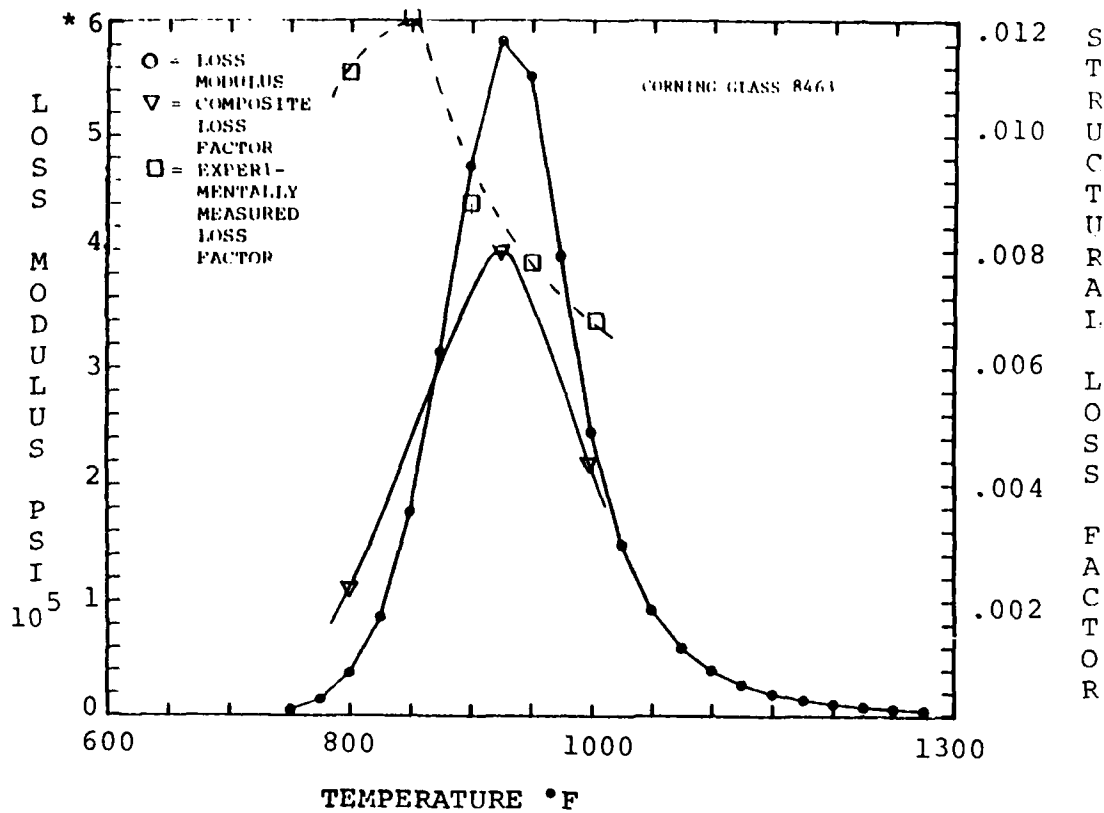

Figure 2.20. Loss Modulus and Composite Factor of Blade with Full Glass Coating versus Temperature.

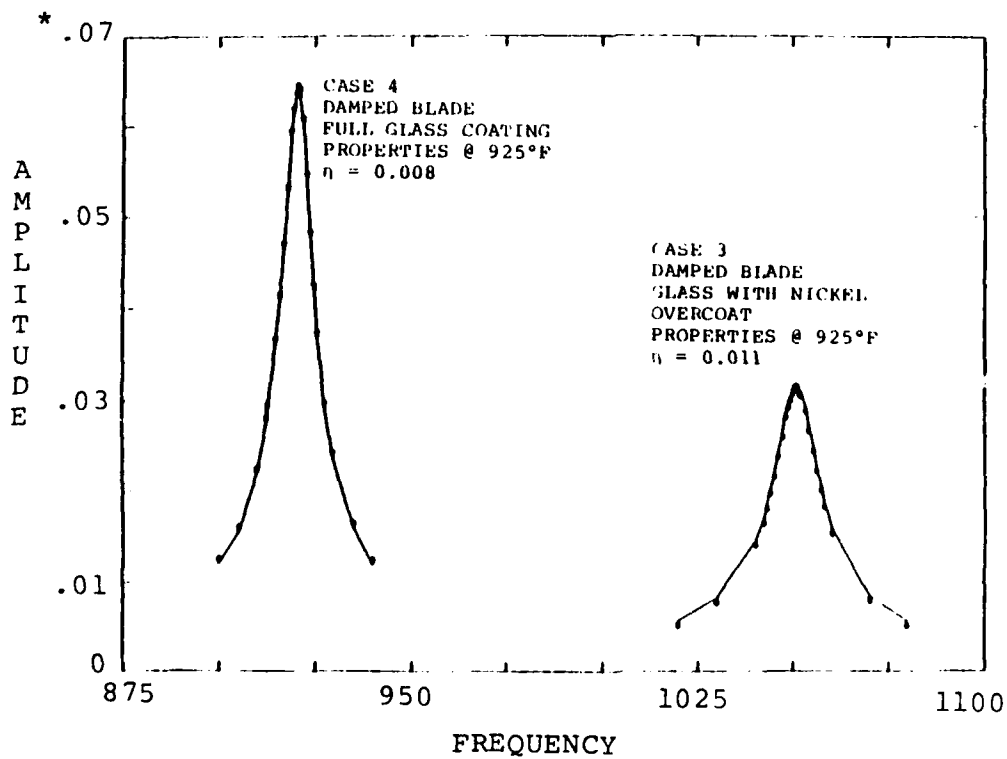

Figure 2.21. Comparison of Blade with Glass and Blade with Glass and Nickel.

\*amplitude in inches 124

Results were obtained for an initially stressed damped blade (case 7, glass coating with nickel overcoat). The initial stress was caused by rotation at 7,500 rpm. The shift in first mode frequency due to rotation can be seen by comparing the rotating and non-rotating cases in Figure 2.22. The width of the peaks in each case are approximately the same, indicating that each has about the same level of damping.

When the blade finite element analysis was initiated, the glass damping layer was modeled with thin-shell (MAGNA-D TYPE 5) elements. This was done because the layer was thin and the glasses ordinarily are applied as free layer damping treatments (extensional deformation). However, the damping layer in constrained layer design is usually modeled with a solid element (TYPE 2). In a constrained layer application, the damping results from shear deformation. The thin-shell element does not accurately model the shear deformation; therefore, the solid elements should be used in these cases. Either element can handle the extensional deformation of a free layer damping application.

To determine the effect of the damping layer element type on the predicted damping, the glass thin-shell elements were changed to solid elements, and a comparison run was made. The test case chosen was the damped blade with glass and a nickel overcoat, non-rotating, at 496°C (925°F). With the glass elements modeled with solid elements, the first mode frequency was 1,058.7 Hz and the composite loss factor was 0.012. With the glass elements modeled with thin-shell elements (as in all previous runs) the first mode frequency was 1,050.7 Hz and the composite loss factor 0.011. The small change in composite loss factor is insignificant since it is determined graphically by the half-power bandwidth method from the amplitude-frequency response plot. The change in frequency is only about 0.8 percent. Both cases are shown in Figure 2.23.

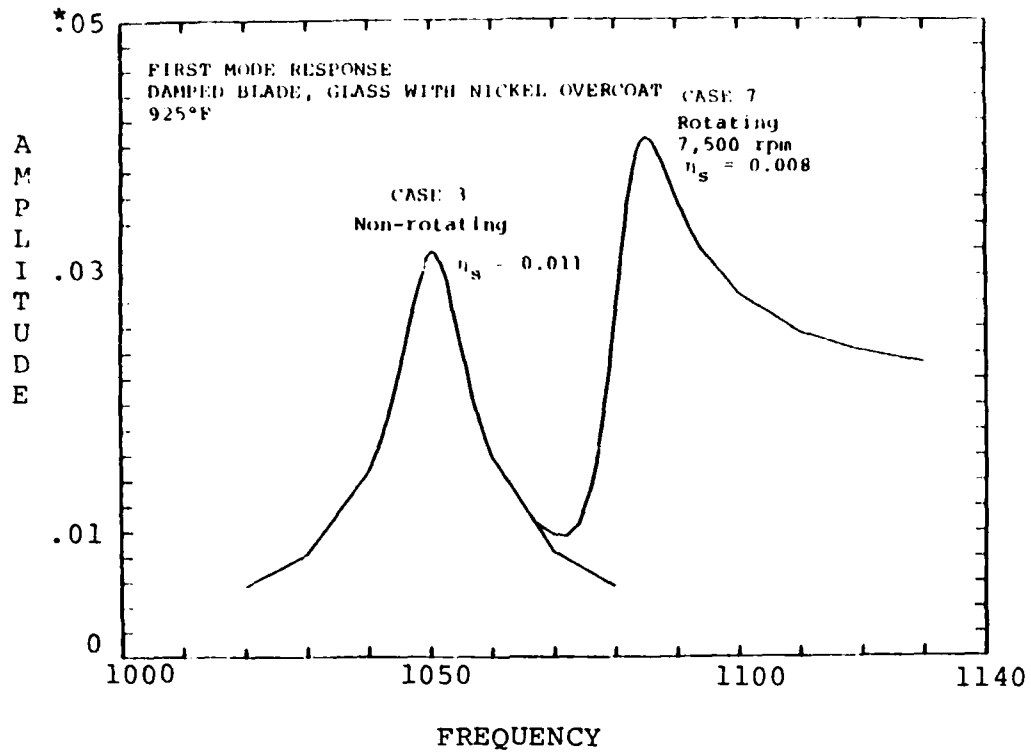

Figure 2.22. First Mode Response of Damped Blade, Rotating and Non-rotating.

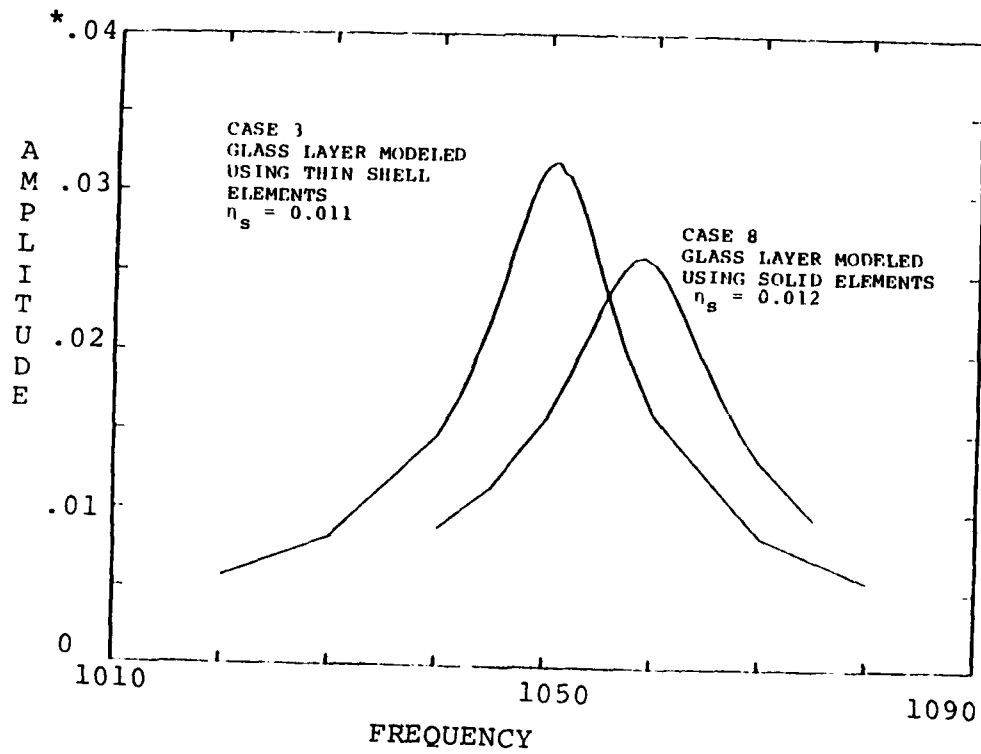

Figure 2.23. Comparison of Results Using Different Element Types to Model the Glass Damping Layer.

\*amplitude in inches 126

Experimental measurements have shown that a glass with a constraining layer acts as a free layer rather than a constrained layer damping treatment, at temperatures near maximum loss modulus. Therefore, the change in composite loss factor for the two cases may be more significant at higher temperatures, as the glass with nickel overcoat starts to behave more like constrained layer damping.

#### 2.1.2.3. Comparison of NASTRAN and MAGNA-D Results

Interest was expressed in comparing the MAGNA-D results on the turbine blade to results from NASTRAN on the same model. Therefore, Conor Johnson of Anamet Laboratories was supplied with two finite element models of the F100 2nd stage turbine blade; they were the UDRI model and the airfoil section only of the P&W model which is shown in Figure 2.24.

The following free vibration runs were made using NASTRAN: (1) P&W airfoil with thin-shell elements and pins connecting suction and pressure surfaces; (2) P&W airfoil with solid elements and pins connecting suction and pressure surfaces; and, (3) the UDRI model with solid elements and the core modeled as solids. The first three frequencies for the various cases are included in Table 2.4.

The NASTRAN runs used a Young's modulus of  $26.5 \times 10^6$  psi which corresponds to blade material properties at 925°F (496°C). To allow comparison between a NASTRAN run and a MAGNA-D run, the frequencies of the NASTRAN run using the UDRI model and solid elements (case 4) were scaled for a Young's modulus of  $31.0 \times 10^6$  psi, corresponding to the blade material at room temperature. The first mode frequency of the UDRI model using MAGNA-D (case 5) is five percent higher than the corresponding NASTRAN run (case 4), and the second and third modes of the NASTRAN model are 0.5 percent and two percent higher than the MAGNA-D frequencies, respectively.



TABLE 2.4  
 COMPARISON OF MAGNA-D AND NASTRAN,  
 FIRST THREE FREQUENCIES OF TURBINE BLADE MODEL

|                                     | NASTRAN<br>E = $26.5 \times 10^6$<br>Thin-shells | NASTRAN<br>E = $31.0 \times 10^6$<br>Thin-shells<br>(Freq. Scaled) | NASTRAN<br>E = $26.5 \times 10^6$<br>Solids    | NASTRAN<br>E = $31.0 \times 10^6$<br>Solids<br>(Freq. Scaled) | MAGNA-D<br>E =<br>$31.0 \times 10^6$              |
|-------------------------------------|--|--|--|---|---|
| P&W mesh<br>(air foil only)<br>(1)  | CASE 1<br>1,356 Hz<br>2,672 Hz<br>4,062 Hz (2)   | CASE 2<br>1,467 Hz<br>2,890 Hz<br>4,393 Hz (2), (4)                | CASE 3<br>1,388 Hz<br>2,925 Hz<br>4,461 Hz (2) | CASE 5<br>1,621 Hz<br>3,555 Hz<br>5,435 Hz (4)                | CASE 6<br>1,704 Hz<br>3,537 Hz<br>5,311 Hz<br>(5) |
| UDRI mesh<br>(air foil only)<br>(1) |  |  | CASE 4<br>1,499 Hz<br>3,287 Hz<br>5,025 Hz (3) |   |   |

- (1) All runs undamped, i.e., no damping layers.
- (2) Model includes pins connecting suction and pressure side.
- (3) Model includes solid core elements.
- (4) Frequencies estimated as proportional to square root of the ratio of Young's modulus; case 2 scaled from case 1; case 5 scaled from case 4.
- (5) Model includes thin-shell and solids; the thin-shells do not have artificial in-plane shear modulus; run UD5R005 (9/30/80).

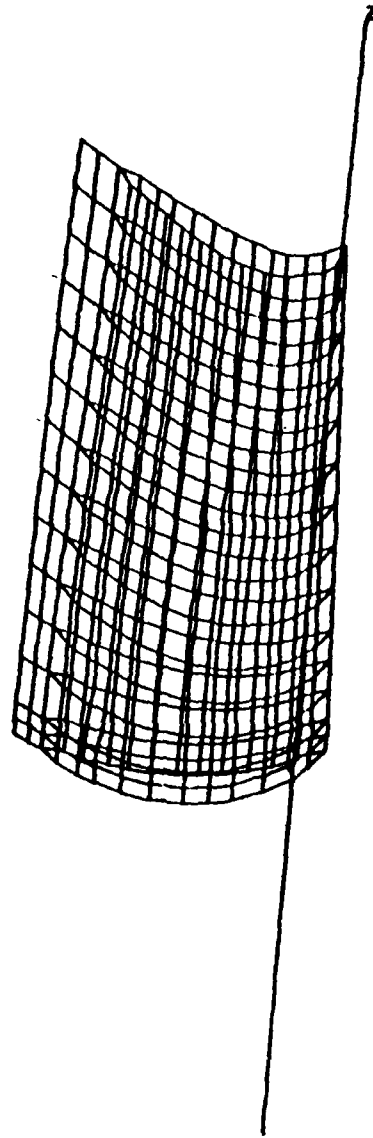

Figure 2.24. Airfoil Section of Pratt and Whitney Model.

The results of the UDRI model using MAGNA-D (case 5) are about 16 percent higher than frequencies of the NASTRAN run with the P&W airfoil and thin-shell elements (case 2). However, this is not surprising since the P&W airfoil has a much finer mesh, which is more flexible and yields lower frequencies.

In general, the MAGNA-D results agree closely with the NASTRAN results for runs using the same model.

## 2.2. FINITE ELEMENT PROGRAMMING

A capability for predicting the linear damped, steady state response of general three-dimensional structures vibrating about a initially stressed state developed in the program MAGNA-D[1] has been added to the program MAGNA[9]\*. This addition extends the damper response analysis capability to include the materially and geometrically nonlinear deformations occurring during initial stressing. Furthermore, the complete element library available in the program MAGNA can be used in the modeling of damped structures. In the following a brief theoretical description of the finite element analyses capability is given.

The finite element formulations is based on the incremental virtual work principle of nonlinear elasticity. It is assumed that the configuration that the initially stressed vibrating structure attains is reached by a succession of two separate motions. First, the structure is subjected to the forces and constraints that are responsible for inducing the initial stresses and deformation. Second, the harmonic motion is superimposed upon this initial deformed state. No further restrictions are made regarding the structural geometry and boundary conditions and the manner in which the initial state of stress is reached. A common initially stressed configuration is that which occurs as a result of rotation.

A summary of the derivation of the finite element equations that govern the forced vibrations of a model is presented in the following paragraphs.

---

\*MAGNA is a proprietary computer program of the UDRI, further details are in Appendix D.

Consider a three-dimensional body in three different stages, as shown in Figure 2.25 state  $C_0$  is the undeformed, unstressed state of the body. State  $C_1$  is an intermediate state of deformation, presumed to be known. This configuration represents the state of the body at the most recent state of load incrementation. State  $C_2$  is the "final" state, to be determined upon application of an additional increment of loading. Actually, state  $C_2$  is found by solving for the increment of deformation that occurs, and then adding the increment to the state  $C_1$  deformation.

With a known intermediate or prestressed state  $C_1$ , the expression for incremental virtual work between states  $C_1$  and  $C_2$  is given by<sup>7</sup>

$$\begin{aligned} & \int_{V_0} [D_{ijkl} e_{kl} \delta e_{ij} + {}_1\sigma_{ij} \delta \eta_{ij} + \rho_0 \ddot{u}_i \delta u_i] dV \\ & = \int_{V_0} f_i \delta u_i dV + \int_{\alpha V_0} \bar{t}_i \delta u_i dA \end{aligned} \quad (1)$$

where the repeated indices indicate summation from 1 to 3, and

$V_0$  = volume in state  $C_0$

$\alpha V_0$  = stress boundary in state  $C_0$

$\rho_0$  = mass density in state  $C_0$

${}_1\sigma_{ij}$  = stresses in state  $C_1$

$f_i$  = increments in applied body forces

$\bar{t}_i$  = increments in applied surface tractions

$D_{ijkl}$  = constitutive tensor relating increments of stress and increments of strain

$u_i$  = increments in displacement from state  $C_1$  to  $C_2$

$\ddot{u}_i$  = increments in acceleration

$e_{kl}$  = linear part of the increment in strain

$\eta_{ij}$  = nonlinear part of the increment in strain

$\delta()$  = virtual change

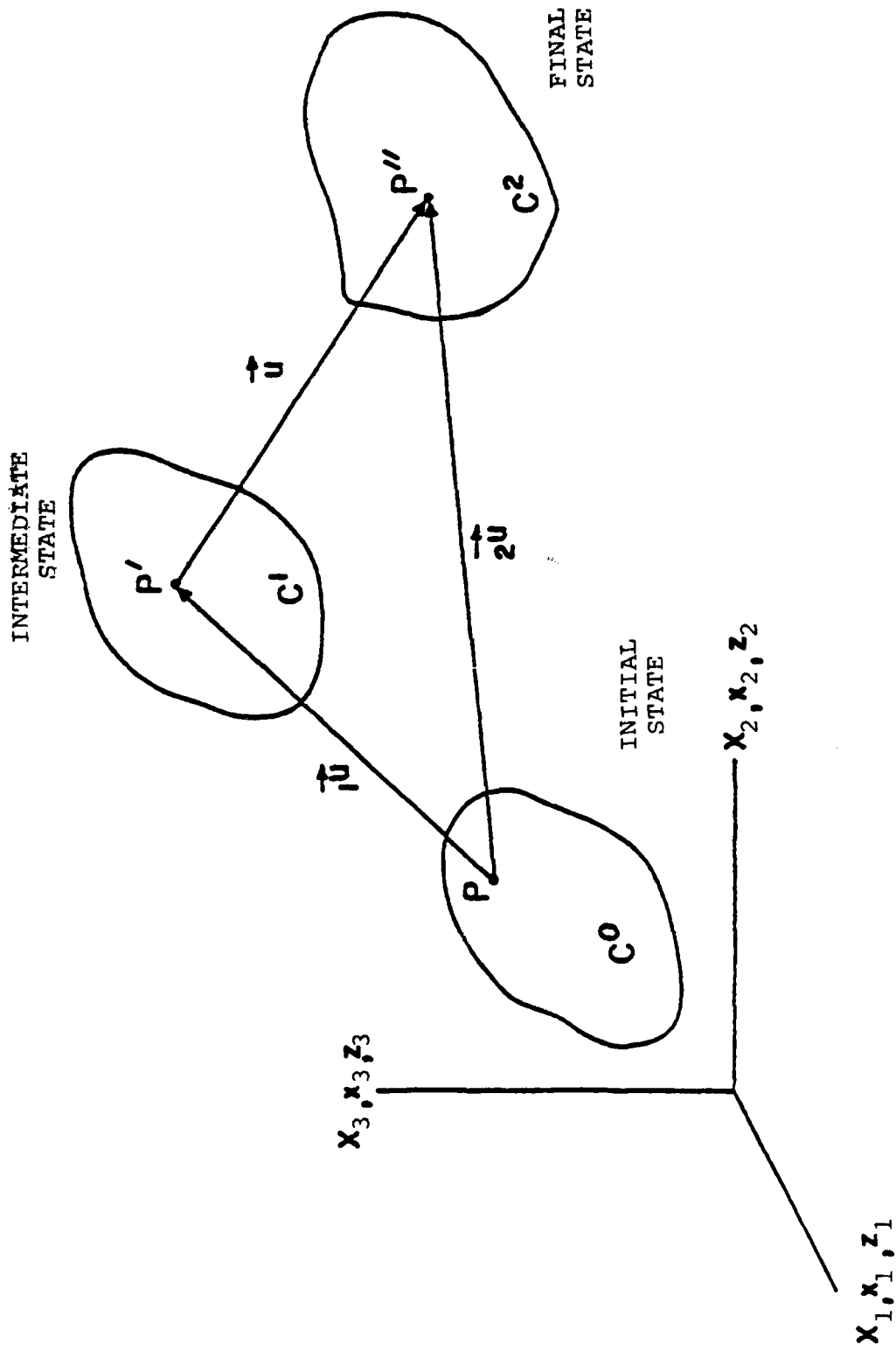

Figure 2.25 Successive States of Deformation of a Three-Dimensional Body.

The first two terms on the left-hand side of the above equation represent the strain energy of incremental deformation and the work performed by the initial stress state during the incremental process, respectively. The third term accounts for the increment of work due to the inertial forces of acceleration. The incremental virtual work done by the prescribed increments in body forces and surface tractions appears on the right-hand side of the equation.

Following the usual finite element discretization procedure, the equations governing the time-dependent nonlinear response of the body are obtained as

$$(\underline{K} + \underline{K}_G) \underline{X} + \underline{M} \ddot{\underline{X}} = \underline{F} \quad (2)$$

where a single underbar denotes a vector and a double underbar indicates a matrix.

As it stands, Equation 2 forms the basis for the development of the MAGNA computer system programs (described in Reference [10]) for transient dynamic analysis of complex three-dimensional structures experiencing large displacements, finite strains, large rotations, and plastic deformation. In this paper we consider a specialization of Equation 2 that permits the development of an analysis method for predicting the linear, damped, steady-state response, of three-dimensional structures, about a nonlinear, initially stressed equilibrium configuration; this method is further specialized to permit the analysis of free vibrations in terms of natural frequencies and normal modes.

Consider that state  $C_1$  of Figure 2.25 is an equilibrium configuration which has been attained by a deformation (possibly nonlinear) from the original state  $C_0$ . Analytically, state  $C_1$  is obtained by applying Equation 1 as implemented in a computer program such as MAGNA. In practice, a common form of state  $C_1$  is that of a body rotating about a fixed axis. We consider here a modification of Equation 2 that will permit the prediction of state  $C_2$ , the small forced oscillations of a body superposed on state  $C_1$ .

Consider the case when the applied forces (increments) in Equation 2 are harmonic in time; that is,

$$\underline{F} = \underline{\bar{F}} e^{i\omega t} \quad (3)$$

where  $\omega$  is the forcing frequency,  $t$  is the time, and  $i = -1$ . It is assumed that the response to the harmonic applied forces is also harmonic of the form

$$\underline{X} = \underline{\bar{X}} e^{i\omega t} \quad (4)$$

where  $\underline{\bar{X}}$  is a vector of nodal displacements that characterizes the spatial form of the response. The elements of  $\underline{\bar{X}}$  are, in general, complex owing to possible phase differences (due to damping) between the response quantities and the forcing function. Incorporation of Equations 3 and 4 into Equation 2 leads to (after eliminating  $e^{i\omega t}$  from each term)

$$[\underline{\bar{K}} + \underline{K}_G - \omega^2 \underline{M}] \underline{X} = \underline{\bar{F}} \quad (5)$$

This equation yields the small nodal vibrational response about a prestressed equilibrium state predicted by Equation 2. The viscoelastic damping behavior is incorporated through the constitutive law

$$\underline{\sigma} = (\underline{D}^R + i\underline{D}^1) \underline{\epsilon} \quad (6)$$

where  $\underline{D}^R$  and  $\underline{D}^1$  are the matrices with frequency-dependent coefficients characterizing the energy storage and dissipative behavior of the material, respectively. The stiffness matrix  $\underline{\bar{K}}$  is thus complex. Equation 5 represents a set of complex, linear algebraic equations. A solution to the equations for a particular value of the forcing frequency  $\omega$  is obtained by the following steps:

$$\text{Decomposition: } (\underline{\bar{K}} + \underline{K}_G - \omega^2 \underline{M}) = \underline{L} \underline{D} \underline{L}^T$$

$$\text{Forward substitution: } \underline{L} \underline{Z} = \underline{\bar{F}}$$

$$\text{Scaling: } \underline{D} \underline{Y} = \underline{Z}$$

$$\text{Back substitution: } \underline{L}^T \underline{X} = \underline{Y}$$

These operations have been programmed using out-of-core storage techniques so that large-scale systems of equations can be considered.

The above solution can be applied to Equation 5 for a single forcing frequency, or alternatively, a number of solutions can be obtained by sweeping through a number of specified frequencies. This capability is useful for making amplitude and phase angle versus frequency plots of displacements, strains, and stresses. System modal damping factors can be computed in two ways: by the half-power bandwidth method and by the strain energy ratio approach. In the half-power bandwidth method computation of the modal damping factor  $\eta_{si}$  for the  $i$ th mode is made by evaluating

$$\eta_{si} = (\omega_2 - \omega_1) / \omega_c \quad (7)$$

where  $\omega_c$  is the frequency corresponding to the maximum amplitude and  $\omega_1$  and  $\omega_2$  are the frequencies associated with amplitudes  $A_{max} / 2$ .

The energy ratio approach to the computation of modal damping factors is expressed as

$$\eta_{si} = \frac{\sum_{j=1}^N \eta_j W_{jc}^{(i)}}{\sum_{j=1}^N W_{jc}^{(i)}} \quad (8)$$

where  $N$  is the number of finite elements in the model,  $\eta_j$  is the material damping factor (defined as  $D_j^L = \eta D_j^R$ ) for element  $j$ , and  $W_{jc}^{(i)}$  is the energy stored in the  $j$ th element when the system is being forced at frequency  $\omega_c$ . A third method of calculating system modal damping based on undamped modal strain energy of the structure is also implemented in the program. In this method the element stored energy  $W_{jc}^{(i)}$  appearing in Equation 8 is calculated using the classical normal modes instead of the damped deflection shapes.

The frequency and temperature dependent material properties of the viscoelastic damping materials are input to the program through a user written subroutine.



The program outputs amplitude, phase angles, and stresses at each frequency as well as the system loss factors as calculated using Equation 8. In the normal mode solution procedure the programs output mode shapes, frequencies, stresses, and the system loss factor as calculated using the modal strain energy method.

The program is stored on CDC mass-storage unit is fully operational.

SECTION 3  
SPECIAL PROJECTS

3.1. STRUCTURAL ANALYSIS

The portable Hewlett Packard Model Number 5451-B Fast Fourier Analyzer was used to perform frequency and modal analysis on various structures as follows:

TF-30 Vibration Monitoring System Analysis

The Fourier Analyzer was shipped to the Engine Overhaul Facility, Tinker Air Force Base, Oklahoma, to collect data to investigate an excessive rate of post overhaul engine rejection due to high vibration levels. The results of this analysis are presented in University of Dayton technical report UDR-TR-81-27, "Structural Analysis of the TF-30 Engine Vibration Transducers V-1 and V-2." [12]

3.2. DDA ELASTOMERIC TOOLING

In mid-December, 1981, UDRI personnel made a trip to the Detroit-Diesel, Allison (DDA) plant in Indianapolis, Indiana to discuss problems they were having in the bonding of damping wraps to the vanes of the TF-41 low pressure bearing support (LPBS). DDA has fabricated a single vane elastomeric expansion tool which is heated by a hair-dryer-type commercial heat gun. They had set up a switching control unit to the heating element which operated on a thermocouple feedback from near the outlet of the air passage inside the baffling of the fixture. The problem they had encountered were debonds or voids in the ISD-110 layer bond to the outer constraining layer of the wrap. (The TF-41 LPBS damping wrap was epoxy bonds only on the edges and requires damping layer adhesive attachment over the majority of the vane surfaces. It has two damping layers of ISD-110 on one side and two damping layers of ISD-112 on the other with two constraining layers on each side.)

The bond failure of the outer damping layer of ISD-110 seemed quite likely to be a problem of overheating the wrap since the heat flow is from the outside to the inside of the installation set-up for the wrap bonding. We suggested the installation of some

thermocouples at the elastomer-outer constraining layer interface to determine the temperature profile over the wrap surface. DDA later reported the temperature survey showed 385°F to be the maximum temperature at the outer surface of the wrap. This temperature is approaching the failure temperature of ISD-110. It is possible the elastomeric tooling configuration was causing some shear between the wrap layers at the failure location. This could quite conceivably cause wrap delamination at maximum stress, maximum temperature locations.

In any case, DDA reported the problem solved by changes to the internal baffling in their bonding. Successful wrap installations, in so far as we know, are now routine. It should be noted that this tooling set-up is a prime candidate for worldwide use in a single vane damping wrap repair kit.

### 3.3. HIGH FORCE, HIGH TEMPERATURE ELECTROMAGNETIC TRANSDUCER DEVELOPMENT

Development of an electromagnetic transducer having greater force output than those used in the high temperature beam tests was undertaken. These transducers were to excite high frequency modes in bladed disks rotating at high speeds, and were of interest to AFWAL/MLLN and AFWAL/POTA.

The principal concern in the design of this transducer was to maximize the force that it can exert on the target disk or beam. The maximum force results from producing the largest possible magnetic field at the target surface. The biggest single complication in the design arose from the requirement for large force at relatively high frequencies. Several refinements were incorporated to minimize the limiting effects and to maximize power transfer to the magnetic field.

The basic geometry of this transducer is that of a relatively long iron core with a multilayer coil of copper wire wrapped around it. This assembly is contained within a closed, externally threaded housing to allow for cooling and mounting. The actual core is square in cross-section, and is contained within a cylindrical coil form. This configuration allows freon to be circulated between the core

and the coil in order to cool the windings. The freon removes much of the heat generated by  $I^2R$  losses, permitting a higher current to be driven through the wire coils, thus resulting in a higher magnetic field. Figure 3.1 shows a schematic cross-section of the cooling flow configuration.

At frequencies above several tens of Hertz, eddycurrent losses become significant. These occur in any conductor that is placed within a changing magnetic field, such as the core of a transformer, or the core of this transducer. As the operating frequency is increased, the eddycurrent losses also increase. This eddycurrent effect can be reduced appreciably by constructing the core of thin, electrically isolated laminations of the core material, again much as within a transformer. The higher the required operating frequency, the thinner the laminations must be.

The core was constructed from 0.015 inch thick silicon-iron transformer sheet steel to produce a nominal 0.25" x 0.25" x 1 5/8" core, laminated parallel to the long direction (see Figure 3.5). The laminations are pressed into a glass-epoxy coil form with a thin layer of electrical tape to fill in the slight gap which resulted from the core's not having a perfectly square cross-section. The back end of the core is almost in contact with the transducer body, providing a magnetic flux return path through the transducer body. The front of the core is pressed against a ~0.015 inch thick non-magnetic stainless steel membrane. This end provides the external magnetic field to the target disk.

The coil consists of eight layers of 30 gauge enameled wire with a copper-constantan thermocouple embedded between the fourth and fifth layers. The resistance of the coil is nominally 12.5. Fusing current for 30 gauge wire is approximately 10 amperes. To avoid possible damage to the coil, do not exceed 6 amperes peak current under any circumstances. At an ambient temperature of 27°C, the cooling should be adequate for currents up to the above recommended limit. During operation in high temperature environments the coil temperature, monitored by the thermocouple, should not be permitted to exceed 85°C.

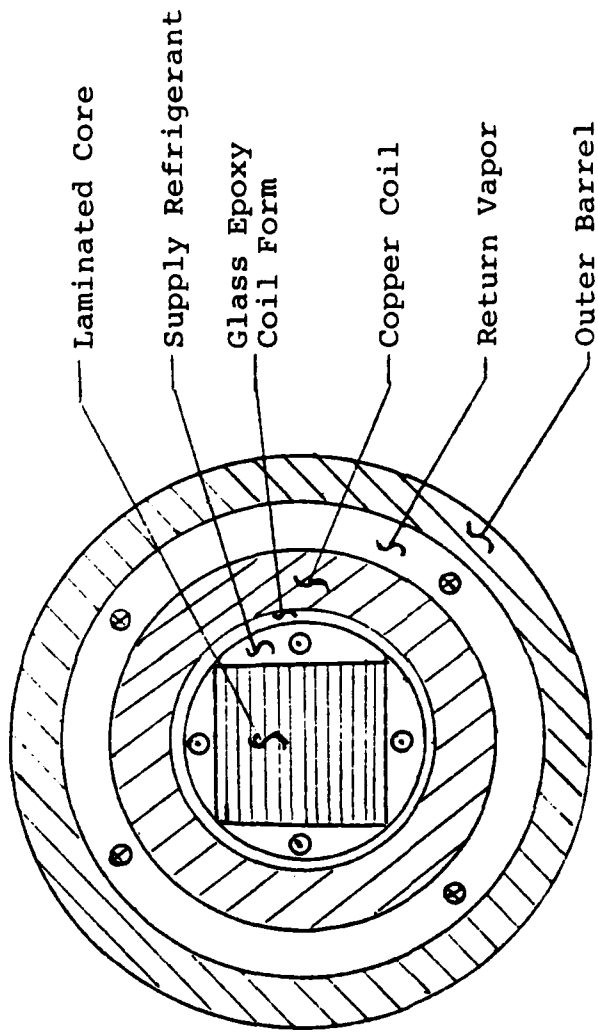

Figure 3.1. Schematic Cross Section of Transducer Showing Coolant Flow

Figures 3.2 through 3.7 show the design drawings of the parts of the transducer assembly.

Performance characteristics of these transducers are shown in Figures 3.8 through 3.12. Figures 3.8 through 3.10 show the Oersted's versus D.C. current input into the transducer. Oersted's are a measure of the magnetic field strength. Figure 3.11 illustrates the increase in power of the transducer as a function of increasing D.C. bias current at a constant A.C. drive voltage. The acceleration output was measured by an accelerometer mounted on a standard aluminum beam. Figure 3.12 illustrates the effect on the drive power an A.C. voltage increase to the transducer with a constant D.C. bias current. Once again the acceleration is monitored on an aluminum beam which is being excited by the transducer.

### 3.3.1. Cooling System

A cooling system, fabricated to cool the transducers manufactured for the Propulsion Laboratory, was delivered with the transducers. The system was built around a Copeland Model FBAH 0050 1AA compressor/condenser unit. The system is designed to provide cooling for two to eight transducers. Refrigerant flow rate is controlled by metering valves in the supply and return lines, a thermostatic expansion valve, and the amount of freon charge in the system. Distribution of refrigerant among transducers is provided by manifolds (Figure 3.13) between the supply and the return line and the transducers. One set of manifolds was provided with the transducer mounting plate to be used on the bladed disk fixture.

Since it is anticipated that the system will occasionally be subjected to contamination, principally due to connecting and disconnecting transducers, two filter-driers were installed. A filter-drier, having 9 cubic inches desiccant and 21 square inches filter surface, installed in the liquid line, would normally be adequate to provide long-term protection to the system. However, anticipating the probability of refrigerant contamination, not only

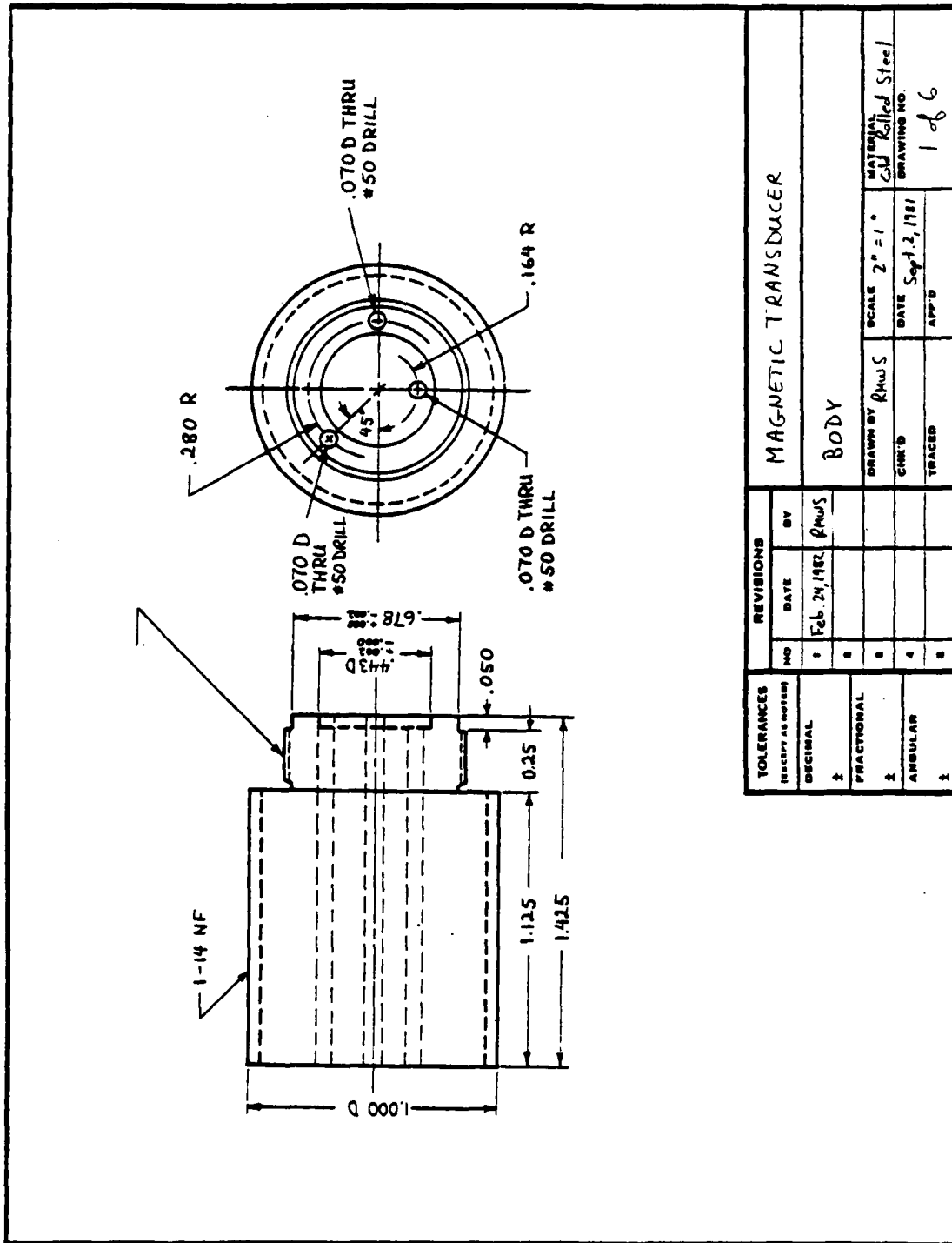

| TOLERANCES<br>(EXCEPT AS NOTED) |            | REVISIONS |               | MAGNETIC TRANSDUCER |  |
|---------------------------------|------------|-----------|---------------|---------------------|--|
| DECIMAL                         | FRACTIONAL | NO        | DATE          | BY                  |  |
| ±                               | ±          | 1         | Feb. 24, 1982 | RHWS                |  |
| ±                               | ±          | 2         |               |                     |  |
| ±                               | ±          | 3         |               |                     |  |
| ±                               | ±          | 4         |               |                     |  |
| ±                               | ±          | 5         |               |                     |  |

|               |        |                   |                            |
|---------------|--------|-------------------|----------------------------|
| DRAWN BY RHWS |        | SCALE 2" = 1"     | MATERIAL Cold Rolled Steel |
| CHK'D         | TRACED | DATE Sep 12, 1981 | DRAWING NO. 1 of 6         |

Figure 3.2. Magnetic Transducer Body

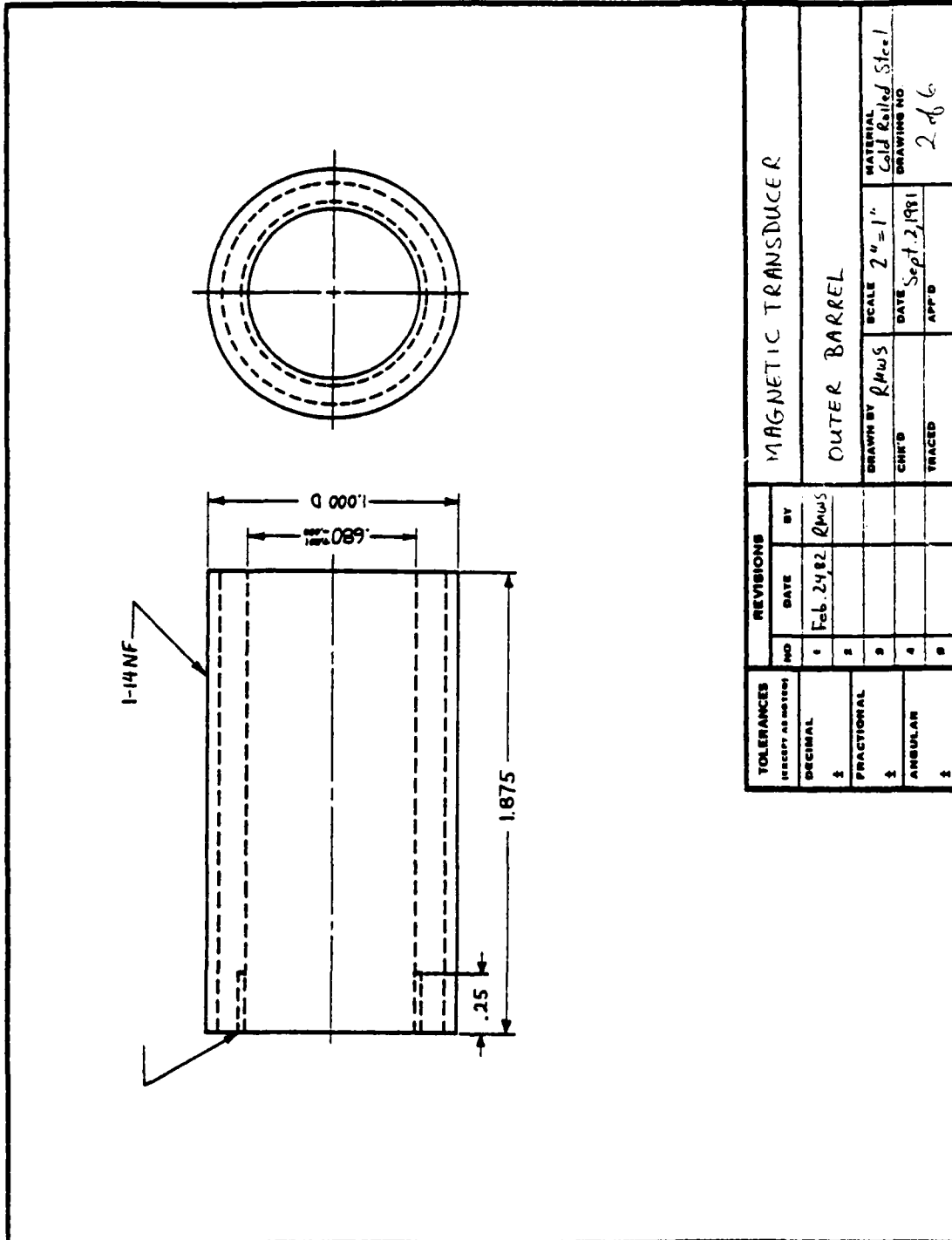
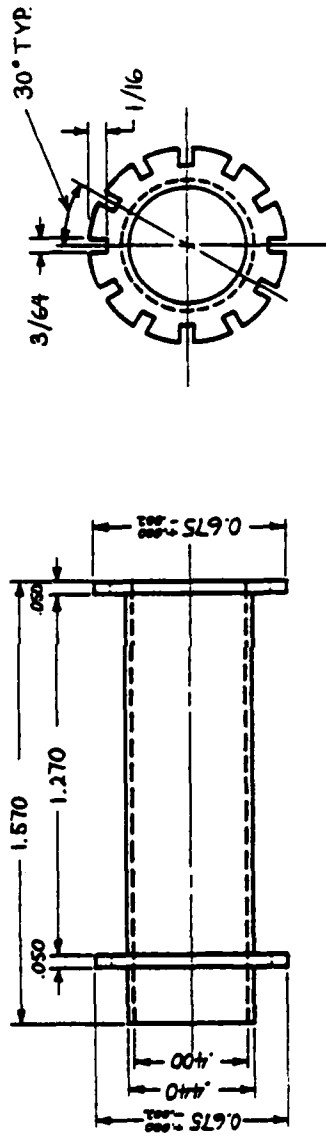

Figure 3.3. Magnetic Transducer Outer Barrel





| TOLERANCES                 |  | REVISIONS |            | MAGNETIC TRANSDUCER |           |
|----------------------------|--|-----------|------------|---------------------|-----------|
| UNLESS OTHERWISE SPECIFIED |  | NO.       | DATE       | BY                  |           |
| DECIMAL                    |  | 1         | Feb 24, 82 | RHWS                | COIL FORM |
| FRACTIONAL                 |  | 2         |            |                     |           |
| ANGULAR                    |  | 3         |            |                     |           |
|                            |  | 4         |            |                     |           |
|                            |  | 5         |            |                     |           |

|          |         |          |              |
|----------|---------|----------|--------------|
| SCALE    | 2" = 1" | MATERIAL | Glass Epoxy  |
| DRAWN BY | RHWS    | DATE     | Sept 2, 1981 |
| CHEK'D   |         | APP'D    |              |
|          |         |          | 3 of 6       |

Figure 3.4. Magnetic Transducer Coil Form

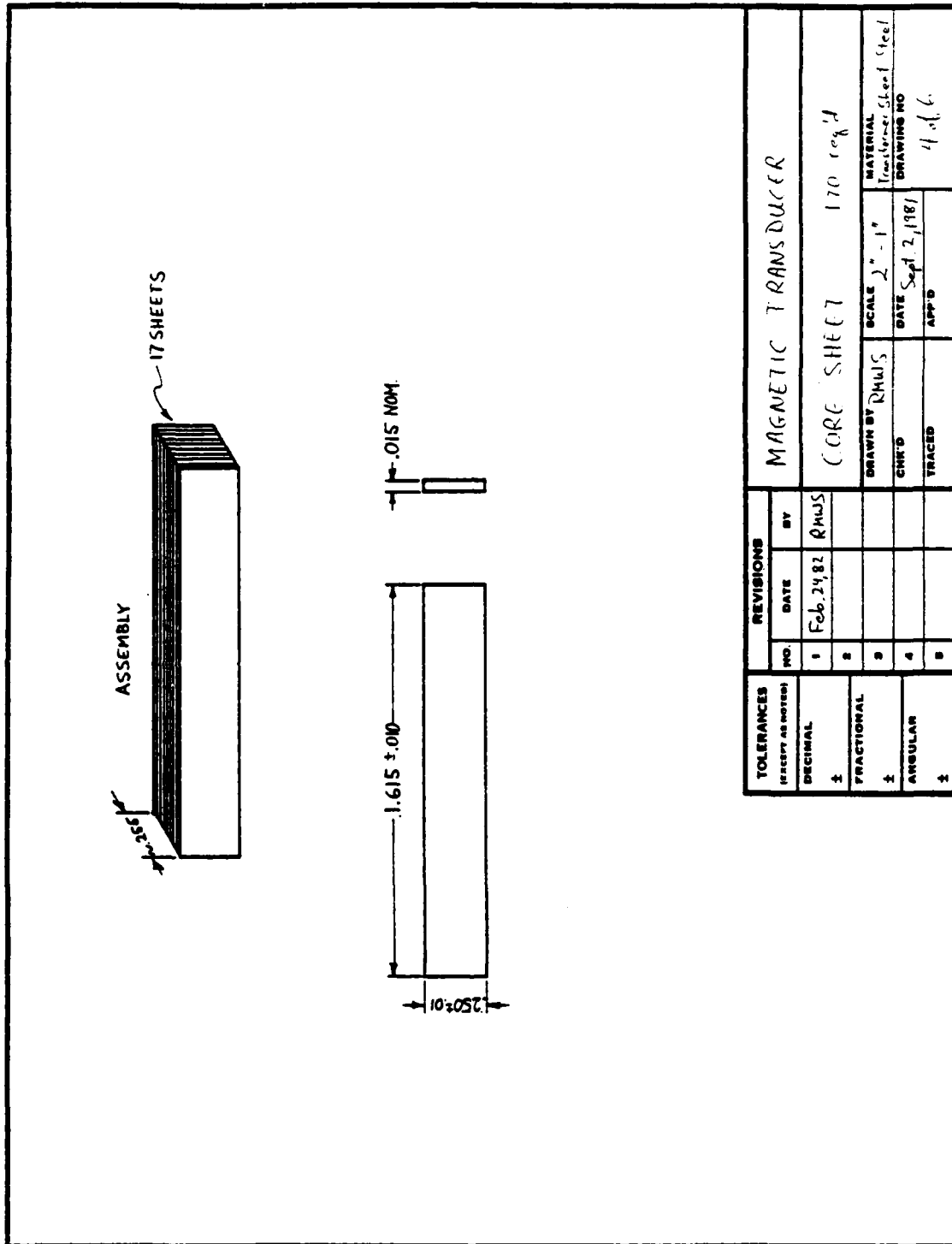
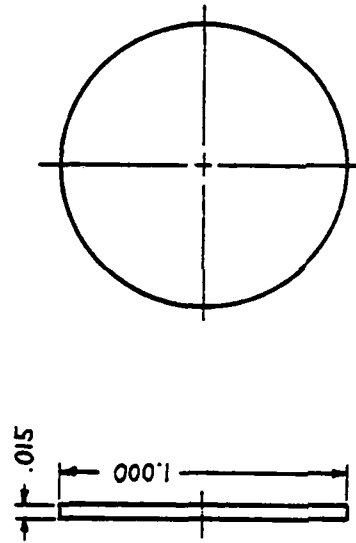
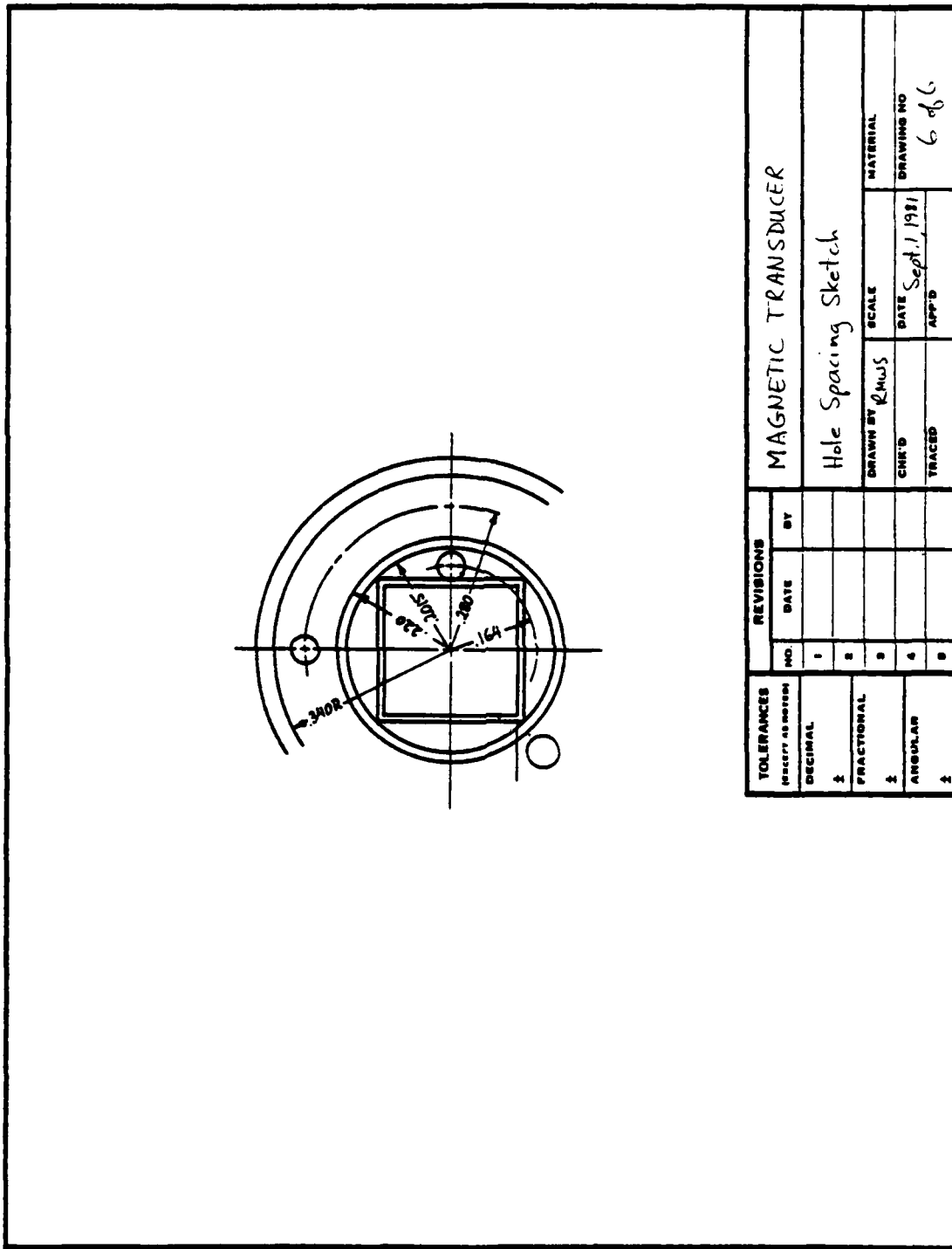

Figure 3.5. Magnetic Transducer Core Sheet



| TOLERANCES<br>UNLESS OTHERWISE SPECIFIED |            | REVISIONS |             | MAGNETIC TRANSDUCER |         |                 |             |
|--|------------|-----------|-------------|---------------------|---------|-----------------|-------------|
| DECIMAL                                  | FRACTIONAL | NO.       | DATE        | BY                  | SCALE   | MATERIAL        | DRAWING NO. |
| ±  | ±          | 1         | Feb. 24, 82 | RHWS                | 2" = 1" | Stainless Steel |             |
|  |            | 2         |             |                     |         |                 |             |
|  |            | 3         |             |                     |         |                 |             |
|  |            | 4         |             |                     |         |                 |             |
|  |            | 5         |             |                     |         |                 |             |
|  |            |           |             |                     |         |                 | 5 of 6      |

Figure 3.6. Magnetic Transducer End Cap



| TOLERANCES<br>(EXCEPT AS NOTED) |      | REVISIONS |    |
|---------------------------------|------|-----------|----|
| NO.                             | DATE | NO.       | BY |
| 1                               |      | 1         |    |
| 2                               |      | 2         |    |
| 3                               |      | 3         |    |
| 4                               |      | 4         |    |
| 5                               |      | 5         |    |

|          |               |             |
|----------|---------------|-------------|
| DRAWN BY | SCALE         | MATERIAL    |
| CHK'D    | DATE          | DRAWING NO. |
| TRACED   | APP'D         |             |
|          | Sept. 1, 1981 | 6 of 6      |

Figure 3.7 Magnetic Transducer Hole Spacing Sketch

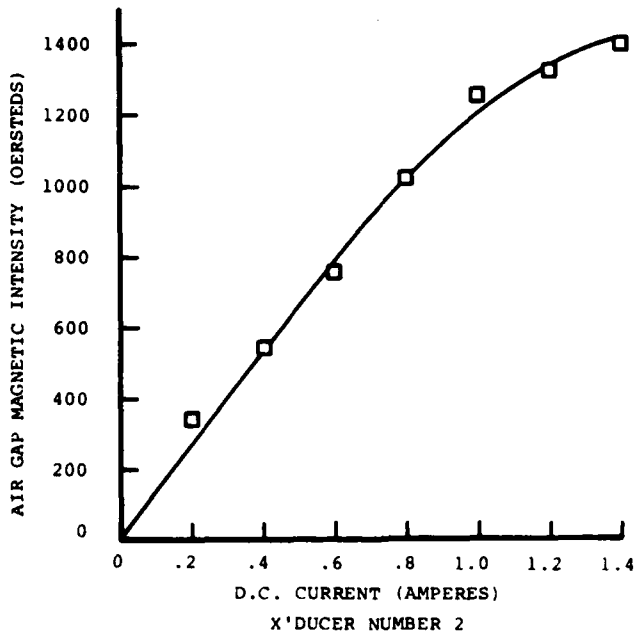
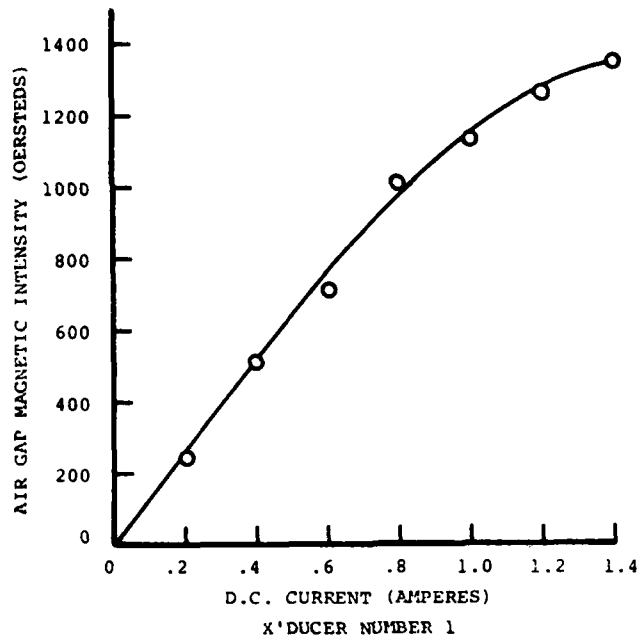

Figure 3.8. Air Gap Magnetic Intensity versus D.C. Current in Coil.

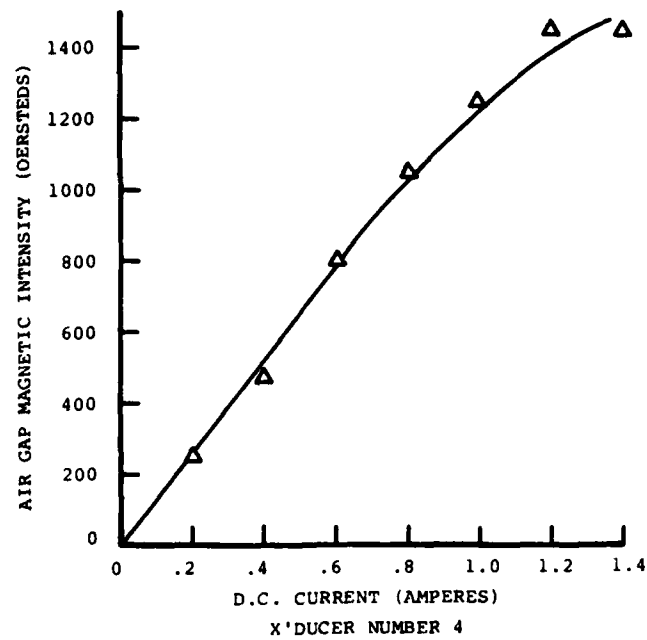
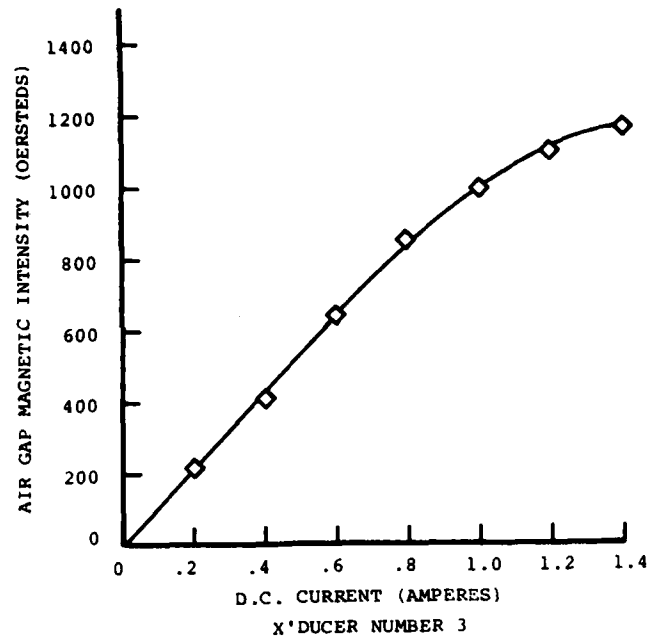

Figure 3.9. Air Gap Magnetic Intensity versus D.C. Current in Coil.

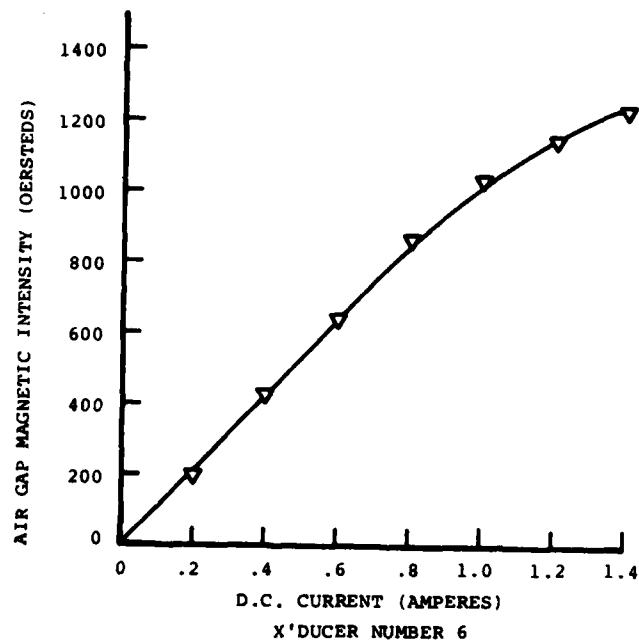
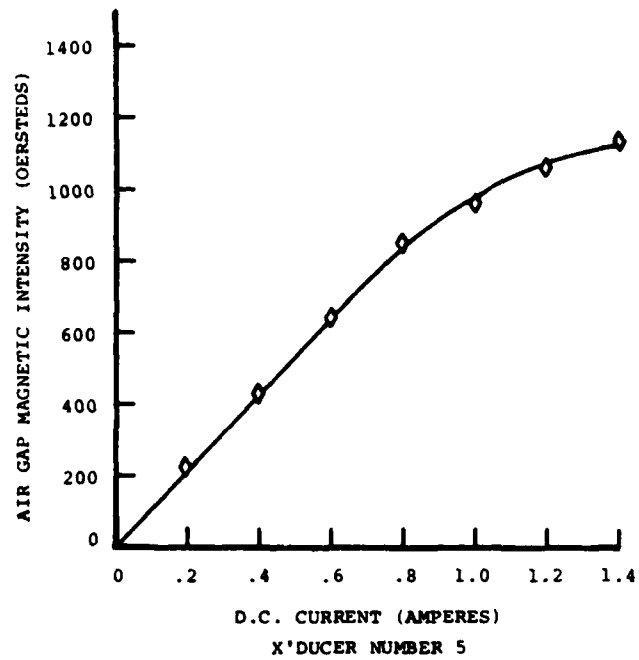

Figure 3.10. Air Gap Magnetic Intensity versus D.C. Current in Coil.

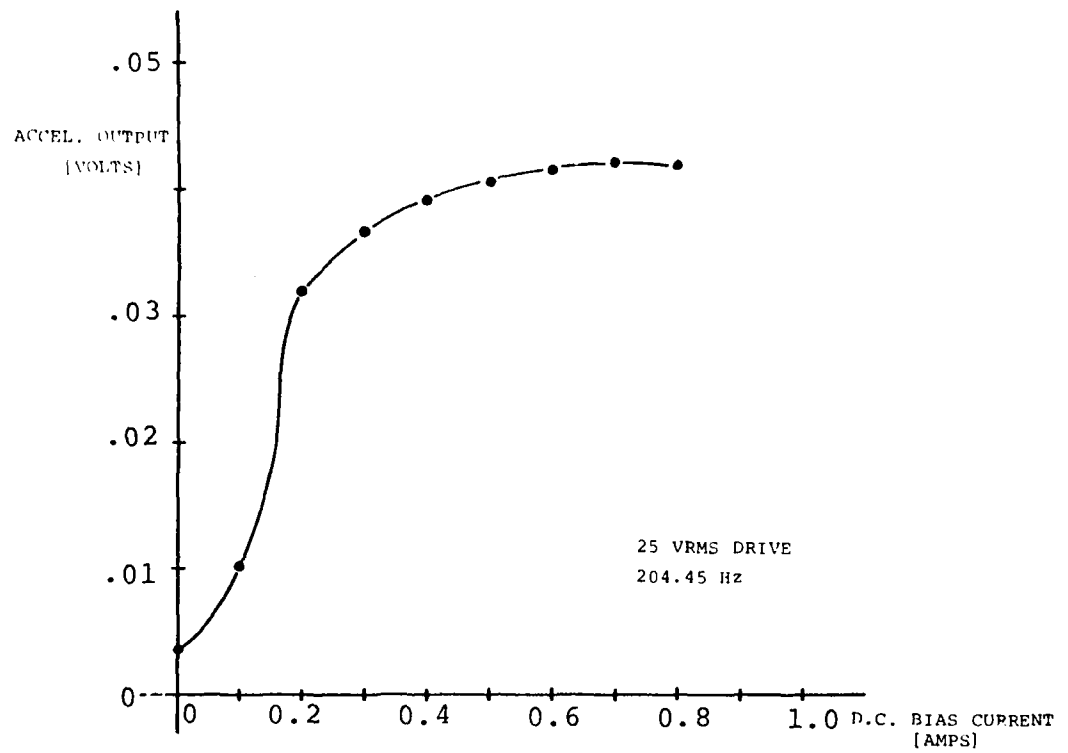

Figure 3.11. Acceleration Response versus D.C. Bias at a Constant A.C. Drive Level.

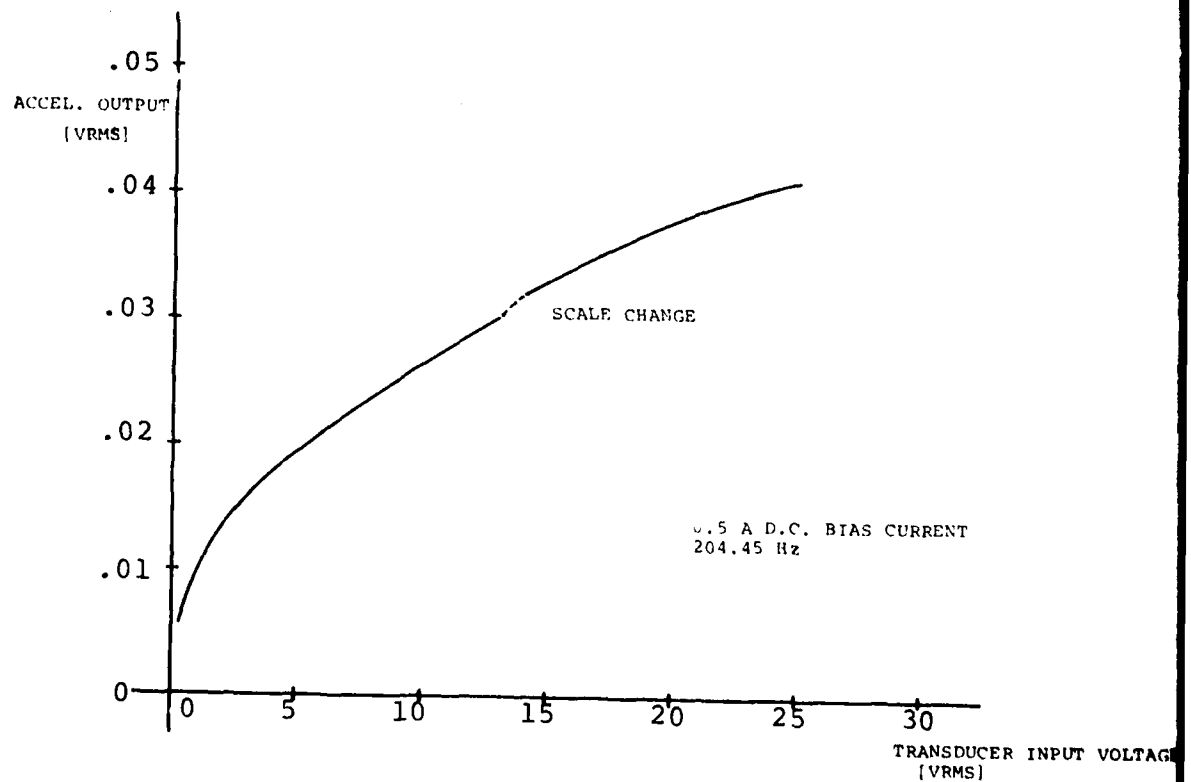
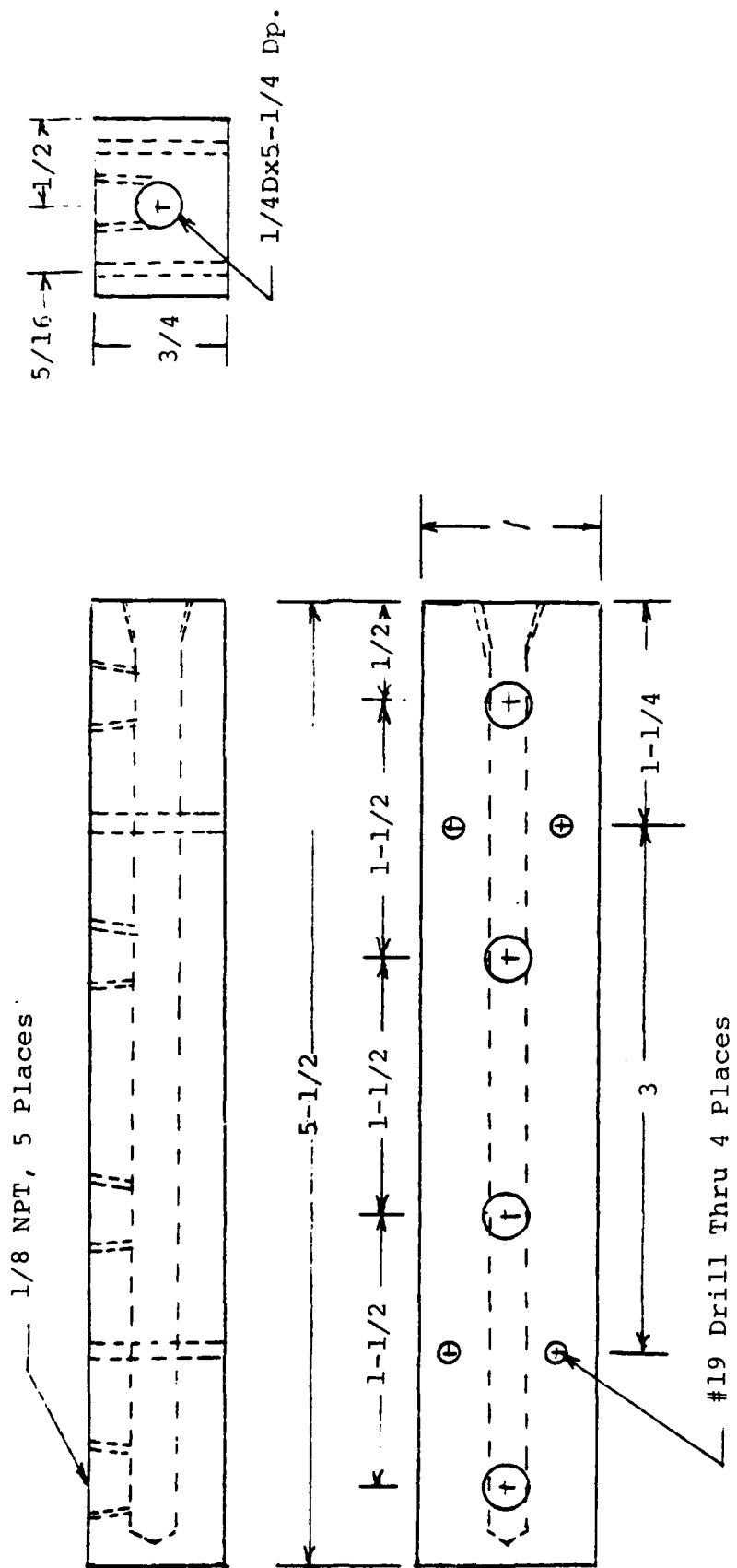

Figure 3.12. Acceleration Response versus A.C. Drive Voltage at a Constant D.C. Bias Current.





MANIFOLD COOLANT

MATERIAL: AL  
2 REQUIRED

Figure 3.13. Coolant Manifold

by moisture but also by solid particulates, a larger filter-drier having 30 cubic inches desiccant and 53 square inches filter area was installed in the suction line. The larger filter-drier was placed in the suction line to trap contaminants before they enter the compressor.

A schematic diagram of the refrigerant circuit is provided in Figure 3.14. Refrigerant vapor is drawn into the compressor. The heat of compression is dissipated in the air cooled condensor and liquid refrigerant flows through the receiver and liquid line filter to the expansion valve. The expansion valve regulates the flow of liquid refrigerant to the transducers in response to the temperature of the vapor return line from the transducers which can be considered to be an evaporator. Two sets of control valves and connections have been incorporated to provide flexibility for cooling a variety of transducer configuration.

#### 3.3.1.1. Transducer Connection

During long quiescent periods, the system will leak down to one atmosphere ( 0 PSI gage pressure). Connecting lines and transducers to the system could introduce ambient air to the system resulting in overburdening filter/driers. To minimize contamination, the following purge is recommended.

- Connect required number of transducers to manifolds.
- Connect supply lines loosely to supply fittings.
- Connect vapor return lines securely to return fittings.
- Open charge valve to purge room air from transducers and lines.
- Secure supply lines to fittings.
- Close charge valve.

The above procedure results in a clean system with the exception of atmospheric contamination (approximately 0.7 in<sup>3</sup>) entrapped between the supply fittings and supply valves.

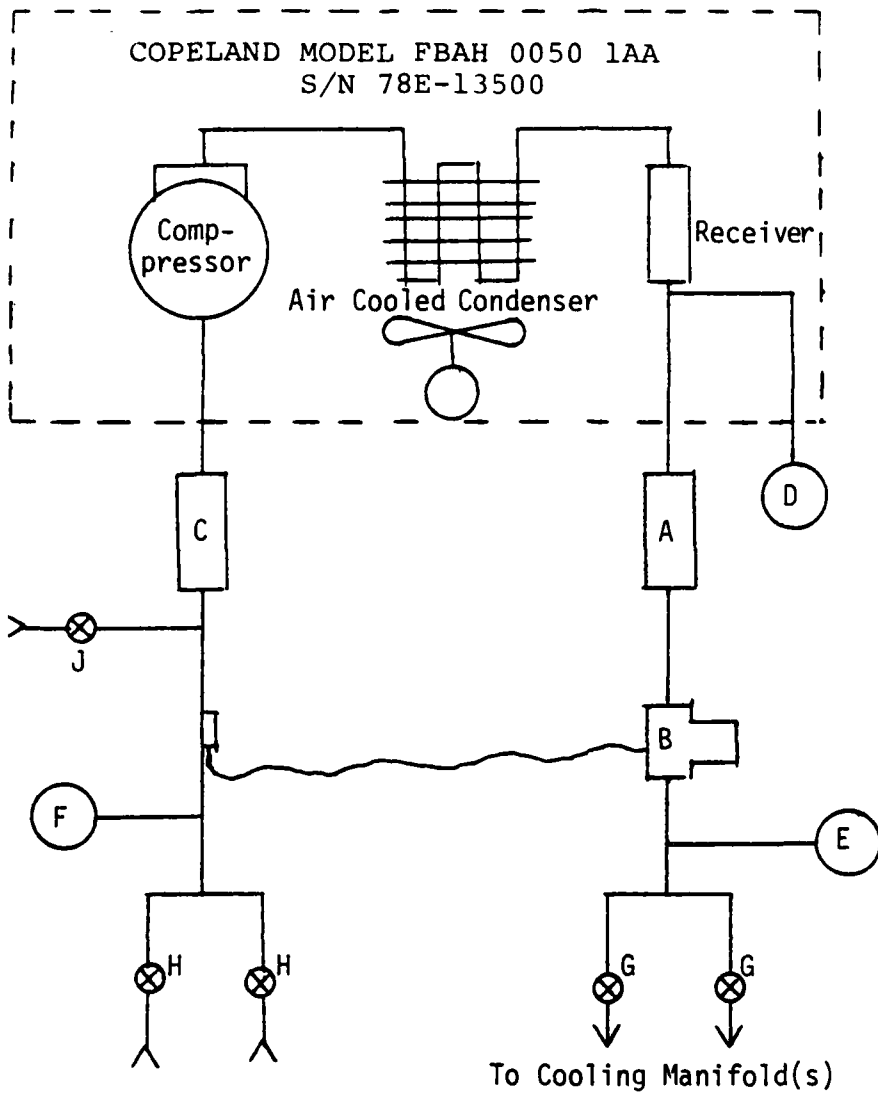

- A. Filter-Drier, Sporlan, Type C082
- B. Thermostatic Expansion Valve, Sporlan, Type FF-1/2-C
- C. Filter-Drier, Sporlan, Type C305
- D. Gauge, Head Pressure, 0-160 PSI
- E. Gauge, Supply Pressure, 0-160 PSI
- F. Gauge, Vapor Pressure, 0-100 PSI
- G. Valve, Transducer Supply
- H. Valve, Transducer Return
- J. Valve, Charging

Figure 3.14. Schematic of Cooling System

### 3.3.1.2. Operation

The system should function satisfactorily, regardless of the number of transducers being cooled, if after turning the system on, the charge valve is opened until the HEAD PRESSURE gauge registers 120 PSI. Operation for prolonged periods may require opening the charge valves occasionally to balance the system due to slight leakage at the many mechanical connections of the system.

The following procedure is recommended for satisfactory operation of the system.

#### Start-up:

- Open (CCW) valve F-12 cylinder.
- Open (CCW) supply and return valves required.
- Turn on AC power switch.
- Open (CCW) charge valve until head pressure builds up to 100-120 PSI.
- Close (CW) charge valve.

During operation the supply pressure gauge should indicate 30-60 PSI and return pressure gauge should indicate 0-20 PSI.

#### Shut-down:

- Turn off AC power switch.
- Close (CW) supply and return valves.
- Close (CW) valve on F-12 cylinder.

### 3.4. DAMPING OF NASA FLUTTER BLADES

Five blades were received from the National Aeronautics and Space Administration (NASA) Lewis Research Center, Cleveland. These blades are used in the study of aerodynamic flutter (see Figure 3.15). The blades are oscillated by a variable speed cam and follower system from 0 Hz to 700 Hz to induce flutter. At certain flutter speeds, the blades were observed to be deforming in the first bending mode and subsequently developing fatigue cracks. It was requested that the UDRI perform a modal analysis on the blades and develop an appropriate damping application to evaluate the effects of additive damping on the flutter characterization of the blades.

Figure 3.16 shows the fixture which was developed to simulate the boundary conditions of the blade when mounted in the wind tunnel. The support blocks on each end have "V" grooves machined into them to keep the center line of the blade parallel to the base plate. This figure also shows the force input point (magnetic disc on upper left of blade) and the response pick-up point (accelerometer on lower left of blade) used for determining the damped and undamped modal loss factors.

Figure 3.17 shows the geometry used for the modal analysis. The small shaft would be between point 5 and 12, and the large shaft between 8 and 9. Response was measured in the Z direction at sixteen points, and the force input was applied in the negative Z direction at point number 4 by a magnetic driver connected to the DAC output of the fast Fourier transform system.

Figures 3.17 through 3.21 illustrate the first seven modes of the flutter blades superimposed on the undeformed shape, as well as the frequency associated with each mode. Mode 1, at 1,105 Hz was the primary mode of interest.

Figure 3.21 compares the measured value of the bare blade loss factor (0.0011) to the measured and predicted values of the loss factor for the chosen damping configuration (0.002-inch, 3M Company's

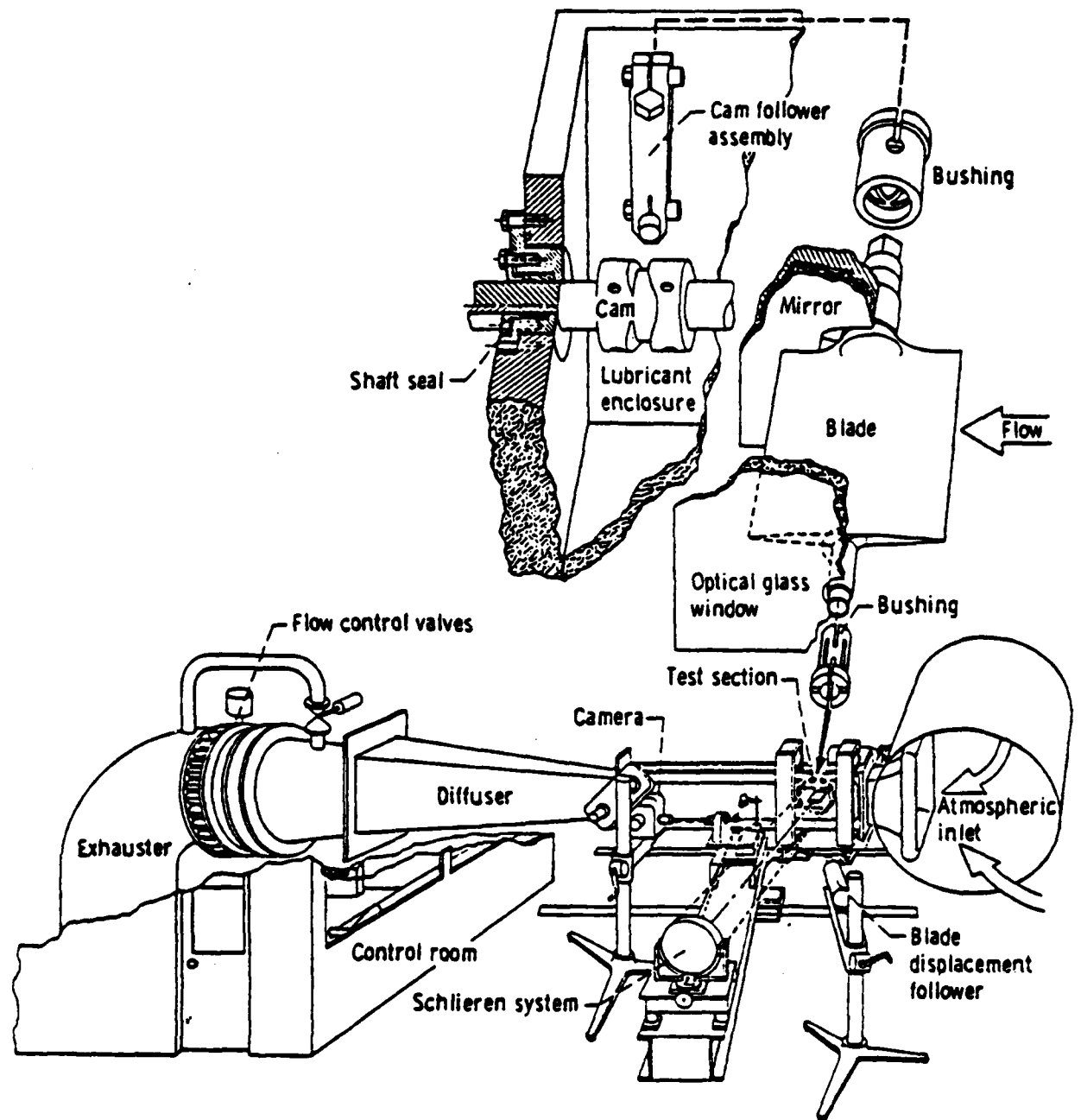

Figure 3.15. NASA Lewis Research Center Facility for Flutter Studies

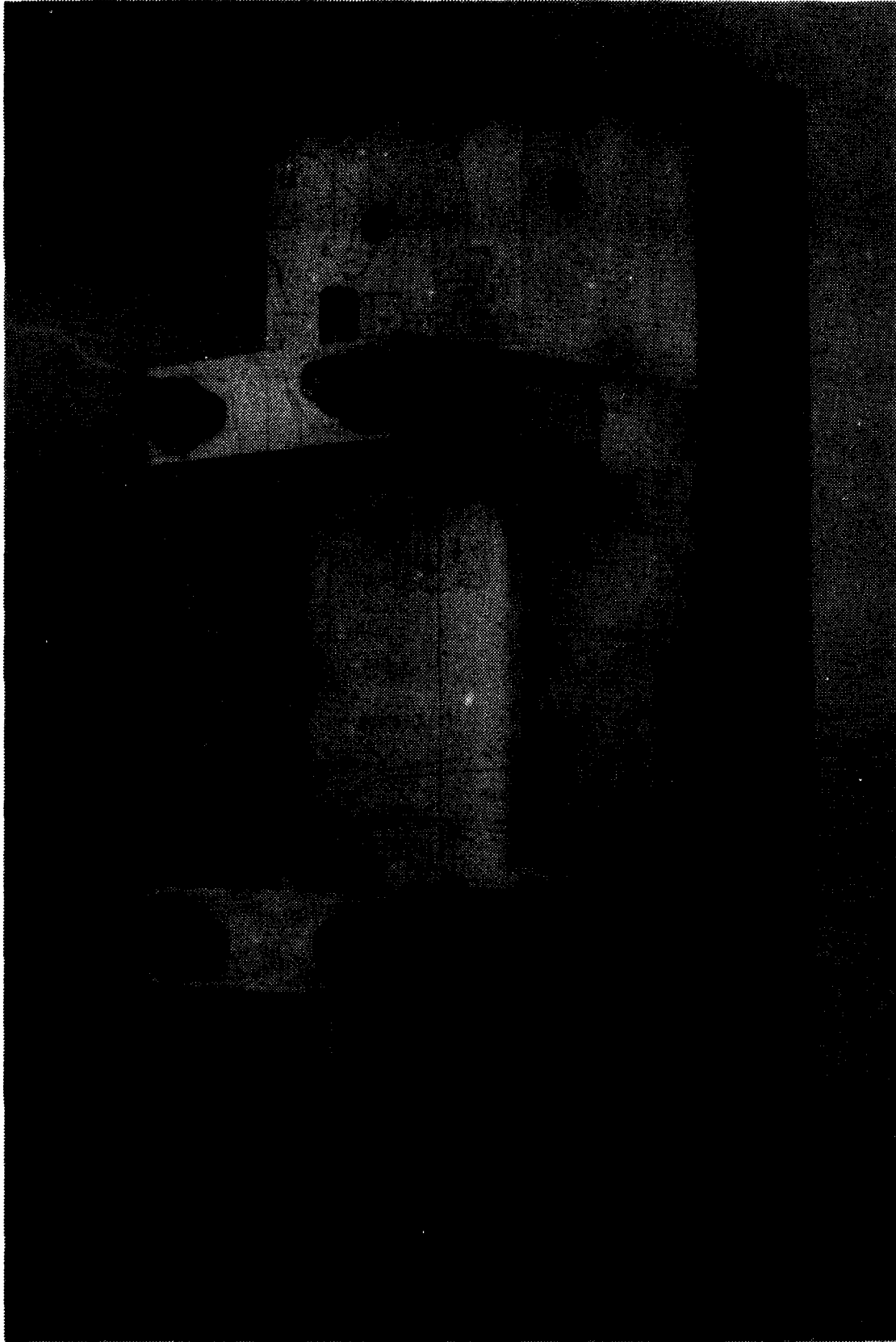

Figure 3.16. Flutter Blade Test Fixture.

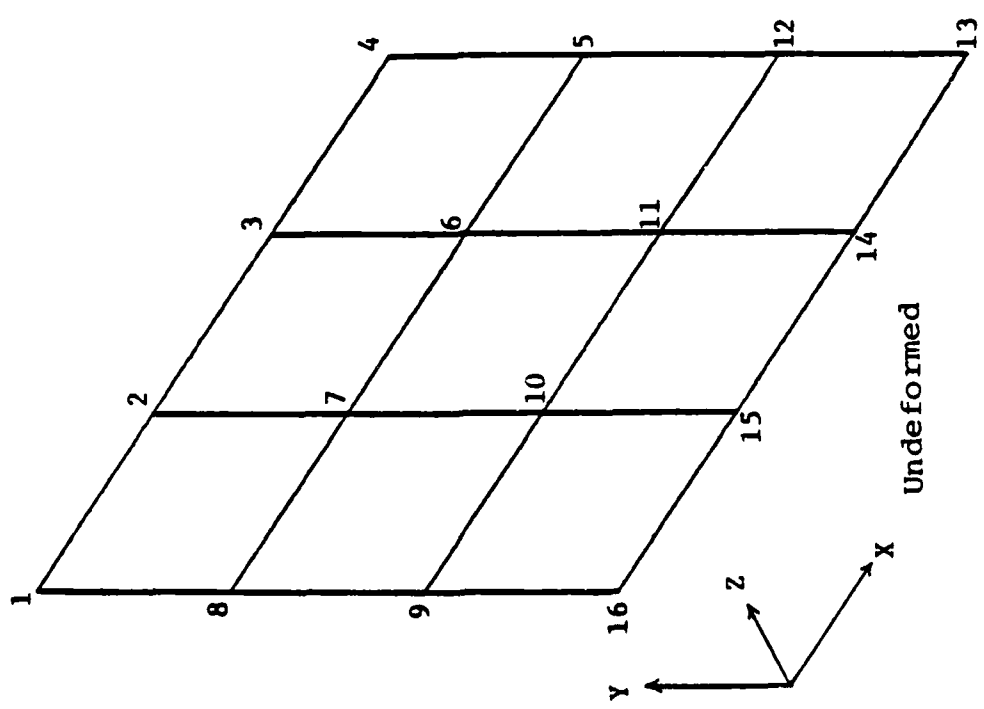
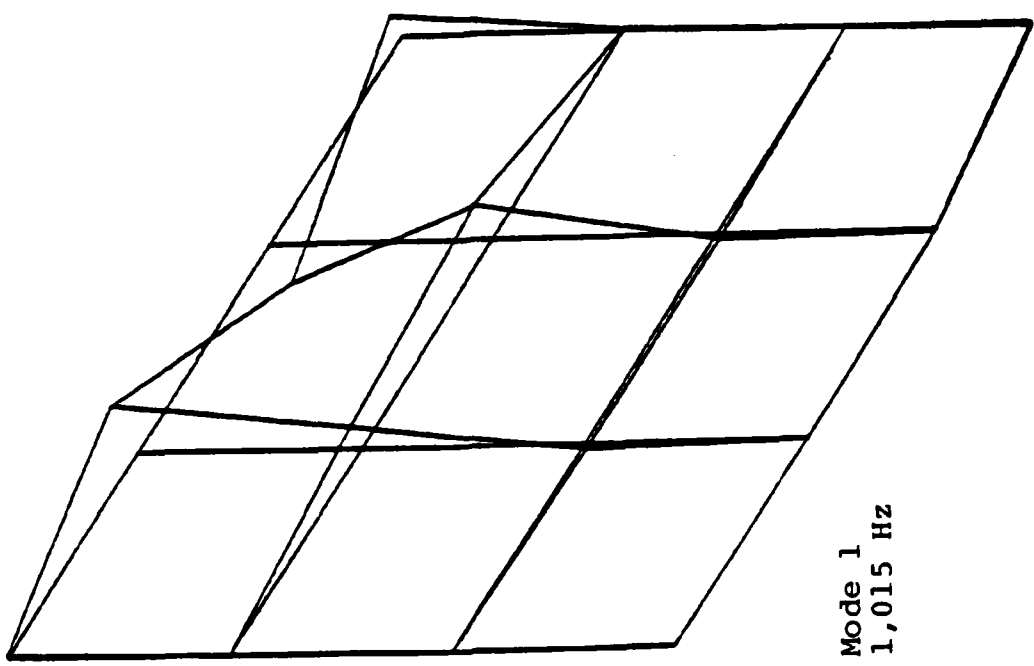

Figure 3.17. Undeformed and Mode 1 Shapes of Flutter Blade Showing Point Numbers and X-Y-Z Orientation.



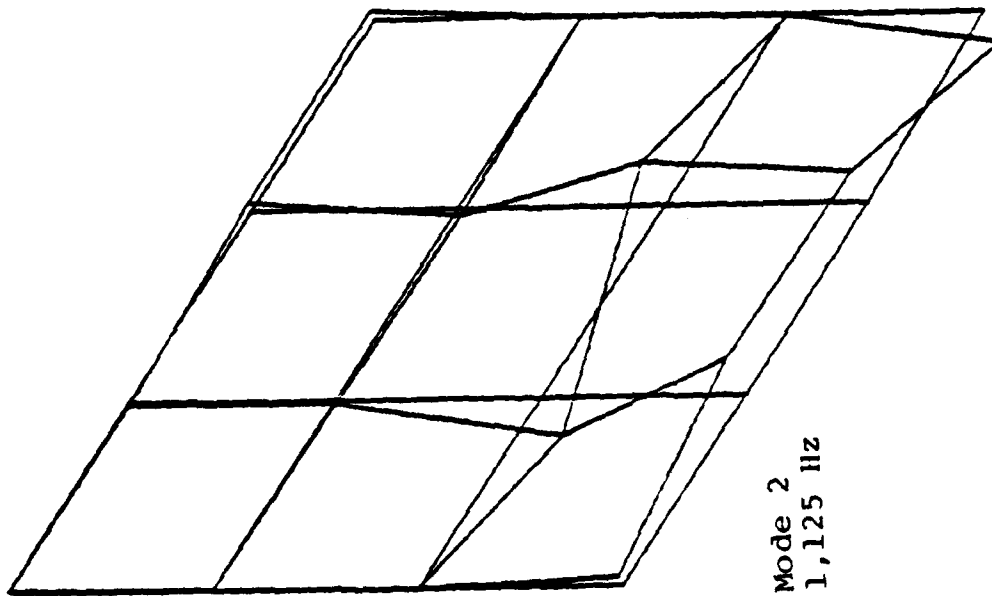
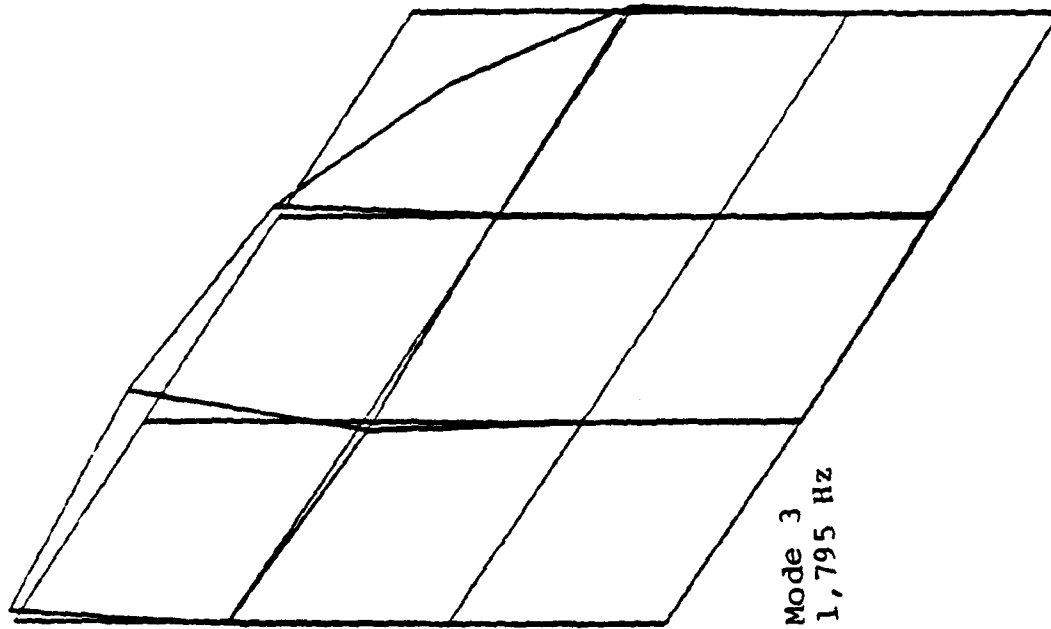

Figure 3.18. Modes 2 and 3 of Flutter Blade Superimposed Over Undeformed Shape.

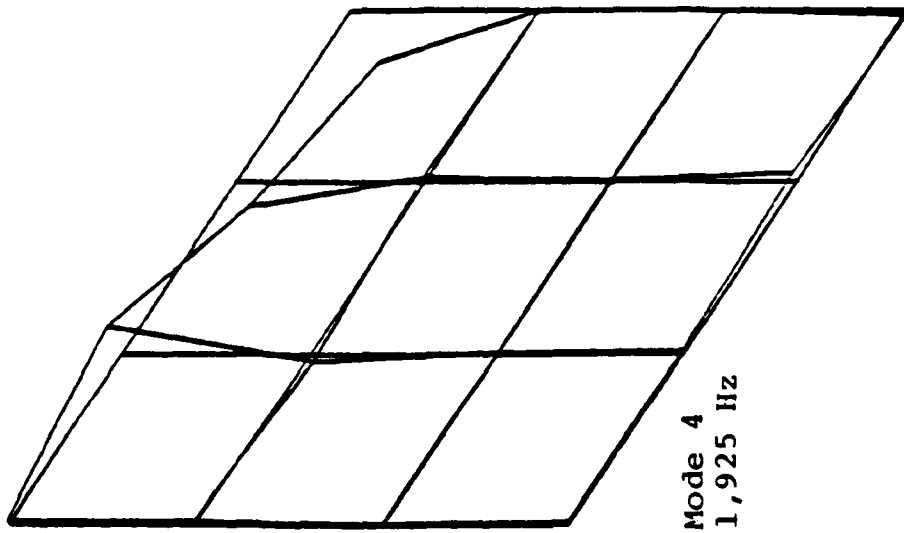
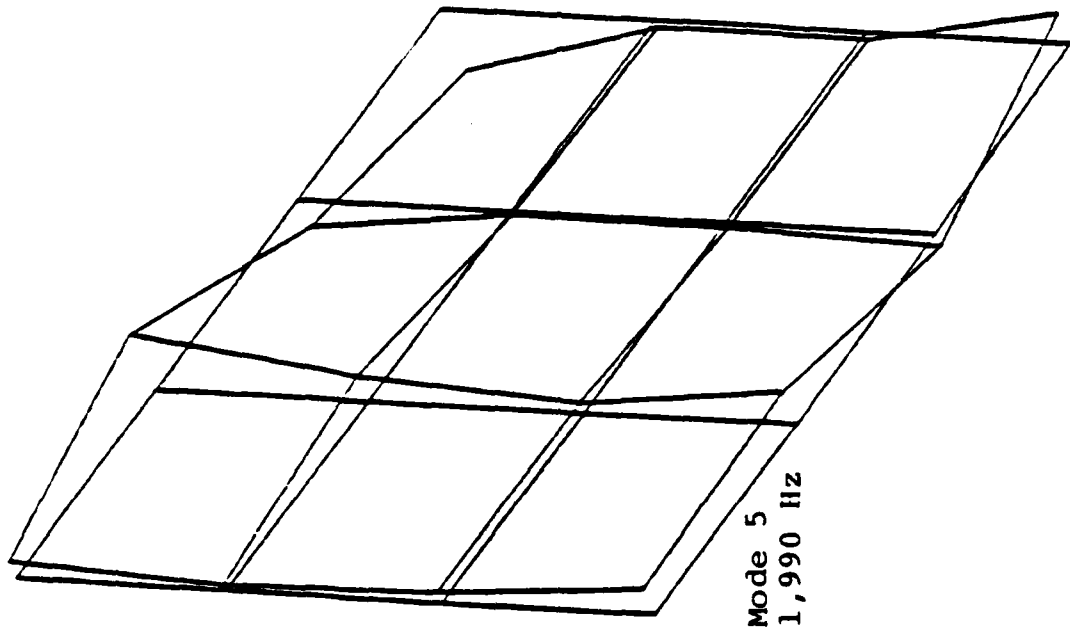

Figure 3.19. Modes 4 and 5 of Flutter Blade Superimposed Over Undeformed Shape.

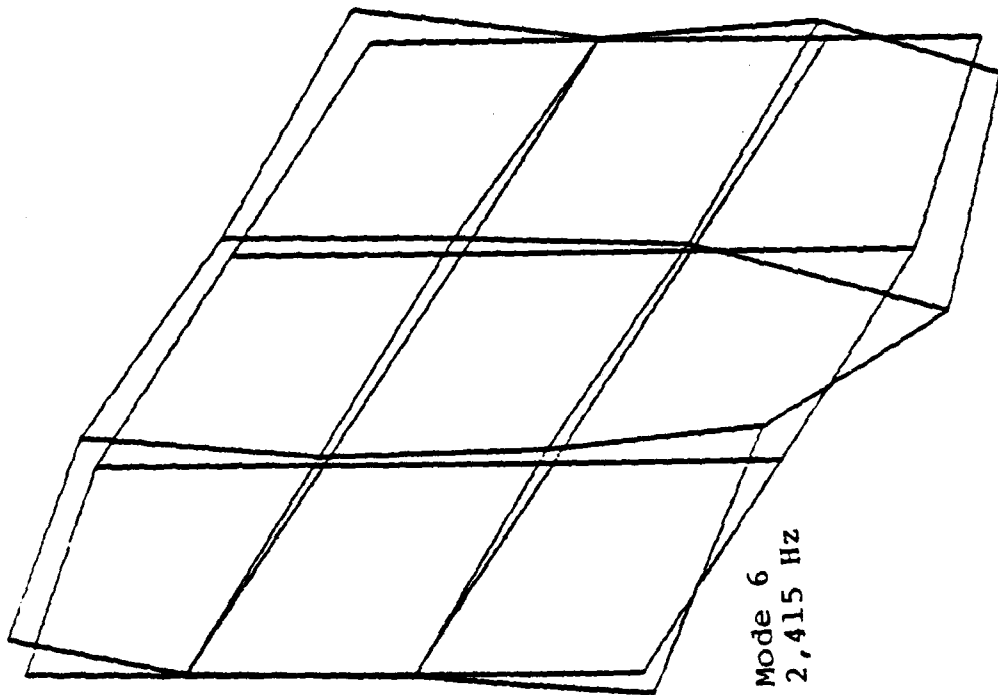
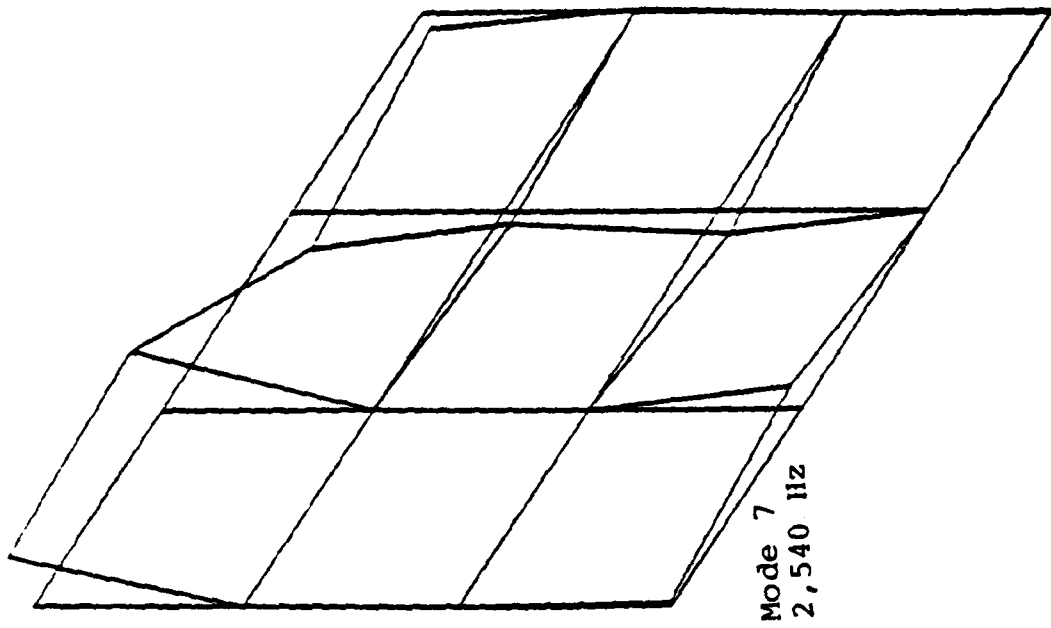
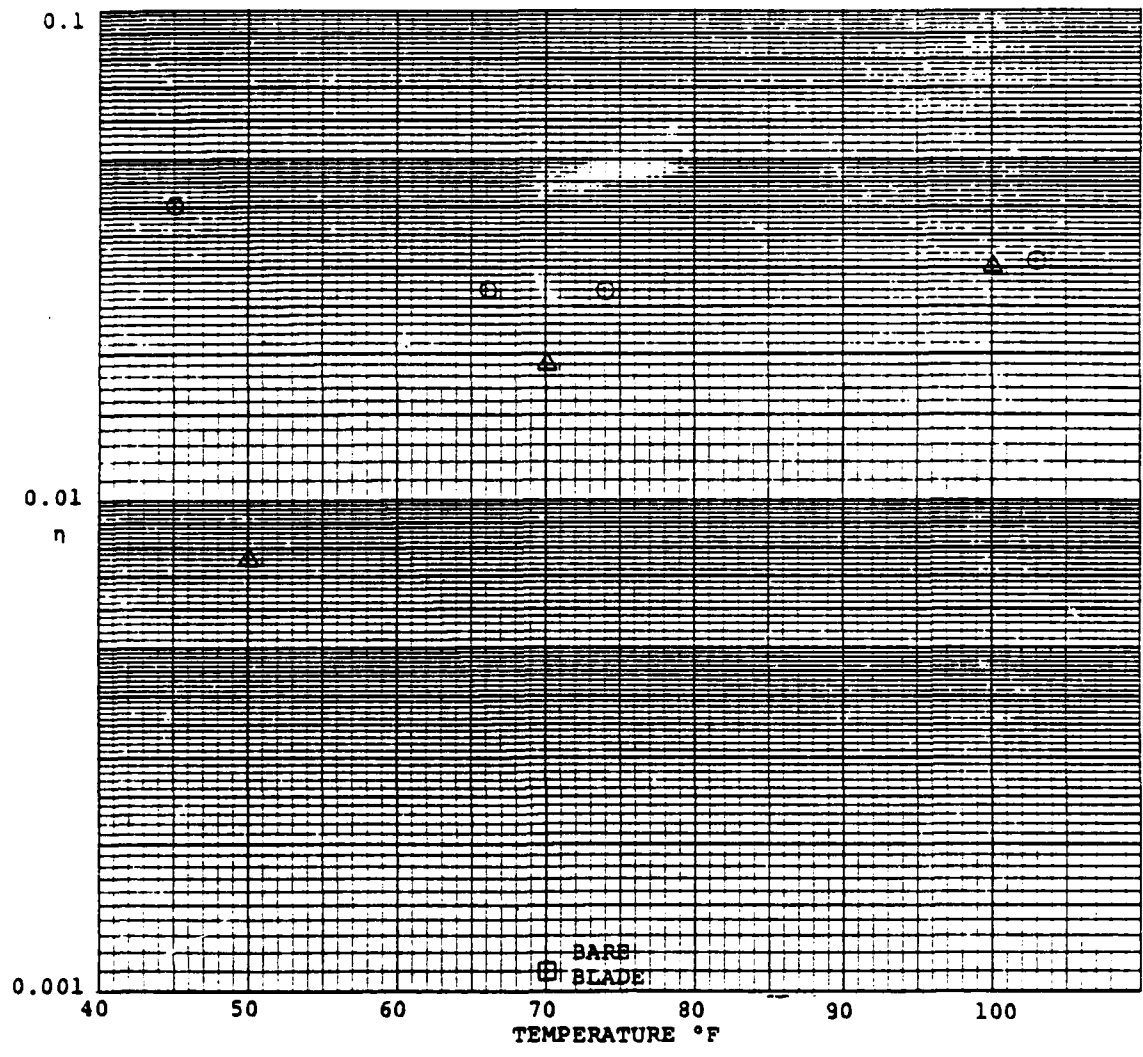

Figure 3.20. Modes 6 and 7 of Flutter Blade Superimposed Over Undeformed Shape.



Predicted  $\triangle$   
 Actual  $\odot$

Figure 3.21. Comparison of Measured Value of Bare Blade Loss Factor to Value of Loss Factor of Chosen Damping Configuration - 0.002-inch ISD 112 and 0.005-inch Aluminum.

ISD-112 and 0.005-inch aluminum constraining layer on both sides). Although this configuration did not provide as much of a damping increase as the one in Figure 3.22, (0.005-inch ISD-112 and 0.005-inch aluminum) it is still provided over an order of magnitude increase in structural damping, and was considerably smoother and conformed better to the leading edge of the blade.

All five blades received had the 0.002 inch ISD-112/0.005 inch aluminum damping configuration applied, and were returned to NASA to be evaluated in the flutter facility.

Data received from NASA Lewis indicates that the damping wraps did not reduce the amplitude of deformation, nor did they delay the onset of flutter.

The project requires considerably more effort to be successful. One area of investigation is to determine the reason for the large difference between our measurement of the resonant frequencies of the blades, and the excitation frequency at which NASA Lewis observes flutter. Another area for investigation is the fact that the amplitude is not reduced despite a large increase in structural damping. The data supplied by NASA does not indicate that a measurement of the flutter onset condition was made. The direct measurements seem to be maximum deflection during flutter. If flutter forces are high enough to over-ride the damping added, hard flutter would appear the same with or without damping; however, the onset of flutter should be delayed. The contract funding and scheduled completion date do not allow for completion of this project. This report terminates our effort on this project.

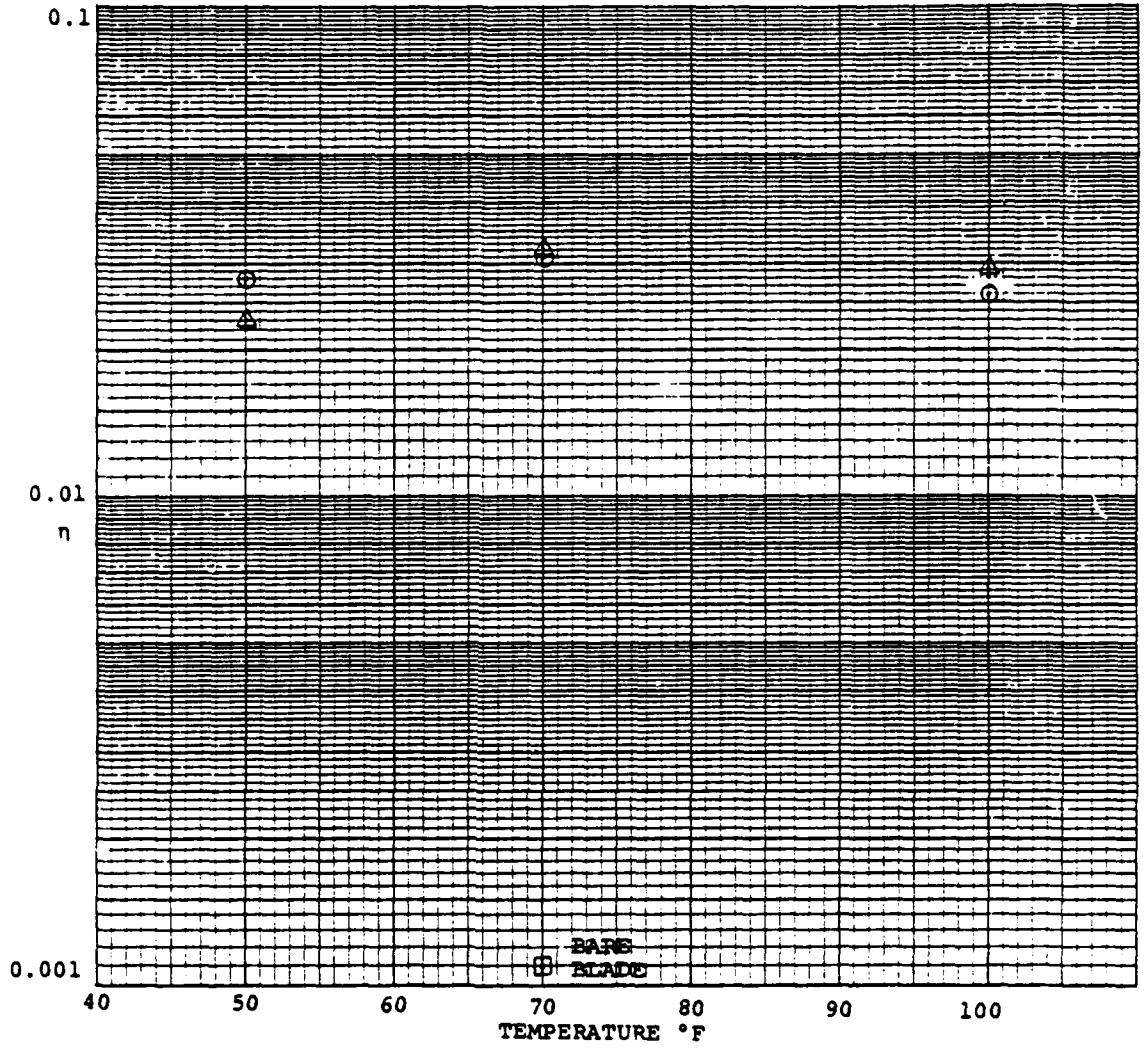

Predicted  $\triangle$   
 Actual  $\odot$

Figure 3.22. Comparison of Measured Value of Bare Blade Loss Factor to Value of Loss Factor of 0.005-inch ISD 112 and 0.005-inch Aluminum Damping Configuration.

### 3.5. CHARACTERIZATION OF MAGNETIC TRANSDUCERS

Four types of magnetic transducers are currently being used by the Vibration Analysis and Control Group of the UDRI: Electro Corporation model 3030HTB, Electro Corporation model 3015HTB, and two freon cooled models developed by UDRI. A test was developed to create plots of relative force output versus frequency at a constant excitation level for each of the four transducers. Two types of excitation were examined: constant current and constant voltage.

Figure 3.23 shows the test fixture that was used to analyze the force/frequency relationship of the model 3030HTB magnetic transducer. The transducer is held rigidly in position 1/16 inch above a magnetic stud mounted in a Wilcoxon Research force gage. The test set-up for the other three transducers (model 3015HTB and two UDRI freon cooled transducers) is identical, except for the transducer mounting bracket.

Figures 3.24 and 3.25 are block diagrams of the instrumentation that were used to maintain constant current and constant voltage during the tests.

The results of the tests are shown in Figures 3.26 through 3.35. Two model 3030HTB transducers were tested to check repeatability.

All four transducer models showed the same basic trends. When driven with a constant voltage, the output force drops rapidly with an increase in frequency. The frequency at which the output drops below 50 percent is approximately 520 Hz for both 3030HTB's, 560 Hz for the 3015HTB, 340 Hz for the original high temperature transducer, and 95 Hz for the new high temperature transducer. When driven with a constant current, both 3030HTB's and the 3015HTB are relatively flat ( $\pm 10\%$ , approximately) out to 1,000 Hz. The original high temperature transducer has lost about 35 percent of its force by 1,000 Hz, and the new high temperature transducer has lost about 38 percent.



Figure 3.23. Test Fixture for Measuring the Force-Frequency Relationship of Magnetic Transducers.



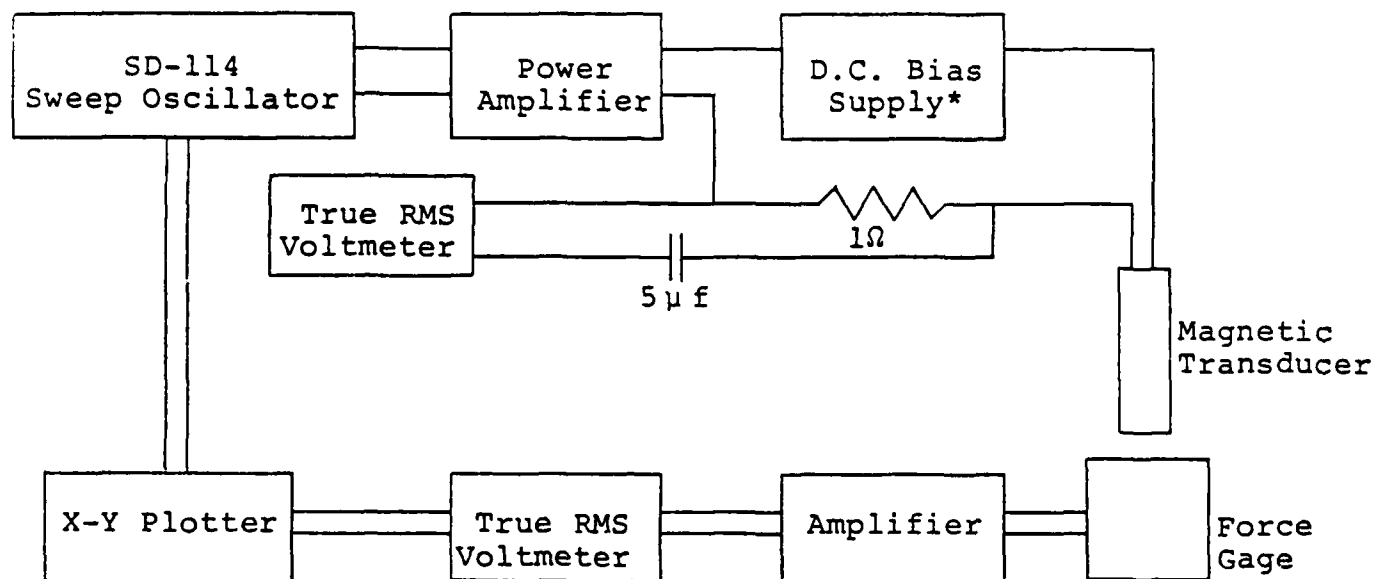
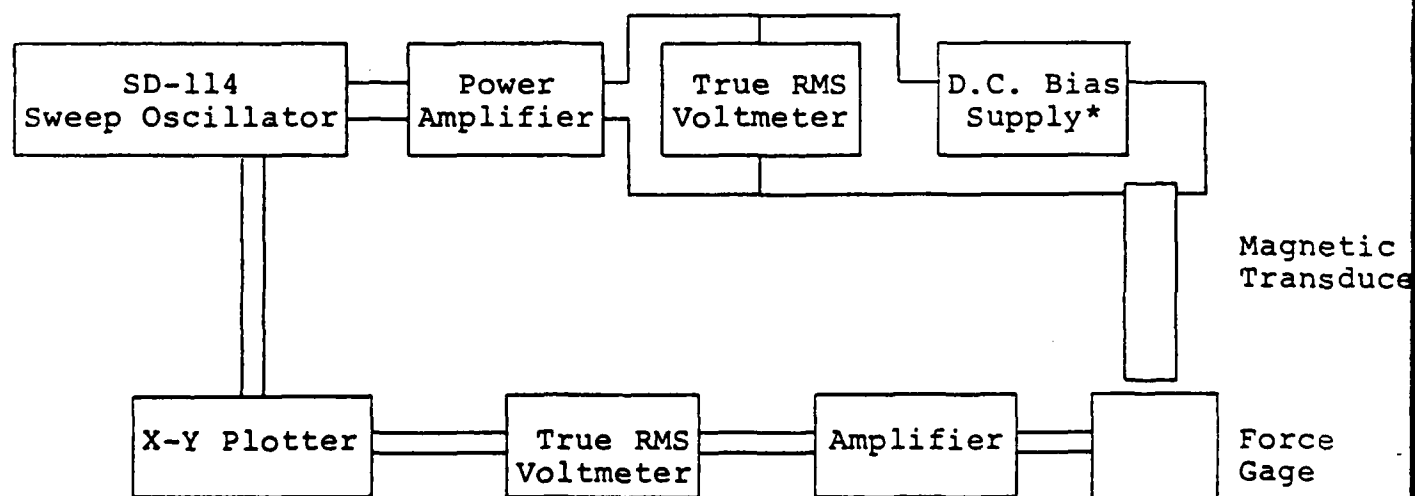

Figure 3.24. Block Diagram of Constant Current Force Gage Test.



\*D.C. bias supply for freon cooled transducers only.

Figure 3.25. Block Diagram of Constant Voltage Force Gage Test.

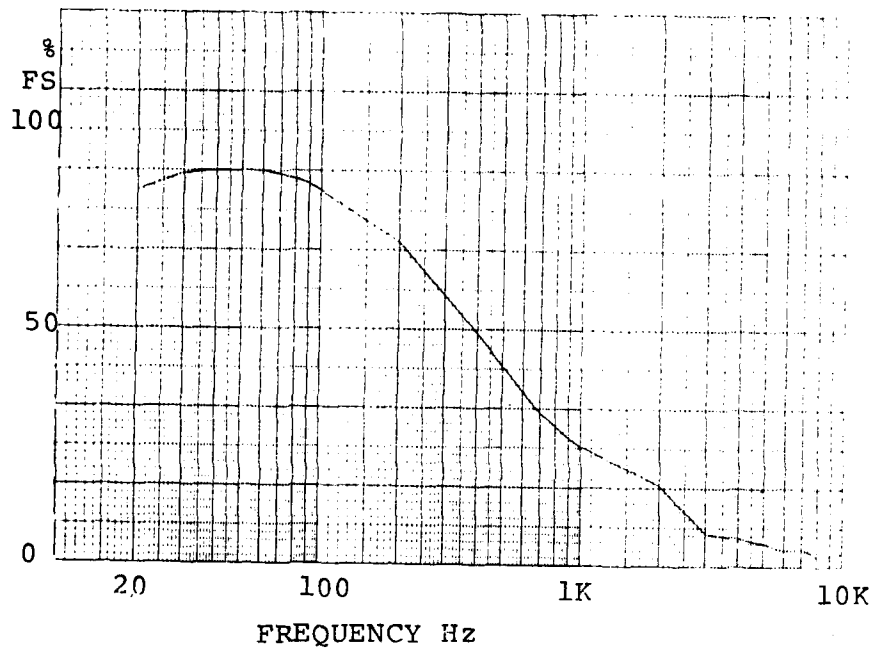

Figure 3.26. Force versus Frequency for First Model 3030 HTB, Constant Voltage,  $20V_{RMS}$ .

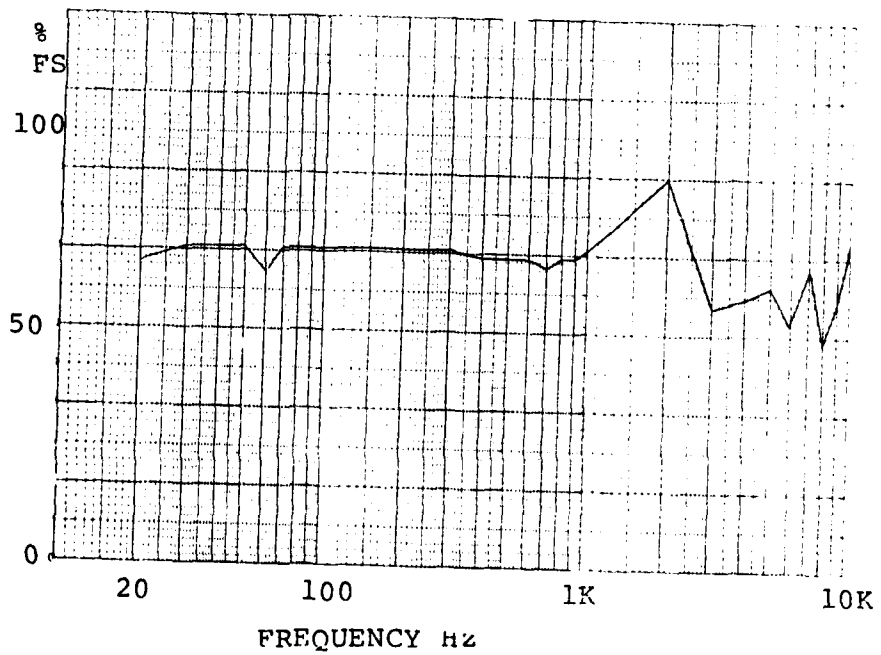

Figure 3.27. Force versus Frequency for First Model 3030 HTB, Constant Current  $0.7mA_{RMS}$ .

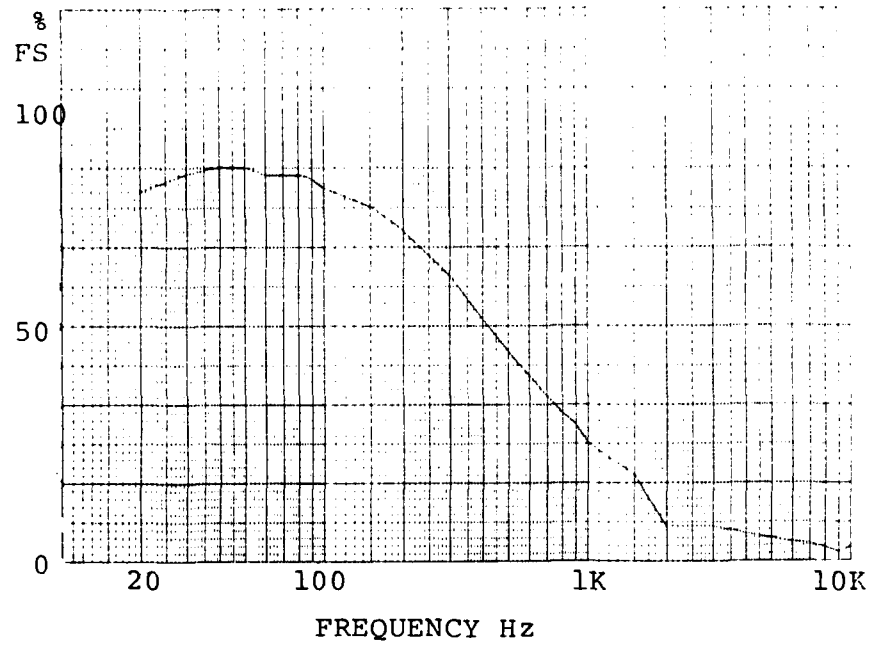

Figure 3.28. Force versus Frequency Second Model 3030 HTB, Constant Voltage, 20V<sub>RMS</sub>.

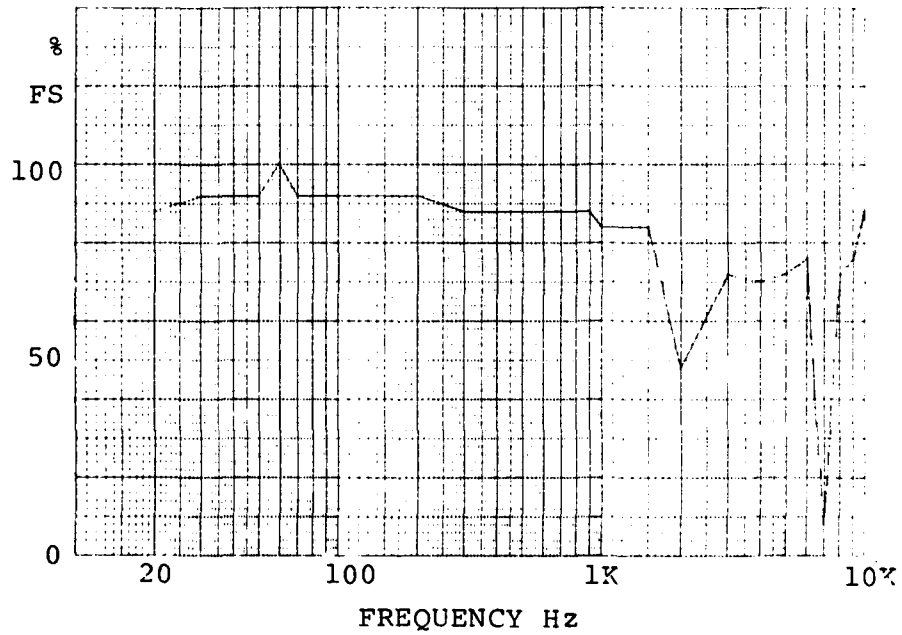

Figure 3.29. Force versus Frequency for Second Model 3030 HTB, Constant Current, 0.7mA<sub>RMS</sub>.

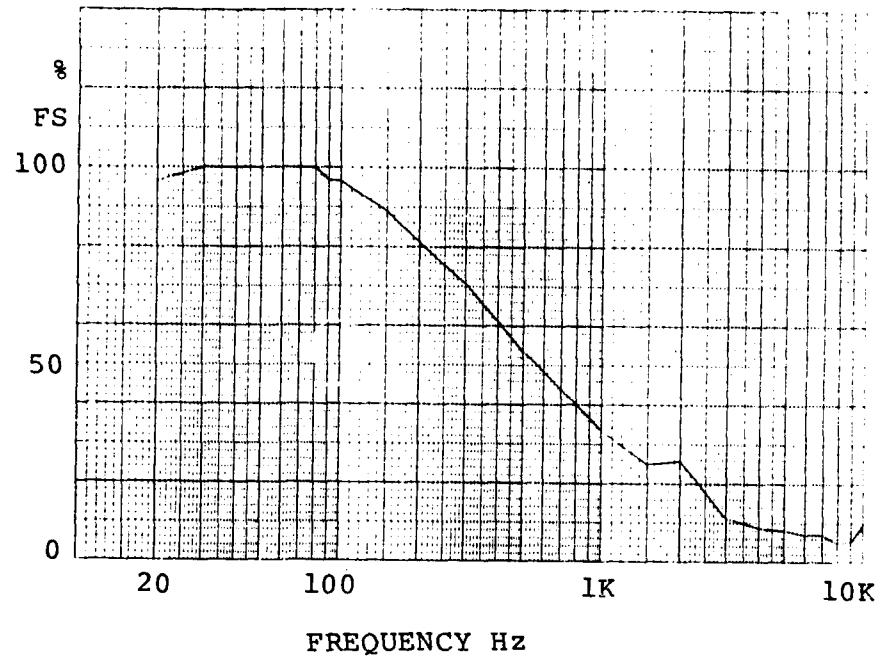

Figure 3.30. Force versus Frequency for Model 3015 HTB, Constant Voltage,  $10V_{RMS}$ .

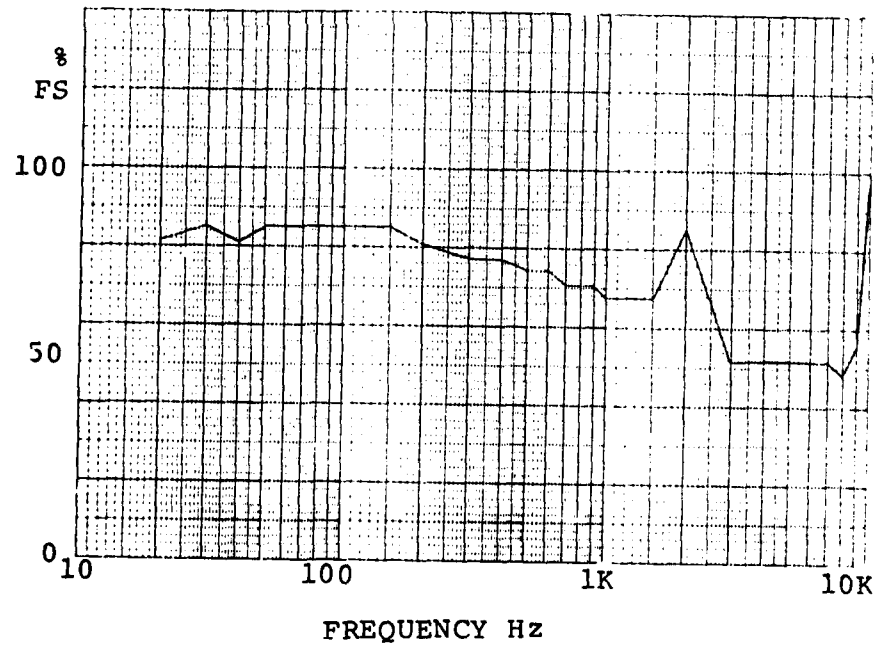

Figure 3.31. Force versus Frequency for Model 3015 HTB, Constant Current,  $50MA_{RMS}$ .

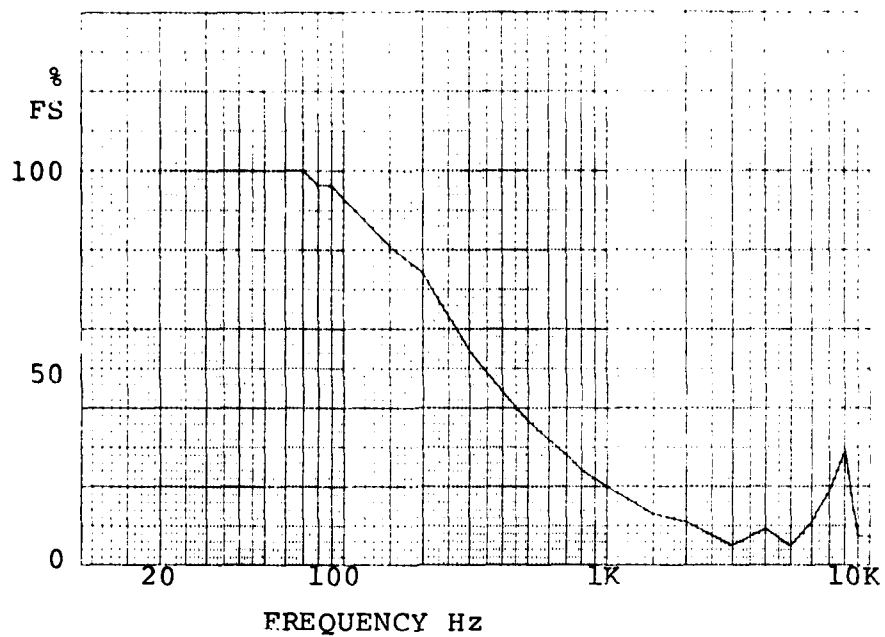

Figure 3.32. Force versus Frequency for Original High Temperature Transducer, Constant Voltage, 2.5V<sub>RMS</sub>.

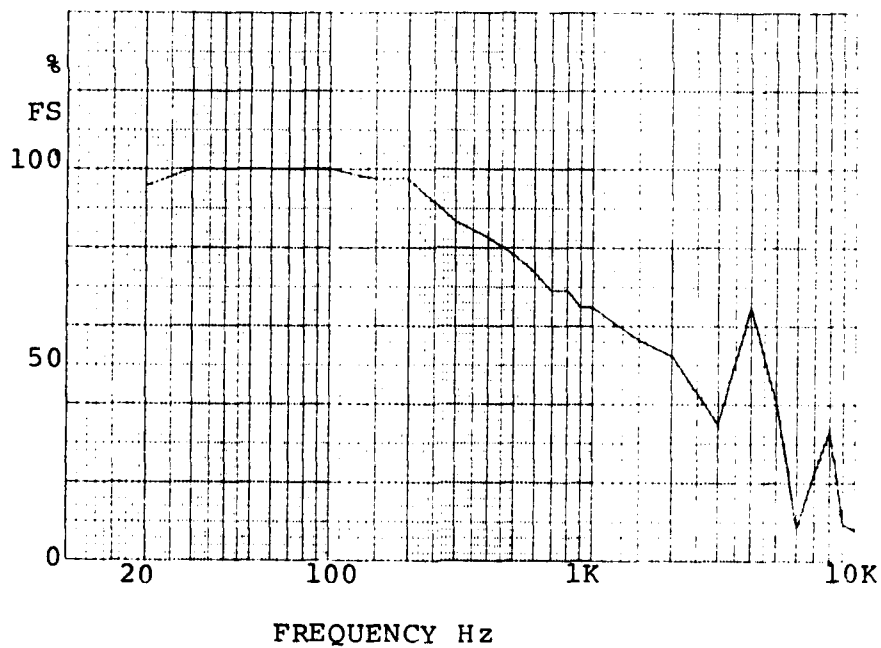

Figure 3.33. Force versus Frequency for Original High Temperature Transducer, Constant Current, 90mA<sub>RMS</sub>.

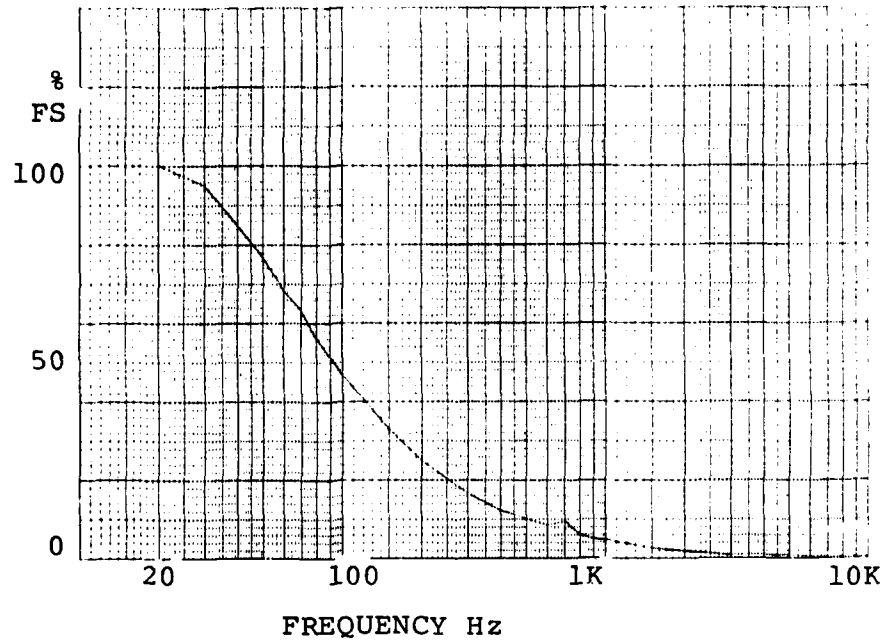

Figure 3.34. Force versus Frequency for New High Temperature Transducer, Constant Voltage, 3V<sub>RMS</sub>.

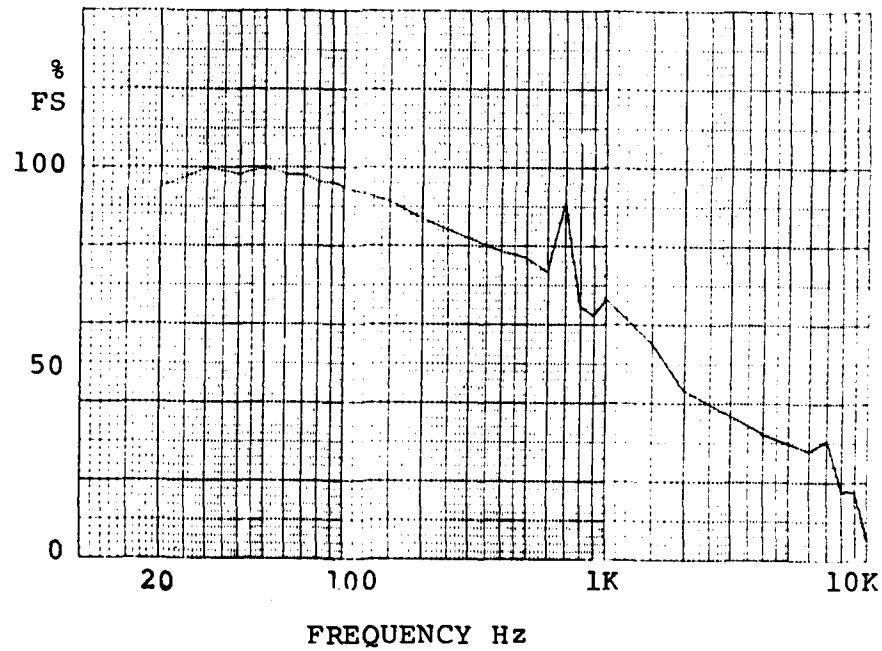

Figure 3.35. Force versus Frequency for New High Temperature Transducer, Constant Current, 15mA<sub>RMS</sub>.

## REFERENCES

1. Hopkins, David M. and Michael L. Drake, "Porcelain Enamel Material Testing Procedures to Determine the Damping Properties and the Results of Selected Materials." UDR-TR-80-47, AFWAL-TR-80-4116, University of Dayton Research Institute, Dayton, Ohio, September 1980.
2. Oberst, H. and Frankenfeld, K., "Uber die Dampfung dunner Bleche durch festhaltende Belage," Acoustics, 1952, Vol. 2, pp. 181-184.
3. Sridharan, R. I., Damping in Porcelain Enamel Coatings, AFWAL-TR-74-191, Materials Laboratory, Wright-Patterson Air Force Base, Ohio, 1976 (also published as Ph.D. dissertation, University of Minnesota, 1975).
4. Bishop, R. E. D. and Johnson, V. Final Report, United States Air Force Contract Number F33615-72-C-1315 (1974).
5. Jones, D. I. G., "A Reduced Temperature Nomogram for Characterization of Damping Material Behavior," Shock and Vibration Bulletin 48, Part 2, 1978.
6. King, C. S. Jr., Computerized Processing and Graphic Representation of Viscoelastic Material Property Data, AFWAL-TR-79-4099, Materials Laboratory, Wright-Patterson Air Force Base, Ohio, 1979.
7. Rogers, L. C. and Nashif, A.D., "Computerized Processing and Empirical Representation of Viscoelastic Material Property Data and Preliminary Constrained Layer Damping Treatment Designs," Shock and Vibration Bulletin 48, 1978.
8. Soni, M. L. , "Finite Element Analysis of Vibrations of Initially Stressed Viscoelastic Structures," UDR-TR-79-113, November 1979.
9. Brockman, R. A. "MAGNA Computer Program Users's Manual," UDR-TR-80-107, November 1980.
10. Brockman, Robert A. MAGNA: A Finite Element Program for the Materially and Geometrically Nonlinear Analysis of Three-Dimensional Structures Subjected to Static and Dynamic Transient Loading, AFWAL-TR-81-3181, Wright-Patterson Air Force Base, Ohio, April 1982.
11. Brockman, Robert A. "MAGNA: Materially and Geometrically Nonlinear Analysis" UDR-TR-82-111 (to be published as an AFWAL TR), University of Dayton Research Institute, Dayton, Ohio, September 1982.

REFERENCES  
(concluded)

12. Drake, Michael L. and David M. Hopkins, "Structural Analysis of TF-30 Engine Vibration Transducers V-1 and V-2," UDR-TR-81-27, University of Dayton Research Institute, Dayton, Ohio, April 1981.



APPENDIX A

DAMPING PROPERTIES OF  
TWELVE COMMERCIAL MATERIALS

MATERIAL CODE :253  
 MATERIAL :MNB-51914-50-8  
 LOG(FR)=LOG(F)-12(T-T0)/(525+T-T0)

MATERIAL CODE :246  
 MATERIAL :MNB 51914-50-2  
 LOG(FR)=LOG(F)-12(T-T0)/(525+T-T0)

| NO. | MODULUS<br>LB./IN <sup>2</sup> | LOSS<br>FACTOR | TEMP.<br>DEG. F | FREQ.<br>HZ | MODE<br>NO. |
|-----|--------------------------------|----------------|-----------------|-------------|-------------|
| 1   | 2.29317E+02                    | 1.1658         | 211.0           | 378.6       | 2.          |
| 2   | 4.20464E+02                    | 1.3576         | 211.0           | 1004.0      | 3.          |
| 3   | 4.61599E+02                    | 1.4762         | 211.0           | 1267.3      | 4.          |
| 4   | 5.92397E+02                    | 1.8881         | 211.0           | 3043.0      | 5.          |
| 5   | 5.98718E+01                    | 1.7542         | 251.5           | 329.0       | 2.          |
| 6   | 8.69745E+01                    | 1.0281         | 251.5           | 595.3       | 3.          |
| 7   | 9.38284E+01                    | 1.3212         | 251.5           | 1737.6      | 4.          |
| 8   | 1.14750E+02                    | 1.6211         | 251.5           | 2865.5      | 5.          |
| 9   | 1.52679E+02                    | 1.6165         | 251.5           | 4277.4      | 6.          |
| 10  | 3.06125E+01                    | .6291          | 275.7           | 318.9       | 3.          |
| 11  | 4.12174E+01                    | .8243          | 275.7           | 877.9       | 2.          |
| 12  | 3.99604E+04                    | .1035          | 64.9            | 1838.1      | 2.          |
| 13  | 4.67468E+04                    | .0716          | 64.9            | 3558.6      | 3.          |
| 14  | 4.30339E+04                    | .0712          | 64.9            | 5691.2      | 4.          |
| 15  | 4.20636E+04                    | .0593          | 64.9            | 8188.2      | 5.          |
| 16  | 5.23286E+04                    | .2512          | 99.3            | 683.3       | 2.          |
| 17  | 2.66747E+04                    | .1561          | 99.3            | 1848.4      | 3.          |
| 18  | 3.20525E+04                    | .1327          | 99.3            | 3451.8      | 4.          |
| 19  | 1.7354E+04                     | .1245          | 99.8            | 5475.2      | 5.          |
| 20  | 3.52567E+04                    | .4379          | 99.8            | 7209.8      | 6.          |
| 21  | 1.08610E+04                    | .4123          | 147.3           | 1696.3      | 3.          |
| 22  | 1.11806E+04                    | .4453          | 147.3           | 3042.9      | 4.          |
| 23  | 1.35424E+04                    | .0806          | 175.4           | 4767.9      | 5.          |
| 24  | 1.82267E+03                    | .8162          | 175.4           | 567.9       | 2.          |
| 25  | 3.6203E+03                     | .8765          | 175.4           | 1468.1      | 3.          |
| 26  | 4.03630E+03                    | 1.581          | 175.4           | 2581.5      | 4.          |
| 27  | 4.4373E+02                     | 1.5712         | 201.3           | 431.6       | 2.          |
| 28  | 7.66323E+02                    | 1.6524         | 201.3           | 1112.8      | 3.          |
| 29  | 9.23370E+02                    | 1.1013         | 201.3           | 2021.7      | 4.          |
| 30  | 1.51485E+02                    | 1.3283         | 226.1           | 365.3       | 2.          |
| 31  | 2.66996E+02                    | 1.4998         | 226.1           | 961.8       | 3.          |
| 32  | 3.41629E+02                    | 1.7020         | 226.1           | 1835.6      | 4.          |
| 33  | 4.58896E+02                    | 1.027          | 249.0           | 299.8       | 5.          |
| 34  | 3.9874E+04                     | .0998          | 249.0           | 691.2       | 2.          |
| 35  | 4.48664E+04                    | .0877          | 249.0           | 1886.1      | 3.          |
| 36  | 4.78900E+04                    | .0787          | 249.0           | 3561.0      | 4.          |
| 37  | 1.41984E+04                    | .3204          | 275.0           | 5685.5      | 5.          |
| 38  | 1.98253E+04                    | .2368          | 275.0           | 1707.1      | 2.          |
| 39  | 2.06425E+04                    | .2240          | 275.0           | 3299.2      | 3.          |
| 40  | 2.96782E+04                    | .0810          | 275.0           | 5194.3      | 4.          |
| 41  | 5.70448E+03                    | .4571          | 275.0           | 149.5       | 5.          |
| 42  | 1.02554E+04                    | .4370          | 275.0           | 638.8       | 2.          |
| 43  | 1.11092E+04                    | .4668          | 275.0           | 1199.5      | 3.          |
| 44  | 1.27301E+04                    | .4668          | 275.0           | 3044.4      | 4.          |
| 45  | 1.27301E+04                    | .4668          | 275.0           | 4730.8      | 5.          |

MATERIAL CODE : 173  
 MATERIAL : ISD 468  
 LOG(FR)-LOG(F)-12(T-T0)/(525+T-T0)

| NO. | MODULUS<br>LB/IN <sup>2</sup> | LOSS<br>FACTOR | TEMP.<br>DEG. F | FREQ.<br>HZ | MODE<br>NO. |
|-----|-------------------------------|----------------|-----------------|-------------|-------------|
| 1   | 1.44744E+02                   | 1.2739         | 100.0           | 319.3       | 2           |
| 2   | 3.33123E+02                   | 1.8252         | 100.0           | 1525.7      | 4           |
| 3   | 4.47729E+02                   | 1.3504         | 100.0           | 2443.7      | 3           |
| 4   | 1.15765E+02                   | 1.2202         | 125.0           | 737.9       | 5           |
| 5   | 1.64285E+02                   | 1.2093         | 124.0           | 1406.8      | 4           |
| 6   | 2.28081E+02                   | 1.1670         | 124.0           | 2301.5      | 5           |
| 7   | 3.92718E+01                   | .9164          | 150.0           | 262.0       | 2           |
| 8   | 5.7497E+01                    | 1.0308         | 150.0           | 700.1       | 3           |
| 9   | 8.90162E+01                   | 1.0086         | 150.0           | 1356.2      | 4           |
| 10  | 1.31657E+02                   | .9381          | 150.0           | 2235.0      | 5           |
| 11  | 1.47550E+02                   | 1.1385         | 150.0           | 3226.4      | 6           |
| 12  | 2.74278E+01                   | .8117          | 175.0           | 254.4       | 2           |
| 13  | 2.87735E+01                   | 1.2959         | 175.0           | 685.0       | 3           |
| 14  | 6.25452E+01                   | .5322          | 175.0           | 1335.1      | 4           |
| 15  | 1.04629E+02                   | .6829          | 175.0           | 2208.4      | 5           |
| 16  | 1.16533E+02                   | .3402          | 175.0           | 3293.6      | 6           |
| 17  | 1.57821E+01                   | .7415          | 201.0           | 248.2       | 2           |
| 18  | 5.42076E+01                   | .5910          | 201.0           | 1324.5      | 3           |
| 19  | 8.71397E+01                   | .4882          | 200.0           | 2187.9      | 4           |
| 20  | 1.0202E+02                    | .5345          | 200.0           | 3267.0      | 5           |
| 21  | 1.49559E+01                   | .5774          | 226.0           | 244.5       | 2           |
| 22  | 2.04341E+01                   | .6977          | 226.0           | 669.9       | 3           |
| 23  | 3.53332E+01                   | .5418          | 225.0           | 1308.1      | 4           |
| 24  | 5.28142E+01                   | .4939          | 225.0           | 2164.7      | 5           |
| 25  | 8.74205E+01                   | .3526          | 224.0           | 3237.4      | 6           |
| 26  | 1.27060E+01                   | .5074          | 250.0           | 242.0       | 2           |
| 27  | 1.59353E+01                   | .6221          | 249.0           | 664.1       | 3           |
| 28  | 2.77050E+01                   | .4797          | 248.0           | 1297.3      | 4           |
| 29  | 5.27142E+01                   | .3564          | 248.0           | 2145.0      | 5           |
| 30  | 8.26470E+01                   | .2831          | 248.0           | 3212.5      | 6           |
| 31  | 1.68737E+02                   | 1.2539         | 112.0           | 328.8       | 2           |
| 32  | 2.80089E+02                   | 1.3392         | 112.0           | 832.8       | 3           |
| 33  | 3.84461E+02                   | 1.3169         | 112.0           | 1538.8      | 4           |
| 34  | 4.45735E+02                   | 1.4395         | 112.0           | 2443.6      | 5           |
| 35  | 3.75232E+02                   | 1.2126         | 87.0            | 389.0       | 2           |
| 36  | 6.77920E+02                   | 1.1773         | 87.0            | 987.0       | 3           |
| 37  | 6.29648E+02                   | 1.0631         | 75.0            | 1423.2      | 2           |
| 38  | 1.20090E+03                   | 1.0249         | 75.0            | 1997.3      | 3           |
| 39  | 2.27482E+03                   | .6437          | 50.0            | 476.5       | 2           |
| 40  | 4.00537E+03                   | .7231          | 50.0            | 1280.2      | 3           |
| 41  | 5.13241E+03                   | .7439          | 50.0            | 2387.6      | 4           |
| 42  | 5.49405E+03                   | .8783          | 50.0            | 3742.4      | 5           |
| 43  | 1.08786E+04                   | .3331          | 25.0            | 1368.0      | 2           |
| 44  | 1.38469E+04                   | .3279          | 25.0            | 2605.4      | 3           |
| 45  | 1.73091E+04                   | .3426          | 25.0            | 4187.5      | 4           |
| 46  | 1.38899E+04                   | .1702          | -1.0            | 509.9       | 2           |
| 47  | 2.90820E+04                   | .1660          | -1.0            | 2698.6      | 3           |
| 48  | 3.18704E+04                   | .1551          | -1.0            | 4388.4      | 4           |
| 49  | 2.30967E+04                   | .1628          | -1.0            | 1402.0      | 5           |

37 6.21279E+01 1.2635 129.6 4311.0 6.  
 38 1.56453E+01 .7067 146.9 320.8 3.  
 39 2.35436E+01 .7033 146.9 889.3 3.  
 40 4.32734E+01 .5871 146.9 1737.3 4.  
 41 6.02709E+01 .5834 146.9 2859.9 5.  
 42 1.73040E+01 1.0533 146.6 4285.5 6.  
 43 9.95350E+00 .6658 174.4 316.8 2.  
 44 1.97764E+01 .5703 174.4 881.7 3.  
 45 3.25234E+01 .4215 174.4 1724.5 4.  
 46 4.31139E+01 .4732 174.4 2849.1 5.  
 47 2.17139E+01 1.3239 174.4 4257.3 6.  
 48 7.60635E+00 .5798 196.7 314.3 2.  
 49 1.64316E+01 .3474 196.7 876.3 3.  
 50 2.63411E+01 .3404 196.7 1715.6 4.  
 51 3.73929E+01 .3305 196.7 2834.5 5.

MATERIAL CODE :242  
 MATERIAL :SOUNDCOAT #12-15-80

$\text{LOG}(M) = \text{LOG}(ML) + (\text{LOG}(MROM/ML)) / (1 + (\text{FROM}/\text{FR})) \times H$   
 $\text{TO} = \text{FROM} \times \text{N}$   
 $\text{A1} = \text{A2}$   
 $\text{A2} = \text{A3}$   
 $\text{A3} = \text{A4}$   
 $\text{A4} = \text{A5}$   
 $\text{A5} = \text{A6}$   
 $\text{A6} = \text{A7}$   
 $\text{A7} = \text{A8}$   
 $\text{A8} = \text{A9}$   
 $\text{A9} = \text{A10}$   
 $\text{A10} = \text{A11}$   
 $\text{A11} = \text{A12}$   
 $\text{A12} = \text{A13}$   
 $\text{A13} = \text{A14}$   
 $\text{A14} = \text{A15}$   
 $\text{A15} = \text{A16}$   
 $\text{A16} = \text{A17}$   
 $\text{A17} = \text{A18}$   
 $\text{A18} = \text{A19}$   
 $\text{A19} = \text{A20}$   
 $\text{A20} = \text{A21}$   
 $\text{A21} = \text{A22}$   
 $\text{A22} = \text{A23}$   
 $\text{A23} = \text{A24}$   
 $\text{A24} = \text{A25}$   
 $\text{A25} = \text{A26}$   
 $\text{A26} = \text{A27}$   
 $\text{A27} = \text{A28}$   
 $\text{A28} = \text{A29}$   
 $\text{A29} = \text{A30}$   
 $\text{A30} = \text{A31}$   
 $\text{A31} = \text{A32}$   
 $\text{A32} = \text{A33}$   
 $\text{A33} = \text{A34}$   
 $\text{A34} = \text{A35}$   
 $\text{A35} = \text{A36}$   
 $\text{A36} = \text{A37}$   
 $\text{A37} = \text{A38}$   
 $\text{A38} = \text{A39}$   
 $\text{A39} = \text{A40}$   
 $\text{A40} = \text{A41}$   
 $\text{A41} = \text{A42}$   
 $\text{A42} = \text{A43}$   
 $\text{A43} = \text{A44}$   
 $\text{A44} = \text{A45}$   
 $\text{A45} = \text{A46}$   
 $\text{A46} = \text{A47}$   
 $\text{A47} = \text{A48}$   
 $\text{A48} = \text{A49}$   
 $\text{A49} = \text{A50}$   
 $\text{A50} = \text{A51}$   
 $\text{A51} = \text{A52}$   
 $\text{A52} = \text{A53}$   
 $\text{A53} = \text{A54}$   
 $\text{A54} = \text{A55}$   
 $\text{A55} = \text{A56}$   
 $\text{A56} = \text{A57}$   
 $\text{A57} = \text{A58}$   
 $\text{A58} = \text{A59}$   
 $\text{A59} = \text{A60}$   
 $\text{A60} = \text{A61}$   
 $\text{A61} = \text{A62}$   
 $\text{A62} = \text{A63}$   
 $\text{A63} = \text{A64}$   
 $\text{A64} = \text{A65}$   
 $\text{A65} = \text{A66}$   
 $\text{A66} = \text{A67}$   
 $\text{A67} = \text{A68}$   
 $\text{A68} = \text{A69}$   
 $\text{A69} = \text{A70}$   
 $\text{A70} = \text{A71}$   
 $\text{A71} = \text{A72}$   
 $\text{A72} = \text{A73}$   
 $\text{A73} = \text{A74}$   
 $\text{A74} = \text{A75}$   
 $\text{A75} = \text{A76}$   
 $\text{A76} = \text{A77}$   
 $\text{A77} = \text{A78}$   
 $\text{A78} = \text{A79}$   
 $\text{A79} = \text{A80}$   
 $\text{A80} = \text{A81}$   
 $\text{A81} = \text{A82}$   
 $\text{A82} = \text{A83}$   
 $\text{A83} = \text{A84}$   
 $\text{A84} = \text{A85}$   
 $\text{A85} = \text{A86}$   
 $\text{A86} = \text{A87}$   
 $\text{A87} = \text{A88}$   
 $\text{A88} = \text{A89}$   
 $\text{A89} = \text{A90}$   
 $\text{A90} = \text{A91}$   
 $\text{A91} = \text{A92}$   
 $\text{A92} = \text{A93}$   
 $\text{A93} = \text{A94}$   
 $\text{A94} = \text{A95}$   
 $\text{A95} = \text{A96}$   
 $\text{A96} = \text{A97}$   
 $\text{A97} = \text{A98}$   
 $\text{A98} = \text{A99}$   
 $\text{A99} = \text{A100}$

$\text{LOG}(\text{ETA}) = \text{LOG}(\text{ETA} \times \text{FROL}) + ((\text{SH} + \text{SL}) \times (\text{SL} - \text{SH})) \times (1 - \text{SQRT}(1 + \text{A} \times \text{X}^2)) \times \text{C} / 2$   
 $\text{TO} = \text{ETA} \times \text{FROL}$   
 $\text{A} = (\text{LOG}(\text{FR}) - \text{LOG}(\text{FROL})) \times \text{C}$

| NO. | MODULUS<br>LB/IN <sup>2</sup> | LOSS<br>FACTOR | TEMP.<br>DEG. F | FREQ.<br>HZ | MODE<br>NO. |
|-----|-------------------------------|----------------|-----------------|-------------|-------------|
| 1   | 1.16447E+02                   | 1.2324         | 74.6            | 373.4       | 2.          |
| 2   | 2.01532E+02                   | 1.4057         | 74.6            | 989.9       | 3.          |
| 3   | 2.14822E+02                   | 1.4558         | 74.6            | 1848.1      | 4.          |
| 4   | 3.16533E+02                   | 1.5086         | 74.6            | 3036.0      | 5.          |
| 5   | 2.85380E+05                   | .0743          | -48.6           | 1895.9      | 3.          |
| 6   | 3.31655E+04                   | .1006          | -48.6           | 3507.9      | 4.          |
| 7   | 3.66620E+04                   | .0595          | -48.6           | 5655.0      | 5.          |
| 8   | 4.85865E+04                   | .0748          | -48.6           | 8306.9      | 6.          |
| 9   | 6.08286E+04                   | .4150          | -24.2           | 1866.9      | 3.          |
| 10  | 6.63913E+04                   | .2358          | -24.2           | 3399.8      | 4.          |
| 11  | 6.64097E+03                   | .0549          | -24.2           | 5461.8      | 5.          |
| 12  | 3.12120E+04                   | .1740          | -24.2           | 9047.0      | 6.          |
| 13  | 1.16588E+04                   | .7870          | -3.2            | 661.5       | 2.          |
| 14  | 1.15560E+04                   | .3103          | -3.2            | 3210.0      | 4.          |
| 15  | 1.4633E+04                    | .2808          | -3.2            | 5123.3      | 5.          |
| 16  | 1.90543E+04                   | .2827          | -3.2            | 7545.0      | 6.          |
| 17  | 1.5815E+04                    | .2933          | -3.2            | 9705.5      | 7.          |
| 18  | 2.0753E+03                    | 1.3453         | 24.4            | 621.5       | 2.          |
| 19  | 4.6874E+03                    | .9943          | 24.4            | 1664.9      | 3.          |
| 20  | 3.6112E+03                    | .8287          | 24.4            | 2777.3      | 4.          |
| 21  | 4.7320E+03                    | .5615          | 24.4            | 4368.7      | 5.          |
| 22  | 6.2710E+03                    | .7721          | 24.4            | 6395.0      | 6.          |
| 23  | 3.3425E+02                    | 2.2040         | 49.0            | 493.4       | 2.          |
| 24  | 8.3117E+02                    | 2.1500         | 49.0            | 1338.5      | 3.          |
| 25  | 6.5616E+02                    | 2.4842         | 49.0            | 2163.1      | 4.          |
| 26  | 1.12917E+03                   | 1.6933         | 49.0            | 3477.0      | 5.          |
| 27  | 1.2742E+03                    | 2.6114         | 49.0            | 5152.9      | 6.          |
| 28  | 3.3527E+01                    | 1.0090         | 99.2            | 332.1       | 2.          |
| 29  | 6.1070E+01                    | 1.0162         | 99.2            | 913.6       | 3.          |
| 30  | 8.67561E+01                   | 1.0039         | 99.2            | 1774.1      | 4.          |
| 31  | 1.16780E+02                   | 1.6125         | 99.2            | 4357.7      | 6.          |
| 32  | 1.40377E+02                   | 1.6591         | 99.2            | 6074.4      | 7.          |
| 33  | 2.05936E+01                   | .8500          | 129.6           | 324.6       | 2.          |
| 34  | 3.65312E+01                   | .9248          | 129.6           | 897.7       | 3.          |
| 35  | 5.17508E+01                   | .7698          | 129.6           | 1748.8      | 4.          |
| 36  | 7.10690E+01                   | .7859          | 129.6           | 2885.4      | 5.          |



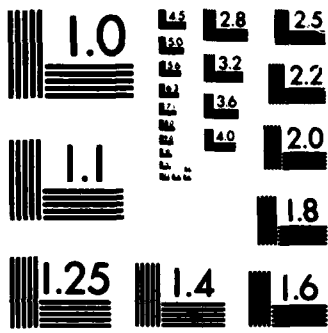

MICROCOPY RESOLUTION TEST CHART  
NATIONAL BUREAU OF STANDARDS-1963-A

MATERIAL CODE 1113  
 MATERIAL SOUNDLOAT D-2  
 LOG(FR)-LOG(F)-12(Y-T) (S25+T-T0)

50 1.03795E+02  
 51 1.98603E+01  
 52 2.66374E+01  
 53 4.35966E+01  
 54 8.15666E+01  
 55 3.58392E+02  
 56 1.64413E+02

5087  
 .6723  
 .8064  
 .6350  
 .1652  
 .6767

275.0  
 300.0  
 300.0  
 300.0  
 165.0  
 225.0

2183.6  
 246.6  
 670.9  
 1302.1  
 2149.8  
 1536.7  
 2254.3

5.  
 2.  
 3.  
 4.  
 5.  
 4.  
 5.

| NO. | MODULUS<br>LB./IN <sup>2</sup> | LOSS<br>FACTOR | TEMP.<br>DEG. F | FREQ.<br>HZ | MODE<br>NO. |
|-----|--------------------------------|----------------|-----------------|-------------|-------------|
| 1   | 1.38197E+03                    | .2321          | 50.0            | 452.1       | 2.          |
| 2   | 1.89953E+03                    | .2016          | 50.0            | 1152.8      | 3.          |
| 3   | 2.20813E+03                    | .2317          | 50.0            | 2078.9      | 4.          |
| 4   | 2.87042E+03                    | .2227          | 50.0            | 3295.3      | 5.          |
| 5   | 9.15337E+02                    | .3137          | 75.0            | 431.8       | 2.          |
| 6   | 1.32246E+03                    | .2742          | 75.0            | 1090.2      | 3.          |
| 7   | 1.55997E+03                    | .2904          | 75.0            | 1954.6      | 4.          |
| 8   | 1.95431E+03                    | .3130          | 75.0            | 3073.4      | 5.          |
| 9   | 5.92246E+02                    | .4117          | 100.0           | 407.2       | 2.          |
| 10  | 9.39118E+02                    | .3538          | 100.0           | 1623.9      | 3.          |
| 11  | 1.10128E+03                    | .3695          | 100.0           | 1837.1      | 4.          |
| 12  | 1.32551E+03                    | .4052          | 100.0           | 2875.9      | 5.          |
| 13  | 3.61351E+02                    | .5377          | 125.0           | 376.9       | 2.          |
| 14  | 6.4350E+02                     | .4696          | 125.0           | 952.6       | 3.          |
| 15  | 7.46302E+02                    | .4902          | 125.0           | 1717.6      | 4.          |
| 16  | 8.51302E+02                    | .5307          | 125.0           | 2678.7      | 5.          |
| 17  | 2.25557E+02                    | .6636          | 150.0           | 347.3       | 2.          |
| 18  | 3.92484E+02                    | .5956          | 150.0           | 883.1       | 3.          |
| 19  | 4.63402E+02                    | .6140          | 150.0           | 1593.4      | 4.          |
| 20  | 5.52144E+02                    | .6353          | 150.0           | 2521.9      | 5.          |
| 21  | 1.32547E+02                    | .7800          | 175.0           | 315.2       | 2.          |
| 22  | 2.72481E+02                    | .6850          | 175.0           | 818.5       | 3.          |
| 23  | 2.89174E+02                    | .7220          | 175.0           | 1495.5      | 4.          |
| 24  | 3.50174E+02                    | .6962          | 175.0           | 2393.0      | 5.          |
| 25  | 8.39205E+01                    | .7927          | 200.0           | 291.0       | 2.          |
| 26  | 1.36911E+02                    | .7935          | 200.0           | 756.1       | 3.          |
| 27  | 1.70133E+02                    | .8235          | 200.0           | 1416.18     | 4.          |
| 28  | 2.48273E+02                    | .6955          | 200.0           | 2316.8      | 5.          |
| 29  | 1.16579E+02                    | .7453          | 185.0           | 307.3       | 2.          |
| 30  | 1.96471E+02                    | .7772          | 185.0           | 792.2       | 3.          |
| 31  | 2.49037E+02                    | .7413          | 185.0           | 1469.1      | 4.          |
| 32  | 3.14812E+02                    | .6987          | 185.0           | 2366.6      | 5.          |
| 33  | 3.02913E+02                    | .6939          | 165.0           | 330.6       | 2.          |
| 34  | 4.50451E+02                    | .6587          | 165.0           | 845.3       | 3.          |
| 35  | 3.06333E+02                    | .6512          | 165.0           | 2458.0      | 4.          |
| 36  | 5.66190E+02                    | .5767          | 135.0           | 366.4       | 2.          |
| 37  | 6.17008E+02                    | .4971          | 135.0           | 922.2       | 3.          |
| 38  | 7.39022E+02                    | .5252          | 135.0           | 1664.9      | 4.          |
| 39  | 5.60376E+01                    | .7908          | 225.0           | 2623.3      | 5.          |
| 40  | 8.88305E+01                    | .9341          | 225.0           | 273.4       | 2.          |
| 41  | 1.10171E+02                    | .8751          | 225.0           | 723.8       | 3.          |
| 42  | 3.17560E+01                    | .8333          | 250.0           | 1374.1      | 4.          |
| 43  | 7.61001E+01                    | 1.0000         | 250.0           | 257.5       | 2.          |
| 44  | 1.21179E+02                    | .7366          | 250.0           | 688.6       | 3.          |
| 45  | 3.58339E+01                    | .6003          | 250.0           | 1338.1      | 4.          |
| 46  | 2.84280E+01                    | .7522          | 275.0           | 2303.4      | 5.          |
| 47  | 3.84280E+01                    | .7652          | 275.0           | 252.2       | 2.          |
| 48  | 8.60051E+01                    | .6865          | 275.0           | 681.1       | 3.          |
| 49  |                                |                |                 | 1320.9      | 4.          |

50 1.15166E+02 .2892 201.0 4297.2 6.  
 51 1.16030E+02 .3460 201.0 5997.4 7.  
 52 6.4213E+03 .6929 25.0 644.0 2.  
 53 1.03534E+04 .4202 25.0 1737.8 3.  
 54 1.1715E+04 .3830 25.0 3254.1 4.  
 55 1.5149E+04 .3696 25.0 5232.1 5.  
 56 1.5526E+04 .1646 25.0 7413.7 6.  
 57 2.53984E+04 .5187 -4.0 662.8 2.  
 58 2.6734E+04 .2101 -4.0 1814.0 3.  
 59 2.4734E+04 .2116 -3.0 3441.1 4.  
 60 3.24514E+04 .1734 5599.3 5.  
 61 6.02175E+04 .6884 669.3 3.  
 62 4.52598E+04 .1534 1841.9 2.  
 63 4.12333E+04 .1216 26.0 3532.9 3.  
 64 4.89044E+04 .1096 -25.0 5751.0 5.

MATERIAL CODE :150  
 MATERIAL :SOUNDCOAT N-5  
 LOG(FR)\*LOG(IF)-12(T-T0)/(525+T-T0)

| NO. | MODULUS<br>LB-INR2 | LOSS<br>FACTOR | TEMP.<br>DEG. F | FREQ.<br>HZ | MODE<br>NO. |
|-----|--------------------|----------------|-----------------|-------------|-------------|
| 1   | 1.36935E+02        | .9084          | 101.0           | 386.8       | 2.          |
| 2   | 1.54239E+02        | 1.1894         | 101.0           | 1028.4      | 3.          |
| 3   | 2.6541E+02         | 1.2844         | 101.0           | 1837.9      | 4.          |
| 4   | 4.41699E+02        | 1.2584         | 101.0           | 3121.3      | 5.          |
| 5   | 4.75557E+02        | 1.5767         | 101.0           | 4559.2      | 6.          |
| 6   | 4.73988E+02        | 1.2453         | 101.0           | 6317.6      | 7.          |
| 7   | 7.16611E+01        | .7923          | 125.0           | 354.0       | 2.          |
| 8   | 1.13582E+02        | .3705          | 125.0           | 945.5       | 3.          |
| 9   | 1.55405E+02        | .3200          | 125.0           | 1814.0      | 4.          |
| 10  | 2.03572E+02        | .9177          | 124.0           | 2968.3      | 5.          |
| 11  | 2.67825E+02        | .9716          | 123.0           | 4438.5      | 6.          |
| 12  | 2.71227E+02        | 1.2094         | 123.0           | 6160.4      | 7.          |
| 13  | 9.04335E+01        | .8349          | 115.0           | 364.1       | 2.          |
| 14  | 1.44316E+02        | 1.1073         | 115.0           | 964.0       | 3.          |
| 15  | 1.90988E+02        | .9672          | 115.0           | 1837.5      | 4.          |
| 16  | 3.33652E+02        | .7783          | 114.0           | 3046.3      | 5.          |
| 17  | 3.42078E+02        | 1.1145         | 114.0           | 4489.3      | 6.          |
| 18  | 3.49645E+02        | 1.4496         | 114.0           | 6214.4      | 7.          |
| 19  | 3.16552E+02        | 1.0404         | 75.0            | 456.1       | 2.          |
| 20  | 7.09236E+02        | 1.2064         | 75.0            | 1234.0      | 3.          |
| 21  | 6.09371E+02        | 1.6477         | 76.0            | 2113.2      | 4.          |
| 22  | 9.44399E+02        | 1.7610         | 77.0            | 3470.2      | 5.          |
| 23  | 1.11855E+03        | 1.0072         | 47.0            | 572.9       | 2.          |
| 24  | 2.89656E+03        | .8455          | 47.0            | 1564.9      | 3.          |
| 25  | 3.43919E+03        | .8754          | 47.0            | 2831.7      | 4.          |
| 26  | 5.03561E+03        | .9900          | 47.0            | 4547.3      | 5.          |
| 27  | 1.80204E+02        | .9235          | 88.0            | 405.6       | 2.          |
| 28  | 3.12402E+02        | 1.3281         | 88.0            | 1067.6      | 3.          |
| 29  | 3.87048E+02        | 1.2677         | 88.0            | 1962.8      | 4.          |
| 30  | 5.66979E+02        | 1.2677         | 88.0            | 3199.9      | 5.          |
| 31  | 5.83667E+02        | 1.1267         | 61.0            | 520.6       | 2.          |
| 32  | 1.40431E+03        | 1.1673         | 61.0            | 1393.6      | 3.          |
| 33  | 1.37409E+03        | 1.5352         | 61.0            | 2476.5      | 4.          |
| 34  | 4.07986E+01        | .6433          | 150.0           | 336.3       | 2.          |
| 35  | 6.60445E+01        | .7591          | 150.0           | 914.4       | 3.          |
| 36  | 1.01584E+02        | .5525          | 149.0           | 1775.2      | 4.          |
| 37  | 1.40267E+02        | .6210          | 149.0           | 2918.5      | 5.          |
| 38  | 1.73317E+02        | .6291          | 148.0           | 4367.1      | 6.          |
| 39  | 2.16919E+02        | .7960          | 148.0           | 6076.9      | 7.          |
| 40  | 2.75343E+01        | .5542          | 175.0           | 327.2       | 2.          |
| 41  | 4.83536E+01        | .6156          | 175.0           | 909.4       | 3.          |
| 42  | 7.90293E+01        | .3055          | 174.0           | 1755.3      | 4.          |
| 43  | 1.25193E+02        | .3736          | 173.0           | 2899.6      | 5.          |
| 44  | 1.35735E+02        | .4240          | 173.0           | 4327.1      | 6.          |
| 45  | 1.39136E+02        | .4990          | 173.0           | 6034.0      | 7.          |
| 46  | 2.13180E+01        | .4547          | 203.0           | 322.8       | 2.          |
| 47  | 4.07239E+01        | .2864          | 203.0           | 882.2       | 3.          |
| 48  | 7.01638E+01        | .2675          | 202.0           | 1742.5      | 4.          |
| 49  | 1.14177E+02        | .2311          | 202.0           | 2879.4      | 5.          |



MATERIAL CODE : 167  
 MATERIAL : SOUNDFOIL M  
 LOG(FR)-LOG(F)-12(T-T0)/(525+T-T0)

| NO. | MODULUS<br>LB./IN <sup>2</sup> | LOSS<br>FACTOR | TEMP.<br>DEG. F | FREQ.<br>HZ | MODE<br>NO. |
|-----|--------------------------------|----------------|-----------------|-------------|-------------|
| 1   | 2.4252E+04                     | .0736          | -48.0           | 1815.3      | 3.          |
| 2   | 2.6997E+04                     | .0771          | -48.0           | 3434.4      | 4.          |
| 3   | 2.5888E+04                     | .0671          | -47.0           | 5528.2      | 5.          |
| 4   | 1.1441E+04                     | .3723          | -25.0           | 6544.7      | 2.          |
| 5   | 1.6922E+04                     | .1667          | -25.0           | 1785.5      | 3.          |
| 6   | 1.9051E+04                     | .1531          | -24.0           | 5350.0      | 5.          |
| 7   | 3.2914E+03                     | .3966          | -2.0            | 632.0       | 2.          |
| 8   | 7.4862E+03                     | .1589          | -1.0            | 1704.3      | 3.          |
| 9   | 7.6215E+03                     | .7154          | 12.0            | 3110.5      | 4.          |
| 10  | 1.0931                         | 1.0931         | 12.0            | 5911.7      | 2.          |
| 11  | 3.8756E+03                     | .7513          | 12.0            | 1613.1      | 3.          |
| 12  | 3.8178E+03                     | .8374          | 12.0            | 2885.9      | 4.          |
| 13  | 5.1539E+02                     | 1.5026         | 26.0            | 528.2       | 2.          |
| 14  | 1.7136E+03                     | 1.0760         | 26.0            | 1465.0      | 3.          |
| 15  | 2.8054E+02                     | 1.1256         | 37.0            | 449.2       | 2.          |
| 16  | 7.5331E+02                     | 1.4739         | 37.0            | 1286.3      | 3.          |
| 17  | 1.3379E+02                     | 1.3226         | 50.0            | 1130.4      | 2.          |
| 18  | 3.9081E+02                     | 1.6847         | 50.0            | 1130.4      | 3.          |
| 19  | 8.1946E+01                     | 1.7643         | 76.0            | 361.1       | 2.          |
| 20  | 1.6158E+02                     | .7903          | 76.0            | 1820.2      | 4.          |
| 21  | 2.2441E+02                     | .9792          | 76.0            | 3005.6      | 5.          |
| 22  | 2.9012E+02                     | 1.1941         | 76.0            | 4484.9      | 6.          |
| 23  | 2.9576E+02                     | 1.5013         | 76.0            | 6221.2      | 7.          |
| 24  | 4.7102E+01                     | 1.5701         | 101.0           | 341.9       | 2.          |
| 25  | 7.8217E+01                     | .6907          | 100.0           | 927.2       | 3.          |
| 26  | 1.6918E+02                     | .5034          | 99.0            | 1792.2      | 4.          |
| 27  | 1.9009E+02                     | .5231          | 99.0            | 2954.7      | 5.          |
| 28  | 1.9009E+02                     | .6341          | 99.0            | 4402.8      | 6.          |
| 29  | 2.0224E+02                     | .7472          | 99.0            | 6141.3      | 7.          |
| 30  | 3.4409E+01                     | .4912          | 126.0           | 913.9       | 2.          |
| 31  | 6.0146E+01                     | .4971          | 126.0           | 1774.5      | 3.          |
| 32  | 8.9675E+01                     | .3255          | 126.0           | 2926.8      | 4.          |
| 33  | 1.3201E+02                     | .3119          | 126.0           | 4371.3      | 5.          |
| 34  | 1.5642E+02                     | .3648          | 126.0           | 6093.0      | 6.          |
| 35  | 1.6284E+02                     | .4295          | 126.0           | 9033.6      | 7.          |
| 36  | 4.9002E+01                     | .3554          | 153.0           | 1760.4      | 2.          |
| 37  | 7.6605E+01                     | .3549          | 151.0           | 2906.9      | 3.          |
| 38  | 1.1475E+02                     | .2128          | 150.0           | 4342.9      | 4.          |
| 39  | 1.3559E+02                     | .2382          | 150.0           | 6056.8      | 5.          |
| 40  | 1.3995E+02                     | .2789          | 150.0           | 8661.1      | 6.          |
| 41  | 1.7158E+04                     | .1474          | -50.0           | 1924.2      | 2.          |
| 42  | 2.8232E+02                     | 1.8558         | 51.0            | 3178.6      | 4.          |
| 43  | 4.5196E+02                     | 1.9689         | 51.0            | 4655.5      | 5.          |
| 44  | 1.3754E+01                     | 1.0269         | 76.0            | 903.6       | 3.          |
| 45  | 1.9002E+01                     | 1.3554         | 152.0           | 903.6       | 3.          |
| 46  | 1.5789E+04                     | .1484          | -24.0           | 3335.6      | 4.          |

MATERIAL CODE : 56  
 MATERIAL : SOUNDFOIL NO. LT.12  
 LOG(FR)-LOG(F)-12(T-T0)/(525+T-T0)

| NO. | MODULUS<br>LB./IN <sup>2</sup> | LOSS<br>FACTOR | TEMP.<br>DEG. F | FREQ.<br>HZ | MODE<br>NO. |
|-----|--------------------------------|----------------|-----------------|-------------|-------------|
| 1   | 3.07659E+01                    | .3219          | 150.0           | 320.7       | 2.          |
| 2   | 6.12631E+01                    | .2276          | 150.0           | 839.4       | 3.          |
| 3   | 1.4388E+02                     | .1354          | 149.0           | 1741.0      | 4.          |
| 4   | 1.96993E+02                    | .1051          | 149.0           | 2980.5      | 5.          |
| 5   | 1.77958E+02                    | .2137          | 149.0           | 5994.4      | 7.          |
| 6   | 3.99431E+01                    | .3768          | 125.0           | 324.8       | 5.          |
| 7   | 7.39665E+01                    | .2976          | 124.0           | 895.8       | 8.          |
| 8   | 1.26618E+02                    | .1460          | 124.0           | 1752.0      | 4.          |
| 9   | 2.11875E+02                    | .1588          | 124.0           | 2897.0      | 5.          |
| 10  | 2.34931E+02                    | .1460          | 124.0           | 4327.1      | 6.          |
| 11  | 3.09861E+02                    | .1588          | 124.0           | 6025.4      | 7.          |
| 12  | 4.92422E+01                    | .4326          | 102.0           | 328.8       | 2.          |
| 13  | 5.56733E+01                    | .3577          | 102.0           | 903.8       | 3.          |
| 14  | 1.40552E+02                    | .2210          | 102.0           | 1762.3      | 4.          |
| 15  | 2.26061E+02                    | .1825          | 102.0           | 2911.2      | 5.          |
| 16  | 2.45666E+02                    | .1987          | 102.0           | 4345.6      | 6.          |
| 17  | 2.21140E+02                    | .2677          | 102.0           | 6051.5      | 7.          |
| 18  | 7.71459E+01                    | .4931          | 74.0            | 339.3       | 2.          |
| 19  | 1.26759E+02                    | .4619          | 74.0            | 920.3       | 3.          |
| 20  | 2.5870E+02                     | .2758          | 74.0            | 1780.5      | 4.          |
| 21  | 2.5870E+02                     | .2546          | 74.0            | 2937.7      | 5.          |
| 22  | 2.92375E+02                    | .2760          | 74.0            | 4370.1      | 6.          |
| 23  | 2.71881E+02                    | .3359          | 74.0            | 6092.4      | 7.          |
| 24  | 1.26754E+02                    | .4453          | 51.0            | 353.3       | 2.          |
| 25  | 1.82286E+02                    | .4521          | 51.0            | 939.8       | 3.          |
| 26  | 2.20772E+02                    | .3520          | 51.0            | 1901.0      | 4.          |
| 27  | 3.19996E+02                    | .3620          | 51.0            | 2966.1      | 5.          |
| 28  | 3.39562E+02                    | .4903          | 51.0            | 4334.7      | 7.          |
| 29  | 2.94325E+02                    | .6365          | 26.0            | 976.0       | 3.          |
| 30  | 4.54733E+02                    | .5330          | 26.0            | 1840.1      | 4.          |
| 31  | 5.49069E+02                    | .6530          | 26.0            | 2920.8      | 5.          |
| 32  | 5.42371E+02                    | .6911          | 26.0            | 4390.8      | 6.          |
| 33  | 6.16863E+02                    | .8129          | 26.0            | 6220.5      | 7.          |
| 34  | 7.74300E+02                    | .7923          | 1.0             | 416.4       | 2.          |
| 35  | 5.64580E+02                    | 1.0279         | 1.0             | 1059.6      | 3.          |
| 36  | 8.59232E+02                    | 1.0406         | 1.0             | 1936.7      | 4.          |
| 37  | 3.08857E+04                    | 1.2337         | 1.0             | 3162.4      | 5.          |
| 38  | 5.45188E+04                    | 1.4635         | -48.0           | 696.8       | 2.          |
| 39  | 2.9003E+04                     | .2270          | -47.0           | 1444.9      | 3.          |
| 40  | 5.27786E+04                    | .1760          | -47.0           | 2855.0      | 4.          |
| 41  | 2.45535E+05                    | .9333          | -74.0           | 704.3       | 2.          |
| 42  | 1.3237E+05                     | .0852          | -73.0           | 1933.9      | 3.          |
| 43  | 4.0202E+04                     | .0422          | -73.0           | 3549.4      | 4.          |
| 44  | 5.2805E+04                     | .1030          | -73.0           | 5769.7      | 5.          |
| 45  | 4.30295E+04                    | .2126          | -47.0           | 5641.5      | 5.          |
| 46  | 2.66048E+02                    | .1305          | 149.0           | 430.4       | 2.          |
| 47  | 3.60048E+02                    | .4125          | 151.0           | 4416.4      | 6.          |

MATERIAL CODE 1143  
 MATERIAL IE A R EXODAMP C-2003  
 $\text{LOG(FR)} = \text{LOG}(F) - 12(T - T_0) / (525 - T - T_0)$

MATERIAL CODE 1143  
 MATERIAL IE A R ISODAMP C-1002  
 $\text{LOG(FR)} = \text{LOG}(F) - 12(T - T_0) / (525 - T - T_0)$

| NO. | MODULUS<br>LB/IN <sup>1/2</sup> | LOSS<br>FACTOR | TEMP.<br>DEG. F | FREQ.<br>HZ | MODE<br>NO. |
|-----|---------------------------------|----------------|-----------------|-------------|-------------|
| 1   | 4.87892E+04                     | 1.1889         | 102.0           | 203.4       | 2           |
| 2   | 1.12477E+05                     | .7779          | 102.0           | 579.2       | 3           |
| 3   | 1.68393E+05                     | .6110          | 102.0           | 1157.7      | 4           |
| 4   | 2.08269E+05                     | .5752          | 102.0           | 1944.0      | 5           |
| 5   | 2.14538E+05                     | .6406          | 102.0           | 2928.7      | 6           |
| 6   | 6.88590E+04                     | .6952          | 125.0           | 1341.9      | 5           |
| 7   | 1.3893E+04                      | .8744          | 125.0           | 2763.8      | 6           |
| 8   | 3.06356E+05                     | .4896          | 75.0            | 222.6       | 2           |
| 9   | 4.35288E+05                     | .3870          | 75.0            | 644.7       | 3           |
| 10  | 5.25810E+05                     | .3448          | 75.0            | 1293.3      | 4           |
| 11  | 5.91735E+05                     | .3238          | 75.0            | 2181.6      | 5           |
| 12  | 6.10289E+05                     | .3299          | 75.0            | 3291.0      | 6           |
| 13  | 8.45937E+05                     | .1622          | 49.0            | 256.5       | 2           |
| 14  | 9.68118E+05                     | .1332          | 49.0            | 734.2       | 3           |
| 15  | 1.06250E+06                     | .1136          | 49.0            | 1464.7      | 4           |
| 16  | 1.12851E+06                     | .1075          | 49.0            | 2456.9      | 5           |
| 17  | 1.14222E+06                     | .1017          | 49.0            | 3695.0      | 6           |
| 18  | 6.2865E+05                      | .2433          | 60.0            | 244.6       | 2           |
| 19  | 7.67675E+05                     | .2058          | 60.0            | 702.6       | 3           |
| 20  | 8.51819E+05                     | .1840          | 60.0            | 1401.6      | 4           |
| 21  | 9.19185E+05                     | .1722          | 60.0            | 2355.7      | 5           |
| 22  | 9.49542E+05                     | .1593          | 60.0            | 3556.3      | 6           |
| 23  | 1.38474E+05                     | .3226          | 87.0            | 210.3       | 2           |
| 24  | 2.36247E+05                     | .2659          | 87.0            | 606.0       | 3           |
| 25  | 3.95297E+05                     | .1975          | 87.0            | 1212.9      | 4           |
| 26  | 3.66945E+05                     | .4600          | 87.0            | 2048.1      | 5           |
| 27  | 3.86314E+05                     | .5030          | 87.0            | 3094.3      | 6           |
| 28  | 1.19881E+06                     | .0490          | 25.0            | 275.6       | 2           |
| 29  | 1.28557E+06                     | .0433          | 25.0            | 780.7       | 3           |
| 30  | 1.37546E+06                     | .0378          | 25.0            | 1552.1      | 4           |
| 31  | 4.71331E+04                     | .7871          | 125.0           | 1102.9      | 4           |
| 32  | 1.42853E+06                     | .0359          | 25.0            | 2593.1      | 5           |
| 33  | 1.44188E+06                     | .0336          | 25.0            | 3897.5      | 6           |
| 34  | 1.43359E+04                     | .7853          | 151.0           | 1085.1      | 4           |
| 35  | 2.45104E+04                     | .6667          | 150.0           | 1803.7      | 5           |
| 36  | 1.47252E+04                     | 1.1211         | 150.0           | 2702.7      | 6           |
| 37  | 1.47566E+03                     | 1.1498         | 175.0           | 1076.1      | 4           |
| 38  | 1.55257E+04                     | .4077          | 174.0           | 1789.0      | 5           |
| 39  | 3.5801E+03                      | 1.3651         | 173.0           | 2680.0      | 6           |
| 40  | 9.64921E+03                     | .4342          | 190.0           | 1774.8      | 5           |

| NO. | MODULUS<br>LB/IN <sup>1/2</sup> | LOSS<br>FACTOR | TEMP.<br>DEG. F | FREQ.<br>HZ | MODE<br>NO. |
|-----|---------------------------------|----------------|-----------------|-------------|-------------|
| 1   | 5.26603E+03                     | .6700          | 102.0           | 1313.1      | 4           |
| 2   | 4.26871E+03                     | 1.1675         | 102.0           | 2172.5      | 5           |
| 3   | 2.30622E+03                     | 1.1242         | 125.0           | 1301.8      | 4           |
| 4   | 4.92857E+03                     | 1.4912         | 75.0            | 670.0       | 3           |
| 5   | 1.22005E+04                     | .7336          | 75.0            | 1334.3      | 4           |
| 6   | 1.35836E+04                     | .9020          | 75.0            | 2216.8      | 5           |
| 7   | 8.19569E+03                     | 1.9207         | 75.0            | 3296.5      | 6           |
| 8   | 2.67686E+04                     | .8180          | 49.0            | 247.1       | 2           |
| 9   | 4.55422E+04                     | .6346          | 49.0            | 717.7       | 3           |
| 10  | 6.12754E+04                     | .6206          | 49.0            | 1443.5      | 4           |
| 11  | 6.86048E+04                     | .6340          | 49.0            | 2417.5      | 5           |
| 12  | 6.39118E+04                     | .7635          | 49.0            | 3599.5      | 6           |
| 13  | 1.29562E+05                     | .3675          | 25.0            | 285.5       | 2           |
| 14  | 1.64315E+05                     | .3003          | 25.0            | 835.0       | 3           |
| 15  | 1.86141E+05                     | .2657          | 25.0            | 1678.2      | 4           |
| 16  | 1.92223E+05                     | .2509          | 25.0            | 2808.9      | 5           |
| 17  | 1.56677E+05                     | .2619          | 25.0            | 4164.7      | 6           |
| 18  | 2.68147E+05                     | .1016          | -2.5            | 327.8       | 2           |
| 19  | 3.10423E+05                     | .0830          | -2.5            | 955.6       | 3           |
| 20  | 3.25371E+05                     | .0750          | -2.5            | 1899.0      | 4           |
| 21  | 3.2172E+05                      | .0721          | -2.5            | 3150.2      | 5           |
| 22  | 1.84762E+05                     | .0712          | 11.0            | 4680.7      | 6           |
| 23  | 2.2589E+05                      | .2149          | 11.0            | 303.5       | 2           |
| 24  | 2.4380E+05                      | .1811          | 11.0            | 886.0       | 3           |
| 25  | 2.48580E+05                     | .1530          | 11.0            | 1774.7      | 4           |
| 26  | 2.38244E+05                     | .1499          | 11.0            | 2952.3      | 5           |
| 27  | 6.47691E+04                     | .5828          | 11.0            | 4379.5      | 6           |
| 28  | 8.46395E+04                     | .5112          | 35.0            | 262.2       | 2           |
| 29  | 1.14305E+05                     | .4111          | 35.0            | 759.3       | 3           |
| 30  | 1.09409E+05                     | .4503          | 35.0            | 2567.9      | 4           |
| 31  | 3.39782E+05                     | .0305          | 35.0            | 3823.5      | 5           |
| 32  | 4.8962E+05                      | .0307          | -26.0           | 348.2       | 2           |
| 33  | 4.8962E+05                      | .0307          | -26.0           | 2010.5      | 3           |
| 34  | 3.75201E+05                     | .0285          | -26.0           | 3311.1      | 4           |
| 35  | 3.75201E+05                     | .0285          | -26.0           | 4885.0      | 5           |
| 36  | 1.09333E+05                     | .4530          | 35.0            | 1531.9      | 6           |
| 37  | 3.91050E+05                     | .0359          | -27.0           | 1015.1      | 4           |

MATERIAL CODE : 187  
 MATERIAL : BUTYL 268  
 LOG(FR)=LOG(F)-12(T-T0)/(525+T-T0)

| NO. | MODULUS<br>LB./INCH <sup>2</sup> | LOSS<br>FACTOR | TEMP.<br>DEG. F | FREQ.<br>HZ. | MODE<br>NO. |
|-----|----------------------------------|----------------|-----------------|--------------|-------------|
| 1   | 9.41375E+01                      | .3393          | 149.0           | 336.7        | 2.          |
| 2   | 1.30928E+02                      | .4752          | 149.0           | 911.5        | 3.          |
| 3   | 2.28952E+02                      | .3763          | 149.0           | 1772.7       | 4.          |
| 4   | 3.59465E+02                      | .3963          | 149.0           | 2918.3       | 5.          |
| 5   | 5.46321E+02                      | .2645          | 148.0           | 4347.1       | 6.          |
| 6   | 7.22289E+02                      | .2597          | 148.0           | 6058.1       | 1.          |
| 7   | 1.16592E+03                      | 5.104          | 124.0           | 342.9        | 2.          |
| 8   | 1.72307E+02                      | .6291          | 124.0           | 924.2        | 3.          |
| 9   | 2.73461E+02                      | .5896          | 124.0           | 1790.3       | 4.          |
| 10  | 4.38440E+02                      | .5238          | 124.0           | 2948.6       | 5.          |
| 11  | 2.10048E+02                      | .4556          | 123.0           | 5103.2       | 2.          |
| 12  | 1.52333E+02                      | .7517          | 100.0           | 356.9        | 3.          |
| 13  | 2.51811E+02                      | .9552          | 100.0           | 946.1        | 4.          |
| 14  | 3.87199E+02                      | .9029          | 100.0           | 1824.0       | 5.          |
| 15  | 5.49625E+02                      | .8355          | 100.0           | 2989.2       | 6.          |
| 16  | 6.73620E+02                      | 1.1193         | 99.0            | 4414.5       | 7.          |
| 17  | 1.23764E+03                      | 1.7025         | 99.0            | 6229.0       | 1.          |
| 18  | 4.78645E+02                      | 1.2767         | 74.0            | 1003.8       | 3.          |
| 19  | 6.56359E+02                      | 1.3527         | 74.0            | 1897.5       | 4.          |
| 20  | 8.90773E+02                      | 1.5622         | 74.0            | 3092.6       | 5.          |
| 21  | 6.59879E+02                      | 1.3369         | 49.0            | 455.9        | 2.          |
| 22  | 1.24880E+03                      | 1.7620         | 49.0            | 1170.4       | 3.          |
| 23  | 1.68698E+03                      | 1.6410         | 25.0            | 586.3        | 4.          |
| 24  | 3.42449E+03                      | 1.3600         | 25.0            | 1483.0       | 5.          |
| 25  | 4.50293E+02                      | 1.1650         | 62.0            | 414.4        | 3.          |
| 26  | 7.08681E+02                      | 1.5308         | 62.0            | 1063.9       | 4.          |
| 27  | 8.71675E+02                      | 1.8594         | 62.0            | 1266.9       | 5.          |
| 28  | 1.03375E+03                      | 2.2432         | 62.0            | 3154.3       | 1.          |
| 29  | 9.14249E+02                      | 1.7123         | 35.0            | 511.1        | 2.          |
| 30  | 2.10642E+03                      | 1.6390         | 35.0            | 1350.1       | 3.          |
| 31  | 6.41378E+03                      | .9901          | .0              | 672.9        | 4.          |
| 32  | 1.12947E+04                      | .8810          | .0              | 1770.5       | 5.          |
| 33  | 1.41185E+04                      | 1.0108         | .0              | 3267.7       | 1.          |
| 34  | 1.84280E+04                      | 1.0811         | -24.0           | 718.4        | 2.          |
| 35  | 3.28453E+04                      | .8253          | -24.0           | 1947.9       | 3.          |
| 36  | 4.86650E+04                      | .5892          | -23.0           | 3690.5       | 4.          |
| 37  | 5.44800E+04                      | .5339          | -23.0           | 5856.8       | 5.          |
| 38  | 1.16020E+05                      | .1661          | -51.0           | 2017.5       | 3.          |
| 39  | 1.27531E+05                      | .1508          | -50.0           | 3864.7       | 4.          |
| 40  | 1.23065E+05                      | .1146          | -50.0           | 6202.7       | 5.          |
| 41  | 3.18518E+02                      | .9627          | 74.0            | 387.6        | 2.          |

50 3.99098E+05  
 51 9.13939E+05  
 52 3.81137E+05  
 53 1.00018E+06  
 54 1.04909E+06  
 55 9.70297E+05  
 56 9.33021E+05  
 57 4.09676E+05  
 58 2.48165E+06  
 59 1.00377E+06  
 60 1.03047E+06  
 61 1.03647E+06  
 62 1.01358E+06

.0551  
 .0247  
 .0196  
 .0187  
 .0198  
 .0196  
 .5198  
 .5862  
 .0166  
 .0158  
 .0152  
 .0148

-75.0  
 -104.0  
 -104.0  
 -104.0  
 -104.0  
 -104.0  
 -118.0  
 -17.0  
 -118.0  
 -118.0  
 -117.0  
 -117.0

498.6  
 499.6  
 1429.6  
 2817.5  
 4680.1  
 6981.0  
 503.4  
 1477.3  
 1886.0  
 1441.9  
 2847.5  
 4725.6  
 7008.4

5.  
 2.  
 3.  
 4.  
 5.  
 6.  
 2.  
 4.  
 3.  
 4.  
 5.  
 6.

MATERIAL CODE :124  
 MATERIAL :BUTYL 268  
 LOG(FR)-LOG(F)-12(T-T0)/(1525-T-T0)

| NO. | MODULUS<br>LB./INCH <sup>2</sup> | LOSS<br>FACTOR | TEMP.<br>DEG. F | FREQ.<br>HZ | MOLE<br>NO. |
|-----|----------------------------------|----------------|-----------------|-------------|-------------|
| 1   | 1.3338E+04                       | .1766          | 122.0           | 256.5       | 2           |
| 2   | 1.31689E+04                      | .2896          | 122.0           | 713.6       | 3           |
| 3   | 1.40691E+04                      | .2819          | 122.0           | 1403.7      | 4           |
| 4   | 1.43731E+04                      | .4710          | 122.0           | 3479.1      | 6           |
| 5   | 1.56887E+04                      | .2458          | 101.0           | 259.1       | 2           |
| 6   | 1.62884E+04                      | .3486          | 101.0           | 719.0       | 3           |
| 7   | 1.70094E+04                      | .3486          | 101.0           | 1413.9      | 4           |
| 8   | 1.74572E+04                      | .5656          | 101.0           | 3507.2      | 6           |
| 9   | 1.48220E+04                      | .7978          | 101.0           | 4824.1      | 7           |
| 10  | 1.93943E+04                      | .2596          | 75.0            | 260.6       | 2           |
| 11  | 2.19016E+04                      | .3692          | 75.0            | 728.1       | 3           |
| 12  | 2.50730E+04                      | .4135          | 75.0            | 1435.9      | 4           |
| 13  | 2.55386E+04                      | .4959          | 75.0            | 2383.0      | 5           |
| 14  | 2.7507E+04                       | .6549          | 75.0            | 5002.0      | 7           |
| 15  | 2.68746E+04                      | .4160          | 49.0            | 264.5       | 2           |
| 16  | 3.26943E+04                      | .4988          | 49.0            | 742.9       | 3           |
| 17  | 4.42037E+04                      | .5796          | 49.0            | 2460.9      | 5           |
| 18  | 3.23054E+04                      | 1.0880         | 49.0            | 5052.2      | 7           |
| 19  | 4.67638E+04                      | .5111          | 23.0            | 277.5       | 2           |
| 20  | 6.15608E+04                      | .5578          | 23.0            | 777.9       | 3           |
| 21  | 7.7662E+04                       | .5550          | 23.0            | 1561.1      | 4           |
| 22  | 8.16876E+04                      | .6158          | 23.0            | 2609.9      | 5           |
| 23  | 9.39021E+04                      | .6657          | 23.0            | 3950.6      | 6           |
| 24  | 8.57595E+04                      | .5021          | 23.0            | 5467.2      | 7           |
| 25  | 8.3608E+04                       | .5121          | -2.0            | 299.1       | 2           |
| 26  | 1.2351E+05                       | .5465          | -2.0            | 834.9       | 3           |
| 27  | 1.24394E+05                      | .5509          | -2.0            | 1659.9      | 4           |
| 28  | 1.51612E+05                      | .6399          | -2.0            | 2836.9      | 5           |
| 29  | 1.45883E+05                      | .4805          | -17.0           | 311.7       | 2           |
| 30  | 1.92843E+05                      | .5397          | -17.0           | 912.1       | 3           |
| 31  | 2.74383E+05                      | .6373          | -17.0           | 3195.2      | 5           |
| 32  | 1.88167E+05                      | .5054          | -26.0           | 326.1       | 2           |
| 33  | 2.54772E+05                      | .5349          | -26.0           | 967.8       | 3           |
| 34  | 3.19268E+05                      | .5707          | -26.0           | 2001.2      | 4           |
| 35  | 3.72956E+05                      | .4154          | -40.0           | 330.6       | 2           |
| 36  | 4.83680E+05                      | .3495          | -40.0           | 1142.1      | 3           |
| 37  | 5.51786E+05                      | .3161          | -40.0           | 2326.3      | 4           |
| 38  | 5.4974E+05                       | .3302          | -40.0           | 3847.5      | 5           |
| 39  | 5.91388E+05                      | .3155          | -40.0           | 5951.1      | 6           |
| 40  | 5.67371E+05                      | .2242          | -40.0           | 8199.1      | 7           |
| 41  | 5.9526E+05                       | .3013          | -51.0           | 415.4       | 2           |
| 42  | 5.9530E+05                       | .2484          | -51.0           | 1215.1      | 3           |
| 43  | 6.42335E+05                      | .2161          | -51.0           | 2437.1      | 4           |
| 44  | 6.81418E+05                      | .2089          | -50.0           | 4110.1      | 5           |
| 45  | 6.7804E+05                       | .0667          | -50.0           | 6130.1      | 6           |
| 46  | 7.06624E+05                      | .0654          | -50.0           | 8689.0      | 7           |
| 47  | 7.95437E+05                      | .0714          | -75.0           | 476.0       | 2           |
| 48  | 8.68951E+05                      | .0617          | -75.0           | 1370.8      | 3           |
| 49  | 8.89055E+05                      | .0613          | -75.0           | 2707.5      | 4           |

APPENDIX B

TABULAR DATA OF TESTS  
PERFORMED ON ISD-110

50 5.06584E+02 2.4397 130.0 1452.9 4.  
 51 2.21433E+02 1.7399 150.0 734.5 3.  
 52 5.04611E+01 2.5033 170.0 260.9 2.

MATERIAL CODE :292  
 MATERIAL :ISD-110  
 LOG(FR)-LOG(F)-12(T-T0)/(525+T-T0)

| NO. | MODULUS<br>LB./IN <sup>2</sup> | LOSS<br>FACTOR | TEMP.<br>DEG. F. | FREQ.<br>HZ | MODE<br>NO. |
|-----|--------------------------------|----------------|------------------|-------------|-------------|
| 1   | 6.59496E+04                    | .0758          | 0                | 1809.3      | 3           |
| 2   | 7.75242E+04                    | .0703          | 0                | 4636.4      | 5           |
| 3   | 6.40430E+04                    | .1451          | 10.0             | 3005.1      | 4           |
| 4   | 6.39517E+04                    | .1022          | 10.0             | 4457.3      | 5           |
| 5   | 4.78021E+04                    | .1364          | 20.0             | 1682.5      | 3           |
| 6   | 5.30275E+04                    | .1431          | 20.0             | 2872.5      | 4           |
| 7   | 5.02529E+04                    | .1546          | 20.0             | 4257.2      | 5           |
| 8   | 3.76074E+04                    | .1851          | 30.0             | 1613.7      | 3           |
| 9   | 4.49448E+04                    | .1904          | 30.0             | 2735.7      | 4           |
| 10  | 4.87305E+04                    | .2105          | 30.0             | 4041.1      | 5           |
| 11  | 2.08695E+04                    | .1936          | 40.0             | 621.1       | 2           |
| 12  | 3.19013E+04                    | .2432          | 40.0             | 1523.9      | 3           |
| 13  | 1.71544E+04                    | .2918          | 50.0             | 605.1       | 2           |
| 14  | 2.49537E+04                    | .3166          | 50.0             | 1439.0      | 3           |
| 15  | 2.95716E+04                    | .3488          | 50.0             | 2442.4      | 4           |
| 16  | 3.23391E+04                    | .3425          | 50.0             | 3651.1      | 5           |
| 17  | 1.34532E+04                    | .4223          | 60.0             | 574.4       | 2           |
| 18  | 1.86141E+04                    | .5453          | 70.0             | 1324.8      | 3           |
| 19  | 9.15232E+03                    | .5422          | 70.0             | 521.7       | 2           |
| 20  | 1.39418E+04                    | .5605          | 70.0             | 1258.5      | 3           |
| 21  | 1.51444E+04                    | .5546          | 70.0             | 2070.9      | 4           |
| 22  | 1.56020E+04                    | .7041          | 80.0             | 3094.6      | 5           |
| 23  | 5.69478E+03                    | .7853          | 80.0             | 460.4       | 2           |
| 24  | 8.62967E+03                    | .9539          | 80.0             | 1093.8      | 3           |
| 25  | 9.12730E+03                    | .7853          | 80.0             | 1661.1      | 4           |
| 26  | 3.79005E+03                    | 1.1844         | 90.0             | 409.1       | 2           |
| 27  | 4.42303E+03                    | 1.1165         | 90.0             | 955.2       | 3           |
| 28  | 5.7120E+03                     | .9361          | 90.0             | 175.3       | 4           |
| 29  | 8.68375E+03                    | 1.9517         | 100.0            | 2813.9      | 5           |
| 30  | 1.83373E+03                    | 1.2905         | 100.0            | 359.7       | 2           |
| 31  | 3.33520E+03                    | 1.7264         | 100.0            | 897.4       | 3           |
| 32  | 4.07161E+03                    | 1.6717         | 100.0            | 1571.9      | 4           |
| 33  | 1.21731E+03                    | 1.4938         | 110.0            | 2592.9      | 5           |
| 34  | 1.87686E+03                    | 1.3196         | 110.0            | 323.4       | 2           |
| 35  | 1.68607E+03                    | 1.7155         | 110.0            | 825.8       | 3           |
| 36  | 2.04994E+03                    | 1.3740         | 110.0            | 1522.2      | 4           |
| 37  | 1.08552E+03                    | 1.2315         | 120.0            | 2526.8      | 5           |
| 38  | 1.02417E+03                    | 1.6707         | 120.0            | 783.5       | 2           |
| 39  | 1.24180E+03                    | 1.8193         | 130.0            | 1483.5      | 3           |
| 40  | 3.68190E+02                    | 1.3285         | 130.0            | 2433.2      | 4           |
| 41  | 8.71741E+02                    | 1.1442         | 130.0            | 279.2       | 5           |
| 42  | 5.34784E+02                    | 1.0413         | 140.0            | 771.4       | 2           |
| 43  | 3.43434E+02                    | 1.8067         | 140.0            | 2302.5      | 3           |
| 44  | 8.44802E+01                    | 2.0550         | 160.0            | 743.5       | 4           |
| 45  | 1.56794E+02                    | 1.7852         | 160.0            | 263.0       | 5           |
| 46  | 7.21701E+01                    | 2.3247         | 180.0            | 730.2       | 2           |
| 47  | 7.44801E+04                    | .0734          | 180.0            | 723.7       | 3           |
| 48  | 7.44801E+04                    | .1026          | 180.0            | 325.1       | 4           |
| 49  | 5.59567E+04                    | .1026          | 10.0             | 1745.3      | 5           |

50 2.00954E+02 1.8631 180.0 2747.4 5.  
 51 1.21291E+02 1.6734 190.0 1657.4 4.  
 52 1.01097E+02 1.5682 200.0 1652.5 4.  
 53 3.43946E+01 2.2088 200.0 2725.7 5.

MATERIAL CODE : J10  
 MATERIAL : ISD-110  
 LOG(F) = LOG(F) - 12(T - T0) / (525 + T - T0)

| NO. | MODULUS             | LOSS   | TEMP.  | FREQ.  | MODE |
|-----|---------------------|--------|--------|--------|------|
|     | LB./IN <sup>2</sup> | FACTOR | DEG. F | Hz     | NO.  |
| 1   | 3.74246E+04         | .0535  | 0      | 869.9  | 2.   |
| 2   | 5.54597E+04         | .0577  | 0      | 2249.1 | 3.   |
| 3   | 7.89653E+04         | .0694  | 0      | 6277.3 | 5.   |
| 4   | 3.36464E+04         | .0766  | 10.0   | 859.4  | 3.   |
| 5   | 4.64644E+04         | .0973  | 20.0   | 2187.7 | 3.   |
| 6   | 3.05363E+04         | .1046  | 20.0   | 849.4  | 2.   |
| 7   | 4.21073E+04         | .1664  | 20.0   | 2149.8 | 3.   |
| 8   | 6.01367E+04         | .1320  | 30.0   | 5896.9 | 5.   |
| 9   | 2.39723E+04         | .1439  | 30.0   | 324.7  | 2.   |
| 10  | 3.54489E+04         | .1923  | 40.0   | 2084.0 | 3.   |
| 11  | 2.32874E+04         | .2040  | 40.0   | 822.2  | 2.   |
| 12  | 3.01066E+04         | .2585  | 50.0   | 2081.0 | 3.   |
| 13  | 2.46807E+04         | .3426  | 60.0   | 1941.6 | 3.   |
| 14  | 9.79735E+03         | .3409  | 70.0   | 713.3  | 2.   |
| 15  | 1.81520E+04         | .4693  | 80.0   | 1816.0 | 3.   |
| 16  | 8.82361E+03         | .5232  | 90.0   | 656.6  | 2.   |
| 17  | 1.42512E+04         | .5876  | 100.0  | 1722.0 | 3.   |
| 18  | 6.51511E+03         | .9877  | 100.0  | 657.7  | 2.   |
| 19  | 1.04065E+04         | .7137  | 80.0   | 1669.3 | 3.   |
| 20  | 1.72662E+04         | .6201  | 90.0   | 611.0  | 2.   |
| 21  | 7.35736E+03         | .2712  | 100.0  | 1474.3 | 3.   |
| 22  | 1.50613E+04         | .9557  | 100.0  | 4248.4 | 5.   |
| 23  | 2.81517E+03         | .1945  | 100.0  | 539.5  | 2.   |
| 24  | 4.33881E+03         | .2712  | 100.0  | 1277.7 | 3.   |
| 25  | 1.38235E+04         | .9890  | 100.0  | 4157.6 | 5.   |
| 26  | 1.97386E+03         | .1035  | 110.0  | 492.2  | 2.   |
| 27  | 2.99264E+04         | .11816 | 100.0  | 1181.5 | 3.   |
| 28  | 1.32333E+04         | .6814  | 110.0  | 4086.1 | 5.   |
| 29  | 1.22464E+03         | .1382  | 120.0  | 435.7  | 2.   |
| 30  | 2.05244E+03         | .11810 | 120.0  | 1086.4 | 3.   |
| 31  | 8.04386E+02         | .11235 | 130.0  | 395.0  | 2.   |
| 32  | 1.24720E+03         | .11596 | 130.0  | 998.3  | 3.   |
| 33  | 4.70359E+02         | .13438 | 140.0  | 359.2  | 2.   |
| 34  | 6.72475E+02         | .14976 | 140.0  | 928.8  | 3.   |
| 35  | 7.83220E+02         | .10961 | 140.0  | 1756.4 | 4.   |
| 36  | 3.09897E+02         | .13344 | 150.0  | 340.1  | 2.   |
| 37  | 4.39635E+02         | .15358 | 150.0  | 898.4  | 3.   |
| 38  | 5.46046E+02         | .13380 | 150.0  | 1223.5 | 4.   |
| 39  | 8.66611E+02         | .10508 | 160.0  | 2847.4 | 5.   |
| 40  | 2.04048E+02         | .18875 | 160.0  | 356.8  | 3.   |
| 41  | 3.15245E+02         | .17765 | 160.0  | 881.5  | 3.   |
| 42  | 3.26673E+02         | .17065 | 160.0  | 1682.7 | 4.   |
| 43  | 4.62334E+02         | .19825 | 170.0  | 2791.4 | 5.   |
| 44  | 1.47984E+02         | .11074 | 170.0  | 319.3  | 2.   |
| 45  | 2.44363E+02         | .16813 | 170.0  | 879.2  | 3.   |
| 46  | 2.35353E+02         | .16998 | 170.0  | 1677.2 | 4.   |
| 47  | 3.12044E+02         | .17277 | 180.0  | 2765.9 | 5.   |
| 48  | 1.66171E+02         |        |        | 1605.9 | 4.   |

MATERIAL CODE 1289  
 MATERIAL : ISD-110  
 LOG(FR) = LOG(F) - 12(T-T0) / (525+T-T0)

| NO. | MODULUS<br>LB/INX12 | LOSS<br>FACTOR | TEMP.<br>DES. F | FREQ.<br>HZ | MODE<br>NO. |
|-----|---------------------|----------------|-----------------|-------------|-------------|
| 1   | 1.36335E+05         | .0309          | -140.8          | 13.0        | 1.          |
| 2   | 1.34885E+05         | .0312          | -137.2          | 13.5        | 1.          |
| 3   | 1.33000E+05         | .0324          | -133.6          | 13.4        | 1.          |
| 4   | 1.30690E+05         | .0332          | -130.0          | 13.3        | 1.          |
| 5   | 1.29084E+05         | .0344          | -126.4          | 13.2        | 1.          |
| 6   | 1.28068E+05         | .0343          | -122.8          | 13.2        | 1.          |
| 7   | 1.27033E+05         | .0355          | -119.2          | 13.1        | 1.          |
| 8   | 1.23282E+05         | .0370          | -115.6          | 12.9        | 1.          |
| 9   | 1.18931E+05         | .0402          | -108.4          | 12.7        | 1.          |
| 10  | 1.17045E+05         | .0421          | -104.8          | 12.6        | 1.          |
| 11  | 1.09213E+05         | .0496          | -86.8           | 12.2        | 1.          |
| 12  | 1.07763E+05         | .0506          | -83.2           | 12.1        | 1.          |
| 13  | 1.05397E+05         | .0525          | -79.6           | 12.0        | 1.          |
| 14  | 1.01962E+05         | .0541          | -76.0           | 11.9        | 1.          |
| 15  | 1.00511E+05         | .0555          | -72.4           | 11.7        | 1.          |
| 16  | 9.86257E+04         | .0575          | -68.8           | 11.6        | 1.          |
| 17  | 9.52898E+04         | .0590          | -65.2           | 11.4        | 1.          |
| 18  | 9.35937E+04         | .0602          | -61.6           | 11.3        | 1.          |
| 19  | 8.99274E+04         | .0647          | -58.0           | 11.1        | 1.          |
| 20  | 8.68751E+04         | .0687          | -54.4           | 10.9        | 1.          |
| 21  | 8.36368E+04         | .0739          | -50.8           | 10.7        | 1.          |
| 22  | 7.97708E+04         | .0801          | -47.2           | 10.5        | 1.          |
| 23  | 7.61706E+04         | .0877          | -43.6           | 10.3        | 1.          |
| 24  | 7.35741E+04         | .0983          | -40.0           | 10.1        | 1.          |
| 25  | 6.98928E+04         | .1130          | -36.4           | 9.8         | 1.          |
| 26  | 6.48319E+04         | .1320          | -32.8           | 9.5         | 1.          |
| 27  | 6.13510E+04         | .1370          | -29.2           | 9.3         | 1.          |
| 28  | 5.84502E+04         | .1340          | -25.6           | 9.1         | 1.          |
| 29  | 5.46792E+04         | .1330          | -22.0           | 8.8         | 1.          |
| 30  | 5.22136E+04         | .1350          | -18.4           | 8.6         | 1.          |
| 31  | 4.93128E+04         | .1410          | -14.8           | 8.4         | 1.          |
| 32  | 4.52518E+04         | .1490          | -11.2           | 8.1         | 1.          |
| 33  | 4.16258E+04         | .1600          | -7.6            | 7.8         | 1.          |
| 34  | 3.81449E+04         | .1700          | -4.0            | 7.5         | 1.          |
| 35  | 3.48091E+04         | .1840          | -0.4            | 7.2         | 1.          |
| 36  | 3.24885E+04         | .1980          | 3.2             | 7.0         | 1.          |
| 37  | 2.89625E+04         | .2130          | 6.8             | 6.6         | 1.          |
| 38  | 2.62518E+04         | .2310          | 10.4            | 6.4         | 1.          |
| 39  | 2.27709E+04         | .2500          | 14.0            | 6.0         | 1.          |
| 40  | 2.00152E+04         | .2730          | 17.6            | 5.7         | 1.          |
| 41  | 1.79847E+04         | .2950          | 21.2            | 5.4         | 1.          |
| 42  | 1.52290E+04         | .3180          | 24.8            | 5.1         | 1.          |
| 43  | 1.26618E+04         | .3450          | 28.4            | 4.8         | 1.          |
| 44  | 1.11244E+04         | .3760          | 32.0            | 4.6         | 1.          |
| 45  | 9.18080E+03         | .4120          | 35.6            | 4.3         | 1.          |
| 46  | 7.44044E+03         | .4560          | 39.2            | 4.0         | 1.          |
| 47  | 5.94655E+03         | .5110          | 42.8            | 3.7         | 1.          |
| 48  | 4.68472E+03         | .5680          | 46.4            | 3.5         | 1.          |
| 49  | 3.69846E+03         | .6190          | 50.0            | 3.3         | 1.          |

|    |             |       |        |     |    |
|----|-------------|-------|--------|-----|----|
| 50 | 2.85734E+03 | .6730 | 53.6   | 3.1 | 1. |
| 51 | 2.24888E+03 | .7040 | 57.2   | 3.1 | 1. |
| 52 | 1.72595E+03 | .7430 | 60.8   | 2.9 | 1. |
| 53 | 1.35900E+03 | .7360 | 64.4   | 2.8 | 1. |
| 54 | 9.30608E+02 | .7540 | 68.0   | 2.7 | 1. |
| 55 | 7.19235E+02 | .7350 | 71.6   | 2.7 | 1. |
| 56 | 5.17735E+02 | .7010 | 75.2   | 2.6 | 1. |
| 57 | 3.94351E+02 | .5730 | 82.4   | 2.5 | 1. |
| 58 | 2.58547E+02 | .4590 | 86.0   | 2.5 | 1. |
| 59 | 1.55252E+02 | .0430 | -101.2 | 2.5 | 1. |
| 60 | 1.13129E+02 | .0450 | -97.6  | 2.3 | 1. |
| 61 | 1.11679E+02 | .0450 | -94.0  | 2.3 | 1. |
| 62 | 1.11244E+02 | .0474 | -90.4  | 2.3 | 1. |
| 63 | 3.42289E+02 | .6240 | 78.8   | 2.6 | 1. |
| 64 | 1.20816E+02 | .0388 | -112.0 | 2.6 | 1. |



MATERIAL CODE :291  
 MATERIAL :ISD-110  
 LOG(FR)-LOG(F)-12(T-T0)/(525+T-T0)

| NO. | MODULUS<br>LB./IN <sup>2</sup> | LOSS<br>FACTOR | TEMP.<br>DEG. F | FREQ.<br>HZ | MODE<br>NO. |
|-----|--------------------------------|----------------|-----------------|-------------|-------------|
| 1   | 3.07480E+05                    | .0254          | -94.0           | 35.0        | 1.          |
| 2   | 2.8625E+05                     | .0266          | -85.0           | 35.0        | 1.          |
| 3   | 2.7702E+05                     | .0292          | -76.0           | 35.0        | 1.          |
| 4   | 2.7557E+05                     | .0306          | -67.0           | 35.0        | 1.          |
| 5   | 2.56915E+05                    | .0360          | -58.0           | 35.0        | 1.          |
| 6   | 2.2770E+05                     | .0424          | -49.0           | 35.0        | 1.          |
| 7   | 2.19007E+05                    | .0480          | -40.0           | 35.0        | 1.          |
| 8   | 2.07404E+05                    | .0553          | -31.0           | 35.0        | 1.          |
| 9   | 1.8769E+05                     | .0636          | -22.0           | 35.0        | 1.          |
| 10  | 1.6679E+05                     | .0706          | -13.0           | 35.0        | 1.          |
| 11  | 1.4793E+05                     | .0820          | -4.0            | 35.0        | 1.          |
| 12  | 1.23427E+05                    | .0924          | 5.0             | 35.0        | 1.          |
| 13  | 8.51830E+04                    | .1420          | 14.0            | 35.0        | 1.          |
| 14  | 6.48319E+04                    | .2070          | 23.0            | 35.0        | 1.          |
| 15  | 3.6114E+04                     | .2440          | 32.0            | 35.0        | 1.          |
| 16  | 1.6524E+04                     | .2950          | 41.0            | 35.0        | 1.          |
| 17  | 1.43587E+04                    | .3300          | 50.0            | 35.0        | 1.          |
| 18  | 3.3668E+05                     | .0222          | -94.0           | 11.0        | 1.          |
| 19  | 3.0930E+05                     | .0244          | -85.0           | 11.0        | 1.          |
| 20  | 2.9427E+05                     | .0260          | -76.0           | 11.0        | 1.          |
| 21  | 2.94427E+05                    | .0280          | -67.0           | 11.0        | 1.          |
| 22  | 2.71221E+05                    | .0322          | -58.0           | 11.0        | 1.          |
| 23  | 2.42213E+05                    | .0376          | -49.0           | 11.0        | 1.          |
| 24  | 2.2335E+05                     | .0456          | -40.0           | 11.0        | 1.          |
| 25  | 2.1030E+05                     | .0532          | -31.0           | 11.0        | 1.          |
| 26  | 1.9145E+05                     | .0608          | -22.0           | 11.0        | 1.          |
| 27  | 1.7114E+05                     | .0718          | -13.0           | 11.0        | 1.          |
| 28  | 1.53740E+05                    | .0870          | -4.0            | 11.0        | 1.          |
| 29  | 1.3290E+05                     | .1050          | 5.0             | 11.0        | 1.          |
| 30  | 1.0196E+05                     | .1470          | 14.0            | 11.0        | 1.          |
| 31  | 4.8442E+04                     | .1700          | 23.0            | 11.0        | 1.          |
| 32  | 3.9052E+04                     | .2060          | 32.0            | 11.0        | 1.          |
| 33  | 1.7839E+04                     | .3090          | 41.0            | 11.0        | 1.          |
| 34  | 1.4625E+04                     | .4700          | 50.0            | 11.0        | 1.          |

APPENDIX C

J-85 AFTERBURNER LINER FOLLOW-UP  
TEST DATA SHEETS

Project J-85 Afterburner Liner Follow-up Experiment No. 01

- 1) Substrate Hastelloy X Alloy base Cobalt  
 Mfr. Huntington Alloy Density 8.23 g/cc Thickness 0.47625 cm.
- 2) Material Base J85-1 Additives None  
 Mfr. UDRI Density 2.82 g/cc Thickness 0.0194 cm.
- 3) Overcoat 1 None Additives \_\_\_\_\_  
 Mfr. \_\_\_\_\_ Density \_\_\_\_\_ Thickness \_\_\_\_\_
- 4) Overcoat 2 \_\_\_\_\_ Additives \_\_\_\_\_  
 Mfr. \_\_\_\_\_ Density \_\_\_\_\_ Thickness \_\_\_\_\_
- 5) Overcoat 3 \_\_\_\_\_ Additives \_\_\_\_\_  
 Mfr. \_\_\_\_\_ Density \_\_\_\_\_ Thickness \_\_\_\_\_

Overall Pretest Description gray-blue tint overall

Overall Posttest Description coating discolored with rough surface

THERMAL HISTORY

|                 |     |     |  |  |  |  |  |  |  |
|-----------------|-----|-----|--|--|--|--|--|--|--|
| Temperature °C  | 815 | 815 |  |  |  |  |  |  |  |
| Duration (hrs.) | 4.3 | 4.2 |  |  |  |  |  |  |  |

CONDITION

REMARKS

- Creep from edge None
- Flake from edge None
- Peel from edge None
- Gravity flow Some evidence
- Downstream flow Some evidence
- Seep through overcoat N.A.
- Devitrification Very evident over entire surface.
- \_\_\_\_\_

Remarks Composition = Corning 0010 + 10% AL<sub>2</sub>O<sub>3</sub> 1%Co<sub>2</sub>O<sub>3</sub>

Project J-85 ABL Follow-up Experiment No. 02

- 1) Substrate Hastelloy X Alloy base Cobalt  
 Mfr. Huntington Alloy Density 8.23 g/cc Thickness 0.47625 cm.
- 2) Material Base J-85-2 Additives None  
 Mfr. UDRI Density 2.82 g/cc Thickness 0.0198 cm.
- 3) Overcoat 1 None Additives \_\_\_\_\_  
 Mfr. \_\_\_\_\_ Density \_\_\_\_\_ Thickness \_\_\_\_\_
- 4) Overcoat 2 \_\_\_\_\_ Additives \_\_\_\_\_  
 Mfr. \_\_\_\_\_ Density \_\_\_\_\_ Thickness \_\_\_\_\_
- 5) Overcoat 3 \_\_\_\_\_ Additives \_\_\_\_\_  
 Mfr. \_\_\_\_\_ Density \_\_\_\_\_ Thickness \_\_\_\_\_

Overall Pretest Description dark gray tint

Overall Posttest Description glossy but with signs of deterioration in some spots.

THERMAL HISTORY

|                 |     |     |  |  |  |  |  |  |  |  |
|-----------------|-----|-----|--|--|--|--|--|--|--|--|
| Temperature °C  | 815 | 815 |  |  |  |  |  |  |  |  |
| Duration (hrs.) | 4.3 | 4.2 |  |  |  |  |  |  |  |  |

CONDITION

REMARKS

- Creep from edge Some
- Flake from edge None
- Peel from edge None
- Gravity flow Very little
- Downstream flow None
- Seep through overcoat N.A.
- Devitrification Some obvious evidence in certain areas.
- \_\_\_\_\_

Remarks Composition = Corning 0010 + 10% AL<sub>2</sub>O<sub>3</sub> + 6% Na<sub>2</sub>O + 1% Co<sub>2</sub>O<sub>3</sub>

Project J-85 ABL Follow-up Experiment No. 03

- 1) Substrate Hastelloy Alloy base Cobalt  
 Mfr. Huntington Alloy Density 8.23 g/cc Thickness 0.47625 cm
- 2) Material Base J-85-3 Additives None  
 Mfr. UDRI Density 2.82 g/cc Thickness 0.0148
- 3) Overcoat 1 None Additives \_\_\_\_\_  
 Mfr. \_\_\_\_\_ Density \_\_\_\_\_ Thickness \_\_\_\_\_
- 4) Overcoat 2 \_\_\_\_\_ Additives \_\_\_\_\_  
 Mfr. \_\_\_\_\_ Density \_\_\_\_\_ Thickness \_\_\_\_\_
- 5) Overcoat 3 \_\_\_\_\_ Additives \_\_\_\_\_  
 Mfr. \_\_\_\_\_ Density \_\_\_\_\_ Thickness \_\_\_\_\_

Overall Pretest Description dark gray overall

Overall Posttest Description dark gray with some debonding occurring

THERMAL HISTORY

|                 |     |     |  |  |  |  |  |  |  |
|-----------------|-----|-----|--|--|--|--|--|--|--|
| Temperature °C  | 815 | 815 |  |  |  |  |  |  |  |
| Duration (hrs.) | 4.3 | 4.2 |  |  |  |  |  |  |  |

CONDITION

REMARKS

- Creep from edge Not obvious
- Flake from edge In spots
- Peel from edge Some debonding from substrate in evidence
- Gravity flow Negligible
- Downstream flow None
- Seep through overcoat N.A.
- Devitrification Not certain
- \_\_\_\_\_

Remarks Composition = Corning 0010 + 12.5% AL<sub>2</sub>O<sub>3</sub> + 2% Co<sub>2</sub>O<sub>3</sub>

Project J-85 ABL Follow-up Experiment No. 04

- 1) Substrate Hastelloy X Alloy base Cobalt  
 Mfr. Huntington Alloy Density 8.23 g/cc Thickness 0.47625 cm.
- 2) Material Base J-85-4 Additives None  
 Mfr. UDRI Density 2.82 g/cc Thickness 0.0203 cm
- 3) Overcoat 1 None Additives \_\_\_\_\_  
 Mfr. \_\_\_\_\_ Density \_\_\_\_\_ Thickness \_\_\_\_\_
- 4) Overcoat 2 \_\_\_\_\_ Additives \_\_\_\_\_  
 Mfr. \_\_\_\_\_ Density \_\_\_\_\_ Thickness \_\_\_\_\_
- 5) Overcoat 3 \_\_\_\_\_ Additives \_\_\_\_\_  
 Mfr. \_\_\_\_\_ Density \_\_\_\_\_ Thickness \_\_\_\_\_

Overall Pretest Description \_\_\_\_\_

Overall Posttest Description Most of coating came off substrate  
 sometime during second exposure period

THERMAL HISTORY

|                 |     |     |  |  |  |  |  |  |  |
|-----------------|-----|-----|--|--|--|--|--|--|--|
| Temperature °C  | 815 | 815 |  |  |  |  |  |  |  |
| Duration (hrs.) | 4.3 | 4.2 |  |  |  |  |  |  |  |

CONDITION

REMARKS

- Creep from edge \_\_\_\_\_
- Flake from edge \_\_\_\_\_
- Peel from edge \_\_\_\_\_
- Gravity flow \_\_\_\_\_
- Downstream flow \_\_\_\_\_
- Seep through overcoat \_\_\_\_\_
- Devitrification \_\_\_\_\_
- Debonding \_\_\_\_\_ Approximately 80% of coating came off during  
 test

Remarks \_\_\_\_\_

Project J-85 ABL Follow-up Experiment No. 05

- 1) Substrate Hastelloy X Alloy base Cobalt  
Mfr. Huntington Alloy Density 8.23 g/cc Thickness 0.47625 cm.
- 2) Material Base J-85-5 Additives None  
Mfr. UDRI Density 2.82 g/cc Thickness 0.0148
- 3) Overcoat 1 None Additives \_\_\_\_\_  
Mfr. \_\_\_\_\_ Density \_\_\_\_\_ Thickness \_\_\_\_\_
- 4) Overcoat 2 \_\_\_\_\_ Additives \_\_\_\_\_  
Mfr. \_\_\_\_\_ Density \_\_\_\_\_ Thickness \_\_\_\_\_
- 5) Overcoat 3 \_\_\_\_\_ Additives \_\_\_\_\_  
Mfr. \_\_\_\_\_ Density \_\_\_\_\_ Thickness \_\_\_\_\_

Overall Pretest Description \_\_\_\_\_

Overall Posttest Description Coating came off substrate sometime during second exposure period.

THERMAL HISTORY

| Temperature °C  | 815 | 815 |  |  |  |  |  |  |  |  |
|-----------------|-----|-----|--|--|--|--|--|--|--|--|
| Duration (hrs.) | 4.3 | 4.2 |  |  |  |  |  |  |  |  |

CONDITION

REMARKS

- Creep from edge \_\_\_\_\_
- Flake from edge \_\_\_\_\_
- Peel from edge \_\_\_\_\_
- Gravity flow \_\_\_\_\_
- Downstream flow \_\_\_\_\_
- Seep through overcoat \_\_\_\_\_
- Devitrification \_\_\_\_\_
- Debonding 100% of coating came off during test

Remarks \_\_\_\_\_  
\_\_\_\_\_  
\_\_\_\_\_

Project Enamel Development

Experiment No. 06

- 1) Substrate Hastelloy X Alloy base Cobalt  
Mfr. Huntington Alloys Density 8.23 g/cc Thickness 0.47625 cm.
- 2) Material Base 8871 Additives None  
Mfr. Corning Density \_\_\_\_\_ Thickness \_\_\_\_\_
- 3) Overcoat 1 None Additives \_\_\_\_\_  
Mfr. \_\_\_\_\_ Density \_\_\_\_\_ Thickness \_\_\_\_\_
- 4) Overcoat 2 None Additives \_\_\_\_\_  
Mfr. \_\_\_\_\_ Density \_\_\_\_\_ Thickness \_\_\_\_\_
- 5) Overcoat 3 None Additives \_\_\_\_\_  
Mfr. \_\_\_\_\_ Density \_\_\_\_\_ Thickness \_\_\_\_\_

Overall Pretest Description smooth, blue-gray

Overall Posttest Description gray-blue with mottled surface

#### THERMAL HISTORY

|                 |     |     |  |  |  |  |  |  |  |  |
|-----------------|-----|-----|--|--|--|--|--|--|--|--|
| Temperature °C  | 540 | 540 |  |  |  |  |  |  |  |  |
| Duration (hrs.) | 4.3 | 4.2 |  |  |  |  |  |  |  |  |

#### CONDITION

#### REMARKS

- Creep from edge Some
- Flake from edge Some
- Peel from edge None
- Gravity flow None
- Downstream flow None
- Seep through overcoat N.A.
- Devitrification 30%-60% of surface
- \_\_\_\_\_

Remarks \_\_\_\_\_  
\_\_\_\_\_  
\_\_\_\_\_



Project Enamel Development Experiment No. 07

- 1) Substrate Hastelloy Alloy base Cobalt  
 Mfr. Huntington Alloys Density 8.23 g/cc Thickness 0.47625 cm.
- 2) Material Base 8871 Additives + 3%  
 Mfr. Corning Density \_\_\_\_\_ Thickness \_\_\_\_\_
- 3) Overcoat 1 None Additives \_\_\_\_\_  
 Mfr. \_\_\_\_\_ Density \_\_\_\_\_ Thickness \_\_\_\_\_
- 4) Overcoat 2 None Additives \_\_\_\_\_  
 Mfr. \_\_\_\_\_ Density \_\_\_\_\_ Thickness \_\_\_\_\_
- 5) Overcoat 3 None Additives \_\_\_\_\_  
 Mfr. \_\_\_\_\_ Density \_\_\_\_\_ Thickness \_\_\_\_\_

Overall Pretest Description Blue-gray with smooth, glossy surface

Overall Posttest Description gray-blue with some bubbles and general mottled appearance; dark blue where flaking had occurred.

THERMAL HISTORY

|                 |     |     |  |  |  |  |  |  |  |
|-----------------|-----|-----|--|--|--|--|--|--|--|
| Temperature °C  | 540 | 540 |  |  |  |  |  |  |  |
| Duration (hrs.) | 4.3 | 4.2 |  |  |  |  |  |  |  |

CONDITION

REMARKS

- Creep from edge Some
- Flake from edge Much in evidence (likely from thermal shock)
- Peel from edge None
- Gravity flow None
- Downstream flow None
- Seep through overcoat N.A.
- Devitrification Over 50% of surface
- \_\_\_\_\_

Remarks \_\_\_\_\_  
 \_\_\_\_\_  
 \_\_\_\_\_

Project Enamel Development Experiment No. 08

- 1) Substrate Hastelloy X Alloy base Cobalt  
Mfr. Huntington Alloys Density 8.23 g/cc Thickness 0.47625 cm
- 2) Material Base Sulfate 2 Additives None  
Mfr. UDRI Density \_\_\_\_\_ Thickness \_\_\_\_\_
- 3) Overcoat 1 None Additives \_\_\_\_\_  
Mfr. \_\_\_\_\_ Density \_\_\_\_\_ Thickness \_\_\_\_\_
- 4) Overcoat 2 \_\_\_\_\_ Additives \_\_\_\_\_  
Mfr. \_\_\_\_\_ Density \_\_\_\_\_ Thickness \_\_\_\_\_
- 5) Overcoat 3 \_\_\_\_\_ Additives \_\_\_\_\_  
Mfr. \_\_\_\_\_ Density \_\_\_\_\_ Thickness \_\_\_\_\_

Overall Pretest Description White-blue, evenly smooth

Overall Posttest Description Whitish-gray, mottled surface

#### THERMAL HISTORY

|                 |     |  |  |  |  |  |  |  |  |  |
|-----------------|-----|--|--|--|--|--|--|--|--|--|
| Temperature °C  | 399 |  |  |  |  |  |  |  |  |  |
| Duration (hrs.) | 2.0 |  |  |  |  |  |  |  |  |  |

#### CONDITION

#### REMARKS

- Creep from edge Some
- Flake from edge None
- Peel from edge None
- Gravity flow Negligible
- Downstream flow Negligible
- Seep through overcoat N.A.
- Devitrification 85-95% after 2 hours
- \_\_\_\_\_

Remarks Test terminated after 2 hours with much evidence of reactive attack.

Project Enamel Development Experiment No. 09

- 1) Substrate Hastelloy X Alloy base Cobalt  
 Mfr. Huntington Alloys Density 8.23 g/cc Thickness 0.47625 cm
- 2) Material Base Lead 1 Additives None  
 Mfr. UDRI Density \_\_\_\_\_ Thickness \_\_\_\_\_
- 3) Overcoat 1 None Additives \_\_\_\_\_  
 Mfr. \_\_\_\_\_ Density \_\_\_\_\_ Thickness \_\_\_\_\_
- 4) Overcoat 2 None Additives \_\_\_\_\_  
 Mfr. \_\_\_\_\_ Density \_\_\_\_\_ Thickness \_\_\_\_\_
- 5) Overcoat 3 None Additives \_\_\_\_\_  
 Mfr. \_\_\_\_\_ Density \_\_\_\_\_ Thickness \_\_\_\_\_

Overall Pretest Description Smooth glossy gray

Overall Posttest Description Lighter gray with dull, mottled surface

THERMAL HISTORY

|                 |     |     |     |     |     |  |  |  |  |  |
|-----------------|-----|-----|-----|-----|-----|--|--|--|--|--|
| Temperature °C  | 635 | 635 | 635 | 635 | 635 |  |  |  |  |  |
| Duration (hrs.) | 4.0 | 4.0 | 8.0 | 8.0 | 4.0 |  |  |  |  |  |

CONDITION

REMARKS

- Creep from edge Some
- Flake from edge Some
- Peel from edge None
- Gravity flow Negligible
- Downstream flow Negligible
- Seep through overcoat N.A.
- Devitrification Much in evidence
- Bubbling Some evidence in spots

Remarks Material showed degradation over entire surface.

Project Enamel Development Experiment No. 010

- 1) Substrate Hastelloy X Alloy base Cobalt  
 Mfr. Huntington Alloys Density 8.23 g/cc Thickness 0.47625 cm.
- 2) Material Base Lead 2 Additives None  
 Mfr. UDRI Density \_\_\_\_\_ Thickness \_\_\_\_\_
- 3) Overcoat 1 None Additives \_\_\_\_\_  
 Mfr. \_\_\_\_\_ Density \_\_\_\_\_ Thickness \_\_\_\_\_
- 4) Overcoat 2 None Additives \_\_\_\_\_  
 Mfr. \_\_\_\_\_ Density \_\_\_\_\_ Thickness \_\_\_\_\_
- 5) Overcoat 3 None Additives \_\_\_\_\_  
 Mfr. \_\_\_\_\_ Density \_\_\_\_\_ Thickness \_\_\_\_\_

Overall Pretest Description Dark gray with smooth, glossy surface

Overall Posttest Description Gray-white with rough mottled surface

**THERMAL HISTORY**

|                 |     |     |     |     |     |  |  |  |  |  |
|-----------------|-----|-----|-----|-----|-----|--|--|--|--|--|
| Temperature °C  | 635 | 635 | 635 | 635 | 635 |  |  |  |  |  |
| Duration (hrs.) | 8.0 | 8.0 | 4.0 | 4.0 | 4.0 |  |  |  |  |  |

**CONDITION**

**REMARKS**

- Creep from edge Some
- Flake from edge Some
- Peel from edge None
- Gravity flow Negligible
- Downstream flow Negligible
- Seep through overcoat N.A.
- Devitrification 85-100% of surface area
- Bubbling Some evidence over entire surface

Remarks Degradation began after 1st 8 hours of exposure.

Degradation seemed to proceed steadily afterwards.

Project J-85 ABL Follow-up Experiment No. 011

- 1) Substrate Hastelloy X Alloy base Co  
 Mfr. Huntington Alloys Density 9.13 g/cc Thickness 0.1875 cm.
- 2) Material Base J-85-14 Additives None  
 Mfr. UDRI Density 2.64 g/cc Thickness ≈.018 cm.
- 3) Overcoat 1 1252 Additives None  
 Mfr. O-Hommel Density \_\_\_\_\_ Thickness ≈.005 cm
- 4) Overcoat 2 None Additives \_\_\_\_\_  
 Mfr. \_\_\_\_\_ Density \_\_\_\_\_ Thickness \_\_\_\_\_
- 5) Overcoat 3 None Additives \_\_\_\_\_  
 Mfr. \_\_\_\_\_ Density \_\_\_\_\_ Thickness \_\_\_\_\_

Overall Pretest Description Bluish-white with evidence of white spots (sputter) over lower 30% of surface

Overall Posttest Description No significant change after 30 hours

THERMAL HISTORY

| Temperature °C  | 675  | 675 | 675 | 675 | 675 | 675 |  |  |  |  |
|-----------------|------|-----|-----|-----|-----|-----|--|--|--|--|
| Duration (hrs.) | 12.0 | 4.0 | 4.0 | 4.0 | 4.0 | 2.0 |  |  |  |  |

CONDITION

REMARKS

- Creep from edge A small amount
- Flake from edge Some apparent after 4 hours (due to thermal shock)
- Peel from edge None
- Gravity flow None
- Downstream flow None
- Seep through overcoat Some evidence in spots
- Devitrification None obvious after 30 hours
- Open cavitation "pock marks" of small dimension in spots

Remarks Composition = 74.5% SiO<sub>2</sub> + 10.75% CaO + 6.375% Na<sub>2</sub>O + 6.375% KHCO<sub>3</sub> + 2% Co<sub>2</sub>O<sub>3</sub>

Project Enamel Development Experiment No. 012

- 1) Substrate Inconel 600 Alloy base Co  
 Mfr. Inco Density \_\_\_\_\_ Thickness \_\_\_\_\_
- 2) Material Base AMB5 Additives None  
 Mfr. UDRI Density \_\_\_\_\_ Thickness \_\_\_\_\_
- 3) Overcoat 1 None Additives \_\_\_\_\_  
 Mfr. \_\_\_\_\_ Density \_\_\_\_\_ Thickness \_\_\_\_\_
- 4) Overcoat 2 None Additives \_\_\_\_\_  
 Mfr. \_\_\_\_\_ Density \_\_\_\_\_ Thickness \_\_\_\_\_
- 5) Overcoat 3 None Additives \_\_\_\_\_  
 Mfr. \_\_\_\_\_ Density \_\_\_\_\_ Thickness \_\_\_\_\_

Overall Pretest Description Uniform smooth, glossy, dark gray

Overall Posttest Description Surface rough with partial loss of gloss, "bubbling" on surface, lighter gray color

THERMAL HISTORY

|                 |     |     |     |     |     |     |     |  |  |  |
|-----------------|-----|-----|-----|-----|-----|-----|-----|--|--|--|
| Temperature °C  | 630 | 630 | 630 | 630 | 630 | 630 | 630 |  |  |  |
| Duration (hrs.) | 4.0 | 4.0 | 4.0 | 4.0 | 4.0 | 4.0 | 4.0 |  |  |  |

CONDITION

REMARKS

- Creep from edge Some
- Flake from edge Some
- Peel from edge Negligible
- Gravity flow Negligible
- Downstream flow Negligible
- Seep through overcoat N.A.
- Devitrification About 10% visually evident
- "Bubbling" About 75% coverage after 28 hours

Remarks Some deterioration seen after 20 hours; testing terminated after 28 hours due to notable changes in overall appearance.

Project Enamel Development

Experiment No. 013

- 1) Substrate Inco 600 Alloy base Co  
Mfr. Inco Density \_\_\_\_\_ Thickness \_\_\_\_\_
- 2) Material Base Sulfate 3 Additives None  
Mfr. UDRI Density \_\_\_\_\_ Thickness \_\_\_\_\_
- 3) Overcoat 1 None Additives \_\_\_\_\_  
Mfr. \_\_\_\_\_ Density \_\_\_\_\_ Thickness \_\_\_\_\_
- 4) Overcoat 2 None Additives \_\_\_\_\_  
Mfr. \_\_\_\_\_ Density \_\_\_\_\_ Thickness \_\_\_\_\_
- 5) Overcoat 3 None Additives \_\_\_\_\_  
Mfr. \_\_\_\_\_ Density \_\_\_\_\_ Thickness \_\_\_\_\_

Overall Pretest Description Blueish-white with globular appearance  
with smooth surface overall, without gloss (flat)

Overall Posttest Description Whitish-blue with smooth surface

#### THERMAL HISTORY

|                 |     |  |  |  |  |  |  |  |  |
|-----------------|-----|--|--|--|--|--|--|--|--|
| Temperature °C  | 399 |  |  |  |  |  |  |  |  |
| Duration (hrs.) | 2.0 |  |  |  |  |  |  |  |  |

CONDITION

REMARKS

- Creep from edge \_\_\_\_\_
- Flake from edge \_\_\_\_\_
- Peel from edge \_\_\_\_\_
- Gravity flow \_\_\_\_\_
- Downstream flow \_\_\_\_\_
- Seep through overcoat \_\_\_\_\_
- Devitrification 80 to 95% after 2 hours
- \_\_\_\_\_

Remarks Test terminated after 2 hours, with no obvious signs of  
reactive attack. Surface, however, was mostly devitrified.

Project Enamel Development Experiment No. 014

1) Substrate Inconel 600 Alloy base Co  
Mfr. Inco Density \_\_\_\_\_ Thickness \_\_\_\_\_  
2) Material Base Sulfate S-7 Additives None  
Mfr. UDRI Density \_\_\_\_\_ Thickness \_\_\_\_\_  
3) Overcoat 1 None Additives \_\_\_\_\_  
Mfr. \_\_\_\_\_ Density \_\_\_\_\_ Thickness \_\_\_\_\_  
4) Overcoat 2 None Additives \_\_\_\_\_  
Mfr. \_\_\_\_\_ Density \_\_\_\_\_ Thickness \_\_\_\_\_  
5) Overcoat 3 None Additives \_\_\_\_\_  
Mfr. \_\_\_\_\_ Density \_\_\_\_\_ Thickness \_\_\_\_\_

Overall Pretest Description Milky-white with foamy appearance, smooth and glossy

Overall Posttest Description Lime-white with dull, mottled surface

#### THERMAL HISTORY

|                 |     |  |  |  |  |  |  |  |  |  |
|-----------------|-----|--|--|--|--|--|--|--|--|--|
| Temperature °C  | 399 |  |  |  |  |  |  |  |  |  |
| Duration (hrs.) | 2.0 |  |  |  |  |  |  |  |  |  |

#### CONDITION

#### REMARKS

- Creep from edge Some
- Flake from edge None
- Peel from edge None
- Gravity flow Some in evidence
- Downstream flow Negligible
- Seep through overcoat N.A.
- Devitrification 90-100% total
- \_\_\_\_\_

Remarks Test terminated after 2 hours. No obvious sign of degradation by reaction, but almost complete devitrification.



Project Enamel Development Experiment No. 015

- 1) Substrate Inconel 600 Alloy base Co  
 Mfr. \_\_\_\_\_ Density \_\_\_\_\_ Thickness \_\_\_\_\_
- 2) Material Base Sulfate S-11 Additives None  
 Mfr. UDRI Density \_\_\_\_\_ Thickness \_\_\_\_\_
- 3) Overcoat 1 None Additives \_\_\_\_\_  
 Mfr. \_\_\_\_\_ Density \_\_\_\_\_ Thickness \_\_\_\_\_
- 4) Overcoat 2 None Additives \_\_\_\_\_  
 Mfr. \_\_\_\_\_ Density \_\_\_\_\_ Thickness \_\_\_\_\_
- 5) Overcoat 3 None Additives \_\_\_\_\_  
 Mfr. \_\_\_\_\_ Density \_\_\_\_\_ Thickness \_\_\_\_\_

Overall Pretest Description Clear violet with some platelet structure visible, surface smooth.

Overall Posttest Description Milky-violet with much evidence of devitrification and phase-separation

**THERMAL HISTORY**

|                 |     |  |  |  |  |  |  |  |  |
|-----------------|-----|--|--|--|--|--|--|--|--|
| Temperature °C  | 399 |  |  |  |  |  |  |  |  |
| Duration (hrs.) | 2.0 |  |  |  |  |  |  |  |  |

- | CONDITION               | REMARKS                                  |
|-------------------------|--|
| • Creep from edge       | <u>None</u>                              |
| • Flake from edge       | <u>Some in evidence</u>                  |
| • Peel from edge        | <u>None</u>                              |
| • Gravity flow          | <u>Some evidence over entire surface</u> |
| • Downstream flow       | <u>Negligible</u>                        |
| • Seep through overcoat | <u>N.A.</u>                              |
| • Devitrification       | <u>Much evidence over entire surface</u> |
| • _____                 | _____                                    |

Remarks Surface mottled and rough with cracks (possible due to migration of material over substrate)

Project Enamel Development Experiment No. 016

- 1) Substrate Inconel 600 Alloy base Co  
 Mfr. \_\_\_\_\_ Density \_\_\_\_\_ Thickness \_\_\_\_\_
- 2) Material Base Sulfate S-11 Additives None  
 Mfr. UDRI Density \_\_\_\_\_ Thickness \_\_\_\_\_
- 3) Overcoat 1 None Additives \_\_\_\_\_  
 Mfr. \_\_\_\_\_ Density \_\_\_\_\_ Thickness \_\_\_\_\_
- 4) Overcoat 2 None Additives \_\_\_\_\_  
 Mfr. \_\_\_\_\_ Density \_\_\_\_\_ Thickness \_\_\_\_\_
- 5) Overcoat 3 None Additives \_\_\_\_\_  
 Mfr. \_\_\_\_\_ Density \_\_\_\_\_ Thickness \_\_\_\_\_

Overall Pretest Description Clear-violet with some evidence of platelet structure, surface relatively smooth

Overall Posttest Description Milky-white with trace of violet tint, much evidence of devitrification and phase separation

THERMAL HISTORY

|                 |     |  |  |  |  |  |  |  |  |  |
|-----------------|-----|--|--|--|--|--|--|--|--|--|
| Temperature °C  | 399 |  |  |  |  |  |  |  |  |  |
| Duration (hrs.) | 2.0 |  |  |  |  |  |  |  |  |  |

CONDITION

REMARKS

- Creep from edge None
- Flake from edge None
- Peel from edge None
- Gravity flow Some in evidence
- Downstream flow Some in evidence
- Seep through overcoat N.A.
- Devitrification Very noticeable over entire surface
- \_\_\_\_\_

Remarks Surface mottled and rough with surface cracks (possibly due to migration of material over substrate)

APPENDIX D

MAGNA COMPUTER PROGRAM

MAGNA is a proprietary computer program of the University of Dayton. User's manuals can be obtained from the Air Force (Reference 10), or a more recent version (Reference 11) can be obtained from the University of Dayton. This program is currently available to Government personnel and Government contractors for use on the ASD CYBER computer system. The program also is available on a time share basis on the CRAY-1 computer of

United Information Services, Inc.  
2525 Washington  
Kansas City, Missouri 64114

Separate annual lease agreements can be arranged through the Director of the University of Dayton Research Institute, Dayton, Ohio 45469.

**END**

**FILMED**

**1-84**

**DTIC**