

AD-A129 905

TECHNICAL  
LIBRARY

AD A129905

TECHNICAL REPORT ARLCB-TR-83010

**RECENT FINDINGS AND DEVELOPMENTS  
IN CHROMIUM PLATED GUN TUBES**

V. P. GRECO

G. D'ANDREA

J. WALDEN

MARCH 1983



**US ARMY ARMAMENT RESEARCH AND DEVELOPMENT COMMAND  
LARGE CALIBER WEAPON SYSTEMS LABORATORY  
BENÉT WEAPONS LABORATORY  
WATERVLIET N.Y. 12189**

APPROVED FOR PUBLIC RELEASE; DISTRIBUTION UNLIMITED

#### DISCLAIMER

The findings in this report are not to be construed as an official Department of the Army position unless so designated by other authorized documents.

The use of trade name(s) and/or manufacture(s) does not constitute an official indorsement or approval.

#### DISPOSITION

Destroy this report when it is no longer needed. Do not return it to the originator.

REPORT DOCUMENTATION PAGE		READ INSTRUCTIONS BEFORE COMPLETING FORM
1. REPORT NUMBER ARLCB-TR-83010	2. GOVT ACCESSION NO.	3. RECIPIENT'S CATALOG NUMBER
4. TITLE (and Subtitle) RECENT FINDINGS AND DEVELOPMENTS IN CHROMIUM PLATED GUN TUBES		5. TYPE OF REPORT & PERIOD COVERED Final
7. AUTHOR(s) V. P. Greco, G. D'Andrea, and J. Walden		6. PERFORMING ORG. REPORT NUMBER
9. PERFORMING ORGANIZATION NAME AND ADDRESS US Army Armament Research & Development Command Benet Weapons Laboratory, DRDAR-LCB-TL Watervliet, NY 12189		8. CONTRACT OR GRANT NUMBER(s)
11. CONTROLLING OFFICE NAME AND ADDRESS US Army Armament Research & Development Command Large Caliber Weapon Systems Laboratory Dover, NJ 07801		10. PROGRAM ELEMENT, PROJECT, TASK AREA & WORK UNIT NUMBERS AMCMS No. 3297.06.8243 PRON No. 1A1282411A1A
14. MONITORING AGENCY NAME & ADDRESS (if different from Controlling Office)		12. REPORT DATE March 1983
		13. NUMBER OF PAGES 22
		15. SECURITY CLASS. (of this report) UNCLASSIFIED
		15a. DECLASSIFICATION/DOWNGRADING SCHEDULE
16. DISTRIBUTION STATEMENT (of this Report)  Approved for public release; distribution unlimited.		
17. DISTRIBUTION STATEMENT (of the abstract entered in Block 20, if different from Report)		
18. SUPPLEMENTARY NOTES Presented at Tri-Service Symposium on Gun Tube Wear and Erosion, Dover, NJ, 25-28 October 1982. Published in proceedings of the symposium.		
19. KEY WORDS (Continue on reverse side if necessary and identify by block number) Rifling Profile Chromium Plated Bores Bore Wear		
20. ABSTRACT (Continue on reverse side if necessary and identify by block number) The shortcomings encountered with conventional high contraction chromium coat- ings in gun bores during past investigations are reviewed. Changes in the application of chromium for improving its performance during firing are proposed. Recent developments on the application of low contraction chromium with a new plating process, effects of partially plated bores on accuracy, and the effects of rifling profile on the wear of chromium coatings are discussed.		

SECURITY CLASSIFICATION OF THIS PAGE(When Data Entered)

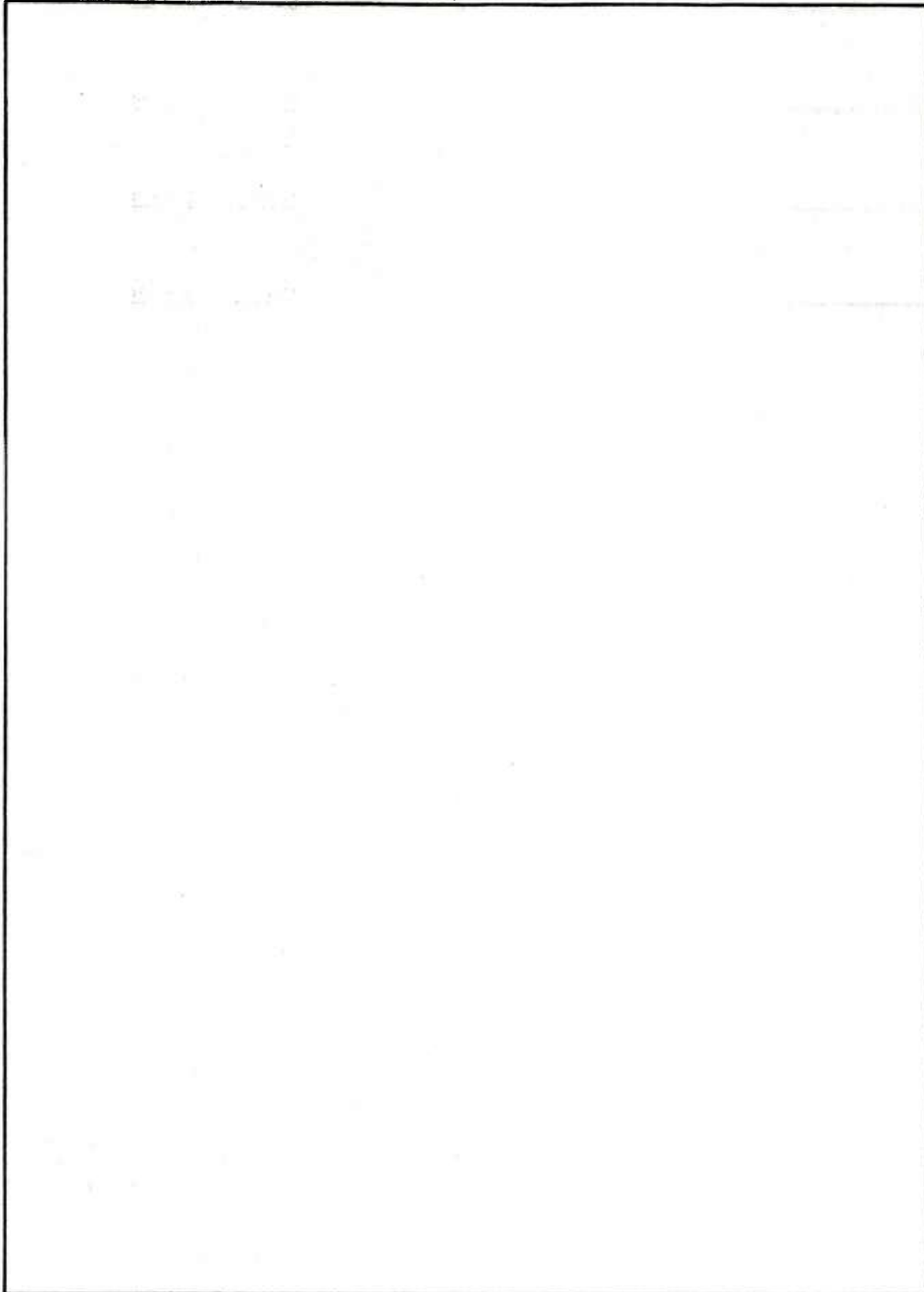

SECURITY CLASSIFICATION OF THIS PAGE(When Data Entered)

## TABLE OF CONTENTS

	<u>Page</u>
INTRODUCTION	1
105 MM M68 CANNON	2
Target Dispersion	2
Behavior of Thick Chromium Deposits	4
120 MM M256 CANNON	5
Behavior of Thick Chromium Deposits	5
Midbore Wear	5
155 MM M199 HOWITZER	7
Muzzle Wear	7
High Torsional Impulse	7
RECENT DEVELOPMENTS	9
Bore Origin of Rifled Bores	9
Low Contraction Chromium	13
Improved Low Contraction Chromium	13
Plating Process	15
Anodes for Chromium Plating Gun Bores	16
CONCLUSIONS	17
REFERENCES	18

### LIST OF ILLUSTRATIONS

1. Target Impact Data for the M392A2 Projectile/105 mm M68 Gun at the 1000 Meter Range During the 1000 Round Test.	3
2. 105 mm M68 Bore Wear Profiles (Showing Effect of Chromium Thickness in Full-Length Plated Bores). Heat Rds. M490 W/O Additive.	5

	<u>Page</u>
3. Progressive Bore Wear Profiles of Fired 120 mm M256 Gun Tubes with 5 Mil Chromium Deposit. (Super Slugs Fired in 60 Rd. Groups at Same Rate of Fire.)	6
4. Bore Surface Cross-Sections of 120 mm M256 (Tube No. 6) at 132 in. From RFT After 297 Super Slug Rds.	8
5. Views of Progressive Bore Damage in a 155 mm M199 Howitzer Tube.	10
6. Sketch of Rifling at Origin of Bore.	11
7. Cross-Sections of Chromium Plated Lands at the C.R. of 155 mm M199 Howitzer Tube.	12
8. Longitudinal Wear Pattern of a Partially Chromium Plated 120 mm M256 Tube.	14
9. A "Pump Thru" Plating System for Plating Long Cylinder Bores.	15

• INTRODUCTION

The present day measures to minimize erosion in gun bores are the application of electrodeposited chromium coatings and the use of ammunition additives. The major shortcoming of chromium is its brittleness and inherent crack pattern which makes it susceptible to spalling and flaking during firing.<sup>1-2</sup> The disadvantages with additives are their relatively high cost and limited effectiveness in some weapon systems, due to difficulties in preparing or properly positioning the material in the propellant system.<sup>3-5</sup>

At the present time, both measures of retarding erosion (i.e., chromium and additive) are incorporated in full-length bores of 8" howitzers, 120 mm M256, and 90 mm M41 cannons with satisfactory results. The combined use of these retardants is the best protection against erosion and wear of bore surfaces exposed to severe environments. However, the use of chromium has not been considered for all gun systems. Due to the success reported with ammunition additives<sup>5-12</sup> in the 1960's, efforts to improve chromium were abandoned. In the case of studies with coatings, attention was given primarily to refractory metals for protection against severe high temperature gaseous environments.

While the search for new erosion resistant coatings has continued for more than three decades, chromium still remains as the only acceptable coating for increasing the wear life of our present day weapons. In view of this, researchers have taken a closer look at the behavior of chromium in gun bores in recent years.

---

References are listed at the end of this report.

This report reviews some of the shortcomings encountered with conventional high contraction chromium coatings in gun bores during past investigations. These experiences are leading to new changes in the application of chromium for meeting the demands of future weapons.

Some of the problems encountered in the 105 mm, 120 mm, and 155 mm, and recent developments to solve these problems are presented below.

• 105 MM M68 CANNON

Target Dispersion

The first change attempted in the application of electrodeposited chromium was prompted by two separate occurrences reported in the 105 mm M68 gun.

1. Chromium Plated Tubes - Chromium plated bores showed a twofold to threefold increase in tube life but unacceptable target dispersion with discarding sabot ammunition.<sup>3</sup> This was due to excessive downbore chipping and spalling of chromium occurring during early stages of firing.

2. Unplated Tubes - Firing the M456E HEAT projectile (with ammunition additive) caused the formation of secondary erosion characterized by a second region of bore enlargement forward of the primary wear region at the commencement of rifling. This new erosion pattern also caused unacceptable target dispersion with discarding sabot ammunition.<sup>4,5,12-15</sup> Secondary wear was believed to be caused by the loss of effectiveness of the wear-reducing additive as the projectile advanced downbore.<sup>5</sup>



An extensive wear test was conducted comparing partially chromium plated bores with full-length plated bores. Results showed that partially plated bores eliminated the downbore chipping and flaking of chromium and successfully retarded primary and secondary erosion without degradation in target dispersion.16-18

### PLOT OF VERTICAL TARGET IMPACTS

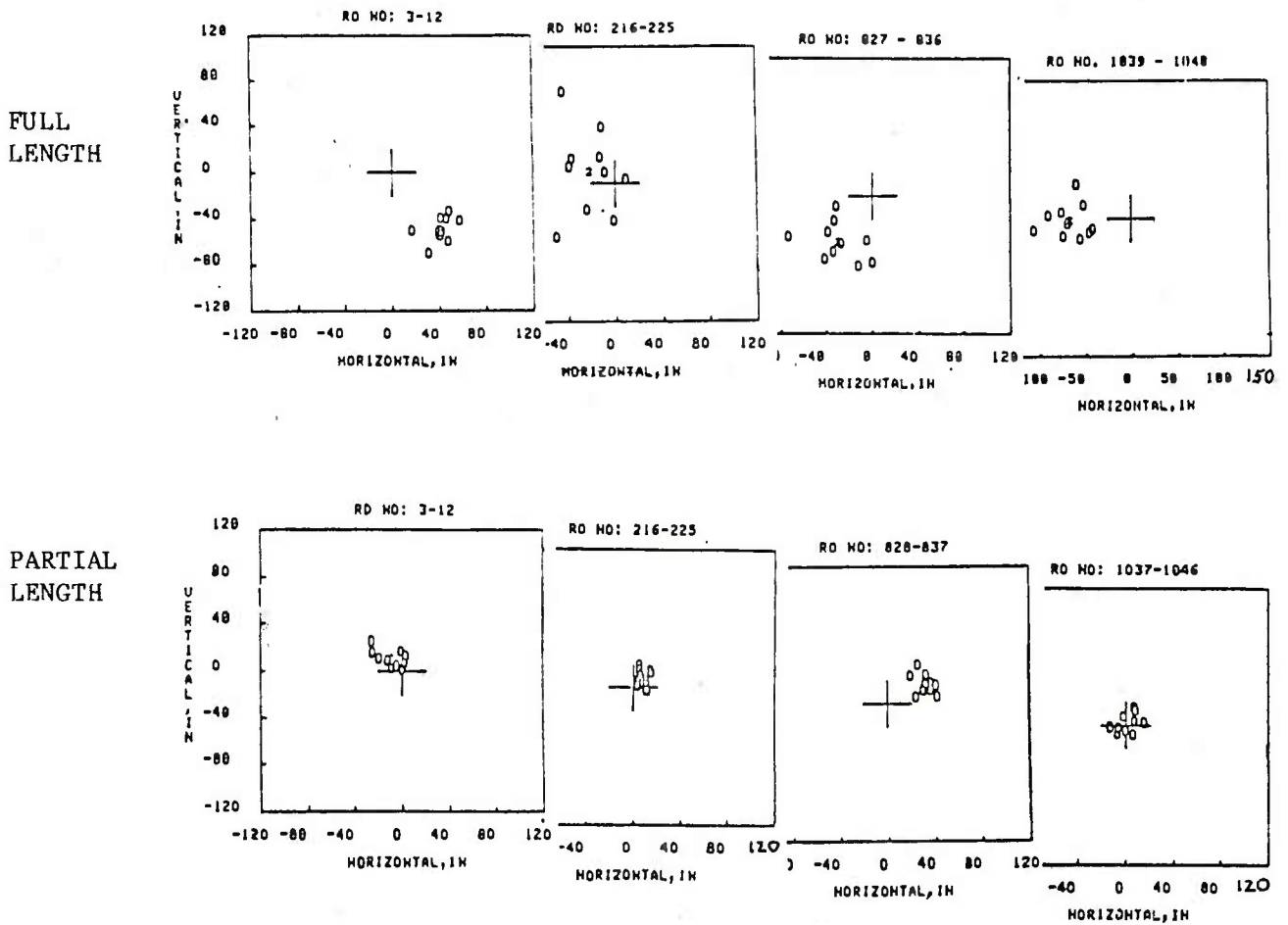

Figure 1. Target Impact Data for the M392A2 Projectile/105 mm M68 Gun at the 1000 Meter Range During the 1000 Round Test.

The accuracy behavior of a 10 mil full-length and partial-length plated gun tube can be observed by the target impacts shown in Figure 1. The impacts from each tube at the start of the test showed an acceptable value of dispersion. However, as firing continued, the full-length tube showed a significant increase in dispersion, whereas the partial-length plated tube showed little change in dispersion throughout the 1000 round test.

#### Behavior of Thick Chromium Deposits

Thick chromium deposits increase the protection of the bore surface against erosion and heat checking. However, increasing the deposit thickness decreases the strength due to defects and the lack of support for the brittle deposit. Therefore, one must compromise between the thermal protection of the surface and the endurance level at which chipping and spalling of the deposit takes place, thereby exposing the substrate.

An example of thicker deposits experiencing a greater amount of spalling and downbore wear during firing can be seen in Figure 2.

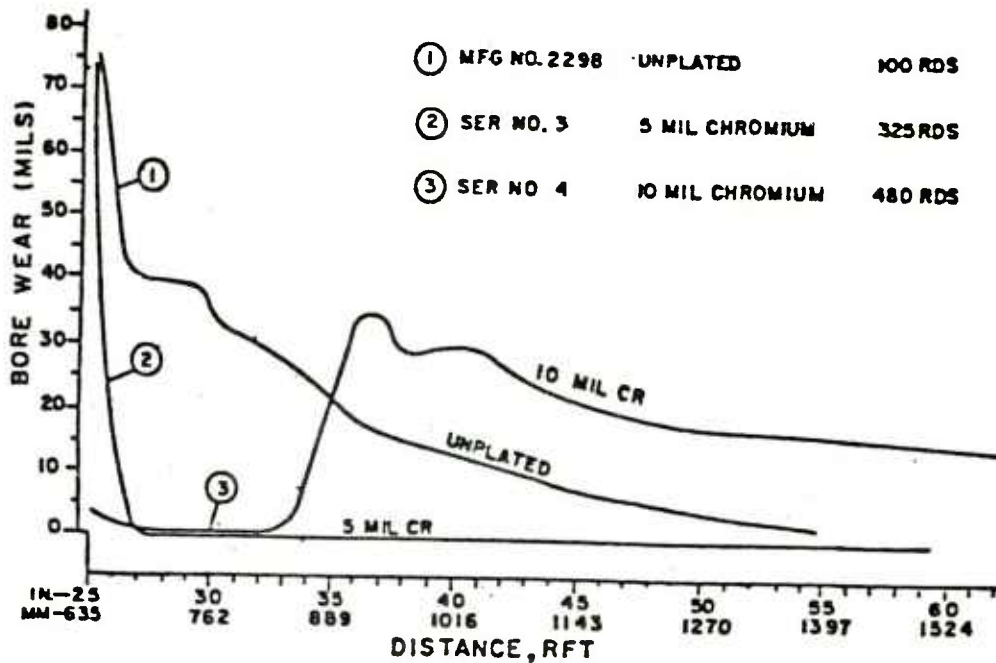

Figure 2. 105 mm Bore Wear Profiles (Showing Effect of Chromium Thickness in Full-Length Plated Bores). Heat Rds. M490 W/O Additive.

● 120 MM M256 CANNON

Behavior of Thick Chromium Deposits

Excessive downbore spalling was also experienced with 10 mil thick deposits in 120 mm XM256 gun tubes during early stages of firing. When 5 mil thick deposits were applied, spalling of the deposit was significantly reduced.

Midbore Wear

Testing of 120 mm M256 gun tubes firing super slugs and heat rounds resulted in the formation of a midbore wear pattern as shown in Figure 3. The wear in this region was smooth and increased with chamber pressure and rate of fire.

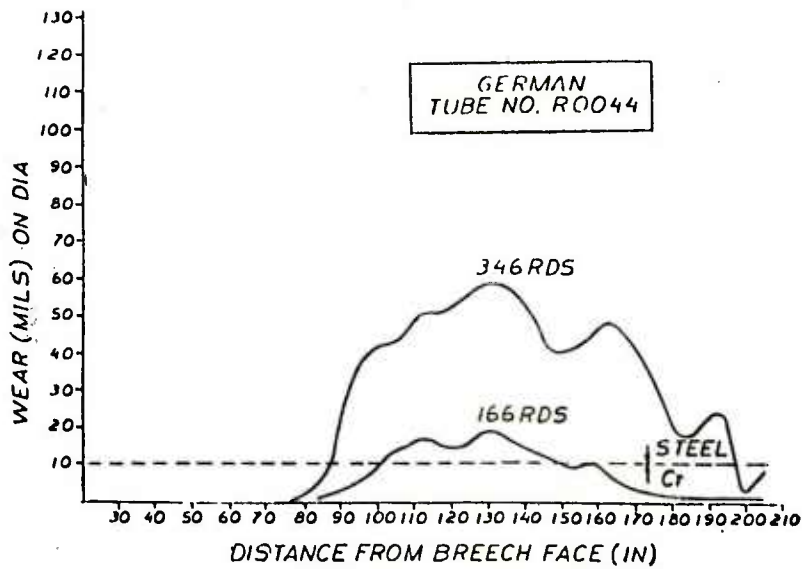
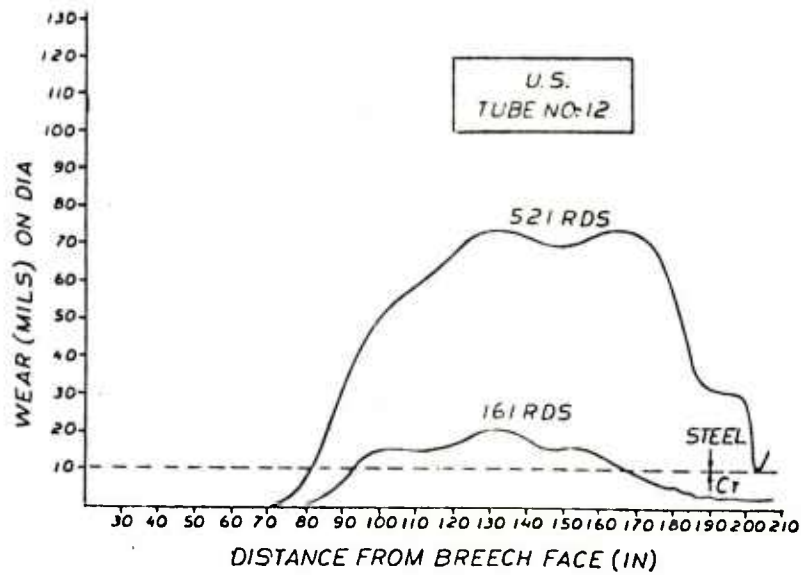

Figure 3. Progressive Bore Wear Profiles of Fired 120 mm M256 Gun Tubes with 5 Mil Chromium Deposit. (Super Slugs Fired in 60 Rd. Groups at Same Rate of Fire.)

Metallographic examination of some gun tube cross-sections showed the wear to be eccentric and predominantly in the nine and three o'clock positions (Figure 4).

- 155 MM M199 HOWITZER

Muzzle Wear

A chromium plated 155 mm tube (No. 83) showed little wear at the origin of rifling and superior ballistic performance compared to unplated tubes after 1800 rounds.<sup>19</sup> However, the plated tube experienced a significant amount of muzzle wear during the latter rounds and was reported to be related to the irregular body engraving found on the M549 projectiles.

It was speculated that the cause of irregular engraving on the M549 projectile was related to the wear pattern at the bore origin. In the case of unplated tubes, irregular projectile engraving was not reported as a problem.

High Torsional Impulse

Another problem of concern was the relatively high torsional impulse readings recorded during the later stage firing of a chromium plated tube.<sup>20</sup> It has been speculated that the high torsional impulses are related to the irregular erosion pattern that develops at the origin of rifling in plated tubes. Investigators have proposed the theory that the latter erosion pattern causes a free run for the projectile during firing which produces the high torsional impulse.

Because of these findings and the associated higher chamber pressures, the incorporation of chromium in 155 mm production tubes was not previously considered.

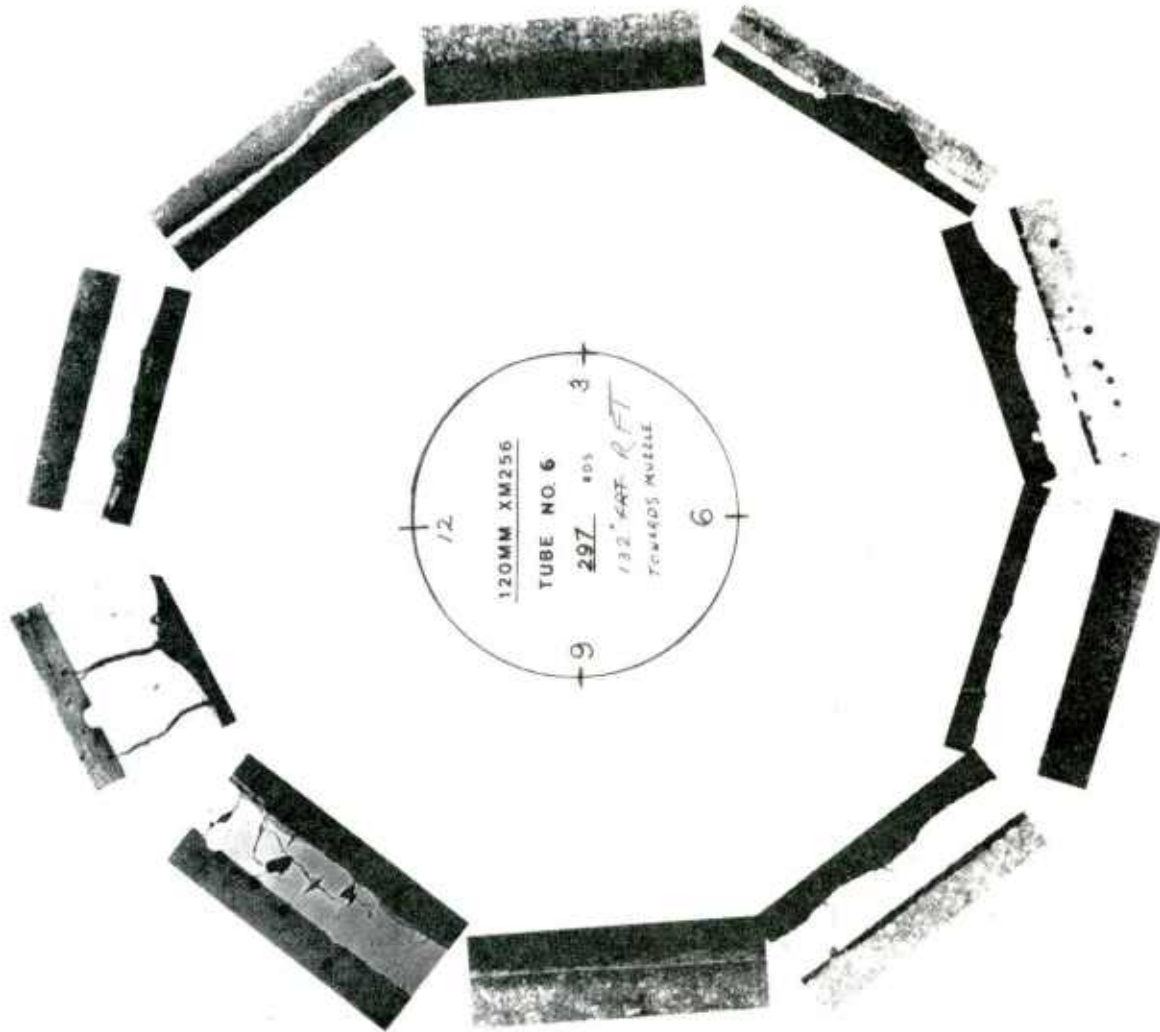

Figure 4. Bore Surface Cross-Sections of 120 mm M256 (Tube No. 6) at 132 in. From RFT After 297 Super Slug Rds.

## ● RECENT DEVELOPMENTS

Regardless of the uncertainties in relating wear with the projectile behavior in large caliber systems, investigations are currently underway which will have a significant effect on the performance of chromium in cannon tubes. These investigations are aimed at improving the properties of chromium, and include three significant process changes:

1. The modification of the rifling profile at the bore origin prior to plating.
2. The application of low contraction chromium.
3. The use of a new plating process.

### Bore Origin of Rifled Bores

The most critical area in which shearing and spalling of chromium occurs during firing is at the corner of the lands at the commencement of rifling (C.R.). Once spalling is initiated, the hot propellant gases undermine the edges of the remaining coating and the substrate is rapidly eroded away. Figure 5 shows how such surface damage progresses from an early to a final stage of firing at the C.R. of a rifled gun tube.

Cause of Chromium Breakthrough at C.R. - The brittle chromium deposit is more susceptible to shearing and spalling at the C.R. due to the sharp corners of the land run-up (i.e., forcing cone) which are unavoidably formed during the rifling operation. Figure 6 shows a sectional surface view of the origin of rifling which represents the specified machined surface of a gun bore prior to chromium plating. Surfaces with sharp corners promote high current density gradients during electrolysis, leading to excessive build-up and weak chromium in rifled bores as shown on land cross-sections in Figure 7.



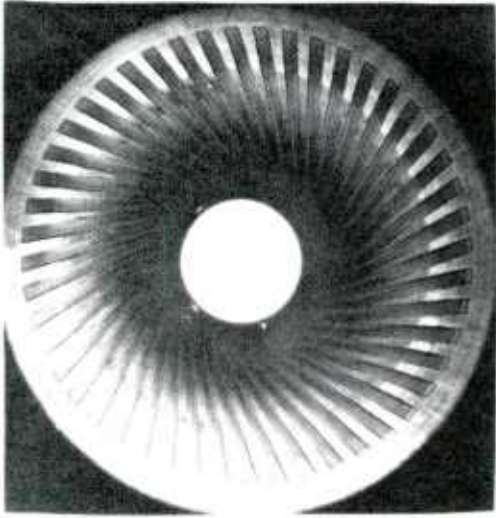

View of Bore Origin Before Firing  
(looking towards muzzle)

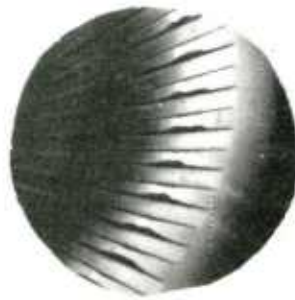

After 200 Rds.  
Note chromium chipping on  
driving edge of rifling  
commencement.

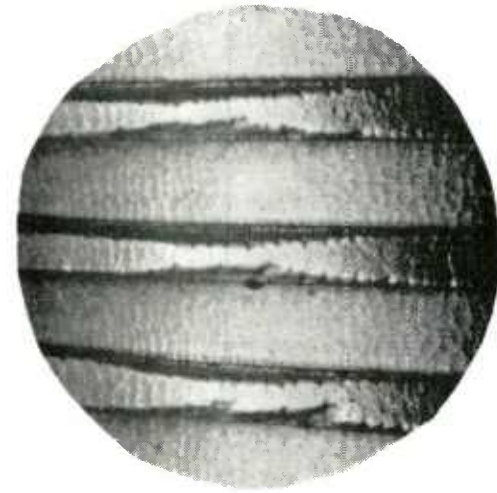

After 600 Rds.  
Note Cr chipping at both sides  
of land at commencement of rifling.

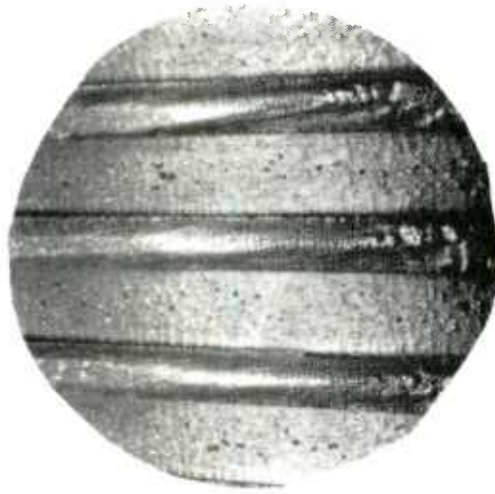

After 2000 Rds.  
Chromium completely gone at  
origin and lands are severely  
worn.

Figure 5. Views of Progressive Bore Damage in a 155 mm M199 Howitzer Tube.



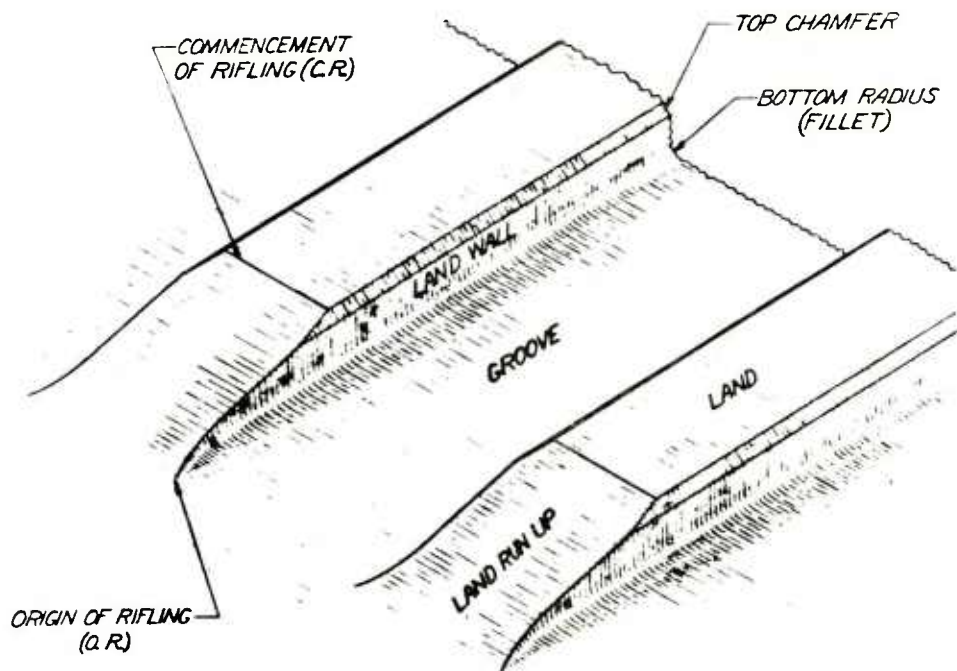
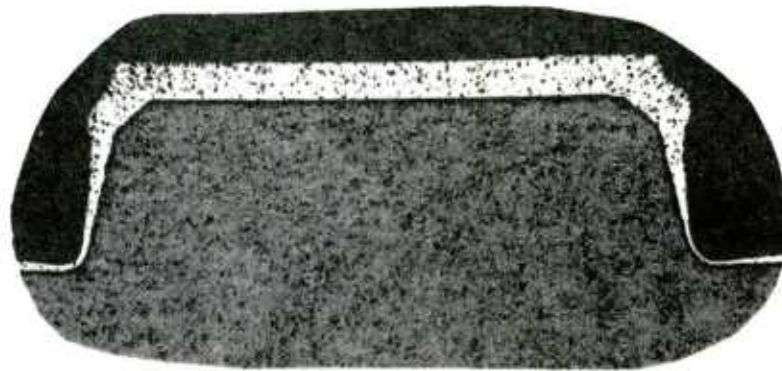
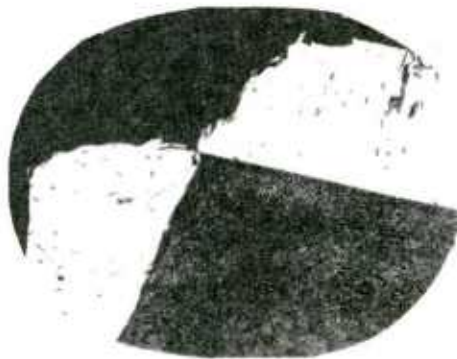

Figure 6. Sketch of Rifling at Origin of Bore.

Optimum Rifling Profile at the C.R. - Recently a study was undertaken for minimizing the shearing and spalling of chromium at the C.R during firing. Previous attempts to round off sharp land corners at the bore origin prior to plating was a "difficult task" due to the remote location and small area of the land run-up at the bore origin. By experimenting with short rifled cylinders which were representative of the bore origin, a special tool and process was developed to successfully produce an optimum rifling profile at the bore origin. The results of these efforts with 155 mm M199 test cylinders are shown in Figure 7.



Conventional



Chipped Corner  
After Firing

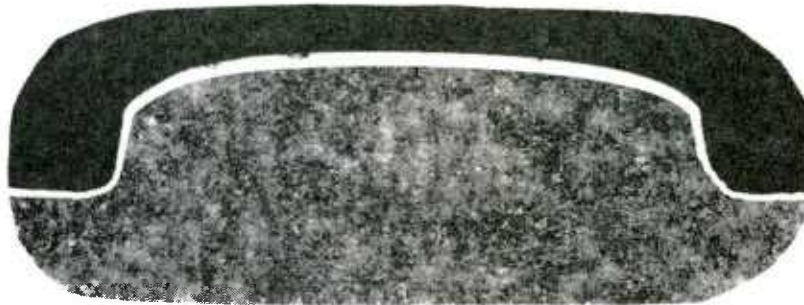

Optimum

Figure 7. Cross-Sections of Chromium Plated Lands at the C.R. of 155 mm M199 Howitzer Tube.

### Low Contraction Chromium

In comparison to the present day high contraction (HC) chromium, low contraction (LC) chromium is softer and less brittle, contains less stress cracks, and experiences less shrinkage after heating. The concept of applying LC chromium in gun tubes was considered and tested in small caliber barrels in the 1950's.<sup>21-23</sup> LC chromium showed great promise against erosion in small arms. However, studies were discontinued because the coating showed a tendency to swage with the steel lands at high projectile velocities and during extended firing when the bore surface of machine gun barrels approached very high temperatures.

As a result of the above, LC chromium was never previously considered for application in large caliber barrels. However, large caliber barrels are not subjected to sustained firing and the heating of the bore surface is not the same as in machine gun barrels. Furthermore, swaging of a 5 mil thick coating in a large barrel (if it occurs at all) should have little effect on a large caliber land as compared to a 5 mil thick coating on top of a 6 mil land height in a 20 mm barrel.

### Improved Low Contraction Chromium

Recent efforts have been undertaken to upgrade the LC chromium plating process to improve coating performance in gun bores.<sup>24</sup> Major emphasis has been placed on the effects of current density, solution aging, and bath additives on the mechanical properties of the deposit. The results show primarily crack-free deposits with higher tensile strengths and lower micro-hardness values when compared to the conventional HC deposits. The

latter studies have been significantly more extensive than those found in the earlier literature.<sup>1</sup>

LC chromium deposits produced by the new plating process have been evaluated through 20 mm test firing<sup>25</sup> and are currently being evaluated in 120 mm M256 gun tubes (Figure 8). Plans have also been made to apply the coating in 105 mm M68 and 155 mm M199 cannon bores for evaluation through extensive firing tests.

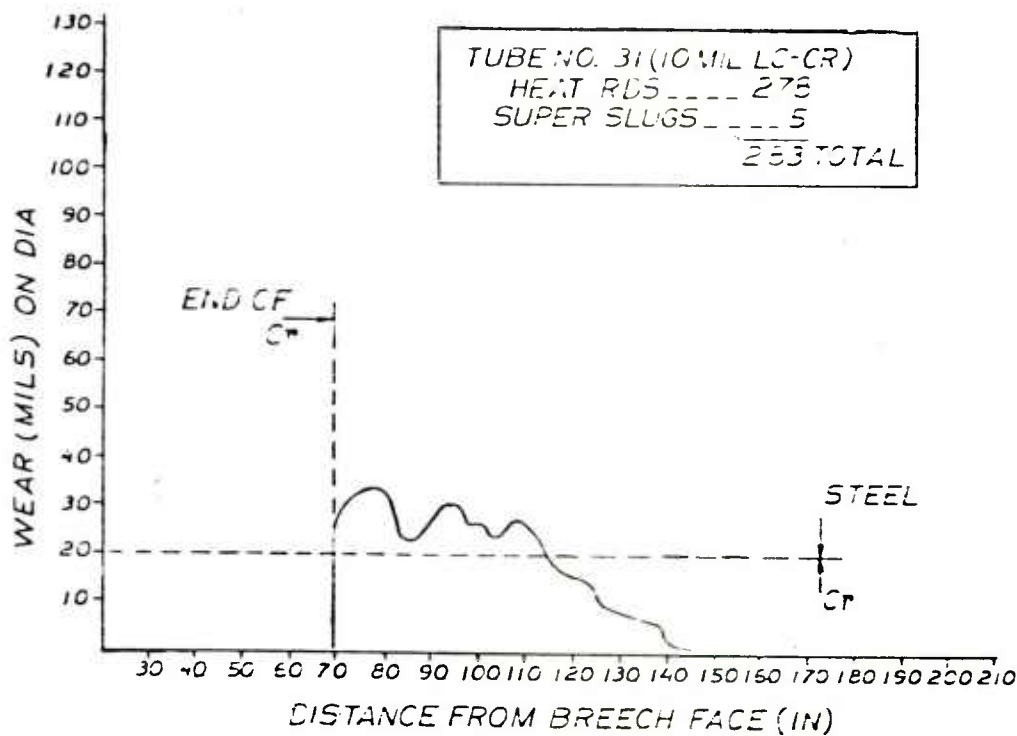

Figure 8. Longitudinal Wear Pattern of a Partially Chromium Plated 120 mm M256 Tube.

## Plating Process

The conventional method of plating gun bores in production includes the immersion of gun tubes in the plating solution which is contained in large open tanks requiring deep pits and high cranes. Another method for plating cylinder bores involves the pumping of the process solution through the bore from a small storage tank. This method offers considerable advantage over the "immersion" technique for controlling the solution temperature and current density distribution.

In view of the above, a prototype "pump thru" plating facility has been constructed for the surface treatment and plating of gun bores using a computer aided system to control the process parameters (Figure 9).<sup>26,27</sup>

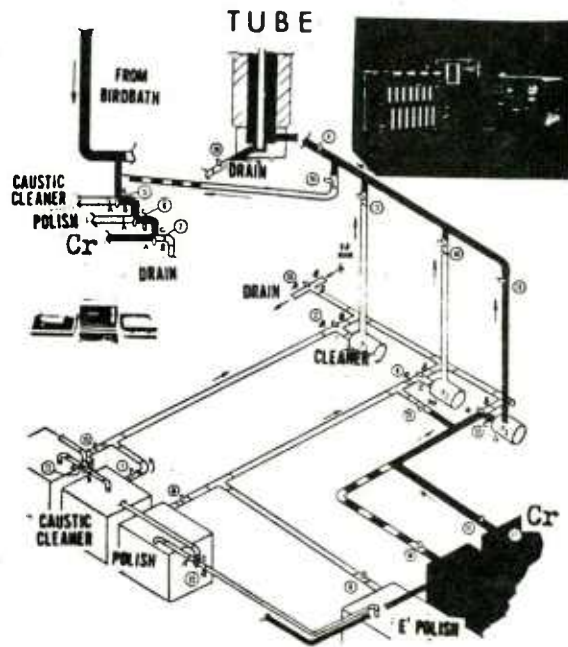

Figure 9. A "Pump Thru" Plating System for Plating Long Cylinder Bores.

The various surface treatments are accomplished by the "pump thru" plating method using a series of tanks, pumps, valves, and associated piping to direct and control the flow rate of the process solutions. The facility is especially suitable for the deposition of LC chromium which requires high solution temperature, high current densities, and a high rate of solution flow to control deposit distribution.

Recent studies have been conducted on the structural characteristics of HC chromium deposits produced with the "pump thru" method of plating bores.<sup>27</sup> X-ray examination of these deposits has shown that increasing the linear flow of the electrolyte produces two significant changes in the deposit:

1. Crystal growth changes from a preferred to a random orientation.
2. Residual stresses change from tensile to a compressive type.

Preliminary tests have shown that deposits produced with the "pump thru" system are significantly stronger than those produced by the immersion process.

#### Anodes for Chromium Plating Gun Bores

The "pump thru" process is currently being employed to deposit higher density and higher purity lead alloy coatings for producing chromium plating anodes. The conventional anodes are produced by a lead burning process which results in coatings with a high percentage of porosity and impurities. Chromium plating anodes have a significant effect on the quality of the deposits in gun bores.

● CONCLUSIONS

Partial-length plated tubes produce acceptable target dispersion with discarding sabot type projectiles.

An optimum rifling profile at the bore origin will result in less tendency for chromium to chip and flake off from the base metal. This, in turn, will prevent the formation of the irregular erosion pattern which occurred in 155 mm M199 tests.

LC chromium deposits will possess greater strength and less brittleness than HC deposits.

The "pump thru" plating process will produce deposits with improved properties.



## REFERENCES

1. Lamb, V. A. and Young, J. P., "Experimental Plating of Gun Bores to Prevent Erosion," Summary Report 5797, NBS, January 1946 - December 1955.
2. Burlew, J. S. (Ed.), "Hypervelocity Guns and the Control of Gun Erosion," Summary Technical Report of NDRC, Div. 1, Vol. 1, Washington, DC, 1946.
3. USA TECOM Report No. DPS-469, "Accuracy and Erosion Studies of Modified T254 Series Gun Tubes For 105 mm Gun M68," APG, 1962.
4. Ward, J. R., "Secondary Wear in M68 Tank Cannon—Cause and Remedy," BRL IMR No. 402, June 1975.
5. Ward, J. R., "Proposed Mechanism for Secondary Wear in the M68 Tank Cannon," BRL MR 2557, Aberdeen Proving Ground, MD, November 1975.
6. Wolff, R., "Reduction of Gun Erosion - Part I, Laminar Coolant," Picatinny Arsenal Technical Report No. 3069, May 1963.
7. Wolff, R. O., "Reduction of Gun Erosion - Part II, Barrel Wear—Reducing Additive," Picatinny Arsenal Technical Report No. 3096, August 1963.
8. APG Report No. DPS-768, "Component Development Test of Laminar Coolant, Barrel-Wear Reducing Additive in Cartridge, 105 mm," APDS-T, M392E2, for 105 mm Gun M68 Ammunition Components, January 1963.
9. APG Report No. DPS-838, "Component Development Test of Swedish Barrel-Wear Reducing Additive for 105 mm M68 Ammunition Components," March 1963.
10. APG Report No. DPS-1520, "Final Report of Product Improvement Test of Ammunition Additive Effect on M41 and M68 Gun Tube Life," December 1964.



11. Lenchitz, C., Velicy, R. W., Bottei, L. A., and Siluestro, G., "Some Aspects of the Erosion Reducing Characteristics of the Titanium Oxide-Wax Additive," Picatinny Arsenal Tech Memo No. 1768, November 1965.
12. Ward, J. R. and Brosseau, T. L., "Role of the Insulating Layer From TiO<sub>2</sub>-Wax Liner in Reducing Gun Tube Wear," Tech. Report ARBRL-TR-02238, April 1980.
13. Albright, A. A. and Friar, G. S., "Analysis of Wear Data From 105 mm M68 Gun Tubes as Field Service," WVT-TR-75047, Watervliet Arsenal, Watervliet, NY, July 1975.
14. Albright, A. A., Coppola, E. E., and Friar, G. S., "The Influence of Late Wear Life 105 mm M68 Gun Tubes on Discarding Sabot Ammunition Flight Stability," ARLCB-TR-77034, ARRADCOM, Benet Weapons Laboratory, Watervliet, NY, July 1977.
15. Albright, A. A., Friar, G. S., and Morris, S. L., "Performance of Chrome Plated 105 mm M68 Gun Tubes With Discarding Sabot Ammunition," WVT-TR-76037, Watervliet Arsenal, Watervliet, NY, September 1976.
16. Musick, C. R., "Product Improvement Test of Cannon, 105 mm M68, (10 mil Chrome Plated)," APG-MT-5516, May 1981.
17. Lannon, J. A., Ahmad, I., Greco, V. P., Stobie, I. C., and Ward, J. R., "The Wear and Accuracy of 105 mm M68 Tank Cannons Electroplated With 0.25 mm (10 mil) and 0.38 mm (15 mil) Thick Chrome Plating," CIPA 340, Vol. III, pp. 337-374, 26-28 May 1981.
18. Greco, V. P., "The Effects of Partial Length Chromium Plating on the Wear and Accuracy Behavior of the 105 mm M68 Cannon," ARLCB-TR-82025, ARRADCOM, Benet Weapons Laboratory, Watervliet, NY, August 1982.

19. Lannon, J. A. and Vallado, A. C., "155 mm M199 Chromium Plated Cannon Tubes Wear Test," SN 83, ARRADCOM Tech Report, Dover, NJ, 1979.
20. Lannon, J. A. and Vallado, A. C., ARLCD-TR-80018, Dover, NJ, February 1981.
21. Lamb, V. A. and Young, J. P., "Experimental Plating of Gun Bores to Retard Erosion," NBS Technical Note 46, May 1960.
22. Young, J. P., NSB Report No. 3B101, 1 August 1954.
23. Wolfe, R. H., Rock Island Arsenal Technical Report No. 57-2498, 15 October 1957.
24. Chen, E. S. and Baldauf, W., "Improved LC Chromium for Gun Tube Application," ARLCB-TR-80008, ARRADCOM, Benet Weapons Laboratory, Watervliet, NY, March 1980.
25. D'Andrea, G., Cullinan, R., Croteau, P., "Study of Erosion Resistant Materials For Gun Bores - Part III: Low Contraction (LC) Chromium Plated Liners," ARLCB-TR-81046, ARRADCOM, Benet Weapons Laboratory, Watervliet, NY, December 1981.
26. D'Andrea, G., Greco, V. P., and Walden, J., "Process and Procedure Guide for the 'Pump Thru' Method of Chromium Plating 120 mm XM256 Gun Bores," ARLCB-TR-81033, ARRADCOM, Benet Weapons Laboratory, Watervliet, NY, October 1981.
27. Capsimalis, G., Private Communication (to be published), ARRADCOM, Benet Weapons Laboratory, Watervliet, NY.

TECHNICAL REPORT INTERNAL DISTRIBUTION LIST

	<u>NO. OF COPIES</u>
CHIEF, DEVELOPMENT ENGINEERING BRANCH	
ATTN: DRDAR-LCB-D	1
-DP	1
-DR	1
-DS (SYSTEMS)	1
-DS (ICAS GROUP)	1
-DC	1
CHIEF, ENGINEERING SUPPORT BRANCH	
ATTN: DRDAR-LCB-S	1
-SE	1
CHIEF, RESEARCH BRANCH	
ATTN: DRDAR-LCB-R	2
-R (ELLEN FOGARTY)	1
-RA	1
-RM	1
-RP	1
-RT	1
TECHNICAL LIBRARY	
ATTN: DRDAR-LCB-TL	5
TECHNICAL PUBLICATIONS & EDITING UNIT	
ATTN: DRDAR-LCB-TL	2
DIRECTOR, OPERATIONS DIRECTORATE	1
DIRECTOR, PROCUREMENT DIRECTORATE	1
DIRECTOR, PRODUCT ASSURANCE DIRECTORATE	1

NOTE: PLEASE NOTIFY DIRECTOR, BENET WEAPONS LABORATORY, ATTN: DRDAR-LCB-TL,  
OF ANY REQUIRED CHANGES.

TECHNICAL REPORT EXTERNAL DISTRIBUTION LIST

	<u>NO. OF COPIES</u>		<u>NO. OF COPIES</u>
ASST SEC OF THE ARMY RESEARCH & DEVELOPMENT ATTN: DEP FOR SCI & TECH THE PENTAGON WASHINGTON, D.C. 20315	1	COMMANDER ROCK ISLAND ARSENAL ATTN: SARRI-ENM (MAT SCI DIV) ROCK ISLAND, IL 61299	1
COMMANDER DEFENSE TECHNICAL INFO CENTER ATTN: DTIC-DDA CAMERON STATION ALEXANDRIA, VA 22314	12	DIRECTOR US ARMY INDUSTRIAL BASE ENG ACT ATTN: DRXIB-M ROCK ISLAND, IL 61299	1
COMMANDER US ARMY MAT DEV & READ COMD ATTN: DRCDE-SG 5001 EISENHOWER AVE ALEXANDRIA, VA 22333	1	COMMANDER US ARMY TANK-AUTMV R&D COMD ATTN: TECH LIB - DRSTA-TSL WARREN, MI 48090	1
COMMANDER US ARMY ARRADCOM ATTN: DRDAR-LC DRDAR-LCA (PLASTICS TECH EVAL CEN)	1	COMMANDER US ARMY TANK-AUTMV COMD ATTN: DRSTA-RC WARREN, MI 48090	1
DRDAR-LCE	1	COMMANDER US MILITARY ACADEMY ATTN: CHM, MECH ENGR DEPT WEST POINT, NY 10996	1
DRDAR-LCM (BLDG 321)	1		
DRDAR-LCS	1	US ARMY MISSILE COMD	
DRDAR-LCU	1	REDSTONE SCIENTIFIC INFO CEN	
DRDAR-LCW	1	ATTN: DOCUMENTS SECT, BLDG 4484	2
DRDAR-TSS (STINFO)	2	REDSTONE ARSENAL, AL 35898	
DOVER, NJ 07801			
DIRECTOR US ARMY BALLISTIC RESEARCH LABORATORY ATTN: DRDAR-TSB-S (STINFO) ABERDEEN PROVING GROUND, MD 21005	1	COMMANDER US ARMY FGN SCIENCE & TECH CEN ATTN: DRXST-SD 220 7TH STREET, N.E. CHARLOTTESVILLE, VA 22901	1
COMMANDER US ARMY ARRCOM ATTN: DRSAR-LEP-L ROCK ISLAND ARSENAL ROCK ISLAND, IL 61299	1	COMMANDER US ARMY MATERIALS & MECHANICS RESEARCH CENTER ATTN: TECH LIB - DRXMR-PL WATERTOWN, MA 02172	2

NOTE: PLEASE NOTIFY COMMANDER, ARRADCOM, ATTN: BENET WEAPONS LABORATORY, DRDAR-LCB-TL, WATERVLIET ARSENAL, WATERVLIET, NY 12189, OF ANY REQUIRED CHANGES.

TECHNICAL REPORT EXTERNAL DISTRIBUTION LIST (CONT'D)

	<u>NO. OF COPIES</u>		<u>NO. OF COPIES</u>
COMMANDER US ARMY RESEARCH OFFICE ATTN: CHIEF, IPO P.O. BOX 12211 RESEARCH TRIANGLE PARK, NC 27709	1	DIRECTOR US NAVAL RESEARCH LAB ATTN: DIR, MECH DIV CODE 26-27 (DOC LIB) WASHINGTON, D.C. 20375	1 1
COMMANDER US ARMY HARRY DIAMOND LAB ATTN: TECH LIB 2800 POWDER MILL ROAD ADELPHIA, MD 20783	1	METALS & CERAMICS INFO CEN BATTELLE COLUMBUS LAB 505 KING AVE COLUMBUS, OH 43201	1
COMMANDER NAVAL SURFACE WEAPONS CEN ATTN: TECHNICAL LIBRARY CODE X212 DAHLGREN, VA 22448	1	MATERIEL SYSTEMS ANALYSIS ACTV ATTN: DRXSY-MP ABERDEEN PROVING GROUND MARYLAND 21005	1

NOTE: PLEASE NOTIFY COMMANDER, ARRADCOM, ATTN: BENET WEAPONS LABORATORY,  
DRDAR-LCB-TL, WATERVLIET ARSENAL, WATERVLIET, NY 12189, OF ANY  
REQUIRED CHANGES.