

AD-A129 507 COMPUTER PROGRAM WITH INTERACTIVE GRAPHICS FOR ANALYSIS 1/1
OF PLANE FRAME ST..(U) ARMY ENGINEER WATERWAYS

UNCLASSIFIED EXPERIMENT STATION VICKSBURG MS J P HARTMAN ET AL.
JAN 83 WES-INSTRUCTION-K-83-1 F/G 13/13 NL

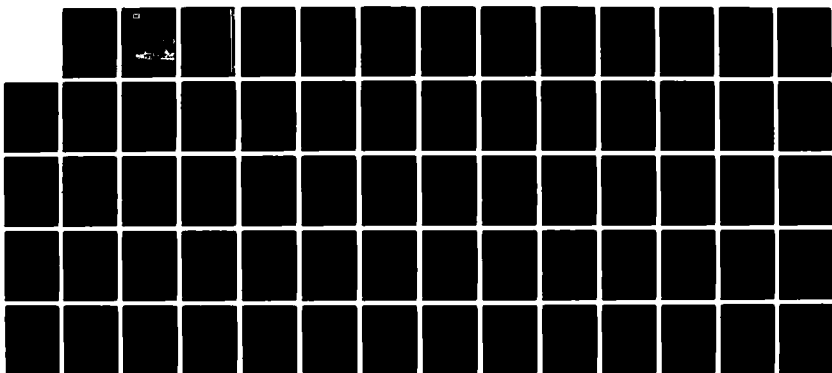

END
DATE
FILMED
BY
DTIC

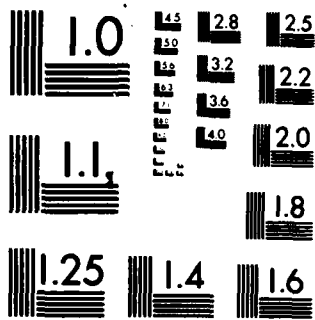

MICROCOPY RESOLUTION TEST CHART
NATIONAL BUREAU OF STANDARDS-1963-A

ADA 129507

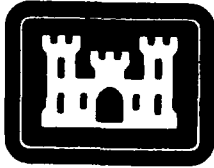

12

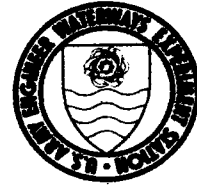

INSTRUCTION REPORT K-83-1

USER'S GUIDE: COMPUTER PROGRAM WITH INTERACTIVE GRAPHICS FOR ANALYSIS OF PLANE FRAME STRUCTURES (CFRAME)

by

Joseph P. Hartman, John J. Jobst

U. S. Army Engineer District, St. Louis
210 Tucker Blvd., North, St. Louis, Mo. 63101

January 1983

Revision of Instruction Report 0-79-2

A report under the Computer-Aided Structural Engineering (CASE) Project

Approved For Public Release; Distribution Unlimited

DTIC
S E D
JUN 17 1983
A



Prepared for Office, Chief of Engineers, U. S. Army
Washington, D. C. 20314

Monitored by Automatic Data Processing Center
U.S. Army Engineer Waterways Experiment Station
P. O. Box 631, Vicksburg, Miss. 39180

DTIC FILE COPY

83 06 17 017

**Destroy this report when no longer needed. Do not return
it to the originator.**

**The findings in this report are not to be construed as an official
Department of the Army position unless so designated.
by other authorized documents.**

**The contents of this report are not to be used for
advertising, publication, or promotional purposes.
Citation of trade names does not constitute an
official endorsement or approval of the use of
such commercial products.**

PROGRAM INFORMATION

Description of Program

CFRAME, called X0030 in the Con conversationally Oriented Real-Time Program-Generating System (CORPS) library, is a general-purpose computer program for the analysis of small or medium plane frame structures. It is intended to be an easy-to-use program incorporating the best features of many similar programs, and to provide the many additional capabilities required by a diverse group of users. CFRAME utilizes the stiffness method of structural analysis. The program is limited to problems with no more than 60 joints and 100 members; except on the U. S. Army Engineer Waterways Experiment Station (WES) system where only 61 members may be used.

Coding and Data Format

CFRAME is written in FORTRAN and is operational on the following systems:

- a. WES Honeywell DPS/1.
- b. Office of Personnel Management Honeywell Series 6000 at Macon, Ga.
- c. Boeing Computer Service's CDC CYBER 175.

Data can be input either interactively at execute time or from a prepared data file with line numbers. Output may be directed to an output file or come directly back to the terminal.

How To Use CFRAME

A short description of how to access the program on each of the three systems is provided below. It is assumed that the user knows how to sign on the appropriate system before trying to use CFRAME. In the example initiation of execution commands below, all user responses are underlined, and each should be followed by a carriage return.

WES and Macon Honeywell Systems

After the user has signed on the system, the two system commands FORT and NEW get the user to the level to execute the program. Next, the user issues the run command

RUN WESLIB/CORPS/X0030,R

to initiate execution of the program. The program is then run as

described in this user's guide. The data file should be prepared prior to issuing the RUN command. An example initiation of execution is as follows, assuming a data file had previously been prepared:

```
HIS SERIES 600 ON 03/04/81 AT 13.301 CHANNEL 5647
USER ID - R0KACASECON
PASSWORD - XXXXXXXXXX
SYSTEM? FORT NEW
READY
*RUN WESLIB/CORPS/X0030,R
```

Boeing CYBER System

The log-on procedure is followed by a call to the CORPS procedure file

```
OLD,CORPS/UN=CECELB
```

to access the CORPS library. The file name of the program is used in the command

```
CALL,CORPS,X0030
```

to initiate execution of the program. An example is:

```
WELCOME TO THE BCS NETWORK
YOUR ACCESS PORT IS SWY 44
SELECT DESIRED SERVICE: EKS1
81/03/04. 13.30.01.
EKS1 175G.N0460.68BA 80/09/14.DS-0 02.39.05. 80/09/16.
USER ID: CER0C7
PASSWORD -
XXXXXXXXXX
TERMINAL 124,TTY
RECOVER/USER ID: CASE
*
C><u>OLD,CORPS/UN=CECELB
C><u>CALL,CORPS,X0030
```

How To Use CORPS

The CORPS system contains many other useful programs which may be catalogued from CORPS by use of the LIST command. The execute command for CORPS on the WES and Macon systems is:

```
RUN WESLIB/CORPS/CORPS,R
ENTER COMMAND (HELP,LIST,BRIEF,MESSAGE,EXECUTE, OR STOP)
*?LIST
```

on the Boeing system, the commands are:

OLD, CORPS/UN=CECELB

CALL, CORPS

ENTER COMMAND (HELP, LIST, BRIEF, MESSAGE, EXECUTE, OR STOP)

*?LIST

Unclassified

SECURITY CLASSIFICATION OF THIS PAGE (When Data Entered)

REPORT DOCUMENTATION PAGE		READ INSTRUCTIONS BEFORE COMPLETING FORM
1. REPORT NUMBER Instruction Report K-83-1	2. GOVT ACCESSION NO. AD A129507	3. RECIPIENT'S CATALOG NUMBER
4. TITLE (and Subtitle) USER'S GUIDE: COMPUTER PROGRAM WITH INTERACTIVE GRAPHICS FOR ANALYSIS OF PLANE FRAME STRUCTURES (CFRAME)	5. TYPE OF REPORT & PERIOD COVERED Revision of Instruction Report 0-79-2	
	6. PERFORMING ORG. REPORT NUMBER	
7. AUTHOR(s) Joseph P. Hartman John J. Jobst	8. CONTRACT OR GRANT NUMBER(s)	
9. PERFORMING ORGANIZATION NAME AND ADDRESS U. S. Army Engineer District, St. Louis 210 Tucker Blvd., North, St. Louis, Mo. 63101	10. PROGRAM ELEMENT, PROJECT, TASK AREA & WORK UNIT NUMBERS	
11. CONTROLLING OFFICE NAME AND ADDRESS Office, Chief of Engineers, U. S. Army Washington, D. C. 20314	12. REPORT DATE January 1983	
	13. NUMBER OF PAGES 62	
14. MONITORING AGENCY NAME & ADDRESS (if different from Controlling Office) U. S. Army Engineer Waterways Experiment Station Automatic Data Processing Center P. O. Box 631, Vicksburg, Miss. 39180	15. SECURITY CLASS. (of this report) Unclassified	
	15a. DECLASSIFICATION/DOWNGRADING SCHEDULE	
16. DISTRIBUTION STATEMENT (of this Report) Approved for public release; distribution unlimited.		
17. DISTRIBUTION STATEMENT (of the abstract entered in Block 20, if different from Report)		
18. SUPPLEMENTARY NOTES Available from National Technical Information Service, Springfield, Va. 22151. This report was prepared under the Computer-Aided Structural Engineering (CASE) Project. A list of published CASE reports is printed on the inside of the back cover.		
19. KEY WORDS (Continue on reverse side if necessary and identify by block number) CFRAME (Computer program) Interactive computer graphics Computer programs Structural analysis Framed structures		
20. ABSTRACT (Continue on reverse side if necessary and identify by block number) This report documents and describes the use of the general-purpose computer program CFRAME for analysis of plane frame structures. The intent was to develop an easy-to-use program incorporating the best features of many similar programs and to provide the many additional capabilities required by a diverse group of users. CFRAME utilizes the stiffness method of structural analysis. The Cholesky decomposition method is used to solve the resulting		

(Continued)

Unclassified

Unclassified

SECURITY CLASSIFICATION OF THIS PAGE(When Data Entered)

20. ABSTRACT (Continued)

matrix equation. Automatically generated routines are available to simplify the data input. Graphic display of the input data is also available. The output may be printed or displayed with graphics.



Accession	
NTIS	
DTIC	
1	
2	
3	
4	
5	
6	
7	
8	
9	
10	
11	
12	
13	
14	
15	
16	
17	
18	
19	
20	
21	
22	
23	
24	
25	
26	
27	
28	
29	
30	
31	
32	
33	
34	
35	
36	
37	
38	
39	
40	
41	
42	
43	
44	
45	
46	
47	
48	
49	
50	
51	
52	
53	
54	
55	
56	
57	
58	
59	
60	
61	
62	
63	
64	
65	
66	
67	
68	
69	
70	
71	
72	
73	
74	
75	
76	
77	
78	
79	
80	
81	
82	
83	
84	
85	
86	
87	
88	
89	
90	
91	
92	
93	
94	
95	
96	
97	
98	
99	
100	

Unclassified

SECURITY CLASSIFICATION OF THIS PAGE(When Data Entered)

PREFACE

This report documents and describes use of a computer program called CFRAME that can be used to analyze plane frame structures. It is a revised and updated version of U. S. Army Engineer Waterways Experiment Station (WES) Instruction Report 0-79-2.

This user's guide was written by Messrs. Joseph P. Hartman and John J. Jobst of the U. S. Army Engineer District, St. Louis, for the Automatic Data Processing (ADP) Center, WES. The work was sponsored through funds provided to WES by the Military Programs Directorate of the Office, Chief of Engineers, U. S. Army (OCE), under the Computer-Aided Structural Engineering (CASE) Project. Major portions of CFRAME were developed by the authors. However, several of the programming methods used are based on portions of the GFRAME program developed by Robert E. Brittain of the U. S. Army Engineer District, Memphis, and on portions of the WILSON 2D-FRAME program developed by W. P. Doherty and E. L. Wilson, University of California at Berkeley.

Specifications for the program were provided by the members of the CASE Task Group on Building Systems. The following were members of the task group (although all may not have served for the entire period) during program development:

- Mr. Dan Reynolds, Sacramento District (Chairman)
- Mr. Jerry Foster, formerly Baltimore District
- Mr. Joseph P. Hartman, St. Louis District
- Mr. David Illias, Portland District
- Mr. Sefton B. Lucas, Memphis District
- Mr. Jun Ouchi, Pacific Ocean Division
- Mr. Peter Rossbach, Baltimore District
- Mr. David Raisanen, North Pacific Division
- Mr. James Simmons, Baltimore District
- Mr. Ollie Werner, Middle East Division
- Mr. Gene A. Wyatt, Mobile District

Mr. Seymour Schneider, Military Programs Directorate, and later Mr. George Matsumura were the OCE points of contact. Dr. N. Radhakrishnan, Special Technical Assistant, ADP Center, WES, was Project Manager for the CASE Project and provided overall guidance. Mr. Paul K. Senter,

Project Coordinator for the Military Programs work of the CASE Project, monitored the work. Mr. H. Wayne Jones, Computer-Aided Design Group, ADP Center, helped in converting the program to the WES computer and in preparing the report for publication. Mr. D. L. Neumann was Chief of the ADP Center.

Commander and Director of WES during the publication of this report was COL Tilford C. Creel, CE. Technical Director was Mr. F. R. Brown.

CONTENTS

	<u>Page</u>
PREFACE	1
CONVERSION FACTORS, NON-SI TO SI (METRIC)	
UNITS OF MEASUREMENT	4
1. INTRODUCTION	5
2. PROGRAM SUMMARY	5
a. Analysis Method	5
b. Structural Input	6
c. Problem Size Limits	6
d. Loading Input	6
e. Output	6
f. Graphics	6
3. INPUT DATA DESCRIPTION	7
a. Units	7
b. Coordinate System	7
c. Format	7
d. General Requirements	7
e. Frames and Trusses	8
f. Specific Input Data	8
4. OUTPUT DESCRIPTION	18
a. Input Data Echo	18
b. Joint Displacements	18
c. Member Forces	18
d. Structure Reactions	18
5. GRAPHICS	18
a. General	18
b. Input Graphics	19
c. Output Graphics	21
APPENDIX A: SAMPLE PROBLEMS	A1
APPENDIX B: SUMMARY OF BASIC INPUT DATA	B1
APPENDIX C: SUMMARY OF COMPLETE INPUT DATA	C1

CONVERSION FACTORS, NON-SI TO SI (METRIC)
UNITS OF MEASUREMENT

Non-SI units of measurement used in this report can be converted to SI (metric) units as follows:

<u>Multiply</u>	<u>By</u>	<u>To Obtain</u>
feet	0.3048	meters
foot-kips (force)	1355.818	newton-meters
inches	2.54	centimeters
inch-kips (force)	112.9848	newton-meters
kips (1000 lb force)	4.448222	kilonewtons
kips (force) per foot	14.5939	kilonewtons per meter
kips (force) per inch	175.12685	kilonewtons per meter
kips (force) per square foot	47.88026	kilopascals
kips (force) per square inch	6.894757	megapascals
pounds (force)	4.448222	newtons
pounds (force) per square foot	47.88026	pascals
pounds (force) per square inch	6.894757	kilopascals

USER'S GUIDE: COMPUTER PROGRAM WITH INTERACTIVE GRAPHICS
FOR ANALYSIS OF PLANE FRAME STRUCTURES (CFRAME)

1. INTRODUCTION

CFRAME is a general-purpose computer program for the analysis of small or medium plane frame structures.* It is intended to be an easy-to-use program incorporating the best features of many similar programs, and to provide the many additional capabilities required by a diverse group of users.

2. PROGRAM SUMMARY

a. Analysis Method. CFRAME utilizes the stiffness method of structural analysis. The properties of individual members are translated into member stiffnesses which include the effects of pinned ends plus shear and axial deformations. These stiffnesses are combined into a stiffness matrix for the entire structure which is then modified to account for fixed joints, elastic supports, and specified joint displacements. For each load case, a load vector is formed consisting of the effects of joint loads, concentrated and distributed member loads, and temperature loads. The load vector is modified to account for the effects of pinned end members and the effects of specified displacements. In the stiffness method, the joint displacements are determined by multiplying the inverted stiffness matrix by the load vector.

$$[U] = [K]^{-1}[F]$$

CFRAME uses the Cholesky decomposition method to solve this matrix equation. The joint displacements are multiplied by the individual member stiffnesses to determine member end forces and moments. The end forces at restrained joints are summed to determine reaction forces acting on the structure. The end forces are used in conjunction with the applied member loads to determine in-span shears, moments, and deflections for each member. In-span shears and deflections are calculated only when output graphics are requested. Further details of the stiffness method may be found in many textbooks on the subject; for example: J. S. Przemieniecki, Theory of Matrix Structural Analysis, McGraw-Hill, New York, 1968.

* CFRAME is designated X0030 in the Con conversationally Oriented Real-Time Program-Generating System (CORPS) library. Three sheets entitled "PROGRAM INFORMATION" have been hand-inserted inside the front cover of this report. They present general information on CFRAME and describe how it can be accessed. If procedures used to access this and other CORPS programs should change, recipients of this report will be furnished revised versions of the "PROGRAM INFORMATION" sheets.

b. Structural Input. The user must input joint locations and fixities and member locations and properties. Automatic generation routines are available to simplify joint and member input. Joints may be fixed for any combination of horizontal, vertical, or rotational movement; may be elastically supported; may have a specified displacement; or may have any combination of these constraints. Members may be pinned (no moment transfer) at either or both ends. Axial deformations of members are included; shear deformations may be included. Multiple material properties may be specified. A variety of units may be used for the above input.

c. Problem Size Limits. The program is limited to problems with no more than 60 joints and 100 members, except on the U. S. Army Engineer Waterways Experiment Station (WES) computer where only 61 members may be used. Even if a problem is within these limits, it still may be too large if it has a large bandwidth. The following equation shows the limits imposed by bandwidth considerations:

$$(B + 1)(NUDF - B/2) + NDF \leq 6500 \text{ (3200 on WES)}$$

where

NDF = number of degrees of freedom (number of joints times 3)

NUDF = number of unrestrained degrees of freedom

B = bandwidth, the maximum numerical difference between any two connected, unrestrained degrees of freedom, discounting restrained degrees of freedom

d. Loading Input. A single load case may contain any combination of the following: joint loads, concentrated, distributed and projected member loads, and gross temperature loads. The program is limited to 15 independent load cases. Fifteen additional load cases may be specified, consisting of factored combinations of the various independent load cases.

e. Output. Output may consist of any combination of the following: an input data echo of joints, members, or loads; joint displacements; structure reactions; member forces grouped by member or by load case. Member force output includes all end forces and moments as well as the minimum and maximum in-span moments and their locations. Output may be suppressed for selected independent load cases and load case combinations.

f. Graphics. The user may display the input data including structure geometry, joint and member numbers, joint and member fixities, and applied loads. The user may also display the calculated shear, moment, and deflected shape diagrams of the entire structure for each load case. Shear and moment diagrams of individual members may also be displayed.

3. INPUT DATA DESCRIPTION

a. Units. A variety of units may be used for input data. See subparagraph 3f below for a full description of the unit capabilities.

b. Coordinate System. The global coordinate system is an orthogonal right-hand system. It is used for displacements, structure reactions, joint coordinates, and applied joint forces.

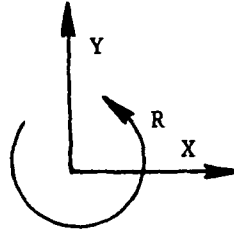

GLOBAL COORDINATE SYSTEM

c. Format. Data should be in a time-sharing file with line numbers and a blank following the line number. Free-field format is used. Numerical data must be in an integer or a real number format; "E" format is not permitted. Input is limited to 80 characters per line, including the line number.

d. General Requirements. Where "list" appears in the following input data descriptions, it refers to a list of joints or members to which the previous input data apply. The "list" should be in the form

3 8 10 TO 17 19 TO 23 27 ...

where "TO" indicates all joints or members from the preceding to the following numbers, inclusive.

In the following input data descriptions, characters in quotation marks are an integral part of a given set of input data. These characters must be included along with the numerical data; the quotation marks themselves should not be included.

Many lines of specific input data listed below may not be necessary to describe a given problem. When an input line is not required, simply omit it from the data file. Input items may also be repeated as often as necessary. For example, several different sets of member properties may be input using different lines.

For examples of the above requirements, see the sample problems in Appendix A.

e. Frames and Trusses. CFRAME can analyze both frames and trusses. Frames are the more general case and may be analyzed by following the general input guide and the sample problems. Trusses are a special case in which the members are pinned at both ends and thus carry no bending moments. When analyzing a truss, the user should use input item X to specify ends A and B of all members as pinned. Since the members will then provide no resistance to rotation of the joints, all joints must be restrained from rotating by using "FIX R" in input item VI below.

f. Specific Input Data.

I. Title. At least one line must be used for a problem title. Multiple title lines may be used by placing an "*" after each line of the title, except the last line.

II. Units.* UE UJ UM UD UF

(Can be omitted if consistent units are used.)

UE = units for the modulus of elasticity
(allowable units are "PSI", "PSF", "KSI", "KSF", "MPA")

UJ = units for joint coordinates. This affects calculated member lengths, input moments, and input distributed loads
("IN", "FT", "M", "CM")

UM = units for member properties. This affects calculated member moments and structure reaction moments
("IN", "FT", "M", "CM")

UD = units for joint displacements. This affects input spring constants, input displacements, and calculated displacements
("IN", "FT", "M", "CM")

UF = units for forces, moments, and spring constants
("LB", "KIP", "N", "KN")

Key: IN = inches
FT = feet
M = meters
CM = centimeters
LB = pounds
KIP = kips (1000 lb)

* A table of factors for converting non-SI units of measurement to SI (metric) units is presented on page 4.

N = newtons
 KN = kilonewtons
 PSI = pounds per square inch
 PSF = pounds per square foot
 KSI = kips per square inch
 KSF = kips per square foot
 MPA = megapascals

Notes: Any combination of units may be specified. All output includes units labels if this line is entered.

If the units line is omitted, the program assumes that consistent units are used throughout and no units labels will be included in the output.

In addition to the above units which may be specified, several units may not be changed. All rotational units must be radians, except as indicated in the member load description. Consistent units must be used for temperature and the coefficient of thermal expansion.

III. Master Control. NJ NM NLC E POI

NJ = number of joints (60 max)

NM = number of members (100 max, 61 max on WES)

NLC = number of independent load cases, not including load case combinations (15 max)

E = default value for modulus of elasticity

POI = default value for Poisson's ratio

Wood	Steel	Concrete
1700	29,000	3000
Use big shear area and POI+.3	0.3	0.15
From p 3-24, <u>Timber Engineering Handbook</u>		

Note: The shear modulus $G = E/[2(1+POI)]$. The values of E and POI are used for all members except when item XII below is used to change these values for specific members.

IV. Joint Coordinates. JN X Y, JN X Y, . . .

JN = joint number

X = X coordinate

Y = Y coordinate

Note: Any number of joint coordinate sets may be grouped on a single line. Joints need not be input in numerical order. However, after all joint input and automatic generation is complete, joints must have numbers from 1 through NJ, consecutively.

V. Automatic Joint Generation. "GJ" JNA JNB INCR

(Can be omitted if no joint generation is desired.)

JNA = beginning joint number

JNB = ending joint number

INCR = joint numbering increment

Note: Joint numbers JNA+1(INCR), JNA+2(INCR), . . . are generated at equal spaces between JNA and JNB. JNA and JNB must be previously defined. More than one "GJ" command may be given on a single line.

Example: 17 19 21 23 25
 •-----•-----•-----•-----•

"GJ" 17 25 2" generates joints 19, 21, and 23 at equally spaced points between 17 and 25.

VI. Joint Fixity. "FIX X" list, "FIX Y" list, "FIX R" list, "FIX KX" KX list, "FIX KY" KY list, "FIX KR" KR list

"FIX X", "FIX Y", "FIX R" indicate complete fixity for X, Y, and R motions of listed joints

"FIX KX", "FIX KY", "FIX KR" indicate an elastic support for X, Y, and R displacements

KX, KY, KR = spring constants of the elastic support

list = list of joints to which fixity applies

Note: The above input may be grouped on a single line or on multiple lines. The "list" is of the form JNA JNB JNC "TO" JND . . . , where "TO" indicates all joints between and including JNC and JND. Sufficient

joint fixity must be specified to make all segments of the structure stable against X, Y, and R motions. Other portions of this line may be omitted. Different spring constants at different joints may be specified by repeating "FIX KX", etc., as often as required. No more than 20 different magnitudes may be specified for KX, for KY, or for KR (60 total).

VII. Specified Joint Displacements. "SD" DX DY DR list

(Can be omitted if no specified displacements are desired.)

DX = specified displacement in +X direction

DY = specified displacement in +Y direction

DR = specified rotation in +R direction, in radians

list = list of joints to which displacements apply

Note: Displacements to be specified as zero should be indicated in the joint fixity input (item VI). When a zero is included in the specified joint displacement input, the zero is ignored. No more than 20 sets of specified displacements may be included.

Example: "SD 0. -1.5 0. 17" would indicate that joint 17 had a specified displacement of -1.5 in the Y direction, but that it was still free to move in the X and R directions.

VIII. Member Incidences. MN JNA JNB, MN JNA JNB, . . .

(Can be omitted if all members can be automatically generated; see item IX.)

MN = member number

JNA = joint number at end A of member

JNB = joint number at end B of member

Note: Any number of member incidences may be input on a single line. Members need not be input in numerical order. However, after all member input and automatic generation, members must have numbers from 1 to NM, consecutively.

IX. Automatic Member Generation. "GM" MN JNA JNB N INCM INCJ

(Can be omitted if no member generation is desired.)

MN = member number of first member generated

JNA = joint number at end A of MN

JNB = joint number at end B of MN

N = number of members to be generated (including the first)

INCM = member number increment

INCJ = joint number increment

Note: This command generates members MN, MN+1(INCM),
The end joints of the generated members are JNA, JNA+1(INCJ), etc.

Example:

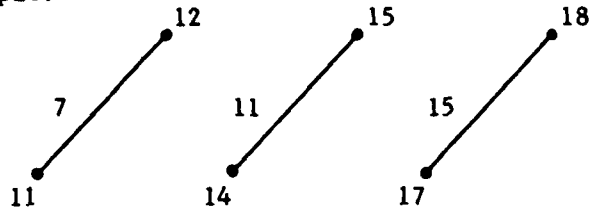

"GM 7 11 12 3 4 3" generates members 7, 11, and 15 by adding multiples of 3 to the end joints specified for member 7.

X. Pinned End Members. "PIN A" list, "PIN B" list

(Can be omitted if no pinned end members are present.)

list = list of members which have a pin (no moment transfer) at end A (or end B) of the member

Note: These commands may be on separate lines or combined on a single line.

XI. Member Properties. I A AS list -or- Zero B H list

I = moment of inertia

A = axial area

AS = shear area

list = list of members to which properties apply

Zero = 0.

B = rectangular member width

H = rectangular member depth

list = list of members to which properties apply

Note: Repeat this line as often as necessary up to a maximum of 40 different member properties. I and A or B and H must have non-zero values. AS may be different from A. If AS is specified as zero, shear deformations are not considered by the program. B and H are used to calculate member properties if the first data item is a zero. Then, $I = BH / 12$, $A = AS = BH$.

XII. Material Properties. "E" E POI list, "E" E POI list, . . .

(This line can be omitted if the default values are satisfactory.)

E = modulus of elasticity

POI = Poisson's ratio

list = list of members to which material applies

Notes: The properties specified for listed members override the default values given on the Master Control line.

The shear modulus $G = E / [2(1+POI)]$.

In addition to the default material properties specified on the Master Control line, as many as 20 material properties may be specified, all on one line or on separate lines.

XIII. Load Case Control. "LOAD CASE" LCN NPLS NDLS NCLS NJLS
NTLS Title

LCN = load case number

NPLS = number of projected load sets for this load case

NDLS = number of member distributed load sets

NCLS = number of member concentrated load sets

NJLS = number of joint load sets

NTLS = number of temperature load sets

Title = load case title

Note: Load case numbers must be unique positive integers but need not be consecutive nor be in increasing order. If NTLS = 0, it may be omitted. If NTLS = NJLS = 0, they may both be omitted. If NTLS = NJLS = NCLS = 0, etc., they may all be omitted from the data and will have default values of zero. The load case title is optional, but if a title is used it must begin with an alphabetic character and may be as long as desired (limited by the 80-character line). One Load Case Control line must be included at the beginning of each load case, except load case combinations. No more than 15 independent load cases may be specified. For each load case, input item XIII and as appropriate items XIV, XV, XVI, XVII, and XVIII immediately following item XIII.

XIV. Member Projected Loads. XY P list

(This line is omitted if NPLS = 0.)

XY = "X" or "Y", direction of load line of action

P = magnitude of projected load

list = list of members to which load set applies

Note: A positive P results in a load acting in the positive X or Y direction; a negative P results in a load in the negative X or Y direction. A uniform projected load is applied to the entire length of the member.

Example: "Y -2.5 4 5"

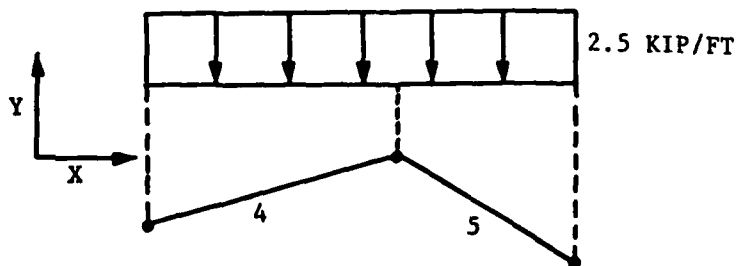

XV. Member Distributed Loads. LA PA LB PB PHI list

(Do this NDLS times; this line is omitted if NDLS = 0.)

LA = distance from end A of member to beginning of distributed load

PA = magnitude of distributed load at LA

LB = distance from end A of member to end of distributed load

PB = magnitude of distributed load at LB

PHI = angle load makes with normal to member, in degrees

list = list of members to which load set applies

Note: Any number of distributed load sets may be applied to a given member to adequately represent any complex load. Sign conventions are identical with those shown below for member concentrated loads. If $PA = PB$, and $LA = 0$, and LB is greater than the length of the member, then the program sets $LB =$ length of member. This permits easy input of uniform loads for different length members.

Example: "5. 1.5 7. 1.0 -30. list"

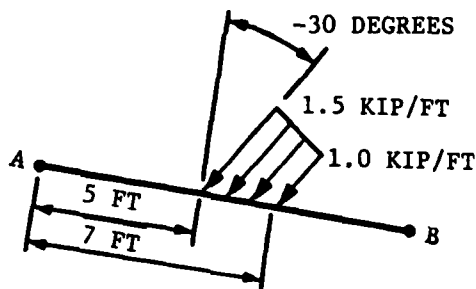

XVI. Member Concentrated Load Set. NL L1 P1 PHI1, L2, P2, PHI2, . . . , list

(Do this NDLS times; this line is omitted if NCLS = 0.)

NL = number of concentrated loads in the set

L1 = distance from end A of member to load

P1 = magnitude of load

PHI1 = angle load makes with normal to member, in degrees

list = list of members to which load set applies

Note: NL must not be greater than 5. The member load sign convention shown below is used for both concentrated and distributed member loads:

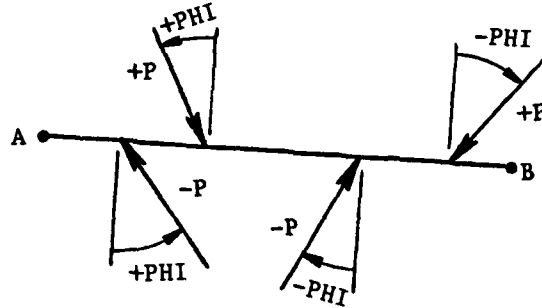

MEMBER LOAD SIGN CONVENTION

Example: "2. 5. 10. 0. 9. 8. -30. list"

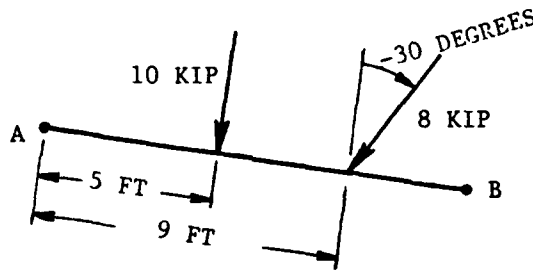

XVII. Joint Load Set. PX PY M list

(Do this NJLS times; this line is omitted if NJLS = 0.)

PX = force in +X direction

PY = force in +Y direction

M = moment in +R direction

list = list of joints to which loads apply

XVIII. Temperature Load Set. ALPHA DT list

(Do this NTLS times; this line is omitted if NTLS = 0.)

ALPHA = coefficient of thermal expansion

DT = change in temperature from base temperature

list = list of members to which temperature load applies

Note = Consistent temperature units must be used for ALPHA and DT.

XIX. Load Case Combination. "COMBINATION" LCN LCN1 C1, LCN2 C2,
. . . , Title

(This line is omitted if no load case combination is desired.)

LCN = load case combination number

LCN1 = number of first independent load case to be combined

C1 = scale factor to be applied to loads of LCN1

Title = load case combination title

Notes: The word "COMBINATION" may be abbreviated as "COMB". Load case combination numbers must be positive integers, unique even with respect to independent load case numbers. However, combination numbers need not be consecutive nor be in numerically increasing sequence. The load combination title is optional, but if a title is used it must begin with an alphabetic character and may be as long as desired (limited by the 80-character line). The applied loads for each specified load case are multiplied by the specified scale factor and are summed to form a load case combination. This combination is then handled by the program as if it were another independent load case. Note that specified displacements are not affected by load case combinations. Therefore, care must be taken when interpreting the results of analyses which include both specified displacements and load case combinations.

Any number of independent load cases may be combined into a new load case combination. No more than 15 load case combinations may be specified. Each specified load case and combination will be solved independently.

Example: "COMBINATION 7 2 1.0 3 -0.5 MAINTENANCE"
Load case combination number 7, maintenance, would consist of the applied loads of load case 2 minus half the applied loads of load case 3.

4. OUTPUT DESCRIPTION

Output examples are presented in Appendix A.

a. Input Data Echo. The user may specify that an input data echo of joint, member, or load data be included as part of the output. The joint data echo includes coordinates, fixities, and specified displacements of each joint. The member data echo includes the end joints, member lengths, section properties, and pinned ends; pinned ends are indicated by a minus sign preceding the appropriate end joint numbers. The load data echo includes all joint and member loads, temperature loads, and load case combinations.

b. Joint Displacements. This output consists of the X, Y, and R displacements of all joints. The R displacement is in radians.

c. Member Forces. Member forces act on the end of the member, with the following sign convention:

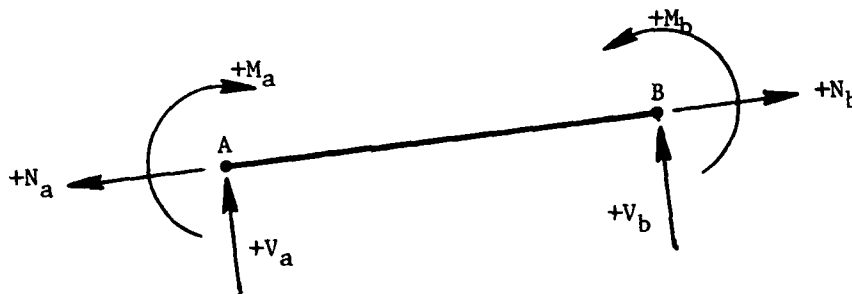

Member force output consists of all these end forces, the joint numbers at each end of the member, and the magnitude and location of the algebraic maximum and minimum in-span moments. The locations of the moment extremes are indicated by printing the distance from end A of the member to the location of each extreme. Member forces may be grouped by member or by load case or both. Grouping by member will cause the forces for one member, for all load cases, to be output consecutively. Grouping by load case will cause the forces for all members, for a single load case, to be output consecutively. See Appendix A for an example of member force grouping.

d. Structure Reactions. The printed reactions are the +X, +Y, and +R direction forces acting on the structure at any fixed joint. Reactions have the same sign convention as applied to joint loads. For example, if the total applied load in the X direction is 500, the total reaction should be -500, so that the sum of all forces is $500 - 500 = 0$.

5. GRAPHICS

a. General. Both input graphics and output graphics are available

as part of CFRAME. The program asks whether either of these will be used during each run. The graphics are available only on a Tektronix 4014 terminal or on a 4014-compatible terminal. The input graphics serve only to display data which have previously been saved in an input file. Graphics cannot be used to create input data. The output graphics may be used only to display certain results of a successful analysis. These results include shears, moments, and deflected shapes for each load case. Examples of graphics displays are included in Appendix A.

b. Input Graphics.

I. Command Summary.

D = displays all members

N = displays members; also numbers joints and members

F = displays members; also indicates the fixity of joints and members

A = all of the above

L n = displays load case "n" superimposed on the frame

E = executes the analysis

S = stops the program







II. Procedure. Once input graphics have been requested, the remaining program control questions must be answered. The program will then print, if requested, an input data echo of joint and member data before requesting an input graphics command. The program will construct the requested display and then await another command. Any command may be given at any time until either an E or S command is given.

III. D Command. D results in a display of all members. A scale size is calculated so that the display will nearly fill the screen. The display is oriented so that +X is to the right and +Y is to the top of the screen. This basic display is used for all of the input graphics displays.

IV. N Command. N results in a display similar to D but adds all joint and member numbers.

V. F Command. F results in a display similar to D but adds joint and member fixity symbols and elastic support valves. Pinned ends are indicated by a small circle near the

appropriate end of each member. The following symbols are used to indicate various combinations of joint fixity:

<u>SYMBOL</u>	<u>FIXITY</u>		
	<u>X</u>	<u>Y</u>	<u>R</u>
	-----	*	*
	-----	*	*
	-----		*
	-----	*	
	-----		*
	-----	*	*
	-----	*	*

The following symbols are used to indicate the locations and magnitudes of elastic supports:

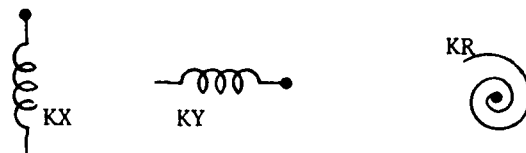

- VI. A Command. A results in a display combining the features of all the above commands, D, N, and F.
- VII. L n Command. L n results in a display similar to D but adds the applied loads for independent load case "n". The load display includes joint loads, member distributed and concentrated loads, and member temperature changes. The loads are drawn to scale and magnitudes are printed adjacent to the load symbol.
- VIII. E Command. E results in execution of the analysis and output portion of CFRAME.
- IX. S Command. S stops the execution of CFRAME and returns the user to the normal time-sharing mode.

c. Output Graphics.

I. Command Summary.

L n = specifies the load case to be used for subsequent displays

D = displays the deflected shape of the frame for the previously specified load case

V = displays a shear diagram for the entire frame

M = displays a moment diagram for the entire frame

I m = displays a shear and moment diagram for member "m" for the previously specified load case

S = stops the output graphics

II. Procedure. After printing all requested output data, the program will request an output graphics command. The first command should be L n to specify the load case for subsequent displays, until a different load case is specified by another L n command. After this initial command is given, the program will then prompt for another command, will construct the requested display, and will give another prompt. Any command may be given in response to any prompt until the S command is given.

III. L n Command. L n specifies that subsequent displays will use output from load case "n", which may be any independent load case or any load case combination. This load case is used for all displays until a different load case is specified by a subsequent L n command.

IV. D Command. D results in a display of the deflected shape of the frame for the current load case. The scale factor for displacements is determined automatically by the program, and a bar scale is included as part of the display.

V. V Command. V results in a display of the shear diagram for the frame for the current load case. The scale factor for shears is determined automatically by the program, and a bar scale is included as part of the display.

VI. M Command. M results in a display of the moment diagram for the frame for the current load case. The scale factor for moments is determined automatically by the program, and a bar scale is included as part of the display.

- VII. I m Command. I m results in a combined display of shear and moment diagrams for member "m" for the current load case. Each member has a scale factor for shears and moments which is computed automatically and is used for all load cases for that member. The ordinate and abscissa of the shear and moment diagrams include labeled scales.
- VIII. S Command. S stops the execution of the output graphics and ends the entire CFRAME run.

APPENDIX A: SAMPLE PROBLEMS

Note: These problems were run on the Boeing Computer Services CDC CYBER 175 system.

Sample Problem 1

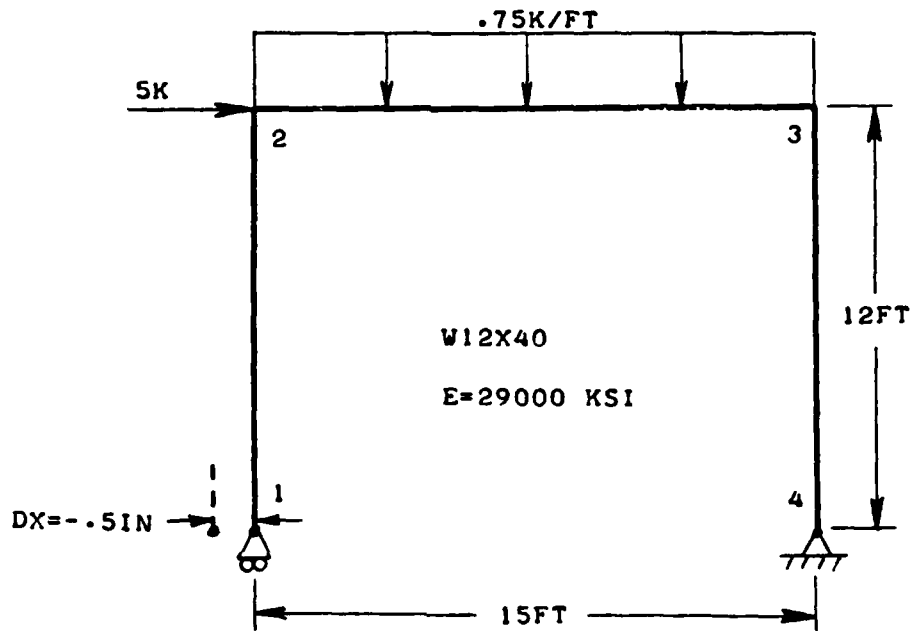

Input Data

NOTE THAT THE UNITS COMMAND HAS BEEN OMITTED
THEREFORE CONSISTENT UNITS ARE USED AND
NO UNITS LABELS APPEAR IN THE OUTPUT

Data Group

I	00100 CFRAME SAMPLE PROBLEM 1
III	00110 4 3 1 29000. .3
IV	00120 1 0. 0. 2 0. 144. 3 180. 144. 4 180. 0.
VI	00130 FIX X 4 FIX Y 1 4
VII	00140 SD -.5 0. 0. 1
VIII	00150 1 1 2 2 2 3 3 3 4
XI	00160 310. 11.8 0. 1 2 3
XIII	00170 LOAD CASE 1 0 1 0 1
XV	00180 0. .0625 180. .0625 0. 2
XVII	00190 5. 0. 0. 2

```

ENTER DATA FILE NAME--7 CHARS MAX
I>CFR251
DO YOU WANT TO USE INPUT GRAPHICS, OUTPUT GRAPHICS ?
ENTER 2 ANSWERS (Y/N)
I>N N
DO YOU WANT OUTPUT
WRITTEN TO THE TERMINAL, A FILE, OR BOTH ?
ENTER T F OR B
I>F
ENTER PRINT FILE NAME--7 CHARS MAX
I>CFR201
DO YOU WANT AN INPUT ECHO OF
JOINT DATA, MEMBER DATA, LOAD DATA ?
ENTER 3 ANSWERS (Y/N)
I>Y Y Y
DO YOU WANT THE OUTPUT TO INCLUDE
DISPLACEMENTS,
REACTIONS,
MEMBER FORCES GROUPED BY LOAD CASE,
MEMBER FORCES GROUPED BY MEMBER ?
ENTER 4 ANSWERS (Y/N)
I>Y Y Y N
DO YOU WANT OUTPUT FOR ALL LOAD CASES?
ENTER Y OR N
I>Y
I>OUTPUT FILE SAVED- CFR201
.101 CP SECONDS EXECUTION TIME
C>OLD,CFR201
C>LIST
12-X-X-X-X-X-X-X-X-X-X-X-X-X-X-X
PROGRAM CFRAME U02.00 14JUL82
X-X-X-X-X-X-X-X-X-X-X-X-X-X-X

```

```

RUN DATE = 82/09/08.
RUN TIME = 12.34.38.

```

CFRAME SAMPLE PROBLEM 1

1 *** JOINT DATA ***

JOINT	X	Y	FIXITY						
			X	Y	R	KX	KY	KR	
1	0.00	0.00			X				
2	0.00	144.00							
3	180.00	144.00							
4	180.00	0.00	X	X					

SPECIFIED DISPLACEMENTS

JOINT	DX	DY	DR
1	-.5000E+00		

1 *** MEMBER DATA ***

MEMBER	END END		LENGTH	I	A	AS	E	G
	A	B						
1	1	2	144.00	.3100E+03	.1180E+02	0.	.2900E+05	.1115E+05
2	2	3	180.00	.3100E+03	.1180E+02	0.	.2900E+05	.1115E+05
3	3	4	144.00	.3100E+03	.1180E+02	0.	.2900E+05	.1115E+05

1 222 LOAD CASE 1

MEMBER	LA	PA	LB	PB	ANGLE
2	0.00	.6250E-01	180.00	.6250E-01	0.00

JOINT	FORCE X	FORCE Y	MOMENT
2	.5000E+01	0.	0.

1 LOAD CASE 1

JOINT	JOINT DISPLACEMENTS		
	DX	DY	DR
1	-.5000E+00	0.	-.5853E-02
2	.2031E+00	-.6838E-03	-.2943E-02
3	.2018E+00	-.4050E-02	-.5028E-03
4	0.	0.	-.2354E-02

MEMBER END FORCES						
MEMBER	JOINT	AXIAL	SHEAR	MOMENT	MOMENT EXTREMA	LOCATION
1	1	-.1625E+01	.2523E+01	0.	.3633E+03	144.00
	2	-.1625E+01	-.2523E+01	.3633E+03	0.	0.00
2	2	-.2477E+01	.1625E+01	.3633E+03	.3844E+03	25.20
	3	-.2477E+01	.9625E+01	-.3567E+03	-.3567E+03	180.00
3	3	-.9625E+01	.2477E+01	-.3567E+03	0.	144.00
	4	-.9625E+01	-.2477E+01	0.	-.3567E+03	0.00

JOINT	STRUCTURE REACTIONS		
	FORCE X	FORCE Y	MOMENT
1	-.2523E+01	.1625E+01	0.
4	-.2477E+01	.9625E+01	0.

 TOTAL -.5000E+01 .1125E+02
 C>

Hand Solution

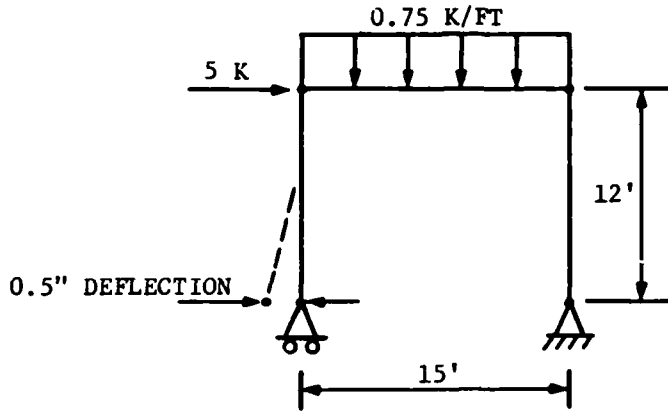

ALL MEMBERS = W12 x 40
 $I = 310 \text{ in}^4$
 $A = 11.8 \text{ in}^2$
 $E = 29,000 \text{ ksi}$

DIVIDE THE PROBLEM INTO 3 CASES, SOLVE, THEN ADD THE RESULTS.

CASE I = PINNED SUPPORTS WITH DISTRIBUTED LOAD ONLY

CASE II = PINNED SUPPORTS WITH LATERAL LOAD ONLY

CASE III = SPECIFIED DEFLECTION AT LEFT SUPPORT, NO LOADS

CASE I - BY MOMENT DISTRIBUTION

DIST. FACTOR*	.484	.516	.516	.484
F. E. MOMENT		14.06	-14.06	
	-6.80	-7.26	-3.63	
		4.56	9.13	8.56
	-2.21	-2.35	-1.18	
		.30	.61	.57
	-.15	-.15	-.08	
		.02	.04	.04
	-9.16 Ft-K	9.18	-9.17	9.17

$$\begin{aligned}
 \text{*DISTRIBUTION FACTOR} &= K_2 \div (K_1 + K_2) = \frac{4EI}{L_2} \div \left(\frac{3EI}{L_1} + \frac{4EI}{L_2} \right) = 4/15 \div (3/12 + 4/15) \\
 &= .516
 \end{aligned}$$

PINNED END \curvearrowright \curvearrowleft FIXED END

CASE I (CONT)

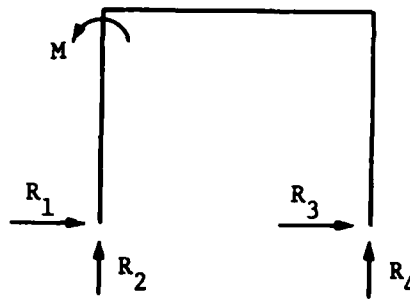

$$R_2 = R_4 = 1/2 (.75) 15 = \underline{5.63K}$$

$$R_1 = -R_3 = -M/L = 9.17/12 = \underline{.76K}$$

CASE II

5K APPLIED LOAD WILL BE REACTED EQUALLY AT EACH SUPPORT

$$R_1 = R_3 = -5/2 = \underline{-2.50K}$$

$$R_2 = -R_4 = -5 \times 12/15 = \underline{-4.00K}$$

$$M = RL = 2.50 \times 12 = \underline{30 \text{ FT-K}}$$

CASE III

REPRESENT THIS CASE AS A SYMMETRICAL CONDITION WITH $R_1 = -R_3 = -P$ AND WITH .25" DEFLECTION ON EACH SIDE OF THE FRAME \underline{E} , AS SHOWN BELOW

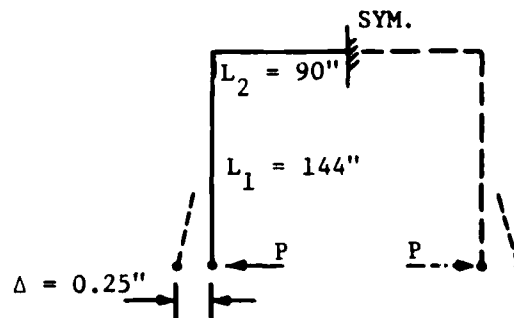

A5

CASE III (CONT)

$$\Delta = \frac{PL_1^3}{3EI} + L_1 \times \theta \quad \text{WHERE } \theta = \text{ } \text{ OF BEND OF TOP BEAM}$$
$$\theta = \frac{ML_2^2}{EI} = \frac{PL_1L_2}{EI}$$

$$\Delta = \frac{PL_1^3}{3EI} + \frac{PL_1^2L_2}{EI} = \frac{PL_1^2}{EI} [(L_1/3) + L_2]$$

$$\rho = \frac{EIA}{L_1^2[(L_1/3) + L_2]} = \frac{29000 \times 310 \times .25}{144^2 (48 + 90)} = .785K$$

$$M = PL = .785 \times 12 = \underline{9.42 \text{ FT-K}}$$

$$R_1 = -R_3 = \underline{-.79K}$$

HAND SOLUTION RESULTS vs CFRAME (in parentheses)

$$R_1 = .76 - 2.50 - .79 = -2.53K \quad (-2.52K)$$

$$R_2 = 5.63 - 4.00 = 1.63K \quad (1.62K)$$

$$R_3 = -.76 - 2.50 + .79 = -2.47K \quad (-2.48K)$$

$$R_4 = 5.63 + 4.00 = 9.63K \quad (9.62K)$$

$$M = (-9.17 + 30.00 + 9.42) 12 = 363 \text{ IN-K} \quad (363 \text{ IN-K}) \quad (30.25 \text{ FT-K})$$

Sample Problem 2

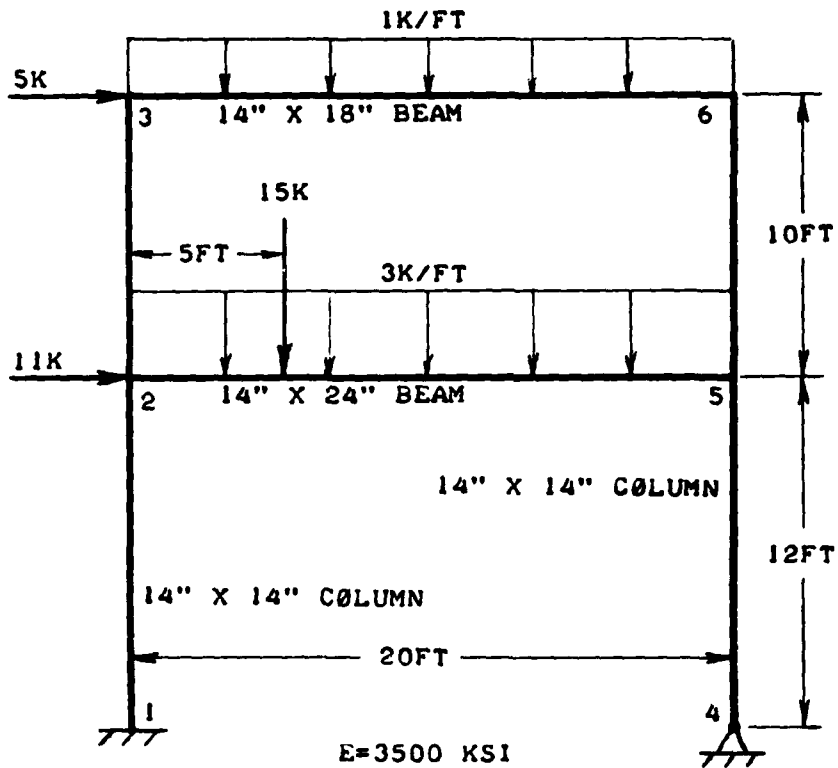

Input Data

Data Group

I	00100 CFRAME SAMPLE PROBLEM 2
II	00110 KSI FT IN IN KIP
III	00120 6 6 1 3500. .15
IV	00130 1 0. 0. 2 0. 12. 3 0. 22. 4 20. 0.
	00140 5 20. 12. 6 20. 22.
VI	00150 FIX X 1 4 FIX Y 1 4 FIX R 1
VIII	00160 1 1 2 2 2 3 3 4 5 4 5 6 5 2 5 6 3 6
	00170 0 14 14 1 TO 4
XI	00180 0 14 24 5
	00190 0 14 18 6
XIII	00200 LOAD CASE 1 2 0 1 2 DEAD LOAD
XIV	00210 Y -3.0 5
	00220 Y -1.0 6
XVI	00230 1 5. 15. 0. 5
XVII	00240 11. 0. 0. 2
	00250 5. 0. 0. 3

```

ENTER DATA FILE NAME--7 CHARS MAX
I>CFR252
DO YOU WANT TO USE INPUT GRAPHICS, OUTPUT GRAPHICS ?
ENTER 2 ANSWERS (Y/N)
I>N N
DO YOU WANT OUTPUT
WRITTEN TO THE TERMINAL, A FILE, OR BOTH ?
ENTER T F OR B
I>F
ENTER PRINT FILE NAME--7 CHARS MAX
I>CFR202
DO YOU WANT AN INPUT ECHO OF
JOINT DATA, MEMBER DATA, LOAD DATA ?
ENTER 3 ANSWERS (Y/N)
I>Y Y Y
DO YOU WANT THE OUTPUT TO INCLUDE
DISPLACEMENTS,
REACTIONS,
MEMBER FORCES GROUPED BY LOAD CASE,
MEMBER FORCES GROUPED BY MEMBER ?
ENTER 4 ANSWERS (Y/N)
I>Y Y Y N
DO YOU WANT OUTPUT FOR ALL LOAD CASES?
ENTER Y OR N
I>Y
1OUTPUT FILE SAUED= CFR202
      .158 CP SECONDS EXECUTION TIME
C>OLD,CFR202
C>LIST
1X-X-X-X-X-X-X-X-X-X-X-X-X
PROGRAM CFRAME V02.00 14JUL82
X-X-X-X-X-X-X-X-X-X-X-X-X

```

```

RUN DATE = 82/09/08.
RUN TIME = 12.37.41.

```

CFRAME SAMPLE PROBLEM 2

1 *** JOINT DATA ***

JOINT	X ---FT---	Y	FIXITY			KX ---KIP/IN---	KY	KR IN-KIP/RAD
			X	Y	R			
1	0.00	0.00	X	X	X			
2	0.00	12.00						
3	0.00	22.00						
4	20.00	0.00	X	X				
5	20.00	12.00						
6	20.00	22.00						

1 *** MEMBER DATA ***

MEMBER	END END		LENGTH FT	I IN**4	A IN**2	AS IN**2	E KSI	G KSI
	A	B						
1	1	2	12.00	.3201E+04	.1960E+03	.1960E+03	.3500E+04	.1522E+04
2	2	3	10.00	.3201E+04	.1960E+03	.1960E+03	.3500E+04	.1522E+04
3	4	5	12.00	.3201E+04	.1960E+03	.1960E+03	.3500E+04	.1522E+04
4	5	6	10.00	.3201E+04	.1960E+03	.1960E+03	.3500E+04	.1522E+04
5	2	5	20.00	.1613E+05	.3360E+03	.3360E+03	.3500E+04	.1522E+04
6	3	6	20.00	.6304E+04	.2520E+03	.2520E+03	.3500E+04	.1522E+04

1 *** LOAD CASE 1 DEAD LOAD

MEMBER	DIRECTION	PROJECTED LOAD KIP/FT
5	Y	-.3000E+01
6	Y	-.1000E+01

MEMBER	L FT	P KIP	ANGLE DEG
5	5.00	.1500E+02	0.00

JOINT	FORCE X KIP	FORCE Y KIP	MOMENT FT-KIP
2	.1100E+02	0.	0.
3	.5000E+01	0.	0.

1 LOAD CASE 1 DEAD LOAD

JOINT	JOINT DISPLACEMENTS		
	DX IN	DY IN	DR RAD
1	0.	0.	0.
2	.3973E+00	-.9012E-02	-.2340E-02
3	.4951E+00	-.1049E-01	-.5401E-03
4	0.	0.	-.4570E-02
5	.3983E+00	-.1093E-01	.9029E-03
6	.4922E+00	-.1295E-01	-.1150E-03

MEMBER END FORCES

MEMBER	JOINT	AXIAL KIP	SHEAR KIP	MOMENT IN-KIP	MOMENT EXTREMA IN-KIP	LOCATION IN
1	1	-.4293E+02	.1008E+02	-.9082E+03	.5440E+03	144.00
	2	-.4293E+02	-.1008E+02	.5440E+03	-.9082E+03	0.00
2	2	-.8446E+01	-.5656E+01	.5074E+03	.5074E+03	0.00
	3	-.8446E+01	.5656E+01	-.1713E+03	-.1713E+03	120.00
3	4	-.5207E+02	.5915E+01	0.	.8518E+03	144.00
	5	-.5207E+02	-.5915E+01	.8518E+03	0.	0.00
4	5	-.1155E+02	.1066E+02	-.7344E+03	.5443E+03	120.00
	6	-.1155E+02	-.1066E+02	.5443E+03	-.7344E+03	0.00
5	2	.4741E+01	.3449E+02	.3662E+02	.2415E+04	139.20
	5	.4741E+01	-.4051E+02	-.1586E+04	-.1586E+04	240.00
6	3	-.1066E+02	.8446E+01	-.1713E+03	.2567E+03	100.80
	6	-.1066E+02	.1155E+02	-.5443E+03	-.5443E+03	240.00

JOINT	STRUCTURE REACTIONS		
	FORCE X KIP	FORCE Y KIP	MOMENT IN-KIP
1	-.1008E+02	.4293E+02	.9082E+03
4	-.5915E+01	.5207E+02	0.

TOTAL - .1600E+02 .9500E+02
C>

Sample Problem 3

INPUT DATA FILE (CFR2S3)

```

DATA
GROUP
I      00100 CFRAME SAMPLE PROBLEM 3*
      00110 THREE STORY FRAME
II     00120 KSI FT IN IN KIP
III    00130 19 28 2 29000. .3
IV     00140 1 0. 0. 5 40. 0. 19 30. 36.
      00150 16 0. 36. 15 40. 24. 10 40. 12.
V      00160 GJ 1 16 5 GJ 1 5 1 GJ 3 10 1 GJ 11 15 1 GJ 16 19 1
VI     00170 FIX X 1 TO 4 FIX Y 1 2 3 5 FIX R 2 FIX KR 8700. 3
      00180 FIX KX 700. 5 6 FIX KY 500. 11 FIX KZ 20000. 4
VIII   00190 26 19 15 27 3 12 26 11 17
IX     00200 GM 1 1 6 14 1 1 GM 15 6 7 4 1 1
      00210 GM 19 11 12 4 1 1 GM 23 16 17 3 1 1
X      00220 FIN A 27 28 FIN B 10 10 14 26 27 28
XI     00230 96.3 5.61 0. 1 TO 14
      00240 156. 6.47 0. 15 TO 22
      00250 66.9 4.41 0. 23 TO 26
      00260 2.49 9.80 0. 27 28
XII    00270 E 30000. .33 23 TO 26
XIII   00280 LOAD CASE 1 1 2 VERTICAL LOADS
XIV    00290 Y -1.6 15 TO 22
XV     00300 0. .7 10. 1.3 0. 23 24 25
      00310 0. .448 15.62 .448 50.12 26
XIII   00320 LOAD CASE 2 1 2 1 2 1 MIXED LOADS
XIV    00330 X .4 1 3 6 8 11
XV     00340 2. .4 6. .4 20. 17 18
      00350 3. 0. 8. -.3 0. 17 18
XVI    00360 2 3.3 2. -20. 6.7 3. 0. 23 24
XVII   00370 3. 0. 0. 10 15
      00380 0. -5. -18. 19
XVIII  00390 .0000065 50. 28 23
XIX    00400 COMBINATION 3 4 1. 2 1.5
XIX    00410 COMB 14 4 .75 2 -.5 COMB. LOADS
  
```

```

ENTER DATA FILE NAME--7 CHARS MAX
I>CFR2S3
DO YOU WANT TO USE INPUT GRAPHICS, OUTPUT GRAPHICS ?
ENTER 2 ANSWERS (Y/N)
I>Y Y
ENTER TERMINAL SPEED (30,120,960,ETC).
I>120
DO YOU WANT OUTPUT
WRITTEN TO THE TERMINAL, A FILE, OR BOTH ?
ENTER T F OR B
I>F
ENTER PRINT FILE NAME--7 CHARS MAX
I>CFR203
PRINT FILE ALREADY EXISTS
DO YOU WANT TO WRITE OVER IT (Y/N) ?
I>Y
DO YOU WANT AN INPUT ECHO OF
JOINT DATA, MEMBER DATA, LOAD DATA ?
ENTER 3 ANSWERS (Y/N)
I>Y Y Y
DO YOU WANT THE OUTPUT TO INCLUDE
DISPLACEMENTS,
REACTIONS,
MEMBER FORCES GROUPED BY LOAD CASE,
MEMBER FORCES GROUPED BY MEMBER ?
ENTER 4 ANSWERS (Y/N)
I>Y N Y
DO YOU WANT OUTPUT FOR ALL LOAD CASES?
ENTER Y OR N
I>Y
  
```

"N" COMMAND

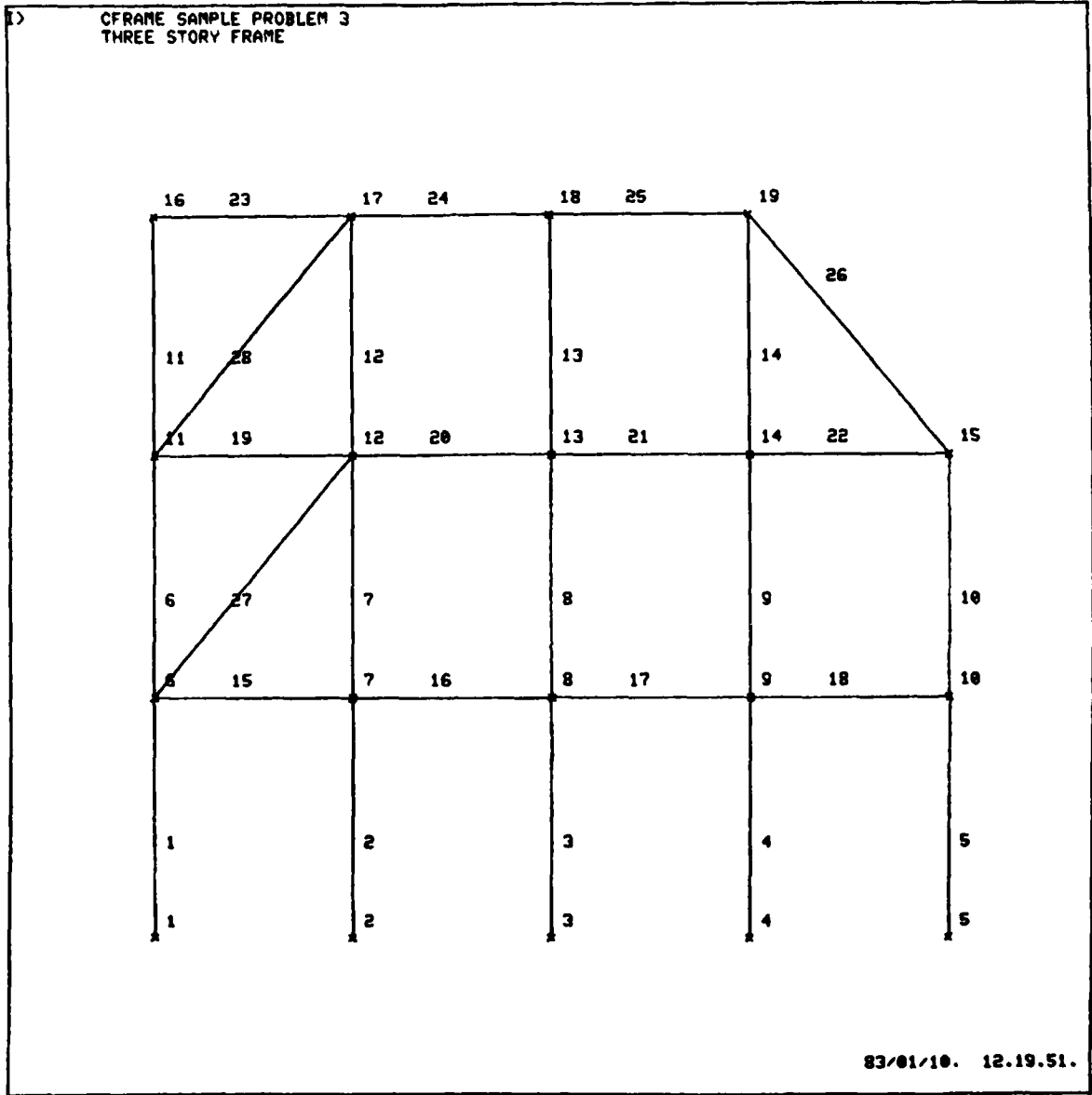

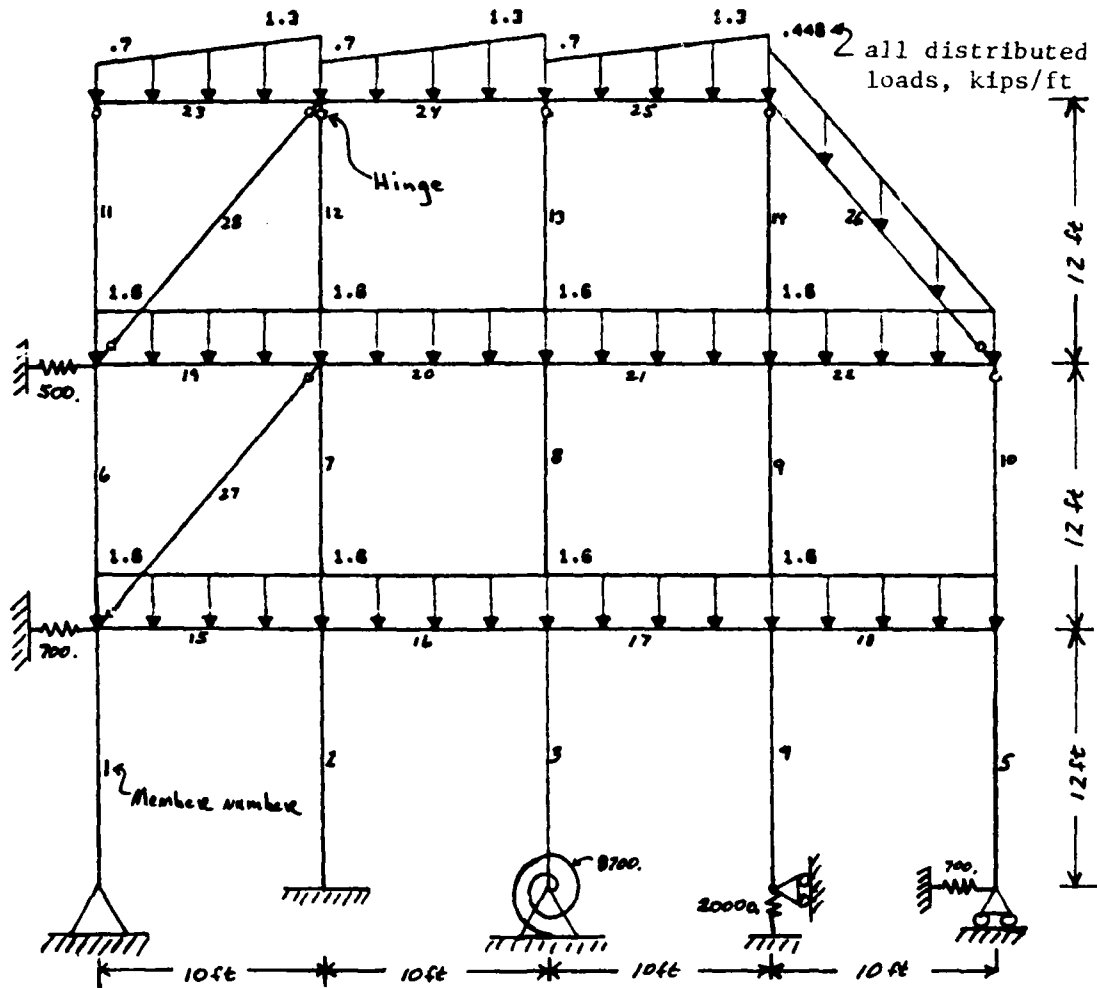

Example Problem 3 - Load Case No. 4

"F" COMMAND

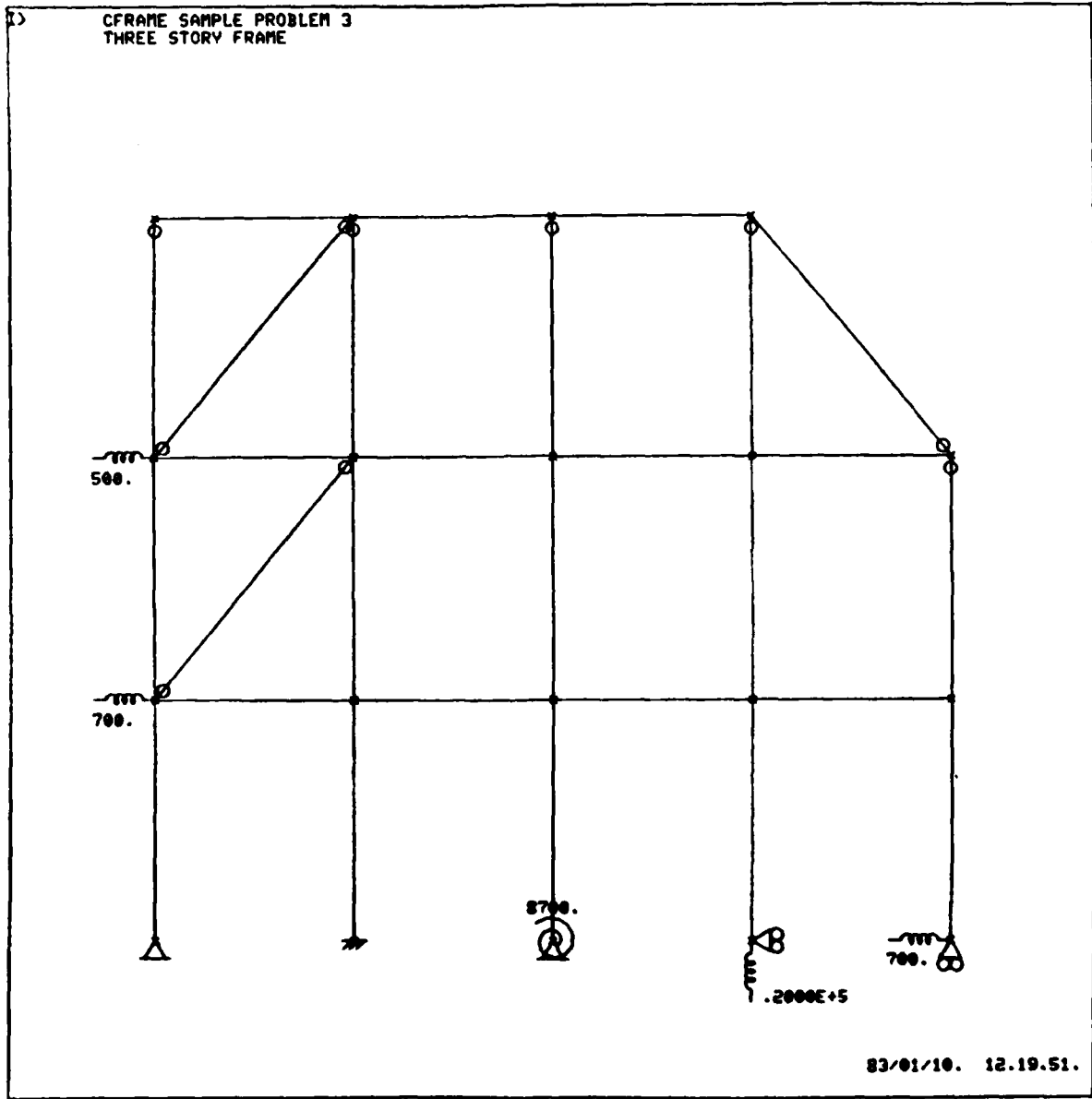

"L 4" COMMAND

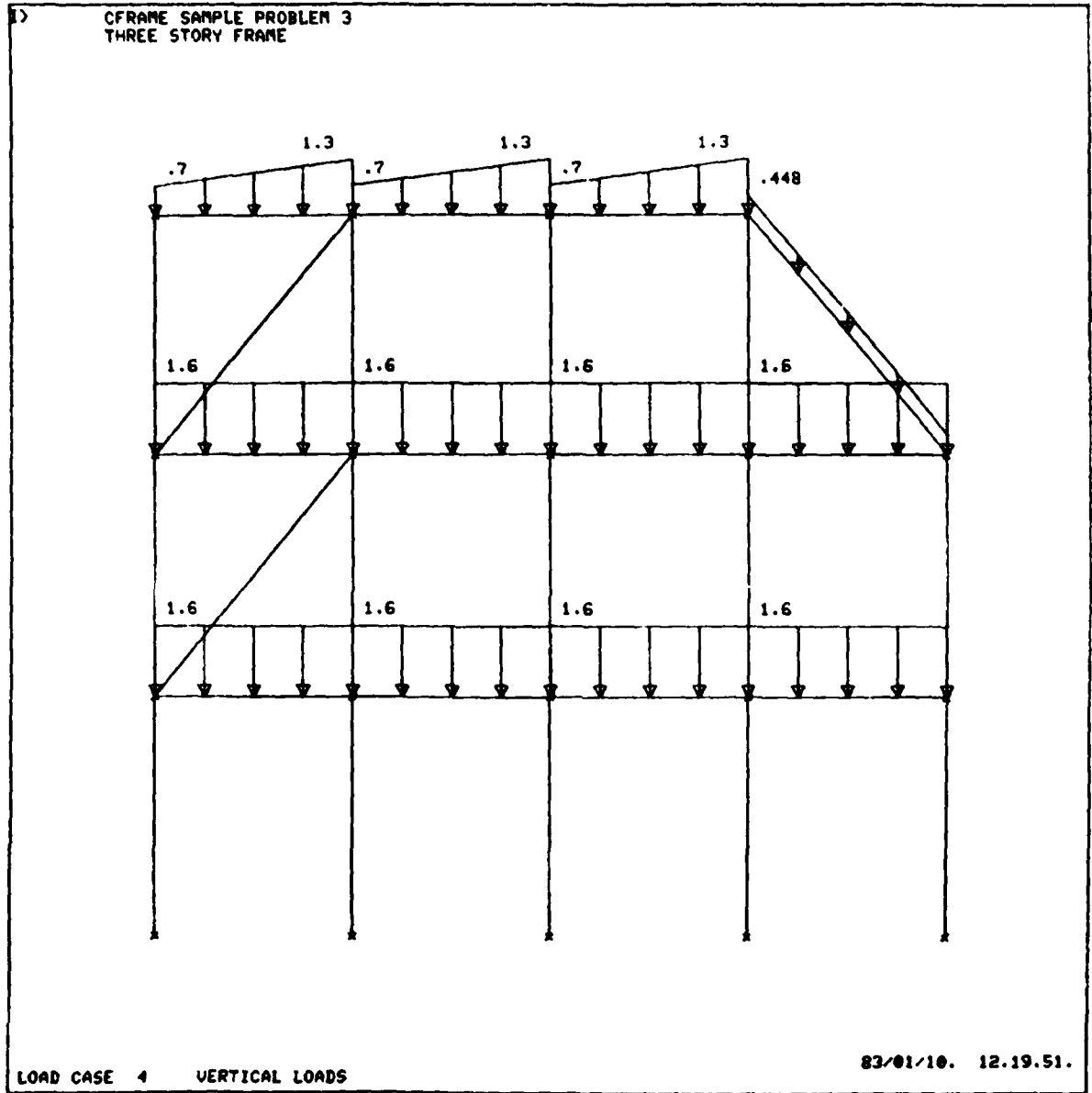

OUTPUT FILE SAVED= CFRS03

ENTER OUTPUT GRAPHICS COMMAND

"L 4" PLUS "D" COMMANDS

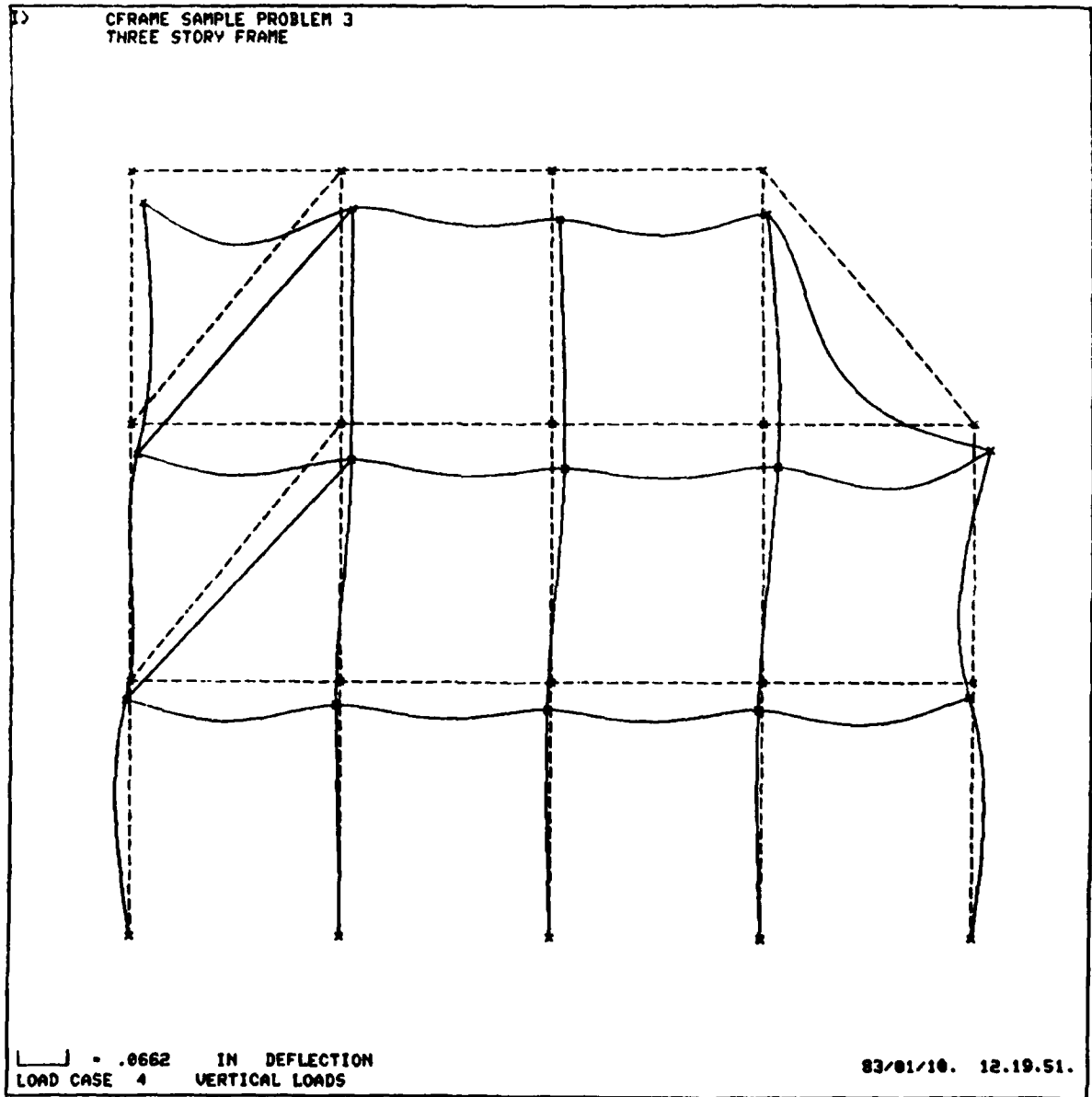

"M" COMMAND

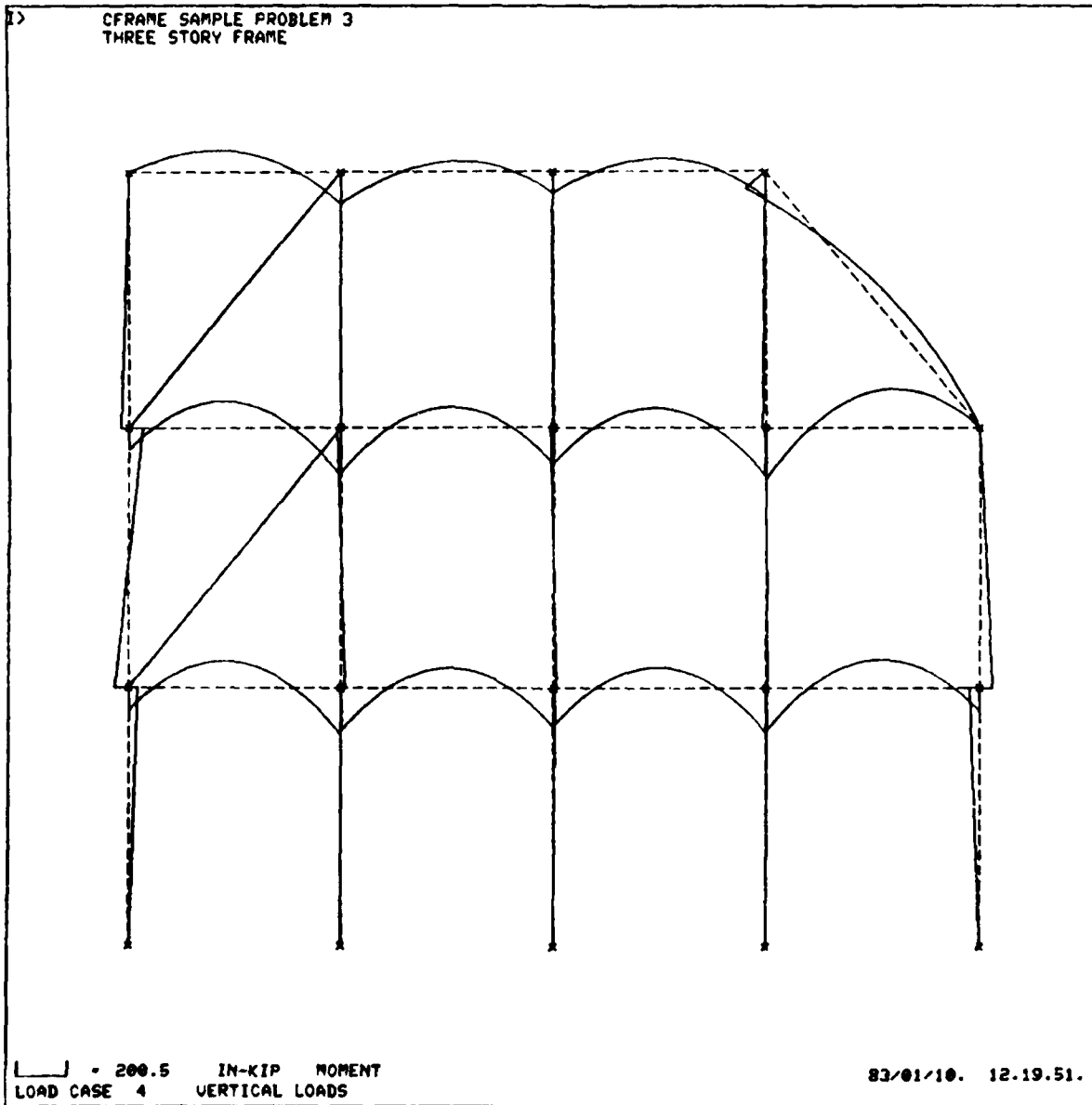

"I 24" COMMAND

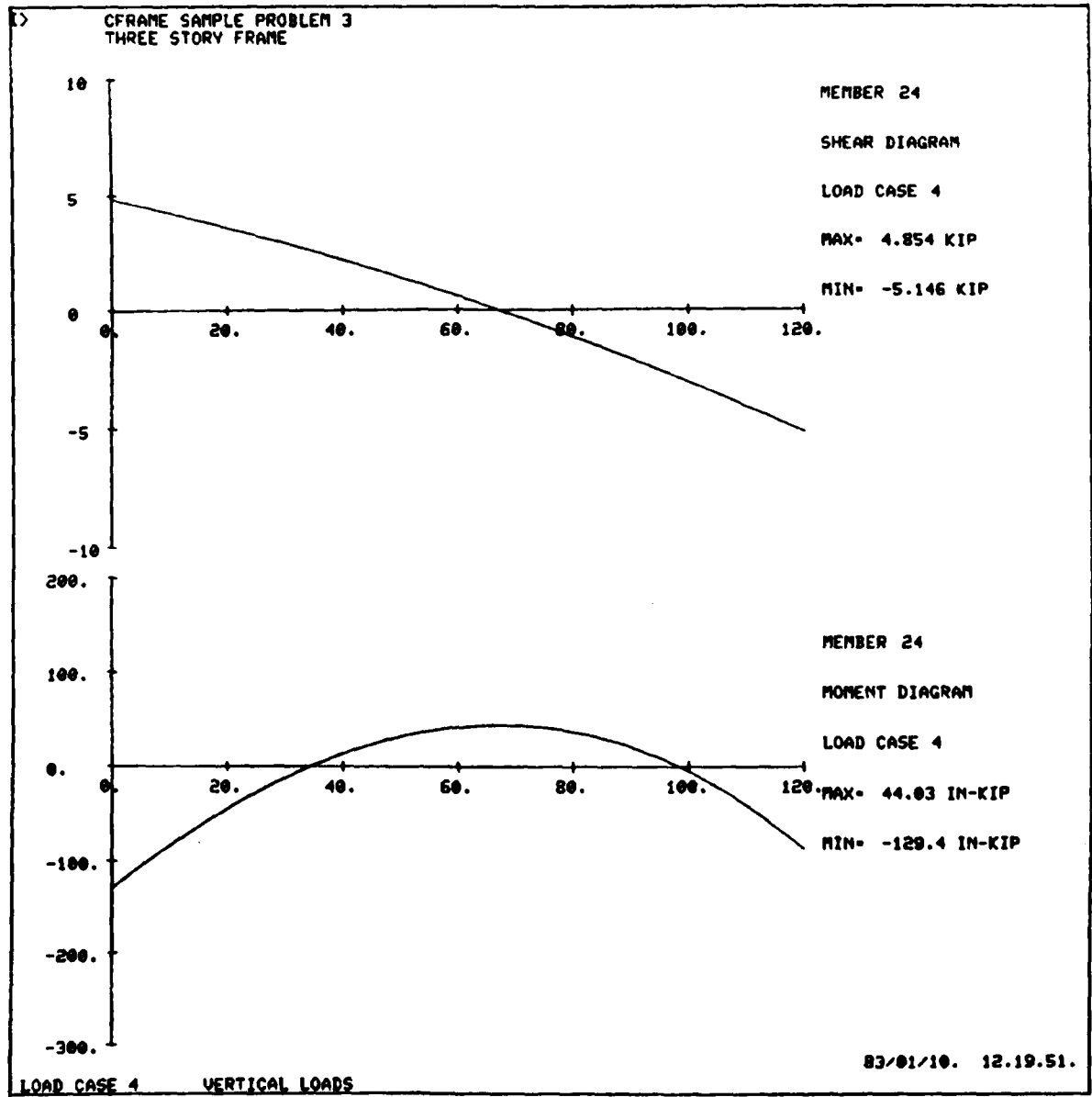

"L 2" PLUS "V" COMMANDS

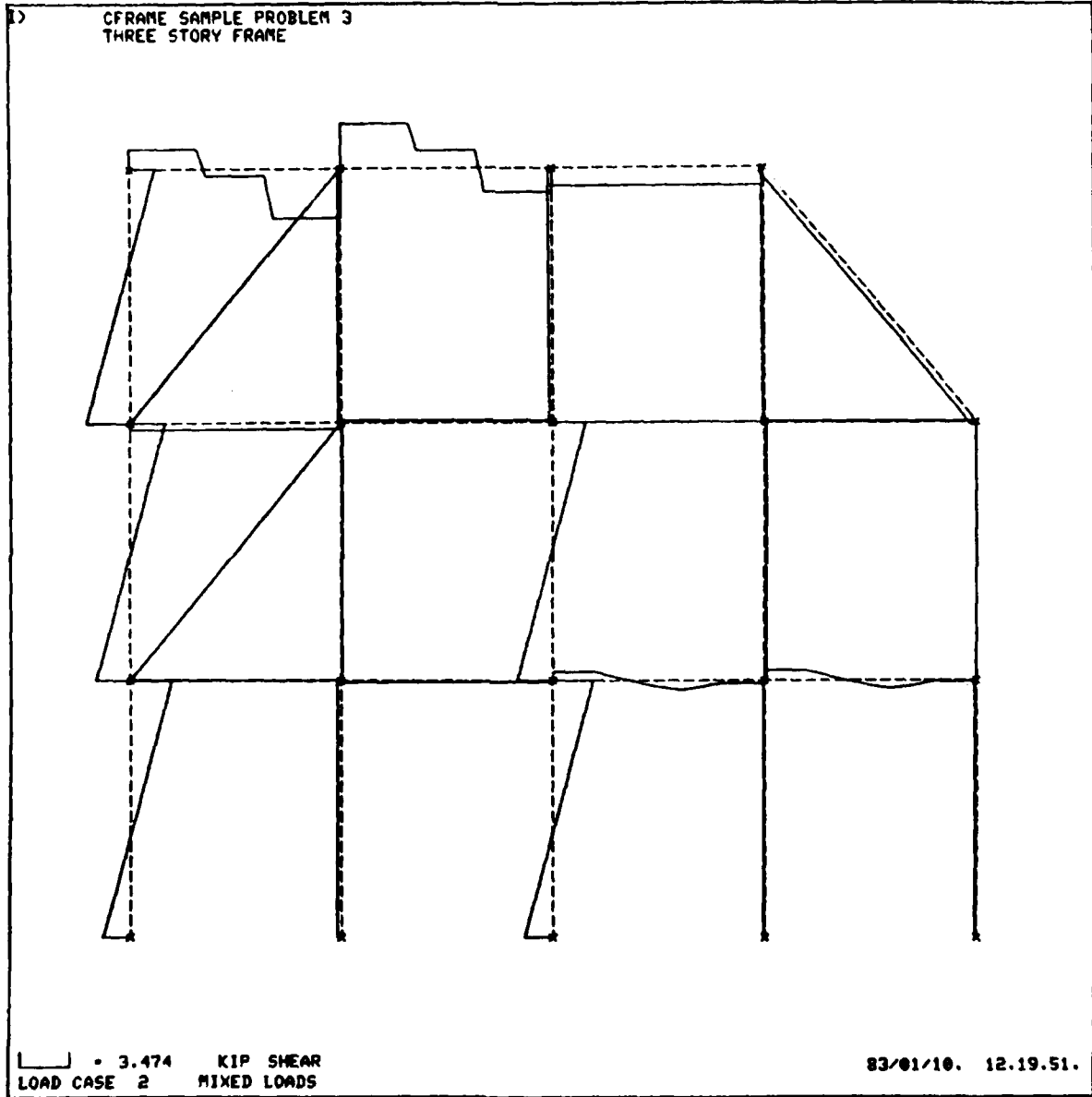

"M" COMMAND

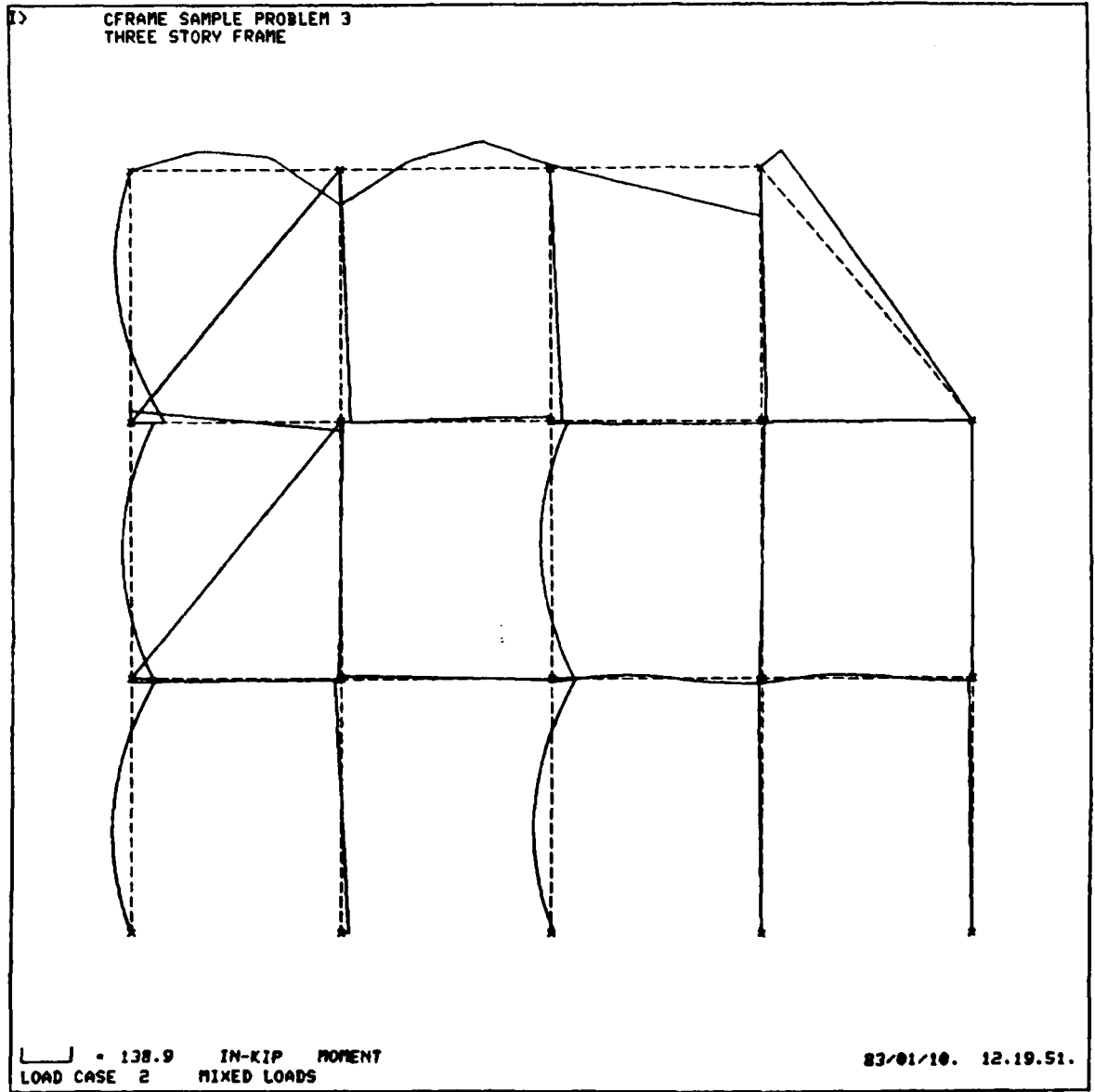

"D" COMMAND

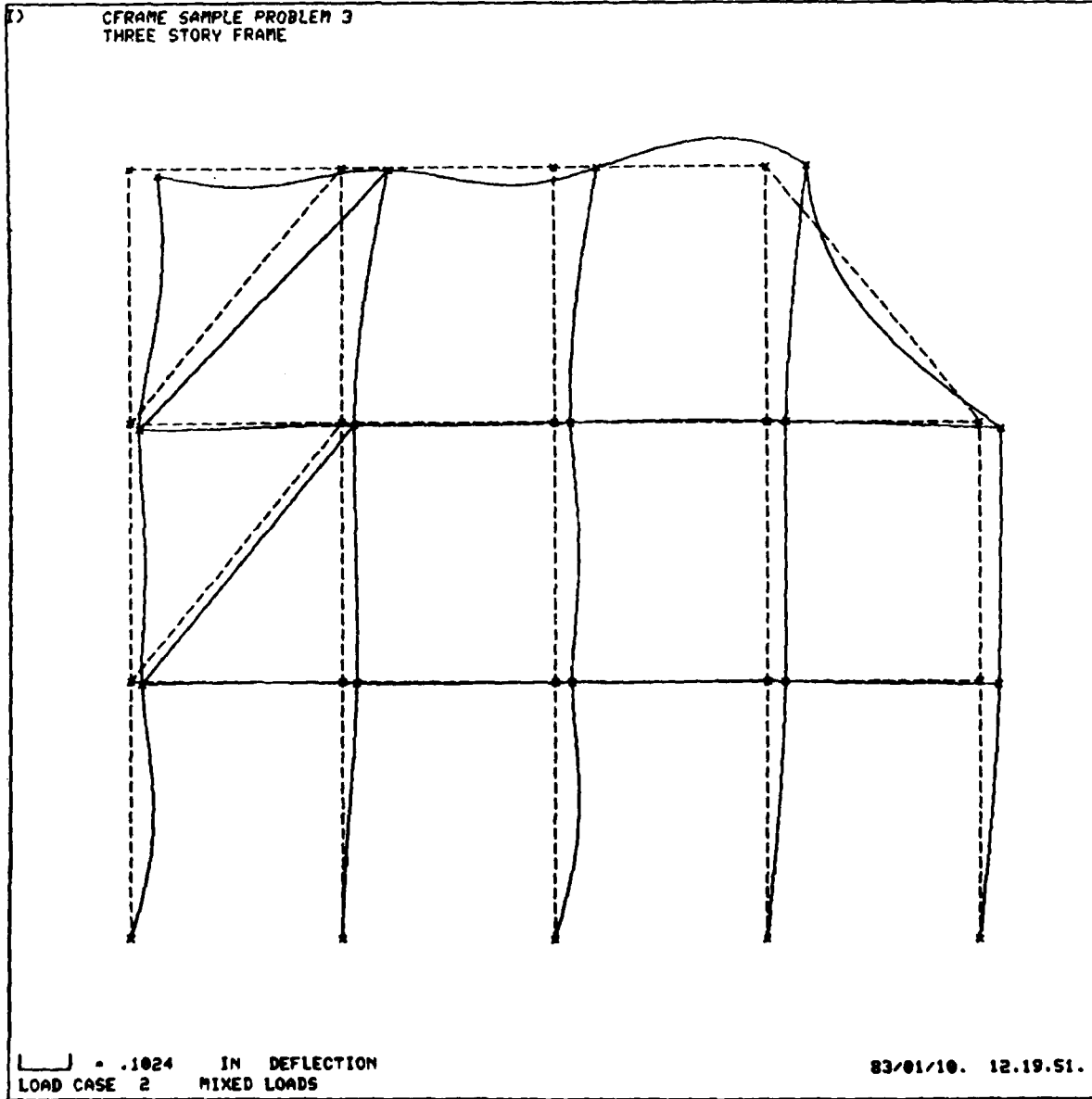

"I 24" COMMAND

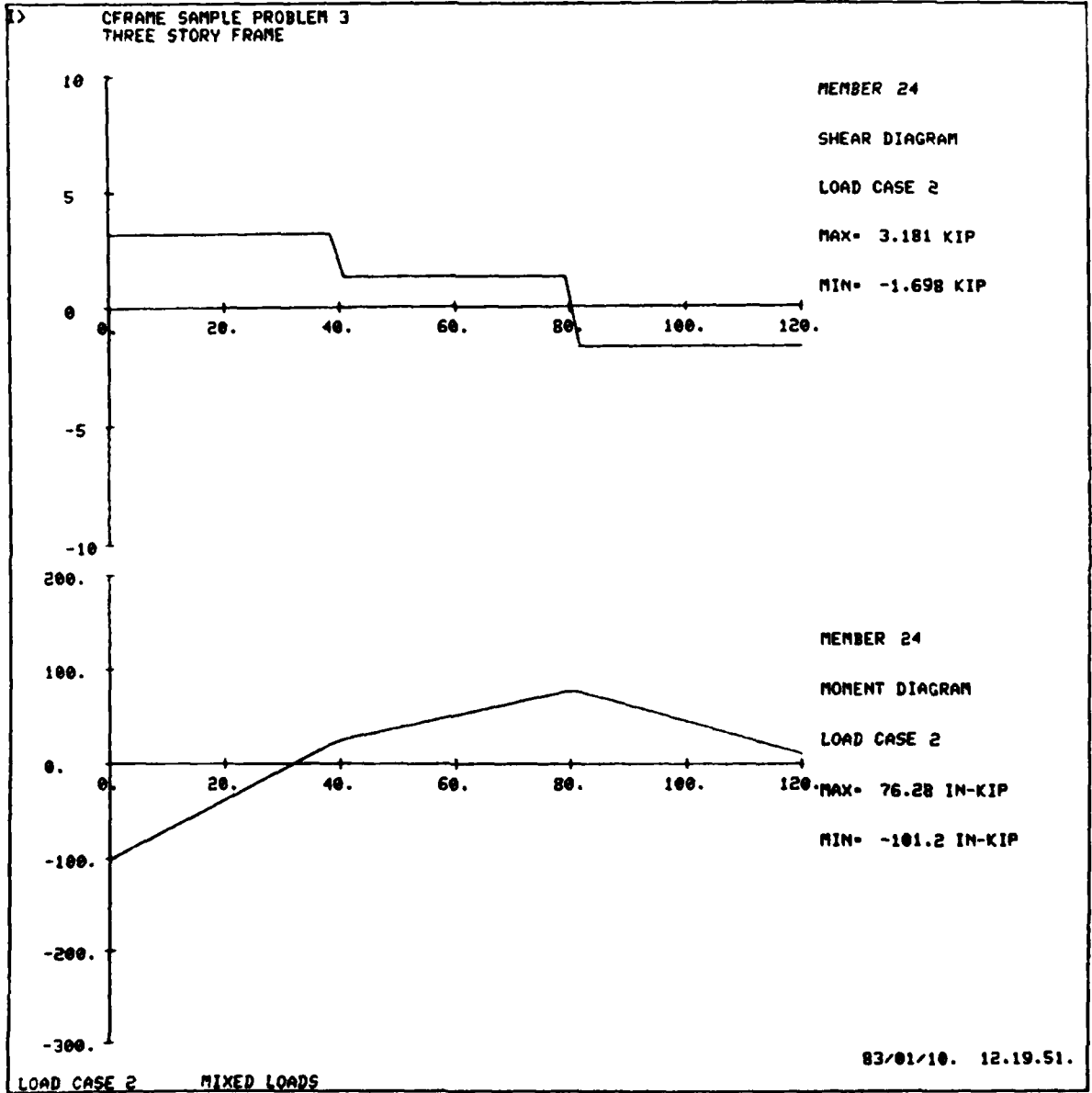

"L 3" PLUS "M" COMMANDS

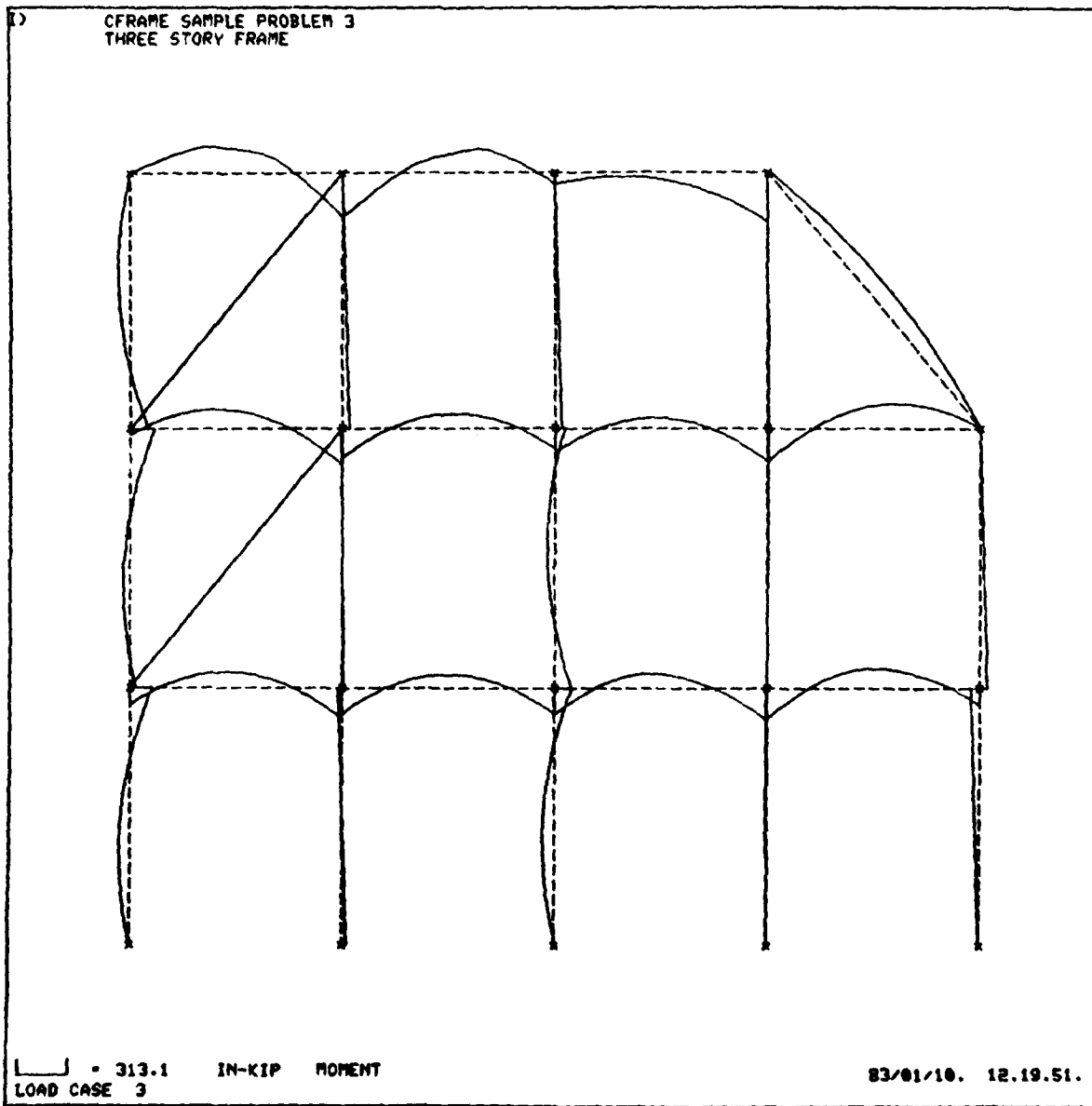

"I 24" COMMAND

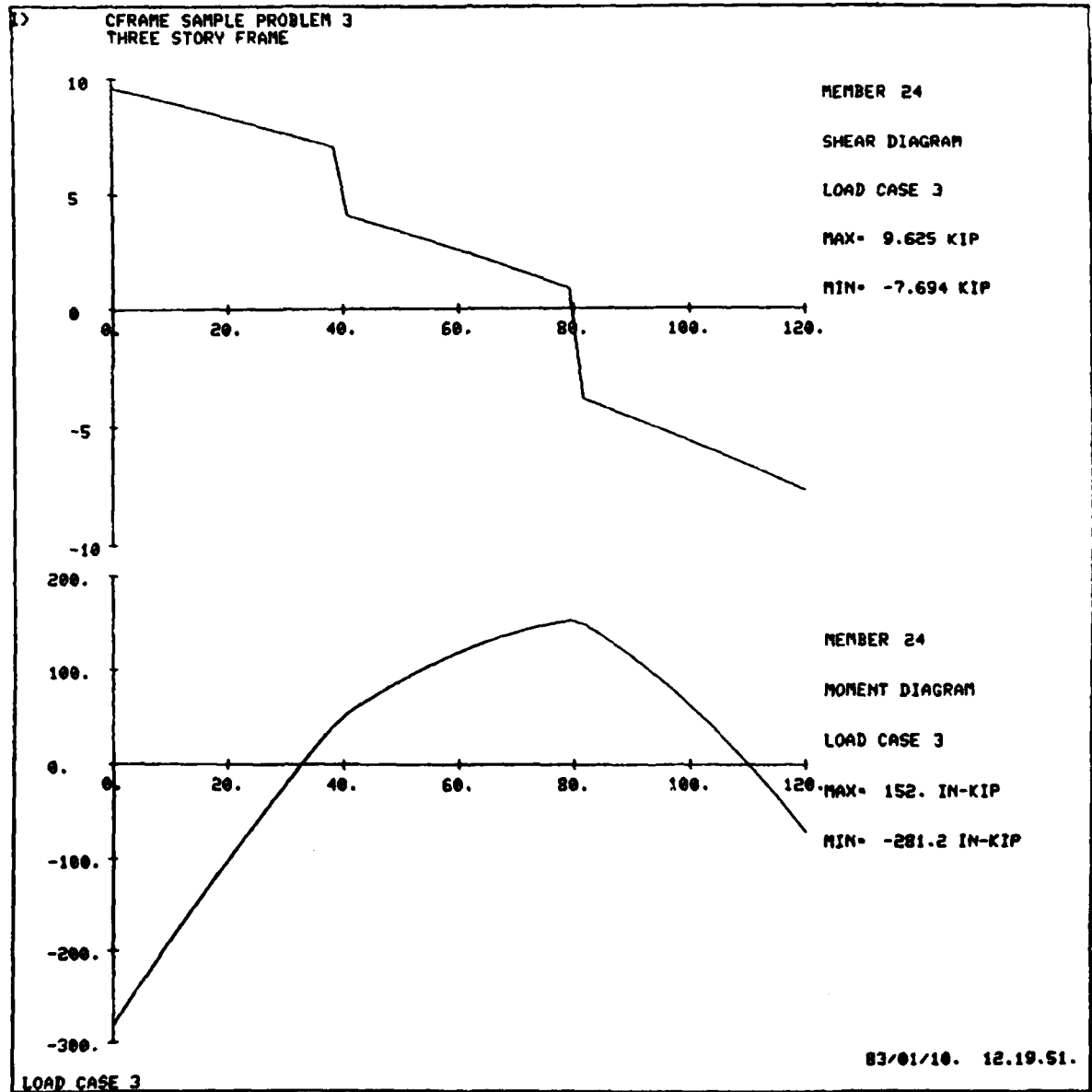

"L 14" PLUS "D" COMMANDS

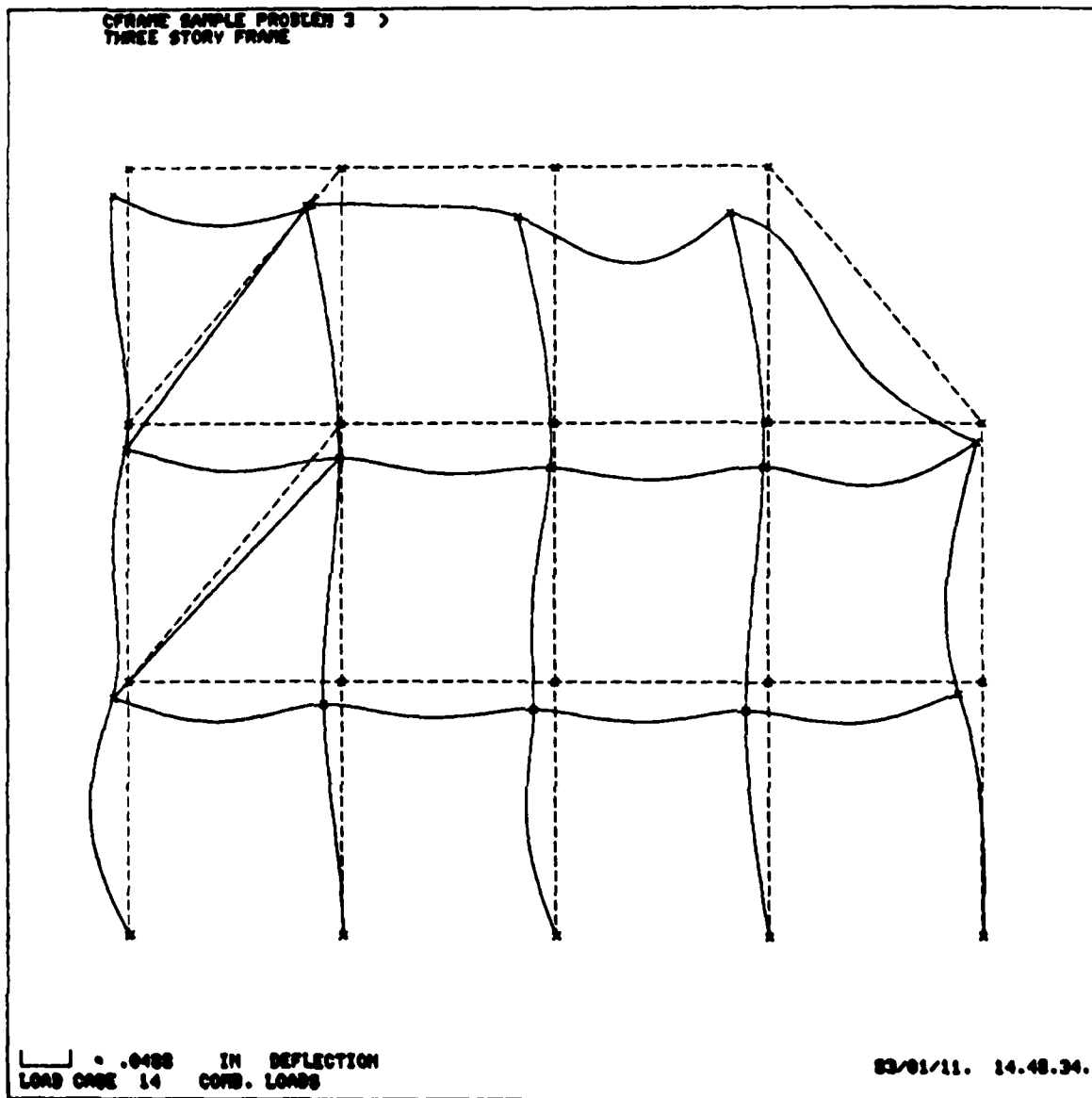

"S" COMMAND STOPS THE PROGRAM

Sample Problem 3 Output File (CFR203)

```
*-*-*-*-*-*-*-*-*-*-*
PROGRAM CFRAME V02.00 10JAN83
*-*-*-*-*-*-*-*-*-**
```

```
RUN DATE = 83/01/10.
RUN TIME = 12.19.51.
```

```
CFRAME SAMPLE PROBLEM 3
THREE STORY FRAME
```

*** JOINT DATA ***

JOINT	X -----FT-----	Y	FIXITY			KX -----KIP/IN-----	KY	KR IN-KIP/RAD
			X	Y	R			
1	0.00	0.00	*	*				
2	10.00	0.00	*	*	*			
3	20.00	0.00	*	*			.870E+04	
4	30.00	0.00	*			.200E+05		
5	40.00	0.00		*		.700E+03		
6	0.00	12.00				.700E+03		
7	10.00	12.00						
8	20.00	12.00						
9	30.00	12.00						
10	40.00	12.00						
11	0.00	24.00				.500E+03		
12	10.00	24.00						
13	20.00	24.00						
14	30.00	24.00						
15	40.00	24.00						
16	0.00	36.00						
17	10.00	36.00						
18	20.00	36.00						
19	30.00	36.00						

*** MEMBER DATA ***

MEMBER	END A	END B	LENGTH FT	I IN**4	A IN**2	AS IN**2	E KSI	G KSI
1	1	6	12.00	.9630E+02	.5610E+01	0.	.2900E+05	.1115E+05
2	2	7	12.00	.9630E+02	.5610E+01	0.	.2900E+05	.1115E+05
3	3	8	12.00	.9630E+02	.5610E+01	0.	.2900E+05	.1115E+05
4	4	9	12.00	.9630E+02	.5610E+01	0.	.2900E+05	.1115E+05
5	5	10	12.00	.9630E+02	.5610E+01	0.	.2900E+05	.1115E+05
6	6	11	12.00	.9630E+02	.5610E+01	0.	.2900E+05	.1115E+05
7	7	12	12.00	.9630E+02	.5610E+01	0.	.2900E+05	.1115E+05
8	8	13	12.00	.9630E+02	.5610E+01	0.	.2900E+05	.1115E+05
9	9	14	12.00	.9630E+02	.5610E+01	0.	.2900E+05	.1115E+05
10	10	-15	12.00	.9630E+02	.5610E+01	0.	.2900E+05	.1115E+05
11	11	-16	12.00	.9630E+02	.5610E+01	0.	.2900E+05	.1115E+05
12	12	-17	12.00	.9630E+02	.5610E+01	0.	.2900E+05	.1115E+05
13	13	-18	12.00	.9630E+02	.5610E+01	0.	.2900E+05	.1115E+05
14	14	-19	12.00	.9630E+02	.5610E+01	0.	.2900E+05	.1115E+05
15	6	7	10.00	.1560E+03	.6470E+01	0.	.2900E+05	.1115E+05
16	7	8	10.00	.1560E+03	.6470E+01	0.	.2900E+05	.1115E+05
17	8	9	10.00	.1560E+03	.6470E+01	0.	.2900E+05	.1115E+05
18	9	10	10.00	.1560E+03	.6470E+01	0.	.2900E+05	.1115E+05
19	11	12	10.00	.1560E+03	.6470E+01	0.	.2900E+05	.1115E+05
20	12	13	10.00	.1560E+03	.6470E+01	0.	.2900E+05	.1115E+05
21	13	14	10.00	.1560E+03	.6470E+01	0.	.2900E+05	.1115E+05
22	14	15	10.00	.1560E+03	.6470E+01	0.	.2900E+05	.1115E+05
23	16	17	10.00	.6890E+02	.4410E+01	0.	.3000E+05	.1128E+05
24	17	18	10.00	.6890E+02	.4410E+01	0.	.3000E+05	.1128E+05
25	18	19	10.00	.6890E+02	.4410E+01	0.	.3000E+05	.1128E+05
26	19	-15	15.62	.6890E+02	.4410E+01	0.	.3000E+05	.1128E+05
27	-6	-12	15.62	.2490E+01	.9800E+01	0.	.2900E+05	.1115E+05
28	-11	-17	15.62	.2490E+01	.9800E+01	0.	.2900E+05	.1115E+05

*** LOAD CASE 4 VERTICAL LOADS

MEMBER	DIRECTION	PROJECTED LOAD KIP/FT
15	Y	-.1600E+01
16	Y	-.1600E+01
17	Y	-.1600E+01
18	Y	-.1600E+01
19	Y	-.1600E+01
20	Y	-.1600E+01
21	Y	-.1600E+01
22	Y	-.1600E+01

MEMBER	LA FT	PA KIP/FT	LB FT	PB KIP/FT	ANGLE DEG
23	0.00	.7000E+00	10.00	.1300E+01	0.00
24	0.00	.7000E+00	10.00	.1300E+01	0.00
25	0.00	.7000E+00	10.00	.1300E+01	0.00
26	0.00	.4480E+00	15.62	.4480E+00	50.19

*** LOAD CASE 2 MIXED LOADS

MEMBER	DIRECTION	PROJECTED LOAD KIP/FT
1	X	.4000E+00
3	X	.4000E+00
6	X	.4000E+00
8	X	.4000E+00
11	X	.4000E+00

MEMBER	LA FT	PA KIP/FT	LB FT	PB KIP/FT	ANGLE DEG
17	2.00	.4000E+00	6.00	.4000E+00	20.00
17	3.00	0.	8.00	-.3000E+00	0.00
18	2.00	.4000E+00	6.00	.4000E+00	20.00
18	3.00	0.	8.00	-.3000E+00	0.00

MEMBER	L FT	P KIP	ANGLE DEG
23	3.30	.2000E+01	-20.00
23	6.70	.3000E+01	0.00
24	3.30	.2000E+01	-20.00
24	6.70	.3000E+01	0.00

JOINT	FORCE X KIP	FORCE Y KIP	MOMENT FT-KIP
10	.3000E+01	0.	0.
15	.3000E+01	0.	0.
19	0.	-.5000E+01	-.1800E+02

MEMBER	ALPHA	DT
23	.6500E-05	.5000E+02
28	.6500E-05	.5000E+02

*** LOAD CASE COMBINATIONS ***

LOAD CASE	4	LOAD CASE FACTORS 2
3	1.00	1.50
14	.75	-.50

LOAD CASE 4 VERTICAL LOADS

JOINT	JOINT DISPLACEMENTS		
	DX IN	DY IN	DR RAD
1	0.	0.	.3384E-03
2	0.	0.	0.
3	0.	0.	.6855E-04
4	0.	-.1947E-02	.8550E-04
5	.3849E-03	0.	-.2973E-03
6	-.5720E-02	-.2512E-01	-.5577E-03
7	-.5283E-02	-.3084E-01	.3301E-04
8	-.5013E-02	-.3583E-01	-.4803E-04
9	-.4875E-02	-.3641E-01	-.6944E-04
10	-.4817E-02	-.1978E-01	.7030E-03
11	.8179E-02	-.3946E-01	-.5770E-03
12	.1346E-01	-.4669E-01	-.1193E-04
13	.1622E-01	-.5779E-01	-.4049E-04
14	.1910E-01	-.5594E-01	-.1588E-03
15	.2210E-01	-.3308E-01	.1426E-02
16	.1561E-01	-.4249E-01	-.1671E-02
17	.1542E-01	-.5181E-01	.3797E-03
18	.1095E-01	-.6620E-01	-.9263E-04
19	.6456E-02	-.5944E-01	.1484E-03

JOINT	STRUCTURE REACTIONS		
	FORCE X KIP	FORCE Y KIP	MOMENT IN-KIP
1	.2414E+00	.2839E+02	0.
2	.3262E-01	.3485E+02	-.2989E+01
3	.3968E-01	.4048E+02	-.5963E+00
4	.4173E-01	.3894E+02	0.
5	-.2694E+00	.2235E+02	0.
6	.4004E+01	0.	0.
11	-.4090E+01	0.	0.

TOTAL	.5734E-03	.1650E+03	

LOAD CASE 2 MIXED LOADS

JOINT	JOINT DISPLACEMENTS		
	DX IN	DY IN	DR RAD
1	0.	0.	-.1043E-02
2	0.	0.	0.
3	0.	0.	-.9927E-03
4	0.	.1948E-04	-.3451E-03
5	.1082E-03	0.	-.3601E-03
6	.2281E-01	-.5037E-02	.1261E-03
7	.2840E-01	-.2101E-02	-.4893E-04
8	.3424E-01	-.8917E-03	0.
9	.3647E-01	.3643E-03	-.6949E-04
10	.3847E-01	-.6713E-02	-.7901E-04
11	.1886E-01	-.1210E 01	-.1066E-03
12	.2512E-01	-.4347E-02	0.
13	.3247E-01	-.1176E-02	.1238E-03
14	.3820E-01	.1460E-02	-.8878E-04
15	.4380E-01	-.1335E-01	-.1407E-03
16	.5702E-01	-.1335E-01	-.7727E-03
17	.9486E-01	-.4006E-02	.4671E-04
18	.8917E-01	-.1577E-02	.1174E-02
19	.8388E-01	.2599E-02	-.2550E-02

JOINT	STRUCTURE REACTIONS		
	FORCE X KIP	FORCE Y KIP	MOMENT IN-KIP
1	-.1915E+01	.5690E+01	0.
2	-.2793E+00	.2373E+01	.2106E+02
3	-.1990E+01	.1007E+01	.8636E+01
4	-.7424E-01	-.3896E+00	0.
5	-.7571E-01	.7584E+01	0.
6	-.1596E+02	0.	0.
11	-.9428E+01	0.	0.

TOTAL	-.2973E+02	.1627E+02	

LOAD CASE 3

JOINT	JOINT DISPLACEMENTS		DR RAD
	DX IN	DY IN	
1	0.	0.	-.1226E-02
2	0.	0.	0.
3	0.	0.	-.1420E-02
4	0.	-.1918E-02	-.4322E-03
5	.5471E-03	0.	-.8374E-03
6	.2849E-01	-.3268E-01	-.3685E-03
7	.3732E-01	-.3399E-01	-.4038E-04
8	.4634E-01	-.3717E-01	-.7344E-04
9	.4983E-01	-.3586E-01	-.1737E-03
10	.5288E-01	-.2985E-01	.5844E-03
11	.3646E-01	-.5761E-01	-.7369E-03
12	.5114E-01	-.5322E-01	-.2674E-04
13	.6492E-01	-.5956E-01	.1451E-03
14	.7640E-01	-.5375E-01	-.2920E-03
15	.8780E-01	-.5310E-01	.1215E-02
16	.1011E+00	-.6251E-01	-.2830E-02
17	.1577E+00	-.5782E-01	.4498E-03
18	.1447E+00	-.6856E-01	.1668E-02
19	.1323E+00	-.5554E-01	-.3677E-02

JOINT	STRUCTURE REACTIONS		MOMENT IN-KIP
	FORCE X KIP	FORCE Y KIP	
1	-.2631E+01	.3692E+02	0.
2	-.3863E+00	.3841E+02	.2859E+02
3	-.2945E+01	.4199E+02	.1236E+02
4	-.6963E-01	.3835E+02	0.
5	-.3830E+00	.3372E+02	0.
6	-.1994E+02	0.	0.
11	-.1823E+02	0.	0.

TOTAL -.4459E+02 .1894E+03

LOAD CASE 14 COMB. LOADS

JOINT	JOINT DISPLACEMENTS		
	DX IN	DY IN	DR RAD
1	0.	0.	.7754E-03
2	0.	0.	0.
3	0.	0.	.5477E-03
4	0.	-.1470E-02	.2367E-03
5	.2346E-03	0.	-.4294E-04
6	-.1569E-01	-.1633E-01	-.4813E-03
7	-.1816E-01	-.2208E-01	.4922E-04
8	-.2088E-01	-.2643E-01	-.4088E-04
9	-.2189E-01	-.2749E-01	-.1734E-04
10	-.2285E-01	-.1148E-01	.5667E-03
11	-.3293E-02	-.2354E-01	-.3794E-03
12	-.2469E-02	-.3285E-01	0.
13	-.4072E-02	-.4276E-01	-.9225E-04
14	-.4774E-02	-.4268E-01	-.7472E-04
15	-.5323E-02	-.1813E-01	.1140E-02
16	-.1680E-01	-.2519E-01	-.8666E-03
17	-.3587E-01	-.3685E-01	.2614E-03
18	-.3637E-01	-.4886E-01	-.6563E-03
19	-.3710E-01	-.4588E-01	.1386E-02

JOINT	STRUCTURE REACTIONS		MOMENT IN-KIP
	FORCE X KIP	FORCE Y KIP	
1	.1139E+01	.1844E+02	0.
2	.1641E+00	.2495E+02	-.1277E+02
3	.1025E+01	.2986E+02	-.4765E+01
4	.6842E-01	.2940E+02	0.
5	-.1642E+00	.1297E+02	0.
6	.1099E+02	0.	0.
11	.1647E+01	0.	0.

TOTAL .1486E+02 .1156E+03

MEMBER	LOAD CASE	MEMBER END FORCES					LOCATION IN
		JOINT	AXIAL KIP	SHEAR KIP	MOMENT IN-KIP	MOMENT EXTREMA IN-KIP	
1	4	1	-.2839E+02	-.2414E+00	0.	0.	0.00
		6	-.2839E+02	.2414E+00	-.3476E+02	-.3476E+02	144.00
	2	1	-.5690E+01	.1915E+01	0.	.5500E+02	57.60
		6	-.5690E+01	.2885E+01	-.6985E+02	-.6985E+02	144.00
	3	1	-.3692E+02	.2631E+01	0.	.6921E+02	51.84
		6	-.3692E+02	.4569E+01	-.1395E+03	-.1395E+03	144.00
	14	1	-.1844E+02	-.1139E+01	0.	.8855E+01	144.00
		6	-.1844E+02	-.1261E+01	.8855E+01	-.3888E+02	69.12
2	4	2	-.3485E+02	-.3262E 01	.2989E+01	.2989E+01	0.00
		7	-.3485E+02	.3262E-01	-.1709E+01	-.1709E+01	144.00
	2	2	-.2373E+01	.2793E+00	-.2106E+02	.1916E+02	144.00
		7	-.2373E+01	-.2793E+00	.1916E+02	-.2106E+02	0.00
	3	2	-.3841E+02	.3863E+00	-.2859E+02	.2703E+02	144.00
		7	-.3841E+02	-.3863E+00	.2703E+02	-.2859E+02	0.00
	14	2	-.2495E+02	-.1641E+00	.1277E+02	.1277E+02	0.00
		7	-.2495E+02	.1641E+00	-.1086E+02	-.1086E+02	144.00
3	4	3	-.4048E+02	-.3968E-01	.5963E+00	.5963E+00	0.00
		8	-.4048E+02	.3968E-01	-.5118E+01	-.5118E+01	144.00
	2	3	-.1007E+01	.1990E+01	-.8636E+01	.5075E+02	60.48
		8	-.1007E+01	.2810E+01	-.6768E+02	-.6768E+02	144.00
	3	3	-.4199E+02	.2945E+01	-.1236E+02	.7434E+02	57.60
		8	-.4199E+02	.4255E+01	-.1066E+03	-.1066E+03	144.00
	14	3	-.2986E+02	-.1025E+01	.4765E+01	.3000E+02	144.00
		8	-.2986E+02	-.1375E+01	.3000E+02	-.2673E+02	60.48
4	4	4	-.3894E+02	-.4173E-01	0.	0.	0.00
		9	-.3894E+02	.4173E-01	-.6010E+01	-.6010E+01	144.00
	2	4	.3896E+00	.7424E-01	0.	.1069E+02	144.00
		9	.3896E+00	-.7424E-01	.1069E+02	0.	0.00
	3	4	-.3835E+02	.6963E-01	0.	.1003E+02	144.00
		9	-.3835E+02	-.6963E-01	.1003E+02	0.	0.00
	14	4	-.2940E+02	-.6842E-01	0.	0.	0.00
		9	-.2940E+02	.6842E-01	-.9853E+01	-.9853E+01	144.00
5	4	5	-.2235E+02	.2694E+00	0.	.3880E+02	144.00
		10	-.2235E+02	-.2694E+00	.3880E+02	0.	0.00
	2	5	-.7584E+01	.7571E-01	0.	.1090E+02	144.00
		10	-.7584E+01	-.7571E-01	.1090E+02	0.	0.00
	3	5	-.3372E+02	.3830E+00	0.	.5515E+02	144.00
		10	-.3372E+02	-.3830E+00	.5515E+02	0.	0.00
	14	5	-.1297E+02	.1642E+00	0.	.2365E+02	144.00
		10	-.1297E+02	-.1642E+00	.2365E+02	0.	0.00
6	4	6	-.1619E+02	-.7609E+00	.5441E+02	.5441E+02	0.00
		11	-.1619E+02	.7609E+00	-.5516E+02	-.5516E+02	144.00
	2	6	-.7983E+01	.2371E+01	-.6005E+02	.2429E+02	72.00
		11	-.7983E+01	.2429E+01	-.6417E+02	-.6417E+02	144.00
	3	6	-.2817E+02	.2796E+01	-.3567E+02	.4248E+02	54.72
		11	-.2817E+02	.4404E+01	-.1514E+03	-.1514E+03	144.00
	14	6	-.8154E+01	-.1756E+01	.7084E+02	.7084E+02	0.00
		11	-.8154E+01	-.6436E+00	-.9284E+01	-.2170E+02	106.56
7	4	7	-.1791E+02	.2274E+00	-.1724E+02	.1550E+02	144.00
		12	-.1791E+02	-.2274E+00	.1550E+02	-.1724E+02	0.00
	2	7	-.2538E+01	-.8434E-01	.6830E+01	.6830E+01	0.00
		12	-.2538E+01	.8434E-01	-.5315E+01	-.5315E+01	144.00
	3	7	-.2172E+02	.1009E+00	-.6998E+01	.7526E+01	144.00
		12	-.2172E+02	-.1009E+00	.7526E+01	-.6998E+01	0.00
	14	7	-.1216E+02	.2127E+00	-.1635E+02	.1428E+02	144.00
		12	-.1216E+02	-.2127E+00	.1428E+02	-.1635E+02	0.00

8	4	8	-.2481E+02	.1667E+00	-.1186E+02	.1215E+02	144.00
		13	-.2481E+02	-.1667E+00	.1215E+02	-.1186E+02	0.00
	2	8	-.3209E+00	.2488E+01	-.6173E+02	.3113E+02	74.88
		13	-.3209E+00	.2312E+01	-.4905E+02	-.6173E+02	0.00
	3	8	-.2529E+02	.3899E+01	-.1044E+03	.4755E+02	77.76
		13	-.2529E+02	.3301E+01	-.6143E+02	-.1044E+02	0.00
14	8	-.1845E+02	-.1119E+01	.2197E+02	.3364E+02	144.00	
	13	-.1845E+02	-.1281E+01	.3364E+02	-.1559E+02	66.24	
9	4	9	-.2206E+02	.8463E-01	-.7826E+01	.4360E+01	144.00
		14	-.2206E+02	-.8463E-01	.4360E+01	-.7826E+01	0.00
	2	9	.1238E+01	-.1085E+00	.7438E+01	.7438E+01	0.00
		14	.1238E+01	.1085E+00	-.8186E+01	-.8186E+01	144.00
	3	9	-.2020E+02	-.7812E-01	.3330E+01	.3330E+01	0.00
		14	-.2020E+02	.7812E-01	-.7919E+01	-.7919E+01	144.00
	14	9	-.1716E+02	.1177E+00	-.9588E+01	.7363E+01	144.00
		14	-.1716E+02	-.1177E+00	.7363E+01	-.9588E+01	0.00
10	4	10	-.1502E+02	.3596E+00	-.5178E+02	0.	144.00
		15	-.1502E+02	-.3596E+00	0.	-.5178E+02	0.00
	2	10	-.7500E+01	-.1697E-01	.2443E+01	.2443E+01	0.00
		15	-.7500E+01	.1697E-01	0.	0.	144.00
	3	10	-.2627E+02	.3341E+00	-.4811E+02	0.	144.00
		15	-.2627E+02	-.3341E+00	0.	-.4811E+02	0.00
	14	10	-.7515E+01	.2781E+00	-.4005E+02	0.	144.00
		15	-.7515E+01	-.2781E+00	0.	-.4005E+02	0.00
11	4	11	-.3422E+01	-.2123E+00	.3057E+02	.3057E+02	0.00
		16	-.3422E+01	.2123E+00	0.	0.	144.00
	2	11	-.1406E+01	.3064E+01	-.9562E+02	.4520E+02	92.16
		16	-.1406E+01	.1736E+01	0.	-.9562E+02	0.00
	3	11	-.5530E+01	.4384E+01	-.1129E+03	.7927E+02	86.40
		16	-.5530E+01	.2816E+01	0.	-.1129E+03	0.00
	14	11	-.1864E+01	-.1691E+01	.7073E+02	.7073E+02	0.00
		16	-.1864E+01	-.7088E+00	0.	-.1507E+02	100.80
12	4	12	-.5777E+01	.6737E-03	-.9702E-01	0.	144.00
		17	-.5777E+01	-.6737E-03	0.	-.9702E-01	0.00
	2	12	.3853E+00	.1917E+00	-.2760E+02	0.	144.00
		17	.3853E+00	-.1917E+00	0.	-.2760E+02	0.00
	3	12	-.5199E+01	.2882E+00	-.4150E+02	0.	144.00
		17	-.5199E+01	-.2882E+00	0.	-.4150E+02	0.00
	14	12	-.4526E+01	-.9533E-01	.1373E+02	.1373E+02	0.00
		17	-.4526E+01	.9533E-01	0.	0.	144.00
13	4	13	-.9497E+01	-.3113E-01	.4483E+01	.4483E+01	0.00
		18	-.9497E+01	.3113E-01	0.	0.	144.00
	2	13	-.4528E+00	.2091E+00	-.3011E+02	0.	144.00
		18	-.4528E+00	-.2091E+00	0.	-.3011E+02	0.00
	3	13	-.1018E+02	.2825E+00	-.4068E+02	0.	144.00
		18	-.1018E+02	-.2825E+00	0.	-.4068E+02	0.00
	14	13	-.6896E+01	-.1279E+00	.1842E+02	.1842E+02	0.00
		18	-.6896E+01	.1279E+00	0.	0.	144.00
14	4	14	-.3956E+01	-.9964E-01	.1435E+02	.1435E+02	0.00
		19	-.3956E+01	.9964E-01	0.	0.	144.00
	2	14	.1287E+01	.9231E-01	-.1329E+02	0.	144.00
		19	.1287E+01	-.9231E-01	0.	-.1329E+02	0.00
	3	14	-.2025E+01	.3882E-01	-.5590E+01	0.	144.00
		19	-.2025E+01	-.3882E-01	0.	-.5590E+01	0.00
	14	14	-.3611E+01	-.1209E+00	.1741E+02	.1741E+02	0.00
		19	-.3611E+01	.1209E+00	0.	0.	144.00

15	4	6	.6829E+00	.7191E+01	-.8917E+02	.1046E+03	52.80
		7	.6829E+00	.8809E+01	-.1863E+03	-.1863E+03	120.00
	2	6	.8754E+01	.5325E-01	-.9794E+01	-.3404E+01	120.00
		7	.8754E+01	-.5325E-01	-.3404E+01	-.9794E+01	0.00
	3	6	.1381E+02	.7271E+01	-.1039E+03	.9434E+02	55.20
		7	.1381E+02	.8729E+01	-.1914E+03	-.1914E+03	120.00
	14	6	-.3865E+01	.5366E+01	-.6198E+02	.8197E+02	52.80
7		-.3865E+01	.6634E+01	-.1380E+03	-.1380E+03	120.00	
16	4	7	.4229E+00	.8128E+01	-.1708E+03	.7694E+02	60.00
		8	.4229E+00	.7872E+01	-.1554E+03	-.1708E+03	0.00
	2	7	.9117E+01	-.1119E+00	.8924E+01	.8924E+01	0.00
		8	.9117E+01	.1119E+00	-.4502E+01	-.4502E+01	120.00
	3	7	.1410E+02	.7961E+01	-.1574E+03	.8026E+02	60.00
		8	.1410E+02	.8039E+01	-.1621E+03	-.1621E+03	120.00
	14	7	-.4241E+01	.6152E+01	-.1325E+03	.5668E+02	62.40
		8	-.4241E+01	.5848E+01	-.1143E+03	-.1325E+03	0.00
17	4	8	.2165E+00	.7797E+01	-.1486E+03	.7930E+02	57.60
		9	.2165E+00	.8203E+01	-.1730E+03	-.1730E+03	120.00
	2	8	.3819E+01	.5746E+00	-.1046E+02	.8616E+01	43.20
		9	.3272E+01	.1789E+00	-.1676E+02	-.1676E+02	120.00
	3	8	.5945E+01	.8659E+01	-.1643E+03	.8839E+02	55.20
		9	.5124E+01	.8472E+01	-.1981E+03	-.1981E+03	120.00
	14	8	-.1747E+01	.5560E+01	-.1062E+03	.5705E+02	60.00
		9	-.1474E+01	.6063E+01	-.1214E+03	-.1214E+03	120.00
18	4	9	.9013E-01	.8672E+01	-.1712E+03	.1108E+03	64.80
		10	.9013E-01	.7328E+01	-.9057E+02	-.1712E+03	0.00
	2	9	.3455E+01	.6692E+00	-.1350E+02	.9763E+01	45.60
		10	.2907E+01	.8435E-01	-.8458E+01	-.1350E+02	0.00
	3	9	.5272E+01	.9676E+01	-.1914E+03	.1201E+03	60.00
		10	.4451E+01	.7455E+01	-.1033E+03	-.1914E+03	0.00
	14	9	-.1660E+01	.169E+01	-.1216E+03	.8070E+02	67.20
		10	-.1386E+01	.5454E+01	-.6370E+02	-.1216E+03	0.00
19	4	11	.8253E+01	.7117E+01	-.8573E+02	.1042E+03	52.80
		12	.8253E+01	.8883E+01	-.1917E+03	-.1917E+03	120.00
	2	11	.9802E+01	-.4633E+00	.3144E+02	-.3144E+02	0.00
		12	.9802E+01	.4633E+00	-.2415E+02	-.2415E+02	120.00
	3	11	.2296E+02	.6422E+01	-.3857E+02	.1161E+03	48.00
		12	.2296E+02	.9578E+01	-.2279E+03	-.2279E+03	120.00
	14	11	.1289E+01	.5570E+01	-.8002E+02	.7507E+02	55.20
12		.1289E+01	.6430E+01	-.1317E+03	-.1317E+03	120.00	
20	4	12	.4312E+01	.8250E+01	-.1761E+03	.7914E+02	62.40
		13	.4312E+01	.7750E+01	-.1461E+03	-.1761E+03	0.00
	2	12	.1148E+02	.1150E+00	-.1863E+01	.1194E+02	120.00
		13	.1148E+02	-.1150E+00	.1194E+02	-.1863E+01	0.00
	3	12	.2153E+02	.8422E+01	-.1789E+03	.8711E+02	62.40
		13	.2153E+02	.7578E+01	-.1282E+03	-.1789E+03	0.00
14	12	-.2506E+01	.6130E+01	-.1311E+03	.5670E+02	62.40	
	13	-.2506E+01	.5870E+01	-.1155E+03	-.1311E+03	0.00	
21	4	13	.4510E+01	.7566E+01	-.1384E+03	.7620E+02	57.60
		14	.4510E+01	.8434E+01	-.1905E+03	-.1905E+03	120.00
	2	13	.8959E+01	-.1687E-01	-.7001E+01	-.7001E+01	0.00
		14	.8959E+01	.1687E-01	-.9025E+01	-.9025E+01	120.00
	3	13	.1795E+02	.7541E+01	-.1489E+03	.6424E+02	57.60
		14	.1795E+02	.8459E+01	-.2040E+03	-.2040E+03	120.00
	14	13	-.1097E+01	.5683E+01	-.1003E+03	.6113E+02	57.60
14		-.1097E+01	.6317E+01	-.1384E+03	-.1384E+03	120.00	

22	4	14	.4694E+01	.9671E+01	-.2005E+03	.1502E+03	72.00
		15	.4694E+01	.6329E+01	0.	-.2005E+03	0.00
	2	14	.8759E+01	.3265E-01	-.3918E+01	0.	120.00
		15	.3759E+01	-.3265E-01	0.	-.3918E+01	0.00
	3	14	.1783E+02	.9720E+01	-.2064E+03	.1479E+03	72.00
		15	.1783E+02	.6280E+01	0.	-.2064E+03	0.00
14	14	-.8584E+00	.7237E+01	-.1484E+03	.1134E+03	72.00	
	15	-.8584E+00	.4763E+01	0.	-.1484E+03	0.00	
23	4	16	-.2123E+00	.3422E+01	0.	.8949E+02	50.40
		17	-.2123E+00	.6578E+01	-.1294E+03	-.1294E+03	120.00
	2	16	-.1736E+01	.1406E+01	0.	.5509E+02	40.80
		17	-.1052E+01	.3474E+01	-.1012E+03	-.1012E+03	120.00
	3	16	-.2816E+01	.5530E+01	0.	.1690E+03	40.80
		17	-.1790E+01	.1179E+02	-.2812E+03	-.2812E+03	120.00
	14	16	.7088E+00	.1864E+01	0.	.4216E+02	52.80
		17	.3668E+00	.3197E+01	-.4641E+02	-.4641E+02	120.00
24	4	17	-.4924E+01	.4854E+01	-.1294E+03	.4403E+02	67.20
		18	-.4924E+01	.5146E+01	-.8691E+02	-.1294E+03	0.00
	2	17	-.6727E+01	.3181E+01	-.1012E+03	.7628E+02	79.20
		18	-.6043E+01	.1698E+01	.1059E+02	-.1012E+03	0.00
	3	17	-.1501E+02	.9625E+01	-.2812E+03	.1520E+03	79.20
		18	-.1399E+02	.7694E+01	-.7102E+02	-.2812E+03	0.00
	14	17	-.3293E+00	.2050E+01	-.4641E+02	.6048E+01	57.60
		18	-.6713E+00	.3010E+01	-.7048E+02	-.7048E+02	120.00
25	4	18	-.4955E+01	.4351E+01	-.8691E+02	.5415E+02	62.40
		19	-.4955E+01	.5649E+01	-.1048E+03	-.1048E+03	120.00
	2	18	-.5834E+01	-.1246E+01	.1059E+02	.1059E+02	0.00
		19	-.5834E+01	.1246E+01	-.1389E+03	-.1389E+03	120.00
	3	18	-.1371E+02	.2483E+01	-.7102E+02	-.2263E+02	38.40
		19	-.1371E+02	.7517E+01	-.3131E+03	-.3131E+03	120.00
	14	18	-.7992E+00	.3886E+01	-.7048E+02	.6048E+02	72.00
		19	-.7992E+00	.3614E+01	-.9156E+01	-.7048E+02	0.00
26	4	19	-.4536E+01	.2799E+01	-.1048E+03	.5911E+02	116.22
		15	-.9912E+01	.1681E+01	0.	-.1048E+03	0.00
	2	19	-.9462E+01	-.4115E+00	.7713E+02	.7713E+02	0.00
		15	-.9462E+01	.4115E+00	0.	0.	187.45
	3	19	-.1873E+02	.2182E+01	.1090E+02	.1105E+03	89.97
		15	-.2411E+02	.2298E+01	0.	0.	187.45
	14	19	-.1329E+01	.2305E+01	-.1172E+03	.3104E+02	127.46
		15	-.2703E+01	.1055E+01	0.	-.1172E+03	0.00
27	4	6	-.6510E+01	0.	0.	0.	0.00
		12	-.6510E+01	0.	0.	0.	0.00
	2	6	.3053E+01	0.	0.	0.	0.00
		12	.3053E+01	0.	0.	0.	0.00
	3	6	-.1930E+01	0.	0.	0.	0.00
		12	-.1930E+01	0.	0.	0.	0.00
14	6	-.6409E+01	0.	0.	0.	0.00	
	12	-.6409E+01	0.	0.	0.	0.00	
28	4	11	-.7361E+01	0.	0.	0.	0.00
		17	-.7361E+01	0.	0.	0.	0.00
	2	11	-.9164E+01	0.	0.	0.	0.00
		17	-.9164E+01	0.	0.	0.	0.00
	3	11	-.2111E+02	0.	0.	0.	0.00
		17	-.2111E+02	0.	0.	0.	0.00
	14	11	-.9384E+00	0.	0.	0.	0.00
		17	-.9384E+00	0.	0.	0.	0.00

C>

APPENDIX B: SUMMARY OF BASIC INPUT DATA

1. Title
2. UE UJ UM UD UF
3. NJ NM NLC E POI
4. JN X Y, JN X Y, . . .
5. "FIX X" list, "FIX Y" list, "FIX R" list
6. MN JNA JNB, MN JNA JNB, . . .
7. "PIN A" list, "PIN B" list
8. I A AS list
9. "LOAD CASE" LCN NPLS NDLS NCLS NJLS Title
10. XY P list
11. LA PA LB PB PHI list
12. NL L1 P1 PHI1, L2 P2 PHI2, . . . , list
13. PX PY M list

Commentary:

1. The title or any text description of the problem.
2. Units for the modulus of elasticity, joint coordinates, member properties, joint displacements, and forces.
3. The number of joints, members, and independent load cases and default values for the modulus of elasticity and Poisson's ratio. The shear modulus $G = E/2(1+POI)$.
4. The joint number and the X and Y coordinates. Any number of joints may be placed on a single line.
5. Specifies zero X, Y, or R displacement for the listed joints.
6. The member number and the joint numbers at the A and B ends of the member. Any number of members may be placed on the single line.
7. Specifies a pin (no moment transfer) at end A or B of the listed members.

8. The moment of inertia, axial area, and shear areas for the listed members. If $AS = 0.$, shear deformations are not included. Use as many of these data lines as required.
9. The load case number, number of projected load sets, number of member distributed load sets, number of member concentrated load sets, and number of joint load sets for the specified load case, followed by a load case title.
10. The direction of the projected load, followed by the load magnitude. Use NPLS of these lines.
11. The distance from end A of the listed members to the start of the distributed load, load magnitude at the start, distance from end A to the end of the load, load magnitude at the end, and angle the load makes with normal to the member. Use NDLS of these lines.
12. The number of concentrated loads on each listed member, distance from end A of the member to each load, magnitude of each load, and angle each load makes with normal to the member. Use NCLS of these lines.
13. Specifies the X and Y forces and the moment applied to the listed joints. Use NJLS of these lines. Return to line 9 for each new load case.

NOTE: Each line must begin with a line number and a blank. Items in quotation marks must be input exactly as shown, without the quotation marks. Numbers must be input as integers or real numbers. Refer to the main text of this report for sign conventions, further commentary, and further capabilities.

APPENDIX C: SUMMARY OF COMPLETE INPUT DATA

1. Title*
- 1a. Title
2. UE UJ UM UD UF
3. NJ NM NLC E POI
4. JN X Y, JN X Y, . . .
5. "GJ" JNA JNB INCR
6. "FIX X" list, "FIX Y" list, "FIX R" list, "FIX KX" KX list,
"FIX KY" KY list, "FIX KR" KR list
7. "SD" DX DY DR list
8. MN JNA JNB, MN JNA JNB, . . .
9. "GM" MN JNA JNB N INCM INCJ
10. "PIN A" list, "PIN B" list
11. I A AS list -or- O. B H list
12. "E" E POI list, "E" E POI list, . . .
13. "LOAD CASE" LCN NPLS NDLS NCLS NJLS NTLS Title
14. XY P list
15. LA PA LB PB PHI list
16. NL L1 P1 PHI1, L2 P2 PHI2, . . . , list
17. PX PY M list
18. ALPHA DT list
19. "COMBINATION" LCN, LCN1 C1, LCN2 C2, . . . , Title

NOTE: Each line must begin with a line number and a blank. Items in quotation marks must be input exactly as shown, without the quotation marks. Numbers must be input as integers or real numbers, as appropriate. Refer to the main text of this report for sign conventions, units, and commentary on the input.

In accordance with letter from DAEN-RDC, DAEN-ASI dated 22 July 1977, Subject: Facsimile Catalog Cards for Laboratory Technical Publications, a facsimile catalog card in Library of Congress MARC format is reproduced below.

Hartman, Joseph P.

User's guide : Computer program with interactive graphics for analysis of plane frame structures (CFRAME) / by Joseph P. Hartman and John J. Jobst (U.S. Army Engineer District, St. Louis). -- Vicksburg, Miss. : U.S. Army Engineer Waterways Experiment Station ; Springfield, Va. ; available from NTIS, 1983.

62 p. in various pagings : ill. ; 27 cm. --
(Instruction report ; K-83-1)

Cover title.

"January 1983."

"Prepared for Office, Chief of Engineers, U.S. Army."

"Monitored by Automatic Data Processing Center, U.S. Army Engineer Waterways Experiment Station."

"Revision of Instruction Report O-79-2."

"A report under the Computer-Aided Structural Engineering (CASE) Project."

Hartman, Joseph P.

User's guide : Computer program with interactive : ... 1983.
(Card 2)

1. CFRAME (Computer program). 2. Computer programs.
3. Structural frames. 4. Structures, Theory of.
I. Jobst, John J. II. United States. Army. Corps of Engineers. St. Louis District. III. United States. Army. Corps of Engineers. Office of the Chief of Engineers.
IV. Computer-Aided Structural Engineering (CASE) Project.
V. U.S. Army Engineer Waterways Experiment Station. Automatic Data Processing Center. V. Title VI. Series: Instruction report (U.S. Army Engineer Waterways Experiment Station) ; K-83-1.
TA7.W34i no.K-83-1

**WATERWAYS EXPERIMENT STATION REPORTS
PUBLISHED UNDER THE COMPUTER-AIDED
STRUCTURAL ENGINEERING (CASE) PROJECT**

	Title	Date
Technical Report K-78-1	List of Computer Programs for Computer-Aided Structural Engineering	Feb 1978
Instruction Report O-79-2	User's Guide: Computer Program with Interactive Graphics for Analysis of Plane Frame Structures (CFRAME)	Mar 1979
Technical Report K-80-1	Survey of Bridge-Oriented Design Software	Jan 1980
Technical Report K-80-2	Evaluation of Computer Programs for the Design/Analysis of Highway and Railway Bridges	Jan 1980
Instruction Report K-80-1	User's Guide: Computer Program for Design/Review of Curvilinear Conduits/Culverts (CURCON)	Feb 1980
Instruction Report K-80-3	A Three-Dimensional Finite Element Data Edit Program	Mar 1980
Instruction Report K-80-4	A Three-Dimensional Stability Analysis/Design Program (3DSAD) Report 1: General Geometry Module Report 3: General Analysis Module (CGAM)	Jun 1980 Jun 1982
Instruction Report K-80-6	Basic User's Guide: Computer Program for Design and Analysis of Inverted-T Retaining Walls and Floodwalls (TWDA)	Dec 1980
Instruction Report K-80-7	User's Reference Manual: Computer Program for Design and Analysis of Inverted-T Retaining Walls and Floodwalls (TWDA)	Dec 1980
Technical Report K-80-4	Documentation of Finite Element Analyses Report 1: Longview Outlet Works Conduit Report 2: Anchored Wall Monolith, Bay Springs Lock	Dec 1980 Dec 1980
Technical Report K-80-5	Basic Pile Group Behavior	Dec 1980
Instruction Report K-81-2	User's Guide: Computer Program for Design and Analysis of Sheet Pile Walls by Classical Methods(CSHTWAL) Report 1: Computational Processes Report 2: Interactive Graphics Options	Feb 1981 Mar 1981
Instruction Report K-81-3	Validation Report: Computer Program for Design and Analysis of Inverted-T Retaining Walls and Floodwalls (TWDA)	Feb 1981
Instruction Report K-81-4	User's Guide: Computer Program for Design and Analysis of Cast-in-Place Tunnel Linings (NEWTUN)	Mar 1981
Instruction Report K-81-6	User's Guide: Computer Program for Optimum Nonlinear Dynamic Design of Reinforced Concrete Slabs Under Blast Loading (CBARCS)	Mar 1981
Instruction Report K-81-7	User's Guide: Computer Program for Design or Investigation of Orthogonal Culverts (CORTCUL)	Mar 1981
Instruction Report K-81-9	User's Guide: Computer Program for Three-Dimensional Analysis of Building Systems (CTABS80)	Aug 1981
Technical Report K-81-2	Theoretical Basis for CTABS80: A Computer Program for Three-Dimensional Analysis of Building Systems	Sep 1981
Instruction Report K-82-6	User's Guide: Computer Program for Analysis of Beam-Column Structures with Nonlinear Supports (CBEAMC)	Jun 1982
Instruction Report K-82-7	User's Guide: Computer Program for Bearing Capacity Analysis of Shallow Foundations (CBEAR)	Jun 1982
Instruction Report K-83-1	User's Guide: Computer Program With Interactive Graphics for Analysis of Plane Frame Structures (CFRAME)	Jan 1983