

MICROCOPY RESOLUTION TEST CHART
NATIONAL BUREAU OF STANDARDS 1963 A

12

Report No. CG-D-12-83

AD A 128768

HAZARDOUS CHEMICAL VAPOR HANDBOOK
FOR MARINE TANK VESSELS

W. J. ASTLEFORD
T. B. MORROW
J. C. BUCKINGHAM

FINAL REPORT - PHASE II
MAY 1979 - OCTOBER 1983



This document is available to the U.S. public through the National
Technical Information Service, Springfield, Virginia 22161

DTIC
ELECTE
MAY 31 1983

Prepared for:

U.S. Department of Transportation
United States Coast Guard

Office of Research and Development
Washington, D.C. 20593

DTIC FILE COPY

83 05 31 077

NOTICE

This document is disseminated under the sponsorship of the Department of Transportation in the interest of information exchange. The United States Government assumes no liability for its contents or use thereof.

The contents of this report do not necessarily reflect the official view or policy of the Coast Guard; and they do not constitute a standard, specification, or regulation.

This report, or portions thereof may not be used for advertising or sales promotion purposes. Citation of trade names and manufacturers does not constitute endorsement or approval of such products.

1. Report No. CG-D-12-83		2. Government Accession No. AD-A128768		3. Recipient's Catalog No.	
4. Title and Subtitle Hazardous Chemical Vapor Handbook for Marine Tank Vessels				5. Report Date April 1983	
				6. Performing Organization Code 06-5686	
7. Author(s) W. J. Astleford, T. B. Morrow, J. C. Buckingham				8. Performing Organization Report No.	
9. Performing Organization Name and Address Southwest Research Institute P. O. Drawer 28510 6220 Culebra Road San Antonio, Texas 78284				10. Work Unit No. (TRAIS)	
				11. Contract or Grant No. DOT-CG-904571-A	
12. Sponsoring Agency Name and Address U.S. Coast Guard 2100 Second Street, S.W. Washington, D.C. 20593				13. Type of Report and Period Covered Final Report - Phase II May 1979 - October 1983	
				14. Sponsoring Agency Code	
15. Supplementary Notes					
16. Abstract <p>The U.S. Coast Guard has regulatory responsibility for the safety of vessels and equipment that are used in the transport of bulk chemicals by water and for the occupational health of the personnel that are involved in marine chemical operations. This responsibility is discharged, in part, by the application of the Coast Guard's Hazard Assessment Computer System (HACS). Currently, HACS consists predominantly of several computer codes for analytical models that describe the fate of hazardous materials that are accidentally released into navigable waters and the atmosphere. HACS has been successfully used (1) to retrospectively analyze accident scenarios, (2) to provide decision making information to response team personnel in the field immediately following an incident, and (3) as a training aid for prospective analysis of hazardous releases.</p> <p>The Coast Guard recognized that HACS did not include models that describe certain ship operations that are non-accidental in nature but could have an impact on health and safety, nor was there a data base for model development. To this end the Coast Guard initiated a two-part research program entitled "Investigation of the Hazards Posed by Chemical Vapors Released in Marine Operations."</p> <p>Models have been developed for:</p> <ul style="list-style-type: none"> • near-field atmospheric dispersion of heavier-than-air chemical vapors that are discharged from a tank during loading, and • gas freeing and entry of cargo tanks. <p>This manual is intended for the CG Hazardous Material Specialist, and is designed as a step-by-step guide to the structure and usage of three computer programs—ONDEK,</p>					
17. Key Words Tankers and barges Chemicals Cargo transfer Flammability Toxicity			18. Distribution Statement TANKM, and TANKP		
Vapor Dispersion Analytical modeling Tank ventilation Evaporation			This document is available to the U.S. public through the National Technical Information Service, Springfield, Virginia 22161.		
19. Security Classif. (of this report) Unclassified		20. Security Classif. (of this page) Unclassified		21. No. of Pages 265	22. Price

TABLE OF CONTENTS

	<u>Page</u>
LIST OF FIGURES	v
LIST OF TABLES	vi
GLOSSARY OF TERMINOLOGY	vii
I. INTRODUCTION	1
I.1 Historical Background	1
I.2 Scope of the Manual	2
I.3 Manual Organization	2
I.4 Computer Program Organization	3
II. TANK VENTILATION MODELS	7
II.1 Tank Cleaning Scenarios	7
II.2 Elements of Program TANKM	8
II.2.1 Model Description Summary	8
II.2.2 Input Data Requirements	13
II.2.3 Default Options	13
II.2.4 Program Output	26
II.2.5 Hazard Assessment	29
II.2.6 Example of TANKM	33
II.3 Elements of Program TANKP	45
II.3.1 Model Description Summary	45
II.3.2 Input Data Requirements	48
II.3.3 Default Options	53
II.3.4 Program Output	54
II.3.5 Hazard Assessment	58
II.3.6 Example of TANKP	59
II.4 Flow Charts for PRETNK, TANKM and TANKP	72
II.5 Model Limitations	72
III. PLUME DISPERSION MODEL	81
III.1 Vapor Emission Scenarios	81
III.2 Elements of Program ONDEK	85
III.2.1 Model Description Summary	85
III.2.2 Input Data Requirements	92
III.2.3 Default Options	94
III.2.4 Program Output	97
III.2.5 Hazard Assessment	104
III.2.6 Flow Charts	105
III.2.7 Example	127



Accession For	
NTIS GRA&I	<input checked="" type="checkbox"/>
ETIC TAB	<input type="checkbox"/>
Unannounced	<input type="checkbox"/>
Justification	
By _____	
Distribution/	
Availability Codes	
Dist	Avail and/or Special
A	

TABLE OF CONTENTS (CONTD)

	<u>Page</u>
III.3 Limitations of the ONDEK Model	139
REFERENCES	141
APPENDIX A Program Listings for:	
PRETNK (Interactive Driver)	A-1
TANKM	A-2
TANKP	A-4
APPENDIX B Program Listing for the ONDEK Plume Dispersion Model	B-1
APPENDIX C Program Listing for the ONDEK3 Plume Dispersion Model	C-1
APPENDIX D ONDEK3 Output for VAM Barge Loading, Example of Section III.2.4	D-1
APPENDIX E ONDEK3 Output for Benzene Barge Loading, Example of Section III.2.7	E-1

LIST OF FIGURES

<u>Figure No.</u>		<u>Page</u>
1	Vapor Emission During Cargo Loading	82
2	Vapor Concentration at the Tank Vent Measured During Loading of Methanol into a Dedicated Tank	83
3	Vapor Concentration at the Tank Vent Measured During Loading of Ethanol into a Clean, Gas Free Tank	84
4	Summary of Input Data for Example of Vinyl Acetate Loading into a Barge	98
5	Computed Values of the Plume Variables for the Output Example of Vinyl Acetate Loading into a Barge	99
6	Graph of Plume Centerline Concentration Versus Downwind Distance for the Output Example of Vinyl Acetate Loading into a Barge	101
7	Graph of Vapor Concentration at Man Breathing Height Versus Downwind Distance for the Output Example of Vinyl Acetate Loading into a Barge	102
8	Graph of Vapor Concentration Contours at Man Breathing Height Downwind of a Vent for the Output Example of Vinyl Acetate Loading into a Barge	103
9	Summary of Input Data for Benzene Loading Example	134
10	Computed Values of Plume Variables for Benzene Barge Loading Example	135
11	Graph of Plume Centerline Concentration Versus Downwind Distance for Benzene Barge Loading Example	136
12	Graph of Vapor Concentration at Man Breathing Height Versus Downwind Distance for Benzene Barge Loading Example	137
13	Contour Plot of Concentration at Man Breathing Height for Benzene Barge Loading Example	138

LIST OF TABLES

<u>Table No.</u>		<u>Page</u>
I	Correlating Constants and Equations for Calculating γ_1	14
II	Input Data Requirements for TANKM	15
III	Input Data Requirements for TANKP	49
IV	Chemical Properties for Use with the ONDEK Program	93

GLOSSARY OF TERMINOLOGY

ACGIH	=	American Conference of Governmental Industrial Hygienists
CHRIS	=	Chemical Hazards Response Information System
HACS	=	Hazard Assessment Computer System
I/O	=	Computer program input/output
LEL	=	Lower explosive limit
ONDEK	=	Model name for atmospheric dispersion of vapors
ppm	=	Concentration in parts per million by volume
SwRI	=	Southwest Research Institute
TANKM	=	Model name for gas freeing of cargo tanks that contain residues of chemical in wash water
TANKP	=	Model name for gas freeing of cargo tanks that contain residues of pure chemical
tlv	=	Turbulence level value
TLV-C	=	Ceiling exposure limit
TLV-STEL	=	Short term exposure limit
TLV-TWA	=	8-hour time weighted average threshold limit value
UEL	=	Upper explosive limit
USCG	=	United States Coast Guard
VDT	=	Video display terminal

1. INTRODUCTION

I.1 Historical Background

The U. S. Coast Guard has regulatory responsibility for the safety of vessels and equipment that are used in the transport of bulk chemicals by water and for the occupational health of the personnel that are involved in marine chemical operations. This responsibility is discharged, in part, by the application of the Coast Guard's Hazard Assessment Computer System (HACS). Currently, HACS consists predominantly of several computer codes for analytical models that describe the fate of hazardous materials that are accidentally released into navigable waters and the atmosphere. HACS has been successfully used (1) to retrospectively analyze accident scenarios, (2) to provide decision making information to response team personnel in the field immediately following an incident and (3) as a training aid for prospective analysis of hazardous releases.

The Coast Guard recognized that HACS did not include models that describe certain ship operations that are non-accidental in nature but could have an impact on health and safety, nor was there a data base for model development. To this end the Coast Guard initiated a two-part research program entitled "Investigation of the Hazards Posed By Chemical Vapors Released in Marine Operations." Among the objectives of Phase I of the program were to (1) establish and document potentially hazardous tanker/barge operations in marine terminals, (2) identify those operations that are amenable to analytical modeling, (3) construct an initial formulation of analytical models that describe these operations, (4) design a test plan for acquiring model validation data, and (5) conduct exploratory tests under that plan. At the conclusion of Phase I, preliminary models had been developed for

- o near-field atmospheric dispersion of heavier-than-air chemical vapors that are discharged from a tank during loading, and
- o gas freeing and entry of cargo tanks.

Phase II of the program consisted of implementing the Phase I test plan and refining the models. The details of the Phase I and Phase II studies are presented in References 21 and 13.

1.2 Scope of the Manual

This manual is intended for the Coast Guard Hazardous Material Specialist, and it is designed to be a step-by-step guide to the structure and usage of three computer programs.

- o ONDEK - Atmospheric dispersion of cargo vapor that is discharged from a tank during product loading or gas freeing.
- o TANKP - Gas freeing of a tank in the presence of evaporation of pure product residues.
- o TANKM - Gas freeing of a tank in the presence of evaporation of residual chemical from a water solution.

1.3 Manual Organization

In this manual, the description of each program follows a uniform format. This format is presented below together with a brief statement of each element in the format.

- o Model Description Summary - This section describes the model, the technical basis for the model both in theory and practice, the scenarios for which the model is designed and the model limitations. Detailed analytical derivations and sets of governing equations are not contained in this manual but are presented in the Final Report for Phase II of this project (Reference 13).
- o Input Data Requirements - All input data is presented in tabular form in the order that it is requested by the interactive driver. The tabulation includes the physical variable name, the equivalent program code and the expected units.
- o Default Options - Certain pieces of input data are assumed to be known, e.g. chemical properties. Other inputs that pertain to ship/barge operations may or may not be available. In these latter cases, the interactive driver asks the user a question regarding the availability of data. If the user responds negatively, the interactive driver will present a series of default options from which the user can make a selection. These sections of the manual present the various

default options and their basis in the order in which they may be encountered.

- o Program Output - Program output consists of tabular data and computer-generated graphs. The tables may contain the plotted variables and other internally computed variables. In this section of the manual, the output variables are defined by physical name, corresponding program code and the applicable units.
- o Hazard Assessment - The basic program outputs are either critical vapor concentration-time histories or vapor concentration files in space. In the case of tank entry following tank cleaning, the programs make an interpretation of the in-tank work environment based on accepted occupational exposure guidelines. A similar assessment of the on-deck environment is neither warranted nor entirely feasible due to the unconstrained, random nature of deck work.
- o Examples - Each program description includes a computer-generated example. Each example is preceded by a brief discussion of the problem that is being simulated, followed by an I/O listing and finally discussion of the results as appropriate.
- o Flow Charts - Each program is flow charted to indicate primary decision points and the major program operations. For clarity, minor IF statements and DO loops have been omitted.
- o References - Primary references are cited to support the model description.
- o Program Listings - Hard copy listings of all programs are presented in the appendices.

I.4 Computer Program Organization

All of the computer programs that are contained in this manual have been written in Fortran IV language and have been executed on both the

Digital Equipment Corporation PDP-1170 and the Control Data Corporation Cyber 172 systems. The programming language is compatible with the HACS software packages.

The programs that are described in this manual are stand-alone in nature and can be executed independently of the current HACS system. They each contain several features that are consistent with the HACS philosophy and will facilitate integration into the HACS system.

- o Access to the main program is controlled by an independent, interactive driver. Through a Video Display Terminal (VDI) or a hard copy input writer, the driver controls the flow of user provided input data and guides the user to default decisions when input data are not known or are not available.
- o The driver controls the transfer of data from the driver to the main program.
- o The main program controls data output and is supported by separate, special-purpose subroutines such as integration and plot routines.

During preparation of these models and this manual, the HACS Operations and User's Manual were reviewed, and there was an opportunity to observe execution of the HACS from a remote terminal. These efforts identified additional features that are currently contained in HACS but could not be conveniently incorporated into the models that are described in this manual. These features, which will need to be recognized during program integration, are enumerated below.

- o In this manual, chemical property data are input by the user. Integration will require eliminating this input mode and replacing it with programmed access to the HACS Chemical Property Data File.
- o The input and computed values of program variables are not currently screened to determine if they fall within a min-max acceptance range as is done in HACS.
- o At the conclusion of data input, the driver programs do not give the user an opportunity to review and possibly change data before executing the main program.

- o At the conclusion of data input, execution is initiated, and output of tables and graphs is displayed on a VDT. The plot routines are an integral part of the USCG HACS System and are not available in the open literature. Non-USCG program users will need to interface an appropriate plot routine with the programs. This entire manual and the plot routines are geared toward execution on the USCG HACS System.

- o Following output of data, the program logic is not currently in place which would permit the user to change one or more pieces of input data and then rerun the updated case as can be performed on HACS.

II. TANK VENTILATION MODELS

II.1 Tank Cleaning Scenarios

There are many reasons for cleaning cargo tanks on parcel chemical/product tankers and barges, and they include

- o preparation for change of cargo grade,
- o insuring product purity (no cross contamination) when the same product is back-loaded into the tank,
- o periodic USCG inspection of tank internals,
- o preparation for hot work,
- o inspection of tank coating materials, and
- o repair of in-tank equipment such as closed gauging systems.

The cleaning operation may or may not include a water wash that precedes gas freeing or ventilation. However, in each case gas freeing is followed by man-entry to accomplish either inspection, repair or manual cleanup of residues and debris.

Two tank cleaning scenarios have been defined based on field observation, and they are described by the models TANKM and TANKP.

TANKM - This model assumes that the tank has been water washed. Following washing and stripping of slops, a residual quantity of liquid in the form of a chemical-water solution remains on the tank bottom. Gas freeing is accomplished by dilution ventilation that is provided by deck mounted blowers. The model predicts the concentration-time history of chemical vapor in air at the ventilation discharge and includes the effect of regeneration of product vapor from the aqueous solution.

TANKP - This model assumes that the tank is not washed. Gas freeing begins following product discharge, and the

model includes the effect of evaporation of pure product residues.

In roughly 80 percent of the field tests that were conducted to support the model development, the tanks were washed prior to gas freeing.

II.2 Elements of Program TANKM

II.2.1 Model Description Summary

The TANKM model is based on the numerical integration of two coupled, time-dependent ordinary differential equations. These equations represent the conservation of mass of (1) the chemical species in the vapor space above the residual binary solution on the tank bottom and (2) the chemical species in the aqueous solution. The two differential equations are coupled through an interface condition that describes mass transfer between the liquid and vapor phases. The formulation is completed by specifying appropriate initial conditions for both liquid and vapor phase concentrations.

A mass balance in the vapor phase yields

$$-V \frac{dC_v}{dt} = -C_v Q + AF \quad (1)$$

where

V = tank volume

C_v = mass concentration of vapor in air

Q = blower flow rate

A = residual liquid surface area

F = net flux of chemical between liquid and vapor phases. F is positive when mass is transferred to the vapor phase from the aqueous solution.

This equation assumes that the concentration in the vapor phase is well-mixed and uniform; there are no spatial variations in concentration.

Similarly, a mass balance on the chemical in the liquid phase results in Equation 2.

$$\frac{dC_L}{dt} = -F/\delta \quad (2)$$

where C_L = mass concentration of chemical (solute)
in water (solvent)
 δ = residue thickness

The interface condition that describes the flux term F is based on the two-layer film model in Reference 1.

$$F = K_{OL} (C_L - C_V/H) \quad (3)$$

where K_{OL} = overall mass transfer coefficient
referenced to the liquid phase
H = Henry's law constant or partition
coefficient

This flux model assumes that both the bulk liquid and vapor phases are well mixed and concentration gradients exist only within the thin two-layer interface film.

Appropriate initial conditions are

$$\left. \begin{array}{l} C_V = C_{OV} \\ C_L = C_{OL} \end{array} \right\} \text{at } t = 0 \quad (4)$$

This formulation requires a set of supplementary expressions for calculating H and K_{OL} .

The form of the mass transfer coefficient follows directly from the derivation of the evaporative flux equation in Reference 1.

$$K_{OL} = \frac{k_l k_g H}{k_l + H k_g} \quad (5)$$

where k_l and k_g are exchange constants for the liquid and vapor films in the two-layer model of mass transfer at the liquid interface. These exchange rates are given by the following expressions from References 2 and 3, respectively.

$$k_l = 0.33 (44/M)^{1/2} \quad (6)$$

$$k_g = 18.95 U_{wind} (18/M)^{1/2} \quad (7)$$

where M = molecular weight of the chemical
 U_{wind} = effective air velocity over the liquid surface

The assumption that the blower produces a well-mixed vapor space implicitly implies that there are no local variations in the air flow velocity over the residual liquid surface. U_{wind} , then, is an integrated average or effective evaporation air velocity that was derived from Reference 4 which is concerned with the normal impingement and axisymmetric turning and spreading of air jets.

$$U_{wind} = \left[\frac{K r_1^2}{2 r_2} + \frac{C}{1-n} r_2^{-n} \left(1 - \frac{r_1}{r_2} \right)^{1-n} \right] \beta \quad (8)$$

where $n = 1.12$
 $r_1 = 0.15 D$
 $D =$ tank depth
 $C = 1.4 U_o d^{1.12}$
 $U_o =$ average blower jet velocity
 $d =$ jet diameter at blower discharge (usually Butterworth opening diameter)
 $K = C/r_1^{n+1}$

The quantity r_2 represents an estimate of the effective range of the blower jet following impingement on the tank bottom and radial spreading over the liquid surface. This estimate attempts to account for the non-axisymmetric flow of air over that tank bottom that results from

- o the lateral constraint of the tank walls and
- o an on-deck blower location that is not normally centered on the tank platform.

Estimates of r_2 range from 0.50L to 0.75L as measured from the blower jet stagnation point where L is the overall tank length.

The quantity β is a free, dimensionless parameter that resulted from correlations between experimental data and theoretical predictions; a nominal value of β is 0.331.

The model incorporates two methods of calculating H, the Henry's law constant or partition coefficient. For dilute, ideal solutions, H is calculated by Dilling's method in Reference 2.

$$H = 16.04 \frac{p_v M}{TS} \quad (9)$$

where p_v = vapor pressure of the solute (chemical)
 at temperature T
 M = solute molecular weight
 S = solute solubility in water (finite)

For highly or infinitely water soluble chemicals, H is calculated by the method proposed by Mackay in Reference 5.

$$H = v_w p_v \gamma_1 / RT \quad (10)$$

where v_w = molar volume of water
 p_v = vapor pressure of solute at temperature T
 γ_1 = solute activity coefficient
 R = Universal gas constant

The activity coefficient, γ , for a chemical (solute) in water (solvent) solution is based on the following approximation to the two-suffix van Laar equations of Reference 6.

$$\log \gamma_1 = \log \gamma_1^\infty (1-x_1)^2 \quad (11)$$

where γ_1^∞ = activity coefficient at infinite dilution
 x_1 = mole fraction of chemical in solution

The mole fraction x_1 , is related to the mass concentration of chemical in water

$$x_1 = \frac{1}{1 + \frac{M_c}{M_w} \rho_w \left(\frac{1}{C_L} - \frac{1}{\rho_c} \right)} \quad (12)$$

where M_c, M_w = molecular weight of chemical and water,
 respectively
 ρ_c, ρ_w = mass density of chemical and water,
 respectively
 C_L = mass concentration of chemical in solution
 (program dependent variable)

This conversion assumes that the chemical and water volumes are additive in solution, and it gives the best representation of x_1 over a range of C_L from zero to ρ_c (Reference 7).

There are a number of systems of correlating equations that can be used in calculating γ_1^∞ as indicated in Reference 8. TANKM presumes that the user has applied one of these methods to calculate γ_1^∞ as an input to the program. All of these methods require varying amounts of basic data in order to perform the calculation. At the present time, these data for calculating γ_1^∞ are not contained in the HACS Chemical Property Data File.

The most readily used method is presented in Table 8-17 of Reference 8. The elements of the method are outlined below.

1. The user identifies the functional group that includes the chemical (solute) of interest with water being the solvent. For example, ethanol is an n-primary alcohol and xylene is an n-alkyl benzene.
2. Table 8-17 of Reference 8 identifies five correlating constants for each functional group and the appropriate correlating equation.
3. The last pieces of information are obtained from a two-dimensional representation of the chemical structure.

N_1, N_2 = total number of carbon atoms in solute and solvent molecules, respectively

N', N'', N''' = number of carbon atoms in respective branches of branched compounds, including polar groups

4. γ_1^∞ is then calculated

Table I illustrates the application of this method for several chemicals in water solution.

II.2.2 Input Data Requirements

A driver or main program entitled PRETNK controls the flow of input data from a user-operated video display terminal (VDT). PRETNK is structured to accept data for either the TANKM model or the TANKP model. The interactive logic in PRETNK guides the user in inputting a data set that is consistent with the requirements of either model.

When the input requirements for the TANKM model have been satisfied in PRETNK, the driver creates a file TANKMI, which enables TANKM to read the input data. The Fortran codes for the input variables in PRETNK are identical to those in TANKMI and TANKM. A similar read file, TANKPI, is created when TANKP is to be executed.

Table II describes the input data requirements and control variables for TANKM in the sequence that they will be requested of the user by PRETNK. Default options and the PRETNK subroutines that control default input are indicated where applicable; a discussion of each default option, together with any input required by the default subroutines, is presented in Section II.2.3.

PRETNK accepts a free field format for input of all real (non-integer) variables. In the event that the number of free fields that are input to PRETNK exceeds the format length specified by TANKM, file TANKMI will truncate to meet the input requirements. Conversely, when the number of free fields is less than the TANKM requirements, the input is used as provided. User supplied responses to interactive questions are A2 formatted within PRETNK.

II.2.3 Default Options

This section describes the input default options that can be selected for TANKM. A default option may be selected if (1) sufficient data is not available to meet the program requirements or (2) the user intends to study the effect of various combinations of variables in the tank cleaning-tank entry scenario.

TABLE I. CORRELATING CONSTANTS AND EQUATIONS FOR CALCULATING γ_1^∞

Solute Category	Solute	Eqn. No.	@25°C (Except As Noted)						N_1	N_2	N_1'	N_1''	$\log_{10} \gamma_1^\infty$
			α	ϵ	ξ	η	θ						
n-Primary Alcohols	n-Butanol	a	-0.995	0.622	0.558	-	0	4	0	-	-	1.6325	
	Ethyl Alcohol	a	-0.995	0.622	0.558	-	0	2	0	-	-	0.528	
n-Secondary Alcohols	Isopropyl-Alcohol	b	-1.22	0.622	0.170	0	-	3	-	2	2	0.816	
n-Ketones	Acetone	b	-1.475	0.622	0.500	0	-	3	0	2	2	0.891	
	MEK	b	-1.475	0.622	0.500	0	-	4	0	2	3	1.4297	
n-Esters	Vinyl Acetate	b(20°C)	-0.930	0.640	0.260	0	-	4	0	2	2	1.890	
n-Monoalkyl Chlorides	Chloroform	a(20°C)	1.265	0.640	0.073	-	0	1	0	-	-	1.978	
	EDC	a(20°C)	1.265	0.640	0.073	-	0	2	0	-	-	2.5815	
n-Alkyl Benzenes	Toluene	f	3.554	0.622	-0.466	-	-	7	-	-	-	9.7054	
	Xylenes	f	3.554	0.622	-0.466	-	-	8	-	-	-	10.3358	

Eqn. a $\log_{10} \gamma_1^\infty = \alpha + \epsilon N_1 + \xi / N_1 + \theta / N_2$

Eqn. b $\log_{10} \gamma_1^\infty = \alpha + \epsilon N_1 + \xi (1/N_1' + 1/N_1'') + \eta (N_1 - N_2)$

Eqn. f $\log_{10} \gamma_1^\infty = \alpha + \epsilon N_1 + \xi (1/N_1 - 4)$

SUBSCRIPTS: 1 = Solute (Chemical)
2 = Solvent (Water)

SOURCE: Reference 12

NOTE: As a result of experimental errors, the correlating equation for n-alkyl benzenes overpredicts the numerical value of $\log_{10} \gamma_1^\infty$ (Reference 13). For chemicals in this class, use activity coefficients estimated from the aqueous solubility (Reference 9).

$\log_{10} \gamma_1^\infty = 3.997$ (Toluene)
 $\log_{10} \gamma_1^\infty = 4.528$ (Xylenes)

TABLE II. INPUT DATA REQUIREMENTS FOR TANKM

Input Sequence	Computer Variable	Description	Units	Default Option Available	Comment
1	ITNK	Program Execution Selector 1 = TANKM, 2 = TANKP	D-I(1)	No(5)	
2	TESTNO	Test Number	D-I	No	For use in identifying field test data or for bookkeeping purposes
3	L W D	Tank Length Tank Width Tank Depth	m m m	Yes	Default controlled by subroutine TKDIM See Section 11.2.3
4	Q	Blower Flow Rate	m ³ /min	Yes	Default controlled by subroutine BLOWER See Section 11.2.3
5	DIA	Jet Diameter at Blower Exit	m	No	Most common diameter is 0.305m
6	HEVAL	Selector for Calculating Henry's Coefficient	D-I	No	HEVAL = 1; H = H (chemical activity coefficient) HEVAL = 2; H = H (chemical solubility)
7	GAMINE C1, C2	Activity Coefficient at Infinite Chemical Dilution in Water(4) Curve Fit Coefficients for Pure Chemical Density (mg/m ³) as a Function of Temperature (°C)	D-R(2) See Comment	No No(3)	 HEVAL = 1; RHOCHEM = C1 + C2 (T)

- (1) Dimensionless - Integer
- (2) Dimensionless - Real Variable
- (3) The curve fit on liquid chemical density will not be required when the program is integrated into the USCG-HACS system. The density as a function of temperature will be obtained from the HACS Chemical Property Data File.
- (4) Reference 8.
- (5) No - Indicates that a default option is not appropriate.

TABLE II. INPUT DATA REQUIREMENTS FOR TANKM (CONTINUED)

Input Sequence	Computer Variable	Description	Units	Default Option Available	Comment
8	S	Chemical Solubility in Water	mg/L	No	Required if HEVAL = 2 or if initial solute concentration COL (see Input Sequence No. 9) is unknown. Enter 1.0E6 or similar large real number for chemicals with infinite solubility.
9	DELTA	Postwash Solute Thickness on Tank Bottom	cm	Yes	Default controlled by subroutine POSTWH See Section II.2.3
	COL	Postwash Solute Concentration	mg/m ³	Yes	
10	PA	Atmospheric Pressure	mm Hg	No	
11	A,B,C	Constants in Antoine Equation for Solute Vapor Pressure	--	No (3)	A, B and C are chemical specific
12	COV	Chemical Vapor Concentration in the Tank Prior to Gas Freeing	ppm ⁽⁶⁾	Yes	Default option controlled by subroutine PREVT See Section II.2.3
13	TI	Time at Beginning of Ventilation	See Comment	No	Normal input is TI = 0
	PT	Integration Time Step	min	No	
14	TN	Duration of Ventilation Prior to Man Entry	min	No	Input controlled by subroutine VTRDPRK See Section II.2.3
	ITWORK	Identifies Type of Work to be Accomplished In-Tank	D-I	Five Options Available	
	TWORK	Length of Time Needed to Complete Work	min	No	

(6) Parts per million by volume

TABLE II. INPUT DATA REQUIREMENTS FOR TANKM (CONTINUED)

Input Sequence	Computer Variable	Description	Units	Default Option Available	Comment
15	TABTIM TABTEM	Array of Times During Ventilation Period, TH Array of Vapor Discharge Temperatures Corresponding to Times in TABTIM	min °C	No Yes	Input controlled by subroutine VENTMP Default options are available for TABTEM
16	TLVC TLVTWA TLVSTL	Ceiling Exposure Limit Time Weighted Average Exposure Limit Short Term Exposure Limit	ppm ppm ppm	No No No	
17	M	Solute Molecular Weight	gm/mole	No (3)	
18	R2	.Jet Deflection Plus Wall .Jet Distance	m	No	
19	NUMEXP	Number of Experimental Vapor Concentration-Time Pairs (Field Data if Available)	D-I	Yes	NUMEXP = 0, No experimental data available
20	ETIME ECVPPM	Array of Times for Experimental Vapor Concentration Measurements Measured Vapor Concentrations at Times in ETIME Array	min ppm	No No	

TABLE II. INPUT DATA REQUIREMENTS FOR TANKM (CONCLUDED)

TABLE II. INPUT DATA REQUIREMENTS FOR TANKM (CONCLUDED)

Input Sequence	Computer Variable	Description	Units	Default Option Available	Comment
21	JSWITCH	Selector for MINIT Calculation	D-I	No	JSWITCH = 1, Calculate mass of chemical in solution at beginning of gas freeing JSWITCH = 2, Bypass mass calculation
22	IBLOW	Indicates Blower Status During Tank Entry	D-I	Two Options Available	

Each default option is programmed as a self contained subroutine. The appropriate subroutine is automatically called when the interactive driver receives a negative user response to a question regarding data availability. These subroutines are also interactive and guide the user in selecting data to satisfy the program requirements. The numerical values for the options are based on a combination of field experience, technical literature, as well as the experience and operating procedures of vessel operators.

The default options are presented below in the order that each subroutine would be called from the PRETNK driver. The location of these calls in the overall input data sequence can be identified by referring to the COMMENT column in Table II.

Subroutine TKDIM

When tank dimensions are not known, the user has the option of selecting a barge tank or a tank on parcel/product carrier. For each tank type there are two default options.

Barge Tank Default Dimensions

Option 1 - Full Beam Tanks

L = 16.5 m

W = 8.2 m

D = 4.4 m

Option 2 - Port/Starboard Tanks Symmetric About Centerline

L = 9.0 m

W = 6.8 m

D = 3.6 m

Ship Tank Default Dimensions

Option 1 - Center Tank

L = 12.2 m

W = 10.9 m

D = 14.6 m

Option 2 - Wing Tank

L = 12.2 m

W = 7.3 m

D = 14.6 m

The above options on tank dimensions reflect actual tank measurements, a review of the barge files in USCG District 8 Offices and data provided by vessel operators. When the appropriate option has been selected for either tank type, the default dimensions are automatically assigned within the subroutine.

Subroutine BLOWER

Entry into this subroutine indicates that either a measured blower flow rate into the tank or discharge flow rate from the tank is not available to the user.

The user's first option is to estimate the flow rate from the manufacturer's specifications. This estimate requires information on the blower model number and the onboard supply pressure of the steam, water or compressed air that drives the blower. If this information is not readily available, then the user's second option is to select an average flow rate from the following alternatives:

Low Flow Rate	Q = 36 m ³ /min (1270 cfm)
Medium Flow Rate	Q = 96 m ³ /min (3390 cfm)
High Flow Rate	Q = 124 m ³ /min (4380 cfm)

These average flow rates were obtained from 19 measurements during gas freeing tests. The test data indicated that the

- o low flow rates extended from 24 to 48 m³/min,
- o medium flow rates extended from 83 to 101 m³/min, and
- o high flow rates extended from 110 to 140 m³/min.

Selection of any of the above flow rate options assumes that the blower is fully mated with the Butterworth opening during ventilation, i.e. the entire output of the blower is directed into the tank. This assumption is

valid in the majority of gas freeing operations. However, this assumption is not valid when the blower is operated in a cocked position that is analogous to an ullage port resting on its pin. This situation occurs occasionally when the design specification (metric versus English units) for the bolt circles on the blower and Butterworth opening are not compatible or when the blower discharge diameter is greater than the diameter of the Butterworth opening.

In either of the above cases, there will be a reduced flow rate into the tank relative to a fully mated blower. The flow rate of air entering the tank is some fraction, K, of the rated flow rate. Subroutine BLOWER does not contain a default option for K. If the user is executing a run in which there will be a flow rate reduction, then K is a user input that is based on judgement. However, a default value of K equal to 0.62 is suggested for at least the case where the blower discharge diameter is greater than that of the Butterworth opening. This value of K was calculated as the ratio of nominal Butterworth opening area divided by the area of a blower having the next largest discharge diameter of 0.39 m, which corresponds to a currently available steam or compressed air driven blower.

Subroutine POSTWH

This subroutine is called from PRETNK if

- o the postwash residue thickness, DELTA, on the tank bottom is unknown but the chemical concentration, COL, in water is known or
- o neither DELTA nor COL are known.

Thus, there are two default branches within this subroutine.

Default Option 1 - DELTA Unknown, COL Known

The rationale for this default branch is that DELTA is not a readily measurable quantity on barges and to greater extent on tank ships. Conversely, a sample of wash water residue can be obtained near the end of washing from a slipstream on the tank discharge line; this sample can then be analyzed for solute concentration, COL, using the appropriate analytical chemistry methods.

The user may select a residue thickness within the following default range.

$$\text{DELTA} = 0.1 \text{ cm} - 2.5 \text{ cm}$$

The lower limit on this range would represent efficient removal of residues by a stripping pump or stripping line. The tank bottom would have the appearance of wet concrete. If the suction inlet on the cargo discharge line is above the tank bottom or there is incomplete stripping, then residue thickness could approach the upper limit of this range.

Default Option 2 - DELTA and COL Unknown

A default value for DELTA is determined as in Default Option 1.

Next, the default value for COL is computed based on the following scenario. After the cargo has been discharged from the tank, a residual volume of cargo, VRES, remains on the tank bottom. The tank is then washed with portable machines at a prescribed water flow rate, QW, for a given period of time, TW. It is assumed that all of the residual chemical goes into solution, and the discharge of wash slops does not begin until the washing has been completed. In practice, the cargo discharge pumps are operated for brief periods of time to remove slops. After washing has been completed, it is further assumed that the slops are pumped and/or stripped from the tank until the prescribed value of DELTA has been reached.

To initiate calculation of the default value for COL, the user may select two options for the residual chemical volume, VRES.

Option 1 - $VRES = 0.2 \text{ m}^3$ for low kinematic viscosity cargos, high draft difference during discharge, deep well pumps with sump and sump stripped with eductor.

Option 2 - $VRES = 5.0 \text{ m}^3$ for high kinematic viscosity cargos, low draft difference during discharge and no deep well pump or sump.

The lower value of VRES is consistent with the experience of owner/operators of parcel chemical tankers and the residual chemical volumes that were measured and predicted in Reference 9. The higher value for VRES represents an upper bound for nearly all of the data that is reported in Reference 9.

The wash water flow rate and washing time are specified by this subroutine.

$$QW = 0.28 \text{ m}^3/\text{min}$$

$$TW = 48 \text{ min}$$

The washing time represents an average for a wide range of tank sizes and chemicals of varying solubility in water. The wash water rate corresponds to 75 gpm and represents an average rate for portable machines (3/8-inch diameter nozzles) operating at supply pressures of approximately 100 psig. These values reflect field observations and the data in Reference 10.

The solute concentration at the end of washing is then calculated.

$$COL = \frac{VRES * PCHEM * 1E9}{QW * TW + VRES}, \text{ mg/m}^3$$

where PCHEM is pure chemical density in gm/cm^3 , and it is a user input that is requested by subroutine POSTWH.

This calculated solute concentration is then compared to the known solubility limit, S, which is a user input to PRETNK. If COL is less than S, the calculated default value will be used in the program. The calculated COL is rejected if it is greater than S; the program proceeds with an assigned value of COL that is equal to S.

Subroutine PREVNT

Within this subroutine, the user will input either a known value for COV, the chemical vapor concentration in the tank before ventilation begins, or a default value will be calculated.

In calculating the default value of COV, it is assumed that before discharge is initiated the ullage space above the cargo contains saturated vapor corresponding to cargo temperature, CTEMP. The user inputs this temperature to the subroutine in °C. It is further assumed that the tank was loaded to some fraction, OMEGA, of its capacity. For a fully loaded tank, OMEGA will normally be 0.95 to 0.98. A short loaded tank may result in an OMEGA of 0.5 to 0.75, i.e. substantially less cargo than the tank capacity. As the cargo is discharged, the

saturated vapor in the ullage space will be diluted by air ingested into the tank. Assuming that there is no additional evaporation of cargo from the residues and that the tank atmosphere reaches equilibrium, then by the perfect gas law

$$\text{COV} = \frac{\text{PVS}(1. - \text{OMEGA})}{\text{PA}} *1\text{E}6$$

where

COV = equilibrium tank vapor concentration following cargo discharge, ppm

PVS = saturated vapor pressure at CTEMP in mmHg as determined by Antoine equation

OMEGA = fractional volume of tank occupied by cargo

PA = atmospheric pressure, mm Hg

The estimated default value for COV is used in both TANKM and TANKP. Its use in the TANKM model is justified because measurements of the tank vapor concentration before and after washing indicate that the water wash has a relatively minor affect on vapor levels. The primary affect of the wash is to dilute chemical residues.

Subroutine VTWORK

The tank cleaning scenario assumes that barge or ship personnel enter the tank at some time after the gas freeing or ventilation has been initiated. The gas freeing time prior to man-entry may be based on crew experience rather than a formal cleaning and entry procedure.

This subroutine permits the user to input TM, which is the ventilation time in minutes prior to man-entry into the tank.

In this subroutine, the user may select from five options that describe the type of work that will be performed in the tank and TWORK, the duration of the work. These options, which are presented interactively to the user are shown below.

- Option 1. Brief visual inspection and odor determination with cargo surveyor. TWORK = 1 - 2 min.
- Option 2. Inspect tank coatings and measure thickness
TWORK = 15 - 45 min.

- Option 3. Hand mucking of residue with towels and rags (relatively dirty tank) TWORK = 90 min.
- Option 4. Sweep debris from tank bottom and wipe pump sump (relatively clean tank) TWORK = 40 min.
- Option 5. User specified such that $(TM + TWORK)/DT$ is less than 500.

In the first two options, the user may input a value of TWORK that is within the indicated time range. Option 5 permits the user to specify work times for in-tank scenarios that are not represented by Options 1 through 4.

Subroutine VENTMP

The purpose of this subroutine is to establish a temperature-time history for the chemical vapors that are discharged from the tank during ventilation.

A measured or hypothetical temperature profile can be used. The subroutine accepts ordered pairs of digitized time and temperature beginning with the lowest time and ending with the largest time. The time values are stored in a one dimensional array TABTIM. Corresponding temperatures are stored in a TABTEM vector. The number of discrete data pairs is equal to NUMTAB. The user inputs each ordered pair sequentially on a separate line. At each input, time is entered first then temperature.

If a discharge temperature profile is not available, there are two default options.

Option 1. - Tank Washed With Hot Water

If the tank was washed with hot water, this option will result in a constant discharge temperature of 41°C (105°F) for all times following initiation of ventilation.

Option 2. - Tank Washed With Cold Water

The tank may be washed entirely with either salt or fresh water. A salt water wash may be followed by a fresh water wall wash. For either type of wash procedure, the model assumes that the wash water corresponds to the temperature of the navigable water surrounding the vessel,

and this temperature prevails during ventilation.

This default option has two alternatives that reflect observed seasonal variations in wash water temperature in the Gulf Coast area.

- o Alternative 1 - Temp = 16.5°C (61°F), Winter/
Gulf Coast
- o Alternative 2 - Temp = 29.4°C (84°F), Summer/
Gulf Coast

Either of these alternatives may be selected under Option 2. The result will be a constant vapor discharge temperature during ventilation.

II.2.4 Program Output

Execution of the TANKM program includes two output operations.

Operation 1. - Initially, the data that is input by the user to PRETNK must be transferred in a compatible format to TANKM. This transfer is accomplished internally through the output of the TANKMI data file in PRETNK; there is no hard copy or video display of the transfer.

Operation 2. - Primary data output is generated and controlled by TANKM. The tabular output is spooled to a printer for hard copy display. The graphical output is displayed on the video screen.

The details of each output operation are presented below.

II.2.4.1 TANKMI Output

The TANKMI output statements are duplicated below. Note that for each WRITE statement there is a corresponding READ statement in TANKM, and the variable sequences are common to both statements. In addition, each WRITE statement contains two integers in parentheses. The first integer, 1, creates the TANKMI file, and the second integer indicates

the format number, which is listed at the end of the WRITE operation.

C
C
C

OUTPUT DATA FOR TANKM

2
3
4
5
6
7
8

```
WRITE(1,2) TESTNO
WRITE(1,3) L, W, D
WRITE(1,3) Q, DELTA
WRITE(1,3) DIA, M
WRITE(1,3) S, GAMINE, C1, C2
WRITE(1,3) A, B, C
WRITE(1,3) PA, R2
WRITE(1,3) CBL, COV
WRITE(1,3) TI, TM, TWORK, DT
WRITE(1,4) NUMTAB
WRITE(1,5) (TABTIM(I), I=1, NUMTAB)
WRITE(1,5) (TABTEM(I), I=1, NUMTAB)
WRITE(1,4) USWICH, HEVAL
WRITE(1,6) NUMEXP
IF (NUMEXP .NE. 0) WRITE(1,7) (ETIME(I), ECVPPM(I), I=1, NUMEXP)
WRITE(1,8) ITWORK, IBLOW
WRITE(1,3) TLVC, TLVWA, TLVSTL
FORMAT(I5)
FORMAT(5E12.5)
FORMAT(2I3)
FORMAT(7F8.3)
FORMAT(1X, I5)
FORMAT(1X, 2F12.4)
FORMAT(I5, A2)
```

II.2.4.2 TANKM Output

TANKM produces six blocks of output information.

BLOCK 1 - This block prints out selected pieces of input data for reference purposes as well as the results of calculations that initialize the problem. The structure of the output block is shown on the next page.

***** TEST NO.

		ONE-TIME OUTPUTS		
VARIABLE	DESCRIPTION		UNITS	RESULT
HEVAL	=1, H(MACKAY); =2, H(DILLING)		*****	**** *
Q	BLOWER FLOW RATE		M3/MIN	
AREA	LIQUID SURFACE AREA		M2	
L	TANK LENGTH		METER	
W	TANK WIDTH		METER	
D	TANK DEPTH		METER	
V	TANK VOLUME		M3	
DELTA	RESIDUE THICKNESS		CM	
COL	INITIAL SOLUTE CONCENTRATION		MG/M3	
S	SOLUTE SOLUBILITY		MG/LITER	
M	SOLUTE MOLECULAR WEIGHT		GM/MOLE	
ROCHEM	CHEM. LIQUID DENSITY		MG/M3	
GAMINF	INF. DILUT. ACTIVITY COEF.		*****	
PA	ATMOSPHERIC PRESSURE		MM HG	
UWIND	CONVECTIVE EVAPORATION VEL		M/SEC	
DIA	DIA. OF B/W OPENING		METER	
UD	BLOWER JET VELOCITY		M/SEC	
KQ	GAS PHASE MASS TRANSFER COEFF		CM/MIN	
R1	JET DEFLECTION REGION (0.150D)		METER	
R2	JET DEFL + WALL JET DIST		METER	
KL	LIQUID PHASE MASS TRANSFER COEFF		CM/MIN	
MINIT	INITIAL CHEMICAL MASS IN SOLUTION		MG	
TLVC	THRESHOLD LIMIT VALUE, CEILING		PPM	
TLVTWA	THRESHOLD LIMIT VALUE, TIME-WEIGHTED AVERAGE		PPM	
TLVSTL	THRESHOLD LIMIT VALUE, SHORT-TERM EXPOSURE LIMIT		PPM	

BLOCK 2 - This block contains three entries.

1. TWORKN - Statement defining the user selected in-tank work activity (N = option selected).
2. TWORK - Duration of the in-tank work, min.
3. Statement defining blower status (on or off) during tank entry.

BLOCK 3 - The third block displays in tabular form the calculated values for nine variables at the end of each integration time step. The table

begins and ends at times corresponding to the start of ventilation and the termination of in-tank work, respectively. At each time step, there are two lines of output.

Line 1: TIME (MIN) - time after initiation of ventilation
CV(PPM) - volumetric vapor concentration
CV(MG/M3) - equivalent mass concentration of vapor
TEMP(C) - vapor discharge temperature
PV(MM-HG) - solute vapor pressure at TEMP(C)
H - Dimensionless Henry's or partition coefficient
CL(MG/M3) - solute (chemical) concentration in water

Line 2: KOL(CM/MIN) - overall mass transfer coefficient referenced
to liquid phase
MDOT(MG/MIN) - solute evaporation rate
MEVAP(M) - cumulative mass of evaporated solute

BLOCK 4 - Block 4 summarizes in tabular form the vapor concentration-time history in the tank during the period of time specified by TWORK. If the blower ON option was selected, then concentration should decrease with time. The calculated concentrations are assessed relative to the TLV-C and the TLV-STEL.

BLOCK 5 - If the TLV-C and TLV-STEL (interpreted as an MAC) are not exceeded at any time during TWORK, then the in-tank CV(PPM) profile is integrated to yield the average exposure concentration, which is an output quantity. The 8-hour TWA exposure is calculated and compared to the TLV-TWA, and the results are displayed in the output.

BLOCK 6 - Block 6 is a computer-generated graph of the calculated gas freeing concentration-time history and includes plotted experimental data if input by the user.

II.2.5 Hazard Assessment

The hazard assessment is programmed in both TANKM and TANKP. The groundrules for this assessment are as follows.

- o The in-tank exposure is to a single chemical.

- o This in-tank exposure is the only one that is received during an 8-hour period. There are no additional exposures to the given chemical or to other chemicals.
- o Exposures are evaluated relative to the Threshold Limit Values (TLVs) that are published by the American Conference of Governmental Industrial Hygienists (ACGIH) in Reference 11.
- o The Short Term Exposure Limit (STEL) is interpreted as a Maximum Allowable Concentration (MAC).

All of the data that is needed for this evaluation has been either input to or calculated within TANKM.

For simplicity, the hazard assessment is indicated as a block operation in the TANKM Flow Chart in Section II.4. The details of the assessment logic are presented below.

The first branch is determined by the input value of IBLOW, which determines if the blower is on or off during tank entry.

BLOWER ON

1. The program scans the calculated concentrations to determine if any $C(t_i)$ exceed the TLV-C or TLV-STEL during the period $t_M \leq t_i \leq t_M + t_{WORK}$. If the answer is YES, proceed to Item 5. If the answer is NO, then proceed to Item 2.
2. The average exposure concentration is calculated and outputted.

$$\bar{C}_{exp} = \frac{\int_{t_M}^{t_M + t_{WORK}} C(t_i) dt_i}{t_{WORK}}$$

3. The 8-hour TWA exposure is calculated next and outputted.

$$C_{TWA} = \bar{C}_{exp} t_{WORK} / 480$$

4. The C_{TWA} is compared to the TLV-TWA
 - a. If C_{TWA} is less than TLV-TWA, then an output appears.
"Predicted Single Exposure is Acceptable With Respect to TLV-C, TLV-STEL and TLV-TWA."
 - b. If the TLV-TWA is exceeded, the following message appears.
"Predicted Eight-Hour TWA Exposure Exceeds the TLV-TWA. Hazardous Conditions May Exist. Single Exposure Does Not Exceed TLV-C or TLV-STEL."

This is the end of the assessment for the NO branch in Item 1.

5. The YES branch in Item 1 will produce a printout of the instantaneous exposure times and the corresponding calculated concentrations where the TLV-C or TLV-STEL is exceeded. These occurrences may include all or part of the entry period, and each occurrence is labeled "Hazardous Working Conditions."
6. The integrated average exposure concentration is calculated and displayed
"Predicted Average In-Tank Exposure as Measured by a Dosimeter = ppm"
7. This average exposure is then compared to the TLV-C or the TLV-STEL. If \bar{C}_{exp} exceeds TLV-C or TLV-STEL, the assessment executes Item 8, otherwise it proceeds to Item 9.
8. The program then prints out the following message.
"Dosimeter Monitoring Would Indicate That The Average In-Tank Exposure Exceeds the TLV-C or TLV-STEL For This Chemical Vapor, and a Hazardous Working Condition Exists. Reduce Exposure Below Either TLV Before Assessing the TWA Exposure."

This completes the assessment for \bar{C}_{exp} greater than TLV-C or TLV-STEL.

9. A negative response in Item 7 produces the following message.
"Dosimeter Monitoring Would Indicate That The Average In-Tank Exposure is Acceptable and Does Not Exceed the TLV-C or TLV-STEL For This Chemical Vapor. However, Instantaneous Concentrations

Do Exceed These Limits. Real-Time Measurements of Vapor Concentration May Be Indicated."

10. Because \bar{C}_{exp} does not exceed the TLV-C or TLV-STEL, the 8-hour time weighted average exposure C_{TWA} is calculated and displayed as in Item 8.
11. C_{TWA} is then compared to the TLV-TWA
 - a. If C_{TWA} is less than TLV-TWA, the message is
"Monitoring Would Also Indicate That The Exposure is Acceptable With Respect to the TLV-TWA."
 - b. If C_{TWA} is greater than TLV-TWA, the following output message appears.

"Predicted Eight-Hour Time Weighted Average Exposure Exceeds The TLV-TWA. Hazardous Conditions May Exist."

This completes the assessment for the BLOWER ON option.

BLOWER OFF

1. Because the blower is off during tank entry, the exposure concentration is constant and equal to $C(t_M)$. The program checks $C(t_M)$ against TLV-C or TLV-STEL. If these levels are exceeded, then Item 4 is executed. Otherwise, proceed to Item 2.
2. The 8-hour TWA exposure is calculated as described earlier. Two messages appear.

"Predicted Average Exposure During Tank Entry = ppm"

"Predicted Eight-Hour Time Weighted Average Exposure = ppm"
3. The 8-hour TWA exposure is then compared to the TLV-TWA. Depending upon the result of this comparison, the message in either Item 4a or 4b of the BLOWER ON assessment will be printed.

This completes the assessment for the NO branch in Item 1.

4. The assessment performs Item 5 of the BLOWER ON option.
5. The messages in Items 6 and 8 of the BLOWER ON option are then displayed.

This completes the assessment for the BLOWER OFF option.

II.2.6 Example of TANKM

The example that was selected to demonstrate the interactive features of PRETNK and the execution of TANKM describes the gas freeing of an acetone tank following washing. Acetone is infinitely soluble in water.

The example includes five elements of hard copy.

Element No. 1 - This first element consists of the conversational interaction between the user and the PRETNK driver. If the user is operating from a VDT, the questions and responses will appear on the screen, but there will be no hard copy record of the input dialog. In this example, a Digital Decwriter II was used so that the interactive input data would be clearly identified in permanent dialog record.

Element No. 2 - This element represents the terminal input commands and system responses that set up the raster scan for the plot routine. This element can be performed following PRETNK input or after Element No. 4.

Element No. 3 - A copy of the output of the TANFMI data file is presented as Element No. 3. This element contains the input data in a format that is compatible for transfer to TANKM. Element No. 3 is not automatically presented, it must be requested by the user.

Element No. 4 - This element displays the execution output of TANK according to the block sequence that was described in a previous section.

Element No. 5 - Finally, the calculated concentration-time history and experimental data (if available) are displayed in graph form.

Comments that pertain to this example are presented below.

- o Acetone is infinitely soluble in water. Therefore, Henry's coefficient is calculated using the activity coefficient approach.
- o An artificially large, finite value of the solubility limit S was input in the event that the default option

on C_{OL} would have been exercised. This large value would prevent the calculated C_{OL} from exceeding a solubility limit which would result in C_{OL} being set equal to S . As this option was not exercised, the pseudo-input for S is irrelevant.

- o Tank entry was assumed to take place 14 minutes after gas freeing was initiated. The blower-on option was selected during tank entry when tank coatings were inspected and thicknesses measured for 44 minutes. The value of T_M is hypothetical because vapor concentration is nearly 6% LEL and would not be an acceptable entry condition. It was selected to demonstrate an important branch in the hazard assessment logic.
- o Initially, mass transfer of acetone is from the vapor phase to liquid phase, the evaporation rate is negative, the mole fraction and concentration of acetone in solution increase with time. The driving force for evaporation is negative. As time proceeds, the vapor space concentration declines because of solute absorption and ventilation discharge of vapor; the driving force trend is reversed, and solute evaporation begins. As MEVAP is the time integral of \dot{m} , there is a time lag between the onset of positive \dot{m} and a positive evaporated mass of chemical.
- o The tabulated time history of calculated variables ends at the time of egress from the tank.
- o The hazard assessment indicates that exposure concentration exceeded the acetone TLV-STEL during the first four minutes of intank work. These exceedences would not be detected by a conventional integrating dosimeter; the result would be an indication that the short-term exposure was acceptable. Because the integrated exposure did not exceed the STEL, the assessment then calculated that the 8-hour TWA exposure to this single event did not exceed the TLV-TWA, which was 750 ppm.

TANKM EXAMPLE

> RUN PRETNK

PROGRAM PRETNK IS AN INTERACTIVE PROGRAM DESIGNED FOR THE USER TO EASILY INPUT DATA COMPATIBLE FOR PROGRAM TANKM OR TANKP

1. TANKM - PROGRAM THAT CALCULATES THE CONCENTRATION-TIME HISTORY OF CHEMICAL VAPORS DISCHARGED FROM A TANK DURING DILUTION VENTILATION IN THE PRESENCE OF CHEMICAL SOLUTE EVAPORATION FROM AN AQUEOUS SOLUTION OF RESIDUAL CARGO ON THE TANK FLOOR.
2. TANKP - PROGRAM THAT CALCULATES THE CONCENTRATION-TIME HISTORY OF CHEMICAL VAPOR DISCHARGED FROM A TANK DURING DILUTION VENTILATION IN THE PRESENCE OF EVAPORATION OF PURE CHEMICAL RESIDUES FROM THE TANK WALLS AND FLOOR.

SELECT A 1 OR 2 TO INDICATE FOR WHICH PROGRAM YOU WISH TO INPUT DATA

1

INPUT TEST NUMBER

1

DO YOU HAVE TANK DIMENSIONS (Y/N)?

Y

ENTER TANK LENGTH, WIDTH, AND DEPTH IN METERS

12.19 6.858 13.26

DO YOU KNOW THE BLOWER FLOW RATE (Y/N)?

Y

INPUT MEASURED FLOW RATE (M3/MIN)

99.41

ENTER DIAMETER OF BUTTERWORTH OPENING IN METERS

0.305

HOW DO YOU WANT TO CALCULATE HENRY S CONSTANT?

1. HENRY S CONSTANT BY MACKAY S METHOD
2. HENRY S CONSTANT BY DILLING S METHOD

SELECT A 1 OR 2

1

INPUT GAMINF, ACTIVITY COEFFICIENT AT INFINITE DILUTION (CHEMICAL IN WATER)

7.78

INPUT C1, C2, CURVE FIT COEFFICIENTS OF LIQ. DENSITY AS FUNCTION OF TEMP. *RDCHEM(MG/M3) = C1+C2*T, T(C)

0.81 -0.1075E-02

ENTER S, SOLUTE VAPOR SOLUBILITY IN MG/LITER

1.0E15

DO YOU KNOW THE POSTWASH RESIDUE THICKNESS AND SOLUTE CONCENTRATION (Y/N)?

Y

ENTER RESIDUE THICKNESS AND SOLUTE CONCENTRATION

0.5 .1E7

ENTER IN ATMOSPHERIC PRESSURE IN MM HG
760

ENTER A, B, C, CHEMICAL VAPOR PRESSURE CONSTANTS
7.158 1231.0 231.8

IS PREVENTILATION VAPOR CONCENTRATION KNOWN (Y/N)?
Y

ENTER CONCENTRATION IN PPM
0.5E4

ENTER FOR INTEGRATION , TI (INITIAL TIME), AND DT
(INTEGRATION TIME STEP). DT MUST BE A WHOLE NUMBER.
TM AND TM+TWORK MUST BE MULTIPLES OF DT.
0.0 2

INPUT VENTILATION TIME, TM, TO MAN ENTRY
14.0

OPTIONS FOR DURATION OF MAN ENTRY, TWORK IN MIN., IS AS
FOLLOWS:

1. BRIEF VISUAL INSPECTION AND ODOR DETERMINATION
WITH CARGO SURVEYOR.
TWORK = 1 - 2 MIN.
2. INSPECT TANK COATINGS AND MEASURE THICKNESS
TWORK = 15 - 45 MIN.
3. HAND MUCKING OF RESIDUE WITH TOWELS AND RAGS
(RELATIVELY DIRTY TANK)
TWORK = 90 MIN.
4. SWEEP DEBRIS FROM TANK BOTTOM AND WIPE PUMP SUMP
(RELATIVELY CLEAN TANK)
TWORK = 40 MIN.
5. USER SPECIFIES

SELECT AND ENTER A 1-5 TO INDICATE WORK DESCRIPTION
2

INPUT DURATION, IN MINUTES, OF MAN ENTRY IN TANK
44

DO YOU KNOW THE VENTILATION TIME-TEMPERATURE DISCHARGE
HISTORY (Y/N) ?
Y

ENTER NUMBER OF TIME HISTORY VALUES
4

ENTER TIME - TEMPERATURE TABLE:

TABTIM(1) , TABTEM(1)

TABTIM(NUMTAB) , TABTEM(NUMTAB)

0.0 8.9
10.0 42.2
40.0 36.6
80.0 34.4

ENTER OCCUPATIONAL EXPOSURE LIMITS (ACGIH)
ALL EXPOSURE LIMITS ARE INPUT IN PPM
DOES THE COMPOUND HAVE A CEILING TLV (Y/N)?
N

INPUT TLVWA AND TLVSTEL
750. 1000.

ENTER M, SOLUTE MOLECULAR WT. IN GM/MOLE
58.08

ENTER R2, JET DEFLECTION + WALL JET DISTANCE IN METERS
7.47

INPUT NUMBER OF POINTS IN EXPERIMENTAL DATA , MAXIMUM
OF 200 POINTS (ENTER 0 (ZERO) IF NO POINTS)
14

INPUT TIME AND CONCENTRATION FOR EACH POINT

ETIME(1)	ECVPPM(1)
ETIME(NUMEXP)	ECVPPM(NUMEXP)
0.0 5000.	
5. 3700.	
10. 2550.	
15. 1700.	
20. 980.	
25. 530.	
30. 310.	
35. 212.	
40. 150.	
45. 90.	
50. 77.	
55. 56.	
60. 46.	
65. 29.	

1. PERFORM MINIT CALCULATION
2. BYPASS MINIT CALCULATION
SELECT 1 OR 2
2

WILL BLOWER BE OPERATING DURING TANK ENTRY (Y/N)?
Y

>@TANKM
>RUN TANKM

DENSIMETRIC FROUDE NO. = 787.666

DENSIMETRIC FROUDE NUMBER AT BEGINNING OF VENTILATION IS GREATER THAN 50, BLOWER CAPACITY IS SUFFICIENT FOR THE VENTILATING JET TO PENETRATE THE VAPOR SPACE AND IMPINGE ON THE TANK BOTTOM. COMPLETE JET PENETRATION AND IMPINGEMENT ENSURES THAT THE VAPOR CONCENTRATION IN THE ULLAGE SPACE IS HOMOGENOUS AND THAT THE WELL-MIXED MODELING ASSUMPTION IS VALID. FOR FURTHER DETAILS, CONSULT REFERENCE 4 OF THE CONTRACT FINAL REPORT.

TT30 -- STOP

>RUN PLTANK
>PIP SCRATCH.DAT;*/DE
>PIP LP.LST=TANKMO.DAT/RE
>* DO YOU WANT A HARD COPY OF TANKMO (Y/N) ? [S]: Y
>PIP LP.LST/SP
>///
>@ <EOF>
>

>TYPE TANKMI.IIAT

1

0.12190E+02 0.68580E+01 0.13260E+02
0.99410E+02 0.50000E+00
0.30500E+00 0.58080E+02
0.10000E+16 0.77800E+01 0.81000E+00-0.10750E-02
0.71580E+01 0.12310E+04 0.23180E+03
0.76000E+03 0.74700E+01
0.10000E+07 0.50000E+04
0.00000E+00 0.14000E+02 0.44000E+02 0.20000E+01

4

0.000 10.000 40.000 80.000
8.900 42.200 36.600 34.400

2 1

14

0.0000	5000.0000
5.0000	3700.0000
10.0000	2550.0000
15.0000	1700.0000
20.0000	980.0000
25.0000	530.0000
30.0000	310.0000
35.0000	212.0000
40.0000	150.0000
45.0000	90.0000
50.0000	77.0000
55.0000	56.0000
60.0000	46.0000
65.0000	29.0000

2Y

0.00000E+00 0.75000E+03 0.10000E+04

>

DENSIMETRIC FROUDE NO. = 787.666

DENSIMETRIC FROUDE NUMBER AT BEGINNING OF VENTILATION IS GREATER THAN 50. BLOWER CAPACITY IS SUFFICIENT FOR THE VENTILATING JET TO PENETRATE THE VAPOR SPACE AND IMPINGE ON THE TANK BOTTOM. COMPLETE JET PENETRATION AND IMPINGEMENT ENSURES THAT THE VAPOR CONCENTRATION IN THE ULLAGE SPACE IS HOMOGENOUS AND THAT THE WELL-MIXED MODELING ASSUMPTION IS VALID. FOR FURTHER DETAILS, CONSULT REFERENCE 4 OF THE CONTRACT FINAL REPORT.

***** TEST NO. 1 *****

VARIABLE	DESCRIPTION	ONE-TIME OUTPUTS	UNITS	RESULT
HEVAL	=1, H(MACKAY); =2, H(DILLING)		*****	****1****
Q	BLOWER FLOW RATE		M3/MIN	0.99410E+02
AREA	LIQUID SURFACE AREA		M2	0.83599E+02
L	TANK LENGTH		METER	0.12190E+02
W	TANK WIDTH		METER	0.68580E+01
D	TANK DEPTH		METER	0.13260E+02
V	TANK VOLUME		M3	0.11085E+04
DELTA	RESIDUE THICKNESS		CM	0.50000E+00
COL	INITIAL SOLUTE CONCENTRATION		MG/M3	0.10000E+07
S	SOLUTE SOLUBILITY		MG/LITER	0.10000E+16
M	SOLUTE MOLECULAR WEIGHT		GM/MOLE	0.58080E+02
ROCHEM	CHEM. LIQUID DENSITY		MG/M3	0.80043E+09
GAMINF	INF. DILUT. ACTIVITY COEF.		*****	0.77800E+01
PA	ATMOSPHERIC PRESSURE		MM HG	0.76000E+03
UWIND	CONVECTIVE EVAPORATION VEL		M/SEC	0.59051E+00
DIA	DIA. OF B/W OPENING		METER	0.30500E+00
UO	BLOWER JET VELOCITY		M/SEC	0.22677E+02
KO	AS PHASE MASS TRANSFER COEFF		CM/MIN	0.62324E+01
R1	JET DEFLECTION REGION (0.3D)		METER	0.19890E+01
R2	JET DEFL + WALL JET DIST		METER	0.74700E+01
KL	LIQUID PHASE MASS TRANSFER COEFF		CM/MIN	0.28726E+00
TLVC	THRESHOLD LIMIT VALUE, CEILING		PPM	0.00000E+00
TLVTA	THRESHOLD LIMIT VALUE,			
	TIME-WEIGHTED AVERAGE		PPM	0.75000E+03
TLVSTL	THRESHOLD LIMIT VALUE,			
	SHORT-TERM EXPOSURE LIMIT		PPM	0.10000E+04

TWORK2 - INSPECT TANK COATINGS AND MEASURE THICKNESS
TWORK = 44.0000 MIN.

BLOWER IS ON DURING MAN - ENTRY INTO TANK

TIME(MIN)	CV(PPM) GAMMA1	CV(MG/M3) KOL(CM/MIN)	TEMP(C)	PV(MM-HG) MDOT(MG/MIN)	H MEVAP(MG)	CL(MG/M3) X1(LIQ. MDL FRACTION)
0.0000E+00	0.5000E+04 0.7780E+01	0.1256E+05 0.5385E-02	0.8900E+01	0.1106E+03 -0.5969E+05	0.8805E-03 0.0000E+00	0.1000E+07 0.3111E-03
0.2000E+01	0.4243E+04 0.7780E+01	0.1041E+05 0.7177E-02	0.1556E+02	0.1519E+03 -0.4537E+05	0.1181E-02 -0.5253E+05	0.1251E+07 0.3893E-03
0.4000E+01	0.3601E+04 0.7780E+01	0.8635E+04 0.9399E-02	0.2222E+02	0.2051E+03 -0.3224E+05	0.1559E-02 -0.9133E+05	0.1436E+07 0.4470E-03
0.6000E+01	0.3060E+04 0.7780E+01	0.7175E+04 0.1210E-01	0.2888E+02	0.2727E+03 -0.2001E+05	0.2028E-02 -0.1175E+06	0.1561E+07 0.4859E-03
0.8000E+01	0.2604E+04 0.7780E+01	0.5973E+04 0.1535E-01	0.3554E+02	0.3576E+03 -0.8565E+04	0.2601E-02 -0.1317E+06	0.1629E+07 0.5071E-03
0.1000E+02	0.2221E+04 0.7780E+01	0.4988E+04 0.1916E-01	0.4220E+02	0.4627E+03 0.2084E+04	0.3295E-02 -0.1350E+06	0.1644E+07 0.5118E-03
0.1200E+02	0.1857E+04 0.7780E+01	0.4175E+04 0.1893E-01	0.4183E+02	0.4562E+03 0.5412E+04	0.3252E-02 -0.1312E+06	0.1626E+07 0.5061E-03
0.1400E+02	0.1555E+04 0.7780E+01	0.3501E+04 0.1871E-01	0.4145E+02	0.4498E+03 0.7868E+04	0.3211E-02 -0.1246E+06	0.1593E+07 0.4961E-03
0.1600E+02	0.1305E+04 0.7780E+01	0.2941E+04 0.1848E-01	0.4108E+02	0.4435E+03 0.9633E+04	0.3169E-02 -0.1158E+06	0.1551E+07 0.4830E-03
0.1800E+02	0.1097E+04 0.7780E+01	0.2475E+04 0.1826E-01	0.4071E+02	0.4372E+03 0.1085E+05	0.3128E-02 -0.1056E+06	0.1502E+07 0.4677E-03
0.2000E+02	0.9238E+03 0.7780E+01	0.2087E+04 0.1803E-01	0.4033E+02	0.4310E+03 0.1164E+05	0.3087E-02 -0.9435E+05	0.1448E+07 0.4508E-03
0.2200E+02	0.7799E+03 0.7780E+01	0.1764E+04 0.1781E-01	0.3996E+02	0.4249E+03 0.1210E+05	0.3047E-02 -0.8248E+05	0.1391E+07 0.4331E-03
0.2400E+02	0.6600E+03 0.7780E+01	0.1495E+04 0.1759E-01	0.3959E+02	0.4188E+03 0.1229E+05	0.3007E-02 -0.7029E+05	0.1333E+07 0.4149E-03
0.2600E+02	0.5599E+03 0.7780E+01	0.1270E+04 0.1738E-01	0.3921E+02	0.4128E+03 0.1229E+05	0.2968E-02 -0.5799E+05	0.1274E+07 0.3965E-03
0.2800E+02	0.4763E+03 0.7780E+01	0.1081E+04 0.1716E-01	0.3884E+02	0.4069E+03 0.1214E+05	0.2929E-02 -0.4577E+05	0.1215E+07 0.3783E-03
0.3000E+02	0.4064E+03 0.7780E+01	0.9236E+03 0.1695E-01	0.3847E+02	0.4011E+03 0.1188E+05	0.2890E-02 -0.3376E+05	0.1158E+07 0.3604E-03
0.3200E+02	0.3477E+03 0.7780E+01	0.7913E+03 0.1674E-01	0.3809E+02	0.3953E+03 0.1154E+05	0.2852E-02 -0.2205E+05	0.1102E+07 0.3429E-03

TIME(MIN)	CV(PPM) GAMMA1	CV(MG/M3) KOL(CM/MIN)	TEMP(C)	PV(MM-HG) MDDT(MG/MIN)	H MEVAP(MG)	CL(MG/M3) X1(LIG MOL FRACTION)
0.3400E+02	0.2985E+03 0.7780E+01	0.6801E+03 0.1653E-01	0.3772E+02	0.3896E+03 0.1114E+05	0.2814E-02 -0.1072E+05	0.1048E+07 0.3260E-03
0.3600E+02	0.2571E+03 0.7780E+01	0.5865E+03 0.1632E-01	0.3735E+02	0.3840E+03 0.1070E+05	0.2777E-02 0.2025E+03	0.9954E+06 0.3097E-03
0.3800E+02	0.2222E+03 0.7780E+01	0.5074E+03 0.1612E-01	0.3697E+02	0.3784E+03 0.1024E+05	0.2740E-02 0.1067E+05	0.9453E+06 0.2941E-03
0.4000E+02	0.1927E+03 0.7780E+01	0.4406E+03 0.1591E-01	0.3660E+02	0.3729E+03 0.9770E+04	0.2703E-02 0.2068E+05	0.8974E+06 0.2792E-03
0.4200E+02	0.1679E+03 0.7780E+01	0.3841E+03 0.1585E-01	0.3649E+02	0.3713E+03 0.9395E+04	0.2692E-02 0.3026E+05	0.8515E+06 0.2649E-03
0.4400E+02	0.1469E+03 0.7780E+01	0.3362E+03 0.1579E-01	0.3638E+02	0.3697E+03 0.9007E+04	0.2682E-02 0.3946E+05	0.8075E+06 0.2512E-03
0.4600E+02	0.1291E+03 0.7780E+01	0.2956E+03 0.1574E-01	0.3627E+02	0.3681E+03 0.8612E+04	0.2671E-02 0.4827E+05	0.7653E+06 0.2381E-03
0.4800E+02	0.1140E+03 0.7780E+01	0.2609E+03 0.1568E-01	0.3616E+02	0.3665E+03 0.8217E+04	0.2660E-02 0.5669E+05	0.7251E+06 0.2256E-03
0.5000E+02	0.1010E+03 0.7780E+01	0.2313E+03 0.1562E-01	0.3605E+02	0.3649E+03 0.7826E+04	0.2650E-02 0.6471E+05	0.6867E+06 0.2136E-03
0.5200E+02	0.8988E+02 0.7780E+01	0.2059E+03 0.1556E-01	0.3594E+02	0.3633E+03 0.7442E+04	0.2639E-02 0.7274E+05	0.6502E+06 0.2022E-03
0.5400E+02	0.8032E+02 0.7780E+01	0.1841E+03 0.1550E-01	0.3583E+02	0.3617E+03 0.7068E+04	0.2629E-02 0.7960E+05	0.6155E+06 0.1914E-03
0.5600E+02	0.7206E+02 0.7780E+01	0.1652E+03 0.1544E-01	0.3572E+02	0.3601E+03 0.6705E+04	0.2618E-02 0.8648E+05	0.5825E+06 0.1812E-03
0.5800E+02	0.6490E+02 0.7780E+01	0.1489E+03 0.1538E-01	0.3561E+02	0.3586E+03 0.6355E+04	0.2608E-02 0.9301E+05	0.5513E+06 0.1715E-03

EVALUATION OF VAPOR CONCENTRATIONS DURING MAN-ENTRY

TANK IS ENTERED AT TIME = 14.0 MIN
TANK IS EXITED AT TIME = 58.0 MIN

PREDICTED INSTANTANEOUS EXPOSURE CONCENTRATIONS EXCEED THE TLV-STEL

TIME (MIN)	CONCENTRATION (PPM)	
14.00	1555.1	HAZARDOUS WORKING CONDITIONS
16.00	1304.7	HAZARDOUS WORKING CONDITIONS
18.00	1096.7	HAZARDOUS WORKING CONDITIONS

PREDICTED AVERAGE IN-TANK EXPOSURE AS MEASURED BY A DOSIMETER = 418.85 PPM

DOSIMETER MONITORING WOULD INDICATE THAT THE AVERAGE IN-TANK EXPOSURE IS ACCEPTABLE AND DOES NOT EXCEED THE TLV-STEL FOR THIS CHEMICAL VAPOR. HOWEVER, INSTANTANEOUS CONCENTRATIONS DO EXCEED THESE LIMITS. REAL TIME MEASUREMENTS OF VAPOR CONCENTRATION MAY BE INDICATED.

PREDICTED EIGHT-HOUR TIME WEIGHTED AVERAGE EXPOSURE = 38.39 PPM

MONITORING WOULD ALSO INDICATE THAT THE EXPOSURE IS ACCEPTABLE WITH RESPECT TO THE TLV-TWA.

TEST NO. 1
VENTILATION TIME HISTORY

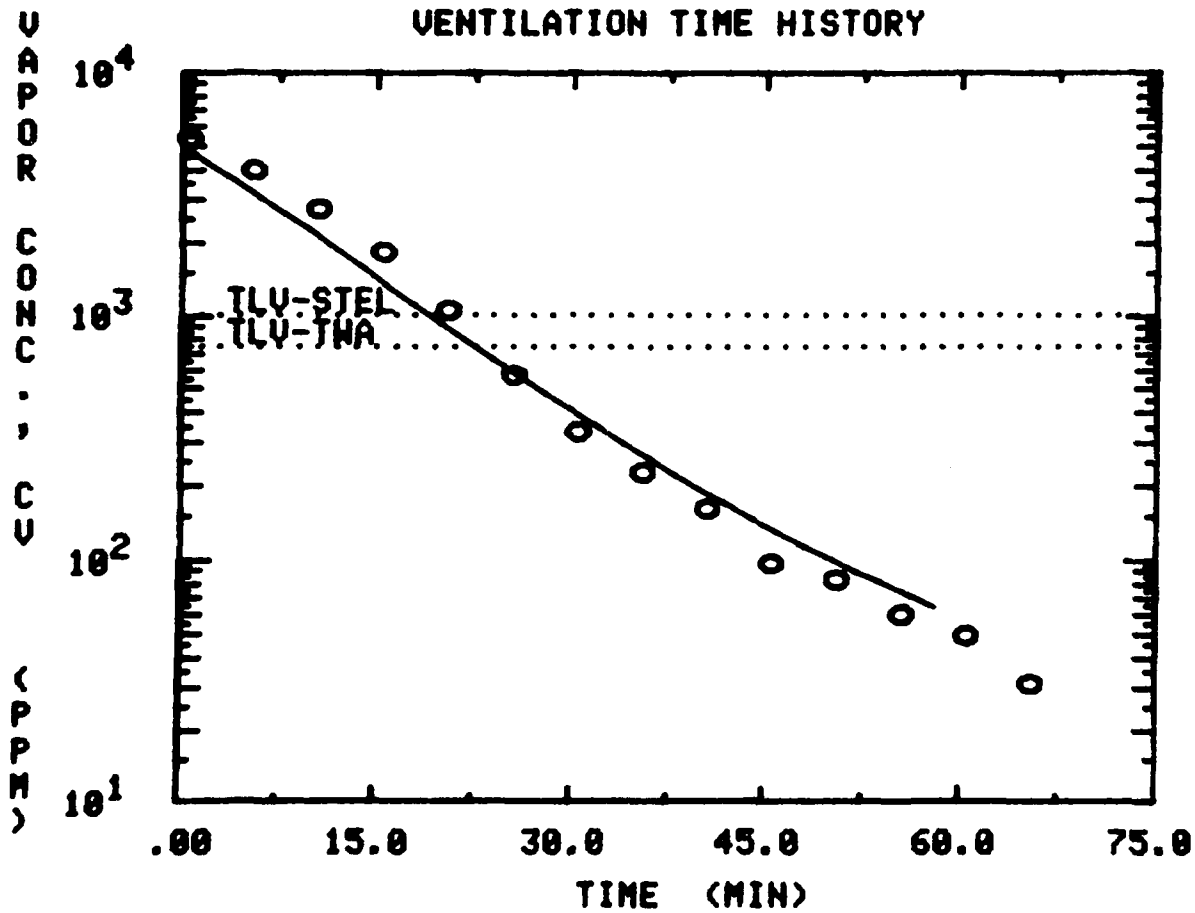

- o The graph presents a visual display of the calculated and experimental vapor concentration-time histories at the ventilation discharge from the tank. The reversal of solute absorption to evaporation produces a smooth transition in the $C(t)$ history at approximately 10 minutes into gas freeing.
- o In this example, mass transfer between liquid and vapor phases is controlled by the vapor phase. The liquid phase offers little resistance to mass transfer. That is, $1/k_l \ll 1/(Hk_g)$ and $1/K_{OL} \approx 1/(Hk_g)$,

$1/k_{OL}$ = total resistance to mass transfer

$1/k_l$ = liquid phase resistance

$1/(Hk_g)$ = vapor phase resistance

II.3 Elements of Program TANKP

II.3.1 Model Description Summary

The TANKP model is based on the numerical integration of an inhomogeneous, ordinary, time-dependent differential equation for the conservation of chemical mass in the vapor space. The inhomogeneity is a source term that represents mass addition to the vapor space as a result of evaporation of pure chemical residues from the tanks walls and tank bottom. Tank vapor concentration is the dependent variable.

A mass balance in the vapor phase yields

$$V \frac{dC}{dt} = \dot{m}_G - CQ \quad (13)$$

where

V = tank volume

C = mass concentration of vapor in air

Q = blower flow rate

\dot{m}_G = instantaneous, total evaporation rate of pure chemical from residual films on the tank walls and bottom.

As in the TANKM program, this conservation of mass formulation assumes that the contents of the vapor space are well-mixed so that vapor concentrations are uniform in space. A consequence of this assumption is that the local air velocity over the tank internal surfaces, and residual chemical films, is constant.

The evaporation rate model for \dot{m}_G is based on Reference 12. Gray's model for the evaporative flux of vapor from an element of liquid surface is expressed by the following equation.

$$\frac{d\dot{m}}{dA} = \frac{DMP_v}{RT_G F} \quad (14)$$

where

- \dot{m} = local mass evaporation rate
- A = local element of liquid surface area
- D = diffusion coefficient
- M = molecular weight
- P_v = vapor pressure of chemical film corresponding to the local wall temperature or tank bottom temperature
- R = Universal gas constant
- T_G = temperature of in-tank vapor space, assumed equal to temperature of vapor discharged from tank during gas freeing
- F = thickness of stagnant interface film that exists between the residual chemical layer and the air flow over the liquid layer

Equation 14 assumes that the driving force for evaporation is the chemical vapor pressure, i.e. $P_v \gg$ partial pressure of vapor in the tank atmosphere. The analytical expression for diffusion coefficient is

$$D = \frac{0.425 T_G^{3/2}}{P(MT_b/G)^{1/2}} \quad (15)$$

where

- T_b = chemical boiling point at atmospheric pressure
- G = liquid surface tension

Finally, an empirical film thickness as described by Gray is

$$1/F = 0.217 S_c^{-0.9} (S_c U)^{0.625} S_c^{0.3} \quad (16)$$

where

S_c = Schmidt number, ν/D

ν = kinematic viscosity of air

U = effective air velocity over the liquid surfaces

The effective air velocity, U , that is contained in Equation 16 is identical to the velocity U_{WIND} that is used in the TANKM model. The assumptions and equations that are used in calculating this velocity are the same in both cases. Consequently, the user is referred to Section II.2 for details concerning the model for U .

The modeling assumptions permit the local evaporation process to be decoupled from the ventilation process in the sense that local evaporation flux rates can be integrated over the liquid surface areas to obtain an $\dot{m}_G(t)$ history for numerical input to Equation 13. The elements of this integration operation are presented below.

1. The thickness T_{FILM} of chemical residue is the same on all vertical tank walls but may differ from the residue thickness T_{POOL} on the tank bottom.
2. Opposite pairs of parallel tank walls have a common variation in wall (and residue) temperature with tank depth. Port-starboard walls may have a temperature profile that differs from the fore-aft walls.
3. The local evaporation flux on a given wall is constant over a wall depth increment DY and strip width of either L or W and reflects local wall temperature.
4. The local evaporation rate is constant for all times less than or equal to τ_ℓ

$$\tau_\ell = t_{FILM} \rho_F / (d\dot{m}/dA) \quad (17)$$

where τ_c = local evaporation time
 ρ = pure chemical density

Local evaporation ceases for time greater than t_v .

5. Statements similar to Items 3 and 4 apply to the tank bottom.
6. Evaporation flux profiles are then integrated using Simpson's Rule over the tank depth ($Y = 0$ to $Y = H$) subject to the local time constraints in Item 4 to yield evaporation rate-time profiles on the vertical walls.
7. The evaporation rate on the tank bottom is calculated by multiplying Equation 14 by the tank planform area, LW . The corresponding evaporation time τ_B is calculated using the equivalent form in Equation 17.
8. Using time as an indicator, total evaporation rate is calculated

$$\dot{m}_G(t) = \dot{m}_B(t) + 2 \left(\dot{m}_{HL}(t) + \dot{m}_{HW}(t) \right), \quad (18)$$
$$t = t_0 \text{ to } t_f$$

9. The \dot{m}_G and time vectors are stored internally for use in Equation 13. The value of \dot{m}_G corresponding to integration time, t , is obtained by table lookup and interpolation, if needed.

II.3.2 Input Data Requirements

Table III describes the input data requirements and control variables for TANKP in the sequence that they will be requested of the user by the interactive driver PRETNK. The majority of the inputs to TANKP are in metric units. Two exceptions are the curve fit constants for chemical density and viscosity of air, which reflect English units. Default options and the PRETNK subroutines that control default input are indicated where applicable. A discussion of the default options and

TABLE III. INPUT DATA REQUIREMENTS FOR TANKP

Input Sequence	Computer Variable	Description	Units	Default Option Available	Comment
1	ITNK	Program Execution Selector 1 = TANKM, 2 = TANKP	D-I(1)	No(2)	
2	TESTNO	Test Number	D-I	No	For use in identifying field test data or for bookkeeping purposes
3	L W D	Tank Length Tank Width Tank Depth	m m m	Yes	Default controlled by subroutine TKDIM See Section II.3.3 TANKP will change variable name from D to H
4	Q	Blower Flow Rate	m ³ /min	Yes	Default controlled by subroutine BLOWER See Section II.3.3
5	DIA	Diameter of Butterworth Opening	m	No	Most common diameter is 0.305 m
6	TPOOL	Residue Thickness on Tank Bottom	cm	Yes	Default controlled by subroutine CHEMRS See Section II.3.3
7	TFILM	Residue Thickness on Tank Walls	cm	Yes	Default controlled by subroutine TKWALL See Section II.3.3
8	PA	Atmospheric Pressure	mm Hg	No	TANKP will change variable name from PA to P
9	A,B,C	Constants in Antoine Equation for Chemical Vapor Pressure	--	No(3)	TANKP will change variable name from C to CEF

(1) Dimensionless - Integer

(2) No - Indicates that a default option is not appropriate.

(3) The curve fit on liquid chemical density will not be required when the program is integrated into the USCG-HACS System. The density as a function of temperature will be obtained from the HACS Chemical Property Data File.

TABLE III. INPUT DATA REQUIREMENTS FOR TANKP (CONTINUED)

Input Sequence	Computer Variable	Description	Units	Default Option Available	Comment
10	COV	Chemical Vapor Concentration in the Tank Prior to Gas Freeing	ppm(4)	Yes	Default controlled by subroutine PREVNT See Section II.3.3
11	TI	Time at Beginning of Ventilation	See Comment	No	TANKP will change variable name to DTIME
	DT	Integration Time Step	min	No	
12	TM	Duration of Ventilation Prior to Man Entry	min	No	Input controlled by Subroutine VIEWRK
	ITWORK	Identifies Type of Work to be Accomplished In-Tank	D-I	Five Options Available	
	TWORK	Length of Time Needed to Complete Work	min	No	
13	TGAS	Vapor Discharge Temperature During Ventilation	°K	No	
14	TLVC	Celling Exposure Limit	ppm	No	
	TLVWA	Time-Weighted Average Exposure Limit	ppm	No	
	TLVSTL	Short Term Exposure Limit	ppm	No	
15	M	Chemical Molecular Weight	gm/mole	No	
16	R2	Jet Deflection Plus Wall Jet Distance	m	No	

(4) Parts per million by volume

TABLE III. INPUT DATA REQUIREMENTS FOR TANKP (CONTINUED)

Input Sequence	Computer Variable	Description	Units	Default Option Available	Comment
17	NUMEXP	Number of Experimental Vapor Concentration-Time Pairs (Field Data if Available)	D-I	Yes	NUMEXP = 0, No experimental data available
18	ETIME	Array of Times for Experimental Vapor Concentration Measurements	min	No	
19	ECVPEM	Measured Vapor Concentrations at Times in ETIME Array	ppm	No	
20	TB	Chemical Boiling Point	°K	No(3)	
21	G	Chemical Surface Tension	dynes/cm	No(3)	
22	R	Universal Gas Constant	$\frac{\text{cm}^3\text{-mm Hg}}{\text{mole}\text{-}^\circ\text{K}}$	No(3)	
23	C ₁ , C ₂	Curve Fit Coefficients for Pure Chemical Density (lb/ft ³) as a Function of Temperature (°F)	-	No(3)	
24	ALPHA, BETA, GAMMA	Curve Fit Coefficients for Wall Temperature (°K) as a Function of Tank Depth (m)	-	No	Walls parallel to x-y plane

TABLE III. INPUT DATA REQUIREMENTS FOR TANKP (CONCLUDED)

TABLE III. INPUT DATA REQUIREMENTS FOR TANKP (CONCLUDED)

Input Sequence	Computer Variable	Description	Units	Default Option Available	Comment
25	ZETA, ETA, THETA	Curve Fit Coefficients for Wall Temperature ($^{\circ}$ K) as a Function of Tank Depth (m)	-	No	Walls parallel to y-z plane
26	DELTA, EPSILN, PHI	Curve Fit Coefficients for Kinematic Viscosity of Air (ft^2/sec) as a Function of Temperature ($^{\circ}$ F)	-	No (3)	
27	STEP	Number of Subdivision of Tank Depth, H	m	No	DY = H/STEP
28	NSTEP	Integer Value of STEP	D-I	No	
29	IBLOW	Indicates Blower Status During Tank Entry	D-I	Two Options Available	

any additional user-supplied default information is presented in Section II.3.3. The next section also includes discussions of other subroutines that have an input control function (with options) but are not default routines. Some of the PRETNK subroutines are common to both TANKM and TANKP. In these instances, Section II.3.3 will refer the reader to a discussion of that subroutine in Section II.2.3.

Interactive input is stored in a PRETANK data file, TANKPI, in a format that is compatible with the input requirements of TANKP.

II.3.3 Default Options

This section describes the input default options that are available in TANKP, and they are presented below in the order that each default subroutine would be called from PRETNK. The location of these calls in the input sequence is noted in the COMMENT column of Table III. Where default options are common to TANKM, the reader is referred to Section II.2.3.

Subroutine TKDIM

See Section II.2.3.

Subroutine BLOWER

See Section II.2.3

Subroutine CHEMRS

The objective of this subroutine is to provide the user with options that lead to calculation of a default value for TPOOL, the thickness of residual pure chemical on the tank bottom after product discharge. Two default options are presented for the residual volume of pure chemical on the tank bottom; these options for VRES are 0.2 and 5.0m³. Note that these options are the same as are contained in subroutine POSTWH for the TANKM model. The rationale for these values is the same in both cases and is contained in Section II.2.3 and the POSTWH subroutine. Following selection of the default VRES, the residual thickness TPOOL is calculated.

$$TPOOL = VRES / (LW)$$

Subroutine TKWALL

This subroutine contains two default options for the chemical film thickness TFILM on the tank walls prior to beginning of ventilation. The following default values were calculated using the film estimation method in Reference 9, which includes the effect of product discharge ullage rate and kinematic viscosity.

Option 1. TFILM = $3.9E-03$ CM for kinematic viscosities of the order of $200E-06$ M²/sec.

Option 2. TFILM = $0.11E-03$ CM for kinematic viscosities approaching $1E-06$ M²/sec.

These options are based on a product discharge rate of 200 MT/hr at a nominal cargo specific gravity of 1.0. Tank length and width have a relatively minor affect on the calculated film thicknesses.

The smaller of the two film thicknesses would be applicable to the bulk of the pure chemicals that do not require heating during shipment and discharge. The larger film thickness would be appropriate for a smaller group of viscous, heated cargoes. The user may perform a separate hand calculation and input TFILM for a specific cargo and discharge temperature.

Subroutine PREVNT

See Section II.2.3

Subroutine VTWORK

See Section II.2.3

II.3.4 Program Output

Execution of the TANKP program includes the same two generic output operations that are performed in TANKM runs.

Operation 1. - Transfer of input data from the TANKPI data file in PRETNK to TANKP. The output format in TANKPI is compatible with the input format in TANKP.

Operation 2. - The results of program execution are output to a printer by TANKP.

The details of each output operation are presented below.

II.3.4.1 TANKMI Output

The TANKPI output statements are duplicated below. Each WRITE statement contains an ordered pair of numbers in parentheses. The first number, 2, creates the TANKPI data file, and the second integer refers to the appropriate FORMAT number. Format numbers 2, 3 and 8 are not shown because they are common to the TANKMI output file.

```
1  WRITE(2,2) TESTNO
   WRITE(2,9) L, W, D, M, PA, TB, G, R, STEP, A, B, C, C1,
   9  C2
   WRITE(2,9) DELTA, EPSILN, PHI
   FORMAT(6E12.6)
  10  WRITE(2,10) NSTEP
   FORMAT(I4)
   WRITE(2,9) COV, Q, TFILM, TPOOL, TGAS, DIA, R2
   WRITE(2,9) ALPHA, BETA, GAMMA
   WRITE(2,9) ZETA, ETA, THETA
   WRITE(2,6) NUMEXP
   IF (NUMEXP .NE. 0) WRITE(2,7) (ETIME(I), ECVPPM(I), I=1, NUMEXP)
   WRITE(2,9) TI, TM, TWORK, DT
   WRITE(2,3) TLVC, TLVTNA, TLVSTL
   WRITE(2,8) ITWORK, IBLOW
```

II.3.4.2 TANKP Output

TANKP produces nine blocks of output information.

BLOCK 1 - This block prints out selected pieces of input or default data. The format of this printout is shown on the next page.

**** TEST NO. ****

VARIABLE	COMMON TANK PARAMETERS DESCRIPTION	UNITS	RESULT
L	TANK LENGTH	M	
W	TANK WIDTH	M	
H	TANK HEIGHT	M	
V	TANK VOLUME	M	
CO	INITIAL CONCENTRATION	MG/M3	
Q	VENTILATION RATE	M3/MIN	
P	TANK PRESSURE	MM HG	
TB	LIQUID BOILING POINT	K	
G	LIQUID SURFACE TENSION	DYNES/CM	
U	WALL AIR VELOCITY	CM/SEC	
M	LIQUID MOLECULAR WEIGHT	CM/MOLE	
TFILM	FILM THICKNESS ON WALLS	CM	
TPOOL	FILM THICKNESS ON BOTTOM	CM	
TLVC	THRESHOLD LIMIT VALUE, CEILING	PPM	
TLVTA	THRESHOLD LIMIT VALUE, TIME-WEIGHTED AVERAGE	PPM	
TLVSTL	THRESHOLD LIMIT VALUE, SHORT-TERM EXPOSURE LIMIT	PPM	

BLOCK 2 - This block contains three entries.

1. TWORKN - Statement defining the user selected in-tank work activity (N = option selected).
2. TWORK - Duration of the in-tank work, min.
3. Statement defining blower status (on or off) during tank entry.

BLOCK 3 - Block 3 displays the numerical values for nine variables that relate to the chemical evaporation process on the tank bottom.

SUMMARY OF TANK BOTTOM QUANTITY	RESULT
FLOOR TEMPERATURE(K)	
VAPOR PRESSURE(MM HG)	
DIFFUSION COEFFICIENT(CM2/SEC)	
KINEMATIC VISCOSITY OF AIR(CM2/SEC)	
SCHMIDT NUMBER	
RHOF(GM/CM3)	
MDOTXZ(GM/CM2-SEC)	
TAUB(SEC)	
1/F(CM**-1)	

BLOCK 4 - This block tabulates eight wall-film chemical quantities and their variation with depth from tank top to tank bottom. The table applies to tank walls that are parallel to the X-Y plane. At a given depth, Y, into the tank, local values of the eight quantities are assumed to be constant over a distance increment DY. These local quantities and their units are:

TEMP(K)	- Wall Temperature
MDOTXY(GM/CM2-SEC)	- Evaporation flux
TAUXY(SEC)	- Time to evaporate TFILM
D(CM2/SEC)	- Diffusion coefficient
NU(CM2/SEC)	- Kinematic viscosity of air
PV(MM HG)	- Chemical vapor pressure
SC (dimensionless)	- Schmidt number, NU/D
1/F(CM ⁻¹)	- Reciprocal of film thickness at surface of evaporating liquid

Note, that this table is presented in the output even though the ventilation scenario may not contain a film on these tank walls.

BLOCK 5 - This block is identical in format and content to BLOCK 4 and pertains to the two remaining tank walls that are parallel to the Y-Z plane.

BLOCK 6 - BLOCK 6 presents a tabulated time history of the calculated tank vapor concentrations and other informational quantities.

CONCENT(PPM)	- Tank vapor concentration
C/CO	- Ratio of instantaneous to initial tank concentration
QT/V	- Cumulative tank turnovers or air exchange at time t
MDOTG(GM/SEC)	- Instantaneous, integrated chemical evaporation rate from all affected surfaces

- MDOTHL (GM/SEC) - Instantaneous, integrated evaporation rate from walls parallel to tank length
- MDOTHW (GM/SEC) - Same as MDOTHL but for walls parallel to tank width
- MDOTB (GM/SEC) - Chemical evaporation rate from the tank bottom

Note that

$$\dot{m}_G = \dot{m}_B + 2 \left(\dot{m}_{HL} + \dot{m}_{HW} \right) \quad (19)$$

BLOCK 7 - BLOCK 7 summarizes in tabular form the vapor concentration-time history in the tank during the period of time specified by TWORK. If the blower ON option was selected, then concentration should decrease with time. The calculated concentrations are assessed relative to the TLV-C and the TLV-STEL, and if these levels are exceeded, "Hazardous Working Conditions" are indicated.

BLOCK 8 - If the TLV-C and TLV-STEL (interpreted as an MAC) are not exceeded at any time during TWORK, then the in-tank CV(PPM) profile is integrated to yield the average exposure concentration, which is an output quantity. The 8-hour TWA exposure is calculated and compared to the TLV-TWA, and the results are displayed in the output.

BLOCK 9 - BLOCK 9 is a computer-generated graph of the calculated gas freeing concentration-time history and includes plotted experimental data if input by the user.

II.3.5 Hazard Assessment

The hazard assessment logic that is programmed into TANKP is identical to the logic in TANKM as described in Section II.2.5.

As in TANKM, the assessment is based on the ACGIH Threshold Limit Values in Reference 11. When time weighted average exposures are calculated, they are referenced to an 8-hour work day because the TLV-TWA is based on this work schedule, i.e. eight hours on followed by 16 hours off.

In the future, on-going research efforts may provide guidance on adjustments to the 8-hour TLV-TWA for maritime work schedules, e.g. 4 on-8 off or 6 on-6 off. If adjustments are indicated, they can be incorporated with minor programming modifications.

II.3.6 Example of TANKP

This example demonstrates the use of the TANKP model for a tank that had carried ethyl acetate and was ventilated without an initial washing. The TANKM example contained five elements of hard copy. These same elements, which pertain to the TANKP run, are included in this example.

Comments concerning this TANKP example are presented below.

- o This example represents a test that was conducted in a small barge-size tank with dimensions of 3.7m x 3.7m x 3.7m.
- o A 90-minute ventilation period preceded a 15-minute in-tank work activity.
- o In this example, the residual chemical is on the tank bottom, the walls do not have a residual film.
- o The output data indicate that the vapor concentration rose initially, and then declined to a steady-state or constant value. This constant level represents an equilibrium between the rate of chemical evaporation and the vapor discharge rate. According to the model formulation, the plateau would extend to 539 min (TAUB), which would signify the termination of evaporation. If the program had been run beyond that time, concentration would have fallen exponentially.
- o The majority of the chemicals that are shipped by water have either a TLV-C or a TLV-TWA and a TLV-STEL. A small group of chemicals that includes ethyl acetate

TANKP EXAMPLE

>RUN PRETNK

PROGRAM PRETNK IS AN INTERACTIVE PROGRAM DESIGNED FOR THE USER TO EASILY INPUT DATA COMPATIBLE FOR PROGRAM TANKM OR TANKP

1. TANKM - PROGRAM THAT CALCULATES THE CONCENTRATION-TIME HISTORY OF CHEMICAL VAPORS DISCHARGED FROM A TANK DURING DILUTION VENTILATION IN THE PRESENCE OF CHEMICAL SOLUTE EVAPORATION FROM AN AQUEOUS SOLUTION OF RESIDUAL CARGO ON THE TANK FLOOR.
2. TANKP - PROGRAM THAT CALCULATES THE CONCENTRATION-TIME HISTORY OF CHEMICAL VAPOR DISCHARGED FROM A TANK DURING DILUTION VENTILATION IN THE PRESENCE OF EVAPORATION OF PURE CHEMICAL RESIDUES FROM THE TANK WALLS AND FLOOR.

SELECT A 1 OR 2 TO INDICATE FOR WHICH PROGRAM YOU WISH TO INPUT DATA

2

INPUT TEST NUMBER

26

DO YOU HAVE TANK DIMENSIONS (Y/N)?

Y

ENTER TANK LENGTH, WIDTH, AND DEPTH IN METERS

3.66 3.66 3.66

DO YOU KNOW THE BLOWER FLOW RATE (Y/N)?

Y

INPUT MEASURED FLOW RATE (M3/MIN)

5.126

ENTER DIAMETER OF BUTTERWORTH OPENING IN METERS

.1016

THE PROGRAM ASSUMES THAT THE VESSEL TRIM ANGLE IS REDUCED TO ZERO AFTER DISCHARGE AND THE CHEMICAL RESIDUE IS UNIFORMLY DISTRIBUTED OVER THE TANK BOTTOM DURING GAS FREEING.

DO YOU KNOW THE THICKNESS OF THIS CHEMICAL RESIDUE ON THE TANK BOTTOM AFTER DISCHARGE (Y/N)?

Y

INPUT TPOOL, THE THICKNESS OF LIQUID LAYER ON TANK BOTTOM, IN CM

1.2

IS THE FILM THICKNESS ON THE TANK WALLS KNOWN(Y/N)?

Y

INPUT THE FILM THICKNESS, TFILM, IN CM.

0.

ENTER IN ATMOSPHERIC PRESSURE IN MM HG
760.

ENTER A, B, C, CHEMICAL VAPOR PRESSURE CONSTANTS
7.10179E00 1.244951E03 0.217881E03

IS PREVENTILATION VAPOR CONCENTRATION KNOWN (Y/N)?
Y

ENTER CONCENTRATION IN PPM
.23692E5

ENTER FOR INTEGRATION, TI (INITIAL TIME), AND DT
(INTEGRATION TIME STEP). DT MUST BE A WHOLE NUMBER.
TM AND TM+TWORK MUST BE MULTIPLES OF DT.
0.0 1.0

INPUT VENTILATION TIME, TM, TO MAN ENTRY
90.

OPTIONS FOR DURATION OF MAN ENTRY, TWORK IN MIN., IS AS
FOLLOWS:

1. BRIEF VISUAL INSPECTION AND ODOR DETERMINATION
WITH CARGO SURVEYOR.
TWORK = 1 - 2 MIN.
2. INSPECT TANK COATINGS AND MEASURE THICKNESS
TWORK = 15 - 45 MIN.
3. HAND MUCKING OF RESIDUE WITH TOWELS AND RAGS
(RELATIVELY DIRTY TANK)
TWORK = 90 MIN.
4. SWEEP DEBRIS FROM TANK BOTTOM AND WIPE PUMP SUMP
(RELATIVELY CLEAN TANK)
TWORK = 40 MIN.
5. USER SPECIFIES

SELECT AND ENTER A 1-5 TO INDICATE WORK DESCRIPTION

2
INPUT DURATION, IN MINUTES, OF MAN ENTRY IN TANK
15.

ENTER VAPOR TEMPERATURE, T_{GAS}, IN DEGREES KELVIN
DURING GAS FREEING. SINCE THE TANK WILL NOT BE
WASHED, AN ISOTHERMAL VENTILATION PROCESS IS ASSUMED
284.7

ENTER OCCUPATIONAL EXPOSURE LIMITS (ACGIH)
ALL EXPOSURE LIMITS ARE INPUT IN PPM
DOES THE COMPOUND HAVE A CEILING TLV (Y/N)?
N

INPUT TL_{TWA} AND TL_{STEL}
400 400

ENTER M, SOLUTE MOLECULAR WT. IN GM/MOLE
88.1

ENTER R₂, JET DEFLECTION + WALL JET DISTANCE IN METERS
2.71

INPUT NUMBER OF POINTS IN EXPERIMENTAL DATA , MAXIMUM
OF 200 POINTS (ENTER 0 (ZERO) IF NO POINTS)
10

INPUT TIME AND CONCENTRATION FOR EACH POINT

ETIME(1)	ECVPPM(1)
ETIME(NUMEXP)	ECVPPM(NUMEXP)
0.0 23692.	
0.5 22118.	
5.0 20890.	
11.5 17894.	
16.0 17050.	
26.0 15360.	
39.0 14899.	
64.0 14899.	
89. 14054.	
114.0 13600.	

ENTER TB, CHEMICAL BOILING POINT, DEG K.
350

ENTER IN G, CHEMICAL SURFACE TENSION, DYNES/CM AT 20
DEG C
25.4

ENTER R, UNIVERSAL GAS CONSTANT (CM³-MM HG) / (MOLE-K)
.62358E5

ENTER C1, C2, CURVE FIT COEFFICIENTS ON LIQUID DENSITY
AS A FUNCTION OF TEMPERATURE
59.093 -0.433E-01

ENTER ALPHA, BETA, GAMMA, CURVE FIT COEFFICIENTS ON WALL
TEMPERATURE FOR WALLS PARALLEL TO X-Y PLANE IN M
28.02E1 0.0 0.0

ENTER ZETA, ETA, THETA, CURVE FIT COEFFICIENTS ON WALL
TEMPERATURE FOR WALLS PARALLEL TO THE Y-Z PLANE IN M.
28.02E1 0.0 0.0

ENTER DELTA, EPSILN, PHI, CURVE FIT COEFFICIENTS FOR
KINEMATIC VISCOSITY OF AIR (FT²/SEC) AS A FUNCTION OF
TEMP(F) AT ATMOSPHERIC PRESSURE.
.116714E-3 0.657143E-6 0.0

ENTER STEP, NUMBER OF SUBDIVISIONS OF H, DY=H/STEP
10

ENTER NSTEP, INTEGER VALUE OF STEP
10

WILL BLOWER BE OPERATING DURING TANK ENTRY (Y/N)?
Y

```
@TANKP  
>RUN TANKP
```

DENSIMETRIC FROUDE NO. = 64.022

DENSIMETRIC FROUDE NUMBER AT BEGINNING OF VENTILATION IS GREATER THAN 50. BLOWER CAPACITY IS SUFFICIENT FOR THE VENTILATING JET TO PENETRATE THE VAPOR SPACE AND IMPINGE ON THE TANK BOTTOM. COMPLETE JET PENETRATION AND IMPINGEMENT ENSURES THAT THE VAPOR CONCENTRATION IN THE ULLAGE SPACE IS HOMOGENOUS AND THAT THE WELL-MIXED MODELING ASSUMPTION IS VALID. FOR FURTHER DETAILS, CONSULT REFERENCE 4 OF THE CONTRACT FINAL REPORT.

TT30 -- STOP

```
>RUN PLTANK  
>PIP SCRATCH.DAT;*/DE  
>PIP LP.LST=TANKPO.DAT/RE  
>* DO YOU WANT A HARD COPY OF TANKPO (Y/N) ? [S]: Y  
>PIP LP.LST/SP  
>///  
>@ <EOF>
```

>TYPE TANKPI.DAT

26

.366000E+010.366000E+010.366000E+010.881000E+020.760000E+030.350000E+03

.254000E+020.623580E+050.100000E+020.710179E+010.124495E+040.217881E+03

.590930E+02-.433000E-01

.116714E-030.657143E-060.000000E+00

10

.236920E+050.512600E+010.000000E+000.120000E+010.284700E+030.101600E+00

.271000E+01

.280200E+030.000000E+000.000000E+00

.280200E+030.000000E+000.000000E+00

10

0.0000	23692.0000
0.5000	22118.0000
5.0000	20890.0000
11.5000	17894.0000
16.0000	17050.0000
26.0000	15360.0000
39.0000	14899.0000
64.0000	14899.0000
89.0000	14054.0000
114.0000	13600.0000

.000000E+000.900000E+020.150000E+020.100000E+01

0.000000E+00 0.400000E+03 0.400000E+03

2Y

DENSIMETRIC FROUDE NO. = 64.022

DENSIMETRIC FROUDE NUMBER AT BEGINNING OF VENTILATION IS GREATER THAN 50. BLOWER CAPACITY IS SUFFICIENT FOR THE VENTILATING JET TO PENETRATE THE VAPOR SPACE AND IMPINGE ON THE TANK BOTTOM. COMPLETE JET PENETRATION AND IMPINGEMENT ENSURES THAT THE VAPOR CONCENTRATION IN THE ULLAGE SPACE IS HOMOGENOUS AND THAT THE WELL-MIXED MODELING ASSUMPTION IS VALID. FOR FURTHER DETAILS, CONSULT REFERENCE 4 OF THE CONTRACT FINAL REPORT.

***** TEST NO. 26 *****

VARIABLE	DESCRIPTION	UNITS	RESULT
L	TANK LENGTH	M	3.7
W	TANK WIDTH	M	3.7
H	TANK HEIGHT	M	3.7
V	TANK VOLUME	M	49.0
CO	INITIAL CONCENTRATION	MG/M3	23692.0
Q	VENTILATION RATE	M3/MIN	5.1
P	TANK PRESSURE	MM HG	760.0
TB	LIQUID BOILING POINT	K	350.0
G	LIQUID SURFACE TENSION	DYNES/CM	25.4
U	WALL AIR VELOCITY	CM/SEC	29.2
M	LIQUID MOLECULAR WEIGHT	GM/MOLE	88.10
TFILM	FILM THICKNESS ON WALLS	CM	0.00
TPOOL	FILM THICKNESS ON BOTTOM	CM	1.20
TLVC	THRESHOLD LIMIT VALUE, CEILING	PPM	0.00000E+00
TLVTA	THRESHOLD LIMIT VALUE, TIME-WEIGHTED AVERAGE	PPM	0.40000E+03
TLVSTL	THRESHOLD LIMIT VALUE, SHORT-TERM EXPOSURE LIMIT	PPM	0.40000E+03

TWORK2 - INSPECT TANK COATINGS AND MEASURE THICKNESS
TWORK2 = 15.0000 MIN.

BLOWER IS ON DURING MAN'S ENTRY

QUANTITY	RESULT
FLOOR TEMPERATURE(K)	280.2
VAPOR PRESSURE(MM HG)	36.9
DIFFUSION COEFFICIENT(CM2/SEC)	0.0771
KINEMATIC VISCOSITY OF AIR(CM2/SEC)	0.1355E+00
SCHMIDT NUMBER	1.7576
RHOF(GM/CM3)	0.917
MDOTXZ(GM/CM2-SEC)	0.3403E-04
TAUB(SEC)	32324.9
1/F(CM**--1)	2.411

SUMMARY OF X-Y WALL

Y(M)	TEMP(K)	MDOTXY(G/C2-S)	TAUXY(SEC)	D(CM2/SEC)	NU(CM2/SEC)	FV(MM HG)	SC	1/F(CM*-1)
0 00	280.2	0.3403E-04	0.0	0.07710	0.1355	36.896	1.758	2.4105
0.37	280.2	0.3403E-04	0.0	0.07710	0.1355	36.896	1.758	2.4105
0.73	280.2	0.3403E-04	0.0	0.07710	0.1355	36.896	1.758	2.4105
1.10	280.2	0.3403E-04	0.0	0.07710	0.1355	36.896	1.758	2.4105
1.46	280.2	0.3403E-04	0.0	0.07710	0.1355	36.896	1.758	2.4105
1.83	280.2	0.3403E-04	0.0	0.07710	0.1355	36.896	1.758	2.4105
2.20	280.2	0.3403E-04	0.0	0.07710	0.1355	36.896	1.758	2.4105
2.56	280.2	0.3403E-04	0.0	0.07710	0.1355	36.896	1.758	2.4105
2.93	280.2	0.3403E-04	0.0	0.07710	0.1355	36.896	1.758	2.4105
3.29	280.2	0.3403E-04	0.0	0.07710	0.1355	36.896	1.758	2.4105
3.66	280.2	0.3403E-04	0.0	0.07710	0.1355	36.896	1.758	2.4105

SUMMARY OF Y-Z WALL

Y (M)	TEMP (K)	MDOTZY (G/C2-S)	TAUZY (SEC)	D (CM2/SEC)	NU (CM2/SEC)	PV (MM HG)	SC	1/F (CM**--1)
0.00	280.2	0.3403E-04	0.0	0.07710	0.1355	36.896	1.758	2.4105
0.37	280.2	0.3403E-04	0.0	0.07710	0.1355	36.896	1.758	2.4105
0.73	280.2	0.3403E-04	0.0	0.07710	0.1355	36.896	1.758	2.4105
1.10	280.2	0.3403E-04	0.0	0.07710	0.1355	36.896	1.758	2.4105
1.46	280.2	0.3403E-04	0.0	0.07710	0.1355	36.896	1.758	2.4105
1.83	280.2	0.3403E-04	0.0	0.07710	0.1355	36.896	1.758	2.4105
2.20	280.2	0.3403E-04	0.0	0.07710	0.1355	36.896	1.758	2.4105
2.56	280.2	0.3403E-04	0.0	0.07710	0.1355	36.896	1.758	2.4105
2.93	280.2	0.3403E-04	0.0	0.07710	0.1355	36.896	1.758	2.4105
3.29	280.2	0.3403E-04	0.0	0.07710	0.1355	36.896	1.758	2.4105
3.66	280.2	0.3403E-04	0.0	0.07710	0.1355	36.896	1.758	2.4105

TANK CONCENTRATION AND EVAPORATION RATE HISTORY

TIME(MIN)	CONCENT (PPM)	C/C/O	QT/V	MDOTG(GM/SEC)	MDDOHL (GM/SEC)	MDDOHW(GM/SEC)	MDDOTB (GM/SEC)
1.00	25502	1.076	0.10	4.558	0.000	0.000	4.558
2.00	24374	1.029	0.21	4.558	0.000	0.000	4.558
3.00	23358	0.986	0.31	4.558	0.000	0.000	4.558
4.00	22443	0.947	0.42	4.558	0.000	0.000	4.558
5.00	21619	0.912	0.52	4.558	0.000	0.000	4.558
6.00	20876	0.881	0.63	4.558	0.000	0.000	4.558
7.00	20207	0.853	0.73	4.558	0.000	0.000	4.558
8.00	19609	0.827	0.84	4.558	0.000	0.000	4.558
9.00	19062	0.805	0.94	4.558	0.000	0.000	4.558
10.00	18574	0.784	1.05	4.558	0.000	0.000	4.558
11.00	18133	0.765	1.15	4.558	0.000	0.000	4.558
12.00	17737	0.749	1.25	4.558	0.000	0.000	4.558
13.00	17380	0.734	1.36	4.558	0.000	0.000	4.558
14.00	17058	0.720	1.46	4.558	0.000	0.000	4.558
15.00	16768	0.708	1.57	4.558	0.000	0.000	4.558
16.00	16507	0.697	1.67	4.558	0.000	0.000	4.558
17.00	16272	0.687	1.78	4.558	0.000	0.000	4.558
18.00	16061	0.678	1.88	4.558	0.000	0.000	4.558
19.00	15870	0.670	1.99	4.558	0.000	0.000	4.558
20.00	15698	0.663	2.09	4.558	0.000	0.000	4.558
21.00	15543	0.656	2.20	4.558	0.000	0.000	4.558
22.00	15404	0.650	2.30	4.558	0.000	0.000	4.558
23.00	15278	0.645	2.40	4.558	0.000	0.000	4.558
24.00	15165	0.640	2.51	4.558	0.000	0.000	4.558
25.00	15063	0.636	2.61	4.558	0.000	0.000	4.558
26.00	14972	0.632	2.72	4.558	0.000	0.000	4.558
27.00	14889	0.628	2.82	4.558	0.000	0.000	4.558
28.00	14815	0.625	2.93	4.558	0.000	0.000	4.558
29.00	14748	0.622	3.03	4.558	0.000	0.000	4.558
30.00	14687	0.620	3.14	4.558	0.000	0.000	4.558
31.00	14633	0.618	3.24	4.558	0.000	0.000	4.558
32.00	14584	0.616	3.35	4.558	0.000	0.000	4.558
33.00	14540	0.614	3.45	4.558	0.000	0.000	4.558
34.00	14500	0.612	3.55	4.558	0.000	0.000	4.558
35.00	14464	0.611	3.66	4.558	0.000	0.000	4.558
36.00	14432	0.609	3.76	4.558	0.000	0.000	4.558
37.00	14403	0.608	3.87	4.558	0.000	0.000	4.558
38.00	14377	0.607	3.97	4.558	0.000	0.000	4.558
39.00	14353	0.606	4.08	4.558	0.000	0.000	4.558
40.00	14332	0.605	4.18	4.558	0.000	0.000	4.558
41.00	14313	0.604	4.29	4.558	0.000	0.000	4.558
42.00	14296	0.603	4.39	4.558	0.000	0.000	4.558
43.00	14280	0.603	4.50	4.558	0.000	0.000	4.558
44.00	14266	0.602	4.60	4.558	0.000	0.000	4.558
45.00	14254	0.602	4.70	4.558	0.000	0.000	4.558
46.00	14242	0.601	4.81	4.558	0.000	0.000	4.558
47.00	14232	0.601	4.91	4.558	0.000	0.000	4.558
48.00	14223	0.600	5.02	4.558	0.000	0.000	4.558
49.00	14215	0.600	5.12	4.558	0.000	0.000	4.558
50.00	14207	0.600	5.23	4.558	0.000	0.000	4.558
51.00	14200	0.599	5.33	4.558	0.000	0.000	4.558
52.00	14194	0.599	5.44	4.558	0.000	0.000	4.558

TANK CONCENTRATION AND EVAPORATION RATE HISTORY

TIME (MIN)	CONCENT (PPH)	C/CO	QT/V	MDOTG (GM/SEC)	MDOTHL (GM/SEC)	MDOTHW (GM/SEC)	MDOTB (GM/SEC)
53.00	14189.	0.599	5.54	4.558	0.000	0.000	4.558
54.00	14184.	0.599	5.65	4.558	0.000	0.000	4.558
55.00	14180.	0.598	5.75	4.558	0.000	0.000	4.558
56.00	14176.	0.598	5.85	4.558	0.000	0.000	4.559
57.00	14172.	0.598	5.96	4.558	0.000	0.000	4.558
58.00	14169.	0.598	6.06	4.558	0.000	0.000	4.558
59.00	14166.	0.598	6.17	4.558	0.000	0.000	4.558
60.00	14163.	0.598	6.27	4.558	0.000	0.000	4.558
61.00	14161.	0.598	6.38	4.558	0.000	0.000	4.558
62.00	14159.	0.598	6.48	4.558	0.000	0.000	4.558
63.00	14157.	0.598	6.59	4.558	0.000	0.000	4.558
64.00	14155.	0.597	6.69	4.558	0.000	0.000	4.558
65.00	14153.	0.597	6.80	4.558	0.000	0.000	4.558
66.00	14152.	0.597	6.90	4.558	0.000	0.000	4.558
67.00	14151.	0.597	7.01	4.558	0.000	0.000	4.558
68.00	14150.	0.597	7.11	4.558	0.000	0.000	4.558
69.00	14149.	0.597	7.21	4.558	0.000	0.000	4.558
70.00	14148.	0.597	7.32	4.558	0.000	0.000	4.558
71.00	14147.	0.597	7.42	4.558	0.000	0.000	4.558
72.00	14146.	0.597	7.53	4.558	0.000	0.000	4.558
73.00	14145.	0.597	7.63	4.558	0.000	0.000	4.558
74.00	14145.	0.597	7.74	4.558	0.000	0.000	4.558
75.00	14144.	0.597	7.84	4.558	0.000	0.000	4.558
76.00	14144.	0.597	7.95	4.558	0.000	0.000	4.558
77.00	14143.	0.597	8.05	4.558	0.000	0.000	4.558
78.00	14143.	0.597	8.16	4.558	0.000	0.000	4.558
79.00	14143.	0.597	8.26	4.558	0.000	0.000	4.558
80.00	14142.	0.597	8.36	4.558	0.000	0.000	4.558
81.00	14142.	0.597	8.47	4.558	0.000	0.000	4.558
82.00	14142.	0.597	8.57	4.558	0.000	0.000	4.558
83.00	14142.	0.597	8.68	4.558	0.000	0.000	4.558
84.00	14141.	0.597	8.78	4.558	0.000	0.000	4.558
85.00	14141.	0.597	8.89	4.558	0.000	0.000	4.558
86.00	14141.	0.597	8.99	4.558	0.000	0.000	4.558
87.00	14141.	0.597	9.10	4.558	0.000	0.000	4.558
88.00	14141.	0.597	9.20	4.558	0.000	0.000	4.558
89.00	14141.	0.597	9.31	4.558	0.000	0.000	4.558
90.00	14140.	0.597	9.41	4.558	0.000	0.000	4.558
91.00	14140.	0.597	9.51	4.558	0.000	0.000	4.558
92.00	14140.	0.597	9.62	4.558	0.000	0.000	4.558
93.00	14140.	0.597	9.72	4.558	0.000	0.000	4.558
94.00	14140.	0.597	9.83	4.558	0.000	0.000	4.558
95.00	14140.	0.597	9.93	4.558	0.000	0.000	4.558
96.00	14140.	0.597	10.04	4.558	0.000	0.000	4.558
97.00	14140.	0.597	10.14	4.558	0.000	0.000	4.558
98.00	14140.	0.597	10.25	4.558	0.000	0.000	4.558
99.00	14140.	0.597	10.35	4.558	0.000	0.000	4.558
100.00	14140.	0.597	10.46	4.558	0.000	0.000	4.558
101.00	14140.	0.597	10.56	4.558	0.000	0.000	4.558
102.00	14140.	0.597	10.66	4.558	0.000	0.000	4.558
103.00	14140.	0.597	10.77	4.558	0.000	0.000	4.558
104.00	14140.	0.597	10.87	4.558	0.000	0.000	4.558
105.00	14140.	0.597	10.98	4.558	0.000	0.000	4.558

EVALUATION OF VAPOR CONCENTRATIONS DURING MAN-ENTRY

TANK IS ENTERED AT TIME = 90.0 MIN
TANK IS EXITED AT TIME = 105.0 MIN

PREDICTED INSTANTANEOUS EXPOSURE CONCENTRATIONS EXCEED THE TLV-STEL

TIME (MIN)	CONCENTRATION (PPM)	
90.00	14140.4	HAZARDOUS WORKING CONDITIONS
91.00	14140.3	HAZARDOUS WORKING CONDITIONS
92.00	14140.2	HAZARDOUS WORKING CONDITIONS
93.00	14140.1	HAZARDOUS WORKING CONDITIONS
94.00	14140.0	HAZARDOUS WORKING CONDITIONS
95.00	14140.0	HAZARDOUS WORKING CONDITIONS
96.00	14139.9	HAZARDOUS WORKING CONDITIONS
97.00	14139.9	HAZARDOUS WORKING CONDITIONS
98.00	14139.8	HAZARDOUS WORKING CONDITIONS
99.00	14139.8	HAZARDOUS WORKING CONDITIONS
100.00	14139.7	HAZARDOUS WORKING CONDITIONS
101.00	14139.7	HAZARDOUS WORKING CONDITIONS
102.00	14139.7	HAZARDOUS WORKING CONDITIONS
103.00	14139.6	HAZARDOUS WORKING CONDITIONS
104.00	14139.6	HAZARDOUS WORKING CONDITIONS
105.00	14139.6	HAZARDOUS WORKING CONDITIONS

PREDICTED AVERAGE IN-TANK EXPOSURE AS MEASURED BY A DOSIMETER = 14139.89 PPM

DOSIMETER MONITORING WOULD INDICATE THAT THE AVERAGE IN-TANK EXPOSURE EXCEEDS THE TLV-STEL FOR THIS CHEMICAL VAPOR AND A HAZARDOUS WORKING CONDITION EXISTS. REDUCE EXPOSURE BELOW TLV-STEL BEFORE ASSESSING THE TWA EXPOSURE.

TEST NO. 26
VENTILATION TIME HISTORY

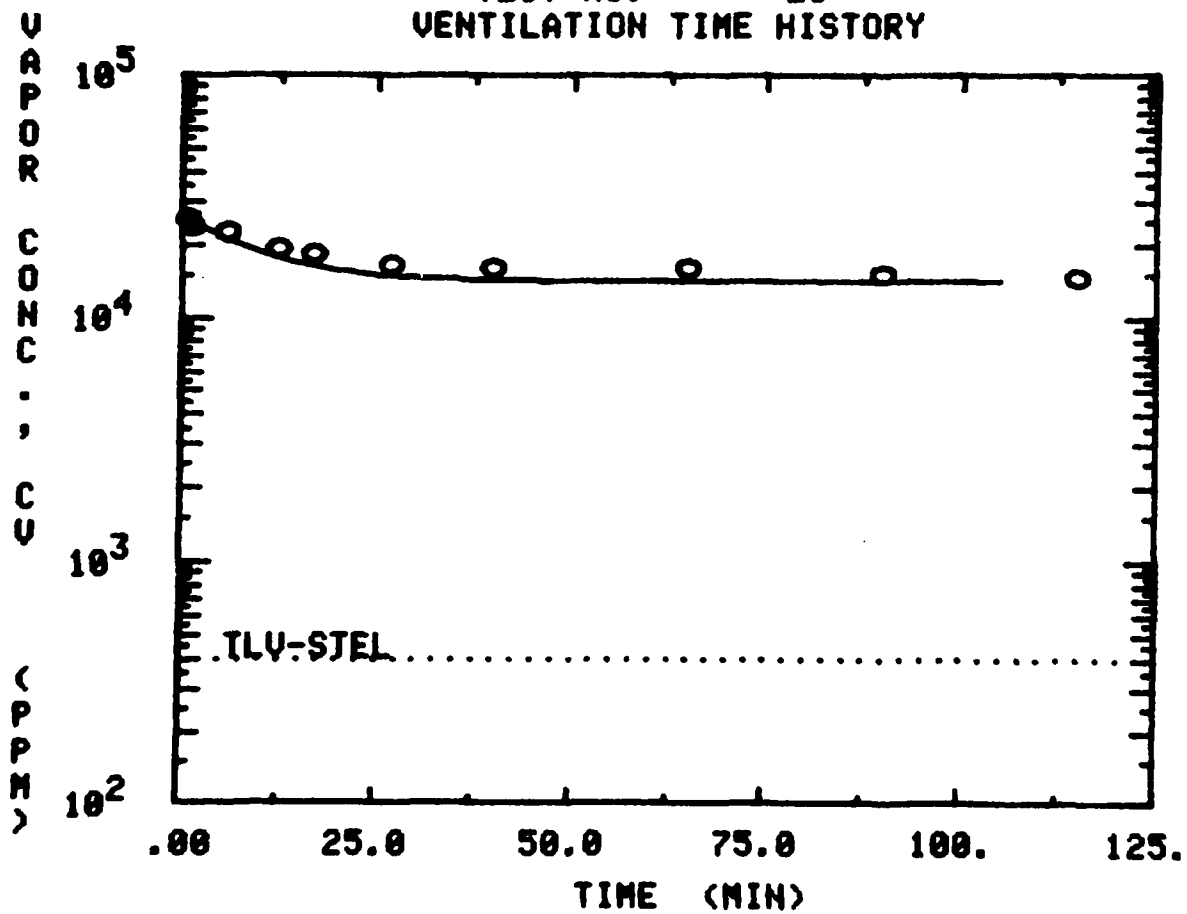

have a TLV-TWA but no STEL. As the hazard assessment does not reflect this minority group, the example was executed with a pseudo-STEEL equal to the TLV-TWA. The assessment indicates that hazardous working conditions exist. In fact, entry should not be permitted because vapor concentrations are above that which is Immediately Dangerous to Life and Health (IDLH), i.e. 10,000 ppm. Therefore, it is recommended that the IDLH value be substituted for the STEL when executing runs for those chemicals that have only a TLV-TWA.

II.4 Flow Charts for PRETNK, TANKM and TANKP

The interactive driver, PRETNK, controls the input, default options and other branched decisions for both TANKM and TANKP. Certain portions of the requirements in PRETNK are common to both tank models. Because of this commonality and for ease of reference, the flow charts for all three programs are presented in this section.

Each flow chart has been prepared using the philosophy that a chart should be functional, clear and devoid of excessive detail. Based on these criteria, the charts indicate the major logic elements and branch points.

TANKM and TANKP models reflect two distinctly different tank conditions at the beginning of ventilation. Because of this difference, there is minimal commonality in the programming of these models. One exception is hazard evaluation, which is common to both programs and is contained in subroutine BLOW.

II.5 Model Limitations

Model limitations derive from assumptions regarding tank internal structure, blower jet penetration, homogeneous vapor space, evaporation of water solvent and sub-saturation solute concentration. The limitations are discussed in detail in Section IV.2.5 of Reference 13.

FLOW CHART FOR INTERACTIVE DRIVER, PRETNK

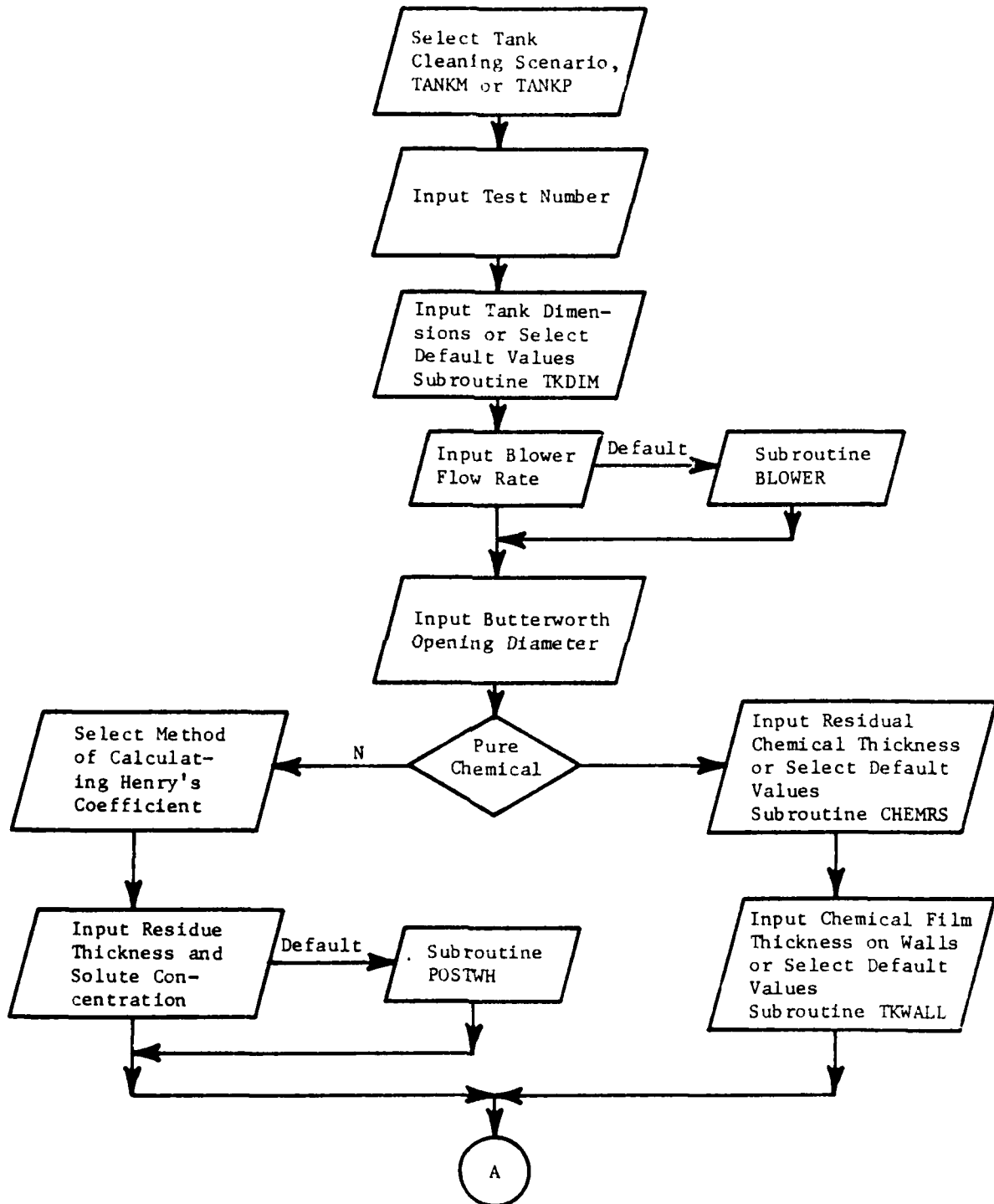

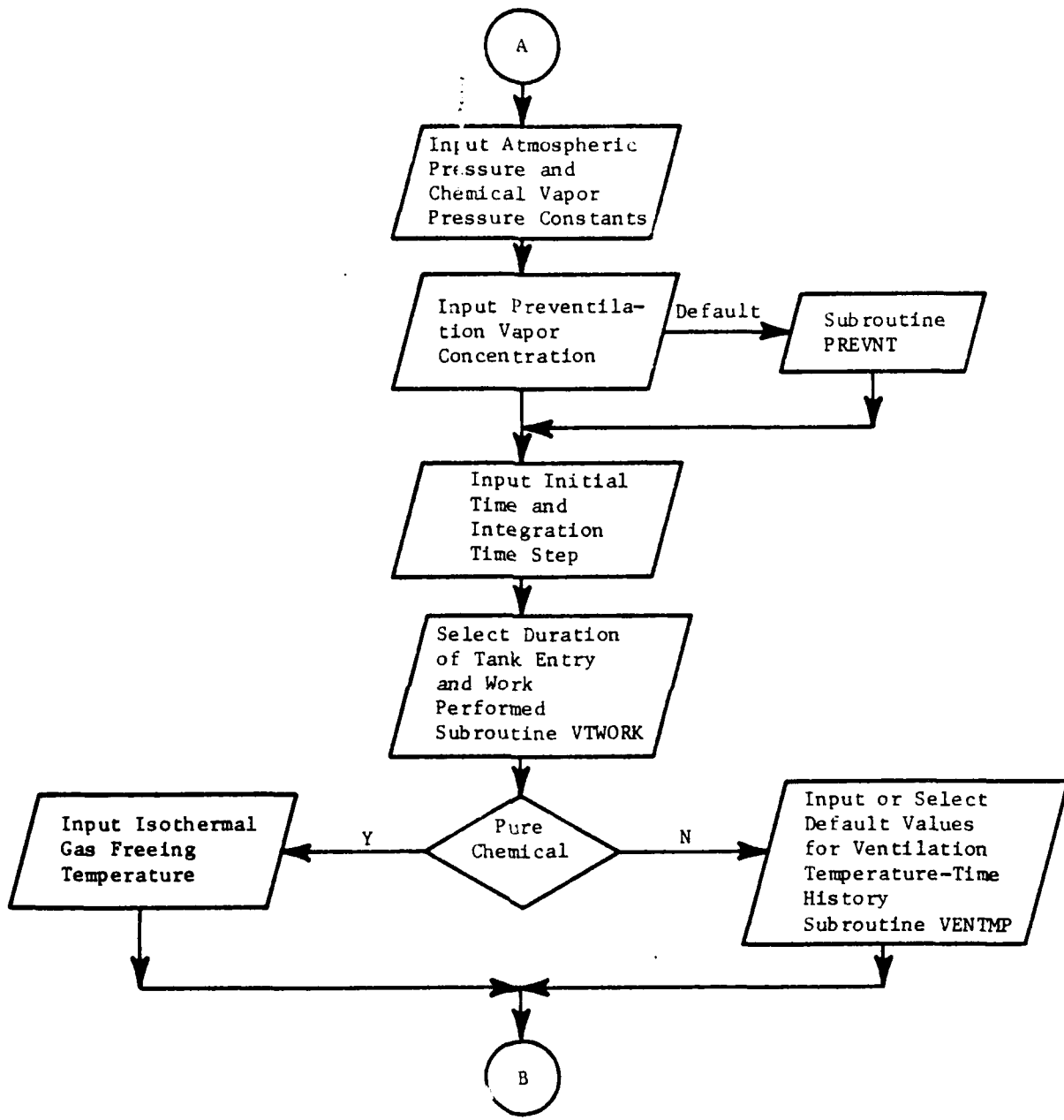

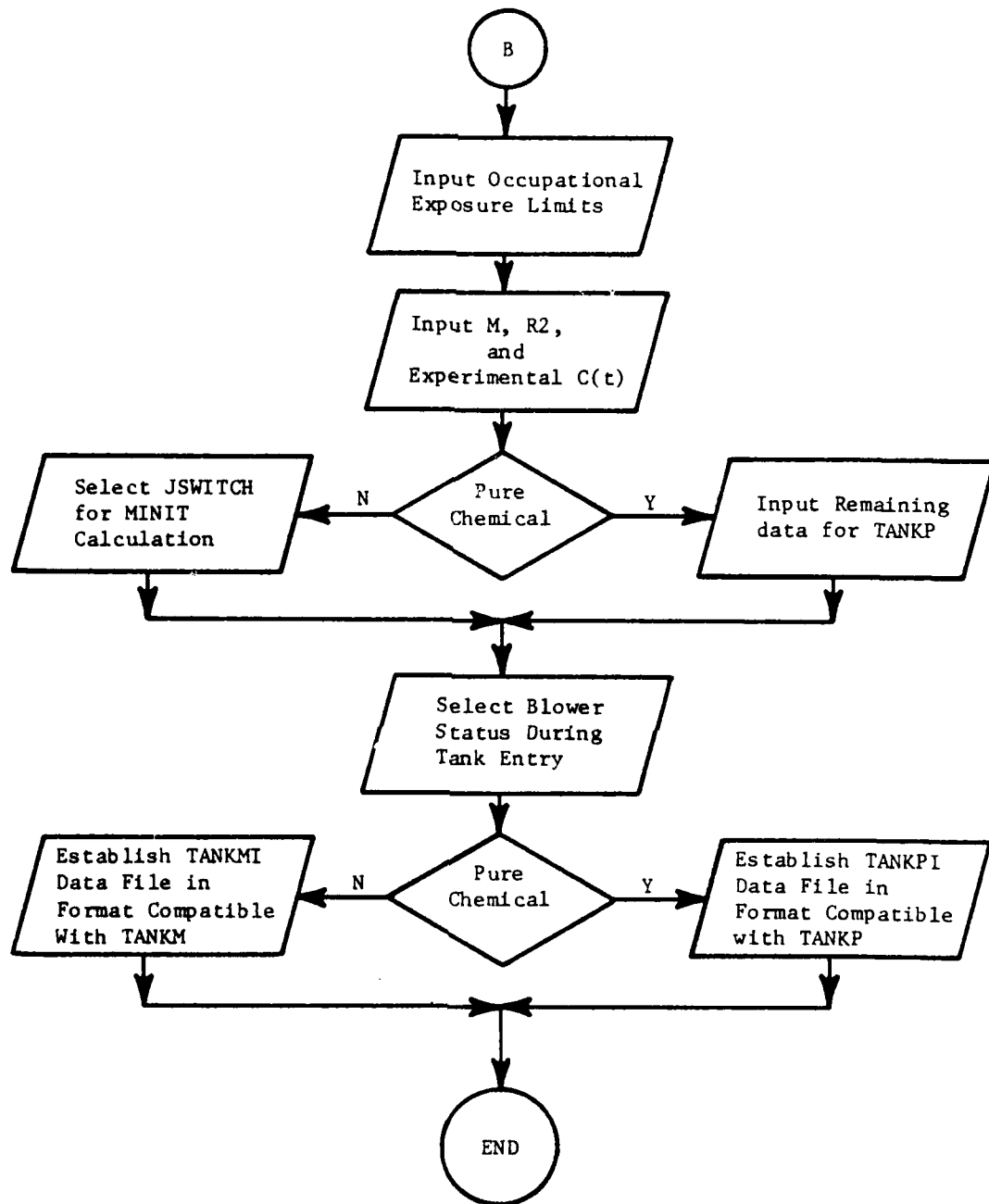

FLOW CHART FOR TANKM

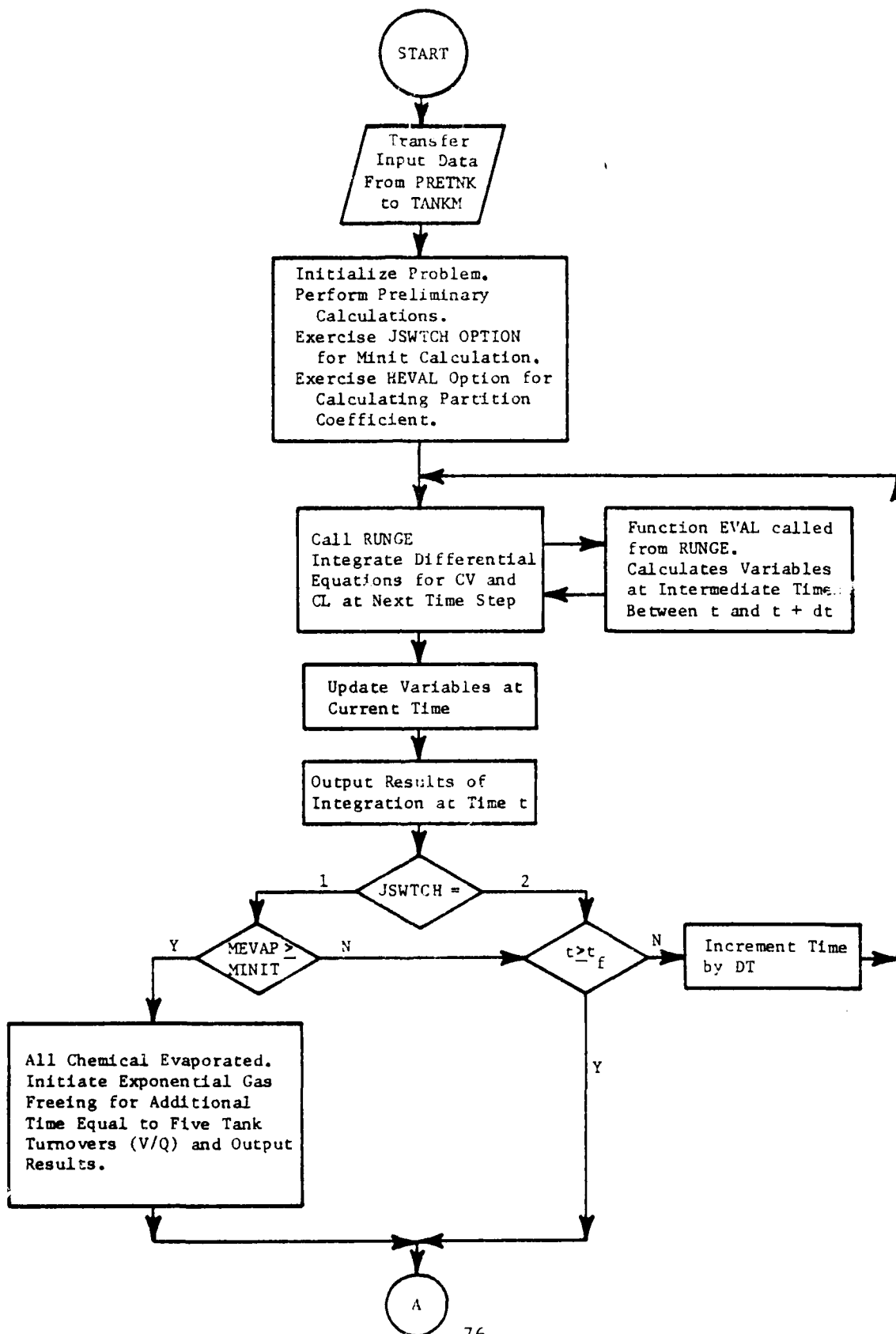

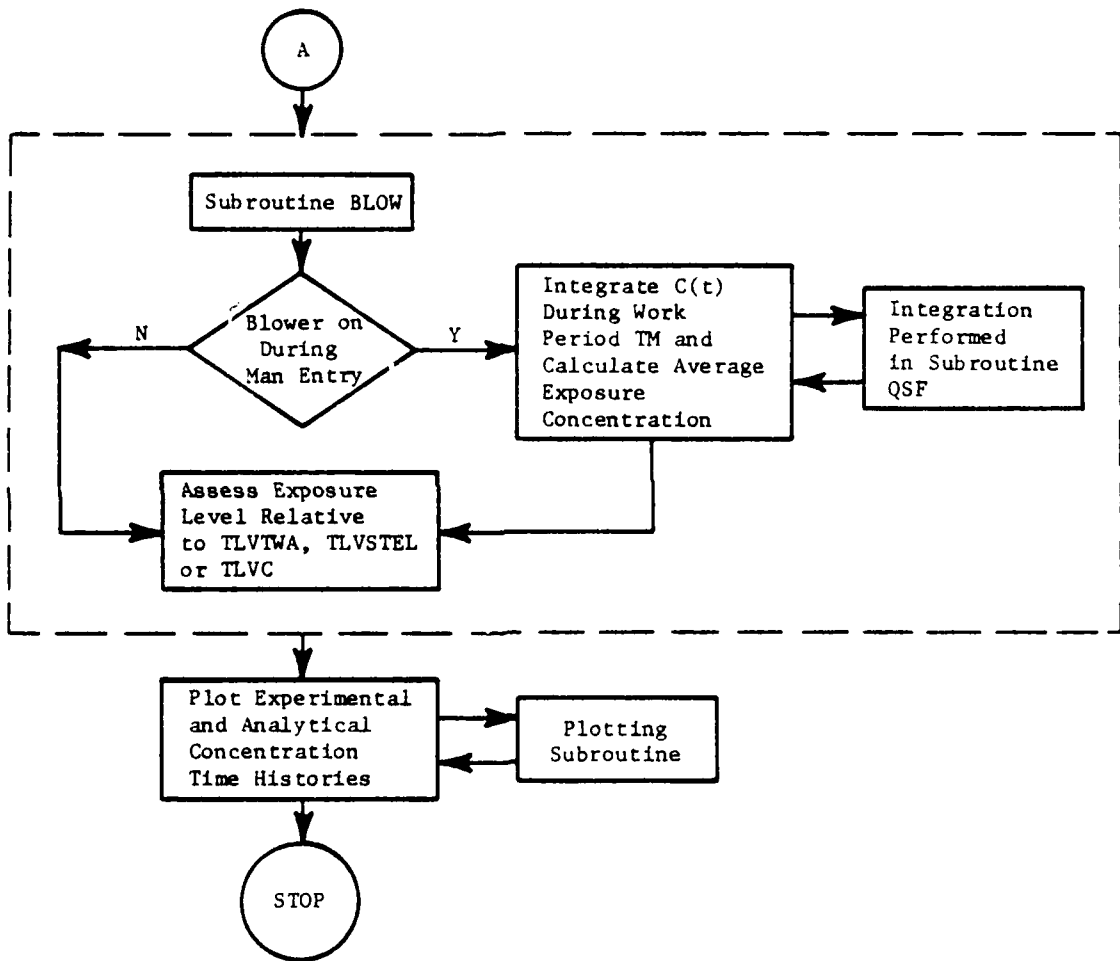

FLOW CHART FOR TANKP

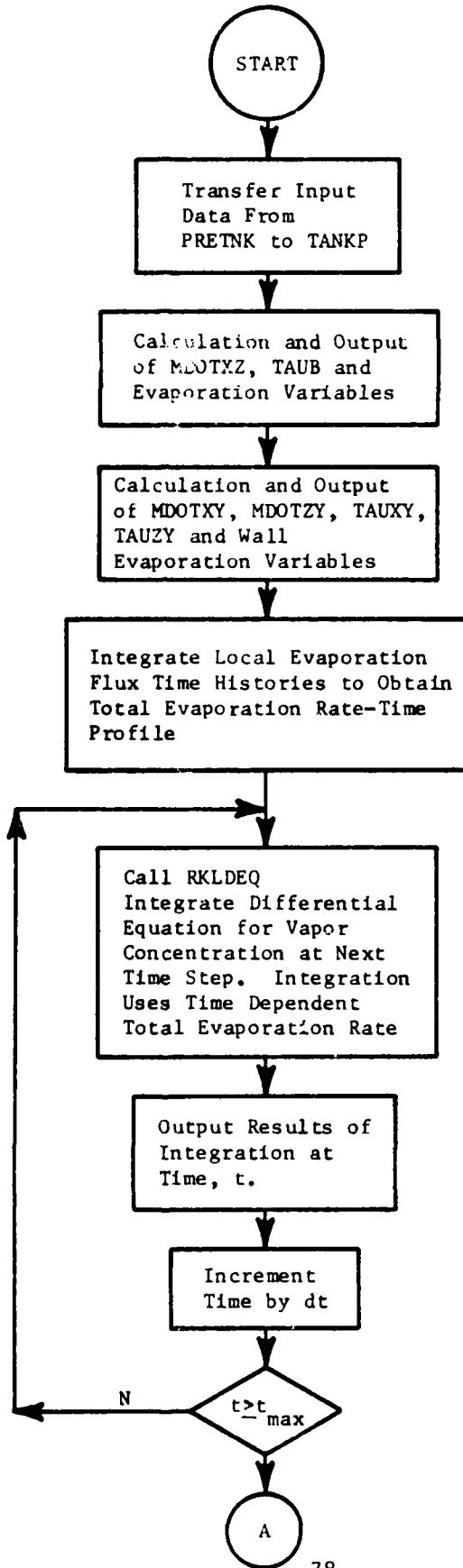

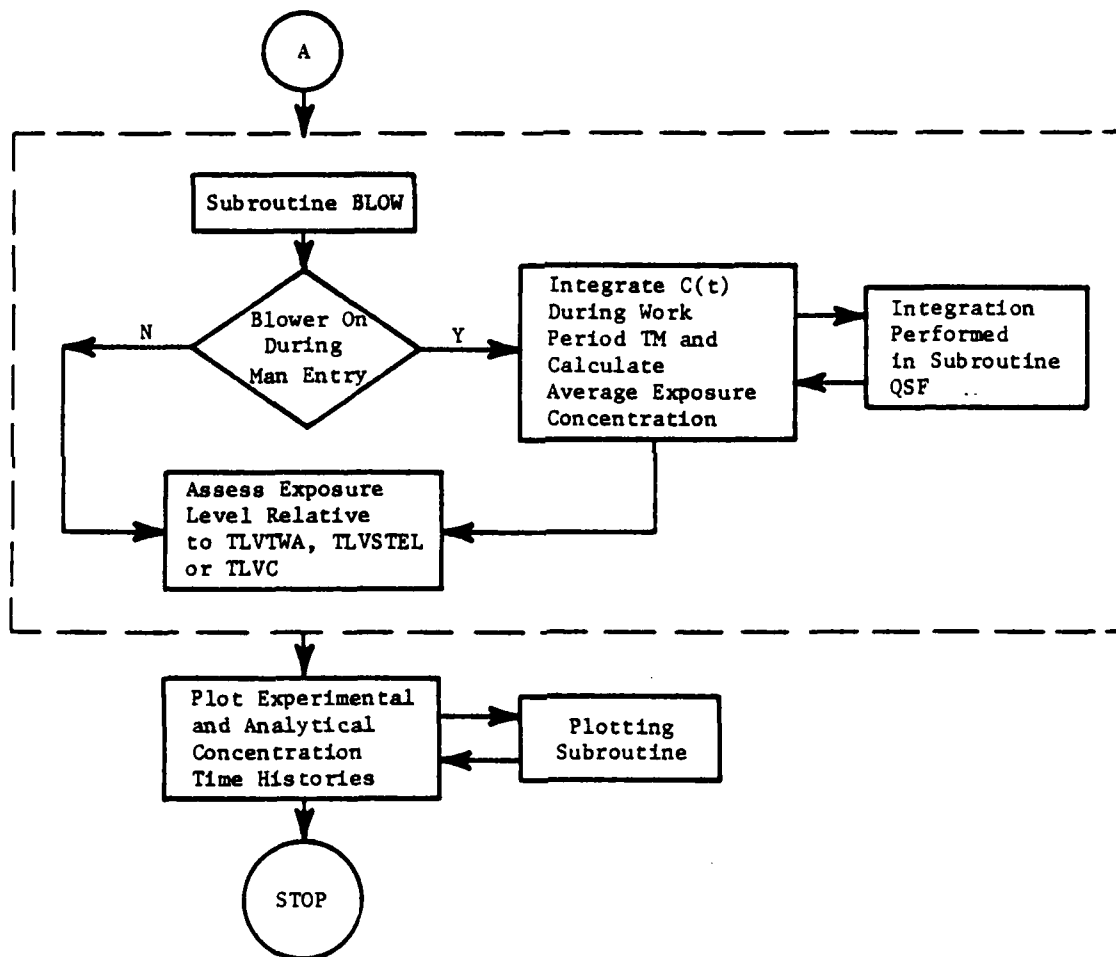

III. PLUME DISPERSION MODEL

III.1 Vapor Emission Scenarios

Plumes of gas containing vapors from liquid bulk cargos are emitted from cargo tank vents into the air above the deck of tankerships and barges during routine operations. While cargo vapors may also be emitted from fugitive emission sources such as P/V valves, drip pans or liquid accumulations beneath leaking pumps, pipes or flanges, these emissions are small in comparison to the vapor plumes emitted during cargo loading or tank ventilation.

During cargo loading, vapor is evaporated from the incoming liquid to form a "vapor blanket" above the liquid/gas interface. This vapor diffuses upward, away from the interface, and mixes with the gas atmosphere initially in the tank. As the liquid level rises, the tank gas atmosphere is displaced from the tank through an open ullage hatch or tank vent, as shown in Figure 1. The volumetric flowrate of vented gas is equal to the cargo loading rate. However, the vapor concentration in the vented gas can vary considerably during loading. The measurements of vent concentration reported in reference [13] showed that

- o for "dedicated" tanks that have not been washed and ventilated before loading, the initial "arrival" vapor concentration can be high. Vapor concentration at the tank vent increases slowly, and may approach the saturated vapor concentration when the vapor blanket approaches the top of the tank near the end of loading. Figure 2 shows a graph of vapor concentration measured at the tank vent versus time for the loading of methanol into a dedicated tank.
- o for tanks that have been washed and ventilated before loading, the initial "arrival" concentration can be low. Vapor concentration at the tank vent increases more rapidly during loading and may also approach the saturated vapor concentration near the end of loading. Figure 3 shows a graph of vent concentration measured during loading of ethanol into a washed and gas-freed tank.

During tank ventilation operations, fresh air is blown into the tank in order to dilute or replace the tank gas atmosphere which contains the vapor of the previous cargo. The vented gas flowrate will be the same as the flowrate of incoming fresh air. As the tank gas atmosphere is diluted or displaced, the vapor concentration at the tank vent may vary with time. The TANKM and TANKP models described in Section II may be used to estimate the time dependent behavior of the vapor concentration in the tank during ventilation.

Unless arrangements are made to collect and return the tank gas atmosphere to shore during cargo loading and tank ventilation operations, the tank atmosphere is vented directly to the air where it is dispersed by the wind. Crewmen working in the vicinity of a tank vent during these operations may inhale air that contains cargo vapor from the vented gas plume.

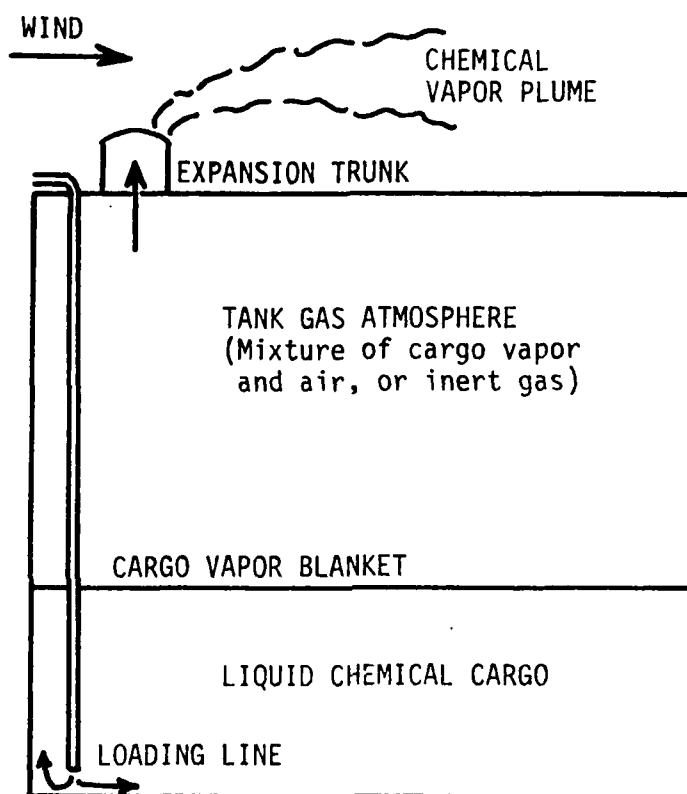

FIGURE 1. VAPOR EMISSION DURING CARGO LOADING

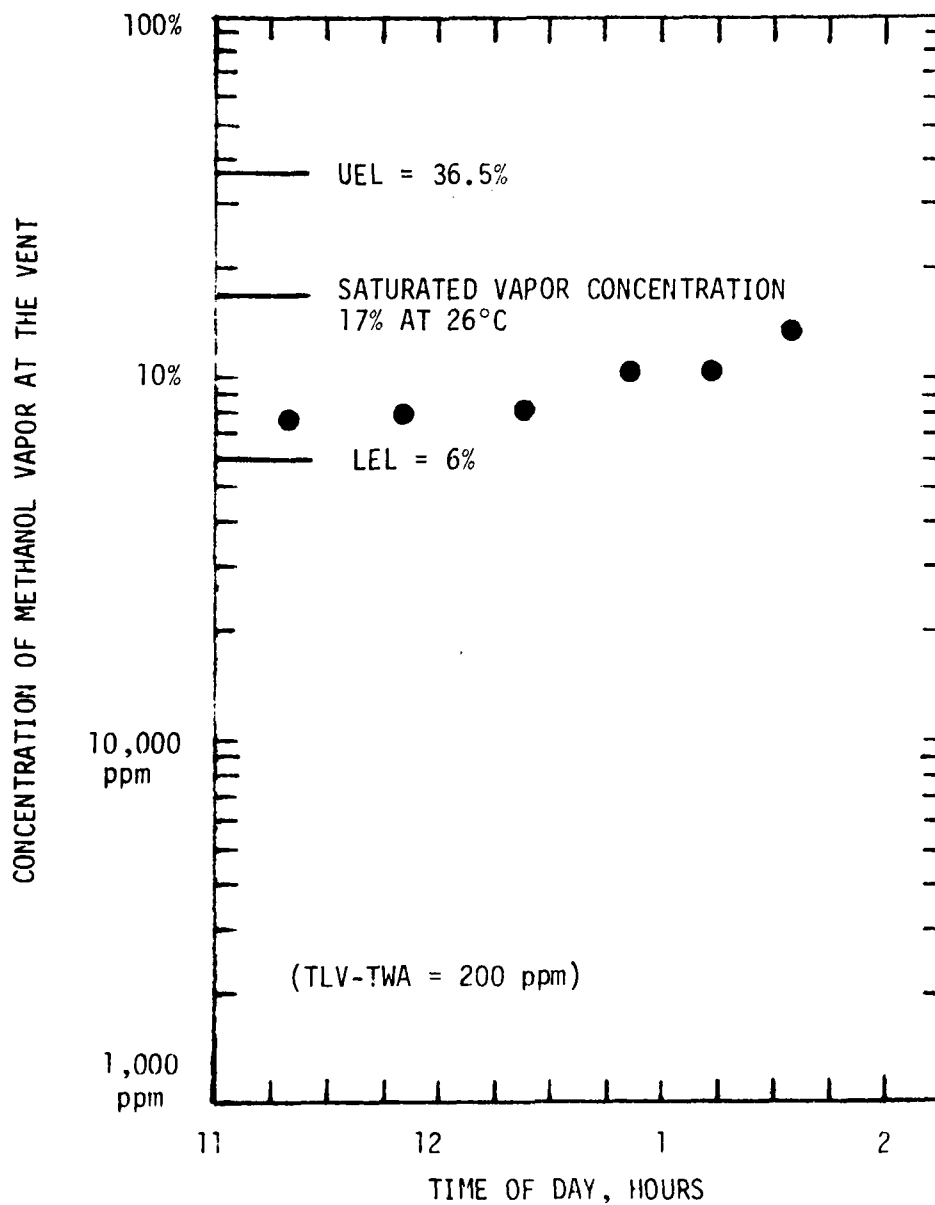

FIGURE 2. VAPOR CONCENTRATION AT THE TANK VENT MEASURED DURING LOADING OF METHANOL INTO A DEDICATED TANK.

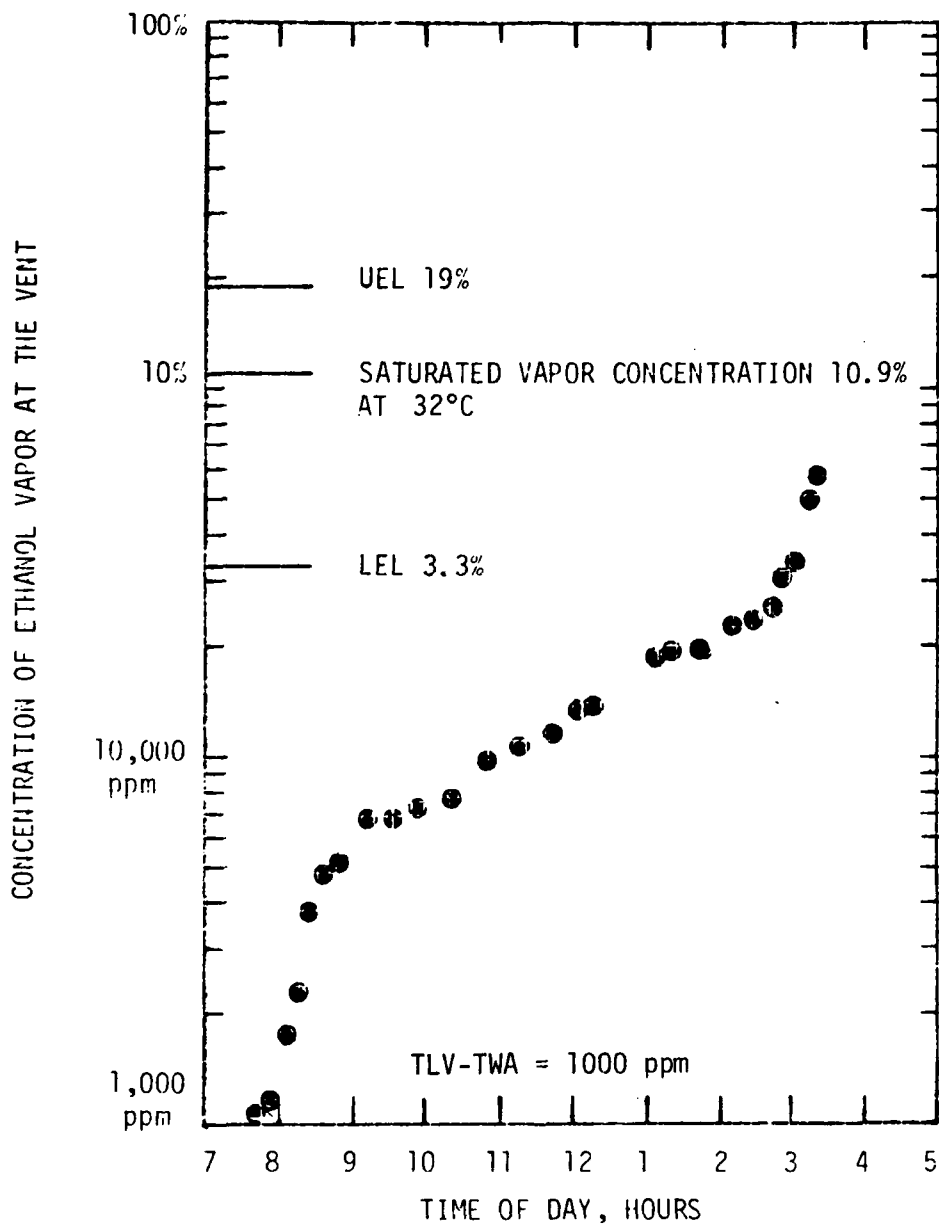

FIGURE 3. VAPOR CONCENTRATION AT THE TANK VENT MEASURED DURING LOADING OF ETHANOL INTO A CLEAN, GAS FREE TANK.

The size of the vapor plume downwind of a tank vent, and the level of vapor concentration at man breathing height, depend upon several factors such as

- o the vented gas flowrate,
- o the vapor concentration in the vented gas stream,
- o the height and the diameter of the vent used to emit the vented gas stream, and
- o the ambient wind velocity.

In many cases, the plume source conditions, characterized by the vented gas flowrate and vapor concentration, vary slowly with time. On the other hand, the ambient wind varies randomly in both speed and direction. These turbulent fluctuations in wind speed and direction affect the instantaneous position of the plume relative to the deck and cause the vapor concentration at downwind locations to fluctuate in time.

For hazards analysis we are interested primarily in the mean, or time average value of vapor concentration. Therefore, it is necessary to define the basis for time averaging and to include the effect of wind turbulence in the plume dispersion model. The plume dispersion experiments reported in reference [13] showed that a sampling period of 10 minutes was sufficient for determining average values of wind speed, wind direction and vapor concentration. The elements of the ONDEK computer model for predicting the dispersion of a chemical vapor plume emitted continuously from a tank vent are described in Section III.2. Listings for two versions of the ONDEK computer model in FORTRAN appear in Appendices B and C. These versions differ only in their graph plotting capability. The ONDEK4 program, listed in Appendix B, prepares an output file for use with PLOT10 graphics software. The ONDEK3 program, listed in Appendix C, produces graphs using standard line printer commands for lineprinter or CRT output.

III.2 Elements of Program ONDEK

III.2.1 Model Description Summary

The ONDEK chemical vapor plume dispersion model is based upon the numerical integration of a set of conservation equations for mass and momentum along the axis of the plume. Ooms' method [14] is used to compute the behavior of plumes that are elevated above deck level. In those circumstances (emission of a very dense plume at low wind speeds) where it may be possible for the plume axis to descent to deck level, TeRiele's method [15] is used to compute plume behavior downwind of the transition point. References [14] and [15] should be consulted for the derivations and detailed descriptions of these models.

Ooms considers the development of plumes that are bent over by the wind but remain symmetrical about their axis. Ooms writes four equations for the conservation of mass, chemical species and momentum within the plume. These equations are:

• Conservation of mass

$$\frac{d}{ds} \left(\int_0^{b\sqrt{2}} \rho u 2\pi r dr \right) = 2\pi b \rho_a \left\{ \alpha_1 |u^*(s)| + \alpha_2 U_a |\sin \theta| \cos \theta + \alpha_3 u' \right\} \quad (20)$$

• Conservation of chemical species

$$\frac{d}{ds} \left(\int_0^{b\sqrt{2}} c u 2\pi r dr \right) = 0 \quad (21)$$

• Conservation of momentum in the x (downwind) direction

$$\begin{aligned} \frac{d}{ds} \left(\int_0^{b\sqrt{2}} \rho u^2 \cos \theta 2\pi r dr \right) &= 2\pi b \rho_a U_a \left\{ \alpha_1 |u^*| + \alpha_2 U_a |\sin \theta| \cos \theta + \alpha_3 u' \right\} \\ &+ C_d \pi b \rho_a U_a^2 |\sin^3 \theta| \end{aligned} \quad (22)$$

• Conservation of momentum in the z (vertical) direction

$$\frac{d}{ds} \left(\int_0^{b\sqrt{2}} \rho u^2 \sin \theta 2\pi r dr \right) = \int_0^{b\sqrt{2}} g(\rho_a - \rho) 2\pi r dr \pm C_d \pi b \rho_a U_a^2 \sin^2 \theta \cos \theta \quad (23)$$

where

- b = plume characteristic radius, m
- C_d = plume drag coefficient, dimensionless
- c = vapor concentration, kg/m³
- g = acceleration of gravity = 9.8 m/sec²
- r = plume radius, m
- s = distance along the plume centerline, m
- U_a = time average wind speed, m/s
- u = local velocity in the plume, m/s
- u' = turbulent entrainment velocity, m/s
- u* = velocity on the plume axis, m/s
- α₁ = entrainment parameter for shear, dimensionless
- α₂ = entrainment parameter for buoyancy, dimensionless
- α₃ = entrainment parameter for turbulence, dimensionless
- θ = angle of the plume axis with respect to the horizon, radians
- ρ = plume density, kg/m³
- ρ_a = ambient air density, kg/m³

The plume density depends upon both the concentration and the temperature of the gas being vented to the atmosphere. In most instances, product is loaded onto the ship or barge from an above-ground storage tank on shore. Then, the temperature of the cargo tank atmosphere is very close to the ambient air temperature, and the plume dispersion process can be assumed to be isothermal. This assumption allows the plume density to be related directly to the plume concentration through

$$\rho = \rho_a + \frac{(\rho_0 - \rho_a)}{\rho_0} c \quad (24)$$

where ρ_0 = density of pure chemical vapor. Gaussian profiles are assumed for the concentration and velocity defect (the difference between the plume velocity and the component of the ambient wind speed in the plume direction).

$$c = c^* e^{-r^2/\lambda^2 b^2} \quad (25)$$

$$u - U_a \cos \theta = u^* e^{-r^2/b^2} \quad (26)$$

In these equations,

c^* = plume centerline concentration, kg/m^3

λ^2 = turbulent Schmidt number squared = 1.35

These similarity profiles are substituted into the conservation equations (20) - (23), and the equations are integrated to give four simultaneous, ordinary differential equations to be integrated numerically. The dependent variables for these four equations are c^* , b , u^* , and θ . Two additional equations are included to compute the trajectory of the plume axis

$$\frac{dz}{ds} = \sin \theta \quad (27)$$

$$\frac{dx}{ds} = \cos \theta \quad (28)$$

where z and x are the vertical and horizontal coordinates of the plume axis.

Ooms suggests values of $\alpha_1 = 0.057$, $\alpha_2 = 0.5$, $\alpha_3 = 1.0$ and $C_d = 0.3$ for the plume model parameters. However, plume concentration measurements reported in [13] and [16] indicate that a value of $\alpha_3 = 3$ is appropriate when u' is taken to be the r.m.s. of the turbulent wind speed fluctuations. When the plume is close to the deck, an image plume is included when the concentration distribution is computed. If the elevation, z , of the plume centerline drops to deck level, a transition is made to a simplified version of TeRiele's model for heavier-than-air gas plumes at ground level.

TeRiele's model consists of four equations for conservation of mass and momentum, and was developed to predict the downwind dispersion of vapors from area sources. TeRiele's equation for mass conservation within the source area is not required. However, the other three equations that apply far downwind of the source area can be applied. There is one equation evaluated at two different limits ($y = Y_L$)

$$\int_0^{Y_L} \left[\frac{\partial}{\partial x} \left[\int_0^{\infty} cu \, dz \right] \right] dy = \left[\int_0^{\infty} K_y \frac{\partial c}{\partial y} dz \right]_{y = Y_L}$$

In this equation Y_L is the crosswind integration limit, equal to either $\sqrt{2}/2 \sigma_y$ or ∞ . Also in this equation,

K_y is an atmospheric dispersion coefficient.

There is one equation for conservation of momentum

$$\frac{d}{dx} \left[\int_0^{\infty} \int_0^{\infty} cu^2 \, dy \, dz \right] = \int_0^{\infty} \frac{c_{gr}}{\rho_{gr}} \cdot \tau_0 \, dy$$

where c_{gr} = concentration at ground (deck) level, kg/m^3
 ρ_{gr} = density of the plume at ground (deck) level, kg/m^3
 τ_0 = wind shear stress at ground (deck) level, kg/ms^2

A Gaussian type profile is assumed for the concentration distribution, and a power law profile for the wind velocity

$$c = c_a \exp \left[-\left(\frac{y}{\sigma_y}\right)^2 - \left(\frac{z}{\sigma_z}\right)^{1+2\alpha} \right]$$

$$u = u_0 \left(\frac{z}{z_0}\right)^\alpha$$

where c_a = concentration on the plume axis at deck level, kg/m^3
 u_0 = wind speed at reference height, m/s
 z_0 = reference height, m
 α = velocity profile parameter, dimensionless
 σ_y = horizontal dispersion coefficient, m
 σ_z = vertical dispersion coefficient, m

Substituting these profile formulas into the conservation equations and performing the integration gives three simultaneous, ordinary differential equations for c_a , σ_y , and σ_z .

Concentration profiles must be matched at the point of transition from Ooms' to TeRiele's model. The following matching equations can be derived to relate c_a and σ_y to c^* and b

$$c_a = 2 c^* \quad (33)$$

$$\sigma_y = \lambda b \quad (34)$$

Since the form of the concentration profiles for Ooms' and TeRiele's method are different (they are the same only if $\alpha = 0.5$), it is necessary to estimate a value of σ_z that gives a good "global" match to the concentration profiles. We have required that the integral

$$\int_0^{\infty} c \, dz \quad \text{be equal for both methods along the } y = 0 \text{ plane.}$$

This gives a relation between σ_z and b

$$\sigma_z = \lambda b \frac{\sqrt{\pi}}{2} \frac{\Gamma(1+2\alpha)}{\Gamma(1/1+2\alpha)} \quad (35)$$

With these values of c_a , σ_y , and σ_z as starting conditions, TeRiele's equations are integrated numerically without further reference to Ooms' variables.

Ooms' plume dispersion method strictly applies only to plumes with self-similar Gaussian concentration profiles as given by equation (25). However, the jet of air and vapor that emerges from the vent exit has a concentration distribution that is flat (the concentration is constant, independent of radius). Turbulence produced by the vent gas stream entrains ambient air into the jet so that the concentration distribution is soon transformed from a top hat profile to a Gaussian profile at some distance downstream from the vent exit. To estimate this distance, and to calculate the appropriate initial values for Ooms' plume variables, two correlation equations for jet development are used.

Kamotani and Greber [17] developed a correlation for the rise height of a turbulent jet in a crossflow

$$Z_v/d = a_v (X/d)^{b_v} \quad (36)$$

where Z_v = jet centerline elevation above the exit, m
 d = vent diameter, m

- X = downstream location, m
- a_v = empirical parameter, dimensionless
- b_v = empirical parameter, dimensionless

Reference [17] presents data in graph form for the empirical parameters, a_v and b_v in terms of the jet momentum ratio, J,

$$J = \rho_j U_j^2 / \rho_a U_a^2 \quad (37)$$

- where ρ_j = jet discharge density, kg/m³
- U_j = jet discharge velocity, m/s

The behavior of a_v and b_v can be approximated by numerical curve fits

$$b_v = 0.4 \quad \text{for } J < 10 \quad \text{and} \quad (38)$$

$$b_v = \exp [-0.744691 - 0.074525 \ln(J)] \quad \text{for } 10 < J < 60 \quad (39)$$

$$a_v = \exp [0.405465 + 0.131368 \ln(J) + 0.054931 (\ln(J))^2] \quad (40)$$

The values of a_v and b_v predicted by Equations (39) and (40) are in good agreement with Kamotani and Greber's own equation

$$Z_v/d = 0.89 J^{0.47} (X/d)^{0.36} \quad (41)$$

which was recommended in [17] for the range of $15 \leq J \leq 60$ and $0 \leq (X/d) \leq 20$.

While equation (36) may be used to predict the plume trajectory close to the vent, another correlation is needed to predict the plume path length required for development of a Gaussian profile. Keefer and Baines [18] investigated the axial velocity decay for jets of air discharged normal to a flowing stream. Their data gives values for the onset of axial velocity decay (an indication that turbulence has "worn down" the sides of the top hat velocity profile) for jets with velocity ratios of $U_j/U_a = 4, 6, 8$

<u>Path Length</u>	<u>Velocity Ratio</u>
S/d	U_j/U_a
1.59	4
1.92	6
2.30	8

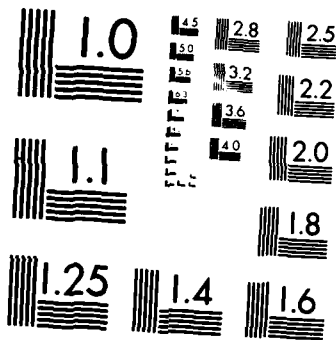

MICROCOPY RESOLUTION TEST CHART
NATIONAL BUREAU OF STANDARDS 1963 A

This data is used as the basis for a numerical curve fit

$$S/D = 0.871667 + 0.1775 * (U_j/U_a) \quad (42)$$

used in the computer program. Equations (42) and (36) are solved simultaneously in subroutine START to determine the initial coordinates of the plume for integration of Ooms' model equations.

The initial value for plume angle, θ , is calculated with the help of equation (36) as

$$\theta = \tan^{-1} \left[a_v b_v (X/d)^{b_v-1} \right] \quad (43)$$

The initial value of plume radius, b , is calculated by requiring that the rate of chemical vapor transport is equal to the rate of chemical vapor discharge from the vent.

The discharge rate from the vent is

$$\dot{m} = \frac{\pi d^2}{4} * C_0 * U_j \quad (44)$$

while the chemical transport rate may be calculated from Ooms's equation (21)

$$\dot{m} = \int_0^\infty C^* e^{-r^2/\lambda^2 b^2} * \left[U_a \cos \theta + u^* e^{-r^2/b^2} \right] 2\pi r dr \quad (45)$$

At the start of computation with Ooms' model

$$C^* = C_0 \quad \text{and} \quad (46)$$

$$u^* = U_j - U_a \cos \theta \quad (47)$$

Integrating equation (45) and equating it to equation (44) gives an algebraic equation for b in terms of d , $U_a \cos \theta$ and U_j

$$b = \frac{d \sqrt{1 + \lambda^2}}{2\lambda \sqrt{\frac{U_a \cos \theta}{U_j} \lambda^2 + 1}} \quad (48)$$

In the computer program, Ooms' recommended value of $\lambda^2 = 1.35$ is used so that equation (48) simplifies to

$$b = \frac{0.6597 d}{[1 + 1.35 U_a \cos \theta / U_j]^{0.5}} \quad (49)$$

III.2.2 Input Data Requirements

All of the input data needed to run the ONDEK plume dispersion model is entered by the user from a remote terminal. In order to identify the output data record, the user is asked to supply the following information first.

- o Today's date (up to 12 characters).
- o The name of a vessel, place or other descriptive phase (up to 40 characters).
- o The name of the cargo vapor or gas being emitted (up to 20 characters).

Next the program takes a set of variables within a particular group, such as "vent geometry", or "atmospheric conditions". The current or default values for each variable in the group are displayed at the user's terminal. The user is asked to signify whether he wishes to change any of the current values. If a change is desired, the program lists each value in turn, and asks whether the user accepts the listed value. If the listed value is not desired, the program accepts a new value entered by the user at his terminal. Table IV furnishes values for the necessary chemical properties of eleven common chemicals, for use with this program. After all variables within a group have been accepted or updated, the program displays the new set of current values. If this set is accepted, the program moves on to the next group.

The input groups and sets of variables are listed below.

- o Vent Geometry
 - vent diameter, m
 - vent height above the deck, m
 - deck height above the water or dock, m
- o Atmospheric Conditions
 - atmospheric pressure, psia
 - atmospheric temperature, °C
 - wind speed at reference height, m/s
 - reference height, m
 - wind turbulence level, m/s
- o Plume Venting Conditions
 - cargo loading rate or gas emission rate, m³/s
 - vapor molecular weight, kg/mole
 - cargo vapor pressure corresponding to vent concentration, psia
- o Plume Computation Conditions
 - initial value for plume path distance, m
 - distance along plume path between printouts, m
 - maximum downwind distance for computation, m
 - zcon, height above deck at which concentration contours are predicted, m

TABLE IV. CHEMICAL PROPERTIES FOR USE WITH THE ONDEK PROGRAM

CHEMICAL	Molecular Weight	Vapor Pressure @ 20°C mm Hg	UEL % Vol.	LEL % Vol.	STIL/STEL		TLV-TWA		Odor Threshold ppm	User Assigned
					ppm CHRIS	ppm ACGIH	ppm CHRIS	ppm ACGIH		
Acetone	58.1	180	12.8	2.6	1000	1000	1000	750	100	20000*
Acrylonitrile	53.1	83	17.0	3.1	40	---	20	2	---	4000*
Benzene	78.1	75	8.0	1.4	75	25	25	10	4.68	2000*
n-Butyraldehyde	72.1	91.5	10.6	2.5	---	---	---	---	0.0046	1000
Carbon Tetrachloride	153.8	90.0	Non-flammable	Non-flammable	25	20	10	5	>10	300*
Ethylene Dichloride	99.0	62	16.0	6.2	200	15	50	10	100	1000*
Gasoline	72.0	190	7.6	1.4	500	500	500-1000	300	0.25	1000
Isopropanol	60.1	33	12.0	2.0	400	500	400	400	200	20000*
Methanol	32.0	100	36.5	5.5	1000	250	200	200	100	25000*
Toluene	92.1	28	7.0	1.3	600	150	100	100	0.17	2000*
Vinyl Acetate	86.1	90	13.4	2.6	---	20	10	10	0.12	1000

* IDLH level from NIOSH/OSHA

** Not available in ACGIH

*** Not available in CHRIS

- o Concentration Values for Hazard Analysis
 - upper flammable limit (UEL), % by volume
 - lower flammable limit (LEL), % by volume
 - short term exposure limit (STEL), ppm
 - time weighted average-threshold limit value (TLV), ppm
 - odor threshold, ppm

- o Concentration Values for Contour Plot
 - CC1, a user selected value, ppm
 - CC2, odor threshold, ppm
 - CC3, upper flammable limit, ppm
 - CC4, lower flammable limit, ppm
 - CC5, short term exposure limit, ppm
 - CC6, threshold limit value, ppm

III.2.3 Default Options

The ONDEK computer program assigns initial or default values to all of the input variables listed in Section III.2.2 with the exception of the current date, the vessel or place name, and the name of the gas or vapor being vented. The user must input this information from his terminal. Default values for chemical vapor properties are furnished as an example for vinyl acetate vapor. To consider the venting of other chemicals, the user must replace the default values for vinyl acetate with the correct values for the new chemical as described in Section III.2.2; chemical properties are included in Table IV for eleven common chemicals. In addition to listing default values, the program also lists other typical values for each input variable as described below.

- o Vent Geometry
 - Vent Diameter
 - o 0.305 m (12 inches)
 - o 0.203 m (8 inches) - DEFAULT VALUE
 - o 0.102 m (4 inches)
 - Vent Height above Deck
 - o 1.0 m (3.3 ft) - DEFAULT VALUE
 - o 4.0 m (13.1 ft)
 - o 6.1 m (20.0 ft), or B/3
 - Deck Height above the Dock
 - o 1.0 m (typical for a barge) - DEFAULT VALUE
 - o 6.1 m (typical for a ship)

- o Atmospheric Conditions
 - Atmospheric Pressure
 - o 14.7 psia - DEFAULT VALUE
 - Atmospheric Temperature
 - o 520 °R - DEFAULT VALUE

- Reference Wind Speed
 - o 1.12 m/s (2.5 mile/hr)
 - o 2.24 m/s (5.0 mile/hr) - DEFAULT VALUE
 - o 4.47 m/s (10.0 mile/hr)
 - o 6.71 m/s (15.0 mile/hr)
- Reference Height for Wind Speed
 - o 10.0 m (32.8 ft) - DEFAULT VALUE
- Wind Speed Turbulence Level
 - o 20% (recommended for wind generated turbulence at wind speeds of 2 m/s or above) - DEFAULT VALUE
 - o 30% (recommended for wind generated turbulence at wind speeds below 2 m/s, or when above deck structures and piping produce additional turbulence)
 - o 0% (recommended only for estimating the instantaneous boundary of the plume)
- o Plume Venting Conditions
 - Cargo Loading Rate or Gas Emission Rate
 - o 794 m³/hr (5000 barrels/hr)
 - o 318 m³/hr (2000 barrels/hr)
 - o 159 m³/hr (1000 barrels/hr) - DEFAULT VALUE
 - o 79 m³/hr (500 barrels/hr)
 - Chemical Vapor Molecular Weight
 - o 86.10 (vinyl acetate vapor) - DEFAULT VALUE
 - Chemical Vapor Pressure
 - o 90.0mm Hg (vinyl acetate) - DEFAULT VALUE

The vapor concentration at the tank vent near the end of cargo loading may approach the saturated concentration of chemical vapor in air. The default value corresponds to the saturated vapor concentration of vinyl acetate vapor in air at a temperature of 20°C (68°F).

If the actual vapor concentration at the vent is less than the saturated vapor concentration, the input value of chemical vapor pressure should be equal to the saturation vapor pressure of the chemical multiplied by the ratio of the actual vapor concentration at the vent divided by the saturation vapor concentration.

For more information on typical values of vent concentration during cargo loading, please refer to Reference 13, Section IV.3.2.
- o Plume Computation Conditions
 - Initial Value for Plume Path Distance
 - o 0.0 m - DEFAULT VALUE
 - Distance Along Plume Path Between Printouts
 - o 1.0 m - DFFAULT VALUE
 - o 5.0 m

- Maximum Distance for Plume Computation
 - o 10 m (recommended for 1.0 m vents) - DEFAULT VALUE
 - o 20 m (recommended for 4.0 m and B/3 vents)
 - o 100 m
- Specified Height Above Deck for Output of Vapor Concentrations Downwind of the Vent
 - o 1.67 m (man breathing height)
- o Concentration values for hazard analysis (the values given below are default values for vinyl acetate. The user must input new values for another chemical).
 - Upper Flammable limit
 - o 13.4%* - DEFAULT VALUE
 - Lower Flammable Limit
 - o 2.6%* - DEFAULT VALUE
 - Short Term Exposure Limit
 - o 20 ppm** - DEFAULT VALUE
 - Threshold Limit Value
 - o 10 ppm* - DEFAULT VALUE
 - Odor Threshold
 - o 0.12 ppm* - DEFAULT VALUE
- o Concentration values for contour plots (default values are supplied for vinyl acetate. The user must input new values for another chemical).
 - CC1, user supplied value
 - o 1000 ppm - DEFAULT VALUE (limit for use of hydrocarbon vapor canister masks)
 - CC2, odor threshold (see above)
 - CC3, upper flammable limit (see above)
 - CC4, lower flammable limit (see above)
 - CC5, short term exposure limit (see above)
 - CC6, threshold limit value (see above)

* CHRIS

** 1982 ACGIH

III.2.4 Program Output

The ONDEK program opens an output file named "RESONDEK.DAT" and outputs

- o A summary of the input data.
- o A table of computed values for the plume variables and the concentration contours.
- o A plot of plume centerline concentration versus downwind distance.
- o A plot of vapor concentration at man breathing height (or other specified height) above deck level versus downwind distance.
- o A plot of vapor concentration contours at man breathing height (or other specified height) in the region downwind of the vent.

To illustrate the form of the output data, an example was run using all of the default values specified in Section III.2.3. Figure 4 shows the summary page listing the input data values for a loading of vinyl acetate into a barge. This example assumes that the tank gas atmosphere is vented through a 0.20 m flame screen in an expansion trunk at a height of 1 m above the deck.

Figure 5 lists the values of the plume variables and the concentration contour locations downwind of the vent. Since the default value for DISTAN was 1.0 m, output was printed at increments of 1 m up to the maximum downwind distance. DISMAX = 10.0 m. The table in Figure 5 lists abbreviations for the names of the plume variables as follows:

- S = distance along the locus of the plume axis, m
- XCL = downwind distance from the center of the vent, m
- ZCL = vertical distance of the plume centerline above the deck, m
- CCL = vapor concentration on the plume centerline, kg/m^3
- CZCON = vapor concentration at man breathing height (or other specified height) (ZCON), kg/m^3
- XCON = downwind distance corresponding to the estimate of CZCON, m
- YC1 thru YC6 = crosswind distance, Y, to the concentration contours corresponding to CC1 through CC6 at $X = XCON$ and $Z = ZCON$, m
- B = plume characteristic width, m
- U* = velocity deficit, the difference between the plume centerline velocity and $U_a \cos \theta$, m/s
- THETA = angle of the plume axis with respect to the horizon, radians.

TITLE= EXAMPLE: VAM BARGE LOADING
METEOROLOGICAL CONDITIONS

DATE= MAR 16, 1983

0 BAROMETRIC PRESSURE=760.000 MM HG AIR TEMPERATURE=520.0 DEG R
0 AVERAGE WIND SPEED= 2.24 M/S AT REFERENCE HEIGHT= 10.00 M
0 WIND EXPONENT= 0.14
0 TURBULENCE LEVEL= 20.00

VAPOR VENTING CONDITIONS

0 VENT DIAMETER= 0.20 METERS
0 VENT HEIGHT= 1.00 METERS ABOVE THE DECK
0 DECK HEIGHT= 1.00 METERS ABOVE THE WATER

0 EMITTED VAPOR= VINYL ACETATE VAPOR
0 MOLECULAR WEIGHT= 35.74 OF GAS AND AIR MIXTURE
0 VENT CONCENTRATION= 0.431E+00 KG/(M**3)

0 VENTING FLOWRATE= 159. (M**3)/HR
0 VENTING VELOCITY= 1.36 M/SEC

VALUES OF CONCENTRATION FOR FLAMMABILITY AND HEALTH HAZARDS

0 UPPER FLAMMABLE LIMIT (UEL) = 0.488E+00 KG/(M**3)
0 LOWER FLAMMABLE LIMIT (LEL) = 0.947E-01 KG/(M**3)
0 SHORT TERM INHALATION LIMIT (STIL) = 0.728E-04 KG/(M**3)
0 THRESHOLD LIMIT VALUE (TLV) = 0.364E-04 KG/(M**3)
0 ODOR THRESHOLD (ODOR) = 0.437E-06 KG/(M**3)

VALUES OF CONCENTRATION CHOSEN FOR CONCENTRATION CONTOURS

0 C1 = 0.364E-02 (KG/M**3)
0 C2 = 0.437E-06 (KG/M**3)
0 C3 = 0.488E+00 (KG/M**3)
0 C4 = 0.947E-01 (KG/M**3)
0 C5 = 0.728E-04 (KG/M**3)
0 C6 = 0.364E-04 (KG/M**3)
0 PREDICTED FOR A HEIGHT OF 1.680 METERS ABOVE DECK LEVEL

NUMERICAL INTEGRATION DATA

0 STEP SIZE= 0.0406 METERS, MAXIMUM DOWNWIND DISTANCE= 10.00 METERS

FIGURE 4. SUMMARY OF INPUT DATA FOR EXAMPLE OF
VINYL ACETATE LOADING INTO A BARGE

BEGIN PLUME COMPUTATION THROUGH THE AIR ABOVE THE DECK

S METERS	XCL METERS	ZCL METERS	CCL KG/M**3	CZCON KG/M**3	XCON METERS	YC1 METERS	YC2 METERS	YC3 METERS	YC4 METERS	YC5 METERS	YC6 METERS
0.16	0.218	1.244	0.1110E+00	0.9628E-03	0.218	0.000	0.555	0.000	0.000	0.321	0.362
0.97	1.029	1.277	0.1225E-01	0.7297E-02	1.029	0.467	1.746	0.000	0.000	1.202	1.289
1.95	2.003	1.283	0.3947E-02	0.3351E-02	2.003	0.000	2.935	0.000	0.000	1.920	2.087
2.96	3.018	1.284	0.1884E-02	0.1767E-02	3.018	0.000	4.087	0.000	0.000	2.533	2.794
3.98	4.033	1.285	0.1100E-02	0.1137E-02	4.033	0.000	5.201	0.000	0.000	3.075	3.441
4.95	5.008	1.285	0.7318E-03	0.8437E-03	5.008	0.000	6.254	0.000	0.000	3.559	4.031
5.97	6.023	1.285	0.5150E-03	0.6597E-03	6.023	0.000	7.332	0.000	0.000	4.023	4.613
6.98	7.038	1.285	0.3820E-03	0.5332E-03	7.038	0.000	8.388	0.000	0.000	4.440	5.155
7.96	8.012	1.285	0.2974E-03	0.4428E-03	8.012	0.000	9.380	0.000	0.000	4.790	5.635
8.97	9.027	1.284	0.2361E-03	0.3702E-03	9.027	0.000	10.391	0.000	0.000	5.103	6.094
9.95	10.001	1.284	0.1934E-03	0.3153E-03	10.001	0.000	11.341	0.000	0.000	5.352	6.495

FIGURE 5. COMPUTED VALUES OF THE PLUME VARIABLES FOR THE OUTPUT
EXAMPLE OF VINYL ACETATE LOADING INTO A BARGE

Both the ONDEK3 and the ONDEK4 versions of the ONDEK model generate graph plots to give a quick overview of the vapor concentration distribution. The ONDEK4 program, listed in Appendix B, writes an output file (named SCRATCH) that can be addressed to draw graph plots using graphics software supplied by the user. The ONDEK3 program, listed in Appendix C, contains a subroutine names PLOTS that generates graphs using WRITE statements for line printer or CRT display. Figures 6, 7, and 8 are plots obtained from ONDEK4 and a graph plotting program. An analogous series of line printer plots obtained from ONDEK3 are shown in Appendix D.

Figure 6 shows the behavior of the plume centerline concentration as a function of distance downwind from the vent. The plume centerline concentration is indicated by the letter C, and the letters U, L, S, and T represent concentration levels equivalent to the UEL, LEL, STEL, and TLV, respectively.

Figure 7 shows the behavior of the vapor concentration at man breathing height as a function of distance downwind from the vent. The vapor concentration at breathing height is indicated by the letter C, and the letters U, L, S, and T represent concentration levels equal to the UEL, LEL, STEL, and TLV, respectively. Like Figure 6, Figure 7 is a semi-log plot of concentration versus downwind distance.

Figure 8 shows a plot of the vapor concentration contours downwind of the vent. Note that the horizontal axis corresponds to the plume centerline, so that only 1/2 of the area covered by the plume downwind of the vent is shown. Note also that the vertical Y axis has been stretched for clarity. Symbols are used to indicate plume concentration contours as follows:

- 1 = CCl, the user specified value
- 0 = Odor threshold
- U = Upper flammable limit
- L = Lower flammable limit
- S = Short term exposure limit
- T = Threshold limit value

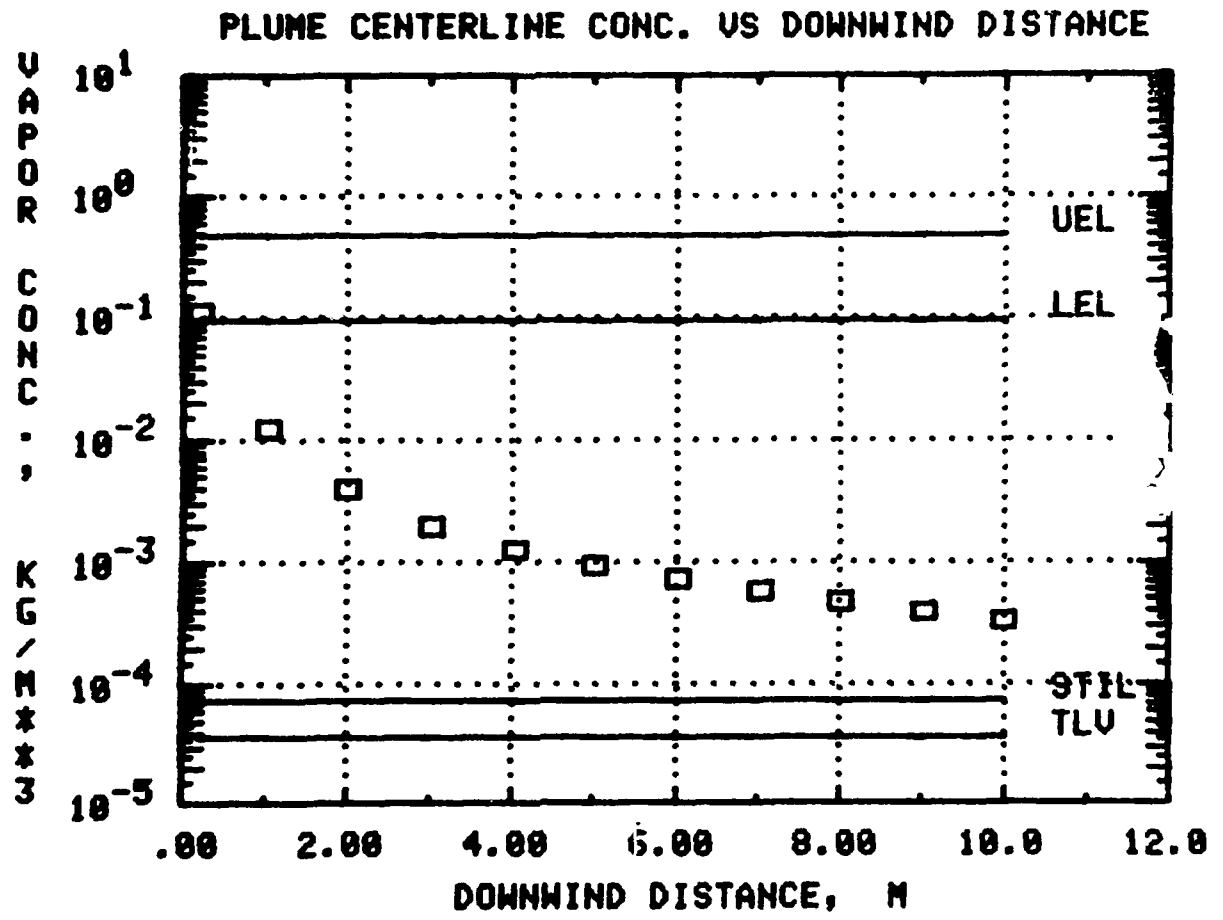

FIGURE 6. GRAPH OF PLUME CENTERLINE CONCENTRATION VERSUS DOWNWIND DISTANCE FOR THE OUTPUT EXAMPLE OF VINYL ACETATE LOADING INTO A BARGE

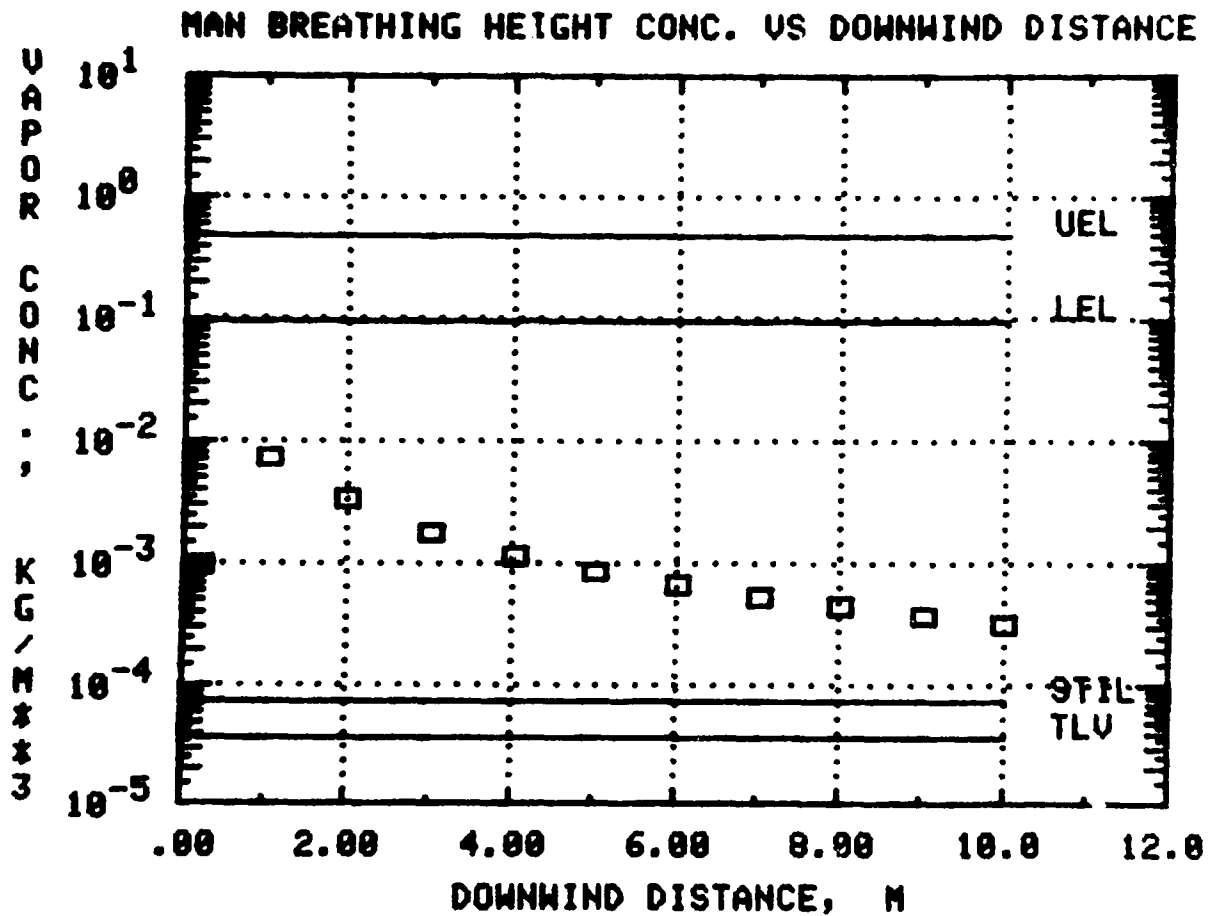

FIGURE 7. GRAPH OF VAPOR CONCENTRATION AT MAN BREATHING HEIGHT VERSUS DOWNWIND DISTANCE FOR THE OUTPUT EXAMPLE OF VINYL ACETATE LOADING INTO A BARGE

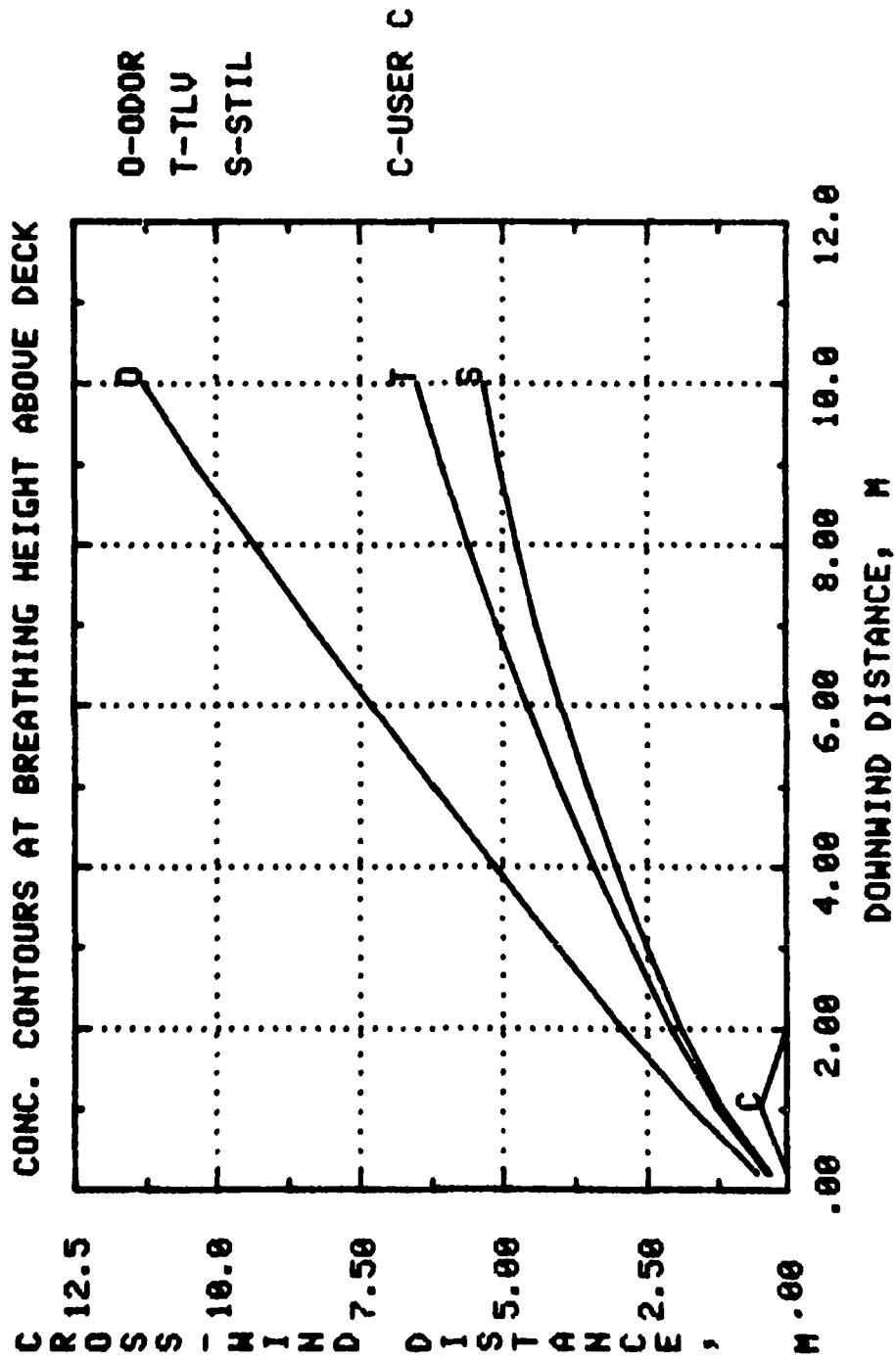

FIGURE 8. GRAPH OF VAPOR CONCENTRATION CONTOURS AT MAN BREATHING HEIGHT DOWNWIND OF A VENT FOR THE OUTPUT EXAMPLE OF VINYL ACETATE LOADING INTO A BARGE

III.2.5 Hazard Assessment

In order to assess whether a potential flammability or toxicity hazard exists during cargo loading or tank ventilation, the ONDEK computer programs produce plots of downwind vapor concentration and vapor concentration contours at man breathing height, or any other height above the deck that is specified by the user. These plots indicate directly whether the vapor concentration is in the flammable concentration range, or if it exceeds either the STEL or TWA-TLV concentration level for a particular chemical. By choosing the scaling factor for the plots of iso-concentration contours to be the same as the scale factor for an arrangement drawing of the vessel deck, the contour plots can be overlaid directly onto the deck arrangement plan. This facilitates the interpretation of the spatial concentration predictions.

For the assessment of potential toxicity hazards, regions of the deck where the vapor concentration exceeds the STEL limit value are most significant. The STEL value is the maximum acceptable time weighted average concentration value that should not be exceeded for exposure of short (usually 15 to 20 minutes) duration. It is appropriate to compare ONDEK plume model predictions for spatial concentration distribution with STEL levels since the model was validated using measurements of the 10-minute time average concentration distribution during actual cargo loading operations [13].

The experiments reported in Reference [13] confirmed that vent height above the deck is an important factor in determining the level of vapor concentration at man breathing height during cargo loading operations. The ONDEK computer program can be used to review current and proposed vapor venting requirements for chemical cargos. A parametric study performed for each hazardous cargo will identify the minimum vent height required to prevent the vapor concentration from exceeding the STEL at man breathing height for a range of cargo loading rates and ambient wind speed. The results of the parametric study could also be used to provide guidance on the use of personal protective equipment on existing vessels that do not have vents of the necessary minimum height.

III.2.6 Flow Charts

The ONDEK computer program consists of a main program PLUME and several function and subroutine subprograms. A flow chart is presented in this section for each program element. It is recommended that the flow charts be reviewed in combination with the computer program listing in Appendix B. The program elements are, in the order of their appearance in the listing,

o	Main Program	ONDEK
o	Integer Function	HAMING
o	Integer Function	RUNGE
o	Real Function	SIMUL
o	Subroutine	RHS
o	Subroutine	CSUM
o	Subroutine	CONT
o	Subroutine	START
o	Subroutine	INDAT
o	Subroutine	PROMPT

Program ONDEK

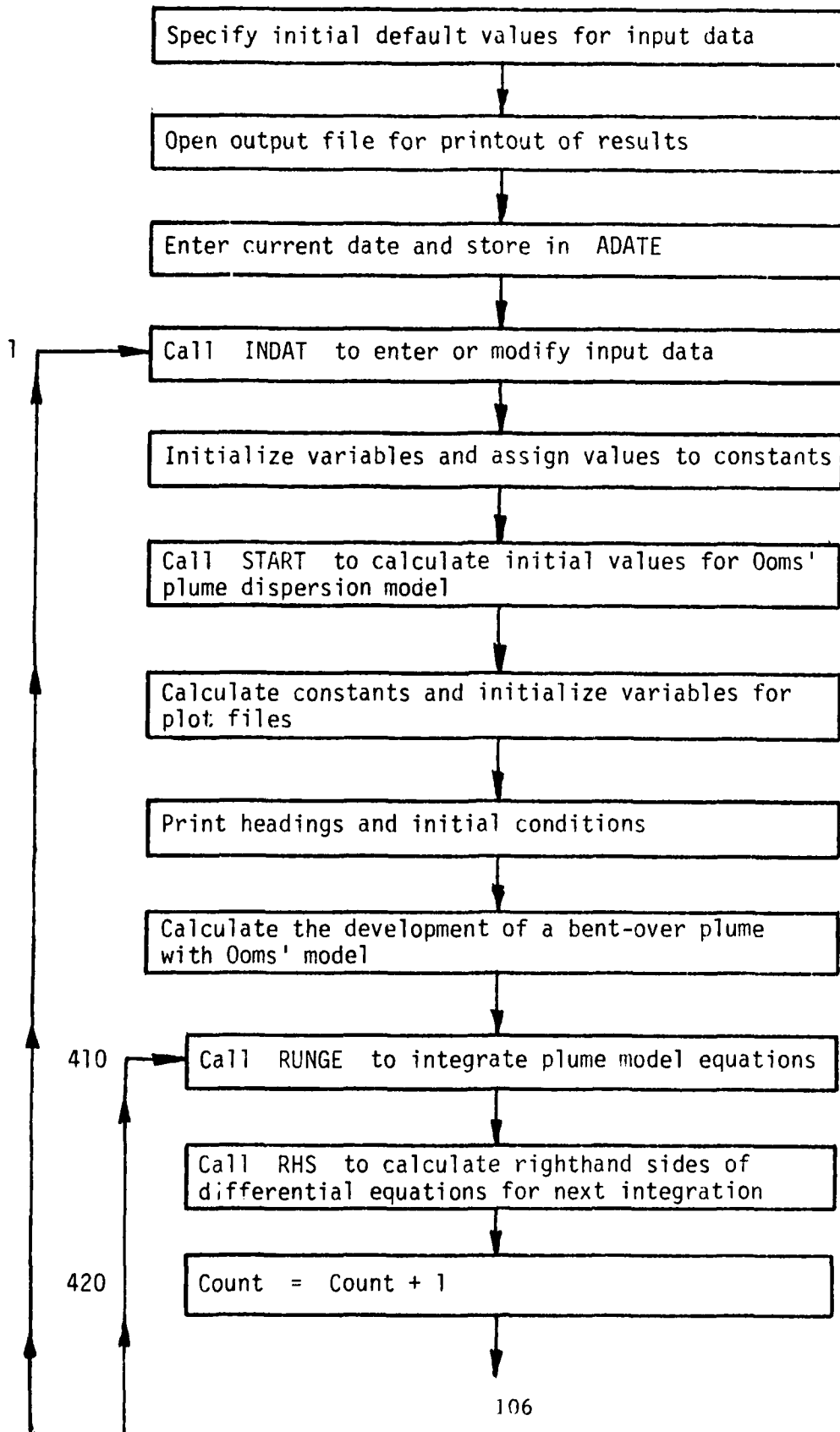

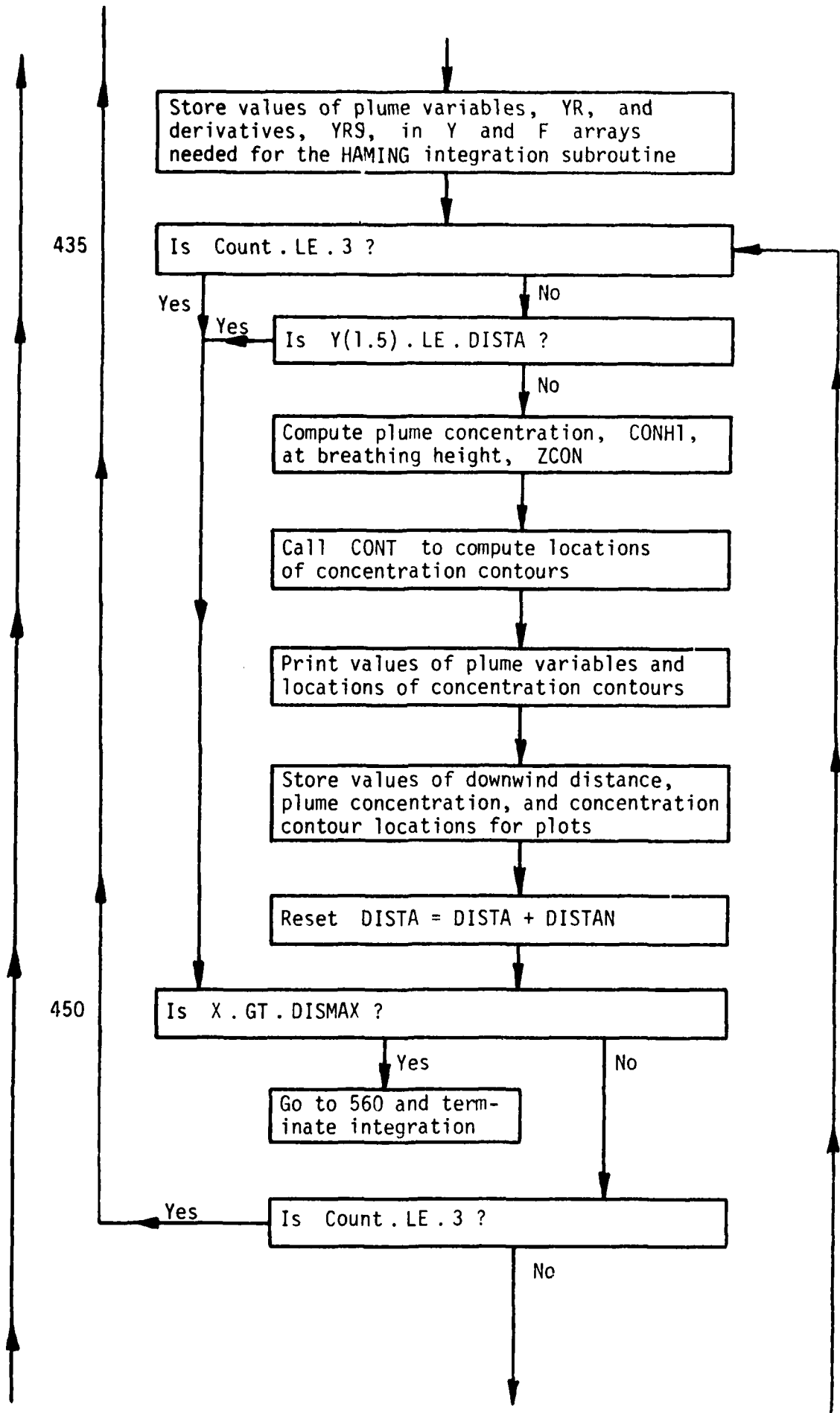

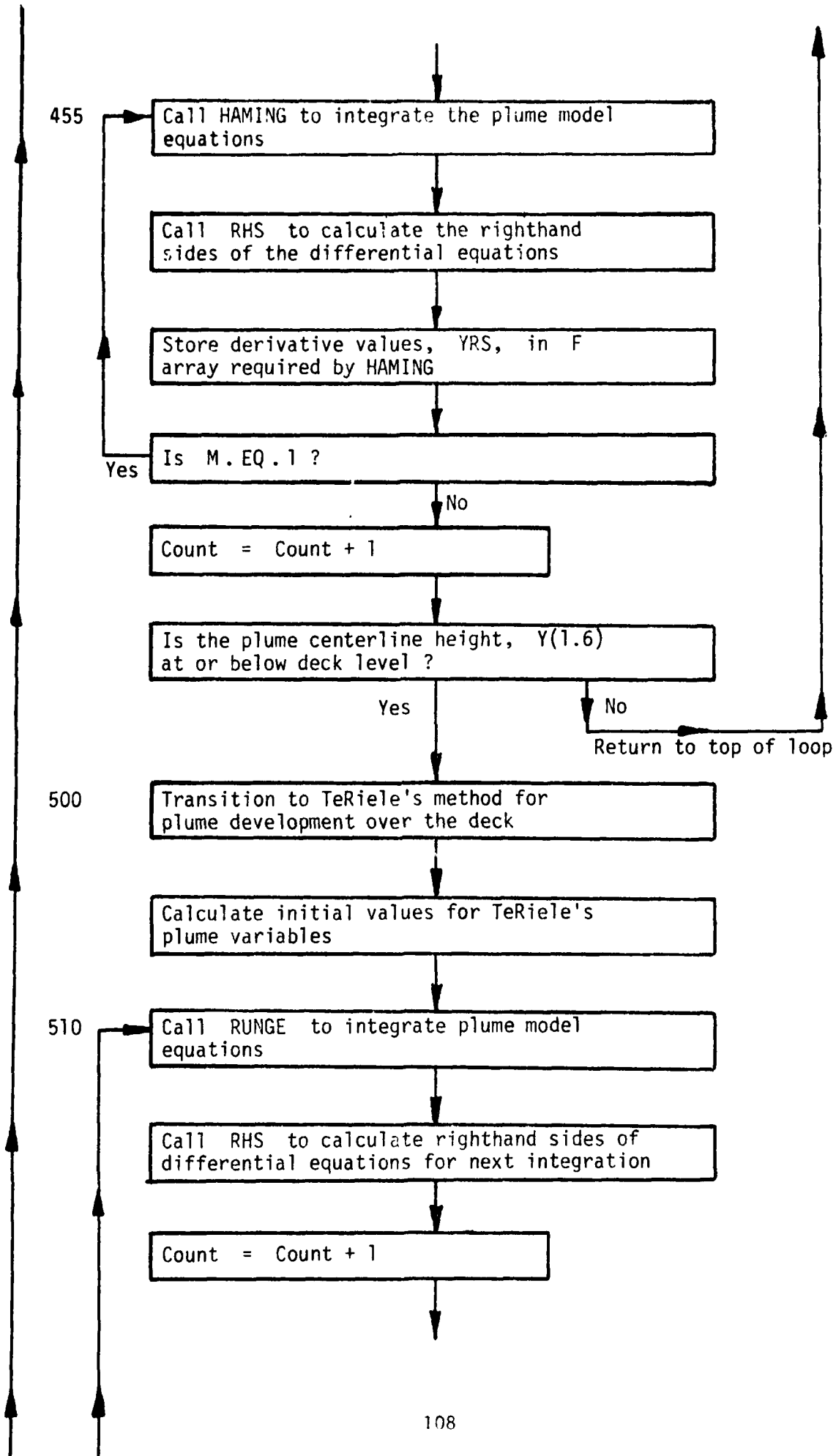

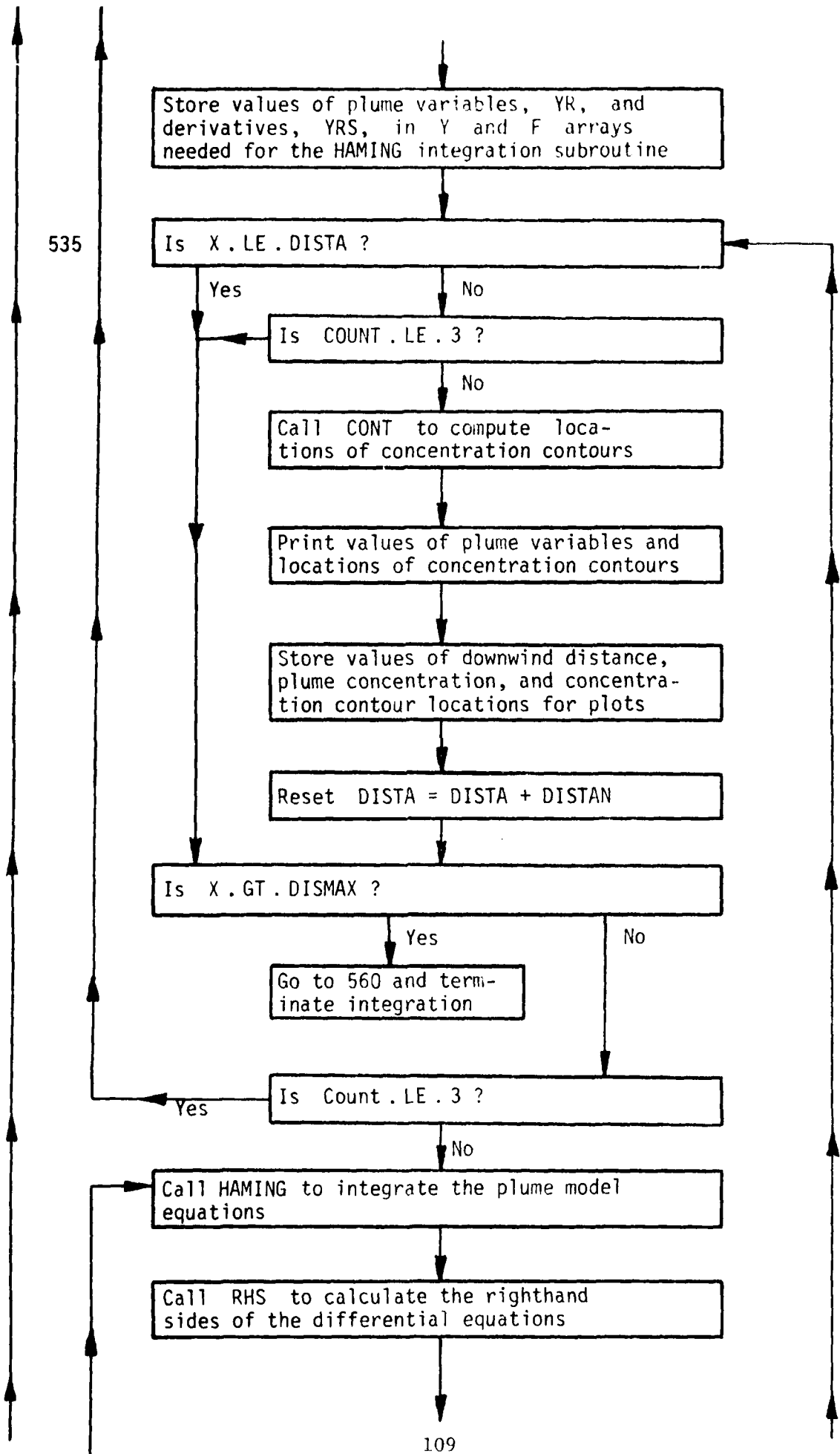

535

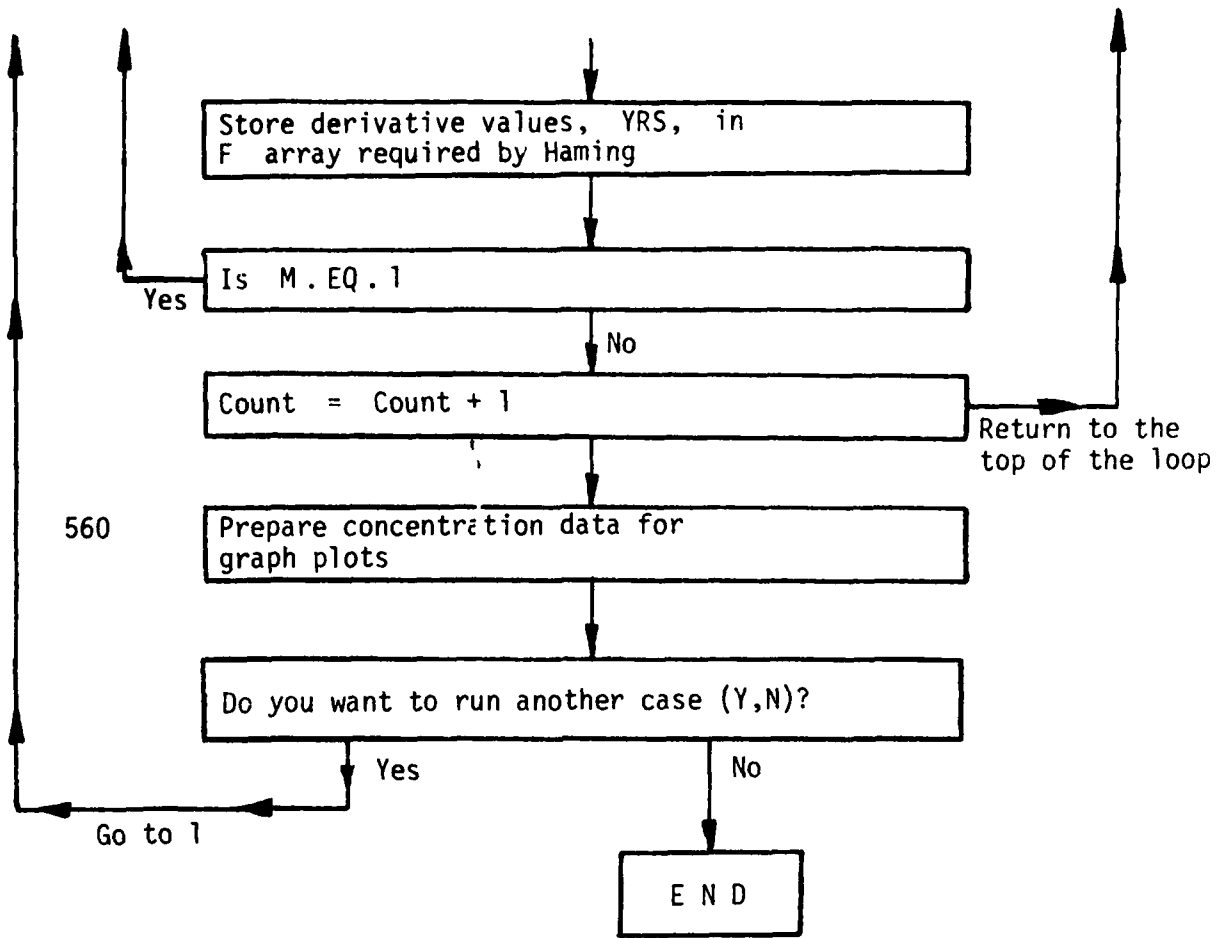

Integer Function HAVING

This program is a general subroutine for solving a set of first order ordinary differential equations. It is called by the main program ONDEK, and is used to continue the solution of the set of plume development equations after RUNGE has provided the set of initial values. The function specification is

Integer Function HAVING (N,Y,F,X,H,TE)

Function HAVING is taken from "Applied Numerical Methods" by B. Carnahan, H. A. Luther, and J. O. Wilkes [19].

The value of N is set in the function call statement. The value of H, the integration step size is assigned a value in Program ONDEK. The reader is referred to the text by Carnahan, et al. for a complete description of this function subroutine. The following paragraph is repeated from the program listing.

HAVING implements Hamming's predictor-corrector algorithm to solve N simultaneous first-order ordinary differential equations. X is the independent variable, and H is the integration stepsize. The routine must be called twice for integration across each step. On the first call, it is assumed that the solution values and derivative values for the N equations are stored in the first N columns of the first four rows of the Y matrix and the first three rows of the F matrix, respectively. The routine computes the N predicted solutions YPRED(J), increments X by H and pushes all values in the Y and F matrices down one row. The predicted solutions YPRED(J) are modified, using the truncation error estimates TE(J) from the previous step, and saved in the first row of the Y matrix. HAVING returns to the calling program with the value 1 to indicate that all derivatives should be computed and stored in the first row of the F array before the second call is made on HAVING. On the second entry to the function (determined by the logical variable PRED), HAVING uses the Hamming corrector to compute new solution estimates, estimates the truncation errors TE(J) for the current step, improves the corrected solutions using the new truncation error estimates, saves the improved solutions in the first row of the Y matrix, and returns to the calling program with a value 2 to indicate completion of one full integration step.

Integer Function RUNGE

This program is a general subroutine for solving a set of first order ordinary differential equations. It is called by the main program ONDEK, and is used to start the solution of the set of plume development equations. After three forward steps are completed, subroutine HAMING is used instead of RUNGE to continue the numerical integration. The function specification is

Integer Function RUNGE (N,Y,F,X,H)

Function RUNGE is taken from "Applied Numerical Methods" by B. Carnahan, H. A. Luther, and J. O. Wilkes [19].

The value of N is set in the function call statement. The value of H, the integration step size is assigned a value in Program ONDEK. The reader is referred to the text by Carnahan, et al. for a complete description of this function subroutine. The following paragraph is repeated from the program listing.

The function RUNGE employs the fourth-order Runge-Kutta method with Kutta's coefficients to integrate a system of N simultaneous first order ordinary differential equations $F(J) = DY(J)/DX$, ($J=1,2,\dots,N$), across one step of length H in the independent variable X, subject to initial conditions $Y(J)$, ($J=1,2,\dots,N$). Each $F(J)$, the derivative of $Y(J)$, must be computed four times per integration step by the calling program. The function must be called five times per step (Pass (1)...Pass (5)) so that the independent variable value (X) and the solution values ($Y(1)\dots Y(N)$) can be updated using the Runge-Kutta algorithm. M is the pass counter. RUNGE returns as its value 1 to signal that all derivatives (the $F(J)$) be evaluated or 0 to signal that the integration process for the current step is finished. SAVEY(J) is used to save the initial value of $Y(J)$ and PHI(J) is the increment function for the J(TH) equation. As written, N may be no larger than 50.

Real Function SIMUL

This program is a general subroutine for solving matrix equations. It is called by subroutine RHS and is used to solve the matrix equation for the derivatives of plume concentration, $\frac{dc^*}{ds}$, etc. The function specification is

Real Function SIMUL (N,A,X,EPS,INDIC,NRC)

Function SIMUL is taken from "Applied Numerical Methods" by B. Carnahan, H. A. Luther, and J. O. Wilkes [19].

Subroutine RHS assigns values of N, INDIC and NRC in the function call statement. The value of EPS is set in Program STEADY. The reader is referred to the text by Carnahan, et al. for a complete description of this function subroutine. The following paragraph is taken from the comment statements in the program listing.

When INDIC is negative, SIMUL computes the inverse of the N by N matrix A in place. When INDIC is zero, SIMUL computes the N solutions X(1)...X(N) corresponding to the set of linear equations with augmented matrix of coefficients in the N by N+1 array A and in addition computes the inverse of the coefficient matrix in place as above. If INDIC is positive, the set of linear equations is solved but the inverse is not computed in place. The Gauss-Jordan complete elimination method is employed with the maximum pivot strategy. Row and column subscripts of successive pivot elements are saved in order in the IROW and JCOL arrays, respectively. K is the pivot counter, PIVOT the algebraic value of the pivot element, MAX the number of columns in A, and DETER the determinant of the coefficient matrix. The solutions are computed in the (N+1) th column of A and then unscrambled and put in proper order in X(1)...X(N) using the pivot subscript information available in the IROW and JCOL arrays. The sign of the determinant is adjusted, if necessary, by determining if an odd or even number of pairwise interchanges is required to put the elements of the JORD array in ascending sequence where JORD (IROW(I)) = JCOL(I). If the inverse is required, it is unscrambled in place using Y(1)...Y(N) as temporary storage. The value of the determinant is returned as the value of the function. Should the potential pivot of largest magnitude be smaller in magnitude than EPS, the matrix is considered to be singular and a true zero is returned as the value of the function.

Subroutine RHS

This subroutine computes values for the derivatives of the plume variables along the plume axis as required by subroutines RUNGE and HAMING. The subroutine is called in the main program ONDEK after every call to RUNGE or HAMING. The subroutine call furnishes current values for the plume variables in array Y. Computed values of the derivatives are returned in array C.

Both Ooms' and TeRiele's plume models lead to sets of coupled first order ordinary differential equations for the derivatives of the plume variables. The subroutine computes values for the coefficients in each equation, then calls subroutine SIMUL to invert the coefficient matrix and calculate the value of each derivative. An integer variable IDECK is used to select Ooms' model equations (IDECK = 1) or TeRiele's model equations (IDECK = 0).

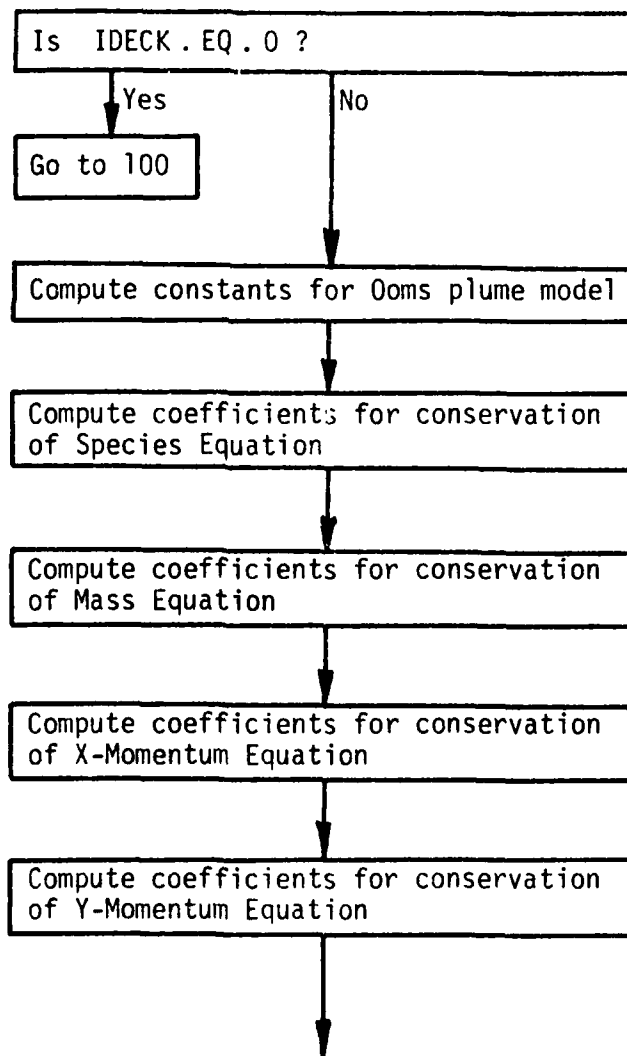

Subroutine CSUM

This subroutine is called to compute the sum of an algebraic series that arises in TeRiele's conservation of momentum equation. The subroutine is called by subroutine RHS. The subroutine call furnishes the local value of CA, the plume centerline concentration. CSUM returns the sum of the series in variable SUM1.

Subroutine CONT

This subroutine computes the distance in the crosswind direction from the center plane of the plume ($y = 0$) to locations where the vapor concentration at height ZCON above the deck has the values stored in array CC. The subroutine is called by the main program ONDEK and distance values are returned in array YC. As written, the subroutine will compute the location of $INUM \leq 9$ concentration contours. The subroutine call in ONDEK requests six contours only.

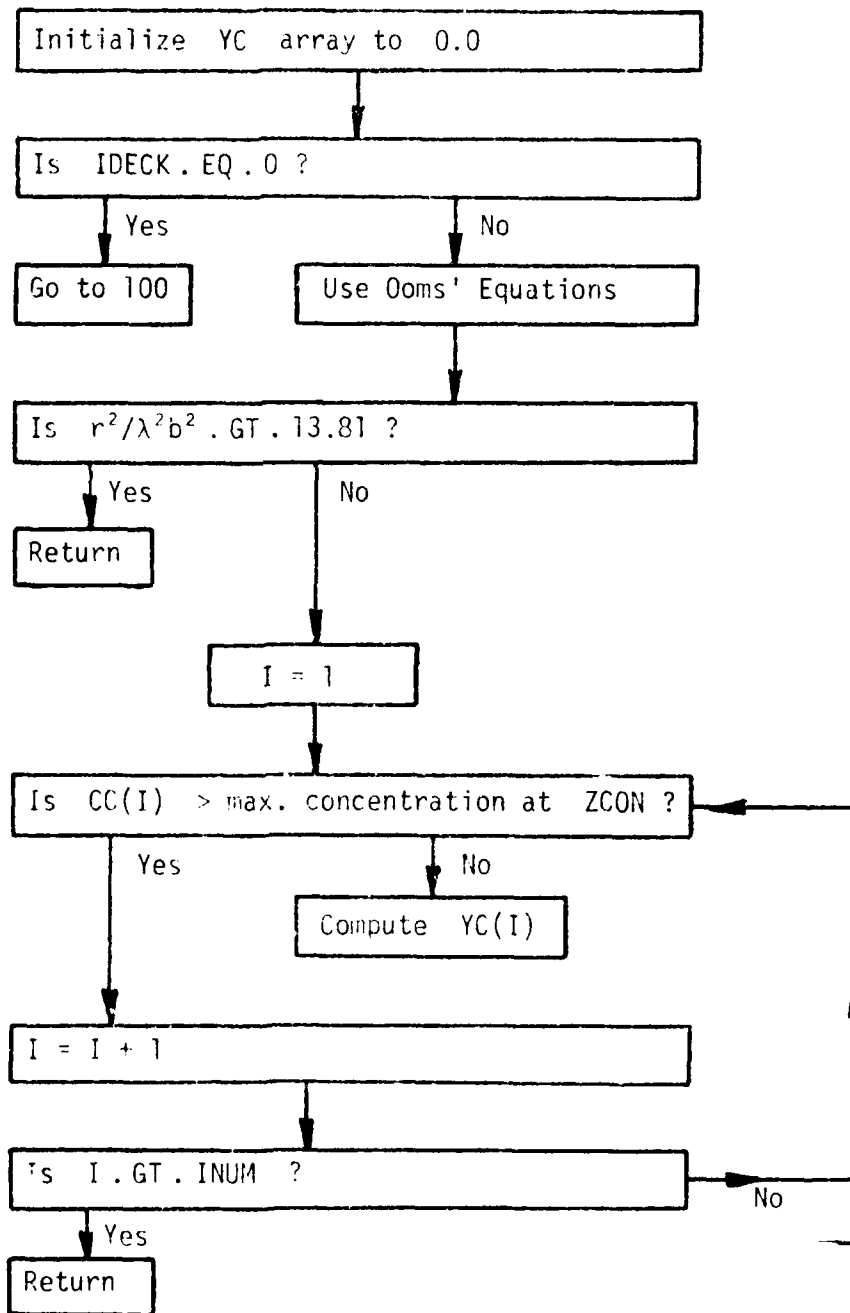

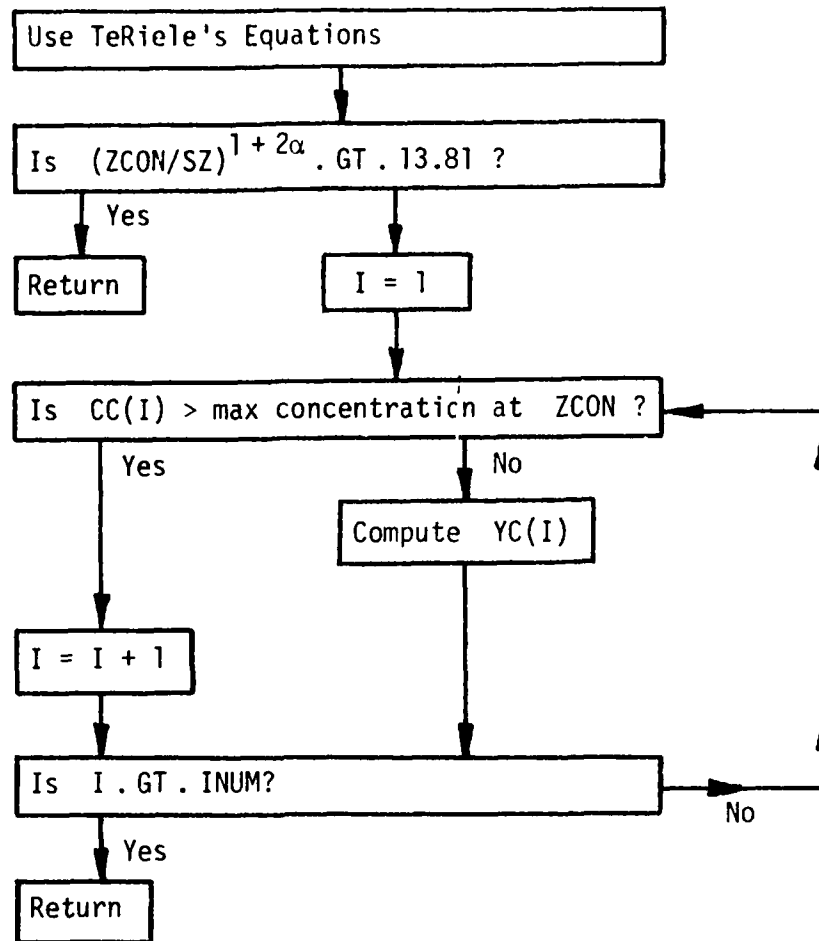

Subroutine START

This subroutine computes a set of initial values for plume radius, plume velocity, plume angle, and the vertical and horizontal coordinates of the plume centerline. This set of initial values is needed to start the numerical computation of Ooms' plume model equations.

The subroutine is called once by the main program ONDEK. Control is returned to ONDEK when the subroutine computations are finished. The subroutine call furnishes values for the molecular weight of air, WMA. The subroutine returns a value for the molecular weight of the air and chemical mixture, WMJ, and the set of initial values for the plume variables in array YR. Other data is furnished to subroutine START through common blocks DAT1, DAT2 and DAT3.

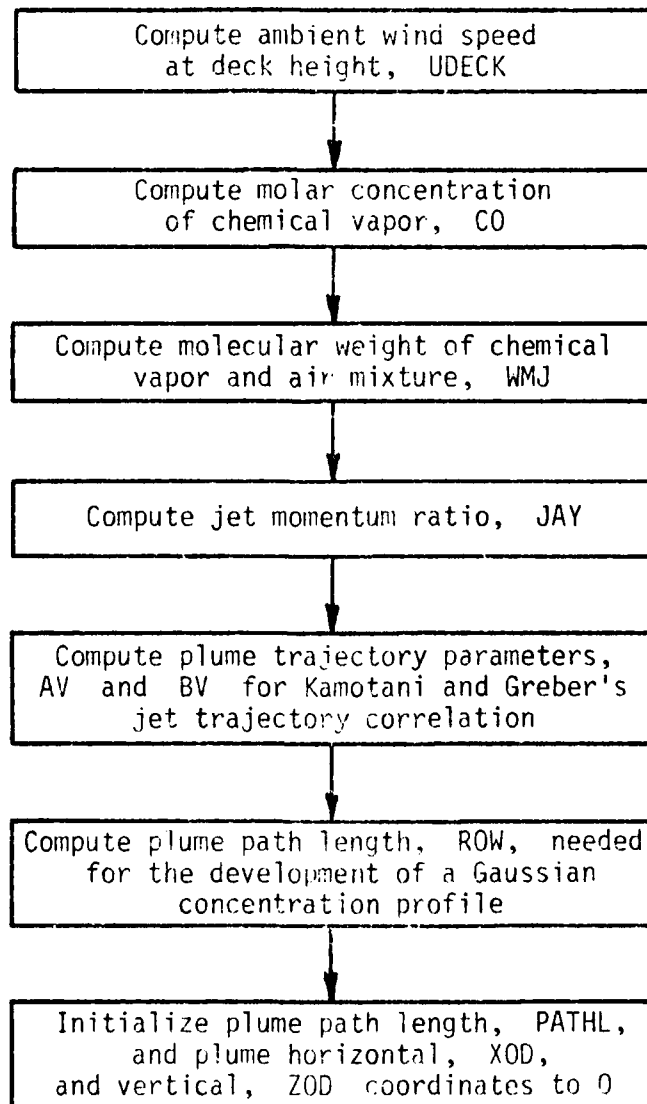

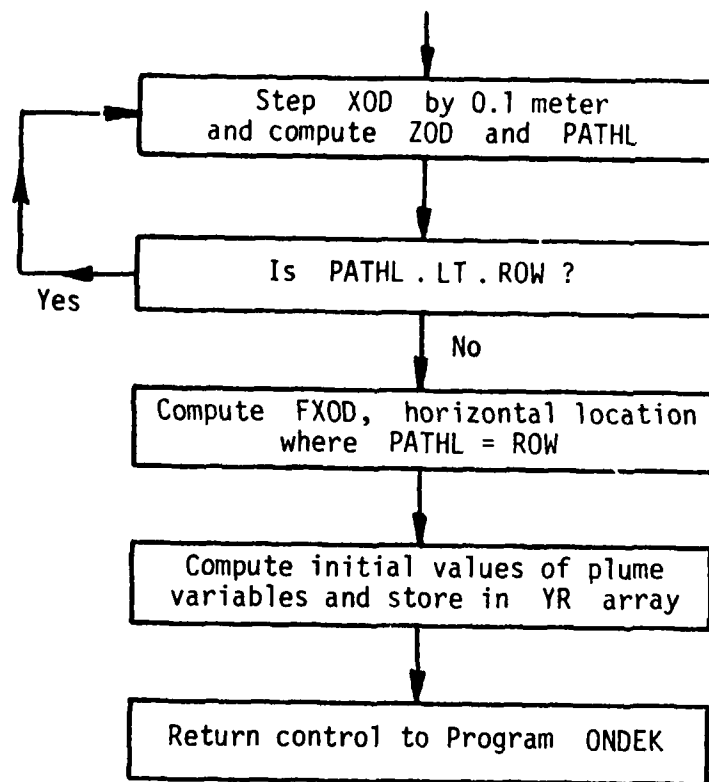

Subroutine INDAT

This subroutine permits the user to supply input data in an interactive manner. The program identifies each variable to be specified, lists the current "default" value, and asks the user if this value is accepted. If the value is accepted, the subroutine advances the next variable and repeats the input process. If the value is rejected, the subroutine asks for and accepts a new value, then advances to the next variable.

The subroutine is called once by the main program ONDEK. Control is returned to ONDEK when all input data values are specified. All input data values are transferred to the main program through common blocks DAT1, DAT2, DAT3, DAT4, DAT5, and DAT6.

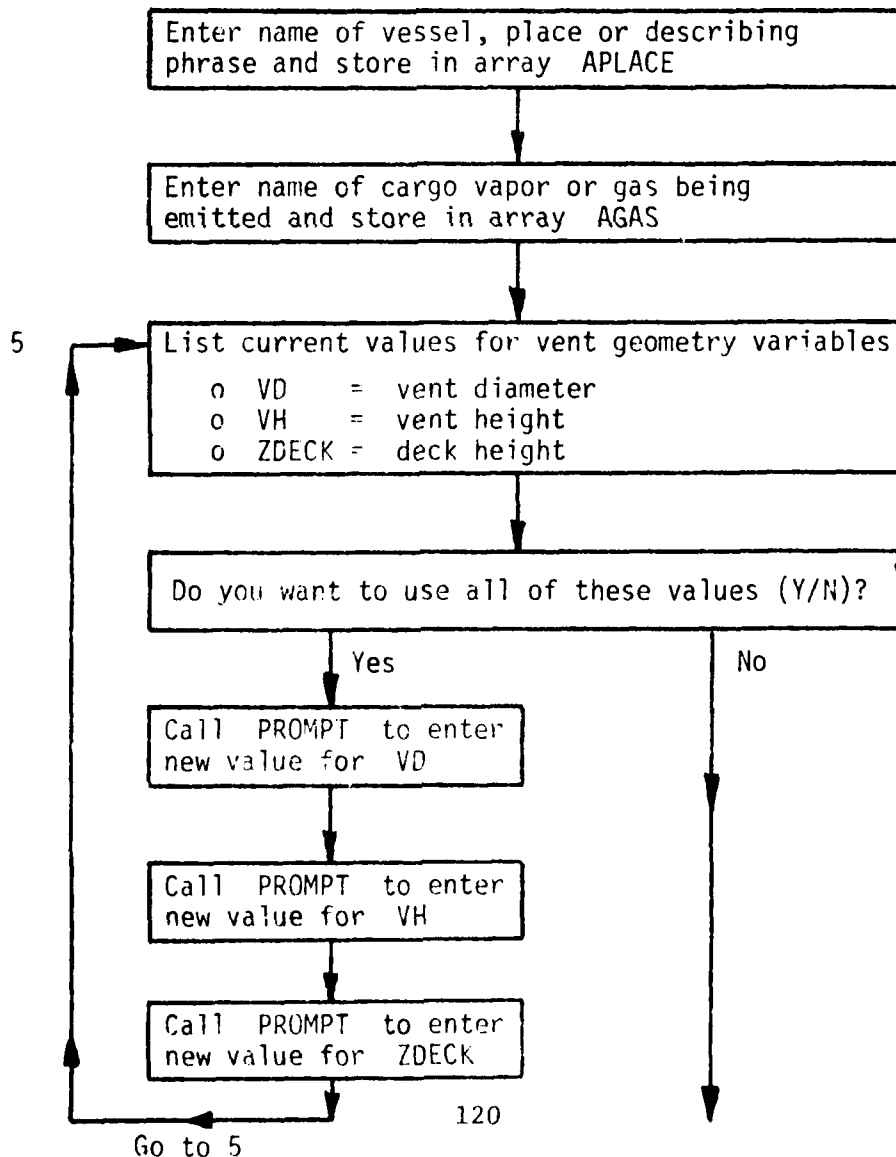

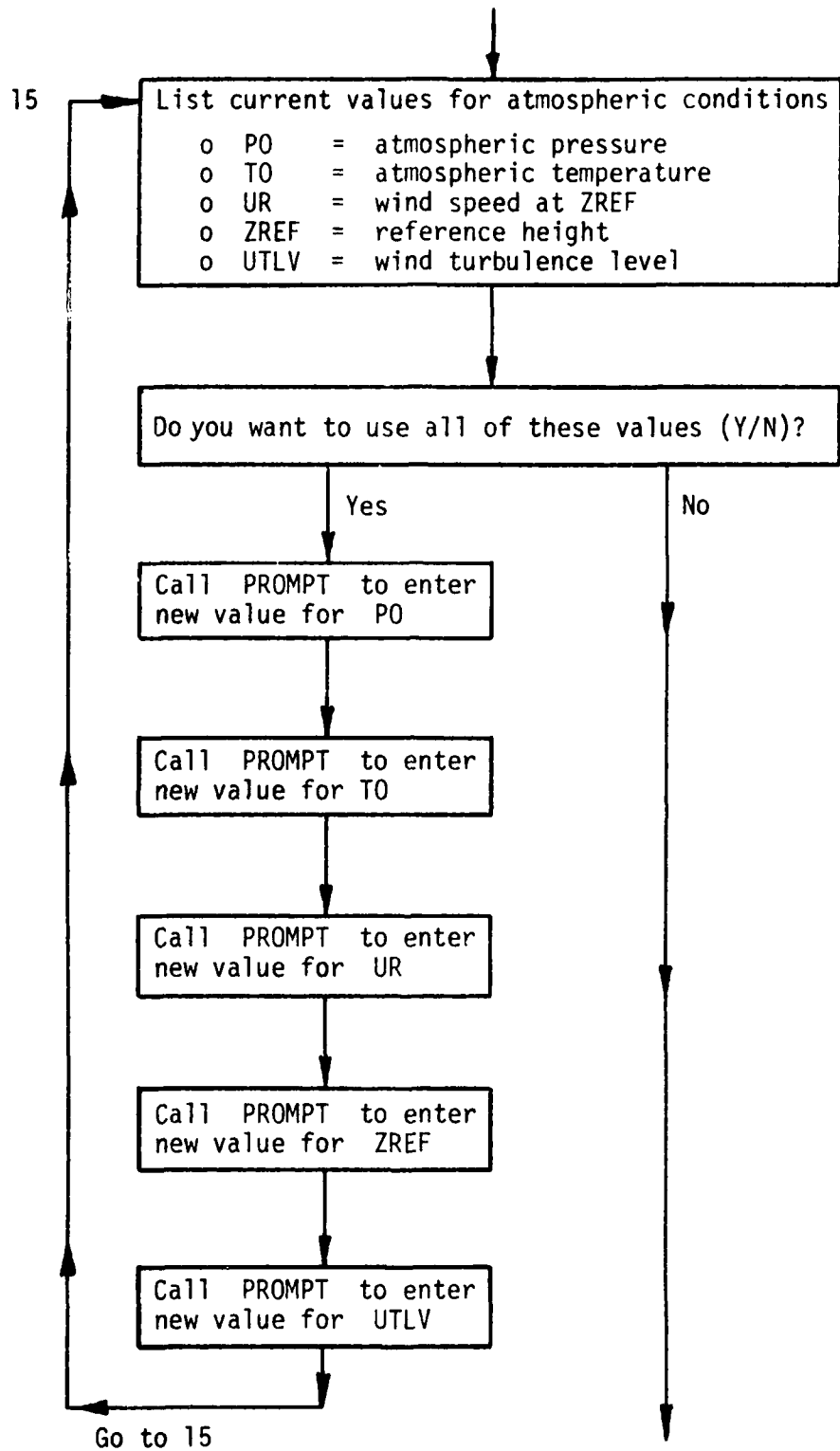

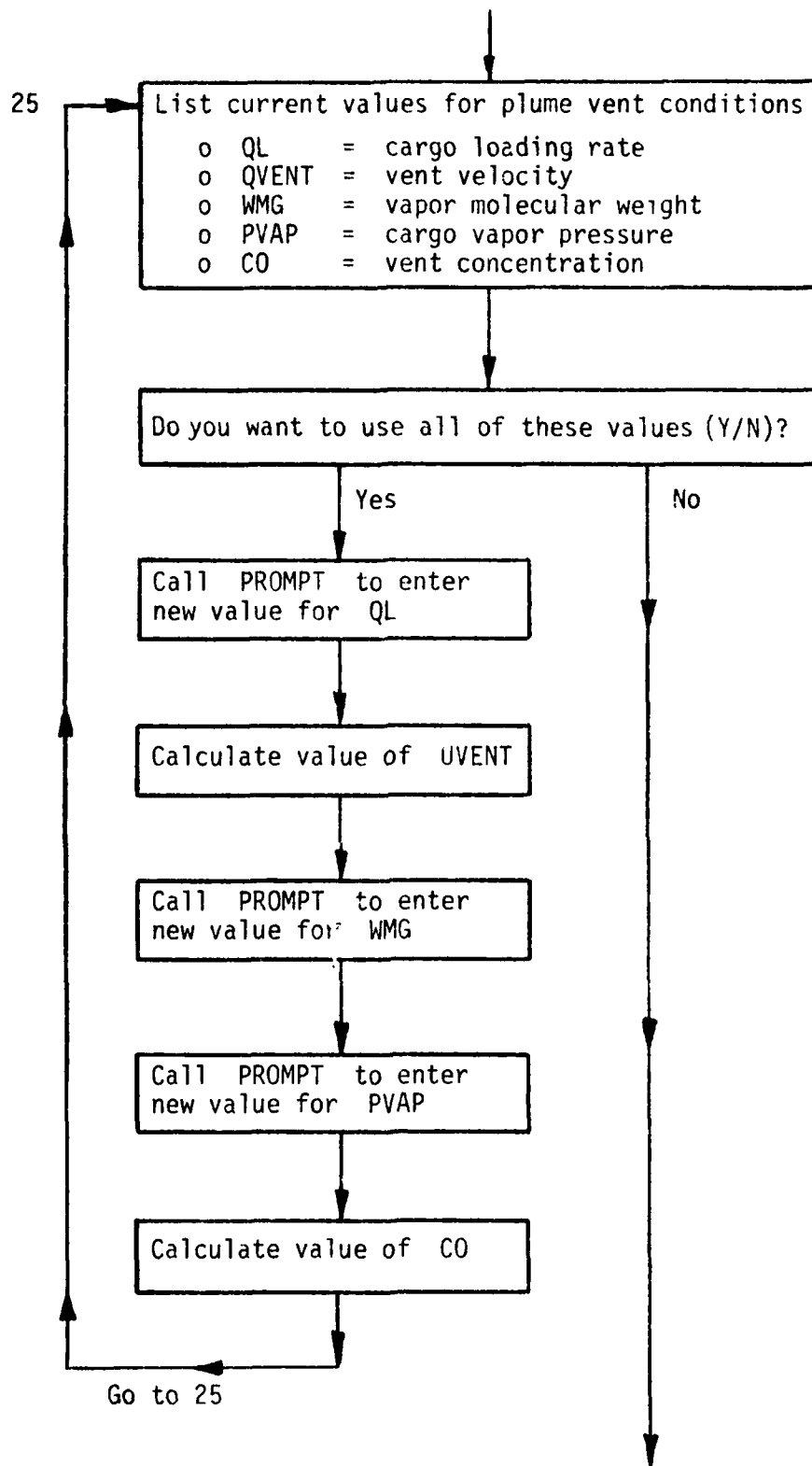

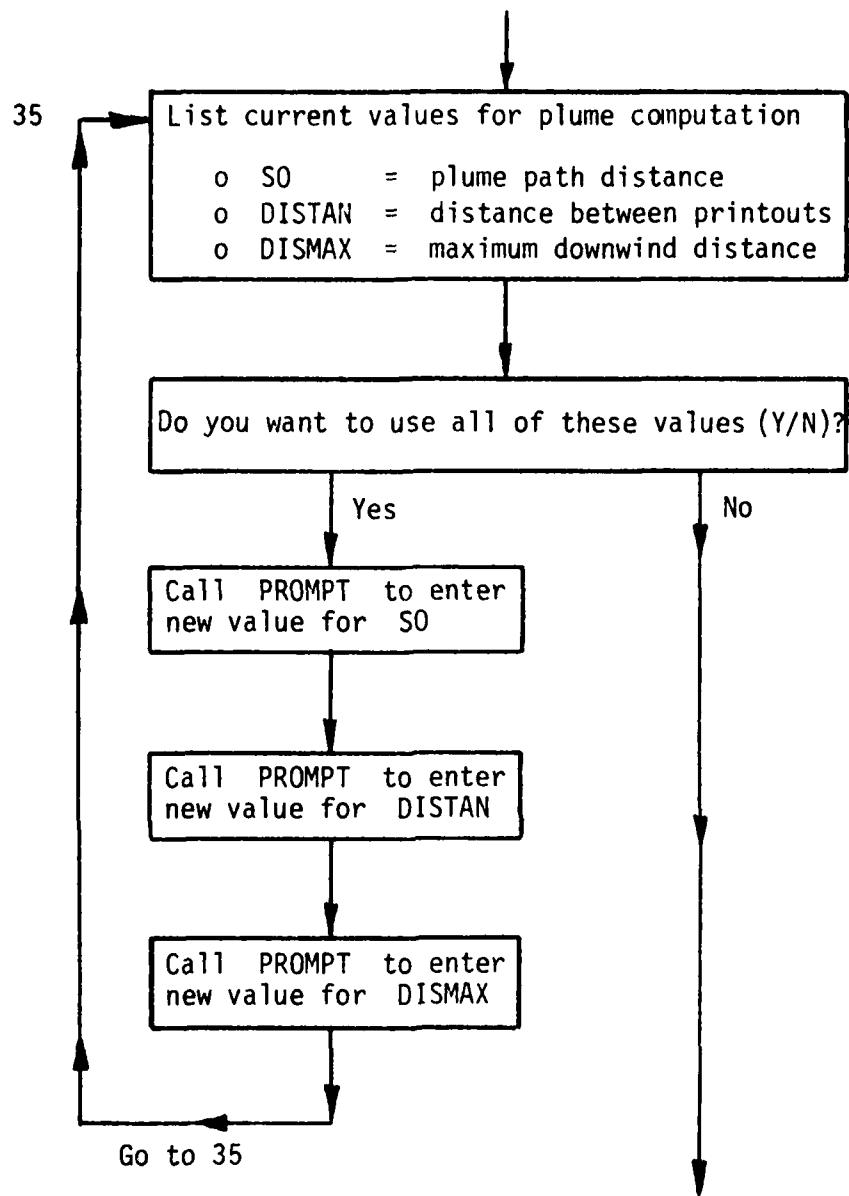

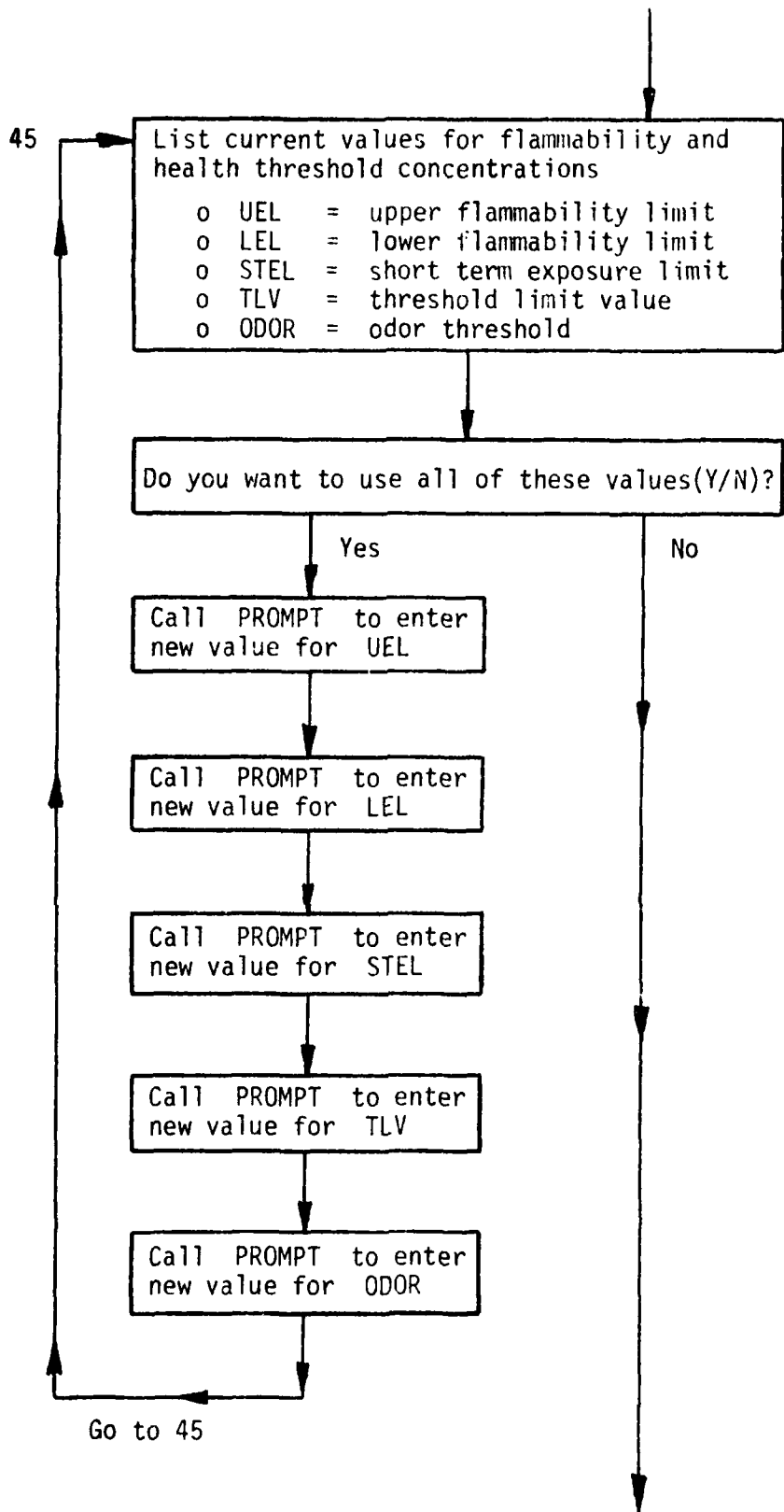

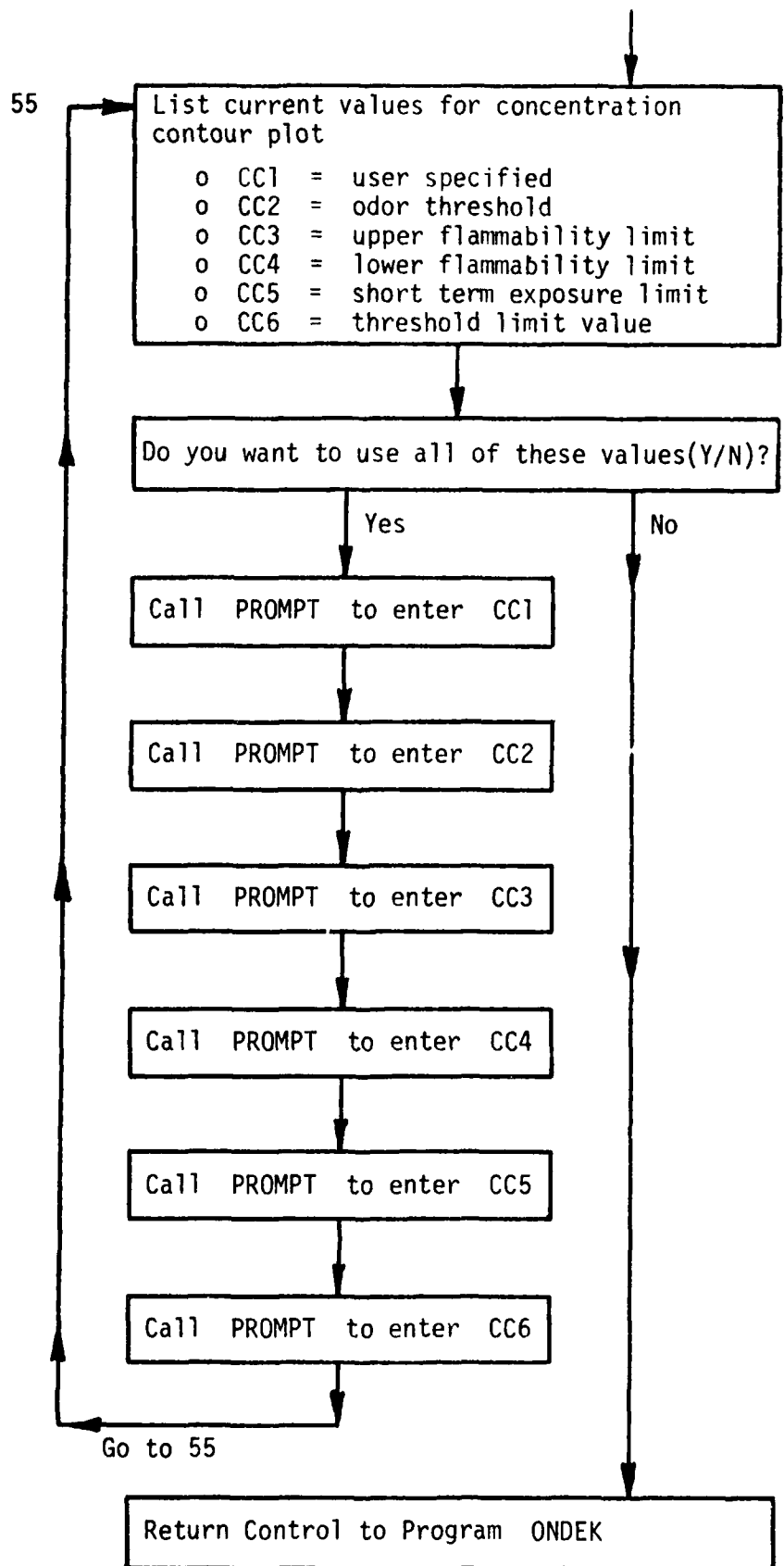

Subroutine PROMPT

This subroutine is used to simplify the control logic in subroutine INDAT. It is called by INDAT to prompt the user to either accept the current value of an input variable or to type in a new value to be stored in VALUE

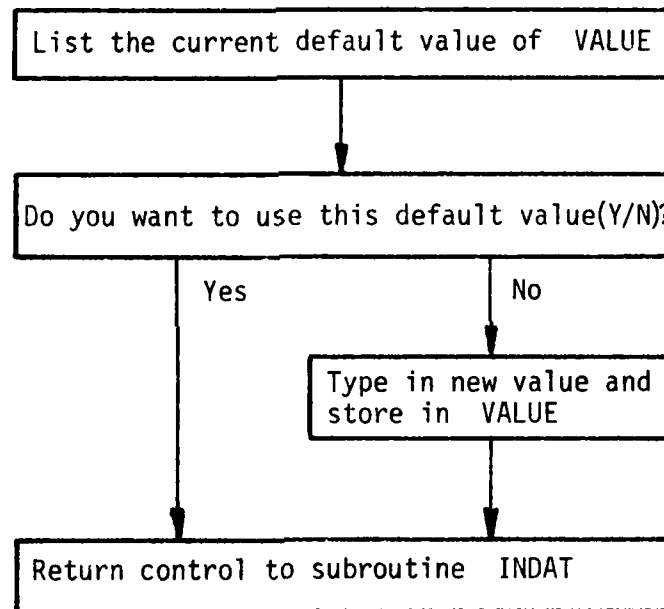

III.2.7 Example

This section gives an example that illustrates the use of program ONDEK to compute the dispersion of a plume of benzene vapor and air emitted from an open ullage hatch during cargo loading on a barge. The desired input data values are given below.

Date:	Mar. 16, 1983
Name:	Benzene Barge Loading
Vapor:	Benzene Vapor
Vent diameter:	0.203 m
Vent height:	1.0 m
Deck height:	1.0 m
Atmospheric pressure:	760 mm Hg
Atmospheric temperature:	520.0 °R
Wind speed:	2.24 m/s
Reference height:	10 m
Turbulence level:	20%
Cargo loading rate:	79 m ³ /hr
Vapor molecular weight:	78.11
Vapor pressure:	77.6 mm Hg (which is equivalent to 100% of the saturation vapor concentration in air)
Initial plume path distance:	0 m
Distance between printouts:	1 m
Maximum downwind distance:	10 m
Upper flammable limit:	7.9%
Lower flammable limit:	1.3%
Short term exposure limit:	75 ppm
Threshold limit value:	25 ppm
Odor threshold	4.68 ppm
CC1 (user specified value):	1000 ppm
CC2 (odor threshold):	4.68 ppm
CC3 (UEL):	79000 ppm
CC4 (LEL):	13000 ppm
CC5 (STEL):	75 ppm
CC6 (TLV):	25 ppm

The interactive input of data by the user from a terminal is shown below. Each line of input typed by the user is signified by the words *** USER INPUT *** typed in the righthand margin.

TRUN UNDER4

***** PROGRAM UNDER *****

THIS PROGRAM COMPUTES THE TRAJECTORY AND CONCENTRATION DISTRIBUTION OF BUOYANT PLUMES OF CHEMICAL VAPOR AND AIR THAT ARE EMITTED INTO THE AIR ABOVE A SHIP OR BARGE DECK

PREPARE TO ENTER INPUT DATA REQUIRED BY THE PROGRAM

ENTER TODAY'S DATE (UP TO 12 CHARACTERS)

MAR 13, 1983

USER INPUT

.....
ENTER NAME OF VESSEL, PLACE OR DESCRIBING PHRASE
(UP TO 40 CHARACTERS)

BENZENE BARGE LOADING

USER INPUT

.....
ENTER NAME OF CARGO VAPOR OR GAS BEING EMITTED
(UP TO 20 CHARACTERS)

BENZENE VAPOR

USER INPUT

.....
LIST THE DEFAULT VALUES FOR VENT GEOMETRY VARIABLES

VENT DIAMETER, VD,	0.2030000	METERS
VENT HEIGHT, VH,	1.000000	METERS
DECK HEIGHT, ZDECK,	1.000000	METERS

DO YOU WANT TO USE ALL OF THESE VALUES (Y/N)?

Y

USER INPUT

LIST THE DEFAULT VALUES FOR ATMOSPHERIC CONDITIONS

ATMOSPHERIC PRESSURE, P0,	760.0000	MM HG
ATMOSPHERIC TEMPERATURE, T0,	520.0000	DEG R
WIND SPEED, UR,	2.240000	M/S
REFERENCE HEIGHT, ZREF,	10.00000	M
WIND TURBULENCE LEVEL, UTLV,	20.00000	Z

DO YOU WANT TO USE ALL OF THESE VALUES (Y/N)?

Y

*USER INPUT***

LIST THE DEFAULT VALUES FOR PLUME VENT CONDITIONS

CARGO LOADING RATE, CL,	159.0000	M**3/HR
VENT VELOCITY, UVENT,	1.364623	M/S
VAPOR MOLECULAR WEIGHT, WMG,	86.10000	
CARGO VAPOR PRESSURE, PVAP,	90.00000	MM HG
VENT CONCENTRATION, CO,	0.4312356	KG/M**3

DO YOU WANT TO USE ALL OF THESE VALUES (Y/N)?

N

USER INPUT

ENTER LOADING RATE (OR GAS VOLUMETRIC FLOW RATE)
OF IN METERS**3/HR

TYPICAL VALUES ARE...

- 794 M**3/HR (5000 BBL/HR)
- 318 M**3/HR (2000 BBL/HR)
- 159 M**3/HR (1000 BBL/HR)
- 79 M**3/HR (500 BBL/HR)

THE CURRENT DEFAULT VALUE IS 159.0000

DO YOU WANT TO USE THIS DEFAULT VALUE (Y/N)?

N

USER INPUT

TYPE IN NEW VALUE

79

USER INPUT

CALCULATED VALUE OF VENT VELOCITY IS 0.6780203 M/S

ENTER VAPOR MOLECULAR WEIGHT, WMG

TYPICAL VALUES ARE...

- 86.10 (VINYL ACETATE)

THE CURRENT DEFAULT VALUE IS = 86.10000

DO YOU WANT TO USE THIS DEFAULT VALUE (Y/N)?

N

USER INPUT

TYPE IN NEW VALUE

78.11

USER INPUT

THE VAPOR CONCENTRATION NEAR THE END OF CARGO LOADING MAY APPROACH THE SATURATED VAPOR CONCENTRATION. ENTER THE VALUE OF SATURATED VAPOR PRESSURE, OR SOME FRACTION THEREOF.....
ENTER VAPOR PRESSURE, PVAP, IN MM HG

TYPICAL VALUES ARE...
90. MM HG (VAPOR AFFINITY)

THE CURRENT DEFAULT VALUE IS = 90.00000
DO YOU WANT TO USE THIS DEFAULT VALUE (Y/N)?

N

USER INPUT

TYPE IN NEW VALUE

99.9

USER INPUT

.....
CALCULATED VALUE OF VENT CONCENTRATION, CO= 0.3373163 KG/M**3

LIST THE DEFAULT VALUES FOR PLUME VENT CONDITIONS

CARGO LOADING RATE, QL,	79.00000	M**3/HR
VENT VELOCITY, UVENT,	0.5786203	M/S
VAPOR MOLECULAR WEIGHT, WMG,	78.11000	
CARGO VAPOR PRESSURE, PVAP,	77.60000	MM HG
VENT CONCENTRATION, CO,	0.3373163	KG/M**3

DO YOU WANT TO USE ALL OF THESE VALUES (Y/N)?

Y

USER INPUT

LIST THE DEFAULT VALUES FOR PLUME COMPUTATION

PLUME PATH DISTANCE, DO,	0.0000000	M
DISTANCE BETWEEN PRELUMBS, DISTAN,	1.000000	M
MAX DOWNWIND DISTANCE, DISMAX,	10.00000	M

DO YOU WANT TO USE ALL OF THESE VALUES (Y/N)?

Y

USER INPUT

LIST THE DEFAULT VALUES FOR UEL,LEL,STIL,TLV AND OADR

UPPER FLAMMABLE LIMIT, UEL,	13.40000	%
LOWER FLAMMABLE LIMIT, LEL,	1.600000	%
SHORT TERM INHALATION LIMIT, STIL,	20.00000	PPM
THRESHOLD EFFECT VALUE, TLV,	10.00000	PPM
OADR THRESHOLD, OADR,	0.100000	PPM

DO YOU WANT TO USE ALL OF THESE VALUES (Y/N)?

N

USER INPUT

.....
ENTER VALUE FOR UEL IN PERCENT BY VOLUME

TYPICAL VALUES ARE...
13.4 % (VINYL ACETATE)
(IF THE UEL VALUE IS NOT KNOWN, ENTER 100.0)

THE CURRENT DEFAULT VALUE IS = 13.40000
DO YOU WANT TO USE THIS DEFAULT VALUE (Y/N)?

N
TYPE IN NEW VALUE
7.9

USER INPUT
USER INPUT

.....
ENTER VALUE FOR LEL IN PERCENT BY VOLUME

TYPICAL VALUES ARE...
2.6 % (VINYL ACETATE)
(IF THE LEL VALUE IS NOT KNOWN, ENTER 100.0)

THE CURRENT DEFAULT VALUE IS = 2.600000
DO YOU WANT TO USE THIS DEFAULT VALUE (Y/N)?

N
TYPE IN NEW VALUE
1.3

USER INPUT
USER INPUT

.....
ENTER VALUE FOR STIL IN PPM

TYPICAL VALUES ARE...
20 PPM (VINYL ACETATE)
(IF A VALUE FOR STIL IS NOT KNOWN, ENTER 1000000.)

THE CURRENT DEFAULT VALUE IS = 20.00000
DO YOU WANT TO USE THIS DEFAULT VALUE (Y/N)?

N
TYPE IN NEW VALUE
75

USER INPUT
USER INPUT

.....
ENTER VALUE FOR TLV IN PPM

TYPICAL VALUES ARE...
10 PPM (VINYL ACETATE)
(IF A VALUE FOR TLV IS NOT KNOWN, ENTER 1000000.)

THE CURRENT DEFAULT VALUE IS = 10.00000
DO YOU WANT TO USE THIS DEFAULT VALUE (Y/N)?

N
TYPE IN NEW VALUE
25

USER INPUT
USER INPUT

.....
ENTER VALUE FOR ODOR IN PPM

TYPICAL VALUES ARE...

0.12 PPM (MINUTE AVERAGE)

(IF A VALUE FOR ODOR IS NOT KNOWN, ENTER 1000000.)

THE CURRENT DEFAULT VALUE IS = 0.1200000

DO YOU WANT TO USE THIS DEFAULT VALUE (Y/N)?

N

TYPE IN NEW VALUE

4.68

USER INPUT

USER INPUT

.....
LIST THE DEFAULT VALUES FOR UEL,LEL,STIL,TLV AND ODOR

UPPER FLAMMABLE LIMIT, UEL, = 7.900000 %

LOWER FLAMMABLE LIMIT, LEL, = 1.300000 %

SHORT TERM INHALATION LIMIT, STIL, = 75.00000 PPM

THRESHOLD LIMIT VALUE, TLV, = 25.00000 PPM

ODOR THRESHOLD, ODOR, = 4.680000 PPM

DO YOU WANT TO USE ALL OF THESE VALUES (Y/N)?

Y

LIST THE DEFAULT VALUES FOR CONCENTRATION CONTOURS

CC1 = 1000.000 PPM (USER ASSIGNED VALUE)

CC2 = 4.680000 PPM (USUALLY THE ODOR THRESHOLD)

CC3 = 79000.00 PPM (USUALLY THE UEL)

CC4 = 13000.00 PPM (USUALLY THE LEL)

CC5 = 75.00000 PPM (USUALLY THE STIL)

CC6 = 25.00000 PPM (USUALLY THE TLV)

DO YOU WANT TO USE ALL OF THESE VALUES (Y/N)?

Y

USER INPUT

USER INPUT

Tabular and graphical outputs were obtained from both the ONDEK3 and ONDEK4 computer programs for this example. Figures 9 through 13 show the output from the ONDEK4 program. The analogous set of tables and graphs obtained from the ONDEK3 program is shown in Appendix E.

Figure 9 shows the input data summary page for this example. Figure 10 shows the computed output for values of the plume variables and concentration contours in table form. Note that concentration contours were found only for CC2, the odor threshold concentration, CC5, the short term exposure limit, and CC6, the threshold limit value.

Figure 11 shows a graph of plume centerline concentration versus downwind distance. Note that the plume centerline concentration exceeds the LEL, STEL, and TLV at different distances downwind of the vent.

Figure 12 shows a graph of vapor concentration at man breathing height versus downwind distance. Note that very close to the vent, the concentration at breathing height is below the TLV. However, further away from the vent the breathing height concentration exceeds both the TLV and STEL levels.

Figure 13 shows a plot of the concentration contours at man breathing height above the deck. Note that the vapor concentration exceeds the STEL for up to 8 meters downwind of the vent, and the TLV for more than 10 meters.

For the specified conditions of cargo loading rate, vent concentration, vent height, and atmospheric conditions, the following conclusions can be drawn:

- o A low tank vent (~ 1m above the deck), as is often used to vent the tank atmosphere during cargo loading on a barge, is not tall enough to prevent the benzene vapor concentration from exceeding both the short term exposure limit, and the threshold limit value over a substantial area downwind of the vent.
- o A tankerman, whose work requires him to be present on the deck of the barge, may receive an exposure to benzene vapor that exceeds either or both the STEL and the TLV depending upon (1) the amount of time he spends on deck, (2) his proximity to the tank vent, (3) his ability to stand upwind, or at right angles to the direction of plume travel.
- o Given the potential for exposure to potentially hazardous levels of benzene vapor during his work activities, a tankerman would be well advised to wear an approved cartridge respirator mask to remove benzene vapor from the air he breaths during cargo loading activities.

TITLE= BENZENE BARGE LOADING
METEOROLOGICAL CONDITIONS

DATE= MAR 16, 1983

0 BAROMETRIC PRESSURE=760.000 MM HG AIR TEMPERATURE=520 0 DEG R
0 AVERAGE WIND SPEED= 2.24 M/S AT REFERENCE HEIGHT= 10.00 M
0 WIND EXPONENT= 0.14
0 TURBULENCE LEVEL= 20.00

VAPOR VENTING CONDITIONS

0 VENT DIAMETER= 0.20 METERS
0 VENT HEIGHT= 1.00 METERS ABOVE THE DECK
0 DECK HEIGHT= 1.00 METERS ABOVE THE WATER

0 EMITTED VAPOR= BENZENE VAPOR
0 MOLECULAR WEIGHT= 33.99 OF GAS AND AIR MIXTURE
0 VENT CONCENTRATION= 0.337E+00 KG/(M**3)

0 VENTING FLOWRATE= 79. (M**3)/HR
0 VENTING VELOCITY= 0.68 M/SEC

VALUES OF CONCENTRATION FOR FLAMMABILITY AND HEALTH HAZARDS

0 UPPER FLAMMABLE LIMIT (UEL) = 0.261E+00 KG/(M**3)
0 LOWER FLAMMABLE LIMIT (LEL) = 0.429E-01 KG/(M**3)
0 SHORT TERM INHALATION LIMIT (STIL) = 0.248E-03 KG/(M**3)
0 THRESHOLD LIMIT VALUE (TLV) = 0.826E-04 KG/(M**3)
0 ODOR THRESHOLD (ODOR) = 0.155E-04 KG/(M**3)

VALUES OF CONCENTRATION CHOSEN FOR CONCENTRATION CONTOURS

0 C1 = 0.330E-02 (KG/M**3)
0 C2 = 0.155E-04 (KG/M**3)
0 C3 = 0.261E+00 (KG/M**3)
0 C4 = 0.429E-01 (KG/M**3)
0 C5 = 0.248E-03 (KG/M**3)
0 C6 = 0.826E-04 (KG/M**3)
0 PREDICTED FOR A HEIGHT OF 1.680 METERS ABOVE DECK LEVEL

NUMERICAL INTEGRATION DATA

0 STEP SIZE= 0.0406 METERS, MAXIMUM DOWNWIND DISTANCE= 10.00 METERS

FIGURE 9. SUMMARY OF INPUT DATA FOR BENZENE LOADING EXAMPLE

BEGIN PLUME COMPUTATION THROUGH THE AIR ABOVE THE DECK

S METERS	XCL METERS	ZCL METERS	CCL KG/M**3	CZCON KG/M**3	XCON METERS	YC1 METERS	YC2 METERS	YC3 METERS	YC4 METERS	YC5 METERS	YC6 METERS	B METERS	U# M/S	THETA RADIAN
0.16	0.219	1.205	0.5799E-01	0.1701E-01	0.219	0.549	1.134	0.000	0.000	0.882	0.990	0.369	-3.140	0.019
0.97	1.031	1.208	0.3089E-02	0.3404E-02	1.031	0.364	4.881	0.000	0.000	3.402	4.053	1.809	-3.189	0.000
1.95	2.005	1.208	0.8214E-03	0.1311E-02	2.005	0.000	8.642	0.000	0.000	5.293	6.819	3.530	-3.192	-0.001
2.96	3.020	1.207	0.3621E-03	0.6513E-03	3.020	0.000	11.961	0.000	0.000	6.080	8.887	5.323	-3.192	-0.001
3.98	4.035	1.207	0.2028E-03	0.3817E-03	4.035	0.000	14.804	0.000	0.000	5.435	10.229	7.116	-3.192	0.000
4.95	5.009	1.206	0.1316E-03	0.2528E-03	5.009	0.000	17.163	0.000	0.000	1.461	10.860	8.837	-3.192	0.000
5.97	6.024	1.206	0.9094E-04	0.1769E-03	6.024	0.000	19.282	0.000	0.000	0.000	10.780	10.629	-3.193	0.000
6.98	7.039	1.205	0.6660E-04	0.1305E-03	7.039	0.000	21.080	0.000	0.000	0.000	9.763	12.422	-3.193	0.000
7.96	8.014	1.205	0.5138E-04	0.1012E-03	8.014	0.000	22.522	0.000	0.000	0.000	7.400	14.143	-3.193	0.000
8.97	9.029	1.205	0.4047E-04	0.7995E-04	9.029	0.000	23.734	0.000	0.000	0.000	0.000	15.936	-3.193	0.000
9.95	10.003	1.205	0.3297E-04	0.6528E-04	10.003	0.000	24.621	0.000	0.000	0.000	0.000	17.657	-3.193	0.000

FIGURE 10. COMPUTED VALUES OF PLUME VARIABLES FOR BENZENE BARGE
LOADING EXAMPLE

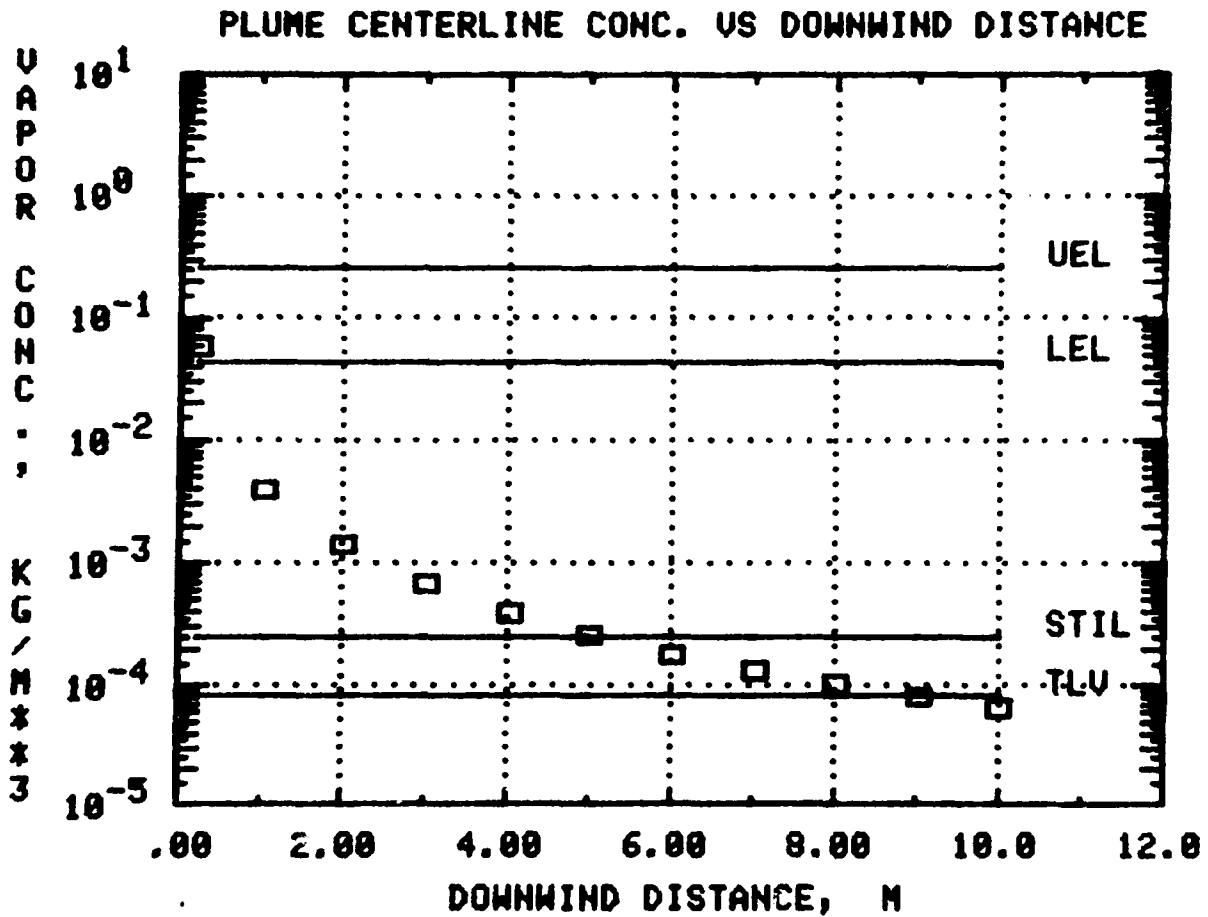

FIGURE 11. GRAPH OF PLUME CENTERLINE CONCENTRATION VERSUS DOWNWIND DISTANCE FOR BENZENE BARGE LOADING EXAMPLE

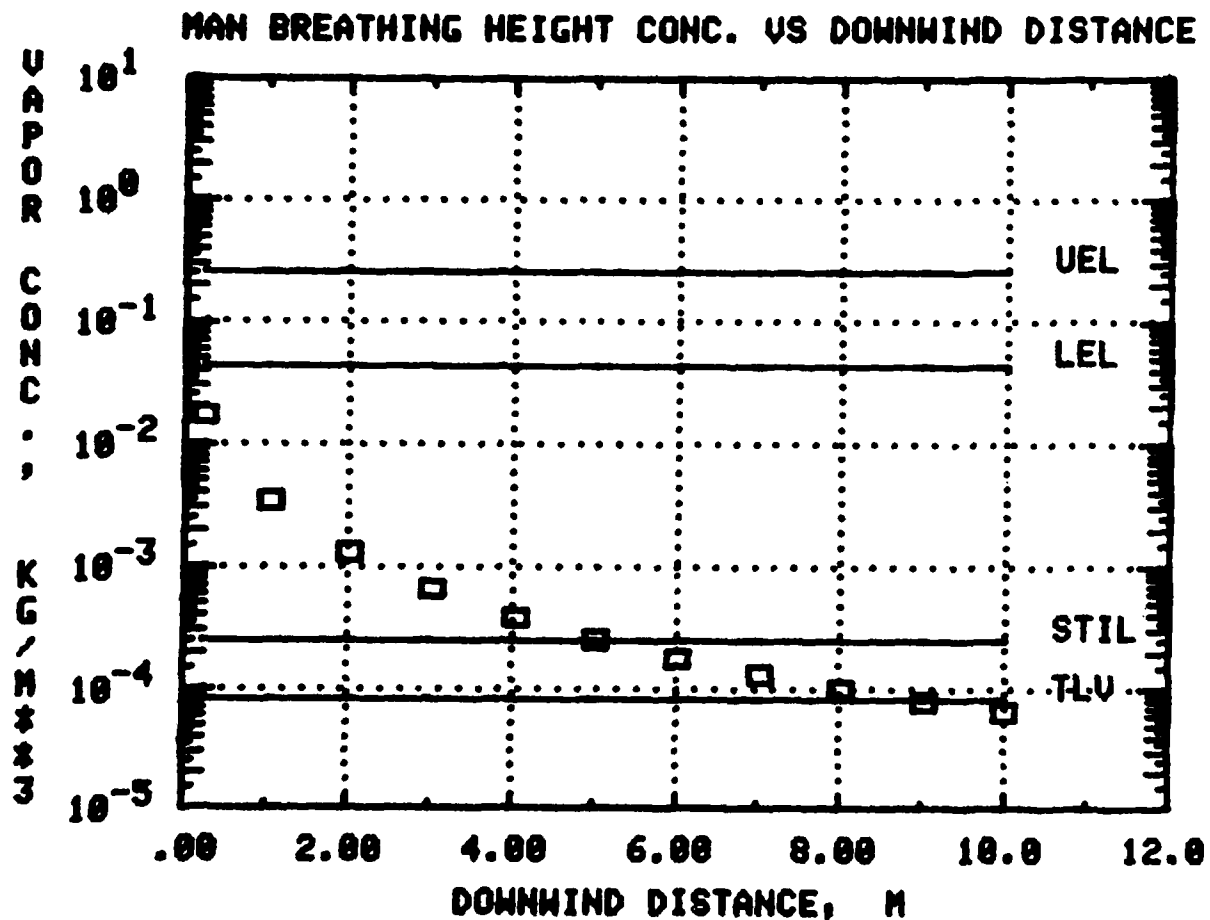

FIGURE 12. GRAPH OF VAPOR CONCENTRATION AT MAN BREATHING HEIGHT VERSUS DOWNWIND DISTANCE FOR BENZENE BARGE LOADING EXAMPLE

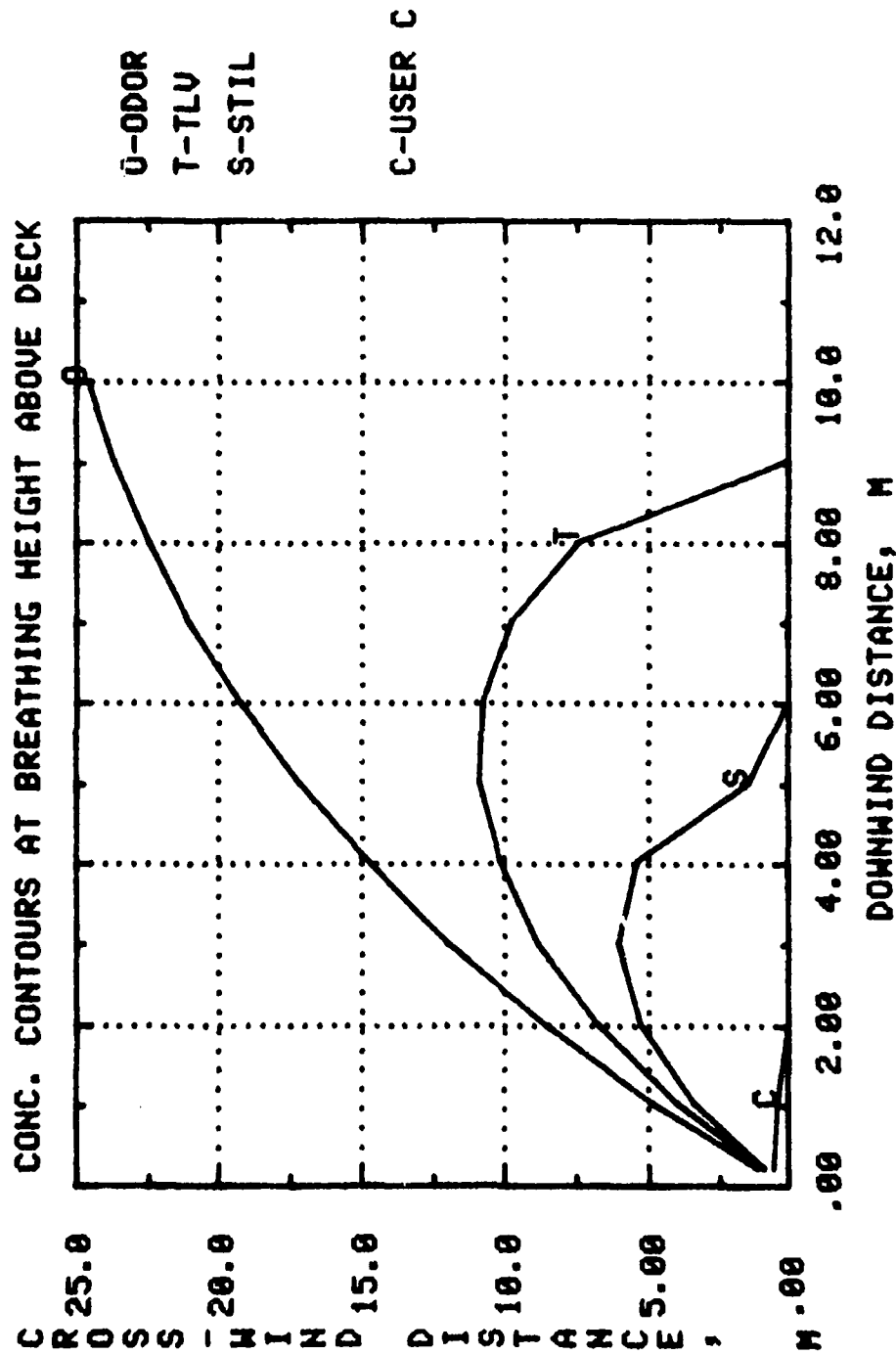

FIGURE 13. CONTOUR PLOT OF CONCENTRATION AT MAN BREATHING HEIGHT FOR BENZENE BARGE LOADING EXAMPLE

III.3 Limitations of the ONDEK Model

The ONDEK chemical plume dispersion model does have some limitations due to assumptions invoked when the model was derived. These key assumptions are the following:

- o the chemical vapor concentration distribution is assumed to be symmetrical about the plume axis;
- o the temperature difference between the plume and the surrounding air stream is assumed to be small;
- o it is assumed that on-deck structure does not shield the tank vent from the wind;
- o the ambient windspeed near the tank vent is assumed to be equal to or greater than 0.5 m/s.

The model limitations resulting from these assumptions are discussed in more depth in Section IV.3.5 of Reference 13.

III.3 Limitations of the ONDEK Model

The ONDEK chemical plume dispersion model does have some limitations due to assumptions invoked when the model was derived. These key assumptions are the following:

- o the chemical vapor concentration distribution is assumed to be symmetrical about the plume axis;
- o the temperature difference between the plume and the surrounding air stream is assumed to be small;
- o it is assumed that on-deck structure does not shield the tank vent from the wind;
- o the ambient windspeed near the tank vent is assumed to be equal to or greater than 0.5 m/s.

The model limitations resulting from these assumptions are discussed in more depth in Section IV.3.5 of Reference 13.

REFERENCES

1. Liss, P. S. and Slater, "Flux of Gases Across the Air-Sea Interface," Nature, Vol. 247, January 25, 1974.
2. Dilling, W. L., "Interphase Transfer Processes II. Evaporation Rates of Chloro Methanes, Ethanes, Ethylenes, Propanes, and Propylenes from Dilute Aqueous Solutions. Comparisons with Theoretical Predictions," Environmental Science and Technology, Vol. 11, No. 4, April 1977.
3. Southworth, G. R., "The Role of Volatilization in Removing Polycyclic Aromatic Hydrocarbons from Aquatic Environments," Bulletin of Environmental Contamination and Toxicology, Vol. 21, 1979.
4. Hyrcak, P., Lee, D. T., and Livingood, J. N. B., "Experimental Flow Characteristics of a Single Jet Impinging on a Flat Plate," NASA TN-D-5690, March 1970.
5. Mackay, D. and Shiu, W. Y., "The Aqueous Solubility and Air-Water Exchange Characteristics of Hydrocarbons Under Environmental Conditions," Symposium on the Chemistry and Physics of Aqueous Solutions, May 1975.
6. Chemical Engineers' Handbook, J. H. Perry, Editor, McGraw-Hill Book Company, Inc. 1963.
7. A Critical Technical Review of Six Hazard Assessment Models, U. S. Coast Guard Report No. CG-D-122-76, NTIS No. ADA03599, December, 1975.
8. Reid, R. C., Prausnitz, J. M. and Sherwood, T. K., The Properties of Gases and Liquids, Third Edition, McGraw-Hill Book Company, 1977.
9. Schuurmans, H. and Schilder, J., "Residue Calculation Method for Chemical Tankers," Internation Shipbuilding Progress, Vol. 26, No. 296, April 1979.
10. Bass, R. L., et al., "Bulk Carrier Operations Safety Enhancement Project," Phase I Final Report, U. S. Maritime Administration Contract No. 5-38044, Southwest Research Institute Project No. 02-4317, June 1976.
11. Threshold Limit Values for Chemical Substances and Physical Agents in the Work Environment with Intended Changes, American Conference of Governmental Industrial Hygienists, Cincinnati, Ohio, 1982.
12. Gray, D. C., "Solvent Evaporation Rates," American Industrial Hygiene Association Journal, November 1974.

13. Astleford, W. J., Morrow, T. B., Magott, R. J., Prevost, R. J., Kaplan, H. L., Bass, R. L., and Buckingham, J. C., "Investigation of the Hazards Posed by Chemical Vapors Released in Marine Operations-Phase II," U. S. Coast Guard Contract DOT-CG-904571-A, Final Report, Southwest Research Institute Project 06-5686, April 1983.
14. Ooms, G., Mathieu, A. P., Zeles, F., "The Plume Path of Vent Gases Heavier Than Air," First International Symposium on Loss Prevention and Safety Promotion in the Process Industries, Delft, 1974.
15. TeRiele, P. H. M., "Atmospheric Dispersion of Heavy Gases Emitted at or Near Ground Level," Second International Symposium on Loss Prevention and Safety Promotion in the Process Industries, Heidelberg, 1977.
16. Morrow, T. B., Astleford, W. J., Magott, R. J., Bass, R. L., "The Dispersion of Chemical Vapors Emitted From Marine Chemical Carriers," Third International Symposium on Loss Prevention and Safety Promotion in the Process Industries, Basle, 1980.
17. Kamotani, Y., Greber, I., "Experiments on a Turbulent Jet in a Cross Flow," AIAA Journal, Vol. 10, No. 11, November 1972.
18. Keffer, J. F., and Baines, W. D., "The Round Turbulent Jet in a Cross Wind," Journal of Fluid Mechanics, Vol. 15, No. 4, 1963.
19. Carnahan, B., Luther, H. A., and Wilkes, J. O., Applied Numerical Methods, J. Wiley and Sons, Inc., New York, 1969.
20. Spalding, D. B., GENMIX: A General Computer Program for Two-Dimensional Parabolic Phenomena, Pergamon Press, New York, 1977.
21. Astleford, W. J., Morrow, T. B., Magott, R. J., and Bass, R. L., "Investigation of Hazards Posed by Chemical Vapors Released in Marine Operations-Phase I," Final Report, Contract DOT-CG-70363-A, DOT Report No. CG-D-41-79, Southwest Research Institute Project 02-4986, May 15, 1979.

APPENDIX A

PROGRAM LISTINGS FOR
PRETNK (Interactive Driver),
TANKM,
and
TANKP

INTERACTIVE DRIVER,

PRETNK

```

0001      PROGRAM PRETNK
           C
           C      THIS PROGRAM IS AN INTERACTIVE DATA INPUT FORMULATION
           C      PROGRAM FOR PROGRAMS TANKM AND TANKP.
           C
0002      DIMENSION MDOT(200), TABTEM(14), TABTIM(14), ETIME(200),
           1      ECVPPM(200)
0003      REAL L, M
0004      INTEGER TESTNO, HEVAL
           C
0005      25  CONTINUE
0006      TYPE*, ' '
0007      TYPE*, 'PROGRAM PRETNK IS AN INTERACTIVE PROGRAM DESIGNED FOR '
0008      TYPE*, 'THE USER TO EASILY INPUT DATA COMPATIBLE FOR PROGRAM '
0009      TYPE*, 'TANKM OR TANKP '
0010      TYPE*, ' '
0011      TYPE*, ' 1. TANKM - PROGRAM THAT CALCULATES THE CONCENTRATION-'
0012      TYPE*, ' TIME HISTORY OF CHEMICAL VAPORS DISCHARGED '
0013      TYPE*, ' FROM A TANK DURING DILUTION VENTILATION IN '
0014      TYPE*, ' THE PRESENCE OF CHEMICAL SOLUTE EVAPORATION '
0015      TYPE*, ' FROM AN AQUEOUS SOLUTION OF RESIDUAL CARGO '
0016      TYPE*, ' ON THE TANK FLOOR '
0017      TYPE*, ' 2. TANKP - PROGRAM THAT CALCULATES THE CONCENTRATION-'
0018      TYPE*, ' TIME HISTORY OF CHEMICAL VAPOR DISCHARGED '
0019      TYPE*, ' FROM A TANK DURING DILUTION VENTILATION IN '
0020      TYPE*, ' THE PRESENCE OF EVAPORATION OF PURE '
0021      TYPE*, ' CHEMICAL RESIDUES FROM THE TANK WALLS AND '
0022      TYPE*, ' FLOOR. '
0023      TYPE*, ' '
0024      TYPE*, 'SELECT A 1 OR 2 TO INDICATE FOR WHICH PROGRAM YOU '
0025      TYPE*, 'WISH TO INPUT DATA '
0026      ACCERT*, ITNK
0027      IF (ITNK .NE. 1 .AND. ITNK .NE. 2) GO TO 25
0028      IF (ITNK .EQ. 1) OPEN(UNIT=1, NAME='TANKMI.DAT', TYPE='NEW')
0029      IF (ITNK .EQ. 2) OPEN(UNIT=2, NAME='TANKPI.DAT', TYPE='NEW')
0030      TYPE*, ' '
0031      TYPE*, 'INPUT TEST NUMBER '
0032      ACCEPT*, TESTNO
           C
           C      CCCCCCCCCCCCCCCCCCCCCCCCCCCCCCCCCCCCCCCCCCCCCCCCCCCCCCCCCCCCC
           C
           C      INPUT TANK DIMENSIONS
           C
           C      CCCCCCCCCCCCCCCCCCCCCCCCCCCCCCCCCCCCCCCCCCCCCCCCCCCCCCCCCCCCC
           C
0033      CALL TKDIM(L, W, D)
           C
           C      CCCCCCCCCCCCCCCCCCCCCCCCCCCCCCCCCCCCCCCCCCCCCCCCCCCCCCCCCCCCC
           C
           C      INPUT BLOWER FLOW RATE
           C
           C      CCCCCCCCCCCCCCCCCCCCCCCCCCCCCCCCCCCCCCCCCCCCCCCCCCCCCCCCCCCCC
           C
0034      50  CONTINUE
0035      TYPE*, ' '
    
```

```
0036      TYPE*, 'DO YOU KNOW THE BLOWER FLOW RATE (Y/N)?'
0037      READ(5,1) IDO
0038      1      FORMAT(A2)
0039      IF (IDO .NE. 1HY AND IDO .NE. 1HN) GO TO 50
0040      IF (IDO .EQ. 1HN) GO TO 100
      C
      C      INPUT MEASURED FLOW RATE
      C
0041      TYPE*, ' '
0042      TYPE*, 'INPUT MEASURED FLOW RATE (M3/MIN)'
0043      ACCEPT*, G
0044      GO TO 200
      C
      C      DEFAULT VALUES USED AND INPUT
      C
0045      100     CONTINUE
0046      CALL BLOWER(Q)
      C
      CCCCCCCCCCCCCCCCCCCCCCCCCCCCCCCCCCCCCCCCCCCCCCCCCCCCCCCCCCCCC
      C
      C      INPUT DIAMETER OF BUTTERWORTH OPENING
      C
      CCCCCCCCCCCCCCCCCCCCCCCCCCCCCCCCCCCCCCCCCCCCCCCCCCCCCCCCCCCCC
      C
0047      200     CONTINUE
0048      TYPE*, ' '
0049      TYPE*, 'ENTER DIAMETER OF BUTTERWORTH OPENING IN METERS'
0050      ACCEPT*, DIA
0051      IF (ITNK .EQ. 2) GO TO 350
      C
      CCCCCCCCCCCCCCCCCCCCCCCCCCCCCCCCCCCCCCCCCCCCCCCCCCCCCCCCCCCCC
      C
      C      INPUT SOLUTE VAPOR SOLUBILITY
      C      (FOR TANKM ONLY)
      C
      CCCCCCCCCCCCCCCCCCCCCCCCCCCCCCCCCCCCCCCCCCCCCCCCCCCCCCCCCCCCC
      C
0052      GAMINF = 0.
0053      C1 = 0.
0054      C2 = 0.
0055      225     CONTINUE
0056      TYPE*, ' '
0057      TYPE*, 'HOW DO YOU WANT TO CALCULATE HENRY S CONSTANT?'
0058      TYPE*, ' 1. HENRY S CONSTANT BY MACKAY S METHOD'
0059      TYPE*, ' 2. HENRY S CONSTANT BY DILLING S METHOD'
0060      TYPE*, 'SELECT A 1 OR 2'
0061      ACCEPT*, HEVAL
0062      IF (HEVAL .NE. 1 AND HEVAL .NE. 2) GO TO 225
0063      IF (HEVAL .EQ. 2) GO TO 250
0064      TYPE*, ' '
0065      TYPE*, 'INPUT GAMINF, ACTIVITY COEFFICIENT AT INFINITE'
0066      TYPE*, 'DILUTION (CHEMICAL IN WATER)'
0067      ACCEPT*, GAMINF
0068      TYPE*, ' '
0069      TYPE*, 'INPUT C1, C2, CURVE FIT COEFFICIENTS OF LIQ. DENSITY'
```

```
0070          TYPE*, 'AS FUNCTION OF TEMP. *ROCHEM(MG/M3) = C1+C2*T, T(C)'  
0071          ACCEPT*, C1, C2  
0072    250    TYPE*, ' '  
0073          TYPE*, 'ENTER S, SOLUTE VAPOR SOLUBILITY IN MG/LITER '  
0074          ACCEPT*, S  
C  
CCCCCCCCCCCCCCCCCCCCCCCCCCCCCCCCCCCCCCCCCCCCCCCCCCCCCCCCCCCC  
C  
C          INPUT POSTWASH RESIDUE THICKNESS AND SOLUTE CONCENTRATION  
C          (FOR TANKM ONLY)  
C  
CCCCCCCCCCCCCCCCCCCCCCCCCCCCCCCCCCCCCCCCCCCCCCCCCCCCCCCCCCCC  
C  
0075    275    CONTINUE  
0076          TYPE*, ' '  
0077          TYPE*, 'DO YOU KNOW THE POSTWASH RESIDUE THICKNESS AND SOLUTE '  
0078          TYPE*, 'CONCENTRATION (Y/N)? '  
0079          READ(5,1) IDO  
0080          IF (IDO .NE. 1HY .AND. IDO .NE. 1HN) GO TO 275  
0081          IF (IDO .EQ. 1HN) GO TO 300  
0082          TYPE*, ' '  
0083          TYPE*, 'ENTER RESIDUE THICKNESS AND SOLUTE CONCENTRATION '  
0084          ACCEPT*, DELTA, COL  
0085          GO TO 400  
C  
C          USE DEFAULTS  
C  
0086    300    CONTINUE  
0087          CALL POSTWH(DELTA, COL, S)  
0088          GO TO 400  
C  
CCCCCCCCCCCCCCCCCCCCCCCCCCCCCCCCCCCCCCCCCCCCCCCCCCCCCCCCCCCC  
C  
C          INPUT THE THICKNESS OF THE CHEMICAL RESIDUE ON THE TANK  
C          BOTTOM AFTER DISCHARGE  
C          (FOR TANKP ONLY)  
C  
CCCCCCCCCCCCCCCCCCCCCCCCCCCCCCCCCCCCCCCCCCCCCCCCCCCCCCCCCCCC  
C  
0089    350    CONTINUE  
0090          CALL CHEMRS(TPOOL, L, W)  
C  
CCCCCCCCCCCCCCCCCCCCCCCCCCCCCCCCCCCCCCCCCCCCCCCCCCCCCCCCCCCC  
C  
C          INPUT THE THICKNESS OF THE RESIDUE ON THE WALLS  
C          (FOR TANKP ONLY)  
C  
CCCCCCCCCCCCCCCCCCCCCCCCCCCCCCCCCCCCCCCCCCCCCCCCCCCCCCCCCCCC  
C  
0091          CALL TKWALL(TFILM)  
C  
CCCCCCCCCCCCCCCCCCCCCCCCCCCCCCCCCCCCCCCCCCCCCCCCCCCCCCCCCCCC  
C  
C          INPUT ATMOSPHERIC PRESSURE AND CHEMICAL VAPOR PRESSURE  
C          CONSTANTS
```

```
C  
CCCCCCCCCCCCCCCCCCCCCCCCCCCCCCCCCCCCCCCCCCCCCCCCCCCCCCCCCCCCCCCC  
C  
0092 400 CONTINUE  
0093 TYPE*, ' '  
0094 TYPE*, 'ENTER IN ATMOSPHERIC PRESSURE IN MM HG '  
0095 ACCEPT*, PA  
0096 TYPE*, ' '  
0097 TYPE*, 'ENTER A, B, C, CHEMICAL VAPOR PRESSURE CONSTANTS '  
0098 ACCEPT*, A, B, C  
  
C  
CCCCCCCCCCCCCCCCCCCCCCCCCCCCCCCCCCCCCCCCCCCCCCCCCCCCCCCCCCCCCCCC  
C  
C PREVENTILATION VAPOR CONCENTRATION  
C  
CCCCCCCCCCCCCCCCCCCCCCCCCCCCCCCCCCCCCCCCCCCCCCCCCCCCCCCCCCCCCCCC  
C  
0099 450 CONTINUE  
0100 TYPE*, ' '  
0101 TYPE*, 'IS PREVENTILATION VAPOR CONCENTRATION KNOWN (Y/N)? '  
0102 READ(5,1) ITIS  
0103 IF (ITIS .NE. 1HY AND. ITIS .NE. 1HN) GO TO 450  
0104 IF (ITIS .EQ. 1HN) GO TO 500  
0105 TYPE*, ' '  
0106 TYPE*, 'ENTER CONCENTRATION IN PPM '  
0107 ACCEPT*, CDV  
0108 GO TO 600  
0109 500 CONTINUE  
0110 CALL PREVNT(CDV, A, B, C, PA)  
  
C  
CCCCCCCCCCCCCCCCCCCCCCCCCCCCCCCCCCCCCCCCCCCCCCCCCCCCCCCCCCCCCCCC  
C  
C MAN ENTRY INTO TANK  
C  
CCCCCCCCCCCCCCCCCCCCCCCCCCCCCCCCCCCCCCCCCCCCCCCCCCCCCCCCCCCCCCCC  
C  
0111 600 CONTINUE  
0112 TYPE*, ' '  
0113 TYPE*, 'ENTER FOR INTEGRATION , TI (INITIAL TIME), AND DT '  
0114 TYPE*, '(INTEGRATION TIME STEP). DT MUST BE A WHOLE NUMBER. '  
0115 TYPE*, 'TM AND TM+TWORK MUST BE MULTIPLES OF DT. '  
0116 ACCEPT*, TI, DT  
0117 CALL VTWORK(TWORK, ITWORK, TM)  
0118 IF (ITNK .EQ. 1) GO TO 650  
  
C  
CCCCCCCCCCCCCCCCCCCCCCCCCCCCCCCCCCCCCCCCCCCCCCCCCCCCCCCCCCCCCCCC  
C  
C INPUT VAPOR TEMPERATURES  
C (FOR TANKP ONLY)  
C  
CCCCCCCCCCCCCCCCCCCCCCCCCCCCCCCCCCCCCCCCCCCCCCCCCCCCCCCCCCCCCCCC  
C  
0119 TYPE*, ' '  
0120 TYPE*, 'ENTER VAPOR TEMPERATURE, TGAS, IN DEGREES KELVIN '  
0121 TYPE*, 'DURING GAS FREEING. SINCE THE TANK WILL NOT BE '
```

```
0122          TYPE*, 'WASHED, AN ISOTHERMAL VENTILATION PROCESS IS ASSUMED'  
0123          ACCEPT*, TGAS  
0124          GO TO 675  
  
C  
CCCCCCCCCCCCCCCCCCCCCCCCCCCCCCCCCCCCCCCCCCCCCCCCCCCCCCCCCCCCCCCC  
C  
C          VENTILATION DISCHARGE TEMPERATURE HISTORY  
C          (FOR TANKM ONLY)  
C  
CCCCCCCCCCCCCCCCCCCCCCCCCCCCCCCCCCCCCCCCCCCCCCCCCCCCCCCCCCCCCCCC  
C  
0125 650      CONTINUE  
0126          TYPE*, ' '  
0127          TYPE*, 'DO YOU KNOW THE VENTILATION TIME-TEMPERATURE DISCHARGE'  
0128          TYPE*, 'HISTORY (Y/N) ?'  
0129          READ(5,1) IDO  
0130          IF (IDO .NE. 1HY .AND. IDO .NE. 1HN) GO TO 650  
0131          TF = TM + TWORK  
0132          CALL VENTMP(TABTEM, TABTIM, NUMTAB, IDO, TI, TF, TM)  
  
C  
CCCCCCCCCCCCCCCCCCCCCCCCCCCCCCCCCCCCCCCCCCCCCCCCCCCCCCCCCCCCCCCC  
C  
C          OCCUPATIONAL EXPOSURE LIMIT  
C  
CCCCCCCCCCCCCCCCCCCCCCCCCCCCCCCCCCCCCCCCCCCCCCCCCCCCCCCCCCCCCCCC  
C  
0133 675      CONTINUE  
0134          TYPE*, ' '  
0135          TYPE*, 'ENTER OCCUPATIONAL EXPOSURE LIMITS (ACGIH)'  
0136          TYPE*, 'ALL EXPOSURE LIMITS ARE INPUT IN PPM'  
0137          TYPE*, 'DOES THE COMPOUND HAVE A CEILING TLV (Y/N) ?'  
0138          READ(5,1) ITDOES  
0139          IF (ITDOES .NE. 1HY .AND. ITDOES .NE. 1HN) GO TO 675  
0140          TLVC = 0.  
0141          TLVTWA = 0.  
0142          TLVSTL = 0.  
0143          IF (ITDOES .EQ. 1HN) GO TO 700  
0144          TYPE*, 'INPUT TLVC'  
0145          ACCEPT*, TLVC  
0146          GO TO 800  
0147 700      CONTINUE  
0148          TYPE*, ' '  
0149          TYPE*, 'INPUT TLVTWA AND TLVSTEL'  
0150          ACCEPT*, TLVTWA, TLVSTL  
  
C  
CCCCCCCCCCCCCCCCCCCCCCCCCCCCCCCCCCCCCCCCCCCCCCCCCCCCCCCCCCCCCCCC  
C  
C          INPUT REMAINING DATA  
C  
CCCCCCCCCCCCCCCCCCCCCCCCCCCCCCCCCCCCCCCCCCCCCCCCCCCCCCCCCCCCCCCC  
C  
0151 800      CONTINUE  
0152          TYPE*, ' '  
0153          TYPE*, 'ENTER M, SOLUTE MOLECULAR WT. IN GM/MOLE'  
0154          ACCEPT*, M
```

```
0155      TYPE*, ' '
0156      TYPE*, 'ENTER R2, JET DEFLECTION + WALL JET DISTANCE IN METERS'
0157      ACCEPT*, R2
0158      TYPE*, ' '
0159      TYPE*, 'INPUT NUMBER OF POINTS IN EXPERIMENTAL DATA , MAXIMUM'
0160      TYPE*, 'OF 200 POINTS (ENTER 0 (ZERO) IF NO POINTS)'
0161      ACCEPT*, NUMEXP
0162      IF (NUMEXP .LE. 200) GO TO B50
0163      TYPE*, '***200 IS MAXIMUM - REMAINDER IS IGNORED***'
0164      NUMEXP = 200
0165      B50 CONTINUE
0166      IF (NUMEXP .EQ. 0) GO TO 900
0167      TYPE*, ' '
0168      TYPE*, 'INPUT TIME AND CONCENTRATION FOR EACH POINT'
0169      TYPE*, ' ETIME(1) , ECVPPM(1)'
0170      TYPE*, ' '
0171      TYPE*, ' ETIME(NUMEXP) , ECVPPM(NUMEXP)'
0172      ACCEPT*, (ETIME(I), ECVPPM(I), I=1, NUMEXP)
0173      900 CONTINUE
0174      IF (ITNK .EQ. 2) GO TO 950

      C
      C      ADDITIONAL INPUTS FOR TANKM
      C
0175      925 CONTINUE
0176      TYPE*, ' '
0177      TYPE*, '1. PERFORM MINIT CALCULATION'
0178      TYPE*, '2. BYPASS MINIT CALCULATION'
0179      TYPE*, 'SELECT 1 OR 2'
0180      ACCEPT*, JSWTC
0181      IF (JSWTC .NE. 1 AND JSWTC .NE. 2) GO TO 925
0182      GO TO 1000

      C
      C      ADDITIONAL INPUTS FOR TANKP
      C
0183      950 TYPE*, ' '
0184      TYPE*, 'ENTER TB, CHEMICAL BOILING POINT, DEG K '
0185      ACCEPT*, TB
0186      TYPE*, ' '
0187      TYPE*, 'ENTER IN G, CHEMICAL SURFACE TENSION, DYNES/CM AT 20'
0188      TYPE*, 'DEG C'
0189      ACCEPT*, G
0190      TYPE*, ' '
0191      TYPE*, 'ENTER R, UNIVERSAL GAS CONSTANT (CM3-MM HG) / (MOLE-K)'
0192      ACCEPT*, R
0193      TYPE*, ' '
0194      TYPE*, 'ENTER C1, C2, CURVE FIT COEFFICIENTS ON LIQUID DENSITY'
0195      TYPE*, 'AS A FUNCTION OF TEMPERATURE'
0196      ACCEPT*, C1, C2
0197      TYPE*, ' '
0198      TYPE*, 'ENTER ALPHA, BETA, GAMMA, CURVE FIT COEFFICIENTS ON WALL'
0199      TYPE*, 'TEMPERATURE FOR WALLS PARALLEL TO X-Y PLANE IN M'
0200      ACCEPT*, ALPHA, BETA, GAMMA
0201      TYPE*, ' '
0202      TYPE*, 'ENTER ZETA, ETA, THETA, CURVE FIT COEFFICIENTS ON WALL'
0203      TYPE*, 'TEMPERATURE FOR WALLS PARALLEL TO THE Y-Z PLANE IN M'
```



```
0204 ACCEPT*, ZETA, ETA, THETA
0205 TYPE*, ' '
0206 TYPE*, 'ENTER DELTA, EPSILN, PHI, CURVE FIT COEFFICIENTS FOR '
0207 TYPE*, 'KINEMATIC VISCOSITY OF AIR (FT2/SEC) AS A FUNCTION OF '
0208 TYPE*, 'TEMP(F) AT ATMOSPHERIC PRESSURE.'
0209 ACCEPT*, DELTA, EPSILN, PHI
0210 TYPE*, ' '
0211 TYPE*, 'ENTER STEP, NUMBER OF SUBDIVISIONS OF H, DY=H/STEP '
0212 ACCEPT*, STEP
0213 TYPE*, ' '
0214 TYPE*, 'ENTER NSTEP, INTEGER VALUE OF STEP '
0215 ACCEPT*, NSTEP
0216 1000 CONTINUE
C
CCCCCCCCCCCCCCCCCCCCCCCCCCCCCCCCCCCCCCCCCCCCCCCCCCCCCCCCCCCC
C
C BLOWER OPERATIONAL WHILE MAN IN TANK
C
CCCCCCCCCCCCCCCCCCCCCCCCCCCCCCCCCCCCCCCCCCCCCCCCCCCCCCCCCCCC
C
0217 TYPE*, ' '
0218 TYPE*, 'WILL BLOWER BE OPERATING DURING TANK ENTRY (Y/N)?'
0219 READ(5,1) IBLOW
0220 IF (IBLOW .NE. 1HY .AND. IBLOW .NE. 1HN) GO TO 1000
C
CCCCCCCCCCCCCCCCCCCCCCCCCCCCCCCCCCCCCCCCCCCCCCCCCCCCCCCCCCCC
C
C OUTPUT DATA IN COMPATIBLE FORMAT
C
CCCCCCCCCCCCCCCCCCCCCCCCCCCCCCCCCCCCCCCCCCCCCCCCCCCCCCCCCCCC
C
0221 IF (ITNK .EQ. 2) GO TO 1100
C
C OUTPUT DATA FOR TANKM
C
0222 WRITE(1,2) TESTNO
0223 WRITE(1,3) L, W, D
0224 WRITE(1,3) G, DELTA
0225 WRITE(1,3) DIA, M
0226 WRITE(1,3) S, GAMINF, C1, C2
0227 WRITE(1,3) A, B, C
0228 WRITE(1,3) PA, R2
0229 WRITE(1,3) COL, CDV
0230 WRITE(1,3) TI, TM, TWORK, DT
0231 WRITE(1,4) NUMTAB
0232 WRITE(1,5) (TABTIM(I), I=1, NUMTAB)
0233 WRITE(1,5) (TABTEM(I), I=1, NUMTAB)
0234 WRITE(1,4) JSWTC, HEVAL
0235 WRITE(1,6) NUMEXP
0236 IF (NUMEXP .NE. 0) WRITE(1,7) (ETIME(I), ECVPPM(I), I=1, NUMEXP)
0237 WRITE(1,8) ITWORK, IBLOW
0238 WRITE(1,3) TLVC, TLVWA, TLVSTL
0239 2 FORMAT(15)
0240 3 FORMAT(5E12.5)
0241 4 FORMAT(2I3)
```

```
0242 5      FORMAT(7F8.3)
0243 6      FORMAT(1X,I5)
0244 7      FORMAT(1X,2F12.4)
0245 8      FORMAT(I5,A2)
0246      GO TO 1200

C
C      OUTPUT DATA FOR TANKP
C
0247 1100   CONTINUE
0248      WRITE(2,2) TESTNO
0249      WRITE(2,9) L, W, D, M, PA, TB, G, R, STEP, A, B, C, C1,
1          C2
0250      WRITE(2,9) DELTA, EPSILN, PHI
0251 9      FORMAT(6E12.6)
0252      WRITE(2,10) NSTEP
0253 10     FORMAT(I4)
0254      WRITE(2,9) COV, G, TFILM, TPOOL, TGAS, DIA, R2
0255      WRITE(2,9) ALPHA, BETA, GAMMA
0256      WRITE(2,9) ZETA, ETA, THETA
0257      WRITE(2,6) NUMEXP
0258      IF (NUMEXP .NE. 0) WRITE(2,7) (ETIME(I), ECVPPM(I), I=1, NUMEXP)
0259      WRITE(2,9) TI, TM, TWORK, DT
0260      WRITE(2,3) TLVC, TLVTA, TLVSTL
0261      WRITE(2,8) ITWORK, IBLOW
0262 1200   CONTINUE
0263      END
```

```
0001          SUBROUTINE TKDIM(L, W, D)
C
CCCCCCCCCCCCCCCCCCCCCCCCCCCCCCCCCCCCCCCCCCCCCCCCCCCCCCCCCCCC
C
C          INPUT OR SELECT TANK DIMENSIONS
C
CCCCCCCCCCCCCCCCCCCCCCCCCCCCCCCCCCCCCCCCCCCCCCCCCCCCCCCCCCCC
C
0002          REAL L
C
0003          50  CONTINUE
0004          TYPE*, ' '
0005          TYPE*, 'DO YOU HAVE TANK DIMENSIONS (Y/N)?'
0006          READ(5,1) IDO
0007          1    FORMAT(A2)
0008          IF (IDO .NE. 1HY .AND. IDO .NE. 1HN) GO TO 50
0009          IF (IDO .EQ. 1HN) GO TO 100
0010          TYPE*, ' '
0011          TYPE*, 'ENTER TANK LENGTH, WIDTH, AND DEPTH IN METERS'
0012          ACCEPT*, L, W, D
0013          GO TO 500
C
C          USER DOES NOT KNOW DIMENSIONS
C
0014          100  CONTINUE
0015          TYPE*, ' '
0016          TYPE*, 'WHAT TYPE OF TANK IS IT?'
0017          TYPE*, ' 1. BARGE'
0018          TYPE*, ' 2. SHIP'
0019          TYPE*, 'SELECT 1 OR 2'
0020          ACCEPT*, ITYPE
0021          IF (ITYPE .NE. 1 .AND. ITYPE .NE. 2) GO TO 100
0022          IF (ITYPE .EQ. 2) GO TO 300
C
C          TANK IS A BARGE
C
0023          150  CONTINUE
0024          TYPE*, ' '
0025          TYPE*, 'DEFAULT DIMENSIONS OF TANK: '
0026          TYPE*, ' 1. LARGE: FULL BEAM TANKS'
0027          TYPE*, '          LENGTH = 16.5 M'
0028          TYPE*, '          WIDTH  =  8.2 M'
0029          TYPE*, '          DEPTH  =  4.4 M'
0030          TYPE*, ' 2. SMALL: PORT/STARBOARD TANK SYMMETRIC ABOUT'
0031          TYPE*, '          CENTER LINE'
0032          TYPE*, '          LENGTH =  9.0 M'
0033          TYPE*, '          WIDTH  =  6.8 M'
0034          TYPE*, '          DEPTH  =  3.6 M'
0035          TYPE*, 'SELECT 1 OR 2'
0036          ACCEPT*, IBARGE
0037          IF (IBARGE .NE. 1 .AND. IBARGE .NE. 2) GO TO 150
0038          IF (IBARGE .EQ. 2) GO TO 200
C
C          LARGE BARGE
C
```

```
0039          L = 16.5
0040          W = 8.2
0041          D = 4.4
0042          GO TO 500

      C
      C      SMALL BARGE
      C
0043      200    CONTINUE
0044          L = 9.0
0045          W = 6.8
0046          D = 3.6
0047          GO TO 500

      C
      C      TANK IS IN A SHIP
      C
      C
0048      300    CONTINUE
0049          TYPE*, ' '
0050          TYPE*, 'DEFAULT DIMENSIONS FOR SHIP TANK: '
0051          TYPE*, ' 1. CENTER TANK '
0052          TYPE*, '      LENGTH = 12.2 M '
0053          TYPE*, '      WIDTH  = 10.9 M '
0054          TYPE*, '      DEPTH  = 14.6 M '
0055          TYPE*, ' 2. WING TANK '
0056          TYPE*, '      LENGTH = 12.2 M '
0057          TYPE*, '      WIDTH  =  7.3 M '
0058          TYPE*, '      DEPTH  = 14.6 M '
0059          TYPE*, 'SELECT 1 OR 2 '
0060          ACCEPT*, ISHIP
0061          IF (ISHIP .NE. 1 .AND. ISHIP .NE. 2) GO TO 300
0062          IF (ISHIP .EQ. 2) GO TO 400

      C
      C      CENTER TANK
      C
0063          L = 12.2
0064          W = 10.9
0065          D = 14.6
0066          GO TO 500

      C
      C      WING TANK
      C
0067      400    CONTINUE
0068          L = 12.2
0069          W =  7.3
0070          D = 14.6
0071      500    CONTINUE
0072          RETURN
0073          END
```

```

0001                      SUBROUTINE BLOWER(Q)
                          C
                          CCCCCCCCCCCCCCCCCCCCCCCCCCCCCCCCCCCCCCCCCCCCCCCCCCCCCCCCCCCCCCCCCCCC
                          C
                          C                      INPUT OR SELECT BLOWER FLOW RATE
                          C
                          CCCCCCCCCCCCCCCCCCCCCCCCCCCCCCCCCCCCCCCCCCCCCCCCCCCCCCCCCCCCCCCCCCCC
                          C
0002                      REAL K
                          C
0003                      50                      CONTINUE
0004                                              TYPE*, ' '
0005                                              TYPE*, 'DO YOU KNOW THE BLOWER TYPE AND PRESSURE (Y/N)?'
0006                                              READ(5,1) IDO
0007                                              1                      FORMAT(A2)
0008                                              IF (IDO .NE. 1HY .AND. IDO .NE. 1HN) GO TO 50
0009                                              IF (IDO .EQ. 1HN) GO TO 100
0010                                                              TYPE*, 'USE MANUFACTURES Q-P DATA - INPUT FLOW RATE'
0011                                                              ACCEPT*, Q
0012                                                              GO TO 200
                          C
                          C                      SELECT DEFAULT VALUESS
                          C
0013                                              100                      CONTINUE
0014                                                              TYPE*, ' '
0015                                                              TYPE*, 'SELECT DEFAULT FLOW RATE:'
0016                                                              TYPE*, ' 1. LOW        = 36 M3/MIN'
0017                                                              TYPE*, ' 2. MEDIUM = 96 M3/MIN'
0018                                                              TYPE*, ' 3. HIGH     = 124 M3/MIN'
0019                                                              TYPE*, 'ENTER A 1, 2, OR 3'
0020                                                              ACCEPT*, IRATE
0021                                                              IF (IRATE .NE. 1 .AND. IRATE .NE. 2 .AND. IRATE .NE. 3) GO TO 100
0022                                                              IF (IRATE .EQ. 1) Q = 36.
0023                                                              IF (IRATE .EQ. 2) Q = 96.
0024                                                              IF (IRATE .EQ. 3) Q = 124.
                          C
                          C                      IS BLOWER OPERATIONAL
                          C
0025                                              200                      CONTINUE
0026                                                              TYPE*, ' '
0027                                                              TYPE*, 'IS BLOWER FULLY OPERATIONAL AND FULLY MATED WITH '
0028                                                              TYPE*, 'BUTTERWORTH OPENINGS (Y/N) ?'
0029                                                              READ(5,1) ITIS
0030                                                              IF (ITIS .NE. 1HY .AND. ITIS .NE. 1HN) GO TO 200
0031                                                              IF (ITIS .EQ. 1HY) GO TO 300
                          C
                          C                      MODIFY Q
                          C
0032                                                              TYPE*, ' '
0033                                                              TYPE*, 'MANY FACTORS CAN CONTRIBUTE TO A REDUCED FLOW RATE.'
0034                                                              TYPE*, 'AS SUCH, A DEFAULT VALUE IS NOT OFFERED BUT IS TO BE'
0035                                                              TYPE*, 'SELECTED BASED ON THE USER JUDGEMENT. INSERT THE'
0036                                                              TYPE*, 'SELECTED VALUE OF K, WHERE : '
0037                                                              TYPE*, '     K = FRACTION OF RATED AIR FLOW ENTERING TANK'
0038                                                              ACCEPT*, K
  
```

```
0039      G := G * K
0040      300      CONTINUE
0041      RETURN
0042      END
```

```
0001          SUBROUTINE POSTWH(DELTA, COL, S)
C
CCCCCCCCCCCCCCCCCCCCCCCCCCCCCCCCCCCCCCCCCCCCCCCCCCCCCCCCCCCC
C
C          INPUT OR SELECT POSTWASH RESIDUE THICKNESS AND SOLUTE
C          CONCENTRATION
C
CCCCCCCCCCCCCCCCCCCCCCCCCCCCCCCCCCCCCCCCCCCCCCCCCCCCCCCCCCCC
C
0002          50      CONTINUE
0003          TYPE*, ' '
0004          TYPE*, 'THE ESTIMATED DEFAULT RANGE FOR POSTWASH RESIDUE '
0005          TYPE*, 'THICKNESS: '
0006          TYPE*, ' DELTA = 0.1 CM - 2.5 CM '
0007          TYPE*, 'SELECT AND INPUT A NUMERICAL VALUE WITHIN THIS RANGE '
0008          ACCEPT*, DELTA
0009          IF (DELTA .LT. .1 .OR. DELTA .GT. 2.5) GO TO 50
0010          75      CONTINUE
0011          TYPE*, ' '
0012          TYPE*, 'DO YOU KNOW THE SOLUTE CONCENTRATION (Y/N)? '
0013          READ(5,1) IDO
0014          1      FORMAT(A2)
0015          IF (IDO .NE. 1HY .AND. IDO .NE. 1HN) GO TO 75
0016          IF (IDO .EQ. 1HN) GO TO 100
C
C          SOLUTE CONCENTRATION KNOWN.  SELECT DELTA FROM DEFAULT
C          RANGE
C
0017          TYPE*, 'INPUT SOLUTE CONCENTRATION, COL '
0018          ACCEPT*, COL
0019          GO TO 300
C
C          NEITHER SOLUTE CONCENTRATION NOR DELTA KNOWN
C
0020          100     CONTINUE
0021          TYPE*, ' '
0022          TYPE*, 'CALCULATE SOLUTE CONCENTRATION '
0023          TYPE*, ' '
0024          TYPE*, 'DEFAULT OPTIONS FOR RESIDUAL CHEMICAL VOLUME AFTER '
0025          TYPE*, 'DISCHARGE ARE: '
0026          TYPE*, ' 1.  FOR LOW KINEMATIC VISCOSITY CARGOS, HIGH DRAFT '
0027          TYPE*, '      DIFFERENCE DURING DISCHARGE, DEEP WELL PUMPS WITH '
0028          TYPE*, '      SUMP AND SUMP STRIPPED WITH EDUCTOR '
0029          TYPE*, '      VRES = 0.2 M3 '
0030          TYPE*, ' 2.  FOR HIGH KINEMATIC VISCOSITY CARGOS, LOW DRAFT '
0031          TYPE*, '      DIFFERENCE DURING DISCHARGE, NO DEEP WELL PUMP OR '
0032          TYPE*, '      SUMP. '
0033          TYPE*, '      VRES = 5.0 M3 '
0034          TYPE*, 'SELECT AND ENTER A "1" OR "2" '
0035          VRES = .2
0036          ACCEPT*, IVRES
0037          IF (IVRES .NE. 1 .AND. IVRES .NE. 2) GO TO 100
0038          IF (IVRES .EQ. 2) VRES = 5.0
0039          TYPE*, ' '
0040          TYPE*, 'DEFAULT WASHING TIME IS 48 MIN. WITH A DEFAULT WASH '
```

```
0041      TYPE*, 'WATER RATE OF 0.28 M3/MIN '  
0042      TYPE*, ' '  
0043      TYPE*, 'INPUT PURE CHEMICAL DENSITY IN G/CC. '  
0044      ACCEPT*, PCHEM  
      C  
      C      CALCULATE CONCENTRATION OF SOLUTE  
      C  
0045      COL = VRES * PCHEM * 1E9 / (.28 * 48. + VRES)  
0046      TYPE*, ' '  
0047      TYPE*, 'COL = ', COL, ' MG/M3 '  
      C  
      C      CHECK CONCENTRATION AGAINST SOLUBILITY LIMIT  
      C  
0048      COLCHK = COL / 1000.  
0049      IF (COLCHK .GE. S) GO TO 200  
      C  
      C      CONCENTRATION IS LESS THAN SOLUBILITY LIMIT  
      C  
0050      TYPE*, 'COL IS LESS THAN SOLUBILITY LIMIT. MODEL WILL USE THE '  
0051      TYPE*, 'DEFAULT VALUE '  
0052      GO TO 300  
      C  
      C      CONCENTRATION IS GREATER THAN OR EQUAL TO SOLUBILITY LIMIT  
      C  
0053      200 CONTINUE  
0054      COL = S * 1000  
0055      TYPE*, ' '  
0056      TYPE*, 'CALCULATED DEFAULT EXCEEDS THE SOLUBILITY LIMIT. MODEL '  
0057      TYPE*, 'WILL USE MODIFIED DEFAULT CONCENTRATION EQUAL TO '  
0058      TYPE*, 'SOLUBILITY LIMIT '  
0059      TYPE*, 'COL = ', COL  
0060      300 CONTINUE  
0061      RETURN  
0062      END
```



```
0001      SUBROUTINE CHEMRS(TPOOL, L, W)
C
C
C
C      INPUT OR SELECT THE THICKNESS OF THE CHEMICAL RESIDUE ON THE
C      TANK BOTTOM AFTER DISCHARGE
C
C
C
C
0002      50      CONTINUE
0003      TYPE*, ' '
0004      TYPE*, 'THE PROGRAM ASSUMES THAT THE VESSEL TRIM ANGLE IS '
0005      TYPE*, 'REDUCED TO ZERO AFTER DISCHARGE AND THE CHEMICAL '
0006      TYPE*, 'RESIDUE IS UNIFORMLY DISTRIBUTED OVER THE TANK BOTTOM '
0007      TYPE*, 'DURING GAS FREEING. '
0008      TYPE*, ' '
0009      TYPE*, 'DO YOU KNOW THE THICKNESS OF THIS CHEMICAL RESIDUE ON '
0010      TYPE*, 'THE TANK BOTTOM AFTER DISCHARGE (Y/N)? '
0011      READ(5,1) IKNOW
0012      IF (IKNOW .NE. 1HY .AND. IKNOW .NE. 1HN) GO TO 50
0013      1      FORMAT(A2)
0014      IF (IKNOW .EQ. 1HN) GO TO 100
C
C
C      USER INPUT TPOOL
C
0015      TYPE*, ' '
0016      TYPE*, 'INPUT TPOOL, THE THICKNESS OF LIQUID LAYER ON TANK '
0017      TYPE*, 'BOTTOM, IN CM '
0018      ACCEPT*, TPOOL
0019      GO TO 400
C
C
C      HELP USER CALCULATE TPOOL
C
0020      100     CONTINUE
0021      TYPE*, ' '
0022      TYPE*, 'DO YOU HAVE AN ESTIMATE OF THE VOLUME OF RESIDUAL '
0023      TYPE*, 'PRODUCT REMAINING ON THE TANK BOTTOM AFTER DISCHARGE '
0024      TYPE*, '(Y/N)? '
0025      READ (5,1) IDO
0026      IF (IDO .NE. 1HY .AND. IDO .NE. 1HN) GO TO 100
0027      IF (IDO .EQ. 1HY) GO TO 200
C
C
C      SELECT RESIDUAL CHEMICAL VALUE
C
0028      150     CONTINUE
0029      TYPE*, ' '
0030      TYPE*, 'DEFAULT OPTIONS FOR RESIDUAL CHEMICAL VOLUME AFTER '
0031      TYPE*, 'DISCHARGE ARE: '
0032      TYPE*, ' 1.  FOR LOW KINEMATIC VISCOSITY CARGOS, HIGH DRAFT '
0033      TYPE*, '      DIFFERENCE DURING DISCHARGE, DEEP WELL PUMPS WITH '
0034      TYPE*, '      SUMP AND SUMP STRIPPED WITH EDUCTOR '
0035      TYPE*, '      VRES = 0.2 M3 '
0036      TYPE*, ' 2.  FOR HIGH KINEMATIC VISCOSITY CARGOS, LOW DRAFT '
0037      TYPE*, '      DIFFERENCE DURING DISCHARGE, NO DEEP WELL PUMP OR '
0038      TYPE*, '      SUMP. '

```

```
0039          TYPE*, '          VRES = 5.0 M3'
0040          TYPE*, 'SELECT AND ENTER A "1" OR "2"'
0041          VRES = .2
0042          ACCEPT*, IVRES
0043          IF (IVRES .NE. 1 .AND. IVRES .NE. 2) GO TO 150
0044          IF (IVRES .EQ. 2) VRES = 5.0
0045          GO TO 300

          C
          C          INPUT RESIDUAL CHEMICAL VOLUME
          C

0046          200          CONTINUE
0047          TYPE*, ' '
0048          TYPE*, 'INPUT VRES, THE VOLUME OF THE RESIDUAL, IN M3.'
0049          ACCEPT*, VRES

          C
          C          CALCULATE TPOOL.
          C

0050          300          CONTINUE
0051          TPOOL = VRES / (L * W) * 100.
0052          TYPE*, ' '
0053          TYPE*, 'TPOOL = ', TPOOL
0054          400          CONTINUE
0055          RETURN
0056          END
```

```
0001          SUBROUTINE TKWALL(TFILM)
C
C
C          INPUT OR SELECT THE THICKNESS OF THE RESIDUE ON
C          THE WALLS
C
C
C          CONTINUE
0002          50          CONTINUE
0003          TYPE*, ' '
0004          TYPE*, 'IS THE FILM THICKNESS ON THE TANK WALLS KNOWN(Y/N)?'
0005          READ(5,1) ITIS
0006          1          FORMAT(A2)
0007          IF (ITIS .NE. 1HY .AND. ITIS .NE. 1HN) GO TO 50
0008          IF (ITIS .EQ. 1HN) GO TO 100
C
C          INPUT FILM THICKNESS
C
0009          TYPE*, ' '
0010          TYPE*, 'INPUT THE FILM THICKNESS, TFILM, IN CM. '
0011          ACCEPT*, TFILM
0012          GO TO 200
C
C          SELECT FILM THICKNESS
C
0013          100         CONTINUE
0014          TYPE*, 'THE FOLLOWING DEFAULT OPTIONS REFLECT A CARGO DISCHARGE '
0015          TYPE*, 'RATE OF APPROXIMATELY 200 METRIC TONS/HOUR. THE OPTIONS '
0016          TYPE*, 'ARE SENSITIVE TO CARGO KINEMATIC VISCOSITY, BUT ARE '
0017          TYPE*, 'RELATIVELY INDEPENDENT OF TANK PLANFORM DIMENSIONS. '
0018          TYPE*, ' 1. TFILM = 3.9E-03 CM FOR KINEMATIC VISCOSITIES '
0019          TYPE*, ' OF THE ORDER OF 200E-06 M2/SEC. '
0020          TYPE*, ' 2. TFILM = 0.11E-03 CM FOR KINEMATIC VISCOSITIES '
0021          TYPE*, ' APPROACHING 1E-06 M2/SEC '
0022          TYPE*, ' '
0023          TYPE*, 'ENTER A 1 OR 2 TO SELECT THE DESIRED TFILM '
0024          ACCEPT*, IOPT
0025          IF (IOPT .NE. 1 .AND. IOPT .NE. 2) GO TO 100
0026          TFILM = 3.9E-03
0027          IF (IOPT .EQ. 2) TFILM = 0.11E-03
0028          200         CONTINUE
0029          RETURN
0030          END
```

```
0001          SUBROUTINE VENTMP(TABTEM, TABTIM, NUMTAB, IDD, TI, TF, TM)
C
CCCCCCCCCCCCCCCCCCCCCCCCCCCCCCCCCCCCCCCCCCCCCCCCCCCCCCCCCCCC
C
C          INPUT OR SELECT VENTILATION DISCHARGE TEMPERATURE HISTORY
C
CCCCCCCCCCCCCCCCCCCCCCCCCCCCCCCCCCCCCCCCCCCCCCCCCCCCCCCCCCCC
C
0002          DIMENSION TABTEM(1), TABTIM(1)
0003          IF (IDD .EQ. 1HN) GO TO 100
0004              TYPE*, ' '
0005              TYPE*, 'ENTER NUMBER OF TIME HISTORY VALUES'
0006              ACCEPT*, NUMTAB
0007              IF (NUMTAB .LE. 14) GO TO 150
0008                  TYPE*, '***14 IS MAXIMUM - REMAINDER IGNORED***'
0009                  NUMTAB = 14
0010          150          CONTINUE
0011              TYPE*, ' '
0012              TYPE*, 'ENTER TIME - TEMPERATURE TABLE:'
0013              TYPE*, ' TABTIM(1)          , TABTEM(1)'
0014              TYPE*, ' '
0015              TYPE*, ' TABTIM(NUMTAB) , TABTEM(NUMTAB)'
0016              ACCEPT*, (TABTIM(I), TABTEM(I), I=1, NUMTAB)
0017              GO TO 300
C
C          SPECIFY DEFAULT FOR COLD OR HOT WATER WASH
C
0018          100          CONTINUE
0019              TYPE*, ' '
0020              TYPE*, 'WAS THE TANK WASHED WITH HOT WATER (Y/N)?'
0021              READ(5, 1) ITWAS
0022              1          FORMAT(A2)
0023              IF (ITWAS .NE. 1HY .AND. ITWAS .NE. 1HN) GO TO 100
0024              IF (ITWAS .EQ. 1HN) GO TO 200
C
C          TANK WASHED WITH HOT WATER
C
0025              TYPE*, ' '
0026              TYPE*, 'DEFAULT TEMPERATURE OF 41C WILL BE USED DURING '
0027              TYPE*, 'VENTILATION'
0028              NUMTAB = 2
0029              TABTEM(1) = 41.
0030              TABTEM(2) = 41.
0031              TABTIM(1) = TI
0032              TABTIM(2) = TM
0033              GO TO 300
C
C          TANK WASHED WITH COLD WATER
C
0034          200          CONTINUE
0035              TYPE*, ' '
0036              TYPE*, 'COLD WATER WASH TEMPERATURE AND RESULTING VAPOR TEMPER-'
0037              TYPE*, 'TURE WILL BE SEASONAL REGARDLESS OF WHETHER SEA OR FRESH'
0038              TYPE*, 'WATER.'
0039              TYPE*, ' 1. WINTER / GULF COAST'
```

```
0040          TYPE*, '      TEMP = 16.5 C'  
0041          TYPE*, ' 2  SUMMER / GULF COAST'  
0042          TYPE*, '      TEMP = 29.4 C'  
0043          TYPE*, 'SELECT AND ENTER A "1" OR "2".'  
0044          ACCEPT*, ITEMP  
0045          IF (ITEMP .NE. 1 .AND. ITEMP .NE. 2) GO TO 200  
0046          TEMP = 16.5  
0047          IF (ITEMP .EQ. 2) TEMP = 29.4  
0048          NUMTAB = 2  
0049          TABTEM(1) = TEMP  
0050          TABTEM(2) = TEMP  
0051          TABTIM(1) = TI  
0052          TABTIM(2) = TF  
0053          300 CONTINUE  
0054          RETURN  
0055          END
```

```
0001          SUBROUTINE PREVNT(COV, A, B, C, P)
C
CCCCCCCCCCCCCCCCCCCCCCCCCCCCCCCCCCCCCCCCCCCCCCCCCCCCCCCCCCCC
C
C          MEASURED PREVENTILATION VAPOR CONCENTRATION NOT KNOWN.  SET
C          SOME DEFAULTS AND GUIDELINES
C
CCCCCCCCCCCCCCCCCCCCCCCCCCCCCCCCCCCCCCCCCCCCCCCCCCCCCCCCCCCC
C
0002          50      CONTINUE
0003              TYPE*, ' '
0004              TYPE*, 'A DEFAULT VALUE OF COV, THE VAPOR CONCENTRATION, CAN BE '
0005              TYPE*, 'SPECIFIED BY THE USER OR IT CAN BE CALCULATED: '
0006              TYPE*, ' 1.  INPUT COV IN PPM.  VALUE SHOULD BE LESS THAN '
0007              TYPE*, ' SATURATION CONCENTRATION CORRESPONDING TO CARGO '
0008              TYPE*, ' TEMPERATURE.  THIS CONDITION CORRESPONDS TO A TANK '
0009              TYPE*, ' THAT HAS BEEN EMPTIED BUT HAS BEEN CLOSED FOR A '
0010              TYPE*, ' LONG TIME BEFORE CLEANING IS INITIATED '
0011              TYPE*, ' 2.  INPUT OMEGA AND CARGO TEMPERATURE.  OMEGA IS THE '
0012              TYPE*, ' FRACTION OF TANK VOLUME OCCUPIED BY CARGO PRIOR '
0013              TYPE*, ' TO DISCHARGE.  CARGO TEMPERATURE IN DEGREES C. '
0014              TYPE*, ' THIS VALUE WILL BE USED TO CALCULATE COV ASSUMING '
0015              TYPE*, ' A SATURATED CONCENTRATION IN THE ULLAGE SPACE '
0016              TYPE*, ' BEFORE DISCHARGE. '
0017              TYPE*, 'SELECT ^ 1 OR 2'
0018              ACCEPT*, ISEL
0019              IF (ISEL .NE. 1 .AND. ISEL .NE. 2) GO TO 50
0020              IF (ISEL .EQ. 2) GO TO 100
0021              TYPE*, 'INPUT COV IN PPM'
0022              ACCEPT*, COV
0023              GO TO 200
C
C          CALCULATE COV
C
0024          100      CONTINUE
0025              TYPE*, ' '
0026              TYPE*, 'ENTER OMEGA AND CARGO TEMPERATURE'
0027              ACCEPT*, OMEGA, CTEMP
0028              PVS = 10. ** (A-B / (C + CTEMP))
0029              COV = (1 - OMEGA) * PVS / P * 1E6
0030          200      CONTINUE
0031              RETURN
0032              END
```

```
0001      SUBROUTINE VTWORK(TWORK, ITWORK, TM)
C
CCCCCCCCCCCCCCCCCCCCCCCCCCCCCCCCCCCCCCCCCCCCCCCCCCCCCCCCCCCCCCCC
C
C      GUIDELINES FOR DURATION OF MAN IN TANK
C
CCCCCCCCCCCCCCCCCCCCCCCCCCCCCCCCCCCCCCCCCCCCCCCCCCCCCCCCCCCCCCCC
C
0002      TYPE*, ' '
0003      TYPE*, 'INPUT VENTILATION TIME, TM, TO MAN ENTRY'
0004      ACCEPT*, TM
0005      100  CONTINUE
0006      TYPE*, ' '
0007      TYPE*, 'OPTIONS FOR DURATION OF MAN ENTRY, TWORK IN MIN., IS AS'
0008      TYPE*, 'FOLLOWS:'
0009      TYPE*, ' 1. BRIEF VISUAL INSPECTION AND ODOR DETERMINATION'
0010      TYPE*, '      WITH CARGO SURVEYOR.'
0011      TYPE*, '      TWORK = 1 - 2 MIN.'
0012      TYPE*, ' 2. INSPECT TANK COATINGS AND MEASURE THICKNESS'
0013      TYPE*, '      TWORK = 15 - 45 MIN.'
0014      TYPE*, ' 3. HAND MUCKING OF RESIDUE WITH TOWELS AND RAGS'
0015      TYPE*, '      (RELATIVELY DIRTY TANK)'
0016      TYPE*, '      TWORK = 90 MIN.'
0017      TYPE*, ' 4. SWEEP DEBRIS FROM TANK BOTTOM AND WIPE PUMP SUMP'
0018      TYPE*, '      (RELATIVELY CLEAN TANK)'
0019      TYPE*, '      TWORK = 40 MIN.'
0020      TYPE*, ' 5. USER SPECIFIES'
0021      TYPE*, 'SELECT AND ENTER A 1-5 TO INDICATE WORK DESCRIPTION'
0022      ACCEPT*, ITWORK
0023      TYPE*, 'INPUT DURATION, IN MINUTES, OF MAN ENTRY IN TANK'
0024      ACCEPT*, TWORK
0025      IF (ITWORK .EQ. 5) GO TO 700
0026      IF (ITWORK .GT. 1) GO TO 200
0027          IF (TWORK .GE. 1. .AND. TWORK .LE. 2) GO TO 700
0028              GO TO 500
0029      200  IF (ITWORK .GT. 2) GO TO 300
0030          IF (TWORK .GE. 15. .AND. TWORK .LE. 45.) GO TO 700
0031              GO TO 500
0032      300  IF (ITWORK .GT. 3) GO TO 400
0033          IF (TWORK .EQ. 90.) GO TO 700
0034              GO TO 500
0035      400  IF (ITWORK .GT. 4) GO TO 600
0036          IF (TWORK .EQ. 40.) GO TO 700
0037      500  CONTINUE
0038          TYPE*, ' '
0039          TYPE*, 'VALUE OF TWORK NOT WITHIN LIMITS OF OPTION ', ITWORK
0040          TYPE*, '***TRY AGAIN***'
0041          GO TO 100
0042      600  CONTINUE
0043          TYPE*, ' '
0044          TYPE*, 'OPTION = ', ITWORK, ' NOT A VALID OPTION - ***TRY AGAIN***'
0045          GO TO 100
0046      700  CONTINUE
0047          RETURN
0048          END
```

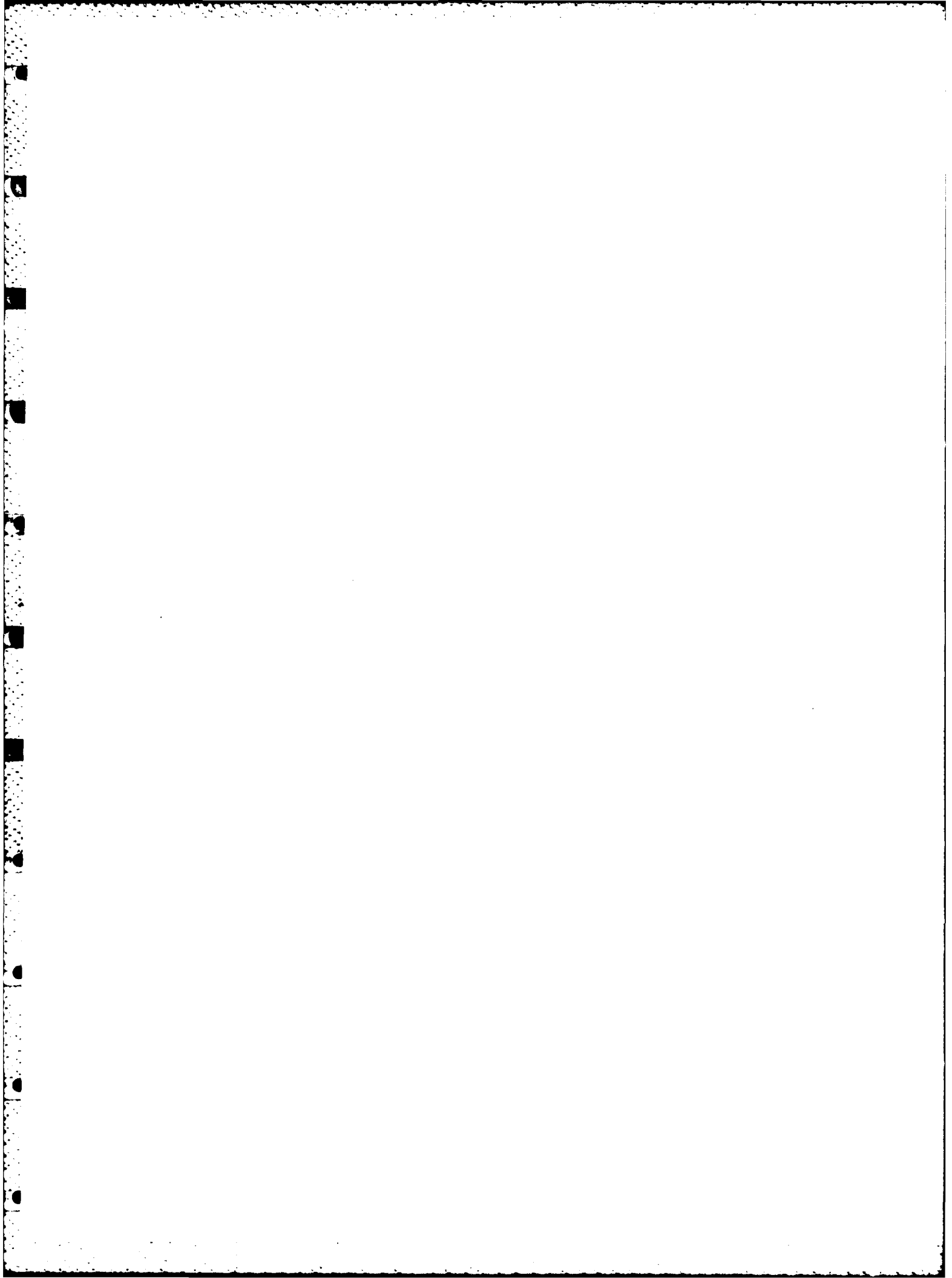

TANKM

1951

A-22

```

0001      PROGRAM TANKM
0002      COMMON /FUNC/G,V,KOL,AREA,COL,T,H,DELTA,PA,M,A,B,C,PV,
           1      S,KL,KQ,NUMTAB,HEVAL,GAMINF,C1,C2
0003      COMMON /RK/DELY,DELZ,CVPPM,TABTIM,TABTEM,III
0004      DIMENSION MDOT(500),TABTEM(14),TABTIM(14),TIME(500),CVPPM(500)
0005      DIMENSION ETIME(30),ECVPPM(30),AR(4),CEXP(500)
0006      INTEGER TESTNO,HEVAL
0007      REAL K,KOL,KQ,KL,L,M,MDOT,MEVAP,MINIT,MAIR
0008      DATA PARAM /O.331/
0009      DATA MAIR /28.97/
    
```

C PROGRAM TANKM CALCULATES THE CONCENTRATION-TIME HISTORY OF CHEMICAL
 C VAPORS DISCHARGED FROM A TANK DURING DILUTION VENTILATION IN THE
 C PRESENCE OF CHEMICAL SOLUTE EVAPORATION FROM AN AQUEOUS SOLUTION OF
 C RESIDUAL CARGO ON THE TANK FLOOR.

C *****

C MODEL INPUTS

C	QUANTITY	DESCRIPTION	UNITS
C	TESTNO	TEST NUMBER	----
C	L	TANK LENGTH	METER
C	W	TANK WIDTH	METER
C	D	TANK DEPTH	METER
C	Q	BLOWER FLOW RATE	M3/MIN
C	DELTA	RESIDUE THICKNESS	CM
C	DIA	DIA. OF B/W OPENING	METER
C	M	SOLUTE MOLECULAR WT.	CM/MOLE
C	S	SOLUTE SOLUBILITY	MG/LITER
C	GAMINF	ACTIVITY COEFFICIENT AT INFINITE DILUTION (CHEMICAL IN WATER)	----
C	C1,C2	CURVE FIT COEFFICIENTS OF LIQ. DENSITY AS FUNCTION OF TEMP. * ROCHEM(MG/M3) = C1+C2*T,T(C)	----
C	A,B,C	SOLUTE VAPOR PRES. CONST.	----
C	PA	ATMOSPHERIC PRESSURE	MM HG
C	R2	JET DEFL.+WALL JET DIST.	METER
C	COL	INITIAL SOLUTE CONCEN.	MG/M3
C	COV	INITIAL VAPOR CONCENTRATION	PPM
C	TI	INITIAL TIME	MIN
C	TM	VENTILATION TIME TO MAN- ENTRY INTO TANK	MIN
C	TWORK	DURATION OF IN-TANK WORK	MIN
C	DT	INTEGRATION TIME STEP	MIN
C	NUMTAB	NUMBER OF INPUT EXPERIMENTAL VAPOR CONCENTRATIONS	----
C	TABTIM	TIME IN MINUTES CORRESPONDING TO TEMPERATURES IN TABTEM VECTOR. TIME=0 REFERENCED TO BEGINNING OF VENTILATION	MIN
C	TABTEM	VAPOR TEMPERATURE AT TANK DISCHARGE	DEG. C
C	JSWTC	JSWTC=1, PERFORM MINIT CALC. JSWTC=2, BYPASS MINIT CALCULATION	----
C	HEVAL	HEVAL=1; HENRY'S CONST=H(MACKAY) HEVAL=2; HENRY'S CONST=H(DILLING)	----
C	NUMEXP	NUMBER OF EXPERIMENTAL DATA	----

C		ENTRIES	
C	ETIME	ARRAY OF TIMES CORRESPONDING	MIN
C		TO ECVPPM	
C	ECVPPM	ARRAY OF INPUT EXPERIMENTAL	PPM
C		VAPOR CONCENTRATIONS	
C	ITWORK	1. BRIEF VISUAL INSPECTION AND	----
C		ODOR DETERMINATION WITH CARGO	
C		SURVEYOR.	
C		TWORK = 1 - 2 MIN.	
C		2. INSPECT TANK COATINGS AND	
C		MEASURE THICKNESS	
C		TWORK = 15 - 5 MIN.	
C		3. HAND MUCKING OF RESIDUE WITH	
C		TOWELS AND RAGS (RELATIVELY	
C		DIRTY TANK)	
C		TWORK = 90 MIN	
C		4. SWEEP DEBRIS ROM TANK BOTTOM	
C		AND WIPE PUMP SUMP	
C		(RELATIVELY CLEAN TANK)	
C		TWORK = 40 MIN.	
C		5. USER SPECIFIES TWORK	
C	IBLOW	Y : BLOWER ON WHILE MAN IN TANK	----
C		N : BLOWER OFF WHILE MAN IN TANK	
C	TLVC	CEILING EXPOSURE LIMIT	PPM
C	TLVTA	TIME WEIGHTED AVERAGE	PPM
C		8 - HOUR EXPOSURE LIMIT	
C	TLVSTL	SHORT TERM EXPOSURE LIMIT	PPM

C CALCULATED QUANTITIES

C	QUANTITY	DESCRIPTION	UNITS
C	H	HENRYS CONSTANT (PARTITION COEFF)	DIMENSIONLESS
C	KL	LIQUID PHASE MASS TRANSFER COEFF	CM/MIN
C	KG	GAS PHASE MASS TRANSFER COEFF	CM/MIN
C	KOL	OVERALL MASS TRANSFER COEFF	CM/MIN
C	AREA	LIQUID SURFACE AREA	M ²
C	V	TANK VOLUME	M ³
C	UWIND	CONVECTIVE EVAPORATION VEL	M/SEC
C	UD	BLOWER JET VELOCITY	M/SEC
C	PV	PARTIAL PRESSURE OF SOLUTE AT TEMP T	MM HG
C	P	PARTIAL PRESSURE OF TANK VAPOR	MM HG
C	CSTAR	EQUILIBRIUM VAPOR CONCENTRATION	MG/M ³
C	MINIT	INITIAL CHEMICAL MASS IN SOLUTION	MG

C *****

```

0010 OPEN(UNIT=6, NAME='SYO: TANKMO. DAT', TYPE='NEW')
0011 OPEN(UNIT=1, NAME='SYO: TANKMI. DAT', TYPE='OLD')
0012 OPEN(UNIT=3, NAME='SYO: SCRATCH. DAT', TYPE='NEW')
0013 READ(1, 5000)TESTNO
0014 READ(1, 5001)L, W, D
0015 READ(1, 5001)G, DELTA
0016 READ(1, 5001)DIA, M
0017 READ(1, 5001)S, GAMINF, C1, C2
0018 READ(1, 5001)A, B, C
0019 READ(1, 5001)PA, R2
0020 READ(1, 5001)COL, COV
    
```

```

0021      READ(1,5001)TI, TM, TWORK, DT
          C      NUMTAB IS THE NUMBER OF VALUES IN THE TIME AND TEMPERATURE TABLES
0022      READ(1,5003) NUMTAB
0023      READ(1,5004) (TABTIM(I), I=1, NUMTAB)
0024      READ(1,5004) (TABTEM(I), I=1, NUMTAB)
0025      READ(1,5003)JSWTCH, HEVAL
0026      READ(1,5005)NUMEXP
0027      IF (NUMEXP .EQ. 0) GO TO 11
0028      DO 10 I=1, NUMEXP
0029      10 READ(1,5006)ETIME(I), ECVPPM(I)
0030      11 CONTINUE
0031      READ(1,5007) ITWORK, IBLOW
0032      5007 FORMAT(15, A2)
0033      READ(1,5001) TLVC, TLVTWA, TLVSTL
0034      5005 FORMAT(1X, I5)
0035      5006 FORMAT(1X, 2F12.4)
          C
          C      TRANSFER OF DATA FROM TANKMI INPUT FILE
          C      IN PRETNK IS COMPLETE
          C

0036      ICT=1
0037      III=1
0038      MEVAP=0.0
0039      WIDTH=1.0
0040      PI=3.1415927
0041      TF = TM + TWORK
0042      IF (IBLOW.EQ. 1HN) TF=TM
          C
          C      PRELIMINARY CALCULATIONS
          C

0043      COVPPM = COV
0044      COV=COV*PA*298.15*M/(760.*(TABTEM(1)+273.15)*24.45)
0045      AREA=L*W
0046      V=AREA*D
0047      UO=G/((60.*PI*DIA**2)/4.)
0048      XHC = COVPPM / 1E6
0049      RHO = (XHC * M + (1 - XHC) * MAIR) / MAIR
0050      FROUDE = (UD * UO) / (9.8 * D * (RHO - 1))
0051      WRITE(5,12) FROUDE
0052      WRITE(6,12) FROUDE
0053      12 FORMAT(//, 1X, 'DENSIMETRIC FROUDE NO. = ', F8.3)
0054      IF (FROUDE .GT. 50.) GO TO 230
0055      WRITE(5,13)
0056      WRITE(6,13)
0057      13 FORMAT(//, 5X, 'DENSIMETRIC FROUDE NUMBER AT THE BEGINNING', /
1          5X, 'OF VENTILATION IS LESS THAN 50. THE BLOWER MAY NOT', /
2          5X, 'HAVE SUFFICIENT CAPACITY FOR THE VENTILATING JET', /
3          5X, 'TO PENETRATE THE VAPOR SPACE AND IMPINGE ON THE', /
4          5X, 'TANK BOTTOM. THE VAPOR CONCENTRATION IN THE ULLAGE', /
5          5X, 'SPACE MAY NOT BE WELL-MIXED AND HOMOGENEOUS THROUGHOUT', /
6          5X, 'THE DURATION OF GAS FREEING. SHORT-CIRCUITING OF THE', /
7          5X, 'BLOWER JET SHOULD BE ANTICIPATED. THE MODEL DOES NOT', /
8          5X, 'INCLUDE THIS CONDITION AND WILL PROCEED WITH THE', /
9          5X, 'WELL-MIXED ASSUMPTION. '//)
0058      GO TO 235

```

```
0059 230 CONTINUE
0060 WRITE(5, 14)
0061 WRITE(6, 14)
0062 14 FORMAT(/, 5X, 'DENSIMETRIC FROUDE NUMBER AT BEGINNING ', /
1 5X, 'OF VENTILATION IS GREATER THAN 50. BLOWER CAPACITY', /
2 5X, 'IS SUFFICIENT FOR THE VENTILATING JET TO PENETRATE', /
3 5X, 'THE VAPOR SPACE AND IMPINGE ON THE TANK BOTTOM ', /
4 5X, 'COMPLETE JET PENETRATION AND IMPINGEMENT ENSURES', /
5 5X, 'THAT THE VAPOR CONCENTRATION IN THE ULLAGE SPACE ', /
6 5X, 'IS HOMOGENOUS AND THAT THE WELL-MIXED MODELING', /
7 5X, 'ASSUMPTION IS VALID. FOR FURTHER DETAILS, CONSULT', /
8 /5X, 'REFERENCE 4 OF THE CONTRACT FINAL REPORT.', /)

0063 235 CONTINUE
0064 CON=1. 4*UO*DIA**1 12
0065 R1=0. 15*D
0066 K=CON/R1**(1. 12+1.)
0067 UWIND=((K*R1**2)/(2. *R2)+CON*(R2**-1. 12)/(1. -1. 12))*(1. -
1 (R1/R2)**(1. -1. 12))*PARAM
0068 KG=18 95*UWIND*(18. 016/M)**. 5
0069 KL=0. 33*(44. 011/M)**. 5
0070 ROCHEM=(C1+C2*TABTEM(1))*10**9
0071 GO TO (240, 245), JSWTC
0072 240 MINIT=COL*AREA*DELTA/100
C ONE-TIME OUTPUTS
0073 245 WRITE(6, 6000)TESTND
0074 WRITE(6, 6001)
0075 WRITE(6, 6012) HEVAL
0076 WRITE(6, 6002)G, AREA
0077 WRITE(6, 6003)L, W
0078 WRITE(6, 6004)D, V
0079 WRITE(6, 6005)DELTA, COL
0080 WRITE(6, 6006)S, M
0081 WRITE(6, 6013) ROCHEM, GAMINF
0082 WRITE(6, 6007)PA, UWIND
0083 WRITE(6, 6008)DIA, UO
0084 WRITE(6, 6009)KG, R1
0085 WRITE(6, 6010)R2, KL
0086 GO TO (246, 247), JSWTC
0087 246 WRITE(6, 6011)MINIT
0088 247 CONTINUE
C *****
0089 WRITE(6, 6014)TLVC, TLVTWA, TLVSTL
0090 6014 FORMAT(1X, 4HTLVC, 6X, 30HTHRESHOLD LIMIT VALUE, CEILING, 5X, 3HPPM,
1 7X, E15. 5, /, 1X, 6HTLVSTA, 4X, 22HTHRESHOLD LIMIT VALUE, /, /,
2 11X, 21HTIME-WEIGHTED AVERAGE, 14X, 3HPPM, 7X, E15. 5, /, 1X,
3 6HTLVSTL, 4X, 22HTHRESHOLD LIMIT VALUE, /, /, 11X,
4 25HSHORT-TERM EXPOSURE LIMIT, 10X, 3HPPM, 7X, E15. 5)
0091 IF (ITWORK EQ. 1) WRITE(6, 1) TWORK
0092 IF (ITWORK EQ. 2) WRITE(6, 2) TWORK
0093 IF (ITWORK EQ. 3) WRITE(6, 3) TWORK
0094 IF (ITWORK EQ. 4) WRITE(6, 4) TWORK
0095 IF (ITWORK EQ. 5) WRITE(6, 5) TWORK
0096 1 FORMAT(/, 1X, 42HTWORK1 - BRIEF VISUAL INSPECTION AND ODOR ,
1 13HDETERMINATION, /, 1X, 30HWITH CARGO SURVEYOR, TWORK = ,
2 F10. 4, 5H MIN )
```

```

0097   2   FORMAT(/,1X,43HTWORK2 - INSPECT TANK COATINGS AND MEASURE ,
1       10HTHICKNESS ,/,1X,9HTWORK = ,F10.4,5H MIN.)
0098   3   FORMAT(42HTWORK3 - HAND MUCKING RESIDUE WITH TOWELS ,/,1X,
1       9HAND RAGS,/,1X,
2       34H(RELATIVELY DIRTY TANK), TWORK = ,F10.4,5H MIN.)
0099   4   FORMAT(/,1X,48HTWORK4 - SWEEP DEBRIS FROM TANK BOTTOM AND WIPE ,
1       9HPUMP SUMP,
2       /,1X,34H(RELATIVELY CLEAN TANK), TWORK = ,F10.4,5H MIN.)
0100   5   FORMAT(/,1X,34HTWORK5 - USER SPECIFIES, TWORK = ,F10.4,5H MIN.)
0101   IF (IBLOW .EQ. 1HN) GO TO 24B
0102   WRITE(6,6)
0103   6   FORMAT(/,1X,41HBLOWER IS ON DURING MAN - ENTRY INTO TANK,/)
0104   GO TO 249
0105   24B WRITE(6,7)
0106   7   FORMAT(/,1X,42HBLOWER IS OFF DURING MAN - ENTRY INTO TANK,/)
0107   249 CONTINUE
C
C *****
C
C CALCULATE INITIAL VALUE OF PARTITION COEFFICIENT
C FOR AQUEOUS SOLUTION:
C HEVAL = 1; H IS CALCULATED USING ACTIVITY COEFFICIENTS
C HEVAL = 2; H IS CALCULATED FOR IDEAL, DILUTE SOLUTIONS
C
0108   GO TO (30,31),HEVAL
0109   30   WRITE(6,8000)
0110   GO TO 32
0111   31   WRITE(6,8002)
0112   32   TIME(III)=TI
0113   LINEKT=6
0114   CV=CDV
0115   CL=COL
0116   T=TABTEM(1)
0117   CVPPM(III)=CV*760. *(T+273.15)*24.45/(PA*298.15*M)
0118   PV=10. *(A-B/(C+T))
0119   GO TO (20,21),HEVAL
0120   20   X1=1. / (1. +(M/18. *0.9970*10**9)*(1. /CL-1. /ROCHEM))
0121   IF(X1-0.05)22,22,23
0122   23   GAMMA1=GAMINF**((1-X1)**2)
0123   GO TO 40
0124   22   GAMMA1=GAMINF
0125   40   H=18. *GAMMA1*(PV/760.)/(82.057*(T+273.15))
0126   GO TO 24
0127   21   H=16.04*PV*M/((T+273.15)*S)
0128   24   KOL=KL*KG*H/(H*KG+KL)
0129   MDOT(ICT)=KOL*AREA*(CL-CV/H)/100.
0130   GO TO (33,34),HEVAL
0131   33   WRITE(6,8001)TIME(III),CVPPM(III),CV,T,PV,H,CL,GAMMA1,KOL,
1       MDOT(ICT),MEVAP,X1
0132   LINEKT=LINEKT+3
0133   GO TO 250
0134   34   WRITE(6,8003)TIME(III),CVPPM(III),CV,T,PV,H,CL,KOL,MDOT(ICT),
1       MEVAP
0135   LINEKT=LINEKT+3
0136   250 CONTINUE
0137   FACTOR=0.0

```

```

0138      MEVAP=0.0
0139      KOUNT=0
0140      ICT=ICT+1
          C
          C ***** BEGIN INTEGRATION *****
          C
0141      CALL RUNGE(TIME(III),CV,CL,DT)
0142      III=III+1
0143      TIME(III)=TIME(III-1)+DT
0144      CV=CV+DELY
0145      CL=CL+DELZ
          C
0146      DO 301 I=1,NUMTAB
0147      IF(TABTIM(I).LE.TIME(III))GO TO 301
0148      G1=TABTIM(I-1)
0149      G2=TABTIM(I)
0150      G3=TABTEM(I-1)
0151      G4=TABTEM(I)
0152      GO TO 302
0153      301 CONTINUE
0154      302 CONTINUE
0155      T=(G4-G3)/(G2-G1)*TIME(III)+(G3*G2-G1*G4)/(G2-G1)
0156      CVPPM(III)=CV*760.*(T+273.15)*24.45/(PA*298.15*M)
0157      PV=10.**((A-B)/(C+T))
0158      ROCHEM=(C1+C2*T)*10**9
0159      GO TO (25,26),HEVAL
0160      25 X1=1./(1+(M/18.*0.997*10**9))*(1./CL-1./ROCHEM)
0161      IF(X1-0.05)27,27,28
0162      28 GAMMA1=GAMINF**((1-X1)**2)
0163      GO TO 41
0164      27 GAMMA1=GAMINF
0165      41 H=18.*GAMMA1*(PV/760.)/(82.057*(T+273.15))
0166      GO TO 29
0167      26 H=16.04*PV*M/((T+273.15)*S)
0168      29 KOL=KL*KG*H/(H*KG+KL)
0169      MDOT(ICT)=KOL*AREA*(CL-CV/H)/100.
0170      460 IF(KOUNT.EQ.ICT)GO TO 475
0171      KOUNT=KOUNT+1
0172      IF((KOUNT.NE.ICT).AND.(KOUNT.NE.1))FACTOR=1.0
0173      MEVAP=MEVAP+MDOT(KOUNT)*(FACTOR+1.0)
0174      FACTOR=0.0
0175      GO TO 460
0176      475 MEVAP=MEVAP*WIDTH/2.
0177      IF(HEVAL.EQ.2)GO TO 36
          C
          C      HENRY'S CONSTANT = MACKAY
          C
0178      IF(LINEKT.LT.56)GO TO 35
0179      WRITE(6,8000)
0180      LINEKT=6
0181      35 WRITE(6,8001)TIME(III),CVPPM(III),CV,T,PV,H,CL,GAMMA1,KOL,
          1      MDOT(ICT),MEVAP,X1
0182      LINEKT=LINEKT+3
0183      GO TO 42
0184      36 CONTINUE

```

```

C
C      HENRY'S CONSTANT = DILLING
C
0185      IF(LINEKT.LT.56)GO TO 37
0186      WRITE(6,8002)
0187      LINEKT = 6
0188      37  WRITE(6,8003)TIME(III), CVPPM(III), CV, T, PV, H, CL, KOL, MDOT(ICT),
           1MEVAP
0189      LINEKT=LINEKT+3
0190      42  GO TO (276,480), JSWTC
0191      276 IF(MEVAP-MINIT)480,600,600
0192      480 IF(TIME(III)-TF) 250,700,700
0193      600 TAU=TIME(III)
0194      CTAU=CV
0195      TTD=ABS(V/Q)
0196      PV=0.0
0197      H=0.0
0198      KOL=0.0
0199      CL=0.0
0200      MDOT(ICT)=0.0
0201      605 III=III+1
0202      TIME(III)=TIME(III-1)+DT
0203      IF(TIME(III) GT (TAU+5 *TTD))GO TO 700
0204      CV=CTAU*EXP(-(Q/V)*(TIME(III)-TAU))
0205      DO 610 I=1,NUMTAB
0206      IF(TABTIM(I).LE.TIME(III)) GO TO 610
0207      G1=TABTIM(I-1)
0208      G2=TABTIM(I)
0209      G3=TABTEM(I-1)
0210      G4=TABTEM(I)
0211      GO TO 620
0212      610 CONTINUE
0213      620 CONTINUE
0214      T=(G4-G3)/(G2-G1)*TIME(III)+(G3*G2-G1*G4)/(G2-G1)
0215      CVPPM(III)=CV*760. *(T+273.15)*24.45/(PA*298.15*M)
0216      IF(HEVAL.EQ.2)GO TO 39
C
C      HENRY'S CONSTANT = MACKAY
C
0217      IF(LINEKT.LT.56)GO TO 38
0218      WRITE(6,8000)
0219      LINEKT=6
0220      38  WRITE(6,8001)TIME(III), CVPPM(III), CV, T, PV, H, CL, GAMMA1, KOL,
           1      MDOT(ICT), MEVAP, X1
0221      LINEKT=LINEKT+3
0222      GO TO 44
0223      39  CONTINUE
C
C      HENRY'S CONSTANT = DILLING
C
0224      IF(LINEKT.LT.56)GO TO 43
0225      WRITE(6,8002)
0226      LINEKT=6
0227      43  WRITE(6,8003)TIME(III), CVPPM(III), CV, T, PV, H, CL, KOL,
           1      MDOT(ICT), MEVAP

```



```

0228         LINEKT=LINEKT+3
0229     44     GO TO 605
0230     5000  FORMAT(I5)
0231     5001  FORMAT(5E12.5)
0232     5003  FORMAT(2I3)
0233     5004  FORMAT(7F8.3)
0234     6000  FORMAT(23X,'***** TEST NO. ',I3,' *****',/)
0235     6001  FORMAT(27X,16HONE-TIME OUTPUTS,/,1X,8HVARIBLE,2X,
           1 11HDESCRIPTION,24X,5HUNITS,10X,6HRESULT,/)
0236     6002  FORMAT(1X,1HG,9X,16HBLOWER FLOW RATE,19X,6HM3/MIN,4X,E15.5,/,
           1 1X,4HAREA,6X,19HLIQUID SURFACE AREA,16X,2HM2,8X,E15.5)
0237     6003  FORMAT(1X,1HL,9X,11HTANK LENGTH,24X,5HMETER,5X,E15.5,/,
           1 1X,1HW,9X,10HTANK WIDTH,25X,5HMETER,5X,E15.5)
0238     6004  FORMAT(1X,1HD,9X,10HTANK DEPTH,25X,5HMETER,5X,E15.5,/,
           1 1X,1HV,9X,11HTANK VOLUME,24X,2HM3,8X,E15.5)
0239     6005  FORMAT(1X,5HDELTA,5X,17HRESIDUE THICKNESS,18X,2HCM,8X,E15.5,/,
           1 1X,3HCOL,7X,28HINITIAL SOLUTE CONCENTRATION,7X,5HMG/M3,5X,
           2 E15.5)
0240     6006  FORMAT(1X,1HS,9X,17HSOLUTE SOLUBILITY,18X,8HMG/LITER,2X,E15.5,/,
           1 1X,1HM,9X,23HSOLUTE MOLECULAR WEIGHT,12X,7HGM/MOLE,3X,E15.5)
0241     6007  FORMAT(1X,2HPA,8X,20HATMOSPHERIC PRESSURE,15X,5HMM HG,5X,E15.5,/,
           1 1X,5HWIND,5X,26HCONVECTIVE EVAPORATION VEL,9X,5HM/SEC,5X,
           2 E15.5)
0242     6008  FORMAT(1X,3HDIA,7X,19HDIA OF B/W OPENING,16X,5HMETER,5X,
           1 E15.5,/,1X,2HVD,8X,19HBLOWER JET VELOCITY,16X,5HM/SEC,5X,
           2 E15.5)
0243     6009  FORMAT(1X,2HKG,8X,29HGAS PHASE MASS TRANSFER COEFF,6X,6HCM/MIN,
           1 4X,E15.5,/,1X,2HR1,8X,28HJET DEFLECTION REGION (0.3D),7X,
           2 5HMETER,5X,E15.5)
0244     6010  FORMAT(1X,2HR2,8X,24HJET DEFL + WALL JET DIST,11X,5HMETER,5X,
           1 E15.5,/,1X,2HKL,8X,32HLIQUID PHASE MASS TRANSFER COEFF,3X,
           2 6HCM/MIN,4X,E15.5)
0245     6011  FORMAT(1X,5HMINIT,5X,33HINITIAL CHEMICAL MASS IN SOLUTION,2X,
           1 2HMG,8X,E15.5,/)
0246     6012  FORMAT(1X,5HHEVAL,5X,26H=1, H(MACKAY), =2, H(DILLING), 9X, 6H*****
           1 , 9X, 4H****, I1, 4H****, /)
0247     6013  FORMAT(1X,6HROCHEM,4X,20HCHEM. LIQUID DENSITY,15X,5HMG/M3,5X,
           1E15.5,/,1X,6HGAMINF,4X,26HINF. DILUT. ACTIVITY COEF.,9X,7H**
           2****,3X,E15.5,/)
0248     8000  FORMAT('1',//4X,'TIME(MIN) CV(PPM)',5X,'CV(MG/M3)',4X,'TEMP(C)',
           2 3X,'PV(MM-HG)',7X,'H',13X,'CL(MG/M3)',/,20X,'GAMMA1',7X,
           3 'KOL(CM/MIN)',4X,'MDOT(MG/MIN)',2X,'MEVAP(MG)',4X,'X1(LIG.
           4 MOL. FRACTION)',/)
0249     8001  FORMAT(1H,6E12.4,3X,E12.4,/,17X,E12.4,2X,E12.4,4X,E12.4,2X
           1 E12.4,7X,E12.4,/)
0250     8002  FORMAT('1',//4X,'TIME(MIN) CV(PPM)',5X,'CV(MG/M3)',4X,'TEMP(C)',
           2 3X,'PV(MM-HG)',7X,'H',11X,'CL(MG/M3)',/,33X,
           3 'KOL(CM/MIN)',4X,'MDOT(MG/MIN)',2X,'MEVAP(MG)',/)
0251     8003  FORMAT(1H,6E12.4,3X,E12.4,/,30X,E12.4,4X,E12.4,2X,E12.4,/)
0252     700    CONTINUE
0253         CALL BLOW(IBLOW, TF, TM, TWORK, CVP, TLVC, TLVSTL, TLVTWA,
           1 DT, TIME, CEXP, TI)
0254         III=(TF-TI)/DT+1
C
C     WRITE DATA TO UNIT 3 FOR PLOTTING

```

```
      C
0255      WRITE(3,*) III, NUMEXP, TESTNO, TLVC, TLVTWA, TLVSTL
0256      DO 800 I = 1, III
0257          WRITE(3,*) TIME(I), CVPPM(I)
0258      800 CONTINUE
0259      IF (NUMEXP .EQ. 0) GO TO 900
0260          DO 850 I = 1, NUMEXP
0261              WRITE(3,*) ETIME(I), ECVPPM(I)
0262      850 CONTINUE
0263      900 CONTINUE
0264      STOP
0265      END
```

```

C *****
0001 C FUNCTION EVAL(X, Y, Z, IKL)
C
0002 C COMMON /FUNC/G, V, KOL, AREA, COL, T, H, DELTA, PA, M, A, B, C, PV,
1 S, KL, KG, NUMTAB, HEVAL, GAMINF, C1, C2
0003 C COMMON /RK/ DELY, DELZ, CVPPM, TABTIM, TABTEM, III
0004 C DIMENSION TABTIM(14), TABTEM(14), CVPPM(500)
0005 C INTEGER HEVAL
0006 C REAL KOL, M, MDOT, KG, KL, PV
C
C IKL = 1 FOR CV DIFF EQUATION
C = 2 FOR CL DIFF EQUATION
C TEMPERATURE CALCULATION AT TIME=X
C
0007 C DO 501 I=1, NUMTAB
0008 C IF(TABTIM(I).LE.X)GO TO 501
0009 C G1=TABTIM(I-1)
0010 C G2=TABTIM(I)
0011 C G3=TABTEM(I-1)
0012 C G4=TABTEM(I)
0013 C GO TO 502
0014 C 501 CONTINUE
0015 C 502 CONTINUE
0016 C T=(G4-G3)/(G2-G1)*X+(G3*G2-G1*G4)/(G2-G1)
C
C END OF TEMPERATURE CALCULATION
C
0017 C CVPPM(III+1)=Y*760. *(T+273. 15)*24. 45/(PA*298. 15*M)
0018 C ROCHEM=(C1+C2*T)*10**9
0019 C PV=10. *(A-B/(C+T))
0020 C GO TO (43, 44), HEVAL
0021 C 43 X1=1. /(1. +(M/18. *0. 997*10**9))*(1. /Z-1. /ROCHEM)
0022 C IF(X1-0. 05)45, 45, 46
0023 C 46 GAMMA1=GAMINF**((1-X1)**2)
0024 C GO TO 47
0025 C GAMMA1=GAMINF
0026 C 47 H=18. *GAMMA1*(PV/760. )/(82. 057*(T+273. 15))
0027 C GO TO 48
0028 C 44 H=16. 04*PV*M/((T+273. 15)*S)
0029 C 48 KOL=KL*KG*H/(H*KG+KL)
0030 C A1=-Q*Y
0031 C A2=KOL*AREA*(Z-Y/H)/100.
0032 C IF(IKL EQ 2)GO TO 570
0033 C EVAL=(A1+A2)/V
0034 C GO TO 600
0035 C 570 EVAL=-KOL*(Z-Y/H)/DELTA
0036 C 600 END

```

```

C *****
0001 SUBROUTINE RUNGE(X, Y, Z, DT)
C
0002 COMMON /FUNC/G, V, KOL, AREA, COL, T, H, DELTA, PA, M, A, B, C, PV,
1      S, KL, KG, NUMTAB, HEVAL, GAMINF, C1, C2
0003 COMMON /RK/DELY, DELZ, CVPPM, TABTIM, TABTEM, III
0004 DIMENSION CVPPM(500)
0005 REAL K1, K2, K3, K4, L1, L2, L3, L4, M, KOL, MDOT, KG, KL, PV
C
0006 K1=EVAL(X, Y, Z, 1)*DT
0007 L1=EVAL(X, Y, Z, 2)*DT
0008 K2=EVAL(X+DT/2, Y+K1/2, Z+L1/2, 1)*DT
0009 L2=EVAL(X+DT/2, Y+K1/2, Z+L1/2, 2)*DT
0010 K3=EVAL(X+DT/2, Y+K2/2, Z+L2/2, 1)*DT
0011 L3=EVAL(X+DT/2, Y+K2/2, Z+L2/2, 2)*DT
0012 K4=EVAL(X+DT, Y+K3, Z+L3, 1)*DT
0013 L4=EVAL(X+DT, Y+K3, Z+L3, 2)*DT
0014 DELY=(K1+2.*K2+2.*K3+K4)*1./6.
0015 DELZ=(L1+2.*L2+2.*L3+L4)*1./6.
0016 END
```

```
0001      SUBROUTINE BLOW(IBLOW, TF, TM, TWORK, CVPPM, TLVC, TLVSTL,  
1          TLVTWA, DT, TIME, CEXP, TI)  
C  
0002      DIMENSION CVPPM(1), TIME(1), CEXP(1), ISAVE(500)  
0003      DOUBLE PRECISION WHICH(2)  
C  
0004      IF (IBLOW.EQ.1HN)TF=TF+TM  
0005      WRITE(6,1) TM, TF  
0006      1  FORMAT(1H1,///,14X,35HEVALUATION OF VAPOR CONCENTRATIONS ,  
1          16HDURING MAN-ENTRY,///,23X,26HTANK IS ENTERED AT TIME = ,  
2          F5 1,4H MIN,/,23X,25HTANK IS EXITED AT TIME = ,F8 1,  
3          4H MIN.//)  
0007      WHICH(1) = BHTLV-C  
0008      WHICH(2) = BHTLV-STEL  
0009      IND = 1  
0010      IF (TLVC EQ. 0) IND = 2  
0011      INDEX = (TM - TI) / DT + 1  
0012      IFLAG = 0  
0013      TCHECK = TLVC  
0014      IF (TLVC .EQ. 0 ) TCHECK = TLVSTL  
0015      KT = 0  
0016      NUMVAL = (TF - TM) / DT + 1  
0017      ITOTAL = (TF - TI) / DT + 1  
0018      IF (IBLOW.EQ.1HY)GO TO 75  
0019      DO 50 I=INDEX+1,ITOTAL  
0020      CVPPM(I)=CVPPM(I-1)  
0021      TIME(I)=TIME(I-1)+DT  
0022      50  CONTINUE  
0023      75  CONTINUE  
0024      DO 100 I = 1, NUMVAL  
0025      J = ITOTAL - (NUMVAL - I )  
0026      IF (CVPPM(J) .LE. TCHECK) GO TO 100  
0027      KT = KT + 1  
0028      ISAVE(KT) = J  
0029      IFLAG = 1  
0030      100 CONTINUE  
0031      IF (IBLOW EQ. 1HN) GO TO 200  
C  
C  
C          BLOWER ON DURING ENTRY OF MAN INTO TANK  
C  
C  
C  
0032      IF (IFLAG .EQ. 0) GO TO 175  
C  
C          VAPOR CONCENTRATIONS EXCEEDED CEILING OR SHORT-TERM  
C          EXPOSURE LIMITS  
C  
0033      WRITE(6,2) WHICH(IND)  
0034      2  FORMAT(///1X,10HPREDICTED ,  
1          38HINSTANTANEOUS EXPOSURE CONCENTRATIONS ,  
2          11HEXCEED THE ,A8,///,5X,10HTIME (MIN),5X,  
3          19HCNTRATION (PPM),/)  
0035      WRITE(6,3) (TIME(ISAVE(J)), CVPPM(ISAVE(J)), J=1, KT)
```

```
0036      3      FORMAT(6X,F7.2,11X,F7.1,12X,28HHAZARDOUS WORKING CONDITIONS)
0037      CALL QSF(DT,CVPPM(INDEX),CEXP,NUMVAL)
0038      EXPOS = CEXP(NUMVAL) / TWORK
0039      WRITE(6,4) EXPOS
0040      4      FORMAT(/,1X,10HPREDICTED ,
                1      40HAVERAGE IN-TANK EXPOSURE AS MEASURED BY ,
                2      14HA DOSIMETER = ,F9.2,4H PPM,/)
0041      IF (EXPOS .LE. TCHECK) GO TO 125
0042      WRITE(6,5) WHICH(IND), WHICH(IND)
0043      5      FORMAT(1X,41HDOSIMETER MONITORING WOULD INDICATE THAT ,/,
                1      1X,41HTHE AVERAGE IN-TANK EXPOSURE EXCEEDS THE ,/,
                2      1X,AB,40H FOR THIS CHEMICAL VAPOR AND A HAZARDOUS,/,
                3      1X,42HWORKING CONDITION EXISTS. REDUCE EXPOSURE,/,
                4      1X,6HBELOW ,AB,17H BEFORE ASSESSING,
                5      18H THE TWA EXPOSURE. ,/)
0044      GO TO 600.
0045      125     CONTINUE
0046      WRITE(6,6) WHICH(IND)
0047      6      FORMAT(1X,44HDOSIMETER MONITORING WOULD INDICATE THAT THE,/,
                1      1X,42HAVERAGE IN-TANK EXPOSURE IS ACCEPTABLE AND,/,
                2      1X,20HDOES NOT EXCEED THE ,AB,18H FOR THIS CHEMICAL,
                3      1X,6HVAPOR. )
0048      WRITE(6,7)
0049      7      FORMAT(1X,40HHOWEVER, INSTANTANEOUS CONCENTRATIONS DO,/,
                1      1X,44HEXCEED THESE LIMITS. REAL TIME MEASUREMENTS ,
                2      /,1X,40HOF VAPOR CONCENTRATION MAY BE INDICATED. )
0050      CTWA = (EXPOS * TWORK) / 480.
0051      WRITE(6,8) CTWA
0052      8      FORMAT(/,1X,10HPREDICTED ,
                1      41HEIGHT-HOUR TIME WEIGHTED AVERAGE EXPOSURE,
                2      3H = ,F6.2,4H PPM,/)
0053      IF (CTWA .LT. TLVTWA) GO TO 150
0054      WRITE(6,9)
0055      9      FORMAT(1X,10HPREDICTED ,
                1      41HEIGHT-HOUR TIME WEIGHTED AVERAGE EXPOSURE,/,
                2      1X,42HEXCEEDS THE TLV-TWA. HAZARDOUS CONDITIONS,/,
                3      1X,10HMAY EXIST. )
0056      GO TO 600
0057      150     WRITE(6,10)
0058      10     FORMAT(1X,39HMONITORING WOULD ALSO INDICATE THAT THE,/,
                1      1X,42HEXPOSURE IS ACCEPTABLE WITH RESPECT TO THE,/,
                2      1X,8HTLV-TWA. )
0059      GO TO 600
C
C      ALL CONCENTRATIONS WERE BELOW CEILING SHORT-TERM
C      EXPOSURE LIMITS
C
0060      175     CONTINUE
0061      CALL QSF(DT,CVPPM(INDEX),CEXP,NUMVAL)
0062      EXPOS = CEXP(NUMVAL) / TWORK
0063      CTWA = (EXPOS * TWORK) / 480.
0064      WRITE(6,11) EXPOS, CTWA
0065      11     FORMAT(/,1X,10HPREDICTED ,
                1      37HAVERAGE EXPOSURE DURING TANK ENTRY = ,F9.2,
                2      4H PPM,/,
```

```

      3      1X,44HEIGHT-HOUR TIME WEIGHTED AVERAGE EXPOSURE = ,
      4      F9.2,4H PPM/)
0066      IF (CTWA .LT. TLVTWA) GO TO 180
0067      WRITE(6,12) WHICH(IND)
0068      12      FORMAT(1X,10HPREDICTED ,
      1          40HEIGHT-HOUR TWA EXPOSURE EXCEEDS TLV-TWA ,
      2          33H HAZARDOUS CONDITIONS MAY EXIST. ,/,
      3          35HSINGLE EXPOSURE DOES NOT EXCEED THE ,AB,/)
0069      GO TO 600
0070      180      CONTINUE
0071      WRITE(6,13)
0072      13      FORMAT(1X,10HPREDICTED ,
      1          45HSINGLE EXPOSURE IS ACCEPTABLE WITH RESPECT TO,
      2          29H TLV-C, TLV-STEL, AND TLV-TWA)
0073      GO TO 600
(
CCCCCCCCCCCCCCCCCCCCCCCCCCCCCCCCCCCCCCCCCCCCCCCCCCCCCCCCCCCC
C
C      BLOWER NOT ON DURING ENTRY OF MAN
C
CCCCCCCCCCCCCCCCCCCCCCCCCCCCCCCCCCCCCCCCCCCCCCCCCCCCCCCCCCCC
C
0074      200      CONTINUE
0075      IF (CVPPM(INDEX) .GE. TCHECK) GO TO 400
0076      CTWA = (CVPPM(INDEX) * TWORK) / 480.
0077      WRITE(6,11) CVPPM(INDEX), CTWA
0078      IF (CTWA .LT. TLVTWA) GO TO 300
0079      WRITE(6,12) WHICH(IND)
0080      GO TO 600
0081      300      CONTINUE
0082      WRITE(6,13)
0083      GO TO 600
0084      400      CONTINUE
0085      WRITE(6,2) WHICH(IND)
0086      WRITE(6,3) (TIME(ISAVE(J)), CVPPM(ISAVE(J)), J=1, KT)
0087      WRITE(6,4) CVPPM(INDEX)
0088      WRITE(6,5) WHICH(IND), WHICH(IND)
0089      600      CONTINUE
0090      RETURN
0091      END
```

```

0001      SUBROUTINE QSF(H, Y, Z, NDIM)
C
C
CCCCCCCCCCCCCCCCCCCCCCCCCCCCCCCCCCCCCCCCCCCCCCCCCCCCCCCCCCCC
C
C      PURPOSE
C      TO COMPUTE THE VECTOR OF INTEGRAL VALUES FOR A GIVEN
C      EQUIDISTANT TABLE OF FUNCTION VALUES.
C
C      DESCRIPTION OF PARAMETERS
C      H          - THE INCREMENT OF ARGUMENT VALUES.
C      Y          - THE INPUT VECTOR OF FUNCTION VALUES.
C      Z          - THE RESULTING VECTOR OF INTEGRAL VALUES.  Z
C                  MAY BE IDENTICAL WITH Y.
C      NDIM       - THE DIMENSION OF VECTORS Y AND Z.
C
C      REMARKS
C      NO ACTION IN CASE NDIM LESS THAN 3.
C
C      SUBROUTINES AND FUNCTION SUBPROGRAMS REQUIRED
C      NONE
C
C      METHOD
C      BEGINNING WITH Z(1) = 0, EVALUATION OF VECTOR Z IS DONE BY
C      MEANS OF SIMPSON'S RULE TOGETHER WITH NEWTONS 3/8 RULE OR A
C      COMBINATION OF THESE TWO RULES. TRUNCATION ERROR IS OF
C      ORDER H**5 (I.E. FOURTH ORDER METHOD). ONLY IN CASE NDIM=3
C      TRUNCATION ERROR OF Z(2) IS OF ORDER H**4.
C      FOR REFERENCE, SEE
C      (1) F.B.HILDEBRANK, INTRODUCTION TO NUMERICAL ANALYSIS,
C          MCGRAW-HILL, NEW YORK/TORONTO/LONDON, 1956, PP. 71-76.
C      (2) R.ZURHUEHL, PRAKTISCHE MATEMATIK FUER INGENIEURE UND
C          PHYSIKER, SPRINGER, BERLIN/GOETTINGEN/HEIDELBERG, 1963,
C          PP. 214-221.
C
CCCCCCCCCCCCCCCCCCCCCCCCCCCCCCCCCCCCCCCCCCCCCCCCCCCCCCCCCCCC
C
0002      DIMENSION Y(1), Z(1)
C
0003      HT = .3333333 * H
0004      IF (NDIM-5) 7, 8, 1
C
C      NDIM IS GREATER THAN 5. PREPARATIONS OF INTEGRATION LOOP
C
0005      1      SUM1 = Y(2) + Y(2)
0006      SUM1 = SUM1 + SUM1
0007      SUM1 = HT * (Y(1) + SUM1 + Y(3))
0008      AUX1 = Y(4) + Y(4)
0009      AUX1 = AUX1 + AUX1
0010      AUX1 = SUM1 + HT * (Y(3) + AUX1 + Y(5))
0011      AUX2 = HT*(Y(1) + 3.875 * (Y(2)+Y(5)) + 2.625*(Y(3)+Y(4))+Y(6))
0012      SUM2 = Y(5) + Y(5)
0013      SUM2 = SUM2 + SUM2
0014      SUM2 = AUX2 - HT * (Y(4) + SUM2 + Y(6))
0015      Z(1) = 0.
0016      AUX = Y(3) + Y(3)

```



```

0017      AUX = AUX + AUX
0018      Z(2) = SUM2 - HT * (Y(2) + AUX + Y(4))
0019      Z(3) = SUM1
0020      Z(4) = SUM2
0021      IF (NDIM-6) 5, 5, 2

      C
      C      INTEGRATION LOOP
      C
0022      2      DO 4 I = 7, NDIM, 2
0023              SUM1 = AUX1
0024              SUM2 = AUX2
0025              AUX1 = Y(I-1) + Y(I-1)
0026              AUX1 = AUX1 + AUX1
0027              AUX1 = SUM1 + HT * (Y(I-2) + AUX1 + Y(I))
0028              Z(I-2) = SUM1
0029              IF (I-NDIM) 3, 6, 6
0030              3      AUX2 = Y(I) + Y(I)
0031              AUX2 = AUX2 + AUX2
0032              AUX2 = SUM2 + HT * (Y(I-1) + AUX2 + Y(I+1))
0033              Z(I-1) = SUM2
0034              4      CONTINUE
0035              5      Z(NDIM-1) = AUX1
0036              Z(NDIM) = AUX2
0037              RETURN
0038              6      Z(NDIM-1) = SUM2
0039              Z(NDIM) = AUX1
0040              RETURN

      C
      C      END OF INTEGRATION LOOP
      C
0041      7      IF (NDIM-3) 12, 11, 8
      C
      C      NDIM IS EQUAL TO 4 OR 5
      C
0042      8      SUM2 = 1.125 * HT * (Y(1)+Y(2)+Y(2)+Y(2)+Y(3)+Y(3)+Y(3)+Y(4))
0043      SUM1 = Y(2) + Y(2)
0044      SUM1 = SUM1 + SUM1
0045      SUM1 = HT * (Y(1) + SUM1 + Y(3))
0046      Z(1) = 0.
0047      AUX1 = Y(3) + Y(3)
0048      AUX1 = AUX1 + AUX1
0049      Z(2) = SUM2 - HT * (Y(2) + AUX1 + Y(4))
0050      IF (NDIM-5) 10, 9, 9
0051      9      AUX1 = Y(4) + Y(4)
0052      AUX1 = AUX1 + AUX1
0053      Z(5) = SUM1 + HT * (Y(3) + AUX1 + Y(5))
0054      10     Z(3) = SUM1
0055           Z(4) = SUM2
0056           RETURN

      C
      C      NDIM IS EQUAL TO 3
      C
0057      11     SUM1 = HT * (1.25 * Y(1) + Y(2) + Y(2) - .25 * Y(3))
0058           SUM2 = Y(2) + Y(2)
0059           SUM2 = SUM2 + SUM2

```

```
0060          Z(3) = HT * (Y(1) + SUM2 + Y(3))
0061          Z(1) = 0.
0062          Z(2) = SUM1
0063      12      CONTINUE
0064          RETURN
0065          END
```

TANKP

REVERSE PAGE

A-40

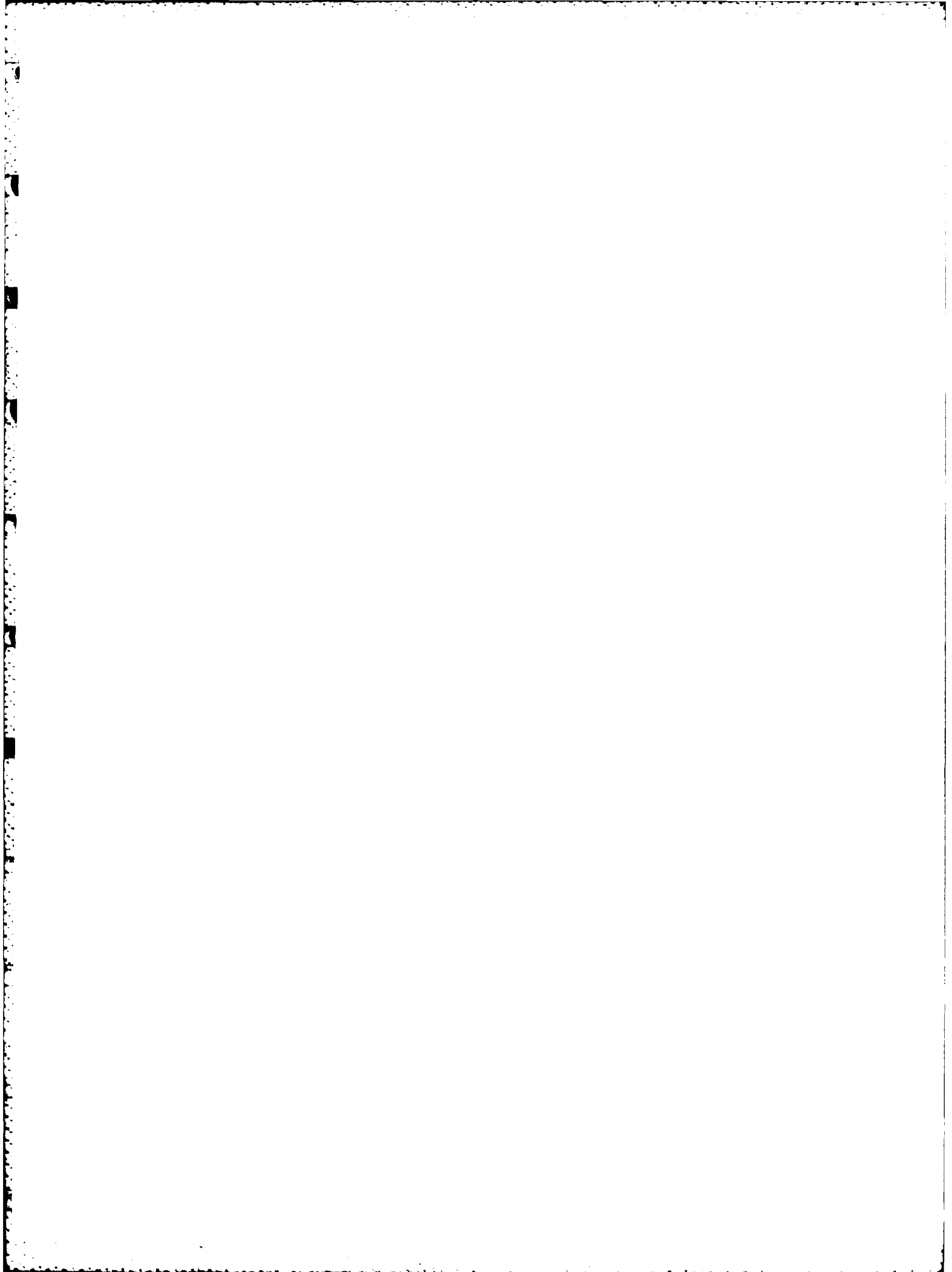

AD-A128 768

HAZARDOUS CHEMICAL VAPOR HANDBOOK FOR MARINE TANK
VESSELS(U) SOUTHWEST RESEARCH INST SAN ANTONIO TX
W J ASTLEFORD ET AL. OCT 83 USCG-D-12-83

3/3

UNCLASSIFIED

DOT-CG-904571-A

F/G 9/2

NL

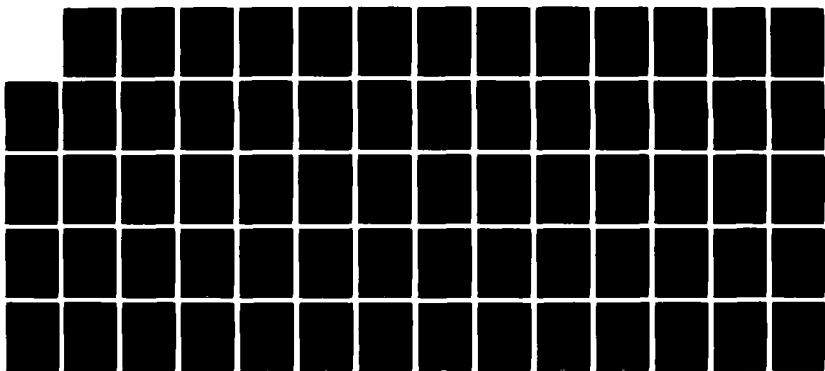

END
DATE
FILMED
7-84
DTIC

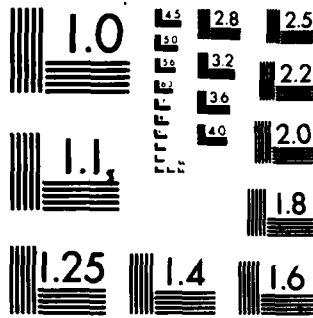

MICROCOPY RESOLUTION TEST CHART
NATIONAL BUREAU OF STANDARDS 1963 A

```

0001      PROGRAM TANKP
0002      REAL NU,MDOTB,M,MDOTHL,MDOTHW,MDOTG,MDOTXY,MDOTZY,MDOTXZ,L,K1
0003      REAL MAIR
0004      INTEGER TESTNO
0005      DIMENSION MDOTXY(275),MDOTZY(275),TAUXY(275),TAUZY(275),MDOTG(275)
          *,MDOTHL(275),MDOTHW(275),TIME(275),C(275),MDOTB(275),CONC(275)
0006      DIMENSION ETIME(30),ECVPPM(30),AR(4),CVPPM(275),CEXP(275)
0007      DOUBLE PRECISION IILX(5),IILY(5),IED(13)
0008      DATA PARAM /0.33107/
0009      DATA MAIR /28.97/
0010      OPEN (UNIT=1,NAME='SYO:TANKPI.DAT',TYPE='OLD')
0011      OPEN (UNIT=2,NAME='SYO:TANKPO.DAT',TYPE='NEW')
0012      OPEN (UNIT=3,NAME='SYO:SCRATCH.DAT',TYPE='NEW')
C
C      PROGRAM TANKP CALCULATES THE CONCENTRATION-TIME HISTORY OF CHEMICAL
C      VAPOR DISCHARGED FROM A TANK DURING DILUTION VENTILATION IN THE
C      PRESENCE OF EVAPORATION OF PURE CHEMICAL RESIDUES FROM THE TANK
C      WALLS AND FLOOR.
C      INPUT QUANTITIES AND DIMENSIONS
C      CO = INITIAL CONCENTRATION,PPM
C      L,W,H =LENGTH,WIDTH AND HEIGHT OF TANK IN METERS IN THE X,Y AND Z
C      DIRECTIONS, RESPECTIVELY
C      G = DILUTION FLOW RATE,M3/MIN
C      M = LIQUID MOLECULAR WEIGHT,GM/MOLE
C      P = MEAN TANK PRESSURE,MM HG
C      TB = LIQUID BOILING TEMPERATURE,K
C      Q = LIQUID SURFACE TENSION,DYNES/CM AT 20C
C      DIA = DIAMETER OF BUTTERWORTH OPENING,M
C      R = UNIVERSAL GAS CONSTANT,(CM3-MM HG)/(MOLE-K)
C      A,B,CEE = CURVE FIT COEFFICIENTS FOR LIQUID VAPOR PRESSURE AS A
C      FUNCTION OF TEMP. LOG10(PV)=A-B/(CEE+T), PV IN MM HG, T IN
C      DEG C
C      ALPHA,BETA,GAMMA = CURVE FIT COEFFICIENTS ON WALL TEMP FOR WALLS
C      PARALLEL TO X-Y PLANE
C      TWALL(K)=ALPHA+BETA(Y)+GAMMA(Y2), Y IN M
C      ZETA,ETA,THETA = CURVE FIT COEFFICIENTS ON WALL TEMP FOR WALLS
C      PARALLEL TO Y-Z PLANE
C      TWALL(K)=ZETA+ETA(Y)+THETA(Y2), Y IN M
C      TFILM = LIQUID CHEMICAL FILM THICKNESS ON VERTICAL WALLS, CM
C      TPOOL = THICKNESS OF LIQUID LAYER ON TANK BOTTOM, CM
C      TEMPERATURE AT TANK BOTTOM MUST BE EQUAL FOR BOTH TWALL DISTRIB.
C      C1,C2 = CURVE FIT COEFFICIENTS ON LIQUID DENSITY AS A FUNCTION OF
C      OF TEMP. RHOFILM(LB/FT3)=C1+C2(T), T(F)
C      DELTA,EPSILN,PHI = CURVE FIT COEFFICIENTS FOR KINEMATIC VISCOSITY
C      OF AIR(FT2/SEC) AS A FUNCTION OF TEMP(F) AT ATMOS. PRESS.
C      NU = DELTA +EPSILN(T)+PHI(T2)
C      TI = INITIAL TIME, MIN.
C      DTIME =TIME INCREMENT BETWEEN SUCCESSIVE CONCENTRATION CALCS,MIN
C      STEP = NUMBER OF SUBDIVISIONS OF H, DY=H/STEP
C      NSTEP = INTEGER VALUE OF STEP
C      TGOAS = GAS DISCHARGE TEMPERATURE(K)
C      NUMEXP = NUMBER OF EXPERIMENTAL POINTS
C      ETIME(I) = TIME AT WHICH EXPERIMENTAL CONCENTRATION OF
C      CHEMICAL VAPOR, ECVPPM(I), WAS TAKEN, MIN
C      ECVPPM(I) = EXPERIMENTAL CONCENTRATION OF CHEMICAL VAPOR
C      TM = DURATION OF TIME ELAPSED BEFORE MAN ENTERS
    
```

```
C          TANK, MIN
C      TWORK      = LENGTH OF TIME MAN IS IN TANK, IN MIN.
C      ITWORK     = 1. BRIEF VISUAL INSPECTION AND ODOR DETERMINATION
C                   WITH CAROD SURVEYOR.
C                   TWORK = 1 - 2 MIN.
C                   2. INSPECT TANK COATINGS AND MEASURE THICKNESS
C                   TWORK = 15 - 45 MIN.
C                   3. HAND MUCKING OF RESIDUE WITH TOWELS AND RAGS
C                   (RELATIVELY DIRTY TANK)
C                   TWORK = 90 MIN.
C                   4. SWEEP DEBRIS FROM TANK BOTTOM AND WIPE PUMP
C                   SUMP (RELATIVELY CLEAN TANK)
C                   TWORK = 40 MIN.
C                   5. USER SPECIFIES TWORK
C      IBLOW      = Y : BLOWER ON WHILE MAN IN TANK
C                   N : BLOWER OFF WHILE MAN IN TANK
C      R2 = JET DEFL. + WALL JET DIST., M
C      TLVWA = TIME WEIGHTED AVERAGE 8-HOUR EXPOSURE LIMIT, PPM
C      TLVSTL = SHORT TERM EXPOSURE LIMIT, PPM
C      TLVC   = CEILING EXPOSURE LIMIT
C
C                   INTERNAL COMMENTS
C      MDOTXY(I) = LOCAL MASS FLUX ON SURFACES PARALLEL TO X-Y
C                   PLANE, GM/CM2-SEC
C      MDOTZY(I) = LOCAL MASS FLUX ON SURFACES PARALLEL TO Y-Z
C                   PLANE, GM/CM2-SEC
C      MDOTXZ = TOTAL MASS FLUX ON TANK BOTTOM, GM/CM2-SEC
C      TAUXY(I) = LOCAL TIME TO EVAPORATE TFILM ON SURFACES PARALLEL
C                   TO X-Y PLANE, SEC
C      TAUZY(I) = LOCAL TIME TO EVAPORATE TFILM ON SURFACES PARALLEL
C                   TO Y-Z PLANE, SEC
C      TAUB = TIME TO EVAPORATE TPOOL ON TANK BOTTOM, SEC
C                   TO Y-Z PLANE, SEC
C      PARAM = OPTIMIZATION PARAMETER FOR CONVECTIVE EVAPORATION VELOCITY,
C                   U (DIMENSIONLESS)
C
0013      READ(1,5000)TESTND
0014      READ(1,1010)L,W,H,M,P,TB,G,R,STEP,A,B,CEE,C1,C2
0015      READ(1,1010)DELTA,EPSILN,PHI
0016      READ(1,1005)NSTEP
0017      10  CONTINUE
0018      20  READ(1,1010)CO,G,TFILM,TPOOL,TGAS,DIA,R2
0019      READ(1,1010)ALPHA,BETA,GAMMA
0020      READ(1,1010)ZETA,ETA,THETA
0021      READ(1,1006)NUMEXP
0022      DO 1 I=1,NUMEXP
0023      1  READ(1,1007)ETIME(I),ECVPPM(I)
0024      1006 FORMAT(1X,I5)
0025      1007 FORMAT(1X,2F12.4)
0026      READ(1,2) TI, TM, TWORK, DTIME
0027      2  FORMAT(5E12.5)
0028      READ(1,2) TLVC, TLVWA, TLVSTL
0029      READ(1,13) ITWORK, IBLOW
0030      13  FORMAT(15,A2)
0031      SAVM=M
C
```



```

0032      PI=3.1415927
0033      UD=Q/((60.*PI*DIA**2.)/4.)
0034      XHC = CO / 1000000.
0035      RHO = (XHC * M + (1 - XHC) * MAIR) / MAIR
0036      FROUDE = (UD * UD) / (9.8 * H * (RHO - 1))
0037      WRITE(5,15) FROUDE
0038      WRITE(2,15) FROUDE
0039      15  FORMAT(//,1X,'DENSIMETRIC FROUDE NO. = ',F8.3)
0040      IF (FROUDE .GT. 50.) GO TO 230
0041      WRITE(5,16)
0042      WRITE(2,16)
0043      16  FORMAT(//,5X,'DENSIMETRIC FROUDE NUMBER AT THE BEGINNING',/
1          5X,'OF VENTILATION IS LESS THAN 50. THE BLOWER MAY NOT',/
2          5X,'HAVE SUFFICIENT CAPACITY FOR THE VENTILATING JET',/
3          5X,'TO PENETRATE THE VAPOR SPACE AND IMPINGE ON THE',/
4          5X,'TANK BOTTOM. THE VAPOR CONCENTRATION IN THE ULLAGE',/
5          5X,'SPACE MAY NOT BE WELL-MIXED AND HOMOGENEOUS THROUGH',/
6          'OUT',/5X,'THE DURATION OF GAS FREEING. SHORT-CIRCUIT',/
7          'ING',/5X,'OF THE BLOWER JET SHOULD BE ANTICIPATED. THE',/
8          'MODEL DOES NOT',/5X,'INCLUDE THIS CONDITION AND WILL',/
9          'PROCEED WITH THE',/5X,'WELL-MIXED ASSUMPTION. '//)
0044      GO TO 235
0045      230  CONTINUE
0046      WRITE(5,17)
0047      WRITE(2,17)
0048      17  FORMAT(//,5X,'DENSIMETRIC FROUDE NUMBER AT BEGINNING',/
1          5X,'OF VENTILATION IS GREATER THAN 50. BLOWER CAPACITY',/
2          5X,'IS SUFFICIENT FOR THE VENTILATING JET TO PENETRATE',/
3          5X,'THE VAPOR SPACE AND IMPINGE ON THE TANK BOTTOM.',/
4          5X,'COMPLETE JET PENETRATION AND IMPINGEMENT ENSURES',/
5          5X,'THAT THE VAPOR CONCENTRATION IN THE ULLAGE SPACE',/
6          5X,'IS HOMOGENEOUS AND THAT THE WELL-MIXED MODELING',/
7          5X,'ASSUMPTION IS VALID. FOR FURTHER DETAILS, CONSULT',/
8          5X,'REFERENCE 4 OF THE CONTRACT FINAL REPORT. '//)
0049      235  CONTINUE
0050      CON=1.4*UD*DIA**1.12
0051      R1=0.15*H
0052      K1=CON/R1**(1.12+1.)
0053      U=((K1*R1**2.)/(2.*R2)+CON*(R2**(-1.12)))/(1.-1.12)*
1(1.-(R1/R2)**(1.-1.12))*100.*PARAM
0054      V=L*W*H
0055      WRITE(2,6000)TESTNO
0056      WRITE(2,1000)
0057      WRITE(2,6001)
0058      WRITE(2,1015)L, W, H, V, CO, Q, P, TB, Q, U, M, TFILM, TPOOL
0059      WRITE(2,6012)TLVC, TLVTTWA, TLVSTL
0060      6012  FORMAT(6X,4HTLVC,6X,30HTHRESHOLD LIMIT VALUE, CEILING,5X,3HPPM,
1          7X,E15.5,/,6X,6HTLVTTWA,4X,22HTHRESHOLD LIMIT VALUE,/,/
2          16X,21HTIME-WEIGHTED AVERAGE,14X,3HPPM,7X,E15.5,/,6X,
3          6HTLVSTL,4X,22HTHRESHOLD LIMIT VALUE,/,/16X,
4          25HSHORT-TERM EXPOSURE LIMIT,10X,3HPPM,7X,E15.5)
0061      IF (ITWORK .EQ. 1) WRITE(2,8) TWORK
0062      IF (ITWORK .EQ. 2) WRITE(2,9) TWORK
0063      IF (ITWORK .EQ. 3) WRITE(2,3) TWORK
0064      IF (ITWORK .EQ. 4) WRITE(2,4) TWORK

```

```

0065      IF (ITWORK.EQ. 5) WRITE(2,5) TWORK
0066      8      FORMAT(/,6X,42HTWORK1 - BRIEF VISUAL INSPECTION AND ODOR ,
1          13HDETERMINATION,/,1X,30HWITH CARGO SURVEYOR, TWORK1 = ,
2          F10.4,5H MIN.)
0067      9      FORMAT(/,6X,43HTWORK2 - INSPECT TANK COATINGS AND MEASURE ,
1          10HTHICKNESS,/,6X,9HTWORK2 = ,F10.4,5H MIN.)
0068      3      FORMAT(/,6X,42HTWORK3 - HAND MUCKING RESIDUE WITH TOWELS,/,1X,
2          9HAND RAGS,/,6X,
2          34H(RELATIVELY DIRTY TANK), TWORK3 = ,F10.4,5H MIN.)
0069      4      FORMAT(/,6X,48HTWORK4 - SWEEP DEBRIS FROM TANK BOTTOM AND WIPE ,
1          9HPUMP SUMP,
2          /,6X,34H(RELATIVELY CLEAN TANK), TWORK4 = ,F10.4,5H MIN.)
0070      5      FORMAT(/,6X,34HTWORK5 - USER SPECIFIES, TWORK5 = ,F10.4,5H MIN.)
0071      IF (IBLOW.EQ. 1HN) GO TO 248
0072      WRITE(2,6)
0073      6      FORMAT(/,6X,31HBLOWER IS ON DURING MAN'S ENTRY,/)
0074      GO TO 249
0075      248    WRITE(2,7)
0076      7      FORMAT(/,6X,32HBLOWER IS OFF DURING MAN'S ENTRY,/)
0077      249    CONTINUE
C
C      CALCULATION OF MDOXTZ AND TAUB (EVAP. FLUX AND EVAP. TIME ON TANK
C      BOTTOM)
C
0078      TO=ALPHA+BETA*H+GAMMA*(H**2)
0079      T=1.8*TO-460.0
0080      TC=TO-273.15
0081      PV=10.**((A-B/(CEE+TC)))
0082      D=0.425/P*SQRT(TGAS**3/(M*TB/G))
0083      NU=DELTA+EPSILN*T+PHI*(T**2)
0084      NU=NU*(2.54*12.)**2
0085      SC=NU/D
0086      POWER=0.625*(SC**0.3)
0087      FREC=0.217*(SC**(-0.9))*(SC*U)**POWER
0088      MDOXTZ=M*D*PV*FREC/(R*TGAS)
0089      RHOF=(C1+C2*T)*454.0/((12.*2.54)**3)
0090      TAUB=TPOOL*RHOF/MDOXTZ
0091      WRITE(2,1020)TO, PV, D, NU, SC, RHOF, MDOXTZ, TAUB, FREC
C
C      CALCULATION OF MDOXTY(I), MDOXTZ(I), TAUXY(I) AND TAUZY(I) VECTORS
C      (FLUX AND TIME QUANTITIES FOR TANK WALLS)
C
0092      DY=H/STEP
0093      I=1
0094      Y=0.0
0095      WRITE(2,1022)
0096      WRITE(2,1024)
0097      LINEKT = 3
0098      100    TXY=ALPHA+BETA*Y+GAMMA*(Y**2)
0099      T=1.8*TXY-460.
0100      TC=TXY-273.15
0101      PV=10.**((A-B/(CEE+TC)))
0102      D=0.425/P*SQRT(TGAS**3/(M*TB/G))
0103      NU=DELTA+EPSILN*T+PHI*(T**2)
0104      NU=NU*(12.*2.54)**2

```

```

0105      SC=NU/D
0106      POWER=0.625*(SC**0.3)
0107      FREC=0.217*(SC**(-0.9))*(SC*U)**POWER
0108      MDOTXY(I)=D*M*PV*FREC/(R*TGAS)
0109      RHOF=(C1+C2*T)*454./((12.*2.54)**3)
0110      TAUXY(I)=TFILM*RHOF/MDOTXY(I)
0111      WRITE(2,1026)Y, TXY, MDOTXY(I), TAUXY(I), D, NU, PV, SC, FREC
0112      LINEKT = LINEKT + 1
0113      IF (LINEKT .LT. 56) GO TO 104
0114          WRITE(2,1022)
0115          WRITE(2,1024)
0116          LINEKT = 3
0117 104  CONTINUE
0118      I=I+1
0119      Y=Y+DY
0120      IF(Y-H)100, 100, 105

C
0121 105  J=1
0122      Y=0.0
0123      WRITE(2,1028)
0124      WRITE(2,1030)
0125      LINEKT = 3
0126 110  TZY=ZETA+ETA*Y+THETA*(Y**2)
0127      T=1.8*TZY-460.
0128      TC=TZY-273.15
0129      PV=10.**(A-B/(CEE+TC))
0130      D=0.425/P*SQRT(TGAS**3/(M*TB/C))
0131      NU=DELTA+EPSILN*T+PHI*(T**2)
0132      NU=NU*(12.*2.54)**2
0133      SC=NU/D
0134      POWER=0.625*(SC**0.3)
0135      FREC=0.217*(SC**(-0.9))*(SC*U)**POWER
0136      MDOTZY(J)=D*M*PV*FREC/(R*TGAS)
0137      RHOF=(C1+C2*T)*454./((12.*2.54)**3)
0138      TAUZY(J)=TFILM*RHOF/MDOTZY(J)
0139      WRITE(2,1026)Y, TZY, MDOTZY(J), TAUZY(J), D, NU, PV, SC, FREC
0140      LINEKT = LINEKT + 1
0141      IF (LINEKT .LT. 56) GO TO 114
0142          WRITE(2,1028)
0143          WRITE(2,1030)
0144          LINEKT = 3
0145 114  CONTINUE
0146      J=J+1
0147      Y=Y+DY
0148      IF(Y-H)110, 110, 115
0149 115  WRITE(2,1060)
0150      LINEKT = 4

C
C      CALCULATION OF LOCAL EVAPORATION FLUX RATE AND EVAPORATION
C      TIMES IS COMPLETE. BEGIN INTEGRATION OF LOCAL EVAPORATION
C      FLUXES TO OBTAIN TOTAL EVAPORATION RATE - TIME HISTORY
C
0151 117  K=1
0152      TIME(K)=TI
0153      TMAX = TM + TWORK

```

```

0154         IF (IBLOW EQ. 1HN) TMAX = TM
0155         NPOINT=NSTEP+1
0156     120 DO 125 I=1,NPOINT
0157         IF (TIME(K)*60.0.GT. TAUXY(I))MDOTXY(I)=0.0
0158         IF (TIME(K)*60.0.GT. TAUZY(I))MDOTZY(I)=0.0
0159     125 CONTINUE
0160         IF (TIME(K)*60.0.GT. TAUB)MDOTXZ=0.0
0161         MDOTB(K)=MDOTXZ*L*W*1.E04
0162         AREA=0.0
0163         DO 130 I=1,NSTEP
0164         AREA=AREA+DY*(MDOTXY(I)+MDOTXY(I+1))/2.0
0165     130 CONTINUE
0166         MDOTHL(K)=AREA*L*1.E04
0167         AREA=0.0
0168         DO 140 I=1,NSTEP
0169         AREA=AREA+DY*(MDOTZY(I)+MDOTZY(I+1))/2.0
0170     140 CONTINUE
0171         MDOTHW(K)=AREA*W*1.E04
0172         MDOTG(K)=MDOTB(K)+2.*(MDOTHL(K)+MDOTHW(K))
0173         K=K+1
0174         TIME(K)=TIME(K-1)+DTIME
0175         IF (TIME(K)-TMAX)120,120,150

C
C     INTEGRATION OF TOTAL EVAPORATIVE FLUXES IS COMPLETE.
C     RUNGE-KUTTA INTEGRATION OF CONCENTRATION DE
C

0176     150 K=1
0177         LPRINT=1
0178         JCOUNT=1
0179         CVPPM(1)=CO
0180         CO=CO*(P/760.)*(298.15/TGAS)*(M/24.45)
0181         C(K)=CO
0182     155 Y=C(K)
0183         DOTMG=MDOTG(K)
0184         F=(60000.*DOTMG/V)-Q*Y/V
0185         X=TIME(K)
0186         NT=0
0187     160 CONTINUE
0188         STUFF=RKLEQ(1,Y,F,X,DTIME,NT)
0189         CONC(K)=Y
0190         DOTMG=MDOTG(K)-((TIME(K)-X)/(TIME(K)-TIME(K+1)))*(MDOTG(K)-MDOTG(K
    *+1))
0191         F=(60000.*DOTMG/V)-Q*CONC(K)/V
0192         IF (STUFF.NE.2.0)GO TO 160
0193         K=K+1
0194         C(K)=CONC(K-1)
0195         CRATIO=C(K)/CO
0196         M=SAVM
0197         CONC(K)=CONC(K-1)*(760./P)*(TGAS/298.15)*24.45/M
0198         CVPPM(K)=CONC(K)
0199         COR=Q*TIME(K)/V
0200         IF (JCUNT-LPRINT)170,165,165
0201     165 WRITE(2,1070)TIME(K),CONC(K),CRATIO,COR,MDOTG(K),MDOTHL(K),
    *MDOTHW(K),MDOTB(K)
0202         LINEKT = LINEKT + 1
    
```

```

0203      IF (LINEKT .LT. 56) GO TO 166
0204      WRITE(2,1060)
0205      LINEKT = 4
0206 166   CONTINUE
0207      JCOUNT=1
0208      GO TO 175
0209      170 JCOUNT=2
0210      175 IF (TIME(K)-TMAX)155,2000,2000
0211      6001 FORMAT(27X,16HONE-TIME OUTPUTS,/,5X,8HVARIABLE,8X,
          1 11HDESCRIPTION,20X,5HUNITS,4X,6HRESULT,/)
0212      1000 FORMAT(80A1)
0213      1005 FORMAT(I4)
0214      1010 FORMAT(6E12.6)
0215      1015 FORMAT(6X,1HL,9X,
          1      11HTANK LENGTH,24X,1HM,9X,F6.1,
          2      /,6X,1HW,9X,10HTANK WIDTH,25X,1HM,9X,F6.1,
          3      /,6X,1HH,9X,11HTANK HEIGHT,24X,1HM,9X,F6.1,
          4      /,6X,1HV,9X,11HTANK VOLUME,24X,1HM,7X,F8.1,
          5      /,6X,2HCO,8X,21HINITIAL CONCENTRATION,14X,5HMG/M3,2X,F9.1,
          6      /,6X,1HQ,9X,16HVENTILATION RATE,19X,6HMM3/MIN,4X,F6.1,
          7      /,6X,1HP,9X,13HTANK PRESSURE,22X,5HMM HG,5X,F6.1,
          8      /,6X,2HTB,8X,20HLIQUID BOILING POINT,15X,1HK,9X,F6.1,
          9      /6X,1HG,9X,22HLIQUID SURFACE TENSION,13X,8HDYNES/CM,2X,F6.1
          1      /,6X,1HU,9X,17HWALL AIR VELOCITY,18X,6HCM/SEC,4X,F6.1,
          2      /6X,1HM,9X,23HLIQUID MOLECULAR WEIGHT,12X,7HGM/MOLE,3X,F7.2
          3      /,6X,5HTFILM,5X,23HFILM THICKNESS ON WALLS,12X,2HCM,9X,F6.2
          4      /6X,5HTPOOL,5X,24HFILM THICKNESS ON BOTTOM,11X,2HCM,9X,F6.2
          5      /)
0216      1020 FORMAT(1HO,9X,22HSUMMARY OF TANK BOTTOM/
          1      3X,8HQANTITY,34X,6HRESULT,/,
          $      1HO,2X,20HFLOOR TEMPERATURE(K),21X,F6.1/
          $      3X,21HVAPOR PRESSURE(MM HG),20X,F6.1/
          $      3X,30HDIFFUSION COEFFICIENT(CM2/SEC),10X,F7.4/
          $      3X,35HKINEMATIC VISCOSITY OF AIR(CM2/SEC),2X,E10.4/
          $      3X,14HSCHMIDT NUMBER,23X,F10.4/
          $      3X,12HRHOF(GM/CM3),29X,F6.3/
          $      3X,18HMDOTXZ(GM/CM2-SEC),19X,E10.4/
          $      3X,9HTAUB(SEC),30X,F8.1/
          $      3X,11H1/F(CM**-1),30X,F6.3)
0217      1022 FORMAT(1H1,57X,19HSUMMARY OF X-Y WALL)
0218      1024 FORMAT(1HO,4X,4HY(M), 9X,7HTEMP(K),5X,14HMDOTXY(G/C2-S),3X,11H TAU
          $XY(SEC),4X,10HD(CM2/SEC),4X,11HNU(CM2/SEC),5X,9HPV(MM HG),8X,2HSC,
          $8X,11H1/F(CM**-1))
0219      1026 FORMAT(4X,F6.2,9X,F6.1,7X,E11.4,6X,F8.1,5X,F8.5,7X,F7.4,8X,F8.3,8X
          $,F6.3,9X,F8.4)
0220      1028 FORMAT(1H1,57X,19HSUMMARY OF Y-Z WALL)
0221      1030 FORMAT(1HO,4X,4HY(M), 9X,7HTEMP(K),5X,14HMDOTZY(G/C2-S),3X,11H TAU
          $ZY(SEC),4X,10HD(CM2/SEC),5X,11HNU(CM2/SEC),5X,9HPV(MM HG),8X,2HSC,
          $8X,11H1/F(CM**-1))
0222      1060 FORMAT(1H1,36X,47HTANK CONCENTRATION AND EVAPORATION RATE HISTORY/
          $      1HO,2X,9HTIME(MIN),5X,12HCONCENT(PPM),7X,4HC/CO,11X,4HQT/V,
          $      6X,13HMDOTG(GM/SEC),4X,14HMDOTHL(GM/SEC),4X,14HMDOTHW(GM/SE
          $C),4X,13HMDOTB(GM/SEC))
0223      1070 FORMAT(4X,F6.2,9X,F8.0,7X,F6.3,10X,F6.2,7X,F9.3,8X,F9.3,9X,F9.3,9X
          $,F9.3)

```

```
0224      5000 FORMAT(15)
0225      6000 FORMAT(23X, '***** TEST NO. ', I3, ' *****')
0226      2000 CONTINUE
0227      CALL BLOW(IBLOW, TMAX, TM, TWORK, CVPPM, TLVC, TLVSTL, TLVTTWA,
1          DTIME, TIME, CEXP, TI)
C
C      WRITE DATA TO UNIT 3 FOR PLOTTING
C
0228      III=K-1
0229      III = (TMAX - TI) / DTIME + 1
0230      WRITE(3,*) III, NUMEXP, TESTNO, TLVC, TLVTTWA, TLVSTL
0231      DO 800 I = 1, III
0232          WRITE(3,*) TIME(I), CVPPM(I)
0233      CONTINUE
0234      800 CONTINUE
0235      IF (NUMEXP .EQ. 0) GO TO 900
0236      DO 850 I = 1, NUMEXP
0237          WRITE(3,*) ETIME(I), ECVPPM(I)
0238      CONTINUE
0239      850 CONTINUE
0240      900 CONTINUE
0241      STOP
0242      END
```

```
0001      FUNCTION RKLDEG(N, Y, F, X, H, NT)
C D2 UCSD RKLDEG RUNGE-KUTTA-GILL LINEAR DIFFERENTIAL EQUATION SOLVER
C D2 UCSD RKLDEG
C MODIFIED MAY 1963 (G REMOVED FROM CALLING SEQUENCE)
C TEST OF ALQOL ALGORITHM
0002      DIMENSION Y(1), F(1), G(1)
C REAL X, H--INTEGER N, NT--COMMENT--BEGIN INTEGER I, J, L--REAL A
0003      NT=NT+1
0004      GO TO (1, 2, 3, 4), NT
C
0005      1 DO 11 J=1, N
0006      11 G(J)=0.
0007      A= .5
0008      X=X+H/2.
0009      GO TO 5
0010      2 A= .29289321881
0011      GO TO 5
0012      3 A=1.7071067812
0013      X=X+H/2.
0014      GO TO 5
0015      4 DO 41 I=1, N
0016      41 Y(I)=Y(I)+H*F(I)/6. -G(I)/3.
0017      NT=0
0018      RKLDEG=2.
0019      GO TO 6
0020      5 DO 51 L=1, N
0021      Y(L)=Y(L)+A*(H*F(L)-G(L))
0022      51 G(L)=2. *A*H*F(L)+(1. -3. *A)*G(L)
0023      RKLDEG=1.
0024      6 CONTINUE
0025      RETURN
0026      END
```



```

0016          AUX = Y(3) + Y(3)
0017          AUX = AUX + AUX
0018          Z(2) = SUM2 - HT * (Y(2) + AUX + Y(4))
0019          Z(3) = SUM1
0020          Z(4) = SUM2
0021          IF (NDIM-6) 5, 5, 2

      C
      C      INTEGRATION LOOP
      C
0022          DO 4 I = 7, NDIM, 2
0023              SUM1 = AUX1
0024              SUM2 = AUX2
0025              AUX1 = Y(I-1) + Y(I-1)
0026              AUX1 = AUX1 + AUX1
0027              AUX1 = SUM1 + HT * (Y(I-2) + AUX1 + Y(I))
0028              Z(I-2) = SUM1
0029              IF (I-NDIM) 3, 6, 6
0030          3      AUX2 = Y(I) + Y(I)
0031              AUX2 = AUX2 + AUX2
0032              AUX2 = SUM2 + HT * (Y(I-1) + AUX2 + Y(I+1))
0033              Z(I-1) = SUM2
0034          4      CONTINUE
0035          5      Z(NDIM-1) = AUX1
0036              Z(NDIM) = AUX2
0037              RETURN
0038          6      Z(NDIM-1) = SUM2
0039              Z(NDIM) = AUX1
0040              RETURN

      C
      C      END OF INTEGRATION LOOP
      C
0041          IF (NDIM-3) 12, 11, 8
      C
      C      NDIM IS EQUAL TO 4 OR 5
      C
0042          SUM2 = 1.125 * HT * (Y(1)+Y(2)+Y(2)+Y(2)+Y(3)+Y(3)+Y(3)+Y(4))

0043          SUM1 = Y(2) + Y(2)
0044          SUM1 = SUM1 + SUM1
0045          SUM1 = HT * (Y(1) + SUM1 + Y(3))
0046          Z(1) = 0.
0047          AUX1 = Y(3) + Y(3)
0048          AUX1 = AUX1 + AUX1
0049          Z(2) = SUM2 - HT * (Y(2) + AUX1 + Y(4))
0050          IF (NDIM-5) 10, 9, 9
0051          9      AUX1 = Y(4) + Y(4)
0052              AUX1 = AUX1 + AUX1
0053              Z(5) = SUM1 + HT * (Y(3) + AUX1 + Y(5))
0054          10     Z(3) = SUM1
0055              Z(4) = SUM2
0056              RETURN

      C
      C      NDIM IS EQUAL TO 3
      C
0057          11     SUM1 = HT * (1.25 * Y(1) + Y(2) + Y(2) - .25 * Y(3))

```

```
0058          SUM2 = Y(2) + Y(2)
0059          SUM2 = SUM2 + SUM2
0060          Z(3) = HT * (Y(1) + SUM2 + Y(3))
0061          Z(1) = 0.
0062          Z(2) = SUM1
0063          12  CONTINUE
0064          RETURN
0065          END
```

```
0001      SUBROUTINE BLOW(IBLOW, TF, TM, TWORK, CVPPM, TLVC, TLVSTL,  
1          TLVTWA, DT, TIME, CEXP, TI)  
C  
0002      DIMENSION CVPPM(1), TIME(1), CEXP(1), ISAVE(275)  
0003      DOUBLE PRECISION WHICH(2)  
C  
0004      IF (IBLOW .EQ. 1HN) TF = TF + TM  
0005      WRITE(2,1) TM, TF  
0006      1  FORMAT(1H1, ///, 14X, 35HEVALUATION OF VAPOR CONCENTRATIONS ,  
1          16HDURING MAN-ENTRY, //, 23X, 26HTANK IS ENTERED AT TIME = ,  
2          F5.1, 4H MIN, //, 23X, 25HTANK IS EXITED AT TIME = , F5.1,  
3          4H MIN, //)  
0007      WHICH(1) = BHTLV-C  
0008      WHICH(2) = BHTLV-STEL  
0009      IND = 1  
0010      IF (TLVC .EQ. 0) IND = 2  
0011      INDEX = (TM - TI) / DT + 1  
0012      IFLAG = 0  
0013      TCHECK = TLVC  
0014      IF (TLVC .EQ. 0.) TCHECK = TLVSTL  
0015      KT = 0  
0016      NUMVAL = (TF - TM) / DT + 1  
0017      ITOTAL = (TF - TI) / DT + 1  
0018      IF (IBLOW .EQ. 1HY) GO TO 75  
0019      DO 50 I = INDEX + 1, ITOTAL  
0020          CVPPM(I) = CVPPM(I-1)  
0021          TIME(I) = TIME(I-1) + DT  
0022      50  CONTINUE  
0023      75  CONTINUE  
0024      DO 100 I = 1, NUMVAL  
0025          J = ITOTAL - (NUMVAL - I)  
0026          IF (CVPPM(J) .LE. TCHECK) GO TO 100  
0027          KT = KT + 1  
0028          ISAVE(KT) = J  
0029          IFLAG = 1  
0030      100 CONTINUE  
0031      IF (IBLOW .EQ. 1HN) GO TO 200  
C  
C  
C          BLOWER ON DURING ENTRY OF MAN INTO TANK  
C  
C  
C  
0032      IF (IFLAG .EQ. 0) GO TO 175  
C  
C          VAPOR CONCENTRATIONS EXCEEDED CEILING OR SHORT-TERM  
C          EXPOSURE LIMITS  
C  
C  
0033      WRITE(2,2) WHICH(IND)  
0034      2  FORMAT(///1X, 10HPREDICTED ,  
1          39HINSTANTANEDUS EXPOSURE CONCENTRATIONS ,  
2          11HEXCEED THE , AB, //, 5X, 10HTIME (MIN), 5X,  
3          19HCONCENTRATION (PPM), //)  
0035      WRITE(2,3) (TIME(ISAVE(J)), CVPPM(ISAVE(J)), J=1, KT)
```

```
0036 3          FORMAT(6X,F7.2,11X,F7.1,12X,28HHAZARDOUS WORKING CONDITIONS)
0037          CALL GSF(DT, CVPPM(INDEX), CEXP, NUMVAL)
0038          EXPOS = CEXP(NUMVAL) / TWORK
0039          WRITE(2,4) EXPOS
0040 4          FORMAT(/1X,10HPREDICTED ,
                1          40HAVERAGE IN-TANK EXPOSURE AS MEASURED BY ,
                2          14HA DOSIMETER = ,F9.2,4H PPM,/)
0041          IF (EXPOS .LE. TCHECK) GO TO 125
0042          WRITE(2,5) WHICH(IND), WHICH(IND)
0043 5          FORMAT(1X,41HDOSIMETER MONITORING WOULD INDICATE THAT ,/,
                1          1X,41HTHE AVERAGE IN-TANK EXPOSURE EXCEEDS THE ,/,
                2          1X,AB,40H FOR THIS CHEMICAL VAPOR AND A HAZARDOUS,/,
                3          1X,42HWORKING CONDITION EXISTS. REDUCE EXPOSURE,/,
                4          1X,6HBELOW ,AB,17H BEFORE ASSESSING,
                5          18H THE TWA EXPOSURE. ,/)
0044          GO TO 600
0045 125         CONTINUE
0046          WRITE(2,6) WHICH(IND)
0047 6          FORMAT(1X,44HDOSIMETER MONITORING WOULD INDICATE THAT THE,/,
                1          1X,42HAVERAGE IN-TANK EXPOSURE IS ACCEPTABLE AND,/,
                2          1X,20HDOES NOT EXCEED THE ,AB,18H FOR THIS CHEMICAL,
                3          1X,6HVAPOR. )
0048          WRITE(2,7)
0049 7          FORMAT(1X,40HHOWEVER, INSTANTANEOUS CONCENTRATIONS DO,/,
                1          1X,44HEXCEED THESE LIMITS. REAL TIME MEASUREMENTS ,
                2          /,1X,40HOF VAPOR CONCENTRATION MAY BE INDICATED. )
0050          CTWA = (EXPOS * TWORK) / 480.
0051          WRITE(2,8) CTWA
0052 8          FORMAT(/1X,10HPREDICTED ,
                1          41HEIGHT-HOUR TIME WEIGHTED AVERAGE EXPOSURE,
                2          3H = ,F6.2,4H PPM,/)
0053          IF (CTWA .LT. TLVTWA) GO TO 150
0054          WRITE(2,9)
0055 9          FORMAT(1X,10HPREDICTED ,
                1          41HEIGHT-HOUR TIME WEIGHTED AVERAGE EXPOSURE,/,
                2          1X,42HEXCEEDS THE TLV-TWA. HAZARDOUS CONDITIONS,/,
                3          1X,10HMAY EXIST. )
0056          GO TO 600
0057 150         WRITE(2,10)
0058 10         FORMAT(1X,39HMONITORING WOULD ALSO INDICATE THAT THE,/,
                1          1X,42HEXPOSURE IS ACCEPTABLE WITH RESPECT TO THE,/,
                2          1X,8HTLV-TWA. )
0059          GO TO 600
C
C          ALL CONCENTRATIONS WERE BELOW CEILING SHORT-TERM
C          EXPOSURE LIMITS
C
0060 175         CONTINUE
0061          CALL GSF(DT, CVPPM(INDEX), CEXP, NUMVAL)
0062          EXPOS = CEXP(NUMVAL) / TWORK
0063          CTWA = (EXPOS * TWORK) / 480.
0064          WRITE(2,11) EXPOS, CTWA
0065 11         FORMAT(/,1X,10HPREDICTED ,
                1          37HAVERAGE EXPOSURE DURING TANK ENTRY = ,F9.2,
                2          4H PPM,/,
```

```

      3          1X,44HEIGHT-HOUR TIME WEIGHTED AVERAGE EXPOSURE = ,
      4          F9.2,4H PPM/)
0066          IF (CTWA .LT. TLVTWA) GO TO 180
0067          WRITE(2,12) WHICH(IND)
0068          12          FORMAT(1X,10HPREDICTED ,
      1          40HEIGHT-HOUR TWA EXPOSURE EXCEEDS TLV-TWA ,
      2          33H HAZARDOUS CONDITIONS MAY EXIST. ,/,
      3          39HSINGLE EXPOSURE DOES NOT EXCEED THE ,AB./)
0069          GO TO 600
0070          180         CONTINUE
0071          WRITE(2,13)
0072          13          FORMAT(1X,10HPREDICTED ,
      1          45HSINGLE EXPOSURE IS ACCEPTABLE WITH RESPECT TO,
      2          29H TLV-C, TLV-STEL, AND TLV-TWA)
0073          GO TO 600
C
CCCCCCCCCCCCCCCCCCCCCCCCCCCCCCCCCCCCCCCCCCCCCCCCCCCCCCCCCCCC
C
C          BLOWER NOT ON DURING ENTRY OF MAN
C
CCCCCCCCCCCCCCCCCCCCCCCCCCCCCCCCCCCCCCCCCCCCCCCCCCCCCCCCCCCC
C
0074          200         CONTINUE
0075          IF (CVPPM(INDEX) .GE. TCHECK) GO TO 400
0076          CTWA = (CVPPM(INDEX) * TWORK) / 480.
0077          WRITE(2,11) CVPPM(INDEX), CTWA
0078          IF (CTWA .LT. TLVTWA) GO TO 300
0079          WRITE(2,12) WHICH(IND)
0080          GO TO 600
0081          300         CONTINUE
0082          WRITE(2,13)
0083          GO TO 600
0084          400         CONTINUE
0085          WRITE(2,2) WHICH(IND)
0086          WRITE(2,3) (TIME(ISAVE(J)), CVPPM(ISAVE(J)), J=1, KT)
0087          WRITE(2,4) CVPPM(INDEX)
0088          WRITE(2,5) WHICH(IND), WHICH(IND)
0089          600         CONTINUE
0090          RETURN
0091          END
```

APPENDIX B

PROGRAM LISTING FOR THE ONDEK PLUME DISPERSION MODEL

Main Program	ONDEK
Integer Function	HAMING
Integer Function	RUNGE
Real Function	SIMUL
Subroutine	RHS
Subroutine	CSUM
Subroutine	CONT
Subroutine	START
Subroutine	INDAT
Subroutine	PROMPT

```

C**** PROGRAM ONDEK *****
C..... THIS PROGRAM COMPUTES THE TRAJECTORY AND CONCENTRATION DISTRI-
C..... BUTION OF BUOYANT PLUMES OF CHEMICAL VAPOR AND AIR THAT ARE
C..... EMITTED INTO AN ATMOSPHERIC BOUNDARY LAYER. THE COMPUTER PRO-
C..... GRAM IS BASED UPON OOMS' METHOD (REFERENCE, G. OOMS, 'A NEW
C..... METHOD FOR THE CALCULATION OF THE PLUME PATH OF GASES EMITTED
C..... BY A STACK', ATMOSPHERIC ENVIRONMENT, VOL 6, 1972) AND TE
C..... RIELE'S METHOD (REFERENCE, P.H.M. TE RIELE, 'ATMOSPHERIC DISPER-
C..... SION OF HEAVY GASES EMITTED AT OR NEAR GROUND LEVELS', 2ND
C..... INTERNATIONAL SYMPOSIUM ON LOSS PREVENTION AND SAFETY PROMOTION
C..... IN THE PROCESS INDUSTRIES, SEPT. 1977)
C
C..... LIST OF INPUT VARIABLES.....
C      SO = STARTING VALUE FOR PLUME PATH TRAJECTORY, M
C      H = INTEGRATION STEP SIZE, M
C      SMAX = TERMINATION VALUE OF PLUME PATH INTEGRATION, M
C      INT = NUMBER OF INTEGRATIONS BETWEEN PRINT-OUTS
C      YR(1) = INITIAL VALUE OF CONCENTRATION, KG/M**3
C      YR(2) = INITIAL VALUE OF PLUME CHARACTERISTIC RADIUS, M
C      YR(3) = INITIAL VALUE OF PLUME VELOCITY - WIND SPEED COMPONENT, M/S
C      YR(4) = INITIAL VALUE OF PLUME ANGLE WITH RESPECT TO HORIZON, RADIANS
C      YR(5) = INITIAL VALUE OF X, HORIZONTAL DISTANCE FROM VENT, M
C      YR(6) = INITIAL VALUE OF Y, VERTICAL HEIGHT ABOVE DECK, M
C      WMJ = MOLECULAR WEIGHT OF EMITTED GAS
C      PO = ATMOSPHERIC PRESSURE, MM HG
C      TO = ATMOSPHERIC TEMPERATURE, DEG RANKINE
C      UR = REFERENCE VELOCITY AT ZREF, M/S
C      ZREF = REFERENCE HEIGHT, M
C      CMF = MASS FRACTION OF TRACER GAS IN EMITTED GAS
C      TLV = TURBULENCE LEVEL
C      ZCON = CONCENTRATION MEASURE HEIGHT, M
C      IC = NUMBER OF CONCENTRATION VALUES FOR CONTOUR LINES, MAX=6
C      C(I) = CONCENTRATION VALUES FOR CONTOURS
C      YRUF = SURFACE ROUGHNESS PARAMETER, CENTIMETERS
C
      INTEGER COUNT, RUNGE, HMING
      REAL APLACE(10), ADATE(3), ACLASS(5), AGAS(5), LEL, LELM
      DIMENSION TE(6), YR(6), FR(6), Y(4,6), F(3,6), YRS(6), C(6), YC(6)
      COMMON/PHYS/DCDR, EPS, UPRI, ROA, ROE, G, ALF, TAU, U10
      COMMON/CONS/IDECK, AF1, AF2, AF21, BTA, DLA, BT1, DBA, BM1, GAM
      COMMON/CON2/ROT
      COMMON/DAT1/SO, VD, VH, ZDECK, ZREF, UR
      COMMON/DAT2/PO, TO, UVENT, CO, UTLV, WMC
      COMMON/DAT3/PVAP, DISTAN, DISMAX, QL, ZCON
      COMMON/DAT4/CC1, CC2, CC3, CC4, CC5, CC6
      COMMON/DAT5/UEL, LEL, STIL, TLV, QDOR
      COMMON/DAT6/APLACE, ADATE, AGAS
C
C**** SPECIFICATION OF DEFAULT VALUES FOR INPUT DATA *****
DATA SO, VD, VH, ZDECK, PO/0.0, 0.203, 1.0, 1.0, 760. /
DATA TO, ZREF, UR, UTLV, WMC/520. , 10. , 2.24, 20. , 86. 10/
DATA QL, DISMAX, DISTAN, WMA, PVAP/159.0, 10. , 1.0, 28.97, 90. /
DATA ZCON, IC/1.68, 6/
DATA CC1, CC2, CC3, CC4, CC5, CC6/1000.0, 12, 134000, 26000, 20, 10/
DATA UEL, LEL, STIL, TLV, QDDR/13.4, 2.6, 20. , 10. , 0. 12/
C
C**** OPEN OUTPUT FILE FOR PRINTING *****
OPEN(UNIT=3, NAME='RESONDEK.DAT', STATUS='NEW')
OPEN(UNIT=2, NAME='SCRATCH.DAT', STATUS='NEW')
TYPE *, '***** PROGRAM ONDEK ***** '

```

```

TYPE *, 'THIS PROGRAM COMPUTES THE TRAJECTORY AND CONCENTRATION '
TYPE *, 'DISTRIBUTION OF BUOYANT PLUMES OF CHEMICAL VAPOR AND AIR '
TYPE *, 'THAT ARE EMITTED INTO THE AIR ABOVE A SHIP OR BARGE DECK '
TYPE *, '
TYPE *, 'PREPARE TO ENTER INPUT DATA REQUIRED BY THE PROGRAM '
TYPE *, '
C ..... ENTER TODAY'S DATE .....
TYPE *, ' ENTER TODAY'S DATE (UP TO 12 CHARACTERS) '
TYPE *, '
ACCEPT 600, (ADATE(J),J=1,3)
TYPE *, '
1 CONTINUE

C
C**** CALL SUBROUTINE INDAT TO ENTER DATA INTERACTIVELY *****
CALL INDAT

C
C**** INITIALIZE VARIABLES AND ASSIGN VALUES TO CONSTANTS *****
G= 9 80665
X= 0.0
DISTA= 0.0
C ..... STEP SIZE SET EQUAL TO 1/5TH OF THE VENT DIAMETER.....
H= VD/5 0
EPS= 0.0000000001
C ..... MASS FRACTION OF GAS CONSTITUENT SET EQUAL TO 1.....
CMF=1.0
IDECK= 1
IA= 0
ALF = 0.14
GAM = 1 18597434
DLA = 0.176877
BTA = 0.911784
YRUF = 1.000
CALL START(WMA, YR, WMJ)
UPRI= 3.0*UTLV*UR/100
UA=UR
DCDR=WMJ/(WMJ-28.96)
ROA=((PO/760 )*14.7)*144. *28.96*16.0522/(1545. *TO)
ROE=ROA*WMJ/28 96
ROVAP= ROA*WMG/28 96
C ..... STORE VALUES OF CONTOUR CONCENTRATIONS FOR PRINT OUT.....
C(1)= CC1*ROVAP/1000000.
C(2)= CC2*ROVAP/1000000.
C(3)= CC3*ROVAP/1000000.
C(4)= CC4*ROVAP/1000000.
C(5)= CC5*ROVAP/1000000.
C(6)= CC6*ROVAP/1000000.
UEL= UEL*ROVAP/100.
LELM= LEL*ROVAP/100.
STILM=STIL*ROVAP/1000000
TLVM= TLV *ROVAP/1000000.
ODORM= ODOR*ROVAP/1000000.
TRACON=YR(1)*CMF
IDECK = 1
CONH1=0.
XCON=YR(5)

C
C**** INITIALIZE VARIABLES FOR PLOT FILES *****
C ..... COMPUTE THE WIND SHEAR STRESS, TAUO.....
C ..... THE EQUATION USED MAY BE ACCURATE ONLY FOR NEUTRAL.....
C ..... ATMOSPHERIC STABILITY CONDITIONS.....
U10=UR*((10. +ZDECK)/ZREF)**ALF
ZP= ALDG(1000./YRUF)
TAU =0.16*U10*U10/(ZP*ZP)

```



```

C..... COMPUTE THE CONSTANTS THAT ARE NEEDED TO INTEGRATE.....
C..... THE EQUATIONS FOR TE RIELE'S PLUME MODEL .....
      AF1=1. +ALF
      AF2=2*ALF
      AF21=1. +AF2
      BT1=1. /BTA
      DBA=DLA**BT1
      BM1=1. -BT1
      ROT=(1. -ROA/ROE)/ROA
      TAUO=TAU*ROA
C..... SET GCON = SQRT(PI)*AF21/(QAM*2. ).....
C..... THIS VARIABLE IS USED IN THE INITIAL VALUE OF SIGMAZ.....
      GCON=0.8862269255*AF21/QAM
C..... PRINT THE HEADING AND THE INITIAL CONDITIONS.....
      WRITE(3,710) (APLACE(J), J=1, 10), (ADATE(J), J=1, 3)
      WRITE(3,711) PO, TO, UR, ZREF, ALF, UTLV
      WRITE(3,712) VD, VH, ZDECK, (AGAS(J), J=1, 5), WMJ, YR(1), QL, UVENT
      WRITE(3,719) UELM, LELM, STILM, TLVM, ODORM
      WRITE(3,713) (C(J), J=1, IC), ZCON
      WRITE(3,714) H, DISMAX
      WRITE(3,715)
C..... INITIALIZE THE STEP COUNTER AND THE FIRST ROW OF THE Y MATRIX..
C..... SET THE INITIAL TRUNCATION ERRORS TO ZERO.....
      COUNT = 0
      DO 405 J=1,6
      TE(J) = 0.
405 Y(4, J)= YR(J)
      TYPE *, ' COMPUTING PLUME TRAJECTORY AND DISPERSION '
C..... CALL RUNGE TO INTEGRATE ACROSS THE FIRST THREE STEPS.....
C..... RUNGE IS USED AS A STARTER FOR HAMING.....
410 IF (RUNGE(6, YR, FR, X, H). NE. 1) GO TO 420
      CALL RHS(YR, YRS)
      DO 415 K=1,4
415 FR(K)=YRS(K)
      FR(5)= COS(YR(4))
      FR(6)= SIN(YR(4))
      GO TO 410
C..... PUT THE APPROPRIATE INITIAL VALUES IN THE Y AND F MATRICES.....
420 COUNT = COUNT + 1
      ISUB = 4 - COUNT
      DO 425 J=1,6
425 Y(ISUB, J) = YR(J)
      CALL RHS(YR, YRS)
      DO 430 K=1,4
430 F(ISUB, K)=YRS(K)
      F(ISUB, 5)= COS(YR(4))
      F(ISUB, 6)= SIN(YR(4))
C
C**** IF X GT DISTA. PRINT VALUES OF THE PLUME VARIABLES *****
435 CONTINUE
      IF (COUNT LE 3) GO TO 450
      IF (Y(1, 5) LE DISTA) GO TO 450
      TRACON = Y(1, 1)*CMF
C..... COMPUTE CONH1, CONCENTRATION AT BREATHING HEIGHT, ZCON .....
      B2=Y(1, 2)*Y(1, 2)*1.35
      CR1=Y(1, 6)-ZCON
      CZ1=CR1*CR1/B2
      IF (CZ1 GT 13.81) GO TO 440
      CR2=Y(1, 6)+ZCON
      CZ2=CR2*CR2/B2
      XCON=Y(1, 5)
      CONH1=Y(1, 1)*CMF*( EXP(-CZ1) + EXP(-CZ2))
      GO TO 445

```

```

440 XCON = Y(1,5)
    CONH1=0.
445 CONTINUE
C     COMPUTE PLUME CENTERLINE CONCENTRATION WITH THE EFFECT OF AN ...
C     IMAGE PLANE AT GROUND LEVEL. ....
    CZ3= 4.*Y(1,6)*Y(1,6)/B2
    IF (CZ3 GT 13.81) GO TO 446
    YCL= Y(1,1)*(1.+EXP(-CZ3))
    GO TO 447
446 YCL= Y(1,1)
447 CONTINUE
    CALL CONTC(C,YC,Y,1,IC,0.,0.,0.,0.,ZCON)
    IF (COUNT GT 3) WRITE(3,716) X,Y(1,5),Y(1,6),Y(1,1),CONH1,XCON,
1(YC(I), I=1,6),Y(1,2),Y(1,3),Y(1,4)
    IA= IA+1
    DIS(IA)= Y(1,5)
C     ASSIGN VALUES TO CONC ARRAY. ....
    DO 448 II=1,6
    CONC(IA,II) = YC(II)
448 CONTINUE
    CON(IA,5)= YCL
    IF (CONH1.LT.CM) CONH1=CM
    CONB(IA,5)=CONH1
    CON(IA,2)= UELM
    CONB(IA,2)=UELMM
    CON(IA,3)= LELM
    CONB(IA,3)=LELMM
    CON(IA,4)= STILM
    CONB(IA,4)=STILMM
    CON(IA,1)= TLVM
    CONB(IA,1)=TLVMM
    DISTA= DISTA + DISTAN
C     IF X EXCEEDS DISMAX, TERMINATE THE INTEGRATION. ....
450 IF (X GT DISMAX+H/2.) GO TO 560
C     CALL RUNGE OR HAMING TO INTEGRATE ACROSS THE NEXT STEP. ....
    IF (COUNT LT 3) GO TO 410
C     CALL HAMING. ....
455 M = HAMING(6,Y,F,X,H,TE)
    DO 460 K=1,4
460 YR(K)=Y(1,K)
    CALL RHS(YR,YRS)
    DO 465 K=1,4
465 F(1,K)=YRS(K)
    F(1,5)= COS(Y(1,4))
    F(1,6)= SIN(Y(1,4))
    IF (M.EQ.1) GO TO 455
C     INCREMENT STEP COUNTER AND CONTINUE INTEGRATION. ....
    COUNT = COUNT + 1
    IF (Y(1,6).LT.0.) GO TO 500
    GO TO 435
500 CONTINUE
C
C**** TRANSITION TO TE RIELE'S METHOD *****
    IDECK = 0
C     FOR INITIAL CONDITIONS, SET ...
C     Y(1,1)=2*Y(1,1) ... CA=2*C ON THE PLUME CENTERLINE. ....
C     Y(1,2)=1.161895*Y(1,2) ... SIGMAY=LAMDA*PLUME WIDTH. ....
C     Y(1,3)=YR(2)*GCDCN ... SIGMAZ=SIGMAY*GCDCN. ....
    YR(1) = 2*Y(1,1)
    YR(2) =1.161895*Y(1,2)
    YR(3) =YR(2)*GCDCN
    WRITE(3,717)
    COUNT = 0

```

```

      DO 505 J=1,3
      TE(J) = 0.
505 Y(4,J) = YR(J)
C     CALL RUNGE TO INTEGRATE ACROSS THE FIRST THREE STEPS.....
510 IF (RUNGE(3,YR,FR,X,H) .NE. 1) GO TO 520
      CALL RHS(YR,YRS)
      DO 515 K=1,3
515 FR(K)=YRS(K)
      GO TO 510
C     PUT THE APPROPRIATE INITIAL VALUES IN THE Y AND F MATRICES.....
520 COUNT = COUNT + 1
      ISUB = 4 - COUNT
      DO 525 J=1,3
525 Y(ISUB,J) = YR(J)
      CALL RHS(YR,YRS)
      DO 530 K=1,3
530 F(ISUB,K)=YRS(K)
C     PRINT SOLUTIONS WHEN X EXCEEDS DISTA.....
535 IF (X .LE. DISTA) GO TO 540
      IF (COUNT .LE. 3) GO TO 540
      CALL CONT(C,YC,Y,0,IC,2,ALF21,Y(1,2),Y(1,3),ZCON)
      IF (COUNT .GT. 3) WRITE(3,718) X,(Y(1,J),J=1,3),(YC(K),K=1,6)
C     IF X EXCEEDS DISMAX, TERMINATE THE INTEGRATION.....
540 IF (X .GT. DISMAX+H/2.) GO TO 560
C     CALL RUNGE OR HAVING TO INTEGRATE ACROSS THE NEXT STEP.....
      IF (COUNT .LT. 3) GO TO 510
C     CALL HAVING.....
545 M= HAVING(3,Y,F,X,H,TE)
      DO 550 K=1,3
550 YR(K)=Y(1,K)
      CALL RHS(YR,YRS)
      DO 555 K=1,3
555 F(1,K)=YRS(K)
      IF (M .EQ. 1) GO TO 545
C     INCREMENT STEP COUNTER AND CONTINUE INTEGRATION.....
      COUNT = COUNT + 1
      GO TO 535
560 CONTINUE
C     WRITE TO SCRATCH FILE.....
      WRITE(2,900)IA
900 FORMAT(I5)
      DO 501 JJ=1,IA
      WRITE(2,910)DIS(JJ)
910 FORMAT(E12.3)
501 CONTINUE
      DO 503 KK=1,5
      DO 502 JJ=1,IA
      WRITE(2,920)CON(JJ,KK),CONB(JJ,KK),CONC(JJ,KK)
920 FORMAT(3E12.3)
502 CONTINUE
503 CONTINUE
      DO 504 JJ=1,IA
      WRITE(2,910)CONC(JJ,6)
504 CONTINUE
C
C**** FORMATS FOR INPUT STATEMENTS *****
600 FORMAT(3A4)
C
C**** FORMATS FOR OUTPUT STATEMENTS *****
710 FORMAT(1H1, 9H TITLE= ,10A4,8H DATE= ,5A4,/)
711 FORMAT(30H0 METEOROLOGICAL CONDITIONS//7X,22H0 BAROMETRIC PRESS
1URE=,F7.3,25H MM HG AIR TEMPERATURE=,F5.1,6H DEG R/7X,22H0 AVER
PAGE WIND SPEED=,F6.2,25H M/S AT REFERENCE HEIGHT=,F7.2,2H M/

```

```

3 7X, 22HD      WIND EXPONENT=, F5. 2/
4 7X, 22HD      TURBULENCE LEVEL=, F6. 2//)
712 FORMAT(28H   VAPOR VENTING CONDITIONS//
1 7X, 22HD      VENT DIAMETER=, F6. 2, 7H METERS , /
2 7X, 22HD      VENT HEIGHT=, F6. 2, 23H METERS ABOVE THE DECK , /
3 7X, 22HD      DECK HEIGHT=, F6. 2, 24H METERS ABOVE THE WATER , //
4 7X, 22HD      EMITTED VAPOR=, 2X, 5A4, /
5 7X, 22HD      MOLECULAR WEIGHT=, F6. 2, 24H OF GAS AND AIR MIXTURE , /
6 7X, 22HD      VENT CONCENTRATION=, E10. 3, 10H KG/(M**3) , //
7 7X, 22HD      VENTING FLOWRATE=, F6. 0. 10H (M**3)/HR, /
8 7X, 22HD      VENTING VELOCITY=, F6. 2, 6H M/SEC , // )
713 FORMAT(61H   VALUES OF CONCENTRATION CHOSEN FOR CONCENTRATION CON
1 TOURS//,
2 7X, 10HD      C1 =, E10. 3, 10H (KG/M**3) , /
3 7X, 10HD      C2 =, E10. 3, 10H (KG/M**3) , /
4 7X, 10HD      C3 =, E10. 3, 10H (KG/M**3) , /
5 7X, 10HD      C4 =, E10. 3, 10H (KG/M**3) , /
6 7X, 10HD      C5 =, E10. 3, 10H (KG/M**3) , /
7 7X, 10HD      C6 =, E10. 3, 10H (KG/M**3) , /
8 7X, 29HD      PREDICTED FOR A HEIGHT OF, F6. 3 , 24H METERS ABOVE DECK
9 LEVEL //)
714 FORMAT(30H   NUMERICAL INTEGRATION DATA//7X, 14HD STEP SIZE=, F7.
14, 38H METERS, MAXIMUM DOWNWIND DISTANCE=, F7. 2, 7H METERS/)
715 FORMAT(1H1, 56H BEGIN PLUME COMPUTATION THROUGH THE AIR ABOVE THE
1 DECK/1H0, 4H S, 7X, 3HXCL, 6X, 3HZCL, 7X, 3HCCL, 8X, 5HCZCON, 6X, 4HXCON, 3X
2, 60HYC1 YC2 YC3 YC4 YC5 YC6 B U* THETA/1
3H , 120H METERS METERS METERS METERS KG/M**3 KG/M**3 METERS
4 METERS METERS METERS METERS METERS METERS METERS M/S RADIAN/)
716 FORMAT(/F7. 2, 2(2X, F7. 3), 2(2X, E10. 4), 1X, F7. 3, 7(1X, F6. 3), 2(1X, F6. 3))
717 FORMAT(/43H CONTINUE PLUME COMPUTATION ALONG THE DECK//98H X(MET
1ERS) CA(KG/M3) SIGMA Y(M) SIGMA Z(M) Y1(M) Y2(M) Y3(M) Y
24(M) Y5(M) Y6(M) )
718 FORMAT(F7. 2, 3X, F9. 6, 1X, F7. 3, 7(3X, F7. 3))
719 FORMAT(63H   VALUES OF CONCENTRATION FOR FLAMMABILITY AND HEALTH
1 HAZARDS , //
2 7X, 35HD      UPPER FLAMMABLE LIMIT (UEL) =, E10. 3, 10H KG/(M**3) , /
3 7X, 35HD      LOWER FLAMMABLE LIMIT (LEL) =, E10. 3, 10H KG/(M**3) , /
4 7X, 37HD      SHORT TERM INHALATION LIMIT (STIL)=, E10. 3, 10H KG/(M**3) , /
5 7X, 35HD      THRESHOLD LIMIT VALUE (TLV) =, E10. 3, 10H KG/(M**3) , /
6 7X, 35HD      ODOR THRESHOLD (ODOR) =, E10. 3, 10H KG/(M**3) //)
720 FORMAT(7H AT X= , F6. 3, 16H METERS, AND Y= , F6. 3, 37H METERS, THE PR
1 EDICTED CONCENTRATION=, E12. 6, 9H KG/M**3 )
724 FORMAT(/)
725 FORMAT(66H GRAPH OF PLUME CENTERLINE CONCENTRATION VERSUS DOWNWIND
1 DISTANCE )
726 FORMAT(55H   0 ORDINATE IS PROPORTIONAL TO LOG(CONCENTRATION) ,
1 / 55H   0 ABSCISSA IS PROPORTIONAL TO DISTANCE ,
2 // 55H   TABLE OF CORRESPONDING VALUES ,
3 / 55H   VALUE X(METERS) Y(KG/M**3) Y(PPM) )
730 FORMAT(4X, F4. 1, 10X, F6. 1, 7X, E10. 3, 4X, F9. 0)
731 FORMAT(75H GRAPH OF VAPOR CONCENTRATION AT MAN BREATHING HEIGHT VS
1 DOWNWIND DISTANCE )
732 FORMAT(77H GRAPH OF VAPOR CONCENTRATION CONTOURS AT MAN BREATHING
1 HEIGHT ABOVE THE DECK )
733 FORMAT(71H   0 ORDINATE IS PROPORTIONAL TO DISTANCE IN THE CROSS-
1 WIND DIRECTION , /
2 71H   0 ABSCISSA IS PROPORTIONAL TO DISTANCE IN THE DOWNST
3 REAM DIRECTION , //
4 71H   TABLE OF CORRESPONDING VALUES CONCENTRA
5 TION CONTOURS , /
6 72H   VALUE X(METERS) Y(METERS) SYMBOL (
7 PPM) (KG/M**3) )
734 FORMAT(4X, F4. 1, 10X, F6. 1, 8X, F6. 1, 8X, A4, F10. 2, E10. 3)

```

```

B4) TYPE *, ' DO YOU WANT TO RUN ANOTHER CASE (Y/N)? '
    READ(5,850)IDO
850 FORMAT(A2)
    IF(IDO.NE.1HN.AND.IDO.NE.1HY)GO TO B4)
    IF(IDO.EQ.1HN)GO TO 1000
C..... PREPARE TO RUN ANOTHER CASE.....
    TYPE *, '
    TYPE *, ' PREPARE TO ENTER INPUT DATA REQUIRED BY THE PROGRAM '
    TYPE *, '
    GO TO 1
1000 CONTINUE
    END

```

```

INTEGER FUNCTION HAMING( N, Y, F, X, H, TE )
C***FUNCTION HAMING IS TAKEN FROM @APPLIED NUMERICAL METHODS@ BY
C** B CARNAHAN, H. A. LUTHER, AND J. O. WILKES, PUBLISHED BY J. WILEY
C** AND SONS, INC. 1959. PAGES 401 TO 402.

```

```

C
C   HAMING IMPLEMENTS HAMMING'S PREDICTOR-CORRECTOR ALGORITHM TO
C   SOLVE N SIMULTANEOUS FIRST-ORDER ORDINARY DIFFERENTIAL
C   EQUATIONS. X IS THE INDEPENDENT VARIABLE AND H IS THE
C   INTEGRATION STEPSIZE. THE ROUTINE MUST BE CALLED TWICE FOR
C   INTEGRATION ACROSS EACH STEP. ON THE FIRST CALL, IT IS ASSUMED
C   THAT THE SOLUTION VALUES AND DERIVATIVE VALUES FOR THE N
C   EQUATIONS ARE STORED IN THE FIRST N COLUMNS OF THE FIRST
C   FOUR ROWS OF THE Y MATRIX AND THE FIRST THREE ROWS OF THE F
C   MATRIX RESPECTIVELY. THE ROUTINE COMPUTES THE N PREDICTED
C   SOLUTIONS YPRED(J), INCREMENTS X BY H AND PUSHES ALL
C   VALUES IN THE Y AND F MATRICES DOWN ONE ROW. THE PREDICTED
C   SOLUTIONS YPRED(J) ARE MODIFIED, USING THE TRUNCATION ERROR
C   ESTIMATES TE(J) FROM THE PREVIOUS STEP, AND SAVED IN THE FIRST
C   ROW OF THE Y MATRIX. HAMING RETURNS TO THE CALLING PROGRAM WITH
C   THE VALUE 1 TO INDICATE THAT ALL DERIVATIVES SHOULD BE COMPUTED
C   AND STORED IN THE FIRST ROW OF THE F ARRAY BEFORE THE SECOND
C   CALL IS MADE ON HAMING. ON THE SECOND ENTRY TO THE FUNCTION
C   (DETERMINED BY THE LOGICAL VARIABLE PRED), HAMING USES THE
C   HAMMING CORRECTOR TO COMPUTE NEW SOLUTION ESTIMATES, ESTIMATES
C   THE TRUNCATION ERRORS TE(J) FOR THE CURRENT STEP, IMPROVES
C   THE CORRECTED SOLUTIONS USING THE NEW TRUNCATION ERROR
C   ESTIMATES, SAVES THE IMPROVED SOLUTIONS IN THE FIRST ROW OF THE
C   Y MATRIX, AND RETURNS TO THE CALLING PROGRAM WITH A VALUE 2 TO
C   INDICATE COMPLETION OF ONE FULL INTEGRATION STEP.
C   LOGICAL PRED
C   DIMENSION YPRED(20), TE(N), Y(4,N), F(3,N)
C   DATA PRED / .TRUE. /

```

```

C
C   .... IS CALL FOR PREDICTOR OR CORRECTOR SECTION ....
C   IF (.NOT.PRED) GO TO 4
C
C   .... PREDICTOR SECTION OF HAMING ....
C   .... COMPUTE PREDICTED Y(J) VALUES AT NEXT POINT ....
C   DO 1 J=1,N
1  YPRED(J) = Y(4,J) + 4.*H*(2.*F(1,J) - F(2,J) + 2.*F(3,J))/3.
C
C   .... UPDATE THE Y AND F TABLES ....
C   DO 2 J=1,N
C   DO 2 K5=1,3
C   K = 5 - K5
C   Y(K,J) = Y(K-1,J)
2  IF (K.LT.4) F(K,J) = F(K-1,J)
C
C   .... MODIFY PREDICTED Y(J) VALUES USING THE TRUNCATION ERROR
C   ESTIMATES FROM THE PREVIOUS STEP INCREMENT X VALUE
C   DO 3 J=1,N

```

```

3 Y(1,J) = YPRED(J) + 112.*TF(J)/9
  X = X + H
C
C      SET PRED AND REQUEST UPDATED DERIVATIVE VALUES
PRED = .FALSE
HAMING = 1
RETURN
C
C      CORRECTOR SECTION OF HAMING
C      COMPUTE CORRECTED AND IMPROVED VALUES OF THE Y(J) AND SAVE
C      TRUNCATION ERROR ESTIMATES FOR THE CURRENT STEP
4 DO 5 J=1,N
  Y(1,J) = (9 *Y(2,J)-Y(4,J) + 3 *H*(F(1,J)+2.*F(2,J)-F(3,J)))/8.
  TE(J) = 9 *(Y(1,J) - YPRED(J))/121
5 Y(1,J) = Y(1,J) - TE(J)
C
C      SET PRED AND RETURN WITH SOLUTIONS FOR CURRENT STEP
PRED = .TRUE
HAMING = 2
RETURN
END
C
C      INTEGER FUNCTION RUNGE(N,Y,F,X,H)
C***FUNCTION RUNGE IS TAKEN FROM @APPLIED NUMERICAL METHODS@ BY
C*** B CARNAHAN, H A. LUTHER, AND J O. WILKES, PUBLISHED BY J. WILEY
C*** AND SONS, INC. 1969 PAGES 374 TO 375.
C
C      THE FUNCTION RUNGE EMPLOYS THE FOURTH-ORDER RUNGE-KUTTA METHOD
C      WITH KUTTA'S COEFFICIENTS TO INTEGRATE A SYSTEM OF N SIMULTAN-
C      EDUS FIRST ORDER ORDINARY DIFFERENTIAL EQUATIONS F(J)=DY(J)/DX,
C      (J=1,2,...,N), ACROSS ONE STEP OF LENGTH H IN THE INDEPENDENT
C      VARIABLE X, SUBJECT TO INITIAL CONDITIONS Y(J), (J=1,2,...,N).
C      EACH F(J), THE DERIVATIVE OF Y(J), MUST BE COMPUTED FOUR TIMES
C      PER INTEGRATION STEP BY THE CALLING PROGRAM. THE FUNCTION MUST
C      BE CALLED FIVE TIMES PER STEP (PASS(1)...PASS(5)) SO THAT THE
C      INDEPENDENT VARIABLE VALUE (X) AND THE SOLUTION VALUES
C      (Y(1)...Y(N)) CAN BE UPDATED USING THE RUNGE-KUTTA ALGORITHM.
C      M IS THE PASS COUNTER. RUNGE RETURNS AS ITS VALUE 1 TO
C      SIGNAL THAT ALL DERIVATIVES (THE F(J)) BE EVALUATED OR 0 TO
C      SIGNAL THAT THE INTEGRATION PROCESS FOR THE CURRENT STEP IS
C      FINISHED. SAVEY(J) IS USED TO SAVE THE INITIAL VALUE OF Y(J)
C      AND PHI(J) IS THE INCREMENT FUNCTION FOR THE J(TH) EQUATION.
C      AS WRITTEN, N MAY BE NO LARGER THAN 50
C
C      DIMENSION PHI(50), SAVEY(50), Y(N), F(N)
C      DATA M/0/
C
C      M = M + 1
C      GO TO (1,2,3,4,5), M
C
C      PASS 1
1  RUNGE = 1
  RETURN
C
C      PASS 2
2  DO 22 J=1,N
    SAVEY(J) = Y(J)
    PHI(J) = F(J)
22 Y(J) = SAVEY(J) + 0.5*H*F(J)
  X = X + 0.5*H
  RUNGE = 1
  RETURN
C

```

```

C      ... PASS 3 ...
3  DO 33 J= 1,N
   PHI(J) = PHI(J) + 2.0*F(J)
34  Y(J) = SAVEY(J) + 0.5*H*F(J)
   RUNGE = 1
   RETURN
C
C      ... PASS 4 ...
4  DO 44 J= 1,N
   PHI(J) = PHI(J) + 2.0*F(J)
44  Y(J) = SAVEY(J) + H*F(J)
   X = X + 0.5*H
   RUNGE = 1
   RETURN
C
C      ... PASS 5 ...
5  DO 55 J = 1,N
56  Y(J) = SAVEY(J) + (PHI(J) + F(J))*H/6.0
   M = 0
   RUNGE = 0
   RETURN
END

```

REAL FUNCTION SIMUL(N, A, X, EPS, INDIC, NRC)
C***FUNCTION SIMUL IS TAKEN FROM @APPLIED NUMERICAL METHODSE BY
C*** R. CARNAHAN, H. A. LUTHER, AND J. O. WILKES, PUBLISHED BY J. WILEY
C*** AND SONS, INC. 1969. PAGES 290 TO 291.

C
C WHEN INDIC IS NEGATIVE, SIMUL COMPUTES THE INVERSE OF THE N BY
C N MATRIX A IN PLACE. WHEN INDIC IS ZERO, SIMUL COMPUTES THE
C N SOLUTIONS X(1)...X(N) CORRESPONDING TO THE SET OF LINEAR
C EQUATIONS WITH AUGMENTED MATRIX OF COEFFICIENTS IN THE N BY
C N+1 ARRAY A AND IN ADDITION COMPUTES THE INVERSE OF THE
C COEFFICIENT MATRIX IN PLACE AS ABOVE. IF INDIC IS POSITIVE,
C THE SET OF LINEAR EQUATIONS IS SOLVED BUT THE INVERSE IS NOT
C COMPUTED IN PLACE. THE GAUSS-JORDAN COMPLETE ELIMINATION METHOD
C IS EMPLOYED WITH THE MAXIMUM PIVOT STRATEGY. ROW AND COLUMN
C SUBSCRIPTS OF SUCCESSIVE PIVOT ELEMENTS ARE SAVED IN ORDER IN
C THE IROW AND JCOL ARRAYS RESPECTIVELY. K IS THE PIVOT COUNTER,
C PIVOT THE ALGEBRAIC VALUE OF THE PIVOT ELEMENT, MAX
C THE NUMBER OF COLUMNS IN A AND DETER THE DETERMINANT OF THE
C COEFFICIENT MATRIX. THE SOLUTIONS ARE COMPUTED IN THE (N+1) TH
C COLUMN OF A AND THEN UNSCRAMBLED AND PUT IN PROPER ORDER IN
C X(1)...X(N) USING THE PIVOT SUBSCRIPT INFORMATION AVAILABLE
C IN THE IROW AND JCOL ARRAYS. THE SIGN OF THE DETERMINANT IS
C ADJUSTED, IF NECESSARY, BY DETERMINING IF AN ODD OR EVEN NUMBER
C OF PAIRWISE INTERCHANGES IS REQUIRED TO PUT THE ELEMENTS OF THE
C JORD ARRAY IN ASCENDING SEQUENCE WHERE JORD(IROW(I)) = JCOL(I).
C IF THE INVERSE IS REQUIRED, IT IS UNSCRAMBLED IN PLACE USING
C Y(1)...Y(N) AS TEMPORARY STORAGE. THE VALUE OF THE DETERMINANT
C IS RETURNED AS THE VALUE OF THE FUNCTION. SHOULD THE POTENTIAL
C PIVOT OF LARGEST MAGNITUDE BE SMALLER IN MAGNITUDE THAN EPS,
C THE MATRIX IS CONSIDERED TO BE SINGULAR AND A TRUE ZERO IS
C RETURNED AS THE VALUE OF THE FUNCTION.

```

C      DIMENSION IROW(15), JCOL(15), JORD(15), Y(15), A(NRC, NRC), X(N)
C
C      MAX=N
C      IF (INDIC GE. 0) MAX=N+1
C      ... BEGIN ELIMINATION PROCEDURE...
C      DETER=1
C      DO 18 K=1, N
C      KM1=K-1

```

```

C     ... SEARCH FOR THE PIVOT ELEMENT ...
      PIVOT=0
      DO 11 I=1,N
      DO 11 J=1,N
C     SCAN IROW AND JCOL ARRAYS FOR INVALID PIVOT SUBSCRIPTS ...
      IF (K.EQ.1) GO TO 9
      DO 8 ISCAN=1,KM1
      DO 8 JSCAN=1,KM1
      IF (I.EQ.IROW(ISCAN)) GO TO 11
      IF (J.EQ.JCOL(JSCAN)) GO TO 11
      8 CONTINUE
      9 IF (ABS(A(I,J)) .LE. ABS(PIVOT)) GO TO 11
      PIVOT=A(I,J)
      IROW(K)=I
      JCOL(K)=J
      11 CONTINUE
C     INSURE THAT SELECTED PIVOT IS LARGER THAN EPS...
      IF (ABS(PIVOT) .GT. EPS) GO TO 13
      WRITE(3,202)
      SIMUL=0
      RETURN
C     UPDATE THE DETERMINANT VALUE ...
      13 IROWK=IROW(K)
      JCOLK=JCOL(K)
      DETER=DETER*PIVOT
C     NORMALIZE PIVOT ROW ELEMENTS ...
      DO 14 J=1,MAX
      14 A(IROWK,J)=A(IROWK,J)/PIVOT
C     CARRY OUT ELIMINATION AND DEVELOP INVERSE...
      A(IROWK,JCOLK)=1./PIVOT
      DO 16 I=1,N
      AIJCK=A(I,JCOLK)
      IF (I.EQ.IROWK) GO TO 18
      A(I,JCOLK) = -AIJCK/PIVOT
      DO 17 J=1,MAX
      17 IF (J.NE.JCOLK) A(I,J)=A(I,J)-AIJCK*A(IROWK,J)
      18 CONTINUE
C     ORDER SOLUTION VALUES (IF ANY) AND CREATE JORD ARRAY...
      DO 20 I=1,N
      IROWI=IROW(I)
      JCOLI=JCOL(I)
      JORD(IROWI)=JCOLI
      20 IF (INDIC GE 0) X(JCOLI)=A(IROWI,MAX)
C     ADJUST SIGN OF DETERMINANT...
      INTCH=0
      NM1=N-1
      DO 22 I=1,NM1
      IP1=I+1
      DO 22 J=IP1,N
      IF (JORD(J) .GE. JORD(I)) GO TO 22
      JTEMP=JORD(J)
      JORD(J)=JORD(I)
      JORD(I)=JTEMP
      INTCH=INTCH+1
      22 CONTINUE
      IF (INTCH/2*2 .NE. INTCH) DETER=-DETER
C     IF INDIC IS POSITIVE RETURN WITH RESULTS...
      IF (INDIC LE 0) GO TO 26
      SIMUL=DETER
      RETURN
C     IF INDIC IS NEGATIVE OR ZERO, UNSCRAMBLE THE INVERSE
C     FIRST BY ROWS ...
      24 DO 26 J=1,N

```



```

DO 27 I=1,N
IROWI=IROW(I)
JCOLI=JCOL(I)
27 Y(JCOLI)=A(IROWI,J)
DO 28 I=1,N
28 A(I,J)=Y(J)
C      THEN BY COLUMNS...
DO 30 I=1,N
DO 29 J=1,N
IROWJ=IROW(J)
JCOLJ=JCOL(J)
29 Y(IROWJ)=A(I,JCOLJ)
DO 30 J=1,N
30 A(I,J)=Y(J)
C      RETURN FOR INDIC NEGATIVE OR ZERO
SIMUL=DETER
RETURN
202 FORMAT(37HOSMALL PIVOT - MATRIX MAY BE SINGULAR)
END

C
SUBROUTINE RHS(Y,C)
DIMENSION Y(6),A(5,5),B(4,4),C(4),D(3)
COMMON/PHYS/DCDR, EPS, UPRI, RGA, ROE, G, ALF, TAU, U10
COMMON/CONS/IDECK, AF1, AF2, AF21, BTA, D.A, BT1, DBA, BM1, GAM
COMMON/DAT1/SO, VD, VH, ZDECK, ZREF, UR
C*** TEST IDECK
C      IDECK=1, PLUME CENTERLINE ABOVE DECK... USE DOMS EQUATIONS
C      IDECK=0, PLUME IS ON THE DECK... USE TE RIELES EQUATIONS
IF (IDECK.EQ.0) GO TO 100
C*** DOMS EQUATIONS FOR GAUSSIAN PROFILES AND VARIABLE DENSITY
ST= SIN(Y(4))
ST2=ST*ST
CT= COS(Y(4))
CT2=CT*CT
UA=UR*((Y(6)+ZDECK)/ZREF)**ALF
UA2=UA*UA
UACT=UA*CT
UAST=UA*ST
Y12=Y(1)*Y(2)
Y33=Y(3)*Y(3)
ROC=Y(1)/DCDR
ROCA=ROC/ROA
AC1=0.772699*UACT+0.412442*Y(3)
AC2=(1.043144*UACT + 0.55679*Y(3))/ROA
AC3=(1.043144*UACT*UACT + 1.113593*UACT*Y(3) + 0.363346*Y33)/ROA
AM1=2.*UACT*UACT + 1.729329*UACT*Y(3) + 0.490842*Y33
AM2=Y(2)*(1.729329*UACT+0.981684*Y(3)+ROCA*(1.113593*UACT
1 +0.726692*Y(3)))
C*** CONSERVATION OF SPECIES
A(1,1)=Y(2)*AC1
A(1,2)=2.*Y(1)*AC1
A(1,3)=0.412442*Y12
A(1,4)=-0.772699*Y12*UAST
A(1,5)=0.
C*** CONSERVATION OF MASS
A(2,1)=Y(2)*AC2/DCDR
A(2,2)=2.*(2.*UACT + 0.864665*Y(3) + ROC*AC2)
A(2,3)=Y(2)*(0.864665 + 0.556796*ROCA)
A(2,4)=Y(2)*UAST*(-2. -1.043144*ROCA)
A(2,5)=2.*(0.057* ABS(Y(3)) + 0.5*UACT* ABS(ST) + UPRI)
C*** CONSERVATION OF X-MOMENTUM
A(3,1)=Y(2)*AC3*CT/DCDR
A(3,2)=2.*(AM1 + AC3*ROC)*CT

```

```

A(3,3)=CT*AM2
A(3,4)=Y(2)*ST*(-6 *UACT#UACT-3.458658*UACT*Y(3)-0.490842*Y33
1 -RCCA*(3.129432*UACT*UACT+2.227186*UACT*Y(3)+0.363346*Y33))
A(3,5)=UA*A(2,5)+0.3*UA2* ABS(ST*ST*ST)
C*** CONSERVATION OF Y-MOMENTUM
A(4,1)=Y(2)*ST*AC3/DCDR
A(4,2)=2.*ST*(AM1 + AC3*RCC)
A(4,3)=ST*AM2
A(4,4)=Y(2)*(2.*UA2*CT*(1.-3.*ST2)+1.729329*UA*Y(3)*(CT2-ST2)
1 +0.490842*Y33*CT + RCCA*(1.043144*UA2*CT*(1.-3.*ST2)
2 +1.113593*Y(3)*UA*(CT2-ST2) + 0.363346*Y33*CT))
IF (ST.LT.0.) GO TO 40
SIG=-1
GO TO 45
40 SIG=1
45 CONTINUE
A(4,5)=-1.043144*RCCA*Y(2)*G + SIG*0.3*UAST*UAST*CT
C*** SIMUL USED FOR MATRIX INVERSION
DETER=SIMUL(4,A,C,EPS,1,5)
RETURN
100 CONTINUE
C*** TE RIELECS EQUATIONS FOR PLUME DEVELOPMENT ALONG THE DECK
Y12=Y(1)*Y(2)
Y13=Y(1)*Y(3)
Y23=Y(2)*Y(3)
C*** MASS CONSERVATION EQUATION, YL=INFINITY
B(1,1)=Y23
B(1,2)=Y13
B(1,3)=AF1*Y12
B(1,4)=0
C*** MASS CONSERVATION EQUATION, YL=Y(2)*.7071
B(2,1)=0.605009*Y23
B(2,2)=0.176127*Y13
B(2,3)=0.605009*Y12*AF1
B(2,4)=-0.4288819*DBA*BTA*Y13*(Y(2)**BM1)
C*** MOMENTUM CONSERVATION EQUATION
CALL CSUM(Y(1),CSUM1)
CL=(U10*U10/AF2)*((0.01*Y(3))**AF2)
CR=Y12*TAU*CSUM1
B(3,1)=CL*Y23
B(3,2)=CL*Y13
B(3,3)=CL*Y12*AF21
B(3,4)=CR
C*** SIMUL USED FOR MATRIX INVERSION
DETER=SIMUL(3,E,D,EPS,1,4)
DO 110 I=1,3
110 C(I)=D(I)
RETURN
END
C
SUBROUTINE CSUM(CA,SUM1)
C*** THIS SUBROUTINE COMPUTES THE SUM OF A SERIES THAT ARISES IN
C TE RIELECS CONSERVATION OF MOMENTUM EQUATION.
COMMON/CON2/ROT
SUM=1
I=1
A=ROT*CA
X0=-1+A
X1=1
1 CONTINUE
X1=X1*X0
I=I+1
ANUM=1/SQRT(1+I)

```

```

X=X1*ANUM
SUM1=SUM+X
IF (ABS(X) LT 0.000001) GO TO 3
SUM=SUM1
IF (I.GT.50) GO TO 2
GO TO 1
2 WRITE(3,10)
3 RETURN
10 FORMAT(37H NUMBER OF TERMS IN CSUM EXCEEDED 50)
END

```

```

C
SUBROUTINE CONT(CC, YC, Y, IDECK, INUM, PR, PS, SIGY, SIGZ, ZCON)
DIMENSION CC(9), YC(9), Y(4,6)
C**** THIS SUBROUTINE COMPUTES THE CROSS-WIND LOCATIONS OF CONTOURS
C**** OF CONSTANT CONCENTRATION*****
C..... VALUES OF CONCENTRATION MUST BE SPFCIFIED WHEN SURROUTINE...
C..... INDAT IS CALLED. IF NO CONTOURS ARE REQUIRED, THEN CONTROL...
C..... IS RETURNED TO THE CALLING PROGRAM.....
IF (INUM.LE.0) GO TO 950
DO 9 I=1, INUM
9 YC(I)=0.
C
C FIRST TEST TO DECIDE WHETHER OOMS OR TE RIELES MODEL WILL BE USED
C
IF (IDECK.EQ.0) GO TO 100
C
DOMS@ MODEL FOR CONCENTRATION PROFILE
ZS = Y(1,6) - ZCON
ZSQ = ZS*ZS
YLM2 = 1.35*Y(1,2)*Y(1,2)
ZSA = ZSQ/YLM2
IF (ZSA.GT.13.81) GO TO 95
ZI = Y(1,6) + ZCON
ZIQ = ZI*ZI
ZIA = ZIQ/YLM2
DK = EXP(-ZSA) + EXP(-ZIA)
DO 90 I=1, INUM
C*** TEST WHETHER CC(I) IS GREATER THAN MAX CONCENTRATION AT MAN HEIGHT
CRAT = CC(I)/(Y(1,1)*DK)
IF (CRAT.GE.1.0) GO TO 90
C*** COMPUTE Y-LOCATION OF CONTOUR
YCSQ = -YLM2 * ALOG(CRAT)
YC(I) = SQRT(YCSQ)
90 CONTINUE
95 RETURN
100 CONTINUE
C*** TE RIELES@ MODEL FOR CONCENTRATION PROFILE
RV=1./PR
ZPW=(ZCON/SIGZ)**PS
IF (ZPW.GT.13.81) GO TO 950
DO 900 I=1, INUM
C*** TEST WHETHER CC(I) IS GREATER THAN CONCENTRATION AT MAN HEIGHT
CRAT = CC(I)/(Y(1,1)*EXP(-ZPW))
IF (CRAT.GE.1.0) GO TO 900
C*** COMPUTE Y-LOCATION OF CONTOUR
YC(I) = SIGY * ((-ALOG(CRAT))**RV)
900 CONTINUE
950 RETURN
END
C
C**** SUBROUTINE START *****
SUBROUTINE START(WMA, YR, WMJ)
C..... THIS SUBROUTINE COMPUTES THE SET OF INITIAL OR STARTING VALUES
C..... OF PLUME RADIUS, PLUME TRAJECTORY AND PLUME ANGLE THAT ARE NEED-

```

```

C..... FOR NUMERICAL COMPUTATION OF OOMS' MODEL EQUATIONS.
C
REAL JAY
DIMENSION XOD(10),ZOD(10),PATHL(10),YR(6)
COMMON/DAT1/SG,VD,VH,ZDECK,ZREF,UR
COMMON/DAT2/PO,TO,UVENT,CO,UTLV,WMG
COMMON/DAT3/PVAP,DISTAN,DISMA%,QL,ZCON
C..... COMPUTE THE WIND SPEED AT DECK HEIGHT ABOVE THE GROUND.
C..... ZDECK = DECK HEIGHT, M.
C..... ZREF = REFERENCE HEIGHT FOR WIND SPEED PROFILE, M.
C..... UR = WIND SPEED AT THE REFERENCE HEIGHT, M/S.
UDECK=UR*(ZDECK/ZREF)**.14
C..... CALCULATE THE VAPOR CONCENTRATION FROM THE CHEMICAL VAPOR.
C..... PRESSURE AT ONE ATMOSPHERE, AND THE VALUE OF ATMOSPHERIC
C..... PRESSURE.
CO=PVAP/760.
C..... CALCULATE THE MOLECULAR WEIGHT OF THE VAPOR AND AIR MIXTURE.
C..... WMG = MOLECULAR WEIGHT OF PURE CHEMICAL VAPOR.
C..... WMA = MOLECULAR WEIGHT OF AIR.
WMJ=(CO*WMG)+(1-CO)*WMA
C..... CALCULATE THE JET MOMENTUM RATIO.
C..... UVENT = VELOCITY OF VAPOR/AIR MIXTURE FROM VENT.
JAY=(WMJ/WMA)*(UVENT/UDECK)**2.
C..... THE KAMOTANI AND GREBER CORRELATION IS USED FOR THE INITIAL
C..... PLUME TRAJECTORY. (Z/D)=AV*(X/D)**BV.
C..... CALCULATE THE PATH LENGTH ALONG THE TRAJECTORY.
AV=EXP( 405465+.0.131368*ALOG(JAY)+.0.054931*(ALOG(JAY))**2)
IF (JAY.LT.10.) GO TO 4
BV=EXP(-0.744691-.0.074525*ALOG(JAY))
GO TO 5
4 BV=0.4
5 CONTINUE
ROW=0.871667+.1775*(UVENT/UDECK)
C..... CALCULATE THE VALUE OF PATH LENGTH (X/D) THAT IS NEEDED TO
C..... SATISFY THE CURVE LENGTH
XOD(0)=0
ZOD(0)=0
PATHL(0)=0
I=0
10 I=I+1
XOD(I)=XOD(I-1)+0.10
ZOD(I)=AV*XOD(I)**BV
PATHL(I)=PATHL(I-1)+SQRT((XOD(I)-XOD(I-1))**2.+(ZOD(I)-ZOD(I-1))
1*2)
IF (PATHL(I).LT.ROW)GO TO 10
FXOD=XOD(I-1)+(XOD(I)-XOD(I-1))*((ROW-PATHL(I-1))/(PATHL(I)-PATHL
2(I-1)))
C..... CALCULATE THE INITIAL VALUE OF YR(5)=X BY MULTIPLYING XOD BY...
C..... THE VENT DIAMETER, VD.
C..... CALCULATE THE INITIAL VALUE OF YR(6)=Z BY MULTIPLYING ZOD BY...
C..... THE VENT DIAMETER, ZD, AND ADDING THE VENT HEIGHT ABOVE THE...
C..... DECK, VH.
C..... CALCULATE THE INITIAL VALUE OF YR(4)=THETA, THE ANGLE OF THE...
C..... PLUME AXIS WITH RESPECT TO THE HORIZON, AS THE INVERSE TANGENT...
C..... OF AV*BV*(X/D)**(BV-1.).
C..... CALCULATE THE INITIAL VALUE OF YR(3)=VELOCITY DEFECT, AS...
C..... THE VALUE OF UVENT-UDECK*COS(THETA).
C..... CALCULATE THE INITIAL VALUE OF YR(2)=B.
YR(5)=FXOD*VD
YR(6)=AV*(FXOD**BV)*VD+VH
YR(4)=ATAN(AV*BV*FXOD**(BV-1.0))
YR(3)=UVENT-UDECK*COS(YR(4))
YR(2)=0.6597*VD/(SQRT(1+.35*UDECK*COS(YR(4))/UVENT))

```

```

YR(1)=CO
RETURN
END

```

```

C
C**** SUBROUTINE INDAT *****
SUBROUTINE INDAT
C..... THIS SUBROUTINE PERMITS THE USER TO FURNISH INPUT DATA IN AN
C..... INTERACTIVE MANNER. THE PROGRAM WILL IDENTIFY THE VARIABLE
C..... TO BE SPECIFIED, PROMPT WITH THE CURRENT DEFAULT VALUE, AND
C..... ASK THE USER IF THIS VALUE IS ACCEPTED. IF NOT THE PROGRAM
C..... WILL ACCEPT A NEW VALUE INPUT BY THE USER.
REAL LEL, APLACE(10), ADATE(3), AGAS(5)
COMMON/DAT1/SO, VD, VH, ZDECK, ZREF, UR
COMMON/DAT2/PO, TO, UVENT, CO, UTLV, WMC
COMMON/DAT3/PVAP, DISTAN, DISMAX, GL, ZCON
COMMON/DAT4/CC1, CC2, CC3, CC4, CC5, CC6
COMMON/DAT5/UCL, LEL, STIL, TLV, ODDR
COMMON/DAT6/APLACE, ADATE, AGAS
C..... ENTER NAME OF VESSEL, PLACE OR DESCRIBING PHRASE
TYPE *, ' ENTER NAME OF VESSEL, PLACE OR DESCRIBING PHRASE '
TYPE *, ' (UP TO 40 CHARACTERS) '
TYPE *, ' '
ACCEPT 101, (APLACE(J), J=1, 10)
TYPE *, ' '
C..... ENTER NAME OF CARGO VAPOR OR GAS BEING EMITTED
TYPE *, ' ENTER NAME OF CARGO VAPOR OR GAS BEING EMITTED '
TYPE *, ' (UP TO 20 CHARACTERS) '
TYPE *, ' '
ACCEPT 102, (AGAS(J), J=1, 5)
TYPE *, ' '
C..... LIST DEFAULT VALUES FOR VENT GEOMETRY AND ASK WHETHER CHANGES
C..... ARE REQUIRED
5 TYPE *, ' LIST THE DEFAULT VALUES FOR VENT GEOMETRY VARIABLES '
TYPE *, ' '
TYPE *, ' VENT DIAMETER, VD, ' VD, ' METERS '
TYPE *, ' VENT HEIGHT, VH, ' VH, ' METERS '
TYPE *, ' DECK HEIGHT, ZDECK, ' ZDECK, ' METERS '
TYPE *, ' '
TYPE *, ' DO YOU WANT TO USE ALL OF THESE VALUES (Y/N)? '
READ(5, 105) IDO
IF (IDO NE 1HN AND IDO NE 1HY) GO TO 5
IF (IDO EQ 1HY) GO TO 10
6 TYPE *, ' '
C..... VALUE FOR VENT DIAMETER, VD, IN METERS
TYPE *, ' ENTER VALUE FOR VENT DIAMETER, VD, IN METERS. '
TYPE *, ' '
TYPE *, ' TYPICAL VALUES ARE... '
TYPE *, ' 0.305 M ( 12 INCHES) '
TYPE *, ' 0.203 M ( 8 INCHES) '
TYPE *, ' 0.102 M ( 4 INCHES) '
CALL PROMPT(VD)
C..... VALUE FOR VENT HEIGHT, VH, IN METERS
TYPE *, ' ENTER VALUE FOR VENT HEIGHT, VH, IN METERS. '
TYPE *, ' '
TYPE *, ' TYPICAL VALUES ARE... '
TYPE *, ' 1.0 M ( 3.3 FT) '
TYPE *, ' 4.0 M (13.1 FT) '
TYPE *, ' 6.1 M (20.0 FT), OR B/3 '
CALL PROMPT(VH)
C..... VALUE FOR DECK HEIGHT, ZDECK, IN METERS
TYPE *, ' ENTER VALUE FOR DECK HEIGHT, ZDECK, IN METERS. '
TYPE *, ' '
TYPE *, ' TYPICAL VALUES ARE... '

```

```

TYPE *, ' 1.0 M (BARGE)
TYPE *, ' 6.1 M (SHIP)
CALL PROMPT(ZDECK)
GO TO 5
10 CONTINUE
C ..... LIST DEFAULT VALUES FOR ATMOSPHERIC CONDITIONS AND ASK .....
C ..... WHETHER CHANGES ARE REQUIRED .....
15 TYPE *, ' LIST THE DEFAULT VALUES FOR ATMOSPHERIC CONDITIONS
TYPE *, '
TYPE *, ' ATMOSPHERIC PRESSURE, PO,          ', PO, ' MM HG '
TYPE *, ' ATMOSPHERIC TEMPERATURE, TO,       ', TO, ' DEG R '
TYPE *, ' WIND SPEED, UR,                    ', UR, ' M/S '
TYPE *, ' REFERENCE HEIGHT, ZREF,           ', ZREF, ' M '
TYPE *, ' WIND TURBULENCE LEVEL, UTLV,      ', UTLV, ' % '
TYPE *, '
TYPE *, ' DO YOU WANT TO USE ALL OF THESE VALUES (Y/N)? '
READ(5,105)IDG
IF(IDO.NE.1HN.AND.IDO.NE.1HY)GO TO 15
IF(IDO.EQ.1HY)GO TO 20
15 TYPE *, '
C ..... VALUE FOR ATMOSPHERIC PRESSURE, PO, IN MM HG .....
TYPE *, ' ENTER VALUE FOR ATMOSPHERIC PRESSURE, PO, IN MM HG '
TYPE *, '
TYPE *, ' TYPICAL VALUES ARE
TYPE *, ' 760. MM HG
CALL PROMPT(PO)
C ..... VALUE FOR ATMOSPHERIC TEMPERATURE, TO, IN DEG. RANKINE .....
TYPE *, ' ENTER VALUE FOR ATMOSPHERIC TEMPERATURE, TO, IN R '
CALL PROMPT(TO)
C ..... VALUE FOR REFERENCE WIND SPEED, UR, IN METERS/SEC. ....
TYPE *, ' ENTER VALUE FOR REFERENCE WIND SPEED, UR, IN M/S '
TYPE *, '
TYPE *, ' TYPICAL VALUES ARE
TYPE *, ' 1.12 M/S ( 2.5 MILE/HR) '
TYPE *, ' 2.24 M/S ( 5.0 MILE/HR) '
TYPE *, ' 4.47 M/S (10.0 MILE/HR) '
TYPE *, ' 6.71 M/S (15.0 MILE/HR) '
CALL PROMPT(UR)
C ..... VALUE FOR WIND SPEED REFERENCE HEIGHT, ZREF, IN METERS. ....
TYPE *, ' ENTER WIND SPEED REFERENCE HEIGHT, ZREF, IN METERS '
TYPE *, '
TYPE *, ' TYPICAL VALUES ARE
TYPE *, ' 10.0 M (32.8 FT)
CALL PROMPT(ZREF)
C ..... VALUE FOR WIND TURBULENCE LEVEL, UTLV, IN PERCENT. ....
TYPE *, ' ENTER WIND TURBULENCE LEVEL, UTLV, IN PERCENT '
TYPE *, '
TYPE *, ' TYPICAL VALUES ARE
TYPE *, ' 20% (FOR ALL WIND SPEEDS)
TYPE *, ' 30% (FOR VERY LOW SPEED OR GUSTY CONDITIONS)
TYPE *, ' 0% (TO ESTIMATE INSTANTANEOUS PLUME BOUNDARY)
CALL PROMPT(UTLV)
GO TO 15
20 CONTINUE
TYPE *, '
C ..... LIST DEFAULT VALUES FOR PLUME VENT CONDITIONS. ....
C ..... AND ASK WHETHER CHANGES ARE REQUIRED. ....
25 TYPE *, ' LIST THE DEFAULT VALUES FOR PLUME VENT CONDITIONS
TYPE *, '
TYPE *, ' CARGO LOADING RATE, GL,          ', GL, ' M**3/HR '
UVENT= GL*0.0003536777/VD/VD
TYPE *, ' VENT VELOCITY, UVENT,          ', UVENT, ' M/S '
TYPE *, ' VAPOR MOLECULAR WEIGHT, WMO,    ', WMO, '

```

```

TYPE *, ' CARGO VAPOR PRESSURE, PVAP, ', PVAP, ' MM HG '
CO= ((PVAP/760.)*14.7)*144.*WMG*16.0522/(1545*T0)
TYPE *, ' VENT CONCENTRATION, CO, ', CO, ' KG/M**3 '
TYPE *, '
TYPE *, ' DO YOU WANT TO USE ALL OF THESE VALUES (Y/N)? '
READ(5,105)IDO
IF(IDO.NE.1HN.AND.IDO.NE.1HY)GO TO 25
IF(IDO.EQ.1HY)GO TO 30
26 TYPE *, '
TYPE *, '
C..... VALUE FOR LOADING RATE (OR GAS FLOW RATE), QL, IN M**3/SEC...
TYPE *, ' ENTER LOADING RATE (OR GAS VOLUMETRIC FLOW RATE) '
TYPE *, ' QL IN METERS**3/HR '
TYPE *, '
TYPE *, ' TYPICAL VALUES ARE... '
TYPE *, ' 794 M**3/HR (5000 BBL/HR) '
TYPE *, ' 318 M**3/HR (2000 BBL/HR) '
TYPE *, ' 159 M**3/HR (1000 BBL/HR) '
TYPE *, ' 79 M**3/HR ( 500 BBL/HR) '
CALL PROMPT(QL)
C..... CALCULATE VENT VELOCITY, UVENT, IN M/S.....
UVENT= QL*0.0003536777/VD/VD
TYPE *, ' CALCULATED VALUE OF VENT VELOCITY IS ', UVENT, ' M/S '
TYPE *, '
TYPE *, '
C..... VALUE FOR VAPOR MOLECULAR WEIGHT.....
TYPE *, ' ENTER VAPOR MOLECULAR WEIGHT, WMG '
TYPE *, '
TYPE *, ' TYPICAL VALUES ARE... '
TYPE *, ' 86.10 (VINYL ACETATE) '
CALL PROMPT(WMG)
C..... VALUE FOR VENT CONCENTRATION, CO, IN KG/M**3.....
TYPE *, ' THE VAPOR CONCENTRATION NEAR THE END OF CARGO LOADING '
TYPE *, ' MAY APPROACH THE SATURATED VAPOR CONCENTRATION. ENTER '
TYPE *, ' THE VALUE OF SATURATED VAPOR PRESSURE, OR SOME FRACT- '
TYPE *, ' ION THEREOF..... '
TYPE *, ' ENTER VAPOR PRESSURE, PVAP, IN MM HG '
TYPE *, '
TYPE *, ' TYPICAL VALUES ARE... '
TYPE *, ' 90. MM HG (VINYL ACETATE) '
CALL PROMPT(PVAP)
C..... CALCULATE THE VENT CONCENTRATION.....
CO= ((PVAP/760.)*14.7)*144.*WMG*16.0522/(1545*T0)
TYPE *, ' CALCULATED VALUE OF VENT CONCENTRATION, CO= ', CO, ' KG/M**3 '
TYPE *, '
TYPE *, '
GO TO 25
30 CONTINUE
C..... LIST DEFAULT VALUES FOR PLUME COMPUTATION CONDITIONS.....
35 TYPE *, ' LIST THE DEFAULT VALUES FOR PLUME COMPUTATION '
TYPE *, '
TYPE *, ' PLUME PATH DISTANCE, SO, ', SO, ' M '
TYPE *, ' DISTANCE BETWEEN PRINTOUTS, DISTAN, ', DISTAN, ' M '
TYPE *, ' MAX DOWNWIND DISTANCE, DISMAX, ', DISMAX, ' M '
TYPE *, '
TYPE *, ' DO YOU WANT TO USE ALL OF THESE VALUES (Y/N)? '
READ(5,105)IDO
IF(IDO.NE.1HN.AND.IDO.NE.1HY)GO TO 35
IF(IDO.EQ.1HY)GO TO 40
36 TYPE *, '
C..... INITIAL VALUE FOR PLUME PATH DISTANCE, SO, IN METERS.....
TYPE *, ' ENTER VALUE FOR PLUME PATH LENGTH, SO, IN METERS '
TYPE *, '

```

```

TYPE *, ' TYPICAL VALUES ARE... '
TYPE *, ' 0.0 M '
CALL PROMPT(SO)
C VALUE FOR DISTANCE BETWEEN PRINTOUTS, DISTAN, IN METERS...
TYPE *, ' ENTER DISTANCE BETWEEN PRINTOUTS, DISTAN, IN METERS '
TYPE *, '
TYPE *, ' TYPICAL VALUES ARE... '
TYPE *, ' 1.0 M '
TYPE *, ' 5.0 M '
CALL PROMPT(DISTAN)
C VALUE FOR MAXIMUM DISTANCE FOR PLUME COMPUTATION...
C DISMAX, IN METERS...
TYPE *, ' ENTER MAXIMUM DISTANCE FOR PLUME COMPUTATION '
TYPE *, ' DISMAX, IN METERS '
TYPE *, '
TYPE *, ' TYPICAL VALUES ARE... '
TYPE *, ' 10 M (RECOMMENDED FOR 1 M VENTS) '
TYPE *, ' 20 M (RECOMMENDED FOR 4 M AND 8/3 VENTS) '
TYPE *, ' 100 M '
CALL PROMPT(DISMAX)
STEPS=DISMAX/DISTAN
IF(STEPS.LE.50)GO TO 35
TYPE *, '*****'
TYPE *, 'THE SPECIFIED CONDITIONS ARE NOT WITHIN THE ARRAY'
$ CAPABILITIES.'
TYPE *, '
TYPE *, ' EITHER DECREASE THE MAXIMUM DISTANCE, DISMAX, '
TYPE *, ' OR '
TYPE *, ' INCREASE THE STEP SIZE, DISTAN. '
TYPE *, '
TYPE *, ' DISMAX/DISTAN MUST BE LESS THAN OR EQUAL TO 50. '
TYPE *, '*****'
TYPE *, '
GO TO 35
40 CONTINUE
C VALUE FOR UEL, LEL, STIL, TLV AND ODOR...
45 TYPE *, ' LIST THE DEFAULT VALUES FOR UEL, LEL, STIL, TLV AND ODOR '
TYPE *, '
TYPE *, ' UPPER FLAMMABLE LIMIT, UEL, = ', UEL, ' % '
TYPE *, ' LOWER FLAMMABLE LIMIT, LEL, = ', LEL, ' % '
TYPE *, ' SHORT TERM INHALATION LIMIT, STIL, = ', STIL, ' PPM '
TYPE *, ' THRESHOLD LIMIT VALUE, TLV, = ', TLV, ' PPM '
TYPE *, ' ODOR THRESHOLD, ODOR, = ', ODOR, ' PPM '
TYPE *, '
TYPE *, ' DO YOU WANT TO USE ALL OF THESE VALUES (Y/N)? '
READ(5,105)IDO
IF(IDO.NE.1HN.AND.IDO.NE.1HY)GO TO 45
IF(IDO.EQ.1HY)GO TO 50
46 TYPE *, '
C VALUE FOR UPPER FLAMMABLE LIMIT, UEL, IN PERCENT...
TYPE *, ' ENTER VALUE FOR UEL IN PERCENT BY VOLUME '
TYPE *, '
TYPE *, ' TYPICAL VALUES ARE... '
TYPE *, ' 13.4 % (VINYL ACETATE) '
TYPE *, ' ( IF THE UEL VALUE IS NOT KNOWN, ENTER 100.0) '
CALL PROMPT(UEL)
C ASSIGN VALUE OF UEL TO CC3...
CC3 = UEL*10000
C VALUE FOR LOWER FLAMMABLE LIMIT, LEL, IN PERCENT...
TYPE *, ' ENTER VALUE FOR LEL IN PERCENT BY VOLUME '
TYPE *, '
TYPE *, ' TYPICAL VALUES ARE '
TYPE *, ' 2.6 % (VINYL ACETATE) '

```



```

TYPE *, ' ( IF THE LEL VALUE IS NOT KNOWN, ENTER 100.0 ) '
CALL PROMPT(LEL)
C ..... ASSIGN VALUE OF LEL TO CC4 .....
CC4 = LEL*10000.
C ..... VALUE FOR SHORT TERM INHALATION LIMIT, STIL, IN PPM .....
TYPE *, ' ENTER VALUE FOR STIL IN PPM '
TYPE *, '
TYPE *, ' TYPICAL VALUES ARE... '
TYPE *, ' 20 PPM (VINYL ACETATE) '
TYPE *, ' (IF A VALUE FOR STIL IS NOT KNOWN, ENTER 1000000.) '
CALL PROMPT(STIL)
C ..... ASSIGN VALUE OF STIL TO CC5 .....
CC5 = STIL
C ..... VALUE FOR THRESHOLD LIMIT VALUE, TLV, IN PPM .....
TYPE *, ' ENTER VALUE FOR TLV IN PPM '
TYPE *, '
TYPE *, ' TYPICAL VALUES ARE... '
TYPE *, ' 10 PPM (VINYL ACETATE) '
TYPE *, ' (IF A VALUE FOR TLV IS NOT KNOWN, ENTER 1000000.) '
CALL PROMPT(TLV)
C ..... ASSIGN VALUE OF TLV TO CC6 .....
CC6 = TLV
C ..... VALUE FOR THE ODOR THRESHOLD, ODOR, IN PPM .....
TYPE *, ' ENTER VALUE FOR ODOR IN PPM '
TYPE *, '
TYPE *, ' TYPICAL VALUES ARE... '
TYPE *, ' 0.12 PPM (VINYL ACETATE) '
TYPE *, ' (IF A VALUE FOR ODOR IS NOT KNOWN, ENTER 1000000.) '
CALL PROMPT(ODOR)
C ..... ASSIGN VALUE OF ODOR TO CC2 .....
CC2 = ODOR
GO TO 45
50 CONTINUE
C ..... LIST DEFAULT VALUES FOR CONCENTRATION CONTOURS .....
55 TYPE *, ' LIST THE DEFAULT VALUES FOR CONCENTRATION CONTOURS '
TYPE *, '
TYPE *, ' CC1 = ',CC1,' PPM (USER ASSIGNED VALUE) '
TYPE *, ' CC2 = ',CC2,' PPM (USUALLY THE ODOR THRESHOLD) '
TYPE *, ' CC3 = ',CC3,' PPM (USUALLY THE UEL) '
TYPE *, ' CC4 = ',CC4,' PPM (USUALLY THE LEL) '
TYPE *, ' CC5 = ',CC5,' PPM (USUALLY THE STIL) '
TYPE *, ' CC6 = ',CC6,' PPM (USUALLY THE TLV) '
TYPE *, '
TYPE *, ' DO YOU WANT TO USE ALL OF THESE VALUES (Y/N)? '
READ(5,105)IDO
IF(IDO.NE.1HN.AND.IDO.NE.1HY)GO TO 55
IF(IDO.EQ.1HY)GO TO 60
56 TYPE *, '
C ..... VALUES FOR CONCENTRATION CONTOURS .....
TYPE *, ' ENTER VALUES FOR CC1 THROUGH CC6 IN PPM '
CALL PROMPT(CC1)
CALL PROMPT(CC2)
CALL PROMPT(CC3)
CALL PROMPT(CC4)
CALL PROMPT(CC5)
CALL PROMPT(CC6)
GO TO 55
60 CONTINUE
101 FORMAT(10A4)
102 FORMAT(5A4)
103 FORMAT(A2)
RETURN
END

```

```
C**** SUBROUTINE PROMPT *****
SUBROUTINE PROMPT(VALUE)
DATA IY, IN/1, 0/
TYPE *, ' '
10 TYPE *, ' THE CURRENT DEFAULT VALUE IS = ', VALUE
TYPE *, ' DO YOU WANT TO USE THIS DEFAULT VALUE (Y/N)? '
READ(5, 100) IDO
100 FORMAT(A2)
IF(IDO.NE.1HN.AND.IDO.NE.1HY)GO TO 10
IF(IDO.EQ.1HY)GO TO 20
16 TYPE *, ' TYPE IN NEW VALUE '
ACCEPT *, VALUE
20 TYPE *, ' .....
TYPE *, ' '
RETURN
END
```

APPENDIX C

PROGRAM LISTING FOR THE ONDEK3
PLUME DISPERSION MODEL

Main Program	ONDEK
Integer Function	HAMING
Integer Function	RUNGE
Real Function	SIMUL
Subroutine	RHS
Subroutine	CSUM
Subroutine	CONT
Subroutine	START
Subroutine	INDAT
Subroutine	PROMPT
Subroutine	PLOTS

```

C**** PROGRAM ONDEK *****
C..... THIS PROGRAM COMPUTES THE TRAJECTORY AND CONCENTRATION DISTRI-
C..... BUTION OF BUOYANT PLUMES OF CHEMICAL VAPOR AND AIR THAT ARE
C..... EMITTED INTO AN ATMOSPHERIC BOUNDARY LAYER. THE COMPUTER PRO-
C..... GRAM IS BASED UPON DOOMS' METHOD (REFERENCE, G. DOOMS, 'A NEW
C..... METHOD FOR THE CALCULATION OF THE PLUME PATH OF GASES EMITTED
C..... BY A STACK', ATMOSPHERIC ENVIRONMENT, VOL 6, 1972) AND TE
C..... RIELE'S METHOD (REFERENCE, P.H.M. TE RIELE, 'ATMOSPHERIC DISPER-
C..... SION OF HEAVY GASES EMITTED AT OR NEAR GROUND LEVELS', 2ND
C..... INTERNATIONAL SYMPOSIUM ON LOSS PREVENTION AND SAFETY PROMOTION
C..... IN THE PROCESS INDUSTRIES, SEPT. 1977)
C
C..... LIST OF INPUT VARIABLES.....
C      SO = STARTING VALUE FOR PLUME PATH TRAJECTORY, M
C      H = INTEGRATION STEP SIZE, M
C      SMAX = TERMINATION VALUE OF PLUME PATH INTEGRATION, M
C      INT = NUMBER OF INTEGRATIONS BETWEEN PRINT-OUTS
C      YR(1) = INITIAL VALUE OF CONCENTRATION, KG/M**3
C      YR(2) = INITIAL VALUE OF PLUME CHARACTERISTIC RADIUS, M
C      YR(3) = INITIAL VALUE OF PLUME VELOCITY - WIND SPEED COMPONENT, M/S
C      YR(4) = INITIAL VALUE OF PLUME ANGLE WITH RESPECT TO HORIZON, RADIANS
C      YR(5) = INITIAL VALUE OF X, HORIZONTAL DISTANCE FROM VENT, M
C      YR(6) = INITIAL VALUE OF Y, VERTICAL HEIGHT ABOVE DECK, M
C      WMJ = MOLECULAR WEIGHT OF EMITTED GAS
C      PO = ATMOSPHERIC PRESSURE, MM HG
C      TO = ATMOSPHERIC TEMPERATURE, DEG RANKINE
C      UR = REFERENCE VELOCITY AT ZREF, M/S
C      ZREF = REFERENCE HEIGHT, M
C      CMF = MASS FRACTION OF TRACER GAS IN EMITTED GAS
C      TLV = TURBULENCE LEVEL
C      ZCON = CONCENTRATION MEASURE HEIGHT, M
C      IC = NUMBER OF CONCENTRATION VALUES FOR CONTOUR LINES, MAX=6
C      C(I) = CONCENTRATION VALUES FOR CONTOURS
C      YRUF = SURFACE ROUGHNESS PARAMETER, CENTIMETERS
C
C      INTEGER COUNT, RUNGE, HAMING
C      REAL APLACE(10), ADATE(3), ACLASS(5), AGAS(5), LEL, LELM
C      DIMENSION TE(6), YR(6), FR(6), Y(4,6), F(3,6), YRS(6), C(6), YC(6)
C      DIMENSION YRSAVE(6), CON(30,5), CONB(30,5), DIS(30), DISB(30), YAXIS(5)
C      DIMENSION CONC(30,6), DISC(30), YCONC(6)
C      COMMON/PHYS/DCDR, EPS, UPRI, RDA, ROE, G, ALF, TAU, U10
C      COMMON/CONS/IDECK, AF1, AF2, AF21, BTA, DLA, BT1, DBA, BM1, GAM
C      COMMON/CON2/ROT
C      COMMON/DAT1/SO, VD, VH, ZDECK, ZREF, UR
C      COMMON/DAT2/PO, TO, UVENT, CO, UTLV, WMG
C      COMMON/DAT3/PVAP, DISTAN, DISMAX, QL, ZCON
C      COMMON/DAT4/CC1, CC2, CC3, CC4, CC5, CC6
C      COMMON/DAT5/UEL, LEL, STEL, TLV, QDOR
C      COMMON/DAT6/APLACE, ADATE, AGAS
C
C**** SPECIFICATION OF DEFAULT VALUES FOR INPUT DATA *****
C      DATA SO, VD, VH, ZDECK, PO/0.0, 0.203, 1.0, 1.0, 760. /
C      DATA TO, ZREF, UR, UTLV, WMG/520. , 10. , 2.24, 20. , 86.10/
C      DATA QL, DISMAX, DISTAN, WMA, PVAP/159.0, 10. , 1.0, 28.97, 90. /
C      DATA ZCON, IC/1.68, 6/
C      DATA CC1, CC2, CC3, CC4, CC5, CC6/1000, 0.12, 134000, 26000, 20, 10/
C      DATA UEL, LEL, STEL, TLV, QDOR/13.4, 2.6, 20. , 10. , 0.12/
C
C**** SPECIFICATION OF DATA FILES FOR PLOTS *****
C      DATA XAXIS/'X(M)'/
C      DATA YAXIS/'TLV. ', 'UEL. ', 'LEL. ', 'STEL. ', 'CONC.'/
C      DATA YCONC/'IC. ', 'QDOR. ', 'UEL. ', 'LEL. ', 'STEL. ', 'TLV. '/

```

```

C
C**** OPEN OUTPUT FILE FOR PRINTING *****
OPEN(UNIT=3, FILE='RESONDEK.DAT', STATUS='NEW')
TYPE *, '***** PROGRAM ONDEK *****'
TYPE *, 'THIS PROGRAM COMPUTES THE TRAJECTORY AND CONCENTRATION'
TYPE *, 'DISTRIBUTION OF BUOYANT PLUMES OF CHEMICAL VAPOR AND AIR'
TYPE *, 'THAT ARE EMITTED INTO THE AIR ABOVE A SHIP OR BARGE DECK'
TYPE *, '
TYPE *, 'PREPARE TO ENTER INPUT DATA REQUIRED BY THE PROGRAM'
TYPE *, '

C ..... ENTER TODAY'S DATE .....
TYPE *, ' ENTER TODAY'S DATE (UP TO 12 CHARACTERS)'
TYPE *, '
ACCEPT 600, (ADATE(J), J=1,3)
TYPE *, '
1 CONTINUE

C
C**** CALL SUBROUTINE INDAT TO ENTER DATA INTERACTIVELY *****
CALL INDAT

C
C**** INITIALIZE VARIABLES AND ASSIGN VALUES TO CONSTANTS *****
Q= 9.80665
X= 0.0
DISTA= 0.0
C ..... STEP SIZE SET EQUAL TO 1/5TH OF THE VENT DIAMETER. ....
H= VD/5.0
EPS= 0.0000000001
C ..... MASS FRACTION OF GAS CONSTITUENT SET EQUAL TO 1. ....
CMF=1.0
IDECK= 1
IA= 0
ALF = 0.14
GAM = 1.18597434
DLA = 0.176877
BTA = 0.911784
YRUF = 1.000
CALL START(WMA, YR, WMJ)
UPRI= 3.0*UTLV*UR/100.
UA=UR
DCDR=WMJ/(WMJ-28.96)
ROA=((PO/760)*14.7)*144.*28.96*16.0522/(1545.*TO)
ROE=ROA*WMJ/28.96
ROVAP= ROA*WMC/28.96
C ..... STORE VALUES OF CONTOUR CONCENTRATIONS FOR PRINT OUT. ....
C(1)= CC1*ROVAP/1000000.
C(2)= CC2*ROVAP/1000000.
C(3)= CC3*ROVAP/1000000.
C(4)= CC4*ROVAP/1000000.
C(5)= CC5*ROVAP/1000000.
C(6)= CC6*ROVAP/1000000.
UEL= UEL*ROVAP/100.
LELM= LEL*ROVAP/100.
STELM=STEL*ROVAP/1000000.
TLVM= TLV *ROVAP/1000000.
ODORM= ODOR*ROVAP/1000000.
TRACON=YR(1)*CMF
IDECK = 1
CONH1=0.
XCON=YR(5)

C
C**** INITIALIZE VARIABLES FOR PLOT FILES *****
C100= ALOG(ROVAP)
CM = ROVAP/1000000.

```

```

CUEL= ALOG(UELM)
CLEL= ALOG(LELM)
CSTEL=ALOG(STELM)
CTLV= ALOG(TLVM)
C      COMPUTE THE WIND SHEAR STRESS, TAUO.....
C      THE EQUATION USED MAY BE ACCURATE ONLY FOR NEUTRAL.....
C      ATMOSPHERIC STABILITY CONDITIONS.....
U10=UR*((10.+ZDECK)/ZREF)**ALF
ZP= ALOG(1000./YRUF)
TAU =0.16*U10*U10/(ZP*ZP)
C      COMPUTE THE CONSTANTS THAT ARE NEEDED TO INTEGRATE.....
C      THE EQUATIONS FOR TE RIELE'S PLUME MODEL.....
AF1=1.+ALF
AF2=2*ALF
AF21=1.+AF2
BT1=1./BTA
DBA=DLA**BT1
BM1=1.-BT1
ROT=(1.-ROA/ROE)/ROA
TAUO=TAU*ROA
C      SET GCON = SQRT(PI)*AF21/(GAM*2.).....
C      THIS VARIABLE IS USED IN THE INITIAL VALUE OF SIGMAZ.....
GCON=0.8862269255*AF21/GAM
C      PRINT THE HEADING AND THE INITIAL CONDITIONS.....
WRITE(3,710) (APLACE(J),J=1,10), (ADATE(J),J=1,3)
WRITE(3,711) PO, TO, UR, ZREF, ALF, UTLV
WRITE(3,712) VD, VH, ZDECK, (AGAS(J),J=1,5), WMJ, YR(1), QL, UVENT
WRITE(3,719) UELM, LELM, STELM, TLVM, ODORM
WRITE(3,713) (C(J),J=1,IC), ZCON
WRITE(3,714) H, DISMAX
WRITE(3,715)
C      INITIALIZE THE STEP COUNTER AND THE FIRST ROW OF THE Y MATRIX..
C      SET THE INITIAL TRUNCATION ERRORS TO ZERO.....
COUNT = 0
DO 405 J=1,6
TE(J) = 0
405 Y(4,J)= YR(J)
TYPE *, ' COMPUTING PLUME TRAJECTORY AND DISPERSION '
C      CALL RUNGE TO INTEGRATE ACROSS THE FIRST THREE STEPS.....
C      RUNGE IS USED AS A STARTER FOR HANING.....
410 IF (RUNGE(6,YR,FR,X,H),NE.1) GO TO 420
CALL RHS(YR,YRS)
DO 415 K=1,4
415 FR(K)=YRS(K)
FR(5)= COS(YR(4))
FR(6)= SIN(YR(4))
GO TO 410
C      PUT THE APPROPRIATE INITIAL VALUES IN THE Y AND F MATRICES.....
420 COUNT = COUNT + 1
ISUB = 4 - COUNT
DO 425 J=1,6
425 Y(ISUB,J) = YR(J)
CALL RHS(YR,YRS)
DO 430 K=1,4
430 F(ISUB,K)=YRS(K)
F(ISUB,5)= COS(YR(4))
F(ISUB,6)= SIN(YR(4))
C
C**** IF X.GT. DISTA, PRINT VALUES OF THE PLUME VARIABLES *****
435 CONTINUE
IF (COUNT.LE.3) GO TO 450
IF (Y(1,5).LE. DISTA) GO TO 450
TRACON = Y(1,1)*CMF

```

```

C..... COMPUTE CONH1, CONCENTRATION AT BREATHING HEIGHT, ZCON.....
  B2=Y(1,2)*Y(1,2)*1.35
  CR1=Y(1,6)-ZCON
  CZ1=CR1*CR1/B2
  IF (CZ1.GT.13.B1) GO TO 440
  CR2=Y(1,6)+ZCON
  CZ2=CR2*CR2/B2
  XCON=Y(1,5)
  CONH1=Y(1,1)*CMF*( EXP(-CZ1) + EXP(-CZ2))
  GO TO 445
440 XCON = Y(1,5)
  CONH1=0.
445 CONTINUE
C..... COMPUTE PLUME CENTERLINE CONCENTRATION WITH THE EFFECT OF AN...
C..... IMAGE PLANE AT GROUND LEVEL .....
  CZ3= 4 *Y(1,6)*Y(1,6)/B2
  IF (CZ3.GT.13.B1) GO TO 446
  YCL= Y(1,1)*(1.+EXP(-CZ3))
  GO TO 447
446 YCL= Y(1,1)
447 CONTINUE
  CALL CONT(C,YC,Y,1,IC,0,0,0,ZCON)
  IF (COUNT.GT.3) WRITE(3,716) X,Y(1,5),Y(1,6),Y(1,1),CONH1,XCON,
1(YC(1),I=1,6),Y(1,2),Y(1,3),Y(1,4)
  IA= IA+1
  DIS(IA)= Y(1,5)
  DISB(IA)=Y(1,5)
  DISC(IA)=Y(1,5)
C..... ASSIGN VALUES TO CONC ARRAY.....
  DO 448 II=1,6
  CONC(IA,II) = YC(II)
448 CONTINUE
  CON(IA,5)= ALOG(YCL)
  IF (CONH1.LT.CM) CONH1=CM
  CONB(IA,5)=ALOG(CONH1)
  CON(IA,2)= CUEL
  CONB(IA,2)=CUEL
  CON(IA,3)= CLEL
  CONB(IA,3)=CLEL
  CON(IA,4)= CSTEL
  CONB(IA,4)=CSTEL
  CON(IA,1)= CTLV
  CONB(IA,1)=CTLV
  DISTA= DISTA + DISTAN
C..... IF X EXCEEDS DISMAX, TERMINATE THE INTEGRATION .....
450 IF (X.GT.DISMAX-H/2.) GO TO 560
C..... CALL RUNGE OR HAMING TO INTEGRATE ACROSS THE NEXT STEP.....
  IF (COUNT.LT.3) GO TO 410
C..... CALL HAMING .....
455 M = HAMING(6,Y,F,X,H,TE)
  DO 460 K=1,4
460 YR(K)=Y(1,K)
  CALL RHS(YR,YRS)
  DO 465 K=1,4
465 F(1,K)=YRS(K)
  F(1,5)= COS(Y(1,4))
  F(1,6)= SIN(Y(1,4))
  IF (M.EQ.1) GO TO 455
C..... INCREMENT STEP COUNTER AND CONTINUE INTEGRATION.....
  COUNT = CGUNT + 1
  IF (Y(1,6).LT.0.) GO TO 500
  GO TO 435
500 CONTINUE

```

```

C
C**** TRANSITION TO TE RIELE'S METHOD *****
      IDECK = 0
C..... FOR INITIAL CONDITIONS, SET.....
C..... Y(1,1)=2*Y(1,1)... CA=2*C ON THE PLUME CENTERLINE.....
C..... Y(1,2)=1.161895*Y(1,2)... SIGMAY=LAMDA*PLUME WIDTH.....
C..... Y(1,3)=YR(2)*GCON... SIGMAZ=SIGMAY*GCON.....
      YR(1) = 2*Y(1,1)
      YR(2) = 1.161895*Y(1,2)
      YR(3) = YR(2)*GCON
      WRITE(3,717)
      COUNT = 0
      DO 505 J=1,3
      TE(J) = 0.
505 Y(4,J) = YR(J)
C..... CALL RUNGE TO INTEGRATE ACROSS THE FIRST THREE STEPS.....
510 IF (RUNGE(3,YR,FR,X,H) .NE. 1) GO TO 520
      CALL RHS(YR,YRS)
      DO 515 K=1,3
515 FR(K)=YRS(K)
      GO TO 510
C..... PUT THE APPROPRIATE INITIAL VALUES IN THE Y AND F MATRICES.....
520 COUNT = COUNT + 1
      ISUB = 4 - COUNT
      DO 525 J=1,3
525 Y(ISUB,J) = YR(J)
      CALL RHS(YR,YRS)
      DO 530 K=1,3
530 F(ISUB,K)=YRS(K)
C..... PRINT SOLUTIONS WHEN X EXCEEDS DISTA.....
535 IF (X.LE.DISTA) GO TO 540
      IF (COUNT.LE.3) GO TO 540
      CALL CONT(C,YC,Y,O,IC,2,ALF21,Y(1,2),Y(1,3),ZCON)
      IF (COUNT.GT.3) WRITE(3,718) X,(Y(1,J),J=1,3),(YC(K),K=1,6)
C..... IF X EXCEEDS DISMAX, TERMINATE THE INTEGRATION.....
540 IF (X.GT.DISMAX-H/2.) GO TO 560
C..... CALL RUNGE OR HAMING TO INTEGRATE ACROSS THE NEXT STEP.....
      IF (COUNT.LT.3) GO TO 510
C..... CALL HAMING.....
545 M= HACING(3,Y,F,X,H,TE)
      DO 550 K=1,3
550 YR(K)=Y(1,K)
      CALL RHS(YR,YRS)
      DO 555 K=1,3
555 F(1,K)=YRS(K)
      IF (M.EQ.1) GO TO 545
C..... INCREMENT STEP COUNTER AND CONTINUE INTEGRATION.....
      COUNT = COUNT + 1
      GO TO 535
560 CONTINUE
C
C**** FORMATS FOR INPUT STATEMENTS *****
600 FORMAT(3A4)
C
C**** FORMATS FOR OUTPUT STATEMENTS *****
710 FORMAT(1H1, 9H TITLE= ,10A4,8H DATE= ,5A4,/)
711 FORMAT(30H0 METEOROLOGICAL CONDITIONS//7X,22H0 BAROMETRIC PRESS
1URE=,F7.3,25H MM HG AIR TEMPERATURE=,F5.1,6H DEG R/7X,22H0 AVER
2AGE WIND SPEED=,F6.2,25H M/S AT REFERENCE HEIGHT=,F7.2,2H M/
3 7X,22H0 WIND EXPONENT=,F5.2/
4 7X,22H0 TURBULENCE LEVEL=,F6.2//)
712 FORMAT(2BH VAPOR VENTING CONDITIONS//
1 7X,22H0 VENT DIAMETER=,F6.2,7H METERS ,/

```



```

2 7X, 22HO VENT HEIGHT=, F6 2, 23H METERS ABOVE THE DECK , /
3 7X, 22HO DECK HEIGHT=, F6 2, 24H METERS ABOVE THE WATER , //
4 7X, 22HO EMITTED VAPOR=, 2X, 5A4, /
5 7X, 22HO MOLECULAR WEIGHT=, F6 2, 24H OF GAS AND AIR MIXTURE , /
6 7X, 22HO VENT CONCENTRATION=, E10 3, 10H KG/(M**3) , //
7 7X, 22HO VENTING FLOWRATE=, F6 0, 10H (M**3)/HR, /
8 7X, 22HO VENTING VELOCITY=, F6 2, 6H M/SEC , // )
713 FORMAT(61H VALUES OF CONCENTRATION CHOSEN FOR CONCENTRATION CON
1 TOURS //,
2 7X, 10HO C1 =, E10 3, 10H (KG/M**3) , /
3 7X, 10HO C2 =, E10 3, 10H (KG/M**3) , /
4 7X, 10HO C3 =, E10 3, 10H (KG/M**3) , /
5 7X, 10HO C4 =, E10 3, 10H (KG/M**3) , /
6 7X, 10HO C5 =, E10 3, 10H (KG/M**3) , /
7 7X, 10HO C6 =, E10 3, 10H (KG/M**3) , /
8 7X, 29HO PREDICTED FOR A HEIGHT OF, F6 3 , 24H METERS ABOVE DECK
9 LEVEL // )
714 FORMAT(30H NUMERICAL INTEGRATION DATA//7X, 14HO STEP SIZE=, F7.
14, 38H METERS, MAXIMUM DOWNWIND DISTANCE=, F7 2, 7H METERS/)
715 FORMAT(1H1, 56H BEGIN PLUME COMPUTATION THROUGH THE AIR ABOVE THE
1 DECK/1HO, 4H 5, 7X, 3HXCL, 6X, 3HZCL, 7X, 3HCCL, 8X, 5HCZCON, 6X, 4HXCON, 3X
2, 6OHCY1 YC2 YC3 YC4 YC5 YC6 B U* THETA/1
3H , 12OH METERS METERS METERS KG/M**3 KG/M**3 METERS
4 METERS METERS METERS METERS METERS METERS METERS METERS M/S RADIANT/)
716 FORMAT(/F7 2, 2(2X, F7 3), 2(2X, E10 4), 1X, F7 3, 7(1X, F6 3), 2(1X, F6 3))
717 FORMAT(/43H CONTINUE PLUME COMPUTATION ALONG THE DECK//98H X(MET
1ERS) CA(KG/M3) SIGMAY(M) SIGMAZ(M) Y1(M) Y2(M) Y3(M) Y
24(M) Y5(M) Y6(M) )
718 FORMAT(F7 2, 3X, F9 6, 1X, F7 3, 7(3X, F7 3))
719 FORMAT(63H VALUES OF CONCENTRATION FOR FLAMMABILITY AND HEALTH
1 HAZARDS , //
2 7X, 35HO UPPER FLAMMABLE LIMIT (UEL) =, E10 3, 10H KG/(M**3) , /
3 7X, 35HO LOWER FLAMMABLE LIMIT (LEL) =, E10 3, 10H KG/(M**3) , /
4 7X, 35HO SHORT TERM EXPOSURE LIMIT (STEL)=, E10 3, 10H KG/(M**3) , /
5 7X, 35HO THRESHOLD LIMIT VALUE (TLV) =, E10 3, 10H KG/(M**3) , /
6 7X, 35HO ODOR THRESHOLD (ODOR) =, E10 3, 10H KG/(M**3) // )
720 FORMAT(7H AT X= , F6 3, 16H METERS, AND Y= , F6 3, 37H METERS, THE PR
1 EDICTED CONCENTRATION=, E12 6, 9H KG/M**3 )
721 FORMAT(//)
725 FORMAT(66H GRAPH OF PLUME CENTERLINE CONCENTRATION VERSUS DOWNWIND
1 DISTANCE )
726 FORMAT(55H 0 ORDINATE IS PROPORTIONAL TO LOG(CONCENTRATION) ,
1 / 55H 0 ABSCISSA IS PROPORTIONAL TO DISTANCE ,
2 // 55H TABLE OF CORRESPONDING VALUES ,
3 / 55H VALUE X(METERS) Y(KG/M**3) Y(PPM) )
730 FORMAT(4X, F4 1, 10X, F6 1, 7X, E10 3, 4X, F9 0)
731 FORMAT(75H GRAPH OF VAPOR CONCENTRATION AT MAN BREATHING HEIGHT VS
1 DOWNWIND DISTANCE )
732 FORMAT(77H GRAPH OF VAPOR CONCENTRATION CONTOURS AT MAN BREATHING
1 HEIGHT ABOVE THE DECK )
733 FORMAT(71H 0 ORDINATE IS PROPORTIONAL TO DISTANCE IN THE CROSS-
1 WIND DIRECTION , /
2 71H 0 ABSCISSA IS PROPORTIONAL TO DISTANCE IN THE DOWNST
3 REAM DIRECTION , //
4 71H TABLE OF CORRESPONDING VALUES CONCENTRA
5 TION CONTOURS , /
6 72H VALUE X(METERS) Y(METERS) SYMBOL (
7 PPM) (KG/M**3) )
734 FORMAT(4X, F4 1, 10X, F6 1, 8X, F6 1, 8X, A4, F10 2, E10 3)
800 CONTINUE
TYPE #, ' PREPARING PLOTS OF CONCENTRATION DISTRIBUTION '
IMA= 1A
CMN= ALDG(RDVAP/1000000. )

```

```

C..... SET VALUES FOR YMAX AND YMIN FOR THIS CALL TO PLOTS.....
YMAX=C100
YMIN=CMN
CALL PLOTS(DIS, 30, IMA, XAXIS, CON, 5, 5, YAXIS, YMAX, YMIN)
WRITE(3, 724)
WRITE(3, 725)
WRITE(3, 726)
DO 820 I=0, 10
ACOR= I*0.1
XPR = DIS(1) + ACOR*(DISMAX-DIS(1))
CXP = CMN + ACOR*(C100-CMN)
CPR = EXP(CXP)
CPPM= CPR*1000000./ROVAP
WRITE(3, 730) ACOR, XPR, CPR, CPPM
820 CONTINUE
C..... SET VALUES FOR YMAX AND YMIN FOR THIS CALL TO PLOTS.....
YMAX=C100
YMIN=CMN
CALL PLOTS(DISB, 30, IMA, XAXIS, CONB, 5, 5, YAXIS, YMAX, YMIN)
WRITE(3, 724)
WRITE(3, 731)
WRITE(3, 726)
DO 830 I=0, 10
ACOR= I*0.1
XPR = DISB(1) + ACOR*(DISMAX-DISB(1))
CXP = CMN + ACOR*(C100-CMN)
CPR = EXP(CXP)
CPPM= CPR*1000000./ROVAP
WRITE(3, 730) ACOR, XPR, CPR, CPPM
830 CONTINUE
C..... SET VALUES FOR YMAX AND YMIN FOR THIS CALL TO PLOTS.....
YMAX=0.5*DISMAX
YMIN=0.0
CALL PLOTS(DISC, 30, IMA, XAXIS, CONC, 6, 6, YCONC, YMAX, YMIN)
WRITE(3, 724)
WRITE(3, 732)
WRITE(3, 733)
DO 840 I=0, 5
ACOR= I*0.2
XPR = DISC(1) + ACOR*(DISMAX-DISC(1))
YPR = 0.5*ACOR*(DISMAX)
IP = I + 1
CPPM= C(IP)*1000000./ROVAP
WRITE(3, 734) ACOR, XPR, YPR, YCONC(IP), CPPM, C(IP)
840 CONTINUE
841 TYPE *, ' DO YOU WANT TO RUN ANOTHER CASE (Y,N)? '
READ(5, 850)ID0
850 FORMAT(A2)
IF(ID0.NE.'1HN.AND.'1HY)GO TO 841
IF(ID0.EQ.'1HN)GO TO 1000
C..... PREPARE TO RUN ANOTHER CASE.....
TYPE *, '
TYPE *, ' PREPARE TO ENTER INPUT DATA REQUIRED BY THE PROGRAM '
TYPE *, '
GO TO 1
1000 CONTINUE
END
C
INTEGER FUNCTION HAMING( N, Y, F, X, H, TE)
C***FUNCTION HAMING IS TAKEN FROM @APPLIED NUMERICAL METHODS BY
C*** B CARNAHAN, H.A. LUTHER, AND J.D. WILKES, PUBLISHED BY J. WILEY
C*** AND SONS, INC. 1969. PAGES 401 TO 402.
C

```

```

C      HAMING INPLEMENTS HAMMING@S PREDICTOR-CORRECTOR ALGORITHM TO
C      SOLVE N SIMULTANEOUS FIRST-ORDER ORDINARY DIFFERENTIAL
C      EQUATIONS.  X IS THE INDEPENDENT VARIABLE AND H IS THE
C      INTEGRATION STEPSIZE.  THE ROUTINE MUST BE CALLED TWICE FOR
C      INTEGRATION ACROSS EACH STEP.  ON THE FIRST CALL, IT IS ASSUMED
C      THAT THE SOLUTION VALUES AND DERIVATIVE VALUES FOR THE N
C      EQUATIONS ARE STORED IN THE FIRST N COLUMNS OF THE FIRST
C      FOUR ROWS OF THE Y MATRIX AND THE FIRST THREE ROWS OF THE F
C      MATRIX RESPECTIVELY.  THE ROUTINE COMPUTES THE N PREDICTED
C      SOLUTIONS YPRED(J), INCREMENTS X BY H AND PUSHES ALL
C      VALUES IN THE Y AND F MATRICES DOWN ONE ROW.  THE PREDICTED
C      SOLUTIONS YPRED(J) ARE MODIFIED, USING THE TRUNCATION ERROR
C      ESTIMATES TE(J) FROM THE PREVIOUS STEP, AND SAVED IN THE FIRST
C      ROW OF THE Y MATRIX.  HAMING RETURNS TO THE CALLING PROGRAM WITH
C      THE VALUE 1 TO INDICATE THAT ALL DERIVATIVES SHOULD BE COMPUTED
C      AND STORED IN THE FIRST ROW OF THE F ARRAY BEFORE THE SECOND
C      CALL IS MADE ON HAMING.  ON THE SECOND ENTRY TO THE FUNCTION
C      (DETERMINED BY THE LOGICAL VARIABLE PRED), HAMING USES THE
C      HAMMING CORRECTOR TO COMPUTE NEW SOLUTION ESTIMATES, ESTIMATES
C      THE TRUNCATION ERRORS TE(J) FOR THE CURRENT STEP, IMPROVES
C      THE CORRECTED SOLUTIONS USING THE NEW TRUNCATION ERROR
C      ESTIMATES, SAVES THE IMPROVED SOLUTIONS IN THE FIRST ROW OF THE
C      Y MATRIX, AND RETURNS TO THE CALLING PROGRAM WITH A VALUE 2 TO
C      INDICATE COMPLETION OF ONE FULL INTEGRATION STEP.
C      LOGICAL PRED
C      DIMENSION YPRED(20), TE(N), Y(4,N), F(3,N)
C      DATA PRED / TRUE /

C      IS CALL FOR PREDICTOR OR CORRECTOR SECTION ....
C      IF (.NOT PRED) GO TO 4

C      PREDICTOR SECTION OF HAMING .....
C      COMPUTE PREDICTED Y(J) VALUES AT NEXT POINT .....
C      DO 1 J=1,N
1) YPRED(J) = Y(4,J) + 4 *H*(2 *F(1,J) - F(2,J) + 2 *F(3,J))/3.
C      UPDATE THE Y AND F TABLES
C      DO 2 J=1,N
C      DO 2 K5=1,3
C      K = 5 - K5
C      Y(K,J) = Y(K-1,J)
2) IF (K.LT 4) F(K,J) = F(K-1,J)

C      MODIFY PREDICTED Y(J) VALUES USING THE TRUNCATION ERROR
C      ESTIMATES FROM THE PREVIOUS STEP.  INCREMENT X VALUE
C      DO 3 J=1,N
3) Y(1,J) = YPRED(J) + 112 *TE(J)/9.
C      X = X + H

C      SET PRED AND REQUEST UPDATED DERIVATIVE VALUES .....
C      PRED = .FALSE.
C      HAMING = 1
C      RETURN

C      CORRECTOR SECTION OF HAMING
C      COMPUTE CORRECTED AND IMPROVED VALUES OF THE Y(J) AND SAVE
C      TRUNCATION ERROR ESTIMATES FOR THE CURRENT STEP .....
4) DO 5 J=1,N
C      Y(1,J) = (9 *Y(2,J)-Y(4,J) + 3 *H*(F(1,J)+2 *F(2,J)-F(3,J)))/8.
C      TE(J) = 9 *(Y(1,J) - YPRED(J))/121.
5) Y(1,J) = Y(1,J) - TE(J)

C      SET PRED AND RETURN WITH SOLUTIONS FOR CURRENT STEP .....

```

```

PRED = .TRUE.
HAMING = 2
RETURN
END

```

```

C
C      INTEGER FUNCTION RUNGE(N, Y, F, X, H)
C***FUNCTION RUNGE IS TAKEN FROM @APPLIED NUMERICAL METHODSE BY
C*** D. CARNAHAN, H. A. LUTHER, AND J. O. WILKES, PUBLISHED BY J. WILEY
C*** AND SONS, INC. 1969. PAGES 374 TO 375.

```

```

C
C      THE FUNCTION RUNGE EMPLOYS THE FOURTH-ORDER RUNGE-KUTTA METHOD
C      WITH KUTTA'S COEFFICIENTS TO INTEGRATE A SYSTEM OF N SIMULTAN-
C      EOUS FIRST ORDER ORDINARY DIFFERENTIAL EQUATIONS  $F(J)=DY(J)/DX$ ,
C      ( $J=1,2,\dots,N$ ), ACROSS ONE STEP OF LENGTH H IN THE INDEPENDENT
C      VARIABLE X, SUBJECT TO INITIAL CONDITIONS  $Y(J)$ , ( $J=1,2,\dots,N$ ).
C      EACH  $F(J)$ , THE DERIVATIVE OF  $Y(J)$ , MUST BE COMPUTED FOUR TIMES
C      PER INTEGRATION STEP BY THE CALLING PROGRAM. THE FUNCTION MUST
C      BE CALLED FIVE TIMES PER STEP (PASS(1)...PASS(5)) SO THAT THE
C      INDEPENDENT VARIABLE VALUE (X) AND THE SOLUTION VALUES
C      ( $Y(1) \dots Y(N)$ ) CAN BE UPDATED USING THE RUNGE-KUTTA ALGORITHM.
C      M IS THE PASS COUNTER. RUNGE RETURNS AS ITS VALUE 1 TO
C      SIGNAL THAT ALL DERIVATIVES (THE  $F(J)$ ) BE EVALUATED OR 0 TO
C      SIGNAL THAT THE INTEGRATION PROCESS FOR THE CURRENT STEP IS
C      FINISHED. SAVEY(J) IS USED TO SAVE THE INITIAL VALUE OF  $Y(J)$ 
C      AND PHI(J) IS THE INCREMENT FUNCTION FOR THE J(TH) EGJATION.
C      AS WRITTEN, N MAY BE NO LARGER THAN 50.

```

```

C
C      DIMENSION PHI(50), SAVEY(50), Y(N), F(N)
C      DATA M/0/

```

```

C
C      M = M + 1
C      GO TO (1,2,3,4,5), M

```

```

C
C      ..... PASS 1 .....
C      1  RUNGE = 1
C      RETURN

```

```

C
C      ..... PASS 2 .....
C      2  DO 22 J=1,N
C      SAVEY(J) = Y(J)
C      PHI(J) = F(J)
C      22  Y(J) = SAVEY(J) + 0.5*H*F(J)
C      X = X + 0.5*H
C      RUNGE = 1
C      RETURN

```

```

C
C      ..... PASS 3 .....
C      3  DO 33 J= 1,N
C      PHI(J) = PHI(J) + 2.0*F(J)
C      33  Y(J) = SAVEY(J) + 0.5*H*F(J)
C      RUNGE = 1
C      RETURN

```

```

C
C      ..... PASS 4 .....
C      4  DO 44 J= 1,N
C      PHI(J) = PHI(J) + 2.0*F(J)
C      44  Y(J) = SAVEY(J) + H*F(J)
C      X = X + 0.5*H
C      RUNGE = 1
C      RETURN

```

```

C
C      ..... PASS 5 .....
C      5  DO 55 J = 1,N

```

```

55  Y(J) = SAVEY(J) + (PHI(J) + F(J))*H/6 0
      M = 0
      RUNGE = 0
      RETURN
      END
C
      REAL FUNCTION SIMUL(N,A,X,EPS,INDIC,NRC)
C***FUNCTION SIMUL IS TAKEN FROM @APPLIED NUMERICAL METHODSE BY
C*** B. CARNAHAN, H A. LUTHER, AND J. O. WILKES, PUBLISHED BY J. WILEY
C*** AND SONS, INC. 1969. PAGES 290 TO 291.
C
C      WHEN INDIC IS NEGATIVE, SIMUL COMPUTES THE INVERSE OF THE N BY
C      N MATRIX A IN PLACE.  WHEN INDIC IS ZERO, SIMUL COMPUTES THE
C      N SOLUTIONS X(1) . . . X(N) CORRESPONDING TO THE SET OF LINEAR
C      EQUATIONS WITH AUGMENTED MATRIX OF COEFFICIENTS IN THE N BY
C      N+1 ARRAY A AND IN ADDITION COMPUTES THE INVERSE OF THE
C      COEFFICIENT MATRIX IN PLACE AS ABOVE.  IF INDIC IS POSITIVE,
C      THE SET OF LINEAR EQUATIONS IS SOLVED BUT THE INVERSE IS NOT
C      COMPUTED IN PLACE.  THE GAUSS-JORDAN COMPLETE ELIMINATION METHOD
C      IS EMPLOYED WITH THE MAXIMUM PIVOT STRATEGY.  ROW AND COLUMN
C      SUBSCRIPTS OF SUCCESSIVE PIVOT ELEMENTS ARE SAVED IN ORDER IN
C      THE IROW AND JCOL ARRAYS RESPECTIVELY.  K IS THE PIVOT COUNTER,
C      PIVOT THE ALGEBRAIC VALUE OF THE PIVOT ELEMENT, MAX
C      THE NUMBER OF COLUMNS IN A AND DETER THE DETERMINANT OF THE
C      COEFFICIENT MATRIX.  THE SOLUTIONS ARE COMPUTED IN THE (N+1) TH
C      COLUMN OF A AND THEN UNSCRAMBLED AND PUT IN PROPER ORDER IN
C      X(1) . . . X(N) USING THE PIVOT SUBSCRIPT INFORMATION AVAILABLE
C      IN THE IROW AND JCOL ARRAYS.  THE SIGN OF THE DETERMINANT IS
C      ADJUSTED, IF NECESSARY, BY DETERMINING IF AN ODD OR EVEN NUMBER
C      OF PAIRWISE INTERCHANGES IS REQUIRED TO PUT THE ELEMENTS OF THE
C      JORD ARRAY IN ASCENDING SEQUENCE WHERE JORD(IROW(I)) = JCOL(I).
C      IF THE INVERSE IS REQUIRED, IT IS UNSCRAMBLED IN PLACE USING
C      Y(1) . . . Y(N) AS TEMPORARY STORAGE.  THE VALUE OF THE DETERMINANT
C      IS RETURNED AS THE VALUE OF THE FUNCTION.  SHOULD THE POTENTIAL
C      PIVOT OF LARGEST MAGNITUDE BE SMALLER IN MAGNITUDE THAN EPS,
C      THE MATRIX IS CONSIDERED TO BE SINGULAR AND A TRUE ZERO IS
C      RETURNED AS THE VALUE OF THE FUNCTION.
C
      DIMENSION IROW(15),JCOL(15),JORD(15),Y(15),A(NRC,NRC),X(N)
C
      MAX=N
      IF (INDIC.GE.0) MAX=N+1
C      BEGIN ELIMINATION PROCEDURE
      DETER=1
      DO 18 K=1,N
      KM1=K-1
C      SEARCH FOR THE PIVOT ELEMENT
      PIVOT=0.
      DO 11 I=1,N
      DO 11 J=1,N
C      SCAN IROW AND JCOL ARRAYS FOR INVALID PIVOT SUBSCRIPTS...
      IF (K.EQ.1) GO TO 9
      DO 8 ISCAN=1,KM1
      DO 8 JSCAN=1,KM1
      IF (I.EQ.IROW(ISCAN)) GO TO 11
      IF (J.EQ.JCOL(JSCAN)) GO TO 11
      8 CONTINUE
      9 IF ( ABS(A(I,J)) .LE. ABS(PIVOT)) GO TO 11
      PIVOT=A(I,J)
      IROW(K)=I
      JCOL(K)=J
      11 CONTINUE
C      INSURE THAT SELECTED PIVOT IS LARGER THAN EPS...

```

```

        IF ( ABS(PIVOT).GT.EPS) GO TO 13
        WRITE(3,202)
        SIMUL=0
        RETURN
C      ... UPDATE THE DETERMINANT VALUE...
13 IROWK=IROW(K)
    JCOLK=JCOL(K)
    DETER=DETER*PIVOT
C      ... NORMALIZE PIVOT ROW ELEMENTS...
    DO 14 J=1,MAX
14 A(IROWK,J)=A(IROWK,J)/PIVOT
C      ... CARRY OUT ELIMINATION AND DEVELOP INVERSE...
    A(IROWK,JCOLK)=1./PIVOT
    DO 16 I=1,N
    AIJCK=A(I,JCOLK)
    IF (I.EQ.IROWK) GO TO 18
    A(I,JCOLK) = -AIJCK/PIVOT
    DO 17 J=1,MAX
17 IF (J.NE.JCOLK) A(I,J)=A(I,J)-AIJCK*A(IROWK,J)
18 CONTINUE
C      ... ORDER SOLUTION VALUES (IF ANY) AND CREATE JORD ARRAY...
    DO 20 I=1,N
    IROWI=IROW(I)
    JCOLI=JCOL(I)
    JORD(IROWI)=JCOLI
20 IF (INDIC GE. 0) X(JCOLI)=A(IROWI,MAX)
C      ... ADJUST SIGN OF DETERMINANT...
    INTCH=0
    NM1=N-1
    DO 22 I=1,NM1
    IP1=I+1
    DO 22 J=IP1,N
    IF (JORD(J).GE.JORD(I)) GO TO 22
    JTEMP=JORD(J)
    JORD(J)=JORD(I)
    JORD(I)=JTEMP
    INTCH=INTCH+1
22 CONTINUE
    IF (INTCH/2*2.NE.INTCH) DETER=-DETER
C      ... IF INDIC IS POSITIVE RETURN WITH RESULTS...
    IF (INDIC.LE.0) GO TO 26
    SIMUL=DETER
    RETURN
C      ... IF INDIC IS NEGATIVE OR ZERO, UNSCRAMBLE THE INVERSE
C      FIRST BY ROWS...
26 DO 28 J=1,N
    DO 27 I=1,N
    IROWI=IROW(I)
    JCOLI=JCOL(I)
27 Y(JCOLI)=A(IROWI,J)
    DO 28 I=1,N
28 A(I,J)=Y(I)
C      ... THEN BY COLUMNS...
    DO 30 I=1,N
    DO 29 J=1,N
    IROWJ=IROW(J)
    JCOLJ=JCOL(J)
29 Y(IROWJ)=A(I,JCOLJ)
    DO 30 J=1,N
30 A(I,J)=Y(J)
C      ... RETURN FOR INDIC NEGATIVE OR ZERO...
    SIMUL=DETER
    RETURN

```

202 FORMAT(37HOSMALL PIVOT - MATRIX MAY BE SINGULAR)
END

```
C
SUBROUTINE RHS(Y,C)
DIMENSION Y(6),A(5,5),B(4,4),C(4),D(3)
COMMON/PHYS/DCDR, EPS, UPR1, ROA, ROE, G, ALF, TAU, U10
COMMON/CONS/IDECK, AF1, AF2, AF21, BTA, DLA, BT1, DBA, BM1, GAM
COMMON/DAT1/SO, VD, VH, ZDECK, ZREF, UR
C*** TEST IDECK
C      IDECK=1, PLUME CENTERLINE ABOVE DECK... USE OOMS@ EQUATIONS
C      IDECK=0, PLUME IS ON THE DECK... USE TE RIELES@ EQUATIONS
      IF (IDECK.EQ.0) GO TO 100
C*** OOMS EQUATIONS FOR GAUSSIAN PROFILES AND VARIABLE DENSITY
      ST= SIN(Y(4))
      ST2=ST*ST
      CT= COS(Y(4))
      CT2=CT*CT
      UA=UR*((Y(6)+ZDECK)/ZREF)**ALF
      UA2=UA*UA
      UACT=UA*CT
      UAST=UA*ST
      Y12=Y(1)*Y(2)
      Y33=Y(3)*Y(3)
      ROC=Y(1)/DCDR
      ROCA=ROC/ROA
      AC1=0.772699*UACT+0.412442*Y(3)
      AC2=(1.043144*UACT + 0.55679*Y(3))/ROA
      AC3=(1.043144*UACT*UACT + 1.113593*UACT*Y(3) + 0.363346*Y33)/ROA
      AM1=2.*UACT*UACT + 1.729329*UACT*Y(3) + 0.490842*Y33
      AM2=Y(2)*(1.729329*UACT+0.981684*Y(3)+ROCA*(1.113593*UACT
1      +0.726692*Y(3)))
C*** CONSERVATION OF SPECIES
      A(1,1)=Y(2)*AC1
      A(1,2)=2.*Y(1)*AC1
      A(1,3)=0.412442*Y12
      A(1,4)=-0.772699*Y12*UAST
      A(1,5)=0
C*** CONSERVATION OF MASS
      A(2,1)=Y(2)*AC2/DCDR
      A(2,2)=2.*(2.*UACT + 0.864665*Y(3) + ROC*AC2)
      A(2,3)=Y(2)*(0.864665 + 0.556796*ROCA)
      A(2,4)=Y(2)*UAST*(-2. -1.043144*ROCA)
      A(2,5)=2.*(0.057*ABS(Y(3)) + 0.5*UACT*ABS(ST) + UPR1)
C*** CONSERVATION OF X-MOMENTUM
      A(3,1)=Y(2)*AC3*CT/DCDR
      A(3,2)=2.*(AM1 + AC3*ROC)*CT
      A(3,3)=CT*AM2
      A(3,4)=Y(2)*ST*(-6.*UACT*UACT-3.458658*UACT*Y(3)-0.490842*Y33
1      -ROCA*(3.129432*UACT*UACT+2.227186*UACT*Y(3)+0.363346*Y33))
      A(3,5)=UA*A(2,5)+0.3*UA2*ABS(ST*ST*ST)
C*** CONSERVATION OF Y-MOMENTUM
      A(4,1)=Y(2)*ST*AC3/DCDR
      A(4,2)=2.*ST*(AM1 + AC3*ROC)
      A(4,3)=ST*AM2
      A(4,4)=Y(2)*(2.*UA2*CT*(1.-3.*ST2)+1.729329*UA*Y(3)*(CT2-ST2)
1      +0.490842*Y33*CT + ROCA*(1.043144*UA2*CT*(1.-3.*ST2)
2      +1.113593*Y(3)*UA*(CT2-ST2) + 0.363346*Y33*CT))
      IF (ST.LT.0.) GO TO 40
      SIG=-1
      GO TO 45
40 SIG=1
45 CONTINUE
      A(4,5)=-1.043144*ROCA*Y(2)*G + SIG*0.3*UAST*UAST*CT
```

```

C***      SIMUL USED FOR MATRIX INVERSION
          DETER=SIMUL(4, A, C, EPS, 1, 5)
          RETURN
100 CONTINUE
C***      TE RIELE@S EQUATIONS FOR PLUME DEVELOPMENT ALONG THE DECK
          Y12=Y(1)*Y(2)
          Y13=Y(1)*Y(3)
          Y23=Y(2)*Y(3)
C***      MASS CONSERVATION EQUATION, YL=INFINITY
          B(1, 1)=Y23
          B(1, 2)=Y13
          B(1, 3)=AF1*Y12
          B(1, 4)=0.
C***      MASS CONSERVATION EQUATION, YL=Y(2)*. 7071
          B(2, 1)=0. 605009*Y23
          B(2, 2)=0. 176127*Y13
          B(2, 3)=0. 605009*Y12*AF1
          B(2, 4)=-0. 4288819*DBA*BTA*Y13*(Y(2)**BM1)
C****     MOMENTUM CONSERVATION EQUATION
          CALL CSUM(Y(1), CSUM1)
          CL=(U10*U10/AF21)*((0. 01*Y(3))**AF2)
          CR=Y12*TAU*CSUM1
          B(3, 1)=CL*Y23
          B(3, 2)=CL*Y13
          B(3, 3)=CL*Y12*AF21
          B(3, 4)=CR
C***      SIMUL USED FOR MATRIX INVERSION
          DETER=SIMUL(3, B, D, EPS, 1, 4)
          DO 110 I=1, 3
110      C(I)=D(I)
          RETURN
          END
C
          SUBROUTINE CSUM(CA, SUM1)
C***      THIS SUBROUTINE COMPUTES THE SUM OF A SERIES THAT ARISES IN
C          TE RIELE@S CONSERVATION OF MOMENTUM EQUATION.
          COMMON/CON2/ROT
          SUM=1.
          I=1
          A=ROT*CA
          XO=-1. *A
          X1=1.
1          CONTINUE
          X1=X1*XO
          I=I+1
          ANUM=1. /SQRT(1. *I)
          X=X1*ANUM
          SUM1=SUM+X
          IF (ABS(X).LT. 0. 000001) GO TO 3
          SUM=SUM1
          IF (I.GT. 50) GO TO 2
          GO TO 1
2          WRITE(3, 10)
3          RETURN
10          FORMAT(37H  NUMBER OF TERMS IN CSUM EXCEEDED 50)
          END
C
          SUBROUTINE CONT(CC, YC, Y, IDECK, INUM, PR, PS, SIGY, SIGZ, ZCON)
          DIMENSION CC(9), YC(9), Y(4, 6)
C****     THIS SUBROUTINE COMPUTES THE CROSS-WIND LOCATIONS OF CONTOURS
C****     OF CONSTANT CONCENTRATION*****
C          ... VALUES OF CONCENTRATION MUST BE SPECIFIED WHEN SUBROUTINE ...
C          ... INDAT IS CALLED.  IF NO CONTOURS ARE REQUIRED, THEN CONTROL ...

```



```

C ..... IS RETURNED TO THE CALLING PROGRAM.....
  IF (INUM.LE.0) GO TO 950
  DO 9 I=1, INUM
  9 YC(I)=0.
C
C   FIRST TEST TO DECIDE WHETHER OOMS OR TE RIELES MODEL WILL BE USED
C
  IF (IDECK.EQ.0) GO TO 100
C   OOMS@ MODEL FOR CONCENTRATION PROFILE
  ZS = Y(1,6) - ZCON
  ZSQ = ZS*ZS
  YLM2 = 1.35*Y(1,2)*Y(1,2)
  ZSA = ZSQ/YLM2
  IF (ZSA.GT.13.81) GO TO 95
  ZI = Y(1,6) + ZCON
  ZIQ = ZI*ZI
  ZIA = ZIQ/YLM2
  DK = EXP(-ZSA) + EXP(-ZIA)
  DO 90 I=1, INUM
C*** TEST WHETHER CC(I) IS GREATER THAN MAX CONCENTRATION AT MAN HEIGHT
  CRAT = CC(I)/(Y(1,1)*DK)
  IF (CRAT.GE.1.0) GO TO 90
C*** COMPUTE Y-LOCATION OF CONTOUR
  YCSQ = -YLM2 * ALOG(CRAT)
  YC(I) = SQRT(YCSQ)
  90 CONTINUE
  95 RETURN
  100 CONTINUE
C*** TE RIELES@S MODEL FOR CONCENTRATION PROFILE
  RV=1 /PR
  ZPW=(ZCON/SIGZ)**PS
  IF (ZPW.GT.13.81) GO TO 950
  DO 900 I=1, INUM
C*** TEST WHETHER CC(I) IS GREATER THAN CONCENTRATION AT MAN HEIGHT
  CRAT = CC(I)/(Y(1,1)*EXP(-ZPW))
  IF (CRAT.GE.1.0) GO TO 900
C*** COMPUTE Y-LOCATION OF CONTOUR
  YC(I) = SIGY * ((- ALOG(CRAT))**RV)
  900 CONTINUE
  950 RETURN
  END
C
C**** SUBROUTINE START *****
SUBROUTINE START(WMA, YR, WMJ)
C   THIS SUBROUTINE COMPUTES THE SET OF INITIAL OR STARTING VALUES
C   OF PLUME RADIUS, PLUME TRAJECTORY AND PLUME ANGLE THAT ARE NEED-
C   FOR NUMERICAL COMPUTATION OF OOMS' MODEL EQUATIONS.
C
  REAL JAY
  DIMENSION XOD(10), ZOD(10), PATHL(10), YR(6)
  COMMON/DAT1/SO, VD, VH, ZDECK, ZREF, UR
  COMMON/DAT2/PO, TO, UVENT, CO, UTLV, WMG
  COMMON/DAT3/PVAP, DISTAN, DISMAX, QL, ZCON
C   COMPUTE THE WIND SPEED AT DECK HEIGHT ABOVE THE GROUND.....
C   ZDECK = DECK HEIGHT, M.....
C   ZREF = REFERENCE HEIGHT FOR WIND SPEED PROFILE, M.....
C   UR = WIND SPEED AT THE REFERENCE HEIGHT, M/S.....
  UDECK=UR*(ZDECK/ZREF)**.14
C   CALCULATE THE VAPOR CONCENTRATION FROM THE CHEMICAL VAPOR.....
C   PRESSURE AT ONE ATMOSPHERE, AND THE VALUE OF ATMOSPHERIC.....
C   PRESSURE.....
  CO=PVAP/760
C   CALCULATE THE MOLECULAR WEIGHT OF THE VAPOR AND AIR MIXTURE....

```

```

C ..... WMG = MOLECULAR WEIGHT OF PURE CHEMICAL VAPOR .....
C ..... WMA = MOLECULAR WEIGHT OF AIR .....
      WMJ=(CO*WMG)+(1-CO)*WMA
C ..... CALCULATE THE JET MOMENTUM RATIO .....
C ..... UVENT = VELOCITY OF VAPOR/AIR MIXTURE FROM VENT .....
      JAY=(WMJ/WMA)*(UVENT/UDECK)**2
C ..... THE KAMOTANI AND GREBER CORRELATION IS USED FOR THE INITIAL .....
C ..... PLUME TRAJECTORY. (Z/D)=AV*(X/D)**BV .....
C ..... CALCULATE THE PATH LENGTH ALONG THE TRAJECTORY .....
      AV=EXP(.405465+0.131368*ALOG(JAY)+0.054931*(ALOG(JAY))**2)
      IF (JAY LT. 10.) GO TO 4
      BV=EXP(-0.744691-0.074525*ALOG(JAY))
      GO TO 5
4 BV=0.4
5 CONTINUE
      ROW=0.871667+.1775*(UVENT/UDECK)
C ..... CALCULATE THE VALUE OF PATH LENGTH (X/D) THAT IS NEEDED TO .....
C ..... SATISFY THE CURVE LENGTH .....
      XOD(0)=0
      ZOD(0)=0
      PATHL(0)=0
      I=0
10 I=I+1
      XOD(I)=XOD(I-1)+0.10
      ZOD(I)=AV*XOD(I)**BV
      PATHL(I)=PATHL(I-1)+SQRT((XOD(I)-XOD(I-1))**2.+(ZOD(I)-ZOD(I-1))
      *2)
      IF (PATHL(I) LT. ROW) GO TO 10
      FXOD=XOD(I-1)+(XOD(I)-XOD(I-1))*((ROW-PATHL(I-1))/(PATHL(I)-PATHL
      2(I-1)))
C ..... CALCULATE THE INITIAL VALUE OF YR(5)=X BY MULTIPLYING XOD BY .....
C ..... THE VENT DIAMETER, VD .....
C ..... CALCULATE THE INITIAL VALUE OF YR(6)=Z BY MULTIPLYING ZOD BY .....
C ..... THE VENT DIAMETER, ZD, AND ADDING THE VENT HEIGHT ABOVE THE .....
C ..... DECK, VH .....
C ..... CALCULATE THE INITIAL VALUE OF YR(4)=THETA, THE ANGLE OF THE .....
C ..... PLUME AXIS WITH RESPECT TO THE HORIZON, AS THE INVERSE TANGENT .....
C ..... OF AV*BV*(X/D)**(BV-1.) .....
C ..... CALCULATE THE INITIAL VALUE OF YR(3)=VELOCITY DEFECT, AS .....
C ..... THE VALUE OF UVENT-UDECK*COS(THETA) .....
C ..... CALCULATE THE INITIAL VALUE OF YR(2)=B .....
      YR(5)=FXOD*VD
      YR(6)=AV*(FXOD**BV)*VD+VH
      YR(4)=ATAN(AV*BV*FXOD**(BV-1.0))
      YR(3)=UVENT-UDECK*COS(YR(4))
      YR(2)=0.6597*VD/(SQRT(1.+1.35*UDECK*COS(YR(4))/UVENT))
      YR(1)=CO
      RETURN
      END
C
C**** SUBROUTINE INDAT *****
      SUBROUTINE INDAT
C ..... THIS SUBROUTINE PERMITS THE USER TO FURNISH INPUT DATA IN AN .....
C ..... INTERACTIVE MANNER. THE PROGRAM WILL IDENTIFY THE VARIABLE .....
C ..... TO BE SPECIFIED, PROMPT WITH THE CURRENT DEFAULT VALUE, AND .....
C ..... ASK THE USER IF THIS VALUE IS ACCEPTED. IF NOT THE PROGRAM .....
C ..... WILL ACCEPT A NEW VALUE INPUT BY THE USER .....
      REAL LEL, APLACE(10), ADATE(3), AGAS(5)
      COMMON/DAT1/SO, VD, VH, ZDECK, ZREF, UR
      COMMON/DAT2/PO, TO, UVENT, CO, UTLV, WMG
      COMMON/DAT3/PVAP, DISTAN, DISMAX, GL, ZCDN
      COMMON/DAT4/CC1, CC2, CC3, CC4, CC5, CC6
      COMMON/DAT5/UEL, LEL, STEL, TLV, ODOR

```

```

COMMON/DAT6/APLACE, ADATE, AGAS
C..... ENTER NAME OF VESSEL, PLACE OR DESCRIBING PHRASE.....
TYPE *, ' ENTER NAME OF VESSEL, PLACE OR DESCRIBING PHRASE '
TYPE *, ' (UP TO 40 CHARACTERS) '
TYPE *, '
ACCEPT 101, (APLACE(J), J=1, 10)
TYPE *, '.....

C..... ENTER NAME OF CARGO VAPOR OR GAS BEING EMITTED.....
TYPE *, ' ENTER NAME OF CARGO VAPOR OR GAS BEING EMITTED '
TYPE *, ' (UP TO 20 CHARACTERS) '
TYPE *, '
ACCEPT 102, (AGAS(J), J=1, 5)
TYPE *, '.....

C..... LIST DEFAULT VALUES FOR VENT GEOMETRY AND ASK WHETHER CHANGES
C..... ARE REQUIRED.....
5 TYPE *, ' LIST THE DEFAULT VALUES FOR VENT GEOMETRY VARIABLES '
TYPE *, '
TYPE *, ' VENT DIAMETER, VD, ' VD, ' METERS '
TYPE *, ' VENT HEIGHT, VH, ' VH, ' METERS '
TYPE *, ' DECK HEIGHT, ZDECK, ' ZDECK, ' METERS '
TYPE *, '
TYPE *, ' DO YOU WANT TO USE ALL OF THESE VALUES (Y/N)? '
READ(5, 105)ID0
IF(ID0.NE.1HN.AND.ID0.NE.1HY)GO TO 5
IF(ID0.EQ.1HY)GO TO 10
6 TYPE *, '.....
C..... VALUE FOR VENT DIAMETER, VD, IN METERS.....
TYPE *, ' ENTER VALUE FOR VENT DIAMETER, VD, IN METERS. '
TYPE *, '
TYPE *, ' TYPICAL VALUES ARE.....
TYPE *, ' 0.305 M (12 INCHES) '
TYPE *, ' 0.203 M ( 8 INCHES) '
TYPE *, ' 0.102 M ( 4 INCHES) '
CALL PROMPT(VD)
C..... VALUE FOR VENT HEIGHT, VH, IN METERS.....
TYPE *, ' ENTER VALUE FOR VENT HEIGHT, VH, IN METERS. '
TYPE *, '
TYPE *, ' TYPICAL VALUES ARE.....
TYPE *, ' 1.0 M ( 3.3 FT) '
TYPE *, ' 4.0 M (13.1 FT) '
TYPE *, ' 6.1 M (20.0 FT), OR B/3 '
CALL PROMPT(VH)
C..... VALUE FOR DECK HEIGHT, ZDECK, IN METERS.....
TYPE *, ' ENTER VALUE FOR DECK HEIGHT, ZDECK, IN METERS. '
TYPE *, '
TYPE *, ' TYPICAL VALUES ARE.....
TYPE *, ' 1.0 M (BARGE) '
TYPE *, ' 6.1 M (SHIP) '
CALL PROMPT(ZDECK)
GO TO 5
10 CONTINUE
C..... LIST DEFAULT VALUES FOR ATMOSPHERIC CONDITIONS AND ASK.....
C..... WHETHER CHANGES ARE REQUIRED.....
15 TYPE *, ' LIST THE DEFAULT VALUES FOR ATMOSPHERIC CONDITIONS '
TYPE *, '
TYPE *, ' ATMOSPHERIC PRESSURE, PO, ' PO, ' MM HG '
TYPE *, ' ATMOSPHERIC TEMPERATURE, TO, ' TO, ' DEG R '
TYPE *, ' WIND SPEED, UR, ' UR, ' M/S '
TYPE *, ' REFERENCE HEIGHT, ZREF, ' ZREF, ' M '
TYPE *, ' WIND TURBULENCE LEVEL, UTLV, ' UTLV, ' % '
TYPE *, '
TYPE *, ' DO YOU WANT TO USE ALL OF THESE VALUES (Y/N)? '
READ(5, 105)ID0

```

```

IF(IDO.NE.1HN.AND.IDO.NE.1HY)GO TO 15
IF(IDO.EQ.1HY)GO TO 20
16 TYPE *, '
C..... VALUE FOR ATMOSPHERIC PRESSURE, PO, IN MM HG.....
TYPE *, ' ENTER VALUE FOR ATMOSPHERIC PRESSURE, PO, IN MM HG '
TYPE *, '
TYPE *, ' TYPICAL VALUES ARE...
TYPE *, ' 760. PSIA '
CALL PROMPT(PO)
C..... VALUE FOR ATMOSPHERIC TEMPERATURE, TO, IN DEG. RANKINE.....
TYPE *, ' ENTER VALUE FOR ATMOSPHERIC TEMPERATURE, TO, IN R '
CALL PROMPT(TO)
C..... VALUE FOR REFERENCE WIND SPEED, UR, IN METERS/SEC.....
TYPE *, ' ENTER VALUE FOR REFERENCE WIND SPEED, UR, IN M/S '
TYPE *, '
TYPE *, ' TYPICAL VALUES ARE...
TYPE *, ' 1.12 M/S ( 2.5 MILE/HR) '
TYPE *, ' 2.24 M/S ( 5.0 MILE/HR) '
TYPE *, ' 4.47 M/S (10.0 MILE/HR) '
TYPE *, ' 6.71 M/S (15.0 MILE/HR) '
CALL PROMPT(UR)
C..... VALUE FOR WIND SPEED REFERENCE HEIGHT, ZREF, IN METERS.....
TYPE *, ' ENTER WIND SPEED REFERENCE HEIGHT, ZREF, IN METERS '
TYPE *, '
TYPE *, ' TYPICAL VALUES ARE...
TYPE *, ' 10.0 M (32.8 FT) '
CALL PROMPT(ZREF)
C..... VALUE FOR WIND TURBULENCE LEVEL, UTLV, IN PERCENT.....
TYPE *, ' ENTER WIND TURBULENCE LEVEL, UTLV, IN PERCENT '
TYPE *, '
TYPE *, ' TYPICAL VALUES ARE...
TYPE *, ' 20% (FOR ALL WIND SPEEDS) '
TYPE *, ' 30% (FOR VERY LOW SPEED OR GUSTY CONDITIONS) '
TYPE *, ' 0% (TO ESTIMATE INSTANTANEOUS PLUME BOUNDARY) '
CALL PROMPT(UTLV)
GO TO 15
20 CONTINUE
TYPE *, '
C..... LIST DEFAULT VALUES FOR PLUME VENT CONDITIONS.....
C..... AND ASK WHETHER CHANGES ARE REQUIRED.....
25 TYPE *, ' LIST THE DEFAULT VALUES FOR PLUME VENT CONDITIONS '
TYPE *, '
TYPE *, ' CARGO LOADING RATE, QL, ' ,QL, ' M**3/HR '
UVENT= QL*0.0003536777/VD/VD
TYPE *, ' VENT VELOCITY, UVENT, ' ,UVENT, ' M/S '
TYPE *, ' VAPOR MOLECULAR WEIGHT, WMG, ' ,WMG, '
TYPE *, ' CARGO VAPOR PRESSURE, PVAP, ' ,PVAP, ' MM HG '
CO= ((PVAP/760 )*14.7)*144.*WMG*16.0522/((1545*TO)
TYPE *, ' VENT CONCENTRATION, CO, ' ,CO, ' KG/M**3 '
TYPE *, '
TYPE *, ' DO YOU WANT TO USE ALL OF THESE VALUES (Y/N)? '
READ(5,105)IDO
IF(IDO.NE.1HN.AND.IDO.NE.1HY)GO TO 25
IF(IDO.EQ.1HY)GO TO 30
26 TYPE *, '
TYPE *, '
C..... VALUE FOR LOADING RATE (OR GAS FLOW RATE), QL, IN M**3/SEC...
TYPE *, ' ENTER LOADING RATE (OR GAS VOLUMETRIC FLOW RATE) '
TYPE *, ' QL IN METERS**3/HR '
TYPE *, '
TYPE *, ' TYPICAL VALUES ARE...
TYPE *, ' 794 M**3/HR (5000 BBL/HR) '
TYPE *, ' 318 M**3/HR (2000 BBL/HR) '

```

```

TYPE *, ' 159 M**3/HR (1000 BBL/HR)
TYPE *, ' 79 M**3/HR ( 500 BBL/HR)
CALL PROMPT(QL)
C ..... CALCULATE VENT VELOCITY, UVENT, IN M/S.
UVENT= QL*0.0003536777/VD/VD
TYPE *, ' CALCULATED VALUE OF VENT VELOCITY IS ,UVENT, ' M/S
TYPE *, '
TYPE *, '
C ..... VALUE FOR VAPOR MOLECULAR WEIGHT.
TYPE *, ' ENTER VAPOR MOLECULAR WEIGHT, WMG
TYPE *, '
TYPE *, ' TYPICAL VALUES ARE
TYPE *, ' 86 10 (VINYL ACETATE)
CALL PROMPT(WMG)
C ..... VALUE FOR VENT CONCENTRATION, CO, IN KG/M**3
TYPE *, ' THE VAPOR CONCENTRATION NEAR THE END OF CARGO LOADING
TYPE *, ' MAY APPROACH THE SATURATED VAPOR CONCENTRATION. ENTER
TYPE *, ' THE VALUE OF SATURATED VAPOR PRESSURE, OR SOME FRACT-
TYPE *, ' ION THEREOF
TYPE *, ' ENTER VAPOR PRESSURE, PVAP, IN MM HG
TYPE *, '
TYPE *, ' TYPICAL VALUES ARE
TYPE *, ' 90 MM HG (VINYL ACETATE)
CALL PROMPT(PVAP)
C ..... CALCULATE THE VENT CONCENTRATION
CO= ((PVAP/760.)*14.7)*144.*WMG*16.0522/((1545*TO)
TYPE *, ' CALCULATED VALUE OF VENT CONCENTRATION, CO= ,CO, 'KG/M**3
TYPE *, '
TYPE *, '
GO TO 25
30 CONTINUE
C ..... LIST DEFAULT VALUES FOR PLUME COMPUTATION CONDITIONS.
35 TYPE *, ' LIST THE DEFAULT VALUES FOR PLUME COMPUTATION
TYPE *, '
TYPE *, ' PLUME PATH DISTANCE, SO, ' M
TYPE *, ' DISTANCE BETWEEN PRINTOUTS, DISTAN, 'DISTAN, ' M
TYPE *, ' MAX DOWNWIND DISTANCE, DISMAX, 'DISMAX, ' M
TYPE *, '
TYPE *, ' DO YOU WANT TO USE ALL OF THESE VALUES (Y/N)?
READ(5,105)IDO
IF(IDO.NE.1HN.AND.IDO.NE.1HY)GO TO 35
IF(IDO.EQ.1HY)GO TO 40
36 TYPE *, '
C ..... INITIAL VALUE FOR PLUME PATH DISTANCE, SO, IN METERS.
TYPE *, ' ENTER VALUE FOR PLUME PATH LENGTH, SO, IN METERS
TYPE *, '
TYPE *, ' TYPICAL VALUES ARE
TYPE *, ' 0.0 M
CALL PROMPT(SO)
C ..... VALUE FOR DISTANCE BETWEEN PRINTOUTS, DISTAN, IN METERS.
TYPE *, ' ENTER DISTANCE BETWEEN PRINTOUTS, DISTAN, IN METERS
TYPE *, '
TYPE *, ' TYPICAL VALUES ARE
TYPE *, ' 1.0 M
TYPE *, ' 5.0 M
CALL PROMPT(DISTAN)
C ..... VALUE FOR MAXIMUM DISTANCE FOR PLUME COMPUTATION.
C ..... DISMAX, IN METERS
TYPE *, ' ENTER MAXIMUM DISTANCE FOR PLUME COMPUTATION
TYPE *, ' DISMAX, IN METERS
TYPE *, '
TYPE *, ' TYPICAL VALUES ARE
TYPE *, ' 10 M (RECOMMENDED FOR 1 M VENTS)

```

```

TYPE *, ' 20 M (RECOMMENDED FOR 4 M AND B/3 VENTS) '
TYPE *, ' 100 M '
CALL PROMPT(DISMAX)
GO TO 35
40 CONTINUE
C ..... VALUE FOR UEL, LEL, STEL, TLV AND ODOR .....
45 TYPE *, ' LIST THE DEFAULT VALUES FOR UEL, LEL, STEL, TLV AND ODOR '
TYPE *, '
TYPE *, ' UPPER FLAMMABLE LIMIT, UEL, = ', UEL, ' % '
TYPE *, ' LOWER FLAMMABLE LIMIT, LEL, = ', LEL, ' % '
TYPE *, ' SHORT TERM EXPOSURE LIMIT, STEL, = ', STEL, ' PPM '
TYPE *, ' THRESHOLD LIMIT VALUE, TLV, = ', TLV, ' PPM '
TYPE *, ' ODOR THRESHOLD, ODOR, = ', ODOR, ' PPM '
TYPE *, '
TYPE *, ' DO YOU WANT TO USE ALL OF THESE VALUES (Y/N)? '
READ(5, 105) IDO
IF (IDO NE 1HN AND IDO NE 1HY) GO TO 45
IF (IDO EQ 1HY) GO TO 50
46 TYPE *, '
C ..... VALUE FOR UPPER FLAMMABLE LIMIT, UEL, IN PERCENT .....
TYPE *, ' ENTER VALUE FOR UEL IN PERCENT BY VOLUME '
TYPE *, '
TYPE *, ' TYPICAL VALUES ARE
TYPE *, ' 13.4 % (VINYL ACETATE)
TYPE *, ' ( IF THE UEL VALUE IS NOT KNOWN, ENTER 100.0 ) '
CALL PROMPT(UEL)
C ..... ASSIGN VALUE OF UEL TO CC3 .....
CC3 = UEL*10000
C ..... VALUE FOR LOWER FLAMMABLE LIMIT, LEL, IN PERCENT .....
TYPE *, ' ENTER VALUE FOR LEL IN PERCENT BY VOLUME '
TYPE *, '
TYPE *, ' TYPICAL VALUES ARE
TYPE *, ' 2.6 % (VINYL ACETATE)
TYPE *, ' ( IF THE LEL VALUE IS NOT KNOWN, ENTER 100.0 ) '
CALL PROMPT(LEL)
C ..... ASSIGN VALUE OF LEL TO CC4 .....
CC4 = LEL*10000
C ..... VALUE FOR SHORT TERM EXPOSURE LIMIT, STEL, IN PPM .....
TYPE *, ' ENTER VALUE FOR STEL IN PPM '
TYPE *, '
TYPE *, ' TYPICAL VALUES ARE
TYPE *, ' 20 PPM (VINYL ACETATE)
TYPE *, ' ( IF A VALUE FOR STEL IS NOT KNOWN, ENTER 1000000. ) '
CALL PROMPT(STEL)
C ..... ASSIGN VALUE OF STEL TO CC5 .....
CC5 = STEL
C ..... VALUE FOR THRESHOLD LIMIT VALUE, TLV, IN PPM .....
TYPE *, ' ENTER VALUE FOR TLV IN PPM '
TYPE *, '
TYPE *, ' TYPICAL VALUES ARE
TYPE *, ' 10 PPM (VINYL ACETATE)
TYPE *, ' ( IF A VALUE FOR TLV IS NOT KNOWN, ENTER 1000000. ) '
CALL PROMPT(TLV)
C ..... ASSIGN VALUE OF TLV TO CC6 .....
CC6 = TLV
C ..... VALUE FOR THE ODOR THRESHOLD, ODOR, IN PPM .....
TYPE *, ' ENTER VALUE FOR ODOR IN PPM '
TYPE *, '
TYPE *, ' TYPICAL VALUES ARE
TYPE *, ' 0.12 PPM (VINYL ACETATE)
TYPE *, ' ( IF A VALUE FOR ODOR IS NOT KNOWN, ENTER 1000000. ) '
CALL PROMPT(ODOR)
C ..... ASSIGN VALUE OF ODOR TO CC2 .....

```

```

        CC2 = ODDR
        GO TO 45
50 CONTINUE
C ..... LIST DEFAULT VALUES FOR CONCENTRATION CONTOURS .....
55 TYPE *, ' LIST THE DEFAULT VALUES FOR CONCENTRATION CONTOURS '
    TYPE *, '
    TYPE *, ' CC1 = ',CC1,' PPM (USER ASSIGNED VALUE) '
    TYPE *, ' CC2 = ',CC2,' PPM (USUALLY THE ODDR THRESHOLD) '
    TYPE *, ' CC3 = ',CC3,' PPM (USUALLY THE UEL) '
    TYPE *, ' CC4 = ',CC4,' PPM (USUALLY THE LEL) '
    TYPE *, ' CC5 = ',CC5,' PPM (USUALLY THE STEL) '
    TYPE *, ' CC6 = ',CC6,' PPM (USUALLY THE TLV) '
    TYPE *, '
    TYPE *, ' DO YOU WANT TO USE ALL OF THESE VALUES (Y/N)? '
    READ(5,105)IDO
    IF(IDO.NE.1HN.AND.IDO.NE.1HY)GO TO 55
    IF(IDO.EQ.1HY)GO TO 60
56 TYPE *, '
C ..... VALUES FOR CONCENTRATION CONTOURS .....
    TYPE *, ' ENTER VALUES FOR CC1 THROUGH CC6 IN PPM '
    CALL PROMPT(CC1)
    CALL PROMPT(CC2)
    CALL PROMPT(CC3)
    CALL PROMPT(CC4)
    CALL PROMPT(CC5)
    CALL PROMPT(CC6)
    GO TO 55
60 CONTINUE
101 FORMAT(10A4)
102 FORMAT(5A4)
105 FORMAT(A2)
    RETURN
    END
C**** SUBROUTINE PROMPT *****
SUBROUTINE PROMPT(VALUE)
    DATA IY,IN/1,0/
    TYPE *, '
    10 TYPE *, ' THE CURRENT DEFAULT VALUE IS = ',VALUE
    TYPE *, ' DO YOU WANT TO USE THIS DEFAULT VALUE (Y/N)? '
    READ(5,100)IDO
100 FORMAT(A2)
    IF(IDO.NE.1HN.AND.IDO.NE.1HY)GO TO 10
    IF(IDO.EQ.1HY)GO TO 20
    16 TYPE *, ' TYPE IN NEW VALUE '
    ACCEPT *, VALUE
    20 TYPE *, '
    TYPE *, '
    RETURN
    END
C
C**** SUBROUTINE PLOTS *****
SUBROUTINE PLOTS(X, IDIME, IMAX, XAXIS, Y, JDIME, JMAX, YAXIS, YMAX, YMIN)
C ..... SUBROUTINE FOR PLOTTING J CURVES OF Y(I, J) AGAINST X(I) .....
C ..... X AND Y ARE SCALED TO THE RANGE 0. TO 1., FOR PLOTTING .....
C ..... AS (Y-YMIN)/(YMAX-YMIN), THE MAXIMUM AND MINIMUM VALUES .....
C ..... ARE PRINTED ..... NOTE THAT THE X AND THE Y ARRAYS MUST .....
C ..... BE REDEFINED BEFORE EACH CALL PLOTS .....
C ..... DEFINITIONS .....
C ..... IDIME IS THE VARIABLE DIMENSION FOR X .....
C ..... IMAX IS THE NUMBER OF X VALUES .....
C ..... XAXIS STORES THE NAME OF THE X-AXIS .....
C ..... JDIME IS THE VARIABLE DIMENSION FOR Y .....
C ..... JMAX IS THE NUMBER OF CURVES TO BE PLOTTED, (UP TO 30) .....

```

```

C..... THE ARRAY YAXIS(J) STORES THE NAMES OF THE CURVES. ....
C..... THE FIRST CHARACTER OF EACH CURVE-NAME IS USED FOR.....
C..... PLOTTING .....
C..... XSIZE ALTERS THE X-PLOT SIZE BY A FACTOR OF .2 TO 1., IN...
C..... STEPS OF 0.1 .....
C..... YSIZE IS THE Y-PLOT SIZE FACTOR OF .2 UPWARDS IN STEPS.....
C..... OF 0.2 (XSIZE=1, YSIZE=1 GIVES NORMAL SIZE PLOT).....
      DIMENSION X(IDIME),Y(IDIME,JDIME),YAXIS(JDIME),
      1          A(101),DIGIT(11)
      DATA DOT,CROSS,BLANK/1H.,1H+,1H /
      1,DIGIT/1HO,1H1,1H2,1H3,1H4,1H5,1H6,1H7,1H8,1H9,1H1/
C**** SET PLOT SIZE FACTORS *****
      XSIZE=0.7
      YSIZE=0.8

C
C**** SCALING X-ARRAY TO RANGE 0 TO 100*XSIZE *****
      XR=100.*XSIZE
      IM= IMAX
C..... ASSIGN VALUES, XMIN=0 AND XMAX=X(IMAX).....
      XMIN=0
      XMAX=X(IMAX)
      S=XR/(XMAX-XMIN+1.E-30)
      DO 2 I=1,IM
      2 X(I)= (X(1)-XMIN)*S

C
C**** SCALING Y-ARRAY TO RANGE 0 TO 50*YSIZE *****
      YR= 50.*YSIZE
      JM= JMAX
C..... SCALE ARRAY USING VALUES OF YMAX AND YMIN INPUT IN SUBROUTINE CALL
      DO 3 J=1,JM
      S= YR/(YMAX-YMIN+1.E-30)
      DO 3 I=1,IM
      3 Y(I,J)=(Y(I,J)-YMIN)*S

C
C**** WRITE CURVE NAMES, WITH ACTUAL MIN AND MAX VALUES *****
      J=1
      L= IFIX(XR/10)
      K=L
      GO TO 6
      5 J=J+L
      K=K+L
      6 K=MINO(JM,K)
      WRITE(3,101)
      IF (K-JM) 5,7,7
      7 WRITE(3,106)
C**** MAIN LOOP - EACH PASS PRODUCES A Y-CONSTANT LINE *****
      IX= IFIX(XSIZE*10)
      KX= IFIX(XR) + 1
      IY= IFIX(YR*0.1)
      KY= IFIX(YR) + 1
      N= KY + 1
      DO 40 M=1,KY
      L= N-M
      IF (L EQ 1 OR L EQ KY) GO TO 32
      GO TO 33

C
C**** PUT . OR + ALONG THE X-AXIS *****
      32 DO 30 K=1,KX
      30 A(K)=DOT
      DO 31 K=1,KX,IX
      31 A(K)=CROSS
      GO TO 45

C

```



```

C**** PUT DR + AND Y-VALUES ALONG Y-AXIS *****
33 A(1)=DOT
   A(KX)=DOT
   K=L-1
46 K=K-IY
   IF (K) 48,47,46
47 A(1)=CROSS
   A(KX)=CROSS
45 YL=FLOAT(L-1)/YR
   GO TO 35
48 YL=-1.
C
C**** SEARCH FOR POINTS ALONG Y-CONSTANT LINE *****
35 DO 42 J=1, JM
   DO 42 I=1, IM
C     DO NOT PLOT POINTS THAT EXTEND BEYOND THE UPPER OR LOWER VERTICAL
C     LIMIT OF THE GRAPH. YMX IS A SCALED VALUE CORRESPONDING TO YMAX.
C     YMN IS SCALED TO ZERO.
   YMX=(YMAX-YMIN)*S
   YMN=0.
   IF (Y(I, J).GT. YMX) GO TO 42
   IF (Y(I, J).LE. YMN) GO TO 42
   IF (IFIX(Y(I, J)+1.5).NE. L) GO TO 42
C
C**** POINT FOUND - ASSIGN SYMBOL - SEARCH FOR MORE *****
   NX= X(I)+1.5
   A(NX)=YAXIS(J)
42 CONTINUE
C
C**** PRINT Y-CONSTANT LINE *****
   IF (YL.NE.-1.) GO TO 37
   WRITE(3, 106) (A(K), K=1, KX)
   GO TO 38
37 WRITE(3, 107) YL, (A(K), K=1, KX)
C
C**** FILL ARRAY A WITH BLANKS *****
36 DO 49 K=1, KX
49 A(K)=BLANK
40 CONTINUE
C**** PRINT BLANK OR X-VALUE FOR X-AXIS *****
L=1
K=KX-1
A(1)=DIGIT(1)
DO 51 I=IX, K, IX
L=L+1
A(I)=DOT
51 A(I+1)=DIGIT(L)
   A(K)=BLANK
   WRITE(3, 106) (A(K), K=1, KX)
   RETURN
101 FORMAT(1H1)
106 FORMAT(6X, 101A1)
107 FORMAT(2H ,F3.1, 1X, 101A1)
END

```

APPENDIX D

ONDEK3 OUTPUT FOR
VAM BARGE LOADING

Example of Section III.2.4

TITLE= EXAMPLE: VAN BARGE LOADING
METEOROLOGICAL CONDITIONS

DATE= MAR 16, 1983

0 BAROMETRIC PRESSURE=760.000 MM HG AIR TEMPERATURE=520.0 DEG R
0 AVERAGE WIND SPEED= 2.24 M/S AT REFERENCE HEIGHT= 10.00 M
0 WIND EXPONENT= 0.14
0 TURBULENCE LEVEL= 20.00

VAPOR VENTING CONDITIONS

0 VENT DIAMETER= 0.20 METERS
0 VENT HEIGHT= 1.00 METERS ABOVE THE DECK
0 DECK HEIGHT= 1.00 METERS ABOVE THE WATER

0 EMITTED VAPOR= VINYL ACETATE VAPOR
0 MOLECULAR WEIGHT= 35.74 OF GAS AND AIR MIXTURE
0 VENT CONCENTRATION= 0.431E+00 KG/(M**3)

0 VENTING FLOWRATE= 159. (M**3)/HR
0 VENTING VELOCITY= 1.36 M/SEC

VALUES OF CONCENTRATION FOR FLAMMABILITY AND HEALTH HAZARDS

0 UPPER FLAMMABLE LIMIT (UEL) = 0.488E+00 KG/(M**3)
0 LOWER FLAMMABLE LIMIT (LEL) = 0.947E-01 KG/(M**3)
0 SHORT TERM EXPOSURE LIMIT (STEL) = 0.728E-04 KG/(M**3)
0 THRESHOLD LIMIT VALUE (TLV) = 0.364E-04 KG/(M**3)
0 ODOR THRESHOLD (ODOR) = 0.437E-06 KG/(M**3)

VALUES OF CONCENTRATION CHOSEN FOR CONCENTRATION CONTOURS

0 C1 = 0.364E-02 (KG/M**3)
0 C2 = 0.437E-06 (KG/M**3)
0 C3 = 0.488E+00 (KG/M**3)
0 C4 = 0.947E-01 (KG/M**3)
0 C5 = 0.728E-04 (KG/M**3)
0 C6 = 0.364E-04 (KG/M**3)
0 PREDICTED FOR A HEIGHT OF 1.680 METERS ABOVE DECK LEVEL

NUMERICAL INTEGRATION DATA

0 STEP SIZE= 0.0406 METERS. MAXIMUM DOWNWIND DISTANCE= 10.00 METERS

BEGIN PLUME COMPUTATION THROUGH THE AIR ABOVE THE DECK

S METERS	XCL METERS	ZCL METERS	CCL KG/M**3	CZCON KG/M**3	XCON METERS	YC1 METERS	YC2 METERS	YC3 METERS
0.16	0.218	1.244	0.1110E+00	0.9628E-03	0.218	0.000	0.555	0.000
0.97	1.029	1.277	0.1225E-01	0.7297E-02	1.029	0.467	1.746	0.000
1.95	2.003	1.283	0.3947E-02	0.3351E-02	2.003	0.000	2.935	0.000
2.96	3.018	1.284	0.1884E-02	0.1767E-02	3.018	0.000	4.087	0.000
3.98	4.033	1.285	0.1100E-02	0.1137E-02	4.033	0.000	5.201	0.000
4.95	5.008	1.285	0.7318E-03	0.8437E-03	5.008	0.000	6.254	0.000
5.97	6.023	1.285	0.5150E-03	0.6597E-03	6.023	0.000	7.332	0.000
6.98	7.038	1.285	0.3820E-03	0.5332E-03	7.038	0.000	8.388	0.000
7.96	8.012	1.285	0.2974E-03	0.4428E-03	8.012	0.000	9.380	0.000
8.97	9.027	1.284	0.2361E-03	0.3702E-03	9.027	0.000	10.391	0.000
9.95	10.001	1.284	0.1934E-03	0.3153E-03	10.001	0.000	11.341	0.000

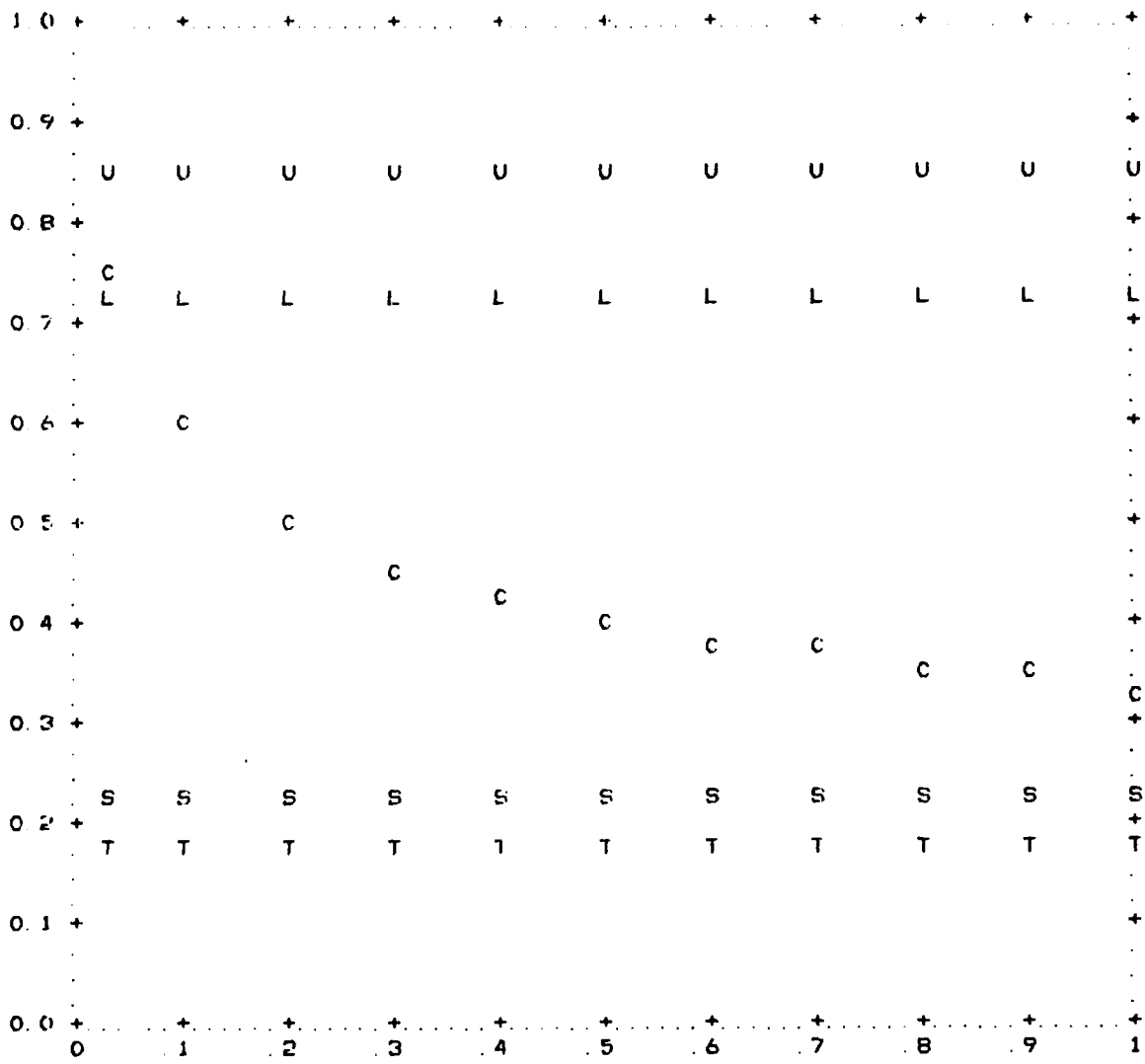

GRAPH OF PLUME CENTERLINE CONCENTRATION VERSUS DOWNWIND DISTANCE
 O ORDINATE IS PROPORTIONAL TO LOG(CONCENTRATION)
 O ABSCISSA IS PROPORTIONAL TO DISTANCE

TABLE OF CORRESPONDING VALUES			
VALUE	X (METERS)	Y (KG/M**3)	Y (PPM)
0.0	1.5	0.364E-05	1.
0.1	2.4	0.145E-04	4.
0.2	3.2	0.577E-04	16.
0.3	4.1	0.230E-03	63.
0.4	4.9	0.915E-03	251.
0.5	5.8	0.364E-02	1000.
0.6	6.6	0.145E-01	3981.
0.7	7.5	0.577E-01	15849.
0.8	8.3	0.230E+00	63096.
0.9	9.2	0.915E+00	251189.
1.0	10.0	0.364E+01	1000000.

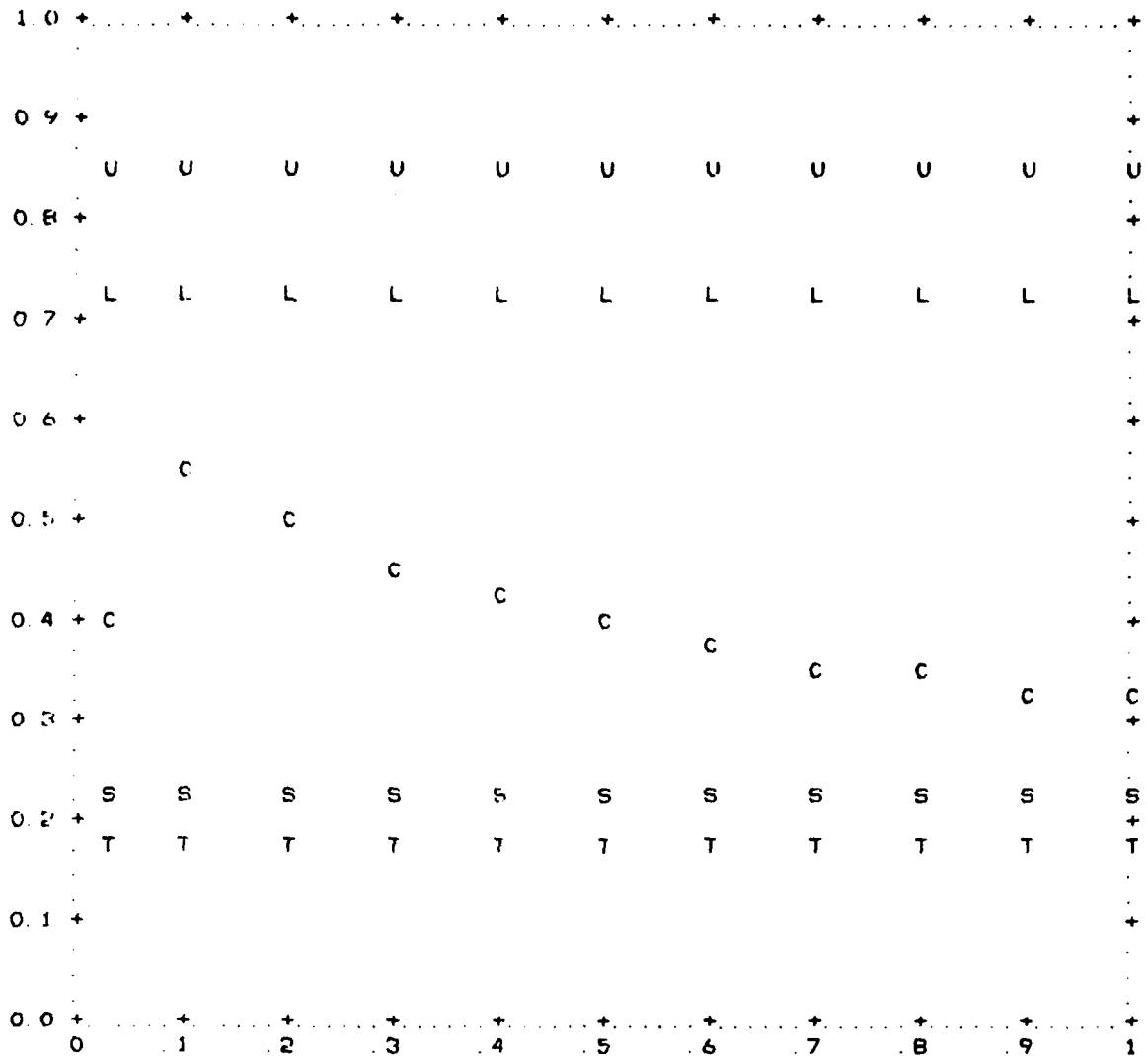

GRAPH OF VAPOR CONCENTRATION AT MAN BREATHING HEIGHT VS DOWNWIND DISTANCE
 O ORDINATE IS PROPORTIONAL TO LOG(CONCENTRATION)
 O ABSCISSA IS PROPORTIONAL TO DISTANCE

TABLE OF CORRESPONDING VALUES

VALUE	X(METERS)	Y(KG/M**3)	Y(PPM)
0.0	1.5	0.364E-05	1.
0.1	2.4	0.145E-04	4.
0.2	3.2	0.577E-04	16.
0.3	4.1	0.230E-03	63.
0.4	4.9	0.915E-03	251.
0.5	5.8	0.364E-02	1000.
0.6	6.6	0.145E-01	3981.
0.7	7.5	0.577E-01	15849.
0.8	8.3	0.230E+00	63096.
0.9	9.2	0.915E+00	251189.
1.0	10.0	0.364E+01	1000000.

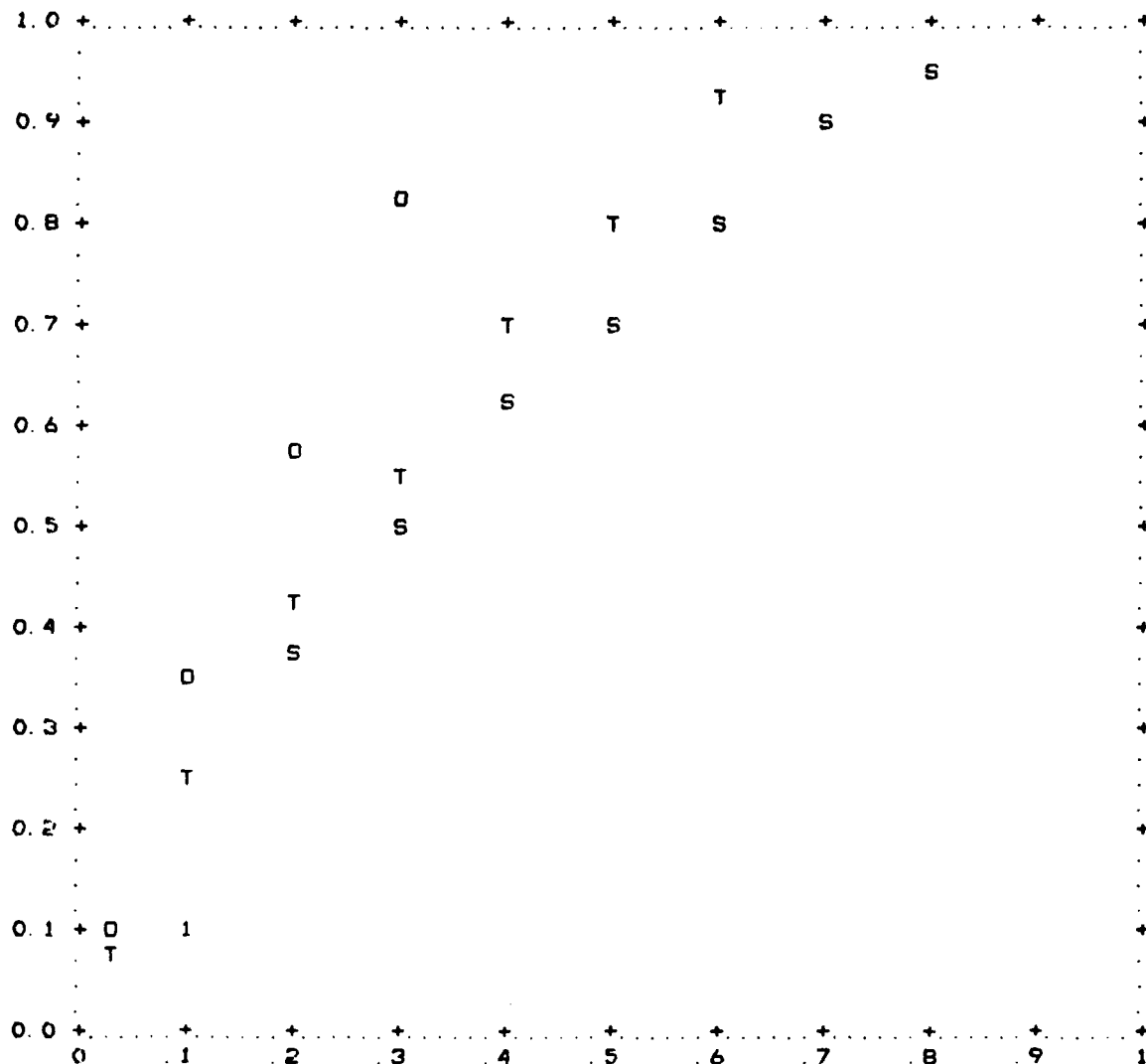

GRAPH OF VAPOR CONCENTRATION CONTOURS AT MAN BREATHING HEIGHT ABOVE THE DECK
 O ORDINATE IS PROPORTIONAL TO DISTANCE IN THE CROSS-WIND DIRECTION
 O ABCISSA IS PROPORTIONAL TO DISTANCE IN THE DOWNSTREAM DIRECTION

TABLE OF CORRESPONDING VALUES			CONCENTRATION CONTOURS	
VALUE	X(METERS)	Y(METERS)	SYMBOL	(PPM) (KG/M**3)
0.0	1.5	0.0	1C.	1000.00 0.364E-02
0.2	3.2	1.0	ODOR	0.12 0.437E-06
0.4	4.9	2.0	UEL.	134000.00 0.488E+00
0.6	6.6	3.0	LEL.	26000.00 0.947E-01
0.8	8.3	4.0	STEL	20.00 0.728E-04
1.0	10.0	5.0	TLV.	10.00 0.364E-04

APPENDIX E

ONDEK3 OUTPUT FOR
BENZENE BARGE LOADING

Example of Section III.2.7

TITLE= BENZENE BARGE LOADING
METEOROLOGICAL CONDITIONS

DATE= MAR 16, 1983

0 BAROMETRIC PRESSURE=760.000 MM HG AIR TEMPERATURE=520.0 DEG R
0 AVERAGE WIND SPEED= 2.24 M/S AT REFERENCE HEIGHT= 10.00 M
0 WIND EXPONENT= 0.14
0 TURBULENCE LEVEL= 20.00

VAPOR VENTING CONDITIONS

0 VENT DIAMETER= 0.20 METERS
0 VENT HEIGHT= 1.00 METERS ABOVE THE DECK
0 DECK HEIGHT= 1.00 METERS ABOVE THE WATER

0 EMITTED VAPOR= BENZENE VAPOR
0 MOLECULAR WEIGHT= 33.99 OF GAS AND AIR MIXTURE
0 VENT CONCENTRATION= 0.337E+00 KG/(M**3)

0 VENTING FLOWRATE= 79. (M**3)/HR
0 VENTING VELOCITY= 0.68 M/SEC

VALUES OF CONCENTRATION FOR FLAMMABILITY AND HEALTH HAZARDS

0 UPPER FLAMMABLE LIMIT (UEL) = 0.261E+00 KG/(M**3)
0 LOWER FLAMMABLE LIMIT (LEL) = 0.429E-01 KG/(M**3)
0 SHORT TERM EXPOSURE LIMIT (STEL) = 0.248E-03 KG/(M**3)
0 THRESHOLD LIMIT VALUE (TLV) = 0.826E-04 KG/(M**3)
0 ODOR THRESHOLD (ODOR) = 0.155E-04 KG/(M**3)

VALUES OF CONCENTRATION CHOSEN FOR CONCENTRATION CONTOURS

0 C1 = 0.330E-02 (KG/M**3)
0 C2 = 0.155E-04 (KG/M**3)
0 C3 = 0.261E+00 (KG/M**3)
0 C4 = 0.429E-01 (KG/M**3)
0 C5 = 0.248E-03 (KG/M**3)
0 C6 = 0.826E-04 (KG/M**3)
0 PREDICTED FOR A HEIGHT OF 1.680 METERS ABOVE DECK LEVEL

NUMERICAL INTEGRATION DATA

0 STEP SIZE= 0.0406 METERS, MAXIMUM DOWNWIND DISTANCE= 10.00 METER

BEGIN PLUME COMPUTATION THROUGH THE AIR ABOVE THE DECK

S METERS	XCL METERS	ZCL METERS	DCL KG/M**3	CZCON KG/M**3	XCON METERS	YC1 METERS	YC2 METERS	YC3 METERS
0.16	0.219	1.205	0.5799E-01	0.1701E-01	0.219	0.549	1.134	0.000
0.97	1.031	1.208	0.3089E-02	0.3404E-02	1.031	0.364	4.881	0.000
1.95	2.005	1.208	0.8214E-03	0.1311E-02	2.005	0.000	8.642	0.000
2.96	3.020	1.207	0.3621E-03	0.6513E-03	3.020	0.000	11.961	0.000
3.98	4.035	1.207	0.2028E-03	0.3817E-03	4.035	0.000	14.804	0.000
4.95	5.009	1.206	0.1316E-03	0.2528E-03	5.009	0.000	17.163	0.000
5.97	6.024	1.206	0.9094E-04	0.1769E-03	6.024	0.000	19.282	0.000
6.98	7.039	1.205	0.6660E-04	0.1305E-03	7.039	0.000	21.080	0.000
7.96	8.014	1.205	0.5138E-04	0.1012E-03	8.014	0.000	22.522	0.000
8.97	9.029	1.205	0.4047E-04	0.7995E-04	9.029	0.000	23.734	0.000
9.95	10.003	1.205	0.3297E-04	0.6528E-04	10.003	0.000	24.621	0.000

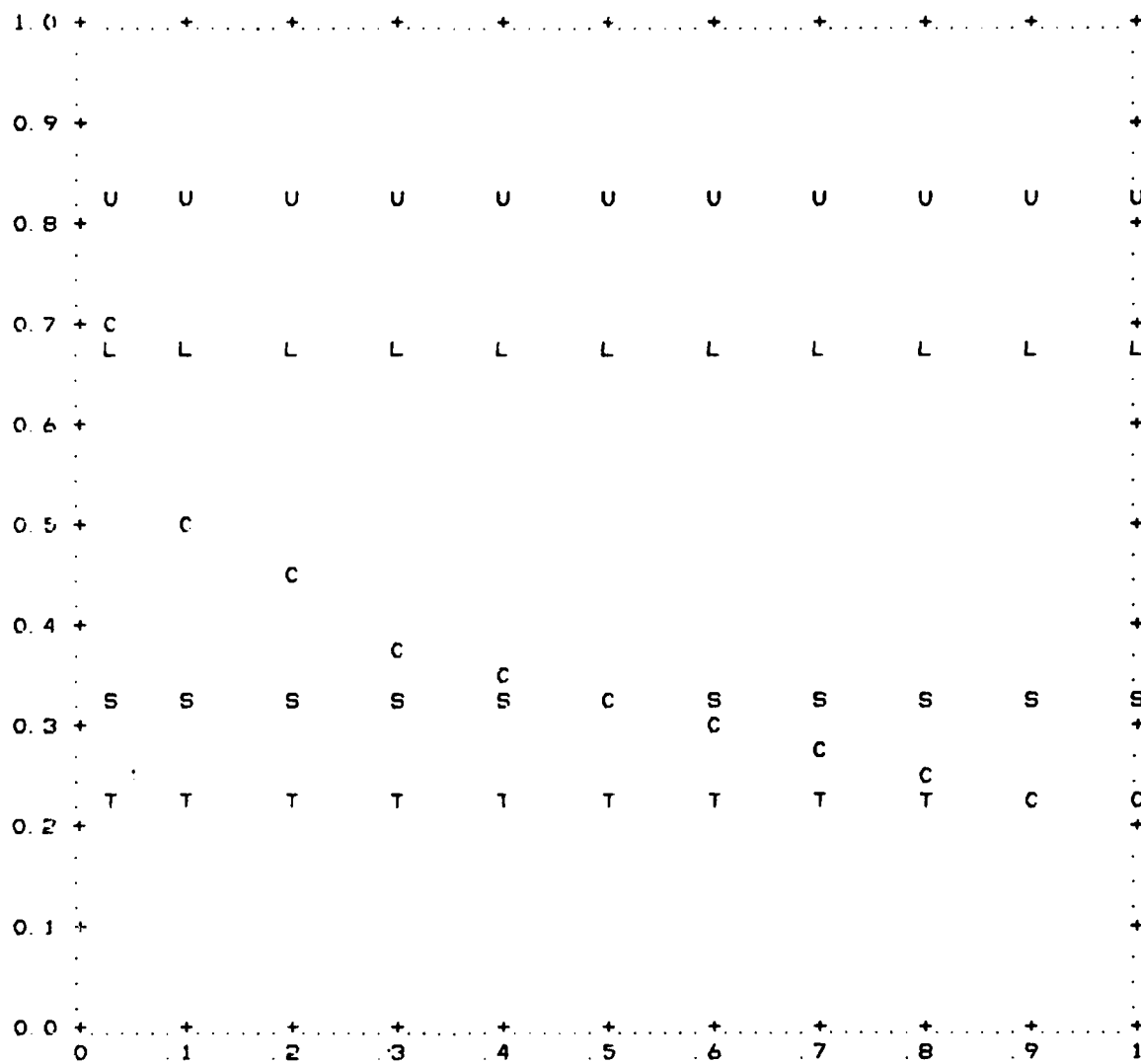

GRAPH OF PLUME CENTERLINE CONCENTRATION VERSUS DOWNWIND DISTANCE
 O ORDINATE IS PROPORTIONAL TO LOG(CONCENTRATION)
 O ABSCISSA IS PROPORTIONAL TO DISTANCE

TABLE OF CORRESPONDING VALUES			
VALUE	X (METERS)	Y (KG/M**3)	Y (PPM)
0.0	1.5	0.330E-05	1.
0.1	2.4	0.132E-04	4.
0.2	3.2	0.524E-04	16.
0.3	4.1	0.208E-03	63.
0.4	4.9	0.830E-03	251.
0.5	5.8	0.330E-02	1000.
0.6	6.6	0.132E-01	3981.
0.7	7.5	0.524E-01	15849.
0.8	8.3	0.208E+00	63096.
0.9	9.2	0.830E+00	251189.
1.0	10.0	0.330E+01	1000000.

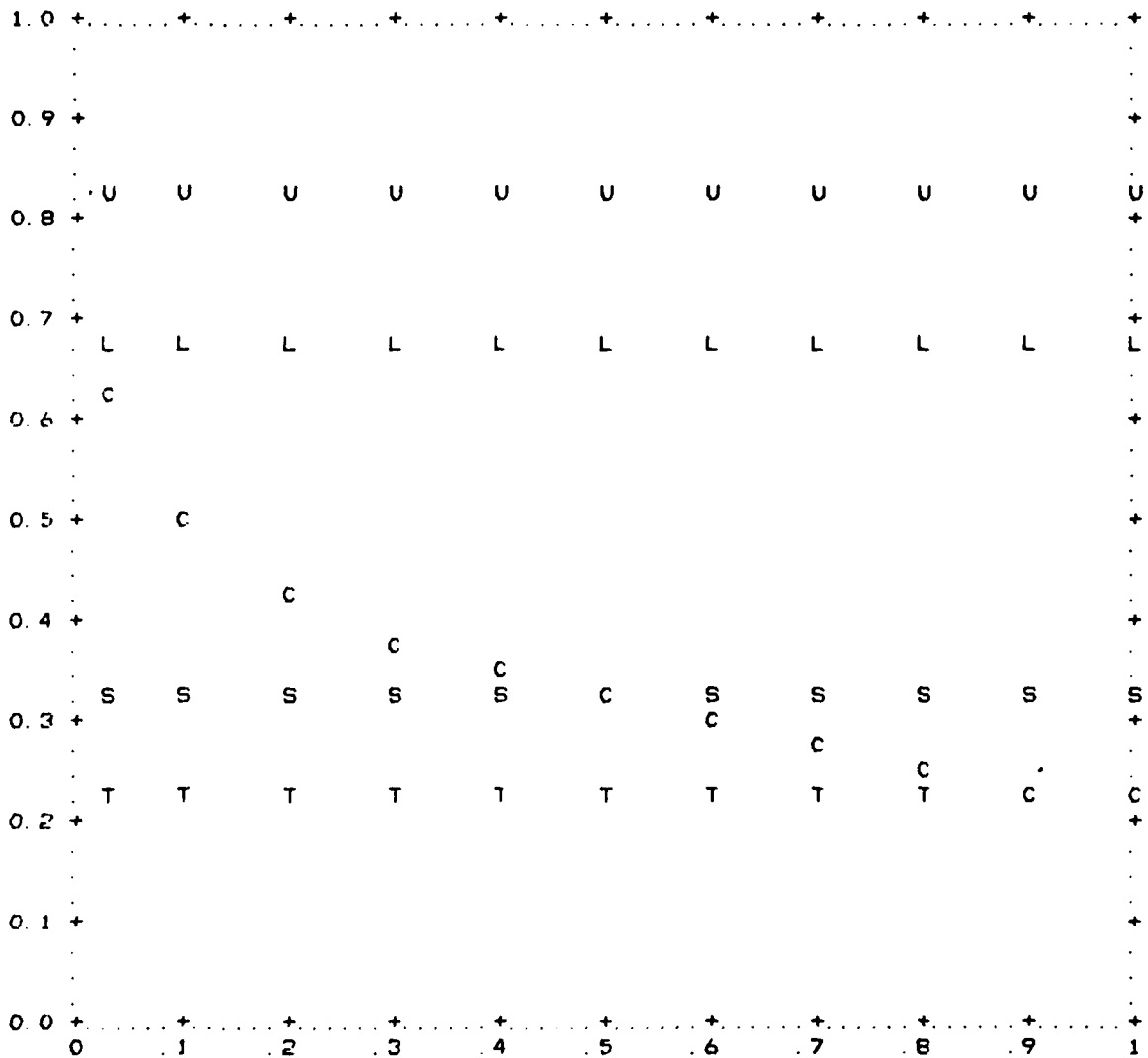

GRAPH OF VAPOR CONCENTRATION AT MAN BREATHING HEIGHT VS DOWNWIND DISTANCE
 O ORDINATE IS PROPORTIONAL TO LOG(CONCENTRATION)
 O ABCISSA IS PROPORTIONAL TO DISTANCE

TABLE OF CORRESPONDING VALUES

VALUE	X(METERS)	Y(KG/M**3)	Y(PPM)
0.0	1.5	0.330E-05	1.
0.1	2.4	0.132E-04	4.
0.2	3.2	0.524E-04	16.
0.3	4.1	0.208E-03	63.
0.4	4.9	0.830E-03	251.
0.5	5.8	0.330E-02	1000.
0.6	6.6	0.132E-01	3981.
0.7	7.5	0.524E-01	15849.
0.8	8.3	0.208E+00	63096.
0.9	9.2	0.830E+00	251189.
1.0	10.0	0.330E+01	1000000.

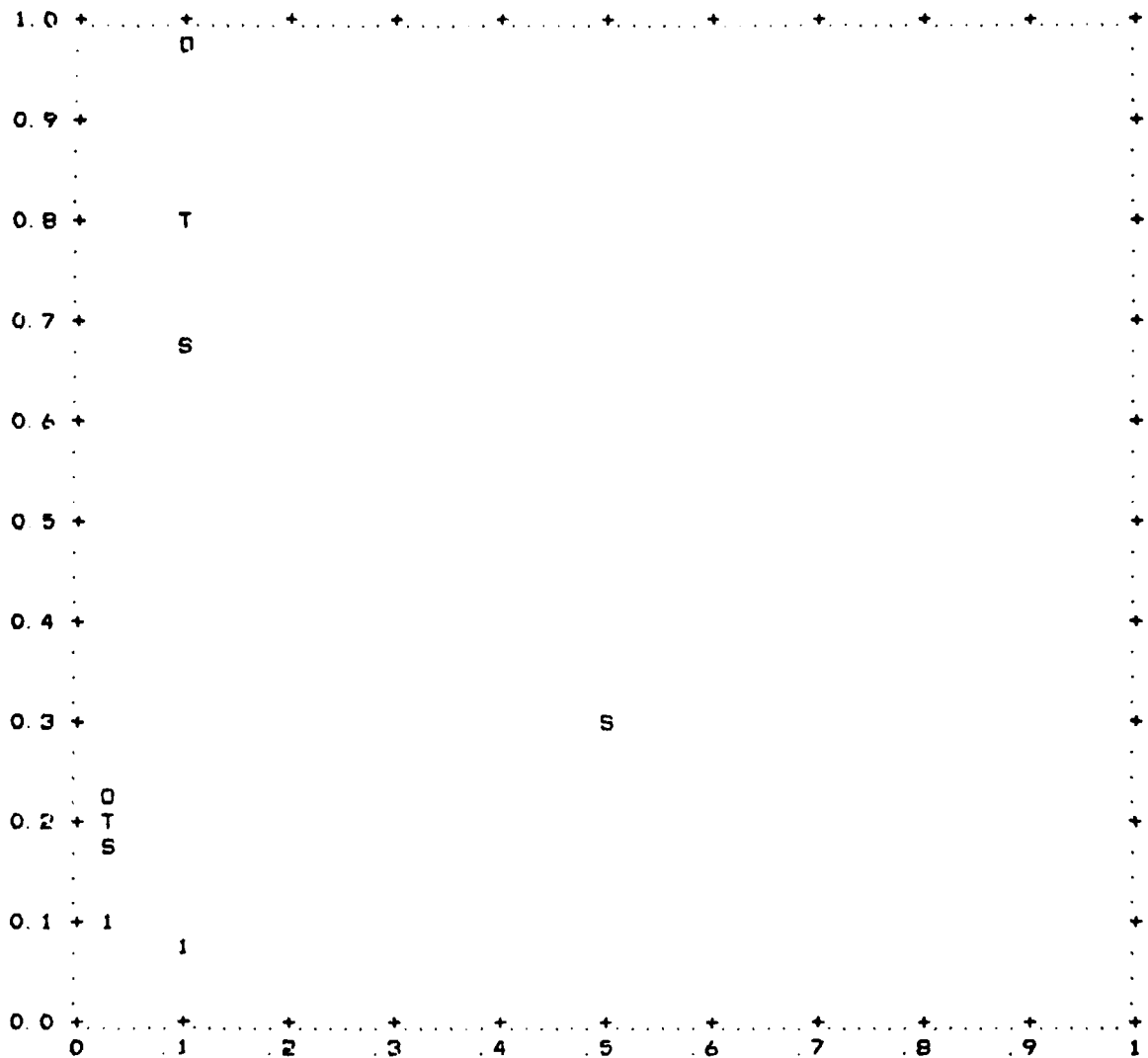

GRAPH OF VAPOR CONCENTRATION CONTOURS AT MAN BREATHING HEIGHT ABOVE THE DECK
 O ORDINATE IS PROPORTIONAL TO DISTANCE IN THE CROSS-WIND DIRECTION
 O ABCISSA IS PROPORTIONAL TO DISTANCE IN THE DOWNSTREAM DIRECTION

TABLE OF CORRESPONDING VALUES			CONCENTRATION CONTOURS	
VALUE	X (METERS)	Y (METERS)	SYMBOL (PPM)	(KG/M**3)
0.0	1.5	0.0	1C..	1000.00 0.330E-02
0.2	3.2	1.0	ODOR	4.68 0.155E-04
0.4	4.9	2.0	UEL.	79000.00 0.261E+00
0.6	6.6	3.0	LEL.	13000.00 0.429E-01
0.8	8.3	4.0	STEL	75.00 0.248E-03
1.0	10.0	5.0	TLV.	25.00 0.826E-04

FILM

7