

AD-A128 125

RANGE REFERENCE ATMOSPHERE 0-70 KM ALTITUDE VANDENBERG
AFB CALIFORNIA(U) RANGE COMMANDERS COUNCIL WHITE SANDS
MISSILE RANGE NM METEOROLOGY GROUP G G BOIRE ET AL.

1/3

UNCLASSIFIED

APR 83 RCC/MG-362-83

F/G 4/2

NL

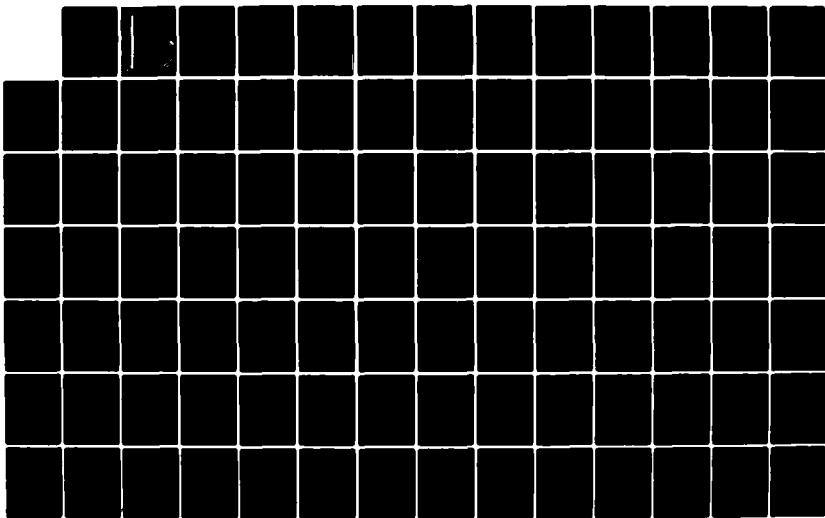

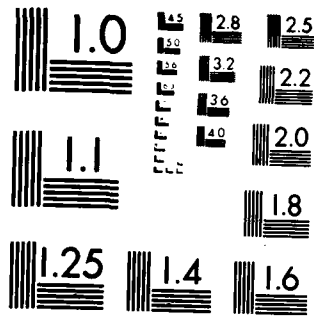

MICROCOPY RESOLUTION TEST CHART
NATIONAL BUREAU OF STANDARDS-1963-A

19

DOCUMENT 362-83

MG

ADA 128125

VANDENBERG AIR FORCE BASE, CALIFORNIA

RANGE REFERENCE ATMOSPHERE
0-70 KM ALTITUDE

APRIL 1983

METEOROLOGY GROUP
RANGE COMMANDERS COUNCIL

WHITE SANDS MISSILE RANGE
KWAJALEIN MISSILE RANGE
YUMA PROVING GROUND

PACIFIC MISSILE TEST CENTER
NAVAL WEAPONS CENTER
ATLANTIC FLEET WEAPONS TRAINING FACILITY
NAVAL AIR TEST CENTER

EASTERN SPACE AND MISSILE CENTER
ARMAMENT DIVISION
WESTERN SPACE AND MISSILE CENTER
AIR FORCE SATELLITE CONTROL FACILITY
AIR FORCE FLIGHT TEST CENTER
AIR FORCE TACTICAL FIGHTER WEAPONS CENTER

DTIC
UNCLASSIFIED
H

DISTRIBUTION STATEMENT A
Approved for Public Release
Distribution Unlimited

DTIC FILE COPY

83 05 13 00T

UNCLASSIFIED

SECURITY CLASSIFICATION OF THIS PAGE (When Data Entered)

REPORT DOCUMENTATION PAGE		READ INSTRUCTIONS BEFORE COMPLETING FORM
1. REPORT NUMBER Document 362-83	2. GOVT ACCESSION NO. AD-A128125	3. RECIPIENT'S CATALOG NUMBER
4. TITLE (and Subtitle) Range Reference Atmosphere, 0-70 KM Altitude, Vandenberg AFB, CA		5. TYPE OF REPORT & PERIOD COVERED
		6. PERFORMING ORG. REPORT NUMBER
7. AUTHOR(s) Meteorology Group Range Commanders Council White Sands Missile Range, NM 88002		8. CONTRACT OR GRANT NUMBER(s)
9. PERFORMING ORGANIZATION NAME AND ADDRESS Same as Block 7.		10. PROGRAM ELEMENT, PROJECT, TASK AREA & WORK UNIT NUMBERS
11. CONTROLLING OFFICE NAME AND ADDRESS Range Commanders Council, Secretariat ATTN: STEWS-SA-R White Sands Missile Range, NM 88002		12. REPORT DATE April 1983
		13. NUMBER OF PAGES 210
14. MONITORING AGENCY NAME & ADDRESS (if different from Controlling Office) Same as Block 11.		15. SECURITY CLASS. (of this report) UNCLASSIFIED
		15a. DECLASSIFICATION/DOWNGRADING SCHEDULE
16. DISTRIBUTION STATEMENT (of this Report) Approved for Public Release; Distribution Unlimited.		
17. DISTRIBUTION STATEMENT (of the abstract entered in Block 20, if different from Report)		
18. SUPPLEMENTARY NOTES New document.		
19. KEY WORDS (Continue on reverse side if necessary and identify by block number) Range reference atmosphere, data quality control, coordinate system, computation of statistical parameters, statistical wind models, orthogonal axes, thermodynamic quantities, required altitude levels, derived monthly mean, annual mean model atmospheres.		
20. ABSTRACT (Continue on reverse side if necessary and identify by block number) FOREWORD - see attached pages.		

DD FORM 1 JAN 73 1473

EDITION OF 1 NOV 65 IS OBSOLETE

UNCLASSIFIED

SECURITY CLASSIFICATION OF THIS PAGE (When Data Entered)

SECURITY CLASSIFICATION OF THIS PAGE(When Data Entered)

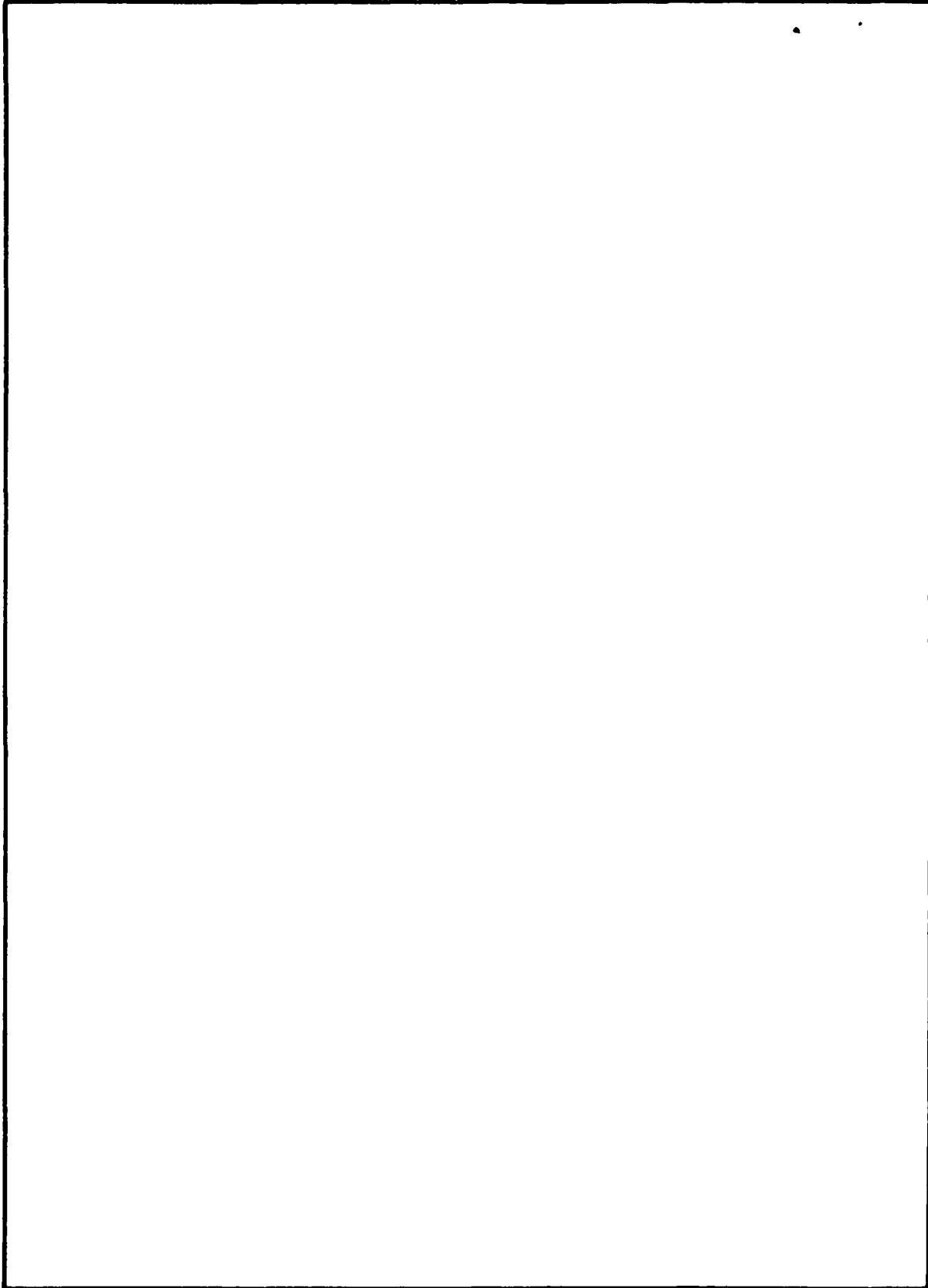

SECURITY CLASSIFICATION OF THIS PAGE(When Data Entered)

FOREWORD

Atmospheric parameters are essential to the research and development of missiles and aerospace vehicles. In the early 1960's, the need was recognized for realistic atmospheric models derived in a consistent manner for each of the several major test ranges. An atmospheric model derived from statistical data for a particular geographical location is referred to as a reference atmosphere.

The first Range Reference Atmosphere (RRA) was issued in 1963 by the Inter-Range Instrumentation Group (IRIG) for Cape Kennedy, Florida, and was followed by additional publications for several ranges up to 1974. Since that time, improved upper air data bases have become available from which to develop the RRA. These resulted from the extended period of records and from improvement in the upper air measuring program by rocketsondes for altitudes above the rawinsonde ceiling of 30 km. Revised and improved RRAs are justified for the following reasons:

- 1) Needs for more definitive statistical atmospheric models have arisen because of changes and advances in aerospace technology. The Space Transportation System (Space Shuttle) is one example.
- 2) Most ranges now have an extended and improved upper air data base from which to develop a more definitive RRA.
- 3) There are requirements for RRAs for new ranges and range sites.
- 4) There have been scientific advances in understanding the upper atmospheric structure and physical relationships.
- 5) Advances in statistical modeling techniques have been made because of the general availability of high-speed electronic computers. These have led to the adoption of advanced concepts in atmospheric modeling.

For these reasons, the Range Reference Atmosphere Committee (RRAC) was tasked by the Range Commanders Council Meteorology Group (RCC MG) to establish new and improved RRAs. The purpose, scope, and objectives of this task are outlined in the following paragraphs.

Purpose: This committee, Task MG-1, establishes RRAs for the several ranges as provided by the RCC. An RRA is a model of the Earth's atmosphere over a geographical location of interest, for use by DOD and other U.S. Government range users. The RRA is used to provide planning data for evaluating environmental constraints for the particular configurations of environment-sensitive systems and components being developed or undergoing tests.

Scope: Using the best available upper atmosphere data base to include rawinsonde, rocketsonde and possibly other high-altitude data sources for the range location, the task is to establish a model of certain statistics for wind and thermodynamic quantities derived in a uniform manner and published in a standardized format.

Objectives: The wind statistics shall be, insofar as practical, modeled to be consistent with rigorous mathematical probability properties of the multivariate normal probability theory. The thermodynamic quantities statistics shall be, insofar as practical, modeled to be consistent with the hydrostatic equation, the equation of state, and the probability principles that are related through these physical equations. The document shall serve as an authoritative source of information and as an atmospheric model for a particular range. The first in the series of revised RRAs to be published is for Kwajalein Missile Range (KMR) (publication date December 1982). The altitude range required for KMR is 0 to 70 km. The order of priority for the subsequent publications is:

<u>Range</u>	<u>Altitude Range Required</u>
1. AFFTC/Edwards AFB, CA	0 - 70 km ^a
2. ESMC/Cape Canaveral AFS, FL	0 - 70 km
3. WSMC/Vandenberg AFB, CA	0 - 70 km ^a
4. WSMR/White Sands, NM	0 - 70 km
5. PMTC/Point Mugu, CA	0 - 70 km
6. UTTR/Dugway (Michael AAF), UT	0 - 30 km ^b
7. AD/Eglin AFB, FL	0 - 30 km
8. ESMC/Ascension Island	0 - 70 km (Terminates at 66 km because of insufficient data)
9. NASA/Wallops Flight Center, VA	0 - 70 km
10. Taquac (Guam)	0 - 30 km
11. PMTC/Barking Sands, HI	0 - 70 km

In keeping with the RCC's objective of standardization, the modeling techniques, basic text, and tabulation format are to be the same for all RRAs. These new and revised RRAs present not only the mean values of the thermodynamic quantities (pressure, temperature, virtual temperature, and density), but also include statistical measures for the dispersion (i.e., standard deviations and skewness coefficients). New quantities presented are water vapor pressure and dewpoint temperature. The statistical modeling for the wind is entirely new. The new approach uses the properties of the bivariate normal probability distribution function.

- a. Use rocketsonde data from PMTC/Point Mugu for altitudes above 30 km.*
b. Consider augmenting data base from Ely or Salt Lake City.

ed
e
is
ti-

All final computations were performed by the United States Air Force Environmental Technical Applications Center (USAFETAC) in response to a task from Eastern Space and Missile Center (ESMC).

The text was prepared jointly by USAFETAC and the NASA/George C. Marshall Space Flight Center's Space Sciences Laboratory, Atmospheric Sciences Division. The editing and preparation of the draft manuscript were performed by the NASA/MSFC organization.

The cochairmen express their gratitude to all RRAC members and their respective colleagues who have made significant technical contributions to the establishment of these RRAs.

Special thanks are tendered to Lt. B. Novograd for his diligence in forming the many computations and the development of the primary tables, I through IV. Special thanks goes to Lt. F. Wirsing for editing and formulating the equations for the derivable thermodynamic equations. These gentlemen performed this outstanding work under the direction of Major B. Lilius, USAFETAC.

Grateful acknowledgment goes to Mrs. Annette Tingle, NASA/MSFC, for editing the draft manuscript.

The RRAC consists of representatives from the U.S. Air Force, U.S. Army, National Aeronautics and Space Administration, U.S. Navy, and National Oceanic and Atmospheric Administration. The committee members for the RRA for the first publication are:

G. G. Boire, WSMC
O. H. Daniel, ESMC
R. de Violini, PMTC
F. G. Finger, NOAA/NWS
E. E. Fisher, HQ AFSC
B. R. Hixon, PMTC
J. M. Hobbie, KMR
E. J. Keppel, AD
S. F. Kubinski, WSMR
F. J. Schmidlin, NASA/WFC

O. E. Smith
Cochairman, NASA/MSFC

Maj. B. W. Galusha
Cochairman, USAF/ETAC

DOCUMENT 362-83

VANDENBERG AIR FORCE BASE, CALIFORNIA

RANGE REFERENCE ATMOSPHERE
0-70 KM ALTITUDE

April 1983

Prepared by
Range Reference Atmosphere Committee
Meteorology Group
Range Commanders Council

Published by
Secretariat
Range Commanders Council
White Sands Missile Range, New Mexico 88002

Requested For	
NA&I	<input checked="" type="checkbox"/>
	<input type="checkbox"/>
	<input type="checkbox"/>
	<input type="checkbox"/>
Distribution	



APPROVED FOR PUBLIC RELEASE: DISTRIBUTION UNLIMITED

TABLE OF CONTENTS

	<u>PAGE</u>
LIST OF ORGANIZATION ACRONYMS	v
FOREWORD	vii
CHAPTER I. INTRODUCTION	1
A. Definition and Purpose of the Range Reference Atmosphere	1
B. Scope of the Range Reference Atmosphere and Arrangement of Tables.	1
C. Data Quality Control Procedures.	2
D. Organization of the Chapters	3
CHAPTER II. WIND STATISTICS AND MODELS;	5
A. General Considerations	5
B. Coordinate System and Computation of Statistical Parameters	8
C. Statistical Wind Models.	10
D. Statistical Parameters With Respect to Any Orthogonal Axes	25
CHAPTER III. STATISTICS OF THERMODYNAMIC QUANTITIES AND MODELS;	29
A. General Considerations	29
B. Establishing Data Samples at the Required Altitude Levels.	32
C. Computation of Statistical Parameters for Tables II and III.	36
D. Derived Monthly Mean and Annual Mean Model Atmospheres.	39
E. Thermodynamic Quantities Derivable from the Basic Tables.	40
CHAPTER IV. CONCLUSIONS AND RECOMMENDATIONS	47
REFERENCES	49
CONVERSION UNITS	53
APPENDIX A	109
APPENDIX B	179

LIST OF ORGANIZATION ACRONYMS

AD	Armament Division
AFFTC	Air Force Flight Test Center
AFSC	Air Force Systems Command
AFSC/AFGL	AFSC/Air Force Geophysics Laboratory
AFSC/SD	AFSC/Space Division
AFSCF	Air Force Satellite Control Facility
AFTFWC	Air Force Tactical Fighter Weapons Center
AWS	Air Weather Service
BMD	Ballistic Missile Division
DOD	Department of Defense
DOE	Department of Energy
DOE/NTS	DOE/Nevada Test Site
DPG	Dugway Proving Ground
ESMC	Eastern Space and Missile Center
ETR	Eastern Test Range
KMR	Kwajalein Missile Range
NASA	National Aeronautics and Space Administration
NASA/MSFC	NASA/Marshall Space Flight Center
NASA/WFC	NASA/Wallops Flight Center
NOAA	National Oceanic and Atmospheric Administration
NWC	Naval Weapons Center
PMTC	Pacific Missile Test Center
USA/DTC	U.S. Army/Deseret Test Center
USAECON	U.S. Army Electronics Command
USAFETAC	United States Air Force Environmental Technical Applications Center

UTTR	Utah Test and Training Range
WSMC	Western Space and Missile Center
WSMR	White Sands Missile Range
WTR	Western Test Range
YPG	Yuma Proving Ground
6585TG	6585th Test Group
TSCF	Targeting Systems Characterization Facility

FOREWORD

Atmospheric parameters are essential to the research and development of missiles and aerospace vehicles. In the early 1960's, the need was recognized for realistic atmospheric models derived in a consistent manner for each of the several major test ranges. An atmospheric model derived from statistical data for a particular geographical location is referred to as a reference atmosphere.

The first Range Reference Atmosphere (RRA) was issued in 1963 by the Inter-Range Instrumentation Group (IRIG) for Cape Kennedy, Florida, and was followed by additional publications for several ranges up to 1974. Since that time, improved upper air data bases have become available from which to develop the RRA. These resulted from the extended period of records and from improvement in the upper air measuring program by rocketsonde for altitudes above the rawinsonde ceiling of 30 km. Revised and improved RRAs are justified for the following reasons:

- 1) Needs for more definitive statistical atmospheric models have arisen because of changes and advances in aerospace technology. The Space Transportation System (Space Shuttle) is one example.
- 2) Most ranges now have an extended and improved upper air data base from which to develop a more definitive RRA.
- 3) There are requirements for RRAs for new ranges and range sites.
- 4) There have been scientific advances in understanding the upper atmospheric structure and physical relationships.
- 5) Advances in statistical modeling techniques have been made because of the general availability of high-speed electronic computers. These have led to the adoption of advanced concepts in atmospheric modeling.

For these reasons, the Range Reference Atmosphere Committee (RRAC) was tasked by the Range Commanders Council Meteorology Group (RCC MG) to establish new and improved RRAs. The purpose, scope, and objectives of this task are outlined in the following paragraphs.

Purpose: This committee, Task MG-1, establishes RRAs for the several ranges as provided by the RCC. An RRA is a model of the Earth's atmosphere over a geographical location of interest, for use by DOD and other U.S. Government range users. The RRA is used to provide planning data for evaluating environmental constraints for the particular configurations of environment-sensitive systems and components being developed or undergoing tests.

Scope: Using the best available upper atmosphere data base to include rawinsonde, rocketsonde and possibly other high-altitude data sources for the range location, the task is to establish a model of certain statistics for wind and thermodynamic quantities derived in a uniform manner and published in a standardized format.

Objectives: The wind statistics shall be, insofar as practical, modeled to be consistent with rigorous mathematical probability properties of the multivariate normal probability theory. The thermodynamic quantities statistics shall be, insofar as practical, modeled to be consistent with the hydrostatic equation, the equation of state, and the probability principles that are related through these physical equations. The document shall serve as an authoritative source of information and as an atmospheric model for a particular range. The first in the series of revised RRAs to be published is for Kwajalein Missile Range (KMR) (publication date December 1982). The altitude range required for KMR is 0 to 70 km. The order of priority for the subsequent publications is:

<u>Range</u>	<u>Altitude Range Required</u>
1. AFFTC/Edwards AFB, CA	0 - 70 km ^a
2. ESMC/Cape Canaveral AFS, FL	0 - 70 km
3. WSMC/Vandenberg AFB, CA	0 - 70 km ^a
4. WSMR/White Sands, NM	0 - 70 km
5. PMTC/Point Mugu, CA	0 - 70 km
6. UTTR/Dugway (Michael AAF), UT	0 - 50 km ^b
7. AD/Eglin AFB, FL	0 - 30 km
8. ESMC/Ascension Island	0 - 70 km (Terminates at 66 km because of insufficient data)
9. NASA/Wallops Flight Center, VA	0 - 70 km
10. Taquac (Guam)	0 - 30 km
11. PMTC/Barking Sands, HI	0 - 70 km

In keeping with the RCC's objective of standardization, the modeling techniques, basic text, and tabulation format are to be the same for all RRAs. These new and revised RRAs present not only the mean values of the thermodynamic quantities (pressure, temperature, virtual temperature, and density), but also include statistical measures for the dispersion (i.e., standard deviations and skewness coefficients). New quantities presented are water vapor pressure and dewpoint temperature. The statistical modeling for the wind is entirely new. The new approach uses the properties of the bivariate normal probability distribution function.

- a. Use rocketsonde data from PMTC/Point Mugu for altitudes above 30 km.
- b. Consider augmenting data base from Ely or Salt Lake City.

All final computations were performed by the United States Air Force Environmental Technical Applications Center (USAFETAC) in response to a task from Eastern Space and Missile Center (ESMC).

The text was prepared jointly by USAFETAC and the NASA/George C. Marshall Space Flight Center's Space Sciences Laboratory, Atmospheric Sciences Division. The editing and preparation of the draft manuscript were performed by the NASA/MSFC organization.

The cochairmen express their gratitude to all RRAC members and their respective colleagues who have made significant technical contributions to the establishment of these RRAs.

Special thanks are tendered to Lt. B. Novograd for his diligence in forming the many computations and the development of the primary tables, I through IV. Special thanks goes to Lt. F. Wirsing for editing and formulating the equations for the derivable thermodynamic equations. These gentlemen performed this outstanding work under the direction of Major B. Lilius, USAFETAC.

Grateful acknowledgment goes to Mrs. Annette Tingle, NASA/MSFC, for editing the draft manuscript.

The RRAC consists of representatives from the U.S. Air Force, U.S. Army, National Aeronautics and Space Administration, U.S. Navy, and National Oceanic and Atmospheric Administration. The committee members for the RRA for the first publication are:

G. G. Boire, WSMC
O. H. Daniel, ESMC
R. de Violini, PMTC
F. G. Finger, NOAA/NWS
E. E. Fisher, HQ AFSC
B. R. Hixon, PMTC
J. M. Hobbie, KMR
E. J. Keppel, AD
S. F. Kubinski, WSMR
F. J. Schmidlin, NASA/WFC

O. E. Smith
Cochairman, NASA/MSFC

Maj. B. W. Galusha
Cochairman, USAF/ETAC

CHAPTER I. INTRODUCTION

A. Definition and Purpose of the Range Reference Atmosphere

A.1 Definition

A reference atmosphere is a statistical model of the Earth's atmosphere derived from upper air measurements over a particular geographical location. Hence, these Range Reference Atmospheres (RRAs) are atmospheric models developed by the Range Reference Atmosphere Committee (RRAC) in response to a task by the Range Commanders Council Meteorology Group (RCC MG) and published by the RCC Secretariat. The RCC MG, formerly called the Inter-Range Instrumentation Group/Meteorology Working Group (IRIG/MWG), published a series of RRAs during the period 1963 through 1974.

A.2 Purpose

A series of revised and expanded RRAs are to be published for locations of interest to the RCC. These publications are to serve as authoritative reference sources on certain upper air statistics and as atmospheric models for particular range sites. The technical usefulness of these documents for the ranges, range users, U.S. aerospace industries, and the scientific community is recognized because of the standardization of the development techniques and the presentation of the tabulations.

B. Scope of the Range Reference Atmosphere and Arrangement of Tables

B.1 Scope

The RRA contains tabulations for monthly and annual means, standard deviations, and skewness coefficients for windspeed, pressure, temperature, density, water vapor pressure, virtual temperature, and dewpoint temperature; the means and standard deviations for the zonal (U) and meridional (V) wind components; and the linear (product moment) correlation coefficient between the wind components. These statistical parameters are tabulated at the station elevation, at 1-km intervals from sea level to 30 km, and at 2-km intervals from 30 to 90 km. The wind statistics are given at approximately 10 m above the station elevations and at altitudes with respect to mean sea level thereafter. For those range sites without rocketsonde measurements, the RRAs terminate at 30 km altitude, or they are extended, if required, when rocketsonde data from a nearby launch site are available. There are four sets of tables for each of the 12 monthly reference periods and the annual reference period.

B.2 Arrangement of Tables

The statistical parameters for the RRA models are presented in four tables, as outlined in the following paragraphs.

Table I contains all the wind statistical parameters. This table gives the monthly and annual means and standard deviations of the U and V wind components and the linear (product moment) correlation coefficient between these

two components; the mean, standard deviation and skewness coefficient of the windspeed; and the number of wind observations (sample size).

Table II contains the monthly and annual means, standard deviations, and skewness values of pressure, temperature, and density, and the number of observations used for each of these thermodynamic quantities.

Table III contains the monthly and annual means, standard deviations and skewness values of the water vapor pressure, virtual temperature and dewpoint, and the number of observations for each of these moisture-related quantities. The statistical parameters for water vapor pressure and dewpoint terminate at 15 km altitude. Above 15 km the statistical parameters for virtual temperature are considered to be the same as those for temperature.

Table IV contains the monthly and annual mean atmospheric models for the thermodynamic variables: pressure, virtual temperature, and density. This table is derived from the monthly and annual mean virtual temperature versus altitude (geometric) using the hydrostatic equation and the equation of state. Also presented is the geopotential height corresponding to the tabulated geometric altitudes.

The physical unit for all wind parameters is meters per second. The physical unit for pressure is millibars; for temperature and virtual temperature, degrees Kelvin; for density, grams per cubic meter; and for water vapor pressure, millibars. In all cases the skewness coefficient and the correlation coefficient between wind components are unitless. All reference to altitude is geometric altitude and is expressed in kilometers. All reference to height is geopotential height and has the unit geopotential meters or kilometers. All geometric altitudes and geopotential heights are with respect to mean sea level.

C. Data Quality Control Procedures

A small portion (less than 10 percent) of the soundings in the data base used to calculate the RRA tables contained erroneous data values. The soundings which contained these erroneous values were eliminated from the data base using the following procedures:

- 1) Soundings containing gaps in their height data greater than 200 mb were rejected. This step was taken because some soundings only contained height values at their "mandatory" pressure levels, which were occasionally missing, resulting in soundings with no height information at all.

- 2) An initial set of RRA statistics was computed using all the remaining soundings. This initial set of statistics was used to determine data limits for the temperature, pressure, U and V components of the wind, and the dewpoint (for the 0- to 30-km portion of the RRA) or the density (for the 30- to 90-km portion of the RRA). The lower (upper) data limits were set at the mean value for a specific parameter, minus (plus) six standard deviations of that quantity. One pair of data limits was computed for each of these parameters: month of the year and data level.

3) This initial set of data limits was then used to screen the data base. All the soundings that contained values outside these data limits were rejected. A new RRA was then computed using the screened data base. This second RRA was used to generate a second set of data limits.

4) The second set of data limits was then used to screen the data base further. A new RRA was again generated. The skewness values in this RRA were then evaluated, according to empirical criteria specified in section II.A.3 of this document for the winds, and according to criteria in section III.A.3 for the thermodynamic quantities. If these criteria were satisfied, the new RRA was then used to generate a final set of data limits, which were used to control the quality of the data base for the final version of the RRA.

5) Occasionally, the third RRA that was generated did not satisfy all of the skewness criteria. This indicated that some incorrect values were still present in the data base. To complete quality control, steps 3 and 4 were repeated for additional iterations (usually one or two) until the resulting RRA satisfied the skewness criteria. At that point, a final set of data limits was generated. This final set of data limits was then used to control the quality of the data base and generate the final RRA.

D. Organization of the Chapters

Because there are plans to publish a series of RRAs, comments on the special organization of the document are in order. The RRA document is arranged in four chapters. Chapter I is the introduction. Chapter II, Wind Statistics and Models, contains the techniques used to arrive at the wind statistical parameters, table I, and the probability functions that are to be used as wind models to derive several wind statistics. Chapter III, Statistics of Thermodynamic Quantities and Models, contains the techniques used to arrive at the thermodynamic and moisture-related statistical parameters given in tables II and III and the atmospheric thermodynamic model presented in table IV. This chapter also contains sets of equations to calculate several atmospheric properties. Chapter IV contains the general conclusions and recommendations. These four chapters are reprinted without change for each documented RRA to assure consistency and for expediency in preparing the documentation. To account for variations particular to a specific RRA, two appendixes have been included. Appendix A, Examples of Wind Statistics, is designed to give a few illustrative examples of wind statistics for the specific RRA and cursory observations, comparisons, or comments on wind statistics. Appendix B, Range Specific Information, is designed to present specific information particular to the range, such as geographical location, data base, etc., and any cursory observations or comments on the thermodynamic quantities.

Read these appendixes! They are located as the last two units in the document because they may vary in length depending on the circumstances. Appendixes A and B and tables I, II, III, and IV are the only differences among the RRA documents published in this new RRA series.

CHAPTER II. WIND STATISTICS AND MODELS

A. General Considerations

A.1. Objectives

An objective of the RRA is to furnish minimum tabulation for the wind statistics. To meet this objective, the bivariate normal probability distribution was adopted as a statistical model for the wind treated as a vector quantity at the RRA data levels. Only five statistical parameters are required to completely describe this probability function. In Cartesian coordinates these parameters are the means and standard deviations of the two orthogonal components and the correlation coefficient between the two components. These five statistical parameters for the U and V (meteorological coordinates) components are given in table I. The statistical properties of the bivariate normal probability distribution are used to derive many wind statistics that are of interest to the ranges and range users. This procedure produces consistent wind statistics that are connected through rigorous mathematical probability functions. By using these functions, extensive tabulations of wind statistics are avoided.

The statistical properties of the bivariate normal probability distribution presented for the vector wind statistical model are:

- 1) The wind components are univariate normally distributed.
- 2) The conditional distribution of one component given a value of the other component is univariate normally distributed.
- 3) The windspeed is of the form of a generalized Rayleigh distribution.
- 4) The frequency distribution of wind direction can be derived.
- 5) The conditional distribution of windspeed given a value of wind direction (wind rose) can be derived.
- 6) The five tabulated wind statistical parameters with respect to the meteorological U and V coordinate system can be derived for any arbitrary rotation of the orthogonal axes.

The probability distribution functions and sets of equations to derive wind statistics for the previously stated properties of the vector wind model are presented in this chapter. Symbols used are summarized in table A. Illustrative examples are presented in appendix A. No attempt is made to give the derivation of the probability functions. The reader is referred to Smith (1976) for some derivations and several applications of the probability distribution properties for wind statistics.

A.2. Data Quality Control

The U and V components of the wind were used to generate data limits set at plus and minus six standard deviations from the mean for each of the

TABLE A. LIST OF SYMBOLS USED IN CHAPTER II

N	- The number of wind measurements in table I
r	- A general variable for the bivariate normal probability distribution in polar coordinates
R	- A generalized Rayleigh variable used for derived windspeed probability distribution
R (U, V)	- The linear (product moment) correlation coefficient between the zonal and meridional wind components in table I
SK (W)	- Skewness parameter for windspeed in table I
S (U)	- The standard deviation of the zonal wind component in table I
S (V)	- The standard deviation of the meridional wind component in table I
S (W)	- The standard deviation of windspeed in table I
t	- A standardized normal variate used in text table B
U	- The zonal wind component
UBAR	- The mean value of the zonal wind component in table I
V	- The meridional wind component
VBAR	- The mean value of the meridional wind component in table I
W	- Windspeed or modulus of wind vector, a scalar quantity
WBAR	- The mean value of windspeed in table I
X	- A general component variable or coordinate axis
Y	- A general component variable or coordinate axis
\bar{X}	- A general component mean value in the [x,y] coordinate system
\bar{Y}	- A general component mean value in the [x,y] coordinate system
α (alpha)	- Rotation angle for the [x,y] coordinate system

TABLE A. (concluded)

θ (theta) - Wind direction in the polar coordinate system

λ () (Lambda) - A parameter in the bivariate normal probability distribution in text table C

ξ (Xi) - The mean value in the standardized normal probability distribution used in text table B

π (Pi) - Constant = 3.14159 ...

ρ (Rho) - The general linear correlation coefficient between the two component variables in the [x,y] coordinate system

σ_x, σ_y - The general standard deviations of the x and y component variables in the [x,y] coordinate system.

quantities. These data limits were used to screen the wind data base, as described in section I.C. The data base was considered to be free from errors under the following conditions:

1) The skewness of the windspeed was below 4.0 at data levels where the mean windspeed was less than 15 m/s, and

2) The skewness of the windspeed was below 2.5 at data levels where the mean windspeed was greater than 15 m/s.

A.3 Limitations

For the wind statistics, the correlation coefficients for like wind components and unlike wind components between altitude levels were not computed. Therefore, wind statistics with respect to altitude (profile) cannot be derived from the RRA statistics. For wind profile modeling techniques the user is referred to Smith (1976). However, the wind statistics at discrete altitudes are valid; all of the probability distribution functions given in chapter II can be derived from the five wind component statistical parameters contained in table I, and the derived distributions can be considered as wind models at discrete altitudes.

By convention, in the statistical literature Greek letters are used for population or theoretically known parameters, and sample estimates are denoted by English alphabetical letters or with a "hat" (^) over the Greek letters. In chapter II Greek letters are used for the variances and the linear correlation coefficient, and the means are denoted by \bar{X} and \bar{Y} when dealing with the bivariate normal distribution. It will always be understood that table I contains sample estimates of the statistical parameters and they are with respect to the meteorological U and V coordinate system.

B. Coordinate System and Computation of Statistical Parameters

B.1. Coordinate System

Wind measurements are recorded in terms of magnitude and direction. The wind direction is measured in degrees clockwise from true north and is the direction from which the wind is blowing. The wind magnitude (the modulus of the vector) is the scalar quantity and is referred to as windspeed or scalar wind. A statistical description that accounts for the wind as a vector quantity is appropriate and requires a coordinate system.

For the RRA the standard meteorological coordinate system has been chosen for the wind statistics, all tables of statistical parameters, and related discussions because the coordinate system used in aerospace and related applied fields has not always been consistent.

Using figure 1, the polar and Cartesian forms for the meteorological coordinate system are defined:

W = windspeed, scalar wind, or magnitude of the wind vector in meters per second.

θ = wind direction. θ is measured in degrees clockwise from true north and is the direction from which the wind is blowing.

U = zonal wind component, positive west to east, in meters per second.

V = meridional wind component, positive south to north, in meters per second.

The components θ and W define the polar form, and the U - V components define the Cartesian forms:

$$U = -W \sin\theta \quad , \quad 0 \leq \theta \leq 360^\circ \quad (1)$$

$$V = -W \cos\theta \quad . \quad (2)$$

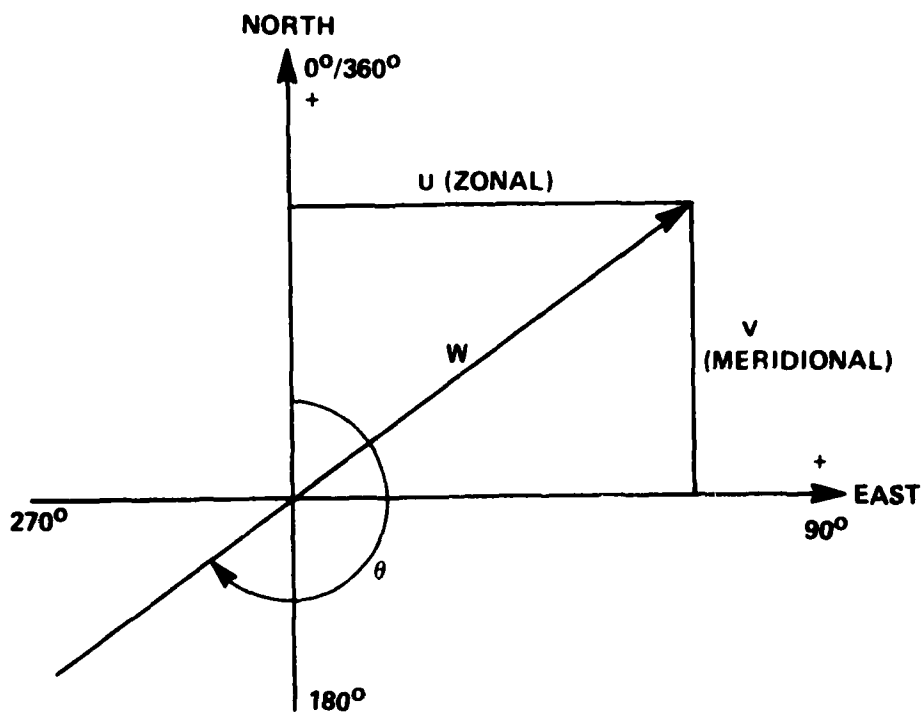

Figure 1. The meteorological coordinate system.

It is helpful to note the difference between the mathematical convention for a vector direction and the meteorological convention for wind direction:

$$\theta \text{ met} = 270 - \theta \text{ math} \quad (3)$$

when $0 \leq \theta \text{ math} \leq 270^\circ$

$$\theta \text{ met} = 360 + (270 - \theta \text{ math})$$

when $270 \leq \theta \text{ math} \leq 360^\circ$

B.2 Computation of Statistical Parameters

The wind statistical parameters in table I for the means and standard deviations of the U and V wind components and windspeed and the skewness parameter of windspeed were computed using the sums technique presented in chapter III.C.3. In addition, the linear (product moment) correlation coefficient between the U and V wind components, $r(u,v)$ in table I, was computed. This correlation coefficient is defined as

$$r(u,v) = \frac{\sum_{i=1}^n (U_i - \bar{U})(V_i - \bar{V})}{N s(u) \cdot s(v)} \quad (4)$$

These statistical parameters are with respect to the Standard Meteorological Coordinate System.

C. Statistical Wind Models

C.1. Wind Component Statistics

The univariate normal (Gaussian) probability distribution function is used to obtain wind component statistics. In generalized notations, this probability density function (pdf) is

$$f(t) = \frac{e^{-\frac{t^2}{2}}}{\sqrt{2\pi}} \quad (5)$$

where $t = \frac{X - \epsilon}{\sigma_x}$ is the standardized variate, with ϵ defining the mean and σ_x the standard deviation. The probability distribution function (PDF) is

$$F(X) = \int_{-\infty}^X f(t) dt \quad (6)$$

Because this integral cannot be obtained in closed form, it is widely tabulated for zero mean and unit standard deviation. For a convenient reference for the RRA, selected values of $F(X)$ are given in table B. To emphasize the connotation of probability, $F(X)$ is shown in table B as $P\{X\}$.

The t values in table B are used as multiplier factors to the standard deviation to express the probability that a normally distributed variable, X , is less than or equal to a given value as

$$P\{X \leq \text{mean} + t \sigma_x\} = \text{probability, } p \quad (7)$$

For example, when $t = 1.6449$, the probability that X is less than or equal to the mean plus 1.6449 standard deviations is 0.95. That value of X that is less than or equal to the mean plus 1.6449 standard deviations is called the 95th percentile value of X . Also given in table B are the numerical values to express the probability that X falls in the interval X_1 and X_2 ; i.e.,

$$P\{X_1 \leq X \leq X_2\} = \text{Interpercentile Range} \quad (8)$$

where

$$X_1 = \bar{X} - t \sigma_x$$

$$X_2 = \bar{X} + t \sigma_x$$

For $t = 1.9602$ the probability that X lies in the interval X_1 and X_2 is 0.95. The values of X_1 and X_2 in this example comprise the 95th interpercentile range.

For a normally distributed variable, the mode (most frequent value) and the median (50th percentile value) are the same as the mean value. The means and standard deviations of the U and V wind components from table 1 are used in equations (7) and (8) to compute the percentile values and interpercentile ranges of the U and V wind components. When equation (7) is illustrated on a normal probability graph, a straight line is formed.

C.2. The Vector Wind Model

Because wind is a vector quantity having direction and magnitude that can be expressed as two components in an orthogonal coordinate system, a probability model that describes the joint relationship is the bivariate normal probability distribution. In general component notation, the bivariate normal probability density function (BNpdf) is

TABLE B. VALUES OF t FOR STANDARDIZED NORMAL
(UNIVARIATE) DISTRIBUTION FOR PERCENTILES
AND INTERPERCENTILE RANGES

t	$P(X)$	X	$P\{X_1 < X < X_2\} (\%)$
-3.0000	0.00135	$\xi - 3.0000 \sigma$	
-2.5758	0.00500	$\xi - 2.5758 \sigma$	
-2.3263	0.01000	$\xi - 2.3263 \sigma$	
-2.2365	0.01266	$\xi - 2.2365 \sigma$	
-2.0000	0.02275	$\xi - 2.0000 \sigma$	
-1.9602	0.02500	$\xi - 1.9602 \sigma$	
-1.6449	0.05000	$\xi - 1.6449 \sigma$	
-1.2816	0.10000	$\xi - 1.2816 \sigma$	
-1.0000	0.15866	$\xi - 1.0000 \sigma$	
-0.8416	0.20000	$\xi - 0.8416 \sigma$	
-0.6745	0.25000	$\xi - 0.6745 \sigma$	
-0.2533	0.40000	$\xi - 0.2533 \sigma$	
0.0000	0.50000	ξ	
0.2533	0.60000	$\xi + 0.2533 \sigma$	
0.6745	0.75000	$\xi + 0.6745 \sigma$	
0.8416	0.80000	$\xi + 0.8614 \sigma$	
1.0000	0.84134	$\xi + 1.0000 \sigma$	
1.2816	0.90000	$\xi + 1.2816 \sigma$	
1.6449	0.95000	$\xi + 1.6449 \sigma$	
1.9602	0.97502	$\xi + 1.9602 \sigma$	
2.0000	0.97725	$\xi + 2.0000 \sigma$	
2.2365	0.98734	$\xi + 2.2365 \sigma$	
2.3263	0.99000	$\xi + 2.3263 \sigma$	
2.5758	0.99500	$\xi + 2.5758 \sigma$	
3.0000	0.99865	$\xi + 3.0000 \sigma$	

where $X_1 = \xi - t\sigma$
 and $X_2 = \xi + t\sigma$

$$f(X,Y) = \frac{1}{2\pi\sigma_x\sigma_y\sqrt{1-\rho^2}} \left[\exp \frac{-1}{2(1-\rho^2)} \left\{ \frac{(X-\bar{X})^2}{\sigma_x^2} - \frac{2\rho(X-\bar{X})(Y-\bar{Y})}{\sigma_x\sigma_y} + \frac{(Y-\bar{Y})^2}{\sigma_y^2} \right\} \right] \quad -\infty \leq X \leq \infty \text{ and} \\ -\infty \leq Y \leq \infty \quad , \quad (9)$$

where the five parameters are \bar{x}, \bar{y} , the component means; σ_x, σ_y , the component standard deviations; and ρ , the correlation coefficient between the two component variables, X and Y .

For many applications the interest is in determining the probability that a point $\{X, Y\}$ will fall within a contour of equal probability density. The exponential terms of equation (9), when set equal to a constant, λ^2 , give a family of ellipses depending on the value of the constant. The ellipses have a common center at the point $\{\bar{X}, \bar{Y}\}$. Integration of equation (9) over the region bounded by the contours of equal probability density gives

$$P(\lambda) = 1 - e^{\frac{-\lambda^2}{2(1-\rho^2)}} \quad (10)$$

Solving for λ^2 and replacing $P(\lambda)$ by p gives

$$\lambda^2 = -2(1-\rho^2) \ln(1-p) \quad (11)$$

Now define

$$\lambda_e = \sqrt{2} \sqrt{-\ln(1-p)} \quad (12)$$

For ready reference and comparisons, λ_e is shown in table C for selected values of p .

TABLE C. VALUES OF λ FOR BIVARIATE NORMAL DISTRIBUTION ELLIPSES AND CIRCLES

P()	λ_c (ellipse)	λ_c (circle)	P()	λ_c (ellipse)	λ_c (circle)
0.000	0.0000	0.0000	65.000	1.4490	1.0246
5.000	0.3203	0.2265	68.268	1.5151	1.0713
10.000	0.4590	0.3246	70.000	1.5518	1.0973
15.000	0.5701	0.4031	75.000	1.6651	1.1774
20.000	0.6680	0.4723	80.000	1.7941	1.2686
25.000	0.7585	0.5363	85.000	1.9479	1.3774
30.000	0.8446	0.5972	86.466	2.0000	1.4142
35.000	0.9282	0.6563	90.000	2.1460	1.5175
39.347	1.0000	0.7071	95.000	2.4477	1.7308
40.000	1.0108	0.7147	95.450	2.4860	1.7579
45.000	1.0935	0.7732	98.000	2.7971	1.9778
50.000	1.1774	0.8325	98.168	2.8284	2.0000
54.406	1.2533	0.8862	98.889	3.0000	2.1213
55.000	1.2637	0.8936	99.000	3.0348	2.1460
60.000	1.3537	0.9572	99.730	3.4393	2.4320
63.212	1.4142	1.0000	99.9877	4.2426	3.0000
$\lambda_c = \sqrt{2} \sqrt{-\ln(1-P)}$ $\lambda_c = \sqrt{-\ln(1-P)}$					

The probability ellipse that contains p-percent of the wind vectors expressed in the most general form is the conic defined by

$$AX^2 + BXY + CY^2 + DX + EY + F = 0 \quad , \quad (13)$$

where

$$A = \sigma_y^2$$

$$B = -2\sigma_x\sigma_y\rho$$

$$C = \sigma_x^2$$

$$D = 2\sigma_x\sigma_y\rho\bar{Y} - 2\sigma_y^2\bar{X} = - (B\bar{Y} + 2A\bar{X})$$

$$E = 2\sigma_x\sigma_y\rho\bar{X} - 2\sigma_x^2\bar{Y} = - (B\bar{X} + 2C\bar{Y})$$

$$F = A\bar{X}^2 + C\bar{Y}^2 + B\bar{X}\bar{Y} - AC(1 - \rho^2)\lambda_e^2 \quad ,$$

and

$$\lambda_e = \sqrt{2} \sqrt{-\ln(1 - p)} \quad .$$

For graphical presentations, the range of the variable is important in order to arrange the scale. The largest and smallest values of X and Y for a given probability ellipse, p, are given by

$$X_{L,S} = \bar{X} \pm \sigma_x\lambda_e \quad (14)$$

$$Y_{L,S} = \bar{Y} \pm \sigma_y\lambda_e \quad , \quad (15)$$

where, as before, $\lambda_e = \sqrt{2} \sqrt{-\ln(1-p)}$.

Although there are several approaches to graphing the probability ellipses, the following procedure is advantageous for electronic computer plotting. In establishing the computer plotting program, the sample estimates for $\bar{X}, \bar{Y}, \sigma_x, \sigma_y,$ and ρ are constants in equation (13). The user makes the choice of probability ellipses desired. Thus, p in equation (12) is programmed as a parameter. The largest and smallest values for X and Y are computed by equations (14) and (15) for the largest probability ellipse selected. This sets the graphical scale. Values of X within the range of "X smallest" to "X largest" are obtained by incrementing X between these limits. Using the quadratic equation, a solution for Y of equation (13) is made and plotted for each value of X . The centroid (\bar{X}, \bar{Y}) for the family of probability ellipses is plotted as a point. Labeling and other identification complete the plotting program.

For a given probability, equation (13) defines an ellipse that contains p -percent of the points X, Y . Since the entire area under the bivariate normal density function [equation (9)] is unity, upon integration for a given probability ellipse, that given ellipse contains p -percent of the total area. In the wind statistics, p -percent of the wind vectors fall within the specified probability ellipse. From this point of view, a specified probability ellipse gives the joint probability that p -percent of the $U-V$ components lie within the given ellipse.

When $\sigma_x^2 = \sigma_y^2 = \sigma^2$ and $\rho = 0$ in the bivariate normal distribution, the probability ellipses of equation (13) reduce to circles whose centers are at the means \bar{X}, \bar{Y} . The radii of the probability circles are $\sigma_{V1} \lambda_c$, where

$$\sigma_{V1} = \sqrt{2\sigma^2} \quad (16)$$

and

$$\lambda_c = \sqrt{-\ln(1-p)} \quad (17)$$

Values for λ_c for selected probabilities, p , are given in table C.

Because this function is simple, it can easily be graphed manually. However, the generalized plotting technique for electronic computer plotters, as represented by equation (13), can be advantageously used.

C.3. Derived Distributions for Wind Statistics

In this subsection the probability distribution functions and sets of equations are presented to derive certain probability distribution functions for wind statistics. These derived probability distributions are:

- 1) The conditional distribution of wind components
- 2) The generalized Rayleigh distribution for windspeed
- 3) The distribution for wind direction
- 4) The conditional distribution of windspeed given a wind direction (wind rose).

The required five statistical parameters for these derived distributions for wind statistics are given in table I.

C.3.1 The Conditional Distribution of Wind Components

Given that two random variables X and Y are bivariate normally distributed, the conditional distribution $f(Y|X)$ is read as f(Y) given X, and likewise $f(X|Y)$ is read as f(X) given Y. The conditional probability distribution function $F(Y|X)$ has the mean $E(Y|X)$ and variance $\sigma^2_{(y|x)}$, where

$$E(Y|X^*) = \bar{Y} + \rho \left(\frac{\sigma_Y}{\sigma_X} \right) (X^* - \bar{X}) \quad (18)$$

and

$$\sigma^2_{(y|x^*)} = \sigma_Y^2 (1 - \rho^2) \quad (19)$$

The conditional standard deviation is

$$\sigma_{(y|x^*)} = \sigma_Y \sqrt{1 - \rho^2} \quad (20)$$

By interchanging the variables and parameters, the conditional distribution function for $F(X|Y^*)$ has the conditional mean

$$E(X|Y^*) = \bar{X} + \rho \left(\frac{\sigma_X}{\sigma_Y} \right) (Y^* - \bar{Y}) \quad (21)$$

conditional variance

$$\sigma^2_{(x|y^*)} = \sigma_x^2 (1 - \rho^2) \quad (22)$$

and conditional standard deviation

$$\sigma_{(x|y^*)} = \sigma_x \sqrt{1 - \rho^2} \quad (23)$$

The preceding conditional probability distribution functions are univariate normal distributions for a (fixed) given value for one of the bivariate normal variables. Thus, the t-values given in table B are applicable for conditional probability statements. For example,

$$F(Y|X^*) = E(Y|X^*) + t \sigma_{(y|x^*)} \quad (24)$$

For $t = 1.6449$ there is a 95 percent chance that Y is less than or equal to $\bar{Y} + 1.6449 \sigma_{(y|x^*)}$ given that $X = X^*$. In symbols this statement reads

$$P \left\{ Y \leq E(Y|X^*) + 1.6449 \sigma_{(y|x^*)} \mid X = X^* \right\} = 0.9500 \quad (25)$$

Interval probability statements can also be made; namely,

$$P \left\{ Y_1 = E(Y|X^*) - t \sigma_{(y|x^*)} \leq Y \leq Y_2 = E(Y|X^*) + t \sigma_{(y|x^*)} \mid X = X^* \right\}$$

where X^* can take on any fixed value of X , but a convenient arrangement is to let $X^* = \bar{X} \pm t \sigma_x$.

The close connection of the regression function of Y on X to the conditional mean for the bivariate normal distribution is noted; namely,

$$Y = \bar{Y} + \rho \left(\frac{\sigma_Y}{\sigma_X} \right) (X - \bar{X}) \quad . \quad (26)$$

Similarly, the regression function of X on Y is

$$X = \bar{X} + \rho \left(\frac{\sigma_X}{\sigma_Y} \right) (Y - \bar{Y}) \quad . \quad (27)$$

These are linear functions and express the same results as would be obtained from a least-squares regression line.

C.3.2. The Generalized Rayleigh Distribution for Windspeed

If two random variables, X and Y, are bivariate normally distributed, then the probability distribution for the modulus, R, can be derived in terms of the five parameters that define the bivariate normal distribution.

$$R = \sqrt{X^2 + Y^2} \quad (28)$$

The distribution of R so derived is called a generalized Rayleigh distribution because there are no restrictions on the parameters. For applications to the RRA, the variable R is recognized as windspeed or the modulus of the wind vector.

The probability density function for R is expressed as

$$f(R) = a_0 R e^{-a_1 R^2} \left[I_0(a_2 R^2) I_0(a_3 R) + 2 \sum_{k=1}^{\infty} I_k(a_2 R^2) I_{2k}(a_3 R) \cos 2k\psi \right] R \geq 0 \quad . \quad (29)$$

The functions $I_0(\cdot)$, $I_k(\cdot)$, and $I_{2k}(\cdot)$ are the modified Bessel functions of the first kind for zero order, kth order, and 2kth order. The coefficients are

$$a_0 = \exp \left[-\frac{1}{2} \left\{ \frac{\bar{X}^2}{\sigma_a^2} + \frac{\bar{Y}^2}{\sigma_b^2} \right\} \right] / \sigma_a \sigma_b ,$$

where σ_a^2 and σ_b^2 are the rotated variances to produce zero correlation between X and Y. σ_a and σ_b are the positive and negative roots¹ of the expression

$$\sigma_{(+,-)}^2 = \frac{1}{2} \left\{ \sigma_x^2 + \sigma_y^2 \pm \left[(\sigma_x^2 + \sigma_y^2)^2 - 4\sigma_x^2\sigma_y^2(1 - \rho^2) \right]^{1/2} \right\} ,$$

$$a_1 = (\sigma_x^2 + \sigma_y^2) / 4(1 - \rho^2) \sigma_x^2 \sigma_y^2 ,$$

$$a_2 = \frac{\left[(\sigma_x^2 - \sigma_y^2)^2 + 4\sigma_x^2\sigma_y^2 \right]^{1/2}}{4(1 - \rho^2) \sigma_x^2 \sigma_y^2} ,$$

$$a_3 = \left[\left(\frac{\bar{X}}{\sigma_a} \right)^2 + \left(\frac{\bar{Y}}{\sigma_b} \right)^2 \right]^{1/2} ,$$

1. This computational form is obtained from the determinant

$$\begin{vmatrix} \sigma_x^2 - K & \sigma_x \sigma_y \rho \\ \sigma_x \sigma_y \rho & \sigma_y^2 - K \end{vmatrix} .$$

where K is $\sigma_{(+,-)}^2$, and σ_a and σ_b are analogous to the standard deviation of the major and minor axes of the bivariate normal probability ellipse.

and

$$\tan \psi = \frac{\bar{Y}}{\bar{X}} \frac{\sigma_a^2}{\sigma_b^2} .$$

Since this density function cannot be integrated in closed form from zero to R, numerical integration is used to obtain practical results for the probability distribution function; i.e.,

$$F(R) = \int_0^R f(R) dR . \quad (30)$$

A number of special cases can be obtained from the general Rayleigh distribution [equation (29)], the simplest of which is to let $\sigma_x = \sigma_y = \sigma$ and $\bar{X} = \bar{Y} = 0$ with independent variables X and Y. This gives

$$f(R) = \frac{R}{\sigma^2} e^{-R^2/2\sigma^2} , \quad (31)$$

which is recognized as the classical Rayleigh probability density function. The density function, equation (31), can be integrated in closed form over any range of the variable R. Hence, the probability distribution function, F(R), for equation (31) is

$$F(R) = 1 - \exp \left\{ \frac{-R^2}{2\sigma^2} \right\} . \quad (32)$$

C.3.3. The Derived Distribution of Wind Direction

Considering the wind as a vector quantity and bivariate normally distributed, the wind direction can be derived. This is done by first writing the bivariate normal probability density function in polar coordinates whose variables are

$$g(r, \theta) = rd_1 e^{-\frac{1}{2}(a^2 r^2 - 2br + c^2)} \quad (33)$$

(see footnote 2)

where

$$a^2 = \frac{1}{(1 - \rho^2)} \left[\frac{\sin^2 \theta}{\sigma_x^2} - \frac{2\rho \cos \theta \sin \theta}{\sigma_x \sigma_y} + \frac{\cos^2 \theta}{\sigma_y^2} \right]$$

$$b = \frac{-1}{(1 - \rho^2)} \left[\frac{\bar{x} \sin \theta}{\sigma_x^2} - \frac{\rho(\bar{x} \cos \theta + \bar{y} \sin \theta)}{\sigma_x \sigma_y} + \frac{\bar{y} \cos \theta}{\sigma_y^2} \right]$$

$$c^2 = \frac{1}{(1 - \rho^2)} \left[\frac{\bar{x}^2}{\sigma_x^2} - \frac{2\rho \bar{x} \bar{y}}{\sigma_x \sigma_y} + \frac{\bar{y}^2}{\sigma_y^2} \right]$$

$$d_1 = \frac{1}{2\pi \sigma_x \sigma_y \sqrt{1 - \rho^2}}$$

$r = \sqrt{x^2 + y^2}$ is the modulus of the vector or speed, and θ is the direction of the vector. After integrating $g(r, \theta)$ over $r = 0$ to ∞ , the probability density function of θ is

$$g(\theta) = \frac{d_1}{a^2} e^{-\frac{1}{2}c^2} \left[1 + \sqrt{2\pi} \left(\frac{b}{a}\right) e^{\frac{1}{2}\left(\frac{b}{a}\right)^2} \Phi\left(\frac{b}{a}\right) \right] \quad (34)$$

2. This expression, equation (33), in Smith 1976) is given with respect to the mathematical convention for a vector direction.

where a_2 , b , c_2 , and d_1 are as previously defined in equation (33) and

$$F\left(\frac{b}{a}\right) = F(x) = \frac{1}{\sqrt{2\pi}} \int_{-\infty}^x e^{-\frac{1}{2}t^2} dt$$

is taken from tables of normal distribution functions or made available through a computer subroutine.

If desired, equation (34) can be integrated numerically over a chosen range of θ to obtain the probability that the vector direction will lie within the chosen range; i.e.,

$$F(\theta) = \int_{\theta_2}^{\theta_1} g(\theta) d\theta \quad (35)$$

One application may be to obtain the probability that the wind will flow from a given quadrant or sector as, for example, onshore.

C.3.4. The Derived Conditional Distribution of Windspeed Given the Wind Direction (Wind Rose)

Continuing with the considerations in section C.3.3. of this chapter, the conditional probability density function (pdf) for windspeed, r , given a specified value for the wind direction, θ , can be expressed as

$$f(r|\theta) = \frac{a^2 r e^{-\frac{1}{2}(a^2 r^2 - br)}}{1 + \sqrt{2\pi} \left(\frac{b}{a}\right) e^{\frac{1}{2}\left(\frac{b}{a}\right)^2} \left\{\frac{b}{a}\right\}} \quad (36)$$

where the coefficients, \underline{a} and \underline{b} and the function $\left\{\frac{b}{a}\right\}$ are as previously defined in equation (33) and in equation (34).

From equation (36) the mode (most frequent value) of the conditional windspeed given a specified value of the wind direction is the positive solution of the quadratic equation,

$$a^2 r^2 - br - 1 = 0 \quad (37)$$

which is

$$(r|\theta) = \frac{1}{2a} \left[\left(\frac{b}{a} \right) + \sqrt{4 + \left(\frac{b}{a} \right)^2} \right] \quad (38)$$

The locus of the conditional modal values of windspeed when plotted in polar form versus the given wind directions forms an ellipse.

The noncentral moment for equation (36) is expressed as

$$\mu'_n = \int_0^{\infty} r^n f(r|\theta) dr \quad (39)$$

Now the first noncentral moment is identical to the first central moment or the expected value, $E(r|\theta)$. The integration of equation (39) for the first moment is sufficiently simple to yield practical computations and can be expressed as

$$E(r|\theta) = \frac{\left(\frac{b}{a} \right) + \left[1 + \left(\frac{b}{a} \right)^2 \right] \sqrt{2\pi} e^{\frac{1}{2} \left(\frac{b}{a} \right)^2} \Phi \left\{ \frac{b}{a} \right\}}{a \left[1 + \left(\frac{b}{a} \right) \sqrt{2\pi} e^{\frac{1}{2} \left(\frac{b}{a} \right)^2} \Phi \left\{ \frac{b}{a} \right\} \right]} \quad (40)$$

Hence, equation (40) gives the conditional mean value of the windspeed given a specified value for the wind direction.

The integration of equation (36) for the limits $r = 0$ to $r = r^*$ gives the probability that the conditional windspeed is $\leq r^*$ given a value for the wind direction, θ . This conditional probability distribution (PDF) can be written as

$$\Pr \left\{ r \leq r^* \mid \theta = \theta_0 \right\} = 1 - \frac{\left[e^{-\frac{1}{2} r_s^2 + \sqrt{2\pi} \left(\frac{b}{a} \right) \left\{ 1 - \Phi(r_s) \right\}} \right]}{\left[e^{-\frac{1}{2} \left(\frac{b}{a} \right)^2 + \sqrt{2\pi} \left(\frac{b}{a} \right) \Phi \left\{ \frac{b}{a} \right\}} \right]} \quad (41)$$

$$\text{where } r_s = \left[a r^* - \left(\frac{b}{a} \right) \right]$$

By definition, equation (41) is an expression for a "wind rose." Empirical wind rose statistics are often tabulated or graphically illustrated giving the frequency that the windspeed is not exceeded for those windspeed values that lie within assigned class intervals of the wind direction. After evaluation of equation (41) for various values of windspeed, r^* , and the given wind directions, θ , interpolations can be performed to obtain various percentile values of the conditional windspeed.

For the special case when \bar{b} in equation (33) equals zero (i.e., for $\bar{x} = \bar{y} = 0$), the conditional modal values of windspeeds [equation (38)], the conditional mean values of windspeeds [equation (40)], and the fixed conditional percentile values of windspeeds [interpolated from evaluations of equation (41)], when plotted in polar form versus the given wind directions, produce a family of ellipses.

For the special case when $\bar{x} = \bar{y} = 0$, equation (36) reduces to the following simple case:

$$\Pr \left\{ r \leq r^* \mid \theta = \theta_0 \right\} = 1 - e^{-\frac{a^2 r^{*2}}{2}} \quad (42)$$

There is a special significance of equation (42) when related to the bivariate normal probability distribution. If r^* and θ are measured from the centroid of the probability ellipse, then the probability that $r \leq r^*$ is the same as the given probability ellipse. Further, solving equation (42) for r^* , gives

$$r^* = \frac{1}{a} \sqrt{-2 \ln (1 - P)} \quad (43)$$

If a probability ellipse P is chosen, equation (42) gives the distance of r along any θ from the centroid of the ellipse to the intercept of the specified probability ellipse. If there is an interest in conditional probability of winds for a given θ relative to the monthly means, equation (43) is applicable. If it is desired to find the magnitude of the wind along any θ relative to the monthly mean to the intercept of a given probability ellipse, equation (43) is applicable.

D. Statistical Parameters With Respect To Any Orthogonal Axes

The five wind statistical parameters presented in table I are given with respect to the standard meteorological coordinate system; i.e., these parameters are for the U and V components. For many aerospace vehicles and range applications, there is a need for wind statistics with respect to orthogonal axes other than west to east and south to north. For example, it may be required to present wind statistics with respect to a flight azimuth of an

aerospace vehicle whose flight azimuth is α degrees from true north measured in a clockwise direction. The following sets of equations are presented to compute the five parameters for the new coordinate axes rotated α degrees clockwise from true north.

a. Rotation of the means through α degrees:

$$\bar{X}_\alpha = \bar{X} \cos (90 - \alpha) + \bar{Y} \sin (90 - \alpha) \quad (44)$$

$$\bar{Y}_\alpha = \bar{Y} \cos (90 - \alpha) - \bar{X} \sin (90 - \alpha) \quad (45)$$

b. Rotation of the variances through α degrees:

$$\begin{aligned} \sigma_{x_\alpha}^2 &= \sigma_x^2 \cos^2 (90 - \alpha) + \sigma_y^2 \sin^2 (90 - \alpha) \\ &+ 2\rho\sigma_x\sigma_y \cos (90 - \alpha) \sin (90 - \alpha) \end{aligned} \quad (46)$$

$$\begin{aligned} \sigma_{y_\alpha}^2 &= \sigma_y^2 \cos^2 (90 - \alpha) + \sigma_x^2 \sin^2 (90 - \alpha) \\ &- 2\rho\sigma_x\sigma_y \cos (90 - \alpha) \sin (90 - \alpha) \end{aligned} \quad (47)$$

c. Rotation of the linear correlation coefficient through α degrees:

$$\rho_\alpha = \frac{\text{cov} (X, Y)_\alpha}{\sigma_{x_\alpha} \sigma_{y_\alpha}} \quad (48)$$

where $\text{cov} (X, Y)_\alpha$ is the rotated covariance,

$$\begin{aligned} \text{cov} (X, Y)_\alpha &= \text{cov} (X, Y) [\cos^2 (90 - \alpha) - \sin^2 (90 - \alpha)] \\ &+ \cos (90 - \alpha) \sin (90 - \alpha) (\sigma_y^2 - \sigma_x^2) \end{aligned}$$

and

$$\text{cov}(X,Y) = \rho \sigma_x \sigma_y$$

By using these rotational equations, the bivariate normal distribution with respect to any desired rotated coordinates can be obtained from sample estimates that have been computed with respect to a specific axis. The marginal distributions after rotation are also normally (univariate) distributed. Using the rotational equations greatly reduces computational efforts for applications requiring statistics with respect to several coordinate axes.

Appendix A presents some illustrative examples for the wind statistics of the specific RRA.

CHAPTER III. STATISTICS OF THERMODYNAMICS QUANTITIES AND MODELS

A. General Considerations

A.1. Objectives

The objective inherent in developing the thermodynamic section of the RRA was to describe the thermodynamic characteristics of the atmosphere using a minimum of data tabulations. A set of parameters was selected which, together, thermodynamically describe the climatological state of the atmosphere. These parameters are the pressure, temperature, density, dewpoint, virtual temperature, and water vapor pressure. Used together, these parameters permit the calculation of a large number of derived quantities. (Symbols used in the calculations in this chapter are summarized in table D.) Some of these quantities, such as the speed of sound, are dealt with in section III.E.

The probability distribution of each of the six thermodynamic RRA parameters is described by its mean value, its standard deviation, and its skewness. Several of these parameters (temperature, pressure, dewpoint and density) have probability distributions that are close to a univariate normal distribution; the others do not. The skewness parameter gives an estimate of the asymmetrical departures of a probability distribution.

Hydrostatically modeled mean values of pressure and density were calculated (table IV), so that users may determine the departure of the actual climatological values of these parameters from hydrostatic conditions. This was done by hydrostatically integrating the pressure from the lowest RRA data level to the termination altitude of the particular RRA.

A.2. Data Quality Control

Data limits derived from the following parameters were used to screen the thermodynamic portion of the RRA data base: temperature, pressure, dewpoint (for the 0- to 30-km portion only), and density (for the 30- to 70-km portion only). These limits were set to plus and minus six standard deviations from the mean values of each of these quantities. These limits were used to screen the thermodynamic portion of the RRA data base, according to the procedures described in section I.C. The data base used to generate the thermodynamic portion of the RRA (tables I, II, and IV) was considered to be free from errors under the following conditions:

- a) The skewness values of the pressure and temperature were between -2.5 and 2.5 at all data levels.
- b) The skewness values of the density were between -3.5 and 3.5 at data levels between 0 and 30 km.
- c) The skewness values of the density were between -3.0 and 3.0 at data levels between 30 and 70 km.
- d) The skewness values of the dewpoint were between -2.5 and 2.5 at all data levels with more than 10 data values.

TABLE D. LIST OF SYMBOLS USED IN CHAPTER III

C_s	- Speed of sound
C_d	- Collision diameter
E	- Vapor pressure
g_l	- Gravity at latitude l
H	- Geopotential height
H_m	- Geopotential height at a mandatory radiosonde data level
H_s	- Geopotential height at a significant radiosonde data level
K_t	- Coefficient of thermal conductivity
L	- Mean free path length
M	- Mean molecular weight of air at sea level
$M3Q$	- Annual or monthly third moment of quantity Q
n	- Refractive modulus
N	- Refractive index
NA	- Avogadro's constant
N_Q	- Number of values of quantity Q
P	- Pressure
P_m	- Pressure at a mandatory radiosonde data level
P_s	- Pressure at a significant radiosonde data level
P_h	- Hydrostatically integrated mean monthly or annual pressure
Q	- Any tabulated RRA quantity
R^*	- Universal gas constant
R'	- Specific gas constant of dry air
r', r^*	- Parameters used in converting z to h and vice versa

TABLE D. (concluded)

S	- Sutherland's constant, used in the calculation of dynamic viscosity
T	- Temperature
T_d	- Dew point
T_v	- Virtual temperature
T_{vm}	- Virtual temperature at a mandatory radiosonde data level
T_{vs}	- Virtual temperature at a significant radiosonde data level
V	- Mean air particle speed
V_c	- Mean collision frequency
w	- Parameter used in the hydrostatic interpolation of pressure and density
Z	- Geometric altitude
	Wavelength
Q	- Skewness of quantity Q
	- Constant used in the equation for viscosity
	- Ratio of specific heat at constant pressure to specific heat at constant volume
	- Kinematic coefficient of viscosity
	- Dynamic coefficient of viscosity
	- Density
h	- Mean monthly or annual density derived from pressure height
	- Standard deviation of the quantity Q

A.3. Limitation of Thermodynamic Statistics

The correlation coefficients between the thermodynamic quantities and the moisture-related quantities were not calculated at discrete altitudes, nor were any of the correlations between altitudes. Therefore, valid statistical dispersion models that require the relationship between two or more of these quantities at the same altitude or between altitudes cannot be derived. Approximations for the correlation coefficients between pressure, virtual temperature, and density at discrete altitudes may be obtained from the coefficients of variation as developed by Buell (1970). The coefficient of variation is the standard deviation divided by the mean. The mean values and the standard deviations are taken from table II. A model for the profile of monthly and annual mean pressure, virtual temperature, and density that is in excellent agreement with the respective statistical mean values is given by table IV. This agreement results because the physical relationships, given by the hydrostatic equation and the equation of state, were used to derive table IV. When only the monthly or annual mean values for pressure, virtual temperature, and density are required, it is recommended that table IV be used.

B. Establishing Data Samples at the Required Altitude Levels

This section describes the computational procedures used to establish data samples of the thermodynamic RRA parameters at the RRA data levels. References are cited only when an equation given is one of many available in the literature or when an equation is stated in an unusual form.

B.1. Conversion of Data Recorded in Geopotential Heights to Geometric Altitude

The upper air rocketsonde observations used to obtain the table values above 30 km were recorded in terms of geometric altitude and can be interpolated directly to the altitude intervals shown in the tables. However, the radiosonde observations used to obtain the tabular values below 30 km were recorded in terms of geopotential heights. The change of coordinates from geopotential heights to geometric altitudes (h to z) is accomplished by calculating a table of geopotential heights that correspond exactly to the geometric altitudes at which the atmospheric parameters are tabulated. The radiosonde observations are then interpolated to these geopotential heights. The relationship used to calculate geometric altitude from geopotential height is

$$H = (r'z)/(r^*z) \quad . \quad (49)$$

where

$$r' = gr^*/9.80665$$

and

$$r^* = -2g_i / (g_i / z_0) \quad .$$

g_0 is the sea-level gravity at the latitude ϕ corresponding to the proper location. This value is given by (List, 1968)

$$g_0 = 9.780356 (1 + 5.2885 \cdot 10^{-3} \sin^2 \phi - 5.9 \cdot 10^{-6} \sin^2 (2\phi)). \quad (50)$$

$\frac{\partial g_0}{\partial \phi}$ is the rate of change of gravity at the sea level. This quantity is given

by the equation

$$\frac{\partial g_0}{\partial \phi} = -3.085462 \cdot 10^{-6} + 2.27 \cdot 10^{-9} \cos (2\phi) - 2 \cdot 10^{-12} \cos (4\phi). \quad (51)$$

The units used for gravity are meters per square second, while the units for

$\frac{\partial g_0}{\partial \phi}$ are per square second.

The resulting table of values of H obtained by using even increments of 2 in equation (49) is shown in table IV of the RRA. The values of H above 30 km are not used in the interpolation of original data, but are included for the convenience of the user.

B.2. Calculations on the Original Rawinsonde Data Records

It was necessary to interpolate the information from the original rawinsonde data records to the geometric altitudes specified as the RRA data levels. The parameters for which this interpolation was required were the temperature, dewpoint, and pressure. The other parameters were calculated from the interpolated values at each RRA data level. These "derived" parameters were the water vapor pressure, density, and virtual temperature.

B.2.1. Calculation of the Geopotential Height at Significant Levels

Two somewhat different interpolation procedures were used to obtain data from radiosonde and rocketsonde observations at the levels shown in the tables. The procedure used to interpolate radiosonde observations began with the calculation of virtual temperature at each data level in a sounding. The virtual temperature was computed by

$$T_v = T / (1. - 0.379 (e/p)) \quad , \quad (52)$$

where T_v and T are in degrees Kelvin and e and p are in millibars.

The radiosonde soundings contain a mix of data taken at "mandatory" and "significant" levels. Pressure, temperature, and dewpoint information was given in these soundings at both types of levels. However, geopotential height information was only given at the mandatory levels. The heights at the significant levels were "filled in" (calculated) hydrostatically using pressure and temperature data from these levels. This procedure permitted the use of most of the significant level data in the calculation of the RRA tables. The equation used for this process was

$$H_s = H_m + 29.2712617 \frac{(T_{vs} - T_{vm})}{2} \ln(P_s/P_m) \quad (53)$$

where the subscripts s and m denote quantities at significant and mandatory levels. This equation was not used if the difference between two adjacent mandatory levels was greater than 200 mb. All soundings with such data gaps were rejected for use in compiling the RRA.

B.2.2. Temperature

Radiosonde temperatures were interpolated logarithmically with respect to pressure using the equation

$$T = T_U + (T_L - T_U) \frac{\ln p - \ln p_L}{\ln p_U - \ln p_L} \quad (54)$$

where the subscripts U and L indicate values at the nearest data levels in the actual sounding above and below the interpolated level.

B.2.3. Pressure

The pressure values in each radiosonde sounding were interpolated to the RRA data levels using the equation

$$p = p_L \exp\left(\frac{H_L - H_U}{29.2712617 (0.5) (T_{vU} + T_{vL})}\right) \quad (55)$$

where the subscript L indicates virtual temperature, geopotential height, and pressure values at the data level below and closest to the level at which data were required.

B.2.4. Dewpoint Temperature

Dewpoint values were interpolated logarithmically with respect to pressure using the equation

$$T_d = T_{dU} + (T_{dL} - T_{dU}) \left(\frac{\ln p - \ln p_L}{\ln p_U - \ln p_L}\right) \quad (56)$$

The subscripts U and L indicate data at the nearest upper and lower data levels in a sounding.

B.2.5. Derived Water Vapor Pressure

The water vapor pressure was calculated from the interpolated dewpoint values at the RRA data levels using Teten's approximation:

$$e = 6.11 \text{ mb} \times 10^{\frac{7.5(T_d - 273.15)}{(T_d - 35.86)}} \quad (57)$$

B.2.6. Derived Density

The density values derived from radiosonde observations were calculated at the RRA data levels using the equation

$$\rho = 348.36787 \text{ p}/T_v \quad (58)$$

B.2.7. Derived Virtual Temperature

The virtual temperature values were calculated at the RRA data levels for each sounding using the equation

$$T_v = T / (1 - 0.379(e/p)) \quad (59)$$

where T_v and T are in degrees Kelvin, and p and e are the pressure and vapor pressure, respectively, in millibars.

B.3. Calculations on the Original Rocketsonde Data Records

The rocketsonde data records used to calculate the RRA table values above 30 km were given in terms of geometric altitude. For this reason, slightly different calculations were required to convert the recorded data values to values at the RRA data levels. The pressure, temperature, and density were all interpolated to the RRA data levels; moisture-related parameters (virtual temperature, water vapor pressure, and dewpoint) were not calculated, since atmospheric moisture at altitudes above 30 km was considered to be negligible.

No interpolation was done across gaps in the pressure or temperature data within a sounding larger than 7,000 m. Data values at the RRA levels within such a gap were set to missing.

B.3.1. Temperature

Rocketsonde temperatures were interpolated linearly with respect to geometric altitude using the equation

$$T = T_U + (T_L - T_U) \frac{Z - Z_L}{Z_U - Z_L}, \quad (60)$$

where the subscripts U and L indicate values at the nearest data level in the actual sounding above and below the interpolated level.

B.3.2. Pressure

The pressure values in each rocketsonde sounding were interpolated to the RRA data levels using the equation

$$P = P_L \exp \left(- \frac{g_\phi}{R^*} \frac{M(Z - Z_L)}{\bar{T}_v} \cdot W^2 \right), \quad (61)$$

where $\bar{T}_v = \frac{T_{vU} + T_{vL}}{2}$ and $W = \frac{r^*}{\left(r^* + Z + \frac{Z - Z_L}{2} \right)}$.

B.3.3. Density

Rocketsonde density values were interpolated using the equation

$$\rho = \rho_L \exp \left(- \frac{g_\phi M}{R^*} \frac{(Z - Z_L)}{\bar{T}_v} \cdot W^2 \right), \quad (62)$$

where W is specified in section III.B.3.2.

C. Computation of Statistical Parameters for Tables II and III

A three-step procedure was used for computing the monthly and annual means, standard deviations, and skewness values from the data values at the RRA data levels. Initially, certain statistical sums were calculated and stored as the soundings in the data base were processed. These sums were then used to calculate the monthly statistics given in the RRA tables. The annual statistics were then calculated from these stored sums and the monthly statistics.

C.1. Stored Statistical Sums

The sums calculated were

$$\sum Q, \sum Q^2, \text{ and } \sum Q^3,$$

where Q is any one of the quantities given in the thermodynamic part of the RRA.

C.2. Calculation of the Monthly Statistics

C.2.1. Monthly Means

The mean monthly values of the thermodynamic RRA quantities were calculated using the equation

$$\bar{Q} = \sum Q / N_Q,$$

where N_Q is the number of observed values of the quantity Q for a given month.

C.2.2. Monthly Standard Deviations

The monthly standard deviations of the thermodynamic RRA quantities were calculated using the equation

$$\sigma_Q = \sqrt{\frac{(N_Q \sum Q^2) - (\sum Q)^2}{N_Q \cdot (N_Q - 1)}} \quad (63)$$

C.2.3. Monthly Skewness Values

The monthly skewness values of the windspeed and of the thermodynamic RRA quantities were calculated using the equation

$$\alpha_Q = \frac{M_{3Q}}{\sigma_Q^3},$$

where M_{3Q} is the third moment of the quantity Q, σ_Q is its standard deviation, and

$$M_{3Q} = \left[\frac{\sum Q^3}{N_Q} - \frac{3 \sum Q \sum Q^2}{N_Q^2} - \frac{2 \sum Q^3}{N_Q^3} \right] \cdot \frac{N_Q^2}{(N_Q - 1)(N_Q - 2)} \quad (64)$$

C.3. Calculation of the Annual Statistics

Equations (63) and (64), used to calculate the monthly values of the standard deviations and skewness values, involve taking the differences between two pairs of large sums containing Q^2 and Q^3 , where Q is any thermodynamic RRA quantity. Using these equations to compute the annual statistics would have resulted in a substantial loss of precision, as these sums become larger by several orders of magnitude in such a case. This problem was avoided by calculating the annual means, standard deviations, and skewness values from the monthly statistics.

C.3.1 Annual Mean Values

The annual mean values of the thermodynamic RRA quantities were calculated using the equation

$$Q_{ANN} = Q_A / N_Q$$

where Q_A is the total of all observed values of Q and N_Q is the total number of observations of Q .

C.3.2. Annual Standard Deviations

The annual standard deviations of the thermodynamic RRA quantities were calculated using the equation

$$\sigma_{Q_{ANN}} = \sqrt{\frac{1}{N_Q} \sum_{i=1}^{12} (N_{Qi} \sigma_{Qi}^2) + \frac{1}{N_Q} \sum_{i=1}^{12} (N_{Qi} \bar{Q}_i^2) - Q_{ANN}^2} \quad (65)$$

where N_{Qi} = the number of data values for Q in month i ($i = 1$ to 12), Q_i = the monthly mean of Q , and σ_{Qi} = the standard deviation of quantity Q in month i .

C.3.3. Annual Skewness Values

The annual skewness values of the thermodynamic RRA quantities were calculated using the equation

$$\begin{aligned}
M3Q_{ANN} &= \frac{1}{N} \sum_{i=1}^{12} (N_{Qi} M_{3Qi}) + \frac{3}{NQ_{ANN}} \sum_{i=1}^{12} (N_{Qi} \bar{Q}_i Q_i^2) \\
&+ \frac{1}{NQ_{ANN}} \sum_{i=1}^{12} (N_{Qi} Q_i^3) - \frac{3\bar{Q}_{ANN}}{NQ_{ANN}} \sum_{i=1}^{12} (N_{Qi} Q_i^2) \\
&- \frac{3\bar{Q}_{ANN}}{NQ_{ANN}} \sum_{i=1}^{12} (N_{Qi} Q_i^2) + 2\bar{Q}_{ANN}^3 \quad (66)
\end{aligned}$$

where M_{3Qi} = the third moment about the mean of quantity Q in month i and $M3Q_{ANN}$ = the annual third moment about the mean of the quantity Q .

D. Derived Monthly Mean and Annual Mean Model Atmospheres

A set of modeled monthly mean and annual mean hydrostatic values of pressure and density was calculated from the lowest RRA data level (0 km, mean sea level) upwards to 30 km, and from 30 km upwards to 70 km. The integration from 0 to 30 km was computed independently of the integration from 30 to 70 km because of the difference in data sources. The two different values for 30 km are provided for comparison. When 30-km data are required, the values given in the 0- to 30-km table should be used. These hydrostatically modeled mean values, which are given in table IV, are useful as a check on the validity of the pressure and density values given in table II. In most cases, the values in tables II and IV for any given data level are within 1 percent of each other. The hydrostatic pressure values in table IV were calculated using the equation

$$p_1 = p_0 \exp \left(- \frac{0.034162 (H_1 - H_0)}{0.5 (T_{v1} + T_{v0})} \right) \quad (67)$$

where $H_1 - H_0$ is in meters and a "0" subscript refers to values at the RRA data level immediately below the level being checked. p_0 at the lowest data level is set equal to the RRA mean pressure; p_1 , calculated for the next highest data level, is taken as p_0 for the level above that. This process is repeated for all the other RRA data levels. The hydrostatic density corresponding to the hydrostatic pressures is calculated from these pressures and the RRA virtual temperature values using the formula

$$\rho_H = 348.36786 P_H / T_v \quad (68)$$

where ρ_H and P_H are the hydrostatic density and pressure shown in table IV of the RRA.

E. Thermodynamic Quantities Derivable from the Basic Tables

Several other quantities can be calculated from the statistics listed in tables I and II. Primary physical constants used in these calculations are listed in table E. The equations given in this section can be used to calculate the approximate mean values of these quantities at each RRA data level. It is not possible to infer or derive any information concerning the standard deviation or skewness values of these quantities from the data in tables II and III of the RRA.

E.1. Mean Air Particle Speed

The mean air particle speed, V , is the arithmetic average of the speeds of all air particles in the volume element being considered. For a valid average to occur, there must be a sufficient number of particles involved to represent mean conditions. The equation for V for dry air is

$$V = \sqrt{\frac{8}{\pi} \cdot \frac{R \cdot T}{M}} \quad (69)$$

A computational form for dry air, using tabulated values, is

$$V = \sqrt{7.3094 \times 10^2 \times T} \text{ (meters per second)} \quad (70)$$

where T is the temperature in degrees Kelvin from table II. Equation (69), when corrected for moist air, becomes

$$V = \sqrt{\frac{8}{\pi} \cdot R' \cdot T_v} \quad (71)$$

The computational form for moist air is

$$V = \sqrt{7.3094 \cdot 10^2 \cdot T_v} \text{ (meters per second)} \quad (72)$$

where T_v is the virtual temperature in degrees Kelvin from table III.

TABLE E. LIST OF PRIMARY PHYSICAL CONSTANTS

P_o = standard atmospheric pressure at sea level
 = 1.013250×10^5 Newton/m² = 2116.22 lb/ft²

ρ_o = standard atmospheric density at sea level
 = 1.2250 kg/m³ = 0.076474 lb/ft³

T_o = standard temperature at sea level = 288.15 K = 15.0°C = 59.0°F

g_o = standard gravity at sea level at latitude 45°32'33"
 = 9.80665 m/s²

s = Sutherland's constant used in calculation of dynamic viscosity
 = 110.4 K

T_I = ice point temperature at P_o = 273.15 K

μ = constant used in calculation of dynamic viscosity
 = 1.458×10^{-6} kg/s m K^{1/2}
 = 7.3025×10^{-7} lb/s ft R^{1/2}

γ = ratio of specific heat of air at constant pressure to specific heat of air at constant volume
 = 1.4

C_D = mean effective collision diameter of air molecules
 = 3.65×10^{-10} m = 1.1975×10^{-9} ft

N_a = Avogadro's constant
 = 6.022169×10^{26} /kg mol = 2.73179×10^{26} /lb mol

R^* = gas constant = 8.31432 J/mol K

R' = gas constant for dry air = 2.8704×10^2 J/kg K

M = molecular weight of dry air = 28.966 g/mol

E.2. Mean Free Path

The mean free path, L , is the mean value of the distance traveled by each neutral air particle in a selected air parcel, between successive collisions with other particles in that parcel. A meaningful average requires that the selected parcel be large enough to contain a substantial number of particles. The equation for L is given by

$$L = \left(\frac{\sqrt{2}}{2\pi} \right) \left(\frac{R \cdot T}{N_a C_d^2 P} \right) \quad (73)$$

where C_d is the effective collision diameter of the mean air molecules. The 1976 standard atmosphere value of 3.65×10^{-10} is valid for the range of altitudes in the RRA.

A computational form for moist air, using tabulated values, is

$$L = 2.335 \cdot 10^{-7} \frac{T}{P} \text{ (meters)} \quad (74)$$

where T is the temperature in degrees Kelvin from table II and P is the pressure in millibars from table II.

A form of (73) to correct L for moist air is

$$L = \left(\frac{\sqrt{2}}{2\pi} \right) \frac{R' M T_v}{N_a C_d^2} \quad (75)$$

The computational form for moist air is

$$L = 2.3325 \times 10^{-7} \frac{T_v}{P} \text{ (meters)} \quad (76)$$

where T_v is the virtual temperature in degrees Kelvin from table III and P is the pressure in millibars from table II.

E.3. Mean Collision Frequency

The mean collision frequency, V_c , is considered to be the average speed of air particles contained in an air parcel, divided by the mean free path of the particles inside that parcel. Computationally this is equivalent to

$$V_c = \frac{V}{L} \text{ (sec}^{-1}\text{)} \quad (77)$$

To determine V_c for dry air, use V and L from equations (70) and (74). To determine V_c for moist air, use V and L from equations (72) and (76).

E.4. Speed of Sound

The expression for the speed of sound, C_s , in meters per second in dry air, is

$$C_s = \sqrt{\frac{R \cdot T}{M}} \quad (78)$$

To compute C_s for dry air from tabulated values, use

$$C_s = \sqrt{4.0185 \cdot 10^2 \cdot T} \text{ (meters per second)} \quad (79)$$

where T is the temperature in degrees Kelvin from table II. One form for the speed of sound in moist air is

$$C_s = \sqrt{R \cdot T_v} \quad (80)$$

where T_v is the virtual temperature from table III. A computational form for moist air is

$$C_s = \sqrt{4.0185 \cdot 10^2 \cdot T_v} \text{ (meters per second)} \quad (81)$$

E.5. Dynamic Coefficient of Viscosity

The coefficient of dynamic viscosity, μ , is defined as a coefficient of internal friction developed where gas regions move adjacent to each other at different velocities. The following expression is taken from the U.S. Standard Atmosphere (1976):

$$\mu = \frac{1.46 \cdot 10^{-4} \cdot T^{3/2}}{T + S} \quad (82)$$

The computational form is

$$\mu = \frac{(1.458 \cdot 10^{-6}) T^{3/2}}{T + 110.4} \quad \text{(kilograms per second per meter)} \quad (83)$$

where T is temperature degrees Kelvin from table II.

E.6. Kinematic Coefficient of Viscosity

The kinematic coefficient of viscosity, designated as ν , is defined to be the ratio of the dynamic coefficient of viscosity of a gas to its density, or

$$\nu = \frac{\mu}{\rho} \quad (84)$$

The computational form is

$$\nu = 1.0 \cdot 10^{-3} \frac{\mu}{\rho} \quad \text{(square meters per second)} \quad (85)$$

where μ is the dynamic coefficient of viscosity from equation (83) and ρ is the density in grams per cubic meter from table II.

E.7. Coefficient of Thermal Conductivity

The empirical expression used for the coefficient of thermal conductivity, designated as K_t , is given in the 1976 Standard Atmosphere as

$$K_t = \frac{2.65019 \cdot 10^{-3} \cdot T^{3/2}}{T + 245.4 \cdot 10^{-(12/T)}} \quad \text{(watts per meter per degree Kelvin)} \quad (86)$$

where T is in degrees Kelvin.

E.8. Refractive Modulus and Refractive Index

The refractive modulus or refractivity (Selby and McClatchey, 1975; Smith and Weintraub, 1953) is defined as N, where

$$N = (n - 1) \cdot 10^6 \quad (87)$$

and n is the refractive index.

For microwave frequencies below approximately 30 GHz (equivalent to wavelengths above 1 cm), N , the refractive modulus, is given by the empirical equation

$$N = 77.6 \frac{P}{T_d} + 3.73 \times 10^5 \frac{e}{T_d^2} \quad (\text{dimensionless}), \quad (88)$$

where E and P are in millibars and i and T_d are in degrees Kelvin.

The following expression is valid for the visible and infrared wavelengths shorter than approximately 30 μm (0.03 mm).

$$N = 77.6 \frac{P}{T} + 0.584 \frac{P}{T^2} \quad (\text{dimensionless}), \quad (89)$$

where λ is the wavelength in microns and T is in degrees Kelvin.

The expression for N for the wavelength from 0.03 mm to 1 cm is an extremely complex function of wavelength.

CHAPTER IV. CONCLUSIONS AND RECOMMENDATIONS

Conclusions

This document satisfies the technical objectives established for the RRAC by the RCC MG. Upper air statistics and models for wind and thermodynamic quantities for the specific site have been derived in a consistent and uniform manner, which will be used in publications for all other assigned site locations. These RRAs represent an improvement over the previously published RRAs because of the availability of more extensive upper air data bases and the adaptation of more advanced statistical techniques. A statistical measure of central tendency (mean values) and a measure of dispersion (standard deviation with respect to the mean values) for monthly and annual reference periods have been tabulated for all variables in a consistent manner from data bases that have been edited and quality-controlled in the same manner. Further, a statistical measure for symmetry (skewness coefficient that involves the third statistical moment) has been tabulated for all variables except the U and V wind components. Even with these improvements, the user of these RRAs must recognize certain limitations of the statistical tabulations:

1) The wind profile structure with respect to altitude cannot be modeled from the RRA statistics because the interlevel and crosslevel correlations were not computed.

2) The profile structure with respect to altitude for any of the thermodynamic variables or any quantities derivable from these variables cannot be modeled because the prerequisite correlations were not computed. However, the profiles of monthly and annual means for pressure, virtual temperature, and density are in agreement (table IV) with the hydrostatic equation and the equation of state.

The preceding limitations are cited to prevent a misuse of the RRAs. More extensive statistical tabulations were beyond the scope of this committee's task. As greater insight is gained through usage of these RRAs, many adaptations of the statistical tabulations for specific engineering and scientific applications are envisioned.

Recommendations

It is recommended that the wind and thermodynamic statistical tabulations and attendant models contained in the RRAs be used as a standard reference source, as may be appropriate, by the ranges and range users. It is further recommended that the respective Range Staff Meteorologist or responsible agency staff member be consulted for the applicability of the RRAs for specific engineering applications.

REFERENCES

- Buell, Eugene C.: "Statistical Relations in a Perfect Gas." Journal of Applied Meteorology, 9, 1970, pp. 729-731.
- List, R. J., Editor: Acceleration of Gravity, Smithsonian Meteorological Tables, Sixth Ed. Smithsonian Institution, Washington, D.C., 1968, pp. 488.
- Selby, J.E.A.; and McClatchey, R.A.: AFCRL-TR-75-0255, Atmospheric Transmittance from 0.25 to 28.5 μ m - Computer Code Lowtran 3, Air Force Cambridge Research Laboratories. Available through the National Technical Information Service, Washington, D.C., 1975.
- Smith, E.K.; and Weintraub, S.: "The Constants in the Equation for Atmospheric Refractive Index at Radio Frequencies," Proceedings of the Institute of Radio Engineers, 41, 8, August 1953, pp. 1035-1037.
- Smith, O.E.: NASA TM X-73319, Vector Wind and Vector Wind Shear Models at 0-27 km Altitude for Cape Kennedy, Florida, and Vandenberg AFB, California. Prepared under sponsorship of the National Aeronautics and Space Administration. Available through the National Technical Information Service, Washington, D.C., July 1976.
- U.S. Standard Atmosphere, 1976. Prepared under the sponsorship of the National Aeronautics and Space Administration, United States Air Force, and United States Weather Bureau. Available through U.S. Government Printing Office, Washington, D.C., October 1976.

PREVIOUS RANGE REFERENCE ATMOSPHERES PUBLISHED BY IRIG

- Atlantic Missile Range Reference Atmosphere for Cape Kennedy, Florida (Part I), Document 104-63, April 16, 1963. (AD451780)
- White Sands Missile Range Reference Atmosphere (Part I), Document 104-63, June 28, 1964. (AD451781)
- Fort Churchill Missile Range Reference Atmosphere for Fort Churchill, Manitoba, Canada (Part I), Document 104-63, August 7, 1964. (AD634727)
- Pacific Missile Range Reference Atmosphere for Eniwetok, Marshall Islands (Part I), Document 104-63, September 1, 1964. (AD479264)
- Fort Greely Missile Range Reference Atmosphere (Part I), Document 104-63, October 6, 1964. (AD634726)
- Eglin Gulf Test Range Atmosphere for Eglin AFB, Florida (Part I), Document 104-63, January 25, 1965. (AD472601)
- Pacific Missile Range Atmosphere for Point Arguello, California (Part I), Document 104-63, April 1965. (AD472602)

Wallops Island Test Range Reference Atmosphere (Part I), Document 104-63, July 10, 1965. (AD474071)

Eastern Test Range Reference Atmosphere for Ascension Island, South Atlantic (Part I), Document 104-63, July 1966. (AD645591)

Johnston Island Test Site Reference Atmosphere (Part I), Document 104-63, January 1970. (AD782652)

Lihue, Kauai, Hawaii Reference Atmosphere (Part I), Document 104-63, January 1970. (AD782653)

Cape Kennedy, Florida Reference Atmosphere (Part II), Document 104-63, September 1971. (AD751581)

White Sands Missile Range Reference Atmosphere (Part II), Document 104-63, September 1971. (AD782654)

Wallops Island Test Range Reference Atmosphere (Part II), Document 104-63, September 1971. (ADA040280)

Fort Greely Missile Range Reference Atmosphere (Part II), Document 104-63, September 1971. (ADA040281)

Edwards Air Force Base Reference Atmosphere (Part I), Document 104-63, September 1972. (AD782651)

Kwajalein Missile Range Reference Atmosphere for Kwajalein, Marshall Islands (Part I), Document 104-63, October 1974. (ADA002664)

Pacific Missile Test Center Reference Atmosphere for Point Arguello, California (Part II), Document 104-63, November 1975. (ADA040279)

REVISED RANGE REFERENCE ATMOSPHERES PUBLISHED BY THE RCC

Kwajalein Missile Range, Kwajalein, Marshall Islands, Range Reference Atmosphere, 0-70 Km Altitude, Document 360-82, December 1982. (AD123424)

Cape Canaveral, Florida, Range Reference Atmosphere, 0-70 Km Altitude, Document 361-83, February 1983. (ADA125553)

In addition to the documents above and the present RRA for Vandenberg AFB, California, the revised series will include RRAs for the following locations:

Edwards AFB, California
White Sands Missile Range, New Mexico
Point Mugu, California
Dugway (Michael AAF), Utah
Eglin AFB, Florida
Ascension Island, South Atlantic

Wallops Island, Virginia
Taquac (Guam)
Barking Sands, Hawaii

CONVERSION UNITS

Physical Constants and Conversion Factors

Numerical values in this document are given in the International System of Units (SI, *Système International d'Unités*). The values in parentheses are equivalent U.S. Customary Units, which are English units adapted for use by the United States of America. The SI and U.S. Customary Units provided in table F are those normally used for measuring and reporting atmospheric data.

By definition, the following fundamental conversion factors are exact:

<u>Type</u>	<u>U.S. Customary Units</u>	<u>Metric</u>
Length	1 U.S. yard (yd)	0.9144 meter (m)
Mass	1 avoirdupois pound (lb)	453.59237 gram (g)
Time	1 second (s)	1 second (s)
Temperature	1 degree Rankine (°R)	9/5 degree Kelvin (K)

To aid in the conversion of units, conversion factors based on the above fundamental conversion factors are given in table F.

TABLE F. FACTORS FOR CONVERSION UNITS

Type - Description	METRIC			U. S. CUSTOMARY			CONVERSION		
	Unit	Abbreviation	Unit	Abbreviation	Multiply	By	To Get		
TEMPERATURE Ambient Temperature	degree Celsius	C	degree Fahrenheit	F	1.32	0.5556	C		
	degree Kelvin	K	degree Rankine	R	C	1.8*	F 1.2		
					R	1.00*	F + 459.67		
					R	459.67	F		
					K	273.15	C + 273.15		
Temperature Change	degree Celsius	C	degree Fahrenheit	F	C to K	1.8*	temp. change F or R		
	degree Kelvin	K	degree Rankine	R	F to R	5/9	temp. change C or K		
DENSITY Water Vapor Vapor Concentration (Absolute Humidity) and Ambient Density	gram per cubic meter	g/m ³	gram per cubic foot	gr/ft ³	g/m ³	0.43700	gr/ft ³		
	gram per cubic centimeter	g/cm ³			g/cm ³	2.20462	lb/m ³		
					lb/ft ³	16.018	lb/ft ³		
					g/cm ³	4.370 x 10 ⁻⁵	gr/cm ³		
					gr/ft ³	2.208 x 10 ⁻⁶	gr/cm ³		
WIND Windspeed	meter per second	m/s	mile per hour	mph	1	2.2369	mph		
			Knots	Knots	mph	0.44704	mph		
			feet per second	ft/s	ft/s	1.9438	ft/s		
				Knots	Knots	0.51444	Knots		
				mph	mph	0.68076	Knots		
				Knots	Knots	1.1508	mph		
				ft/s	ft/s	2.2068	ft/s		
				ft/s	ft/s	0.69448*	ft/s		
DISTANCE Length	meter	m	foot	ft	1	3.2808	ft		
	millimeter	mm	inch	in	1	0.03937*	in		
	Metric ton (1000 kg)	Mt	Short ton (2000 lb)	St	St	2.2046 x 10 ⁻⁶	St		
				St	St	2.5348 x 10 ⁻⁶	St		

* Do not use for conversions.

TABLE F. (continued)

Type of Data	METRIC			U. S. CUSTOMARY			CONVERSION	
	Unit	Abbreviation	Unit	Abbreviation	Multiply	By	Eq.	
DISTANCE (Cont. Indeb)							10^{-6}	m
							3.937×10^{-5}	m
							10^{-10}	m
							3.937×10^{-9}	m
MASS Weight	gram	g	gram	gr	lb	0.45359237*		kg
	kilogram	kg	pound	lb	lb	453.59237*		g
					kg	2.20462		lb
					g	15.4324		gr
					gr	0.06480		g
PRESSURE Atmospheric	new ton per square meter	new ton m^{-2}	pound force per square inch	lb in^{-2}	mb	10^{-3} *		bar
	millimeter of Mercury	mmHg	inch of Mercury	in.Hg	bar	10^{-3} *		mb
	bar	bar			new ton m^{-2}	10^{-2} *		mb
	millibar	mb			new ton m^{-2}	1.4504×10^{-4}		lb m^{-2}
	dynes per square centimeter (microbar)	$dyn. cm^{-2}$			lb m^{-2}	6.8948×10^{-3}		new ton m^{-2}
	kilogram force per square meter	$kg. m^{-2}$			mb	1.4504×10^{-2}		lb m^{-2}
					lb in^{-2}	68.948		bar
					mb	10^{-3} *		dyn. cm^{-2}
					$dyn. cm^{-2}$	10^{-3} *		dyn. cm^{-2}
					lb m^{-2}	6.8948×10^{-4}		mb
					$dyn. cm^{-2}$	1.4504×10^{-8}		dyn. cm^{-2}
					mb	10^{-10} †		bar
					$kg. m^{-2}$	0.0980665		mb
					lb m^{-2}	7.030696		$kg. m^{-2}$
					$kg. m^{-2}$	0.0014223		lb m^{-2}
				mb	2.9530×10^{-2}		in.Hg (32°F)	
				mb	0.76006		mmHg (0°C)	
				in.Hg (32°F)	28.40*		mmHg (0°C)	
				mmHg (0°C)	1.35952		in.Hg (32°F)	
				in.Hg (32°F)	33.8609		mb	
				Pa	1.01325		atm	

* In metric units conversion factor

TABLE I-1. WIND STATISTICAL PARAMETERS

JANUARY

STATION # 723930		VANDENBERG AFB								
Z	MEAN U	S.D. U	R(U,V)	MEAN V	S.D. V	MEAN WS	S.D. WS	SKEW WS	NOBS	
KM	M/S	M/S		M/S	M/S	M/S	M/S			
.100	.37	2.78	-.4934	-1.72	3.33	3.59	7.57	1.22	807.	
1.000	.83	4.20	-.0637	-1.44	6.97	6.91	4.61	1.11	857.	
2.000	3.15	5.50	.0795	-2.38	7.64	8.81	5.15	.79	869.	
3.000	5.79	7.29	.1400	-3.10	8.90	11.55	6.47	.80	873.	
4.000	8.11	8.99	.1856	-3.47	9.86	14.55	7.64	.70	875.	
5.000	10.29	10.53	.2130	-3.40	10.78	16.35	8.79	.56	876.	
6.000	12.10	12.02	.2394	-3.39	12.02	18.62	10.01	.57	877.	
7.000	13.98	13.37	.2606	-3.64	13.12	20.97	10.94	.59	875.	
8.000	15.67	14.91	.2652	-3.99	14.19	23.29	11.93	.57	868.	
9.000	17.52	16.18	.2720	-4.43	15.35	25.66	12.81	.55	859.	
10.000	19.65	17.21	.2479	-4.30	16.08	27.06	13.54	.52	857.	
11.000	21.60	17.30	.2465	-5.12	15.78	29.23	13.66	.47	844.	
12.000	23.19	16.30	.2399	-5.07	14.96	29.54	13.43	.59	832.	
13.000	23.72	13.74	.2655	-4.38	12.72	27.71	11.54	.54	828.	
14.000	21.45	11.65	.3335	-3.81	10.94	25.25	9.85	.31	816.	
15.000	19.99	9.99	.2693	-3.52	9.41	22.09	8.52	.68	806.	
16.000	18.25	8.36	.3465	-3.07	7.91	19.84	7.14	.42	800.	
17.000	15.28	7.22	.3329	-3.00	6.43	15.58	5.99	.63	781.	
18.000	9.87	6.41	.2818	-3.04	5.18	12.15	5.20	1.00	780.	
19.000	6.95	5.81	.2925	-2.99	4.25	9.44	4.48	1.13	763.	
20.000	4.35	5.87	.2807	-3.08	3.73	7.69	4.18	1.19	747.	
21.000	2.31	6.48	.2370	-3.15	3.55	7.21	4.24	1.46	723.	
22.000	.73	7.10	.2641	-3.14	3.46	7.51	4.05	1.36	713.	
23.000	-.17	7.70	.3055	-3.10	3.54	8.01	4.15	1.52	705.	
24.000	-.23	8.97	.3508	-2.86	3.94	8.92	5.02	1.53	705.	
25.000	-1.76	10.35	.3740	-2.59	4.13	9.94	5.76	1.62	695.	
26.000	-.84	11.79	.4353	-2.57	4.50	11.10	6.56	1.36	680.	
27.000	-.33	13.29	.5145	-2.53	5.00	12.31	7.54	1.34	636.	
28.000	.43	14.47	.5727	-2.70	5.94	13.62	8.15	1.30	586.	
29.000	1.46	15.16	.6048	-2.69	6.74	15.33	8.97	1.24	516.	
30.000	3.15	17.98	.5969	-2.48	7.58	17.16	10.09	1.21	452.	
32.000	7.29	19.73	.5144	-.16	7.47	18.50	10.62	.81	167.	
34.000	10.77	21.16	.5814	-.31	8.76	21.73	12.89	.62	167.	
36.000	13.29	23.09	.6029	-.81	9.21	23.66	15.26	.66	167.	
38.000	15.92	24.70	.5108	-1.52	9.92	25.49	17.07	.61	168.	
40.000	18.56	24.63	.4082	-1.57	11.29	27.27	18.29	.62	158.	
42.000	22.20	25.32	.3070	-.35	13.28	30.42	19.56	.56	168.	
44.000	28.77	25.53	.3993	2.75	15.31	35.32	21.25	.35	168.	
45.000	36.23	30.13	.4236	8.74	18.45	44.96	24.10	.43	167.	
48.000	42.91	31.79	.4329	8.72	19.03	51.47	25.23	.26	167.	
50.000	46.30	31.52	.4139	10.50	18.99	54.03	26.16	.21	166.	
52.000	48.14	30.08	.4032	10.53	17.53	54.89	24.99	-.03	166.	
54.000	50.10	29.81	.4019	10.30	17.69	56.69	24.50	-.08	162.	
55.000	51.83	29.84	.3181	9.20	16.87	57.85	24.50	-.33	150.	
53.000	55.21	29.70	.2318	10.01	17.55	60.19	26.67	-.29	136.	
60.000	59.92	32.44	.4057	8.38	20.56	64.78	30.57	-.20	93.	
62.000	59.74	30.52	.4814	11.83	18.57	73.52	29.33	-.36	64.	
64.000	77.55	32.97	.3750	9.41	18.33	80.95	31.06	-.30	57.	
65.000	84.97	31.44	.3150	3.56	15.83	97.21	29.85	-.32	58.	
68.000	84.36	28.90	.3509	-2.91	15.75	95.29	27.51	-.30	53.	
70.000	78.61	30.23	.2030	-5.42	17.28	81.21	28.63	-.28	53.	

PRECEDING PAGE BLANK-NOT FILMED

TABLE I-2. WIND STATISTICAL PARAMETERS

FEBRUARY

STATION # 723930		VANCOUVER AFB			MEAN V	S.D. V	MEAN WS	S.D. WS	SKEW WS	NOBS
Z	MEAN U	S.D. U	R(U,V)	M/S	M/S	M/S	M/S			
KM	M/S	M/S								
100	.82	2.98	-.5922	-.93	3.47	3.88	2.72	1.06	733.	
1.000	.51	4.23	-.1799	-1.42	7.36	7.33	4.45	.80	777.	
2.000	2.66	5.30	-.1010	-1.91	8.39	9.07	5.18	.61	788.	
3.000	5.43	6.75	-.0052	-2.44	9.47	11.34	6.48	.64	787.	
4.000	8.02	8.33	-.0224	-2.62	10.59	13.88	7.74	.67	789.	
5.000	10.35	9.60	.0267	-2.57	11.44	16.07	8.85	.67	788.	
6.000	12.34	10.85	.0743	-2.66	12.62	18.40	9.88	.73	784.	
7.000	14.30	12.31	.1200	-3.06	14.11	21.04	11.02	.87	783.	
8.000	16.31	13.66	.1112	-3.52	15.07	23.53	11.74	.65	778.	
9.000	18.70	15.30	.1552	-3.84	16.03	26.21	12.97	.69	770.	
10.000	21.01	16.69	.1926	-4.09	16.74	28.59	14.12	.81	758.	
11.000	22.87	18.36	.1945	-4.00	16.46	29.70	13.95	.69	755.	
12.000	24.51	14.91	.2004	-3.52	15.29	29.83	13.36	.57	744.	
13.000	24.25	12.91	.1845	-2.56	13.14	28.24	11.58	.55	738.	
14.000	23.24	11.55	.1570	-1.81	11.34	26.16	10.55	.52	730.	
15.000	20.43	9.74	.1552	-1.70	9.86	23.09	8.88	.37	726.	
16.000	17.62	8.35	.1771	-1.64	8.28	19.85	7.55	.49	720.	
17.000	14.46	6.94	.1783	-1.45	6.83	16.35	6.20	.56	706.	
18.000	11.27	6.34	.1341	-1.56	5.63	12.95	5.70	.93	712.	
19.000	8.11	5.64	.1872	-1.73	4.50	9.86	4.84	.87	703.	
20.000	5.52	5.69	.2604	-1.70	3.95	7.81	4.50	1.47	700.	
21.000	3.25	6.01	.1866	-1.77	3.45	6.64	4.20	1.04	675.	
22.000	1.79	6.34	.1373	-2.09	3.13	6.49	3.93	1.52	661.	
23.000	.93	5.75	.1387	-2.08	2.77	6.62	3.80	1.39	650.	
24.000	.44	7.44	.1011	-2.03	3.11	7.12	4.31	1.21	644.	
25.000	.45	8.22	.0786	-1.95	3.28	7.74	4.73	1.08	631.	
26.000	1.00	9.35	.1313	-1.82	3.58	8.73	5.30	1.06	615.	
27.000	2.65	10.23	.1714	-1.71	3.69	9.70	5.93	.99	540.	
28.000	4.93	11.46	.2261	-1.57	3.83	11.30	6.69	.98	511.	
29.000	7.10	13.17	.3045	-1.35	4.24	13.58	7.67	.99	425.	
30.000	9.23	15.09	.2938	-1.20	4.59	15.88	9.09	.95	404.	
32.000	11.00	18.42	.4303	-.72	5.12	19.61	10.04	.22	166.	
34.000	15.00	21.73	.5111	-.04	6.45	24.75	11.90	-.03	166.	
36.000	20.11	25.01	.5548	-.29	7.08	29.28	14.82	-.05	165.	
38.000	24.15	28.12	.5250	-.09	6.59	33.59	17.79	.06	169.	
40.000	26.99	29.18	.4533	-.57	10.75	36.44	19.08	.12	169.	
42.000	29.66	29.52	.4467	.22	12.44	38.82	19.89	.06	169.	
44.000	32.20	29.91	.4457	2.50	15.02	42.01	19.85	.08	169.	
46.000	34.85	30.27	.3839	4.79	15.87	44.60	20.31	.00	169.	
48.000	36.90	29.29	.3748	6.94	14.55	45.96	19.33	-.08	168.	
50.000	38.93	27.64	.3080	7.82	16.34	47.59	18.40	-.11	168.	
52.000	41.35	26.30	.3845	7.99	15.73	48.92	17.76	-.04	166.	
54.000	45.66	24.75	.4000	8.16	15.65	51.73	18.16	-.11	158.	
56.000	49.56	25.83	.3646	8.39	15.61	55.26	19.53	-.11	149.	
58.000	54.27	25.04	.4049	9.18	15.42	58.98	20.28	-.50	120.	
60.000	60.72	23.64	.4025	7.84	18.89	65.62	18.77	-.38	91.	
62.000	67.99	22.94	.2683	9.52	17.76	71.77	19.93	.14	56.	
64.000	72.70	26.04	.0698	8.36	15.26	75.64	23.17	.44	47.	
66.000	73.61	27.15	.1421	5.79	13.32	76.20	23.48	.31	44.	
68.000	72.47	28.33	.0140	2.99	12.70	75.54	22.54	-.03	41.	
70.000	68.19	22.05	-.1098	-2.01	17.07	70.72	20.21	-.16	39.	

TABLE I-3. WIND STATISTICAL PARAMETERS

MARCH

STATION = 723930		VANDENBERG AFB		MEAN V		S.D. V		MEAN WS		S.D. WS		SKEW WS		NOBS
Z	MEAN U	S.D. U	R(U,V)	M/S	M/S	M/S	M/S	M/S	M/S	M/S	M/S			
KM	M/S	M/S												
.100	1.82	2.69	-.5954	-1.92	3.51	4.18	3.01					.82	835.	
1.000	1.24	4.04	-.1138	-3.07	6.46	7.27	4.00					.67	864.	
2.000	3.05	5.12	-.0780	-3.08	7.73	9.02	4.83					.53	885.	
3.000	5.76	6.75	-.0456	-3.33	9.04	11.48	6.30					.65	886.	
4.000	8.34	8.66	-.0078	-3.38	10.47	14.21	7.98					.76	888.	
5.000	10.59	10.39	.0339	-3.19	11.62	16.64	9.39					.83	889.	
6.000	12.72	11.83	.0778	-3.22	12.91	19.16	10.56					.73	895.	
7.000	14.75	13.24	.1217	-3.48	14.36	21.72	11.80					.66	894.	
8.000	16.59	14.43	.1517	-3.82	16.07	24.20	13.04					.63	880.	
9.000	18.50	15.32	.2218	-3.94	17.34	26.46	13.83					.53	876.	
10.000	20.77	15.60	.2520	-3.77	17.86	28.45	14.06					.38	871.	
11.000	22.83	15.07	.2456	-3.46	17.26	29.57	13.64					.29	860.	
12.000	24.50	13.73	.2485	-2.52	15.43	29.57	12.59					.38	853.	
13.000	24.48	11.50	.2414	-1.62	13.33	28.21	10.78					.23	852.	
14.000	23.32	10.05	.2387	-1.15	11.34	26.11	9.63					.52	845.	
15.000	20.64	8.05	.1981	-.74	9.34	22.83	7.57					.09	841.	
16.000	17.86	7.23	.1532	-.61	7.94	19.69	6.86					.27	840.	
17.000	15.00	6.49	.1423	-.77	6.44	16.53	5.99					.37	820.	
18.000	11.83	5.88	.1296	-.65	5.19	13.13	5.43					.59	823.	
19.000	8.80	5.33	.1844	-.85	4.19	10.12	4.67					.58	817.	
20.000	6.29	5.18	.1404	-.93	3.58	7.98	4.04					.62	813.	
21.000	4.25	5.52	.0755	-1.03	3.24	6.81	3.70					.93	789.	
22.000	2.78	5.84	.0787	-1.13	3.03	6.40	3.36					1.06	772.	
23.000	2.63	6.24	.1859	-.98	2.71	6.31	3.43					1.23	759.	
24.000	1.63	6.94	.3053	-.74	2.83	6.62	3.94					1.26	750.	
25.000	1.97	7.78	.3179	-.69	2.84	7.28	4.46					1.19	749.	
26.000	2.50	8.57	.3706	-.67	2.85	8.05	4.83					1.02	730.	
27.000	3.57	9.82	.4012	-.67	3.14	9.40	5.58					.80	665.	
28.000	5.65	11.40	.4332	-.77	3.59	11.47	6.61					.69	605.	
29.000	7.44	13.17	.4211	-.72	3.77	13.66	7.53					.59	528.	
30.000	9.48	14.84	.3719	-.46	4.17	15.88	8.68					.40	502.	
32.000	13.10	15.20	.3004	1.08	5.10	17.92	10.39					.48	140.	
34.000	18.23	17.00	.2374	2.16	5.87	22.49	12.40					.35	140.	
36.000	23.32	18.90	.4001	2.06	7.13	27.70	14.68					.23	140.	
38.000	28.42	21.42	.4207	2.35	7.99	32.30	17.06					.23	141.	
40.000	32.00	22.47	.2574	3.43	9.02	35.86	10.29					.06	141.	
42.000	34.47	20.89	.2407	4.32	10.94	37.85	18.12					-.02	141.	
44.000	35.85	19.85	.2889	5.68	11.82	39.24	17.60					-.03	141.	
46.000	36.63	18.72	.3385	8.00	11.69	39.62	17.95					.11	141.	
48.000	38.02	17.73	.2779	8.89	11.39	40.82	17.34					.06	141.	
50.000	38.10	17.43	.3243	9.49	12.52	41.64	16.36					.09	140.	
52.000	38.10	17.53	.3462	11.01	13.15	41.97	17.03					.04	139.	
54.000	39.11	16.97	.3933	11.83	13.03	42.82	17.10					.14	135.	
56.000	41.88	17.91	.3389	13.20	13.24	45.11	17.46					.12	128.	
58.000	42.73	20.14	.3701	10.88	13.48	46.56	19.01					.00	114.	
60.000	44.56	21.80	.3506	8.47	14.20	47.71	21.35					.01	79.	
62.000	43.42	22.89	.1844	6.22	15.73	46.95	22.07					.03	59.	
64.000	40.14	24.71	.2328	3.02	16.33	44.06	23.43					-.01	47.	
66.000	35.52	24.30	.0904	.61	18.38	41.50	21.38					.09	44.	
68.000	27.52	24.03	-.0429	-1.05	16.11	35.19	18.58					.33	42.	
70.000	20.53	24.04	-.0753	-.50	16.64	31.27	16.88					.33	41.	

TABLE 1-4. WIND STATISTICAL PARAMETERS

APRIL

STATION # 723930		VANDENBERG AFB							
Z	MEAN U	S.D. U	R(U,V)	MEAN V	S.D. V	MEAN WS	S.D. WS	SKEW WS	NOBS
KM	M/S	M/S		M/S	M/S	M/S	M/S		
.100	2.11	2.80	-.6346	-2.31	3.23	4.32	3.09	.85	766.
1.000	1.52	3.83	-.0869	-3.93	5.55	7.02	3.73	.85	813.
2.000	2.63	4.58	-.0967	-3.53	6.82	8.20	4.43	.62	825.
3.000	5.50	5.99	-.0161	-3.69	8.53	10.70	6.16	1.02	826.
4.000	8.47	7.70	.0444	-3.92	10.50	13.87	8.02	.90	826.
5.000	11.19	9.47	.1490	-3.53	11.85	16.73	9.36	.79	825.
6.000	13.71	11.18	.1889	-3.42	13.34	19.62	10.84	.75	822.
7.000	15.99	12.49	.2314	-3.38	15.03	22.42	12.09	.74	819.
8.000	18.07	13.95	.2801	-3.49	16.44	25.03	13.28	.81	815.
9.000	19.79	14.66	.3644	-3.39	17.01	27.01	13.32	.57	809.
10.000	21.52	15.00	.3801	-3.46	17.12	28.58	13.26	.45	805.
11.000	22.85	14.40	.3779	-2.79	16.19	29.01	12.55	.37	793.
12.000	23.81	13.35	.3728	-1.80	14.98	28.86	11.82	.51	788.
13.000	23.40	11.18	.3480	-.34	12.61	26.93	10.29	.60	787.
14.000	21.90	9.34	.3395	.05	10.72	24.59	8.81	.41	782.
15.000	19.52	7.92	.3444	1.22	9.29	21.74	7.65	.39	777.
16.000	16.61	6.76	.3096	1.29	7.90	18.49	6.60	.38	774.
17.000	13.61	5.71	.2609	1.30	6.39	15.18	5.45	.37	758.
18.000	10.42	5.10	.1779	1.27	5.16	11.79	4.89	.46	756.
19.000	7.44	4.75	.0992	1.13	4.10	8.84	4.23	.69	753.
20.000	5.08	4.45	.0711	.70	3.39	6.66	3.64	.99	747.
21.000	3.29	4.57	.0738	.40	2.86	5.40	3.29	1.44	723.
22.000	2.21	4.83	.1488	.20	2.66	5.06	3.10	1.46	714.
23.000	1.80	5.09	.1593	.16	2.41	4.98	3.18	1.68	704.
24.000	1.69	5.55	.1706	.10	2.57	5.24	3.58	1.52	710.
25.000	2.54	5.93	.2005	-.10	2.66	5.84	3.82	1.51	708.
26.000	3.50	6.48	.2734	-.18	2.71	6.54	4.34	1.60	693.
27.000	4.97	7.02	.3131	-.09	3.03	7.66	4.94	1.20	627.
28.000	6.96	7.27	.3315	.05	3.35	9.02	5.57	.97	580.
29.000	8.84	7.89	.3132	.11	3.81	10.80	6.17	.92	534.
30.000	10.74	8.07	.2940	.09	4.01	12.34	6.65	.93	509.
32.000	11.65	8.29	.2853	.88	4.83	13.17	7.41	.57	145.
34.000	15.29	9.24	.3127	1.20	5.40	16.56	8.67	.41	145.
36.000	18.07	10.89	.4647	1.74	5.79	19.29	10.27	.53	147.
38.000	19.21	12.62	.3762	.34	7.16	21.07	11.62	.35	147.
40.000	18.30	15.64	.3200	-.84	6.71	21.12	13.36	.48	147.
42.000	14.50	16.73	.0435	1.05	7.95	19.61	12.05	.69	147.
44.000	13.20	15.35	.1457	4.00	8.20	18.86	12.97	.79	147.
46.000	13.40	17.01	.2510	5.05	8.26	19.43	13.66	.74	147.
48.000	12.83	18.45	.2271	5.88	7.14	20.04	13.70	.80	147.
50.000	12.82	18.43	.1091	5.53	7.78	20.18	13.65	.72	146.
52.000	10.65	18.36	.1358	5.19	7.62	19.36	12.62	.78	146.
54.000	7.41	19.33	.0634	4.75	8.85	18.64	11.94	.76	143.
56.000	5.55	18.29	.2315	6.75	8.38	18.31	11.02	.98	135.
58.000	4.19	17.18	.1297	6.60	9.25	19.41	10.03	.83	126.
60.000	2.33	18.41	.2710	4.32	10.37	19.18	9.94	.64	87.
62.000	.19	15.83	.0003	4.30	9.03	16.63	8.33	.36	51.
64.000	-1.08	14.82	-.1153	3.90	10.15	16.16	8.51	.21	45.
66.000	-2.24	14.60	-.3729	1.48	11.98	16.74	8.77	.39	43.
68.000	-2.73	10.39	-.0621	-.87	12.05	14.31	7.21	.32	42.
70.000	-5.14	12.94	.1416	-4.23	8.40	14.76	7.76	.33	41.

TABLE I-5. WIND STATISTICAL PARAMETERS

MAY

STATION = 723930		VANDENBERG AFB									
Z	MEAN U	S.D. U	R(U,V)	MEAN V	S.D. V	MEAN WS	S.D. WS	SKEW WS	NOBS		
KM	M/S	M/S		M/S	M/S	M/S	M/S				
1.000	2.23	2.42	-.6244	-2.18	2.66	3.86	2.79	.90	805.		
1.000	1.00	3.32	-.1672	-3.83	4.37	5.94	3.24	.72	849.		
2.000	.97	3.96	-.3510	-3.09	5.37	6.39	3.77	.99	880.		
3.000	2.71	5.65	-.3682	-2.70	6.43	7.93	5.00	1.05	882.		
4.000	4.01	7.19	-.2645	-2.63	7.33	9.72	6.31	1.14	883.		
5.000	6.18	8.45	-.1401	-2.49	8.19	11.18	7.58	1.47	883.		
6.000	7.62	9.62	-.0740	-2.60	9.18	12.86	8.75	1.37	881.		
7.000	8.84	10.62	.0083	-2.93	10.34	14.52	9.76	1.20	879.		
8.000	9.91	11.41	.0801	-3.13	11.72	16.23	10.58	1.04	875.		
9.000	11.24	12.35	.1219	-3.34	12.96	18.09	11.42	.96	874.		
10.000	12.52	13.29	.1735	-3.36	13.93	19.83	12.01	.99	872.		
11.000	13.65	13.53	.2277	-3.28	14.15	20.91	11.95	.72	869.		
12.000	14.79	13.04	.2521	-2.55	13.29	21.09	11.25	.76	866.		
13.000	14.98	10.83	.2587	-1.29	11.17	19.59	9.17	.54	864.		
14.000	14.66	8.75	.1766	-.17	8.96	17.68	7.68	.47	863.		
15.000	13.10	7.02	.1597	.64	7.35	15.28	6.45	.60	860.		
16.000	11.06	5.87	.1308	1.03	6.02	12.76	5.60	.64	854.		
17.000	8.59	4.83	.1201	1.11	4.71	10.01	4.50	.53	829.		
18.000	5.79	4.06	.1001	.84	3.73	7.22	3.53	.65	829.		
19.000	3.04	3.62	.0525	.50	2.93	4.83	2.80	1.24	823.		
20.000	.79	3.29	.0726	.07	2.40	3.61	2.05	1.00	811.		
21.000	-1.01	3.16	.0797	-.28	2.19	3.47	1.97	.82	788.		
22.000	-2.00	3.37	.0131	-.45	2.08	3.89	2.18	.73	783.		
23.000	-2.40	3.42	.0248	-.55	2.04	4.11	2.24	.57	767.		
24.000	-2.39	3.61	.0555	-.60	2.24	4.33	2.30	.71	762.		
25.000	-2.15	3.94	.0452	-.60	2.18	4.44	2.35	.63	755.		
26.000	-1.64	4.41	.0102	-.48	2.27	4.62	2.48	.71	745.		
27.000	-1.22	4.82	-.0073	-.37	2.54	4.90	2.69	.69	574.		
28.000	-.44	5.54	-.0212	-.41	2.64	5.11	2.70	.46	543.		
29.000	.14	6.14	.0037	-.39	2.73	6.07	2.89	.61	501.		
30.000	.66	6.30	.0126	-.44	2.71	6.17	3.10	.48	477.		
32.000	-.14	5.73	.0141	1.57	3.35	6.00	3.22	.75	164.		
34.000	.29	6.16	.1085	1.64	3.56	6.40	3.50	.95	164.		
36.000	-.95	7.70	.0881	1.03	3.61	7.53	4.18	.70	164.		
38.000	-2.83	8.62	-.0405	.12	4.10	8.72	4.76	1.07	165.		
40.000	-6.27	8.53	-.3259	-.11	4.44	10.04	5.53	.79	165.		
42.000	-10.10	8.29	-.1420	.09	4.26	11.99	6.70	.50	165.		
44.000	-13.74	7.50	-.0830	1.34	4.87	14.97	6.94	.13	164.		
46.000	-16.22	8.27	.1839	3.97	5.11	17.92	7.20	.08	164.		
48.000	-18.02	8.62	.0770	6.08	5.43	20.20	7.57	.12	164.		
50.000	-18.81	9.57	.0830	6.93	4.90	21.16	8.33	.19	163.		
52.000	-19.66	9.39	-.1482	5.37	6.63	21.83	8.89	.20	162.		
54.000	-23.55	9.15	-.1689	3.83	6.06	24.68	8.97	.42	156.		
54.000	-26.85	9.98	-.1800	3.42	6.06	27.99	9.79	.03	144.		
56.000	-30.67	9.58	.2199	3.27	9.72	32.41	9.29	.31	123.		
60.000	-31.60	11.24	.3544	5.80	10.33	34.29	10.03	-.17	86.		
62.000	-32.46	13.63	.2634	6.03	9.94	35.00	12.15	-.24	62.		
64.000	-33.15	13.73	-.1118	4.54	11.88	35.57	13.44	-.40	49.		
66.000	-32.16	13.66	.0086	5.87	9.06	34.18	12.92	.46	49.		
68.000	-27.50	17.44	-.1600	4.08	11.65	31.20	15.32	.99	49.		
70.000	-25.41	14.03	-.2516	3.34	12.15	28.79	12.99	.61	48.		

TABLE I-6. WIND STATISTICAL PARAMETERS

JUNE

STATION # 723330		VANDENBERG AFB								
Z	MEAN U	S.D. U	R(U,V)	MEAN V	S.D. V	MEAN WS	S.D. WS	SKEW WS	NOBS	
KM	M/S	M/S		M/S	M/S	M/S	M/S			
.100	2.25	2.28	-.6058	-1.92	2.47	3.64	2.60	.86	738.	
1.000	.89	3.17	-.1978	-3.61	4.14	5.59	3.14	1.01	752.	
2.000	1.02	3.91	-.2983	-2.45	4.73	5.82	3.30	.85	782.	
3.000	2.78	5.32	-.2002	-1.19	5.59	7.12	4.24	.91	784.	
4.000	4.37	6.45	-.0818	-.38	6.58	8.70	5.24	.91	785.	
5.000	5.75	7.43	-.0178	.09	7.49	10.30	6.18	.94	784.	
6.000	7.13	8.42	-.0161	.44	8.70	11.95	7.39	1.24	783.	
7.000	8.66	9.56	.0190	.76	9.98	13.81	8.68	1.19	783.	
8.000	9.94	10.71	.0751	.94	11.44	15.78	9.81	1.00	784.	
9.000	11.18	11.60	.1436	1.31	12.71	17.65	10.57	.70	780.	
10.000	12.83	12.65	.1842	1.74	13.84	19.72	11.48	.62	783.	
11.000	14.76	13.25	.2316	2.24	14.56	21.67	11.84	.47	777.	
12.000	16.30	13.11	.2745	3.11	14.23	22.65	11.68	.40	774.	
13.000	16.81	11.99	.2826	4.01	12.98	22.28	10.71	.33	773.	
14.000	15.45	9.80	.2315	4.37	11.01	19.82	9.07	.28	769.	
15.000	12.45	7.40	.1561	4.15	8.55	15.92	6.85	.22	767.	
16.000	8.84	5.44	.0330	3.13	6.26	11.48	5.00	.26	761.	
17.000	5.18	4.17	-.0257	2.09	4.61	7.55	3.57	.43	737.	
19.000	1.45	3.63	-.0670	1.27	3.51	4.81	2.46	.85	741.	
19.000	-1.71	3.25	-.0362	.70	2.63	4.10	2.02	.71	738.	
20.000	-3.83	3.12	-.0420	.45	2.08	4.80	2.43	.75	730.	
21.000	-5.35	2.08	-.0391	.25	1.91	5.83	2.69	.77	710.	
22.000	-6.51	2.82	.0449	-.10	1.78	6.90	2.68	.80	710.	
23.000	-7.59	2.97	.0471	-.38	1.72	7.84	2.83	.79	702.	
24.000	-8.25	3.43	.0162	-.41	1.81	8.56	3.19	.44	693.	
25.000	-8.90	3.59	.0051	-.41	1.90	9.16	3.42	.37	703.	
25.000	-9.37	3.79	-.0220	-.34	1.87	9.63	3.60	.34	696.	
27.000	-9.67	4.09	.0084	-.20	2.13	10.01	3.82	.18	628.	
28.000	-10.02	3.91	.0143	.00	1.92	10.29	3.67	.15	574.	
29.000	-10.48	3.85	.0043	.05	2.18	10.76	3.70	.14	525.	
30.000	-10.83	4.04	.0244	-.06	2.06	11.10	3.94	.06	505.	
32.000	-14.56	4.86	-.0749	1.39	2.80	14.91	4.79	.05	144.	
34.000	-16.01	5.35	-.0920	1.42	2.75	16.32	5.28	-.28	144.	
36.000	-18.38	5.45	-.0571	.58	3.02	18.65	5.38	-.16	145.	
38.000	-22.18	5.36	.1446	.49	3.36	22.46	5.25	.03	145.	
40.000	-25.91	6.39	.1834	.58	3.65	26.20	6.28	-.19	145.	
42.000	-29.67	6.99	-.1242	.41	4.30	29.99	6.98	.20	145.	
44.000	-33.15	6.13	-.1053	2.50	5.26	33.66	6.09	-.02	145.	
45.000	-35.77	6.75	.1424	4.70	5.17	36.48	6.51	-.34	145.	
48.000	-34.50	7.36	.0929	4.73	5.29	39.17	7.26	-.25	144.	
50.000	-41.36	8.25	.0216	5.45	6.16	42.22	8.00	.02	142.	
52.000	-44.07	8.92	.0796	6.12	6.09	44.95	8.63	-.08	132.	
54.000	-46.76	9.41	-.0417	5.38	6.26	47.48	9.39	.10	124.	
56.000	-50.39	9.92	-.1146	5.38	6.51	51.09	9.87	.23	117.	
58.000	-53.04	11.10	.1542	3.13	7.82	53.71	11.02	.30	90.	
60.000	-53.52	12.24	.0233	2.78	10.22	54.47	12.55	.37	62.	
62.000	-57.70	14.32	.1882	5.66	14.06	59.50	14.44	-.05	41.	
64.000	-55.49	17.34	.2488	8.51	10.03	57.24	16.48	.33	33.	
66.000	-52.61	14.41	-.3780	7.18	11.22	54.22	14.32	-.32	32.	
68.000	-49.78	18.84	-.0700	5.97	12.72	51.25	18.65	-.09	31.	
70.000	-44.92	21.59	.1080	9.20	13.49	48.41	19.95	.07	29.	

TABLE I-7. WIND STATISTICAL PARAMETERS

JULY

STATION = 723930		VANDENBERG AFB		MEAN V		S.D. V		MEAN WS		S.D. WS		SKEW WS		NOBS
Z	MEAN U	S.D. U	R(U,V)	M/S	M/S	M/S	M/S	M/S	M/S	M/S	M/S	M/S	M/S	
KM	M/S	M/S												
1.000	2.05	2.13	-.5745	-1.78	2.10	3.23	2.43			.97			725.	
1.000	.25	2.63	-.2496	-2.06	3.92	4.48	2.54			.83			753.	
2.000	-.17	2.97	-.2205	-.49	3.89	4.25	2.47			1.10			841.	
3.000	1.22	3.86	-.1138	1.35	4.16	5.12	3.06			1.14			842.	
4.000	2.01	4.76	.0281	2.62	4.48	6.30	3.73			1.32			843.	
5.000	2.52	5.58	.0809	3.38	4.83	7.28	4.39			1.19			844.	
6.000	3.17	6.47	.1183	3.91	5.39	8.27	5.26			1.17			844.	
7.000	4.22	7.23	.1317	4.51	6.09	9.54	6.04			1.25			844.	
8.000	5.33	8.11	.1506	5.34	6.83	11.02	6.96			1.21			845.	
9.000	6.60	8.98	.1350	6.55	7.66	12.91	7.67			1.06			844.	
10.000	7.84	9.81	.1361	7.87	8.40	14.84	8.38			1.01			841.	
11.000	9.02	10.54	.1216	9.50	9.25	16.89	9.08			.95			838.	
12.000	9.88	10.56	.1094	10.60	9.36	17.94	9.32			.80			834.	
13.000	10.01	10.19	.1522	10.80	9.10	17.81	9.29			.76			829.	
14.000	8.76	8.92	.2063	9.77	8.04	15.83	8.11			.69			828.	
15.000	6.26	7.35	.2201	7.62	6.20	12.23	6.36			.67			824.	
16.000	2.87	5.50	.2045	5.43	4.55	8.38	4.30			.78			822.	
17.000	-.43	4.09	.2284	3.54	3.53	5.80	2.87			.87			789.	
18.000	-3.27	3.38	.2676	2.06	2.73	5.33	2.30			.42			790.	
19.000	-5.64	2.68	.1751	1.26	2.04	6.23	2.42			.34			786.	
20.000	-7.38	2.39	.1257	.82	1.77	7.67	2.26			.30			775.	
21.000	-9.05	2.55	.0730	.51	1.78	9.25	2.48			.14			762.	
22.000	-10.44	2.44	.0627	.16	1.72	10.58	2.43			.26			747.	
23.000	-11.84	2.44	.0600	-.08	1.70	11.96	2.42			.20			732.	
24.000	-13.18	2.55	-.0250	-.13	1.81	13.30	2.55			.10			724.	
25.000	-14.18	2.61	-.0314	-.09	1.74	14.29	2.60			.18			724.	
26.000	-15.02	2.79	-.0180	.05	1.90	15.15	2.78			.44			708.	
27.000	-15.72	3.00	-.0287	-.03	2.11	15.86	3.00			.36			675.	
28.000	-16.15	2.93	-.0307	.06	1.95	16.27	2.93			.22			588.	
29.000	-16.69	3.10	.0107	.13	2.22	16.83	3.04			.05			570.	
30.000	-17.42	3.19	.0323	-.01	2.11	17.54	3.18			.12			540.	
32.000	-22.68	3.62	-.1768	1.62	2.74	22.90	3.64			-.15			139.	
34.000	-23.71	3.45	.0008	1.35	3.06	23.95	3.42			.01			140.	
36.000	-26.52	4.35	-.0731	1.03	3.40	26.76	4.32			-.03			140.	
38.000	-29.23	4.81	-.1289	1.18	4.27	29.58	4.74			-.21			142.	
40.000	-33.29	4.27	.0572	-.08	4.25	33.55	4.33			-.05			142.	
42.000	-38.10	4.87	.0443	.05	5.28	38.46	4.87			-.20			142.	
44.000	-42.09	5.35	.0585	2.13	5.87	42.56	5.25			-.21			142.	
46.000	-44.74	6.25	.1210	4.62	5.34	45.30	6.15			.23			142.	
48.000	-47.31	6.55	.1203	4.97	6.18	47.98	6.48			.18			142.	
50.000	-51.36	7.16	.1017	5.79	5.95	52.04	7.05			-.01			141.	
52.000	-53.83	8.32	.2111	7.11	7.00	54.78	8.07			.04			136.	
54.000	-54.76	9.04	.1272	7.42	7.32	55.78	8.80			-.24			129.	
56.000	-57.97	10.73	.1770	5.20	9.87	59.10	10.30			.03			122.	
58.000	-59.85	13.02	.2448	1.75	12.31	61.18	12.69			-.06			105.	
60.000	-60.03	17.21	.1480	2.25	13.50	61.68	16.71			-.25			76.	
62.000	-62.04	20.10	.0455	5.62	12.38	63.50	19.77			.08			61.	
64.000	-56.71	21.39	.1401	7.79	11.35	58.56	20.77			.13			54.	
66.000	-45.11	23.71	.1581	10.43	14.17	49.25	21.80			.04			51.	
68.000	-35.08	21.35	-.0473	9.30	21.22	42.90	19.30			.45			49.	
70.000	-25.92	22.64	.0338	5.10	25.12	37.96	19.59			.58			46.	

TABLE I-8. WIND STATISTICAL PARAMETERS

AUGUST

STATION = 723930		VANDENBERG AFB		MEAN V		S.D. V		MEAN WS		S.D. WS		SKEW WS		NOBS					
Z	MEAN U	S.D. U	R(U,V)	MEAN V	S.D. V	MEAN WS	S.D. WS	SKEW WS	NOBS	Z	MEAN U	S.D. U	R(U,V)	MEAN V	S.D. V	MEAN WS	S.D. WS	SKEW WS	NOBS
KM	M/S	M/S		M/S	M/S	M/S	M/S			M/S	M/S			M/S	M/S	M/S	M/S		
.100	1.94	2.01	-.5937	-1.54	2.00	3.00	2.27	.95	785.										
1.000	.47	2.60	-.2735	-1.98	4.00	4.47	2.62	.75	807.										
2.000	.11	3.29	-.3116	-.41	4.14	4.54	2.75	1.12	845.										
3.000	1.44	4.19	-.2384	1.16	4.19	5.32	3.20	.89	844.										
4.000	2.24	5.04	-.1396	2.10	4.33	6.22	3.85	1.20	850.										
5.000	2.87	5.96	-.0397	2.67	4.70	7.23	4.55	1.37	952.										
6.000	3.92	6.75	-.0023	3.01	5.45	8.37	5.45	1.35	852.										
7.000	5.27	7.28	-.0659	3.62	6.38	9.79	6.22	1.37	853.										
8.000	6.77	7.89	-.0553	4.39	7.15	11.35	7.05	1.30	856.										
9.000	8.35	8.53	.0610	5.39	7.94	13.21	7.75	1.19	857.										
10.000	9.96	9.27	-.0885	6.60	8.62	15.22	8.44	.99	858.										
11.000	11.55	10.16	.0853	7.77	9.36	17.33	9.17	.83	858.										
12.000	12.49	10.37	.0279	8.76	9.36	18.49	9.27	.62	856.										
13.000	12.47	9.84	-.0182	9.04	8.96	18.32	8.06	.61	853.										
14.000	11.13	8.33	-.0147	8.22	7.75	16.28	7.49	.40	848.										
15.000	8.29	6.73	-.0149	6.55	5.94	12.63	5.72	.40	845.										
16.000	4.61	5.27	-.0363	4.70	4.45	8.63	4.06	.58	838.										
17.000	1.10	4.39	-.0080	2.94	3.56	5.71	3.04	1.06	814.										
18.000	-1.88	3.65	.0507	1.82	2.79	4.75	2.32	.45	813.										
19.000	-4.43	3.21	-.0067	.99	2.22	5.44	2.49	.54	806.										
20.000	-6.43	2.74	-.0745	.59	1.88	6.82	2.50	.23	793.										
21.000	-8.04	2.70	-.0233	.36	1.85	8.28	2.63	.06	784.										
22.000	-9.57	2.58	-.0242	.06	1.56	9.71	2.56	.20	769.										
23.000	-11.01	2.57	-.0515	-.02	1.63	11.13	2.55	.22	756.										
24.000	-12.34	2.74	-.1185	-.05	1.78	12.47	2.74	.05	750.										
25.000	-13.37	2.77	-.1167	-.05	1.73	13.48	2.76	.13	744.										
26.000	-14.30	2.80	-.0069	-.12	1.79	14.41	2.79	.17	731.										
27.000	-15.04	3.06	-.0036	.01	1.92	15.16	3.05	.05	704.										
28.000	-15.47	3.17	-.0676	.15	1.86	15.58	3.15	.09	584.										
29.000	-15.93	3.36	-.0517	.21	2.10	16.07	3.34	.22	543.										
30.000	-16.37	3.30	-.0570	.11	2.08	16.51	3.26	.05	457.										
32.000	-20.93	3.57	-.0391	1.64	2.78	21.18	3.55	-.02	126.										
34.000	-21.71	4.96	-.2729	1.17	2.72	21.92	4.88	-.08	126.										
36.000	-23.34	5.34	-.0641	.72	3.07	23.56	5.30	-.26	129.										
38.000	-25.44	6.10	-.0518	.17	3.89	25.74	6.07	.10	130.										
40.000	-27.30	7.53	-.0218	.10	4.39	27.65	7.51	-.11	132.										
42.000	-30.51	7.68	-.0360	-.01	4.60	30.87	7.59	.38	132.										
44.000	-34.58	8.42	-.1267	1.02	4.68	34.91	8.40	.53	133.										
46.000	-36.66	7.63	-.0488	2.53	6.17	37.26	7.60	.01	133.										
48.000	-37.52	9.74	-.0958	4.78	7.50	38.62	9.45	-.15	133.										
50.000	-38.48	10.90	-.2193	6.08	7.71	39.80	10.64	-.20	133.										
52.000	-37.82	13.18	-.1219	6.07	8.79	39.47	12.64	-.44	132.										
54.000	-37.13	14.25	-.0231	6.34	9.36	39.02	13.64	.02	131.										
56.000	-36.07	17.96	-.0825	5.18	10.02	38.30	16.81	.12	129.										
58.000	-33.72	17.78	-.0014	4.34	10.48	36.15	16.55	.46	115.										
60.000	-32.06	17.75	-.0782	2.06	12.60	35.07	16.55	.25	85.										
62.000	-32.40	19.15	-.3019	1.15	13.68	35.85	17.77	-.17	67.										
64.000	-24.69	19.63	-.1932	3.23	15.19	30.66	17.04	.50	56.										
66.000	-16.35	19.05	-.0879	1.88	19.21	26.91	16.44	.61	54.										
68.000	-11.01	23.18	-.3064	1.46	20.89	27.11	18.72	.70	54.										
70.000	-1.94	21.64	-.2588	2.87	16.05	23.39	13.42	1.18	51.										

TABLE I-9. WIND STATISTICAL PARAMETERS

SEPTEMBER

STATION - 723930		VANDENBERG AFB			MEAN V	S.D. V	MEAN WS	S.D. WS	SKEW WS	NOBS
Z	MEAN U	S.D. U	R(U,V)	M/S	M/S	M/S	M/S			
KM	M/S	M/S								
.100	1.67	2.15	-.5420	-1.40	2.21	2.99	2.30	.96	764.	
1.000	-.33	2.68	-.2944	-1.48	4.41	4.69	2.83	.86	804.	
2.000	-.51	4.07	-.2976	-.09	5.11	5.54	3.50	1.32	838.	
3.000	.69	5.28	-.2091	.83	5.71	6.68	4.12	1.13	836.	
4.000	1.74	6.43	-.1358	1.14	6.36	7.79	5.05	1.08	839.	
5.000	3.01	7.36	-.10730	.96	7.09	8.89	5.93	1.10	837.	
6.000	4.29	8.51	.0216	.74	8.03	10.31	7.03	1.13	837.	
7.000	5.61	9.47	.1054	.85	8.99	12.04	7.60	.98	836.	
8.000	7.24	10.43	.1963	1.05	10.12	13.99	8.30	.90	835.	
9.000	9.08	11.53	.2876	1.43	11.33	16.16	9.30	.96	835.	
10.000	11.23	12.59	.3252	2.00	12.29	18.28	10.26	.75	837.	
11.000	13.62	13.46	.3314	2.53	12.84	20.29	11.23	.72	833.	
12.000	15.41	13.32	.3271	3.22	12.59	21.25	11.49	.78	830.	
13.000	15.83	12.26	.3367	3.61	11.73	20.72	11.06	.87	828.	
14.000	14.44	10.09	.2840	3.38	9.75	18.26	9.13	.70	826.	
15.000	11.79	8.18	.2573	2.66	7.80	14.87	7.25	.68	820.	
16.000	8.35	6.58	.2218	1.90	5.93	10.85	5.84	1.18	804.	
17.000	4.91	5.15	.1154	.97	4.46	7.29	4.28	1.12	781.	
18.000	1.81	4.31	.1047	.32	3.41	4.97	2.98	1.16	783.	
19.000	-.50	3.93	.1245	-.03	2.65	4.14	2.35	1.07	769.	
20.000	-2.03	3.73	.0977	-.24	2.16	4.23	2.21	.60	766.	
21.000	-3.35	3.55	.0410	-.35	2.10	4.78	2.36	.67	745.	
22.000	-4.28	3.43	.0944	-.39	1.84	5.24	2.47	.28	739.	
23.000	-5.05	3.72	.1103	-.38	1.74	5.93	2.70	.18	718.	
24.000	-5.72	4.20	.0730	-.38	1.94	6.64	3.17	.72	711.	
25.000	-6.21	4.33	.0970	-.18	1.89	7.08	3.27	.28	719.	
26.000	-6.75	4.71	.0670	-.10	1.96	7.63	3.60	.32	697.	
27.000	-7.09	5.12	.0550	.00	2.01	8.05	3.97	.36	634.	
28.000	-7.43	5.08	.0418	.17	1.88	8.33	3.89	.25	645.	
29.000	-7.60	5.25	.0066	.28	2.14	8.61	3.97	.37	501.	
30.000	-7.45	5.34	.0665	.24	2.17	8.45	4.16	.32	470.	
32.000	-9.04	5.80	.1580	1.46	2.87	10.01	5.03	.52	111.	
34.000	-7.35	5.84	.1810	2.60	3.33	9.27	4.45	.36	111.	
36.000	-5.06	6.75	.1430	1.06	3.33	8.28	5.07	.58	112.	
38.000	-6.80	7.35	-.0398	-.13	4.17	9.39	5.39	.51	112.	
40.000	-8.31	8.47	-.0810	-.73	4.00	10.96	6.05	.49	113.	
42.000	-9.74	8.52	-.0728	.50	5.06	12.12	6.77	.30	113.	
44.000	-10.59	8.82	-.0290	1.33	5.93	13.16	7.30	.47	113.	
46.000	-10.10	10.47	-.0130	2.60	5.46	13.75	7.64	.78	113.	
48.000	-8.38	11.60	-.0924	3.55	5.62	12.95	8.19	.93	112.	
50.000	-7.03	11.33	-.0344	4.33	6.78	13.28	8.07	.95	111.	
52.000	-4.97	12.70	.0056	4.44	6.81	13.28	8.63	1.05	107.	
54.000	-1.85	12.66	-.1756	5.94	6.23	13.65	7.06	.81	104.	
56.000	2.75	11.12	-.2022	5.08	7.52	13.08	6.40	.14	99.	
58.000	4.53	12.45	.0026	1.80	8.07	14.20	6.38	.60	86.	
60.000	4.56	15.02	.0640	2.55	8.38	15.81	8.36	.55	69.	
62.000	7.77	15.00	-.1038	5.83	7.52	16.70	9.63	.76	44.	
64.000	12.61	12.69	-.0533	6.51	8.79	19.22	8.13	.24	41.	
66.000	15.09	12.13	-.3377	5.69	9.80	20.97	7.65	.23	40.	
68.000	16.03	10.87	-.0277	4.23	9.21	19.49	9.77	.59	39.	
70.000	19.64	12.98	.2132	-1.21	11.05	23.00	12.04	.39	39.	

TABLE I-10. WIND STATISTICAL PARAMETERS

OCTOBER

STATION = 723930		VANDENBERG AFB		MEAN V		S. D. V		MEAN WS		S. D. WS		SKEW WS	NOBS
Z	MEAN U	S. D. U	R(U,V)	M/S	M/S	M/S	M/S	M/S	M/S	M/S			
KM	M/S	M/S											
.100	1.33	2.37	-.5680	-1.33	2.59	3.09	2.50	1.05	798.				
1.000	.08	2.99	-.1145	-1.95	5.17	5.26	3.42	1.07	831.				
2.000	.41	4.42	-.2822	-1.37	6.09	6.64	3.83	.86	855.				
3.000	1.88	5.88	-.2099	-1.56	7.07	8.14	4.92	1.09	856.				
4.000	3.64	7.45	-.1021	-1.93	8.38	10.13	6.32	1.05	857.				
5.000	5.24	8.73	.0179	-1.81	9.56	12.02	7.32	.95	857.				
6.000	6.73	9.92	.0721	-1.68	10.89	14.02	8.28	.90	857.				
7.000	8.22	11.15	.1195	-1.78	12.43	16.17	9.38	.84	857.				
8.000	9.67	12.37	.1756	-1.56	13.92	18.30	10.36	.75	855.				
9.000	11.24	13.38	.2584	-1.43	15.31	20.36	11.23	.62	855.				
10.000	12.88	13.98	.3149	-1.33	16.20	22.13	11.64	.53	854.				
11.000	14.79	14.37	.3318	-1.04	16.13	23.30	11.96	.54	851.				
12.000	16.46	14.11	.3489	-.78	15.18	23.59	12.01	.59	851.				
13.000	18.81	12.43	.2951	-.56	13.45	22.39	10.81	.38	851.				
14.000	15.89	10.88	.2651	-.28	11.56	20.25	9.71	.46	850.				
15.000	14.18	9.30	.2375	-.49	9.39	17.48	8.37	.46	845.				
16.000	11.67	7.68	.2132	-.69	7.35	14.16	6.99	.42	824.				
17.000	9.03	6.24	.2111	-.77	5.64	11.04	5.56	.50	801.				
18.000	6.37	5.39	.1738	-1.05	4.44	8.33	4.59	1.12	801.				
19.000	3.98	4.72	.2401	-1.28	3.52	6.28	3.56	1.15	792.				
20.000	2.59	4.28	.3313	-1.27	3.20	5.32	2.92	1.06	783.				
21.000	1.71	4.25	.2674	-1.25	2.92	4.76	2.91	1.31	757.				
22.000	1.61	4.23	.2175	-1.15	2.75	4.58	2.89	1.45	745.				
23.000	1.81	4.24	.2272	-.86	2.64	4.46	2.99	1.52	726.				
24.000	2.21	4.71	.1726	-.56	2.84	4.92	3.35	1.60	723.				
25.000	2.95	5.07	.1401	-.26	2.69	5.32	3.66	1.56	717.				
26.000	3.84	5.57	.2000	-.09	2.78	6.09	4.04	1.36	695.				
27.000	4.92	6.25	.1999	.07	2.91	7.05	4.69	1.38	635.				
28.000	6.66	6.71	.2085	.14	3.10	8.30	5.48	1.40	554.				
29.000	8.01	7.31	.2894	.16	3.31	9.57	6.08	1.38	511.				
30.000	9.11	7.92	.2934	.19	3.45	10.58	6.75	1.37	463.				
32.000	11.78	10.28	.2582	1.77	3.95	13.47	9.03	1.01	139.				
34.000	15.27	10.87	.2372	3.04	5.12	17.09	9.74	.83	139.				
36.000	19.74	11.16	.3395	2.89	5.41	20.91	10.70	.62	139.				
38.000	23.33	13.08	.4642	2.17	5.66	24.27	12.75	.34	139.				
40.000	26.38	14.48	.2461	.74	5.48	27.24	13.92	.20	140.				
42.000	28.73	16.24	.0407	.94	5.66	30.01	14.87	.05	140.				
44.000	31.20	15.03	-.0037	1.68	6.09	32.21	15.25	-.16	140.				
46.000	35.02	16.24	-.0444	3.90	7.41	36.32	15.51	-.27	139.				
48.000	39.43	16.64	.1350	5.95	8.41	40.99	16.16	-.58	139.				
50.000	42.13	18.27	.1543	7.22	8.19	43.92	17.26	-.42	138.				
52.000	45.35	18.06	.1817	7.76	8.80	46.95	17.76	-.33	135.				
54.000	47.55	17.94	.3327	8.12	8.82	49.02	18.25	-.34	132.				
56.000	50.09	17.10	.3883	8.59	8.72	51.44	17.47	-.38	131.				
58.000	50.39	18.01	.4785	7.76	9.83	51.80	18.35	-.26	124.				
60.000	52.31	18.43	.4057	8.18	10.67	53.94	18.60	.29	90.				
62.000	53.56	20.42	.6356	6.43	11.54	54.98	20.86	.19	65.				
64.000	54.17	23.12	.7104	7.67	12.39	55.68	24.07	.47	53.				
66.000	51.85	27.18	.5963	4.94	14.79	53.75	27.88	.45	53.				
68.000	47.25	32.81	.2508	3.92	15.54	51.04	30.88	.28	52.				
70.000	45.35	30.33	.0091	-.05	15.78	49.38	27.91	.14	48.				

TABLE I-11. WIND STATISTICAL PARAMETERS

NOVEMBER

STATION # 723930		VANCEMBERG AFB									
Z	MEAN U	S.D. U	R(U,V)	MEAN V	S.D. V	MEAN WS	S.D. WS	SKEW WS	NOBS		
KM	M/S	M/S		M/S	M/S	M/S	M/S				
.100	.82	2.61	-.5500	-1.29	3.09	3.53	2.49	1.19	844.		
1.000	.29	3.70	-.0846	-1.89	6.65	6.61	4.22	.96	874.		
2.000	2.12	4.91	-.0842	-1.89	7.64	8.23	4.78	.68	892.		
3.000	4.60	6.54	.0165	-2.43	8.79	10.64	5.81	.73	894.		
4.000	7.00	8.08	.0737	-2.50	9.96	13.07	6.99	.58	897.		
5.000	9.16	9.60	.1403	-2.43	11.21	15.40	8.37	.69	897.		
6.000	11.08	10.95	.2083	-2.40	12.84	17.92	9.60	.84	894.		
7.000	12.79	12.17	.2473	-2.67	14.56	20.38	10.74	.83	892.		
8.000	14.47	13.34	.2700	-2.75	15.74	22.57	11.52	.67	884.		
9.000	16.12	14.55	.3308	-2.82	17.33	24.81	12.80	.76	882.		
10.000	17.68	15.42	.3474	-3.04	18.19	26.64	12.42	.73	878.		
11.000	18.97	15.68	.3666	-3.24	18.07	27.67	13.31	.65	867.		
12.000	20.03	15.33	.3758	-2.91	17.23	27.79	12.99	.62	863.		
13.000	20.02	13.73	.3731	-2.58	15.15	26.36	11.41	.48	859.		
14.000	18.50	11.49	.3674	-1.97	12.54	23.34	9.50	.34	851.		
15.000	16.61	9.55	.3483	-1.86	10.66	20.40	8.22	.36	846.		
16.000	14.07	8.02	.3242	-1.55	8.62	17.01	7.05	.33	841.		
17.000	11.59	6.88	.3091	-1.66	7.13	14.06	6.12	.45	813.		
18.000	8.70	6.01	.2824	-1.71	5.61	10.93	5.15	.65	812.		
19.000	6.45	5.44	.2760	-1.75	4.62	8.70	4.48	1.00	802.		
20.000	4.84	5.23	.2189	-1.93	3.96	7.39	3.92	1.07	792.		
21.000	3.89	5.40	.1424	-2.02	3.55	6.82	3.79	.92	778.		
22.000	3.51	5.92	.1169	-2.04	3.48	6.90	4.00	1.45	773.		
23.000	3.66	6.40	.1783	-1.67	3.19	7.09	4.12	1.23	766.		
24.000	3.87	7.21	.1677	-1.37	3.20	7.60	4.61	1.06	762.		
25.000	4.86	7.95	.2661	-.99	3.33	8.46	5.21	1.11	751.		
26.000	5.95	9.07	.3901	-.84	3.29	9.46	6.31	1.08	731.		
27.000	7.08	10.64	.4473	-.64	3.53	10.89	7.58	1.09	669.		
28.000	9.03	12.20	.4895	-.58	4.01	13.02	8.78	.99	590.		
29.000	10.72	13.30	.5287	-.44	4.31	14.51	10.00	1.01	531.		
30.000	12.72	14.37	.5465	-.23	4.79	16.23	11.30	.96	512.		
32.000	20.05	15.95	.5868	1.99	5.63	21.79	14.72	.75	99.		
34.000	24.41	17.33	.5526	2.79	6.23	25.93	16.41	.70	99.		
36.000	29.23	16.78	.5215	3.65	7.42	30.62	16.31	.38	101.		
38.000	33.92	18.38	.6656	2.57	7.36	35.15	17.69	.30	101.		
40.000	37.76	19.32	.5942	1.65	7.62	38.74	18.92	.30	101.		
42.000	40.88	19.07	.5222	1.57	7.10	41.53	19.03	.16	100.		
44.000	45.81	19.82	.4125	2.27	7.98	46.58	19.74	.08	100.		
46.000	51.36	21.79	.3918	3.79	9.45	52.32	21.88	-.12	100.		
48.000	55.88	23.62	.3984	6.67	11.59	57.35	23.86	-.03	100.		
50.000	60.82	26.09	.3974	8.36	13.42	62.61	26.62	-.07	99.		
52.000	63.97	27.54	.4548	8.73	15.14	66.21	27.74	-.08	98.		
54.000	66.87	27.58	.3958	8.88	14.65	68.88	27.93	-.20	97.		
56.000	67.78	26.63	.3155	7.45	14.36	69.68	26.61	-.37	93.		
58.000	65.33	26.23	.2997	4.33	16.48	68.54	26.08	-.35	89.		
60.000	59.57	27.74	.3832	1.06	18.31	62.91	26.31	-.23	70.		
62.000	59.65	27.63	.5009	.58	21.46	63.43	27.35	.00	46.		
64.000	55.70	27.12	.6446	-3.02	19.57	59.46	26.14	.50	37.		
66.000	54.45	27.08	.6277	-3.28	26.06	61.06	25.27	.10	36.		
68.000	54.66	26.08	.5110	.51	23.59	60.08	24.44	.00	36.		
70.000	53.62	23.04	.5227	-2.04	23.51	59.15	21.10	.51	34.		

TABLE I-12. WIND STATISTICAL PARAMETERS

DECEMBER

STATION # 723930		VANDENBERG AFB								
Z	MEAN U	S.D. U	R(U,V)	MEAN V	S.D. V	MEAN WS	S.D. WS	SKEW WS	NOBS	
M	M/S	M/S		M/S	M/S	M/S	M/S			
.100	.47	2.70	-.5086	-1.11	3.00	3.50	2.34	1.09	852.	
1.000	.75	4.32	-.1554	-2.22	7.20	7.32	4.73	.93	909.	
2.000	3.07	5.64	-.0641	-3.01	8.20	9.36	5.47	.64	925.	
3.000	5.70	7.22	.0108	-3.81	9.29	11.81	6.77	.69	926.	
4.000	8.28	9.08	.0245	-4.42	11.16	14.83	8.64	.69	929.	
5.000	10.45	10.54	.0855	-4.57	12.42	17.23	9.92	.68	930.	
6.000	12.48	11.97	.1524	-4.86	14.10	19.85	11.28	.66	929.	
7.000	14.38	13.46	.2154	-5.32	15.81	22.48	12.68	.62	925.	
8.000	16.19	14.98	.2640	-5.55	17.13	24.83	13.92	.68	916.	
9.000	17.83	16.06	.3132	-5.73	18.01	26.86	14.54	.64	899.	
10.000	19.54	16.67	.3469	-5.98	18.71	28.64	15.00	.65	883.	
11.000	20.87	16.62	.3358	-5.98	18.00	29.29	14.58	.52	871.	
12.000	21.83	15.39	.3053	-5.46	16.76	28.87	13.80	.51	863.	
13.000	21.46	13.56	.3114	-4.52	14.59	26.90	12.40	.53	859.	
14.000	20.02	11.53	.3466	-3.53	12.71	24.40	10.59	.48	855.	
15.000	17.88	9.76	.3318	-3.05	10.52	21.40	8.77	.44	847.	
16.000	15.03	8.16	.3571	-2.71	8.98	18.05	7.39	.64	837.	
17.000	12.30	7.06	.3608	-2.57	7.55	14.96	6.39	.92	800.	
18.000	9.23	6.12	.3731	-2.39	6.03	11.60	5.48	1.09	799.	
19.000	6.38	5.74	.3025	-2.61	4.89	9.01	4.81	1.02	792.	
20.000	4.08	5.53	.3206	-2.70	3.94	7.19	4.29	1.32	783.	
21.000	2.40	5.73	.2456	-2.80	3.66	6.60	4.04	1.08	736.	
22.000	1.29	6.67	.2611	-2.66	3.79	7.05	4.21	1.45	725.	
23.000	.57	7.28	.2533	-2.50	3.65	7.37	4.30	1.70	718.	
24.000	.04	7.84	.2537	-2.66	3.59	7.87	4.42	1.02	730.	
25.000	.29	8.52	.3017	-2.53	3.99	8.64	5.23	1.26	720.	
26.000	.88	10.42	.3533	-2.40	4.54	9.66	6.50	1.44	709.	
27.000	2.38	12.18	.3958	-2.28	4.92	11.06	7.81	1.30	637.	
28.000	3.62	13.59	.4837	-2.42	5.48	12.33	9.03	1.38	595.	
29.000	5.83	15.43	.5419	-2.49	6.14	14.46	10.32	1.44	523.	
30.000	8.38	16.91	.5405	-2.64	7.07	16.65	11.64	1.38	561.	
32.000	12.87	21.23	.6253	-2.34	7.42	21.88	14.00	.80	142.	
34.000	20.56	24.50	.6840	-1.05	8.81	29.30	15.63	.51	143.	
36.000	28.66	25.74	.7000	-.13	9.80	35.73	17.31	.11	144.	
38.000	37.02	26.54	.6913	.07	10.53	42.70	18.95	-.13	144.	
40.000	43.95	26.37	.6860	.35	11.28	48.78	19.28	-.32	144.	
42.000	50.11	27.07	.5720	3.43	13.29	55.02	20.04	-.52	144.	
44.000	57.63	27.50	.4416	6.39	14.22	62.63	19.84	-.69	144.	
46.000	64.73	27.95	.3451	9.57	16.10	70.04	20.27	-.68	144.	
48.000	70.51	28.56	.3387	12.84	16.79	75.97	21.70	-.45	143.	
50.000	73.94	29.62	.2949	14.41	18.13	79.41	23.89	-.25	142.	
52.000	75.62	30.96	.2607	15.44	19.46	81.11	25.93	-.23	141.	
54.000	77.17	31.75	.2244	15.11	18.57	82.09	28.16	-.23	140.	
56.000	78.83	31.51	.1994	12.03	18.45	82.44	29.86	-.28	135.	
58.000	78.38	31.65	.2741	11.21	21.12	82.31	30.62	-.07	121.	
60.000	75.95	33.96	.3312	8.85	24.06	80.70	32.33	.01	87.	
62.000	73.71	31.37	.3101	3.57	28.78	79.15	31.26	-.35	48.	
64.000	72.26	29.19	.5334	9.03	22.48	75.79	30.06	-.43	39.	
66.000	69.46	30.01	.4224	6.60	23.29	73.37	30.26	-.32	38.	
68.000	69.20	31.20	.2920	4.05	25.52	73.75	31.19	-.39	36.	
70.000	68.55	32.93	.3178	1.09	25.67	73.32	32.34	-.06	34.	

TABLE I-13. WIND STATISTICAL PARAMETERS

ANNUAL

STATION • 723930	VANDENBERG AFB									
Z	MEAN U	S.D. U	R(U,V)	MEAN V	S.D. V	MEAN WS	S.D. WS	SKEW WS	NOBS	
KM	M/S	M/S		M/S	M/S	M/S	M/S			
.100	1.47	2.60	-.5816	-1.53	2.90	3.57	2.64	1.04	9452.	
1.000	.63	3.60	-.1568	-2.41	5.77	6.11	3.89	1.11	9890.	
2.000	1.56	4.75	-.1587	-1.99	6.62	7.18	4.60	1.01	10225.	
3.000	3.65	6.31	-.1216	-1.77	7.75	9.03	5.97	1.08	10236.	
4.000	5.60	7.94	-.0826	-1.66	8.93	11.12	7.33	1.07	10261.	
5.000	7.34	9.40	-.0205	-1.46	9.97	13.00	8.64	1.06	10262.	
6.000	8.98	10.74	.0299	-1.40	11.21	15.01	9.92	1.03	10245.	
7.000	10.62	11.97	.0758	-1.43	12.59	17.13	11.09	1.01	10230.	
8.000	12.20	13.15	.1103	-1.38	13.85	19.22	12.10	.95	10191.	
9.000	13.84	14.17	.1570	-1.22	15.01	21.30	12.87	.87	10140.	
10.000	15.61	14.97	.1737	-1.00	15.83	23.24	13.39	.80	10107.	
11.000	17.24	15.13	.1701	-.58	15.86	24.54	13.26	.68	10016.	
12.000	18.53	14.54	.1538	.09	15.12	24.91	12.77	.66	9954.	
13.000	18.56	12.93	.1200	.80	13.44	23.74	11.38	.57	9921.	
14.000	17.30	11.22	.0662	1.15	11.47	21.44	9.94	.53	9503.	
15.000	14.94	9.63	.0471	.96	9.47	18.27	8.53	.53	9804.	
16.000	12.01	8.52	.0077	.61	7.64	14.80	7.53	.62	9725.	
17.000	9.02	7.74	-.0195	.14	6.11	11.64	6.56	.72	9429.	
18.000	5.94	7.16	-.0386	-.23	4.87	8.98	5.45	1.04	9439.	
19.000	3.22	6.71	-.0529	-.55	3.94	7.24	4.34	1.19	9344.	
20.000	1.14	6.44	-.0648	-.76	3.37	6.42	3.67	1.22	9240.	
21.000	-.51	6.51	-.0936	-.91	3.09	6.32	3.61	1.03	8770.	
22.000	-1.62	6.82	-.0651	-1.05	2.93	6.69	3.74	.95	8851.	
23.000	-2.29	7.32	-.0165	-1.02	2.76	7.16	4.03	.84	8703.	
24.000	-2.74	8.05	.0272	-.95	2.89	7.80	4.95	.75	8570.	
25.000	-2.76	8.93	.0691	-.85	2.94	8.47	4.59	.80	8616.	
26.000	-2.55	9.98	.1212	-.78	3.09	9.26	5.54	.87	8420.	
27.000	-2.12	11.25	.1632	-.68	3.35	10.23	6.17	.93	7726.	
28.000	-1.05	12.58	.2048	-.66	3.70	11.33	6.73	1.09	6855.	
29.000	-.35	14.00	.2279	-.58	4.04	12.59	7.34	1.25	6208.	
30.000	.75	15.44	.2476	-.56	4.40	13.76	8.33	1.33	5953.	
32.000	1.86	18.75	.2049	.77	5.00	16.64	10.20	.92	1682.	
34.000	4.47	21.73	.2656	1.23	5.77	19.58	12.00	.91	1684.	
36.000	6.61	24.96	.3443	1.02	6.32	22.62	14.02	.77	1693.	
38.000	8.03	28.50	.3100	.56	7.03	25.82	16.14	.74	1703.	
40.000	8.58	31.46	.2589	.18	7.71	28.56	17.54	.66	1707.	
42.000	8.54	34.29	.2551	1.04	8.87	31.30	18.69	.57	1706.	
44.000	9.19	37.49	.2432	2.89	10.00	34.70	19.87	.52	1706.	
46.000	10.68	40.70	.2515	5.12	11.07	38.16	21.53	.59	1704.	
48.000	12.13	43.40	.2847	6.76	11.40	40.97	22.97	.61	1700.	
50.000	12.84	45.55	.2762	7.74	12.09	43.12	24.24	.64	1689.	
52.000	13.80	46.84	.2790	8.05	12.34	44.38	25.15	.61	1660.	
54.000	14.68	48.28	.2859	8.04	12.46	45.88	25.75	.63	1611.	
56.000	15.49	50.13	.2636	7.58	12.52	47.73	26.27	.51	1540.	
58.000	17.08	50.98	.2656	6.51	13.80	48.98	26.94	.49	1357.	
60.000	18.00	51.93	.2553	5.53	15.53	50.18	27.87	.50	980.	
62.000	15.99	54.20	.1856	5.68	16.00	51.61	28.66	.36	664.	
64.000	18.00	53.88	.1534	5.86	15.03	50.85	30.10	.53	558.	
66.000	20.32	52.06	.0449	4.29	16.46	49.69	30.80	.84	540.	
68.000	20.92	49.61	-.0077	2.54	17.25	47.22	31.21	.64	526.	
70.000	21.34	45.89	-.0695	.33	17.70	44.62	29.84	.77	503.	

TABLE II-1. THERMODYNAMIC STATISTICAL PARAMETERS

JANUARY

STATION # 723930		VANDEBERG AFB		S.D. T		SKEW T		MEAN T		S.D. K		S.D. T		SKEW T		MEAN D		S.D. D		SKEW D		NOBS P		NOBS T		NOBS D		
Z	KM	MEAN P	MB	S.D. P	MB	DEG K	DEG K	DEG K	DEG K	DEG K	DEG K	DEG K	DEG K	DEG K	DEG K	G/M3	G/M3	G/M3	G/M3	G/M3	G/M3	G/M3	G/M3	G/M3	G/M3	G/M3	G/M3	G/M3
.000	1018.9200	4.5834	-71	284.73	4.67	.09	1242.0000	22.6600	.24	854.	854.																	
.100	1006.7000	4.4834	-74	284.39	4.52	.12	1229.0000	21.4500	.22	867.	867.																	
1.000	304.3100	4.6171	-69	283.07	5.23	.25	1111.0000	18.2200	-.08	884.	884.																	
2.000	800.9300	5.2231	-51	278.50	5.22	-.30	1001.0000	14.5000	.46	884.	884.																	
3.000	707.9500	5.3265	-44	273.34	4.96	-.71	901.5000	11.0700	1.51	884.	884.																	
4.000	623.9300	6.4647	-49	267.42	4.76	-.69	812.3000	8.2560	.56	884.	884.																	
5.000	548.4700	6.8525	-50	260.79	4.77	-.69	732.0000	6.9630	.21	884.	884.																	
6.000	480.7100	7.0749	-56	253.71	4.73	-.94	653.9000	5.9010	-.28	884.	884.																	
7.000	419.3200	7.0280	-55	246.22	4.67	-.38	593.5000	5.4340	-.36	883.	883.																	
8.000	364.5700	6.9633	-53	239.53	4.51	-.25	532.0000	5.3150	-.76	883.	883.																	
9.000	315.3400	6.7476	-46	230.89	4.20	-.09	475.8000	6.0630	-1.53	880.	880.																	
10.000	271.4700	6.7052	-32	223.63	3.76	-.70	422.8000	7.9030	-1.29	880.	880.																	
11.000	232.7600	5.6256	-14	218.05	4.04	.46	372.0000	10.6800	-1.79	878.	878.																	
12.000	199.9500	4.7300	.02	215.13	5.45	.19	322.4000	12.5700	-.47	876.	876.																	
13.000	169.8600	3.8020	.13	214.43	5.46	-.19	276.2000	11.0700	.15	872.	872.																	
14.000	144.0900	3.0097	.22	213.55	4.32	-.21	236.5000	8.3630	.25	864.	864.																	
15.000	123.4700	2.3442	.22	211.62	3.97	-.05	203.4000	6.8620	.25	858.	858.																	
16.000	105.1000	1.8014	.22	209.52	4.16	-.04	174.8000	5.8190	.23	855.	855.																	
17.000	89.3350	1.3620	.23	208.47	4.22	-.04	149.4000	4.7190	.27	832.	832.																	
18.000	75.9040	1.0140	.07	208.43	4.07	-.18	126.9000	3.5850	.35	827.	827.																	
19.000	64.5320	.8000	.03	209.46	3.68	-.31	107.4000	2.5090	.37	802.	802.																	
20.000	54.9170	.6701	.01	210.71	3.51	-.41	90.6200	1.7930	.27	785.	785.																	
21.000	46.7660	.5933	-.05	212.09	3.49	-.51	76.6100	1.3190	.19	630.	630.																	
22.000	39.8800	.5581	-.14	213.41	3.52	-.46	65.1100	.9828	.13	615.	615.																	
23.000	34.0390	.5250	-.19	214.54	3.54	-.48	55.6600	.7726	.21	606.	606.																	
24.000	29.0870	.4854	-.30	215.67	3.52	-.54	46.5600	.6408	-.01	714.	714.																	
25.000	24.8890	.4655	-.26	216.91	3.52	-.34	39.9700	.5511	-.19	714.	714.																	
26.000	21.3330	.4328	-.23	218.09	3.52	-.40	34.3700	.4783	-.25	703.	703.																	
27.000	18.2370	.4005	-.22	219.25	3.55	-.29	28.9400	.4253	-.27	554.	554.																	
28.000	15.6360	.3666	-.22	220.64	3.55	-.01	24.1900	.4536	-.44	508.	508.																	
29.000	13.4260	.3291	-.23	222.11	3.77	.25	17.9700	.4160	-.36	483.	483.																	
30.000	11.5460	.2943	-.19	223.83	3.96	.41	13.6200	.4154	-.40	473.	473.																	
32.000	6.6061	.1945	.31	230.25	5.67	.04	9.5370	.3328	-.29	145.	145.																	
34.000	6.4435	.1536	.45	235.52	6.79	.19	7.1270	.2771	-.22	150.	150.																	
36.000	4.8520	.1253	.19	240.68	8.53	.31	5.6080	.2000	-.39	150.	150.																	
38.000	3.6753	.1065	-.32	246.15	10.01	-.14	3.6870	.1353	-.15	150.	150.																	
40.000	2.8014	.0964	-.65	251.19	10.12	-.35	2.9090	.1102	-.04	150.	150.																	
42.000	2.1435	.0872	-.75	257.35	10.35	-.31	2.1970	.0924	-.41	150.	150.																	
44.000	1.6568	.0752	-.75	262.97	9.53	-.16	1.6220	.0769	-.12	149.	149.																	
46.000	1.2667	.0636	-.69	268.34	8.93	-.75	1.2090	.0595	-.19	149.	149.																	
48.000	.9995	.0529	-.50	273.70	7.41	-.20	1.0270	.0544	-.82	148.	148.																	
50.000	.7753	.0438	-.54	279.73	6.40	-.03	.8051	.0447	-.99	148.	148.																	
52.000	.5982	.0353	-.53	283.32	6.25	-.13	.6260	.0366	-.75	146.	146.																	
54.000	.4618	.0216	-.33	287.62	5.59	.46	.4859	.0293	-.50	142.	142.																	
56.000	.3559	.0216	-.06	293.30	6.48	.00	.3748	.0219	-.13	123.	123.																	
58.000	.2729	.0166	.11	293.67	6.40	.38	.2890	.0173	-.09	91.	91.																	
60.000	.2083	.0133	.20	291.11	5.77	.57	.2192	.0117	-.22	53.	53.																	
62.000	.1544	.0094	.36	285.33	4.40	1.49	.1686	.0094	-.64	47.	47.																	
64.000	.1164	.0077	.58	280.59	11.03	1.43	.1300	.0055	-.07	41.	41.																	
66.000	.0837	.0052	.93	274.89	13.65	1.53	.0997	.0055	-.58	39.	39.																	
68.000	.0653	.0060	.93	227.98	14.55	1.53	.0997	.0055	-.58	39.	39.																	
70.000	.0479	.0034	-.22	222.98	9.25	.02	.0749	.0049	-.48	36.	36.																	

TABLE II-2. THERMODYNAMIC STATISTICAL PARAMETERS

FEBRUARY

STATION Z KM	MEAN D		S.D. P MB	SKEW P	MEAN T DEG K	S.D. T DEG K	SKEW T	MEAN D G/M ³	S.D. D G/M ³	SKEW D	MOBS P	MOBS T	MOBS D
	MB	MB											
1.000	1018.7000	1.4404	-1.07	284.99	4.10	.14	1241.0000	19.5800	.18	763.	763.	763.	
1.100	1059.0000	4.3109	-1.10	284.61	3.94	.19	1228.5000	18.3800	.13	771.	771.	771.	
1.200	963.8900	4.4051	-1.09	282.05	4.76	.39	1112.0000	16.3500	-.28	784.	784.	784.	
2.000	860.3500	4.9132	-.82	277.88	4.73	-.05	1002.0000	13.0000	.10	784.	784.	784.	
3.000	707.2300	5.4004	-.64	272.52	4.45	-.49	903.5000	9.8400	.77	784.	784.	784.	
4.000	623.0000	5.9714	-.64	266.54	4.28	-.72	813.9000	7.5200	.78	783.	783.	783.	
5.000	547.8400	6.2079	-.63	260.86	4.36	-.84	733.7000	6.4460	.46	783.	783.	783.	
6.000	479.5000	6.5189	-.67	252.70	4.45	-.84	661.0000	5.7940	.00	784.	784.	784.	
7.000	418.0700	6.4572	-.69	245.15	4.43	-.71	594.1000	5.1800	-.17	783.	783.	783.	
8.000	363.2600	6.4573	-.71	237.53	4.23	-.45	532.8000	5.0290	-.88	781.	781.	781.	
9.000	314.0500	6.2512	-.63	230.00	3.94	.09	475.7000	6.3230	-.17	780.	780.	780.	
10.000	270.2100	5.7684	-.48	222.98	3.89	.63	422.2000	8.5220	-.77	779.	779.	779.	
11.000	231.5800	5.1107	-.30	217.47	4.75	.84	371.1000	11.0000	-.12	777.	777.	777.	
12.000	197.9300	4.3359	-.15	215.42	6.12	.47	320.4000	12.1900	-.46	772.	772.	772.	
13.000	169.0200	3.5969	-.04	215.60	5.14	-.45	273.3000	9.6220	.21	767.	767.	767.	
14.000	144.3200	2.9773	.00	214.58	3.62	-.29	234.9000	7.2330	.10	759.	759.	759.	
15.000	123.0700	2.3640	-.04	212.49	3.39	-.01	201.9000	6.3300	.11	758.	758.	758.	
16.000	104.8300	1.8609	-.11	210.43	3.76	-.15	173.6000	5.6110	-.18	754.	754.	754.	
17.000	89.1740	1.4291	-.17	209.14	3.91	-.22	148.6000	4.6230	.17	741.	741.	741.	
18.000	75.8140	1.0940	-.21	208.96	3.81	-.24	126.5000	3.5630	.17	739.	739.	739.	
19.000	64.4860	.8673	-.20	209.78	3.34	-.15	107.1000	2.5210	.02	731.	731.	731.	
20.000	54.8850	.7179	-.09	210.98	3.03	.09	90.6500	1.7820	-.23	725.	725.	725.	
21.000	46.7200	.6274	.14	212.18	2.30	.66	76.7200	1.3480	-.29	589.	589.	589.	
22.000	39.8350	.5347	.05	213.28	2.83	-.03	65.0700	1.0130	-.25	574.	574.	574.	
23.000	34.0000	.4632	.10	214.24	2.93	-.01	55.2900	.8582	-.29	563.	563.	563.	
24.000	29.0700	.4432	.08	215.47	3.09	.03	47.0000	.6428	-.22	660.	660.	660.	
25.000	24.8860	.4267	.33	216.62	3.08	-.16	39.9900	.5172	-.08	644.	644.	644.	
26.000	21.2000	.3965	.34	217.88	3.14	-.26	34.0200	.4606	-.11	634.	634.	634.	
27.000	18.2180	.3720	.47	219.20	3.10	-.38	29.1400	.4423	.17	494.	494.	494.	
28.000	15.6050	.3349	.26	220.77	3.29	-.60	24.6200	.4209	.08	449.	449.	449.	
29.000	13.3400	.2984	.28	222.05	3.14	-.49	20.9000	.3684	-.21	420.	420.	420.	
30.000	11.5600	.2673	.20	224.76	3.35	-.46	17.9600	.3633	.12	411.	411.	411.	
32.000	8.6740	.2254	.33	232.40	5.30	-.01	13.0200	.3618	.21	142.	142.	142.	
34.000	6.5042	.1720	.13	237.98	5.97	-.37	9.5200	.3225	.20	140.	140.	140.	
36.000	4.9118	.1371	.08	244.57	7.23	-.14	7.0010	.2634	-.11	141.	141.	141.	
38.000	3.7407	.1103	.00	250.62	8.26	-.15	5.2300	.1932	-.23	142.	142.	142.	
40.000	2.8650	.0932	-.10	255.53	9.07	-.03	3.9000	.1496	-.37	142.	142.	142.	
42.000	2.2058	.0794	-.21	260.09	8.84	-.08	2.9500	.1051	-.07	142.	142.	142.	
44.000	1.7045	.0600	-.28	263.08	7.70	.01	2.2500	.0785	.12	141.	141.	141.	
46.000	1.3205	.0494	-.27	264.81	6.68	-.02	1.7510	.0637	-.37	143.	143.	143.	
48.000	1.0208	.0405	-.32	265.81	6.68	-.02	1.3510	.0563	-.67	141.	141.	141.	
50.000	.7928	.0348	-.05	262.79	6.43	-.15	1.0510	.0463	-.48	140.	140.	140.	
52.000	.6129	.0276	.06	261.31	6.28	-.07	.8179	.0396	-.32	137.	137.	137.	
54.000	.4731	.0205	.05	259.15	5.57	.23	.6341	.0335	-.34	139.	139.	139.	
56.000	.3652	.0168	.27	260.33	5.93	-.04	.4946	.0266	-.17	128.	128.	128.	
58.000	.2810	.0168	.38	255.31	6.95	-.11	.3935	.0215	.18	112.	112.	112.	
60.000	.2158	.0137	.37	254.07	8.43	-.07	.2930	.0162	-.09	89.	89.	89.	
62.000	.1677	.0103	.45	243.64	9.41	.39	.2215	.0110	.03	52.	52.	52.	
64.000	.1217	.0079	.50	241.53	8.63	.26	.1748	.0088	-.09	36.	36.	36.	
66.000	.0903	.0053	.64	235.15	9.73	.95	.1341	.0062	.40	31.	31.	31.	
68.000	.0692	.0046	.76	229.56	12.28	.63	.1048	.0084	.96	31.	31.	31.	
70.000	.0505	.0035	.81	220.49	9.49	-.07	.0730	.0053	.24	24.	24.	24.	

TABLE II-3. THERMODYNAMIC STATISTICAL PARAMETERS

MARCH

STATION Z KM	VANDENBERG AFB		S.D. T DEC K	SKEW T	MEAN T G/M3	S.D. D G/M3	SKEW D	NOBS P	NOBS T	NOBS D
	MEAN P MB	SKEW P								
0.000	1017.5000	4.0929	3.72	.13	1240.0000	18.1000	.13	847.	847.	847.
.100	1005.7000	4.0176	3.60	.13	1227.0000	17.1400	.14	869.	869.	869.
2.000	902.9200	4.2319	5.14	-.31	1111.0000	18.3800	-.31	885.	885.	885.
3.000	793.4300	4.8518	5.28	-.25	1001.0000	15.2400	.22	887.	887.	887.
4.000	706.5200	5.5355	4.87	-.56	901.9000	11.0600	.59	887.	887.	887.
5.000	622.3900	6.1523	4.53	-.78	812.3000	8.4450	.66	886.	886.	886.
6.000	547.0300	6.5288	4.54	-.66	732.3000	6.7070	.48	886.	886.	886.
7.000	479.2300	6.7882	4.52	-.84	660.0000	5.6500	-.14	886.	886.	886.
8.000	417.7800	6.9558	4.44	-.74	593.0000	4.9380	-.46	886.	886.	886.
9.000	363.0100	7.0553	4.12	-.33	532.0000	5.1440	-1.25	885.	885.	885.
10.000	313.6800	7.1277	3.69	-.05	474.9000	6.4990	-1.87	884.	884.	884.
11.000	270.1200	7.1899	3.42	.23	421.5000	8.7080	-1.63	884.	884.	884.
12.000	197.9500	7.2329	3.32	.92	370.3000	11.0400	-1.16	883.	883.	883.
13.000	169.0400	7.2536	5.42	.37	320.5000	12.4600	-.39	880.	880.	880.
14.000	144.3300	7.2611	5.28	-.50	273.7000	10.4100	.30	879.	879.	879.
15.000	123.1000	7.2654	3.85	-.47	234.2000	7.2180	.21	875.	875.	875.
16.000	104.9100	7.2689	3.38	-.14	201.4000	5.7080	.12	872.	872.	872.
17.000	89.3120	7.2700	3.39	-.14	173.1000	4.7260	.14	870.	870.	870.
18.000	76.0010	7.2700	2.82	-.31	126.0000	2.8510	.23	857.	857.	857.
19.000	64.7120	7.2700	2.73	-.24	106.8000	2.0430	.10	843.	843.	843.
20.000	55.1250	7.2700	2.58	-.06	76.8100	1.1490	-.14	689.	689.	689.
21.000	46.9120	7.2700	2.53	-.04	55.3200	.8914	-.17	672.	672.	672.
22.000	40.0840	7.2700	2.56	-.20	47.0400	.5455	-.23	765.	765.	765.
23.000	34.2480	7.2700	2.66	.27	40.0400	.4616	-.13	754.	754.	754.
24.000	29.3000	7.2700	2.66	.31	34.0800	.4199	-.13	744.	744.	744.
25.000	25.0860	7.2700	3.11	.47	29.0000	.3741	-.14	609.	609.	609.
26.000	21.4900	7.2700	3.53	.55	24.7000	.3401	.02	562.	562.	562.
27.000	18.4350	7.2700	3.90	.61	21.0600	.3269	.00	533.	533.	533.
28.000	15.8320	7.2700	4.11	.52	17.9700	.3054	-.05	523.	523.	523.
29.000	13.6200	7.2700	5.89	.79	13.1500	.2873	.21	119.	119.	119.
30.000	11.7250	7.2700	6.27	.82	9.6960	.2397	.40	116.	116.	116.
31.000	10.1187	7.2700	6.18	.00	7.1620	.2126	.31	115.	115.	115.
32.000	8.6178	7.2700	6.18	.01	5.3620	.1596	.29	116.	116.	116.
33.000	7.2963	7.2700	6.13	.39	4.0050	.1292	.79	116.	116.	116.
34.000	6.1382	7.2700	5.15	.16	3.0290	.0868	.57	116.	116.	116.
35.000	5.0187	7.2700	5.29	-.10	1.7630	.0699	.53	116.	116.	116.
36.000	4.0178	7.2700	5.83	-.19	1.3610	.0594	.44	115.	115.	115.
37.000	3.2163	7.2700	5.30	-.84	1.0580	.0440	.44	115.	115.	115.
38.000	2.6173	7.2700	5.30	-.26	.8445	.0371	.22	113.	113.	113.
39.000	2.1410	7.2700	5.01	-.07	.6438	.0305	-.02	110.	110.	110.
40.000	1.7296	7.2700	6.10	.07	.5035	.0239	-.18	105.	105.	105.
41.000	1.3376	7.2700	6.31	-.08	.3836	.0192	-.12	95.	95.	95.
42.000	1.0306	7.2700	7.52	-.07	.3018	.0148	-.34	65.	65.	65.
43.000	.8073	7.2700	7.80	.42	.2344	.0106	.55	51.	51.	51.
44.000	.6273	7.2700	8.02	1.17	.1813	.0077	.34	32.	32.	32.
45.000	.4963	7.2700	10.89	1.09	.1375	.0054	.82	25.	25.	25.
46.000	.3759	7.2700	10.89	.62	.1089	.0037	.56	24.	24.	24.
47.000	.2908	7.2700	10.05	.22	.0825	.0046	1.43	21.	21.	21.

TABLE II-4 THERMODYNAMIC STATISTICAL PARAMETERS

APRIL

STATION Z KM	MEAN P		S.D. P		SKEW P		MEAN T DEG K	S.D. T DEG K	SKEW T	MEAN D G/M3	S.D. D G/M3	SKEW D	NOBS P	NOBS T	NOBS D
	MB	MM	MB	MM	MB	MM									
100	1017	1000	3.0	49	-05	29	29	3.63	.23	1239	16	8200	809	809	809
100	1005	9700	2	58	-06	29	52	3.51	.25	1226	16	8000	829	829	829
1000	900	5000	3	59	-18	29	19	5.40	.17	1109	19	6700	831	831	831
2000	700	4000	3	109	-38	27	97	5.42	-0.30	999	20	1500	832	832	832
3000	705	6000	4	61	-51	27	49	5.22	-0.72	899	20	12500	832	832	832
4000	622	8100	5	3	-72	27	70	5.28	-1.10	810	20	161500	832	832	832
5000	57	5000	5	9125	-88	26	120	4.96	-1.28	730	20	77810	832	832	832
6000	480	6200	6	237	-100	25	09	4.63	-1.34	658	20	60510	830	830	830
7000	418	7000	6	374	-105	24	62	4.18	-1.05	591	20	48130	831	831	831
8000	36	1000	6	1182	-104	23	16	3.57	-0.52	530	20	57430	828	828	828
9000	315	1900	5	697	-91	23	65	3.23	-0.14	474	20	6000	828	828	828
10000	271	4000	5	2712	-72	22	56	2.84	-0.19	421	20	8300	828	828	828
11000	232	6100	4	5112	-49	21	50	3.36	1.11	371	20	9000	826	826	826
12000	199	8300	3	6633	-21	21	73	4.73	.83	323	20	111900	826	826	826
13000	163	8600	2	8157	-03	21	32	5.18	-0.2	276	20	99350	822	822	822
14000	144	9000	2	1630	.16	21	32	4.00	-.34	235	20	6830	819	819	819
15000	123	6400	1	6836	.21	21	49	3.26	-.05	201	20	50370	818	818	818
16000	105	4500	1	3150	.22	21	18	3.29	-.09	173	20	41570	818	818	818
17000	89	8300	1	676	.24	21	00	3.09	-.16	147	20	32960	793	793	793
18000	65	2430	1	6095	.21	21	73	2.66	-.18	106	20	17790	782	782	782
20000	55	6370	1	5041	.23	21	37	2.41	-.09	90	20	13090	776	776	776
21000	47	4680	1	5043	.24	21	65	2.58	-.04	77	20	10740	634	634	634
22000	40	3720	1	4535	.22	21	04	2.70	-.18	65	20	8828	627	627	627
23000	34	7070	1	4182	.18	21	48	2.65	-.03	55	20	6895	620	620	620
24000	29	6020	1	3566	.19	21	67	2.66	-.10	47	20	5303	697	697	697
25000	25	4620	1	3709	.20	22	17	2.75	-.04	40	20	4714	719	719	719
26000	21	4050	1	3482	.17	22	83	2.75	-.04	34	20	4232	712	712	712
27000	18	3950	1	3273	.18	23	81	3.13	-.02	29	20	3733	574	574	574
28000	16	1700	1	2841	.11	22	72	3.21	.03	24	20	3345	529	529	529
29000	13	9370	1	2614	.11	22	72	3.29	-.05	21	20	3049	506	506	506
30000	12	8190	1	2413	.00	22	83	3.32	.01	18	20	2877	500	500	500
32000	9	6443	1	2233	.16	23	47	4.23	.13	13	20	2902	123	123	123
34000	6	440	1	1869	-.02	24	96	4.44	-.09	9	20	2575	122	122	122
35000	5	1778	1	1513	-.19	24	57	5.25	.62	7	20	2293	122	122	122
36000	3	9476	1	1218	-.30	25	87	4.73	-.34	5	20	1528	123	123	123
40000	3	8049	1	6924	-.34	26	14	4.82	.06	4	20	1102	124	124	124
42000	2	3321	1	6787	-.31	26	93	4.79	.10	3	20	1100	124	124	124
44000	1	8079	1	6095	-.22	26	73	4.61	.14	2	20	1079	124	124	124
46000	1	4208	1	6095	-.12	26	26	4.79	-.43	1	20	1047	124	124	124
48000	1	2951	1	6099	-.02	26	10	4.97	-.17	1	20	1040	124	124	124
50000	1	2533	1	6034	.09	26	10	4.48	-.56	1	20	1038	123	123	123
52000	1	2245	1	6073	.16	26	13	4.47	-.17	1	20	1032	123	123	123
54000	1	2167	1	6078	.23	26	18	5.10	-.04	1	20	1020	124	124	124
56000	1	2007	1	6165	.27	26	24	5.73	-.55	1	20	1008	120	120	120
58000	1	1945	1	6132	.41	26	22	6.18	-.70	1	20	1004	115	115	115
60000	1	1895	1	6129	.54	26	23	7.78	-.51	1	20	1024	110	110	110
62000	1	1738	1	6099	.23	25	05	9.86	-.14	1	20	1006	84	84	84
64000	1	1652	1	6069	-.13	24	21	8.98	1.11	1	20	1006	51	51	51
66000	1	1520	1	6059	.15	24	67	9.15	1.96	1	20	1007	48	48	48
68000	1	1470	1	6046	1.56	24	92	12.27	1.69	1	20	1005	39	39	39
70000	1	1363	1	6036	.95	24	16	11.06	1.53	1	20	1004	30	30	30

TABLE II-5. THERMODYNAMIC STATISTICAL PARAMETERS

MAY

STATION Z	STATION • 722933		YANSENBERG AFB		S.O. T DEG K	SKEW T	MEAN D G/M3	S.O. D G/M3	SKEW D	NOBS P	NOBS T	NOBS D
	KB	MEAN P	S.D. P	SKEW P								
.000	1015.3000	2.8820	.05	285.81	3.43	.67	1233.0000	15.3900	-.51	859.	859.	859.
.100	1003.8000	2.8118	-.01	285.64	3.33	.69	1219.0000	14.8600	-.52	880.	880.	880.
1.000	902.0100	2.8499	-.27	287.35	5.92	.00	1091.0000	21.6100	.02	888.	888.	888.
3.000	800.5000	3.4742	-.55	283.44	5.21	-.51	982.6000	15.8500	.48	890.	890.	890.
4.000	708.9900	4.1555	-.72	277.84	4.64	-.81	888.2000	11.4800	.69	890.	890.	890.
5.000	656.1200	4.7656	-.85	271.78	4.43	-.97	802.1000	8.8470	.63	890.	890.	890.
6.000	561.6400	5.1932	-.98	265.23	4.21	-1.03	724.3000	6.8220	.37	890.	890.	890.
7.000	423.6100	5.5229	-1.05	258.12	4.19	-.99	653.9000	5.5630	-.07	889.	889.	889.
8.000	369.1400	5.5674	-1.08	252.76	4.16	-.95	589.1000	4.7480	-.36	888.	888.	888.
9.000	320.1300	5.4271	-1.02	235.01	3.97	-.76	529.7000	4.2090	-.73	884.	884.	884.
10.000	277.3500	5.1895	-.81	227.46	3.53	-.41	474.6000	4.4720	-1.95	883.	883.	883.
11.000	244.4700	4.6244	-.62	220.69	3.10	-.32	423.3000	5.7820	-2.80	881.	881.	881.
12.000	203.1700	4.0244	-.40	215.58	3.34	1.05	328.4000	8.8920	-1.49	881.	881.	881.
13.000	173.4200	3.3104	-.19	213.46	4.28	.41	283.2000	9.2670	-.55	879.	879.	879.
14.000	147.9100	2.6454	-.03	213.49	3.86	-.01	241.5000	7.3610	-.10	876.	876.	876.
15.000	126.0300	2.0330	-.03	212.65	3.35	-.18	206.6000	5.6470	-.06	875.	875.	875.
16.000	107.4600	1.6746	.01	211.76	3.42	-.12	176.8000	4.7310	.18	874.	874.	874.
17.000	91.5110	1.3131	-.01	211.39	3.23	-.24	150.9000	3.7250	.29	852.	852.	852.
18.000	77.9400	1.0582	-.04	211.76	2.98	-.24	128.3000	2.9270	.21	845.	845.	845.
19.000	66.4300	.8549	-.13	212.62	2.44	-.23	108.9000	2.0350	.15	834.	834.	834.
20.000	56.6650	.7184	-.19	213.90	2.13	-.14	92.2000	1.5650	.09	828.	828.	828.
21.000	48.3930	.6037	-.02	215.31	2.02	-.11	78.2900	1.1660	.13	677.	677.	677.
22.000	41.3640	.5288	.03	216.88	2.00	-.11	66.4400	.8948	.23	662.	662.	662.
23.000	35.4090	.4498	.03	218.61	1.98	-.17	56.4300	.7096	.20	651.	651.	651.
24.000	30.3120	.4409	-.22	220.35	2.04	-.12	47.9300	.5884	-.28	664.	664.	664.
25.000	26.0400	.3959	-.16	222.15	2.15	-.04	40.8400	.4777	-.33	762.	762.	762.
26.000	22.3730	.3638	-.13	223.99	2.26	-.08	34.8500	.4167	-.26	755.	755.	755.
27.000	19.2520	.3342	.13	225.96	2.42	.03	29.6900	.3787	.10	619.	619.	619.
28.000	16.5300	.3109	.11	227.79	2.48	.13	25.3700	.3349	-.02	580.	580.	580.
29.000	14.3030	.2835	.11	229.57	2.49	.19	21.7000	.2997	.07	544.	544.	544.
30.000	12.3520	.2539	.07	231.40	2.41	.20	18.5900	.2772	.06	527.	527.	527.
32.000	9.3171	.1544	.44	237.27	3.34	.55	13.6900	.2102	.06	145.	145.	145.
34.000	7.0276	.1029	.38	242.36	3.41	.48	10.1100	.1672	.19	146.	146.	146.
36.000	5.3323	.1049	.42	245.86	3.61	-.23	7.5260	.1453	.26	146.	146.	146.
38.000	4.0702	.0833	.63	252.33	4.01	-.47	5.6210	.1285	.85	148.	148.	148.
40.000	3.1433	.0719	.49	259.03	3.29	.20	4.2180	.0904	.69	147.	147.	147.
42.000	2.4131	.0595	.40	263.92	3.45	-.38	3.1850	.0717	.26	147.	147.	147.
44.000	1.8732	.0452	.39	268.29	3.95	.00	2.4320	.0561	.72	144.	144.	144.
46.000	1.4536	.0312	.29	270.88	4.17	-.12	1.8760	.0428	.48	145.	145.	145.
48.000	1.1390	.0311	.23	271.64	4.42	-.26	1.4050	.0332	.55	144.	144.	144.
50.000	.8632	.0250	.15	271.72	4.42	-.09	1.1100	.0291	.20	144.	144.	144.
52.000	.6939	.0214	.13	263.48	4.45	-.63	.8568	.0244	.53	143.	143.	143.
54.000	.5401	.0178	.13	265.81	4.55	.06	.7650	.0188	.24	141.	141.	141.
56.000	.4189	.0153	.13	263.78	5.28	-.12	.5634	.0157	.06	130.	130.	130.
58.000	.3241	.0125	.03	263.39	5.12	-.28	.4335	.0129	.01	114.	114.	114.
60.000	.2451	.0097	.33	260.26	5.86	.28	.3372	.0108	.07	81.	81.	81.
62.000	.1894	.0080	.93	243.96	6.51	.21	.2639	.0084	.37	54.	54.	54.
64.000	.1426	.0047	.62	243.78	7.05	.35	.2051	.0066	.81	39.	39.	39.
66.000	.1073	.0040	.82	233.48	8.65	.65	.1601	.0044	.48	37.	37.	37.
68.000	.0799	.0033	1.01	223.49	11.65	1.12	.1250	.0034	1.07	36.	36.	36.
70.000	.0587	.0028	1.33	213.01	14.54	1.95	.0960	.0039	.61	34.	34.	34.

TABLE II-6. THERMODYNAMIC STATISTICAL PARAMETERS

JUNE

STATION Z	HEIGHT MH	MEAN P MB	MEAN T DEG K	WEAR T DEG K	S.D. T DEG K	SKEN T	MEAN D G/M ³	S.D. D G/M ³	SKEN D	NOBS P	NOBS T	NOBS D
1.000	1014.7000	2.5730	-20	295.83	3.49	.73	1227.0000	15.0500	-.60	756.	756.	756.
1.000	1002.7000	2.5476	-21	295.86	3.34	.78	1212.0000	14.6700	-.63	775.	775.	775.
1.000	981.9000	2.5099	-33	291.54	5.97	-1.50	1075.0000	21.2600	-.52	789.	789.	789.
2.000	801.8800	3.2604	-47	298.03	4.52	-.68	968.4000	13.1600	.71	790.	790.	790.
3.000	711.6200	3.7575	-56	292.36	3.95	-.77	877.0000	9.1550	.64	790.	790.	790.
4.000	659.7000	4.1797	-65	276.23	3.69	-.72	793.0000	7.0480	.33	789.	789.	789.
5.000	565.0700	4.4453	-72	279.55	3.53	-.76	717.0000	5.1900	.23	790.	790.	790.
6.000	483.4600	4.6163	-80	271.72	3.50	-.93	648.0000	4.9110	.03	788.	788.	788.
7.000	428.9900	4.7015	-83	275.31	3.46	-1.01	595.0000	4.3700	-.16	788.	788.	788.
8.000	374.8100	4.7562	-85	270.03	3.49	-.80	527.0000	3.9570	-.36	788.	788.	788.
9.000	325.9100	4.7981	-86	251.82	3.41	-.51	473.0000	3.6410	-.59	786.	786.	786.
10.000	282.3100	4.8110	-78	224.98	3.13	-.27	423.6000	3.9660	-.61	786.	786.	786.
11.000	243.3700	4.2446	-66	224.98	2.95	-.10	376.6000	5.0620	-2.00	782.	782.	782.
12.000	208.6800	3.7976	-50	219.03	3.01	.07	327.0000	6.4630	-1.58	781.	781.	781.
13.000	178.4500	3.2837	-35	214.82	3.41	.34	293.4000	7.5180	-.92	778.	778.	778.
14.000	152.8700	2.6823	-27	212.43	3.51	.31	249.6000	7.2900	-.34	777.	777.	777.
15.000	129.6000	2.0845	-23	212.43	3.56	.00	214.6000	6.3410	-.09	774.	774.	774.
16.000	110.2500	1.5319	-27	209.96	3.64	-.03	183.9000	5.2590	-.12	772.	772.	772.
17.000	93.7030	1.2672	-17	209.70	3.32	-.08	156.5000	3.9660	-.08	748.	748.	748.
18.000	79.6720	.9451	-20	209.81	2.77	.09	132.3000	2.7060	-.21	749.	749.	749.
19.000	67.8300	.7700	-18	211.95	2.18	.10	111.5000	1.7650	-.21	743.	743.	743.
20.000	57.6530	.6424	-13	214.01	1.80	.03	94.1800	1.2520	-.21	738.	738.	738.
21.000	49.4160	.5430	.01	215.96	1.61	.11	79.7100	.9749	-.09	574.	574.	574.
22.000	42.2420	.4705	.01	219.80	1.56	.31	57.3500	.7949	-.03	538.	538.	538.
24.000	31.0320	.4198	-.06	221.56	1.63	.37	48.7800	.5141	-.22	534.	534.	534.
25.000	26.6820	.3732	-.05	223.31	1.68	.19	41.6000	.4561	-.18	699.	699.	699.
26.000	23.7470	.3403	-.06	225.12	1.70	.22	35.4800	.4132	-.18	699.	699.	699.
27.000	19.7430	.3139	-.03	227.01	1.82	.08	30.3100	.3775	-.12	569.	569.	569.
28.000	17.0000	.2845	-.10	228.67	1.86	.26	25.9600	.3453	-.08	505.	505.	505.
29.000	14.0050	.2412	-.08	230.32	1.97	-.25	22.1900	.2988	-.02	468.	468.	468.
30.000	12.6730	.2279	-.15	232.17	2.00	-.25	19.0200	.2757	-.08	455.	455.	455.
32.000	9.5765	.1740	.34	237.94	3.18	.24	14.0500	.2301	-.16	118.	121.	116.
40.000	7.2462	.1408	.22	242.71	3.45	.33	10.4500	.1979	-.28	118.	121.	117.
50.000	5.3001	.1126	.19	247.39	4.40	-.01	7.7430	.1650	-.50	118.	121.	118.
60.000	4.1964	.0948	.19	252.05	4.26	-.07	5.7960	.1196	-.23	118.	122.	118.
70.000	3.2217	.0784	.20	258.44	3.90	.77	4.3410	.0957	-.02	117.	122.	117.
80.000	2.4687	.0645	.19	264.09	4.16	-.15	3.2810	.0810	-.02	117.	121.	117.
90.000	1.9414	.0523	.18	269.17	3.64	-.03	2.5070	.0624	.03	116.	114.	116.
100.000	1.5045	.0431	.23	273.58	4.37	.03	1.9400	.0497	-.03	116.	109.	116.
120.000	1.1741	.0355	.27	271.94	4.53	-.04	1.4500	.0392	-.12	115.	109.	115.
150.000	.9160	.0317	.37	272.24	4.81	-.14	1.1200	.0314	-.03	111.	106.	111.
200.000	.7150	.0248	.37	272.36	4.96	-.62	.9198	.0305	-.45	104.	98.	104.
300.000	.5728	.0203	.28	267.78	4.91	-.09	.7228	.0239	-.34	98.	95.	98.
400.000	.4334	.0168	.39	264.20	5.27	-.12	.5709	.0181	-.11	93.	95.	93.
500.000	.3349	.0150	.43	260.35	5.47	-.29	.4482	.0145	-.34	71.	75.	71.
600.000	.2806	.0121	.69	251.57	6.25	-.17	.3446	.0113	-.34	51.	55.	51.
800.000	.1939	.0140	1.10	244.53	8.44	.01	.2723	.0096	-.47	30.	30.	30.
1000.000	.1454	.0077	1.62	243.97	12.10	.59	.2179	.0091	.66	23.	26.	23.
1500.000	.1087	.0047	.66	234.09	12.24	.31	.1578	.0057	.82	22.	25.	22.
2000.000	.0811	.0040	.41	233.09	12.74	.82	.1176	.0043	.71	24.	24.	24.
3000.000	.0537	.0038	.23	235.46	15.78	1.33	.0975	.0045	-.50	19.	20.	19.

TABLE II-7. THERMODYNAMIC STATISTICAL PARAMETERS

JULY

STATION = 723315 Z KM	MEAN P MB		VAN DER WAALS A/B		MEAN T DEG K	S.D. DEG K	SKEW T	MEAN D G/M ³	S.D. D G/M ³	SKFH D	MOBS P	MOBS T	MOBS D
	MB	MB	SKFH P	SKFH K									
1.000	1015.0000	1.1442	-1.11	3.17	287.39	3.17	.31	1224.0000	13.7500	-.29	809.	809.	809.
1.100	1003.0000	1.8353	-1.15	3.03	287.54	3.03	.36	1209.0000	12.8000	-.33	833.	833.	833.
1.200	993.1000	2.0720	-1.26	2.95	295.77	2.95	-.71	1061.0000	14.1600	.53	843.	843.	843.
2.000	804.1000	2.2104	-1.36	2.99	291.70	2.99	-.54	958.3000	8.7900	.53	847.	847.	847.
3.000	714.5000	2.5075	-1.57	2.94	285.52	2.94	-.40	870.6000	5.8950	-.17	846.	846.	846.
4.000	633.2000	2.6646	-1.57	2.78	278.92	2.78	-.17	789.9000	5.0350	-.05	845.	845.	845.
5.000	559.7800	2.8398	-1.59	2.72	272.14	2.72	.03	715.9000	4.7150	-.08	845.	845.	845.
6.000	493.5400	2.9756	-1.55	2.65	265.42	2.65	-.15	647.4000	4.1230	-.02	843.	843.	843.
7.000	433.1000	2.6514	-1.49	2.68	268.35	2.68	-.30	593.8000	3.5560	-.02	844.	844.	844.
8.000	379.0700	2.6872	-1.49	2.51	251.02	2.51	-.35	529.9000	3.2310	-.16	843.	843.	843.
9.000	330.2000	2.7050	-1.49	2.36	236.00	2.36	-.40	472.4000	3.0170	-.27	843.	843.	843.
10.000	286.7200	2.7293	-1.51	2.35	235.00	2.35	-.36	423.1000	2.8580	-.57	842.	842.	842.
11.000	247.7500	2.6912	-1.49	2.28	228.87	2.28	-.41	377.1000	2.9050	-.83	840.	840.	840.
12.000	212.9600	2.4874	-1.50	2.22	222.35	2.22	-.50	333.7000	3.5810	-.96	841.	841.	841.
13.000	182.4100	2.2276	-1.42	2.16	216.45	2.16	-.27	293.6000	4.5530	-.93	832.	832.	832.
14.000	155.6000	1.8558	-1.32	2.11	211.29	2.11	.75	256.7000	4.9890	-.84	832.	832.	832.
15.000	132.3100	1.4893	-1.14	2.07	207.26	2.07	.83	222.5000	3.9730	-.77	827.	827.	827.
16.000	112.3000	1.1883	-.95	2.05	205.75	2.05	.84	190.2000	3.9730	-.55	827.	827.	827.
17.000	95.2500	.9091	-.12	2.06	206.68	2.06	.65	160.6000	2.8700	-.19	796.	796.	796.
18.000	80.9000	.7514	.11	2.08	208.88	2.08	.25	134.3000	1.9890	-.02	789.	789.	789.
19.000	68.8310	.6323	-.12	2.11	211.62	2.11	.22	113.3000	1.3600	-.06	783.	783.	783.
20.000	58.7110	.5683	.09	2.14	214.14	2.14	.55	95.5200	1.0500	.03	773.	773.	773.
21.000	50.1750	.4924	.01	2.16	216.44	2.16	.06	83.7600	.8200	-.02	702.	702.	702.
22.000	42.9000	.4294	-.04	2.18	218.44	2.18	-.06	69.4200	.6520	.07	588.	588.	588.
23.000	36.7620	.3935	-.04	2.20	220.24	2.20	-.12	58.1500	.5475	.11	584.	584.	584.
24.000	31.5340	.3558	-.07	2.21	221.90	2.21	-.14	49.5100	.4590	.02	577.	577.	577.
25.000	27.0950	.3216	-.04	2.22	222.46	2.22	-.19	42.2400	.3929	.722.	722.	722.	722.
26.000	23.3020	.2938	-.03	2.25	225.15	2.25	.10	36.0500	.3543	-.02	715.	715.	715.
27.000	20.0750	.2652	-.05	2.26	226.97	2.26	.09	30.8100	.3165	-.15	656.	656.	656.
28.000	17.2950	.2473	-.01	2.28	228.53	2.28	-.07	26.3600	.2829	-.20	526.	526.	526.
29.000	14.9230	.2265	-.04	2.30	230.20	2.30	.08	21.5800	.2455	-.09	496.	496.	496.
30.000	12.8940	.2060	.06	2.31	231.61	2.31	.04	19.3800	.2369	-.03	484.	484.	484.
32.000	9.7042	.1560	.56	2.34	234.70	2.34	.30	14.2700	.2333	-.04	484.	484.	484.
34.000	7.3137	.1279	.53	2.40	240.94	2.40	.18	10.5000	.1625	-.18	113.	113.	113.
36.000	5.5333	.1046	.64	2.45	245.20	2.45	-.18	7.8750	.1301	.32	111.	111.	111.
38.000	4.2159	.0874	.56	2.49	249.97	2.49	-.47	5.8780	.1131	.34	111.	111.	111.
40.000	3.2271	.0726	.52	2.50	250.69	2.50	-.39	4.3560	.0842	.33	111.	111.	111.
42.000	2.4860	.0604	.50	2.50	250.69	2.50	-.29	3.3190	.0703	.48	110.	110.	110.
44.000	1.9237	.0500	.44	2.44	244.50	2.44	-.35	2.5340	.0584	.08	110.	110.	110.
46.000	1.4539	.0419	.35	2.50	250.65	2.50	-.41	1.9450	.0473	.22	108.	108.	108.
48.000	1.1159	.0345	.25	2.50	250.65	2.50	-.72	1.5380	.0375	.27	107.	107.	107.
50.000	.9030	.0280	.38	2.51	251.07	2.51	-.46	1.1750	.0310	.25	103.	103.	103.
52.000	.7020	.0241	.40	2.50	250.65	2.50	-.27	.9193	.0259	.03	103.	103.	103.
54.000	.5455	.0202	.41	2.50	250.65	2.50	-.10	.7230	.0196	.25	98.	98.	98.
56.000	.4213	.0176	.45	2.51	251.11	2.51	.16	.5670	.0160	.64	94.	94.	94.
58.000	.3235	.0153	.48	2.51	251.11	2.51	.13	.4444	.0150	.72	81.	81.	81.
60.000	.2479	.0132	.50	2.51	251.11	2.51	.03	.3441	.0129	.22	59.	59.	59.
62.000	.1822	.0116	.50	2.51	251.11	2.51	.12	.2703	.0123	.49	44.	44.	44.
64.000	.1363	.0097	.51	2.51	251.11	2.51	.16	.2073	.0100	.41	37.	37.	37.
66.000	.1027	.0081	.49	2.51	251.11	2.51	.11	.1578	.0094	.67	34.	34.	34.
68.000	.0755	.0065	.47	2.51	251.11	2.51	.31	.1204	.0079	.55	35.	35.	35.
70.000	.0533	.0057	.46	2.51	251.11	2.51	.12	.0925	.0053	.41	30.	30.	30.

TABLE II-8. THERMODYNAMIC STATISTICAL PARAMETERS

AUGUST

STATION #	Z	MEAN P	VALENBERG AFB	MEAN T	S.D. T	SKEW T	MEAN D	S.D. D	SKEW D	NOBS P	NOBS T	NOBS D
	KM	MB	S.D. P	DEG K	DEG K		G/M3	G/M3				
0.000	1014.4000	2.2705	-1.13	249.27	3.17	.18	1219.0000	13.6700	-.17	823.	823.	823.
1.000	1002.4000	2.2705	-1.10	248.41	3.01	.20	1204.0000	12.7000	-.20	853.	853.	853.
2.000	902.8000	2.1319	-1.33	205.69	4.51	-.62	1061.0000	16.1400	.63	854.	854.	854.
3.000	803.8000	2.0913	-1.30	231.35	3.70	-.78	973.1000	11.2300	.75	854.	854.	854.
4.000	714.3000	2.0944	-1.56	205.17	3.01	-.89	871.2000	7.9300	.65	854.	854.	854.
5.000	632.9000	2.0961	-1.63	218.62	2.63	-.67	793.0000	5.7940	-.14	854.	854.	854.
6.000	569.4000	3.1338	-1.73	211.97	2.55	-.55	715.3000	5.1340	-.01	854.	854.	854.
7.000	493.1000	3.1175	-1.93	205.21	2.56	-.68	647.3000	4.4840	-.04	855.	855.	855.
8.000	432.7000	3.1416	-1.95	208.26	2.58	-.71	593.5000	3.6020	-.05	855.	855.	855.
9.000	378.7000	3.2152	-1.01	200.98	2.74	-.74	505.5000	3.1770	-.33	855.	855.	855.
10.000	329.9000	3.2117	-1.94	243.44	2.91	-.59	472.0000	3.1480	-.54	855.	855.	855.
11.000	287.5000	3.1652	-1.96	235.99	3.04	-.48	422.6000	3.0700	-.67	855.	855.	855.
12.000	212.7000	2.9549	-1.75	222.34	2.98	-.50	370.7000	3.2430	-.123	854.	854.	854.
13.000	182.2000	2.6753	-1.58	216.57	2.67	-.62	293.2000	4.7900	-.131	849.	849.	849.
14.000	155.5000	2.2824	-1.35	211.50	2.57	-.62	256.3000	5.5690	-.108	845.	845.	845.
15.000	132.2000	1.7424	-1.18	207.55	3.36	-.86	222.0000	5.6360	-.186	841.	841.	841.
16.000	112.2000	1.3214	-.04	205.87	3.71	-.84	190.0000	4.9900	-.160	839.	839.	839.
17.000	95.2000	.9607	-.18	206.97	3.21	-.51	160.3000	3.5090	-.33	819.	819.	819.
18.000	80.8000	.7328	.24	209.25	2.64	-.13	134.7000	2.2960	-.113	818.	818.	818.
19.000	68.8000	.6591	.21	211.97	1.66	-.09	113.2000	1.4330	.06	811.	811.	811.
20.000	59.7000	.5727	.13	214.31	1.56	-.09	95.4000	1.0360	.12	802.	802.	802.
21.000	50.2100	.4954	.04	216.34	1.49	.02	80.8600	.7789	.04	719.	719.	719.
22.000	42.9100	.4686	.16	218.08	1.49	.01	68.5000	.6573	-.04	588.	588.	588.
23.000	36.7700	.4210	.15	219.76	1.51	.00	58.3000	.5335	-.14	583.	583.	583.
24.000	31.6300	.3879	.15	221.46	1.52	.08	49.6100	.4590	.13	580.	580.	580.
25.000	27.0910	.3303	.12	223.05	1.59	.04	42.3000	.3900	.02	748.	748.	748.
26.000	23.2510	.3002	.12	224.62	1.65	.03	36.1100	.3430	.14	735.	735.	735.
27.000	20.0500	.2747	-.03	225.39	1.77	-.04	30.9000	.3194	.02	658.	658.	658.
28.000	17.2800	.2510	.04	227.68	1.91	.19	26.3000	.2786	.18	548.	548.	548.
29.000	14.8900	.2322	.05	229.39	2.11	.12	22.5000	.2475	.22	500.	500.	500.
30.000	12.8400	.2146	.04	231.88	2.15	.11	19.3000	.2269	-.05	470.	470.	470.
32.000	9.6593	.1891	.44	235.80	4.33	.79	14.3000	.2136	-.19	98.	138.	96.
34.000	7.2572	.1221	.23	233.12	4.94	.83	10.6000	.2135	-.60	101.	111.	131.
36.000	5.4896	.0915	.07	240.78	4.85	.07	7.8910	.1218	.08	101.	112.	101.
38.000	4.1662	.0789	.93	247.52	4.34	.33	5.8780	.1008	.63	101.	112.	101.
40.000	3.1818	.0604	1.03	253.19	4.12	.18	4.3800	.0984	.03	101.	112.	101.
42.000	2.4431	.0545	1.06	257.99	4.06	.26	3.3570	.0761	.60	101.	113.	101.
44.000	1.8950	.0448	1.04	263.71	4.21	-.60	2.5000	.0583	.66	101.	111.	101.
46.000	1.4613	.0377	.86	264.84	4.48	-.50	1.9000	.0426	.74	100.	110.	100.
48.000	1.1139	.0303	.95	264.91	4.93	-.33	1.4300	.0343	.61	98.	104.	98.
50.000	.8737	.0253	.77	263.12	5.22	-.48	1.1570	.0271	1.00	99.	108.	99.
52.000	.6824	.0224	.60	264.06	4.94	-.22	.9076	.0221	.48	98.	107.	98.
54.000	.5599	.0196	.55	261.30	6.11	.09	.7079	.0220	.48	98.	107.	98.
56.000	.4683	.0168	.64	263.83	7.31	.07	.5429	.0163	.29	97.	107.	97.
58.000	.3140	.0140	.63	264.39	7.30	.04	.4314	.0169	1.28	83.	98.	89.
60.000	.2478	.0119	.73	264.50	8.10	.30	.3438	.0124	.79	64.	71.	64.
62.000	.1757	.0091	1.03	264.31	9.17	.48	.2575	.0100	1.00	51.	55.	51.
64.000	.1176	.0072	1.62	264.12	10.64	.94	.1920	.0087	1.43	45.	48.	45.
66.000	.0801	.0061	1.40	264.50	11.64	1.40	.1507	.0076	1.93	44.	44.	44.
68.000	.0543	.0047	.90	265.00	11.60	-.19	.1177	.0078	2.29	45.	45.	45.
70.000	.0305	.0033	.58	213.56	9.91	-.52	.0890	.0060	1.45	40.	40.	40.

TABLE II-9. THERMODYNAMIC STATISTICAL PARAMETERS

SEPTEMBER

STATION = 723930		VANDENBERG AFB		S.O. P		S.O. T		S.O. D		S.O. D		S.O. D		S.O. D		S.O. D		S.O. D	
Z	KH	MEAN P	MB	SKEM P	SKEM P	MEAN T	DEG K	SKEM T	DEG K	MEAN D	G/MS	SKEM D	G/MS	MEAN D	G/MS	SKEM D	G/MS	MEAN D	G/MS
1.000	1013.6000	2.5882	-0.38	289.04	3.92	.75	1215.0000	17.2700	745	745	745	745	745	745	745	745	745	745	745
1.100	1001.7000	2.5780	-0.38	288.97	3.72	.75	1215.0000	16.0500	818	818	818	818	818	818	818	818	818	818	818
1.000	901.8300	2.4480	-0.16	293.26	4.90	-27	1038.0000	17.1500	779	779	779	779	779	779	779	779	779	779	779
2.000	802.2300	2.6556	-0.19	296.7	3.68	-57	965.0000	10.7400	783	783	783	783	783	783	783	783	783	783	783
3.000	712.1700	3.0264	-0.49	296.6	3.03	-58	875.1000	7.3230	783	783	783	783	783	783	783	783	783	783	783
4.000	630.4200	3.2905	-0.61	276.63	2.88	-61	793.1000	6.3130	783	783	783	783	783	783	783	783	783	783	783
5.000	556.5600	3.3651	-0.72	270.39	2.85	-55	716.8000	5.6540	782	782	782	782	782	782	782	782	782	782	782
6.000	490.3400	3.5139	-0.80	263.71	2.67	-76	67.5000	4.8370	781	781	781	781	781	781	781	781	781	781	781
7.000	429.9100	3.5334	-0.86	256.40	2.93	-74	534.0000	4.1660	780	780	780	780	780	780	780	780	780	780	780
8.000	375.6000	3.5612	-0.84	248.81	2.93	-53	526.1000	3.7200	780	780	780	780	780	780	780	780	780	780	780
9.000	326.9700	3.4507	-0.82	241.10	2.93	-23	472.0000	3.7700	779	779	779	779	779	779	779	779	779	779	779
10.000	283.4800	3.4446	-0.70	233.67	2.99	.00	422.6000	4.3380	774	774	774	774	774	774	774	774	774	774	774
11.000	244.6600	3.2625	-0.57	226.83	3.14	-07	375.7000	5.0890	774	774	774	774	774	774	774	774	774	774	774
12.000	210.0700	2.9292	-0.45	221.03	3.01	-16	331.1000	5.3640	772	772	772	772	772	772	772	772	772	772	772
13.000	179.6200	2.5851	-0.32	216.08	2.95	.14	290.0000	5.5310	772	772	772	772	772	772	772	772	772	772	772
14.000	153.4600	2.1835	-0.25	211.77	2.73	.49	252.5000	5.3640	767	767	767	767	767	767	767	767	767	767	767
15.000	130.5000	1.7943	-0.09	208.25	2.99	.42	218.4000	5.0690	762	762	762	762	762	762	762	762	762	762	762
16.000	110.8200	1.4400	-0.02	206.30	3.18	.26	187.2000	4.4460	751	751	751	751	751	751	751	751	751	751	751
17.000	94.0430	1.1374	-0.06	206.59	3.00	.32	158.6000	3.3680	748	748	748	748	748	748	748	748	748	748	748
18.000	80.1170	1.5466	2.45	208.22	2.59	.08	134.1000	3.5070	789	789	789	789	789	789	789	789	789	789	789
19.000	68.1540	1.3780	2.57	210.72	2.12	.05	112.7000	2.6080	784	784	784	784	784	784	784	784	784	784	784
20.000	58.0980	1.1767	2.51	213.20	1.86	.16	94.9400	2.0490	621	621	621	621	621	621	621	621	621	621	621
21.000	49.6350	1.1027	2.28	215.34	1.68	.05	80.3400	1.7970	578	578	578	578	578	578	578	578	578	578	578
22.000	42.4510	.9695	2.22	217.19	1.62	-11	68.0900	1.5080	574	574	574	574	574	574	574	574	574	574	574
23.000	36.3510	.8432	2.15	219.00	1.60	-01	57.8200	1.2760	714	714	714	714	714	714	714	714	714	714	714
24.000	31.1520	.7390	2.05	220.69	1.65	-08	49.1700	1.1250	568	568	568	568	568	568	568	568	568	568	568
25.000	26.9420	.6660	2.04	222.12	1.60	.13	41.8800	.8646	2.51	2.51	2.51	2.51	2.51	2.51	2.51	2.51	2.51	2.51	2.51
26.000	22.9420	.6151	1.91	223.64	1.69	.00	35.7300	.7399	2.28	2.28	2.28	2.28	2.28	2.28	2.28	2.28	2.28	2.28	2.28
27.000	19.7550	.4893	1.67	225.30	1.84	.15	30.5500	.6566	2.07	2.07	2.07	2.07	2.07	2.07	2.07	2.07	2.07	2.07	2.07
28.000	17.0140	.4216	1.62	226.71	2.08	.08	26.1400	.5689	1.12	1.12	1.12	1.12	1.12	1.12	1.12	1.12	1.12	1.12	1.12
29.000	14.6630	.3325	1.50	228.04	2.21	-10	22.4000	.5076	1.00	1.00	1.00	1.00	1.00	1.00	1.00	1.00	1.00	1.00	1.00
30.000	12.6540	.3427	1.39	229.38	2.26	.07	19.2200	.4478	.87	.87	.87	.87	.87	.87	.87	.87	.87	.87	.87
32.000	9.4813	.1879	.79	234.37	3.69	.63	14.1200	.2459	.66	.66	.66	.66	.66	.66	.66	.66	.66	.66	.66
34.000	7.1194	.1598	.82	237.62	3.70	.35	10.4800	.1999	.59	.59	.59	.59	.59	.59	.59	.59	.59	.59	.59
35.000	5.3715	.1363	.56	241.31	4.58	-22	7.7610	.1789	.51	.51	.51	.51	.51	.51	.51	.51	.51	.51	.51
36.000	4.0745	.1072	1.09	245.79	3.43	.64	5.7730	.1272	.48	.48	.48	.48	.48	.48	.48	.48	.48	.48	.48
40.000	3.1034	.6982	1.22	250.97	4.60	.02	4.3140	.1138	.82	.82	.82	.82	.82	.82	.82	.82	.82	.82	.82
42.000	2.3811	.6722	1.31	250.65	4.10	.18	3.2330	.0815	.87	.87	.87	.87	.87	.87	.87	.87	.87	.87	.87
44.000	1.8369	.6428	1.40	252.05	4.20	.14	2.4440	.0707	.87	.87	.87	.87	.87	.87	.87	.87	.87	.87	.87
46.000	1.4324	.6453	1.45	254.49	4.64	-50	1.8750	.0571	.87	.87	.87	.87	.87	.87	.87	.87	.87	.87	.87
48.000	1.1041	.6401	1.45	266.30	5.06	-50	1.4440	.0445	.86	.86	.86	.86	.86	.86	.86	.86	.86	.86	.86
50.000	.8672	.6487	1.22	265.30	5.32	-58	1.1220	.0351	.86	.86	.86	.86	.86	.86	.86	.86	.86	.86	.86
54.000	.5173	.6243	1.15	253.29	5.65	-42	.6236	.0235	.89	.89	.89	.89	.89	.89	.89	.89	.89	.89	.89
56.000	.3908	.6203	1.10	251.23	5.46	-68	.5429	.0209	.89	.89	.89	.89	.89	.89	.89	.89	.89	.89	.89
58.000	.2282	.6173	1.09	250.48	6.35	.21	.4158	.0175	.89	.89	.89	.89	.89	.89	.89	.89	.89	.89	.89
60.000	.2355	.6142	1.28	253.29	7.57	.27	.3337	.0132	.89	.89	.89	.89	.89	.89	.89	.89	.89	.89	.89
62.000	.1771	.6091	1.40	248.02	8.24	.78	.2492	.0071	.89	.89	.89	.89	.89	.89	.89	.89	.89	.89	.89
64.000	.1324	.6048	.08	240.13	7.45	.72	.1927	.0059	.89	.89	.89	.89	.89	.89	.89	.89	.89	.89	.89
66.000	.0398	.6039	.05	233.91	7.01	.06	.1485	.0047	.89	.89	.89	.89	.89	.89	.89	.89	.89	.89	.89
68.000	.0746	.6034	.08	224.50	9.94	-07	.1157	.0042	.89	.89	.89	.89	.89	.89	.89	.89	.89	.89	.89
70.000	.0549	.6028	.12	218.33	7.44	.19	.0875	.0032	.89	.89	.89	.89	.89	.89	.89	.89	.89	.89	.89

TABLE II-10. THERMODYNAMIC STATISTICAL PARAMETERS

OCTOBER

STATION	Z	MEAN P MB	VARIANCE MB	S.D. P MB	MEAN T °C	S.D. T °C	MEAN D G/M ³	S.D. D G/M ³	MEAN P NOBS	SKEW D	NOBS P	NOBS T	NOBS D
1.000	1015	7000			249.22	3.94	1.19	1227.0000	18.2700	.03	876.	826.	826.
1.000	1003	7000			250.56	3.94	1.50	1207.0000	17.1000	.04	870.	870.	870.
1.000	983	6000			259.92	5.35	1.52	1084.0000	18.9100	.30	865.	865.	865.
2.000	882	4500			265.09	4.61	1.31	979.1000	13.6800	.83	866.	866.	866.
3.000	711	3400			273.50	4.01	1.04	887.7000	9.7030	.78	866.	866.	866.
4.000	628	2400			279.58	3.87	1.04	799.6000	7.6930	.64	865.	865.	865.
5.000	554	1600			287.27	3.82	1.19	727.3000	6.5340	.51	865.	865.	865.
6.000	487	1000			293.29	3.75	1.28	658.4000	5.5340	.22	863.	863.	863.
7.000	425	700			298.76	3.68	1.21	588.1000	4.8850	-.15	863.	863.	863.
8.000	372	500			295.11	3.52	1.01	529.1000	4.4570	-.40	862.	862.	862.
9.000	323	3400			237.52	3.05	1.31	474.2000	4.0910	-.28	862.	862.	862.
10.000	273	2400			233.27	2.89	1.03	423.0000	6.1620	-.92	861.	861.	861.
11.000	240	1600			223.80	3.21	1.51	374.9000	7.4130	-.61	858.	858.	858.
12.000	206	1000			218.56	3.51	1.54	329.2000	7.7390	-.13	858.	858.	858.
13.000	176	700			214.82	3.45	1.39	286.3000	7.2080	-.68	858.	858.	858.
14.000	150	500			211.70	3.23	1.14	247.8000	6.3720	-.38	857.	857.	857.
15.000	128	3400			208.90	3.23	1.14	213.6000	5.5150	-.29	854.	854.	854.
16.000	108	2400			206.56	3.31	1.08	183.2000	4.6850	-.21	853.	853.	853.
17.000	92	1600			203.66	3.31	1.08	155.7000	3.7230	-.20	817.	817.	817.
18.000	78	1000			200.64	2.92	1.06	110.7000	1.9040	-.05	815.	815.	815.
19.000	66	700			209.64	2.42	1.10	76.7000	1.4010	.18	800.	800.	800.
20.000	56	500			211.68	2.18	1.10	62.0000	1.0280	.34	634.	634.	634.
21.000	48	3400			213.79	2.10	1.10	50.0000	.8111	.26	621.	621.	621.
22.000	41	2400			215.99	2.10	1.03	40.0000	.6100	.26	610.	610.	610.
23.000	35	1600			217.25	2.19	1.17	30.0000	.5932	.26	646.	646.	646.
24.000	30	1000			218.80	2.24	1.19	24.0000	.5692	.11	646.	646.	646.
25.000	25	700			220.36	2.23	1.24	20.0000	.5116	.01	731.	731.	731.
26.000	22	500			221.62	2.31	1.32	16.0000	.4408	.00	717.	717.	717.
27.000	19	3400			222.97	2.40	1.36	13.0000	.3838	-.03	563.	563.	563.
28.000	16	2400			224.06	2.46	1.44	10.0000	.3441	-.09	510.	510.	510.
29.000	14	1600			225.14	2.83	1.34	8.0000	.3186	-.01	479.	479.	479.
30.000	12	1000			226.22	2.97	1.15	6.0000	.2938	-.13	468.	468.	468.
31.000	9	700			231.79	4.41	1.11	4.0000	.2415	-.36	105.	105.	105.
32.000	6	500			234.80	4.20	1.15	3.0000	.1945	-.10	104.	104.	104.
33.000	5	3400			239.35	3.89	1.07	2.0000	.1710	-.32	104.	104.	104.
34.000	3	2400			243.93	4.58	1.10	1.5000	.1562	-.21	106.	106.	106.
35.000	2	1600			249.95	5.00	1.18	1.0000	.1279	.49	106.	106.	106.
36.000	2	1000			255.69	5.35	1.24	0.9000	.1069	.29	107.	107.	107.
37.000	1	700			260.37	5.65	1.53	0.8000	.0832	.38	107.	107.	107.
38.000	1	500			265.29	5.72	1.20	0.7000	.0630	.36	105.	105.	105.
39.000	1	3400			269.85	5.70	1.45	0.6000	.0535	.20	105.	105.	105.
40.000	1	2400			274.85	6.10	1.24	0.5000	.0473	.06	103.	103.	103.
41.000	1	1600			279.80	6.14	1.05	0.4000	.0465	.06	101.	101.	101.
42.000	1	1000			284.88	6.78	1.22	0.3000	.0280	.01	100.	100.	100.
43.000	1	700			289.22	6.31	1.18	0.2000	.0251	-.13	99.	99.	99.
44.000	1	500			293.71	5.76	1.19	0.1000	.0203	-.03	94.	94.	94.
45.000	1	3400			298.41	6.54	1.51	0.0000	.0183	.05	63.	63.	63.
46.000	1	2400			299.43	6.31	1.57	0.0000	.0158	-.04	55.	55.	55.
47.000	1	1600			299.30	10.54	1.54	0.0000	.0114	-.46	39.	39.	39.
48.000	1	1000			295.37	9.43	1.33	0.0000	.0098	-.20	37.	37.	37.
49.000	1	700			292.47	10.01	1.29	0.0000	.0088	-.14	34.	34.	34.
50.000	1	500			289.13	9.75	1.13	0.0000	.0064	-.21	31.	31.	31.

TABLE II-11. THERMODYNAMIC STATISTICAL PARAMETERS

NOVEMBER

STATION = 723330 Z KM	MEAN P MB	VANDEBERG AFB S.D. P MB	SKEW P	MEAN T DEG K	S.D. T DEG K	SKEW T	MEAN D G/M3	S.D. D G/M3	SKEW D	MOBS P	MOBS T	MOBS D
.000	1017.7000	4.0617	-.58	266.71	4.24	.13	1232.0000	20.2400	.19	868.	868.	868.
.100	1025.6000	3.9632	-.62	266.45	4.09	.17	1218.0000	19.0900	.17	882.	882.	882.
1.000	934.0300	3.9036	-.82	265.90	5.08	.12	1039.0000	17.7500	-.11	894.	894.	894.
2.000	801.6400	4.4941	-.79	261.49	5.04	-.37	990.8000	14.3100	.34	895.	895.	895.
3.000	709.5300	5.1935	-.76	275.47	4.82	-.62	893.3000	10.9600	.61	895.	895.	895.
4.000	626.2400	5.7071	-.78	270.67	4.64	-.77	805.5000	8.5800	.74	895.	895.	895.
5.000	551.4200	6.0777	-.80	264.22	4.52	-.86	728.7000	6.8660	.77	895.	895.	895.
6.000	484.2200	6.4316	-.79	267.32	4.40	-.86	635.4000	5.8100	.39	895.	895.	895.
7.000	423.1900	6.4010	-.77	250.03	4.28	-.86	589.5000	5.3460	-.29	894.	894.	894.
8.000	368.6600	6.2931	-.77	242.57	4.07	-.67	529.4000	5.2660	-.12	892.	892.	892.
9.000	319.7100	6.0309	-.73	235.09	3.67	-.29	473.7000	5.9460	-.17	889.	889.	889.
10.000	276.0300	5.6511	-.59	227.92	3.38	.10	421.9000	7.2640	-.17	889.	889.	889.
11.000	237.3000	5.0785	-.44	221.39	3.53	.82	373.5000	8.8080	-.14	886.	886.	886.
12.000	203.1500	4.3255	-.30	216.15	4.15	.50	327.5000	9.7730	-.96	884.	884.	884.
13.000	173.2800	3.5942	-.14	212.85	4.39	-.16	283.9000	9.4320	-.51	879.	879.	879.
14.000	147.7100	2.9340	.03	210.73	3.80	.08	244.3000	7.8930	-.24	873.	873.	873.
15.000	125.5900	2.2837	.11	208.74	3.53	.27	209.7000	6.5330	-.13	870.	870.	870.
16.000	106.6800	1.7741	.13	207.13	3.57	.23	179.5000	5.5890	.00	867.	867.	867.
17.000	90.5460	1.3335	.19	206.72	3.72	.08	152.7000	4.4930	.10	842.	842.	842.
18.000	76.8650	1.0262	.25	207.36	3.47	-.05	129.2000	3.3450	.17	840.	840.	840.
19.000	65.5350	.7706	.18	208.75	3.00	.00	109.0000	2.3300	.08	825.	825.	825.
20.000	56.5350	.6351	.27	211.73	2.19	-.01	92.0800	1.5960	-.05	815.	815.	815.
21.000	47.2720	.5389	.27	211.73	2.19	-.01	77.8900	1.1150	-.04	681.	681.	681.
22.000	40.3040	.4668	.14	213.21	2.10	-.05	65.8600	.8611	-.20	676.	676.	676.
23.000	34.4080	.4203	.17	214.78	2.14	.00	56.8100	.6524	-.16	668.	668.	668.
24.000	29.3340	.3774	.15	216.11	2.23	-.19	47.3800	.5287	-.02	768.	768.	768.
25.000	25.1630	.3577	.22	217.49	2.38	-.18	40.3100	.4735	.72	763.	763.	763.
26.000	21.5450	.3296	.19	218.86	2.57	-.08	34.2000	.4346	.51	751.	751.	751.
27.000	18.4460	.2931	.15	220.01	2.70	.17	29.2100	.3812	.01	589.	589.	589.
28.000	15.8240	.2679	.15	221.20	2.85	-.05	24.9600	.3411	-.20	548.	548.	548.
29.000	13.5850	.2450	.15	222.38	2.92	-.05	21.2800	.3057	-.07	516.	516.	516.
30.000	11.6020	.2270	.15	223.65	3.01	.01	18.2000	.2867	-.05	517.	517.	517.
32.000	8.7733	.2071	.49	228.78	3.80	.62	13.4000	.2333	.14	79.	79.	79.
34.000	6.5254	.1576	.74	232.95	4.12	.29	9.8210	.2268	.00	81.	81.	81.
36.000	4.9643	.1352	.85	237.49	5.33	.19	7.2260	.2072	.27	82.	82.	82.
38.000	3.7220	.1157	.86	241.56	6.44	.13	5.3700	.1819	.77	84.	84.	84.
40.000	2.8246	.0951	.89	247.23	6.04	-.53	3.9810	.1302	.39	84.	84.	84.
42.000	2.1567	.0818	.86	252.48	7.23	-.58	2.9770	.1070	.60	83.	83.	83.
44.000	1.6575	.0675	1.01	257.69	6.89	-.56	2.2400	.0863	.39	83.	83.	83.
46.000	1.2796	.0560	.96	261.52	6.84	-.46	1.7200	.0666	.89	83.	83.	83.
50.000	.9915	.0449	.79	264.45	6.72	-.52	1.3050	.0534	.97	82.	82.	82.
52.000	.8970	.0389	.62	264.92	6.63	-.35	1.0100	.0466	.96	81.	81.	81.
54.000	.8229	.0321	.52	264.80	6.54	-.28	.7846	.0374	.87	79.	79.	79.
56.000	.7620	.0273	.47	263.26	6.33	-.31	.6121	.0317	.15	77.	77.	77.
58.000	.7283	.0220	.47	263.83	6.93	-.48	.4770	.0258	.36	75.	75.	75.
60.000	.7149	.0179	.52	260.23	7.62	-.24	.3719	.0201	.16	73.	73.	73.
62.000	.7179	.0153	.60	257.03	9.25	.12	.2503	.0147	.36	57.	57.	57.
64.000	.7125	.0100	.64	253.49	12.34	.45	.2159	.0134	.28	37.	37.	37.
66.000	.6944	.0059	.68	243.05	16.50	.16	.1750	.0116	.17	26.	26.	26.
68.000	.6683	.0057	.80	235.97	11.19	-.28	.1354	.0074	.05	25.	25.	25.
70.000	.6055	.0047	.96	218.76	10.89	.39	.0802	.0062	.21	24.	24.	24.

TABLE II-12. THERMODYNAMIC STATISTICAL PARAMETERS

DECEMBER

STATION #	MEAN P	VOLUME	MEAN T	S.D. T	SKEN T	MEAN D	S.D. D	SKEN D	NOBS P	NOBS T	NOBS D
Z	MB	MB	DEG K	DEG K	G/M ³	G/M ³	G/M ³	G/M ³			
72330											
1	1016.9000	4.5228	284.77	4.71	-0.07	1242.0000	22.6400	.32	902.	902.	902.
2	1056.7500	4.4467	284.45	4.57	-0.04	1209.0000	21.4800	.30	919.	919.	919.
3	904.1200	4.5221	293.21	5.21	-0.05	1110.0000	18.5100	.16	932.	932.	932.
4	800.8000	5.0718	278.79	5.49	-0.45	999.0000	15.6900	.47	934.	934.	934.
5	707.9300	5.9682	273.83	5.30	-0.82	900.0000	11.9600	.87	934.	934.	934.
6	624.1000	6.4044	268.15	5.14	-1.03	810.4000	9.2440	.98	934.	934.	934.
7	548.9500	6.9753	261.66	4.97	-1.08	730.5000	7.2170	.72	933.	933.	933.
8	481.2700	7.4500	254.52	4.87	-0.97	650.4000	5.9800	.24	931.	931.	931.
9	420.0100	7.8227	247.33	4.57	-0.68	590.5000	5.3910	-.49	931.	931.	931.
10	365.3700	7.9045	233.92	4.20	-0.35	530.5000	5.7300	-1.22	929.	929.	929.
11	316.3700	6.7272	232.48	3.81	-0.07	474.0000	6.9180	-1.80	928.	928.	928.
12	272.0500	6.2046	225.36	3.53	.27	421.5000	8.4700	-1.72	926.	926.	926.
13	234.0200	5.5189	219.35	3.25	.69	371.8000	10.2100	-1.27	923.	923.	923.
14	200.1400	4.5039	215.44	2.98	.48	323.8000	11.4500	-.74	923.	923.	923.
15	170.8100	3.9340	212.83	2.71	-.04	278.5000	10.4600	-.24	919.	919.	919.
16	145.6600	3.1317	212.55	2.42	-.03	236.9000	8.3140	-.09	917.	917.	917.
17	105.4700	1.9199	208.91	2.13	-.24	205.2000	6.8740	-.74	905.	905.	905.
18	89.6200	1.4551	208.04	1.88	-0.04	150.0000	4.8690	.33	868.	868.	868.
19	76.1350	1.0973	208.21	1.67	-.28	127.5000	3.7350	.52	861.	861.	861.
20	64.7110	.8458	209.17	1.46	-.47	107.8000	2.5400	.69	842.	842.	842.
21	55.0540	.6650	210.34	1.25	-.52	91.2100	1.8300	.66	823.	823.	823.
22	46.8440	.5119	211.76	1.04	-.22	77.0800	1.3070	.49	674.	674.	674.
23	39.9410	.3714	213.10	0.84	.00	65.3000	.9705	.43	657.	657.	657.
24	34.0320	.2469	214.43	0.65	-0.04	55.3000	.7676	.53	641.	641.	641.
25	29.1440	.1495	215.67	0.53	.02	47.0800	.5820	.33	750.	750.	750.
26	25.0270	.0915	216.82	0.42	.13	40.0500	.4870	.16	733.	733.	733.
27	21.3340	.0637	218.00	0.34	.33	34.0900	.4423	.09	729.	729.	729.
28	18.2510	.0425	219.01	0.28	.33	29.0300	.4282	.01	589.	589.	589.
29	15.0720	.0274	220.05	0.23	.31	24.7100	.4058	.07	535.	535.	535.
30	13.4310	.0178	221.17	0.20	.15	21.1600	.3702	.12	495.	495.	495.
31	11.5410	.0115	222.33	0.18	.15	18.0600	.3516	.03	478.	478.	478.
32	8.7158	.0072	223.70	0.15	.64	13.3500	.2979	-.17	130.	130.	130.
33	6.5215	.0042	224.13	0.12	.46	9.7540	.2678	-.04	126.	126.	126.
34	4.8792	.0021	226.41	0.10	.45	7.1890	.2350	.08	126.	126.	126.
35	3.6743	.0011	227.00	0.08	.44	5.2930	.2031	.54	125.	125.	125.
36	2.7901	.0006	227.40	0.07	.00	3.9310	.1622	.82	125.	125.	125.
37	2.1317	.0003	228.25	0.06	-.13	2.9240	.1268	.00	126.	126.	126.
38	1.6419	.0001	229.04	0.05	-.39	2.1890	.0970	.85	126.	126.	126.
39	1.2754	.0000	229.74	0.04	-.29	1.6670	.0766	.49	129.	129.	129.
40	0.9110	0.0000	230.49	0.03	-.04	1.2040	.0545	.27	126.	126.	126.
41	0.7201	0.0000	231.21	0.03	-.35	1.0000	.0349	.28	125.	125.	125.
42	0.5591	0.0000	231.73	0.02	-.62	.7690	.0453	.03	123.	123.	123.
43	0.4151	0.0000	232.11	0.02	-.60	.6143	.0397	.04	125.	125.	125.
44	0.3079	0.0000	232.18	0.02	-.46	.4798	.0347	.03	119.	119.	119.
45	0.2287	0.0000	232.69	0.01	.21	.3751	.0279	-.11	107.	107.	107.
46	0.1704	0.0000	233.03	0.01	.01	.2800	.0217	-.11	79.	79.	79.
47	0.1244	0.0000	233.01	0.01	.22	.2027	.0162	.21	43.	43.	43.
48	0.1114	0.0000	233.10	0.01	.91	.1736	.0119	.30	32.	32.	32.
49	0.0743	0.0000	233.28	0.01	1.17	.1374	.0099	.41	31.	31.	31.
50	0.0515	0.0000	233.61	0.01	1.43	.1077	.0070	.58	28.	28.	28.
51	0.0375	0.0000	233.68	0.01	1.16	.0834	.0062	.89	26.	26.	26.

TABLE II-13. THERMODYNAMIC STATISTICAL PARAMETERS

ANNUAL

STATION = 723930 Z KM	VAN DER BERG AFB		S.D. T °C/G K	MEAN T °C/G K	S.D. T °C/G K	SKEW T	MEAN D G/M ³	S.D. D G/M ³	SKEW D	MOBS P	MOBS T	MOBS O
	S.D. P MB	SKEW P										
.000	1016.6000	3.1987	.07	265.34	4.18	.10	1218.0000	20.3500	.23	9861.	9861.	9861.
.100	1004.5000	3.8031	.06	266.16	4.18	.08	1218.0000	19.7200	.24	10136.	10136.	10136.
1.000	963.1300	3.5395	-.34	267.74	7.14	.06	1031.0000	26.7300	-.06	10228.	10228.	10228.
2.000	891.4600	4.2209	-.80	269.39	5.37	-.23	894.2000	21.4900	.17	10246.	10246.	10246.
3.000	769.8800	5.3501	-1.00	277.97	6.42	-.43	893.3000	15.7400	.35	10245.	10245.	10245.
4.000	636.9200	6.3203	-.78	271.64	6.13	-.54	603.0000	11.8000	.37	10240.	10240.	10240.
5.000	522.3100	7.0361	-.77	265.29	6.06	-.56	725.0000	9.2370	.32	10239.	10239.	10239.
6.000	485.2300	7.5293	-.75	259.31	6.15	-.50	654.3000	7.4390	.19	10229.	10229.	10229.
7.000	424.2500	7.8619	-.69	252.93	6.19	-.37	549.0000	6.0650	.05	10226.	10226.	10226.
8.000	369.8100	8.0239	-.62	243.40	6.11	-.26	519.3000	5.2390	-.38	10210.	10210.	10210.
9.000	300.6300	7.9655	-.53	235.82	5.92	-.02	473.0000	5.4560	-1.51	10198.	10198.	10198.
10.000	277.1500	7.8322	-.38	228.54	5.67	.11	422.4000	6.7130	-2.15	10190.	10190.	10190.
11.000	248.3700	7.4104	-.22	222.16	5.37	.12	373.6000	8.6300	-1.86	10162.	10162.	10162.
12.000	204.1800	6.6450	-.07	217.54	5.26	-.08	327.1000	10.5000	-1.22	10148.	10148.	10148.
13.000	174.4900	5.8391	.06	214.86	4.42	-.29	283.0000	11.1800	-.55	10106.	10106.	10106.
14.000	148.8600	4.9153	.14	212.73	3.84	.11	243.9000	10.6500	-.12	10068.	10068.	10068.
15.000	126.7500	3.9767	.17	210.43	4.04	.11	210.0000	9.5700	.09	10025.	10025.	10025.
16.000	107.8100	3.1954	.19	209.76	4.21	.13	160.0000	8.0000	.12	9936.	9936.	9936.
17.000	91.6140	2.5686	.21	208.45	3.91	.06	153.2000	6.0850	.05	9717.	9717.	9717.
18.000	77.9210	2.1663	.38	209.23	3.43	-.15	129.8000	4.5100	.09	9724.	9724.	9724.
19.000	66.2910	1.8377	.43	210.78	3.03	-.45	109.6000	3.2280	.13	9591.	9591.	9591.
20.000	56.4810	1.6032	.43	212.38	2.81	-.57	92.6000	2.4130	.17	9487.	9487.	9487.
21.000	48.2030	1.4531	.43	214.07	2.91	-.57	78.4400	1.9610	.28	7824.	7824.	7824.
22.000	41.1060	1.2725	.48	215.56	3.04	-.53	66.4300	1.5910	.45	7409.	7409.	7409.
23.000	35.1540	1.1438	.43	217.88	3.20	-.53	56.4300	1.3440	.55	7205.	7205.	7205.
24.000	30.6200	1.0140	.50	218.37	3.40	-.44	47.8900	1.1360	.69	7829.	7829.	7829.
25.000	25.8400	.8980	.27	220.08	3.54	-.51	40.8000	1.0090	.48	8710.	8710.	8710.
26.000	21.1510	.8023	.23	221.57	3.76	-.49	34.8000	.9059	.56	8503.	8503.	8503.
27.000	14.0140	.7010	.15	223.24	4.05	-.46	29.7400	.8349	.36	7042.	7042.	7042.
28.000	16.3630	.7001	.15	224.66	4.25	-.41	25.3700	.7510	.31	6313.	6313.	6313.
29.000	14.0820	.6308	.14	226.22	4.41	-.36	21.6900	.6876	.26	5921.	5921.	5921.
30.000	12.1330	.5679	.14	227.84	4.54	-.38	18.5700	.6374	.20	5769.	5769.	5769.
32.000	9.1077	.4357	.08	233.68	5.57	-.07	13.5700	.5425	-.10	1400.	1400.	1400.
34.000	6.8798	.3200	.06	237.18	6.02	-.23	10.0100	.4537	-.11	1411.	1411.	1411.
36.000	5.1574	.2932	.04	242.24	6.67	-.22	7.4120	.3733	-.20	1413.	1413.	1413.
38.000	3.8234	.2267	.00	247.88	7.23	-.25	5.5190	.2921	-.19	1421.	1421.	1421.
40.000	2.9985	.1828	-.05	253.38	7.41	-.44	4.1230	.2222	-.12	1420.	1420.	1420.
42.000	2.5046	.1488	-.12	258.91	7.51	-.64	3.1010	.1756	-.12	1420.	1420.	1420.
44.000	1.7810	.1205	-.16	263.57	6.94	-.50	2.3530	.1418	-.15	1416.	1416.	1416.
46.000	1.3815	.0972	-.19	266.27	6.89	-.52	1.8500	.1149	.22	1410.	1410.	1410.
48.000	1.0735	.0796	-.19	267.34	6.72	-.45	1.3800	.0913	-.25	1402.	1402.	1402.
50.000	.8348	.0633	-.20	265.46	6.63	-.42	1.0920	.0724	-.29	1323.	1323.	1323.
52.000	.6484	.0514	-.19	263.31	6.42	-.43	.8000	.0523	-.31	1345.	1345.	1345.
54.000	.5027	.0415	-.16	263.76	6.26	-.20	.6650	.0408	-.31	1336.	1336.	1336.
56.000	.3819	.0332	-.08	262.64	6.78	-.10	.5190	.0402	-.27	1283.	1283.	1283.
58.000	.2945	.0261	-.01	261.84	7.18	-.11	.4040	.0378	-.14	1140.	1140.	1140.
60.000	.2293	.0203	-.05	254.27	8.08	-.05	.3100	.0298	-.12	881.	881.	881.
62.000	.1738	.0154	-.10	248.47	9.24	.26	.2400	.0204	-.02	560.	560.	560.
64.000	.1325	.0114	.11	243.80	12.43	.37	.1890	.0182	-.07	427.	427.	427.
66.000	.0991	.0087	.18	237.41	13.57	.19	.1461	.0129	-.09	375.	375.	375.
68.000	.0733	.0069	.33	235.21	13.57	.12	.1130	.0105	-.07	387.	387.	387.
70.000	.0513	.0053	.59	234.45	13.57	.10	.0861	.0096	-.02	345.	345.	345.

TABLE III-1. MOISTURE RELATED STATISTICAL PARAMETERS

JANUARY

STATION # 723330		VANCOENBERG AFB		TV		DEWPT T		S.D. OPT		NOBS T+P	NOBS TV
Z	VAPOR P	S.D. VP	SKEW VP	TV	TV	SKEW TV	MEAN	S.D. OPT	SKEW OPT		
KM	MEAN MB	MB		MEAN DEG K	S.D. DEG K		DEG K	DEG K			
.000	9.676	7.144	.29	295.76	4.83	.01	278.86	5.02	-.49	854.	854.
.100	9.435	3.022	.26	295.41	4.68	.04	278.58	4.93	-.52	867.	867.
1.000	4.967	2.754	.92	283.67	5.19	.23	268.57	7.37	.08	877.	894.
2.000	2.929	2.063	1.19	276.93	5.23	-.32	261.00	8.36	.16	871.	894.
3.000	1.802	1.385	1.60	273.62	4.99	-.73	254.78	8.45	.22	862.	884.
4.000	1.126	.928	1.82	267.61	4.79	-.70	249.10	8.50	.21	860.	884.
5.000	.710	.604	1.72	260.93	4.81	-.68	243.67	8.88	.03	862.	884.
6.000	.416	.366	1.63	253.80	4.75	-.54	237.69	9.25	-.15	855.	884.
7.000	.208	.205	1.58	246.29	4.69	-.36	231.50	9.39	-.27	856.	883.
8.000	.127	.104	1.36	238.62	4.53	-.25	226.45	8.81	-.56	680.	883.
9.000	.084	.061	.68	230.90	4.21	-.09	222.81	8.90	-.82	149.	880.
10.000	.073	.016	1.17	223.69	3.76	.23	213.51	5.97	-.43	18.	880.
11.000	99.999	99.999	999.99	218.05	4.04	.70	999.99	99.99	999.99	5.	878.
12.000	99.999	99.999	999.99	215.13	5.45	.46	999.99	99.99	999.99	4.	876.
13.000	99.999	99.999	999.99	214.43	5.46	-.19	999.99	99.99	999.99	1.	872.
14.000	99.999	99.999	999.99	213.55	4.32	-.21	999.99	99.99	999.99	0.	864.
15.000	99.999	99.999	999.99	211.62	3.97	-.05	999.99	99.99	999.99	0.	858.
16.000	99.999	99.999	999.99	209.52	4.16	-.04	999.99	99.99	999.99	0.	855.
17.000	99.999	99.999	999.99	208.47	4.22	-.04	999.99	99.99	999.99	0.	832.
18.000	99.999	99.999	999.99	208.43	4.07	-.18	999.99	99.99	999.99	0.	827.
19.000	99.999	99.999	999.99	203.46	3.68	-.31	999.99	99.99	999.99	0.	802.
20.000	99.999	99.999	999.99	210.71	3.51	-.41	999.99	99.99	999.99	0.	785.
21.000	99.999	99.999	999.99	212.09	3.49	-.51	999.99	99.99	999.99	0.	630.
22.000	99.999	99.999	999.99	213.41	3.52	-.46	999.99	99.99	999.99	0.	615.
23.000	99.999	99.999	999.99	214.54	3.54	-.48	999.99	99.99	999.99	0.	606.
24.000	99.999	99.999	999.99	215.67	3.52	-.54	999.99	99.99	999.99	0.	714.
25.000	99.999	99.999	999.99	216.91	3.52	-.34	999.99	99.99	999.99	0.	714.
26.000	99.999	99.999	999.99	218.09	3.52	-.40	999.99	99.99	999.99	0.	703.
27.000	99.999	99.999	999.99	219.25	3.55	-.29	999.99	99.99	999.99	0.	554.
28.000	99.999	99.999	999.99	220.64	3.55	-.01	999.99	99.99	999.99	0.	508.
29.000	99.999	99.999	999.99	222.11	3.77	.16	999.99	99.99	999.99	0.	483.
30.000	99.999	99.999	999.99	223.83	3.96	.25	999.99	99.99	999.99	0.	473.

TABLE III-2. MOISTURE RELATED STATISTICAL PARAMETERS

FEBRUARY

STATION - 723930		VANDENBERG AFB			TV	TV	SKEW TV	DEHPT T	S.D. DPT	SKEW DPT	NOBS T-P	NOBS TV
Z	VAPOR P	S.D. VP	SKEW VP	TV	TV	SKEW TV	DEHPT T	S.D. DPT	SKEW DPT	NOBS T-P	NOBS TV	
	MEAN			MEAN	S.D.		MEAN					
KM	MB	MB		DEG K	DEG K		DEG K	DEG K				
.000	10.342	2.685	-.11	285.09	4.24	.05	280.13	4.20	-1.01	763.	763.	
.100	10.100	2.576	-.14	285.70	4.09	.10	279.60	4.12	-1.05	770.	771.	
1.000	5.000	2.329	.70	283.25	4.69	.37	283.11	6.45	-.17	779.	784.	
2.000	2.645	1.715	1.24	278.23	4.70	-.05	283.02	7.79	.15	778.	784.	
3.000	1.636	1.167	1.47	272.76	4.45	-.50	253.91	8.00	.16	775.	784.	
4.000	1.009	.784	1.69	266.71	4.29	-.73	248.13	8.04	.21	774.	783.	
5.000	.641	.505	1.52	259.97	4.38	-.84	242.97	8.32	-.07	774.	783.	
6.000	.378	.321	2.07	252.77	4.47	-.84	237.19	8.61	-.27	772.	784.	
7.000	.203	.177	1.89	245.19	4.45	-.71	230.71	9.03	-.44	756.	783.	
8.000	.110	.089	1.93	237.54	4.24	-.43	225.33	8.46	-.64	577.	781.	
9.000	.059	.050	.77	230.00	3.94	.09	221.28	8.39	-.72	99.	780.	
10.000	.016	.014	1.64	222.98	3.89	.63	210.18	5.45	.79	15	779.	
11.000	99.999	99.999	999.99	217.47	4.75	.84	999.99	99.99	999.99	1.	777.	
12.000	99.999	99.999	999.99	215.42	6.12	.47	999.99	99.99	999.99	1.	772.	
13.000	99.999	99.999	999.99	215.60	5.14	-.45	999.99	99.99	999.99	0.	767.	
14.000	99.999	99.999	999.99	214.58	3.62	-.29	999.99	99.99	999.99	0.	759.	
15.000	99.999	99.999	999.99	212.49	3.39	-.01	999.99	99.99	999.99	0.	758.	
16.000	99.999	99.999	999.99	210.43	3.76	-.15	999.99	99.99	999.99	0.	754.	
17.000	99.999	99.999	999.99	209.14	3.91	-.22	999.99	99.99	999.99	0.	741.	
18.000	99.999	99.999	999.99	208.96	3.81	-.24	999.99	99.99	999.99	0.	737.	
19.000	99.999	99.999	999.99	209.78	3.34	-.15	999.99	99.99	999.99	0.	731.	
20.000	99.999	99.999	999.99	210.38	3.03	.09	999.99	99.99	999.99	0.	725.	
21.000	99.999	99.999	999.99	212.18	2.90	.06	999.99	99.99	999.99	0.	589.	
22.000	99.999	99.999	999.99	213.28	2.83	-.03	999.99	99.99	999.99	0.	574.	
23.000	99.999	99.999	999.99	214.24	2.93	-.01	999.99	99.99	999.99	0.	563.	
24.000	99.999	99.999	999.99	215.47	3.09	.03	999.99	99.99	999.99	0.	660.	
25.000	99.999	99.999	999.99	216.62	3.08	-.16	999.99	99.99	999.99	0.	644.	
26.000	99.999	99.999	999.99	217.80	3.14	-.26	999.99	99.99	999.99	0.	634.	
27.000	99.999	99.999	999.99	219.28	3.16	-.38	999.99	99.99	999.99	0.	494.	
28.000	99.999	99.999	999.99	220.77	3.28	-.60	999.99	99.99	999.99	0.	449.	
29.000	99.999	99.999	999.99	222.65	3.14	-.49	999.99	99.99	999.99	0.	420.	
30.000	99.999	99.999	999.99	224.76	3.35	-.45	999.99	99.99	999.99	0.	411.	

TABLE III-3. MOISTURE RELATED STATISTICAL PARAMETERS

MARCH

STATION = 723930		VANDENBERG AFB		TV		DEWPT T		S.O. OPT		NOBS T+P	NOBS TV
Z	VAPOR P	S.O. VP	SKEW VP	TV	TV	SKEW TV	MEAN	S.O. OPT	SKEW OPT		
KM	MEAN	MB		MEAN	S.O.		DEG K	DEG K			
	MB			DEG K	DEG K						
.000	10.630	2.375	-.16	286.00	3.87	.05	280.65	3.54	-.85	847.	847.
.100	10.422	2.316	-.20	285.66	3.74	.04	280.38	3.52	-.86	869.	869.
1.000	5.120	2.300	.62	283.23	5.11	.30	269.45	6.43	-.34	877.	875.
2.000	2.602	1.669	1.40	278.33	5.29	-.25	259.92	7.56	.18	865.	887.
3.000	1.508	1.152	1.52	272.96	4.90	-.56	253.94	8.22	.06	860.	887.
4.000	.979	.765	1.74	266.96	4.72	-.78	247.62	8.48	-.03	861.	896.
5.000	.593	.485	1.88	260.26	4.57	-.85	242.05	8.43	-.11	863.	886.
6.000	.352	.297	1.78	252.97	4.55	-.82	236.37	8.71	-.27	861.	895.
7.000	.185	.170	1.88	245.32	4.47	-.72	230.68	9.05	-.28	849.	886.
8.000	.101	.090	1.95	237.74	4.15	-.32	224.38	9.59	-.47	623.	885.
9.000	.076	.060	1.83	230.24	3.71	-.04	221.83	8.76	-.65	96.	884.
10.000	.020	.013	.30	223.29	3.42	.23	212.63	5.45	-.17	17.	883.
11.000	.009	.004	.39	217.93	3.92	.92	207.57	2.88	.10	7.	880.
12.000	.008	.002	.32	215.36	5.42	.37	206.66	1.89	.23	7.	879.
13.000	99.999	99.999	999.99	215.38	5.28	-.50	999.99	99.99	999.99	4.	879.
14.000	99.999	99.999	999.99	214.80	3.85	-.47	999.99	99.99	999.99	2.	875.
15.000	99.999	99.999	999.99	212.99	3.38	-.14	999.99	99.99	999.99	1.	872.
16.000	99.999	99.999	999.99	211.25	3.39	-.14	999.99	99.99	999.99	0.	870.
17.000	99.999	99.999	999.99	210.32	3.38	-.21	999.99	99.99	999.99	0.	868.
18.000	99.999	99.999	999.99	210.23	3.19	-.31	999.99	99.99	999.99	0.	857.
19.000	99.999	99.999	999.99	211.04	2.82	-.24	999.99	99.99	999.99	0.	843.
20.000	99.999	99.999	999.99	211.97	2.73	-.24	999.99	99.99	999.99	0.	839.
21.000	99.999	99.999	999.99	213.06	2.58	-.06	999.99	99.99	999.99	0.	809.
22.000	99.999	99.999	999.99	214.42	2.56	-.04	999.99	99.99	999.99	0.	672.
23.000	99.999	99.999	999.99	215.69	2.53	-.20	999.99	99.99	999.99	0.	658.
24.000	99.999	99.999	999.99	216.93	2.59	.22	999.99	99.99	999.99	0.	765.
25.000	99.999	99.999	999.99	218.26	2.66	.27	999.99	99.99	999.99	0.	744.
26.000	99.999	99.999	999.99	219.71	2.83	.31	999.99	99.99	999.99	0.	744.
27.000	99.999	99.999	999.99	221.43	3.11	.47	999.99	99.99	999.99	0.	609.
28.000	99.999	99.999	999.99	223.29	3.53	.55	999.99	99.99	999.99	0.	562.
29.000	99.999	99.999	999.99	225.36	3.90	.61	999.99	99.99	999.99	0.	533.
30.000	99.999	99.999	999.99	227.54	4.11	.52	999.99	99.99	999.99	0.	573.

TABLE III-4. MOISTURE RELATED STATISTICAL PARAMETERS

APRIL

STATION = 723930		VANDENBERG AFB		TV	TV	SKEW TV	DEWPT T	S.D. OPT	SKEW OPT	NOBS T+P	NOBS TV
Z	VAI/O P	S.D. VP	SKEW VP	MEAN	S.D.		MEAN				
KM	MB	MB		DEG K	DEG K		DEG K	DEG K			
.000	10.609	1.793	-.13	286.00	3.74	.19	280.80	2.60	-.78	809.	809.
.100	10.374	1.751	-.13	285.84	3.62	.21	280.50	2.59	-.75	829.	829.
1.000	4.905	2.054	.38	283.78	5.35	.16	269.27	6.05	-.51	823.	831.
2.000	2.302	1.396	1.53	278.88	5.32	-.29	258.67	6.98	-.18	813.	832.
3.000	1.368	.935	2.00	273.70	5.22	-.72	252.23	7.15	.21	807.	832.
4.000	.873	.656	2.68	267.05	5.11	-1.09	246.39	7.18	.37	808.	832.
5.000	.515	.422	2.47	261.31	4.89	-1.27	241.01	7.42	.21	808.	832.
6.000	.297	.252	2.42	254.15	4.66	-1.33	235.28	7.45	.10	811.	830.
7.000	.162	.147	2.32	246.69	4.20	-1.04	228.99	7.93	-.04	805.	831.
8.000	.086	.073	1.82	239.17	3.58	-.52	223.30	7.80	-.29	692.	828.
9.000	.058	.049	1.03	231.67	3.04	-.14	219.35	8.72	-.41	118.	828.
10.000	.016	.008	.84	224.56	2.84	.19	211.53	3.70	.28	14.	828.
11.000	.016	.010	1.11	218.50	3.36	1.11	211.55	3.98	.53	7.	826.
12.000	.014	.010	1.04	214.73	4.73	.83	210.11	5.21	.05	7.	825.
13.000	99.999	99.999	999.99	214.33	5.18	-.02	999.99	99.99	999.99	5.	802.
14.000	99.999	99.999	999.99	214.52	4.00	-.34	999.99	99.99	999.99	4.	819.
15.000	99.999	99.999	999.99	213.49	3.26	.05	999.99	99.99	999.99	3.	818.
16.000	99.999	99.999	999.99	212.18	3.28	-.09	999.99	99.99	999.99	0.	818.
17.000	99.999	99.999	999.99	211.70	3.18	-.16	999.99	99.99	999.99	0.	793.
18.000	99.999	99.999	999.99	212.00	3.09	-.37	999.99	99.99	999.99	0.	793.
19.000	99.999	99.999	999.99	212.73	2.66	-.18	999.99	99.99	999.99	0.	782.
20.000	99.999	99.999	999.99	213.37	2.41	.09	999.99	99.99	999.99	0.	776.
21.000	99.999	99.999	999.99	214.65	2.58	-.04	999.99	99.99	999.99	0.	654.
22.000	99.999	99.999	999.99	216.04	2.70	-.18	999.99	99.99	999.99	0.	627.
23.000	99.999	99.999	999.99	217.48	2.65	.03	999.99	99.99	999.99	0.	620.
24.000	99.999	99.999	999.99	218.67	2.66	.10	999.99	99.99	999.99	0.	697.
25.000	99.999	99.999	999.99	220.17	2.75	-.04	999.99	99.99	999.99	0.	719.
26.000	99.999	99.999	999.99	221.83	2.95	-.04	999.99	99.99	999.99	0.	712.
27.000	99.999	99.999	999.99	223.81	3.13	.02	999.99	99.99	999.99	0.	574.
28.000	99.999	99.999	999.99	225.72	3.21	.03	999.99	99.99	999.99	0.	529.
29.000	99.999	99.999	999.99	227.72	3.28	.05	999.99	99.99	999.99	0.	506.
30.000	99.999	99.999	999.99	229.83	3.32	.01	999.99	99.99	999.99	0.	500.

TABLE III-5. MOISTURE RELATED STATISTICAL PARAMETERS

MAY

STATION # 723930		VANDENBERG AFB		TV		TV	SKER TV	DEPHT T	S.D. DPT	SKEM DPT	NOBS T+P	NOBS TV
Z	VAPOR P	S.D. VP	SKEM VP	MEAN	S.D.	DEG K	MEAN	S.D. DPT	SKEM DPT	NOBS T+P	NOBS TV	
KM	MB	MB	DEG K	DEG K	DEG K	DEG K	DEG K	DEG K	DEG K			
.000	11.621	1.572	-.02	287.06	3.51	.61	282.21	2.06	-.53	859.	859.	
.100	11.540	1.588	-.05	286.89	3.41	.62	282.10	2.10	-.57	880.	880.	
1.000	5.773	2.313	.33	288.06	5.33	.02	271.27	6.10	-.66	877.	888.	
2.000	3.158	1.529	.69	283.87	5.25	-.49	263.02	6.50	-.28	868.	890.	
3.000	1.917	1.122	1.18	278.14	4.58	.00	246.42	7.13	-.14	859.	890.	
4.000	1.143	.749	1.52	271.97	4.46	-.00	240.16	7.22	-.03	873.	890.	
5.000	.649	.425	1.49	265.3F	4.23	-1.03	243.96	6.86	-.05	874.	890.	
6.000	.368	.243	1.50	256.2	4.20	-1.00	237.97	6.89	-.29	874.	889.	
7.000	.191	.134	1.68	250.54	4.16	-.97	231.32	7.04	-.36	872.	888.	
8.000	.101	.072	1.47	242.19	3.97	-.77	225.26	7.20	-.52	807.	884.	
9.000	.052	.040	1.22	235.01	3.53	-.41	219.10	7.86	-.53	426.	883.	
10.000	.024	.011	.70	227.46	3.10	-.32	214.70	3.90	-.77	20.	881.	
11.000	.012	.006	1.33	220.09	2.79	.22	209.05	3.49	.19	13.	881.	
12.000	.006	.003	1.48	215.58	3.24	1.05	205.07	3.10	.56	13.	881.	
13.000	99.999	99.999	999.99	213.46	4.28	.41	999.99	99.99	999.99	5.	879.	
14.000	99.999	99.999	999.99	213.49	3.86	-.01	999.99	99.99	999.99	2.	876.	
15.000	99.999	99.999	999.99	212.65	3.35	.18	999.99	99.99	999.99	2.	875.	
16.000	99.999	99.999	999.99	211.76	3.42	-.12	999.99	99.99	999.99	0.	874.	
17.000	99.999	99.999	999.99	211.39	3.23	-.31	999.99	99.99	999.99	0.	852.	
18.000	99.999	99.999	999.99	211.76	2.98	-.24	999.99	99.99	999.99	0.	845.	
19.000	99.999	99.999	999.99	212.62	2.44	-.23	999.99	99.99	999.99	0.	834.	
20.000	99.999	99.999	999.99	213.90	2.13	-.14	999.99	99.99	999.99	0.	828.	
21.000	99.999	99.999	999.99	215.31	2.02	-.11	999.99	99.99	999.99	0.	877.	
22.000	99.999	99.999	999.99	216.88	2.00	-.11	999.99	99.99	999.99	0.	862.	
23.000	99.999	99.999	999.99	218.61	1.98	-.17	999.99	99.99	999.99	0.	851.	
24.000	99.999	99.999	999.99	220.35	2.04	-.12	999.99	99.99	999.99	0.	864.	
25.000	99.999	99.999	999.99	222.15	2.15	-.04	999.99	99.99	999.99	0.	762.	
26.000	99.999	99.999	999.99	223.99	2.26	-.08	999.99	99.99	999.99	0.	755.	
27.000	99.999	99.999	999.99	225.96	2.42	.03	999.99	99.99	999.99	0.	619.	
28.000	99.999	99.999	999.99	227.79	2.48	.13	999.99	99.99	999.99	0.	580.	
29.000	99.999	99.999	999.99	229.57	2.49	.19	999.99	99.99	999.99	0.	544.	
30.000	99.999	99.999	999.99	231.40	2.41	.20	999.99	99.99	999.99	0.	527.	

TABLE III-6. MOISTURE RELATED STATISTICAL PARAMETERS

JUNE

STATION - 72330		VANOLNBORG AFB		TV		TV		DEWPT T		S.D. DPT		SKEW DPT		NOBS T+P		NOBS TV	
Z	VAPOR P	S.O. VP	SKEW VP	TV	TV	SKEW TV	DEWPT T	S.O. DPT	SKEW DPT	NOBS T+P	NOBS TV						
KM	MEAN	MEAN	MEAN	MEAN	S.O.		MEAN	DEG K									
	MB	MB	DEG K	DEG K	DEG K		DEG K										
.000	12.570	1.681	-.09	268.18	3.58	.63	283.33	2.07	-.70	756.	756.						
.100	12.624	1.649	-.14	268.24	3.42	.67	283.45	2.03	-.75	775.	775.						
1.000	6.110	2.658	.54	292.30	5.94	-.46	271.05	6.24	-.22	777.	789.						
2.000	3.577	1.662	.08	288.53	4.55	-.66	264.82	5.95	.02	774.	790.						
3.000	2.668	1.157	1.23	282.72	3.98	-.75	258.94	5.94	.24	769.	790.						
4.000	1.425	.831	1.45	276.49	3.72	-.71	253.16	6.27	.29	768.	789.						
5.000	.860	.568	1.90	269.84	3.57	-.75	247.22	6.41	.40	771.	790.						
6.000	.503	.377	2.45	262.84	3.53	-.91	241.15	6.73	.32	768.	788.						
7.000	.276	.242	2.80	255.39	3.49	-.99	234.54	7.33	.25	763.	788.						
8.000	.150	.135	2.71	247.68	3.52	-.79	228.48	7.50	.10	744.	788.						
9.000	.072	.067	2.52	239.84	3.42	-.51	221.61	7.88	-.16	683.	786.						
10.000	.036	.040	1.82	232.16	3.15	-.26	214.59	8.92	.21	169.	786.						
11.000	.026	.027	2.64	224.98	2.95	-.10	214.60	4.71	1.88	13.	782.						
12.000	.013	.011	2.50	219.03	3.01	.07	209.60	3.97	1.94	12.	781.						
13.000	.010	.012	2.13	214.92	3.41	.34	207.22	5.14	1.42	10.	778.						
14.000	.014	.019	1.35	212.43	3.51	.31	207.73	7.10	1.24	6.	777.						
15.000	99.999	99.999	999.99	210.43	3.56	.00	999.99	99.99	999.99	3.	774.						
16.000	99.999	99.999	999.99	208.96	3.64	-.03	999.99	99.99	999.99	0.	772.						
17.000	99.999	99.999	999.99	208.70	3.32	-.09	999.99	99.99	999.99	0.	748.						
18.000	99.999	99.999	999.99	209.81	2.77	.09	999.99	99.99	999.99	0.	749.						
19.000	99.999	99.999	999.99	211.95	2.18	.10	999.99	99.99	999.99	0.	743.						
20.000	99.999	99.999	999.99	214.01	1.80	.03	999.99	99.99	999.99	0.	738.						
21.000	99.999	99.999	999.99	215.96	1.61	.11	999.99	99.99	999.99	0.	574.						
22.000	99.999	99.999	999.99	217.89	1.56	.09	999.99	99.99	999.99	0.	538.						
23.000	99.999	99.999	999.99	219.80	1.58	.31	999.99	99.99	999.99	0.	533.						
24.000	99.999	99.999	999.99	221.55	1.63	.37	999.99	99.99	999.99	0.	534.						
25.000	99.999	99.999	999.99	223.31	1.68	.19	999.99	99.99	999.99	0.	699.						
26.000	99.999	99.999	999.99	225.12	1.70	.22	999.99	99.99	999.99	0.	649.						
27.000	99.999	99.999	999.99	227.01	1.82	.28	999.99	99.99	999.99	0.	569.						
28.000	99.999	99.999	999.99	228.67	1.86	.26	999.99	99.99	999.99	0.	535.						
29.000	99.999	99.999	999.99	230.32	1.97	-.25	999.99	99.99	999.99	0.	468.						
30.000	99.999	99.999	999.99	232.17	2.00	-.25	999.99	99.99	999.99	0.	455.						

TABLE III-7. MOISTURE RELATED STATISTICAL PARAMETERS

JULY

STATION = 723930		VANDEMBERG AFB		TV		DEWPT T		S.O. DPT		NOBS T+P	NOBS TV
Z	VAPOR P MEAN	S. D. VP	SKEW VP	TV MEAN	TV S. D.	SKEW TV	MEAN DEG K	S. D. DPT DEG K	SKEW DPT		
KM	MB	MR		DEG K	DEG K						
.000	13.544	1.588	.10	288.85	3.28	.30	284.53	1.79	-.33	809.	809.
.100	13.733	1.545	.04	289.04	3.13	.35	284.75	1.73	-.40	830.	833.
1.000	6.330	2.844	1.11	296.60	4.09	-.65	272.64	5.94	.13	818.	843.
2.000	4.428	2.293	1.32	292.33	3.04	-.54	267.43	6.34	.35	824.	847.
3.000	3.075	1.935	1.34	286.01	2.39	-.42	262.18	7.18	.52	816.	846.
4.000	2.027	1.473	1.58	279.29	2.10	-.23	256.60	7.64	.63	815.	845.
5.000	1.199	.955	1.86	272.39	2.11	.02	250.19	7.67	.71	815.	845.
6.000	.636	.547	2.35	265.59	2.22	-.15	243.21	7.22	.80	804.	843.
7.000	.321	.284	2.47	258.46	2.36	-.27	236.11	7.10	.60	804.	844.
8.000	.165	.148	2.14	251.09	2.50	-.30	229.30	7.50	.30	797.	843.
9.000	.079	.074	2.46	243.53	2.64	-.33	222.48	7.67	.07	793.	843.
10.000	.036	.036	1.97	236.06	2.69	-.24	215.35	8.09	.17	429.	842.
11.000	.023	.017	1.84	228.89	2.58	-.20	213.78	5.47	-.32	25.	840.
12.000	.012	.005	1.52	222.35	2.33	-.27	209.42	2.81	.92	17.	841.
13.000	99.999	99.999	999.99	216.46	2.27	.23	999.99	99.99	999.99	5.	832.
14.000	99.999	99.999	999.99	211.28	2.61	.75	999.99	99.99	999.99	0.	832.
15.000	99.999	99.999	999.99	207.26	2.95	.83	999.99	99.99	999.99	0.	827.
15.000	99.999	99.999	999.99	205.75	2.98	.84	999.99	99.99	999.99	0.	827.
17.000	99.999	99.999	999.99	206.68	2.65	.51	999.99	99.99	999.99	0.	796.
18.000	99.999	99.999	999.99	208.88	2.25	.22	999.99	99.99	999.99	0.	789.
19.000	99.999	99.999	999.99	211.62	1.78	.09	999.99	99.99	999.99	0.	783.
20.000	99.999	99.999	999.99	214.14	1.65	.02	999.99	99.99	999.99	0.	773.
21.000	99.999	99.999	999.99	216.44	1.58	.04	999.99	99.99	999.99	0.	762.
22.000	99.999	99.999	999.99	218.44	1.49	-.06	999.99	99.99	999.99	0.	588.
23.000	99.999	99.999	999.99	220.24	1.49	-.12	999.99	99.99	999.99	0.	584.
24.000	99.999	99.999	999.99	221.90	1.53	-.12	999.99	99.99	999.99	0.	577.
25.000	99.999	99.999	999.99	223.46	1.56	-.14	999.99	99.99	999.99	0.	722.
25.000	99.999	99.999	999.99	225.15	1.66	.10	999.99	99.99	999.99	0.	715.
27.000	99.999	99.999	999.99	226.97	1.79	.09	999.99	99.99	999.99	0.	656.
27.000	99.999	99.999	999.99	228.53	1.85	-.07	999.99	99.99	999.99	0.	526.
29.000	99.999	99.999	999.99	230.20	2.03	.08	999.99	99.99	999.99	0.	496.
30.000	99.999	99.999	999.99	231.81	2.00	.04	999.99	99.99	999.99	0.	484.

AD-A128 125

RANGE REFERENCE ATMOSPHERE 0-70 KM ALTITUDE VANDENBERG

AFB CALIFORNIA(U) RANGE COMMANDERS COUNCIL WHITE SANDS

MISSILE RANGE NM METEOROLOGY GROUP G G BOIRE ET AL.

213

UNCLASSIFIED

APR 83 RCC/MG-362-83

F/G 4/2

NL

A large grid of 10 columns and 11 rows of black squares, representing a microfilm frame or a data table. The grid is completely filled with solid black squares, indicating that the data or images stored on the microfilm are not visible in this scan.

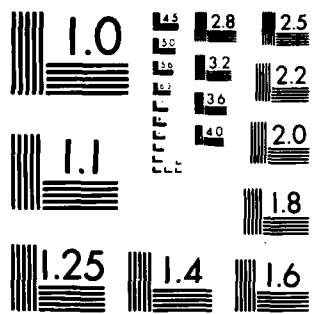

MICROCOPY RESOLUTION TEST CHART
NATIONAL BUREAU OF STANDARDS-1963-A

TABLE III-8. MOISTURE RELATED STATISTICAL PARAMETERS

AUGUST

STATION - 723930		VANDENBERG AFB		TV	TV	SKEW TV	DEWPT T	S.D. DPT	SKEW DPT	NOBS T-P	NOBS TV
Z	VAPOR P	S.D. VP	SKEW VP	MEAN	S.D.		MEAN				
KH	MD	MD		DEG K	DEG K		DEG K	DEG K			
.000	14.336	1.696	-.03	269.83	3.29	.15	287.39	1.84	-.90	823.	823.
.100	14.497	1.629	-.13	290.00	3.11	.17	285.57	1.75	-.58	853.	853.
1.000	6.874	2.908	.86	296.58	4.51	-.56	273.69	5.93	-.10	826.	854.
2.000	4.616	2.365	1.20	292.02	3.79	-.72	267.94	6.53	.15	820.	854.
3.000	3.054	1.863	1.27	285.67	3.11	-.82	262.07	7.39	.22	820.	854.
4.000	1.960	1.337	1.31	278.99	2.69	-.64	256.26	7.78	.33	821.	854.
5.000	1.136	.855	1.64	272.22	2.60	-.52	243.72	7.77	.48	814.	854.
6.000	.649	.542	2.03	265.39	2.61	-.62	243.31	7.19	.52	814.	855.
7.000	.323	.287	2.51	258.37	2.64	-.63	235.00	7.44	.41	801.	855.
8.000	.168	.151	2.05	251.07	2.80	-.66	223.35	7.75	.21	809.	855.
9.000	.084	.079	1.90	243.50	2.97	-.51	222.24	8.17	.03	804.	855.
10.000	.041	.040	1.64	236.04	3.11	-.37	216.12	8.36	.11	436.	855.
11.000	.029	.017	1.06	228.91	3.02	-.39	215.80	5.13	-.69	35.	854.
12.000	.011	.005	.89	222.34	2.56	-.49	203.73	3.17	.00	14.	852.
13.000	.005	.002	.60	216.57	2.07	-.07	203.63	2.89	.07	9.	849.
14.000	99.999	99.999	999.99	211.50	2.57	.62	999.99	99.99	999.99	0.	845.
15.000	99.999	99.999	999.99	207.55	3.36	.86	999.99	99.99	999.99	0.	841.
15.000	99.999	99.999	999.99	205.87	3.71	.84	999.99	99.99	999.99	0.	839.
17.000	99.999	99.999	999.99	206.97	3.21	.51	999.99	99.99	999.99	0.	819.
18.000	99.999	99.999	999.99	209.25	2.64	.13	999.99	99.99	999.99	0.	818.
19.000	99.999	99.999	999.99	211.97	1.98	-.09	999.99	99.99	999.99	0.	811.
20.000	99.999	99.999	999.99	214.31	1.66	-.08	999.99	99.99	999.99	0.	802.
21.000	99.999	99.999	999.99	216.34	1.49	.02	999.99	99.99	999.99	0.	719.
22.000	99.999	99.999	999.99	218.08	1.49	.01	999.99	99.99	999.99	0.	588.
23.000	99.999	99.999	999.99	219.76	1.51	.00	999.99	99.99	999.99	0.	581.
24.000	99.999	99.999	999.99	221.46	1.58	.08	999.99	99.99	999.99	0.	580.
25.000	99.999	99.999	999.99	223.05	1.59	.04	999.99	99.99	999.99	0.	748.
26.000	99.999	99.999	999.99	224.62	1.65	.03	999.99	99.99	999.99	0.	735.
27.000	99.999	99.999	999.99	226.38	1.77	-.04	999.99	99.99	999.99	0.	658.
28.000	99.999	99.999	999.99	227.80	1.91	-.19	999.99	99.99	999.99	0.	548.
29.000	99.999	99.999	999.99	229.39	2.11	.12	999.99	99.99	999.99	0.	500.
30.000	99.999	99.999	999.99	230.88	2.15	.11	999.99	99.99	999.99	0.	470.

TABLE III-9. MOISTURE RELATED STATISTICAL PARAMETERS

SEPTEMBER

STATION = 723930		VANDENBERG AFB										
Z	VAPOR P	S.D. VP	SKEM VP	TV	TV	SKEM TV	DEHPT T	S.D. DPT	SKEM DPT	NOBS T+P	NOBS TV	
PM	MEAN	MM		MEAN	S.D.		MEAN	DEG K				
				DFG K	DEG K							
.000	14.293	2.381	-.32	290.60	4.02	.64	209.24	2.74	-1.25	745.	745.	
.100	14.303	2.257	-.52	290.54	3.80	.63	209.27	2.62	-1.44	818.	818.	
1.000	7.356	3.353	.88	294.18	4.84	-.26	274.43	6.56	-.22	770.	779.	
2.000	4.479	2.510	1.35	289.52	3.69	-.56	267.31	6.98	.25	767.	783.	
3.000	2.883	1.807	1.40	283.20	3.04	-.59	261.32	7.35	.29	766.	783.	
4.000	1.686	1.226	1.97	276.93	2.86	-.46	254.58	7.20	.66	761.	783.	
5.000	.925	.732	2.51	270.57	2.84	-.57	247.68	6.79	.87	752.	782.	
6.000	.498	.422	3.26	263.83	2.88	-.76	240.97	6.64	.70	750.	781.	
7.000	.257	.243	3.35	256.47	2.93	-.72	233.90	6.96	.63	752.	780.	
8.000	.138	.137	2.89	248.85	2.89	-.54	227.47	7.54	.42	747.	780.	
9.000	.067	.069	2.68	241.13	2.93	-.22	220.60	7.95	.20	721.	780.	
10.000	.029	.035	2.44	233.69	3.01	.01	212.97	7.99	.65	224.	779.	
11.000	.021	.015	2.43	226.83	3.15	.10	213.18	5.04	-.06	24.	774.	
12.000	.011	.007	1.84	221.03	3.01	.16	208.42	4.10	.06	20.	774.	
13.000	.005	.002	.40	216.08	2.85	.14	203.21	3.11	-.10	15.	772.	
14.000	99.999	99.999	999.99	211.77	2.73	.49	999.99	99.99	999.99	4.	772.	
15.000	99.999	99.999	999.99	208.25	2.99	.42	999.99	99.99	999.99	1.	767.	
16.000	99.999	99.999	999.99	206.30	3.18	.26	999.99	99.99	999.99	0.	762.	
17.000	99.999	99.999	999.99	206.59	3.00	.32	999.99	99.99	999.99	0.	751.	
18.000	99.999	99.999	999.99	208.22	2.99	.08	999.99	99.99	999.99	0.	791.	
19.000	99.999	99.999	999.99	210.72	2.12	.05	999.99	99.99	999.99	0.	788.	
20.000	99.999	99.999	999.99	213.20	1.86	.16	999.99	99.99	999.99	0.	784.	
21.000	99.999	99.999	999.99	215.34	1.68	.05	999.99	99.99	999.99	0.	621.	
22.000	99.999	99.999	999.99	217.19	1.62	-.11	999.99	99.99	999.99	0.	591.	
23.000	99.999	99.999	999.99	219.00	1.60	-.01	999.99	99.99	999.99	0.	578.	
24.000	99.999	99.999	999.99	220.69	1.65	-.08	999.99	99.99	999.99	0.	574.	
25.000	99.999	99.999	999.99	222.12	1.60	.13	999.99	99.99	999.99	0.	721.	
26.000	99.999	99.999	999.99	223.64	1.69	.00	999.99	99.99	999.99	0.	714.	
27.000	99.999	99.999	999.99	225.30	1.84	.15	999.99	99.99	999.99	0.	568.	
28.000	99.999	99.999	999.99	226.71	2.08	.08	999.99	99.99	999.99	0.	513.	
29.000	99.999	99.999	999.99	228.04	2.21	-.10	999.99	99.99	999.99	0.	481.	
30.000	99.999	99.999	999.99	229.38	2.26	.07	999.99	99.99	999.99	0.	463.	

TABLE III-10. MOISTURE RELATED STATISTICAL PARAMETERS

OCTOBER

STATION = 723330		VANDENBERG AFB		TV		TV		DEWPT T		S.D. DPT		NOBS T+P		NOBS TV	
Z	VAPOR P	S.D. VP	SKEW VP	TV	TV	SKEW TV	DEWPT T	S.D. DPT	SKEW DPT	NOBS T+P	NOBS TV	NOBS T+P	NOBS TV	NOBS T+P	NOBS TV
KPI	MEAN	MB		MEAN	S.D.		MEAN	DEG K							
.000	12.912	3.044	-.67	289.62	4.14	.09	283.44	4.22	-1.70	826.	826.				
.100	12.761	2.977	-.75	289.46	3.98	.09	283.27	4.19	-1.74	840.	840.				
1.000	6.120	2.902	.82	290.57	5.29	-.06	271.84	6.48	.04	856.	856.				
2.000	3.443	2.006	1.41	285.57	4.59	-.84	253.83	6.94	.29	851.	856.				
3.000	2.110	1.358	1.75	279.83	4.01	-.86	257.54	6.97	.39	852.	866.				
4.000	1.275	.882	1.90	273.90	3.87	-1.01	251.45	6.95	.40	852.	865.				
5.000	.777	.568	2.06	267.41	3.82	-1.20	245.73	7.08	.26	855.	865.				
6.000	.471	.366	2.04	260.39	3.77	-1.28	240.12	7.42	.11	854.	863.				
7.000	.263	.212	2.00	252.82	3.69	-1.21	233.93	7.80	-.11	852.	863.				
8.000	.141	.120	1.72	245.14	3.50	-.86	227.61	8.22	-.22	809.	862.				
9.000	.069	.060	1.71	237.94	3.06	-.31	221.03	8.40	-.35	647.	862.				
10.000	.040	.048	1.75	230.29	2.89	.03	215.41	8.89	.29	75.	861.				
11.000	.013	.003	1.01	223.80	3.21	.51	210.76	1.35	.69	11.	858.				
12.000	.008	.002	1.04	218.56	3.61	.54	206.85	1.63	.89	10.	858.				
13.000	99.999	99.999	999.99	214.82	3.45	.39	999.99	99.99	999.99	4.	858.				
14.000	99.999	99.999	999.99	211.70	3.23	.14	999.99	99.99	999.99	1.	857.				
15.000	99.999	99.999	999.99	208.90	3.23	.14	999.99	99.99	999.99	1.	854.				
16.000	99.999	99.999	999.99	206.88	3.35	.02	999.99	99.99	999.99	0.	853.				
17.000	99.999	99.999	999.99	206.56	3.31	.08	999.99	99.99	999.99	0.	817.				
18.000	99.999	99.999	999.99	207.68	2.92	.11	999.99	99.99	999.99	0.	815.				
19.000	99.999	99.999	999.99	209.84	2.42	.06	999.99	99.99	999.99	0.	807.				
20.000	99.999	99.999	999.99	211.68	2.18	.10	999.99	99.99	999.99	0.	800.				
21.000	99.999	99.999	999.99	213.79	2.10	.10	999.99	99.99	999.99	0.	634.				
22.000	99.999	99.999	999.99	215.59	2.10	-.09	999.99	99.99	999.99	0.	621.				
23.000	99.999	99.999	999.99	217.26	2.18	-.17	999.99	99.99	999.99	0.	610.				
24.000	99.999	99.999	999.99	218.80	2.24	-.18	999.99	99.99	999.99	0.	646.				
25.000	99.999	99.999	999.99	220.36	2.23	-.24	999.99	99.99	999.99	0.	731.				
26.000	99.999	99.999	999.99	221.62	2.31	-.32	999.99	99.99	999.99	0.	717.				
27.000	99.999	99.999	999.99	222.87	2.48	-.36	999.99	99.99	999.99	0.	567.				
28.000	99.999	99.999	999.99	224.06	2.66	-.44	999.99	99.99	999.99	0.	510.				
29.000	99.999	99.999	999.99	225.14	2.83	-.34	999.99	99.99	999.99	0.	479.				
30.000	99.999	99.999	999.99	226.22	2.97	-.15	999.99	99.99	999.99	0.	468.				

TABLE III-11. MOISTURE RELATED STATISTICAL PARAMETERS

NOVEMBER

STATION - 723930		VANDENBERG AFB		TV		TV		DEWPT T		S.D. DPT		NOBS T+P		NOBS TV	
Z	VAPOR P	S.D. VP	SKEM VP	TV	TV	SKEM TV	DEWPT T	S.D. DPT	SKEM DPT	NOBS T+P	NOBS TV				
	MEAN	MB		MEAN	S.D.		MEAN	DEG K							
KM	MB			DEG K	DEG K		DEG K								
.000	11.137	3.237	-.02	287.91	4.40	.04	281.09	4.69	-.75	868.	868.				
.100	10.979	3.133	-.06	287.64	4.24	.07	280.90	4.61	-.79	882.	882.				
1.000	5.676	2.892	.80	286.58	5.02	.09	270.58	7.04	-.09	890.	894.				
2.000	3.143	2.088	1.27	281.92	5.02	-.38	262.07	8.07	.19	879.	895.				
3.000	1.885	1.366	1.72	276.77	4.84	-.64	255.64	7.95	.21	878.	895.				
4.000	1.190	.935	1.92	270.89	4.67	-.78	250.00	8.11	.22	877.	895.				
5.000	.774	.636	1.97	264.38	4.56	-.86	244.93	8.42	.05	878.	895.				
6.000	.468	.412	2.08	257.43	4.44	-.85	239.24	8.70	-.02	877.	895.				
7.000	.271	.255	2.01	250.10	4.31	-.84	233.28	9.17	-.13	872.	894.				
8.000	.145	.132	1.67	242.61	4.09	-.65	227.24	9.26	-.34	820.	892.				
9.000	.079	.068	1.54	235.11	3.69	-.27	221.88	8.97	-.47	476.	899.				
10.000	.033	.029	1.29	227.93	3.39	.12	215.26	7.11	.08	43.	889.				
11.000	.015	.010	1.48	221.39	3.53	.52	210.47	4.43	.78	17.	886.				
12.000	.008	.004	.71	216.15	4.15	.50	206.59	3.63	.26	15.	884.				
13.000	99.999	99.999	999.99	212.85	4.39	.16	999.99	99.99	999.99	5.	879.				
14.000	99.999	99.999	999.99	210.73	3.80	.08	999.99	99.99	999.99	1.	873.				
15.000	99.999	99.999	999.99	208.74	3.53	.27	999.99	99.99	999.99	0.	870.				
16.000	99.999	99.999	999.99	207.13	3.67	.23	999.99	99.99	999.99	0.	867.				
17.000	99.999	99.999	999.99	206.72	3.72	.08	999.99	99.99	999.99	0.	842.				
18.000	99.999	99.999	999.99	207.36	3.47	-.05	999.99	99.99	999.99	0.	840.				
19.000	99.999	99.999	999.99	208.75	3.00	.00	999.99	99.99	999.99	0.	825.				
20.000	99.999	99.999	999.99	210.13	2.55	-.01	999.99	99.99	999.99	0.	815.				
21.000	99.999	99.999	999.99	211.73	2.19	-.01	999.99	99.99	999.99	0.	801.				
22.000	99.999	99.999	999.99	213.21	2.18	-.05	999.99	99.99	999.99	0.	676.				
23.000	99.999	99.999	999.99	214.78	2.14	.00	999.99	99.99	999.99	0.	668.				
24.000	99.999	99.999	999.99	216.11	2.23	-.19	999.99	99.99	999.99	0.	768.				
25.000	99.999	99.999	999.99	217.49	2.38	-.18	999.99	99.99	999.99	0.	763.				
26.000	99.999	99.999	999.99	218.86	2.57	.08	999.99	99.99	999.99	0.	751.				
27.000	99.999	99.999	999.99	220.01	2.70	.17	999.99	99.99	999.99	0.	589.				
28.000	99.999	99.999	999.99	221.20	2.85	.17	999.99	99.99	999.99	0.	548.				
29.000	99.999	99.999	999.99	222.38	2.92	.05	999.99	99.99	999.99	0.	516.				
30.000	99.999	99.999	999.99	223.65	3.01	.01	999.99	99.99	999.99	0.	517.				

TABLE III-12. MOISTURE RELATED STATISTICAL PARAMETERS

DECEMBER

STATION = 723930		VANDERBERG AFB			TV	TV	SKEN TV	OCMPT T	S.D. DPT	SKEN DPT	NOBS T-P	NOBS TV
Z	VAPOR P	S.D. VP	SKEN VP	TV	TV	SKEN TV	OCMPT T	S.D. DPT	SKEN DPT	NOBS T-P	NOBS TV	
MM	MEAN	MEAN	MEAN	MEAN	S.D.	S.D.	MEAN	DEG K	DEG K			
	MB	MB	DEG K	DEG K	DEG K	DEG K	DEG K	DEG K	DEG K			
.000	9.409	3.129	.24	285.77	4.87	-.14	278.46	5.23	-.72	902.	902.	
.100	9.231	3.022	.23	285.44	4.72	-.12	278.21	5.15	-.75	918.	919.	
1.000	4.763	2.777	1.17	283.78	5.17	-.10	267.92	7.47	.18	926.	932.	
2.000	2.792	1.931	1.44	279.17	5.49	-.48	260.47	8.17	.21	917.	934.	
3.000	1.000	1.332	1.64	274.10	5.33	-.84	254.98	8.07	.27	914.	934.	
4.000	1.099	.882	1.89	268.33	5.17	-1.09	248.97	8.29	.23	917.	934.	
5.000	.672	.599	2.02	261.79	5.02	-1.09	243.09	8.71	.13	922.	933.	
6.000	.399	.359	1.93	254.68	4.90	-.97	237.40	8.93	-.03	919.	931.	
7.000	.227	.208	1.66	247.37	4.99	-.66	231.57	9.09	-.16	913.	931.	
8.000	.125	.110	1.55	239.94	4.21	-.35	226.13	8.89	-.37	777.	929.	
9.000	.082	.057	1.37	232.49	3.82	-.06	222.52	8.65	-.58	254.	928.	
10.000	.031	.028	1.06	225.36	3.53	.27	215.38	6.31	.24	34.	926.	
11.000	.014	.004	.52	219.35	3.85	.68	211.06	2.16	.23	8.	923.	
12.000	.009	.003	1.17	215.44	4.98	.48	207.46	2.50	.56	8.	923.	
13.000	99.999	99.999	999.99	213.83	5.19	-.04	999.99	99.99	999.99	1.	919.	
14.000	99.999	99.999	999.99	212.58	4.25	.03	999.99	99.99	999.99	0.	917.	
15.000	99.999	99.999	999.99	210.67	3.91	.24	999.99	99.99	999.99	0.	911.	
16.000	99.999	99.999	999.99	208.91	3.99	.17	999.99	99.99	999.99	0.	905.	
17.000	99.999	99.999	999.99	208.04	4.08	-.04	999.99	99.99	999.99	0.	868.	
18.000	99.999	99.999	999.99	208.21	3.87	-.28	999.99	99.99	999.99	0.	861.	
19.000	99.999	99.999	999.99	209.17	3.36	-.47	999.99	99.99	999.99	0.	842.	
20.000	99.999	99.999	999.99	210.34	2.91	-.52	999.99	99.99	999.99	0.	823.	
21.000	99.999	99.999	999.99	211.76	2.73	-.22	999.99	99.99	999.99	0.	674.	
22.000	99.999	99.999	999.99	213.10	2.84	.00	999.99	99.99	999.99	0.	657.	
23.000	99.999	99.999	999.99	214.43	2.59	-.74	999.99	99.99	999.99	0.	641.	
24.000	99.999	99.999	999.99	215.67	2.63	.02	999.99	99.99	999.99	0.	750.	
25.000	99.999	99.999	999.99	216.82	2.78	.07	999.99	99.99	999.99	0.	733.	
26.000	99.999	99.999	999.99	218.00	3.07	.13	999.99	99.99	999.99	0.	729.	
27.000	99.999	99.999	999.99	219.01	3.34	.30	999.99	99.99	999.99	0.	589.	
28.000	99.999	99.999	999.99	220.05	3.48	.37	999.99	99.99	999.99	0.	535.	
29.000	99.999	99.999	999.99	221.17	3.50	.31	999.99	99.99	999.99	0.	495.	
30.000	99.999	99.999	999.99	222.33	3.50	.15	999.99	99.99	999.99	0.	478.	

TABLE III-13. MOISTURE RELATED STATISTICAL PARAMETERS

ANNUAL

STATION = 723930		VANDENBERG AFB		TV	TV	SKWH TV	DEHPT T	S.D. OPT	SKWH OPT	NOBS T+P	NOBS TV
Z	VAPOR P	S.D. VP	SKWH VP	MEAN	S.D.	SKWH TV	MEAN	S.D. OPT	SKWH OPT	NOBS T+P	NOBS TV
KM	MB	MB	DEG K	DEG K	DEG K	DEG K	DEG K	DEG K	DEG K		
.000	11.704	2.971	-.30	287.60	4.36	.01	281.95	4.26	-1.18	9861.	9861.
.100	11.638	2.981	-.31	287.45	4.29	-.01	281.85	4.30	-1.18	10131.	10135.
1.000	5.737	2.806	.89	288.45	7.19	.07	270.83	6.84	-.18	10098.	10228.
2.000	3.328	2.094	1.37	283.84	7.06	-.21	262.88	7.86	.02	10033.	10246.
3.000	2.105	1.517	1.69	278.20	6.50	-.41	256.90	8.21	.11	9988.	10245.
4.000	1.306	1.048	2.03	272.08	6.19	-.53	250.97	8.32	.18	9987.	10240.
5.000	.784	.662	2.27	265.45	6.11	-.55	245.12	8.27	.10	9988.	10239.
6.000	.451	.399	2.52	258.42	6.19	-.49	239.10	8.31	-.04	9969.	10229.
7.000	.242	.224	2.56	251.00	6.22	-.37	232.99	8.48	-.16	9901.	10226.
8.000	.131	.121	2.33	243.44	6.14	-.19	226.80	8.34	-.24	8882.	10210.
9.000	.073	.067	2.17	235.84	5.94	-.01	221.54	8.26	-.22	5266.	10198.
10.000	.036	.037	1.96	228.55	5.69	.12	214.98	8.18	.25	1494.	10190.
11.000	.020	.016	2.73	222.17	5.38	.13	212.67	5.04	.36	166.	10162.
12.000	.010	.001	3.44	217.54	5.08	-.08	207.89	3.56	.83	128.	10148.
13.000	99.999	99.999	999.99	214.86	4.42	-.29	999.99	99.99	999.99	64.	10106.
14.000	99.999	99.999	999.99	212.73	3.84	.14	999.99	99.99	999.99	20.	10066.
15.000	99.999	99.999	999.99	210.43	4.04	.18	999.99	99.99	999.99	11.	10025.
16.000	99.999	99.999	999.99	208.76	4.21	.13	999.99	99.99	999.99	0.	9936.
17.000	99.999	99.999	999.99	208.45	3.91	.06	999.99	99.99	999.99	0.	9717.
18.000	99.999	99.999	999.99	209.23	3.49	-.15	999.99	99.99	999.99	0.	9724.
19.000	99.999	99.999	999.99	210.78	3.03	-.45	999.99	99.99	999.99	0.	9501.
20.000	99.999	99.999	999.99	212.38	2.88	-.57	999.99	99.99	999.99	0.	9487.
21.000	99.999	99.999	999.99	214.07	2.91	-.57	999.99	99.99	999.99	0.	7824.
22.000	99.999	99.999	999.99	215.56	3.04	-.53	999.99	99.99	999.99	0.	7409.
23.000	99.999	99.999	999.99	217.08	3.20	-.53	999.99	99.99	999.99	0.	7295.
24.000	99.999	99.999	999.99	218.37	3.40	-.44	999.99	99.99	999.99	0.	7929.
25.000	99.999	99.999	999.99	220.08	3.54	-.51	999.99	99.99	999.99	0.	8710.
26.000	99.999	99.999	999.99	221.57	3.76	-.49	999.99	99.99	999.99	0.	8598.
27.000	99.999	99.999	999.99	223.24	4.05	-.46	999.99	99.99	999.99	0.	7042.
28.000	99.999	99.999	999.99	224.66	4.25	-.41	999.99	99.99	999.99	0.	6313.
29.000	99.999	99.999	999.99	226.22	4.41	-.36	999.99	99.99	999.99	0.	5921.
30.000	99.999	99.999	999.99	227.84	4.54	-.38	999.99	99.99	999.99	0.	5769.

TABLE IV-1. HYDROSTATIC MODEL
ATMOSPHERE

JANUARY

STATION = 723930		VANDENBERG AFB		TV
Z	GEO. HT.	P	D	DEG K
KM	KM	MB	G/M3	
.000	.000	1018.9000	1242.0000	265.76
.100	.100	1006.8000	1229.0000	265.41
1.000	.999	903.7500	1110.0000	263.67
2.000	1.997	800.5300	999.9000	278.89
3.000	2.996	707.5600	900.9000	273.62
4.000	3.994	623.8100	812.1000	267.61
5.000	4.991	548.3300	732.1000	260.93
6.000	5.988	480.3400	659.3000	253.80
7.000	6.985	419.1700	592.9000	246.28
8.000	7.982	364.2500	531.8000	238.62
9.000	8.979	315.0800	475.4000	230.90
10.000	9.975	271.2700	422.5000	223.69
11.000	10.970	232.5500	371.5000	218.05
12.000	11.966	198.7600	321.9000	215.13
13.000	12.961	169.6600	275.6000	214.43
14.000	13.956	144.7500	236.1000	213.55
15.000	14.950	123.3700	203.1000	211.62
16.000	15.944	104.9900	174.6000	207.52
17.000	16.938	89.2490	149.1000	208.47
18.000	17.932	75.8380	126.8000	208.43
19.000	18.925	64.4700	107.2000	209.46
20.000	19.918	54.8580	90.7000	210.71
21.000	20.910	46.7270	76.7500	212.09
22.000	21.903	39.8450	65.0400	213.41
23.000	22.895	34.0080	55.2200	214.54
24.000	23.886	29.0530	46.9300	215.67
25.000	24.878	24.8420	39.9000	216.91
26.000	25.869	21.2610	33.9600	218.09
27.000	26.859	18.2120	28.9400	219.25
28.000	27.850	15.6150	24.6500	220.64
29.000	28.840	13.4020	21.0200	222.11
30.000	29.830	11.5158	17.9200	223.83
32.000	31.806	8.5546	13.0000	230.35
34.000	33.784	6.4005	9.5150	235.52
36.000	35.760	4.8204	7.0120	240.68
38.000	37.735	3.6535	5.1970	246.15
40.000	39.708	2.7861	3.8830	251.19
42.000	41.681	2.1373	2.9080	257.35
44.000	43.652	1.6499	2.1970	262.97
46.000	45.622	1.2795	1.6820	268.34
48.000	47.590	.9937	1.3090	265.70
50.000	49.558	.7705	1.0270	262.73
52.000	51.524	.5957	.8042	259.32
54.000	53.489	.4593	.6256	257.02
56.000	55.453	.3535	.4847	255.30
58.000	57.415	.2716	.3748	253.67
60.000	59.377	.2083	.2904	251.11
62.000	61.337	.1590	.2269	245.33
64.000	63.295	.1208	.1757	240.59
66.000	65.253	.0911	.1358	234.89
68.000	67.209	.0683	.1048	227.98
70.000	69.165	.0508	.0797	222.88

TABLE IV-2. HYDROSTATIC MODEL
ATMOSPHERE

FEBRUARY

STATION - 723930		VANDENBERG AFB		
Z	GEO. HT.	P	D	TV
KM	KM	MB	G/M ³	DEG K
.000	.000	1018.7000	1241.0000	286.09
.100	.100	1006.6000	1227.0000	285.70
1.000	.999	903.6100	1111.0000	283.25
2.000	1.997	800.2200	1002.0000	278.23
3.000	2.996	707.0500	903.0000	272.76
4.000	3.994	623.1000	813.9000	266.71
5.000	4.991	547.4600	733.6000	259.97
6.000	5.988	479.3300	660.6000	252.77
7.000	6.985	418.0500	594.0000	245.19
8.000	7.982	363.0400	532.4000	237.54
9.000	8.979	313.8500	475.4000	230.00
10.000	9.975	270.0700	421.9000	222.98
11.000	10.970	231.4100	370.7000	217.47
12.000	11.966	197.7700	319.8000	215.42
13.000	12.961	168.9100	272.9000	215.60
14.000	13.956	144.2200	234.1000	214.58
15.000	14.950	123.0100	201.7000	212.49
16.000	15.944	104.7500	173.4000	210.43
17.000	16.938	89.1010	148.4000	209.14
18.000	17.932	75.7470	126.3000	208.96
19.000	18.925	64.4140	107.0000	209.78
20.000	19.918	54.8220	90.5200	210.98
21.000	20.910	46.7040	76.6600	212.18
22.000	21.903	39.8240	65.0500	213.28
23.000	22.895	33.9850	55.2600	214.24
24.000	23.886	29.0200	46.9300	215.47
25.000	24.878	24.8160	39.9100	216.62
26.000	25.869	21.2350	33.9500	217.88
27.000	26.859	18.1880	28.9000	219.29
28.000	27.850	15.5960	24.6100	220.77
29.000	28.840	13.3890	20.9500	222.65
30.000	29.830	11.5104	17.8400	224.76
32.000	31.806	8.5671	13.0000	232.10
34.000	33.784	6.4277	9.5290	237.98
36.000	35.760	4.8590	7.0090	244.57
38.000	37.735	3.7000	5.2090	250.62
40.000	39.708	2.8349	3.9140	255.53
42.000	41.681	2.1827	2.9610	260.08
44.000	43.652	1.6973	2.2630	263.08
46.000	45.622	1.3071	1.7470	264.01
48.000	47.590	1.0131	1.3550	263.81
50.000	49.558	.7848	1.0540	262.79
52.000	51.524	.6074	.8000	261.31
54.000	53.489	.4695	.6357	260.15
56.000	55.453	.3623	.4966	257.33
58.000	57.415	.2789	.3854	255.31
60.000	59.377	.2144	.2977	254.07
62.000	61.337	.1643	.2322	249.64
64.000	63.295	.1251	.1828	241.53
66.000	65.253	.0946	.1413	236.16
68.000	67.209	.0709	.1103	226.56
70.000	69.165	.0525	.0841	220.49

TABLE IV-3. HYDROSTATIC MODEL
ATMOSPHERE

MARCH

STATION - 723930		VANDENBERG AFB		
Z	GEO. HT.	P	D	TV
KM	KM	MB	G/M3	DEG K
.000	.000	1017.9000	1240.0000	286.00
.100	.100	1005.6000	1227.0000	285.66
1.000	.933	902.8400	1110.0000	283.23
2.000	1.937	799.5500	1001.0000	278.33
3.000	2.996	706.5000	931.7000	272.96
4.000	3.994	622.6900	812.6000	266.96
5.000	4.931	547.1700	732.4000	260.26
6.000	5.988	479.1400	659.8000	252.97
7.000	6.985	417.9100	593.4000	245.32
8.000	7.982	362.9600	531.9000	237.74
9.000	8.979	313.8200	474.8000	230.24
10.000	9.975	270.1000	421.4000	223.29
11.000	10.970	231.5000	370.1000	217.93
12.000	11.956	197.8700	320.1000	215.36
13.000	12.961	168.9800	273.3000	215.38
14.000	13.956	144.2800	234.0000	214.80
15.000	14.950	123.0900	201.3000	212.99
16.000	15.944	104.8800	172.9000	211.25
17.000	16.938	89.2750	147.9000	210.32
18.000	17.932	75.9670	125.9000	210.23
19.000	18.925	64.6650	106.7000	211.04
20.000	19.918	55.0820	90.5300	211.97
21.000	20.910	46.9580	76.7800	213.06
22.000	21.903	40.0710	65.1000	214.42
23.000	22.895	34.2290	55.2900	215.68
24.000	23.886	29.2670	46.9900	216.98
25.000	24.878	25.0490	39.9800	218.26
26.000	25.869	21.4610	34.0300	219.71
27.000	26.859	18.4080	28.9600	221.43
28.000	27.850	15.8100	24.6700	223.29
29.000	28.840	13.5970	21.0200	225.36
30.000	29.830	11.7107	17.9300	227.54
32.000	31.806	8.7416	13.1300	234.18
34.000	33.784	6.5688	9.6780	238.74
36.000	35.760	4.9672	7.1500	244.35
38.000	37.735	3.7768	5.3530	248.17
40.000	39.708	2.8871	4.0030	253.65
42.000	41.681	2.2185	3.0230	258.10
44.000	43.652	1.7125	2.2990	262.04
46.000	45.622	1.3262	1.7630	264.53
48.000	47.590	1.0291	1.3630	265.58
50.000	49.558	.7991	1.0570	265.91
52.000	51.524	.6204	.8235	264.97
54.000	53.489	.4811	.6435	262.96
56.000	55.453	.3726	.5005	261.81
58.000	57.415	.2881	.3900	259.80
60.000	59.377	.2222	.3050	256.21
62.000	61.337	.1707	.2388	251.36
64.000	63.295	.1305	.1860	246.63
66.000	65.253	.0992	.1446	241.20
68.000	67.209	.0748	.1131	232.49
70.000	69.165	.0559	.0870	225.78

TABLE IV-4. HYDROSTATIC MODEL
ATMOSPHERE

APRIL

STATION = 723330		VANDENBERG AFB		
Z	GEOM. HT.	P	D	TV
KM	KM	MB	G/MS	DEG K
.000	.000	1017.4000	1239.0000	286.00
.100	.100	1005.3000	1226.0000	285.64
1.000	.999	632.5500	1103.0000	283.78
2.000	1.997	799.4800	998.7000	278.88
3.000	2.996	706.6500	899.4000	273.70
4.000	3.994	623.0500	810.3000	267.85
5.000	4.991	547.7400	730.2000	261.31
6.000	5.988	479.3100	657.8000	254.15
7.000	6.985	418.8700	591.5000	246.69
8.000	7.982	364.1000	530.3000	239.17
9.000	8.979	315.0300	473.8000	231.67
10.000	9.975	271.4200	421.1000	224.56
11.000	10.970	232.7900	371.1000	218.50
12.000	11.966	198.9700	322.6000	214.73
13.000	12.961	169.8100	276.0000	214.33
14.000	13.956	144.9200	235.3000	214.52
15.000	14.952	123.6400	201.8000	213.49
16.000	15.944	105.4100	173.1000	212.18
17.000	16.938	89.8050	147.8000	211.70
18.000	17.932	76.5100	125.7000	212.00
19.000	18.925	65.2110	106.8000	212.73
20.000	19.918	55.6130	90.8000	213.37
21.000	20.910	47.4640	77.0300	214.65
22.000	21.903	40.5600	65.3900	216.04
23.000	22.895	34.6810	55.5500	217.43
24.000	23.886	29.6910	47.3000	218.67
25.000	24.878	25.4440	40.2600	220.17
26.000	25.869	21.8300	34.2800	221.83
27.000	26.859	18.7540	29.1900	223.81
28.000	27.850	16.1330	24.9000	225.72
29.000	28.840	13.8970	21.7000	227.72
30.000	29.830	11.9072	18.1700	229.83
32.000	31.805	8.9730	13.3100	236.47
34.000	33.784	6.7055	9.8080	241.96
36.000	35.760	5.1319	7.3000	246.57
38.000	37.735	3.9126	5.4700	250.87
40.000	39.708	2.9732	4.1070	256.14
42.000	41.681	2.3120	3.0960	261.93
44.000	43.652	1.7921	2.3570	266.73
46.000	45.622	1.3735	1.8220	268.26
48.000	47.590	1.0854	1.4110	267.81
50.000	49.558	.8457	1.1020	269.10
52.000	51.524	.6586	.8615	268.13
54.000	53.489	.5122	.6761	265.68
56.000	55.453	.3975	.5286	263.74
58.000	57.415	.3078	.4141	260.72
60.000	59.377	.2376	.3240	257.23
62.000	61.337	.1826	.2551	251.06
64.000	63.295	.1393	.2009	243.21
66.000	65.253	.1053	.1568	235.67
68.000	67.209	.0790	.1215	227.80
70.000	69.165	.0585	.0941	219.16

TABLE IV-5. HYDROSTATIC MODEL
ATMOSPHERE

MAY

STATION = 723930		VANDENBERG AFB		TV
Z	GEO. HT.	P	D	OCG K
KM	KM	MB	G/M3	
.000	.000	1015.9000	1233.0000	287.06
.100	.100	1003.9000	1219.0000	296.99
1.000	.999	902.1400	1091.0000	293.06
2.000	1.997	800.6900	982.6000	283.87
3.000	2.996	709.1800	888.2000	278.14
4.000	3.994	626.5100	802.5000	271.97
5.000	4.991	551.8700	724.5000	265.36
6.000	5.988	484.5200	653.7000	258.20
7.000	6.985	423.8000	589.3000	250.54
8.000	7.982	369.1600	529.7000	242.78
9.000	8.979	320.1300	474.5000	235.01
10.000	9.975	276.3200	423.2000	227.46
11.000	10.970	237.4000	374.8000	220.69
12.000	11.966	203.1300	328.3000	215.58
13.000	12.951	173.3600	282.9000	213.46
14.000	13.956	147.8500	241.3000	213.49
15.000	14.950	126.0600	206.5000	212.65
16.000	15.944	107.4100	176.7000	211.76
17.000	16.938	91.4880	150.8000	211.39
18.000	17.932	77.9270	128.2000	211.76
19.000	18.925	66.4110	108.8000	212.62
20.000	19.918	56.6440	92.2500	213.90
21.000	20.910	48.3650	78.2600	215.31
22.000	21.903	41.3430	66.4100	216.88
23.000	22.895	35.3040	56.3300	218.61
24.000	23.886	30.3230	47.9400	220.35
25.000	24.878	26.0190	40.8000	222.15
26.000	25.669	22.3950	34.7700	223.39
27.000	26.859	19.2330	29.6500	225.96
28.000	27.850	16.5680	25.3400	227.79
29.000	28.840	14.2900	21.6800	229.57
30.000	29.830	12.3397	18.5800	231.40
32.000	31.606	9.2512	13.6900	237.27
34.000	33.784	6.9796	10.1100	242.36
36.000	35.760	5.2964	7.5340	246.86
38.000	37.735	4.0419	5.6250	252.33
40.000	39.708	3.1036	4.2230	259.03
42.000	41.681	2.3972	3.1670	263.92
44.000	43.652	1.8613	2.4360	266.29
46.000	45.622	1.4501	1.8800	270.88
48.000	47.590	1.1319	1.4610	271.94
50.000	49.558	.8839	1.1420	271.72
52.000	51.524	.6896	.8985	269.48
54.000	53.489	.5369	.7065	266.81
56.000	55.453	.4169	.5550	263.78
58.000	57.415	.3228	.4353	260.39
60.000	59.377	.2491	.3413	256.26
62.000	61.337	.1912	.2685	249.96
64.000	63.295	.1456	.2115	241.78
66.000	65.253	.1099	.1653	233.48
68.000	67.209	.0820	.1293	222.69
70.000	69.165	.0603	.0994	213.01

TABLE IV-6. HYDROSTATIC MODEL
ATMOSPHERE

JUNE

STATION = 723930		VANDENBERG AFB		
Z	GEO. HT.	P	D	TV
KM	KM	MB	G/CM3	CM. K
.000	.000	1014.7000	1227.0000	259.18
.100	.100	1002.8000	1212.0000	259.24
1.000	.999	902.0900	1075.0000	257.30
2.000	1.997	802.1100	968.5000	259.53
3.000	2.996	711.8400	877.1000	252.72
4.000	3.994	630.1300	793.9000	256.49
5.000	4.991	556.2100	718.1000	263.84
6.000	5.988	489.4200	648.7000	262.84
7.000	6.985	429.1400	585.4000	265.33
8.000	7.982	374.8100	527.2000	247.66
9.000	8.979	325.0600	473.5000	232.94
10.000	9.975	282.1900	423.4000	232.15
11.000	10.970	243.1700	376.5000	224.98
12.000	11.966	208.6300	331.8000	219.03
13.000	12.961	178.3800	289.1000	214.90
14.000	13.956	152.1500	249.5000	212.43
15.000	14.950	129.5600	214.5000	210.43
16.000	15.944	110.1900	183.7000	208.06
17.000	16.938	93.6530	156.3000	208.70
18.000	17.932	79.6300	132.2000	209.81
19.000	18.925	67.7940	111.4000	211.95
20.000	19.918	57.8130	94.1100	214.01
21.000	20.910	49.3770	79.6500	215.96
22.000	21.903	42.2330	67.5200	217.89
23.000	22.895	36.1740	57.3300	219.80
24.000	23.886	31.0260	48.7900	221.55
25.000	24.878	26.6440	41.5700	223.31
26.000	25.869	22.9090	35.4500	225.12
27.000	26.859	19.7240	30.2700	227.01
28.000	27.850	17.0020	25.9000	228.57
29.000	28.840	14.6720	22.1900	230.32
30.000	29.830	12.6757	19.0200	232.17
32.000	31.806	9.5115	14.0300	237.94
34.000	33.784	7.1802	10.3900	242.71
36.000	35.760	5.4513	7.7300	247.39
38.000	37.735	4.1611	5.7910	252.05
40.000	39.708	3.1928	4.3410	256.44
42.000	41.681	2.4691	3.2820	264.09
44.000	43.652	1.9171	2.5100	268.17
46.000	45.622	1.4933	1.9370	270.58
48.000	47.590	1.1654	1.5050	271.84
50.000	49.558	.9103	1.1740	272.24
52.000	51.524	.7106	.9227	270.36
54.000	53.489	.5537	.7253	267.78
56.000	55.453	.4303	.5717	264.00
58.000	57.415	.3332	.4493	260.35
60.000	59.377	.2571	.3524	256.07
62.000	61.337	.1971	.2705	249.53
64.000	63.295	.1500	.2185	240.97
66.000	65.253	.1132	.1697	234.02
68.000	67.209	.0845	.1329	224.09
70.000	69.165	.0623	.1015	215.46

TABLE IV-7. HYDROSTATIC MODEL
ATMOSPHERE

JULY

STATION # 723930		VANDENBERG AFB		
Z	GEO. HT.	P	D	TV
KM	KM	MB	G/M3	DEG K
.000	.000	1015.0000	1224.0000	289.85
.100	.100	1003.0000	1209.0000	289.04
1.000	.999	903.1600	1061.0000	296.60
2.000	1.997	804.3600	958.6000	292.33
3.000	2.996	714.8000	870.7000	286.01
4.000	3.994	633.6500	790.4000	279.29
5.000	4.991	560.0000	716.2000	272.39
6.000	5.988	493.3000	647.2000	265.59
7.000	6.985	433.2400	584.0000	258.46
8.000	7.982	379.0400	525.9000	251.09
9.000	8.979	330.3100	472.5000	243.53
10.000	9.975	286.6100	423.0000	236.06
11.000	10.970	247.5900	376.8000	228.89
12.000	11.966	212.9500	333.6000	222.35
13.000	12.961	182.3800	293.5000	216.46
14.000	13.956	155.5900	256.5000	211.28
15.000	14.950	132.2700	222.3000	207.26
16.000	15.944	112.2100	190.0000	205.75
17.000	16.938	95.1780	160.4000	206.68
18.000	17.932	80.8330	134.8000	208.88
19.000	18.925	68.7860	113.2000	211.62
20.000	19.918	58.6540	95.4200	214.14
21.000	20.910	50.1060	80.6500	216.44
22.000	21.903	42.8730	68.3700	218.44
23.000	22.895	36.7350	58.1100	220.24
24.000	23.886	31.5150	49.4800	221.90
25.000	24.878	27.0690	42.2000	223.46
26.000	25.869	23.2770	36.0100	225.15
27.000	26.859	20.0400	30.7600	226.97
28.000	27.850	17.2730	26.3300	228.53
29.000	28.840	14.9050	22.5000	230.20
30.000	29.830	12.8750	19.3500	231.81
32.000	31.826	9.6516	14.2900	236.70
34.000	33.784	7.2731	10.5500	240.94
36.000	35.760	5.5095	7.8730	245.20
38.000	37.735	4.1952	5.8810	249.96
40.000	39.708	3.2135	4.4040	255.68
42.000	41.681	2.4754	3.3250	260.89
44.000	43.652	1.9157	2.5380	264.50
46.000	45.622	1.4870	1.9530	266.80
48.000	47.590	1.1564	1.5110	268.05
50.000	49.558	.8997	1.1780	267.67
52.000	51.524	.6995	.9218	265.87
54.000	53.489	.5426	.7236	262.69
56.000	55.453	.4195	.5673	259.11
58.000	57.415	.3231	.4457	253.03
60.000	59.377	.2475	.3479	249.24
62.000	61.337	.1884	.2735	241.31
64.000	63.295	.1422	.2125	234.39
66.000	65.253	.1064	.1640	227.33
68.000	67.209	.0789	.1264	218.65
70.000	69.165	.0579	.0952	212.89

TABLE IV-8. HYDROSTATIC MODEL
ATMOSPHERE

AUGUST

STATION = 723930		VANDEBEEK AFB		
Z	OCG. HT.	P	D	TV
KM	KM	MB	G/CM ³	DEG K
.000	.000	1014.4000	1219.0000	289.83
.100	.100	1002.5000	1204.0000	290.00
1.000	.999	902.8500	1061.0000	296.58
2.000	1.997	804.0300	959.2000	292.02
3.000	2.996	714.4900	871.3000	285.67
4.000	3.994	633.2700	790.7000	278.09
5.000	4.991	559.5600	716.1000	272.22
6.000	5.988	494.9700	647.1000	265.39
7.000	6.985	432.8300	583.6000	258.37
8.000	7.982	378.6700	525.4000	251.07
9.000	8.979	329.9800	472.1000	243.50
10.000	9.975	286.3200	422.5000	236.04
11.000	10.970	247.3400	376.4000	228.91
12.000	11.966	212.7400	333.3000	222.34
13.000	12.961	182.2100	293.1000	216.57
14.000	13.956	155.4600	256.1000	211.50
15.000	14.950	132.1900	221.9000	207.55
16.000	15.944	112.1600	189.8000	205.87
17.000	16.938	95.1470	160.1000	206.97
18.000	17.932	80.6280	134.6000	209.25
19.000	18.925	68.8010	113.1000	211.97
20.000	19.918	58.6780	95.3000	214.31
21.000	20.910	50.1180	80.7000	216.34
22.000	21.903	42.6040	68.5000	218.08
23.000	22.895	36.7340	58.2300	219.75
24.000	23.886	31.5050	49.5000	221.46
25.000	24.878	27.0520	42.2500	223.05
26.000	25.869	23.2540	36.0700	224.62
27.000	26.860	20.0130	30.8000	226.39
28.000	27.850	17.2430	26.3000	227.88
29.000	28.840	14.8720	22.5900	229.32
30.000	29.830	12.8394	19.3700	230.68
32.000	31.806	9.6141	14.2500	235.60
34.000	33.784	7.2331	10.5700	239.12
36.000	35.760	5.4658	7.8700	242.78
38.000	37.735	4.1507	5.8620	247.52
40.000	39.708	3.1710	4.3780	253.19
42.000	41.681	2.4360	3.3010	257.99
44.000	43.652	1.8809	2.5030	262.71
46.000	45.622	1.4573	1.9230	264.84
48.000	47.590	1.1306	1.4920	264.91
50.000	49.558	.8773	1.1570	265.12
52.000	51.524	.6806	.9009	264.06
54.000	53.489	.5272	.7049	261.38
56.000	55.453	.4071	.5518	257.09
58.000	57.415	.3134	.4306	254.88
60.000	59.377	.2402	.3366	249.36
62.000	61.337	.1830	.2633	240.91
64.000	63.295	.1393	.2056	215.10
66.000	65.253	.1037	.1579	211.50
68.000	67.209	.0770	.1174	200.00
70.000	69.165	.0566	.0846	213.56

TABLE IV-9. HYDROSTATIC MODEL
ATMOSPHERE

SEPTEMBER

STATION = 723930 VANDENBERG AFB

Z	GEO. HT.	P	D	TV
KM	KM	MB	G/M3	DEG K
.000	.000	1013.6000	1215.0000	290.60
.100	.100	1001.8000	1201.0000	290.54
1.000	.999	901.9100	1008.0000	294.18
2.000	1.997	802.4200	965.5000	209.52
3.000	2.996	712.3300	976.2000	283.20
4.000	3.994	630.6000	793.4000	276.93
5.000	4.991	556.8000	717.0000	270.57
6.000	5.988	490.1900	647.3000	263.83
7.000	6.985	430.0400	584.1000	256.47
8.000	7.982	375.8200	526.1000	248.85
9.000	8.979	327.0700	472.5000	241.13
10.000	9.975	283.3700	422.5000	233.69
11.000	10.970	244.4700	375.5000	226.83
12.000	11.966	210.0300	331.0000	221.03
13.000	12.961	179.7700	289.6000	216.08
14.000	13.956	153.3700	252.3000	211.77
15.000	14.950	130.4600	218.2000	208.25
16.000	15.944	110.7400	187.0000	206.30
17.000	16.938	93.9470	158.4000	206.50
18.000	17.932	79.7640	133.5000	208.22
19.000	18.925	67.8350	112.1000	210.72
20.000	19.918	57.8030	94.4500	213.20
21.000	20.910	49.3430	79.8300	215.34
22.000	21.903	42.1840	67.6600	217.19
23.000	22.895	36.1130	57.4400	219.00
24.000	23.886	30.9550	48.8000	220.69
25.000	24.878	26.5650	41.6600	222.12
26.000	25.869	22.8210	35.5500	223.64
27.000	26.859	19.6270	30.3500	225.30
28.000	27.850	16.8980	25.9700	226.71
29.000	28.840	14.5620	22.2500	229.04
30.000	29.830	12.5600	19.0800	229.38
32.000	31.806	9.3879	14.0800	234.37
34.000	33.784	7.0479	10.4500	237.02
36.000	35.760	5.3147	7.7410	241.31
38.000	37.735	4.0287	5.7610	245.79
40.000	39.708	3.0712	4.3010	250.97
42.000	41.681	2.3552	3.2230	256.65
44.000	43.652	1.8160	2.4370	262.05
46.000	45.622	1.4070	1.8700	264.49
48.000	47.590	1.0422	1.4410	265.30
50.000	49.558	.8495	1.1190	265.41
52.000	51.524	.6691	.8731	265.30
54.000	53.489	.5113	.6625	263.28
56.000	55.453	.3959	.5320	261.58
58.000	57.415	.3060	.4160	259.48
60.000	59.377	.2355	.3267	253.29
62.000	61.337	.1803	.2594	248.02
64.000	63.293	.1370	.2006	240.13
66.000	65.253	.1033	.1553	233.91
68.000	67.209	.0772	.1209	224.50
70.000	69.165	.0571	.0919	218.33

TABLE IV-10. HYDROSTATIC MODEL
ATMOSPHERE

OCTOBER

STATION - 723930		VANCOUVER AFB		TV
Z	GEO. HT.	P	D	DEG K
KM	KM	MB	G M3	
.000	.000	1015.7000	1227.0000	287.62
.100	.100	1003.8000	1208.0000	289.46
1.000	.999	902.9000	1082.0000	290.57
2.000	1.937	802.0700	978.5000	285.57
3.000	2.936	710.9200	885.1000	279.83
4.000	3.994	628.5500	799.4000	273.90
5.000	4.991	554.1800	721.9000	267.41
6.000	5.968	487.0600	651.6000	260.39
7.000	6.965	426.5200	587.7000	252.82
8.000	7.982	372.0000	528.7000	245.14
9.000	8.979	323.0700	473.8000	237.54
10.000	9.975	279.3300	422.5000	230.29
11.000	10.970	240.4600	374.3000	223.80
12.000	11.966	206.1900	328.7000	218.56
13.000	12.961	176.2500	285.8000	214.82
14.000	13.956	150.2300	247.3000	211.70
15.000	14.950	127.8700	213.2000	208.90
16.000	15.944	108.6000	182.9000	206.88
17.000	16.938	92.1470	155.4000	206.56
18.000	17.932	78.2190	131.2000	207.68
19.000	18.925	66.4790	110.5000	209.64
20.000	19.918	56.5920	93.1400	211.68
21.000	20.910	48.2530	78.6300	213.79
22.000	21.903	41.2050	66.5800	215.59
23.000	22.895	35.2330	56.4900	217.26
24.000	23.886	30.1620	48.0200	218.80
25.000	24.878	25.8510	40.8700	220.36
26.000	25.869	22.1790	34.8000	221.62
27.000	26.859	19.0460	29.7000	222.87
28.000	27.850	16.3700	25.4500	224.06
29.000	28.840	14.0810	21.7900	225.14
30.000	29.830	12.1213	18.6700	226.22
32.000	31.806	9.0244	13.7500	231.38
34.000	33.784	6.7533	10.1400	234.80
36.000	35.760	5.0790	7.4890	239.05
38.000	37.735	3.8410	5.5500	243.93
40.000	39.708	2.9235	4.1220	249.75
42.000	41.681	2.2393	3.0870	256.69
44.000	43.652	1.7254	2.3310	260.87
46.000	45.622	1.3359	1.7760	265.09
48.000	47.590	1.0375	1.3700	266.85
50.000	49.558	.8064	1.0650	266.85
52.000	51.524	.6208	.8331	266.03
54.000	53.489	.4865	.6493	264.09
56.000	55.453	.3770	.5057	262.22
58.000	57.415	.2916	.3957	260.71
60.000	59.377	.2248	.3102	259.41
62.000	61.337	.1725	.2478	258.43
64.000	63.295	.1316	.1995	243.30
66.000	65.253	.0995	.1490	235.37
68.000	67.209	.0744	.1164	225.47
70.000	69.165	.0552	.0883	220.13

TABLE IV-11. HYDROSTATIC MODEL
ATMOSPHERE

NOVEMBER

STATION = 723930 VANDEBORG AFB

Z	GEO. HT.	P	D	TV
KM	KM	MB	G/M3	DEG K
.000	.000	1017.7000	1232.0000	287.91
.100	.100	1005.7000	1218.0000	287.64
1.000	.999	903.6400	1098.0000	286.58
2.000	1.997	801.4500	990.4000	291.92
3.000	2.996	709.3400	892.8000	276.77
4.000	3.994	626.3000	805.4000	270.89
5.000	4.991	551.4200	726.6000	264.38
6.000	5.988	483.9100	654.9000	257.43
7.000	6.985	423.1300	589.4000	250.10
8.000	7.982	368.5100	529.2000	242.61
9.000	8.979	319.5700	473.5000	235.11
10.000	9.975	275.8900	421.7000	227.93
11.000	10.970	237.1200	373.1000	221.39
12.000	11.966	202.9800	327.1000	216.15
13.000	12.961	173.2300	283.5000	212.85
14.000	13.956	147.5500	243.9000	210.73
15.000	14.950	125.4800	209.4000	208.74
16.000	15.944	106.5700	179.2000	207.13
17.000	16.938	90.4460	152.4000	206.72
18.000	17.932	76.7700	129.0000	207.36
19.000	18.925	65.2170	108.8000	208.75
20.000	19.918	55.4650	91.9500	210.13
21.000	20.910	47.2280	77.7100	211.73
22.000	21.903	40.2630	65.7900	213.21
23.000	22.895	34.3660	55.7400	214.78
24.000	23.886	29.3650	47.3400	216.11
25.000	24.878	25.1180	40.2300	217.49
26.000	25.869	21.5080	34.2300	218.66
27.000	26.859	18.4340	29.1900	220.01
28.000	27.850	15.8120	24.9000	221.20
29.000	28.840	13.5760	21.2700	222.38
30.000	29.830	11.6657	18.1700	223.65
32.000	31.806	8.6559	13.3500	228.78
34.000	33.784	6.4595	9.7840	232.05
36.000	35.763	4.8480	7.2030	237.49
38.000	37.735	3.5579	5.3430	241.56
40.000	39.708	2.7763	3.9610	247.29
42.000	41.681	2.1200	2.9630	252.48
44.000	43.652	1.6281	2.2290	257.69
46.000	45.622	1.2563	1.6950	261.52
48.000	47.590	.9729	1.2980	264.45
50.000	49.558	.7547	1.0050	264.92
52.000	51.524	.5857	.7803	264.80
54.000	53.489	.4542	.6087	263.26
56.000	55.453	.3518	.4740	261.83
58.000	57.415	.2721	.3689	260.23
60.000	59.377	.2100	.2882	257.09
62.000	61.337	.1615	.2256	252.49
64.000	63.295	.1233	.1789	243.05
66.000	65.253	.0932	.1394	235.47
68.000	67.209	.0698	.1090	225.93
70.000	69.165	.0517	.0833	218.76

TABLE IV-12. HYDROSTATIC MODEL
ATMOSPHERE

DECEMBER

STATION = 723930		VANDENBERG AFB		
Z	GEOM. HT.	P	D	TV
KM	KM	MB	G/MS	DEG K
.000	.000	1018.9000	1242.0000	285.77
.100	.100	1006.8000	1229.0000	285.44
1.000	.999	903.7700	1109.0000	283.78
2.000	1.997	800.6100	999.1000	279.17
3.000	2.996	707.7500	899.5000	274.10
4.000	3.994	624.1500	810.3000	268.33
5.000	4.991	548.8400	730.4000	261.79
6.000	5.988	481.0100	657.9000	254.69
7.000	6.985	419.9000	591.4000	247.37
8.000	7.982	365.2000	530.2000	239.94
9.000	8.979	316.1900	473.8000	232.49
10.000	9.975	272.5200	421.3000	225.38
11.000	10.970	233.6600	371.4000	219.35
12.000	11.966	200.0000	323.4000	215.44
13.000	12.961	170.7000	278.1000	213.83
14.000	13.956	145.5000	239.5000	212.56
15.000	14.950	123.9000	205.0000	210.67
16.000	15.944	105.4300	175.8000	208.91
17.000	16.938	89.1650	150.0000	208.04
18.000	17.932	76.1040	127.3000	208.21
19.000	18.925	64.6840	107.7000	203.17
20.000	19.918	55.0250	91.1400	210.34
21.000	20.910	46.8580	77.0900	211.76
22.000	21.903	39.9460	65.3000	213.10
23.000	22.895	34.0900	55.3800	214.43
24.000	23.886	29.1210	47.0400	215.67
25.000	24.878	24.8990	40.0100	216.82
26.000	25.869	21.3080	34.0500	218.00
27.000	26.859	18.2910	29.0300	219.01
28.000	27.850	15.6440	24.7700	220.05
29.000	28.840	13.4200	21.1400	221.17
30.000	29.830	11.5217	18.0500	222.33
32.000	31.805	8.5355	13.3400	227.70
34.000	33.784	6.3619	9.7530	232.13
36.000	35.760	4.7692	7.1790	236.41
38.000	37.735	3.5971	5.2900	242.00
40.000	39.708	2.7310	3.9280	247.40
42.000	41.681	2.0875	2.9220	254.25
44.000	43.652	1.6074	2.1910	261.04
46.000	45.622	1.2451	1.6600	266.04
48.000	47.590	.9679	1.2850	267.88
50.000	49.558	.7531	1.0000	267.97
52.000	51.524	.5857	.7826	266.33
54.000	53.489	.4547	.6135	263.71
56.000	55.453	.3521	.4797	261.18
58.000	57.415	.2721	.3742	258.63
60.000	59.377	.2097	.2915	255.63
62.000	61.337	.1610	.2282	251.01
64.000	63.295	.1228	.1797	243.10
66.000	65.253	.0931	.1384	239.28
68.000	67.209	.0701	.1076	231.61
70.000	69.165	.0523	.0825	225.68

TABLE IV-13. HYDROSTATIC MODEL
ATMOSPHERE

ANNUAL

STATION = 723930 VANDENBERG AFB

Z	QEO. HT.	P	D	TV
KM	KM	MB	G MS	DEG K
.000	.000	1016.6000	1030.0000	287.60
.100	.100	1004.6000	1210.0000	287.45
1.000	.999	902.9000	1101.0000	268.45
2.000	1.997	801.4000	1000.0000	263.84
3.000	2.996	709.9000	908.9000	258.20
4.000	3.994	627.1700	803.0000	272.08
5.000	4.991	552.4700	725.0000	265.45
6.000	5.988	485.0900	653.9000	258.42
7.000	6.985	424.3700	589.0000	251.00
8.000	7.982	369.7700	529.2000	243.44
9.000	8.979	320.6300	473.9000	235.84
10.000	9.975	277.0700	422.3000	228.55
11.000	10.970	238.2500	373.6000	222.17
12.000	11.966	204.1100	326.9000	217.54
13.000	12.961	174.4100	282.8000	214.86
14.000	13.956	148.7800	243.6000	212.73
15.000	14.950	126.7100	209.8000	210.43
15.000	15.944	107.7500	179.8000	208.76
17.000	16.938	91.5670	153.0000	208.45
18.000	17.932	77.8310	129.6000	203.23
19.000	18.925	66.2190	109.4000	210.78
20.000	19.918	56.4100	92.5300	212.38
21.000	20.910	48.1160	78.3000	214.07
22.000	21.903	41.0910	65.4100	215.56
23.000	22.895	35.1330	56.3800	217.08
24.000	23.886	30.0700	47.9700	218.37
25.000	24.878	25.7660	40.7800	220.08
26.000	25.869	22.1030	34.7500	221.57
27.000	26.859	18.9930	29.6200	223.24
28.000	27.850	16.3210	25.3100	224.66
29.000	28.840	14.0470	21.6300	226.22
30.000	29.830	12.1028	18.5100	227.84
32.000	31.806	9.0332	13.5700	233.68
34.000	33.784	6.7836	9.9950	238.18
36.000	35.760	5.1238	7.4020	242.94
38.000	37.735	3.8922	5.5100	247.88
40.000	39.708	2.9744	4.1190	253.38
42.000	41.681	2.2862	3.0990	258.91
44.000	43.652	1.7668	2.3520	263.57
45.000	45.622	1.3704	1.8060	266.27
49.000	47.590	1.0652	1.3980	267.34
50.000	49.558	.8281	1.0890	266.86
52.000	51.524	.6434	.8510	265.31
54.000	53.489	.4990	.6657	263.06
56.000	55.453	.3862	.5200	260.54
58.000	57.415	.2982	.4050	257.84
60.000	59.377	.2296	.3168	254.27
62.000	61.337	.1759	.2464	248.47
64.000	63.295	.1338	.1949	240.00
66.000	65.251	.1010	.1512	231.41
68.000	67.209	.0755	.1176	225.21
70.000	69.165	.0559	.0897	218.45

APPENDIX A

EXAMPLES OF WIND STATISTICS FOR VANDENBERG AFB, CALIFORNIA (Data base 32-70 km altitude from Point Mugu, CA)

Appendix A gives some examples of graphical displays of wind statistics that can be derived from the statistical parameters presented in table I. These illustrations should aid the user of the RRA to understand the functional relationships of the probability wind models and, thus, to develop an appreciation of the powerful properties of the bivariate normal probability distribution function.

All illustrations for this appendix are derived from the five wind component statistical parameters from table I.1 for January and table I.7 for July for eight selected altitudes. These selected altitudes are 4, 12, 20, 30, 40, 50, 60, and 70 km.

1. Windspeed (Figures A-1 through A-4)

The five wind components from table I are used as inputs to the generalized Rayleigh probability density function, equation (29), and then integrated as indicated by equation (30) to obtain the probability distribution function for windspeed. The derived distribution functions for windspeed are shown in figures A-1 through A-4 on the normal probability scale.

2. Frequency of Wind Direction (Figures A-5 through A-20)

The derived frequencies for wind direction shown in figures A-5 through A-20 were obtained using the five wind component parameters from tables I.1 and I.7 as input values in equation (35). The limits of integration (performed numerically) are over the 22.5-degree interval for each of the 16 compass points. These graphs give the percentage frequency that the wind will blow from the direction intervals.

3. Mean Wind Components and 80th Interpercentile Range of Wind Components (Figures A-21 through A-36)

The wind component means with respect to any orthogonal axes are obtained by using the zonal and meridional mean wind components in equations (44) and (45). These component means form the circles shown in figures A-21 through A-36. Further, the zonal and meridional wind component variances and correlation coefficients are used in equations (46) and (47) to obtain the variances with respect to any orthogonal axes. These rotated component variances and the rotated component means are used in equation (8) to obtain the 80th interpercentile range of wind components and are then illustrated in figures A-21 through A-36.

4. Probability Ellipses (Figures A-37 through A-52)

Using the five wind component parameters from tables I.1 and I.7 and $p = 0.50$, $p = 0.95$, and $p = 0.99$ as input values to equation (13), the wind

probability ellipses shown in figures A-37 through A-52 were obtained by computer graphics. The statistical inferences are, for example, that 50 percent of the wind vectors lie within the smaller ellipse and 99 percent of the wind vectors lie within the outer ellipse. These probability ellipses are illustrated using the standard meteorological coordinate system explained in section I.B.1.

5. Conditional Windspeed Given the Wind Direction (Figures A-53 through A-68)

The five wind component parameters from table I.1 and table I.7 are used to evaluate the conditional probability distribution function, equation (41). Figures A-53 through A-68 show interpolations of the conditional function made to obtain the 5th, 15th, 50th (median), 85th, 95th, and 99th conditional percentile values of windspeed, given the wind directions. The conditional mean windspeed, given the wind direction, is obtained from equation (40). The conditional mode (most probable) windspeed, given the wind direction, is obtained from equation (38). The conditional mean windspeed and the conditional windspeed modal value, given the wind direction, are also shown in these figures. For some figures, the conditional windspeed values are invalid for the given wind direction near 270° (from the west). This is caused by the lack of computational precision in evaluating equations (40) and (41) when the arguments for the Gaussian probability distribution have large negative values, i.e., when the coefficients (b/a) become less than -4 in these equations.

This appendix contains only a few of the many options in presenting wind statistics illustrations.

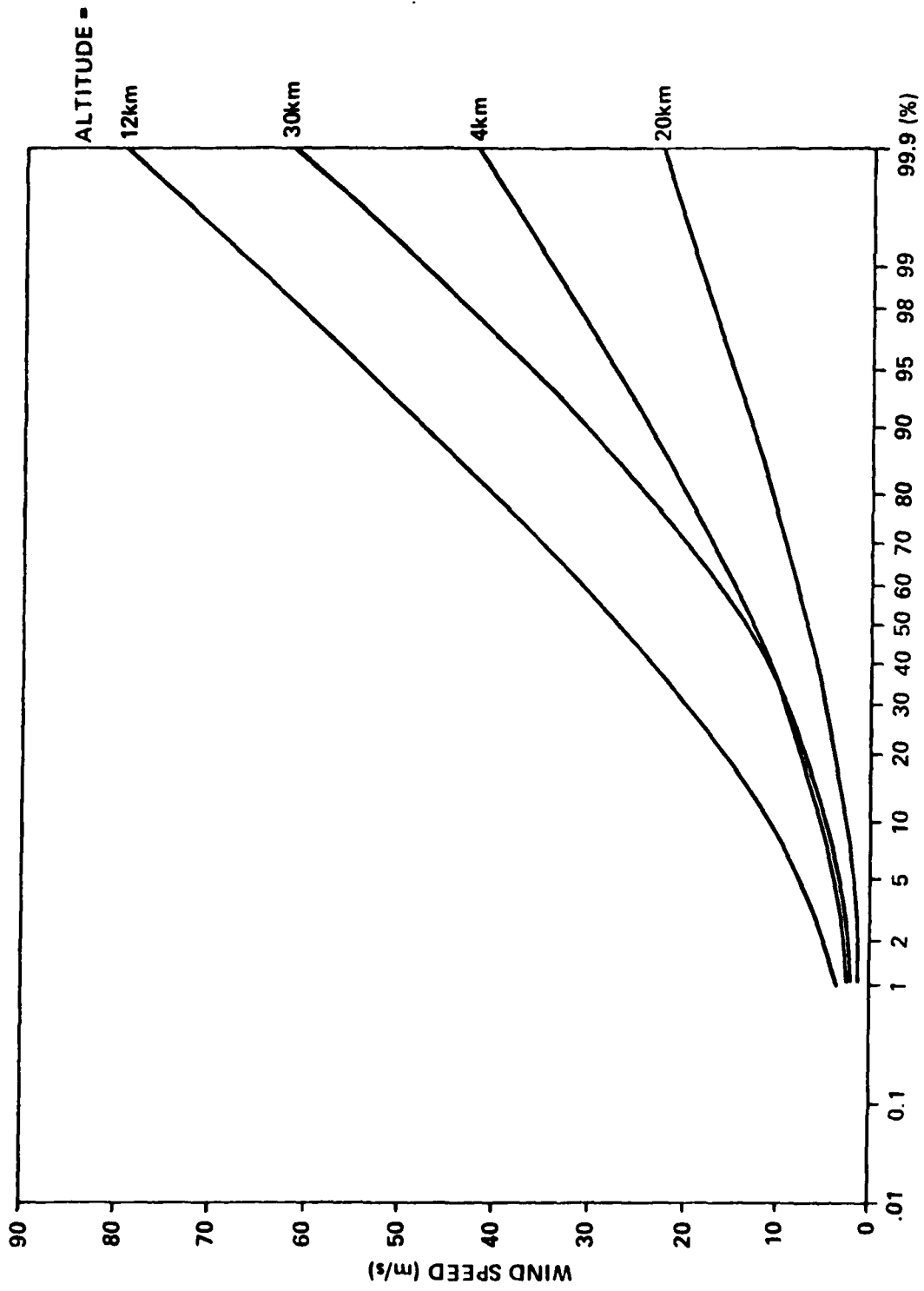

Fig. A-1. Rayleigh PDF of wind speed, Vandenberg AFB, January.

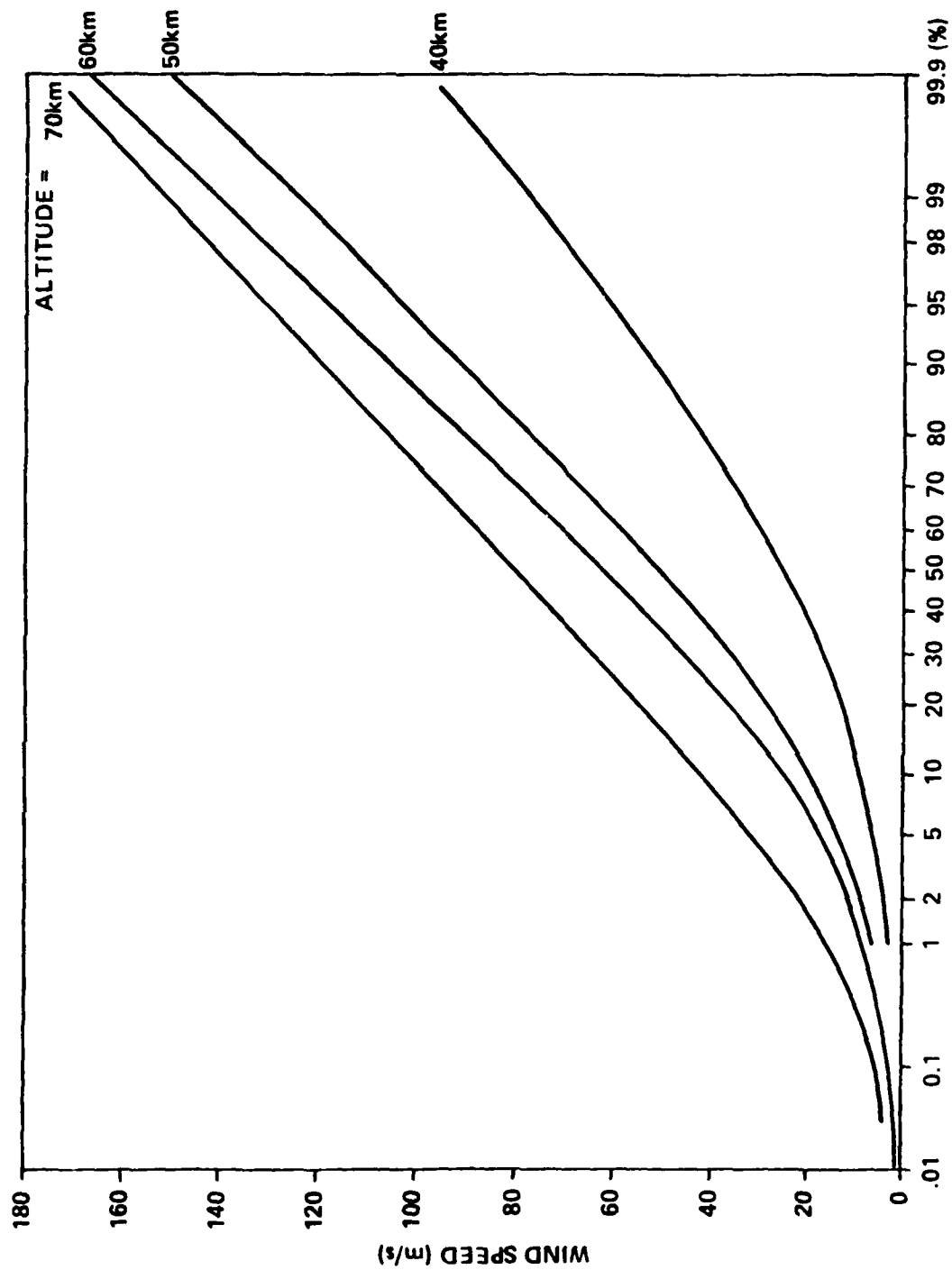

Fig. A-2. Rayleigh PDF of wind speed, Vandenberg AFB, January.

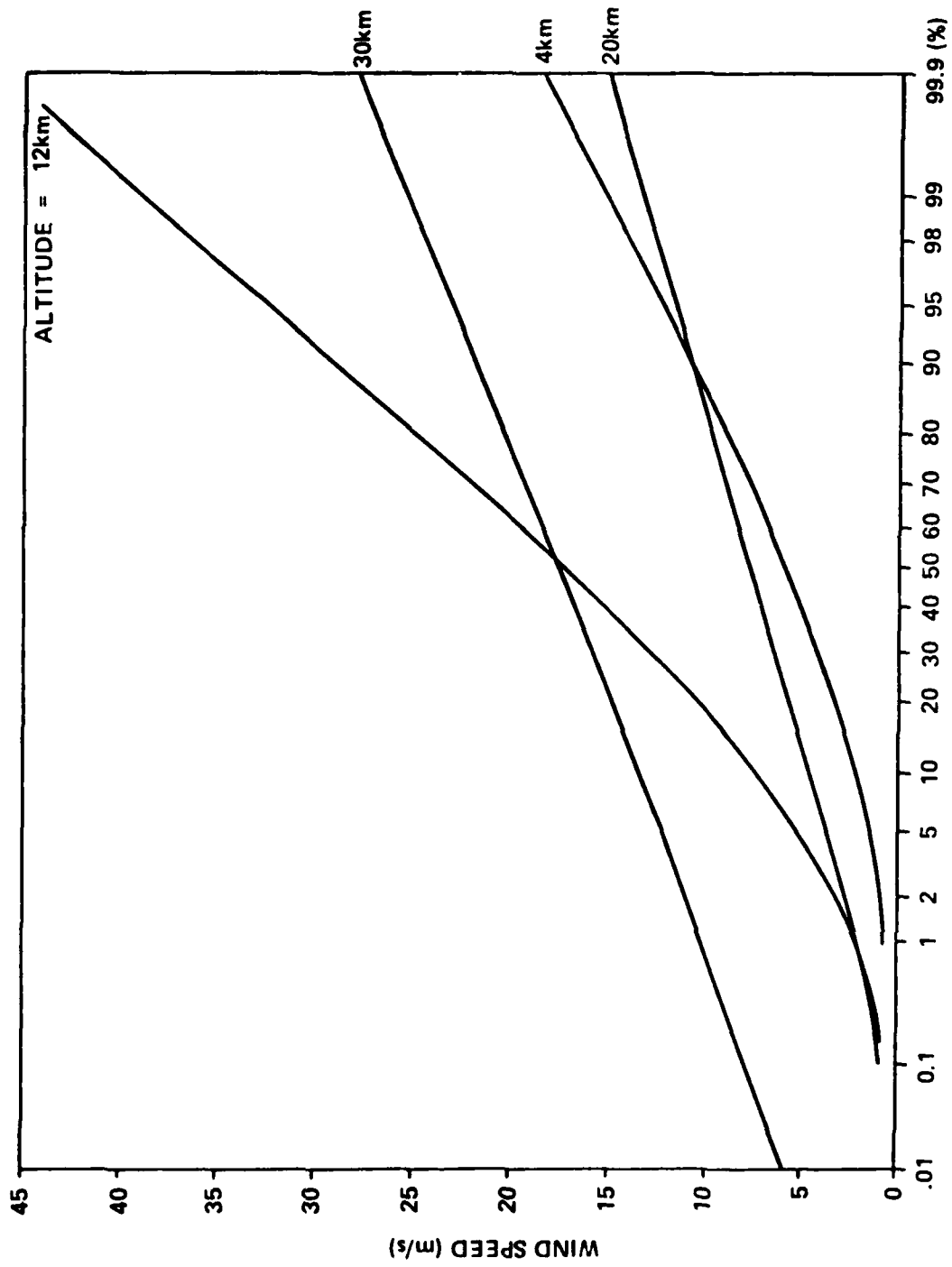

Fig. A-3. Rayleigh PDF of wind speed, Vandenberg AFB, July.

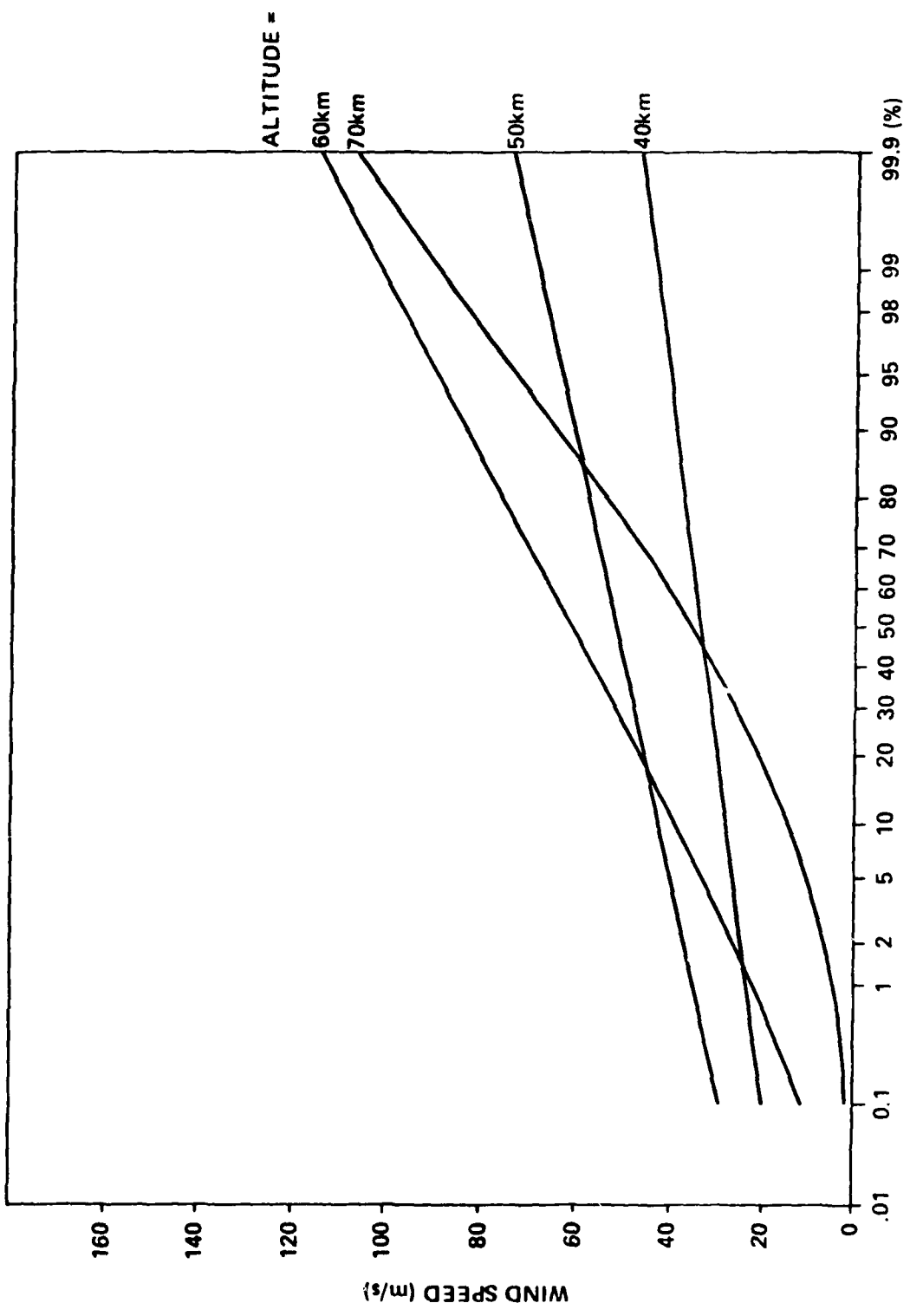

Fig. A-4. Rayleigh PDF of wind speed, Vandenberg AFB, July.

WIND STATION-VAFB MONTH-JAN. ALTITUDE= 4 101

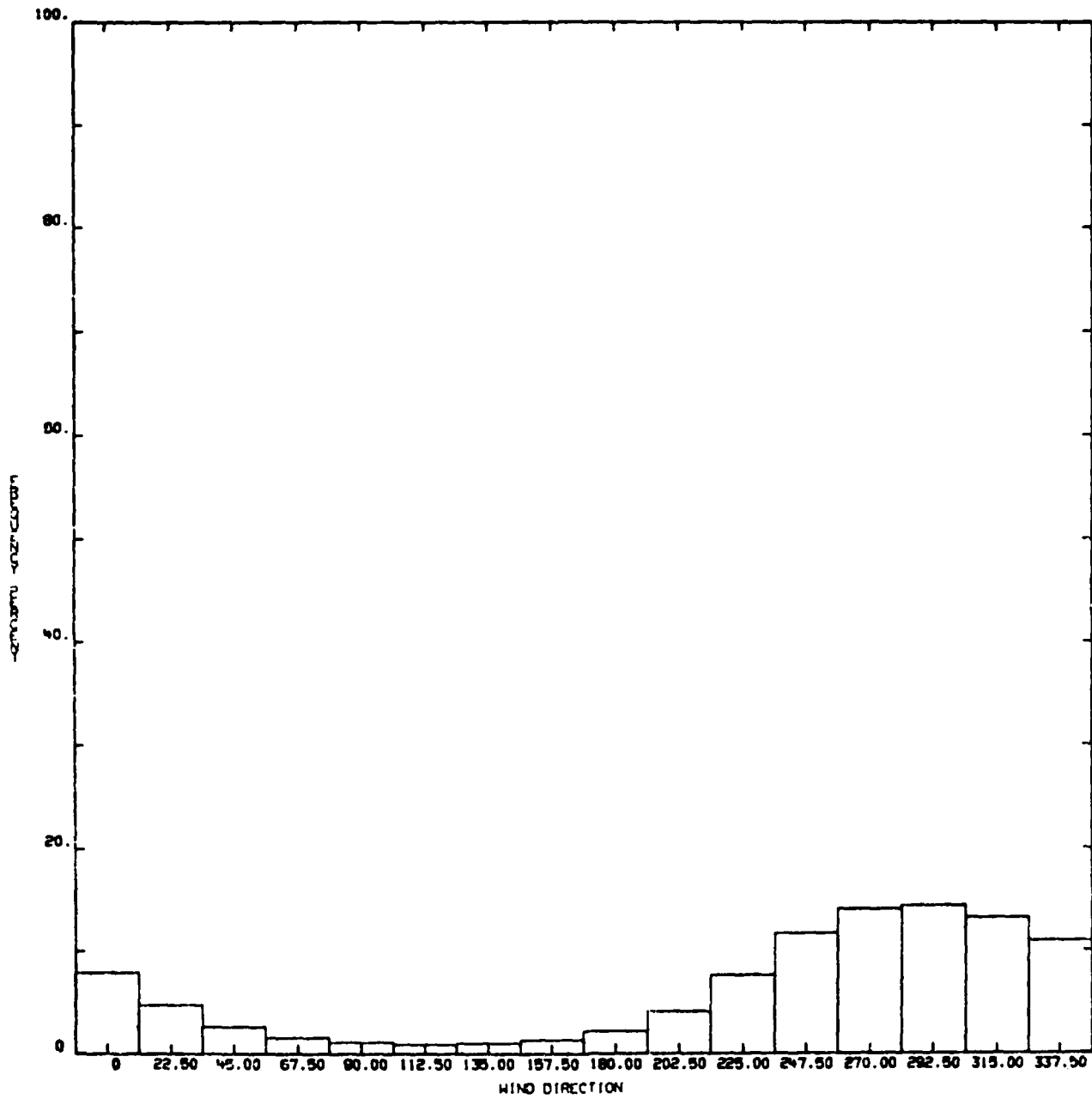

Fig. A-5

WIND STATION-VAFB MONTH-JAN. ALTITUDE=12 KM

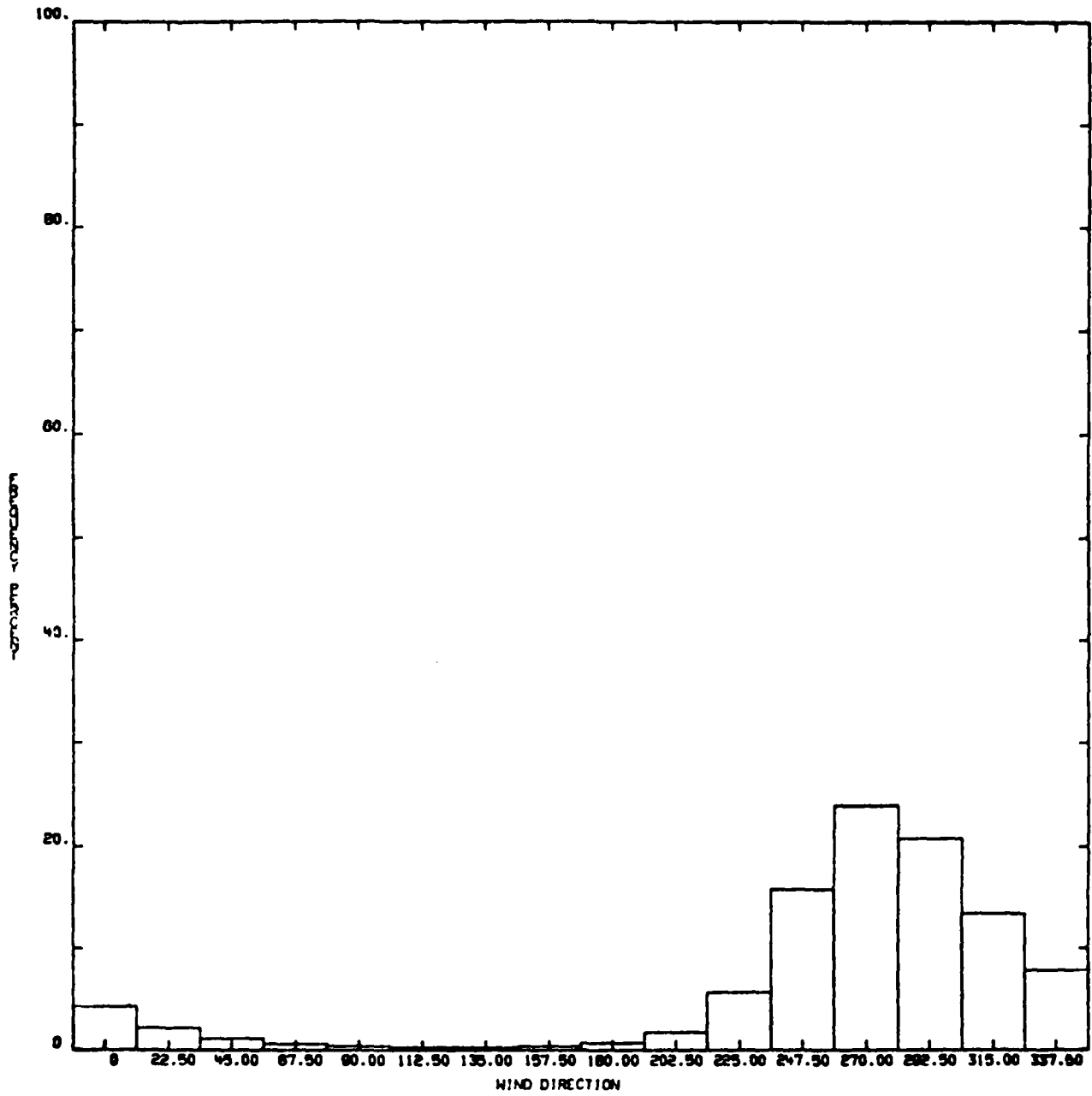

Fig. A-6

WIND STATION-VAFB MONTH-JAN. ALTITUDE-20 K91

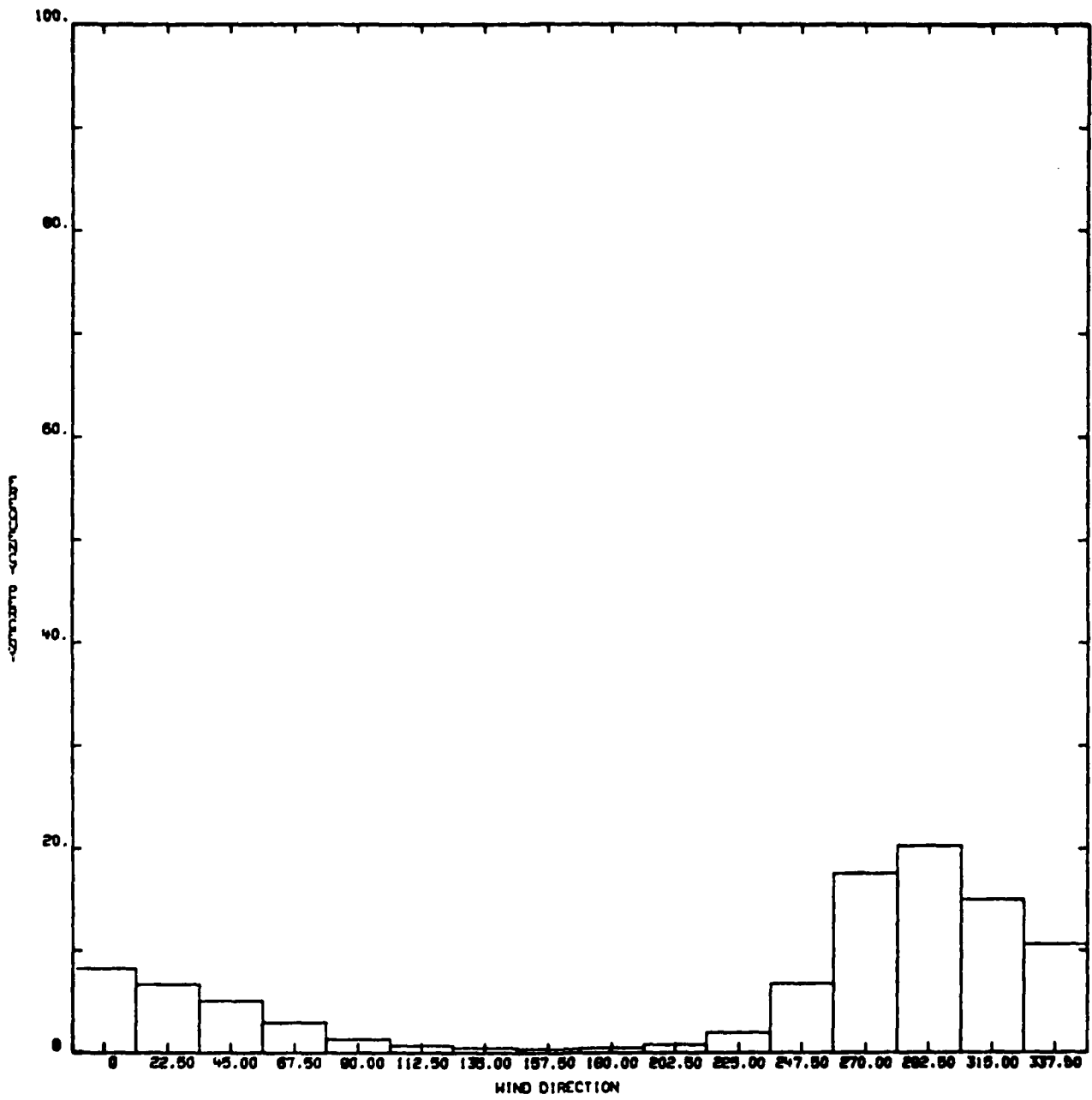

Fig. A-7

WIND STATION=VAFB MONTH=JAN. ALTITUDE=30 KM

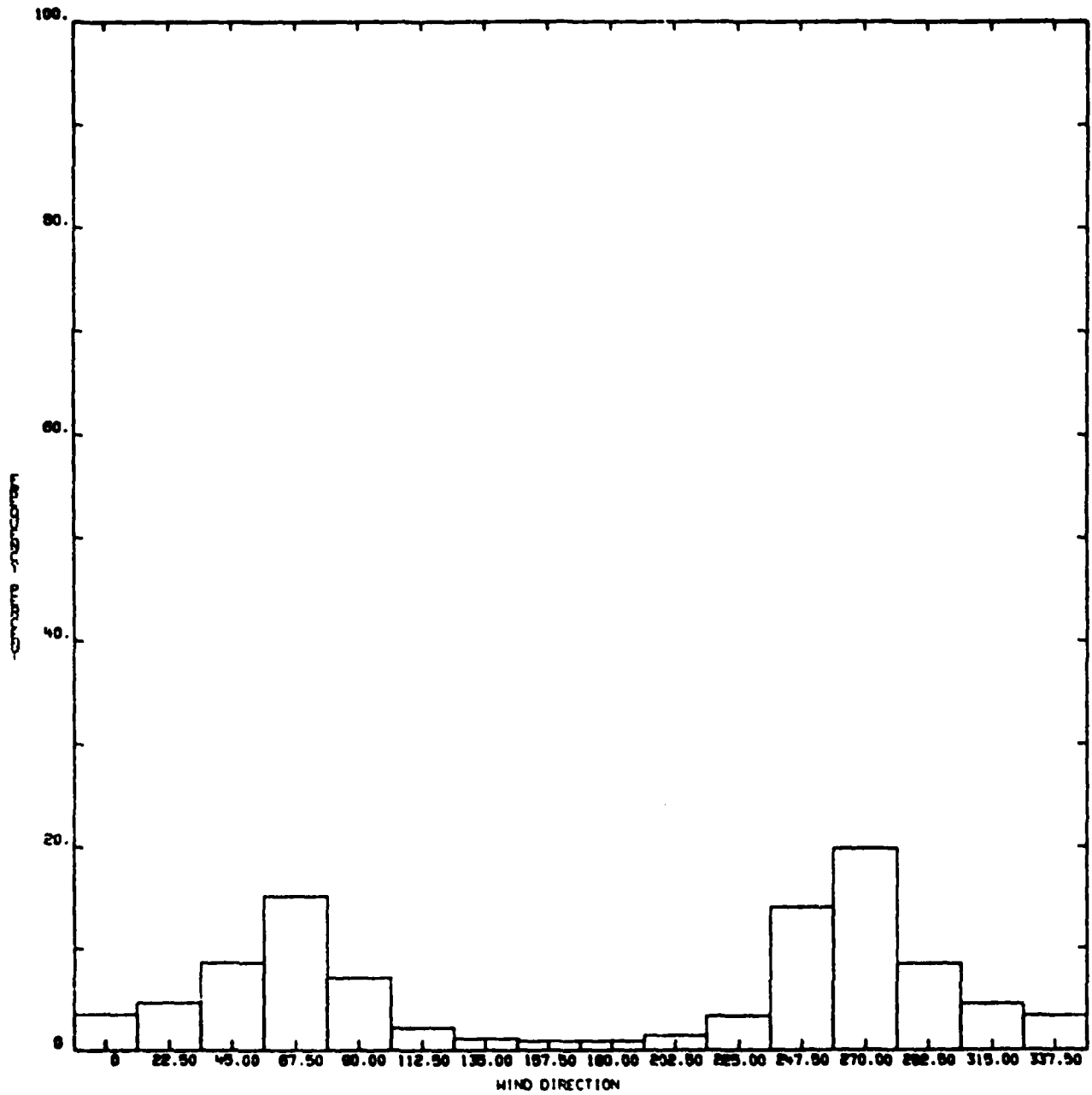

Fig. A-3

WIND STATION=VAFB MONTH=JAN. ALTITUDE=40 KM

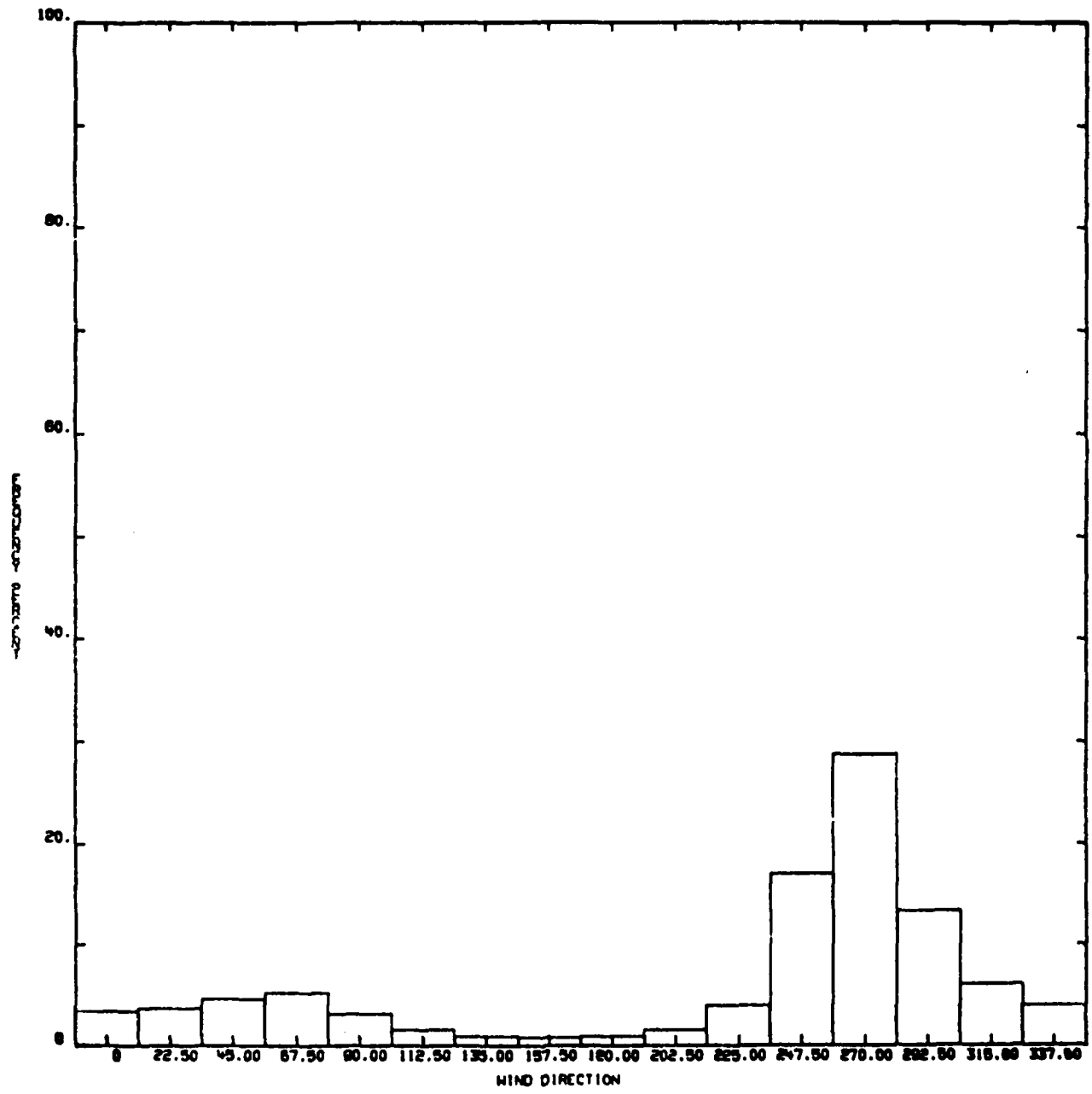

Fig. A-9

WIND STATION-VAFB MONTH- ALTITUDE-50 KM

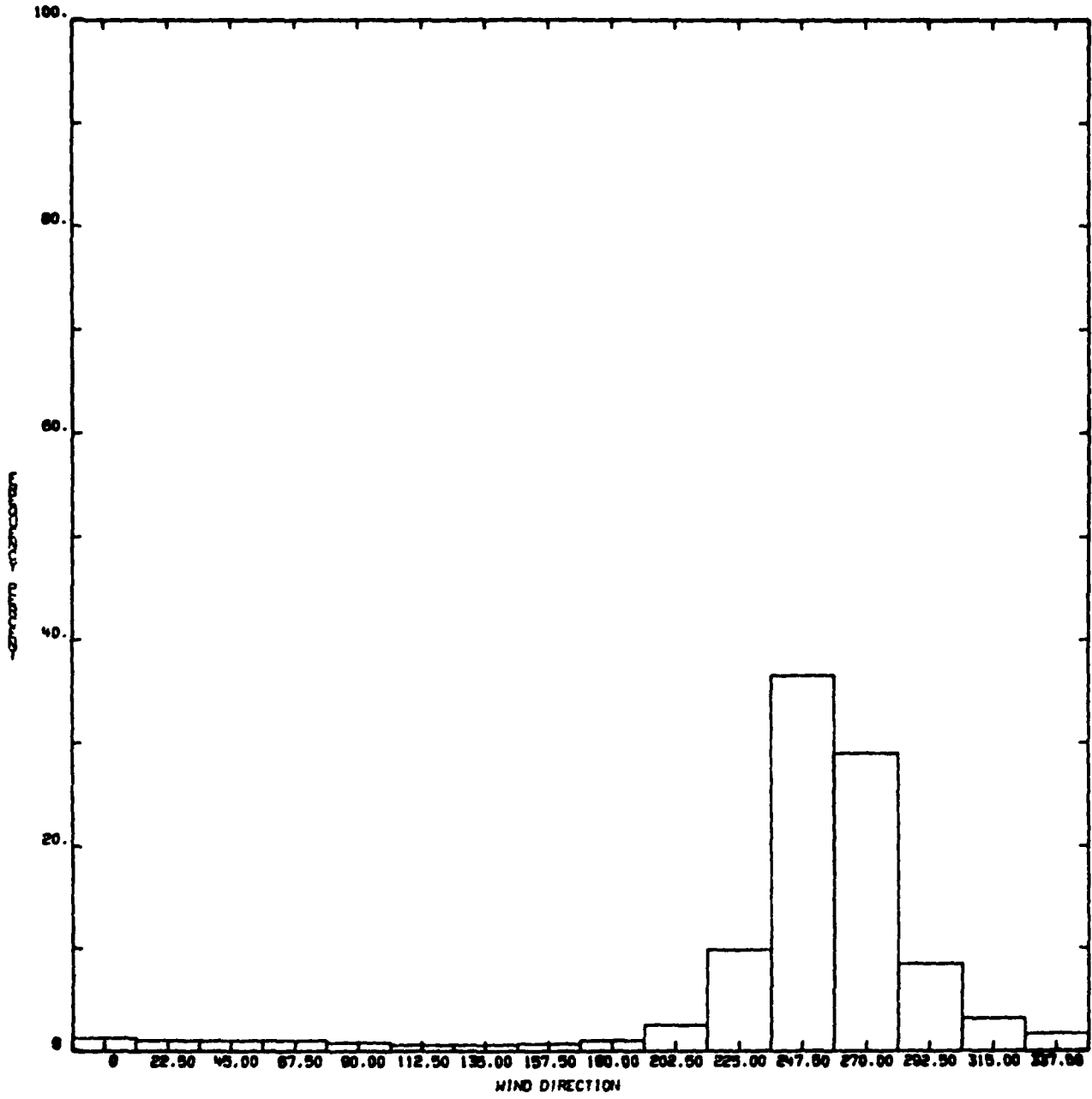

Fig. A-10

WIND STATION-VAFB MONTH-JAN., ALTITUDE-80 KM

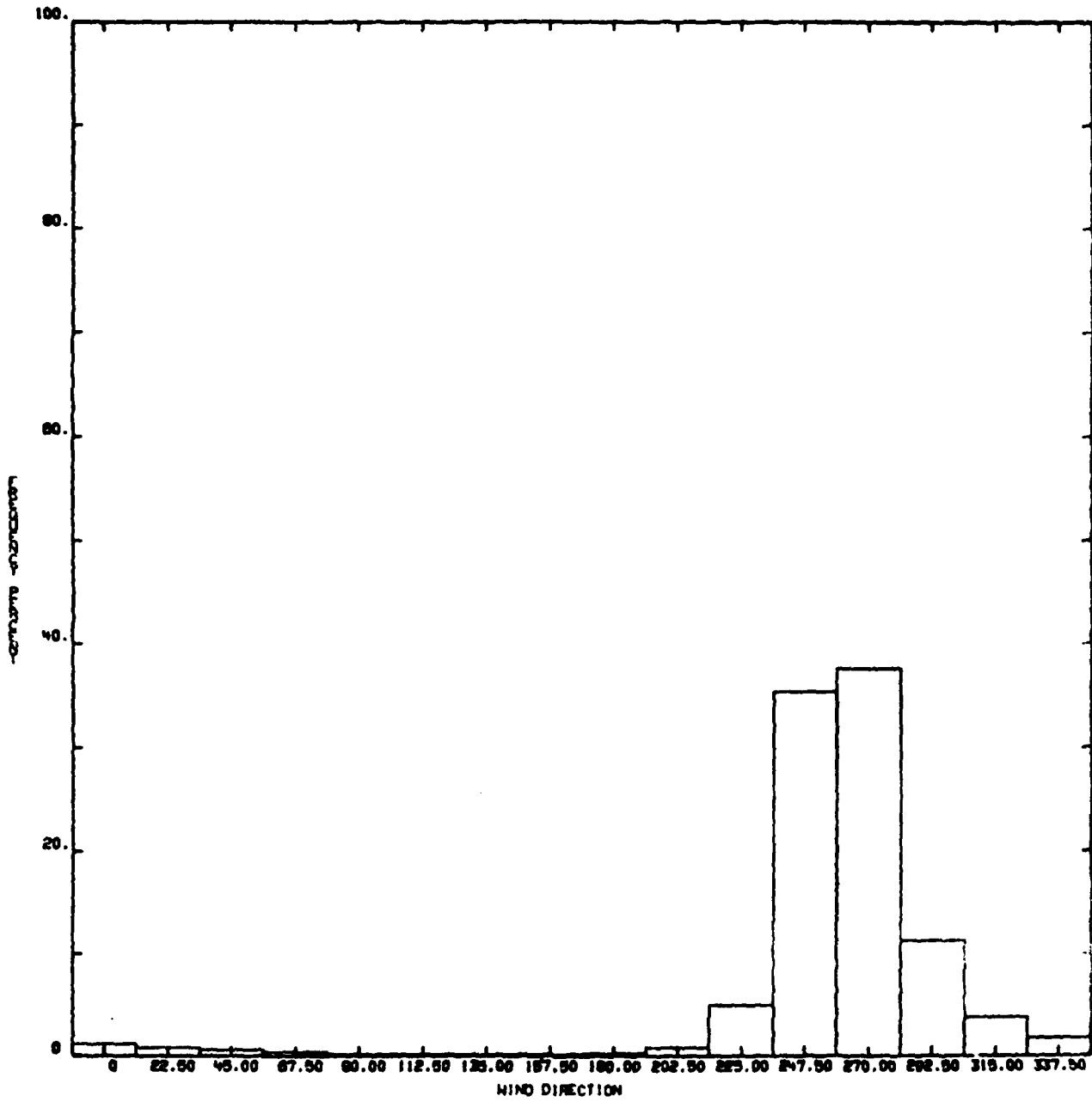

Fig. A-11

WIND STATION-VAFB MONTH-JAN. ALTITUDE-70 KM

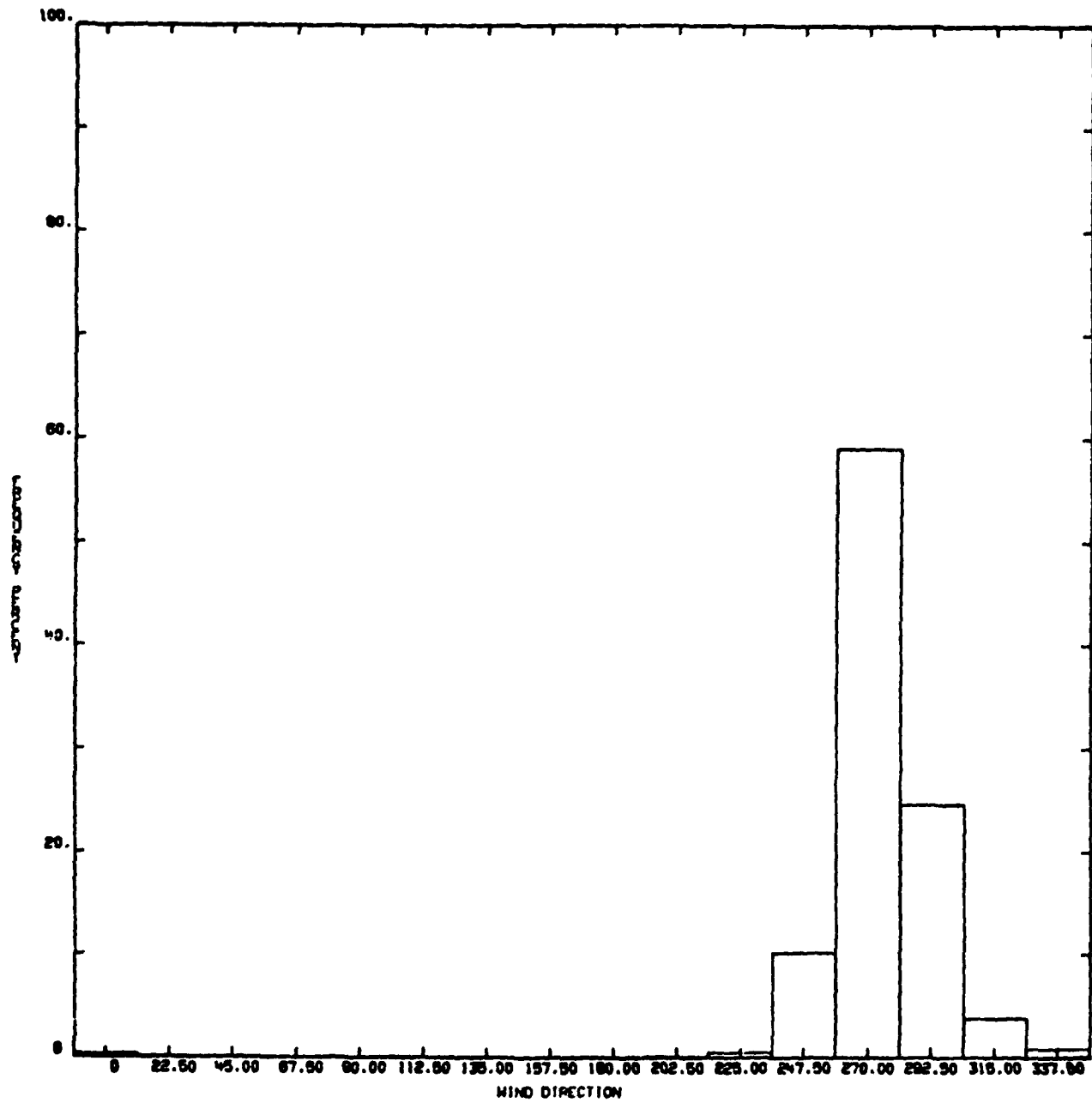

Fig. A-12

WIND STATION-VAFB MONTH-JUL. ALTITUDE- 4 KM

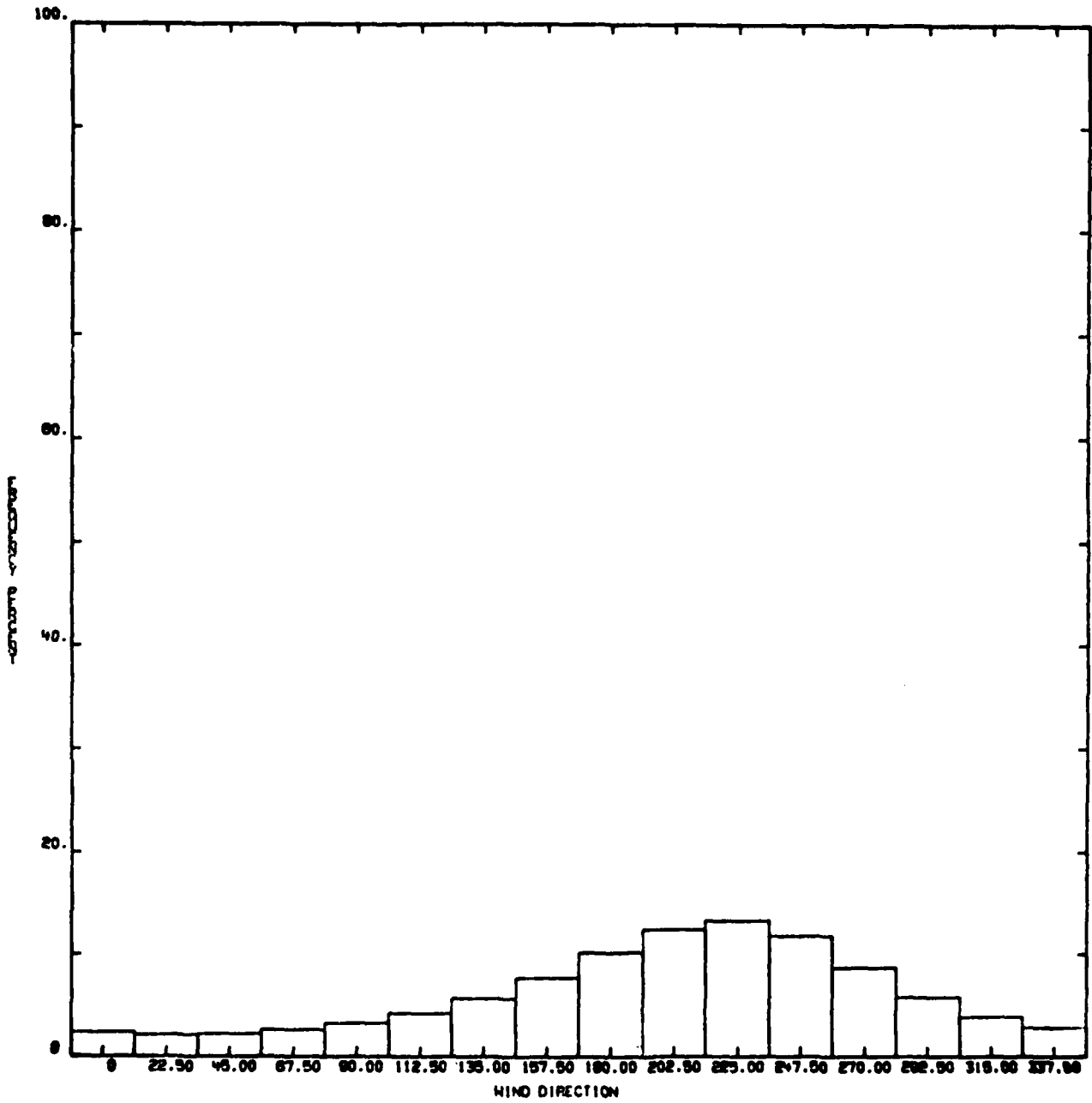

Fig. A-13

WIND STATION-VAFB MONTH-JUL. ALTITUDE=12 101

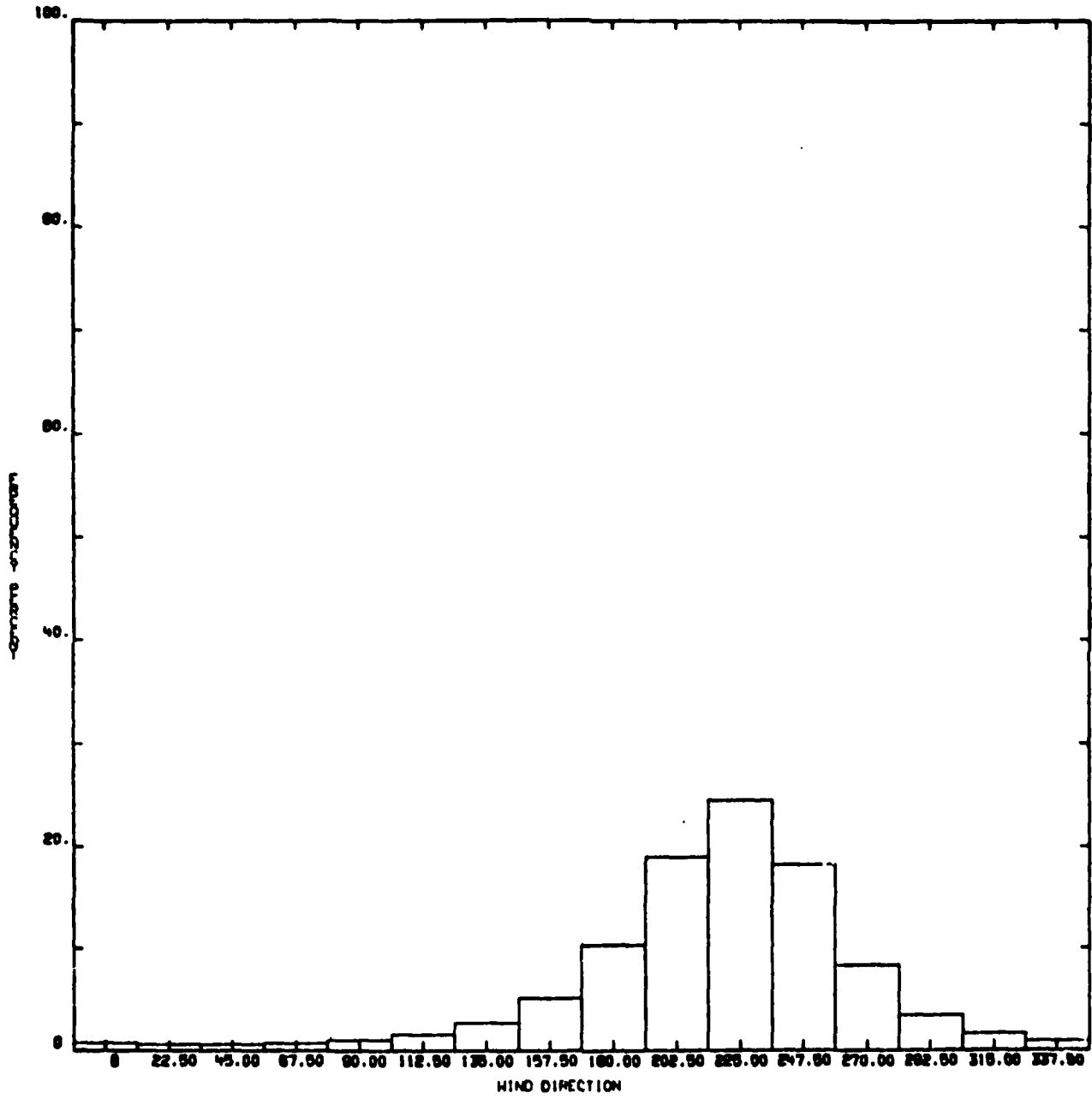

Fig. A-14

WIND STATION-VAFB MONTH-JUL. ALTITUDE-20 KM

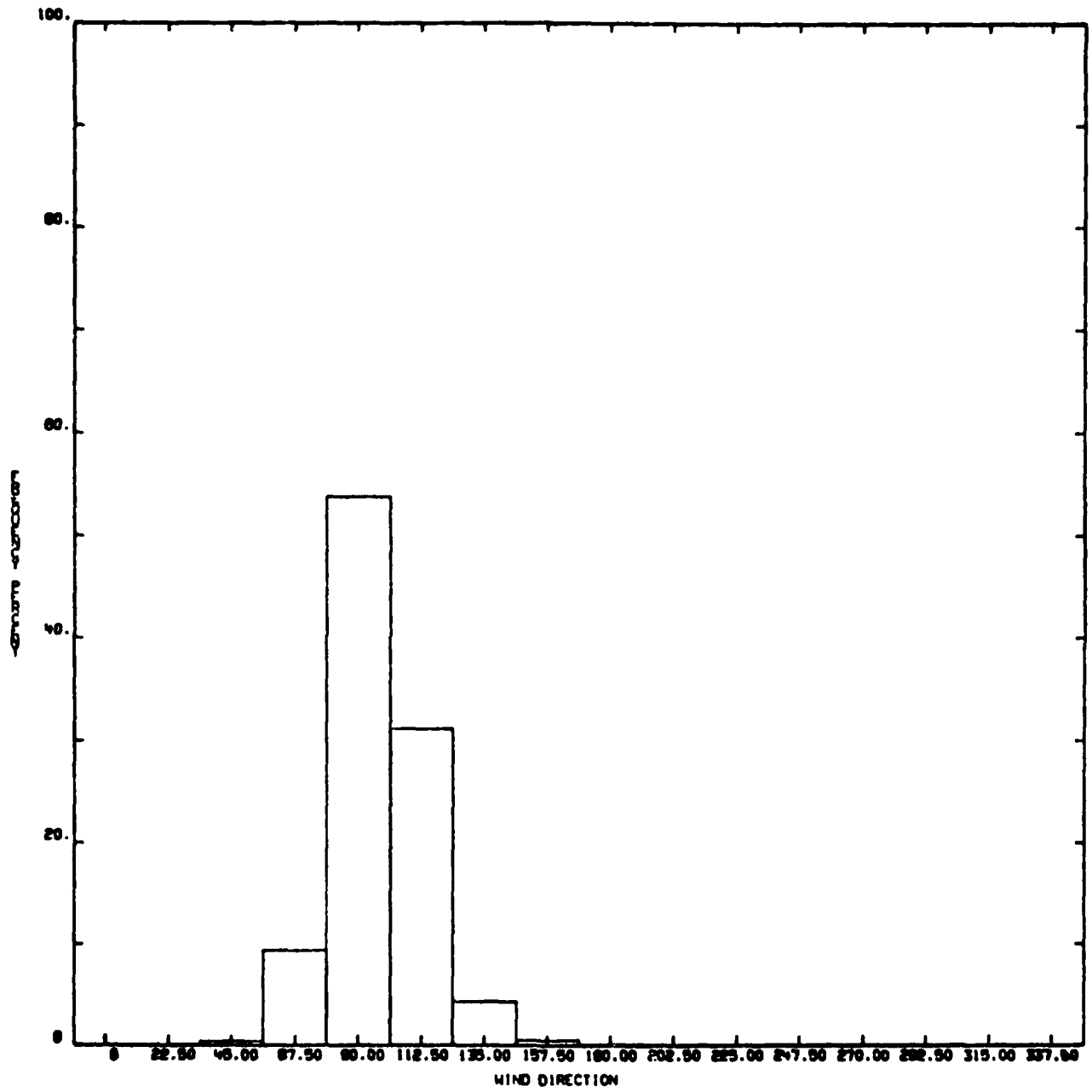

Fig. A-15

WIND STATION-VAFB MONTH-JUL. ALTITUDE-50 M

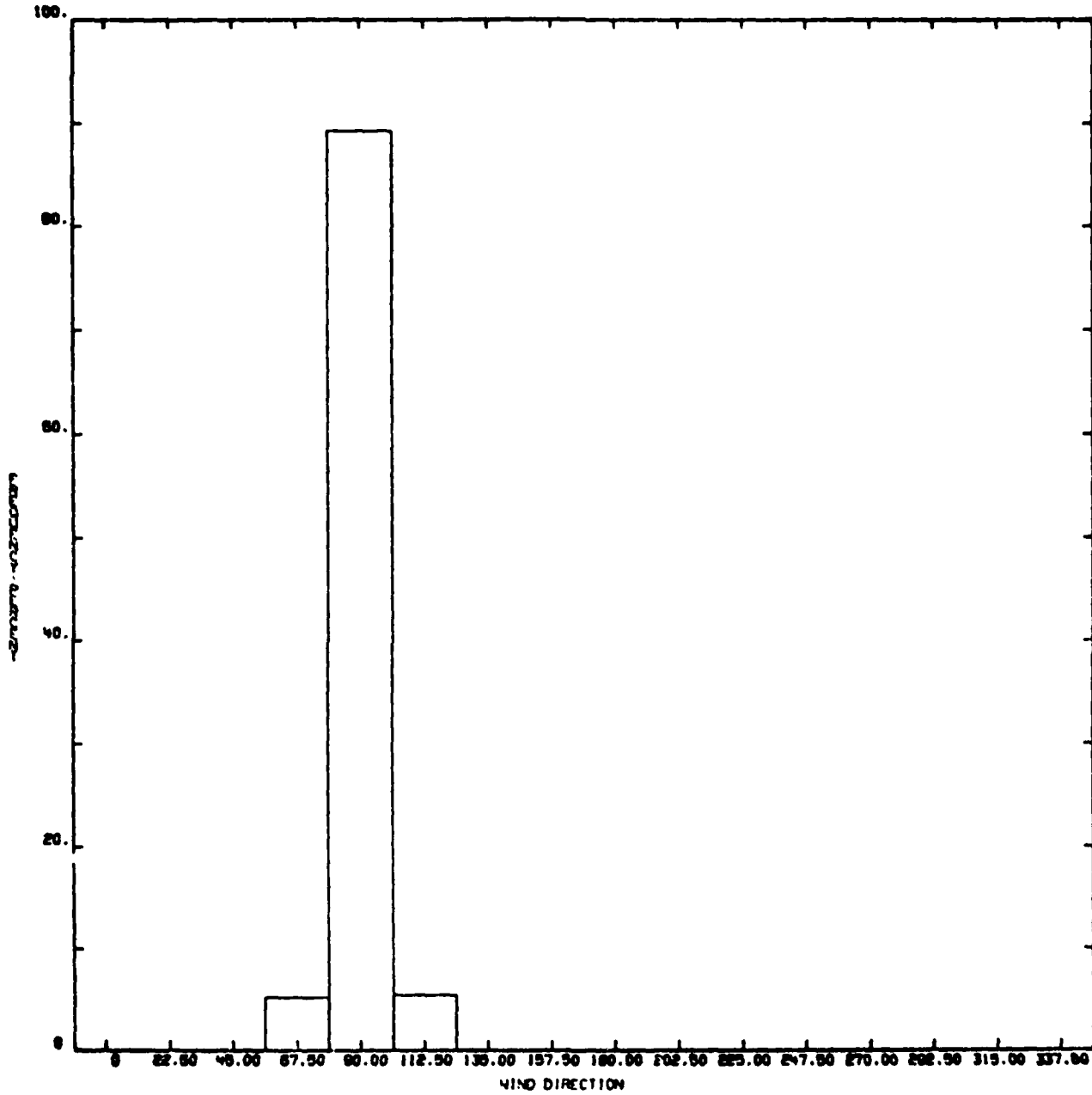

Fig. A-16

WIND STATION=VAFB MONTH= ALTITUDE=40 KM

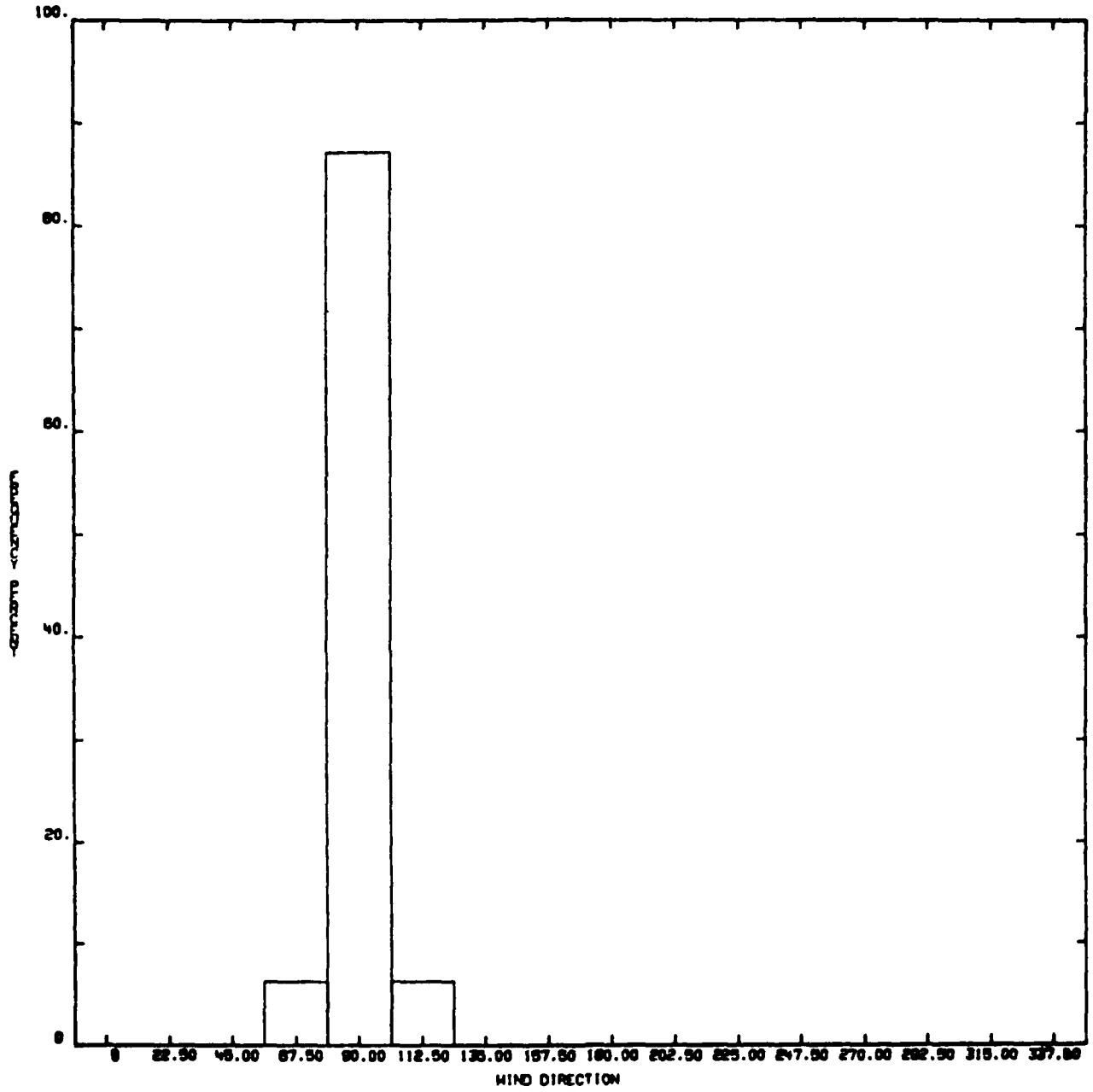

Fig. A-17

WIND STATION-YAFB MONTH-JUL. ALTITUDE-50 KM

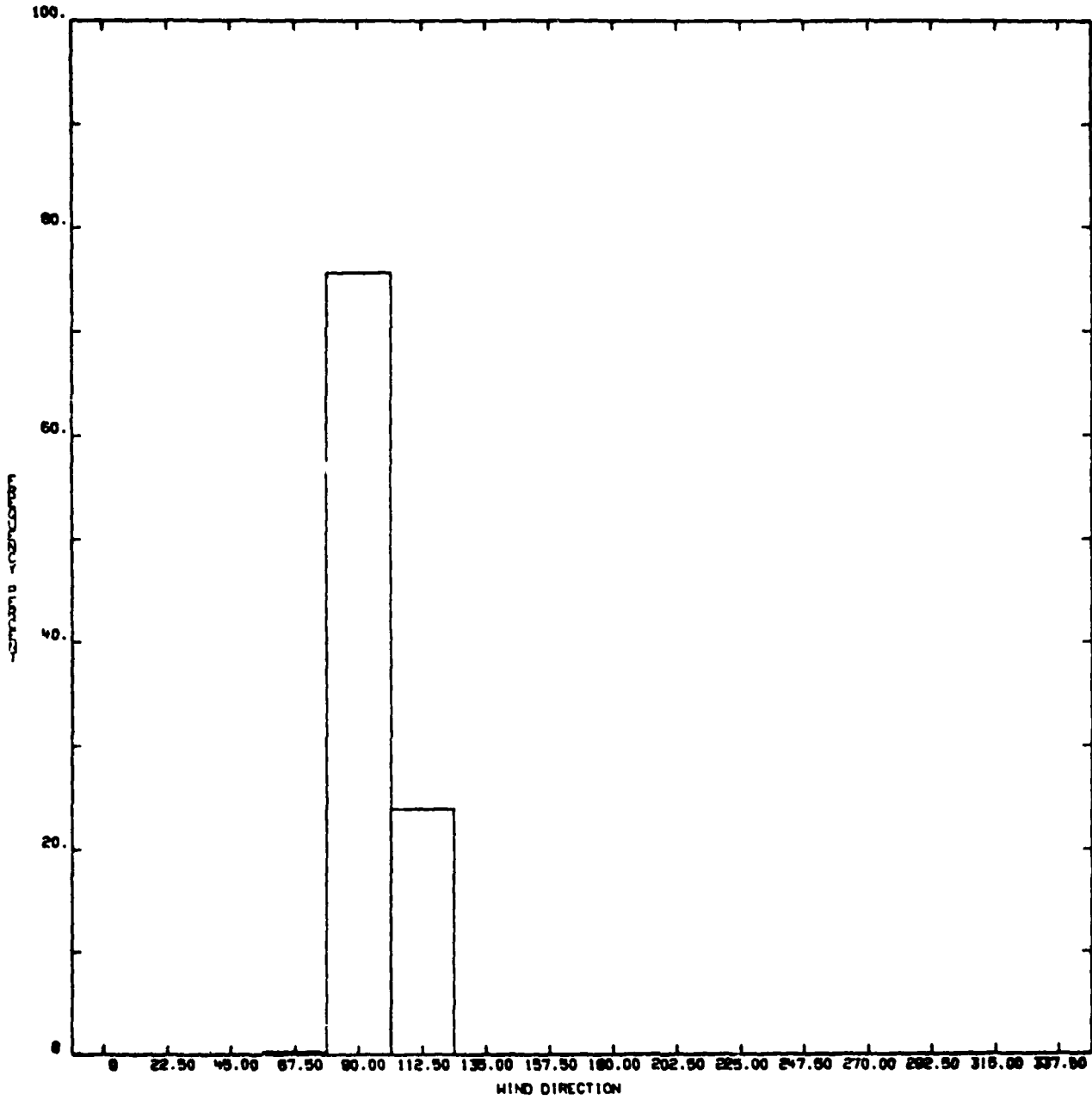

Fig. A-18

WIND STATION-VAFB MONTH-JUL. ALTITUDE-60 KM

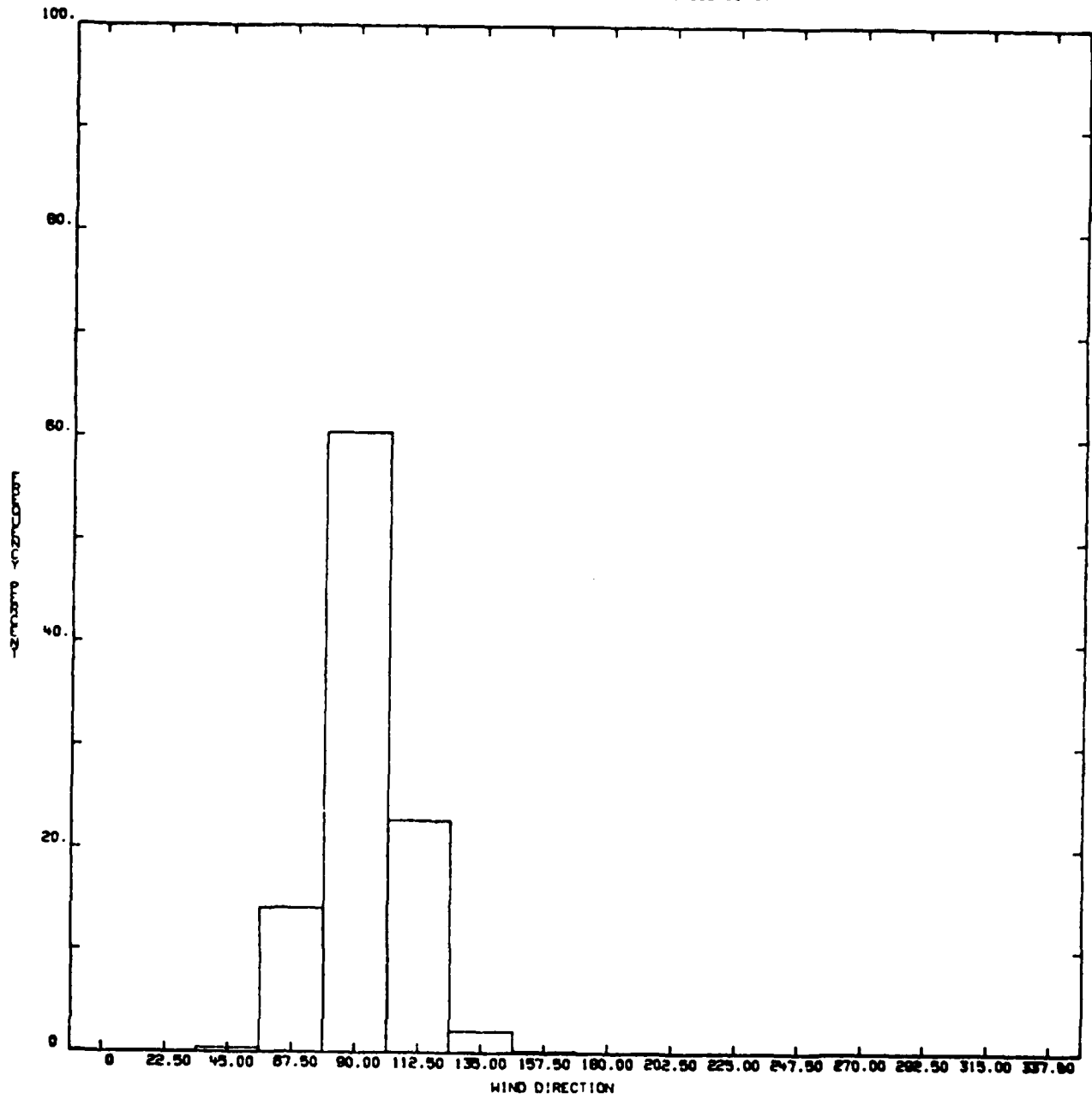

Fig. A-19

WIND STATION-VAFB MONTH-JUL. ALTITUDE-70 KM

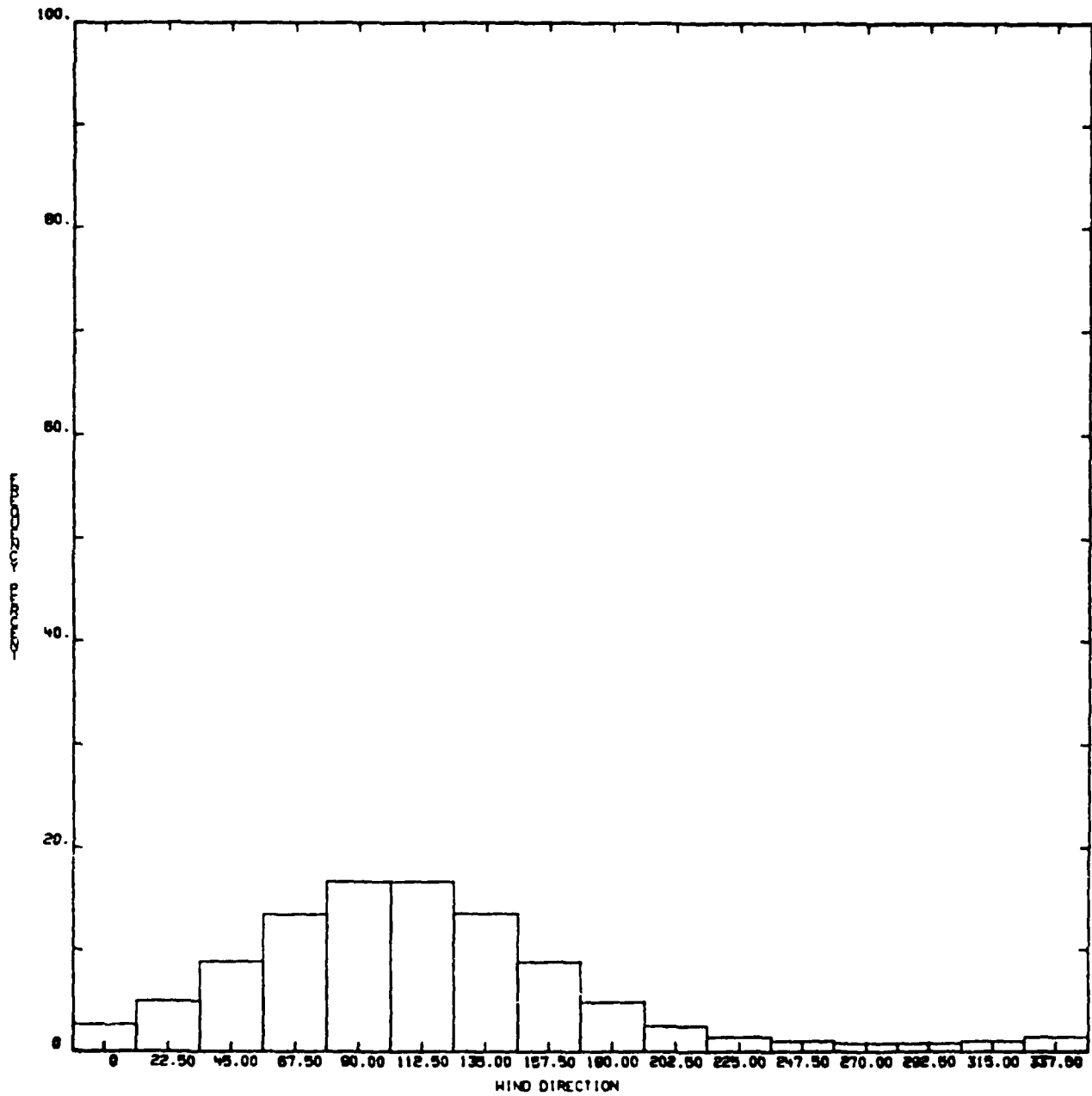

Fig. A-20

XBAR= 8.18 SIGMAX= 8.96 RHO= .1799 YBAR= -3.40 SIGMAY= 9.85 PERCENT= 90.

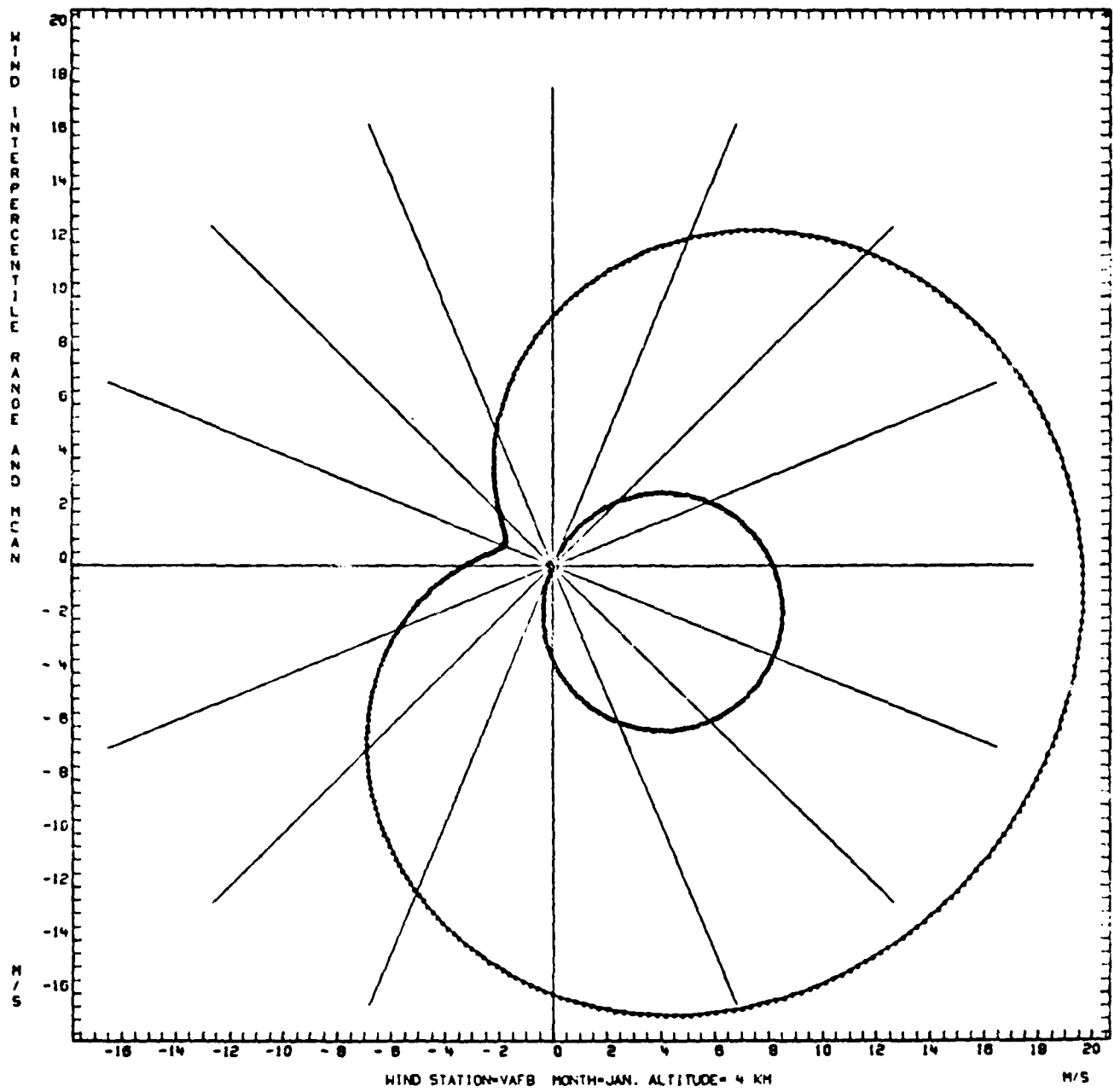

Fig. A-21

XBAR= 23.23 SIGMAX= 16.21 RHO= .2442 YBAR= -4.94 SIGMAY= 15.04 PERCENT= 80.

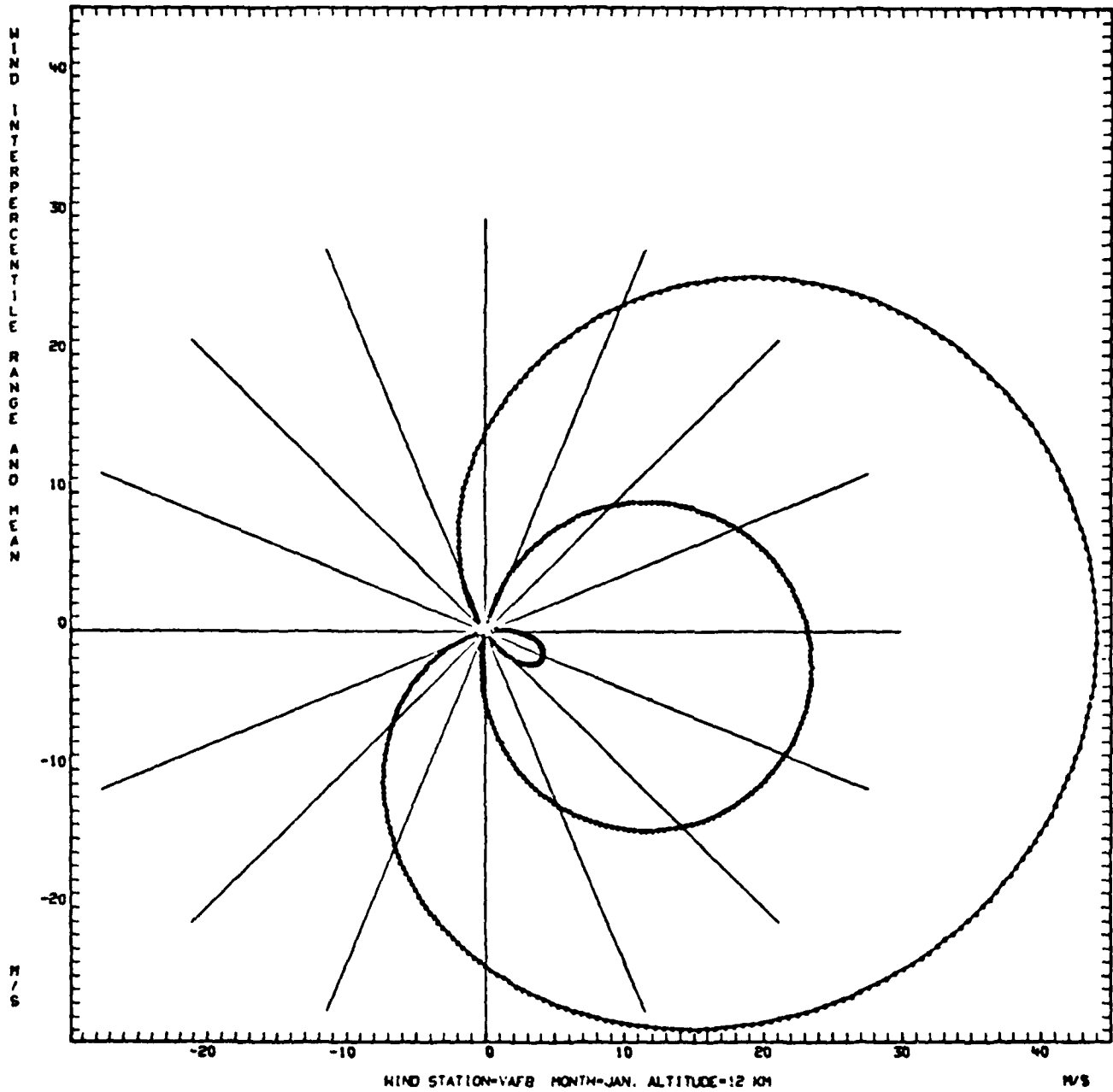

Fig. A-22

XBAR= 4.37 SIGMAX= 5.67 RHO= .2425 YBAR= -3.04 SIGMAY= 3.63 PERCENT= 80.

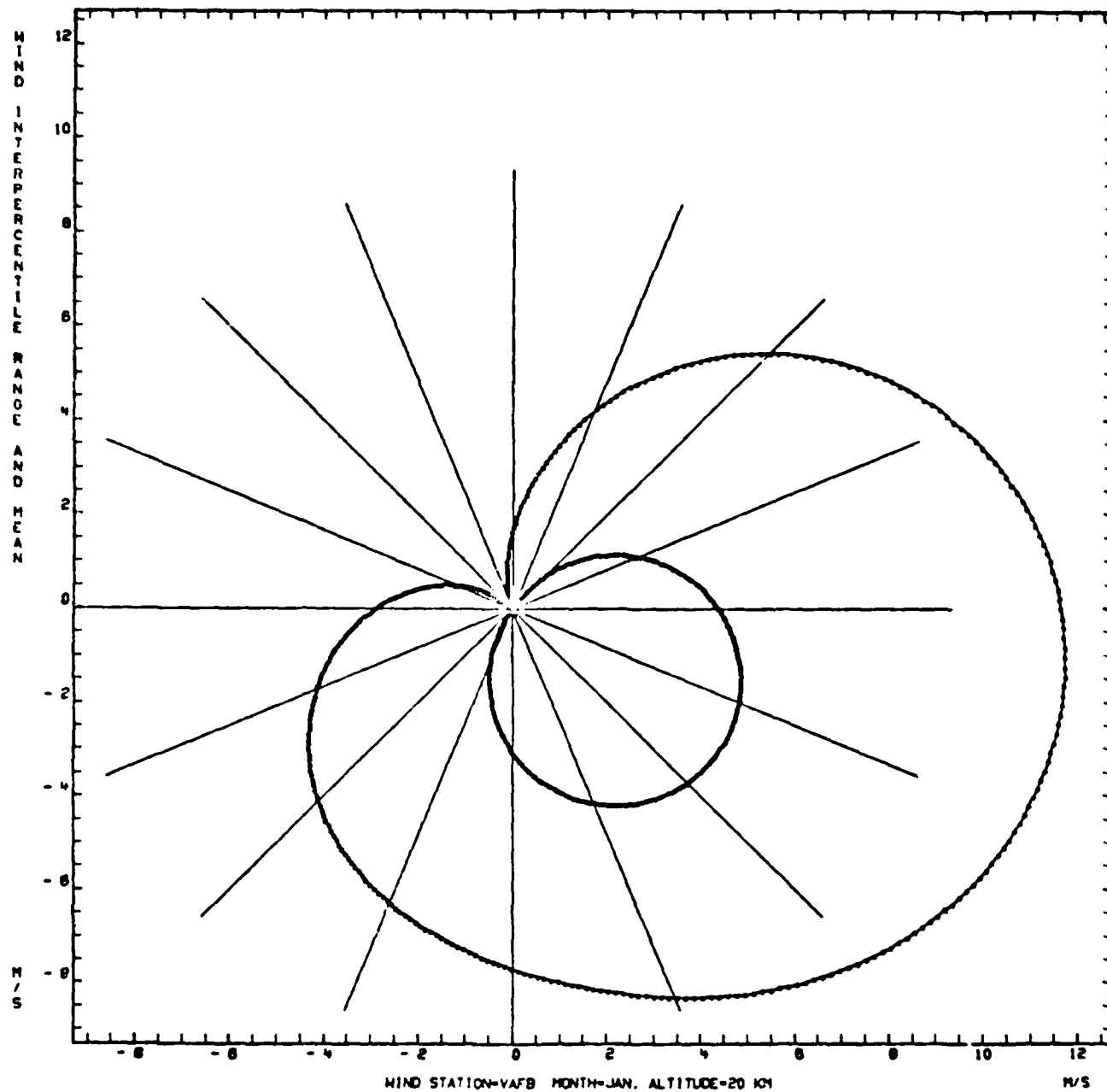

Fig. A-23

XBAR= 3.42 SIGMAX= 17.82 RHO= .5823 YBAR= -2.08 SIGMAY= 7.04 PERCENT= 90.

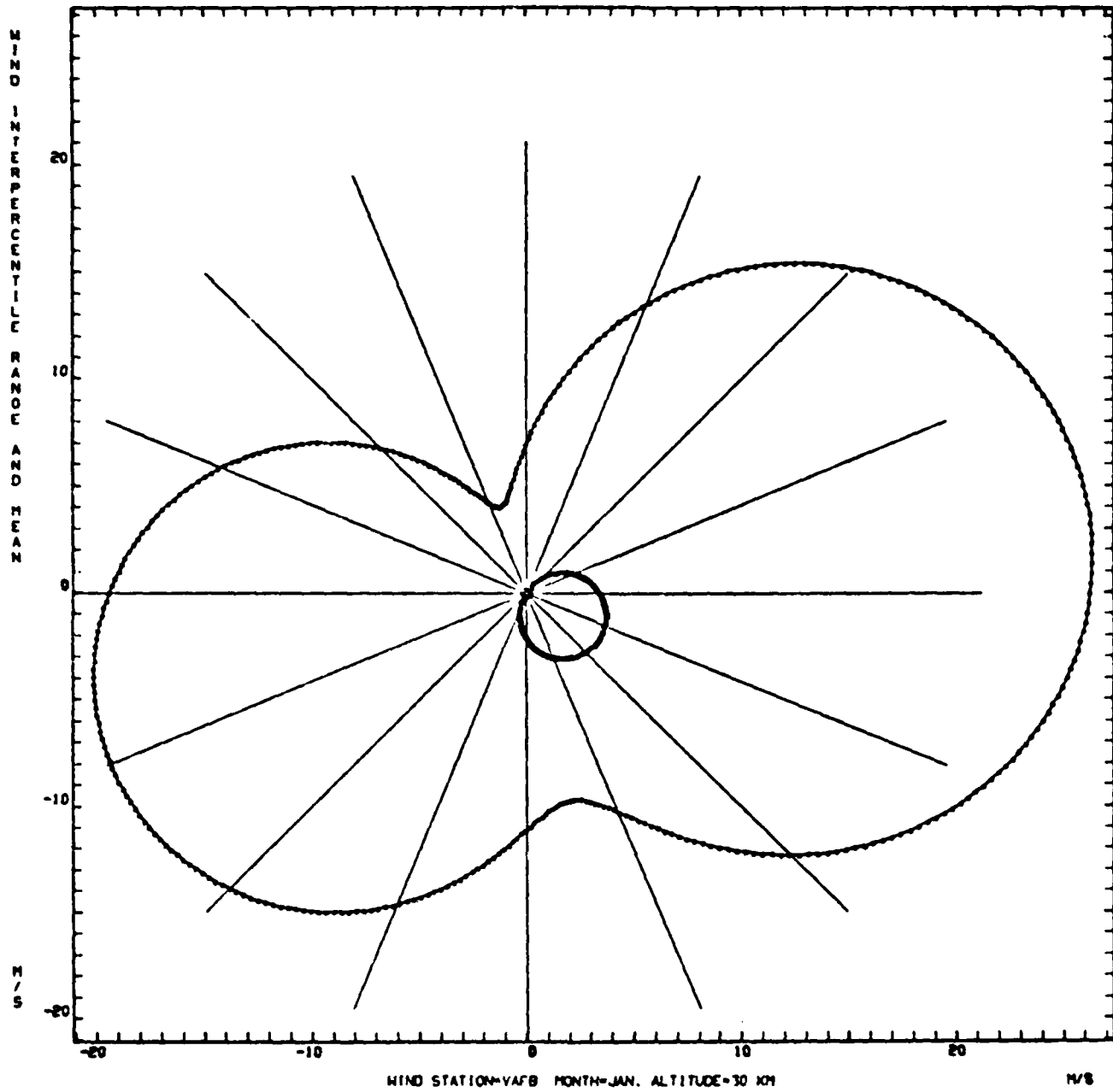

Fig. A-24

XBAR= 18.56 SIGMAX= 24.63 RHO= .4082 YBAR= -1.57 SIGMAY= 11.25 PERCENT= 80.

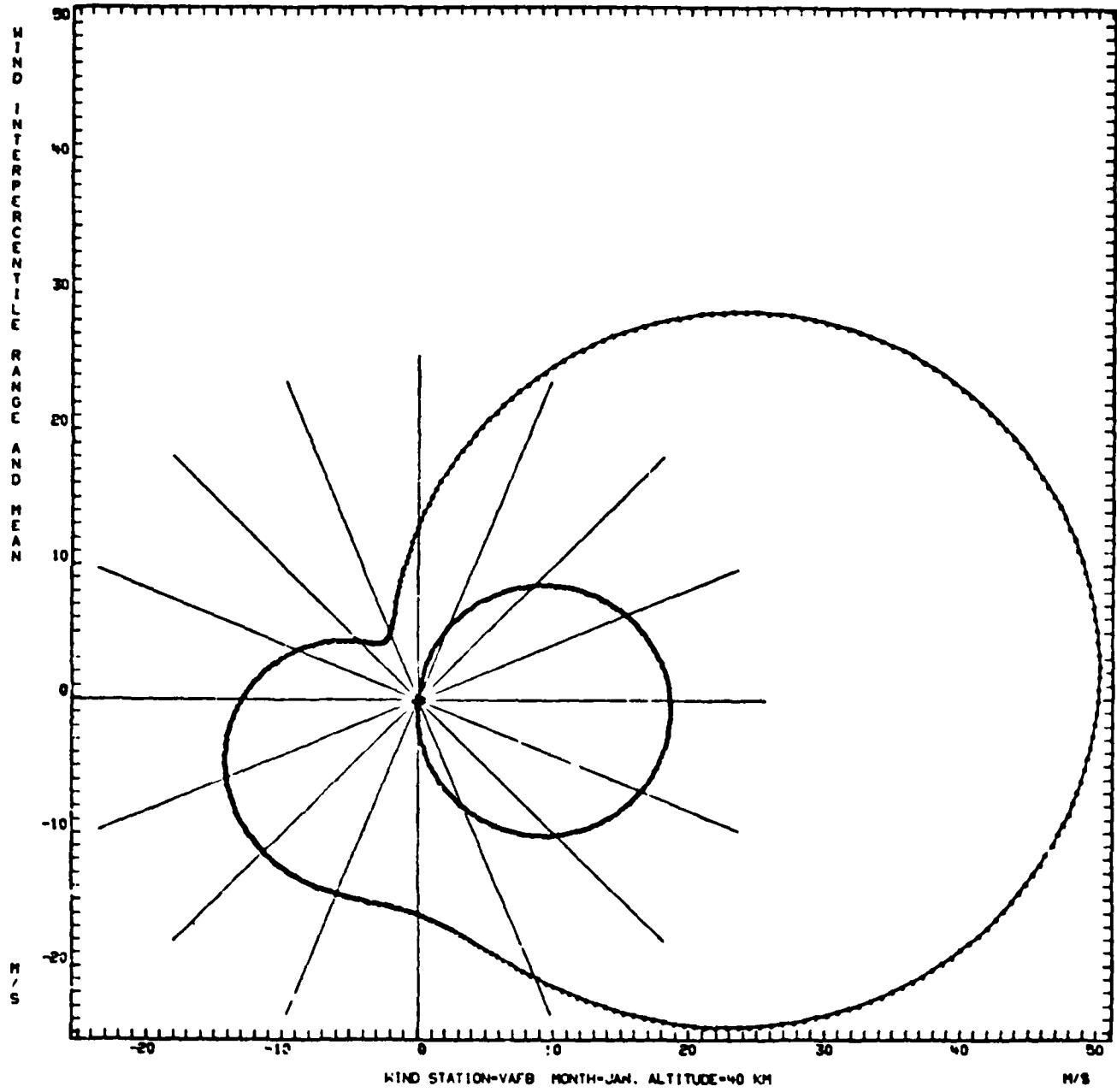

Fig. A-25

XBAR= 46.30 SIGMAX= 31.52 RHO= .4139 YB. 10.50 SIGMAY= 18.99 PERCENT= 80.

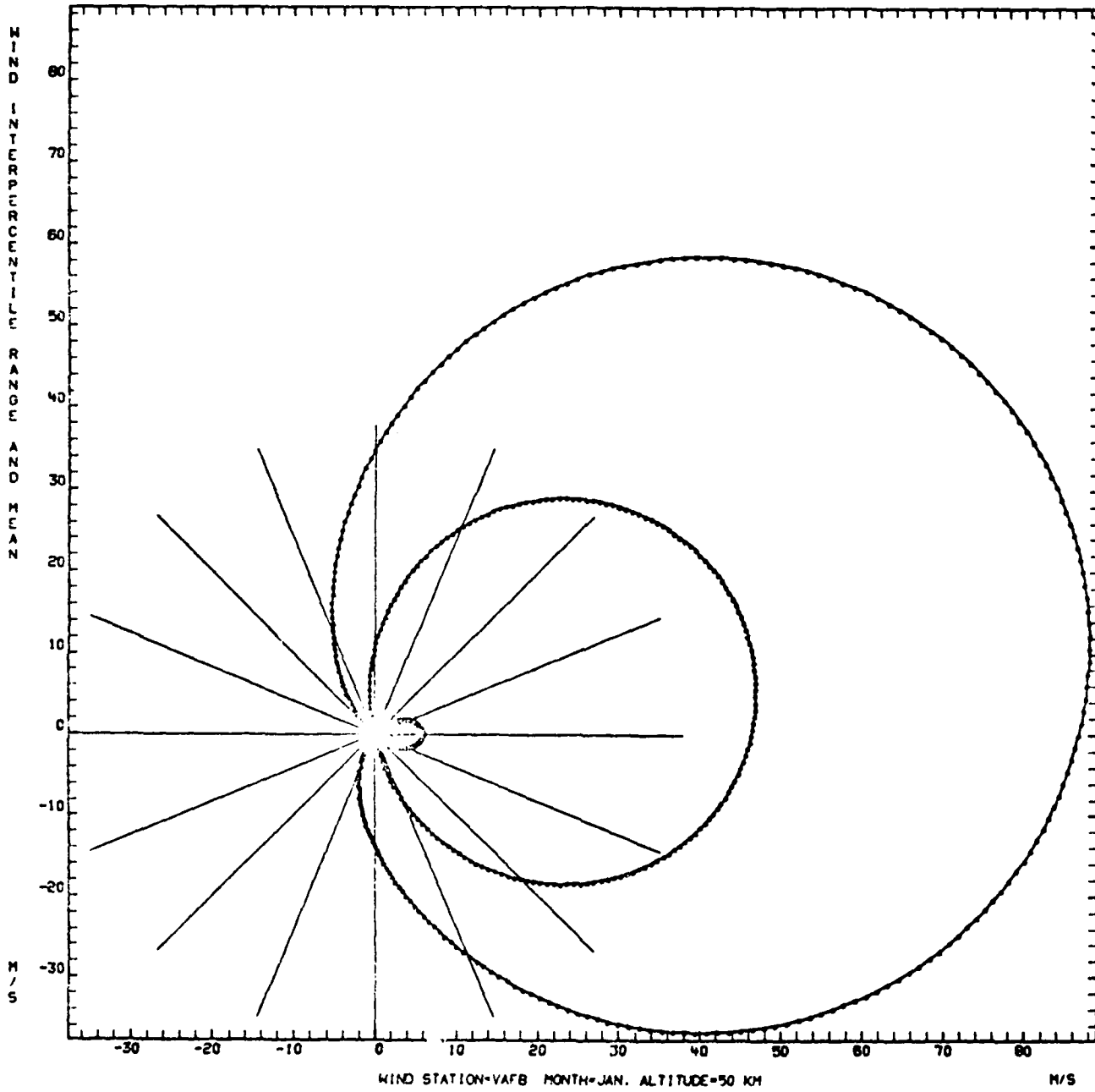

Fig. A-26

XBAR= 59.92 SIGMAX= 32.44 RHO= .4657 YBAR= 8.38 SIGMAY= 20.56 PERCENT= 80.

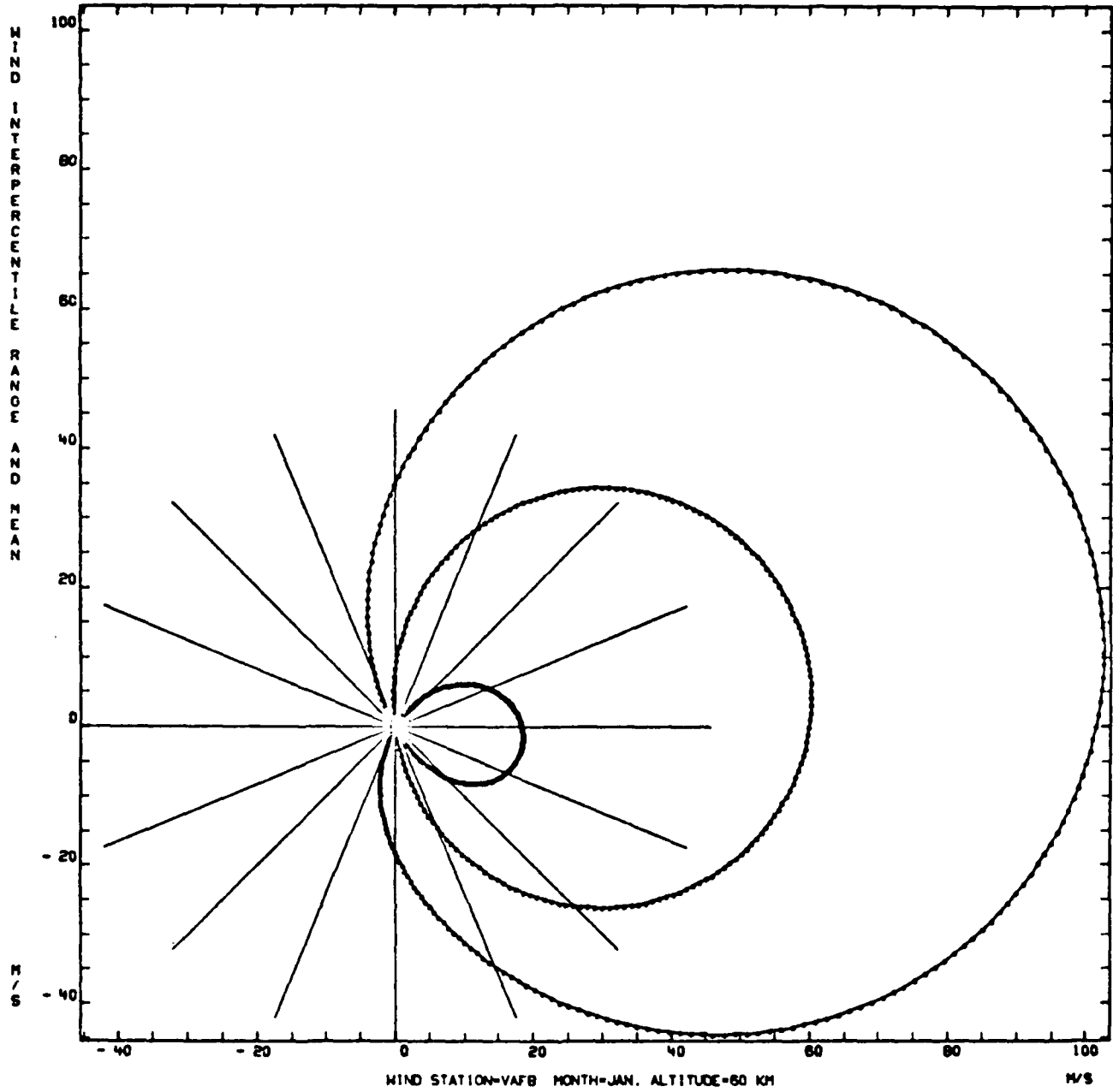

Fig. A-27

XBAR= 78.81 SIGMAX= 30.23 RHO= .2030 YBAR= -5.42 SIGMAY= 17.28 PERCENT= 80.

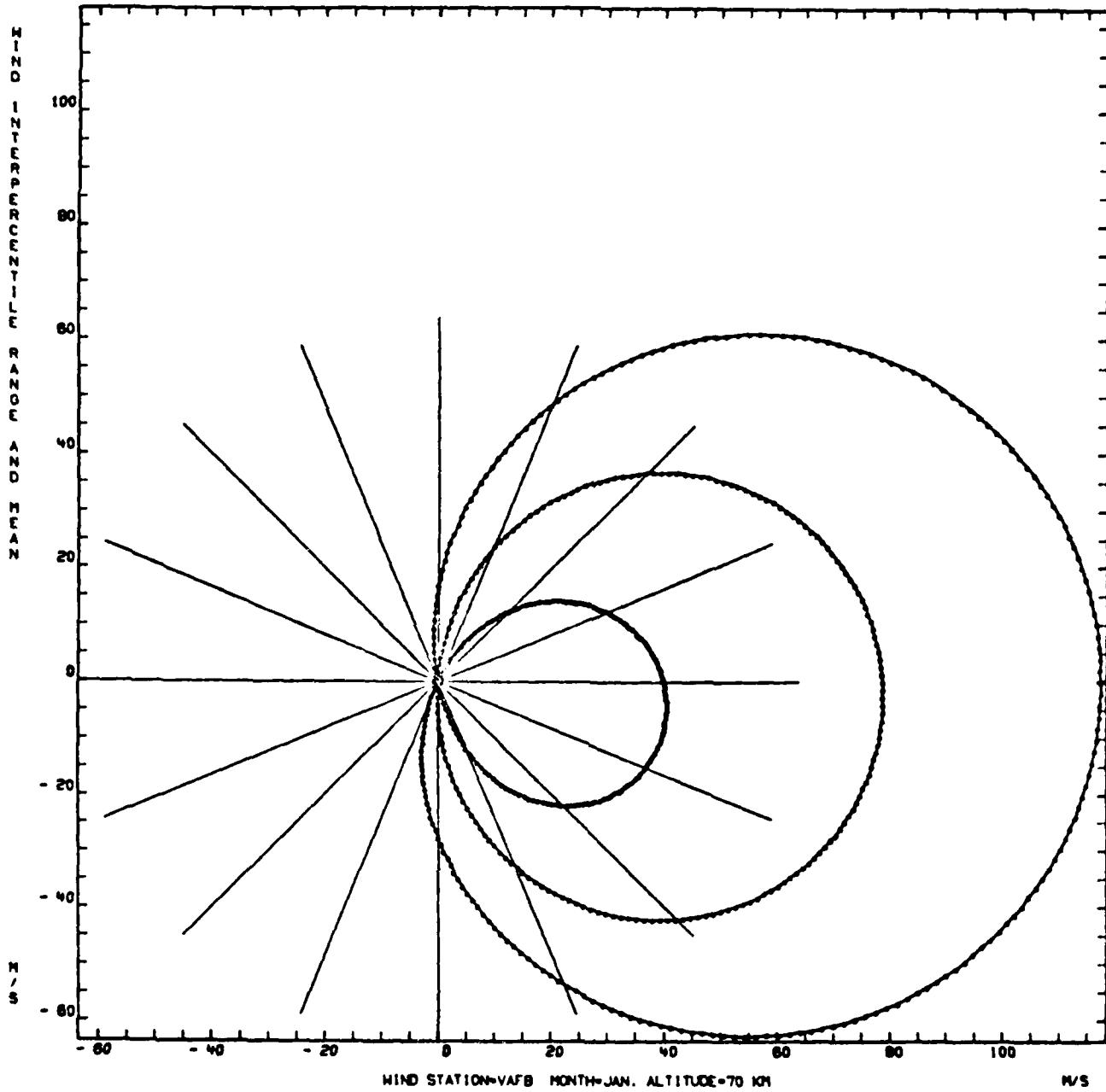

Fig. A-28

XBAR= 1.00 SIGMAX= 4.66 RHO= .0239 YBAR= 2.60 SIGMAY= 4.38 PERCENT= 80.

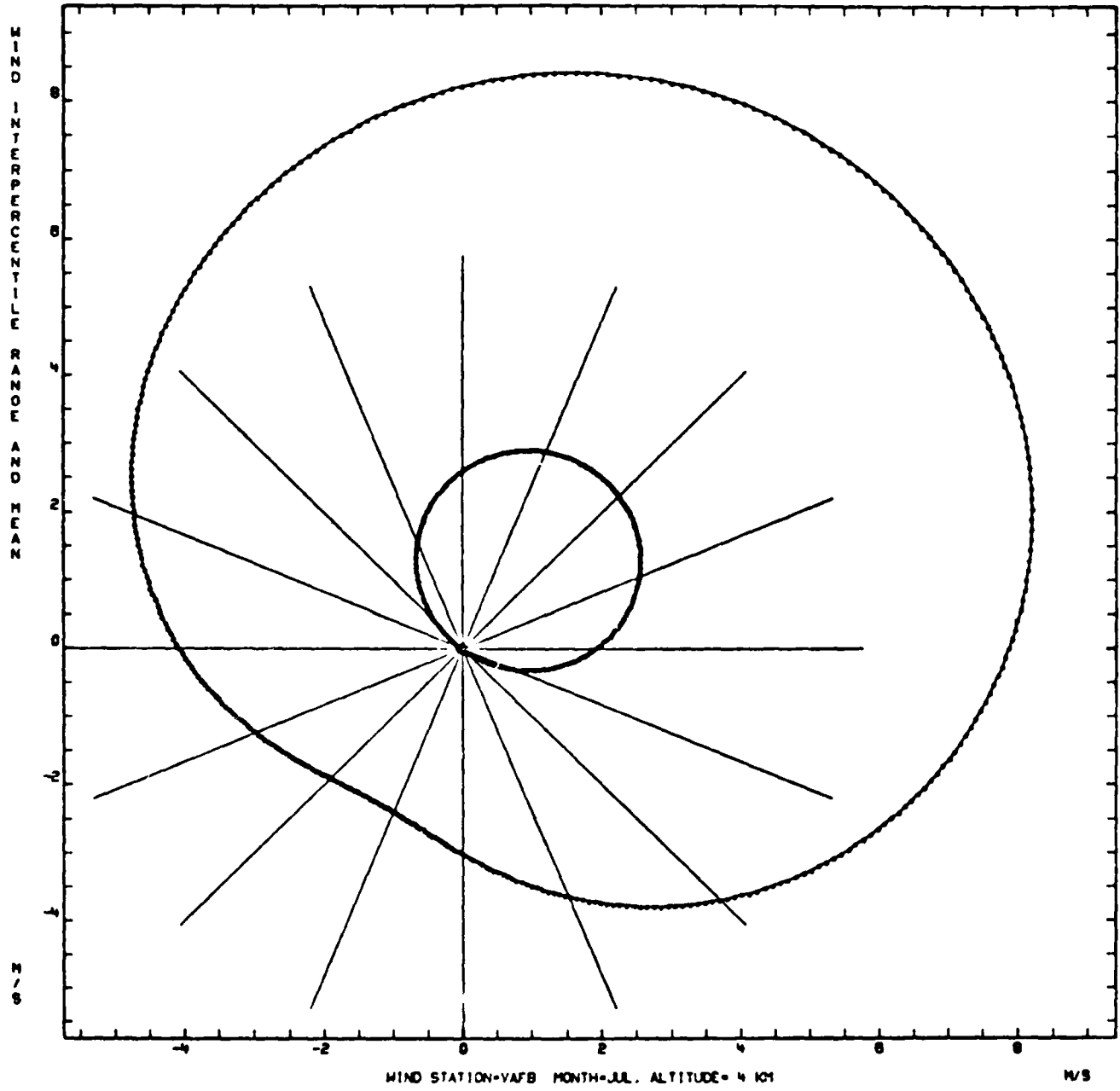

Fig. A-29

XBAR= 9.53 SIGMAX= 10.08 RHO= .119° YBAR= 10.59 SIGMAY= 9.26 PERCENT= 80.

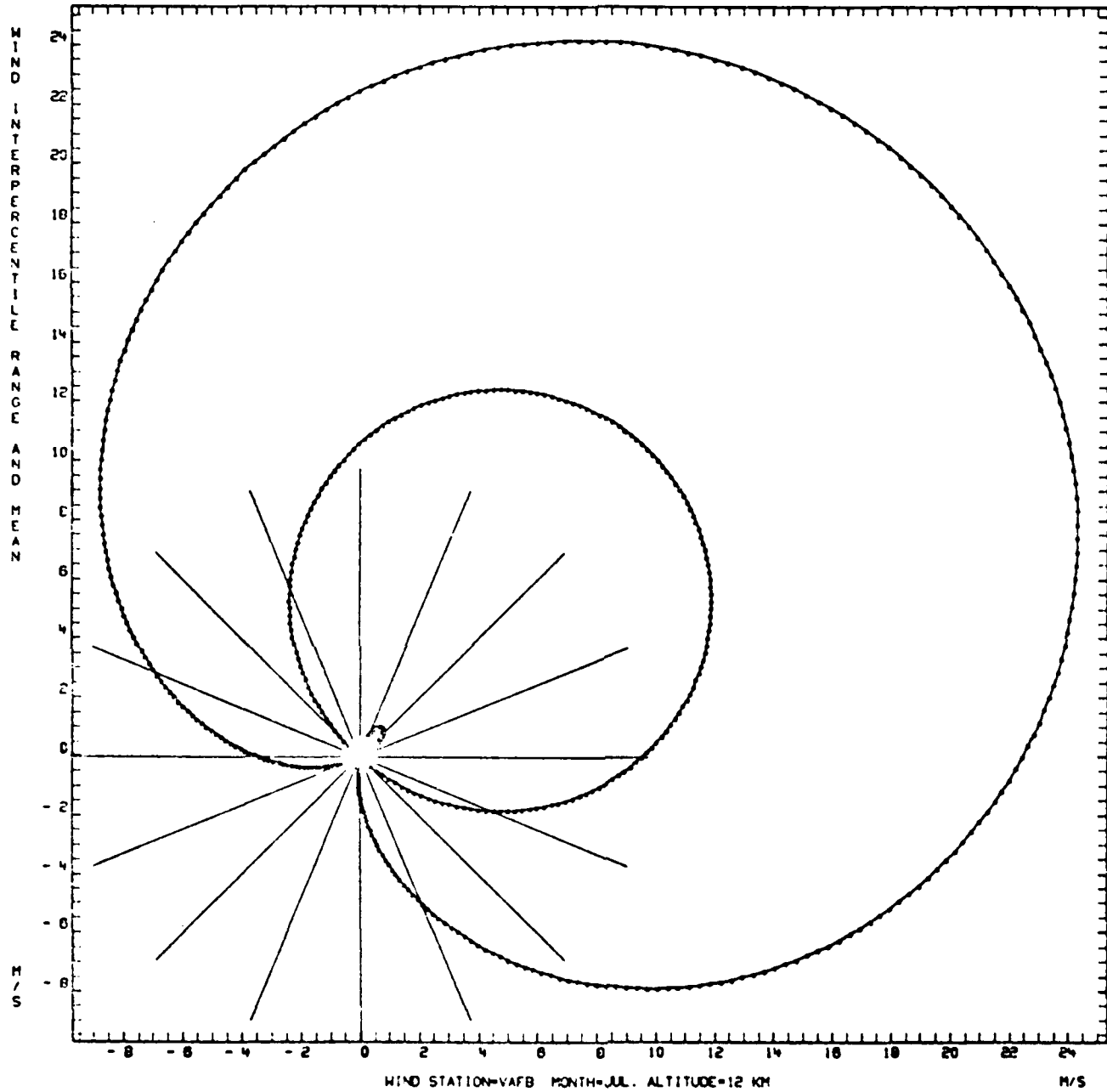

Fig. A-30

XBAR= -7.40 SIGMAX= 2.39 RHO= .1278 YBAR= .81 SIGMAY= 1.77 PERCENT= 80.

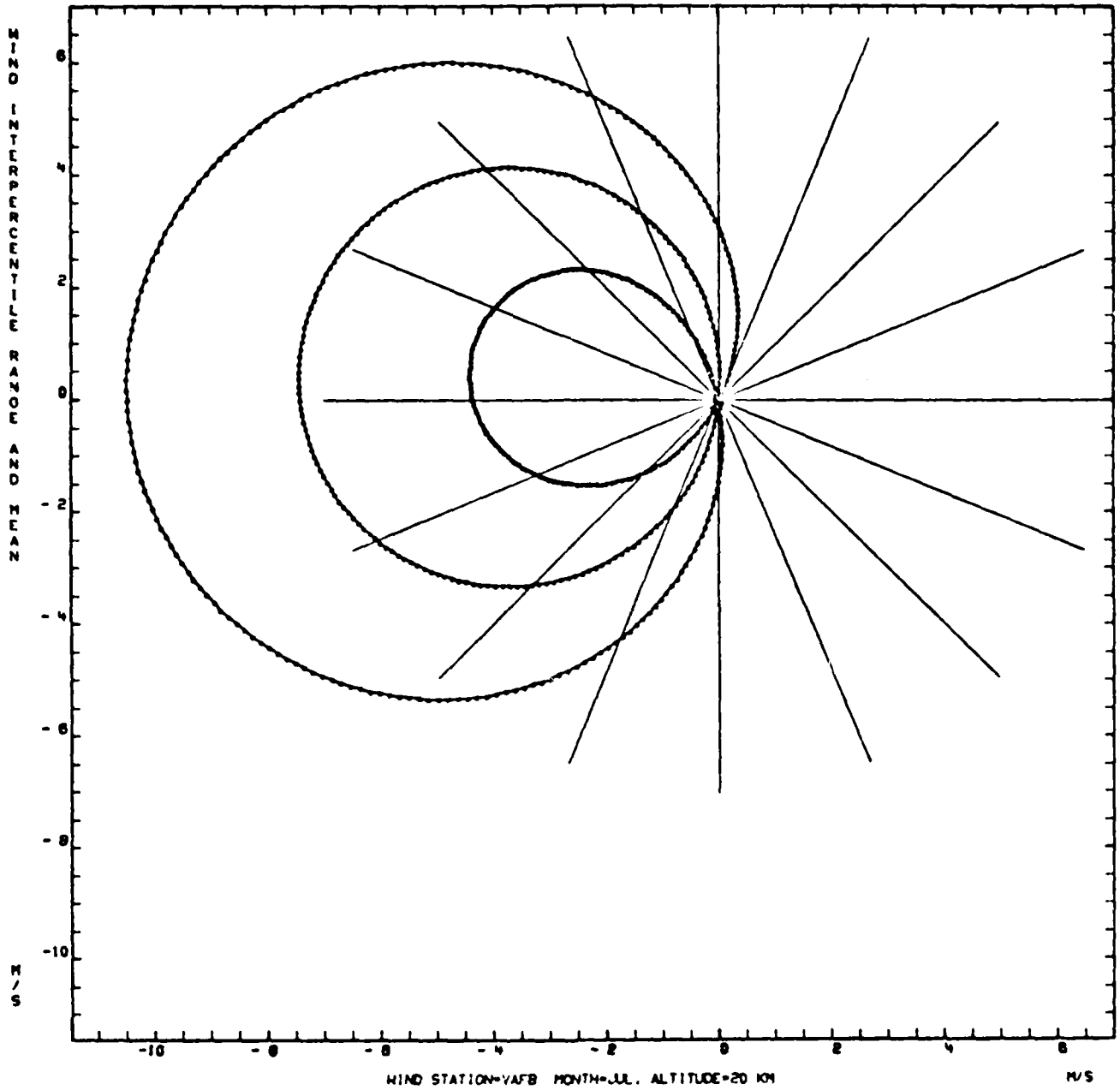

Fig. A-31

XBAR=-17.58 SIGMAX= 3.25 RHO= .0565 YBAR= -.04 SIGMAY= 2.07 PERCENT= 80.

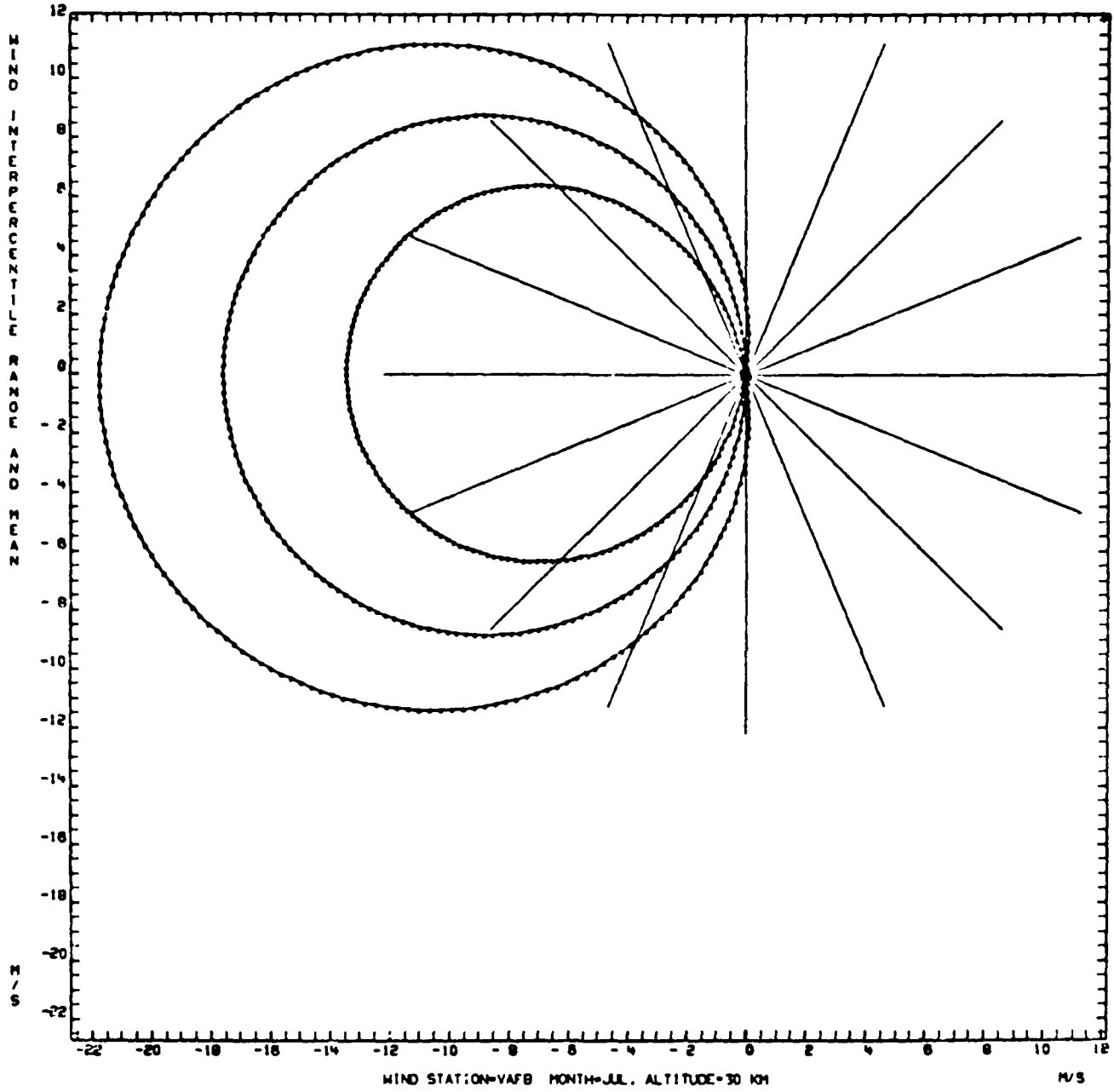

Fig. A-32

XBAR=-33.29 SIGMAX= 4.27 RHO= .0572 YBAR= -.08 SIGMAY= 4.25 PERCENT= 80.

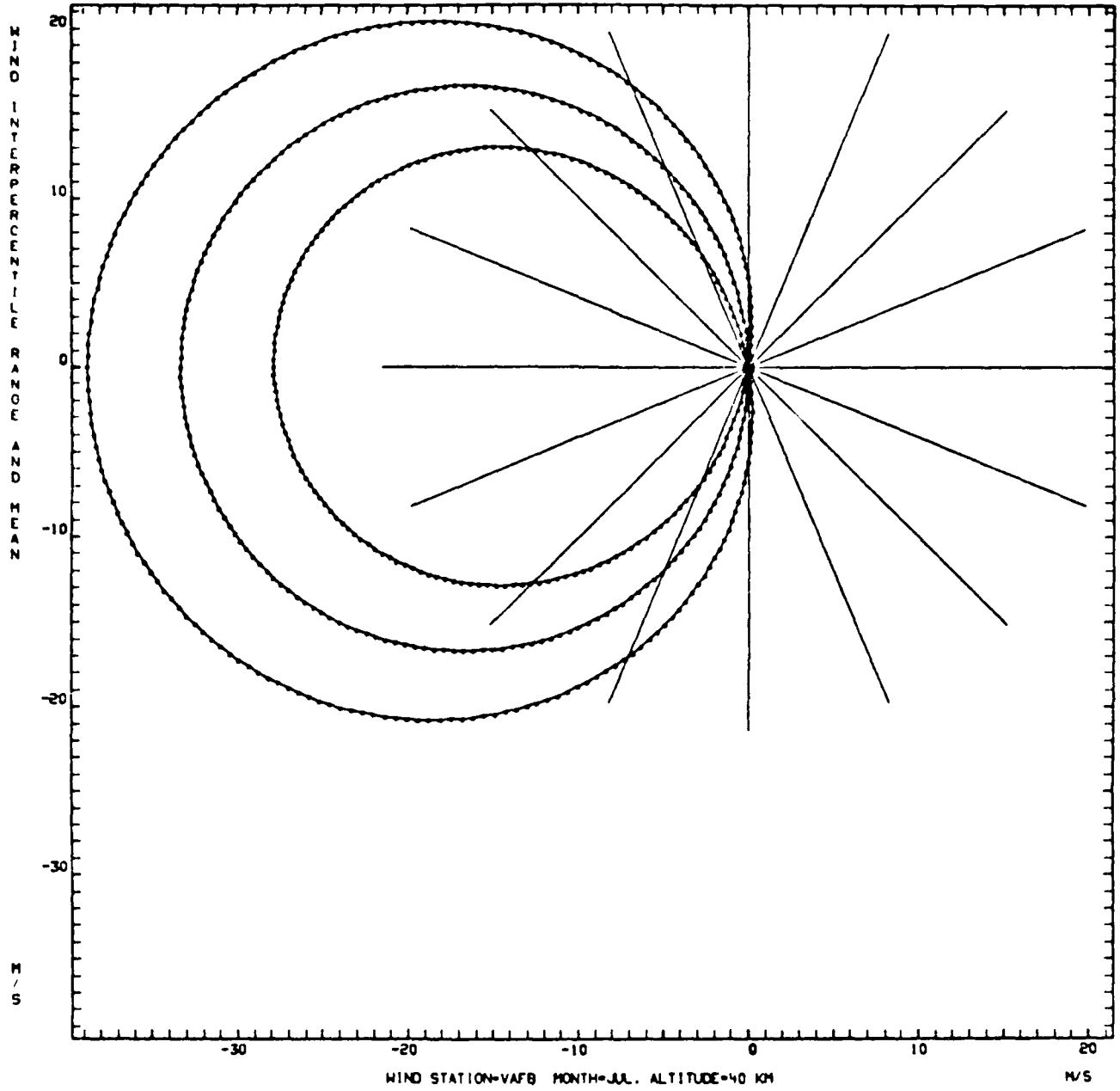

Fig. A-33

XBAR=-51.36 SIGMAX= 7.16 RHO= .1017 YBAR= 5.79 SIGMAY= 5.95 PERCENT= 80.

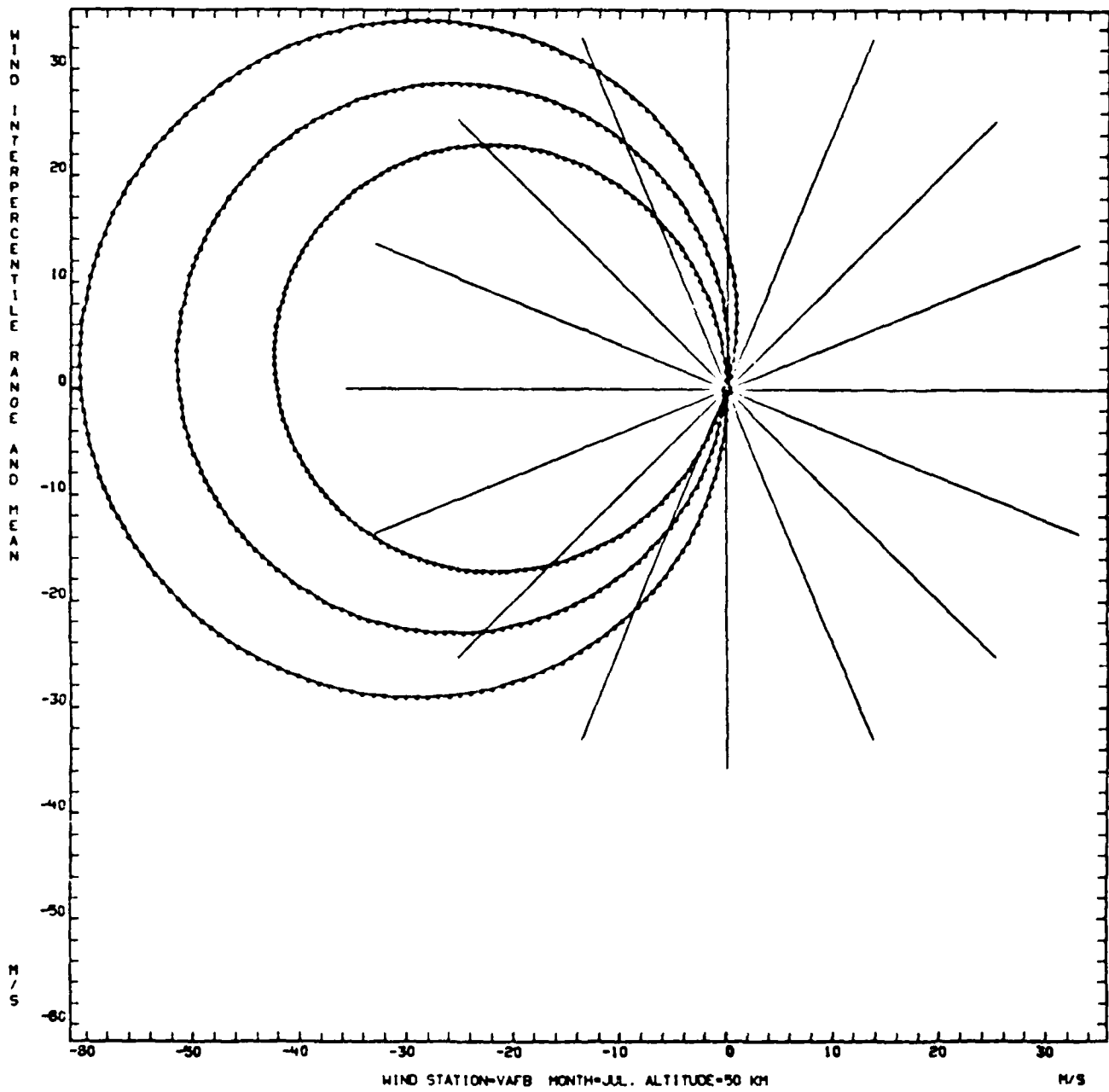

Fig. A-34

XBAR=-60.03 SIGMAX= 17.21 RHO= .1480 YBAR= 2.25 SIGMAY= 13.50 PERCENT= 80.

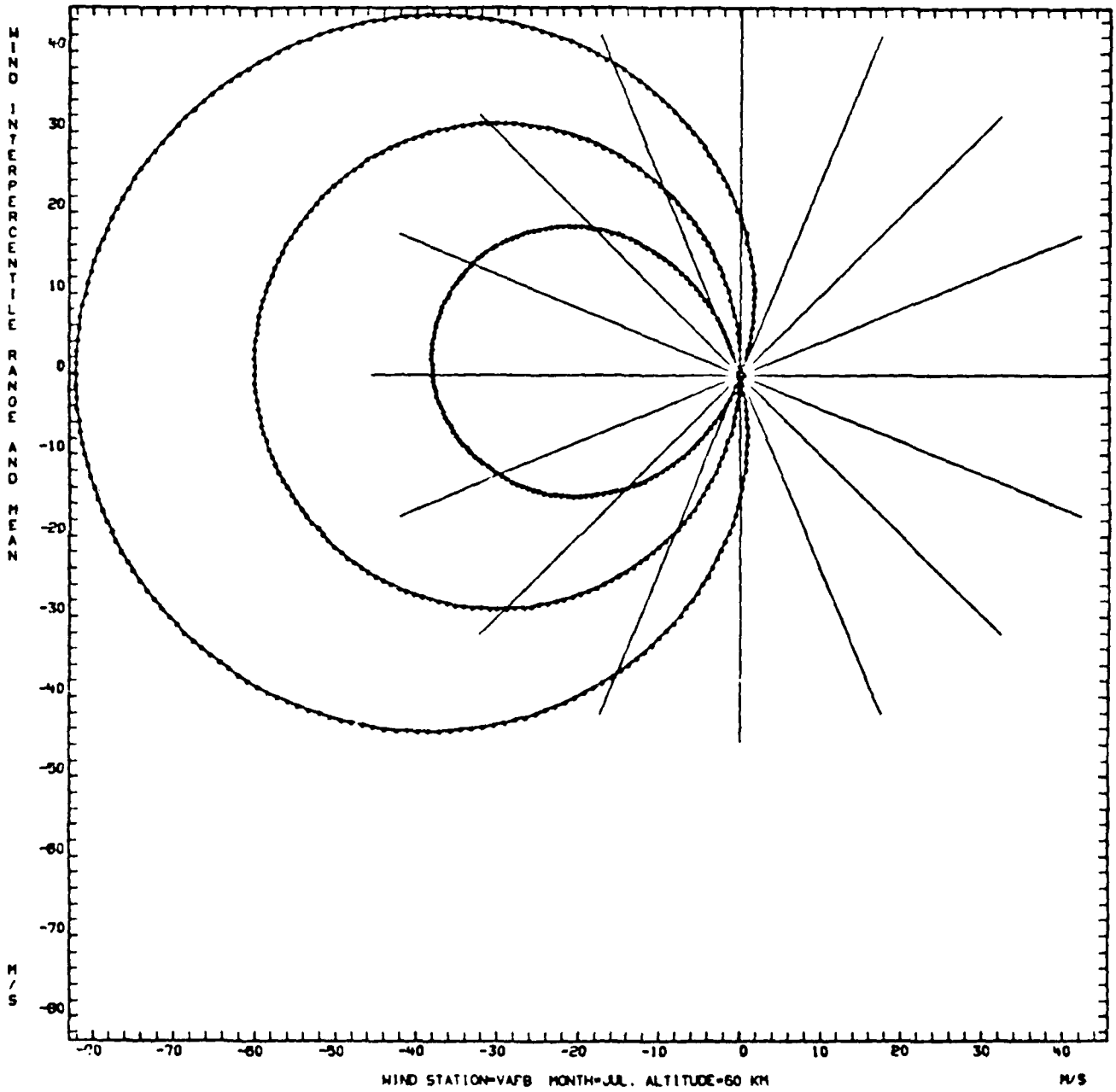

Fig. A-35

XBAR=-25.92 SIGMAX= 22.64 PNC= .0393 YBAR= 5.10 SIGMAY= 25.12 PERCENT= 80.

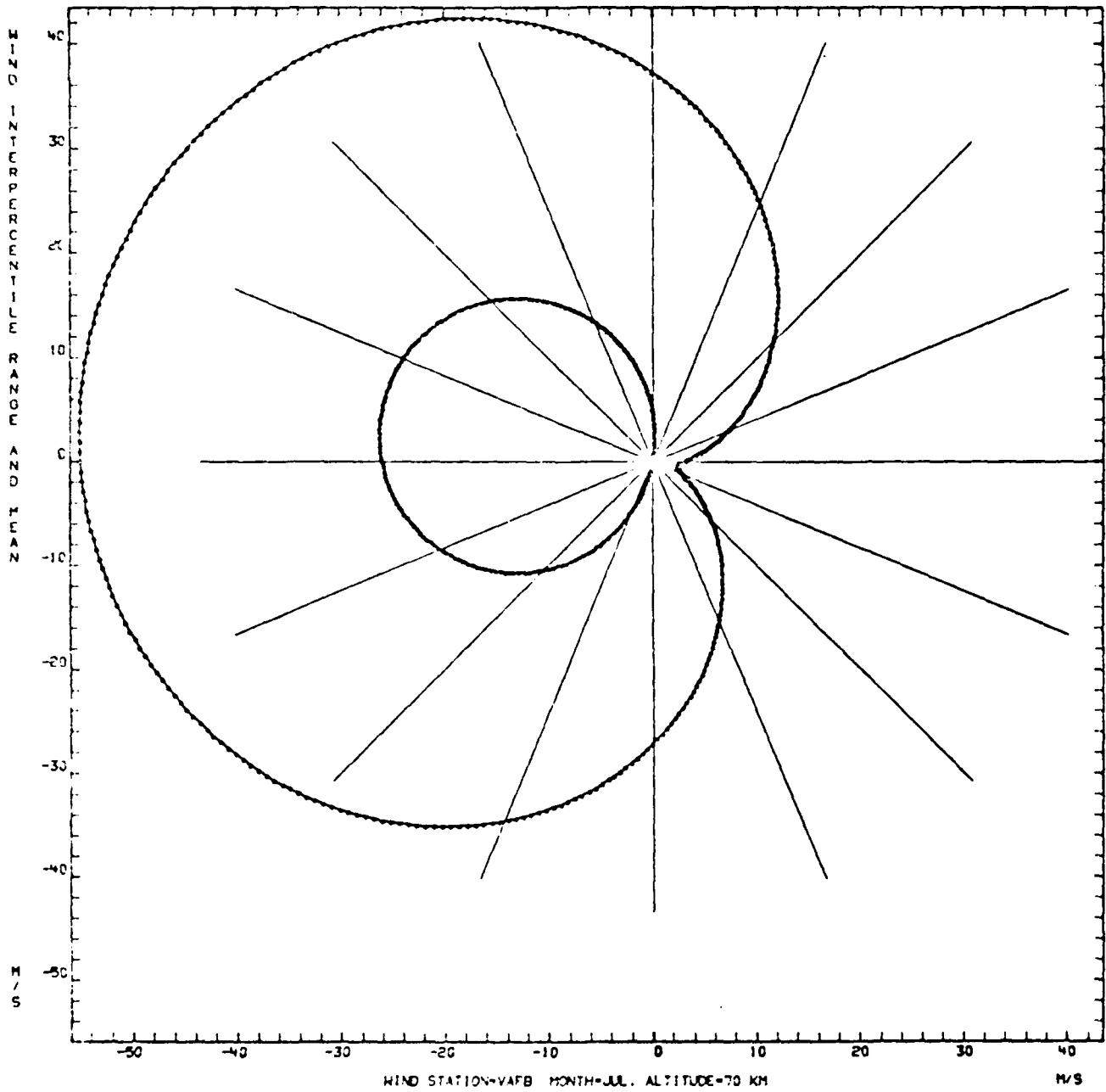

Fig. A-36

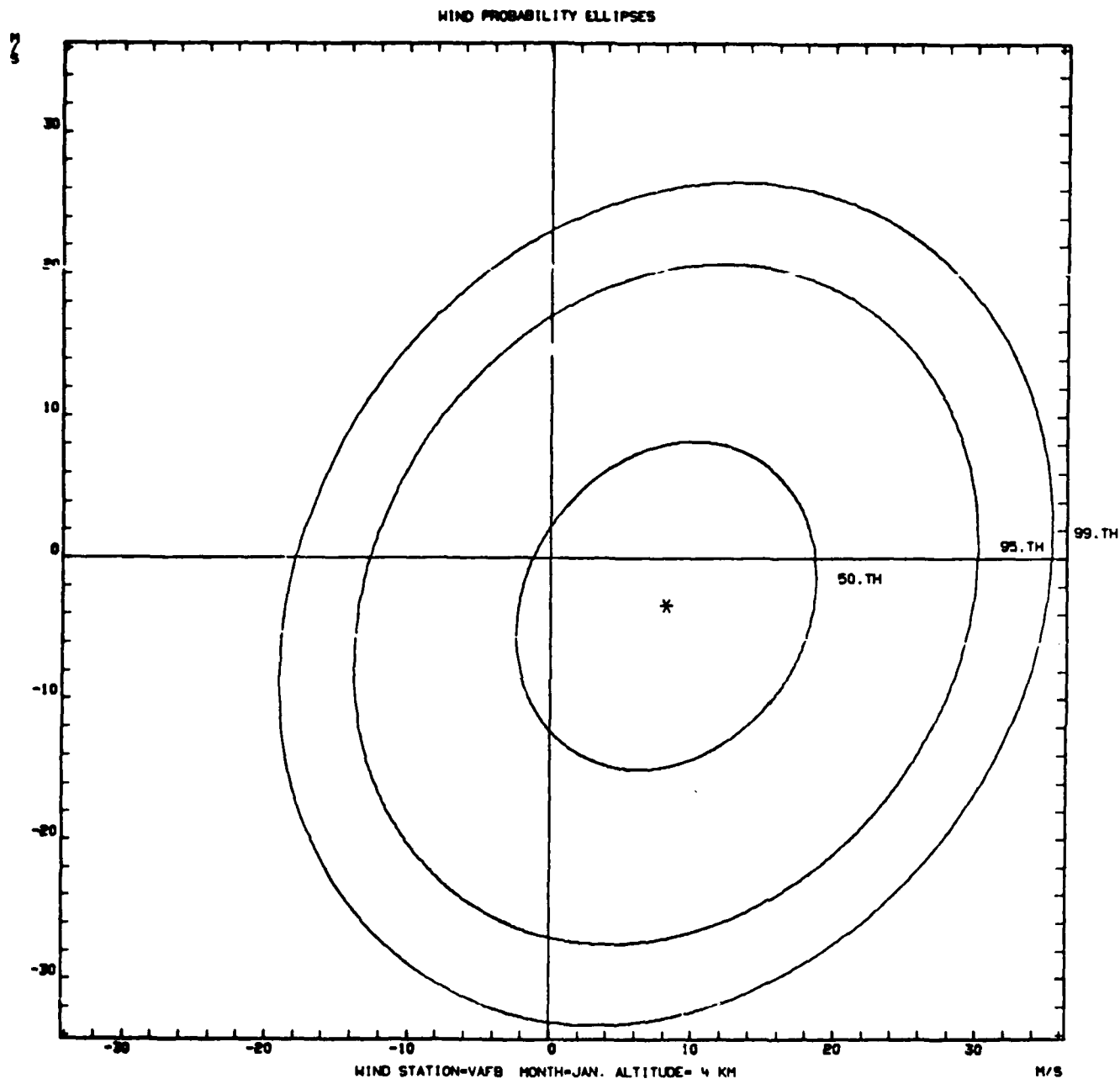

Fig. A-37

WIND PROBABILITY ELLIPSES

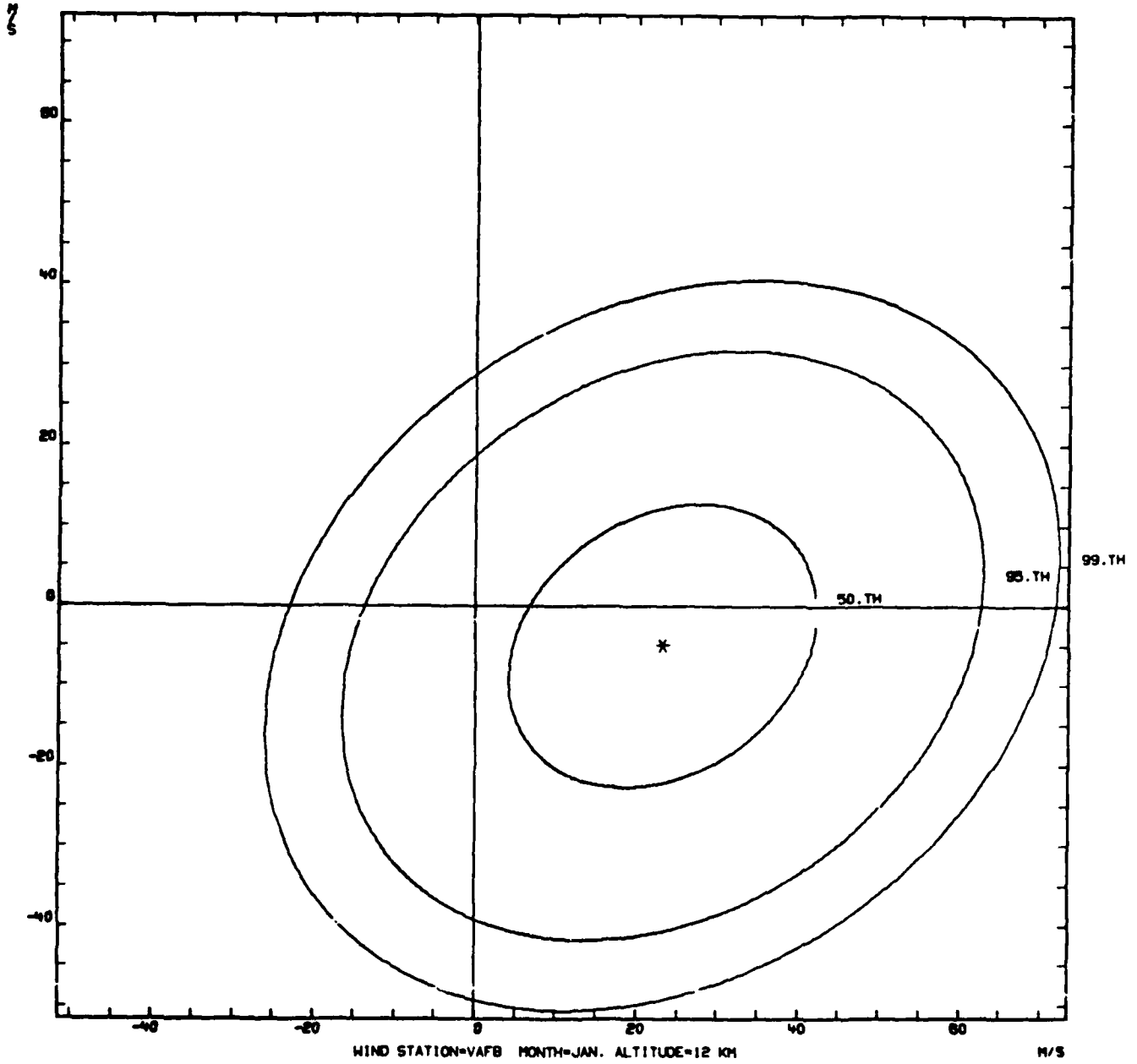

Fig. A-38

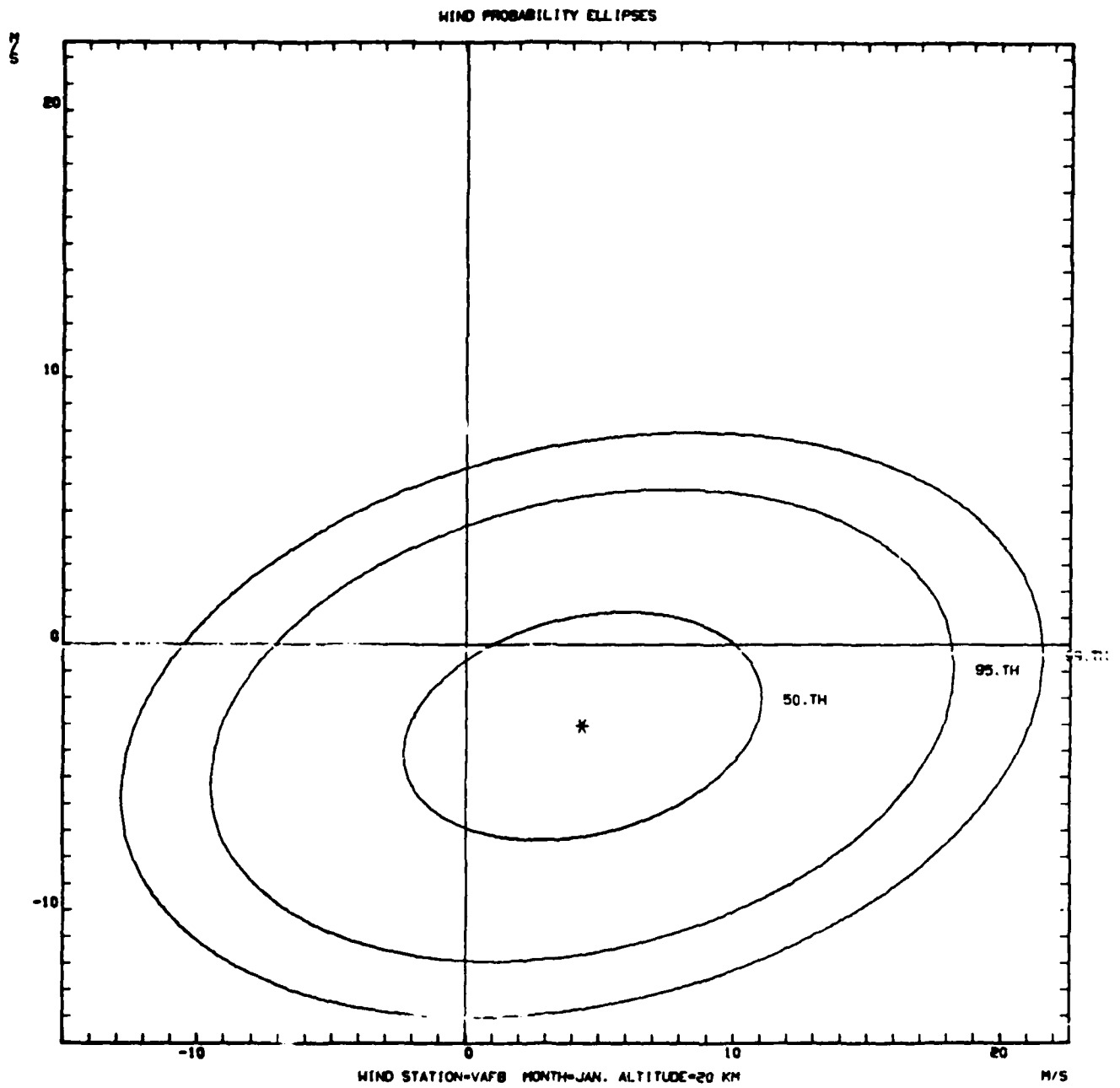

Fig. A-39

HIND PROBABILITY ELLIPSES

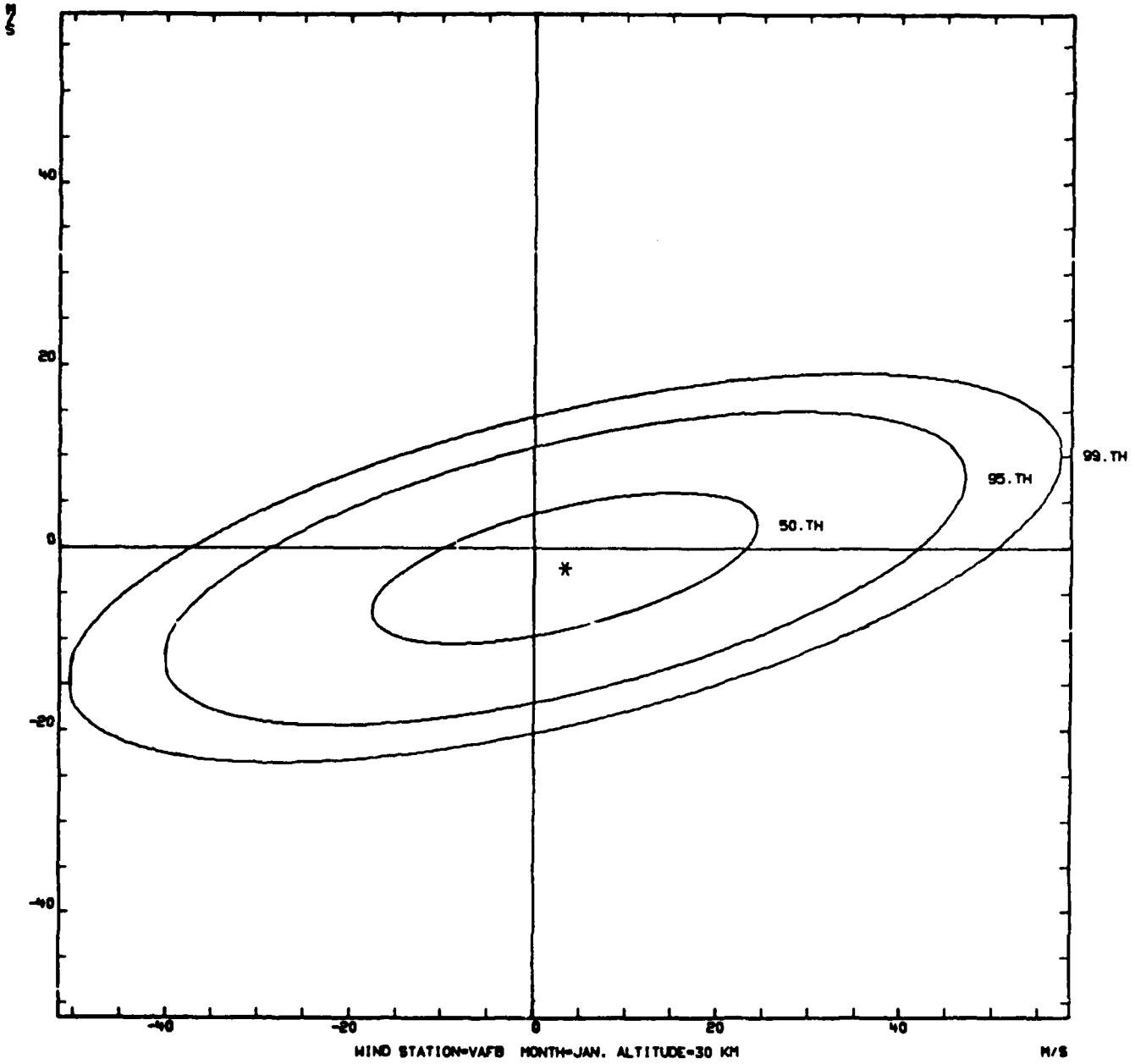

Fig. A-40

WIND PROBABILITY ELLIPSES

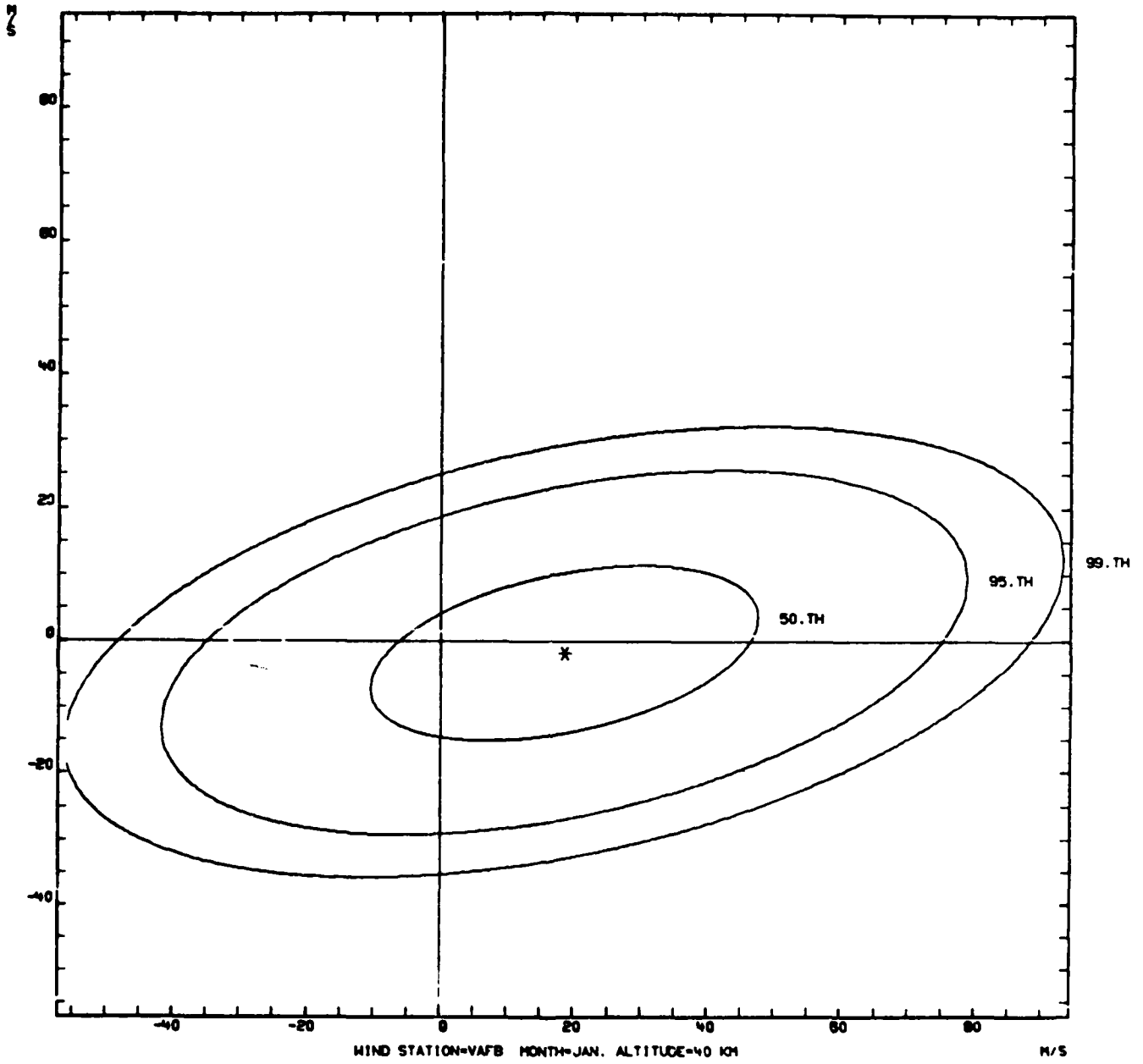

Fig. A-41

WIND PROBABILITY ELLIPSES

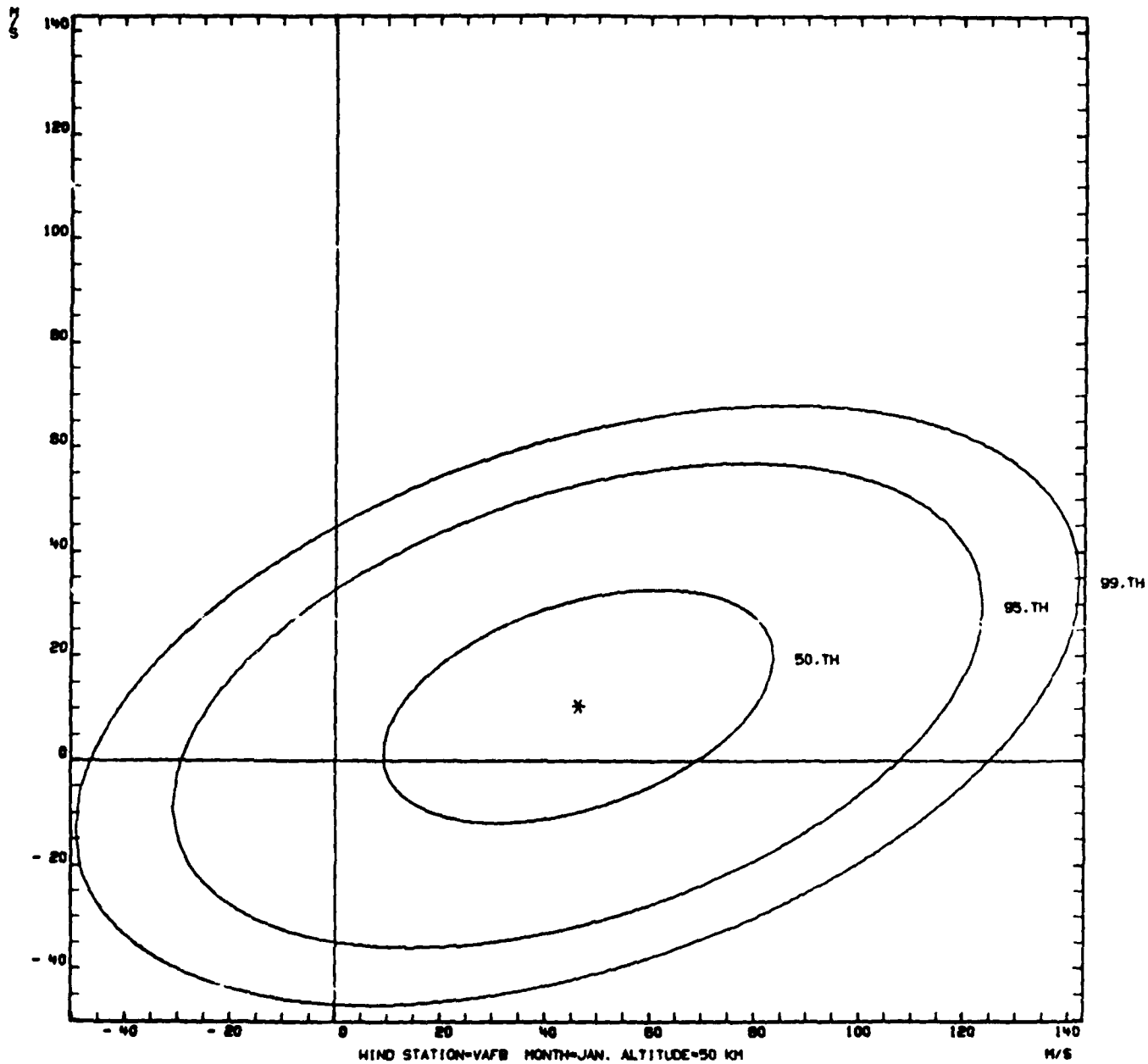

Fig. A-42

WIND PROBABILITY ELLIPSES

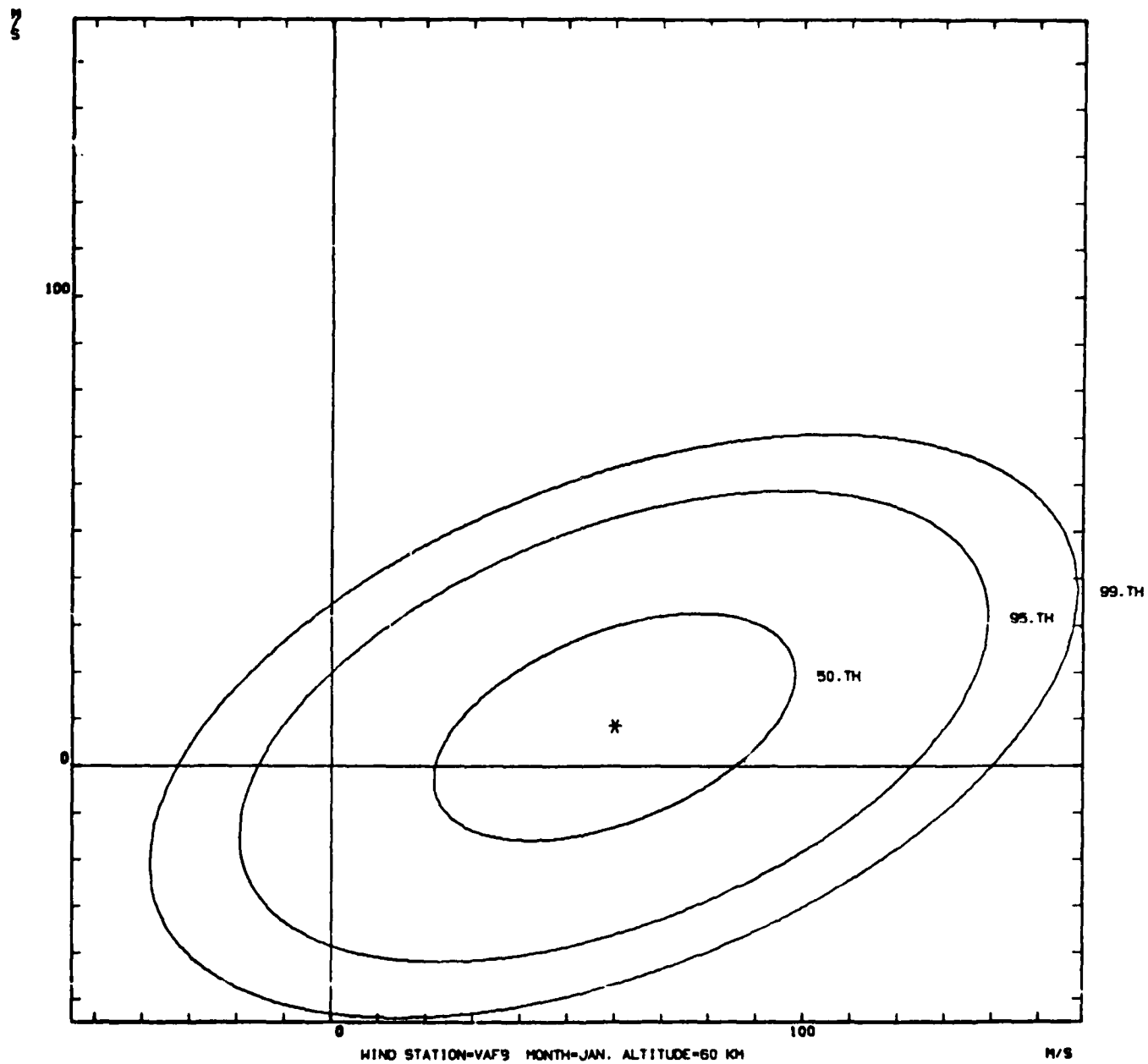

Fig. A-43

WIND PROBABILITY ELLIPSES

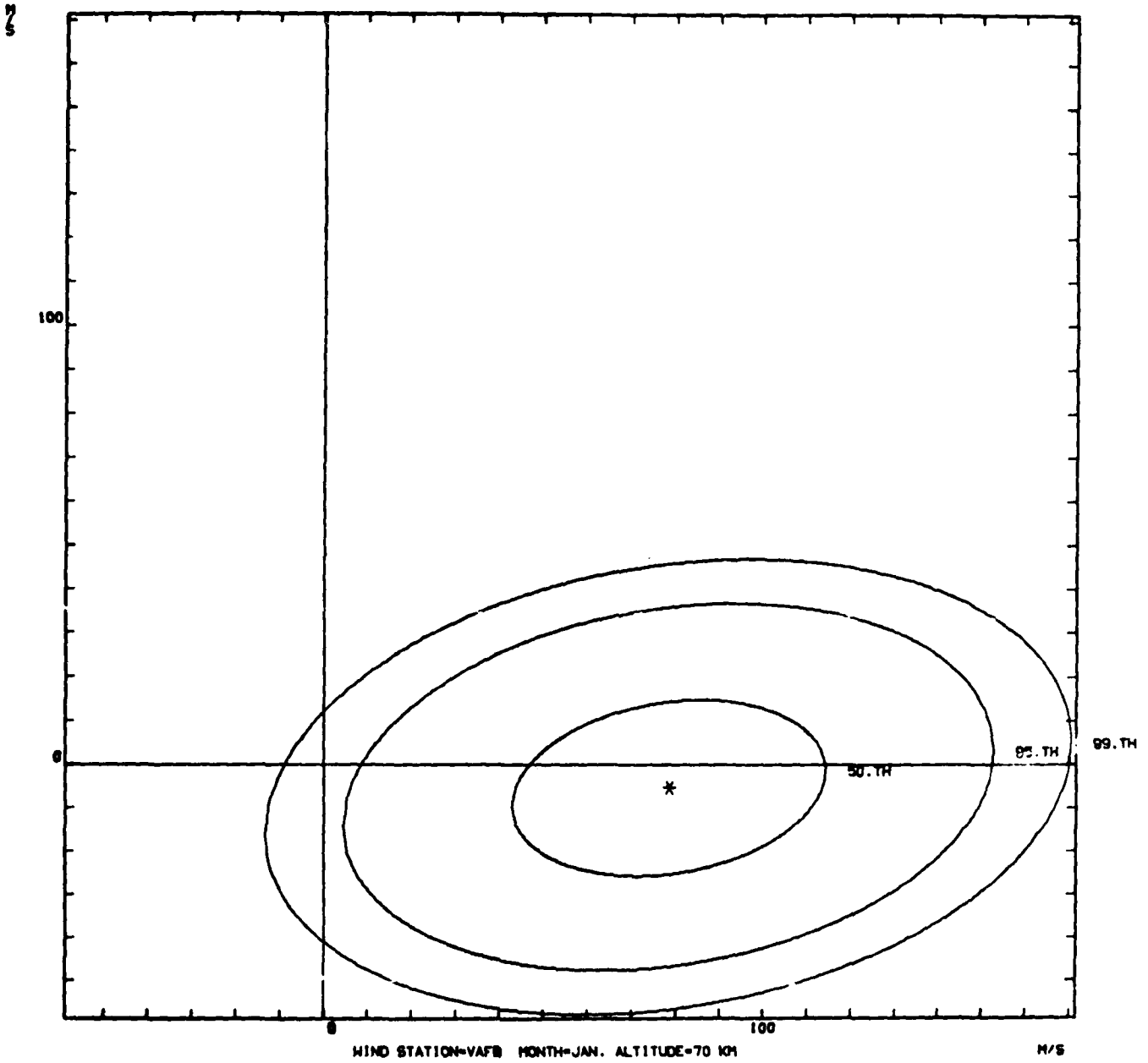

Fig. A-44

WIND PROBABILITY ELLIPSES

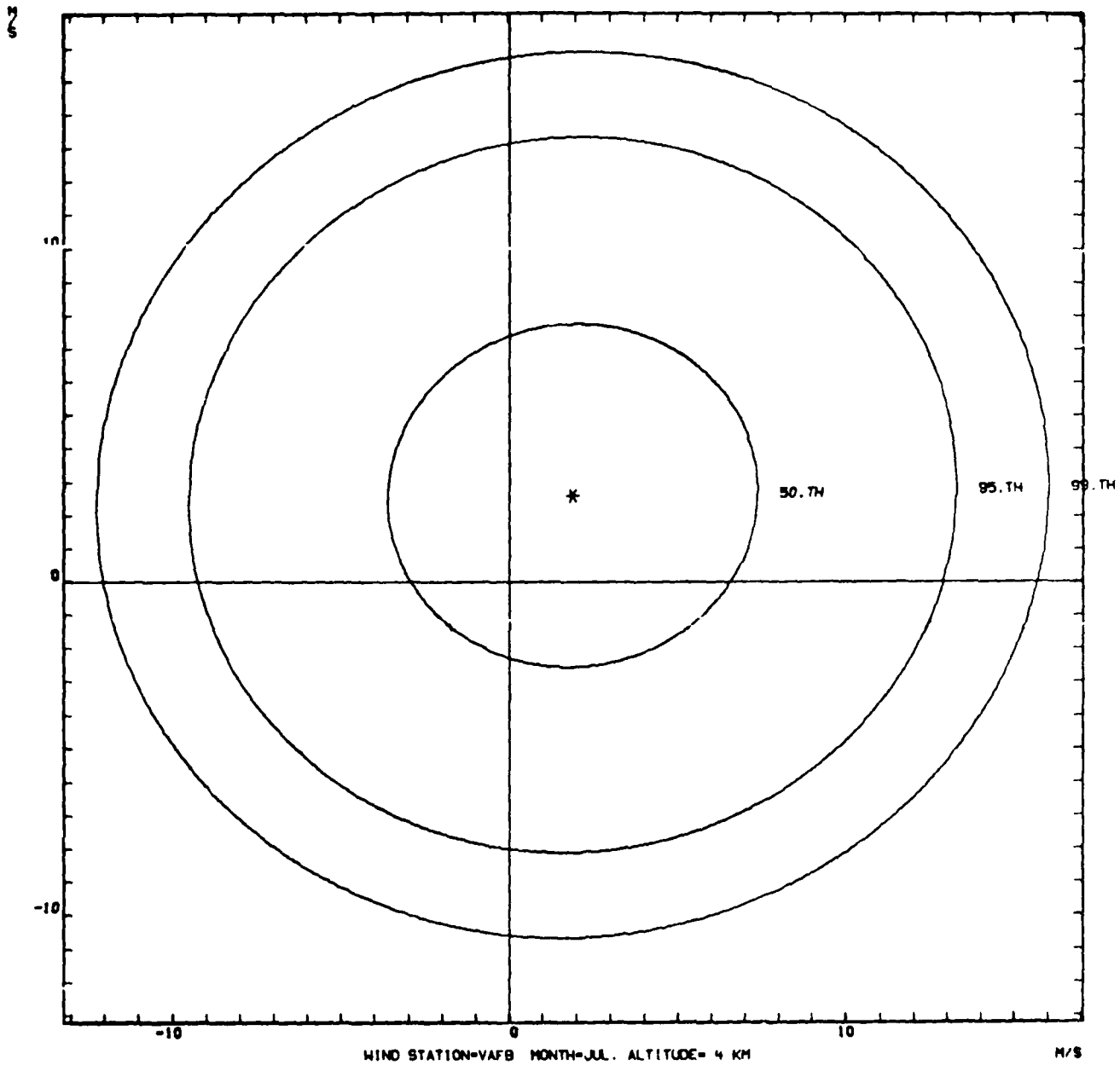

Fig. A-45

WIND PROBABILITY ELLIPSES

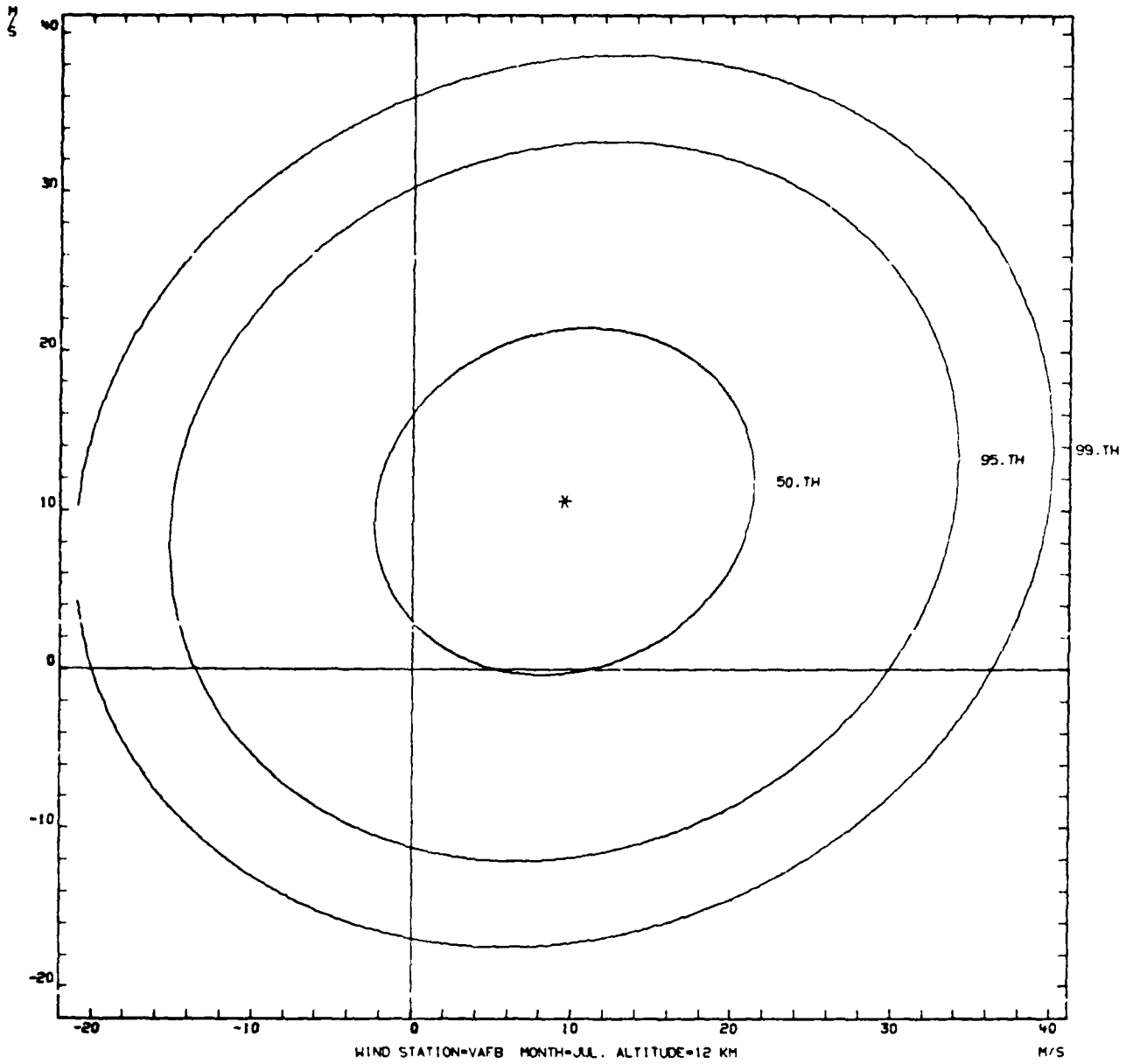

Fig. A-46

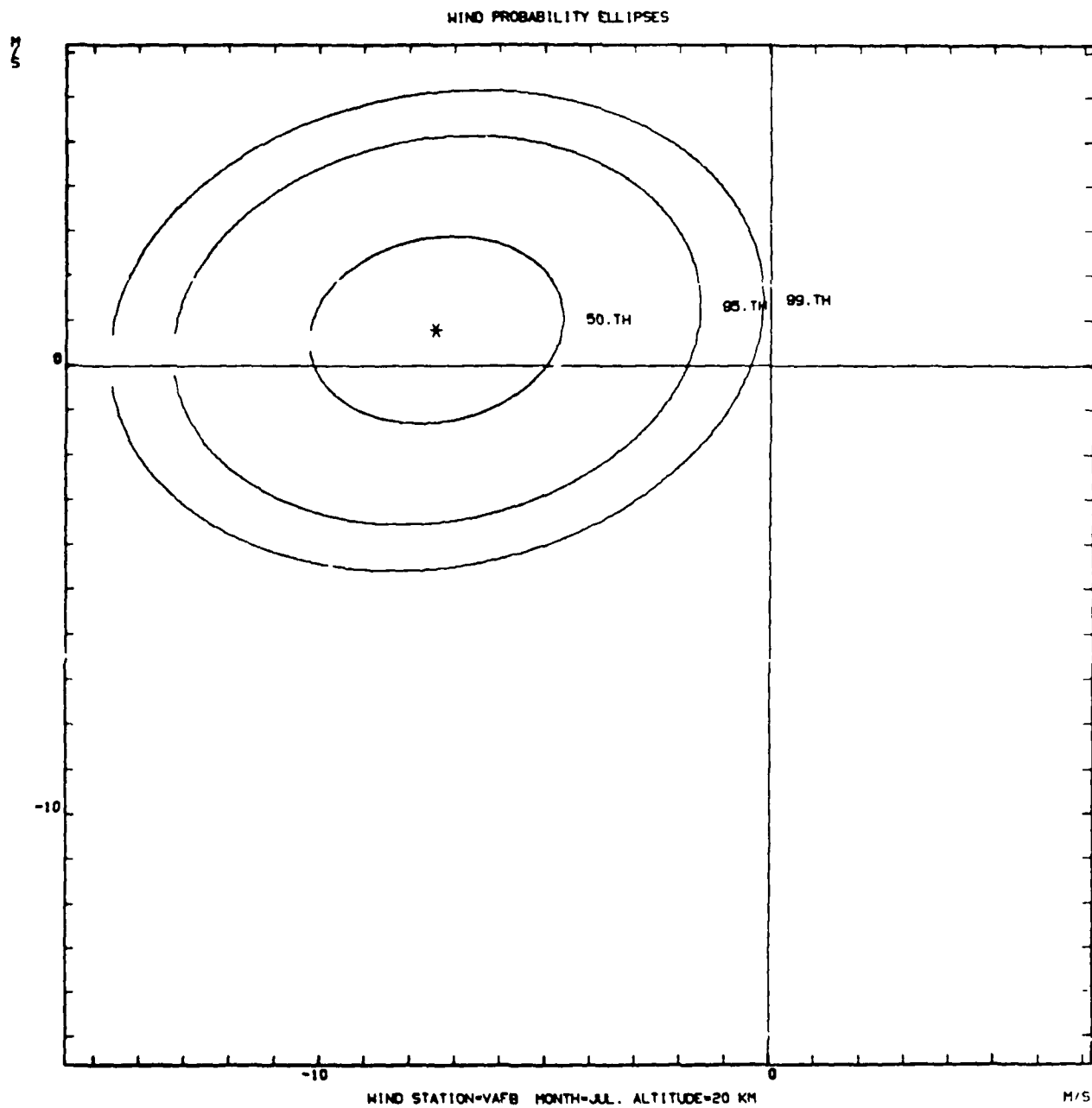

Fig. A-47

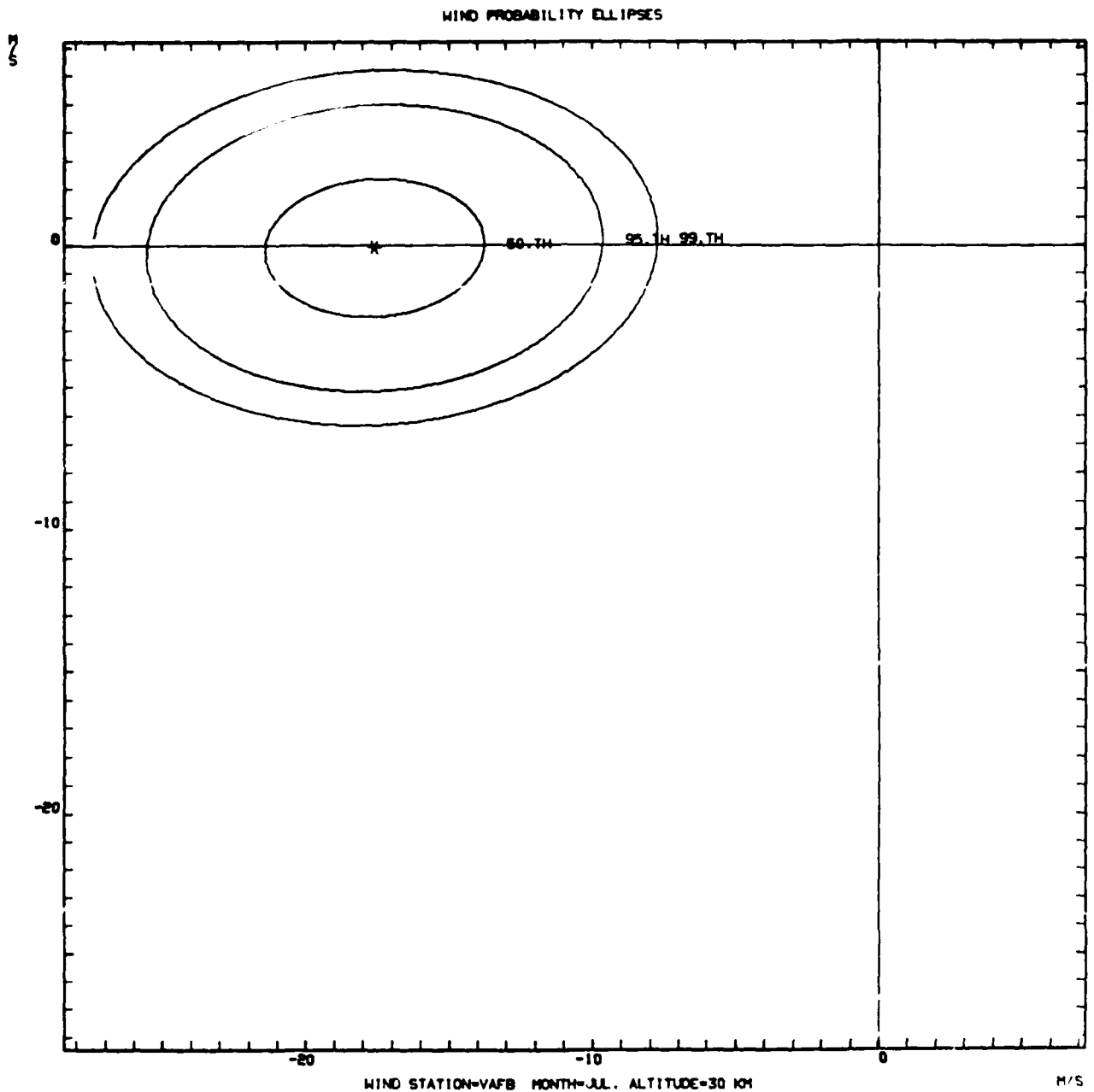

Fig. A-48

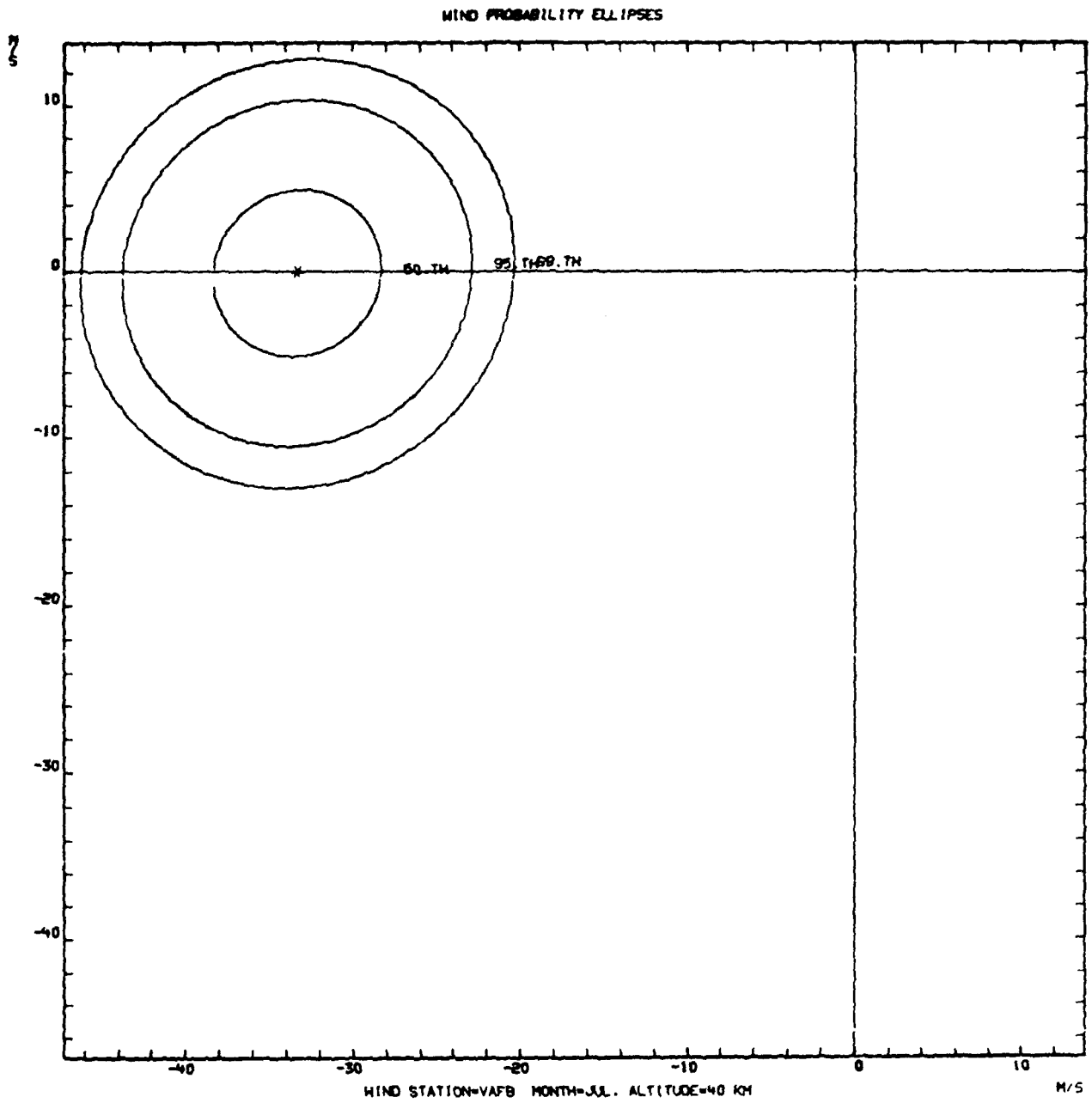

Fig. A-49

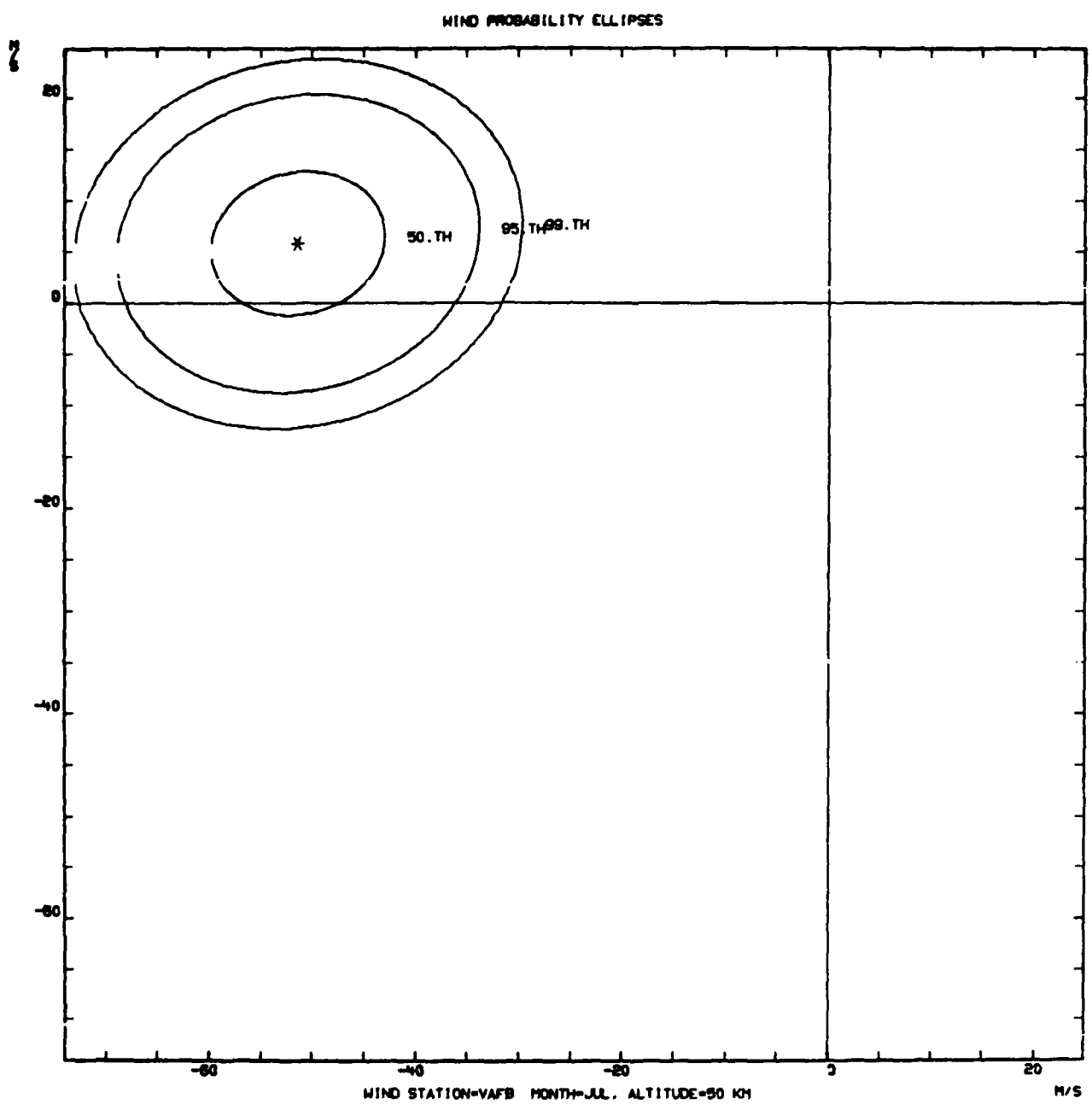

Fig. A-50

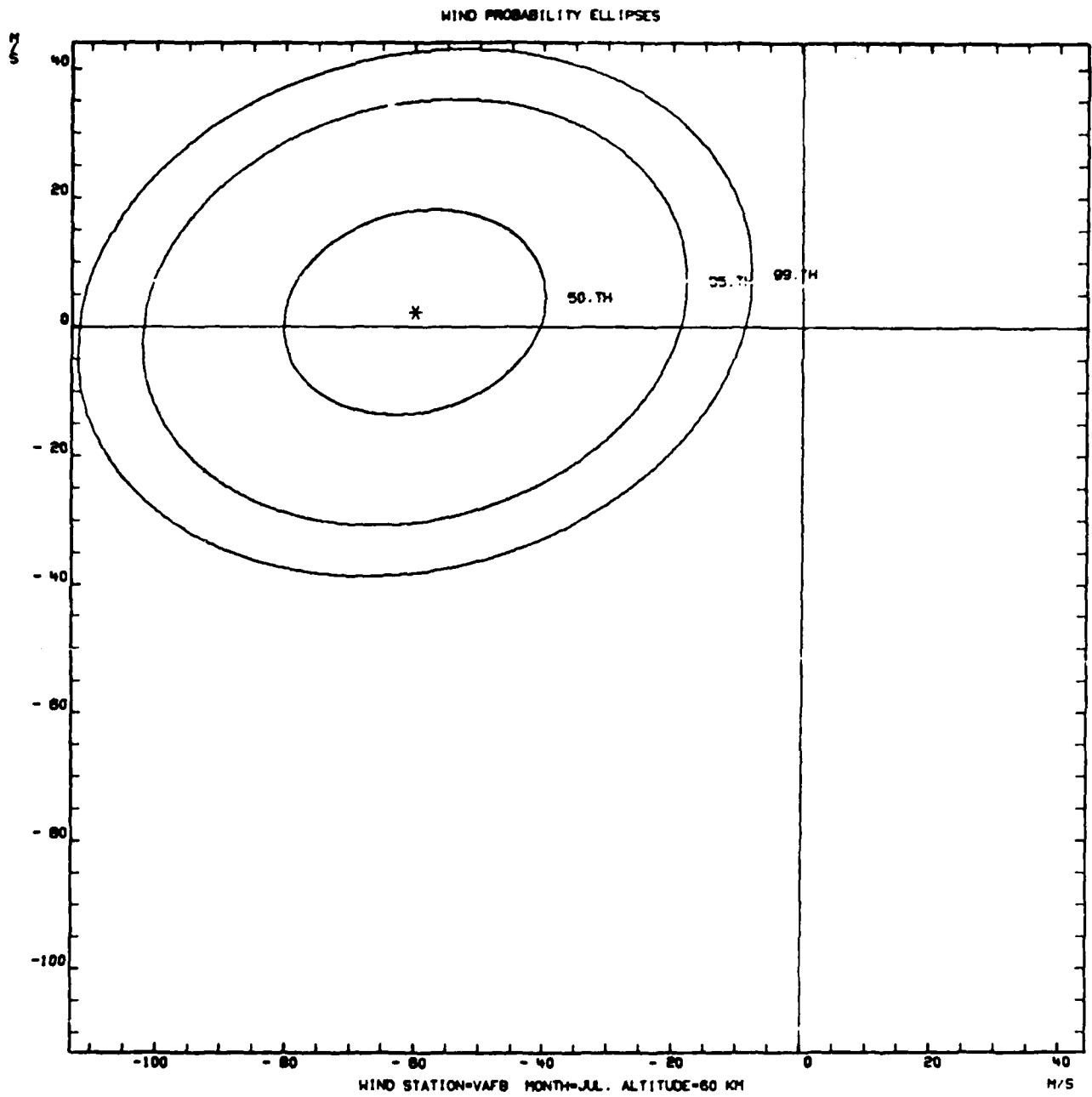

Fig. A-51

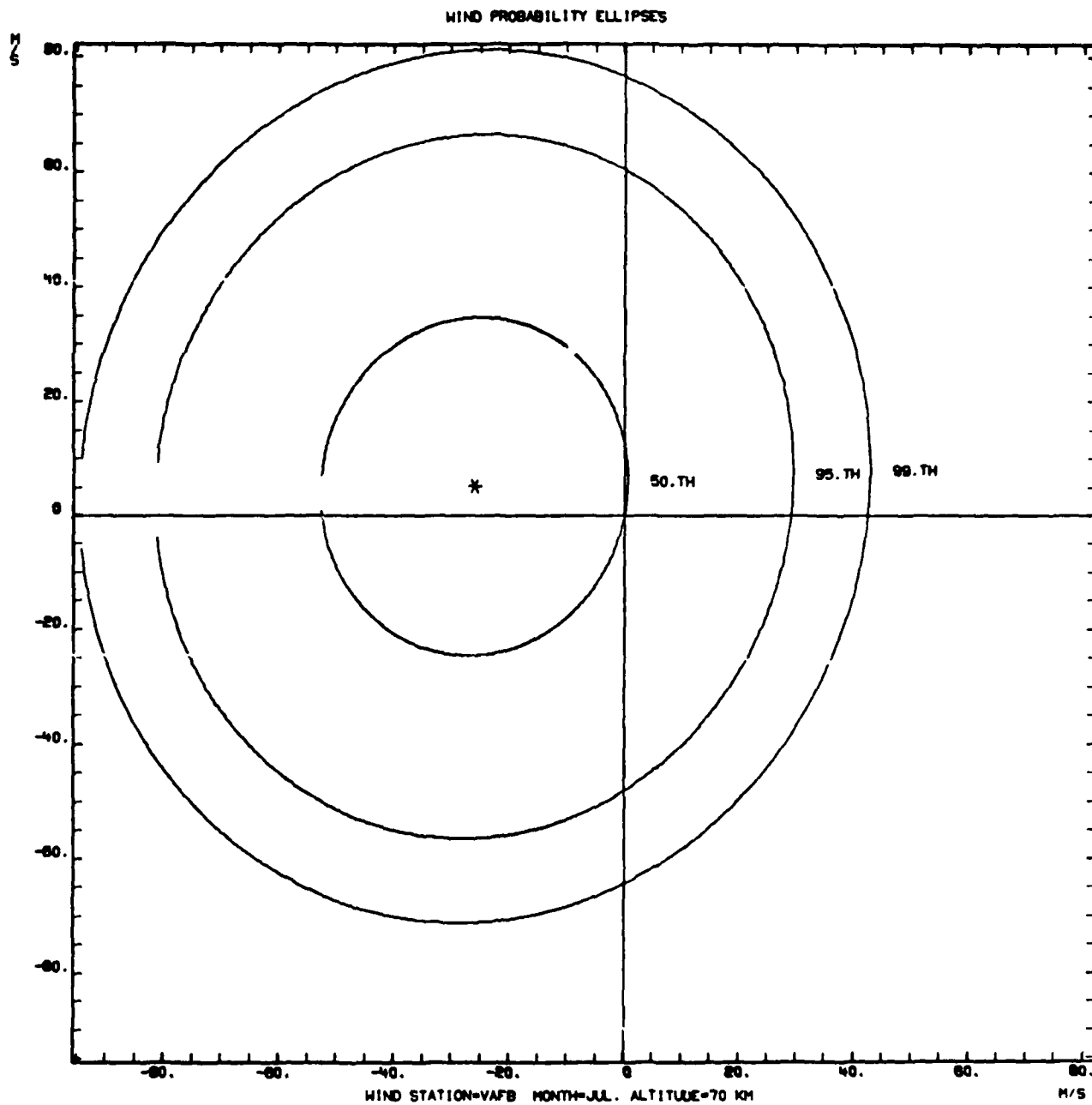

Fig. A-52

WIND STATION=VAFB MONTH=JAN. ALTITUDE= 4 KM

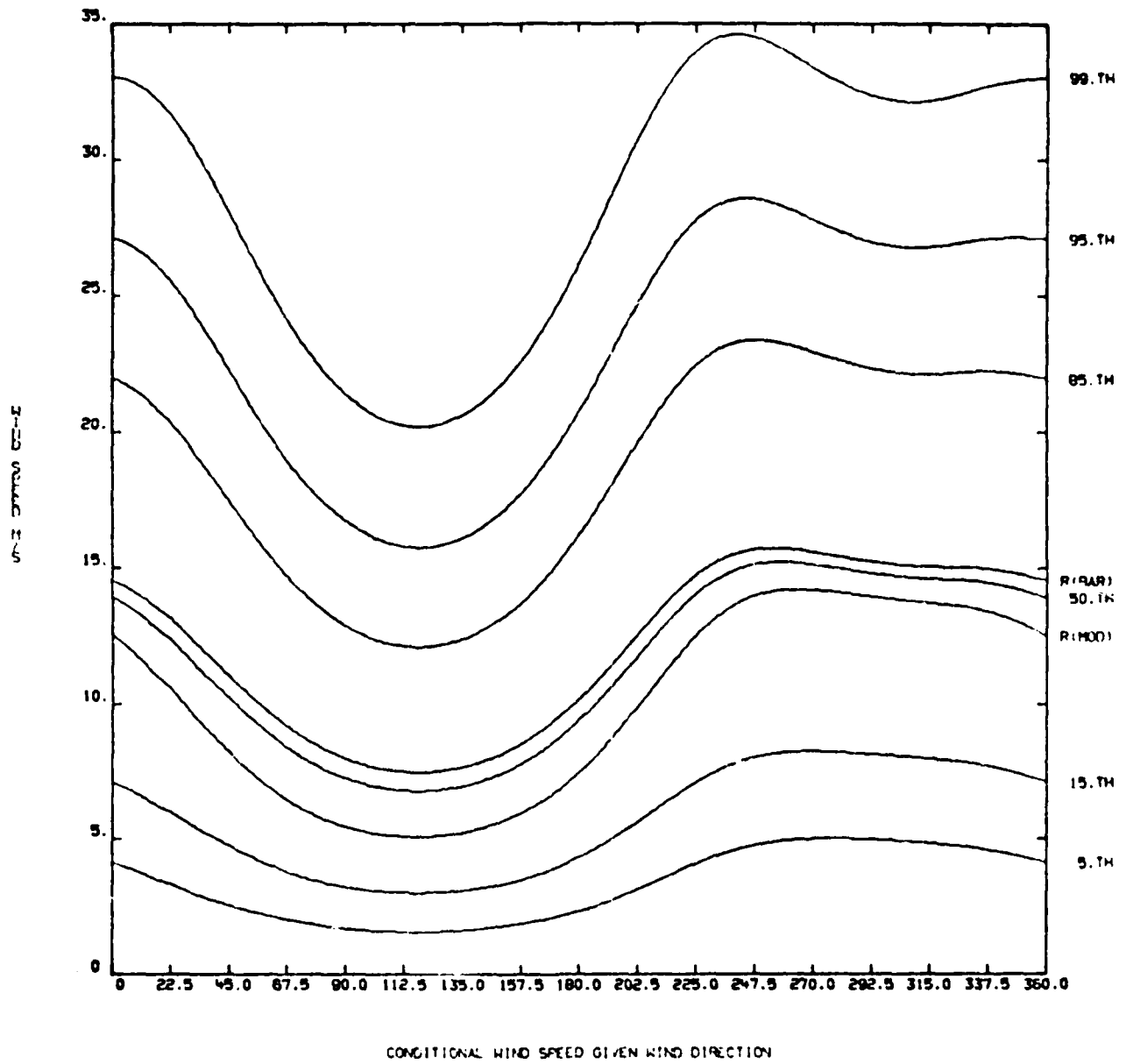

Fig. A-53

WIND STATION=VAFB MONTH=JAN. ALTITUDE=12 KM

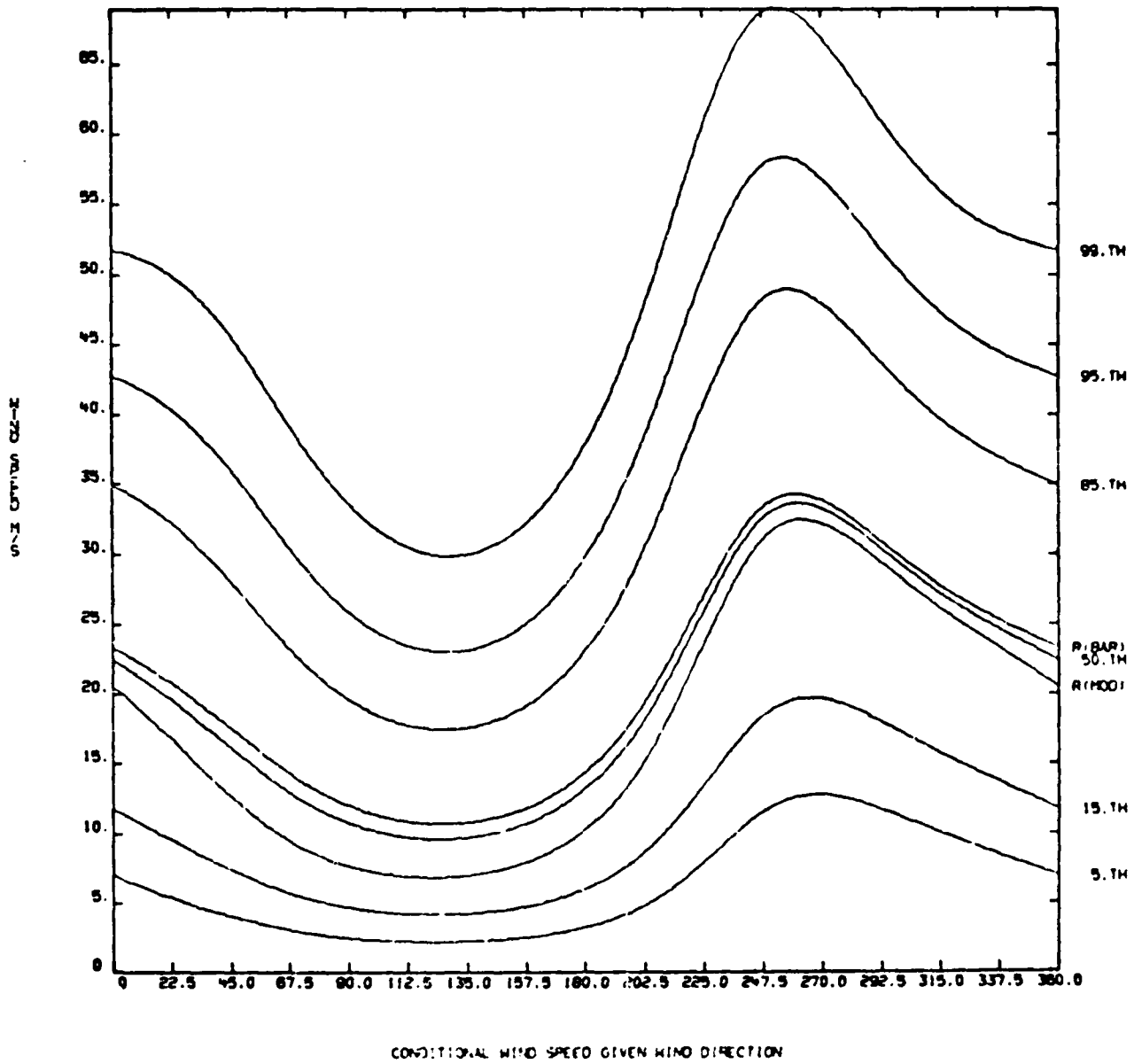

Fig. A-54

WIND STATION-VAFB MONTH 1. ALTITUDE-20 KM

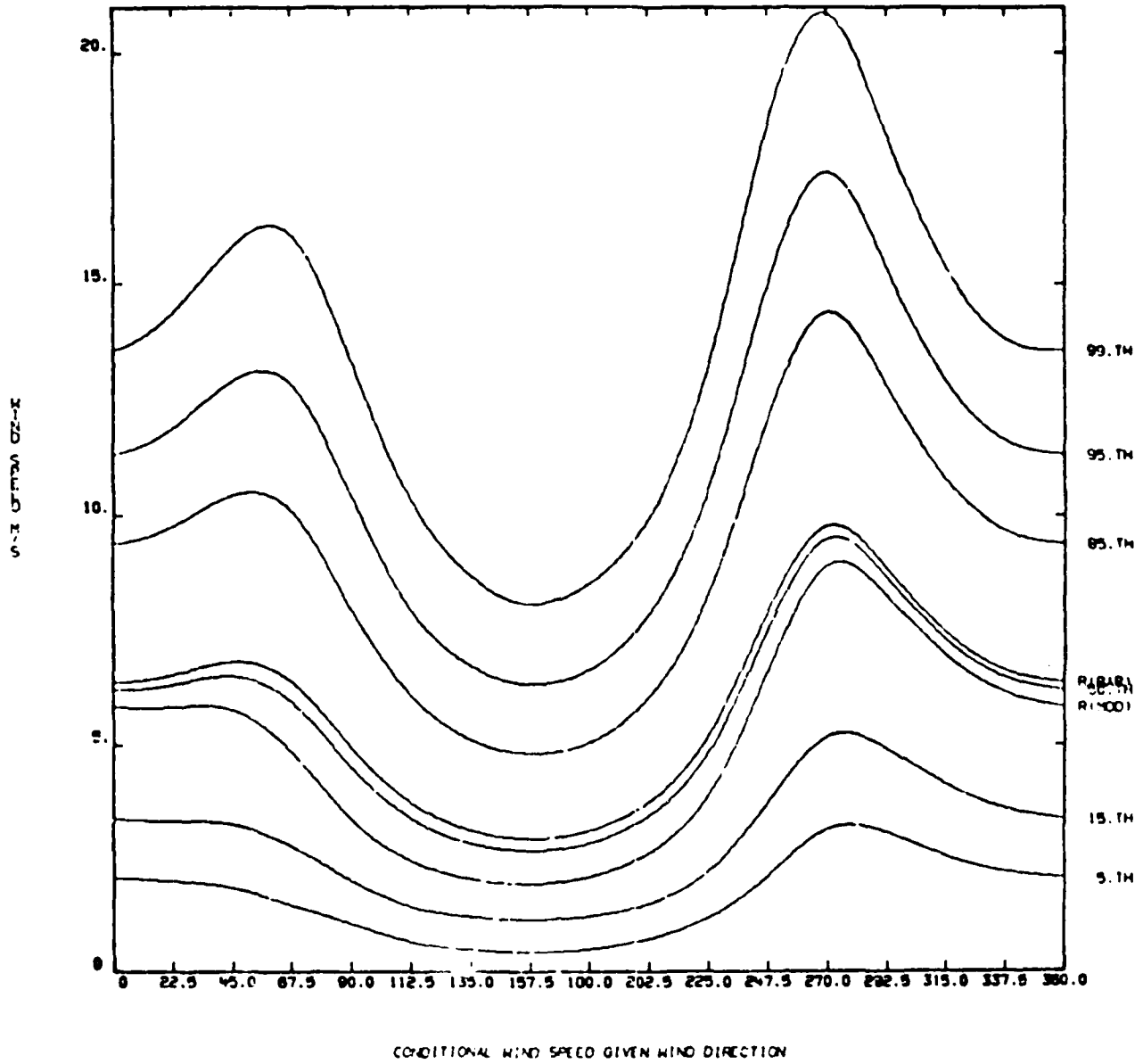

Fig. A-55

WIND STATION-VAFB MONTH-JAN. ALTITUDE-30 KM

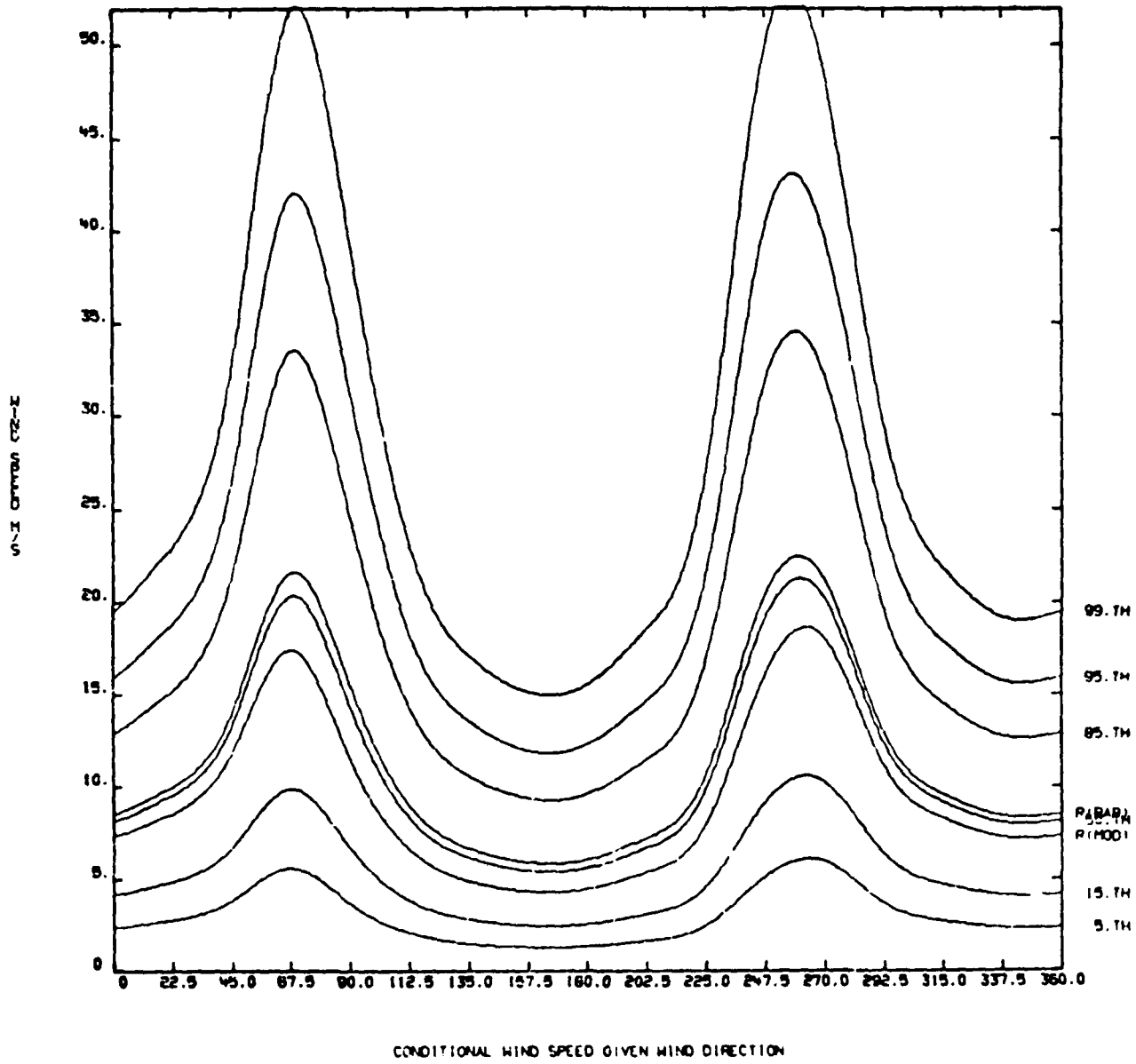
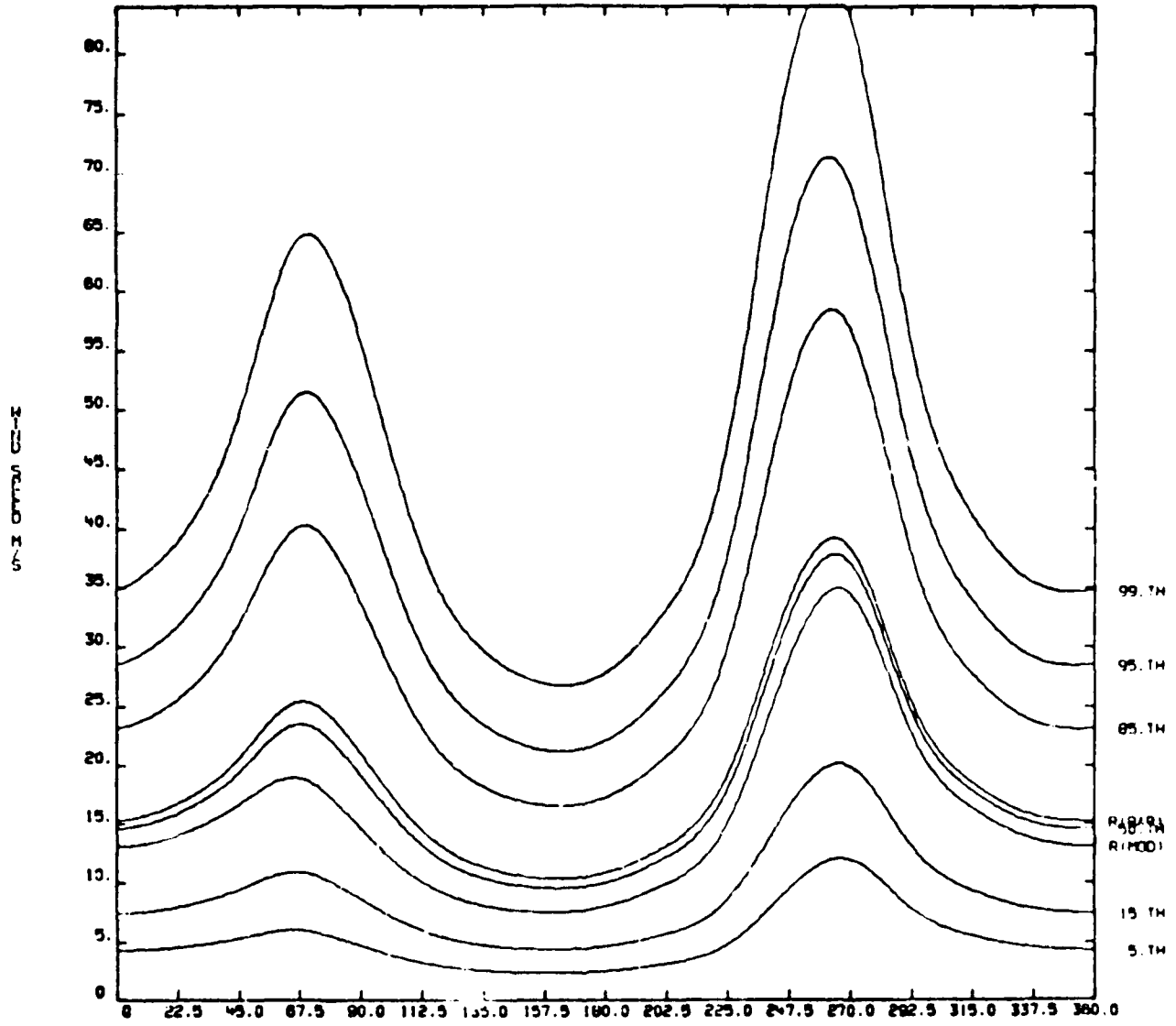

Fig. A-56

WIND STATION=VAFB MONTH=JAN. ALTITUDE=0 KM



CONDITIONAL WIND SPEED GIVEN WIND DIRECTION

Fig. A-57

WIND STATION=VAFB MONTH=JAN. ALTITUDE=50 KM

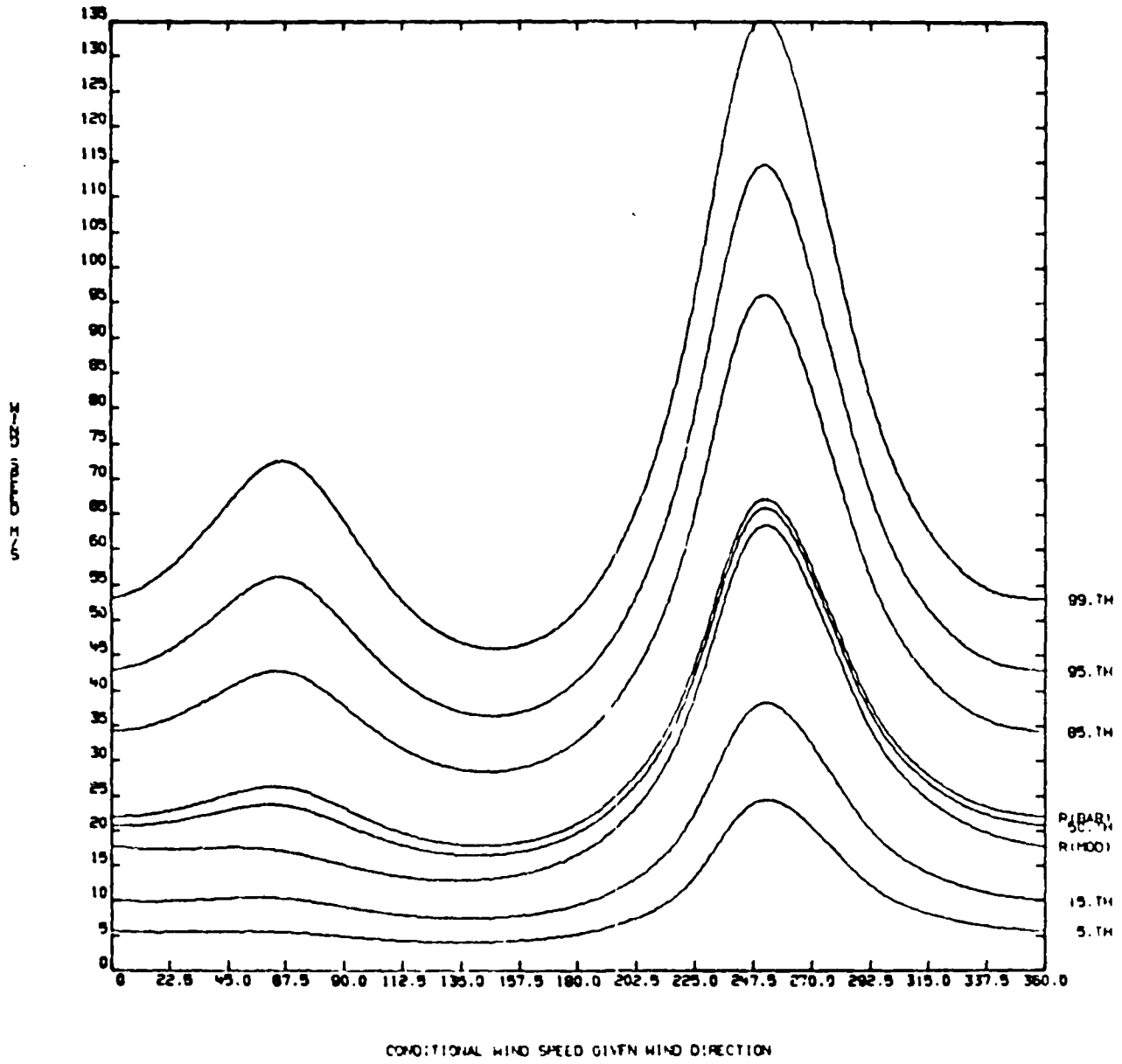

Fig. A-58

WIND STATION=VAFB MONTH=JAN. ALTITUDE=60 KM

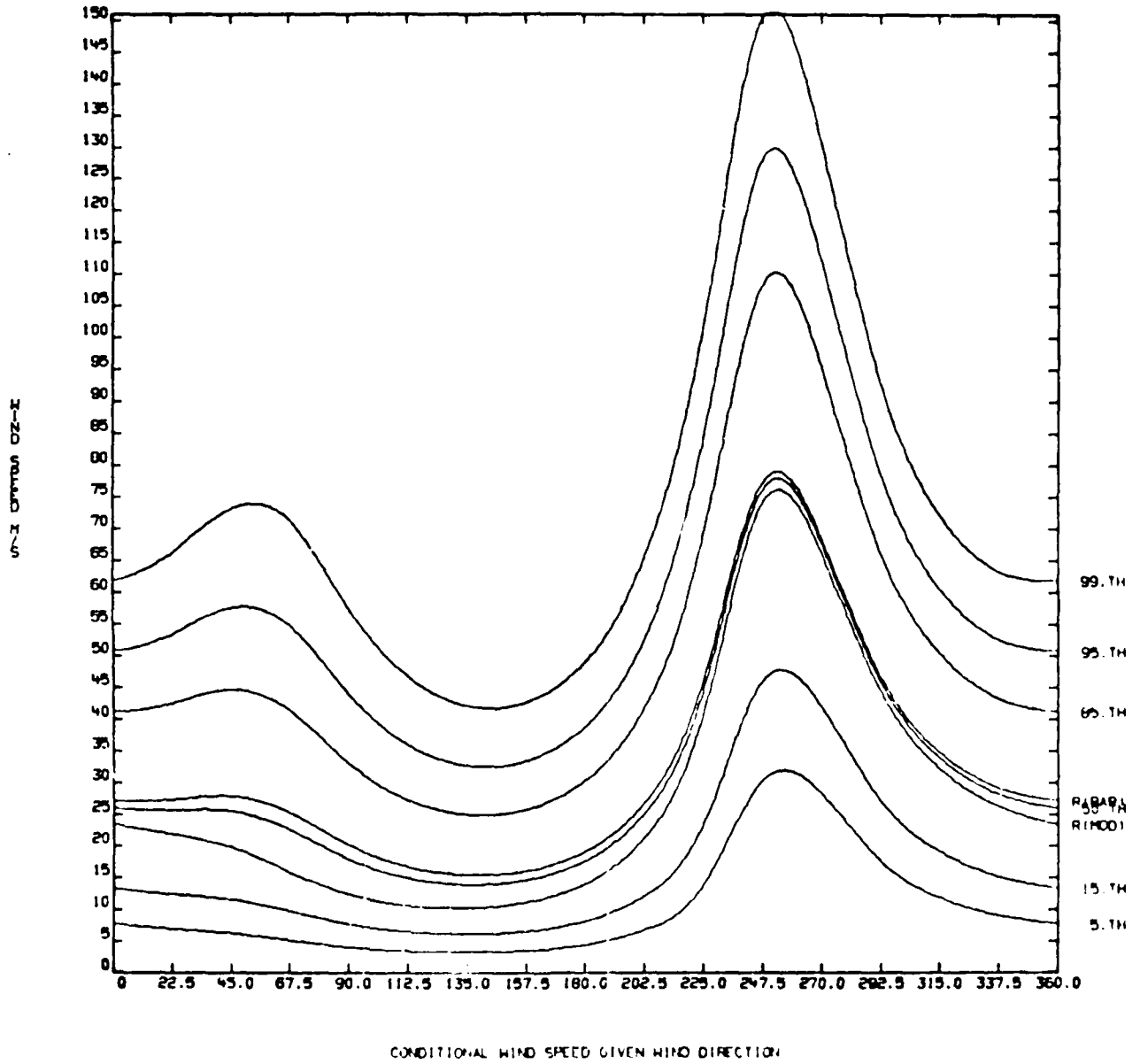

Fig. A-59

WIND STATION=VAFB MONTH=JAN. ALTITUDE=70 KM

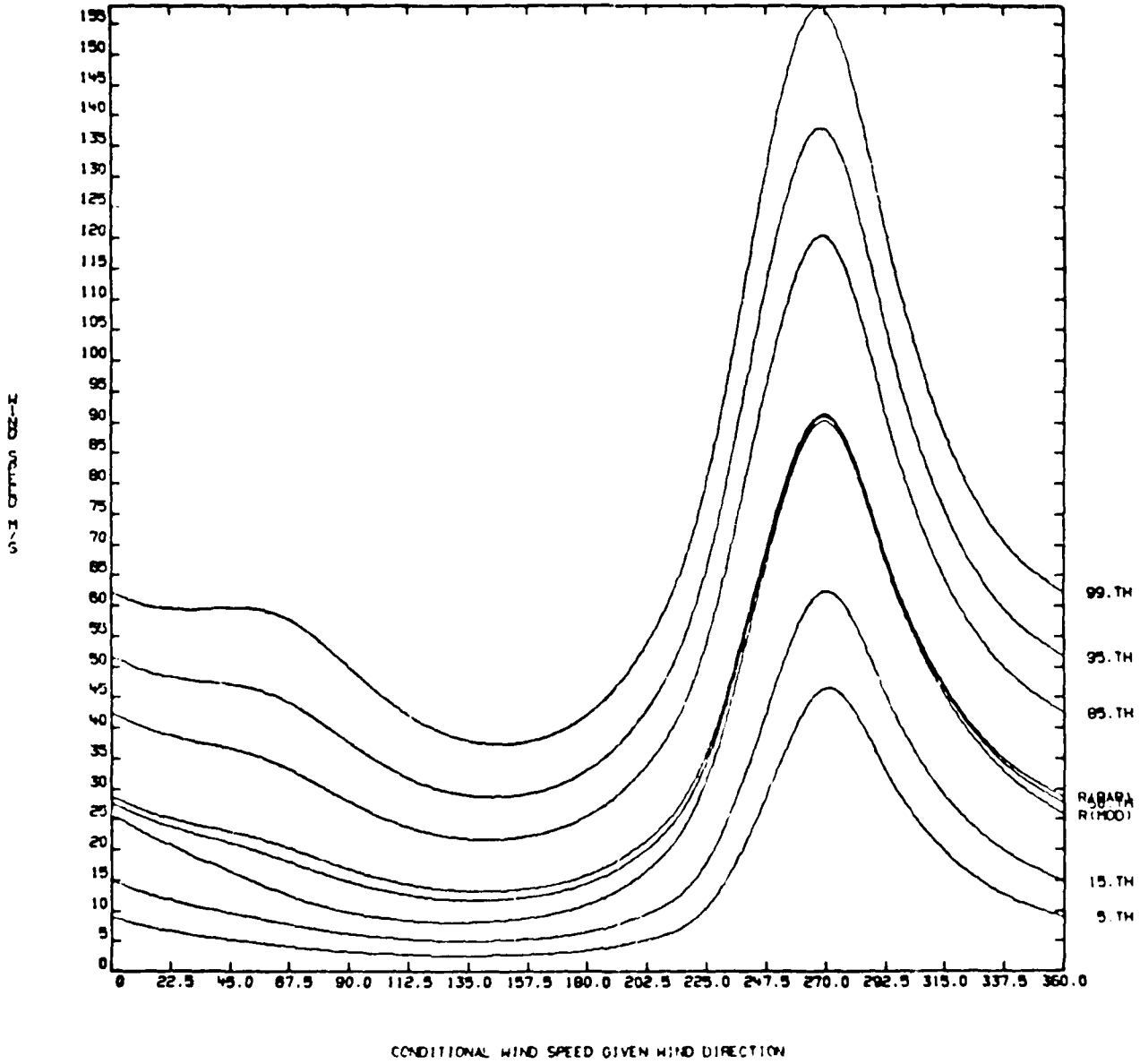
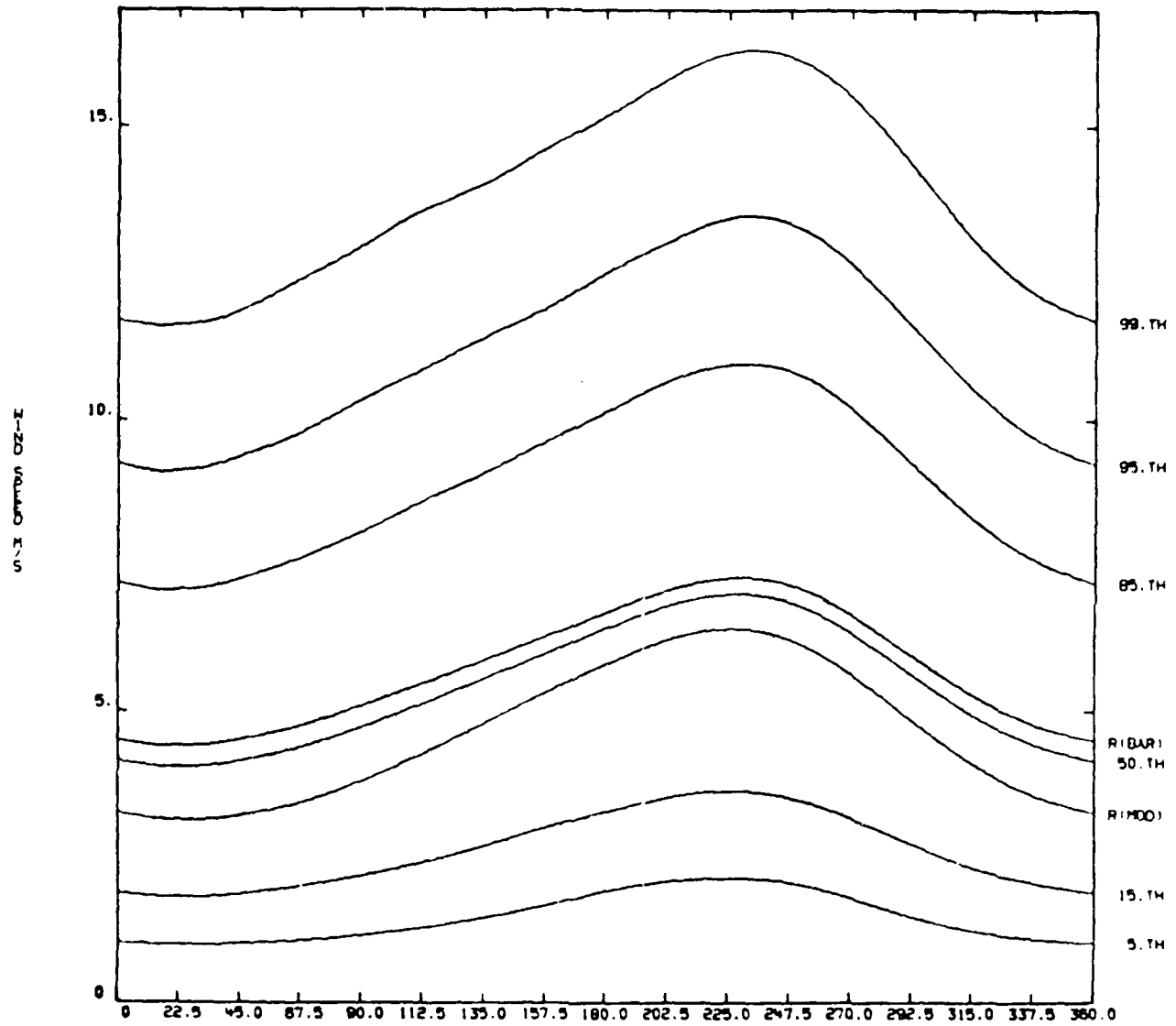

Fig. A-60

WIND STATION=VAFB MONTH=JUL. ALTITUDE= 4 KM



CONDITIONAL WIND SPEED GIVEN WIND DIRECTION

Fig. A-61

WIND STATION=VAFB MONTH . . . ALTITUDE=12 KM

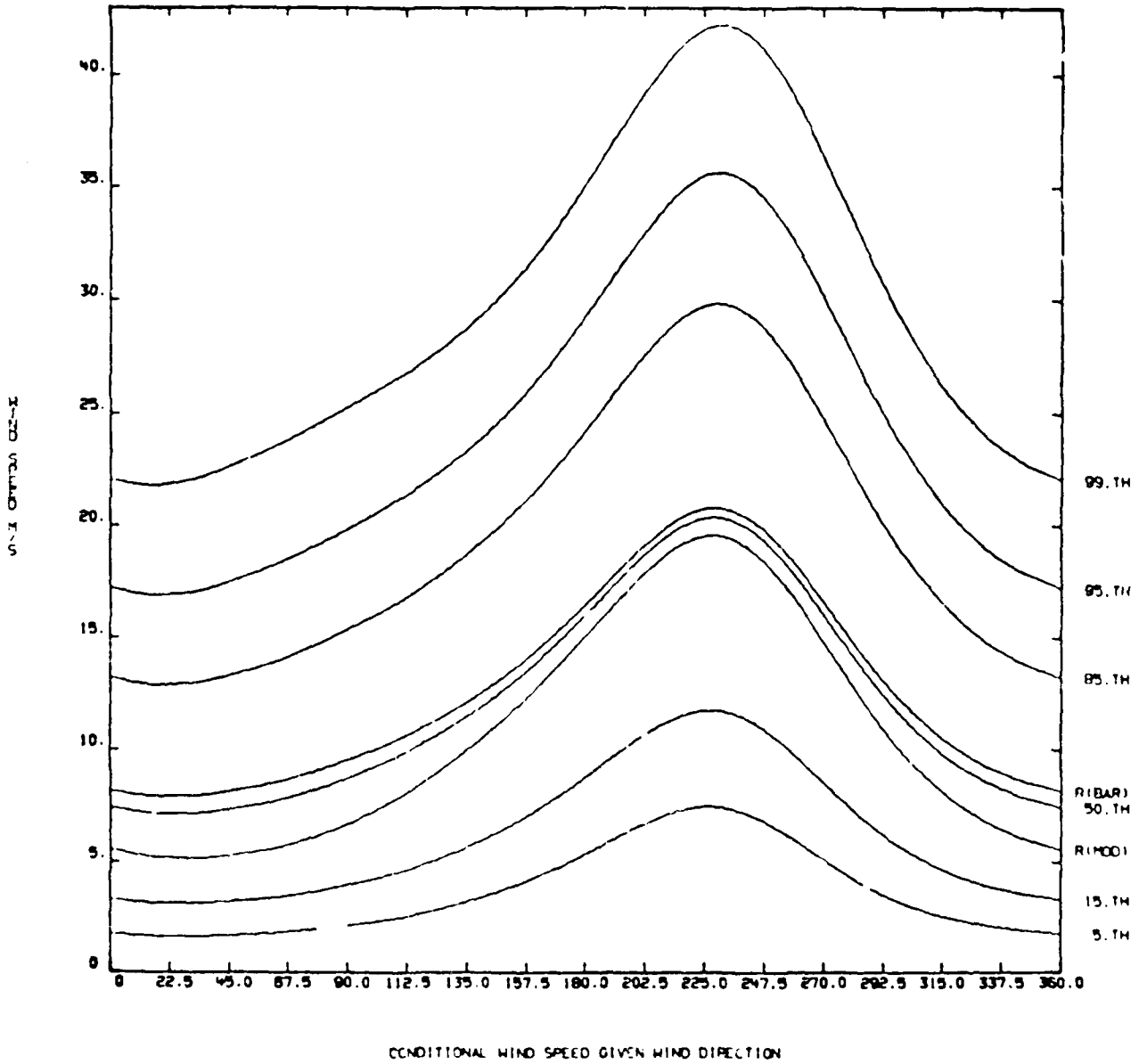
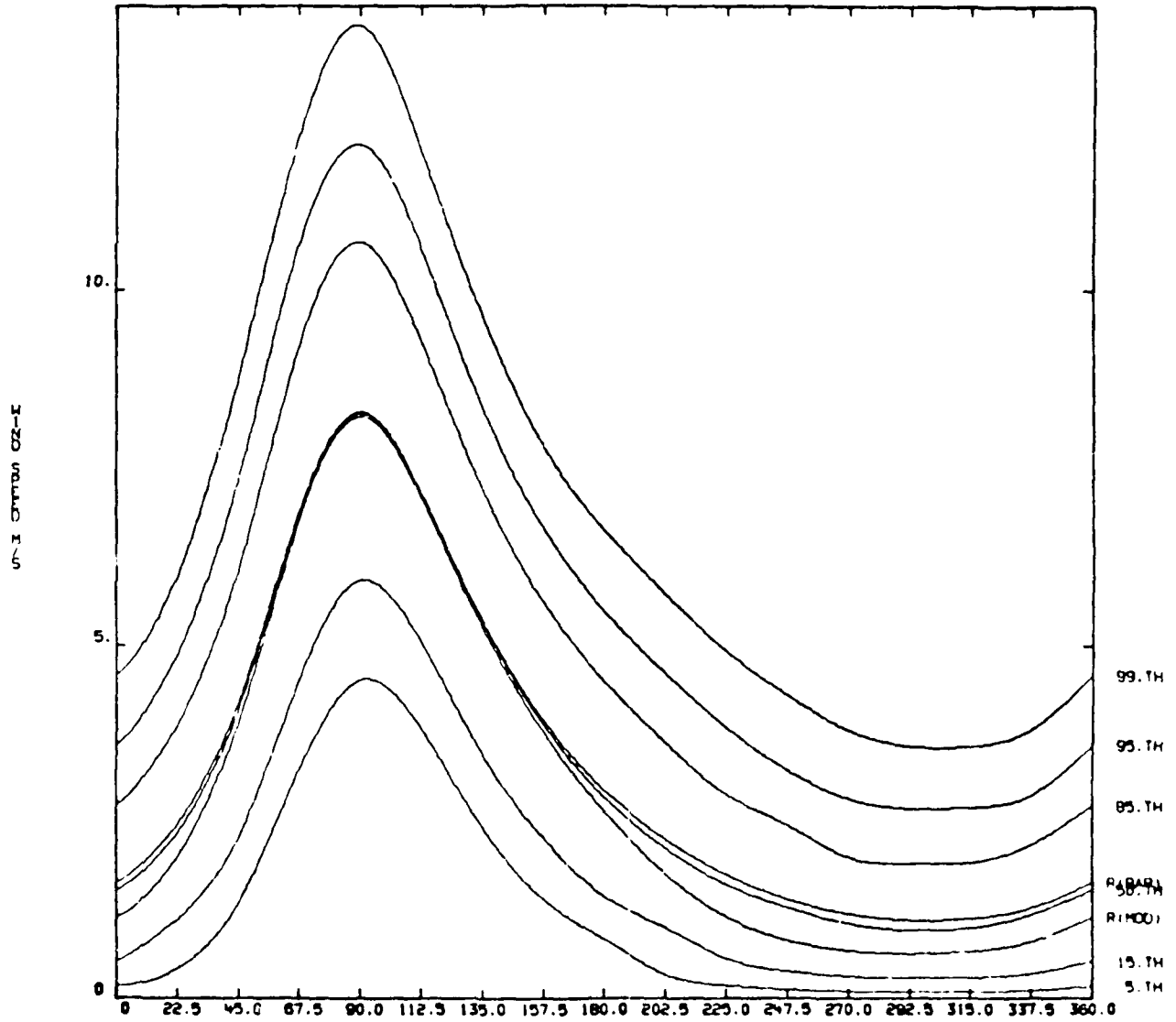

Fig. A-62

WIND STATION=VAFB MONTH=JUL. ALTITUDE=20 KM



CONDITIONAL WIND SPEED GIVEN WIND DIRECTION

Fig. A-63

WIND STATION-VAFB MONTH-JUL. ALTITUDE=30 KM

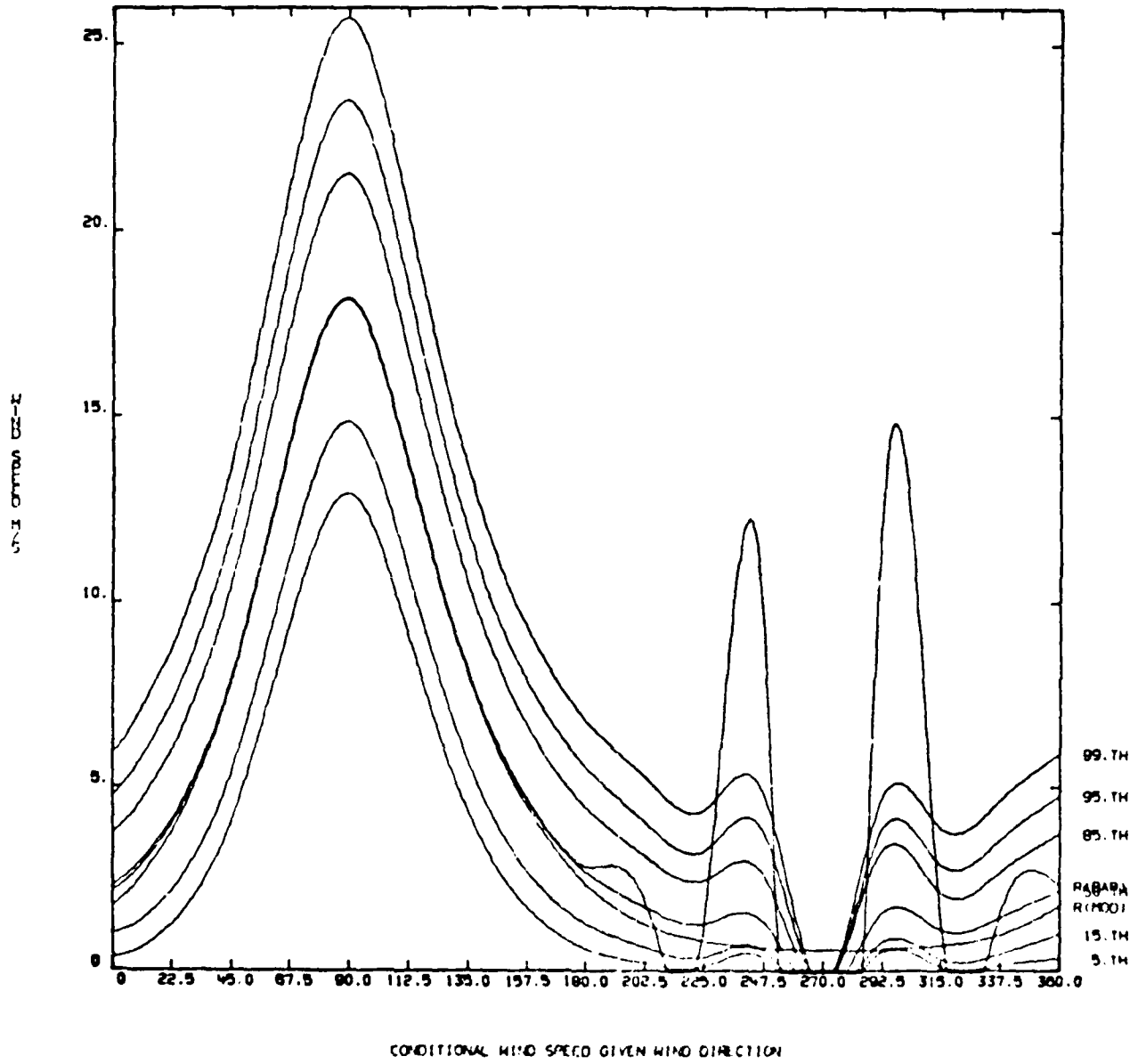

Fig. A-64

WIND STATION-VAFB MONTH=JUL. ALTITUDE=40 KM

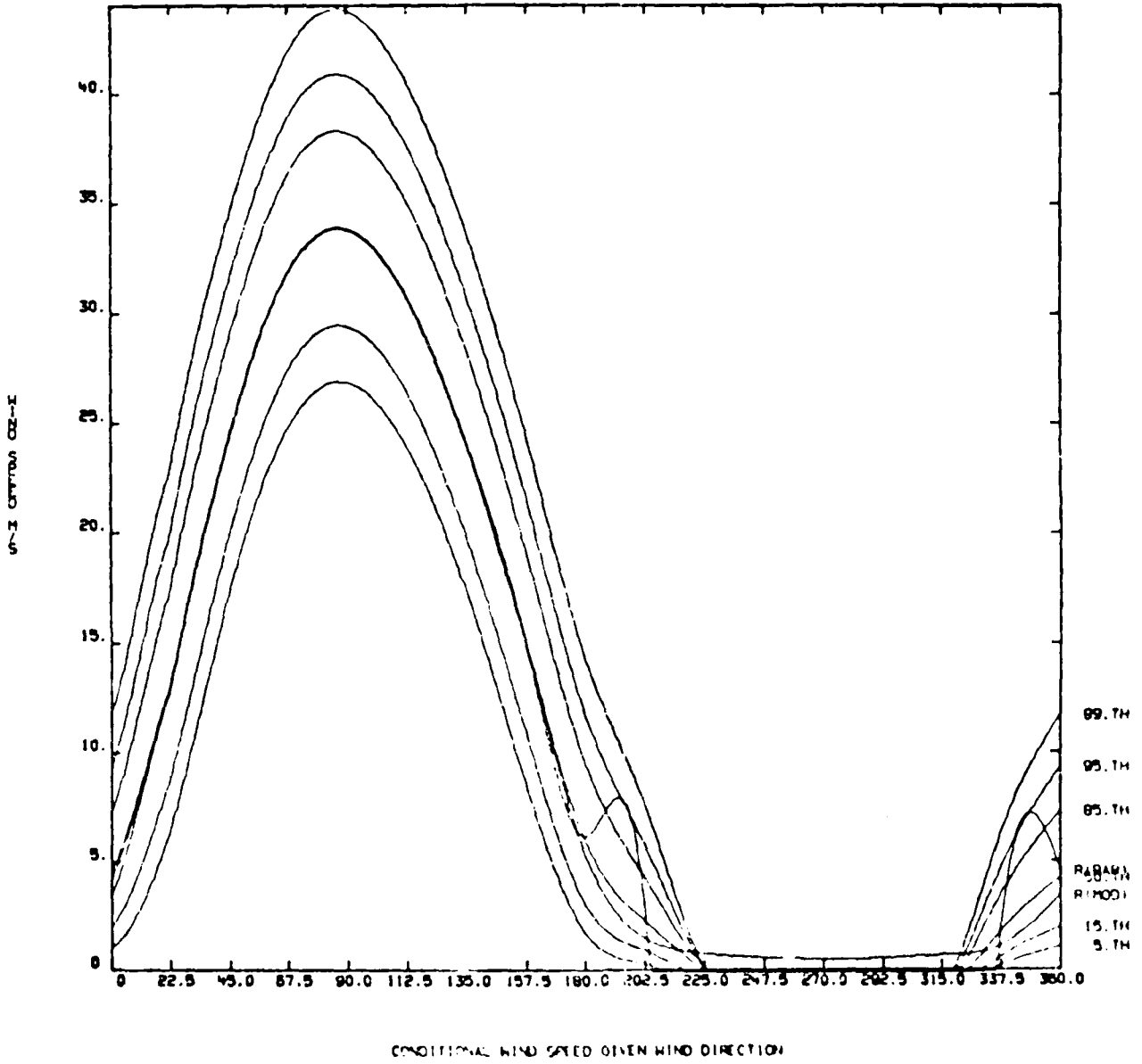

Fig. A-65

WIND STATION=VAFB MONTH=JUL. ALTITUDE=50 KM

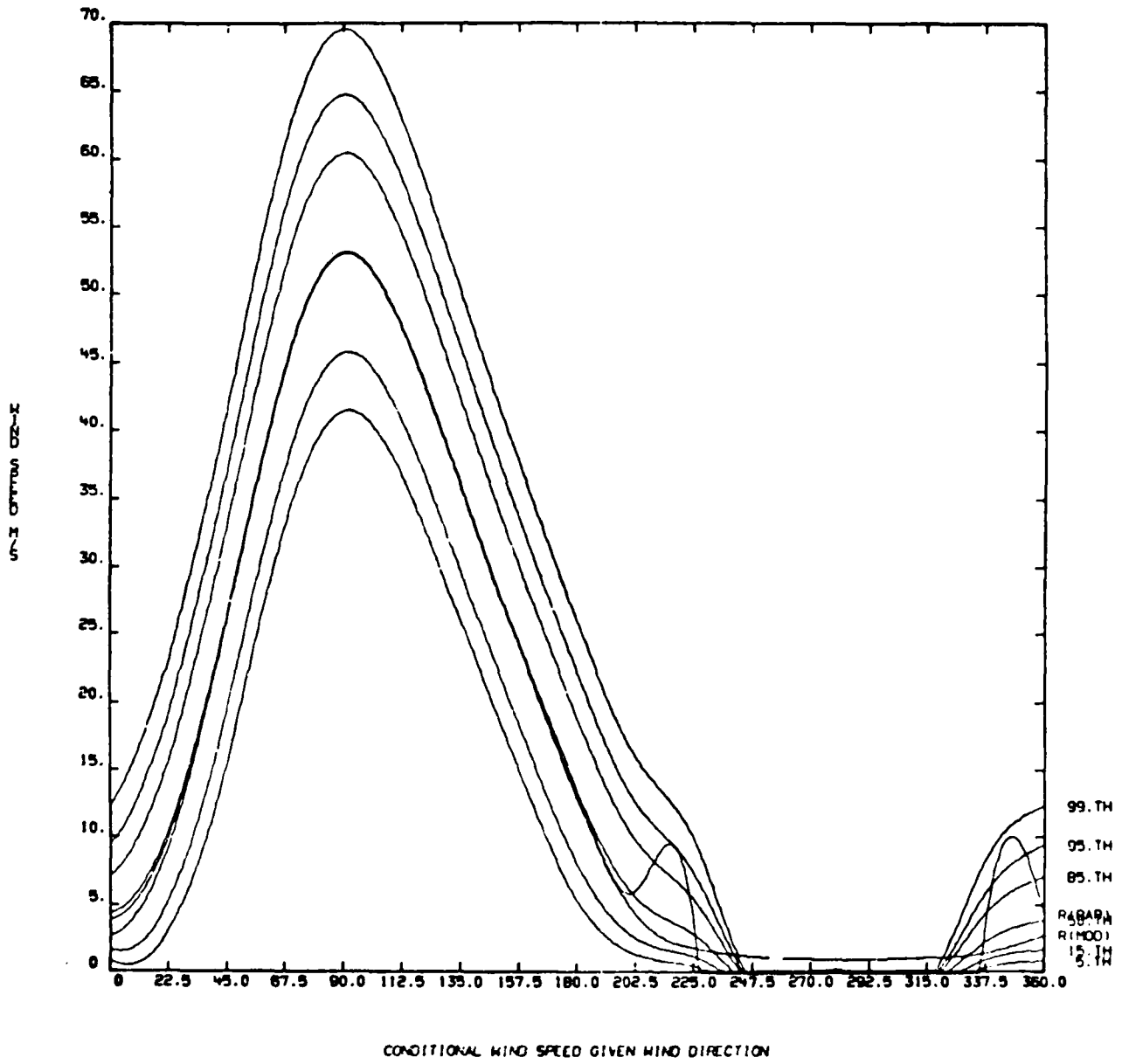

Fig. A-66

WIND STATION=VAFB MONTH=JUL. ALTITUDE=60 KM

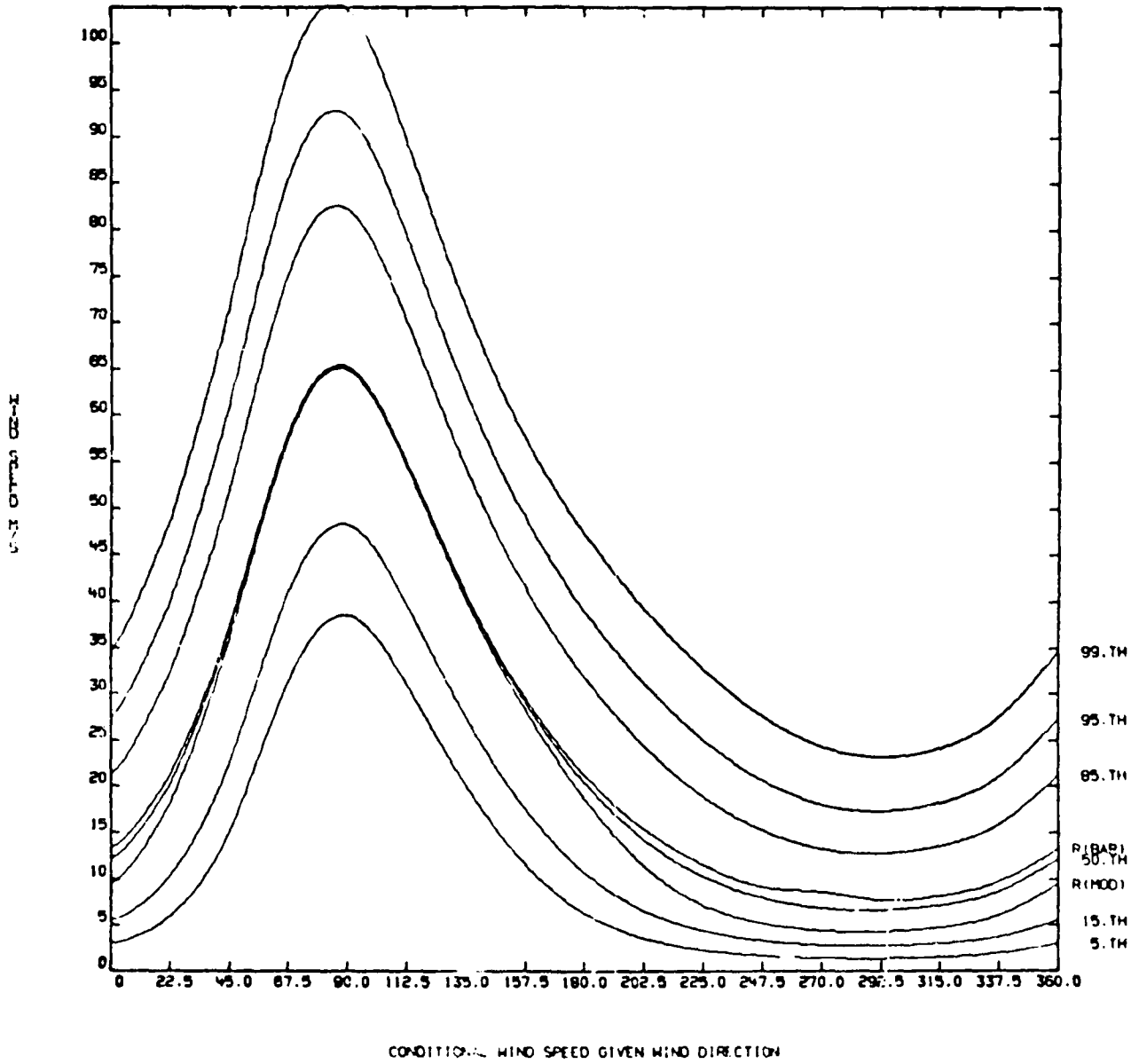
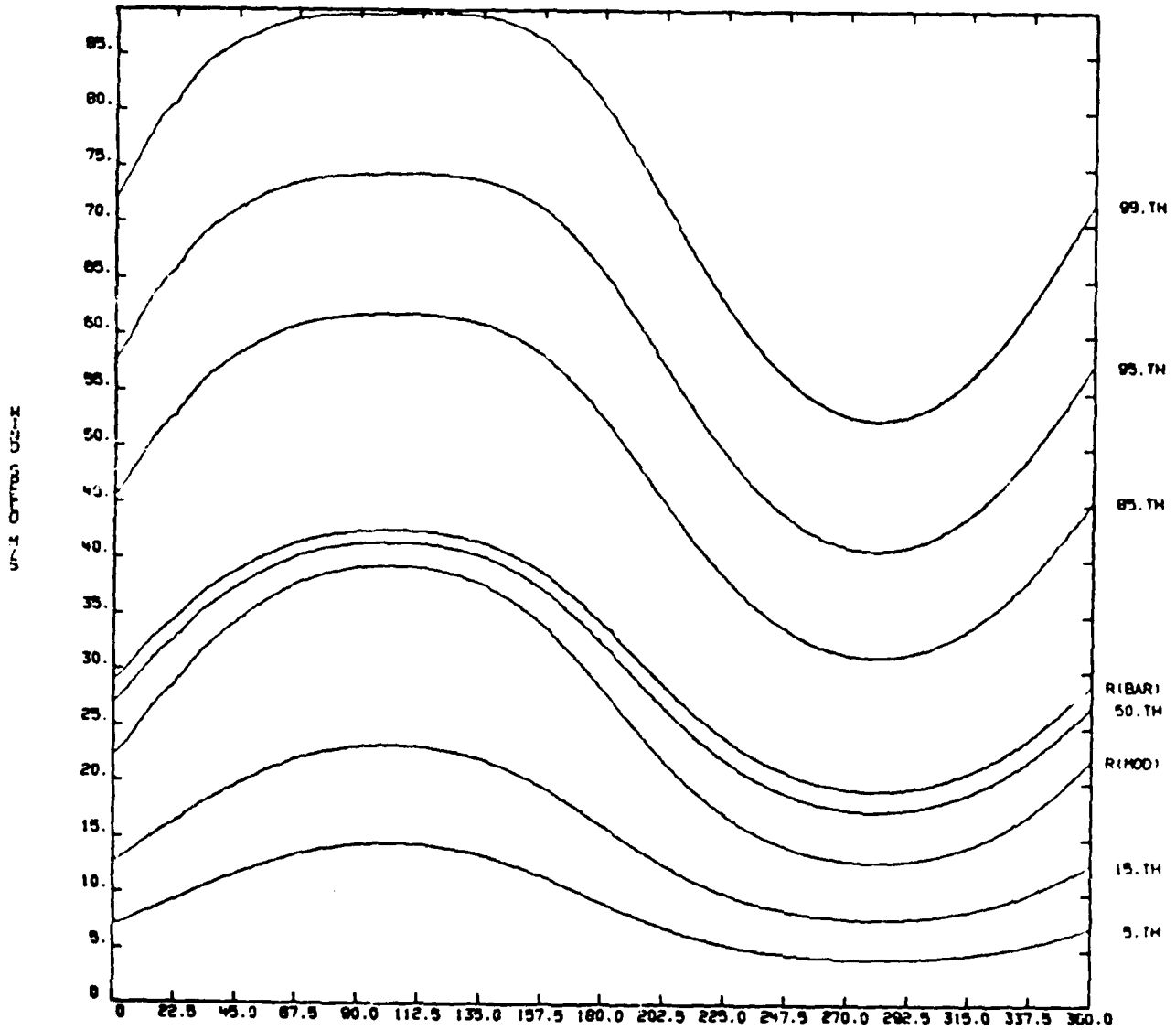

Fig. A-67

WIND STATION=VA'S MONTH=JUL. ALTITUDE=70 KM



CONDITIONAL WIND SPEED GIVEN WIND DIRECTION

Fig. A-68

APPENDIX B

RANGE SPECIFIC INFORMATION AND THERMODYNAMIC QUANTITIES FOR
 VANDENBERG AFB, CALIFORNIA
 (Data base 32-70 km altitude from Point Mugu, CA)

1. Range Specific Information

To prevent further character size reduction for tables I through IV, certain range-specific information has been omitted. This important information is given in table B-1.

TABLE B-1

<u>Header Record 0-30 Km</u>	<u>Header Record 32-70 Km</u>
Table Number-----0	Table Number-----0
Data Source	Data Source
(1 = DATSAV, 2 = WDC-A)-----1	(1 = DATSAV, 2 = WDC-A)-----2
Call Letters-----VBG	Call Letters-----NTD
WMO Number-----723930	WMO Number-----723910
Latitude-----34°,45'	Latitude-----34°,07'
Direction (N or S)-----N	Direction (N or S)-----N
Longitude-----120°,34'	Longitude-----119°,07'
Direction (E or W)-----W	Direction (E or W)-----W
Elevation in Meters-----100	Elevation in Meters-----4
Start Period of Record	Start Period of Record
(Mo-Yr)-----160	(Mo-Yr)-----169
End Period of Record	End Period of Record
(Mo-Yr)-----1279	(Mo-Yr)-----1278
No. of Time Windows	No. of Time Windows
(0, 1 or 2)-----2	(0, 1 or 2)-----1
Start Time Window	Start Time Window
#1 (Hr-MNZ)-----2200	#1 (Hr-MNZ)-----1200
End Time Window #1-----200	End Time Window #1-----2200
Start Time Window #2-----1000	Start Time Window #2-----0
End Time Window #2-----1400	End Time Window #2-----0
Date of RRA-----980	Date of RRA-----1080
Altitude Range of RRA	Altitude Range of RRA
Low Level (km)-----0	Low Level (km)-----30
Altitude Range of RRA	Altitude Range of RRA
High Level (km)-----7	High Level (km)-----70
Standard Deviation of	Standard Deviation of
Thermodynamic Limits-----6.0	Thermodynamic Limits-----6.0
Wind Limits-----6.0	Wind Limits-----6.0

2. Thermodynamic Quantities

This section presents examples of further computations and graphical displays of pressure, density, and virtual temperature statistics that can be derived from the data given in tables II, III, and IV. No attempt is made to

present complete nor exhaustive illustrations that can be made to aid in visualizing the relationships that can be made from the data in tables II and IV. The choices are those that aided the committee to verify the reasonableness of the tabulations.

2.1 Monthly Means from the Annual Mean

The hydrostatic model values in table IV are used to compute (1) the monthly mean differences relative to the annual mean values of pressure, density, and virtual temperature expressed in percent and (2) the monthly mean difference in virtual temperature for the annual mean virtual temperature expressed in degrees Kelvin. Examples of these four statistics are given in table B-2 for January and table B-3 for July. Graphical displays of the four statistics contained in tables B-2 and B-3 are shown in figures B-1 through B-8. Also, the relative differences between the monthly mean values from table IV-1 through IV-12 for all months from the annual mean values (table IV-13) are illustrated in figure B-9 for pressure, in figure B-10 for density, and in figure B-11 for virtual temperature. The monthly mean virtual temperature differences from the annual mean virtual temperature for all months are given in figure B-12. The simple sum of the monthly mean differences from the annual mean values of these quantities is not zero. This is because the annual mean statistical parameters are computed (see section C of text) by weighting the monthly means by the number of observations in each month.

2.2 Coefficients of Variation and Derived Correlation Coefficients

The coefficient of variation, C_V , is defined by the standard deviation with respect to the mean divided by the mean. The coefficients of variation for pressure, C_{VP} , and density, C_{VD} , were computed using the standard deviations from table II and the hydrostatic mean values from table IV. The coefficient of variation for temperature uses the standard deviations of virtual temperature from table III to the altitude where virtual temperature exists. Above this altitude, the standard deviations of temperature are from table II. The mean values for temperature (virtual temperature to the altitude where it exists) are taken from table IV. No distinction is made in the table headings in table B-4 (Jan) and table B-5 (July) and all related figures between virtual temperature and temperature.

From the coefficients of variation for pressure, density, and temperature (virtual temperature to the altitude where it exists), the correlation coefficients between these quantities are derived using Buell's method (see reference in text). The equations for these derived correlation coefficients are

$$r(P,T) = \frac{(C_{VT})^2 + (C_{VP})^2 - (C_{VD})^2}{2[C_{VT} \cdot C_{VP}]}, \quad (B-1)$$

$$r(P,D) = \frac{(C_{VD})^2 - (C_{VT})^2 + (C_{VP})^2}{2[C_{VD} \cdot C_{VP}]} \quad (B-2)$$

$$r(T,D) = \frac{(C_{VP})^2 - (C_{VD})^2 - (C_{VT})^2}{2[C_{VT} \cdot C_{VD}]} \quad (B-3)$$

The correlation coefficients in tables B-4 and B-5 are derived from the above equations.

A test for the validity of the derived correlation coefficients is that all three of the following inequalities be satisfied.

$$\left. \begin{aligned} C_{VP} - (C_{VD} + C_{VT}) &< 0 \\ C_{VD} - (C_{VT} + C_{VP}) &< 0 \\ C_{VT} - (C_{VP} + C_{VD}) &< 0 \end{aligned} \right\} \quad (B-4)$$

In these examples (tables B-4 and B-5) the numerical values from equation (B-4) are all negative; hence, the derived correlation test is considered valid. The rare exceptions to this test for several RRAs occur at the extreme highest altitudes, where sample sizes for the statistical sample are small.

The statistical parameters from table B-4 (January) and table B-5 (July) are illustrated in figures B-13 through B-16.

For all months the C_{VP} values are shown in figure B-17, the C_{VD} values are shown in figure B-18, and C_{VT} values are shown in figure B-19. If the abscissa on the figures for the coefficient of variation were multiplied by 100, these figures would show the percentage of the random dispersion of these quantities over the month with respect to the monthly mean for these thermodynamic quantities.

The derived correlation coefficients for all months are illustrated in the following figures:

- a) Figure B-20 gives $r(P,D)$.
- b) Figure B-21 gives $r(P,T)$.
- c) Figure B-22 gives $r(T,D)$.

Table B-2

STATION 723930		MONTH 1		
DELTA'S IN PERCENT RELATIVE TO ANNUAL				
LEVEL	PRESSURE	DENSITY	TEMP.	TM1-TANN(DEC. K)
.000	.23	.81	-1.64	-1.87
.100	.22	.90	-1.71	-2.14
1.000	.09	1.74	-1.60	-4.79
2.000	-.12	1.65	-1.74	-4.95
3.000	-.33	1.35	-1.65	-4.58
4.000	-.54	1.13	-1.64	-4.47
5.000	-.75	.98	-1.70	-4.52
6.000	-.93	.83	-1.79	-4.62
7.000	-1.23	.65	-1.81	-4.72
8.000	-1.49	.49	-1.99	-4.80
9.000	-1.78	.32	-2.09	-4.94
10.000	-2.09	.05	-2.13	-4.86
11.000	-2.33	-.56	-1.65	-4.12
12.000	-2.62	-1.53	-1.11	-2.91
13.000	-2.72	-2.55	-.20	-1.43
14.000	-2.71	-3.08	.39	-.82
15.000	-2.64	-3.19	.57	1.19
16.000	-2.56	-2.89	.36	.70
17.000	-2.53	-2.55	.01	.02
18.000	-2.56	-2.16	-.38	-.67
19.000	-2.64	-2.01	-.63	-1.32
20.000	-2.75	-1.98	-.79	-1.67
21.000	-2.89	-1.98	-.97	-1.98
22.000	-3.03	-2.05	-1.00	-2.15
23.000	-3.20	-2.06	-1.17	-2.54
24.000	-3.38	-2.17	-1.24	-2.70
25.000	-3.59	-2.16	-1.44	-3.17
26.000	-3.81	-2.27	-1.57	-3.48
27.000	-4.06	-2.30	-1.79	-3.99
28.000	-4.33	-2.61	-1.79	-4.02
29.000	-4.53	-2.82	-1.82	-4.11
30.000	-4.65	-3.19	-1.76	-4.01
32.000	-5.30	-4.20	-1.43	-3.33
34.000	-5.55	-4.80	-1.17	-2.66
36.000	-5.92	-5.27	-.93	-2.25
38.000	-6.13	-5.69	-.70	-1.73
40.000	-6.33	-5.73	-.85	-2.19
42.000	-6.51	-6.16	-.80	-1.58
44.000	-6.61	-6.59	-.83	-.50
46.000	-6.64	-6.87	-.03	.07
48.000	-6.71	-6.57	-.61	-1.64
50.000	-6.96	-5.69	-1.55	-4.13
52.000	-7.42	-5.50	-2.86	-8.99
54.000	-7.96	-6.02	-2.30	-6.04
56.000	-8.40	-6.79	-2.05	-5.34
58.000	-8.74	-7.66	-1.60	-4.17
60.000	-9.24	-8.33	-1.24	-3.16
62.000	-9.58	-8.66	-1.26	-3.14
64.000	-9.75	-9.85	-.12	-.30
66.000	-9.74	-10.19	.20	.46
68.000	-9.56	-10.88	1.23	2.77
70.000	-9.12	-11.13	2.03	4.43

Table B-3

STATION 723930 MONTH 7
 DELTAS IN PERCENT RELATIVE TO ANNUAL

LEVEL	PRESSURE	DENSITY	TEMP.	TMO-TANN(DEC.K)
.000	-1.16	-1.65	.43	1.25
.100	-1.16	-1.74	.55	1.59
1.000	.02	-2.75	2.83	8.15
2.000	.35	-2.55	2.99	8.49
3.000	.70	-2.05	2.81	7.81
4.000	1.03	-1.57	2.65	7.21
5.000	1.36	-1.21	2.61	6.94
6.000	1.71	-1.02	2.77	7.17
7.000	2.09	-.85	2.97	7.46
8.000	2.51	-.62	3.14	7.65
9.000	2.96	-.30	3.26	7.69
10.000	3.44	.17	3.29	7.51
11.000	3.92	.86	3.02	6.72
12.000	4.33	2.05	2.21	4.81
13.000	4.57	3.78	.74	1.60
14.000	4.58	5.32	-.68	-1.45
15.000	4.39	5.96	-1.51	-3.17
16.000	4.14	5.67	-1.44	-3.01
17.000	3.94	4.84	-.85	-1.77
18.000	3.66	4.01	-.17	-.35
19.000	3.88	3.47	.40	.84
20.000	3.98	3.12	.83	1.76
21.000	4.14	3.00	1.11	2.37
22.000	4.34	2.95	1.34	2.89
23.000	4.56	3.07	1.46	3.15
24.000	4.81	3.15	1.62	3.53
25.000	5.06	3.48	1.54	3.38
26.000	5.31	3.63	1.62	3.58
27.000	5.57	3.85	1.67	3.73
28.000	5.83	4.03	1.72	3.87
29.000	6.11	4.30	1.76	3.98
30.000	6.38	4.54	1.74	3.97
32.000	6.85	5.31	1.29	3.02
34.000	7.22	5.85	1.16	2.75
36.000	7.53	6.36	.93	2.26
38.000	7.79	6.73	.84	2.08
40.000	8.04	6.92	.91	2.30
42.000	8.27	7.29	.76	1.98
44.000	8.43	7.91	.35	.93
46.000	8.50	8.14	.00	.53
48.000	8.57	8.08	.27	.71
50.000	8.65	8.17	.30	.81
52.000	8.72	8.32	.21	.66
54.000	8.77	8.70	-.14	-.37
56.000	8.81	9.10	-.59	-1.53
58.000	8.85	9.81	-1.52	-3.91
60.000	7.82	9.92	-1.98	-5.03
62.000	7.11	10.10	-2.98	-7.15
64.000	5.28	9.03	-2.70	-6.50
66.000	5.40	8.47	-3.02	-7.08
68.000	4.47	7.48	-2.91	-6.96
70.000	3.59	6.13	-2.55	-5.56

STATION = 723930 MONTH = 1

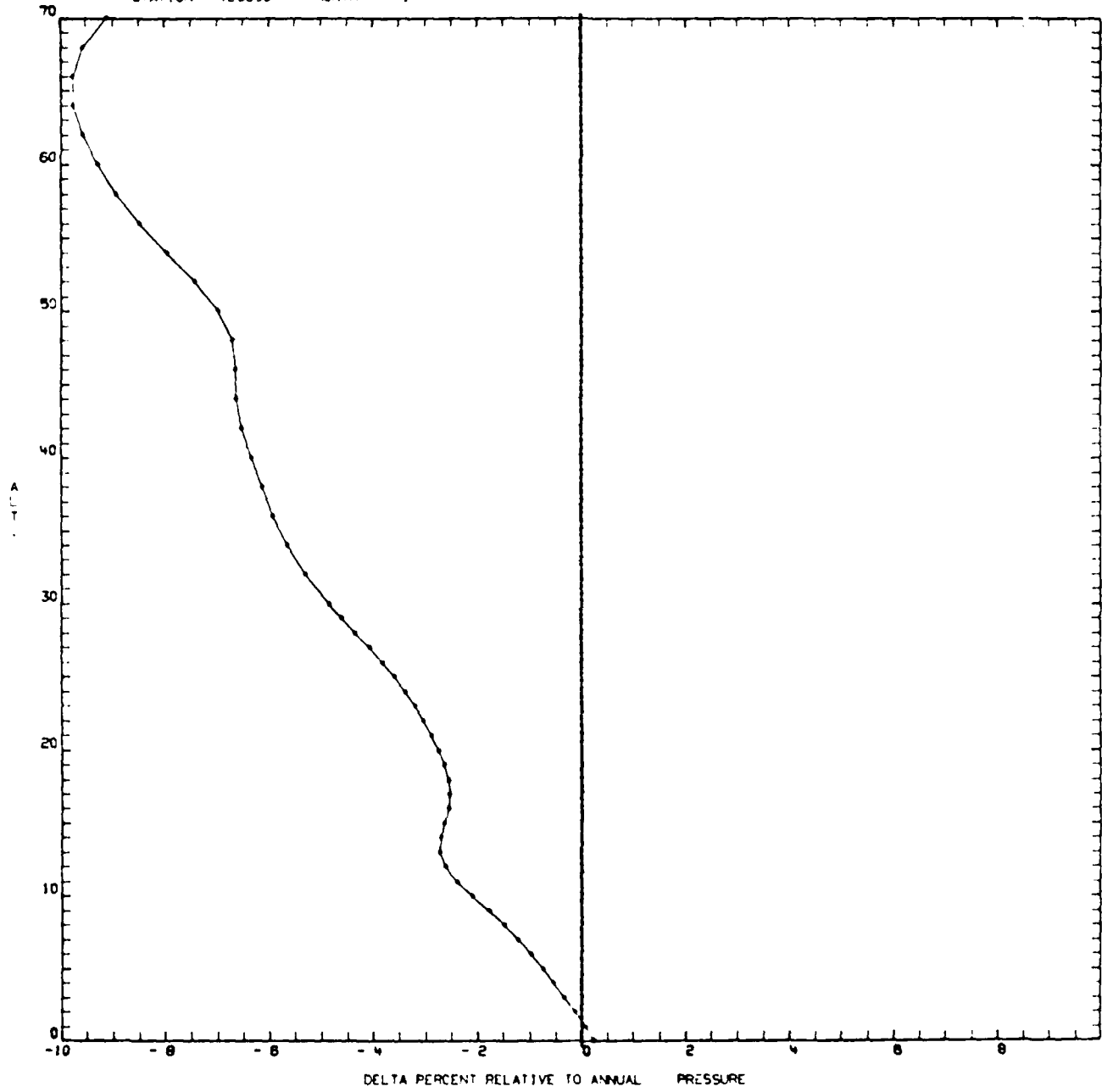

Fig. B-1

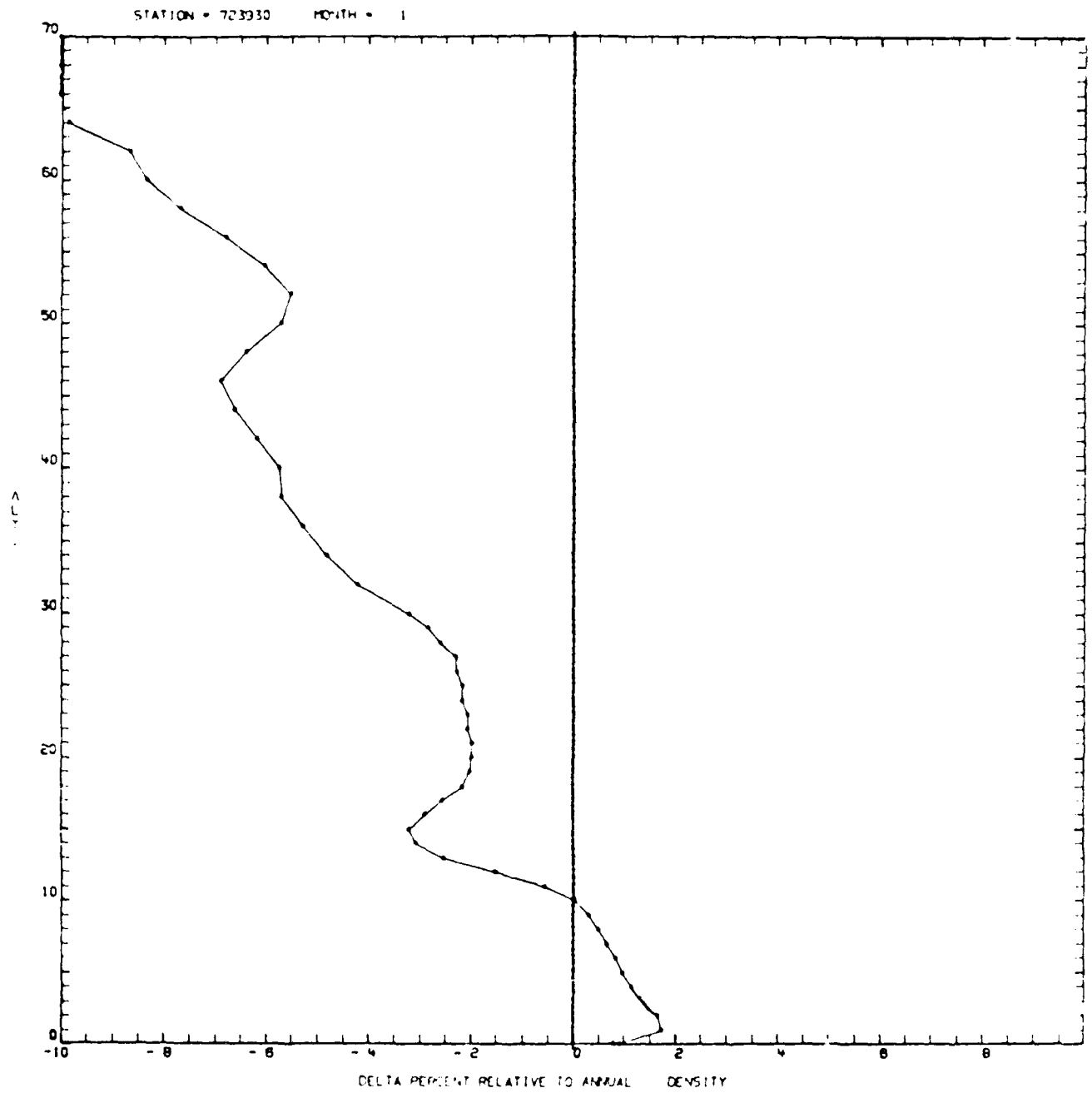

Fig. B-2

AD-A128 125

RANGE REFERENCE ATMOSPHERE 0-70 KM ALTITUDE VANDENBERG
AFB CALIFORNIA(U) RANGE COMMANDERS COUNCIL WHITE SANDS
MISSILE RANGE NM METEOROLOGY GROUP G G BOIRE ET AL.
APR 83 RCC/MG-362-83 F/G 4/2

3/3

UNCLASSIFIED

NL

													END DATE FILMED 6-83 DTIC	

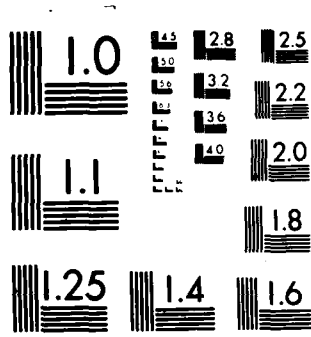

MICROCOPY RESOLUTION TEST CHART
NATIONAL BUREAU OF STANDARDS-1963-A

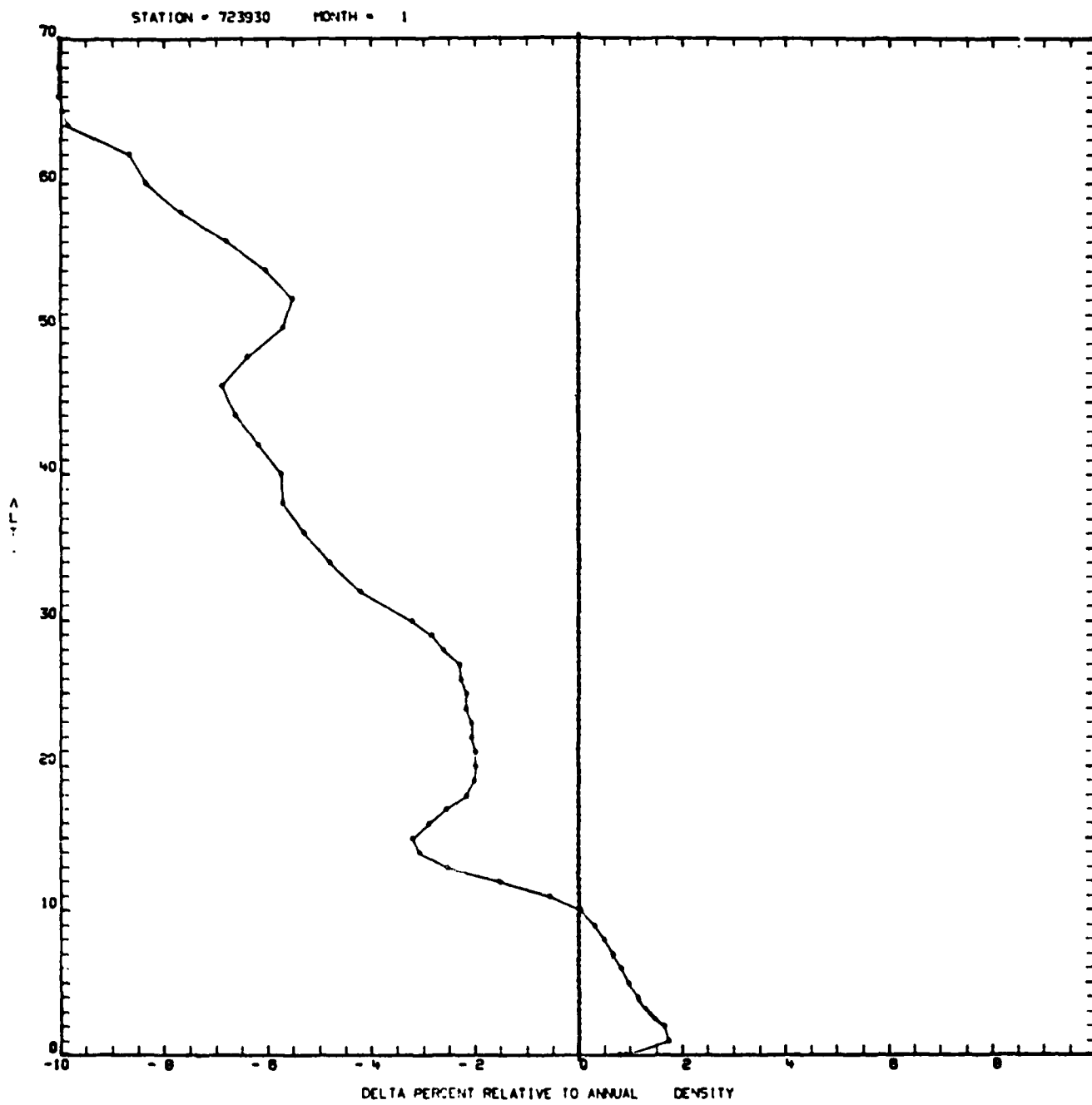

Fig. B-2

STATION = 723930 MONTH = 1

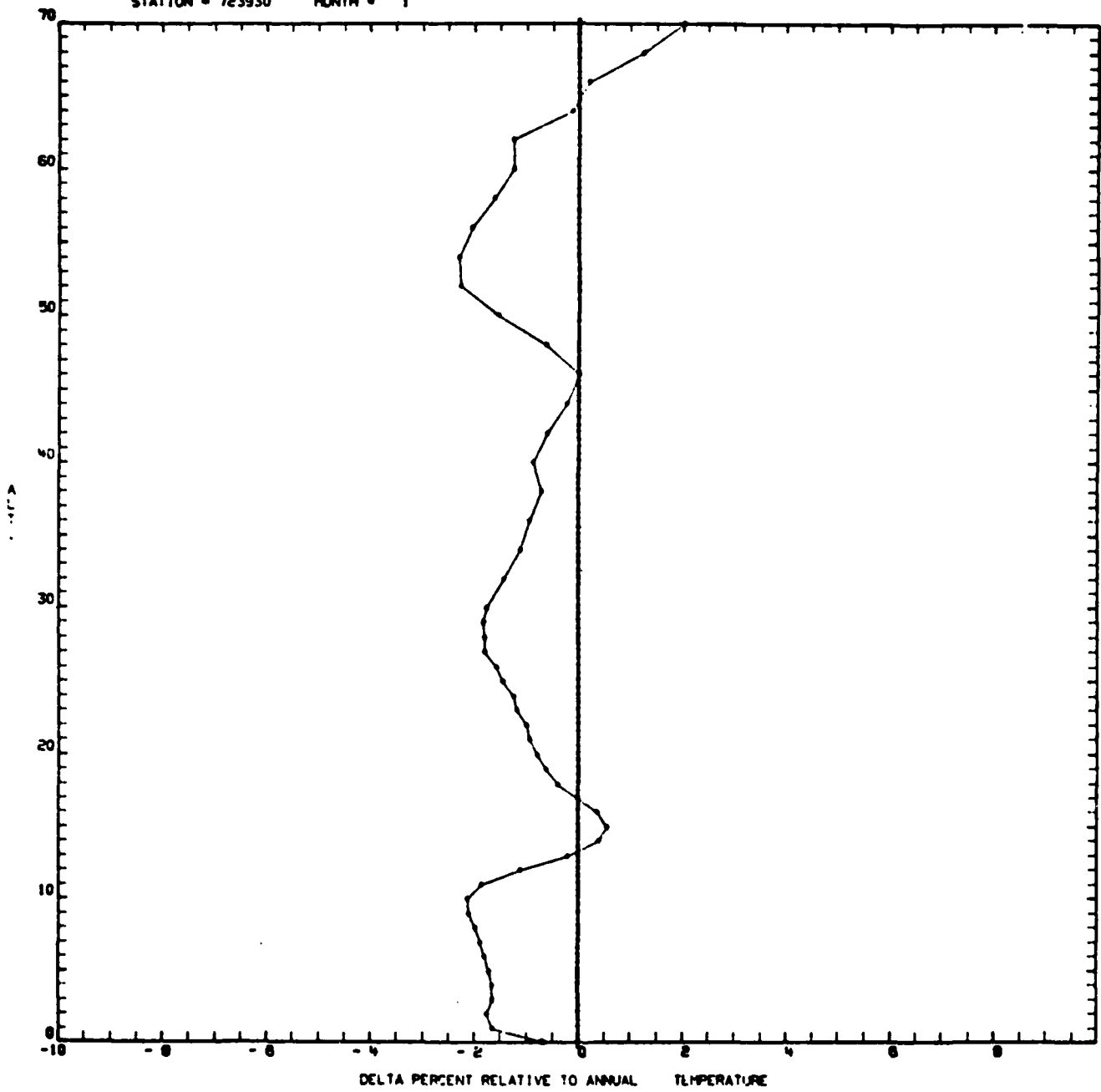

Fig. B-3

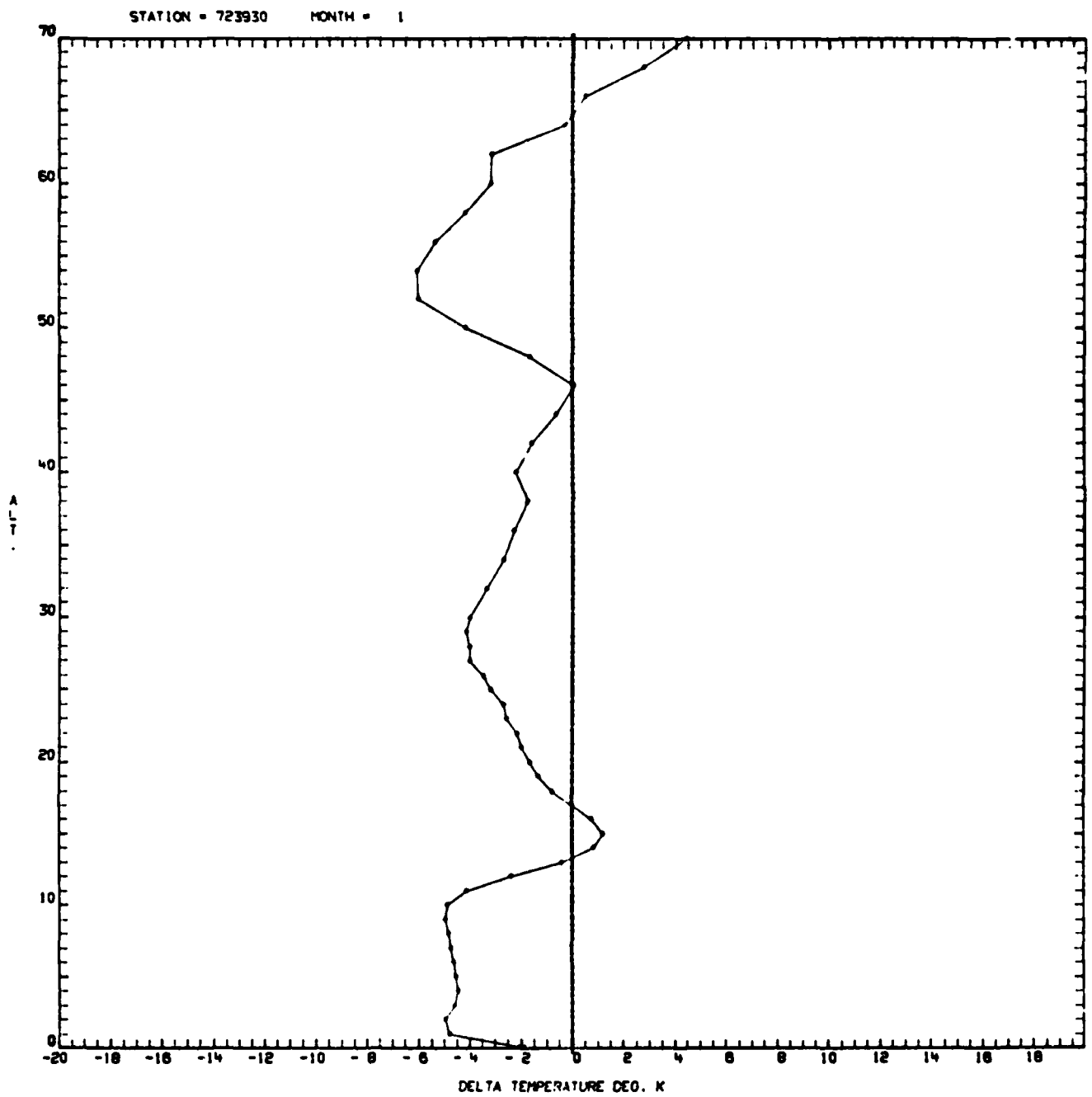

Fig. B-4

STATION - 723930 MONTH - 7

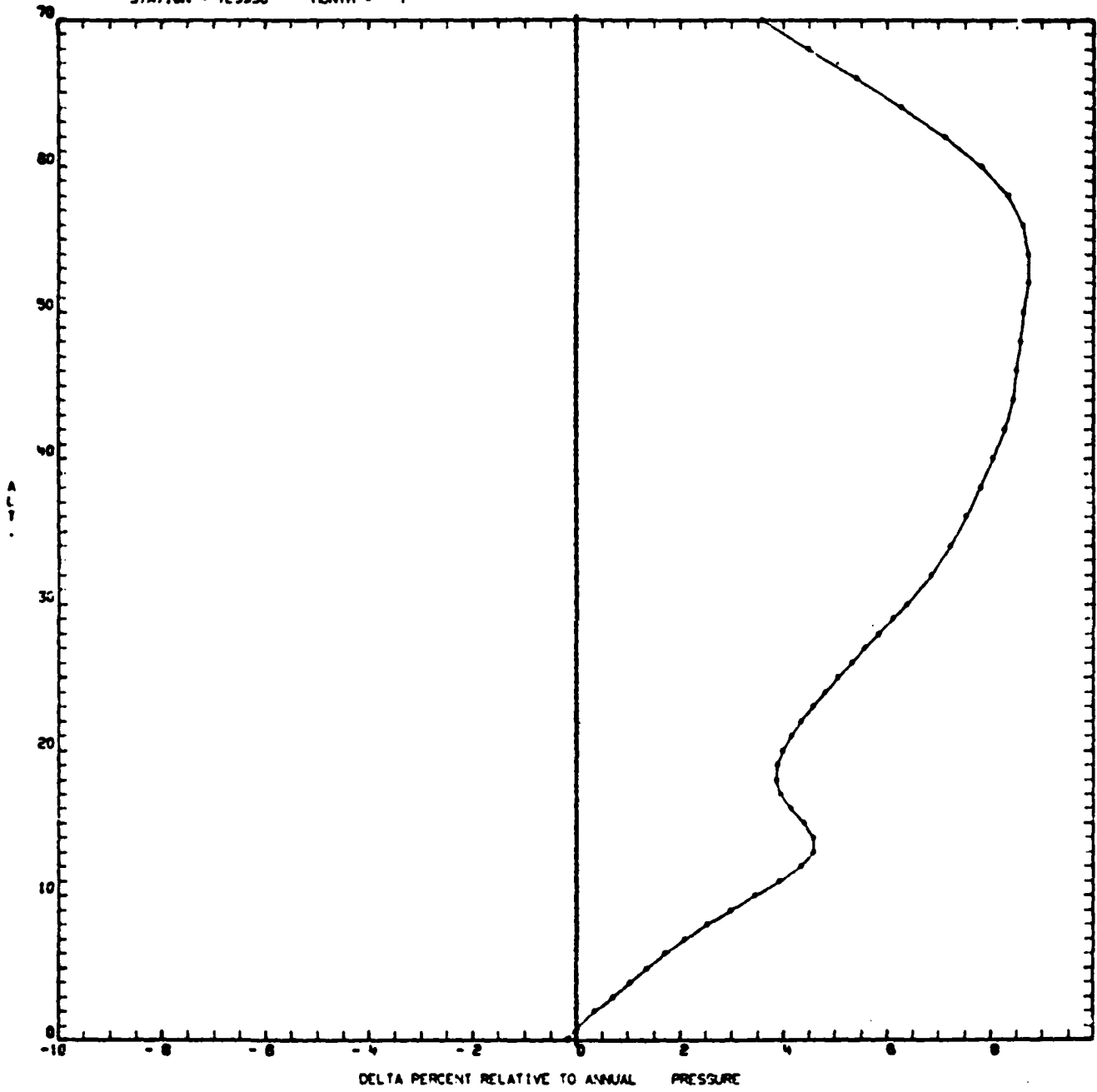

Fig. B-5

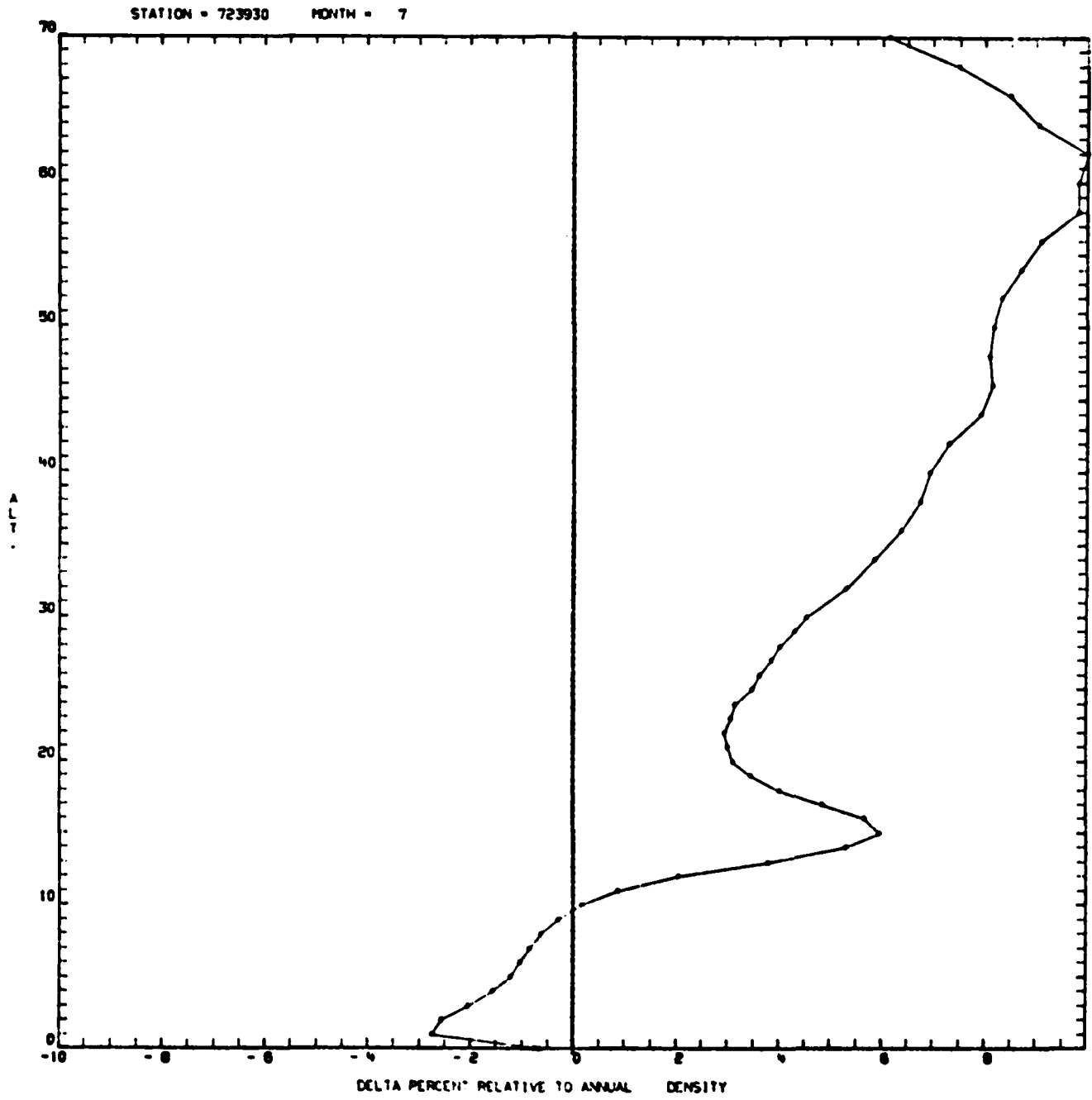

Fig. B-6

STATION - 723933 MONTH - 7

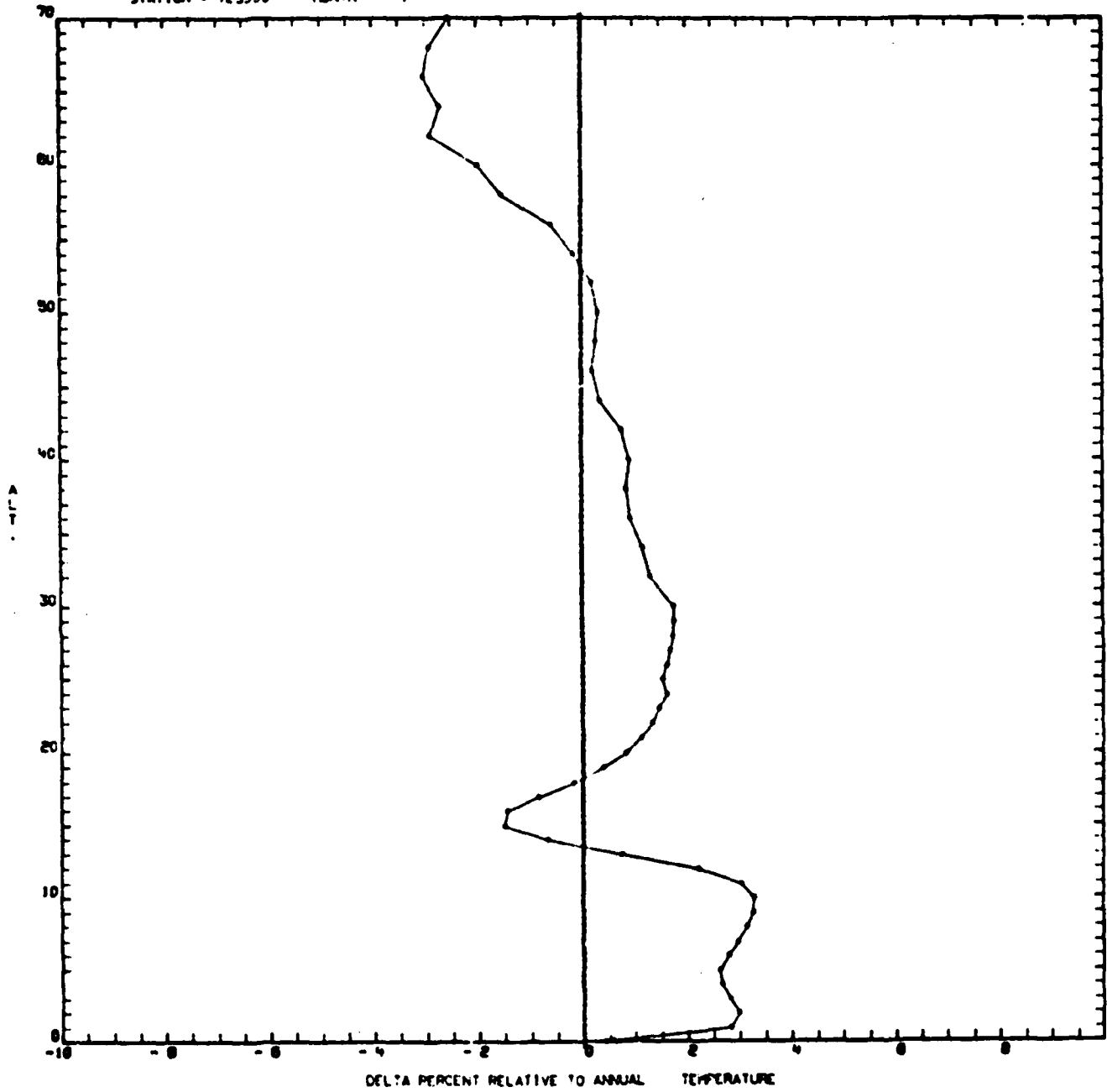

Fig. B-7

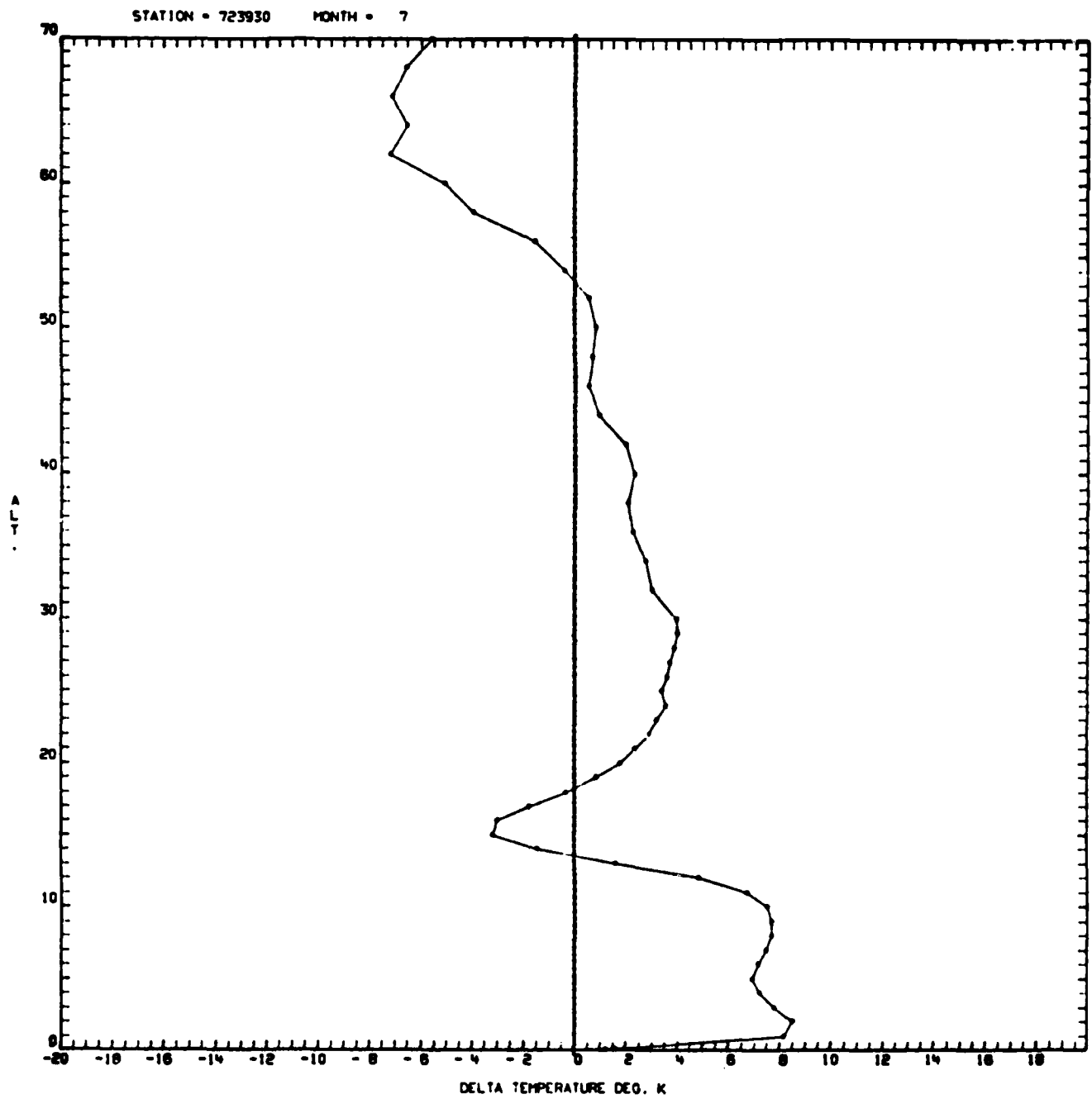

Fig. B-8

STATION - 723930 ALL MONTHS

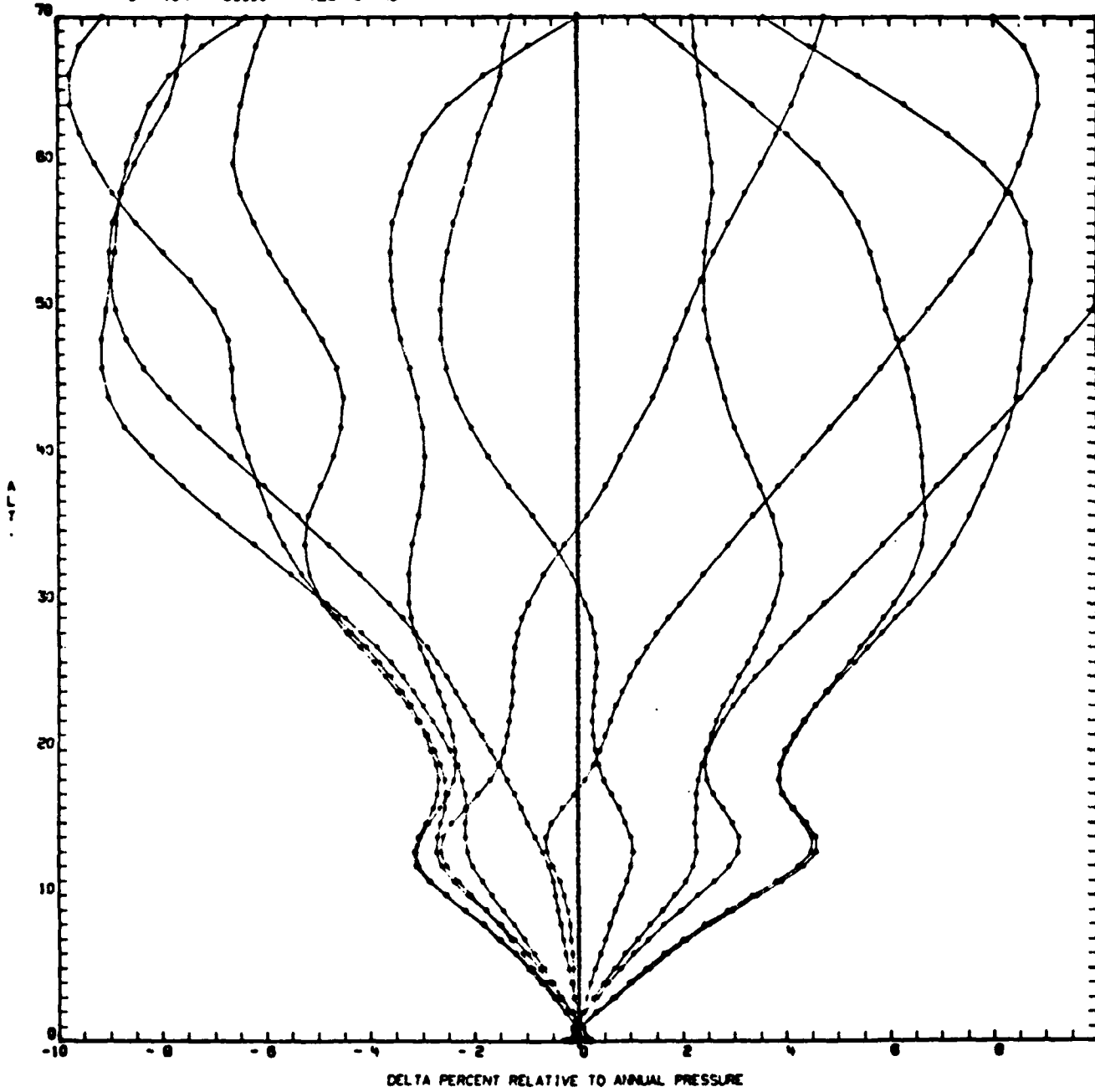

Fig. B-9

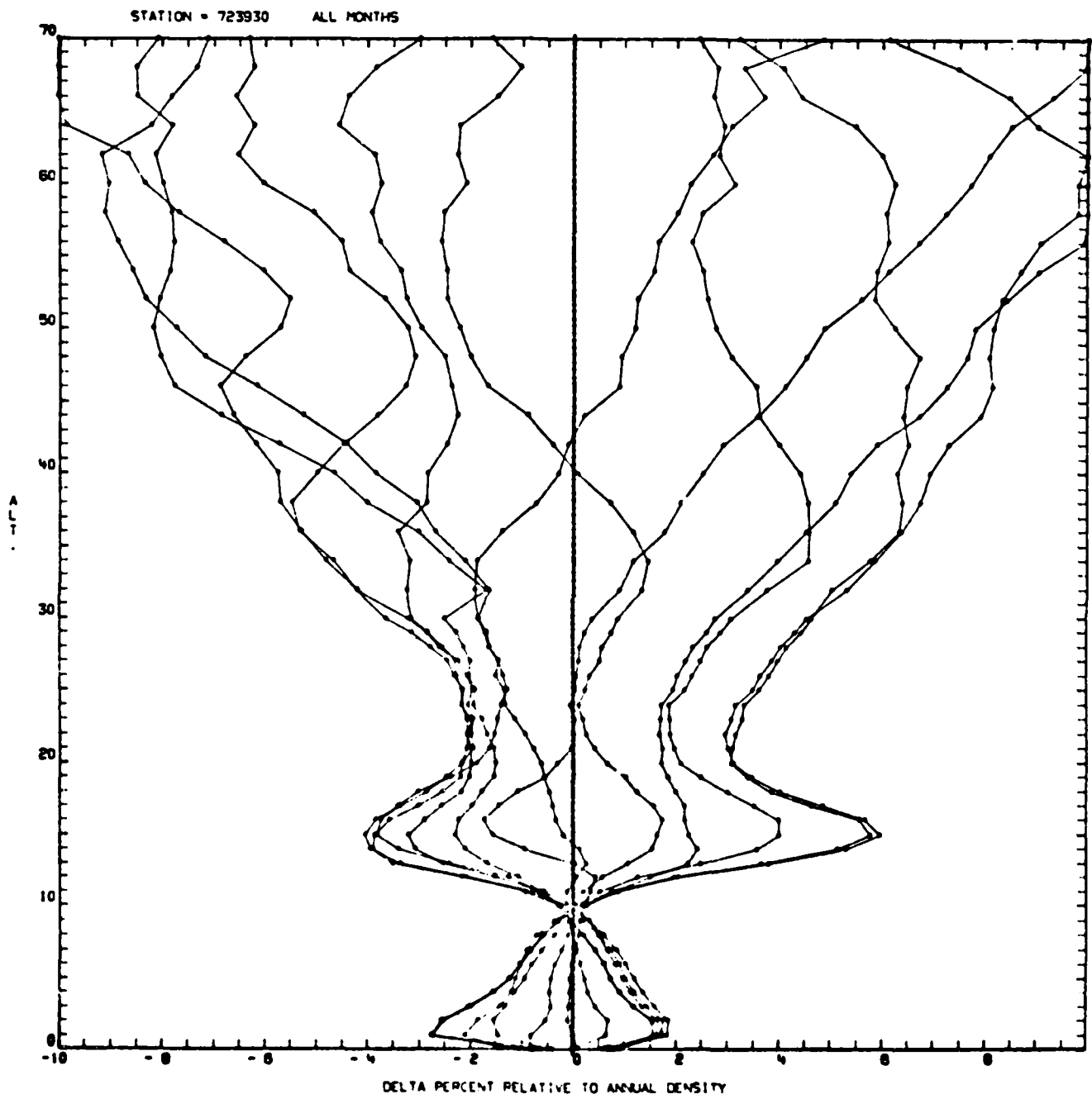

Fig. B-10

STATION - 729930 ALL MONTHS

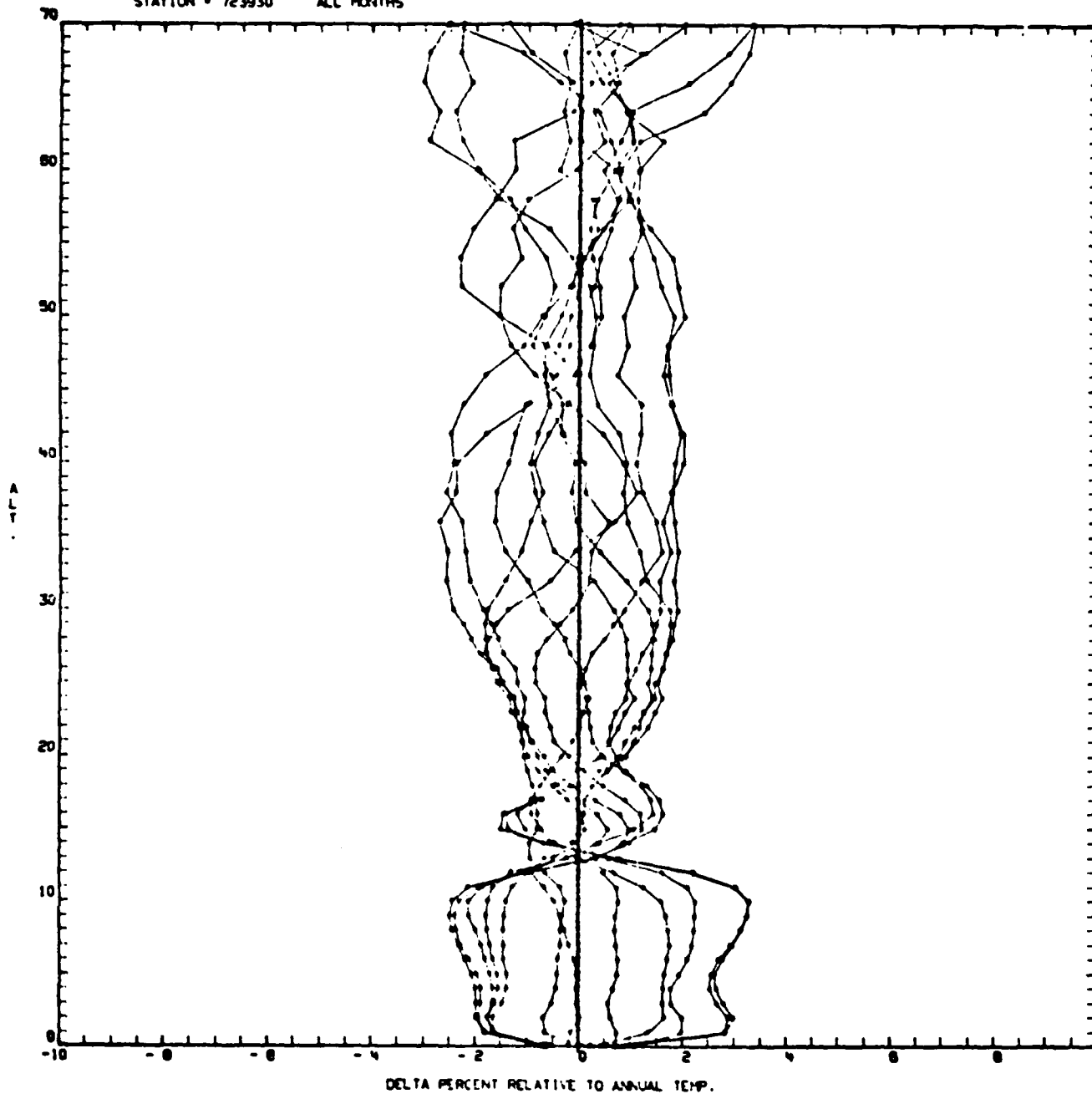

Fig. B-11

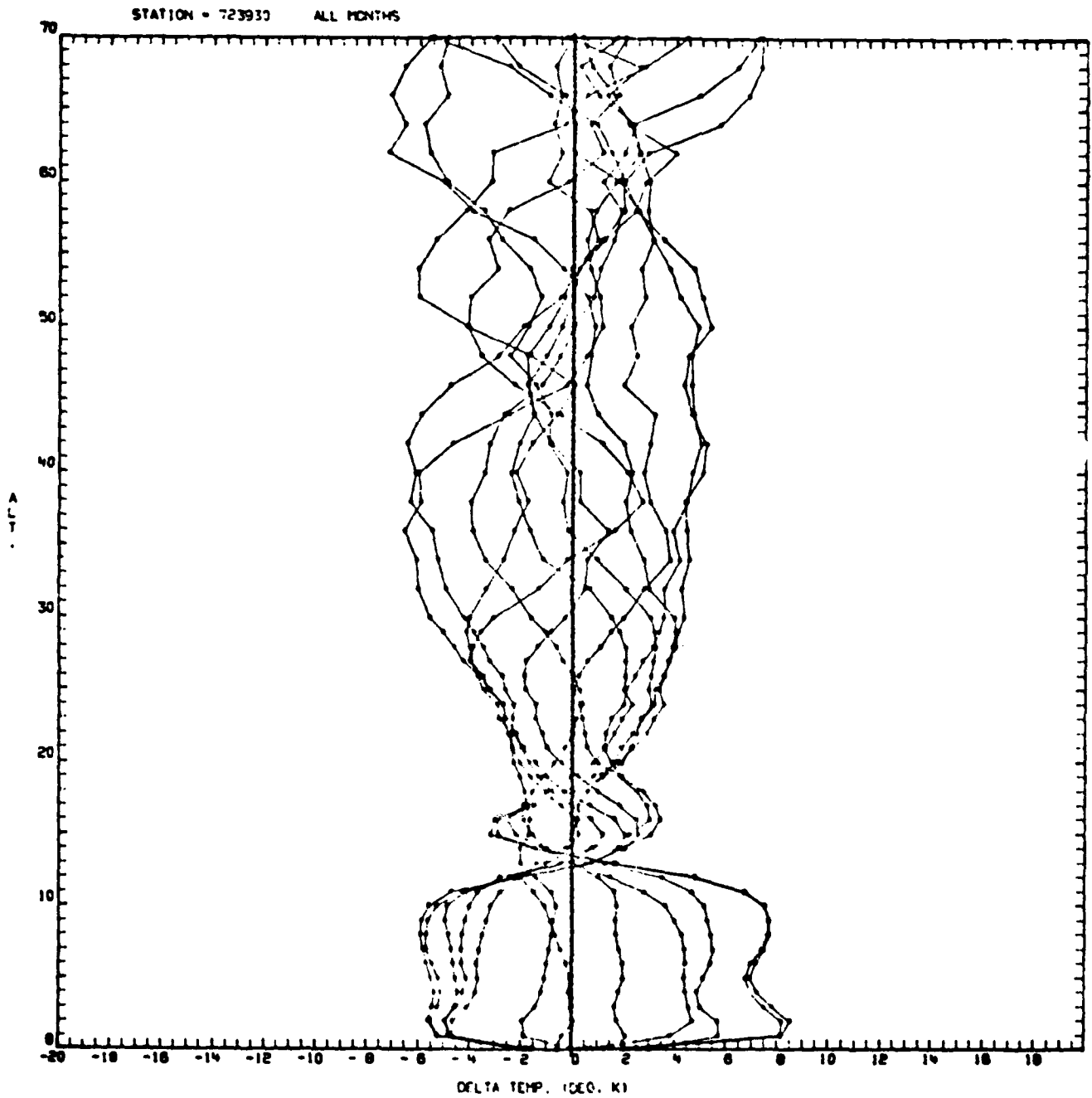

Fig. B-12

Table B-4

STATION 723930	MONTH 1									
LEVEL	CVP	CVD	CVT	R(P,T)	R(P,D)	R(T,D)	DCVP	DCVD	DCVT	
.000	.0045	.0182	.0169	-.1772	.4107	-.9701	-.0306	-.0032	-.0058	
.100	.0045	.0175	.0164	-.1089	.3575	-.9673	-.0294	-.0034	-.0055	
1.000	.0051	.0164	.0163	-.4890	-.2338	-.9624	-.0296	-.0070	-.0032	
2.000	.0065	.0145	.0188	.7517	-.5222	-.9550	-.0267	-.0108	-.0023	
3.000	.0084	.0123	.0182	.8241	-.5414	-.9224	-.0221	-.0143	-.0024	
4.000	.0104	.0102	.0179	.8745	-.5203	-.9692	-.0177	-.0181	-.0026	
5.000	.0125	.0095	.0184	.8802	-.3920	-.7817	-.0154	-.0214	-.0036	
6.000	.0147	.0090	.0188	.8643	-.2074	-.6401	-.0130	-.0245	-.0049	
7.000	.0168	.0092	.0190	.8766	.0082	-.4740	-.0114	-.0266	-.0069	
8.000	.0192	.0100	.0190	.8528	.2753	-.2444	-.0098	-.0282	-.0102	
9.000	.0214	.0128	.0182	.8047	.5286	-.0784	-.0096	-.0209	-.0159	
10.000	.0232	.0187	.0168	.6052	.6988	-.1466	-.0123	-.0213	-.0251	
11.000	.0242	.0287	.0185	.1138	.7681	-.5487	-.0231	-.0140	-.0344	
12.000	.0238	.0390	.0253	-.2527	.7790	-.8088	-.0406	-.0101	-.0375	
13.000	.0274	.0402	.0255	-.4056	.8150	-.8602	-.0432	-.0077	-.0371	
14.000	.0288	.0354	.0202	-.4911	.8575	-.8994	-.0349	-.0056	-.0360	
15.000	.0190	.0338	.0188	-.6011	.8961	-.8933	-.0335	-.0040	-.0340	
15.000	.0172	.0333	.0199	-.6196	.8939	-.9147	-.0360	-.0037	-.0306	
17.000	.0153	.0316	.0202	-.5812	.8539	-.9198	-.0368	-.0039	-.0267	
18.000	.0134	.0283	.0195	-.4582	.7894	-.9074	-.0344	-.0046	-.0221	
19.000	.0124	.0274	.0176	-.1952	.6767	-.8542	-.0286	-.0066	-.0182	
20.000	.0122	.0158	.0167	.0842	.5436	-.7881	-.0242	-.0071	-.0153	
21.000	.0109	.0172	.0165	.3315	.4399	-.7101	-.0208	-.0121	-.0136	
22.000	.0140	.0151	.0155	.5192	.3602	-.6102	-.0175	-.0154	-.0126	
23.000	.0154	.0140	.0165	.6183	.3746	-.4974	-.0151	-.0179	-.0129	
24.000	.0167	.0137	.0103	.6584	.4367	-.3696	-.0133	-.0194	-.0140	
25.000	.0197	.0133	.0162	.6565	.5381	-.2223	-.0113	-.0212	-.0163	
26.000	.0224	.0151	.0161	.6793	.6214	-.1533	-.0109	-.0214	-.0193	
27.000	.0210	.0163	.0162	.6732	.6795	-.0851	-.0105	-.0219	-.0211	
28.000	.0235	.0184	.0161	.6240	.7302	-.0783	-.0110	-.0212	-.0258	
29.000	.0245	.0201	.0170	.5849	.7233	-.1209	-.0125	-.0214	-.0277	
30.000	.0255	.0232	.0177	.4724	.7408	-.2421	-.0154	-.0200	-.0311	
32.000	.0227	.0320	.0246	.0907	.6415	-.7058	-.0338	-.0154	-.0301	
34.000	.0240	.0350	.0288	.1327	.5767	-.7342	-.0398	-.0173	-.0301	
36.000	.0250	.0375	.0354	.2010	.4777	-.7646	-.0490	-.0219	-.0331	
38.000	.0292	.0395	.0407	.4313	.3017	-.7300	-.0500	-.0313	-.0270	
40.000	.0346	.0348	.0403	.5762	.3270	-.5840	-.0405	-.0401	-.0292	
42.000	.0408	.0379	.0402	.5625	.4796	-.4558	-.0373	-.0431	-.0345	
44.000	.0455	.0420	.0362	.4917	.6609	-.3205	-.0327	-.0398	-.0514	
46.000	.0497	.0457	.0345	.4512	.7379	-.2432	-.0296	-.0375	-.0519	
48.000	.0532	.0447	.0279	.5430	.8519	.0228	-.0194	-.0364	-.0761	
50.000	.0569	.0491	.0244	.5117	.9047	.0969	-.0166	-.0321	-.0817	
52.000	.0603	.0555	.0241	.3996	.9164	-.0116	-.0194	-.0289	-.0917	
54.000	.0614	.0586	.0217	.3054	.9354	-.0500	-.0189	-.0246	-.0982	
56.000	.0611	.0598	.0254	.2573	.9120	-.1617	-.0241	-.0267	-.0955	
58.000	.0613	.0586	.0256	.3124	.9098	-.1100	-.0229	-.0283	-.0943	
60.000	.0607	.0595	.0369	.4623	.8349	-.1023	-.0297	-.0442	-.0893	
62.000	.0532	.0515	.0427	.5290	.7105	-.2213	-.0350	-.0504	-.0680	
64.000	.0638	.0537	.0458	.5525	.7078	-.1858	-.0351	-.0560	-.0716	
66.000	.0602	.0484	.0590	.7189	.5332	-.2047	-.0392	-.0787	-.0577	
68.000	.0875	.0519	.0638	.7058	.6847	-.0317	-.0387	-.0894	-.0856	
70.000	.0652	.0617	.0415	.4176	.7916	-.2247	-.0370	-.0460	-.0864	

Table B-5

STATION LEVEL	723930 CVT	MONTH 7 CVD	CVT	RIP.T1	RIP.O1	R(T.O1)	OCVP	OCVO	OC'Y
.000	.0018	.0112	.0114	.1455	.0119	-.9974	-.0208	-.0019	-.0017
.100	.0013	.0106	.0108	.2151	-.0472	-.9857	-.0196	-.0021	-.0016
1.000	.0022	.0133	.0138	.2759	-.1195	-.9871	-.0249	-.0027	-.0018
2.000	.0027	.0092	.0104	.5531	-.3276	-.9683	-.0168	-.0040	-.0015
3.000	.0035	.0068	.0094	.6155	-.2476	-.9139	-.0116	-.0051	-.0019
4.000	.0042	.0104	.0075	.5770	.0322	-.8252	-.0097	-.0054	-.0031
5.000	.0047	.0066	.0077	.5324	.0095	-.7954	-.0095	-.0059	-.0036
6.000	.0053	.0064	.0024	.5477	-.0240	-.7772	-.0095	-.0072	-.0033
7.000	.0061	.0061	.0091	.7494	-.1187	-.7464	-.0091	-.0092	-.0031
8.000	.0071	.0061	.0100	.7929	-.1277	-.7080	-.0090	-.0109	-.0033
9.000	.0082	.0064	.0128	.8100	-.0920	-.6590	-.0090	-.0126	-.0037
10.000	.0095	.0068	.0114	.8058	.0503	-.5559	-.0086	-.0142	-.0049
11.000	.0109	.0077	.0113	.7591	.3015	-.3932	-.0081	-.0144	-.0073
12.000	.0117	.0107	.0105	.5352	.5657	-.3938	-.0095	-.0114	-.0119
13.000	.0122	.0155	.0105	.0723	.7385	-.6191	-.0138	-.0072	-.0172
14.000	.0119	.0195	.0124	-.2932	.7931	-.8088	-.0199	-.0048	-.0190
15.000	.0113	.0213	.0142	-.3843	.7864	-.8725	-.0242	-.0042	-.0183
16.000	.0106	.0209	.0145	-.3760	.7668	-.8830	-.0248	-.0042	-.0170
17.000	.0096	.0179	.0128	-.2634	.7226	-.8572	-.0212	-.0045	-.0146
18.000	.0093	.0148	.0108	-.0762	.6957	-.7781	-.0162	-.0053	-.0133
19.000	.0092	.0120	.0084	.0705	.7157	-.6462	-.0112	-.0056	-.0128
20.000	.0095	.0110	.0077	.1968	.7271	-.5300	-.0092	-.0062	-.0128
21.000	.0098	.0102	.0073	.3224	.7342	-.4060	-.0077	-.0069	-.0127
22.000	.0102	.0095	.0068	.4335	.7645	-.2494	-.0061	-.0075	-.0130
23.000	.0107	.0094	.0058	.4950	.7815	-.1552	-.0055	-.0081	-.0134
24.000	.0113	.0093	.0069	.5712	.7923	-.0482	-.0049	-.0089	-.0137
25.000	.0119	.0093	.0070	.6220	.8095	-.0438	-.0044	-.0095	-.0142
26.000	.0126	.0098	.0074	.6278	.8123	.0559	-.0046	-.0102	-.0151
27.000	.0132	.0103	.0079	.6299	.8035	.0437	-.0049	-.0108	-.0156
28.000	.0143	.0107	.0091	.6699	.8084	.1378	-.0045	-.0117	-.0170
29.000	.0152	.0118	.0088	.6351	.8155	.0708	-.0054	-.0122	-.0181
30.000	.0160	.0122	.0086	.6541	.8461	.1502	-.0049	-.0124	-.0196
32.000	.0162	.0163	.0145	.4369	.6021	-.4551	-.0147	-.0143	-.0180
34.000	.0176	.0154	.0138	.5430	.6576	-.2755	-.0116	-.0160	-.0192
36.000	.0190	.0165	.0140	.5331	.6979	-.2338	-.0115	-.0165	-.0215
39.000	.0208	.0192	.0157	.4747	.6063	-.3011	-.0141	-.0173	-.0244
40.000	.0226	.0191	.0154	.5522	.7378	-.1576	-.0120	-.0189	-.0263
42.000	.0244	.0212	.0135	.5817	.9330	-.0607	-.0103	-.0168	-.0320
44.000	.0251	.0230	.0169	.4753	.7709	-.1715	-.0138	-.0199	-.0322
46.000	.0282	.0242	.0024	.5422	.7065	-.2116	-.0164	-.0243	-.0320
48.000	.0308	.0249	.0185	.5993	.7990	-.0149	-.0126	-.0244	-.0371
50.000	.0322	.0263	.0158	.5843	.8742	.1167	-.0099	-.0217	-.0428
52.000	.0345	.0281	.0160	.5954	.8888	.1609	-.0096	-.0224	-.0465
54.000	.0372	.0271	.0205	.7032	.8431	.2092	-.0104	-.0306	-.0439
56.000	.0420	.0282	.0228	.7795	.8621	.3547	-.0089	-.0366	-.0474
58.000	.0474	.0337	.0287	.7111	.8002	.1474	-.0150	-.0425	-.0524
60.000	.0493	.0372	.0269	.6570	.6263	-.1631	-.0269	-.0510	-.0475
62.000	.0560	.0449	.0414	.6109	.6833	-.1637	-.0304	-.0525	-.0474
64.000	.0566	.0470	.0430	.5856	.6665	-.2140	-.0336	-.0529	-.0474
66.000	.0574	.0572	.0415	.3647	.7374	-.3599	-.0414	-.0416	-.0474
68.000	.0572	.0614	.0501	.3533	.6453	-.4896	-.0543	-.0458	-.0685
70.000	.0633	.0559	.0474	.5221	.6899	-.2571	-.0400	-.0549	-.0718

STATION = 723930 MONTH = 1

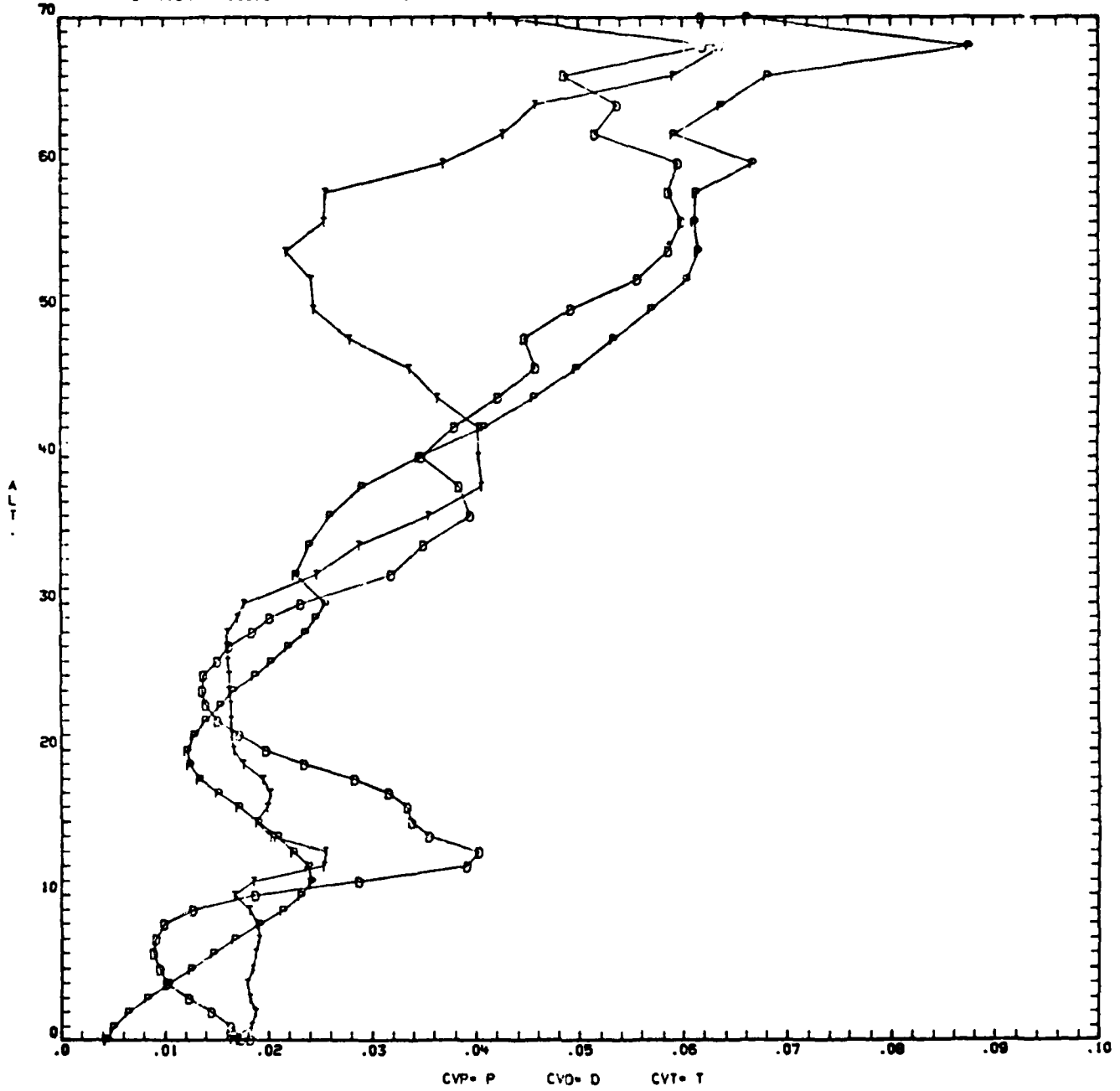

Fig. B-13

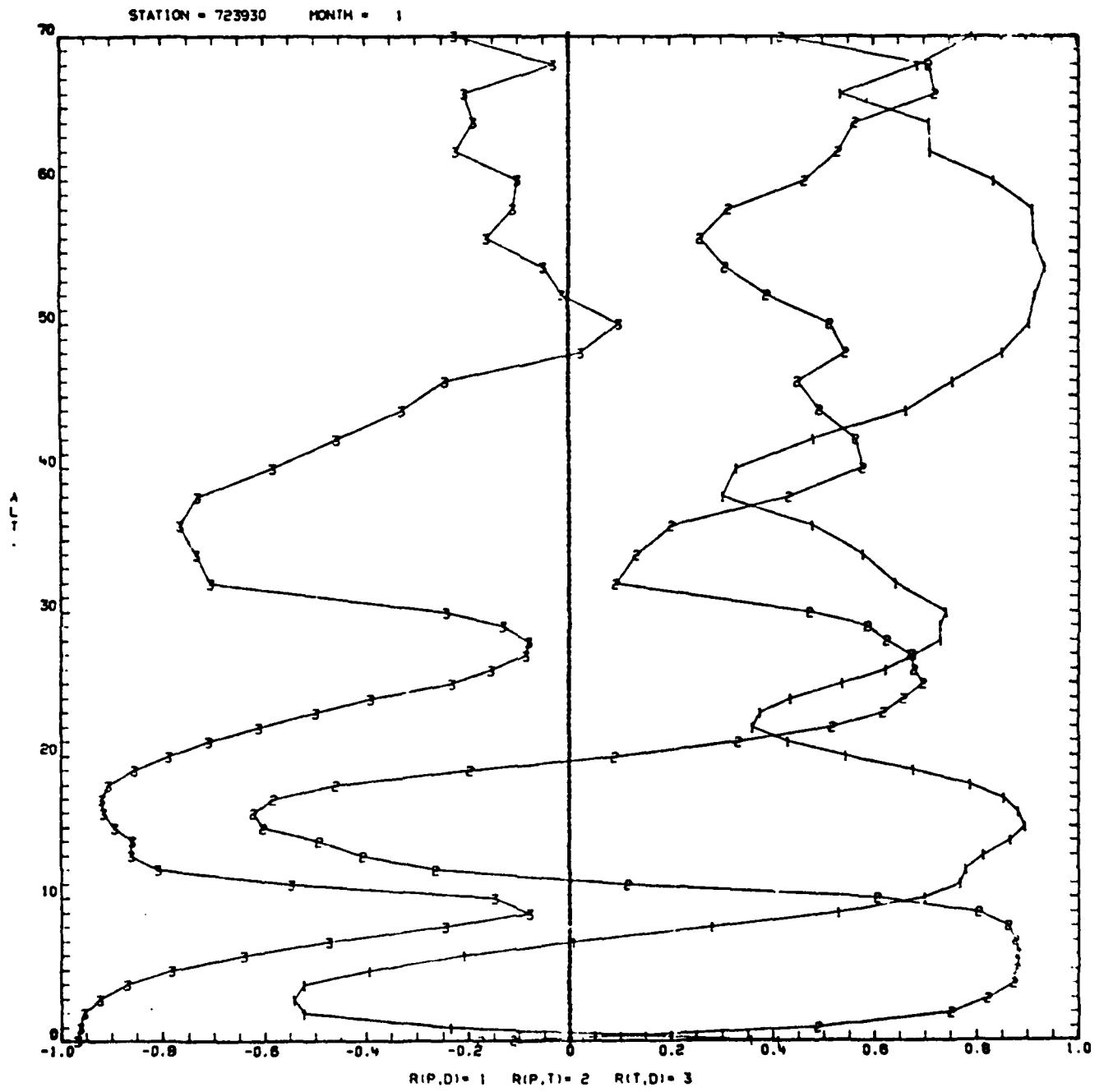

Fig. B-14

STATION = 723930 MONTH = 7

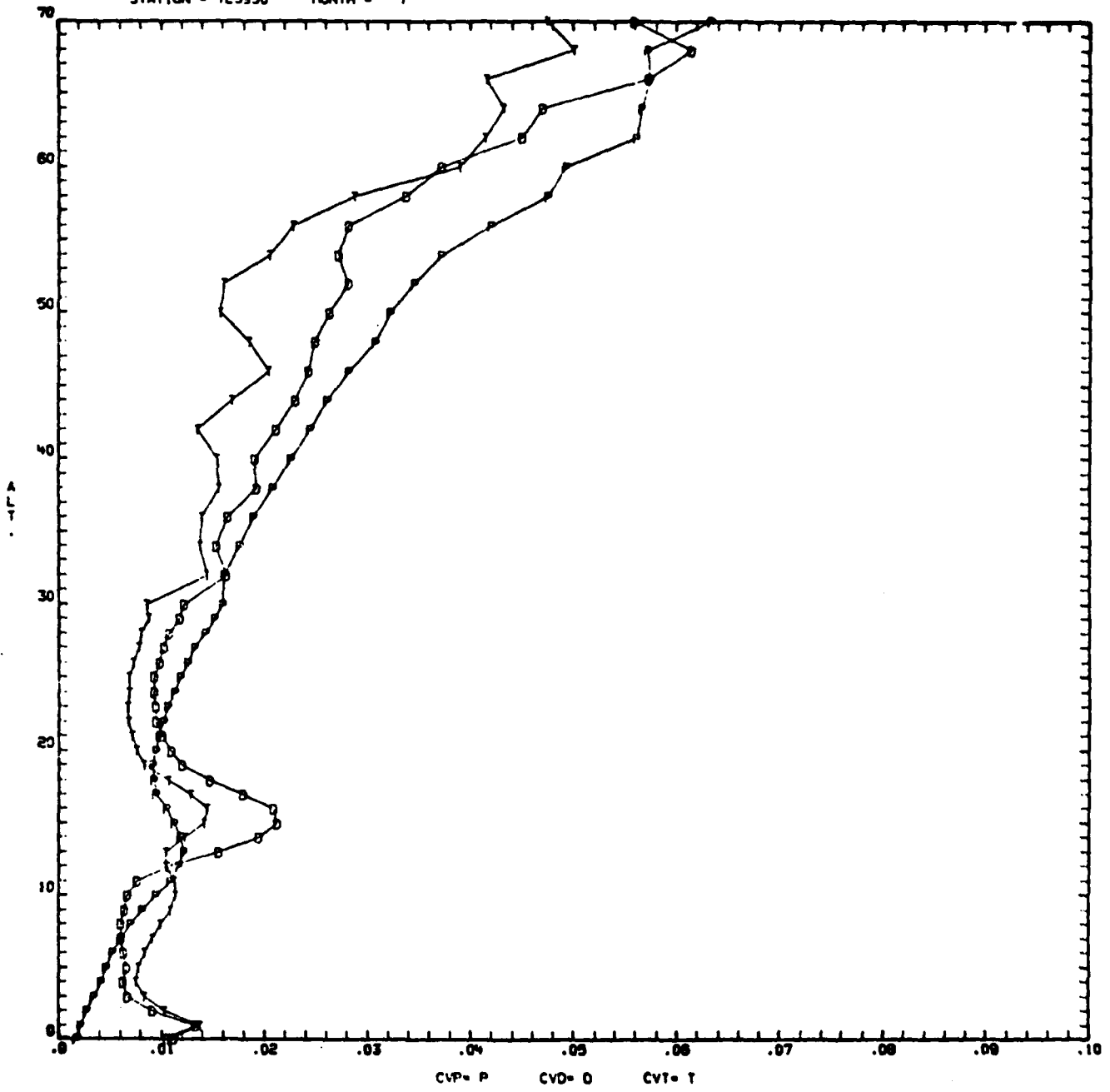

Fig. B-15

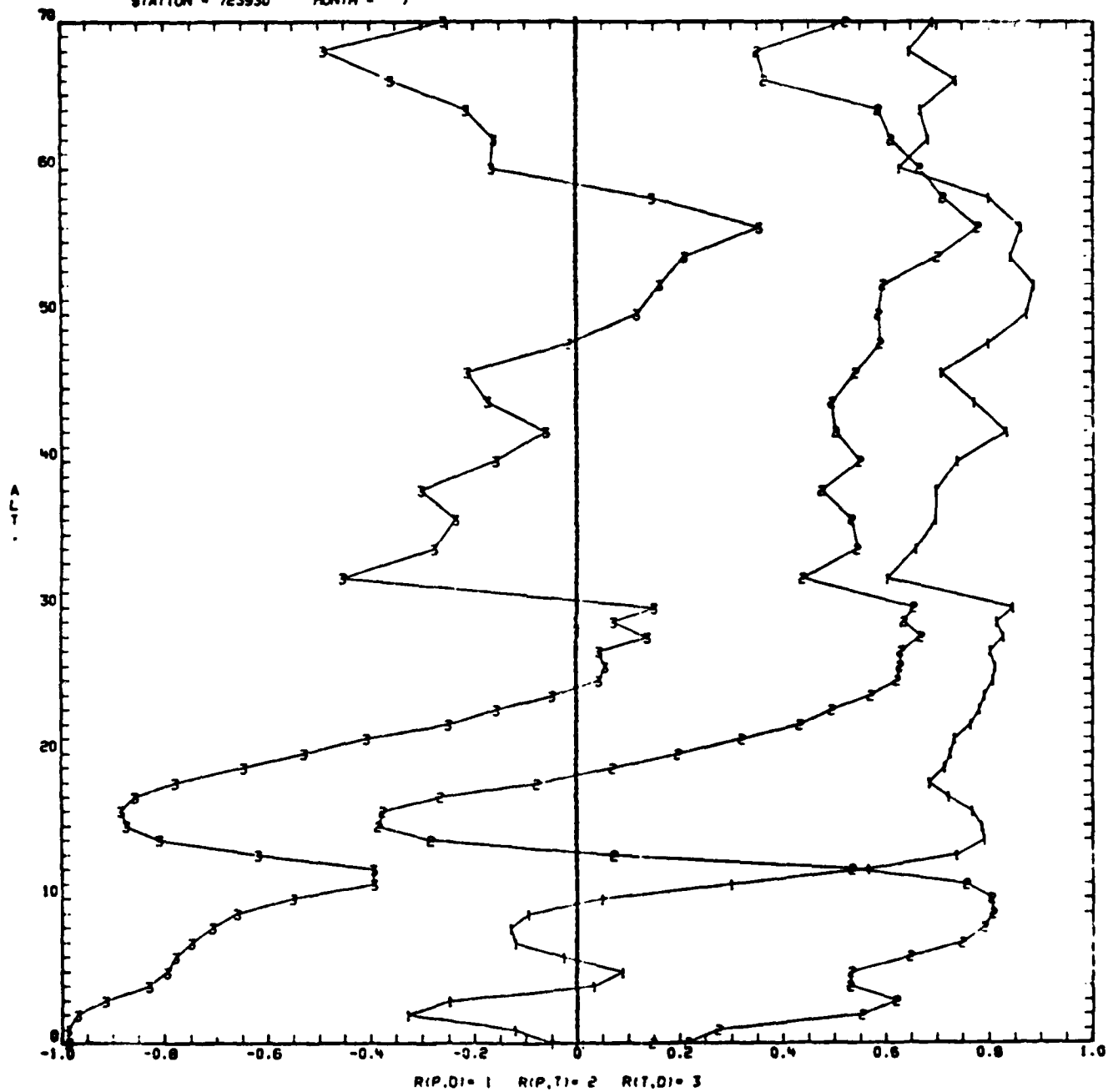

Fig. B-16

STATION - 723930 ALL MONTHS

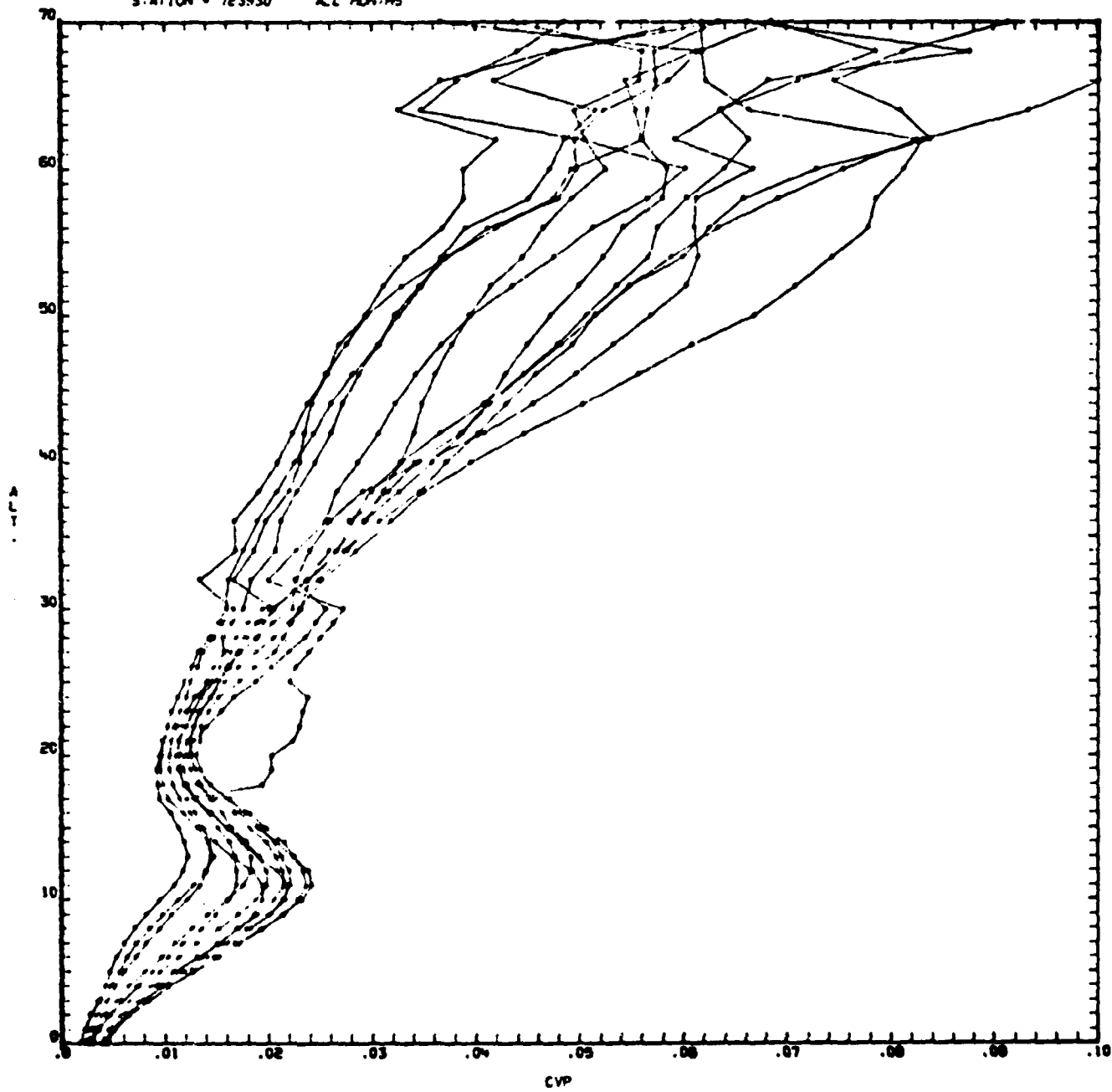
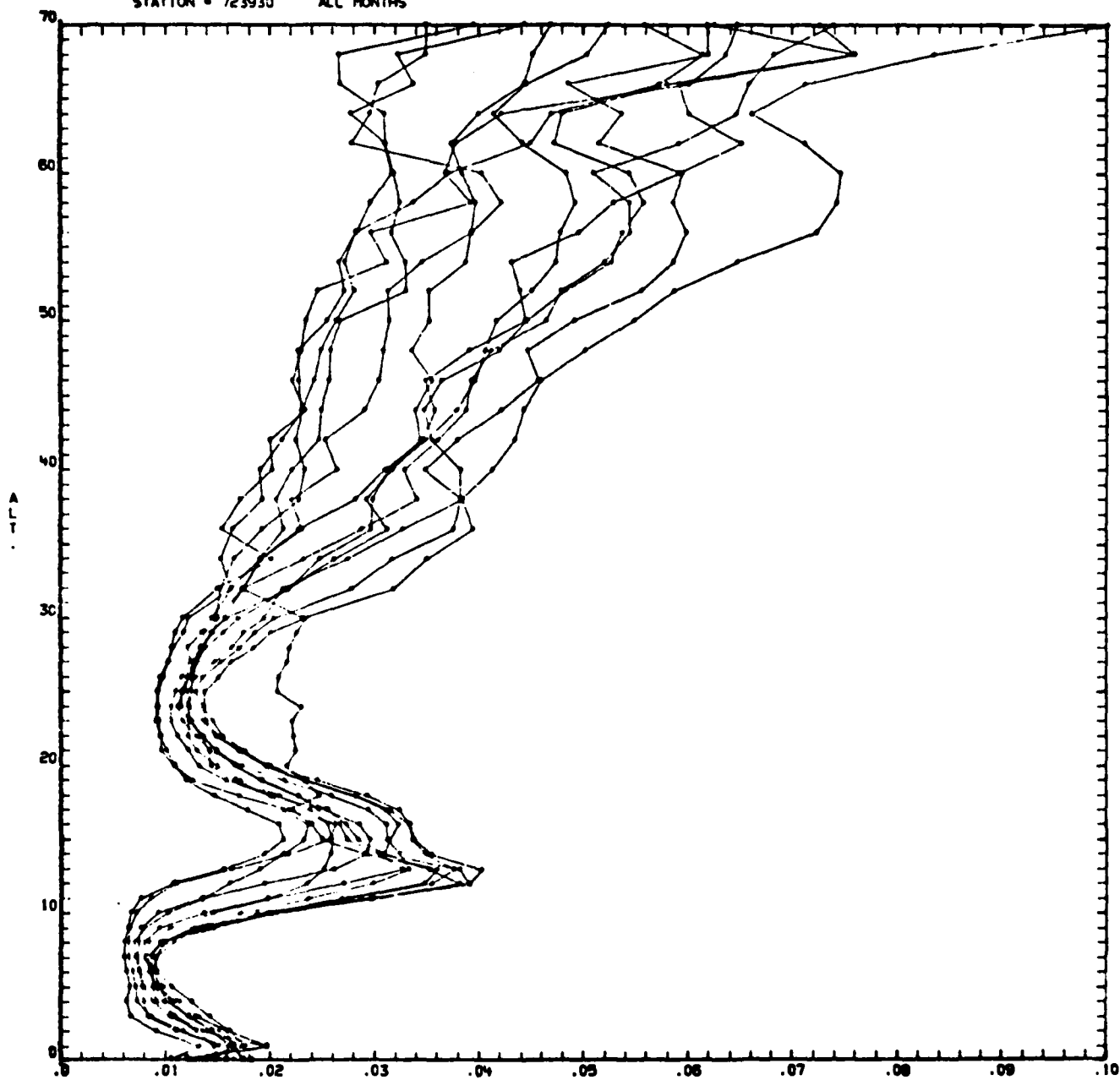

Fig. B-17

STATION = 723930 ALL MONTHS



ig. B-18

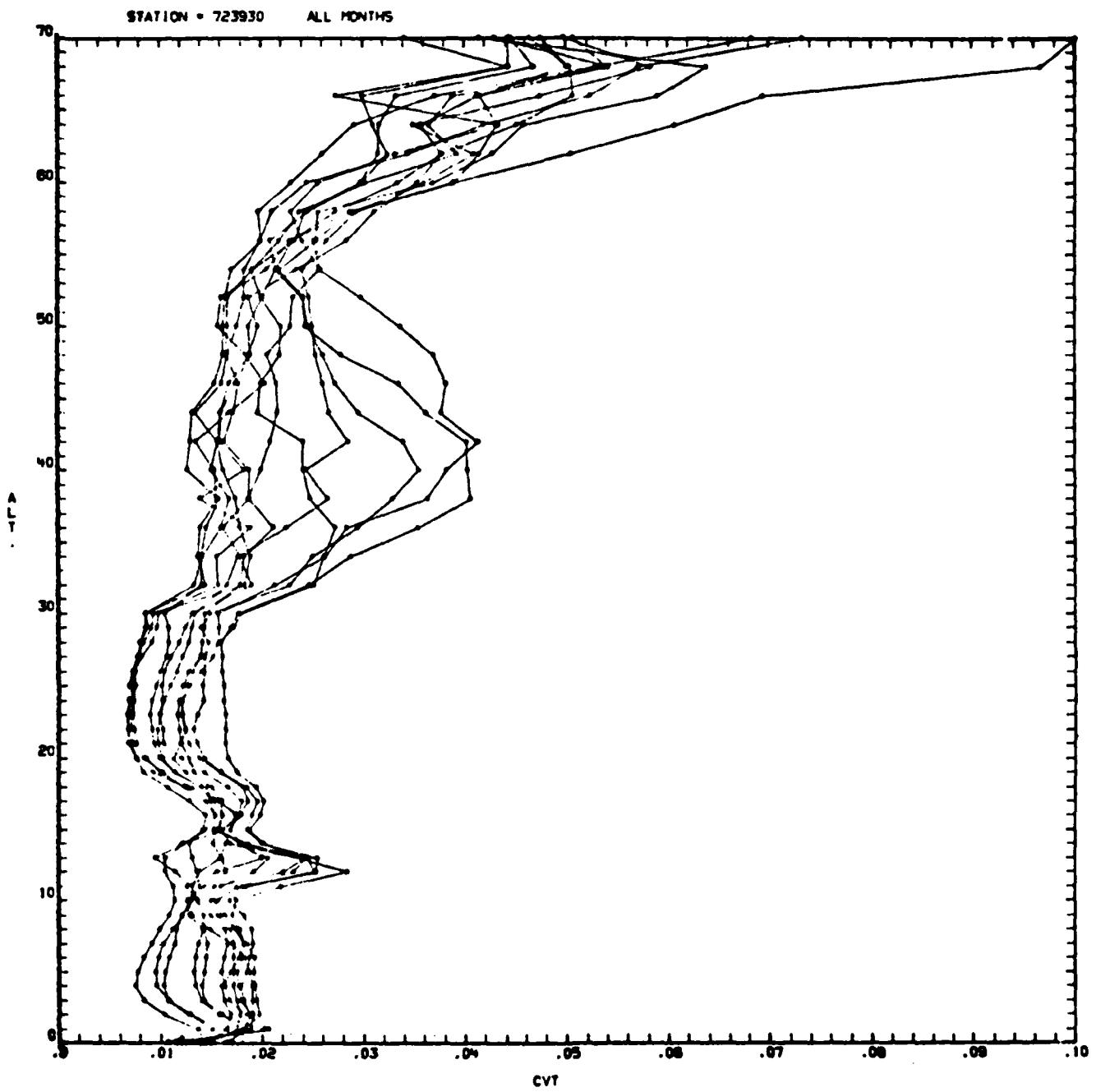

Fig. B-19

STATION = 723930 ALL MONTHS

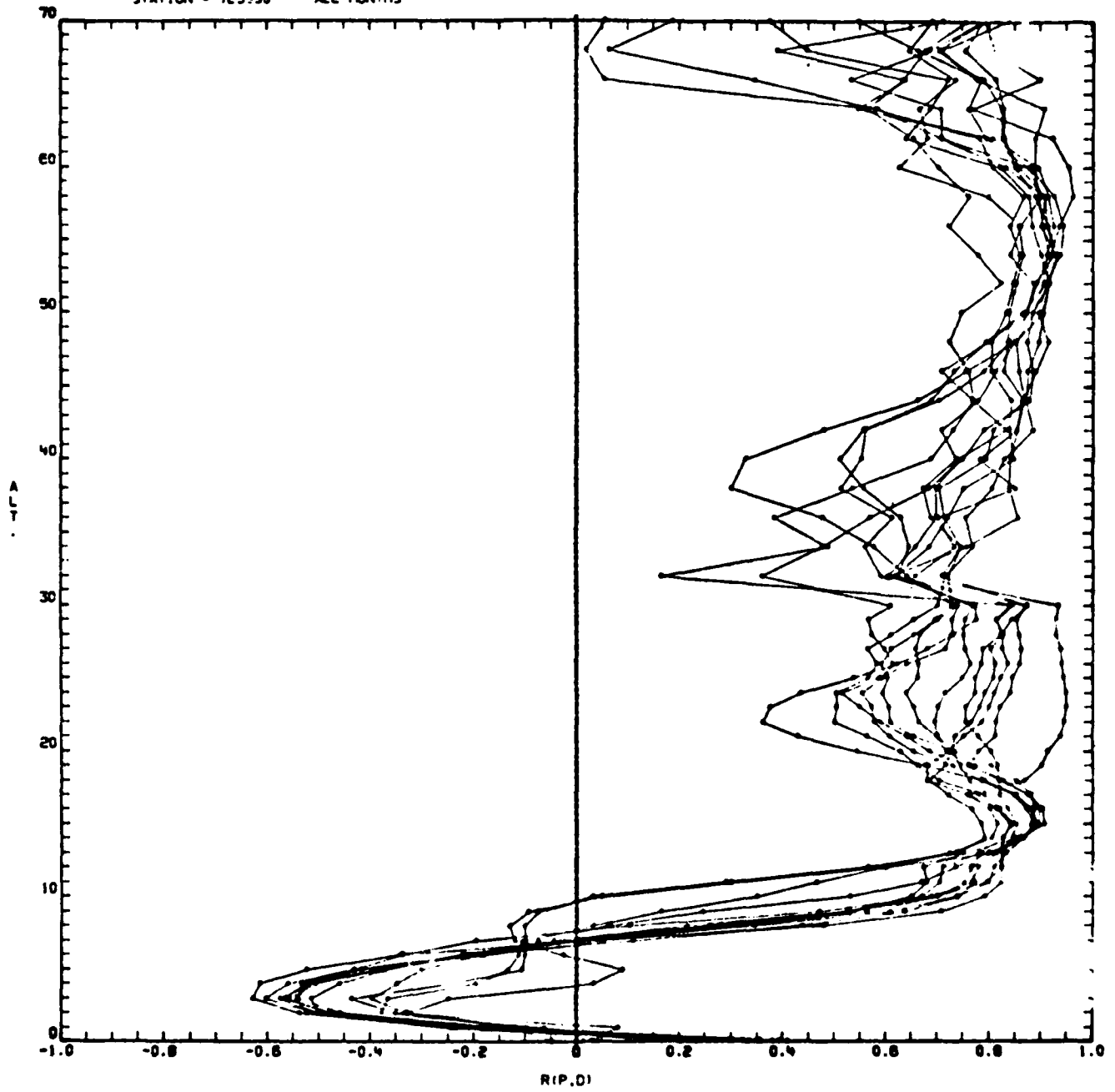

Fig. B-20

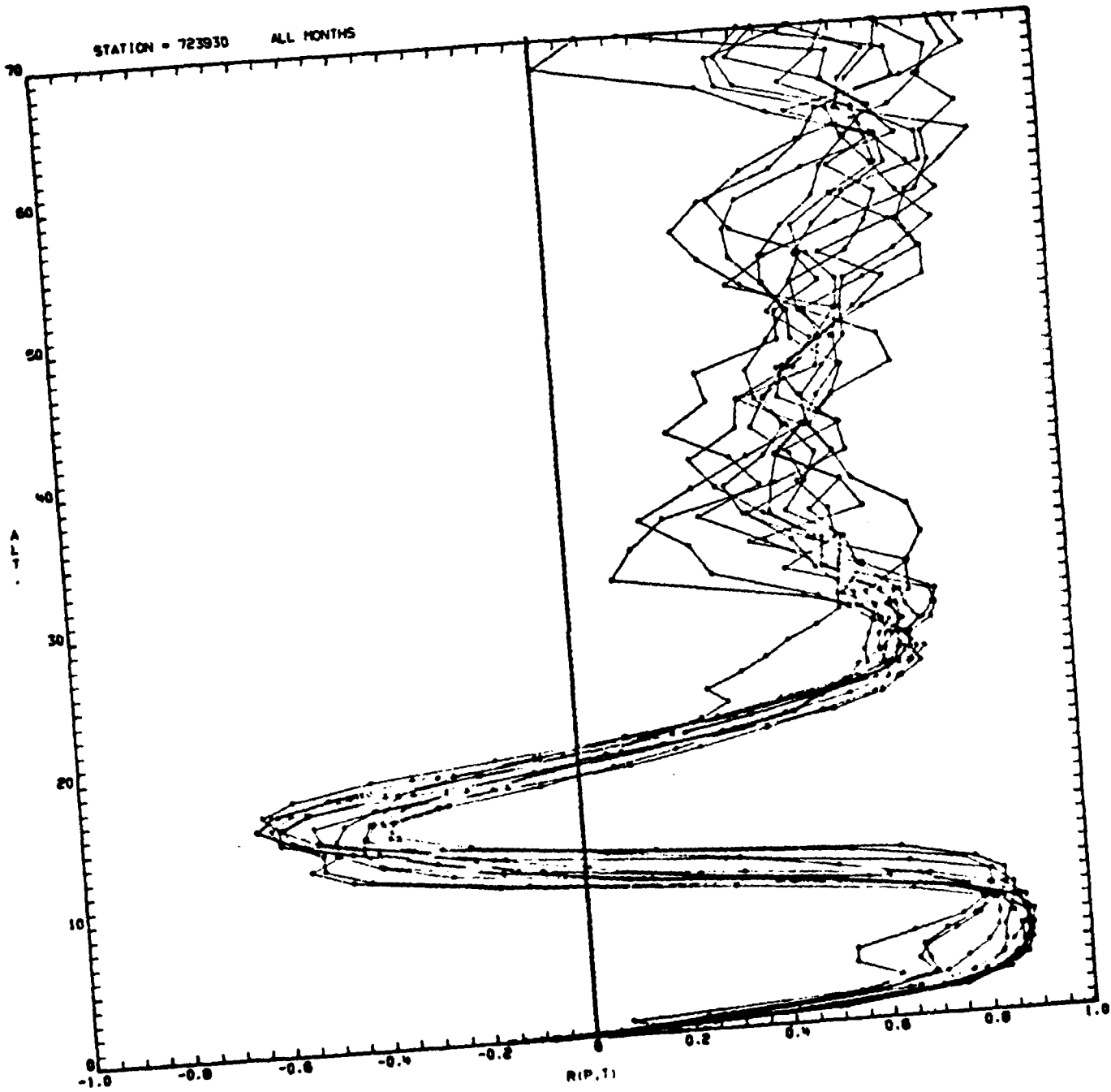

Fig. B-21

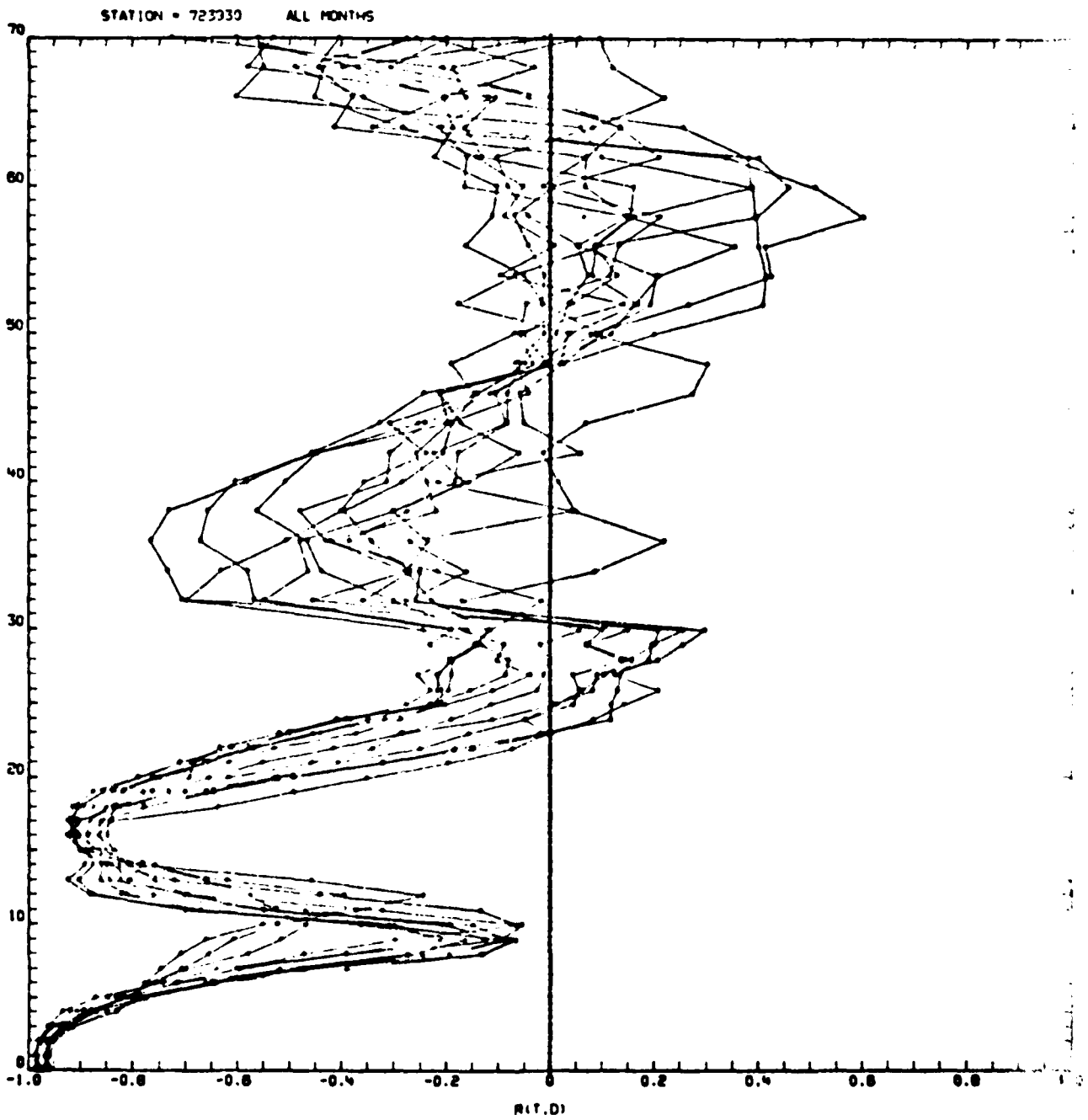

Fig. B-22

LMED
-8