

AD-A125 615

A PROTOTYPE DECISION SUPPORT SYSTEM FOR THE SELECTION
OF AMMUNITION TRANS. (U) GEORGIA INST OF TECH ATLANTA
SCHOOL OF INDUSTRIAL AND SYSTEMS. L G CALLAHAN ET AL.
NOV 82 DRSHI/RD-CR-83-2 DAAH01-81-D-A003 F/G 15/2

1/2

UNCLASSIFIED

NL

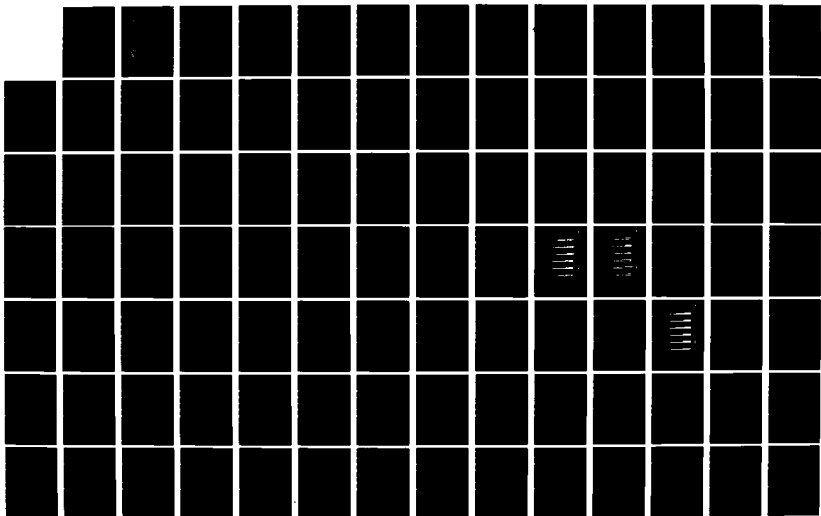

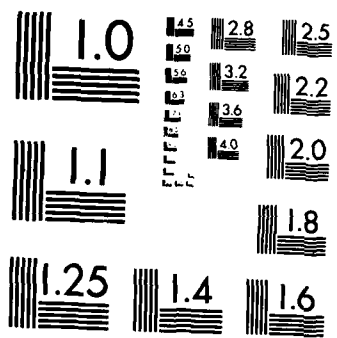

MICROCOPY RESOLUTION TEST CHART
NATIONAL BUREAU OF STANDARDS 1963-A

AD A1 2:00 15



TECHNICAL REPORT RD-CR-83-2

A PROTOTYPE DECISION SUPPORT SYSTEM FOR THE SELECTION OF AMMUNITION TRANSFER POINTS BASED ON FIELD ARTILLERY ROLE ASSIGNMENTS - FINAL SUMMARY REPORT

Prepared by:

Leslie G. Callahan, Jr. and Patrick F. Link
Georgia Institute of Technology
Atlanta, Georgia

Prepared for:

System Simulation & Development Directorate
US Army Missile Laboratory
Redstone Arsenal, Alabama

October 1982



U.S. ARMY MISSILE COMMAND

Redstone Arsenal, Alabama 35809

Approved for public release; distribution unlimited.

DTIC FILE COPY

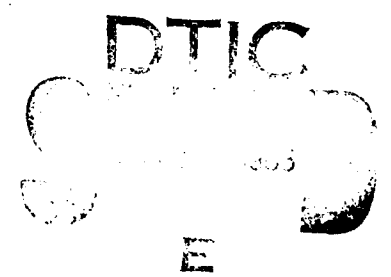

DISPOSITION INSTRUCTIONS

**DESTROY THIS REPORT WHEN IT IS NO LONGER NEEDED. DO NOT
RETURN IT TO THE ORIGINATOR.**

DISCLAIMER

**THE FINDINGS IN THIS REPORT ARE NOT TO BE CONSTRUED AS AN
OFFICIAL DEPARTMENT OF THE ARMY POSITION UNLESS SO DESIG-
NATED BY OTHER AUTHORIZED DOCUMENTS.**

TRADE NAMES

**USE OF TRADE NAMES OR MANUFACTURERS IN THIS REPORT DOES
NOT CONSTITUTE AN OFFICIAL INDORSEMENT OR APPROVAL OF
THE USE OF SUCH COMMERCIAL HARDWARE OR SOFTWARE.**

UNCLASSIFIED

SECURITY CLASSIFICATION OF THIS PAGE (When Data Entered)

REPORT DOCUMENTATION PAGE		READ INSTRUCTIONS BEFORE COMPLETING FORM
1. REPORT NUMBER CR-RD-83-2	2. GOVT ACCESSION NO. DAHS 615	3. RECIPIENT'S CATALOG NUMBER
4. TITLE (and Subtitle) A Prototype Decision Support System for the Selection of Ammunition Transfer Points Based on Field Artillery Role Assignments		5. TYPE OF REPORT & PERIOD COVERED Final Summary Report
		6. PERFORMING ORG. REPORT NUMBER 12/9/82 - 9/30/82
7. AUTHOR(s) Leslie G. Callahan Jr. and Patrick F. Link		8. CONTRACT OR GRANT NUMBER(s) DAAH 01-81-D-A003 Deliver Order No. 034
9. PERFORMING ORGANIZATION NAME AND ADDRESS Commander, US Army Missile Command ATTN: DRSMI-RD, Redstone Arsenal, AL 35898		10. PROGRAM ELEMENT, PROJECT, TASK AREA & WORK UNIT NUMBERS
11. CONTROLLING OFFICE NAME AND ADDRESS Commander, US Army Missile Command ATTN: DRSMI-RPT, Redstone Arsenal, AL 35898		12. REPORT DATE Nov. 1982
		13. NUMBER OF PAGES 109
14. MONITORING AGENCY NAME & ADDRESS (if different from Controlling Office)		15. SECURITY CLASS. (of this report) unclassified
		15a. DECLASSIFICATION/DOWNGRADING SCHEDULE
16. DISTRIBUTION STATEMENT (of this Report) Approved for public release , distribution unlimited.		
17. DISTRIBUTION STATEMENT (of the abstract entered in Block 20, if different from Report)		
18. SUPPLEMENTARY NOTES		
19. KEY WORDS (Continue on reverse side if necessary and identify by block number) Decision Support System, Optimum Location of Ammunition Transfer Points, Field Artillery		
20. ABSTRACT (Continue on reverse side if necessary and identify by block number) A prototype decision support system has been developed, documented, and test- ed for the interactive analysis of the location of ammunition transfer points (ATP) based upon Field Artillery role assignments. The system is unique in that it provides a procedure for the subjective evaluation of varying Field Artillery roles in the selection of ATPs. Further, the system also incorporates how these roles are influenced by supported unit missions, battlefield posture, and target- ing priorities to determine a weight to be applied to each firing unit operating in the brigade area that is indicative of that unit's CONTINUED		

DD FORM 1473 EDITION OF 1 NOV 65 IS OBSOLETE

FORM
1 JAN 73

SECURITY CLASSIFICATION OF THIS PAGE (When Data Entered)

20. ABSTRACT (continued)

contribution to the overall fire support mission of the division.

This system allows input of the road network in the brigade area of operations. All candidate ATP locations, firing battery positions, and road intersections are entered, followed by the generation of the roads connecting each of the above locations. Scaled distances are automatically determined by the system. The system allows interactive input of the problem parameters, both as initial data and as revision of current parameters. The system determines the "best" location for the ATP through an application of 1-median location theory. Through subsequent analysis of data determined by the system based upon this 1-median, the user is able to determine where the ATP should be placed. The system also conducts a sensitivity of each of the problem parameters and generates a "circle of effectiveness" within which a firing battery may reposition without compromising the ATP location.

This decision support system has been developed for use on the Chromatics CG-1999 color-graphic minicomputer. Computer options employed by the system are the digitizer tablet, light pen, and dual-drive disk operating system. Although this system has been designed strictly for Field Artillery implementation, it could be adapted to other weapons systems that employ the ATP concept. (CONTINUED)

Accession For	
NTIS GRA&I	<input checked="" type="checkbox"/>
DTIC TAB	<input type="checkbox"/>
Unannounced	<input type="checkbox"/>
Justification	
By _____	
Distribution/	
Availability Codes	
Dist	Special

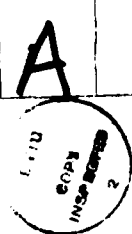

TABLE OF CONTENTS

	Page
CHAPTER	
I. INTRODUCTION	1
Objective of the Research	
Scope of the Research	
Overview	
II. REVIEW OF THE LOCATION THEORY LITERATURE	5
III. APPLICATION OF LOCATION THEORY TO THE ATP PROBLEM	8
Assumptions	
Procedure	
Mathematical Formulation	
IV. THE PROPOSED ATP SELECTION PROCESS	21
V. IMPLEMENTATION AND DOCUMENTATION	28
Instrumentation and Equipment	
Implementation	
Data Storage and Manipulation	
Menu Operation	
VI. RESULTS, CONCLUSIOS AND RECOMMENDATIONS	38
Results	
Conclusions	
Recommendations	
APPENDICES	47
I. Initiation Procedure	
II. Sample Output of Decision Support System	
III. Program <u>ATPI</u>	
IV. Program <u>ATPII</u>	
V. Program <u>Offense</u>	
VI. Program <u>Defense</u>	
VII. Program <u>Delay</u>	
VIII. Program <u>Retrograde</u>	
BIBLIOGRAPHY	107

SUMMARY

A prototype decision support system has been developed, documented, and tested for the interactive analysis of the location of ammunition transfer points (ATP) based upon Field Artillery role assignments. The system is unique in that it provides a procedure for the subjective evaluation of varying Field Artillery roles in the selection of ATPs. Further, the system also incorporates how these roles are influenced by supported unit missions, battlefield posture, and targeting priorities to determine a weight to be applied to each firing unit operating in the brigade area that is indicative of that unit's contribution to the overall fire support mission of the division.

This system allows input of the road network in the brigade area of operations. All candidate ATP locations, firing battery positions, and road intersections are entered, followed by the generation of the roads connecting each of the above locations. Scaled distances are automatically determined by the system.

The system allows interactive input of the problem parameters, both as initial data and as revision of current parameters. The system determines the "best" location for the ATP through an application of 1-median location theory. Through subsequent analysis of data determined by the system based upon this 1-median, the user is able to determine where the ATP should be placed. The system also conducts a sensitivity of each of the problem parameters and generates a "circle of effectiveness" within which a firing battery may reposition without compromising the ATP

location.

This decision support system has been developed for use on the Chromatics CG-1999 color-graphic minicomputer. Computer options employed by the system are the digitizer tablet, light pen, and dual-drive disk operating system.

Although this system has been designed strictly for Field Artillery implementation, it could be adapted to other weapons systems that employ the ATP concept.

CHAPTER I

INTRODUCTION

In combat, maximal ammunition resupply to the artillery firing units is paramount. Since ammunition resources will, in all likelihood, be limited, it becomes crucial that those available assets be expended most effectively.

Current doctrine calls for the establishment of an ammunition transfer point within each Brigade Supply Area (BSA) in the division sector of operations. The mission of the ammunition transfer point (ATP) is to provide rapid resupply of highly consumable ammunition. The ATP must remain highly mobile due to the fluidity of the situation on the modern battlefield.

By making the resupply effort as responsive as possible and providing essential support to the maneuver commander when and where he needs it, the potential for battlefield victory is increased. One method of insuring support and efficiency is by minimizing the resupply travel distance of the firing units that are expected to support the critical area of enemy contact while still providing maximum support to the remaining firing units positioned within the brigade sector. Through appropriate weight distributions in this system, maximum support, consistent with the tactical situation, is insured for all firing batteries.

After consideration of a variety of analytical techniques, 1-median location theory was selected as the most appropriate approach to a solution. Problems of this type involve the establishment of a single facility whose positioning minimizes the sum of the weighted distances that its

customers must travel to reach it. What must be determined is the location of the ATP and the appropriate weights of each firing unit so that the total resupply operation most improves mission effectiveness. The system solution should be one that will maximize the effectiveness of the resupply system and provide "best" location patterns over time.

In practice, the maneuver brigade commander, upon recommendation of appropriate members of his staff, will determine the locations of the brigade supply area. A map reconnaissance is performed for potential locations of the ATP. Under current doctrine, reconnaissance teams are dispatched to each site that has been deemed suitable from the map inspection. These locations are selected with only a subjective consideration of the firing unit positioning and no consideration of the other factors (Field Artillery (FA) roles, missions, posture target values and intelligence reports) pertinent to the situation. The ATP is chosen from the sites generated by the map inspection and the subsequent reconnaissance.

Objective of the Research

The purpose of this research is to develop a procedure for the use of interactive computer color-graphic technologies for the selection of ammunition supply point locations for U.S. Army Field Artillery units, with specific application to supporting roles (i.e., direct support, reinforcing, general support, and general support-reinforcing) of Division and Corps artillery units.

Scope of the Research

The above objective will be accomplished by developing a prototype Decision Support System for the Division Artillery Commander that

will assist him in selecting, within the Brigade Supply Area, those locations that minimize the total distance units travel with each battery appropriately weighted to reflect the Division Artillery Commander's perception of its contribution to the overall mission of the supported brigade. This prototype system will provide the user with an analytical tool to aid him in determining the "best" location for the ATP, based upon numerical consideration of the factors that contribute to each firing battery's potential to affect the combat situation. It allows the decision-maker to utilize state-of-the-art computational methods to enhance his fire support effectiveness. By interactive operations with color-graphic computer logic, the decision-maker can utilize his knowledge and experience to achieve the "best" analytical location to place his ATP.

This system is developed to specifically consider situational factors, then to analytically provide a set of rank-ordered locations for the ATP.

It must be emphasized that this decision support system will be a "personal" tool, valid only for each individual user and the parameters that he establishes.

This system is intended for use following the consumption of the basic load when the controlled supply rate (CSR) governs the resupply situation. Controlled supply rates determine the number of rounds, by type, received per weapon per day under combat conditions. This system has been developed to allow a variable CSR that requires input of the CSR that is in effect at the time the decision support system is being utilized.

This research will only consider the high explosive dual-purpose

improved conventional munitions (DPICM) and the cannon-launched guided projectile (Copperhead) for the 155mm firing systems. For the 8-inch system, the DPICM and the rocket-assisted projectile (RAP) will be considered. The system is designed for a mechanized/armored division with attached artillery assets.

Overview

This introduction is designed to familiarize the reader with the problem, the objective of this research and the scope of the project. Chapter II reviews the location theory that applies to the ATP problem. Chapter III provides a detailed discussion of the ATP problem, the assumptions used in this system, the procedure for establishing the problem parameters, and the specific mathematical formulation of the system. Chapter IV provides a step-by-step discussion for the ATP selection. Chapter V describes in detail the development procedure of the system. Chapter VI contains the conclusions based upon case problems and recommendations for future development. Finally, the computer programs utilized by the system, a guide to problem initiation, and sample output are contained in appendices.

CHAPTER II

REVIEW OF THE LOCATION THEORY LITERATURE

This chapter discusses the location theory literature pertinent to the ATP problem. A review of published articles indicates much research on the problem of location on networks. Much of the literature has been generated since 1964. The quantity of literature is rapidly increasing.

Tansel *et. al.* [31] provide a survey of network literature which was highly useful in the conduct of this research. They concentrated their survey to those articles of the literature that exploited the network structure. This essentially limited the source of papers to be investigated in the ATP problem. Francis and Goldstein [10] and Golden and Magnanti [13] also provide bibliographies on location theory.

Determination was made early that the ATP problem was to be the minimization of the sum of the weighted distances between customers and sources in a network. This problem type is known as a "median" problem in location theory. Since the problem is restricted to the location of a single ATP within the brigade road network to support all the deployed firing units, the problem is further restricted to be a "1-median" problem. Because of this early determination of the problem type, the literature search was restricted to those which directly pertained to the median problem.

Hakimi [14] defined the absolute median of a weighted graph. Using a communication network, Hakimi identified the absolute median of a graph

as the optimum location for a switching center in this network. The criteria for the location of the switching center was the minimization of wire lengths in the network, analagous to the minimization of travel distances in the ATP problem. Additionally, Hakimi [14, 15] theorized that the absolute median of a tree network is always located at a vertex of the graph. Therefore, the "absolute median" of a graph can be no better than one of the "vertex medians" of the graph. This result proved highly useful in the investigation of the ATP problem since it restricted the candidate locations to the road intersections within the Brigade Supply Area. It should be noted that this restriction is arbitrarily relaxed by the decision-maker to be "the vicinity of the road intersection." This relaxation is allowed to enhance the survivability of the ATP while closely maintaining optimal analytical results.

There have been a number of solution techniques developed for median problems. Many base their findings on Hakimi's vertex result. There have been linear, dynamic and integer programming techniques developed in these algorithms.

Maranzana [21] provides an algorithm for locating supply points based upon transport costs. The method utilizes an iterative procedure that may yield a final solution that is nonoptimal. Teitz and Bart [32] provide an analysis of several heuristic methods for the median problem. These techniques include a direct enumeration procedure, a partition method, and a vertex substitution algorithm.

Branch-and-bound algorithms are provided by Narula et. al. [23], Galvão [11], El-Shaieb [8], and Järvinen et. al. [17]. The Narula et. al. algorithm used bounds obtained by solving the Lagrangian relaxation

of the generalized median problem by a subgradient optimization method. The Galvão technique obtained its bound from the dual of the relaxed linear programming problem. Järvinen et. al. and El-Shaieb provide similar techniques, both using partitioning, but with different updating sets defined.

Kariv and Hakimi [18] provide a dynamic programming approach to the "p-median" problem. The Garfinkel et. al. [12] technique is modeled as an integer programming problem that concludes through its relaxation to a linear programming problem and solution by decomposition.

Since this system result is a deterministic 1-median, any of the formulations for this type location problem could be utilized. This researcher has chosen the formulation proposed by Krarup and Pruzan [20] for use in this prototype decision support system. This formulation, adapted for use in the ATP problem, will be presented in the next chapter after a complete discussion of the parameter determination procedure and problem assumptions.

CHAPTER III

APPLICATION OF LOCATION THEORY TO THE ATP PROBLEM

The previous chapter provided insight into the state-of-the-art of location theory as it applies to the ATP problem. From the review of the literature, a mathematical formulation was obtained for use in the ATP problem. This formulation will be presented later in this chapter. First, a thorough discussion of the criteria that will constitute the parameters of the problem is presented.

The problem may be summarized as follows:

Given:

The firing battery locations (x_i, y_i) .

The candidate ATP locations (x_j, y_j) within the BSA.

The one-way distance from all candidate ATP locations to all firing batteries (d_{ij}) .

Determine:

The weights (w_i) for each firing battery.

Select:

The location (x_j, y_j) of the "best" ATP location, the second "best" and so forth until all candidate locations have been exhausted.

The criteria considered by the Division Artillery Commander in making his decisions are many. If the current tactical situation calls for an offensive posture, then it is paramount that the maneuver units

designated to conduct the main thrust of the offense also receive the greatest amount of artillery fire support. At the same time, other maneuver units must still receive effective fire support to insure their survivability. Traditionally, one battalion of 'direct support' artillery is assigned for each committed brigade, then battalions are assigned roles 'reinforcing' the 'direct support' battalions. Additional fire support may come from artillery battalions with a 'general support-reinforcing' role. Finally, no fire support can be expected from battalions with a 'general support' role. The main criteria for role assignment in the offense is the decentralization of fire support. That is, in the offense, as much fire support as possible needs to be under the immediate control of the maneuver commander. In the defense, the opposite is true. The criteria is the centralization of fire support, since the highest level commander must have the maximum available fire support to respond to the changing battlefield situation. Traditionally, this implies a 'direct support' battalion for each committed brigade and all other battalions either 'general support-reinforcing' or 'general support', with the bulk of these battalions in 'general support'. The delay posture requires a 'direct support' battalion for each committed brigade, and as much 'reinforcing' artillery as possible. It must be noted that the "delay" is a type of retrograde operation. However, since it is based on "trading space for time", it is considered the most demanding of all ground combat operations [24]. Therefore, this research considered it separately. When reference is made to a retrograde posture, "withdrawal" in the conventional sense is implied. The retrograde posture also requires each committed brigade have its 'direct support' battalion and as much

'reinforcing' artillery as possible. Delay and retrograde both imply a reduction in the number of firing units commensurate with a similar reduction in maneuver forces. However, the volume of fire and priorities differ significantly between the two postures.

Although I have cited the "traditional" role assignment of the battalions in each posture, this system is designed to allow "nontraditional" role assignments as well. This flexibility is required simply to accommodate the prerogative that the Division Artillery Commander possesses while preparing his organization for combat. Figure 1 displays the possibilities, incorporated into this system, by which each battery may be governed in the offense. Figure 2 shows the system options in the defense. Figure 3 has the considerations of the system under a delay and retrograde scenario.

Assumptions

In order to construct a consistent system for this research, a number of assumptions must be made. They are essential in order to establish a frame of reference that is common to all users of this decision support system. The assumptions of this system are:

- 1) The unweighted "cost" is proportional to the total distance all firing batteries must travel for r supply.
- 2) All needed information (for example, organization for combat, unit positions, intelligence reports, operations orders, etc.) is readily available to the Division Artillery Commander.
- 3) Other than specific results of this research, there is no additional fixed "cost" of selecting one ATP location over another.
- 4) Ammunition trucks are dedicated to carrying specific types of ammunition. Limited dual loading takes place.

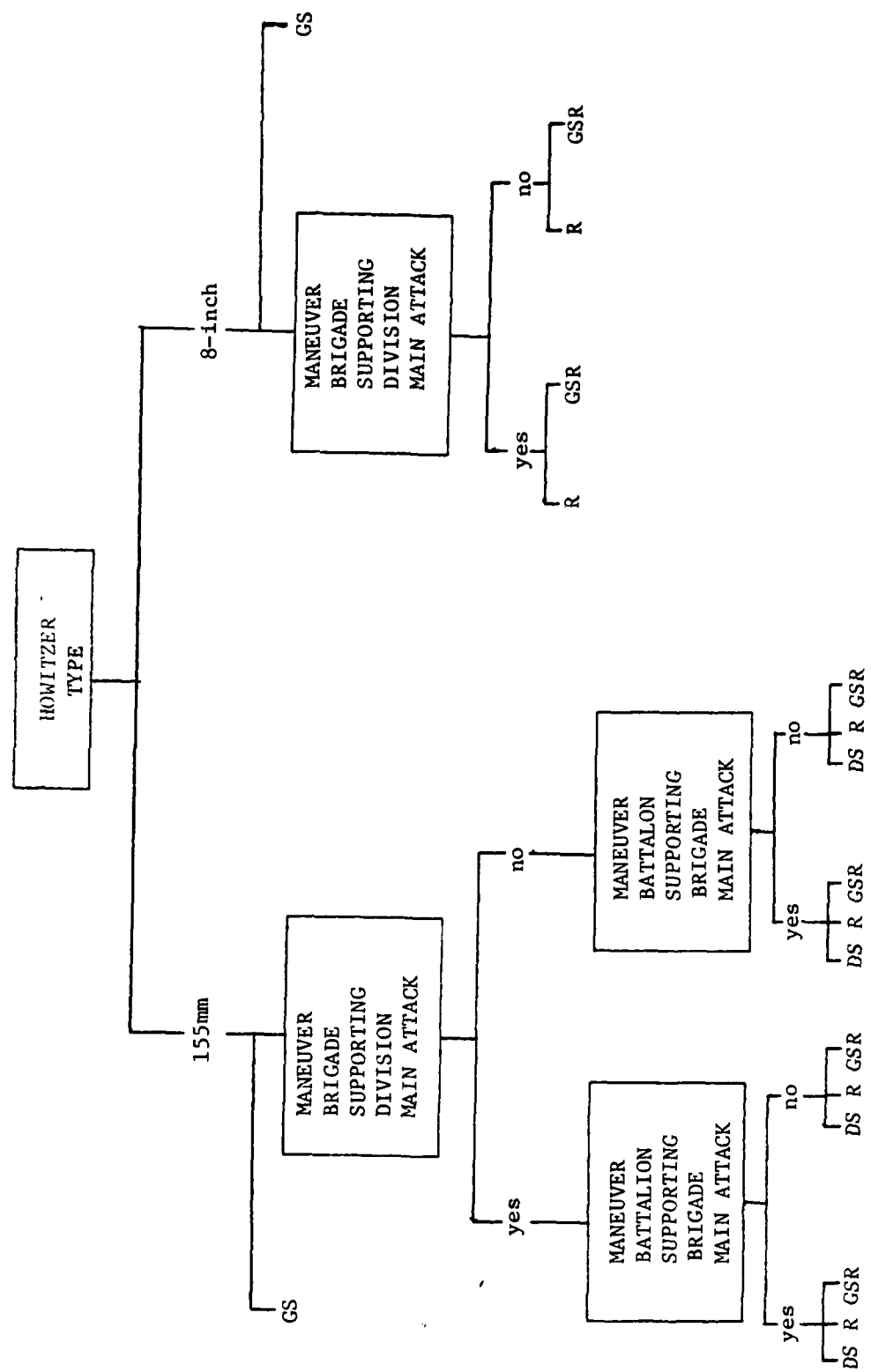

Figure 1. System Options in the Offense Posture.

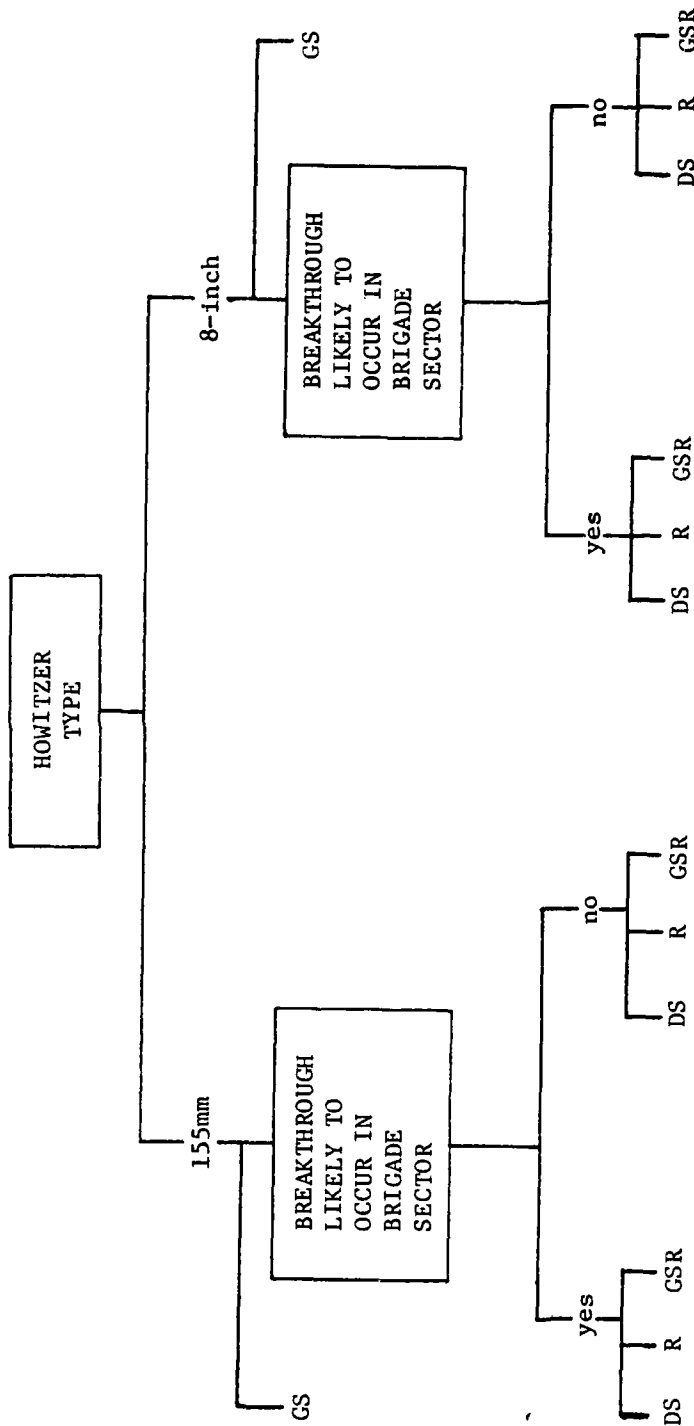

Figure 2. System Options in the Defense Posture.

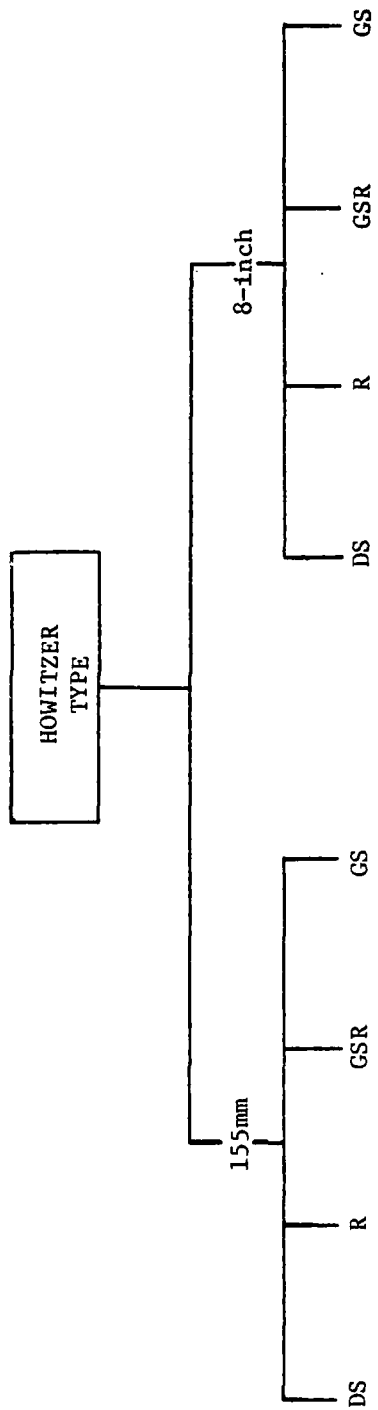

Figure 3. System Options in the Delay and Retrograde Posture.

- 5) The division slice of the corps transportation assets for ammunition resupply will be one medium truck company of sixty tractors and 120 trailers. This company will provide ammunition from the corps support area to the ATPs and will provide some support to the ASP in the division rear. With this capability, all CSR levels are capable of being obtained from the ATP.
- 6) Travel times, both day and night, are constant at 500 scaled distance-units per hour for both weapons systems.
- 7) Ammunition trucks are combat-loaded. Powders will be transported in 1-1/2 ton trailers. Mixture will be one-third green bag and two-thirds white bag.
- 8) Weapons survivability is continuous. Each battery is assumed to have its full Table of Organization and Equipment (TO&E) complement of equipment at all times.
- 9) On load/off load time for trucks within a system is constant. One-half hour is required for each phase in the 155mm system; one full hour is required for each phase in the 8-inch system.
- 10) Ammunition trucks are not subject to interdiction or operational failure. Each battery has its full TO&E complement of ammunition vehicles available.
- 11) All weapons will draw and expend their full CSR, if possible.
- 12) A full-day operation includes 24 hours. A night-only operation includes ten hours of reduced visibility.
- 13) The following is indicative of the ammunition consumption percentages:
- | | <u>HE</u> | <u>APICM</u> | <u>DPICM</u> | <u>RAP</u> | <u>CLGP</u> | <u>FASCAM</u> | <u>SMK</u> | <u>ILLUM</u> |
|--------|-----------|--------------|--------------|------------|-------------|---------------|------------|--------------|
| 155mm | 15 | 6 | 55 | 10 | 7 | 5 | 1 | 1 |
| 8-inch | 20 | 8 | 60 | 12 | | | | |
- 14) Copperhead (CLGP) will be used exclusively for armor targets (category 1 and category 3).
- 15) Rocket-assisted projectiles (RAP) rounds will be used for suppression of enemy air defense (SEAD) and logistical targets (categories 4 and 7).
- 16) DPICM are effective on all target categories.
- 17) Resupply always involves identical breakdown of ammunition.

(155mm: 8/9 DPICM and 1/9 Copperhead; 8-inch: 5/6 DPICM and 1/6 RAP).

18) Based on ammunition consumption percentages, 62% of battery transport assets are available for ATP resupply for the 155mm system and 72% for the 8-inch system.

19) Fractional portions of trips per day are allowed.

20) Intelligence gathering is not sufficient to determine possibility of breakthrough below brigade level.

Procedure

The changing situation of the modern battlefield does not permit calculation and input of excessive amounts of supporting data. After an examination of the needs of the Division Artillery Commander, existing solution procedures, and state-of-the-art technology, a heuristic solution procedure was selected for this system. This yields a "best" analytical solution for this problem and its parameters, but not necessarily an optimal solution under operations research criteria. The procedure is:

- 1) Interactive data input by user and computer: road network of the AO, distances from each firing battery to each candidate ATP, firing battery locations, and candidate ATP locations.
- 2) Specification by user of posture of battle.
- 3) Determination by user and computer of firing battery weights.
- 4) Solution of shortest path problem by computer.
- 5) Location problem solution interactively by user and computer.
- 6) Solution quality indicators and sensitivity analysis by computer and user.
- 7) Selection of ATP location or respecification of the problem.

Step one is the designation of the road network that is applicable within the brigade area of operations. It is input through use of the digitizer tablet or from memory files. Scaled distances are obtained directly through the digitizer tablet operation. All occupied firing battery locations, intersections and all potential ATP locations within the Brigade Supply Area are entered as nodes on the road net.

Step two is the specification of the posture of the battle: offense, defense, delay, or retrograde. The data required to be entered for each posture are the relative values of the seven target types and the posture priorities of the commander included in the system. Both of these sets of data are at the discretion of the Division Artillery Commander. As cited in Chapter I, this system is a "personal" tool, valid only for each user and the parameters he sets. The seven target categories are shown in Figure 4.

- 1 - In contact (includes maneuver targets and accompanying Air Defense and Field Artillery)
- 2 - Command posts (division and higher)
- 3 - Armor assembly areas
- 4 - SEAD (suppression of enemy air defense)
- 5 - Counterfire
- 6 - Troop assembly areas
- 7 - Logistical areas

Figure 4. Target Categories.

Step three calculates each firing battery weight, based upon its Field Artillery role, its responsibility with respect to supported

maneuver unit missions, the weapon caliber, and the posture. The system is designed to allow units assigned particular roles to engage only certain target categories. This is due to the traditional target types engaged, the range of the weapon, the rate of fire of the weapon, its mobility, and similar factors. These allowed target engagement factors are constant, regardless of the posture considered. The FA role and its allowed target categories are shown in Figure 5. Target values are

<u>FA Role</u>	<u>Target Category Engagement Allowed</u>
Direct Support	1, 3, 6
Reinforcing	1, 3, 6
General Support-Reinforcing	All types
General Support	2, 3, 4, 5, 6, 7

Figure 5. Target Category Engagement Allowed vs. FA Role.

arbitrarily assigned by the Division Artillery Commander. For each posture, the target values are integers assigned in ascending order; i.e., the highest priority target gets assigned the lowest value. It should be noted that this is highly flexible and can be qualitatively assigned weights (e.g., categories 1 and 6 are equally important and twice as important as all others. This could yield example target values of 5 for categories 1 and 6 and 10 for all other types). Additionally, priorities are assigned by the Commander based upon the fire support responsibilities of each firing battery. In all postures, the priorities are integer values assigned in descending order. Here, the highest priority gets the highest value. Again, qualitative assignment is

possible.

In the offense, there are eight priority values that must be considered and ranked. These are:

- 1) Supported brigade constitutes division main attack.
- 2) Supported brigade constitutes division supporting attack.
- 3) Supported battalion/task force constitutes brigade main attack.
- 4) Supported battalion/task force constitutes brigade supporting attack.
- 5) Parent FA battalion is assigned a 'direct support' role.
- 6) Parent FA battalion is assigned a 'reinforcing' role.
- 7) Parent FA battalion is assigned a 'general support-reinforcing' role.
- 8) Parent FA battalion is assigned a 'general support' role.

In the defense, the following six priorities are assigned:

- 1) Intelligence reports indicate breakthrough is most likely to occur in brigade sector.
- 2) Intelligence reports do not indicate breakthrough is likely to occur in brigade sector.
- 3) through 6) Same as 5) through 8) for the offense.

In both the delay and retrograde, the only priorities considered are the four FA roles.

The target values and the Artillery Commander's priorities for each posture allow the computer to generate a firing battery weight for each unit through interactive input.

The fourth step is the computation of all the shortest routes from each candidate ATP location to all the deployed firing units.

Step five involves the rank ordering of the candidate ATP locations

with respect to the sum of the weighted distances to each unit from each ATP candidate. The rank ordering is from minimal to maximal sum.

The sixth step provides an indicator as to the degree effectiveness would be enhanced based upon each ATP selection. Additionally, it provides a sensitivity analysis of how much each parameter can vary without effecting the choice of the ATP location.

The final step requires the user to decide which ATP locations should have reconnaissances. Also, it includes changes in the situation which could cause reinitiation of the analysis.

Mathematical Formulation

The mathematical formulation that most closely represents the ATP location problem is that of the 1-median. As given by Krarup and Pruzan [20], the formulation is:

$$\underset{j \in V}{\text{minimize}} \quad \sum_{i \in V} w_i d_{ij} \quad \text{where } V \text{ is a vertex set.}$$

The objective function is to minimize the sum of the weighted distances all customers must travel for service. Specifically, the goal is to minimize the total sum that all batteries positioned within the brigade AO must travel for resupply, where each battery receives a weight based upon how much its resupply contributes to the overall mission accomplishment. The distances (d_{ij}) are scaled from the road network. For each posture, the weights are calculated as follows:

- 1) The parent FA battalion role is considered.
- 2) The target values and the target engagements allowed are considered, resulting in a target value total (TVT). TVT is the sum of the allowed target values.

3) The Division Artillery Commander's posture priorities are assigned.

4) The weight (w_i) of each firing battery is the sum of the target values divided by the product of the pertinent posture priorities or $TVT/(DAP(k)*\dots*DAP(m))$.

Therefore, the formulation of the l-median ATP problem becomes:

$$\text{minimize}_{j \in V} \sum_{i \in V} (TVT/(DAP(k)*\dots*DAP(m)))_i d_{ij} \quad \text{where } i \text{ are}$$

the firing units and j are the candidate ATP locations.

This is the formulation that the system incorporates. The output of the problem is the objective function value for each candidate ATP location. The user then rank orders these output to determine which ATP location is "best," second "best," etc. and due further consideration.

The criteria presented in this chapter for parameter determination and problem formulation will be utilized in the subsequent chapter which details the proposed ATP selection process.

CHAPTER IV

THE PROPOSED ATP SELECTION PROCESS

In the previous chapter, the procedure for establishing the defining parameters for the ATP problem was presented. In this chapter, the selection process of the decision support system is discussed. The system implementation from the establishment of the need for an ATP through its actual selection is considered. This chapter explains the various options available to the user during this selection process.

Since the concept of the ATP is that it is highly mobile, this decision process is never final. Rather, the ATP is susceptible to relocation each time the input parameters change. This is not necessarily ideal; therefore, the sensitivity analyses may be used to determine just how much a parameter may change without necessitating an ATP move.

The highlights of this decision support system are the use of computer color-graphic techniques, which can display the brigade road net, the shortest route from the ATP to each firing battery, and graphical and numerical output for site evaluation; techniques for establishing target values and priorities for FA roles and maneuver unit missions for varying battle postures; network analysis to obtain data for the 1-median location problem.

The structure of the decision support system is simple to understand. Figure 6 is a flow chart of user actions. First, the brigade AO road network must be established. All firing unit locations must be designated. Candidates ATP locations are selected within the BSA. The

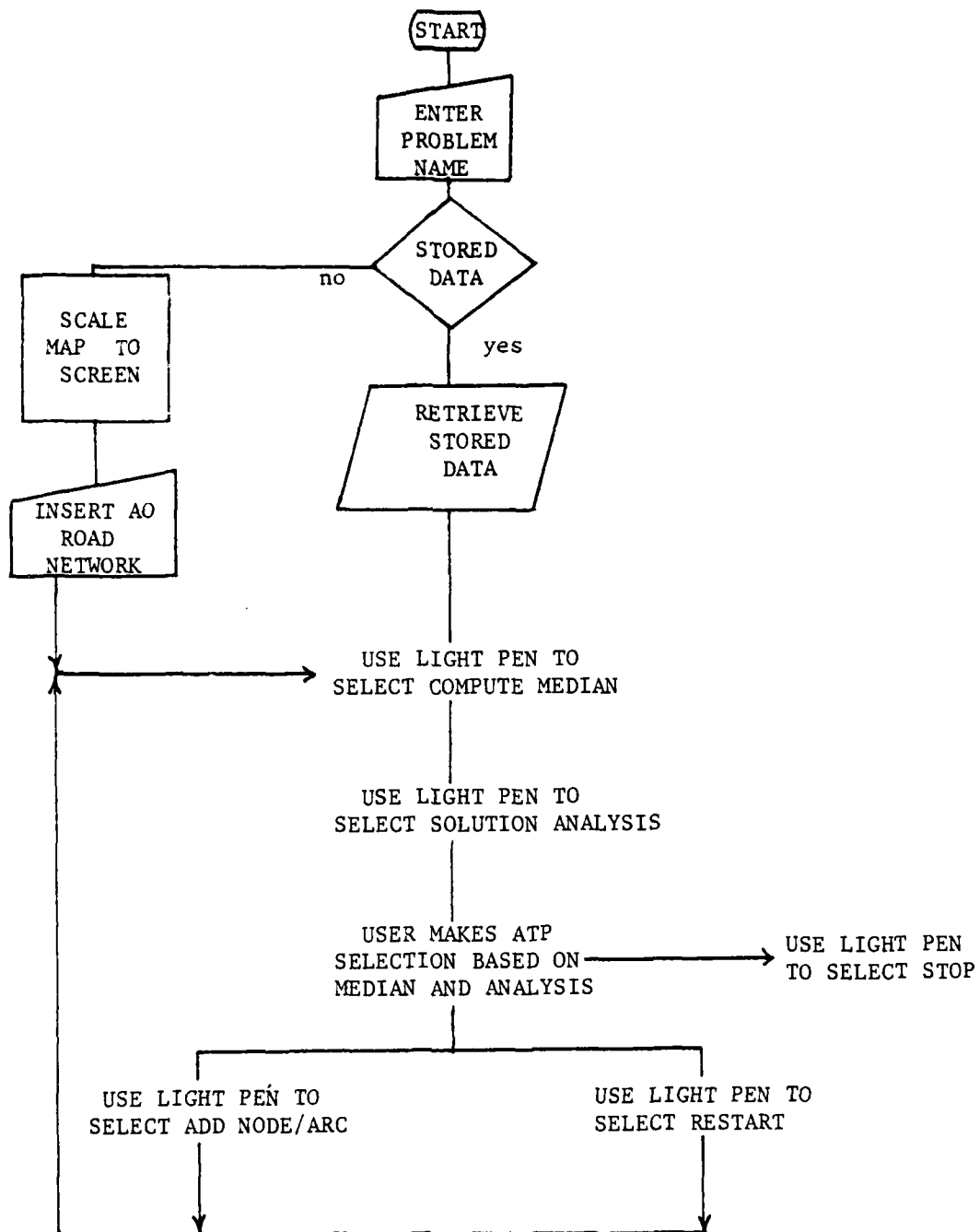

Figure 6. Flowchart of User Actions.

problem now consists of a shortest path problem between each candidate ATP location and all the deployed batteries. Input data (assigned FA roles, target values, posture priorities) is used to determine a relative weight for each firing unit. See Figures 13 through 17 in Appendix II. These weighted distances of all batteries to each candidate ATP location are totaled and the ATP location whose sum is minimal is considered the "best" location. See Figure 18 of Appendix II.

Subsequent to the initial calculations to determine the location of the ATP, this system provides three types of solution indicators that assist in the actual selection of the ATP. These are graphical display of the controlled supply rates for each weapon system ammunition type versus the number of rounds that could be resupplied to each firing battery under full day and night-only operations based on the selection of each candidate ATP (Figures 19 and 20 of Appendix II); graphical display of the weight assigned each firing battery in the median calculation; and numerical analyses that display the shortest route of each firing battery to the ATP (Figure 21 of Appendix II), determine the range of each subjective input parameter based upon ATP selection (Figures 22 and 23 of Appendix II), and show allowable distances that firing batteries may displace without effecting ATP location (Figure 24 of Appendix II).

There are five different graphs that may be requested. Access to each of these graphs is initiated with a light pen strike on the "SOLUTION ANALYSIS" menu circle. This allows the user to select from the following:

- 1) CSR vs DPICM rounds resupplied per 155mm firing battery.

- 2) CSR vs Copperhead rounds resupplied per 155mm firing battery.
- 3) CSR vs DPICM rounds resupplied per 8-inch firing battery.
- 4) CSR vs RAP rounds resupplied each 8-inch firing battery.
- 5) Weights assigned to each firing battery.
- 6) Numerical analysis.
- 7) Return to light pen control.

A keyboard entry controls all analysis subsequent to the initial light pen hit.

Each of the first four graphs displays the resupply potential for each firing battery of a weapon system and ammunition type. Each battery receives three vertical bars. The red bar is the controlled supply rate (CSR) of that ammunition type. This indicates the maximum number of rounds resupplied per weapon per day, totaled by battery. This bar is common to all firing batteries of a system type. The green bar shows the total number of rounds that could be resupplied to each firing battery if continuous 24-hour day ammunition resupply operations are possible. The blue bar displays the resupply effort if ammunition resupply operations must be limited to periods of reduced visibility. These graphs may be displayed for each candidate ATP location. This capability has extreme potential. If the "best" ATP location with respect to the subjective input yields a resupply operation that has some unit resupply surplus to the CSR while other units do not fulfill the CSR, a search of the other candidate ATP locations may be made to find one that provides maximal CSR resupply. This consideration is essential since the number of rounds a unit will receive is limited by the CSR and total resupply

should be achieved, if possible, regardless of which ATP location is analytically "best".

The weight graph displays, by battery, the sum of the target values of the allowable target categories divided by the product of its posture priorities. This graph provides a quick display of which batteries are receiving priority resupply effort. Small ratios are indicative of high priority.

Selection of "Numerical Analysis" will prompt a choice of the following:

- 1) Shortest route for each battery to ATP.
- 2) Target value sensitivity analysis.
- 3) Divarty Commander priority sensitivity analysis.
- 4) Firing battery location sensitivity analysis.
- 5) Return to graph menu.

The shortest route for each battery to ATP provides the route to be followed to support the ATP choice. Target value sensitivity analysis calculates the range that a requested target value may have without causing an ATP change. Additionally, when a changed target value exceeds the calculated range and necessitates a new ATP location, the system automatically provides the new "best" ATP location. The same analysis for target values above is provided by the Divarty Commander priority sensitivity analysis.

Due to the artillery battery's detection possibilities on the modern battlefield, movement to avoid detection and subsequent destruction is paramount. The firing battery location sensitivity analysis provides the most beneficial data of the system with respect to

survivability. Assuming that movements to the rear would only reinforce the ATP choice, the system determines the scaled distance that a firing battery may displace upon receipt of enemy indirect fire forward from its current location without degradation of the ATP location. The system automatically plots a "circle of effectiveness" within which the battery may displace, if necessary.

Selection of the "RESTART" menu circle results in a choice of the following items:

- 1) New problem.
- 2) Minor change.
- 3) Return to light pen control.

A new problem necessitates a new AO be entered. Only Program ATPI and data pertinent to the network are stored on the drive #1 disk. Therefore, it must be saved if it is possible to use the old disk at a future date. This may be accomplished by reloading on drive #1, loading Program ATPI and recalling its BSA name. Due to the excessive amounts of memory space used by this system, it is necessary to use a new disk, initialized with system files and Program ATPI, for the new network. A minor change occurs when parameters change singularly. This only includes changes in target values and posture priorities.

This system has been developed such that any user with an understanding of the employment of artillery fire support under the varying postures can reach an acceptable solution. This system could be used by Division Artillery operations staff personnel, aware of the Divarty Commander's target values and priorities to achieve initial output and this data be presented to the Commander for the final command decision.

This chapter has summarized the step-by-step selection process. The subsequent chapter summarizes the procedures necessary for the actual problem implementation.

CHAPTER V

IMPLEMENTATION AND DOCUMENTATION

The previous chapters detailed the development of the ATP model. This chapter discusses the technicalities required in its implementation.

Instrumentation and Equipment

The item of hardware primarily utilized in this research is the Chromatics color-graphic CG 1999 minicomputer. It is a self-contained, high resolution color-graphic terminal with an internal Z-80 microprocessor, an attached disk operating system, and 64K bytes of random access memory (RAM). It can display in eight colors, provide graphical output, and plot geometric figures [25]. Each of these capabilities is used in this system.

One of the options available to the CG 1999 is a light pen, capable of detecting light on the terminal screen and sending a signal back to the minicomputer. This light pen was a primary means of controlling execution of the computer programs of this decision support system.

The applicable road net is input via the digitizer tablet [3], which translates the two dimensional graphical information into a form capable of being processed by the Z-80 microprocessor. Positioning crosshairs or touching the stylus to any position on a map attached to the digitizer tablet, results in that point's coordinates being translated into their digital equivalents and transmitted to the terminal for processing.

Implementation

The language used in programming is that of Chromatics BASIC [3, 4, 7, 25]. Although the computational portions of the computer code are standard computer BASIC language, the portions of the code that utilize video display commands are peculiar to the Chromatics BASIC language. Therefore, this code should not be used in any other computer without appropriate modifications.

The decision support system utilizes six programs: ATPI, ATPII, OFFENSE, DEFENSE, DELAY, RETROGRADE. Programs ATPI and ATPII are adaptations of previous work by Anderson [2]. A listing of each code is contained in Appendices III through VIII. Figures 7 and 8 provide flowcharts of Programs ATPI and ATPII. Figure 9 is a posture program flowchart.

ATPI primarily controls entry of the road net and locations of firing batteries and candidate ATP locations. It chains one of the four posture programs for input of target values, posture priorities, and calculations of battery weights. ATPI chains ATPII for median computations and sensitivity analyses. ATPI allows light pen selection of the following menu items: ADD NODE/ARC, STOP and RESTART. A selection of COMPUTE MEDIAN or SOLUTION ANALYSIS while operating in ATPI causes ATPII to be retrieved and executed.

ATPII is the primary computational program. Additionally, it controls all graphical output. Light pen selection of COMPUTE MEDIAN and SOLUTION ANALYSIS is controlled by ATPII. Selection of any other menu item causes the chaining back to ATPI for execution. Computations must be performed prior to any graphical display. To insure this happens the program is designed to require calculations prior to any display of

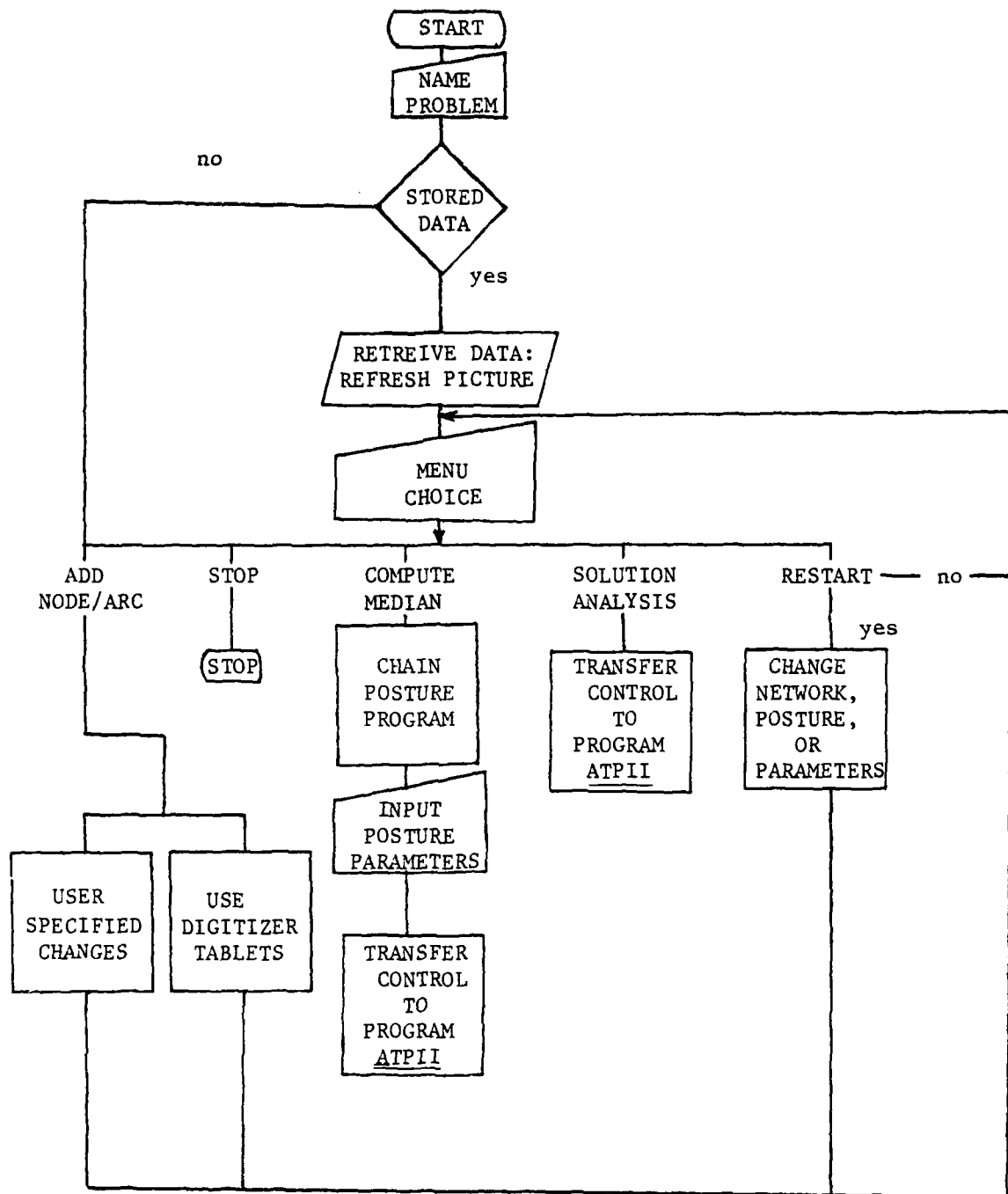

Figure 7. Flowchart for Program ATPI

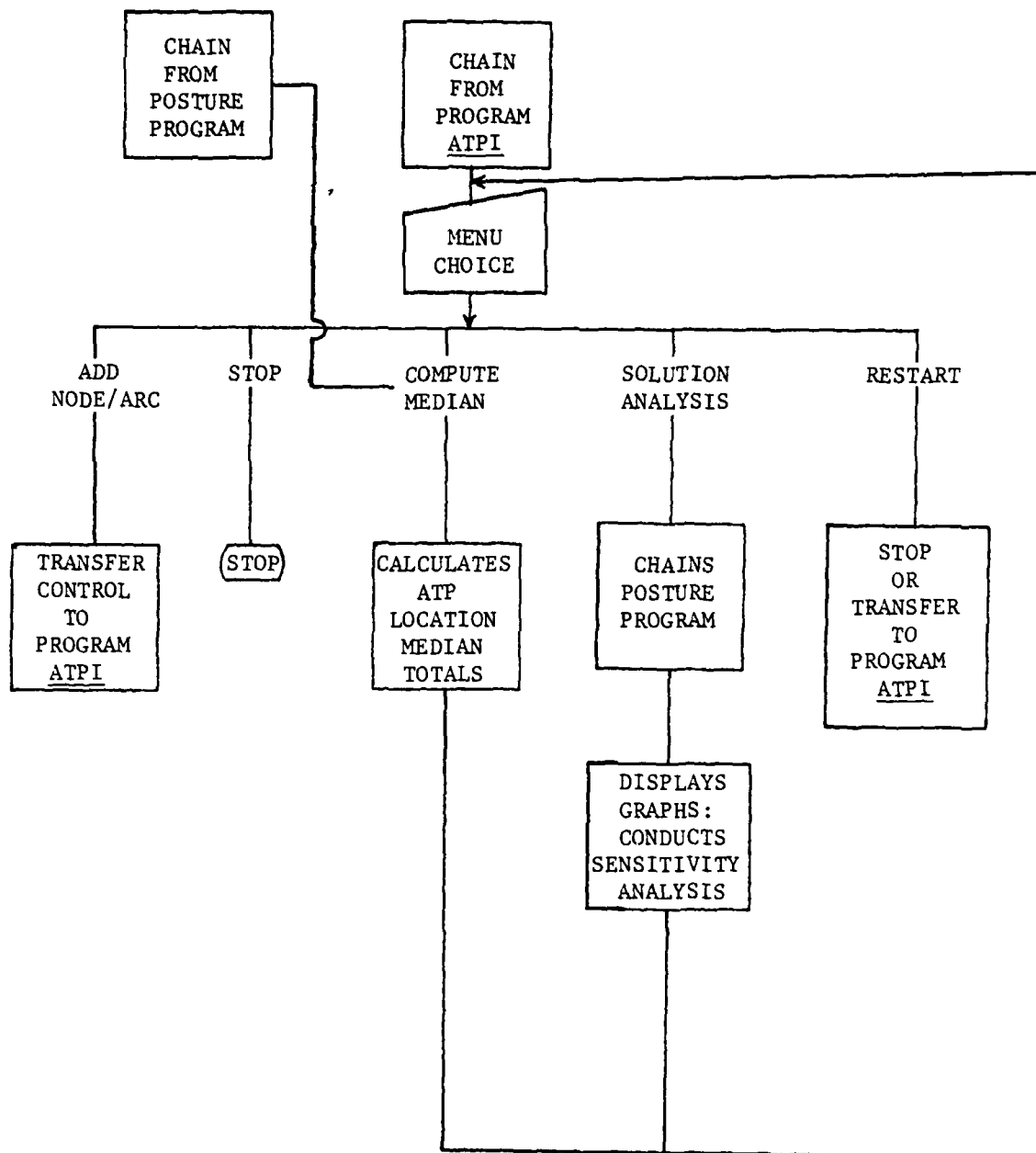

Figure 8. Flowchart of Program ATPII.

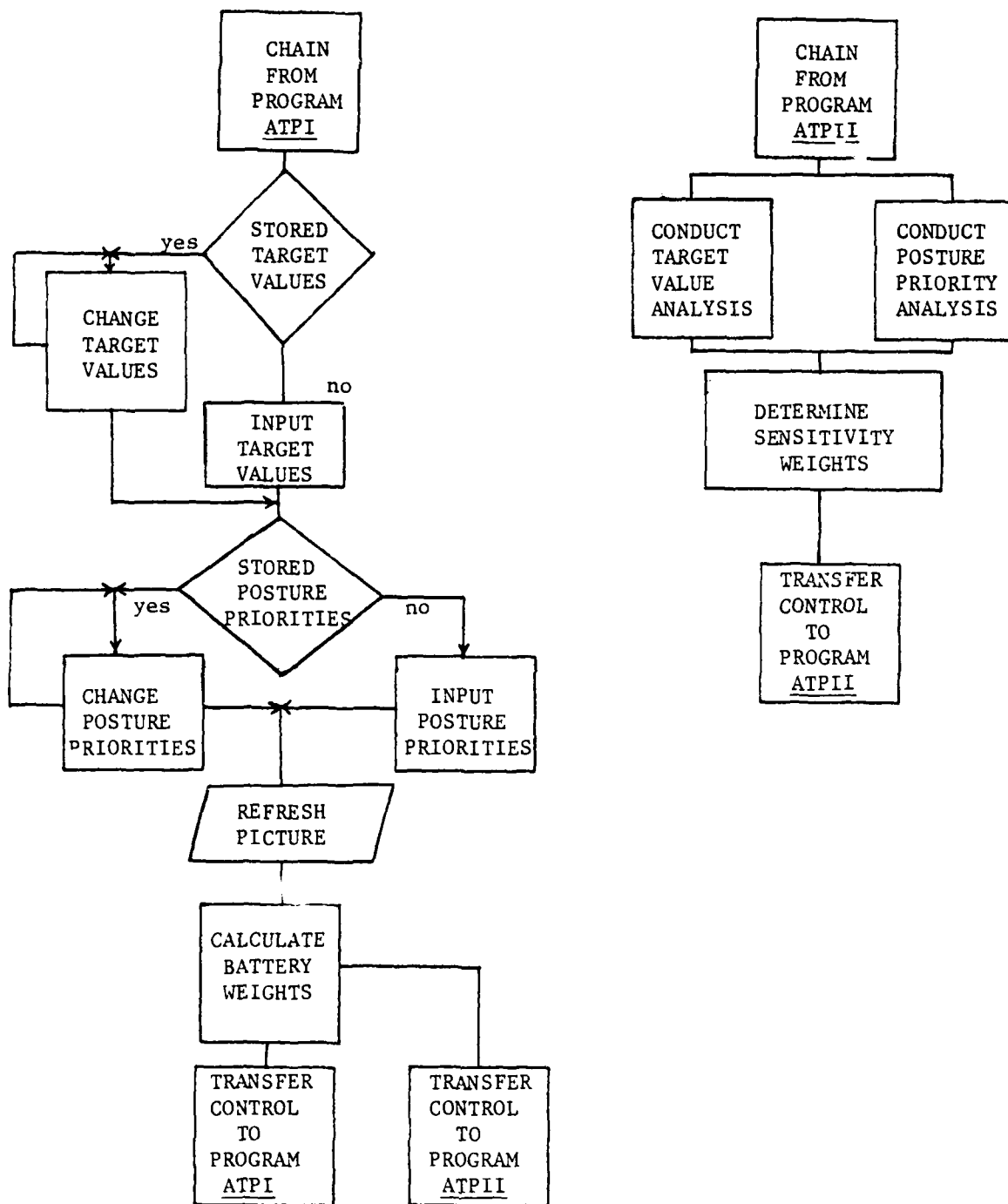

Figure 9. Flowchart of Posture Program.

results. Program ATPI must be loaded on disk drive #1 and Program ATPII with the appropriate posture program must be on drive #2.

Data Storage and Manipulation

The primary array, GP, is used as a general purpose storage array. GP stores limiting parameters of the problem. Subsequent arrays are often dimensioned using values of GP.

Storage of map data utilizing the digitizer tablet, requires three storage arrays. Array DI is a two-dimensional array containing the symmetric distances between all nodes in the road network. The maximum allowable size of DI is 60 by 60. However, in this system it takes dimension TN, the total number of nodes actually in the problem. The other two arrays used to store the road network data are XX and YY. These arrays store the X and Y coordinates of the nodes on the screen. Arrays XX and YY are also dimensioned to the total number of nodes.

"The search for an efficient shortest path algorithm resulted in the next set of arrays. A shortest path algorithm by Pape required input to be in a forward star format." [2] Arrays ASP, BSP, and CSP were utilized to generate linklist data arrays from the DI matrix which were used in this algorithm to generate shortest distance arrays from a subroutine of Program ATPII. "In simple terms, they compress all the zeros representing nonexistent arcs out of the [DI] matrix. This greatly reduces the amount of memory required and also permits rapid access to the next arc when finding shortest distance paths." [2] Consideration of roads within the brigade AO that are capable of handling ammunition traffic reduces the total number of arcs to be considered.

This system assumes six roads per intersection are capable of bearing the traffic. This results in the dimensioning of arrays BSP and CSP to six times the node total to begin with. The shortest distance arrays that resulted were AD, BD, CD, and DST. Total arcs actually in the problem are determined and BSP and CSP are redimensioned to this number in order to save memory space.

Arrays AZTP, OB, and EB are pointers to the candidate ATPs, 155mm and 8-inch firing units, respectively. Array AZTP is dimensioned to the value stores in GP(8) and arrays OB and EB are dimensioned to the values in GP(12) and GP(13), respectively. Array FU is often used as a pointer to firing units, regardless of type. FU is dimensioned to GP(9), the total number of firing batteries.

Initial data necessary for calculations is stored in two posture-dependent arrays. These arrays are identified as TD and PD. Array TD stores the target values for each posture assigned to the seven target categories. Array PD is the array for storing the Divarty Commander posture priorities. Additionally, array WT, dimensioned GP(9), was used to store the calculated weight of each firing battery in the AO.

Calculation of the "1-median" required the use of array MED. IMED was used to successively store the sum of the weighted distances from all firing batteries to each candidate ATP. MED stored the final total for each candidate ATP. MED was dimensioned GP(8), the number of candidate ATP nodes.

The solution indicators of the problem required two arrays: OB as a pointer to the 155mm batteries and EB as a pointer to the 8-inch batteries. TM for round-trip resupply time was used.

Sensitivity analyses used array SMED for comparison with the value of array MED in this limit determination.

The graphing subroutines used two arrays. Arrays GX and GY stored the values that would generate the vertical bar graphs.

Menu Operation

Like Anderson [2], the value of the flagword HIT and the location of a light pen hit determine the succession of the program.

HIT takes on integer values that are used in the branching statements of Programs ATPI and ATPII. This dual-identifier method is used to insure that inexact screen hits do not branch the routine through unwanted steps. Rather, it ignores these hits and returns to the correct line for program resumption.

New menu action is initiated only when flagword HIT=1. All other flagword HIT values branch to appropriate lines of the programs. Hits in the menu section are ignored if HIT≠1.

HIT=2 is used in the designation of the candidate ATPs on the screen network. These node numbers are stored in array AZTP and are colored yellow on the screen. HIT=3 is for the selection of the 155mm firing batteries. These are colored red on the screen and their node labels are stored in array OB. The 8-inch firing batteries are stored in array EB and appear with cyan nodes on the screen. These labels are constructed when the flagword HIT=4. HIT=5 is used in the initial input of the road network with the digitizer tablet.

Additionally, flagword JP is used in bitpad operations when additions are necessary to an already constructed road network.

Add Node/Arc

Although not specifically initiated through a light pen hit, the Add Node/Arc operation, in effect, is entered each time the user responds in the negative to the prompt "Is there data on problem 'X' already stored?" This allows initial input of network data. While performing this operation, the user is alerted to the fact through display of the message DIGITIZER TABLET ENABLED.

The Add Node/Arc operation is specifically used subsequent to the initial network input when there are changes to the network entered. This is a highly useful capability in a wartime scenario, since it allows the addition of new batteries and the removal of roads that may have been eliminated from use. Road removal is accomplished by insertion of a large distance in the change subroutine. This causes the road not to be considered in shortest path generation. As stated earlier, the distance matrices used in the programs are symmetric; therefore, changes in arc lengths must be made in both directions. Original distances must be recorded for future use if the possibility exists.

Compute Median

Prior to the calculation of the median, it is necessary to obtain two data sets. The first of these is the weight of each firing battery. These weights are obtained through Program ATPI by "chaining" the particular posture program designated by the Divarty Commander. Then, through an interactive procedure, each battery is assigned a weight that reflects its contribution to the fire support effort "in the eyes of the user". The second set of data required is the distance from every firing unit to every candidate ATP location.

Upon determination of the battery weights and the various distances, the "1-median" calculation is a simple mathematical operation. The median value is calculated and displayed so that the user may rank-order the candidate ATPs for further consideration.

Solution Analysis

The graphical displays of controlled supply rates and firing battery weights are obtained through calculation of previously obtained data. The numerical analyses necessitated the use of three flagwords (P9, FLAG and KEY) that, when "chained" to Program ATPII and the appropriate posture program, were able to execute immediately only the necessary lines and then resume with the sensitivity analysis being conducted.

Restart

The restart section is as fluid as the modern battlefield. It will allow the entry of a new road network which could result from relocation of the brigade supply area or major unit movements. This option is executed with selection of "New Problem".

When individual parameters change, a "Minor Change" results. This occurs, for example, when a battery's FA role changes or when target values and/or priorities are reconsidered. FG = 2 is used in "Minor Change" operations, while FG = 1 was used as a flagword when chaining between Program ATPI and the posture program during initial problem parameter input.

This chapter has discussed the specific techniques for system manipulation. The next chapter will discuss the experimental results and conclusions of this research.

CHAPTER VI

RESULTS, CONCLUSIONS AND RECOMMENDATIONS

Results

Three ATP location problems were tested by U.S. Army Field Artillery Officers who were graduates of an Officer Advanced Course. Each was familiar with the concepts of artillery target values and posture priorities as they influence Field Artillery roles. Each officer hypothetically established the brigade operations area, positioned the firing units and selected the BSA location.

The maps used in the experimental testing were of the Federal Republic of Germany, scaled 1:50000. The roads digitized were the primary and secondary roads in the area of operations considered capable of bearing ammunition traffic. All roads were accessible to two-way traffic.

Numbers of batteries positioned in the area of operations were subjectively determined by each user. As stated in Chapter I, this system is a "personal" tool. Thus, each user provided his individual evaluation of target category values and rankings of the priority options under each posture.

For each case problem, the brigade operations area was input with the digitizer tablet. Since each was representative of a brigade-size battle area, no reduction was necessary to fit on the allowable area of the screen.

Figure 10 shows the digitized road network of Problem LANGE. All

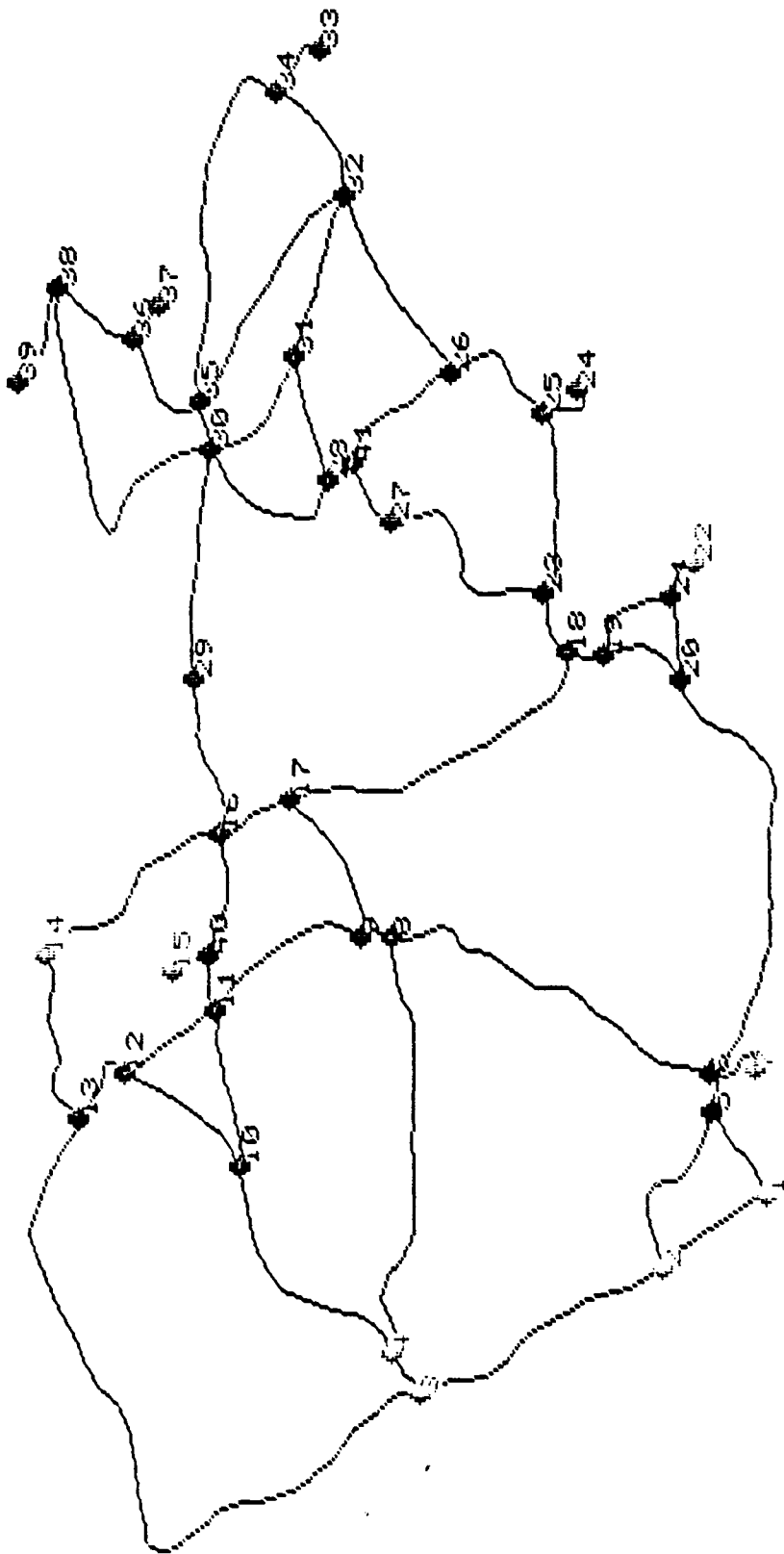

Figure 10. Road Network of Problem LANGE.

discussion of results are based on Problem LANGE. Figure 10 represents the brigade AO after the designation of candidate ATPs, 8-inch batteries, and 155mm batteries. Problem LANGE considered four candidate ATPs and deployed six 155mm batteries and four 8-inch batteries. The candidate ATPs are colored yellow and are located at nodes 1, 2, 3, and 4. The 8-inch batteries are colored cyan and are located at nodes 7, 14, 15, and 22. The 155mm batteries are red and are located at nodes 24, 27, 29, 33, 37, and 39.

Table 1 shows the target values that were applied for each posture considered.

Table 1. Problem LANGE Target Values by Posture

	Delay	Retrograde	Offense	Defense
In contact	1	4	1	1
Command Posts (Div and higher)	2	2	2	1
Armor Assembly Areas	2	2	1	2
SEAD	7	3	2	3
Counterfire	4	3	3	3
Troop Assembly Areas	3	2	1	2
Logistical Areas	10	20	6	10

Table 2 contains the Posture Priorities used in calculations for Problem LANGE.

Table 2. Problem LANGE Divarty Posture Priorities

	Delay	Retrograde	Offense	Defense
(1)	4	4	10	10
(2)	1	1	5	5
(3)	2	2	10	4
(4)	3	4	5	1
(5)	na	na	5	3
(6)	na	na	3	4
(7)	na	na	2	na
(8)	na	na	1	na

Median calculations for Problem LANGE using the above values resulted in selection of candidate ATP #1 for all postures. Table 3 contains the median totals for each node upon which this conclusion was based.

Table 3. Candidate ATP Median Totals

	Delay	Retrograde	Offense	Defense
(1)	24818*	27692*	13903*	5659*
(2)	26128	29248	14235	5929
(3)	26125	29212	14232	5903
(4)	25356	28252	14230	5865

After selection of the median was complete the results were analyzed. This was accomplished through the use of the controlled supply rate graphs for the various ammunition types of each caliber.

The analysis considered three ammunition trucks were available to be used in resupply operations. The number of pallets of ammunition that were able to be carried on the ammunition trucks were twenty for 155mm and fifteen for 8-inch. The controlled supply rates considered were 250, 50, 200, and 50 for 155mm DPICM, Copperhead, 8-inch DPICM, and RAP, respectively. Candidate ATP #1 was selected as the ATP for consideration in response to the median totals determined. As can be seen in Figure 11, all batteries receive slightly less DPICM ammunition than was available. This is indicated by the green bar below the CSR (red bar). This is where the flexibility of the system is demonstrated. Inspection of Figure 12, the graph for DPICM with candidate ATP #4 selected, shows that one battery could receive excess rounds if they were available, but, more importantly, four batteries have an increase in their resupply potential with ATP #4. Therefore, this demonstrates that the best place for the ATP using the "personal" values of the Divarty Commander is candidate ATP #1, while candidate ATP #4 has better resupply potential. The Divarty Commander could then use a combination of this information to make his selection. The other ATP candidate resupply potential was far below either #1 or #4.

The same analysis for each ammunition type could be conducted to determine which ATP candidate is best for each. The analysis could then include intelligence information available to the Divarty Commander to determine what target categories are most likely and use this

7

CONTROLLED SUPPLY RATE VS DPICM ROUNDS RESUPPLIED EACH 155mm FIRING BATTERY

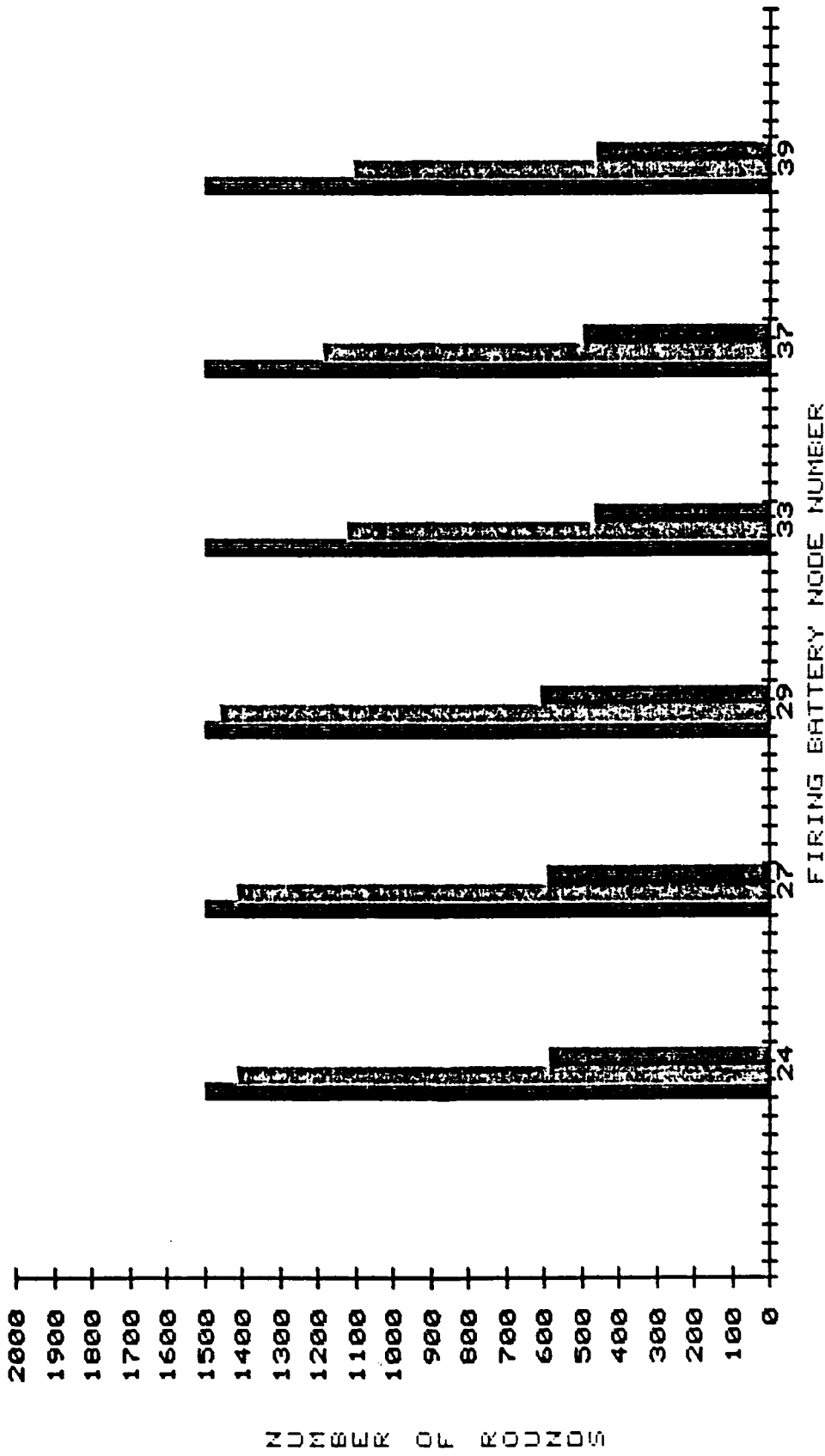

CSR--155mm DPICM
 DPICM RESUPPLIED--NIGHT OPS ONLY
 Hit the CAPRAISE RETURN to continue

Figure 11. Graph--CSR vs DPICM Resupplied (ATP #1).

CONTROLLED SUPPLY RATE VS DPICM ROUNDS RESUPPLIED EACH 155mm FIRING BATTERY

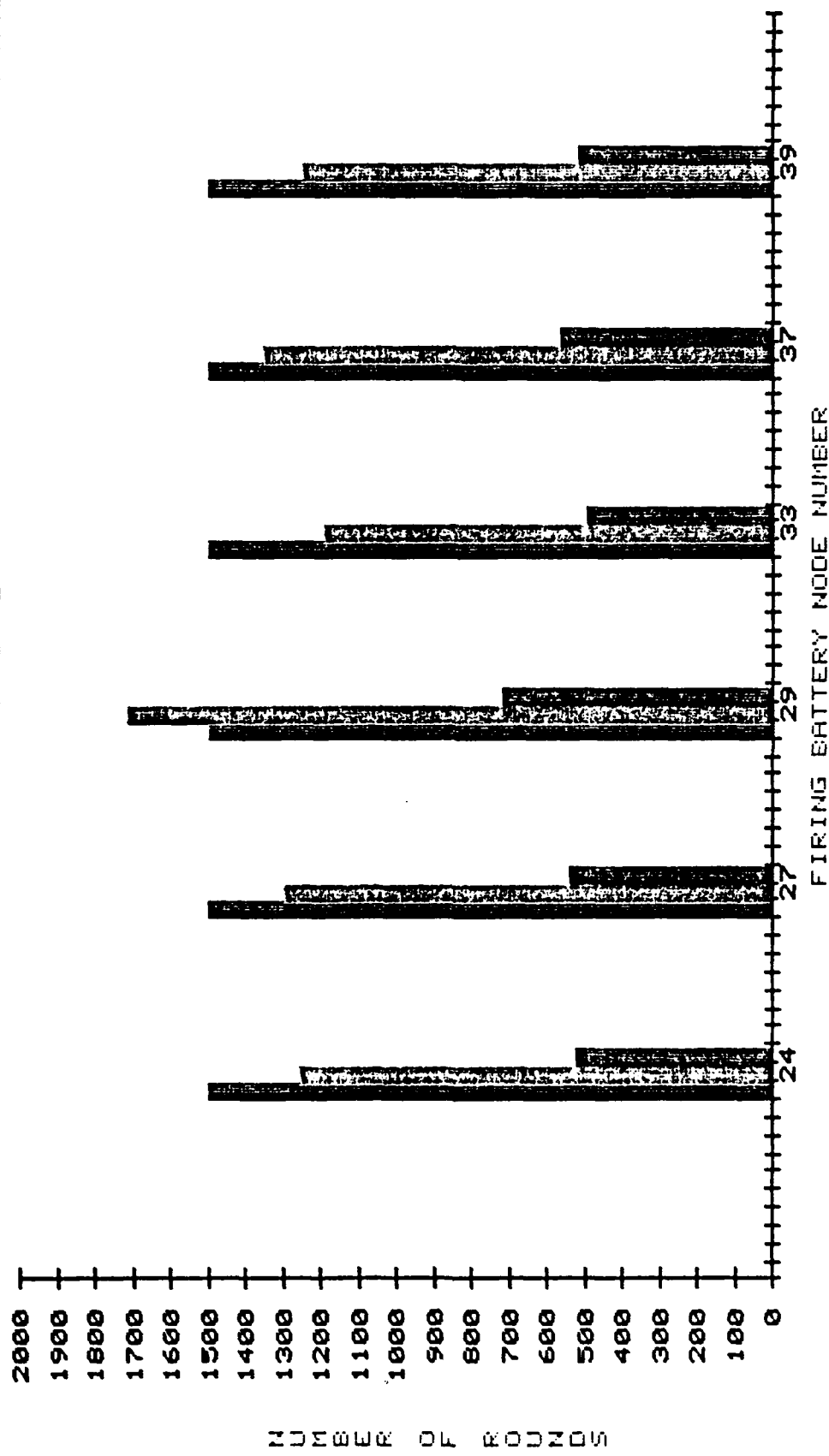

CSR--155mm DPICM= [Solid Bar] DPICM RESUPPLIED-NIGHT OPS ONLY= [Hatched Bar]
 DPICM RESUPPLIED-ALL DAY OPS= [Dotted Bar] Hit the CARRIAGE RETURN to continue

Figure 12. Graph--CSR vs DPICM Resupplied (ATP #4).

information, combined with the potential for resupply shown by the graphs, in his ATP choice. Additionally, if intelligence can indicate a greater enemy activity in one region than in another, the graph analyses for the various ATP candidate could be used to insure the firing units likely to engage the targets in the active region are most effectively resupplied.

As a demonstration of wartime activity, road arc 6 to 8 was considered untrafficable. Its distance was changed to 1000 to demonstrate how this would affect the ATP median totals. Retrograde posture values were used. This resulted in median totals of 29654, 29570, 28972, and 28072 in order #1 through #4. Under this situation, candidate ATP #4 is now the choice, again demonstrating the flexibility of the system.

Conclusions

It must be emphasized that this system is only an aid in the selection of the ATP location. It provides a reliable analytical basis upon which to implement the selection process by ordering the candidate ATPs. Reconnaissances could then be conducted, in order, on the candidate ATPs until the location most enhancing survivability is found. This system is able to determine the best location based on the subjective values of the user. This provides a source of confidence in the location selection. Additionally, this system is flexible in that it allows input as the situation changes, such as the CSR and the number or types of trucks.

Recommendations

The following recommendations are made with respect to this

system:

(1) That the Army Map Service initiate a program to provide pre-digitized disks identical to map sheets presently available in any potential theater of operations. This would significantly increase the accuracy of the data base and reduce the implementation time of the system. The system would then require slight modification in the node-type designation procedure. The digitizer tablet routine would then only be required as the physical road network changed.

(2) That, in lieu of the above recommendation, accurate road distances be provided between all nodes to allow manual insertion of data.

(3) That a procedure be developed to allow the movement of a unit out of the area of operations without having to reinitiate the system.

(4) That a procedure be built into the hardware to allow the recall of data from the disk as required.

(5) That this system serve as a basis for a new system that incorporates the probabilistic nature of the situation. This could account for varying amounts of ammunition expended, varying numbers of trucks available throughout the brigade area, enemy interdiction action, variances in travel time and on/off load time, etc.

APPENDIX I

INITIATION PROCEDURE

Initiation Procedure

This is an interactive decision support system. As data is needed to proceed, the computer will query the user for the information. In most cases, this will be through a request for information or simply a prompt for the execution to continue. The system is designed to accept extraneous information and requery the user for the correct information. In some, but not all situations, the computer informs the user as to the nature of an erroneous entry. When this is not the case, the user must determine the nature of his incorrect entry and make appropriate corrections.

The program is unable to execute entirely without the storage of the road network and locations of firing units and candidate ATP locations. This may be accomplished through the insertion of a disk that had been previously digitized or through use of the digitizer tablet. Prior to this, a map displaying the brigade area must be obtained. This area of concern can be no larger than ten inches square in order to use the digitizer tablet. Any reduction means available is appropriate to come within these constraints so long as the road net remains legible for tracing. It is recommended that the user trace the road network on a sheet of manifold carbon paper prior to use of the bitpad and insure all nodes are indicated and labeled. This significantly reduces the time spend working with the bitpad.

Proper scaling is insured through a series of prompts from the computer. This scaling is necessary to insure the picture displayed in the computer window is proportionate to the map area of concern.

The computer then directs the user through the entry of the road network in the brigade AO. All intersections, candidate ATP locations, and firing units must be input as nodes and arcs must be drawn to connect all those nodes. The entire road network that the user feels has the potential to be used for a resupply route must be entered.

The crosshair assembly connected to the digitizer tablet is used for the entry of the nodes and arcs of the network. The blue button (#2) is used to designate the nodes of the network, while the green button (#3) is utilized in the arc entry. The green button must be continuously depressed while creating the concatenated vectors that portray the roads. The program is designed to find a node within 25 dots of the terminal point on the arc or require a reentry of point data. Erronously traced arcs may be retraced for correction; however, incorrect nodes require a restart of the digitizing operation.

The program is written to immediately save the road net input prior to problem execution. This allows restart of the program at the user's option.

Once network data is input, the candidate ATP locations and firing units must be designated. This is accomplished automatically through use of flagword HIT. The computer will then guide the user through a series of prompts to accomplish this operation.

Following the designation of ATP candidates and firing units, it is necessary to establish the parameters defining the problem posture. The computer guides the user through these value assignments. Then, it directs the user to successively designate the firing batteries with the light pen. The user then provides responses pertinent to each

firing battery so that weights may be calculated.

Completion of battery weight assignments allows calculation of the "1-median".

"Display Analysis" may then be requested. This, along with the median totals provided by the "Compute Median" step will allow the user to determine which of the candidate ATP locations would most enhance the fire support mission.

APPENDIX II

SAMPLE OUTPUT OF DECISION SUPPORT SYSTEM

YOU HAVE CHOSEN AN OFFENSE POSTURE. YOU MUST NOW PROCEED TO ESTABLISH PARAMETERS FOR EACH FIRING BATTERY IN THE BRIGADE AO.

ASSIGN TARGET VALUES TO THE FOLLOWING SEVEN TARGET CATEGORIES: IN CONTACT, COMMAND POSTS, ARMOR ASSEMBLY AREAS, SEAD, CF, TROOP ASSEMBLY AREAS, LOGISTICAL AREAS. ASSIGN INTEGER VALUES IN ASCENDING ORDER--THAT IS, THE HIGHEST PRIORITY TARGET GETS THE LOWEST VALUE. YOU MAY ASSIGN EQUAL TARGET VALUES OR MAKE QUALITATIVE JUDGEMENTS (e.g. IN CONTACT IS 4 TIMES MORE IMPORTANT THAN ALL OTHERS. THIS COULD MEAN YOU ASSIGN VALUE 1 TO CATEGORY 1 AND 4 TO ALL OTHER CATEGORIES)

ENTER YOUR ASSIGNED VALUE FOR IN CONTACT: ? 1
ENTER YOUR ASSIGNED VALUE FOR COMMAND POSTS: ? 2
ENTER YOUR ASSIGNED VALUE FOR ARMOR ASSEMBLY AREAS: ? 1
ENTER YOUR ASSIGNED VALUE FOR SEAD: ? 2
ENTER YOUR ASSIGNED VALUE FOR CF: ? 3
ENTER YOUR ASSIGNED VALUE FOR TROOP ASSEMBLY AREAS: ? 1
ENTER YOUR ASSIGNED VALUE FOR LOGISTICAL AREAS: ? 6

Figure 13. Posture Target Values.

ASSIGN DIVARTY COMMANDER PRIORITIES TO THE FOLLOWING:

- (1) SUPPORTED BRIGADE CONSTITUTES DIVISION MAIN ATTACK
- (2) SUPPORTED BRIGADE CONSTITUTES DIVISION SUPPORTING ATTACK
- (3) SUPPORTED BATTALION/TASK FORCE CONSTITUTES BRIGADE MAIN ATTACK
- (4) SUPPORTED BATTALION/TASK FORCE CONSTITUTES BRIGADE SUPPORTING ATTACK
- (5) PARENT FA BATTALION ASSIGNED A 'DIRECT SUPPORT' ROLE
- (6) PARENT FA BATTALION ASSIGNED A 'REINFORCING' ROLE
- (7) PARENT FA BATTALION ASSIGNED A 'GENERAL SUPPORT-REINFORCING' ROLE
- (8) PARENT FA BATTALION ASSIGNED A 'GENERAL SUPPORT' ROLE

ASSIGN INTEGER VALUES IN DESCENDING ORDER--THAT IS, THE HIGHEST PRIORITY GETS THE HIGHEST VALUE. RANK ONLY AS FOLLOWS:

BETWEEN (1) AND (2) ABOVE

BETWEEN (3) AND (4) ABOVE

BETWEEN (5), (6), (7), AND (8) ABOVE

YOU MAY ASSIGN EQUAL VALUES OR MAKE QUALITATIVE JUDGEMENTS WITHIN GROUPINGS.

ENTER YOUR ASSIGNED VALUE FOR (1): ? 10

ENTER YOUR ASSIGNED VALUE FOR (2): ? 5

ENTER YOUR ASSIGNED VALUE FOR (3): ? 10

ENTER YOUR ASSIGNED VALUE FOR (4): ? 5

ENTER YOUR ASSIGNED VALUE FOR (5): ? 5

ENTER YOUR ASSIGNED VALUE FOR (6): ? 3

ENTER YOUR ASSIGNED VALUE FOR (7): ? 2

ENTER YOUR ASSIGNED VALUE FOR (8): ? 1

Figure 14. Posture Divarty Priority Values.

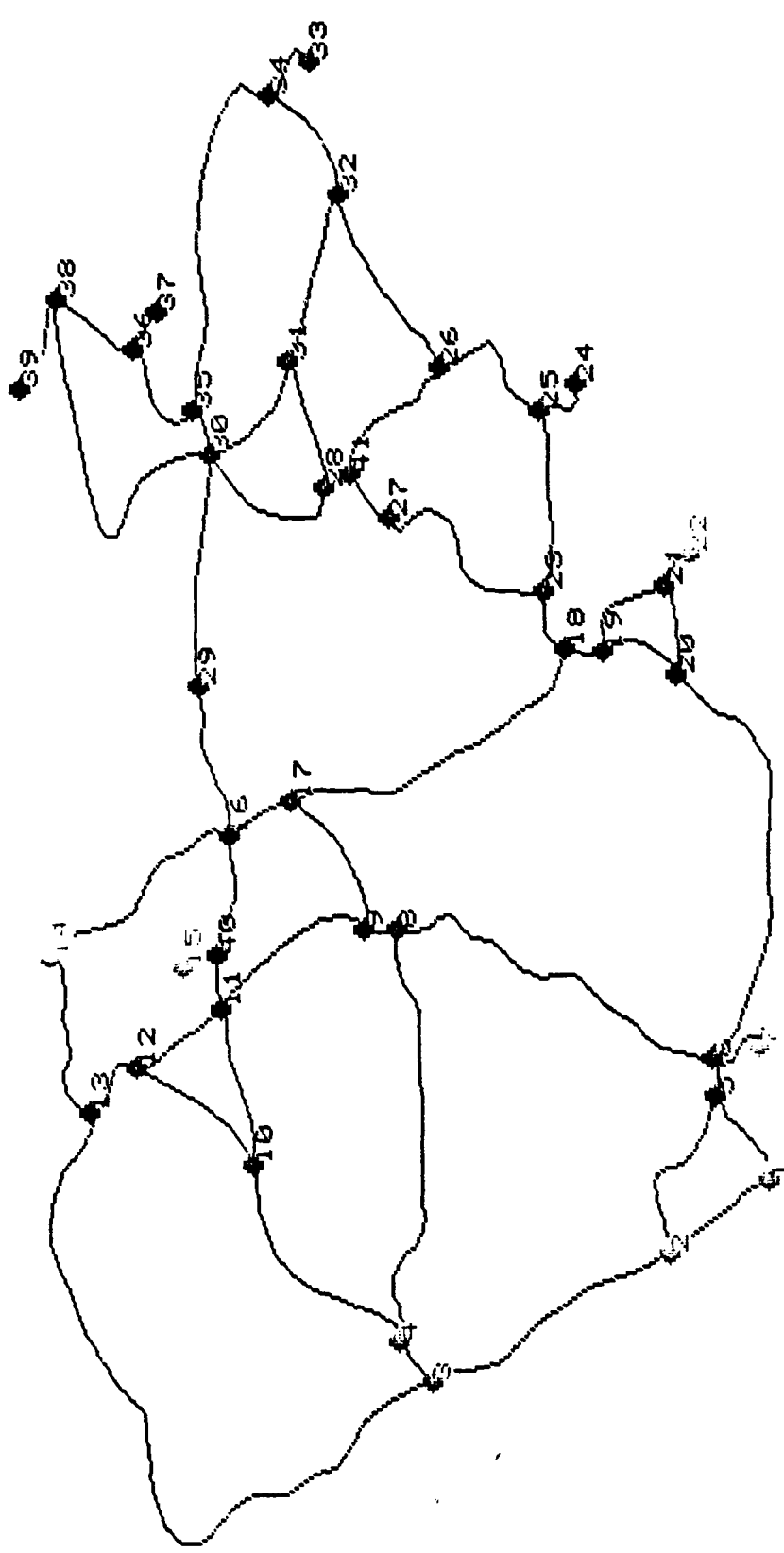

DESIGNATE THE CALIBER OF HOWITZER:

Type I=155mm or 8-inch ? I

IS THIS 155mm BATTERY PROVIDING FIRE SUPPORT (DS,R OR GSR ONLY) TO THE BRIGADE ASSIGNED THE DIVISION'S MAIN ATTACK? Type YES or NO ? I

Figure 15. Battery Parameter Designation (1).

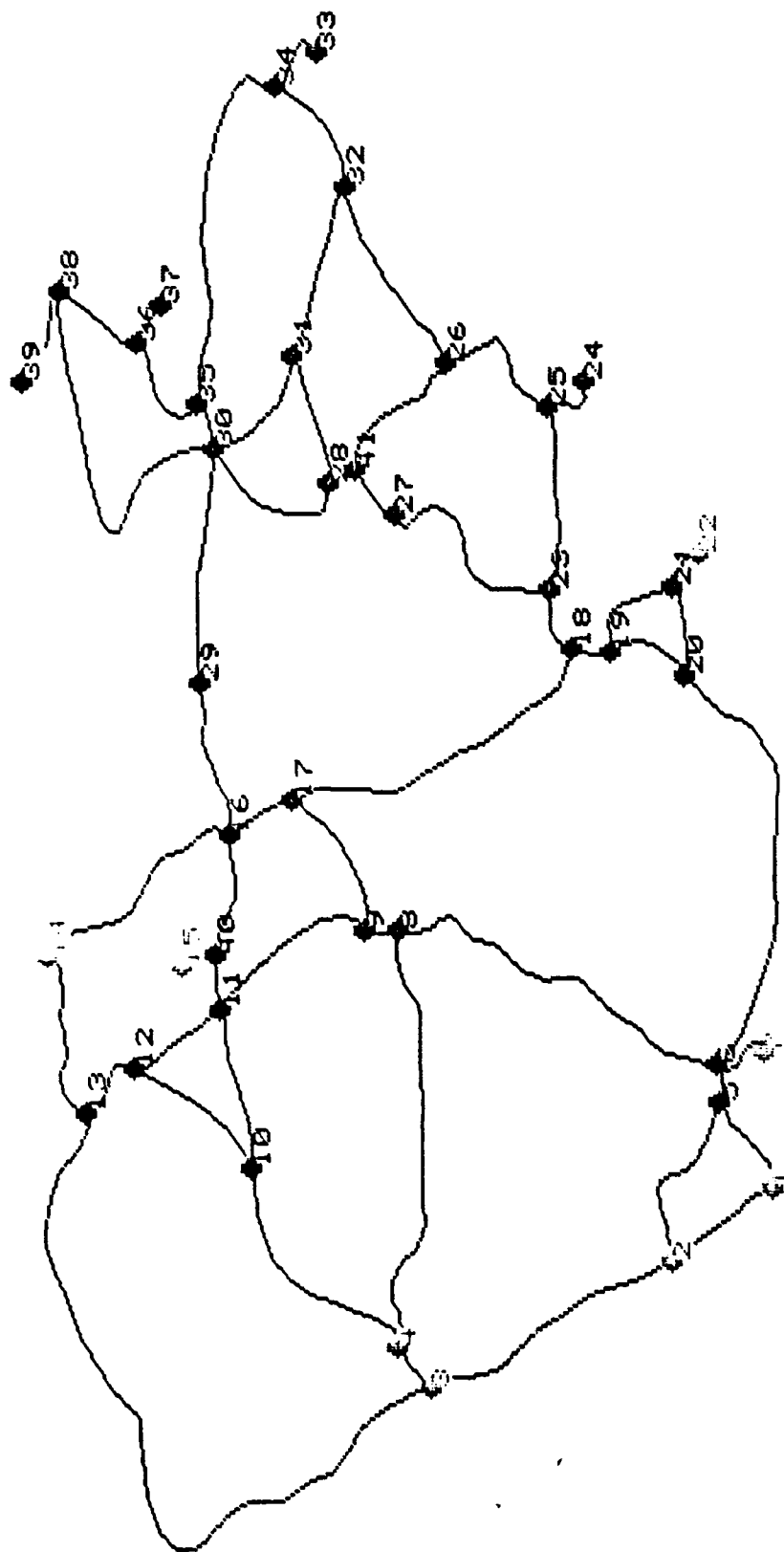

DESIGNATE THE RESPECTIVE BATTERY'S ASSIGNED

FA ROLE

#1DESIGNATES 'DIRECT SUPPORT'

#2DESIGNATES 'REINFORCING'

#3DESIGNATES 'GENERAL SUPPORT-REINFORCING'

#4DESIGNATES 'GENERAL SUPPORT'

ENTER CHOICE FROM ABOVE OPTIONS? 1

Figure 16: Battery Parameter Designation (2).

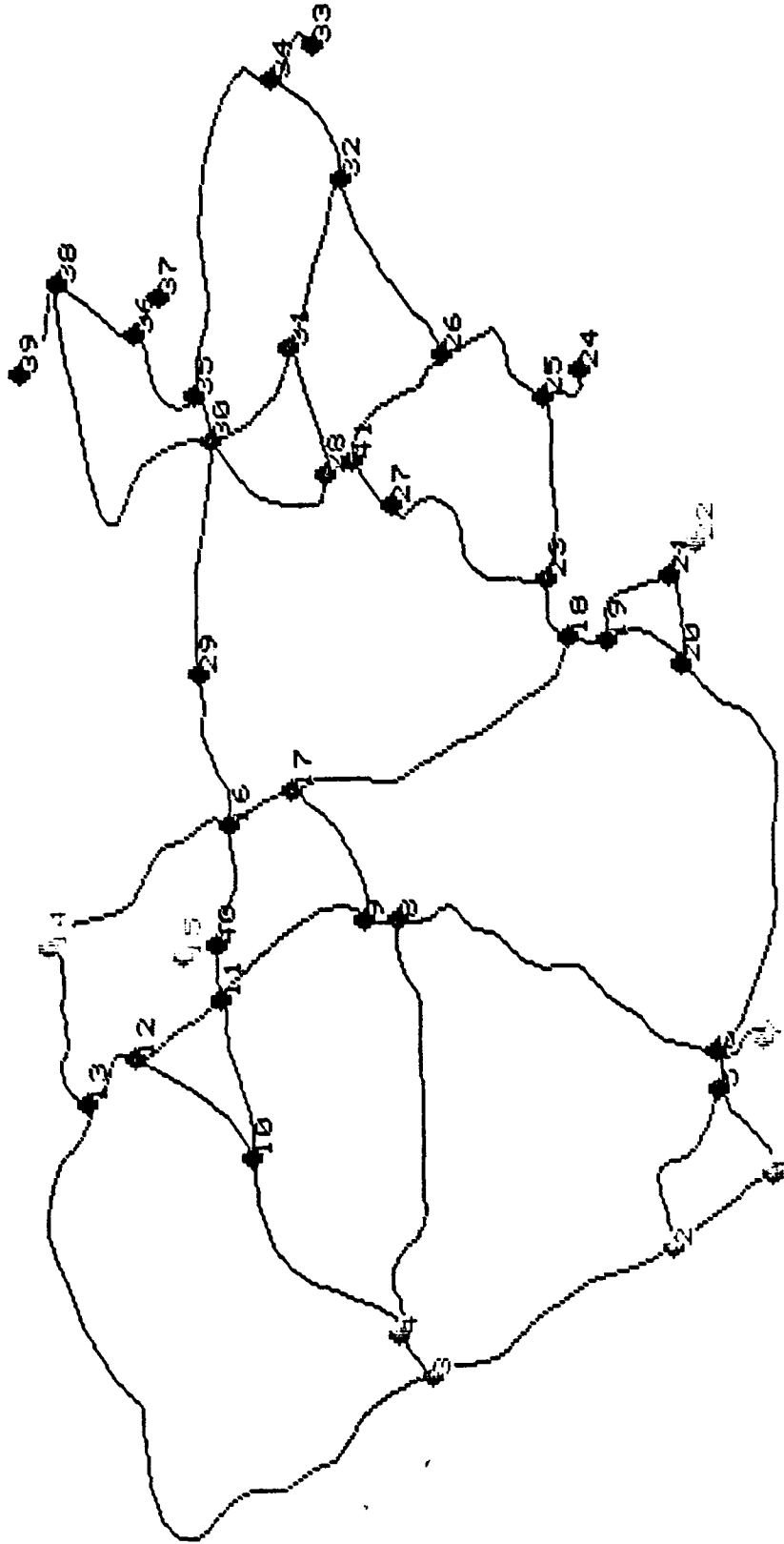

IS THIS 155mm BATTERY PROVIDING FIRE SUPPORT TO THE
 BATTALION/TASK FORCE ASSIGNED THE BRIGADE'S MAIN
 ATTACK? Type Value or None
 ? Y_

Figure 17. Battery Parameter Designation (3).

MEDIAN OF ATP CANDIDATE AT NODE 1 IS 13903
MEDIAN OF ATP CANDIDATE AT NODE 2 IS 14235
MEDIAN OF ATP CANDIDATE AT NODE 3 IS 14232
MEDIAN OF ATP CANDIDATE AT NODE 4 IS 14230

RECORD THESE VALUES FOR FUTURE REFERENCE

Figure 18. Median Report.

YOU HAVE REQUESTED THE GRAPH--CONTROLLED SUPPLY RATE VS OPICM ROUNDS RESUPPLIED EACH
155mm FIRING BATTERY

HOW MANY PALLETS OF 155mm OPICM CAN ORGANIC TRUCKS CARRY? 20

HOW MANY TRUCK/TRAILER COMBINATIONS DOES EACH BATTERY HAVE AVAILABLE FOR AMMO RESUPPL
Y? 3

WHAT IS THE CSR FOR 155mm OPICM ? 250

WHAT IS THE NODE # OF THE SELECTED ATP? 1

Figure 19. Graph-Input.

CONTROLLED SUPPLY RATE VS DPICM ROUNDS RESUPPLIED EACH 155mm FIRING BATTERY

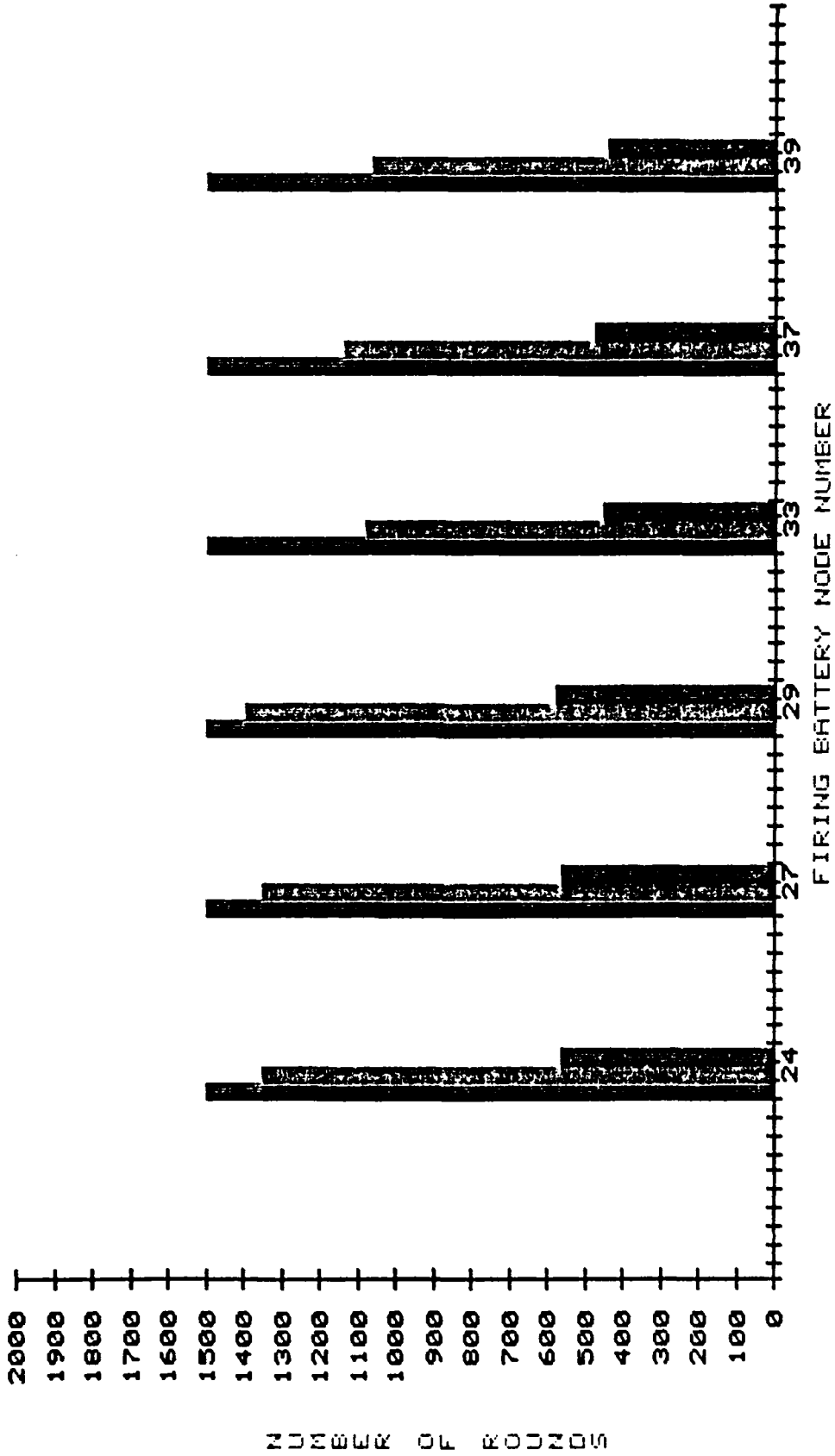

CSR--155mm DPICM
 DPICM RESUPPLIED--ALL DAY OPS
 DPICM RESUPPLIED--NIGHT OPS ONLY
 Hit the CHARGE RETURN to continue

Figure 20. Graph-155mm DPICM.

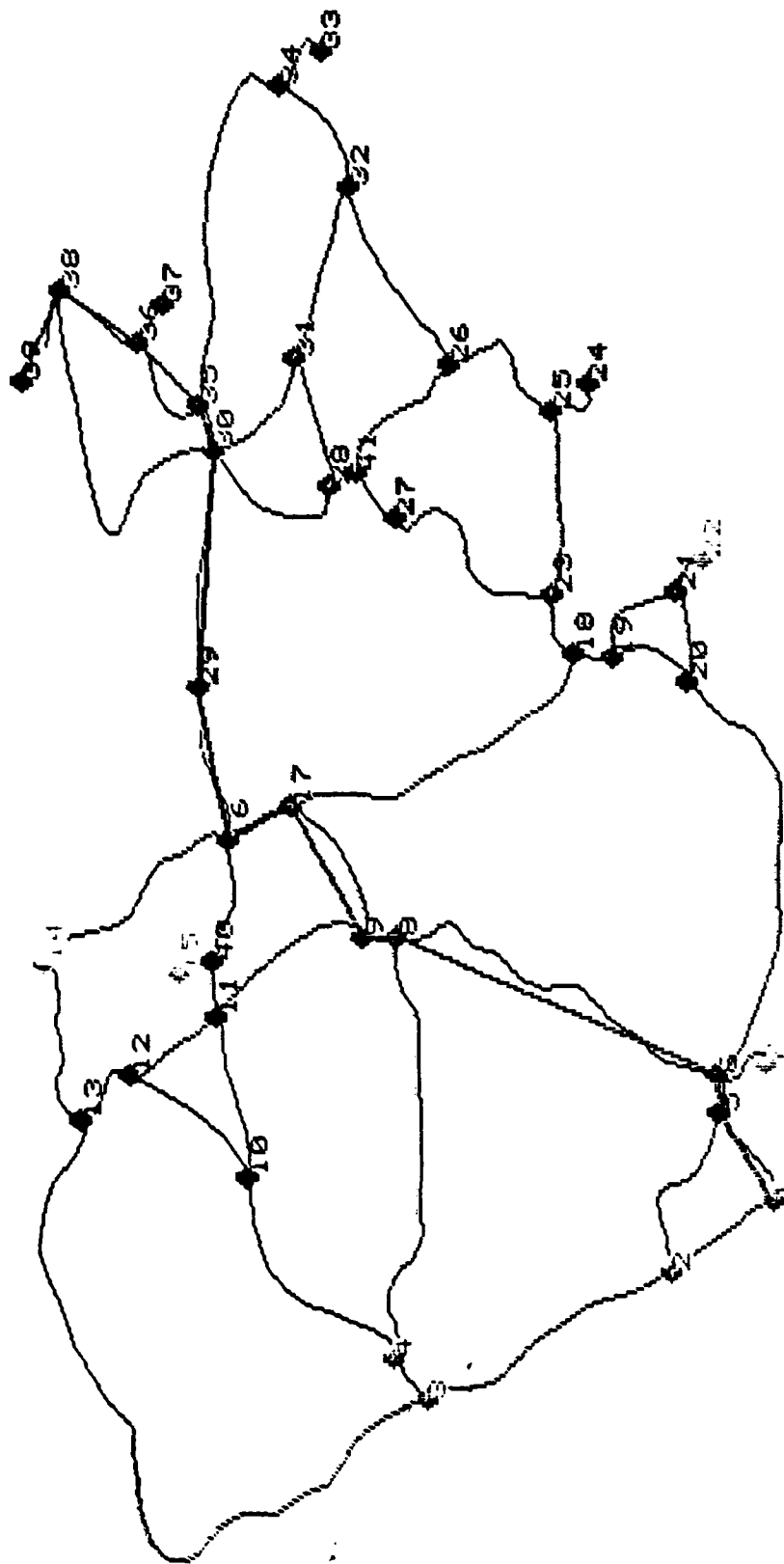

DO YOU WANT TO SEE ANY MORE PATHS?
TYPE NUMBER OF PATH

Figure 21. Shortest Route.

WHICH CATEGORY'S TARGET VALUE DO YOU WANT ANALYSIS ON?

- #1=IN CONTACT
- #2=COMMAND POSTS
- #3=ARMOR ASSEMBLY AREAS
- #4=SEAD
- #5=COUNTERFIRE
- #6=TROOP ASSEMBLY AREAS
- #7=LOGISTICAL AREAS

ENTER ONLY ONE CHOICE ? 1

CURRENT ATP NO LONGER BEST WITH CATEGORY 1 TARGET
VALUE INCREASE TO 5
ATP 4 IS NOW A BETTER LOCATION TO SUPPORT THE FI
RE SUPPORT MISSION.
CURRENT ATP NO LONGER BEST WITH CATEGORY 1 TARGET
VALUE DECREASE TO 3

ATP 2 IS NOW A BETTER LOCATION TO SUPPORT THE FI. ? 2 Hit the carriage RETURN to continue
RE SUPPORT MISSION.

Figure 22. Target Value Sensitivity Analysis.

WHICH PRIORITY DO YOU WANT ANALYSIS ON?

- #1=PARENT FA BATTALION ASSIGNED A 'DIRECT SUPPORT' ROLE
- #2=PARENT FA BATTALION ASSIGNED A 'REINFORCING' ROLE
- #3=PARENT FA BATTALION ASSIGNED A 'GENERAL SUPPORT REINFORCING' ROLE
- #4=PARENT FA BATTALION ASSIGNED A 'GENERAL SUPPORT' ROLE

ENTER ONLY ONE CHOICE ? 1

CURRENT ATP NO LONGER BEST WITH DIVARTY COMMANDER
PRIORITY 1 INCREASE TO 5
ATP 2 IS NOW A BETTER LOCATION TO SUPPORT THE FI
RE SUPPORT MISSION.
CURRENT ATP NO LONGER BEST WITH DIVARTY COMMANDER
PRIORITY 1 DECREASE TO 3
ATP 2 IS NOW A BETTER LOCATION TO SUPPORT THE FIhit the CARRIAGE RETURN to continue
? _

Figure 23. Posture Priority Sensitivity Analysis.

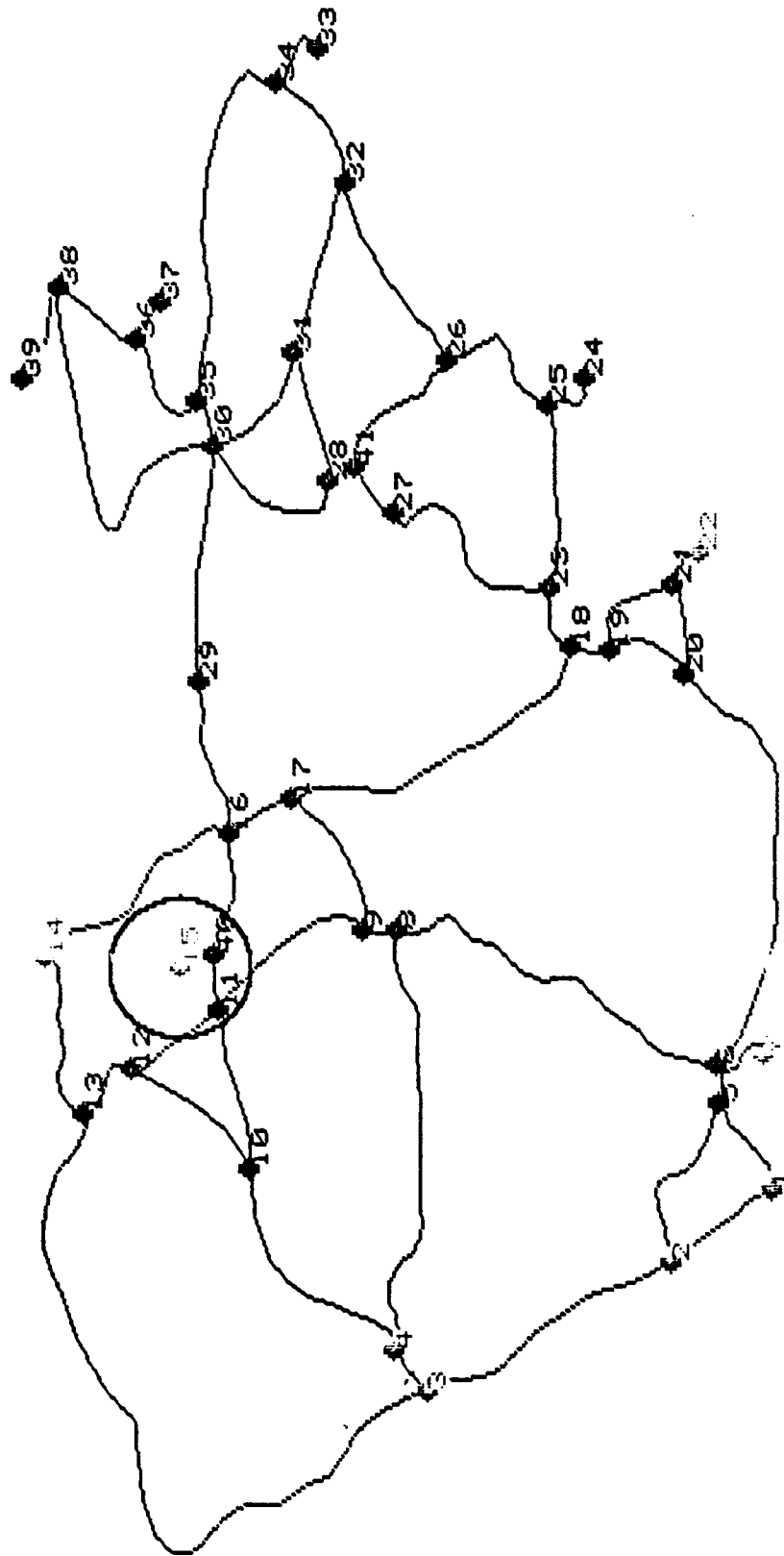

Hit the CORRIAGE RETURN to continue .? -

Figure 24. Firing Battery Sensitivity Analysis.

APPENDIX III

PROGRAM ATPI

```

6 PROGRAM ATPI
71 IF FG=2 THEN FO=0:GOTO 796
72 HIT=0:TOT=0
73 IF MX THEN 76 ELSE 80
74 GOSUB 2000:GOTO 460
75 IF MUCH THEN 85 ELSE 100
76 GOSUB 2000:GOTO 790
77 CLEAR:DEFINT A,I,J,N,L,O,C,Z
78 PRINT CHR$(12);"~U000350~C1~06~X2,~Y2, ENTER PROBLEM NAME(use town nearest BSA)"
79 INPUT "C1":NAME1$
80 IF LEN(NAME1$)=0 THEN 100
81 DIM OP(15)
82 DIM DI(1,1),XX(1),YY(1),ASP(1),BSP(1),CSP(1)
83 DIM AZTP(1),FU(1)
84 DIM AD(1),BD(1),CD(1),DST(1,1)
85 DIM MED(1),MT(1)
86 DIM OB(1),EB(1),SMED(1),SMT(1)
87 DIM FO(1),GO(1),HO(1),OO(1)
88 DIM JO(7),PD(8)
89 DIM OX(1),OY(1),TH(1)
90 PRINT CHR$(12);"~U000350~C718 THERE DATA ON PROBLEM~C1 ~,NAME1$, " ~C7ALREADY STORED?~X1,~Y1,":PRINT:PRINT
91 INPUT "C3 Type Y=Yes~C7 or ~C3N=No~C7~J ~,B$
92 IF LEFT$(B$,1)="" THEN GOSUB 2700:GOSUB 2000:GOTO 375
93 PRINT CHR$(12);"~U0002900~C1PREPARE TO ENTER THE ROAD NETWORK WITHIN YOUR BRIGADE SECTOR THAT IS ABLE TO ACCOMMODATE ";
94 PRINT "AMMUNITION-BEARING TRAFFIC UNDER PROBLEM NAME:";NAME1$:PRINT:PRINT
95 PRINT "C7~100 YOU NEED INSTRUCTIONS?~2~C3Type Y=Yes~C7 or ~C3 N=No~C7~J ~:INPUT A$
96 IF LEFT$(A$,1)<"Y" GOTO 225 ELSE PRINT CHR$(12);"~U001300";
97 PRINT "YOUR MAP AREA OF OPERATIONS (AO) MAY BE NO LARGER THAN 10 INCHES BY 10 INCHES. ";
98 PRINT "CENTER YOUR AO ON THE DIGITIZER TABLET AND SECURE IT. IDENTIFY A POINT IN THE LOWER LEFT CORNER ";
99 PRINT "OF THE MAP THAT IS WITHIN ONE-FOURTH INCH OF BOTH THE X AND Y AXIS BOUNDARIES OF THE IDENTIFIED AREA. ";
100 PRINT "REPEAT THIS PROCEDURE FOR THE UPPER RIGHT CORNER. THESE TWO POINTS WILL BE USED TO SCALE YOUR AO";
101 PRINT " TO THE FULL SIZE OF THE SCREEN. ";CHR$(10)
102 INPUT "Hit ~C1~CARRIAGE RETURN~C7~2when ready to start. ~C3~0+00000511511";C$
103 PRINT CHR$(12);"~U001100~C7~KTOUCH LOWER LEFT CORNER SCALE POINT WITH PEN POINT OR DEPRESS ~C1ANY~C7 BUTTON ";
104 PRINT "ON THE CROSSHAIR ASSEMBLY AFTER IT IS CENTERED OVER THE SCALE POINT. A BEEP SHOULD SOUND. ~C4(NO BEEP INDICATES ";
105 PRINT "YOU ARE OUTSIDE THE DIGITIZER TABLET'S SENSITIVE AREA--DECREASE THE SIZE OF THE AO TO BE TRACED)~C7"
106 INPUT#4;X,Y,F$:IF F$="1" OR F$="2" OR F$="4" OR F$="8" THEN OP(1)=X:OP(2)=Y:PRINT CHR$(7) ELSE 240
107 PRINT CHR$(12);"~U200250~C6~X3,~Y3,WAIT~X1,~Y1,~7050"
108 PRINT CHR$(12);"~U001250~C7TOUCH UPPER RIGHT SCALE POINT WITH PEN POINT OR DEPRESS ~C1ANY~C7 BUTTON ON ";
109 PRINT "THE CROSSHAIR ASSEMBLY AFTER IT IS CENTERED OVER THE SCALE POINT. A BEEP SHOULD SOUND. ~C4(NO BEEP INDICATES ";
110 PRINT "YOU ARE OUTSIDE THE DIGITIZER TABLET'S SENSITIVE AREA--DECREASE THE SIZE OF THE AO TO BE TRACED)~C7"
111 F$=""
112 INPUT#4;X,Y,F$:IF F$="1" OR F$="2" OR F$="4" OR F$="8" THEN OP(3)=X:OP(4)=Y ELSE 265
113 OP(5)=OP(3)-OP(1)/512:OP(6)=(OP(4)-OP(2))/412
114 PRINT CHR$(12);"~C6~U001450";CHR$(7);:IF LEFT$(A$,1)<"Y" THEN 325 ELSE 285
115 PRINT "THE MAP HAS BEEN SCALED. PREPARE TO PLOT THE LOCATIONS OF ALL ROAD INTERSECTIONS AND ROAD END ";
116 PRINT "POINTS THAT:";PRINT
117 PRINT " (1) LEAVE THE EDGE OF AN AREA THAT WAS SCALED PREVIOUSLY,":PRINT
118 PRINT " (2) END AT ANY POINT INSIDE OF THE SCALED AREA.":PRINT:PRINT
300

```

```

305 PRINT "C7 TO DESIGNATE A NODE, POSITION THE CURSOR OVER THE DESIRED POINT AND DEPRESS THE C1 BLUE BUTTON";
310 PRINT "C7. THE BEEP WILL SOUND INDICATING THAT THE NODE HAS BEEN ACCEPTED. A C2 GREEN CIRCLE C7 WILL APPEAR ON THE ";
315 PRINT "SCREEN. PLOT THE INTERSECTIONS OF ALL PREVIOUSLY IDENTIFIED ROADS.":PRINT:PRINT
316 PRINT "C7 TO DRAW A ROAD, POSITION THE CURSOR OVER THE START NODE AND DEPRESS THE C2 GREEN BUTTON";
317 PRINT "C7. THE BEEP WILL SOUND AND THE NODE WILL BEGIN TO BLINK. C1 CAREFULLY C2";
318 PRINT "C7 TRACE THE ROAD TO THE END NODE C1 C4 CONSTANTLY PRESSING C2 C7 THE C2 GREEN BUTTON C7. RELEASE THE C2 GREEN ";
319 PRINT "BUTTON C7. THE START NODE WILL NOW APPEAR C1 BLUE C7. PLOT ALL PREVIOUSLY IDENTIFIED ROADS.":
320 PRINT " WHEN FINISHED, RESPOND TO THE SCREEN PROMPT.":PRINT:PRINT
321 INPUT "Hit C1 CARRIAGE RETURN C7 to continue.":C#
325 ERASE DI: DIM DI(KZ,KZ)
327 PRINT CHR$(27); "DA0"K";
330 ON ERROR# 0 TO 371: OUT#H90,0
335 PRINT CHR$(27); "DA1"; CHR$(12); "C1 DIGITIZER TABLET ENABLED K":PRINT
340 PRINT "C3 CENTER ROAD NETWORK K":PRINT
345 PRINT "C6 DESIGNATE ANY MENU CIRCLE WHEN ALL ARCS HAVE BEEN ENTERED K"
350 PRINT "C3 LIGHT PEN ENABLED K"
360 PRINT#4;"j"
365 INPUT#4;X,Y,F#;IF F#="8" THEN 366 ELSE 365
366 IF X<=0 OR Y<=0 GOTO 365
367 XP=FNPX(X):YP=FNPY(Y)
368 IF XP<0 OR YP>511 OR YP<0 OR YP>511 THEN 365
369 GOSUB 2200
370 OUT#H90,0:GOTO 365
371 IF ERR=24 THEN OUT#H90,0:RESUME 400 ELSE OUT#H90,0:GOTO 330
375 TOT=1:ON ERROR#2 GOTO 400:OUT#H90,0
380 PRINT CHR$(27); "DA1"; CHR$(12):PRINT "C3 LIGHT PEN ENABLED C7 K":PRINT
385 PRINT "C5 PROCEED WITH MENU SELECTION K"
390 PRINT CHR$(27); "DA0"K";
395 OUT#H90,0:GOTO 395
400 IF ERR=24 GOTO 405 ELSE ON ERROR#0 GOTO 0
405 IF HIT=0 GOTO 440
410 XP=CURSX(4):YP=CURBY(4)
415 ON HIT GOTO 420,820,840,860,900
420 XL=25:FOR I=1 TO 5:YL=50
425 HSS=ABS(XP-XL)+ABS(YP-YL)
430 IF HSS<20 THEN PRINT CHR$(7);:ON I GOTO 455,515,560,570,650
435 XL=XL+50:NEXT
440 OUT#H90,0:RESUME 380
445 OUT#H90,0:RESUME 460
450 OUT#H90,0:RESUME 460
460 JP=1:PRINT CHR$(27); "DA1"; CHR$(12);
465 PRINT "C5 STANDBY C7 C3 DATA BEING RETRIEVED K":ERASE DI: DIM DI(KZ,KZ):DOS"ARYLOAD/1 "+NAME1$+"DI DI"
480 GOSUB 2500:PRINT CHR$(12):INPUT "C7 C1 DO YOU WANT TO USE THE DIGITIZER TABLET? C2 C3 Type Y=YES C7 or C3N=No K";B#
485 IF LEFT$(B#,1)<>"Y" THEN 505 ELSE 490
490 PRINT CHR$(27); "RIC"; CHR$(27); "DE5"; CHR$(27); "IE5":PRINT#4;"K"
495 PRINT CHR$(27); "DA0"K" H000100511000"; CHR$(12);
500 DOS"REFRESH/1 "+NAME1$:GOSUB 2100:GOSUB 3200
505 GOSUB 2000:GOSUB 3000:ERASE DI: DIM DI(1,1):PRINT CHR$(12);
510 IF TOT THEN OUT#H90,0:GOTO 380 ELSE OUT#H90,0:GOTO 375
515 PRINT CHR$(27); "DA1"K"; CHR$(12):PRINT "C3 LIGHT PEN ENABLED K":CLEAR:END

```

```

560 OUT&H90,0: RESUME 561
561 PRINT CHR$(27);"0A1";CHR$(12):INPUT "~C7HAVE POSTURE PARAMETERS BEEN DEFINED? ~C3Type Y=Yes ~C7or ~C3N=No ~J~C7";A$
562 IF LEFT$(A$,1)<"Y" THEN F0=1:GOTO 3100 ELSE F0=1:GOTO 565
565 PRINT CHR$(27);"0A0";CHR$(12):DOS"CHAIN/2 ATP11"
570 PRINT CHR$(27);"0A1";CHR$(12):INPUT "~C7HAS ATP BEEN SELECTED? ~C3Type Y=Yes ~C7or ~C3N=No ~J~C7";A$
571 IF LEFT$(A$,1)="" THEN P9=1:GOTO 586 ELSE 580
580 PRINT CHR$(12);"~C7YOU CANNOT DISPLAY SOLUTION ANALYSIS UNTIL ATP HAS ";
585 PRINT "BEEN DETERMINED. ~7020":GOTO 595
586 ERASE TD,PD:DIM TD(7),PD(8):DOS"ARYLOAD/2 "+NAME1$+"TD TD":DOS"ARYLOAD/2 "+NAME1$+"PD PD"
588 OUT&H90,0: RESUME 590
590 PRINT CHR$(27);"0A0";CHR$(12):F0=3:DOS"CHAIN/2 ATP11"
595 OUT&H90,0: RESUME 375
600 OUT&H90,0: RESUME 651
651 PRINT CHR$(27);"0A1";CHR$(12);
655 PRINT "~C7M~C11~C7=~C1NEM PROBLEM~C7. "
665 PRINT "~C7M~C12~C7=~C1MINOR CHANGE~C7. "
670 PRINT "~C7M~C13~C7=~C1RETURN TO MENU CONTROL~C7. "
675 INPUT "~C1~ENTER CHOICE FROM ABOVE OPTIONS~2~C7~J";C:PRINT CHR$(12)
680 IF C<1 OR C>2 GOTO 805
685 ON C GOTO 690,790
690 PRINT CHR$(12);"~C7A ~C1NEM PROBLEM ~C7REQUIRES A NEW ROAD NETWORK BE ENTERED. START OVER. ~7030"
695 PRINT "~";CHR$(12);CHR$(27);"E"
700 PRINT CHR$(12);"~C7A ~C1~MINOR CHANGE ~2~C7OCCURS WHEN STATED PARAMETERS OF PROBLEM ~C1";NAME1$;"~C7 CHANGE. ~7050"
705 IF TD(1) AND PD(1) THEN 794 ELSE 792
792 PRINT "~C5STANDBY~C7--~C3DATA BEING RETRIEVED~K~7020":ERASE TD,PD:DIM TD(7),PD(8)
793 DOS"ARYLOAD/2 "+NAME1$+"TD TD":DOS "ARYLOAD/2 "+NAME1$+"PD PD"
794 PRINT CHR$(12);CHR$(27);"0A0~K"
795 F0=2:GOTO 3100
796 PRINT "~J";CHR$(12):DOS"REFRESH/1 "+NAME1$
800 GOSUB 2000
805 HIT=1:MUCH=0
810 IF TOT THEN OUT&H90,0:GOTO 300 ELSE GOTO 375
820 CP(8)=CP(8)+1:ERASE AZTP:DIM AZTP(OP(8)):DOS"ARYLOAD/1 "+NAME1$+"AZTP AZTP"
821 PRINT CHR$(27);"0A0~K"; OUT&H90,0:RESUME 822
822 ON ERROR#2 GOTO 826:OUT&H90,0
823 PRINT CHR$(27);"0A1";CHR$(12):PRINT "~C6~KDESIGNATE NEW ATP NODE WITH LIGHT PEN"
824 PRINT "~K~CLIGHT PEN ENABLED"
825 GOTO 825
826 IF ERR=24 THEN XP=CURSX(4):YP=CURS(4) ELSE ON ERROR#0 GOTO 0
827 NPN=25:GOSUB 2300:AZTP(OP(8))=CLN
829 PRINT CHR$(7);CHR$(27);"0A0~C6";:GOSUB 2400:GOTO 870
840 CP(12)=CP(12)+1:ERASE OB:DIM OB(OP(12)):DOS"ARYLOAD/1 "+NAME1$+"OB OB"
841 PRINT CHR$(27);"0A0~K";:OUT&H90,0:RESUME 842
842 ON ERROR#2 GOTO 846:OUT&H90,0
843 PRINT CHR$(27);"0A1";CHR$(12):PRINT "~C4~KDESIGNATE NEW 155mm NODE WITH LIGHT PEN"
844 PRINT "~K~CLIGHT PEN ENABLED"
845 GOTO 845
846 IF ERR=24 THEN XP=CURSX(4):YP=CURS(4) ELSE ON ERROR#0 GOTO 0
847 NPN=25:GOSUB 2300:OB(OP(12))=CLN:FU(OP(9))=CLN
849 PRINT CHR$(7);CHR$(27);"0A0~C4";:GOSUB 2400:GOTO 870
860 CP(13)=CP(13)+1:ERASE EB:DIM EB(OP(13)):DOS"ARYLOAD/1 "+NAME1$+"EB EB"

```

```

851 PRINT CHR$(27); "OA0^K": OUT&H90,0: RESUME 852
852 ON ERROR#2 GOTO 866: OUT&H90,0
853 PRINT CHR$(27); "OA1"; CHR$(12): PRINT "--C3~KDESIGNATE NEW 8-inch NODE WITH LIGHT PEN"
854 PRINT "--K~C3LIGHT PEN ENABLED"
855 GOTO 865
856 IF ERR=24 THEN XP=CURSY(4): YP=CURSY(4) ELSE ON ERROR#0 GOTO 0
857 NPN=25: OOSUB 2300: EB(OP(13))=CLN: FU(OP(9))=CLN
859 PRINT CHR$(7); CHR$(27); "OA0~C3"; OOSUB 2400: GOTO 870
870 PRINT CHR$(27); "OA1";
871 PRINT CHR$(12); "--C5STANDBY~C7--~C3 DATA BEING SAVED~K~?030"
872 PRINT CHR$(27); "OA0~K~H000100511000"; CHR$(12);
873 DOS"PICTURE/1 "+NAME1$
874 DOS"ARYSAVE/1 "+NAME1$+"XX XX": DOS"ARYSAVE/1 "+NAME1$+"YY YY"
875 DOS"ARYSAVE/1 "+NAME1$+"AZTP AZTP": DOS"ARYSAVE/1 "+NAME1$+"OB OB"
876 DOS"ARYSAVE/1 "+NAME1$+"DI DI": DOS"ARYSAVE/1 "+NAME1$+"OP OP"
877 DOS"ARYSAVE/1 "+NAME1$+"EB EB": DOS"ARYSAVE/1 "+NAME1$+"FU FU"
878 OOSUB 3000: ERASE DI, OB, EB: DIM DI(1,1), OB(1), EB(1): PRINT CHR$(27); "OA0~K~H000100511000"; CHR$(12);
879 OOSUB 2000
880 HIT=1: IF TOT THEN OUT&H90,0: GOTO 380 ELSE TOT=1: GOTO 375
900 OUT&H90,0: OOSUB 1000: OOSUB 1100: OOSUB 1200: OOSUB 1300: GOTO 870

1000 IF AP THEN 1001 ELSE 1055
1001 KK=1: ERASE AZTP: DIM AZTP(OP(8))
1005 PRINT CHR$(27); "OA0~K";
1010 OUT&H90,0: ON ERROR#2 GOTO 1030: OUT&H90,0
1015 PRINT CHR$(27); "OA1"; CHR$(12): PRINT "--C6~KDESIGNATE AN ATP NODE WITH LIGHT PEN"
1020 PRINT "--K~C3LIGHT PEN ENABLED"
1025 GOTO 1025
1030 IF ERR=24 THEN XP=CURSY(4): YP=CURSY(4) ELSE ON ERROR#0 GOTO 0
1035 NPN=25: OOSUB 2300: AZTP(KK)=CLN
1040 PRINT CHR$(7); CHR$(27); "OA0~C5"; OOSUB 2400
1045 KK=KK+1: IF KK>OP(8) THEN OUT&H90,0: RESUME 1050 ELSE OUT&H90,0: RESUME
1050 KK=0
1055 RETURN

1100 IF OB THEN 1101 ELSE 1155
1101 MM=1: ERASE OB: DIM OB(OP(12))
1105 PRINT CHR$(27); "OA0~K";
1110 ON ERROR#2 GOTO 1130: OUT&H90,0
1115 PRINT CHR$(27); "OA1"; CHR$(12): PRINT "--C4~KDESIGNATE A 155mm NODE WITH LIGHT PEN"
1120 PRINT "--K~C3LIGHT PEN ENABLED"
1125 GOTO 1125
1130 IF ERR=24 THEN XP=CURSY(4): YP=CURSY(4) ELSE ON ERROR#0 GOTO 0
1135 NPN=25: OOSUB 2300: OB(MM)=CLN
1140 PRINT CHR$(7); CHR$(27); "OA0~C4"; OOSUB 2400
1145 MM=MM+1: IF MM>OP(12) THEN OUT&H90,0: RESUME 1150 ELSE OUT&H90,0: RESUME
1150 MM=0

```

```

1200 IF ZP THEN 1201 ELSE 1255
1201 NN=1:ERASE EB: DIM EB(OP(13))
1205 PRINT CHR$(27); "0A0~K";
1210 ON ERROR#2 GOTO 1230: OUT&H90,0
1215 PRINT CHR$(27); "0A1"; CHR$(12):PRINT "~C3~KDESIGNATE A 8-inch NODE WITH LIGHT PEN"
1220 PRINT "~K~GLIGHT PEN ENABLED"
1225 GOTO 1225
1230 IF ERR=24 THEN XP=CURSX(4):YP=CURSY(4) ELSE ON ERROR#0 GOTO 0
1235 NPN=25:OSUB 2300:EB(NN)=CLN
1240 PRINT CHR$(7);CHR$(27);"0A0~C3";:GOSUB 2400
1245 NN=NN+1:IF NN>OP(13) THEN OUT&H90,0:RESUME 1250 ELSE OUT&H90,0:RESUME
1250 NN=0
1255 HIT=1:RETURN

1300 ERASE FU: DIM FU(OP(9))
1301 FOR N=1 TO OP(12):ZD=OB(N):FU(N)=ZD:NEXT
1302 IF ZP THEN 1305 ELSE 1310
1305 FOR M=1 TO OP(13):ZE=EB(M):FU(OP(12)+M)=ZE:NEXT
1310 RETURN

2000 PRINT "~=";CHR$(12)
2005 PRINT CHR$(27); "0A1~="300100511000~R~01";CHR$(12);
2010 PRINT CHR$(27); "0A0~="K~C7~F~0";
2015 PRINT "~025050010;075050010;125050010;175050010;225050010~L";CHR$(21)
2020 PRINT "~C1~U01600ADD~U001030NODE/ARC";
2025 PRINT "~C2~U060080STOP";
2030 PRINT "~C3~U107000COMPUTE~U110030MEDIAN";
2035 PRINT "~C4~U154000SOLUTION~U155030ANALYSIS";
2040 PRINT "~C5~U204000RESTART":RETURN

2100 DEF FNPX(X)=FIX((X-OP(1))/OP(5)+.5):DEF FNPY(Y)=FIX((Y-OP(2))/OP(6)+.5)+100
2105 PRINT CHR$(27); "0A1";CHR$(12);"~C10IOTIZER TABLET ENABLED ~K":PRINT
2106 PRINT "~C3CENTER CANDIDATE ATPs;BATTERIES, ANDROAD INTERSECTIONS~K":PRINT
2107 PRINT "~C6CENTER CANDIDATE ATPs~1~C4 FIRST~2~K"
2108 IF JP=1 THEN 2112 ELSE 2110
2110 ERASE XX,YY: DIM XX(KZ),YY(KZ)
2111 GOTO 2115
2112 ERASE XX,YY: DIM XX(KZ+1),YY(KZ+1):GOTO 2120
2115 M=0
2120 PRINT#4;"P":PRINT CHR$(27); "0A0";
2125 INPUT#4;X,Y,F8:IF F8="4" GOTO 2130 ELSE 2125
2130 IF X<=0 OR Y<=0 GOTO 2125
2135 XP=FNPX(X):YP=FNPY(Y)
2140 IF XP<0 OR XP>511 OR YP<0 OR YP>511 THEN 2125
2141 IF JP=1 GOTO 2155
2145 PRINT CHR$(7);M=M+1:CLN=M:OP(11)=M
2150 XX(CLN)=XP:YY(CLN)=YP:PRINT "~C2":GOSUB 2400:GOTO 2155
2155 IF M=OP(0) THEN 2160 ELSE 2125
2156 PRINT CHR$(7);:CLN=OP(11)+1:OP(11)=CLN

```

```

2157 XX(CLN)=XP:YY(CLN)=YP:PRINT "C2":GOSUB 2400:GOTO 2158
2158 PRINT CHR$(27);"0A1";CHR$(12);"C3HAT IS NEW NODE TYPE? ~J"
2159 PRINT "C7M~C11~C7=C1NEH ATP CANDIDATE~C7 "
2160 PRINT "C7M~C12~C7=C1NEH 155mm BATTERY~C7. "
2161 PRINT "C7M~C13~C7=C1NEH 8-Inch BATTERY~C7. ":PRINT "C7M~C14~C7=C1NEH ROAD INTERSECTION~C7. "
2162 INPUT "C1~ENTER CHOICE FROM ABOVE OPTIONS~C7~J";C
2163 IF C<1 OR C>4 GOTO 2158
2164 ON C GOTO 2165,2166,2167,2170
2165 HIT=2:GOTO 2170
2166 HIT=3:GOTO 2173
2167 HIT=4:GOTO 2173
2168 JP=0:M=0:HIT=5:RETURN
2170 JP=0:RETURN
2173 OP(9)=OP(9)+1:JP=0:RETURN

2200 PRINT#4:"I"
2201 NPN=25:GOSUB 2300
2205 PRINT CHR$(7);:PRINT "1~K~C2~0*";
2210 PLOT XX(CLN),YY(CLN),3
2215 PRINT "2~L("";:PLOT XX(CLN),YY(CLN):PLOT XP,YP,XL=XP:YL=YP:S=CLN
2220 INPUT#4:X,Y,F$
2225 XP=FNPX(X):YP=FNPY(Y):ZA=XP-XL:ZB=YP-YL:MSS=FIX(SQR(ZA^2+ZB^2))
2230 IF MSS>100 THEN 2220
2231 PLOT XP,YP
2235 IF F$(">") THEN 2245
2240 XL=XP:YL=YP:SUM=SUM+MSS:GOTO 2220
2245 NPN=25:GOSUB 2300
2255 PLOT XX(CLN),YY(CLN):PRINT "F~C1*";:PLOT XX(S),YY(S),3:PRINT "L":PRINT CHR$(21);
2265 DI(S,CLN)=SUM:DI(CLN,S)=SUM:SUM=0
2266 RETURN

2300 FOR J=1 TO OP(11):MSS=ABS(XX(J)-XP)+ABS(YY(J)-YP)
2305 IF MSS<NPN THEN NPN=MSS:CLN=J
2310 NEXT:RETURN

2400 PRINT "U";:PLOT XX(CLN),YY(CLN):PRINT CHR$(21);
2405 IF CLN<10 THEN PRINT USING "M";CLN; ELSE PRINT USING "MM";CLN;
2410 PRINT "K~F~0*";:PLOT XX(CLN),YY(CLN),3:RETURN

2500 PRINT CHR$(27);"0A1";CHR$(12);PRINT "C7HAVE THERE BEEN ANY C1~CHANGES~2~C7 IN SPECIFIC ARC LENGTHS? "
2501 INPUT "C3Type Y=Yes ~C7or ~C3N=No ~J~C7";A$
2505 IF LEFT$(A$,1)<>"Y" THEN 2549:PRINT

```

```

2510 ST:=0: INPUT "~C1ENTER ~C7THE START NODE # ~C6":ST:PRINT
2515 ND:=0: INPUT "~C1ENTER ~C7THE END NODE # ~C6":ND:PRINT
2520 IF ST<1 OR ST>OP(11) OR ND<1 OR ND>OP(11) THEN PRINT "~C3~ERROR--START OR END NODE INPUT INCORRECT~2~C7":GOTO 2500
2525 PRINT CHR$(12): "~C1THE CURRENT ARC LENGTH BETWEEN NODE # ~C6":ST: "~C1 AND NODE # ~C6":ND: "~C1IS: ~C5":DI(ST,ND):
2530 PRINT "~C7NOTE: THIS DISTANCE IS SYMMETRIC, I. E., THE SAME IN BOTH DIRECTIONS."
2535 PRINT "~C1ENTER ~C7THE NEW DISTANCE.":PRINT "~C7A ~C1CARRIAGE RETURN ~C7 ALONE MAY BE HIT AND NO CHANGE WILL ";
2540 PRINT "~C1OCCUR, OTHERWISE ~C1ENTER NEW DISTANCE.":INPUT "~J~C6":DI(ST,ND):DI(ND,ST)=DI(ST,ND)
2545 GOTO 2500
2549 PRINT CHR$(12): "~C5STANDBY~C7--~C3 DATA BEING SAVED~K"
2550 DOS"ARYSAVE/1 "+NAME1$+"DI DI":HIT=1:RETURN

2700 PRINT CHR$(12):PRINT CHR$(27);"0A1~H300100511000":CHR$(12);
2701 PRINT "~C5STANDBY~C7--~C3DATA BEING RETRIEVED~K~7010"
2702 PRINT "~K":CHR$(12):DOS"REFRESH/1 "+NAME1$+"DOS"ARYLOAD/1 "+NAME1$+"OP OP":KZ=OP(0)
2705 ERASE XX:DIM XX(KZ):DOS"ARYLOAD/1 "+NAME1$+"XX XX"
2710 ERASE YY:DIM YY(KZ):DOS"ARYLOAD/1 "+NAME1$+"YY YY"
2715 ERASE AZTP:DIM AZTP(OP(8)):DOS"ARYLOAD/1 "+NAME1$+"AZTP AZTP"
2740 ERASE FU:DIM FU(OP(9)):DOS"ARYLOAD/1 "+NAME1$+"FU FU"
2755 PRINT CHR$(21):HIT=1:RETURN

2900 PRINT "~C5THE MAXIMUM NUMBER OF NODES ALLOWED AS INITIAL DATA IS ~C360~C5.":PRINT:PRINT
2901 PRINT "~C6PREPARE TO ENTER THE DATA TO BE USED AS CONSTANT VALUES IN CALCULATIONS FOR PROBLEM: ~C4":NAME1$:PRINT
2905 PRINT "~C6HOW MANY NODES INITIALLY WILL BE IN PROBLEM ~C4":NAME1$:~C6~J":INPUT TN:PRINT:PRINT
2910 IF TN<1 OR TN>50 THEN 2900 ELSE OP(0)=TN
2915 PRINT "~C3HOW MANY FIRING BATTERIES WILL BE IN PROBLEM ~C3":NAME1$:~C6~J":INPUT FB:PRINT:PRINT
2920 IF FB<1 OR FB>6 THEN 2900 ELSE OP(9)=FB
2925 PRINT "~C2HOW MANY 155mm FIRING BATTERIES WILL BE IN PROBLEM ~C3":NAME1$:~C2~J":INPUT OB:PRINT:PRINT
2930 IF OB<0 OR OB>6 THEN 2900 ELSE OP(12)=OB
2935 PRINT "~C2HOW MANY 8-inch FIRING BATTERIES WILL BE IN PROBLEM ~C3":NAME1$:~C2~J":INPUT ZP:PRINT:PRINT
2940 IF ZP<0 OR ZP>6 THEN 2900 ELSE OP(13)=ZP
2945 PRINT "~C6HOW MANY CANDIDATE ATP LOCATIONS WILL BE IN PROBLEM ~C3":NAME1$:~C6~J":INPUT AP:PRINT:PRINT
2950 IF AP<1 OR AP>6 THEN 2900 ELSE OP(8)=AP
2951 B=OB+ZP:IF B<=FB GOTO 2953
2952 PRINT "~I~C4RECHECK BATTERY TOTALS~2":INPUT "~C7Hit ~C6CARRIAGE RETURN~C7 to continue":AS:GOTO 2915
2953 C=FB+AP:IF C<=TN GOTO 2955
2954 PRINT "~I~C4RECHECK BATTERY, INTERSECTION, AND ATP TOTALS~2":INPUT "~C7Hit ~C6CARRIAGE RETURN~C7 to continue":AS
2955 GOTO 2905
2956 PRINT CHR$(12):KZ=OP(0):RETURN

3000 ERASE ASP,BSP,CSP:DIM ASP(OP(11)+1),BSP(OP(11)+6),CSP(OP(11)+6)
3005 PRINT CHR$(27);"0A1":CHR$(12);
3010 PRINT "~C7 STANDBY: COMPUTING NUMBER OF ARCS IN PROBLEM: ~C1":NAME1$:PRINT "~7050":GOTO 3015
3011 ERASE ASP,BSP,CSP:DIM ASP(OP(11)+1),BSP(OP(15)),CSP(OP(15))
3012 PRINT CHR$(27);"0A1":CHR$(12);
3013 PRINT "~C7 STANDBY: COMPUTING LINKLIST DATA FOR PROBLEM: ~C1":NAME1$:PRINT "~7050"

```



```

3015 N=OP(11):A=0:FOR I=1 TO N:FOR J=1 TO N
3020 IF DI(I,J)>0 THEN 3025 ELSE 3026
3025 A=A+1:BSP(A)=J:CSP(A)=DI(I,J)
3026 NEXT J:ASP(I+1)=A:NEXT I
3028 IF PZ=1 THEN PZ=0:GOTO 3035 ELSE 3030
3030 PRINT CHR$(12):CHR$(7); "~C7PROBLEM ~C1".NAME1$;" ~C7HAS ~C6";ASP(N+1); "~C7 ARCS. ~7030":OP(15)=ASP(N+1):PZ=1:A=0
3031 GOTO 3011
3035 PRINT "~C7~KSTANDBY: SAVING DATA"
3040 DO$"ARYSAVE/1 "+NAME1$+"ASP ASP"
3041 DO$"ARYSAVE/1 "+NAME1$+"OP OP"
3045 DO$"ARYSAVE/1 "+NAME1$+"BSP BSP":DO$"ARYSAVE/1 "+NAME1$+"CSP CSP"
3046 ERASE ASP,BSP,CSP:DIM ASP(1),BSP(1),CSP(1)
3050 RETURN

3100 PRINT CHR$(27); "0A0"; CHR$(12); "~U001250~C4~1YOU MUST NOW DESIGNATE THE ~C1POSTURE ~C4OF THE BATTLE ~2":PRINT
3101 PRINT "~C6INSURE THE DISK ON DRIVE#2 HAS THE ~1~C4CORRECT~2~C6 POSTURE. ":PRINT
3105 PRINT "~C7M~C1~C7=~C1~1OFFENSE~2~C7. ":PRINT
3110 PRINT "~C7M~C12~C7=~C1~1DEFENSE~2~C7. ":PRINT
3115 PRINT "~C7M~C13~C7=~C1~1DELAY~2~C7. ":PRINT
3120 PRINT "~C7M~C14~C7=~C1~1RETROGRADE~2~C7. ":PRINT
3125 INPUT "~C4~1ENTER CHOICE FROM ABOVE OPTIONS~2~C7~J";C
3126 IF C<1 OR C>4 THEN PRINT "~1~C4INDICATED POSTURE DOES NOT EXIST~2~C7":GOTO 3100 ELSE PRINT CHR$(12):GOTO 3130
3130 ON C GOTO 3135,3140,3145,3150
3135 DO$"CHAIN/2 OFFENSE "
3140 DO$"CHAIN/2 DEFENSE "
3145 DO$"CHAIN/2 DELAY "
3150 DO$"CHAIN/2 RETROGRADE "

3200 V=0:INPUT "~C2HOW MANY NEW ROADS ARE BEING ADDED?~K":0
3201 PRINT CHR$(27); "R1C"; CHR$(27); "0E5"; CHR$(27); "IES";:PRINT#4;"J"
3202 PRINT CHR$(27); "0A1"; CHR$(12); "~C1DIOITIZER TABLET ENABLED ~K":PRINT
3203 PRINT "~C3CENTER NEW ROADS~K":PRINT
3204 PRINT "~C5STANDBY~C7--~C3DATA BEING RETRIEVED~K~7010"
3212 ERASE DI:DIM DI(OP(11),OP(11))
3216 PRINT#4;"J"
3220 INPUT#4;X,Y,F$:IF F$="8" THEN 3225 ELSE 3220
3225 IF X<=0 OR Y<=0 GOTO 3220
3230 XF=FNPX(X):YP=FNPY(Y)
3235 IF XP<0 OR XP>511 OR YP<0 OR YP>511 THEN 3220
3240 GOSUB 2200
3241 V=V+1:IF V<G THEN G=0:RETURN ELSE 3220

```

APPENDIX IV

PROGRAM ATPII

```

0 'PROGRAM ATP11
50 IF KEY=8 GOTO 3959
51 IF KEY=9 GOTO 4024
52 IF KEY=10 GOTO 3959
53 IF KEY=11 GOTO 3979
54 IF KEY=12 GOTO 4024
55 IF KEY=13 GOTO 4049
120 IF F0=1 THEN HIT=1:TOT=0:GOTO 350 ELSE HIT=1:GOTO 121
121 IF F0=3 THEN HIT=1:TOT=0:GOTO 380 ELSE HIT=1:GOTO 130
130 F0=0:TOT=1:ON ERROR#2 GOTO 160:OUT&H90,0
140 PRINT CHR$(27);"0A1";CHR$(12):PRINT "~C3LIGHT PEN ENABLED~C7~K":PRINT
141 PRINT "~C5PROCEED WITH MENU SELECTION~K"
150 PRINT CHR$(27);"0A0~K";
155 GOTO 155
160 IF ERR=24 GOTO 180 ELSE ON ERROR#0 GOTO 0
180 XP=CURS(4):YP=CURS(4)
190 ON HIT GOTO 200
200 XL=25:FOR I=1 TO 5:YL=50
210 HSS=ABS(XP-XL)+ABS(YP-YL)
220 IF HSS<20 THEN PRINT CHR$(7):ON I GOTO 250,320,350,380,555
230 XL=XL+50:NEXT
240 OUT&H90,0:RESUME 140
250 PRINT CHR$(27);"0A1~K";CHR$(12):PRINT "~C7 THE ~C1ADD ~C7MENU POINT HAS BEEN HIT.":PRINT
260 PRINT " TO ADD A NODE, AN ARC, OR MAKE ROAD NETWORK CHANGES TO PROBLEM ~C3";NAME1$
270 INPUT "~C3Type Y=Yes ~C7or ~C3N=No~J ";A$
280 IF LEFT$(A$,1)="Y" THEN MX=1:GOTO 290 ELSE PRINT CHR$(12):GOTO 310
290 OUT&H90,0:RESUME 300
300 DOS"CHAIN/1 ATP1"
310 OUT&H90,0:RESUME 140
320 PRINT CHR$(27);"0A1~K";CHR$(12);"~C7THE ~C1STOP~C7 MENU POINT HAS BEEN HIT. ~?090"
330 PRINT "~":CHR$(12);CHR$(27);"E"
350 PRINT CHR$(27);"0A1";CHR$(12):GOSUB 2800:PRINT "~C1DISTANCE MATRIX DST(I,J) COMPLETE~C7"
360 GOSUB 2900:GOSUB 2000
370 IF TOT THEN OUT&H90,0:RESUME 140 ELSE 130
380 ERASE OX,OY:DIM OX(KZ),OY(KZ)
381 DEF FNL(PO)=L00(PO)/L00(10)
382 DEF FNR(PO)=10*(INT(FNL(PO)+<FNL(PO)>)):DEF FND(PO)=INT(PO+.5+<X(0))
385 P9=1
385 PRINT CHR$(27);"0A0";CHR$(12);
390 PRINT CHR$(12);CHR$(27);"0A2~H000000300150~K";
410 PRINT "~C7YOU HAVE A CHOICE OF GRAPHS OR NUMERICAL DATA."
420 PRINT "~C7W~C21~C7 IS ~C3GRAPH--CSR VS DPICM ROUNDS RESUPPLIED PER 155mm FIRING BATTERY."
420 PRINT "~C7W~C22~C7 IS ~C3GRAPH--CSR VS COPPERHEAD ROUNDS RESUPPLIED PER 155mm FIRING BATTERY."
421 PRINT "~C7W~C23~C7 IS ~C3GRAPH--CSR VS DPICM ROUNDS RESUPPLIED PER 8-inch FIRING BATTERY."
422 PRINT "~C7W~C24~C7 IS ~C3GRAPH--CSR VS RAP ROUNDS RESUPPLIED PER 8-inch FIRING BATTERY."
430 PRINT "~C7W~C25~C7 IS ~C3GRAPH--HEIGHTS ASSIGNED TO EACH FIRING BATTERY."
431 PRINT "~C7W~C26~C7 IS ~C3NUMERICAL ANALYSIS."
440 PRINT "~C7W~C27~C7 IS ~C3RETURN TO LIGHT PEN CONTROL."
450 INPUT "~C1 ~1 ENTER CHOICE FROM ABOVE OPTIONS~2~C7~J ";C
460 IF C<1 OR C>6 GOTO 519

```

```

470 PRINT CHR$(12); CHR$(27); "0A0~W000511511100";
475 IF C=5 THEN 485 ELSE 480
480 ON C GOSUB 3000, 3200, 3400, 3600, 3800
481 GOTO 518
485 GOTO 3900
518 ERASE GX, OY: DIM OX(1), OY(1)
519 PRINT CHR$(27); "0A0~W0005115111~4"
520 PRINT CHR$(27); "0A1"; CHR$(12): INPUT "~C7 DO YOU NEED THE PICTURE REDRAWN~C7? ~C3Type Y=Yes ~C7or ~C3N=No~J "; A$
530 IF LEFT$(A$, 1) = "Y" THEN PRINT "~K"; CHR$(12): DOS "REFRESH/1 "+NAME1$
540 PRINT CHR$(27); "0A0~K"; CHR$(12): GOSUB 2000
550 P9=0: IF ERR=24 THEN OUT=H90, 0: RESUME 140 ELSE 130
555 OUT=H90, 0: RESUME 560
560 PRINT CHR$(27); "0A1"; CHR$(12);
570 PRINT "~C7M~C11~C7=~C1NEW PROBLEM~C7. "
590 PRINT "~C7M~C12~C7=~C1MINOR CHANGE~C7 "
600 PRINT "~C7M~C13~C7=~C1RETURN TO LIGHT PEN CONTROL~C7. "
610 INPUT "~C1 ~1 ENTER CHOICE FROM ABOVE OPTIONS~2~C7~J "; C
620 IF C<1 OR C>2 GOTO 690
630 ON C GOTO 640, 670
640 PRINT CHR$(12); "~C7A ~C1NEW PROBLEM ~C7REQUIRES A NEW ROAD NETWORK BE ENTERED. "
650 PRINT "~C"; CHR$(12); CHR$(27); "E"
670 MUCH=1
680 DOS "CHAIN/1 ATPI"
690 PRINT CHR$(12): GOTO 130

2000 PRINT "~"; CHR$(12)
2005 PRINT CHR$(27); "0A1~W300100511000~R~01"; CHR$(12);
2010 PRINT CHR$(27); "0A0~K~C7~F~0";
2015 PRINT "~025050010, 075050010, 125050010, 175050010, 225050010~L"; CHR$(21)
2020 PRINT "~C1~U01600A00~U00103NODE/ARC";
2025 PRINT "~C2~U060000STOP";
2030 PRINT "~C3~U10700COMPUTE~U100030MEDIAN";
2035 PRINT "~C4~U15400SOLUTION~U155030ANALYSIS";
2040 PRINT "~C5~U20400RESTART": RETURN

2100 FOR J=1 TO OP(11): MSS=ABS(XX(J)-XP)+ABS(YY(J)-YP)
2105 IF MISS<NPN THEN NPN=MISS: CLN=J
2110 NEXT: RETURN

2300 IF CSP(1) GOTO 2325
2305 ERASE ASP, BSP, CSP: DIM ASP(OP(11)+1), BSP(OP(15)), CSP(OP(15))
2310 DOS "ARYLOAD/1 "+NAME1$+"ASP ASP"
2315 DOS "ARYLOAD/1 "+NAME1$+"BSP BSP"
2320 DOS "ARYLOAD/1 "+NAME1$+"CSP CSP"
2325 RETURN

```

```

2600 ERASE AD, BD, CD, DIM AD(OP(I1)), BD(OP(I1)), CD(OP(I1)): LV=32000
2605 PRINT CHR$(27): "0A1" H300100511000": CHR$(12): "CSSTANDBY--CALCULATING ALL PATHS FOR NODE #: ~C3~K"; SDN
2610 FOR I=1 TO OP(I1): AD(I)=LV: NEXT
2615 AD(SDN)=0: CD(SDN)=LV: LL=SDN: M1=SDN
2619 N1=ASP(LL+1): O2=AD(LL): N2=ASP(LL)+1
2624 IF N2>N1 GOTO 2665
2625 FOR H=N2 TO N1: M=BSP(H): M3=O2+C8P(H)
2630 IF M3>AD(K) GOTO 2660
2635 AD(K)=LL: AD(K)=M3
2640 IF CD(K)=0 GOTO 2655
2645 IF CD(K)=0 GOTO 2660 ELSE CD(M1)=K: M1=K
2650 CD(K)=LV: GOTO 2660
2655 CD(K)=CD(LL): CD(LL)=K
2660 NEXT
2665 N3=CD(LL): CD(LL)=-1: LL=N3
2670 IF LL<LV GOTO 2619
2675 RETURN

2700 SDN=0: ST=0: ND=0
2705 PRINT CHR$(27): "0A1": CHR$(12): "C7TO SEE THE ~C3SHORTEST ROUTE ~C7FROM ANY ~C4 FIRING BATTERY";
2710 PRINT "C7TO ANY ~C6CANDIDATE ATP LOCATION, ~C7ENTER THEIR RESPECTIVE NODE NUMBERS.": PRINT
2715 INPUT "C7 DO YOU NEED THE AD ROAD NETWORK REDRAWN~C7? ~C3Type Y=Yes ~C7or ~C3N=No~J "; AS
2720 IF LEFT$(AS, 1)="Y" THEN PRINT CHR$(12): "K": CHR$(27): "0A0": CHR$(12): DOS"REFRESH/1 "+NAME1$
2725 PRINT CHR$(27): "0A1" H300100511000": CHR$(12): "C4 FIRING BATTERY ~C7NODE #: IS: ~J~C3": INPUT ST: IF ST<=0 GOTO 2770
2730 GOSUB 2300: IF ST<SDN THEN SON=ST: GOSUB 2600
2735 PRINT CHR$(27): "0A1": CHR$(12): "C6CANDIDATE ATP ~C7NODE #: IS: ~J~C5": INPUT ND: IF ND<=0 GOTO 2770
2740 PRINT CHR$(12): CHR$(27): "0A0" C4 0": PLOT XX(ND), YY(ND): OT=ND
2745 N=BD(ND): IF N<0 THEN ND=N: PLOT XX(N), YY(N): GOTO 2745
2750 PRINT CHR$(27): "0A1" C700 YOU WANT TO SEE ANY MORE PATHS? Type ~C3Y=Yes ~C7or ~C3N=No~J~C5"
2755 INPUT AS: PRINT CHR$(12): CHR$(27): "0A0" C5": ND=OT: PLOT XX(ND), YY(ND)
2760 N=BD(ND): IF N<0 THEN ND=N: PLOT XX(N), YY(N): GOTO 2760
2765 IF LEFT$(AS, 1)="Y" GOTO 2705
2770 RETURN

2800 GOSUB 2300: ERASE DST: DIM DST(OP(8), OP(9))
2805 PRINT CHR$(27): "0A1" H300100511000": CHR$(12): "C1STANDBY--C3COMPUTING DISTANCE MATRIX~?050"
2810 FOR ST=1 TO OP(8): SON=AZTP(ST): GOSUB 2600
2825 FOR MD=1 TO OP(9): DST(SDN, MD)=AD(FU(MD)): NEXT MD, ST: DOS"ARYSAVE/1 "+NAME1$+"DST.DST"
2830 ERASE ASP, BSP, CSP: DIM ASP(1), BSP(1), CSP(1)
2835 DOS"ARYSAVE/1 "+NAME1$+"AD AD"
2840 DOS"ARYSAVE/1 "+NAME1$+"BO BO"
2845 DOS"ARYSAVE/1 "+NAME1$+"CD CD"
2850 ERASE AD, BD, CD: DIM AD(1), BD(1), CD(1)
2855 RETURN

```

```

2900 ERASE MED: DIM MED(OP(8)): GOSUB 4355
2905 FOR M=1 TO OP(8): K=AZTP(M): IMED=0: LX=0
2910 FOR N=1 TO OP(9): LX=HT(N)*DST(K,N): IMED=IMED+LX: NEXT
2915 MED(M)=IMED: NEXT: DO$="ARYSAVE/2 "+NAME1$+"MED MED"
2920 PRINT CHR$(27); "0A0": CHR$(12): FOR I=1 TO OP(8): CLN=AZTP(I)
2921 PRINT "C7MEDIAN OF ATP CANDIDATE AT NODE "C3"; CLN; "C7IS C4".MED(I); "C7"
2925 PRINT: NEXT: PRINT
2930 PRINT "CSRECORD THESE VALUES FOR FUTURE REFERENCE": PRINT
2935 PRINT CHR$(27); "0A1": CHR$(12): INPUT "Hit the ~1C3CARRIAGE RETURN~2~C7 to continue"; AS
2940 ERASE DST: DIM DST(1,1): ERASE HT: DIM HT(1): RETURN

3000 PRINT "YOU HAVE REQUESTED THE GRAPH--C3CONTROLLED SUPPLY RATE VS DPICH ROUNDS RESUPPLIED EACH 155mm FIRING BATTERY"
3001 PRINT
3005 TIS="CONTROLLED SUPPLY RATE VS DPICH ROUNDS RESUPPLIED EACH 155mm FIRING BATTERY"
3010 X$="FIRING BATTERY NODE NUMBER"
3015 Y$="NUMBER OF ROUNDS"
3016 INPUT "C3HOW MANY PALLETS OF 155mm DPICH CAN ORGANIC TRUCKS CARRY?~C7~J": DOP: PRINT
3017 GOSUB 4415
3018 ERASE TM: DIM TM(OP(9))
3020 INPUT "C2HOW MANY TRUCK/TRAILER COMBINATIONS DOES EACH BATTERY HAVE AVAILABLE FOR ~C5AMMO RESUPPLY~C7~J "; C: PRINT
3025 DPO=(INT(8*DOP/9)*8)*(INT(C*.52)): INPUT "WHAT IS THE ~C3CSR FOR 155mm DPICH~C7 ? ~J"; F: COD=F: PRINT: PRINT
3030 INPUT "WHAT IS THE ~C3NODE # ~C7OF THE ~C4SELECTED ATP~C7~J~C5"; ST
3035 ERASE OP: DIM OP(12): DO$="ARYLOAD/1 "+NAME1$+"OB 08"
3040 I=0: FOR S=1 TO OP(12): OX(I)=S: OY(I)=COD*6: XN=OX(I): YN=OY(I): I=I+1: NEXT
3045 YN=0: LST=I-1: GOSUB 4500: PRINT CHR$(12): GOSUB 4600: PRINT "C4": SS=77: GOSUB 4700
3100 I=0: FOR S=1 TO OP(12): TM(S)=(2*.5)+(2*DST(ST,S)/500): TFD=24/TM(S): OY(I)=DPO*TFD
3101 I=I+1: NEXT
3105 LST=I-1: PRINT "C2": SS=82: GOSUB 4700: PRINT "C7": GOSUB 4750
3110 I=0: FOR S=1 TO OP(12): OY(I)=DPO*(10/TH(S)): I=I+1: NEXT: LST=I-1: PRINT "C1": SS=88: GOSUB 4700
3115 PRINT CHR$(27); "0A0":
3120 PRINT "U000030~C4CSR--155mm DPICH~C7=":
3125 PRINT "U000015~C3DPICH RESUPPLIED-ALL DAY OPS~C7=":
3130 PRINT "U000030~C1DPICH RESUPPLIED-NIGHT OPS ONLY~C7=":
3135 PRINT "F~C4~0+190030211020~C2190015211005~C1490030511020~L": CHR$(21): ERASE DST, TM, OB: DIM DST(1,1), TH(1), OB(1)
3140 INPUT "U000015Hit the ~1C3CARRIAGE RETURN~2~C7 to continue"; AS: RETURN

```

```

3290 I=0:FOR S=1 TO OP(12):JX(I)=S:OY(I)=S:CC#6:YN=OX(I):YI=I+1:NEXT
3295 YN=0:LST=I-1:OOSUB 4500:PRINT CHR$(12):OOSUB 4600:PRINT "C4":SS=77:OOSUB 4700
3300 I=0:FOR S=1 TO OP(12):TH(S)=(2*S.5)+(2*OST(ST,S)/500):TFO=24/TH(S):OY(I)=CPO*TFO
3301 I=I+1:NEXT
3305 LST=I-1:PRINT "C2":SS=82:OOSUB 4700:PRINT "C7":OOSUB 4750
3310 I=0:FOR S=1 TO OP(12):ZF=FU(S):OY(I)=CPO*(10/TH(S)):I=I+1:NEXT:LST=I-1:PRINT "C1":SS=88:OOSUB 4700
3315 PRINT CHR$(27):"0A0":
3320 PRINT "U000030~C4CSR--155mm COPPERHEAD~C7=":
3325 PRINT "U000015~C2COPPERHEAD RESUPPLIED-ALL DAY OPS~C7=":
3330 PRINT "U300030~C1COPPERHEAD RESUPPLIED-NIGHT OPS ONLY~C7=":
3335 PRINT "F~C4~0+190030211020~C2190015211005~C1490030511020~L":CHR$(21):ERASE DST,TH,OB:DIM DST(1,1),TH(1),OB(1)
3340 INPUT "U300015Hit the ~1~C3CARRIAOE RETURN~2~C7 to continue":AS:RETURN

3400 PRINT "YOU HAVE REQUESTED THE GRAPH--~C3CONTROLLED SUPPLY RATE VS OPICH ROUNDS RESUPPLIED EACH 8-inch FIRINO BATTERY"
3401 PRINT
3405 TI#="CONTROLLED SUPPLY RATE VS OPICH ROUNDS RESUPPLIED EACH 8-inch FIRINO BATTERY"
3410 X#="FIRINO BATTERY NODE NUMBER"
3415 Y#="NUMBER OF ROUNDS"
3416 INPUT "C3HOW MANY PALLETS OF 8-inch DPICH CAN ORGANIC TRUCKS CARRY?~C7~J":REP:PRINT
3417 OOSUB 4415
3418 ERASE TH:DIM TH(OP(9))
3420 INPUT "C2HOW MANY TRUCK/TRAILER COMBINATIONS DOES EACH BATTERY HAVE AVAILABLE FOR ~C5AMMO RESUPPLY~C7~J ";C:PRINT
3425 DEP=(INT(5*REP/6)*8)*(INT(C/72)):INPUT "WHAT IS THE ~C3CSR FOR 8-inch DPICH~C7 ? ~J":F:CEDE:F:PRINT:PRINT
3485 INPUT "WHAT IS THE ~C3NODE # ~C7OF THE ~C4SELECTED ATP~C7~J~C5":S
3486 ERASE EB:DIM EB(OP(13)):DOS"ARYLOAD/1 "+NAME1#+"EB EB"
3490 I=0:FOR S=1 TO OP(13):TH(S)=(2*1)+(2*OST(ST,S)/500):TFO=24/TH(S):OX(I)=S:YN=OX(I):OY(I)=DEP*TFO:YI=I+1:NEXT
3495 YN=0:LST=I-1:OOSUB 4500:PRINT CHR$(12):OOSUB 4600:PRINT "C2":SS=82:OOSUB 4700
3500 I=0:FOR S=1 TO OP(13):OY(I)=CED#4:I=I+1:NEXT
3505 LST=I-1:PRINT "C4":SS=77:OOSUB 4700:PRINT "C7":OOSUB 4800
3510 I=0:FOR S=1 TO OP(13):OY(I)=DEP*(10/TH(S)):I=I+1:NEXT:LST=I-1:PRINT "C1":SS=88:OOSUB 4700
3515 PRINT CHR$(27):"0A0":
3520 PRINT "U000030~C4CSR--8-inch DPICH~C7=":
3525 PRINT "U000015~C2DPICH RESUPPLIED-ALL DAY OPS~C7=":
3530 PRINT "U300030~C1DPICH RESUPPLIED-NIGHT OPS ONLY~C7=":
3535 PRINT "F~C4~0+190030211020~C2190015211005~C1490030511020~L":CHR$(21):ERASE DST,TH,EB:DIM DST(1,1),TH(1),EB(1)
3540 INPUT "U300015Hit the ~1~C3CARRIAOE RETURN~2~C7 to continue":AS:RETURN

3600 PRINT "YOU HAVE REQUESTED THE GRAPH--~C3CONTROLLED SUPPLY RATE VS RAP ROUNDS RESUPPLIED EACH 8-inch FIRINO BATTERY"
3601 PRINT
3605 TI#="CONTROLLED SUPPLY RATE VS RAP ROUNDS RESUPPLIED EACH 8-inch FIRINO BATTERY"
3610 X#="FIRINO BATTERY NODE NUMBER"
3615 Y#="NUMBER OF ROUNDS"
3616 INPUT "C3HOW MANY PALLETS OF RAP CAN ORGANIC TRUCKS CARRY?~C7~J":RAP:PRINT

```

```

3617 GOSUB 4415
3618 ERASE TM: DIM TM(OP(9))
3620 INPUT "C2HOW MANY TRUCK/TRAILER COMBINATIONS DOES EACH BATTERY HAVE AVAILABLE FOR ~CSAMMO RESUPPLY~C7?~J "; C: PRINT
3625 RPE=(INT(18RAP/6)*8)*(INT(C*72)): INPUT "WHAT IS THE ~C3CSR FOR 8-Inch RAP~C7 ? ~J": F: CRE=F: PRINT: PRINT
3635 INPUT "WHAT IS THE ~C3NODE # ~C7OF THE ~C4SELECTED ATP~C7~J~C5"; ST
3636 ERASE EB: DIM EB(OP(13)): DOS"ARYLOAD/1 "+NAME19+"EB EB"
3638 I=0: FOR S=1 TO OP(13): TH(S)=(2*1)+(2*ST(ST,S)/500): TFD=24/TM(S): OX(I)=S: XN=OX(I): OY(I)=RPE*TFD: YN=OY(I): I=I+1: NEXT
3639 YN=0: LST=I-1: GOSUB 4500: PRINT CHR$(12): GOSUB 4600: PRINT "C2": SS=82: GOSUB 4700
3640 I=0: FOR S=1 TO OP(13): OY(I)=CRE*4: I=I+1: NEXT
3645 LST=I-1: PRINT "C4": SS=77: GOSUB 4700: PRINT "C7": GOSUB 4800
3646 I=0: FOR S=1 TO OP(13): OY(I)=RPE*(10/TM(S)): I=I+1: NEXT: LST=I-1: PRINT "C1": SS=88: GOSUB 4700
3647 PRINT CHR$(27); "0A0";
3648 PRINT "U000030~C4CSR--8-Inch RAP~C7=";
3649 PRINT "U000015~C2RAP RESUPPLIED-ALL DAY OPS~C7=";
3650 PRINT "U300030~C1RAP RESUPPLIED-NIGHT OPS ONLY~C7=";
3651 PRINT "F~C4~0+190030211020~C2190015211005~C1490030511020~L"; CHR$(21): ERASE DST, TM, EB: DIM DST(1,1), TM(1), EB(1)
3652 INPUT "U300015Hit the ~1~C3CARRIAGE RETURN~2~C7 to continue"; AS: RETURN

3800 I=0: WEIGHTS ASSIGNED TO EACH FIRING BATTERY"
3805 X0="FIRING BATTERY NODE NUMBER"
3810 Y0="WEIGHT"
3812 GOSUB 4350
3815 I=0: FOR S=1 TO OP(9): OX(I)=S: XN=OX(I): OY(I)=HT(S): YN=OY(I): I=I+1: NEXT
3816 YN=0: LST=I-1: GOSUB 4500: PRINT CHR$(12): GOSUB 4600: PRINT "C4": SS=77: GOSUB 4700: PRINT "C7": GOSUB 4850
3820 PRINT CHR$(27); "0A0";
3825 PRINT "U050030~C6SMALL WEIGHTS INDICATE UNITS RECEIVING ";
3830 PRINT "PRIORITY RESUPPLY SUPPORT": ERASE HT: DIM HT(1)
3840 INPUT "U300015Hit the ~1~C3CARRIAGE RETURN~2~C7 to continue"; AS: RETURN

3900 PRINT CHR$(27); "0A0"; CHR$(12)
3901 KEY=0: C=0: PRINT CHR$(27); "0A2~H0000030150"; CHR$(12); "C3YOU HAVE A CHOICE OF NUMERICAL DATA"
3905 PRINT "C7~C21~C7 IS ~C3SHORTEST ROUTE FOR EACH BATTERY TO ATP."
3910 PRINT "C7~C22~C7 IS ~C3TARGET VALUE SENSITIVITY ANALYSIS."
3915 PRINT "C7~C23~C7 IS ~C3DIVARTY COMMANDER PRIORITY SENSITIVITY ANALYSIS."
3920 PRINT "C7~C24~C7 IS ~C3FIRING BATTERY LOCATION SENSITIVITY ANALYSIS."
3925 PRINT "C7~C25~C7 IS ~C3RETURN TO GRAPH MENU.": PRINT
3930 INPUT "C1 ~1 ENTER CHOICE FROM ABOVE OPTIONS~2~C7~J "; C
3935 IF C<1 OR C>4 GOTO 4145
3936 PRINT CHR$(12)
3940 ON C GOTO 3945, 3949, 4010, 4085
3945 PRINT CHR$(12): GOSUB 2700: GOTO 3900
3949 PRINT CHR$(12): KEY=8: INPUT "C2CENTER CURRENT ATP NODE # ~J~C3"; ST
3950 ERASE PD: DIM PD(OP(9))
3951 DOS"ARYLOAD/2 "+NAME19+"PD PD"
3952 IF OP(8)=1 THEN 3900 ELSE 3953
3953 GOSUB 4400: ERASE SMT: DIM SMT(OP(9))
3958 DOS"CHAIN/2 RETROGRADE"
3959 GOSUB 4200: IF FLAG=10 GOTO 3960 ELSE 3976

```

' THIS LINE REFLECTS THE POSTURE PROGRAM THAT SHARES THE DISK WITH PROGRAM ATP11

```

3960 FOR P=1 TO OP(8): IF P=ST THEN 3961 ELSE 3962
3961 IF P=OP(8) THEN 3966 ELSE 3964
3962 IF P=OP(8) THEN 3965 ELSE 3963
3963 IF SMED(P)<MED(ST) THEN 3970 ELSE 3964
3964 NEXT
3965 IF SMED(P)<MED(ST) THEN 3970 ELSE 3966
3966 KEY=10: GOTO 3958
3970 PRINT CHR$(12); "~C4CURRENT ATP NO LONGER BEST WITH ~C5CATEGORY ~C6"; U; "~C5TARGET VALUE INCREASE TO ~C6 "; TV; "~C7 ";
3971 PRINT
3975 PRINT "~C2ATP ~1C3"; P; "~C2~2 IS NOW A BETTER LOCATION TO SUPPORT THE FIRE SUPPORT MISSION. ": GOTO 3986
3976 PRINT CHR$(12); "~C2TARGET VALUE~CA "; U; "~C2 MAY BE INCREASED WITHOUT AFFECTING CURRENT ATP": GOTO 3986
3979 GOSUB 4200: IF FLAG=20 GOTO 3980 ELSE 4003
3980 FOR P=1 TO OP(8): IF P=ST THEN 3981 ELSE 3982
3981 IF P=OP(8) THEN 3990 ELSE 3984
3982 IF P=OP(8) THEN 3985 ELSE 3983
3983 IF SMED(P)<MED(ST) THEN 3995 ELSE 3984
3984 NEXT
3985 IF SMED(P)<MED(ST) THEN 3995 ELSE 3990
3986 ERASE TO: DIM TD(7): DO8"ARYLOAD/2 "+NAME1$+"TD TO"
3990 KEY=11: GOTO 3958
3995 PRINT "~C4CURRENT ATP NO LONGER BEST WITH ~C5CATEGORY ~C6"; U; "~C5TARGET VALUE DECREASE TO ~C6 "; TV; "~C7 ";
3996 PRINT
4000 PRINT "~C2ATP ~1C3"; P; "~C2~2 IS NOW A BETTER LOCATION TO SUPPORT THE FIRE SUPPORT MISSION. ": GOTO 4004
4003 PRINT "~C5CATEGORY ~C6"; U; "~C5TARGET VALUE MAY BE REDUCED TO ~C4LOWEST VALUE~C5 WITHOUT EFFECTING ATP LOCATION!"
4004 PRINT CHR$(27); "0A1"; CHR$(12): INPUT "Hit the ~1~C3CARRIAGE RETURN~2~C7 to continue. ": AS: PRINT CHR$(12)
4007 ON V4 GOSUB 5000: GOSUB 4450: GOTO 3900
4010 PRINT CHR$(12): KEY=9: INPUT "~C2CENTER CURRENT ATP NODE # ~J~C3"; ST
4015 ERASE TO: DIM TD(OP(9))
4016 DOS"ARYLOAD/2 "+NAME1$+"TD TO"
4018 GOSUB 4400: ERASE SNT: DIM SNT(OP(9))
4023 DOS"CHAIN/2 OFFENSE" ' THIS LINE REFLECTS THE POSTURE PROGRAM THAT SHARES THE DISK WITH PROGRAM ATP11
4024 GOSUB 4200: IF FLAG=15 GOTO 4030 ELSE 4046
4030 FOR P=1 TO OP(8): IF P=ST THEN 4031 ELSE 4032
4031 IF P=OP(8) THEN 4036 ELSE 4034
4032 IF P=OP(8) THEN 4035 ELSE 4033
4033 IF SMED(P)<MED(ST) THEN 4040 ELSE 4034
4034 NEXT
4035 IF SMED(P)<MED(ST) THEN 4040 ELSE 4036
4036 KEY=12: GOTO 4023
4040 PRINT CHR$(12); "~C4CURRENT ATP NO LONGER BEST WITH ~C5DIVARTY COMMANDER PRIORITY ~C6": O; "~C5 INCREASE TO ~C6 "; DAP; "~C7 ";
4041 PRINT
4045 PRINT "~C2ATP ~1C3"; P; "~C2~2 IS NOW A BETTER LOCATION TO SUPPORT THE FIRE SUPPORT MISSION. ": GOTO 4057
4046 PRINT CHR$(12); "~C2POSTURE PRIORITY~C4 "; O; "~C2 MAY BE INCREASED WITHOUT AFFECTING CURRENT ATP": GOTO 4057
4049 GOSUB 4200: IF FLAG=30 GOTO 4050 ELSE 4078
4050 FOR P=1 TO OP(8): IF P=ST THEN 4051 ELSE 4052
4051 IF P=OP(8) THEN 4056 ELSE 4054
4052 IF P=OP(8) THEN 4055 ELSE 4053
4053 IF SMED(P)<MED(ST) THEN 4070 ELSE 4054
4054 NEXT
4055 IF SMED(P)<MED(ST) THEN 4070 ELSE 4056
4056 KEY=13: GOTO 4023

```

```

678 PRINT "~C4CURRENT ATP NO LONGER BEST WITH ~C5DIVARTY COMMANDER PRIORITY ~C6";Q;"~C5 DECREASE TO ~C6 ";DAP;"~C7 ";
4071 PRINT
~C2ATP ~1~C3";P;"~C2~2 IS NOW A BETTER LOCATION TO SUPPORT THE FIRE SUPPORT MISSION.":00TO 4079
4075 PRINT "~C5DIVARTY COMMANDER PRIORITY ~C6";Q;"~C5 MAY BE REDUCED TO ~C4LOWEST VALUE~C5 WITHOUT EFFECTING ATP LOCATION:"
4079 PRINT CHR$(27);"0A1";CHR$(12):INPUT "Hit the ~1~C3CARRIAGE RETURN~2~C7 to continue. ";AS:PRINT CHR$(12)
4082 ON V4 00SUB 5000:00SUB 4450:00TO 3900
4085 PRINT CHR$(27);"0A2";CHR$(12);"~C2ENTER THE CURRENT ATP NODE # ~J~C3":INPUT ST:PRINT CHR$(12)
4086 PRINT "~C2ENTER THE NODE # OF THE BATTERY YOU WANT ANALYZED. ~J~C3":INPUT ND:PRINT CHR$(12)
4087 FOR JJ=1 TO OP(9):IF ND=FU(JJ) THEN JZ=JJ:00TO 4088 ELSE NEXT
4088 00SUB 4400:00SUB 4350
4090 PRINT "~C7 CURRENT CANDIDATE ATP ~C5MEDIAN TOTALS~C7 ARE:":PRINT:FOR I=1 TO OP(8):PRINT MED(I):NEXT
4095 INPUT "ENTER THE ~C6MEDIAN TOTAL~C7 THAT IS ~1~C4SECOND SMALLEST~2~C7: ~J";X:I:PRINT CHR$(12)
4115 01=OST(ST,JZ):Y9=MED(ST)-(MT(JZ)*D1)
4120 01=01+1:X9=Y9+(MT(JZ)*D1)
4125 IF X9>: 00TO 4130 ELSE 4120
4130 01=01-1:00=01-OST(ST,JZ):PRINT "~C4FIRING BATTERY ~C7AT NODE ~C2";ND;"CAN DISPLACE ~C2";00;"~C7 SCALED ROAD UNITS ";
4131 PRINT "FORWARD FROM ITS CURRENT LOCATION WITHOUT DEGRADING ATP LOCATION. ";
4135 PRINT " SEE AO FOR PERIMETER AND TRANSFER THIS DATA TO YOUR MAP. ":PRINT "~?100"
4136 PRINT "~="K"; CHR$(12):DOS"REFRESH/1 "+NAME1$
4140 PRINT "~U~K~0*":PLOT XX(ND),YY(ND),DD
4141 PRINT CHR$(27);"0A1";CHR$(12):INPUT "Hit the ~1~C3CARRIAGE RETURN~2~C7 to continue. ";AS
4142 ERASE _OST,MED:DIM OST(1,1),MED(1)
4143 ERASE MT:DIM WT(1)
4144 00TO 3900
4145 PRINT CHR$(27);"0A8";CHR$(12):00SUB 2000:IF ERR=24 THEN OUT$H90,0:RESUME 130 ELSE 130

4200 ERASE $MED:DIM $MED(OP(8))
4205 FOR M=1 TO OP(8):K=AZTP(M):IMED=0:LX=0
4210 FOR N=1 TO OP(9):LX=$HT(N)*OST(K,N):IMED=IMED+LX:NEXT
4230 $MED(M)=IMED:NEXT:RETURN

4350 IF WT(1) THEN 4365 ELSE 4355
4355 ERASE WT:DIM WT(OP(9))
4360 DOS"ARYLOAD/2 "+NAME1$+"WT.WT"
4365 RETURN

```

```

4400 IF MED(1) THEN 4415 ELSE 4405
4405 ERASE MED: DIM MED(OP(9))
4410 DO$ "ARYLOAD/2 "+NAME1$+"MED MED"
4415 IF DST(1,1) THEN 4430 ELSE 4420
4420 ERASE DST: DIM DST(OP(8),OP(9))
4425 DO$ "ARYLOAD/1 "+NAME1$+"DST DST"
4430 RETURN

4450 ERASE SMT, MED, DST, SMED: DIM SMT(1), MED(1), DST(1,1), SMED(1)
4455 RETURN

4500 X1=0: X2=0: Y1=0: Y2=0: XM=0: YM=0: FOR I=0 TO LST
4505 IF OX(I)>XM THEN XM=OX(I)
4506 IF OY(I)>YM THEN YM=OY(I)
4510 IF OX(I)<XN THEN XN=OX(I)
4511 IF OY(I)<YN THEN YN=OY(I)
4512 NEXT I
4515 XD=XM-XN: YD=YM-YN: IF YD=0 THEN YD=YM: YN=0
4520 X1=(INT(XM/FNR(XD))+1)*(FNR(XD))
4525 Y1=(INT(YM/FNR(YD))+1)*(FNR(YD)): IF XN=0 OR YN=0 THEN 4560
4530 X2=(INT(XN/FNR(XD)))*(FNR(XD))
4535 Y2=(INT(YN/FNR(YD)))*(FNR(YD)): IF X2=0 OR Y2=0 THEN 4560
4540 OX=FND(FNL(X1))-FND(FNL(X2))
4545 IF OX<0 THEN X2=0
4550 OY=FND(FNL(Y1))-FND(FNL(Y2))
4555 IF OY<0 THEN Y2=0
4560 OX=10*(FND(FNL(X1-X2)-1))
4565 OY=10*(FND(FNL(Y1-Y2)-1))
4570 O1=DX*(40/(X1-X2)): O2=OY*(35/(Y1-Y2)): RETURN

4600 PRINT "P^K^0^C7^U000050,^5": PS=77: VL=Y2
4605 ZP=55: IF VL=0 THEN 4615
4610 ZP=55-(INT(FNL(VL+5))*6): IF VL<0 THEN ZP=40
4611 PRINT
4615 PRINT "U": PLOT ZP, PS+4: PRINT CHR$(21): VL: "0";
4620 VL=VL+OY: IF VL>Y1 THEN 4635
4625 PRINT "(": PLOT 74, PS: PLOT 80, PS: PLOT 77, PS
4630 PS=PS+O2: PLOT 77, PS: OTO 4605
4635 PRINT "(": PLOT 74, PS: PLOT 80, PS
4636 PRINT CHR$(21)

```

```

4648 P8=77: VL=X2
4641 PRINT
4651 PRINT "~0";
4655 VL=VL+DX: IF VL>X1 THEN 4678
4668 PRINT "(;": PLOT PS,74: PLOT PS, 88: PLOT PS, 77
4665 PS=PS+D1: PLOT PS, 77: GOTO 4641
4678 PRINT "(;": PLOT PS,74: PLOT PS, 88
4675 VE=232+(18*LEN(Y8))/2: HO=282-(6*LEN(X8))/2: TT=282-(6*LEN(TI8))/2
4688 PRINT "~CS~U": PLOT HO, 68
4685 PRINT CHR$(21); X8; "~0";: PRINT: PLOT "U": PLOT 22, VE
4698 PRINT CHR$(21); "~U"; Y8; "~H~0";: PRINT: PLOT "U": PLOT TT, 445
4695 PRINT CHR$(21); TI8: RETURN

```

```

4788 X0=418/(X1-X2)
4785 Y0=358/(Y1-Y2)
4718 PRINT "~0+~F";: FOR I=8 TO L8T
4715 VU=((OX(I)-X2)*X0)+88
4728 WU=((OY(I)-Y2)*Y0)+77
4725 IF WU<=8 THEN 4735
4738 PLOT VU, WU: VU+5, 78
4735 NEXT
4748 PRINT CHR$(21): RETURN

```

```

4758 R7=1
4754 FOR I=8 TO L8T: Z8=O8(R7)
4756 VU=((OX(I)-X2)*X0)+88
4768 PRINT "~U";: PLOT VU, 74: PRINT CHR$(21);
4762 IF Z8<18 THEN PRINT USING "#"; Z8; ELSE PRINT USING "##"; Z8
4764 R7=R7+1
4768 NEXT
4778 PRINT CHR$(21): RETURN

```

```
4800 R7=1
4804 FOR I=0 TO LST:ZS=EB(R7)
4806 VU=((OX(I)-X2)*X0)+SS
4810 PRINT "U";:PLOT VU,74:PRINT CHR$(21);
4812 IF ZS<10 THEN PRINT USING "M";ZS; ELSE PRINT USING "##";ZS
4814 R7=R7+1
4816 NEXT
4820 PRINT CHR$(21):RETURN
```

```
4850 R7=1
4854 FOR I=0 TO LST:ZS=FU(R7)
4856 VU=((OX(I)-X2)*X0)+SS
4860 PRINT "U";:PLOT VU,74:PRINT CHR$(21);
4862 IF ZS<10 THEN PRINT USING "M";ZS; ELSE PRINT USING "##";ZS
4864 R7=R7+1
4866 NEXT
4870 PRINT CHR$(21):RETURN
```

```
5000 ON V4 GOTO 5005,5010,5015
5005 ERASE FD,00,HD,00:DIM FD(1),00(1),HD(1),00(1):GOTO 5020
5010 ERASE FD,00,HD:DIM FD(1),00(1),HD(1):GOTO 5020
5015 ERASE FD,00:DIM FD(1),00(1):GOTO 5020
5020 RETURN
```

APPENDIX V

PROGRAM OFFENSE

```

10 'PROGRAM OFFENSE
45 IF F0=2 GOTO 155
50 IF KEY=10 GOTO 1401
51 IF KEY=11 GOTO 1402
52 IF KEY=12 GOTO 1501
53 IF KEY=13 GOTO 1502
89 IF P9=1 THEN 91 ELSE 90
90 ERASE FD,OD,HD,OD: DIM FD(OP(9)),OD(OP(9)),HD(OP(9)),OD(OP(9)): GOTO 95
91 ERASE FD: DIM FD(OP(9)): DOS"ARYLOAD/2 "+NAME1$+"FD FD"
92 ERASE OD: DIM OD(OP(9)): DOS"ARYLOAD/2 "+NAME1$+"OD OD"
93 ERASE HD: DIM HD(OP(9)): DOS"ARYLOAD/2 "+NAME1$+"HD HD"
94 ERASE OD: DIM OD(OP(9)): DOS"ARYLOAD/2 "+NAME1$+"OD OD"
95 IF KEY=8 GOTO 161
96 IF KEY=9 GOTO 241
100 PRINT CHR$(27):"OA0":CHR$(12):"C7~X2,~Y2, YOU HAVE CHOSEN AN ~C4~10FFENSE~2~C7 POSTURE. YOU MUST NOW PROCEED TO ";
105 PRINT "ESTABLISH PARAMETERS FOR EACH FIRING BATTERY IN THE BRIGADE AD.~X1,~Y1,"
120 GOSUB 500
136 IF PD(1) THEN 235 ELSE 140
140 GOSUB 600
150 GOTO 315
155 PRINT "OA0~U000350~C7DD YOU WANT TO CHANGE TARGET VALUES? ~C3Type Y=Yes ~C7or~C3 N=No~J~C7 ": INPUT AS:PRINT
160 IF LEFT$(AS,1)<>"Y" GOTO 136 ELSE 165
161 PRINT CHR$(12):"~U000350~WHICH~1~C5 CATEGORY'S~2~C7 TARGET VALUE DO YOU WANT ANALYSIS ON?":PRINT: GOTO 170
165 PRINT "U000350~WHICH~1~C5 CATEGORY'S ~2~C7 TARGET VALUE DO YOU WANT TO CHANGE? ":PRINT
170 PRINT "~C7M~C4~11~2~C7=~C6IN CONTACT":PRINT
175 PRINT "~C7M~C4~12~2~C7=~C6COMMAND POSTS":PRINT
180 PRINT "~C7M~C4~13~2~C7=~C6ARMOR ASSEMBLY AREAS":PRINT
185 PRINT "~C7M~C4~14~2~C7=~C6SEAD":PRINT
190 PRINT "~C7M~C4~15~2~C7=~C6COUNTERFIRE":PRINT
195 PRINT "~C7M~C4~16~2~C7=~C6TROOP ASSEMBLY AREAS":PRINT
200 PRINT "~C7M~C4~17~2~C7=~C6LOGISTICAL AREAS":PRINT
205 INPUT "ENTER ONLY~1~C2 ONE ~2~C7 CHOICE ~J ":J
206 IF U<1 OR U>7 THEN PRINT "~1~C4 INDICATED CATEGORY DOES NOT EXIST~C7~2": GOTO 161 ELSE 207
207 IF KEY=8 GOTO 1400
210 INPUT "ENTER THE ~1~C6 NEW TARGET VALUE~2~C7 FOR THE CHOICE ABOVE~J ":CX
215 TD(U)=CX
220 INPUT "~C7DD YOU WANT TO MAKE ANY MORE CHANGES? ~C3Type Y=Yes ~C7or~C3 N=No~J~C7 ":AS
225 IF LEFT$(AS,1)<>"Y" GOTO 231
230 GOTO 165
231 DOS"ARYSAVE/2 "+NAME1$+"TD TD": GOTO 136
235 INPUT "U000350~C7DD YOU WANT TO CHANGE OFFENSIVE DIVARTY COMMANDER PRIORITIES? ~C3Type Y=Yes ~C7or~C3 N=No~J~C7 ":AS
236 PRINT CHR$(12)
240 IF LEFT$(AS,1)<>"Y" GOTO 315 ELSE 245
241 PRINT CHR$(12):"~U000350~WHICH OFFENSIVE DIVARTY COMMANDER PRIORITY DO YOU WANT ANALYSIS ON? ":PRINT: GOTO 250
245 PRINT "U000350~WHICH OFFENSIVE DIVARTY COMMANDER PRIORITY DO YOU WANT TO CHANGE? ":PRINT
250 PRINT "~C7M~11~2~C7=~C3 SUPPORTED BRIGADE CONSTITUTES DIVISION MAIN ATTACK":PRINT
255 PRINT "~C7M~12~2~C7=~C3 SUPPORTED BRIGADE CONSTITUTES DIVISION SUPPORTING ATTACK":PRINT

```

```

260 PRINT "C7M132C7=C3SUPPORTED BATTALION/TASK FORCE CONSTITUTES BRIGADE MAIN ATTACK":PRINT
265 PRINT "C7M142C7=C3SUPPORTED BATTALION/TASK FORCE CONSTITUTES BRIGADE SUPPORTING ATTACK":PRINT
270 PRINT "C7M152C7=C3PARENT FA BATTALION ASSIGNED A 'DIRECT SUPPORT' ROLE":PRINT
275 PRINT "C7M162C7=C3PARENT FA BATTALION ASSIGNED A 'REINFORCING' ROLE":PRINT
280 PRINT "C7M172C7=C3PARENT FA BATTALION ASSIGNED A 'GENERAL SUPPORT-REINFORCING' ROLE":PRINT
285 PRINT "C7M182C7=C3PARENT FA BATTALION ASSIGNED A 'GENERAL SUPPORT' ROLE":PRINT
290 INPUT "ENTER ONLY Y OR N":C7C7="Y"
291 IF C7C7="Y" THEN PRINT "C4INDICATED PRIORITY DOES NOT EXIST":GOTO 241 ELSE GOTO 292
292 IF C7C7="N" THEN GOTO 1500
295 INPUT "ENTER THE PRIORITY FOR THE CHOICE ABOVE":P
300 INPUT "DO YOU WANT TO MAKE ANY MORE CHANGES? (Y/N)":C7C7="Y"
305 IF LEFT$(A$,1)="" THEN GOTO 311
310 GOTO 245
311 DOS"ARYSAVE/2 "+NAME1$+"PD PD"
315 VORSX=TD(1)+TD(3)+TD(6):VORSX=VORSX+TD(2)+TD(3)+TD(4)+TD(5)+TD(6)+TD(7)
320 VORSX=VORSX-TD(1)
325 ERASE WT:DIM WT(9)
327 PRINT "K":PRINT CHR$(12):DOS"REFRESH/1 "+NAME1$:N=0
328 PRINT CHR$(27);"OAG"K";
329 ON ERROR#2 GOTO 335:OUT&H90,0
330 PRINT CHR$(27);"OAI"=W30010511000":CHR$(12);
331 PRINT "K"=C7DESIGNATE A FIRING BATTERY NODE WITH THE LIGHT PEN"
332 PRINT "K"=C3LIGHT PEN ENABLED"
334 GOTO 334
335 IF ERR=24 THEN XP=CURS(4):YP=CURS(4) ELSE ON ERROR#0 GOTO 0
339 NPN=25:GOSUB 1600
340 PRINT CHR$(27);"OAI":CHR$(12);
341 PRINT "K"=ENTER PARAMETERS FOR BATTERY AT NODE"C4":CLN:PRINT "7010":CHR$(12)
343 GOSUB 900
344 M=M+1:IF M=9 THEN OUT&H90,0:RESUME 346 ELSE OUT&H90,0:RESUME 329
346 DOS"ARYSAVE/2 "+NAME1$+"WT WT"
347 DOS"ARYSAVE/2 "+NAME1$+"FD FD"
348 DOS"ARYSAVE/2 "+NAME1$+"OD OD"
349 DOS"ARYSAVE/2 "+NAME1$+"HD HD"
350 DOS"ARYSAVE/2 "+NAME1$+"OD OD"
351 ERASE FD,OD,HD,OD,WT:DIM FD(1),OD(1),HD(1),WT(1)
352 IF FC=2 GOTO 355
353 IF FC=1 GOTO 354
354 DOS"CHAIN/2 ATP11"
355 DOS"CHAIN/1 ATP1"

500 PRINT "U000350C7ASSIGN C41TARGET VALUES C7 TO THE FOLLOWING SEVEN TARGET CATEGORIES: C3";
505 PRINT "IN CONTACT, COMMAND POSTS(Div & higher), ARMOR ASSEMBLY AREAS, SEAD, ";
510 PRINT "CF, TROOP ASSEMBLY AREAS, LOGISTICAL AREAS. ";
515 PRINT "C7ASSIGN C4INTEGER C7 VALUES IN ASCENDING ORDER--THAT IS, THE HIGHEST PRIORITY TARGET GETS THE LOWEST VALUE. ";
520 PRINT "YOU MAY ASSIGN EQUAL TARGET VALUES OR MAKE QUALITATIVE JUDGEMENTS (e.g. IN CONTACT IS 4 TIMES MORE. ";
525 PRINT "IMPORTANT THAN ALL OTHERS. THIS COULD MEAN YOU ASSIGN VALUE 1 TO CATEGORY 1 AND 4 TO ALL OTHER CATEGORIES)"
530 INPUT "ENTER YOUR ASSIGNED VALUE FOR C4 IN CONTACT C7":C7C7="Y":C1X:TD(1)=C1X:PRINT

```



```

535 INPUT "ENTER YOUR ASSIGNED VALUE FOR 1^C4 COMMAND POSTS^2^C7^J: ";C2X:TD(2)=C2X:PRINT
540 INPUT "ENTER YOUR ASSIGNED VALUE FOR 1^C4 ARMOR ASSEMBLY AREAS^2^C7^J: ";C3X:TD(3)=C3X:PRINT
545 INPUT "ENTER YOUR ASSIGNED VALUE FOR 1^C4 SEAD^2^C7^J: ";C4X:TD(4)=C4X:PRINT
550 INPUT "ENTER YOUR ASSIGNED VALUE FOR 1^C4 CF^2^C7^J: ";C5X:TD(5)=C5X:PRINT
555 INPUT "ENTER YOUR ASSIGNED VALUE FOR 1^C4 TROOP ASSEMBLY AREAS^2^C7^J: ";C6X:TD(6)=C6X:PRINT
560 INPUT "ENTER YOUR ASSIGNED VALUE FOR 1^C4 LOGISTICAL AREAS^2^C7^J: ";C7X:TD(7)=C7X:PRINT
565 DOS"ARYSAVE/2 "+NAME1$+"TD TD":RETURN

```

```

600 PRINT CHR$(12);"~U000450^C7ASSION ^C4^DIVARTY COMMANDER PRIORITIES ^2^C7TO THE FOLLOWING: ^C9":PRINT:PRINT
605 PRINT "(1) SUPPORTED BRIGADE CONSTITUTES DIVISION MAIN ATTACK":PRINT
610 PRINT "(2) SUPPORTED BRIGADE CONSTITUTES DIVISION SUPPORTING ATTACK":PRINT
615 PRINT "(3) SUPPORTED BATTALION/TASK FORCE CONSTITUTES BRIGADE MAIN ATTACK":PRINT
620 PRINT "(4) SUPPORTED BATTALION/TASK FORCE CONSTITUTES BRIGADE SUPPORTING ATTACK":PRINT
625 PRINT "(5) PARENT FA BATTALION ASSIGNED A 'DIRECT SUPPORT' ROLE":PRINT
630 PRINT "(6) PARENT FA BATTALION ASSIGNED A 'REINFORCING' ROLE":PRINT
635 PRINT "(7) PARENT FA BATTALION ASSIGNED A 'GENERAL SUPPORT-REINFORCING' ROLE":PRINT
640 PRINT "(8) PARENT FA BATTALION ASSIGNED A 'GENERAL SUPPORT' ROLE":PRINT
645 PRINT "~C7ASSION ^1^C4INTEGEE^2^C7 VALUES IN DESCENDING ORDER--THAT IS, THE HIGHEST PRIORITY GETS THE HIGHEST VALUE. ";
650 PRINT "RANK ONLY AS FOLLOWS: ";PRINT
655 PRINT " BETWEEN ^C2(1) ^C7AND ^C2(2)^C7 ABOVE" :PRINT
660 PRINT " BETWEEN ^C2(3) ^C7AND ^C2(4)^C7 ABOVE":PRINT
670 PRINT " BETWEEN ^C2(5), (6), (7), ^C7AND ^C2(8)^C7 ABOVE":PRINT
675 PRINT "YOU MAY ASSIGN EQUAL VALUES OR MAKE QUALITATIVE JUDGEMENTS WITHIN GROUPINGS. ":PRINT
680 INPUT "ENTER YOUR ASSIGNED VALUE FOR 1^C4 (1)^2^C7^J: ";P1X:PD(1)=P1X:PRINT
685 INPUT "ENTER YOUR ASSIGNED VALUE FOR 1^C4 (2)^2^C7^J: ";P2X:PD(2)=P2X:PRINT
690 INPUT "ENTER YOUR ASSIGNED VALUE FOR 1^C4 (3)^2^C7^J: ";P3X:PD(3)=P3X:PRINT
695 INPUT "ENTER YOUR ASSIGNED VALUE FOR 1^C4 (4)^2^C7^J: ";P4X:PD(4)=P4X:PRINT
700 INPUT "ENTER YOUR ASSIGNED VALUE FOR 1^C4 (5)^2^C7^J: ";P5X:PD(5)=P5X:PRINT
705 INPUT "ENTER YOUR ASSIGNED VALUE FOR 1^C4 (6)^2^C7^J: ";P6X:PD(6)=P6X:PRINT
710 INPUT "ENTER YOUR ASSIGNED VALUE FOR 1^C4 (7)^2^C7^J: ";P7X:PD(7)=P7X:PRINT
715 INPUT "ENTER YOUR ASSIGNED VALUE FOR 1^C4 (8)^2^C7^J: ";P8X:PD(8)=P8X:PRINT
720 DOS"ARYSAVE/2 "+NAME1$+"PD PD":RETURN

```

```

900 PRINT CHR$(27);"0A2~"~H000000300100";CHR$(12);
901 PRINT CHR$(27);"0A2~"~H000000300100";CHR$(12);
902 PRINT "~C7DESIGNATE THE CALIBER OF HOWITZER~J":PRINT
903 INPUT "~C4Type^1 I=155mm ^C7or^C38-inch^2^J ";A$:PRINT
905 IF LEFT$(A$,1)<"I" GOTO 1030
910 PRINT "~C7IS THIS 155mm BATTERY PROVIDING FIRE SUPPORT (DS,R OR GSR ONLY) TO THE BRIGADE ASSIGNED THE ";
915 INPUT "~C2DIVISION^S^C7 MAIN ATTACK? ^C3Type Y=Yes ^C7or^C3 N=No ^J ";A$
920 IF LEFT$(A$,1)<"Y" GOTO 980
925 GOSUB 1100:ON D GOTO 930,945,960,975
930 GOSUB 1200:IF LEFT$(A$,1)<"Y" GOTO 940
935 HT:=0:HT:=VDOSX/(PD(1)*PD(3)*PD(5)):FD:=1:OD:=1:HD:=1:HD:=2:PRINT CHR$(12):GOTO 1080
940 HT:=0:HT:=VDOSX/(PD(1)*PD(4)*PD(5)):FD:=1:OD:=1:HD:=1:HD:=2:PRINT CHR$(12):GOTO 1080
945 GOSUB 1200:IF LEFT$(A$,1)<"Y" GOTO 955

```

AD-A125 615

A PROTOTYPE DECISION SUPPORT SYSTEM FOR THE SELECTION
OF AMMUNITION TRANS. (U) GEORGIA INST OF TECH ATLANTA
SCHOOL OF INDUSTRIAL AND SYSTEMS. L G CALLAHAN ET AL.
NOV 82 DRSNI/RD-CR-83-2 DAAH01-81-D-0003 F/G 15/2

2/2

UNCLASSIFIED

NL



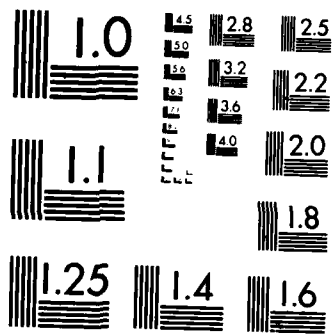

MICROCOPY RESOLUTION TEST CHART
NATIONAL BUREAU OF STANDARDS-1963 A

```

1400 TV=TD(U)
1401 TV=TV+1:TD(U)=TV:IF TV>25 THEN FLA0=30:00TO 1420 ELSE FLA0=10:00TO 1405
1402 TV=TD(U)
1403 TV=TV-1:IF TV<1 00TO 1404 ELSE TD(U)=TV:FLA0=20:00TO 1405
1404 FLA0=25:00TO 1420
1405 VD0SX=TD(1)+TD(3)+TD(6):V0SR0X=TD(1)+TD(2)+TD(3)+TD(4)+TD(5)+TD(6)+TD(7)
1410 V00SX=V0SR0X-TD(1)
1415 FOR M=1 TO 0P(9):NN=M:HT=0:00SUB 1700:SHT(NN)=HT::NEXT
1420 V4=1:00TO 354

1500 DAP=PD(0)
1501 DAP=DAP+1:PD(0)=DAP:IF DAP>25 THEN FLA0=35:00TO 1510 ELSE FLA0=15:00TO 1505
1502 DAP=PD(0)
1503 DAP=DAP-1:IF DAP<1 00TO 1504 ELSE PD(0)=DAP:FLA0=30:00TO 1505
1504 FLA0=40:00TO 1510
1505 FOR N=1 TO 0P(9):NN=N:HT=0:00SUB 1700:SHT(NN)=HT::NEXT
1510 V4=1:00TO 354

1600 FOR J=1 TO 0P(11):MSS=ABS(XX(J)-XP)+ABS(YY(J)-YP)
1605 IF MSS<NPN THEN NPN=MSS:CLN=J
1610 NEXT:RETURN

1700 IF FD(NN)=1 AND 0D(NN)=1 AND 0D(NN)=1 AND 0D(NN)=1 AND HD(NN)=1 THEN HT:=VD0SX/(PD(1)*PD(3)*PD(5))
1705 IF FD(NN)=1 AND 0D(NN)=1 AND 0D(NN)=1 AND 0D(NN)=1 AND HD(NN)=2 THEN HT:=VD0SX/(PD(1)*PD(4)*PD(5))
1710 IF FD(NN)=2 AND 0D(NN)=1 AND 0D(NN)=1 AND 0D(NN)=1 AND HD(NN)=1 THEN HT:=V0R0X/(PD(1)*PD(3)*PD(6))
1715 IF FD(NN)=2 AND 0D(NN)=1 AND 0D(NN)=1 AND 0D(NN)=1 AND HD(NN)=2 THEN HT:=V0R0X/(PD(1)*PD(4)*PD(6))
1720 IF FD(NN)=3 AND 0D(NN)=1 AND 0D(NN)=1 AND 0D(NN)=1 AND HD(NN)=1 THEN HT:=V0SR0X/(PD(1)*PD(3)*PD(7))
1725 IF FD(NN)=3 AND 0D(NN)=1 AND 0D(NN)=1 AND 0D(NN)=1 AND HD(NN)=2 THEN HT:=V0SR0X/(PD(1)*PD(4)*PD(7))
1730 IF FD(NN)=4 AND 0D(NN)=1 AND 0D(NN)=1 AND 0D(NN)=1 AND HD(NN)=0 THEN HT:=V00SX/PD(8)
1735 IF FD(NN)=1 AND 0D(NN)=1 AND 0D(NN)=1 AND 0D(NN)=1 AND HD(NN)=1 THEN HT:=VD0SX/(PD(2)*PD(3)*PD(5))
1740 IF FD(NN)=1 AND 0D(NN)=1 AND 0D(NN)=1 AND 0D(NN)=1 AND HD(NN)=2 THEN HT:=VD0SX/(PD(2)*PD(4)*PD(5))
1745 IF FD(NN)=2 AND 0D(NN)=1 AND 0D(NN)=1 AND 0D(NN)=1 AND HD(NN)=1 THEN HT:=TV0R0X/(PD(2)*PD(3)*PD(6))
1750 IF FD(NN)=2 AND 0D(NN)=1 AND 0D(NN)=1 AND 0D(NN)=1 AND HD(NN)=2 THEN HT:=V0R0X/(PD(2)*PD(4)*PD(6))
1755 IF FD(NN)=3 AND 0D(NN)=1 AND 0D(NN)=1 AND 0D(NN)=1 AND HD(NN)=1 THEN HT:=V0SR0X/(PD(2)*PD(3)*PD(7))
1760 IF FD(NN)=3 AND 0D(NN)=1 AND 0D(NN)=1 AND 0D(NN)=1 AND HD(NN)=2 THEN HT:=V0SR0X/(PD(2)*PD(4)*PD(7))
1765 IF FD(NN)=2 AND 0D(NN)=2 AND 0D(NN)=1 AND 0D(NN)=1 AND HD(NN)=0 THEN HT:=V0R0X/(PD(1)*PD(6))
1770 IF FD(NN)=2 AND 0D(NN)=2 AND 0D(NN)=2 AND 0D(NN)=0 THEN HT:=V0R0X/(PD(2)*PD(6))
1775 IF FD(NN)=3 AND 0D(NN)=2 AND 0D(NN)=2 AND 0D(NN)=0 THEN HT:=V0SR0X/(PD(1)*PD(7))
1780 IF FD(NN)=3 AND 0D(NN)=2 AND 0D(NN)=2 AND 0D(NN)=0 THEN HT:=V0SR0X/(PD(2)*PD(7))
1785 IF FD(NN)=4 AND 0D(NN)=2 AND 0D(NN)=2 AND 0D(NN)=0 THEN HT:=V00SX/PD(8)
1790 RETURN

```

APPENDIX VI

PROGRAM DEFENSE

```

100 'PROGRAM DEFENSE
45 IF F0=2 GOTO 155
50 IF KEY=10 GOTO 1401
51 IF KEY=11 GOTO 1402
52 IF KEY=12 GOTO 1501
53 IF KEY=13 GOTO 1502
89 IF P9=1 THEN 91 ELSE 90
90 ERASE FD:OD:HD:DIM FD(OP(9)):OD(OP(9)):HD(OP(9)):GOTO 95
91 ERASE FD:DIM FD(OP(9)):DOS"ARYLOAD/2 "+NAME1$+"FD FD"
92 ERASE OD:DIM OD(OP(9)):DOS"ARYLOAD/2 "+NAME1$+"OD OD"
93 ERASE HD:DIM HD(OP(9)):DOS"ARYLOAD/2 "+NAME1$+"HD HD"
95 IF KEY=8 GOTO 161
96 IF KEY=9 GOTO 241
100 PRINT CHR$(27):"QA0";CHR$(12):"~C7~X2,~Y2, YOU HAVE CHOSEN A ~C4~IDEFENSE~2~C7 POSTURE. YOU MUST NOW PROCEED TO ";
105 PRINT "ESTABLISH PARAMETERS FOR EACH FIRING BATTERY IN THE BRIGADE AD. ~X1,~Y1,"
120 GOSUB 590
136 IF PD(1) THEN 235 ELSE 140
140 GOSUB 600
150 GOTO 315
155 PRINT CHR$(27):"QA0~U000350~C700 YOU WANT TO CHANGE TARGET VALUES? ~C3Type Y=Yes ~C7or~C3 N=No~J~C7 ":INPUT AS
156 PRINT
160 IF LEFT$(AS,1)<>"Y" GOTO 130 ELSE 165
161 PRINT CHR$(12):"~U000350~C7HIGH~1~C5 CATEGORY'S~2~C7 TARGET VALUE DO YOU WANT ANALYSIS ON?":PRINT:GOTO 170
165 PRINT "~U000350~WHICH ~1~C5CATEGORY'S ~2~C7TARGET VALUE DO YOU WANT TO CHANGE? ":PRINT
170 PRINT "~C7~C4~11~2~C7=~C6IN CONTACT":PRINT
175 PRINT "~C7~C4~12~2~C7=~C6COMMAND POSTS":PRINT
180 PRINT "~C7~C4~13~2~C7=~C6ARMOR ASSEMBLY AREAS":PRINT
185 PRINT "~C7~C4~14~2~C7=~C6SEAD":PRINT
190 PRINT "~C7~C4~15~2~C7=~C6COUNTERFIRE":PRINT
195 PRINT "~C7~C4~16~2~C7=~C6TROOP ASSEMBLY AREAS":PRINT
200 PRINT "~C7~C4~17~2~C7=~C6LOGISTICAL AREAS":PRINT
205 INPUT "ENTER ONLY~1~C2 ONE ~2~C7CHOICE ~J ~":U
206 IF U<1 OR U>7 THEN PRINT "~1~C4INDICATED CATEGORY DOES NOT EXIST~C7~2":GOTO 161 ELSE 207
207 IF KEY=8 GOTO 1400
210 INPUT "ENTER THE ~1~C6GENEN TARGET VALUE~2~C7 FOR THE CHOICE ABOVE~J ~":CX
215 TD(U)=CX
220 INPUT "~C700 YOU WANT TO MAKE ANY MORE CHANGES? ~C3Type Y=Yes ~C7or~C3 N=No~J~C7 ~":AS
225 IF LEFT$(AS,1)<>"Y" GOTO 231
230 GOTO 165
231 DOS"ARYSAVE/2 "+NAME1$+"TD TD":GOTO 136
235 INPUT "~U000350~C700 YOU WANT TO CHANGE DEFENSIVE DIVARTY COMMANDER PRIORITIES? ~C3Type Y=Yes ~C7or~C3 N=No~J~C7 ~":AS
236 PRINT CHR$(12)
240 IF LEFT$(AS,1)<>"Y" GOTO 315 ELSE 245
241 PRINT CHR$(12):"~U000350~WHICH DEFENSIVE DIVARTY COMMANDER PRIORITY DO YOU WANT ANALYSIS ON? ":PRINT:GOTO 250
245 PRINT "~U000350~WHICH OFFENSIVE DIVARTY COMMANDER PRIORITY DO YOU WANT TO CHANGE? ":PRINT
250 PRINT "~C7~11~2~C7=~C3INTELLIGENCE REPORTS INDICATE BREAKTHROUGH IS MOST LIKELY TO OCCUR IN BRIGADE SECTOR":PRINT
255 PRINT "~C7~12~2~C7=~C3INTELLIGENCE REPORTS DO NOT INDICATE BREAKTHROUGH IS LIKELY TO OCCUR IN BRIGADE SECTOR"
256 PRINT
270 PRINT "~C7~13~2~C7=~C3PARENT FA BATTALION ASSIGNED A 'DIRECT SUPPORT' ROLE":PRINT

```

```

275 PRINT "C7W14~2~C7~C3PARENT FA BATTALION ASSIGNED A 'REINFORCING' ROLE":PRINT
280 PRINT "C7W15~2~C7~C3PARENT FA BATTALION ASSIGNED A 'GENERAL SUPPORT-REINFORCING' ROLE":PRINT
285 PRINT "C7W16~2~C7~C3PARENT FA BATTALION ASSIGNED A 'GENERAL SUPPORT' ROLE":PRINT
290 INPUT "ENTER ONLY~1~C2 ONE ~2~C7CHOICE ~J " :J
291 IF Q<1 OR Q>6 THEN PRINT "~1~C4INDICATED PRIORITY DOES NOT EXIST~C7~2":GOTO 241 ELSE 292
292 IF KEY=9 GOTO 1500
295 INPUT "ENTER THE ~1~C6NEM PRIORITY~2~C7 FOR THE CHOICE ABOVE~J " :PX:PD(Q)=PX
300 INPUT "C700 YOU WANT TO MAKE ANY MORE CHANGES? ~C3Type Y=Yes ~C7or~C3 N=No~J~C7 " :AS:PRINT CHR$(12)
305 IF LEFT$(AS,1)~"Y" GOTO 311
310 GOTO 245
311 DO$ "ARYSAVE/2 "+NAME1$+"PD PD"
315 VDX=TD(1)+TD(3)+TD(6):VRX=VDX:V0X=TD(1)+TD(2)+TD(3)+TD(4)+TD(5)+TD(6)+TD(7)
320 V0X=V0X-TD(1)
325 ERASE HT:DIM HT(9)
327 PRINT "K":PRINT CHR$(12):DO$ "REFRESH/1 "+NAME1$:M=0
328 PRINT CHR$(27):"OAG~K";
329 ON ERROR 2 GOTO 335:OUT&H90,0
330 PRINT CHR$(27):"OAI~M300100511000":CHR$(12);
331 PRINT "K~C7DESIGNATE A FIRING BATTERY NODE WITH THE LIGHT PEN"
332 PRINT "K~C3LIGHT PEN ENABLED"
334 GOTO 334
335 IF ERR=24 THEN XP=CURSX(4):YP=CURSY(4) ELSE ON ERROR 0 GOTO 0
339 NFN=25:GOSUB 1600
340 PRINT CHR$(27):"OAI":CHR$(12);
341 PRINT "K~ENTER PARAMETERS FOR BATTERY AT NODE~C4 " :CLN:PRINT "7010":CHR$(12)
343 GOSUB 900
344 M=M+1:IF M=0(9) THEN OUT&H90,0:RESUME 346 ELSE OUT&H90,0:RESUME 329
345 DO$ "ARYSAVE/2 "+NAME1$+"HT HT"
347 DO$ "ARYSAVE/2 "+NAME1$+"FD FD"
348 DO$ "ARYSAVE/2 "+NAME1$+"OD OD"
349 DO$ "ARYSAVE/2 "+NAME1$+"HD HD"
351 ERASE FD,OD,HD,HT:DIM FD(1),OD(1),HD(1),HT(1)
352 IF F0=2 GOTO 355
353 IF F0=1 GOTO 354
354 DO$ "CHAIN/2 ATPII"
355 DO$ "CHAIN/1 ATPI"

500 PRINT "U000350~C7ASSIGN ~C4~1TARGET VALUES ~2~C7 TO THE FOLLOWING SEVEN TARGET CATEGORIES: ~C3";
505 PRINT "IN CONTACT, COMMAND POSTS(Div & higher), ARMOR ASSEMBLY AREAS, SEAD, ";
510 PRINT "CF, TROOP ASSEMBLY AREAS, LOGISTICAL AREAS. ";
515 PRINT "C7ASSIGN ~1~C4INTEGER~2~C7 VALUES IN ASCENDING ORDER--THAT IS, THE HIGHEST PRIORITY TARGET GETS THE LOWEST VALUE. ";
520 PRINT " YOU MAY ASSIGN EQUAL TARGET VALUES OR MAKE QUALITATIVE JUDGEMENTS (e.g. IN CONTACT IS 4 TIMES MORE";
525 PRINT " IMPORTANT THAN ALL OTHERS. THIS COULD MEAN YOU ASSIGN VALUE 1 TO CATEGORY 1 AND 4 TO ALL OTHER CATEGORIES)"
526 PRINT:PRINT
530 INPUT "ENTER YOUR ASSIGNED VALUE FOR ~1~C4 IN CONTACT~2~C7~J " :C1X:TD(1)=C1X:PRINT
535 INPUT "ENTER YOUR ASSIGNED VALUE FOR ~1~C4 COMMAND POSTS~2~C7~J " :C2X:TD(2)=C2X:PRINT
540 INPUT "ENTER YOUR ASSIGNED VALUE FOR ~1~C4 ARMOR ASSEMBLY AREAS~2~C7~J " :C3X:TD(3)=C3X:PRINT
545 INPUT "ENTER YOUR ASSIGNED VALUE FOR ~1~C4 SEAD~2~C7~J " :C4X:TD(4)=C4X:PRINT
550 INPUT "ENTER YOUR ASSIGNED VALUE FOR ~1~C4 CF~2~C7~J " :C5X:TD(5)=C5X:PRINT
555 INPUT "ENTER YOUR ASSIGNED VALUE FOR ~1~C4 TROOP ASSEMBLY AREAS~2~C7~J " :C6X:TD(6)=C6X:PRINT
560 INPUT "ENTER YOUR ASSIGNED VALUE FOR ~1~C4 LOGISTICAL AREAS~2~C7~J " :C7X:TD(7)=C7X:PRINT
565 DO$ "ARYSAVE/2 "+NAME1$+"TD TD":RETURN

```



```

600 PRINT CHR$(12); "U000450~C7ASSION ~C4~DIVARTY COMMANDER PRIORITIES ~2~C7TO THE FOLLOWING: ~C3"; PRINT: PRINT
605 PRINT "(1) INTELLIGENCE REPORTS INDICATE BREAKTHROUGH IS MOST LIKELY TO OCCUR IN BRIGADE SECTOR": PRINT
610 PRINT "(2) INTELLIGENCE REPORTS DO NOT INDICATE BREAKTHROUGH IS LIKELY TO OCCUR IN BRIGADE SECTOR": PRINT
625 PRINT "(3) PARENT FA BATTALION ASSIGNED A 'DIRECT SUPPORT' ROLE": PRINT
630 PRINT "(4) PARENT FA BATTALION ASSIGNED A 'REINFORCING' ROLE": PRINT
635 PRINT "(5) PARENT FA BATTALION ASSIGNED A 'GENERAL SUPPORT-REINFORCING' ROLE": PRINT
640 PRINT "(6) PARENT FA BATTALION ASSIGNED A 'GENERAL SUPPORT' ROLE": PRINT
645 PRINT "~C7ASSION ~1~C4INTEGER~2~C7 VALUES IN DESCENDING ORDER--THAT IS, THE HIGHEST PRIORITY GETS THE HIGHEST VALUE. ";
650 PRINT "RANK ONLY AS FOLLOWS: "; PRINT
655 PRINT "    BETWEEN ~C2(1) ~C7AND ~C2(2)~C7 ABOVE": PRINT
670 PRINT "    BETWEEN ~C2(3), (4), (5), ~C7AND ~C2(6)~C7 ABOVE": PRINT
675 PRINT "YOU MAY ASSIGN EQUAL VALUES OR MAKE QUALITATIVE JUDGEMENTS WITHIN GROUPINGS. "; PRINT
680 INPUT "ENTER YOUR ASSIGNED VALUE FOR ~1~C4 (1)~2~C7~J: "; P1X: PD(1)=P1X: PRINT
685 INPUT "ENTER YOUR ASSIGNED VALUE FOR ~1~C4 (2)~2~C7~J: "; P2X: PD(2)=P2X: PRINT
690 INPUT "ENTER YOUR ASSIGNED VALUE FOR ~1~C4 (3)~2~C7~J: "; P3X: PD(3)=P3X: PRINT
695 INPUT "ENTER YOUR ASSIGNED VALUE FOR ~1~C4 (4)~2~C7~J: "; P4X: PD(4)=P4X: PRINT
700 INPUT "ENTER YOUR ASSIGNED VALUE FOR ~1~C4 (5)~2~C7~J: "; P5X: PD(5)=P5X: PRINT
705 INPUT "ENTER YOUR ASSIGNED VALUE FOR ~1~C4 (6)~2~C7~J: "; P6X: PD(6)=P6X: PRINT
720 DOS"ARYSAVE/2 "+NAME1$+"PD PD": RETURN

900 PRINT CHR$(27); "0A2=="H0000000000000000"; CHR$(12);
901 PRINT CHR$(27); "0A2=="H0000000000000000"; CHR$(12);
902 PRINT "~C7DESIGNATE THE CALIBER OF MORTAR: ~J": PRINT
903 INPUT "~C4Type~1 I=155mm ~C7or~C38-inch~2~J "; A$: PRINT
905 IF LEFT$(A$, 1) < "I" GOTO 1005
910 GOSUB 1200: IF LEFT$(A$, 1) < "Y" GOTO 970
915 GOSUB 1100: ON D GOTO 920, 930, 925, 950
920 WT:=0: HT:=VDX/(PD(1)*PD(3)): FD:=1: OD:=1: HD:=1: PRINT WT: "~2010": PRINT CHR$(12): GOTO 1000
925 WT:=0: HT:=VDX/(PD(1)*PD(5)): FD:=3: OD:=1: HD:=1: PRINT WT: "~2010": PRINT CHR$(12): GOTO 1000
930 PRINT "~C7YOU HAVE ASSIGNED A ~C4REINFORCING ~C7ROLE IN THE DEFENSE TO A ~C3155mm ~C7 BATTERY. IS THIS CORRECT?"
935 INPUT "~C3Type Y=Yes ~C7or~C3 N=No~J~C7 "; A$: PRINT
940 IF LEFT$(A$, 1) < "Y" GOTO 915
945 WT:=0: HT:=VRX/(PD(1)*PD(4)): FD:=2: OD:=1: HD:=1: PRINT WT: "~2010": PRINT CHR$(12): GOTO 1000
950 PRINT "~C7YOU HAVE ASSIGNED A ~C4GENERAISUPPORT ~C7ROLE IN THE DEFENSE TO A ~C2155mm ~C7 BATTERY. IS THIS CORRECT?"
955 INPUT "~C3Type Y=Yes ~C7or~C3 N=No~J~C7 "; A$: PRINT
960 IF LEFT$(A$, 1) < "Y" GOTO 915
970 GOSUB 1100: ON D GOTO 975, 980, 1000, 950
975 WT:=0: HT:=VDX/(PD(2)*PD(3)): FD:=1: OD:=1: HD:=2: PRINT WT: "~2010": PRINT CHR$(12): GOTO 1000
980 PRINT "~C7YOU HAVE ASSIGNED A ~C4REINFORCING ~C7ROLE IN THE DEFENSE TO A ~C3155mm ~C7 BATTERY. IS THIS CORRECT?"

```

```

985 INPUT "~C3Type Y=Yes ~C7or~C3 N=No~J~C7 ":A$:PRINT
990 IF LEFT$(A$,1)<"Y" GOTO 915
995 WT:=0:WT:=VRX/(PD(2)*PD(4)):FD=2:GD=1:HD=2:PRINT WT:"~?010":PRINT CHR$(12):GOTO 1080
1000 WT:=0:WT:=VOX/(PD(2)*PD(5)):FD=3:GD=1:HD=2:PRINT WT:"~?010":PRINT CHR$(12):GOTO 1080
1005 GOSUB 1100:ON D GOTO 1010,1020,1050,1065
1010 PRINT "~C7YOU HAVE ASSIGNED A ~C4DIRECT SUPPORT ~C7ROLE IN THE DEFENSE TO A ~C28-Inch ~C7 BATTERY. MAKE APPROPRIATE ";
1015 PRINT "CHANGE."GOTO 1085
1020 PRINT "~C7YOU HAVE ASSIGNED A ~C4REINFORCING ~C7ROLE IN THE DEFENSE TO A ~C28-Inch ~C7 BATTERY. IS THIS CORRECT?"
1025 INPUT "~C3Type Y=Yes ~C7or~C3 N=No~J~C7 ":A$:PRINT
1030 IF LEFT$(A$,1)<"Y" GOTO 1085
1035 GOSUB 1200:IF LEFT$(A$,1)<"Y" GOTO 1045
1040 WT:=0:WT:=VRX/(PD(1)*PD(4)):FD=2:GD=2:HD=1:PRINT WT ~?010":PRINT CHR$(12):GOTO 1080
1045 WT:=0:WT:=VRX/(PD(2)*PD(4)):FD=2:GD=2:HD=2:PRINT WT: ~?010":PRINT CHR$(12):GOTO 1080
1050 GOSUB 1200:IF LEFT$(A$,1)<"Y" GOTO 1060
1055 WT:=0:WT:=VOX/(PD(1)*PD(5)):FD=3:GD=2:HD=1:PRINT WT:"~?010":PRINT CHR$(12):GOTO 1080
1060 WT:=0:WT:=VOX/(PD(2)*PD(5)):FD=3:GD=2:HD=2:PRINT WT:"~?010":PRINT CHR$(12):GOTO 1080
1065 WT:=0:WT:=VOX/PD(6):FD=4:GD=0:HD=0:PRINT WT:"~?010":PRINT CHR$(12):GOTO 1080
1070 PRINT "~C7YOU HAVE ASSIGNED A ~C4DIRECT SUPPORT ~C2~C7ROLE TO AN ~C28-Inch ~C7 BATTERY. MAKE APPROPRIATE ";
1075 PRINT "CHANGE."GOTO 1085
1080 FOR I=1 TO 9:IF CLN=FU(I) THEN J6=I:GOTO 1085 ELSE NEXT
1085 HT(J6)=HT:FD(J6)=FD:GD(J6)=GD:HD(J6)=HD
1090 PRINT CHR$(27);"0A0":RETURN

1100 PRINT CHR$(27);"0A2";CHR$(12);"~C7DESIGNATE THE RESPECTIVE BATTERY'S ASSIGNED":PRINT
1101 PRINT "~CSFA ROLE ~C7":PRINT
1105 PRINT "~C7~C4~1~2~C7DESIGNATES ~1~C4'DIRECT SUPPORT'^2"
1110 PRINT "~C7~C4~12~2~C7DESIGNATES ~1~C4'REINFORCING'^2"
1115 PRINT "~C7~C4~13~2~C7DESIGNATES ~1~C4'GENERAL SUPPORT-REINFORCING'^2"
1120 PRINT "~C7~C4~14~2~C7DESIGNATES ~1~C4'GENERAL SUPPORT'^2":PRINT
1125 INPUT "~C3~ENTER CHOICE FROM ABOVE OPTIONS^2~C7~J";D
1130 IF D<1 OR D>4 THEN PRINT "~1~C4INDICATED ROLE DOES NOT EXIST~C7~2":GOTO 1100 ELSE PRINT CHR$(12):RETURN

1200 PRINT CHR$(27);"0A2";CHR$(12);"~C700 INTELLIGENCE REPORTS INDICATE THAT ~C4THREAT ~CSBREAKTHROUGH ~C7 IS MOST";
1205 PRINT "LIKELY TO OCCUR IN THIS BRIGADE SECTOR? ~C3Type Y=Yes ~C7or~C3 N=No~J~C7 ":INPUT A$:PRINT CHR$(12):RETURN

1400 TV:=TD(U)
1401 TV=TV+1:TD(U)=TV:IF TV>25 THEN FLAG=30:GOTO 1420 ELSE FLAG=10:GOTO 1405
1402 TV:=TD(U)
1403 TV=TV-1:IF TV<1 GOTO 1404 ELSE TD(U)=TV:FLAG=20:GOTO 1405
1404 FLAG=25:GOTO 1420
1405 VDX=TD(1)+TD(3)+TD(6):VRX=VOX:VDX=TD(1)+TD(2)+TD(3)+TD(4)+TD(5)+TD(6)+TD(7)
1410 VDX=VDX-TD(1)
1415 FOR M=1 TO 9:NM=M:HT:=0:GOSUB 1700:SHT(NM)=HT:NEXT
1420 V4=2:GOTO 354

```

```

1588 DAP=PD(Q)
1591 DAP=DAP+1:PD(Q)=DAP:IF DAP>25 THEN FLA0=35:00TO 1510 ELSE FLA0=15:00TO 1585
1592 DAP=PD(Q)
1593 DAP=DAP-1:IF DAP<1 00TO 1594 ELSE PD(Q)=DAP:FLA0=30:00TO 1585
1594 FLA0=40:00TO 1510
1595 FOR N=1 TO 0P(9):NN=N:WT:=0:00SUB 1700:SHT(NN)=HT::NEXT
1510 V4=2:00TO 354

```

```

1600 FOR J=1 TO 0P(11):MSS=ABS(XX(J)-XP)+ABS(YY(J)-YP)
1605 IF MSS<NPN THEN NPN=MSS:CLN=J
1610 NEXT RETURN

```

```

1700 IF FD(NN)=1 AND 0D(NN)=1 AND HD(NN)=1 THEN WT:=VOX/(PD(1)*PD(3))
1705 IF FD(NN)=2 AND 0D(NN)=1 AND HD(NN)=1 THEN WT:=VRX/(PD(1)*PD(4))
1710 IF FD(NN)=3 AND 0D(NN)=1 AND HD(NN)=1 THEN WT:=VOX/(PD(1)*PD(5))
1715 IF FD(NN)=4 AND 0D(NN)=1 AND HD(NN)=0 THEN WT:=VOX/PD(6)
1720 IF FD(NN)=1 AND 0D(NN)=1 AND HD(NN)=2 THEN WT:=VOX/(PD(2)*PD(3))
1725 IF FD(NN)=2 AND 0D(NN)=1 AND HD(NN)=2 THEN WT:=VRX/(PD(2)*PD(4))
1730 IF FD(NN)=3 AND 0D(NN)=1 AND HD(NN)=2 THEN WT:=VOX/(PD(2)*PD(5))
1735 IF FD(NN)=4 AND 0D(NN)=2 AND HD(NN)=1 THEN WT:=VRX/(PD(1)*PD(4))
1740 IF FD(NN)=2 AND 0D(NN)=2 AND HD(NN)=2 THEN WT:=VRX/(PD(2)*PD(4))
1745 IF FD(NN)=3 AND 0D(NN)=2 AND HD(NN)=1 THEN WT:=VOX/(PD(1)*PD(5))
1750 IF FD(NN)=3 AND 0D(NN)=2 AND HD(NN)=2 THEN WT:=VOX/(PD(2)*PD(5))
1755 IF FD(NN)=4 AND 0D(NN)=2 AND HD(NN)=0 THEN WT:=VOX/PD(6)
1790 RETURN

```

APPENDIX VII

PROGRAM DELAY

```

10 'PROGRAM DELAY
45 IF FC=2 GOTO 155
85 IF KEY=10 GOTO 1281
86 IF KEY=11 GOTO 1262
87 IF KEY=12 GOTO 1481
88 IF KEY=13 GOTO 1482
89 IF P9=1 THEN 91 ELSE 90
90 ERASE FD,OD: DIM FD(OP(9)), OD(OP(9)): GOTO 95
91 ERASE FD,OD: DIM FD(OP(9)), OD(OP(9)): DO8"ARYLOAD/2 "+NAME1$+"FD FD": DO8"ARYLOAD/2 "+NAME1$+"OD OD"
95 IF KEY=8 GOTO 161
96 IF KEY=9 GOTO 241
100 PRINT CHR$(27); "OD#"; CHR$(12) ""C7~X2,~Y2, YOU HAVE CHOSEN A ~C4~IDELAY~2~C7 POSTURE. YOU MUST NOW PROCEED TO ";
105 PRINT "ESTABLISH PARAMETERS FOR EACH FIRING BATTERY IN THE BRIGADE A0~X1,~Y1."
120 GOSUB 500
136 IF PD(1) THEN 235 ELSE 140
140 GOSUB 600
150 GOTO 315
155 PRINT CHR$(27); "OD#~C7~U00035000 YOU WANT TO CHANGE TARGET VALUES? ~C3Type Y=Yes ~C7or~C3 N=No~J~C7"
156 INPUT AS: PRINT CHR$(12)
160 IF LEFT$(AS,1)<>"Y" GOTO 136 ELSE 165
161 PRINT CHR$(12); ""U000350HHICH ~1~C5CATEGORY'S ~2~CTARGET VALUE DO YOU WANT ANALYSIS ON?": PRINT: GOTO 170
165 PRINT ""U000350HHICH ~1~C5CATEGORY'S ~2~CTARGET VALUE DO YOU WANT TO CHANGE? ": PRINT
170 PRINT ""C7~C4~11~2~C7=~C6IN CONTACT": PRINT
175 PRINT ""C7~C4~12~2~C7=~C6COMMAND POSTS": PRINT
180 PRINT ""C7~C4~13~2~C7=~C6ARMOR ASSEMBLY AREAS": PRINT
185 PRINT ""C7~C4~14~2~C7=~C6SEAD": PRINT
190 PRINT ""C7~C4~15~2~C7=~C6COUNTERFIRE": PRINT
195 PRINT ""C7~C4~16~2~C7=~C6TROOP ASSEMBLY AREAS": PRINT
200 PRINT ""C7~C4~17~2~C7=~C6LOGISTICAL AREAS": PRINT
205 INPUT "ENTER ONLY ~1~C2 ONE ~2~C7CHOICE ~J "; U
206 IF UK1 OR U>7 THEN PRINT ""~1~C4INDICATED CATEGORY DOES NOT EXIST~2~C7": GOTO 161 ELSE 207
207 IF KEY=8 GOTO 1200
210 INPUT "ENTER THE ~1~C6NEW TARGET VALUE~2~C7 FOR THE CHOICE ABOVE~J "; CX
215 TO(U)=CX
220 PRINT ""C700 YOU WANT TO MAKE ANY MORE CHANGES? ~C3Type Y=Yes ~C7or~C3 N=No~J~C7": INPUT AS: PRINT CHR$(12)
225 IF LEFT$(AS,1)<>"Y" GOTO 231
230 GOTO 165
231 DO8"ARYSAVE/2 "+NAME1$+"TD TD": GOTO 136
235 PRINT ""C7~U00035000 YOU WANT TO CHANGE DELAY DIVARTY COMMANDER PRIORITIES? ~C3Type Y=Yes ~C7or~C3 N=No~J~C7"
236 INPUT AS: PRINT CHR$(12)
240 IF LEFT$(AS,1)<>"Y" GOTO 315 ELSE 245
241 PRINT CHR$(12); ""U000350HHICH ~1~C5PRIORITY~2~C7 DO YOU WANT ANALYSIS ON?": PRINT: GOTO 270
245 PRINT ""WHICH DELAY DIVARTY COMMANDER PRIORITY DO YOU WANT TO CHANGE? ": PRINT
270 PRINT ""C7~1~C41~2~C7=~C3PARENT FA BATTALION ASSIGNED A 'DIRECT SUPPORT' ROLE": PRINT

```

```

275 PRINT ""~C7M~1~C42~2~C7~C3PARENT FA BATTALION ASSIGNED A 'REINFORCING' ROLE":PRINT
280 PRINT ""~C7M~1~C43~2~C7~C3PARENT FA BATTALION ASSIGNED A 'GENERAL SUPPORT-REINFORCING' ROLE":PRINT
285 PRINT ""~C7M~1~C44~2~C7~C3PARENT FA BATTALION ASSIGNED A 'GENERAL SUPPORT' ROLE":PRINT
290 INPUT "ENTER ONLY~1~C2 ONE ~2~C7CHOICE ~J ";Q
291 IF Q<1 OR Q>4 THEN PRINT ""~1~C4INDICATED PRIORITY DOES NOT EXIST~2~C7":GOTO 241 ELSE 292
292 IF KEY=9 GOTO 1400
295 INPUT "ENTER THE ~1~C6NEW PRIORITY~2~C7 FOR THE CHOICE ABOVE~J ";PX:PD(Q)=PX
300 INPUT ""~C700 YOU WANT TO MAKE ANY MORE CHANGES? ~C3Type Y=Yes ~C7or~C3 N=No~J~C7":A$:PRINT CHR$(12)
305 IF LEFT$(A$,1)<>"Y" GOTO 311
310 GOTO 245
311 DOS"ARYSAVE/2 "+NAME1$+"PD PD"
315 TSX=TD(1)+TD(3)+TD(6):ORX=TSX
320 D0SRX=TD(1)+TD(2)+TD(3)+TD(4)+TD(5)+TD(6)+TD(7):VTD0SX=D0SRX-TD(1)
325 ERASE MT:DIM MT(0P(9))
327 PRINT ""~K":PRINT CHR$(12):DOS"REFRESH/1 "+NAME1$:M=0
328 PRINT CHR$(27):"0A0~K";
329 ON ERROR#2 GOTO 335:OUT&H00,0
330 PRINT CHR$(27):"0A1~H300100511000";CHR$(12);
331 PRINT ""~K~C7DESIGNATE A FIRING BATTERY NODE WITH THE LIGHT PEN."
332 PRINT ""~K~C3LIGHT PEN ENABLED"
334 GOTO 334
335 IF ERR=24 THEN XP=CURS(4):YP=CURS(4) ELSE ON ERROR#0 GOTO 0
339 NPN=25:GOSUB 1300
340 PRINT CHR$(27):"0A1":CHR$(12);
341 PRINT ""~K~C7ENTER PARAMETERS FOR BATTERY AT NODE~C4 ";CLN:PRINT ""~7010";CHR$(12)
343 GOSUB 900
344 M=H+1:IF M=0P(9) THEN OUT&H90,0:RESUME 340 ELSE OUT&H90,0:RESUME 329
348 DOS"ARYSAVE/2 "+NAME1$+"MT MT"
349 DOS"ARYSAVE/2 "+NAME1$+"FD FD"
350 DOS"ARYSAVE/2 "+NAME1$+"0D 0D"
351 ERASE FD,0D,MT:DIM FD(1),0D(1),MT(1)
352 IF F0=2 GOTO 355
353 IF F0=1 GOTO 354
354 DOS"CHAIN/2 ATP11"
355 DOS"CHAIN/1 ATP1"

500 PRINT ""~U000300~C7ASSIGN ~C4~1TARGET VALUES ~2~C7 TO THE FOLLOWING SEVEN TARGET CATEGORIES: ~C3";
505 PRINT "IN CONTACT, COMMAND POSTS(Div & higher), ARMOR ASSEMBLY AREAS, SEAD, ";
510 PRINT "CF, TROOP ASSEMBLY AREAS, LOGISTICAL AREAS ";
515 PRINT ""~C7ASSIGN ~1~C4INTEGER~2~C7 VALUES IN ASCENDING ORDER--THAT IS, THE HIGHEST PRIORITY TARGET GETS THE LOWEST VALUE. ";
520 PRINT " YOU MAY ASSIGN EQUAL TARGET VALUES OR MAKE QUALITATIVE JUDGEMENTS (e.g. IN CONTACT IS 4 TIMES MORE";
525 PRINT " IMPORTANT THAN ALL OTHERS. THIS COULD MEAN YOU ASSIGN VALUE 1 TO CATEGORY 1 AND 4 TO ALL OTHER CATEGORIES)"
526 PRINT:PRINT
530 INPUT "ENTER YOUR ASSIGNED VALUE FOR ~1~C4 IN CONTACT~2~C7~J ";C1X:TD(1)=C1X:PRINT
535 INPUT "ENTER YOUR ASSIGNED VALUE FOR ~1~C4 COMMAND POSTS~2~C7~J ";C2X:TD(2)=C2X:PRINT
540 INPUT "ENTER YOUR ASSIGNED VALUE FOR ~1~C4 ARMOR ASSEMBLY AREAS~2~C7~J ";C3X:TD(3)=C3X:PRINT

```

```

545 INPUT "ENTER YOUR ASSIGNED VALUE FOR ~1^C4 SEAD~2^C7~J: ";C4X:TD(4)=C4X:PRINT
550 INPUT "ENTER YOUR ASSIGNED VALUE FOR ~1^C4 CF~2^C7~J: ";C5X:TD(5)=C5X:PRINT
555 INPUT "ENTER YOUR ASSIGNED VALUE FOR ~1^C4 TROOP ASSEMBLY AREAS~2^C7~J: ";C6X:TD(6)=C6X:PRINT
560 INPUT "ENTER YOUR ASSIGNED VALUE FOR ~1^C4 LOGISTICAL AREAS~2^C7~J: ";C7X:TD(7)=C7X:PRINT
565 DOS"ARYSAVE/2 "+NAME1$+"TD TD"
570 RETURN

600 PRINT CHR$(12);""~U000300~C7ASSION ~C4~IDIVARTY COMMANDER PRIORITIES ~2^C7TO THE FOLLOWING: ~C3":PRINT:PRINT
625 PRINT "(1) PARENT FA BATTALION ASSIGNED A 'DIRECT SUPPORT' ROLE":PRINT
630 PRINT "(2) PARENT FA BATTALION ASSIGNED A 'REINFORCING' ROLE":PRINT
635 PRINT "(3) PARENT FA BATTALION ASSIGNED A 'GENERAL SUPPORT-REINFORCINO' ROLE":PRINT
640 PRINT "(4) PARENT FA BATTALION ASSIGNED A 'GENERAL SUPPORT' ROLE":PRINT
645 PRINT "~C7ASSION ~1^C4INTEGER~2^C7 VALUES IN DESCENDING ORDER--THAT IS, THE HIGHEST PRIORITY GETS THE HIGHEST VALUE. ";
675 PRINT " YOU MAY ASSIGN EQUAL VALUES OR MAKE QUALITATIVE JUDGEMENTS .":PRINT
680 INPUT "ENTER YOUR ASSIGNED VALUE FOR ~1^C4 (1)~2^C7~J: ";P1X:PD(1)=P1X:PRINT
685 INPUT "ENTER YOUR ASSIGNED VALUE FOR ~1^C4 (2)~2^C7~J: ";P2X:PD(2)=P2X:PRINT
690 INPUT "ENTER YOUR ASSIGNED VALUE FOR ~1^C4 (3)~2^C7~J: ";P3X:PD(3)=P3X:PRINT
695 INPUT "ENTER YOUR ASSIGNED VALUE FOR ~1^C4 (4)~2^C7~J: ";P4X:PD(4)=P4X:PRINT
720 DOS"ARYSAVE/2 "+NAME1$+"PD PD"
725 RETURN

900 PRINT CHR$(27);"0A2~""~H000000000100":CHR$(12);
901 PRINT "~C7DESIGNATE THE CALIBER OF HOBITZER:~J":PRINT
903 INPUT "~C4Type ~11=155mm ~C7or ~C4E=8-inch~2~J ";A$:PRINT
905 IF LEFT$(A$,1(">"I" 00TO 935
910 DOSUB 1100:ON D 00TO 915,920,925,930
915 WT:=0:WT:=TSX/PD(1):FD=1:0D=1:PRINT WT:"~7010":PRINT CHR$(12):00TO 960
920 WT:=0:WT:=DRX/PD(2):FD=2:0D=1:PRINT WT:"~7010":PRINT CHR$(12):00TO 960
925 WT:=0:WT:=00SRX/PD(3):FD=3:0D=1:PRINT WT:"~7010":PRINT CHR$(12):00TO 960
930 WT:=0:WT:=VTD0SX/PD(4):FD=4:0D=1:PRINT WT:"~7010":PRINT CHR$(12):00TO 960
935 DOSUB 1100:ON D 00TO 935,940,945,950
940 WT:=0:WT:=DRX/PD(2):FD=2:0D=2:PRINT WT:"~7010":PRINT CHR$(12):00TO 960
945 WT:=0:WT:=00SRX/PD(3):FD=3:0D=2:PRINT WT:"~7010":PRINT CHR$(12):00TO 960
950 WT:=0:WT:=VTD0SX/PD(4):FD=4:0D=2:PRINT WT:"~7010":PRINT CHR$(12):00TO 960
955 PRINT "~C7YOU HAVE ASSIGNED A ~1^C4DIRECT SUPPORT ~2^C7ROLE TO AN ~C28-inch ~C7BATTERY. MAKE APPROPRIATE CHANGE. ~7050"
956 00TO 935
960 FOR I=1 TO 0P(9):IF CLN=FU(I) THEN J6=I:00TO 965 ELSE NEXT
965 WT(J6)=WT:FD(J6)=FD:0D(J6)=0D
970 PRINT CHR$(27);"0A0":RETURN

```

```

1100 PRINT CHR$(27);"0A2";CHR$(12);"~C7DESIGNATE THE RESPECTIVE BATTERY'S ~C6ASSIGNED":PRINT
1101 PRINT "~C6FA ROLE ~C7":PRINT
1105 PRINT "~C4~11~2~C7DESIGNATES ~1~C4DIRECT SUPPORT~2~C7"
1110 PRINT "~C4~12~2~C7DESIGNATES ~1~C4REINFORCING~2~C7"
1115 PRINT "~C4~13~2~C7DESIGNATES ~1~C4GENERAL SUPPORT-REINFORCING~2~C7"
1120 PRINT "~C4~14~2~C7DESIGNATES ~1~C4GENERAL SUPPORT~2~C7":PRINT
1125 INPUT "~C3~1ENTER CHOICE FROM ABOVE OPTIONS~2~C7~J":D
1130 IF D<1 OR D>4 THEN PRINT CHR$(12);"~1~C4INDICATED ROLE DOES NOT EXIST~2~C7":GOTO 1100 ELSE PRINT CHR$(12):RETURN

1200 TV=TD(U)
1201 TV=TV+1:TD(U)=TV:IF TV>25 THEN FLAG=30:GOTO 1220 ELSE FLAG=10:GOTO 1205
1202 TV=TD(U)
1203 TV=TV-1:IF TV<1 GOTO 1204 ELSE TD(U)=TV:FLAG=20:GOTO 1205
1204 FLAG=25:GOTO 1220
1205 TSX=TD(1)+TD(3)+TD(6):DRX=TSX
1210 DGSRX=TD(1)+TD(2)+TD(3)+TD(4)+TD(5)+TD(6)+TD(7):VTDGSX=DGSRX-TD(1)
1215 FOR I=1 TO OP(9):NN=I:HT:=0:GOSUB 1500:SHT(NN)=HT:GOTO 1220
1220 V4=3:GOTO 354

1300 FOR J=1 TO OP(11):MSS=ABS(XX(J)-XP)+ABS(YY(J)-YP)
1305 IF MSS<NPN THEN NPN=MSS:CLN=J
1310 NEXT:RETURN

1400 DAP=PD(Q)
1401 DAP=DAP+1:PD(Q)=DAP:IF DAP>25 THEN FLAG=35:GOTO 1410 ELSE FLAG=15:GOTO 1405
1402 DAP=PD(Q)
1403 DAP=DAP-1:IF DAP<1 GOTO 1404 ELSE PD(Q)=DAP:FLAG=30:GOTO 1405
1404 FLAG=40:GOTO 1410
1405 FOR I=1 TO OP(9):NN=I:HT:=0:GOSUB 1500:SHT(NN)=HT:GOTO 1410
1410 V4=3:GOTO 354

1500 IF FD(NN)=1 AND GD(NN)=1 THEN HT:=TSX/PD(1)
1505 IF FD(NN)=2 AND GD(NN)=1 THEN HT:=DRX/PD(2)
1510 IF FD(NN)=3 AND GD(NN)=1 THEN HT:=DGSRX/PD(3)
1515 IF FD(NN)=4 AND GD(NN)=1 THEN HT:=VTDGSX/PD(4)
1520 IF FD(NN)=1 AND GD(NN)=2 THEN HT:=TSX/PD(1)
1525 IF FD(NN)=2 AND GD(NN)=2 THEN HT:=DRX/PD(2)
1530 IF FD(NN)=3 AND GD(NN)=2 THEN HT:=DGSRX/PD(3)
1535 IF FD(NN)=4 AND GD(NN)=2 THEN HT:=VTDGSX/PD(4)
1540 RETURN

```

APPENDIX VIII

PROGRAM RETROGRADE

```

10 PROGRAM RETROGRADE
45 IF F0=2 GOTO 155
85 IF KEY=10 GOTO 1201
86 IF KEY=11 GOTO 1202
87 IF KEY=12 GOTO 1401
88 IF KEY=13 GOTO 1402
89 IF P9=1 THEN 91 ELSE 90
90 ERASE FD,0D: DIM FD(OP(9)),0D(OP(9)): GOTO 95
91 ERASE FD,0D: DIM FD(OP(9)),0D(OP(9)): DOB"ARYLOAD/2 "+NAME1$+"FD FD": DOB"ARYLOAD/2 "+NAME1$+"0D 00"
95 IF KEY=8 GOTO 161
96 IF KEY=9 GOTO 241
100 PRINT CHR$(27):"0A0":CHR$(12) "C7^X2,^Y2, YOU HAVE CHOSEN A ^C4^1RETROGRADE^2^C7 POSTURE. YOU MUST NOW PROCEED TO ";
105 PRINT "ESTABLISH PARAMETERS FOR EACH FIRING BATTERY IN THE BRIGADE AD^X1, ^Y1, ."
120 GOSUB 500
136 IF PD(1) THEN 235 ELSE 140
140 GOSUB 600
150 GOTO 315
155 INPUT A$: PRINT CHR$(12)
160 IF LEFT$(A$,1)(">")="Y" GOTO 196 ELSE 165
161 PRINT CHR$(12): "U000350HHICH ^1^C5CATEGORY^8 ^2^C7TARGET VALUE DO YOU WANT ANALYSIS ON?": PRINT: GOTO 170
165 PRINT "U000350HHICH ^1^C5CATEGORY^8 ^2^C7TARGET VALUE DO YOU WANT TO CHANGE? ": PRINT
170 PRINT "C7^C4^11^2^C7="C6IN CONTACT": PRINT
175 PRINT "C7^C4^12^2^C7="C6COMMAND POSTS": PRINT
180 PRINT "C7^C4^13^2^C7="C6ARMOR ASSEMBLY AREAS": PRINT
185 PRINT "C7^C4^14^2^C7="C6SEAD": PRINT
190 PRINT "C7^C4^15^2^C7="C6COUNTERFIRE": PRINT
195 PRINT "C7^C4^16^2^C7="C6TROOP ASSEMBLY AREAS": PRINT
200 PRINT "C7^C4^17^2^C7="C6LOGISTICAL AREAS": PRINT
205 INPUT "ENTER ONLY ^1^C2 ONE ^2^C7 CHOICE ^J ^"; U
206 IF U<1 OR U>7 THEN PRINT " ^1^C4 INDICATED CATEGORY DOES NOT EXIST ^2^C7": GOTO 161 ELSE 207
207 IF KEY=8 GOTO 1200
210 INPUT "ENTER THE ^1^C6 NEM TARGET VALUE ^2^C7 FOR THE CHOICE ABOVE ^J ^"; CX
215 TD(U)=CX
220 PRINT " ^C700 YOU WANT TO MAKE ANY MORE CHANGES? ^C3Type Y=Yes ^C7or^C3 N=No ^J ^C7": INPUT A$: PRINT CHR$(12)
225 IF LEFT$(A$,1)(">")="Y" GOTO 231
230 GOTO 165
231 DOB"ARYSAVE/2 "+NAME1$+"TD TD": GOTO 136
235 PRINT " ^C7^U00035000 YOU WANT TO CHANGE RETROGRADE DIVARTY COMMANDER PRIORITIES? ^C3Type Y=Yes ^C7or^C3 N=No ^J ^C7"
236 INPUT A$: PRINT CHR$(12)
240 IF LEFT$(A$,1)(">")="Y" GOTO 315 ELSE 245
241 PRINT CHR$(12): "U000350HHICH ^1^C5PRIORITY^2^C7 DO YOU WANT ANALYSIS ON?": PRINT: GOTO 270
245 PRINT "WHICH RETROGRADE DIVARTY COMMANDER PRIORITY DO YOU WANT TO CHANGE? ": PRINT
270 PRINT " ^C7^U ^1^C4 ^1^2^C7="C3PARENT FA BATTALION ASSIGNED A 'DIRECT SUPPORT' ROLE": PRINT

```

```

275 PRINT "~C7M~1~C42~2~C7~C3PARENT FA BATTALION ASSIGNED A 'REINFORCING' ROLE":PRINT
280 PRINT "~C7M~1~C43~2~C7~C3PARENT FA BATTALION ASSIGNED A 'GENERAL SUPPORT-REINFORCING' ROLE":PRINT
285 PRINT "~C7M~1~C44~2~C7~C3PARENT FA BATTALION ASSIGNED A 'GENERAL SUPPORT' ROLE":PRINT
290 INPUT "ENTER ONLY ~1~C2 ONE ~2~C7CHOICE ~J " : J
291 IF Q<1 OR Q>4 THEN PRINT "~1~C4INDICATED PRIORITY DOES NOT EXIST~2~C7":GOTO 241 ELSE 292
292 IF KEY=9 GOTO 1400
295 INPUT "ENTER THE ~1~C6NEW PRIORITY~2~C7 FOR THE CHOICE ABOVE~J " : PX:PD(Q)=PX
300 INPUT "~C7DO YOU WANT TO MAKE ANY MORE CHANGES? ~C3Type Y=Yes ~C7or~C3 N=No~J~C7":A9:PRINT CHR$(12)
305 IF LEFT$(A9,1)<>"Y" GOTO 311
310 GOTO 245
311 DOS"ARYSAVE/2 "+NAME1$+"PD PD"
315 TSX=TD(1)+TD(3)+TD(6):DRX=TSX
320 D0SRX=TD(1)+TD(2)+TD(3)+TD(4)+TD(5)+TD(6)+TD(7):VTD0SX=D0SRX-TD(1)
325 ERASE HT:DIM HT(GP(9))
327 PRINT "--K":PRINT CHR$(12):DOS"REFRESH/1 "+NAME1$:M=0
328 PRINT CHR$(27):"0A0~K":
329 ON ERROR#2 GOTO 335:OUT&H90,0
330 PRINT CHR$(27):"0A1~H300100511000":CHR$(12):
331 PRINT "~K~C7DESIGNATE A FIRING BATTERY NODE WITH THE LIGHT PEN."
332 PRINT "~K~C3LIGHT PEN ENABLED"
334 GOTO 334
335 IF ERR=24 THEN XP=CURSX(4):YP=CURS(4) ELSE ON ERROR#0 GOTO 0
339 NPN=25:GOSUB 1300
340 PRINT CHR$(27):"0A1":CHR$(12):
341 PRINT "~K~C7ENTER PARAMETERS FOR BATTERY AT NODE~C4 " : CLN:PRINT "~?010":CHR$(12)
343 GOSUB 990
344 M=M+1:IF M<GP(9) THEN OUT&H90,0:RESUME 340 ELSE OUT&H90,0:RESUME 329
348 DOS"ARYSAVE/2 "+NAME1$+"HT HT"
349 DOS"ARYSAVE/2 "+NAME1$+"FD FD"
350 DOS"ARYSAVE/2 "+NAME1$+"OD OD"
351 ERASE FD,OD,HT:DIM FD(1),OD(1),HT(1)
352 IF F0=2 GOTO 355
353 IF F0=1 GOTO 354
354 DOS"CHAIN/2 ATP11"
355 DOS"CHAIN/1 ATP1"

500 PRINT "~U000900~C7ASSIGN ~C4~1TARGET VALUES ~2~C7 TO THE FOLLOWING SEVEN TARGET CATEGORIES: ~C9":
505 PRINT "IN CONTACT, COMMAND POSTS(Div & higher), ARMOR ASSEMBLY AREAS, SEAD, ";
510 PRINT "CF, TROOP ASSEMBLY AREAS, LOGISTIC AREAS. ";
515 PRINT "~C7ASSIGN ~1~C4INTEGER~2~C7 VALUES IN ASCENDING ORDER--THAT IS, THE HIGHEST PRIORITY TARGET GETS THE LOWEST ";
520 PRINT "VALUE. YOU MAY ASSIGN EQUAL TARGET VALUES OR MAKE QUALITATIVE JUDGEMENTS (e.g. IN CONTACT IS 4 TIMES MORE";
525 PRINT " IMPORTANT THAN ALL OTHERS. THIS COULD MEAN YOU ASSIGN VALUE 1 TO CATEGORY 1 AND 4 TO ALL OTHER CATEGORIES)"
526 PRINT:PRINT
530 INPUT "ENTER YOUR ASSIGNED VALUE FOR ~1~C4 IN CONTACT~2~C7~J " : C1X:TD(1)=C1X:PRINT
535 INPUT "ENTER YOUR ASSIGNED VALUE FOR ~1~C4 COMMAND POSTS~2~C7~J " : C2X:TD(2)=C2X:PRINT
540 INPUT "ENTER YOUR ASSIGNED VALUE FOR ~1~C4 ARMOR ASSEMBLY AREAS~2~C7~J " : C3X:TD(3)=C3X:PRINT

```

```

545 INPUT "ENTER YOUR ASSIGNED VALUE FOR ~1~C4 SEAD~2~C7~J: ";C4X:TD(4)=C4X:PRINT
550 INPUT "ENTER YOUR ASSIGNED VALUE FOR ~1~C4 CF~2~C7~J: ";C5X:TD(5)=C5X:PRINT
555 INPUT "ENTER YOUR ASSIGNED VALUE FOR ~1~C4 TROOP ASSEMBLY AREAS~2~C7~J: ";C6X:TD(6)=C6X:PRINT
560 INPUT "ENTER YOUR ASSIGNED VALUE FOR ~1~C4 LOGISTICAL AREAS~2~C7~J: ";C7X:TD(7)=C7X:PRINT
565 DOS"ARYSAVE/2 "&NAME1$+"TD TD"
570 RETURN

600 PRINT CHR$(12);"~U000300~C7ASSION ~C4~DIVARTY COMMANDER PRIORITIES ~2~C7TO THE FOLLOWING: ~C3":PRINT:PRINT
625 PRINT "(1) PARENT FA BATTALION ASSIGNED A 'DIRECT SUPPORT' ROLE":PRINT
630 PRINT "(2) PARENT FA BATTALION ASSIGNED A 'REINFORCING' ROLE":PRINT
635 PRINT "(3) PARENT FA BATTALION ASSIGNED A 'GENERAL SUPPORT-REINFORCING' ROLE":PRINT
640 PRINT "(4) PARENT FA BATTALION ASSIGNED A 'GENERAL SUPPORT' ROLE":PRINT
645 PRINT "~C7ASSION ~1~C4INTEGER~2~C7 VALUES IN DESCENDING ORDER--THAT IS, THE HIGHEST PRIORITY GETS THE HIGHEST VALUE. ";
675 PRINT " YOU MAY ASSION EQUAL VALUES OR MAKE QUALITATIVE JUDGEMENTS .":PRINT
680 INPUT "ENTER YOUR ASSIGNED VALUE FOR ~1~C4 (1)~2~C7~J: ";P1X:PD(1)=P1X:PRINT
685 INPUT "ENTER YOUR ASSIGNED VALUE FOR ~1~C4 (2)~2~C7~J: ";P2X:PD(2)=P2X:PRINT
690 INPUT "ENTER YOUR ASSIGNED VALUE FOR ~1~C4 (3)~2~C7~J: ";P3X:PD(3)=P3X:PRINT
695 INPUT "ENTER YOUR ASSIGNED VALUE FOR ~1~C4 (4)~2~C7~J: ";P4X:PD(4)=P4X:PRINT
720 DOS"ARYSAVE/2 "&NAME1$+"PD PD"
725 RETURN

900 PRINT CHR$(27);"0A2~="H000000300100";CHR$(12);
901 PRINT "~C7DESIGNATE THE CALIBER OF HOWITZER:~J":PRINT
905 INPUT "~C4Type ~I1=155mm ~C7or ~C4E=8-inch~2~J ";A$:PRINT
905 IF LEFT$(A$,1)<"I" THEN 935
910 DOSUB 1100:ON D 00TO 915,920,925,930
915 HT:=0:WT:=TSX/PD(1):FD=1:OD=1:PRINT HT;"~7010":PRINT CHR$(12):00TO 960
920 HT:=0:WT:=ORX/PD(2):FD=2:OD=1:PRINT HT;"~7010":PRINT CHR$(12):00TO 960
925 HT:=0:WT:=DCSRX/PD(3):FD=3:OD=1:PRINT HT;"~7010":PRINT CHR$(12):00TO 960
930 HT:=0:WT:=VTDOSX/PD(4):FD=4:OD=1:PRINT HT;"~7010":PRINT CHR$(12):00TO 960
935 DOSUB 1100:ON D 00TO 935,940,945,950
940 HT:=0:WT:=ORX/PD(2):FD=2:OD=2:PRINT HT;"~7010":PRINT CHR$(12):00TO 960
945 HT:=0:WT:=DCSRX/PD(3):FD=3:OD=2:PRINT HT;"~7010":PRINT CHR$(12):00TO 960
950 HT:=0:WT:=VTDOSX/PD(4):FD=4:OD=2:PRINT HT;"~7010":PRINT CHR$(12):00TO 960
955 PRINT "~C7YOU HAVE ASSIGNED A ~1~C4DIRECT SUPPORT ~2~C7ROLE TO AN ~C2B-Inch ~C7BATTERY. MAKE APPROPRIATE CHANGE. ~7050"
956 00TO 935
960 FOR I=1 TO 0P(9):IF CLN=FU(I) THEN J6=I:00TO 965 ELSE NEXT
965 HT(J6)=HT:FD(J6)=FD:00(J6)=00
970 PRINT CHR$(27);"0A0":RETURN

```

```

1100 PRINT CHR$(27);"0A2";CHR$(12); "~C7DESIGNATE THE RESPECTIVE BATTERY'S ~C6ASSIGNED":PRINT
1101 PRINT "~C6FA ROLE ~C7":PRINT
1105 PRINT "#C4~11~2~C7DESIGNATES ~1~C4DIRECT SUPPORT~2~C7"
1110 PRINT "#C4~12~2~C7DESIGNATES ~1~C4REINFORCING~2~C7"
1115 PRINT "#C4~13~2~C7DESIGNATES ~1~C4GENERAL SUPPORT~2~C7"
1120 PRINT "#C4~14~2~C7DESIGNATES ~1~C4GENERAL SUPPORT~2~C7":PRINT
1125 INPUT "~C3~ENTER CHOICE FROM ABOVE OPTIONS~2~C7~J":D
1130 IF D<1 OR D>4 THEN PRINT CHR$(12); "~1~C4INDICATED ROLE DOES NOT EXIST~2~C7":GOTO 1100 ELSE PRINT CHR$(12):RETURN

1200 TV=TD(U)
1201 TV=TV+1:TD(U)=TV:IF TV>25 THEN FLA0=30:GOTO 1220 ELSE FLA0=10:GOTO 1205
1202 TV=TD(U)
1203 TV=TV-1:IF TV<1 GOTO 1204 ELSE TD(U)=TV:FLA0=20:GOTO 1205
1204 FLA0=25:GOTO 1220
1205 TSX=TD(1)+TD(3)+TD(6):DRX=TSX
1210 DGRX=TD(1)+TD(2)+TD(3)+TD(4)+TD(5)+TD(6)+TD(7):VT00SX=DGRX-TD(1)
1215 FOR I=1 TO OP(9):NN=I:WT=:0:00SUB 1500:SHT(NN)=WT:NEXT
1220 V4=:3:GOTO 354

1300 FOR J=1 TO OP(11):NSS=ABS(XX(J)-XP)+ABS(YY(J)-YP)
1305 IF NSS<NPN THEN NPN=NSS:CLN=J
1310 NEXT:RETURN

1400 DAP=PD(Q)
1401 DAP=DAP+1:PD(Q)=DAP:IF DAP>25 THEN FL :0=35:GOTO 1410 ELSE FLA0=15:GOTO 1405
1402 DAP=PD(Q)
1403 DAP=DAP-1:IF DAP<1 GOTO 1404 ELSE PD(Q)=DAP:FLA0=30:GOTO 1405
1404 FLA0=40:GOTO 1410
1405 FOR I=1 TO OP(9):NN=I:WT=:0:00SUB 1500:SHT(NN)=WT:NEXT
1410 V4=:3:GOTO 354

1500 IF FD(NN)=1 AND GD(NN)=1 THEN HT=:TSX/PD(1)
1505 IF FD(NN)=2 AND GD(NN)=1 THEN HT=:DRX/PD(2)
1510 IF FD(NN)=3 AND GD(NN)=1 THEN HT=:DGRX/PD(3)
1515 IF FD(NN)=4 AND GD(NN)=1 THEN HT=:VT00SX/PD(4)
1520 IF FD(NN)=1 AND GD(NN)=2 THEN HT=:TSX/PD(1)
1525 IF FD(NN)=2 AND GD(NN)=2 THEN HT=:DRX/PD(2)
1530 IF FD(NN)=3 AND GD(NN)=2 THEN HT=:DGRX/PD(3)
1535 IF FD(NN)=4 AND GD(NN)=2 THEN HT=:VT00SX/PD(4)
1540 RETURN

```

BIBLIOGRAPHY

1. Ammunition Service in Theater of Operations, Department of the Army Field Manual, FM 9-6, (1975).
2. Anderson, M. J., "A Prototype Decision Support System for the Location of Military Water Points," Masters Thesis, Georgia Institute of Technology, Atlanta, GA, (1980).
3. BIT PAD ONE USERS MANUAL, Summagraphics Corporation, Manual #64, 35 Brentwood Avenue, Fairfield, Connecticut 06430 W/Revision 8, January 21, 1980.
4. CG BASIC Reference Manual, Chromatics, Inc., 2558 Mountain Industrial Blvd., Atlanta, Georgia 30084, (1981).
5. Christofides, N., Graph Theory: An Algorithmic Approach, Academic Press, New York, N.Y., (1975).
6. DeLoch, LTC, Private Communication, Project Planning and Control Office, US Army Concepts Analysis Agency, Bethesda, MD, Winter 1981.
7. Disk Software Reference Manual CG Series Color Graphics Computers, Chromatics, Inc., 2558 Mountain Industrial Blvd., Atlanta, Georgia 30084, (1978).
8. El-Shaieb, A. M., "A New Algorithm for Locating Sources among Destinations," Management Sci., 20, 221-231, (1973).
9. Field Artillery Reference Data, US Army Field Artillery School, ST 6-1-1, Fort Sill, OK, (1977).
10. Francis, R. L. and J. M. Goldstein, "Location Theory: A Selective Bibliography," Opns. Res., 22(2), 400-410, (1974).
11. Galvão, R. D., "A Dual-Bounded Algorithm for the p-Median Problem," Opns. Res., 28, 1112-1121, (1980).
12. Garfinkel, R., A. Neebe and M. Rao, "An Algorithm for the m-Median Plant Location Problem," Transportation Sci., 8, 217-236, (1974).
13. Golden, B. L. and T. L. Magnanti, "Deterministic Network Optimization: A Bibliography," Networks, 7, 149-183, (1977).
14. Hakimi, S. L., "Optimal Locations of Switching Centers and the Absolute Centers and Medians of a Graph," Opns. Res., 12, 450-459, (1964).

15. Hakimi, S. L., "Optimum Distribution of Switching Centers in a Communication Network and Some Related Graph Theoretic Problems," Opns. Res. 13, 462-475, (1965).
16. Handler, G. Y. and P. B. Mirchandani, Location on Networks, The M.I.T. Press, Cambridge, Mass., (1979)
17. Järvinen, P., J. Fajala and H. Sinervo, "A Branch-and-Bound Algorithm for Seeking the p-Median," Opns. Res., 20, 173-182, (1972).
18. Kariv, O. and S. L. Hakimi, "An Algorithmic Approach to Network Location Problems. Part 2: The p-Medians," SIAM J. App. Math., 37, 539-560, (1979).
19. Kelley, E. M., "A Methodology for Predicting Ammunition Requirements as a Function of Force Size," Masters Thesis, US Army Command and General Staff College, Fort Leavenworth, KS, (1976).
20. Krarup, J. and P. Pruzan, "Selected Families of Location Problems," Ann. Discrete Math., 5, 327-387, (1979).
21. Maranzana, F. E., "On the Location of Supply Points to Minimize Transport Costs," Opl. Res. Quart., 15, 261-270, (1964).
22. Minieka, E., Optimization Algorithms for Networks and Graphs, Marcel Dekker, Inc., New York, N. Y., (1978).
23. Narula, S. C., V. I. Ogbu and H. M. Samuelsson, "An Algorithm for the p-Median Problem," Opns. Res., 25, 709-712, (1977).
24. Operations, Department of the Army Field Manual, FM 100-5 W/C1, (1977).
25. Operators Manual CG Series Color Graphics Computers, Chromatics, Inc. 2558 Mountain Industrial Blvd., Atlanta, Georgia 30084, (1981).
26. Remen, D. J., R. B. Clarke and J. Fox, "Ammunition Resupply Model: Methodology and Users Manual," Vol. I, Army Combined Arms Studies and Analysis Activity, US Army Combined Arms Center, Fort Leavenworth, KS, (1980).
27. Scheider, LTC, Private Communication, US Army Command and General Staff College, Fort Leavenworth, KS, Winter (1981).
28. Schoch, B. P., "Moving Ammunition for the Army of the Future," National Defense, 35-40, (1982).
29. Sheridan, MAJ, Private Communication, Tactics and Combined Arms Department, US Army Field Artillery School, Fort Sill, OK, Winter (1981).

30. Staff Officers' Field Manual, Organizational, Technical and Logistic Data (Unclassified Data), Department of the Army Field Manual, FM 101-10-1, w/C1, (1976).
31. Tansel, B. C., R. L. Francis and T. J. Lowe, "Location on Networks: A Survey," Research Report No. 81-12, School of Industrial and Systems Engineering, Georgia Institute of Technology, Atlanta, GA 30332, (1981).
32. Teitz, M. B., and P. Bart, "Heuristic Methods for Estimating the Generalized Vertex Median of a Weighted Graph," Opns. Res., 16, 955-961, (1968).
33. Tillery, MAJ, Private Communication, Project Planning and Control Office, US Army Concepts Analysis Agency, Bethesda, MD, Winter (1981).
34. Toole, CPT, Private Communication, Directorate of Combat Development, US Army Field Artillery School, Fort Sill, OK, Winter (1981).
35. Turpin, Mr., Private Communication, Weapons Department, US Army Field Artillery School, Fort Sill, OK, Winter (1981).

DISTRIBUTION

Addressee	No. Copies
Dr. L. G. Callahan, Jr. School of Industrial & Systems Engineering Georgia Institute of Technology Atlanta, GA 30332	10
DRSMI-RDF, Mr. Hallum	1
DRSMI-LP, Mr. Voigt	1
DRSMI-RPR	15
DRSMI-RPT, Record Copy	1

