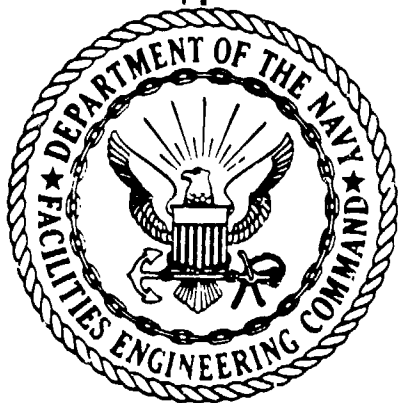


AD A 123 637

NAVFAC DM-7.2
MAY 1982

①

APPROVED FOR PUBLIC RELEASE



FOUNDATIONS AND EARTH STRUCTURES

DESIGN MANUAL 7.2

DTIC
ELECTE
JAN 21 1983
S D
E

DEPARTMENT OF THE NAVY
NAVAL FACILITIES ENGINEERING COMMAND
200 STOVALL STREET
ALEXANDRIA, VA. 22332

DTIC FILE COPY

DISTRIBUTION: (1 copy each unless otherwise specified)

SNDL	2	FG3	(Cheltenham and East Machias only)	7	FT6	
1 23A1 (COMNAVFORAZORES only)				2	FT13	(Less Millington)
1 24J1	2	FG6	(Wahiawa and Norfolk only)	4	FT18	
3 27G	1	FH3	(Beaufort only)	1	FT19	(San Diego only)
2 39B	1	FH6	(Bethesda only)	2	FT22	
1 39C1	1	FH8	(Cairo only)	1	FT27	(Idaho Falls only)
2 39E	7	FH25	(Philadelphia, Portsmouth VA, Camp Lejeune, Oakland, Newport, Great Lakes, and Long Beach only)	1	FT28	
1 42A3				4	FT31	
4 45B				1	FT37	
1 49				1	FT55	
2 51A	1	FJ5		1	FT64	
3 51B1	1	FKA6A1		1	FT73	
3 51B3	1	FKA6A2		1	FT74A	(MYT only)
4 B2A (JCS, NSA, DLA, and DNA only)	1	FKA6A3A		4	FT74B	(California, Illinois, Rensselaer, Georgia Tech only)
3 B5 (USCG only)	1	FKA6A3B				
1 C34 (Holy Loch only)	1	FFA6A9		1	FT78	(2 copies)
2 E3A	1	FKA6A12		1	V2	
6 FA6 (Bermuda, Brunswick, Cecil Field, Key West, Jacksonville, Virginia Beach only)	1	FFA6A15 (Code 521)		2	V3	
	1	FKA6A16		9	V5	
	1	FKA9		2	V8	
6 FA7 (Guantanamo, Keflavik, Brooklyn, Panama Canal, Mayport, Roosevelt Roads only)	6	FKM8		1	V12	
	1	FKM9		1	V14	
	1	FKM12		6	V15	
	1	FKM13		3	V16	(less Camp Smith)
1 FA10	1	FKM15 (Philadelphia only)		2	V17	
1 FA18	200	FKN1 (West and Lant only, 100 copies each)		2	V23	
4 FA23 (Antigua, Brawdy, Buxton, Lewes only)	150	FKN1 (South and North only, 75 copies each)		1	V25	
5 FA32	100	FKN1 (Pac and Ches only, 50 copies each)				
4 FB6	1	FKN1 (Ches, FPO-1 only)				
7 FB7 (Alameda, Fallon, Lemoore, Oak Harbor, Miramar, North Island, Moffet Field only)	2	FKN2 (Pt. Hueneme only, 13 copies)				
2 FB10 (Adak, Midway only)	36	FKN3 (6 copies each)				
1 FB13 (Bremen on only)	45	FKN5 (5 copies each)				
1 FB21	1	FKN7				
1 FB31 (Guam only)	1	FKN8				
2 FB34 (Kadena, Sasebo only)	1	FKN10				
4 FB36 (Big Sur, Coos Head, Ferudale, and Pacific Beach only)	4	FKN11				
	3	FKP1B (less Concord)				
	3	FKP1E (Concord only, 3 copies)				
6 FB41	1	FKP1E				
1 FB48	3	FKP1J				
1 FC3 (London only)	1	FKP1M				
2 FC5	4	FKP3A				
1 FC7	8	FKP7				
1 FC12	16	FKP8				
1 FC14	2	FKP11				
1 FD2	5	FKQ3				
1 FE2	2	FKR1A				
8 FE4 (Adak, Edzell, Hanza, Galeta Island, Homestead, Winter Harbor, Sebana Seca, and Sonoma only)	2	FKR1B (2 copies)				
	1	FKR2A (Dallas only)				
	1	FKR3A				
	1	FKR3H				
	1	FKR4B				
	1	FKR5				
	3	FKR7E (3 copies)				
1 FF1	6	FR3				
1 FF5	2	FR4				
1 FF6	1	FT1				
2 FF19 (New Orleans, Seattle only)	1	FT2				
1 FF38						
6 FG2 (Balboa, Harold Holt, Mea Makri, Thurso, Stockton, and Ponce only)						

Copy to: (One copy each unless otherwise indicated)

3	21A	
1	A2A	(ONR only)
1	A3	
1	A4A	
2	A5	
1	A6	(Code LFF)
2	C7	(Brazil and Chile only)
1	FD1	
1	FE1	
1	FG1	
1	FKA1A	
2	FKA1B	(2 copies)
50	FKA1C	(Code 043 - 50 copies)
1	FKA17	
1	FRN2	(Port Hueneme (Code 156) only)
1	FR1	

REPORT DOCUMENTATION PAGE		READ INSTRUCTIONS BEFORE COMPLETING FORM	
1. REPORT NUMBER NAVFAC DM-7.2	2. GOVT ACCESSION NO. AD-A223637	3. RECIPIENT'S CATALOG NUMBER	
4. TITLE (and Subtitle) NAVFAC Design Manual DM-7.2 Foundations and Earth Structures		5. TYPE OF REPORT & PERIOD COVERED Design Criteria Final	
		6. PERFORMING ORG. REPORT NUMBER DM-7.2	
7. AUTHOR(s) Naval Facilities Engineering Command 200 Stovall Street Alexandria, VA 22332 (Code 0452)		8. CONTRACT OR GRANT NUMBER(s)	
9. PERFORMING ORGANIZATION NAME AND ADDRESS Naval Facilities Engineering Command 200 Stovall Street Alexandria, VA 22332		10. PROGRAM ELEMENT, PROJECT, TASK AREA & WORK UNIT NUMBERS Engineering and Design	
11. CONTROLLING OFFICE NAME AND ADDRESS Naval Facilities Engineering Command (Code 0432) 200 Stovall Street Alexandria, VA 22332		12. REPORT DATE May 1982	
		13. NUMBER OF PAGES 270	
14. MONITORING AGENCY NAME & ADDRESS (if different from Controlling Office)		15. SECURITY CLASS. (of this report) UNCLASSIFIED	
		15a. DECLASSIFICATION/DOWNGRADING SCHEDULE	
16. DISTRIBUTION STATEMENT (of this Report) Unclassified/Unlimited			
17. DISTRIBUTION STATEMENT (of the abstract entered in Block 20, if different from Report) Unclassified/Unlimited			
18. SUPPLEMENTARY NOTES			
19. KEY WORDS (Continue on reverse side if necessary and identify by block number) Compaction; deep foundations; earthwork; excavations; excavation stabilization; hydraulic fills; shallow foundations; walls and retaining structures.			
20. ABSTRACT (Continue on reverse side if necessary and identify by block number) Design guidance is presented for use by experienced engineers. The contents include: excavations; compaction, earthwork, and hydraulic fills; analysis of walls and retaining structures; shallow foundations; and deep foundations.			

ABSTRACT

Design guidance is presented for use by experienced engineers. The contents include: excavations; compaction, earthwork, and hydraulic fills; analysis of walls and retaining structures; shallow foundations; and deep foundations.

Accession For	
NTIS GRA&I	<input checked="" type="checkbox"/>
DTIC TAB	<input type="checkbox"/>
Unannounced	<input type="checkbox"/>
Justification	
By _____	
Distribution/	
Availability Codes	
Dist	Avail and/or Special
A	

DTIC
copy
inserted
2

FOREWORD

This design manual for Foundations and Earth Structures is one of a series that has been developed from an extensive re-evaluation of the relevant portions of Soil Mechanics, Foundations, and Earth Structures, NAVFAC DM-7 of March 1971, from surveys of available new materials and construction methods, and from selection of the best design practices of the Naval Facilities Engineering Command, other Government agencies, and private industry. This manual includes a modernization of the former criteria and the maximum use of national professional society, association and institute codes. Deviations from these criteria should not be made without the prior approval of the Naval Facilities Engineering Command Headquarters (NAVFAC HQ).

Design cannot remain static any more than can the naval functions it serves, or the technologies it uses. Accordingly, this design manual, Foundations and Earth Structures, NAVFAC DM-7.2, along with the companion manuals, Soil Mechanics NAVFAC DM-7.1 and Soil Dynamics, Deep Stabilization, and Special Geotechnical Construction, NAVFAC DM-7.3, cancel and supersede Soil Mechanics, Foundations, and Earth Structures, NAVFAC DM-7 of March 1971 in its entirety, and all changes issued.



W. M. Zobel
Rear Admiral, CEC, U. S. Navy
Commander
Naval Facilities Engineering Command

PREFACE

This manual covers the application of basic engineering principles of soil mechanics in the design of foundations and earth structures for naval shore facilities. Companion manuals (NAVFAC DM-7.1 and DM-7.2) cover the principles of soil mechanics and special aspects of geotechnical engineering. These criteria, together with the definitive designs and guideline specifications of the Naval Facilities Engineering Command, constitute the Command's design guidance. These standards are based on functional requirements, engineering judgment, knowledge of materials and equipment, and the experience gained by the Naval Facilities Engineering Command and other commands and bureaus of the Navy in the design, construction, operation, and maintenance of naval shore facilities.

The design manual series presents criteria that shall be used in the design of facilities under the cognizance of the Naval Facilities Engineering Command. The direction and standards for procedures, methods, dimensions, materials, loads and stresses will be included. Design manuals are not textbooks, but are for the use of experienced architects and engineers. Many criteria and standards appearing in technical texts issued by Government agencies, professional architectural and engineering groups, and trade and industry groups are suitable for, and have been made integral parts of, this series. The latest edition of each publication source shall be used.

Bibliographies of publications containing background information and additional reading on the various subjects are included in the manuals. This material, however, is not a part of the criteria, nor is a reading of these sources necessary for the use of the criteria presented in the manuals.

To avoid duplication and to facilitate future revisions, criteria are presented only once in this series as far as possible. Criteria having general applications appear in the basic manuals numbered DM-1 through DM-10 (numbers DM-11 through DM-20 were unassigned in the original issues). Manuals numbered DM-21 and above contain criteria that usually are applicable only to the specific facility class covered by each manual. When criteria for one facility also have an application in another facility class, the basic rule has been to present such criteria in the basic, or lowest numbered, manual and cite it by reference where required in later manuals.

The specific design manuals (DM-21 and above), with but three exceptions, list design criteria for specific facilities in the order of the category codes. The exceptions are:

- (1) Drydocking Facilities, NAVFAC DM-29, which includes both Category Codes 213 and 223.
- (2) Criteria for facility class 800, Utilities and Ground Improvements, which have been included in the basic manuals on mechanical, electrical, and civil engineering.

- (3) Weight Handling Equipment and Service Craft, NAVFAC DM-38, which includes the design criteria for these facilities under the cognizance of the Naval Facilities Engineering Command that are not classified as real property. These include weight and line handling equipment, dredges, yard craft, and piledriving equipment.

For the effective use of these criteria, the designer must have access to:

- (1) The basic and specific design manuals applicable to the project. See list on page ix.
- (2) Published criteria sources.
- (3) Applicable definitive designs, Definitive Designs for Naval Shore Facilities, NAVFAC P-272.
- (4) Command guideline specifications.

LIST OF DESIGN MANUALS

BASIC MANUALS

Title	Number
Architecture.....	NAVFAC DM-1
Civil Engineering.....	NAVFAC DM-5
Cold Regions Engineering.....	NAVFAC DM-9
Cost Data for Military Construction.....	NAVFAC DM-10
Drawings and Specifications.....	NAVFAC DM-6
Electrical Engineering.....	NAVFAC DM-4
Foundations and Earth Structures.....	NAVFAC DM-7.2
Fire Protection Engineering.....	NAVFAC DM-8
Mechanical Engineering.....	NAVFAC DM-3
Soil Dynamics, Deep Stabilization and Special Geotechnical Construction.....	NAVFAC DM-7.3
Soil Mechanics.....	NAVFAC DM-7.1
Structural Engineering.....	NAVFAC DM-2

SPECIFIC MANUALS

Administrative Facilities.....	NAVFAC DM-34
Airfield Pavements.....	NAVFAC DM-21
Communications, Navigational Aids, and Airfield Lighting.....	NAVFAC DM-23
Community Facilities.....	NAVFAC DM-37
Drydocking Facilities.....	NAVFAC DM-29
Family Housing.....	NAVFAC DM-35
Harbor and Coastal Facilities.....	NAVFAC DM-26
Hospital and Medical Facilities.....	NAVFAC DM-33
Land Operational Facilities.....	NAVFAC DM-24
Liquid Fueling and Dispensing Facilities.....	NAVFAC DM-22
Maintenance Facilities.....	NAVFAC DM-28
Production Facilities.....	NAVFAC DM-30
Research, Development, and Test Facilities.....	NAVFAC DM-31
Supply Facilities.....	NAVFAC DM-32
Training Facilities.....	NAVFAC DM-27
Troop Housing.....	NAVFAC DM-36
Waterfront Operational Facilities.....	NAVFAC DM-25
Weight Handling Equipment and Service Craft.....	NAVFAC DM-38

INDEX MANUAL

Cumulative Index.....	NAVFAC DM-50
-----------------------	--------------

CONTENTS

Page

CHAPTER 1. EXCAVATIONS

Section 1.	Introduction.....	7.2-1
Section 2.	Open Cuts.....	7.2-1
Section 3.	Trenching.....	7.2-2
Section 4.	Braced Excavations.....	7.2-13
Section 5.	Rock Excavation.....	7.2-19
Section 6.	Groundwater Control.....	7.2-27
Section 7.	Excavation Stabilization, Monitoring, and Safety....	7.2-27

CHAPTER 2. COMPACTION, EARTHWORK, AND HYDRAULIC FILLS

Section 1.	Introduction.....	7.2-37
Section 2.	Embankment Cross-Section Design.....	7.2-38
Section 3.	Compaction Requirements and Procedures.....	7.2-45
Section 4.	Embankment Compaction Control.....	7.2-50
Section 5.	Borrow Excavation.....	7.2-52
Section 6.	Hydraulic and Underwater Fills.....	7.2-54

CHAPTER 3. ANALYSIS OF WALLS AND RETAINING STRUCTURES

Section 1.	Introduction.....	7.2-59
Section 2.	Computation of Wall Pressures.....	7.2-59
Section 3.	Rigid Retaining Walls.....	7.2-82
Section 4.	Design of Flexible Walls.....	7.2-85
Section 5.	Cofferdams.....	7.2-116

CHAPTER 4. SHALLOW FOUNDATIONS

Section 1.	Introduction.....	7.2-129
Section 2.	Bearing Capacity Analysis.....	7.2-129
Section 3.	Spread Footing Design Considerations.....	7.2-146
Section 4.	Mat and Continuous Beam Foundations.....	7.2-150
Section 5.	Foundations on Engineered Fill.....	7.2-159
Section 6.	Foundations on Expansive Soils.....	7.2-159
Section 7.	Foundation Waterproofing.....	7.2-163
Section 8.	Uplift Resistance.....	7.2-169

CHAPTER 5. DEEP FOUNDATIONS

Section 1. Introduction.....7.2-177
Section 2. Foundation Types and Design Criteria.....7.2-178
Section 3. Bearing Capacity and Settlement.....7.2-191
Section 4. Pile Installation and Load Tests.....7.2-213
Section 5. Distribution of Loads on Pile Groups.....7.2-230
Section 6. Deep Foundations on Rock.....7.2-232
Section 7. Lateral Load Capacity.....7.2-234

BIBLIOGRAPHY.....7.2-B-1
APPENDIX A - Listing of Computer Programs.....7.2-A-1
GLOSSARY.....7.2-G-1
SYMBOLS.....7.2-S-1
INDEX.....7.2-INDEX-1

FIGURES

Figure	Title	Page
CHAPTER 1		
1	Sliding Trench Shield.....	7.2-7
2	Skeleton Shoring.....	7.2-10
3	Close (Tight) Sheeting.....	7.2-11
4	Box Shoring.....	7.2-12
5	Telescopic Shoring.....	7.2-12
6	Support System - Walled Excavation.....	7.2-15
7	General Guidance for Underpinning.....	7.2-20
8	Rippability of Subsurface Materials Related to Longitudinal Seismic Velocity for a Heavy Duty Ripper (Tractor-Mounted)....	7.2-22
9	Suggested Guide for Ease of Excavation.....	7.2-23
10	Cube Root Scaling Versus Maximum Particle Velocity.....	7.2-24
11	Guideline for Assessing Potential for Damage Induced by Blasting Vibration to Residential Structure Founded on Dense Soil or Rock.....	7.2-25
12	Guide for Predicting Human Response to Vibrations and Blasting Effects.....	7.2-26
13	Methods of Construction Dewatering.....	7.2-31
14	Limits of Dewatering Methods Applicable to Different Soils.....	7.2-33
CHAPTER 2		
1	Resistance of Earth Dam Embankment Materials to Piping and Cracking.....	7.2-42
CHAPTER 3		
1	Effect of Wall Movement on Wall Pressures.....	7.2-60
2	Computation of Simple Active and Passive Pressures.....	7.2-62
3	Active and Passive Coefficients, Sloping Backfill (Granular Soils).....	7.2-64
4	Position of Failure Surface for Active and Passive Wedges (Granular Soils).....	7.2-65
5	Active and Passive Coefficients with Wall Friction (Sloping Wall).....	7.2-66
6	Active and Passive Coefficients with Wall Friction (Sloping Backfill).....	7.2-67
7	Computation of General Active Pressures.....	7.2-68
8	Coefficients K_A and K_p for Walls with Sloping Wall and Friction, and Sloping Backfill.....	7.2-69
9	Computation of General Passive Pressures.....	7.2-71
10	Effect of Groundwater Conditions on Wall Pressures.....	7.2-72
11	Horizontal Pressures on Rigid Wall from Surface Load.....	7.2-74
12	Lateral Pressure on an Unyielding Wall Due to Uniform Rectangular Surface Load.....	7.2-75

Figure	Title	Page
CHAPTER 3 (continued)		
13	Horizontal Pressure on Walls from Compaction Effort.....	7.2-77
14a	Values of F for Determination of Dynamic Lateral Pressure Coefficients.....	7.2-79
14b	Example Calculations for Dynamic Loading on Walls.....	7.2-80
15	Design Criteria for Rigid Retaining Walls.....	7.2-83
16	Design Loads for Low Retaining Walls (Straight Slope Backfill)...	7.2-86
17	Design Loads for Low Retaining Walls (Broken Slope Backfill)....	7.2-87
18	Design Criteria for Anchored Bulkhead (Free Earth Support).....	7.2-88
19	Reduction in Bending Moments in Anchored Bulkhead from Wall Flexibility.....	7.2-89
20	Design Criteria for Deadman Anchorage.....	7.2-91
21	Example of Analysis of Anchored Bulkhead.....	7.2-93
22	Sand Dike Scheme for Controlling Active Pressure.....	7.2-94
23	Analysis for Cantilever Wall.....	7.2-95
24	Cantilever Steel Sheet Pile Wall in Homogeneous Granular Soil...	7.2-97
25	Cantilever Steel Sheet Pile Wall in Cohesive Soil with Granular Backfill.....	7.2-98
26	Pressure Distribution for Brace Loads in Internally Braced Flexible Walls.....	7.2-100
27	Design Criteria for Braced Flexible Walls.....	7.2-102
28	Stability of Base for Braced Cut.....	7.2-104
29	Pressure Distribution for Tied-Back Walls.....	7.2-105
30	Example of Analysis of Pressures on Flexible Wall of Narrow Cut in Clay - Undrained Conditions.....	7.2-107
31	Example of Excavation in Stages.....	7.2-108
32	Culmann Method for Determining Passive Resistance of Earth Berm (Granular Soil).....	7.2-113
33	Passive Pressure Distribution for Soldier Piles.....	7.2-114
34	Gabion Wall.....	7.2-115
35	Reinforced Earth.....	7.2-117
36	Design Criteria for Crib and Bin Walls.....	7.2-118
37	Design Criteria for Cellular Cofferdams.....	7.2-119
CHAPTER 4		
1	Ultimate Bearing Capacity of Shallow Footings with Concentric Loads.....	7.2-131
2	Ultimate Bearing Capacity with Groundwater Effect.....	7.2-132
3a	Ultimate Bearing Capacity of Continuous Footings with Inclined Load.....	7.2-133
3b	Eccentrically Loaded Footings.....	7.2-134
4a	Ultimate Bearing Capacity for Shallow Footing Placed on or Near a Slope.....	7.2-135
4b	Bearing Capacity Factors for Shallow Footing Placed on or Near a Slope.....	7.2-136
5	Ultimate Bearing Capacity of Two Layer Cohesive Soil ($\phi=0$).....	7.2-137
6	Examples of Computation of Allowable Bearing Capacity Shallow Footings on Cohesive Soils.....	7.2-139

Figure	Title	Page
CHAPTER 4 (continued)		
7	Examples of Computation of Allowable Bearing Capacity Shallow Footings on Granular Soils.....	7.2-140
8	Allowable Bearing Pressure for Sand from Static Cone Penetration Tests.....	7.2-147
9	Example of Proportioning Footing Size to Equalize Settlements...	7.2-148
10	Computation of Shear, Moment, and Deflection, Berms on Elastic Foundation.....	7.2-153
11	Functions for Shear, Moment, and Deflection, Beams on Elastic Foundations.....	7.2-154
12	Functions for Shear, Moment, and Deflections, Mats on Elastic Foundations.....	7.2-157
13	Limits of Compaction Beneath Square and Continuous Footings.....	7.2-160
14	Construction Details for Swelling Soils.....	7.2-162
15	Typical Foundation Drainage and Waterproofing.....	7.2-167
16	Capacity of Anchor Rods in Fractured Rock.....	7.2-170
17	Resistance of Footings and Anchorages to Combined Transient Loads.....	7.2-171
18	Tower Guy Anchorage in Soil by Concrete Deadman.....	7.2-172
CHAPTER 5		
1	Load Carrying Capacity of Single Pile in Granular Soils.....	7.2-193
2	Ultimate Load Capacity of Single Pile or Pier in Cohesive Soils.....	7.2-196
3	Bearing Capacity of Pile Groups in Cohesive Soils.....	7.2-206
4	Settlement of Pile Groups.....	7.2-210
5	Principles of Operation of Pile Drivers.....	7.2-222
6	Interpretation of Pile Load Test.....	7.2-229
7	Load Test Analysis Where Downdrag Acts on Piles.....	7.2-231
8	Example Problem - Batter Pile Group as Guy Anchorage.....	7.2-233
9	Coefficient of Variation of Subgrade Reaction.....	7.2-236
10	Design Procedure for Laterally Loaded Piles.....	7.2-237
11	Influence Values for Pile with Applied Lateral Load and Moment (Case I. Flexible Cap or Hinged End Condition).....	7.2-238
12	Influence Values for Laterally Loaded Pile (Case II. Fixed Against Rotation at Ground Surface).....	7.2-239
13	Slope Coefficient for Pile with Lateral Load or Moment.....	7.2-240

TABLES

Table	Title	Page
 CHAPTER 1		
1	Factors Controlling Stability of Sloped Cut in Some Problem Soils.....	7.2-3
2	Factors Controlling Excavation Stability.....	7.2-4
3	OSHA Requirements (Minimum) for Trench Shoring.....	7.2-8
4	Types of Walls.....	7.2-14
5	Factors Involved in Choice of a Support System For a Deep Excavation (> 20 feet).....	7.2-16
6	Design Considerations for Braced and Tieback Walls.....	7.2-17
7	Methods of Groundwater Control.....	7.2-28
 CHAPTER 2		
1	Typical Properties of Compacted Soils.....	7.2-39
2	Relative Desirability of Soils as Compacted Fill.....	7.2-40
3	Clay Dispersion Potential.....	7.2-44
4	Compaction Requirements.....	7.2-46
5	Compaction Equipment and Methods.....	7.2-48
6	Methods of Fill Placement Underwater.....	7.2-55
 CHAPTER 3		
1	Friction Factors and Adhesion for Dissimilar Materials.....	7.2-63
 CHAPTER 4		
1	Presumptive Values of Allowable Bearing Pressure for Spread Foundations.....	7.2-142
2	Selection of Allowable Bearing Pressures for Spread Foundations.....	7.2-144
3	Definitions and Procedures, Analysis of Beams on Elastic Foundation.....	7.2-151
4	Definitions and Procedures, Mats on Elastic Foundations.....	7.2-155
5	Requirements for Foundation Waterproofing and Dampproofing.....	7.2-164
 CHAPTER 5		
1	Design Criteria for Bearing Piles.....	7.2-179
2	Characteristics of Common Excavated/Drilled Foundations.....	7.2-184
3	Design Parameters for Side Friction for Drilled Piers in Cohesive Soils.....	7.2-198
4	Application of Pile Driving Resistance Formulas.....	7.2-203

Table	Title	Page
CHAPTER 5 (continued)		
5	Typical Values of Coefficient C_p for Estimating Settlement of a Single Pile.....	7.2-208
6	General Criteria for Installation of Pile Foundations.....	7.2-214
7	Supplementary Procedures and Appurtenances Used in Pile Driving.....	7.2-213
8	Impact and Vibratory Pile-Driver Data.....	7.2-219
9	Treatment of Field Problems Encountered During Pile Driving.....	7.2-226
10	Drilled Piers: Construction Problems.....	7.2-227

ACKNOWLEDGEMENTS

Figure or Table	Acknowledgement
Figure 13, Chapter 1	Mazurkiewicz, D.K., <u>Design and Construction of Dry Docks</u> , Trans Tech Publications, Rockport, MA., 1980.
Figure 1, Chapter 2	Sherard, J.L., <u>Influence of Soil Properties and Construction Methods on the Performance of Homogeneous Earth Dams</u> , Technical Memorandum 645, U.S. Department of the Interior, Bureau of Reclamation.
Figures 5, 6 & 7, Chapter 3	Caquot, A., and Kerisel, J., <u>Tables for the Calculation of Passive Pressure, Active Pressure and Bearing Capacity of Foundations</u> , Gauthier-Villars, Paris.
Figure 16 & 17 Chapter 3	Terzaghi, K. and Peck, R.B., <u>Soil Mechanics in Engineering Practice</u> , John Wiley & Sons, Inc., New York, NY.
Figures 23, 24 & 25, Chapter 3	U.S. Steel, <u>Sheet Piling Design Manual</u> , July, 1975.
Figure 36, Chapter 3	Portland Cement Association, <u>Concrete Crib Retaining Walls</u> , Concrete Information No. St. 46, Chicago, IL., May, 1952.
Figures 10 & 11, Chapter 4	Hetenyi, M., <u>Beams on Elastic Foundation</u> , The University of Michigan Press, Ann Arbor, MI.
Figure 14, Chapter 4	Parcher, J.V., and Means, R.E., <u>Soil Mechanics and Foundations</u> , Charles E. Merrill Publishing Company, Columbus, OH., 1968.
Figure 2, Chapter 5 (upper panel, right)	Skempton, A.W., <u>The Bearing Capacity of Clays</u> , Proceedings, Building Research Congress, London, 1951.

CHAPTER 1. EXCAVATIONS

Section 1. INTRODUCTION

1. SCOPE. This chapter covers the methods of evaluating the stability of shallow and deep excavations. There are two basic types of excavations: (a) "open excavations" where stability is achieved by providing stable side slopes, and (b) "braced excavations" where vertical or sloped sides are maintained with protective structural systems that can be restrained laterally by internal or external structural elements. Guidance on performance monitoring is given in DM-7.1, Chapter 2.

2. METHODOLOGY. In selecting and designing the excavation system, the primary controlling factors will include: (a) soil type and soil strength parameters; (b) groundwater conditions; (c) slope protection; (d) side and bottom stability; and (e) vertical and lateral movements of adjacent areas, and effects on existing structures.

3. RELATED CRITERIA. For additional criteria on excavations, see the following source:

Subject	Source
Dewatering and Groundwater Control of Deep Excavations....	NAVFAC P-418

Section 2. OPEN CUTS

1. SLOPED CUTS.

a. General. The depth and slope of an excavation, and groundwater conditions control the overall stability and movements of open excavations. In granular soils, instability usually does not extend significantly below the excavation provided seepage forces are controlled. In rock, stability is controlled by depths and slopes of excavation, particular joint patterns, in situ stresses, and groundwater conditions. In cohesive soils, instability typically involves side slopes but may also include materials well below the base of the excavation. Instability below the base of excavation, often referred to as bottom heave, is affected by soil type and strength, depth of cut, side slope and/or berm geometry, groundwater conditions, and construction procedures. Methods for controlling bottom heave are given in DM-7.1, Chapter 6.

b. Evaluation. Methods described in DM-7.1, Chapter 7 may be used to evaluate the stability of open excavations in soils where behavior of such soils can be reasonably determined by field investigation, laboratory testing, and analysis. In certain geologic formations (stiff clays, shales, sensitive clays, clay tills, etc.) stability is controlled by construction procedures, side effects during and after excavation, and inherent geologic planes of weaknesses. Table 1 (modified from Reference 1, Effects of Construction on Geotechnical Engineering, by Clough and Davidson) presents a

summary of the primary factors controlling excavation slopes in some problem soils. Table 2 (modified from Reference 1 and Reference 2, Soils and Geology, Procedures for Foundation Design of Buildings and Other Structures, Departments of Army and Air Force) summarizes measures that can be used for excavation protection for both conventional and problem soils.

2. VERTICAL CUTS. Many cuts in clays will stand with vertical slopes for a period of time before failure occurs. However, changes in the shear strength of the clay with time and stress release resulting from the excavation can lead to progressive deterioration in stability. This process can be rapid in stiff, highly fissured clays, but relatively slow in softer clays. (See DM-7.1, Chapter 7 for critical heights for vertical cuts in cohesive soils.) For cuts in hard unweathered rock, stability is mostly controlled by strength along bedding planes, groundwater condition, and other factors (see DM-7.1, Chapter 6 and Reference 3, Stability of Steep Slopes on Hard Unweathered Rock, by Terzaghi for detailed discussion on the effects of rock discontinuities). Cuts in rock can stand vertical without bolting or anchoring depending on rock quality and joint pattern.

Section 3. TRENCHING

1. SITE EXPLORATION. Individual trenching projects frequently extend over long distances. An exploration program should be performed to define the soil and groundwater conditions over the full extent of the project, so that the design of the shoring system can be adjusted to satisfy the varying site conditions.

2. TRENCH STABILITY. Principal factors influencing trench stability are the lateral earth pressures on the wall support system, bottom heave, and the pressure and erosive effects of infiltrating groundwater (see Chapter 3 and DM-7.1, Chapter 6). External factors which influence trench stability include:

a. Surface Surcharge. The application of any additional load between the edge of the excavation and the intersection of the ground surface with the possible failure plane must be considered in the stability analyses for the excavation.

b. Vibration Loads. The effects of vibrating machinery, blasting or other dynamic loads in the vicinity of the excavation must be considered. The effects of vibrations are cumulative over periods of time and can be particularly dangerous in brittle materials such as clayey sand or gravel.

c. Groundwater Seepage. Improperly dewatered trenches in granular soils can result in quick conditions and a complete loss of soil strength or bottom heave. (See DM-7.1, Chapter 6.)

d. Surface Water Flow. This can result in increased loads on the wall support system and reduction of the shear strength of the soil. Site drainage should be designed to divert water away from trenches.

TABLE 1
Factors Controlling Stability of Sloped Cut in Some Problem Soils

SOIL TYPE	PRIMARY CONSIDERATIONS FOR SLOPE DESIGN
Stiff-fissured Clays and Shales	Field shear resistance may be less than suggested by laboratory tests. Slope failures may occur progressively and shear strengths reduced to residual values compatible with relatively large deformations. Some case histories suggest that the long-term performance is controlled by the residual friction angle which for some shales may be as low as 12°. The most reliable design procedure would involve the use of local experience and recorded observations.
Loess and Other Collapsible Soils	Strong potential for collapse and erosion of relatively dry material upon wetting. Slopes in loess are frequently more stable when cut vertical to prevent infiltration. Benches at intervals can be used to reduce effective slope angles. Evaluate potential for collapse as described in DM 7.1, Chapter 1. (See DM-7.3, Chapter 3 for further guidance.)
Residual Soils	Significant local variations in properties can be expected depending on the weathering profile from parent rock. Guidance based on recorded observation provides prudent basis for design.
Sensitive Clays	Considerable loss of strength upon remolding generated by natural or man-made disturbance. Use analyses based on unconsolidated undrained tests or field vane tests.
Talus	Talus is characterized by loose aggregation of rock that accumulates at the foot of rock cliffs. Stable slopes are commonly between 1-1/4 to 1-3/4 horizontal to 1 vertical. Instability is associated with abundance of water, mostly when snow is melting.
Loose Sands	May settle under blasting vibration, or liquify, settle, and lose strength if saturated. Also prone to erosion and piping.

TABLE 2
Factors Controlling Excavation Stability

Construction Activity	Objectives	Comments
Dewatering	To prevent boiling, softening, or heave in excavation bottom, reduce lateral pressures on sheeting, reduce seepage pressures on face of open cut, eliminate piping of fines through sheeting.	Investigate soil compressibility and effect of dewatering on settlement of nearby structures; consider recharging or slurry wall cutoff. Examine for presence of lower aquifer and need to dewater. Install piezometer if needed. Consider effects of dewatering in cavity-laden limestone. Dewater in advance of excavation.
Excavation and Grading	Pipe trenching, basement excavation, site grading.	Analyze safe slopes (see DM-7, i, Chapter 7) or bracing requirement (see Chapter 3), effects of stress reduction on overconsolidated, soft or swelling soils and shales. Consider horizontal and vertical movements in adjacent areas due to excavation and effect on nearby structures. Keep equipment and stockpiles a safe distance from top of excavation.
Excavation Wall Construction	To support vertical excavation walls, to stabilize trenching in limited space.	See Chapter 3 for wall design. Reduce earth movements and bracing stresses, where necessary, by installing lagging on front flange of soldier pile. Consider effect of vibrations due to driving sheet piles or soldier piles. Consider dewatering requirements as well as wall stability in calculating sheeting depth. Movement monitoring may be warranted.

TABLE 2 (continued)
Factors Controlling Excavation Stability

Construction Activity	Objectives	Comments
Blasting	To remove or to facilitate the removal of rock in the excavation.	Consider effect of vibrations on settlement or damage to adjacent areas. Design and monitor or require the contractor to design and monitor blasting in critical areas; require a pre-construction survey of nearby structures.
Anchor or Strut Installation, Wedging of Struts, Pre-stressing Ties	To obtain support system stiffness and interaction.	Major excavations require careful installation and monitoring, e.g., case anchor holes in collapsible soils; measure stress in ties and struts; wedging, etc.

3. SUPPORT SYSTEMS. Excavation support systems commonly used are as follows:

a. Trench Shield. A rigid prefabricated steel unit used in lieu of shoring, which extends from the bottom of the excavation to within a few feet of the top of the cut. Pipes are laid within the shield, which is pulled ahead, as trenching proceeds, as illustrated in Figure 1 (from Reference 4, Cave-In! by Petersen). Typically, this system is useful in loose granular or soft cohesive soils where excavation depth does not exceed 12 feet. Special shields have been used to depths of 30 feet.

b. Trench Timber Shoring. Table 3 illustrates the Occupational Safety and Health Act's minimum requirements for trench shoring. Braces and shoring of trench are carried along with the excavation. Braces and diagonal shores of timber should not be subjected to compressive stresses in excess of:

$$S = 1300 - 20 L/D$$

where: L = unsupported length (inches)

D = least side of the timber (inches)

S = allowable compressive stress in pounds per square inch of cross section

Maximum Ratio L/D = 50

(1) Skeleton Shoring. Used in soils where cave-ins are expected. Applicable to most soils to depth up to 20 feet. See Figure 2 (from Reference 4) for illustration and guidance for skeleton shoring. Structural components should be designed to safely withstand earth pressures.

(2) Close (Tight) Sheeting. Used in granular or other running soils, compared to skeleton shoring, it is applicable to greater depths. See illustration in Figure 3 (from Reference 4).

(3) Box Shoring. Applicable to trenching in any soil. Depth limited by structural strength and size of timber. Usually limited to 40 feet. See illustration in Figure 4 (from Reference 4).

(4) Telescopic Shoring. Used for excessively deep trenches. See illustration in Figure 5 (Reference 4).

c. Steel Sheeting and Bracing. Steel sheeting and bracing can be used in lieu of timber shoring. Structural members should safely withstand water and lateral earth pressures. Steel sheeting with timber wales and struts have also been used.

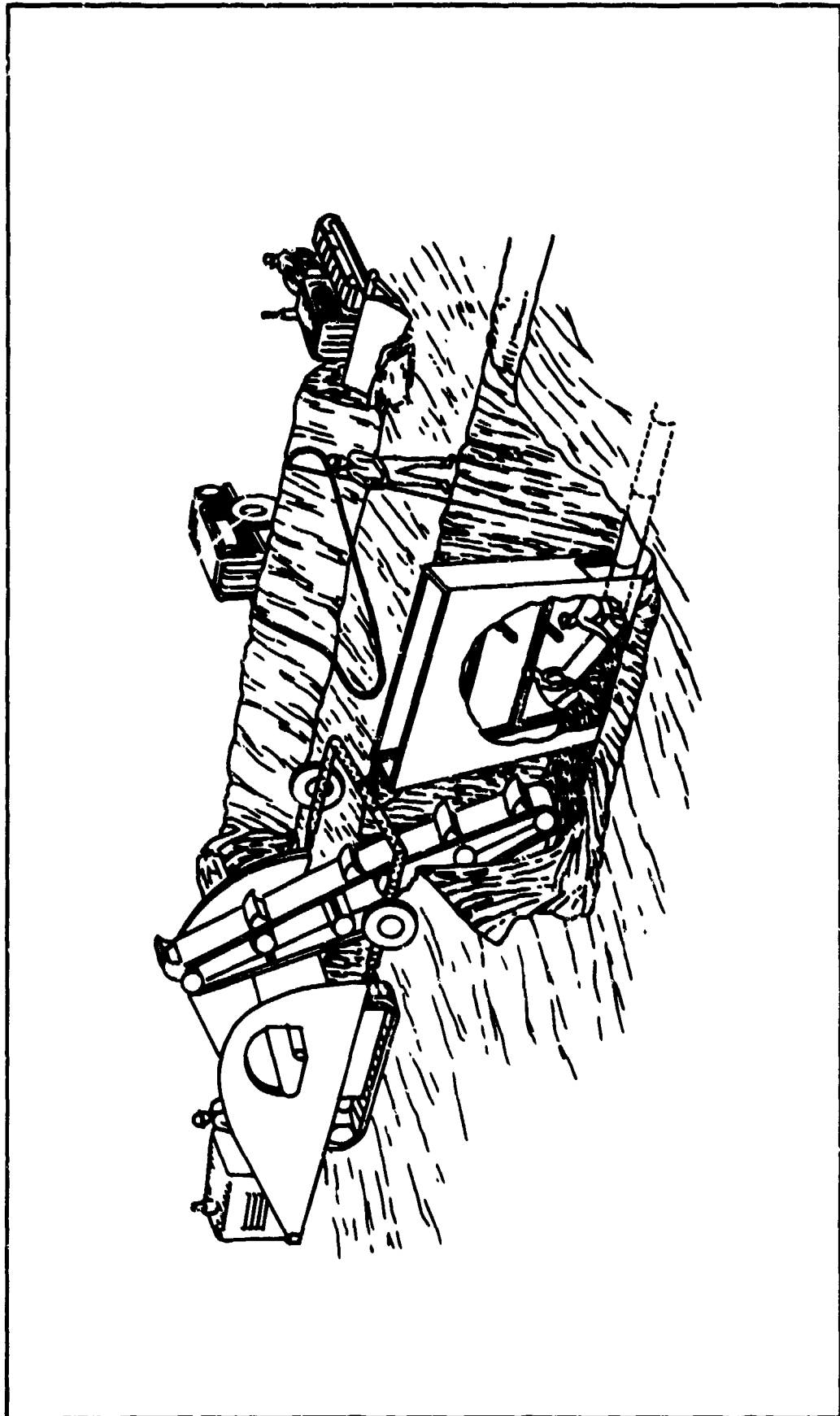


FIGURE 1
Sliding Trench Shield

TABLE 3
OSHA Requirements (Minimum) for Trench Shoring

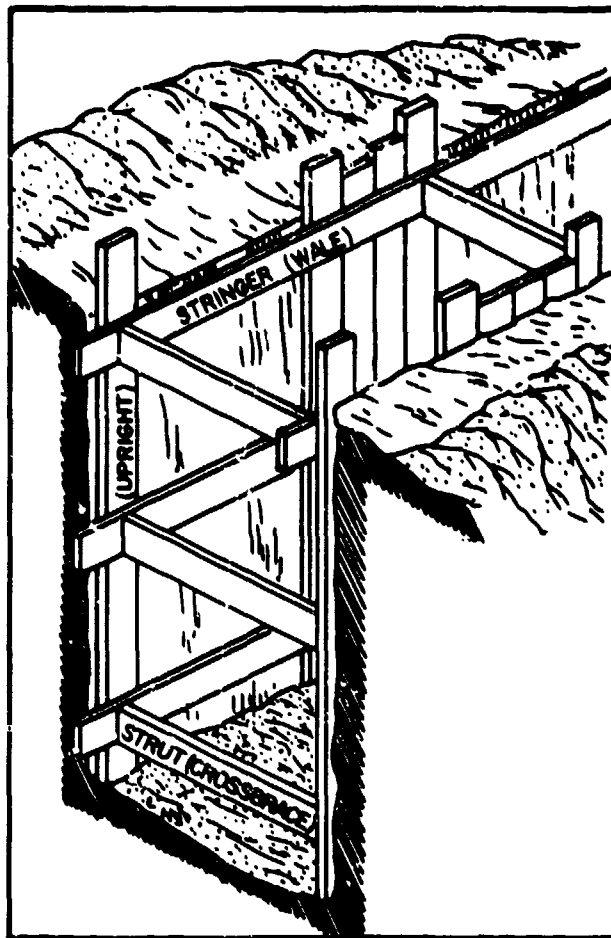
Depth of Trench		Size and Spacing of Members											Maximum Spacing	
		Uprights		Stringers		Cross Braces ¹								
		Minimum Dimension	Maximum Spacing	Minimum Dimension	Maximum Spacing	Width of Trench								
Feet	Inches	Feet	Inches	Inches	Feet	Inches	Up to 3 feet	4 to 6 feet	7 to 9 feet	10 to 12 feet	13 to 15 feet	Vertical	Horizontal	
5 to 10	Hard, compact	3/4 or 2x6	6	2 x 6	4 x 4	4 x 6	6 x 5	6 x 8	4	6	
	Likely to crack	3/4 or 2x6	3	4 x 6	4	2 x 6	4 x 4	4 x 6	6 x 6	6 x 8	6 x 8	4	6	
	Soft, sandy, or filled	3/4 or 2x6	Close sheeting	4 x 6	4	4 x 4	4 x 6	6 x 6	6 x 8	8 x 8	8 x 8	4	6	
11 to 15	Hydrostatic pressure	3/4 or 2x6	Close sheeting	6 x 8	4	4 x 4	4 x 6	6 x 6	6 x 8	8 x 8	8 x 8	4	6	
	Hard	3/4 or 2x6	4	4 x 6	4	4 x 4	4 x 6	6 x 6	6 x 8	8 x 8	8 x 8	4	6	
	Likely to crack	3/4 or 2x6	2	4 x 6	4	4 x 4	4 x 6	6 x 6	6 x 8	8 x 8	8 x 8	4	6	
	Soft, sandy or filled	3/4 or 2x6	Close sheeting	4 x 6	4	4 x 6	6 x 6	6 x 8	8 x 8	8 x 10	8 x 10	4	6	
	Hydrostatic pressure	3x6	Close sheeting	8 x 10	4	4 x 6	6 x 6	6 x 8	8 x 8	8 x 10	8 x 10	4	6	

¹ Trench jacks may be used in lieu of, or in combination with, cross braces. Where desirable, steel sheet piling and bracing of equal strength may be substituted for wood.

TABLE 3 (continued)
 OSHA Requirements (Minimum) for Trench Shoring

Size and Spacing of Members																		
Depth of Trench	Kind or Condition of Earth	Uprights		Stringers		Cross Braces ¹				Maximum Spacing								
		Minimum Dimension	Maximum Spacing	Minimum Dimension	Maximum Spacing	Width of Trench				Vertical	Horizontal							
						Inches	Feet	Inches	Feet			Inches	Feet	Inches	Feet			
16 to 20	All kinds or conditions	3x6	Close sheeting	4 x 12	4	Up to 3 feet	4 x 12	4 to 6 feet	6 x 8	8 x 8	8 x 10	10 to 12 feet	8 x 10	10 x 10	13 to 15 feet	10 x 10	4	6
Over 20	All kinds or conditions	3x6	Close sheeting	6 x 8	4	4 x 12	4 x 12	8 x 10	8 x 10	8 x 10	10 x 10	10 x 12	10 x 10	10 x 12	10 x 12	4	4	

¹ Trench jacks may be used in lieu of, or in combination with, cross braces. Where desirable, steel sheet piling and bracing of equal strength may be substituted for wood.



Requirements for Skeleton Shoring

<u>TRENCH</u>		<u>UPRIGHTS</u>		<u>STRINGERS</u>		<u>STRUTS</u>	
Width	Depth	Size	Horizontal Spacing	Size	Vertical Spacing	Size	Horizontal Spacing
Up to 42"	4' to 10'	2" x 6"	3' c-c	2" x 6"	(a)	2" x 6"(b)	6' c-c
Over 42"	4' to 10'	2" x 6"	3' c-c	4" x 6"	4' c-c	4" x 6"(b)	6' c-c
Up to 42"	10' to 15'	2" x 6"	3' c-c	2" x 6"	(c)	2" x 6"(d)	6' c-c
Up to 42"	Over 15'	2" x 6"	CLOSE	4" x 12"	4' c-c	4" x 12"	6' c-c

NOTES:

CLOSE: Close uprights up tight.

c-c: Center-to-Center

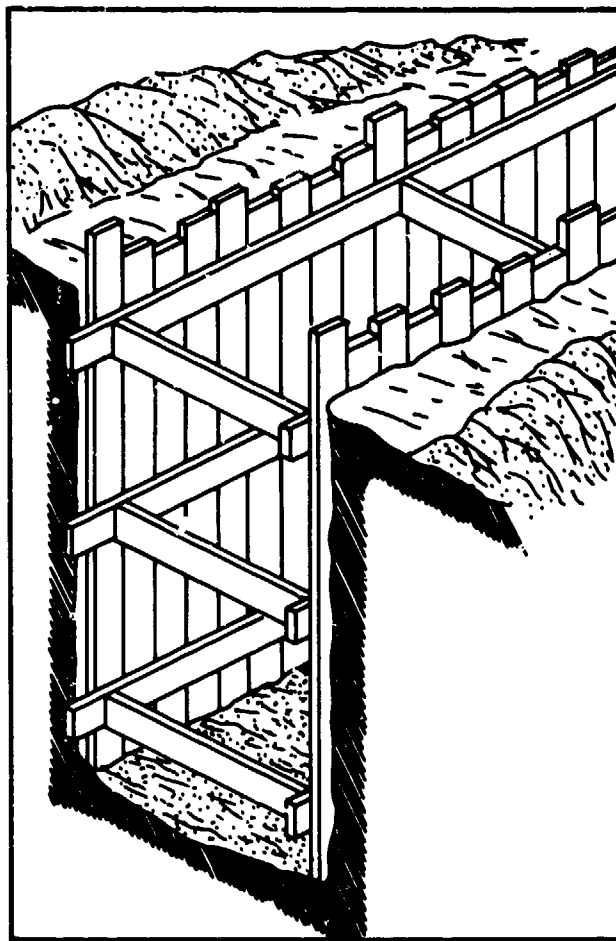
(a) Minimum: Two stringers, one on top and one on bottom.

(b) Minimum: Two struts to 7' depth and three to 10'.

(c) Minimum: Three stringers, placed top, bottom and center.

(d) Minimum: Three struts to 13' depth and four to 15'.

FIGURE 2
Skeleton Shoring



Requirements for Close Sheetting

<u>TRENCH</u>		<u>UPRIGHTS</u>		<u>STRINGERS</u>		<u>STRUTS</u>	
Width	Depth	Size	Horizontal Spacing	Size	Vertical Spacing	Size	Horizontal Spacing
Up to 42"	4' to 10'	2" x 6"	CLOSE	4" x 6"	(a)	4" x 6"	6' c-c
Over 42"	4' to 10'	2" x 6"	CLOSE	4" x 6"	(a)	4" x 6"	6' c-c
Up to 42"	10' to 15'	2" x 6"	CLOSE	4" x 6"	(b)	4" x 6"	6' c-c
Up to 42"	Over 15'	2" x 6"	CLOSE	4" x 12"	4' c-c	4" x 12"	6' c-c

NOTES:

CLOSE: Close uprights up tight.

c-c: Center-to-Center

- (a) Minimum: Two stringers, one on top and one on bottom.
- (b) Minimum: Two struts to 7' depth and three to 10'.
- (c) Minimum: Three stringers, placed top, bottom and center.
- (d) Minimum: Three struts to 13' depth and four to 15'.

FIGURE 3
Close (fight) Sheetting
7.2-11

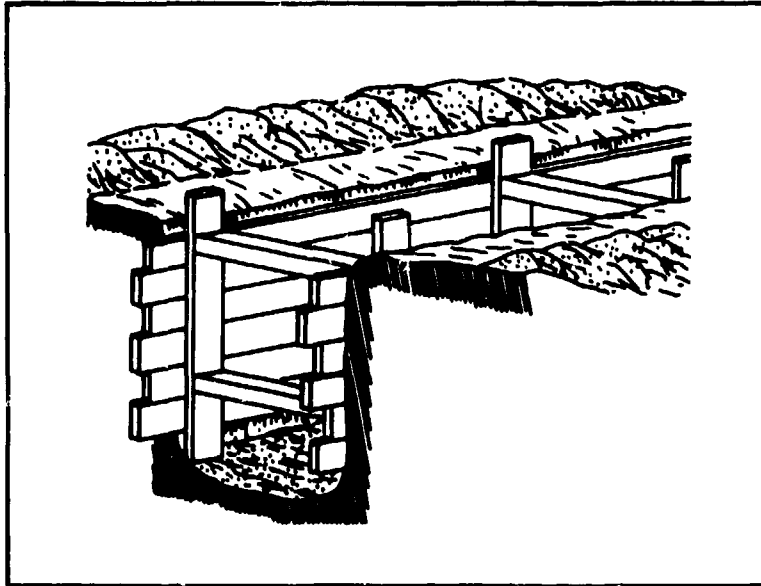


FIGURE 4
Box Shoring

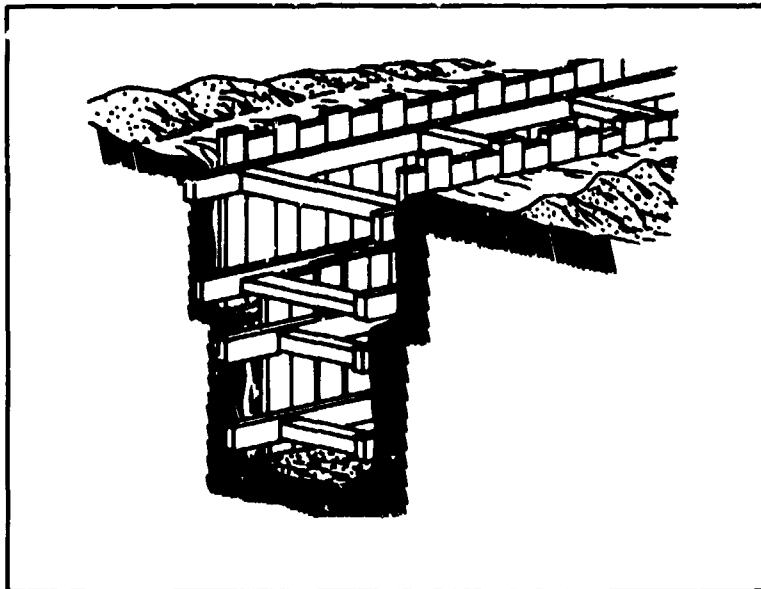


FIGURE 5
Telescopic Shoring

Section 4. BRACED EXCAVATIONS

1. WALL TYPES. Commonly used wall types and limitations to be considered in selection are given in Table 4. Schematics of support systems are shown on Figure 6. A description of wall types listed in Table 4 is presented in Reference 5, Lateral Support Systems and Underpinning, by Goldberg, et al.

2. SELECTION OF SUPPORT SYSTEM. Factors to be considered in selecting types of support systems are given in Table 5.

3. EARTH PRESSURES. The two limiting pressures which may act on the wall are the states of active pressure and passive pressure. Definitions and methods for computing earth pressures are presented in Chapter 3.

For most practical cases, criteria for earth pressures do not exactly conform to the state of active, passive or at rest pressure. Actual earth pressure depends on wall deformation and this in turn depends on several factors. Among the principal factors are: (1) stiffness of wall and support systems; (2) stability of the excavation; and (3) depth of excavation and wall deflection.

The effects of wall deflection on pressure distribution, and differences between strut loads computed from active earth pressure theory and those actually measured for deep excavation in soft clay, are illustrated in Reference 6, Stability of Flexible Structures by Bjerrum, et al. As many different variables affect pressures acting on walls, many types of analyses are available for special situations. (Details concerning these are given in Reference 7, Braced Excavation by Lambe.) Examples of earth pressure computations are given in Chapter 3.

4. OTHER DESIGN AND CONSTRUCTION CONSIDERATIONS. Several factors other than earth pressures affect the selection, design and the performance of braced excavations. See Table 6 for a summary of these factors.

5. LATERAL MOVEMENTS. For well constructed strutted excavations in dense sands and till, maximum lateral wall movements are often less than 0.2% of excavation depth. Lateral movements are usually less for tied back walls. In stiff fissured clays, lateral movements may reach 0.5% or higher depending on quality of construction. In soft clays, a major portion of movement occurs below excavation bottom. Lateral movement may be in the range of 0.5% to 2% of excavation depth, depending on the factor of safety against bottom instability. Higher movements are associated with lesser factors of safety.

6. SOIL SETTLEMENTS BEHIND WALLS. Reference 8, Deep Excavations and Tunneling in Soft Ground by Peck, provides guidance based on empirical observation of settlement behind wall. Settlements up to about 1% of the excavation depth have been measured behind well constructed walls for cuts in sand and in medium stiff clays. In softer clays, this may be as high as 2% and considerably more in very soft clays.

TABLE 4
Types of Walls

Name	Typical EI Values Per Foot (ksf)	Comments
(1) Steel Sheeting	900 - 90,000	<ul style="list-style-type: none"> - Can be impervious - Easy to handle and construct
(2) Soldier Pile and Lagging	2,000 - 120,000	<ul style="list-style-type: none"> - Easy to handle and construct - Permits drainage - Can be driven or augered
(3) Cast-in-place or Pre-cast Concrete Slurry Wall (diaphragm walls, see DM-7.3, Chapter 3)	288,000 - 2,300,000	<ul style="list-style-type: none"> - Can be impervious - Relatively high stiffness - Can be part of permanent structure - Can be prestressed - Relatively less lateral wall movement permitted compared to (1) and (2) - High initial cost - Specialty contractor required to construct - Very large and heavy wall must be used for deep systems - Permits yielding of sub-soils, but precast concrete usually shows less yielding than steel sheeting or soldier pile procedures.
(4) Cylinder Pile Wall	115,000 - 1,000,000	<ul style="list-style-type: none"> - Secant piles impervious - Relatively high stiffness - Highly specialized equipment not needed for tangent piles - Slurry not needed

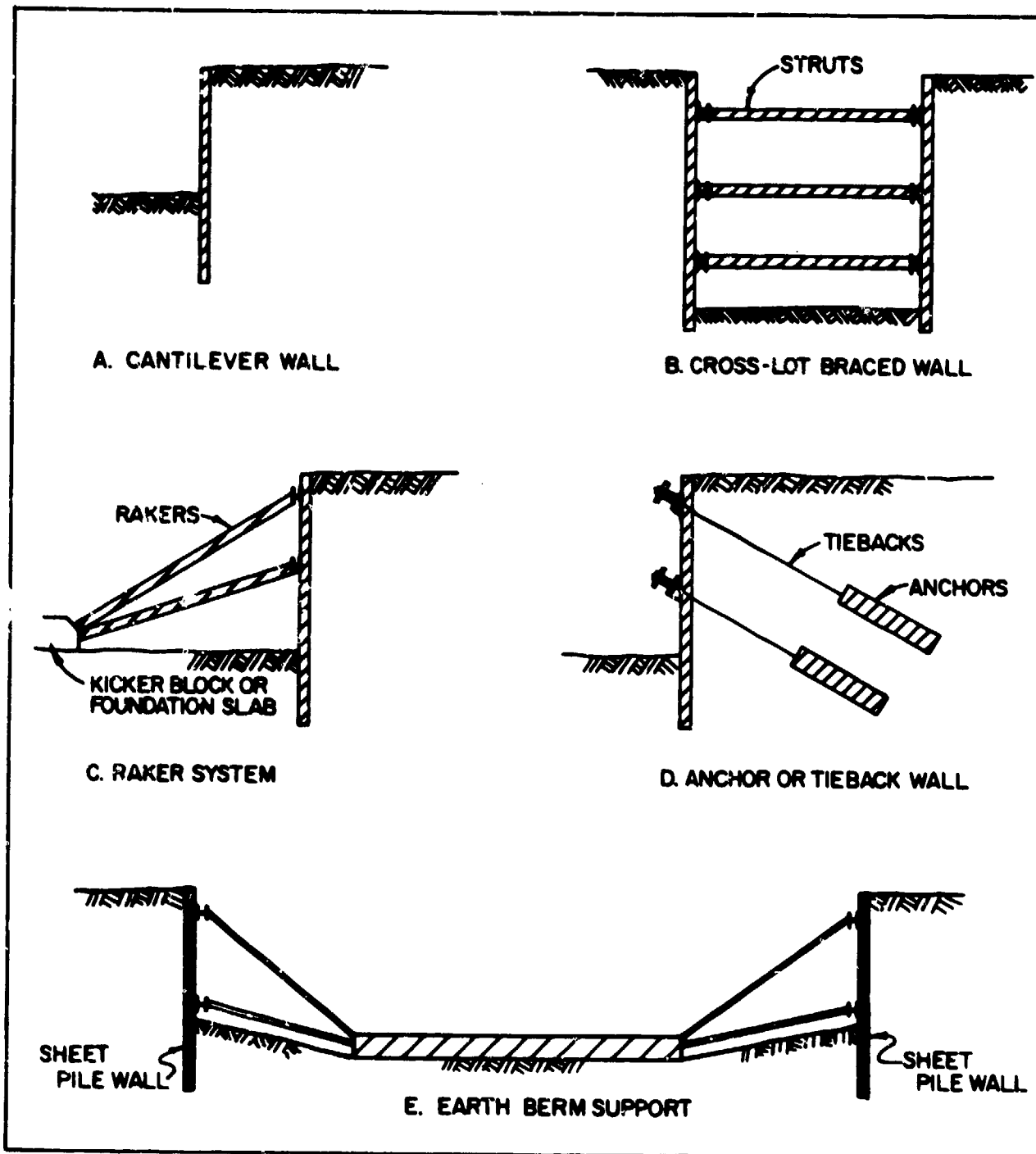


FIGURE 6
Support System - Walled Excavation

TABLE 5
Factors Involved in Choice of A Support System
For A Deep Excavation (> 20 feet)

Requirements	Lends Itself to Use Of	Comments
1. Open excavation area	Tiebacks or rakers or cantilever walls (shallow excavation)	-
2. Low initial cost	Soldier pile or sheetpile walls; combined soil slope with wall	-
3. Use as part of permanent structure	Diaphragm (see DM 7.3 Chapter 3) or cylinder pile walls	Diaphragm wall most common as permanent wall.
4. Deep, soft clay subsurface conditions	Strutted or raker supported diaphragm or cylinder pile walls	Tieback capacity not adequate in soft clays.
5. Dense, gravelly sand or clay subsoils	Soldier pile, diaphragm or cylinder pile	Sheetpiles may lose interlock on hard driving.
6. Deep, overconsolidated clays	Struts, long tiebacks or combination tiebacks and struts.	High in situ lateral stresses are relieved in overconsolidated soils. Lateral movements may be large and extend deep into soil.
7. Avoid dewatering	Diaphragm walls, possibly sheetpile walls in soft subsoils	Soldier pile wall is pervious.
8. Minimize movements	High preloads on stiff strutted or tied-back wall	Analyze for stability of bottom of excavation.
9. Wide excavation (greater than 65 feet wide)	Tiebacks or rakers	Tiebacks preferable except in very soft clay subsoils.
10. Narrow excavation (less than 65 feet wide)	Crosslot struts	Struts more economical but tiebacks still may be preferred to keep excavation open.

TABLE 6
Design Considerations for Braced and Tieback Walls

Design Factor	Comments
1. Water Loads	Often greater than earth load on impervious wall. Recommended piezometers during construction to monitor water levels. Should consider possible lower water pressures as a result of seepage through or under wall. Dewatering can be used to reduce water loads. Seepage under wall reduces passive resistance.
2. Stability	Consider possible instability in any berm or exposed slope. Sliding potential beneath the wall or behind tiebacks should be evaluated. Deep seated bearing failure under weight of supported soil to be checked in weak soils. Stability should consider weight of surcharge or the weight of other facilities in close proximity to excavation.
3. Piping	Loss of ground caused by high groundwater table and silty and fine sand soils. Difficulties occur due to flow beneath wall, through bad joints in walls, or through unsealed sheetpile handling holes. Dewatering may be required.
4. Movements	Movements can be minimized through use of stiff wall supported by preloaded tieback or braced system.
5. Dewatering - recharge	Dewatering reduces loads on wall systems and minimizes possible loss of ground due to piping. May cause settlements and will then need to recharge outside of support system.
6. Surcharge	Construction materials usually stored near wall systems. Allowance should always be made for surcharge.
7. Prestressing of tie backs or struts	Useful to remove slack from system and minimize soil movements.

TABLE 6 (continued)
Design Considerations for Braced and Tieback Walls

Design Factor	Comments																	
8. Construction Sequence	The amount of wall movement is dependent on the depth of excavation. The amount of load on the tie backs is dependent on the amount of wall movement which occurs before they are installed. Movements of wall should be checked at every major construction stage. Upper struts should be installed early.																	
9. Temperature	Struts subject to load fluctuation due to temperature loads; may be important for long struts.																	
10. Frost Penetration	In very cold climates, frost penetration can cause significant loading on wall system. Design of upper portion of system should be conservative. Anchors may have to be heated. Freezing temperatures also can cause blockage of flow and thus unexpected buildup of water pressure.																	
11. Earthquakes	Seismic loads may be induced during earthquake. See DM-7.3, Chapter 1.																	
12. Factors of Safety	Suggested Minimum Design Factor of Safety for Overall Stability																	
	<table border="1"> <thead> <tr> <th data-bbox="1011 869 1081 1421">Item</th> <th data-bbox="1011 541 1081 869">Permanent</th> <th data-bbox="1011 176 1081 541">Temporary</th> </tr> </thead> <tbody> <tr> <td data-bbox="1086 869 1123 1421">• Earth Berms</td> <td data-bbox="1086 541 1123 869">2.0</td> <td data-bbox="1086 176 1123 541">1.5</td> </tr> <tr> <td data-bbox="1123 869 1161 1421">• Cut Slopes</td> <td data-bbox="1123 541 1161 869">1.5</td> <td data-bbox="1123 176 1161 541">1.3</td> </tr> <tr> <td data-bbox="1161 869 1226 1421">• Bottom heave above foundation level</td> <td data-bbox="1161 541 1226 869">1.5</td> <td data-bbox="1161 176 1226 541">1.5</td> </tr> <tr> <td data-bbox="1226 869 1263 1421">• General stability</td> <td data-bbox="1226 541 1263 869">1.5</td> <td data-bbox="1226 176 1263 541">1.3</td> </tr> <tr> <td data-bbox="1263 869 1333 1421">• Bottom heave at foundation level</td> <td data-bbox="1263 541 1333 869">2.0</td> <td data-bbox="1263 176 1333 541">1.5</td> </tr> </tbody> </table> <p data-bbox="1339 176 1419 1421">Note: These values are suggested guidelines only. Design safety factor depends on project requirements.</p>	Item	Permanent	Temporary	• Earth Berms	2.0	1.5	• Cut Slopes	1.5	1.3	• Bottom heave above foundation level	1.5	1.5	• General stability	1.5	1.3	• Bottom heave at foundation level	2.0
Item	Permanent	Temporary																
• Earth Berms	2.0	1.5																
• Cut Slopes	1.5	1.3																
• Bottom heave above foundation level	1.5	1.5																
• General stability	1.5	1.3																
• Bottom heave at foundation level	2.0	1.5																

7. PROTECTION OF ADJACENT STRUCTURES. Evaluate the effects of braced excavations on adjacent structures to determine whether existing building foundations are to be protected. See DM-7.3, Chapters 2 and 3 on stabilizing foundation soils and methods of underpinning. Figure 7 (modified from Reference 9, Damage to Brick Bearing Wall Structures Caused by Adjacent Braced Cuts and Tunnels, by O'Rourke, et al.) illustrates areas behind a braced wall where underpinning is or may be required.

Factors influencing the type of bracing used and the need for underpinning include:

(a) Lateral distance of existing structure from the braced excavation. Empirical observations on this can be found in Reference 8.

(b) Lowering groundwater can cause soil consolidation and settlement of structures.

(c) Dewatering should be properly controlled to ensure there is no removal of foundation soils outside the excavation.

(d) Tolerance of structures to movement. See DM-7.1, Chapter 5 for evaluation of tolerance of structure to vertical movements. Vertical and lateral movements produce horizontal strains in structure. Guidance on permissible horizontal strains for structures is given in Reference 9.

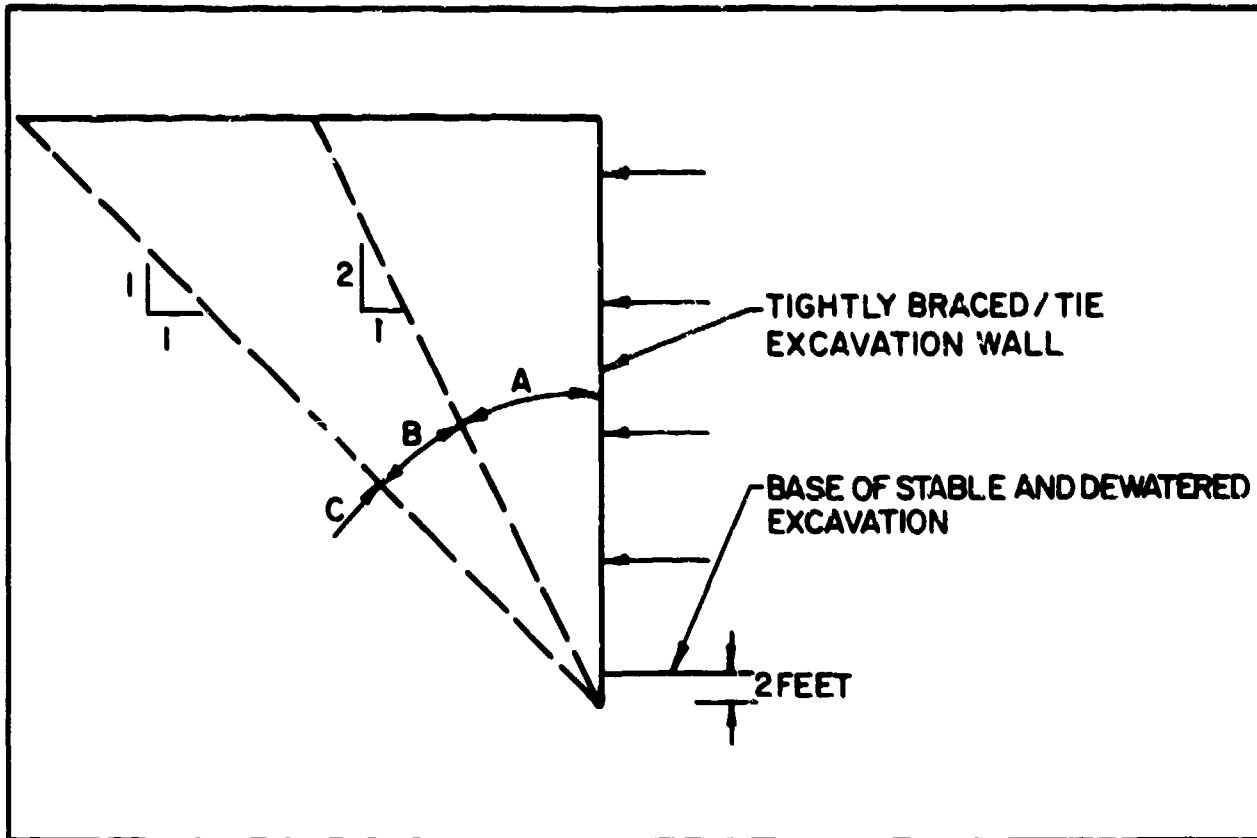
Section 5. ROCK EXCAVATION

1. OBJECTIVE. Primary objective is to conduct work in such a manner that a stable excavation will be maintained and that rock outside the excavation prism will not be adversely disturbed.

2. PRELIMINARY CONSIDERATIONS. Rock excavation planning must be based on detailed geological data at the site. To the extent possible, structures to be constructed in rock should be oriented favorably with the geological setting. For example, tunnels should be aligned with axis perpendicular to the strike of faults or major fractures. Downslope dip of discontinuities into an open cut should be avoided.

In general, factors that must be considered in planning, designing and constructing a rock excavation are as follows: (1) presence of strike, dip of faults, folds, fractures, and other discontinuities; (2) in situ stresses; (3) groundwater conditions; (4) nature of material filling joints; (5) depth and slope of cut; (6) stresses and direction of potential sliding surfaces; (7) dynamic loading, if any; (8) design life of cut as compared to weathering or deterioration rate of rock face; (9) rippability and/or the need for blasting; and (10) effect of excavation and/or blasting on adjacent structures.

The influence of most of these factors on excavations in rock is similar to that of excavations in soil, see DM-7.1, Chapter 7.



ZONE A:

FOUNDATIONS WITHIN THIS ZONE GENERALLY REQUIRE UNDERPINNING.

ZONE B:

FOUNDATIONS WITHIN THIS ZONE GENERALLY MAY NOT REQUIRE UNDERPINNING DEPENDING ON TYPE OF STRUCTURE AND LOADING CONDITIONS.

ZONE C:

UNDERPINNING IF USED MUST BE FOUNDED IN THIS ZONE TO APPROPRIATE DEPTHS ESTABLISHED BY EXPLORATION AND ANALYSIS.

Note: Additional details on underpinning may be found in DM-7.3, Chapter 3.

FIGURE 7
General Guidance for Underpinning

3. RIPPABILITY. Excavation ease or rippability can be assessed approximately from field observation in similar materials or by using seismic velocity, fracture spacing, or point load strength index. Figure 8 (from Reference 10, Handbook of Ripping, by Caterpillar Tractor Co.) shows an example of charts for heavy duty ripper performance (ripper mounted on tracked bulldozer) as related to seismic wave velocity. Charts similar to Figure 8 are available from various equipment manufacturers. Figure 8 is for guidance and restricted in applicability to large tractors heavier than 50 tons with engine horsepower greater than 350 Hp. Ripper performance is also related to configuration of ripper teeth, equipment condition and size, and fracture orientation.

Another technique of relating physical properties of rock to excavation ease is shown on Figure 9 (from Reference 11, Logging the Mechanical Character of Rock, by Franklin, et al.) where fracture frequency (or spacing) is plotted against the point load strength index corrected to a reference diameter of 50 mm. (See Reference 12, The Point-Load Strength Test, by Broch and Franklin.)

A third and useful technique is exploration trenching in which the depth of unrippable rock can be established by digging test trenches in rock using rippers (or other excavation equipment) anticipated to be used for the project. The size and shape of the area to be excavated is a significant factor in determining the need for blasting, or the equipment needed to remove the rock.

4. BLASTING. Of major concern is the influence of the blasting on adjacent structures. The maximum particle velocity (the longitudinal velocity of a particle in the direction of the wave that is generated by the blast) is accepted as a criterion for evaluating the potential for structural damage induced by blasting vibration. The critical level of the particle velocity depends on the frequency characteristics of the structure, frequency of ground and rock motion, nature of the overburden, and capability of the structure to withstand dynamic stress. Figure 10 can be used for estimating the maximum particle velocity, which can then be used in Figure 11 (from Reference 13, Blasting Vibrations and Their Effects on Structures, by Bureau of Mines) to estimate potential damage to residential structures. Guidance for human response to blasting vibrations is given in Figure 12 (from Reference 14, Engineering of Rock Blasting on Civil Projects, by Hendron).

Once it has been determined that blasting is required, a pre-blasting survey should be performed. As a minimum, this should include: (a) examination of the site; (b) detailed examination and perhaps photographic records of adjacent structures; and (c) establishment of horizontal and vertical survey control points. In addition, the possibility of vibration monitoring should be considered, and monitoring stations and schedules should be established. During construction, detailed records should be kept of: (a) charge weight, (b) location of blast point and distance from existing structures, (c) delays, and (d) response as indicated by vibration monitoring. For safety, small charges should be used initially to establish a site specific relationship between charge weight, distance, and response.

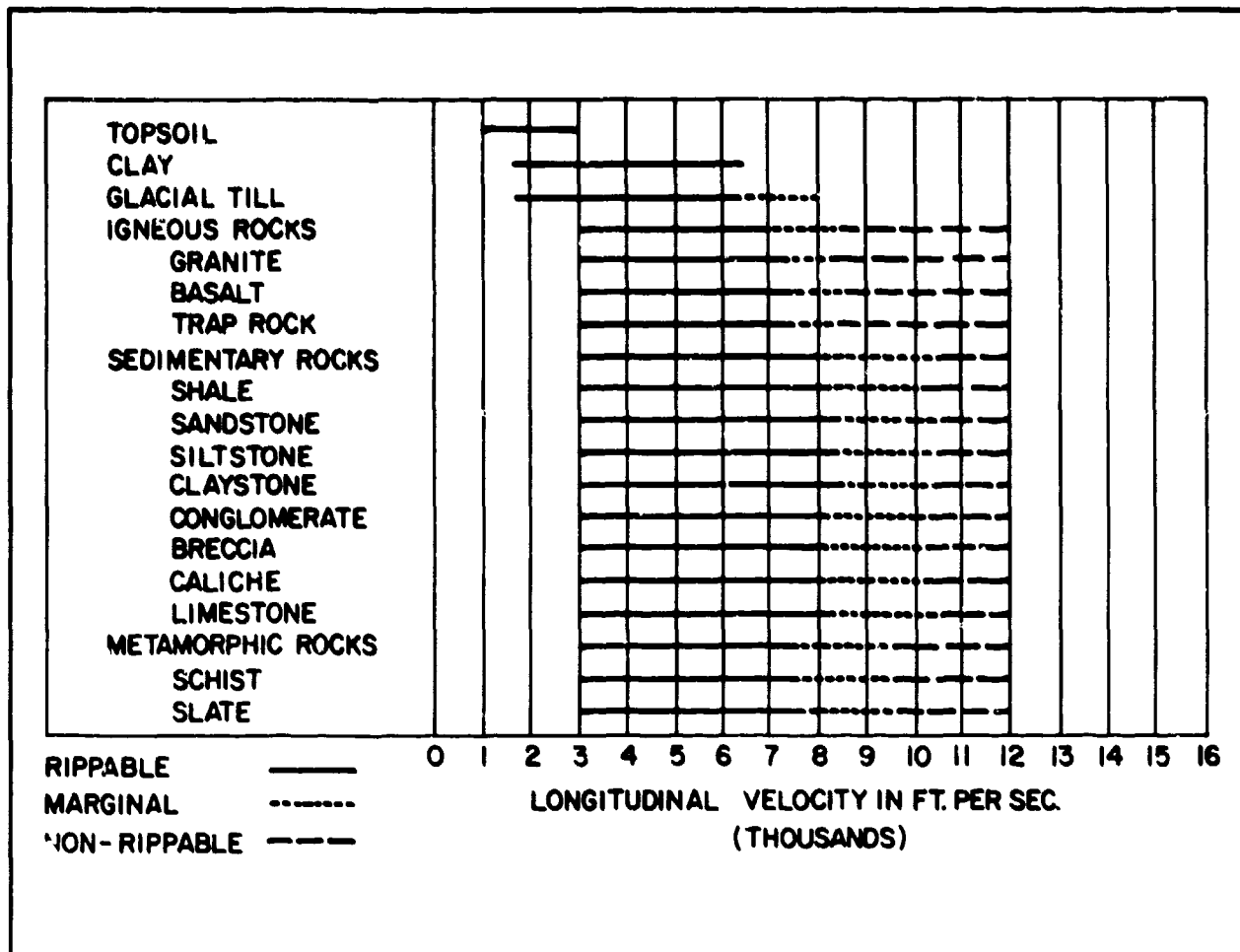


FIGURE 8
Rippability of Subsurface Materials Related to Longitudinal Seismic Velocity for a Heavy Duty Ripper (Tractor-Mounted)

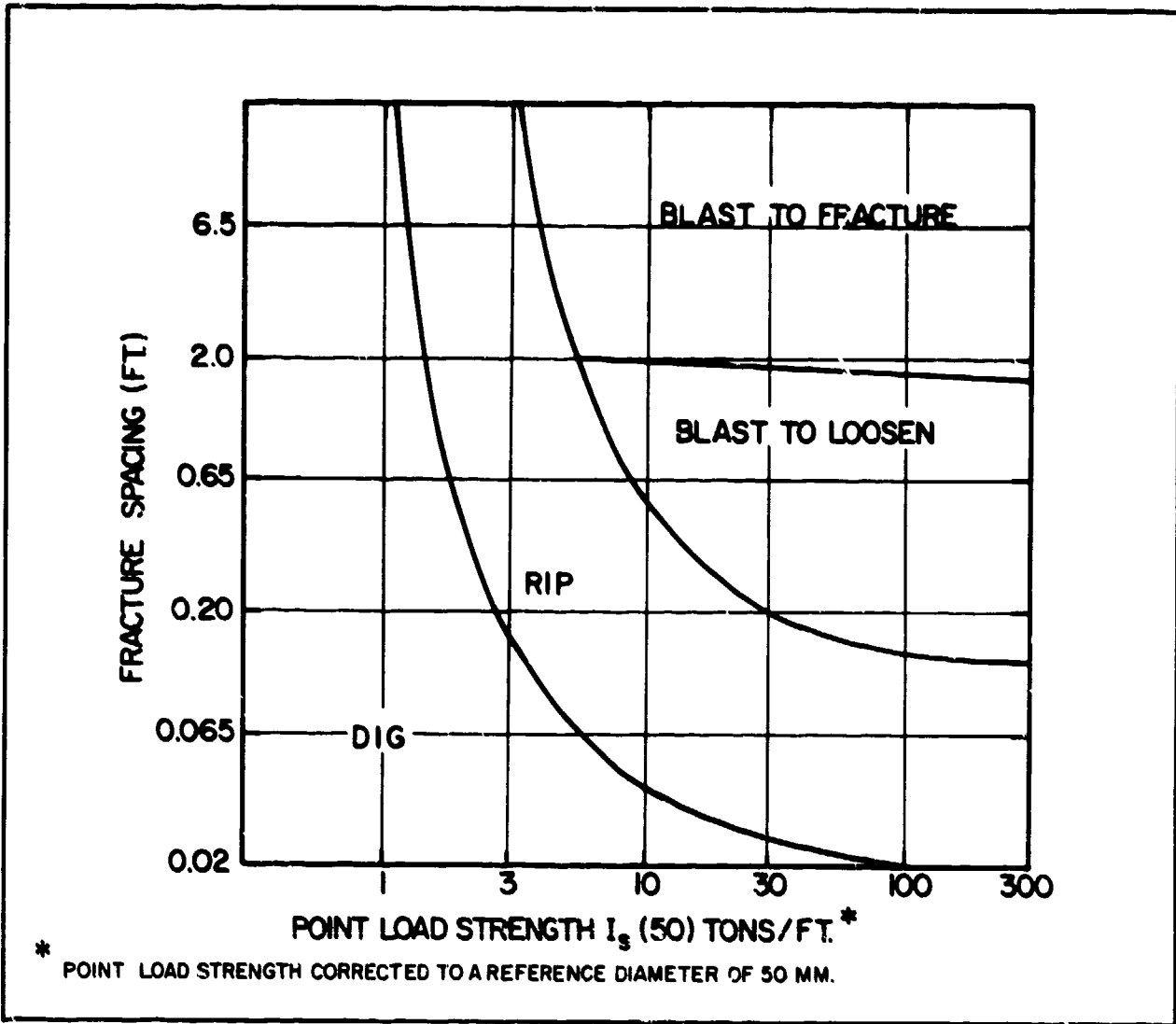
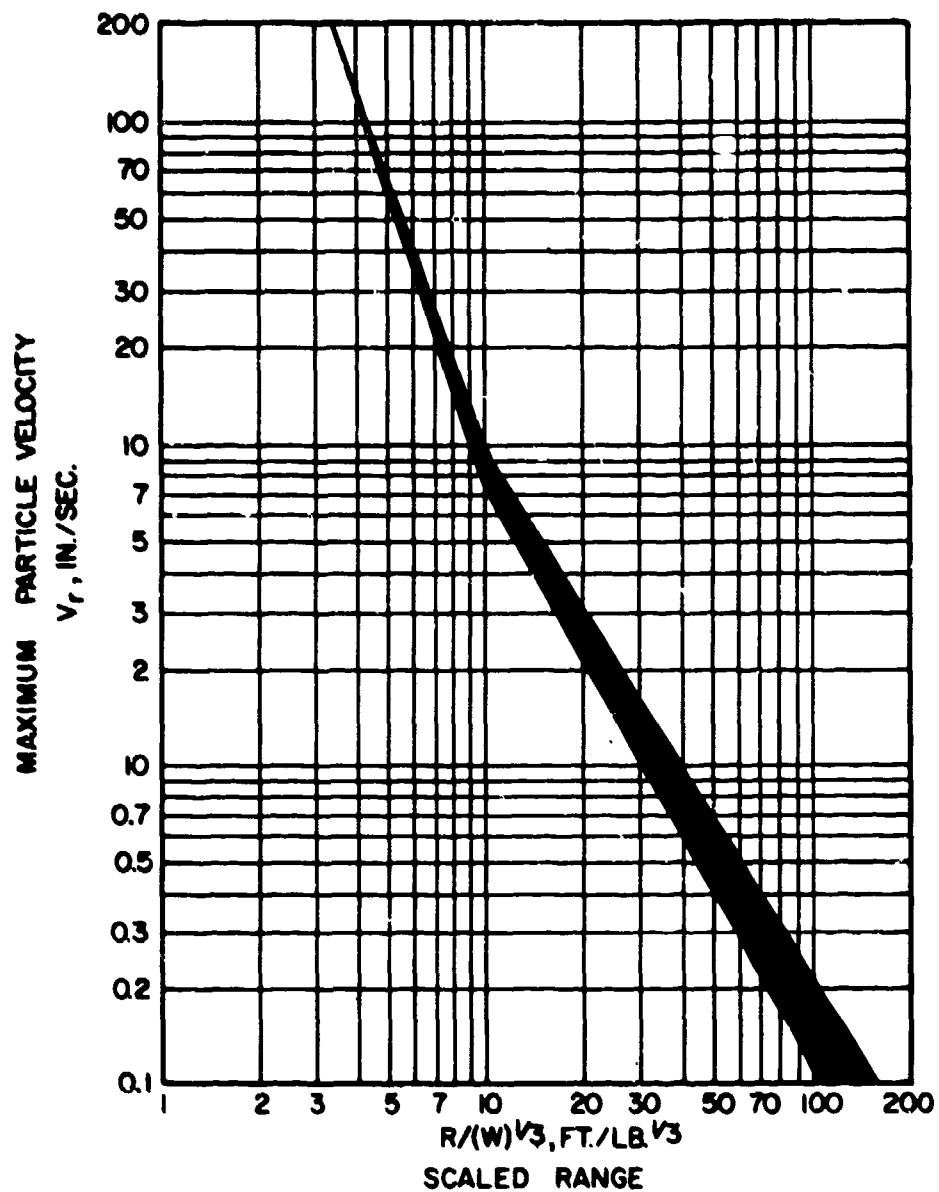


FIGURE 9
Suggested Guide for Ease of Excavation



EXAMPLE:

Weight of Explosive Charge = 8 lbs. = W

Distance from Blast Point = 100 ft. = R

$$R/(W)^{1/3} = 50$$

Peak $V_r = 0.5$ in/sec from chart

FIGURE 10
Cube Root Scaling Versus Maximum Particle Velocity

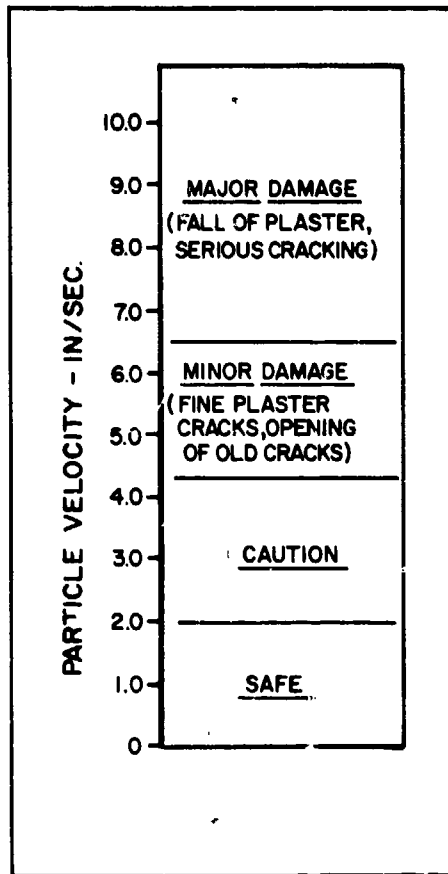


FIGURE 11
 Guideline for Assessing Potential for Damage Induced by
 Blasting Vibration to Residential Structure Founded on
 Dense Soil or Rock

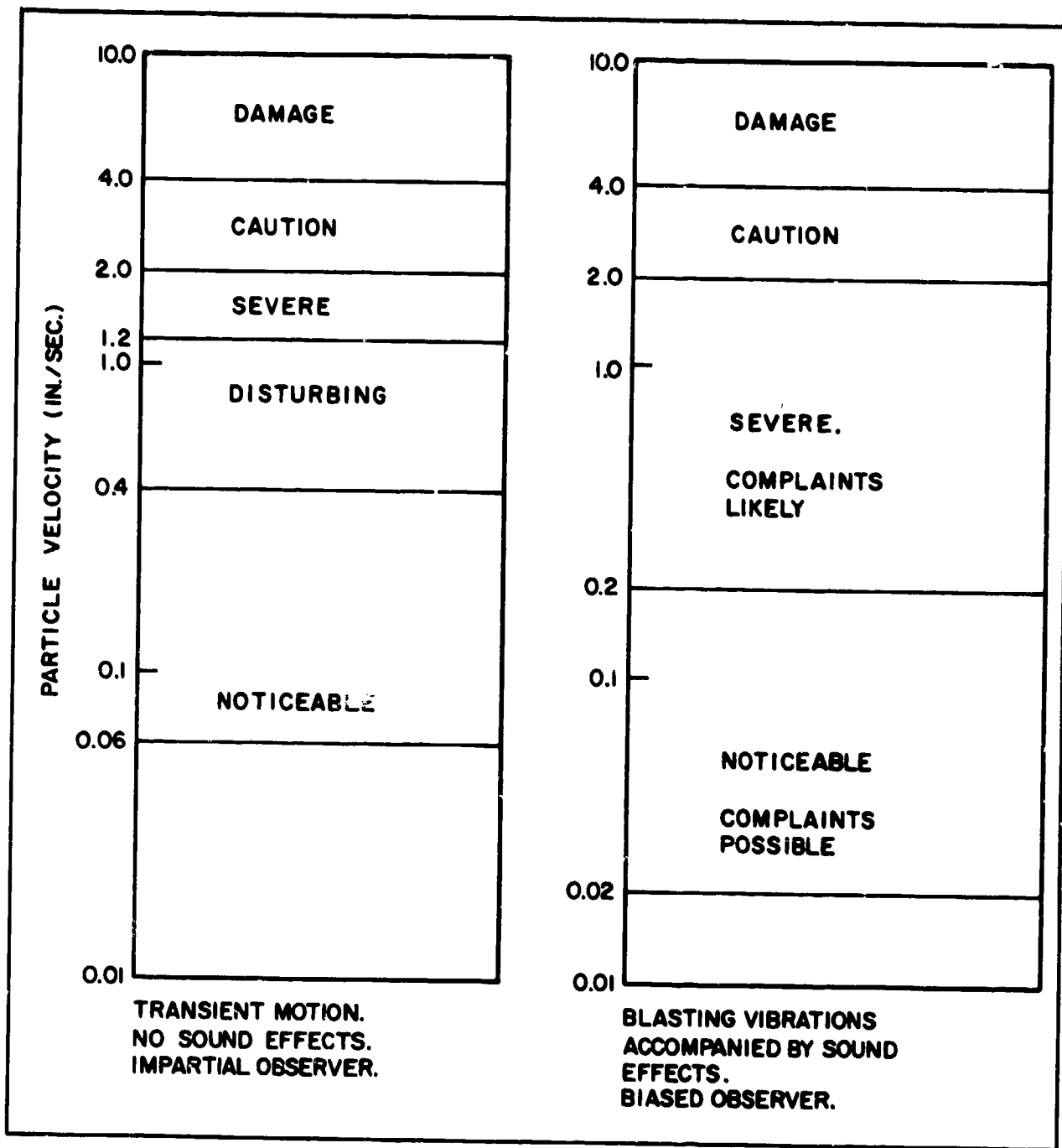


FIGURE 12
 Guide for Predicting Human Response to Vibrations and Blasting Effects

Section 6. GROUNDWATER CONTROL

1. APPLICATION. Excavations below the groundwater table require groundwater control to permit construction in the dry and maintain the stability of excavation base and sides. This is accomplished by controlling seepage into the excavation and controlling artesian water pressures below the bottom of the excavation.
2. METHOD. See Table 7 (modified from Reference 15, Control of Groundwater by Water Lowering, by Cashman and Harris) for methods of controlling groundwater, their applicability, and limitations. Wellpoints, deep wells, and sumps are most commonly used. Figures 13(A) (from Reference 2) and 13(B) (from Reference 16, Design and Construction of Dry Docks, by Mazurkiewicz) show a dewatering system using deep wells, and a two stage well point system. Figures 13(C) and 13(D) (from Reference 16) shows details of a wellpoint system, and a deep well with electric submersible pump. See Figure 14 (from Reference 2) for applicable limits of dewatering methods.
3. DESIGN PROCEDURE. See DM-7.1, Chapter 6 for description of design procedures for groundwater control. For additional guidance on groundwater control see NAVFAC P-418.

Section 7. EXCAVATION STABILIZATION, MONITORING, AND SAFETY

1. STABILIZATION. During the planning and design stage, if analyses indicate potential slope instability, means for slope stabilization or retention should be considered. Some methods for consideration are given in Chapter 3.

On occasion, the complexity of a situation may dictate using very specialized stabilization methods. These may include grouting and injection, ground freezing, deep drainage and stabilization, such as vacuum wells or electro-osmosis (see DM-7.3, Chapter 2), and diaphragm walls (see DM-7.3, Chapter 3).

2. MONITORING. During excavation, potential bottom heave, lateral wall or slope movement, and settlement of areas behind the wall or slope should be inspected carefully and monitored if critical. Monitoring can be accomplished by conventional survey techniques, or by more sophisticated means such as heave points, settlement plates, extensometers or inclinometers, and a variety of other devices. See DM-7.1, Chapter 2.

3. SAFETY. Detailed safety requirements vary from project to project. As a guide, safety requirements are specified by OSHA, see Reference 17, Public Law 91-596. A summary of the 1980 requirements follows:

- a. OSHA Rules.

- (1) Banks more than 4 feet high shall be shored or sloped to the angle of repose where a danger of slides or cave-ins exists as a result of excavation.

TABLE 7
Methods of Groundwater Control

Method	Soils Suitable For Treatment	Uses	Comments
1. Sump pumping	Clean gravels and coarse sands.	Open shallow excavations.	Simplest pumping equipment. Fines easily removed from ground. Encourages instability of formation.
2. Wellpoint systems with suction pumps	Sandy gravels down to fine sands (with proper control can be also used in silty sands).	Open excavations including pipe trench excavations.	Quick and easy to install in suitable soils. Suction lift is limited to about 18 feet. If greater lift is needed multi-stage installation is necessary.
3. Deep wells with electric submersible pumps	Gravels to silty fine sands, and water bearing rocks.	Deep excavations in, through or above water bearing formations.	No limitation on depth of drawdown. Wells can be designed to draw water from several layers throughout its depth. Wells can be sited clear of working area.
4. Jet eductor system using high pressure water to create vacuum as well as to lift the water	Sands, silty sands and sandy silts.	Deep excavations in space so confined that multistage wellpointing cannot be used.	No limitation on depth of drawdown.

TABLE 7 (continued)
Methods of Groundwater Control

Method	Soils Suitable For Treatment	Uses	Comments
5. Sheet piling cut-off	All types of soil (except boulder beds). Tongue and groove wood sheeting utilized for shallow excavations in soft and medium soils.	Practically unrestricted use.	Well-understood method using readily available plant. Rapid installation. Steel can be incorporated in permanent works or recovered. Sump pumping may be required. Estimate seepage flow based on 0.01 gpm/sq ft of wall per foot of differential head. Decrease interlock leakage by filling interlock with sawdust, bentonite, cement grout, or similar materials.
6. Slurry trench cut-off (see DM-7.3, Chapter 3 and DM-7.1, Chapter 6)	Silts, sands, gravels, and cobbles.	Practically unrestricted. Extensive curtain walls around open excavations.	Rapidly installed. Can be keyed into impermeable strata such as clays or soft shales. May be impractical to key in to hard or irregular bedrock surfaces, or in open gravels.
7. Freezing (see DM-7.3, Chapter 2) a. Ammonium/brine refrigerator	All types of saturated soils and rock.	Formation of ice in the voids stops water.	Treatment effective from working surface outwards. Better for large applications of long duration. Treatment takes longer time to develop.

TABLE 7 (continued)
Methods of Groundwater Control

Method	Soils Suitable For Treatment	Uses	Comments
b. Liquid nitrogen refrigerant	All types of saturated soils and rock.	Formation of ice in the voids stops water.	Better for small applications of short duration where quick freezing is required. Liquid nitrogen is expensive. Requires strict site control. Some ground heave occurs.
8. Diaphragm structural walls			
a. Diaphragm walls (structural concrete) (see DM-7.3, Chapter 3)	All soil types including those containing boulders.	Deep basements, underground construction, shafts.	Can be designed to form part of a permanent foundation. Particularly efficient for circular excavations. Can be keyed into rock. Minimum vibration and noise. Can be used in restricted space. Can be put down very close to existing foundation.
b. Contiguous bored pile walls or impervious wall of mixed in place piles	All soil types but penetration through boulders may be difficult and costly	Deep basements, underground construction, shafts.	A rapidly installed, form of diaphragm wall. Can be keyed into impermeable strata such as clays or soft shales.

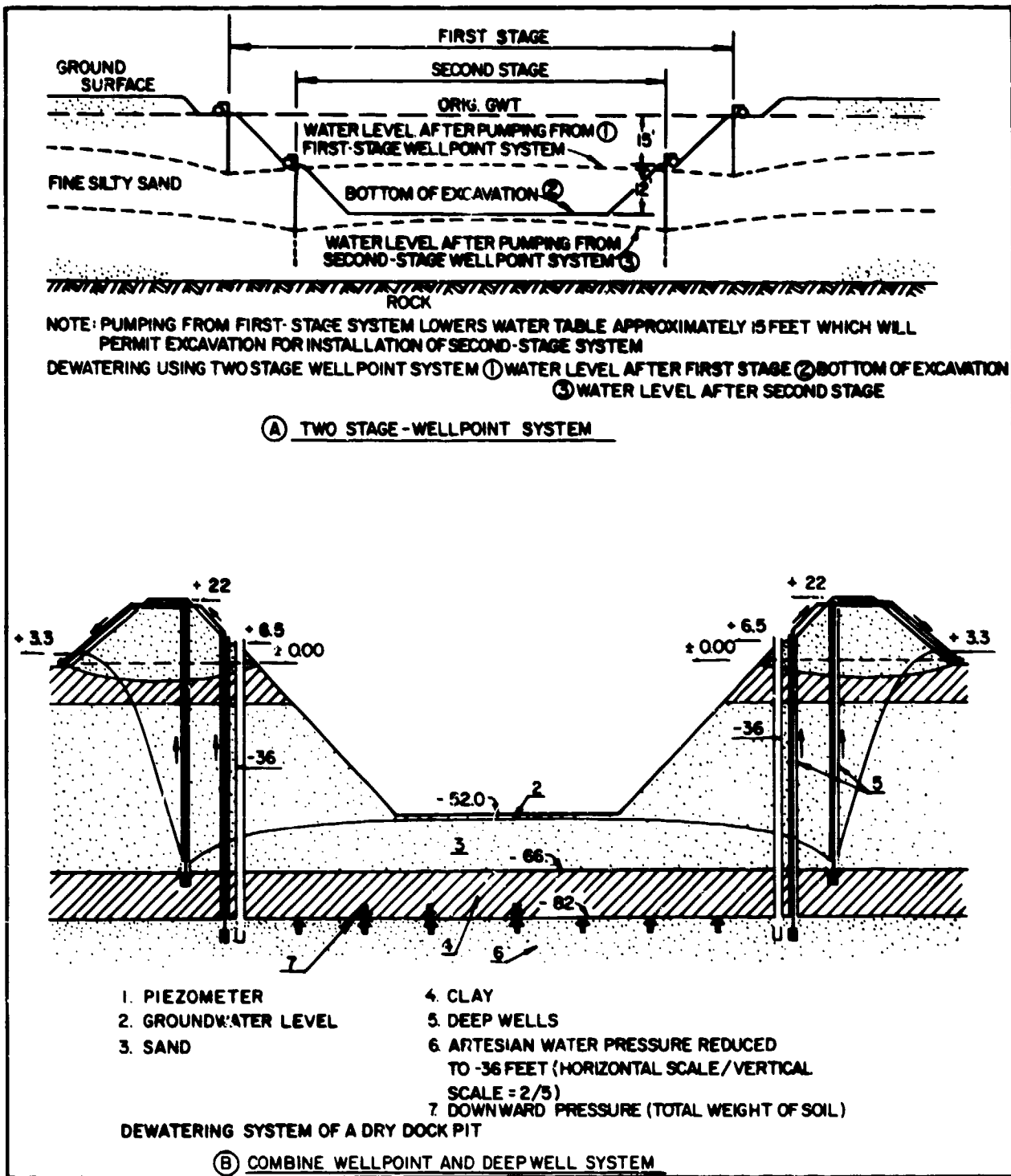


FIGURE 13
 Methods of Construction Dewatering

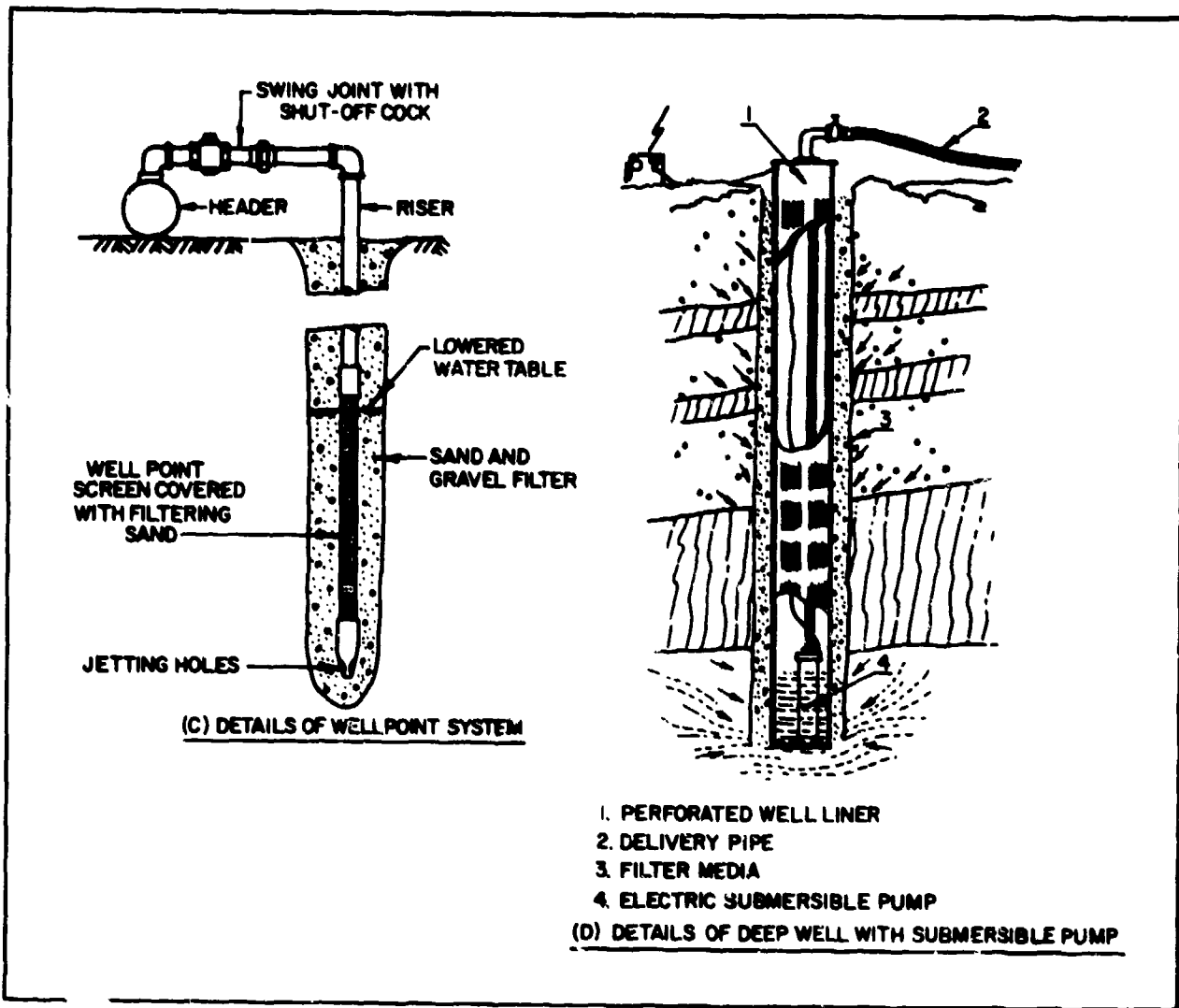


FIGURE 13 (continued)
Methods of Construction Dewatering

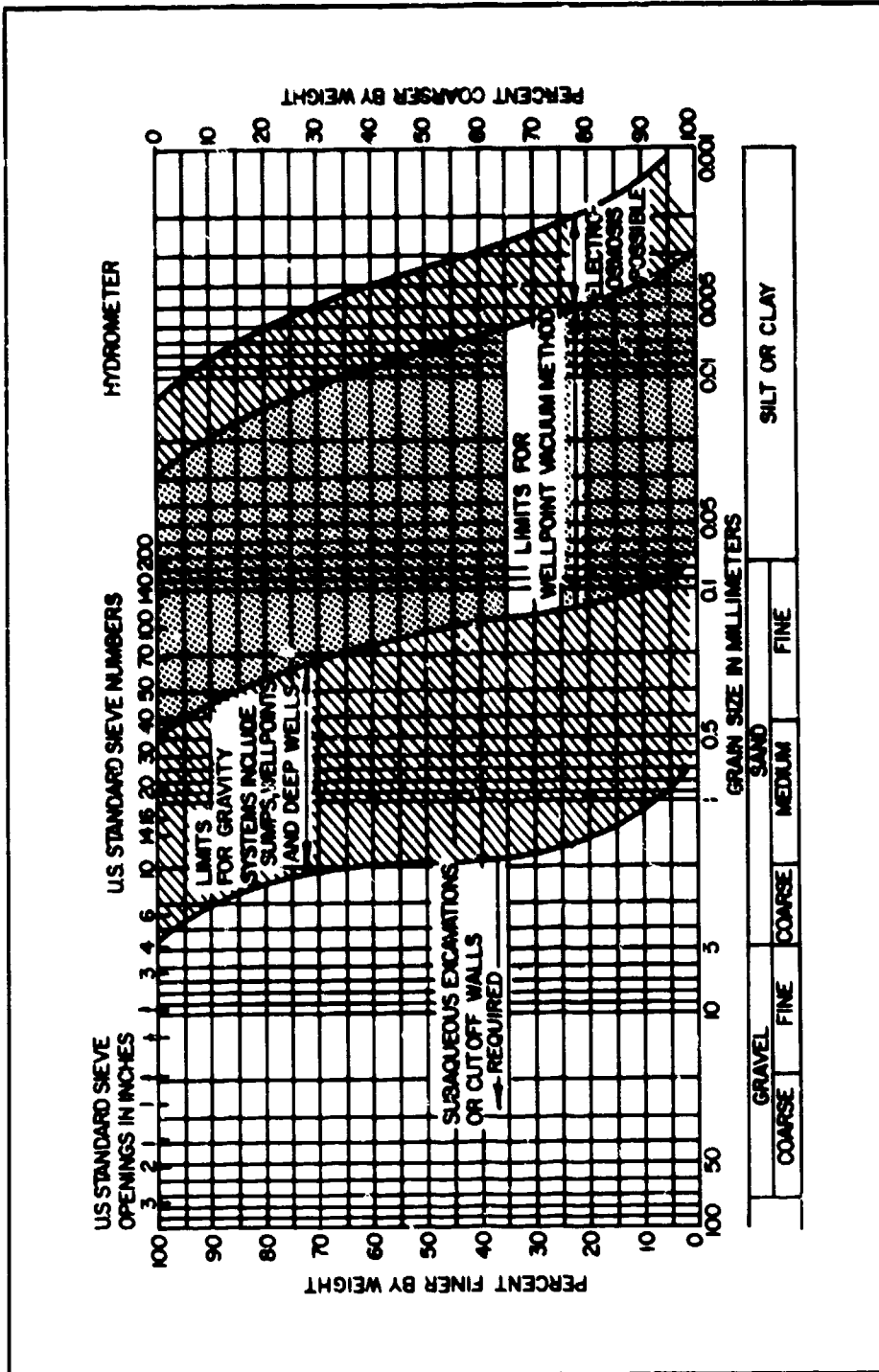


FIGURE 14
Limits of Dewatering Methods Applicable to Different Soils

(2) Sides of trenches in unstable or soft material, 4 feet or more in depth, shall be shored, sheeted, braced, sloped, or otherwise supported by means of sufficient strength to protect the employee working within them.

(3) Sides of trenches in hard or compact soil, including embankments, shall be shored or otherwise supported when the trench is more than 4 feet in depth and 8 feet or more in length. In lieu of shoring, the sides of the trench above the 4-foot level may be sloped to preclude collapse, but shall not be steeper than a 1-foot rise to each 1/2-foot horizontal. When the outside diameter of a pipe is greater than 5 feet, a bench of 4-foot minimum shall be provided at the toe of the sloped portion.

(4) Materials used for sheeting and sheet piling, bracing, shoring, and underpinning shall be in good serviceable condition. Timbers used shall be sound and free from large or loose knots, and shall be designed and installed so as to be effective to the bottom of the excavation.

(5) Additional precautions by way of shoring and bracing shall be taken to prevent slides or cave-ins when (a) excavations or trenches are made in locations adjacent to backfilled excavations; or (b) where excavations are subjected to vibrations from railroad or highway traffic, operation of machinery, or any other source.

(6) Employees entering bell-bottom pier holes shall be protected by the installation of a removable-type casing of sufficient strength to resist shifting of the surrounding earth. Such temporary protection shall be provided for the full depth of that part of each pier hole which is above the bell. A lifeline, suitable for instant rescue and securely fastened to the shafts, shall be provided. This lifeline shall be individually manned and separate from any line used to remove materials excavated from the bell footing.

(7) Minimum requirements for trench timbering shall be in accordance with Table 3.

(8) Where employees are required to be in trenches 3 feet deep or more, ladders shall be provided which extend from the floor of the trench excavation to at least 3 feet above the top of the excavation. They shall be located to provide means of exit without more than 25 feet of lateral travel.

(9) Bracing or shoring of trenches shall be carried along with the excavation.

(10) Cross braces or trench jacks shall be placed in true horizontal position, spaced vertically, and secured to prevent sliding, falling, or kick-outs.

(11) Portable trench boxes or sliding trench shields may be used for the protection of employees only. Trench boxes or shields shall be designed, constructed, and maintained to meet acceptable engineering standards.

(12) Backfilling and removal of trench supports shall progress together from the bottom of the trench. Jacks or braces shall be released slowly, and in unstable soil, ropes shall be used to pull out the jacks or braces from above after employees have cleared the trench.

REFERENCES

1. Clough, G.W. and Davidson, R.R., Effects of Construction on Geotechnical Engineering, Specialty Session No. 3, Relationship Between Design and Construction in Soil Engineering, Ninth International Conference on Soil Mechanics and Foundation Engineering, Tokyo, 1977.
2. Departments of the Army and the Air Force, Soils and Geology, Procedures for Foundation Design of Buildings and Other Structures (Except Hydraulic Structures), TM 5/818-1/AFM 88-3, Chapter 7, Washington, D.C., 1979.
3. Terzaghi, K., Stability of Steep Slopes on Hard Unweathered Rock, Norwegian Geotechnical Institute, Publication No. 50, 1963.
4. Petersen, E.V., Cave-In!, Roads and Engineering Construction, November 1963, December 1963, January 1964.
5. Goldberg, D.T., Jaworski, W.E., and Gordon, M.D., Lateral Support Systems and Underpinning, Vol. II, Design Fundamentals, Vol. III. Construction Methods, Federal Highway Administration, Report Nos. FHWA-RD-75-129, 130, 1976.
6. Bjerrum, L., Clausen, J.F. and Duncan, J.M., Stability of Flexible Structures, General Report, Proceedings, Fifth International European Conference on Soil Mechanics and Foundation Engineering, Vol. 11, 1977.
7. Lambe, T.W., Braced Excavation, 1970 Specialty Conference, Lateral Stresses in the Ground and Design of Earth Retaining Structures, June 22-24, Cornell University, ASCE, 1971.
8. Peck, R.B., Deep Excavations and Tunneling in Soft Ground, Proceedings, Seventh International Conference on Soil Mechanics and Foundation Engineering, State-of-the-Art Vol. 1, 1969.
9. O'Rourke, T.P., Cording, E.J. and Boscardin, M., Damage to Brick Bearing Wall Structures Caused by Adjacent Braced Cuts and Tunnels, Large Ground Movements, John Wiley & Sons, 1977.
10. Caterpillar Tractor Co., Handbook of Ripping, Fifth Edition, Peoria, IL., 1975.
11. Franklin, J.A., Broch, E. and Walton, G., Logging the Mechanical Character of Rock, Transactions, Institution of Mining and Metallurgy, January 1971.
12. Broch, E. and Franklin, J.A., The Point-load Strength Test, International Journal Rock Mechanics and Mining Science, Vol. 9, 1972.
13. Bureau of Mines, Blasting Vibrations and Their Effect on Structures, United States Department of the Interior, 1971.

14. Hendron, A.J., Engineering of Rock Blasting on Civil Projects, Rock Excavation Seminar Lectures, ASCE, New York, October, 1976.
15. Cashman, P.M. and Harris, E.T., Control of Groundwater by Water Lowering, Conference on Ground Engineering, Institute of Civil Engineers, London, 1970.
16. Mazurkiewicz, B.K., Design and Construction of Dry Docks, Trans Tech Publications, Rockport, MA, 1980.
17. Public Law 91-596 (Williams-Steiger Act), Occupational Safety and Health Act (OSHA) of 1970, Dec. 29, 1970.

CHAPTER 2. COMPACTION, EARTHWORK, AND HYDRAULIC FILLS

Section 1. INTRODUCTION

1. **SCOPE.** This chapter concerns design and construction of compacted fills and performance of compacted materials. Compaction requirements are given for various applications and equipment. Earthwork control procedures and analysis of control test data are discussed. Guidance on hydraulic fills is also included.

2. **RELATED CRITERIA.** For additional criteria concerned with compaction and earthwork operations, consult the following sources:

Subject	Source
Pavements.....	NAVFAC DM-5.4
Soil Conservation.....	NAVFAC DM-5.11
Flexible Pavement Design for Airfield.....	NAVFAC DM-21.3
Dredging	NAVFAC DM-26
Types of Dredging Equipment.....	NAVFAC DM-38

3. **PURPOSE OF COMPACTION.**

- (1) Reduce material compressibility.
- (2) Increase material strength.
- (3) Reduce permeability.
- (4) Control expansion.
- (5) Control frost susceptibility.

4. **APPLICATIONS.** The principal uses of compacted fill include support of structures or pavements, embankments for water retention or for lining reservoirs and canals, and backfill surrounding structures or buried utilities.

5. **TYPES OF FILL.**

a. Controlled Compacted Fills. Properly placed compacted fill will be more rigid and uniform and have greater strength than most natural soils.

b. Hydraulic Fills. Hydraulic fills cannot be compacted during placement and therefore it is important that the source materials be selected carefully.

c. Uncontrolled Fills. These consist of soils or industrial and domestic wastes, such as ashes, slag, chemical wastes, building rubble, and refuse. Use of ash, slag, and chemical waste is stringently controlled and current Environmental Protection Agency or other appropriate regulations must be considered.

Section 2. EMBANKMENT CROSS-SECTION DESIGN

1. INFLUENCE OF MATERIAL TYPE. Table 1 lists some typical properties of compacted soils which may be used for preliminary analysis. For final analysis engineering property tests are necessary.

a. Utilization. See Table 2 for relative desirability of various soil types in earth fill dams, canals, roadways and foundations. Although practically any nonorganic insoluble soil may be incorporated in an embankment when modern compaction equipment and control standards are employed, the following soils may be difficult to use economically:

(1) Fine-grained soils may have insufficient shear strength or excessive compressibility.

(2) Clays of medium to high plasticity may expand if placed under low confining pressures and/or at low moisture contents. See DM-7.1, Chapter 1 for identification of soils susceptible to volume expansion.

(3) Plastic soils with high natural moisture are difficult to process for proper moisture for compaction.

(4) Stratified soils may require extensive mixing of borrow.

2. EMBANKMENTS ON STABLE FOUNDATION. The side slopes of fills not subjected to seepage forces ordinarily vary between 1 on 1-1/2 and 1 on 3. The geometry of the slope and berms are governed by requirements for erosion control and maintenance. See DM-7.1, Chapter 7 for procedures to calculate stability of embankments.

3. EMBANKMENTS ON WEAK FOUNDATIONS. Weak foundation soils may require partial or complete removal, flattening of embankment slopes, or densification. Analyze cross-section stability by methods of DM-7.1, Chapter 7. See DM-7.3, Chapter 2 for methods of deep stabilization, and Chapter 3 for special problem soils.

4. EMBANKMENT SETTLEMENT. Settlement of an embankment is caused by foundation consolidation, consolidation of the embankment material itself, and secondary compression in the embankment after its completion.

a. Foundation Settlement. See DM-7.1, Chapter 5 for procedures to decrease foundation settlement or to accelerate consolidation. See DM-7.3, Chapter 1 for guidance on settlement potential under seismic conditions.

b. Embankment Consolidation. Significant excess pore pressures can develop during construction of fills exceeding about 80 feet in height or for lower fills of plastic materials placed wet of optimum moisture. Dissipation of these excess pore pressures after construction results in settlement. For earth dams and other high fills where settlement is critical, construction pore pressures should be monitored by the methods of DM-7.1, Chapter 2.

TABLE 1
Typical Properties of Compacted Soils

Group Symbol	Soil Type	Range of Maximum Dry Unit Weight, pcf	Range of Optimum Moisture, Percent	Typical Value of Compression		Typical Strength Characteristics				Typical Coefficient of Permeability ft./min.	Range of CBR Values	Range of Subgrade Modulus k lbs/cu in.
				At 1.4 tsf (20 psf)	At 3.6 tsf (50 psf)	Cohesion (as compacted) psf	Cohesion (saturated) psf	(Effective Stress Envelope Degrees)	Tan ϕ			
GM	Well graded clean gravels, gravel-sand mixtures.	125 - 135	11 - 8	0.3	0.6	0	0	>38	>0.79	5×10^{-2}	40 - 80	300 - 500
GP	Poorly graded clean gravels, gravel-sand mix	115 - 125	14 - 11	0.4	0.9	0	0	>37	>0.74	10^{-1}	30 - 60	250 - 400
GM	Silty gravels, poorly graded gravel-sand-silt.	120 - 135	12 - 8	0.5	1.1	>34	>0.67	$>10^{-6}$	20 - 60	100 - 400
GC	Clayey gravels, poorly graded gravel-sand-clay.	115 - 130	14 - 9	0.7	1.6	>31	>0.60	$>10^{-7}$	20 - 40	100 - 300
SM	Well graded clean sands, gravelly sands.	110 - 130	16 - 9	0.6	1.2	0	0	38	0.79	$>10^{-3}$	20 - 40	200 - 300
SP	Poorly graded clean sands, sand-gravel mix.	100 - 120	21 - 12	0.8	1.4	0	0	37	0.74	$>10^{-3}$	10 - 40	200 - 300
SM	Silty sands, poorly graded sand-silt mix.	110 - 125	16 - 11	0.8	1.6	1050	420	34	0.67	$5 \times >10^{-5}$	10 - 40	100 - 300
SM-SC	Sand-silt clay mix with slightly plastic fines.	110 - 130	15 - 11	0.8	1.4	1050	300	33	0.66	$2 \times >10^{-6}$	5 - 30	100 - 300
SC	Clayey sand, poorly graded sand-clay-mix.	105 - 125	19 - 11	1.1	2.2	1550	230	31	0.60	$5 \times >10^{-7}$	5 - 20	100 - 300
ML	Inorganic silts and clayey silts.	95 - 120	24 - 12	0.9	1.7	1400	190	32	0.62	$>10^{-5}$	15 or less	100 - 200
ML-CL	Mixture of inorganic silt and clay.	100 - 120	22 - 12	1.0	2.2	1350	460	32	0.62	$5 \times >10^{-7}$
CL	Inorganic clays of low to medium plasticity.	95 - 120	24 - 12	1.3	2.5	1800	270	28	0.54	$>10^{-7}$	15 or less	50 - 200
OL	Organic silts and silt-clays, low plasticity.	80 - 100	33 - 21	5 or less	50 - 100
MH	Inorganic clayey silts, elastic silts.	70 - 95	40 - 24	2.0	3.8	1500	420	25	0.47	$5 \times >10^{-7}$	10 or less	50 - 100
CH	Inorganic clays of high plasticity	75 - 105	36 - 19	2.6	3.9	2150	230	19	0.35	$>10^{-7}$	15 or less	50 - 150
OH	Organic clays and silty clays	65 - 100	45 - 21	5 or less	25 - 100

Notes:

- All properties are for condition of "Standard Proctor" maximum density, except values of k and CBR which are for "modified Proctor" maximum density.
- Typical strength characteristics are for effective strength envelopes and are obtained from USBR data.
- Compression values are for vertical loading with complete lateral confinement.
- ($>$) indicates that typical property is greater than the value shown.
(\dots) indicates insufficient data available for an estimate.

TABLE 2
Relative Desirability of Soils as Compacted Fill

Group Symbol	Soil Type	RELATIVE DESIRABILITY FOR VARIOUS USES (No. 1 is Considered the Best, No. 14 Least Desirable)									
		Rolled Earth Fill Dams			Canal Sections		Foundations		Roadways		
		Homogeneous Embankment	Core	Shell	Erosion Resistance	Compacted Earth Lining	Seepage Important	Seepage Not Important	Fills		Surfacing
									Frost Heave Not Possible	Frost Heave Possible	
CW	Well graded gravels, gravel-sand mixtures, little or no fines	-	-	1	1	-	-	1	1	1	3
GP	Poorly-graded gravels, gravel-sand mixtures, little or no fines	-	-	2	2	-	-	3	3	3	-
GM	Silty gravels, poorly graded gravel-sand-silt mixtures	2	4	-	4	4	1	4	4	9	5
GC	Clayey gravels, poorly graded gravel-sand-clay mixtures	1	1	-	3	1	2	6	5	5	1
SW	Well-graded sands, gravelly sands, little or no fines	-	-	3 if gravelly	6	-	-	2	2	2	4
SP	Poorly-graded sands, gravelly sands, little or no fines	-	-	4 if gravelly	7 if gravelly	-	-	5	6	4	-
SM	Silty sands, poorly graded sand-silt mixtures	4	5	-	8 if gravelly	5 erosion critical	3	7	6	10	6
SC	Clayey sands, poorly graded sand-clay mixtures	3	2	-	5	2	4	8	7	6	2
ML	Inorganic silts and very fine sands, rock flour, silty or clayey fine sands with slight plasticity	6	6	-	-	6 erosion critical	6	9	10	11	-
CL	Inorganic clays of low to medium plasticity, gravelly clays, sandy clays, silty clays, lean clays	5	3	-	9	3	5	10	9	7	7
OL	Organic Silts and organic silt-clays of low plasticity	8	8	-	-	7 erosion critical	7	11	11	12	-
MN	Inorganic silts, micaceous or diatomaceous fine sandy or silty soils, elastic silts	9	9	-	-	-	8	12	12	13	-
CH	Inorganic clays of high plasticity, fat clays	7	7	-	10	8-vol change critical	9	13	13	8	-
OH	Organic clays of medium high plasticity	10	10	-	-	-	10	14	14	14	-

- Not appropriate for this type of use.

c. Secondary Compression. Even for well-compacted embankments, secondary compression and shear strain can cause slight settlements after completion. Normally this is only of significance in high embankments, and can amount to between 0.1 and 0.2 percent of fill height in three to four years or between 0.3 and 0.6 percent in 15 to 20 years. The larger values are for fine-grained plastic soils.

5. EARTH DAM EMBANKMENTS. Evaluate stability at three critical stages; the end of construction stage, steady state seepage stage, and rapid drawdown stage. See DM-7.1, Chapter 7 for pore pressure distribution at these stages. Seismic forces must be included in the evaluation. Requirements for seepage cutoff and stability dictate design of cross section and utilization of borrow materials.

a. Seepage Control. Normally the earthwork of an earth dam is zoned with the least pervious, fine-grained soils in the central zone and coarsest, most stable material in the shell. Analyze seepage by the methods of DM-7.1, Chapter 6.

(1) Cutoff Trench. Consider the practicability of a positive cutoff trench extending to impervious strata beneath the embankment and into the abutments.

(2) Intercepting Seepage. For a properly designed and constructed zoned earth dam, there is little danger from seepage through the embankment. Drainage design generally is dictated by necessity for intercepting seepage through the foundation or abutments. Downstream seepage conditions are more critical for homogeneous fills. See DM-7.1, Chapter 6 for drainage and filter requirements.

b. Piping and Cracking. A great danger to earth dams, particularly those of zoned construction, is the threat of cracking and piping. Serious cracking may result from tension zones caused by differences in stress-strain properties of zoned material. See Figure 1 (Reference 1, Influence of Soil Properties and Construction Methods on the Performance of Homogeneous Earth Dams, by Sherard) for classification of materials according to resistance to piping or cracking. Analyze the embankment section for potential tension zone development. Place an internal drainage layer immediately downstream of the core to control seepage from possible cracking if foundation settlements are expected to be high.

c. Dispersive Soil. Dispersive clays should not be used in dam embankments. Determine the dispersion potential using Table 3 or the method outlined in Reference 2, Pinhole Test for Identifying Dispersive Soils, by Sherard, et al. A hole through a dispersive clay will increase in size as water flows through (due to the breakdown of the soil structure), whereas the size of a hole in a non-dispersive clay would remain essentially constant. Therefore, dams constructed with dispersive clays are extremely susceptible to piping.

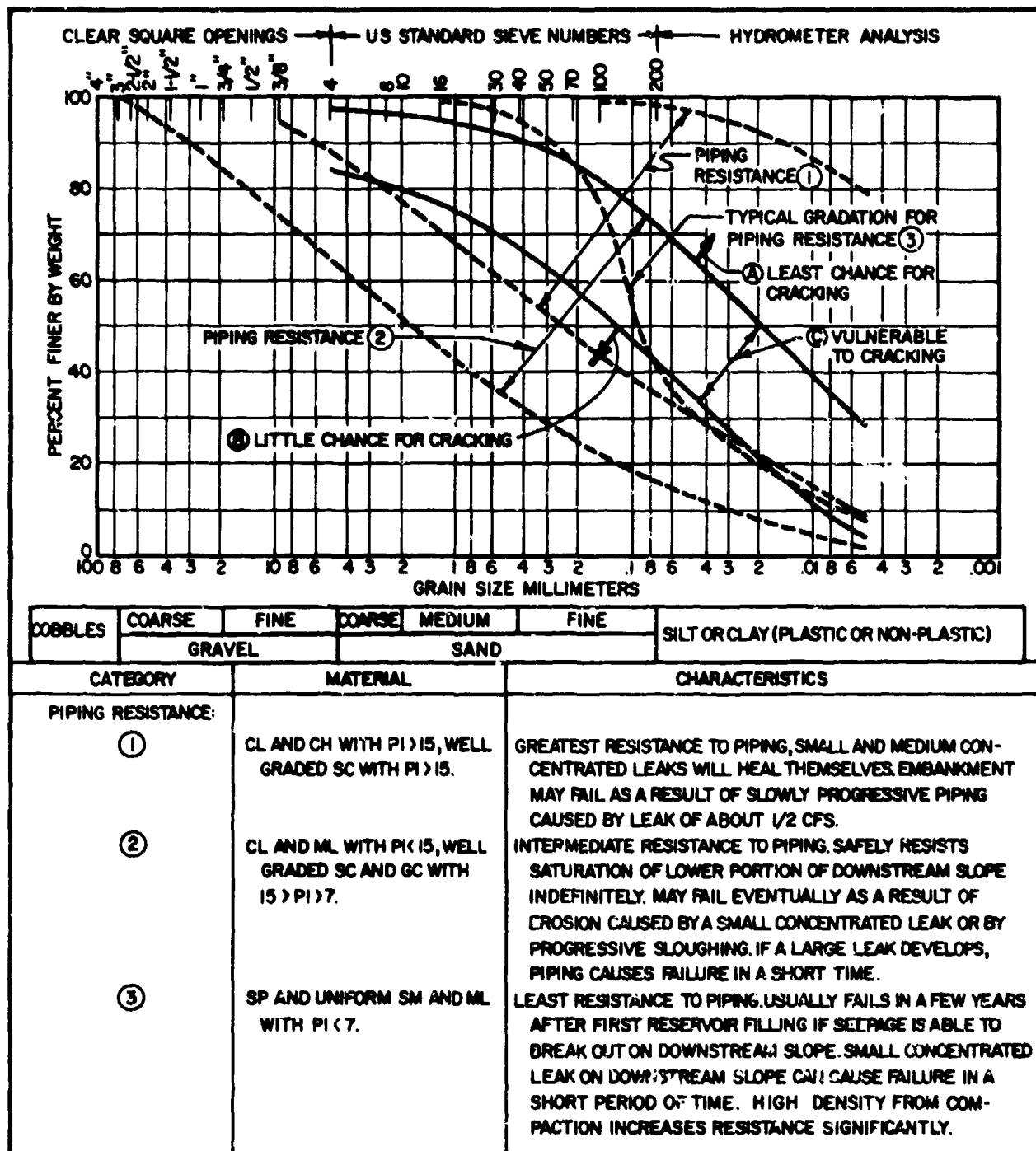


FIGURE 1
Resistance of Earth Dam Embankment Materials To Piping and Cracking

CATEGORY	MATERIAL	CHARACTERISTICS
CRACKING RESISTANCE		
(A)	CH WITH $D_{50} < 0.02 \text{ MM}$ AND $P_1 > 20$	HIGH POSTCONSTRUCTION SETTLEMENT, PARTICULARLY IF COMPACTED DRY. HAS SUFFICIENT DEFORMABILITY TO UNDERGO LARGE SHEAR STRAINS FROM DIFFERENTIAL SETTLEMENT WITHOUT CRACKING.
(B)	GC, SC, SM, SP WITH $D_{50} > 0.15 \text{ MM}$	SMALL POSTCONSTRUCTION SETTLEMENT. LITTLE CHANCE FOR CRACKING UNLESS POORLY COMPACTED AND LARGE SETTLEMENT IS IMPOSED ON EMBANKMENT BY CONSOLIDATION OF THE FOUNDATION.
(C)	CL, ML AND SM WITH $P_1 < 20$, $0.15 \text{ MM} > D_{50} > 0.02 \text{ MM}$.	MEDIUM TO HIGH POSTCONSTRUCTION SETTLEMENT AND VULNERABLE TO CRACKING. SHOULD BE COMPACTED AS WET AS POSSIBLE CONSISTENT WITH STRENGTH REQUIREMENTS.

FIGURE 1 (continued)
Resistance of Earth Dam Embankment Materials To Piping and Cracking

TABLE 3
Clay Dispersion Potential

*Percent Dispersion	Dispersive Tendency
Over 40	Highly Dispersive (do not use)
15 to 40	Moderately Dispersive
0 to 15	Resistant to Dispersion

*The ratio between the fraction finer than 0.005 mm in a soil-water suspension that has been subjected to a minimum of mechanical agitation, and the total fraction finer than 0.005 mm determined from a regular hydrometer test x 100.

Section 3. COMPACTION REQUIREMENTS AND PROCEDURES

1. COMPACTION REQUIREMENTS.

a. Summary. See Table 4 for a summary of compaction requirements of fills for various purposes. Modify these to meet conditions and materials for specific projects.

b. Specification Provisions. Specify the desired compaction result. State the required density, moisture limits, and maximum lift thickness, allowing the contractor freedom in selection of compaction methods and equipment. Specify special equipment to be used if local experience and available materials so dictate.

2. COMPACTION METHODS AND EQUIPMENT. Table 5 lists commonly used compaction equipment with typical sizes and weights and guidance on use and applicability.

3. INFLUENCE OF MATERIAL TYPE.

a. Soils Insensitive to Compaction Moisture. Coarse-grained, granular well-graded soils with less than 4 percent passing No. 200 sieve (8 percent for soil of uniform gradation) are insensitive to compaction moisture. (These soils have a permeability greater than about 2×10^{-3} fpm.) Place these materials at the highest practical moisture content, preferably saturated. Vibratory compaction generally is the most effective procedure. In these materials, 70 to 75 percent relative density can be obtained by proper compaction procedures. If this is substantially higher than Standard Proctor maximum density, use relative density for control. Gravel, cobbles and boulders are insensitive to compaction moisture. Compaction with smooth wheel vibrating rollers is the most effective procedure. Use large scale tests, as outlined in Reference 3, Control of Earth Rockfill for Oroville Dam, by Gordon and Miller.

b. Soils Sensitive to Compaction Moisture. Silts and some silty sands have steep moisture-density curves, and field moisture must be controlled within narrow limits for effective compaction. Clays are sensitive to moisture in that if they are too wet they are difficult to dry to optimum moisture, and if they are dry it is difficult to mix the water in uniformly. Sensitive clays do not respond to compaction because they lose strength upon remolding or manipulation.

c. Effect of Oversize. Oversize refers to particles larger than the maximum size allowed using a given mold (i.e. No. 4 for 4-inch mold, 3/4 inch for 6-inch mold, 2-inch for a 12-inch mold). Large size particles interfere with compaction of the finer soil fraction. For normal embankment compaction the maximum size cobble should not exceed 3 inches or 50 percent of the compacted layer thickness. Where economic borrow sources contain larger sizes, compaction trials should be run before approval.

TABLE 4
Compaction Requirements

Fill Utilized for:	Required Density, Percent of Modified Proctor	Tolerable Range of Moisture About Optimum, Percent	Maximum Permissible Lift Thickness, Compacted in.	Special Requirements
Support of structure	95	-2 to +2	12	Fill should be uniform. Blending or processing of borrow may be required. For plastic clays, investigate expansion under saturation for various compaction moisture and densities at loads equal to those applied by structure, to determine condition to minimize expansion. Clays that show expansive tendencies generally should be compacted at or above optimum moisture to a density consistent with strength and incompressibility required of the fill.
Lining for canal or small reservoir	90	-2 to +2	6	For thick linings, GM-CC, CC, SC are preferable for stability and to resist erosive forces. Single size silty sands with PI less than five generally are not suitable. Remove fragments larger than 6 inches before compaction.
Earth dam greater than 50 ft. high	95	-1 to +2	12(+)	Utilize least pervious materials as central core and coarsest materials in outer shells. Core should be free of lenses, pockets, or layers of pervious material and successive lifts well bonded to each other. Amounts of oversize exceeding 1 percent of total material should be removed from the borrow prior to arrival on the embankment.
Earth dam less than 50 ft. high	92	-1 to +3	12(+)	In small dams that lack elaborate zoning, materials that are the most vulnerable to cracking and piping should be compacted to 98 percent density at moisture content from optimum to 3 percent in excess of optimum.
Support of pavements:				
highways.....	See NAVFAC DM-5	-2 to +2	8(+)	Place coarsest borrow materials at top of fill. Investigate expansion of plastic clays placed near pavement subgrade to determine compaction moisture and density that will minimize expansion and provide required soaked CBR values.
Airfields.....	See NAVFAC DM-21	-2 to +2	8(+)	
Backfill surrounding structure	90	-2 to +2	8(+)	Where backfill is to be drained, provide pervious coarse-grained soils. For low walls, do not permit heavy rolling compaction equipment to operate closer to the wall than a distance equal to about 2/3 the unbalanced height of fill at any time. For highwalls or walls of special design, evaluate the surcharge produced by heavy compaction equipment by the methods of Chapter 3 and specify safe distances back of the wall for its operations.

TABLE 4 (continued)
Compaction Requirements

Fill Utilized for:	Required Density, Percent of Modified Proctor	olerable Range of Moisture About Optimum, Percent	Maximum Permissible Lift Thickness, Compacted in.	Special Requirements
Backfill in pipe or utility trenches	90	-2 to +2	8(+)	Material excavated from trench generally is suitable for backfill if it does not contain organic matter or refuse. If backfill is fine grained, a cradle for the pipe is formed in natural soil and backfill placed by tamping to provide the proper bedding. Where free draining sand and gravel is utilized, the trench bottom may be finished flat and the granular material placed saturated under and around the pipe and compacted by vibration.
Drainage blanket or filter	90	Thoroughly wetted	8	Ordinarily vibratory compaction equipment is utilized. Bleeding of materials may be required for homogeneity. Segregation must be prevented in placing and compaction. For compaction adjacent to and above drainage pipe, use hand tamping or light travelling vibrators.
Subgrade of excavation for structure	95	-2 to +2	-	For uniform bearing or to break up pockets of frost susceptible material, scarify the upper 8 to 12 in. of the subgrade, dry or moisten as necessary and recompact. Certain materials, such as heavily preconsolidated clays which will not benefit by compaction, or saturated silts and silty fine sands that become quick during compaction, should be blanketed with a working mat of lean concrete or coarse grained material to prevent disturbance or softening. Depending on foundation conditions revealed in exploration, a substantial thickness of loose soils may have to be removed below subgrade and recompact, or compacted in place by vibration, or pile driving.
Rock fill		Thoroughly wetted	2 to 3 ft.	For fill containing sizes no larger than ft., place in layers not exceeding 24 in., thoroughly wetted and compacted by travel or heavy crawler tractors in spreading. Material with sizes up to 2 ft. may be placed in 3 ft lifts. Placing should be such that the maximum size of rock increases toward the outer slopes. Rocks larger than 1 cu yd in volume should be embedded on the slope.

Notes:

- Density and moisture content refer to "Standard Proctor" test values, (ASTM D 698)
- Generally, a fill compacted dry of OMC will have higher strength and a lower compressibility even after saturation.
- Compaction of "Coarse-grained, granular soil" is not sensitive to moisture content so long as bulking moisture is avoided. Where practicable, they should be placed saturated and compacted by vibratory methods.

TABLE 5
Compaction Equipment and Methods

Equipment Type	Applicability	Requirements for Compaction of 95 to 100 Percent Standard Proctor Maximum Density			Possible Variations in Equipment
		Compacted Lift Thickness, in.	Passes or Coverages	Dimensions and Weight of Equipment	
Sheepsfoot Rollers	For fine-grained soils or dirty coarse-grained soils with more than 20 percent passing No. 200 sieve. Not suitable for clean coarse-grained soils. Particularly appropriate for compaction of impervious zone for earth dam or linings where bonding of lifts is important.	6	4 to 6 passes for fine-grained soil. 6 to 8 passes for coarse-grained soil.	<p>Foot Contact Area sq. ft. Ecc. Contact Pressures psi</p> <p>Soil Type</p> <p>Fine-grained soil PI > 30 5 to 12 250 to 500</p> <p>Fine-grained soil PI < 30 7 to 14 200 to 400</p> <p>Coarse-grained soil 10 to 14 150 to 250</p> <p>Efficient compaction of soils wet of optimum requires less contact pressure than the same soils at lower moisture contents.</p>	For earth dam, highway and airfield work, articulated self propelled rollers are commonly used. For smaller projects, towed 40 to 60 inch drums are used. Foot contact pressure should be regulated so as to avoid shearing the soil on the third or fourth pass.
Rubber Tire Roller Do.....	For clean, coarse-grained soils with 4 to 8 percent passing the No. 200 sieve. For fine-grained soils or well graded, dirty coarse-grained soils with more than 8 percent passing the No. 200 sieve.	10 6 to 8	3 to 5 coverages 4 to 6 coverages	<p>Tire inflation pressures of 35 to 30 psi for clean granular material or base course and subgrade compaction. Wheel load 18,000 to 25,000 lbs.</p> <p>Tire inflation pressures in excess of 65 psi, for fine-grained soils of high plasticity. For uniform clean sands or silty fine sands, use large size tires with pressures of 40 to 50 psi.</p>	Wide variety of rubber tire compaction equipment is available. For cohesive soils, light-wheel loads, such as provided by wobble-wheel equipment, may be substituted for heavy-wheel load if lift thickness is decreased. For granular soils, large-size tires are desirable to avoid shear and rutting.
Smooth Wheel Rollers Do....	Appropriate for subgrade or base course compaction of well-graded sand-gravel mixtures. May be used for fine-grained soils other than in earth dams. Not suitable for clean well-graded sands or silty uniform sands.	8 to 12 6 to 8	4 coverages 6 coverages	<p>Tandem type rollers for base course or subgrade compaction 10 to 15 ton weight, 300 to 500 lbs per lineal in. of width of rear roller.</p> <p>3-wheel roller for compaction of fine-grained soil; weights from 5 to 6 tons for materials of low plasticity to 10 tons for materials of high plasticity.</p>	3-wheel rollers obtainable in wide range of sizes. 2-wheel tandem rollers are available in the range of 1 to 20 ton weight. 3-Axle tandem rollers are generally used in the range of 10 to 20 tons weight. Very heavy rollers are used for proof rolling of subgrade or base course.

TABLE 5 (continued)
 Compaction Equipment and Methods

Equipment Type	Applicability	Requirements for Compaction of 95 to 100 Percent Standard Proctor Maximum Density				Possible Variations in Equipment
		Compacted Lift Thickness, in.	Passes or Coverages	Dimensions and Weight of Equipment		
Vibrating Sheetsfoot Rollers	For coarse-grained soils sand-gravel mixtures	8 to 12	3 to 5	1 to 20 tons ballasted weight. Dynamic force up to 20 tons.	May have either fixed or variable cyclic frequency.	
Vibrating Smooth Drum Rollers	For coarse-grained soils sand-gravel mixtures - rock fills	6 to 12 (soil) to 36 (rock)	3 to 5 4 to 6	- do -	- do -	
Vibrating Baseplate Compactors	For coarse-grained soils with less than about 12 percent passing No. 200 sieve. Best suited for materials with 4 to 8 percent passing No. 200 sieve, placed thoroughly wet.	8 to 10	3 coverages	Single pads or plates should weigh no less than 200 lbs. May be used in tandem where working space is available. For clean coarse-grained soil, vibration frequency should be no less than 1,600 cycles per minute.	Vibrating pads or plates are available, hand-propelled, single or in gangs, with width of coverage from 1-1/2 to 15 ft. Various types of vibrating-drum equipment should be considered for compaction in large areas.	
Crawler Tractor	Best suited for coarse-grained soils with less than 4 to 8 percent passing No. 200 sieve, placed thoroughly wet.	6 to 10	3 to 4 coverages	Vehicle with "Standard" tracks having contact pressure not less than 10 psf.	Troctor weight up to 85 tons.	
Power Tamper or Rammer	For difficult access, trench backfill. Suitable for all inorganic soils.	4 to 6 in. for silt or clay, 6 in. for coarse-grained soils.	2 coverages	30-lb minimum weight. Considerable range is tolerable, depending on materials and conditions.	Weights up to 250 lbs., foot diameter 4 to 10 in.	

Adjust laboratory maximum standard density (from moisture-density relations test, see DM-7.1, Chapter 3) to provide a reference density to which field density test results (with oversize) can be compared. Use the following equations to adjust the laboratory maximum dry density and optimum moisture content to values to which field test data (with oversize particles) may be compared.

$$\gamma_{\max} = \frac{1 - (0.05)(F)}{\frac{F}{162} + \frac{1-F}{\gamma_1}}$$

where: γ_{\max} = adjusted maximum dry density pcf

γ_1 = laboratory maximum dry density without oversize, pcf

F = fraction of oversize particles by weight (from field density test)

$$w_j = F(w_g) + (1-F)w_o$$

where: w_j = adjusted optimum moisture content

w_g = moisture content of oversize (from field data)

w_o = laboratory optimum moisture content without oversize

The density of oversize material is assumed as 162 pcf, obtained from bulk specific gravity 2.60, multiplied by 62.4.

This method is considered suitable when the weight of oversize is less than 60% by weight, for well-graded materials. For poorly graded materials, further adjustment may be appropriate. This method is modified after that described in Reference 4, Suggested Method for Correcting Maximum Density and Optimum Moisture Content of Compacted Soils for Oversize Particles, by McLeod; also see Reference 5, Scalping and Replacement Effects on the Compaction Characteristics of Earth-Rock Mixtures, by Donaghe and Townsend.

Section 4. EMBANKMENT COMPACTION CONTROL

1. GROUND PREPARATION.

(1) Strip all organics and any other detrimental material from the surface. In prairie soils this may amount to removal of 2 or 3 inches of topsoil, and in forest covered land between 2 and 5 or more feet. Only the heavy root mat and the stumps need be removed, not the hair-like roots.

(2) Remove subsurface structures or debris which will interfere with the compaction or the specified area use.

(3) Scarify the soil, and bring it to optimum moisture content.

(4) Compact the scarified soil to the specified density.

2. **FIELD TEST SECTION.** By trial, develop a definite compaction procedure (equipment, lift thickness, moisture application, and number of passes) which will produce the specified density. Compaction cannot be controlled adequately by spot testing unless a well defined procedure is followed.

3. **REQUIREMENTS FOR CONTROL TESTS.** Perform in-place field density tests plus sufficient laboratory moisture-density tests to evaluate compaction. For high embankments involving seepage, settlement, or stability, perform periodic tests for engineering properties of density test samples, e.g., permeability tests, shear strength tests. See DM-7.1, Chapter 3 for laboratory moisture density test procedures and DM-7.1, Chapter 2 for field density test methods.

a. Number of Field Density Tests. Specify the following minimum test schedule:

(1) One test for every 500 cu yd of material placed for embankment construction.

(2) One test for every 500 to 1,000 cu yd of material for canal or reservoir linings or other relatively thin fill sections.

(3) One test for every 100 to 200 cu yd of backfill in trenches or around structures, depending upon total quantity of material involved.

(4) At least one test for every full shift of compaction operations on mass earthwork.

(5) One test whenever there is a definite suspicion of a change in the quality of moisture control or effectiveness of compaction.

b. Field Density Test Methods. See DM-7.1, Chapter 2, for field density test methods.

Proofrolling (spotting soft spots with a rubber-tired roller or any loaded earth-moving equipment) may be used in conjunction with density testing, but is practical only for extensive earthwork or pavement courses.

c. Laboratory Compaction Tests. Prior to important earthwork operations, obtain a family of compaction curves representing typical materials. Ideally, this family will form a group of parallel curves and each field density test will correspond to a specific compaction curve.

During construction obtain supplementary compaction curves on field density test samples, approximately one for every 10 or 20 field tests, depending on the variability of materials.

4. **ANALYSIS OF CONTROL TEST DATA.** Compare each field determination of moisture and density with appropriate compaction curve to evaluate conformance to requirements.

a. Statistical Study. Overall analysis of control test data will reveal general trends in compaction and necessity for altering methods. Inevitably, a certain number of field determinations will fall below specified density or outside specified moisture range. Tabulate field tests, noting the percentage difference between field density and laboratory maximum density and between field moisture and optimum.

b. Moisture Control. Close moisture control is evidenced if two-thirds of all field values fall in a range ± 1 percent about the median moisture content specified. Erratic moisture control is evidenced if approximately two-thirds of all field values fall in a range ± 3 percent about the median moisture content specified. To improve moisture control, blend materials from wet and dry sections of borrow area.

c. Compactive Effort. Suitable compaction methods are being utilized if approximately two-thirds of all field densities fall in a range of ± 3 percent about the percent maximum density required. Insufficient or erratic compaction is evidenced if approximately two-thirds of all field values fall in a range of ± 5 percent about the percent maximum density required. To improve compaction, consider methods for more uniform moisture control, alter the number of coverages, weights, or pressures of compaction equipment.

d. Overcompaction. A given compactive effort yields a maximum dry density and a corresponding optimum moisture content. If the compactive effort is increased, the maximum dry density increases but the corresponding optimum moisture content decreases. Thus, if the compactive effort used in the field is higher than that used in the laboratory for establishing the moisture density relationship, the soil in the field may be compacted above its optimum moisture content, and the strength of the soil may be lower even though it has been compacted to higher density. This is of particular concern for high embankments and earth dams. For further guidance see Reference 6, Stabilization of Materials by Compaction, by Turnbull and Foster.

5. INDIRECT EVALUATION OF COMPACTION IN DEEP FILLS. The extent of compaction accomplished is determined by comparing the results from standard penetration tests and cone penetration tests before and after treatment (DM-7.1, Chapter 2).

6. PROBLEM SOILS. The compaction of high volume change soils requires special treatment. See DM-7.3, Chapter 3.

Section 5. BORROW EXCAVATION

1. BORROW PIT EXPLORATION

a. Extent. The number and spacing of borings or test pits for borrow exploration must be sufficient to determine the approximate quantity and quality of construction materials within an economical haul distance from the project. For mass earthwork, initial exploration should be on a 200-foot grid. If variable conditions are found during the initial explorations, intermediate borings or test pits should be done. Explorations should develop the following information:

(1) A reasonably accurate subsurface profile to the anticipated depth of excavation.

(2) Engineering properties of each material considered for use.

(3) Approximate volume of each material considered for use.

(4) Water level.

(5) Presence of salts, gypsums, or undesirable minerals.

(6) Extent of organic or contaminated soils, if encountered.

2. EXCAVATION METHODS.

a. Equipment. Design and efficiency of excavation equipment improves each year. Check various construction industry publications for specifications.

b. Ripping and Blasting. Determine rippability of soil or rock by borings (RQD and core recovery, see DM-7.1, Chapters 1 and 2), geophysical exploration, and/or trial excavation.

3. UTILIZATION OF EXCAVATED MATERIALS. In the process of earthmoving there may be a reduction of the volume ("shrinkage") because of waste and densification, or an increase of volume ("swell") in the case of rock or dense soils, because the final density is less than its original density.

a. Borrow Volume. Determine total borrow volume, V_B required for compacted fill as follows:

$$V_B = \left(\frac{\gamma_F}{\gamma_B} \cdot V_F \right) + \frac{W_L}{B}$$

where: γ_F = dry unit weight of fill

γ_B = dry unit weight of borrow

V_F = required fill volume

W_L = weight lost in stripping, waste, oversize and transportation

(1) Compacted Volume. The volume of borrow soil required should be increased according to the volume change indicated above. A "shrinkage" factor of 10 to 15 percent may be used for estimating purposes.

(2) Exclusions. A large percentage of cobble size material will increase the waste, because sizes larger than 3 inches are generally excluded from compacted fill.

b. Rock Fill.

(1) Maximum Expansion. Maximum expansion ("swell") from in situ conditions to fill occurs in dense, hard rock with fine fracture systems that

breaks into uniform sizes. Unit volume in a quarry will produce approximately 1.5 volumes in fill.

(2) Minimum Expansion. Minimum expansion occurs in porous, friable rock that breaks into broadly graded sizes with numerous spalls and fines. Unit volume in quarry will produce approximately 1.1 volumes in fill.

Section 6. HYDRAULIC AND UNDERWATER FILLS

1. GENERAL. Where large quantities of soil must be transported and ample water is available, hydraulic methods are economical. The choice of methods for placing hydraulic fill is governed by the type of equipment available, accessibility of borrow, and environmental regulations; see Table 6 (Reference 7, Control for Underwater Construction, by Johnson, et al.). Removal or placement of soil by hydraulic methods must conform to applicable water pollution control regulations.

2. PLACEMENT METHODS. Placement, either under water or on land, should be done in a manner that produces a usable area with minimum environmental impact.

a. Deep Water Placement (over 75 feet). Most deep water placement is by bottom dump scows and is unconfined, with no control on turbidity, except by the rate of dumping.

b. Shallow Water Placement. Placement by pipeline, by mechanical equipment, or by side dumping from deck scows are the most common methods in shallow water. Sheet pile containment, silt "curtains", or dikes are required to minimize lateral spreading and environmental impact. Where lateral spreading is not desired and steeper side slopes are needed, control the method of placement or use a mixed sand and gravel fill material. With borrow containing about equal amounts of sand and gravel, underwater slopes as steep as 1:3 or 1:2-3/4 may be achieved by careful placement. To confine the fill, provide berms or dikes of the coarsest available material or stone on the fill perimeter. Where rock is placed underwater, sluice voids with sand to reduce compressibility and possible loss of material into the rock.

c. Land Placement. On land, hydraulic fills are commonly placed by pipeline or by mechanical procedures (i.e. clam shell, dragline, etc.). Dikes with adjustable weirs or drop inlets to control the quality of return water are used for containment.

3. PERFORMANCE OF HYDRAULIC FILLS.

a. Coarse-Grained Fills. The most satisfactory hydraulically placed fills are those having less than 15 percent non-plastic fines or 10 percent plastic fines because they cause the least turbidity during placement, drain faster, and are more suitable for structural support than fine-grained material. Relative densities of 50 to 60 percent can be obtained without compaction. Bearing values are in the range of 500 to 2000 pounds per square foot depending on the level of permissible settlement. Density, bearing and

TABLE 6
Methods of Fill Placement Underwater

Methods	Characteristics
Bottom-dump scows	<ol style="list-style-type: none"> 1. Limited to minimum depths of about 15 ft. because of scow and tug drafts. 2. Rapid; quick discharge entraps air and minimizes segregation.
Deck scows	<ol style="list-style-type: none"> 1. Usable in shallow water. 2. Unloading is slow, by dozer, clamshell, or hydraulic jets. 3. Inspection of material being placed may be difficult.
Dumping at land edge of fill and pushing material into water by bulldozer	<ol style="list-style-type: none"> 1. Fines in material placed below water tend to separate and accumulate in front of advancing fill. 2. Work arrangement should result in central portion being in advance of side portions to displace sideways any soft bottom materials. 3. In shallow water, bulldozer blade can shove materials downward to assist displacement of soft materials.

resistance to seismic liquefaction may be increased substantially by vibro-probe methods. See DM-7.3, Chapter 2.

b. Fine-Grained Fills. Hydraulically placed, bottom silts and clays such as produced by maintenance dredging will initially be at very high water contents. Depending on measures taken to induce surface drainage, it will take approximately 2 years before a crust sufficient to support light equipment is formed and the water content of the underlying materials approaches the liquid limit. Placing 1 to 3 feet of additional granular borrow will improve these areas rapidly so that they can support surcharge fills, with or without vertical sand drains to accelerate consolidation. Care must be exercised in applying the surcharge so that the shear strength of the soil is not exceeded.

4. CONSOLIDATION OF HYDRAULIC FILLS. If the coefficient of permeability of a hydraulic fill is less than 0.002 feet per minute, the consolidation time for the fill will be long and prediction of the behavior of the completed fill will be difficult. For coarse-grained materials, fill consolidation and strength build-up will be rapid and reasonable strength estimates can be made. Where fill and/or foundation soils are fine-grained, it may be desirable to monitor settlement and pore water pressure dissipation if structures are planned. Settlement plates may be placed both on the underlying soil and within the fill to observe settlement rates and amounts.

REFERENCES

1. Sherard, J.L., Influence of Soil Properties and Construction Methods on the Performance of Homogeneous Earth Dams, Technical Memorandum 645, U.S. Department of the Interior, Bureau of Reclamation.
2. Sherard, J.L., Dunnigan, L. P., Becker, R. S., and Steele, E. S., Pinhole Test for Identifying Dispersive Soils, Journal of the Geotechnical Engineering Division, ASCE, Vol. 102, No. GT1, 1976.
3. Gordon, B.B., Miller, R.K., Control of Earth and Rockfill for Oroville Dam, Journal of the Geotechnical Engineering Division, ASCE, Vol. 92, No. SM3, 1966.
4. McLeod, N.W., Suggested Method for Correcting Maximum Density and Optimum Moisture Content of Compacted Soils for Oversize Particles, Special Procedures for Testing Soil and Rock for Engineering Purposes, ASTM STP 479, ASTM, 1970.
5. Donaghe, R.T., and Townsend, F.C., Scalping and Replacement Effects on the Compaction Characteristics of Earth-Rock Mixtures, Soil Specimen Preparation for Laboratory Testing, ASTM STP 599, ASTM, 1976.
6. Turnbull, W.J. and Foster, C.R. Stabilization of Materials by Compaction, Journal of the Soil Mechanics and Foundation Division, ASCE, Vol. 82, No. SM2, 1956.
7. Johnson, S. J., Compton, J. R., and Ling, S. C., Control for Underwater Construction, Underwater Sampling, Testing, and Construction Control, ASTM STP 501, ASTM, 1972.

CHAPTER 3. ANALYSIS OF WALLS AND RETAINING STRUCTURES

Section 1. INTRODUCTION

1. SCOPE. Methods of determining earth pressures acting on walls and retaining structures are summarized in this chapter. Types of walls considered include concrete retaining walls and gravity walls that move rigidly as a unit, braced or tied bulkheads of thin sheeting that deflect according to the bracing arrangement, and double-wall cofferdams of thin sheeting to confine earth or rock fill.

2. RELATED CRITERIA. Additional criteria relating to the design and utilization of walls appear in the following sources:

Subject	Source
Application of Bulkheads and Cofferdams to Waterfront Construction.....	NAVFAC DM-25
Structural Design of Retaining Walls.....	NAVFAC DM-2

Section 2. COMPUTATION OF WALL PRESSURES

1. CONDITIONS. The pressure on retaining walls, bulkheads, or buried anchorages is a function of the relative movement between the structure and the surrounding soil.

a. Active State. Active earth pressure occurs when the wall moves away from the soil and the soil mass stretches horizontally sufficient to mobilize its shear strength fully, and a condition of plastic equilibrium is reached. (See Figure 1 from Reference 1, Excavations and Retaining Structures, by the Canadian Geotechnical Society.) The ratio of the horizontal component of active pressure to the vertical stress caused by the weight of soil is the active pressure coefficient (K_a). The active pressure coefficient as defined above applies only to cohesionless soils.

b. Passive State. Passive earth pressure occurs when a soil mass is compressed horizontally, mobilizing its shear resistance fully (see Figure 1). The ratio of the horizontal component of passive pressure to the vertical stress caused by the weight of the soil is the passive pressure coefficient (K_p). The passive coefficient, as defined here, applies only to cohesionless soil. A soil mass that is neither stretched nor compressed is said to be in an at-rest state. The ratio of lateral stress to vertical stress is called the at-rest coefficient (K_0).

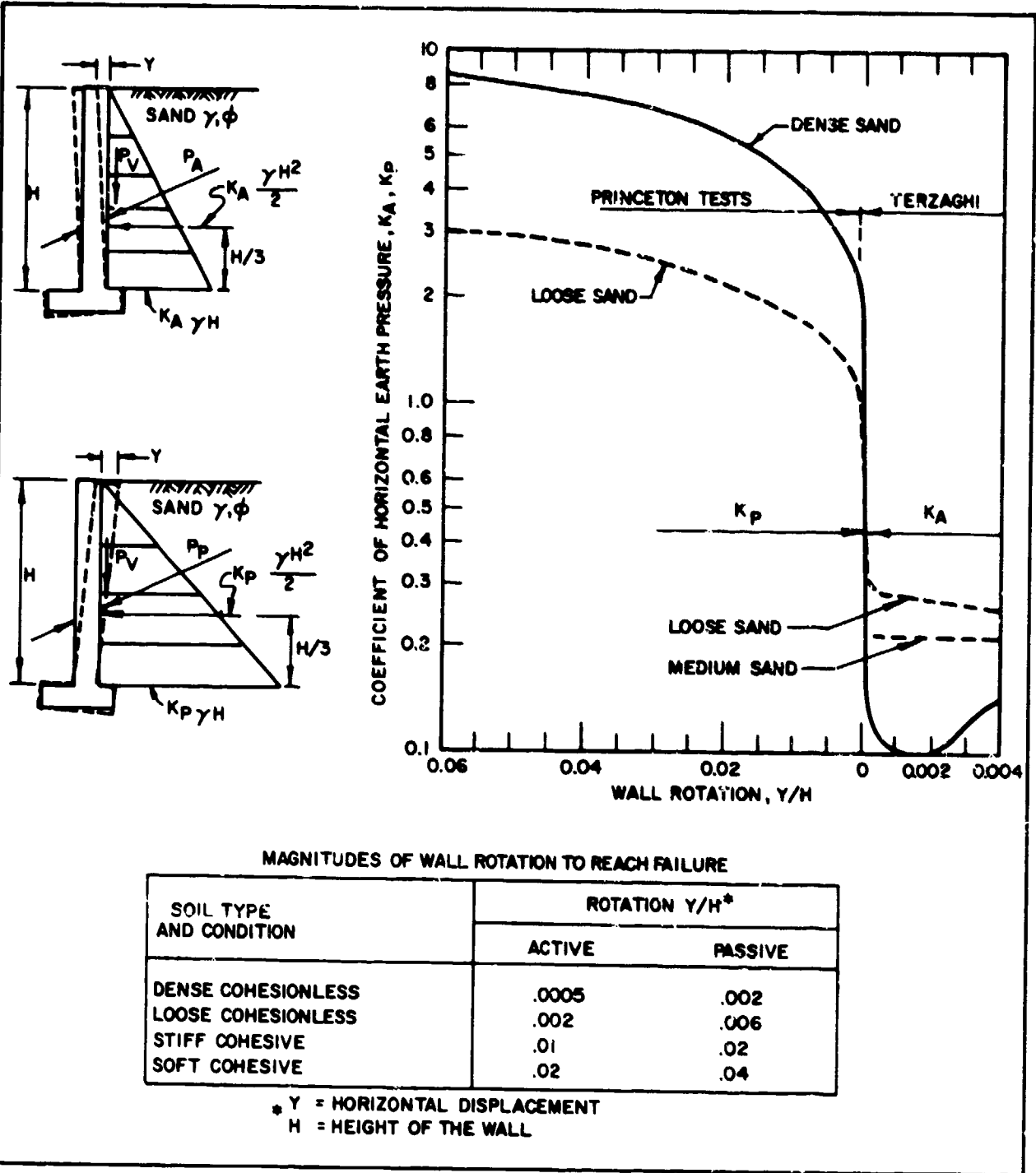


FIGURE 1
 Effect of Wall Movement on Wall Pressures

2. COMPUTATION OF ACTIVE AND PASSIVE PRESSURES. See Figure 2 for formulas for active and passive pressures for the simple case on a frictionless vertical face with horizontal ground surface. Three basic conditions required for validity of the formulas are listed in Figure 2. Under these conditions the failure surface is a plane and the formulas represent pressures required for equilibrium of the wedge shaped failure mass.

The intensity of pressures applied depends on wall movements, as these control the degree of shear strength mobilization in surrounding soil. (See Figure 1 for the magnitude of the movement necessary for active condition to exist.) Wall friction and wall vertical movements also affect the passive and active pressures.

The effect of wall friction on active pressures is small and ordinarily is disregarded except in case of a settling wall where it can be very significant. The effect of wall friction on passive pressures is large, but definite movement is necessary for mobilization of wall friction. (See Table 1 for typical ultimate friction factors and adhesion between wall and backfill.) In the absence of specific test data, use these values in computations that include effects of wall friction.

Unless a wall is settling, friction on its back acts upward on the active wedge (angle δ is positive, see Figure 5), reducing active pressures. Generally, wall friction acts downward against the passive wedge (angle δ is negative), resisting its upward movement and increasing passive pressures.

a. Uniform Backfill, No Groundwater. Compute active and passive pressures by methods from Figure 2.

b. Sloping Backfill, No Groundwater, Granular Soil, Smooth Wall. Compute active and passive pressures by methods from Figure 3. Use Figure 4 to determine the position of failure surface for active and passive wedge.

c. Sloping Wall, Granular Soil With Wall Friction. Use Figure 5 (Reference 2, Tables for the Calculation of the Passive Pressure, Active Pressure and Bearing Capacity of Foundations, by Caquot and Kerisel) to compute active and passive earth pressure coefficients.

d. Sloping Backfill, Granular Soil with Wall Friction. Use Figure 6 (Reference 2) to compute active and passive earth pressure coefficient.

e. Uniform Backfill, Static Groundwater. Compute active earth and water pressures by formulas in Figure 7.

f. General Formula for Coefficients of Passive and Active Earth Pressure. Use Figure 8 for sloping wall with friction and sloping backfill.

g. Stratified Backfill, Sloping Groundwater Level. When conditions include layered soil, irregular surcharge, wall friction, and sloping groundwater level, determine active pressures by trial failure wedge. (See Figure 7.) Trial wedge is bounded by a straight failure plane or a series of straight segments at different inclination in each stratum. Commence the analysis with failure plane oriented at the angle shown in Figure 4.

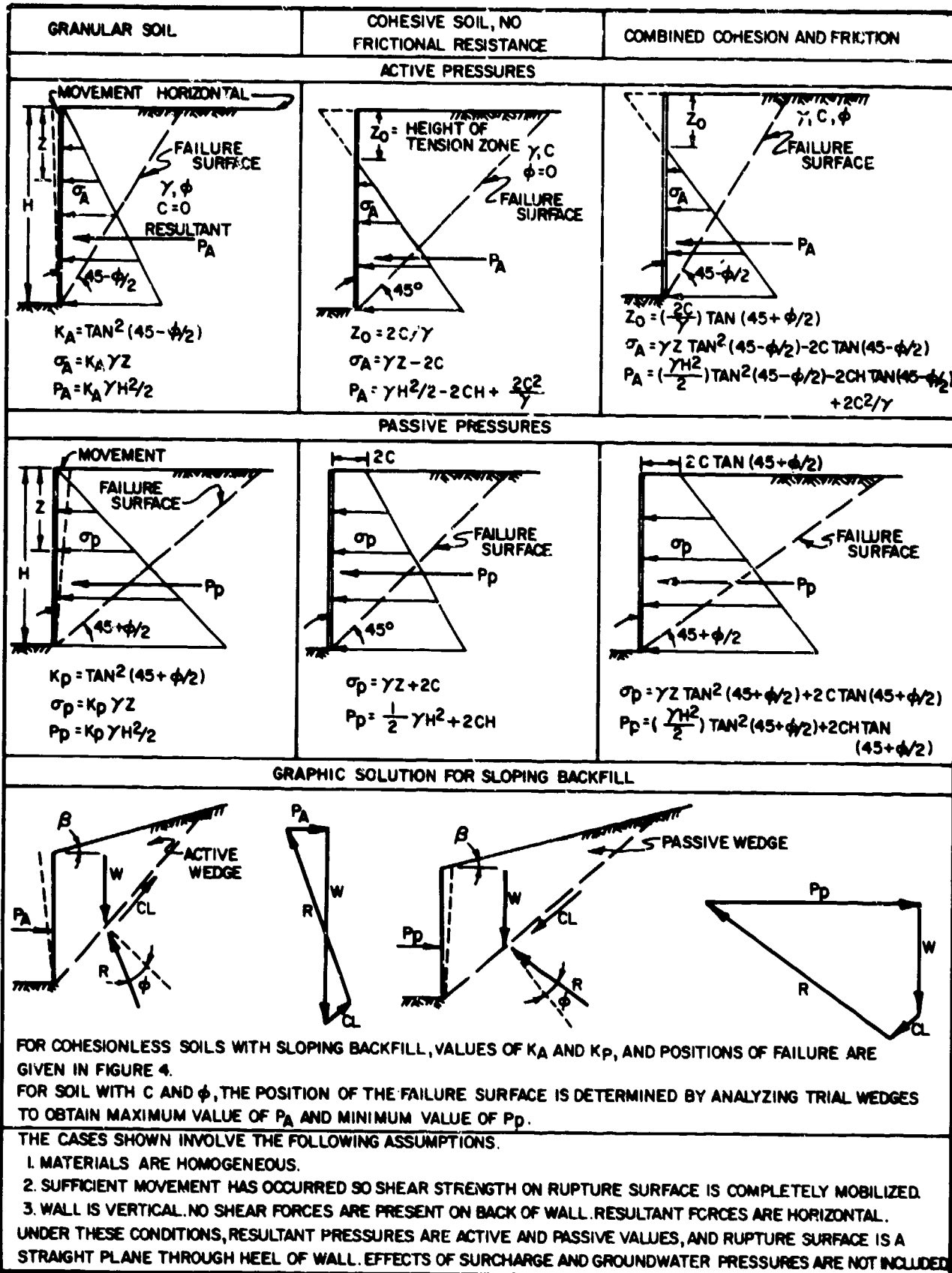
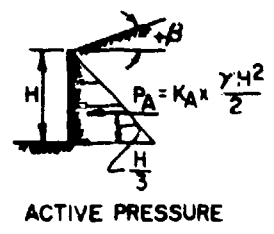
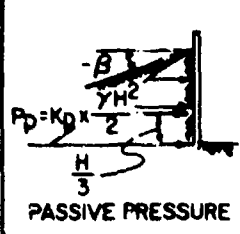
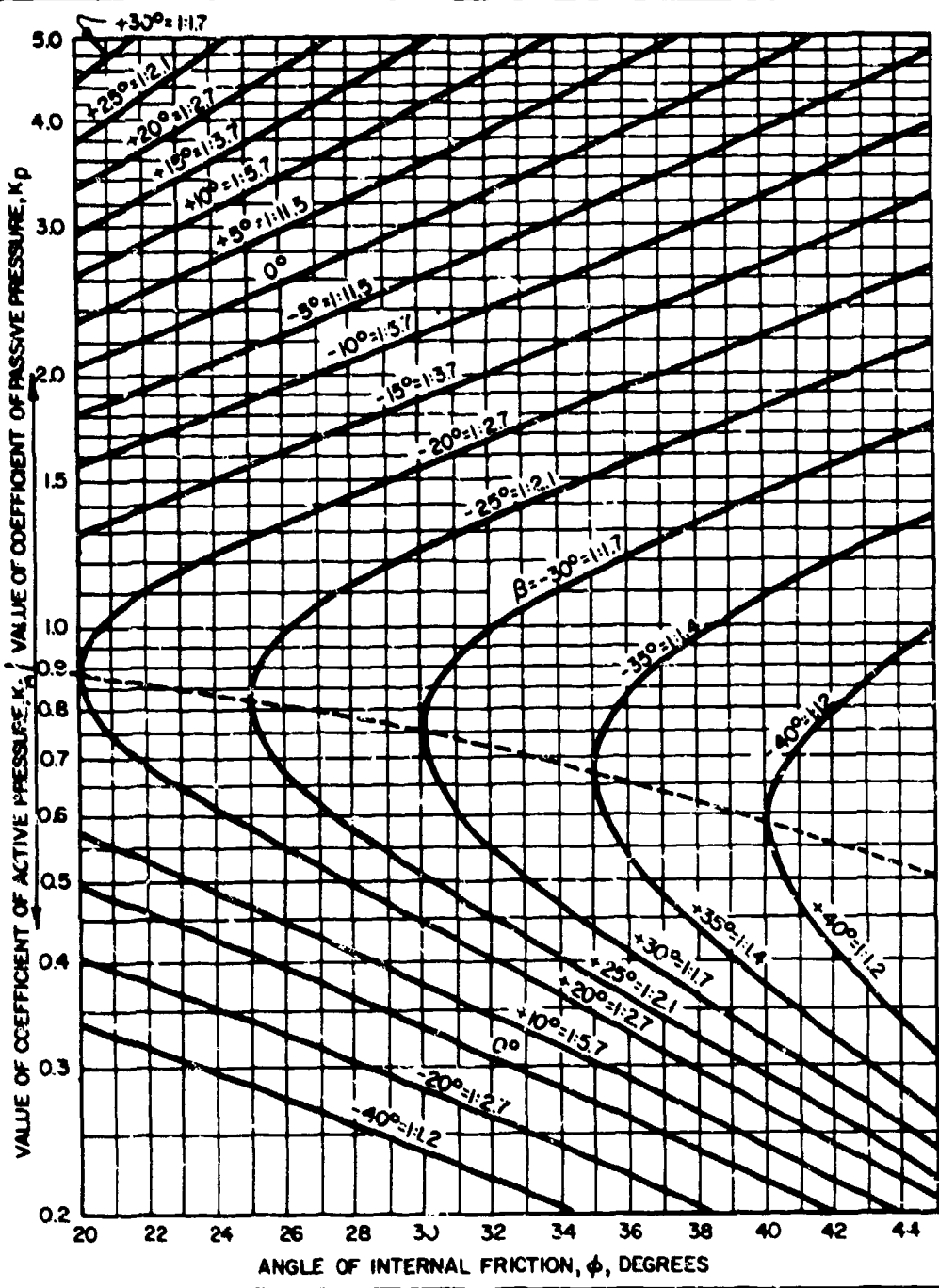


FIGURE 2
Computation of Simple Active and Passive Pressures

TABLE 1
Ultimate Friction Factors and Adhesion for Dissimilar Materials

Interface Materials	Friction factor, $\tan \delta$	Friction angle, δ degrees
Mass concrete on the following foundation materials:		
Clean sound rock.....	0.70	35
Clean gravel, gravel-sand mixtures, coarse sand...	0.55 to 0.60	29 to 31
Clean fine to medium sand, silty medium to coarse sand, silty or clayey gravel.....	0.45 to 0.55	24 to 29
Clean fine sand, silty or clayey fine to medium sand.....	0.35 to 0.45	19 to 24
Fine sandy silt, nonplastic silt.....	0.30 to 0.35	17 to 19
Very stiff and hard residual or preconsolidated clay.....	0.40 to 0.50	22 to 26
Medium stiff and stiff clay and silty clay..... (Masonry on foundation materials has same friction factors.)	0.30 to 0.35	17 to 19
Steel sheet piles against the following soils:		
Clean gravel, gravel-sand mixtures, well-graded rock fill with spalls.....	0.40	22
Clean sand, silty sand-gravel mixture, single size hard rock fill.....	0.30	17
Silty sand, gravel or sand mixed with silt or clay	0.25	14
Fine sandy silt, nonplastic silt.....	0.20	11
Formed concrete or concrete sheet piling against the following soils:		
Clean gravel, gravel-sand mixture, well-graded rock fill with spalls.....	0.40 to 0.50	22 to 26
Clean sand, silty sand-gravel mixture, single size hard rock fill.....	0.30 to 0.40	17 to 22
Silty sand, gravel or sand mixed with silt or clay	0.30	17
Fine sandy silt, nonplastic silt.....	0.25	14
Various structural materials:		
Masonry on masonry, igneous and metamorphic rocks:		
Dressed soft rock on dressed soft rock.....	0.70	35
Dressed hard rock on dressed soft rock.....	0.65	33
Dressed hard rock on dressed hard rock.....	0.55	29
Masonry on wood (cross grain).....	0.50	26
Steel on steel at sheet pile interlocks.....	0.30	17
Interface Materials (Cohesion)	Adhesion C_a (psf)	
Very soft cohesive soil (0 - 250 psf)	0 - 250	
Soft cohesive soil (250 - 500 psf)	250 - 500	
Medium stiff cohesive soil (500 - 1000 psf)	500 - 750	
Stiff cohesive soil (1000 - 2000 psf)	750 - 950	
Very stiff cohesive soil (2000 - 4000 psf)	950 - 1,300	

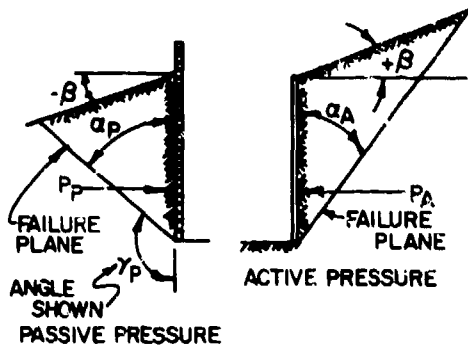
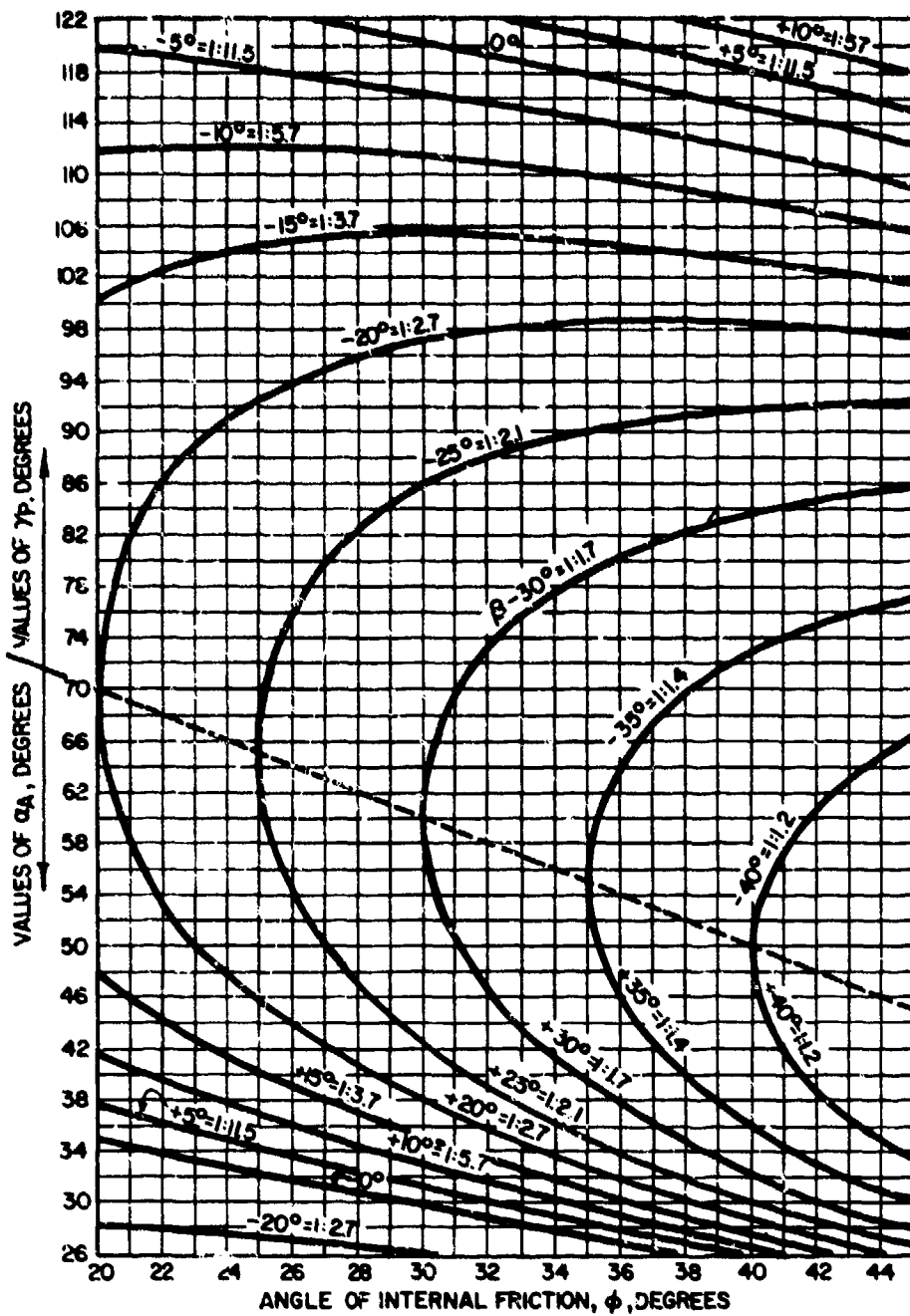


$$K_A = \left[\frac{\cos \phi}{1 + \sqrt{\sin \phi (\sin \phi - \cos \phi \tan \beta)}} \right]^2; \quad K_P = \left[\frac{\cos \phi}{1 - \sqrt{\sin \phi (\sin \phi + \cos \phi \tan \beta)}} \right]^2$$

K_A & K_P = COEFFICIENTS FOR COULOMB'S EQUATION FOR ACTIVE AND PASSIVE EARTH PRESSURE (NO SHEAR STRESS ON VERTICAL PLANES).

- P_A = ACTIVE RESULTANT ϕ = ANGLE OF INTERNAL FRICTION
- P_P = PASSIVE RESULTANT β = SLOPE ANGLE
- γ = UNIT WEIGHT OF SOIL
- H = HEIGHT OF WALL

FIGURE 3
Active and Passive Coefficients, Sloping Backfill
(Granular Soils)



$$\cot \alpha_A = \tan \phi + \sqrt{1 + \tan^2 \phi - \frac{\tan \beta}{\sin \phi \cos \phi}}$$

$$\cot \alpha_P = -\tan \phi + \sqrt{1 + \tan^2 \phi - \frac{\tan \beta}{\sin \phi \cos \phi}}$$

α_A & α_P = ANGLE BETWEEN CRITICAL FAILURE PLANE AND VERTICAL

ϕ = ANGLE OF INTERNAL FRICTION

β = SLOPE ANGLE

THE ANGLES SHOWN CORRESPOND TO THE COEFFICIENTS OF ACTIVE AND PASSIVE PRESSURE GIVEN IN FIGURE 3.

FIGURE 4
Position of Failure Surface for Active and Passive Wedges
(Granular Soils)

REDUCTION FACTOR (R) OF K_p FOR VARIOUS RATIOS OF $-\delta/\phi$								
δ/ϕ	-0.7	-0.6	-0.5	-0.4	-0.3	-0.2	-0.1	0.0
10	.978	.962	.946	.929	.912	.895	.881	.864
15	.961	.934	.907	.881	.854	.830	.803	.775
20	.939	.901	.862	.824	.787	.752	.718	.678
25	.912	.860	.808	.759	.711	.666	.620	.574
30	.878	.811	.746	.686	.627	.574	.520	.467
35	.836	.752	.674	.603	.536	.475	.417	.362
40	.783	.682	.592	.512	.439	.375	.316	.262
45	.718	.600	.500	.414	.339	.276	.221	.174

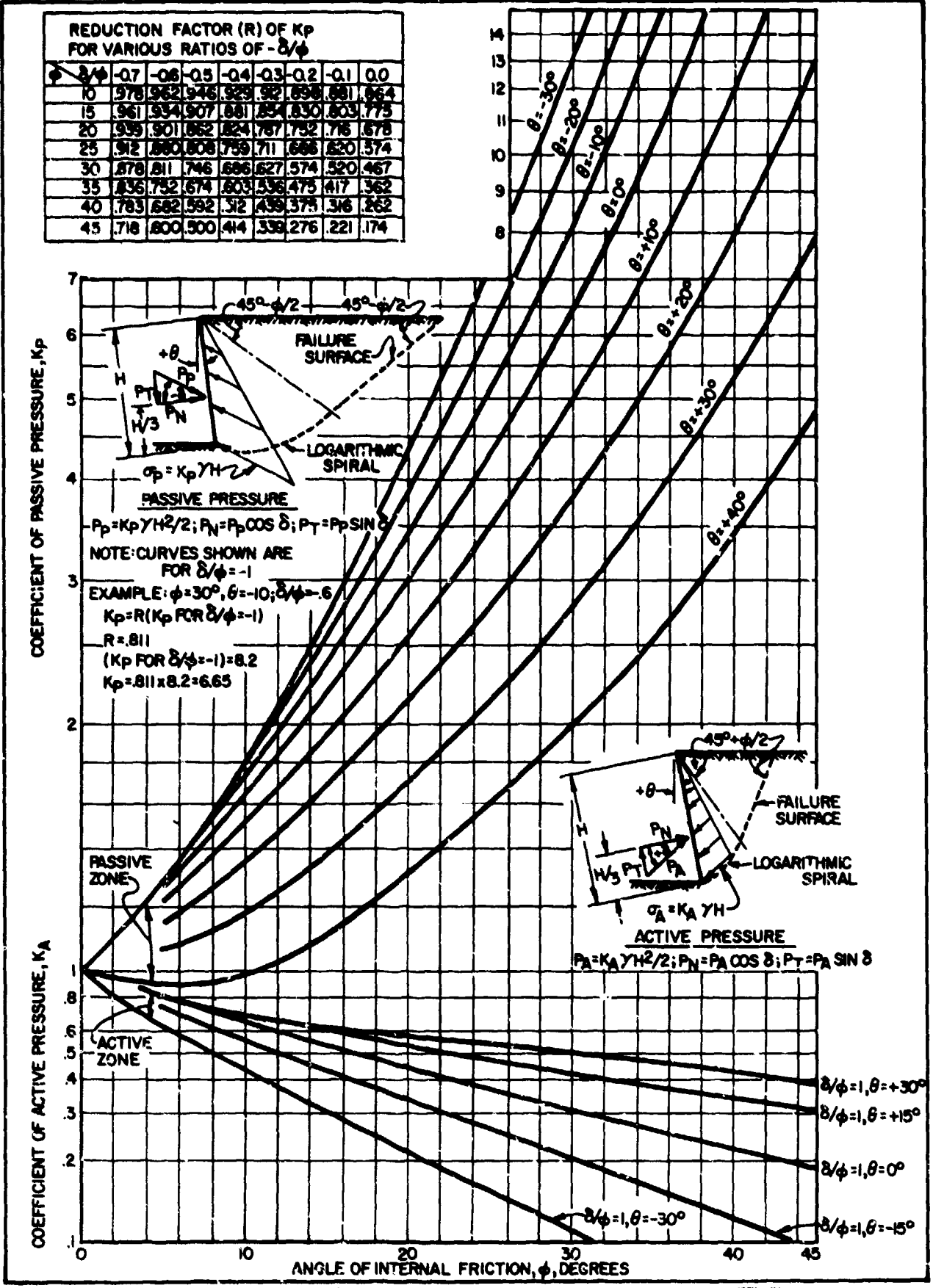


FIGURE 5
Active and Passive Coefficients with Wall Friction
(Sloping Wall)

REDUCTION FACTOR (R) OF K_p FOR VARIOUS RATIOS OF $-\delta/\phi$								
δ/ϕ	-0.7	-0.6	-0.5	-0.4	-0.3	-0.2	-0.1	0.0
10	.978	.962	.946	.929	.912	.898	.881	.864
15	.961	.934	.907	.881	.854	.830	.803	.775
20	.939	.901	.862	.824	.787	.752	.716	.678
25	.912	.860	.808	.759	.711	.666	.620	.574
30	.878	.811	.746	.686	.627	.574	.520	.467
35	.836	.752	.674	.603	.536	.475	.417	.362
40	.783	.682	.592	.512	.439	.375	.316	.262
45	.718	.600	.500	.414	.339	.276	.221	.174

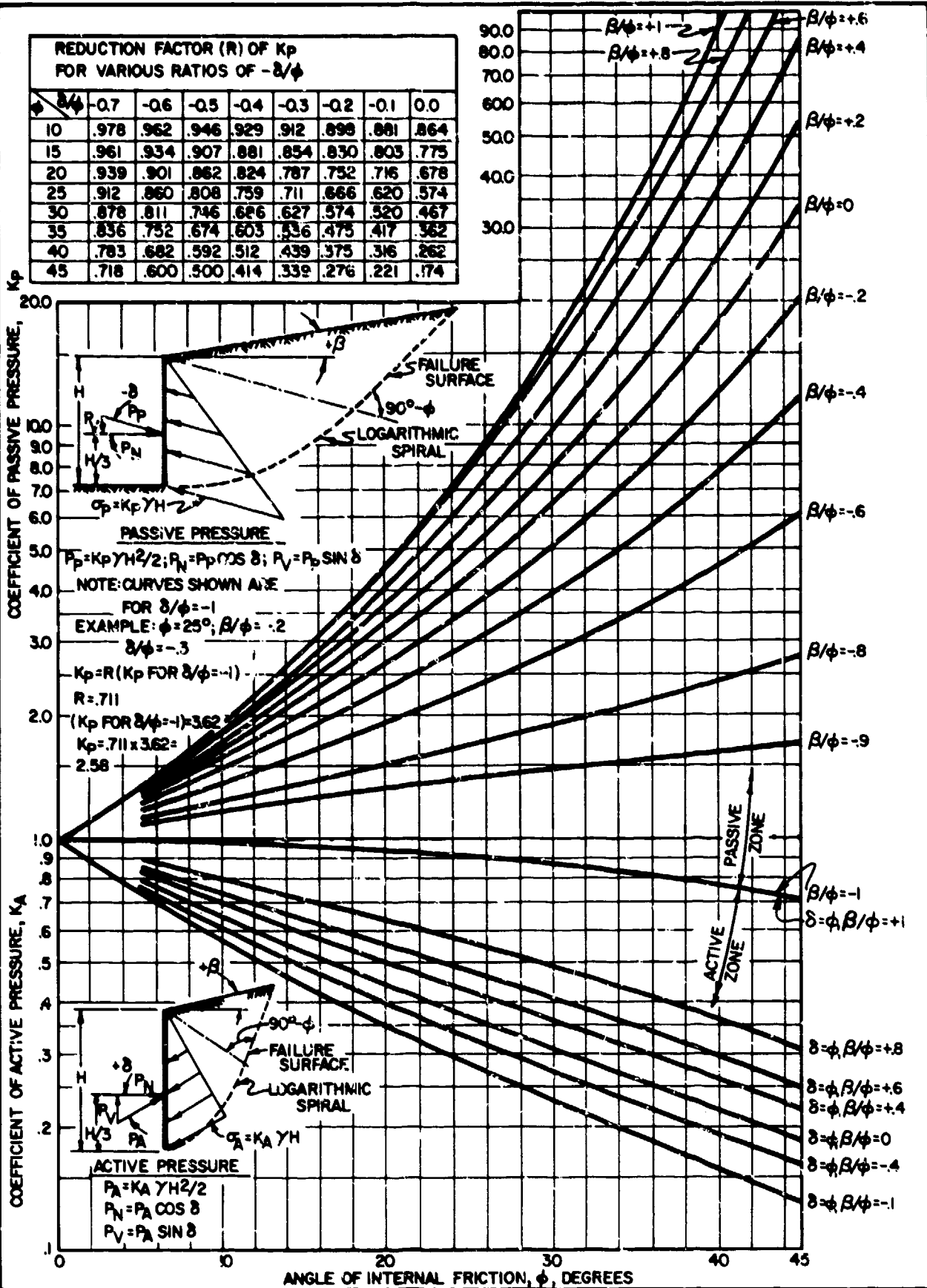


FIGURE 6
Active and Passive Coefficients with Wall Friction
(Sloping Backfill)

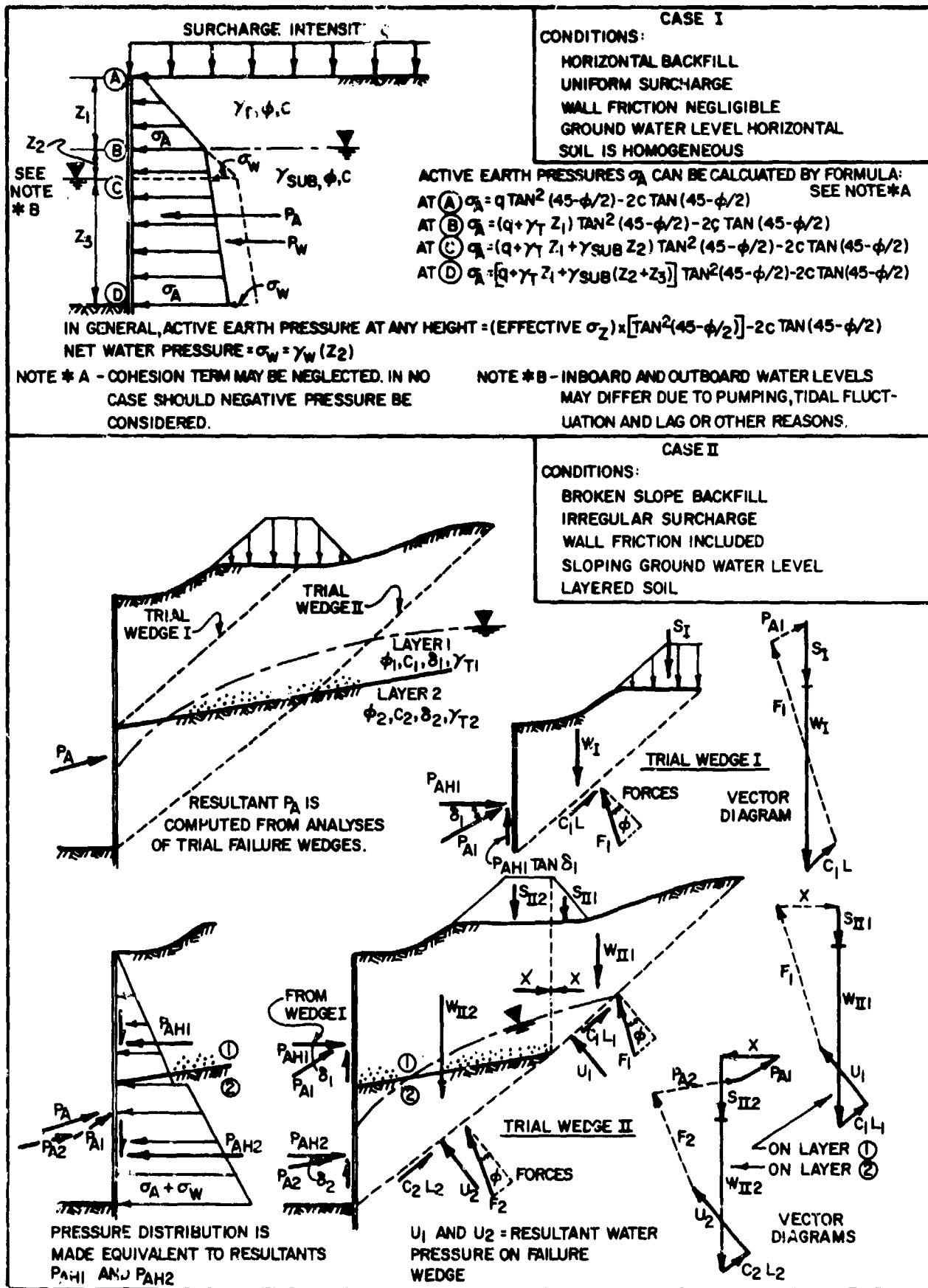
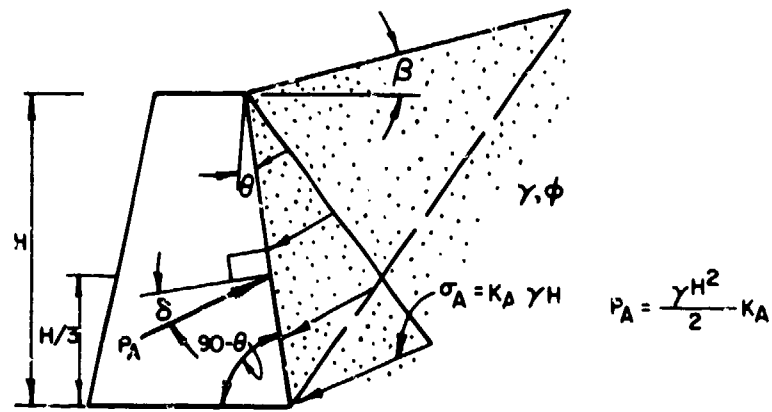
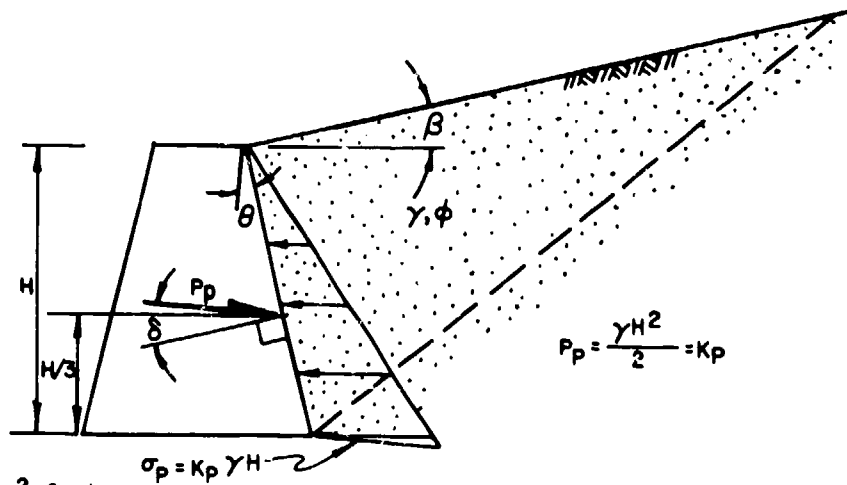


FIGURE 7
 Computation of General Active Pressures
 7.2-68



$$K_A = \frac{\cos^2(\phi - \theta)}{\cos^2 \theta \cos(\theta + \delta) \left[1 + \frac{\sin(\phi + \delta) \sin(\phi - \beta)}{\cos(\theta + \delta) \cos(\theta - \beta)} \right]^2}$$



$$K_P = \frac{\cos^2(\theta + \phi)}{\cos^2 \theta \cos(\theta - \delta) \left[1 - \frac{\sin(\phi + \delta) \sin(\phi + \beta)}{\cos(\theta - \delta) \cos(\theta - \beta)} \right]^2}$$

K_P VALUES ARE SATISFACTORY FOR $\delta \leq \phi/3$ BUT ARE UNCONSERVATIVE FOR $\delta > \phi/3$ AND THEREFORE SHOULD NOT BE USED.

FIGURE 8
Coefficients K_A and K_P for Walls with Sloping Wall and Friction, and Sloping Backfill

Compute resultant passive force by trial failure wedge analysis. (See Figure 9). When wall friction is included, compute pressures from a failing mass bounded by a circular arc and straight plane. Determine location of passive resultant by summing moments about toe of wall of all forces on that portion of the failing mass above the circular arc. Depending on complexity of cross section, distribute passive pressures to conform to location of resultant, or analyze trial failure surfaces at intermediate heights in the passive zone. When wall friction is neglected, the trial failure surface is a straight plane. See Figure 2.

(1) Simple Cross Section. For a simple cross section behind a wall, analyze the trial failure plane extending upward from the lowest point of the active zone on the wall. Determine the location of the active resultant by summing moments of all forces on the wedge about toe of wedge. Distribute active pressures to conform to the location of resultant.

(2) Complicated Cross Section. For complicated cross sections, analyze trial wedges at intermediate heights above the base of the active zone to determine pressure distribution in more detail. Force acting on an increment of wall height equals difference in resultant forces for wedges taken from the top and bottom of that increment.

3. EFFECT OF GROUNDWATER CONDITIONS. Include in pressure computations the effect of the greatest unbalanced water head anticipated to act across the wall.

a. General Conditions. For a major structure, analyze seepage and drainage effect by flow net procedures. Uplift pressures influencing wall forces are those acting on failure surface of active or passive wedge. Resultant uplift force on failure surface determined from flow net is applied in force diagram of the failure wedge. See vector U, the resultant water force, in Figures 7 and 9.

b. Static Differential Head. Compute water pressures on walls as shown in top panel of Figure 10.

c. Rainfall on Drained Walls. For cohesionless materials, sustained rainfall increases lateral force on wall 20 to 40 percent over dry backfill, depending on backfill friction angle. The center panel of Figure 10 (Reference 3, Contribution to the Analysis of Seepage Effects in Backfills, by Gray) shows flow net set up by rainfall behind a wall with vertical drain. This panel gives the magnitude of resultant uplift force on failure wedge for various inclinations of failure plane to be used in analysis of the active wedge.

d. Seepage Beneath Wall. See bottom panel of Figure 10 (Reference 4, The Effect of Seepage on the Stability of Sea Walls, by Richart and Schmertmann) for correction to be applied to active and passive pressures in cohesionless material for steady seepage beneath a wall.

4. SURCHARGE LOADING. For the effects of surcharge loading, see Figures 7 and 9.

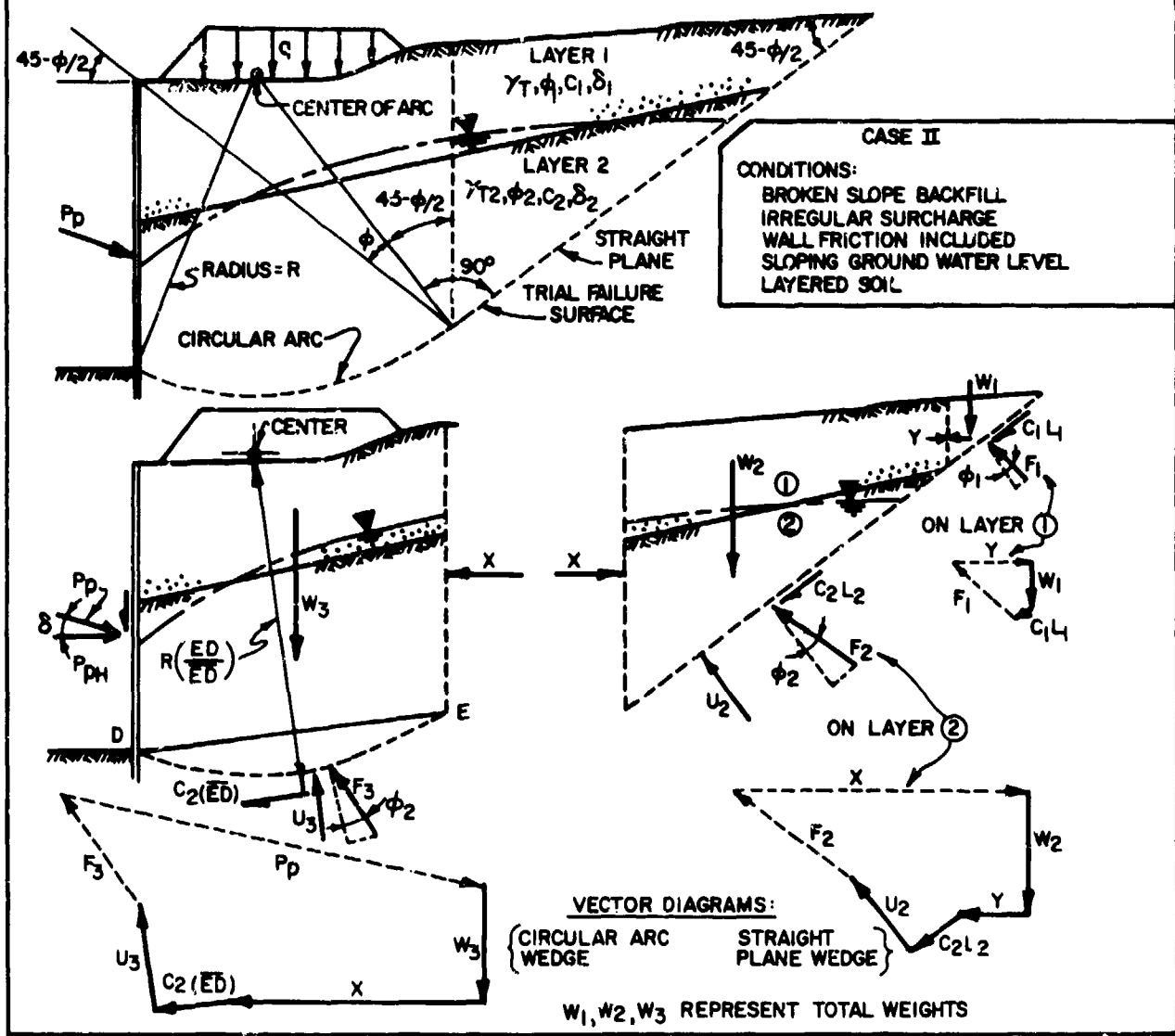
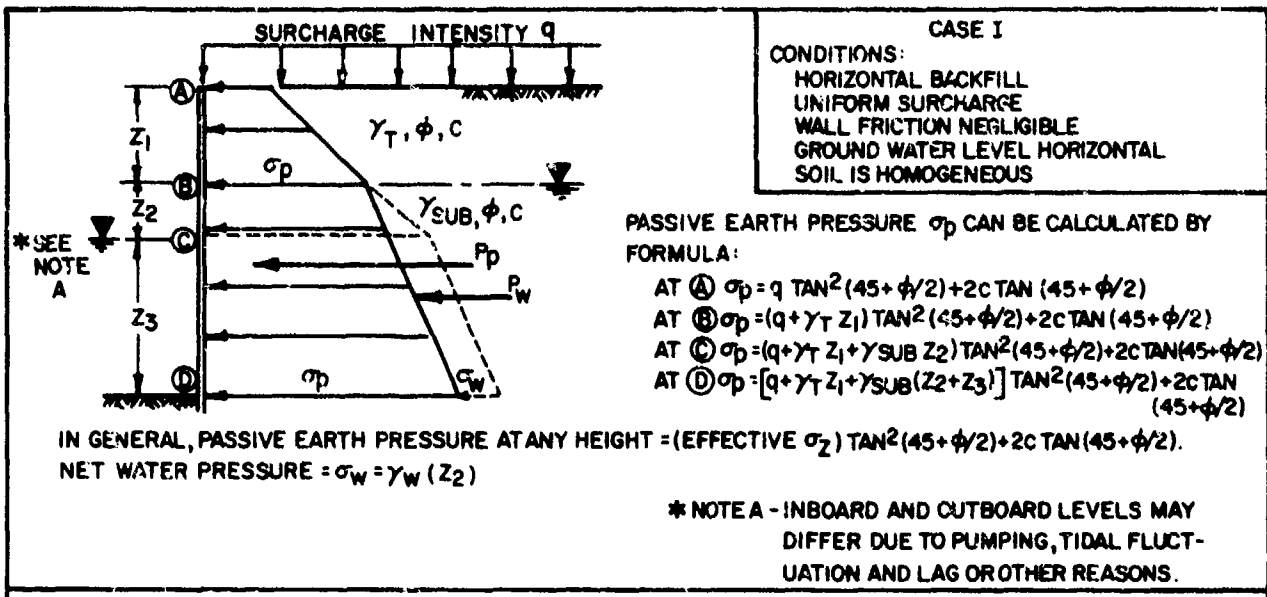


FIGURE 9
 Computation of General Passive Pressures
 7.2-71

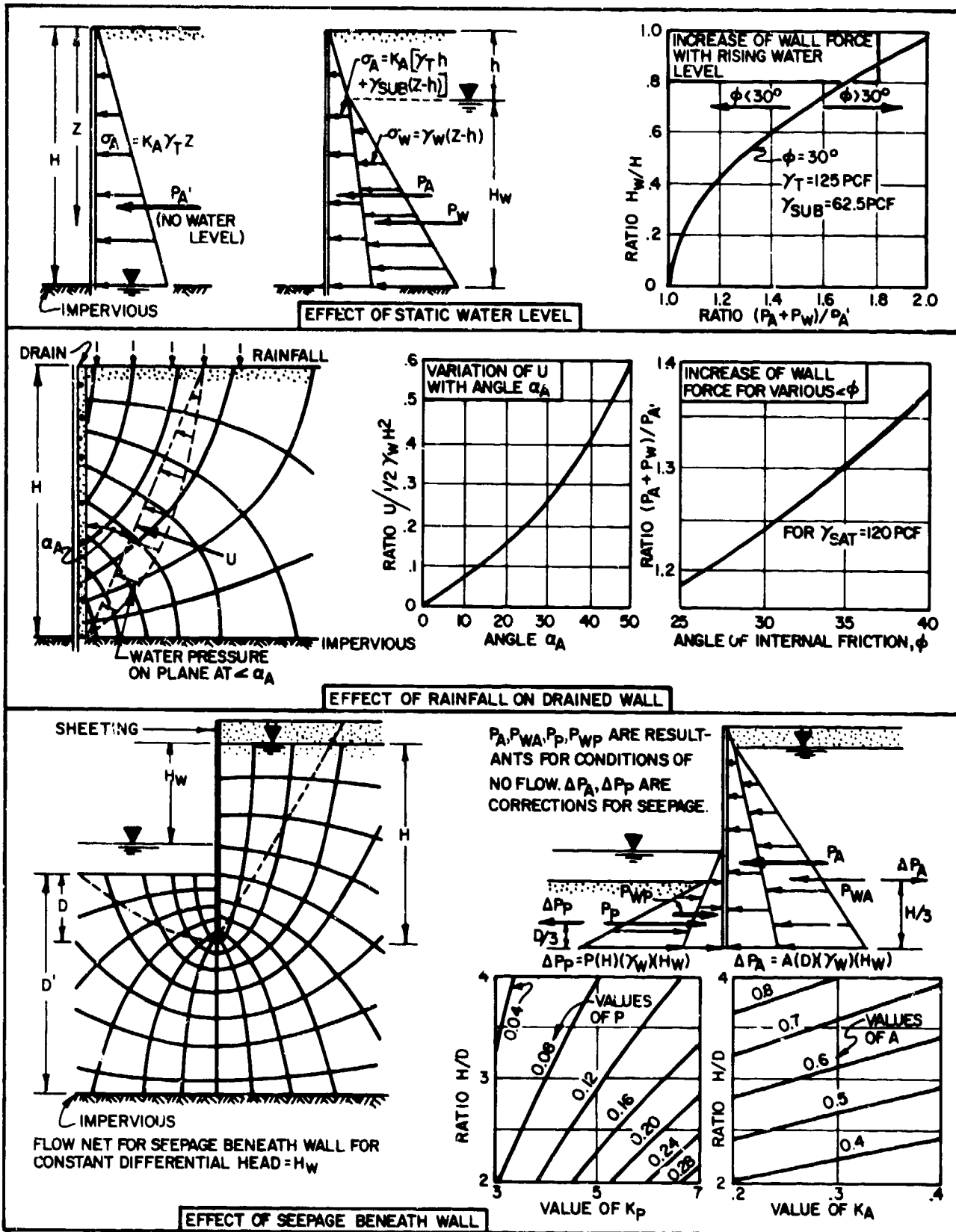


FIGURE 10
Effect of Groundwater Conditions on Wall Pressures

a. Point Load and Live Load. Use Figure 11 (Reference 5, Anchored Bulkheads, based on the work by Terzaghi) to compute lateral pressure on wall due to point load and line loads; this assumes an unyielding rigid wall and the lateral pressures are approximately double the values obtained by elastic equations. The assumption of an unyielding rigid wall is conservative and its applicability should be evaluated for each specific wall.

b. Uniform Loading Area. For uniform surcharge loading lateral stress can be computed by treating the surcharge as if it were backfill and multiplying the vertical stress at any depth by the appropriate earth pressure coefficient.

c. Uniform Rectangular Surcharge Loading. For the effect of this loading see Figure 12 (see Reference 6, Lateral Support Systems and Underpinning, Volume 1, Design and Construction (Summary), by Goldberg, et al.). If the construction procedures are such that the wall will move during the application of live loads, then the pressure calculated from Figure 12 will be conservative.

d. Practical Considerations. For design purposes, it is common to consider a distributed surface load surcharge on the order of 300 psf to account for storage of construction materials and equipment. This surcharge is usually applied within a rather limited work area of about 20 feet to 30 feet from the wall and is also intended to account for concentrated loads from heavy equipment (concrete trucks, cranes, etc.) located more than about 20 feet away. If such equipment is anticipated within a few feet of the wall, it must be accounted for separately.

5. WALL MOVEMENT. For the effect of wall movement on the earth pressure coefficients, see Figure 1.

a. Wall Rotation. When the actual estimated wall rotation is less than the value required to fully mobilize active or passive conditions, adjust the earth pressure coefficients by using the diagram on the upper right hand corner of Figure 1. Relatively large movements are required to mobilize the passive resistance. A safety factor must be applied to the ultimate passive resistance in order to limit movements.

b. Wall Translation. Wall uniform translation required to mobilize ultimate passive resistance or active pressure is approximately equivalent to movement of top of wall based on rotation criteria given in Figure 1.

c. Internally Braced Flexible Wall. Sheet piling on cuts rigidly braced at the top undergoes insufficient movement to produce fully active conditions. Horizontal pressures are assumed to be distributed in a trapezoidal diagram. (See Section 4.) The resultant force is higher than theoretical active force. For clays, the intensity and distribution of horizontal pressures depend on the stability number $N_0 = \gamma H/c$. (See Section 4.)

d. Tied Back Walls. Soil movement associated with prestressed tied back walls is usually less than with internally braced flexible walls, and design pressures are higher. (See Section 4.)

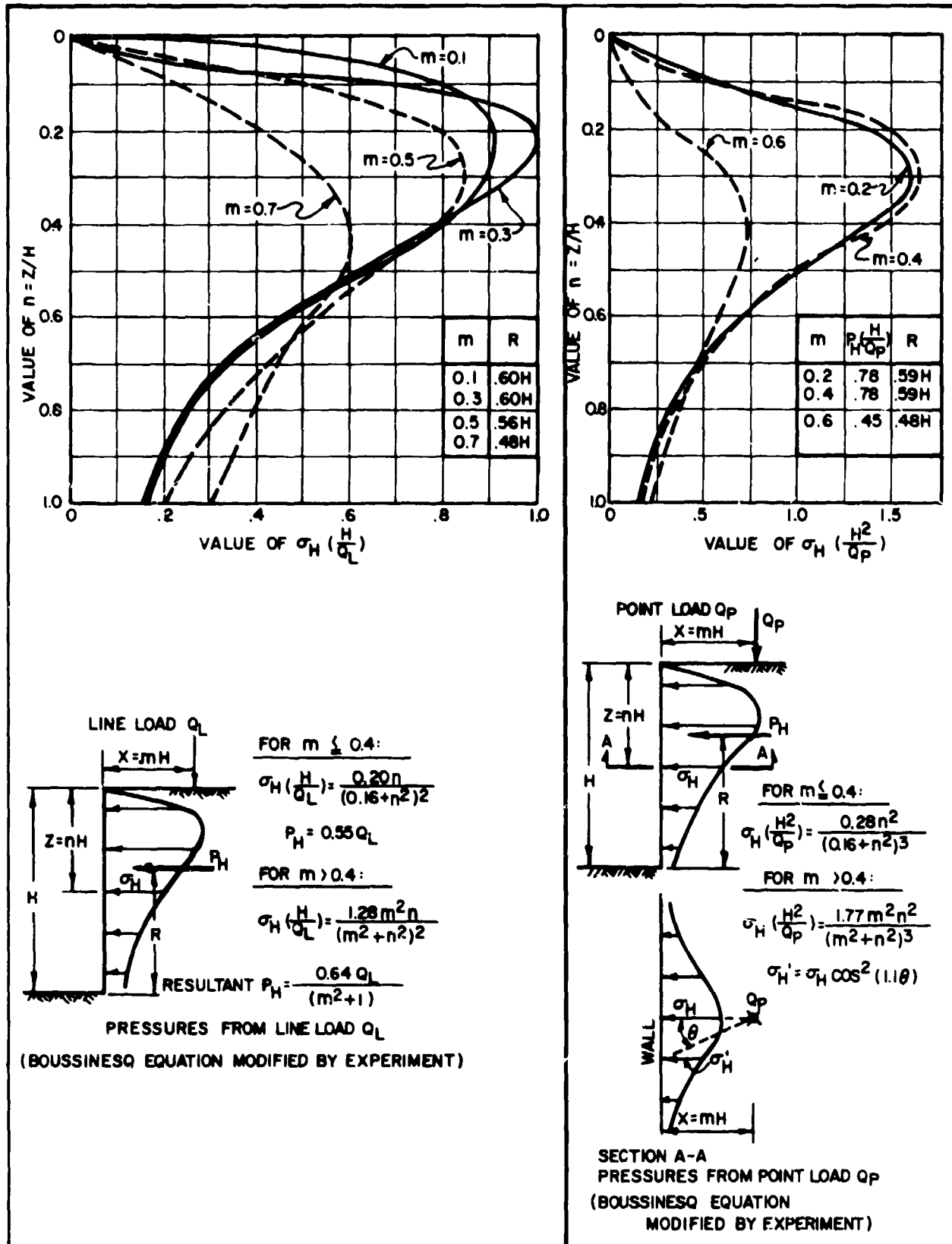


FIGURE 11
Horizontal Pressures on Rigid Wall from Surface Load

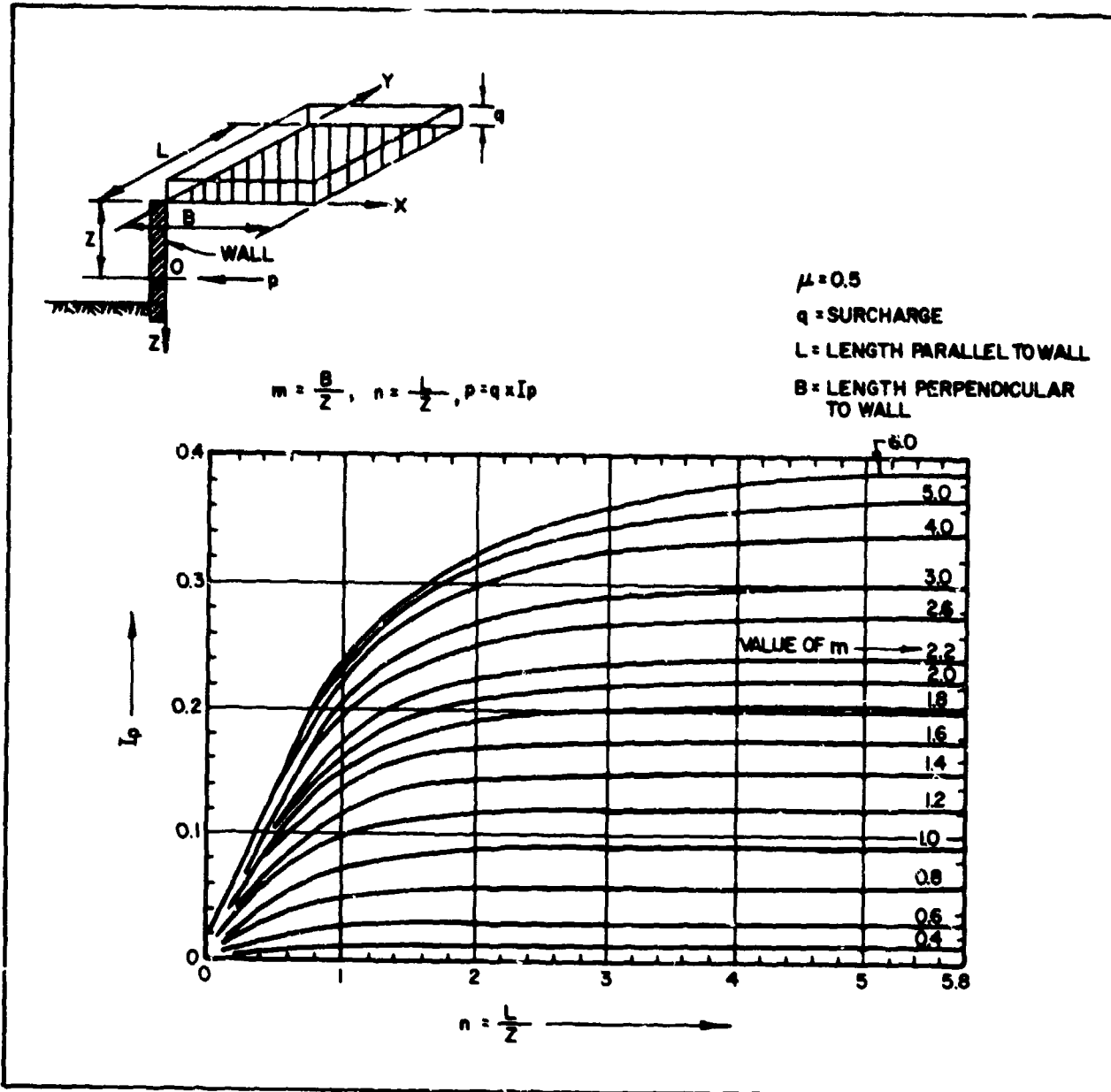


FIGURE 12
 Lateral Pressure on an Unyielding Wall due to
 Uniform Rectangular Surface Load

e. Restrained Walls. If a wall is prevented from even slight movement, then the earth remains at or near the value of at-rest conditions. The coefficient of earth pressure at-rest, K_0 , for normally consolidated cohesive or granular soils is approximately:

$$K_0 = 1 - \sin \theta'$$

where: θ' = effective friction angle

Thus for $\theta' = 30^\circ$, $K_0 = 0.5$.

For over-consolidated soils and compacted soils the range of K_0 may be on the order of 1.0. In cohesionless soils, full at-rest pressure will occur only with the most rigidly supported wall. In highly plastic clays, soil may creep, and if wall movement is prevented, at-rest conditions may redevelop even after active pressures are established.

f. Basement and Other Below Grade Walls. Pressure on walls below grade may be computed based on restraining conditions that prevail, type of backfill, and the amount of compaction.

6. EFFECT OF CONSTRUCTION PROCEDURES.

a. Staged Construction. As earth pressures are influenced by wall movement, it is important to consider each stage of construction, especially with regard to brace placement and its effects.

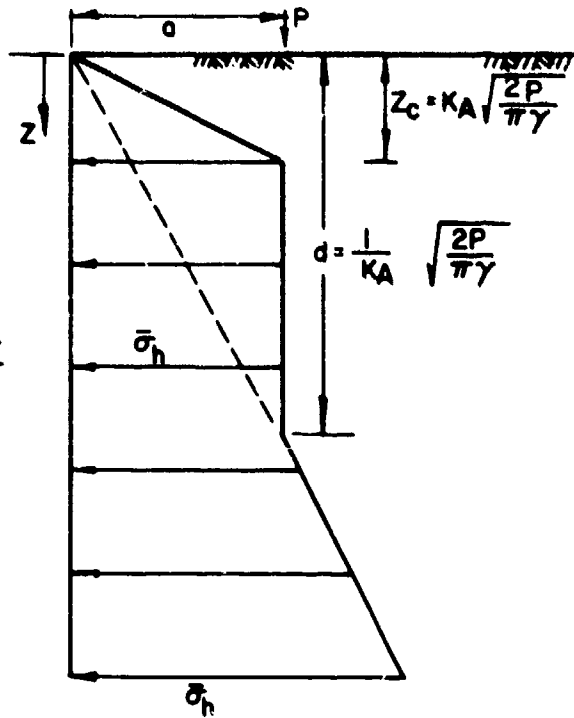
b. Compaction. Compaction of backfill in a confined wedge behind the wall tends to increase horizontal pressures beyond those represented by active or at-rest values. For guidance on horizontal pressure computations associated with the compaction of granular soil, see Figure 13 (after Reference 7, Retaining Wall Performance During Backfilling, by Ingold).

Clays and other fine-grained soils, as well as granular soils, with considerable amount of clay and silt (>15%) are not normally used as backfill material. Where they must be used, the earth pressure should be calculated on the basis of "at-rest" conditions or higher pressure with due consideration to potential poor drainage conditions, swelling, and frost action.

c. Hydraulic Fills. Active pressure coefficients for loose hydraulic fill materials range from about 0.35 for clean sands to 0.50 for silty fine sands. Place hydraulic fill by procedures which permit runoff of wash water and prevent building up large hydrostatic pressures. For further guidance see discussion on dredging in DM-7.3, Chapter 3.

7. EARTHQUAKE LOADING. The pressure during earthquake loading can be computed by the Coulomb theory with the additional forces resulting from ground acceleration. For further guidance on the subject see Reference 8, Design of Earth Retaining Structures for Dynamic Loads, by Seed and Whitman. A synopsis of some material from this Reference follows:

FOR $Z_c \leq Z \leq d$
 $\bar{\sigma}_h = \sqrt{\frac{2P\gamma}{\pi}} \cdot \frac{L}{a+L}$
 FOR $Z > d$
 $\bar{\sigma}_h = K_A \cdot \gamma \cdot Z$



P (ROLLER LOAD) = $\frac{\text{DEAD WT. OF ROLLER} + \text{CENTRIFUGAL FORCE}}{\text{WIDTH OF ROLLER}}$

a : DISTANCE OF ROLLER FROM WALL

L : LENGTH OF ROLLER

USE FIGURES 2, 3, 5 OR 6 FOR K_A

FIGURE 13
 Horizontal Pressure on Walls from Compaction Effort

(1) A simple procedure for determining the lateral force due to an earthquake is to compute the initial static pressure and add to it the increase in pressure from ground motion. For a vertical wall, with horizontal backfill slope, and θ of 35° , (which may be assumed for most practical cases involving granular fill), the earth pressure coefficient for dynamic increase in lateral force can be approximated as $3/4 k_h$, k_h being the horizontal acceleration in g's. The combined effect of static and dynamic force is:

$$P_{AE} = 1/2 \gamma H^2 K_A + 3/8 \gamma H^2 k_h$$

Assume the dynamic lateral force $P_E = 3/8 \gamma H^2 k_h$ acts at $0.6 H$ above the wall base. Effect of liquefaction is considered in DM-7.3, Chapter 1.

(2) For other soil and wall properties, the combined resultant active force:

$$P_{AE} = 1/2 H^2 K_A (\beta^*, \theta^*) (1 - k_v) F$$

where:

$$\beta^* = \beta + \psi = \text{modified slope of backfill}$$

$$\theta^* = \theta + \psi = \text{modified slope of wall back}$$

$$\psi = \tan^{-1} \frac{k_h}{1 - k_v}$$

$$F = \frac{\cos^2 \theta^*}{\cos \psi \cos^2 \theta}$$

$$k_v = \text{vertical ground acceleration in g's.}$$

For modified slope β^* and θ^* , obtain $K_A(\beta^*, \theta^*)$ from the applicable Figures 3 through 8. Determine F from Figure 14. Dynamic pressure increment ΔP_E can be obtained by subtracting P_A (also to be determined from Figures 3, 7, or 8 for given β and θ values) from P_{AE} . The resultant force will vary in its location depending on wall movement, ground acceleration, and wall batter. For practical purposes it may be applied at $0.6 H$ above the base.

(3) Unless the wall moves or rotates sufficiently, pressures greater than active case will exist and the actual lateral pressures may be as large as three times the value derived from Figure 14. In such situations, detailed analysis using numerical techniques may be desirable.

(4) Under the combined effect of static and earthquake load a factor of safety between 1.1 and 1.2 is acceptable.

(5) In cases where soil is below water, add the hydrodynamic pressure computed based on:

$$(P_w)_z = 1.5 k_h \gamma_w (h \cdot z)^{1/2}$$

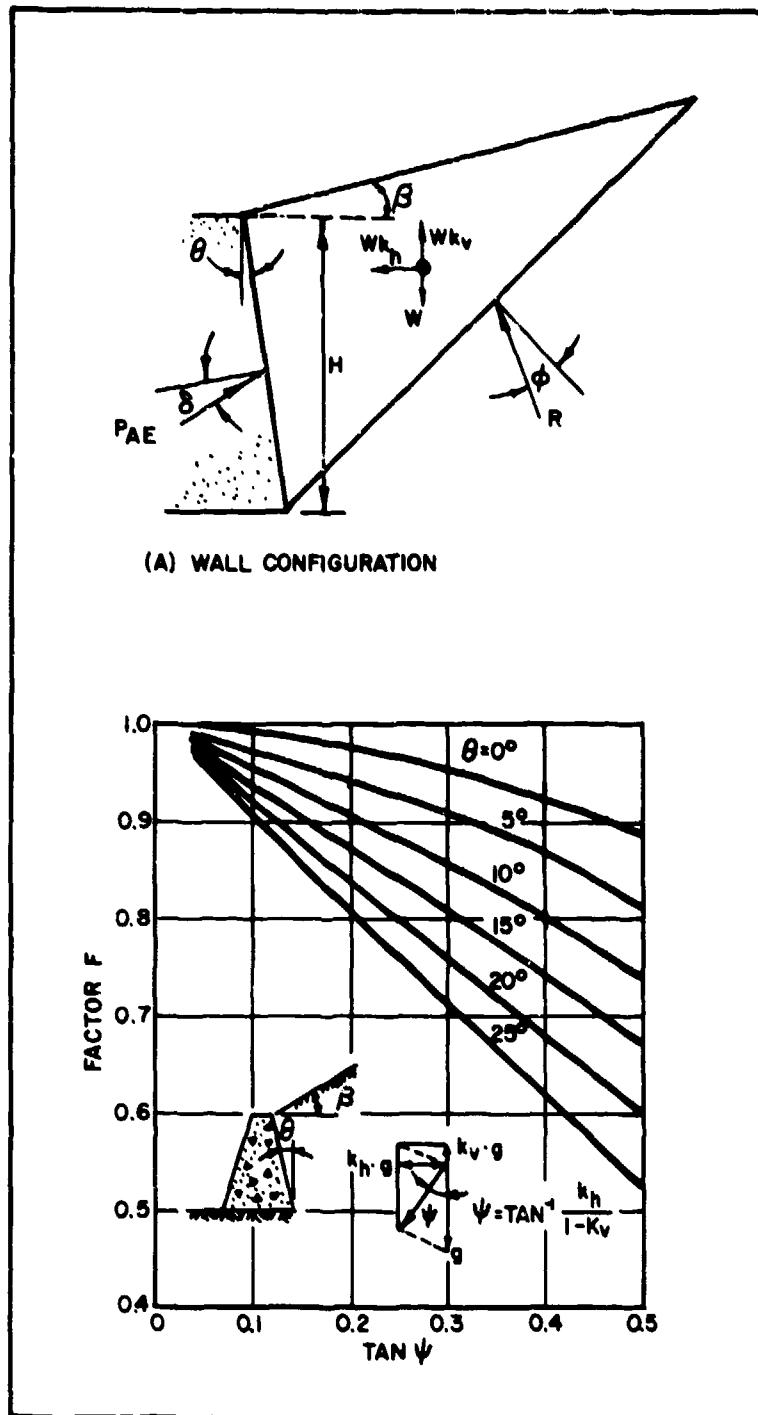
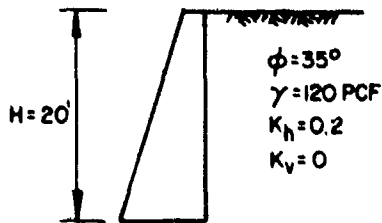


FIGURE 14(a)
 Values of F for Determination of Dynamic Lateral Pressure Coefficients

EXAMPLES:

CASE 1 - VERTICAL WALL WITH HORIZONTAL BACKFILL



COMBINED EFFECT OF STATIC AND DYNAMIC FORCE.

$$P_{AE} = F_1 + F_2$$

$$K_A = 0.27 \text{ (FROM FIGURE 2 FOR } \phi = 35^\circ \text{)}$$

$$F_1 = 1/2 \gamma H^2 K_A =$$

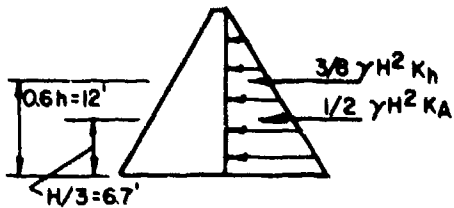
$$1/2 (120)(20)^2 (0.27) = 6480 \text{ LB}$$

RESULTANT ACTING AT A DISTANCE OF $H/3 = 6.7'$ FROM BASE OF WALL

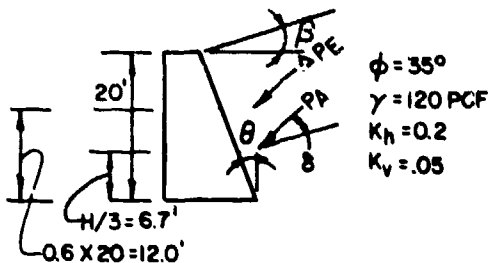
$$F_2 = 3/8 \gamma H^2 K_h =$$

$$3/8 (120)(20)^2 (0.2) = 3600 \text{ LB.}$$

ACTING AT $1/2 H = 10'$ FROM BASE OF WALL



CASE 2 - SLOPING WALL WITH SLOPING BACKFILL



$$\psi = \tan^{-1} \frac{0.2}{1-0.05} = 12^\circ$$

$$\tan \psi = 0.21$$

$$\theta = 10^\circ$$

$$\beta = 15^\circ$$

$$F = 0.9 \text{ (FROM FIGURE 14a)}$$

ASSUME A SMOOTH WALL, $\delta = 0$

$$\theta^* = \theta + \psi = 10 + 12 = 22^\circ$$

$$\beta^* = \beta + \psi = 15 + 12 = 27^\circ$$

FROM THE EQUATION IN FIGURE 8 $K_A(\beta, \theta^*) = \frac{\cos^2(35-22)}{\cos^2 22 \cos 22 \left[1 + \frac{\sin 35 \sin(35-27)}{\cos 22 \cos(22-27)} \right]^2} = 0.71$

$$K_A(\beta, \theta) = 0.41, P_A = 1/2 \times (120) \times (20)^2 \times 0.41 = 9840 \text{ LB.}$$

$$P_{AE} = 1/2 \gamma H^2 K_A (1 - K_V) F$$

$$= 1/2 (120)(20)^2 (0.71)(1-0.05)(0.9) = 14569 \text{ LB.}$$

$$\Delta P_E = 14569 - 9840 = 4729 \text{ LB.}$$

FIGURE 14(b)

Example Calculations for Dynamic Loading on Walls

where: p_w = hydrodynamic pressure at depth z below water surface
 γ_w = unit weight of water
 h = depth of water
 z = depth below the water surface

(6) Add the other inertia effect of the structure itself for calculating the required structural strength. An optimum design is to select the thinnest section with the largest bending and shear resistance (i.e. most flexible).

(7) When applying this earthquake loading analysis to existing earth retaining structures, particularly where high groundwater levels exist, it may be found that resulting safety factor is less than 1.1. In such cases, proposed corrective measures must be submitted to NAVFAC HQ for review and approval.

8. FROST ACTION. Lateral forces due to frost action are difficult to predict and may achieve high values.

Backfill materials such as silts and clayey silts (CL, MH, ML, OL) are frost susceptible, and will exert excessive pressure on wall if proper precautions are not taken to curb frost. Swelling pressures may be exerted by clays of high plasticity (CH). Under these conditions, design for active pressures is inadequate, even for yielding walls, as resulting wall movement is likely to be excessive and continuous. Structures usually are not designed to withstand frost generated stresses. Instead, provisions should be made so that frost related stresses will not develop or be kept to a minimum. Use of one or more of the following may be necessary:

(i) Permanently isolate the backfill from sources of water either by providing a very permeable drain or a very impermeable barrier.

(ii) Provide pervious backfill and weep holes. (See DM-7.1, Chapter 6 for the illustration on complete drainage and prevention of frost thrust.)

(iii) Provide impermeable soil layer near the soil surface, and grade to drain surface water away from the wall.

9. SWELLING ACTION. Expansion of clay soils can cause very high pressures on the back of a retaining structure. Clay backfills should be avoided whenever possible. Swelling pressures may be evaluated based on laboratory tests and wall designed to withstand swelling pressures. Providing granular non-expansive filter between the clay fill and back of wall diminishes swelling pressures and significantly limits access to moisture. Guidance on soil stabilization methods for control of heave are given in DM-7.3, Chapter 3. Complete drainage (see DM-7.1, Chapter 6) is one of the techniques to control heave.

10. SELECTION OF STRENGTH PARAMETERS. The choice of strength parameters is governed by the soil permeability characteristics, boundary drainage and loading conditions, and time.

a. Saturated Cohesive Soils. For saturated cohesive soils of low permeability, where sufficient time is not available for complete drainage, use undrained shear strength, and total stress for earth pressure computations. Such condition will exist during and immediately after completion of construction.

b. Coarse-grained Soils. In coarse-grained soils such as sand, which have high permeability, use effective stress strength parameter θ' , for earth pressure computations. Also, where sufficient time is available for the dissipation of pore pressure in less than pervious soil, use effective stress strength parameters c' and θ' . In this case, pore pressure is hydrostatic and can be estimated fairly accurately.

In soils such as silt and clayey sand, where partial drainage occurs during the time of construction, perform analysis for limiting conditions, i.e. effective stress with θ' only, total stress with c , and design for the worst case.

Section 3. RIGID RETAINING WALLS

1. GENERAL CRITERIA. Rigid retaining walls are those that develop their lateral resistance primarily from their own weight. Examples of rigid structures are concrete gravity walls, thick concrete slurry walls, gabion walls, and some reinforced earth walls reinforced for limited movements. Theoretical wall pressures are discussed in Section 2. Requirements for resistance against overturning and sliding of four principal wall types are given in Figure 15. Evaluate overall stability against deep foundation failure. (See DM-7.1, Chapter 7.) Determine allowable bearing pressures on the base of the wall (see Chapter 4).

a. Sliding Stability. Place the base at least 3 ft below ground surface in front of the wall and below depth of frost action, zone of seasonal volume change, and depth of scour. Sliding stability must be adequate without including passive pressure at the toe. If insufficient sliding resistance is available, increase base width, provide pile foundation or, lower base of wall and consider passive resistance below frost depth. If the wall is supported by rock or very stiff clay, a key may be installed below the foundation to provide additional resistance to sliding (see Figure 15).

b. Settlement and Overturning. For walls on relatively incompressible foundations, apply overturning criteria of Figure 15. If foundation is compressible, compute settlement by methods of DM-7.1, Chapter 5 and estimate tilt of rigid wall from the settlement. If the consequent tilt will exceed acceptable limits, proportion the wall to keep the resultant force at the middle third of base. If a wall settles such that the resulting movement forces it into the soil which it supports, then the lateral pressure on the active side increases substantially.

c. Overall Stability. Where retaining walls are underlain by weak soils, the overall stability of the soil mass containing the retaining wall should be checked with respect to the most critical surface of sliding (see DM-7.1, Chapter 7). A minimum factor of safety of 2.0 is desirable.

TYPE OF WALL	LOAD DIAGRAM	DESIGN FACTORS
GRAVITY		<p><u>LOCATION OF RESULTANT</u></p> <p>MOMENTS ABOUT TOE:</p> $d = \frac{W a + P_v e - P_H b}{W + P_v}$ <p>ASSUMING $P_p = 0$</p> <p><u>OVERTURNING</u></p> <p>MOMENTS ABOUT TOE:</p> $F_s = \frac{W a}{P_H b - P_v e} \geq 1.5$
SEMIGRAVITY		<p>IGNORE OVERTURNING IF R IS WITHIN MIDDLE THIRD (SOIL), MIDDLE HALF (ROCK). CHECK R AT DIFFERENT HORIZONTAL PLANES FOR GRAVITY WALLS.</p> <p><u>RESISTANCE AGAINST SLIDING</u></p> $F_s = \frac{(W + P_v) \tan \delta + C_a B}{P_H} \geq 1.5$ $F_s = \frac{(W + P_v) \tan \delta + C_a B + P_p}{P_H} \geq 2.0$ $F = (W + P_v) \tan \delta + C_a B$
CANTILEVER		<p>FOR COEFFICIENTS OF FRICTION BETWEEN BASE AND SOIL SEE TABLE - I</p> <p>C_a = ADHESION BETWEEN SOIL AND BASE $\tan \delta$ = FRICTION FACTOR BETWEEN SOIL AND BASE</p> <p>W = INCLUDES WEIGHT OF WALL AND SOIL IN FRONT FOR GRAVITY AND SEMIGRAVITY WALLS. INCLUDES WEIGHT OF WALL AND SOIL ABOVE FOOTING, FOR CANTILEVER AND COUNTERFORT WALLS.</p>
COUNTERFORT		<p><u>CONTACT PRESS. RE ON FOUNDATION</u></p> <p>FOR ALLOWABLE BEARING PRESSURE FOR INCLINED LOAD ON STRIP FOUNDATION, SEE CHAPTER 4. FOR ANALYSIS OF PILE LOADS BENEATH STRIP FOUNDATION, SEE CHAPTER 7.</p> <p><u>OVERALL STABILITY</u></p> <p>FOR ANALYSIS OF OVERALL STABILITY, SEE DM-71, CHAPTER 7.</p>

FIGURE 15
Design Criteria for Rigid Retaining Walls

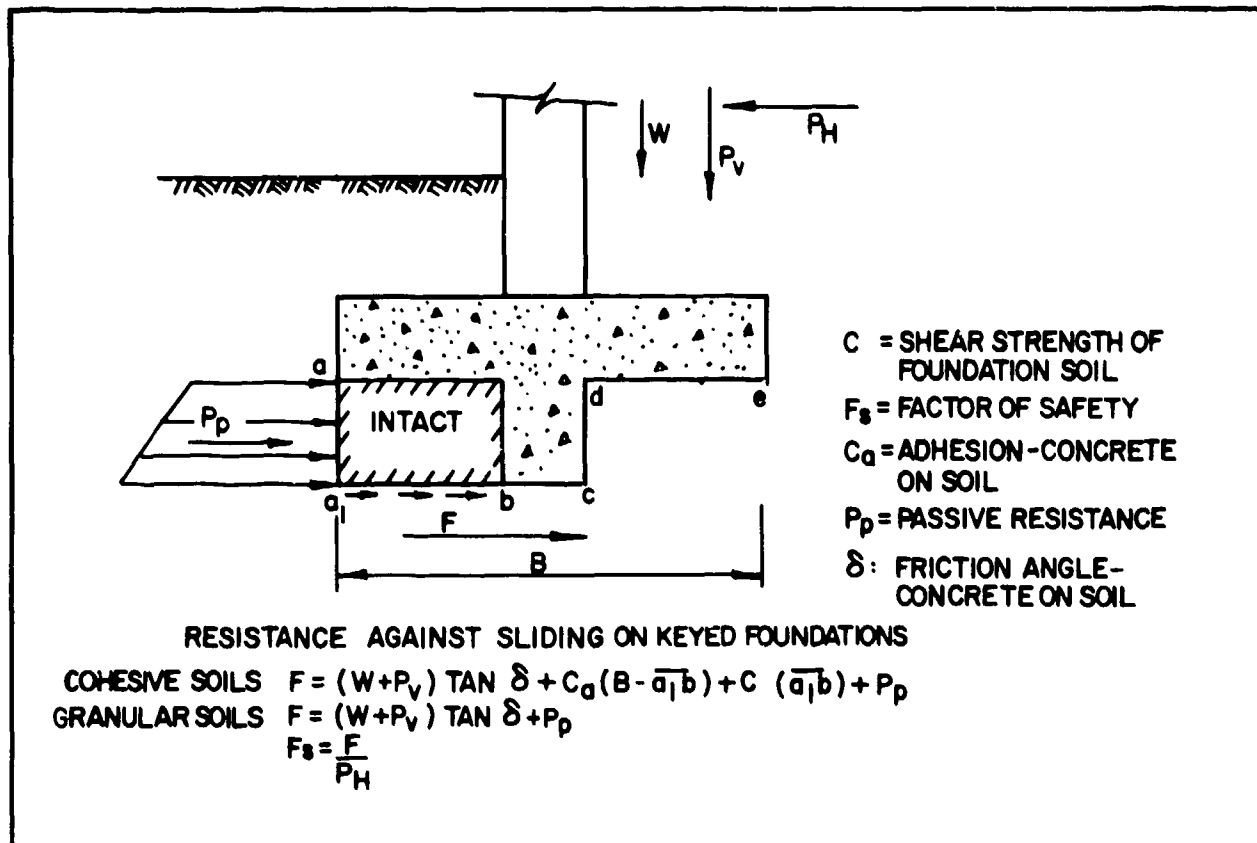


FIGURE 15 (continued)
Design Criteria for Rigid Retaining Walls

d. Drainage. Positive drainage of backfill is desirable. (See DM-7.1, Chapter 6 for drainage design.) As a minimum, provide weep holes with pockets of coarse-grained material at the back of the wall. An impervious surface layer should cover the backfill, and a gutter should be provided for collecting runoff.

2. LOW WALLS. It has been the practice of the Naval Facilities Engineering Command to consider walls less than 12 feet in height "low walls." For these, knowledge of soil properties could be adequate for design, and detailed testing and elaborate pressure computations may not be justified economically.

a. Equivalent Fluid Pressures. Use equivalent fluid pressures of Figure 16 (Reference 9, Soil Mechanics in Engineering Practice, by Terzaghi and Peck) for straight slope backfill and of Figure 17 (Reference 9) for broken slope backfill. Include dead load surcharge as an equivalent weight of backfill. For resultant force of line load surcharge, see bottom left panel of Figure 11. If a wall rests on a compressible foundation and moves downward with respect to the backfill, increase pressures by 50 percent.

b. Drainage. The equivalent fluid pressures include effects of seepage and time conditioned changes in the backfill. However, provisions should be made to prevent accumulation of water behind the wall. As a minimum, provide weep holes for drainage. Cover backfill of soil types 2 and 3 (Figure 16) with a surface layer of impervious soil.

Section 4. DESIGN OF FLEXIBLE WALLS

1. ANCHORED BULKHEADS. Anchored bulkheads are formed of flexible sheeting restrained by tieback and by penetration of sheeting below dredge line. See Figure 18 for design procedures for three common penetration conditions.

a. Wall Pressures. Compute active and passive pressures using the appropriate Figures 2 through 7. Determine required depth of penetration of sheeting and anchor pull from these pressures. See Figure 18 for guidance.

b. Wall Movements. Active pressures are redistributed on the wall by deflection, moving away from the position of maximum moment. Reduce the computed maximum moment to allow for flexibility of sheeting. Moment reduction is a function of the wall flexibility number. See Figure 19 (Reference 10, Anchored Sheet Pile Walls, by Rowe). Select sheeting size by successive approximations so that sheeting stiffness is compatible with reduced design moment.

c. Drainage. Include the effect of probable maximum differential head in computing wall pressures. Where practicable, provide weep holes or special drainage at a level above mean water to limit differential water pressures.

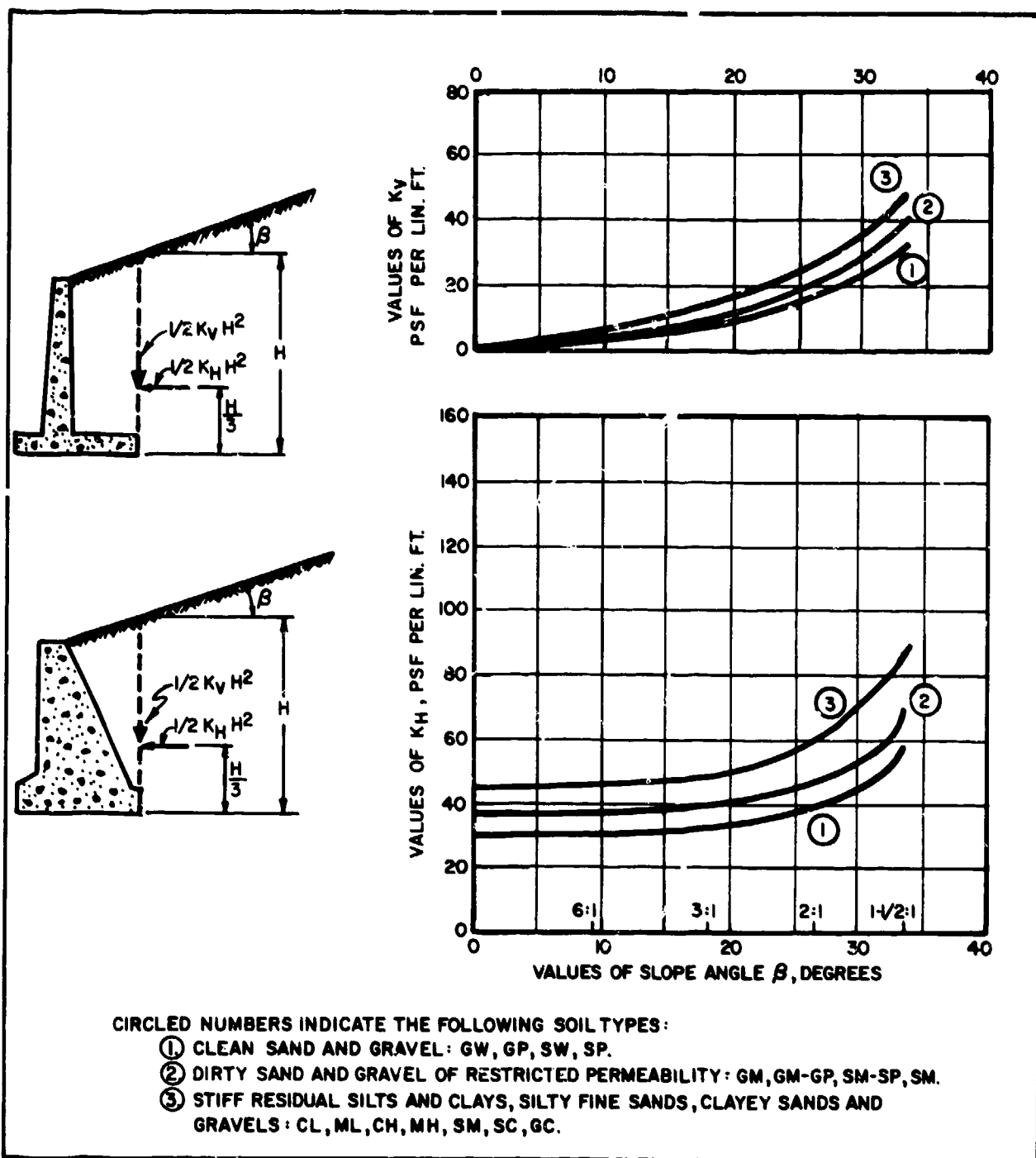
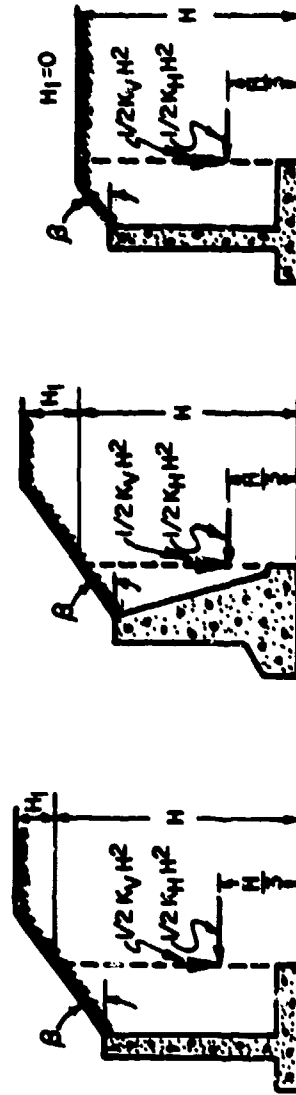
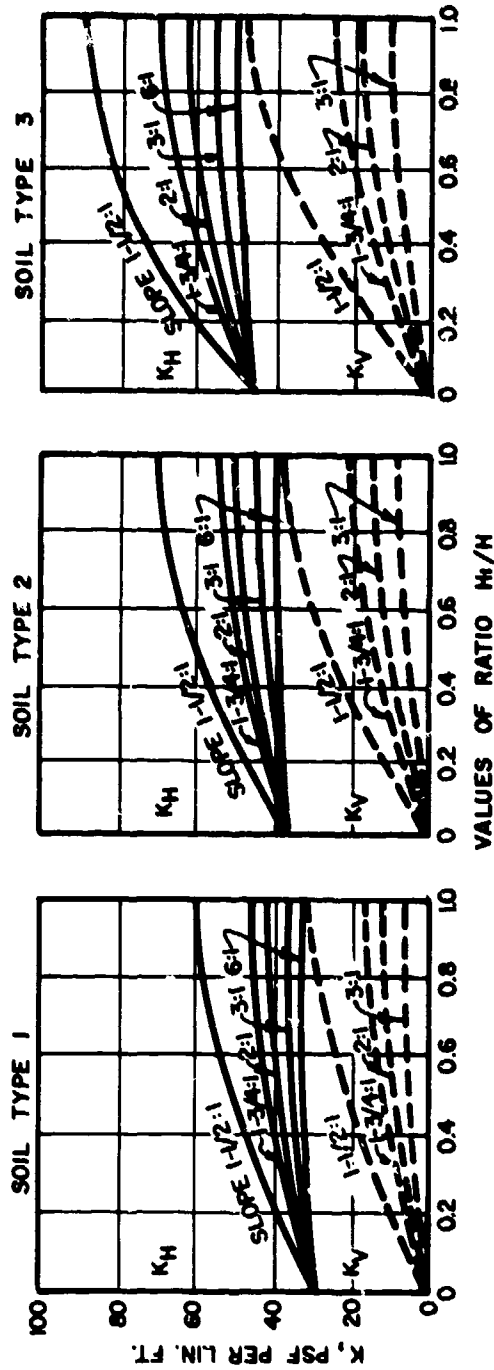


FIGURE 16
Design Loads for Low Retaining Walls (Straight Slope Backfill)



FOR DESCRIPTION OF SOIL TYPE SEE FIGURE 16

FIGURE 17
Design Loads for Low Retaining Walls (Broken Slope Backfill)

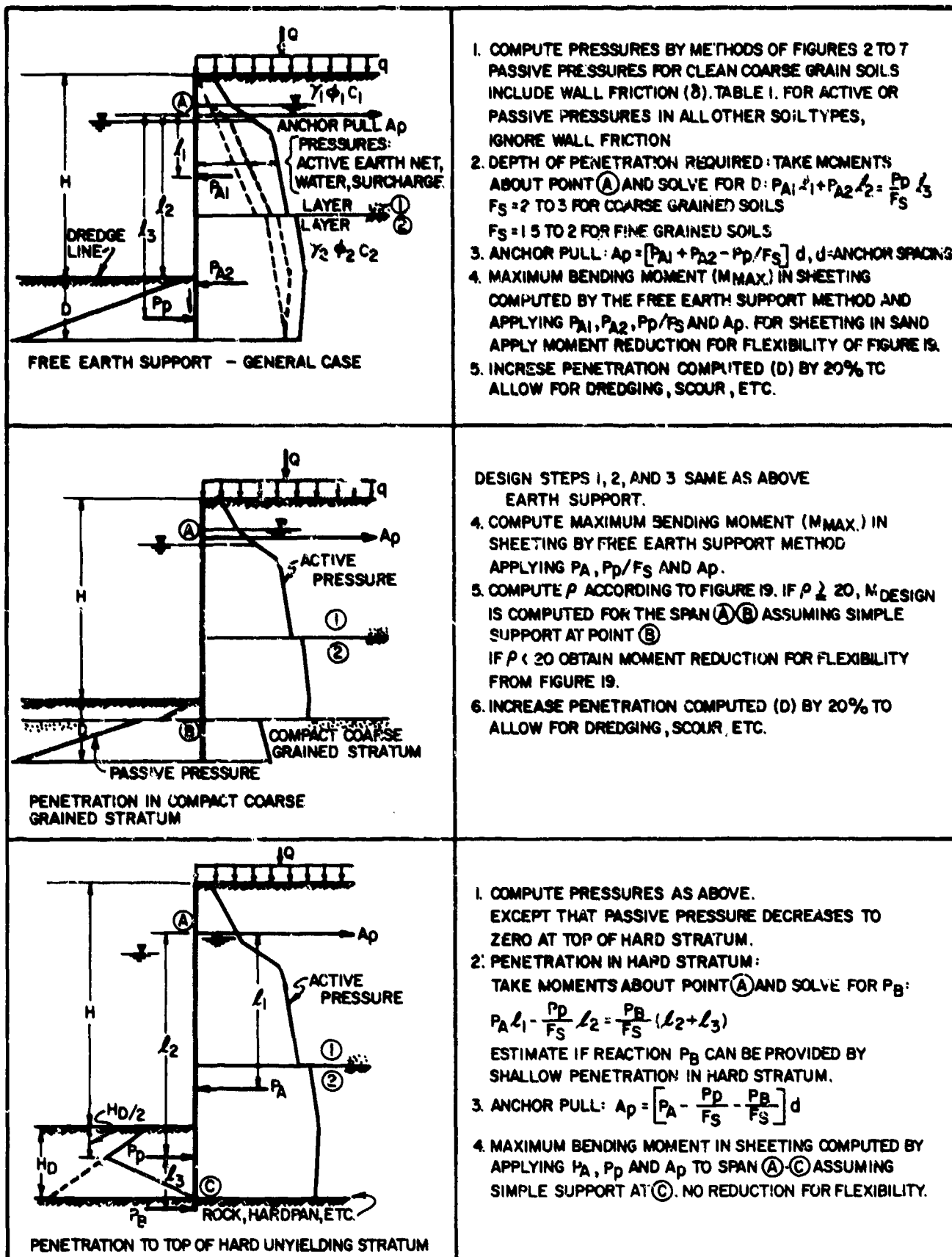
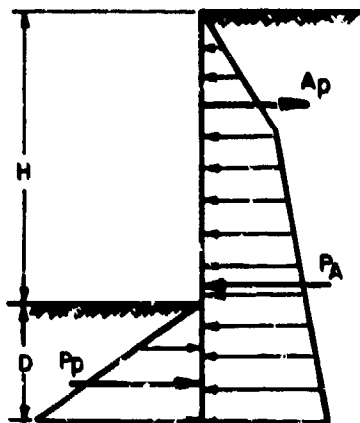
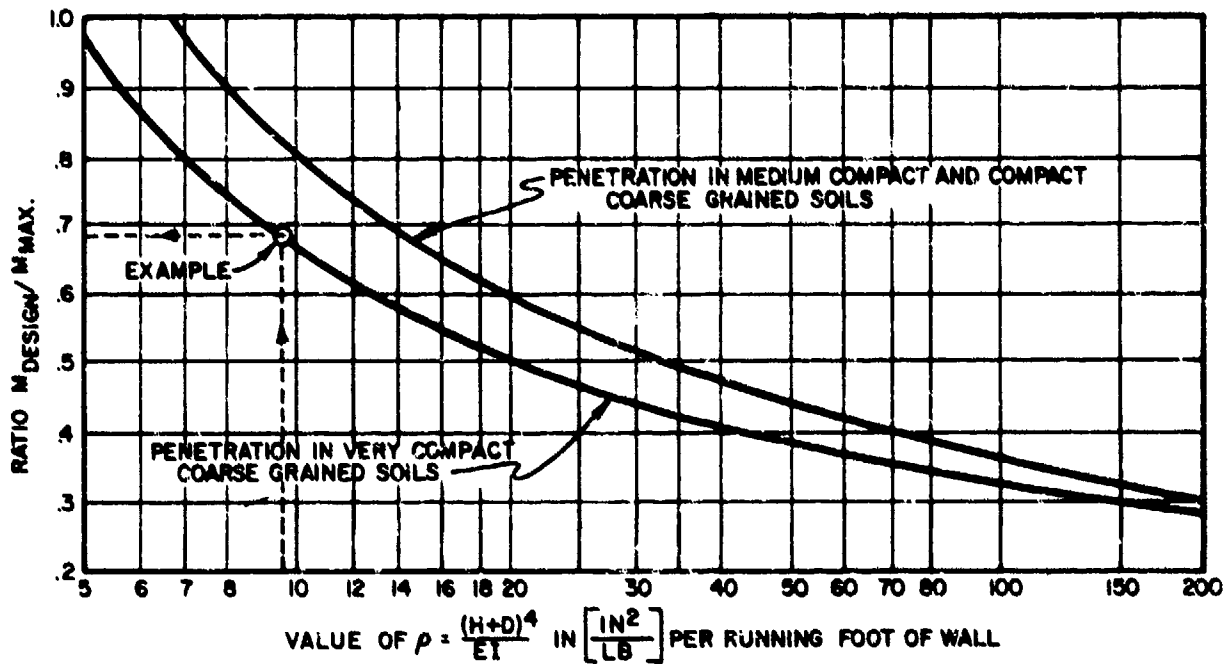
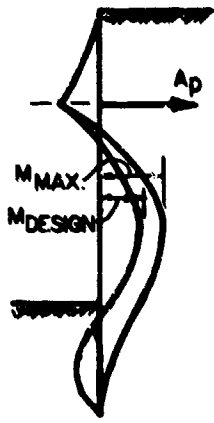


FIGURE 18
 Design Criteria for Anchored Bulkhead (Free Earth Support)



LOAD DIAGRAM



MOMENT DIAGRAM

EXAMPLE: PENETRATION IN VERY COMPACT SAND

$M_{MAX} = 950,000$ IN. LB/FT.

$H = 33$ FT, $D = 15$ FT.

$f_s = 25,000$ PSI, $E = 30,000,000$ PSI

TRY ZP 32, $I = 385.7$ IN.⁴, $S = 38.3$ IN.³

$$\rho = \frac{(33+15)^4 \times 12^4}{30,000,000 \times 385.7} = 9.5 \frac{IN^2}{LB}$$

$$\frac{M_{DESIGN}}{M_{MAX}} = 0.68, M_{DESIGN} = 645,000 \text{ IN. LB/FT}$$

$$f_s = \frac{M}{S} = \frac{645,000}{38.3} = 16,800 \text{ PSI}$$

16,800 < 25,000 PSI

TRY A SMALLER SECTION.

LEGEND

M_{MAX} = MAXIMUM POSITIVE MOMENT IN SHEETING COMPUTED BY METHODS OF FIGURE 18.

M_{DESIGN} = MAXIMUM POSITIVE MOMENT FOR DESIGN OF SHEETING.

ρ = FLEXIBILITY NUMBER = $\frac{(H+D)^4}{EI}$, E = SHEETING MODULUS OF ELASTICITY, PSI
 I = SHEETING MOMENT OF INERTIA, IN.⁴ PER RUNNING FOOT OF WALL.

NOTES

1. M_{DESIGN} IS OBTAINED BY SUCCESSIVE TRIALS OF SHEETING SIZE UNTIL MAX. BENDING STRESS IN SHEETING EQUALS ALLOWABLE BENDING STRESS.
2. NO REDUCTION IN M_{MAX} IS PERMITTED FOR PENETRATION IN FINE GRAINED SOILS OR LOOSE OR VERY LOOSE COARSE GRAINED SOILS.
3. FLEXIBILITY NUMBER IS COMPUTED ON THE BASIS OF LUBRICATED INTERLOCKS.

FIGURE 17

Reduction in Bending Moments in Anchored Bulkhead from Wall Flexibility

d. Anchorage System. Most of the difficulties with anchored bulkheads are caused by their anchorage. A tieback may be carried to a buried deadman anchorage, to pile anchorage, parallel wall anchorage, or it may be a drilled and grouted anchor (see DM-7.3, Chapter 3). See Figure 20 for criteria for design of deadman anchorage. If a deadman must be positioned close to a wall, anchorage resistance is decreased and an additional passive reaction is required for stability at the wall base. Protect tie rods by wrapping, painting, or encasement to resist corrosion. Where backfill will settle significantly or unevenly, to avoid loading by overburden, enclose tie rod in a rigid tube, providing vertical support if needed to eliminate sag.

e. Example of Computation. See Figure 21 for example of analysis of anchored bulkhead.

f. Construction Precautions. Precautions during construction are as follows:

(1) Removal of soft material, or placement of fill in the "passive" zone should precede the driving of sheet piles.

(2) Deposit backfill by working away from the wall rather than toward it to avoid trapping soft material adjacent to sheeting.

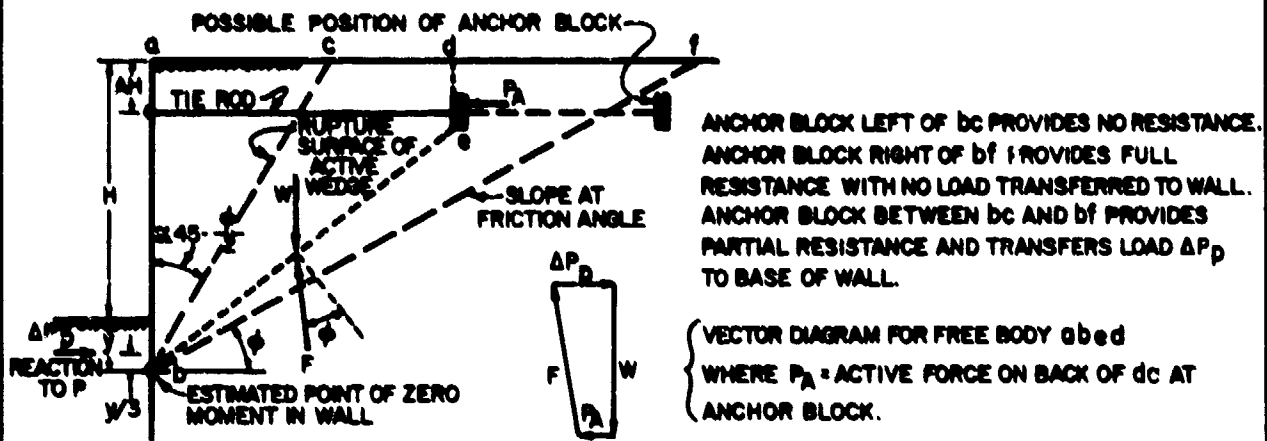
(3) Before anchorage is placed, sheeting is loaded as a cantilever wall, and safety during construction stages should be checked.

g. Sand Dike Backfill. When granular backfill is scarce, a sand dike may be placed to form a plug across the potential failure surface of the active wedge as shown in Figure 22. Where such a dike rests on firm foundation soil, the lateral pressure on the bulkhead will be only the active pressure of the dike material. For further guidance, see Reference 11, Foundations, Retaining and Earth Structures, by Tschebotarioff.

2. CANTILEVER SHEET PILE WALLS. A cantilever wall derives support from the passive resistance below the dredge line to support the active pressure from the soil above the dredge line without an anchorage. This type of wall is suitable only for heights up to about 15 feet and can be used only in granular soils or stiff clays. See Figure 23 for a method of analysis (after Reference 12, Steel Sheet Piling Design Manual, by U.S. Steel Corporation). For cohesive soils consider no negative pressure in tension zone. Figures 24 and 25 (Reference 12) may be used for simple cases.

3. INTERNALLY BRACED FLEXIBLE WALLS. To restrain foundation or trench excavations, flexible walls can be braced laterally as the excavation proceeds. This restrains lateral movement of the soil and cause loads on the braces which exceed those expected from active earth pressure. Braces may be either long raking braces or relatively short horizontal cross braces between trench walls. Design earth pressure diagram for internally braced flexible walls are shown in Figure 26 (after Reference 6) for excavations in sand, soft clay, or stiff clay.

EFFECT OF ANCHOR LOCATION
RELATIVE TO THE WALL



CONTINUOUS ANCHOR WALL LOCATED
BETWEEN RUPTURE SURFACE AND
SLOPE AT FRICTION ANGLE

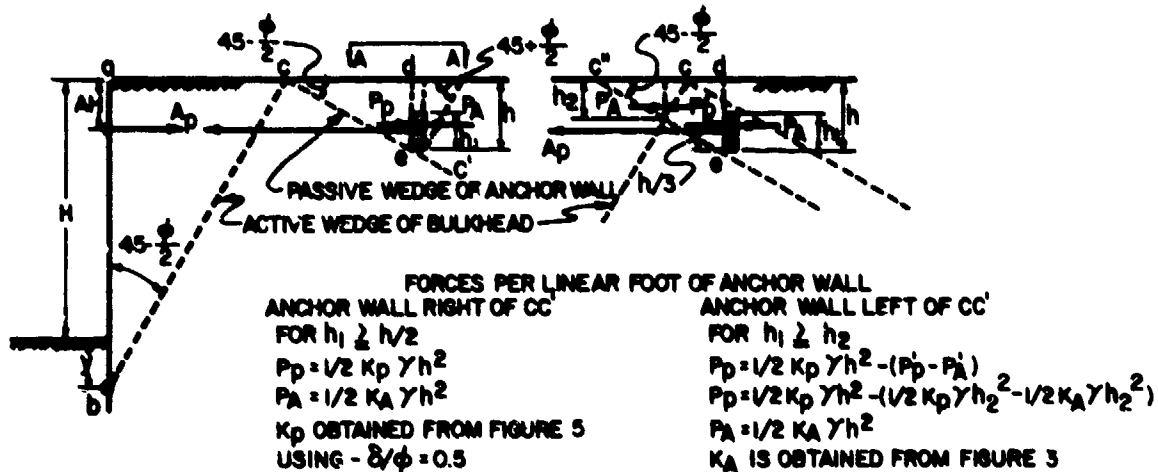
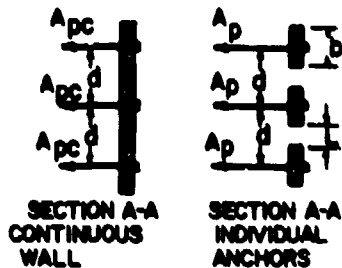


FIGURE 20
Design Criteria for Deadman Anchorage

EFFECT OF DEPTH AND SPACING
OF ANCHOR BLOCKS



ANCHOR RESISTANCE FOR $h_1 \geq \frac{d}{2}$

1. CONTINUOUS WALL:

ULTIMATE $A_{pc}/d = P_p - P_a$ WHERE A_{pc}/d IS ANCHOR RESISTANCE AND P_p, P_a TAKEN PER LINEAL FOOT OF WALL.

2. INDIVIDUAL ANCHORS:

IF $d > b+h$, ULTIMATE $A_p = b(P_p - P_a) + 2P_0 \tan \phi$, WHERE P_0 = RESULTANT FORCE OF SOIL AT REST ON VERTICAL AREA cde OR $c'de$.

IF $d = h+b$, A_p/d IS 70% OF A_{pc}/d FOR CONTINUOUS WALL.

L FOR THIS CONDITION IS L' AND $L' = h$.

IF $d < h+b$, $A_p/d = A_{pc}/d - \frac{1}{h} (.3 A_{pc}/d)$, $L' = h$.

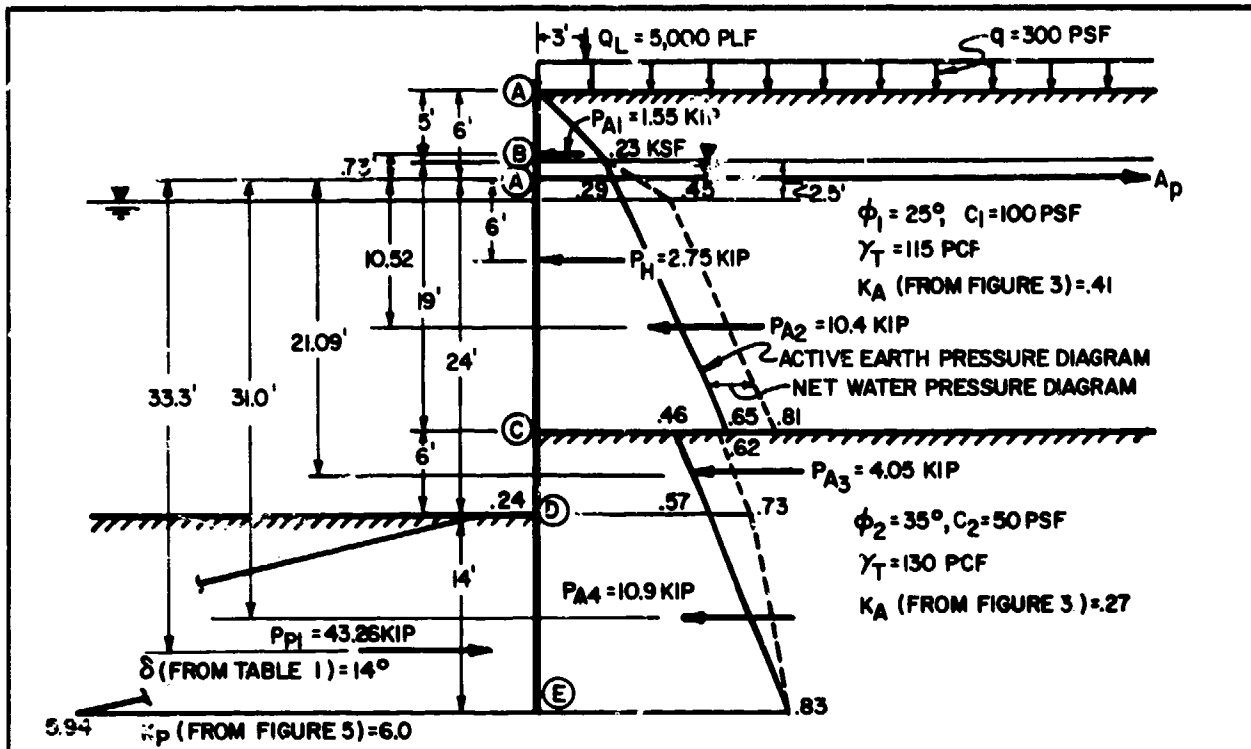
ANCHOR RESISTANCE FOR $h_1 < \frac{d}{2}$

ULTIMATE A_p/d OR A_{pc}/d EQUALS BEARING CAPACITY OF STRIP FOOTING OF WIDTH h_1 AND SURCHARGE LOAD $\gamma(h - \frac{d}{2})$, SEE FIGURE 1, CHAPTER 4 USE FRICTION ANGLE ϕ' WHERE $\tan \phi' = 0.6 \tan \phi$.

GENERAL REQUIREMENTS:

1. ALLOWABLE VALUE OF A_p AND A_{pc} = ULTIMATE VALUE/2, FACTOR OF SAFETY OF 2 AGAINST FAILURE.
2. VALUES OF K_A AND K_p ARE FOR COHESIONLESS MATERIALS. IF BACKFILL HAS BOTH ϕ AND c STRENGTHS, COMPUTE ACTIVE AND PASSIVE FORCES ACCORDING TO FIGURES 7 AND 9 FINE GRAINED SOILS OF MEDIUM TO HIGH PLASTICITY SHOULD NOT BE USED AT THE ANCHORAGE.
3. SOILS WITHIN PASSIVE WEDGE OF ANCHORAGE SHALL BE COMPACTED TO NO LESS THAN 90% OF MAX. UNIT WEIGHT (ASTM D698 TEST).
4. TIE ROD IS DESIGNED FOR ALLOWABLE A_p OR A_{pc} . TIE ROD CONNECTIONS TO WALL AND ANCHORAGE ARE DESIGNED FOR 1.2 (ALLOWABLE A_p OR A_{pc}).
5. TIE ROD CONNECTION TO ANCHORAGE IS MADE AT THE LOCATION OF THE RESULTANT EARTH PRESSURES ACTING ON THE VERTICAL FACE OF THE ANCHORAGE.

FIGURE 20 (continued)
Design Criteria for Deadman Anchorage



<p>ACTIVE EARTH PRESSURE (SEE FIGURE 2) INCLUDING UNIFORM SURCHARGE q</p> $\sigma_H = \gamma Z K_A - 2C \sqrt{K_A}$ <p> (A), $\sigma_H = .30 \times .41 - 2 \times .10 \sqrt{.41} = 0$ (B), $\sigma_H = (.30 + 5 \times .115) \times .41 - 2 \times .10 \sqrt{.41} = .23 \text{ KSF}$ (C), $\sigma_H = (.30 + 5 \times .115 + 19 \times .053) \times .41 - 2 \times .10 \sqrt{.41} = .65 \text{ KSF}$ (D), $\sigma_H = (.30 + 5 \times .115 + 19 \times .053) \times .27 - 2 \times .05 \sqrt{.27} = .46 \text{ KSF}$ (E), $\sigma_H = .46 + (6 + 14) \times .068 \times .27 = .83 \text{ KSF}$ </p>	<p>SAFETY FACTOR AGAINST TOE FAILURE:</p> <p>TAKE MOMENTS ABOUT (A)</p> $F_s = \frac{\sum \text{MOMENTS OF PASSIVE FORCES}}{\sum \text{MOMENTS OF ACTIVE FORCES}}$ $= \frac{43.26 \times 33.3}{1.55 \times 0.73 + 2.75 \times 6 + 10.4 \times 10.52 + 4.05 \times 21.09 + 10.9 \times 31.0}$ $= 2.61 > 2.5$
<p>PRESSURE OF LINE LOAD SURCHARGE (SEE FIGURE 11)</p> $m = \frac{x}{H} = \frac{3}{30} = 0.1$ $P_H = 0.55 Q_L = 0.55 \times 5 = 2.75 \text{ KIP}$ <p>LOCATION OF RESULTANT:</p> $R = .60 H = .60 \times 30 = 18'$	<p>ANCHOR PULL</p> $A_p = \sum P_A - \sum P_p / F_s$ $= 1.55 + 2.75 + 10.4 + 4.05 + 10.9 - \frac{43.26}{2.5} = 12.37 \text{ KIPS}$
<p>NET WATER PRESSURE</p> $\sigma_w = \gamma_w Z = .0625 \times 2.5 = .16 \text{ KSF}$	<p>MAXIMUM BENDING MOMENT IN SHEETING</p> <p>POINT OF ZERO SHEAR:</p> $12.37 - 1.55 - 2.75 - .45x - .022 \times \frac{x^2}{2} = 0$ $x \approx 13.6' \text{ BELOW OUTSIDE WATER LEVEL}$ $M_{MAX} = 1.55 \times 15.7 + 12.37 \times 15.1 - 2.75 \times 9.1 - .45 \times \frac{13.6^2}{2} - .022 \times \frac{13.6^2}{2} \times 4.52 = 86.9 \text{ FT-KIPS}$ <p>MOMENT REDUCTION:</p> <p>ASSUME: $f_s = 27,000 \text{ PSI}$, $E = 30,000,000 \text{ PSI}$ TRY ZP 32, $I = 385.7 \text{ IN}^4$, $S = 38.3 \text{ IN}^3$ $\rho = (\text{FROM FIGURE 19}) = \frac{(H+D)^4}{EI}$ $\rho = \frac{(30 \times 12 + 14 \times 12)^4}{30,000,000 \times 385.7} = 6.7 \frac{\text{IN}^2}{\text{LB}}$</p>
<p>PASSIVE PRESSURE</p> $\sigma_H = \gamma Z K_p + 2C \sqrt{K_p}$ <p> (D), $\sigma_H = 0 + 2 \times .05 \sqrt{6.0} = .24 \text{ KSF}$ (E), $\sigma_H = .068 \times 14 \times 6.0 + 2 \times .05 \sqrt{6.0} = 5.94 \text{ KSF}$ </p>	<p>$\frac{M_{DESIGN}}{M_{MAX}} = .83$; $M_{DESIGN} = .83 \times 86.9 = 72.1 \text{ FT-KIPS}$</p> $f_s = \frac{M}{S} = \frac{72.1 \times 1000 \times 12}{38.3} = 22,600 \text{ PSI} < 27,000$ <p>TRY A SMALLER SECTION</p>

FIGURE 21
Example of Analysis of Anchored Bulkhead

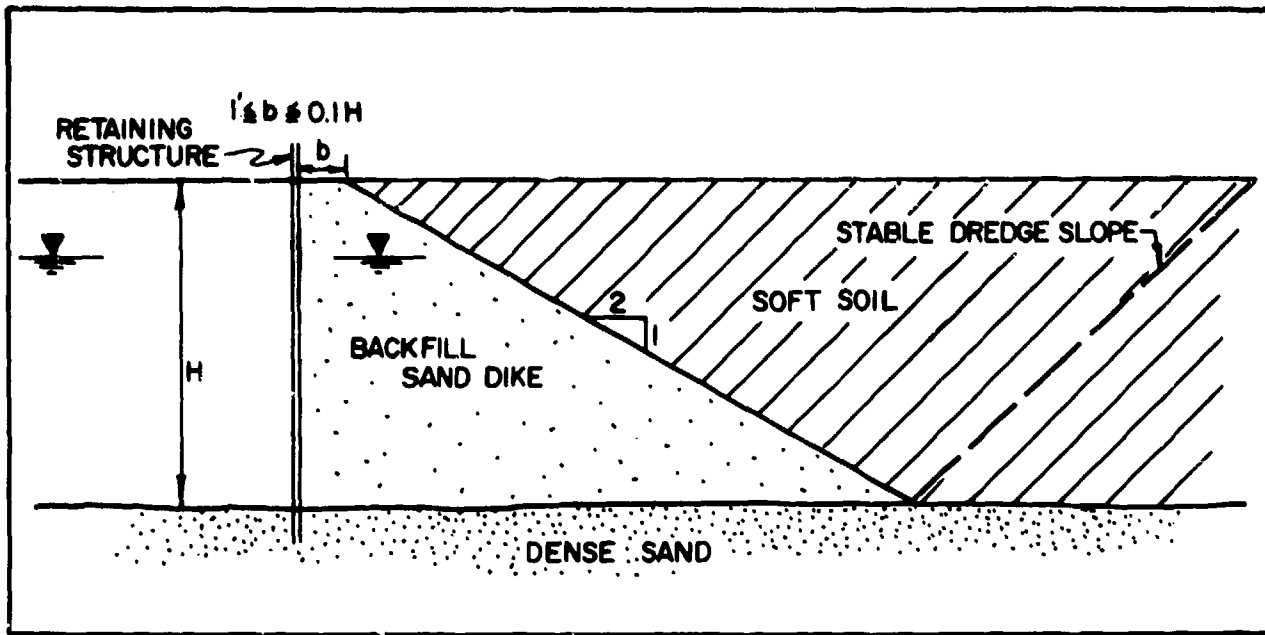
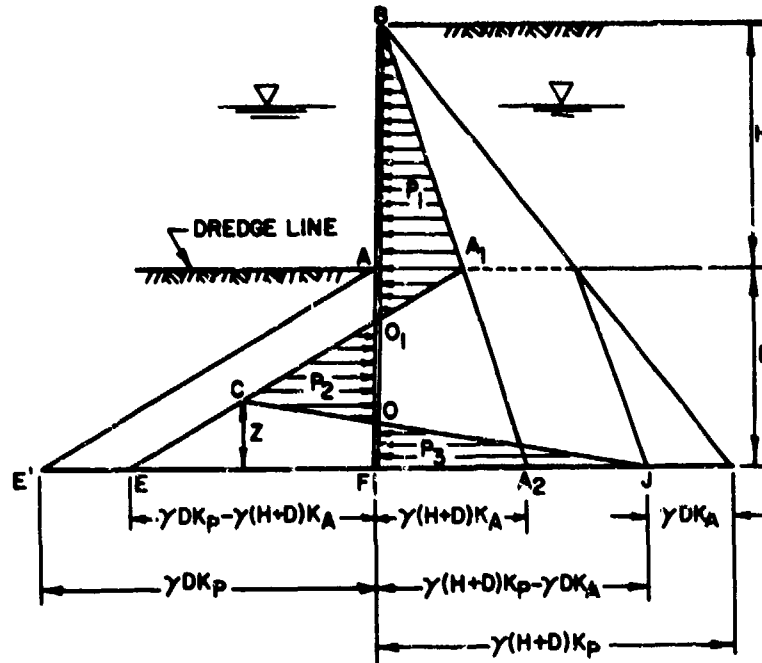


FIGURE 22
Sand Dike Scheme for Controlling Active Pressure

NOTE: WATER LEVELS CAN BE DIFFERENT ON OPPOSITE SIDES DUE TO PUMPING, TIDAL FLUCTUATIONS AND OTHER REASONS.



1. Assume a trial depth of penetration, D. This may be estimated from the following approximate correlation.

Standard Penetration Resistance, N Blows/foot	Depth of Penetration*
0 - 4	2.0H
5 - 10	1.5H
11 - 30	1.25H
31 - 50	1.0H
+50	0.75H

* H = height of piling above dredge line

2. Determine the active and passive lateral pressure using appropriate coefficients of lateral earth pressure. If the Coulomb method is used, it should be used conservatively for the passive pressure.
3. Satisfy the requirements of static equilibrium: the sum of the forces in the horizontal direction must be zero and the sum of the moments about any point must be zero. The sum of the horizontal forces may be written in terms of pressure areas:

$$\Delta(EA_1A_2) - \Delta(FBA_2) - \Delta(ECJ) = 0$$

Solve the above equation for the distance, Z. For a uniform granular soil,

$$Z = \frac{K_p D^2 - K_A (H+D)^2}{(K_p - K_A) (H+2D)}$$

FIGURE 23
Analysis for Cantilever Wall

4. Take moments about point F. If sum of moments is other than zero, readjust D and repeat calculations until sum of moments around F is zero.
5. Compute maximum moment at point of zero shear.
6. Increase D by 20% - 40% to result in approximate factor of safety of 1.5 to 2.

FIGURE 23 (continued)
Analysis for Cantilever Wall

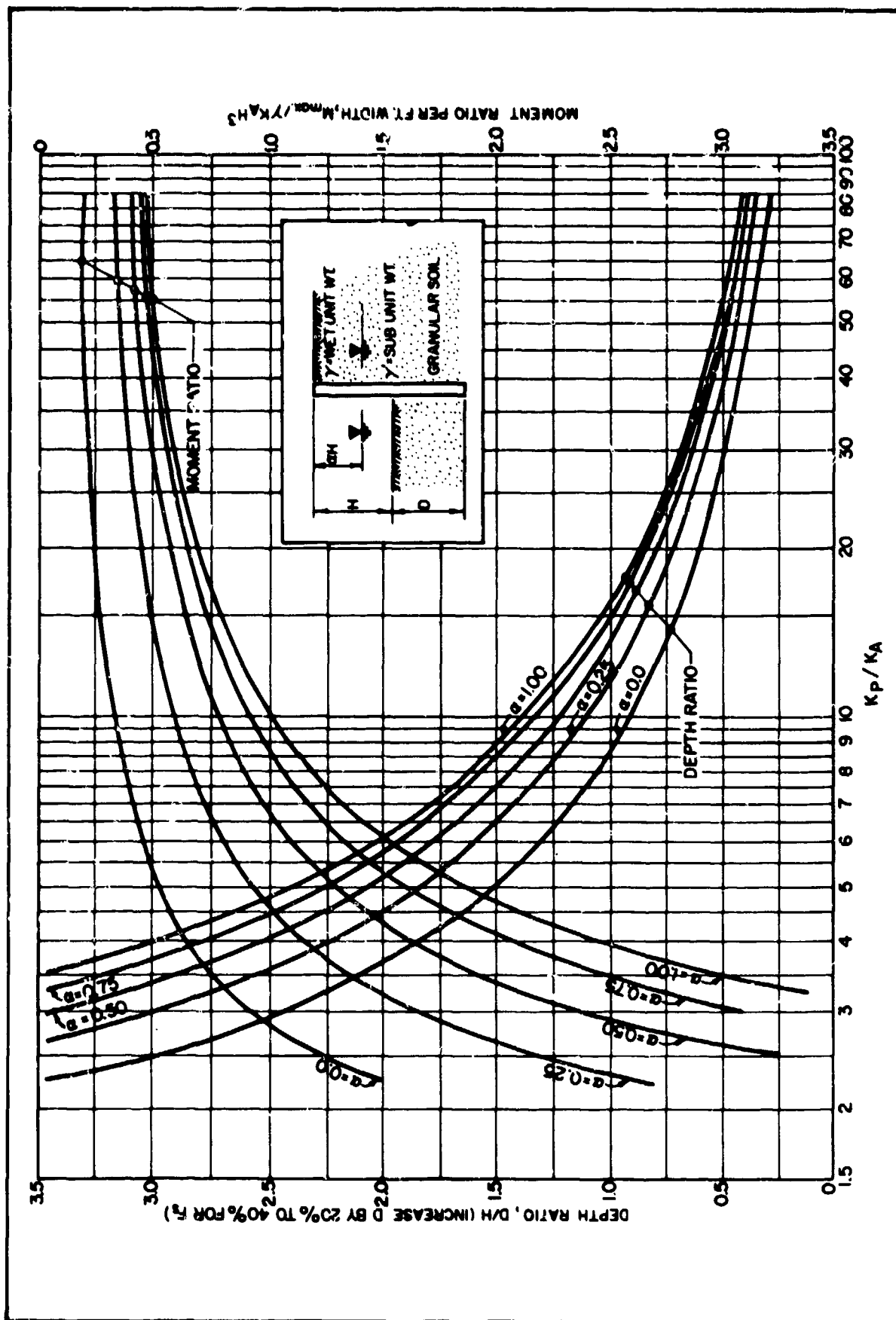


FIGURE 24
Cantilever Steel Sheet Pile Wall in Homogeneous Granular Soil

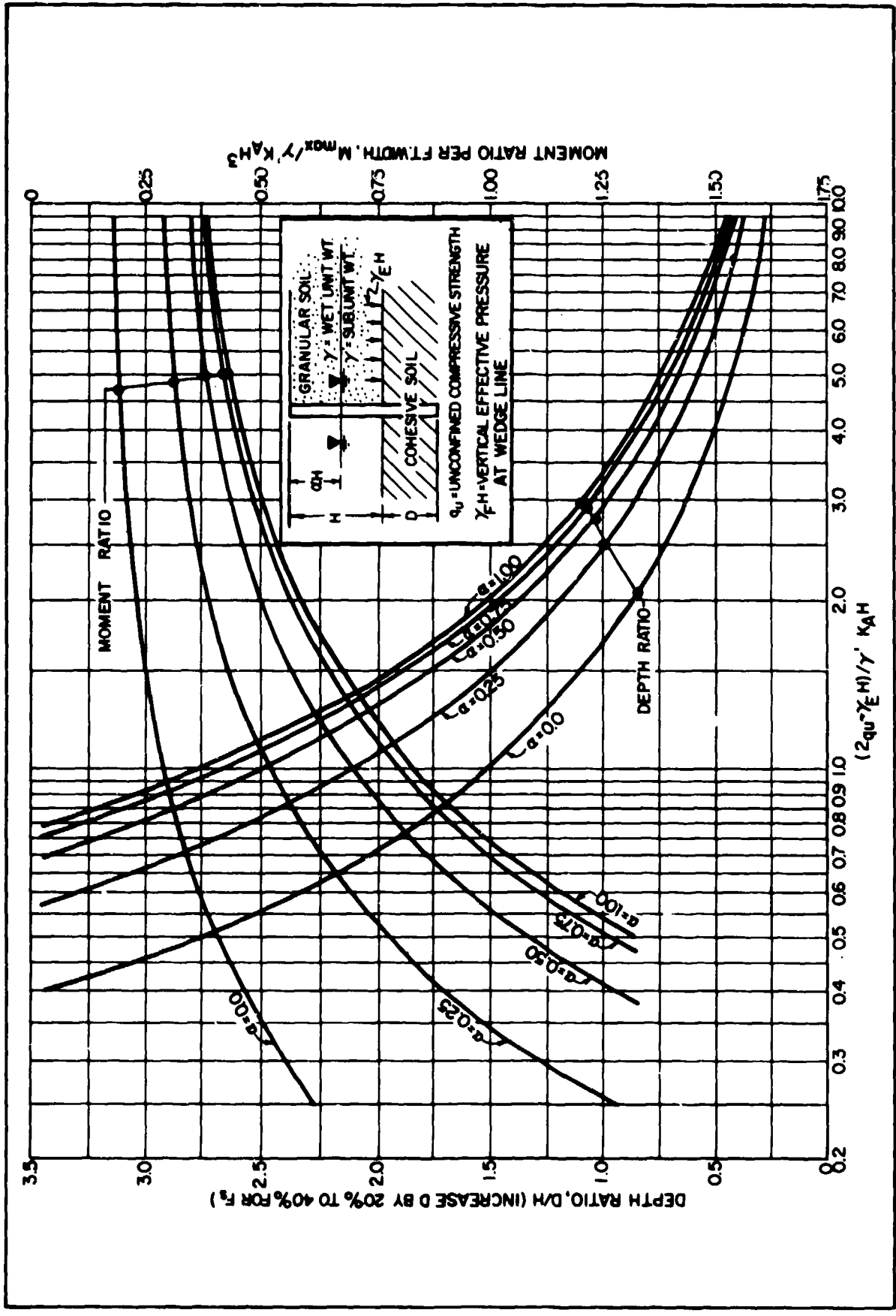


FIGURE 25
 Cantilever Steel Sheet Pile Wall in Cohesive Soil with Granular Backfill

EXAMPLE

Backfill: $\phi = 30^\circ$ Underlying Cohesive Stratum: $C = 750$ psf
 $\gamma = 120$ pcf $\gamma' \approx 60$ pcf
 $\gamma' = 60$ pcf

Depth H to mud line = 20 ft

Depth to water = 5 ft

$$\alpha = 5/20 = 0.25$$

Wall friction = 0.3 (Table 1)

$$K_A = 0.31 \text{ (Figure 5)}$$

$$\gamma_E H = 120 \times 5 + 15 \times 60 = 1,500 \text{ psf}$$

$$q_u = 2C = 1,500 \text{ psf}$$

USING FIGURE 25:

$$\frac{2q_u - \gamma_E H}{\gamma' K_A H} = \frac{3000 - 1500}{60 \times 0.31 \times 20} = 4.03$$

$$\text{Depth ratio } , \frac{D}{H} = 0.69$$

$$D \text{ calculated} = 0.69 \times 20 = 13.8 \text{ ft}$$

$$D \text{ design} = 13.8 \times 1.3 = 17.9 \text{ ft}$$

$$\text{Moment ratio} = 0.33$$

$$M_{\max} = 0.33 \times 60 \times 0.31 \times (20)^3 = 49,104 \text{ ft-lb/ft of wall}$$

FIGURE 25 (continued)
Cantilever Steel Sheet Pile Wall in Cohesive Soil with Granular Backfill

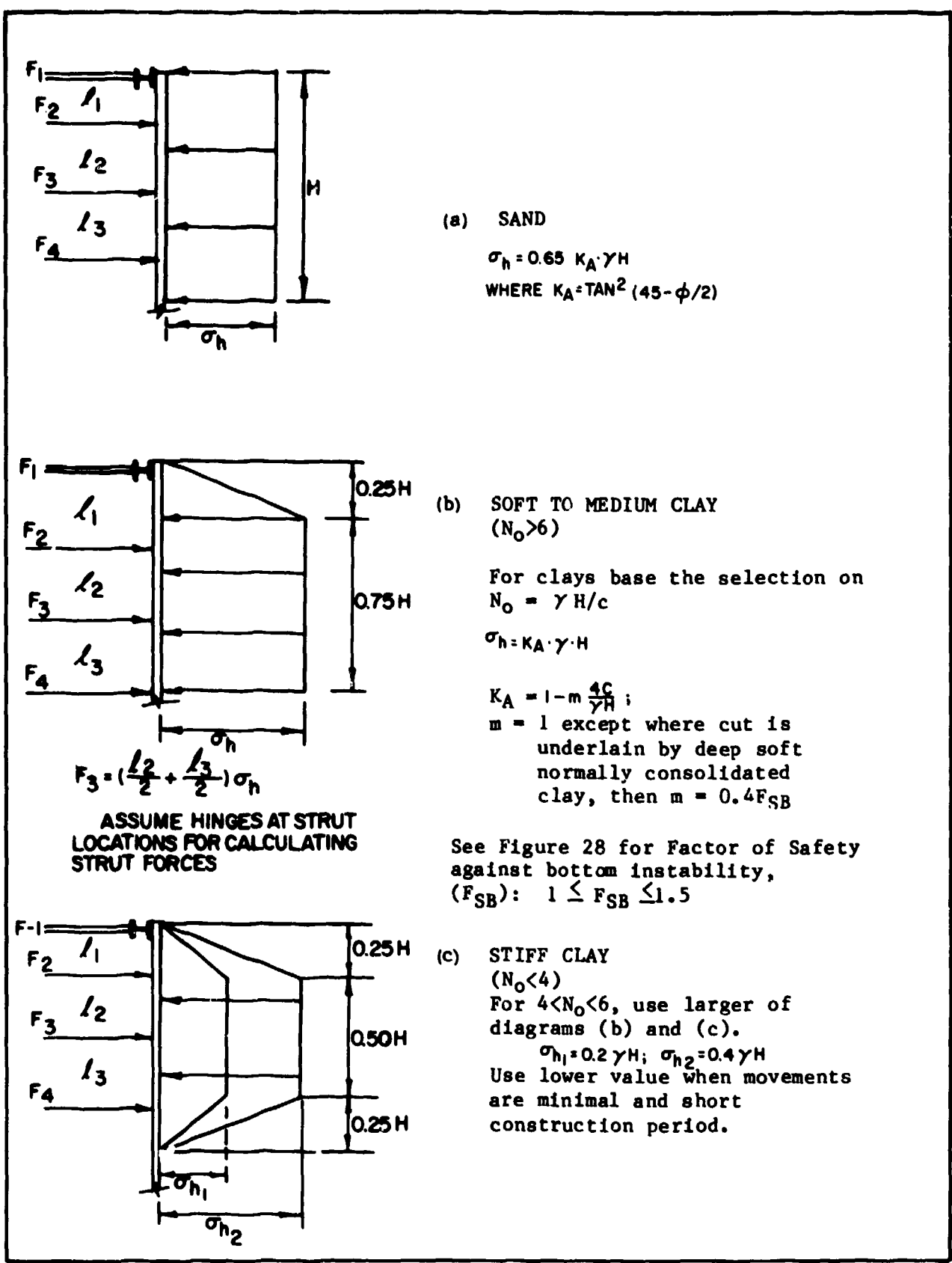


FIGURE 26
Pressure Distribution for Brace Loads in Internally Braced Flexible Walls

a. Wall with Raking Braces. When substantial excavation is made before placing an upper brace, movement of the wall is greatest at the top and pressures approach active values. See Figure 27 for design criteria.

b. Braced Narrow Cuts. When a narrow cut is braced stiffly as excavation proceeds, sheeting is restrained at the top and the wall deflects inward at the base. Design the wall employing the following steps:

(1) Compute factor of safety against bottom instability (Figure 28).

(2) Compute strut forces utilizing the method in upper panel of Figure 27.

(3) Compute required section for wall and wale using method in upper panel of Figure 27. In computing the required wall sections, arching could be accounted for by reducing these pressures somewhat in all but the upper span. A reduction of 80% of the values shown would be appropriate.

(4) Re-compute strut forces and the required sections of wales and wall using the pressure diagram of lower panel of Figure 27 for each construction stage.

(5) Compare strut forces, and required sections computed in Step (4) to those computed in Step (3) and select the larger force or section for design. See example in Figure 31.

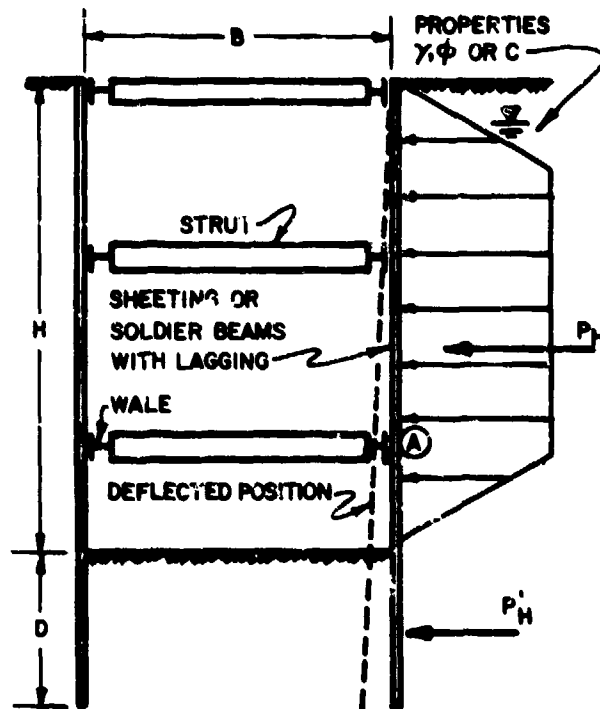
4. TIED BACK FLEXIBLE WALL. Depending on the width of excavation and other factors (see Chapter 1) it may be economical to restrain excavation walls by tie backs. The use of tie backs depends on the existence of subsoils adequate to provide required anchorage. For multi-level tie back systems, drilled tie backs (i.e. anchors) are usually used. For a single level tie back (e.g., bulkheads), a deadman anchorage, batter pile anchorage or a parallel wall anchorage are usually considered. For details on the drilled anchors - process and hardware, see Reference 6. For details on other anchorage systems see Reference 12 and Reference 13, Foundation Construction, by Carson.

a. Pressure Distribution. For soft to medium clay use a triangular distribution, increasing linearly with depth. For all other soils use a uniform pressure distribution. See Figure 29.

b. Design Procedures. Apply a design procedure similar to internally braced excavation as shown in Figure 27.

5. EXAMPLE OF COMPUTATION. See Figure 30 for example of analysis of braced wall of narrow cut, and Figure 31 for an example of excavation in stages.

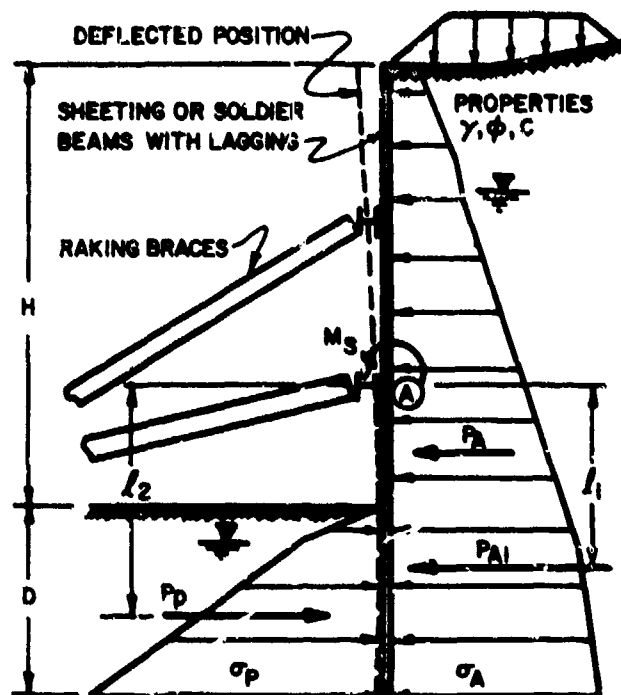
6. STABILIZING BERMS. On occasion it is practical to increase the resistance of flexible walls by using stabilizing berms. The lateral resistance of a stabilizing berm will be less than that for an earth mass bounded by a horizontal plane at the top elevation of the berm.



FLEXIBLE WALL OF NARROW CUT

1. COMPUTE PRESSURES ON WALL ABOVE BASE OF CUT BY METHODS OF FIGURE 26. FOR WATER AT BACKFILL SURFACES USE $\gamma = \gamma_{SUB}$ AND ADD PRESSURES FOR UNBALANCED WATER LEVEL. FOR WATER AT BASE OF CUT USE $\gamma = \gamma_T$. INTERPOLATE BETWEEN THESE PRESSURE DIAGRAM FOR AN INTERMEDIATE WATER LEVEL.
2. DETERMINE STABILITY OF BASE OF CUT BY METHODS OF FIGURE 28. IF BASE IS STABLE, SHEETING TOES IN SEVERAL FEET AND NO FORCE ACTS ON BURIED LENGTH. IF BASE IS UNSTABLE, SHEETING PENETRATES AS SHOWN IN FIGURE 28 AND UNBALANCED FORCE P'_H ACTS ON BURIED LENGTH. IN ANY CASE, PENETRATION MAY BE CONTROLLED BY REQUIREMENT FOR CUT-OFF OF UNDERSEEPAGE.
3. MOMENTS IN SHEETING BETWEEN BRACES = 0.8 x (SIMPLE SPAN MOMENTS), EXCEPT FOR UPPER SPAN WHERE MOMENT = 1.0 x (SIMPLE SPAN MOMENT). MOMENTS IN SHEETING AT POINT A IS COMPUTED FOR CANTILEVER SPAN BELOW A , INCLUDING UNBALANCED FORCE P'_H .
4. REACTION AT BRACES COMPUTED ASSUMING SIMPLE SPAN BETWEEN BRACES.

FIGURE 27
Design Criteria for Braced Flexible Walls



P_A = RESULTANT ACTIVE PRESSURE

P_{A1} = RESULTANT ACTIVE BELOW POINT A

FLEXIBLE WALL WITH RAKING BRACES

1. COMPUTE ACTIVE AND PASSIVE PRESSURES BY METHODS IN SECTION 2. PASSIVE PRESSURES FOR CLEAN, COARSE-GRAINED SOILS INCLUDE WALL FRICTION (δ), TABLE 1. IGNORE WALL FRICTION FOR PASSIVE PRESSURES IN OTHER SOIL TYPES AND FOR ACTIVE PRESSURES IN ALL SOILS.
2. MAXIMUM MOMENTS IN SHEETING AND MAXIMUM LOADS IN BRACES ARE USUALLY OBTAINED AT A CONSTRUCTION STAGE WHEN EXCAVATION FOR A BRACE AND WALE IS COMPLETE AND JUST PRIOR TO PLACING THE BRACE. FOR EACH SUCCESSIVE STAGE OF EXCAVATION COMPUTE SHEETING MOMENTS AND BRACE LOADS BY ASSUMING SIMPLE SPAN BETWEEN LOWEST BRACE THEN IN PLACE AND POINT OF ZERO NET PRESSURE BELOW EXCAVATION.
3. FOR TEMPORARY CONSTRUCTION CONDITIONS, APPLY FACTOR OF SAFETY OF 1.5 TO COMPUTE PASSIVE PRESSURES. TO ALLOW FOR POSSIBLE CONSTRUCTION SURCHARGE AND RIGIDITY OF UPPER BRACE POINT, INCREASE LOAD ON UPPER WALE AND BRACE BY 15% OF COMPUTED VALUE.
4. REQUIRED PENETRATION OF SHEETING BELOW FINAL SUBGRADE GENERALLY IS CONTROLLED BY CONDITIONS AT COMPLETION OF EXCAVATION. PENETRATION REQUIRED IS DETERMINED BY EQUILIBRIUM OF FREE ENDED SPAN BELOW POINT A. ASSUMING FIXITY AT POINT A:

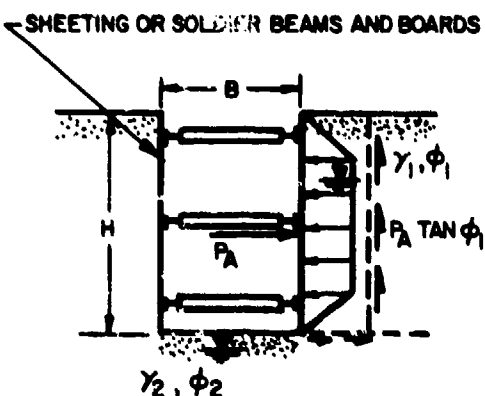
$$P_{A1} l_1 - \frac{P_D}{F_s} l_2 - M_s = 0$$

M_s = ALLOWABLE MOMENT IN SHEETING

5. CHECK POSITIVE MOMENTS IN SPAN BELOW POINT A FOR THIS FINAL LOADING CONDITION.

FIGURE 27 (continued)
Design Criteria for Braced Flexible Walls

CUT IN COHESIONLESS SOIL



STABILITY IS INDEPENDENT OF H AND B, BUT VARIES WITH γ, ϕ AND SEEPAGE CONDITION.

SAFETY FACTOR, $F_s = 2N\gamma_2 \left(\frac{\gamma_2}{\gamma_1}\right) K_A \tan \phi$

$N\gamma_2$ = BEARING CAPACITY FACTOR, FIGURE 1, CHAPTER 4
IF GROUNDWATER IS AT A DEPTH OF (B) OR MORE BELOW BASE OF CUT:

γ_1 AND γ_2 ARE TAKEN AS MOIST UNIT WEIGHT

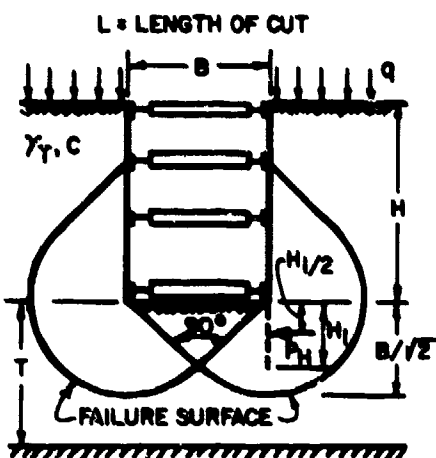
IF GROUNDWATER IS STATIC AT BASE OF CUT:

γ_1 = MOIST WEIGHT, γ_2 = SUBMERGED WEIGHT.

IF SEEPAGE IS MOVING UPWARD TO BASE OF CUT:

γ_2 = (SATURATED UNIT WEIGHT) - (UPLIFT PRESSURE)

CUT IN CLAY, DEPTH OF CLAY UNLIMITED ($T > 0.7B$)



IF SHEETING TERMINATES AT BASE OF CUT:

SAFETY FACTOR, $F_s = \frac{N_c C}{\gamma_T H + q}$

N_c = BEARING CAPACITY FACTOR, FIGURE 2, CHAPTER 5 WHICH DEPENDS ON DIMENSIONS OF THE EXCAVATION: B, L AND H (USE $H = Z$).

C = UNDRAINED SHEAR STRENGTH OF CLAY IN FAILURE ZONE BENEATH AND SURROUNDING BASE OF CUT.

q = SURFACE SURCHARGE.

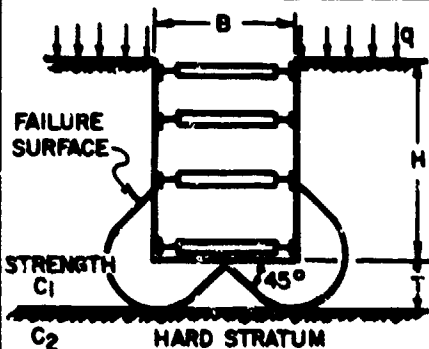
IF SAFETY FACTOR IS LESS THAN 1.5, SHEETING MUST BE CARRIED BELOW BASE OF CUT TO INSURE STABILITY.

FORCE ON BURIED LENGTH:

IF $H_1 > \frac{2}{3} \frac{B}{\sqrt{2}}$, $P_H = .7 (\gamma_T H B - 1.4 C H - \pi C B)$

IF $H_1 < \frac{2}{3} \frac{B}{\sqrt{2}}$, $P_H = 1.5 H_1 (\gamma_T H - \frac{1.4 C H}{B} - \pi C)$

CUT IN CLAY, DEPTH OF CLAY LIMITED BY HARD STRATUM ($T \leq 0.7B$)



SHEETING TERMINATES AT BASE OF CUT. SAFETY FACTOR:

CONTINUOUS EXCAVATION; $F_s = N_{CD} \frac{C_1}{\gamma_T H + q}$

RECTANGULAR EXCAVATION; $F_s = N_{CR} \frac{C_1}{\gamma_T H + q}$

N_{CD} AND N_{CR} = BEARING CAPACITY FACTORS.

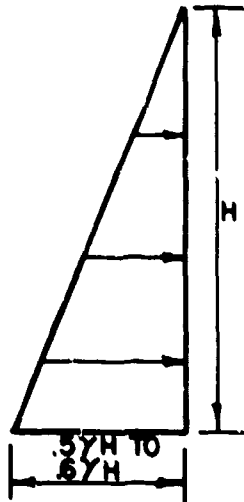
FIGURE 5 CHAPTER 4, WHICH DEPEND ON DIMENSIONS OF THE EXCAVATION: B, L AND H, (USE $H = Z$)

NOTE: IN EACH CASE FRICTION AND ADHESION ON BACK OF SHEETING IS DISREGARDED.

CLAY IS ASSUMED TO HAVE A UNIFORM SHEAR STRENGTH = C THROUGHOUT FAILURE ZONE.

FIGURE 28
Stability of Base for Braced Cut

SOFT TO MEDIUM CLAY



Compute pressure based on at-rest conditions with K_0 from 0.5 to 0.6. In normally consolidated clays excessive prestressing should not be permitted because of the potential for induced consolidation. Use design procedure as in Figure 26.

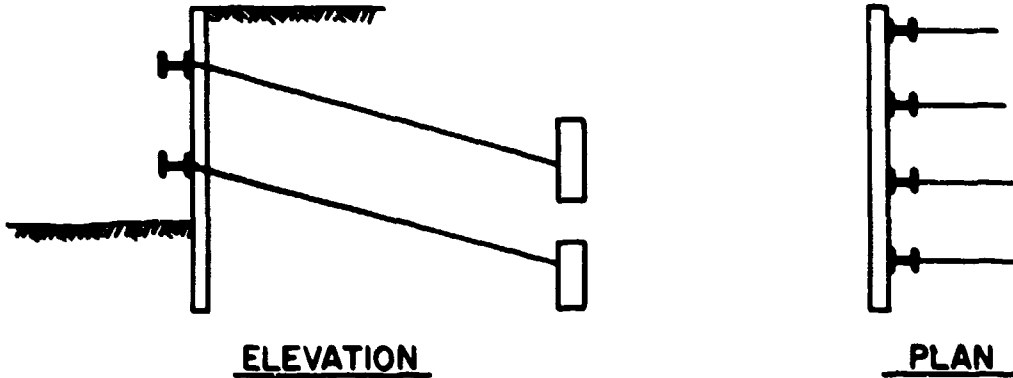
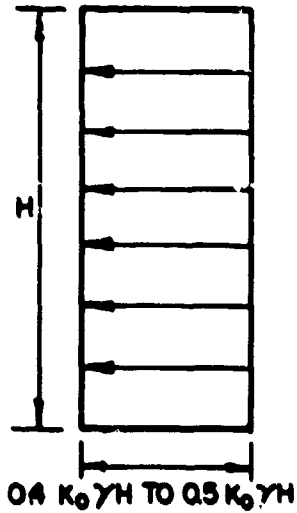


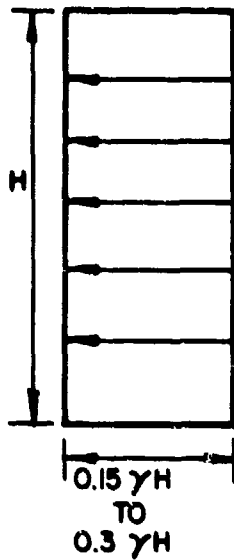
FIGURE 29
Pressure Distribution for Tied-Back Walls

SANDS



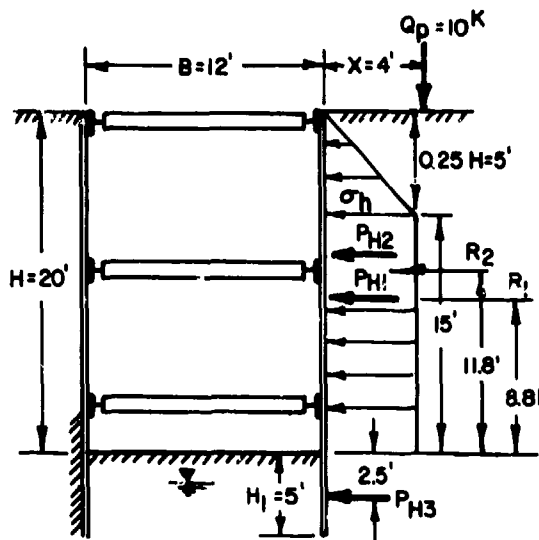
Where deformations are critical and tie-backs are prestressed to 100% of design load, compute pressure based on at-rest conditions. Use $K_0 = 0.4$ for dense sand, and $K_0 = 0.5$ for loose sand.

STIFF TO VERY STIFF CLAY



Use pressure ordinate to produce the same force as for braced excavation. 0.3 is applicable for stability number of about 4, and 0.15 is applicable when stability number is less than 4. Use design procedure as in Figure 26.

FIGURE 29 (continued)
Pressure Distribution for Tied-Back Walls



GIVEN CONDITIONS:

EXCAVATION IN SILTY CLAY.
 $C = 400 \text{ PSF}$, $\phi = 0$, $\gamma_T = 120 \text{ PCF}$
 LENGTH OF EXCAVATION, $L = 80'$

DETERMINE: PRESSURES ON WALL. FORCE ON BURIED LENGTH OF SHEETING AND STABILITY OF BASE OF CUT.

STABILITY OF BASE OF CUT (SEE FIGURE 28)

$$F_{SB} = \frac{N_c C}{\gamma_T H + q}, q = 0 \text{ (NO UNIFORM SURCHARGE)}$$

$$\text{FOR } N_c, \text{ (FIGURE 2, CHAPTER 5)} \quad \frac{H}{B} = \frac{Z}{B} = \frac{20}{12} = 1.67,$$

$$\frac{B}{L} = \frac{12}{80} = 0.15, N_{cc} = 6.9$$

$$N_{CR} = N_{cc} (1 + 0.2 B/L) = 6.9 (1 + 0.2 (0.15)) = 7.1$$

$$F_s = \frac{7.1 \times 400}{120 \times 20 + 0} = 1.18 < 1.5$$

DRIVE SHEETING BELOW BOTTOM OF EXCAVATION

PRESSURE ON WALL FROM SURROUNDING SOIL (SEE FIGURE 26)

$$K_A = 1 - m \frac{4C}{\gamma H}; \quad m = 0.4 F_{SB} = 0.4 \times 1.18 = 0.47$$

$$= 1 - (0.47) \left(\frac{4 \times 400}{120 \times 20} \right) = 0.69$$

$$\sigma_h = K_A \gamma H = 0.69 \times 0.12 \times 20 = 1.66 \text{ KSF}$$

$$P_{H1} = \frac{(15+20)(1.66)}{2} = 29.05 \text{ KIPS}$$

LOCATION OF RESULTANT:

$$R_1 = \frac{1.66 \times 5/2 \times (15+5/3) + 1.66 \times 15 \times 15/2}{29.05} = 8.81'$$

PRESSURES ON WALL FROM SURCHARGE (SEE FIGURE 11)

$$m = \frac{X}{H} = \frac{4}{20} = 0.2$$

$$P_{H2} = .78 \frac{Q_p}{H} = .78 \frac{10}{20} = .39 \text{ KIP}$$

LOCATION OF RESULTANT:

$$R_2 = .59 H = .59 \times 20 = 11.8'$$

FORCE ON BURIED LENGTH OF SHEETING: (SEE FIGURE 28)

$$\text{ASSUME } H_1 = 5 < \frac{2}{3} \frac{B}{\sqrt{2}}, \text{ FOR } T > 0.7B \text{ RESULTANT FORCE } P_{H3}:$$

$$P_{H3} = 1.5 H_1 (\gamma_T H - \frac{1.4CH}{B} - \pi C)$$

$$P_{H3} = 1.5 \times 5 (0.12 \times 20 - \frac{1.4 \times 4 \times 20}{12} - 3.14 \times 4) = 1.6 \text{ KIP}$$

NOTE: ALL COMPUTATIONS ARE PER LINEAR FOOT OF WALL.

FIGURE 30

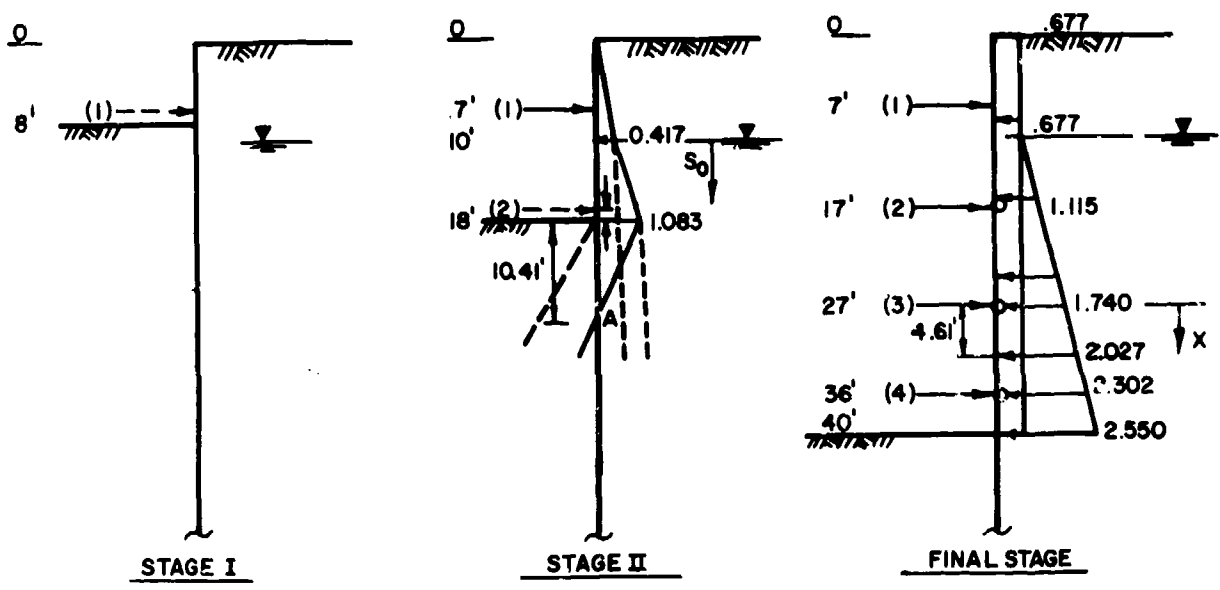
Example of Analysis of Pressures on Flexible Wall of Narrow Cut
 In Clay - Undrained Conditions

ASSUMPTIONS

1. NO SURCHARGE LOAD. 2. NO WALL FRICTION

PROPERTIES

$\phi = 30^\circ$ $\gamma = 0.125 \text{ KCF}$ $\gamma' = 0.0625 \text{ KCF}$
 $c = 0$ DEPTH OF EXCAVATION 40'
 GWL = 10' BELOW
 GROUND LEVEL



COMPUTATIONS

FROM FIGURE 2

$K_A = 1/3, K_P = 3$

A. STAGE I

(PRIOR TO INSTALLATION OF BRACE 1)
 SHEETING ACTS AS CANTILEVER WALL.

USE FIGURE 24

$\alpha = 0 \quad K_P/K_A = 9$

$D/H = 0.95 \quad \therefore \text{REQUIRED } D = 0.95 \times 8 \times 1.4 = 10.64' < 40'$

$M_{MAX} / \gamma' K_A \cdot H^3 = 0.37 \quad M_{MAX} = 3.946 \text{ FT-KIP}$

FIGURE 31
 Example of Excavation in Stages

B. STAGE II

1. ACTIVE PRESSURE

AT WATER LEVEL, $\sigma_A (10) = 1/3 \times 0.125 \times 10 = 0.417 \text{ KSF}$

AT EXCAVATION LEVEL, $\sigma_A (18) = 0.417 + 1/3 \times 0.0625 \times 8 = 0.583 \text{ KSF}$

WATER PRESSURE ON ACTIVE SIDE

$P_w (18) = 0.0625 \times 8 = 0.500 \text{ KSF}$

TOTAL PRESSURE (18) = $\sigma_A (18) + P_w (18) = 1.083 \text{ KSF}$

2. POINT OF ZERO NET PRESSURE

APPLY $F_s = 1.5$ TO K_p

SLOPE OF THE NET PRESSURE DIAGRAM = $(3/1.5 - 1/3) 0.0625 = 0.104$

DISTANCE TO (A) = $\frac{1.083}{0.104} = 10.41 \text{ FT}$

3. REACTION AT (I) AND (A) PER LINEAR FOOT OF WALL

ASSUME HINGE (ZERO BENDING MOMENT) AT (A)

$R(I) = \left[(1.083 \times 10.41 \times 1/2 \times (2/3 \times 10.41)) + (1.083 - 0.417) \times 8 \times 1/2 \times (10.41 + 8/3) + 0.417 \times 8 \times (10.41 + 8/2) + 0.417 \times 10 \times 1/2 \times (10.41 + 8 + 10/3) \right] \times \frac{1}{(10.41 + 11)}$

$R(I) = 7.817 \text{ K}$, USE $R(I) = 1.15 \times 7.817 = 8.99 \text{ K} \approx 9.0 \text{ K}$

$R(A) = 5.905 \text{ K} \approx 5.9 \text{ K}$

4. POINT OF ZERO SHEAR

TRY A LOCATION BETWEEN BOTTOM OF EXCAVATION (DEPTH 18') AND (I)

$7.817 - (1/2 \times 10 \times 0.417) - (S_0 \times 0.417) - (1/2 \times S_0 \times \frac{0.666}{8} S_0) = 0$, $S_0 = 7.75'$

5. MAXIMUM MOMENT

$M_{MAX} = [7.817 \times (7.75 + 3)] - \left[(1/2 \times 10 \times 0.417) \times (7.75 + \frac{10}{3}) \right] - \left[(7.75 \times 0.417) \times \frac{7.75}{2} \right] - \left[(1/2 \times 7.75^2 \times \frac{0.666}{8}) \times \frac{7.75}{3} \right] = 41.9 \text{ FT-KP}$

C. FINAL STAGE

1. PRESSURE DISTRIBUTION

USE PRESSURE DIAGRAM FROM FIGURE 26

$\gamma_{av} = 0.25 \times 0.125 + 0.75 \times 0.0625 = 0.0781 = 1 \text{ KSF}$

$\sigma_h = 0.65 \times 1/3 \times 0.0781 \times 40 = 0.677 \text{ KSF}$

$P_w (30) = 0.0625 \times 30 = 1.875 \text{ KSF}$

FIGURE 31 (continued)
Example of Excavation in Stages

2. STRUT LOADS PER LINEAR FOOT OF WALL

$$R(1) = [0.677 \times 17^2/2 + 0.0625 \times 7^2/2 \times 7/3] / 10 = 10.14 \text{ K, FOR DESIGN } R1 = 1.15 \times 10.14 = 11.66 \text{ K}$$

$$R(2) = \left(\left[(0.677 \times 17) + (1/2 \times (1.115 - 0.677) \times 7) - 10.14 \right] + (1.115 \times 10 \times 10/2) + (1/2 \times (1.740 - 1.115) \times 10 \times 10/3) \right) / 10 = 9.52 \text{ K}$$

$$R(3) = \left(\left[(0.677 \times 27) + (1/2 \times (1.740 - 0.677) \times 17) - 10.14 - 9.52 \right] + (1.740 \times 9 \times 9/2) + (1/2 \times (2.302 - 1.740) \times 9 \times 9/3) \right) / 9 = 16.33 \text{ K}$$

$$R(4) = \left(\left[(36 \times 0.677) + (1/2 \times (2.302 - 0.677) \times 26) - 10.14 - 9.52 - 16.33 \right] + (2.302 \times 4 \times 4/2) + (1/2 \times (2.550 - 2.302) \times 4 \times 4/3) \right) / 4 = 14.27 \text{ K}$$

3. MOMENT

MAXIMUM MOMENT IS LIKELY TO OCCUR BETWEEN (3) AND (4).
POINT OF ZERO SHEAR FROM (3).

$$\frac{8.67}{\left[(1.74 \times 9 \times 9/2) + 1/2 \times (2.302 - 1.74) \times 9 \times 9/3 \right]} \times 1/9 = 1.74(x) + (1/2) \left(\frac{2.302 - 1.74}{9} \right) (x)(x)$$

$$x = 4.61 \text{ FT, } \sigma = 2.027 \text{ KSF}$$

$$M_{\text{MAX}} = (8.67 \times 4.61) - (1.74 \times 4.61 \times \frac{4.61}{2}) - 1/2 \times (2.027 - 1.74) \times 4.61 \times \frac{4.61}{3}$$

$$= 20.5 \text{ FT-KIP; } M_{\text{DESIGN}} = 0.8 \times 20.5 = 16.4 \text{ FT-KIP.}$$

4. SUMMARY

CONSTRUCTION STAGE	STRUT LOADS KIP	MOMENTS FT-KIP
I	-	3.95
II	R(1) = 8.99	41.9 BETWEEN (1) AND (4)
FINAL	R(1) = 11.66; R(2) = 9.52 R(3) = 16.33; R(4) = 14.27	16.4 BETWEEN (3) AND (4)

NOTE: (A) THE MOMENT AT STAGE II IS GREATER THAN THE FINAL MOMENT.
INTERMEDIATE STAGES MUST ALSO BE CHECKED AS PER PROCEDURE IN FIGURE 27.

(B) IF SIMPLE AREA METHOD IS SELECTED FOR THE COMPUTATIONS OF LOADS IN STRUTS (1) AND (2), THEN LOAD IN (1) WILL DECREASE AND (2) WILL INCREASE.

FIGURE 31 (continued)
Example of Excavation in Stages

E. PENETRATION BELOW SUBGRADE

I. PRESSURE COMPUTATION

ACTIVE $\sigma_A (10') = 1/3 \times 0.125 \times 10 = 0.417 \text{ KSF}$

$\sigma_A (36') = 1/3 \times 0.125 \times 10 + 1/3 \times 0.0625 \times 26 = 0.958 \text{ KSF}$

$\sigma_A (40') = 1/3 \times 0.125 \times 10 + 1/3 \times 0.0625 \times 30 = 1.042 \text{ KSF}$

WATER PRESSURE (UNBALANCED HEAD)

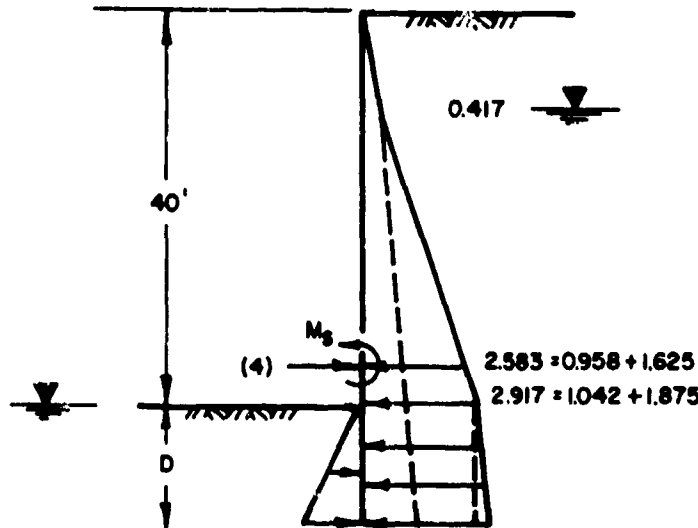
$P_W (36') = 0.0625 \times 26 = 1.625 \text{ KSF}$

$P_W (40') = 0.0625 \times 30 = 1.875 \text{ KSF}$

PASSIVE PRESSURE

$\sigma_p (D) = \frac{3}{1.5} \times 0.0625 \times D = 0.125 D$

(APPLY $F_S = 1.5$ TO PASSIVE PRESSURE)



2. DEPTH REQUIREMENT TO LIMIT MOMENT IN SHEETING

(SEE FIGURE 27 (CONTINUED), 4.)

USE PZ 27 $S = 30.2 \text{ IN}^3/\text{FT OF WALL}$

USE $\sigma_a = 27,000 \text{ PSI}$

ALLOWABLE MOMENT = $\frac{30.2 \times 27}{12} = 67.95 \text{ FT-KIP} = M_S$

TAKE MOMENTS ABOUT (4) TO DETERMINE D.

$$67.95 + \left(\frac{1}{2} \times 0.125 D \times D \times (4 + \frac{2}{3} D) \right) - 2.583 \times 4 \times \frac{4}{2} - \frac{1}{2} \times (2.917 - 2.583) \times 4 \times \frac{2}{3} \times 4 - 2.917 \times D \times (4 + \frac{D}{2}) - \frac{1}{2} \times (1/3 \times 0.0625) D \times D \times (4 + \frac{2}{3} D) = 0$$

$$D^3 - 35.3 D^2 - 332.5 D + 1296.6 = 0$$

$D \approx 3 \text{ FT.}$

3. DEPTH REQUIREMENT FOR CONTROL OF PIPING. (DM-7.1, CHAPTER 6)

ASSUME $W/H_W = 1.5$ (I.E., WIDE EXCAVATION)

$F_S = 1.2$

$D/H_W = 0.65$

OR $D = 30 \times 0.65 = 19.5 \text{ FT}$

HENCE PIPING GOVERNS THE DEPTH OF PENETRATION FOR THE SHEETING.

FIGURE 31 (continued)
Example of Excavation in Stages

a. Method of Analysis. Perform wedge force equilibrium for several trial failure surfaces, and plot corresponding values of horizontal resistance for each trial failure surface. The minimum value of horizontal resistance obtained from the curve is the total passive earth pressure for the berm. An approximate method of analysis is to replace the berm with an equivalent sloping plane, and assign an appropriate passive pressure coefficient.

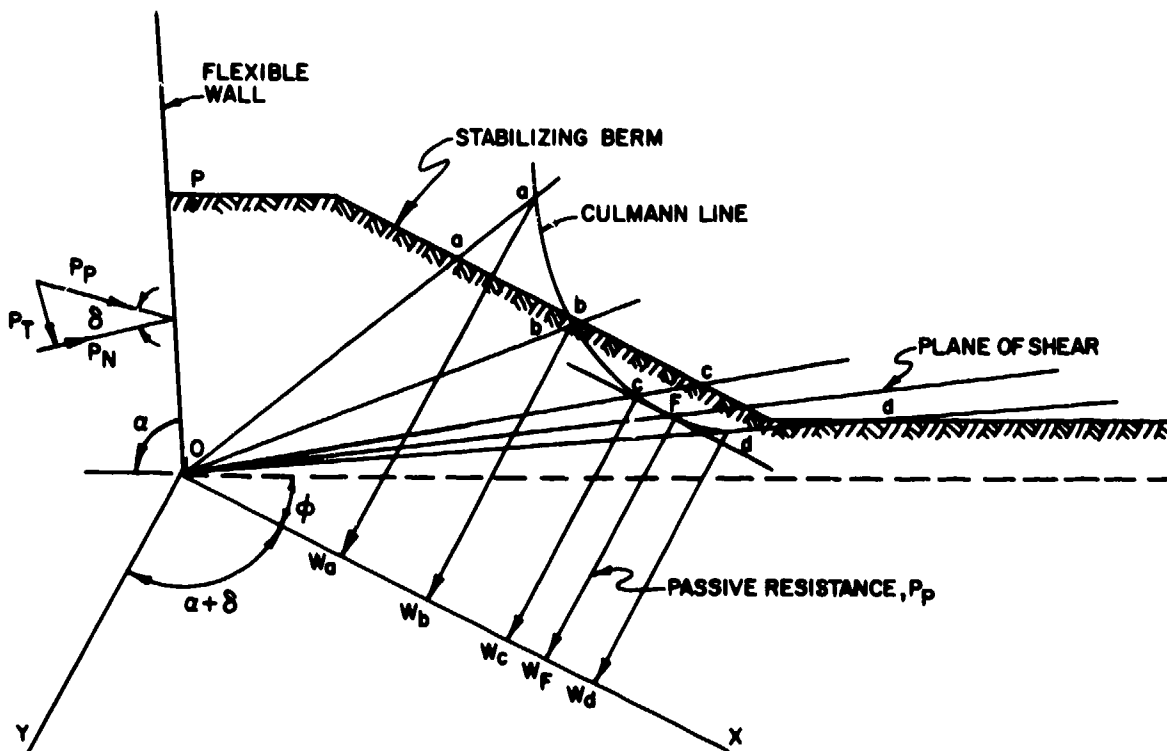
b. Graphic Procedure. A graphic procedure (Culmann Method) for evaluating the lateral resistance for granular soils is given in Figure 32.

7. SOLDIER PILES. A frequently used internal bracing system consists of soldier piles with lagging. The passive earth resistance acting on individual soldier piles may be computed as shown in Figure 33. For cohesive soils use uniform resistance of $2c$ neglecting the soil resistance to a depth of 1.5 times the pile width b from the bottom of the excavation. For granular soils, determine K_p without wall friction and neglect the soil resistance to a depth equal to b below the bottom of the excavation. Total resisting force is computed by assuming the pile to have an effective width of $3b$, for all types of soils. This is because the failure in soil due to individual pile elements is different from that of continuous walls for which pressure distributions are derived.

8. GABION STRUCTURES. As illustrated in Figure 34, gabions are compartmented, rectangular containers made of heavily galvanized steel or polyvinylchloride (PVC) coated wire, filled with stone from 4 to 8 inches in size, and are used for control of bank erosion and stabilization. When water quality is in doubt ($12 < \text{pH} < 6$) or where high concentration of organic acid may be present, PVC coated gabions are necessary. At the construction site, the individual gabion units are laced together and filled with stone.

a. Design. Gabions are designed as mass gravity structures (see Figure 15). When designing a vertical face wall it should be battered at an angle of about 6° to keep the resultant force toward the back of the wall. The coefficient of friction between the base of a gabion wall and a cohesionless soil can be taken as $\tan \phi$ for the soil. The angle of wall friction, δ , may be taken as 0.9ϕ . Where the retained material is mostly sand, a filter cloth or granular filter is recommended to prevent any leaching of the soil. Determine the unit weight of gabions by assuming the porosity to be 0.3. Specific gravity of common material ranges between 2.2 (sandstone) and 3.0 (basalt). Along all exposed gabion faces the outer layer of stones should be hand placed to ensure proper alignment, and a neat compact square appearance.

b. Cohesive Soils. A system of gabion counterforts is recommended when designing gabion structures to retain clay slopes. They should be used as headers and should extend from the front of the wall to a point at least one gabion length beyond the critical slip circle of the bank. Counterforts may be spaced from 13 feet (very soft clay) to 30 feet (stiff clay). A filter is also required on the back of the wall so that clay will not clog the free draining gabions.



1. Draw berm to scale.
2. Layout OX from point O at angle θ below horizontal.
3. Layout OY from point O at angle $(\alpha + \delta)$ below OX.
4. Assume failure surfaces originating at point O and passing through points a, b, c, etc.
5. Compute the weight of each failure wedge.
6. Layout the weight of each failure wedge along OX to a convenient scale.
7. Draw a line parallel to OY for each failure wedge from its weight plotted on OX to its failure plane (extrapolated where necessary).
8. Connect the intersecting points from 7 above with a smooth curve - this is the Culmann Curve. Draw a tangent to this curve which is also parallel to OX.
9. Through the tangent point F, draw a line parallel to OY to intersect OX at W_F . Distance FW_F is the value of P_p in the weight scale.
10. Normal component of the passive resistance, $P_N = P_p \cos \delta$.
11. To compute pressure distribution on the wall, assume a triangular distribution.

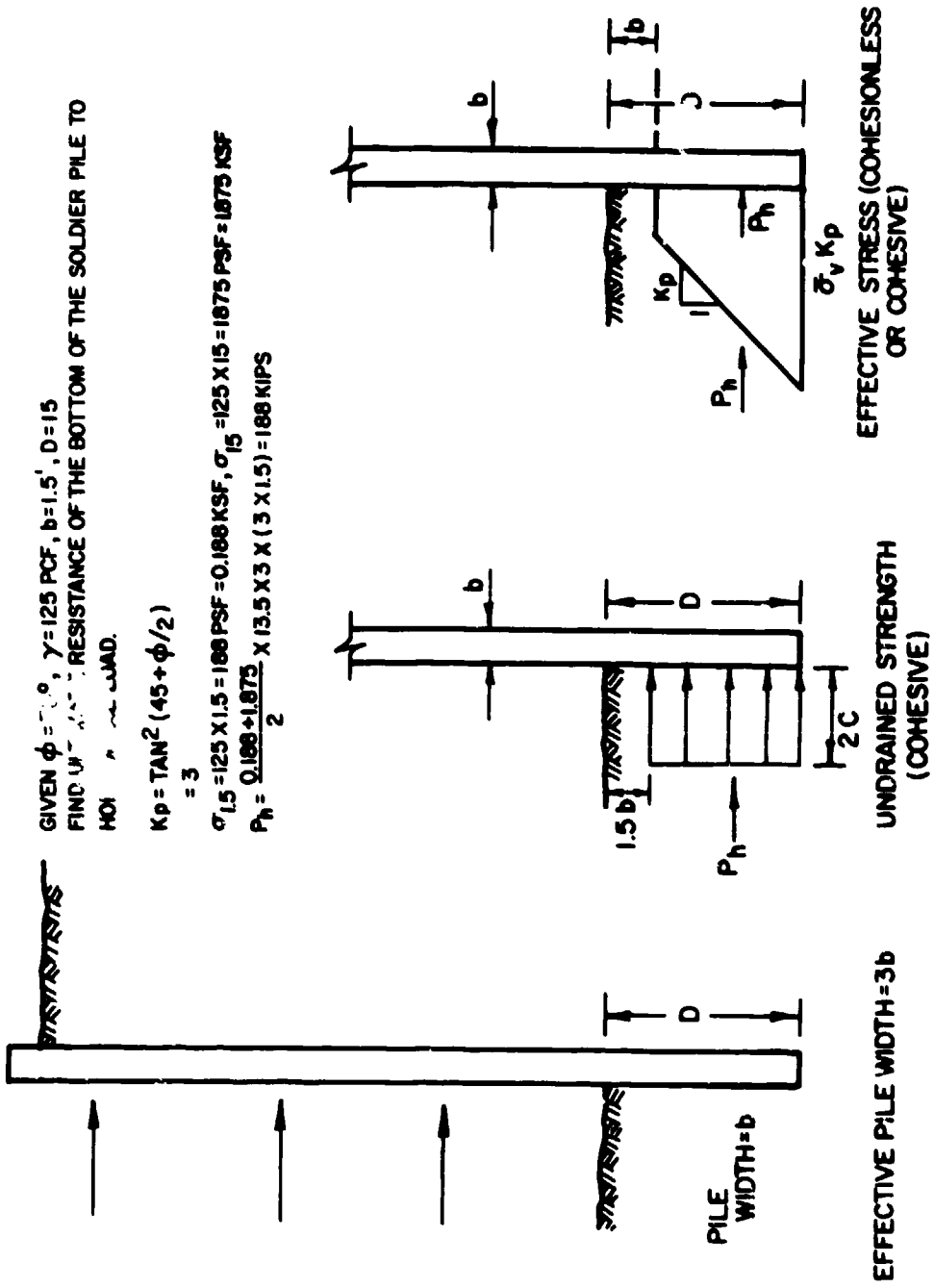
Figure 32
 Culmann Method for Determining Passive Resistance of Earth Berm
 (Granular Soil)
 7.2-113

GIVEN $\phi = 30^\circ$, $\gamma = 125$ PCF, $b = 1.5'$, $D = 15'$
 FIND: PASSIVE RESISTANCE OF THE BOTTOM OF THE SOLDIER PILE TO
 HORIZONTAL LOAD.

$$K_p = \frac{\tan^2(45 + \phi/2)}{3}$$

$$\sigma_{1.5} = 125 \times 1.5 = 188 \text{ PSF} = 0.188 \text{ KSF}, \sigma_{15} = 125 \times 15 = 1875 \text{ PSF} = 1.875 \text{ KSF}$$

$$P_h = \frac{0.188 + 1.875}{2} \times 13.5 \times 3 \times (3 \times 1.5) = 188 \text{ KIPS}$$



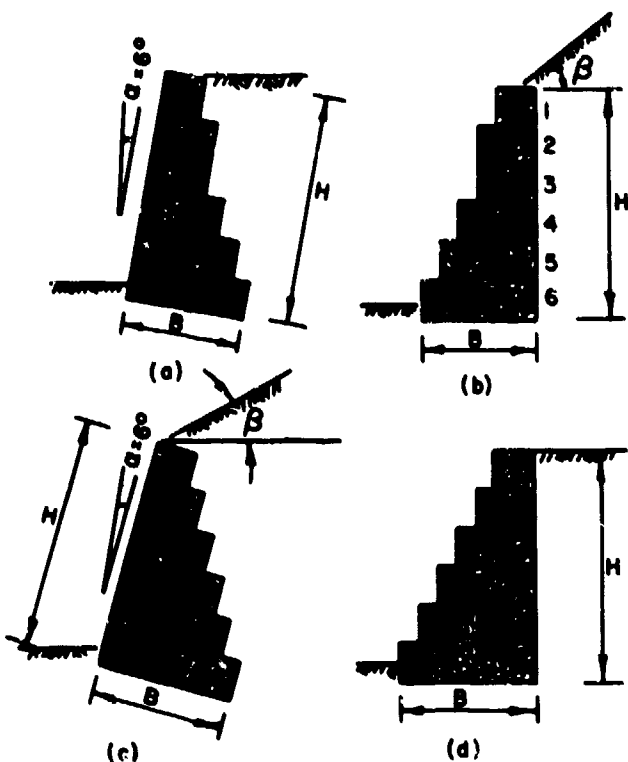
NOTE: RESISTANCE SHOWN IS PER FOOT OF EFFECTIVE PILE WIDTH.

FIGURE 33
 Passive Pressure Distribution for Soldier Piles

Gabion Retaining Wall

Types - Common Gabion walls shown on accompanying diagrams are:

- a) Battered face wall with horizontal backfill.
- b) Stepped face wall with sloped backfill.
- c) Battered face wall with sloped backfill.
- d) Stepped face wall with horizontal backfill.



The choice of either battered or stepped faces rests with designer; stepped face recommended if wall is more than 10 feet high.

Gabion Fill - Hard, durable, clean stone 4 to 8 inches in size or other approved size.

Design: Design criteria for gravity walls apply. Wall section resisting overturning and sliding. To increase wall stability, recommended to tilt the wall at an angle of 6° (i.e. 1:10).

The angle of friction between the base of gabion wall and granular soil may be assumed 0.9 times the angle of internal friction of soil.

For retaining clay slopes, a system of gabion counterforts is recommended.

Compute active soil pressure behind the wall using Coulomb Wedge theory and design mass of the wall to balance the force exerted by that soil wedge. (Higher than active pressures may be used depending on compaction conditions and limitations on deformations.)

Maximum pressure at the base of gabion wall must be less than the anticipated bearing capacity of the soil under the wall.

When water quality is in doubt (pH below 6 or greater than 12) or where high concentration of organic acids may be present, use of PVC (polyvinylchloride) coated gabions is recommended.

FIGURE 34
Gabion Wall

9. REINFORCED EARTH. Reinforced earth is a system of tying vertical facing units into a soil mass with their tensile strips. It consists of four elements: (1) a soil backfill, (2) tensile reinforcing strips, (3) facing elements at boundaries, and (4) mechanical connections between reinforcements and facing elements. The soil backfill is generally granular material with not more than 15% by weight passing a No. 200 mesh sieve. It should not contain materials corrosive to reinforcing strips. Reinforcing strips include smooth and rough strips of non-corrodable metals or treated metals about 3 inches wide. Facing consists of steel skin or precast concrete panels about 7 inches thick.

A wall constructed of reinforced earth is a gravity wall and its safety should be checked as in Figure 15.

Internal safety of reinforced earth is checked as illustrated in Figure 35. For further guidance on reinforced earth see Reference 14, Reinforced Earth Retaining Walls, by Lee, et al. and Reference 15, Symposium of Earth Reinforcement, Proceedings of a Symposium, by American Society of Civil Engineers.

10. EARTH FILLED CRIB WALLS. See Figure 36 (Reference 16, Concrete Crib Retaining Walls, by Portland Cement Association) for types and design criteria. For stability against external forces, a crib wall is equivalent to gravity retaining wall (Figure 15). For design of structural elements, see Reference 17, Foundations, Design and Practice, by Seelye.

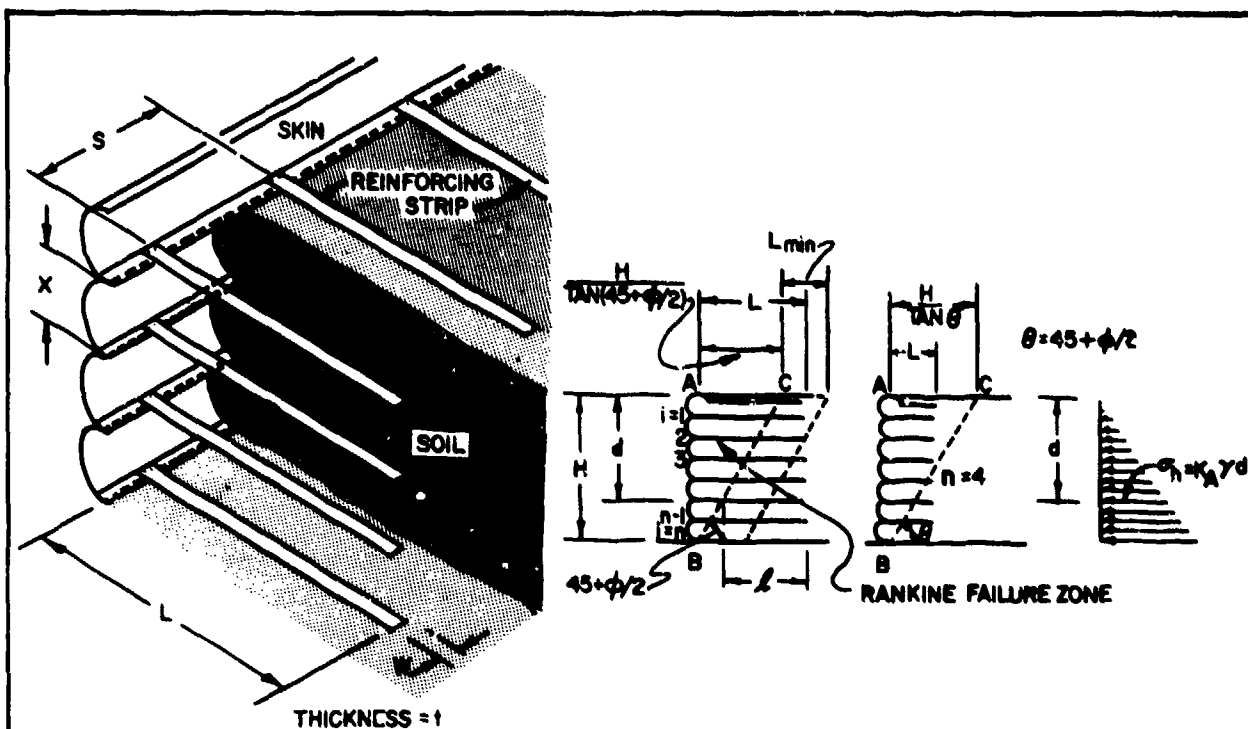
Section 5. COFFERDAMS

1. TYPES. Double-wall or cellular cofferdams consist of a line of circular cells connected by smaller arcs, parallel semi-circular walls connected by straight diaphragms, or a succession of cloverleaf cells (see Figure 37). For analysis, these configurations are transformed into equivalent parallel wall cofferdams of width B.

2. ANALYSIS. Stability depends on ratio of width to height, the resistance of an inboard berm, if any, and type and drainage of cell fill materials.

a. Exterior Pressures. Usually active and passive pressures act on exterior faces of the sheeting. However, there are exceptions to this and these are illustrated in Figure 37.

b. Stability Requirements. A cell must be stable against sliding on its base, shear failure between sheeting and cell fill, shear failure on centerline of cell, and it must resist bursting pressures through interlock tension. These factors are influenced by foundation type. See Figure 37 for design criteria for cofferdams with and without berms, on foundation of rock or of coarse-grained or fine-grained soil. See Reference 18, Design, Construction and Performance of Cellular Cofferdams, by Lacroix, et al., for further guidance.



Safety against breaking of reinforced strips.

$$F_s = \frac{f_s W t}{K_A \gamma H S X}$$

S = Horizontal spacing between strips X = Vertical Spacing between strips
 f_s = allowable stress of reinforced strips.

Typically $W = 3"$. A high factor of safety, $F_s = 3.2$, is used even though allowable metal stress is utilized in computing strip thickness. This is done to account for unknowns such as durability and corrosion.

$$\text{SAFETY AGAINST PULLOUT } F_s = \frac{2 L_{\min} W \tan \delta}{K_A \cdot S \cdot X}$$

L_{\min} is measured beyond zone of Rankine failure. The upper strips may not have enough length to fulfill this requirement, but as long as the average length of all the strips satisfies this condition the wall is considered satisfactory.

d = depth beneath top of wall

t = thickness of strip

γ = unit weight of backfill

B = width of wall

K_A = coefficient of each active pressure (higher than active value may be used depending on compaction conditions and limitations on deformations).

δ = angle of friction between reinforcing strip and the backfill material

l = effective length of tie beyond potential sliding surface

FIGURE 35
Reinforced Earth

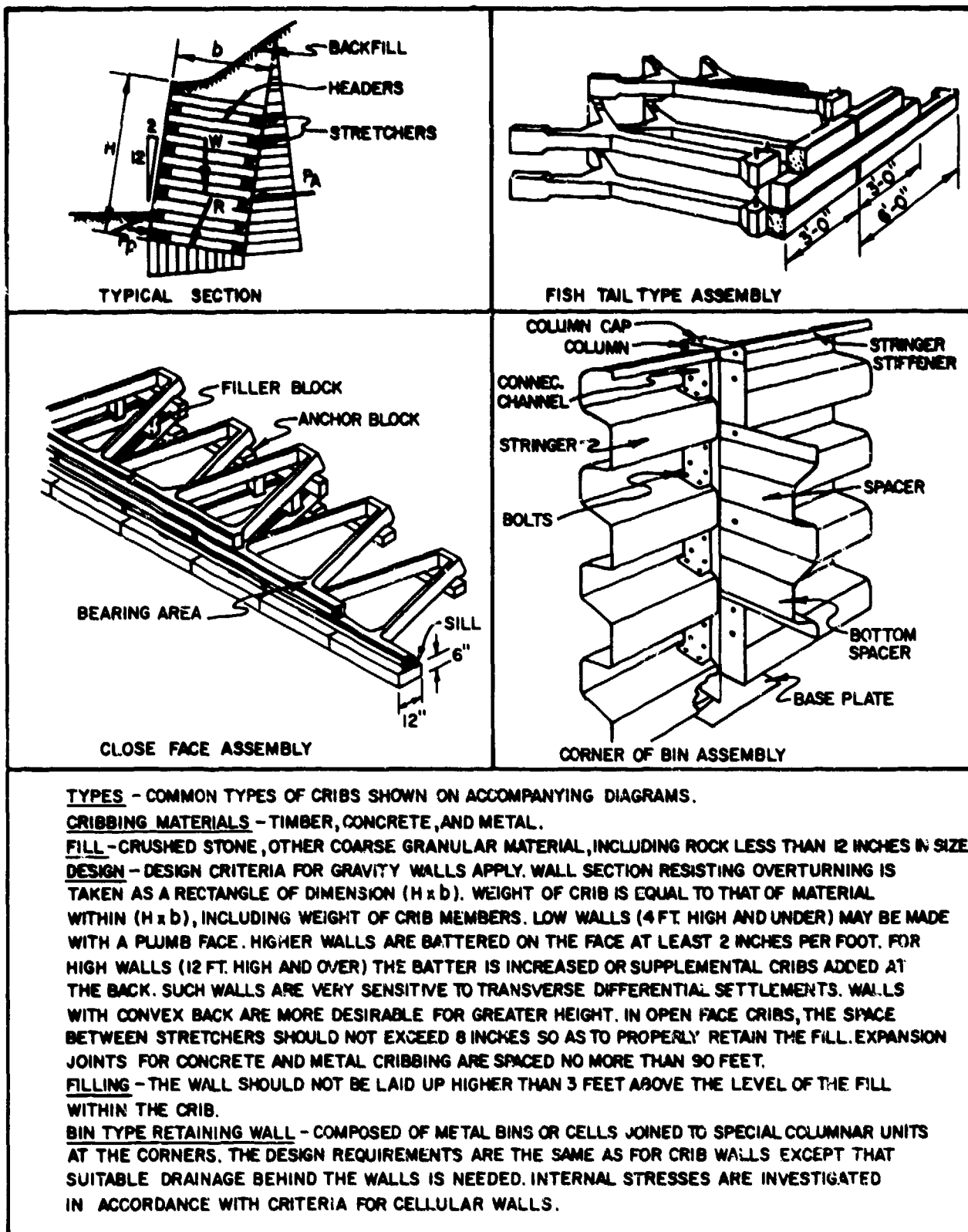
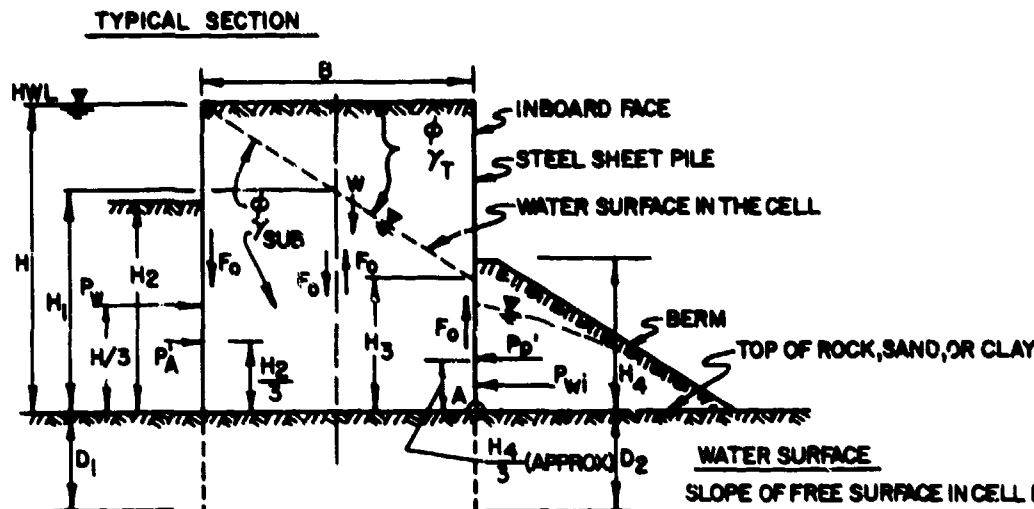
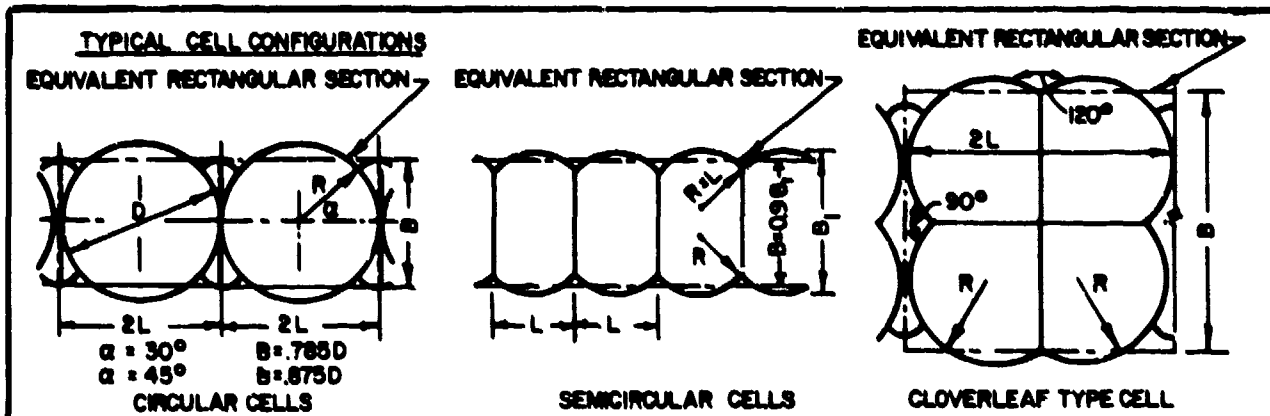


FIGURE 36
Design Criteria for Crib and Bin Walls



HORIZONTAL STRESS DIAGRAMS IN CELL FILL

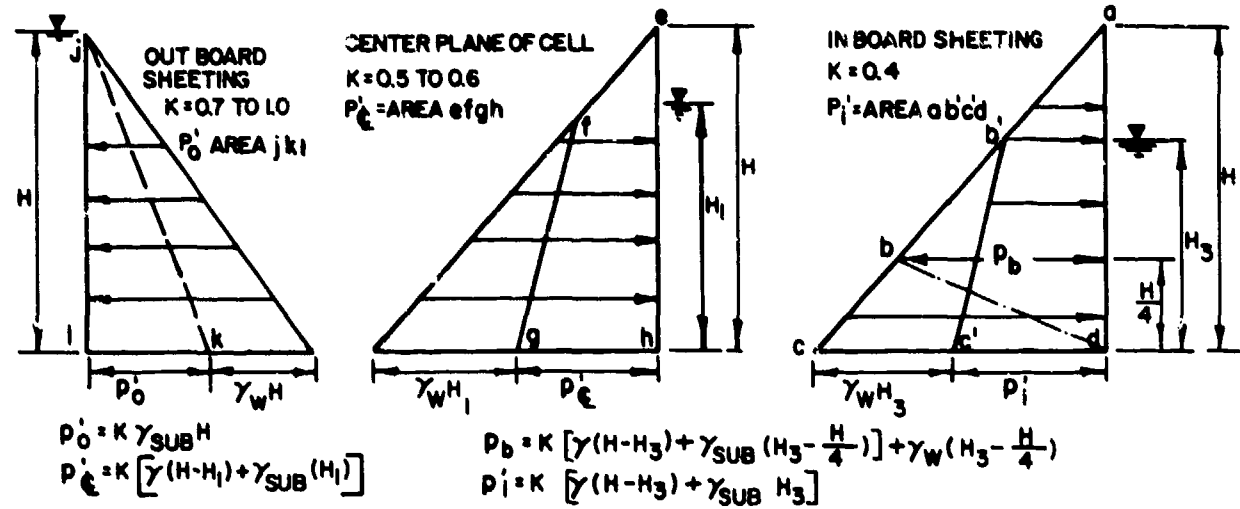


FIGURE 27
 Design Criteria for Cellular Cofferdams
 7.2-119

PARAMETERS FOR ANALYSIS

1. Equivalent width of cofferdam.	Assume $B = 0.85H$ for first trial.
2. Effective weight of cell fill.	$W = [B(H-H_1)\gamma_T + B(H_1)\gamma_{sub}]$
3. Average distance between cross walls.	L
4. Horizontal active force on outboard side - compute using $K_A = \tan^2(45 - \phi/2)$.	$P'_A = K_A \frac{\gamma_{SUB}(H_2)^2}{2}$
5. Coefficient of horizontal earth pressure.	K (varies - see horizontal pressure - diagram)
6. Water force on outboard side.	$P_W = \gamma_W \frac{(H)^2}{2}$
7. Horizontal passive force due to berm plus water force.	$P_P = P'_P + P_{W1}$ (include wall friction between sheet pile and soil)
8. Net overturning moment due to total horizontal force.	$M_O = (P_W \times \frac{H}{3}) + (P'_A \times \frac{H_2}{3}) - (P_P \times \frac{H_4}{3})$ (point of application of P_P is approximated as $H_4/3$, see References in text for further guidance)
9. Resisting moment due to cell fill.	$M_R = W(B/2)$
10. Radius of cell wall.	R
11. Interlock tension.	$T = P_b L$ where P_b = total horizontal stress at point b Zone at maximum interlock tension located at $H/4$ above base. See stress diagram, Inboard Sheeting and references cited in text
12. Ultimate interlock strength.	$T_U = 16$ kip/in for ordinary U.S. steel sheet piles and 28 kips/in for high interlock U.S. sheet piles
13. Effective unit weight.	γ_E = weighted average of cell fill γ_T and γ_{SUB} (above and below water in the cell)

FIGURE 37 (continued)
Design Criteria for Cellular Cofferdams

14. Friction angle of soil and steel.	$\delta = 2/3 \phi'$
15. Coefficient of friction between cell fill and rock.	$\lambda =$ use 0.5 for smooth rock, for all other use $\tan \theta$
16. Drained angle of shearing resistance of soil.	ϕ'
17. Coefficient of interlock friction.	$f = 0.3$
18. Horizontal effect <u>stress</u> on a vertical plane.	$p' =$ (see pressure diagram for subscript)
19. Horizontal effect <u>force</u> on a vertical plane.	$P' =$ (see pressure diagram for subscript)

FIGURE 37 (continued)
Design Criteria for Cellular Cofferdams

DESIGN METHODS

COFFERDAM ON ROCK - WITH BERM

- Factor of safety against sliding on Base

$$F_s = \frac{W \lambda}{P_{wo} + P_A - P_p} \geq 1.25 \text{ (TEMPORARY) TO } 1.5 \text{ (PERMANENT)}$$

- Factor of safety against overturning, F_o

$$F_o = \frac{M_R}{M_o} \geq 3 \text{ TO } 3.5$$

- Factor of safety against excessive interlock tension, F_i

$$F_i = \frac{T_u}{T} \geq 1.5 \text{ TO } 2.0$$

- Factor of safety against vertical shear on centerline, F_{vs} (Terzaghi)

$$F_{vs} = 2/3 \frac{B}{M_o} [P'_c \tan \phi + (P'_i - P_p) f] \geq \begin{matrix} 1.25 \text{ (TEMPORARY WALL)} \\ 1.50 \text{ (PERMANENT WALL)} \end{matrix}$$

Where P'_c is calculated using the effective stress diagram for the Center Plane of cell, and equals the area efg with $K = 0.5$ to 0.6 ; and P'_i is calculated using the effective stress diagram of Inboard Sheeting, and equals area ab'c'd with $K = 0.4$.

- Factor of safety against tilting, F_t

$$F_t = \frac{1}{M_o} \frac{1}{6} \gamma_E B^2 H \left(3 \tan^2 \phi - \frac{B}{H} \tan^3 \phi + \frac{3KfH}{B} \right) \geq \begin{matrix} 1.25 \text{ (TEMPORARY)} \\ 1.50 \text{ (PERMANENT)} \end{matrix}$$

FOR $K = \tan^2(45 - \phi/2)$

- Factor of safety against shear at cell fill, sheet pile interface, F_{sf}

$$F_{sf} = \frac{B}{M_o} \left[(P'_o + P_A + \frac{P'_c}{L}) \tan \delta + P'_c f \frac{B}{L} \right] \geq \begin{matrix} 1.25 \text{ (TEMPORARY)} \\ 1.50 \text{ (PERMANENT)} \end{matrix}$$

Where P'_o is calculated using the effective stress diagram for Outboard Sheeting, and is equivalent to area jkl with $K = 0.7$ to 1.0 .

- Select value of B which satisfies all requirements.

COFFERDAM ON ROCK - WITHOUT BERM

Follow design Steps 1 through 7 as above for cofferdam with berm.

- Put $P_p = 0$ in all equations to compute M_o and factor of safety.
- In computing F_{vs} , P'_i is calculated using the stress diagram for Inboard Sheeting, and equals area ab'c'd with $K = 0.4$.

FIGURE 37 (Continued)
Design Criteria for Cellular Cofferdams

COFFERDAM ON DEEP SAND FOUNDATION - WITHOUT BERM

10. Penetration of sheet piling may depend on underseepage requirements which are evaluated with flow net. In general, this is to avoid piping at inboard toe.

$$D_1 = D_2 = \frac{2H}{3}$$

or $D_1 = D_2 = \frac{H}{2}$ if water level is lowered at least $\frac{H}{6}$ below inboard ground surface.

11. Check factors of safety for Steps 2, 3, 4, 5, and 6 above for cofferdams on rock.
12. Factor of safety for stability against bearing capacity failure, F_{bc}

$$F_{bc} = \frac{Q_{ult}}{\frac{W}{B} + \frac{6M_o}{B^2}} \geq 2 \quad (\text{NOTE: } P_p = 0)$$

Q_{ult} = ULTIMATE BEARING CAPACITY FOR CONTINUOUS FOOTING OF WIDTH B (SEE CHAPTER 4)

13. Penetration to avoid pull-out of outboard sheeting.

$$\frac{Q_{ult}}{Q_p} \geq 1.5, \text{ WHERE } Q_{ult} = \text{ULTIMATE PULLOUT CAPACITY PER LINEAR FOOT OF WALL} = 1/2 K_o \gamma_E D_1^2 \tan \delta \times \text{PERIMETER (NOTE: } P_p = 0), \text{ AND } Q_p = \frac{M_o}{3B(1 + \frac{B}{4L})}$$

COFFERDAM ON DEEP SAND FOUNDATION - WITH BERM

14. Design as per steps for cofferdam on deep sand foundation without berm, except that passive resultant P_p is included in resisting overturning moment.
15. Stability against bearing capacity failure is not as critical with presence of berm.
16. Penetration of sheeting required to avoid piping is evaluated with flow net.
17. Penetration of Outboard Sheeting to avoid pull-out is the same as for cofferdam on deep sand without berm except include P_p in calculation of M_o .

COFFERDAM ON STIFF TO HARD CLAY

18. Design procedures same as for cofferdams on sand. Stability against bearing capacity failure of inboard toe $F_{bc} \geq 2.5$. Penetration of sheeting to avoid piping is usually not important.
19. Penetration to avoid pull-out of Outboard Sheeting

$$\frac{Q_{ult}}{Q_p} \geq 1.5; Q_p \text{ SAME AS STEP 13}$$
$$Q_{ult} = C_o D_1 \times \text{PERIMETER (} C_o \text{ FROM TABLE I)}$$

FIGURE 37 (Continued)
Design Criteria for Cellular Cofferdams
7.2-123

COFFERDAM ON SOFT TO MEDIUM STIFF CLAY

20. Design procedures same as for cofferdams on deep sand, with modifications as per following steps. Penetration to avoid piping is usually not important.
21. Factor of Safety for stability against bearing capacity failure, F_{bc}

$$F_{bc} \text{ from Step 12 } \geq 3$$

22. Because of internal instability due to settlement of compressible foundation, factor of safety against vertical stress on centerline F_{vs} from Step 4 should be

$$F_{vs} = \frac{P_c}{M_0} \times \frac{RfB}{L} \times \frac{(L+0.25B)}{(L+0.5B)} \geq \begin{cases} 1.25 \text{ (TEMPORARY)} \\ 1.50 \text{ (PERMANENT)} \end{cases}$$

Investigate overall stability of cofferdam with respect to sliding along a curved surface below the bottom of the sheeting by slope stability analysis from DM-7.1 CHAPTER 7.

23. Investigate and evaluate seams of pervious sand within the clay deposit which could develop excessive uplift pressure below the base of the cofferdam.
24. Evaluate penetration of outboard sheeting to avoid pull-out as per Step 19.

FIGURE 37 (continued)
Design Criteria for Cellular Cofferdams

(1) Sand Base. For cell walls on sand, penetration of sheeting must be sufficient to avoid piping at interior toe of wall and to prevent pullout of outboard sheeting.

(2) Clay Base. For cofferdams on clay, penetration of outboard sheeting usually is controlled by the pullout requirement and piping is not critical.

(3) Bearing Capacity. For cofferdams on either clay or sand, check the bearing capacity at the inboard toe by methods of Chapter 4.

c. Cell Deformations. The maximum bulging of cells occurs at about $1/4$ of the height above the base of the cofferdam and the cells tilt about 0.02 to 0.03 radians due to the difference in lateral loads on the outboard and inboard faces. Deflections under the lateral overturning loads are a function of the dimensions, the foundation support, and the properties of the cell fill (see Reference 19, Field Study of Cellular Cofferdams, by Brown).

3. CELL FILL. Clean, coarse-grained, free-draining soils are preferred for cell fill. They may be placed hydraulically or dumped through water without compaction or special drainage.

a. Materials. Clean granular fill materials should be used in large and critical cells. Every alternative should be studied before accepting fine-grained backfill. These soils produce high bursting pressures and minimum cell rigidity. Their use may necessitate interior berms, increased cell width, or possibly consolidation by sand drains or pumping within the cell. All soft material trapped within the cells must be removed before filling.

b. Drainage. Weep holes should be installed on inboard sheeting to the cell fill. For critical cells and marginal fill material, supplementary drainage by wellpoints, or wells within cells have been used to increase cell stability.

c. Retardation of Corrosion. When cofferdams are used as permanent structures, especially in brackish or seawater, severe corrosion occurs from top of the splash zone to a point just below mean low water level. Use protective coating, corrosion resistant steel and/or cathodic protection in these areas.

REFERENCES

1. Canadian Geotechnical Society, Excavations and Retaining Structures, Canadian Foundation Engineering Manual, Part 4, 1978.
2. Caquot, A., and Kerisel, F., Tables for the Calculation of Passive Pressure, Active Pressure and Bearing Capacity of Foundations, Gauthier-Villars, Paris.
3. Gray, H., Contribution to the Analysis of Seepage Effects in Backfills, Geotechnique, 1958.
4. Richart, F.E., and Schmertmann, F., The Effects of Seepage on the Stability of Sea Walls, Proceedings, First Conference on Coastal Engineering, University of Florida, Gainesville, FL.
5. Based on work by Terzaghi, K., Anchored Bulkheads, Transaction, ASCE, Paper No. 2720, Vol. 119, 1954.
6. Goldberg, D.T., Jaworski, W.E., and Gordon, M.D., Lateral Support Systems and Underpinning, Vol. I, Design and Construction (Summary), FHWA-RD-75, Federal Highway Administration, 1976.
7. Ingold, T.S., Retaining Wall Performance During Backfilling, Journal of the Geotechnical Engineering Division, ASCE, Vol. 105, GT5, 1979.
8. Seed, H.B. and Whitman, R.V., Design of Earth Retaining Structures for Dynamic Loads, Lateral Stresses in the Ground and Design of Earth Retaining Structures, ASCE, Cornell University, 1970.
9. Terzaghi, K., and Peck, R.B., Soil Mechanics in Engineering Practice, John Wiley & Sons, Inc., New York, 1967.
10. Rowe, P.W., Anchored Sheet Pile Walls, Proceedings, Institution of Civil Engineers, London, January, 1952.
11. Tschebotarioff, G.P., Foundations, Retaining and Earth Structures, 2nd Edition, McGraw-Hill, New York, 1973.
12. United States Steel Corporation, Steel Sheet Piling Design Manual, United States Steel, Pittsburgh, PA., 1975.
13. Carson, A.C., Foundation Construction, McGraw-Hill Book Co., 1965.
14. Lee, K.L., Dean, B. and Vageron, J.M.J., Reinforced Earth Retaining Walls, Journal of Soil Mechanics and Foundation Division, ASCE, Vol. 99, No. SM10, 1973.
15. ASCE Proceedings, Symposium on Earth Reinforcement, ASCE Annual Convention, Pittsburgh, PA., 1978.
16. Portland Cement Association, Concrete Crib Retaining Walls, Concrete Information No. St. 46, Chicago, IL., May, 1952.

17. Seelye, E.E., Foundations, Design and Practice, John Wiley & Sons, Inc., New York, New York, 1956.
18. Lacroix, Y., Esrig, M.I. and Luschem, U., Design, Construction and Performance of Cellular Cofferdams, Lateral Stresses in the Ground and Design of Earth Retaining Structures, ASCE, Cornell University, 1970.
19. Brown, P.P., Discussion of Paper by White, Chency and Duke, Field Study of Cellular Cofferdams, Transaction, ASCE, Paper No. 3426, Vol. 128, Part 1, 1963.

CHAPTER 4. SHALLOW FOUNDATIONS

Section 1. INTRODUCTION

1. SCOPE. This chapter presents criteria for the design of shallow foundations, methods of determining allowable bearing pressures, and treatment of problems in swelling and collapsing subsoils. For the majority of structures the design of footings is controlled by limiting settlements. (See RELATED CRITERIA below.) This chapter discusses permissible bearing pressures as limited by shear failure. Shallow foundations are of the following types; spread footings for isolated columns, combined footings for supporting the load from more than one structural unit, strip footings for walls, and mats or rafts beneath the entire building area. Also, included is guidance for footings subjected to uplift. Design of deep anchors for such footings is covered in DM-7.3, Chapter 3.
2. RELATED CRITERIA. See DM-7.1, Chapter 5 for determination of settlements of shallow foundations. See NAVFAC DM-2 for criteria for loads applied to foundations by various structures and structural design of foundations.
3. APPLICATIONS. Shallow foundations can be used where there is a suitable bearing stratum near the surface, no highly compressible layers below, and calculated settlements are acceptable. Where the bearing stratum at ground surface is underlain by weaker and more compressible materials, consider the use of deep foundations or piles. See Chapter 5.

Section 2. BEARING CAPACITY ANALYSIS

1. LIMITATIONS. Allowable bearing pressures for shallow foundations are limited by two considerations. The safety factor against ultimate shear failure must be adequate, and settlements under allowable bearing pressure should not exceed tolerable values. In most cases, settlement governs the foundation pressures. See DM-7.1, Chapter 5 for evaluation of settlements. For major structures, where relatively high foundation bearing pressures yield substantial economy, determine ultimate bearing capacity by detailed exploration, laboratory testing, and theoretical analysis. For small or temporary structures, estimate allowable bearing pressures from penetration tests, performance of nearby buildings, and presumptive bearing values; see Paragraphs 3 and 4.
2. THEORETICAL BEARING CAPACITY.
 - a. Ultimate Bearing Capacity. To analyze ultimate bearing capacity for various loading situations, see Figures 1 through 5. For these analyses the depth of foundation embedment is assumed to be less than the foundation width, and friction and adhesion on the foundation's vertical sides are neglected. In general, the analyses assume a rough footing base such as would occur with cast-in-place concrete.

Figures 1 through 5 present ultimate bearing capacity diagrams for the following cases:

(1) See Figure 1 (Reference 1, Influence of Roughness of Base and Ground Water Condition on the Ultimate Bearing Capacity of Foundations, by Meyerhof) for shallow footings with concentric vertical load. Formulas shown assume groundwater at a depth below base of footing equal to or greater than the narrow dimension of the footing.

(2) Use Figure 2 (Reference 1) to determine groundwater effect on ultimate bearing capacity and the depth of failure zone. For cohesive soils, changes in groundwater level do not affect theoretical ultimate bearing capacity.

(3) Use Figure 3a (Reference 2, The Bearing Capacity of Foundations Under Eccentric and Inclined Loads, by Meyerhof) for inclined load on continuous horizontal footing and for inclined load on continuous inclined footing.

(4) Use Figure 3b for eccentric load on horizontal footing.

(5) Use Figures 4a; 4b (Reference 3, The Ultimate Bearing Capacity of Foundations on Slopes, by Meyerhof) for shallow footing with concentric vertical load placed on a slope or near top of slope.

(6) Use Figure 5 (Reference 4, The Bearing Capacity of Footings on a Two-Layer Cohesive Subsoil, by Button) for shallow footing with concentric vertical load on two layered cohesive soil.

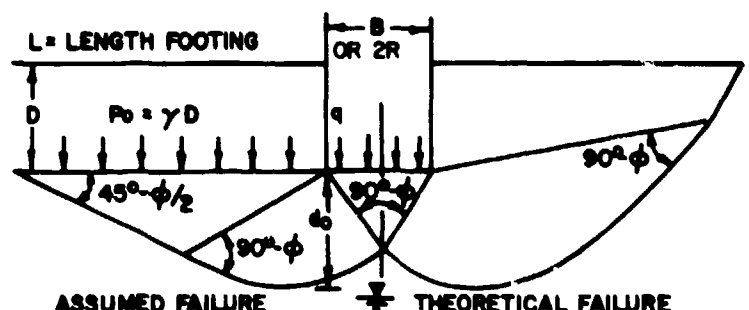
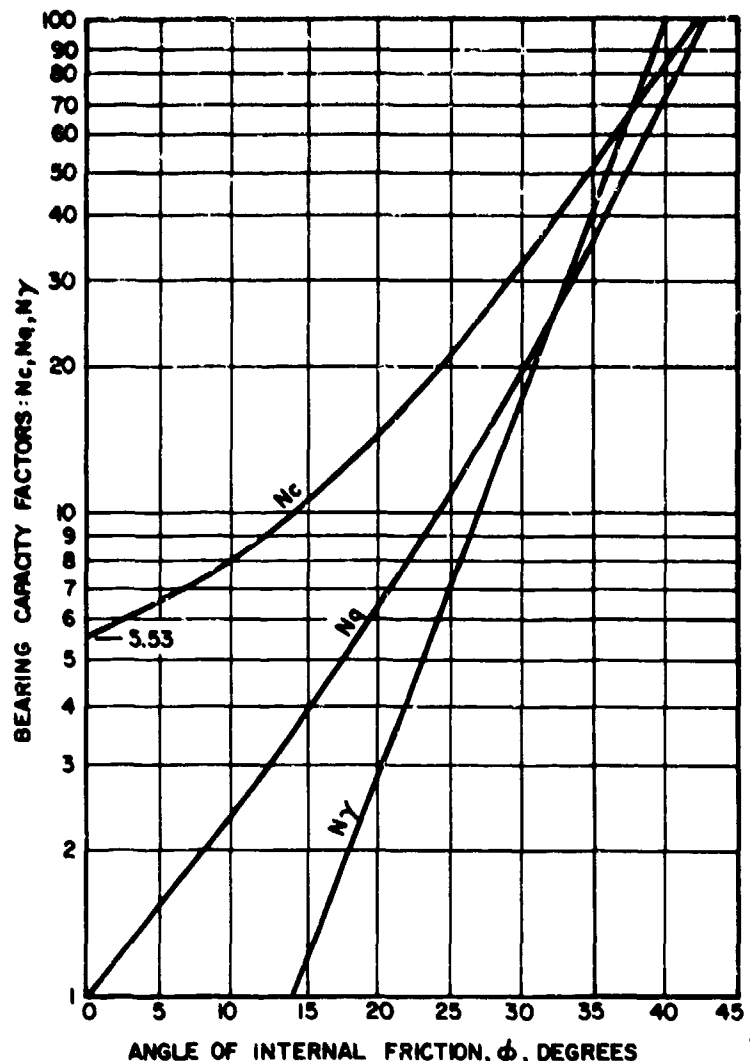
These diagrams assume general shear failure which normally occurs in dense and relatively incompressible soils. This type of failure is usually sudden and catastrophic; it is characterized by the existence of a well-defined failure pattern. In contrast, in loose or relatively compressible soils, punching or local shear failures may occur at lower bearing pressures. Punching or local shear failures are characterized by a poorly defined failure surface, significant vertical compression below the footing and very little disturbance around the footing perimeter.

To approximate the local or punching shear failures, the bearing capacity factors should be calculated with reduced strength characteristics c^* and ϕ^* defined as:

$$c^* = 0.67 c$$
$$\phi^* = \tan^{-1} (0.67 \tan \phi)$$

For more detailed and precise analysis, see Reference 5, Bearing Capacity of Shallow Foundations, by Vesic.

b. Allowable Bearing Capacity. To obtain allowable bearing capacity, use a safety factor of 3 for dead load plus maximum live load. When part of the live loads are temporary (earthquake, wind, snow, etc.) use a safety factor of 2. Include in design dead load the effective weight of footing and soil directly above footing. See Figures 6 and 7 for examples of allowable bearing capacity calculations.



- ASSUMED CONDITIONS:**
1. $D \leq B$
 2. SOIL IS UNIFORM TO DEPTH $d_0 > B$.
 3. WATER LEVEL LOWER THAN d_0 BELOW BASE OF FOOTING.
 4. VERTICAL LOAD CONCENTRIC.
 5. FRICTION AND ADHESION ON VERTICAL SIDES OF FOOTING ARE NEGLECTED.
 6. FOUNDATION SOIL WITH PROPERTIES c, ϕ, γ

ULTIMATE BEARING CAPACITY = q_{ult}

CONTINUOUS FOOTING; GENERAL CASE

$q_{ult} = q' + q''$
 q' = PORTION OF BEARING CAPACITY ASSUMING WEIGHTLESS FOUNDATION SOIL
 q'' = PORTION OF BEARING CAPACITY FROM WEIGHT OF FOUNDATION SOIL
 $q' = cN_c + \gamma D N_q$
 $q'' = \gamma \frac{B}{2} N_y$
 $q_{ult} = cN_c + \gamma D N_q + \frac{\gamma B}{2} N_y$
SQUARE OR RECTANGULAR FOOTING

$q_{ult} = cN_c (1 + 1.3 \frac{B}{L}) + \gamma D N_q + 0.4 \gamma B N_y$
CIRCULAR FOOTING: $R = B/2$
 $q_{ult} = 1.3 cN_c + \gamma D N_q + 0.6 \gamma R N_y$

FOR COHESIONLESS FOUNDATION SOILS ($c = 0$)

CONTINUOUS FOOTING:

$q_{ult} = \gamma D N_q + \frac{\gamma B}{2} N_y$

SQUARE OR RECTANGULAR FOOTING:

$q_{ult} = \gamma D N_q + 0.4 \gamma B N_y$

CIRCULAR FOOTING:

$q_{ult} = \gamma D N_q + 0.6 \gamma R N_y$

FOR COHESIVE FOUNDATION SOILS ($\phi = 0$)

CONTINUOUS FOOTING:

$q_{ult} = cN_c + \gamma D$

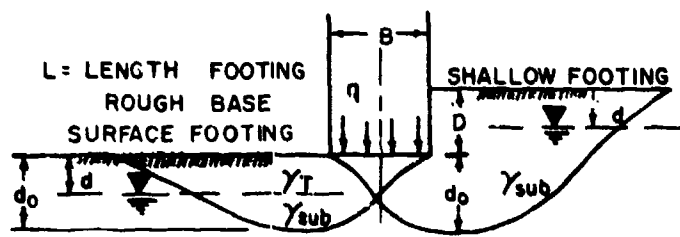
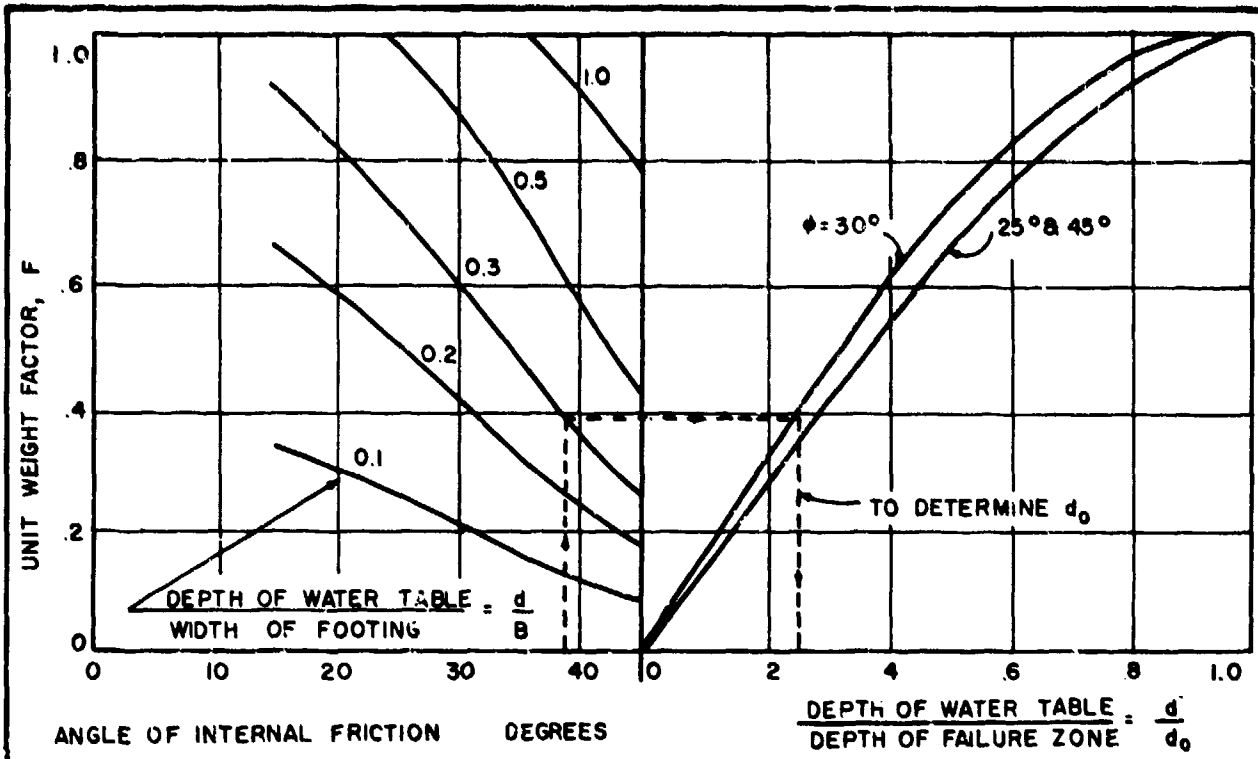
SQUARE OR RECTANGULAR FOOTING:

$q_{ult} = cN_c (1 + 1.3 \frac{B}{L}) + \gamma D$

CIRCULAR FOOTING:

$q_{ult} = 1.3 cN_c + \gamma D$

FIGURE 1
 Ultimate Bearing Capacity of Shallow Footings With Concentric Loads



ASSUMED CONDITIONS:

1. GROUNDWATER LEVEL IS HORIZONTAL
2. PRESENCE OF GROUNDWATER HAS NO EFFECT ON COHESIVE SOIL WITH $\phi = 0$.

CONTINUOUS FOOTING:

SURFACE FOOTING: $D = 0$
 $q_{ult} = cN_c + [\gamma_{sub} + F(\gamma_T - \gamma_{sub})] \frac{B}{2} N_y$

SHALLOW FOOTING: $D \leq B$

IF $d \leq D$
 $q_{ult} = cN_c + [\gamma_{sub} D + (\gamma_T - \gamma_{sub}) d] N_q + 0.5 \gamma_{sub} B N_y$

IF $D < d \leq (D + d_0)$

$q_{ult} = cN_c + \gamma_T D N_q + [\gamma_{sub} + F(\gamma_T - \gamma_{sub})] \frac{B}{2} N_y$

VALUES OF BEARING CAPACITY FACTORS N_c , N_q AND N_y ARE SHOWN IN FIGURE 1.

RECTANGULAR FOOTING:

SURFACE FOOTING: $D = 0$
 $q_{ult} = cN_c (1 + 3 \frac{B}{L}) + [\gamma_{sub} + F(\gamma_T - \gamma_{sub})] 0.4 B N_y$

SHALLOW FOOTING: $D \leq B$, IF $d \leq D$
 $q_{ult} = cN_c (1 + 3 \frac{B}{L}) + [\gamma_{sub} D + (\gamma_T - \gamma_{sub}) d] N_q + 0.4 \gamma_{sub} B N_y$

IF $D < d \leq (D + d_0)$
 $q_{ult} = cN_c (1 + 3 \frac{B}{L}) + \gamma_T D N_q + [\gamma_{sub} + F(\gamma_T - \gamma_{sub})] 0.4 B N_y$

CIRCULAR FOOTING: RADIUS = $R = B/2$

SURFACE FOOTING: $D = 0$
 $q_{ult} = 1.3 cN_c + [\gamma_{sub} + F(\gamma_T - \gamma_{sub})] 0.6 R N_y$

SHALLOW FOOTING: $D \leq 2R$, IF $d \leq D$
 $q_{ult} = 1.3 cN_c + [\gamma_{sub} D + (\gamma_T - \gamma_{sub}) d] N_q + [0.6 \gamma_{sub} + R N_y]$

IF $D < d \leq (D + d_0)$
 $q_{ult} = 1.3 cN_c + \gamma_T D N_q + [\gamma_{sub} + F(\gamma_T - \gamma_{sub})] 0.6 R N_y$

FIGURE 2
 Ultimate Bearing Capacity With Groundwater Effect

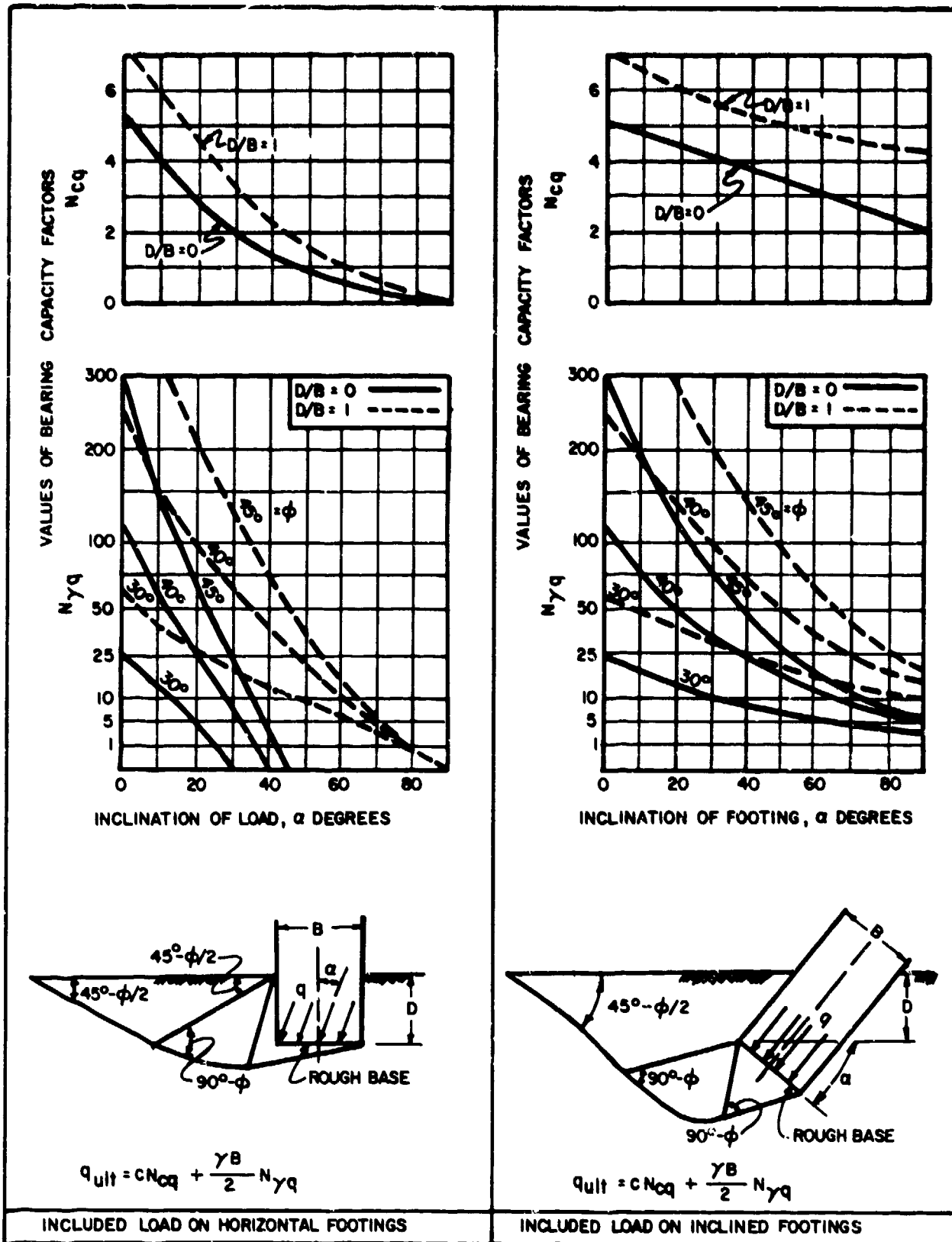
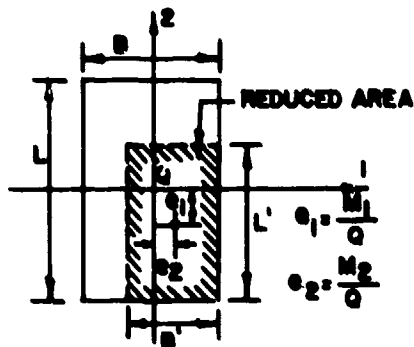


FIGURE 3a
 Ultimate Bearing Capacity of Continuous Footings With Inclined Load



Resultant force acts at the centroid of the reduced area.

(A) EQUIVALENT LOADINGS



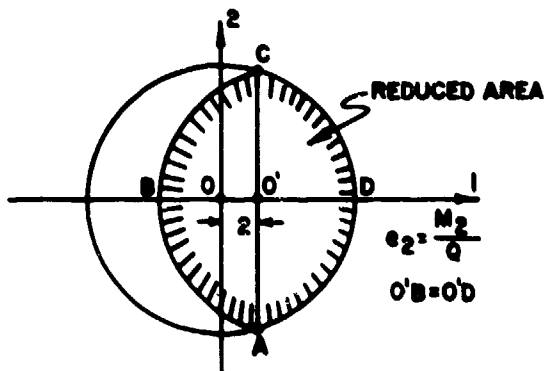
For rectangular footings
reduce dimension as follows:

$$L' = L - 2e_1 \quad e_1 = \frac{M_1}{Q}$$

$$B' = B - 2e_2 \quad e_2 = \frac{M_2}{Q}$$

(B) REDUCED AREA-RECTANGULAR FOOTINGS

For a circular footing of radius R, the effective area $A'_e = 2 \times$ (area of circular segment ADC), consider A'_e to be a rectangle with $L'/B' = \frac{AC}{BD}$



$$e = \frac{M}{Q}$$

$$A'_e = 2S = B'L'$$

$$L' = \left(2S \sqrt{\frac{R+e_2}{R-e_2}} \right)^{1/2}$$

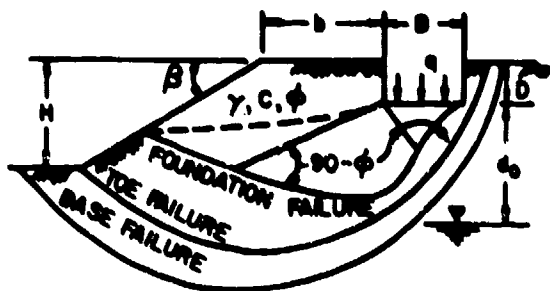
$$B' = L' \sqrt{\frac{R-e_2}{R+e_2}}$$

$$S = \frac{\pi R^2}{2} - \left[e_2 \sqrt{R^2 - e_2^2} + R^2 \sin^{-1} \left(\frac{e_2}{R} \right) \right]$$

(C) REDUCED AREA-CIRCULAR FOOTINGS

FIGURE 3b
Eccentrically Loaded Footings

CASE I: CONTINUOUS FOOTING AT TOP OF SLOPE



Water at $d_0 \geq B$

$$q_{ult} = cN_{cq} + \gamma_T \frac{B}{2} N_{\gamma q} \quad (1)$$

Water at Ground Surface

$$q_{ult} = cN_{cq} + \gamma_{sub} \frac{B}{2} N_{\gamma q} \quad (2)$$

If $B \leq H$:

Obtain N_{cq} from Figure 4b for Case I with $N_0 = 0$.

Interpolate for values of $0 < D/B < 1$

Interpolate q_{ult} between EQ (1) and (2) for water at intermediate level between ground surface and $d_0 = B$.

If $B > H$:

Obtain N_{cq} from Figure 4b for Case I with stability number

$$N_0 = \frac{\gamma H}{c}$$

Interpolate for values $0 < D/B < 1$ for $0 < N_0 < 1$. If $N_0 \geq 1$, stability of slope controls ultimate bearing pressure.

Interpolate q_{ult} between EQ (1) and (2) for water at intermediate level between ground surface and $d_0 = B$. For water at ground surface and sudden drawdown: substitute ϕ' for ϕ in EQ (2)

$$\phi' = \tan^{-1} \left(\frac{\gamma_{sub}}{\gamma_T} \tan \phi \right)$$

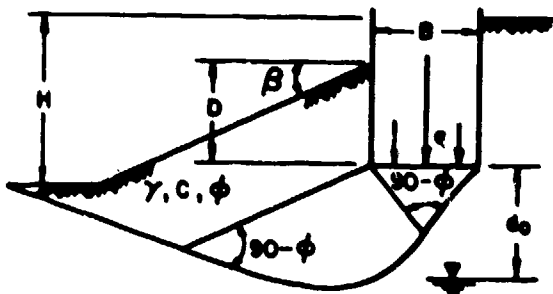
Cohesive soil ($\phi = 0$)

Substitute in EQ (1) and (2) D for $B/2$ and $N_{\gamma q} = 1$.

Rectangular, square or circular footing:

$$q_{ult} = \left[q_{ult} \text{ for continuous footing as given above} \right] \times \left[\frac{q_{ult} \text{ for finite footing}}{q_{ult} \text{ for continuous footing}} \right] \text{ from Fig. 1}$$

CASE II: CONTINUOUS FOOTINGS ON SLOPE



Same criteria as for Case I except that N_{cq} and $N_{\gamma q}$ are obtained from diagrams for Case II

FIGURE 4a

Ultimate Bearing Capacity For Shallow Footing Placed on or Near a Slope

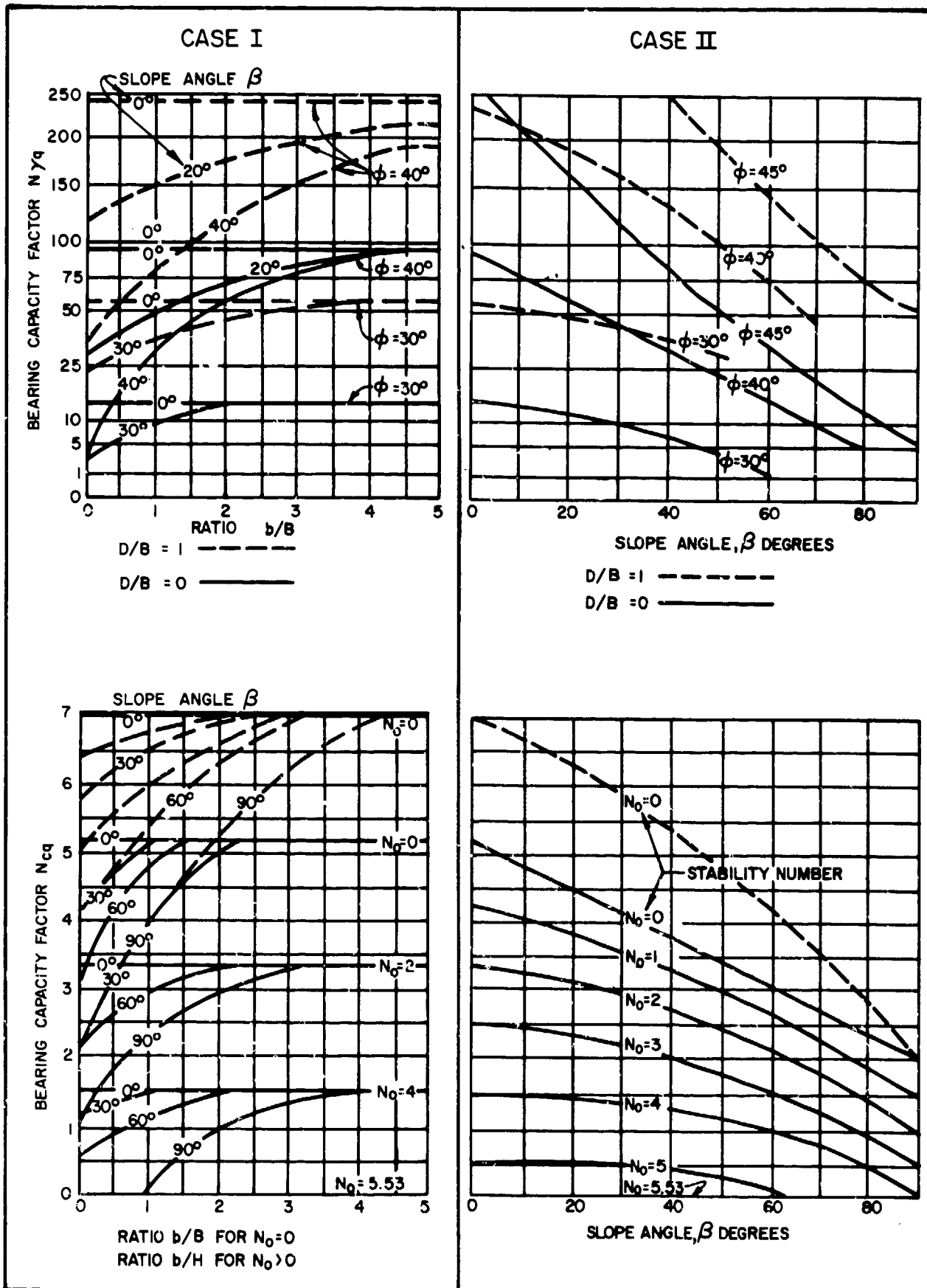


FIGURE 4b
 Bearing Capacity Factors for Shallow Footing Placed on or Near a Slope
 7.2-136

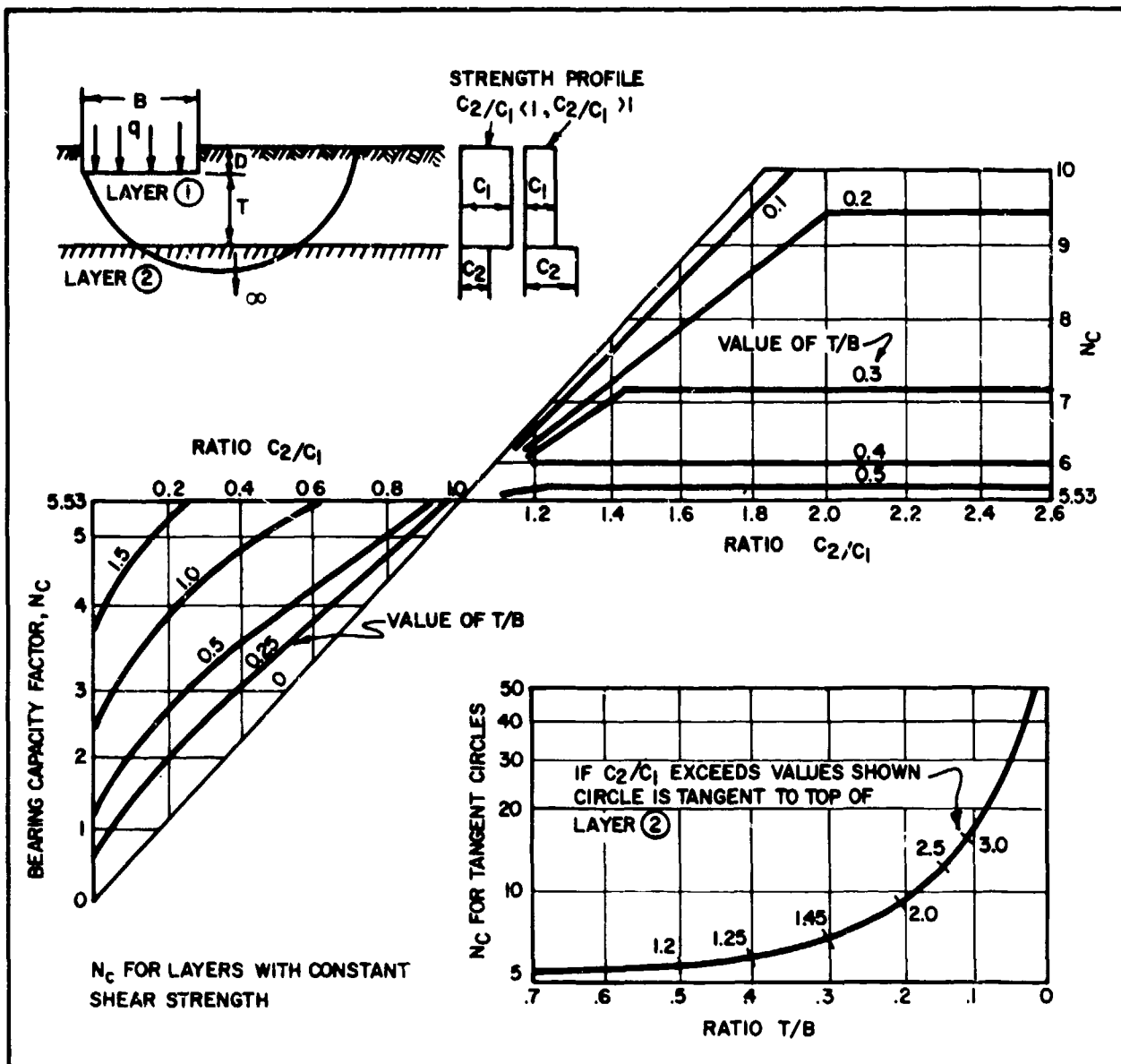


FIGURE 5
 Ultimate Bearing Capacity of Two Layer Cohesive Soil ($\phi=0$)

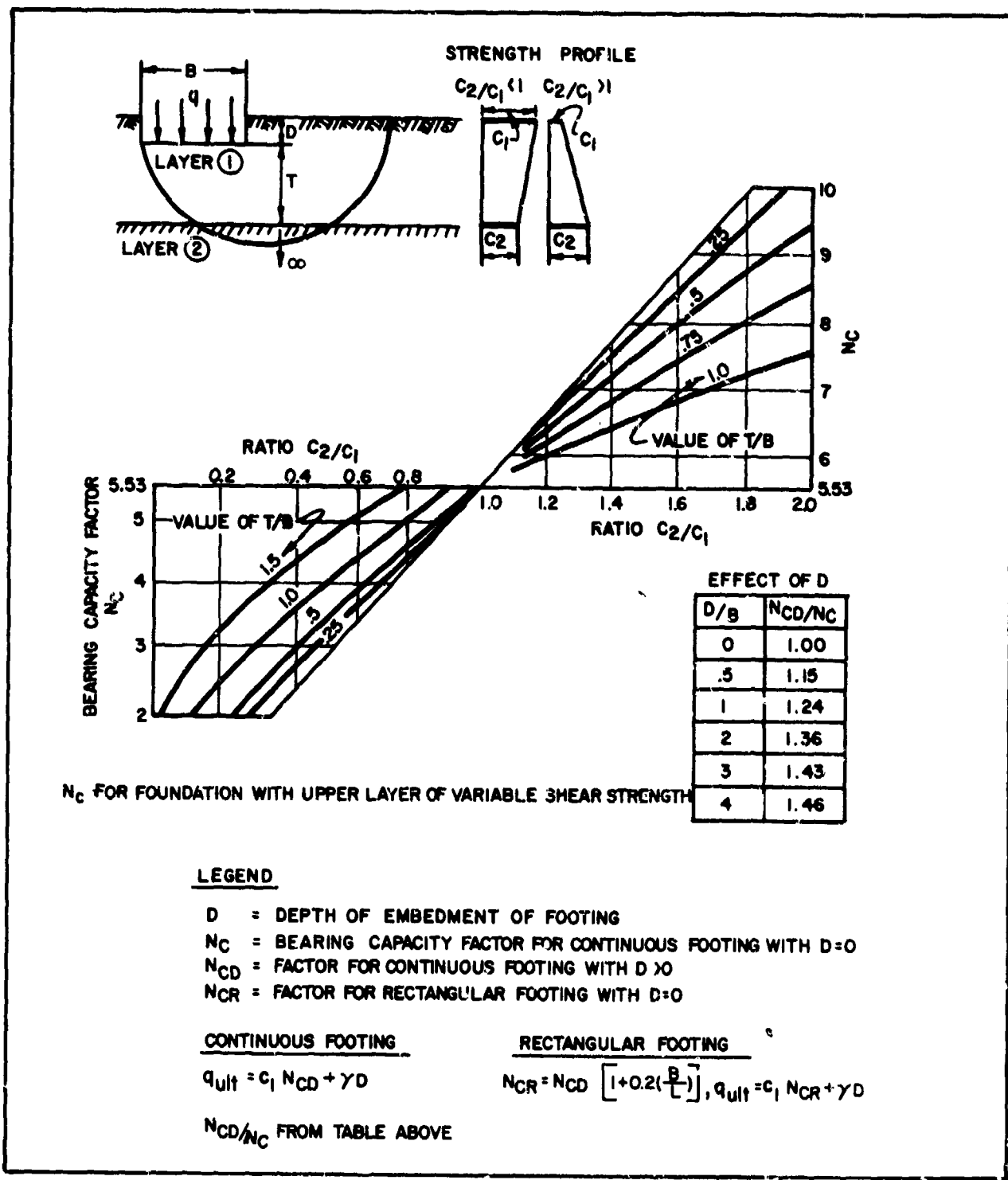


FIGURE 5 (continued)
Ultimate Bearing Capacity of Two Layer Cohesive Soil ($\phi=0$)

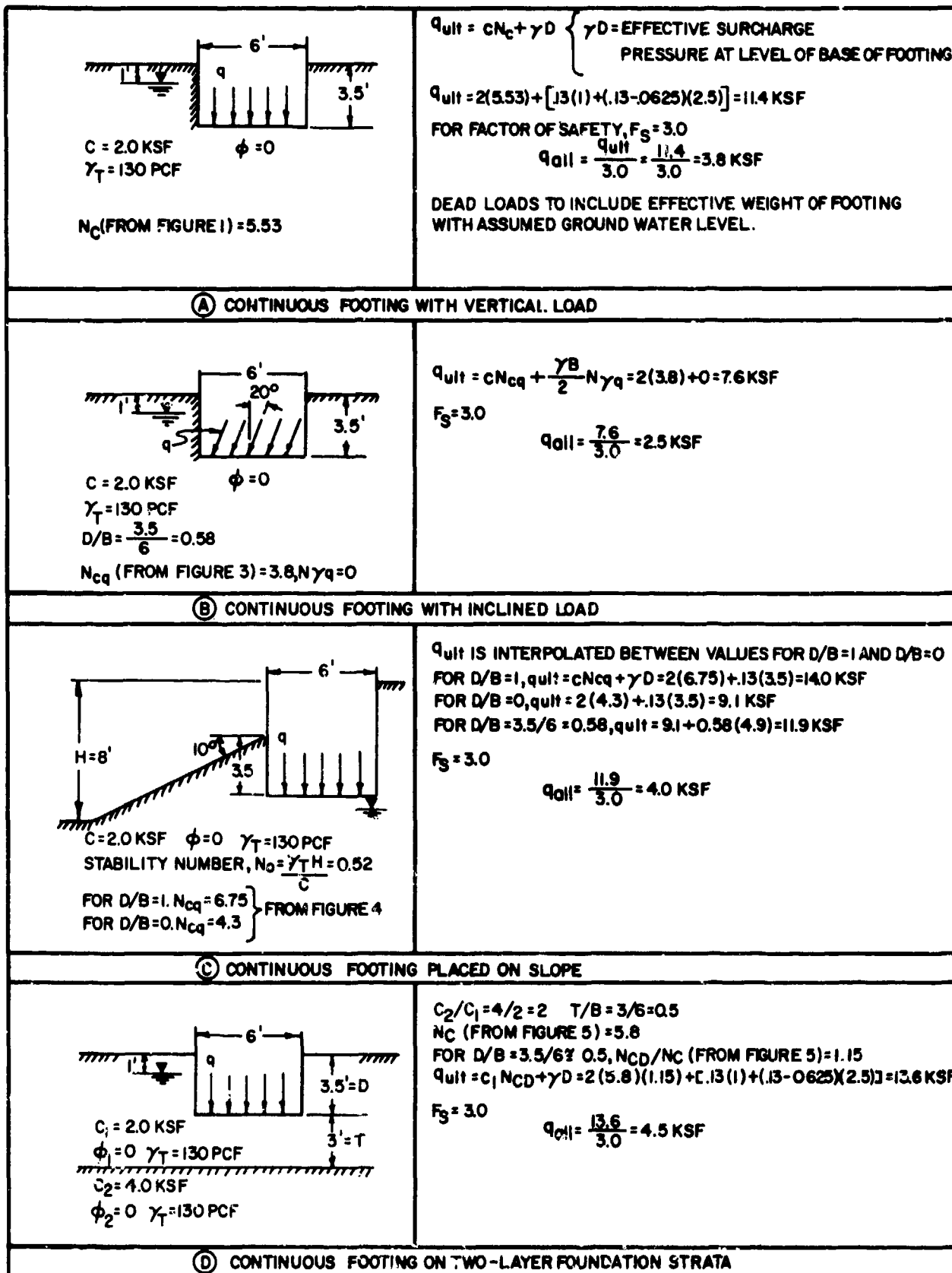


FIGURE 6
 Examples of Computation of Allowable Bearing Capacity
 Shallow Footings on Cohesive Soils

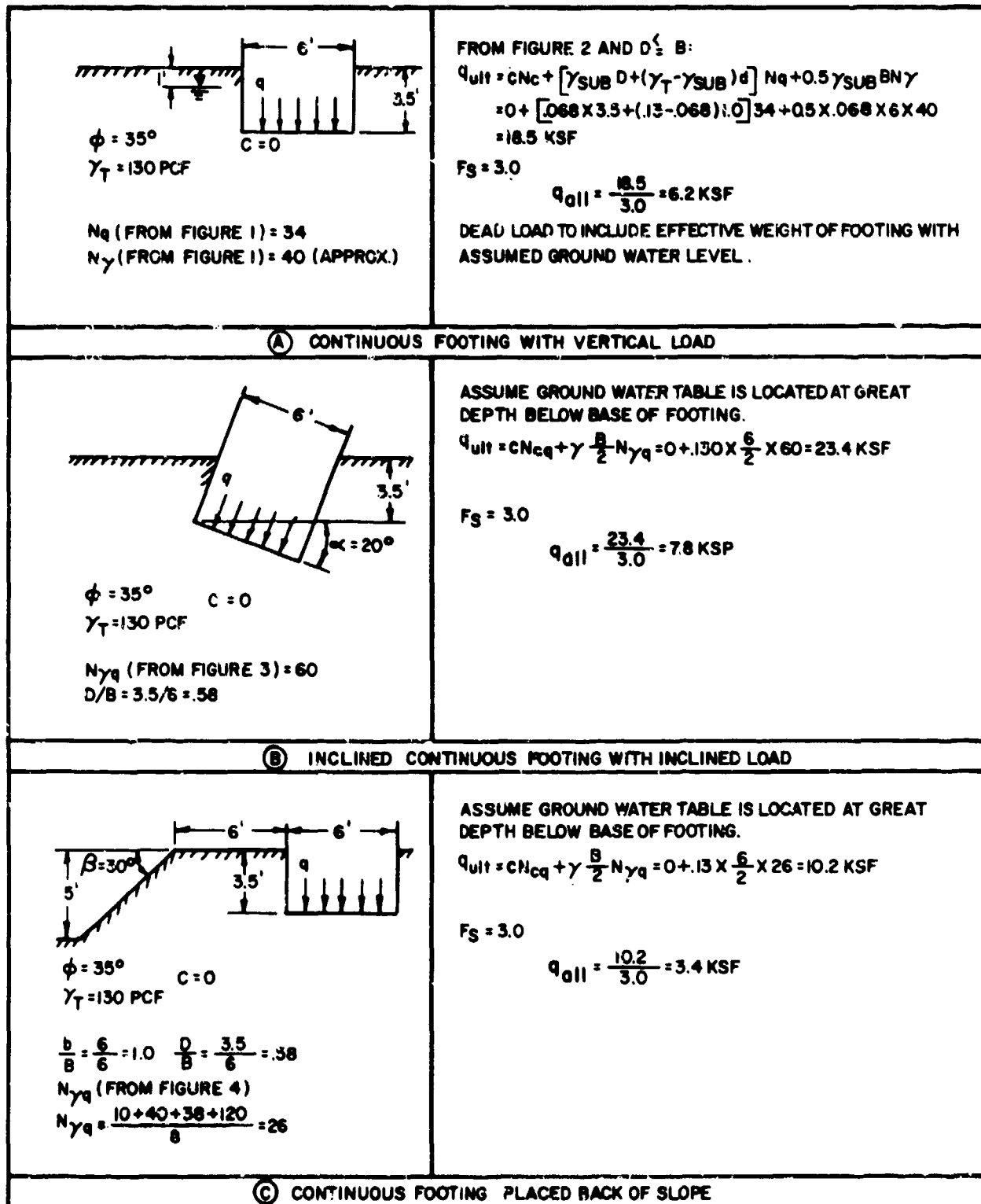


FIGURE 7
 Examples of Computation of Allowable Bearing Capacity
 Shallow Footings on Granular Soils

c. Soil Strength Parameters.

(1) Cohesive Soils. In the case of fine-grained soils which have low permeability, total stress strength parameters are used. Value of cohesion may be determined from laboratory unconfined compression tests, vane shear tests, or undrained triaxial tests. Shear strength correlations with standard penetration tests and cone penetration tests may also be used. (See DM-7.1, Chapter 1.)

(2) Granular Soils. In the case of coarse-grained soils which drain freely use the effective stress strength parameter (ϕ'). Field tests (e.g., standard penetration tests or cone penetration) are almost always used to estimate this strength.

(3) In the case where partial drainage may occur during construction (e.g., newly compacted fill) perform two analyses, one assuming drained, the other assuming undrained conditions, and design for the most conservative results.

3. PRESUMPTIVE BEARING PRESSURES. For preliminary estimates or when elaborate investigation of soil properties is not justified, use bearing pressure from Table 1.

a. Utilization. These load intensities are intended to provide a reasonable safety factor against ultimate failure and to avoid detrimental settlements of individual footings. Where differential settlements cannot be tolerated, exploration, testing and analysis should be performed. Presumptive bearing pressures must be used with caution and verified, if practicable, by performance of nearby structures.

b. Modifications of Presumptive Bearing Pressures. See Table 2 for variations in allowable bearing pressure depending on footing size and position. (See Reference 6, Foundation Analysis and Design, by Bowles for more detailed analyses of uplift resistance than shown in Table 2). Nominal bearing pressures may be unreliable for foundations on very soft to medium-stiff fine-grained soils or over a shallow groundwater table and should be checked by an estimate of theoretical bearing capacity. Where bearing strata are underlain by weaker and more compressible material, or where compressibility of subsoils is constant with depth, analyze consolidation settlement of the entire foundation (see DM-7.1, Chapter 5).

4. EMPIRICAL ALLOWABLE BEARING PRESSURES. Allowable bearing pressures for foundation may be based upon the results of field tests such as the Standard Penetration Test (SPT) or Cone Penetration Test (CPT). These bearing pressures are based on maximum foundation settlements but do not consider settlement effects due to the adjacent foundations. In the case of closely spaced foundations where the pressure beneath a footing is influenced by adjoining footings a detailed settlement analysis must be made.

TABLE 1
Presumptive Values of Allowable Bearing Pressures for Spread Foundations

Type of Bearing Material	Consistency In Place	Allowable Bearing Pressure Tons Per sq ft	
		Range	Recommended Value for Use
Massive crystalline igneous and metamorphic rock: granite, diorite, basalt, gneiss, thoroughly cemented conglomerate (sound condition allows minor cracks).	Hard, sound rock	60 to 100	80.0
Foliated metamorphic rock: slate, schist (sound condition allows minor cracks).	Medium hard sound rock	30 to 40	35.0
Sedimentary rock; hard cemented shales, siltstone, sandstone, limestone without cavities.	Medium hard sound rock	15 to 25	20.0
Weathered or broken bed rock of any kind except highly argillaceous rock (shale). RQD less than 25.	Soft rock	8 to 12	10.0
Compaction shale or other highly argillaceous rock in sound condition.	Soft rock	8 to 12	10.0
Well graded mixture of fine and coarse-grained soil: glacial till, hardpan, boulder clay (GW-GC, GC, SC)	Very compact	8 to 12	10.0
Gravel, gravel-sand mixtures, boulder gravel mixtures (SW, SP, SW, SP)	Very compact	6 to 10	7.0
	Medium to compact	4 to 7	5.0
	Loose	2 to 6	3.0
Coarse to medium sand, sand with little gravel (SW, SP)	Very compact	4 to 6	4.0
	Medium to compact	2 to 4	3.0
	Loose	1 to 3	1.5
Fine to medium sand, silty or clayey medium to coarse sand (SW, SM, SC)	Very compact	3 to 5	3.0
	Medium to compact	2 to 4	2.5
	Loose	1 to 2	1.5

TABLE 1 (continued)
Presumptive Values of Allowable Bearing Pressures for Spread Foundations

Type of Bearing Material	Consistency In Place	Allowable Bearing Pressure Tons Per sq ft.	
		Range	Recommended Value for Use
Homogeneous inorganic clay, sandy or silty clay (CL, CH)	Very stiff to hard	3 to 6	4.0
	Medium to stiff	1 to 3	2.0
	Soft	.5 to 1	0.5
Inorganic silt, sandy or clayey silt, varved silt-clay-fine Sand	Very stiff to hard	2 to 4	3.0
	medium to stiff	1 to 3	1.5
	Soft	.5 to 1	0.5

Notes:

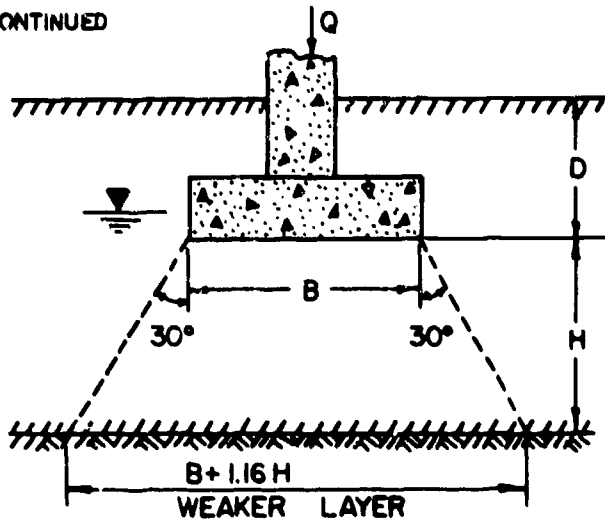
1. Variations of allowable bearing pressure for size, depth and arrangement of footings are given in Table 2.
2. Compacted fill, placed with control of moisture, density, and lift thickness, has allowable bearing pressure of equivalent natural soil.
3. Allowable bearing pressure on compressible fine grained soils is generally limited by considerations of overall settlement of structure.
4. Allowable bearing pressure on organic soils or uncompacted fills is determined by investigation of individual case.
5. If tabulated recommended value for rock exceeds unconfined compressive strength of intact specimen, allowable pressures equals unconfined compressive strength.

TABLE 2
Selection of Allowable Bearing Pressures for Spread Foundations

1. For preliminary analysis or in the absence of strength tests of foundation soil, design and proportion shallow foundations to distribute their loads using presumptive values of allowable bearing pressure given in Table 1. Modify the nominal value of allowable bearing pressure for special conditions in accordance with the following items.
2. The maximum bearing pressure beneath the footing produced by eccentric loads that include dead plus normal live load plus permanent lateral loads, shall not exceed the nominal bearing pressure of Table 1.
3. Bearing pressures up to one-third in excess of the nominal bearing values are permitted for transient live load from wind or earthquake. If overload from wind or earthquake exceeds one-third of nominal bearing pressures, increase allowable bearing pressures by one-third of nominal value.
4. Extend footings on soft rock or on any soil to a minimum depth of 18 inches below adjacent ground surface or surface of adjacent floor bearing on soil, whichever elevation is the lowest.
5. For footings on soft rock or on coarse-grained soil, increase allowable bearing pressures by 5 percent of the nominal values for each foot of depth below the minimum depth specified in 4.
6. Apply the nominal bearing pressures of the three categories of hard or medium hard rock shown on Table 1 where base of foundation lies on rock surface. Where the foundation extends below the rock surface increase the allowable bearing pressure by 10 percent of the nominal values for each additional foot of depth extending below the surface.
7. For footing smaller than 3 feet in least lateral dimension, the allowable bearing pressure shall be one-third of the nominal bearing pressure multiplied by the least lateral dimension in feet.
8. Where the bearing stratum is underlain by a weaker material determine the allowable bearing pressure as follows:

TABLE 2 (continued)
 Selection of Allowable Bearing Pressures for Spread Foundations

8. CONTINUED



Q = applied load, not including weight of foundation itself.

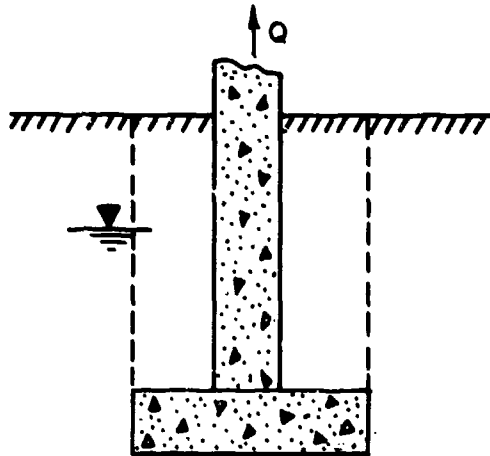
L = length of foundation.

$(B + 1.16H)(L + 1.16H)$ = area stressed in weaker layer.

$$\frac{Q}{(B + 1.16H)(L + 1.16H)} \leq \text{nominal value of allowable bearing pressure.}$$

Area stressed in weaker layer shall not extend beyond intersection of 30° planes extending downward from adjacent foundations.

9. Where the footing is subjected to a sustained uplift force, compute ultimate resistance to uplift as follows:



Q = applied uplift load.

W = total effective weight of soil and concrete located within prism bounded by vertical lines at base of foundation. Use total unit weights above water table and buoyant unit weights below.

$$\text{Safety Factor} = \frac{W}{Q} \geq 2$$

(This is a conservative procedure; see text for reference on more detailed analyses procedures.)

a. Standard Penetration Test. Relationships are presented in Reference 7, Foundation Engineering, by Peck, Hanson and Thornburn, for allowable bearing values in terms of standard penetration resistance and for limiting settlement. When SPT tests are available, use the correlation in DM-7.1, Chapter 2 to determine relative density and Figure 6, DM-7.1, Chapter 3 to estimate ϕ values. Use Figure 1 to compute ultimate bearing pressure.

b. Cone Penetration Test. The results of CPT may be used directly to compute allowable bearing pressure for coarse-grained soils. See Figure 8 (Reference 8, Shallow Foundations, by the Canadian Geotechnical Society).

c. Bearing Capacity From Pressuremeter. If pressuremeter is used to determine in situ soil characteristics, bearing capacity can be computed from these test results. (See Reference 8.)

Section 3. SPREAD FOOTING DESIGN CONSIDERATIONS

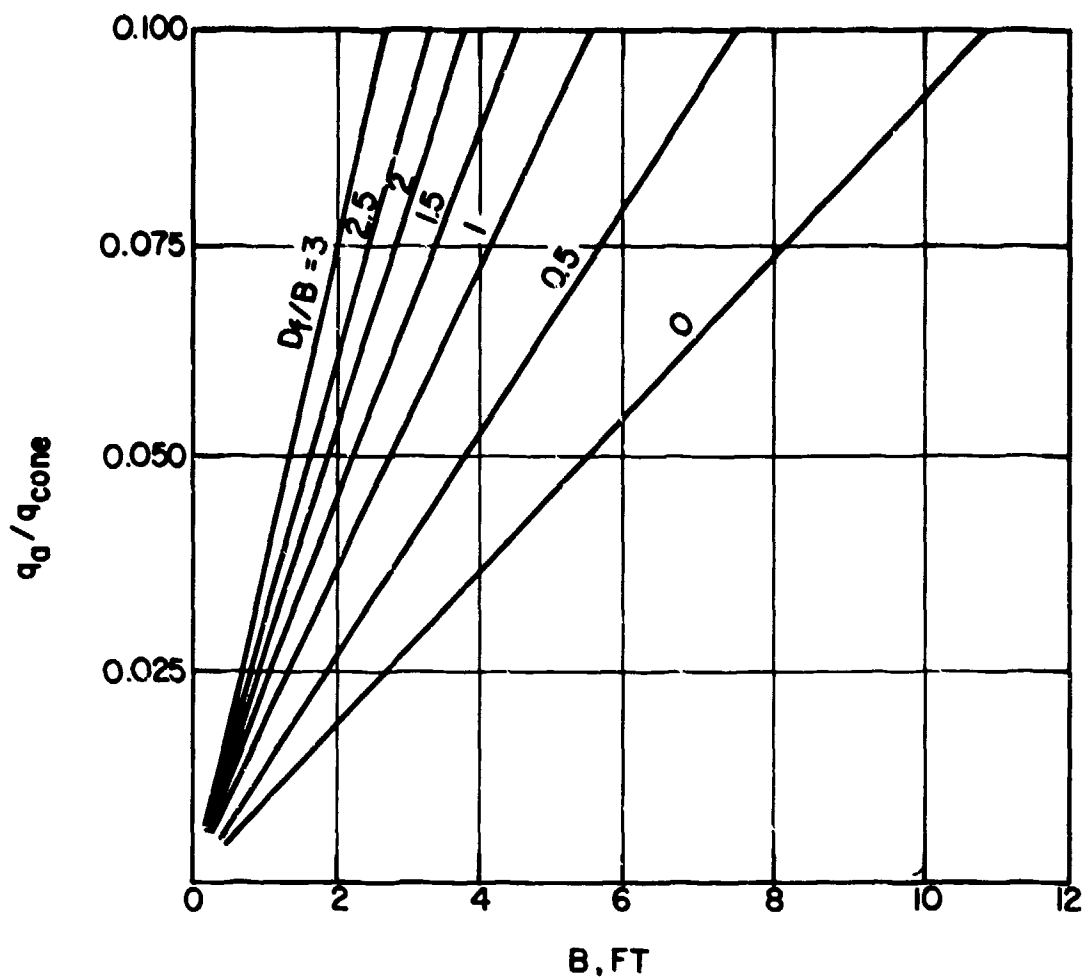
1. FOUNDATION DEPTH. In general footings should be carried below:

- (a) The depth of frost penetration;
- (b) Zones of high volume change due to moisture fluctuations;
- (c) Organic materials;
- (d) Disturbed upper soils;
- (e) Uncontrolled fills;
- (f) Scour depths in rivers and streams.
- (g) Zones of collapse-susceptible soils.

2. ALTERNATIVE FOUNDATION METHODS - Light Structures. Light structures may be supported by other types of shallow foundation treatment such as: (a) deep perimeter wall footings; (b) overexcavation and compaction in footing lines; (c) mat design with thickened edge; (d) preloading surcharge.

3. PROPORTIONING INDIVIDUAL FOOTINGS. Where significant compression will not occur in strata below a depth equal to the distance between footings, individual footings should be proportioned to give equal settlements, using formulas from DM-7.1, Chapter 5. See Figure 9 for an example.

4. CORROSION PROTECTION. Foundation design should consider potentially detrimental substances in soils, such as chlorides and sulphates, with appropriate protection for reinforcement, concrete and metal piping. If the analysis indicates sulphate concentration to be more than 0.5% in the soil or more than 1200 parts per million in the groundwater, the use of a sulphate resisting cement such as Type V Portland cement should be considered. In additions, other protection such as lower water-cement ratio, bituminous coating, etc. may be required depending upon the sulphate concentration. See Reference 9, Sulphates in Soils and Groundwaters, BRS Digest, for guidance.



q_a = ALLOWABLE BEARING PRESSURE

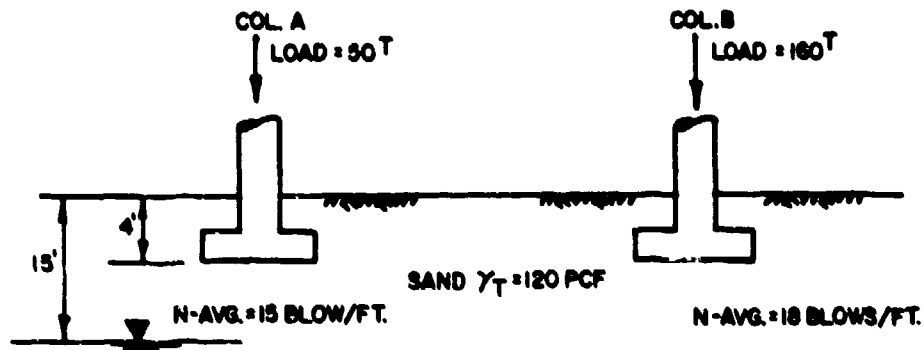
q_{cone} = CONE RESISTANCE

D_f = DEPTH OF SURCHARGE ABOVE THE BASE OF FOOTING

B = FOOTING WIDTH

FIGURE 8
 Allowable Bearing Pressure for Sand From Static Cone Penetration Tests

EXAMPLE



Column load A = 50 tons , Avg. N = 15 blows/ft.
 Column load B = 160 tons , Avg. N = 18 blows/ft.
 Soil: well graded sand (SW) , $\gamma_T = 120$ pcf

Column A

Assume square footing 5ft. x 5ft., B = 5ft.

Average overburden pressure at 6.5 ft. ($D_f + B/2$) below ground level:

$$P_o = 120 \times 6.5 = 780 \text{ psf} = 0.39 \text{ tsf}$$

From Figure 3, DM-7.1, Chapter 2, $D_r = 80\%$

From Figure 7, DM-7.1, Chapter 3, $\phi = 37.5^\circ$

a) Determine Bearing Capacity

$$\text{From Figure 1, } q_{ult} = \left[120 \times 4 \times 45 + 0.4 \times 120 \times 5 \times 70 \right] \frac{1}{2000} = 19.2 \text{ tsf}$$

$$q_{ult}(\text{net}) = 19.2 - \frac{120 \times 4}{2000} \approx 19 \text{ tsf}$$

$$\text{Use } F_s = 3, \therefore q_{all} = \frac{19}{3} = 6.3 \text{ tsf}$$

Minimum required footing size: $\frac{50}{6.3} \approx 3\text{ft.} \times 3\text{ft.}$ which is less than assumed size 5ft. x 5ft.

b) Check for settlement.

To limit settlement, assume a 5ft. x 5ft. footing with $q = \frac{50T}{5\text{ft.} \times 5\text{ft.}} = 2 \text{ tsf.}$

From Figure 6, DM-7.1, Chapter 5 $K_{v1} = 255 \text{ tons/ft}^3$

$$\Delta H = \frac{4 \times 2 \times 5^2}{255 \times (5 + 1)^2} \times 12 = 0.26 \text{ inches}$$

Column B

Assume 8ft. x 8ft. square footing

Average overburden pressure at 8ft. = ($D_f + B/2$) below ground level.

$$P_o = 120 \times 8 \times \frac{1}{2000} = 0.48 \text{ tsf}$$

From Figure 3, DM-7.1, Chapter 2, $D_r = 87\%$

From Figure 7, DM-7.1, Chapter 3, $\phi = 39^\circ$

a) Determine Bearing Capacity

$$\text{From Figure 1, } q_{ult} = \left[120 \times 4 \times 58 + 0.4 \times 120 \times 8 \times 96 \right] \frac{1}{2000} = 32.3 \text{ tsf}$$

$$q_{ult}(\text{net}) = 32.3 - \frac{120 \times 4}{2000} \approx 32 \text{ tsf}$$

$$\text{Use } F_s = 3.0 \therefore q_{all} = \frac{32}{3} = 10.7 \text{ tsf}$$

FIGURE 9

Example of Proportioning Footing Size to Equalize Settlements

Minimum required footing size: $\frac{160}{10.7} = 3.9 \text{ ft.} \times 3.9 \text{ ft.}$

b) Footing size required for settlement equal to that of Column A.

From Figure 6, DM-7.1, Chapter 5, $K_{v1} = 290 \text{ tons/ft.}^3$

$$0.26 = \frac{4 \times 160 \times B^2}{290 \times B^2 \times (B + 1)^2} \times 12$$

$$\text{Or } B = \sqrt{\frac{4 \times 160 \times 12}{0.26 \times 290}} - 1 = 9.1 \gg 3.9$$

Settlement Governs

Use 9.1 x 9.1 footing for Column B

FIGURE 9 (continued)
Example of Proportioning Footing Size to Equalize Settlements

Electrical corrosive properties of soil are important where metal structures such as pipe lines, etc. are buried underground. A resistivity survey of the site may be necessary to evaluate the need for cathodic protection.

Section 4. MAT AND CONTINUOUS BEAM FOUNDATIONS

1. **APPLICATIONS.** Depending on economic considerations mat foundations are generally appropriate if the sum of individual footing base areas exceeds about one-half the total foundation area; if the subsurface strata contain cavities or compressible lenses; if shallow shear strain settlements predominate and the mat would equalize differential settlements; or if resistance to hydrostatic uplift is required.

2. **STABILITY AND SETTLEMENT REQUIREMENTS.** As with other types of foundations, a mat foundation must have an ample factor of safety (see Section 2) against overall shear failure and it must not exhibit intolerable settlement (see DM-7.1, Chapter 5).

Since mat footings are simply large footings, the bearing capacity principles outlined in Sections 2 and 3 of this chapter are applicable. The ultimate bearing capacity of large mats on coarse-grained soils is usually very high and design is usually controlled by settlement (see DM-7.1, Chapter 5). For mats on cohesive soils, shear strength parameters for soils at depth must be determined for the proper evaluation of factor of safety against deep-seated failure.

3. **DESIGN PROCEDURES.** A design method based on the theory for beams or plates on discrete elastic foundations (Reference 10, Beams on Elastic Foundation, by Hetenyi) has been recommended by ACI Committee 436 (Reference 11, Suggested Design Procedures for Combined Footings and Mats) for design of mat foundations. This analysis is suitable for foundations on coarse-grained soils.

a. **Two-dimensional Problems.** For walls or crane track footings or mat foundations subjected to plane strain, such as drydock walls and linear blocking loads, use the procedures of Table 3 and Figures 10 and 11 (Reference 10). Superpose shear, moment, and deflection produced by separate loads to obtain the effect of combined loads.

b. **Three-dimensional Problems.** For individual loads applied in irregular pattern to a roughly equi-dimensional mat, analyze stresses by methods of plates on elastic foundations. Use the procedures of Table 4 and Figure 12.

Superpose shear, moment, or deflection produced by separate loads to obtain the effect of combined loads.

TABLE 3
Definitions and Procedures, Analysis of Beams on Elastic Foundation

Definitions:

K_{v1} = Modulus of subgrade reaction for a 1 sq ft bearing plate.

K_b = Modulus of subgrade reaction for beam of width b, $K_b = (K_{v1})/b$

y = Deflection of beam at a point.

p = Pressure intensity on the subgrade at a point, $p = y(K_b)$

b = Width of beam at contact surface

I = Moment of inertia of beam

E = Modulus of elasticity of beam material

l = Beam length

λ = Characteristics of the system of beam and supporting soil =

$$\lambda = \sqrt[4]{\frac{K_b b}{4 EI}}$$

Procedure for Analysis:

1. Determine E and establish K_{v1} from Figure 1 in DM-7.1, Chapter 5 or from plate bearing tests.
2. Determine depth of beam from shear requirements at critical section and width from allowable bearing pressure. Compute characteristic λ of beam and supporting soil.
3. Classify beams in accordance with relative stiffness into the following three groups. Analysis procedure differs with each group.

Group 1 - Short beams: $\lambda l < \pi/4$. Beam is considered rigid. Assume linear distribution of foundation contact pressure as for a rigid footing. Compute shear and moment in beam by simple statics.

TABLE 3 (continued)
 Definitions and Procedures, Analysis of Beams on Elastic Foundation

Group 2 - Beams of medium length: $\pi/4 < \lambda l < \pi$. End conditions influence all sections of the beam. Compute moments and shears throughout the beam length by the infinite beam formulas, top panel of Figure 10. Determine in this way the shear and moments at the two ends of the beam. By superposing on the loaded beam two pairs of concentrated forces and moments at the ends of the beam, solutions for the infinite beam are modified to conform to the actual end conditions. For example, if $Q = 0$ and $M = 0$ at the ends of a free-ended beam, apply redundant shear and moment at the ends equal and opposite to that determined from the infinite beam formulas. See reference cited in text for formulas for moments and shears in end loaded beam of finite length.

Group 3 - Long beams: $\lambda l > \pi$. End condition at distant end has negligible influence on moment and shear in the interior of the beam. Consider beam as extending an infinite distance away from loaded end. Compute moment and shear caused by interior loads by formulas for infinite beam, top panel of Figure 10. Compute moment and shear for loads applied near the beam ends by formulas for semi-infinite beam, bottom panel of Figure 10. Superpose moment and shear obtained from the two load systems.

4. Obtain functions $A_{\lambda x}$, $B_{\lambda x}$, $C_{\lambda x}$, $D_{\lambda x}$, for use in formulas of Figure 10 from Figure 11.

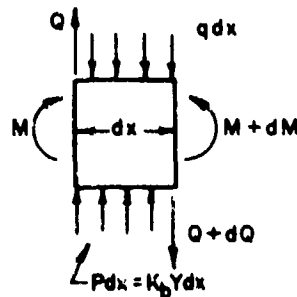
Sign Convention:

Consider infinitely small element of beam between two vertical cross sections at a distance dx apart.

+Q = Upward acting shear force to left of section.

+M = Clockwise movement acting from the left to the section.

+y = Downward deflection.





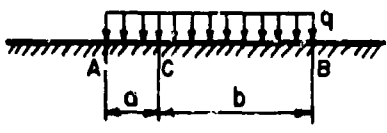
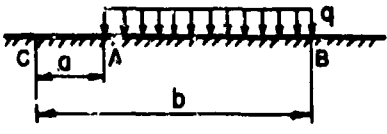
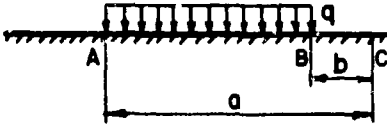


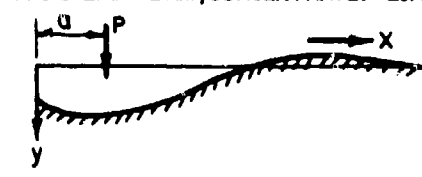
		CONCENTRATED LOAD	APPLIED MOMENT	
INFINITE BEAM				
		DEFLECTION: $y = \frac{P\lambda}{2K} A_{\lambda x}$ MOMENT: $M = \frac{P}{4\lambda} C_{\lambda x}$ SHEAR: $Q = -\frac{P}{2} D_{\lambda x}$	DEFLECTION: $y = \frac{M_o \lambda^2}{K} B_{\lambda x}$ MOMENT: $M = \frac{M_o}{2} D_{\lambda x}$ SHEAR: $Q = -\frac{M_o \lambda}{2} A_{\lambda x}$	
		UNIFORMLY DISTRIBUTED LOAD		
		POINT C IS UNDER LOAD 	DEFLECTION: $y_c = \frac{q}{2K} (2 - D_{\lambda a} - D_{\lambda b})$ MOMENT: $M_c = \frac{q}{4\lambda^2} (B_{\lambda a} + B_{\lambda b})$ SHEAR: $Q_c = \frac{q}{4\lambda} (C_{\lambda a} - C_{\lambda b})$	
	POINT C IS LEFT OF LOAD 	DEFLECTION: $y_c = \frac{q}{2K} (D_{\lambda a} - D_{\lambda b})$ MOMENT: $M_c = -\frac{q}{4\lambda^2} (B_{\lambda a} - B_{\lambda b})$ SHEAR: $Q_c = \frac{q}{4\lambda} (C_{\lambda a} - C_{\lambda b})$		
	POINT C IS RIGHT OF LOAD 	DEFLECTION: $y_c = -\frac{q}{2K} (D_{\lambda a} - D_{\lambda b})$ MOMENT: $M_c = \frac{q}{4\lambda^2} (B_{\lambda a} - B_{\lambda b})$ SHEAR: $Q_c = \frac{q}{4\lambda} (C_{\lambda a} - C_{\lambda b})$		
SEMI-INFINITE BEAM		FREE END, CONCENTRATED LOAD 	DEFLECTION: $y = \frac{2P_1\lambda}{K} D_{\lambda x}$ MOMENT: $M = -\frac{P_1}{\lambda} B_{\lambda x}$ SHEAR: $Q = -P_1 C_{\lambda x}$	
		FREE END, MOMENT 	DEFLECTION: $y = -\frac{2M_1\lambda^2}{K} C_{\lambda x}$ MOMENT: $M = M_1 A_{\lambda x}$ SHEAR: $Q = -2M_1\lambda B_{\lambda x}$	
		FREE END BEAM, CONCENTRATED LOAD NEAR END 	DEFLECTION: $y = \frac{P\lambda}{2K} [(C_{\lambda a} + 2D_{\lambda a})A_{\lambda x} - 2(D_{\lambda a} + D_{\lambda a})B_{\lambda x} + A_{\lambda(a+x)}]$ IF NOTATION $(C_{\lambda a} + 2D_{\lambda a}) = \alpha$ AND $(C_{\lambda a} + D_{\lambda a}) = \beta$ IS USED MOMENT: $M = \frac{P}{4\lambda} \{ \alpha C_{\lambda x} - 2\beta D_{\lambda x} + C_{\lambda(a-x)} \}$ SHEAR: $Q = -\frac{P}{2} \{ \alpha D_{\lambda x} - \beta A_{\lambda x} \pm D_{\lambda(a-x)} \}$	

FIGURE 10
Computation of Shear, Moment, and Deflection, Beams on Elastic Foundation

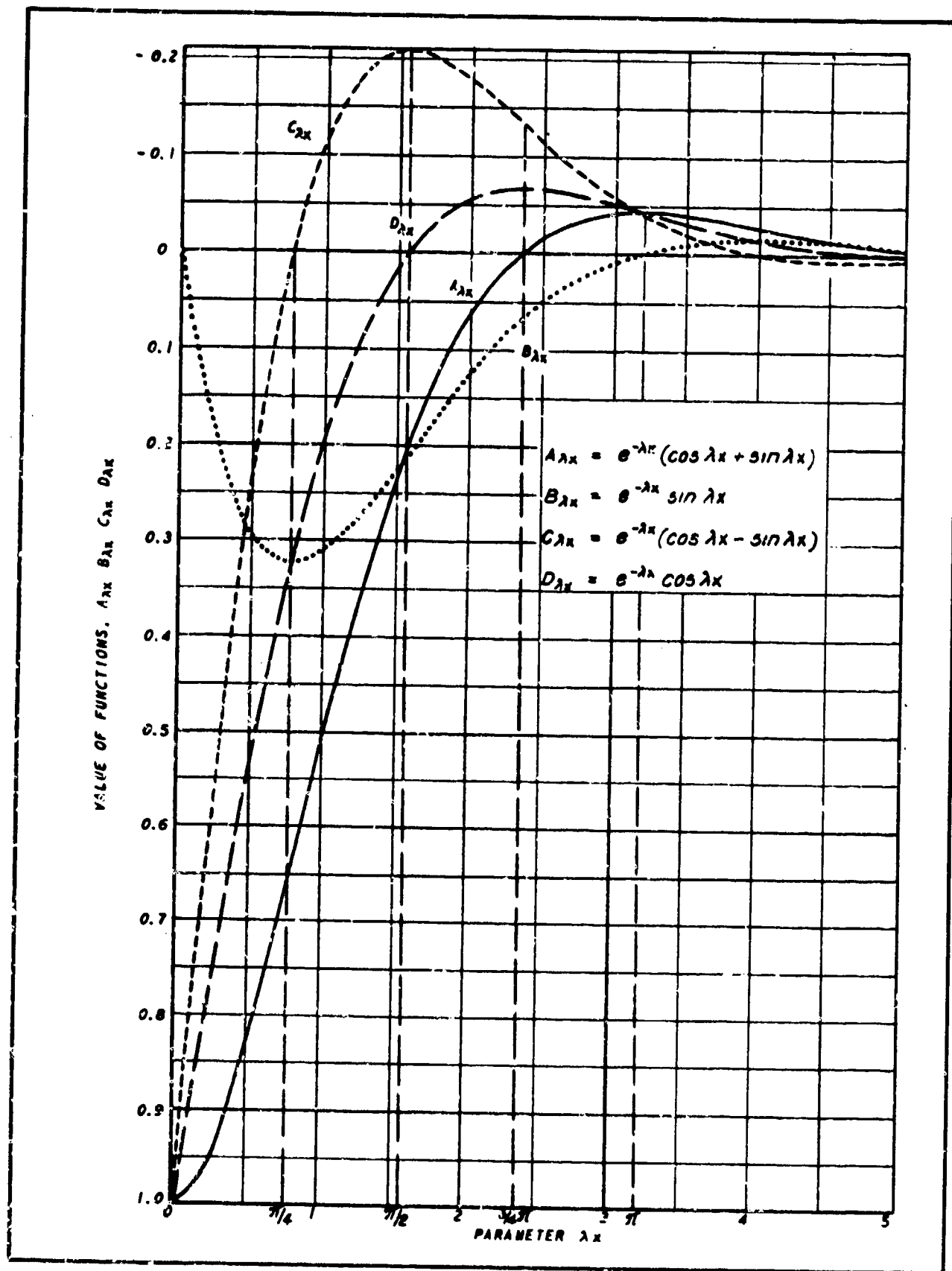


FIGURE 11
 Functions for Shear, Moment, and Deflection, Beams on Elastic Foundations

TABLE 4
Definitions and Procedures, Mats on Elastic Foundations

Definitions:

- r = Distance of point under investigation from point column load along radius
- M_r, M_t = Radial and tangential moments (polar coordinates) for a unit width of mat
- Q = Shear per unit width of mat
- M_x = Moment which causes a stress in the x-direction (rectangular coordinates)
- M_y = Moment which causes a stress in the y-direction (rectangular coordinates)
- σ_x = Stress due to M_x
- σ_y = Stress due to M_y
- y = Deflection of mat at a point
- b = width of mat

Procedure for Analysis:

1. Determine modulus of subgrade reaction for foundation width "b" - as follows:

For cohesive soils: $K_b = K_{v1} / b,$

For granular soils: $K_b = K_{v1} \left(\frac{b+1}{2b} \right)^2$

2. Determine mat thickness h from shear requirements at critical sections.

3. Determine values of E and Poisson's ratio μ for mat.

4. Calculate flexural rigidity of mat, $D = \frac{Eh^3}{12(1-\mu^2)}$

5. Calculate radius of effective stiffness: $L = \sqrt[4]{\frac{D}{K_b}}$

6. Radius of influence of individual column load equals approximately 4L.

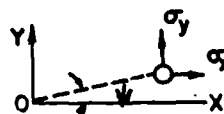
TABLE 4 (continued)
 Definitions and Procedures, Mats on Elastic Foundations

7. To determine radial and tangential moments and deflections at any point from an interior column load use the following formulas:

$$M_r = -\frac{P}{4} \left[Z_4(\xi) - (1-\mu) \frac{Z_3'(\xi)}{\xi} \right], \quad \xi = \frac{r}{L}, \quad Q = -\frac{P}{4L} \cdot Z_4'(\xi)$$

$$M_t = -\frac{P}{4} \left[\mu Z_4(\xi) + (1-\mu) \frac{Z_3'(\xi)}{\xi} \right], \quad y = \frac{PL^2}{4D} Z_3(\xi)$$

To convert radial and tangential moments to rectangular coordinates, use the following relationships:



$$M_x = M_r \cos^2 \psi + M_t \sin^2 \psi$$

$$M_y = M_r \sin^2 \psi + M_t \cos^2 \psi$$

Determine functions $Z_3(\xi)$, $Z_3'(\xi)$, $Z_4(\xi)$, and $Z_4'(\xi)$ from Figure 12.

8. To determine moments or deflections from a combination of interior column loads, superpose the effects from individual column loads at points under consideration.
9. When edge of mat is located within the radius of influence of the individual column load, apply the following correction:
- Calculate moments and shears that occur perpendicular to the edge of mat within the radius of influence of the column load by analyzing the location of the edge in infinite mat formulas.
 - Apply redundant moments and shears of opposing signs at the edge of the mat. Determine moments and shears produced within the mat by the redundants by analyzing a series of beams on elastic foundations positioned perpendicular to the edge, applying formulas of the bottom panel of Figure 10. Utilize a similar procedure for large openings in the interior of the mat. Superpose these moments to moments computed in Step 8.
10. When superstructure loads are distributed through deep foundation walls, use the following procedure:
- Estimate an approximate distribution of superstructure loads as a line load along the wall.
 - Divide the mat into a series of strips 1 foot wide perpendicular to the foundation wall with the line load acting at the end. Analyze the strips as beams on elastic foundations using formulas of the top panel of Figure 10 for interior foundation walls and formulas of the bottom panel of Figure 10 for foundation walls at edge of mat.
 - Superpose moments and shears determined from this analysis with those obtained from interior column loads on the mat.

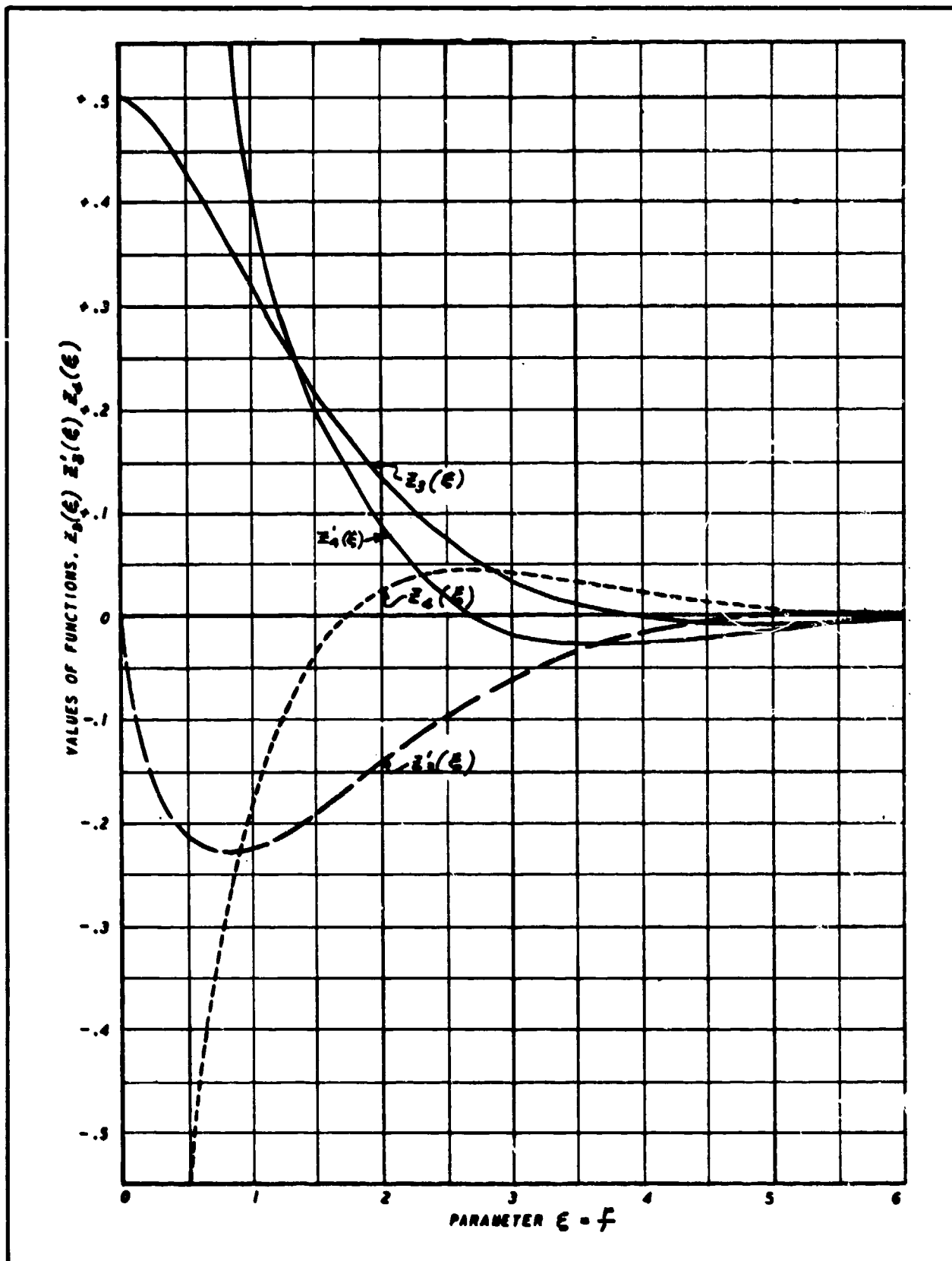


FIGURE 12
 Functions for Shear, Moment, and Deflection, Mats on Elastic Foundation

c. Modulus of Subgrade Reaction. The modulus of subgrade reaction (K) is expressed as:

$$K = p/\Delta H$$

where: p = contact pressure (stress unit)

ΔH = soil deformation (length)

(1) K varies with the width and shape of the loaded area. Empirical correction for strip footings from Reference 12, Evaluation of Coefficient of Subgrade Reaction, by Terzaghi are:

(a) Cohesive soil.

$$K_b = K_{v1}/b$$

where: K_b = coefficient of subgrade reaction for foundation of width b

K_{v1} = coefficient of subgrade reaction for a 1' x 1' plate

If the loaded area is of width, b , and length, mb , k_b assumes the value:

$$K_b = \frac{K_{v1}}{b} \left(\frac{m + 0.5}{1.5m} \right)$$

If actual plate load tests on cohesive soil are not available, estimates of K_v can be made in general accordance with the recommendations in Reference 12. If actual plate load tests are not available use correlation for K_{v1} in Figure 6, DM-7.1, Chapter 5.

(b) Granular soil.

$$K_b = K_{v1} \left(\frac{b + 1}{2b} \right)^2$$

(c) Limitations. Values of K_b as determined from extrapolation of plate bearing tests should be utilized with judgement and care. Unlike the deformation in full size mat the deformation from plate load tests is not reflective of the underlying deeper strata. Also results from plate load tests on saturated or partially saturated clays may be unreliable because time may not permit complete consolidation of loaded clay.

(2) An estimate of K_b may be obtained by back calculating from a settlement analysis. The settlement of the mat can be calculated assuming a uniform contact pressure and utilizing the methods outlined in DM-7.1, Chapter 5. The contact pressure is then divided by the average settlement to obtain an estimate of K_b :

$$K_b = \frac{F}{\Delta H_{avg}}$$

where ΔH_{avg} = average computed settlement of the mat.

For a flexible circular mat resting on a perfectly elastic material $\Delta H_{avg} = 0.85 \times$ settlement at the center. For other shapes see DM-7.1, Chapter 5, Table 1.

d. Numerical Methods. Methods of analyses of mat foundation which account for the stiffness of the superstructure and the foundation, in which the soil is modelled as an elastic half space continuum utilizing finite element techniques are more accurate. A variety of soil constitutive relationships such as linear elastic, non-linear elastic, elasto-plastic, etc. can be utilized. Finite element techniques are well suited to these problems. See Appendix for listing of computer programs.

Section 5. FOUNDATIONS ON ENGINEERED FILL

1. UTILIZATION. Fills placed with controlled compaction may be used beneath structures for the following purposes:

(a) To raise the general grade of the structure or to replace unsuitable foundation soils.

(b) To provide a relatively stiff mat over soft subsoils in order to spread bearing pressures from column loads and decrease column settlements.

(c) To bridge over subsoils with erratic hard and soft spots or small cavities.

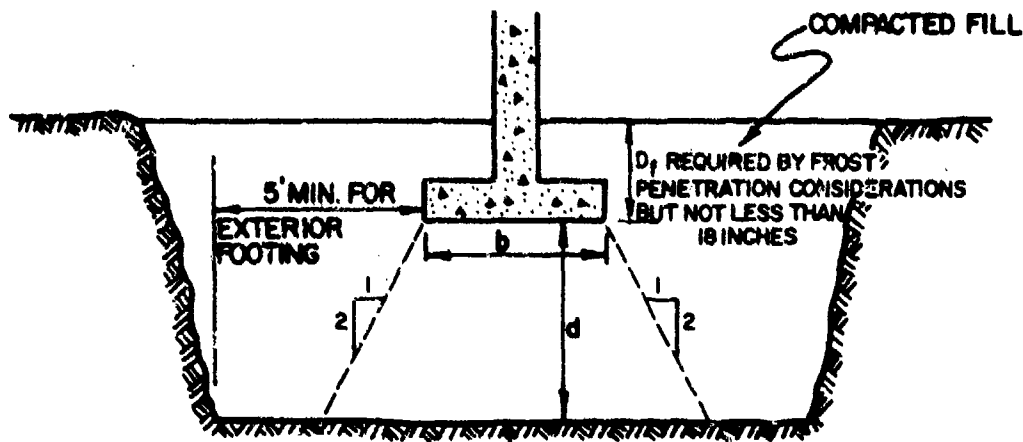
(d) To accelerate subsoil consolidation and to eliminate all or part of settlement of the completed structure when used with surcharge.

2. COMPACTION CONTROL. Rigidity, strength, and homogeneity of many natural soils may be increased by controlled compaction with appropriate equipment. A complete discussion of compaction requirements and control is presented in Chapter 2. Other methods of densifying in-place soils are given in DM-7.3, Chapter 2.

3. GEOMETRIC LIMITS OF COMPACTION. The limits of the zone of compacted soil beneath a footing should consider the vertical stresses imposed by the footing (stress-bulb) on the soils beneath it. Recommended requirements for compaction beneath a square and a continuous footing are illustrated in Figure 13. For large footings, the necessary depth of compacted fill should be determined from a settlement analysis.

Section 6. FOUNDATIONS ON EXPANSIVE SOILS

1. POTENTIAL EXPANSION CONDITIONS. Soils which undergo volume changes upon wetting and drying are termed expansive or swelling soils. If surface clays above the water table have a PI greater than about 22 (CH clays) and relatively low natural water content, potential expansion must be considered. These soils are most commonly found in arid climates with a deficiency of rainfall, over-evaporation, and where the groundwater table is low. Mottled, fractured,



CONTINUOUS FOOTING

$d = \text{DEPTH TO ADEQUATE BEARING MATERIAL}$ } WHICHEVER IS LESS
 $d = 2 \times b$

SQUARE FOOTING

$d = \text{DEPTH TO ADEQUATE BEARING MATERIAL}$ } WHICHEVER IS LESS
 $d = 1-1/2 \times b$

FIGURE 13
 Limits of Compaction Beneath Square and Continuous Footings

or slickensided clays, showing evidence of past desiccation, are particularly troublesome. For other causes of swelling in soils and for the computations of resulting heave see DM-7.1, Chapter 5, and DM-7.3, Chapter 3 for further guidance.

2. **ELIMINATING SOIL EXPANSION POTENTIAL.** Where economically feasible, remove potentially expansive soils from beneath footings and replace with compacted fill of granular soils or nonexpansive materials. If this cannot be done, consider spread footings or drilled and underreamed caissons founded below the zone of active swelling. Design the shafts of such foundations with sufficient reinforcing to resist tensile forces applied to shaft by friction or adhesion in the swelling materials. Reinforcing must be carried into the belled section to a point 4" above the base. At any depth, tensile forces exerted on a shaft equal circumferential area of the shaft times the difference between average swelling pressure above and below the point under consideration.

Placing the base of foundation near the water table reduces heave damage because of little change in moisture content. For construction techniques in such soil see Figure 14 (top and center, Reference 13, Soil Mechanics and Foundation, by Parcher and Means), DM-7.3, Chapter 3, and Reference 14, Design and Performance of Mat Foundation on Expansive Clay, by Lytton and Woodburn.

Footing foundations can be successful if sufficient dead load is exerted to eliminate heave completely or reduce it significantly in conjunction with a structure rigid enough to withstand stress due to heaving. See DM-7.1, Chapter 5, and DM-7.3, Chapter 3 for methods of estimating the magnitude of swell.

3. **MINIMIZING EXPANSION EFFECTS.** Where it is not economically feasible to remove expansive materials or to support foundations below depths of possible expansion, the effects can be minimized as follows:

(a) Where large seasonal changes in soil moisture are responsible for swelling, schedule construction during or immediately after a prolonged rainy period when there will be less potential volume change in the future.

(b) For concrete floor slabs placed directly on potentially expansive clays, provide expansion joints so the floor can move freely from the structural frame.

(c) For foundations on fill materials containing plastic fines and susceptible to swelling, place fill at moisture content above optimum with density no higher than required for strength and rigidity. Excessive compaction will result in greater swelling.

(d) Grade beams should contain sufficient steel reinforcement to resist the horizontal and vertical thrust of swelling soils. If practical, place compressible joint filler or open blocks or boxes beneath grade beams to minimize swelling pressures.

(e) Provide impervious blankets and surface grading around the foundations to prevent infiltration of surface water.

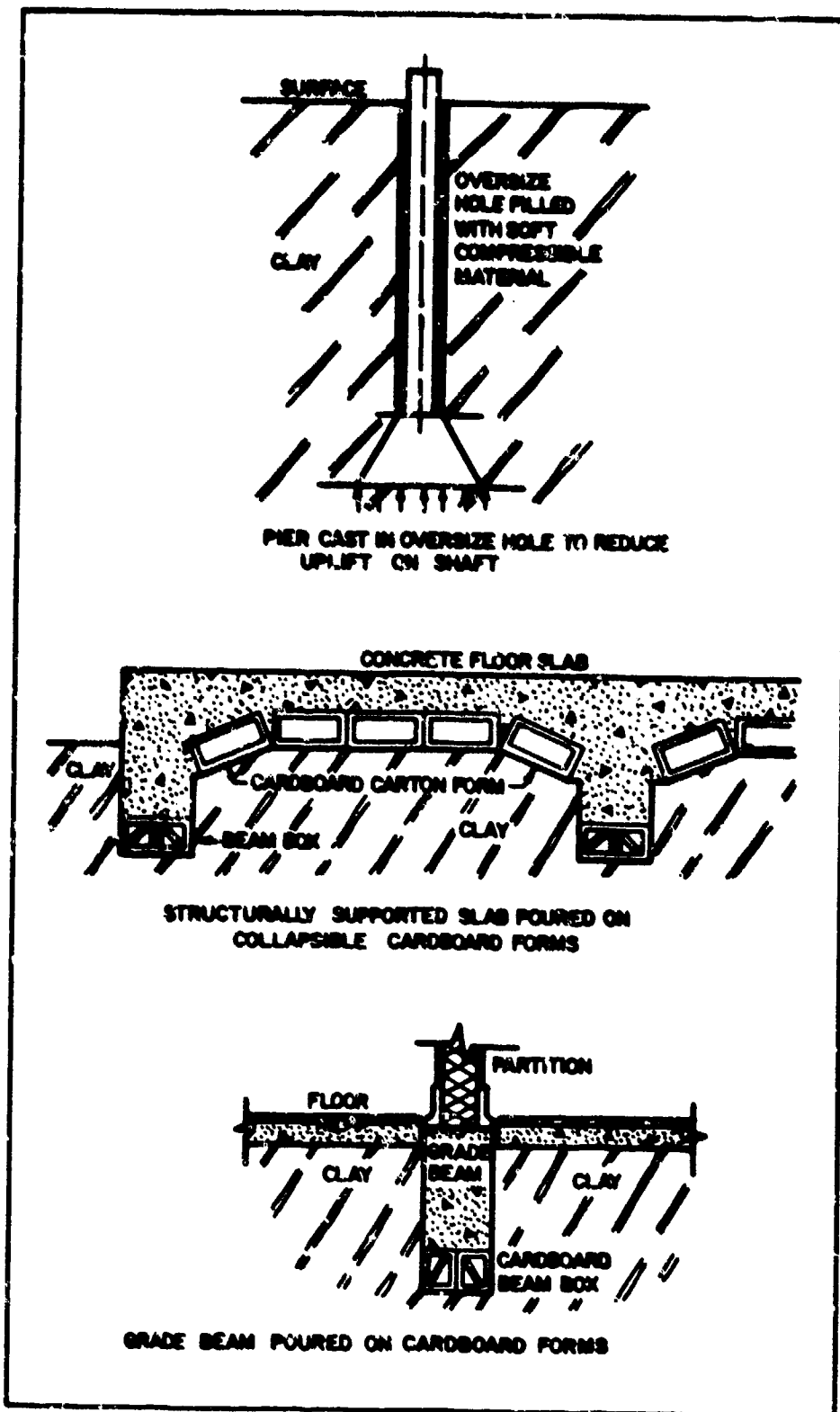


FIGURE 14
Construction Details for Swelling Soils

(f) Locate water and drainage lines so that if any leakage occurs, water will not be readily accessible to foundation soils thereby causing damage.

(g) Consider stabilization of the foundation soils and backfill materials by lime and other agents.

For further guidance see Reference 15, Foundations on Expansive Soils, by Chen, and DM-7.3, Chapter 3.

4. COLLAPSING SOILS. Many collapsing soils will slake upon immersion, but this is not a definitive indicator. Definite identification requires a pair of consolidation tests with and without saturation, or by plate load tests where water is added with the plate under stress. In the case of collapsible soil, the e -log p curve for the specimen, which was allowed to come in contact with water, is below that of the dry specimen. See DM-7.1, Chapter 3 for testing procedures.

(a) If positive measures are practical for avoiding water foundation contact, the "dry" strength of soil can be used for design purposes.

(b) Alternately, under some conditions, prewetting of the soil is found effective in reducing settlements. By this process, the soil structure breaks down resulting in its densification. This increases its strength and reduces the total and differential settlement. This method is not very successful especially where little additional load is applied during wetting. For further guidance see DM-7.3, Chapter 3, and Reference 7.

Section 7. FOUNDATION WATERPROOFING

1. APPLICATIONS. See Table 5 for general requirements for waterproofing, dampproofing, and waterstops. See References 16, 17, and 18; Foundation Design, by Teng, NAVFAC TS-07110, Membrane Waterproofing, and NAVFAC TS-07160, Bituminous Dampproofing, respectively, for guidance. For basements below ground, two general schemes are employed as follows:

(a) Where the permanent water table is above the top of basement slab, provide pressure resistant slab (pressure slab) or relieve uplift pressures by underdrainage (relieved slab).

(b) Where the water table is deep but infiltration of surface water dampens backfill surrounding basement, provide dampproof walls and slabs (see Table 5, Dampproofing).

2. PRESSURE AND RELIEVED SLABS.

a. Pressure Slabs. In general, the choice between pressure or relieved slab depends on overall economy, maintenance, layout, and operation, and must be evaluated individually for each project. For basements extending only a small depth below groundwater, a pressure slab to resist maximum probable hydrostatic uplift usually is economical. Also, when the soil below water level is very pervious, an extensive and consequently very costly drainage system may be necessary. See Case A, Figure 15. Drainage material should be

TABLE 5
Requirements for Foundation Waterproofing and Dampproofing

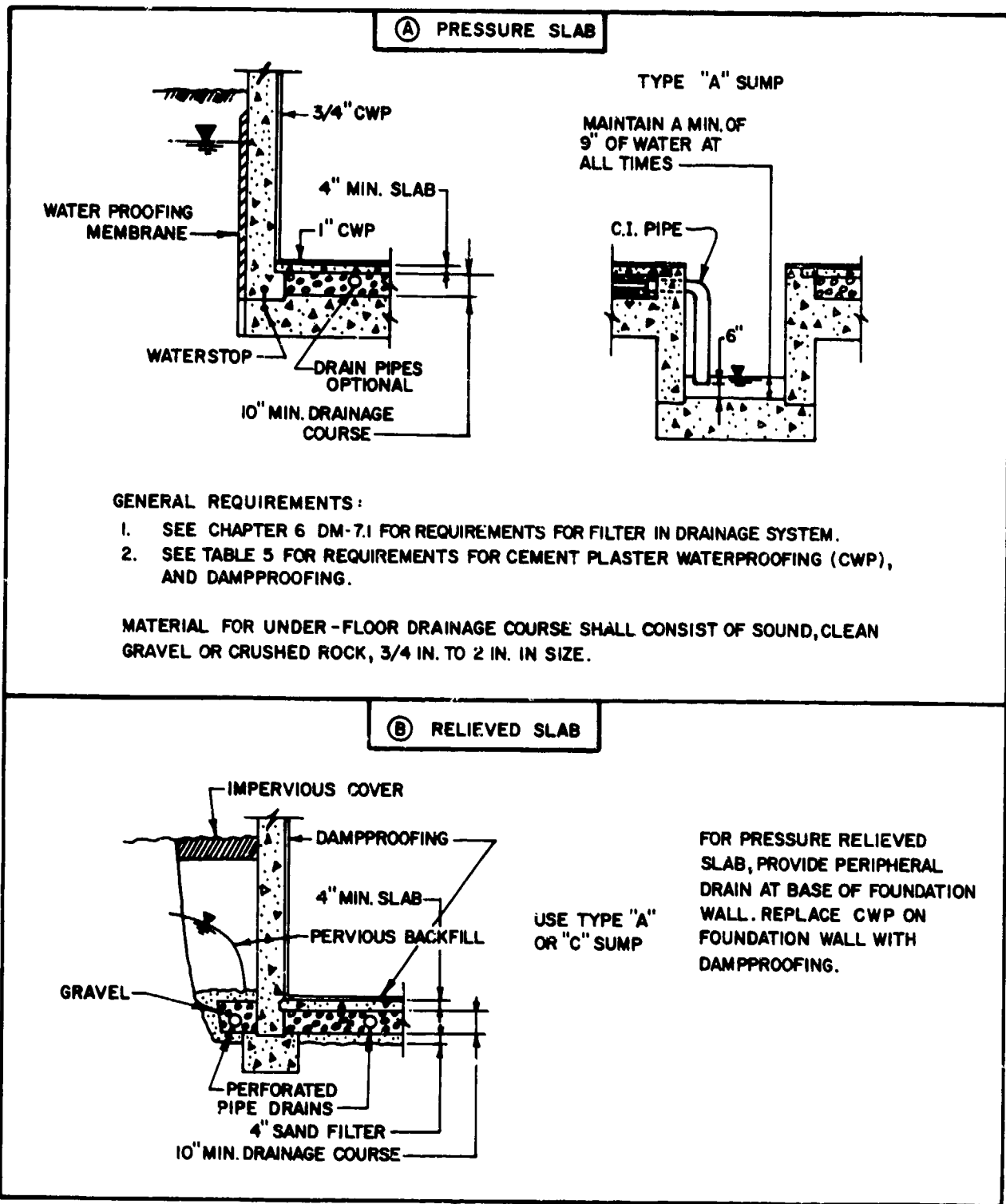
Type	Materials	Workmanship	Applicability	Remarks
Waterproofing 1. Membrane	Bitumen: 1) ASTM D449, Type [A] [B] [C] Asphalt, ASTM D450, Type II Coal-tar; 2) Bituminous plastic cement; Federal Specifications SS-C-153, Type I for asphalt, Type II for coal-tar; 3) Felt or fabric material impregnated with asphalt or coal-tar as specified in references cited in text; 4) for primer, protective covering, prefabricated laminated asphalt waterproofing see references.	Before starting the work inspect all surfaces to be waterproofed to determine that they are in satisfactory condition. Complete conduit, piping, and other required rough-in. Start after all defects and unsatisfactory conditions have been corrected. Surfaces to be treated should be clean and dry, smooth and free from deleterious and excess materials and projections. Use priming coat of creosote and asphalt at no less than one gallon per 100 sq ft on surface receiving coal-tar membrane waterproofing and asphalt membrane water proofing respectively. For membrane application, use at least 3-ply for dampproofing and 5-ply for hydrostatic pressure. Apply membrane using shingle method. For detailed requirements see references.	Use on exterior wall surfaces, over roofs or underground structures, for patching openings through walls formed for utilities or structural members. Method is frequently utilized, but careful inspection and control is required to obtain completely satisfactory application.	Vulnerable to damage. Hard to locate and repair damaged area.

TABLE 5 (continued)
Requirements for Foundation Waterproofing and Dampproofing

Type	Materials	Workmanship	Applicability	Remarks
2. Cement plaster	One part Portland cement, no more than two parts of sand and no more than two parts of water. Sand should contain no sizes smaller than No. 200 sieve and preferably is well graded between No. 100 and No. 8 sieve sizes. Waterproofing compounds are optional, except that no salts or deliquescent materials are permitted.	All surfaces in contact with form shall be entirely chipped away. Floor concrete shall have rake finish. All faces shall be rinsed thoroughly with clean water. Wall and ceiling coat shall be applied in 2 coats that together total between 5/8 to 3/4 inch in thickness. Floors to have one coat of 1 inch thickness. All surfaces are to be floated with wood float and hand finished by steel troweling.	Used on exposed interior surfaces of walls, floors and occasionally on ceilings where the ceiling is exposed on the outside to water-pressures. Appropriate for highest type of basement occupancy. Care is required to obtain a seal surrounding wall openings for utilities, etc.	Can resist high hydrostatic pressures without injury. Easily inspected for imperfections and can be easily repaired.
<u>Dampproofing</u> 1. Interior faces	Coating consisting of finely divided iron mixed with sand, cement, and oxidizing agent.	Surfaces to be thoroughly cleaned and roughened. Apply in at least four brush coats.	Used on basement walls below ground at damp or wet locations, below temporary groundwater levels, or under hydrostatic heads of only several feet.	Lower cost. If appearance of interior surfaces is important, use cement plaster waterproofing.

TABLE 5 (continued)
Requirements for Foundation Waterproofing and Dampproofing

Type	Materials	Workmanship	Applicability	Remarks
2. Exterior faces	Hot coal tar, straight run, pitch, Type B coating, or asphalt Type B mopping. Built-up in successive coats to a minimum of 1/8 inch thickness.	Concrete and masonry surfaces to be dry and free from dust, dirt, grease, oil, or other coatings before application. Use primary cost of creosote and asphalt at no less than one gallon per 100 sq ft as surface receiving coal-tar pitch dampproofing and asphalt or fibrous asphalt dampproofing, respectively. Either the hot application method using asphalt or coal tar bitumen or the coal application method using fibrous asphalt may be used. For further details on application method and protective covering see references.	Used on basement walls below ground at damp or wet locations, below temporary groundwater levels, or under hydrostatic heads of only several feet.	Lower cost. If appearance of interior surfaces is important, use cement plaster water-proofing.



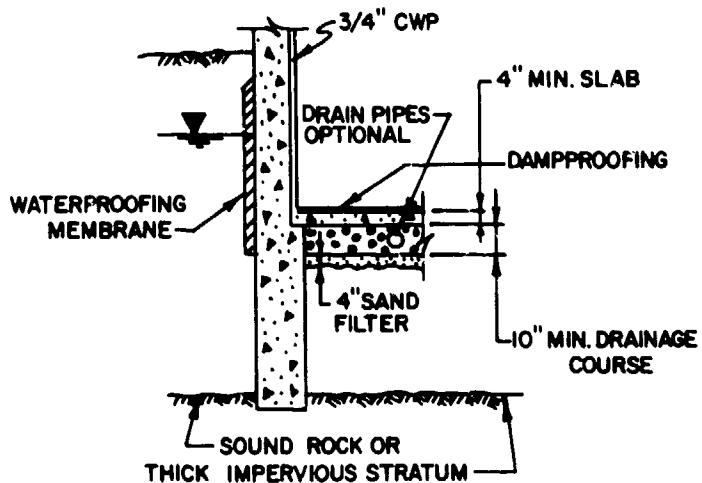
GENERAL REQUIREMENTS:

1. SEE CHAPTER 6 DM-7.1 FOR REQUIREMENTS FOR FILTER IN DRAINAGE SYSTEM.
2. SEE TABLE 5 FOR REQUIREMENTS FOR CEMENT PLASTER WATERPROOFING (CWP), AND DAMPPROOFING.

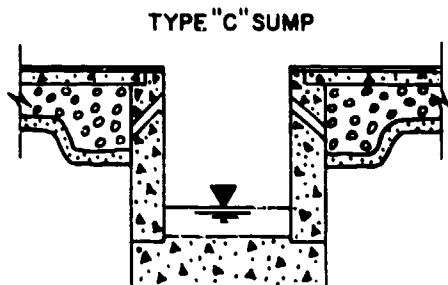
MATERIAL FOR UNDER-FLOOR DRAINAGE COURSE SHALL CONSIST OF SOUND, CLEAN GRAVEL OR CRUSHED ROCK, 3/4 IN. TO 2 IN. IN SIZE.

FIGURE 15
Typical Foundation Drainage and Waterproofing

© SEALED SITE



NOTE: IMPERVIOUS STRATUM OF SMALL THICKNESS MAY NOT BE ABLE TO WITHSTAND PRESSURE DUE TO HIGH WATER TABLE OUTSIDE THE FOUNDATION.



IF SOUND ROCK OR IMPERVIOUS STRATUM EXTENDING TO A GREAT DEPTH IS ENCOUNTERED AT SHALLOW DEPTH BELOW FOUNDATION, CARRY OUTSIDE WALL AS CUTOFF. DISPENSE WITH WALL DRAIN AND REPLACE CAP ON FLOOR SLAB WITH DAMPPROOFING. ARRANGE DISCHARGE FROM DRAINAGE SYSTEM TO PREVENT AERATION OF DRAINAGE COURSE.

FIGURE 15 (continued)
Typical Foundation Drainage and Waterproofing

sound, clean gravel or crushed stone graded between 3/4 and 2 inches, compacted by two or three coverages of vibrating base plate compactor. Open joint drain pipe should be added beneath slabs of large plan dimensions. Provide water-stops at the construction joints between pressure slab and wall.

b. Relieved Slabs. For basements at considerable depth below groundwater level, it is usually economical to provide pressure relief beneath the foundation slab. See Cases B and C, Figure 15. If pervious materials of great depth underlie the foundation level, include a wall drain and drainage course beneath the slab. See DM-7.1, Chapter 6 for filter requirements and drain spacing. If foundation walls can be carried economically to underlying sound impervious rock or thick impervious stratum, omit wall drains. Arrange sumps for drainage discharge to avoid aerating drainage course.

3. WATERPROOFING REQUIREMENTS. In addition to leakage under pressure through joints and cracks, water may move through basement walls and floors by capillary action and as water vapor. A drainage course can be used to interrupt capillary action, but it will not prevent movement of water vapor through slabs. Plastic vapor barriers are useful in providing an effective vapor barrier.

a. Membrane Waterproofing and Dampproofing. Apply membrane (see Figure 15B) for basements utilized for routine purposes where appearances are unimportant and some dampness is tolerable.

b. Cement Plaster Waterproofing. Where it is important to prevent dampness or moisture in a basement, specify cement plaster waterproofing, consisting of sand-cement mortar hand troweled on chipped and roughened concrete surface. Properly applied, this is a very effective method against dampness and moisture.

Section 8. UPLIFT RESISTANCE

1. ROCK FOUNDATION. Resistance to direct uplift of tower legs, guys, and antennas, where the foundation is resting directly over rock, may be provided by reinforcing bars grouted in rock. In the absence of pullout tests, determine uplift resistance by empirical formulas of Figures 16 and 18. These formulas apply to bars in fractured rock near the rock surface. Higher shear strength is to be expected in sound, unweathered rock. To develop rock strength, sufficient bond must be provided by grout surrounding the bar. Bond strengths may be increased by using washers, rock bolts, deformed bars, or splayed bar ends.

Guidance for design rules is given in DM-7.3, Chapter 3 and quality control associated with pre-stressed, cement grouted rock anchors is found in Reference 19, Rock Anchors - State of the Art, by Littlejohn and Bruce.

2. SOIL FOUNDATION. For sustained uplift on a footing, see Table 2. Transient uplift from live loads applied to footings, piers, posts or anchors is

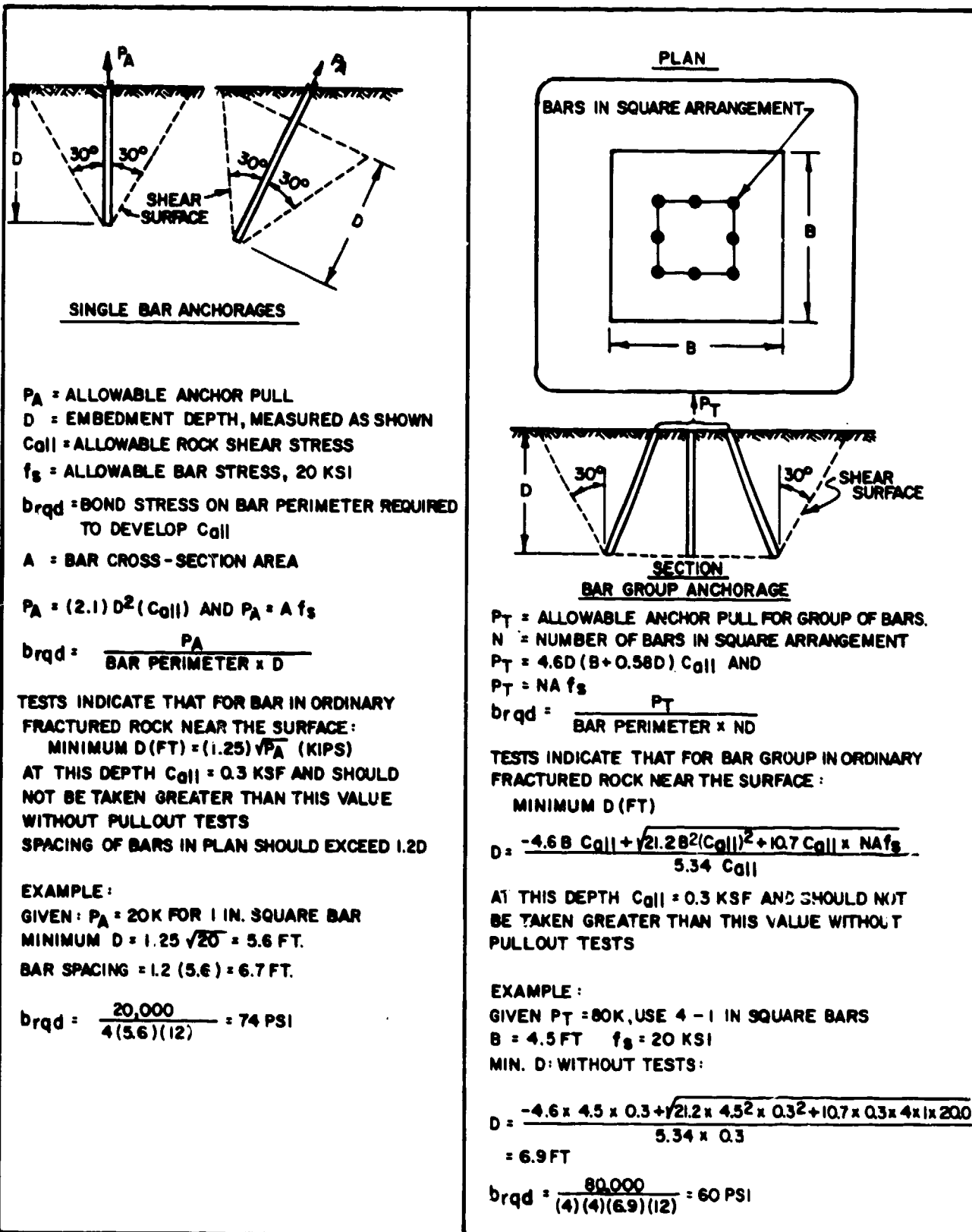


FIGURE 16
Capacity of Anchor Rods in Fractured Rock

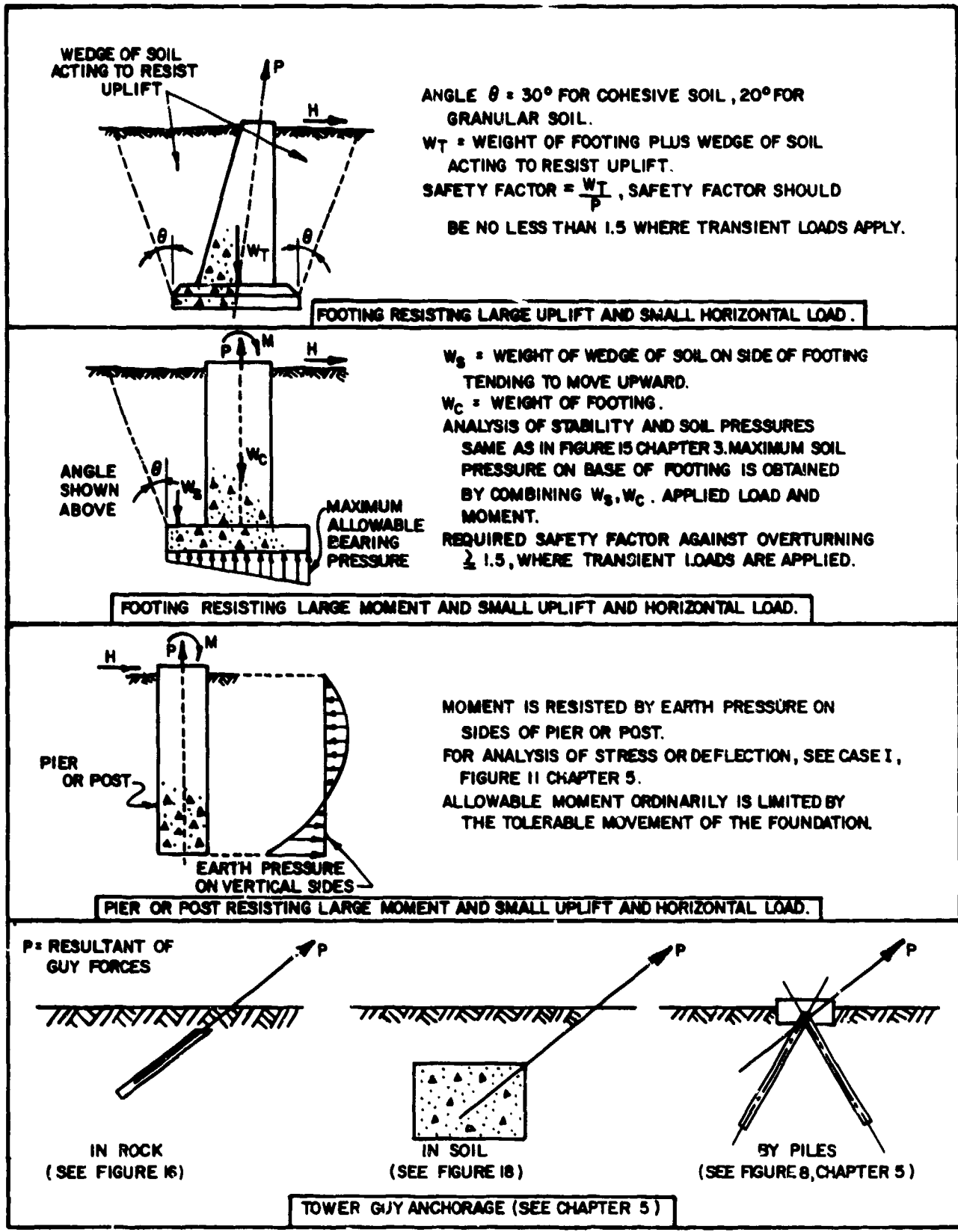
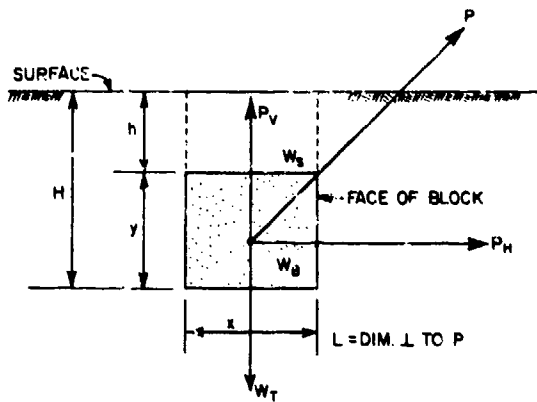


FIGURE 17
 Resistance of Footings and Anchorages to Combined Transient Loads



P = RESULTANT OF MAXIMUM GUY FORCES
 P_V, P_H = COMPONENTS OF P
 W_T = WEIGHT OF BLOCK + SOIL ON BLOCK
 W_B, W_S
 x, y, L = BLOCK DIMENSIONS
 γ = UNIT WEIGHT OF SOIL, pcf
 $W_S = x \cdot L \cdot h \cdot \gamma$
 P_P = TOTAL PASSIVE PRESSURE LBS./L.F.
 ϕ = ANGLE OF INTERNAL FRICTION
 C = COHESION, psf

1. RESISTANCE TO VERTICAL FORCE

SAFETY FACTORS IN VERTICAL DIRECTION :
 [USE TOTAL UNIT WEIGHTS ABOVE WATER TABLE,
 " BUOYANT " " BELOW " "]

$$\left\{ \begin{array}{l} \frac{W_T}{P_V} \geq 1.5 \\ \frac{W_B}{P_V} \geq 1.0 \end{array} \right.$$

2. RESISTANCE TO HORIZONTAL FORCE

SAFETY FACTOR IN HORIZONTAL DIRECTION :
 a. SEE SECTION 2, CHAPTER 3 FOR P_P COMPUTATIONS
 b. PASSIVE RESISTANCE CONSIDERED ON FACE OF BLOCK (AREA $y \times L$) ONLY.

$$\left\{ \frac{P_P}{P_H} = 1.5 \right.$$

NOTES: BACKFILL SHALL BE COMPACTED AS SPECIFIED IN TABLE 4, CHAPTER 2

EXAMPLE :

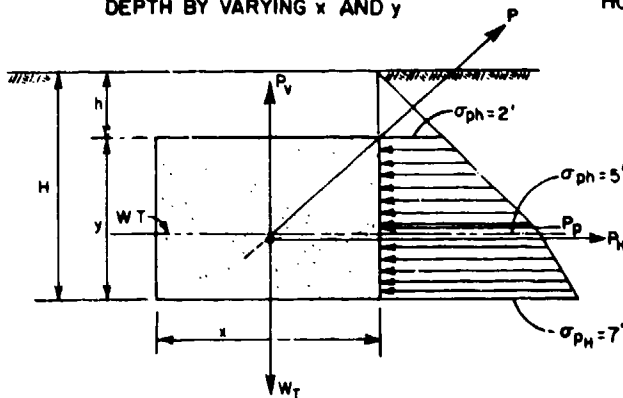
$\phi = 30^\circ$; $C = 0$
 WATER TABLE AT 5' DEPTH
 $P = 40^K$; $P_V = 27^K$; $P_H = 30^K$
 $\gamma = 110$ pcf, $\gamma_B = 60$ pcf
 TRY BLOCK $x, y, L = 6', 5', 8'$
 $h = 2', H = 7'$

KEEP P_H AT 1/2 TO 2/3 BLOCK DEPTH BY VARYING x AND y

VERT: W_B (ABOVE W.T.) = $6' \times 8' \times 3' \times 150$ pcf = 21,600 #
 W_B (BELOW W.T.) = $6' \times 8' \times 2' \times 87.5$ pcf = 8,400
 $W_B = 30,000$
 $W_S = 6' \times 8' \times 2' \times 110$ pcf = 10,500
 $W_S = 10,500$
 $W_T = 40,500$

FS CHECK } $\frac{W_T}{P_V} = \frac{40.5^K}{27^K} = 1.5$ $\frac{W_B}{P_V} = \frac{30^K}{27} = 1.1$
 ∴ OK VERT.

HORIZ: FROM FIG. 3, CHAPT. 3 WITH $\phi = 30^\circ, \beta = 0^\circ, K_p = 3.0$



$\sigma_{ph=2} = K_p \gamma h = 3.0 \times 110 \times 2 = 660$
 $\sigma_{ph=5} = K_p \gamma h = 3.0 \times 110 \times 5 = 1650$
 $\sigma_{ph=7} = 1650 + 3.0 \times 60 \times 2 = 2010$
 $P_P = 1/2 \cdot 3 (660 + 1650) L + 1/2 \cdot 2 (1650 + 2010) L$
 $= 3465 L + 3660 L = 7125 \times 8 = 57,000$ #
 $\frac{P_P}{P_H} = \frac{57^K}{30^K} = 1.9 > 1.5$ S.F.
 ∴ OK HORIZ.

MAKE ADDITIONAL TRIALS VARYING h, x, y, L

FIGURE 18

Tower Guy Anchorage in Soil by Concrete Deadman

analyzed as shown in Figure 17. Tower guy anchorage in soil is analyzed in Figure 18. For a deadman in weak soil, it may be feasible to replace a considerable volume of soil with granular backfill and construct the block within the new backfill. If this is done, the passive wedge should be contained entirely within the granular fill, and the stresses on the remaining weak material should be investigated. See Reference 6 for guidance.

3. CORROSION. For temporary anchors minimal protection is needed unless the environments are such that rapid deterioration takes place. Permanent anchor bars are covered with grout. In corrosive environments it is common practice to provide additional protection by coating with material (epoxy, polyester resin) with proven resistance to existing or anticipated corrosive agents. The coating agent should not have any adverse effect on the bond.

4. ROCK AND SOIL ANCHORS. When the load to be resisted is large, wire tendons which can also be prestressed to reduce movements are employed.

Also, because of corrosion special precautions may be necessary when permanent anchors are provided in marine environments. In the analysis of anchors, because of submergence, the bouyant unit weight of soils should be used. The buildup of excess pore pressure due to repetitive loads should also be evaluated in the case of granular soils. For a discussion of cyclic mobility and liquefaction see DM-7.3, Chapter 1. For the design of anchors see DM-7.3, Chapter 3.

REFERENCES

1. Meyerhof, G.G., Influence of Roughness of Base and Ground Water Condition on the Ultimate Bearing Capacity of Foundations, Geotechnique, 1955.
2. Meyerhof, G.G., The Bearing Capacity of Foundations Under Eccentric and Inclined Loads, Proceedings, Third International Conference on Soil Mechanics and Foundation Engineering, Zurich, 1953.
3. Meyerhof, G.G., The Ultimate Bearing Capacity of Foundations on Slopes, Proceedings, Fourth International Conference on Soil Mechanics and Foundation Engineering, London, 1957.
4. Button, S.F., The Bearing Capacity of Footings on a Two-Layer Cohesive Subsoil, Proceedings, Third International Conference on Soil Mechanics and Foundation Engineering, Zurich, 1953.
5. Vesic, A.S., Bearing Capacity of Shallow Foundations, Foundation Engineering Handbook, Winterkorn and Fang, eds., Van Nostrand Reinhold Company, New York, Chapter 3, 1975.
6. Bowles, J.E., Foundation Analysis and Design, McGraw Hill Book Co., New York, pp. 137-139, 1977
7. Peck, R.B., Hanson, W.E. and Thornburn, T.H., Foundation Engineering, 2nd Edition, John Wiley & Sons, Inc., New York, 1974.
8. Canadian Geotechnical Society, Shallow Foundations, Canadian Foundation Engineering Manual, Montreal, Canada, Part 2, 1978.
9. CP2004, Sulphates in Soils and Groundwater, Classification and Recommendations, BRS Digest, No. 90, Second Series, London, England, 1972.
10. Hetenyi, M., Beams on Elastic Foundation, University of Michigan Press, Ann Arbor, MI, 1946.
11. ACI Committee 436, Suggested Design Procedures for Combined Footings and Mats, American Concrete Institute, 1966.
12. Terzaghi, K., Evaluation of Coefficient of Subgrade Reaction, Geotechnique, Vol. 5, No. 4, 1955.
13. Parcher, J.V. and Means, R.E., Soil Mechanics and Foundations, Charles E. Merrill Publishing Company, Columbus, OH, 1968.
14. Lytton, R.L. and Woodburn, J.A., Design and Performance of Mat Foundations on Expansive Clay, Proceedings of the Third International Conference on Expansive Soils, 1973.
15. Chen, F.H., Foundations on Expansive Soils, Footing Foundations, Elsevier Scientific Publishing Co., New York, Chapter 5, 1975.

16. Teng, W.C., Foundation Drainage and Waterproofing, Foundation Design, Prentice Hall, Englewood Cliffs, NJ, Chapter 5, 1962.
17. NAVFAC TS-07110, Membrane Waterproofing, Naval Facilities, Engineering Command, Guide Specifications, 1979.
18. NAVFAC TS-07160, Bituminous Dampproofing, Naval Facilities, Engineering Command, Guide Specifications, 1978.
19. Littlejohn, G.S. and Bruce, D.A., Rock Anchors-State of the Art, Foundation Publications Ltd., England, 1977.

CHAPTER 5. DEEP FOUNDATIONS

Section 1. INTRODUCTION

1. **SCOPE.** This chapter presents information on the common types of deep foundations, analysis and design procedures, and installation procedures. Deep foundations, as used in this chapter, refer to foundations which obtain support at some depth below the structure, generally with a foundation depth to width ratio (D/B) exceeding five. These include driven piles, drilled piles, drilled piers/caissons, and foundations installed in open or braced excavations well below the general structure. Diaphragm walls are discussed in DM-7.3, Chapter 3.

2. **APPLICATION.** Deep foundations are used in a variety of applications including:

(a) To transmit loads through an upper weak and/or compressible stratum to underlying competent zone.

(b) To provide support in areas where shallow foundations are impractical, such as underwater, in close proximity to existing structures, and other conditions.

(c) To provide uplift resistance and/or lateral load capacity.

3. **RELATED CRITERIA.** For additional criteria relating to the design of deep foundations and the selection of driving equipment and apparatus, see the following sources:

Subject	Source
Pile Driving Equipment.....	NAVFAC DM-38
General Criteria for Piling in Waterfront Construction....	NAVFAC DM-25

4. **LOCAL PRACTICE.** The choice of the type of deep foundation such as pile type(s), pile design capacity, and installation procedures is highly dependent on local experience and practice. A design engineer unfamiliar with these local practices should contact local building/engineering departments, local foundation contractors, and/or local foundation consultants.

5. **INVESTIGATION PROGRAM.** Adequate subsurface exploration must precede the design of pile foundations. Investigations must include the following:

(a) Geological section showing pattern of major strata and presence of possible obstructions, such as boulders, buried debris, etc.

(b) Sufficient test data to estimate strength and compressibility parameters of major strata.

(c) Determination of probable pile bearing stratum.

For field explorations and testing requirements, see DM-7.1, Chapter 2.

6. CONSTRUCTION INSPECTION. The performance of a deep foundation is highly dependent on the installation procedures, quality of workmanship, and installation/design changes made in the field. Thus, inspection of the deep foundation installation by a geotechnical engineer normally should be required.

Section 2. FOUNDATION TYPES AND DESIGN CRITERIA

1. COMMON TYPES. Tables 1 and 2 summarize the types of deep foundations, fabricated from wood, steel, or concrete, in common usage in the United States. Table 1 presents pile types and Table 2 presents excavated foundation types including drilled piers/caissons. General comments on applicability of the various foundation types are given in Table 2, but local experience and practices, comparative costs, and construction constraints should be reviewed carefully for each site.

a. Driven Piles. These are piles which are driven into the ground and include both low displacement and high displacement piles. Low displacement piles include H and I section steel piles. Open end piles which do not form a plug, jettied piles, and pre-bored driven piles may function as low displacement piles. Solid section piles, hollow section closed end piles, and open end piles forming a soil plug function as high displacement piles. All the pile types in Table 1 except auger-placed piles are driven piles.

b. Excavated Foundations. These foundations include both drilled piles and piers and foundations constructed in open or braced excavations (see Reference 1, Foundation Design, by Teng). Drilled piles include auger-placed piles and drilled piers/caissons either straight shaft or belled.

2. OTHER DEEP FOUNDATION TYPES. Tables 1 and 2 include only the most commonly used types and deep foundation construction procedures. New and innovative types are being developed constantly, and each must be appraised on its own merits.

a. Drilled-in Tubular Piles. These consist of heavy-gauge steel tubular pile capable of being rotated into the ground for structure support. Soils in the tube may be removed and replaced with concrete. Used in penetration of soil containing boulders and obstructions, or drilling of rock socket to resist uplift and lateral forces. Steel H-sections within concrete cores are used to develop full end bearing for high load capacity.

b. TPT (Tapered Pile Tip) Piles. These consist of a mandrel drive corrugated shell with an enlarged precast concrete base. This type of pile is usually considered in conditions suitable for pressure injected footings. The principal claimed advantage is the avoidance of punching through a relatively thin bearing stratum.

c. Interpiles. These consist of an uncased concrete pile, formed by a mandrel driven steel plate. A steel pipe mandrel of smaller diameter than the plate is used, and the void created by the driven plate is kept continuously filled with concrete. It is claimed that this pile develops greater side friction in a granular soil than drilled piers and conventional driven piles.

TABLE 1
Design Criteria for Bearing Piles

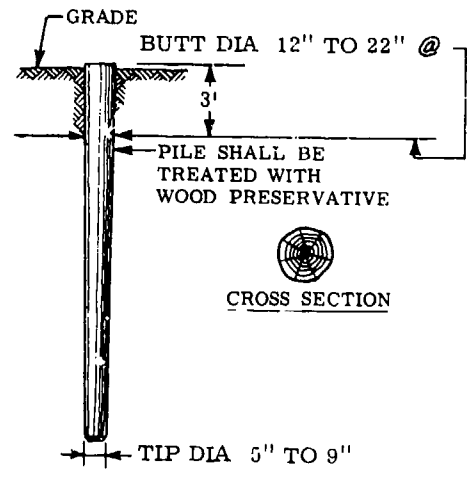
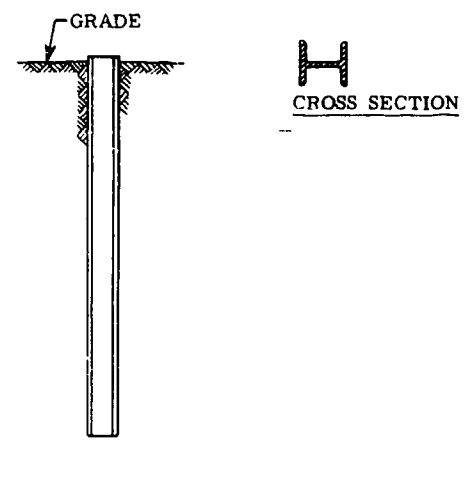
PILE TYPE	TIMBER	STEEL - H SECTIONS
<p>CONSIDER FOR LENGTH OF</p> <p>APPLICABLE MATERIAL SPECIFICATIONS.</p> <p>MAXIMUM STRESSES.</p> <p>CONSIDER FOR DESIGN LOADS OF.</p> <p>DISADVANTAGES</p> <p>ADVANTAGES</p> <p>REMARKS</p>	<p>30-60 FT</p> <p>ASTM -D25</p> <p>MEASURED AT MOST CRITICAL POINT, 1200 PSI FOR SOUTHERN PINE AND DOUGLAS FIR. SEE U.S.D.A. WOOD HANDBOOK NO.72 FOR STRESS VALUES OF OTHER SPECIES.</p> <p>10-50 TONS</p> <p>DIFFICULT TO SPLICE. VULNERABLE TO DAMAGE IN HARD DRIVING, TIP MAY HAVE TO BE PROTECTED. VULNERABLE TO DECAY UNLESS TREATED, WHEN PILES ARE INTERMITTENTLY SUBMERGED.</p> <p>COMPARATIVELY LOW INITIAL COST. PERMANENTLY SUBMERGED PILES ARE RESISTANT TO DECAY. EASY TO HANDLE.</p> <p>BEST SUITED FOR FRICTION PILE IN GRANULAR MATERIAL.</p>	<p>40-100 FT.</p> <p>ASTM-A36</p> <p>12,000 PSI.</p> <p>40-120 TONS</p> <p>VULNERABLE TO CORROSION WHERE EXPOSED HP SECTION MAY BE DAMAGED OR DEFLECTED BY MAJOR OBSTRUCTIONS.</p> <p>EASY TO SPLICE. AVAILABLE IN VARIOUS LENGTHS AND SIZES. HIGH CAPACITY. SMALL DISPLACEMENT. ABLE TO PENETRATE THROUGH LIGHT OBSTRUCTIONS. HARDER OBSTRUCTIONS MAY BE PENETRATED WITH APPROPRIATE POINT PROTECTION OR WHERE PENETRATION OF SOFT ROCK IS REQUIRED.</p> <p>BEST SUITED FOR ENDBEARING ON ROCK. REDUCE ALLOWABLE CAPACITY FOR CORROSIVE LOCATIONS.</p>
<p>TYPICAL ILLUSTRATIONS.</p>	 <p>GRADE</p> <p>BUTT DIA 12" TO 22" @</p> <p>3'</p> <p>PILE SHALL BE TREATED WITH WOOD PRESERVATIVE</p> <p>CROSS SECTION</p> <p>TIP DIA 5" TO 9"</p>	 <p>GRADE</p> <p>CROSS SECTION</p>

TABLE 1 (continued)
Design Criteria for Bearing Piles

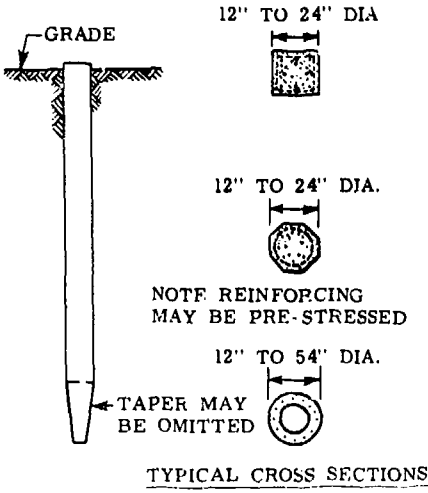
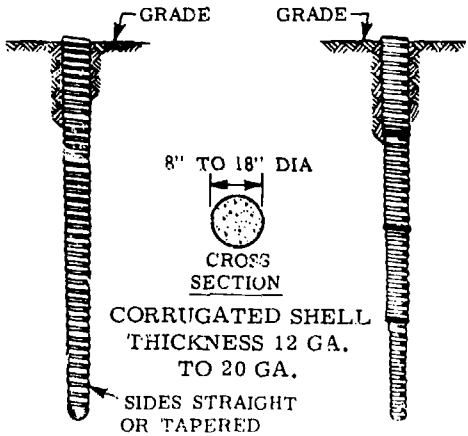
PILE TYPE	PRECAST CONCRETE (INCLUDING PRESTRESSED)	CAST-IN-PLACE CONCRETE (THIN SHELL DRIVEN WITH MANDREL)
<p>CONSIDER FOR LENGTH OF</p> <p>APPLICABLE MATERIAL SPECIFICATIONS.</p> <p>MAXIMUM STRESSES.</p> <p>DISADVANTAGES</p> <p>ADVANTAGES</p> <p>REMARKS</p>	<p>40-50 FT. FOR PRECAST 60-100 FT. FOR PRESTRESSED.</p> <p>ACI 318 FOR CONCRETE ASTM A15-FOR REINFORCING STEEL</p> <p>FOR PRECAST-33% OF 28 DAY STRENGTH OF CONCRETE. FOR PRESTRESSED-$F_c = 0.33 F'_c - 0.27 F_{pe}$ (WHERE: F_{pe} IS THE EFFECTIVE PRESTRESS STRESS ON THE GROSS SECTION).</p> <p>SPECIFICALLY DESIGNED FOR A WIDE RANGE OF LOADS.</p> <p>UNLESS PRESTRESSED, VULNERABLE TO HANDLING RELATIVELY HIGH BREAKAGE RATE ESPECIALLY WHEN PILES ARE TO BE SPLICED. HIGH INITIAL COST. CONSIDERABLE DISPLACEMENT. PRESTRESSED DIFFICULT TO SPLICE.</p> <p>HIGH LOAD CAPACITIES. CORROSION RESISTANCE CAN BE ATTAINED. HARD DRIVING POSSIBLE.</p> <p>CYLINDER PILES IN PARTICULAR ARE SUITED FOR BENDING RESISTANCE. GENERAL LOADING RANGE IS 40-400 TONS.</p>	<p>10-120 FT. BUT TYPICALLY IN THE 50 - 80 FT. RANGE</p> <p>ACI CODE 318 - FOR CONCRETE.</p> <p>33% OF 28-DAY STRENGTH OF CONCRETE, WITH INCREASE TO 40% OF 28 DAY STRENGTH. PROVIDING:</p> <p>(A) CASING IS A MINIMUM 14 GAUGE THICKNESS (B) CASING IS SEAMLESS OR WITH WELDED SEAMS (C) RATIO OF STEEL YIELD STRENGTH TO CONCRETE 28 DAY STRENGTH IS NOT LESS THAN 6. (D) PILE DIAMETER IS NOT GREATER THAN 17".</p> <p>SPECIFICALLY DESIGNED FOR A WIDE RANGE OF LOADS.</p> <p>DIFFICULT TO SPLICE AFTER CONCRETING. REDRIVING NOT RECOMMENDED. THIN SHELL VULNERABLE DURING DRIVING TO EXCESSIVE EARTH PRESSURE OR IMPACT.</p> <p>CONSIDERABLE DISPLACEMENT.</p> <p>INITIAL ECONOMY. TAPERED SECTIONS PROVIDE HIGHER BEARING RESISTANCE IN GRANULAR STRATUM CAN BE INTERNALLY INSPECTED AFTER DRIVING RELATIVELY LESS WASTE STEEL MATERIAL. CAN BE DESIGNED AS END BEARING OR FRICTION PILE, GENERALLY LOADED IN THE 40-100 TON RANGE. BEST SUITED FOR MEDIUM LOAD FRICTION PILES IN GRANULAR MATERIALS.</p>
<p>TYPICAL ILLUSTRATIONS</p>	 <p>12" TO 24" DIA</p> <p>12" TO 24" DIA.</p> <p>NOTE REINFORCING MAY BE PRE-STRESSED</p> <p>12" TO 54" DIA.</p> <p>TAPER MAY BE OMITTED</p> <p>TYPICAL CROSS SECTIONS</p>	 <p>GRADE GRADE</p> <p>8" TO 18" DIA</p> <p>CROSS SECTION</p> <p>CORRUGATED SHELL THICKNESS 12 GA. TO 20 GA.</p> <p>SIDES STRAIGHT OR TAPERED</p>

TABLE 1 (continued)
Design Criteria for Bearing Piles

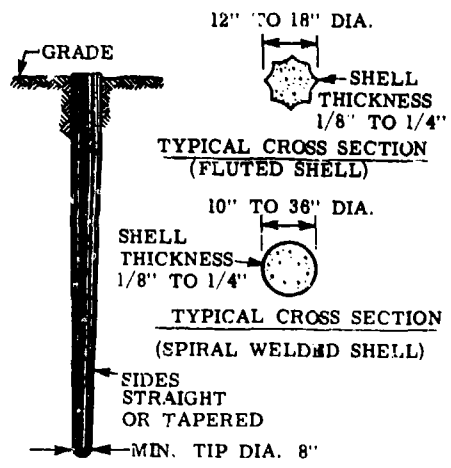
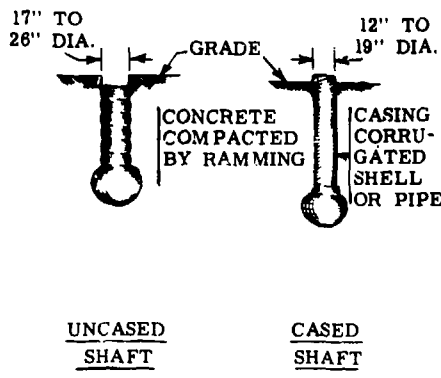
PILE TYPE	CAST-IN-PLACE CONCRETE PILES (SHELLS DRIVEN WITHOUT MANDREL)	PRESSURE INJECTED FOOTINGS
<p>CONSIDER FOR LENGTH OF</p> <p>APPLICABLE MATERIAL SPECIFICATION.</p> <p>MAXIMUM STRESSES</p> <p>CONSIDER FOR DESIGN LOADS OF DISADVANTAGES</p> <p>ADVANTAGES</p> <p>REMARKS</p>	<p>30-90 FT</p> <p>ACI CODE 318</p> <p>33% OF 28-DAY STRENGTH OF CONCRETE. 9,000 PSI IN SHELL, MORE THAN 1/8 INCH THICK.</p> <p>50-70 TONS.</p> <p>HARD TO SPLICE AFTER CONCRETING. CONSIDERABLE DISPLACEMENT.</p> <p>CAN BE REDRIVEN. SHELL NOT EASILY DAMAGED.</p> <p>BEST SUITED FOR FRICTION PILES OF MEDIUM LENGTH.</p>	<p>10 TO 60 FT.</p> <p>ACI CODE 318</p> <p>33% OF 28-DAY STRENGTH OF CONCRETE. 9,000 PSI FOR PIPE SHELL IF THICKNESS GREATER THAN 1/8 INCH</p> <p>60-120 TONS.</p> <p>BASE OF FOOTING CANNOT BE MADE IN CLAY OR WHEN HARD SPOTS (E.G. ROCK LEDGES) ARE PRESENT IN SOIL PENETRATED. WHEN CLAY LAYERS MUST BE PENETRATED TO REACH SUITABLE MATERIAL, SPECIAL PRECAUTIONS ARE REQUIRED FOR SHAFTS IF IN GROUPS.</p> <p>PROVIDES MEANS OF PLACING HIGH CAPACITY FOOTINGS ON BEARING STRATUM WITHOUT NECESSITY FOR EXCAVATION OR DEWATERING.</p> <p>HIGH BLOW ENERGY AVAILABLE FOR OVERCOMING OBSTRUCTIONS.</p> <p>GREAT UPLIFT RESISTANCE IF SUITABLY REINFORCED.</p> <p>BEST SUITED FOR GRANULAR SOILS WHERE BEARING IS ACHIEVED THROUGH COMPACTION AROUND BASE.</p> <p>MINIMUM SPACING 4'-6" ON CENTER.</p>
<p>TYPICAL ILLUSTRATIONS</p>	 <p>12" TO 18" DIA.</p> <p>GRADE</p> <p>SHELL THICKNESS 1/8" TO 1/4"</p> <p>TYPICAL CROSS SECTION (FLUTED SHELL)</p> <p>10" TO 36" DIA.</p> <p>SHELL THICKNESS 1/8" TO 1/4"</p> <p>TYPICAL CROSS SECTION (SPIRAL WELDED SHELL)</p> <p>SIDES STRAIGHT OR TAPERED</p> <p>MIN. TIP DIA. 8"</p>	 <p>17" TO 26" DIA.</p> <p>GRADE</p> <p>12" TO 19" DIA.</p> <p>CONCRETE COMPACTED BY RAMMING</p> <p>CASING CORRUGATED SHELL OR PIPE</p> <p>UNCASED SHAFT</p> <p>CASED SHAFT</p>

TABLE 1 (continued)
Design Criteria for Bearing Piles

PILE TYPE	CONCRETE FILLED STEEL PIPE PILES	COMPOSITE PILES
<p>CONSIDER FOR LENGTH OF</p> <p>APPLICABLE MATERIAL SPECIFICATIONS</p> <p>MAXIMUM STRESSES.</p> <p>CONSIDER FOR DESIGN LOAD OF</p> <p>DISADVANTAGES</p> <p>ADVANTAGES</p> <p>REMARKS</p>	<p>40-120 FT. OR MORE</p> <p>ASTM A36 - FOR CORE. ASTM A252 - FOR PIPE. ACI CODE 318 - FOR CONCRETE.</p> <p>9,000 PSI FOR PIPE SHELL 33% OF 28-DAY STRENGTH OF CONCRETE. 12,000 PSI ON STEEL CORES OF STRUCTURAL REINFORCING STEEL.</p> <p>80-120 TONS WITHOUT CORES. 500-1,500 TONS WITH CORES.</p> <p>HIGH INITIAL COST. DISPLACEMENT FOR CLOSED END PIPE.</p> <p>BEST CONTROL DURING INSTALLATION. NO DISPLACEMENT FOR OPEN END INSTALLATION. OPEN END PIPE BEST AGAINST OBSTRUCTIONS. CAN BE CLEANED OUT AND DRIVEN FURTHER. HIGH LOAD CAPACITIES. EASY TO SPLICE.</p> <p>PROVIDES HIGH BENDING RESISTANCE WHERE UNSUPPORTED LENGTH IS LOADED Laterally.</p>	<p>60-200 FT.</p> <p>ACI CODE 318 - FOR CONCRETE. ASTM A36 - FOR STRUCTURAL SECTION. ASTM A252 - FOR STEEL PIPE. ASTM D25 - FOR TIMBER. 33% OF 28-DAY STRENGTH OF CONCRETE. 9,000 PSI FOR STRUCTURAL AND PIPE SECTIONS. SAME AS TIMBER PILES FOR WOOD COMPOSITE.</p> <p>30-100 TONS.</p> <p>DIFFICULT TO ATTAIN GOOD JOINT BETWEEN TWO MATERIALS EXCEPT FOR PIPE COMPOSITE PILE.</p> <p>CONSIDERABLE LENGTH CAN BE PROVIDED AT COMPARATIVELY LOW COST. FOR WOOD COMPOSITE PILES. HIGH CAPACITY FOR PIPE AND HP COMPOSITE PILES. INTERNAL INSPECTION FOR PIPE COMPOSITE PILES.</p> <p>THE WEAKEST OF ANY MATERIAL USED SHALL GOVERN ALLOWABLE STRESSES AND CAPACITY.</p>
<p>TYPICAL ILLUSTRATIONS</p>	<p>8" TO 36" DIA.</p> <p>GRADE</p> <p>CROSS SECTION OF PLAIN PIPE PILE. SHELL THICKNESS 5/16"-1/2"</p> <p>12" TO 36" DIA.</p> <p>CROSS SECTION OF PIPE PILE WITH CORE</p> <p>SOCKET REQ'D FOR VERTICAL HIGH LOADS ONLY</p> <p>END CLOSURE MAY BE OMITTED</p> <p>ROCK</p>	<p>TYPICAL COMBINATIONS</p> <p>GRADE</p> <p>CASED OR UNCASD CONCRETE</p> <p>STEEL PIPE CONCRETE FILLED</p> <p>CONCRETE FILLED STEEL SHELL</p> <p>TIMBER</p> <p>BP SECTION</p>

TABLE 1 (continued)
Design Criteria for Bearing Piles

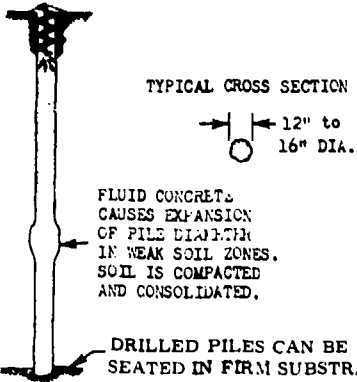
PILE TYPE	AUGER-PLACED, PRESSURE-INJECTED CONCRETE PILES	GENERAL NOTES
<p>CONSIDER FOR LENGTH OF APPLICABLE MATERIAL SPECIFICATIONS.</p> <p>MAXIMUM STRESSES.</p> <p>CONSIDER FOR DESIGN LOAD OF</p> <p>DISADVANTAGES</p> <p>ADVANTAGES</p> <p>REMARKS</p>	<p>30-60 FT.</p> <p>ACI-318</p> <p>33% OF 28-DAY STRENGTH OF CONCRETE.</p> <p>35-70 TONS</p> <p>MORE THAN AVERAGE DEPENDENCE ON QUALITY WORKMANSHIP. NOT SUITABLE THRU PEAT OR SIMILAR HIGHLY COMPRESSIBLE MATERIAL. REQUIRES RELATIVELY MORE EXTENSIVE SUBSURFACE INVESTIGATION.</p> <p>ECONOMY. COMPLETE NONDISPLACEMENT. MINIMAL DRIVING VIBRATION TO ENDANGER ADJACENT STRUCTURES. HIGH SKIN FRICTION. GOOD CONTACT ON ROCK FOR END BEARING. CONVENIENT FOR LOW-HEADROOM UNDERPINNING WORK. VISUAL INSPECTION OF AUGERED MATERIAL. NO SPLICING REQUIRED.</p> <p>BEST SUITED AS A FRICTION PILE.</p>	<p>1. STRESSES GIVEN FOR STEEL PILES ARE FOR NONCORROSIVE LOCATIONS. FOR CORROSIVE LOCATIONS, ESTIMATE POSSIBLE REDUCTION IN STEEL CROSS SECTION OR PROVIDE PROTECTION FROM CORROSION.</p> <p>2. LENGTHS AND LOADS INDICATED ARE FOR FEASIBILITY GUIDANCE ONLY. THEY GENERALLY REPRESENT TYPICAL CURRENT PRACTICE, GREATER LENGTHS ARE OFTEN USED.</p> <p>3. DESIGN LOAD CAPACITY SHOULD BE DETERMINED BY SOIL MECHANICS PRINCIPLES, LIMITING STRESSES IN PILES, AND TYPE AND FUNCTION OF STRUCTURE. SEE TEXT.</p>
<p>TYPICAL ILLUSTRATIONS</p>	 <p>TYPICAL CROSS SECTION</p> <p>12" to 16" DIA.</p> <p>FLUID CONCRETE CAUSES EXPANSION OF PILE DIAMETER IN WEAK SOIL ZONES. SOIL IS COMPACTED AND CONSOLIDATED.</p> <p>DRILLED PILES CAN BE PROPERLY SEATED IN FIRM SUBSTRATA</p>	

TABLE 2
Characteristics of Common Excavated/Drilled Foundations

1. PIERS (also called Shafts)

a. Description and Procedures - Formed by drilling or excavating a hole, removing the soil, and filling with concrete. Casing may be necessary for stabilization, and/or to allow for inspection and may or may not be pulled as the concrete is poured. Types include straight shaft piers and belled or underreamed piers. Drilled shaft diameters are typically 18 to 36 inches but can exceed 84 inches; belled diameters vary but are generally not larger than 3 times the diameter of the shaft. Excavated piers can be larger (shaft diameters exceeding 12 feet with belled diameters exceeding 30 feet have been constructed). Lengths can exceed 200 feet. Pier size depends on design load and allowable soil loads.

b. Advantages

- Completely non-displacement.
- Excavated material can be examined and bearing surface can be visually inspected in cased piers exceeding 30 inches in diameter (or smaller using TV cameras).
- Applicable for a wide variety of soil conditions.
- Pile caps usually not needed since most loads can be carried on a single pier.
- No driving vibration.
- With bellings, large uplift capacities possible.
- Design pier depths and diameters readily modified based on field conditions.
- Can be drilled into bedrock to carry very high loads.

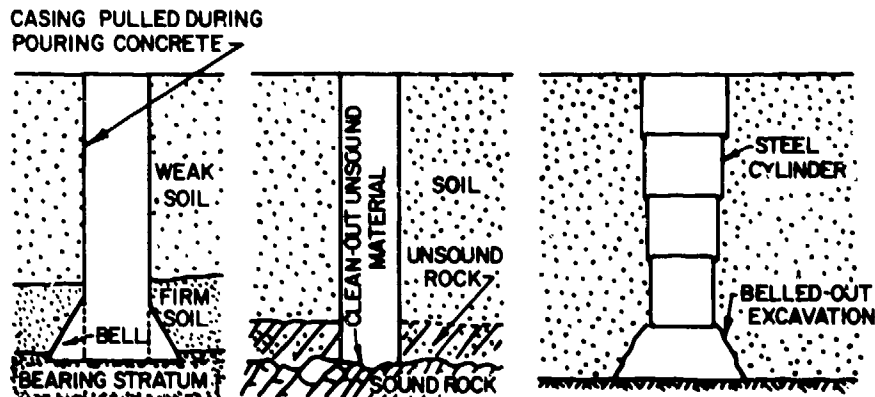
c. Disadvantages

- More than average dependence on quality of workmanship; inspection required.
- Danger of lifting concrete when pulling casing can result in voids or inclusions of soil in concrete.
- Loose granular soils below the water table can cause construction problems.

TABLE 2 (continued)
 Characteristics of Common Excavated/Drilled Foundations

- ° Bell usually cannot be formed in granular soils below the water table.
- ° Small diameter piers (less than 30 inches) cannot be easily inspected to confirm bearing and are particularly susceptible to necking problems.

d. Typical Illustration



2. INTERNALLY-BRACED COFFERDAM IN OPEN WATER

a. Description and Procedures - Generally only applicable if structure extends below mudline.

- (1) Cofferdam constructed and dewatered before pouring of foundation.
 - (a) Install cofferdam and initial bracing below water in existing river/sea bottom. Cofferdam sheeting driven into bearing strata to control underseepage.
 - (b) Pump down water inside cofferdam.
 - (c) Excavate to bearing stratum completing bracing system during excavation.
 - (d) Construct foundation within completed and dewatered cofferdam.
 - (e) Guide piles or template required for driving cofferdams.
 - (f) Cofferdam designed for high water, ice forces, or load of floating debris.
 - (g) Cellular wall or double-wall cofferdams will eliminate or reduce required bracing system.

TABLE 2 (continued)
 Characteristics of Common Excavated/Drilled Foundations

(2) Cofferdam excavated underwater

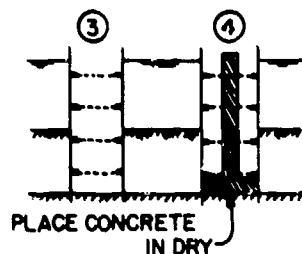
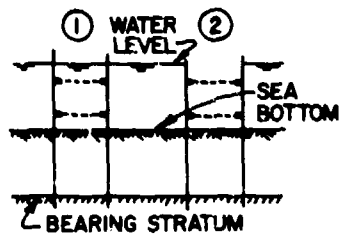
- (a) Install cofferdam and initial bracing below water to existing river/sea bottom.
- (b) Excavate underwater and place additional bracing to subgrade in bearing stratum.
- (c) Seal bottom with tremie mat of sufficient weight to balance expected hydrostatic uplift.
- (d) Pump out cofferdam and erect remainder of foundation structure.
- (e), (f) and (g) same as dewatered cofferdam.
- (h) Relief of water pressures below tremie slab may be used to decrease weight of tremie slab.

b. Advantages - Generally more economical than caissons if foundation is in less than 40 feet of water.

c. Disadvantages - Requires complete dewatering or tremie mat.

d. Typical Illustration

COFFERDAM EXCAVATED IN DRY



COFFERDAM EXCAVATED UNDER WATER

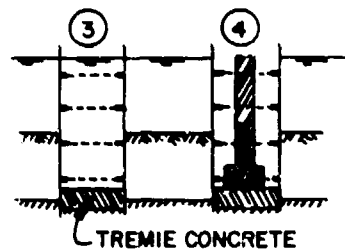
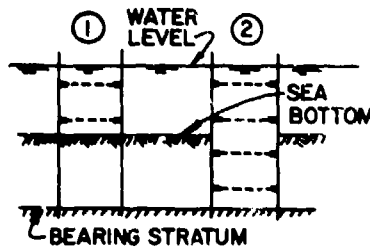


TABLE 2 (continued)
Characteristics of Common Excavated/Drilled Foundations

3. OPEN CAISSON

a. Description and Procedure - An open box or circular section with a cutting shoe on its lower edge. The caisson is sunk into place under its own weight by removal of the soil inside the caisson, jetting on the outside wall is often used to facilitate the process.

(1) Caissons should be considered when one or more of the following conditions exist:

- (a) A substructure is required to extend to or below the river/sea bed.
- (b) The soil contains large boulders which obstruct penetration of piles or drilled piers.
- (c) The foundation is subject to very large lateral forces.

If these conditions do not exist the use of a caisson is not warranted because it is generally more expensive than other types of deep foundations. In open water, if the bearing stratum is less than about 40 feet below the water surface, a spread footing foundation constructed within cofferdams is generally less expensive.

(2) General method of construction includes:

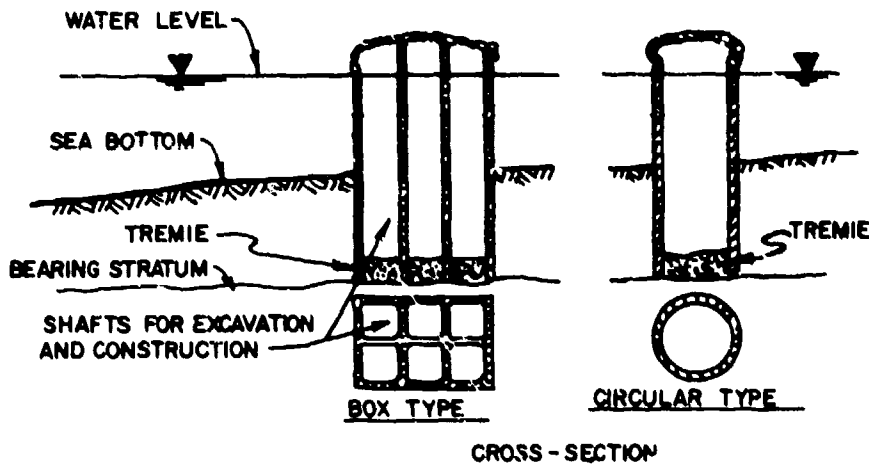
- (a) Float caisson shell into position.
- (b) Build up shell in vertical lifts and place fill within shell until it settles to sea bottom.
- (c) Continue buildup and excavate by dredging within caisson so as to sink it through unsuitable upper strata.
- (d) Upon reaching final elevation in bearing stratum, pour tremie base.
- (e) Provide anchorage or guides for caisson shell during sinking.
- (f) Floating and sinking operations can be facilitated by the use of false bottoms or temporary domes.
- (g) Dredging operations may be assisted by the use of jets or airlifts.

TABLE 2 (continued)
 Characteristics of Common Excavated/Drilled Foundations

Generally appropriate for depths exceeding 50 to 60 feet and when final subgrade in the bearing stratum is not threatened by uplift from underlying pervious strata.

- b. Advantages - Feasibility of extending to great depths.
- c. Disadvantages
 - Bottom of the caisson cannot be thoroughly cleaned and inspected.
 - Concrete seal placed in water is not as satisfactory as placed in the dry.
 - Soil directly under the haunched portion near the cutting edges may require hand excavation by diver.
 - Construction is slowed down if obstruction of boulders or logs is encountered.

d. Typical Illustration



4. PNEUMATIC CAISSON

- a. Description and Procedure - Similar to an open caisson but the box is closed and compressed air is used to keep water and mud from flowing into the box. Because of high costs, it is generally only used on large projects where an acceptable bearing stratum cannot be reached by open caisson methods because of excessive depth of water.
 - (1) Generally required for sinking to great depths where inflow of material during excavation can be damaging to surrounding areas and/or where uplift is a threat from underlying pervious strata.

TABLE 2 (continued)
Characteristics of Common Excavated/Drilled Foundations

- (2) General method of construction includes:
- (a) Float caisson into position.
 - (b) Build up on top of caisson in vertical lifts until the structure settles to sea bottom.
 - (c) Continue buildup and excavate beneath the caisson, using compressed air when passing through unstable strata.
 - (d) Pour concrete base in the dry upon reaching final position in the bearing stratum.
 - (e) Provide anchorage or guides for caisson during sinking. For excavation in the dry, air pressure is generally made equal to total head of water above bottom of caisson.

b. Advantages

- All work is done in the dry; therefore, controls over the foundation preparation and materials are better.
- Plumbness of the caisson is easier to control as compared with the open caisson.
- Obstruction from boulders or logs can be readily removed. Excavation by blasting may be done if necessary.

c. Disadvantages

- The construction cost is high due to the use of compressed air.
- The depth of penetration below water is limited to about 120 feet (50 psi). Higher pressures are beyond the endurance of the human body.
- Use of compressed air restricts allowable working hours per man and requires strict safety precautions.

d. Typical Illustration

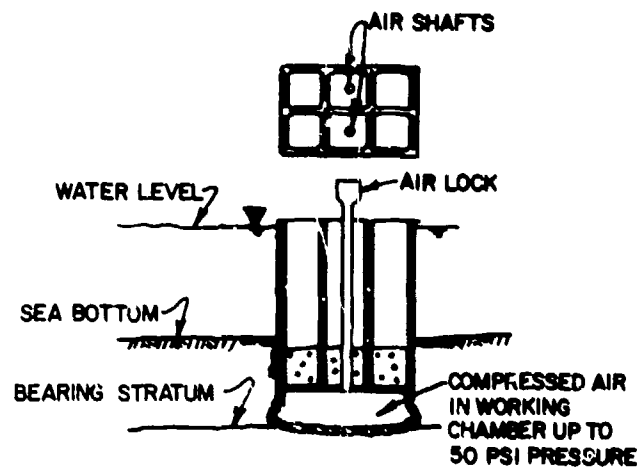
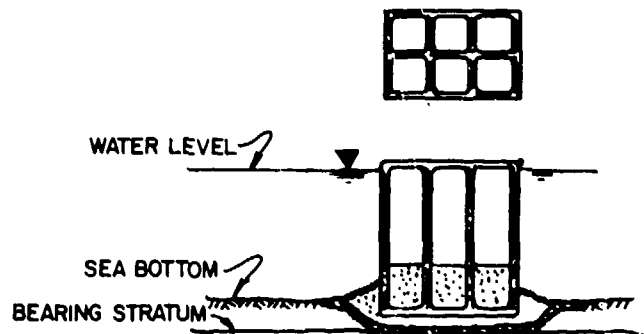


TABLE 2 (continued)
Characteristics of Common Excavated/Drilled Foundations

5. BOX CAISSON (Floating Caisson)

- a. Description and Procedure - Essentially a cast-on-land floating foundation sunk into position by backfilling.
- (1) Used primarily for wharfs, piers, bulkheads, and breakwaters in water not more than 40 feet deep.
 - (2) General construction method includes:
 - (a) Prepare subgrade at sea bottom by dredging, filling, or combination of dredging and filling.
 - (b) Float caisson into position.
 - (c) Sink caisson to prepared foundation at the sea bottom by use of ballast.
 - (d) Provide anchorage or guides to protect floating caisson against water currents.
 - (e) Backfill for suitable foundation should be clean granular material and may require compaction in place under water.
- b. Advantages
- The construction cost is relatively low.
 - Benefit from precasting construction.
 - No dewatering necessary.
- c. Disadvantages
- The ground must be level or excavated to a level surface.
 - Use is limited to only those conditions where bearing stratum is close to ground surface.
 - Provisions must be made to protect against undermining by scour.
 - The bearing stratum must be adequately compacted to avoid adverse settlements.

d. Typical Illustration



d. Earth Stabilization Columns. Many methods are available for forming compression reinforcement elements (see DM-7.3, Chapter 2) including:

(1) Mixed-In-Place Piles. A mixed-in-place soil-cement or soil-lime pile.

(2) Vibro-Replacement Stone Columns. A vibroflot or other device is used to make a cylindrical, vertical hole which is filled with compacted gravel or crushed rock.

(3) Grouted Stone Columns. This is similar to the above but includes filling voids with bentonite-cement or water-sand-bentonite cement mixtures.

(4) Concrete Vibro Columns. Similar to stone columns but concrete introduced instead of gravel.

Section 3. BEARING CAPACITY AND SETTLEMENT

1. DESIGN PROCEDURES. The design of a deep foundation system should include the following steps:

(1) Evaluate the subsurface conditions.

(2) Review the foundation requirements including design loads and allowable settlement or deflection.

(3) Evaluate the anticipated construction conditions and procedures.

(4) Incorporate local experience and practices.

(5) Select appropriate foundation type(s) based on the above items, costs, and comments on Tables 1 and 2.

(6) Determine the allowable axial foundation design loads based on an evaluation of ultimate foundation capacity including reductions for group action or downdrag if applicable, anticipated settlement and local requirements and practices.

The axial load capacity of deep foundations is a function of the structural capacity of the load carrying member (with appropriate reduction for column action) and the soil load carrying capacity. Usually, the latter consideration controls design. The methods available for evaluating the ultimate axial load capacity are listed below. Some or all of these should be considered by the design engineer as appropriate.

(a) Static analysis utilizing soil strength.

(b) Empirical analysis utilizing standard field soil tests.

(c) Building code requirements and local experience.

(d) Full-scale load tests.

(e) Dynamic driving resistance.

(7) Determine design and construction requirements, and incorporate the requirements into construction specifications.

Inspection of foundation construction should be considered an integral part of the design procedures. Perform a pile test program as required. The pile test can also be used as a design tool in item (6).

2. BEARING CAPACITY OF SINGLE PILE

a. Allowable Stresses. See Table 1 for allowable stresses within the pile and quality requirements for pile materials. Allowable stresses should be reduced for column action where the pile extends above firm ground, i.e. through water and very soft bottom sediments.

b. Soil Support. The soil must be capable of supporting the element when it is in compression, tension, and subject to lateral forces. The soil support can be computed from soil strength data, determined by load tests, and/or estimated from driving resistance. These determinations should include the following stages:

(1) Design Stage. Compute required pile lengths from soil strength data to determine bidding length and pile type.

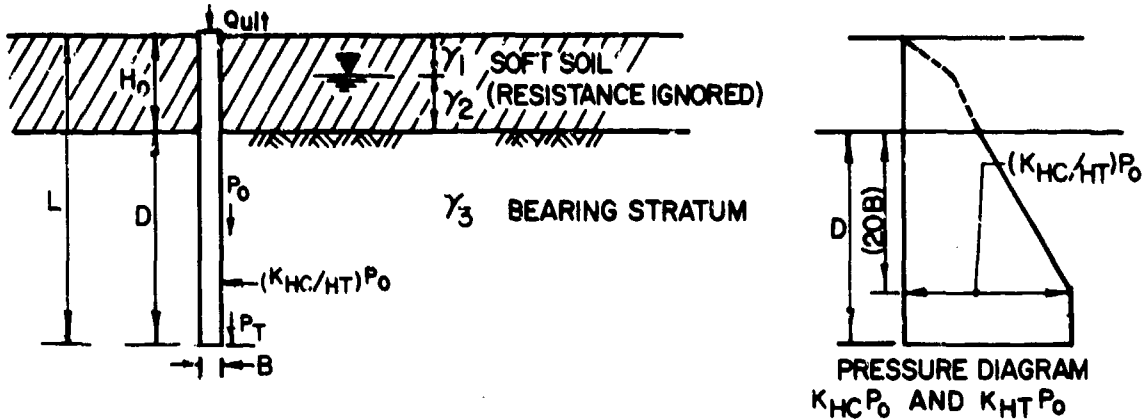
(2) Early in Construction Stage. Drive test piles at selected locations. For small projects where performance of nearby pile foundations is known, base design length and load capacity on knowledge of the soil profile, nearby pile performance, and driving resistance of test piles. On large projects where little experience is available, perform load tests on selected piles and interpret the results as shown in Figure 7.

(3) Throughout Construction Stage. Record driving resistance of all piles for comparison with test piles and to insure against local weak subsurface formations. Record also the type and condition of cushioning material used in the pile hammer.

c. Theoretical Load Capacity. See Figure 1 for analysis of ultimate load carrying capacity of single piles in homogeneous granular soils; for pile in homogeneous cohesive soil see Figure 2 (upper panel right, Reference 2, The Bearing Capacity of Clays, by Skempton; remainder of figure, Reference 3, The Adhesion of Piles Driven in Clay Soils, by Tomlinson).

(1) Compression Load Capacity. Compression load capacity equals end-bearing capacity, plus frictional capacity on perimeter surface.

(2) Pullout Capacity. Pullout capacity equals the frictional force on the perimeter surface of the pile or pier.



(A) ULTIMATE LOAD CAPACITY IN COMPRESSION

$$Q_{ult} = P_T N_q A_T + \sum_{H=H_0}^{H=H_0+D} (K_{HC} P_0 \tan \delta) (S)$$

WHERE Q_{ult} = ULTIMATE LOAD CAPACITY IN COMPRESSION

P_T = EFFECTIVE VERTICAL STRESS AT PILE TIP (SEE NOTE 1)

N_q = BEARING CAPACITY FACTOR (SEE TABLE, FIGURE 1 CONTINUED)

A_T = AREA OF PILE TIP

K_{HC} = RATIO OF HORIZONTAL TO VERTICAL EFFECTIVE STRESS ON SIDE OF ELEMENT WHEN ELEMENT IS IN COMPRESSION.

P_0 = EFFECTIVE VERTICAL STRESS OVER LENGTH OF EMBEDMENT, D (SEE NOTE 1)

δ = FRICTION ANGLE BETWEEN PILE AND SOIL (SEE TABLE, FIGURE 1 CONTINUED)

S = SURFACE AREA OF PILE PER UNIT LENGTH

FOR CALCULATING Q_{all} , USE F_S OF 2 FOR TEMPORARY LOADS, 3 FOR PERMANENT LOADS. (SEE NOTE 2)

(B) ULTIMATE LOAD CAPACITY IN TENSION

$$T_{ult} = \sum_{H=H_0}^{H=H_0+D} (K_{HT}) (P_0 \tan \delta) (S) (H)$$

WHERE: T_{ult} = ULTIMATE LOAD CAPACITY IN TENSION, PULLOUT

K_{HT} = RATIO OF HORIZONTAL TO VERTICAL EFFECTIVE STRESS ON SIDE OF ELEMENT WHEN ELEMENT IS IN TENSION

FOR CALCULATING T_{all} , USE $F_S = 3$ ON T_{ult} PLUS THE WEIGHT OF THE PILE (W_P), THUS $T_{all} = \frac{T_{ult}}{3} + W_P$ (SEE NOTE 2)

NOTE-1: EXPERIMENTAL AND FIELD EVIDENCE INDICATE THAT BEARING PRESSURE AND SKIN FRICTION INCREASE WITH VERTICAL EFFECTIVE STRESS P_0 UP TO A LIMITING DEPTH OF EMBEDMENT, DEPENDING ON THE RELATIVE DENSITY OF THE GRANULAR SOIL AND POSITION OF THE WATER TABLE. BEYOND THIS LIMITING DEPTH ($10B \pm$ TO $40B \pm$) THERE IS VERY LITTLE INCREASE IN END BEARING, AND INCREASE IN SIDE FRICTION IS DIRECTLY PROPORTIONAL TO THE SURFACE AREA OF THE PILE. THEREFORE, IF D IS GREATER THAN $20B$, LIMIT P_0 AT THE PILE TIP TO THAT VALUE CORRESPONDING TO $D = 20B$.

NOTE-2: IF BUILDING LOADS AND SUBSURFACE CONDITION ARE WELL DOCUMENTED IN THE OPINION OF THE ENGINEER, A LESSER FACTOR OF SAFETY CAN BE USED BUT NOT LESS THAN 2.0 PROVIDED PILE CAPACITY IS VERIFIED BY LOAD TEST AND SETTLEMENTS ARE ACCEPTABLE.

FIGURE 1
Load Carrying Capacity of Single Pile in Granular Soils

BEARING CAPACITY FACTORS - N_q

ϕ^* (DEGREES)	26	28	30	31	32	33	34	35	36	37	38	39	40
N_q (DRIVEN PILE DISPLACEMENT)	10	15	21	24	29	35	42	50	62	77	86	120	145
N_q^{**} (DRILLED PIERS)	5	8	10	12	14	17	21	25	30	38	43	60	72

EARTH PRESSURE COEFFICIENTS K_{HC} AND K_{HT}

PILE TYPE	K_{HC}	K_{HT}
DRIVEN SINGLE H-PILE	0.5 - 1.0	0.3 - 0.5
DRIVEN SINGLE DISPLACEMENT PILE	1.0 - 1.5	0.6 - 1.0
DRIVEN SINGLE DISPLACEMENT TAPERED PILE	1.5 - 2.0	1.0 - 1.3
DRIVEN JETTED PILE	0.4 - 0.9	0.3 - 0.6
DRILLED PILE (LESS THAN 24" DIAMETER)	0.7	0.4

FRICION ANGLE - δ

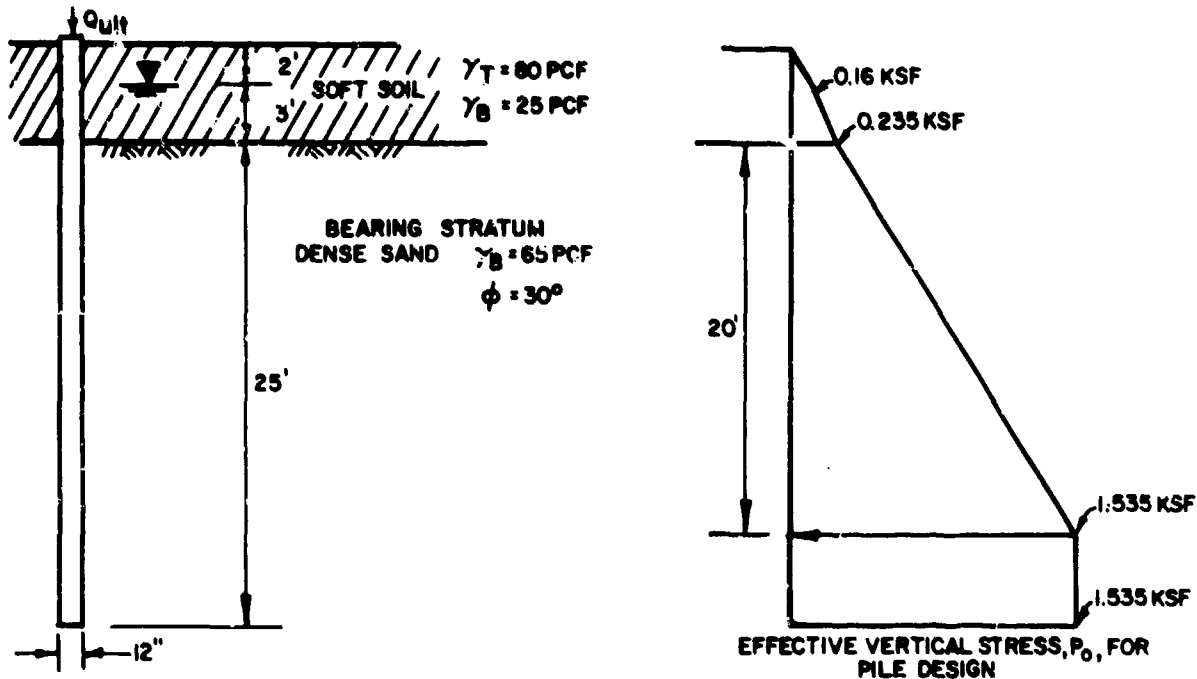
PILE TYPE	δ
STEEL	20°
CONCRETE	3/4 ϕ
TIMBER	3/4 ϕ

* LIMIT ϕ TO 28° IF JETTING IS USED

** (A) IN CASE A BAILER OR GRAB BUCKET IS USED BELOW GROUNDWATER TABLE, CALCULATE END BEARING BASED ON ϕ NOT EXCEEDING 28°.

(B) FOR PIERS GREATER THAN 24-INCH DIAMETER, SETTLEMENT RATHER THAN BEARING CAPACITY USUALLY CONTROLS THE DESIGN. FOR ESTIMATING SETTLEMENT, TAKE 50% OF THE SETTLEMENT FOR AN EQUIVALENT FOOTING RESTING ON THE SURFACE OF COMPARABLE GRANULAR SOILS. (CHAPTER 5, DM-7.1).

FIGURE 1 (continued)
Load Carrying Capacity of Single Pile in Granular Soils



FOR A 12" DIAMETER CLOSED END, DRIVEN PIPE PILE, CONCRETE FILLED, FIND Q_{all} AND T_{all} FOR A 30 FOOT LONG PILE.

P_0 MAX OCCURS AT 20B, OR 20' INTO BEARING STRATUM.

$\phi = 30^\circ$, $N_q = 21$

$K_{HC} = 1.5$, $\delta = 20^\circ$

$K_{HT} = 1.0$

$A_T = \pi \times 0.5^2 = 0.78 \text{ SF}$

CIRCUM. AREA / $l_f = 1 \times \pi = 3.14 \text{ SF/l}_f$

$$Q_{ult} = 1.535 \times 21 \times 0.78 + \left[(1.5 \times \frac{0.235 + 1.535}{2}) \times \text{TAN } 20^\circ \times 20 \times 3.14 + (1.5 \times 1.535 \times \text{TAN } 20^\circ \times 5 \times 3.14) \right]$$

$$= 25.14 + [30.34 + 13.16]$$

$$= 68.64 \text{ K}$$

$$\text{FOR } F_s = 3, Q_{all} = \frac{68.64}{3} = 22.9 \text{ K}$$

$$T_{ult} = 1.0 \times (\frac{0.235 + 1.535}{2}) \times \text{TAN } 20^\circ \times 20 \times 3.14 + 1.0 \times 1.535 \times \text{TAN } 20^\circ \times 5 \times 3.14$$

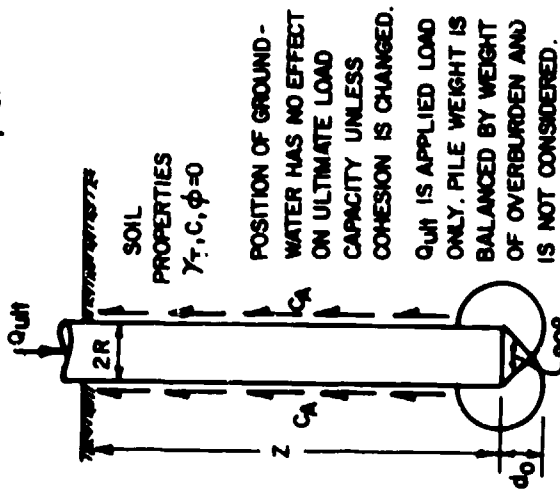
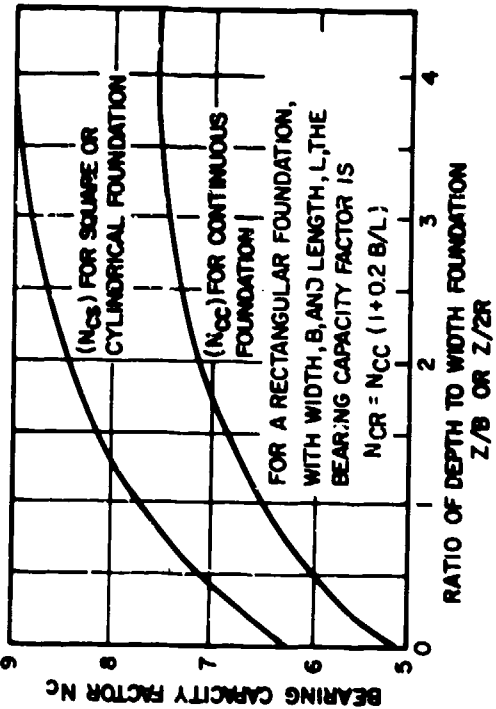
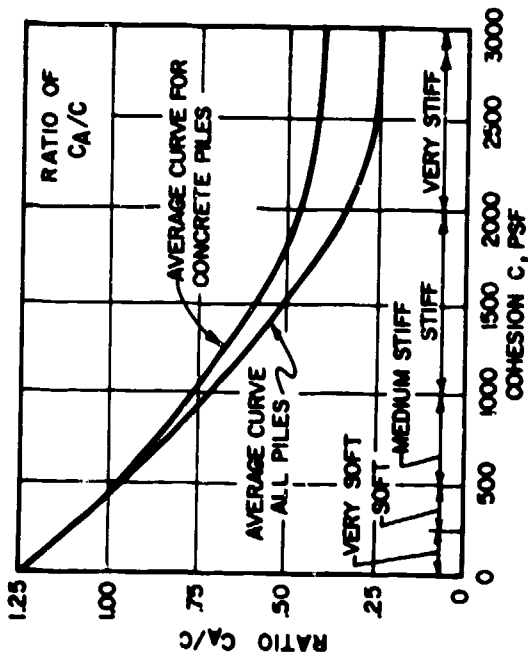
$$= 20.23 + 8.77$$

$$= 29.0 \text{ K}$$

$$W_p \approx .117 \text{ K/l}_f \times 30' = 3.5 \text{ K}$$

$$T_{all} = \frac{29.0}{3} + 3.5 = 13.2 \text{ K}$$

FIGURE 1 (continued)
Load Carrying Capacity of Single Pile in Granular Soils



ULTIMATE LOAD CAPACITY IN COMPRESSION
 $Q_{ult} = c(N_{cs}) \pi R^2 + c_A 2 \pi R Z$
 (N_{cc})

RECOMMENDED VALUES OF ADHESION

PILE TYPE	CONSISTENCY OF SOIL	COHESION, C PSF	ADHESION, C _A PSF
TIMBER AND CONCRETE	VERY SOFT	0 - 250	0 - 250
	SOFT	250 - 500	250 - 460
	MED. STIFF	500 - 1000	460 - 750
	STIFF	1000 - 2000	750 - 950
	VERY STIFF	2000 - 4000	950 - 1300
STEEL	VERY SOFT	0 - 250	0 - 250
	SOFT	250 - 500	250 - 460
	MED. STIFF	500 - 1000	460 - 700
	STIFF	1000 - 2000	700 - 720
	VERY STIFF	2000 - 4000	720 - 750

ULTIMATE LOAD CAPACITY IN TENSION
 $T_{ult} = C_A 2 \pi R Z$
 T_{ult} UNDER SUSTAINED LOAD MAY BE LIMITED BY OTHER FACTORS, SEE TEXT.

FIGURE 2
 Ultimate Load Capacity of Single Pile or Pier in Cohesive Soils

(3) Drilled Piers. For drilled piers greater than 24 inches in diameter settlement rather than bearing capacity may control. A reduced end bearing resistance may result from entrapment of bentonite slurry if used to maintain an open excavation to the pier's tip. Bells, or enlarged bases, are usually not stable in granular soils.

(4) Piles and Drilled Piers in Cohesive Soils. See Figure 2 and Table 3. Experience demonstrates that pile driving permanently alters surface adhesion of clays having a shear strength greater than 500 psf (see Figure 2). In softer clays the remolded material consolidates with time, regaining adhesion approximately equal to original strength. Shear strength for point-bearing resistance is essentially unchanged by pile driving. For drilled piers, use Table 3 from Reference 4, Soils and Geology, Procedures for Foundation Design of Buildings and Other Structures, by the Departments of Army and Air Force, for determining side friction. Ultimate resistance to pullout cannot exceed the total resistance of reduced adhesion acting over the pile surface or the effective weight of the soil mass which is available to react against pullout. The allowable sustained pullout load usually is limited by the tendency for the pile to move upward gradually while mobilizing an adhesion less than the failure value.

Adhesion factors in Figure 2 may be very conservative for evaluating piles driven into stiff but normally consolidated clays. Available data suggests that for piles driven into normally to slightly overconsolidated clays, the side friction is about 0.25 to 0.4 times the effective overburden.

(5) Piles Penetrating Multi-layered Soil Profile. Where piles penetrate several different strata, a simple approach is to add supporting capacity of the individual layers, except where a soft layer may consolidate and relieve load or cause drag on the pile. For further guidance on bearing capacity when a pile penetrates layered soil and terminates in granular strata see Reference 5, Ultimate Bearing Capacity of Foundations on Layered Soils Under Inclined Loads, by Meyerhoff and Hanna, which considers the ultimate bearing capacity of a deep member in sand underlying a clay layer and for the case of a sand bearing stratum overlying a weak clay layer.

(6) Pile Buckling. For fully embedded piles, buckling usually is not a problem. For a fully embedded, free headed pile with length equal to or greater than $4T$, the critical load for buckling is as follows (after Reference 6, Design of Pile Foundations, by Vesic):

$$P_{crit} = 0.78 T^3 f \quad \text{for } L \geq 4T$$

where: P_{crit} = critical load for buckling

f = coefficient of variation of lateral subgrade reaction (see Figure 10)

T = relative stiffness factor (see Figure 10)

L = length of pile.

TABLE 3
Design Parameters for Side Friction for Drilled Piers in Cohesive Soils

Design Category	Side Resistance		Remarks
	C_A/C	Limit on side shear - tsf	
A. Straight-sided shafts in either homogeneous or layered soil with no soil of exceptional stiffness below the base	0.6	2.0	(a) C_A/C may be increased to 0.6 and side shear increased to 2.0 tsf for segments drilled dry
	0.3(a)	0.5(a)	
B. Belled shafts in either homogeneous or layered clays with no soil of exceptional stiffness below the base	0.3	0.5	(b) C_A/C may be increased to 0.3 and side shear increased to 0.5 tsf for segments drilled dry
	0.15(b)	0.3(b)	

TABLE 3 (continued)
 Design Parameters for Side Friction for Drilled Piers in Cohesive Soils

Design Category	Side Resistance		Remarks
	C_A/C	Limit on side shear - tsf	
C. Straight-sided shafts with base resting on soil significantly stiffer than soil around stem	0	0	
D. Belled shafts with base resting on soil significantly stiffer than soil around stem	0	0	

Note: In calculating load capacity, exclude: (1) top 5 feet of drilled shaft; (2) periphery of bell; and (3) bottom 5 feet of straight shaft and bottom 5 feet of stem of shaft above bell.

For piles with the head fixed against rotation and translation, increase P_{crit} by 13%. If the pile head is pinned (i.e. prevented from translation but free to rotate), increase P_{crit} by 62%.

For a partially embedded pile, assume a free standing column fixed at depth $1.8T$ below the soil surface. Compute the critical buckling load by methods of structural analysis. For such piles compute allowable pile stresses to avoid buckling. For the case where the coefficient of lateral subgrade reaction (K_h) of the embedment soil is constant with depth, calculate the depth of fixity as $1.4\sqrt{\frac{EI}{K_h B}}$, where EI is the flexural rigidity of the pile, B is pile width (diameter) and K_h is defined in the units of Force/Length³. Buckling for a fully embedded length of other pile types does not control pile stress. For further guidance see Reference 6.

d. Empirical Bearing Capacity. Results from the Standard Penetration Test, Static Cone penetrometer (Dutch Cone with friction sleeve), and Pressuremeter have been correlated with model and full scale field tests on piles and deep foundations so that empirical expressions are available to estimate foundation capacities.

(1) Standard Penetration. Use of the Standard Penetration Test to predict capacities of deep foundations should be limited to granular soils and must be considered a crude estimate.

Tip Resistance of driven piles (after Reference 7, Bearing Capacity and Settlement of Pile Foundations, by Meyerhof):

$$q_{ult} = \frac{0.4 \bar{N} D}{B} \leq q$$

where:

$$\bar{N} = C_N \cdot N$$

N = standard penetration resistance (blow/ft)
near pile tip

$$C_N = 0.77 \log_{10} \frac{20}{p} \quad (\text{for } p \geq 0.25 \text{ TSF})$$

p = effective overburden stress at pile tip (TSF)

q_{ult} = ultimate point resistance of driven pile (TSF)

\bar{N} = average corrected Standard Penetration Resistance
near pile tip (blows/ft)

D = depth driven into granular bearing stratum (ft)

B = width or diameter of pile tip (feet)

q_1 = limiting point resistance (TSF), equal to
4N for sand and 3N for non-plastic silt.

For drilled piers, use 1/3 times q_{ult} computed from the above expression.

Use a factor of safety of 3 to compute allowable tip resistance.

Skin Friction of driven piles:

$$f_s = \frac{N}{50} \leq f_l$$

where:

N = average standard penetration along pile shaft

f_s = ultimate skin friction for driven pile (TSF)

f_l = limiting skin friction (for driven pile, $f_l = 1$ TSF)

Use factor of safety of 3 for allowable skin friction.

For driven piles tapered more than 1 percent, use 1.5 times above expression.

For drilled piers, use 50 percent of above expression

(2) The Cone Penetrometer. The Cone Penetrometer provides useful information as a "model pile" and is best suited for loose to dense sands and silts. Penetrometer results are not considered accurate for very dense sands or deposits with gravel.

Point Resistance:

$$q_{ult} = q_c$$

where:

q_{ult} = ultimate tip resistance for driven pile

q_c = cone penetration resistance

Depth of penetration to granular bearing stratum is at least 10 times the pile tip width.

Shaft Resistance:

$$f_{ult} = f_c$$

where:

f_{ult} = ultimate shaft friction of driven cylindrical pile

f_c = unit resistance of local friction sleeve of static penetrometer

Use factor of safety of 3 for allowable skin friction.

For drilled piers in cohesionless soil, use 1/2 of f_{ult} or q_{ult} based on the above expressions for driven piles.

(3) Pressuremeter. Results from pressuremeter tests can be used to estimate design capacity of deep foundation elements. See Reference 8, The Pressuremeter and Foundation Engineering, by Baguelin, et al., or Reference 9, Canadian Foundation Engineering Manual, by the Canadian Geotechnical Society, for details of design correlation.

The pressuremeter method is useful in soft rock, weathered or closely jointed rock, granular soils, and very stiff cohesive soils. Results are generally not suitable in soft clays because of the disturbance during drilling. The self-boring pressuremeter is designed to reduce this problem.

e. Bearing Capacity from Dynamic Driving Resistance.

(1) General. The ultimate capacity of a pile may be estimated on the basis of driving resistance during installation of the pile. The results are not always reliable, and may over-predict or grossly under-predict pile capacities, and therefore should be used with caution. Use must be supported by local experience or testing. Dynamic resistance based on the wave equation analysis is a more rational approach to calculating pile capacities.

(2) Pile Driving Formulas:

(a) General. Because of the uncertainties of the dynamics of pile driving, the use of formulas more elaborate than those in Table 4 is not warranted. A minimum of three test piles should be driven for each installation, with more tests if subsurface conditions are erratic.

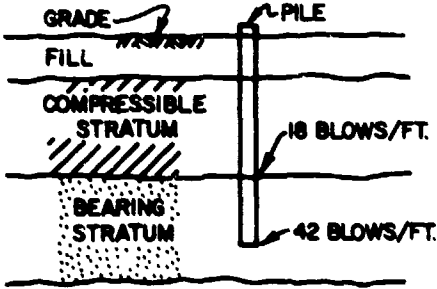
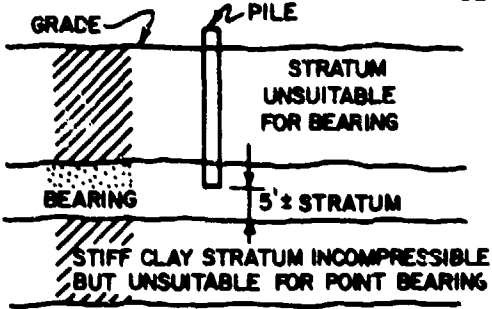
(b) Control During Construction. The embedment of piles should be controlled by specifying a minimum tip elevation on the basis of the subsurface profile and driving tests or load tests, if available, and also by requiring that the piles be driven beyond the specified elevation until the driving resistance equals or exceeds the value established as necessary from the results of the test piles. However, if the pile penetration consistently overruns the anticipated depth, the basis for the specified depth and driving resistance should be reviewed.

(c) Formulas. Dynamic pile driving formulas should not be used as criteria for establishing load capacity without correlation with the results of an adequate program of soil exploration. For critical structures and where local experience is limited, or where unfamiliar pile types or equipment are being used, load tests should be performed.

(3) Wave Equation Analysis. The wave equation analysis is based on the theory of one dimensional wave propagation. For the analysis the pile is divided into a series of masses connected by springs which characterize the pile stiffness, and dashpots which simulate the damping below the pile tip and along pile embedded length.

This method was first put into practical form in 1962 (Reference 10, Pile Driving by the Wave Equation, by Smith). The wave equation analysis provides a means of evaluating the suitability of the pile stiffness to transmit driving energy to the tip to achieve pile penetration, as well as the ability of pile section to withstand driving stresses without damage. The results of the analysis can be interpreted to give the following:

TABLE 4
Application of Pile Driving Resistance Formulas

BASIC PILE DRIVING FORMULAS (SEE COMMENT IN SECTION 2)		
FOR DROP HAMMER	FOR SINGLE - ACTING HAMMER	FOR DOUBLE - ACTING DIFFERENTIAL HAMMER
$Q_{all} = \frac{2WH}{S+1}$	$Q_{all} = \frac{2WH}{S+0.1}$ <p>USE WHEN DRIVEN WEIGHTS ARE SMALLER THAN STRIKING WEIGHTS.</p> $Q_{all} = \frac{2WH}{S+0.1} \frac{W_D}{W_S}$ <p>USE WHEN DRIVEN WEIGHTS ARE LARGER THAN STRIKING WEIGHTS.</p>	$Q_{all} = \frac{2E}{S+0.1}$ <p>USE WHEN DRIVEN WEIGHTS ARE SMALLER THAN STRIKING WEIGHTS.</p> $Q_{all} = \frac{2E}{S+0.1} \frac{W_D}{W_S}$ <p>USE WHEN DRIVEN WEIGHTS ARE LARGER THAN STRIKING WEIGHTS.</p>
<p>Q_{all} = ALLOWABLE PILE LOAD IN POUNDS. W = WEIGHT OF STRIKING PARTS OF HAMMER IN POUNDS. H = THE EFFECTIVE HEIGHT OF FALL IN FEET. E = THE ACTUAL ENERGY DELIVERED BY HAMMER PER BLOW IN FOOT-POUNDS. S = AVERAGE NET PENETRATION IN INCHES PER BLOW FOR THE LAST 6 IN. OF DRIVING. W_D = DRIVEN WEIGHTS W_S = WEIGHTS OF STRIKING PARTS</p> <p>NOTE: RATIO OF DRIVEN WEIGHTS TO STRIKING WEIGHTS SHOULD NOT EXCEED 3.</p>		
MODIFICATIONS OF BASIC PILE DRIVING FORMULAS		
<p>A. FOR PILES DRIVEN TO AND SEATED IN ROCK AS HIGH CAPACITY END-BEARING PILES: DRIVE TO REFUSAL (APPROXIMATELY 4 TO 5 BLOWS FOR THE LAST QUARTER INCH OF DRIVING). REDRIVE OPEN END PIPE PILES REPEATEDLY UNTIL RESISTANCE FOR REFUSAL IS REACHED WITHIN 1 IN. OF ADDITIONAL PENETRATION.</p>		
<p>B. PILES DRIVEN THROUGH STIFF COMPRESSIBLE MATERIALS UNSUITABLE FOR PILE BEARING TO AN UNDERLYING BEARING STRATUM:</p> <p>ADD BLOWS ATTAINED BEFORE REACHING BEARING STRATUM TO REQUIRED BLOWS ATTAINED IN BEARING STRATUM (SEE EXAMPLE).</p>  <p>EXAMPLE: REQUIRED LOAD CAPACITY OF PILE $Q_{all} = 25$ TONS HAMMER ENERGY $E = 15,000$ FT.-LB.</p> $\frac{W_D}{W_S} < 1$ <p>PENETRATION(S) AS PER BASIC FORMULA = 1/2" OR 2 BLOWS PER INCH (24 BLOWS/FT). REQUIRED BLOWS FOR PILE $24 + 18 = 42$ BLOWS/FT.</p>		
<p>C. PILES DRIVEN INTO LIMITED THIN BEARING STRATUM, DRIVE TO PREDETERMINED TIP ELEVATION. DETERMINE ALLOWABLE LOAD BY LOAD TEST.</p> 		

(a) Equipment compatibility: appropriate hammer size and cushion.

(b) Driving stresses: plots of stress vs. set can be made to evaluate the potential for pile overstress.

(c) Pile capacity: plot of ultimate pile capacity vs. set can be developed.

The soil is modeled by approximating the static resistance (quake), the viscous resistance (damping), and the distribution of the soil resistance along the pile. The assigned parameter for springs and dashpots cannot be related to routinely measured soil parameters which constitutes the major draw back of the wave equation analysis. The input for the driving system is provided by the anticipated hammer performance, coefficient of restitution of the cushion, and stiffness of the pile. Computer programs are available to perform the lengthy calculations.

(4) Case Method. The wave equation analysis can be used in conjunction with field measurements by using the Case Method (Reference 11, Soil Resistance Predictions from Pile Dynamics, by Rausche, et al.). This procedure electronically measures the acceleration and strain near the top of the pile, and by using the wave equation analysis estimates the static soil resistance for each blow of the hammer. Energy transferred to the pile is computed by integrating the product of force and velocity. A distribution of the soil resistance along the pile length is assumed and the wave equation analysis is performed. The assumed soil strength parameters are checked against the measured force at the pile top and these are then adjusted to result in an improved match between the analytical and measured pile force at the top.

3. BEARING CAPACITY OF PILE GROUPS.

a. General. The bearing capacity of pile groups in soils is normally less than the sum of individual piles in the group and must be considered in design. Group efficiency is a term used for the ratio of the capacity of a pile group to the sum of the capacities of single piles at the same depth in the same soil deposit. In evaluating the performance of pile groups in compression, settlement is a major consideration. Expressions for estimating uplift resistance of pile groups are included in this section.

b. Group Capacity in Rock. The group capacity of piles installed to rock is the number of members times the individual capacity of each member. Block failure is a consideration only if foundations are on a sloping rock formation, and sliding may occur along unfavorable dipping, weak planes. The possibility of such an occurrence must be evaluated from the site geology and field exploration.

c. Group Capacity in Granular Soil. Piles driven into cohesionless soil in a group configuration act as individual piles if the spacing is greater than 7 times the average pile diameter. They act as a group at close spacings. Center to center spacing of adjacent piles in a group should be at least two times the butt diameter.

Block failure of a pile group in granular soils is not a design consideration provided each individual pile has an adequate factor of safety against bearing failure and the cohesionless soil is not underlain by a weaker deposit. In loose sand and/or gravel deposits, the load carrying capacity of an individual pile may be greater in the group than single because of densification during driving. This increased efficiency should be included in design with caution, and only where demonstrated by field experience or tests.

The ultimate capacity of a pile group founded in dense cohesionless soil of limited thickness underlain by a weak deposit is the smaller of:

(1) sum of the single pile capacities

(2) block failure of a pier equivalent in size to the piles and enclosed soil mass, punching through the dense deposit into the underlying weak deposit (Reference 12, Ultimate Bearing Capacity of Footings on Sand Layer Overlying Clay, by Meyerhof).

d. Group Capacity in Cohesive Soil. Estimate the group capacity using the method in Figure 3 (upper panel, Reference 13, Experiments with Model Piles in Groups, by Whitaker).

e. Uplift Resistance of Groups.

(1) Granular Soil. Ultimate uplift resistance of pile group is lesser of:

(a) Sum of skin friction on the piles in the group (no reduction for tapered piles), use a factor of safety of 3.0.

(b) Effective weight of block of soil within the group and within a 4 vertical on 1 horizontal wedge extending up from pile tips - weight of piles assumed equal to volume of soil they displace. Factor of safety should be unity.

(2) Cohesive Soil. Ultimate uplift resistance of pile group is the lesser of:

(a) Sum of skin friction on the piles in the group

(b) $T_u = L (B + A) C + W_p$

where: T_u = ultimate uplift resistance of pile group

A = length of group

B = width of group

L = depth of soil block below pile cap

C = average undrained strength of soil around the sides of the group

W_p = weight of piles, pile cap, and block of soil enclosed by the piles.

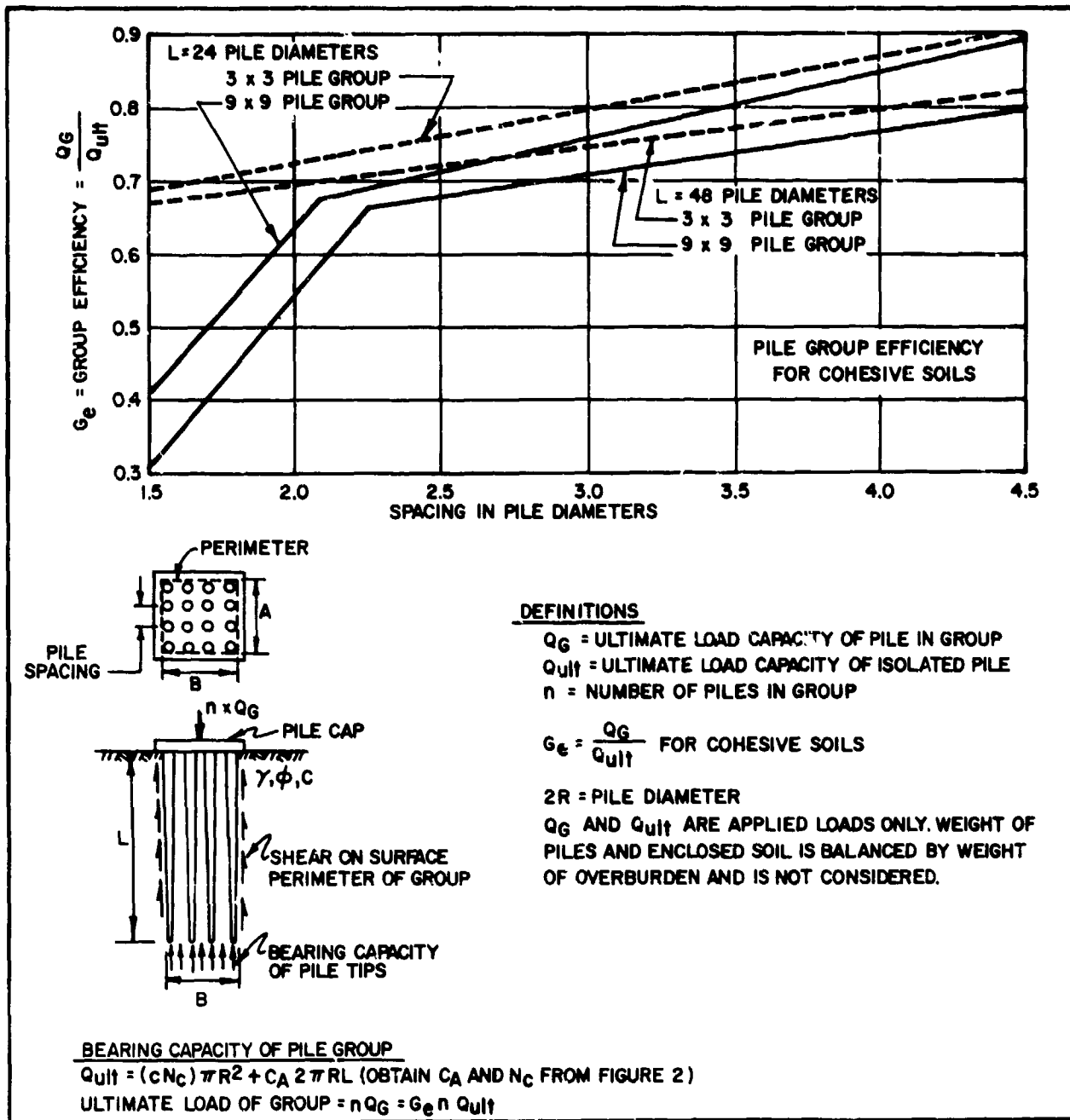


FIGURE 3
 Bearing Capacity of Pile Groups in Cohesive Soils

Factors of Safety: 2 for short-term loads, 3 for sustained uplifting loading.

4. SETTLEMENTS OF PILE FOUNDATIONS

a. Single Pile. The settlement at the top of pile can be broken down into three components (after Reference 6).

(1) Settlement due to axial deformation of pile shaft; W_s

$$W_s = (Q_p + \alpha_s Q_s) \frac{L}{AE_p}$$

where: Q_p = point load transmitted to the pile tip in the working stress range.

Q_s = shaft friction load transmitted by the pile in the working stress range (in force units)

$\alpha_s = 0.5$ for parabolic or uniform distribution of shaft friction

0.67 for triangular distribution of shaft friction starting from zero friction at pile head to a maximum value at pile point

0.33 for triangular distribution of shaft friction starting from a maximum at pile head to zero at the pile point.

L = pile length

A = pile cross sectional area

E_p = modulus of elasticity of the pile

(2) Settlement of pile point caused by load transmitted at the point

W_{pp} :

$$W_{pp} = \frac{C_p Q_p}{Bq_o}$$

where: C_p = empirical coefficient depending on soil type and method of construction, see Table 5

B = pile diameter

q_o = ultimate end bearing capacity

(3) Settlement of pile points caused by load transmitted along the pile shaft, W_{ps} :

$$W_{ps} = \frac{C_s Q_s}{Dq_o}$$

TABLE 5
 Typical* Values of Coefficient C_p for Estimating
 Settlement of a Single Pile

Soil Type	Driven Piles	Bored Piles
Sand (dense to loose)	0.02 to 0.04	0.09 to 0.18
Clay (stiff to soft)	0.02 to 0.03	0.03 to 0.06
Silt (dense to loose)	0.03 to 0.05	0.09 to 0.12

* Bearing stratum under pile tip assumed to extend at least 10 pile diameters below tip and soil below tip is of comparable or higher stiffness.

where : $C_s = (0.93 + 0.16 D/B) C_p$

D = embedded length

(4) Total settlement of a single pile, W_o :

$$W_o = W_s + W_{pp} + W_{ps}$$

b. Settlement of Pile Group in Granular Soils. Compute group settlement W_g based on (after Reference 6):

$$W_g = W_o \sqrt{\bar{B}/B}$$

where: \bar{B} = the smallest dimension of pile group

B = diameter of individual pile

W_o = Settlement of a single pile estimated or determined from load tests

c. Settlement of Pile Groups in Saturated Cohesive Soils. Compute the group settlement as shown in Figure 4.

d. Limitations. The above analyses may be used to estimate settlement, however, settlement estimated from the results of load tests are generally considered more accurate and reliable.

5. NEGATIVE SKIN FRICTION.

a. General. Deep foundation elements installed through compressible materials can experience "downdrag" forces or negative skin friction along the shaft which results from downward movement of adjacent soil relative to the pile. Negative skin friction results primarily from consolidation of a soft deposit caused by dewatering or the placement of fill.

Negative skin friction is particularly severe on batter pile installations because the force of subsiding soil is large on the outer side of the batter pile and soil settles away from the inner side of the pile. This can result in bending of the pile. Batter pile installations should be avoided where negative skin friction is expected to develop.

b. Distribution of Negative Skin Friction on Single Pile. The distribution and magnitude of negative skin friction along a pile shaft depends on:

- (1) relative movement between compressible soil and pile shaft;
- (2) relative movement between upper fill and pile shaft;
- (3) elastic compression of pile under working load;
- (4) rate of consolidation of compressible soils.

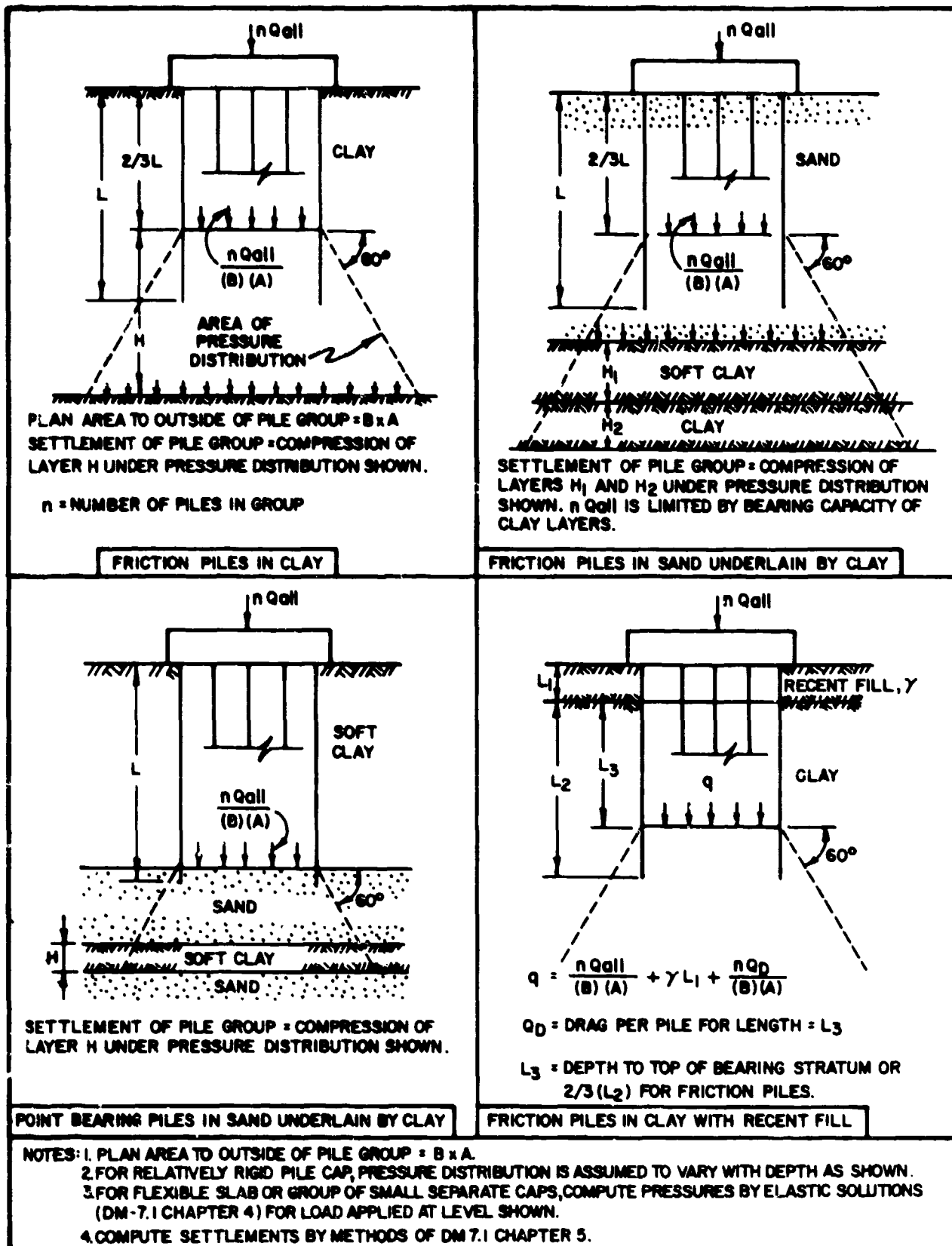


FIGURE 4
 Settlement of Pile Groups

Negative skin friction develops along that portion of the pile shaft where settlement of the adjacent soil exceeds the downward displacement of the shaft. The "neutral point" is that point of no relative movement between the pile and adjacent soil. Below this point, skin friction acts to support pile loads. The ratio of the depth of the neutral point to the length of the pile in compressible strata may be roughly approximated as 0.75. The position of the neutral point can be estimated by a trial and error procedure which compares the settlement of the soil to the displacement of adjacent sections of the pile. (For further guidance see Reference 14, Pile Design and Construction Practice, by Tomlinson.)

Observations indicate that a relative downward movement of 0.6 inch is expected to be sufficient to mobilize full negative skin friction (Reference 6).

c. Magnitude of Negative Skin Friction on Single Pile. The peak negative skin friction in granular soils and cohesive soils is determined as for positive skin friction.

The peak unit negative skin friction can also be estimated from (after Reference 15, Prediction of Downdrag Load at the Cutler Circle Bridge, by Garlanger):

$$f_n = \beta P_o$$

where: f_n = unit negative skin friction (to be multiplied by area of shaft in zone of subsiding soil relative to pile)

P_o = effective vertical stress

β = empirical factor from full scale tests

<u>Soil</u>	<u>β</u>
Clay	0.20 - 0.25
Silt	0.25 - 0.35
Sand	0.35 - 0.50

d. Safety Factor for Negative Skin Friction. Since negative skin friction is usually estimated on the safe side, the factor of safety associated with this load is usually unity. Thus:

$$Q_{all} = \frac{Q_{ult}}{F_s} - P_n$$

where: Q_{all} = allowable pile load

Q_{ult} = ultimate pile load

F_s = factor of safety

P_n = ultimate negative skin friction load

For further discussion of factor of safety in design including transient loads, see Reference 16, Downdrag on Piles Due to Negative Skin Friction, by Fellenius.

e. Negative Skin Friction on Pile Groups. The negative skin friction on a pile group does not usually exceed the total weight of fill and/or compressible soil enclosed by the piles in the group. For the case of recent fill underlain by a compressible deposit over the bearing stratum:

$$P_{\text{total}} \leq W + (B)(L) (\gamma_1 D_1 + \gamma_2 D_2)$$

where:

P_{total} = total load on pile group

W = working load on pile group

B = width of pile group

L = length of pile group

γ_1, γ_2 = effective unit weight of fill and underlying compressible soil respectively

D_1, D_2 = depth over which fill and compressible soil is moving downward relative to the piles

f. Reduction of Negative Skin Friction. Several methods have been developed to reduce the expected negative skin friction on deep foundations. These include:

(a) Use of slender piles, such as H-sections, to reduce shaft area subject to drag.

(b) Predrilled oversized hole through compressible material prior to insertion of pile (resulting annular space filled with bentonite slurry or vermiculite)

(c) Provide casing or sleeve around pile to prevent direct contact with settling soil.

(d) Coat pile shaft with bitumen to allow slippage.

Bitumen compounds which can be sprayed or poured on clean piles are available to reduce negative skin friction. Coatings should be applied only to those portions of the pile anticipated to be within a zone of subsidence and the lower portion of the pile (at least ten times the diameter) should remain uncoated so that the full lower shaft and point resistance may be mobilized. Reductions of negative friction of 50% or greater have been measured for bituminous coatings on concrete and steel piling (see Reference 17, Reducing Negative Skin Friction with Bitumen Layers, by Claessen and Horvat, and Reference 18, Reduction of Negative Skin Friction on Steel Piles to Rock, by Bjerrum, et al.).

Section 4. PILE INSTALLATION AND LOAD TESTS

1. PILE INSTALLATION.

a. General Criteria. See Table 6.

b. Installation Techniques. Table 7 summarizes the more common supplementary procedures and appurtenances used in driven pile installations.

c. Pile Driving Hammers. Table 8 (Reference 6) summarizes the characteristics of the more common types of hammers in use in the U.S. Figure 5 shows principal operation of pile drivers (modified from Reference 6):

(1) Drop Hammer. Generally, it is only appropriate on small, relatively inaccessible jobs due to their slow rate of blows.

(2) Single Action Steam or Air Hammers. Blow rate is higher than drop hammer with maximum speeds generally ranging from about 35 to 60 blows per minute. Single acting hammers have an advantage over double acting hammers when driving piles in firm cohesive soils since the slower rate allows the soil and pile to relax before striking the next blow; thereby giving greater penetration per blow. In driving batter piles, single acting hammers can lose considerable energy due to the shortening fall and increases in friction.

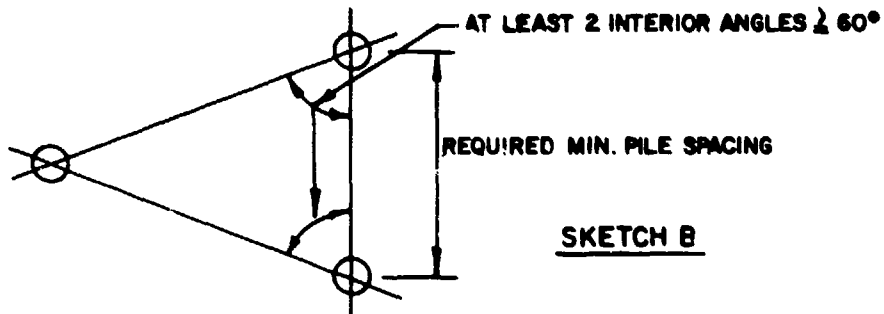
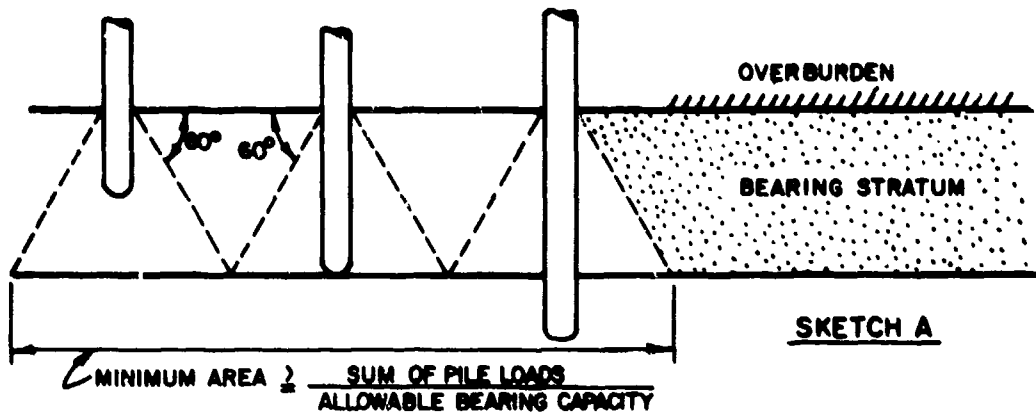
(3) Double Acting Steam or Air Hammers. They provide a blow rate nearly double that of the single acting hammers and lose less energy driving batter piles. They are generally best suited for driving piles in granular soils or in soft clays. The energy per blow delivered by a double-acting hammer decreases rapidly as its speed of operation drops below the rated speed.

(4) Diesel Hammers. They have a relatively low fuel consumption, operate without auxiliary equipment, and can operate at low temperatures and are more efficient for driving batter piles. Maximum blow rates are about 35 to 60 blows per minute for single acting and about 80 to 100 blows per minute for double acting. Diesel hammers operate best in medium to hard ground; in soft ground the resistance and resulting compression may be too low to ignite the fuel.

(5) Vibratory Hammers. They are best suited to wet soils and low displacement piles but occasionally have been used successfully in cohesive soils and with high displacement piles. They can also be effective in extracting piles. When conditions are suitable, vibratory hammers have several advantages over impact hammers including lower driving vibrations, reduced noise, greater speed of penetration and virtually complete elimination of pile damage. However, there is the possibility that the pile may not be efficiently advanced, obstructions generally can not be penetrated, and there is no generally accepted method of determining ultimate pile capacity based on the rate of penetration.

TABLE 6
General Criteria for Installation of Pile Foundations

GEOMETRIC REQUIREMENTS



ITEM	CRITERIA AND LIMITATIONS
<p><u>GENERAL REQUIREMENTS</u> MINIMUM SPACING (CENTER TO CENTER)</p> <p>MINIMUM NUMBER OF PILES IN GROUP</p>	<p>(1) PILES TO ROCK: TWICE THE AVERAGE FILE DIAMETER OR 1.75 TIMES THE DIAGONAL DIMENSION OF PILE CROSS SECTION, BUT NO LESS THAN 24"</p> <p>(2) ALL OTHER PILES: TWICE THE AVERAGE DIAMETER OF THE PILE OR 1.75 TIMES THE DIAGONAL DIMENSION OF PILE CROSS SECTION, BUT NO LESS THAN 30" IN ADDITION, THE MINIMUM SPACING SHALL BE LIMITED BY THE REQUIREMENT THAT THE PILE LOAD DISTRIBUTED INTO THE BEARING STRATUM SHALL NOT EXCEED THE NOMINAL BEARING CAPACITY OF THE STRATUM (TABLE 1, CHAPTER 4.) PILES OR PILE GROUPS SHALL BE ASSUMED TO TRANSFER THEIR LOADS TO THE UNDERLYING MATERIALS BY SPREADING THE LOAD UNIFORMLY AT AN ANGLE OF 60° WITH THE HORIZONTAL, STARTING AT A POLYGON CIRCUMSCRIBING THE PILES AT THE TOP OF THE BEARING STRATUM IN WHICH THEY ARE EMBEDDED. THE AREA CONSIDERED AS SUPPORTING THE LOAD SHALL NOT EXTEND BEYOND THE INTERSECTION OF THE 60° PLANES OF ADJACENT PILES OR PILE GROUPS. (SEE SKETCH A)</p> <p>PILE GROUPS SUPPORTING SUPERSTRUCTURE LOADS NORMALLY CONSIST OF AT LEAST 3 PILES (FOR ARRANGEMENT SEE SKETCH B), EXCEPT FOR INDIVIDUAL PILES SUPPORTING THE FLOOR SLAB OR IN CASES WHERE LATERAL TIES ARE PROVIDED.</p>

TABLE 6 (continued)
 General Criteria for Installation of Pile Foundations

Item	Criteria and Limitations
Embedment in pile cap. Pile length..... Tolerances in pile location and alignment	Single pile supports may be used if the pile has a butt diameter of 12" or greater, if the upper soils are not of a weak nature, and if proper consideration is given to reinforcement of column and pile to accommodate potential eccentricities. Tops of piles shall extend at least 4" into the pile cap. No pile shall be shorter than 10 feet.
Driving Order..... <u>Allowable loads:</u> Allowable overload of piles.....	(1) Vertical piles shall not vary more than 2 percent from the plumb position. (2) No pile shall be driven more than 4" in horizontal dimension from its design location, unless the effect of this deviation is analyzed and found acceptable (3) Eccentricity of reaction of the pile group with respect to the load resultant shall not exceed a dimension that would produce overloads of more than 10 percent in any pile. Pile groups shall be driven from the interior outward to preclude densification and excessively hard driving conditions on the interior.
	(1) Up to 10 percent overload is permitted due to eccentricity of reaction of the pile group. (2) Overload due to wind is permitted if it does not exceed 33 percent of allowable capacity of pile under dead plus live loads.

TABLE 6 (continued)
 General Criteria for Installation of Pile Foundations

Item	Criteria and Limitations
Lateral loads on vertical piles.....	<p>Maximum 1 ton per pile, if pile is embedded in soil for its entire length, except that no lateral load is permitted on vertical piles in very soft fine-grained soils or very loose coarse-grained soils. For piles with unsupported length or for larger horizontal loads, use batter piles or use analysis of Figure 10 to determine lateral load capacity of vertical piles.</p>
Relative load capacity of piles in a group...	<p>All bearing piles within a group shall be of the same type and be of equal load capacity.</p>
Maximum allowable pile load.....	<p>Shall be limited by both allowable stress in pile as given in Table 1 and supporting capacity of soil.</p>
Static and dynamic pick-up loads.....	<p>Induced flexural stresses incurred during pick-up and placement of long concrete piles shall not exceed the allowable bending stresses prescribed for that pile length.</p>
Splices.....	<p>Shall be able to transmit the resultant vertical and lateral forces adequately.</p>
<u>Load tests:</u>	<p>Load tests to be performed for any of the following condition:</p>
Conditions requiring tests.....	<p>(1) To verify or modify estimate of pile load capacity determined by other means.</p>

TABLE 6 (continued)
 General Criteria for Installation of Pile Foundations

Item	Criteria and Limitations
<p>(2) Where size of project and soil conditions indicate a significant savings is possible.</p> <p>(3) Where unique or unfamiliar types are to be used.</p> <p>(4) Where bearing stratum is underlain by a more compressible or questionable stratum.</p> <p>A minimum of 3 test piles shall be driven per installation with uniform soil conditions. Two of these piles shall be test loaded, but no less than 1 load test for each 15,000 square feet of building area.</p> <p>All pile driving projects shall have on the site inspection by a person who has experience in such work, preferably a Registered Professional Engineer.</p> <p>Records shall be kept for the driving of each pile. The record shall include: date of driving, type, size, length, deviation from design location and alignment, pile hammer used, hammer speed, type and condition of cushion, and blows per foot for each foot of penetration for the full length of the pile, blows per inch for the final 6 inches of driving, except where an abrupt high increase in resistance is encountered, the final counts may be reduced to penetration for the last 5 blows.</p> <p>Material, quality of the pile straightness, application of preservatives, radiographic inspection of marine piling welds. For light weight mandrel driven shell piles, check interior for damage prior to concreting, check driving equipment for operational capabilities.</p>	<p>Number of load tests..</p> <p><u>Supervision:</u></p> <p>Inspection.....</p> <p>Records.....</p> <p>General items to be checked.....</p>

TABLE 7
Supplementary Procedures and Appurtenances Used in Pile Driving

Method	Equipment and procedure utilized	Applicability
Means of reducing driving resistance above bearing stratum:		
Temporary casing	Open end pipe casing driven and cleaned out. May be pulled later.	a. To drive through minor obstructions. b. To minimize displacement. c. To prevent caving or squeezing of holes. d. To permit concreting of pile before excavation to subgrade of foundation.
Pre-coring	By continuous flight auger or churn drill, a hole is formed into which the pile is lowered. Pile is then driven to bearing below the cored hole.	a. To drive through thick stratum of stiff to hard clay. b. To avoid displacement and heave of surrounding soil. c. To avoid injury to timber and thin shell pipes. d. To eliminate driving resistance in strata unsuitable for bearing.
Spudding	Heavy structural sections or closed end pipes are alternately raised and dropped to form a hole into which pile is lowered. Pile is then driven to bearing below the spudded hole.	a. To drive past individual obstruction b. To drive through strata of fill with large boulders or rock fragments.
Jetting	Water, air, or mixture of both forced through pipe at high pressures and velocity, jets are sometimes built into piles.	a. Used to facilitate penetration, should not be permitted in fine grained, poorly draining soils where frictional support may be permanently destroyed. Piles should be driven to final embedment after jetting.
Means of increasing driving resistance in bearing stratum:		
Upside down piles	Tapered piles, specifically timber, driven with large butt downward.	a. For end bearing timber piles, where it is necessary to minimize penetration into bearing stratum. b. To avoid driving through to incompressible but unsuitable bearing material.
Lagging	Short timber or steel sections connected by bolting or welding to timber or steel pipes.	a. To increase frictional resistance along sides of pile. b. To increase end bearing resistance when mounted near tip.
Means of overcoming obstructions:		
Shoes and reinforced tips.	Metal reinforcing, such as bands and shoes for all types of piles.	a. To provide protection against damage of tip. b. To provide additional cutting power.
Explosives	Drill and blast ahead of pile tip ..	a. To remove obstructions to open end piles under very severe conditions.
Preexcavation	Hand or machine excavation	a. Used for removal of obstruction close to ground surface.
Special equipment for advancing piles:		
Jacking	Hydraulic or mechanical screw jacks are used to advance pile. Pile is built up in short, convenient lengths.	a. To be used instead of pile hammer where access is difficult. b. To eliminate vibrations.
Vibration	High amplitude vibrators	a. Advantageous for driving in waterlogged sands and gravel. b. Advantageous for driving sheetpiling.
Follower	Temporary filler section between hammer and pile top, preferably of same material as pile.	a. To drive pile top to elevation below reach of hammer or below water.

TABLE 8
Impact and Vibratory Pile-Driver Data

1. IMPACT PILE HAMMER							
Rated Energy Kip - ft.	Make of Hammer*	Model No.	Types*	Blows per min	Stroke at Rated Energy	Weight Striking Parts Kips	Total Weight Kips
180.0	Vulcan	060	S-A	62	36	60.0	121.0
130.0	MKT	S-40	S-A	55	39	40.0	96.0
120.0	Vulcan	040	S-A	60	36	40.0	87.5
113.5	S-Vulcan	400C	Diff.	100	16.5	40.0	83.0
97.5	MKT	S-30	S-A	60	39	30.0	86.0
79.6	Kobe	K42	Dies.	52	98	9.2	22.0
60.0	Vulcan	020	S-A	60	36	20.0	39.0
60.0	MKT	S20	S-A	60	36	20.0	38.6
56.5	Kobe	K32	Dies.	52	98	7.0	15.4
50.2	S-Vulcan	200C	Diff.	98	15.5	20.0	39.0
48.7	Vulcan	016	S-A	60	36	16.2	30.2
48.7	Raymond	0000	S-A	46	39	15.0	23.0
44.5	Kobe	K22	Dies.	52	98	4.8	10.6
42.0	Vulcan	014	S-A	60	36	14.0	27.5
40.6	Raymond	000	S-A	50	39	12.5	21.0
39.8	Delmag	D-22	Dies.	52	N/A	4.8	10.0
37.5	MKT	S14	S-A	60	32	14.0	31.6
36.0	S-Vulcan	140C	Diff.	103	15.5	14.0	27.9
32.5	MKT	S10	S-A	55	39	10.0	22.2
32.5	Vulcan	010	S-A	50	39	10.0	18.7
32.5	Raymond	00	S-A	50	39	10.0	18.5
32.0	MKT	DE-40	Dies.	48	96	4.0	11.2
30.2	Vulcan	OR	S-A	50	39	9.3	16.7
26.3	Link-Belt	520	Dies.	82	43.2	5.0	12.5
26.0	MKT	C-8	D-A	81	20	8.0	18.7
26.0	Vulcan	08	S-A	50	39	8.0	16.7
26.0	MKT	S8	S-A	55	39	8.0	18.1
24.4	S-Vulcan	80C	Diff.	111	16.2	8.0	17.8
24.4	Vulcan	8M	Diff.	111	N/A	8.0	18.4
24.3	Vulcan	0	S-A	50	39	7.5	16.2
24.0	MKT	C-826	D-A	90	18	8.0	17.7
22.6	Delmag	D-12	Dies.	51	N/A	2.7	5.4
22.4	MKT	DE-30	Dies.	48	96	2.8	9.0
24.4	Kobe	K13	Dies.	52	98	2.8	6.4
19.8	Union	K13	D-A	110	24	3.0	14.5
19.8	MKT	1133	D-A	95	19	5.0	14.5
19.5	Vulcan	06	S-A	60	36	6.5	11.2
19.2	S-Vulcan	65C	Diff.	117	15.5	6.5	14.8
18.2	Link-Belt	440	Dies.	88	36.9	4.0	10.3

TABLE 8 (continued)
Impact and Vibratory Pile-Driver Data

Rated** Energy Kip-ft	Make of Hammer*	Model No.	Types*	Blows per min	Stroke at Rated Energy	Weight Striking Parts Kips	Total Weight Kips
16.2	MKT	S5	S-A	60	39	5.0	12.3
16.0	MKT	DE-20	Dies.	48	96	2.0	6.3
16.0	MKT	C5	Comp.	110	18	5.0	11.8
15.1	S-Vulcan	50C	Diff.	120	15.5	5.0	11.7
15.1	Vulcan	5M	Diff.	120	15.5	5.0	12.9
15.0	Vulcan	1	S-A	60	36	5.0	10.1
15.0	Link-Belt	312	Dies.	100	30.9	3.8	10.3
13.1	MKT	10B3	D-A	105	19	3.0	10.6
12.7	Union	1	D-A	125	21	1.6	10.0
9.0	Delmag	D5	Dies.	51	N/A	1.1	2.4
9.0	MKT	C-3	D-A	130	16	3.0	8.5
9.0	MKT	S3	S-A	65	36	3.0	8.8
8.8	MKT	DE-10	Dies.	48	96	11.0	3.5
8.7	MKT	9B3	D-A	145	17	1.6	7.0
8.2	Union	1.5A	D-A	135	18	1.5	9.2
8.1	Link-Belt	180	Dies.	92	37.6	1.7	4.5
7.2	Vulcan	2	S-A	70	29.7	3.0	7.1
7.2	S-Vulcan	30C	Diff.	133	12.5	3.0	7.0
7.2	Vulcan	3M	Diff.	133	N/A	3.0	8.4
6.5	Link-Belt	105	Dies.	94	35.2	1.4	3.8
4.9	Vulcan	DGH900	Diff.	238	10	.9	5.0
3.6	Union	3	D-A	160	14	.7	4.7
3.6	MKT	7	D-A	225	9.5	.8	5.0
.4	Union	6	D-A	340	7	.1	.9
.4	Vulcan	DGH100A	Diff.	303	6	.1	.8
.4	MKT	3	D-A	400	5.7	.06	.7
.3	Union	7A	D-A	400	6	.08	.5

* Codes

MKT - McKiernan-Terry D-A - Double-Acting
S-Vulcan - Super-Vulcan Diff. - Differential
S-A - Single-Acting Dies. - Diesel
 Comp. - Compound

** In calculations of pile capacities by dynamic formula, effective energy delivered by hammer should be used. Hammer energy is affected by pressures used to operate the hammer, stroke rate, etc. Double-acting, differential, and diesel hammers may operate at less than rated energies; double-acting hammers deliver significantly less than rated energy when operated at less than rated speed. Consult manufacturers.

TABLE 8 (continued)
Impact and Vibratory Pile-Driver Data

2. VIBRATORY DRIVERS						
Make	Model	Total Weight Kips	Available HP	Frequency Range cps	Force Kips***, Frequency cps	
Foster (France)	2-17	6.2	34	18-21		
	2-35	9.1	70	14-19	62/19	
	2-50	11.2	100	11-17	101/17	
Menck (Germany)	MVB22-30	4.8	50		48/	
	MVB65-30	2.0	7.5		14/	
	MVB44-30	8.6	100		97/	
Miller (Germany)	MS-26	9.6	72			
	MS-26D	16.1	145			
Uraga (Japan)	VHD-1	8.4	40	16-20	43/20	
	VHD-2	11.9	80	16-20	86/20	
	VHD-3	15.4	120	16-20	129/20	
Bodine (USA)	B	22	1000	0-150	63/100 - 175/100	
(Russia)	BT-5	2.9	37	42	48/42	
	VPP-2	4.9	54	25	49/25	
	100	4.0	37	13	44/13	
	VP	11.0	80	6.7	35/7	
	VP-4	25.9	208		198/	

*** Forces given are present maximums. These can usually be raised or lowered by changing weights in the oscillator.

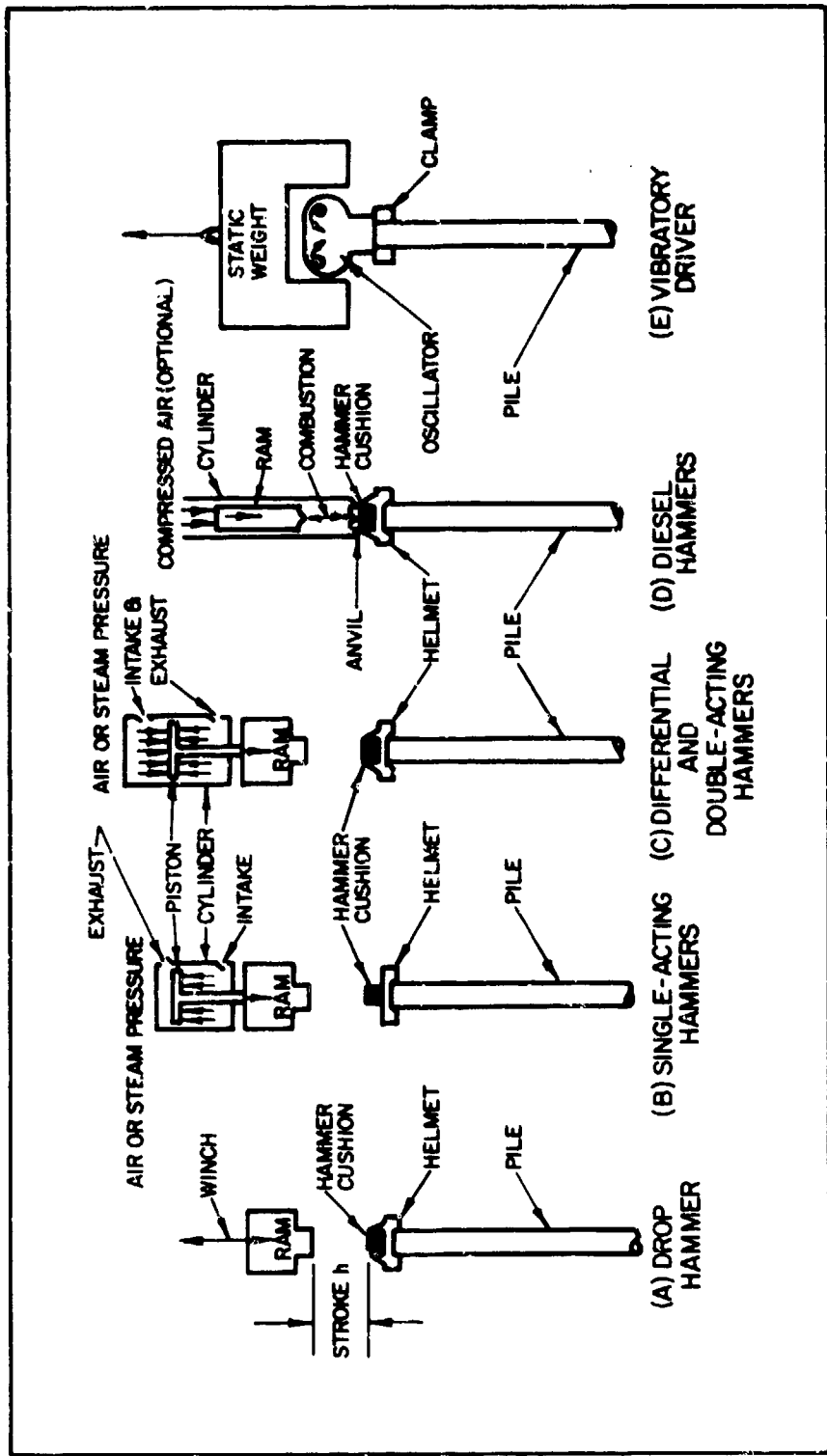


FIGURE 5
Principles of Operation of Pile Drivers

d. Inspection Guidelines. See Table 6 for general guidance and Reference 19, Inspectors' Manual for Pile Foundations, by the Deep Foundation Institute.

(1) Driven Piles. The inspector should normally assess the performance of the driving equipment, record the driving resistances, particularly the final set (net penetration per blow), record the driven depth and tip elevation, and continually observe the pile for evidence of damage or erratic driving. The criteria for termination of pile driving is normally a penetration resistance criteria or a required depth of penetration. Normally, a set criteria would be used for end bearing piles or piles where soil freeze is not a major factor while penetration criteria would be more appropriate for friction piles, piles into clay, and/or when soil freeze is a major factor.

(a) Timber Piles. (Reference 20, AWPI Technical Guidelines for Pressure-Treated Wood, Timber Piling, and ASTM Standard D25, Round Timber Piles.) Site Engineer/Inspector should check the following items:

- Overstressing at the top of pile, usually visible brooming.
- Properly fitted driving cap.
- Straightness.
- Sound wood free of decay and insect attack.
- Pressure treatment.
- Low frequency of knots.

(b) Concrete Piles. (Reference 21, Recommendations for Design, Manufacture, and Installation of Concrete Piles, by the American Concrete Institute.) Site Engineer/Inspector should check the following items:

- That pile length, geometry, thickness, and straightness conforms to specifications.
- Note extent, amount, and location of spalling or cracking in the pile during driving and pick up, and set.
- Thickness and type of cushion - should comply with specification.

(c) Steel Piles. Site Engineer/Inspector should check the following items:

- Compliance with applicable codes and specifications.
- Structural damage to pile due to over-driving/overstressing.
- Pile orientation conforms to the plans.

(2) Drilled Piers. Minimum requirements for proper inspection of drilled shaft construction are as follows:

(a) For Dry or Casing Method of Construction;

- A qualified inspector should record the material types being removed from the hole as excavation proceeds.
- When the bearing soil has been encountered and identified and/or the designated tip elevation has been reached, the shaft walls and base should be observed for anomalies, unexpected soft soil conditions, obstructions or caving.
- Concrete placed freefall should not be allowed to hit the sidewalls of the excavation.
- Structural stability of the rebar cage should be maintained during the concrete pour to prevent buckling.
- The volume of concrete should be checked to ensure voids did not result during extraction of the casing.
- Concrete must be tremied into place with an adequate head to displace water or slurry if groundwater has entered the bore hole.
- Pulling casing with insufficient concrete inside should be restricted.
- Bottom of hole should be cleaned.

(b) For Slurry Displacement Method of Construction.

- A check on the concrete volume and recording the material types and depth of shaft apply the same as above.
- The tremie pipe should be watertight and should be fitted with some form of valve at the lower end.

(3) Caissons on Rock. Inspection of caisson bottom is usually accomplished by either:

(a) Probing with a 2-1/2" diameter probe hole to a minimum of 8 feet or 1.5 times the caisson shaft diameter (whichever is larger).

(b) Visual inspection by a qualified geologist at caisson bottom with proper safety precautions or from the surface utilizing a borehole camera. The purpose of the inspection is to determine the extent of seams, cavities and fractures. The allowable cumulative seam thickness within the probe depth varies depending on performance criteria. Values as low as 1/4" of cumulative thickness can be specified for the top 1/2 diameter.

e. Installation Guidelines.

(1) Driven Piles.

(a) For pile groups, drive interior piles first to avoid hard driving conditions, overstressing, and to minimize heave.

(b) Make sure pile driving caps and/or cushions are appropriate.

(c) Check for compression bands around the top of concrete and timber piles to avoid overstressing.

(d) Check for proper alignment of the driving head.

(e) If the pile suddenly changes directions or a substantially reduced driving resistance is noted, the pile is probably broken.

Table 9 summarizes some of the common installation problems and recommended procedures. Table 10 (Reference 22, Drilled Shafts: Design and Construction Guideline Manual, Vol 1: Construction Procedures and Design for Axial Load, by Reese and Wright) summarizes some of the more common installation problems and procedures for drilled piers.

(2) Performance Tolerance. It is normal practice to tailor the specifications to particular site conditions and to structural performance criteria. In many applications the following criteria may apply:

(a) Allowable Deviation from Specified Location. In the absence of another over-riding project specification criteria, use 4 inches. Consider the technical feasibility of increasing to more than 4 inches for caps with 4 piles or less.

(b) Allowable out-of-vertical. In the absence of the over-riding project specification criteria, use 2% provided that the allowable deviation is not exceeded. Values of 4%, 2% and 1/4 inch out of plumb have been used.

(c) Allowable Heave Before Redriving. Require redriving of piles if heave exceeds 0.01 feet for essentially friction piles, or any detectable heave if piles are known to be essentially end-bearing.

(d) Minimum Distance of Pile Being Driven from Fresh Concrete. In the absence of over-riding project specification criteria, use 15 feet. Values of 10 feet to 50 feet have been used in practice.

TABLE 9
Treatment of Field Problems Encountered During Pile Driving

Description of problem	Procedures to be applied
<p>Category: <u>Obstructions:</u> Old foundations, boulders, rubble fill, cemented lenses, and similar obstacles to driving.</p> <p>General problems: <u>Vibration in Driving:</u> May compact loose granular materials causing settlement of existing structures near piles. Effect most pronounced in driving displacement piles. <u>Damage to Thin Shells:</u> Driven shells may have been crimped, buckled, or torn, or be leaking at joints as the results of driving difficulties or presence of obstructions. <u>Inappropriate Use of Pile Driving Formula:</u> Piles driven to a penetration determined solely by driving resistance may be bearing in a compressible stratum. This may occur in thick strata of silty fine sand, varved silts and clays, or medium stiff cohesive soils. Difficulties at pile tip: <u>Fracturing of Bearing Materials:</u> Fracturing of material immediately below tips of piles driven to required resistance as a result of driving adjacent piles. Brittle weathered rock, clay-shale, shale, siltstone, and sandstone are vulnerable materials. Swelling of stiff fissured clays or shales at pile tip may complicate this problem. <u>Steeply Sloping Rock Surface:</u> Tips of high capacity end bearing piles may slide or move laterally on a steeply sloping surface of sound hard rock which has or no overlying weathered material. <u>Loss of Ground:</u> May occur during installation of open end pipe piles. Materials vulnerable to piping, particularly fine sands or silts, may flow into pipe under the influence of an outside differential head, causing settlement in surrounding areas or loss of ground beneath tips of adjacent piles. Movement of piles subsequent to driving: <u>Heave:</u> Completed piles rise vertically as the result of driving adjacent piles. Particularly common for displacement piles in soft clays and medium compact granular soils. Heave becomes serious in soft clays when volume displaced by piles exceeds 2% of volume of soil enclosed within the limits of the pile foundation. <u>Lateral Movement of Piles:</u> Completed piles move horizontally as the result of driving adjacent piles.</p>	<p>Excavate or break up shallow obstruction if practical. For deeper obstructions use spudding, jetting, or temporary casings, or use drive shoes and reinforced tips where pile is strong enough to be driven through obstructions.</p> <p>Select pile type with minimum displacement, and/or precure or jet with temporary casing or substitute jacking for pile driving.</p> <p>Each pile is inspected with light beam. If diameter at any location varies more than 15% from original diameter or if other damage to shell cannot be repaired, pile is abandoned, filled with sand and a replacement is driven. Concrete shall be placed in dry shell only.</p> <p>Unsuitable bearing strata should be determined by exploration program. Piles should not be permitted to stop in these strata, regardless of driving resistance. For bearing in stiff and brittle cohesive soils and in soft rock, load tests are particularly important.</p> <p>For piles bearing in these materials specify driving resistance test on selected piles after completion of driving adjacent piles. If damage to the bearing stratum is evidenced, require redriving until specified resistance is met.</p> <p>Provide special shoes or pointed tips or use open end pipe pile socketed into sound rock.</p> <p>Avoid cleaning in advance of pile cutting edge, and/or retain sufficient material within pipe to prevent inflow of soil from below.</p> <p>For piles of solid cross sections (timber, steel, precast concrete), survey top elevations during driving of adjacent piles to determine possible heave. For piles that have risen more than 0.01 ft, redrive to at least the former tip elevation, and beyond that as necessary to reach required driving resistance. Heave is minimized by driving temporary open-end casing, precoring, or jetting so that total volume displaced by pile driving is less than 2 or 3% of total volume enclosed within limits of pile foundation.</p> <p>Survey horizontal position of completed piles during the driving of adjacent piles. Movement is controlled by procedures used to minimize heave.</p>

TABLE 10
 Drilled Piers: Construction Problems

Problem	Solution
Pouring concrete through water	Removal of water by bailing or use of tremie
Segregation of concrete during placing	If free-fall is employed, exercising care to see that concrete falls to final location without striking anything, or use of tremie
Restricted flow of concrete through or around rebar cage	Designing of rebar cage with adequate spacing for normal concrete (all clear spaces at least three times the size of largest aggregate) or use of special mix with small-sized coarse aggregate
Torsional buckling of rebar cage during concrete placement with casing method	Strengthening rebar cage by use of circumferential bands welded to lower portion of cage, use of concrete with improved flow characteristics, use of retarder in concrete allowing casing to be pulled very slowly
Pulling casing with insufficient concrete inside	Always having casing extending above ground surface and always having casing filled with a sufficient head of concrete with good flow characteristics before casing is pulled
Weak soil or undetected cavity beneath base of foundation	Requiring exploration to a depth of a few diameters below the bottom of the excavation
Deformation or collapse of soil	Such problems are readily detected by even the minimums of inspection

2. PILE LOAD TEST.

a. General. The results of pile load tests are the most reliable means of evaluating the load capacity of a deep foundation. Load tests can be performed during the design phase as a design tool and/or during construction to verify design loads. Pile load tests should be considered for large and/or critical projects, for pile types and soil conditions for which there is limited previous local experience, when proposed design loads exceed those normally used, and for other design/site conditions such as the need to use lower than specified factor of safety in the design.

The types of pile load tests normally performed include:

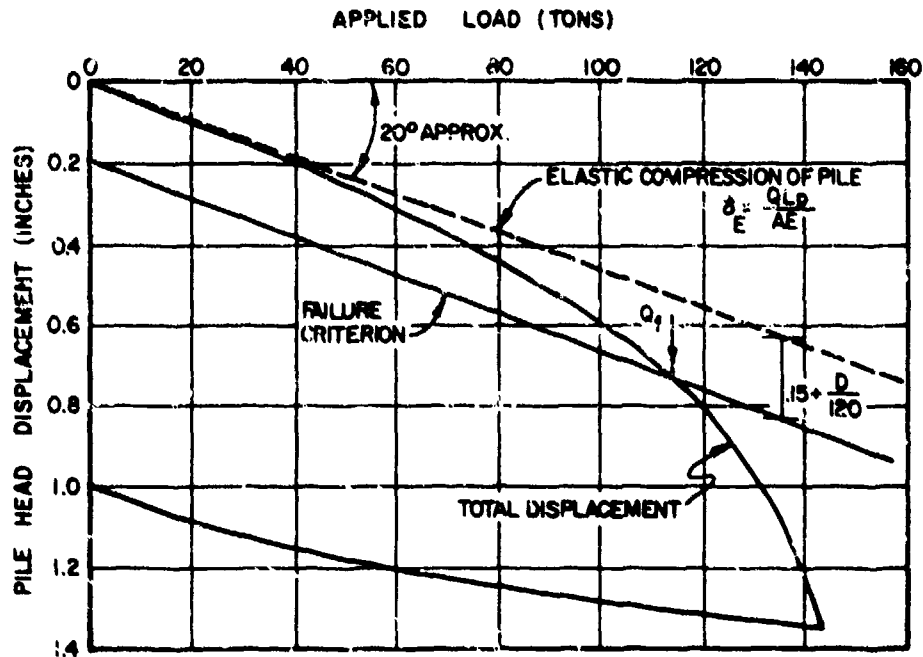
(1) Standard Loading Procedures or Slow Maintained-Load Test Method. For procedure, refer to ASTM Standard D3689, Individual Piles under Static Axial Tensile Load. It is the most common load test currently used. It is a long duration test (typically 70 hours or longer) loaded to 200 percent of the design load, or to failure. To determine curve of plastic deformation, the test procedure should be altered to include at least three unload-reload cycles. This procedure is described in ASTM Standard D1143, Pile Under Axial Compressive Load.

(2) Quick Maintained-Load Test Method. For procedure, refer to ASTM Standard D1143. This is a short duration test, typically 1 to 4 hours, generally loaded to 300 percent of the design load or failure. It is suitable for design load test and can be effectively used for load proof testing during construction.

(3) Constant Rate of Penetration (or Uplift) Test Method. A displacement-controlled method. For procedure, refer to ASTM Standard D1143 or ASTM Standard D3689. It is a short duration test, typically 2 to 3 hours, and may require special loading equipment as described in Reference 23, A Device for the Constant Rate of Penetration Test for Piles, by Garneau and Samson. This method is recommended for testing piles in cohesive soils and for all tests where only the ultimate capacity is to be measured. The method can provide information regarding behavior of friction piles and is well suited for load tests during design.

b. Interpretation of Results. There are numerous procedures for interpretation of pile load test results including those specified by local building codes. A deflection criteria is normally used to define failure. In the absence of an over-riding project specification criteria, use 3/4 inch net settlement at twice the design load. Values of 1/4 and 1 inch at twice the design load and 1/4 inch at three times the design load have been used. Figure 6 presents a procedure for determining the failure load based on a permanent set of $0.15 + D/120$ inches (where D is the pile diameter in inches). This procedure can be used for either of the three test methods presented above.

Where negative skin friction (downdrag) may act on the pile, only load carried by the pile below the compressible zone should be considered. This may be determined by minimizing shaft resistance during the load test (e.g., predrilling oversized hole, case and clean, using bentonite slurry, etc.) or by measuring movement of tip directly by extension rods attached to the pile tip and analyzing test results in accordance with Figure 7.



TYPICAL TEST PLOT

1. Calculate elastic compression of pile (δ_E) when considered as a free column by:

$$\delta_E = \frac{QL_p}{E AE}$$

Q = test load, lbs
 L_p = pile length, in. (for end-bearing pile)
 A = cross-sectional area of pile material, sq in
 E = Young's Modulus for pile material, psi

2. Determine scales of plot such that slope of pile elastic compression line is approximately 20°.
3. Plot pile head total displacement vs. applied load.
4. Failure load is defined as that load which produces a displacement of the pile head equal to:

$$S_f = \delta_E + (.15 + \frac{D}{120})$$

S_f = displacement at failure, in.
 D = pile diameter, in.

5. Plot failure criterion as described in (4), represented as a straight line, parallel to line of pile elastic compression. Intersection of failure criterion with observed load deflection curve defines failure load, Q_f .
6. Where observed load displacement curve does not intersect failure criterion, the maximum test load should be taken as the failure load.
7. Apply factor of safety of at least 2.0 to failure load to determine allowable load.

FIGURE 6
Interpretation of Pile Load Test

c. Pullout Tests. Methods of determining failure load for tension load tests vary depending on the tolerable movement of the structure. In general, failure load is more easily defined than for compression load tests since available resistance generally decreases more distinctly after reaching failure. Failure load may be taken as that value at which upward movement suddenly increases disproportionately to load applied, i.e. the point of sharpest curvature on the load-displacement curve.

d. Lateral Load Tests. Lateral load tests are usually performed by jacking apart two adjacent pile and recording deflections of the piles for each load increment. See Reference 24, Model Study of Laterally Loaded Pile, by Davison and Salley, for further guidance. In some applications testing of a pile group may be required.

e. Other Comments. A response of a driven pile in a load test can be greatly affected by the time elapsed between driving and testing. In most cases, a gain in pile bearing capacity is experienced with time and is governed by the rate of dissipation of excess pore water pressures generated by driving the pile throughout the surrounding soil mass. This is frequently termed "freezing." The time required for the soil to regain its maximum shear strength can range from a minimum of 3 to 30 days or longer. The actual required waiting period may be determined by redriving piles or from previous experience. Generally, however, early testing will result in an underestimate of the actual pile capacity especially for piles deriving their capacity from saturated cohesive soils.

Piles driven through saturated dense fine sands and silts may experience loss of driving resistance after periods of rest. When redriven after periods of rest the driving resistance (and bearing capacity) will be less compared to the initial driving resistance (and capacity). This phenomenon is commonly referred to as relaxation.

Section 5. DISTRIBUTION OF LOADS ON PILE GROUPS

1. VERTICAL PILE GROUPS.

a. Eccentric Vertical Loading. Distribution of design load on piles in groups is analyzed by routine procedures as follows:

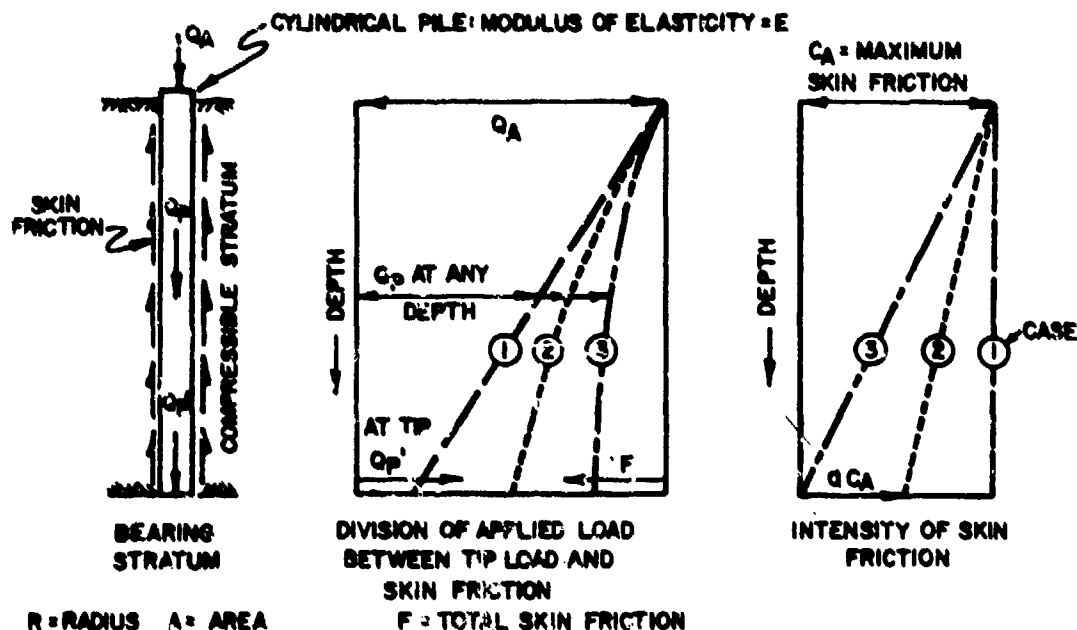
(1) For distribution of applied load eccentric about one or two axes, see Reference 6.

(2) Overload from eccentricity between applied load and center of gravity of pile group shall be permitted up to 10 percent of allowable working load when a safety factor of 2-1/2 to 3 is available for the working load.

(3) Overload from wind plus other temporary live loads up to 33 percent of the allowable working load is permitted, when a safety factor of 2-1/2 to 3 is available for the working load.

(4) Except in unusual circumstances, all bearing piles in a group shall be of the same type, and of equal load capacity.

1. IF SKIN FRICTION ACTING ON TEST PILE MAY BE REVERSED IN THE PROTOTYPE BY CONSOLIDATION OF MATERIALS ABOVE THE BEARING STRATUM, ANALYZE LOAD TEST TO DETERMINE RELATION OF LOAD VS SETTLEMENT FOR PILE TIP ALONE.
2. COMPUTE THEORETICAL ELASTIC SHORTENING ASSUMING SEVERAL POSSIBLE VARIATIONS OF SKIN FRICTION ON PILE AS SHOWN BELOW FOR A CYLINDRICAL PILE.
3. COMPARE THEORETICAL WITH OBSERVED ELASTIC SHORTENING AND DETERMINE PROBABLE VARIATION OF SKIN FRICTION ON PILE. USING THIS VARIATION OF SKIN FRICTION, COMPUTE LOAD AT TIP.



δ_E = ELASTIC SHORTENING OF PILE WITH LOAD Q_A AT BUTT AND Q_p' AT TIP.

CASE ①, SKIN FRICTION CONSTANT WITH DEPTH:

$$\delta_E = (Q_A - \pi R C_A L) \frac{L}{AE}$$

$$Q_p' = \frac{2AE \delta_E}{L} - Q_A$$

CASE ②, SKIN FRICTION DECREASING TO 0 AT TIP:

$$\delta_E = \left(Q_A - 2\pi R C_A L \left(\frac{0+2}{3(0+1)} \right) \right) \frac{L}{AE}$$

$$Q_p' = \frac{3AE \delta_E}{L} \left(\frac{0+1}{0+2} \right) - Q_A \left(\frac{20+1}{0+2} \right)$$

CASE ③, SKIN FRICTION DECREASING TO ZERO AT TIP:

$$\delta_E = \left(Q_A - \frac{4\pi R C_A L}{3} \right) \frac{L}{AE}$$

$$Q_p' = \frac{3AE \delta_E}{2L} - \frac{Q_A}{2}$$

FIGURE 7
Load Test Analysis Where Downdrag Acts on Pile

2. GROUPS WITH VERTICAL AND BATTER PILES. Analyze distribution of pile loads according to criteria in Reference 25, Pile Foundations, by Chellis. The following limitations apply:

(1) Assume inclination of batter piles no flatter than 1 horizontal to 3 vertical unless special driving equipment is specified.

(2) When batter piles are included in a group, no allowance is made for possible resistance of vertical piles to horizontal forces.

(3) For analysis of loads on piles in relieving platforms, see Reference 26, American Civil Engineering Practice, Vol. 1, by Abbett.

(4) For analysis of batter pile anchorage for tower guys, see Figure 8.

Section 6. DEEP FOUNDATIONS ON ROCK

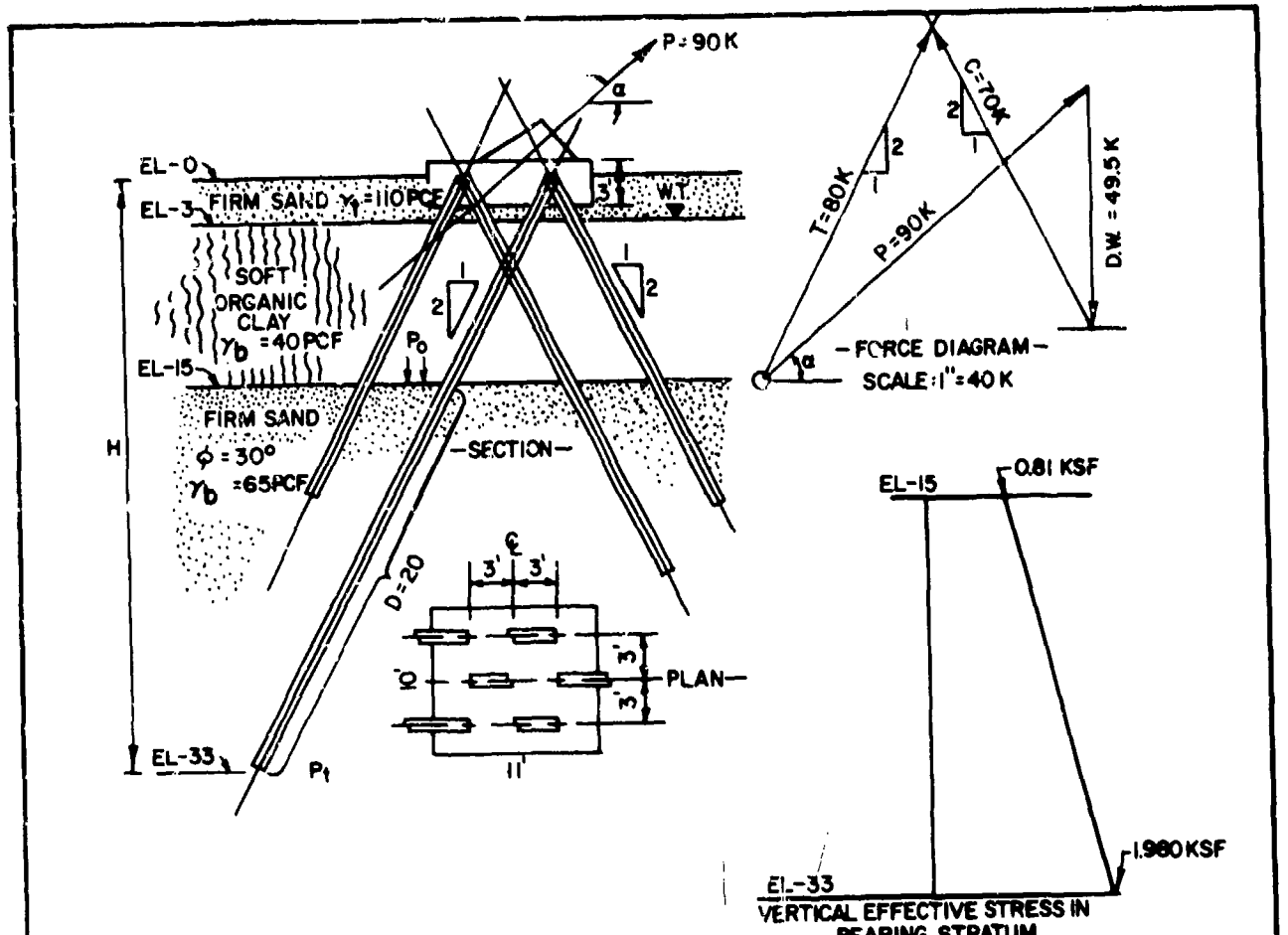
1. GENERAL. For ordinary structures, most rock formations provide an ideal foundation capable of supporting large loads with negligible settlement. Normally, the allowable loads on piles driven into rock are based on pile structural capacity while the allowable bearing pressures for footings/piers on rock are based on a nominal values of allowable bearing capacity (see Chapter 4).

There are however certain unfavorable rock conditions (e.g., cavernous limestone, see DM-7.1, Chapter 1) which can result in excessive settlement and/or failure. These potential hazards must be considered in the design and construction of foundations on rock.

2. PILES DRIVEN INTO ROCK. Piles driven into rock normally meet refusal at a nominal depth below the weathered zone and can be designed based on the structural capacity of the pile imposed by both the dynamic driving stresses and the static stresses. Highly weathered rocks such as decomposed granite or limestone and weakly cemented rocks such as soft clay-shales can be treated as soils.

The possibility of buckling below the mudline should be evaluated for high capacity pile driven through soft soils into bedrock (see Reference 27, The Design of Foundations for Buildings, by Johnson and Kavanaugh).

3. ALLOWABLE LOADS ON PIERS IN ROCK. Piers drilled through soil and a nominal depth into bedrock should be designed on the basis of an allowable bearing pressure given in Chapter 4 or other criteria (see Reference 28, Foundation Engineering, by Peck, et al.). Piers are normally drilled a nominal depth into the rock to ensure bearing entirely on rock and to extend the pier through the upper, more fractured zones of the rock. Increase in allowable bearing with embedment depth should be based on encountering more competent rock with depth.



FOR A SIX PILE GROUP - 4 TENSION, 2 COMPRESSION ASSUME A 14" SQUARE STRAIGHT CONCRETE PILE, AS SHOWN, $D = 20'$ ($D < 20 B$) PILE CAP WEIGHT ($D.W.$) = $10 \times 11 \times 3 \times 0.15$ KCF = 49.5 K

FIND F_s AGAINST Q_{ult} AND T_{ult}

DETERMINE PILE FORCES BY A FORCE DIAGRAM.

IGNORE RESISTANCE ABOVE FIRM SAND STRATUM.

BEARING STRATUM $\phi = 30^\circ$, $N_q = 21$

$$K_{HC} = 1.5, K_{HT} = 1.0, \delta = \frac{3}{4} (30^\circ) = 22.5^\circ \text{ (FROM FIGURE 1)}$$

$$A_T = \left(\frac{14}{12}\right)^2 = 1.36 \text{ SF}$$

$$\text{PERIM. AREA} / l_f = 4 \times \frac{14}{12} = 4.7 \text{ SF} / l_f$$

$$Q_{ult} = 1.98 \times 21 \times 1.36 + (1.5 \times \frac{0.81 + 1.98}{2}) \times \text{TAN } 22.5 \times 4.7 \times 20$$

$$= 56.54 + 81.47$$

$$= 138 \text{ K}$$

COMPRESSION LOAD ON PILES FROM FORCE DIAGRAM IS 70 KIPS. LOAD PER PILE $70 \times \frac{1}{2} = 35 \text{ K}$

$$F_s = \frac{138 \text{ K}}{35 \text{ K}} = 3.9 > 2, \text{ REQ'D } F_s$$

$$T_{ult} = 1.0 \times \left(\frac{0.81 + 1.98}{2}\right) \times \text{TAN } 22.5 \times 4.7 \times 20$$

$$= 54.31 \text{ K}$$

TENSION LOAD ON PILES FROM FORCE DIAGRAM IS 80 KIPS. LOAD PER PILE $\frac{80 \text{ K}}{4} = 20 \text{ K}$

$$\text{WEIGHT OF PILE} = 0.204 \text{ Kp} / l_f \times 37 = 7.6 \text{ K}$$

$$F_s = \frac{54.3}{(20.0 - 7.6)} = 4.3 > 3 \text{ REQ'D } F_s$$

FIGURE 8
Example Problem - Batter Pile Group as Guy Anchorage
1.2-233

Rock-socketed drilled piers extending more than a nominal depth into rock derive capacity from both shaft resistance and end bearing. The proportion of the load transferred to end bearing depends on the relative stiffness of the rock to concrete and the shaft geometry. Generally, the proportion transferred to end bearing decreases for increasing depth of embedment and for increasing rock stiffness. This proportion increases with increased loading. Field tests indicate that the ultimate shaft resistance is developed with very little deformation (usually less than 0.25 inches) and that the peak resistance developed tends to remain constant with further movement. Based on load test data, the ultimate shaft resistance can be estimated approximately from:

$$S_r = (2.3 \text{ to } 3)(fw')^{1/2} \quad (\text{pier diameter } > 16 \text{ inches})$$
$$S_r = (3 \text{ to } 4)(fw')^{1/2} \quad (\text{pier diameter } < 16 \text{ inches})$$

where: S_r = ultimate shaft resistance in force per shaft contact area
 fw' = unconfined compressive strength of either the rock or the concrete, whichever is weakest.

See Reference 29, Shaft Resistance of Rock Socketed Drilled Piers, by Horvath and Kenney.

4. SETTLEMENT OF DEEP FOUNDATIONS IN ROCK. Settlement is normally negligible and need not be evaluated for foundations on rock designed for an appropriate allowable bearing pressure.

For very heavy or for extremely settlement sensitive structures, the settlement can be computed based on the solution for elastic settlement presented in Chapter 5 of DM-7.1. The choice of the elastic modulus, E , to use in the analysis should be based on the rock mass modulus which requires field investigation. For guidance see Reference 9 and Reference 30, Rock Mechanics in Engineering Practice, by Stagg and Zienkiewicz, eds. In cases where the seismic Young's modulus is known, the static modulus can be conservatively assumed to be 1/10th the seismic modulus.

Section 7. LATERAL LOAD CAPACITY

1. DESIGN CONCEPTS. A pile loaded by lateral thrust and/or moment at its top, resists the load by deflecting to mobilize the reaction of the surrounding soil. The magnitude and distribution of the resisting pressures are a function of the relative stiffness of pile and soil.

Design criteria is based on maximum combined stress in the piling, allowable deflection at the top or permissible bearing on the surrounding soil. Although 1/4-inch at the pile top is often used as a limit, the allowable lateral deflection should be based on the specific requirements of the structure.

2. DEFORMATION ANALYSIS - SINGLE PILE.

a. General. Methods are available (e.g., Reference 9 and Reference 31, Non-Dimensional Solutions for Laterally Loaded Piles, with Soil Modulus Assumed Proportional to Depth, by Reese and Matlock) for computing lateral pile load-deformation based on complex soil conditions and/or non-linear soil stress-strain relationships. The COM 622 computer program (Reference 32, Laterally Loaded Piles: Program Documentation, by Reese) has been documented and is widely used. Use of these methods should only be considered when the soil stress-strain properties are well understood.

Pile deformation and stress can be approximated through application of several simplified procedures based on idealized assumptions. The two basic approaches presented below depend on utilizing the concept of coefficient of lateral subgrade reaction. It is assumed that the lateral load does not exceed about 1/3 of the ultimate lateral load capacity.

b. Granular Soil and Normally to Slightly Overconsolidated Cohesive Soils. Pile deformation can be estimated assuming that the coefficient of subgrade reaction, K_h , increases linearly with depth in accordance with:

$$K_h = \frac{fz}{D}$$

where: K_h = coefficient of lateral subgrade reaction (tons/ft³)
 f = coefficient of variation of lateral subgrade reaction (tons/ft³)
 z = depth (feet)
 D = width/diameter of loaded area (feet)

Guidance for selection of f is given in Figure 9 for fine-grained and coarse-grained soils.

c. Heavily Overconsolidated Cohesive Soils. For heavily overconsolidated hard cohesive soils, the coefficient of lateral subgrade reaction can be assumed to be constant with depth. The methods presented in Chapter 4 can be used for the analysis; K_h varies between $35c$ and $70c$ (units of force/length³) where c is the undrained shear strength.

d. Loading Conditions. Three principal loading conditions are illustrated with the design procedures in Figure 10, using the influence diagrams of Figure 11, 12 and 13 (all from Reference 31). Loading may be limited by allowable deflection of pile top or by pile stresses.

Case I. Pile with flexible cap or hinged end condition. Thrust and moment are applied at the top, which is free to rotate. Obtain total deflection, moment, and shear in the pile by algebraic sum of the effects of thrust and moment, given in Figure 11.

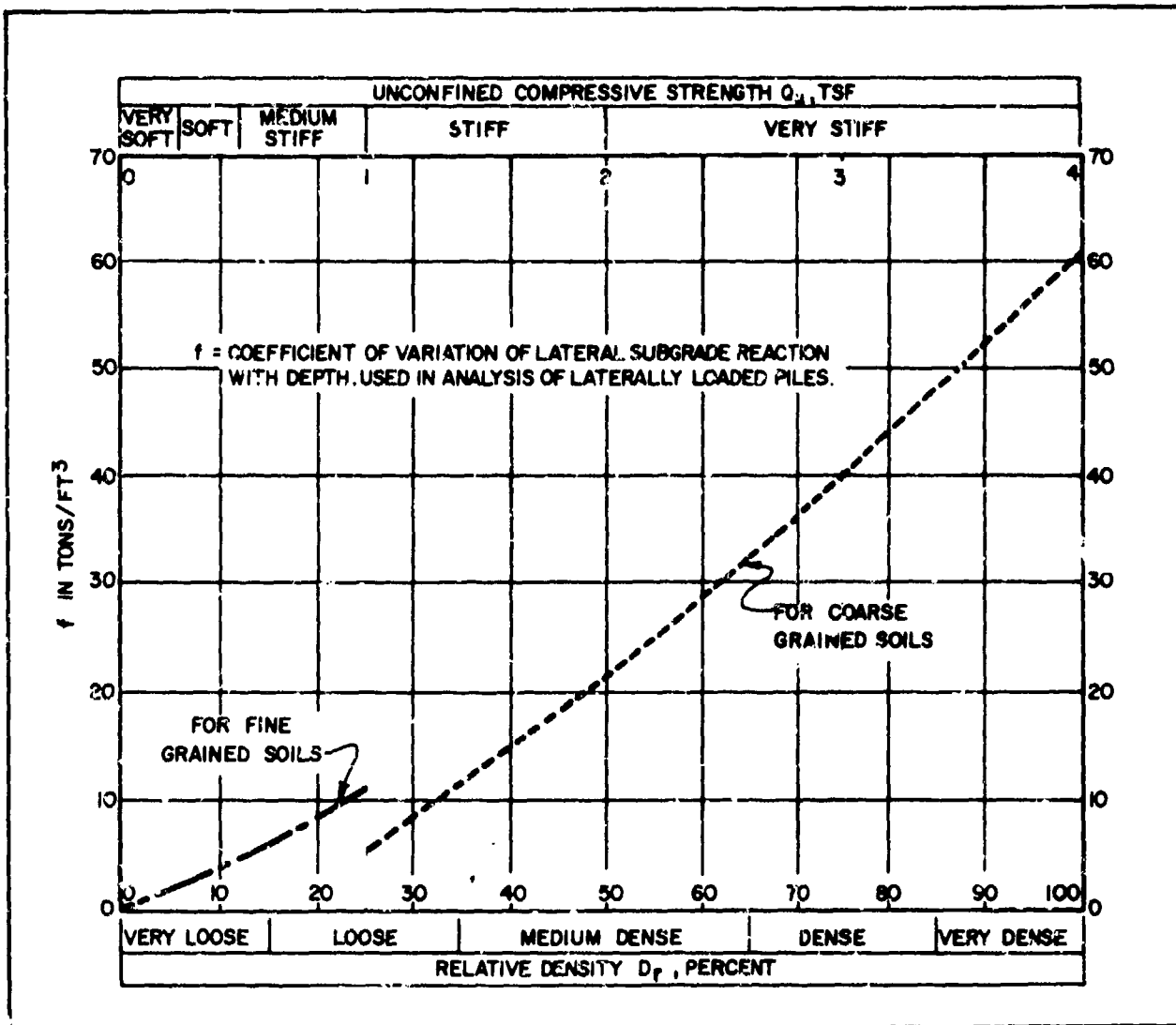


FIGURE 9
Coefficient of Variation of Subgrade Reaction

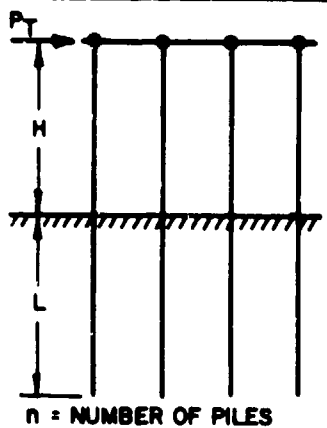

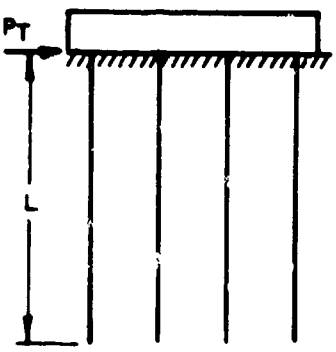

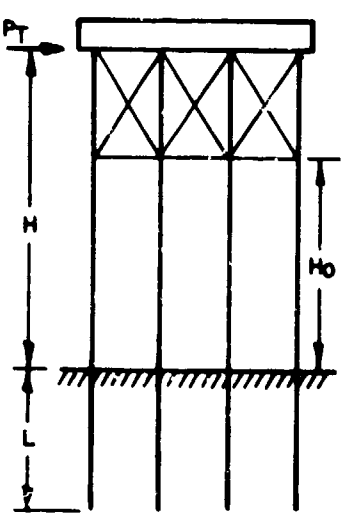

CASE I. FLEXIBLE CAP, ELEVATED POSITION		
CONDITION	LOAD AT GROUND LINE	DESIGN PROCEDURE
 <p>$n = \text{NUMBER OF PILES}$</p>	<p>FOR EACH PILE:</p> $P = \frac{P_T}{n}$ $M = PH$  <p>DEFLECTED POSITION</p>	<p>FOR DEFINITION OF PARAMETERS SEE FIGURE 12</p> <ol style="list-style-type: none"> 1. COMPUTE RELATIVE STIFFNESS FACTOR. $T = \left(\frac{EI}{\rho} \right)^{1/3}$ 2. SELECT CURVE FOR PROPER $\frac{L}{T}$ IN FIGURE 11. 3. OBTAIN COEFFICIENTS F_θ, F_M, F_V AT DEPTHS DESIRED. 4. COMPUTE DEFLECTION, MOMENT AND SHEAR AT DESIRED DEPTHS USING FORMULAS OF FIGURE 11. <p>NOTE: "ρ" VALUES FROM FIGURE 9 AND CONVERT TO LB/IN³.</p>
CASE II. PILES WITH RIG'D CAP AT GROUND SURFACE		
		<ol style="list-style-type: none"> 1. PROCEED AS IN STEP 1, CASE I. 2. COMPUTE DEFLECTION AND MOMENT AT DESIRED DEPTHS USING COEFFICIENTS F_θ, F_M AND FORMULAS OF FIGURE 12. 3. MAXIMUM SHEAR OCCURS AT TOP OF PILE AND EQUALS $p = \frac{P_T}{n}$ IN EACH PILE.
CASE III. RIGID CAP, ELEVATED POSITION		
	<p>DEFLECTED POSITION</p> 	<ol style="list-style-type: none"> 1. ASSUME A HINGE AT POINT A WITH A BALANCING MOMENT M APPLIED AT POINT A. 2. COMPUTE SLOPE θ_2 ABOVE GROUND AS A FUNCTION OF M FROM CHARACTERISTICS OF SUPERSTRUCTURE. 3. COMPUTE SLOPE θ_1 FROM SLOPE COEFFICIENTS OF FIGURE 13 AS FOLLOWS: $\theta_1 = F_\theta \left(\frac{PT^2}{EI} \right) + F_\theta \left(\frac{MT}{EI} \right)$ 4. EQUATE $\theta_1 = \theta_2$ AND SOLVE FOR VALUE OF M. 5. KNOWING VALUES OF P AND M, SOLVE FOR DEFLECTION, SHEAR, AND MOMENT AS IN CASE I. <p>NOTE: IF GROUND SURFACE AT PILE LOCATION IS INCLINED, LOAD P TAKEN BY EACH PILE IS PROPORTIONAL TO I/H_0^3.</p>

FIGURE 10
Design Procedure for Laterally Loaded Piles

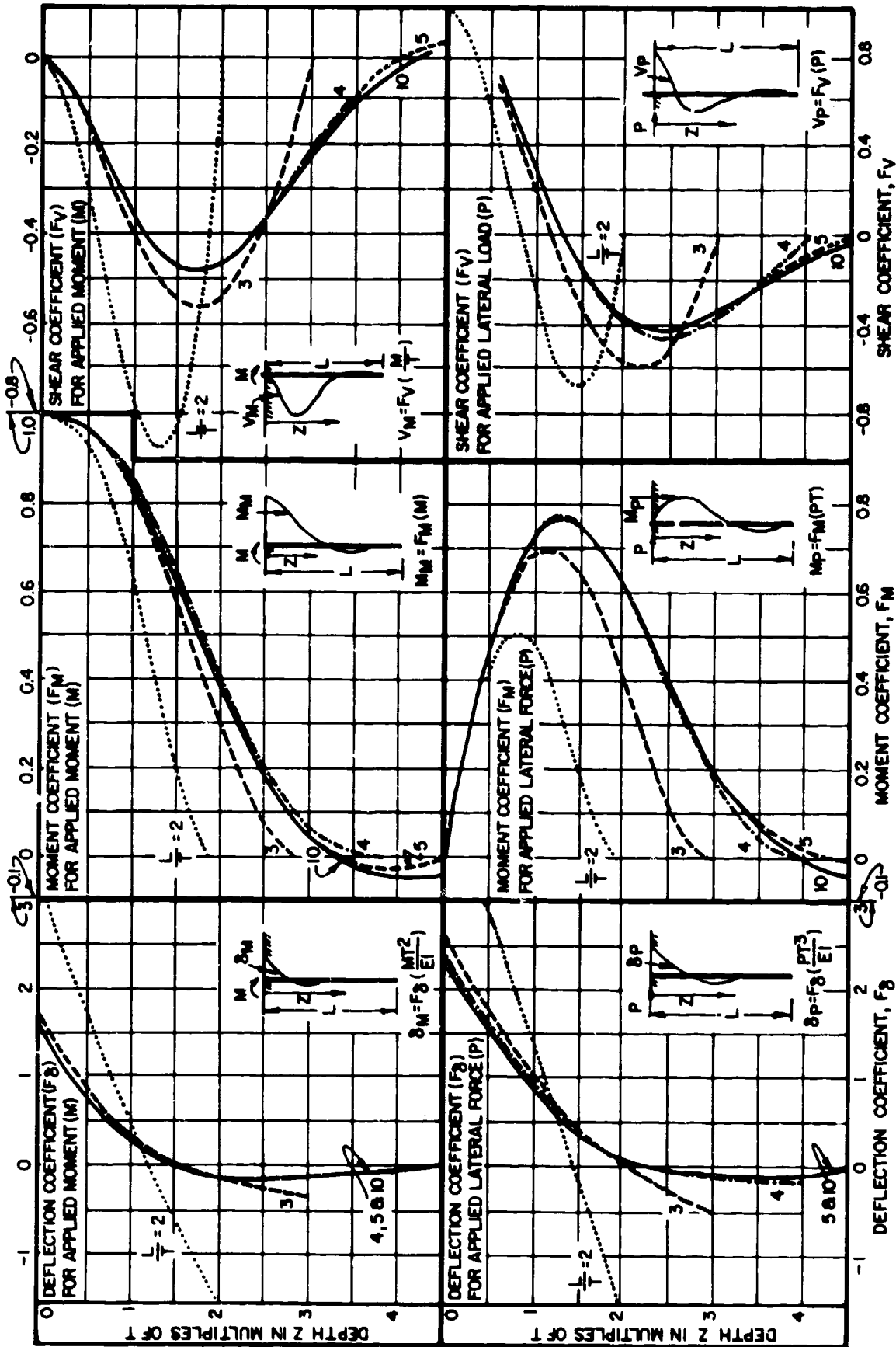


FIGURE 11
 Influence Values for Pile with Applied Lateral Load and Moment
 (Case I. Flexible Cap or Hinged End Condition)

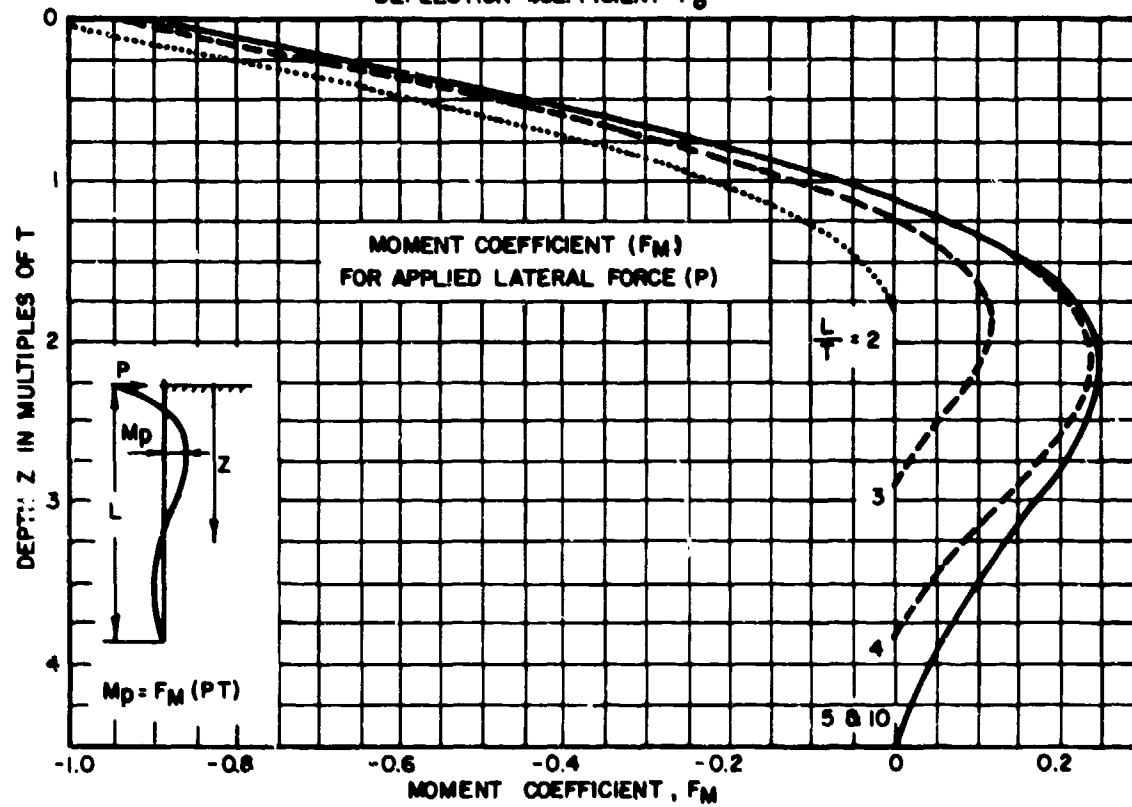
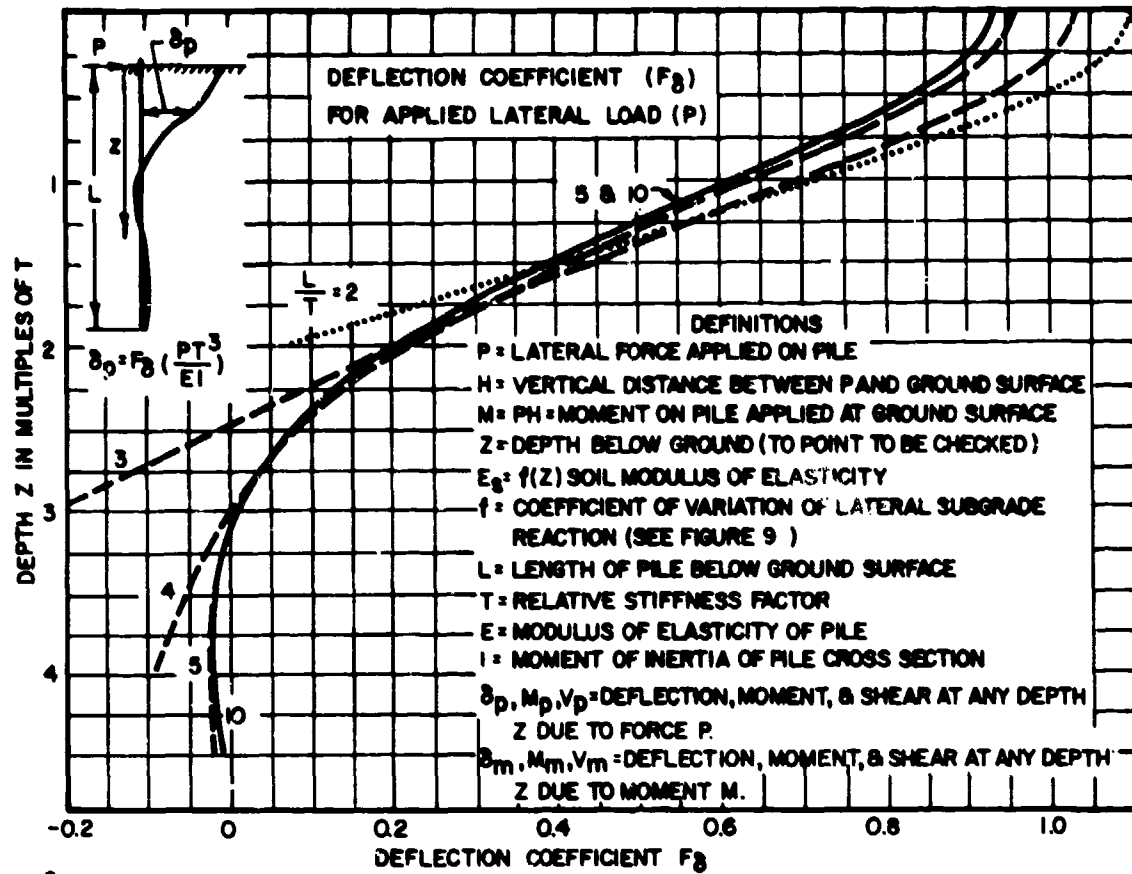


FIGURE 12
 Influence Values for Laterally Loaded Pile
 (Case II. Fixed Against Rotation at Ground Surface)
 7.2-239

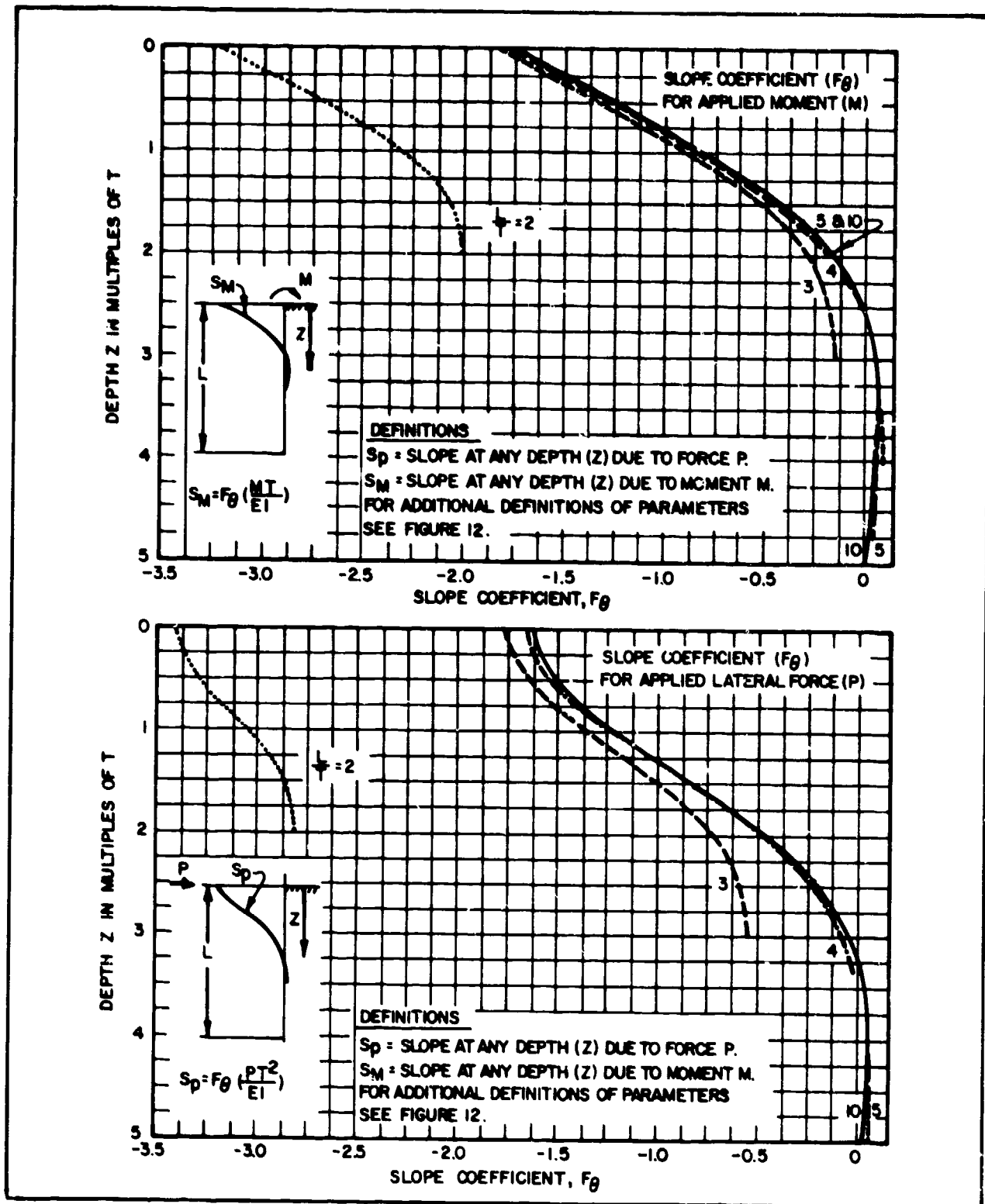


FIGURE 13
 Slope Coefficient for Pile with Lateral Load or Moment

Case II. Pile with rigid cap fixed against rotation at ground surface. Thrust is applied at the top, which must maintain a vertical tangent. Obtain deflection and moment from influence values of Figure 12.

Case III. Pile with rigid cap above ground surface. Rotation of pile top depends on combined effect of superstructure and resistance below ground. Express rotation as a function of the influence values of Figure 13 and determine moment at pile top. Knowing thrust and moment applied at pile top, obtain total deflection, moment and shear in the pile by algebraic sum of the separate effects from Figure 11.

3. CYCLIC LOADS.

Lateral subgrade coefficient values decrease to about 25% the initial value due to cyclic loading for soft/loose soils and to about 50% the initial value for stiff/dense soils.

4. LONG-TERM LOADING. Long-term loading will increase pile deflection corresponding to a decrease in lateral subgrade reaction. To approximate this condition reduce the subgrade reaction values to 25% to 50% of their initial value for stiff clays, to 20% to 30% for soft clays, and to 80% to 90% for sands.

5. ULTIMATE LOAD CAPACITY - SINGLE PILES. A laterally loaded pile can fail by exceeding the strength of the surrounding soil or by exceeding the bending moment capacity of the pile resulting in a structural failure. Several methods are available for estimating the ultimate load capacity.

The method presented in Reference 33, Lateral Resistance of Piles in Cohesive Soils, by Broms, provides a simple procedure for estimating ultimate lateral capacity of piles.

6. GROUP ACTION. Group action should be considered when the pile spacing in the direction of loading is less than 6 to 8 pile diameters. Group action can be evaluated by reducing the effective coefficient of lateral subgrade reaction in the direction of loading by a reduction factor R (Reference 9) as follows:

File Spacing in Direction of Loading <u>D = Pile Diameter</u>	Subgrade Reaction Reduction Factor <u>R</u>
8D	1.00
6D	0.70
4D	0.40
3D	0.25

REFERENCES

1. Teng, W.C., Foundation Design, Prentice Hall International, 1962
2. Skempton, A.W., The Bearing Capacity of Clays, Proceedings, Building Research Congress, London, 1951.
3. Tomlinson, M.F., The Adhesion of Piles Driven in Clay Soils, Proceedings, Fourth International Conference on Soil Mechanics and Foundation Engineering, London, 1957.
4. Departments of the Army and Air Force, Soils and Geology, Procedures for Foundation Design of Buildings and Other Structures (Except Hydraulic Structures), TM5/818-1/AFM88-3, Chapter 7, Washington, D.C. 1979.
5. Meyerhof, G.G., and Hanna, A.M., Ultimate Bearing Capacity of Foundations on Layered Soils Under Inclined Load, Canadian Geotechnical Journal, Vol. 15, No. 4, 1978.
6. Vesic, A.S., Design of Pile Foundations, National Cooperative Highway Research Program Synthesis 42, Transportation Research Board, 1977.
7. Meyerhof, G.G., Bearing Capacity and Settlement of Pile Foundations, Journal of Geotechnical Engineering Division, ASCE, Vol. 102, No. GT3, 1976.
8. Baguelin, F., Jexequel, J.F., and Shields, D.H., The Pressuremeter and Foundation Engineering, TransTech Publications, 1978.
9. Canadian Geotechnical Society, Canadian Foundation Engineering Manual, Canadian Geotechnical Society, 1978.
10. Smith, E.A., Pile Driving by the Wave Equation, Transactions, American Society of Civil Engineers, Vol. 127, Part II, pp 1145-193, 1962.
11. Rausche, F., Moses, F., and Goble, G.G., Soil Resistance Predictions from Pile Dynamics, Journal of the Soil Mechanics and Foundation Division, ASCE, Vol. 98, No. SM9, 1972.
12. Meyerhof, G.G., Ultimate Bearing Capacity of Footings on Sand Layer Overlying Clay, Canadian Geotechnical Journal, Vol. 11, No. 2, 1974.
13. Whitaker, T., Experiments with Model Piles in Groups, Geotechnique, London, 1957.
14. Tomlinson, M.J., Pile Design and Construction Practice, Viewpoint Publications, Cement and Concrete Association, London, 1957.
15. Garlanger, J.E., Prediction of the Downdrag Load at Culter Circle Bridge, Symposium on Downdrag of Piles, Massachusetts Institute of Technology, 1973.
16. Fellenius, B.H., Downdrag on Piles Due to Negative Skin Friction, Canadian Geotechnical Journal, Vol. 9, No. 4, 1972.

17. Claessen, A.I.M. and Horvat, E., Reducing Negative Skin Friction with Bitumen Slip Layers, Journal of the Geotechnical Engineering Division, ASCE, Vol. 100, No. GT8, 1974.
18. Bjerrum, L., Johannessin, I.J., and Kide, O., Reduction of Negative Skin Friction on Steel Piles to Rock, Proceedings of the Seventh International Conference on Soil Mechanics and Foundation Engineering, Vol. 2, pp 27-34, 1960.
19. Deep Foundation Institute, Inspectors' Manual for Deep Foundations, The Deep Foundations Institute, Springfield, NJ, 1978.
20. AWPI, Technical Guidelines for Pressure-Treated Wood, Timber Piling, PI American Wood Preservers Institute, 1976.
21. ACI Committee 543, Recommendations for Design, Manufacture and Installation of Concrete Piles, ACI Manual of Concrete Practice, American Concrete Institute, Part 3, October, 1974.
22. Reese, L.C. and Wright, S.J., Drilled Shafts: Design and Construction, Guideline Manual, Vol. 1; Construction Procedures and Design for Axial Load, Federal Highway Authority, July, 1977.
23. Garneau, R., and Samson, L., A Device for the Constant Rate of Penetration Test for Piles, Canadian Geotechnical Journal, Vol. 11, No. 2, 1974.
24. Davisson, M.T. and Salley, J.R., Model Study of Laterally Loaded Pile, Journal of Soil Mechanics and Foundation Division, ASCE, Vol. 96, No. SM5, 1970.
25. Chellis, R.D., Pile Foundations, McGraw Hill Book Company, 1961
26. Abbett, American Civil Engineering Practice, Vol. 1.
27. Johnson, S.M. and Kavanaugh, T.C., The Design of Foundations for Buildings, McGraw Hill Book Company, 1968.
28. Peck, R.B., Hanson, W.E., and Thornburn, T.H., Foundation Engineering, John Wiley & Sons, Inc., 1974.
29. Horvath, N.G. and Kenney, T.C., Shaft Resistance of Rock-Socketed Drilled Pier, ASCE, Preprint #3698, 1979.
30. Stagg, K.G. and Zienkiewicz, O.C., Eds., Rock Mechanics in Engineering Practice, John Wiley & Sons, Inc., 1968.
31. Reese, L.C. and Matlock, H., Non-Dimensional Solutions for Laterally Loaded Piles with Soil Modulus Assumed Proportional to Depth, Proceedings, Eighth Texas Conference on Soil Mechanics and Foundation Engineering, Austin, Texas, ASCE, 1956.

32. Reese, L.C., Laterally Loaded Piles: Program Documentation, Journal of Geotechnical Engineering Division, ASCE, Vol. 103, No. GT4, 1977.
33. Broms, B.B., Lateral Resistance of Piles in Cohesive Soils, Journal of Soil Mechanics and Foundations Division, ASCE, Vol. 90, No. SM2 and SM3, 1964.

BIBLIOGRAPHY

American Petroleum Institute, Recommended Practice for Planning, Designing and Constructing Fixed Offshore Platforms, API RP 2A, January 1971.

Casagrande, L., Comments on Conventional Design of Retaining Wall Structures, Journal of the Soil Mechanics and Foundation Engineering Division, ASCE, Vol. 99, No. SM2, 1973.

Davisson, M.T., Inspection of Pile Driving Operations, Tech. Report M-22, Cold Regions Research Engineering Laboratories Corps of Engineers, U.S. Department of the Army, 1972.

Foster, C.R., Field Problems: Compaction, Foundation Engineering, Leonards, G.A., Editor, McGraw-Hill Book Co., Inc., New York, Chapter 12, 1952.

Fuller, F.N. and Hoy, H.E., Pile Load Tests Including Quick Load Test Method, Conventional Methods and Interpretations, Highway Research Record No. 333, HRB U.S. National Research Council, pp 74-86, 1970.

Hunt, H.W., Design and Installation of Pile Foundations, Associated Pile Fitting Corporation, Clifton, NJ, 1974.

McClelland, B., Design of Deep Penetration Piles for Ocean Structures, Terzaghi Lectures: 1963-1972, ASCE, New York, pp 383-421, 1974.

Meyerhof, G.G., Bearing Capacity and Settlement of Pile Foundations, Journal of the Geotechnical Engineering Division, ASCE, Vol. 102, No. GT3, 1976.

National Bureau of Standards, Corrosion of Steel Pilings in Soils, Monographs 58 and 127, U.S. Department of Commerce, Washington, D.C.

Reese, L.C. and Welch, R.C., Lateral Loading of Deep Foundations in Stiff Clay, Journal of the Geotechnical Engineering Division, ASCE, Vol. 101, No. GT7, 1975.

USBR, Earth Manual, Second Edition, U.S. Department of Interior, Bureau of Reclamation, U.S. Government Printing Office, Washington, D.C., 1974.

Vesic, A.S., Ultimate Loads and Settlements of Deep Foundations in Sand, Procs., Symposium on Bearing Capacity and Settlement of Foundations, Duke University, Durham, NC., 1967.

Winterkorn, H.F., and Fang, H.Y., Editors, Foundation Engineering Handbook, Van Nostrand Reinhold Co., New York, 1975.

Woodward, R.J., Gardner, W.S. and Greer, D.M., Drilled Pier Foundations, McGraw-Hill Book Co., Inc., New York, 1972.

APPENDIX A
Listing of Computer Programs

Subject	Program	Description	Availability
Shallow Foundations (Chapter 4)	QULT GESA Catalog No. E03-0001-00043	Bearing capacity analysis by Silla, Brinch Hansen, Meyerhof- Prandtl, Sokolovski and Terzaghi Methods.	Geotechnical Engineering Software Activity University of Colorado Boulder, CO 80309
Excavation, and Earth Pressures (Chapter 1) and (Chapter 3)	SOIL-STRUCT	Two dimensional finite element program to analyze tieback walls.	Stanford University
	SSTINGS-2DFE	Two dimensional finite element program to analyze tieback walls.	Virginia Polytechnic Institute and State University, Blacksburg, VA 24061
Deep Foundations (Chapter 5)	COM622 GESA Catalog No. E04-0003-00044	Program solves for deflection and bending moment in a lat- erally loaded pile based on theory of a beam on an elastic foundation using finite differ- ence techniques. Soil proper- ties are defined by a set of load-deflection curves.	GESA or University of Texas at Austin
	TTI	Program for analysis of pile driving by the Wave Equation; developed at Texas A&M University.	U.S. Department of Transportation FHWA R&D Implementation Div.
	WEAP GESA Catalog No. E04-0004-00046	Wave Equation analysis for pile driven by impact hammers, diesel hammers and air/steam hammers.	GESA

APPENDIX A
Listing of Computer Programs (continued)

Subject	Program	Description	Availability
Deep Foundations (Chapter 5)	WINIT GESA Catalog No. E04-005-00047	Auxillary program for WEAP.	GESA
	WEHAM GESA Catalog No. E04-006-00048	Hammer data for WEAP.	"
	WDATA GESA Catalog No. E04-007-00049	WEAP data generator.	"

GLOSSARY

Downdrag. Force induced on deep foundation resulting from downward movement of adjacent soil relative to foundation element. Also referred to as negative skin friction.

Homogeneous Earth Dam. An earth dam whose embankment is formed of one soil type without a systematic zoning of fill materials.

Modulus of Subgrade Reaction. The ratio between the bearing pressure of a foundation and the corresponding settlement at a given point.

Nominal Bearing Pressures. Allowable bearing pressures for spread foundation on various soil types, derived from experience and general usage, which provide safety against shear failure or excessive settlement.

Optimum Moisture Content. The moisture content, determined from a laboratory compaction test, at which the maximum dry density of a soil is obtained using a specific effort of compaction.

Piping. The movement of soil particles as the result of unbalanced seepage forces produced by percolating water, leading to the development of boils or erosion channels.

Swell. Increase in soil volume, typically referring to volumetric expansion of particular soils due to changes in water content.

Zoned Earth Dam. An earth dam embankment zoned by the systematic distribution of soil types according to their strength and permeability characteristics, usually with a central impervious core and shells of coarser materials.

SYMBOLS

Symbol	Designation
A	Cross-sectional area.
A_p	Anchor pull in tieback system for flexible wall.
B, b	Width in general, or narrow dimension of a foundation unit.
c_a	Unit adhesion between soil and pile surface or surface of some other foundation material.
c_{all}	Allowable cohesion that can be mobilized to resist shear stresses.
C_s	Shape factor coefficient for computation of immediate settlement.
c	Cohesion intercept for Mohr's envelope of shear strength based on total stresses.
c'	Cohesion intercept for Mohr's envelope of shear strength based on effective stresses.
c_v	Coefficient of consolidation.
D, d	Depth, diameter, or distance.
D_r	Relative density.
D_5, D_{60} D_{85}	Grain size division of a soil sample, percent of dry weight smaller than this grain size is indicated by subscript.
E	Modulus of elasticity of structural material.
E_s	Modulus of elasticity or "modulus of deformation" of soil.
e	Void ratio.
F_s	Safety factor in stability or shear strength analysis.
f	Coefficient of variation of soil modulus of elasticity with depth for analysis of laterally loaded piles.
G	Specific gravity of solid particles in soil sample, or shear modulus of soil.
H, h	In general, height or thickness.
H_w	Height of groundwater or of open water above a base level.
I	Influence value for vertical stress produced by superimposed load, equals ratio of stresses at a point in the foundation to intensity of applied load.
i	Gradient of groundwater pressures in underseepage analysis.
K_A	Coefficient of active earth pressures.
K_H	Ratio of horizontal to vertical earth pressures on side of pile or other foundation.
k_h	Coefficient of lateral subgrade reaction.
K_p	Coefficient of passive earth pressures.
K_b	Modulus of subgrade reaction for bearing plate or foundation of width b.
K_{v1}	Modulus of subgrade reaction for 1 ft square bearing plate at ground surface.
k	Coefficient of permeability.
ksf	Kips per sq ft pressure intensity.
ksi	Kips per sq in pressure intensity.

Symbol	Designation
L, l	Length in general or longest dimension of foundation unit.
$N_c, N_{cs},$ $N_q, N_y,$ N_{yq}	Bearing capacity factors.
N_o	Stability number for slope stability.
n	Porosity of soil sample.
n_c	Effective porosity.
OMC	Optimum moisture content of compacted soil.
P_A	Resultant active earth force.
P_{AH}	Component of resultant active force in horizontal direction.
pcf	Density in pounds per cubic foot.
P_h	Resultant horizontal earth force.
P_p	Resultant passive earth force.
P_{PH}	Component of resultant passive earth force in horizontal direction.
P_v	Resultant vertical earth force.
P_w	Resultant force of water pressure.
p	Intensity of applied load.
P_o	Existing effective overburden pressure acting at a specific height in the soil profile.
P_c	Preconsolidation pressure.
Q_{all}	Allowable load capacity of deep foundation element.
Q_{ult}	Ultimate load that causes shear failure of foundation unit.
q	Intensity of vertical load applied to foundation unit.
q_{all}	Allowable bearing capacity of shallow foundation unit.
q_u	Unconfined compressive strength of soil sample.
Q_{ult}	Ultimate bearing pressure that causes shear failure of foundation unit.
R, r	Radius of well or other right circular cylinder.
s	Shear strength of soil for a specific stress or condition in situ, used instead of strength parameters c and ϕ .
T	Thickness of soil stratum, or relative stiffness factor of soil and pile in analysis of laterally loaded piles.
Z	Depth.
γ_D	Dry unit weight of soil.
γ_E	Effective unit weight of soil.
γ_{MAX}	Maximum dry unit weight of soil determined from moisture content dry unit weight curve; or, for cohesionless soil, by vibratory compaction.
γ_{MIN}	Minimum dry unit weight.
γ_{SUB}	Submerged (buoyant) unit weight of soil mass.
γ_T	Wet unit weight of soil above the groundwater table.
γ_W	Unit weight of water, varying from 62.4 pcf for fresh water to 64 pcf for sea water.
P	Magnitude of settlement for various conditions.
ϕ	Angle of internal friction or "angle of shearing resistance," obtained from Mohr's failure envelope for shear strength.
ν	Poisson's Ratio.

INDEX

A

Anchorage, tower guy.....7.2-169
 See Foundations, shallow,
 Tower Guy Anchorages

B

Bibliography.....7.2-B-1

C

Cofferdams, double-wall.....7.2-116
 See Walls and retaining
 structures.
 Compaction procedures.....7.2-45
 Computer Programs, Listing of..7.2-A-1

E

Embankments compacted, compac-
tion procedures, and hydrau-
lic fills.....7.2-37
 Applications.....7.2-37
 Compaction control, embank-
 ment.....7.2-50
 Analysis of control
 test data.....7.2-51
 Compactive effort.....7.2-52
 Moisture control.....7.2-52
 Statistical study.....7.2-52
 Number of field density
 tests.....7.2-51
 Number of laboratory
 compaction tests.....7.2-51
 Compaction requirements
 and procedures.....7.2-45
 Material type influence..7.2-45
 Oversize effect.....7.2-45
 Soils insensitive to
 compaction moisture.7.2-45
 Soils sensitive to
 compaction moisture.7.2-45
 Methods.....7.2-45
 Requirements.....7.2-45
 Specification pro-
 visions.....7.2-45
 Cross-section design.....7.2-38
 Earth dam embankments....7.2-41
 Piping and cracking...7.2-41
 Seepage control.....7.2-41

Embankment compacted, compaction pro-
cedures, and hydraulic fills
 (continued)

Cross-section design (continued)
 Material type influence..7.2-38
 Utilization.....7.2-38
 Settlement.....7.2-38
 Embankment consolida-
 tion.....7.2-38
 Foundation settlement.7.2-38
 Secondary compression.7.2-41
 Stable foundation.....7.2-38
 Weak foundation.....7.2-38
 Excavation, borrow.....7.2-52
 Methods of excavation....7.2-53
 Utilization of excavated
 materials.....7.2-53
 Borrow volume.....7.2-53
 Rock fill.....7.2-53
 Fills, hydraulic and under-
 water.....7.2-54
 Construction methods.....7.2-54
 Hydraulic fill on
 land.....7.2-54
 Underwater fills.....7.2-54
 Performance of fill mate-
 rials.....7.2-54
 Coarse-grained fills..7.2-54
 Hard clay fills.....7.2-56
 Equipment, pile driving.....7.2-213
 See Foundations, deep,
 Types.
 Excavation, borrow.....7.2-52
 See Embankments, compacted,
 Excavation.

F

Fills, hydraulic and under-
 water.....7.2-54
 See Embankments compacted,
 Fills.
Foundations, deep.....7.2-177
 Application.....7.2-177
 Bearing capacity.....7.2-191
 Dynamic Driving Resis-
 tance.....7.2-202
 Pile group.....7.2-204
 Single pile, theoretical.7.2-192

Foundations, deep (continued)

Distribution of loads on
 pile groups.....7.2-230
 Downdrag.....7.2-209
 Installation.....7.2-213
 Investigation program.....7.2-177
 Lateral load capacity.....7.2-234
 Load tests.....7.2-228
 Rock, deep foundations on...7.2-232
 Settlement.....7.2-207
 Pile group.....7.2-209
 Single pile.....7.2-207
 Types.....7.2-178
 Allowable stresses.....7.2-179
 Design criteria.....7.2-179
Foundations, shallow.....7.2-129
 Applications.....7.2-129
 Bearing capacity.....7.2-129
 Footings, proportioning
 individual.....7.2-146
 Nominal bearing pres-
 sures.....7.2-141
 Modifications.....7.2-141
 Utilization.....7.2-141
 Ultimate shear failure...7.2-129
 Bearing capacity dia-
 grams.....7.2-129
 Theoretical bearing
 capacity.....7.2-129
 Uplift capacity.....7.2-169
 Rock anchorages.....7.2-169
 Soil anchorages.....7.2-169
 Collapsing soils.....7.2-163
 Engineered fill.....7.2-159
 Compaction control.....7.2-159
 Utilization.....7.2-159
 Expansive soils.....7.2-159
 Eliminating swell.....7.2-161
 Minimizing swell effects.7.2-161
 Potential swelling con-
 ditions.....7.2-159
 Mat and continuous beam
 foundations.....7.2-150
 Applications.....7.2-150
 Design.....7.2-150
 Settlement.....7.2-150
 Stability requirements...7.2-150
 Tower guy anchorages.....7.2-169
 Anchoring tower guy
 loads.....7.2-169
 Deadman anchorages....7.2-172
 Piling anchorages.....7.2-233
 Rock.....7.2-169

Foundations, shallow (continued)

Underdrainage and water-
 proofing.....7.2-163
 Pressure slabs.....7.2-163
 Relieved slabs.....7.2-169
 Waterproofing require-
 ments.....7.2-169
 G
 Glossary.....7.2-G-1
 M
 Mat foundations.....7.2-150
 See Foundations, shallow,
 Mat.
 P
 Piles:
 Foundations (see Foundations,
 deep).....7.2-177
 S
 Symbols.....7.2-S-1
 W
Walls and retaining structures,
analysis.....7.2-59
 Cofferdams, double-wall....7.2-116
 Analysis.....7.2-116
 Exterior pressures...7.2-116
 Stability require-
 ments.....7.2-116
 Cell fill.....7.2-125
 Drainage.....7.2-125
 Materials.....7.2-125
 Types.....7.2-116
 Flexible walls design.....7.2-85
 Anchored bulkheads.....7.2-85
 Anchorage system.....7.2-90
 Computation example...7.2-93
 Construction pre-
 cautions.....7.2-90
 Drainage.....7.2-85
 Movements, wall.....7.2-85
 Pressures, wall.....7.2-85
 Braced sheet pile walls..7.2-90
 Computation example...7.2-107
 Narrow cuts braced....7.2-101

Walls and retaining structures,
analysis (continued)

Flexible walls design (continued)
Braced sheet pile walls (con-
tinued)
Raking braces with
wall.....7.2-101
Stability of base of
excavation.....7.2-104
Tied backwalls.....7.2-101
Crib walls.....7.2-116
Gabions.....7.2-112
Pressures, wall, computa-
tions.....7.2-59
Active pressures.....7.2-59
Stratified backfill,
sloping groundwater
level.....7.2-61
Uniform backfill, no
groundwater.....7.2-61
Uniform backfill,
static groundwater..7.2-61
Coefficients with wall
friction.....7.2-61
Effect of construction
procedures.....7.2-76
Compacted fills.....7.2-76
Hydraulic fills.....7.2-76
Effect of seepage and
Drainage.....7.2-70
Beneath walls seepage.7.2-70
Conditions, general...7.2-70
Rainfall on drained
walls.....7.2-70
Static differential
head.....7.2-70
Loading, surcharge.....7.2-70
Area loads.....7.2-73
Live loads.....7.2-73
Movement, wall.....7.2-73
Braced flexible
sheeting.....7.2-73
Restrained walls.....7.2-76
Tilting retaining
walls.....7.2-73
Passive pressures.....7.2-59
Stratified backfill,
sloping groundwater
level.....7.2-61
Uniform backfill, no
groundwater.....7.2-61
Uniform backfill,
static groundwater
level.....7.2-61

Walls and retaining structures,
analysis (continued)

Pressures, wall, computation (con-
tinued)
Reinforced earth.....7.2-116
Rigid retaining walls....7.2-82
Criteria, general.....7.2-82
Drainage.....7.2-85
Settlement and over-
turning.....7.2-82
Stability.....7.2-82
High walls.....7.2-82
Low walls.....7.2-85
Drainage.....7.2-85
Equivalent fluid
pressures.....7.2-85

*U.S. GOVERNMENT PRINTING OFFICE: 1982-O-374-637/BID