

MICROCOPY RESOLUTION TEST CHART
NATIONAL BUREAU OF STANDARDS-1963-A

AD A 121 535

12

NOSC TD 516

NOSC TD 516

Technical Document 516

MININEC: A MINI-NUMERICAL ELECTROMAGNETICS CODE

Alfredo J Julian
James C Logan
John W Rockway

6 September 1982

DTIC
ELECTE
NOV 10 1982
S D E

Approved for public release; distribution unlimited

DTIC FILE COPY

NOSC

NAVAL OCEAN SYSTEMS CENTER
San Diego, California 92152

82 11 10 016



NAVAL OCEAN SYSTEMS CENTER, SAN DIEGO, CA 92152

A N A C T I V I T Y O F T H E N A V A L M A T E R I A L C O M M A N D

SL GUILLE, CAPT, USN

Commander

HL BLOOD

Technical Director

ADMINISTRATIVE INFORMATION

This work was performed under 62762N, XF54585, of the NAVELEX 614 Ships Electromagnetic Compatibility Program (Ships EMC).

Released by
MS Kvigne
Communications Research and
Technology Division

Under authority of
HD Smith, Head
Communications Systems and
Technology Department

ACKNOWLEDGMENTS

The authors wish to credit the contribution of Dr Donald Wilton of the Department of Electrical Engineering, University of Mississippi. The theoretical approach to the solution of the thin wire antenna problem used in MININEC was developed by Dr Wilton. The approach leads to a relatively compact computer code especially suited to solutions on small computers. The existence of MININEC is possible only due to these concepts.

UNCLASSIFIED

SECURITY CLASSIFICATION OF THIS PAGE (When Data Entered)

REPORT DOCUMENTATION PAGE		READ INSTRUCTIONS BEFORE COMPLETING FORM
1. REPORT NUMBER NOSC/Technical Document 516 (TD 516)	2. GOVT ACCESSION NO. AD-A1535	3. RECIPIENT'S CATALOG NUMBER
4. TITLE (and Subtitle) MININEC: A MINI-NUMERICAL ELECTROMAGNETICS CODE		5. TYPE OF REPORT & PERIOD COVERED Final: April 1981 to May 1982
7. AUTHOR(s) Alfredo J Julian James C Logan John W Rockway		6. PERFORMING ORG. REPORT NUMBER
9. PERFORMING ORGANIZATION NAME AND ADDRESS Naval Ocean Systems Center San Diego, CA 92152		8. CONTRACT OR GRANT NUMBER(s)
11. CONTROLLING OFFICE NAME AND ADDRESS Naval Electronic Systems Command (ELEX 614) Washington, DC 20360		10. PROGRAM ELEMENT, PROJECT, TASK AREA & WORK UNIT NUMBERS 62762N, XF54585
14. MONITORING AGENCY NAME & ADDRESS (if different from Controlling Office)		12. REPORT DATE 6 September 1982
		13. NUMBER OF PAGES 62
		15. SECURITY CLASS. (of this report) Unclassified
		15a. DECLASSIFICATION/DOWNGRADING SCHEDULE
16. DISTRIBUTION STATEMENT (of this Report) Approved for public release; distribution unlimited		
17. DISTRIBUTION STATEMENT (of the abstract entered in Block 20, if different from Report)		
18. SUPPLEMENTARY NOTES		
19. KEY WORDS (Continue on reverse side if necessary and identify by block number) Antennas Method of moments Microcomputers Numerical modeling		
20. ABSTRACT (Continue on reverse side if necessary and identify by block number) An investigation of the merits of techniques that may result in a reduced version of an antenna modeling code applicable to small problems and small computer resources. The result is the identification of one promising numerical approach suggested by Dr DR Wilton of the University of Mississippi. The approach has been coded in BASIC and implemented on a microcomputer. The computer code has been dubbed MININEC (Mini-Numerical Electromagnetics Code). MININEC solves an integral equation relating the electric field and the vector and scalar potentials. The solution involves a modified Galerkin procedure. This formulation results in a compact code suitable for use on a (Continued on reverse side)		

DD FORM 1 JAN 73 1473

EDITION OF 1 NOV 65 IS OBSOLETE

S/N 0102-LF-014-6601

1

UNCLASSIFIED

SECURITY CLASSIFICATION OF THIS PAGE (When Data Entered)

UNCLASSIFIED

SECURITY CLASSIFICATION OF THIS PAGE (When Data Entered)

20. Continued

microcomputer. MININEC solves for the impedance and currents on arbitrarily oriented wires including configurations with multiple junctions. Options include lumped impedance loading and far field patterns. MININEC has been written in the BASIC language compatible with many popular microcomputers. MININEC has been implemented on the NOSC Univac 1100/82, the NOSC VAX, a CDI microcomputer, and an Apple microcomputer.

S/N 0102- LF- 014- 6601

UNCLASSIFIED

SECURITY CLASSIFICATION OF THIS PAGE(When Data Entered)

CONTENTS

1.0 Introduction . . . page 5

 1.1 Background . . . 5

 1.2 Computer Requirements . . . 7

2.0 The Theory of MININEC . . . 8

 2.1 The Electric Field Integral Equation and Its Solution . . . 8

 2.2 Wire Junctions . . . 16

 2.3 The Ground Plane . . . 19

 2.4 Lumped Parameter Impedance Loading . . . 19

 2.5 Far Zone Radiation Patterns . . . 20

3.0 Validation . . . 21

4.0 Conclusions . . . 31

References . . . 32

Appendix A: Input/Output Format of MININEC . . . 34

Appendix B: MININEC Sample Run . . . 40

Appendix C: Code Description . . . 44

Appendix D: Computer Listing of MININEC . . . 46

ALL INFORMATION CONTAINED
HEREIN IS UNCLASSIFIED

Accession For	
NTIS GRA&I	<input type="checkbox"/>
DTIC TAB	<input checked="" type="checkbox"/>
Unannounced	<input type="checkbox"/>
Justification	
By _____	
Distribution/	
Availability Codes	
Dist	Avail and/or Special
A	

MININEC: A MINI-NUMERICAL ELECTROMAGNETICS CODE

1.0 INTRODUCTION

MININEC is a method of moments computer code for the analysis of thin wire antennas. A modified Galerkin procedure is used to solve an integral equation representation for the electric field following an approach described by DR Wilton of the University of Mississippi [1]. This formulation results in an unusually compact (ie, requiring relatively little core storage) code suitable for implementation on a microcomputer. The MININEC code solves for impedance and currents on arbitrarily oriented wires including configurations with multiple wire junctions. Options include lumped parameter impedance loading of the wires and calculation of far field patterns in free space and over a flat, perfectly conducting, infinite ground plane. MININEC is written in a BASIC language compatible with popular microcomputers. MININEC has been implemented on the NOSC Univac 1100/82, a DEC VAX 11/780, a CDI microcomputer, and an Apple microcomputer.

1.1 BACKGROUND

The Numerical Electromagnetics Code (NEC) [2] is the most advanced computer code available for the analysis of thin wire antennas. It is a highly user-oriented computer code offering a comprehensive capability for analysis of the interaction of electromagnetic waves with conducting structures. The program is based on the numerical solution of integral equations for the currents induced on the structure by an exciting field.

NEC combines an integral equation for smooth surfaces with one for wires to provide convenient and accurate modeling for a wide range of applications. A NEC model may include nonradiating networks and transmission lines, perfect and imperfect conductors, lumped element loading, and ground planes. The ground planes may be perfectly or imperfectly conducting. Excitation may be via an applied voltage source or incident plane wave. The output may include induced currents and charges, near or far zone electric or magnetic fields, and impedance or admittance. Many other commonly used parameters such as gain and directivity, power budget, and antenna to antenna coupling are also available.

NEC was developed at the Lawrence Livermore National Laboratory under the joint sponsorship of the Naval Ocean Systems Center and the Air Force Weapons Laboratory. Additional sponsorship has been provided by the US Army Communications-Engineering Installation Agency, Ft Huachuca. The NEC user community comprises 17 government facilities (including NOSC, Naval Research Laboratory, Naval Surface Weapons Center, Naval Underwater Systems Center, Air Force Weapons Center, and Army Communications Command), 11 domestic universities, over 20 domestic companies and at least 8 foreign organizations (Australia, Canada, Denmark, France, Great Britain, Italy, Japan, and West Germany).

NEC is a powerful tool for many engineering applications. It is ideal for modeling co-site antenna environments in which the interaction between antenna and environment cannot be ignored. In many problems, however, the extensive full capability of NEC is not really required because the antenna and its environment are not very complex or the information sought requires only a simplified model. In addition, NEC requires the support of and access to a large main-frame computer system. These computer systems are expensive and not always readily available at remote field activities. Even when the computer facilities are available, heavy demand usage may result in slow turn-around, even for relatively simple (or small) NEC runs. One viable solution is a "stripped down" version of NEC that would retain only the basic solution and the most frequently used options and which could be implemented on a mini- or microcomputer.

This study investigates the merits of techniques that may result in a reduced version of NEC (or a more compact method of moments code) applicable to smaller problems and employing smaller computer resources. The result is the identification of one promising numerical technique, developed by DR Wilton [3]. This approach, the subject of this report, has been coded in BASIC and successfully implemented on a microcomputer. The computer code has been appropriately dubbed MININEC. Sections 2.0 and 3.0 describe the underlying theory of MININEC and present the results of validation tests. Appendix A is a detailed discussion of the input and output formats. Appendix B is an example run. Appendix C is a brief description of the coding. Appendix D is a complete listing.

1.2 COMPUTER REQUIREMENTS

Occasionally a technology develops which is destined to produce significant changes in the way people think and conduct their business. For many decades, scientists and engineers struggled with unmanageable equations and data using trial and error techniques, employing logarithmic tables and inadequate slide rule calculations. Then came the digital computer.

In the 1950s and 60s, physically large and expensive computing machines (that were relatively slow, with limited capability compared to today's standards) became available to a few. At first, stored programs were accessible through direct connection of individual terminals a short distance away. The revolution had begun.

In the 70s, technologists rushed to convert proven algorithms into computer programs or to develop new algorithms suitable for efficient computer programming for use as analysis and synthesis tools by the scientific community. These tools, for the most part, required the support of large central machines. Meanwhile, slide rules were being replaced by hand held calculators with trigonometric functions and which could be programmed for simple repetitive algorithms.

Today, large central processing systems are being replaced or at least supplemented with small powerful mini- and microcomputers. The development of the low cost microprocessor chip means that computers with capabilities that equal or exceed those of the earlier machines of the 50s are now available in compact size. Sizes range from suitcase or desktop machines (the microcomputer) to file cabinet machines (the minicomputer) that can be expanded or configured to meet specialized needs. The microcomputer is becoming more and more affordable as a personal computing tool. The microcomputer or "home computer" is emerging as *the* engineering and scientific tool. In addition, there is widespread use of computer networking, making accessible to anyone with a microcomputer or terminal with an acoustic coupler and telephone, a wide variety of computer facilities dispersed around the country as well as a virtually limitless source of information.

MININEC has been written with the microcomputer in mind. But, it can also be implemented on mini- or larger computers that have the BASIC language capability. An attempt has been made to keep the programming simple with no

machine-dependent program statements so that it will be compatible with most BASIC languages. MININEC consists of 550 statements. On the Univac, the maximum array size is set at 50 unknowns, which occupies one track (or 1.792 kilowords or 64.512 kilobits). As mentioned above, MININEC has also been implemented on a CDI and an Apple machine, which requires a reduction to 40 unknowns to fit in a 64-kilobit memory. It is possible to use a TRS-80 as well or any other microcomputer with BASIC capability and at least 48 kilobits of core memory.

2.0 THE THEORY OF MININEC

The MININEC program is based on the numerical solution of an integral equation representation of the electric fields. There is nothing very new or unusual about this formulation. The real advantage is that the solution technique results in a relatively compact (ie, short) computer code. The discussion that follows in this section is condensed from reference 1.

2.1 The Electric Field Integral Equation and Its Solution

It has become customary in solving wire antenna problems to make several assumptions which are valid for thin wires. They are that the wire radius, a , is very small with respect to the wavelength and is very small with respect to the wire length. Because it is necessary to subdivide wires into short segments, the radius is assumed small with respect to the segment lengths as well so that the currents can be assumed to be axially directed; ie, there are no azimuthal components of current.

Figure 1 gives the geometry of a typical arbitrarily oriented wire. It is assumed here for simplicity that the wire is straight, but the theory applies equally to bent configurations. Also shown is the same wire broken into segments or subsections.

The vector and scalar potentials are given by

$$\bar{A} = \frac{\mu}{4\pi} \int_C I(s) \hat{s}(s) k(s-s') ds \quad (1)$$

$$\Phi = \frac{1}{4\pi\epsilon} \int_c q(s)k(s-s')ds \quad (2)$$

where

$$k(s-s') = \frac{1}{2\pi} \int_{-\pi}^{\pi} \frac{e^{-jkr}}{r} d\phi,$$

$$r = \left((s-s')^2 + 4a^2 \sin^2 \frac{\phi}{2} \right)^{\frac{1}{2}}$$

and the linear charge density (via the continuity equation) is

$$q(s) = \frac{-1}{j\omega} \frac{dI}{ds} \quad (3)$$

The kernel k becomes the "exact kernel" when $\vec{r} \rightarrow \vec{r}'$ on c , but can be accurately replaced by the "reduced kernel," $k_0 = e^{-jkr}/r$, $r = |\vec{r} - \vec{r}(s)|^2 + a^2(s)^{\frac{1}{2}}$ for $|\vec{r} - \vec{r}'| \gg a$.

The integral equation relating the incident field, \vec{E}_{inc} , and the vector and scalar potentials is

$$-\vec{E}_{inc} \cdot \hat{s} = -j\omega\vec{A} \cdot \hat{s} - \hat{s} \cdot \nabla\Phi \quad (4)$$

Equation (4) is solved in MININEC by using the following procedure.

The wires are divided into equal segments and as shown in figure 1 the vectors \vec{r}_n , $n=0,1,\dots,N+1$ are defined, with respect to the global coordinate origin, 0. The unit vectors parallel to the wire axis for each segment shown are defined as

$$\hat{s}_{n+\frac{1}{2}} = \frac{\vec{r}_{n+1} - \vec{r}_n}{|\vec{r}_{n+1} - \vec{r}_n|} \quad (5)$$

Pulse testing and pulse expansion functions used in MININEC are defined as

$$P_n(s) = \begin{cases} 1, & s_{n-\frac{1}{2}} < s < s_{n+\frac{1}{2}} \\ 0, & \text{otherwise} \end{cases} \quad (6)$$

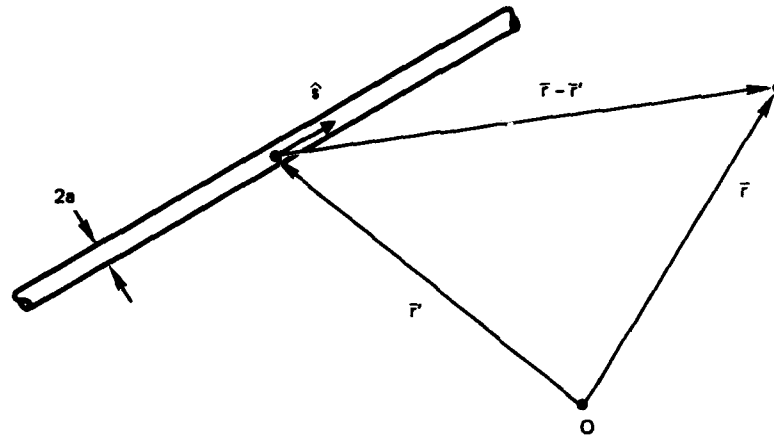

(a) An arbitrarily oriented wire.

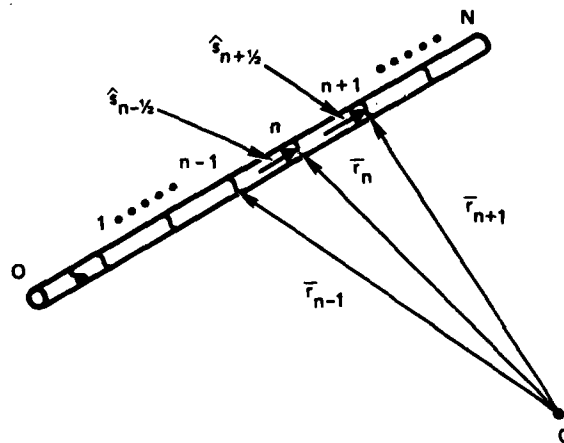

(b) Segmentation scheme for the same wire.

Figure 1. Definition of the position vectors with respect to the global origin O .

where the points $s_{n+\frac{1}{2}}$ designate segment midpoints,

$$s_{n+\frac{1}{2}} = \frac{s_{n+1} + s_n}{2} \quad (7)$$

or in terms of the global coordinates,

$$\bar{r}_{n+\frac{1}{2}} = \frac{\bar{r}_{n+1} + \bar{r}_n}{2} \quad (8)$$

It is assumed that the components of the vectors \bar{E}_{inc} and \bar{A} in equation (4) are sufficiently smooth over each segment that their respective values on each segment may be replaced by those taken at the point s_m . The pulse functions of (6) are then used as testing functions on (4), resulting in

$$\begin{aligned} \bar{E}_{inc}(s_m) \cdot \left[\left(\frac{s_m - s_{m-1}}{2} \right) \hat{s}_{m-\frac{1}{2}} + \left(\frac{s_{m+1} - s_m}{2} \right) \hat{s}_{m+\frac{1}{2}} \right] = \\ j\omega \bar{A}(s_m) \cdot \left[\left(\frac{s_m - s_{m-1}}{2} \right) \hat{s}_{m-\frac{1}{2}} + \left(\frac{s_{m+1} - s_m}{2} \right) \hat{s}_{m+\frac{1}{2}} \right] + \\ \phi(s_{m+\frac{1}{2}}) - \phi(s_{m-\frac{1}{2}}) \end{aligned} \quad (9)$$

The vector quantities in brackets are simply $(\bar{r}_{m+\frac{1}{2}} - \bar{r}_{m-\frac{1}{2}})$, so (9) can be written as

$$\begin{aligned} \bar{E}_{inc}(s_m) \cdot (\bar{r}_{m+\frac{1}{2}} - \bar{r}_{m-\frac{1}{2}}) = \\ j\omega \bar{A}(s_m) \cdot (\bar{r}_{m+\frac{1}{2}} - \bar{r}_{m-\frac{1}{2}}) + \phi(s_{m+\frac{1}{2}}) - \phi(s_{m-\frac{1}{2}}) \end{aligned} \quad (10)$$

The currents are expanded in pulses centered at the junctions of adjacent segments as illustrated in figure 2(a). Note that pulses are omitted from the wire ends. This is equivalent to placing a half pulse of zero amplitude at each end, thus imposing the boundary condition for zero current at unattached wire ends. The current expansion can be written as

$$I(s) = \sum_{n=1}^N I_n p_n(s) \quad (11)$$

A difference approximation is applied to (3) to compute the charge. Thus, as shown in figure 2(b), the charge can be represented as pulses displaced from the current pulses by a half pulse width.

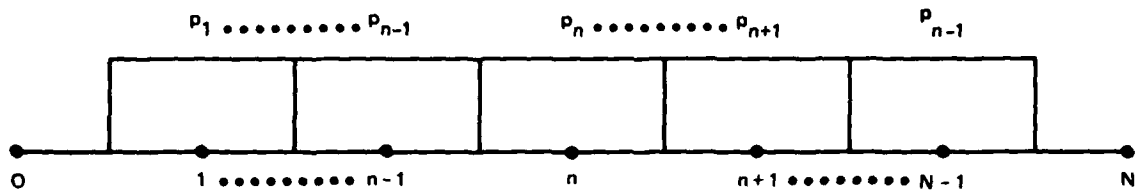

(a) Unweighted current pulses.

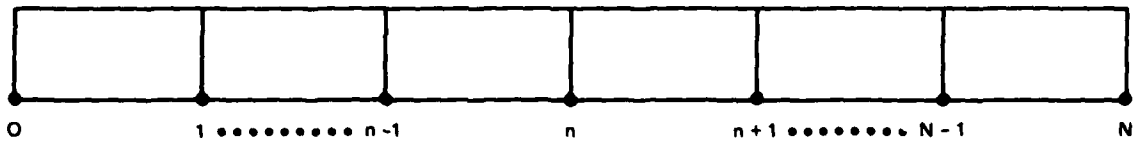

(b) Unweighted charge representation.

Figure 2. Wire segmentation scheme illustrating equally weighted pulses for current and charge.

Substituting (11) into (10) produces a system of equations that can be expressed in matrix form. Each matrix element, Z_{mn} , associated with the n -th current and the s_m observation point involves scalar and vector potential terms with integrals of the form

$$\psi_{m,u,v} = \int_{s_u}^{s_v} k(s_m - s') ds' \quad (12)$$

where

$$k(s-s') = \frac{1}{2\pi} \int_{-\pi}^{\pi} \frac{e^{-jkr_m}}{r_m} d\phi \quad (13)$$

and

$$r_m = \left((s_m - s')^2 + 4a^2 \sin^2 \frac{\phi}{2} \right)^{\frac{1}{2}} \quad (14)$$

Equation (12) does not lend itself to straightforward integration because of the singularity at $r=0$. The $1/r$ can be subtracted from the integrand and then added as a separate term to yield

$$k(s-s') = \frac{1}{2\pi} \int_{-\pi}^{\pi} \frac{d\phi}{r_m} + \frac{1}{2\pi} \int_{-\pi}^{\pi} \frac{e^{-jkr_m} - 1}{r_m} d\phi \quad (15)$$

The first term of (15) can be rewritten as an elliptic integral of the first kind [4].

$$\frac{\beta}{\pi a} F\left(\frac{\pi}{2}, \beta\right) = \frac{1}{2\pi} \int_{-\pi}^{\pi} \frac{d\phi}{r_m} \quad (16)$$

where

$$\beta = \frac{2a}{\left[(s_m - s')^2 + 4a^2 \right]^{\frac{1}{2}}}$$

$F\left(\frac{\pi}{2}, \beta\right)$ has an approximation [4]

$$F\left(\frac{\pi}{2}, \beta\right) \cong [a_0 m + a_1 m + a_2 m^2 + a_3 m^3] \cdot [b_0 + b_1 m + b_2 m^2 + b_3 m^3] \ln(1/m) \quad (17)$$

where

$$m = 1 - \beta^2 = \frac{(s_m - s')^2}{(s_m - s')^2 + 4a^2}$$

and

$a_0 = 1.38629$	436112	$b_0 = .5$
$a_1 = .09666$	344259	$b_1 = .12498$
$a_2 = .03590$	092383	$b_2 = .06880$
$a_3 = .03742$	563713	$b_3 = .03328$
$a_4 = .01451$	196212	$b_4 = .00441$

Thus

$$\frac{\beta}{\pi a} F\left(\frac{\pi}{2}, \beta\right) \xrightarrow{s \rightarrow s'} -\frac{1}{\pi a} \ell n \left[\frac{|s_m - s'|}{8a} \right] \quad (18)$$

and this singularity is also subtracted from $k(s_m - s')$.

Thus

$$k(s_m - s') = -\frac{1}{\pi a} \ell n \left[\frac{|s_m - s'|}{8a} \right] + \frac{\beta F\left(\frac{\pi}{2}, \beta\right) + \ell n \left[\frac{|s_m - s'|}{8a} \right]}{\pi a} + \frac{1}{2\pi} \int_{-\pi}^{\pi} \frac{e^{-jkr} - 1}{r} d\phi \quad (19)$$

This equation is substituted into equation (12) and written as

$$\int_{s_u}^{s_v} k(s-s') ds' = I_1 + I_2 + I_3 \quad (20)$$

I_1 , I_2 , and I_3 are defined as

$$I_1 = -\frac{1}{\pi a} \int_{s_u}^{s_v} \ell n \left[\frac{|s-s'|}{8a} \right] ds' \quad (21)$$

$$= \frac{\beta}{\pi} u(1 - \ell n|u|) \Big|_{u_1}^{u_2}$$

where

$$u_1 = \frac{s_u - s}{8a} \text{ and } u_2 = \frac{s_v - s}{8a}$$

Similarly,

$$I_2 = \int_{s_u}^{s_v} \frac{\beta F\left(\frac{\pi}{2}, \beta\right) + \ell n \left[\frac{|s-s'|}{8a} \right]}{\pi a} ds' \quad (22)$$

This integral has a well behaved integrand and can be integrated numerically. The integration is broken up into two integrals over the ranges (s_u, s) and

(s, s_v) for best accuracy. Four point Gaussian quadrature is used for the numerical integration [5]. The final integral is

$$I_3 = \frac{1}{2\pi} \int_{s_u}^{s_v} \int_{-\pi}^{\pi} \frac{e^{-jkr} - 1}{r} d\phi \quad (23)$$

The integrand is nonsingular and can be integrated numerically. To obviate the need for double integration, it is convenient to approximate the integral by replacing r by a reduced kernel approximation of equation (14).

Thus

$$I_3 = \int_{s_u}^{s_v} \frac{e^{-jkr_a} - 1}{r_a} ds' \quad (24)$$

where

$$r_a = \sqrt{(s_v - s') + a^2}.$$

The integral can be integrated numerically by the same procedure as for I_2 .

Thus, equation (12) with its singularity problem is evaluated by adding I_1 of equation (21), I_2 of equation (22), and I_3 of equation (24).

By substitution, the matrix equation to be solved is

$$[Z_{mn}] [I_n] = [V_m] \quad (25)$$

where

$$Z_{mn} = \frac{-1}{4\pi j\omega\epsilon} \left[k^2 (\bar{r}_{m+\frac{1}{2}} - \bar{r}_{m-\frac{1}{2}}) \cdot (\hat{s}_{n+\frac{1}{2}} \psi_{m,n,n+\frac{1}{2}} + \hat{s}_{n-\frac{1}{2}} \psi_{m,n-\frac{1}{2},n}) \right. \\ \left. - \frac{\psi_{m+\frac{1}{2},n,n+1}}{s_{n+1} - s_n} + \frac{\psi_{m+\frac{1}{2},n-1,n}}{s_n - s_{n-1}} + \frac{\psi_{m-\frac{1}{2},n,n+1}}{s_{n+1} - s_n} - \frac{\psi_{m-\frac{1}{2},n-1,n}}{s_n - s_{n-1}} \right] \quad (26)$$

and

$$V_m = \bar{E}_{inc}(s_m) \cdot (\bar{r}_{m+\frac{1}{2}} - \bar{r}_{m-\frac{1}{2}}) \quad (27)$$

$[Z_{mn}]$ is a square matrix and $[I_n]$ and $[V_m]$ are column matrices with $n=1,2,\dots,N$ and $m=1,2,\dots,N$ for N total unknowns (N is the total number of current pulses). The extension of these equations to two or more coupled wires follows the same line of development and will not be covered here.

The column vector $[V_m]$ represents an applied voltage that superimposes a constant tangential electric field along the wire for a distance of one segment length centered coincident with the location of the current pulses. Hence, for a transmitting antenna, all elements of $[V_m]$ are set to zero except for the element(s) corresponding to the segment(s) located at the desired feed point(s). For an incident plane wave, all elements of $[V_m]$ must be assigned a value depending on the strength, polarization (or orientation), and angle of incidence of the plane wave. The applied voltage source (transmit case), however, is the only ready-made or programmed option in MININEC.

As stated above, the $[Z_{mn}]$ matrix in (25) is filled by the evaluation of an elliptic integral and use of Gaussian quadrature for numerical integration. The solution of (25) can be accomplished by using any one of a number of standard matrix solution techniques. MININEC uses the Gauss elimination procedure with partial pivoting [5].

2.2 WIRE JUNCTIONS

The theory developed thus far for straight wires is equally applicable to bent wires. However, for coding simplicity in MININEC, bent wires are treated in the same way as the junctions of multiple numbers of wires. That is, a bend in an otherwise straight wire is treated as the junction of two straight wires.

It has been generally accepted that the currents at junctions of thin wires conform to Kirchoff's current law [6]. Rather than explicitly enforcing this condition in MININEC, an overlapping segment scheme [7] is employed at junctions of two or more wires. A detailed discussion of this approach, including arguments for validity, appears in both references 6 and 7. Only those aspects essential to the use of MININEC are discussed here.

Consider a wire having no connections at either end. The wire is subdivided into segments and the current is expanded in pulses centered at adjacent segment junctions as described above and illustrated in figure 3(a).

The end points have no pulses, or alternatively the end points have half pulses with zero amplitude. A second wire is to be attached to one end of the first. The second wire is subdivided into segments with pulses for currents located as in the first case. However, a full pulse is located at the attachment end with half the pulse extending onto wire two and half onto wire one, as illustrated in figure 3(b). The half on wire one assumes the dimensions (length and radius) of a half segment on wire one while the half on wire two assumes the dimensions appropriate to wire two. Wire two overlaps onto wire one with a full pulse centered at the junction end. Note that the free end of the wire has a zero half pulse. A third wire may be assumed to also overlap onto wire one, as illustrated in figure 3(c). Alternatively, wire three could have overlapped onto wire two (not illustrated here). The choice is a user option. It is assumed that a wire can overlap onto another wire provided that another wire was previously specified. Either end of a wire may overlap onto either end of another wire. All that is required to impose the continuity conditions at the junction is that there be N-1 overlaps for a junction of N wires.

Current reference directions are assumed based on the order in which the coordinates of a wire are specified. A positive wire current is from the end first specified, end one, towards the other end, end two. By use of Kirchoff's current law and the current reference direction, the currents at the junction can be found. For example, suppose the wires in figure 3(c) are all specified from left to right. Then the currents out of the junction into wires two and three are the complex amplitudes of the first pulses, the overlapping pulses, on wires two and three, respectively. Hence, the current on wire one into the junction is the sum of these currents; ie, $I_1 = I_2 + I_3$.

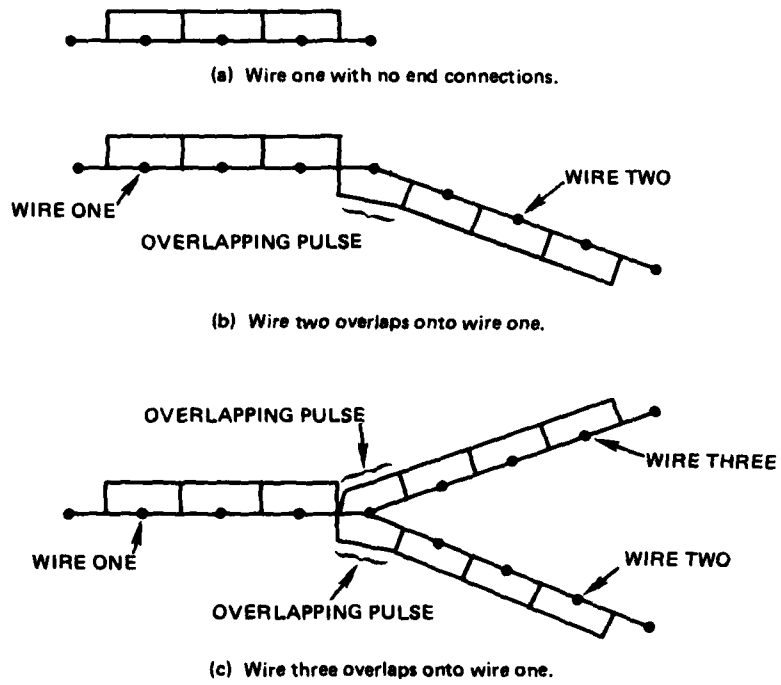

Figure 3. Illustration of the overlap scheme used at multiple wire junctions.

2.3 THE GROUND PLANE

The method of images is used in MININEC to solve for currents in wires located over a perfectly conducting ground plane.

Consider a wire structure represented by N segments. In the presence of a perfectly conducting ground plane, by image theory, the structure and ground plane may be replaced by the original structure and its image. Hence, there are now $2N$ segments and $2N$ unknowns to be determined. Equation (25) can be written as

$$\begin{bmatrix} V_{.1} \\ \vdots \\ V_{.N} \\ \vdots \\ V_{2N} \end{bmatrix} = \begin{bmatrix} Z_{.11} & \cdots & Z_{.1N} & \cdots & Z_{.2N} \\ \vdots & & \vdots & & \vdots \\ Z_{.N1} & \cdots & Z_{.NN} & & \vdots \\ \vdots & & \vdots & & \vdots \\ Z_{.N,2N} & \cdots & \cdots & \cdots & Z_{.2N,2N} \end{bmatrix} \begin{bmatrix} I_{.1} \\ \vdots \\ I_{.N} \\ \vdots \\ I_{2N} \end{bmatrix} \quad (28)$$

The image currents, $I_{N+1} \dots I_{2N}$, are equal to the currents on the original structure, $I_1 \dots I_N$, so that $I_n = I_{2N-n+1}$. Half the equations represented in (28) contain redundant information and may be discarded. It may be reduced to a square matrix again by adding appropriate columns; ie, by using the current identity. Hence, (28) becomes

$$V = [Z'_{ij}] I \quad (29)$$

where $Z'_{ij} = Z_{ij} + Z_{i, 2N-j+1}$.

For a wire attached to ground, a current pulse is automatically added to the wire end point connected to ground so that current continuity with its image is observed; ie, a half segment is placed on both the wire end and its image. The voltage in (29) is divided by two in this case. Either end of a wire may be attached to ground.

2.4 LUMPED PARAMETER IMPEDANCE LOADING

The wire structures modeled so far consist of perfectly conducting wires. If an impedance due to a fixed load, $Z_L = R + jX$, is added to the structure so that its location coincides with that of one or more of the non-zero-current pulse functions—ie, a lumped load is placed on the wire at the junction of

two segments—then the load introduces an additional voltage (a voltage drop) equal to the product of the current pulse magnitude and Z_L . Hence, (25) becomes:

$$[Z'_{mn}][I_n] = [V_m] \quad (30)$$

where $Z'_{mn} = Z_{mn}$ for $m \neq n$ and $Z'_{mn} = Z_{mn} + Z_L$ for $m = n$. Hence, a specified impedance represented as the sum of a resistance and a reactance and located on a wire coincident with a current pulse is simply added to the diagonal impedance element or self-term corresponding to that pulse.

A distributed impedance such as wire conductivity can be treated in the same way by use of an equivalent lumped circuit element impedance relationship.

2.5 FAR ZONE RADIATION PATTERNS

Once the induced currents on the wires have been determined from (25), the radiated electric fields are computed by

$$\vec{E}(\vec{r}_o) = \frac{j k \eta}{4\pi} \cdot \frac{e^{-j k r_o}}{r_o} \cdot \int_L [(\hat{k} \cdot \vec{I}(s)) \hat{k} - \vec{I}(s)] e^{i \vec{K} \cdot \vec{r}} ds \quad (31)$$

where \vec{r}_o is the position vector at the observation point, $\hat{k} = \vec{r}_o / |\vec{r}_o|$, and $\vec{K} = k \hat{k} = \frac{2\pi}{\lambda} \hat{k}$. In MININEC, the factor $e^{-j k r_o} / r_o$ is set to one and the integral evaluated in closed form by an approach similar to that in NEC [2].

The power gain of an antenna in a given direction (θ, ϕ) in spherical coordinates is

$$G = 10 \log \left(\frac{4\pi P(\theta, \phi)}{P_{IN}} \right) \quad (32)$$

where $P(\theta, \phi)$ is the power radiated per unit steradian in the direction (θ, ϕ) and P_{IN} is the total input power to the antenna.¹ P_{IN} is calculated from the applied voltages and the corresponding feed point currents as

¹ Note that directive gain could be obtained by replacing P_{IN} by the total power radiated. This step is not done in MININEC.

$$P_{IN} = \sum_{i=1}^N \frac{1}{2} \text{Re}(V_n I_n^*) \quad (33)$$

where I_n^* denotes complex conjugate and n is the number of sources. $P(\theta, \phi)$ is determined from

$$P(\theta, \phi) = \frac{1}{2} r_o^2 \text{Re}[\bar{E} \times \bar{H}] = \frac{r_o^2}{2\eta} \bar{E} \cdot \bar{E}^* \quad (34)$$

where r_o is the magnitude of the position vector \bar{r}_o in the (θ, ϕ) direction. In MININEC, the gains are calculated for individual orthogonal components of the field determined from (31). The power gain thus obtained from (32) is in dB above gain of an isotropic antenna.

3.0 VALIDATION

The solution to an antenna problem generated by a thin wire method of moments computer program is at best an approximation. Nonetheless, highly accurate answers can be obtained by careful modeling of the antenna configuration, taking into account the inherent limitations of the computer code. Reliable, accurate answers are obtained when the user has accumulated sufficient experience from frequent exercise of the program to recognize problem areas. He must be fully aware of potential difficulties when initially setting up a problem and when interpreting the results. Consequently, the uninitiated user should run through a number of elementary problems, comparing the results to independent solutions or real world measurements, until he has the confidence to apply the code to a problem for which the answer is unknown.

Development of confidence in the computer solution entails modeling of a number of simple antenna structures found in standard textbooks on antenna theory. The approach is to progress from the simple case to the more complex. Natural first choices are dipoles in free space and over ground (ie, monopoles), followed by inverted T antennas and L antennas, etc. For each antenna type, a number of problems should be selected involving different wire

lengths and radii. The problem should be run a number of times, the segmentation varied (ie, a convergence test performed), and other parameters varied to reveal the program limits first hand. Comparison to measured data or highly accurate and well-converged numerical results can provide the insight required for effective application of the code.

Figures 4, 5, and 6 show the results of a set of convergence tests of MININEC for an electrically short dipole (shorter than first resonance length), a dipole near resonance, and a dipole near antiresonance, respectively. Each is an electrically thin, center driven dipole in free space. For convenience of comparison, the admittance computed by RWP King [8] is indicated by dotted lines.

The rapid convergence and stability of solution typical of MININEC for antennas shorter than a wavelength are readily apparent in Figures 4 and 5. With only four segments the admittance of the electrically short antenna, figure 4, is within 10% of the real part and within 4% of the imaginary part compared to King. With 22 segments, the maximum number plotted, the real part is within 4% and the imaginary part within 2%. In figure 5, four segments place the real part within 2% and the imaginary part within 26%. At 8 segments, the imaginary part is down to 1% but the real part is 14%. With 22 segments, the real part has returned to within 1% and the imaginary part is within 3%. The rapid convergence of MININEC compared to NEC on a resonant dipole is to be expected because of the Galerkin procedure used. The rapid convergence on antennas away from resonance is an unexpected result verified for a number of cases with different radii and antenna length.

A much more severe test of convergence for most methods of moments codes is the antiresonance or one wavelength dipole. This case is shown in figure 6. Also shown for reference is the convergence test for NEC. The codes exhibit similar behavior. The real part of the admittance is fairly stable but never gets closer than about 4% to King for either code. The imaginary part does not converge for either code; however, MININEC reaches the same value as King with fewer segments than NEC. The failure to converge is probably related to the source model representation in both cases. The NEC results were obtained by using a FORTRAN version on a VAX while the MININEC results are from a BASIC version running on a Univac computer. Differences in

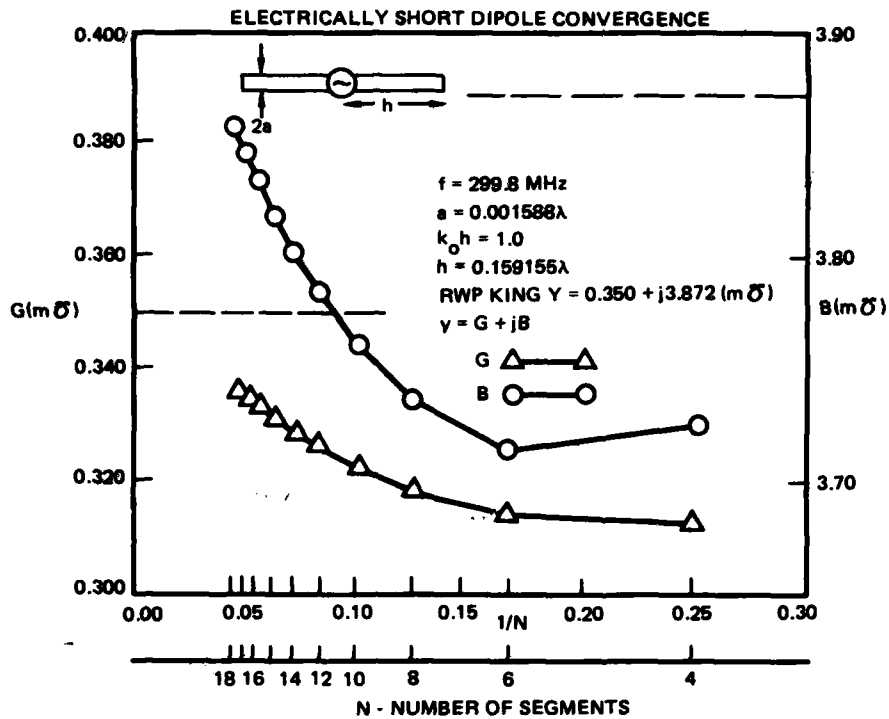

Figure 4. Convergence test of MININEC for an electrically short dipole.

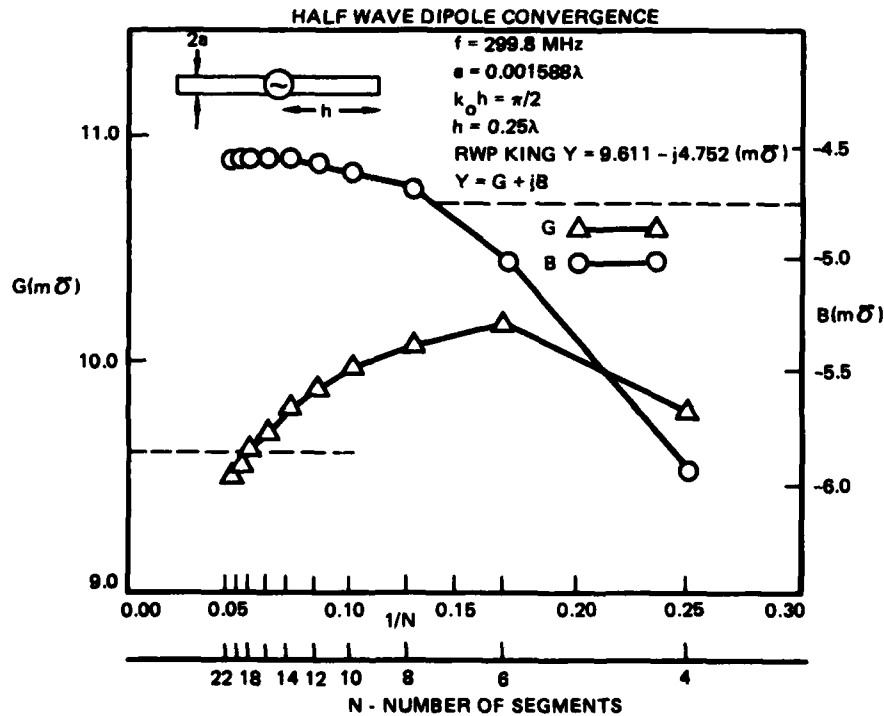

Figure 5. Convergence test of MININEC for a dipole near first resonance.

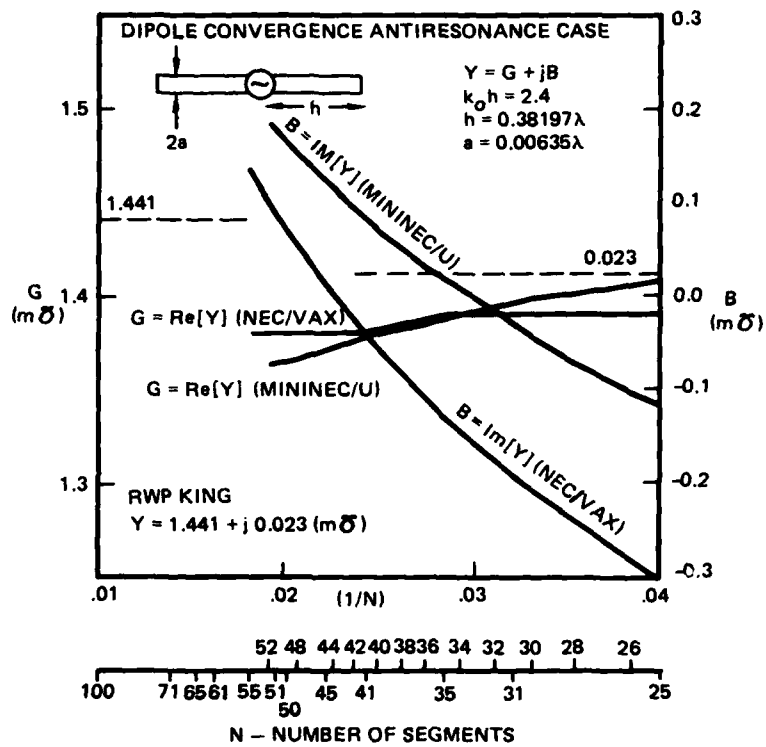

Figure 6. Convergence test of MININEC and NEC for a one-wavelength dipole.

computer word lengths and computer languages must be addressed before any conclusions are drawn. This aspect of the assessment of the MININEC formulation has yet to be completed.

Another useful test is to observe the current behavior of a dipole as the frequency is reduced. The results of such a test of MININEC are given in figure 7 for a 10-segment dipole in free space. The source point current is plotted against antenna length. Also shown for reference is a 9-segment dipole test (essentially the same test) of NEC performed by Burke on a CDC computer [9]. The MININEC results were obtained from the Univac. The MININEC currents behave well with antenna lengths as short as 10^{-3} wavelength. At 10^{-4} , the currents are nonphysical and cannot be plotted here. The CDC version of NEC works down to 10^{-7} wavelength before the currents begin to deviate from the expected behavior. The Univac and VAX versions of NEC break up in the vicinity of 10^{-4} wavelength. The point at which the solution is no longer accurate is highly machine dependent and in principle can be predicted. The longer word length of the CDC machine accounts for the big difference shown. However, it is worth noting that MININEC written in BASIC can keep pace with the Univac and VAX versions of NEC.

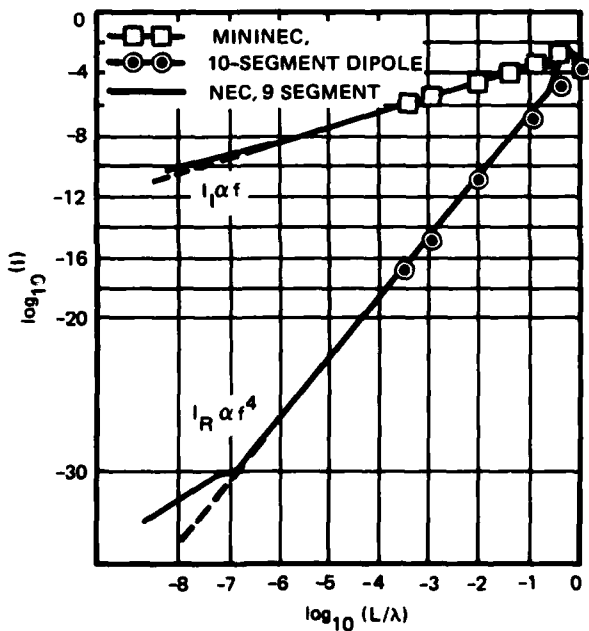

Figure 7. Comparison of the low frequency behavior of MININEC to that of NEC. The NEC data are from a CDC version.

The results of convergence tests of MININEC indicate that for dipoles shorter than a wavelength, as few as 4 segments can give an accurate result. For best results 8 to 18 segments should be used. For a one-wavelength antenna, 30 to 36 segments should be used.

The accuracy of a method of moments solution using the thin wire approximation depends on the ratio of segment length to radius, Δ/a , as well as the number of segments and antenna length, as shown above. Figure 8 gives some results of a test on MININEC designed to explore the radius limitation. A 20 segment model of a half wave dipole in free space is used. Shown is the admittance versus radius. The Δ/a ratio is also shown. As expected, the dipole approaches resonance for very thin wires as the end cap effect becomes less important. The data for thick wires stop at $\Delta/a = 1$, where the dipole again passes through resonance. The validity of the solution is questionable for thicker wires. For comparison, a few values for thick dipoles taken from King [9] are plotted. The insert is a table of these data including the results from MININEC. Both real and imaginary parts agree closely with King. The real part is within 0.3% to 10% of King and the imaginary part varies from 3% to 10%. The data indicate that accurate answers can be obtained for thick wires when Δ/a is 2.5 or greater.

Figure 9 compares five computer programs including MININEC for two different T antennas. In each case, the programs were tested for convergence and the best answer with respect to measurements is given. The measured data are by Parsad [10]. NEC is the code previously described [2]. TGP (Triangular-Galerkin Procedure) is the code written by Kuo and Straight [7] using triangular expansion and testing functions in a Galerkin procedure (ie, triangles for both testing and expansion functions). PSRT (Piece-wise Sinusoidal Reaction Technique) is a sinusoidal Galerkin code written by Richmond [11]. TWTD (Thin Wire Time Domain) is a time domain method of moments code written by Van Blaricum and Miller [12]. TWTD uses subsection collocation (quadratic interpolation with point matching) to solve for the time-dependent induced currents and time-dependent radiated fields. Admittance data are obtained from a discrete Fourier transform of the source current. All codes except MININEC are in FORTRAN and require main-frame (large) computers. The data show that MININEC can provide equally accurate answers.

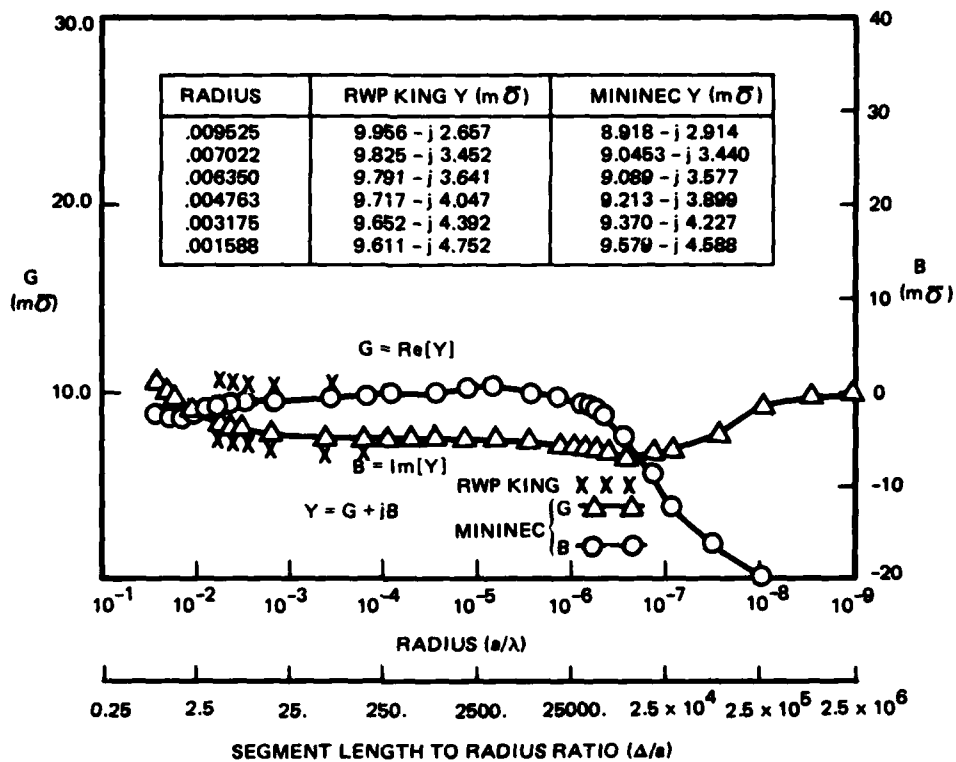

Figure 8. Test of MININEC for dependence on radius.

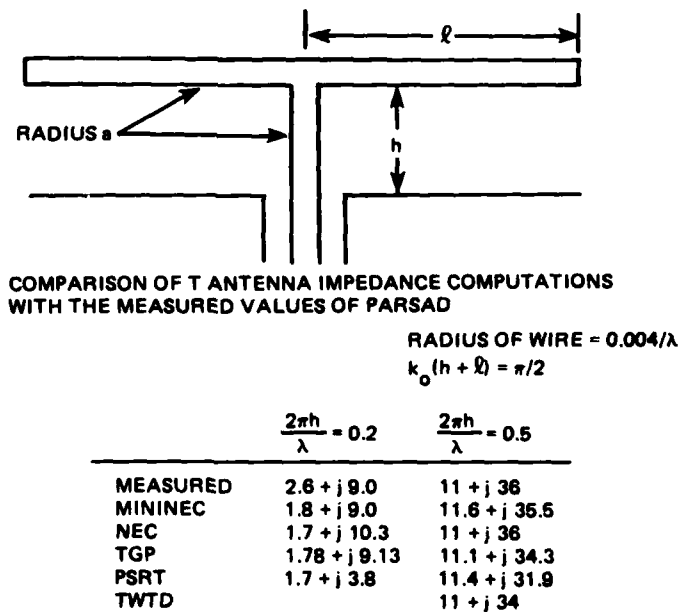

Figure 9. Comparison of MININEC to measurements and other computer codes.

Antenna problems often involve modeling structures with abrupt changes in wire radii. Figure 10 shows the geometry of a stepped radius problem extensively studied by Glisson and Wilton [13]. Figures 11, 12, and 13 show their results for stepped radius ratios of 1.25, 10, and 100, respectively. The solid curves are from PEC, a body of revolution computer code adapted by Glisson and Wilton to very accurately solve the stepped radius problem. The NEC values are also from their report. The MININEC results agree fairly well near the stepped radius junction and along the thinner wires. Most of the difference can be attributed to the displacement in the source location. In each figure, the source for the MININEC data is at FEED-2 while the source for the other data is at FEED-1. This displacement results from the segmentation scheme used to model the problem.

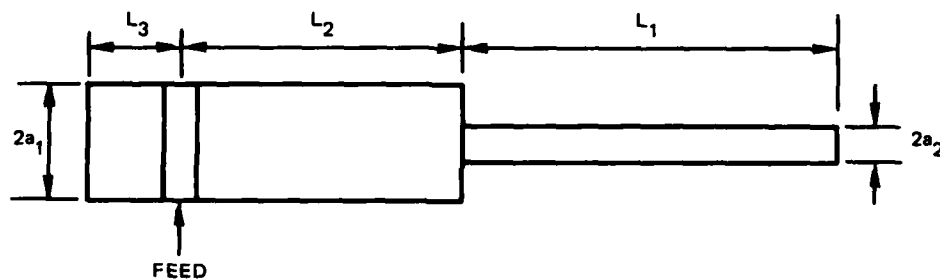

Figure 10. Geometry for the stepped radius problem.

The last example is a loop antenna. Figure 14 shows the current distribution on a one-wavelength-circumference loop antenna. The solid curves are taken from King [14]. Only half of the loop is shown since the currents are symmetric. The feed is at 0 degrees. The MININEC model consisted of a ten-side polygon, since curved wires must be modeled with short straight wires. Each wire except the first had two segments. The first wire had three segments, the minimum requirement for unconnected wires (which is the case for the first wire input). Twenty-one pulses in all were used.

The differences in the data are mostly attributable to the polygon model of the loop. A larger number of sides and, hence, unknowns (pulses) could also improve the results. The data shown were obtained on an Apple computer which took 1.5 hours. Hence, no attempt was made to improve the answer by adding more wires. However, the currents thus obtained are within 10% of King's results.

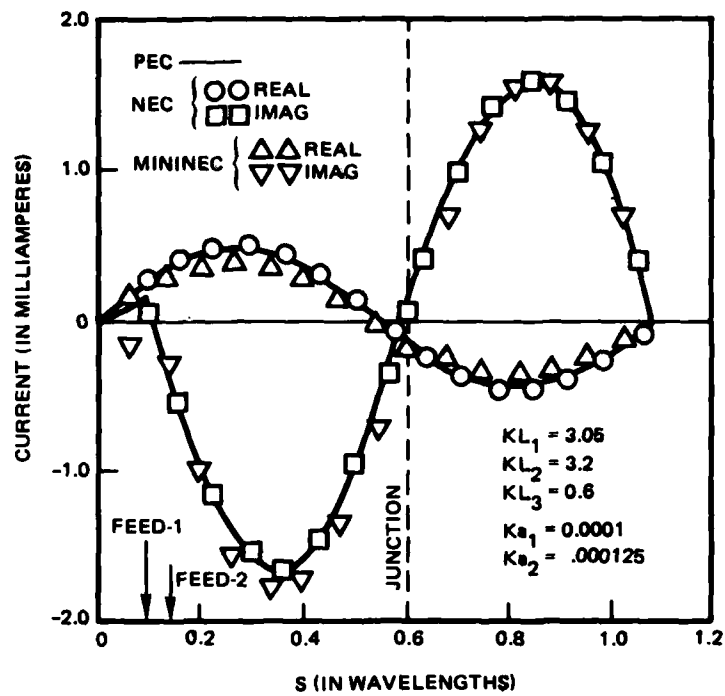

Figure 11. Currents for the stepped radius problem with $a_2/a_1 = 1.25$.

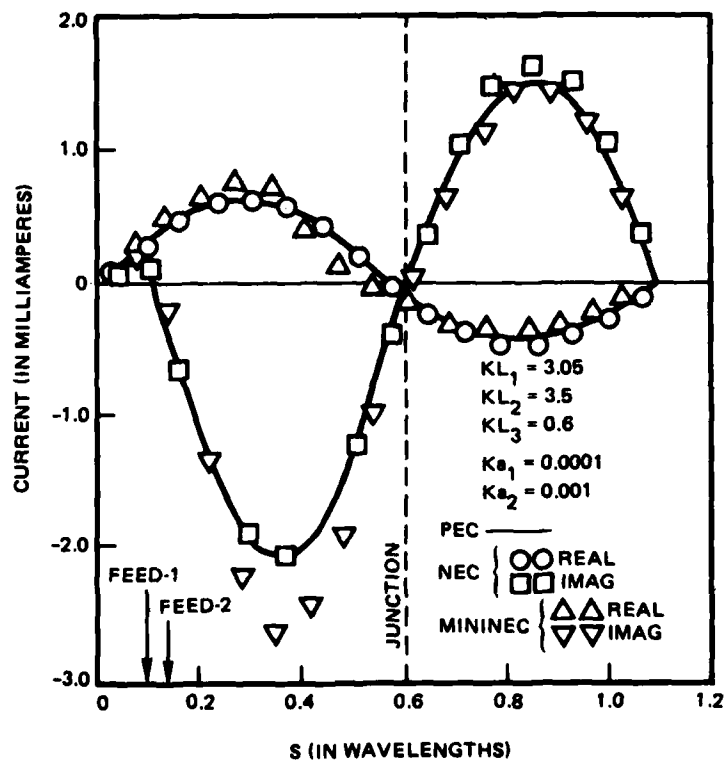

Figure 12. Currents for a stepped radius of $a_2/a_1 = 10$.

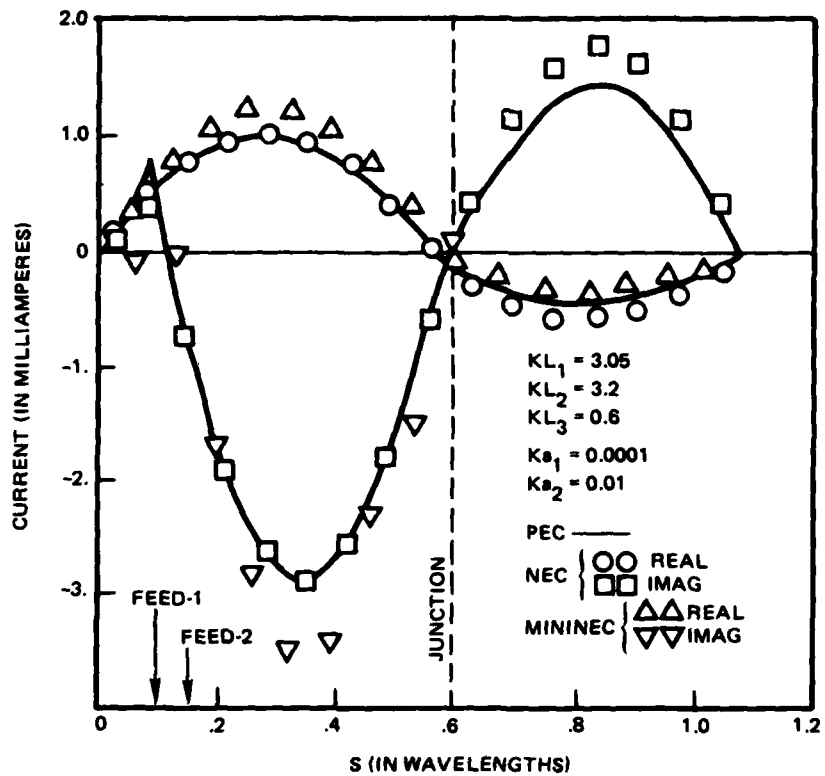

Figure 13. Currents for a stepped radius of $a_2/a_1 = 100$.

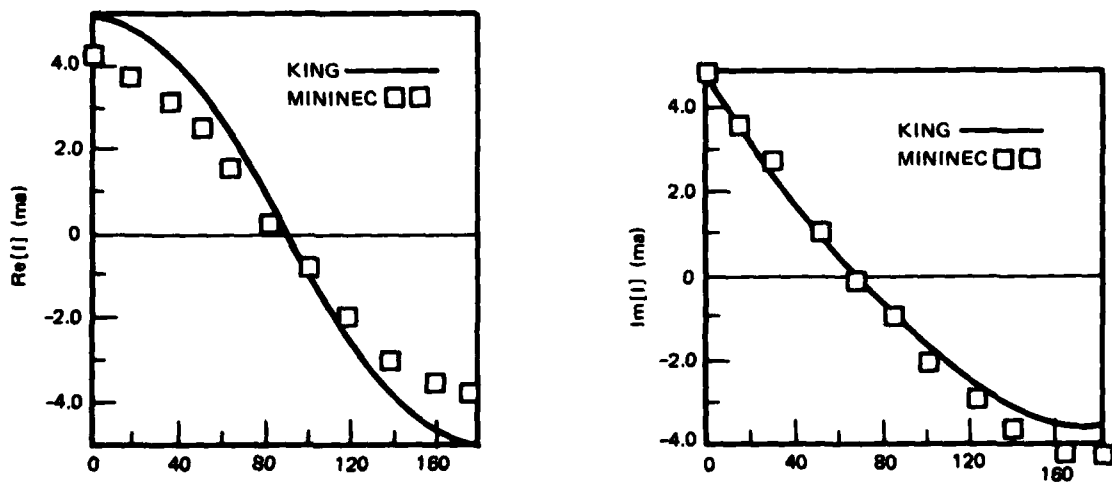

Figure 14. Real and imaginary current components for a one-wavelength circumference loop with wire radius of 0.00674λ .

4.0 CONCLUSIONS

The formulation used in MININEC results in a compact computer code suitable for use on microcomputers. The results indicate that MININEC is as accurate as any of the presently available thin wire computer codes, most of which, in contrast to MININEC, must be supported by large, main-frame computer facilities. It is possible to design and analyze a wide range of antenna types by using MININEC.

It has been demonstrated that MININEC converges rapidly and displays very good solution stability. The BASIC language version provides valid results for a very broad range of wire thicknesses and segment sizes. This implies a potential for superior performance on many difficult antenna problems that often limit the use of other computer codes. An example is in the low frequency limit. Translation of MININEC into FORTRAN and utilization of high precision computers may prove highly successful for modeling LF and VLF antennas. The savings in computer code size and the stability, convergence, and accuracy of the solution make this formulation a leading candidate for the next generation antenna modeling code (ie, the next generation NEC).

REFERENCES

1. D.R. Wilton, "Wire Problems," Lecture Notes for Short Course on Computational Methods in Electromagnetics, 1981.
2. G.J. Burke and A.J. Poggio, "Numerical Electromagnetics Code (NEC)--Method of Moments," NOSC TD 116, January 1981.
3. D.R. Wilton, Private Communication.
4. M. Abramowitz and I. Stegun, editor, Handbook of Mathematical Functions, NBS Applied Mathematics Series 35, Government Printing Office, November 1980, pp 590-592.
5. A. Ralston, "A First Course in Numerical Analysis," McGraw-Hill, New York, 1965.
6. J.C. Logan, "A Comparison of Techniques for Treating Radiation and Scattering by Bent Wire Configurations with Junctions," Syracuse University Technical Report, TR-73-10, National Science Foundation Grant GK-4227, August 1973.
7. H.H. Chao and B.J. Strait, "Computer Programs for Radiation and Scattering by Arbitrary Configurations of Bent Wires," Scientific Report No. 7, Contract F19628-68-0180, AFCRL-700374, September 1970.
8. R.W.P. King, "Tables of Antenna Characteristics," IFI/Plenum Data Corporation, 1971.
9. R. Adler, G.J. Burke and J.C. Logan, Lecture Notes for NEC Short Course, 1981.

10. S. Parsad and R.W.P. King, "Experimental Study of Inverted L-, T-, and Related Transmission Line Antennas," Journal of Research of the National Bureau of Standards--D Radio Propagation, V. 65D, no. 5, September-October 1961.
11. J.H. Richmond, "Computer Program for Thin-Wire Structures in a Homogeneous Conducting Medium," NASA Technical Report 2902-12, Grant No. NGL 36-008-138, August 1973.
12. M. Van Blaricum and E.K. Miller, "TWTD: A Computer Program for Time Domain Analysis of Thin Wire Structures," Lawrence Livermore Laboratory Report, UCRL-51277, October 28, 1972.
13. A.W. Glisson and D.R. Wilton, "Numerical Procedures for Handling Stepped-Radius Wire Functions," University of Mississippi final report for contract N66001-E-0156, March 1974.
14. R.W.P. King, "Antennas and Waves: A Modern Approach," MIT Press, 1969.

APPENDIX A

INPUT/OUTPUT FORMAT OF MININEC

INPUT/OUTPUT FORMAT OF MININEC

The input format for running MININEC has been designed for use in an interactive mode from a suitable terminal. The user is prompted with key questions to set up the antenna geometry and environment. Execution of the solution routines is automatic as soon as the antenna problem is fully specified. Appendix B contains a sample run showing the input/output format.

Figure A-1 is a flow diagram illustrating user options. First the antenna geometry is set up. The user is prompted to supply the number of wires. Then, for each wire in turn, he is prompted for the number of segments, coordinates of end points, connection data, and radius. The coordinates of wire ends are specified with respect to the global coordinate system illustrated in figure A-2. Coordinates and radii must be in meters. Up to 10 wires with a total of 70 segments are allowed. This corresponds to a maximum of 50 current pulses. The wires are automatically segmented with the specified number of equal segments on each wire and the results are displayed. The display gives the location (coordinates) of each current pulse, the corresponding radius, and the wire connection data. The connection data are a set of integers that can be interpreted to verify the wire antenna configuration. The user may then elect to change the geometry or continue.

The wire connection data are user-specified information that allows the code to keep track of wire junctions, impose the boundary conditions along the wire (choose the limits of integration), and force the current to zero at free wire ends. The convention uses an integer, related to the wire number, whose value determines the connection. The connection data are requested for each wire end after the wire end coordinates have been specified. The code determines individual pulse connection data automatically. Of course, a proper connection requires identical coordinates for the end points of wires to be connected, or zero elevation ($z=0$) for connection to ground. The ground plane is in the X-Y principal plane.

A zero indicates no connection; ie, a free wire end.

A negative integer with a magnitude equal to the wire number indicates a connection to ground. For example, specifying -1 when prompted for the

connection to end one of wire one will connect that end to ground. Either end of a wire (but not both) may be connected to ground.

A positive or negative integer with a magnitude less than the wire number indicates a wire junction. Note that connection can only be made to a previously specified or already existing wire. A negative integer indicates end one of the wire is connected to end one of another wire or end two of the wire is connected to end two of another wire. A positive integer indicates end one connected to end two or end two connected to end one. For example, figure A-3 is a sketch of a wire T antenna. Suppose the wires are specified in the order shown, with end one of wire one connected to ground. The connection datum for end two of wire one must be zero. End one of wire two is connected to end two of wire one so the connection datum for end one of wire two is +1. End two of wire three is connected to end two of wire one, so the connection datum for end two of wire three is -1. Of course, alternative connection schemes are possible for this antenna provided only two overlaps are used. As described in section 2.2, the connection of wires is accomplished by overlapping segments from one wire onto another, which requires $N-1$ overlaps for a junction of N wires. Specifying the connection data determines the required overlaps.

After the antenna geometry has been set up satisfactorily, the user is prompted to supply the antenna environment and program control. Environment and control data requested include frequency, free space or perfectly conducting ground, whether or not to print the currents, antenna excitation, whether or not patterns are required, and impedance loading.

Excitation and impedance loading are specified by the current pulse number where they are to be applied. The desired pulse number and location can be chosen from inspection of the display of the wire geometry. The excitation is in volts and the impedance in ohms. Up to 50 voltage sources and 50 loads are presently allowed.

The patterns are calculated with respect to the same global coordinate system used to specify the wire geometry. Figure A-2 defines the zenith (θ) and azimuth (ϕ) angles. The user is prompted to give the initial angle, the increment or change in angle between field points, and the number of field points desired. The pattern data displayed give the appropriate zenith and

azimuth angles and the vertical and horizontal (theta and phi components) power gains (in dB).

After the program control has been specified, MININEC solves for the currents and displays the impedances of all sources specified. The currents will be printed and the patterns calculated and printed if these options have been specified. Additional patterns can be calculated without recalculation of the currents. The user may then elect to change any of the control parameters as desired or return to the geometry section to specify a new antenna problem.

The sample output given in appendix A is for the T antenna shown in figure A-3.

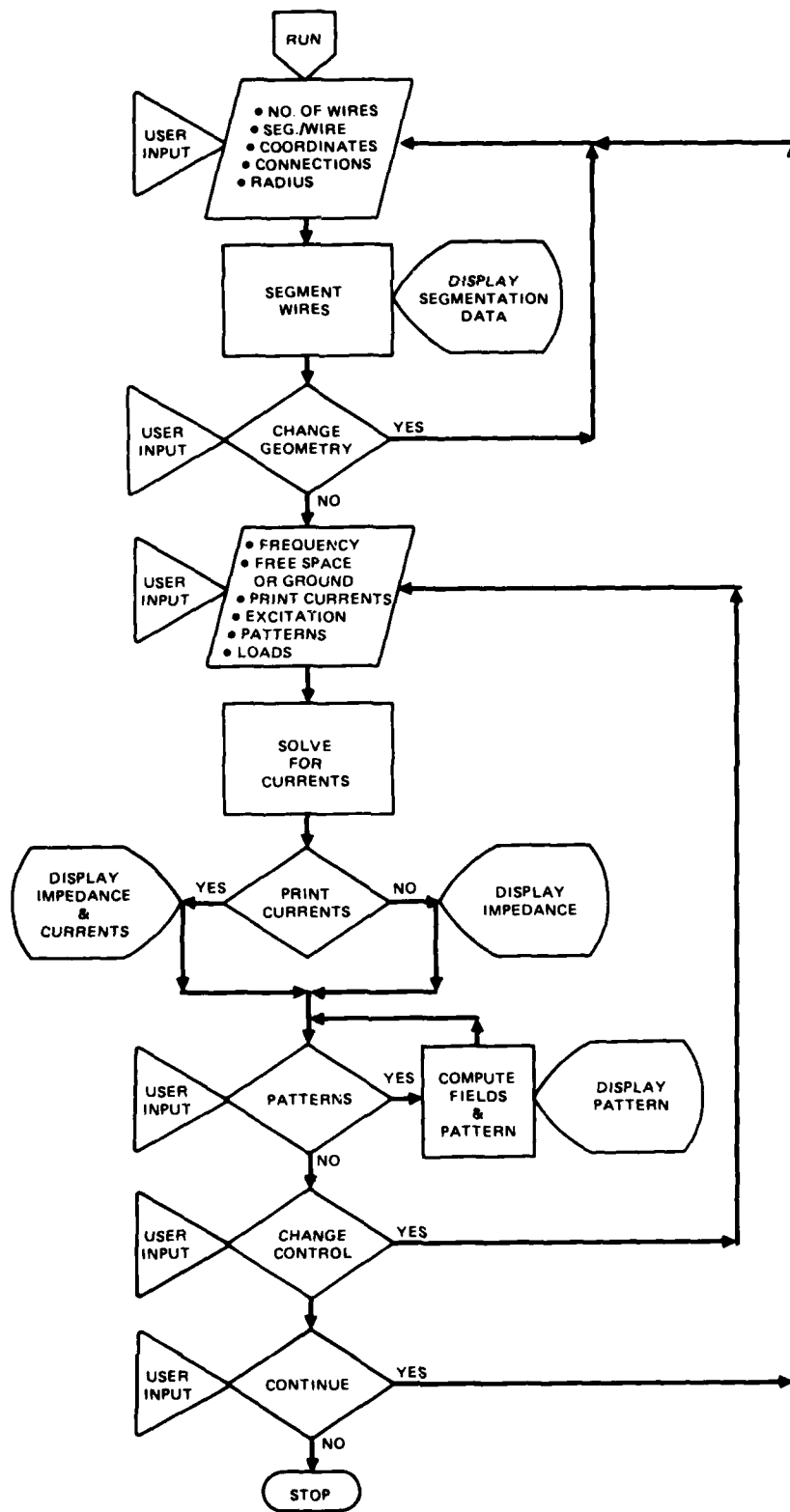

Figure A-1. Flow diagram showing user input options.

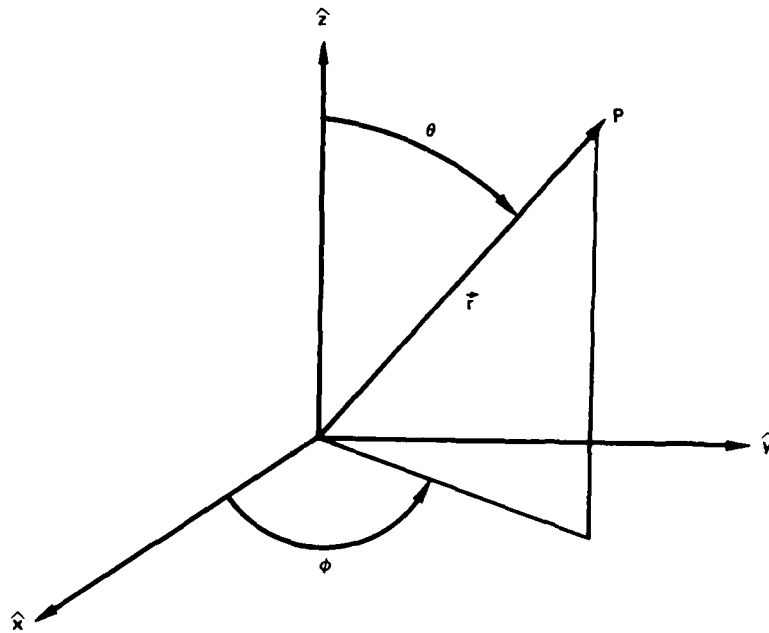

Figure A-2. Global coordinate system for defining wire geometry and patterns.

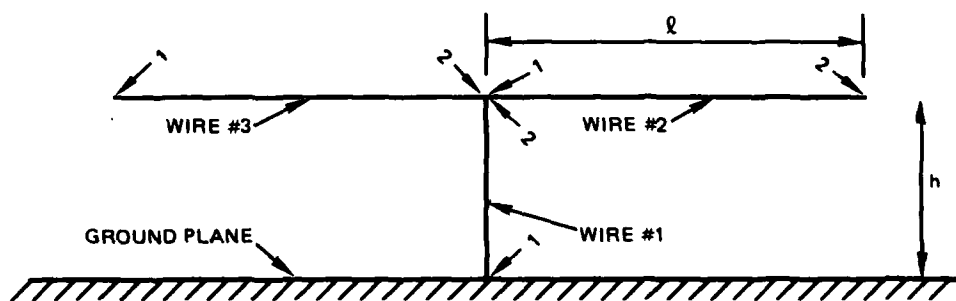

Figure A-3. Sketch of wire T antenna configuration. For this example $h = 0.07958\lambda$, $l = 0.170423\lambda$ and the radius is 0.004λ .

APPENDIX B

MININEC SAMPLE RUN

This sample run is for the T antenna given in Figure A-3

 MINI-NEC

ANTENNA GEOMETRY:
 NO. OF WIRES? >3

WIRE NO. 1
 NO. OF SEGMENTS? >8
 END ONE COORDINATES (X,Y,Z)? >0,0,0
 END ONE CONNECTION?>-1
 END TWO COORDINATES (X,Y,Z)? >0,0,.07958
 END TWO CONNECTION?>0
 RADIUS?>.004

WIRE NO. 2
 NO. OF SEGMENTS? >17
 END ONE COORDINATES (X,Y,Z)? >0,-.170423,.07958
 END ONE CONNECTION?>0
 END TWO COORDINATES (X,Y,Z)? >0,0,.07958
 END TWO CONNECTION?>-1
 RADIUS?>.004

WIRE NO. 3
 NO. OF SEGMENTS? >17
 END ONE COORDINATES (X,Y,Z)? >0,.170423,.07958
 END ONE CONNECTION?>0
 END TWO COORDINATES (X,Y,Z)? >0,0,.07958
 END TWO CONNECTION?>-1
 RADIUS?>.004

**** ANTENNA GEOMETRY ****

X	COORDINATES			RADIUS	CONNECTION		PULS NO.
	Y	Z			END1	END2	
0	0	0		.004	-1	1	1
0	0	.0099475		.004	1	1	2
0	0	.019895		.004	1	1	3
0	0	.0298425		.004	1	1	4
0	0	.03979		.004	1	1	5
0	0	.0497375		.004	1	1	6
0	0	.059685		.004	1	1	7
0	0	.0696325		.004	1	0	8
0	-.16039812	.07958		.004	0	2	9
0	-.15037324	.07958		.004	2	2	10
0	-.14034835	.07958		.004	2	2	11
0	-.13032347	.07958		.004	2	2	12
0	-.12029859	.07958		.004	2	2	13
0	-.11027371	.07958		.004	2	2	14
0	-.10024882	.07958		.004	2	2	15
0	-.09022394	.07958		.004	2	2	16
0	-.08019906	.07958		.004	2	2	17
0	-.07017418	.07958		.004	2	2	18
0	-.0601493	.07958		.004	2	2	19
0	-.05012441	.07958		.004	2	2	20
0	-.04009953	.07958		.004	2	2	21
0	-.03007465	.07958		.004	2	2	22
0	-.02004977	.07958		.004	2	2	23
0	-.01002488	.07958		.004	2	2	24
0	-1.8626451E-09	.07958		.004	2	-1	25

0	.16039812	.07958	.004	0	3	26
0	.15037324	.07958	.004	3	3	27
0	.14034835	.07958	.004	3	3	28
0	.13032347	.07958	.004	3	3	29
0	.12029859	.07958	.004	3	3	30
0	.11027371	.07958	.004	3	3	31
0	.10024882	.07958	.004	3	3	32
0	.09022394	.07958	.004	3	3	33
0	.08019906	.07958	.004	3	3	34
0	.07017418	.07958	.004	3	3	35
0	.0601493	.07958	.004	3	3	36
0	.05012441	.07958	.004	3	3	37
0	.04009953	.07958	.004	3	3	38
0	.03007465	.07958	.004	3	3	39
0	.02004977	.07958	.004	3	3	40
0	.01002488	.07958	.004	3	3	41
0	1.8626451E-09	.07958	.004	3	-1	42

DO YOU WISH TO CHANGE GEOMETRY (Y/N)? >N

PROGRAM CONTROL:

FREQUENCY(MHZ)?>299.8

WAVELENGTH - 1 METERS

ENVIRONMENT (1-FREE SPACE, 2-GROUND)? >2

NO. OF EXCITATIONS?>1

PULSE NO., VOLTAGE MAGNITUDE AND PHASE (DEGREES)? >1,1,0

CURRENT PRINTOUT (Y/N)?>Y

PATTERN (Y/N)? >Y

ZENITH ANGLE: INITIAL, INCREMENT, NUMBER?>0,10,10

AZMUTH ANGLE: INITIAL, INCREMENT, NUMBER? >0,90,2

NO. OF LOADS? >0

*** SOURCE DATA ***

PULSE 1 VOLTAGE = (1 , 0 J)
 CURRENT = (.00828734 , -.02546144 J)
 IMPEDANCE = (11.558916 , 35.512814 J)
 POWER = .00414367 WATTS

***** CURRENT DATA *****

PULSE NO.	REAL (AMPS)	IMAGINARY (AMPS)	MAGNITUDE (AMPS)	PHASE (DEGREES)
1	.00828734	-.02546144	.0267762	-71.970669
2	.00828047	-.02679056	.02804105	-72.824582
3	.00826	-.02709062	.02832188	-73.043397
4	.00822638	-.02731408	.02852599	-73.238897
5	.00818037	-.02740688	.02860167	-73.380751
6	.00812331	-.02739933	.02857816	-73.486047
7	.00805774	-.02730546	.02846956	-73.558861
8	.00798628	-.02713675	.02828752	-73.600968
9	-.00054485	.00185742	.00193568	-73.651496
10	-.00086402	.00294164	.00306591	-73.631376
11	-.00117365	.00399137	.00416035	-73.614176
12	-.00146307	.00497048	.00518133	-73.598087
13	-.00173852	.00590055	.00615134	-73.58313
14	-.00200124	.00678619	.00707512	-73.569304
15	-.0022518	.00762966	.00795502	-73.556705
16	-.00249021	.00843139	.00879144	-73.5455
17	-.0027162	.0091909	.00958386	-73.535945
18	-.0029293	.00990718	.01033117	-73.5284
19	-.00312893	.01057894	.01103197	-73.523369
20	-.0033144	.0112047	.01168463	-73.52154

21	-.00348488	.01178275	.01228729	-73.523845
22	-.00363934	.01231106	.01283772	-73.531516
23	-.00377609	.01278587	.01333182	-73.546368
24	-.00389418	.01320564	.01376784	-73.569881
25	-.00397104	.0135063	.01407797	-73.615914
26	-.00054485	.00185742	.00193568	-73.651497
27	-.00086402	.00294164	.00306591	-73.631377
28	-.00117365	.00399137	.00416035	-73.614178
29	-.00146307	.00497048	.00518133	-73.598088
30	-.00173852	.00590056	.00615134	-73.583131
31	-.00200124	.00678619	.00707512	-73.569304
32	-.0022518	.00762966	.00795502	-73.556705
33	-.00249021	.00843139	.00879144	-73.545501
34	-.0027162	.0091909	.00958386	-73.535946
35	-.0029293	.00990718	.01033117	-73.528401
36	-.00312893	.01057895	.01103197	-73.52337
37	-.0033144	.0112047	.01168463	-73.521541
38	-.00348488	.01178275	.0122873	-73.523846
39	-.00363934	.01231107	.01283773	-73.531518
40	-.0037761	.01278587	.01333182	-73.546369
41	-.00389418	.01320565	.01376785	-73.569882
42	-.00397105	.01350631	.01407798	-73.615916

*** PATTERN DATA ***

ZENITH ANGLE	AZIMUTH ANGLE	HORIZONTAL PATTERN (DB)	VERTICAL PATTERN (DB)
0	0	-132.43736	-999
10	0	-132.90986	-10.950399
20	0	-132.78057	-5.0302875
30	0	-133.94117	-1.6823215
40	0	-134.32722	.56029421
50	0	-135.66638	2.1483884
60	0	-138.36025	3.2742286
70	0	-141.73136	4.0323702
80	0	-147.20159	4.471631
90	0	-163.93231	4.6156869
0	90	-276.79058	-132.43736
10	90	-167.26426	-9.0226239
20	90	-161.80064	-3.2677325
30	90	-159.23718	-.17551738
40	90	-158.15267	1.7488951
50	90	-158.18692	2.9927105
60	90	-159.33578	3.7894699
70	90	-161.95171	4.2751719
80	90	-167.44956	4.5345134
90	90	-294.64912	4.6156869

PATTERNS (Y/N)?>N
CHANGE OF EXCITATION (Y/N)?>N
CONTINUE (Y/N)?>N

APPENDIX C

CODE DESCRIPTION

CODE DESCRIPTION

The following discussion applies to the program listing in Appendix D.

MININEC is written in the BASIC language for use on a microcomputer with at least 64 kilobits memory. It may be used on smaller machines by reducing the array dimensions and accepting the resulting limits on antenna size. The programming approach was to use only those features of the UNIVAC BASIC language that were most likely to be found on microcomputers.

Many microcomputers use BASIC language interpreters rather than compilers. Usually, when searching for subroutines and functions, an interpreter will start at the beginning of the program. Hence, it is faster to place often referenced functions and subroutines at the beginning.

Lines 110 through 360 contain a subroutine to perform the elliptical integrals.

Lines 370 through 940 contain the subroutine for evaluation of the ψ functions including the numerical integration.

Lines 1060 through 1950 are the geometry section. In this section the wire data is input and arrays for the pulse coordinates, segment connection data and segment directional cosines are set up. The results are displayed to the user.

Lines 1960 through 2360 are for input of program control and antenna environment data. In this section the user specifies frequency, free space or ground plane, source and load data, pattern cuts, and current printing.

Lines 2370 through 3410 compute the elements of the Z-matrix.

Lines 3430 through 3480 modify the Z-matrix to account for impedance loading.

Lines 3490 through 4100 apply Gaussian elimination to the Z-matrix.

Lines 4110 through 4280 solve for the currents.

Lines 4290 through 4450 calculate and print out the source impedance and power input.

Lines 4460 through 4530 print out the currents.

Lines 4560 through 5500 calculate and print out the radiation patterns.

APPENDIX D

COMPUTER LISTING OF MININEC

```

00100 GOTO 950
00110 X3=T*D(P4)
00120 Y3=T*F(P4)
00130 Z3=F*T*G(P4)
00140 D=D0-2*F3*(X3*X2+Y3*Y2+Z3*Z2)+X3*X3+Y3*Y3+Z3*Z3
00150 D=SQR(D)
00160 IF I6=H0 GOTO 330
00170 D3=D*D-A2
00180 B=D3/(D3+4*A2)
00190 V1=W(1)
00200 V2=W(6)
00210 B1=1
00220 B2=-36
00230 FOR L2=2 TO 5
00240 B2=B2/(L2-1)
00250 IF B<10^(B2) GOTO 300
00260 B1=B1*B
00270 V1=V1+W(L2)*B1
00280 V2=V2+W(L2+5)*B1
00290 NEXT L2
00300 V=(V1-V2*LOG(B))*SQR(1-B)
00310 D3=SQR(D3)/8/A(P4)
00320 T3=T3+(LOG(D3)+V)/P/A(P4)-1/D
00330 B1=D*W
00340 T3=T3+COS(B1)/D
00350 T4=T4-SIN(B1)/D
00360 RETURN
00370 IF FRP(P1)=H0 GOTO 500
00380 I4=INT(P1+1)
00390 I5=INT(P1)
00400 X1=(X(I4)+X(I5))/2
00410 Y1=(Y(I4)+Y(I5))/2
00420 Z1=(Z(I4)+Z(I5))/2
00430 X2=X1-X(P2)
00440 Y2=Y1-Y(P2)
00450 Z2=Z1-Z(P2)*F
00460 X3=X1-X(P3)
00470 Y3=Y1-Y(P3)
00480 Z3=Z1-Z(P3)*F
00490 GOTO 590
00500 I4=INT(P2+1)
00510 IF FRP(P2)=H0 THEN I4=P2
00520 I5=INT(P2)
00530 X2=X(P1)-(X(I4)+X(I5))/2
00540 Y2=Y(P1)-(Y(I4)+Y(I5))/2
00550 Z2=Z(P1)-F*(Z(I4)+Z(I5))/2
00560 X3=X(P1)-X(P3)
00570 Y3=Y(P1)-Y(P3)
00580 Z3=Z(P1)-F*Z(P3)
00590 D0=X2*X2+Y2*Y2+Z2*Z2
00600 D3=X3*X3+Y3*Y3+Z3*Z3
00610 S4=(P3-P2)*S(P4)
00620 F2=1
00630 N3=7
00640 T1=H0
00650 T2=T1

```

```

00660 T=S(P4)+.001*A(P4)
00670 A2=A(P4)*A(P4)
00680 IF SQR(D3)+SQR(D0)>T GOTO 740
00690 I6=16*A(P4)/S(P4)
00700 IF FRP(P1)>0 THEN F2=2
00710 I6=F2*(1+LOG(I6))*S(P4)/P/A(P4)/2
00720 IF FRP(P1)>0 THEN S4=S(P4)/2
00730 GOTO 780
00740 T=SQR(D0)/ABS(S4)
00750 IF T>3 THEN N3=3
00760 IF T>5 THEN N3=1
00770 I6=H0
00780 I5=N3*2
00790 D0=D0+A2
00800 L=N3
00810 T3=H0
00820 T4=T3
00830 T=S4*(Q(L)+.5)
00840 GOSUB 110
00850 T=S4*(.5-Q(L))
00860 GOSUB 110
00870 L=L+1
00880 T1=T1+Q(L)*T3
00890 T2=T2+Q(L)*T4
00900 L=L+1
00910 IF L<I5 GOTO 810
00920 T1=F2*T1*S4+I6
00930 T2=F2*T2*S4
00940 RETURN
00950 DIM R(50,50),N(50),X(70),Y(70),Z(70),E(50),L(50),M(50),D(10),F(10),A(
00960 DIM C(50,2),H(50),I(50),J(50),K(50),Q(14),W(10),B(50,50),G(10),S(10).
00970 P=4*ATN(1)
00980 PO=P/180
00990 READ Q(1),Q(2),Q(3),Q(4),Q(5),Q(6),Q(7),Q(8),Q(9),Q(10),Q(11),Q(12)
01000 READ Q(13),Q(14),GO,W(1),W(2),W(3),W(4),W(5),W(6),W(7),W(8),W(9),W(10)
01010 DATA .288675135,.5,.430568156,.173927423,.169990522,.326072577
01020 DATA .480144928,.050614268,.398333239,.111190517
01030 DATA .262766205,.156853323,.091717321,.181341892,29.979221
01040 DATA 1.38629436,.09666344,.03590092,.03742563713,.01451196
01050 DATA .5,.12498594,.06880249,.0332836,.0041787
01060 PRINT '*****'
01070 PRINT 'MINI-NEC'
01080 PRINT '*****'
01090 PRINT 'ANTENNA GEOMETRY:'
01100 PRINT 'NO. OF WIRES';
01110 INPUT W
01120 N=0
01130 PRINT
01140 FOR I=1 TO W
01150 PRINT 'WIRE NO. ';I
01160 PRINT 'NO. OF SEGMENTS';
01170 INPUT S1
01180 PRINT 'END ONE COORDINATES (X,Y,Z)';
01190 INPUT X1,Y1,Z1
01200 PRINT 'END ONE CONNECTION';
01210 INPUT I1
01220 PRINT 'END TWO COORDINATES (X,Y,Z)';
01230 INPUT X2,Y2,Z2

```



```

01820 FOR I=1 TO N
01830 J=C(I,2)
01840 IF C(I,2)<C(I,1) THEN J=C(I,1)
01850 I1=I1+1
01860 IF C(I,2)<=0 GOTO 1880
01870 IF C(I,1)<C(I,2) THEN I1=I1+1
01880 PRINT X(I1),Y(I1),Z(I1),A(J),C(I,1);' ';C(I,2);' ';I
01890 IF C(I,2)< C(I,1) THEN I1=I1+1
01900 IF C(I,1)=0 THEN C(I,1)=C(I,2)
01910 IF C(I,2)=0 THEN C(I,2)=C(I,1)
01920 NEXT I
01930 PRINT 'DO YOU WISH TO CHANGE GEOMETRY (Y/N)';
01940 INPUT AS
01950 IF AS='Y' GOTO 1090
01960 HO=0
01970 PRINT 'PROGRAM CONTROL:'
01980 PRINT 'FREQUENCY(MHZ)';
01990 INPUT F
02000 W=299.8/F
02010 M=4.77783352*W
02020 PRINT 'WAVELENGTH - ';W;' METERS'
02030 W=2*P/W
02040 W2=W*W/2
02050 PRINT 'ENVIRONMENT (1-FREE SPACE, 2-GROUND)';
02060 INPUT G
02070 IF G<1 GOTO 2050
02080 IF G>2 GOTO 2050
02090 PRINT 'NO. OF EXCITATIONS';
02100 INPUT E3
02110 FOR I=1 TO E3
02120 PRINT 'PULSE NO., VOLTAGE MAGNITUDE AND PHASE (DEGREES)';
02130 INPUT E(I),I2,I3
02140 L(I)=I2*COS(I3*P0)
02150 M(I)=I2*SIN(I3*P0)
02160 NEXT I
02170 PRINT 'CURRENT PRINTOUT (Y/N)';
02180 INPUT BS
02190 IF HO=1 GOTO 4110
02200 PRINT 'PATTERN (Y/N)';
02210 INPUT CS
02220 IF CS='N' GOTO 2280
02230 PRINT 'ZENITH ANGLE: INITIAL, INCREMENT, NUMBER';
02240 INPUT Q2,G2,G3
02250 PRINT 'AZMUTH ANGLE: INITIAL, INCREMENT, NUMBER';
02260 INPUT Q1,M2,M3
02270 IF HO=1 GOTO 4560
02280 PRINT 'NO. OF LOADS';
02290 INPUT W4
02300 IF W4=HO GOTO 2370
02310 FOR I=1 TO W4
02320 PRINT 'PULSE NO., RESISTANCE, REACTANCE';
02330 INPUT N(I),I2,I3
02340 H(I)=I3/M
02350 I(I)=-I2/M
02360 NEXT I
02370 FOR I=1 TO N
02380 P(I)=HO
02390 FOR J=1 TO N

```

```

02400 R(I,J)=HO
02410 B(I,J)=HO
02420 NEXT J
02430 NEXT I
02440 I=HO
02450 I=I+1
02460 J=HO
02470 J=J+1
02480 I1=ABS(C(I,1))
02490 I2=ABS(C(I,2))
02500 J4=I2
02510 IF I1>I2 THEN J4=I1
02520 F4=SGN(C(I,1))*S(I1)
02530 F5=SGN(C(I,2))*S(I2)
02540 IF C(I,1)<>-C(I,2) GOTO 2570
02550 F4=S(I1)
02560 F5=S(I2)
02570 T5=F5*D(I2)+F4*D(I1)
02580 T6=F5*F(I2)+F4*F(I1)
02590 T7=F5*G(I2)+F4*G(I1)
02600 J1=ABS(C(J,1))
02610 J2=ABS(C(J,2))
02620 J3=J2
02630 IF J1>J2 THEN J3=J1
02640 F4=SGN(C(J,1))
02650 F5=SGN(C(J,2))
02660 IF C(J,1)<>-C(J,2) GOTO 2690
02670 F4=1
02680 F5=F4
02690 K=HO
02700 K=K+1
02710 IF C(J,1)<>-C(J,2) GOTO 2730
02720 IF K>1 GOTO 3390
02730 IF K>1 GOTO 2750
02740 IF R(I,J)<>0 GOTO 3260
02750 F=3-2*K
02760 P1=2*J4+I-1
02770 P2=2*J3+J-1
02780 P3=P2+.5
02790 P4=J2
02800 F3=F5
02810 GOSUB 370
02820 U1=T1*F5
02830 U2=T2*F5
02840 P3=P2
02850 P2=P2-.5
02860 P4=J1
02870 F3=F4
02880 IF K>1 GOTO 2910
02890 IF J1<>J2 GOTO 2910
02900 IF I=J GOTO 2920
02910 GOSUB 370
02920 X3=U1*D(J2)+F4*T1*D(J1)
02930 Y3=U1*F(J2)+F4*T1*F(J1)
02940 Z3=(U1*G(J2)+F4*T1*G(J1))*F
02950 D1=(X3*T5+Y3*T6+Z3*T7)*W2
02960 X3=U2*D(J2)+F4*T2*D(J1)
02970 Y3=U2*F(J2)+F4*T2*F(J1)

```

```

02980 Z3=(U2*G(J2)+F4*T2*G(J1))*F
02990 D2=(X3*T5+Y3*T6+Z3*T7)*W2
03000 P1=P1+.5
03010 P2=P3
03020 P3=P3+1
03030 P4=J2
03040 F3=F5
03050 GOSUB 370
03060 U1=-T1
03070 U2=-T2
03080 P1=P1-1
03090 GOSUB 370
03100 U1=(U1+T1)/S(J2)
03110 U2=(U2+T2)/S(J2)
03120 P1=P1+1
03130 P3=P2
03140 P2=P2-1
03150 P4=J1
03160 F3=F4
03170 GOSUB 370
03180 U3=T1
03190 U4=T2
03200 P1=P1-1
03210 GOSUB 370
03220 U1=U1+(U3-T1)/S(J1)
03230 U2=U2+(U4-T2)/S(J1)
03240 R(I,J)=R(I,J)+F*(D1+U1)
03250 B(I,J)=B(I,J)+F*(D2+U2)
03260 IF K>1 GOTO 3390
03270 IF J<I GOTO 3390
03280 IF J1<>J2 GOTO 3390
03290 IF I1*I2<>J1*J2 GOTO 3390
03300 R(J,I)=R(I,J)
03310 B(J,I)=B(I,J)
03320 P1=J+1
03330 IF P1>N GOTO 3390
03340 IF ABS(C(P1,2))<>ABS(C(J,2)) GOTO 3390
03350 P2=I+1
03360 IF P2>N GOTO 3390
03370 R(P2,P1)=R(I,J)
03380 B(P2,P1)=B(I,J)
03390 IF K<G GOTO 2700
03400 IF J<N GOTO 2470
03410 IF I<N GOTO 2450
03420 H0=1
03430 IF W4=P(1) GOTO 3490
03440 FOR I=H0 TO W4
03450 J=N(I)
03460 R(J,J)=R(J,J)+H(I)
03470 B(J,J)=B(J,J)+I(I)
03480 NEXT I
03490 FOR I=H0 TO N
03500 S1=0
03510 FOR J=H0 TO N
03520 IF P(J)=H0 GOTO 3610
03530 FOR K=H0 TO N
03540 IF P(K)=H0 GOTO 3600
03550 S2=R(J,K)*R(J,K)+B(J,K)*B(J,K)

```

```

03560 IF (S1-S2)>0 GOTO 3600
03570 I1=J
03580 I2=K
03590 S1=R(J,K)*R(J,K)+B(J,K)*B(J,K)
03600 NEXT K
03610 NEXT J
03620 P(I2)=P(I2)+1
03630 IF I1=I2 GOTO 3720
03640 FOR L=H0 TO N
03650 S1=R(I1,L)
03660 S2=B(I1,L)
03670 R(I1,L)=R(I2,L)
03680 B(I1,L)=B(I2,L)
03690 R(I2,L)=S1
03700 B(I2,L)=S2
03710 NEXT L
03720 H(I)=I1
03730 I(I)=I2
03740 S1=R(I2,I2)
03750 S2=B(I2,I2)
03760 T=S1*S1+S2*S2
03770 R(I2,I2)=H0
03780 B(I2,I2)=0
03790 FOR L=H0 TO N
03800 H1=(R(I2,L)*S1+B(I2,L)*S2)/T
03810 B(I2,L)=(B(I2,L)*S1-R(I2,L)*S2)/T
03820 R(I2,L)=H1
03830 NEXT L
03840 FOR L=H0 TO N
03850 IF I2=L GOTO 3950
03860 S1=R(L,I2)
03870 S2=B(L,I2)
03880 R(L,I2)=0
03890 B(L,I2)=R(L,I2)
03900 FOR J=H0 TO N
03910 H1=R(L,J)-(R(I2,J)*S1-B(I2,J)*S2)
03920 B(L,J)=B(L,J)-(R(I2,J)*S2+B(I2,J)*S1)
03930 R(L,J)=H1
03940 NEXT J
03950 NEXT L
03960 NEXT I
03970 FOR I=H0 TO N
03980 L=N+1-I
03990 IF H(L)=I(L) GOTO 4100
04000 I1=H(L)
04010 I2=I(L)
04020 FOR K=H0 TO N
04030 S1=R(K,I1)
04040 S2=B(K,I1)
04050 R(K,I1)=R(K,I2)
04060 B(K,I1)=B(K,I2)
04070 R(K,I2)=S1
04080 B(K,I2)=S2
04090 NEXT K
04100 NEXT I
04110 FOR I=H0 TO N
04120 J(I)=0
04130 K(I)=J(I)

```



```

04140 NEXT I
04150 FOR I=H0 TO E3
04160 I1=H0
04170 IF C(E(I),1)=-C(E(I),2) THEN I1=2
04180 J(E(I))=I1*M(I)/M
04190 K(E(I))=-I1*L(I)/M
04200 NEXT I
04210 FOR I=H0 TO N
04220 H(I)=0
04230 I(I)=H(I)
04240 FOR J=H0 TO N
04250 H(I)=H(I)+R(I,J)*J(J)-B(I,J)*K(J)
04260 I(I)=I(I)+R(I,J)*K(J)+B(I,J)*J(J)
04270 NEXT J
04280 NEXT I
04290 PRINT
04300 PRINT ' ', '*** SOURCE DATA ***'
04310 O1=0
04320 FOR I=H0 TO E3
04330 J=E(I)
04340 H1=-K(J)*M/I1
04350 H2=J(J)*M/I1
04360 T=H(J)*H(J)+I(J)*I(J)
04370 T1=(H1*H(J)+H2*I(J))/T
04380 T2=(H2*H(J)-H1*I(J))/T
04390 O1=O1+(H1*H(J)+H2*I(J))/2
04400 PRINT 'PULSE ';J,'VOLTAGE = (';L(I);',';M(I);'J)'
04410 PRINT ' ', 'CURRENT = (';H(J);',';I(J);'J)'
04420 PRINT ' ', 'IMPEDANCE = (';T1;',';T2;'J)'
04430 NEXT I
04440 PRINT 'POWER = ';O1;'WATTS'
04450 IF B8='N' GOTO 4540
04460 PRINT ' ', '***** CURRENT DATA *****'
04470 PRINT 'PULSE', 'REAL', 'IMAGINARY', 'MAGNITUDE', 'PHASE'
04480 PRINT ' NO.', '(AMPS)', '(AMPS)', '(AMPS)', '(DEGREES)'
04490 FOR I=H0 TO N
04500 S1=SQR(H(I)*H(I)+I(I)*I(I))
04510 S2=ATN(I(I)/H(I))/PO
04520 PRINT I,H(I),I(I),S1,S2
04530 NEXT I
04540 PRINT
04550 IF C8='N' GOTO 5510
04560 K9=.016678/O1
04570 PRINT ' ', '*** PATTERN DATA ***'
04580 PRINT 'ZENITH', 'AZIMUTH', 'HORIZONTAL', 'VERTICAL'
04590 PRINT ' ANGLE', ' ANGLE', 'PATTERN (DB)', 'PATTERN (DB)'
04600 M1=Q1
04610 FOR I1=H0 TO M3
04620 G1=Q2
04630 FOR I2=H0 TO G3
04640 U3=M1*PO
04650 U4=G1*PO
04660 V1=-SIN(U3)
04670 V2=COS(U3)
04680 R3=COS(U4)
04690 T1=R3*V2
04700 T2=-R3*V1
04710 T3=-SIN(U4)

```

```

04720 R1=-T3*V2
04730 R2=T3*V1
04740 FOR K=H0 TO G
04750 IF K=H0 GOTO 4830
04760 R3=-R3
04770 X3=X1
04780 Y3=Y1
04790 Z3=Z1
04800 X4=X2
04810 Y4=Y2
04820 Z4=Z2
04830 X1=0
04840 Y1=X1
04850 Z1=X1
04860 X2=X1
04870 Y2=X1
04880 Z2=X1
04890 FOR I=H0 TO N
04900 IF K=H0 GOTO 4920
04910 IF C(I,1)=-C(I,2) GOTO 5230
04920 L=C(I,2)
04930 IF L<C(I,1) THEN L=C(I,1)
04940 J=2*L-1+I
04950 I3=3
04960 F3=H0
04970 F4=F3
04980 IF ABS(C(I,H0))=ABS(C(I,2)) GOTO 5030
04990 I3=2
05000 F4=I3
05010 F3=SGN(C(I,I3))
05020 L=ABS(C(I,I3))
05030 O=-(R1*D(L)+R2*F(L)+R3*G(L))*F3
05040 S1=W*S(L)/2
05050 IF ABS(O)<1E-7 GOTO 5070
05060 GOTO 5090
05070 O=(2-O*O*S1*S1/3)*S1
05080 GOTO 5100
05090 O=2*SIN(O*S1)/O
05100 S2=W*(X(J)*R1+Y(J)*R2+Z(J)*R3)
05110 S1=COS(S2)
05120 S2=SIN(S2)
05130 B1=(S1*H(I)-S2*I(I))*O/F4
05140 B2=(S1*I(I)+S2*H(I))*O/F4
05150 X1=X1+B1*D(L)*F3
05160 X2=X2+B2*D(L)*F3
05170 Y1=Y1+B1*F(L)*F3
05180 Y2=Y2+B2*F(L)*F3
05190 Z1=Z1+B1*G(L)*F3
05200 Z2=Z2+B2*G(L)*F3
05210 I3=I3-H0
05220 IF I3=H0 GOTO 5010
05230 NEXT I
05240 IF K=H0 GOTO 5310
05250 X1=X3-X1
05260 X2=X4-X2
05270 Y1=Y3-Y1
05280 Y2=Y4-Y2
05290 Z1=Z3+Z1

```

```

05300 Z2=Z4+Z2
05310 NEXT K
05320 H2=(X1*T1+Y1*T2+Z1*T3)*GO
05330 H1=(X2*T1+Y2*T2+Z2*T3)*GO
05340 X4=(X1*V1+Y1*V2)*GO
05350 X3=(X2*V1+Y2*V2)*GO
05360 P1=(X3*X3+X4*X4)*K9
05370 IF P1>1E-30 GOTO 5400
05380 P1=-999
05390 GOTO 5410
05400 P1=4.343*LOG(P1)
05410 P2=K9*(H1*H1+H2*H2)
05420 IF P2>1E-30 GOTO 5450
05430 P2=-999
05440 GOTO 5460
05450 P2=4.343*LOG(P2)
05460 PRINT G1,M1,P1,P2
05470 G1=G1+G2
05480 NEXT I2
05490 M1=M1+M2
05500 NEXT I1
05510 PRINT 'PATTERNS (Y/N)';
05520 INPUT CS
05530 IF CS='Y' GOTO 2230
05540 PRINT 'CHANGE OF EXCITATION (Y/N)';
05550 INPUT AS
05560 IF AS='Y' GOTO 2090
05570 PRINT 'CONTINUE (Y/N)';
05580 INPUT AS
05590 IF AS='Y' GOTO 1100
05600 END

```