

PHOTOGRAPH THIS SHEET

AD-A113201

DTIC ACCESSION NUMBER

II

LEVEL

1

INVENTORY

**FN-TR-BT**  
DOCUMENT IDENTIFICATION

This document has been approved for public release and sale; its distribution is unlimited.

DISTRIBUTION STATEMENT

ACCESSION FOR	
NTIS	GRA&I <input checked="" type="checkbox"/>
DTIC	TAB <input type="checkbox"/>
UNANNOUNCED	<input type="checkbox"/>
JUSTIFICATION	
BY	
DISTRIBUTION /	
AVAILABILITY CODES	
DIST	AVAIL AND/OR SPECIAL
A	

DISTRIBUTION STAMP

DTIC  
SELECTE  
APR 07 1982  
E

DATE ACCESSIONED

DTIC  
COPY  
INSPECTED  
2

"Original contains color plates; all DTIC reproductions will be in black and white"

8 0 0 0 1 0 0 6

DATE RECEIVED IN DTIC

PHOTOGRAPH THIS SHEET AND RETURN TO DTIC-DDA-2

**Best  
Available  
Copy**

GEOTECHNICAL INVESTIGATION  
COMPACTED BACKFILL  
BREAK-OUT AND ERECTION TRENCHES  
MAV TEST SITE  
SAN CRISTOBAL VALLEY, ARIZONA

Prepared For:

U. S. Department of the Air Force  
Space and Missile Systems Organization (SAMSO)  
Norton Air Force Base, California 92409

Prepared By:

Fugro National, Inc.  
3777 Long Beach Boulevard  
Long Beach, California 90807

23 October 1978

REPORT DOCUMENTATION PAGE		READ INSTRUCTIONS BEFORE COMPLETING FORM
1. REPORT NUMBER <b>FN-TR-BT-78-OCT</b>	2. GOVT ACCESSION NO.	3. RECIPIENT'S CATALOG NUMBER
4. TITLE (and Subtitle) <b>Geotechnical Investigation compact &amp; Backfill Breakout &amp; erection trenches MAV test site San Cristobal Valley, Arizona</b>		5. TYPE OF REPORT & PERIOD COVERED <b>Final</b>
7. AUTHOR(s)		6. PERFORMING ORG. REPORT NUMBER <b>FN-TR-BT-78-OCT</b>
9. PERFORMING ORGANIZATION NAME AND ADDRESS <b>Ertec Western Inc. (formerly Fugro National) P.O. Box 7765 Lana Beach Ca 90807</b>		8. CONTRACT OR GRANT NUMBER(s) <b>FO4704-77-C-0010</b>
11. CONTROLLING OFFICE NAME AND ADDRESS <b>U.S. Department of the Air Force Space and Missile Systems Organization Warton AFIS RA 92409 (SAMSO)</b>		10. PROGRAM ELEMENT, PROJECT, TASK AREA & WORK UNIT NUMBERS <b>64312 F</b>
14. MONITORING AGENCY NAME & ADDRESS (if different from Controlling Office)		12. REPORT DATE <b>23 Oct 78</b>
		13. NUMBER OF PAGES <b>7</b>
		15. SECURITY CLASS. (of this report)
		15a. DECLASSIFICATION/DOWNGRADING SCHEDULE
16. DISTRIBUTION STATEMENT (of this Report)  <b>Distribution Unlimited</b>		
17. DISTRIBUTION STATEMENT (of the abstract entered in Block 20, if different from Report)  <b>Distribution Unlimited</b>		
18. SUPPLEMENTARY NOTES		
19. KEY WORDS (Continue on reverse side if necessary and identify by block number) <del>site description, Field location Program, Laboratory Program Test Bounce, trench, boring log, grain size, specific gravity, triaxial compression, atterberg limit, density, moisture content</del>		
20. ABSTRACT (Continue on reverse side if necessary and identify by block number) <b>This report presents the results of our geotechnical investigation of the compacted backfill material in the break-out and erection demonstration trenches constructed at the MAV Test site in San Cristobal Valley, Arizona.</b>		

## TABLE OF CONTENTS

		<u>Page</u>
1.0	<u>INTRODUCTION AND SCOPE</u> .....	1
2.0	<u>SITE DESCRIPTION</u> .....	1
2.1	SITE LOCATION .....	1
2.2	GENERAL SITE AND SUBSURFACE CONDITIONS .....	2
2.3	BREAK-OUT AND ERECTION DEMONSTRATION TRENCHES .....	2
3.0	<u>FIELD PROGRAM</u> .....	3
4.0	<u>LABORATORY PROGRAM</u> .....	4
5.0	<u>RESULTS</u> .....	5

## LIST OF FIGURES

### Figure

1	SITE LOCATION MAP
2	LOCATION OF DEMONSTRATION TRENCHES
3	TYPICAL TRENCH SECTIONS
4	LOCATION OF TEST BORINGS
5	RANGE IN GRADATION OF BACKFILL MATERIAL
6	TRIAXIAL COMPRESSION TESTS - BOEING GAS SITE
7	TRIAXIAL COMPRESSION TESTS - BOEING HYDRAULIC SITE
8	TRIAXIAL COMPRESSION TESTS - MARTIN MARIETTA GAS SITE
9	P-Q DIAGRAM - BOEING GAS SITE
10	P-Q DIAGRAM - BOEING HYDRAULIC SITE
11	P-Q DIAGRAM - MARTIN MARIETTA GAS SITE

LIST OF TABLES

Table

- 1 BORING LOGS - BOEING GAS SITE
- 2 BORING LOGS - BOEING HYDRAULIC SITE
- 3 BORING LOGS - MARTIN MARIETTA GAS SITE
- 4 SUMMARY OF LABORATORY TEST RESULTS - BOEING GAS SITE
- 5 SUMMARY OF LABORATORY TEST RESULTS - BOEING HYDRAULIC SITE
- 6 SUMMARY OF LABORATORY TEST RESULTS - MARTIN MARIETTA GAS SITE
- 7 SUMMARY OF TRIAXIAL COMPRESSION TESTS - BOEING GAS SITE
- 8 SUMMARY OF TRIAXIAL COMPRESSION TESTS - BOEING HYDRAULIC SITE
- 9 SUMMARY OF TRIAXIAL COMPRESSION TESTS - MARTIN MARIETTA GAS SITE

## 1.0 INTRODUCTION AND SCOPE

This report presents the results of our geotechnical investigation of the compacted backfill material in the break-out and erection demonstration trenches constructed at the MAV Test Site in San Cristobal Valley, Arizona. The purpose of this investigation was to evaluate the engineering properties of the backfill material with particular emphasis on its moisture/density and strength characteristics. This study was performed for the Department of the Air Force, Space and Missile Systems Organization (SAMSO), in compliance with the conditions of the statement of work as part of contract No. F04704-77-C-0010.

This geotechnical investigation included:

- o drilling and sampling 24 test borings,
- o performing the requested series of laboratory tests,
- o analyzing the results of the field and laboratory programs,  
and
- o the preparation of this report.

Preliminary laboratory test results were submitted to Captain B. Collins/MNNM on 31 July, 8 August, and 21 August 1978.

## 2.0 SITE DESCRIPTION

### 2.1 SITE LOCATION

The MAV Test Site is located in the northwest corner of San Cristobal Valley, Arizona (Figure 1) nearly halfway between Yuma (approximately 50 nm west) and Gila Bend (approximately 50 nm east). Interstate Highway 8 and the Southern Pacific Railroad are adjacent to the site on the north.

The location of the break-out and erection demonstration trenches is shown in Figure 2. These trenches lie approximately 1.5 miles (1.3 nm) west of Stoval Air Field and one mile (0.9 nm) south of Interstate Highway 8.

## 2.2 GENERAL SITE AND SUBSURFACE CONDITIONS

A detailed description of the general site and subsurface conditions is presented in the Fugro National report FN-TR-14, titled "MX Siting Investigation, Geotechnical Evaluation, Multiple Aim-Point Validation (MAV) Program, Luke Bombing and Gunnery Range, Arizona", dated 30 September 1976.

Since the date of the above study, numerous facilities have been constructed at the MAV Test Site as part of an evaluation of the MX buried trench basing mode concept. These new facilities include various support facilities for the construction of the 20,000 foot (6.1 km) long trench as well as the break-out and erection demonstration trenches.

## 2.3 BREAK-OUT AND ERECTION DEMONSTRATION TRENCHES

These demonstration trenches have been constructed to evaluate the performance of the MX missile pre-launch break-out and erection mechanisms developed by the Boeing Company and the Martin Marietta Company. Three trench sections have been constructed; one each for the Boeing gas system, the Boeing hydraulic system, and the Martin Marietta gas system. Each trench contains a precast concrete pipe which simulates the actual buried trench protective structure.



Typical cross sections for the Boeing and Martin Marietta trenches are shown in Figure 3. The trench at both sites is 20 feet (6 m) wide at its base and has side slopes of 3/4:1 (horizontal: vertical). The Martin Marietta trench walls are benched. In both sections, the precast concrete pipe has an outside diameter of 15.67 feet (4.8 m) and rests on sand-cement bedding material. Compacted backfill was placed around and over the pipe, completely filling the trench.

Fugro personnel were not present during the construction of these trenches. We understand that the material excavated from the trenches was used for backfill. Apparently, this material was excavated, stockpiled, replaced, and compacted to a minimum dry density of 80 percent of ASTM D-1557, Method A.

### 3.0 FIELD PROGRAM

The field program performed as part of this investigation consisted of drilling and sampling 24 test borings at the locations shown in Figures 3 and 4. All borings at the Boeing gas and hydraulic sites and three borings at the Martin Marietta gas site were completed during the period of 17 July to 20 July 1978. The remaining seven borings at the Martin Marietta gas site were drilled and sampled on 17 August 1978.

As shown in Figure 3, the test borings above the crown of the concrete pipe were approximately five feet (1.5 m) deep, while the borings beyond the edge of the pipe were about ten feet (3 m) deep. Drilling was accomplished using the rotary-air technique. Continuous sampling was accomplished using primarily the Shelby

tube sampling technique. However, a few samples were also obtained using Pitcher barrel and Fugro drive samplers. All test borings were logged during the drilling and sampling operation and the resulting boring logs are presented in Tables 1, 2, and 3.

The backfill samples were sealed in the field and transported to our laboratory in Long Beach, California for testing.

#### 4.0 LABORATORY PROGRAM

The laboratory testing program consisted of performing moisture/density, grain size analyses, Atterberg Limits, specific gravity, and consolidated-drained triaxial compression tests. The number of tests performed in this laboratory program is summarized below.

<u>Laboratory Test</u>	<u>Number of Tests</u>
Moisture/Density	224
Grain Size Analysis	24
Atterberg Limits	21
Specific Gravity	3
Consolidated-Drained Triaxial Compression	60

The moisture/density tests were performed on samples at a maximum depth interval of one foot (0.3 m). Samples for consolidated-drained triaxial compression testing were selected in accordance with the instructions received from Captain B. Collins/MNNM. These triaxial compression tests were conducted using isotropic confining pressures of 0.7, 2.9 and 5.8 ksf (33.5, 138.9 and

277.7 kN/m<sup>2</sup>). A moisture/density test was performed on each tri-axial compression test specimen. Representative grain size analysis and Atterberg Limits tests were performed on selected samples to confirm their field classification.

The results of the moisture/density, grain size analysis, Atterberg Limits, and specific gravity tests are summarized in Tables 4, 5, and 6. The results of the consolidated-drained tri-axial compression tests are presented in Figures 6, 7, and 8 and Tables 7, 8, and 9.

#### 5.0 RESULTS

As shown in the boring logs, the backfill material encountered in the test borings consisted of brown, firm to stiff sandy clay (CL), and medium dense to dense, fine- to medium-grained clayey sand (SC). These soils contained occasional gypsum and caliche fragments as well as fine gravel. The range in gradation of the backfill material is shown in Figure 5. Considerable variation in both the moisture content and consistency of the backfill material was observed during the drilling and sampling program.

The dry density of the soil samples tested ranged from 90.0 to 119.2 pcf (1440 to 1907 kg/m<sup>3</sup>) and the moisture content ranged from 5.4 to 20.3 percent. Differences were observed between the dry densities and moisture contents for the three test sites, as shown on the following table.

<u>Test Site</u>	<u>Dry Density pcf (kg/m<sup>3</sup>)</u>	<u>Moisture Content percent</u>
Boeing Gas	93.3 - 113.5 (1493 - 1816)	7.8 - 16.3
Boeing Hydraulic	90.0 - 117.9 (1440 - 1886)	8.6 - 20.3
Martin Marietta Gas	91.4 - 119.2 (1462 - 1907)	5.4 - 16.3

The results of the consolidated-drained triaxial compression tests were used to evaluate the strength characteristics of the backfill material. Figures 6, 7, and 8 present the Mohr's circles for these triaxial compression tests. The results of these tests are also summarized in the p-q diagrams presented in Figures 9, 10, and 11 for the Boeing gas, Boeing hydraulic, and Martin Marietta gas sites, respectively. Each p-q diagram plots the quantity  $\frac{\sigma_1 - \sigma_3}{2}$  on the ordinate and the quantity  $\frac{\sigma_1 + \sigma_3}{2}$  on the abscissa, where  $\sigma_1$  is the major principle stress at failure and  $\sigma_3$  is the minor principle stress (sample confining pressure). A p-q diagram has the characteristic that a straight-line fit through the data points will have a slope of  $\sin(\phi)$  and an intercept of  $c \cos(\phi)$  where  $c$  and  $\phi$  are the soil cohesion and angle of internal friction, respectively.

Using the method of least-squares, such a straight-line fit was made to the test data for each of the sites, and the following average values for  $c$  and  $\phi$  were obtained.

<u>Test Site</u>	<u>Cohesion, c ksf (kN/m<sup>2</sup>)</u>	<u>Friction Angle, <math>\phi</math> degrees</u>
Boeing Gas	1.4 (67.1)	28
Boeing Hydraulic	1.7 (81.4)	28
Martin Marietta Gas	1.4 (67.1)	31

The above average values for  $c$  and  $\phi$  fall in a fairly narrow range. However, as shown by the Mohr's circles plotted in Figures 6, 7, and 8, relatively large variations in  $c$  and  $\phi$  were observed between individual sets of test results.

As part of this investigation, attempts were made to develop correlations between the cohesion and angle of internal friction of the backfill material and such parameters as dry density, moisture content, gradation, and Atterberg Limits. Based on our analyses, no significant correlations were apparent.

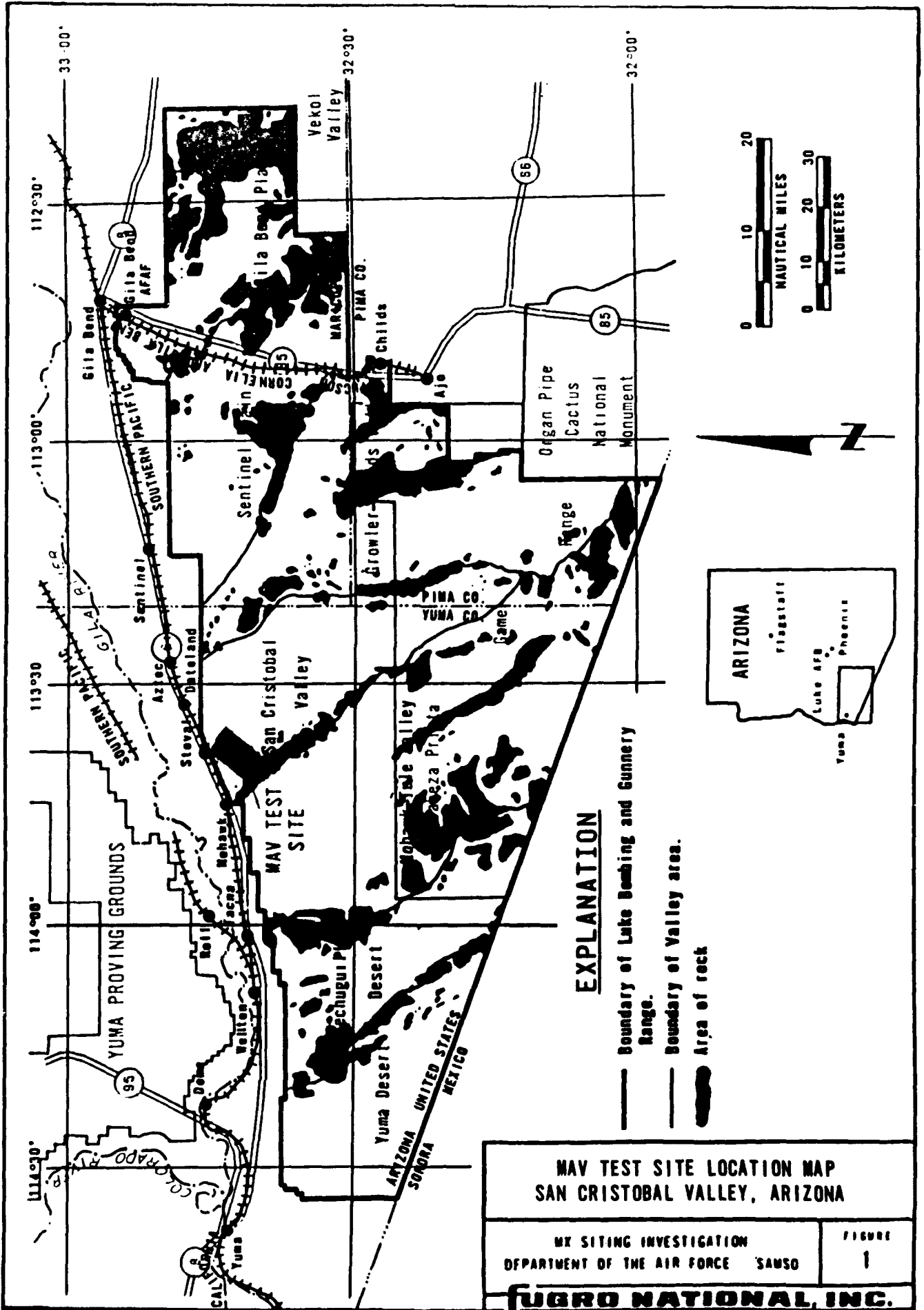

**EXPLANATION**

- Boundary of Luke Bombing and Gunnery Range.
- Boundary of Valley area.
- Area of rock

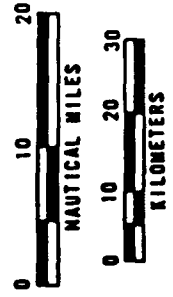
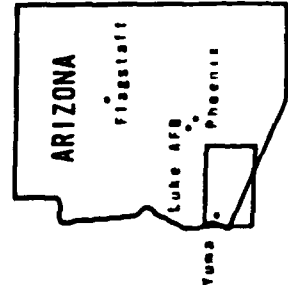

<b>MAV TEST SITE LOCATION MAP SAN CRISTOBAL VALLEY, ARIZONA</b>	
MX SITING INVESTIGATION DEPARTMENT OF THE AIR FORCE SAUSO	FIGURE <b>1</b>
<b>JUGRO NATIONAL, INC.</b>	

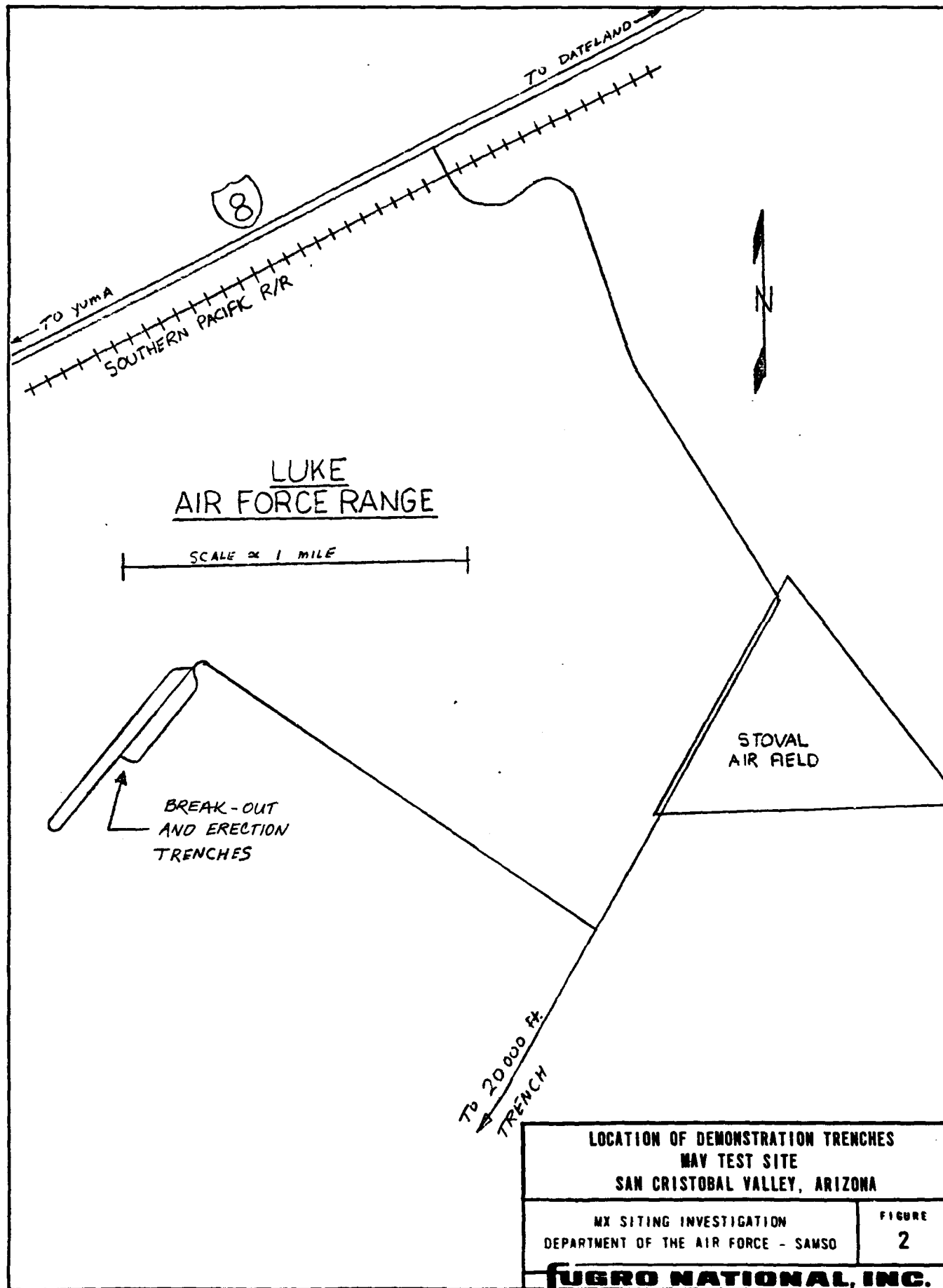

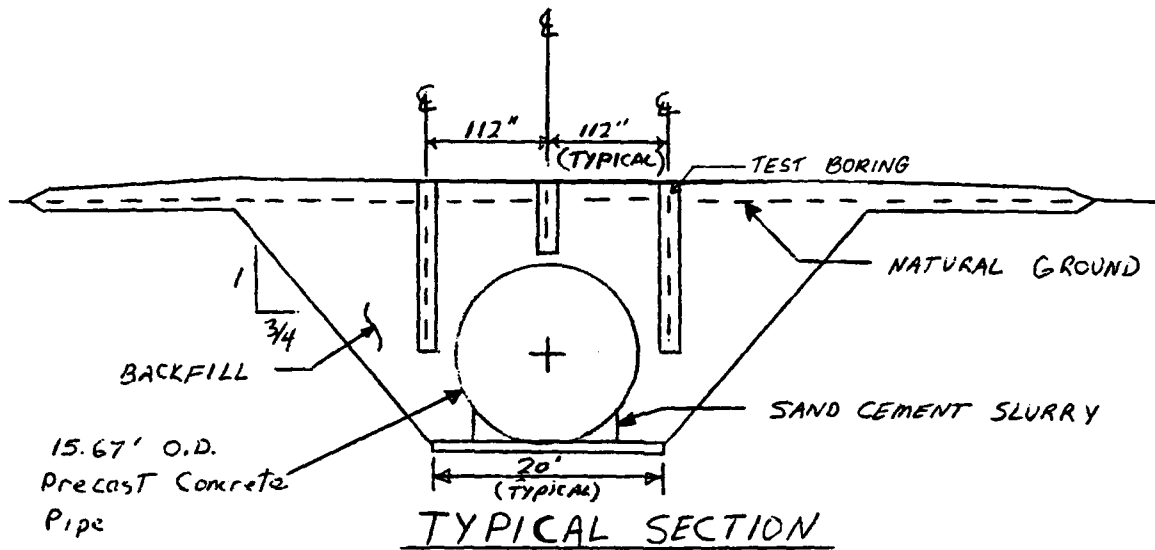

BOEING HYDRAULIC AND GAS SITES

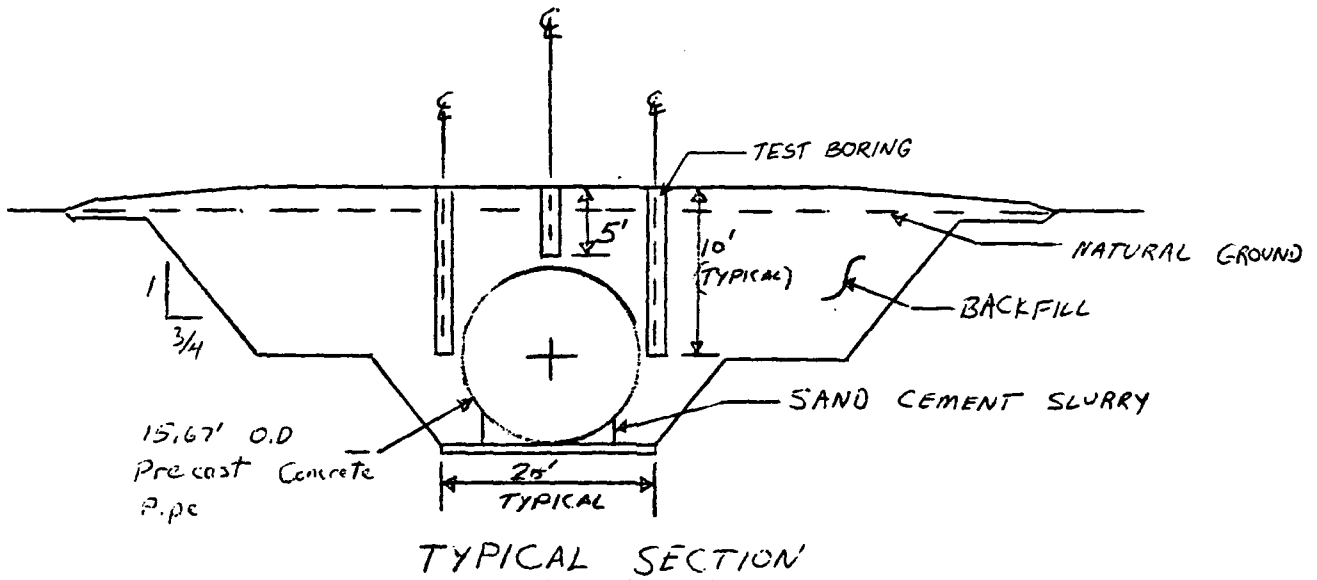

MARTIN MARIETTA GAS SITE

**TYPICAL TRENCH SECTIONS  
MAV TEST SITE  
SAN CRISTOBAL VALLEY, ARIZONA**

MX SITING INVESTIGATION  
DEPARTMENT OF THE AIR FORCE - SAMSO

FIGURE  
3

**FUGRO NATIONAL, INC.**



BOEING GAS SITE

BOEING HYDRAULIC SITE

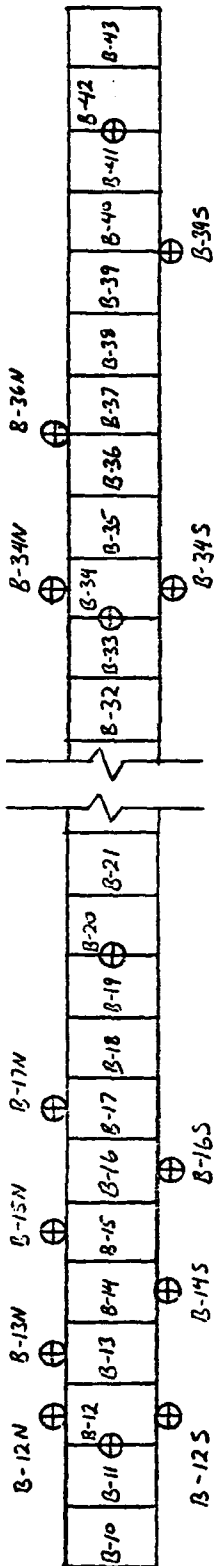

MARTIN MARIETTA GAS SITE

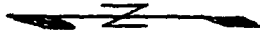
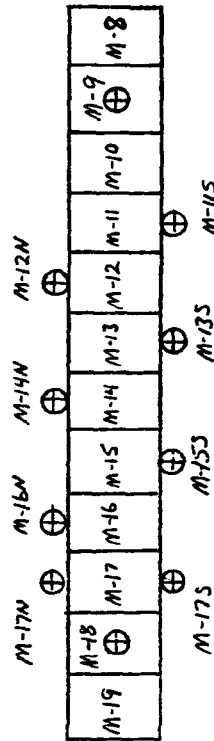

SCALE: 1" = 30'

EXPLANATION

⊕ TEST BORING LOCATION

<b>LOCATION OF TEST BORINGS MAV TEST SITE SAN CRISTOBAL VALLEY, ARIZONA</b>	
MX SITING INVESTIGATION DEPARTMENT OF THE AIR FORCE - SAWSO	FIGURE <b>4</b>
<b>FUGRO NATIONAL, INC.</b>	

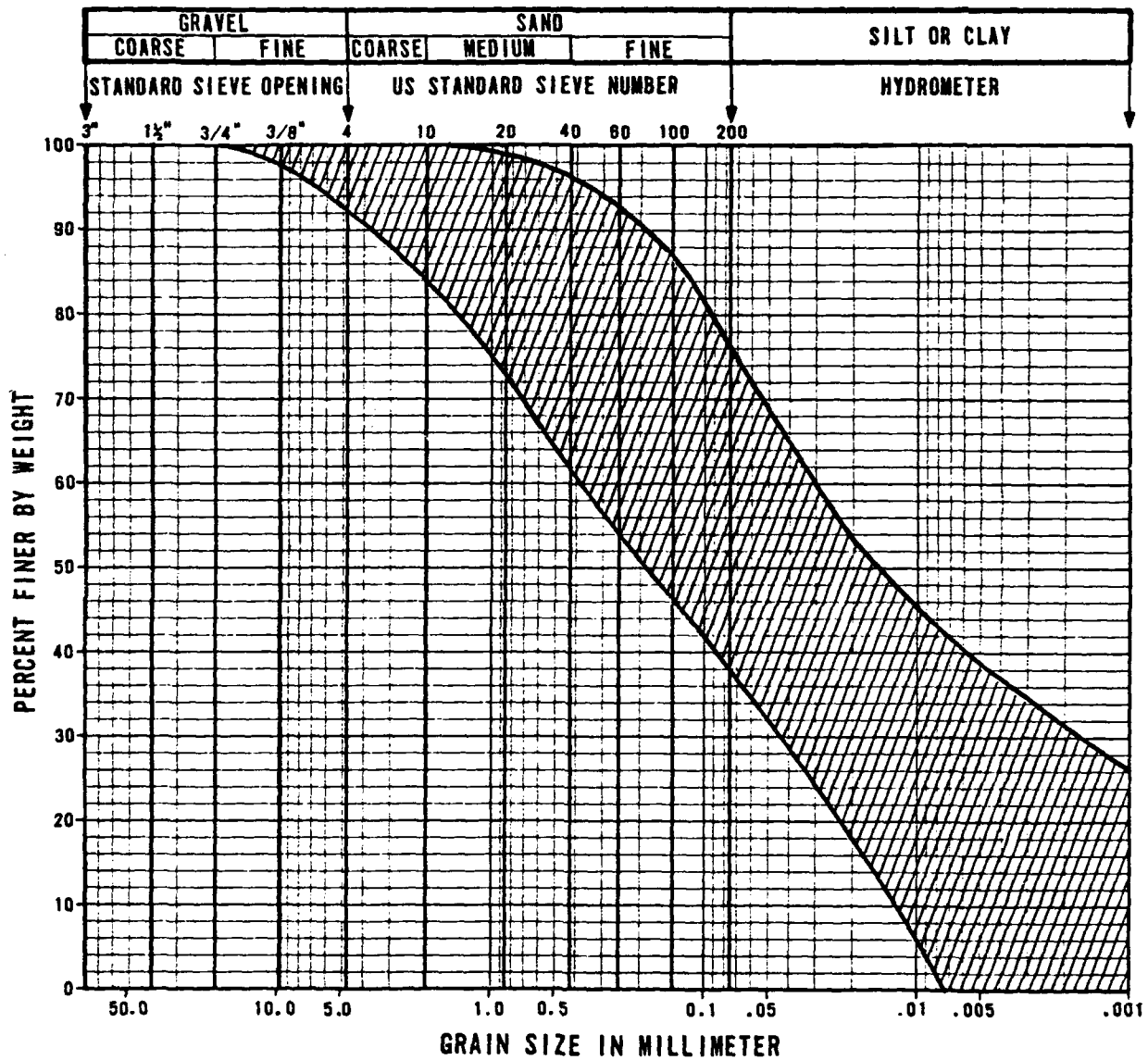

RANGE IN GRADATION OF BACKFILL MATERIAL  
 MAY TEST SITE  
 SAN CRISTOBAL VALLEY, ARIZONA

MX SITING INVESTIGATION  
 DEPARTMENT OF THE AIR FORCE - SANSO

FIGURE  
 5

**FUGRO NATIONAL, INC.**

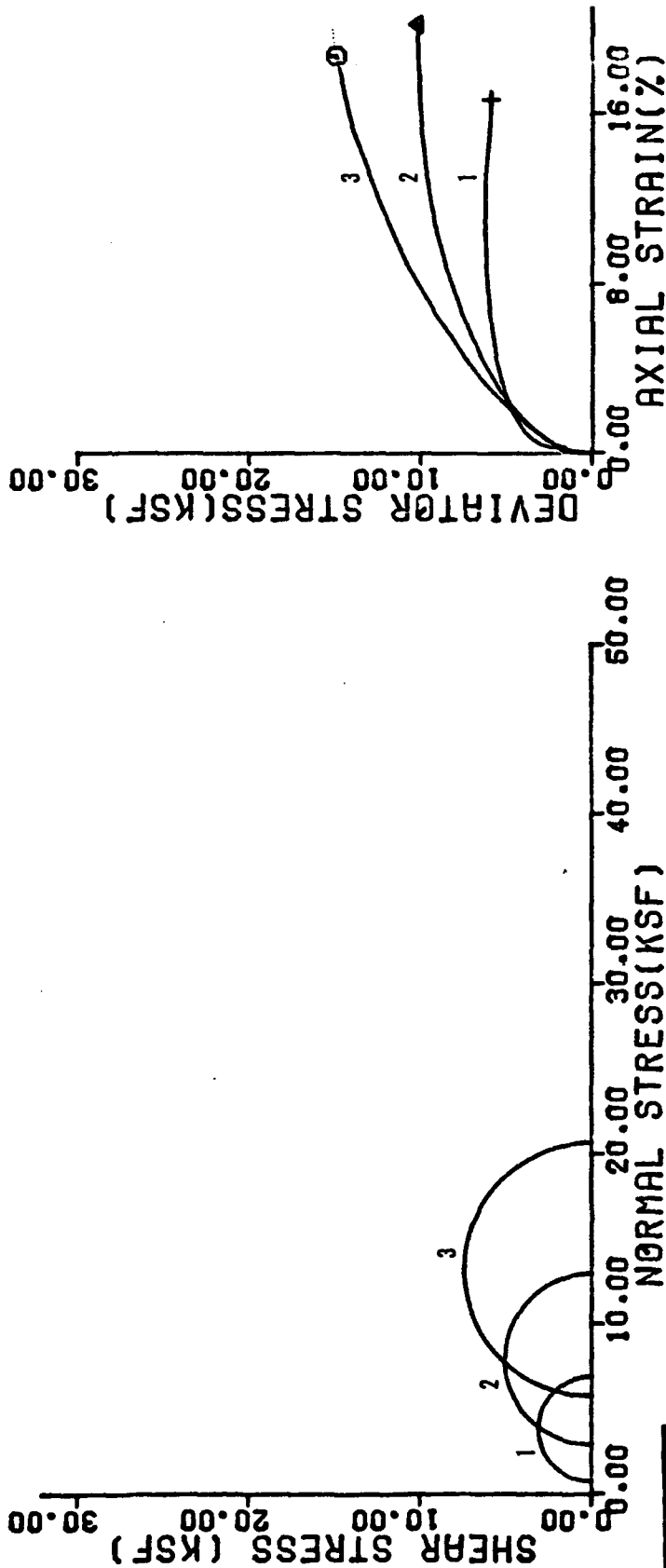

SYMBOL NO.	BORING NO.	SAMPLE NO.	SAMPLE INTERVAL		CONFINING PRESSURE (KSF)	CONFINING PRESSURE (KN/M <sup>2</sup> )	MAXIMUM DEVIATOR STRESS (KSF)	MAXIMUM DEVIATOR STRESS (KN/M <sup>2</sup> )
			FEET	METERS				
1	B-11	S-1-2	1.1-1.8	0.34-0.55	0.7	33.5	6.2	297
2	B-11	S-1-3	1.8-2.5	0.55-0.76	2.9	138.9	10.1	484
3	B-11	S-2-2	3.8-4.3	1.10-1.52	5.6	277.7	14.9	713

TRIAXIAL COMPRESSION TESTS  
BOEING GAS SITE  
MAY TEST SITE, SAN CRISTOBAL VALLEY, ARIZONA

MX SITING INVESTIGATION  
DEPARTMENT OF THE AIR FORCE - SANSO

FIGURE  
6  
1 OF 7

UGRO NATIONAL, INC.

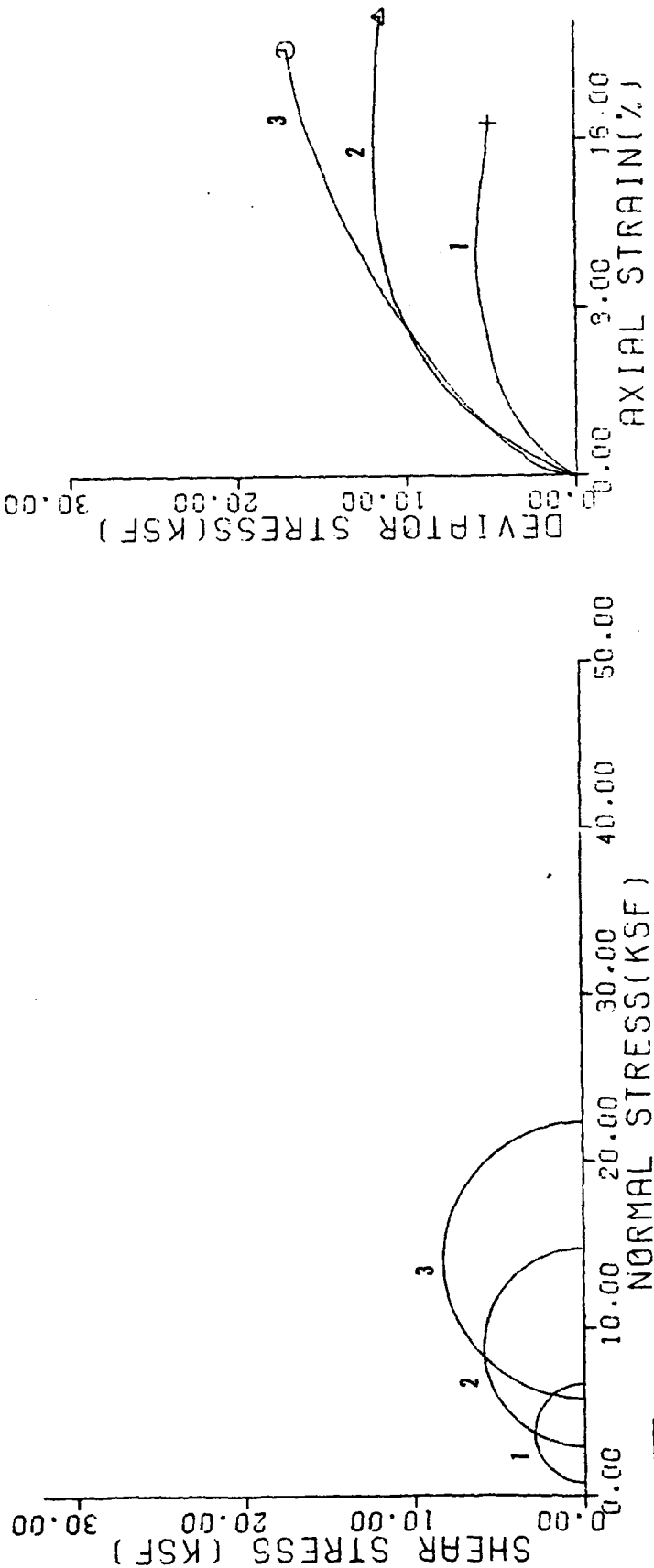

SYMBOL NO.	BORING NO.	SAMPLE NO.	SAMPLE INTERVAL		CONFINING PRESSURE (Q <sub>3</sub> )		MAXIMUM DEVIATOR STRESS (Q <sub>1</sub> -Q <sub>3</sub> )	
			FEET	METERS	ksf	KN/m <sup>2</sup>		
1	B-12N	S-2-3	4.3-5.0	1.31-1.52	0.7	33.5	5.9	282
2	B-12N	S-3-1	5.0-5.7	1.52-1.74	2.9	138.9	11.9	570
3	B-12N	S-3-2	5.7-6.4	1.74-1.85	5.8	277.7	17.0	814

**TRIAxIAL COMPRESSION TESTS  
BOEING GAS SITE  
MAV TEST SITE, SAN CRISTOBAL VALLEY, ARIZONA**

MX SITING INVESTIGATION  
DEPARTMENT OF THE AIR FORCE - SAMSO

FIGURE  
**6**  
2 OF 7

**TUGRO NATIONAL, INC.**

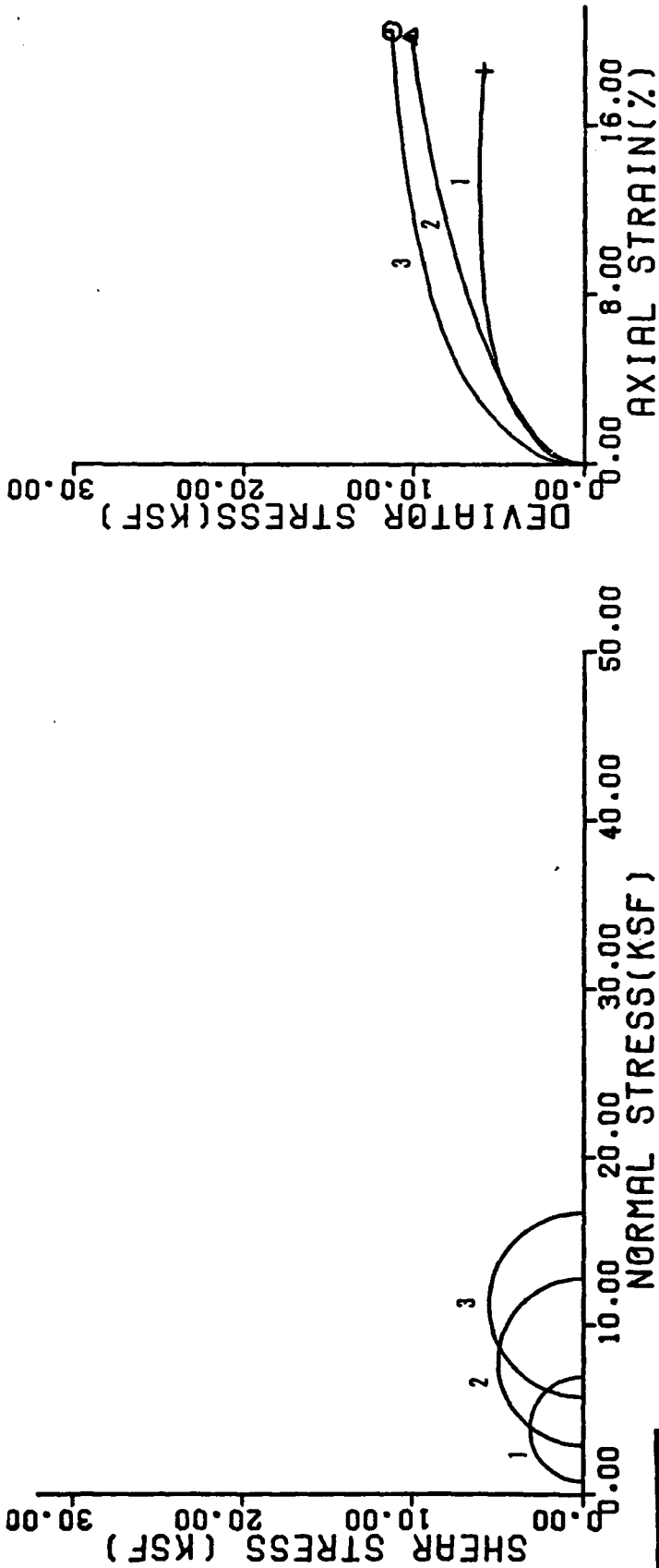

SYMBOL NO.	BORING NO.	SAMPLE NO.	SAMPLE INTERVAL		CONFINING PRESSURE (σ <sub>3</sub> )		MAXIMUM DEVIATOR STRESS (σ <sub>1</sub> -σ <sub>3</sub> )	
			FEET	METERS	ksf	KN/m <sup>2</sup>		
1	B-12S	S-2-3	4.3-5.0	1.31-1.52	0.7	33.5	6.2	297
2	B-12S	S-3-1	5.0-5.7	1.52-1.74	2.9	138.9	10.2	488
3	B-12S	S-3-2	5.7-6.4	1.74-1.95	5.8	277.7	11.3	541

TRIAxIAL COMPRESSION TESTS  
BOEING GAS SITE  
MAV TEST SITE, SAN CRISTOBAL VALLEY, ARIZONA

MX SITING INVESTIGATION  
DEPARTMENT OF THE AIR FORCE - SAMSO

FIGURE

6

3 OF 7

**UGRO NATIONAL, INC.**

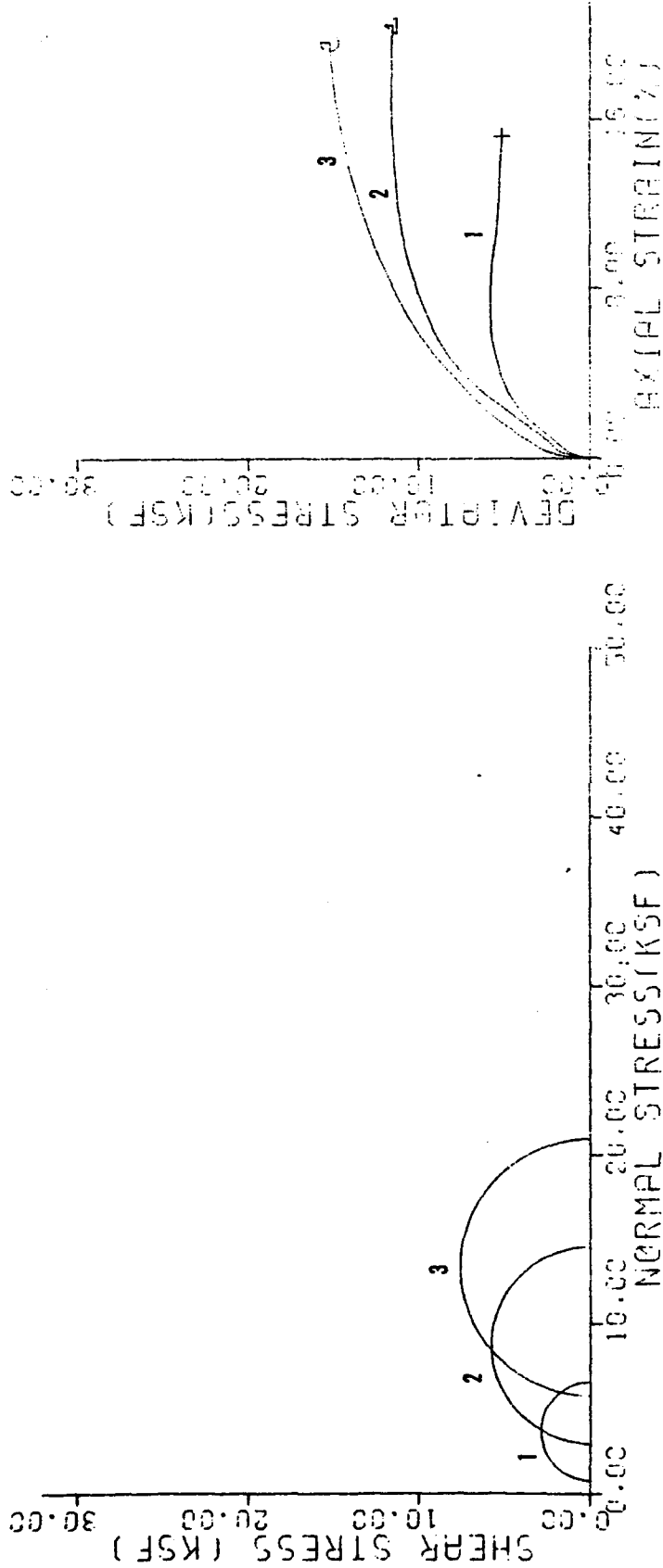

SYMBOL NO.	BORING NO.	SAMPLE NO.	SAMPLE INTERVAL		CONFINING PRESSURE (Q)		MAXIMUM DEVIATOR STRESS (σ <sub>1</sub> -σ <sub>3</sub> )	
			FEET	METERS	ksf	KN/m <sup>2</sup>	ksf	KN/m <sup>2</sup>
1	B-13N	S-2-3	4.3-5.0	1.31-1.52	0.7	33.5	5.8	278
2	B-13N	S-3-1	5.0-5.7	1.52-1.74	2.9	138.9	11.6	555
3	B-13N	S-3-2	5.7-6.4	1.74-1.95	5.8	277.7	15.2	728

**TRIAxIAL COMPRESSION TESTS**  
**BOEING GAS SITE**  
**MAV TEST SITE, SAN CRISTOBAL VALLEY, ARIZONA**

MX SITING INVESTIGATION  
DEPARTMENT OF THE AIR FORCE - SANSO

FIGURE  
**6**  
4 OF 7

**UGRO NATIONAL, INC.**

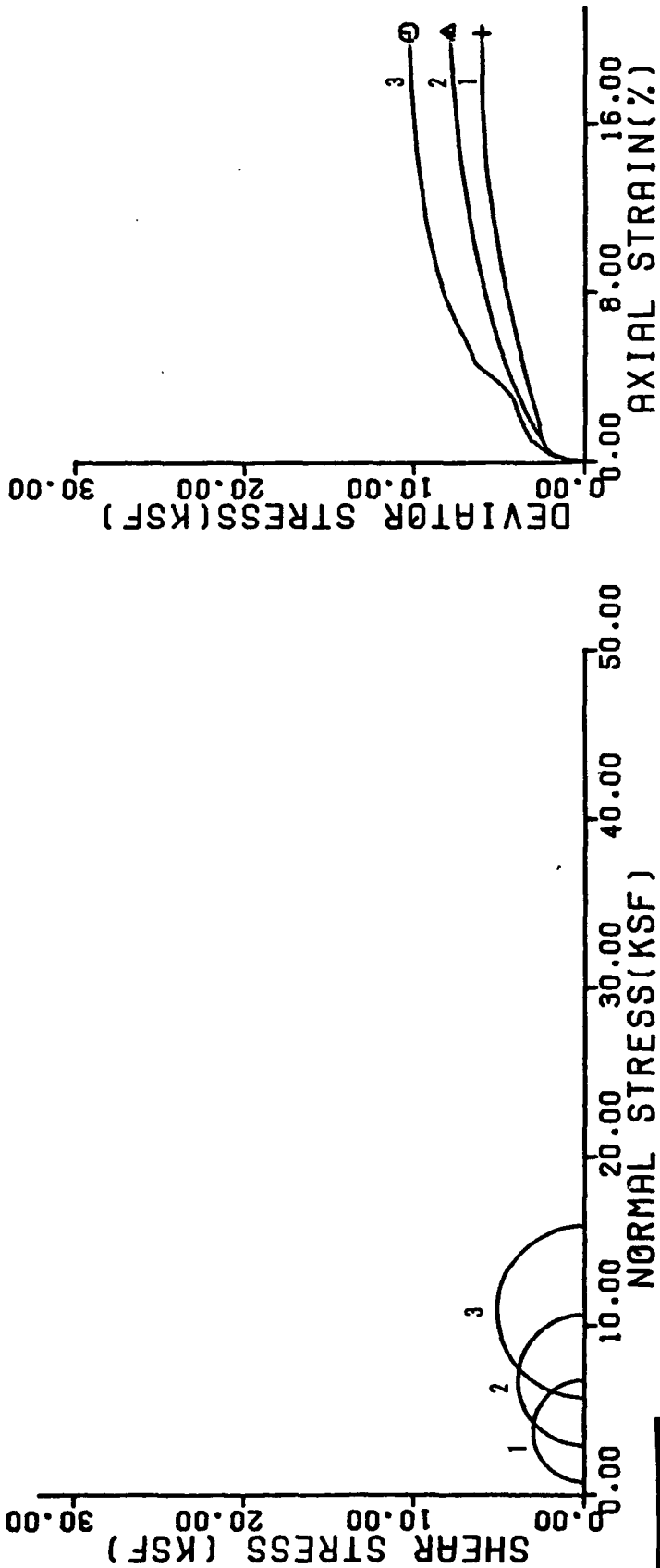

SYMBOL NO.	BORING NO.	SAMPLE NO.	SAMPLE INTERVAL		CONFINING PRESSURE (psf)		MAXIMUM DEVIATOR STRESS (psf)	
			FEET	METERS	ksf	KN/m <sup>2</sup>	ksf	KN/m <sup>2</sup>
1	B-14S	S-2-3	4.3-5.0	1.31-1.52	0.7	33.5	6.0	287
2	B-14S	S-3-1	5.1-5.8	1.55-1.77	2.9	138.9	7.6	373
3	B-14S	S-3-2	5.8-6.5	1.77-1.98	5.8	277.7	10.2	488

**TRIAxIAL COMPRESSION TESTS**  
**BOEING GAS SITE**  
**NAV TEST SITE, SAN CRISTOBAL VALLEY, ARIZONA**

MX SITING INVESTIGATION  
 DEPARTMENT OF THE AIR FORCE - SANSO

FIGURE  
**6**  
 5 OF 7

**UGRO NATIONAL, INC.**

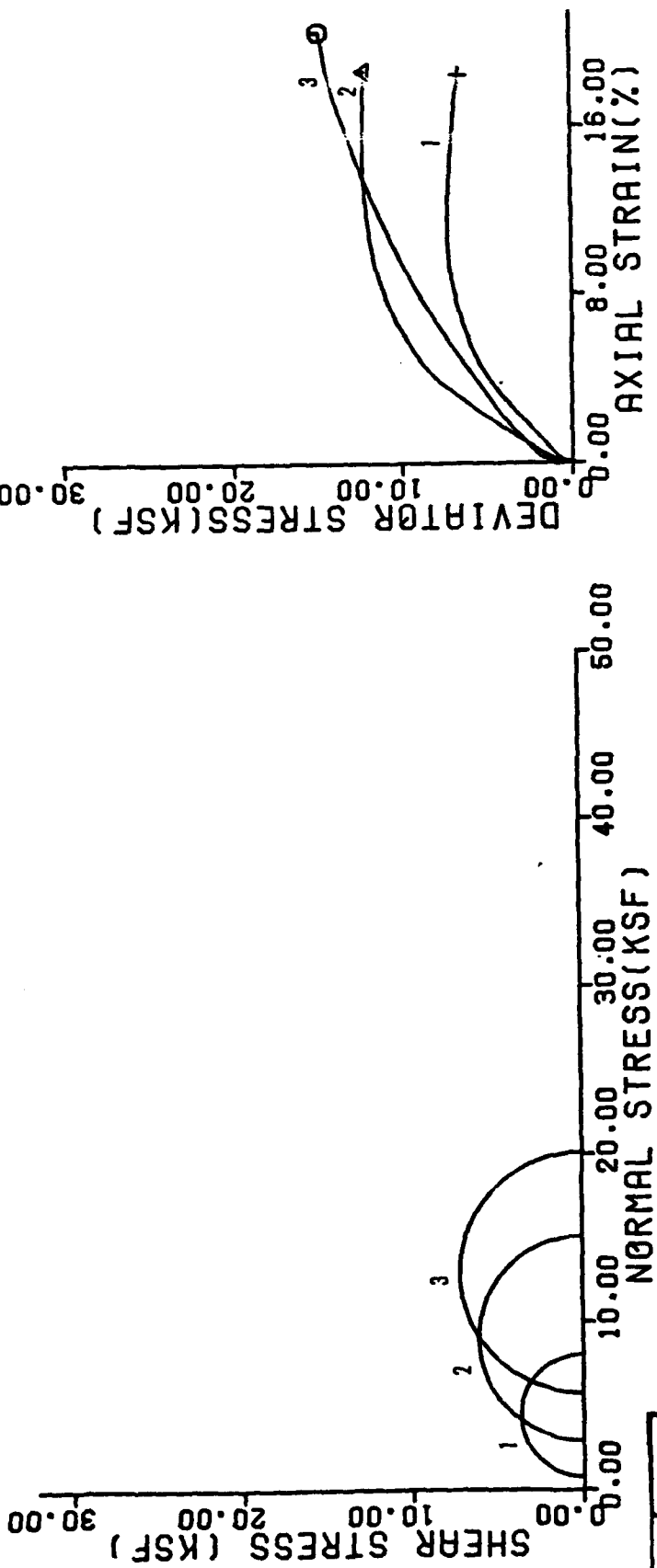

SYMBOL NO.	BORING NO.	SAMPLE NO.	SAMPLE INTERVAL		CONFINING PRESSURE (Q <sub>3</sub> )		MAXIMUM DEVIATOR STRESS (Q <sub>1</sub> -Q <sub>3</sub> )	
			FEET	METERS	ksf	KN/m <sup>2</sup>		
1	B-15N	S-2-3	4.3-5.0	1.31-1.52	0.7	33.5	7.3	350
2	B-15N	S-3-1	5.0-5.7	1.52-1.74	2.9	138.9	12.2	584
3	B-15N	S-3-2	5.7-6.4	1.74-1.95	5.8	277.7	14.4	709

**TRIAxIAL COMPRESSION TESTS**  
**BOEING GAS SITE**  
**MAV TEST SITE, SAN CRISTOBAL VALLEY, ARIZONA**

MX SITING INVESTIGATION  
 DEPARTMENT OF THE AIR FORCE - SAMSO

FIGURE  
**6**  
 6 OF 7

**FUGRO NATIONAL, INC.**



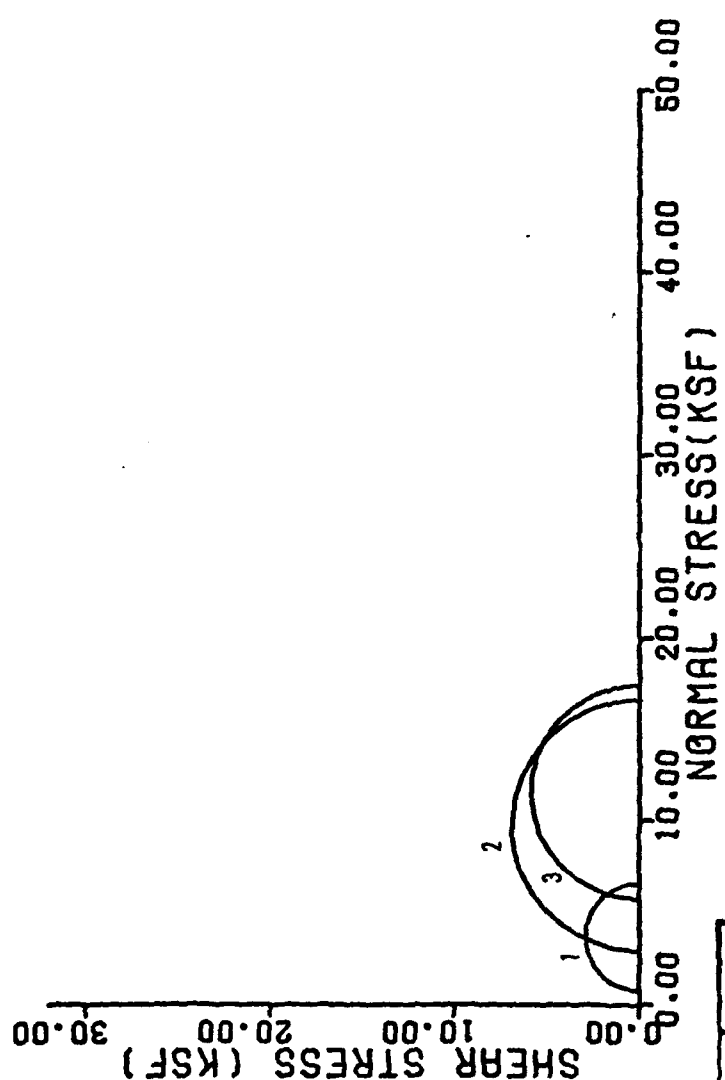
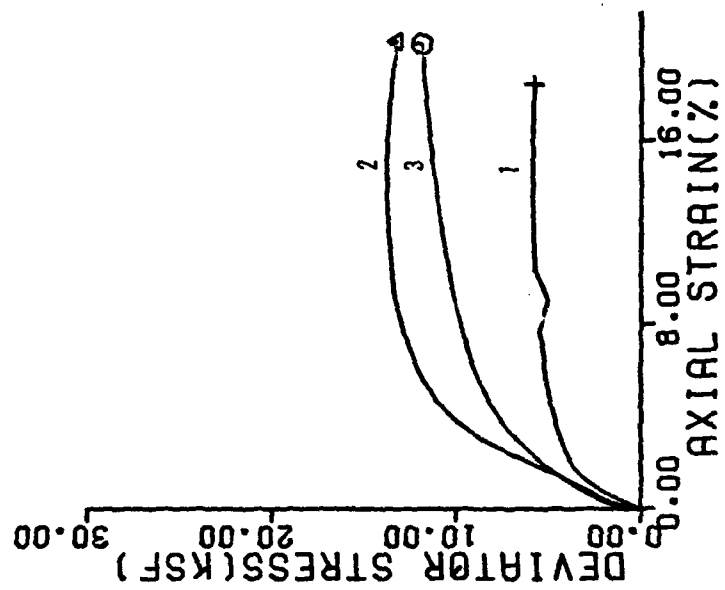

SYMBOL NO.	BORING NO.	SAMPLE NO.	SAMPLE INTERVAL		CONFINING PRESSURE (σ <sub>3</sub> )		MAXIMUM DEVIATOR STRESS (σ <sub>1</sub> -σ <sub>3</sub> )	
			FEET	METERS	ksf	KN/m <sup>2</sup>		
1	B-17N	S-2-3	4.3-5.0	1.31-1.52	0.7	33.5	5.8	278
2	B-17N	S-3-1	5.1-5.8	1.55-1.77	2.9	138.9	13.8	661
3	B-17N	S-3-2	5.8-6.5	1.77-1.98	5.8	277.7	18.6	565

TRIAXIAL COMPRESSION TESTS  
 BOEING GAS SITE  
 MAV TEST SITE, SAN CRISTOBAL VALLEY, ARIZONA

MX SITING INVESTIGATION  
 DEPARTMENT OF THE AIR FORCE - SAMSO

FIGURE  
 6  
 1 OF 7

**UGRO NATIONAL, INC.**

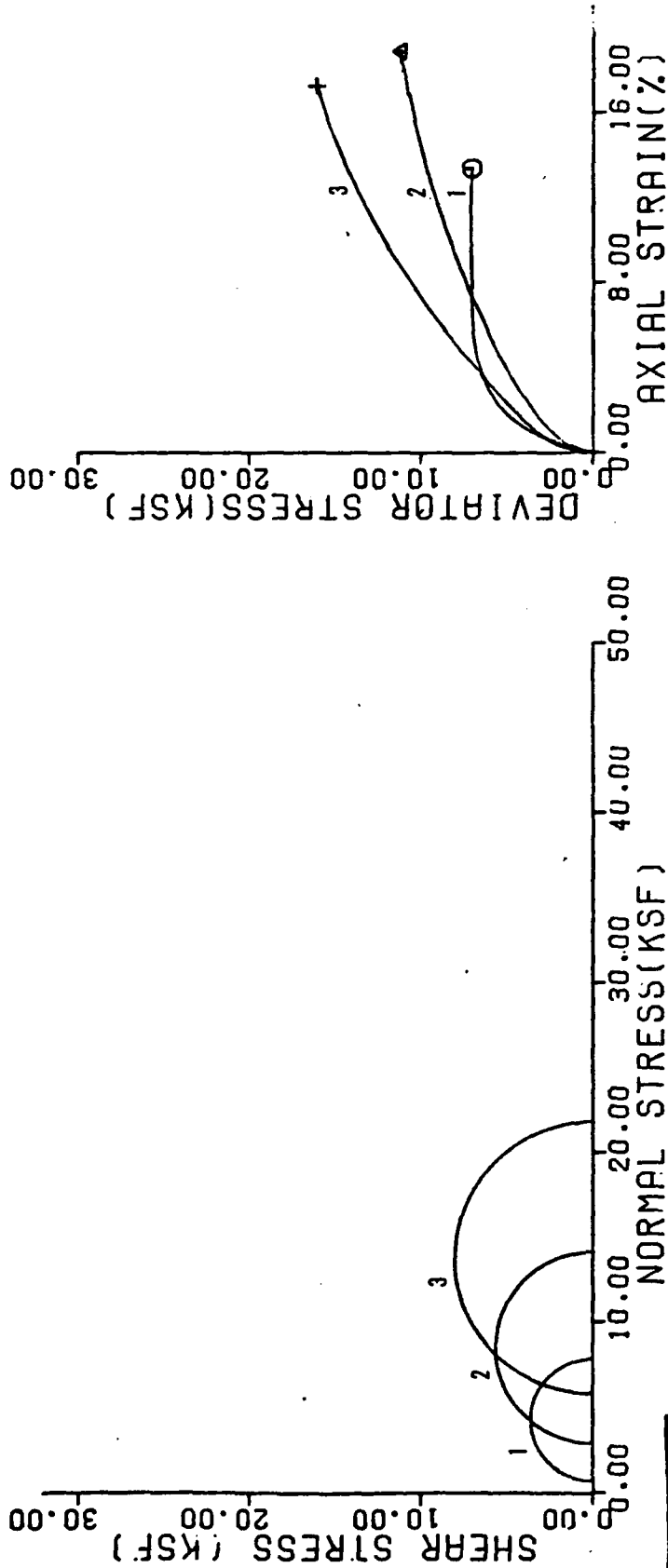

SYMBOL NO.	BORING NO.	SAMPLE NO.	SAMPLE INTERVAL		CONFINING PRESSURE ( $\sigma_3$ )		MAXIMUM DEVIATOR STRESS ( $\sigma_1 - \sigma_3$ )	
			FEET	METERS	ksf	KN/m <sup>2</sup>	ksf	KN/m <sup>2</sup>
1	B-33	S-1-2	1.1-1.8	0.34-0.55	0.7	33.5	7.1	340
2	B-33	S-1-3	1.8-2.5	0.55-0.76	2.9	138.9	11.3	541
3	B-33	S-2-2	3.4-4.1	1.04-1.25	5.8	277.7	16.0	786

**TRIAxIAL COMPRESSION TESTS  
BORING HYDRAULIC SITE  
MAV TEST SITE, SAN CRISTOBAL VALLEY, ARIZONA**

MX SITING INVESTIGATION  
DEPARTMENT OF THE AIR FORCE - SAMSO

FIGURE  
**7**  
1 OF 4

**FUGRO NATIONAL, INC.**

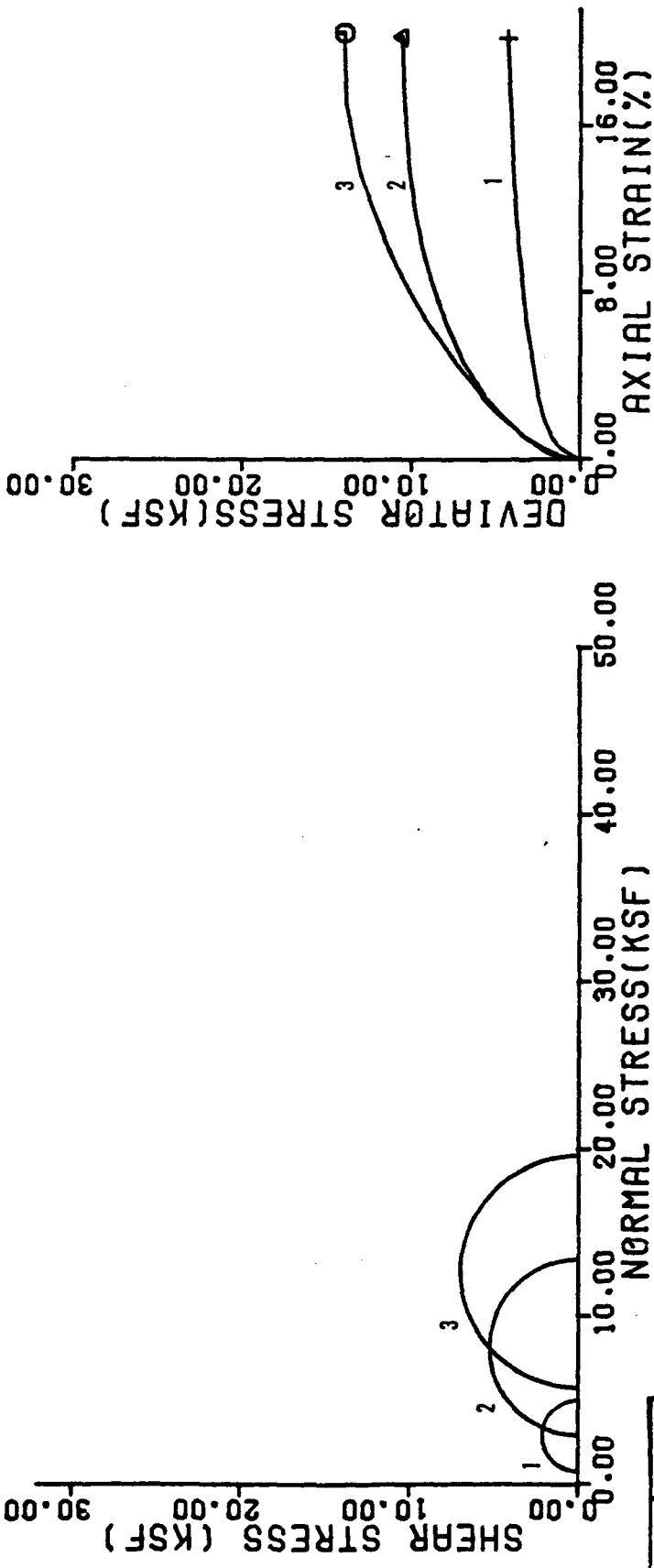

SYMBOL NO.	BORING NO.	SAMPLE NO.	SAMPLE INTERVAL		CONFINING PRESSURE (σ <sub>3</sub> )		MAXIMUM DEVIATOR STRESS (σ <sub>1</sub> -σ <sub>3</sub> )	
			FEET	METERS	ksf	KN/m <sup>2</sup>		
1	B-34N	P-3-3	4.8-5.2	1.46-1.68	0.7	33.5	4.3	206
2	B-34N	S-4-1	5.7-6.4	1.74-1.95	2.9	138.9	10.6	508
3	B-34N	S-4-2	6.4-7.1	1.95-2.16	5.8	277.7	13.9	670

**TRIAxIAL COMPRESSION TESTS  
BOEING HYDRAULIC SITE  
NAV TEST SITE, SAN CRISTOBAL VALLEY, ARIZONA**

MX SITING INVESTIGATION  
DEPARTMENT OF THE AIR FORCE - SAMSO

FIGURE  
**7**  
2 OF 4

**UGRO NATIONAL, INC.**

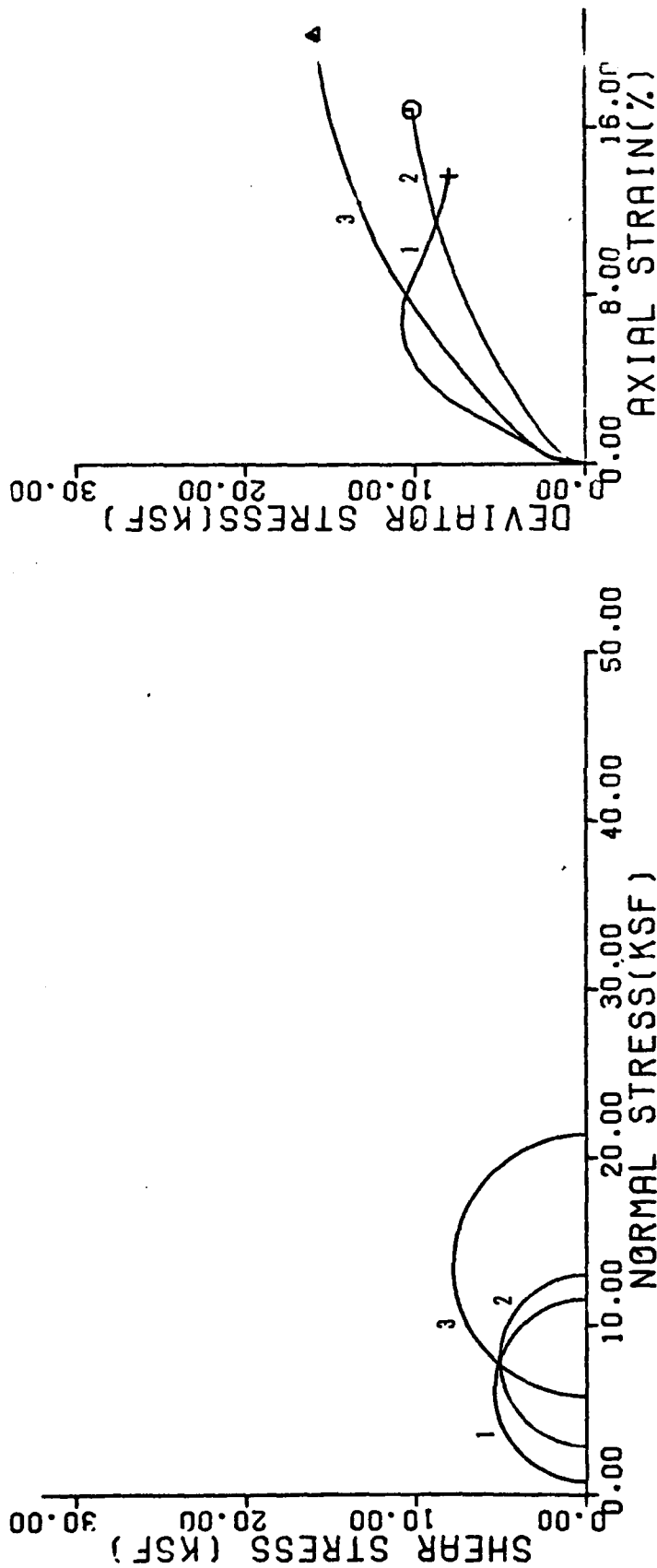

SYMBOL NO.	BORING NO.	SAMPLE NO.	SAMPLE INTERVAL		CONFINING PRESSURE ( $\sigma_3$ )		MAXIMUM DEVIATOR STRESS ( $\sigma_1 - \sigma_3$ )	
			FEET	METERS	ksf	KN/m <sup>2</sup>	ksf	KN/m <sup>2</sup>
1	B-34S	S-2-3	4.3-5.0	1.31-1.52	0.7	33.5	10.8	517
2	B-34S	S-3-2	5.8-6.5	1.77-1.98	2.9	138.9	10.1	484
3	B-34S	S-3-3	6.5-7.5	1.98-2.29	5.8	277.7	15.6	747

TRIAxIAL COMPRESSION TESTS  
BOEING HYDRAULIC SITE  
MAY TEST SITE, SAN CRISTOBAL VALLEY, ARIZONA

MX SITING INVESTIGATION  
DEPARTMENT OF THE AIR FORCE - SANSO

FIGURE  
7  
3 OF 4

FUGRO NATIONAL, INC.

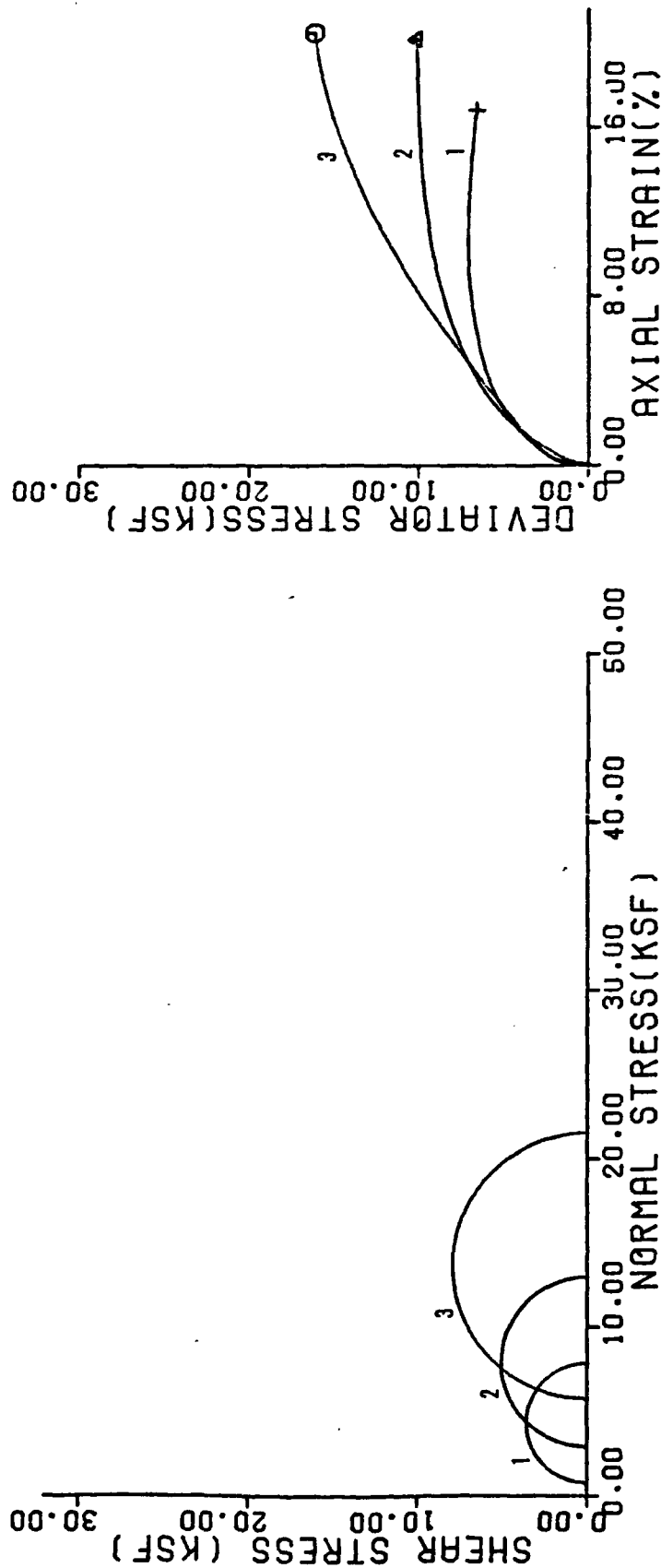

SYMBOL NO.	BORING NO.	SAMPLE NO.	SAMPLE INTERVAL		CONFINING PRESSURE ( $\sigma_3$ )	MAXIMUM DEVIATOR STRESS ( $\sigma_1 - \sigma_3$ )
			FEET	METERS		
1	B-36N	S-2-3	4.3-5.0	1.31-1.52	0.7 ksf / 33.5 kN/m <sup>2</sup>	7.1 ksf / 340 kN/m <sup>2</sup>
2	B-36N	S-3-1	5.1-5.8	1.55-1.77	2.9 ksf / 138.9 kN/m <sup>2</sup>	10.1 ksf / 484 kN/m <sup>2</sup>
3	B-36N	S-3-2	5.8-6.5	1.77-1.98	5.8 ksf / 277.7 kN/m <sup>2</sup>	15.8 ksf / 757 kN/m <sup>2</sup>

TRIAxIAL COMPRESSION TESTS  
BOEING HYDRAULIC SITE  
MAV TEST SITE, SAN CRISTOBAL VALLEY, ARIZONA

MX SITING INVESTIGATION  
DEPARTMENT OF THE AIR FORCE - SAMSO

FIGURE  
7  
4 OF 4

**UGRO NATIONAL, INC.**

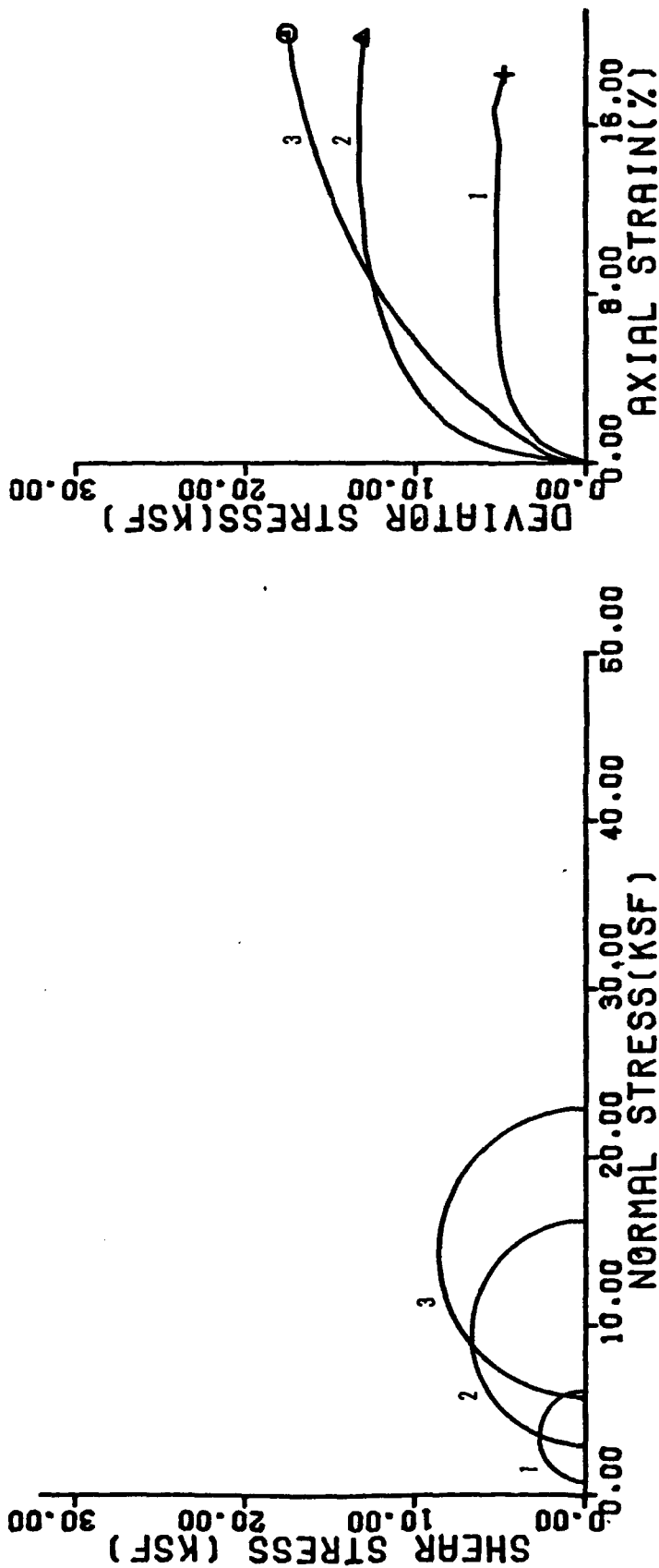

SYMBOL NO.	BORING NO.	SAMPLE NO.	SAMPLE INTERVAL		CONFINING PRESSURE (σ <sub>3</sub> )	MAXIMUM DEVIATOR STRESS (σ <sub>1</sub> -σ <sub>3</sub> )
			FEET	METERS		
1	M-9	S-1-3	1.8-2.5	0.55-0.76	0.7 ksf / 33.5 kN/m <sup>2</sup>	5.3 ksf / 254 kN/m <sup>2</sup>
2	M-9	S-2-1	2.5-3.2	0.76-0.96	2.9 ksf / 136.9 kN/m <sup>2</sup>	13.4 ksf / 642 kN/m <sup>2</sup>
3	M-9	S-2-2	3.2-3.9	0.96-1.19	5.8 ksf / 277.7 kN/m <sup>2</sup>	17.6 ksf / 843 kN/m <sup>2</sup>

TRIAXIAL COMPRESSION TESTS  
 MARTIN MARIETTA GAS SITE  
 MAV TEST SITE, SAN CRISTOBAL VALLEY, ARIZONA

MX SITING INVESTIGATION  
 DEPARTMENT OF THE AIR FORCE - SANSO

FIGURE  
 8  
 1 OF 10

**FUGRO NATIONAL, INC.**

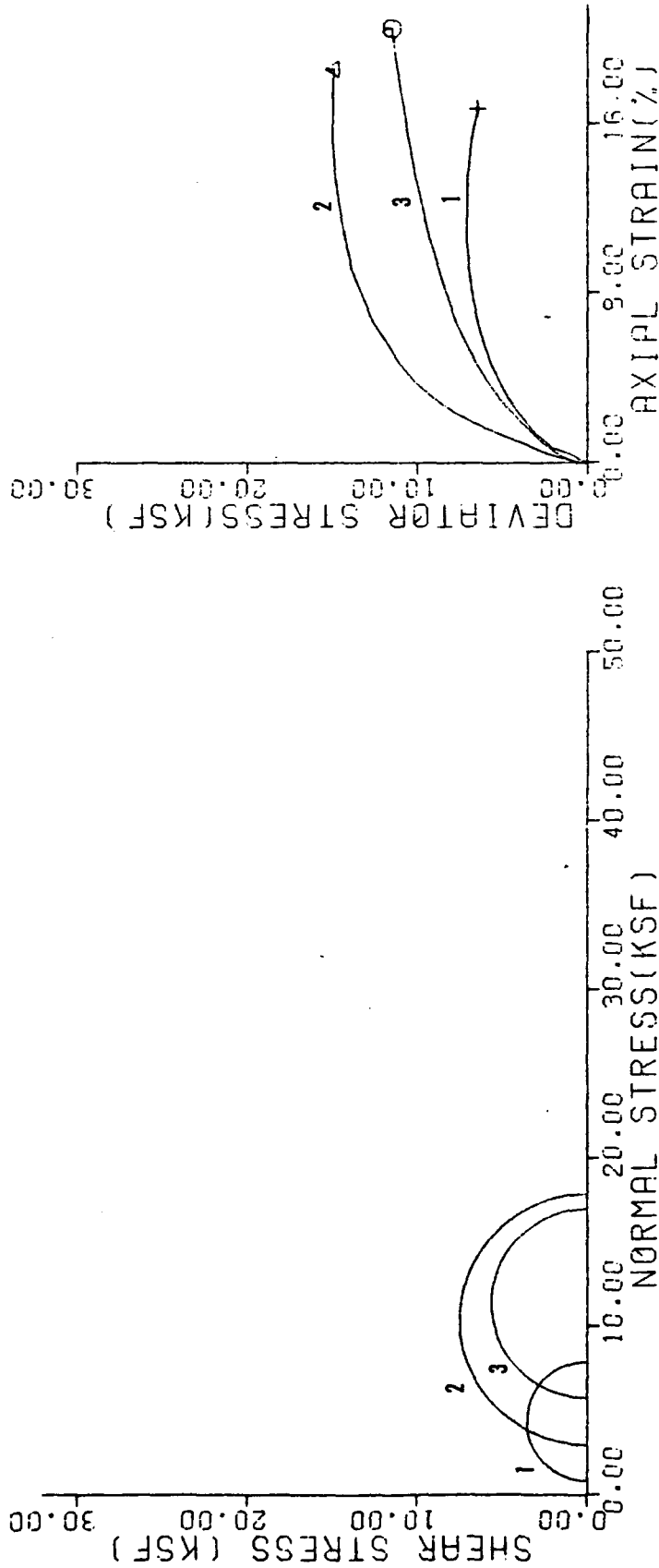

SYMBOL NO.	BORING NO.	SAMPLE NO.	SAMPLE INTERVAL		CONFINING PRESSURE (Q <sub>2</sub> )	MAXIMUM DEVIATOR STRESS (Q <sub>1</sub> -Q <sub>2</sub> )
			FEET	METERS		
1	M-11S	S-2-2	3.6-4.3	1.10-1.52	0.7	33.5
2	M-11S	S-3-1	5.2-5.9	1.58-1.80	2.9	138.9
3	M-11S	S-3-3	6.8-7.5	2.01-2.29	5.8	277.7

TRIAxIAL COMPRESSION TESTS  
 MARTIN MARIETTA GAS SITE  
 MAV TEST SITE, SAN CRISTOBAL VALLEY, ARIZONA

MX SITING INVESTIGATION  
 DEPARTMENT OF THE AIR FORCE - SAMS0

FIGURE  
 8  
 2 OF 10

**FUGRO NATIONAL, INC.**

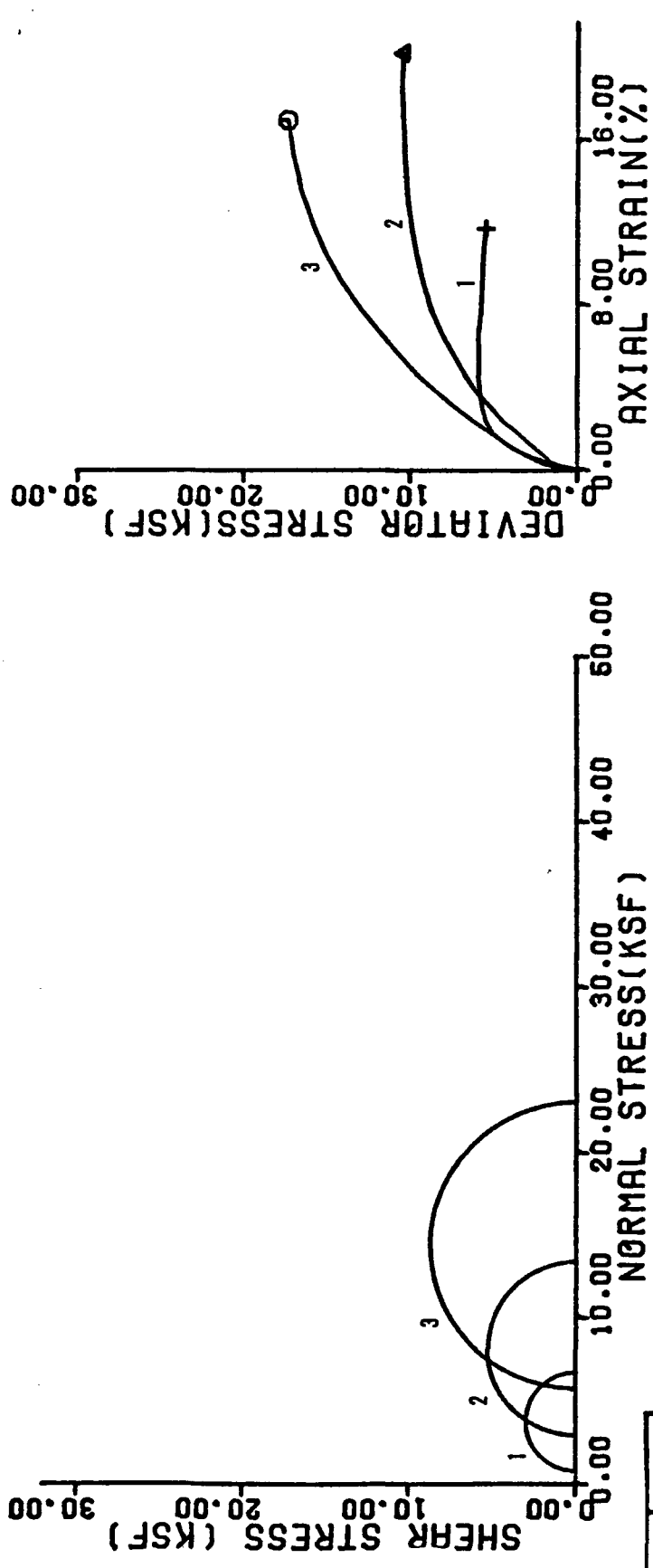

SYMBOL NO.	BORING NO.	SAMPLE NO.	SAMPLE INTERVAL		CONFINING PRESSURE (Q <sub>3</sub> )	MAXIMUM DEVIATOR STRESS (Q <sub>1</sub> -Q <sub>3</sub> )
			FEET	METERS		
1	M-12N	S-2-3	4.3-5.0	1.31-1.52	0.7	5.9
2	M-12N	S-3-1	5.0-5.7	1.52-1.74	2.9	10.5
3	M-12N	S-3-2	5.7-6.4	1.74-1.95	5.8	17.3

**TRIAxIAL COMPRESSION TESTS**  
**MARTIN MARIETTA GAS SITE**  
**MAV TEST SITE, SAN CRISTOBAL VALLEY, ARIZONA**

MX SITING INVESTIGATION  
DEPARTMENT OF THE AIR FORCE - SAMS0

FIGURE  
**8**  
3 OF 10

**FUGRO NATIONAL, INC.**



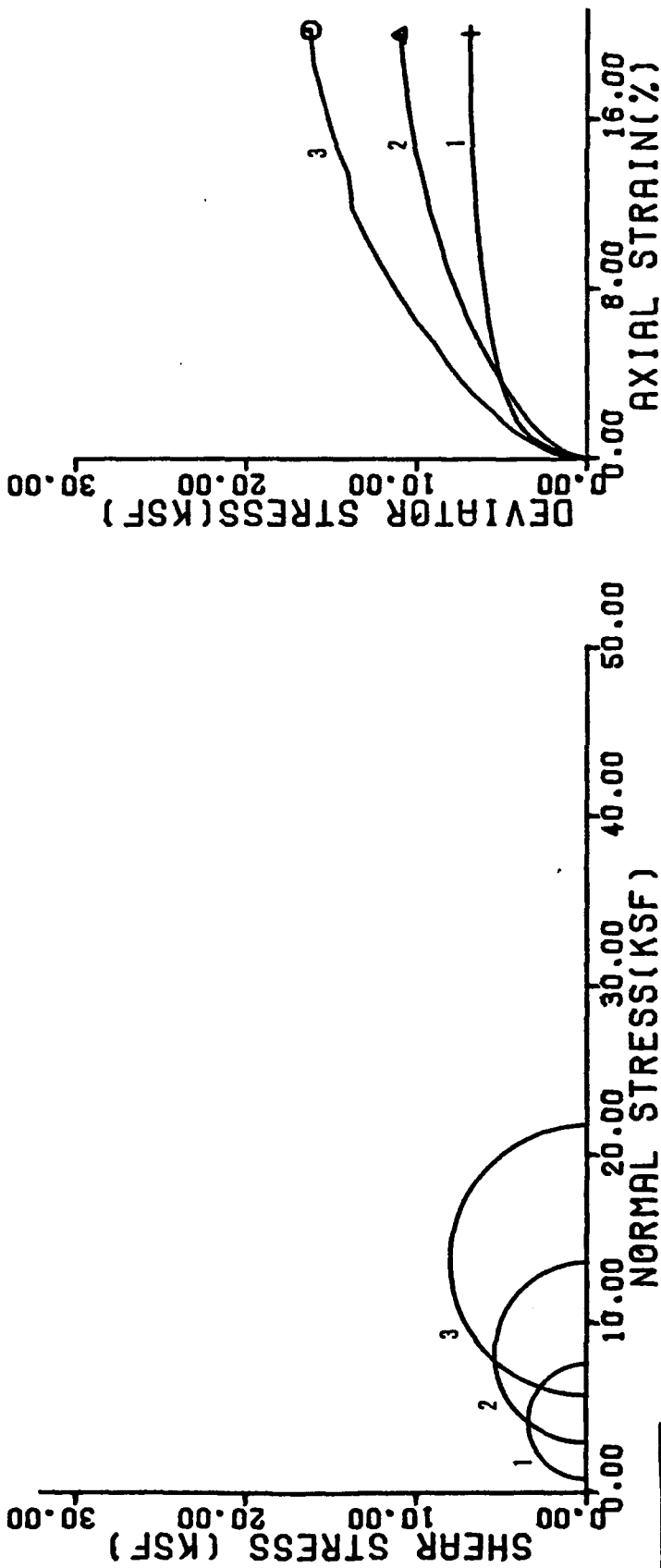

SYMBOL NO.	BORING NO.	SAMPLE NO.	SAMPLE INTERVAL		CONFINING PRESSURE (σ <sub>3</sub> )	MAXIMUM DEVIATOR STRESS (σ <sub>1</sub> -σ <sub>3</sub> )
			FEET	METERS		
1	M-13S	S-2-3	4.3-5.0	1.31-1.52	0.7 ksf / 33.5 kN/m <sup>2</sup>	6.9 ksf / 330 kN/m <sup>2</sup>
2	M-13S	S-3-1	5.0-5.7	1.52-1.74	2.9 ksf / 136.9 kN/m <sup>2</sup>	11.0 ksf / 527 kN/m <sup>2</sup>
3	M-13S	S-3-2	5.7-6.4	1.74-1.95	5.8 ksf / 277.7 kN/m <sup>2</sup>	16.3 ksf / 780 kN/m <sup>2</sup>

TRIAXIAL COMPRESSION TESTS  
 MARTIN MARIETTA GAS SITE  
 MAV TEST SITE, SAN CRISTOBAL VALLEY, ARIZONA

MX SITING INVESTIGATION  
 DEPARTMENT OF THE AIR FORCE - SANSO

FIGURE  
 8  
 4 OF 10

**UGRO NATIONAL, INC.**

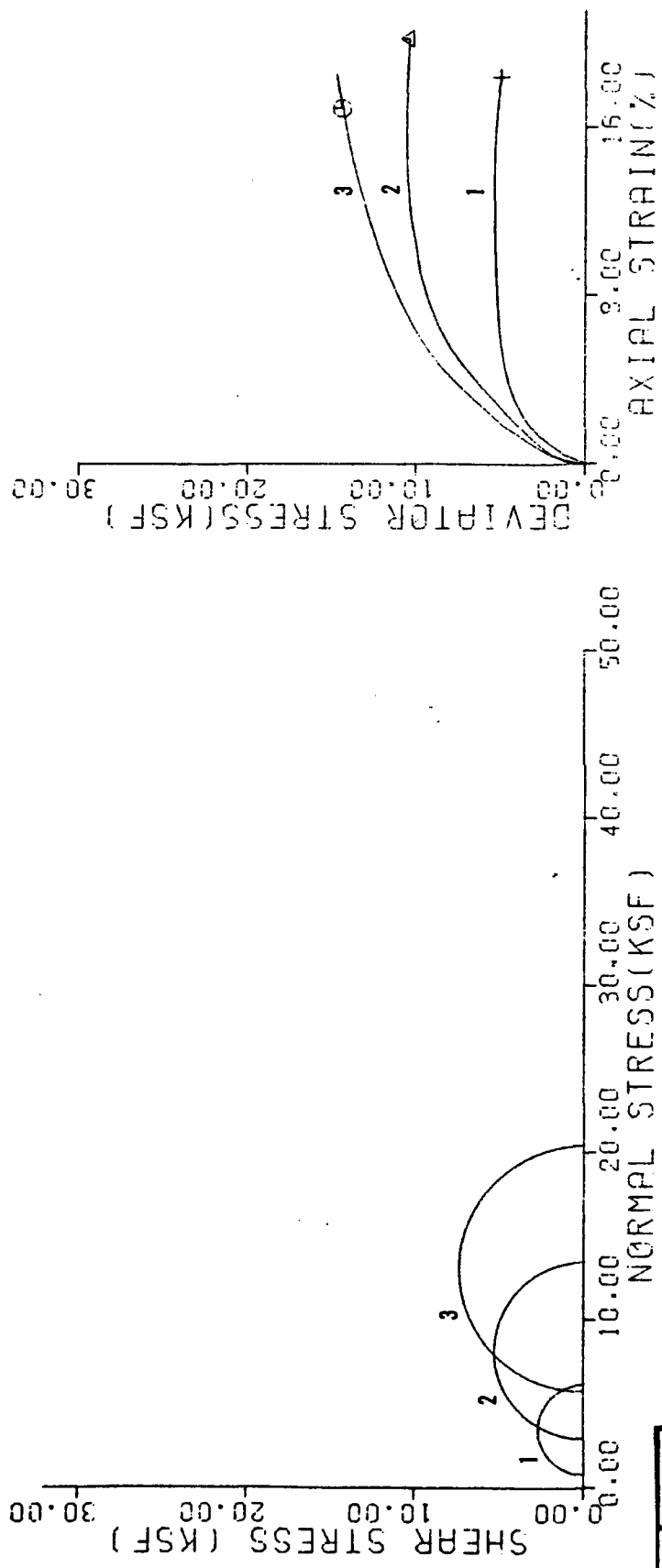

SYMBOL NO.	BORING NO.	SAMPLE NO.	SAMPLE INTERVAL		CONFINING PRESSURE (σ <sub>3</sub> )		MAXIMUM DEVIATOR STRESS (σ <sub>1</sub> -σ <sub>3</sub> )	
			FEET	METERS	ksf	kn/m <sup>2</sup>	ksf	kn/m <sup>2</sup>
1	M-14N	S-2-3	4.3-5.0	1.31-1.52	0.7	33.5	5.4	239
2	M-14N	S-3-1	5.0-5.7	1.52-1.74	2.9	138.9	10.6	508
3	M-14N	S-3-2	5.7-6.4	1.74-1.95	5.8	277.7	14.7	704

**TRIAxIAL COMPRESSION TESTS  
MARTIN MARIETTA GAS SITE  
NAV TEST SITE, SAN CRISTOBAL VALLEY, ARIZONA**

MX SITING INVESTIGATION DEPARTMENT OF THE AIR FORCE - SANSO	FIGURE <b>8</b> 5 OF 10
--	-------------------------------

**UGRO NATIONAL, INC.**

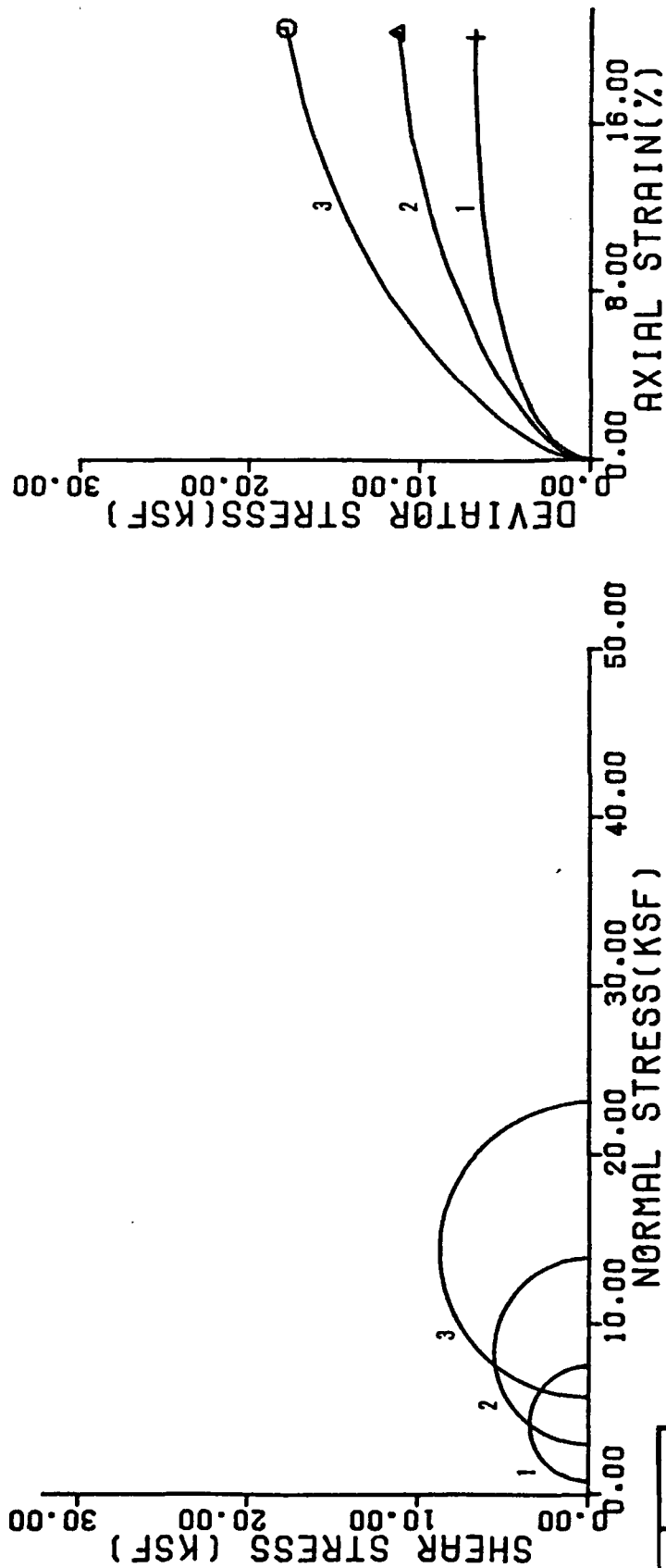

SYMBOL NO.	BORING NO.	SAMPLE NO.	SAMPLE INTERVAL		CONFINING PRESSURE (σ <sub>3</sub> )		MAXIMUM DEVIATOR STRESS (σ <sub>1</sub> -σ <sub>3</sub> )	
			FEET	METERS	ksf	kn/m <sup>2</sup>	ksf	kn/m <sup>2</sup>
1	M-15S	S-2-3	4.3-5.0	1.31-1.52	0.7	33.5	6.8	326
2	M-15S	S-3-1	5.0-5.7	1.52-1.74	2.9	138.9	11.3	541
3	M-15S	S-3-2	5.7-6.4	1.74-1.95	5.8	277.7	17.9	857

TRIAXIAL COMPRESSION TESTS  
MARTIN MARIETTA GAS SITE  
MAY TEST SITE, SAN CRISTOBAL VALLEY, ARIZONA

MX SITING INVESTIGATION  
DEPARTMENT OF THE AIR FORCE - SANSO

FIGURE  
**8**  
6 OF 10

**UGRO NATIONAL, INC.**

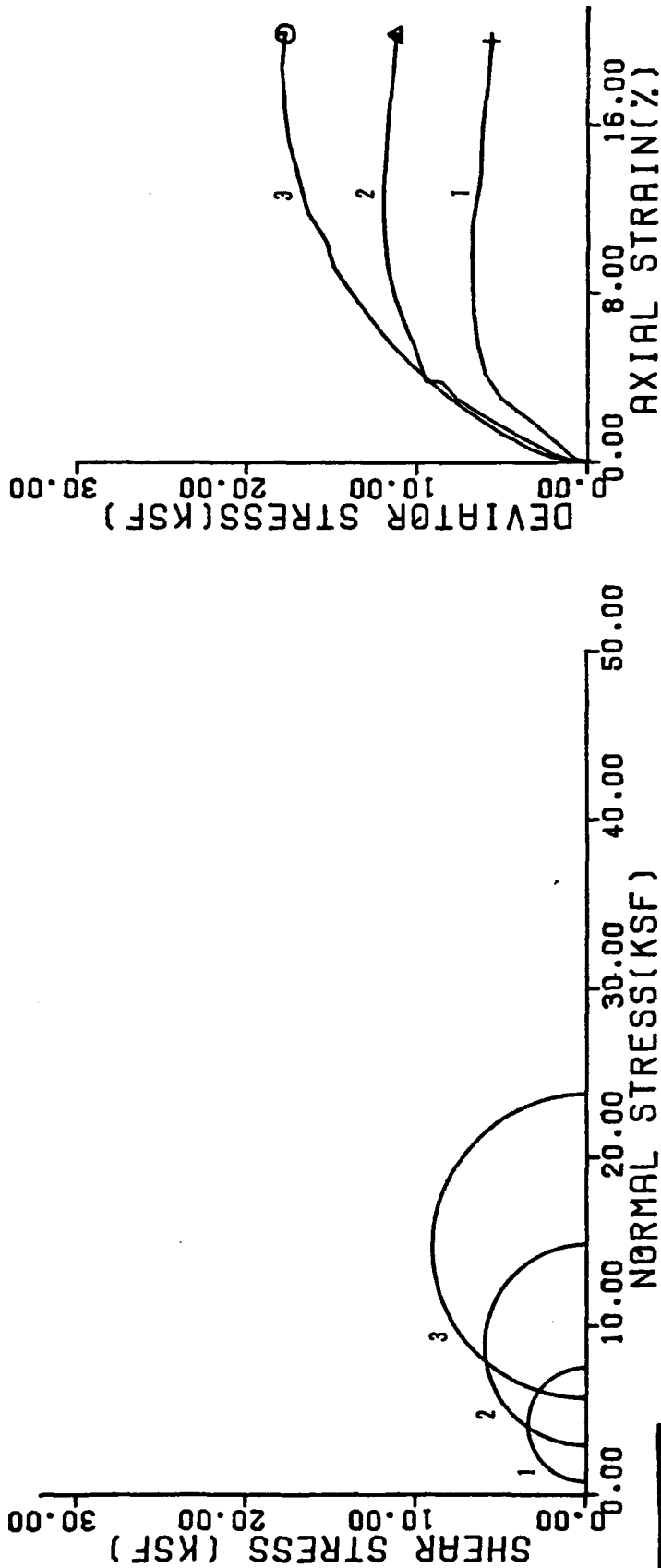

SYMBOL NO.	BORING NO.	SAMPLE NO.	SAMPLE INTERVAL		CONFINING PRESSURE (σ <sub>3</sub> )		MAXIMUM DEVIATOR STRESS (σ <sub>1</sub> -σ <sub>3</sub> )	
			FEET	METERS	ksf	kN/m <sup>2</sup>		
1	M-16N	S-2-3	4.3-5.0	1.31-1.52	0.7	33.5	6.8	326
2	M-16N	S-3-1	5.0-5.7	1.52-1.74	2.9	138.9	12.0	575
3	M-16N	S-4-1	7.5-8.2	2.29-2.50	5.8	277.7	18.0	862

TRIAXIAL COMPRESSION TESTS  
 MARTIN MARIETTA GAS SITE  
 MAV TEST SITE, SAN CRISTOBAL VALLEY, ARIZONA

MX SITING INVESTIGATION  
 DEPARTMENT OF THE AIR FORCE - SAMSOC

FIGURE  
 8  
 7 OF 10

**JUGRO NATIONAL, INC.**

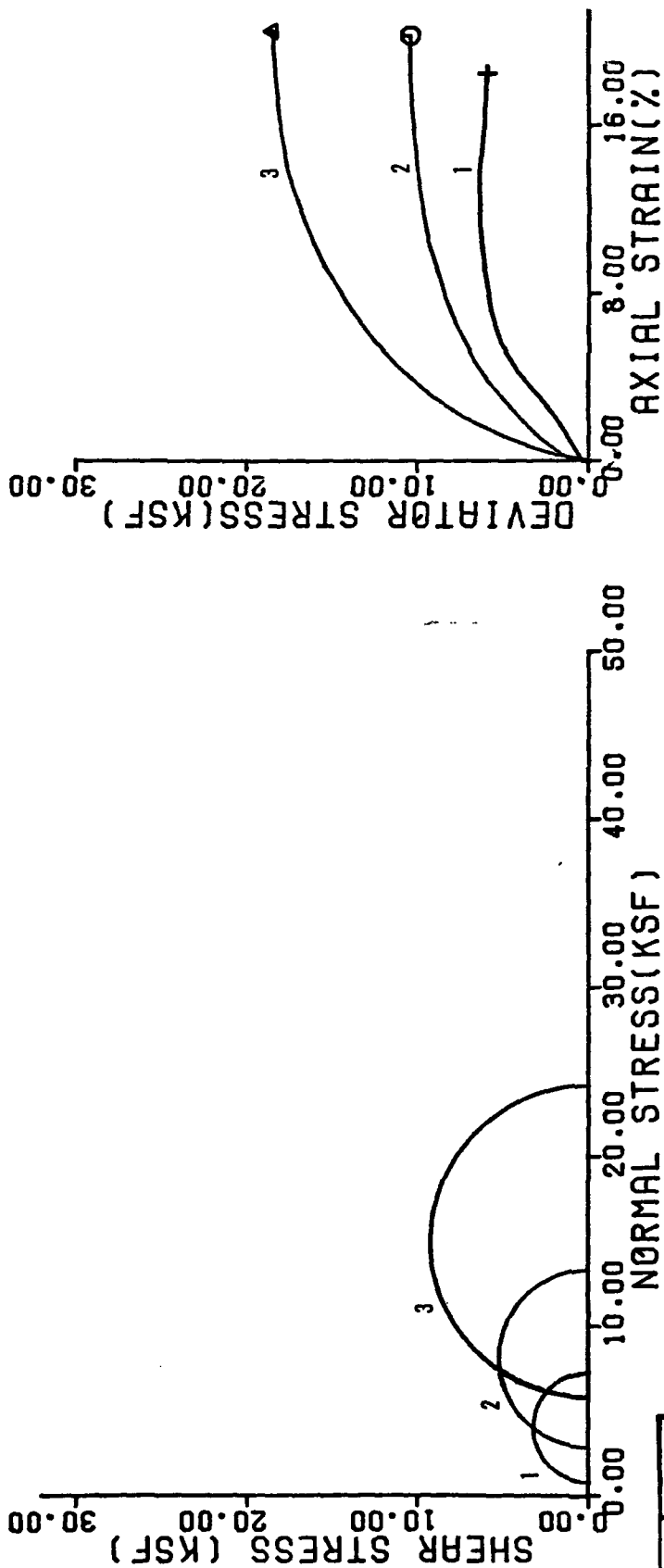

SYMBOL NO.	BORING NO.	SAMPLE NO.	SAMPLE INTERVAL		CONFINING PRESSURE (Q <sub>3</sub> )		MAXIMUM DEVIATOR STRESS (D <sub>3</sub> )	
			FEET	METERS	ksf	KN/m <sup>2</sup>	ksf	KN/m <sup>2</sup>
1	M-17N	S-2-3	4.3-5.0	1.31-1.52	0.7	33.5	6.5	311
2	M-17N	S-3-1	5.0-5.7	1.55-1.74	2.9	138.9	10.5	503
3	M-17N	S-3-2	5.7-6.4	1.74-1.95	5.8	277.7	18.4	891

TRIAxIAL COMPRESSION TESTS  
 MARTIN MARIETTA GAS SITE  
 MAV TEST SITE, SAN CRISTOBAL VALLEY, ARIZONA

MX SITING INVESTIGATION  
 DEPARTMENT OF THE AIR FORCE - SAMSO

FIGURE  
 8  
 8 OF 10

**FUGRO NATIONAL, INC.**

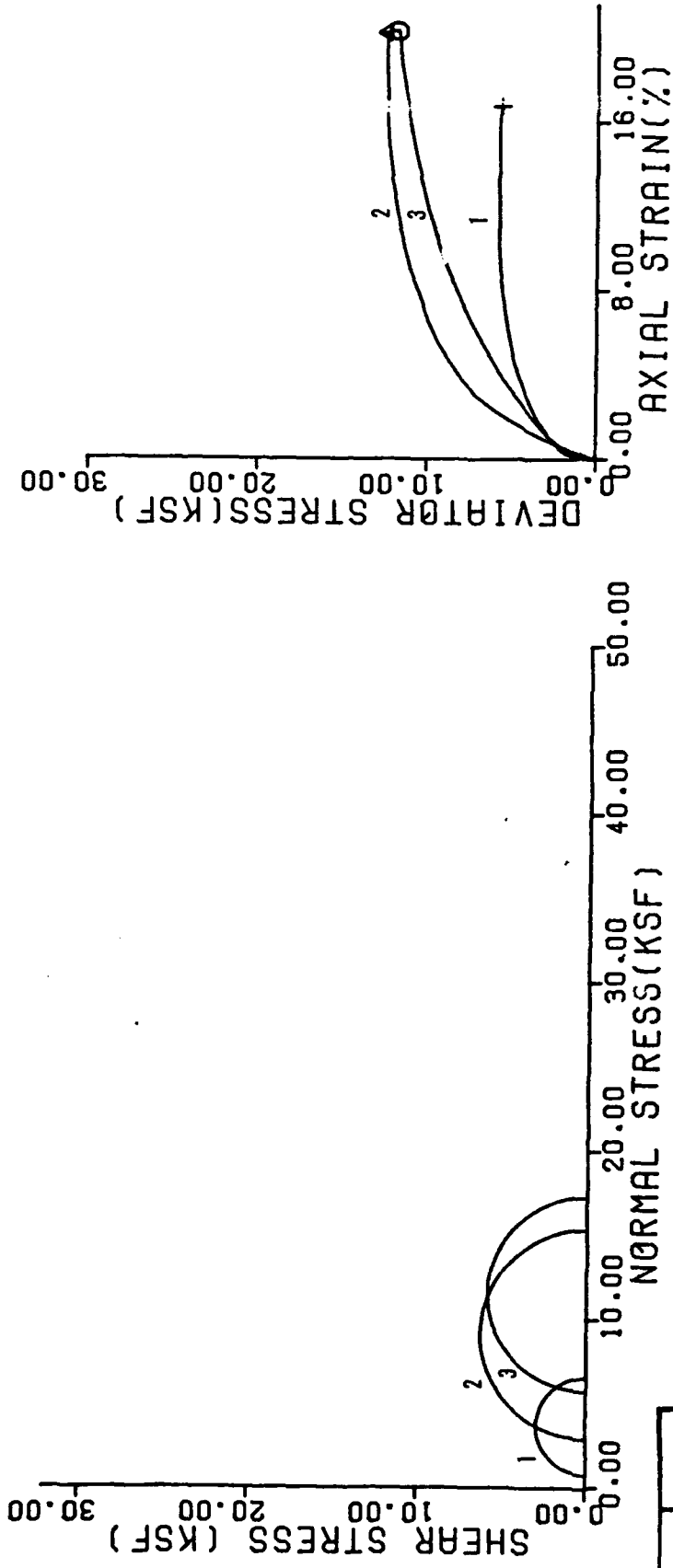

SYMBOL NO.	BORING NO.	SAMPLE NO.	SAMPLE INTERVAL		CONFINING PRESSURE (σ <sub>3</sub> )		MAXIMUM DEVIATOR STRESS (σ <sub>1</sub> -σ <sub>3</sub> )	
			FEET	METERS	ksf	KN/m <sup>2</sup>	ksf	KN/m <sup>2</sup>
1	M-17S	S-2-3	4.3-5.0	1.31-1.52	0.7	33.5	5.8	278
2	M-17S	S-3-1	5.0-5.7	1.52-1.74	2.9	138.9	12.5	599
3	M-17S	S-3-2	5.7-6.4	1.74-1.95	5.8	277.7	11.6	555

**TRIAXIAL COMPRESSION TESTS  
MARTIN MARIETTA GAS SITE  
MAV TEST SITE, SAN CRISTOBAL VALLEY, ARIZONA**

MX SITING INVESTIGATION  
DEPARTMENT OF THE AIR FORCE - SANSO

FIGURE  
**8**  
9 OF 10

**TRUGRO NATIONAL, INC.**

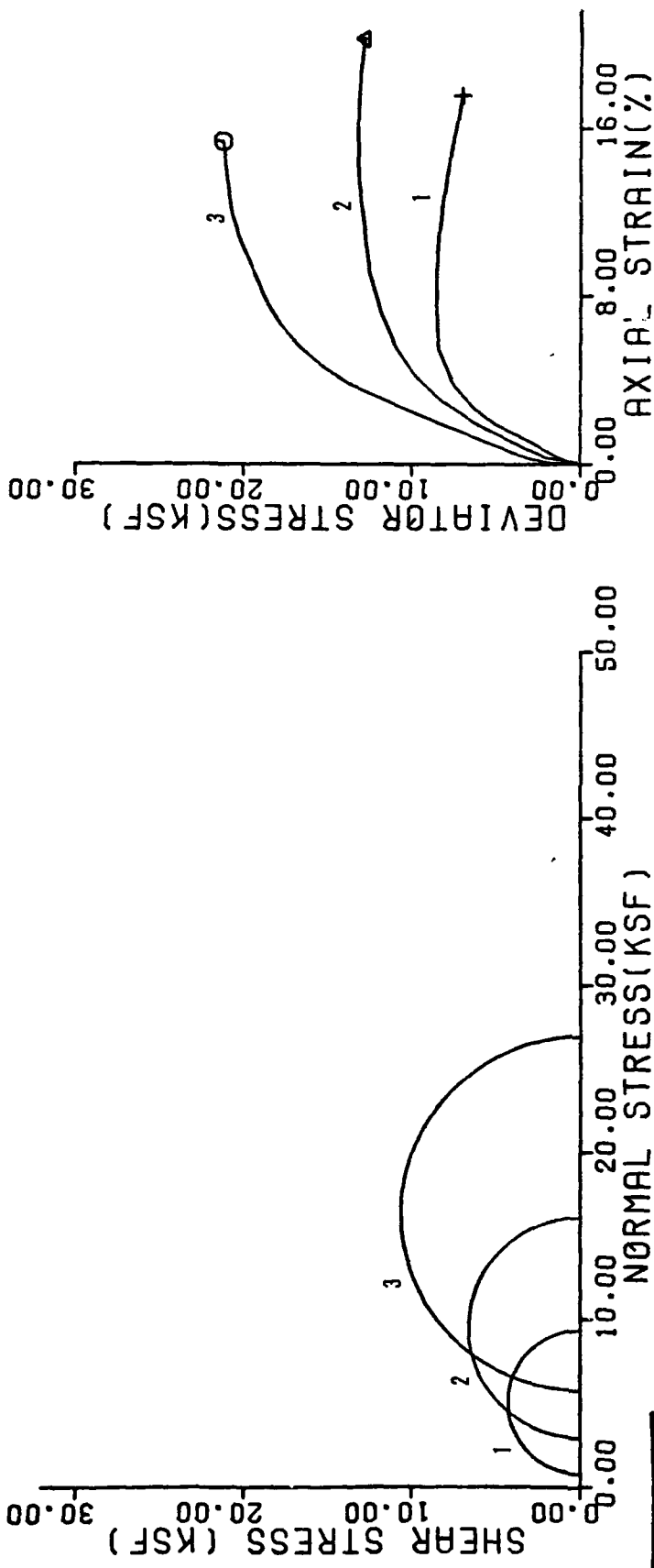

SYMBOL NO.	BORING NO.	SAMPLE NO.	SAMPLE INTERVAL		CONFINING PRESSURE (σ <sub>3</sub> )		MAXIMUM DEVIATOR STRESS (σ <sub>1</sub> -σ <sub>3</sub> )	
			FEET	METERS	ksf	KN/m <sup>2</sup>	ksf	KN/m <sup>2</sup>
1	M-18	S-1-2	1.1-1.8	0.34-0.55	0.7	33.5	8.6	412
2	M-18	S-1-3	1.8-2.5	0.55-0.76	2.9	138.9	13.2	632
3	M-18	S-2-1	2.5-3.2	0.76-0.98	5.8	277.7	21.2	1015

**TRIAxIAL COMPRESSION TESTS**  
**MARTIN MARIETTA GAS SITE**  
**MAV TEST SITE, SAN CRISTOBAL VALLEY, ARIZONA**

MX SITING INVESTIGATION  
DEPARTMENT OF THE AIR FORCE - SAMSO

FIGURE  
**8**  
10 OF 10

**UGRO NATIONAL, INC.**

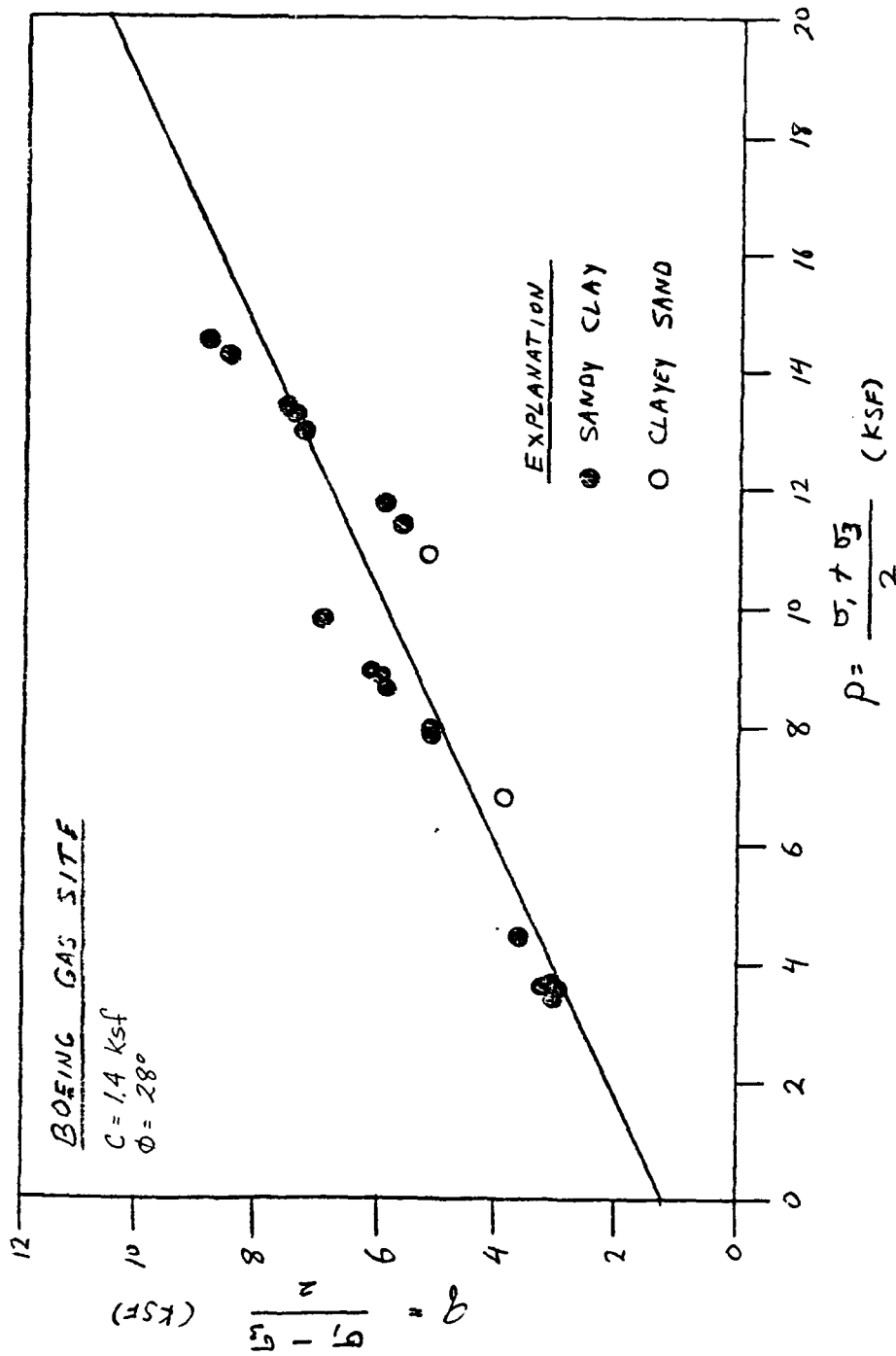

**P-Q DIAGRAM-BOEING GAS SITE  
 MAV TEST SITE  
 SAN CRISTOBAL VALLEY, ARIZONA**

MX SITING INVESTIGATION DEPARTMENT OF THE AIR FORCE - SAMS0	FIGURE <b>9</b>
--	--------------------

**UGRO NATIONAL, INC.**



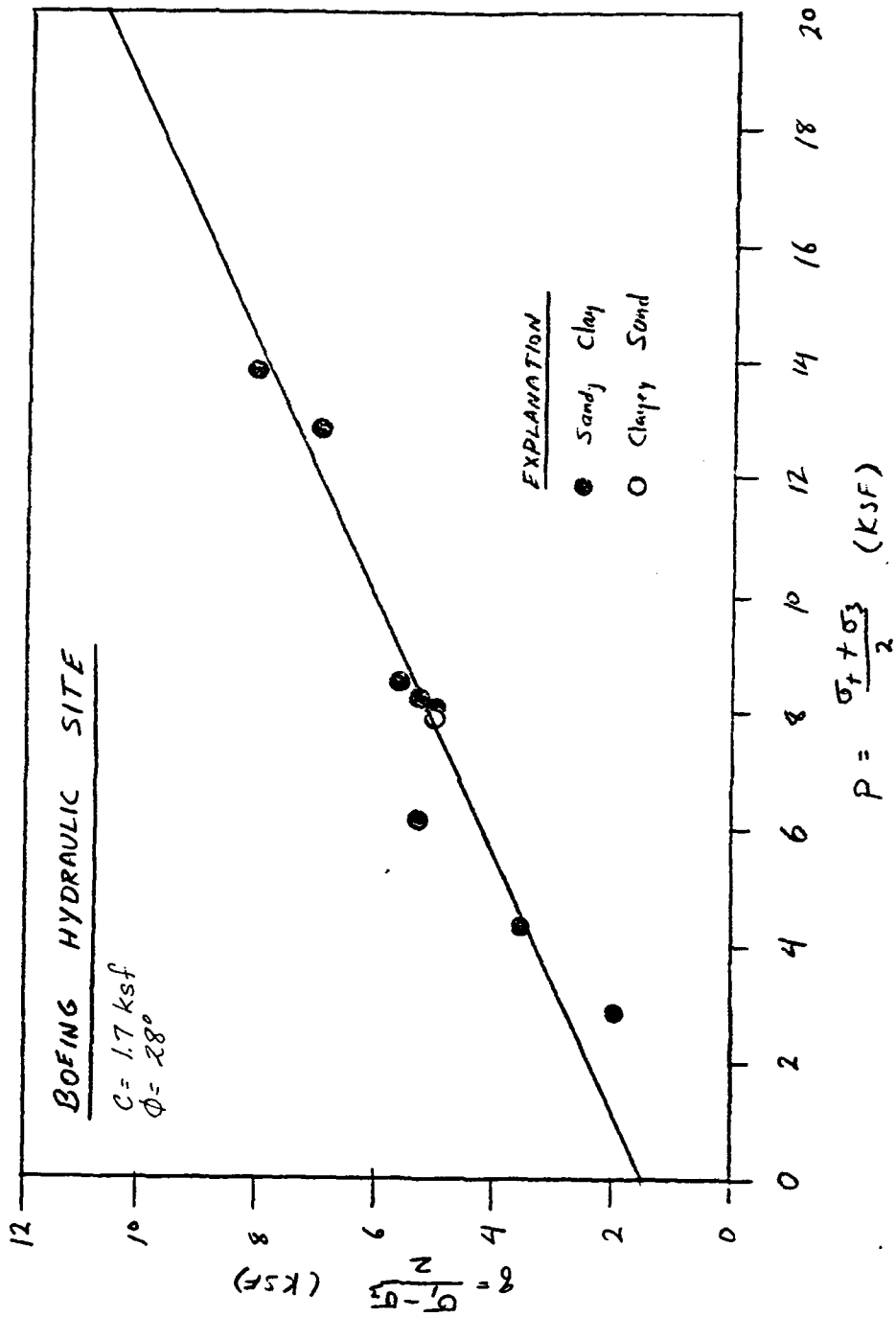

**P-Q DIAGRAM-BOEING HYDRAULIC SITE  
 MAY TEST SITE  
 SAN CRISTOBAL VALLEY, ARIZONA**

MX SITING INVESTIGATION DEPARTMENT OF THE AIR FORCE - SAMSO	FIGURE <b>10</b>
--	---------------------

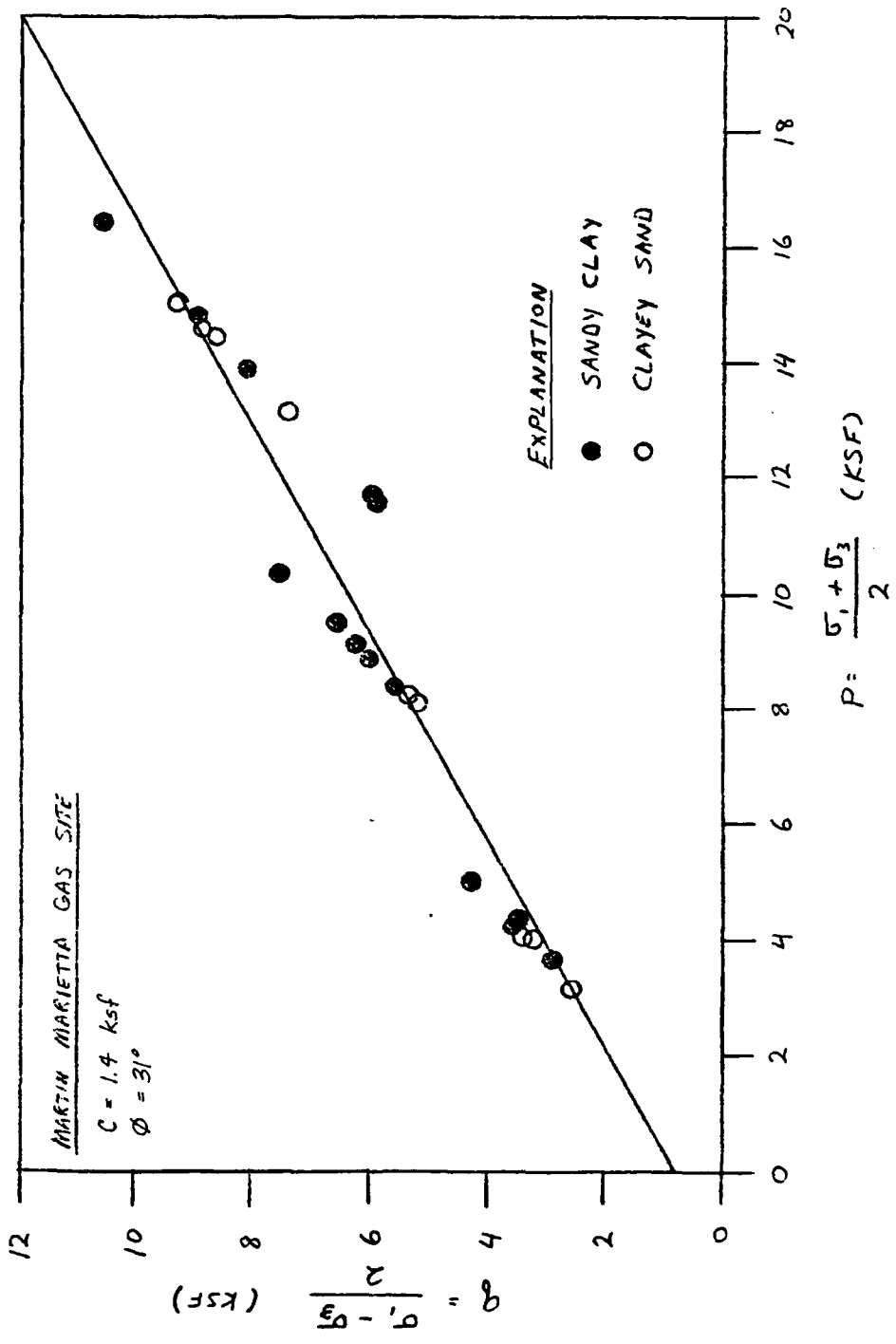

**P-Q DIAGRAM-MARTIN MARIETTA GAS  
 MAV TEST SITE  
 SAN CRISTOBAL VALLEY, ARIZONA**

MX SITING INVESTIGATION DEPARTMENT OF THE AIR FORCE - SANSO	FIGURE 11
--	--------------

**UGRO NATIONAL, INC.**

BORING NO.	DEPTH (FT)	SOIL DESCRIPTION
MAV-B-11	0 - 5.0	SANDY CLAY (CL) brown, firm to stiff, low to medium plasticity, occasional fine gravel, gypsum and caliche fragments
MAV-B-12N	0 - 10.0	SANDY CLAY (CL) brown, firm to stiff, low to medium plasticity, calcareous, occasional fine gravel, gypsum and caliche fragments
MAV-B-12S	0 - 10.0	SANDY CLAY (CL) brown, firm to stiff, low to medium plasticity, calcareous, occasional fine gravel, gypsum and caliche fragments
MAV-B-13N	0 - 10.0	SANDY CLAY (CL) brown, firm to stiff, low to medium plasticity, calcareous, occasional fine gravel, gypsum and caliche fragments
MAV-B-14S	0 - 10.0	CLAYEY SAND (SC) brown, fine to medium, poorly graded, subangular to subrounded, medium dense to dense, occasional fine gravel, gypsum and caliche fragments
MAV-B-15N	0 - 10.0	SANDY CLAY (CL) brown, firm to stiff, low to medium plasticity, calcareous, occasional fine gravel, gypsum and caliche fragments
MAV-B-16S	0 - 10.0	SANDY CLAY (CL) brown, firm to stiff, low to medium plasticity, calcareous, occasional fine gravel, gypsum and caliche fragments
MAV-B-17N	0 - 10.0	SANDY CLAY (CL) brown, firm to stiff, low to medium plasticity, calcareous, occasional fine gravel, gypsum and caliche fragments
MAV-B-19	0 - 5.0	SANDY CLAY (CL) brown, firm to stiff, low to medium plasticity, calcareous, occasional fine gravel, gypsum and caliche fragments

BORING LOGS-BOEING GAS SITE  
MAV TEST SITE  
SAN CRISTOBAL VALLEY, ARIZONA

MX SITING INVESTIGATION  
DEPARTMENT OF THE AIR FORCE - SAMS0

TABLE  
1

**UGRO NATIONAL, INC.**

BORING NO.	DEPTH (FT)	SOIL DESCRIPTION
MAV-B-33	0 - 2.5	SANDY CLAY (CL) brown, firm to stiff, low to medium plasticity, calcareous, occasional fine gravel, gypsum and caliche fragments
	2.5 - 5.0	CLAYEY SAND (SC) brown, fine to medium, poorly graded, subangular to subrounded, medium dense to dense, occasional fine gravel, gypsum and caliche fragments
MAV-B-34N	0 - 10.0	SANDY CLAY (CL) brown, firm to stiff, low to medium plasticity, calcareous, occasional fine gravel, gypsum and caliche fragments
MAV-B-34S	0 - 10.0	SANDY CLAY (CL) brown, firm to stiff, low to medium plasticity, calcareous, occasional fine gravel, gypsum and caliche fragments
MAV-B-36N	0 - 10.0	SANDY CLAY (CL) brown, firm to stiff, low to medium plasticity, calcareous, occasional fine gravel, gypsum and caliche fragments
MAV-B-39S	0 - 10.0	SANDY CLAY (CL) brown, firm to stiff, low to medium plasticity, calcareous, occasional fine gravel, gypsum and caliche fragments
MAV-B-41	0 - 5.0	SANDY CLAY (CL) brown, firm to stiff, low to medium plasticity, calcareous, occasional fine gravel, gypsum and caliche fragments

BORING LOGS-BOEING HYDRAULIC SITE  
MAV TEST SITE  
SAN CRISTOBAL VALLEY, ARIZONA

MX SITING INVESTIGATION  
DEPARTMENT OF THE AIR FORCE - SAMS0

TABLE  
2

**FUGRO NATIONAL INC.**

BORING NO.	DEPTH (FT)	SOIL DESCRIPTION
MAV-M-9	0 - 4.5	SANDY CLAY (CL) brown, stiff, low to medium plasticity, occasional fine gravel, gypsum and caliche fragments
MAV-M-11S	0 - 10.0	SANDY CLAY (CL) brown, stiff, low to medium plasticity, calcareous, occasional fine gravel, gypsum and caliche fragments
MAV-M-12N	0 - 10.0	CLAYEY SAND (SC) brown, fine to medium, poorly graded, subangular to subrounded, dense, calcareous, occasional fine gravel, gypsum and caliche fragments
MAV-M-13S	0 - 10.0	SANDY CLAY (CL) brown, stiff, low to medium plasticity, occasional fine gravel, gypsum and caliche fragments
MAV-M-14N	0 - 10.1	CLAYEY SAND (SC) brown, fine to medium, poorly graded, subangular to subrounded, dense, occasional fine gravel, gypsum and caliche fragments
MAV-M-15S	0 - 10.0	SANDY CLAY (CL) brown, stiff, low to medium plasticity, calcareous, occasional fine gravel, gypsum and caliche fragments
MAV-M-16N	0 - 10.0	CLAYEY SAND (SC) brown, fine to coarse, poorly graded, subrounded to subangular, dense, occasional fine gravel, gypsum and caliche fragments
MAV-M-17N	0 - 10.0	CLAYEY SAND (SC) brown, fine to coarse, poorly graded, subangular to subrounded, dense, calcareous, occasional fine gravel, gypsum and caliche fragments
MAV-M-17S	0 - 10.0	SANDY CLAY (CL) brown, stiff, low to medium plasticity, calcareous, occasional fine gravel, gypsum and caliche fragments
MAV-M-18	0 - 4.5	SANDY CLAY (CL) brown, stiff, low to medium plasticity, calcareous, occasional fine gravel, gypsum and caliche

BORING LOGS-MARTIN MARIETTA GAS SITE  
MAV TEST SITE  
SAN CRISTOBAL VALLEY, ARIZONA

MX SITING INVESTIGATION  
DEPARTMENT OF THE AIR FORCE - SANSO

TABLE  
3

**UGRO NATIONAL, INC.**

BORING NUMBER	SAMPLE NUMBER (a)	SAMPLE INTERVAL		PERCENT FINER BY WEIGHT												
				STANDARD SIEVE OPENING						U S STANDARD SIEV						
				BLDRS	COBBLES		GRAVEL			SAND						
					24"	12"	6"	3"	1½"	3/4"	3/8"	4	10	40	100	
B-11	S-1	0.1-1.1	0.03-0.34													
		1.1-1.8	0.34-0.55													
		1.8-2.5	0.55-0.76													
	S-2	2.6-3.3	0.79-1.01													
		3.6-4.3	1.10-1.22													
B-12N	S-1	4.0-5.0	1.22-1.52													
		0.2-0.9	0.06-0.27													
		0.9-1.6	0.27-0.49													
	S-2	1.6-2.5	0.49-0.76													
		2.5-3.6	0.76-1.10													
	S-3	3.6-4.3	1.10-1.31													
		4.3-5.0	1.31-1.52													
		5.0-5.7	1.52-1.74													
		5.7-6.4	1.74-1.95													
		6.4-7.5	1.95-2.29													
S-4	7.5-8.2	2.29-2.50														
	8.2-8.9	2.50-2.71														
B-12S	S-1	8.9-10.0	2.71-3.05													
		0.1-0.8	0.03-0.24													
		0.8-1.5	0.24-0.46													
	S-2	1.5-2.5	0.46-0.76													
		2.7-3.6	0.82-1.10													
	S-3	3.6-4.3	1.10-1.31													
		4.3-5.0	1.31-1.52													
		5.0-5.7	1.52-1.74													
		5.7-6.4	1.74-1.95													
		6.4-7.5	1.95-2.29													
S-4	7.5-8.2	2.29-2.50														
	8.2-8.9	2.50-2.71														
B-13N	S-1	8.9-10.0	2.71-3.05													
		0.2-0.9	0.06-0.27													
		0.9-1.6	0.27-0.49													
	S-2	1.6-2.5	0.49-0.76													
		2.6-3.6	0.79-1.10													
	S-3	3.6-4.3	1.10-1.31													
		4.3-5.0	1.31-1.52													
		5.0-5.7	1.52-1.74													
		5.7-6.4	1.74-1.95													
		6.4-7.5	1.95-2.29													
S-4	7.5-8.2	2.29-2.50														
	8.2-8.9	2.50-2.71														
		8.9-10.0	2.71-3.05													

NOTES:

(a) Sample types:

- S - Shelby Tube Sample
- P - Pitcher Barrel Sample
- D - Fugro Drive Sample

- \* Visual classification
- \*\* Classification based on
- \*\*\* Test performed and

SIEVE NO.					PARTICLE SIZE (mm)			ATTERBERG LIMITS			USCS*	IN-SITU				COMPACTED			SPECIFIC GRAVITY OF SOLIDS	TRIAXIAL	UNCONFINED
SILT OR CLAY					LL	PL	PI	DRY UNIT WEIGHT		MOISTURE CONTENT (%)		SATURATION (%)	VOID RATIO	MAXIMUM DRY DENSITY		OPTIMUM MOISTURE (%)					
40	100	200	.005	.001				(pcf)	(kg/m <sup>3</sup> )					(pcf)	(kg/m <sup>3</sup> )						
									CL	98.6	1579	14.5	55.3	.708							
									CL	106.5	1706	14.5	67.3	.582						***	
91	78	60	0	0	30	15	15		CL**	99.0	1586	14.1	54.2	.702						***	
									CL	96.7	1549	12.1	44.0	.743							
									CL	96.4	1544	13.5	48.7	.748						***	
									CL	104.3	1671	11.7	51.2	.615							
									CL	97.7	1565	12.5	46.6	.725							
									CL	103.9	1664	15.2	66.2	.621							
									CL	98.9	1584	13.7	52.8	.703							
84	72	57	20	10	28	19	9		CL**	103.0	1649	10.5	44.9	.636						***	
					33	17	16		CL**	101.6	1627	10.5	42.9	.659						***	
									CL	99.1	1587	13.1	50.6	.701						***	
									CL	102.6	1643	14.6	61.4	.642							
									CL	103.9	1664	14.1	61.1	.622							
									CL	107.6	1724	12.8	61.1	.566							
									CL	102.7	1645	14.2	59.8	.640							
									CL	102.7	1645	9.4	39.5	.640							
									CL	96.2	1541	12.3	44.3	.751							
									CL	101.6	1627	14.9	61.1	.658							
									CL	99.2	1589	14.7	56.7	.699							
									CL	104.5	1674	14.4	63.5	.602						***	
87	77	64	2	0	34	20	14		CL**	103.2	1653	14.7	62.8	.632				2.75		***	
									CL	103.9	1664	15.7	68.2	.622						***	
									CL	102.4	1640	13.9	57.9	.646							
									CL	106.6	1708	12.5	57.9	.581							
									CL	104.9	1680	11.8	52.7	.605							
									CL	110.0	1762	12.0	60.6	.531							
									CL	101.3	1623	8.5	34.5	.662							
									CL	102.4	1640	12.5	52.3	.646							
									CL	102.4	1640	14.4	60.3	.645							
									CL	98.9	1584	14.8	56.9	.704							
									CL	107.2	1716	15.2	72.1	.571							
									CL	101.9	1632	11.8	48.8	.653						***	
									CL	109.0	1746	12.8	63.3	.546						***	
89	78	62	10	0	32	18	14		CL**	103.2	1653	13.8	58.9	.633						***	
									CL	97.0	1554	14.9	54.7	.737							
									CL	99.3	1591	13.2	51.0	.697							
									CL	95.1	1523	13.7	48.1	.771							
									CL	112.8	1807	11.8	64.7	.494							

Classification  
 based on lab tests  
 and results included in this report

**SUMMARY**  
 MAY TEST S  
 MX S I  
 DEPARTMENT  
**FURN**

IN-SITU					COMPACTED			SPECIFIC GRAVITY OF SOLIDS	TRIAXIAL	UNCONFINED COMPRESSION	DIRECT SHEAR	CONSOLIDATION	CHEMICAL	RELATIVE DENSITY
DRY UNIT WEIGHT		MOISTURE CONTENT (%)	SATURATION (%)	VOID RATIO	MAXIMUM DRY DENSITY		OPTIMUM MOISTURE (%)							
(pcf)	(kg/m <sup>3</sup> )				(pcf)	(kg/m <sup>3</sup> )								
98.6	1579	14.5	55.3	.708										
106.5	1706	14.5	67.3	.582					***					
99.0	1586	14.1	54.2	.702					***					
96.7	1549	12.1	44.0	.743										
98.4	1544	13.5	48.7	.748					***					
104.3	1671	11.7	51.2	.615										
97.7	1565	12.5	46.6	.725										
103.9	1664	15.2	66.2	.621										
98.9	1584	13.7	52.8	.703										
103.0	1649	10.5	44.9	.636					***					
101.6	1627	10.5	42.9	.659					***					
99.1	1587	13.1	50.6	.701					***					
102.6	1643	14.6	61.4	.642										
103.9	1664	14.1	61.1	.622										
107.6	1724	12.8	61.1	.566										
102.7	1645	14.2	59.8	.640										
102.7	1645	9.4	39.5	.640										
96.2	1541	12.3	44.3	.751										
101.6	1627	14.9	61.1	.658										
99.2	1589	14.7	56.7	.699										
104.5	1674	14.4	63.5	.602					***					
103.2	1653	14.7	62.8	.632				2.75	***					
103.9	1664	15.7	68.2	.622					***					
102.4	1640	13.9	57.9	.646										
106.6	1708	12.5	57.9	.581										
104.9	1680	11.8	52.7	.605										
110.0	1762	12.0	60.8	.531										
101.3	1623	8.5	34.5	.662										
102.4	1640	12.5	52.3	.646										
102.4	1640	14.4	60.3	.645										
98.9	1584	14.8	56.9	.704										
107.2	1716	15.2	72.1	.571										
101.9	1632	11.8	48.8	.653					***					
109.0	1746	12.8	63.3	.546					***					
103.2	1653	13.8	58.9	.633					***					
97.0	1554	14.9	54.7	.737										
99.3	1591	13.2	51.0	.697										
95.1	1523	13.7	48.1	.771										
112.8	1807	11.8	64.7	.494										

SUMMARY OF LABORATORY TEST RESULTS  
BOEING GAS SITE  
NAV TEST SITE, SAN CRYSTOBAL VALLEY, ARIZONA

MX SITING INVESTIGATION  
DEPARTMENT OF THE AIR FORCE - SAMS0

TABLE  
4  
1 OF 8

**FUSRO NATIONAL, INC.**

3



8.3-9.0	2.53-2.74				
9.0-10.0	2.74-3.05				
0.2-0.9	0.06-0.27				
0.9-1.6	0.27-0.49				
1.6-2.5	0.49-0.76				
2.6-3.6	0.79-1.10				
3.6-4.3	1.10-1.31				
4.3-5.0	1.31-1.52				
5.0-5.7	1.52-1.74				
5.7-6.4	1.74-1.95				
6.4-7.5	1.95-2.29				
7.5-8.2	2.29-2.50				
8.2-8.9	2.50-2.71				
8.9-10.0	2.71-3.05				
0.1-0.8	0.03-0.24				
0.8-1.5	0.24-0.46				
1.5-2.5	0.46-0.76				
2.7-3.6	0.82-1.10				
3.6-4.3	1.10-1.31				
4.3-5.0	1.31-1.52				
5.0-5.7	1.52-1.74				
5.7-6.4	1.74-1.95				
6.4-7.5	1.95-2.29				
7.7-8.4	2.35-2.56				

SIEVE NO.					PARTICLE SIZE (mm)			ATTENBERG LIMITS			USCS *	IN-SITU				COMPACTED		SPECIFIC GRAVITY OF SOLIDS	TRIAxIAL	UNCONFINED COMPRESSION
SILT OR CLAY					LL	PL	PI	DRY UNIT WEIGHT		MOISTURE CONTENT (%)		SATURATION (%)	VOID RATIO	MAXIMUM DRY DENSITY		OPTIMUM MOISTURE (%)				
10	20	40	60	100				(pcf)	(kg/m <sup>3</sup> )					(pcf)	(kg/m <sup>3</sup> )					
									SC	95.4	1528	7.8	27.7	.765						
									SC	95.6	1531	14.8	52.5	.762						
									SC	97.1	1555	14.4	53.0	.735						
									SC	93.3	1495	15.1	50.8	.805						
									SC	89.8	1437	16.2	49.8	.875						
									SC	108.5	1737	14.9	72.7	.553					***	
1	49	36	0	0	32	17	15		SC**	105.0	1682	14.6	65.2	.605					***	
									SC	106.0	1698	15.5	71.1	.589					***	
									SC	111.8	1790	12.4	66.0	.507					***	
									SC	102.8	1647	12.1	51.3	.639						
									SC	102.4	1640	12.1	50.7	.645						
									CL	103.5	1658	8.1	34.7	.627						
									CL	101.2	1621	10.8	43.7	.665						
									CL	98.9	1584	14.3	55.1	.702						
									CL	95.9	1536	14.5	51.8	.757						
									CL	101.2	1620	15.2	61.7	.665					***	
									CL	110.8	1775	14.3	74.1	.521					***	
0	80	77	28	1	32	20	12		CL**	109.1	1748	13.5	67.0	.544					***	
									CL	97.2	1557	13.5	49.7	.733						
									CL	95.2	1525	14.1	49.5	.770						
									CL	104.3	1671	12.3	54.2	.615						
									CL	104.6	1676	12.4	54.6	.611						
									CL	101.2	1621	11.7	47.5	.664						
									CL	100.8	1615	13.3	53.4	.671						
									CL	96.7	1549	14.8	53.9	.742						
									CL	98.3	1575	14.4	54.5	.714						
									CL	98.9	1584	15.0	57.4	.703						
									CL	92.9	1487	13.9	46.2	.814						
									CL	102.4	1639	14.3	59.8	.645						
									CL	105.2	1684	14.5	65.2	.602						
									CL	105.5	1689	15.7	70.9	.597						
									CL	104.9	1680	16.3	77.8	.606						
									CL	105.0	1682	13.5	60.3	.604						
									CL	102.5	1642	12.3	51.5	.647						
									CL	108.7	1741	11.4	56.1	.549						
									CL	96.1	1539	11.4	40.9	.754						
									CL	101.4	1624	11.0	44.7	.662						
									CL	103.5	1658	15.4	66.1	.628						
									CL	98.3	1575	14.7	55.6	.713						
									CL	104.2	1669	13.8	60.4	.617					***	

ication  
 based on lab tests  
 and results included in this report

SUMMARY OF  
 MAY TEST SITE  
 MX SITING  
 DEPARTMENT OF  
**UBRO**

CS*	IN-SITU					COMPACTED			SPECIFIC GRAVITY OF SOLIDS	TRIAXIAL	UNCONFINED COMPRESSION	DIRECT SHEAR	CONSOLIDATION	CHEMICAL	RELATIVE DENSITY
	DRY UNIT WEIGHT		MOISTURE CONTENT (%)	SATURATION (%)	VOID RATIO	MAXIMUM DRY DENSITY		OPTIMUM MOISTURE (%)							
	(pcf)	(kg/m <sup>3</sup> )				(pcf)	(kg/m <sup>3</sup> )								
C	95.4	1528	7.8	27.7	.765										
C	95.6	1531	14.8	52.5	.762										
C	97.1	1555	14.4	53.0	.735										
C	93.3	1495	15.1	50.8	.805										
C	89.8	1437	16.2	49.8	.875										
K	108.5	1737	14.9	72.7	.553					***					
C**	105.0	1682	14.6	65.2	.605					***					
K	106.0	1698	15.5	71.1	.589					***					
K	111.8	1790	12.4	66.0	.507					***					
K	102.8	1647	12.1	51.3	.639										
K	102.4	1640	12.1	50.7	.645										
EL	103.5	1658	8.1	34.7	.627										
EL	101.2	1621	10.8	43.7	.665										
EL	98.9	1584	14.3	55.1	.702										
EL	95.9	1536	14.5	51.8	.757										
EL	101.2	1620	15.2	61.7	.665					***					
EL	110.8	1775	14.3	74.1	.521					***					
EL**	109.1	1748	13.5	67.0	.544					***					
EL	97.2	1557	13.5	49.7	.733										
EL	95.2	1525	14.1	49.5	.770										
EL	104.3	1671	12.3	54.2	.615										
EL	104.6	1676	12.4	54.6	.611										
EL	101.2	1621	11.7	47.5	.664										
EL	100.8	1615	13.3	53.4	.671										
EL	96.7	1549	14.8	53.9	.742										
EL	98.3	1575	14.4	54.5	.714										
EL	98.9	1584	15.0	57.4	.703										
EL	92.9	1487	13.9	46.2	.814										
EL	102.4	1639	14.3	59.8	.645										
EL	105.2	1684	14.5	65.2	.602										
EL	105.5	1689	15.7	70.9	.597										
EL	104.9	1680	16.3	77.8	.606										
EL	105.0	1682	13.5	60.3	.604										
EL	102.5	1642	12.3	51.5	.647										
EL	108.7	1741	11.4	56.1	.549										
EL	96.1	1539	11.4	40.9	.754										
EL	101.4	1624	11.0	44.7	.662										
EL	103.5	1658	15.4	66.1	.628										
EL	98.3	1575	14.7	55.6	.713										
EL	104.2	1669	13.8	60.4	.617					***					

SUMMARY OF LABORATORY TEST RESULTS  
BOEING GAS SITE  
NAV TEST SITE, SAN CRISTOBAL VALLEY, ARIZONA

MX SITING INVESTIGATION  
DEPARTMENT OF THE AIR FORCE - SAMSO

TABLE  
4  
2 OF 2

UGRO NATIONAL, INC.

BORING NUMBER	SAMPLE NUMBER (a)	SAMPLE INTERVAL		PERCENT FINER BY WEIGHT											
				STANDARD SIEVE OPENING						U S STANDARD S					
				BLDRS.	COBBLES		GRAVEL			SAND					
24"	12"	6"	3"	1½"	¾"	3/8"	4	10	40						
B-17N	S-3	5.1-5.8	1.55-1.77								100	99	97	88	
		5.8-6.5	1.77-1.98												
	S-4	6.5-7.5	1.98-2.29												
		7.5-8.2	2.29-2.50												
B-19	S-1	8.2-8.9	2.50-2.71												
		8.9-10.0	2.71-3.05												
		0.1-1.1	0.03-0.34												
	S-2	1.1-1.8	0.34-0.55												
		1.8-2.5	0.55-0.76												
		2.7-3.4	0.82-1.04												
		3.4-4.1	1.04-1.25												
		4.1-5.0	1.25-1.52												

**NOTES:**

(a) Sample types:

- S - Shelby Tube Sample
- P - Pitcher Barrel Sample
- D - Fugro Drive Sample

- \* Visual classification
- \*\* Classification based on
- \*\*\* Test performed and

LIGHT						ATTERBERG LIMITS			USCS *	IN-SITU				COMPACTED		SPECIFIC GRAVITY OF SOLIDS	TRIAxIAL	
STANDARD SIEVE NO.			PARTICLE SIZE (mm)							LL	PL	PI	DRY UNIT WEIGHT		MOISTURE CONTENT (%)			SATURATION (%)
SAND			SILT OR CLAY			(pcf)	(kg/m <sup>3</sup> )	(pcf)	(kg/m <sup>3</sup> )									
10	40	100	200	.005	.001													
97	88	78	65	25	7	32	19	13	CL**	113.5	1818	12.6	70.3	.484				
						29	17	12	CL**	108.9	1744	13.6	67.1	.547				
									CL	97.9	1568	14.6	54.5	.721				
									CL	107.4	1720	12.3	58.5	.568				
									CL	104.1	1668	11.5	50.2	.618				
									CL	97.6	1563	10.9	40.5	.727				
									CL	97.2	1556	14.8	54.6	.733				
									CL	102.9	1647	14.3	60.5	.636				
									CL	100.6	1610	16.2	64.9	.674				
									CL	102.1	1634	13.7	56.8	.650				
									CL	88.5	1417	13.4	39.9	.903				
									CL	93.3	1495	12.3	41.4	.806				

classification  
 classification based on lab tests  
 performed and results included in this report

SUM  
 MAY 19  
 DEPART



BORING NUMBER	SAMPLE NUMBER (a)	SAMPLE INTERVAL		PERCENT FINER BY WEIGHT									
				STANDARD SIEVE OPENING						U S STANDARD			
				BLDRS	COBBLES		GRAVEL			SAND			
					24"	12"	6"	3"	1½"	3/4"	3/8"	4	10
B-33	S-1	0.3-1.1	0.09-0.34										
		1.1-1.8	0.34-0.55							100	99	96	89
		1.8-2.5	0.55-0.76							100	99	97	89
	S-2	2.7-3.4	0.82-1.04										
		3.4-4.1	1.04-1.25							100	98	95	91
B-34N	D-1	0.7-1.4	0.21-0.43										
		2.1-2.8	0.64-0.85										
	P-3	3.2-4.4	0.98-1.34										
		4.4-4.8	1.34-1.46										
		4.8-5.5	1.46-1.68										
	S-4	5.7-6.4	1.74-1.95							100	99	94	81
		6.4-7.1	1.95-2.16										
		7.1-8.0	2.16-2.44										
	S-5	8.0-8.7	2.44-2.65										
		8.7-9.4	2.65-2.87										
		9.4-10.0	2.87-3.05										
	B-34S	S-1	0.1-0.8	0.03-0.24									
0.8-1.5			0.24-0.46										
1.5-2.5			0.46-0.76										
S-2		3.0-3.6	0.91-1.10										
		3.6-4.3	1.10-1.31										
		4.3-5.0	1.31-1.52							100	99	96	88
S-3		5.1-5.8	1.55-1.77							100	98	96	88
		5.8-6.5	1.77-1.98							100	99	95	84
		6.5-7.5	1.98-2.29										
S-4		7.9-8.6	2.41-2.62										
		8.6-9.3	2.62-2.83										
		9.3-10.0	2.83-3.05										
B-36N	S-1	0.2-0.9	0.06-0.27										
		0.9-1.6	0.27-0.49										
		1.6-2.5	0.49-0.76										
	S-2	2.5-3.6	0.76-1.10										
		3.6-4.3	1.10-1.31										
		4.3-5.0	1.31-1.52										
	S-3	5.1-5.8	1.55-1.77										
		5.8-6.5	1.77-1.98							100	98	94	84
		6.5-7.5	1.98-2.29										
	S-4	7.6-8.3	2.32-2.53										
		8.3-9.0	2.53-2.74										
		9.0-10.0	2.74-3.05										

NOTES:

(a) Sample types:

- S - Shelby Tube Sample
- P - Pitcher Barrel Sample
- D - Fugro Drive Sample

- \* Visual classification
- \*\* Classification
- \*\*\* Test performed

LIGHT						ATTERBERG LIMITS			USCS *	IN-SITU				COMPACTED			SPECIFIC GRAVITY OF SOLIDS	TRAIL	
STANDARD SIEVE NO.			PARTICLE SIZE (mm)			LL	PL	PI		DRY UNIT WEIGHT		MOISTURE CONTENT (%)	SATURATION (%)	VOID RATIO	MAXIMUM DRY DENSITY				OPTIMUM MOISTURE (%)
SAND			SILT OR CLAY							(pcf)	(kg/m <sup>3</sup> )				(pcf)	(kg/m <sup>3</sup> )			
10	40	100	200	.005	.001														
									CL	98.7	1580	10.0	38.1	.706					
96	89	79	63	24	4	33	16	17	CL**	103.8	1663	13.8	59.7	.623					
97	89	79	66	24	4				CL**	95.0	1522	14.7	51.3	.773					
									SC	103.0	1650	12.3	52.1	.636					
91	76	63	48	18	5				SC**	95.1	1523	13.2	46.1	.772					
									SC	90.1	1442	12.5	38.9	.869					
									CL	99.4	1592	20.3	78.8	.695					
									CL	116.5	1866	14.7	89.1	.446					
									CL	100.1	1603	14.9	58.8	.684					
									CL	102.2	1636	11.5	47.9	.648					
									CL	99.7	1596	15.1	59.1	.690					
94	81	67	53	24	5	29	19	10	CL**	107.7	1724	12.5	59.8	.564					
									CL	105.6	1690	13.1	59.4	.595					
									CL	97.5	1562	13.9	51.5	.728					
									CL	105.9	1696	13.1	59.7	.592					
									CL	104.5	1674	11.7	51.9	.611					
									CL	101.9	1632	11.6	48.1	.652					
									CL	105.4	1688	8.9	40.1	.599					
									CL	92.1	1475	12.5	40.7	.830					
									CL	100.6	1611	14.3	57.1	.674					
									CL	106.8	1711	13.6	63.7	.577					
									CL	105.2	1685	14.3	64.1	.602					
96	88	78	65	29	3				CL**	115.2	1845	14.3	83.5	.463					
96	88	77	63	12	2	32	17	15	CL**	99.6	1595	12.3	48.0	.691			2.66		
95	84	72	58	21	1				CL**	99.2	1589	13.7	53.0	.698					
									CL	92.2	1477	17.2	56.1	.827					
									CL	117.9	1889	8.6	54.4	.429					
									CL	101.9	1632	12.4	51.4	.654					
									CL	97.1	1555	12.8	47.2	.735					
									CL	101.8	1631	9.4	38.5	.656					
									CL	105.5	1690	15.2	68.8	.596					
									CL	105.4	1688	13.4	60.3	.599					
									CL	102.9	1648	16.9	71.9	.636					
									CL	105.2	1685	12.8	57.6	.602					
									CL	113.6	1820	14.4	80.5	.483					
									CL	113.1	1812	12.5	68.9	.490					
94	84	74	60	16	0	28	16	12	CL**	97.6	1563	12.1	45.0	.726					
									CL	100.9	1616	13.2	53.3	.670					
									CL	106.4	1704	14.0	64.9	.583					
									CL	102.4	1640	13.4	56.0	.645					
									CL	109.3	1751	11.8	58.9	.542					

Classification based on lab tests performed and results included in this report

MAY  
DEPA



USCS *	IN-SITU					COMPACTED			SPECIFIC GRAVITY OF SOLIDS	TRIAXIAL	UNCONFINED COMPRESSION	DIRECT SHEAR	CONSOLIDATION	CHEMICAL	RELATIVE DENSITY
	DRY UNIT WEIGHT		MOISTURE CONTENT (%)	SATURATION (%)	VOID RATIO	MAXIMUM DRY DENSITY		OPTIMUM MOISTURE (%)							
	(pcf)	(kg/m <sup>3</sup> )				(pcf)	(kg/m <sup>3</sup> )								
CL	98.7	1580	10.0	38.1	.706										
CL**	103.8	1663	13.8	59.7	.623				***						
CL**	95.0	1522	14.7	51.3	.773				***						
SC	103.0	1650	12.3	52.1	.636										
SC**	95.1	1523	13.2	46.1	.772				***						
SC	90.1	1442	12.5	38.9	.869										
CL	99.4	1592	20.3	78.8	.695										
CL	116.5	1866	14.7	89.1	.446										
CL	100.1	1603	14.9	58.8	.684										
CL	102.2	1636	11.5	47.9	.648										
CL	99.7	1596	15.1	59.1	.690				***						
CL**	107.7	1724	12.5	59.8	.564				***						
CL	105.6	1690	13.1	59.4	.595				***						
CL	97.5	1562	13.9	51.5	.728										
CL	105.9	1696	13.1	59.7	.592										
CL	104.5	1674	11.7	51.9	.611										
CL	101.9	1632	11.6	48.1	.652										
CL	105.4	1688	8.9	40.1	.599										
CL	92.1	1475	12.5	40.7	.830										
CL	100.6	1611	14.3	57.1	.674										
CL	106.8	1711	13.6	63.7	.577										
CL	105.2	1685	14.3	64.1	.602										
CL**	115.2	1845	14.3	83.5	.463				***						
CL**	99.6	1595	12.3	48.0	.691			2.66							
CL**	99.2	1589	13.7	53.0	.698				***						
CL	92.2	1477	17.2	56.1	.827				***						
CL	117.9	1889	8.6	54.4	.429										
CL	101.9	1632	12.4	51.4	.654										
CL	97.1	1555	12.8	47.2	.735										
CL	101.8	1631	9.4	38.5	.656										
CL	105.5	1690	15.2	68.8	.596										
CL	105.4	1688	13.4	60.3	.599										
CL	102.9	1648	16.9	71.9	.636										
CL	105.2	1685	12.8	57.6	.602										
CL	113.6	1820	14.4	80.5	.483				***						
CL	113.1	1812	12.5	68.9	.490				***						
CL**	97.6	1563	12.1	45.0	.726				***						
CL	100.9	1616	13.2	53.3	.670										
CL	106.4	1704	14.0	64.9	.583										
CL	102.4	1640	13.4	56.0	.645										
CL	109.3	1751	11.8	58.9	.542										

SUMMARY OF LABORATORY TEST RESULTS  
BOEING HYDRAULIC SITE  
NAV TEST SITE, SAN CRISTOBAL VALLEY, ARIZONA

MX SITING INVESTIGATION  
DEPARTMENT OF THE AIR FORCE - SAMSO

TABLE  
5  
1 OF 2

**FUGRO NATIONAL, INC.**

BORING NUMBER	SAMPLE NUMBER (a)	SAMPLE INTERVAL		PERCENT FINER BY WEIGHT										
				STANDARD SIEVE OPENING							U S STANDARD			
				BLDRS	COBBLES		GRAVEL			SAND				
					24"	12"	6"	3"	1½"	¾"	3/8"	4	10	20
FEET	METERS													
B-39S	S-1	0.1-0.8	0.03-0.24											
		0.8-1.5	0.24-0.46											
		1.5-2.5	0.46-0.76											
	S-2	2.6-3.6	0.79-1.10											
		3.6-4.3	1.10-1.31											
		4.3-5.0	1.31-1.52											
	S-3	5.0-5.7	1.52-1.74											
		5.7-6.4	1.74-1.95											
		6.4-7.5	1.95-2.29											
	S-4	7.5-8.2	2.29-2.50											
		8.2-8.9	2.50-2.71											
		8.9-10.0	2.71-3.05											
B-41	S-1	0.3-1.1	0.09-0.34											
		1.1-1.8	0.34-0.55											
		1.8-2.5	0.55-0.76											
	S-2	2.7-3.4	0.82-1.04											
		3.4-4.1	1.04-1.25											
		4.1-5.0	1.25-1.52											

**NOTES:**

(a) Sample types:

- S - Shelby Tube Sample
- P - Pitcher Barrel Sample
- D - Fugro Drive Sample

- \* Visual classification
- \*\* Classification
- \*\*\* Test performed

EIGHT						ATTERBERG LIMITS			USCS *	IN-SITU				COMPACTED		SPECIFIC GRAVITY OF SOLIDS	
STANDARD SIEVE NO.			PARTICLE SIZE (mm)							LL	PL	PI	DRY UNIT WEIGHT		MOISTURE CONTENT (%)		SATURATION (%)
SAND			SILT OR CLAY			(pcf)	(kg/m <sup>3</sup> )	(pcf)	(kg/m <sup>3</sup> )				(pcf)	(kg/m <sup>3</sup> )		OPTIMUM MOISTURE (%)	
10	40	100	200	.005	.001												
									CL	102.5	1642	10.0	42.0	.643			
									CL	100.1	1603	12.7	50.3	.683			
									CL	100.8	1615	16.7	67.5	.671			
									CL	97.8	1567	14.9	55.7	.723			
									CL	101.6	1626	14.5	59.4	.658			
									CL	97.2	1556	14.8	54.4	.733			
									CL	101.8	1629	15.0	61.7	.655			
									CL	96.5	1545	14.2	51.3	.745			
									CL	90.0	1442	18.0	55.8	.871			
									CL	101.2	1621	11.9	48.3	.665			
									CL	102.3	1639	12.5	52.3	.647			
									CL	103.2	1653	11.1	47.4	.633			
									CL	98.8	1583	11.3	43.4	.705			
									CL	98.1	1570	11.2	42.2	.717			
									CL	111.6	1786	12.9	68.0	.510			
									CL	96.6	1546	13.4	48.6	.745			
									CL	95.2	1524	12.9	45.2	.769			
									CL	93.5	1498	12.3	41.3	.801			

Classification based on lab tests performed and results included in this report

MAV  
DEPA  
F

USCS *	IN-SITU					COMPACTED			SPECIFIC GRAVITY OF SOLIDS	TRIAXIAL	UNCONFINED COMPRESSION	DIRECT SHEAR	CONSOLIDATION	CHEMICAL	RELATIVE DENSITY
	DRY UNIT WEIGHT		MOISTURE CONTENT (%)	SATURATION (%)	VOID RATIO	MAXIMUM DRY DENSITY		OPTIMUM MOISTURE (%)							
	(pcf)	(kg/m <sup>3</sup> )				(pcf)	(kg/m <sup>3</sup> )								
CL	102.5	1642	10.0	42.0	.643										
CL	100.1	1603	12.7	50.3	.683										
CL	100.8	1615	16.7	67.5	.671										
CL	97.8	1567	14.9	55.7	.723										
CL	101.6	1626	14.5	59.4	.658										
CL	97.2	1556	14.8	54.4	.733										
CL	101.8	1629	15.0	61.7	.655										
CL	96.5	1545	14.2	51.3	.745										
CL	90.0	1442	18.0	55.8	.871										
CL	101.2	1621	11.9	48.3	.665										
CL	102.3	1639	12.5	52.3	.647										
CL	103.2	1653	11.1	47.4	.633										
CL	98.8	1583	11.3	43.4	.705										
CL	98.1	1570	11.2	42.2	.717										
CL	111.6	1786	12.9	68.0	.510										
CL	96.6	1546	13.4	48.6	.745										
CL	95.2	1524	12.9	45.2	.769										
CL	93.5	1498	12.3	41.3	.801										

SUMMARY OF LABORATORY TEST RESULTS  
BOEING HYDRAULIC SITE  
MAY TEST SITE, SAN CRISTOBAL VALLEY, ARIZONA

MX SITING INVESTIGATION  
DEPARTMENT OF THE AIR FORCE - SAMS0

TABLE  
**5**  
2 OF 2

**UGRO NATIONAL, INC.**

BORING NUMBER	SAMPLE NUMBER (a)	SAMPLE INTERVAL		PERCENT FINER BY WEIGHT													
				STANDARD SIEVE OPENING						U S STANDARD							
				BLDRS	COBBLES		GRAVEL			SAND							
					24"	12"	6"	3"	1½"	¾"	⅜"	4	10	40			
M-9	S-1	0.7-1.1	0.21-0.34														
		1.1-1.8	0.34-0.55														
		1.8-2.5	0.55-0.76									100	96	83			
	S-2	2.5-3.2	0.76-0.98														
		3.2-3.9	0.98-1.19														
		3.9-4.5	1.19-1.37														
M-11S	S-1	0.2-0.9	0.06-0.27														
		0.9-1.6	0.27-0.49														
		1.6-2.5	0.49-0.76														
	S-2	2.7-3.6	0.82-1.10														
		3.6-4.3	1.10-1.31														
		4.3-5.0	1.31-1.52														
	S-3	5.2-5.9	1.58-1.80											100	96		
		5.9-6.6	1.80-2.01														
		6.6-7.5	2.01-2.29														
	S-4	7.5-8.2	2.29-2.50														
		8.2-8.9	2.50-2.71														
		8.9-10.0	2.71-3.05														
M-12N	S-1	0.2-0.9	0.06-0.27														
		0.9-1.6	0.27-0.49														
		1.6-2.5	0.49-0.76														
	S-2	2.5-3.6	0.76-1.10														
		3.6-4.3	1.10-1.31														
		4.3-5.0	1.31-1.52														
	S-3	5.0-5.7	1.52-1.74								100	98	92	88	68		
		5.7-6.4	1.74-1.95														
		6.4-7.5	1.95-2.29														
	S-4	7.5-8.2	2.29-2.50														
		8.2-8.9	2.50-2.71														
		8.9-10.0	2.71-3.05														
M-13S	S-1	0.1-0.8	0.03-0.24														
		0.8-1.5	0.24-0.46														
		1.5-2.5	0.46-0.76														
	S-2	2.5-3.6	0.76-1.10														
		3.6-4.3	1.10-1.31														
		4.3-5.0	1.31-1.52														
	S-3	5.0-5.7	1.52-1.74											100	96	93	
		5.7-6.4	1.74-1.95														
		6.4-7.5	1.95-2.29														
	S-4	7.5-8.2	2.29-2.50														
		8.2-8.9	2.50-2.71														
		8.9-10.0	2.71-3.05														

NOTES:

(a) Sample types:

- S - Shelby Tube Sample
- P - Pitcher Barrel Sample
- D - Fugro Drive Sample

- \* Visual classification
- \*\* Classification
- \*\*\* Test performed

CHECKED BY APPROVED BY

RD SIEVE NO.					PARTICLE SIZE (mm)			ATTERBERG LIMITS			USCS *	IN-SITU				COMPACTED		SPECIFIC GRAVITY OF SOLIDS	TRIAxIAL	UNCONFINED COMPRESSION
SILT OR CLAY					LL	PL	PI	DRY UNIT WEIGHT		MOISTURE CONTENT (%)		SATURATION (%)	VOID RATIO	MAXIMUM DRY DENSITY		OPTIMUM MOISTURE (%)				
40	100	200	.005	.001				(pcf)	(kg/m <sup>3</sup> )					(pcf)	(kg/m <sup>3</sup> )					
									CL	95.3	1527	7.1	24.9	.767						
83	70	57	24	14	30	15	15		CL**	98.2	1572	10.9	41.1	.716						***
									CL	104.2	1668	13.5	59.3	.617						***
									CL	104.1	1666	13.6	59.4	.618						***
									CL	93.9	1504	11.8	40.1	.794						
									CL	98.2	1573	12.3	46.6	.715						
									CL	105.1	1684	13.1	58.7	.602						
									CL	107.8	1727	12.8	61.4	.563						
									CL	105.2	1685	14.0	62.7	.602						***
									CL	112.3	1799	13.0	71.5	.501						
96	88	75	32	10	31	17	14		CL**	109.2	1749	13.8	68.6	.543						***
									CL	97.1	1554	13.0	47.9	.735						***
									CL	102.8	1647	13.8	53.3	.639						
									CL	93.7	1501	12.5	42.3	.797						
									CL	93.8	1503	13.3	45.1	.797						
									SC	103.0	1650	5.4	23.1	.636						
									SC	112.6	1804	10.9	59.8	.496						
									SC	114.2	1829	11.2	64.1	.470						
									SC	105.0	1682	11.9	53.4	.604						
									SC	108.4	1736	12.8	62.4	.554						
									SC	116.5	1865	10.6	64.2	.446						***
68	53	39	18	10	31	15	16		SC**	110.8	1774	11.0	57.0	.521						***
									SC	105.3	1685	9.8	41.1	.600						***
									SC	107.7	1725	10.9	52.0	.564						
									SC	101.4	1624	9.8	39.9	.662						
									SC	112.8	1807	10.2	55.8	.493						
									SC	101.9	1632	11.7	48.6	.653						
									CL	96.1	1539	7.3	26.1	.753						
									CL	101.4	1624	12.3	50.3	.661						
									CL	102.9	1649	13.6	57.3	.638						
									CL	104.9	1680	12.7	56.5	.606						
									CL	98.6	1579	15.1	57.7	.708						
									CL	106.4	1703	14.5	67.2	.583						***
93	86	73	38	26	29	17	12		CL**	105.4	1687	13.8	62.3	.598						***
									CL	103.9	1663	13.9	60.3	.622						***
									CL	98.7	1581	13.2	50.3	.706						
									CL	102.4	1640	13.7	57.3	.646						
									CL	97.0	1554	11.6	42.7	.736						
									CL	99.4	1592	13.4	52.0	.695						

Classification  
 based on lab tests  
 and results included in this report

SUMMARY  
 NAV TEST  
 WX S  
 DEPARTMENT  
**FUEL**

				***				
				***				
				***				
				***				
				***				
				***				

APPROVED BY: \_\_\_\_\_  
CHECKED BY: \_\_\_\_\_

BORING NUMBER	SAMPLE NUMBER (a)	SAMPLE INTERVAL		PERCENT FINER BY WEIGHT										
				STANDARD SIEVE OPENING						U S STANDARD				
				BLDRS	COBBLES		GRAVEL			SAND				
					24"	12"	6"	3"	1½"	¾"	⅜"	4	10	40
FEET	METERS													
M-14N	S-1	0.3-1.0	0.09-0.30											
		1.0-1.7	0.30-0.52											
		1.7-2.5	0.52-0.76											
	S-2	2.6-3.6	0.79-1.10											
		3.6-4.3	1.10-1.31											
		4.3-5.0	1.31-1.52											
	S-3	5.0-5.7	1.52-1.74											
		5.7-6.4	1.74-1.95								100	98	90	69
6.4-7.6		1.95-2.32												
S-4	7.6-8.3	2.32-2.53												
	8.3-9.0	2.53-2.74												
	9.0-10.1	2.74-3.08												
M-15S	S-1	0.3-1.0	0.09-0.30											
		1.0-1.7	0.30-0.52											
		1.7-2.5	0.52-0.76											
	S-2	2.6-3.6	0.79-1.10											
		3.6-4.3	1.10-1.31											
		4.3-5.0	1.31-1.52											
	S-3	5.0-5.7	1.52-1.74									100	98	94
		5.7-6.4	1.74-1.95											
6.4-7.5		1.95-2.29												
S-4	7.5-8.2	2.29-2.50												
	8.2-8.9	2.50-2.71												
	8.9-10.0	2.71-3.05												
M-16N	S-1	0.1-0.8	0.03-0.24											
		0.8-1.5	0.24-0.46											
		1.5-2.5	0.46-0.76											
	S-2	2.5-3.6	0.76-1.10											
		3.6-4.3	1.10-1.31											
		4.3-5.0	1.31-1.52											
	S-3	5.0-5.7	1.52-1.74											
		5.7-6.4	1.74-1.95								100	99	96	87
6.4-7.5		1.95-2.29												
S-4	7.5-8.2	2.29-2.50												
	8.2-8.9	2.50-2.71												
	8.9-10.0	2.71-3.05												
M-17S	S-1	0.1-0.8	0.03-0.24											
		0.8-1.5	0.24-0.46											
		1.5-2.5	0.46-0.76											
	S-2	2.5-3.6	0.76-1.10											
		3.6-4.3	1.10-1.31											
		4.3-5.0	1.31-1.52											

**NOTES:**

(a) Sample types:

- S - Shelby Tube Sample
- P - Pitcher Barrel Sample
- D - Fugro Drive Sample

- \* Visual classification
- \*\* Classification
- \*\*\* Test performed



STANDARD SIEVE NO.						PARTICLE SIZE (mm)			ATTERBERG LIMITS			USCS*	IN-SITU				COMPACTED		SPECIFIC GRAVITY OF SOLIDS	TRIAxIAL
SAND			SILT OR CLAY			LL	PL	PI	DRY UNIT WEIGHT		MOISTURE CONTENT (%)		SATURATION (%)	VOID RATIO	MAXIMUM DRY DENSITY		OPTIMUM MOISTURE (%)			
0	40	100	200	.005	.001				(pcf)	(kg/m <sup>3</sup> )					(pcf)	(kg/m <sup>3</sup> )				
									SC	98.4	1576	12.0	45.6	.712						
									SC	112.4	1800	10.6	57.5	.498						
									SC	108.2	1733	12.2	59.4	.556						
									SC	108.0	1730	11.1	53.6	.560						
									SC	108.3	1735	10.6	51.3	.556						
									SC	114.4	1833	11.1	63.5	.472					***	
									SC	119.9	1921	11.8	78.9	.405					***	
0	69	51	38	14	11	29	18	11	SC**	112.0	1794	12.3	66.1	.504					***	
									SC	108.8	1743	10.7	52.8	.548						
									SC	108.8	1743	9.6	47.4	.548						
									SC	105.5	1690	10.4	46.9	.597						
									SC	112.2	1797	11.8	63.6	.502						
									CL	97.3	1559	8.3	30.5	.731						
									CL	100.6	1611	11.5	46.1	.670						
									CL	103.9	1664	14.4	62.6	.621						
									CL	104.0	1666	15.5	67.5	.621						
									CL	105.2	1685	12.9	57.7	.602						
									CL	109.6	1754	14.5	72.9	.537					***	
08	94	86	72	33	12	29	16	13	CL**	103.6	1658	14.1	60.8	.626					***	
									CL	106.0	1697	14.2	65.1	.589					***	
									CL	100.1	1603	13.5	53.3	.683						
									CL	104.6	1676	12.3	54.4	.611						
									CL	91.4	1464	13.4	42.9	.844						
									CL	94.5	1514	13.0	45.0	.782						
									SC	103.9	1664	6.7	29.3	.621						
									SC	99.3	1591	13.8	53.3	.697						
									SC	112.9	1808	10.5	57.4	.492						
									SC	108.4	1736	13.4	65.5	.554						
									SC	115.2	1844	11.5	67.2	.463						
									SC	115.2	1844	11.8	68.8	.463					***	
97	69	55	41	20	16	30	16	14	SC**	114.5	1833	11.4	65.4	.471					***	
									SC	113.3	1815	11.0	61.1	.486						
									SC	114.8	1838	8.6	49.6	.468					***	
									SC	103.9	1664	10.4	45.4	.622						
									SC	104.8	1679	12.6	56.0	.608						
									CL	99.8	1599	12.8	50.4	.688						
									CL	98.9	1584	12.2	46.7	.702						
									CL	104.1	1668	13.1	57.1	.619						
									CL	103.0	1650	15.1	64.1	.636						
									CL	103.7	1661	14.3	61.7	.624						
									CL	104.8	1679	15.0	66.4	.608					***	

Classification  
 based on lab tests  
 performed and results included in this report

SUM  
 MAY TES  
 MX  
 DEPARTME

USCS*	IN-SITU					COMPACTED			SPECIFIC GRAVITY OF SOLIDS	TRIAxIAL	UNCONFINED COMPRESSION	DIRECT SHEAR	CONSOLIDATION	CHEMICAL	RELATIVE DENSITY
	DRY UNIT WEIGHT		MOISTURE CONTENT (%)	SATURATION (%)	VOID RATIO	MAXIMUM DRY DENSITY		OPTIMUM MOISTURE (%)							
	(pcf)	(kg/m <sup>3</sup> )				(pcf)	(kg/m <sup>3</sup> )								
SC	98.4	1576	12.0	45.6	.712										
SC	112.4	1800	10.6	57.5	.498										
SC	108.2	1733	12.2	59.4	.556										
SC	108.0	1730	11.1	53.6	.560										
SC	108.3	1735	10.6	51.3	.556										
SC	114.4	1833	11.1	63.5	.472					***					
SC	119.9	1921	11.8	78.9	.405					***					
SC**	112.0	1794	12.3	66.1	.504					***					
SC	108.8	1743	10.7	52.8	.548										
SC	108.8	1743	9.6	47.4	.548										
SC	105.5	1690	10.4	46.9	.597										
SC	112.2	1797	11.8	63.6	.502										
CL	97.3	1559	8.3	30.5	.731										
CL	100.6	1611	11.5	46.1	.670										
CL	103.9	1664	14.4	62.6	.621										
CL	104.0	1666	15.5	67.5	.621										
CL	105.2	1685	12.9	57.7	.602										
CL	109.6	1754	14.5	72.9	.537					***					
CL**	103.6	1658	14.1	60.8	.626					***					
CL	106.0	1697	14.2	65.1	.589					***					
CL	100.1	1603	13.5	53.3	.683										
CL	104.6	1676	12.3	54.4	.611										
CL	91.4	1464	13.4	42.9	.844										
CL	94.5	1514	13.0	45.0	.782										
SC	103.9	1664	6.7	29.3	.621										
SC	99.3	1591	13.8	53.3	.697										
SC	112.9	1808	10.5	57.4	.492										
SC	108.4	1736	13.4	65.5	.554										
SC	115.2	1844	11.5	67.2	.463										
SC	115.2	1844	11.8	68.8	.463					***					
SC**	114.5	1833	11.4	65.4	.471					***					
SC	113.3	1815	11.0	61.1	.486										
SC	114.8	1838	8.6	49.6	.468					***					
SC	103.9	1664	10.4	45.4	.622										
SC	104.8	1679	12.6	56.0	.608										
CL	99.8	1599	12.8	50.4	.688										
CL	98.9	1584	12.2	46.7	.702										
CL	104.1	1668	13.1	57.1	.619										
CL	103.0	1650	15.1	64.1	.636										
CL	103.7	1661	14.3	61.7	.624										
CL	104.8	1679	15.0	66.4	.608					***					

SUMMARY OF LABORATORY TEST RESULTS  
MARTIN MARIETTA GAS SITE  
NAV TEST SITE, SAN CRISTOBAL VALLEY, ARIZONA

MX SITING INVESTIGATION  
DEPARTMENT OF THE AIR FORCE - SANSO

TABLE  
**6**  
2 OF 3

**UGRO NATIONAL, INC.**

BORING NUMBER	SAMPLE NUMBER (a)	SAMPLE INTERVAL		PERCENT FINER BY WEIGHT										
				STANDARD SIEVE OPENING						U S STANDARD				
				BLDRS.	COBBLES			GRAVEL			SAND			
					24"	12"	6"	3"	1 1/2"	3/4"	3/8"	4	10	40
M-17S	S-3	5.0-5.7	1.52-1.74									100	99	95
		5.7-6.4	1.74-1.95											
		6.4-7.5	1.95-2.29											
	S-4	7.5-8.2	2.29-2.50											
		8.2-8.9	2.50-2.71											
		8.9-10.0	2.71-3.05											
M-17N	S-1	0.4-1.1	0.12-0.34											
		1.1-1.8	0.34-0.55											
		1.8-2.5	0.55-0.76											
	S-2	2.6-3.6	0.79-1.10											
		3.6-4.3	1.10-1.31											
		4.3-5.0	1.31-1.52											
	S-3	5.0-5.7	1.52-1.74											
		5.7-6.4	1.74-1.95								100	97	89	70
		6.4-7.5	1.95-2.29											
	S-4	7.6-8.3	2.32-2.53											
		8.3-9.0	2.53-2.74											
		9.0-10.0	2.74-3.05											
M-18	S-1	0.5-1.1	0.15-0.34											
		1.1-1.8	0.34-0.55											
		1.8-2.5	0.55-0.76								100	98	93	
	S-2	2.5-3.2	0.76-0.98											
		3.2-3.9	0.98-1.19											
		3.9-4.5	1.19-1.37											

NOTES:

(a) Sample types:

- S - Shelby Tube Sample
- P - Pitcher Barrel Sample
- D - Fugro Drive Sample

- \* Visual classification
- \*\* Classification
- \*\*\* Test performed

GHT						ATTERBERG LIMITS			USCS *	IN-SITU				COMPACTED		SPECIFIC GRAVITY OF SOLIDS	TRIAxIAL			
STANDARD SIEVE NO.				PARTICLE SIZE (mm)		LL	PL	PI		DRY UNIT WEIGHT		MOISTURE CONTENT (%)	SATURATION (%)	VOID RATIO	MAXIMUM DRY DENSITY			OPTIMUM MOISTURE (%)		
SAND			SILT OR CLAY							(pcf)	(kg/m <sup>3</sup> )				(pcf)				(kg/m <sup>3</sup> )	
10	40	100	200	.005	.001															
99	95	87	74	0	0				CL**	107.6	1724	13.8	65.8	.566					***	
									CL	101.4	1624	14.7	60.0	.662					2.70	***
									CL	90.4	1448	15.1	47.1	.862						
									CL	106.1	1700	12.2	55.9	.588						
									CL	92.9	1488	15.0	49.8	.813						
									CL	106.5	1706	12.6	58.4	.582						
									SC	103.2	1653	7.5	32.2	.632						
									SC	108.4	1736	10.2	49.6	.554						
									SC	112.2	1797	12.0	64.9	.501						
									SC	108.0	1730	16.3	78.5	.560						
									SC	115.7	1853	12.8	75.7	.457						
									SC	114.0	1825	11.2	64.1	.478						***
									SC	114.1	1826	11.7	61.6	.476						***
89	70	54	40	18	15	29	17	12	SC**	111.6	1786	10.4	55.7	.509						***
									SC	110.7	1773	11.8	61.0	.521						
									SC	104.9	1680	10.2	45.6	.607						
									SC	106.3	1703	10.7	49.3	.584						
									SC	104.1	1668	11.1	48.3	.618						
									CL	104.0	1666	9.3	40.5	.619						
									CL	110.6	1772	11.6	49.6	.524						***
98	93	85	73	38	0	32	15	17	CL**	119.2	1909	12.2	79.7	.414						***
									CL	114.0	1826	13.3	75.1	.479						***
									CL	98.7	1581	14.1	53.8	.707						
									CL	105.6	1692	14.1	64.1	.596						

classification  
classification based on lab tests  
performed and results included in this report

SUN  
MAY TE  
DEPART  
fu

USCS *	IN-SITU					COMPACTED			SPECIFIC GRAVITY OF SOLIDS	TRIAxIAL	UNCONFINED COMPRESSION	DIRECT SHEAR	CONSOLIDATION	CHEMICAL	RELATIVE DENSITY
	DRY UNIT WEIGHT		MOISTURE CONTENT (%)	SATURATION (%)	VOID RATIO	MAXIMUM DRY DENSITY		OPTIMUM MOISTURE (%)							
	(pcf)	(kg/m <sup>3</sup> )				(pcf)	(kg/m <sup>3</sup> )								
CL**	107.6	1724	13.8	65.8	.566				2.70	***					
CL	101.4	1624	14.7	60.0	.662					***					
CL	90.4	1448	15.1	47.1	.862										
CL	106.1	1700	12.2	55.9	.588										
CL	92.9	1488	15.0	49.8	.813										
CL	106.5	1706	12.6	58.4	.582										
SC	103.2	1653	7.5	32.2	.632										
SC	108.4	1736	10.2	49.6	.554										
SC	112.2	1797	12.0	64.9	.501										
SC	108.0	1730	16.3	78.5	.560										
SC	115.7	1853	12.8	75.7	.457										
SC	114.0	1825	11.2	64.1	.478					***					
SC	114.1	1826	11.7	61.6	.476					***					
SC**	111.6	1786	10.4	55.7	.509					***					
SC	110.7	1773	11.8	61.0	.521										
SC	104.9	1680	10.2	45.6	.607										
SC	106.3	1703	10.7	49.3	.584										
SC	104.1	1668	11.1	48.3	.618										
CL	104.0	1666	9.3	40.5	.619										
CL	110.6	1772	11.6	49.6	.524					***					
CL**	119.2	1909	12.2	79.7	.414					***					
CL	114.0	1826	13.3	75.1	.479					***					
CL	98.7	1581	14.1	53.8	.707										
CL	105.6	1692	14.1	64.1	.596										

SUMMARY OF LABORATORY TEST RESULTS  
MARTIN MARIETTA GAS SITE  
NAV TEST SITE, SAN CRISTOBAL VALLEY, ARIZONA

MX SITING INVESTIGATION  
DEPARTMENT OF THE AIR FORCE - SAMSO

TABLE  
**6**  
3 8 9 3

**UGRO NATIONAL, INC.**

BORING NO.	SAMPLE NO.	SAMPLE INTERVAL		SOIL TYPE	*TYPE OF TEST	DRY DENSITY		MOISTURE CONTENT (%)	CONFINING PRESSURE (σ <sub>3</sub> )		MAXIMUM DEVIATOR STRESS (σ <sub>1</sub> -σ <sub>3</sub> )		STRAIN RATE		BACK PRESSURE	
		FEET	METERS			pcf	kg/m <sup>3</sup>		ksf	KN/m <sup>2</sup>	ksf	KN/m <sup>2</sup>	(%/min)	ksf	KN/m <sup>2</sup>	
B-11	S-1-2	1.1-1.8	0.34-0.55	CL	CD	106.5	1706	14.5	0.7	33.5	6.2	297	0.07	0	0	
	S-1-3	1.8-2.5	0.55-0.76	CL**	CD	99.0	1586	14.1	2.9	138.9	10.1	484	0.07	0	0	
	S-2-	3.6-4.3	1.10-1.52	CL	CD	96.4	1544	13.5	5.8	277.7	14.9	713	0.07	0	0	
B-12N	S-2-3	4.3-5.0	1.31-1.52	CL**	CD	103.0	1649	10.5	0.7	33.5	5.8	282	0.07	0	0	
	S-3-1	5.0-5.7	1.52-1.74	CL	CD	101.6	1627	10.5	2.9	138.9	11.9	570	0.07	0	0	
	S-3-2	5.7-6.4	1.74-1.95	CL	CD	99.1	1587	13.1	5.8	277.7	17.0	814	0.07	0	0	
B-12S	S-2-3	4.3-5.0	1.31-1.52	CL	CD	104.5	1674	14.4	0.7	33.5	6.2	297	0.07	0	0	
	S-3-1	5.0-5.7	1.52-1.74	CL**	CD	103.2	1653	14.7	2.9	138.9	10.2	488	0.07	0	0	
	S-3-2	5.7-6.4	1.74-1.95	CL	CD	103.9	1684	15.7	5.8	277.7	11.3	541	0.07	0	0	
B-13N	S-2-3	4.3-5.0	1.31-1.52	CL	CD	101.9	1632	11.8	0.7	33.5	5.8	278	0.07	0	0	
	S-3-1	5.0-5.7	1.52-1.74	CL	CD	109.0	1746	12.8	2.9	138.9	11.6	555	0.07	0	0	
	S-3-2	5.7-6.4	1.74-1.95	CL**	CD	103.2	1653	13.8	5.8	277.7	15.2	728	0.07	0	0	
B-14S	S-2-3	4.3-5.0	1.31-1.52	SC	CD	108.5	1738	14.9	0.7	33.5	6.0	287	0.07	0	0	
	S-3-1	5.1-5.8	1.55-1.77	SC**	CD	105.0	1682	14.6	2.9	138.9	7.8	373	0.07	0	0	
	S-3-2	5.8-6.5	1.77-1.98	SC	CD	106.0	1698	15.5	5.8	277.7	10.2	488	0.07	0	0	
	S-3-3	6.5-7.5	1.98-2.28	SC	CD	111.8	1790	12.4	5.8	277.7	17.6	843	0.07	0	0	
B-15N	S-2-3	4.3-5.0	1.31-1.52	CL	CD	110.8	1775	14.3	0.7	33.5	7.3	350	0.07	0	0	
	S-3-1	5.0-5.7	1.52-1.74	CL**	CD	109.1	1748	13.5	2.9	138.9	12.2	584	0.07	0	0	
	S-3-2	5.7-6.4	1.74-1.95	CL	CD	97.2	1557	13.5	5.8	277.7	14.8	709	0.07	0	0	
B-17N	S-2-3	4.3-5.0	1.31-1.52	CL	CD	104.2	1689	13.8	0.7	33.5	5.8	278	0.07	0	0	
	S-3-1	5.1-5.8	1.55-1.77	CL**	CD	113.5	1818	12.6	2.9	138.9	13.8	661	0.07	0	0	
	S-3-2	5.8-6.5	1.77-1.98	CL	CD	108.9	1744	13.6	5.8	277.7	11.8	585	0.07	0	0	

\* Visual classification

\*\* Classification based on lab tests

SUMMARY OF TRIAXIAL COMPRESSION TESTS  
BOEING GAS SITE  
MAY TEST SITE, SAN CRISTOBAL VALLEY, ARIZONA

MX SITING INVESTIGATION  
DEPARTMENT OF THE AIR FORCE - SAMS0

TABLE  
7

**TUGRO NATIONAL, INC.**

BORING NO.	SAMPLE NO.	SAMPLE INTERVAL		SOIL TYPE	*TYPE OF TEST	DRY DENSITY		MOISTURE CONTENT (%)	CONFINING PRESSURE (σ <sub>3</sub> )		MAXIMUM DEVIATOR STRESS (σ <sub>1</sub> -σ <sub>3</sub> )	STRAIN RATE (%/min)	BACK PRESSURE		
		FEET	METERS			pcf	kg/m <sup>3</sup>		kst	KN/m <sup>2</sup>			kst	KN/m <sup>2</sup>	
B-33	S-1-2	1.1-1.8	0.34-0.55	CL**	CD	103.8	1663	13.8	0.7	33.5	7.1	340	0.07	0	0
	S-1-3	1.8-2.5	0.55-0.76	CL	CD	95.0	1522	14.7	2.9	138.9	11.3	541	0.07	0	0
	S-2-2	3.4-4.1	1.04-1.25	SC**	CD	95.1	1523	13.2	5.8	277.7	16.0	766	0.07	0	0
B-34N	P-3-3	4.8-5.5	1.46-1.68	CL	CD	99.9	1596	15.1	0.7	33.5	4.3	206	0.07	0	0
	S-4-1	5.7-6.4	1.74-1.95	CL**	CD	107.7	1724	12.5	2.9	138.9	10.6	508	0.07	0	0
	S-4-2	6.4-7.1	1.95-2.16	CL	CD	105.6	1690	13.1	5.8	277.7	14.0	670	0.07	0	0
B-34S	S-2-3	4.3-5.0	1.31-1.52	CL**	CD	115.2	1845	14.3	0.7	33.5	10.8	517	0.07	0	0
	S-3-3	6.5-7.5	1.98-2.29	CL	CD	92.2	1477	17.2	2.9	338.9	10.1	747	0.07	0	0
	S-3-2	5.8-6.5	1.77-1.98	CL	CD	99.2	1589	13.7	5.8	277.7	15.6	484	0.07	0	0
B-36N	S-2-3	4.3-5.0	1.31-1.52	CL	CD	113.6	1820	14.4	0.7	33.5	7.1	340	0.07	0	0
	S-3-1	5.1-5.8	1.55-1.77	CL	CD	113.1	1812	12.5	2.9	138.9	10.1	484	0.07	0	0
	S-3-2	5.8-6.5	1.77-1.98	CL**	CD	91.6	1563	12.1	5.8	277.7	15.8	756	0.07	0	0

\* Visual classification  
\*\* Classification based on lab tests

**SUMMARY OF TRIAXIAL COMPRESSION TESTS  
BOEING HYDRAULIC SITE  
MAY TEST SITE, SAN CRISTOBAL VALLEY, ARIZONA**

MX SITING INVESTIGATION  
DEPARTMENT OF THE AIR FORCE - SAMS0

TABLE  
**8**

**UGRO NATIONAL, INC.**

BORING NO.	SAMPLE NO.	SAMPLE INTERVAL		SOIL TYPE	*TYPE OF TEST	DRY DENSITY		MOISTURE CONTENT (%)	CONFINING PRESSURE (σ <sub>v</sub> )		MAXIMUM DEVIATOR STRESS (σ <sub>1</sub> -σ <sub>3</sub> )		STRAIN RATE (%/min)	BACK PRESSURE	
		FEET	METERS			pcf	kg/m <sup>3</sup>		ksf	kn/m <sup>2</sup>	ksf	kn/m <sup>2</sup>		ksf	kn/m <sup>2</sup>
M-9	S-1-3	1.8-2.5	0.55-0.76	CL	CD	98.2	1572	10.9	0.7	33.5	5.3	254	0.07	0	0
	S-2-1	2.5-3.2	0.76-0.98	CL	CD	104.2	1668	13.5	2.9	138.9	13.4	642	0.07	0	0
	S-2-2	3.2-3.9	0.98-1.19	CL	CD	104.1	1666	13.6	5.8	277.7	17.6	843	0.07	0	0
M-11S	S-2-2	3.6-4.3	1.10-1.52	CL	CD	105.2	1685	14.0	0.7	33.5	7.1	340	0.07	0	0
	S-3-1	5.2-5.9	1.58-1.80	CL**	CD	109.2	1749	13.8	2.9	138.9	15.0	718	0.07	0	0
	S-3-3	6.6-7.5	2.01-2.29	CL	CD	97.1	1555	13.0	5.8	277.7	11.5	551	0.07	0	0
M-12N	S-2-3	4.3-5.0	1.31-1.52	SC	CD	116.5	1865	10.6	0.7	33.5	5.9	282	0.07	0	0
	S-3-1	5.0-5.7	1.52-1.74	SC**	CD	110.8	1774	11.0	2.9	138.9	10.5	503	0.07	0	0
	S-3-2	5.7-6.4	1.74-1.95	SC	CD	105.3	1685	9.8	5.8	277.7	17.3	828	0.07	0	0
M-13S	S-2-3	4.3-5.0	1.31-1.52	CL**	CD	106.4	1703	14.5	0.7	33.5	6.9	330	0.07	0	0
	S-3-1	5.0-5.7	1.52-1.74	CL	CD	105.4	1687	13.8	2.9	138.9	11.0	527	0.07	0	0
	S-3-2	5.7-6.4	1.74-1.95	CL	CD	103.9	1663	13.9	5.8	277.7	16.3	780	0.07	0	0
M-14N	S-2-3	4.3-5.0	1.31-1.52	SC	CD	114.4	1833	11.1	0.7	33.5	5.4	239	0.07	0	0
	S-3-1	5.0-5.7	1.52-1.74	SC	CD	119.9	1921	11.8	2.9	138.9	10.6	508	0.07	0	0
	S-3-2	5.7-6.4	1.74-1.95	SC**	CD	112.0	1794	12.3	5.8	277.7	14.7	704	0.07	0	0
M-15S	S-2-3	4.3-5.0	1.31-1.52	CL**	CD	109.6	1754	14.5	0.7	33.5	6.8	326	0.07	0	0
	S-3-1	5.0-5.7	1.52-1.74	CL	CD	103.6	1658	14.1	2.9	138.9	11.3	541	0.07	0	0
	S-3-2	5.7-6.4	1.74-1.95	CL	CD	106.0	1167	14.2	5.8	277.7	17.9	857	0.07	0	0
M-16N	S-2-3	4.3-5.0	1.31-1.52	CL**	CD	115.2	1844	11.8	0.7	33.5	6.8	326	0.07	0	0
	S-3-1	5.0-5.7	1.52-1.74	CL	CD	114.5	1833	11.4	2.9	138.9	12.0	575	0.07	0	0
	S-4-1	7.5-8.2	2.29-2.50	CL	CD	114.8	1838	8.6	5.8	277.7	18.0	862	0.07	0	0

\* Visual classification

\*\* Classification based on lab tests

SUMMARY OF TRIAXIAL COMPRESSION TESTS  
MARTIN MARIETTA GAS SITE  
MAV TEST SITE, SAN CRISTOBAL VALLEY, ARIZONA

MX SITING INVESTIGATION  
DEPARTMENT OF THE AIR FORCE - SANSO

TABLE  
9  
1 OF 2

FUGRO NATIONAL, INC.



BORING NO.	SAMPLE NO.	SAMPLE INTERVAL		SOIL TYPE	* TYPE OF TEST	DRY DENSITY		MOISTURE CONTENT (%)	CONFINING PRESSURE (σ <sub>3</sub> )		MAXIMUM DEVIATOR STRESS (σ <sub>1</sub> -σ <sub>3</sub> )		STRAIN RATE (%/min)	BACK PRESSURE	
		FEET	METERS			pcf	kg/m <sup>3</sup>		ksf	kN/m <sup>2</sup>	ksf	kN/m <sup>2</sup>		ksf	kN/m <sup>2</sup>
M-17N	S-2-3	4.3-5.0	1.31-1.52	SC	CD	114.0	1828	11.2	0.7	33.5	6.5	311	0.07	0	0
	S-3-1	5.0-5.7	1.52-1.74	SC	CD	114.1	1828	11.7	2.9	138.9	10.5	503	0.07	0	0
	S-3-2	5.7-6.4	1.74-1.95	SC**	CD	111.6	1787	10.4	5.8	277.7	18.6	891	0.07	0	0
M-17S	S-2-3	4.3-5.0	1.31-1.52	CL	CD	104.8	1679	15.0	0.7	33.5	5.8	278	0.07	0	0
	S-3-1	5.0-5.7	1.52-1.74	CL**	CD	107.6	1724	13.8	2.9	138.9	12.5	599	0.07	0	0
	S-3-2	5.7-6.4	1.74-1.95	CL	CD	101.4	1624	14.7	5.8	277.7	11.6	555	0.07	0	0
M-18	S-1-2	1.1-1.8	0.34-0.55	CL	CD	110.6	1772	11.8	0.7	33.5	8.6	412	0.07	0	0
	S-1-3	1.8-2.5	0.55-0.76	CL**	CD	119.2	1909	12.2	5.8	277.7	13.2	632	0.07	0	0
	S-2-1	2.5-3.2	0.76-0.96	CL	CD	114.0	1826	13.3	2.9	138.9	21.2	1015	0.07	0	0

\* Visual classification  
\*\* Classification based on lab tests

**SUMMARY OF TRIAXIAL COMPRESSION TESTS**  
**MARTIN MARIETTA GAS SITE**  
**NAV TEST SITE, SAN CRISTOBAL VALLEY, ARIZONA**

MX SITING INVESTIGATION  
DEPARTMENT OF THE AIR FORCE - SANSO

TABLE  
**9**  
2 OF 2

**FUGRO NATIONAL, INC.**