

AD-A112 204

SENCOR INC NEPTUNE NJ F/G 4/2
COMPUTER PROGRAM USER'S MANUAL FOR FIREFINDER DIGITAL TOPOGRAPH--ETC(U)
JAN 82 M CERES, L R HESELTON DAAK20-79-D-0500

UNCLASSIFIED

DRCPM-FFR-TM-0182

NL

1 of 2
2/2/86

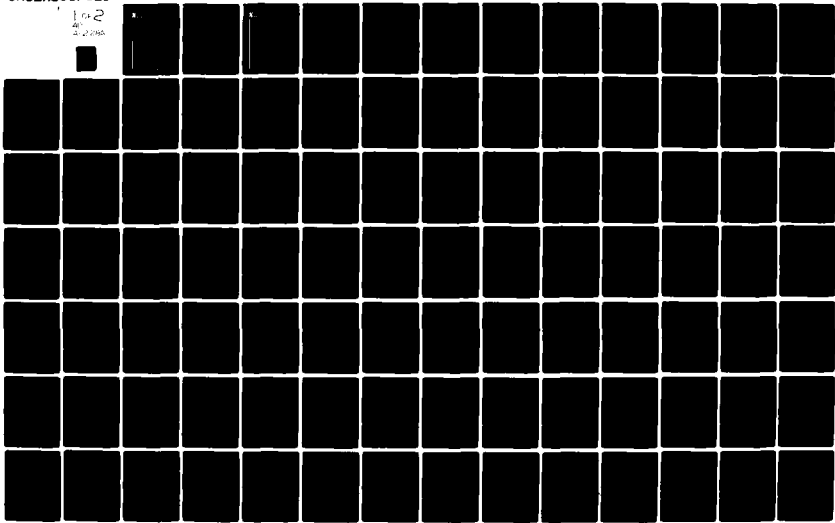

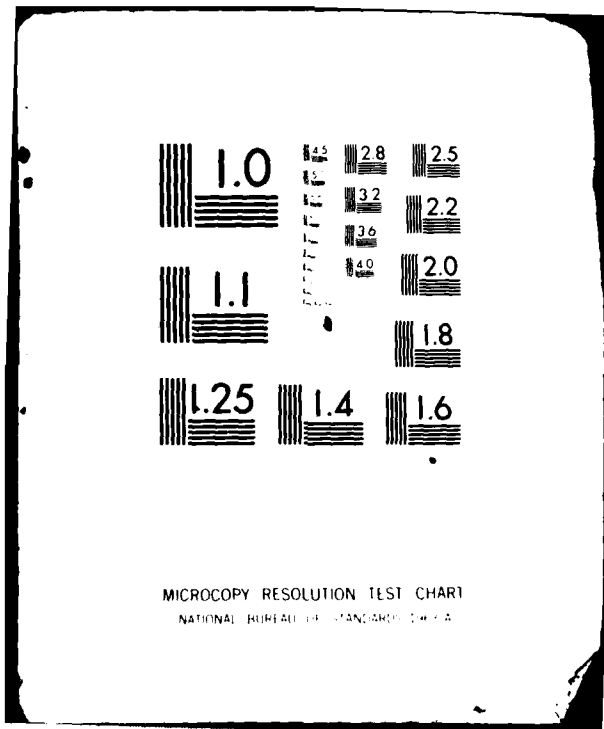

MICROCOPY RESOLUTION TEST CHART
NATIONAL BUREAU OF STANDARDS-1963-A

12



Moorestown, NJ - Warminster, PA - Lexington Park, MD - Arlington, VA - San Diego, CA - Neptune, NJ - Norfolk, VA

COMPUTER PROGRAM USER'S MANUAL
FOR
FIREFINDER
DIGITAL TOPOGRAPHIC DATA
VERIFICATION LIBRARY DUBBING SYSTEM
VOLUME II
DUBBING

29 JANUARY 1982

by:

Marie Ceres
Leslie R. Heselton, III
Technical Consultant

SEMCOR, Inc.
Plaza Building
3301 Route #66
Neptune, New Jersey 07753

Prepared for:

Office of the Project Manager
FIREFINDER/REMBASS
Fort Monmouth, New Jersey 07703

Contract Number:
DAAK20-79-D-0500

DISTRIBUTION STATEMENT A
Approved for public release;
Distribution Unlimited

SDTIC
SELECTE
MAR 23 1982
D

H

82 08 22 129

ADA 112284

DTIC FILE COPY

UNCLASSIFIED

SECURITY CLASSIFICATION OF THIS PAGE (When Data Entered)

REPORT DOCUMENTATION PAGE		READ INSTRUCTIONS BEFORE COMPLETING FORM
1. REPORT NUMBER DRCPM-FFR-TM-0182	2. GOVT ACCESSION NO. AD A112 284	3. RECIPIENT'S CATALOG NUMBER
4. TITLE (and Subtitle) Computer Program User's Manual for FIREFINDER Digital Topographic Data Verification Library Dubbing System, Volume II, Dubbing		5. TYPE OF REPORT & PERIOD COVERED Final Technical Report
		6. PERFORMING ORG. REPORT NUMBER
7. AUTHOR(s) Marie Ceres Leslie R. Heselton, III		8. CONTRACT OR GRANT NUMBER(s) DAAK20-79-D-0500
9. PERFORMING ORGANIZATION NAME AND ADDRESS SEMCOR, Inc. Plaza Building, 3301 Route 66 Neptune, NJ 07753		10. PROGRAM ELEMENT, PROJECT, TASK AREA & WORK UNIT NUMBERS 05-1 14-1
11. CONTROLLING OFFICE NAME AND ADDRESS Office of the Project Manager FIREFINDER/REMBASS (DRCPM-FFR-TM) Ft. Monmouth, NJ 07703		12. REPORT DATE 29 January 1982
		13. NUMBER OF PAGES 115
14. MONITORING AGENCY NAME & ADDRESS (if different from Controlling Office)		15. SECURITY CLASS. (of this report) Unclassified
		15a. DECLASSIFICATION/DOWNGRADING SCHEDULE
16. DISTRIBUTION STATEMENT (of this Report) Approved for Public Release; Distribution Unlimited.		
17. DISTRIBUTION STATEMENT (of the abstract entered in Block 20, if different from Report)		
18. SUPPLEMENTARY NOTES		
19. KEY WORDS (Continue on reverse side if necessary and identify by block number) Digital Mapping Software Library FIREFINDER Dubbing		
20. ABSTRACT (Continue on reverse side if necessary and identify by block number) This manual describes the computer programs for the FIREFINDER Digital Topographic Verification Library Dubbing System, and assists in the maintenance of these programs. The manual contains detailed flow diagrams and associated descriptions of each computer program routine or subroutine. The operating system has been designed to minimize operator intervention.		

DD FORM 1473
1 JAN 73EDITION OF 1 NOV 65 IS OBSOLETE
S/N 0102-LF-014-6601

UNCLASSIFIED

SECURITY CLASSIFICATION OF THIS PAGE (When Data Entered)



SEMCOR

Moorestown, NJ — Warrminster, PA — Lexington Park, MD — Arlington, VA — San Diego, CA — Neptune, NJ — Norfolk, VA

COMPUTER PROGRAM USER'S MANUAL
FOR
FIREFINDER
DIGITAL TOPOGRAPHIC DATA
VERIFICATION LIBRARY DUBBING SYSTEM
VOLUME II
DUBBING

29 JANUARY 1982

by:

Marie Ceres
Leslie R. Heselton, III
Technical Consultant

SEMCOR, Inc.
Plaza Building
3301 Route #66
Neptune, New Jersey 0775

Prepared for:

Office of the Project Manager
FIREFINDER/REMBASS
Fort Monmouth, New Jersey 07703

Contract Number:
DAAK20-79-D-0500

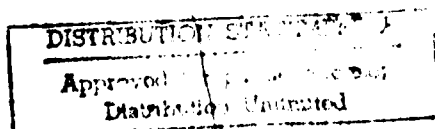

ACKNOWLEDGMENT

The author would like to thank the individuals at the Office of the Project Manager, FIREFINDER/REMBASS that contributed directly and indirectly to this manual. These include those who have commented on the various iterations of this Computer Program User's Manual, specifically Lawrence De Cosimo and Craig Emigh. I would especially like to acknowledge Teresa De Ment's thorough and painstaking effort in the extensive reviews and production assistance required in the preparation of this manual. And, of course, special thanks and grateful appreciation to Les Heselton, for bringing it all together.



Accession For	
NTIS GRA&I	<input checked="" type="checkbox"/>
DTIC TAB	<input type="checkbox"/>
Unannounced	<input type="checkbox"/>
Justification	<input type="checkbox"/>
By _____	
Distribution/	
Availability Codes	
Dist _____	
A	

TABLE OF CONTENTS

<u>Section</u>		<u>Page</u>
1	INTRODUCTION	1-1
	1.1 Purpose and Scope	1-1
	1.2 System Overview	1-1
	1.2.1 Verification	1-1
	1.2.2 Library	1-2
	1.2.3 Dubbing	1-2
	1.3 Dubbing Process Overview	1-3
2	DUBBING TAPE DESCRIPTIONS	2-1
	2.1 General	2-1
	2.2 Scratch Tape	2-1
	2.3 Cassette	2-4
3	COMMONS AREA DESCRIPTION	3-1
	3.1 General	3-1
	3.2 Commons	3-1
4	SUBROUTINE DESCRIPTIONS	4-1
	4.1 CASSET	4-2
	4.2 WKTAPE	4-9
	4.3 ENTRY	4-13
	4.4 CRTCK	4-18
	4.5 GRIDCK	4-22
	4.6 NUMCK	4-25
	4.7 EXTRAS	4-27
	4.8 CTLFND	4-33
	4.9 DECIDE	4-42
	4.10 CPYMAP	4-47
	4.11 POSTAP	4-54
	4.12 UTLDUB	4-57
	4.13 XFRHDR	4-59
	4.14 TAPDUB	4-61
	4.15 CHANGE	4-66
	4.16 CSTCPY	4-70
	4.17 JMPSW	4-75
	4.18 CMPCD	4-79
	4.19 RSUMCK	4-80
	4.20 SELECT	4-83
	4.21 YESNO	4-85
	4.22 HOWMNY	4-87
	4.23 WRRING	4-89
5	COMPUTER PROGRAM LISTINGS	5-1

LIST OF ILLUSTRATIONS

<u>Figure</u>		<u>Page</u>
1-1	Dubbing Process	1-4
2-1	Scratch Tape Header File	2-3
2-2	Cassette Header Records	2-5
4-1	CASSET Flow Diagram	4-3
4-2	WKTAPE Flow Diagram	4-10
4-3	ENTRY Flow Diagram	4-14
4-4	CRTCK Flow Diagram	4-19
4-5	GRIDCK Flow Diagram	4-23
4-6	NUMCK Flow Diagram	4-26
4-7	EXTRAS Flow Diagram	4-28
4-8	CTLFND Flow Diagram	4-34
4-9	DECIDE Flow Diagram	4-43
4-10	Decision Output	4-46
4-11	CPYMAP Flow Diagram	4-48
4-12	POSTAP Flow Diagram	4-55
4-13	UTLDUB Flow Diagram	4-58
4-14	XFRHDR Flow Diagram	4-60
4-15	TAPDUB Flow Diagram	4-62
4-16	CHANGE Flow Diagram	4-67
4-17	CSTCPY Flow Diagram	4-71
4-18	JMPSW Flow Diagram	4-77
4-19	CMPRCD Flow Diagram	4-79
4-20	RSUMCK Flow Diagram	4-81
4-21	SELECT Flow Diagram	4-84
4-22	YESNO Flow Diagram	4-86
4-23	HOWMNY Flow Diagram	4-88
4-24	WRRING Flow Diagram	4-90

LIST OF TABLES

<u>Table</u>		<u>Page</u>
2-1	Cassette Designator Record	2-7
3-1	Common Areas Accessed by Each Subroutine	3-2
4-1	Dubbing Options	4-2
4-2	Actions Associated with IXRTN Values	4-76

SECTION 1
INTRODUCTION

1.1 PURPOSE AND SCOPE

This manual describes the computer programs for the dubbing portion of the FIREFINDER Digital Topographic Data Verification-Library-Dubbing System (FFDTDVLDS). Detailed flow diagrams and associated descriptions for each computer program routine and subroutine are given to assist in the maintenance of these programs. Complete computer listings are also included. This information should be used when changes are made in the computer programs. The operating system has been designed to minimize operator intervention.

1.2 SYSTEM OVERVIEW

The FFDTDVLDS is the central source of digitized topographic data for the fielded FIREFINDER Artillery and Mortar Locating Radar Systems. This facility is responsible for:

- Receiving data cells from the Defense Mapping Agency (DMA).
- Verifying that they contain reasonably accurate data in the prescribed format.
- Accurately cataloging the data cells in the library so as to facilitate timely access when they are needed.
- Converting the cataloged data cells to other optimal grid sizes for subsequent cataloging.
- Transferring requested data cells to field cassettes.
- Validating the cassette files before shipment to operational units.

1.2.1 Verification

The incoming DMA tapes and accompanying documentation will be compared. The cell definition records containing critical data will be dumped for cross-check with the printed dump accompanying the tapes. Next the actual data is

displayed on a color-coded master graphic CRT system. Radically inconsistent color mismatches indicate probable bad data items. Rough contouring routines are also utilized. Any doubt as to the accuracy and validity of a cell will render it unusable by FFDTDLDS.

1.2.2 Library

The library operations will be software-determined, self-updating, and crosschecking. Operators will be instructed as to what tapes to mount, when to mount them, what switches to throw, and so forth. Operations will not proceed until the program is satisfied that the specific actions have been correctly performed. Routines will be available to aid operators in error recovery if bad library data is encountered.

Auxiliary routines will be available to periodically condense the catalog and data tapes, crosscheck the catalog against the data tapes to be sure no errors have been introduced, and reorder tapes and data files to make more efficient use of the existing tapes. These routines will be used infrequently. Auxiliary software will also include several utility and maintenance programs for various purposes.

The library system is completely described in Volume I of this manual.

1.2.3 Dubbing

This portion of the system will be responsible for receiving field user requests for data, locating it in the library, and transferring the data to the output medium and format (usually a cassette or 9-track tape) specified by the requester. Software reprogramming would allow other formats, and firmware-driven changes in Raymond interface could accommodate other output tape or disk subsystems.

Field user requests may be made in either of the following formats:

- a. Grid zone plus alphabetic cell designator.
- b. Grid zone plus S/W corner northing/easting coordinates.

Established policy will furnish the grid size selected for FIREFINDER systems. All transfers within the VLD will be error-checked as a standard procedure. Procedures will also be established to verify outgoing tapes using the verification program prior to shipment.

1.3 DUBBING PROCESS OVERVIEW

The dubbing system dubs digital maps from the library tapes onto Raymond cassettes for field use. As shown in Figure 1-1, when a request is received from the field, the library catalog is checked to see if the requested map is in the library. If it is, a cassette is made. The cassette is verified by the verification program before being sent out to the field. Any maps not in the library are documented and requested from DMA.

To maximize cassette use, approximately eight maps are placed on each cassette.

When a field request is received, the operator enters the map designator. A maximum of 20 can be entered at once. The maps can be entered by the grid zone designator (32UKA, 2PKQ) or by the grid zone and the S/W corner northing and easting points (16S 3600000, 700000). For each map entered, the operator is asked if any overlapping border cells are required. If so, they are automatically entered by the program.

When all the maps are entered, the operator is directed to mount the current library working tape. The replacement record, containing replaced catalog entries, is loaded into memory.

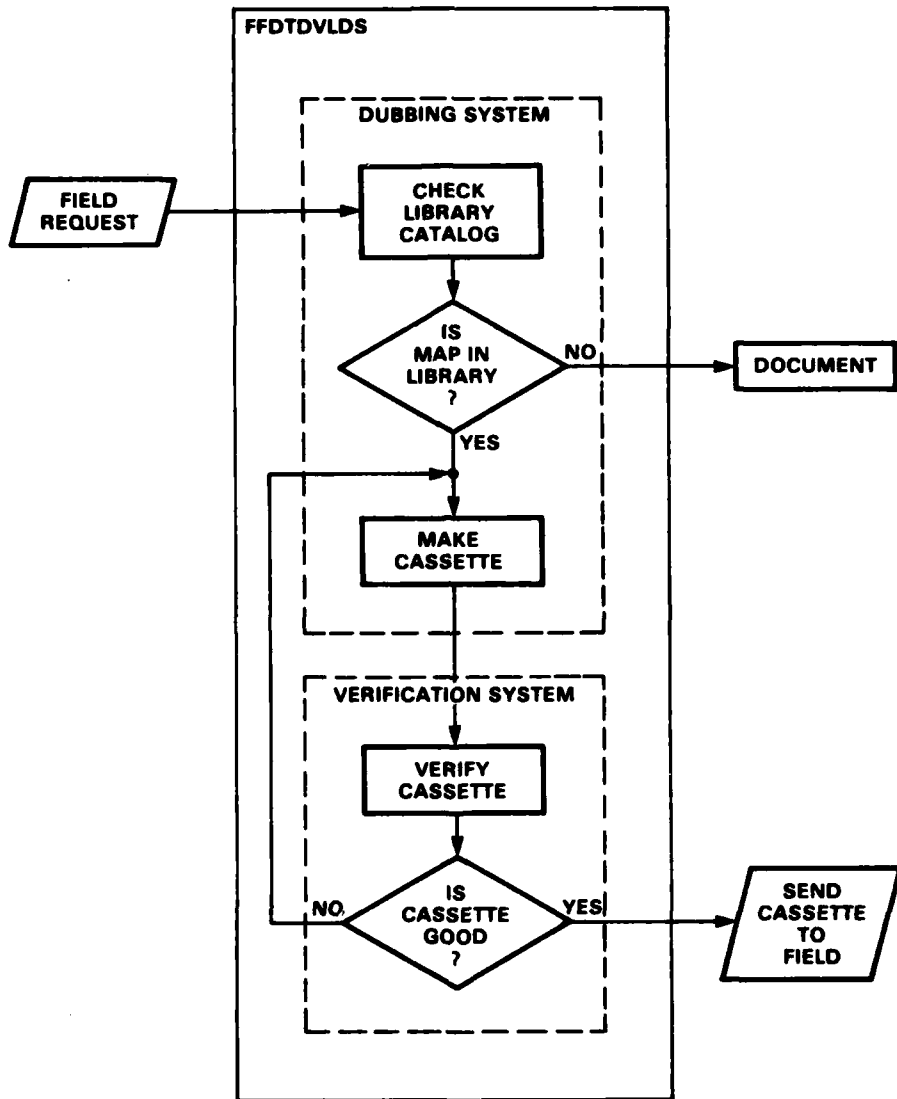

Figure 1. Dubbing Process

The operator is then directed to mount the library's master catalog. The program then searches the catalog for the maps to be dubbed. Maps not contained in the library are identified.

Using information from the catalog entry, the number of words each map contains is computed. As each map is added, the total words required is compared to the maximum number of words the cassette can handle. The optimum fill of the cassette is then decided and the operator is notified. If the optimum fill is not acceptable, the operator has the opportunity to reenter the maps in a different order. The maps should be entered in priority order since the first maps are considered first.

If the optimum fill is acceptable, the operator is prompted to mount a scratch tape. This scratch tape will contain the data records which will eventually be placed on the cassette. The scratch tape is required to construct the cassette header. As each map is copied onto the scratch tape, information from its designator record is transferred to the buffer and will be written out to the cassette.

The operator is directed to mount the required library field file (FF) tape for each map. The tape is spaced down to the required maps, and the data records are copied onto the scratch tape.

After all the maps are copied, the cassette header records are written out to the scratch tape as a separate file.

The cassette is then prepared from the scratch tape. The cassette header information is written out and the data records are copied. After a cassette

is prepared, it is verified before being sent to the field. If only one cassette is to be made, the operator chooses a single cassette option which will make a single cassette.

If more than one cassette is to be made (i.e., four copies of the same map), the operator can choose a multiple cassette option. This option will make only the scratch tape. It will direct the operator to verify the scratch tape before proceeding with the cassette copies.

Once the scratch tape is verified, the operator can make from one to five copies by choosing a copy only option. Each cassette is then verified before being sent to the field.

SECTION 2
DUBBING TAPE DESCRIPTIONS

2.1 GENERAL

The dubbing system uses five types of tapes:

- The working tape
- The catalog tape
- The field file tape
- A scratch tape
- The Raymond cassette tape

The working tape, catalog tape, and field file (FF) tape are actually part of the library program. The dubbing system creates only the scratch tape and cassette tape.

The dubbing system refers to the library tapes for the information required to make the scratch tape or cassette tape.

2.2 SCRATCH TAPE

The scratch tape contains all the data records (in Hughes format) to be put on the cassette. A scratch tape is required because the cassette designator record must contain information on each map and its location on the cassette. Since the information is taken from the designator record of each map, the cassette designator record cannot be assembled until each map is read. To save time, the data records of each map are converted to Hughes format and stored on the scratch tape as the map's designator record information is

transferred to the cassette designator record. After all the maps are converted, the FLR and designator records for the cassette are written out to the scratch tape for storage.

When a cassette is prepared, the cassette header records are retrieved from the scratch tape and written out to the cassette. The data records are then copied onto the cassette.

Physically, the scratch tape is set up as follows:

Header File:	Fixed Length Record (FLR) Designator Record EOF	FLRRCD DESRCD
Data File:	First data record of first map . . . Last data record of first map First data record of second map. . . . Last data record of second map . . . First data record of last map . . . Last data record of last map EOF	
Cassette Header File:	FLR Designator Record EOF EOT	FLRDUB DESDUB

Figure 2-1 depicts a breakdown of the scratch tape header file.

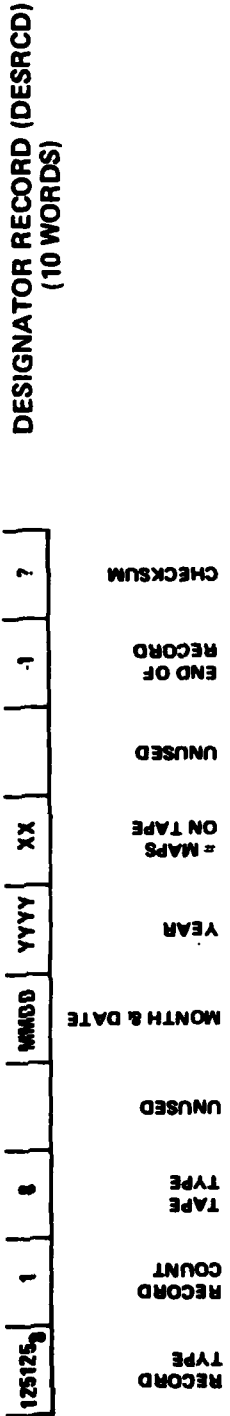
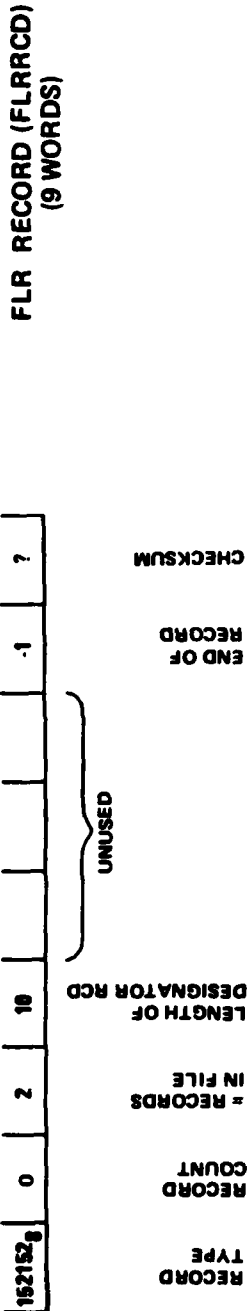

END-OF-FILE

Figure 2-1. Scratch Tape Header File

The data records are the library field file data records converted to Hughes format. (Refer to reference (a) for a detailed explanation of the field file records.) For Hughes format, an end-of-scan (-1) is placed after each scan, and an end-of-record (-1) is placed after the final scan of a record.

The cassette header file contains the FLR and designator record which will be output to the cassette. Paragraph 2.3 explains the cassette header records.

2.3 CASSETTE

The Raymond cassette is the final output of the dubbing system. The cassette consists of one file as follows:

```
CPC Record
FLR Record
Designator Record
First data record of first map
      .
      .
      .
Last data record of first map
First data record of second map
      .
      .
      .
Last data record of second map
      .
      .
      .
First data record of last map
      .
      .
      .
Last data record of last map
```

A breakdown of the cassette header records is shown in Figure 2-2.

The CPC record is used internally by the Raymond cassette unit as a self-test processor check. It has no record count, and is for use only by the Raymond unit.

The FLR has a record count of zero, and the designator record has a count of one. The data records follow, numbered sequentially. End-of-file and end-of-tape marks are not used on the cassette tape.

The cassette designator record contains information on each map on the cassette, including its location. The record number of each map's first data record is in the designator record so that the map can be retrieved. The cassette designator record is variable; its length depends on the number of maps placed on the cassette tape. The length of the designator record is computed by the formula:

$$\text{DESBUB}_L = 6 + (\text{Number of maps} * 20)$$

NOTE: The cassette FLR and designator record are in Hughes format. Two 16-bit words are used as end-of-record.

A breakdown of the entire definition record is shown in Table 2-1.

TABLE 2-1. CASSETTE DESIGNATOR RECORD

<u>WORD</u>			
1	Record Type	}	
2	Record Count		
3	Number of maps on tape		
4-6	UTM grid designator		
7-8	S/W Northing		
9-10	S/W Easting		
11-12	UTM scale factor		
13	Lowest elevation (Base Ht in meters)		
14	Height scale factor		
15	Spacing Multiple		For 1st map
16	Number of kilometers in N/S direction		
17	Number of kilometers in E/W direction		
18	Number of first data record		}
19	Grid zone azimuth		
20	Maximum elevation (in meters)		
21	Number of words/data record		
22	Number of scan profiles/cell		
23	Length of last data record		
24-26	UTM grid designator		
27-28	S/W Northing	For 2nd map	
	·		
	·		
44-46	UTM grid zone designator	For 3rd map	
	·		
	·		
	·		

SECTION 3
COMMONS AREA DESCRIPTION

3.1 GENERAL

Many variables used in the dubbing system are held in a common data base (commons). Each area in commons has a name and several variables held in that commons. The commons used in the dubbing system are:

/ALL/, /BASIC/, /TABLES/, /INFO/, /FLAGG/, /HEADER/, /FUNCTN/, /COUNT/

The following paragraphs describe each variable held in the data base and the function it performs. Table 3-1 shows the common areas accessed by each subroutine.

In the following descriptions, the common variable names are given in capital letters; the subroutines are in capital letters and underlined>.

3.2 COMMONS

/ALL/ IOBUFO (2048), IOBUF1 (2048), IOBUF2 (2048)

ALL contains three I/O buffers of 2048 words each. These buffers are involved in all I/O routines and computations.

/BASIC/ CRT, PRINTR, INPDEV, OUTDEV, ON, OFF, DONE, NTDONE, IOBUF, LOGDEV, MMDD, YYYY, MM, DD, YY, GBGMSG, OPTION, TYPOPT, MAXIM, NUMMPS, RAYMON

BASIC contains I/O assignments and test conditions. The I/O assignments are system-dependent.

CRT = 5

PRINTR = 6

INPDEV = input device

OUTDEV = output device

} can be either 2 or 3 for tape drive
2 or 3, respectively

TABLE 3-1. COMMON AREAS ACCESSED BY EACH SUBROUTINE

SUBROUTINE	ALL	BASIC	TABLES	INFO	FLAGG	HEADER	FUNCTN	COUNT
CASSET	✓	✓		✓	✓		✓	
WKTAPE		✓	✓					
ENTRY		✓	✓	✓				
CRTCK	✓	✓	✓	✓				
GRIDCK		✓		✓				
NUMCK		✓		✓				
EXTRAS		✓	✓	✓				
CTLFND	✓	✓	✓					
DECIDE		✓	✓	✓				
CPYMAP	✓	✓	✓	✓	✓	✓	✓	
POSTAP	✓	✓		✓			✓	
UTLDUB	✓				✓			
XFRHDR		✓	✓		✓	✓	✓	✓
TAPDUB	✓	✓			✓	✓	✓	✓
CHANGE	✓	✓			✓		✓	
CSTCPY	✓	✓	✓		✓	✓	✓	
JMP SW		✓			✓			
CMPRCD	✓	✓			✓			
RSUMCK	✓	✓			✓			
SELECT								
YESNO		✓						
HOWMNY		✓						
WRRING		✓						

ON = 0

OFF = 1

DONE = 1

NTDONE = 0

IOBUF and LOGDEV are variables used by the RSUMCK subroutine.

IOBUF determines the input buffer RSUMCK will read into:

IOBUF = 0 for IOBUFO
= 1 for IOBUF1
= 2 for IOBUF2

LOGDEV is the input device RSUMCK will read from:

LOGDEV = 2 for tape drive 2
= 3 for tape drive 3
= 8 for Raymond Cassette

MMDD = month and day values
YYYY = year
MM = month
DD = day
YY = year

All set in CASSET,
contain date information.

GBGMSG = flag for a bad tape read. GBGMSG will vary depending on which magnetic tape had a read failure.

GBGMSG = 1 for read failure on the work tape
= 5 for read failure on the scratch tape
= 10 for read failure on the catalog tape

OPTION = the dubbing system option selected:

OPTION = 1 for single cassette option
= 2 for multiple cassette option
= 3 for copy only option

TYPOPT = the reference form in which the map was entered - either UTM grid zone designation or grid zone and the S/W northing/easting coordinates.

TYPOPT = 1 for UTM grid zone designator (32UKC, 53STM)
= 2 for grid zone and S/W northing/easting coordinates (32U 4200000, 300000)

MAXIM = the maximum number of maps which the operator can enter for dubbing at one time. This is set in the Block Data routine to 20.

NUMMPS = the number of maps actually entered for dubbing. NUMMPS includes any overlap border cells given.

RAYMON = 8

/TABLES/ RETREV(30, 30), GLBRPL(90), FLR(9), DESR(20)

TABLES contains the RETREV array and replacement record.

RETREV(30, 30) = an array of 30 entries, 30 words each. (Only 20 entries are allowed at this time.) Each entry contains information on the given map. The RETREV words are assigned as follows:

1|2|3|4|5|6|7|8|9|10|11|12|13|14|15|16|17|18|19|20|21|22|23|24|25|26|27|28|29|30|

RETREV (, 1) = Overlap Cell Identifier	(, 16) = Entry Type = 1 UTM Grid Designator
= 1 East/West	= 2 S/W Northing/Easting
= 2 North/South	= 1 250m
= 3 Both	= 2 500m
RETREV (, 2) = MIDVAL - Center of map (used for overlap boundary cell determination)	= 3 1,000m
(, 3) = UTM Grid Designation	(, 17) = Format
(, 4) = UTM Grid Designation	(, 18) = Located = 0 Not in Library
(, 5) = UTM Grid Designation	= 1 In Library
(, 6) = S/W Corner Northing, High	(, 19) = Copy = 0 Do Not Copy
(, 7) = S/W Corner Northing, Low	= 1 For Copy
(, 8) = S/W Corner Easting, High	(, 20) = Status = 0 Not Copied
(, 9) = S/W Corner Easting, Low	= 1 Copied
(, 10) = Number of km in N/S Direction	(, 21) = not used
(, 11) = Number of km in E/W Direction	(, 22) = not used
(, 12) = PRFX	(, 23) = not used
(, 13) = INFX	(, 24) = not used
(, 14) = Location in Library - FF Tape Number	(, 25) = not used
(, 15) = Location in Library - FF File Number	(, 26) = not used
	(, 27) = not used
	(, 28) = not used
	(, 29) = not used
	(, 30) = not used

GLBRPL(90) = global replacement record. Maps which have been replaced in the catalog are recorded here. This record is read off the library system working tape. In the dubbing program, an equivalence is established between GLBRPL(3) and GLBTBL. CTLFND checks the GLBTBL when searching the catalog.

FLR(9) = fixed length records (FLR's), nine words dimensioned for header.

DESR(20) = designate records, 20 words dimensioned for header.

/INFO/ MAP(3), CPYCT, MAPNO, PRFX, INFX, NORTH(2), EAST(2), NO, EO

INFO contains map information.

MAP(3) = grid zone designator. CRTCK calculates the designator words from the UTM grid designator entered by the operator. The designator is stored in the RETREV array, words 3, 4, and 5 by the ENTRY routine.

CPYCT = the number of maps to be put on the cassette tape. CPYCT is computed in the DECIDE routine.

PRFX and INFX = the first two or three characters of the UTM grid zone designator. CRTCK and GRIDCK interpret the operator's entries and separate them as follows:

2KPQ:				15KPQ:			
2	K	PQ		15	K	PQ	
PRFX	INFX			PRFX	INFX		

PRFX and INFX are stored in the RETREV array, words 12 and 13 by the ENTRY routine.

NORTH(2) = the S/W corner northing coordinate, high and low words. NUMCK interprets the operator's input and converts it into two 16-bit words. The northing values are put into the RETREV array, words 6 and 7 by the ENTRY routine.

EAST(2) = the S/W corner easting coordinate, high and low words. NUMCK interprets the operator's input and converts it into two 16-bit words. The easting values are then put into the RETREV array, words 8 and 9 by the ENTRY routine.

NO = the northing coordinate entered by the operator as a real.

EO = the easting coordinate entered by the operator as a real.

/FLAGG/ IXRTN, STSVL, RTRY, WTRY, ISCS, RC, RECSUM, CMPBAD, ILAST, CASETE

FLAGG contains the status return variables, flags, and record counts.

IXRTN = status flag for read and write processes:

RSUMCK returns IXRTN = 1 for good read
= 2 for EOT encountered
= 3 for bad read
= 4 for sum check error

TAPDUB sets IXRTN = 5 for improper record type/unexpected EOT on output device
= 6 for bad read after write
= 7 for sum check error after write
= 8 for bad compare, second time

STSVL = status flag returned to UTLDUB by JMPSW.

STSVL = 1 OK, continue
= 2 bad read first time, try again
= 3 bad write first time, try again
= 4 processing stopped due to nonrecoverable errors

UTLDUB branches on STSVL and goes to the appropriate step in the program.

RTRY = read try flag. RTRY is set equal to zero in UTLDUB prior to attempting a copy. If a bad read is detected, JMPSW sets RTRY equal to 1 and retries the record. On the second try, JMPSW tests RTRY and goes to the half processing logic.

WTRY = write try flag. WTRY is set equal to zero in UTLDUB prior to attempting a copy. If a bad write is detected, JMPSW sets WTRY equal to 1 and retries the record. On the second try, JMPSW tests WTRY and goes to the half processing logic.

ISCS = status flag for compare routine CMPRCD

ISCS = 0 for good compare
= 1 for bad compare

RC = record count for each individual map

RECSUM = record count for entire scratch tape or cassette tape.

CMPBAD = compare try flag. If a record fails the comparison, TAPDUB tests CMPBAD to determine if it was the first failure. The first time, the record is rewritten and CMPBAD is set equal to 1. If the record fails again, TAPDUB is exited with IXRTN = 8.

ILAST = passed parameter in some SIO calls. Tested by CMPRCD to verify record length. Also, CHANGE sets ILAST to the number of words to be output to the scratch tape after the Hughes format conversion.

CASETE = a logical set. .TRUE. for cassette copy.

/HEADER/ FLRDUB(9), DESDUB(200), FLRRCD(9), DESRCD(30)

HEADER contains the header arrays for the scratch tape and cassette tape.

FLRDUB(9) = FLR record, nine words dimensioned for the cassette.
DESDUB(200) = designator record, 200 words dimensioned for the cassette.
FLRRCD(9) = FLR record, nine words dimensioned for the scratch tape.
DESRCD(30) = designator record, 30 words dimensioned for the scratch
tape.

/FUNCTN/ FILBCK, FILFOR, RECBCK, RECFOR, READ, WRITE

FUNCTN contains variables used by the system-dependent I/O routine, SIO.

FILBCK = 8 pass file backward

FILFOR = 5 pass file forward

RECBCK = 4 pass record backward

RECFOR = 3 pass record forward

READ = 0 read

WRITE = 1 write

/COUNT/ OVERT

COUNT contains each map's location in the cassette designator record.

OVERT = used to place tack map's location in the cassette designator
record, DESDUB.

SECTION 4
SUBROUTINE DESCRIPTIONS

The subroutines that comprise the dubbing system are described in this section. Each subroutine description is accompanied by a flow diagram.

Two subroutines, WRRING and YESNO, are used so often that calls to them are not shown on the flow diagrams. Instead, WRRING calls are shown as a write ring decision marked with one asterisk (*). Calls to YESNO are shown as yes/no responses and marked with two asterisks (**).

Subroutine names are underlined to distinguish them from variables.

A Block Data routine initializes the following variables at compilation:

CRT	= 5	FILBCK	= 8
PRINTR	= 6	FILFOR	= 5
ON	= 0	RECBCK	= 4
OFF	= 1	RECFOR	= 3
DONE	= 1	WRITE	= 1
NTDONE	= 0	READ	= 0
MAXIM	= 20		
RAYMON	= 8		

4.1 CASSET

CASSET is the control program for the dubbing system. It presents the functions available for the operator's selection, and controls the required processing.

In addition to initializing I/O variables, CASSET calls the system subroutine SETTRT to set system parameters so that a "1" is returned on a bad read. The last statement in CASSET is a call to SETSYS, which resets the system parameters.

CASSET directs the operator to set the tape density, enter the date, and select one of the options available.

When a selection has been made, CASSET calls the appropriate routines for processing. Table 4-1 lists the options available on the dubbing system. For the CASSET flow diagram, refer to Figure 4-1.

TABLE 4-1. DUBBING OPTIONS

SINGLE CASSETTE	-- Makes a single cassette
MULTIPLE CASSETTE	-- Makes a scratch tape from which cassette copies can be made after verification
COPY ONLY	-- Makes from one to five cassette copies from a scratch tape

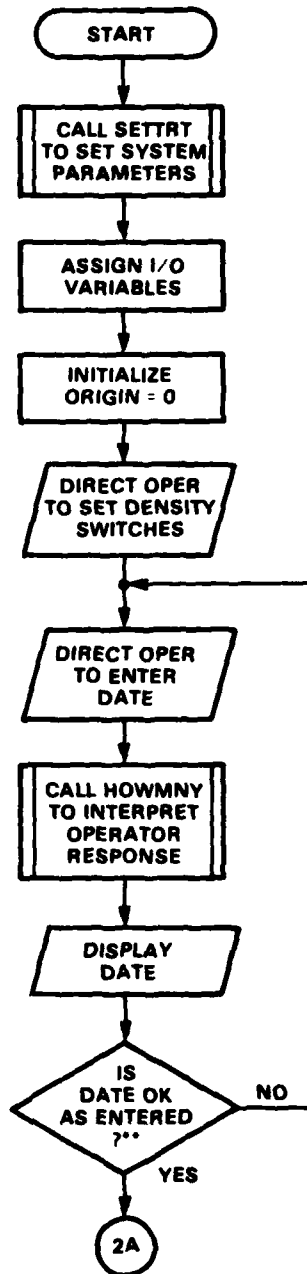

**YESNO

Figure 4-1. CASSET Flow Diagram (Sheet 1 of 6)

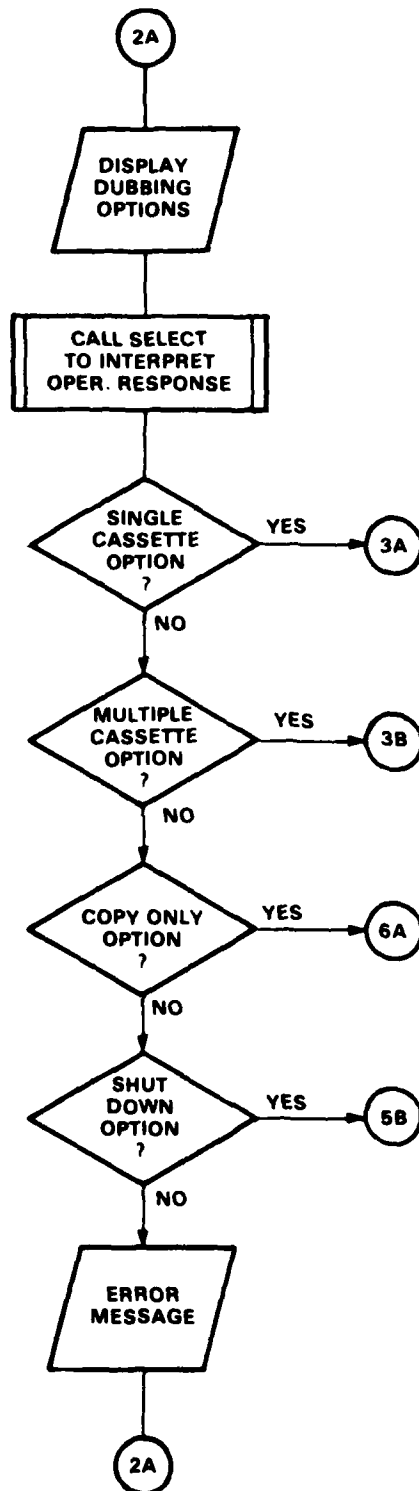
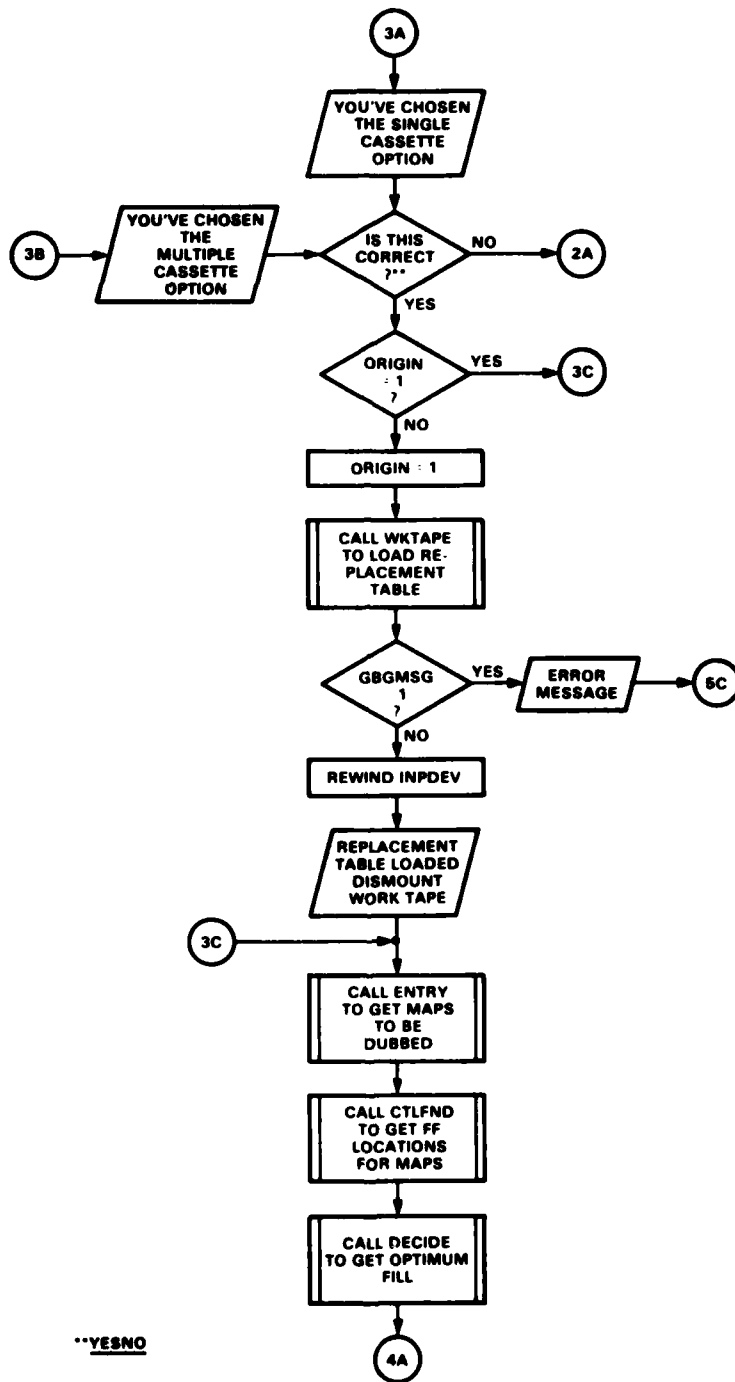
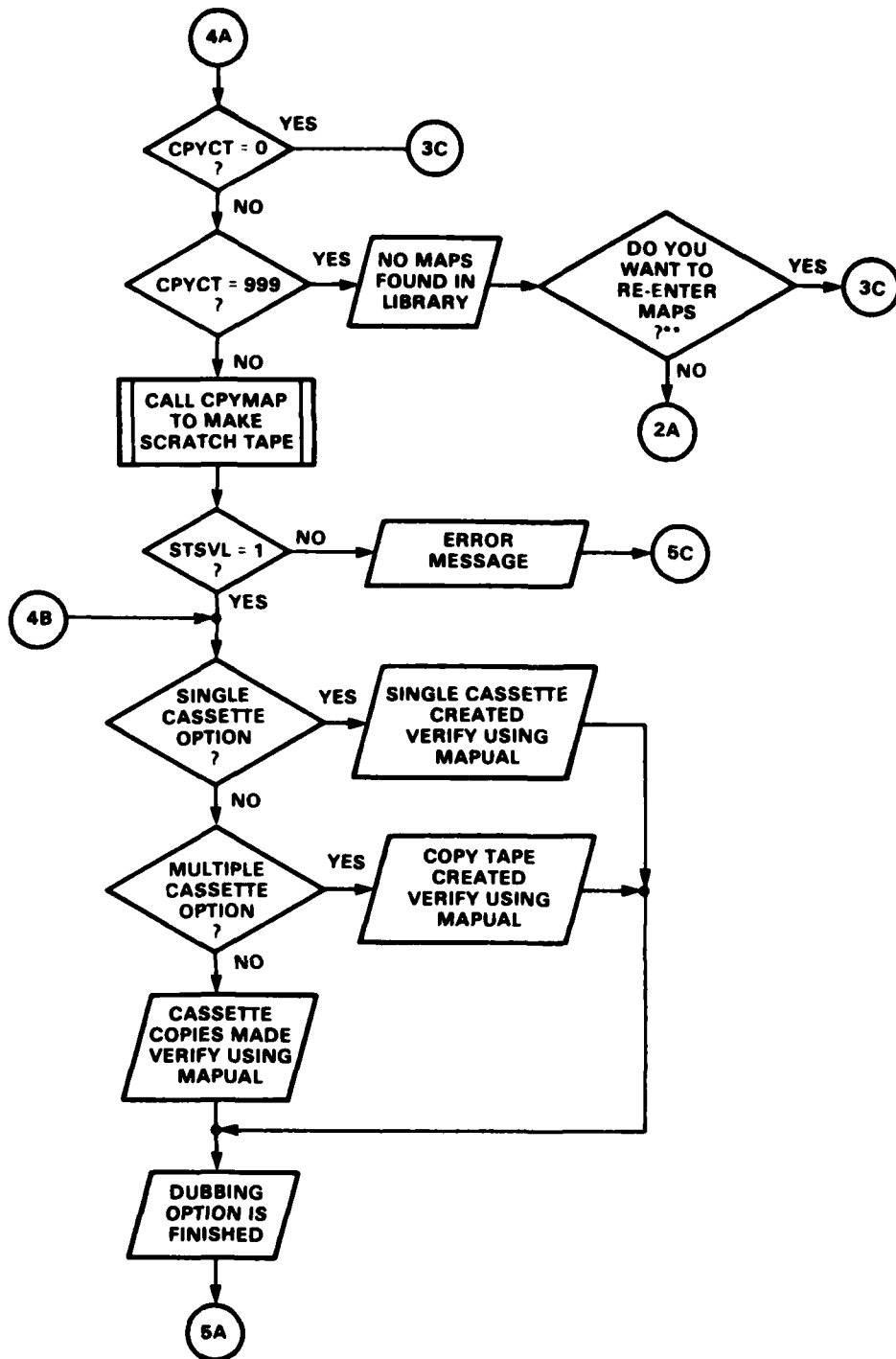

Figure 4-1. CASSET Flow Diagram (Sheet 2 of 6)



**YESNO

Figure 4-1. CASSET Flow Diagram (Sheet 3 of 6)



**YESNO

Figure 4-1. CASSET Flow Diagram (Sheet 4 of 6)

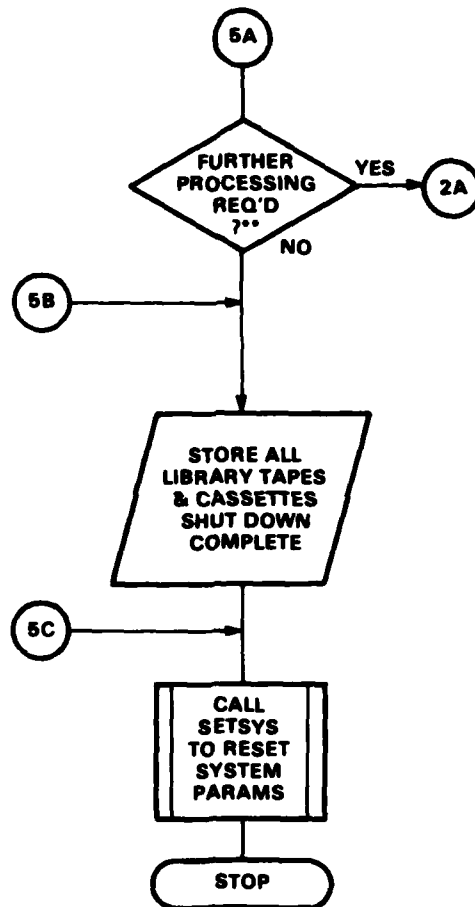

****YESNO**

Figure 4-1. CASSET Flow Diagram (Sheet 5 of 6)

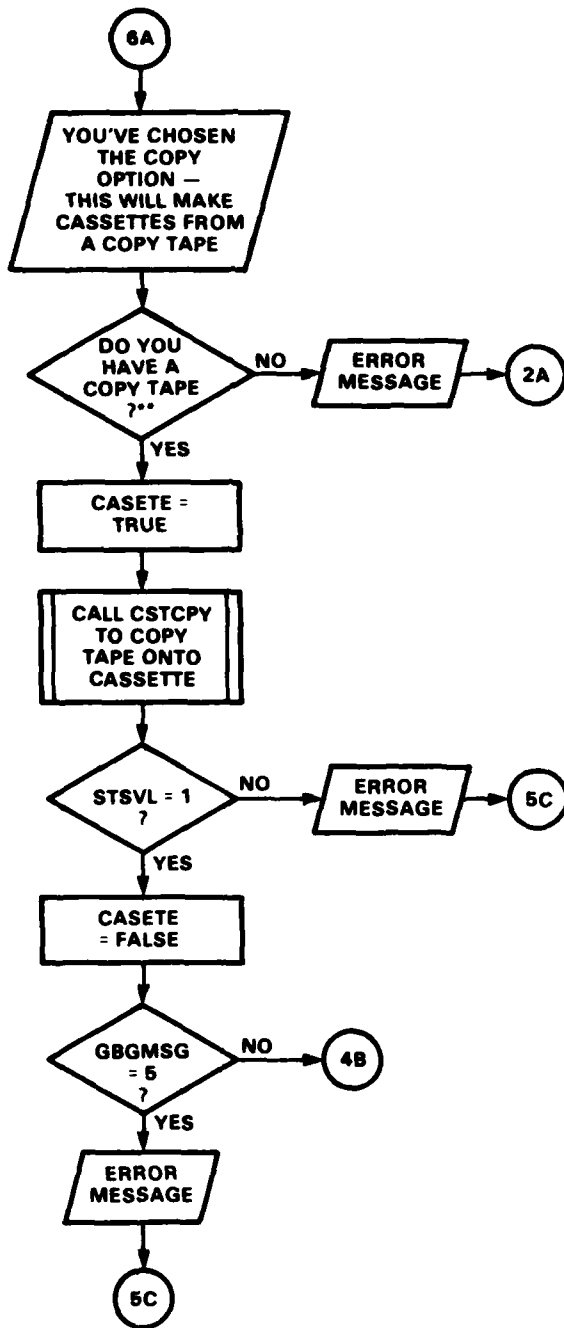

****YESNO**

Figure 4-1. CASSET Flow Diagram (Sheet 6 of 6)

4.2 WKTAPE

WKTAPE reads the replacement table working file, stored on the library working tape, into memory. WKTAPE is called by CASSET when the single or multiple cassette option is selected.

The replacement file is required for locating maps on the catalog tape. Replaced entries are ignored during this search.

If the working tape does not load, the backup tape is requested and WKTAPE tries to read the backup tape. If this does not load either, WKTAPE is exited with GBGMSG = 1. This flags CASSET to the failure.

The flow diagram for WKTAPE is given in Figure 4-2.

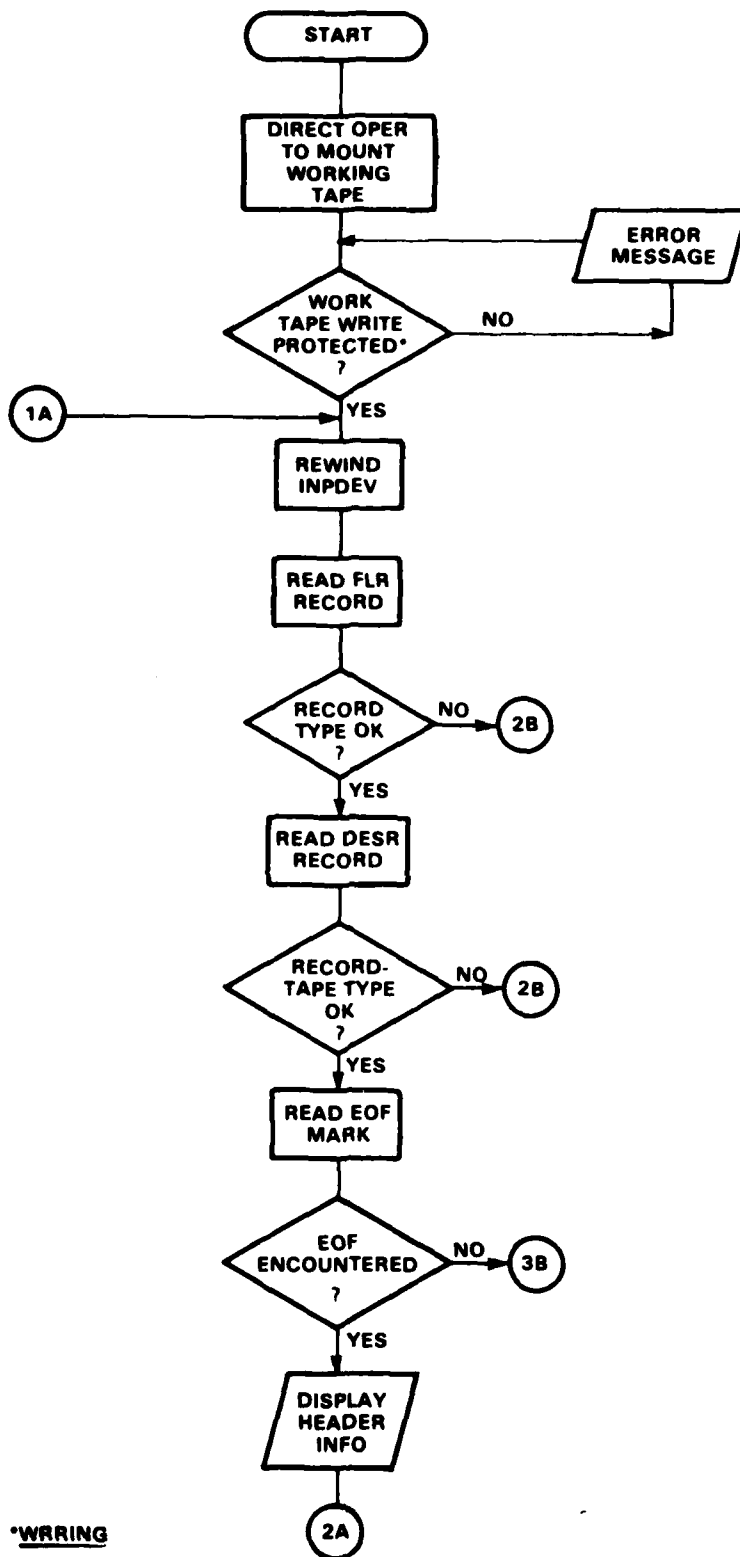

Figure 4-2. WKTAPE Flow Diagram (Sheet 1 of 3)

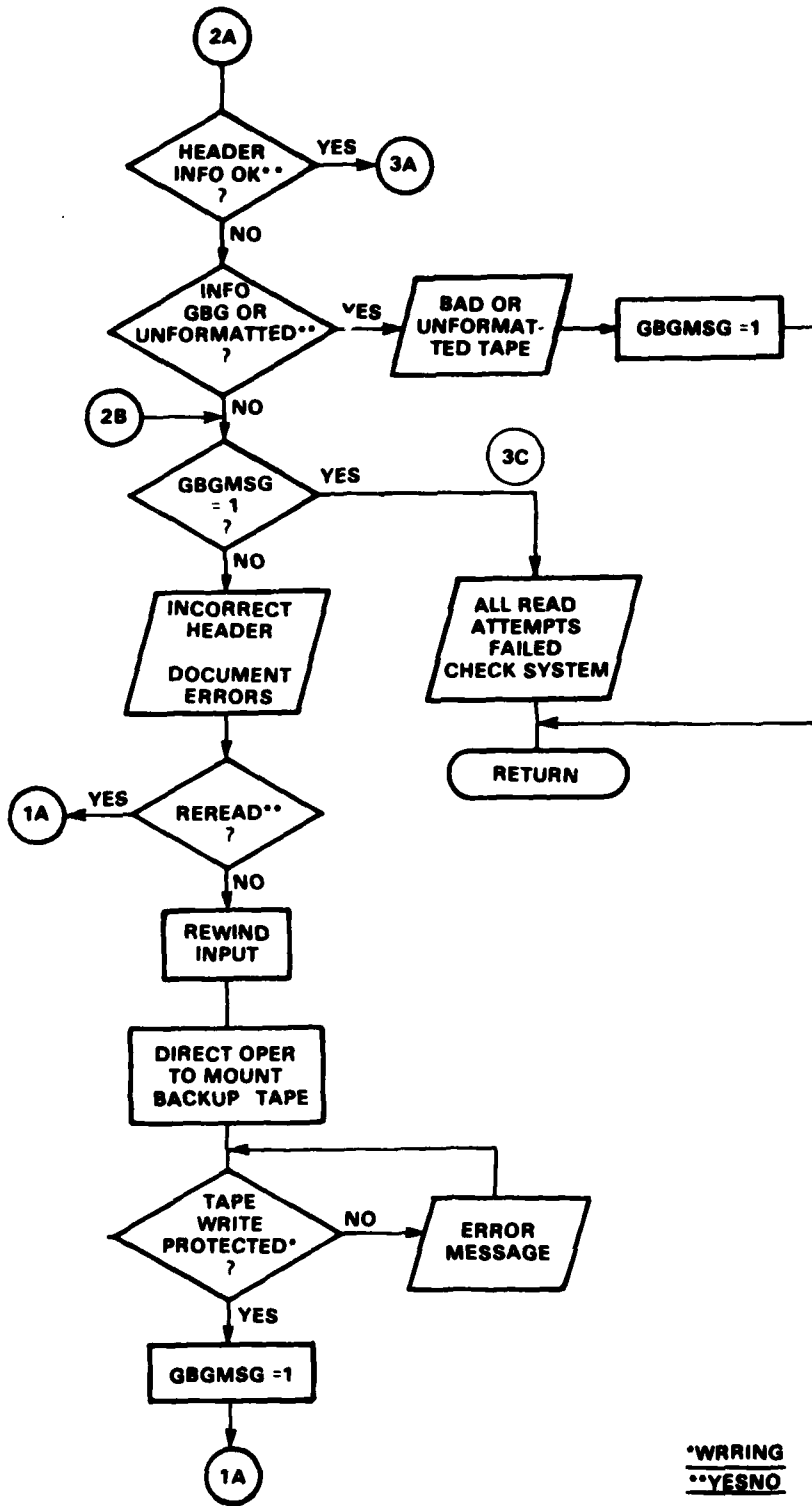

Figure 4-2. WKTAPE Flow Diagram (Sheet 2 of 3)

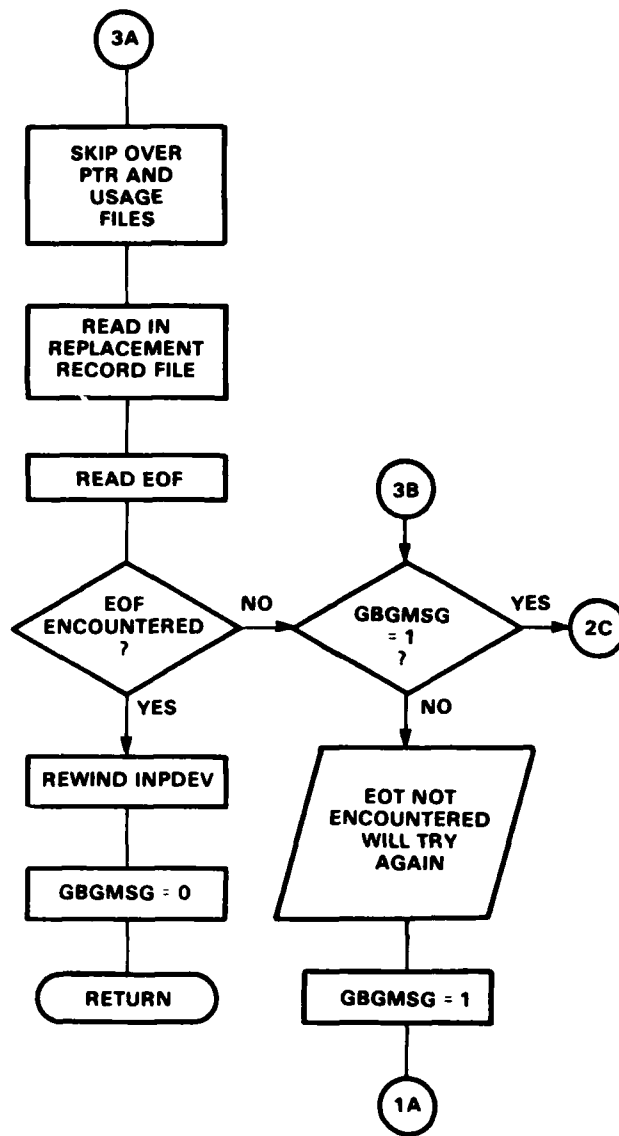

Figure 4-2. WKTape Flow Diagram (Sheet 3 of 3)

4.3 ENTRY

ENTRY requests the operator to enter the maps to be dubbed. A maximum of 20 entries is allowed at this time. The operator is given the choice of entering a map by UTM grid zone designator (32UKM, 2PKQ) or grid zone and S/W corner northing and easting coordinates (32U, 7000000, 400000). Appropriate routines are called for each type of entry.

After the map is entered, EXTRAS is called if the operator indicated that an overlap cell was required.

ENTRY then places all the map information in the RETREV array.

The flow diagram for ENTRY is given in Figure 4-3.

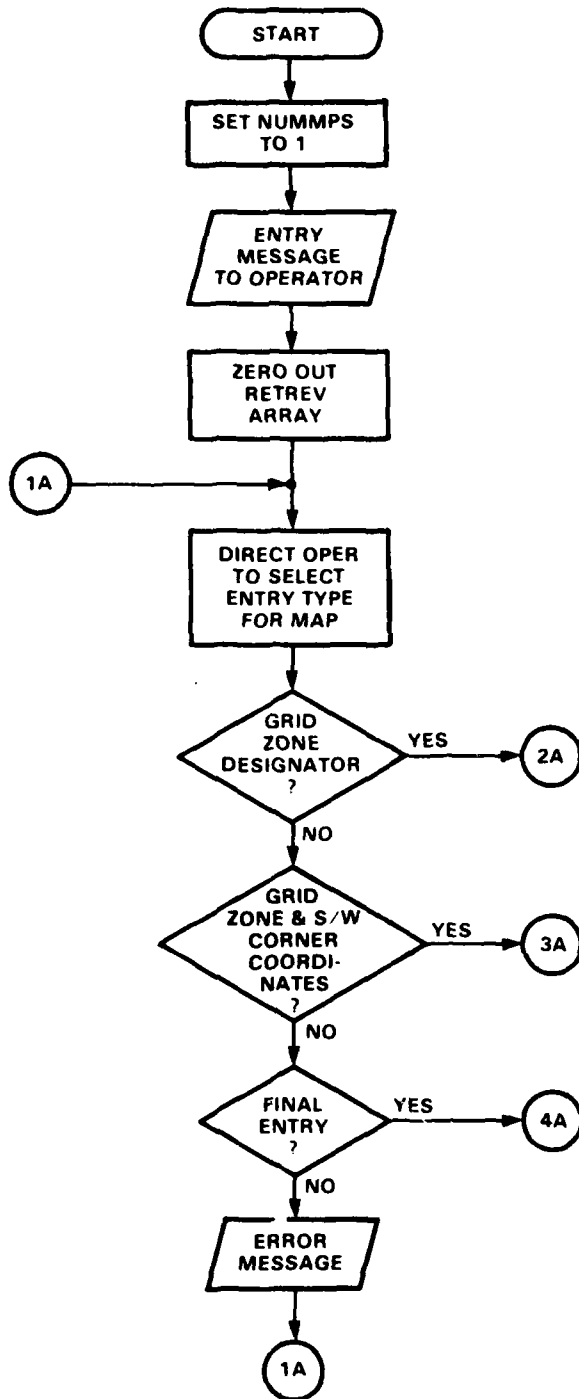
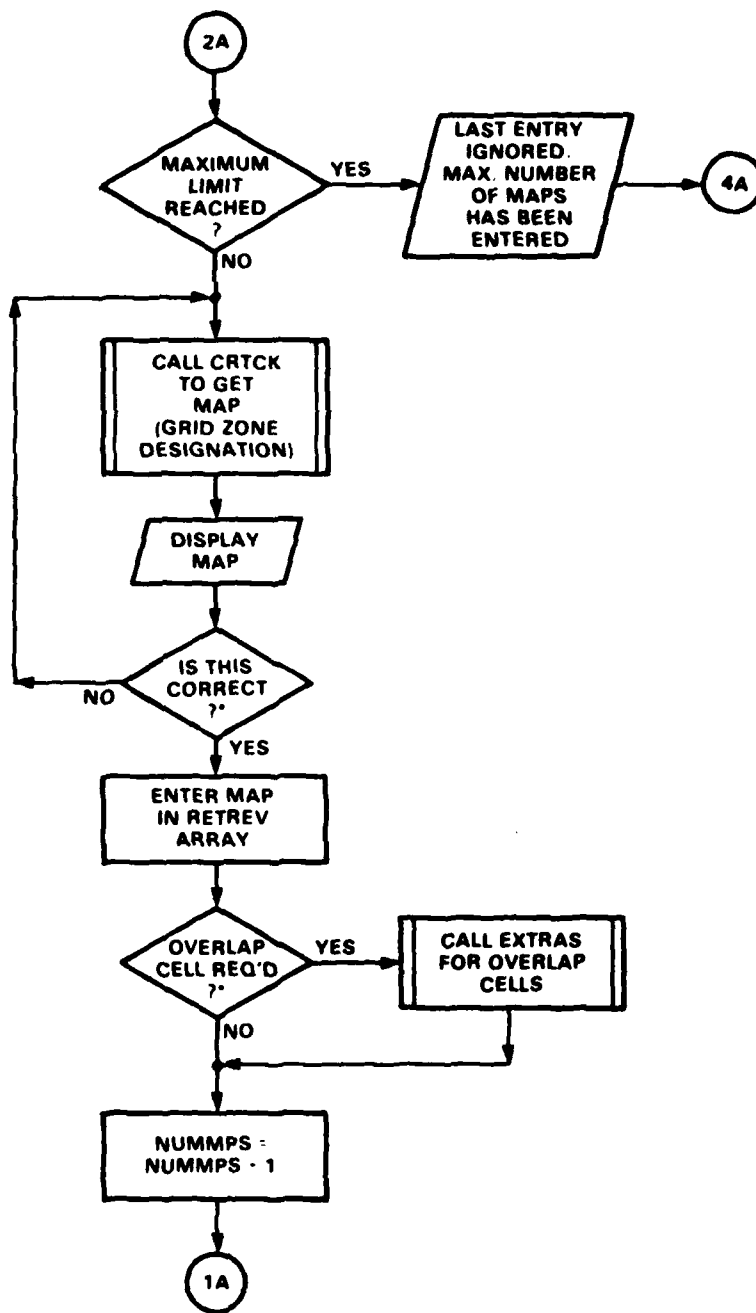

Figure 4-3. ENTRY Flow Diagram (Sheet 1 of 4)



*YESNO

Figure 4-3. ENTRY Flow Diagram (Sheet 2 of 4)

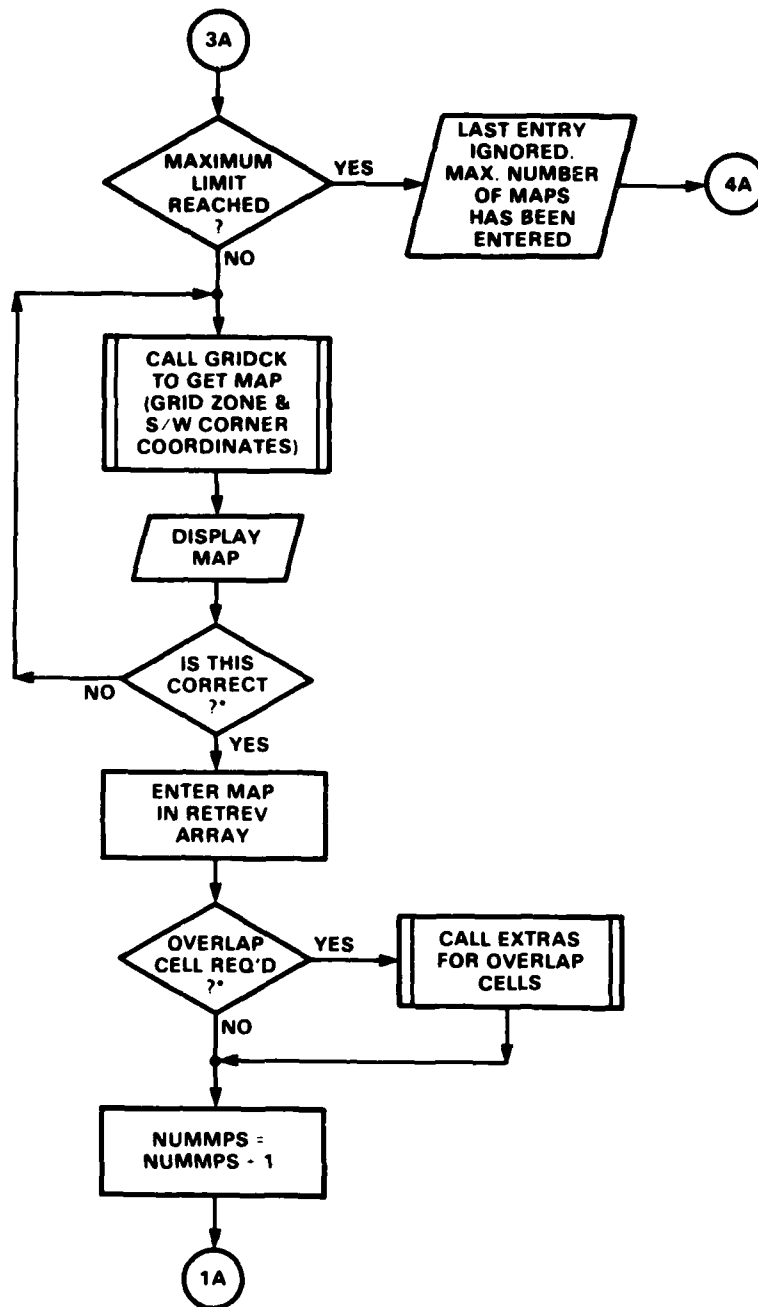

Figure 4-3. ENTRY Flow Diagram (Sheet 3 of 4)

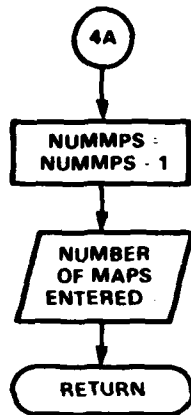

Figure 4-3. ENTRY Flow Diagram (Sheet 4 of 4)

4.4 CRTCK

CRTCK requests the operator to enter a UTM map designator (15PKQ; 2PKQ, etc.). It checks that the entered designator is valid. That is, it checks that I or O is not one of the alpha characters, that only a maximum of five characters are entered, and that the PRFX is valid. CRTCK then separates the designator into PRFX, INFX, SFFX1, and SFFX2 values. The designator is separated as shown below:

4-character designators

2PKQ	2	P	K	Q
	PRFX	INFX	SFFX1	SFFX2

5-character designators

15PKQ	15	P	K	Q
	PRFX	INFX	SFFX1	SFFX2

CRTCK is called by ENTRY to get the maps that will be entered for dubbing when the operator elects to enter a map by the UTM grid zone designation.

There is one passed variable, CELLCT. This keeps track of the number entry of the map.

CELLCT = 1 for the first entry

CELLCT = 2 for the second entry, etc.

The CRTCK flow diagram is shown in Figure 4-4.

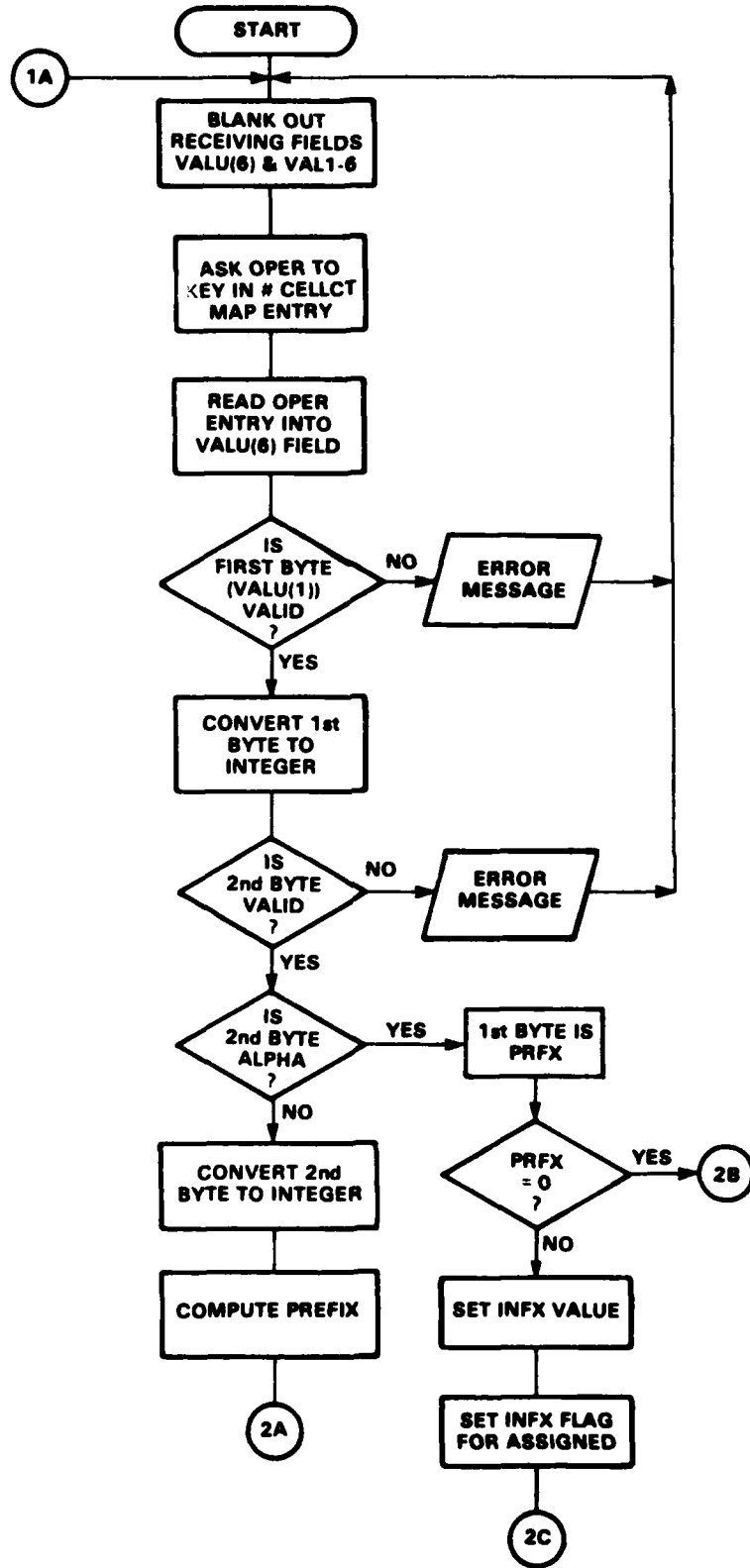

Figure 4-4. CRTCK Flow Diagram (Sheet 1 of 3)

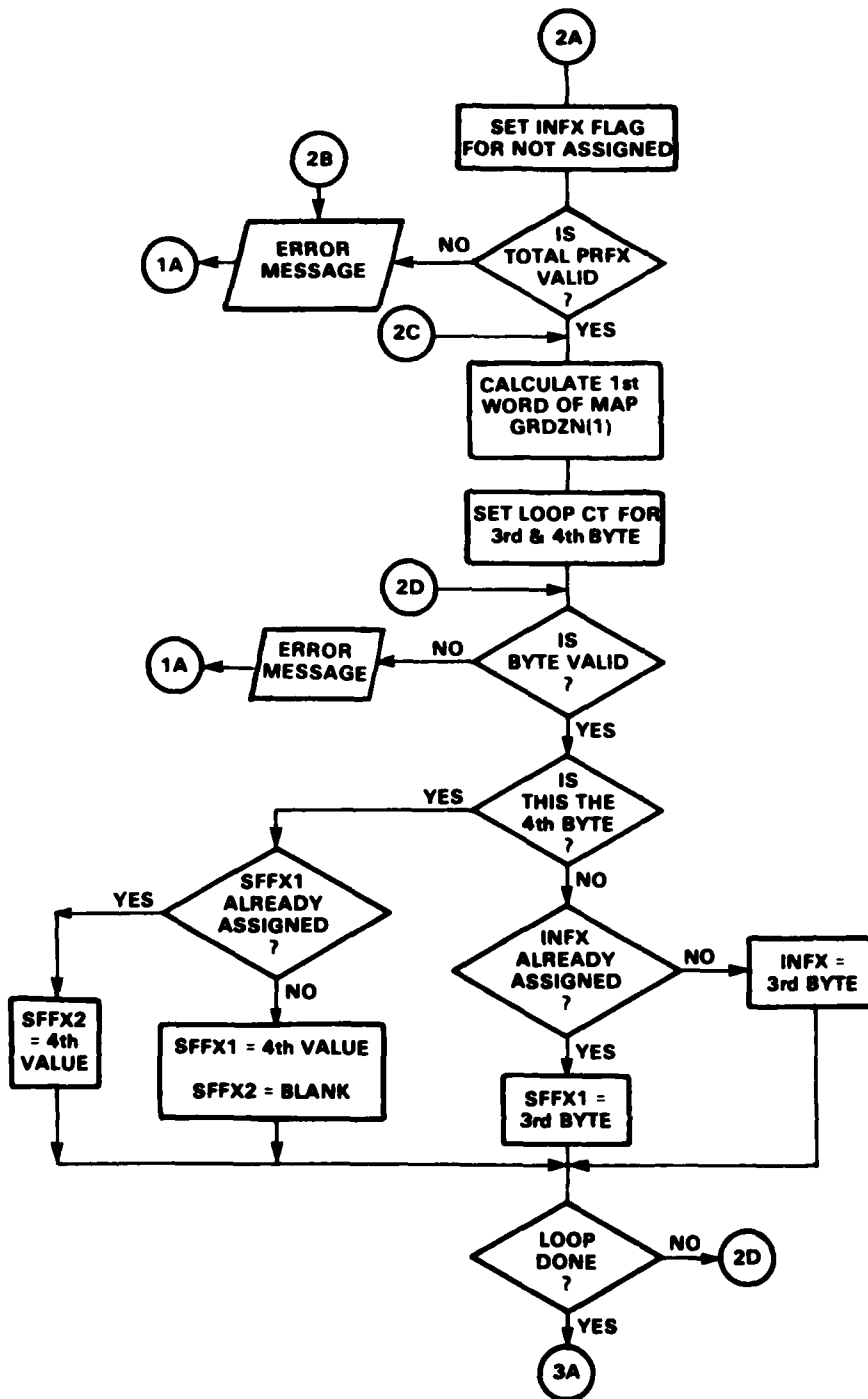

Figure 4-4. CRCK Flow Diagram (Sheet 2 of 3)

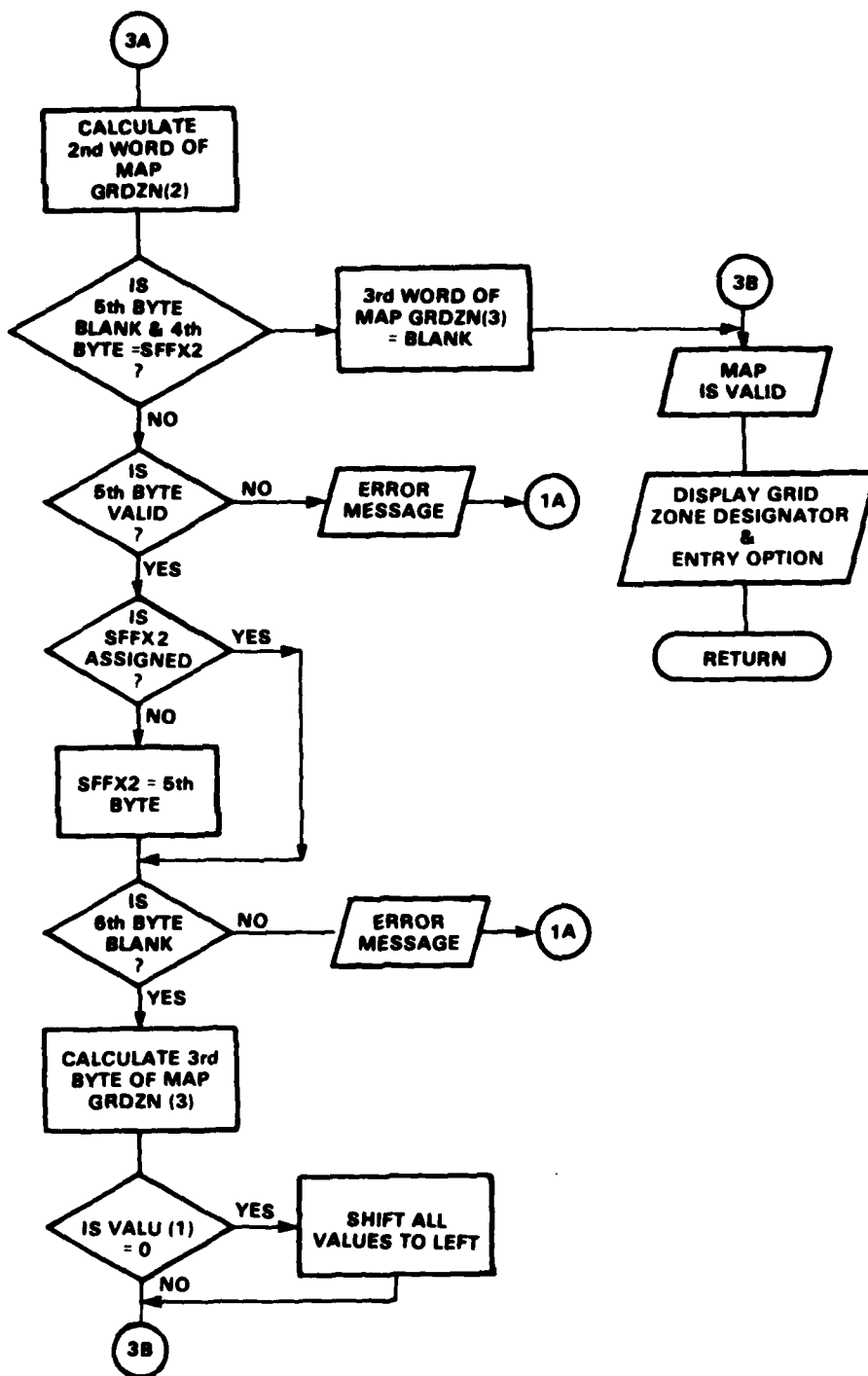
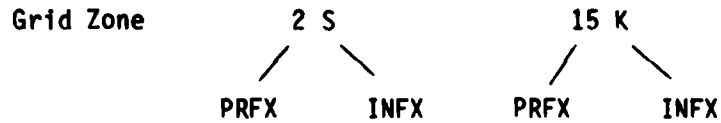

Figure 4-4. CRTCK Flow Diagram (Sheet 3 of 3)

4.5 GRIDCK

GRIDCK requests the operator to enter a UTM grid zone (2S, 15K, etc.). It verifies that the grid zone is valid, and then separates the grid zone into PRFX and INFX values as follows:



GRIDCK then calls the subroutine NUMCK to get the S/W northing and easting coordinates to complete the grid zone designator entry.

GRIDCK is called by ENTRY when the operator elects to enter a map by grid zone and S/W northing and easting coordinates.

There is one passed variable, INCR, which keeps track of the number entry of the map:

INCR = 1 for the first entry
= 2 for the second entry, etc.

The GRIDCK flow diagram is shown in Figure 4-5.

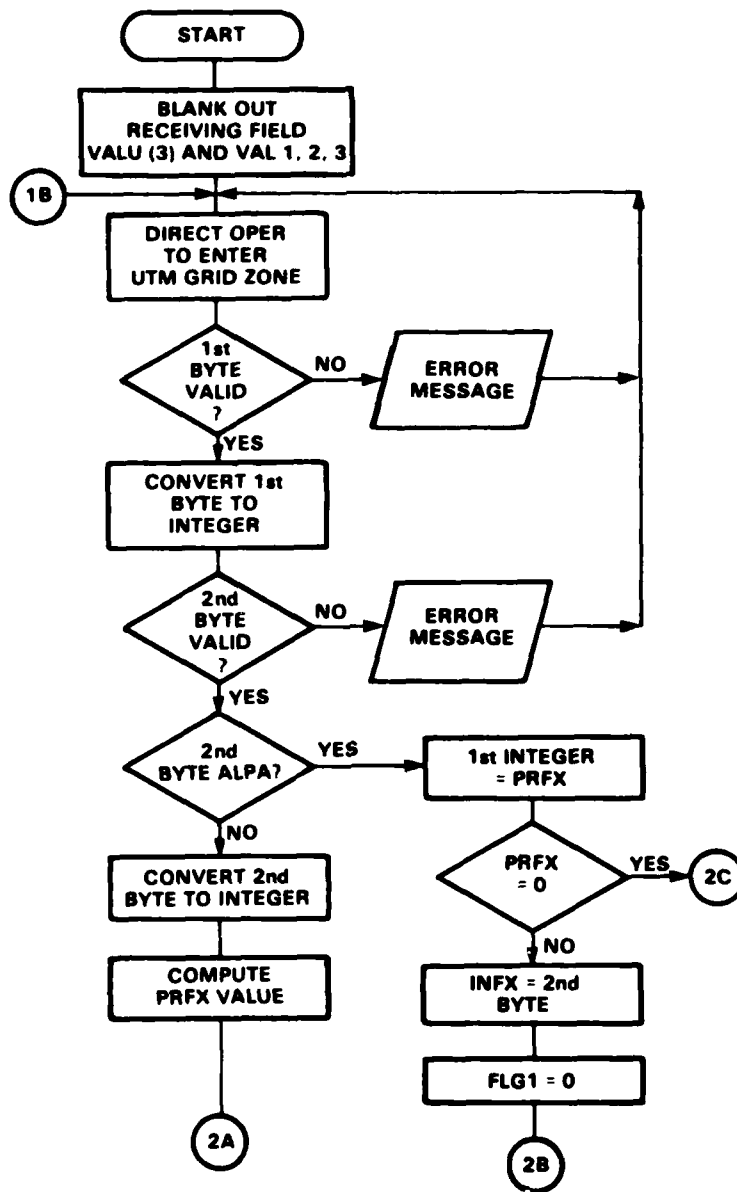

Figure 4-5. GRIDCK Flow Diagram (Sheet 1 of 2)

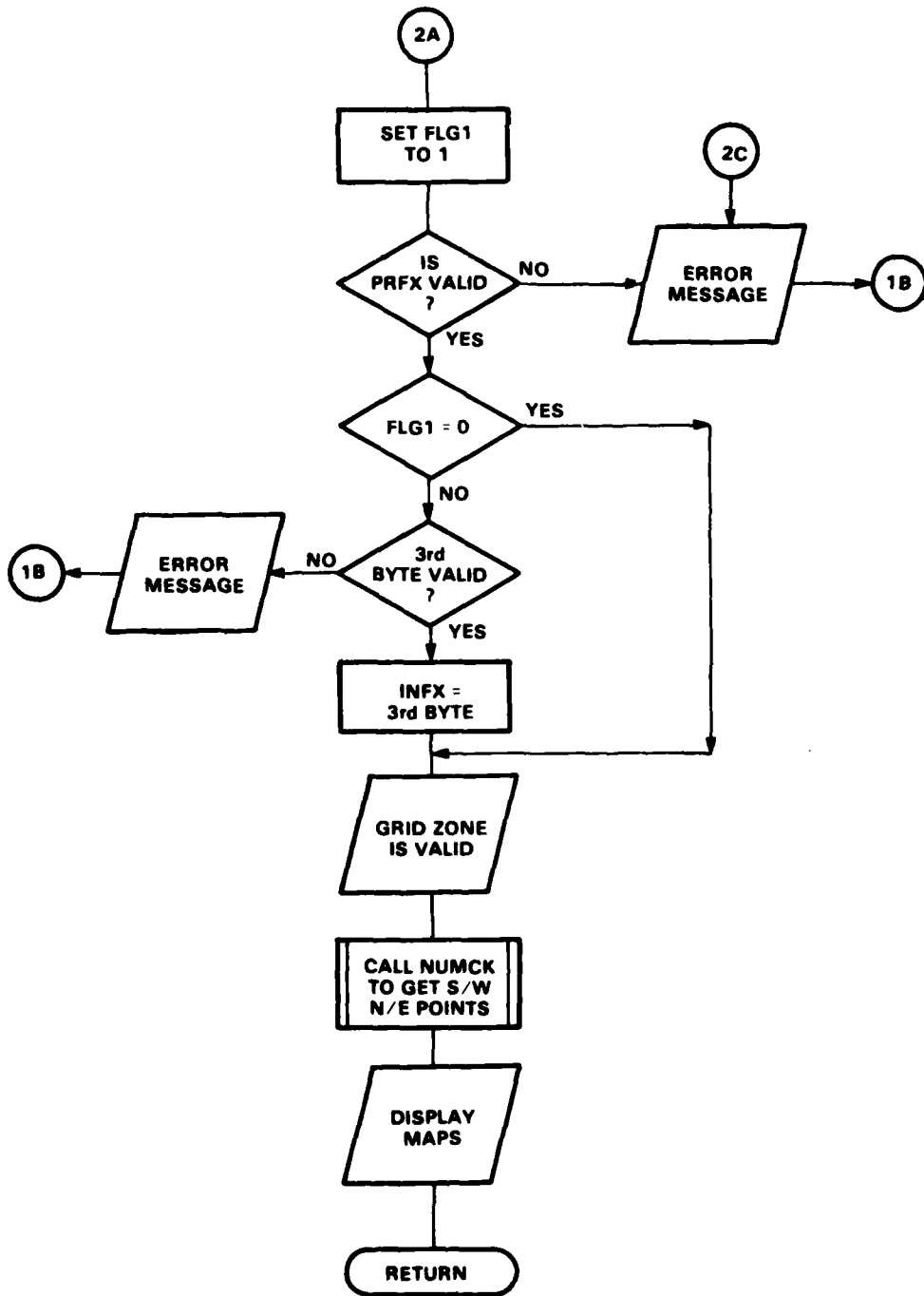

Figure 4-5. GRIDCK Flow Diagram (Sheet 2 of 2)

4.6 NUMCK

NUMCK requests the operator to enter the S/W corner northing and easting coordinates. It is called by GRIDCK when an operator is entering a map by the grid zone and S/W corner coordinates.

NUMCK verifies the operator's entry and converts the two coordinates into two 16-bit words.

The flow diagram for NUMCK is given in Figure 4-6.

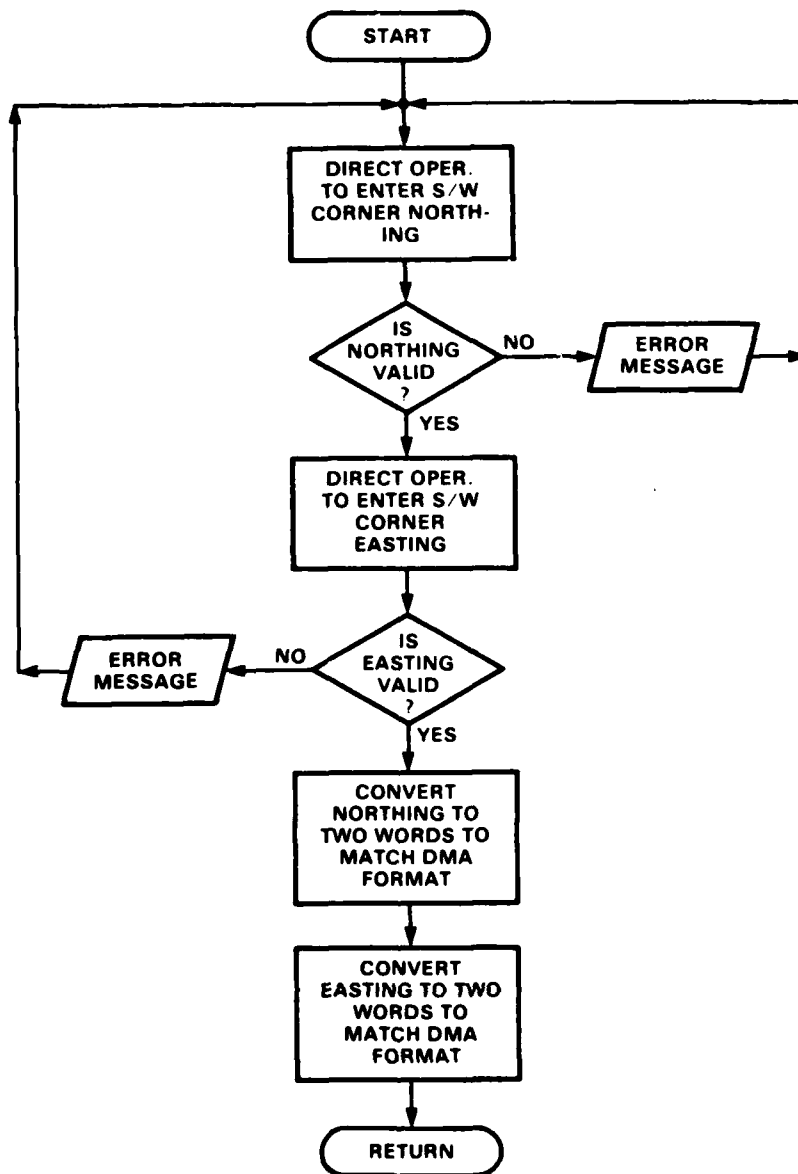

Figure 4-6. NUMCK Flow Diagram

4.7 EXTRAS

EXTRAS automatically makes an entry into the RETREV array for any required overlapping boundary cells. This routine is called by ENTRY when the operator indicates that overlapping boundary cells are required for a particular map. The operator enters the directions for which the overlapping boundary cell(s) are needed: east/west (E/W), or north/south (N/S), or both E/W and N/S. If overlapping boundary cells are requested for both the E/W and N/S directions, a third cell, the corner one, is also entered.

EXTRAS evaluates the original map to decide if the overlapping boundary cells will be to the east or west (for E/W cells), or to the north or south (for N/S cells). EXTRAS requires that the S/W corner northing/easting coordinates get the overlapping cells. If the original map was entered using the grid zone and S/W corner northing/easting coordinates, EXTRAS enters the overlapping cell(s) into the RETREV array. If the original map was entered using the grid zone designation, only the grid zone is entered into the RETREV array, and the entry is flagged as an overlapping cell. The CTLFND routine fills in the remaining information for these cells.

Refer to Figure 4-7 for the EXTRAS flow diagram.

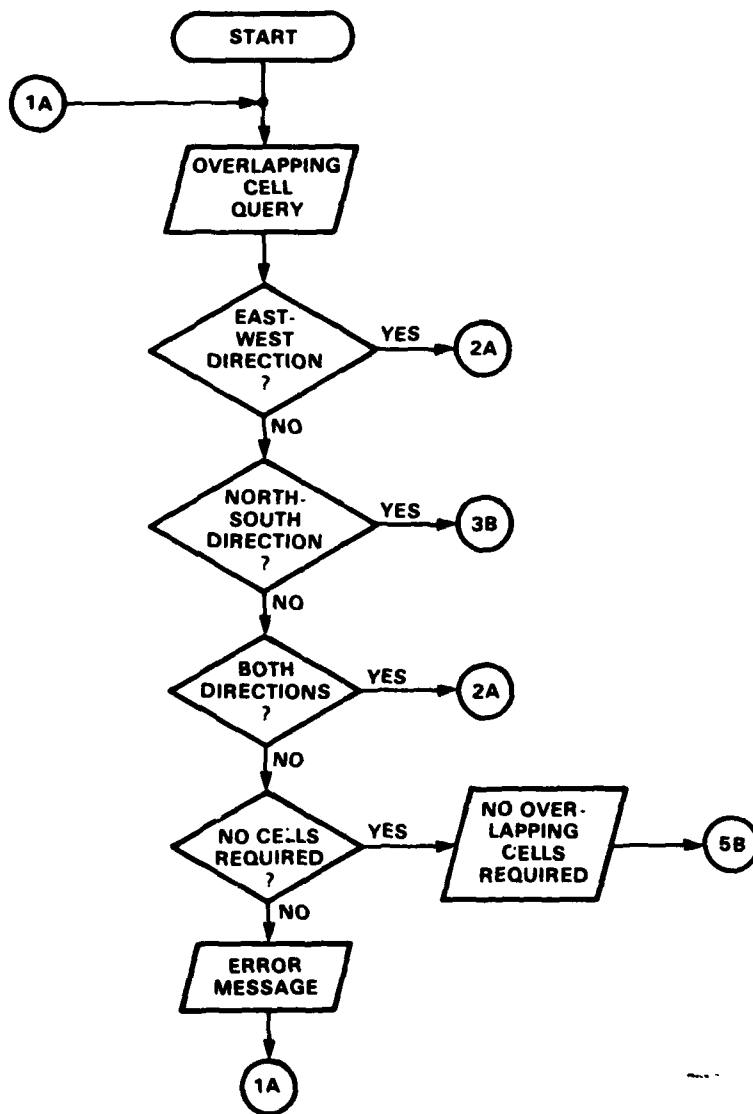

Figure 4-7. EXTRAS Flow Diagram (Sheet 1 of 5)

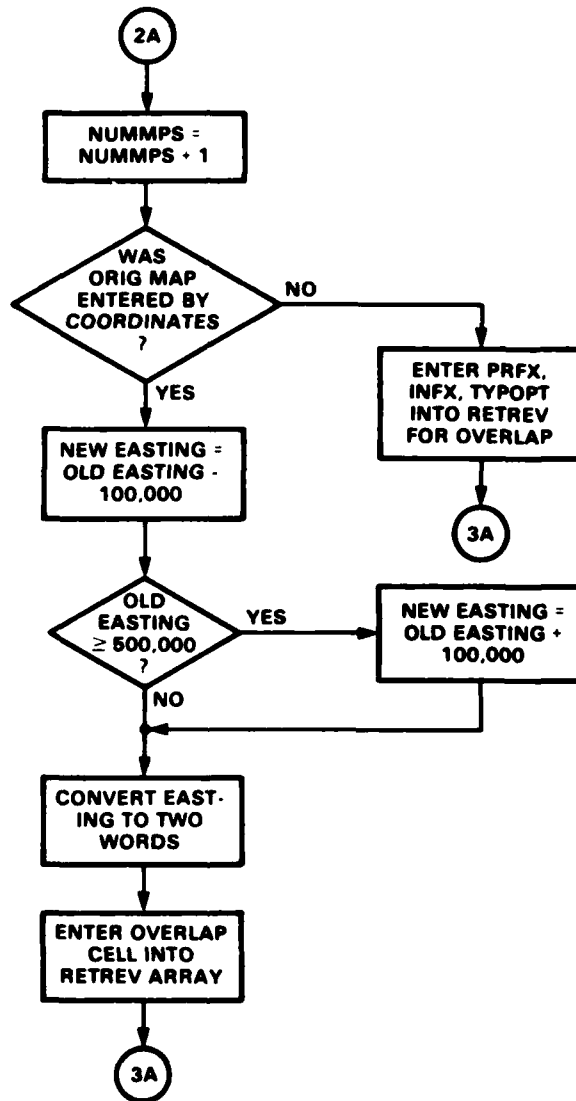

Figure 4-7. EXTRAS Flow Diagram (Sheet 2 of 5)

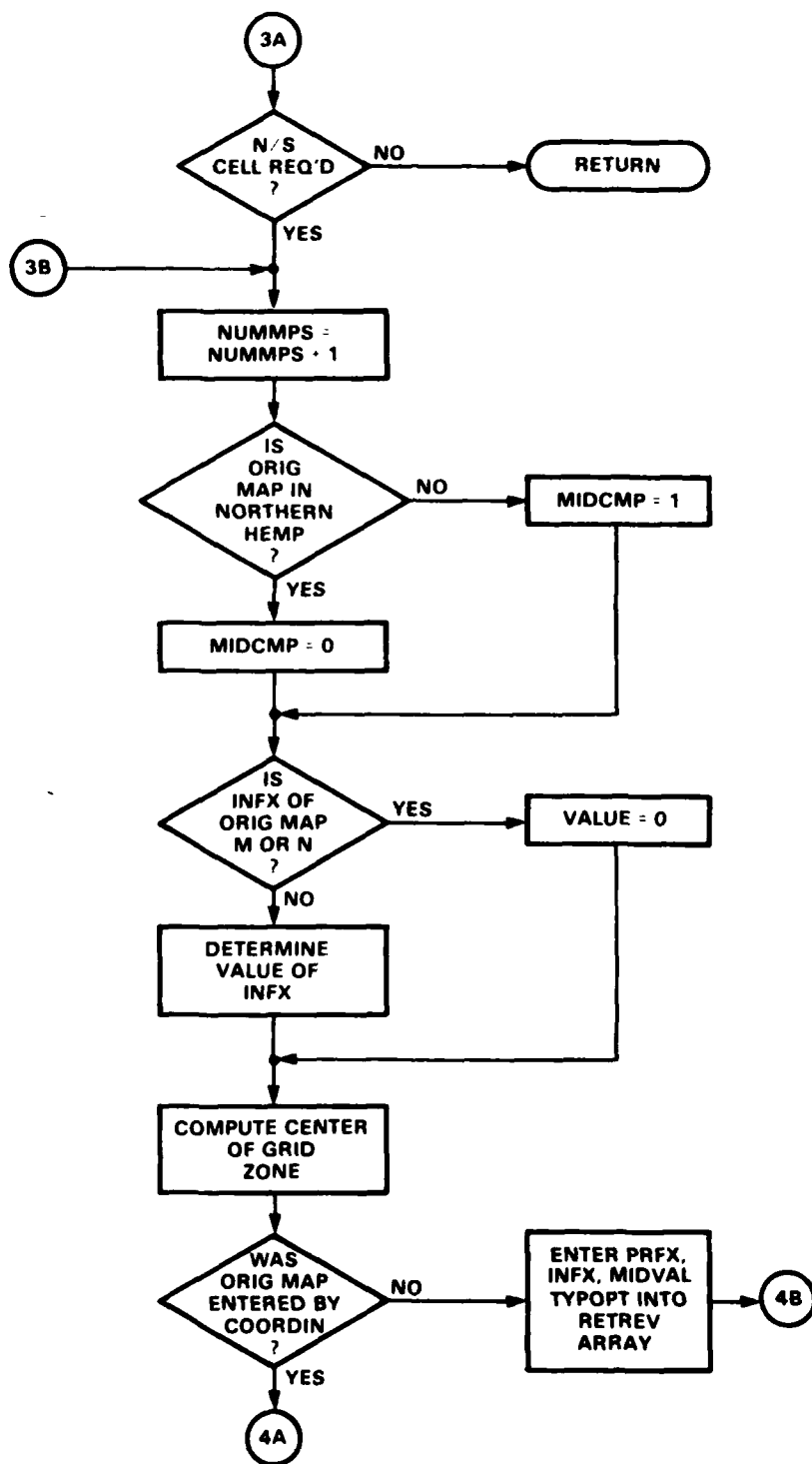

Figure 4-7. EXTRAS Flow Diagram (Sheet 3 of 5)

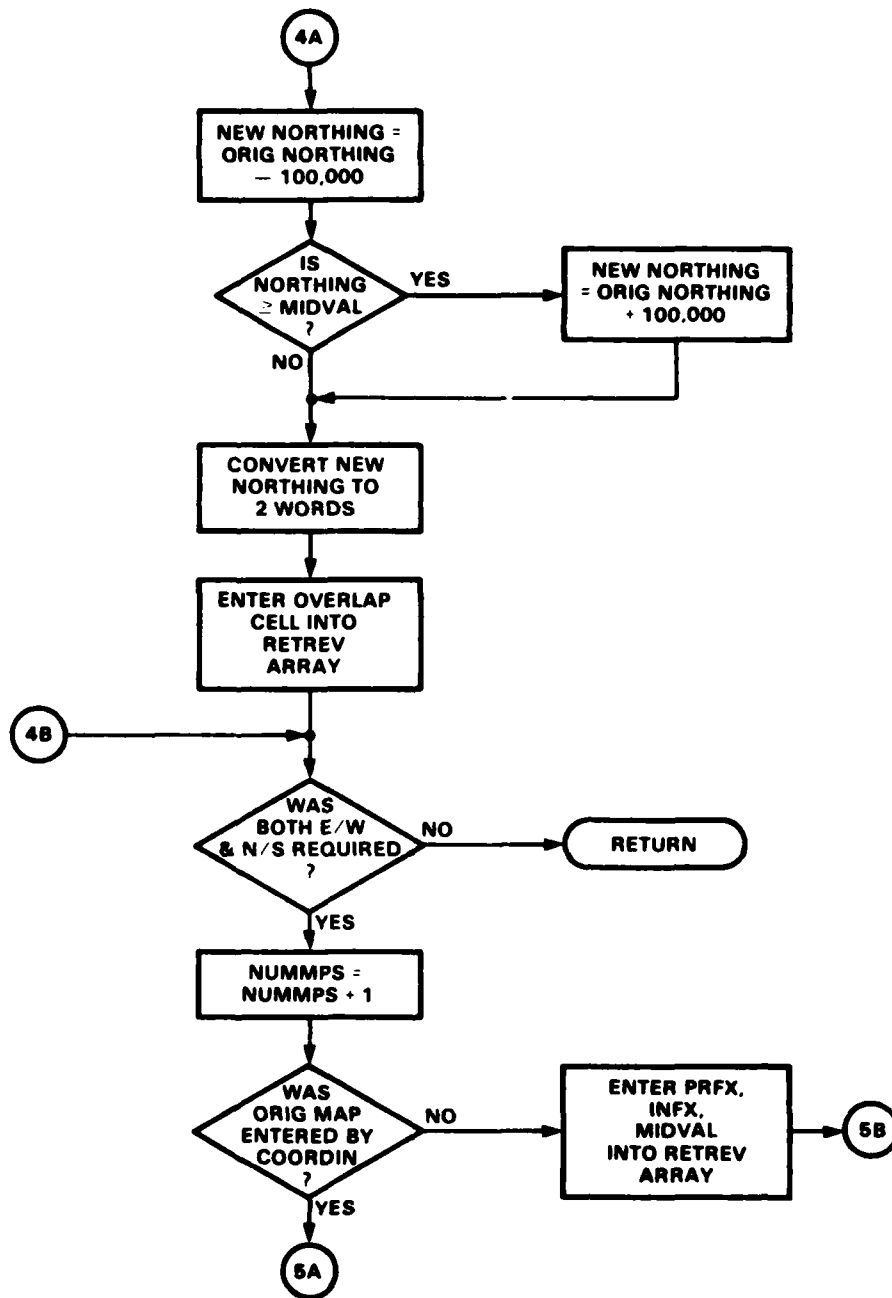

Figure 4-7. EXTRAS Flow Diagram (Sheet 4 of 5)

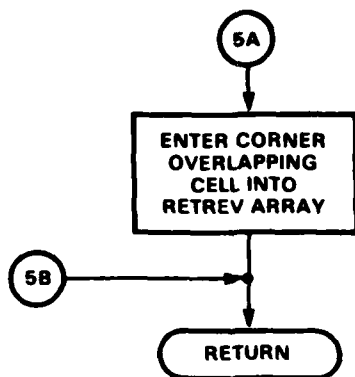

Figure 4-7. EXTRAS Flow Diagram (Sheet 5 of 5)

4.8 CTLFND

The CTLFND routine searches the library catalog tape to determine whether a map is in the library and, if so, where it is located. In addition to locating whatever maps are in RETREV, CTLFND identifies any overlapping boundary cells EXTRAS did not handle and completes the entry. CTLFND is called by CASSET.

Each catalog record is read and checked for replacement. If it has been replaced, it is ignored and the next record is read. If it has not been replaced, the record is compared to the maps in the RETREV array. The comparison is first done on the UTM grid zone designators, and then on grid zone and S/W northing/easting coordinates.

When there is a match, any information concerning the map not in the RETREV array is transferred, along with the field file location for the map to the RETREV array. At this time, the format word RETREV (, 17) is set to 1 for 250m.

Every time a map that was entered by UTM grid zone designator is located, CTLFND checks the next RETREV entry. If it is an overlapping boundary cell flagged by EXTRAS, CTLFND makes the necessary computations and completes the overlapping cell entry. These cells must then be located the same as any other entry.

Because it is possible for an overlapping boundary cell to be entered after its catalog record has been passed, the catalog is searched twice if all the maps are not found the first time.

Catalog records are read until all the maps are found or the end of the catalog is reached for the second time.

Refer to Figure 4-8 for the CTLFND flow diagram.

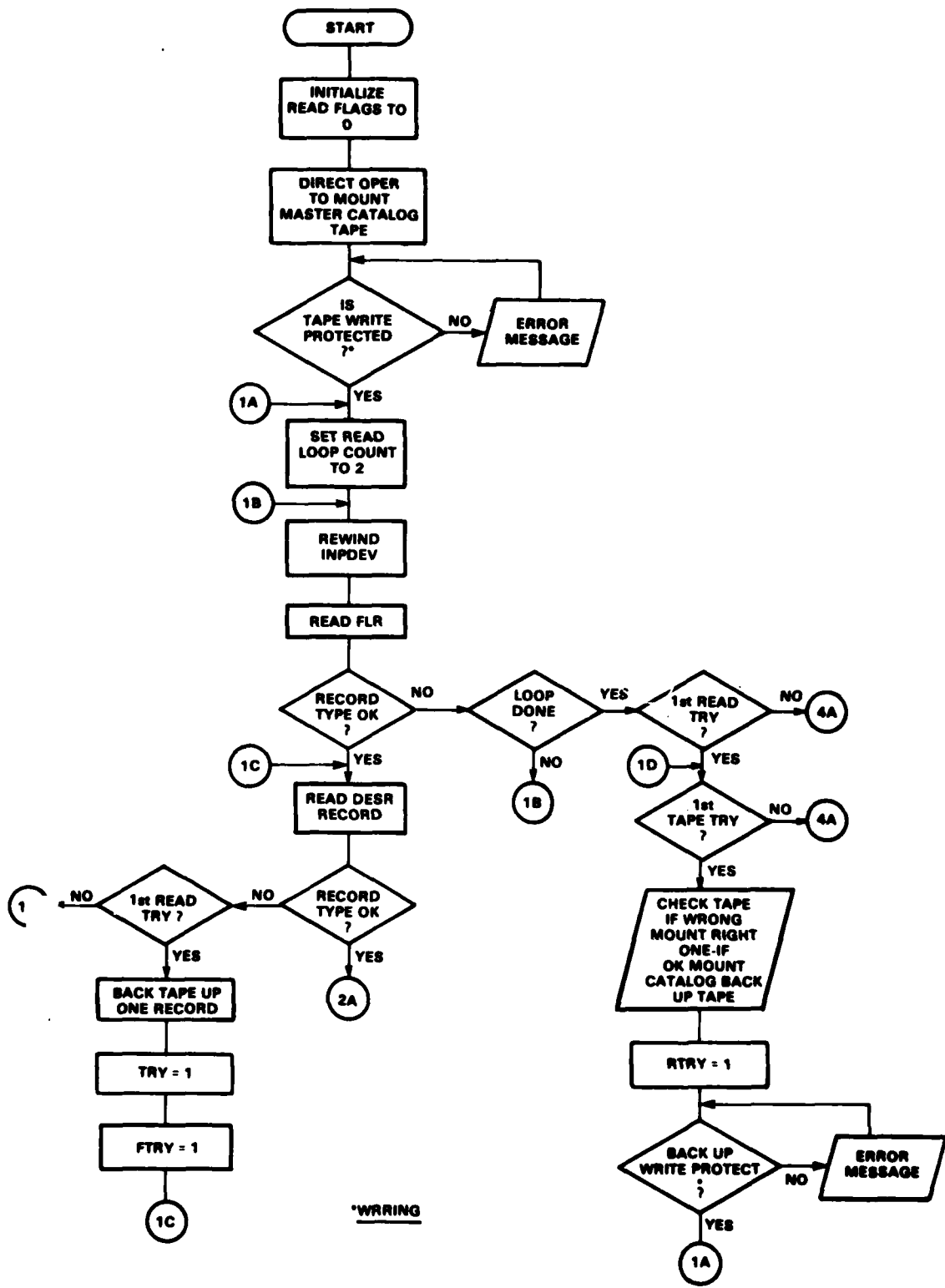

Figure 4-8. CTLFND Flow Diagram (Sheet 1 of 8)

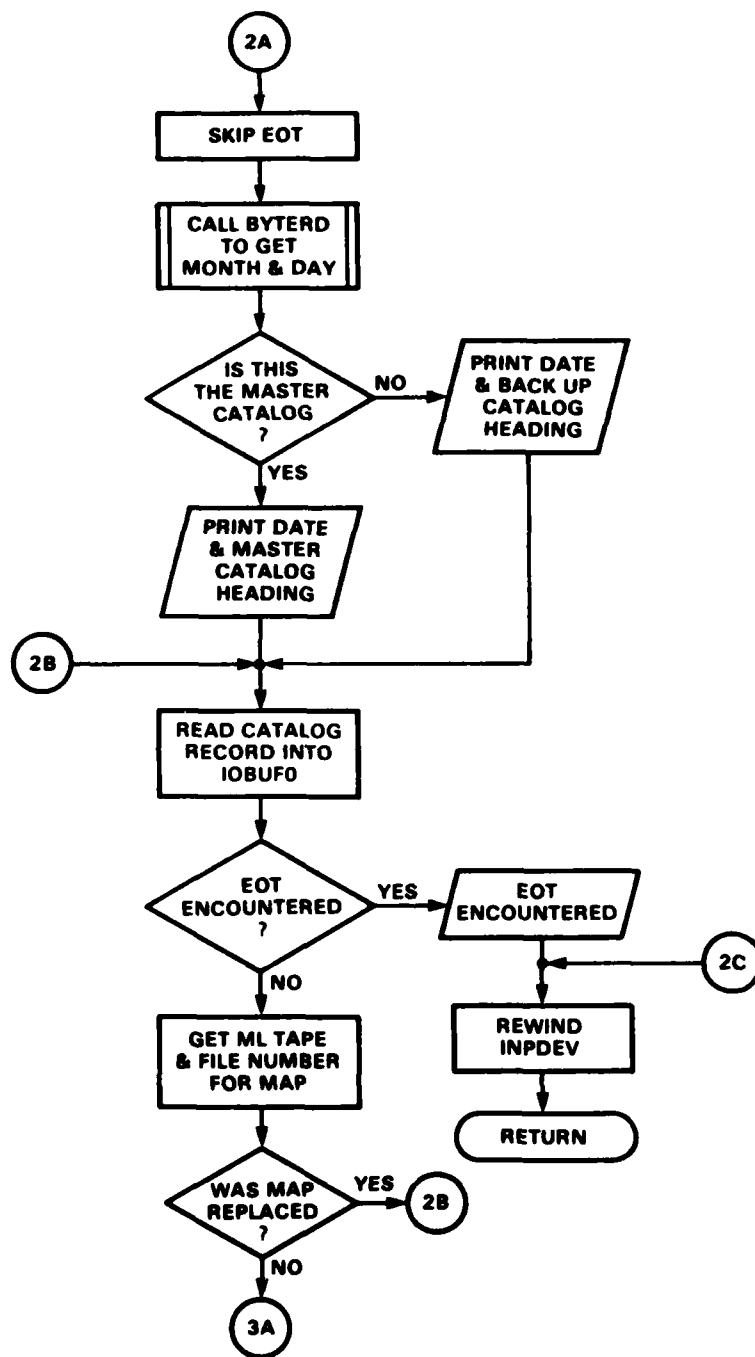

Figure 4-8. CTLFND Flow Diagram (Sheet 2 of 8)

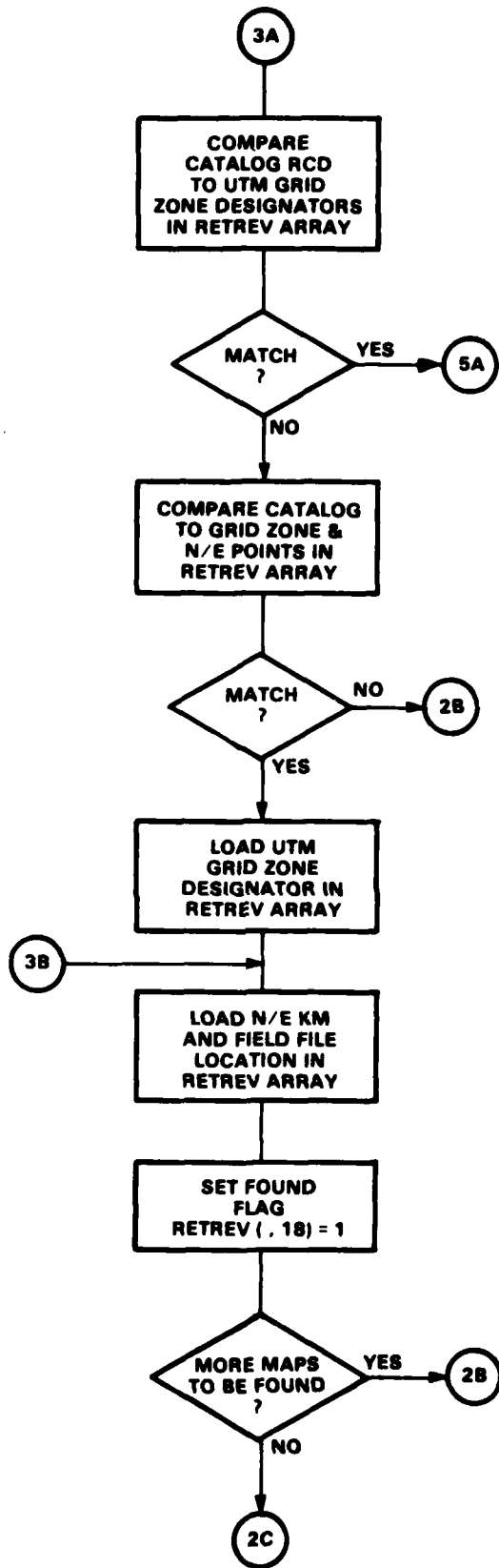

Figure 4-8. CTLFND Flow Diagram (Sheet 3 of 8)

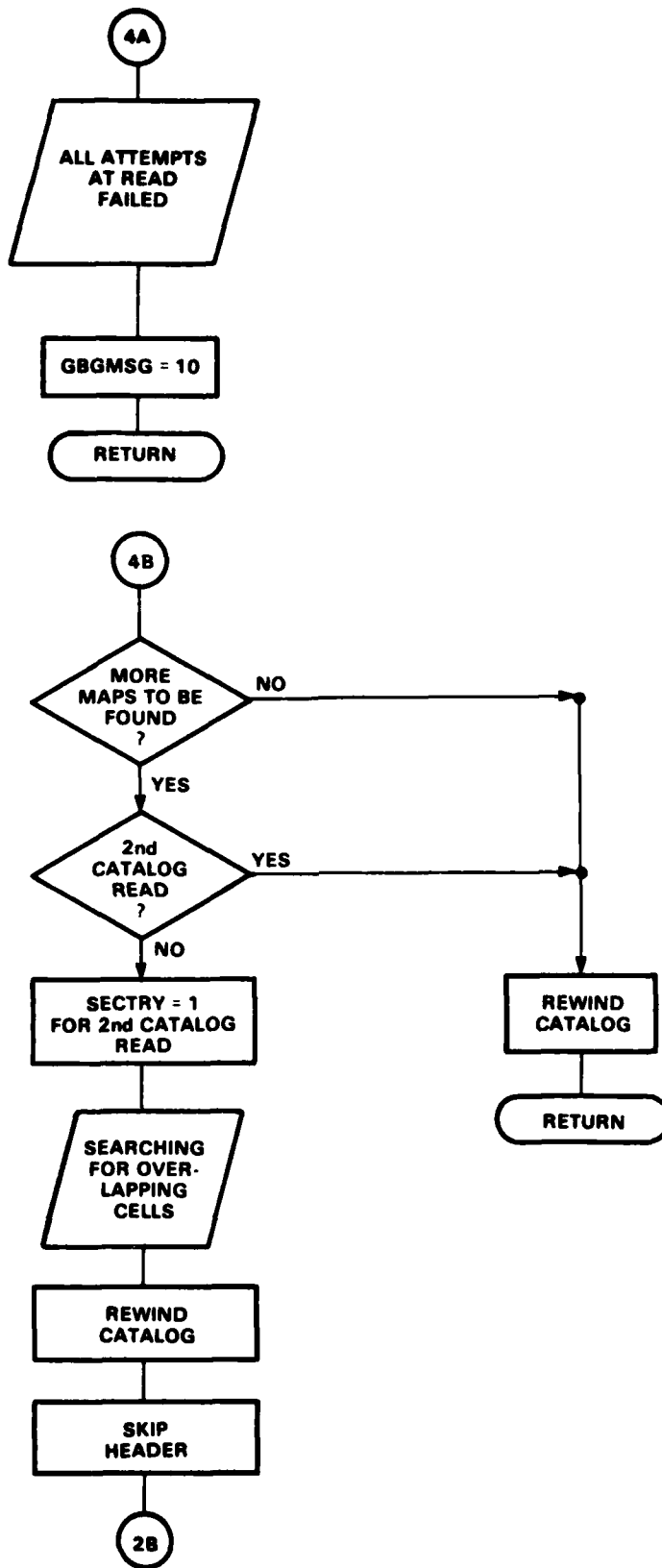

Figure 4-8. CTLFND Flow Diagram (Sheet 4 of 8)

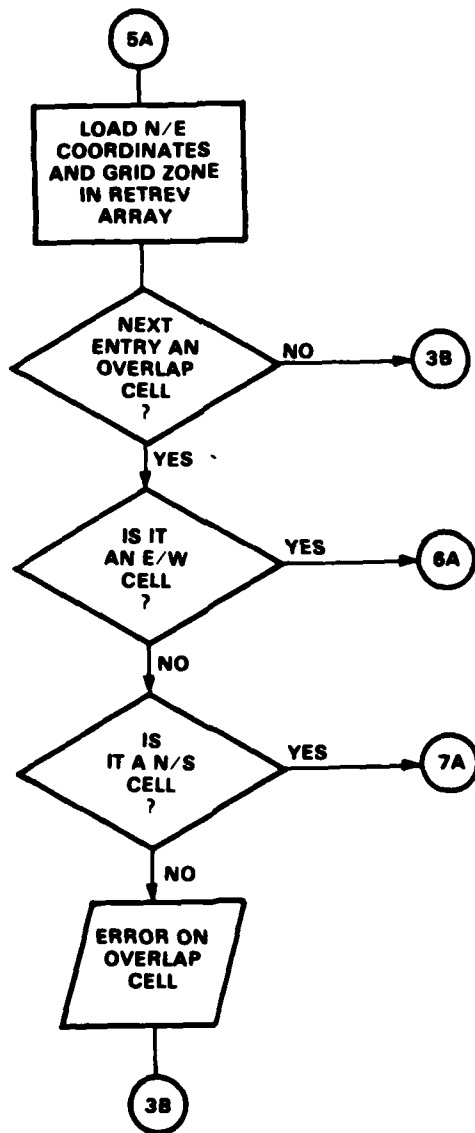

Figure 4-8. CTLFND Flow Diagram (Sheet 5 of 8)

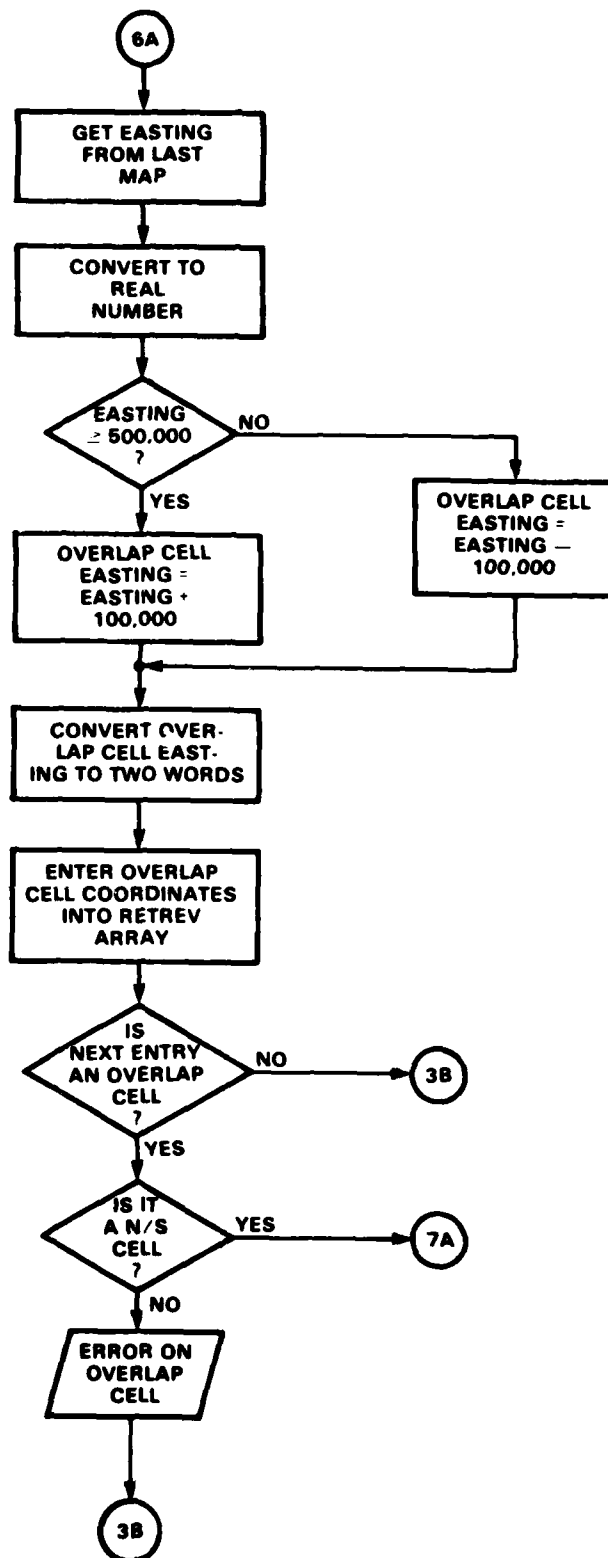

Figure 4-8. CTLFND Flow Diagram (Sheet 6 of 8)

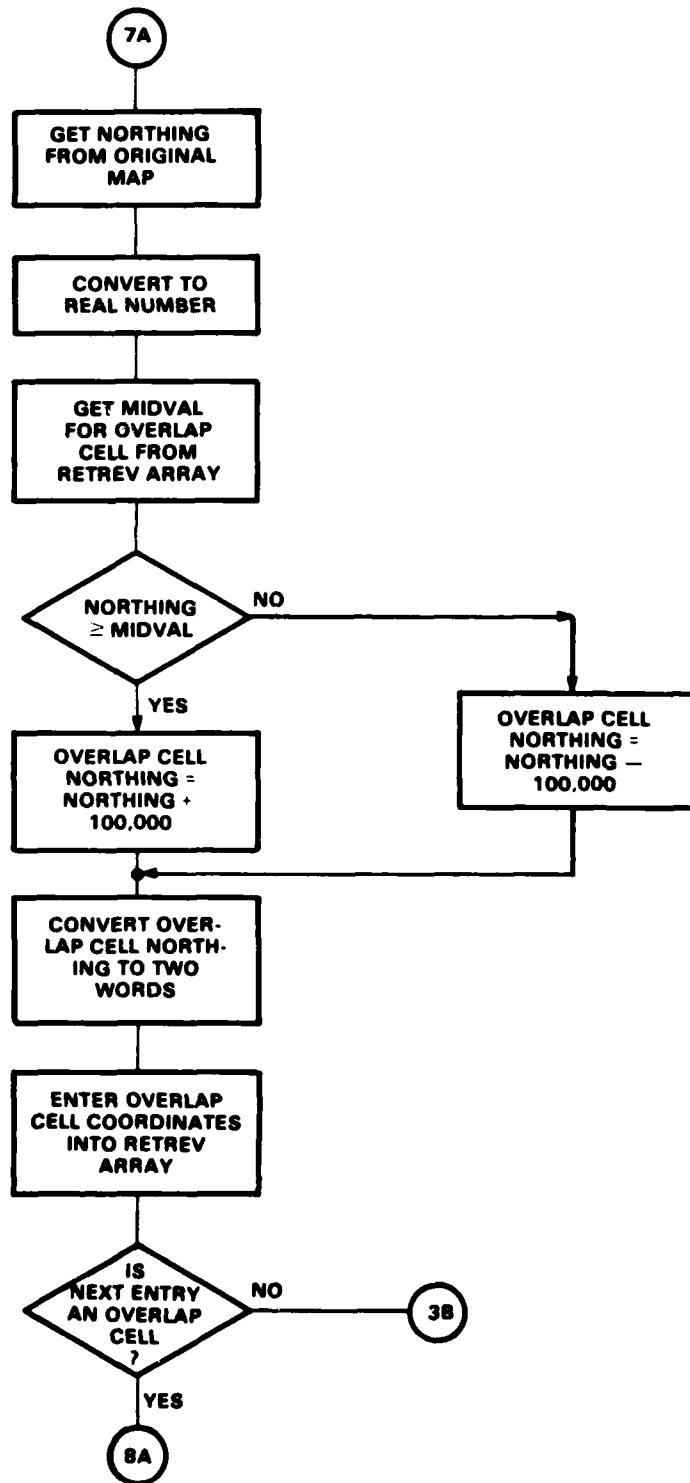

Figure 4-8. CTLFND Flow Diagram (Sheet 7 of 8)

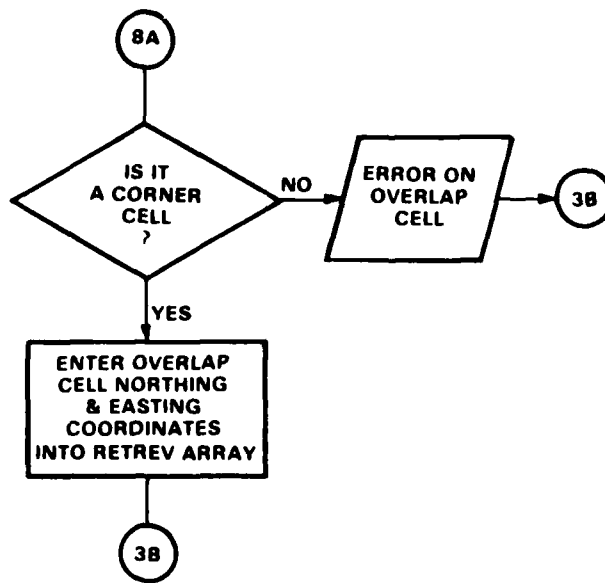

Figure 4-8. CTLFND Flow Diagram (Sheet 8 of 8)

4.9 DECIDE

DECIDE determines the optimum fill for the cassette tape. It determines how many of the maps entered and located in the library can physically fit on the cassette tape. The total number of words which the cassette tape can hold is determined by the tape length, record gap, and tape density. The number of words each map consists of is calculated and subtracted from the total available. At this time, approximately eight maps in 250m format can fit on any cassette tape.

DECIDE is called by CASSET. Refer to Figure 4-9 for the DECIDE flow diagram. Figure 4-10 shows the result of the DECIDE subroutine.

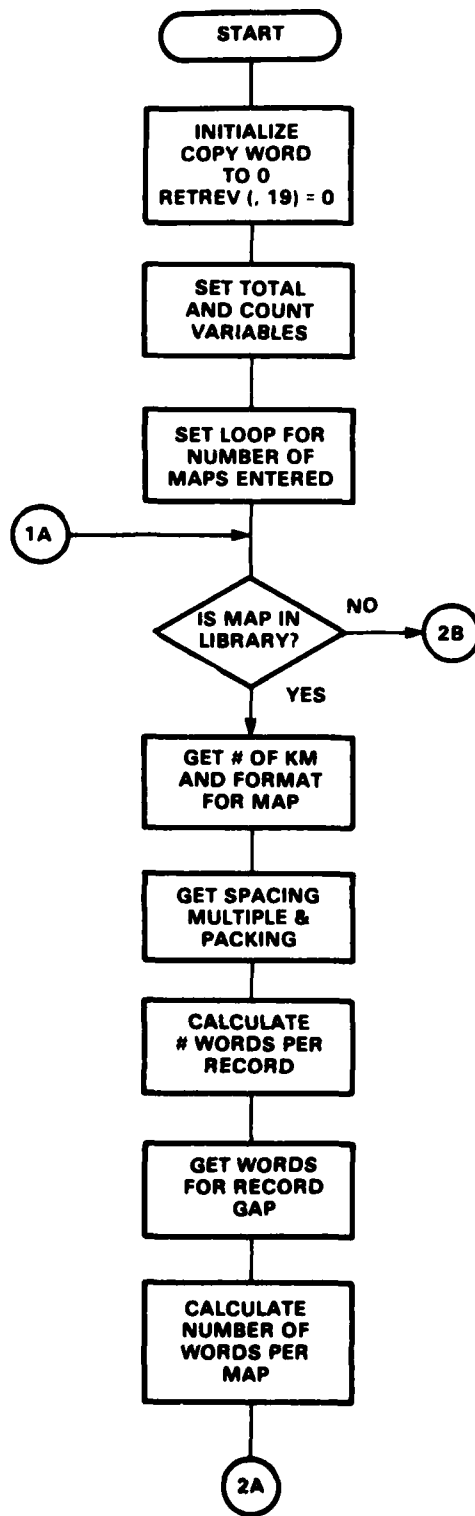

Figure 4-9. DECIDE Flow Diagram (Sheet 1 of 3)

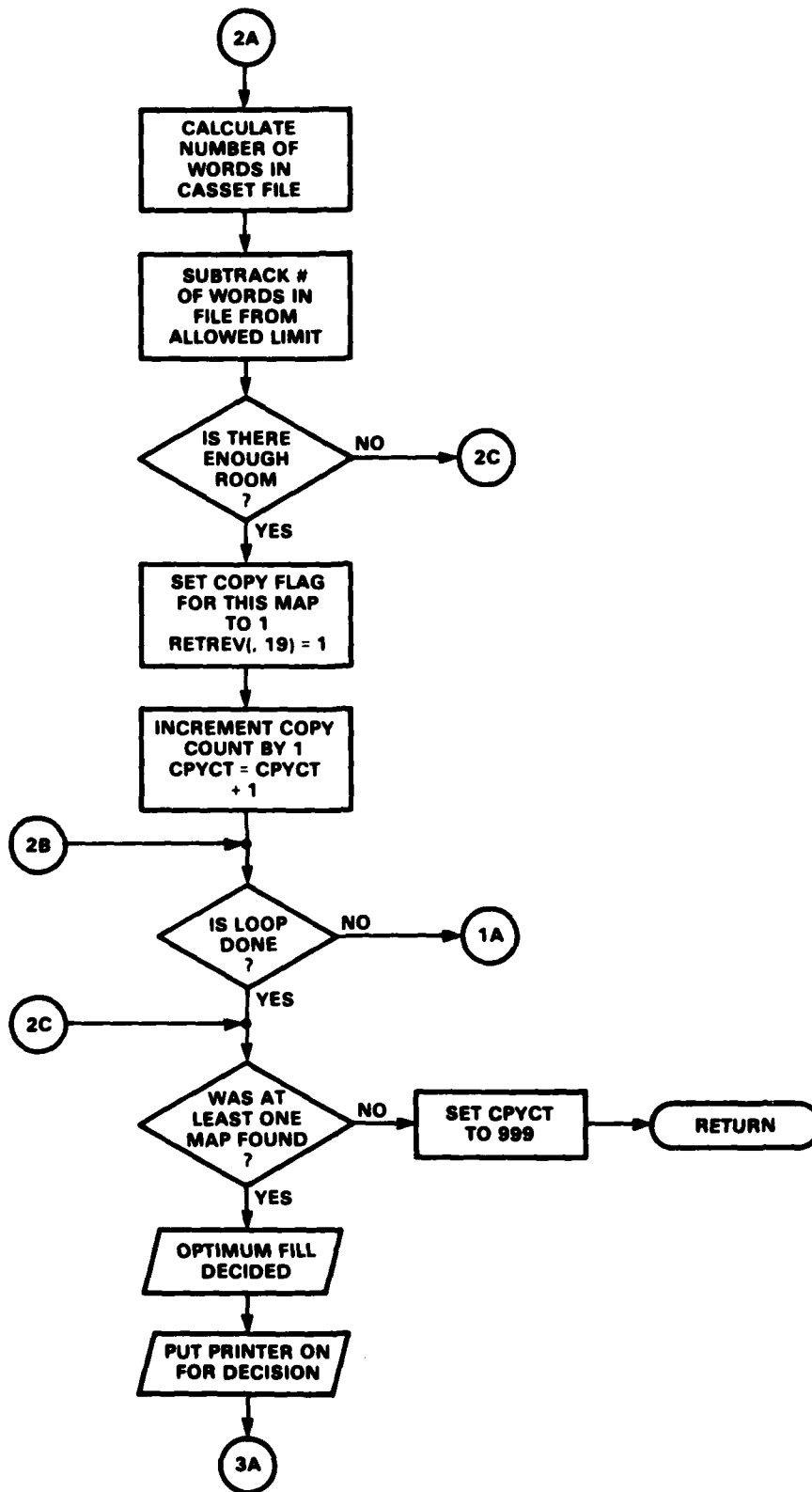

Figure 4-9. DECIDE Flow Diagram (Sheet 2 of 3)

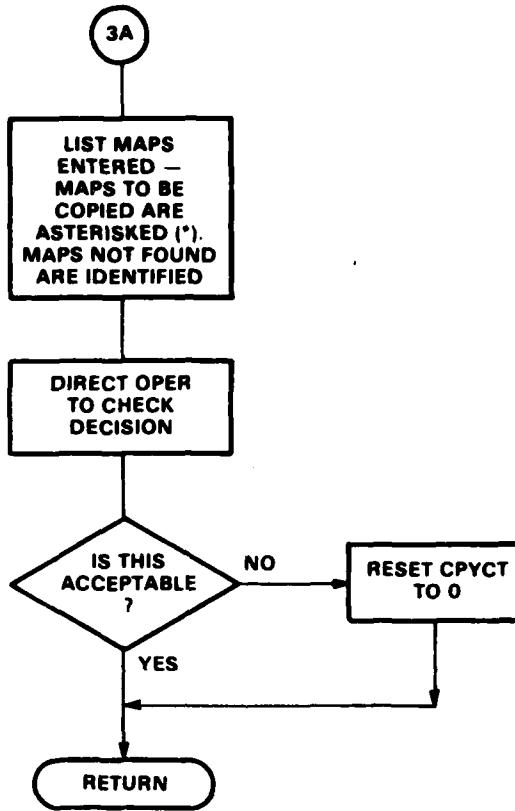

Figure 4-9. DECIDE Flow Diagram (Sheet 3 of 3)

THE NUMBER OF MAPS TO BE PUT ON THE CASSETTE IS: 2

THE MAPS ENTERED ARE LISTED BELOW
THE MAPS MARKED WITH AN ASTERISK (*) WILL BE COPIED
ONTO THE CASSETTE IN THE ORDER PRINTED
MAPS NOT LOCATED IN THE LIBRARY ARE CALLED OUT
REMAINING MAPS WILL NOT BE COPIED DUE TO SPACE
LIMITATION OF CASSETTE

51SX* * FIELD FILE TAPE = 4007 FILE = 8

51SYB * FIELD FILE TAPE = 4007 FILE = 11

Figure 4-10. Decision Output

4.10 CPYMAP

The CPYMAP routine makes a scratch tape containing the maps to be placed on the cassette tape. The header for the scratch tape is constructed and written to the tape. Then, for each map to be placed on the cassette, the operator is asked to mount the appropriate field file tape. CPYMAP calls POSTAP to position the tape to the correct file, and then calls XFRHDR to read the map header and transfer the required information to the cassette header being constructed. UTLDUB is then called to transfer the data records of the map file. This process continues until all the maps have been copied.

After the map data is copied, the cassette headers are finalized and written out to the scratch tape for later retrieval. After the EOT mark is output to the tape, CPYMAP is exited.

If only one cassette is being made, CPYMAP calls CSTCPY to make the cassette tape before exiting.

Refer to Figure 4-11 for the CPYMAP flow diagram.

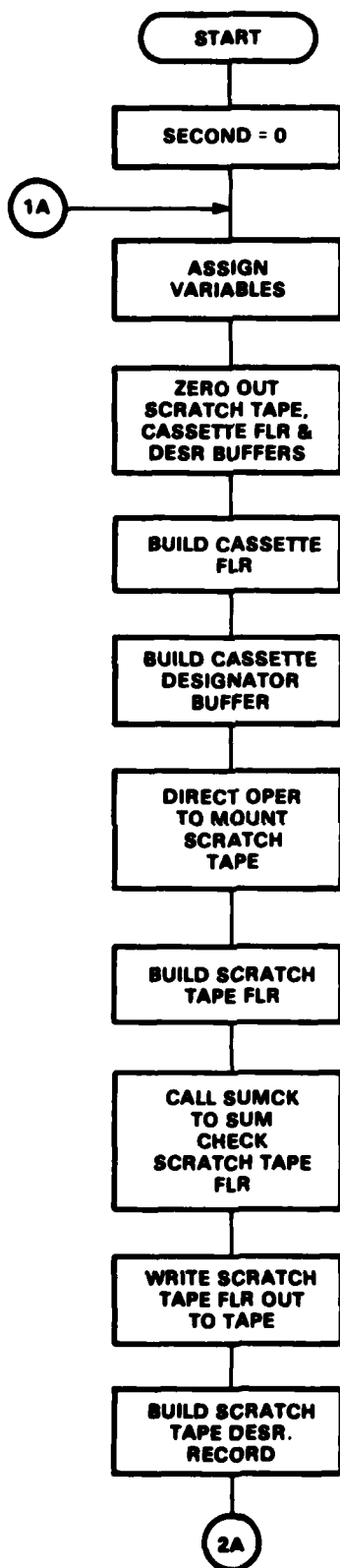

Figure 4-11. CPYMAP Flow Diagram (Sheet 1 of 6)

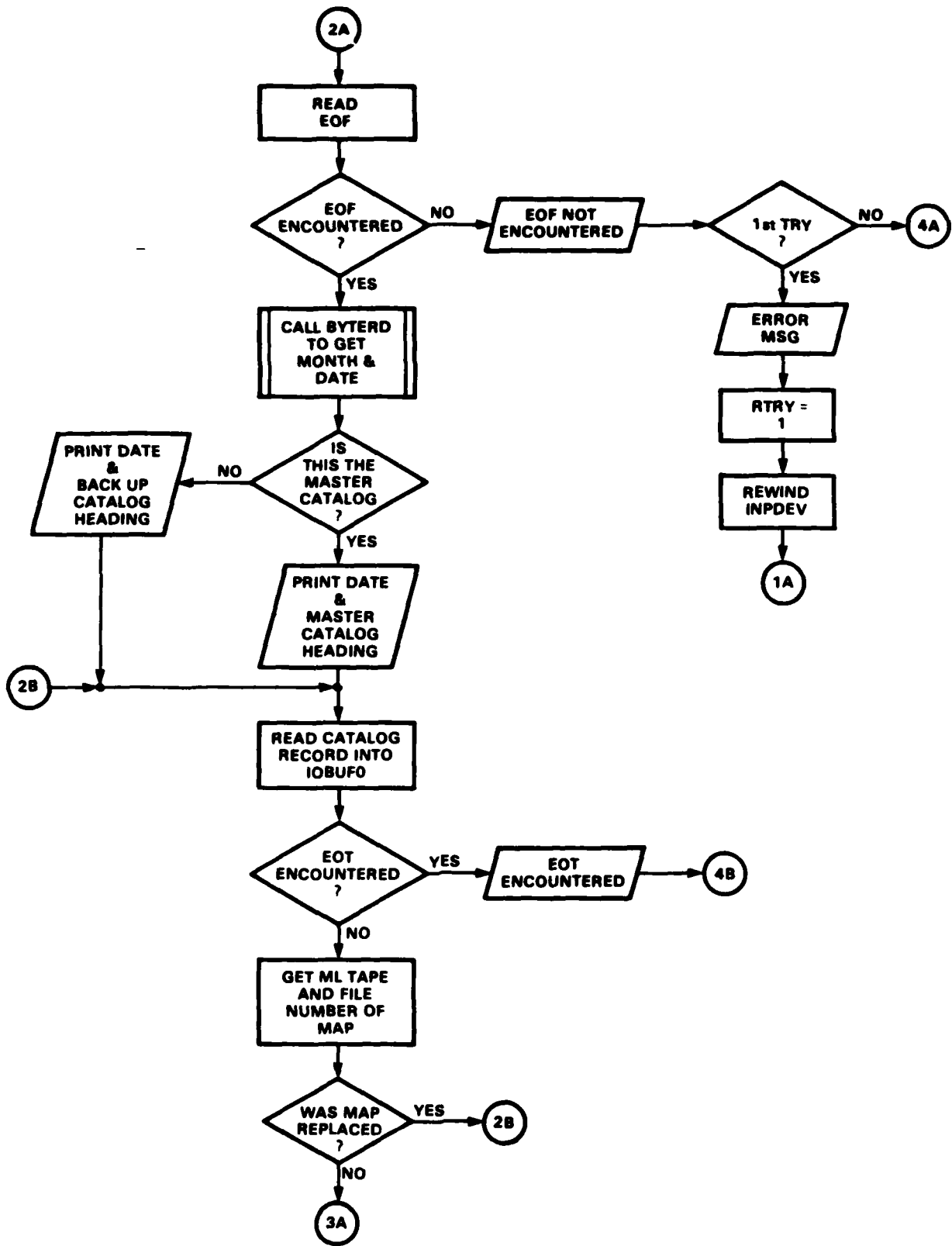

Figure 4-11. CPYMAP Flow Diagram (Sheet 2 of 6)

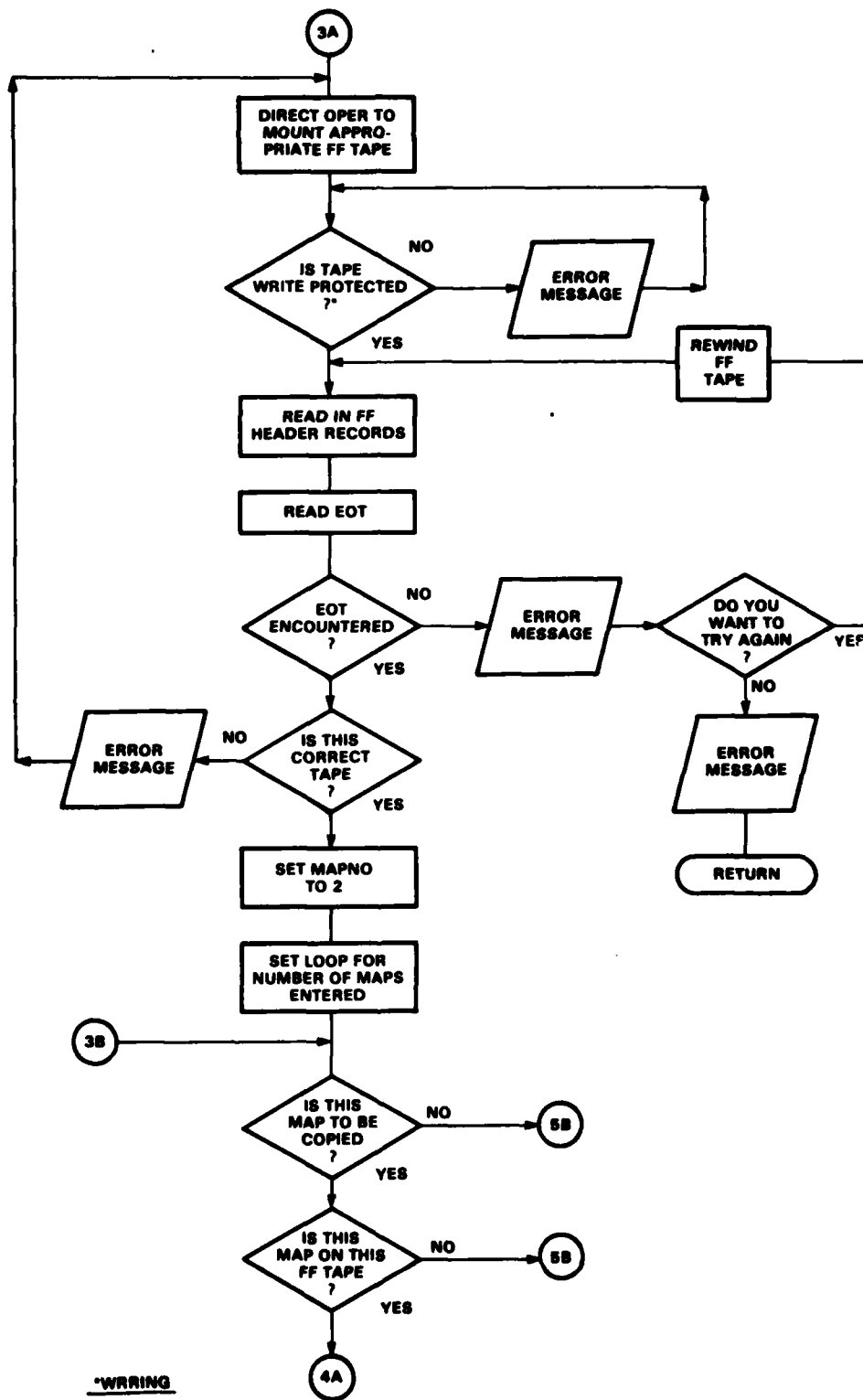

Figure 4-11. CPYMAP Flow Diagram (Sheet 3 of 6)

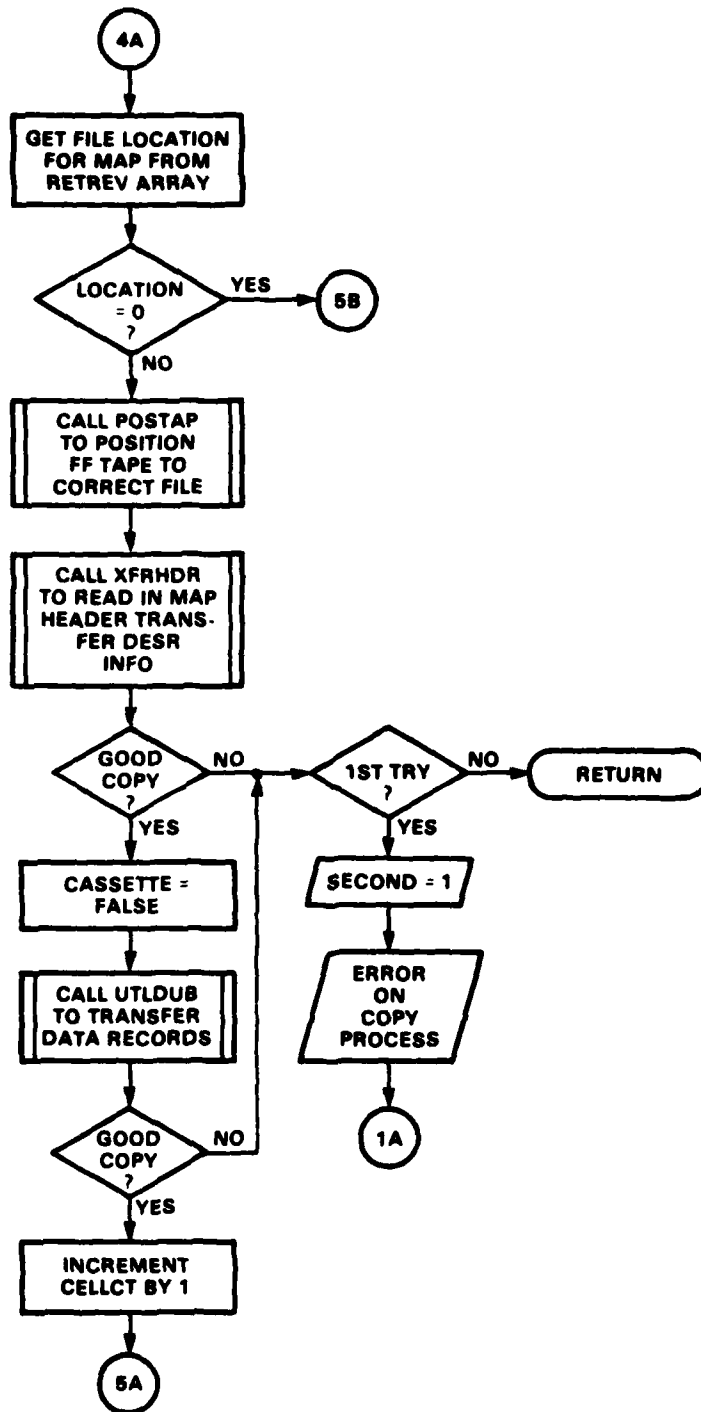

Figure 4-11. CPYMAP Flow Diagram (Sheet 4 of 6)

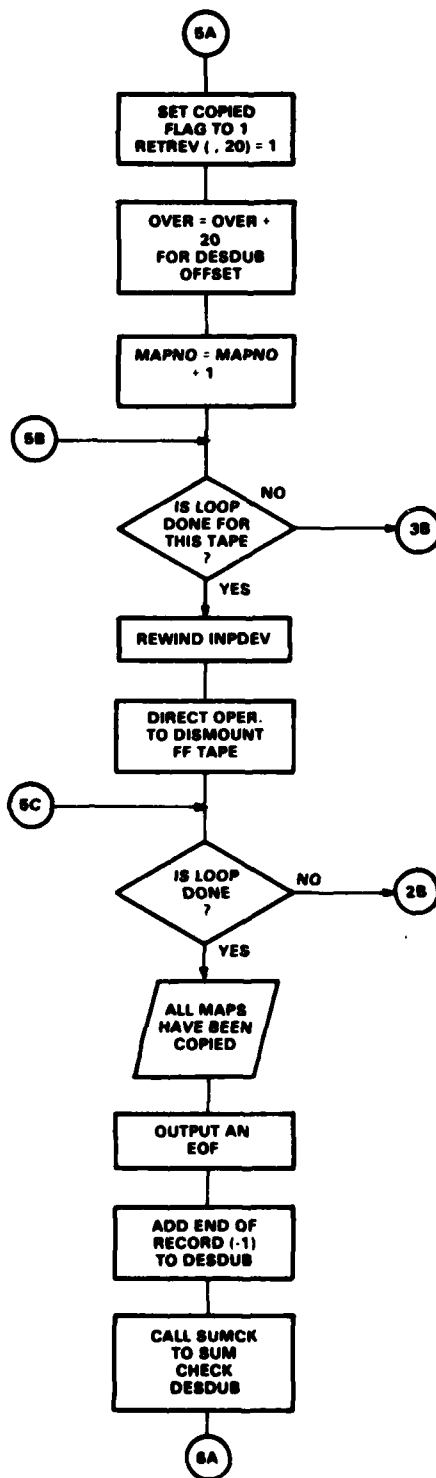

Figure 4-11. CPYMAP Flow Diagram (Sheet 5 of 6)

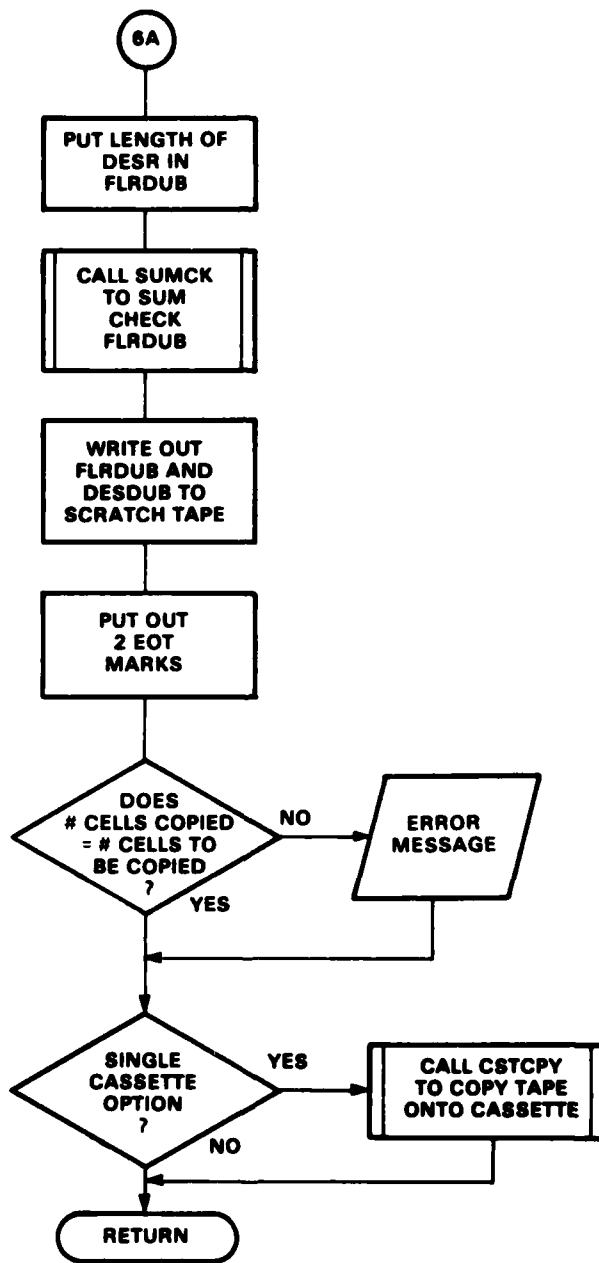

Figure 4-11. CPYMAP Flow Diagram (Sheet 6 of 6)

4.11 POSTAP

POSTAP positions the field file tape to a specified file. When the scratch tape is being made, CPYMAP calls POSTAP prior to each map copy to position the field file tape to the correct file. POSTAP compares the file number of the map to be copied with the file where the field file tape is presently positioned. POSTAP then spaces the field file tape ahead or back so that the file wanted is under the read head.

There are two passed variables: NUMBER and FOUND. NUMBER is the file number of the next map to be copied. FOUND is the returned parameter, taking on a logical true if the file is found and a logical false if the end-of-tape is encountered before the file is found. MAPNO, the file number at which the field file tape is positioned, is passed to the routine through the common /INFO/. MAPNO and NUMBER are compared, and appropriate action is taken.

The POSTAP flow diagram is shown in Figure 4-12.

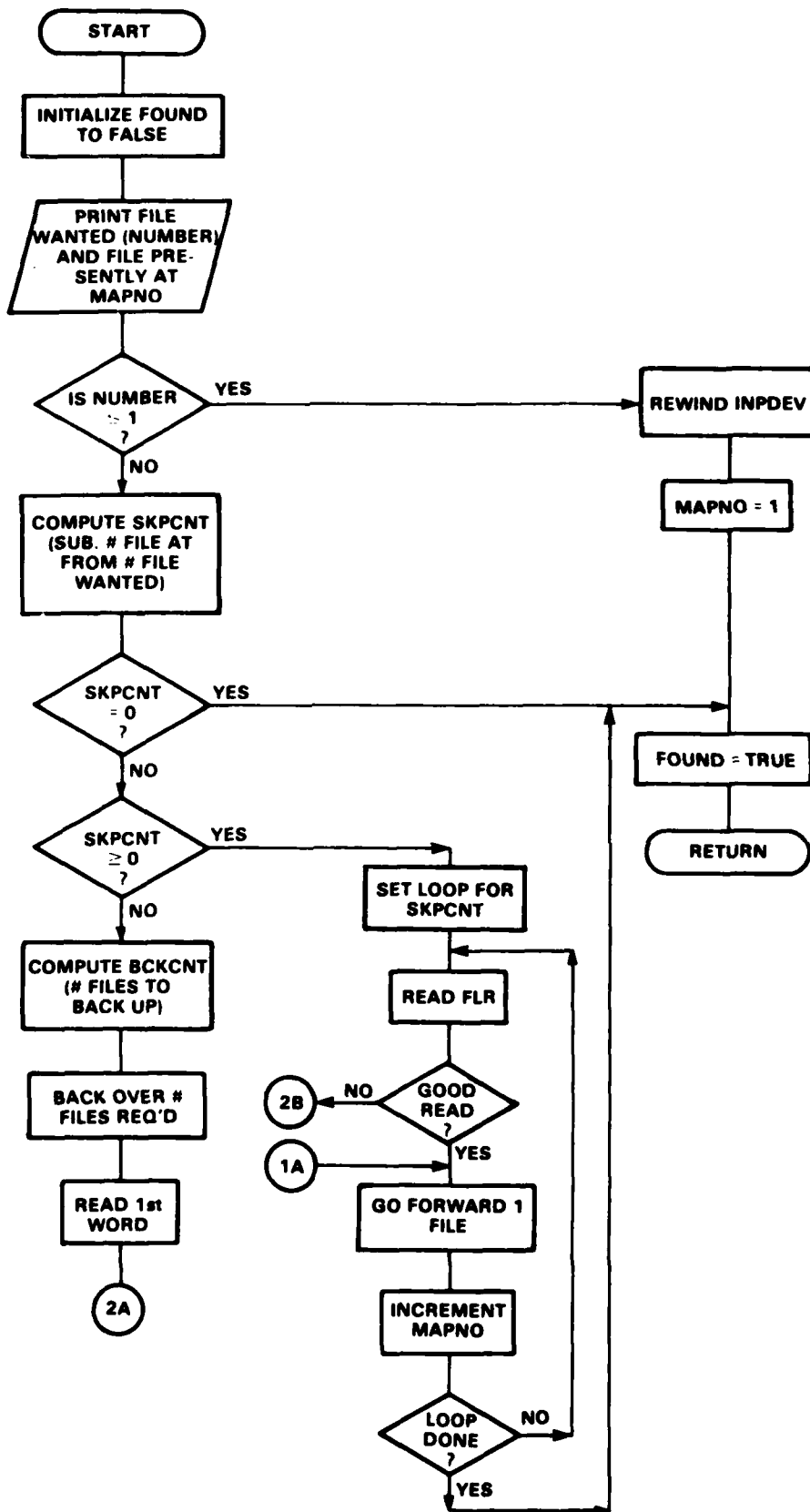

Figure 4-12. POSTAP Flow Diagram (Sheet 1 of 2)

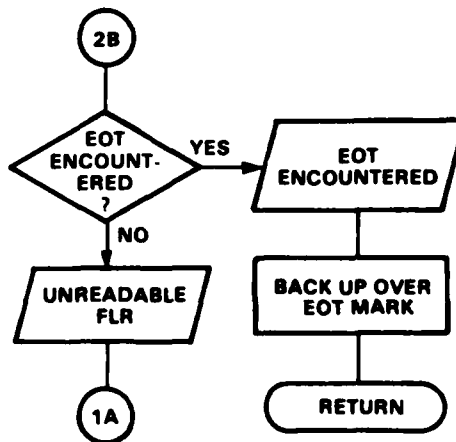
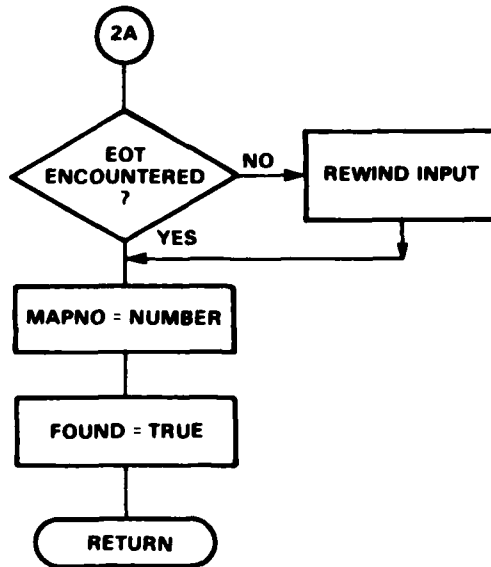

Figure 4-12. POSTAP Flow Diagram (Sheet 2 of 2)

4.12 UTLDUB

UTLDUB controls the copying of the maps. It sets control flags and calls the appropriate routines to copy the maps onto the scratch tape or cassette tape. After the maps are copied, it calls JMPSW to get the status of the copy. The flow diagram for UTLDUB is shown in Figure 4-13.

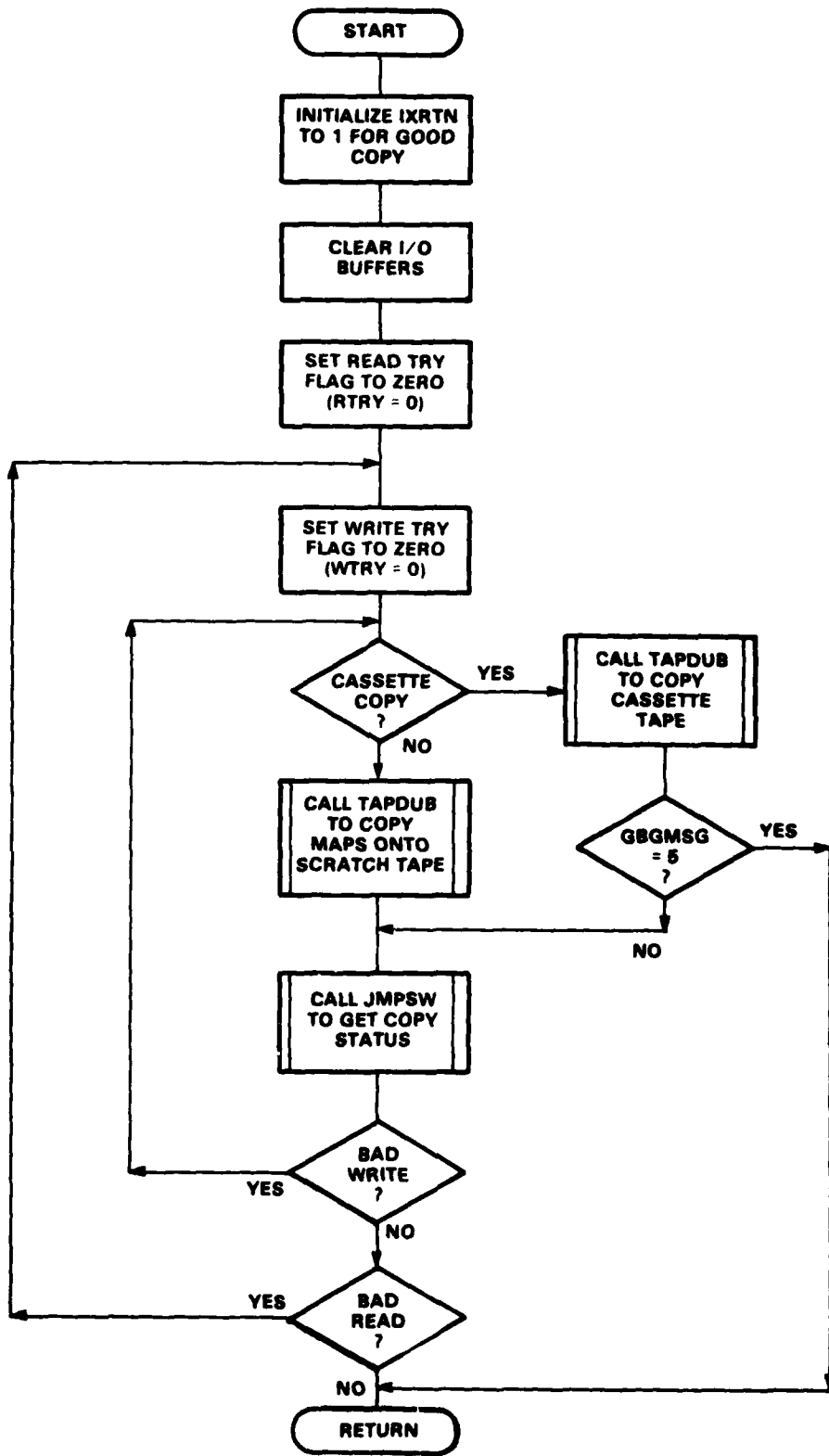

Figure 4-13. UTLDUB Flow Diagram

4.13 XFRHDR

XFRHDR transfers the information from each individual map's designator record to the cassette's designator record. XFRHDR reads the FLR and designator record for each map to be placed on the cassette tape. The information, in words 4 through 20 of the designator record, is put into the DESDUB buffer.

There is one passed variable, ADDR, which controls the packing offset for the DESDUB buffer. XFRHDR is called by CPYMAP.

Refer to Figure 4-14 for the XFRHDR flow diagram.

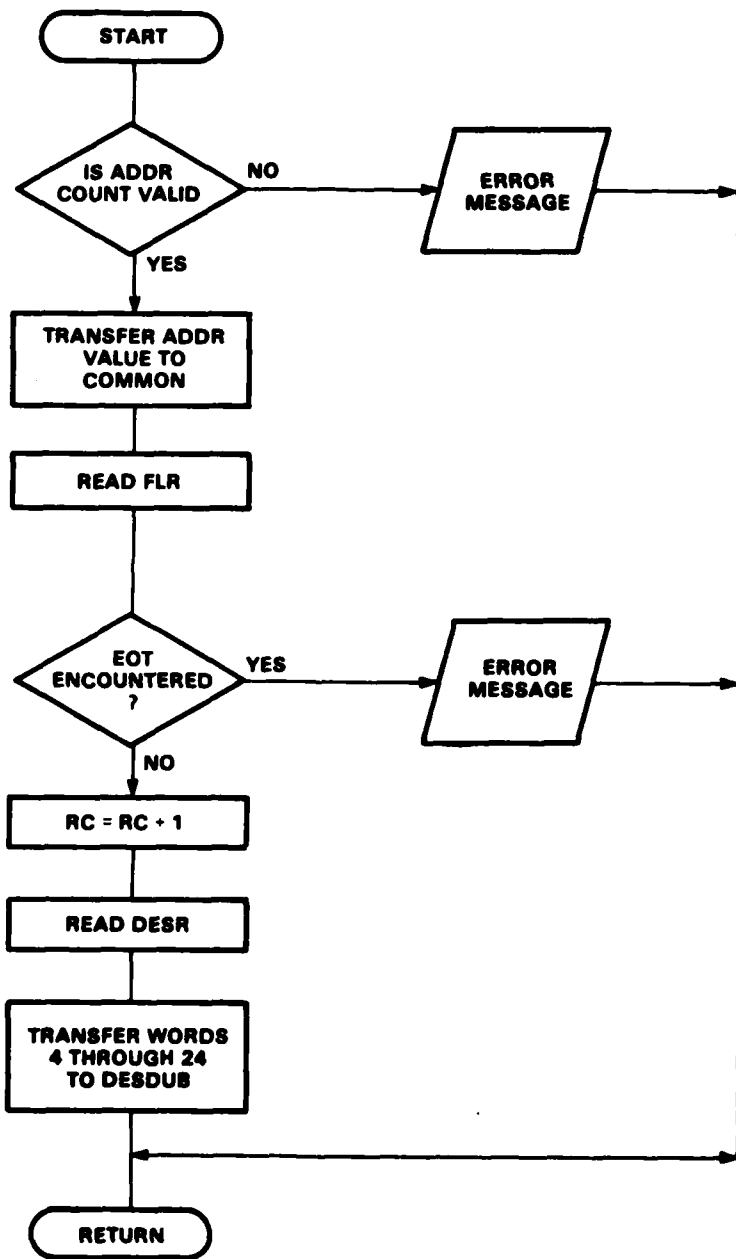

Figure 4-14. XFRHDR Flow Diagram

4.14 TAPDUB

TAPDUB copies records from an input device to an output device. It is called by UTLDUB when copying original data records from the field file tape to the scratch tape, and when copying the scratch tape to the cassette tape.

RSUMCK is called to read in the original record. If the read is good, the record is written out to the output device. When making a scratch tape, CHANGE is called before writing out the record to reformat the data in Hughes format. Also during scratch tape copying, the record count of the first data record of each map is placed in the cassette designator record.

After the record is written out, the output device is backed up, and the record is reread. If the read was good, the two records are compared. If the compare is good, the next record is read. This continues until an EOF is encountered and TAPDUB is exited.

Bad reads and compares are flagged, and the program is exited.

Refer to Figure 4-15 for the TAPDUB flow diagram.

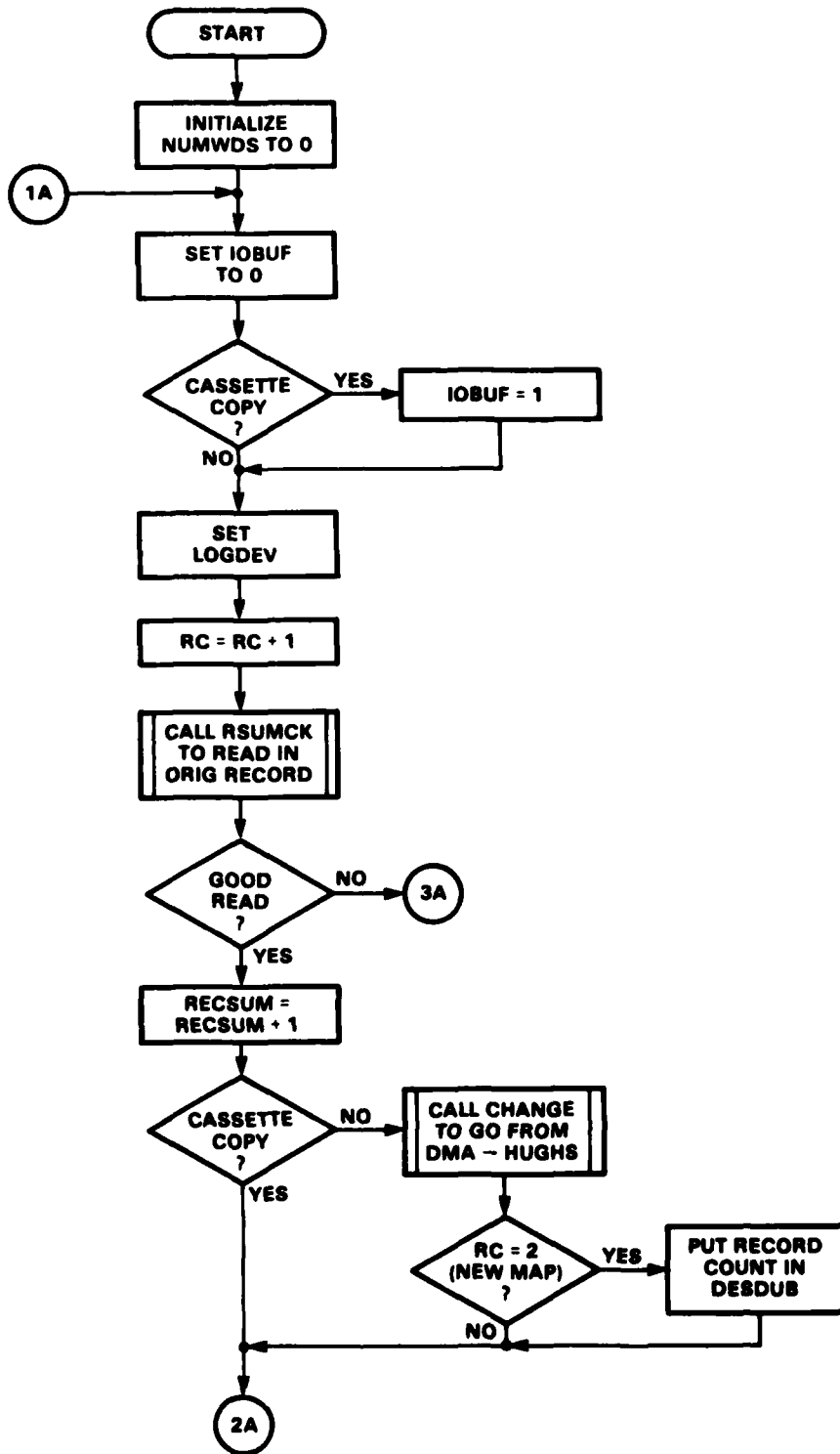

Figure 4-15. TAPDUB Flow Diagram (Sheet 1 of 4)

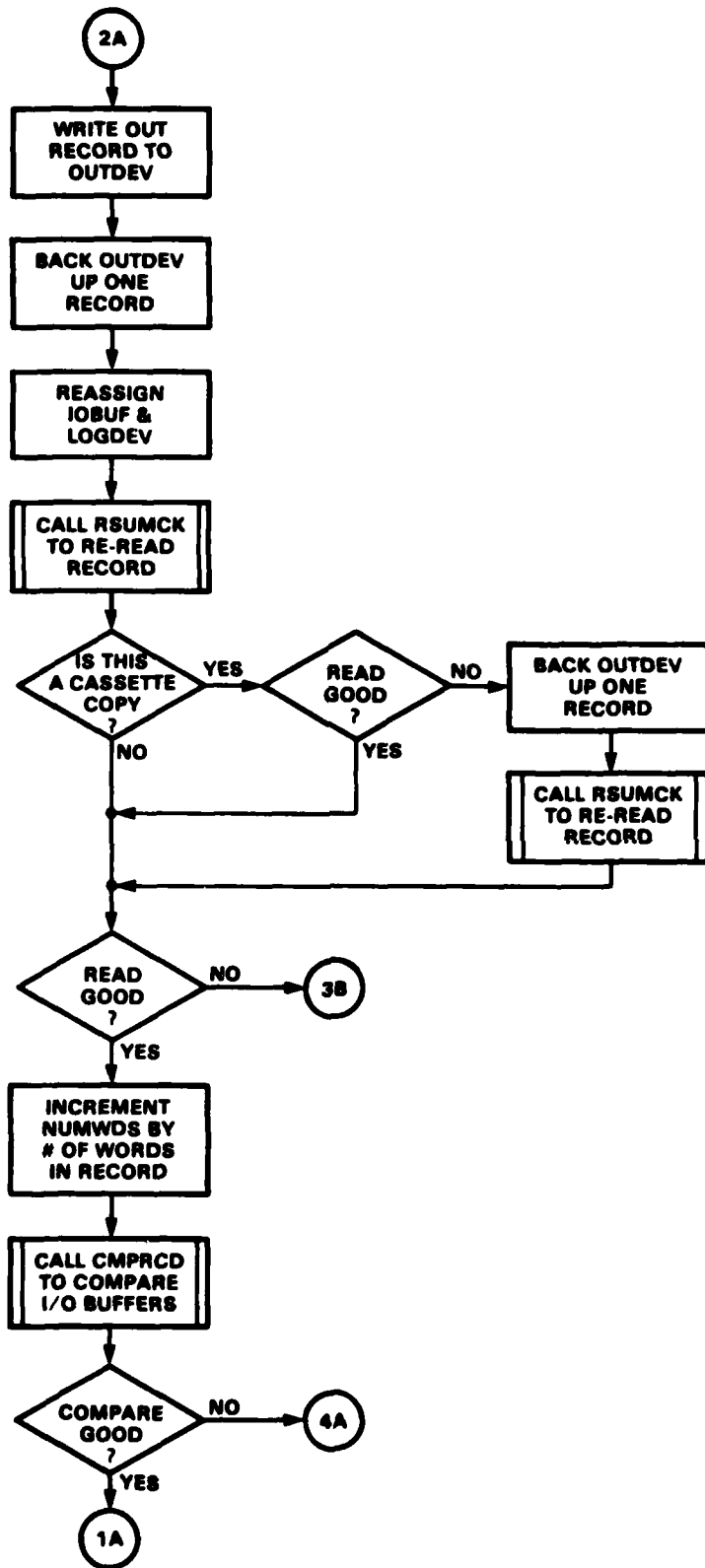

Figure 4-15. TAPDUB Flow Diagram (Sheet 2 of 4)

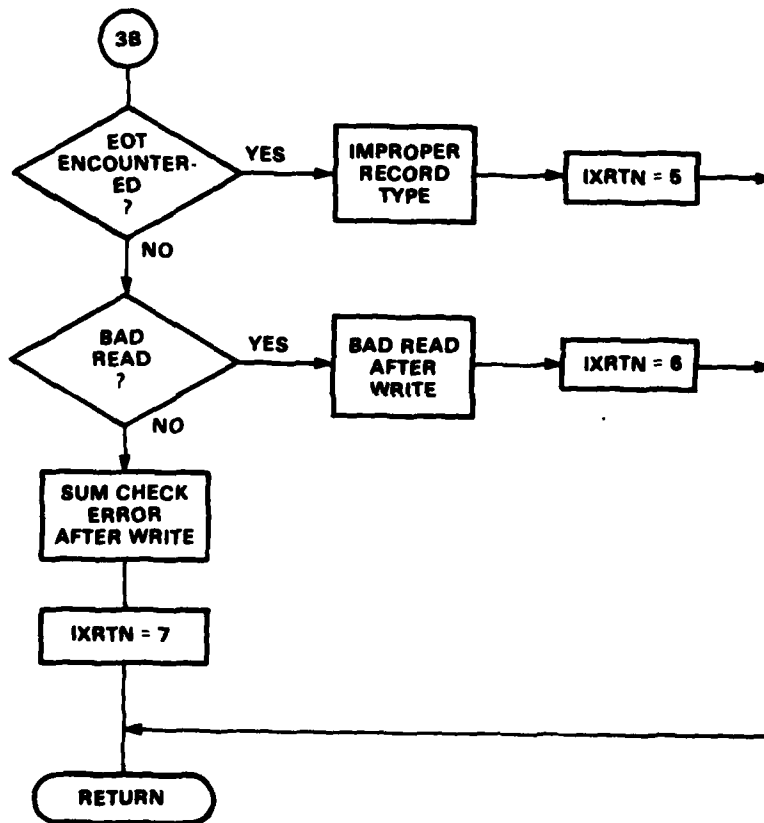
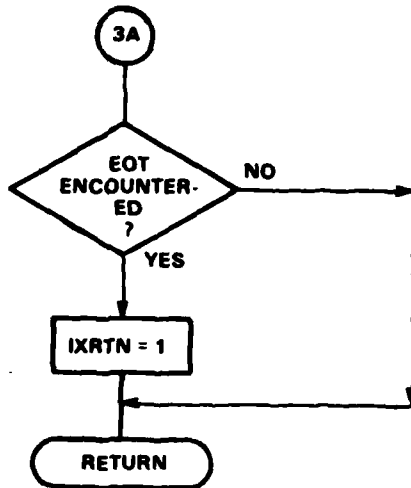

Figure 4-15. TAPDUR Flow Diagram (Sheet 3 of 4)

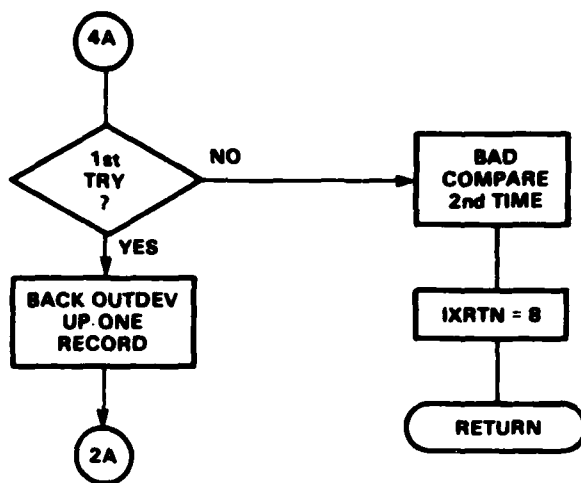

Figure 4-15. TAPDUB Flow Diagram (Sheet 4 of 4)

4.15 CHANGE

CHANGE reformats the field file library data records from DMA to Hughes format. The major differences are given below:

- WORD 3 -- The upper byte has the number of scans in record.
 -- The lower byte has the actual scan count.

- WORD 5 -- Upper byte of HD5 word is not reserved. This causes
 all HD values to be shifted up one byte.

- End of Scan -- A -1 is placed at the end of each scan.

- End of Record -- A second -1 is placed in the next-to-last word on each
 record.

CHANGE is called by TAPDUB when a scratch tape is being made. Refer to Figure 4-16 for the CHANGE flow diagram.

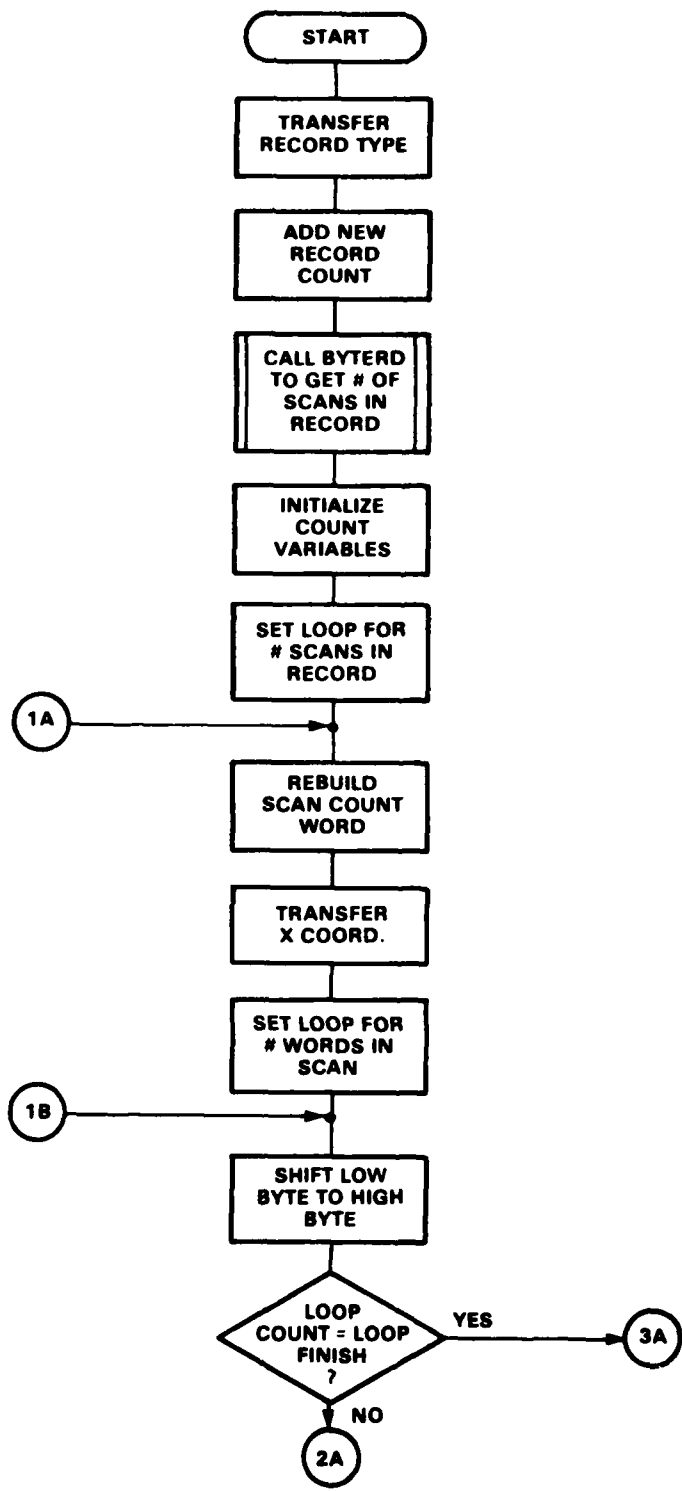

Figure 4-16. CHANGE Flow Diagram (Sheet 1 of 3)

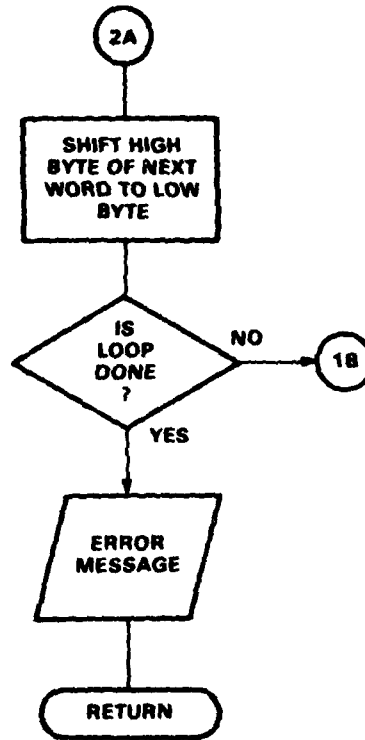

Figure 4-16. CHANGE Flow Diagram (Sheet 2 of 3)

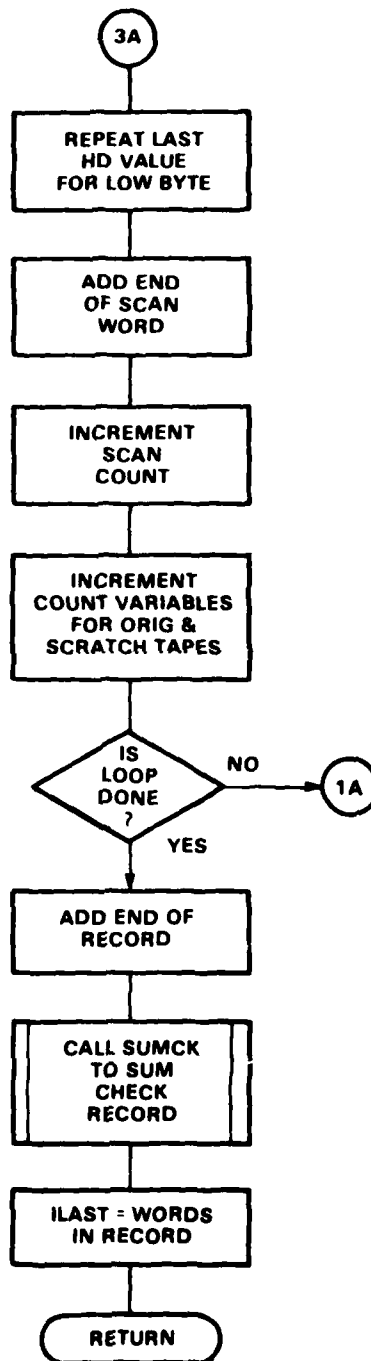

Figure 4-16. CHANGE Flow Diagram (Sheet 3 of 3)

4.16 CSTCPY

CSTCPY makes a cassette tape from a verified scratch tape. It constructs the CPC record and writes it out to the cassette tape. The cassette header is read off the scratch tape and output to the cassette tape. The data words are then copied by calling UTLDUR.

CSTCPY is called by CASSET when the COPY ONLY dubbing function is selected. It is also called by CPYMAP when a single cassette is being created.

Refer to Figure 4-17 for the CSTCPY flow diagram.

AD-A112 284

SENCOR INC NEPTUNE NJ
COMPUTER PROGRAM USER'S MANUAL FOR FIREFINDER DIGITAL TOPOGRAPH--ETC(U)
JAN 82 H CERES, L R HESELTON DAAK20-79-D-0500

F/6 4/2

UNCLASSIFIED

DRCPM-FFR-TM-0182

NL

2-2
2-2



END
DATE
FILMED
4-82
DTIC

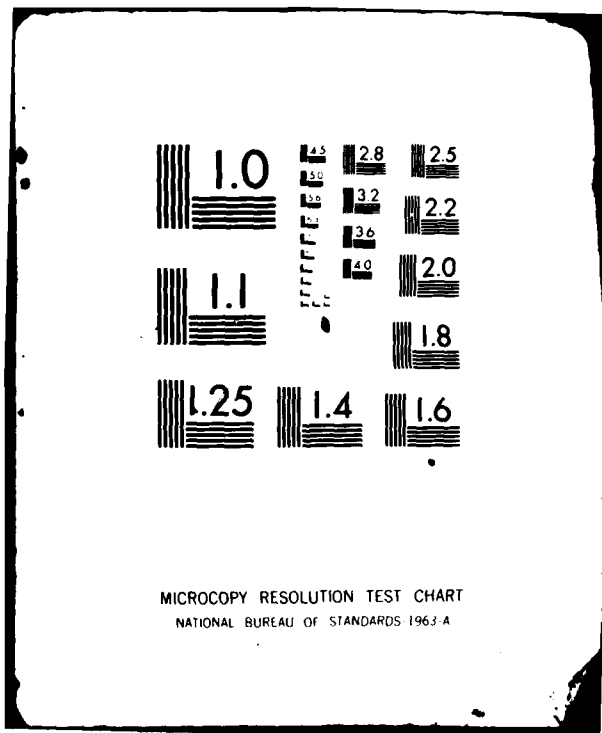

MICROCOPY RESOLUTION TEST CHART
NATIONAL BUREAU OF STANDARDS 1963-A

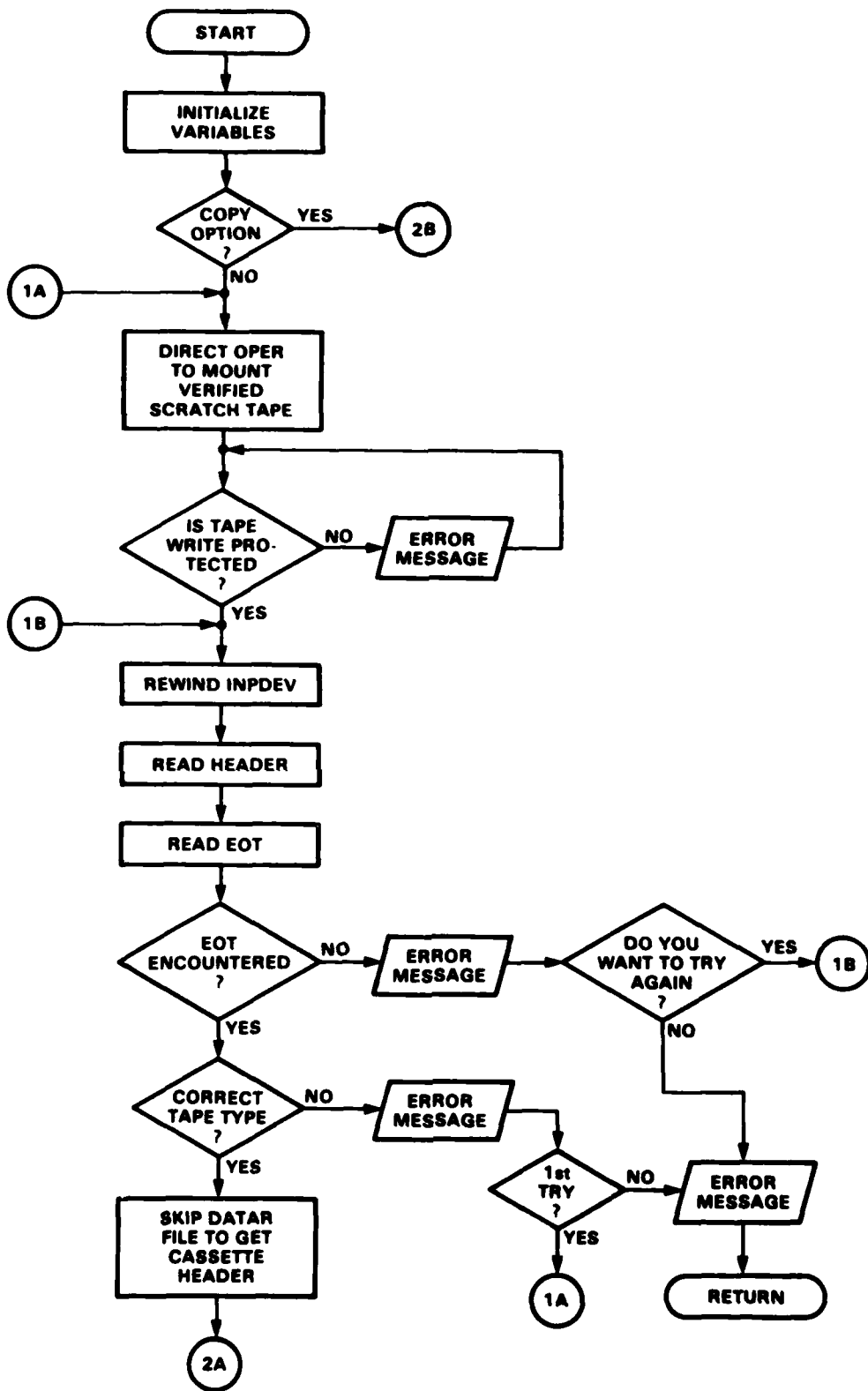

Figure 4-17. CSTCPY Flow Diagram (Sheet 1 of 4)

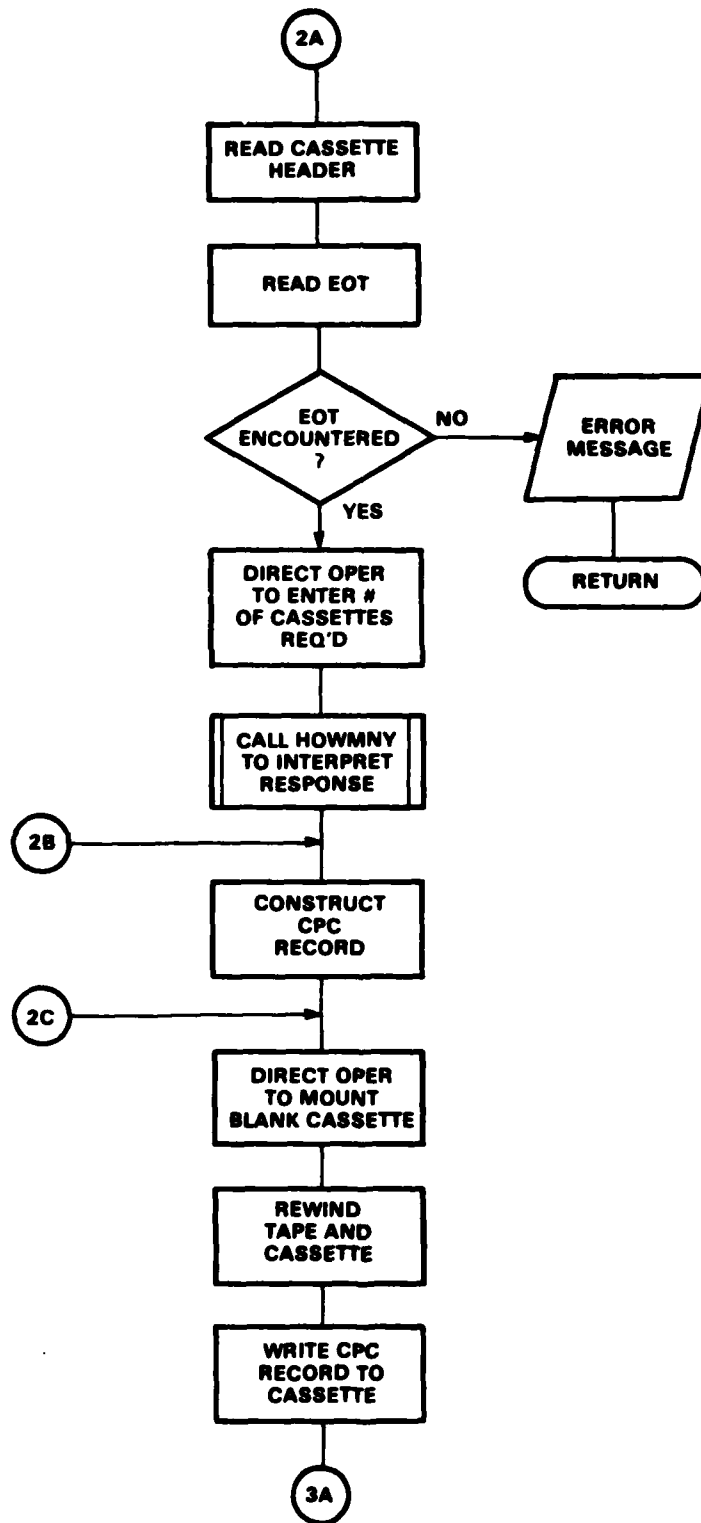

Figure 4-17. CSTCPY Flow Diagram (Sheet 2 of 4)

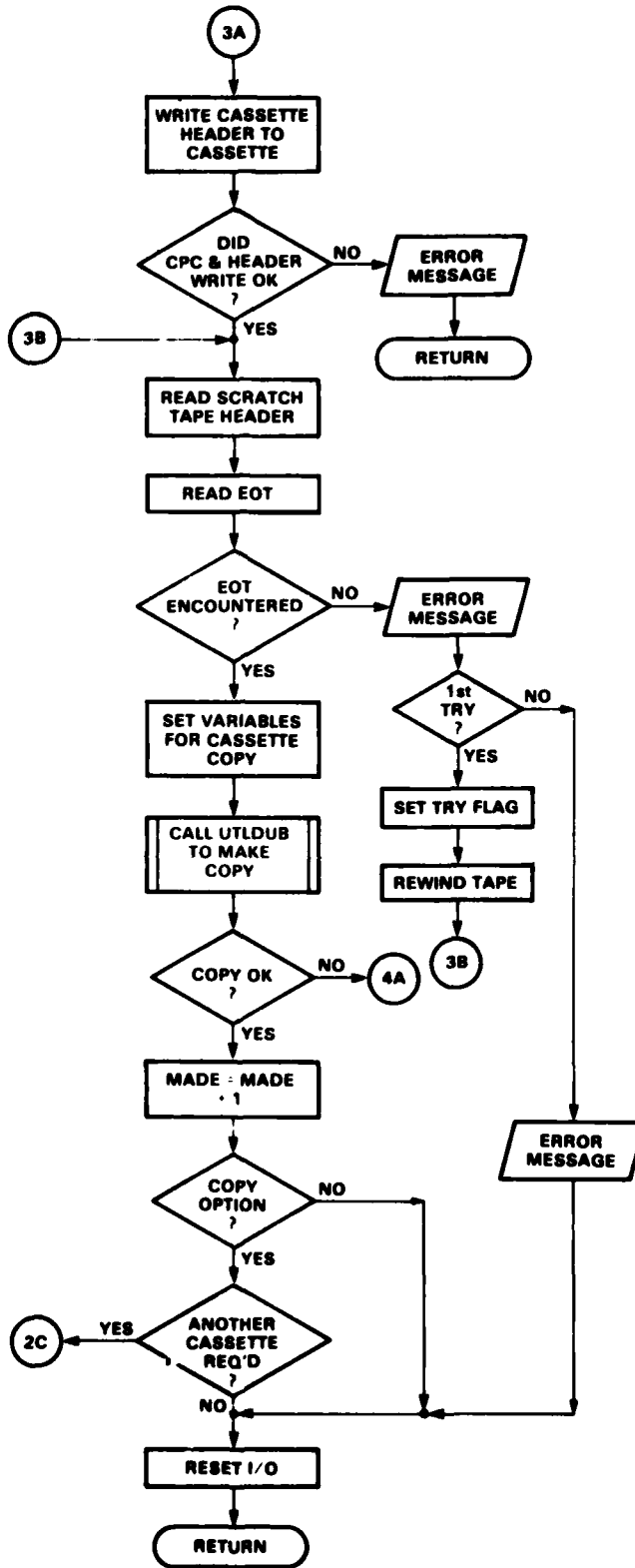

Figure 4-17. CSTCPY Flow Diagram (Sheet 3 of 4)

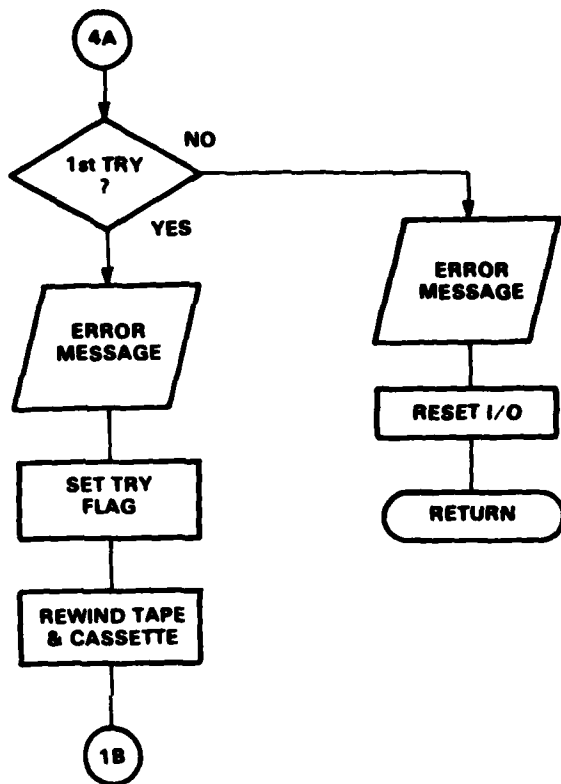

Figure 4-17. CSTCPY Flow Diagram (Sheet 4 of 4)

4.17 JMPSW

JMPSW interprets the result of a copy process and takes appropriate action. UTLDUB calls JMPSW after each copy process.

JMPSW checks the status variable, IXRTN, and takes appropriate action depending on its value. Table 4-2 gives the action associated with each IXRTN value. JMPSW returns a value of STSVL (through the common /FLAGG/) to UTLDUB, which then performs the appropriate action. The values for STSVL are as follows:

- STSVL = 1 Continue with next map
- = 2 Read same record again
- = 3 Write same record again
- = 4 Stop processing

In general, if everything was good, the program goes on to the next map. If there was a bad read or sum check error on an input record, the record is re-read a second time. If there is still an error, JMPSW stops processing the scratch tape or cassette tape.

If there was a bad read or sum check error on an output record, or if an improper record was detected, JMPSW tries to write the record out again. The input and output devices are backed up one record, and the program tries to re-write the record again. If an error occurs again, JMPSW stops processing the scratch tape or cassette tape.

A wrong record count or a second bad compare stops the processing of the scratch tape or cassette tape.

Refer to Figure 4-18 for the JMPSW flow diagram.

TABLE 4-2. ACTIONS ASSOCIATED WITH IXRTN VALUES

<u>IXRTN VALUE</u>	<u>ACTION</u>
IXRTN = 1	Good copy; "FILE TRANSFER OK;" STSVL = 1; Continue.
IXRTN = 2	EOT ENCOUNTERED; "EOF/EOT ENCOUNTERED ON INPUT DEVICE;" STSVL = 1; Continue.
IXRTN = 3	"BAD READ ON ORIGINAL TAPE RECORD ___" First time, try to read same record again; STSVL = 2. Second time, halt processing of scratch tape or cassette tape; STSVL = 4.
IXRTN = 4	"BAD SUMCK ON RECORD ___" Handled same as = 3 above.
IXRTN = 5	"IMPROPER RECORD TYPE ENCOUNTERED" On first try, back up input and output devices one record. Try to rewrite the record. STSVL = 3. On second try, halt processing of scratch tape cassette. STSVL = 4.
IXRTN = 6	"BAD READ AFTER WRITE" Handled same as = 5 above.
IXRTN = 7	"BAD SUMCK ON OUTPUT RECORD ___" Handled same as = 5 above.
IXRTN = 8	"BAD COMPARE - SECOND TIME POSSIBLE SYSTEM PROBLEM" Halt processing of scratch tape or cassette. STSVL = 4.

NOTE: The message displayed to operator is in quotes.

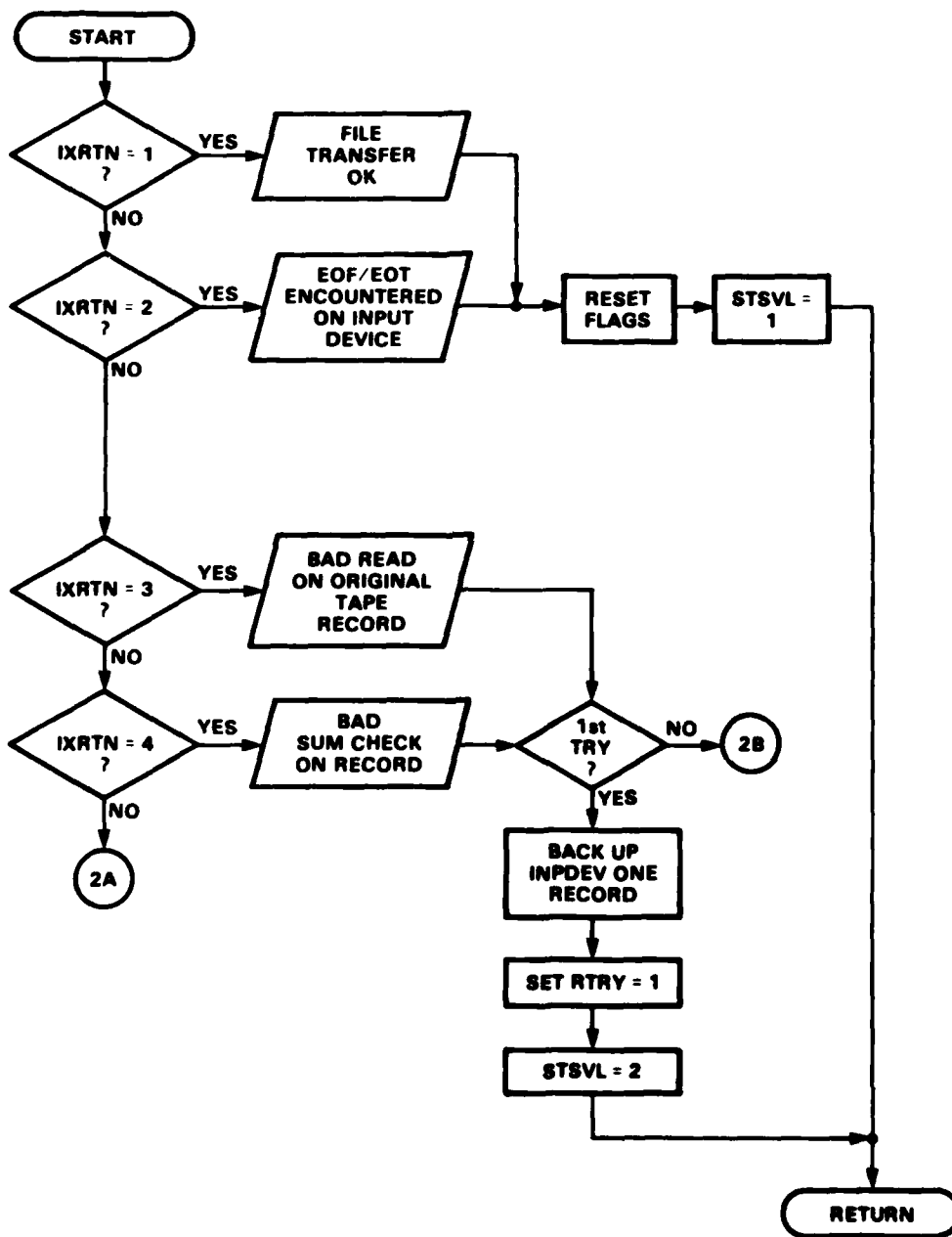

Figure 4-18. JMPSW Flow Diagram (Sheet 1 of 2)

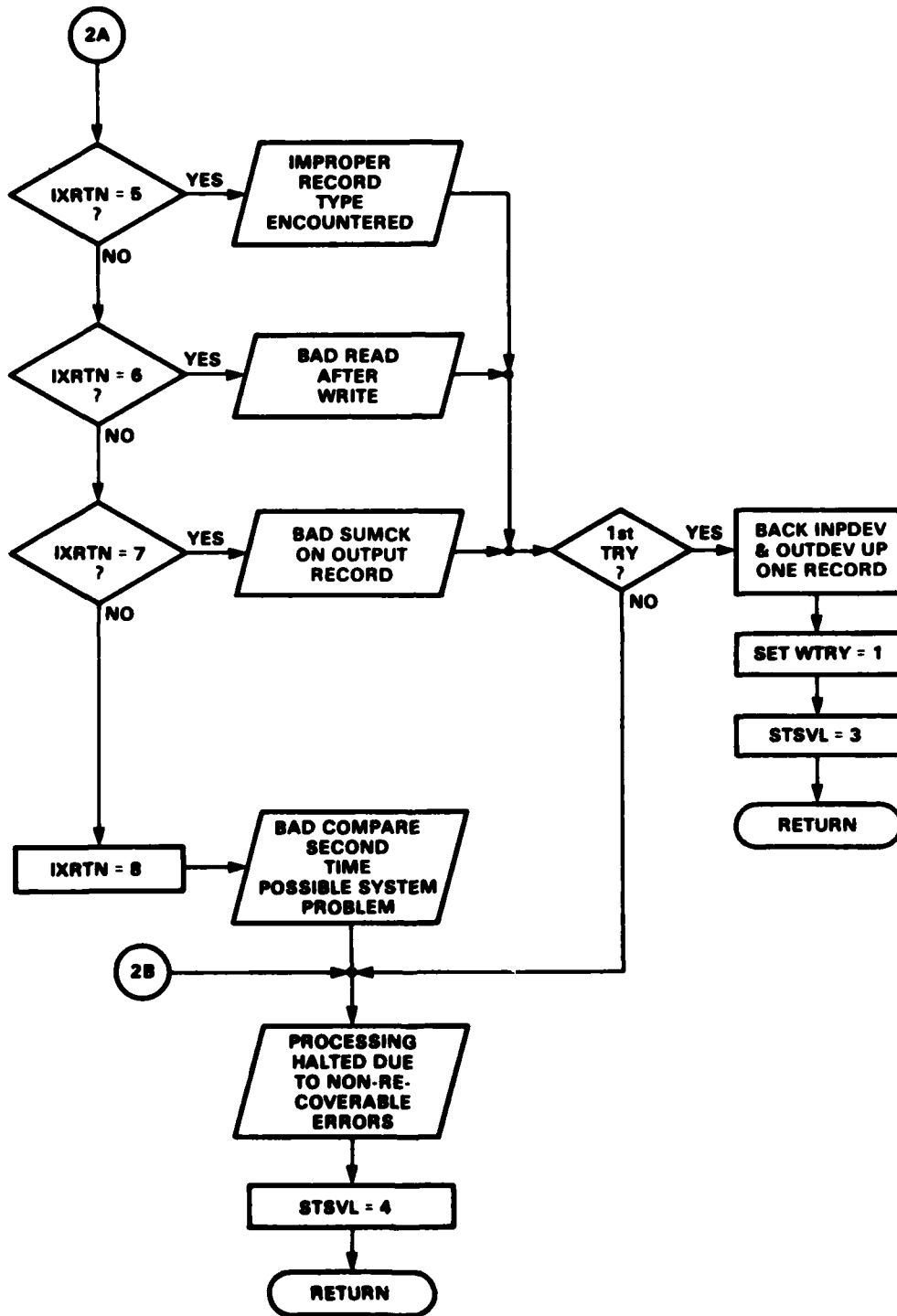

Figure 4-18. JMPSW Flow Diagram (Sheet 2 of 2)

4.18 CMPRCD

CMPRCD compares each word of IOBUF1 and IOBUF2. If all the words are the same, the variable, ISCS (in common /FLAGG/), is set to zero. If the comparison fails, ISCS is set to 1.

CMPRCD is called by the copy routines to check that what was written out is what was supposed to be written out.

Figure 4-19 is the flow diagram for CMPRCD.

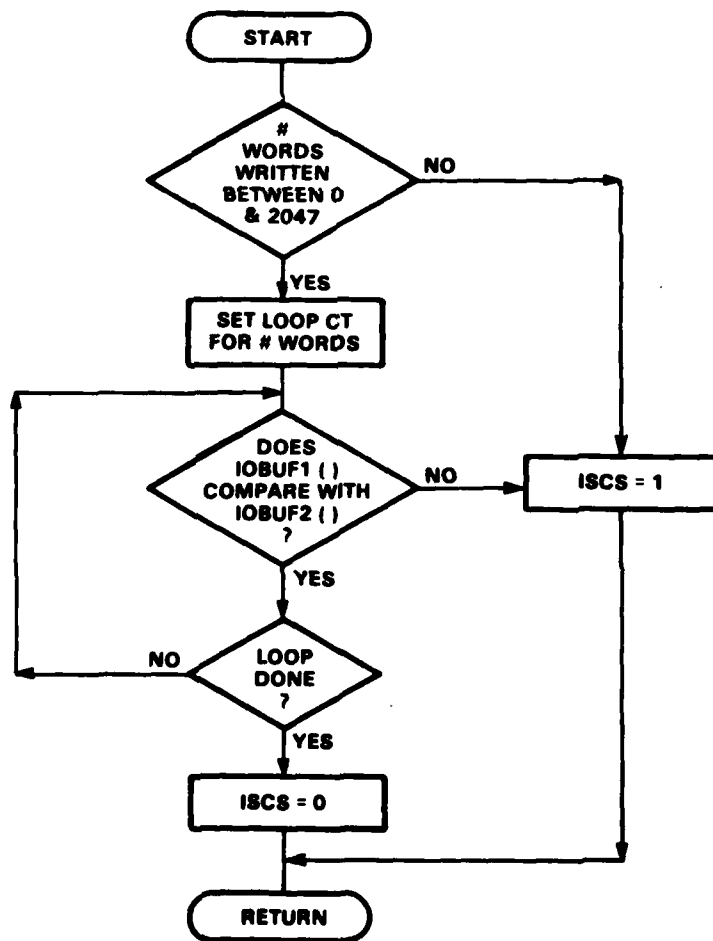

Figure 4-19. CMPRCD Flow Diagram

4.19 RSUMCK

RSUMCK reads a record from a tape device and checks the read to determine if an EOT was encountered, if the read was bad, or if a sum check error was detected. Depending on values assigned to variables IOBUF and LOGDEV, RSUMCK will read from any tape device into IOBUF0, IOBUF1, or IOBUF2. The read status is returned via IXRTN (in the common /FLAGG/):

- IXRTN = 1 Good read
- = 2 EOT encountered
- = 3 Bad read
- = 4 Sum check error detected

RSUMCK is called whenever a read and check operation is required. Refer to Figure 4-20 for the RSUMCK flow diagram.

I
I
I
I
I

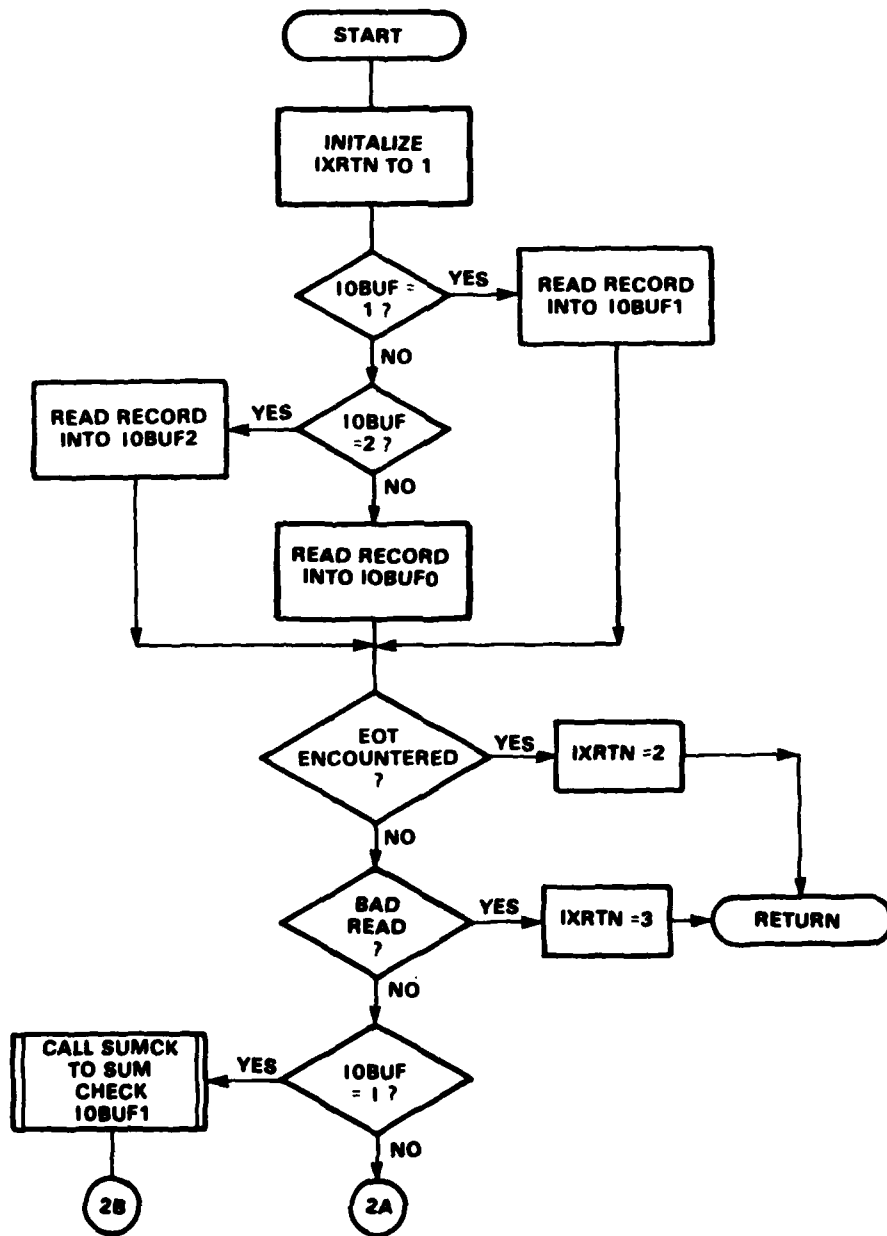

Figure 4-20. RSUMCK Flow Diagram (Sheet 1 of 2)

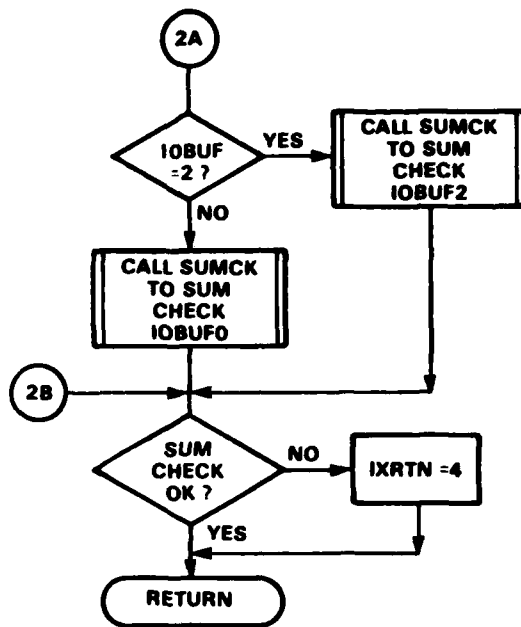

Figure 4-20. RSUMCK Flow Diagram (Sheet 2 of 2)

4.20 SELECT

SELECT interprets an operator's response to alphabetical choices and returns a numerical value for the calling routine to evaluate. SELECT is called whenever the operator is given an alphabetic format choice (e.g., A, B, C, etc.).

There are two passed parameters, N and CHC. N is the number of choices presented to the operator; it is set by the calling routine. CHC is the return parameter, giving the numerical equivalent to the operator's selection. If the operator enters an invalid choice, an error message is displayed and the operator is asked to select again.

Refer to Figure 4-21 for the SELECT flow diagram.

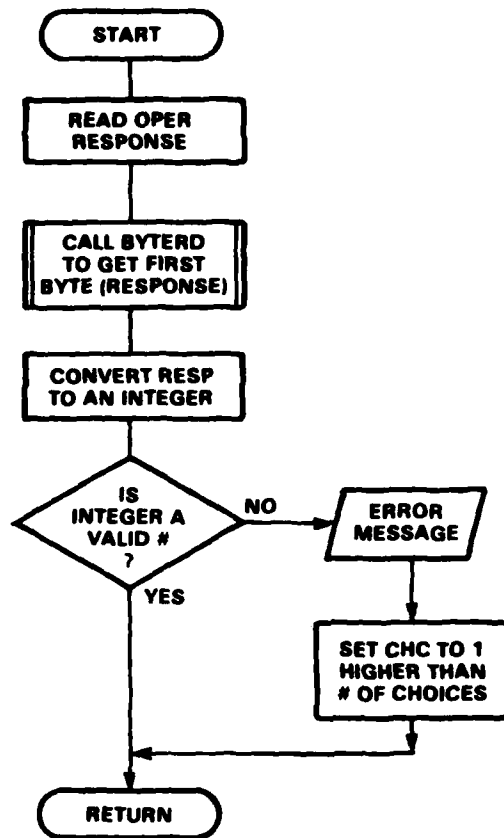

Figure 4-21. SELECT Flow Diagram

4.21 YESNO

YESNO interprets the operator's "yes" or "no" response and returns a logical value for the calling routine to evaluate. YESNO is called whenever the operator is asked for a YES/NO decision. There is one passed parameter, FLAG, which returns the logical equivalent of the operator's response to the calling program. If the operator answers with anything other than "Y," "YE," "YES," "N," or "NO," an error message is displayed and the operator is asked to reenter the response.

The YESNO flow diagram is shown in Figure 4-22.

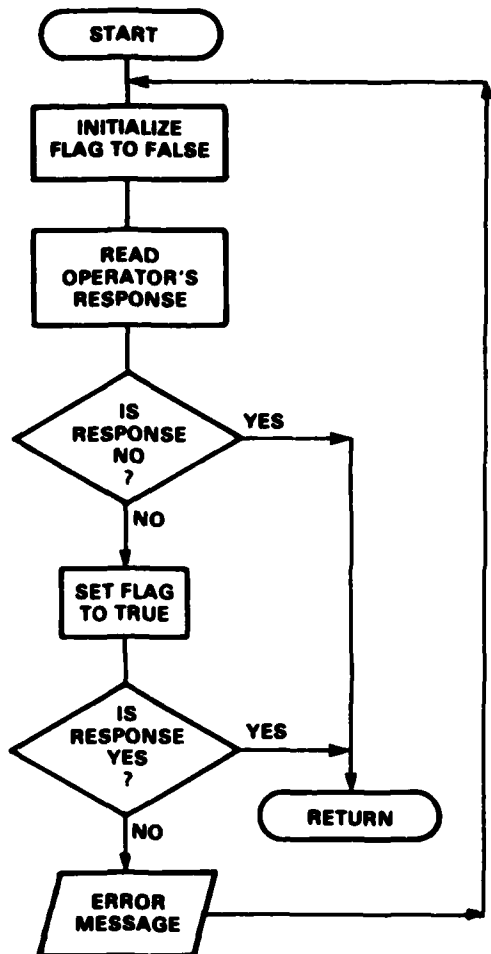

Figure 4-22. YESNO Flow Diagram

4.22 HOWMNY

HOWMNY interprets an operator's numerical response and determines if it is within acceptable limits. HOWMNY is called whenever the operator is directed to enter numerical values. There are two passed variables, NUM and LMT. NUM is the value returned to the calling program. LMT is the maximum value NUM can have. LMT is set by the calling program. If the number entered is greater than the specified limit, an error message is displayed and the operator is directed to reenter the number.

See Figure 4-23 for the flow diagram for HOWMNY.

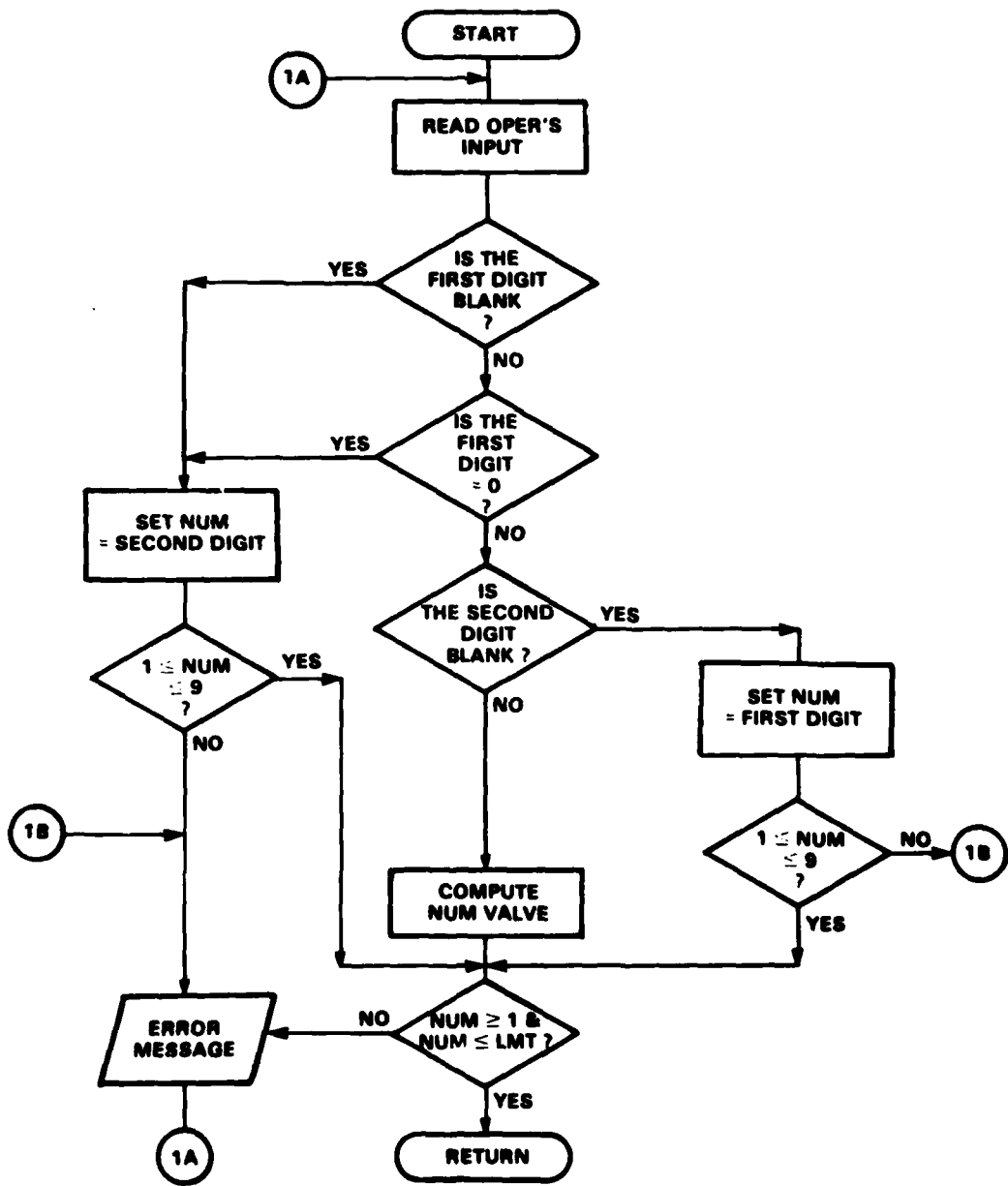

Figure 4-23. HOWMNY Flow Diagram

4.23 WRRING

WRRING checks whether or not a write ring is present on a tape mounted on a given tape drive. It is called by various subroutines to check whether a given tape is write protected/enabled. There are two passed variables, DEVNUM and STAT; both are set by the calling program. DEVNUM is the logical device number of the tape drive on which the tape is mounted. STAT is the condition for which the program is checking:

STAT = 0 Write ring should be on

STAT = 1 Write ring should be off

If the correct condition does not exist, WRRING interrupts with an error message directing the operator to take appropriate action. When the correct condition is met, WRRING is exited.

See Figure 4-24 for the WRRING flow diagram.

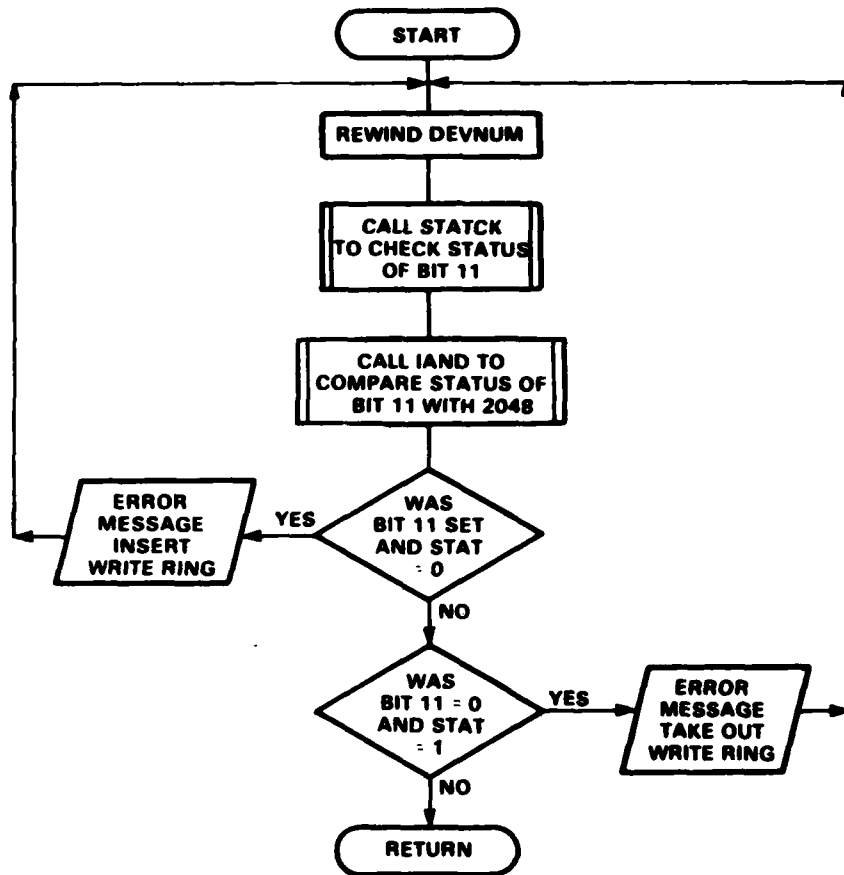

Figure 4-24. WRRING Flow Diagram

SECTION 5

COMPUTER PROGRAM LISTINGS

This section contains the computer program listings for the FFDTDLDS. An explanation of the operating system SIO subroutine is given below to help the reader to fully understand these listings.

SIO

The SIO subroutine is the nonstandard system I/O call used throughout the library program to perform the following operations: read, write, pass records or files, and finalize. The routine has six passed parameters:

CALL SIO (FUNCTION, DEVICE, ARRADR, WDCNT, STATUS, WSDONE)

FUNCTION defines the function that SIO is to perform:

0 = Read	5 = Pass File Forward
1 = Write	6 = Finalize
2 = Initialize	7 = Rewind
3 = Pass Record Forward	8 = Pass File Backward
4 = Pass Record Backward	

DEVICE is the logical number assigned to a given device:

1 = T1	6 = PRINTR
2 = T2	7 = RAMTEK
3 = T3	8 = RAYMOND
4 = T4	9 = CARD READER
5 = UNISCOPE	

ARRADR is the location (word or array) to be loaded or read from.

WDCNT is the index count for various functions:

- For Read or Write functions, WDCNT is the number of 16-bit words to be read or written out. The maximum for a single call is 32,767.
- For the Initialize or Rewind functions, WDCNT has no effect.

- For the Pass Record or Files functions, WDCNT is the number of records or files to be passed forward or back.
- For the Finalize function, WDCNT is the number of termination marks to be output. A maximum of 63 is allowed.

STATUS is returned by the system; it indicates the status of the operation:

- 0 = Good Operation
- 1 = Bad Packet or Fatal I/O Error
- 2 = End-of-File Encountered

WDSDONE gives the number of words read or operations actually performed.

5.1	CASSET	5.12	UTLDUB
5.2	WKTAPE	5.13	XFRHDR
5.3	ENTRY	5.14	TAPDUB
5.4	CRTCK	5.15	CHANGE
5.5	GRIDCK	5.16	CSTCPY
5.6	NUMCK	5.17	JMP SW
5.7	EXTRAS	5.18	CMPRCD
5.8	CTLFND	5.19	RSUMCK
5.9	DECIDE	5.20	SELECT
5.10	CPYMAP	5.21	YESNO
5.11	POSTAP	5.22	HOWMNY
		5.23	WRRING

OMITTED FROM THIS DOCUMENT

DATE
FILMED
— 8