

AD-A109 682 PENNSYLVANIA STATE UNIV UNIVERSITY PARK APPLIED RESE--ETC F/8 17/1

EFFECTS OF PHASE CANCELLATION ON THE SCATTERING MEASUREMENTS.(U)

JUL 81 J M DZIERZANOWSKI

N00024-79-C-6043

UNCLASSIFIED

ARL/PSU/TM-81-201

NL

Fig 2
AL
200mg

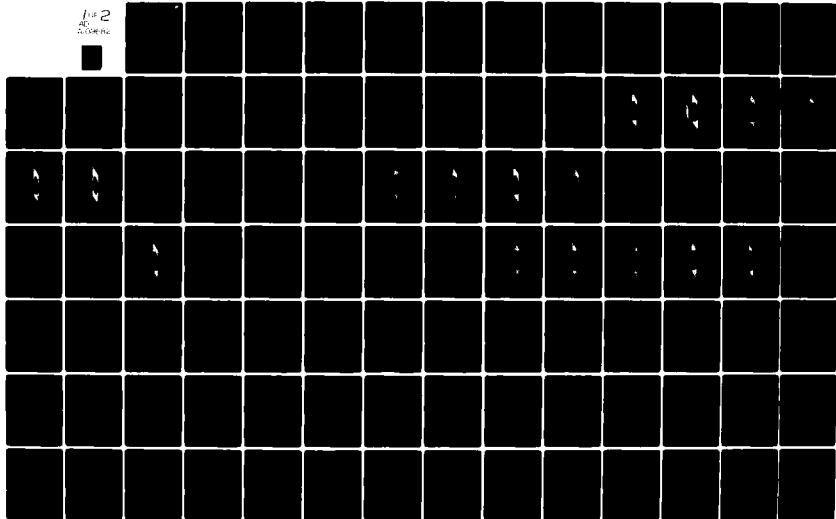

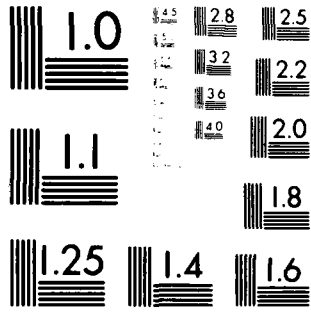

MICROCOPY RESOLUTION TEST CHART
NATIONAL BUREAU OF STANDARDS-1963-A

6

LEVEL II

AD A109682

EFFECTS OF PHASE CANCELLATION ON THE SCATTERING MEASUREMENTS

James M. Dzierzanowski

DTIC
SELECTED
JAN 18 1982
E

Technical Memorandum
File No. TM 81-201
July 1, 1981
Contract No. N00024-79-C-6043

Copy No. 5

The Pennsylvania State University
Intercollege Research Programs and Facilities
APPLIED RESEARCH LABORATORY
Post Office Box 30
State College, PA 16801

APPROVED FOR PUBLIC RELEASE
DISTRICT OF COLUMBIA

NAVY DEPARTMENT
NAVAL SEA SYSTEMS COMMAND

BIG FILE COPY

01 15 82 048

UNCLASSIFIED

SECURITY CLASSIFICATION OF THIS PAGE (When Data Entered)

REPORT DOCUMENTATION PAGE		READ INSTRUCTIONS BEFORE COMPLETING FORM
1. REPORT NUMBER TM 81-201	2. GOVT ACCESSION NO. AD-A1c 9682	3. RECIPIENT'S CATALOG NUMBER
4. TITLE (and Subtitle) EFFECTS OF PHASE CANCELLATION ON THE SCATTERING MEASUREMENTS		5. TYPE OF REPORT & PERIOD COVERED M.S. Thesis, August 1981
		6. PERFORMING ORG. REPORT NUMBER TM 81-201
7. AUTHOR(s) James M. Dzierzanowski		8. CONTRACT OR GRANT NUMBER(s) N00024-79-C-6043
9. PERFORMING ORGANIZATION NAME AND ADDRESS The Pennsylvania State University Applied Research Laboratory, P.O. Box 30 State College, PA 16801		10. PROGRAM ELEMENT, PROJECT, TASK AREA & WORK UNIT NUMBERS
11. CONTROLLING OFFICE NAME AND ADDRESS Naval Sea Systems Command Department of the Navy Washington, DC 20362		12. REPORT DATE July 1, 1981
		13. NUMBER OF PAGES 101 pages and figures
14. MONITORING AGENCY NAME & ADDRESS (if different from Controlling Office)		15. SECURITY CLASS. (of this report) Unclassified, Unlimited
		15a. DECLASSIFICATION/DOWNGRADING SCHEDULE
16. DISTRIBUTION STATEMENT (of this Report) Approved for public release, distribution unlimited, per NSSC (Naval Sea Systems Command), 12/7/81		
17. DISTRIBUTION STATEMENT (of the abstract entered in Block 20, if different from Report)		
18. SUPPLEMENTARY NOTES		
19. KEY WORDS (Continue on reverse side if necessary and identify by block number) thesis, phase, cancellation, scattering, measurements		
20. ABSTRACT (Continue on reverse side if necessary and identify by block number) Piezoelectric transducers are used for converting between electrical energy and acoustic energy in such diversified fields as medical imaging, underwater acoustic propagation, and non-destructive material testing. This type of transducer when used as a receiver is sensitive to the phase of the received pressure wave. The effect of phase cancellation on the measurements of attenuation coefficients of heterogeneous materials with piezoelectric transducers has been studied extensively. However, the fact that the phase cancellation effect may		

DD FORM 1473
1 JAN 73

EDITION OF 1 NOV 65 IS OBSOLETE

UNCLASSIFIED

SECURITY CLASSIFICATION OF THIS PAGE (When Data Entered)

UNCLASSIFIED

SECURITY CLASSIFICATION OF THIS PAGE(When Data Entered)

,also produce considerable error in scattering measurements has only recently been recognized.

In this thesis, a mathematical model for interpretation of error arising from the phase cancellation effect on backscattered waves is developed. Computer simulation has been performed to elucidate the influence of phase cancellation on the average received pressure in terms of transducer aperture size, number of scatterers, target range and frequency for five different scattering configurations; a single point scatterer; linear, rectangular and random arrays; and random volume distributions of point scatterers.

Accession For		
NTIS GRA&I	<input checked="" type="checkbox"/>	
DTIC TAB	<input type="checkbox"/>	
Unannounced	<input type="checkbox"/>	
Justification		
By _____		
Distribution/		
Availability Codes		
Distribution and/or		
Dist		
A		

UNCLASSIFIED

SECURITY CLASSIFICATION OF THIS PAGE(When Data Entered)

ABSTRACT

Piezoelectric transducers are used for converting between electrical and acoustic energy in such diversified fields as medical imaging, underwater acoustic propagation, and non-destructive material testing. This type of transducer when used as a receiver is sensitive to the phase of the received pressure wave. The effect of phase cancellation on the measurements of attenuation coefficients of heterogeneous materials with piezoelectric transducers has been studied extensively. However, the fact that the phase cancellation effect may also produce considerable error in scattering measurements has only recently been recognized.

In this thesis, a mathematical model for interpretation of error arising from the phase cancellation effect on backscattered waves is developed. Computer simulation has been performed to elucidate the influence of phase cancellation on the average received pressure in terms of transducer aperture size, number of scatterers, target range, and frequency for five different scattering configurations; a single point scatterer; linear, rectangular and random arrays; and random volume distribution of point scatterers.

Results of the computer simulation demonstrate that judicious choice of transducer aperture, target range, and operating frequency is necessary to minimize artifact induced by the phase cancellation effect. Based on a maximum 10% error, aperture values of .75 cm or less, farfield target range and frequency range of 1.00 to 15.00 megahertz should be employed when implementing phase-sensitive transducers as receivers.

TABLE OF CONTENTS

	<u>Page</u>
Abstract	iii
List of Figures.	v
Acknowledgments.	ix
 <u>CHAPTER</u>	
I. INTRODUCTION	1
II. FORMULATION OF THE PROBLEM	5
III. RESULTS AND DISCUSSION	11
Single Point Scatterer	11
Linear Scatterer Array	31
Rectangular and Randomly-Distributed Scatterers.	34
Random Volumetric Distribution	48
IV. SUMMARY AND CONCLUSIONS.	50
REFERENCES	56
APPENDIX A: Histogram of Average Received Pressure.	57
APPENDIX B: How To Use The Computer Programs.	66

LIST OF FIGURES

<u>Figure</u>	<u>Page</u>
1. Geometrical configuration of the scattering arrangements.	6
2. Four scattering arrangements which are studied are graphically illustrated	10
3. Phase-cancellation at the transducer surfaces of different size due to a spherical wave generated by a single scatterer located at the center of the incident beam	12
4. Computed normalized pressure amplitude distribution on the face of a 5.00 MHz transducer of .10 cm in diameter situated at 10.00 cm away from the transducer. . .	13
5. Computed normalized pressure amplitude distribution on the face of a 5.00 MHz transducer of .25 cm in diameter situated at 10.00 cm away from the transducer. . .	14
6. Computed normalized pressure amplitude distribution on the face of a 5.00 MHz transducer of .50 cm in diameter situated at 10.00 cm away from the transducer. . .	15
7. Computed normalized pressure amplitude distribution on the face of a 5.00 MHz transducer of .75 cm in diameter situated at 10.00 cm away from the transducer. . .	16
8. Computed normalized pressure amplitude distribution on the face of a 5.00 MHz transducer of 1.00 cm in diameter situated at 10.00 cm away from the transducer. . .	17
9. Computed normalized pressure amplitude distribution on the face of a 5.00 MHz transducer of 1.25 cm in diameter situated at 10.00 cm away from the transducer. . .	18
10. Two-dimensional normalized phase distribution on the face of a 5.00 MHz transducer of .75 cm in aperture at a target range of 10.00 cm	20
11. Two-dimensional normalized amplitude distribution on the face of a 5.00 MHz transducer of .75 cm in aperture at a target range of 10.00 cm.	21
12. Computed normalized pressure amplitude distribution on the face of a 5.00 MHz transducer of .50 cm in diameter at a target range of 5.00 cm	23

<u>Figure</u>	<u>Page</u>
13. Computed normalized pressure amplitude distribution on the face of a 5.00 MHz transducer of .50 cm in diameter at a target range of 7.50 cm	24
14. Computed normalized pressure amplitude distribution on the face of a 5.00 MHz transducer of .50 cm in diameter at a target range of 10.00 cm.	25
15. Computed normalized pressure amplitude distribution on the face of a 5.00 MHz transducer of .50 cm in diameter at a target range of 12.50 cm.	26
16. Computed normalized pressure amplitude distribution on the face of a 5.00 MHz transducer of .50 cm in diameter at a target range of 15.00 cm.	27
17. Computed normalized pressure amplitude distribution on the face of a 5.00 MHz transducer of .50 cm in diameter at a target range of 20.00 cm.	28
18. Average received pressure measured by transducers of .25, .50, .75, 1.00, 1.25, and 1.50 cm in diameter due to a scatterer is plotted versus the range of the system at 5.00 MHz.	29
19. Average received pressure measured by transducers of .10, .25, .50, .75, 1.00, and 1.25 cm in diameter due to a scatterer located 20.00 cm away is plotted versus frequency of the wave	30
20. Computed normalized pressure amplitude distribution on the face of a 5.00 MHz transducer of 1.00 cm in diameter due to a linear array of 25 scatterers located 20.00 cm away from the transducer.	32
21. Computed normalized pressure amplitude distribution on the face of a 5.00 MHz transducer of 1.00 cm in diameter due to a linear array of 100 scatterers located 20.00 cm away from the transducer.	33
22. Average received pressure measured by transducers of .25, .50, .75, 1.00, and 1.25 cm in diameter at 5.00 megahertz and at a range of 15.00 cm versus the number of scatterers.	35
23a. Average received pressure measured by transducers of .25, .50, .75, and 1.00 cm in diameter at 5.00 megahertz and at a range of 20.00 cm versus the number of scatterers.	37

<u>Figure</u>	<u>Page</u>
23b. Average received pressure measured by transducers of .25, .50, .75, and 1.00 cm in diameter at 5.00 megahertz and at a range of 20.00 cm versus the number of scatterers.	38
24. Normalized pressure amplitude distribution on the face of a 5.00 megahertz transducer of .50 cm in diameter due to 50 scatterers located 10.00 cm away from the transducer.	39
25. Normalized pressure amplitude distribution on the face of a 5.00 megahertz transducer of .75 cm in diameter due to 50 scatterers located 10.00 cm away from the transducer.	40
26. Normalized pressure amplitude distribution on the face of a 5.00 megahertz transducer of 1.25 cm in diameter due to 50 scatterers located 10.00 cm away from the transducer.	41
27. Normalized pressure amplitude distribution on the face of a 5.00 megahertz transducer of .50 cm in diameter due to 50 scatterers located 10.00 cm away from the transducer.	42
28. Normalized pressure amplitude distribution on the face of a 5.00 megahertz transducer of .75 cm in diameter due to 50 scatterers located 10.00 cm away from the transducer.	43
29. Normalized pressure amplitude distribution on the face of a 5.00 megahertz transducer of 1.25 cm in diameter due to 50 scatterers located 10.00 cm away from the transducer.	44
30. Average received pressure measured by transducers of .25, .50, .75, 1.00, and 1.25 cm due to 200 scatterers arranged in a rectangular distribution at 5.00 megahertz versus range.	46
31. Average received pressure measured by transducers of .10, .25, .50, .75, and 1.00 cm in diameter due to 200 scatterers at a range of 20.00 cm versus frequency. . .	47
32. Average received pressure measured by a .25 cm transducer at a range of 15.00 cm with a frequency of 5.00 megahertz versus the number of scatterers.	49
33. Average received pressure versus R/D for the random planar distribution	52

<u>Figure</u>	<u>Page</u>
34. Average received pressure measured by transducers of .25, .50, .75, 1.00, 1.25, and 1.50 cm in diameter versus R/F for the random planar distribution	53
35. Average received pressure versus $R\lambda/D$ for the random planar distribution	54
36. Average received pressure versus the number of occurrences for a single point scatterer at a range of 7.50 cm and aperture of .50 cm over 25 trials.	59
37. Average received pressure versus the number of occurrences for a single point scatterer at a range of 7.50 cm and aperture of .75 cm over 25 trials.	60
38. Average received pressure versus the number of occurrences for a single point scatterer at a range of 7.50 cm and aperture of 1.00 cm over 25 trials	61
39. Average received pressure versus the number of occurrences for a single point scatterer at a range of 7.50 cm and aperture of 1.25 cm over 25 trials	62
40. Average received pressure versus the number of occurrences for 200 scatterers at a range of 20.00 cm and aperture of .50 cm over 25 trials.	63
41. Average received pressure versus the number of occurrences for 200 scatterers at a range of 20.00 cm and aperture of .75 cm over 25 trials.	64
42. Average received pressure versus the number of occurrences for 200 scatterers at a range of 20.00 cm and aperture of 1.00 cm over 25 trials	65
43. Sample input to program PHASE	67

ACKNOWLEDGMENTS

The author gratefully acknowledges the continued support and direction of Dr. K. Kirk Shung. The author also wishes to acknowledge the staff of the Hybrid Computer Laboratory, Mr. Adam D. Savakus and Mr. Alan J. Snyder for the assistance they have provided in this work.

This work was supported by The Pennsylvania State University, Applied Research Laboratory under contract with the U.S. Naval Sea Systems Command and NSF grant DAR 80-18415.

CHAPTER I

INTRODUCTION

Sound is a mechanical wave which can be produced by an object vibrating in a medium, such as air, water, metal, or tissue. Sound waves have been found extremely useful in such diversified fields as medical imaging, non-destructive material testing and underwater warfare. Ultrasound refers to sound waves above the frequency of human hearing (approximately 20 kilohertz). It is sensitive to density and structural variations in biological tissue and materials. In the case of ultrasonic medical imaging, in vivo measurements are possible without harmful side effects of ionizing radiation, such as X-rays. Similarly, ultrasonic material evaluation for flaw detection and fatigue can be performed without actual destruction of the material during the testing procedure. Fundamentally, scattering and reflection of sound waves occurs if there is a mismatch of acoustic propagation properties such as velocity, density, and compressibility between two media. The reflected or scattered sound waves are detected and electronically processed to provide information regarding the dimensions and locations of nonuniformities within the interrogated material. Overall, the success of utilizing sound waves as a medium for investigation purposes lies within the non-destructive nature of sound and its sensitivity to changes in elastic properties of the material on a level significant to imaging requirements. In some applications, sound is generated by electrically exciting a piezoelectric crystal such as quartz or Lead Zirconate Titanate (PZT).

The piezoelectric transducer, when used as a receiver of sound waves, however, is sensitive to the phase of the impinging sound wave. This phase sensitive nature of the piezoelectric transducer may give rise to serious consequences in situations involving the determinations of acoustic propagation parameters such as attenuation and scattering of inhomogeneous materials. This is basically due to the non-uniformness of the wavefront of the scattered wave or waves which have traversed through heterogeneous materials arriving at the face of a finite-aperture transducer. This fact implies that the phase differences among wavelets arriving at different areas of the transducers surface may be significant enough that signal cancellation results.

The artifact caused by the phase-sensitive nature of the piezoelectric receivers which is termed the phase cancellation effect in the attenuation measurements of an inhomogeneous medium was first addressed by Marcus and Carstensen (1975). Their work indicated a good correlation between the relative degree of sample inhomogeneity and the magnitude of the absorption error, as measured by a conventional phase-sensitive receiver. Marcus and Carstensen experimentally compared a radiation force known as an acoustic-electric receiver (AET) with a conventional piezoelectric receiver (PET) for the measurement of the absorption coefficient of various homogeneous and inhomogeneous materials. For 2% agar samples, an acoustically uniform material, the attenuation measured by both types of transducers proved similar. However, for beef muscle, an acoustically inhomogeneous tissue, attenuation values differed. For measurements at 2.00 megahertz, the piezoelectric receiver had absorption coefficients ranging from 0.21 to 1.15 nepers/cm, whereas a radiation force receiver measured 0.21 to

0.24 nepers/cm. The wide range of absorption values measured by a piezoelectric transducer was attributed to the phase cancellation artifact on the surface of the receiving piezoelectric element. They, therefore, suggested the use of a phase-insensitive acoustic-electric receiver in this type of measurement.

Further work by Busse and Miller (1976) substantiated the existence of phase cancellation effects, noting the influence of transducer aperture on absorption measurements (indicating that a reduction of phase cancellation error is possible with a decrease in transducer aperture) and experimentally compared the PZT and AET. The AET, utilizing a cadmium sulfide crystal, virtually eliminated the phase cancellation effect arising from structurally inhomogeneous tissue specimens. This transducer was sensitive to the total power of the incident acoustic wave, not the impinging phasefront. Heyman (1979) investigated the effects of phase cancellation on inhomogeneous material characterization (largely anisotropic stressed metal samples) by PZT and AET and found a notable difference in the attenuation measurements. Furthermore, materials with irregular flatness and parallelism also influence the degree of phase cancellation.

Reid, Shung, and Kak (1979) have expanded the concept of phase cancellation to include scattered or reflected waves. Data for scattered waves showed that the scattered strength per unit volume of scatterers of dilute polystyrene spheres, suspended in mixed solution of water and glycerine and measured with a piezoelectric transducer of 1.00 cm in diameter located 16.00 cm from the scatterers, is 1.7 dB lower than that obtained with a piezoelectric transducer of smaller diameter (0.635 cm).

In this thesis errors which may be introduced due to the phase cancellation artifact in backscattering measurements are examined based on computer simulation of the experimental process. Parameters of interest include transducer aperture, number of scatterers, distance between the transducer and scattering medium, and frequency. The pressure received by the transducer is compared to a small microprobe with a diameter of 1.0 mm which can be approximated as a point receiver in the lower megahertz range. This investigation also includes varied scattering arrangements. The first and simplest case is a single point scatterer located at the center of the ultrasonic beam profile. This arrangement is useful for two reasons: the effect of path length differences on the phase of the pressure wave between the center and edges of the transducer are readily apparent and computations are greatly simplified. The second scattering arrangement is a linear array, or a single line of point scatterers extending from one edge of the transducer to the opposite edge. Rectangular and random two-dimensional arrangements of point scatterers distributed over a plane parallel to the transducer face are other configurations modelled. These two configurations, along with a random volume arrangement, more closely approximate the experimental acoustic backscattering arrangements.

CHAPTER II

FORMULATION OF THE PROBLEM

To facilitate computation, the transducer aperture is divided into N elements, which are small enough so that the pressure received by element n can be represented by the pressure received at the center of the small element (point n), as shown in Figure 1. Assuming that the incident wave is a monochromatic plane wave, we have:

$$\begin{aligned} P_i &= \text{incident pressure at scatterer } j \\ &= P(0)e^{ikR_j} \end{aligned} \quad [1]$$

where k is the wave number (radians/cm), $P(0)$ is the pressure transmitted by the transducer and R_j is the distance along the axis perpendicular to the transducer face to scatterer j within the volume.

For conversion from the three-dimensional case as presented in Figure 1 to the two-dimensional case, let $R_j = R$, where R is the target range, or let L , the thickness of the scattering volume, approach zero. The scatterers would then be placed within the plane rather than in the scattering volume. Introducing the condition $R \gg D^2/\lambda$, where D is the diameter of the scatterers and λ is the wavelength, the scattered wave, P_{nj} , at point n on the transducer face due to a scatterer j within the scattering volume, can be approximated by the following equation:

$$P_{nj} = P_i \frac{S_j(\hat{o}, \hat{i})}{r_{nj}} e^{ik(r_{nj})} \quad [2]$$

where $S_j(\hat{o}, \hat{i})$ is the scattering amplitude function of the j th scatterer and \hat{o}, \hat{i} are unit vectors representing observation and incident directions,

TRANSDUCER FACE SCATTERING VOLUME

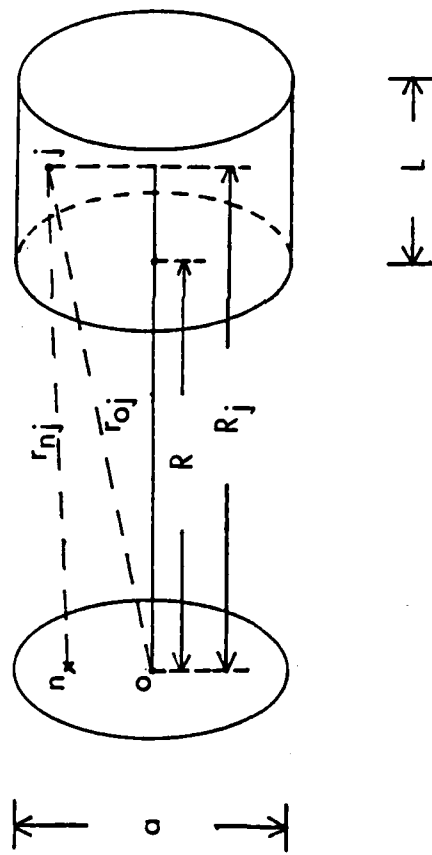

Figure 1. Geometrical configuration of the scattering arrangements.

respectively. Substituting P_i from equation [1] into equation [2] yields:

$$P_{nj} = \frac{P(0) S_j(\hat{\theta}, \hat{\mathbf{i}})}{r_{nj}} e^{ik(R_j + r_{nj})} \quad [3]$$

Similarly the scattered wave at the center of the transducer face, point o, due to the scatterer j, P_{oj} is given by:

$$P_{oj} = \frac{P(0) S_j(\hat{\theta}, \hat{\mathbf{i}})}{r_{oj}} e^{ik(R_j + r_{oj})} \quad [4]$$

P_{oj} will be simultaneously developed with P_{nj} for use as a reference (this will be elaborated in several steps). If $kD \gg 1$, we can further assume that scatterers within the scattering volume are identical point scatterers and are at rest within the scattering arrangement. For identical point scatterers, $S_j(\hat{\theta}, \hat{\mathbf{i}})$ is a constant independent of $\hat{\theta}$ and $\hat{\mathbf{i}}$, therefore $S_j(\hat{\theta}, \hat{\mathbf{i}}) = s$.

$$P_{nj} = \frac{P(0)s}{r_{nj}} e^{ik(R_j + r_{nj})} \quad [5]$$

and

$$P_{oj} = \frac{P(0)s}{r_{oj}} e^{ik(R_j + r_{oj})} \quad [6]$$

Here a single scattering process is assumed. The assumptions generally hold if the scatterer concentration is low and $kD \gg 1$. Now further assuming $R \gg a$ (a is diameter of the transducer aperture) and $R \gg L$ (L is the thickness of the scattering volume), $r_{nj} \cong r_{oj} \cong R$. However,

this approximation is not applicable to the phase term because very small changes in path lengths produce substantial phase variation.

We thus obtain:

$$P_{nj} = \frac{P(0)s}{R} e^{ik(R_j+r_{nj})} \quad [7]$$

and

$$P_{oj} = \frac{P(0)s}{R} e^{ik(R_j+r_{oj})} \quad [8]$$

As previously stated, the intention of this thesis is to elucidate the phase cancellation effect on the transducer aperture. This is accomplished by expressing the average received pressure as determined by finite-aperture transducers in terms of pressure received by a point receiver located at point o, therefore P_{nj} is normalized with respect to P_{oj} . In this way, the phase at point o is used as reference and only the relative phase difference between point n and point o is considered, i.e.,

$$\begin{aligned} P_{nj}/P_{oj} &= e^{ik(r_{nj}-r_{oj})} \\ &= e^{i\theta_{nj}} \end{aligned} \quad [9]$$

The phase value at the center becomes 0.0 degrees as a result of this normalization process and as a consequence, the calculated phase value over a certain point on the transducer face indicates the phase of the wave at that point relative to the center of the transducer.

If there are M scatterers in the scattering volume, the average received pressure P_{ave} received by the transducer is then given by:

$$\begin{aligned}
 P_{ave} &= \frac{1}{N} \sum_{n=1}^N \sum_{j=1}^M e^{i\theta_{nj}} \\
 &= P e^{i\theta}
 \end{aligned}
 \tag{10}$$

where P , θ are the magnitude and phase of P_{ave} .

The amplitude of the average pressure AMP can be obtained by taking the real part of P_{ave} :

$$AMP = \text{Real}(P e^{i\theta})
 \tag{11}$$

Figure 2 depicts the first four scattering arrangements used in the computer model. The particle dimension in this figure is exaggerated for the sake of illustrating the scattering configurations. Although not depicted here, the random volumetric arrangement is similar to the random planar distribution, except that the scatterers are randomly dispersed within a cylinder of thickness L .

In the computer model, N , the number of elements representing the transducer surface area, is assigned a value of 431.

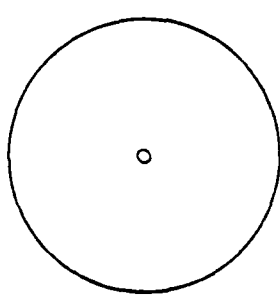

POINT

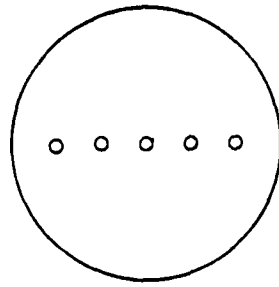

LINEAR

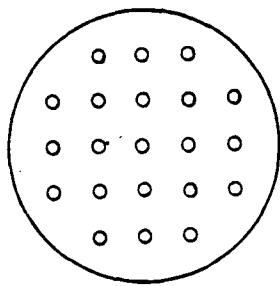

RECTANGULAR

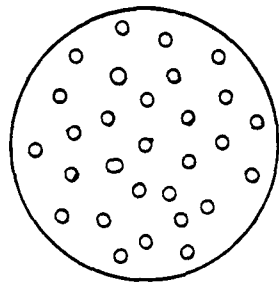

RANDOM

Figure 2. Four scattering arrangements which are studied are graphically illustrated.

CHAPTER III

RESULTS AND DISCUSSION

The results and discussion are presented in the following according to the five scattering configurations studied.

Single Point Scatterer

The significance of a physical phenomenon can usually be revealed more readily with simple examples. Therefore, this study included the simplest scattering arrangement possible, depicted in Figure 3, which shows a spherical wave originated from a scatterer located at the center of the ultrasonic beam impinging upon circular transducers with aperture sizes of A_1 and A_2 . It becomes readily apparent from this figure that the phase differences θ_1 and θ_2 between waves arriving at the center and the edge of the transducers depend upon the aperture size of the transducer and the target range as well as the frequency of the wave. These are the three parameters which have been investigated for this case.

Figures 4 through 9 show the three-dimensional normalized amplitude distribution across the transducer face for apertures of .10, .25, .50, .75, 1.00, and 1.25 cm at a frequency of 5.00 megahertz and range of 10.00 cm. Figure 4 establishes that the pressure amplitude over a transducer with an aperture of 1.00 mm in diameter is virtually constant. Therefore, the phase cancellation effect for transducers with small apertures is negligible. It will be seen later on that this statement holds for all scattering configurations studied. This is

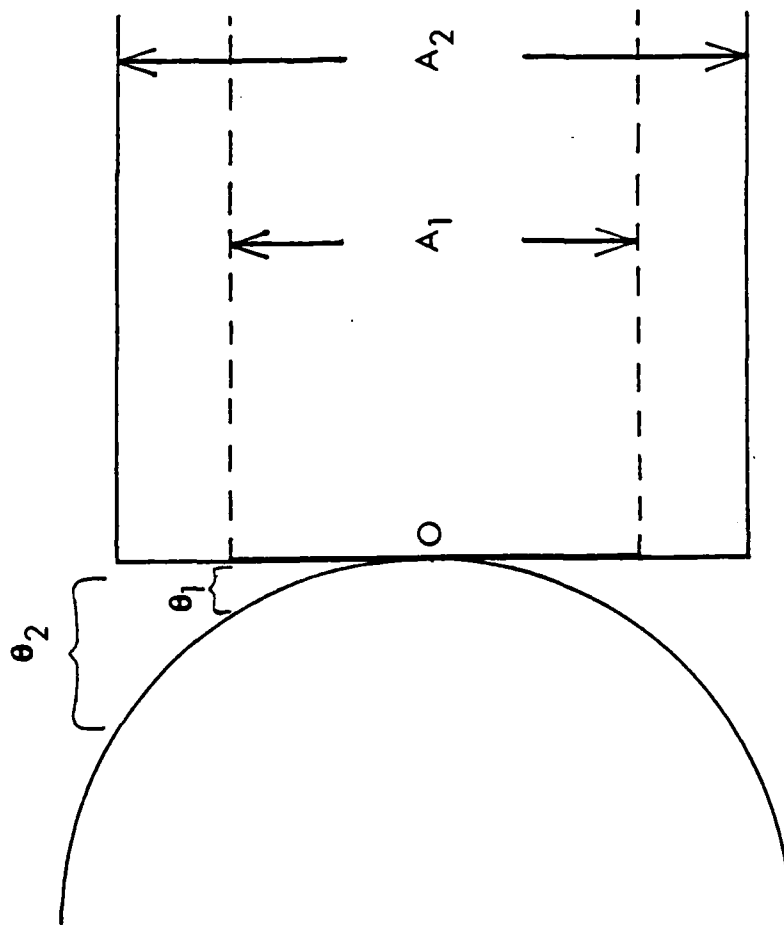

Figure 3. Phase-cancellation at the transducer surfaces of different size due to a spherical wave generated by a single scatterer located at the center of the incident beam.

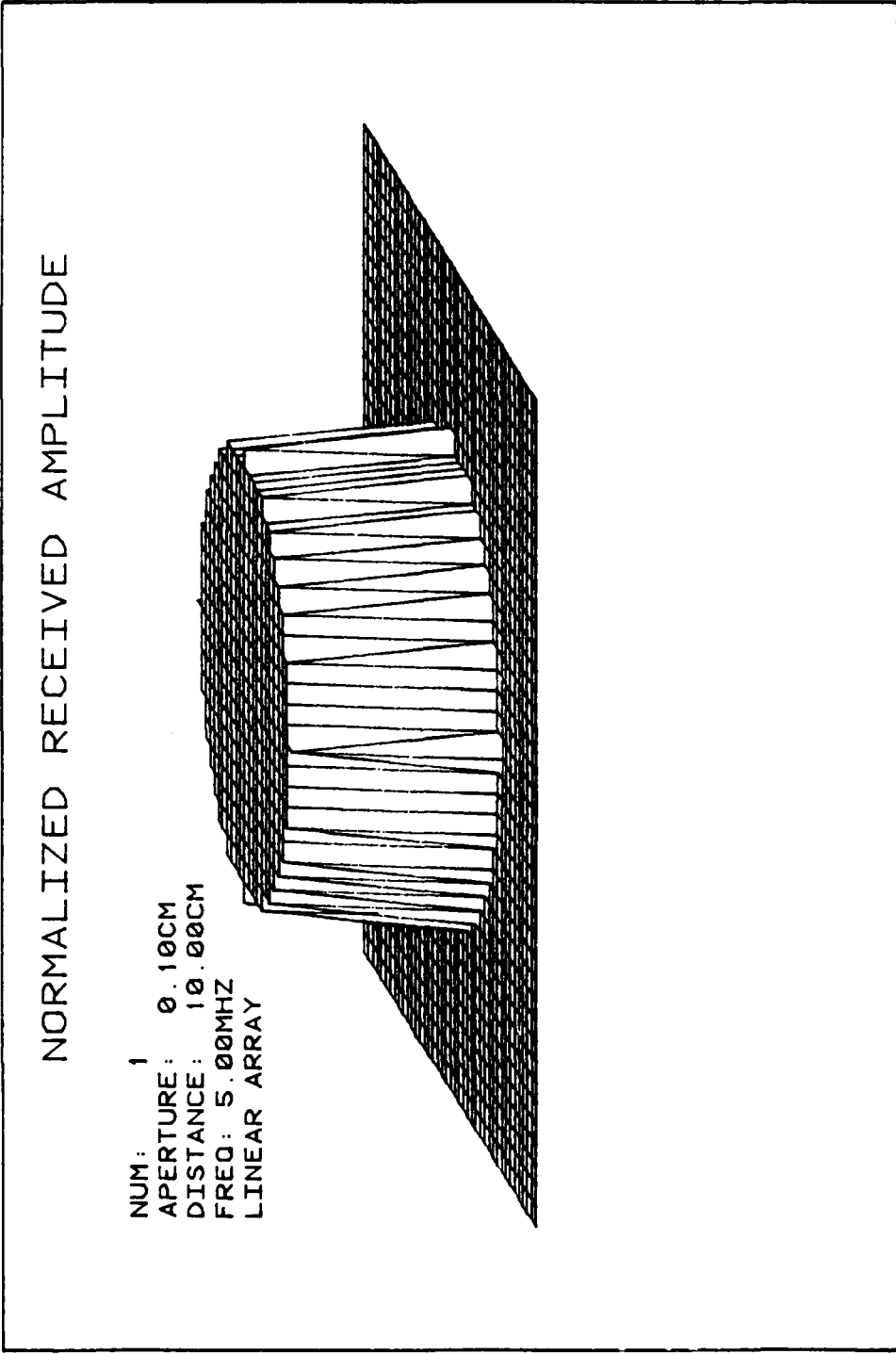

Figure 4. Computed normalized pressure amplitude distribution on the face of a 5.00 MHz transducer of .10 cm in diameter situated at 10.00 cm away from the transducer.

NORMALIZED RECEIVED AMPLITUDE

NUM: 1
APERTURE: 0.25CM
DISTANCE: 10.00CM
FREQ: 5.00MHZ
LINEAR ARRAY

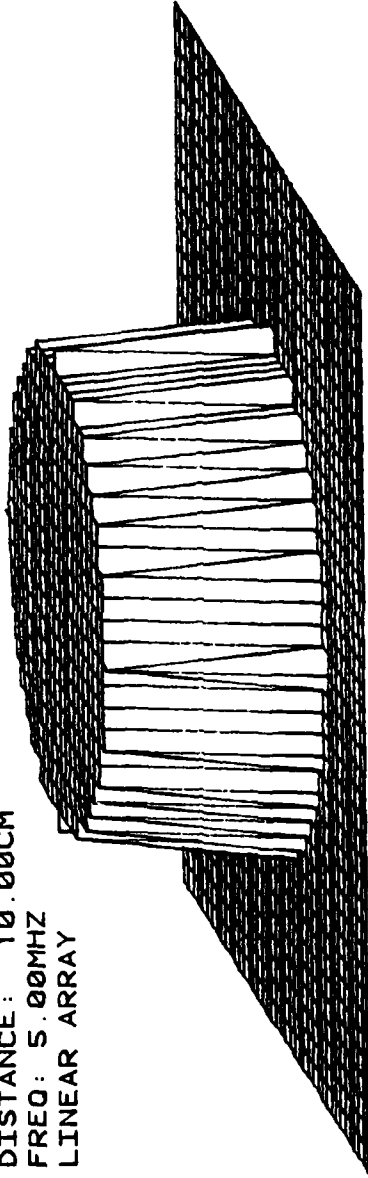

Figure 5. Computed normalized pressure amplitude distribution on the face of a 5.00 MHz transducer of .25 cm in diameter situated at 10.00 cm away from the transducer.

NORMALIZED RECEIVED AMPLITUDE

NUM: 1
APERTURE: 0.50CM
DISTANCE: 10.00CM
FREQ: 5.00MHZ
LINEAR ARRAY

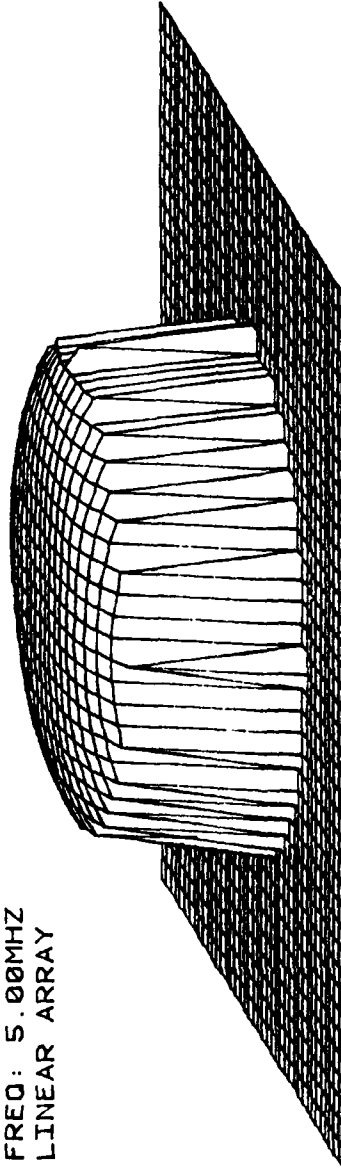

Figure 6. Computed normalized pressure amplitude distribution on the face of a 5.00 MHz transducer of .50 cm in diameter situated at 10.00 cm away from the transducer.

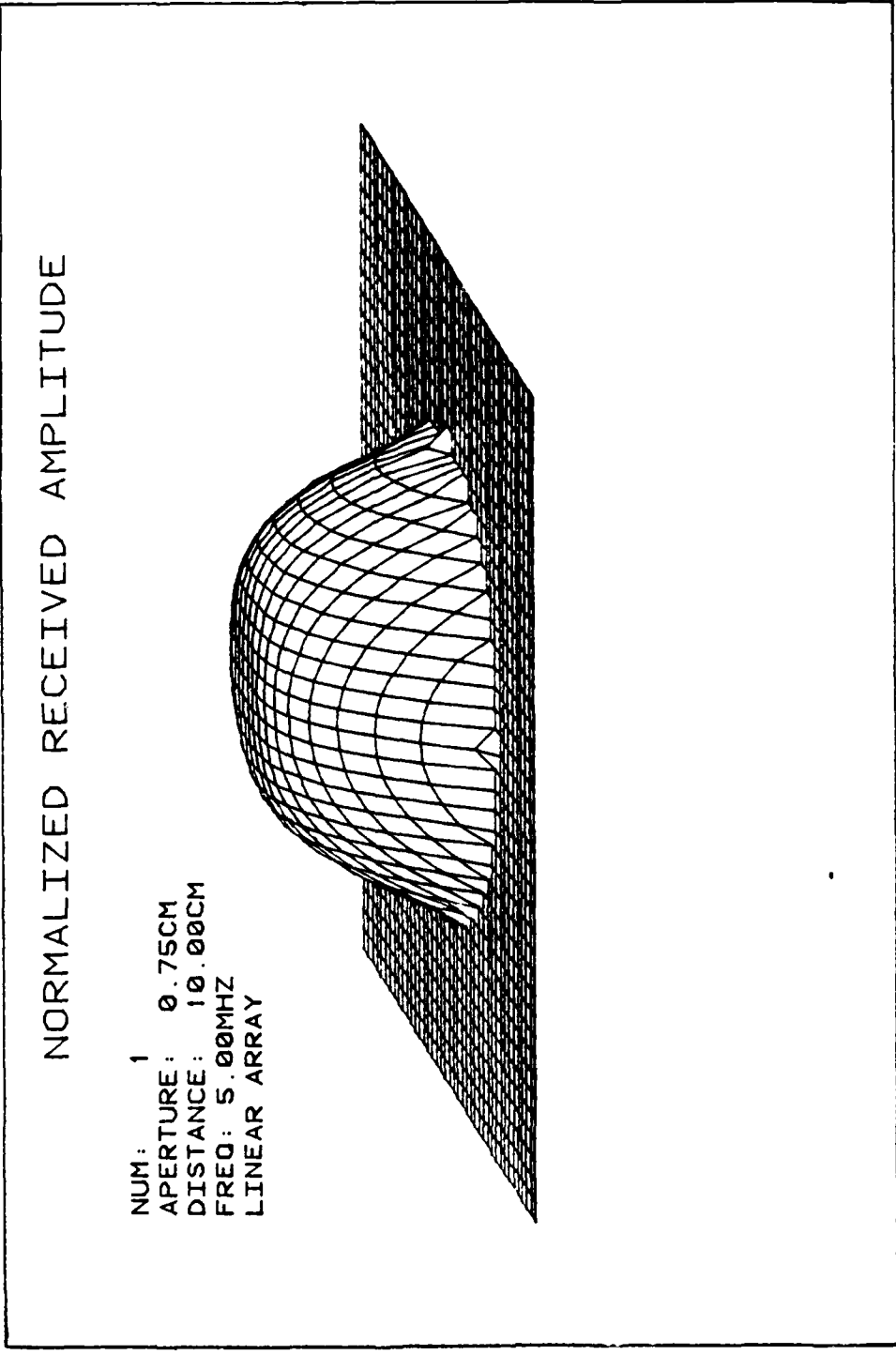

Figure 7. Computed normalized pressure amplitude distribution on the face of a 5.00 MHz transducer of .75 cm in diameter situated at 10.00 cm away from the transducer.

NORMALIZED RECEIVED AMPLITUDE

NUM: 1
APERTURE: 1.00CM
DISTANCE: 10.00CM
FREQ: 5.00MHZ
LINEAR ARRAY

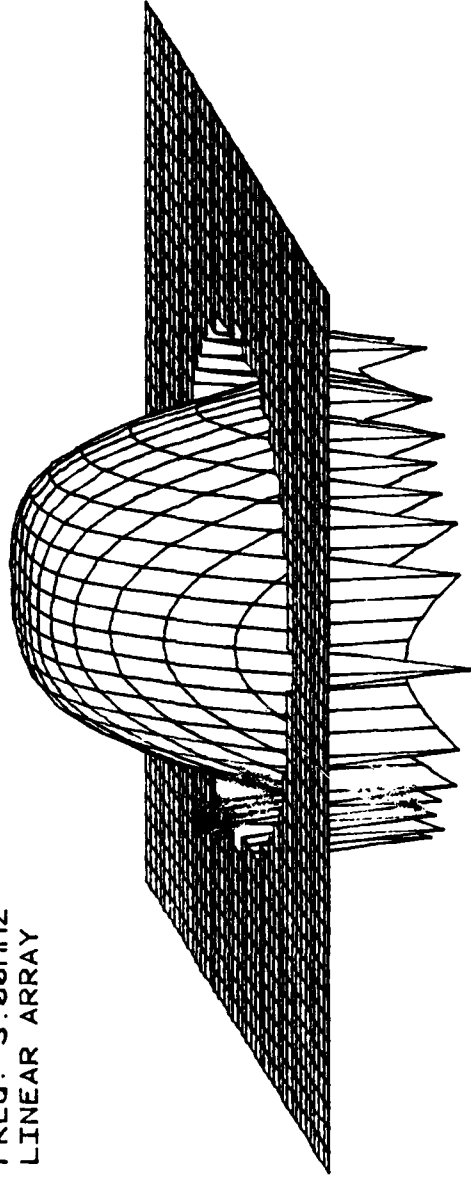

Figure 8. Computed normalized pressure amplitude distribution on the face of a 5.00 MHz transducer of 1.00 cm in diameter situated at 10.00 cm away from the transducer.

NORMALIZED RECEIVED AMPLITUDE

NUM: 1
APERTURE: 1.25CM
DISTANCE: 10.00CM
FREQ: 5.00MHZ
LINEAR ARRAY

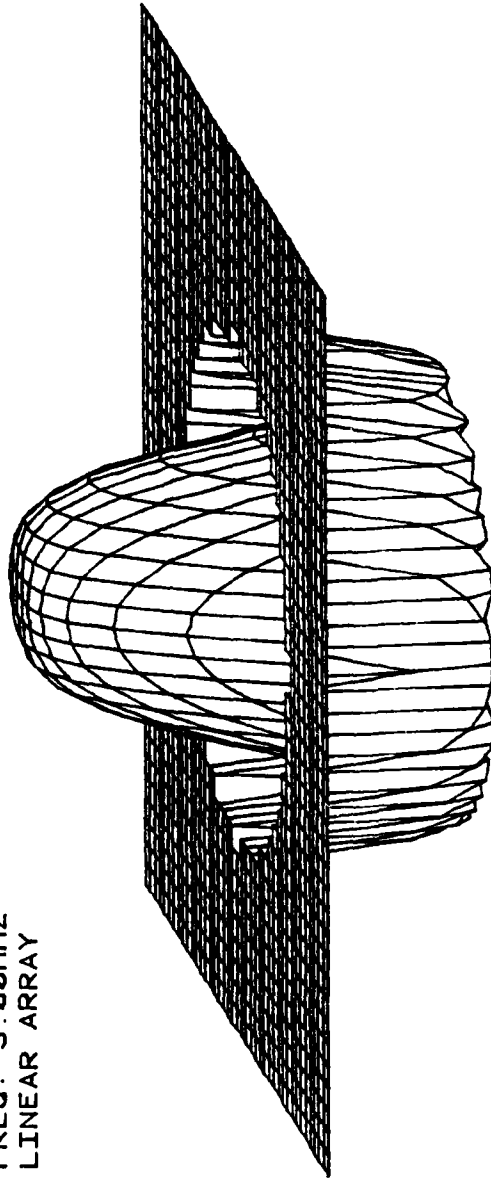

Figure 9. Computed normalized pressure amplitude distribution on the face of a 5.00 MHz transducer of 1.25 cm in diameter situated at 10.00 cm away from the transducer.

part of the reason that 1.00 mm aperture probe has been adopted as the reference to which results obtained for transducers of larger size are compared. Results for an aperture of .25 cm, shown in Figure 5, also indicate an excellent response with little error due to phase cancellation. Upon increasing the aperture to .50 cm a slight distortion appears at the edges of the transducer resulting in a moderate 6.88% drop in the average received pressure (Figure 6). The maximum phase difference of 37.49° occurs near the edge of the transducer. The average received pressure drops an overall 31.94% as the transducer aperture is increased to .75 cm. The two-dimensional display of the phase distribution across this transducer face is shown in Figure 10. The phase value at the center of the transducer is zero degrees as discussed in the section on the mathematical formulation. To simplify the illustration without loss of meaningful data, only the integer values at each location were printed. Note the symmetry of the phase distribution across the transducer face. It follows that the amplitude distribution would also be symmetrical as seen in Figure 11. Further enlargement of the transducer apertures increases the influence of phase cancellation on the amplitude and phase distributions, average received pressure, and phase differences (Figures 8 and 9). Results for an aperture of 1.25 cm show that the amplitude pressure vary across the full range of 1.00 to -1.00; similarly, the phase varies from 0.00° to 360.00° . It is reasonable to predict, just based on these results, that experimental data measured from a transducer of this aperture (target range of 10.00 cm and frequency of 5.00 megahertz) would not best portray the acoustic properties of the material under investigation.

Target range has a strong effect on transducer performance as

well. Intuitively, as R , the distance between the transducer and scatterers is increased, the scattered wave front that reaches the receiver should more approach a plane wave due to $1/R$ nature of scattered spherical waves.

Holding aperture constant at .50 cm (frequency: 5.00 megahertz) Figures 12 through 17 demonstrate, as range is increased from 5.00 cm to 20.00 cm, the normalized received amplitude variation on the transducer face diminishes. Data also indicate, that the maximum phase differences decrease markedly from 74.95° to 18.75° for the previously mentioned range values. Distances greater than 10.00 cm indicate an error in the amplitude distribution of under 5%, which can be visually substantiated from Figure 15 through 17 where little edge distortion is evident.

A summary of average received pressure versus target range at apertures of .25, .50, .75, 1.00, 1.25, and 1.50 cm is presented in Figure 18 (frequency: 5.00 megahertz). At an aperture of 1.00 cm, minimum target ranges of 48.00 and 34.00 cm are necessary for maintaining the decreases in average received pressure at 5% and 10% respectively while ranges of only 12.00 and 9.00 cm are required for an aperture of .50 cm. Overall, this plot indicates that for apertures above .75 cm, large distances are required to reduce the phase cancellation effect.

The influence of frequency on transducer performance is illustrated in Figure 19, in which average received pressure determined by transducers of various aperture sizes due to a scatterer located at 20.00 cm from the transducer is plotted versus the frequency of the wave. Clearly indicated in this figure is that phase cancellation

NORMALIZED RECEIVED AMPLITUDE

NUM: 1
APERTURE: 0.50CM
DISTANCE: 5.00CM
FREQ: 5.00MHZ
LINEAR ARRAY

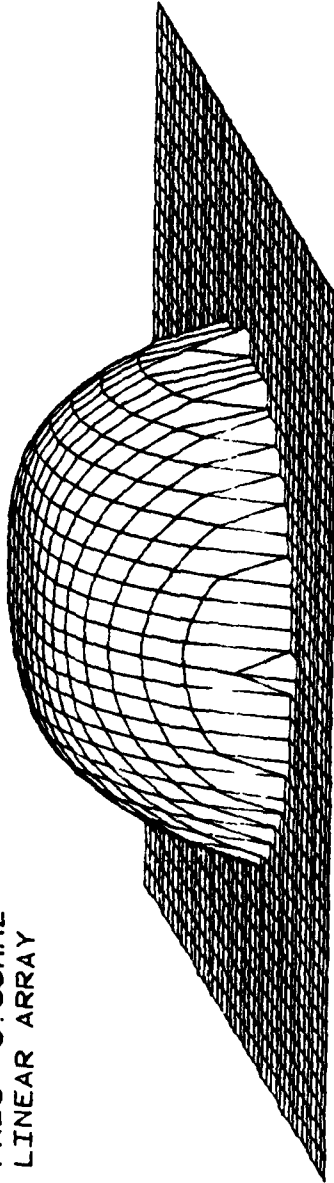

Figure 12. Computed normalized pressure amplitude distribution on the face of a 5.00 MHz transducer of .50 cm in diameter at a target range of 5.00 cm.

NORMALIZED RECEIVED AMPLITUDE

NUM: 1
APERTURE: 0.50CM
DISTANCE: 7.50CM
FREQ: 5.00MHZ
LINEAR ARRAY

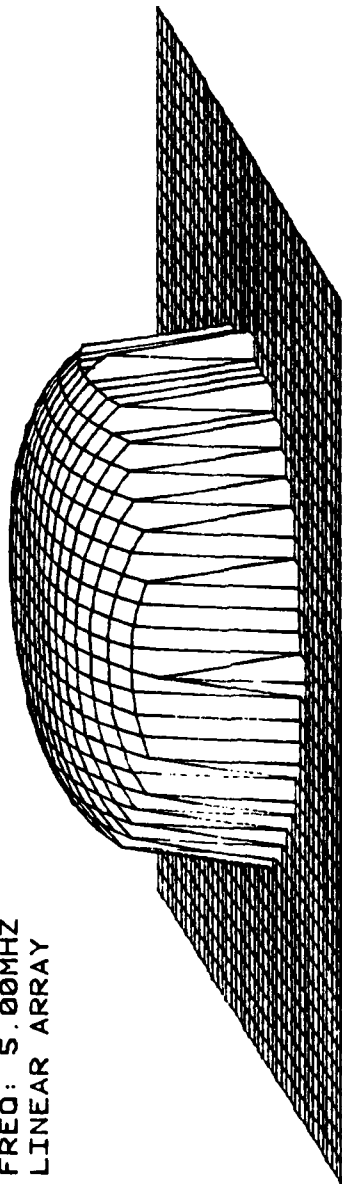

Figure 13. Computed normalized pressure amplitude distribution on the face of a 5.00 MHz transducer of .50 cm in diameter at a target range of 7.50 cm.

NORMALIZED RECEIVED AMPLITUDE

NUM: 1
APERTURE: 0.50CM
DISTANCE: 10.00CM
FREQ: 5.00MHZ
LINEAR ARRAY

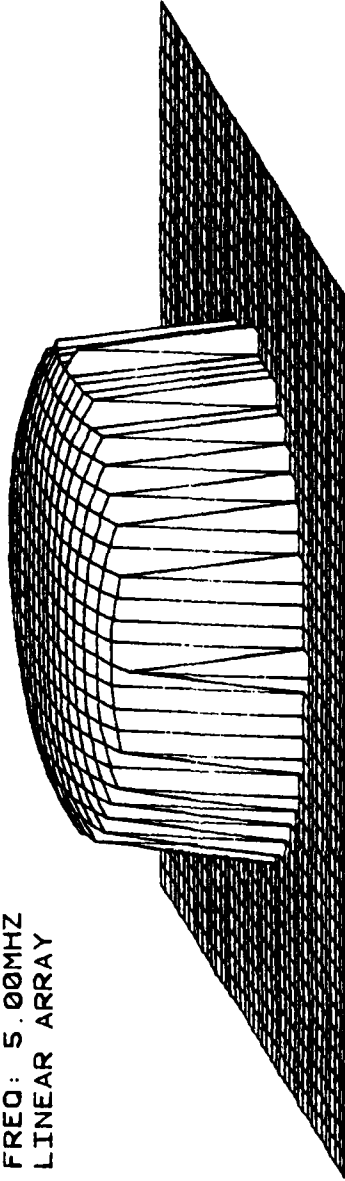

Figure 14. Computed normalized pressure amplitude distribution on the face of a 5.00 MHz transducer of .50 cm in diameter at a target range of 10.00 cm.

NORMALIZED RECEIVED AMPLITUDE

NUM: 1
APERTURE: 0.50CM
DISTANCE: 12.50CM
FREQ: 5.00MHZ
LINEAR ARRAY

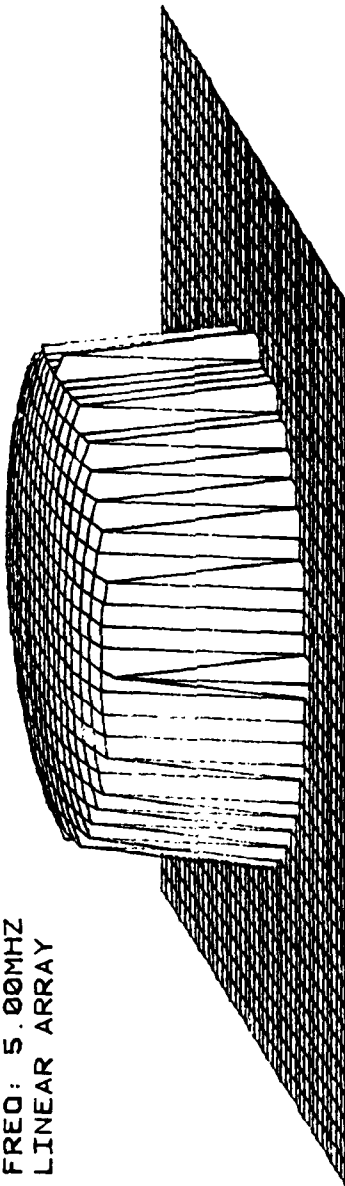

Figure 15. Computed normalized pressure amplitude distribution on the face of a 5.00 MHz transducer of .50 cm in diameter at a target range of 12.50 cm.

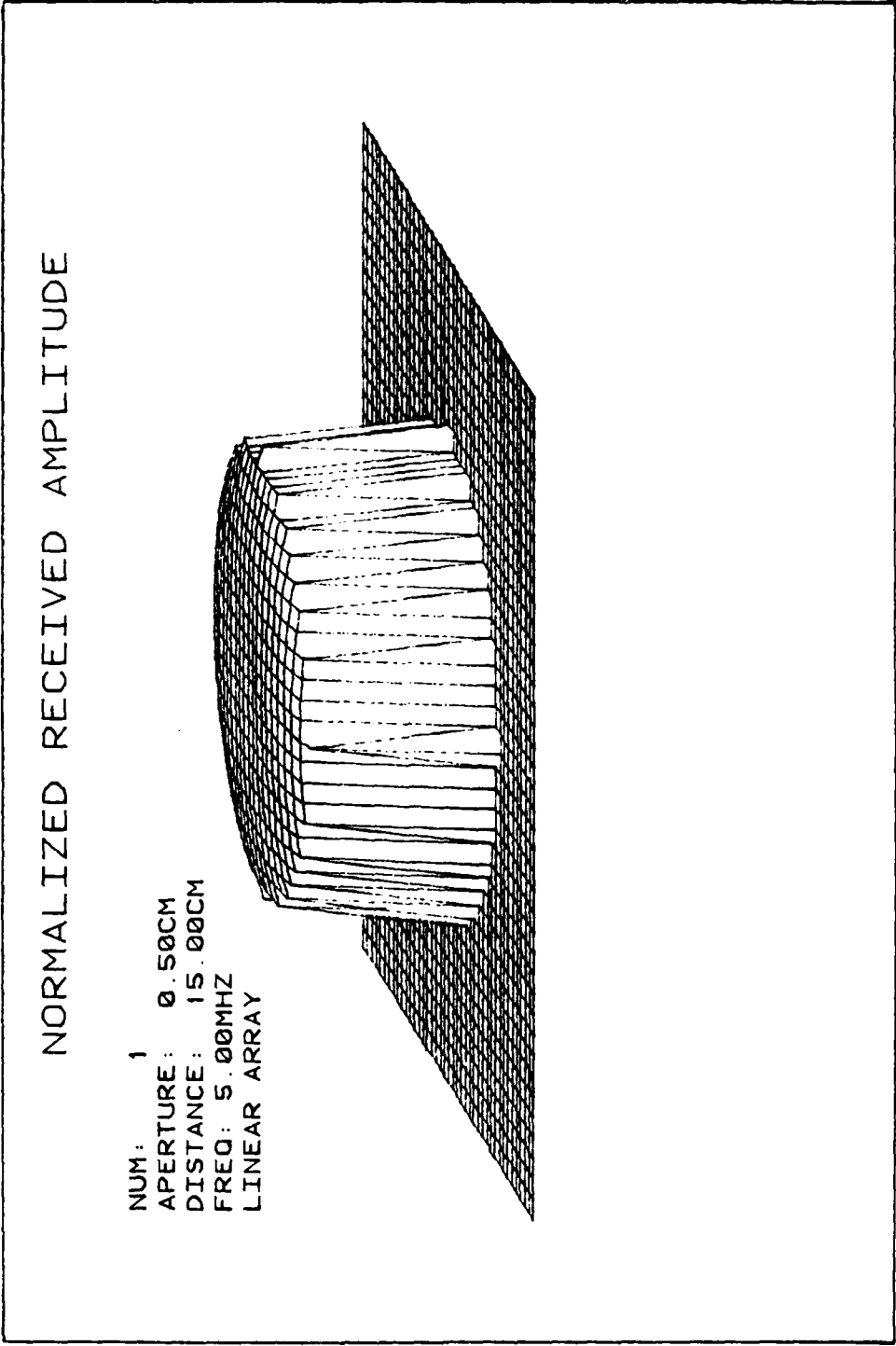

Figure 16. Computed normalized pressure amplitude distribution on the face of a 5.00 MHz transducer of .50 cm in diameter at a target range of 15.00 cm.

NORMALIZED RECEIVED AMPLITUDE

NUM: 1
APERTURE: 0.50CM
DISTANCE: 20.00CM
FREQ: 5.00MHZ
LINEAR ARRAY

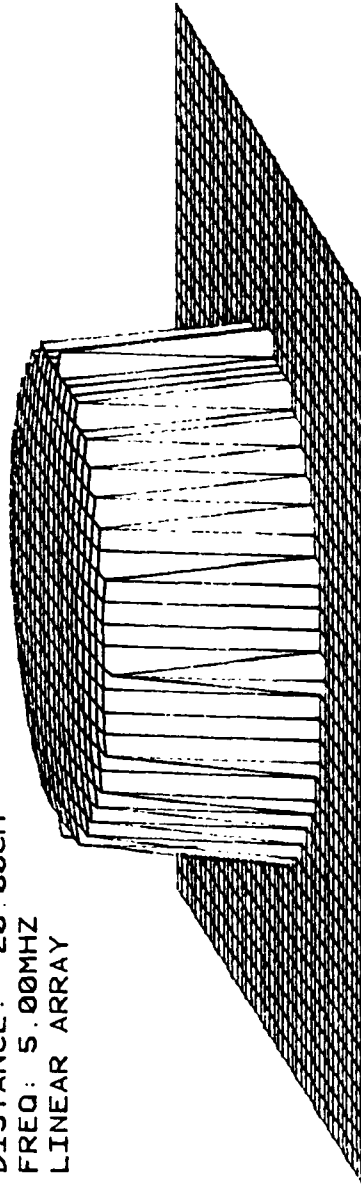

Figure 17. Computed normalized pressure amplitude distribution on the face of a 5.00 MHz transducer of .50 cm in diameter at a target range of 20.00 cm.

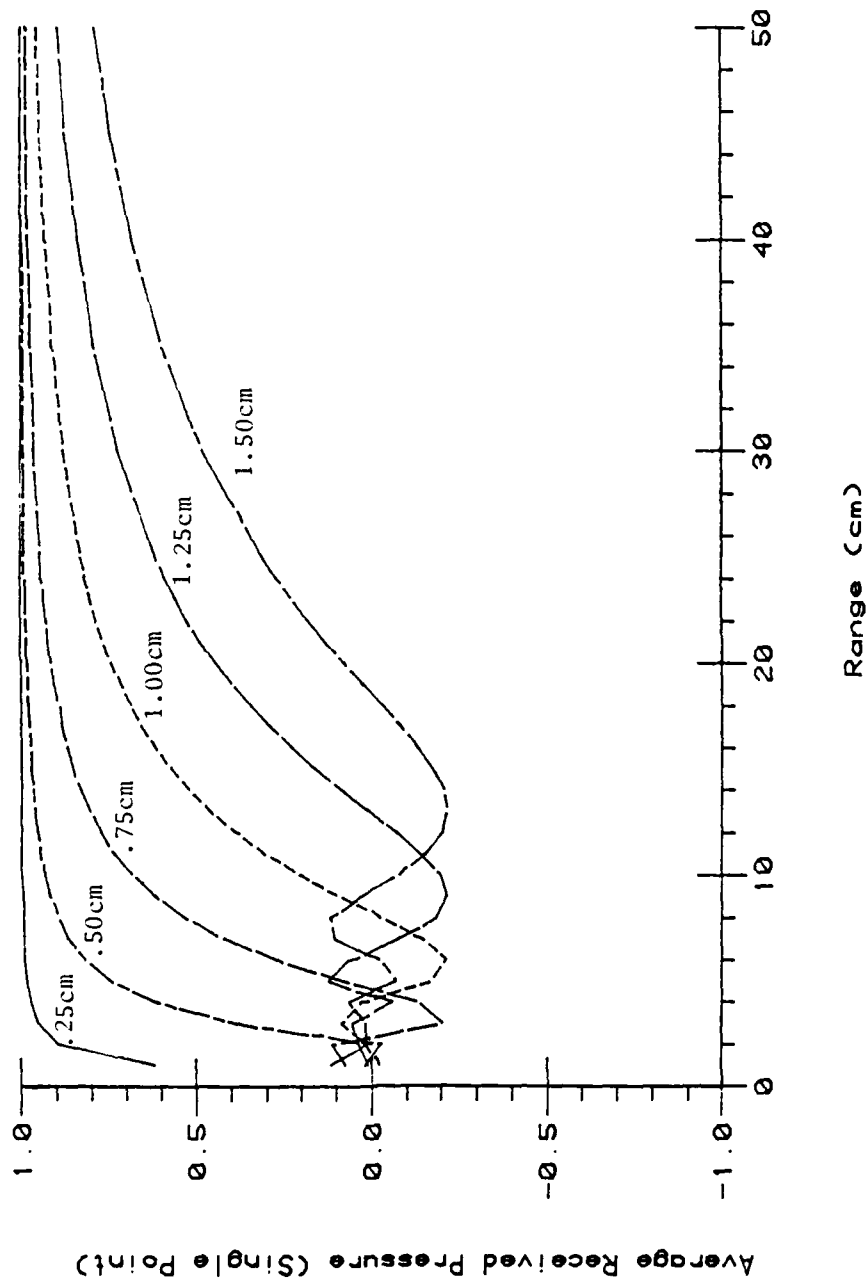

Figure 18. Average received pressure measured by transducers of .25, .50, .75, 1.00, 1.25, and 1.50 cm in diameter due to a scatterer is plotted versus the range of the system at 5.00 MHz.

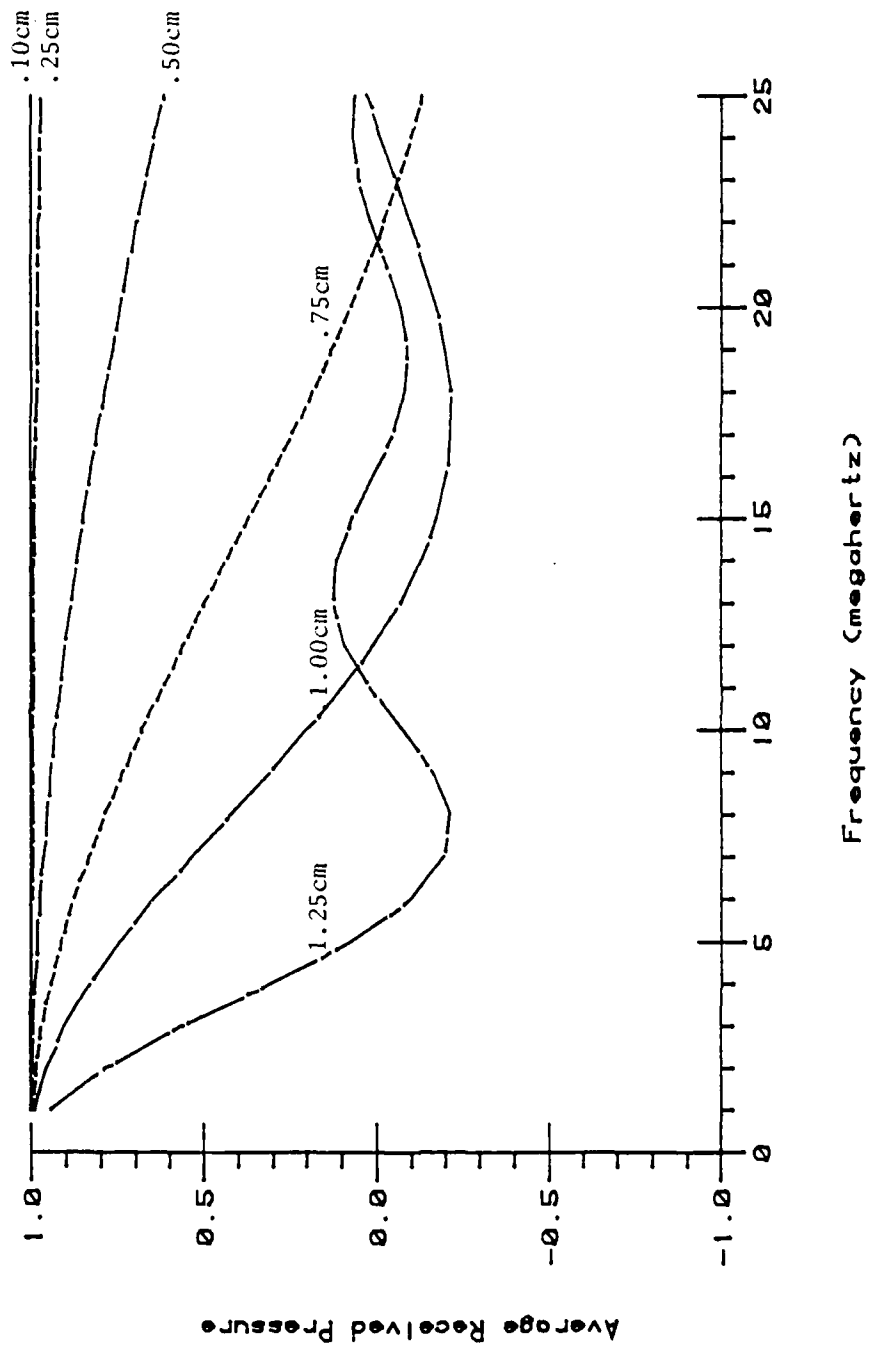

Figure 19. Average received pressure measured by transducers of .10, .25, .50, .75, 1.00, and 1.25 cm in diameter due to a scatterer located 20.00 cm away is plotted versus frequency of the wave.

error can be reduced by using small aperture transducers and that this is especially critical for frequencies above 10.00 megahertz. Transducers with apertures less than .50 cm at frequencies under 10.00 megahertz when operated at this range suffer a maximum drop in average received pressure of less than 20%.

The above presented data for aperture, range, and frequency demonstrate a clear interrelationship between these experimental parameters and the magnitude of error induced by the phase cancellation effect.

Linear Scatterer Array

The normalized pressure distribution on a 5.00 megahertz transducer surface of 1.00 cm in diameter, with 25 scatterers arranged in a linear format as indicated in Figure 2 located 20.00 cm away from the transducer, is depicted in Figure 20. This figure shows that severe destructive interference due to phase cancellation occurs near the edges of the transducer perpendicular to the axis of the array. Along these edges a maximum phase difference of 74.97° was calculated, whereas at the opposing edge, where little error is evident, a phase difference of 2.09° was determined. This amplitude distribution had an average received pressure of .8489. When the number of scatterers was increased to 100, holding all other parameters constant, only extremely small changes in the three-dimensional plot, phase difference and average received pressure occurred (less than .01%). The three-dimensional plot utilizing 100 scatterers is shown in Figure 21 and the associated average received pressure is .8485.

Further computation relating the average received pressure to the number of scatterers for 5.00 megahertz using different aperture

NORMALIZED RECEIVED AMPLITUDE

NUM: 25
APERTURE: 1.00CM
DISTANCE: 20.00CM
FREQ: 5.00MHZ
LINEAR ARRAY

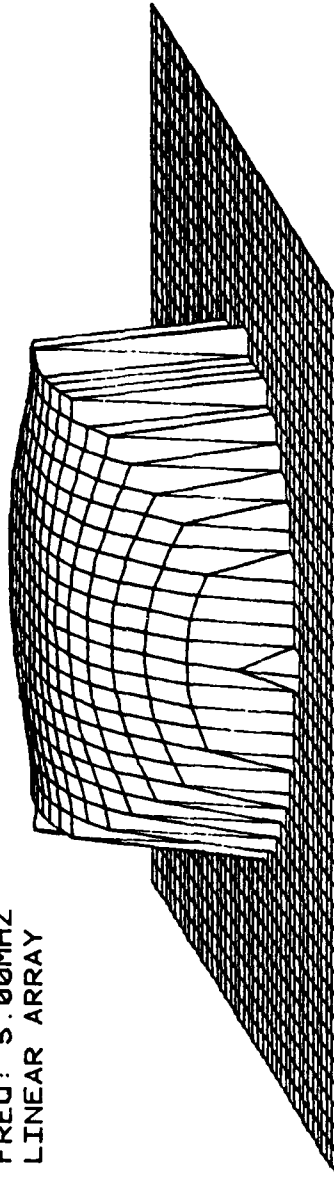

Figure 20. Computed normalized pressure amplitude distribution on the face of a 5.00 MHz transducer on the face of a 5.00 MHz transducer of 1.00 cm in diameter due to a linear array of 25 scatterers located 20.00 cm away from the transducer.

NORMALIZED RECEIVED AMPLITUDE

NUM: 100
APERTURE: 1.00CM
DISTANCE: 20.00CM
FREQ: 5.00MHZ
LINEAR ARRAY

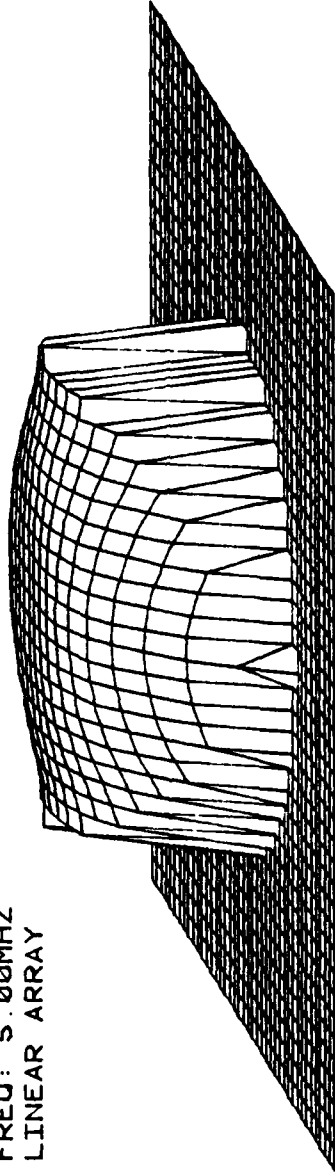

Figure 21. Computed normalized pressure amplitude distribution on the face of a 5.00 MHz transducer of 1.00 cm in diameter due to a linear array of 100 scatterers located 20.00 cm away from the transducer.

sizes at a range of 15.00 cm (Figure 22) reveals that error arising from phase cancellation is independent of the number of scatterers if that number is sufficiently large. However, this error becomes negligibly small if a small aperture is used or if the range is increased. The pronounced dip in Figure 22 at apertures of .50, .75, and 1.00 cm for two scatterers indicates the consequences of severe phase cancellation.

Rectangular and Randomly-Distributed Scatterers

These two planar enlargements have been studied most extensively even though the configuration of scatterers randomly distributed within a volume approximates more closely the real experimental arrangement in scattering measurements. This is because the computer time required for computing the results for volume scatterers is too excessive and calculations based on two-dimensional simulations may be extrapolated to the three-dimensional random volumetric distribution.

Calculations involving the rectangular and random arrays indicated that only a small number of scatterers were needed before a numeric equilibrium was reached. This conclusion supports a similar computer simulation result presented by Reid, Shung, and Kak (1979). Figure 23a summarizes results for average received pressure versus the number of scattering particles, with aperture values ranging from .25 to 1.00 cm, for a random array (range: 20.00 cm; frequency: 5.00 megahertz). For all apertures presented, a minimum of 25 scatterers were needed before oscillations damped out. This figure also provides further evidence that decreasing the aperture size increases the average received pressure seen by the receiver, and indicates apertures equal

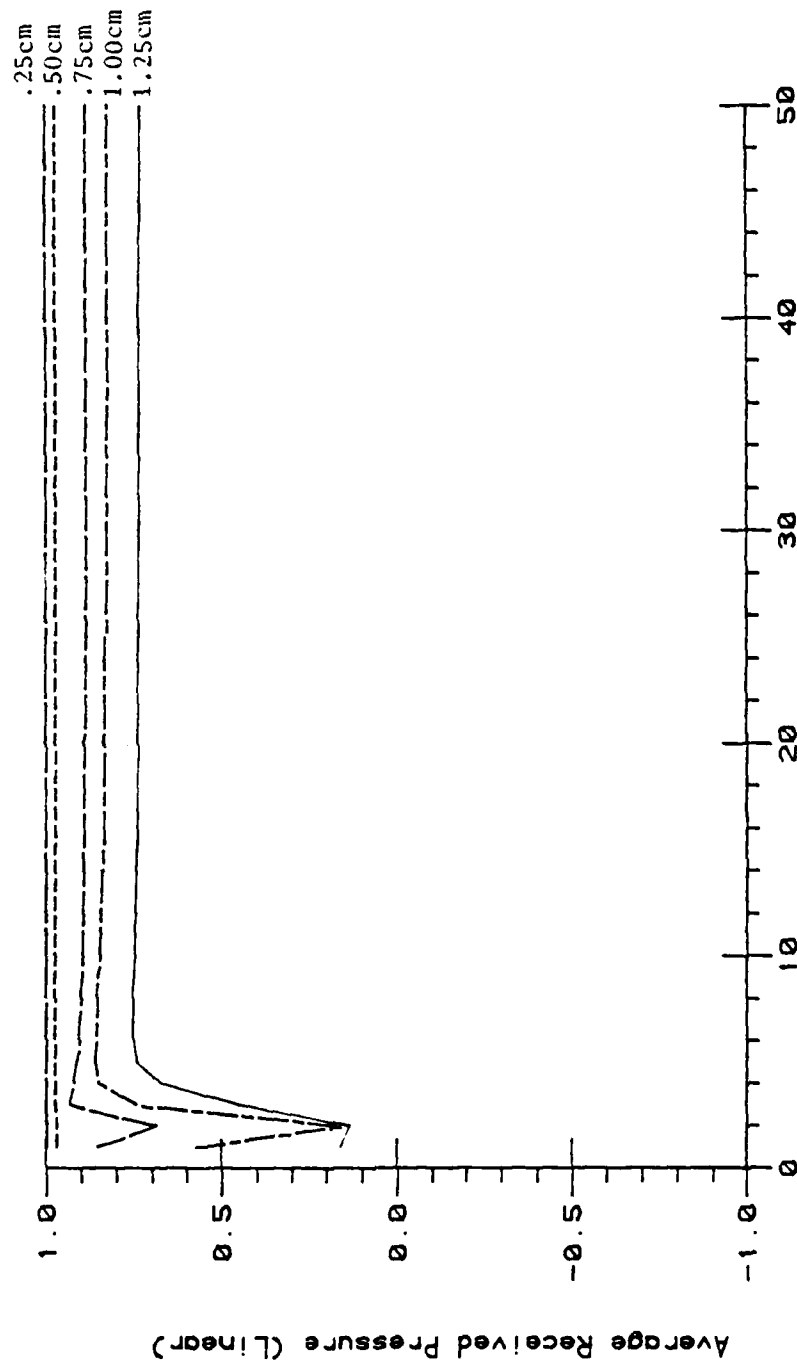

Number of Scatterers

Figure 22. Average received pressure measured by transducers of .25, .50, .75, 1.00, and 1.25 cm in diameter at 5.00 megahertz and at a range of 20.00 cm versus the number of scatterers.

to or less than .50 cm present a signal loss of less than 10% (average received pressure greater than .9000). Figure 23b was generated utilizing identical parameters as in calculations of 23a except that the range was decreased to 10.00 cm. For an aperture of .50 cm in Figure 23a, the average received pressure was approximately .95, whereas the same aperture value in Figure 23b yielded an average received pressure of .82. Thus increasing the distance between the receiver and scatterers dramatically improves the signal strength.

In the remainder of this section, the influence of aperture on the phase cancellation effect for both the rectangular and random arrays will be further developed, and each scattering arrangement will be compared under identical parameters.

Under the more realistic conditions of the rectangular and random scattering arrangements, increasing aperture distorts the amplitude and phase distributions as shown in Figure 24, 25, and 26 for the rectangular case and Figure 27, 28, and 29 for the random case. For both cases, data were generated at a frequency of 5.00 megahertz and target range of 10.00 cm for 50 scatterers. At an aperture of .50 cm. Figures 24 and 27 demonstrate near ideal conditions for ultrasonic measurement with an overall average received pressure of .9364 and .9780 for rectangular and random distributions, respectively. An increase of aperture to .75 cm introduces a greater amount of error as shown in Figures 25 and 28. The rectangular distribution had a 16.55% drop in average received pressure while the random array distribution had a similar drop of 17.61%. The result of employing an inappropriate set of experimental conditions are illustrated in Figure 26 and 29 where severe amplitude fluctuations are seen especially in the random case.

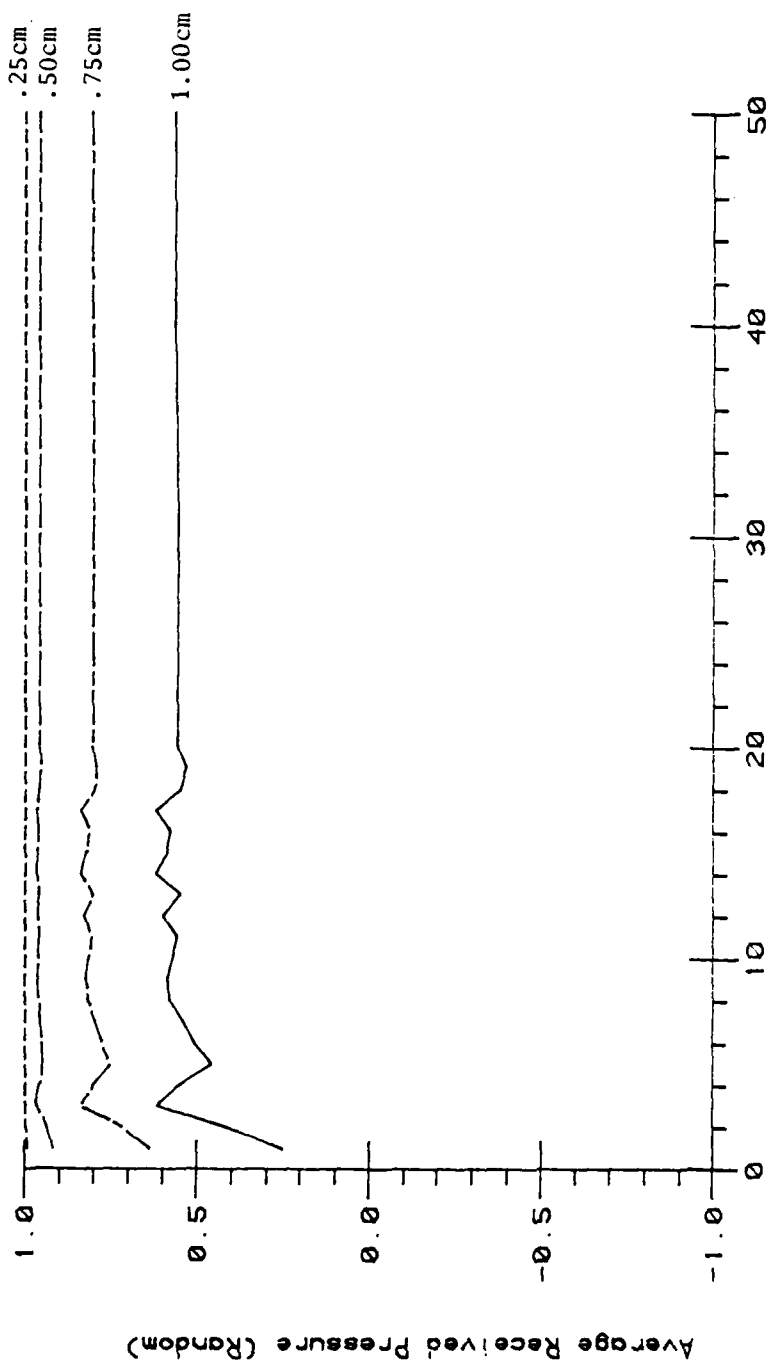

Number of Scatterers (Range = 20.00cm)

Figure 23a. Average received pressure measured by transducers of .25, .50, .75, and 1.00 cm in diameter at 5.00 megahertz and at a range of 20.00 cm versus the number of scatterers.

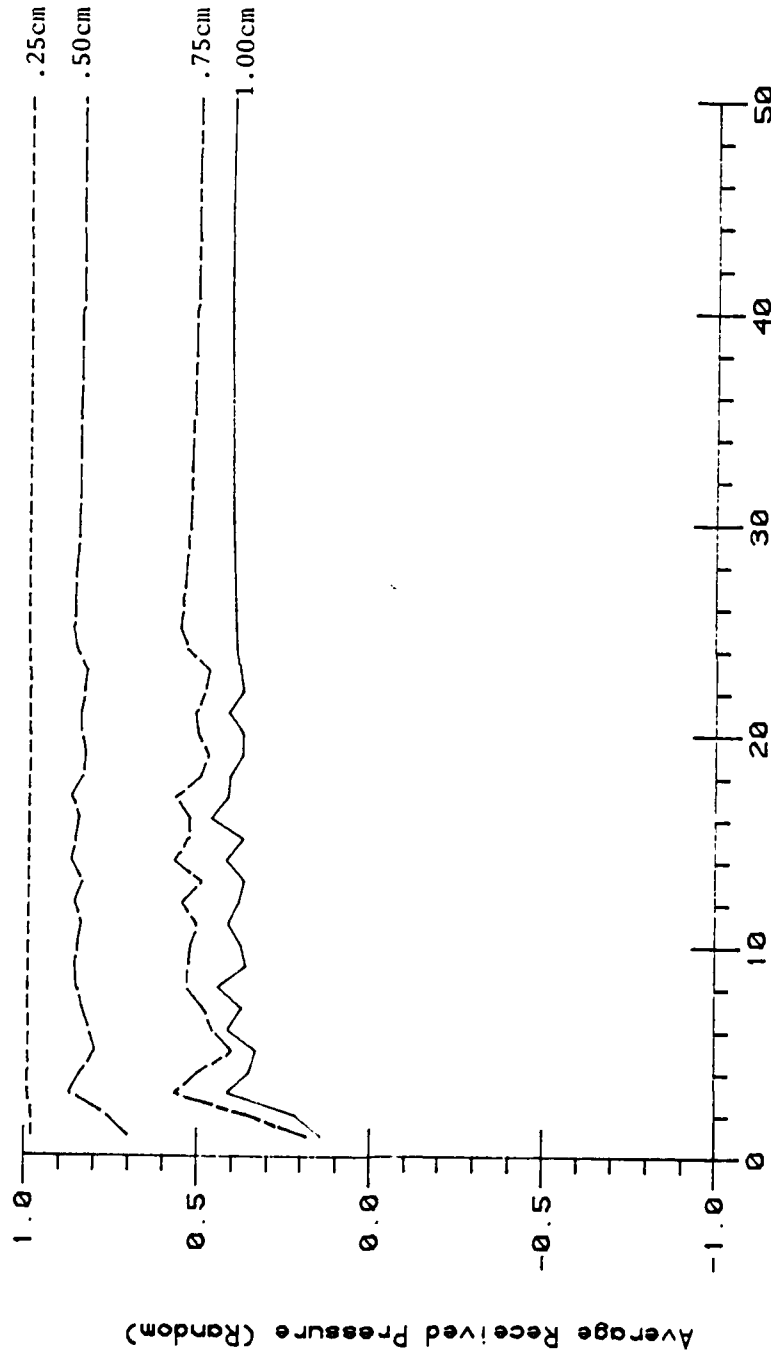

Number of Scatterers (Range = 10.00cm)

Figure 23b. Average received pressure measured by transducers of .25, .50, .75, and 1.00 cm in diameter at 5.00 megahertz and at a range of 10.00 cm versus the number of scatterers.

NORMALIZED RECEIVED AMPLITUDE

NUM: 50
APERTURE: 0.50CM
DISTANCE: 10.00CM
FREQ: 5.00MHZ
RECTANGULAR ARRAY

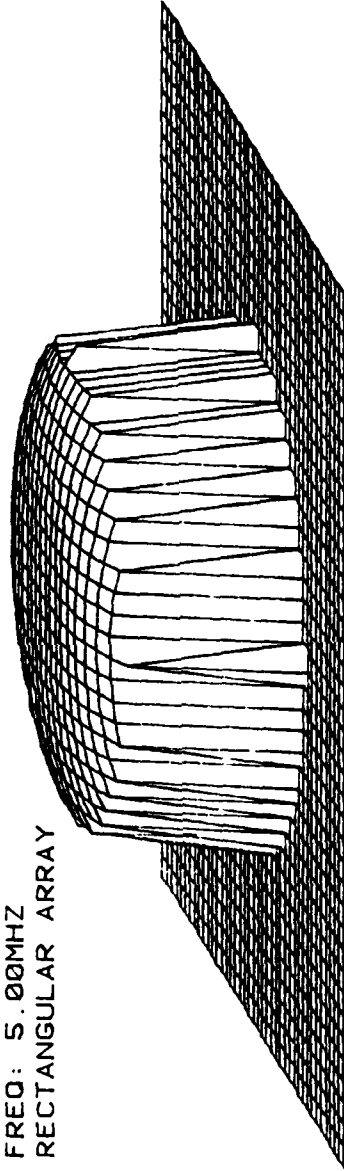

Figure 24. Normalized pressure amplitude distribution on the face of a 5.00 megahertz transducer of .50 cm in diameter due to 50 scatterers located 10.00 cm away from the transducer.

NORMALIZED RECEIVED AMPLITUDE

NUM: 50
APERTURE: 0.75CM
DISTANCE: 10.00CM
FREQ: 5.00MHZ
RECTANGULAR ARRAY

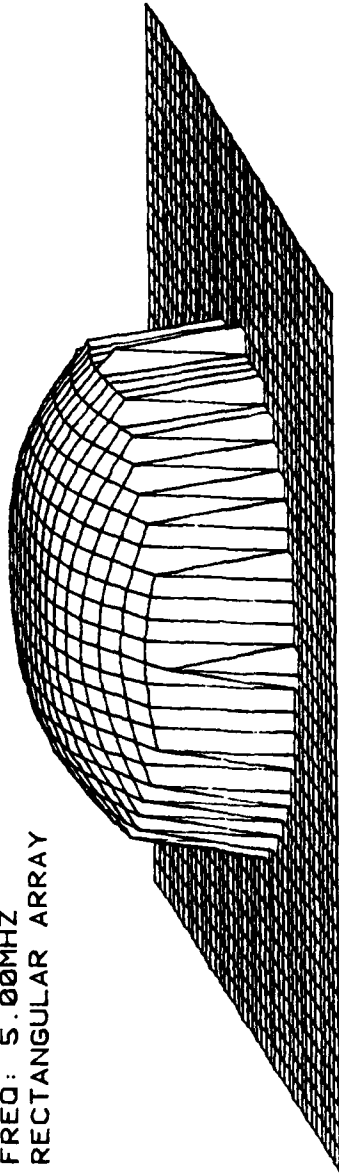

Figure 25. Normalized pressure amplitude distribution on the face of a 5.00 megahertz transducer of .75 cm in diameter due to 50 scatterers located 10.00 cm away from the transducer.

NORMALIZED RECEIVED AMPLITUDE

NUM: 50
APERTURE: 1.25CM
DISTANCE: 10.00CM
FREQ: 5.00MHZ
RECTANGULAR ARRAY

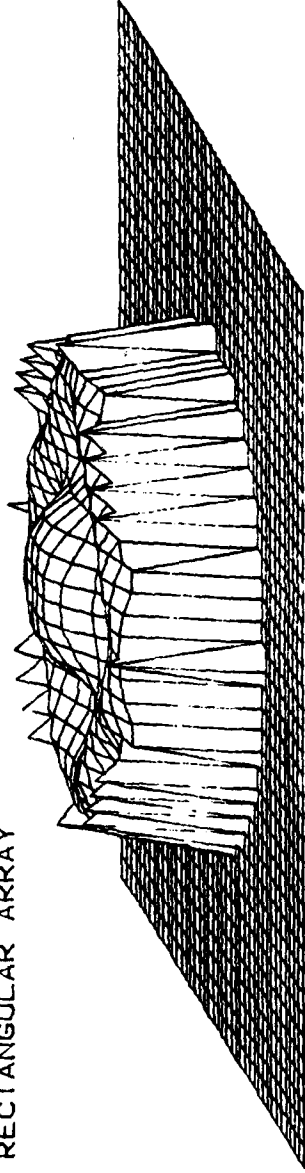

Figure 26. Normalized pressure amplitude distribution on the face of a 5.00 megahertz transducer of 1.25 cm in diameter due to 50 scatterers located 10.00 cm away from the transducer.

NORMALIZED RECEIVED AMPLITUDE

NUM: 50
APERTURE: 0.50CM
DISTANCE: 10.00CM
FREQ: 5.00MHZ
RANDOM ARRAY

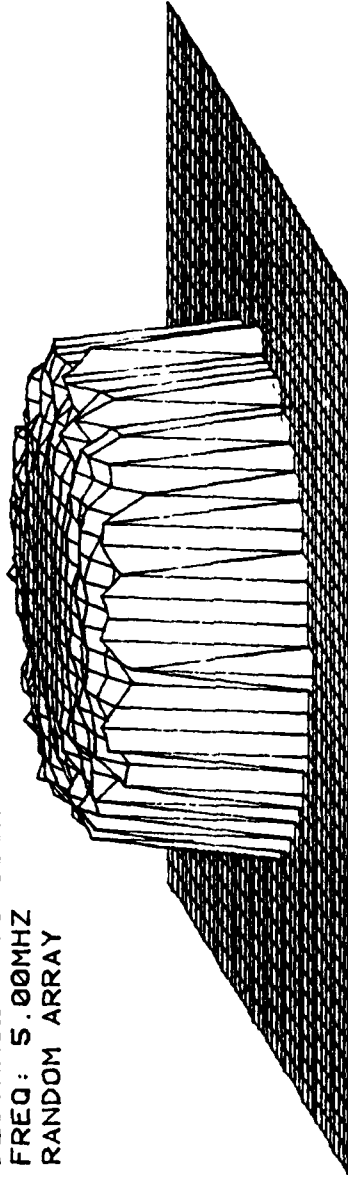

Figure 27. Normalized pressure amplitude distribution on the face of a 5.00 megahertz transducer of .50 cm in diameter due to 50 scatterers located 10.00 cm away from the transducer.

NORMALIZED RECEIVED AMPLITUDE

NUM: 50
APERTURE: 0.75CM
DISTANCE: 10.00CM
FREQ: 5.00MHZ
RANDOM ARRAY

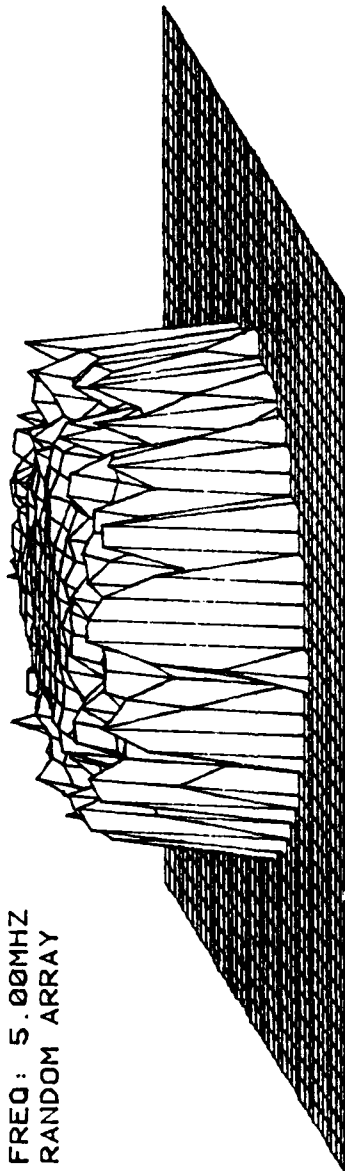

Figure 28. Normalized pressure amplitude distribution on the face of a 5.00 megahertz transducer of .75 cm in diameter due to 50 scatterers located 10.00 cm away from the transducer.

NORMALIZED RECEIVED AMPLITUDE

NUM: 50
APERTURE: 1.25CM
DISTANCE: 10.00CM
FREQ: 5.00MHZ
RANDOM ARRAY

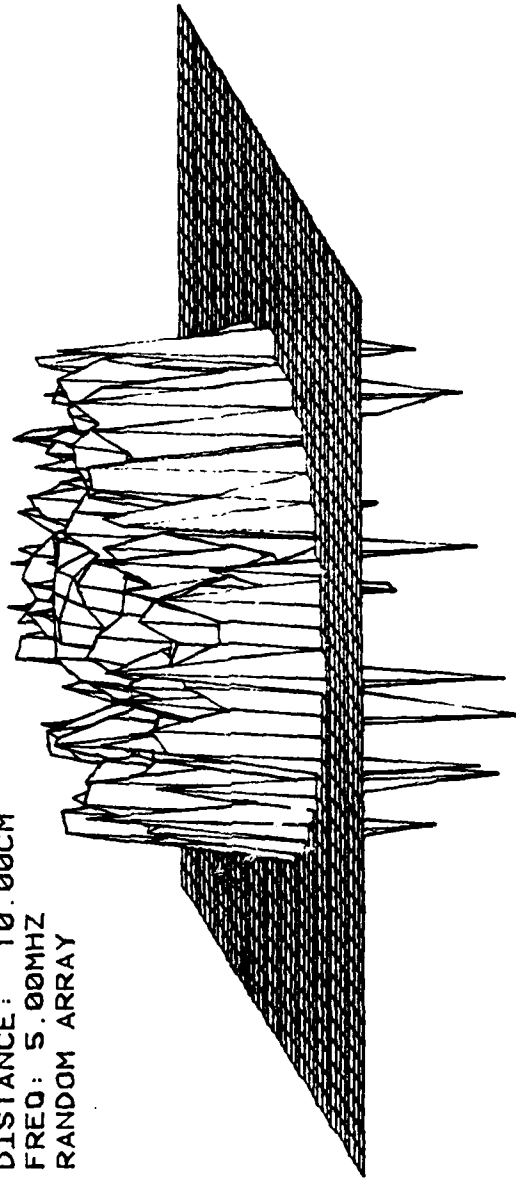

Figure 29. Normalized pressure amplitude distribution on the face of a 5.00 megahertz transducer of 1.25 cm in diameter due to 50 scatterers located 10.00 cm away from the transducer.

The average received pressure of each distribution decreased substantially (rectangular: .7708; random planar: .5255). Up to an aperture value of 1.25 cm, the results obtained for the rectangular and random planar distribution were nearly identical.

Increasing the distance between the transducer and target improves average received pressure. Figure 30 depicts average received pressure calculated at apertures of .25, .50, .75, 1.00, and 1.25 cm with 200 scatterers at a frequency of 5.00 megahertz utilizing the rectangular scattering arrangement. Apertures greater than .75 cm need values of range greater than 30.00 cm before average received pressure approaches .9000. An aperture of .25 cm needs only a range of 3.00 cm for a 10% signal drop; however, a .50 cm transducer requires 12.50 cm. To obtain an average received pressure of approximately .95, range values of 5.00 and 20.00 cm are necessary (apertures of .25 and .50 cm respectively).

Increasing frequency has a pronounced effect on errors produced by phase cancellation. This influence of frequency on average received pressure is shown by Figure 31. The average received pressure was calculated from a random distribution of 200 particles at a target range of 20.00 cm, by varying frequency at apertures of .10, .25, .50, .75, and 1.00 cm. For a frequency range of 1.00 to 10.00 megahertz, apertures of .10, .25, and .50 cm provide reasonable performance in terms of minimal signal loss due to phase cancellation. The data calculated for .10 cm transducer aperture further verifies the near ideal performance expected for a microprobe used as a receiver and its role in comparing results of various transducer apertures. When using apertures greater than .25 cm at frequencies above 10.00 megahertz, the

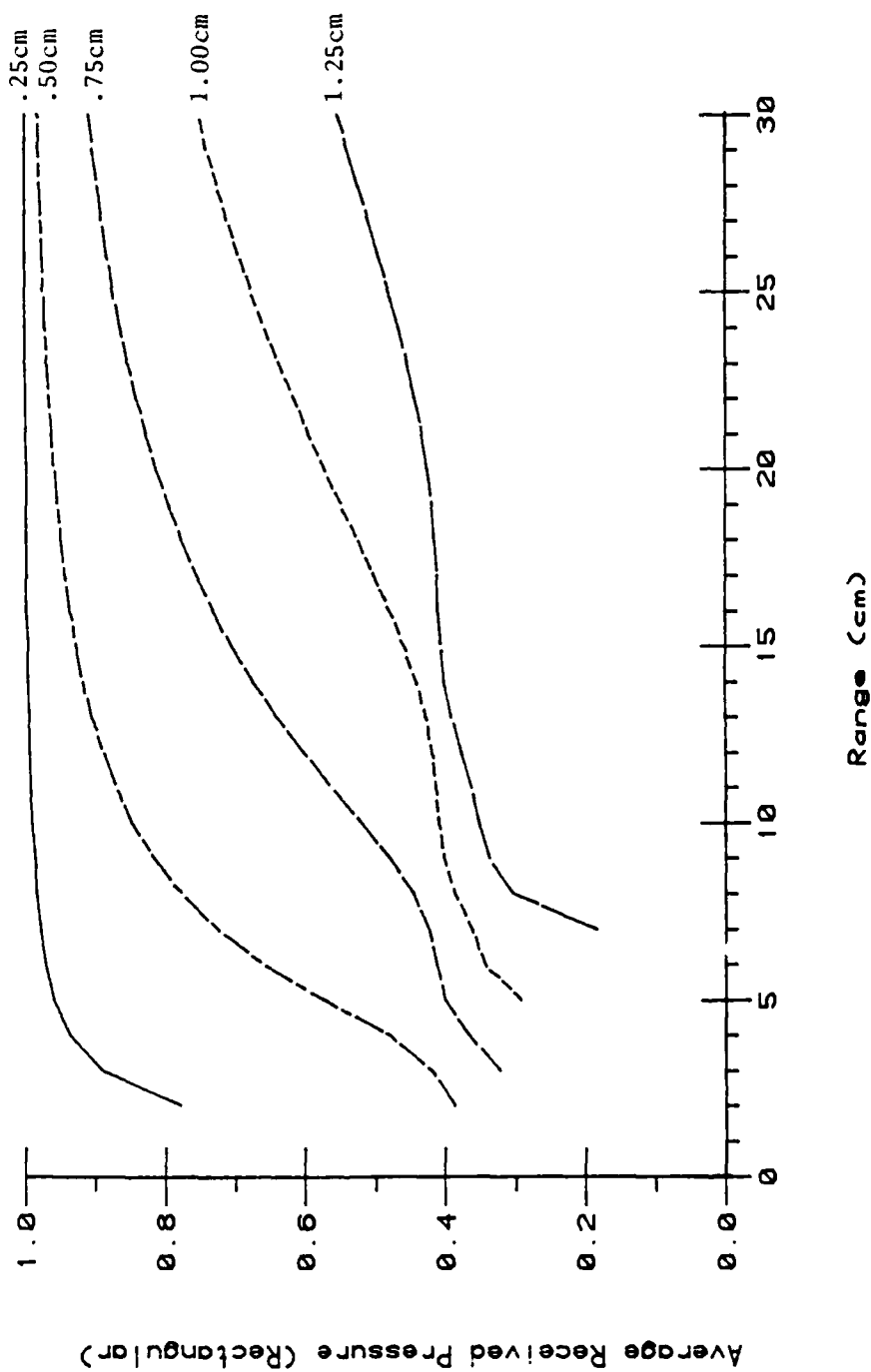
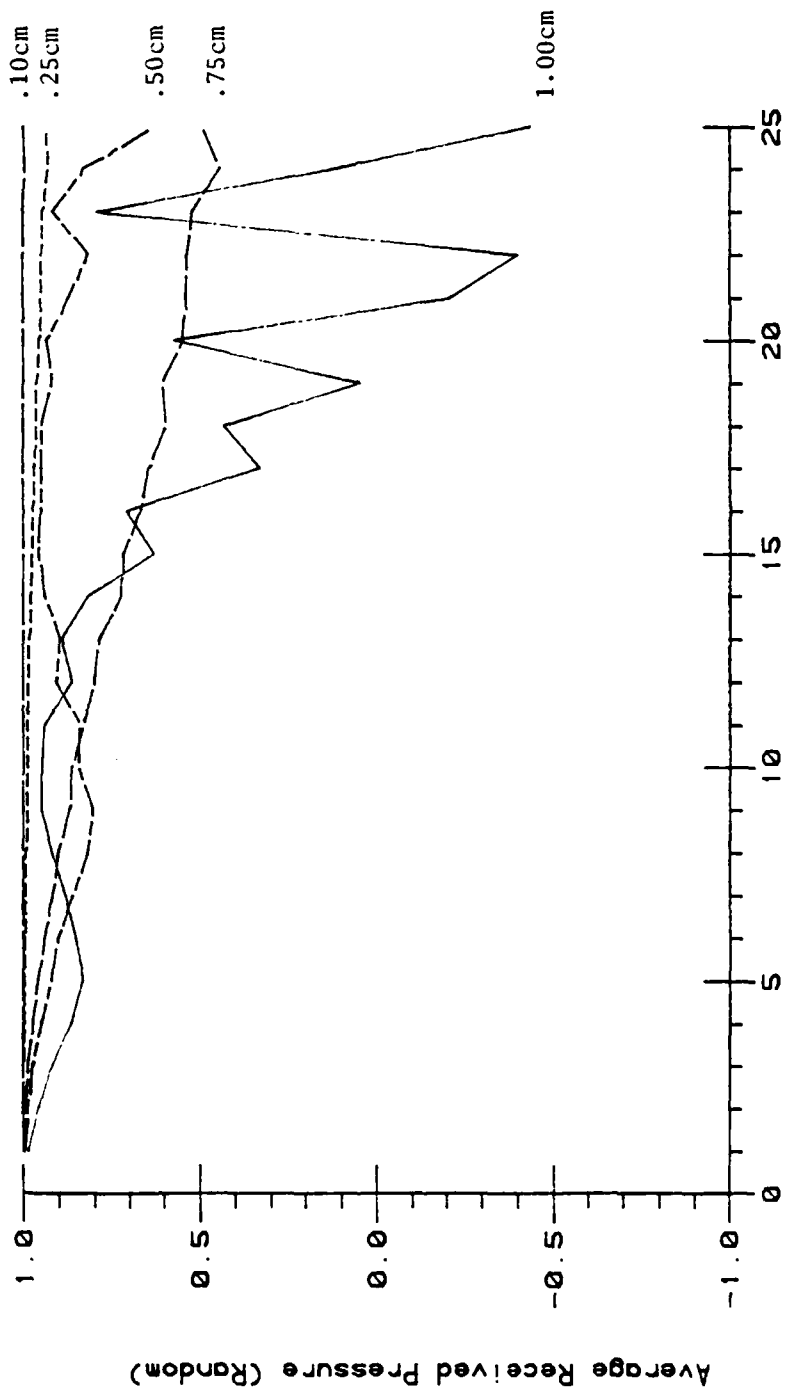

Figure 30. Average received pressure measured by transducers of .25, .50, .75, 1.00, and 1.25 cm due to 200 scatterers arranged in a rectangular distribution at 5.00 megahertz versus range.



Frequency (Megahertz)

Figure 31. Average received pressure measured by transducers of .10, .25, .50, .75, and 1.00 cm in diameter due to 200 scatterers at a range of 20.00 cm versus frequency.

average received pressure declined rapidly in magnitude. See Appendix A for discussion of the oscillations.

Random Volumetric Distribution

The random volumetric scattering arrangement (illustrated in Figure 1) was simulated by a cylinder, with the base aligned parallel to the transducer face. During the simulation the diameter of the cylinder was assigned the value of the interrogating transducer aperture for simplification of geometry. Simulation results depicted by Curve a in Figure 32 for L equal to 1.00 mm, range equal to 15.00 cm, frequency equal to 5.00 megahertz and an aperture of .25 cm, demonstrated that 2500 scatterers, which correspond to a scatterer volume concentration of approximately 500 per cubic millimeter, were necessary before an average received pressure of .9 was achieved. The identical computation was performed for a cylinder depth of 2.00 mm (Curve b in Figure 32). A depth value of 1.00 mm resulted in a more rapid convergence to a low signal loss condition than a depth of 2.00 mm. It became apparent that a greater number of particles is required to obtain the same accuracy even for cases of extended range and small aperture. However, this requirement should not be of much concern in biomedical ultrasound because it is generally satisfied by biological specimens. For example, erythrocyte concentration in normal blood approaches five million per cubic millimeters.

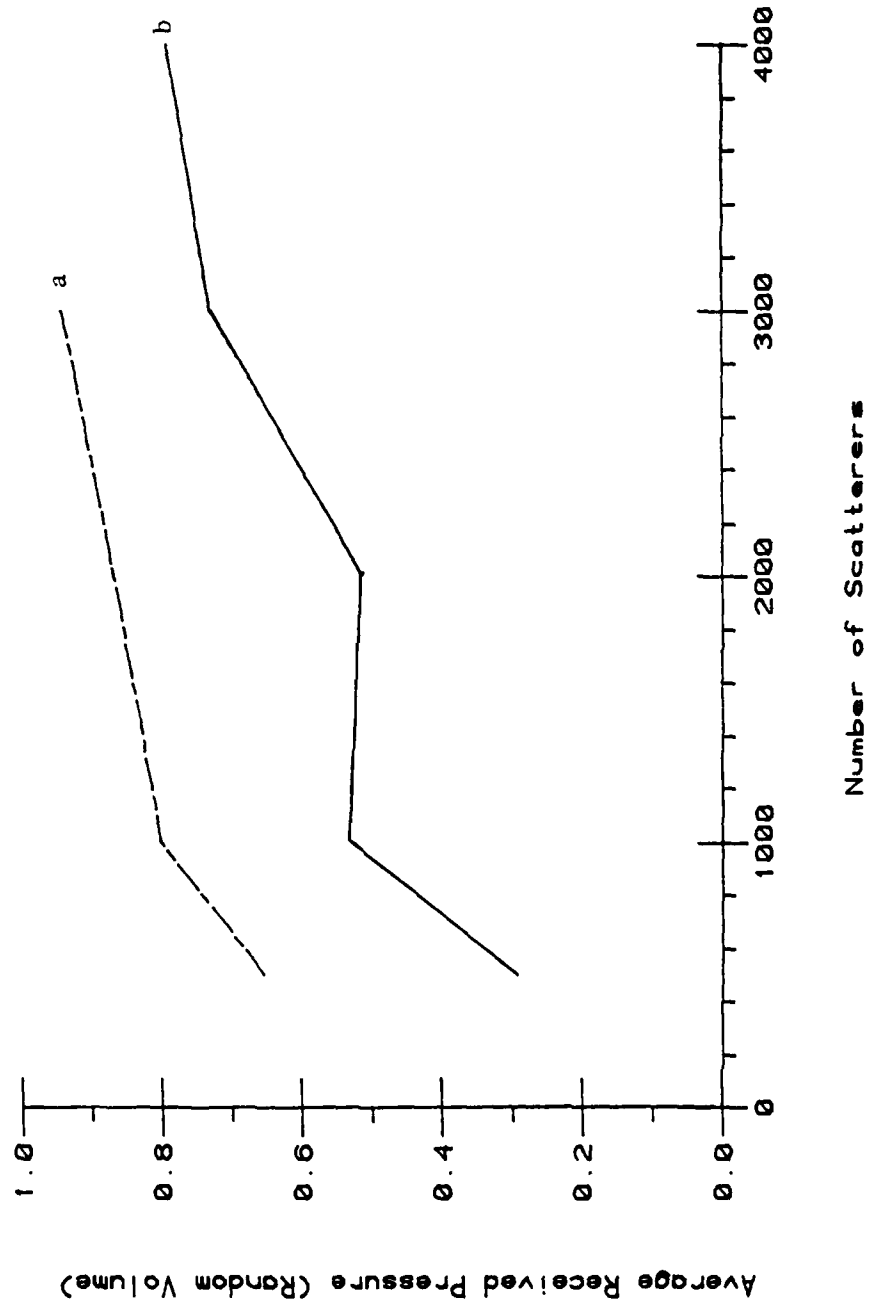

Figure 32. Average received pressure measured by a .25 cm transducer at a range of 15.00 cm with a frequency of 5.00 megahertz versus the number of scatterers (Curve a: $L = 1.00$ mm and Curve b: $L = 2.00$ mm).

CHAPTER IV

SUMMARY AND CONCLUSIONS

Piezoelectric transducers are sensitive to the phase of the incident pressure. Substantial error may result if such a phase-sensitive transducer is used when measuring the acoustic properties, such as attenuation and scattering, of inhomogeneous materials which distort the shape of the wave front. This is due to the phase cancellation effect. A mathematical model for the interpretation of error arising from the phase cancellation effect on the measurement of back-scattered waves has been developed. A computer program was implemented on a DEC-10 to simulate the ultrasonic wave interaction between a piezoelectric transducer and an acoustic scattering environment. The influence of the phase cancellation effect on amplitude and phase distributions across the surface area of the ultrasonic receiver were quantified in terms of aperture size, frequency, target range, and number of scatterers. This investigation included varied scattering arrangements: a single point scatterer; linear, rectangular, and random arrays; and random volumetric distribution.

To minimize the influence of phase cancellation on ultrasonic measurements, proper experimental parameters such as aperture, frequency, and range may be judiciously selected. The results from this investigation are summarized in Figures 33, 34, and 35 where average received pressure is plotted versus ratios of R/D , R/F , and $R\lambda/D$ (λ is wavelength, R is the range, and F is frequency) in terms of data obtained for the random array case. Although R/D and R/F are ultri-

mately included within the plot of average received pressure versus $R\lambda/D$, they are useful if the researcher is constrained to a particular frequency or aperture in the experimental apparatus.

Results shown in Figure 33 indicate the necessity of high R/D values for minimization of error due to phase cancellation. These results are tabulated from data generated at 5.00 megahertz. For other frequencies, separate R/D values must be calculated. R/D values of 40.00 and 25.00 are required for 10% and 5% drops in average received pressure, respectively. The units of range and transducer diameter are centimeters.

Figure 34 represents a graphical summary of average received pressure versus R/F for apertures of .25, .50, .75, 1.00, 1.25, and 1.50 cm with the line demarking an aperture of .25 labelled a and continuing through f for each respective aperture value. R , the target range, is measured in centimeters and F is in megahertz; therefore, the units of R/F are cm-sec/cycle. Assuming a 10% drop in average received pressure (.9000) and choosing a diameter, the reader can extrapolate to the x-axis to determine the minimum R/F value. For example, selecting a diameter of 1.00 cm, a R/F of no less than 7.00 is required. For a larger diameter, a greater R/F ratio is necessary to maintain an adequate average received pressure. Furthermore, if the experiment can only tolerate a five percent drop in average received pressure (.9500), then much higher values of R/F are needed. It is important to note that for the range of frequencies most often encountered in medical imaging (1.00 to 15.00 megahertz), R/F values greater than 15.00 are desirable assuming a 10% pressure drop.

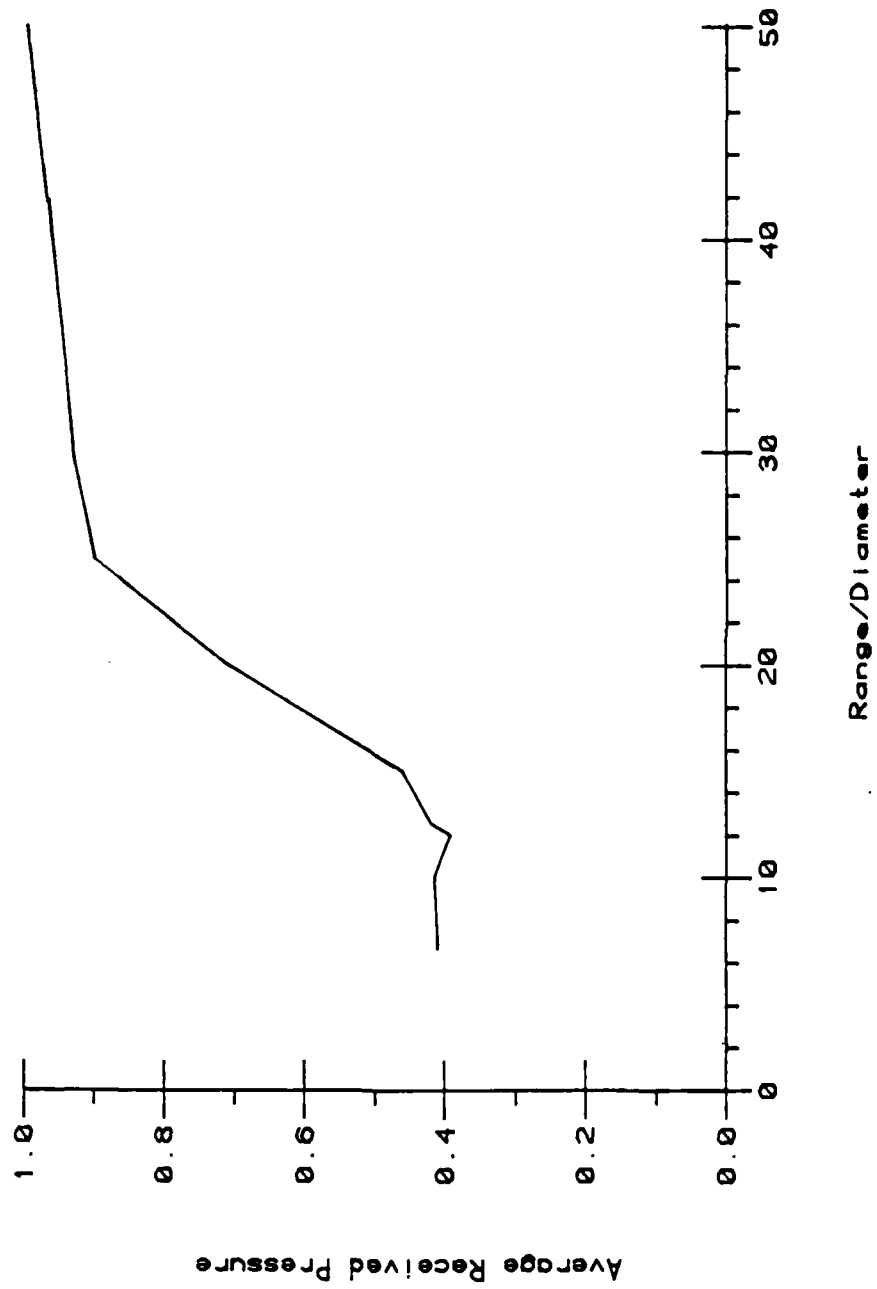

Figure 33. Average received pressure versus R/D for the random planar distribution.

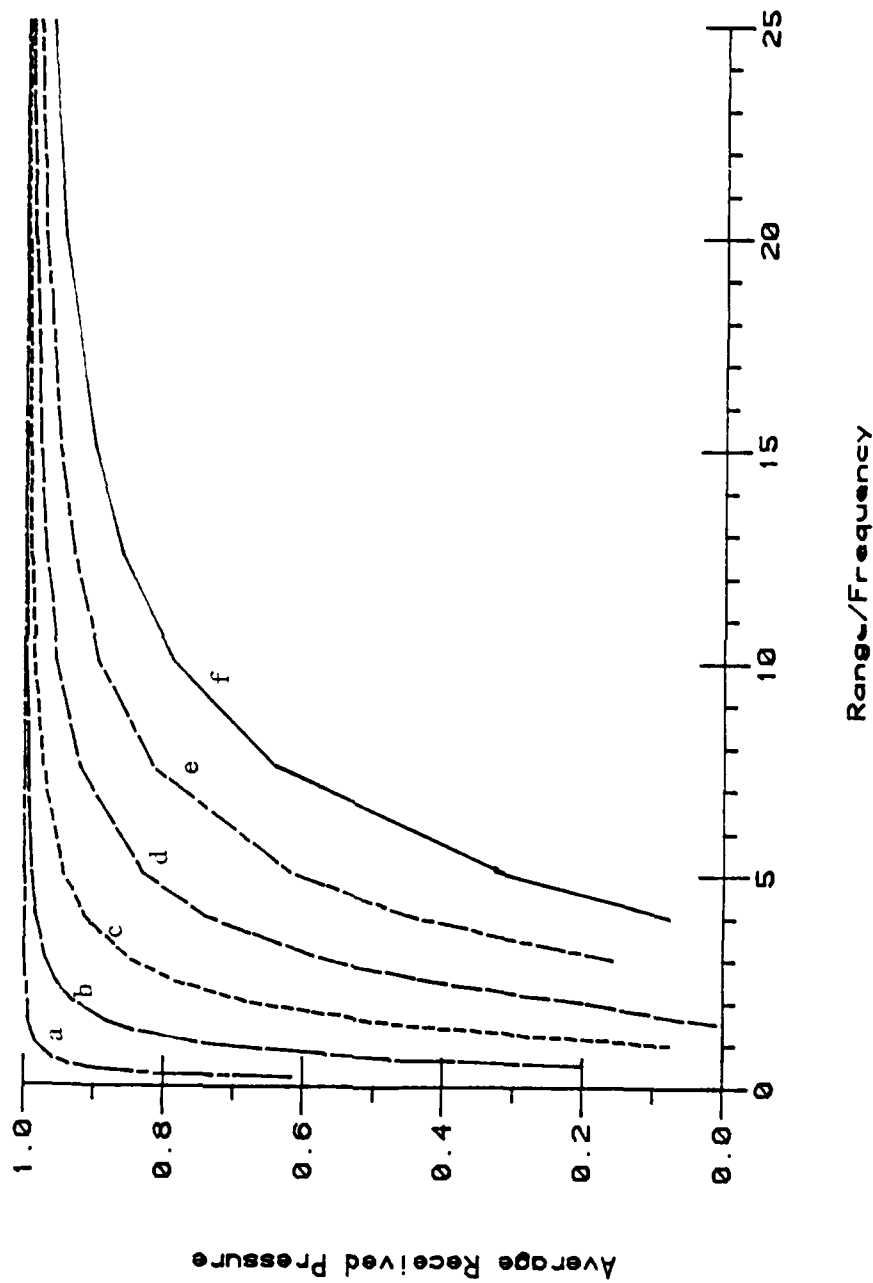

Figure 34. Average received pressure measured by transducers of .25 (a), .50 (b), .75 (c), 1.00 (d), 1.25 (e), and 1.50 cm (f) in diameter versus R/F for the random planar distribution.

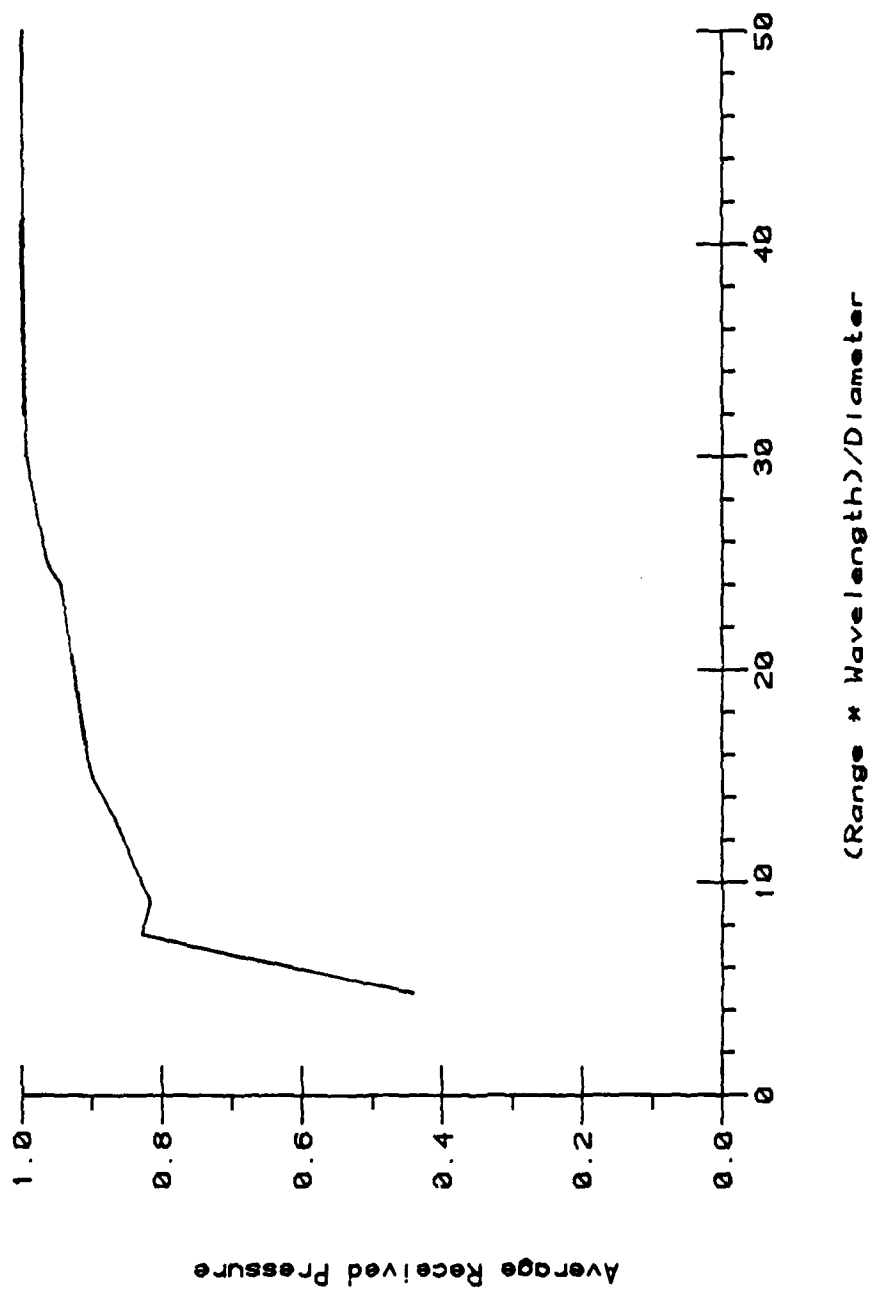

Figure 35. Average received pressure versus $R\lambda/D$ for the random planar distribution.

The influence of aperture, range, and frequency on the phase cancellation effect is graphically summarized in Figure 35 in which range was measured in centimeters, transducer diameter in centimeters and wavelength in millimeters. Minimum $R\lambda/D$ values of 25.00 and 15.00 are necessary to achieve an experimental accuracy of 5% and 10% respectively. The units of $R\lambda/D$ is in millimeters.

In conclusion, the body of data provided in this thesis should be very useful to establishing criteria which enable investigators engaged in research involving the measurements of acoustic parameters, such as attenuation and scattering of heterogeneous materials, to choose suitable experimental conditions for their measurements when phase-sensitive devices are employed.

REFERENCES

- Busse, L. J., J. G. Miller, D. E. Yuhas, J. W. Mimbs, A. N. Weiss, and B. E. Sobel. Phase Cancellation Effects: A Source of Attenuation Artifact Eliminated by A CdS Acoustoelectric Receiver, In D. White (Ed.), Ultrasound in Medicine (Vol. 2). New York: Plenum Press, 1976.
- Heyman, J. S. and J. H. Cantrell, Jr. Application of An Ultrasonic Phase Insentive Receiver to Material Measurements, IEEE Ultrasonics Symposium Proceedings, 1977, 124-128.
- Heyman, J.S., J. H. Cantrell, Jr., and W. P. Winfree. Influence of Phase Cancellation and Pulse Shape Artifacts on Ultrasonic Spectrum Analysis, IEEE Ultrasonics Symposium Proceedings, 1979, 289-296.
- Marcus, P. W. and E. L. Carstensen. Problems with Absorption Measurements of Inhomogeneous Solids, J. Acoust. Soc. Am., 1975, 58, 1334-1335.
- Reid, J. M., K. K. Shung, and A. C. Kak. Phase-Cancellation Effects with Scattered Waves. Proceedings of the 4th International Symposium on Ultrasonic Imaging and Tissue Characterization, 1979, 84.

APPENDIX A

HISTOGRAM OF AVERAGE RECEIVED PRESSURE

Investigation into the variability over a series of trials of average received pressure calculated from a single point scatterer randomly placed on a plane parallel to the transducer face provides further evidence of the influence of increased aperture on the phase cancellation effect. The data was calculated by the FORTRAN program ARPVAR. Results were plotted as a histogram for each modelling condition.

For 25 trials, the average received pressure was calculated on transducer apertures of .50, .75, 1.00, and 1.25 cm (Figures 36, 37, 38, and 39) at a range of 7.50 cm and a frequency of 5.00 megahertz. For an aperture of .50 cm received pressures for all 25 trials fell within the .90 to 1.00 interval. The mean average received pressure was .9798 and had a variance of .0006. Increasing the aperture to .75 cm resulted in a decrease of the mean average received pressure to .9008 and increased sample variance to .00138. Referring to Figure 38, the variability of average received pressure outcomes increased with increasing aperture. For 1.00 cm aperture, the sample distribution had a mean of .7148 and variance of .00961. Concluding with Figure 39, an aperture of 1.25 cm shows the large fluctuations in average received pressure due to phase cancellation calculated for a single point scatterer. This outcome is expected and emphasizes that correct aperture size is extremely important when utilizing phase-sensitive piezoelectric transducers.

The variability of average received pressure was investigated at a range of 20.00 cm, a frequency of 25.00 megahertz and 200 scatterers for apertures of .50, .75, and 1.00 cm (Figures 40, 41, and 42). Twenty-five trials were performed at each of these aperture values. These parameters were chosen in order to compare data summarized in Figure 31. In Figure 31, each point was obtained from only one trial. As evident from Figures 41 and 42, there is considerable variation from trial to trial for apertures of .75 and 1.00 cm and results of one trial are not representative of the typical outcome under these conditions. For example, the results in Figure 42 demonstrate a large variance in average received pressure when using a 1.00 cm aperture transducer. The sample mean of this distribution is .2525 and has a variance of .0463. The consequence is that results obtained from one trial may differ substantially from the other. Therefore, data for higher frequencies, e.g., data above 13.00 megahertz at an aperture of 1.00 cm and above 22.00 megahertz at an aperture of .75 cm would be expected to show considerable variation for different arrangements of 200 scatterers. This result explains the large fluctuations seen in Figure 31 at higher frequencies for large apertures.

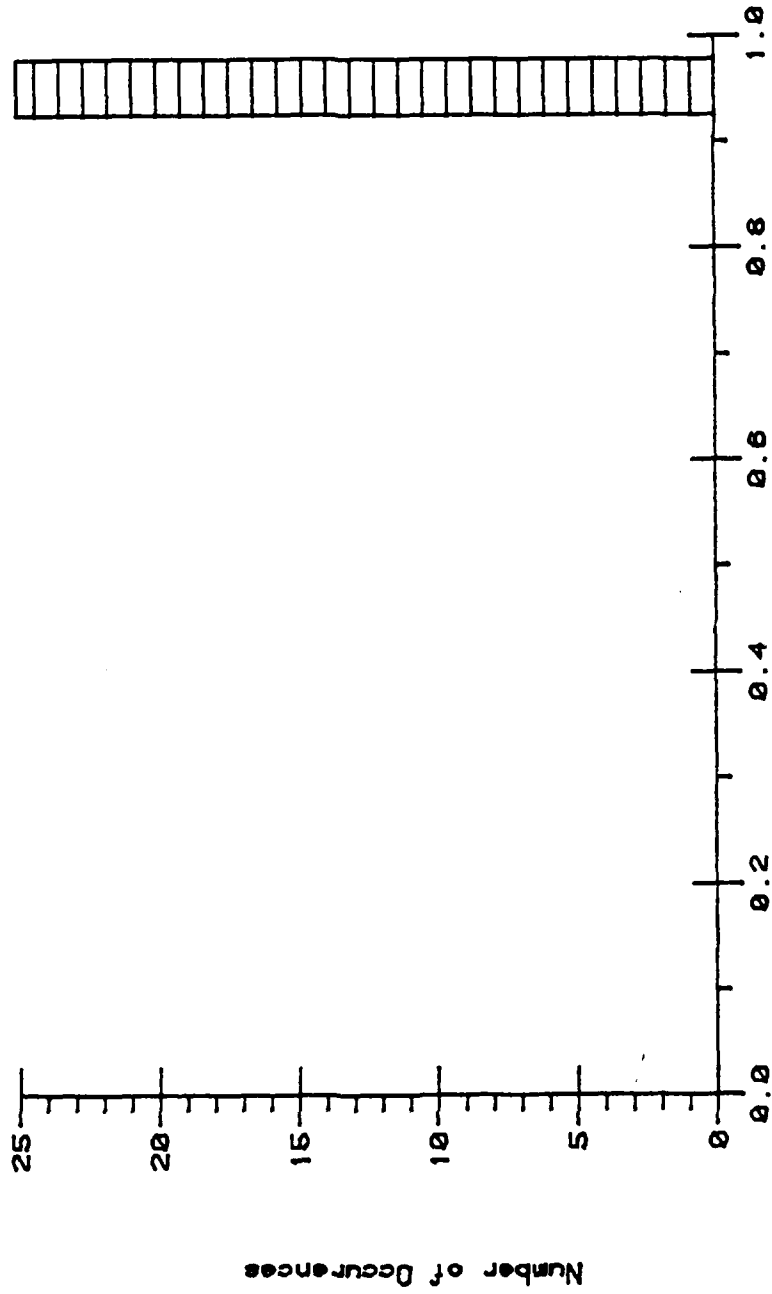

Average Received Pressure

Figure 36. Average received pressure versus the number of occurrences for a single point scatterer at a range of 7.50 cm and aperture of .50 cm over 25 trials.

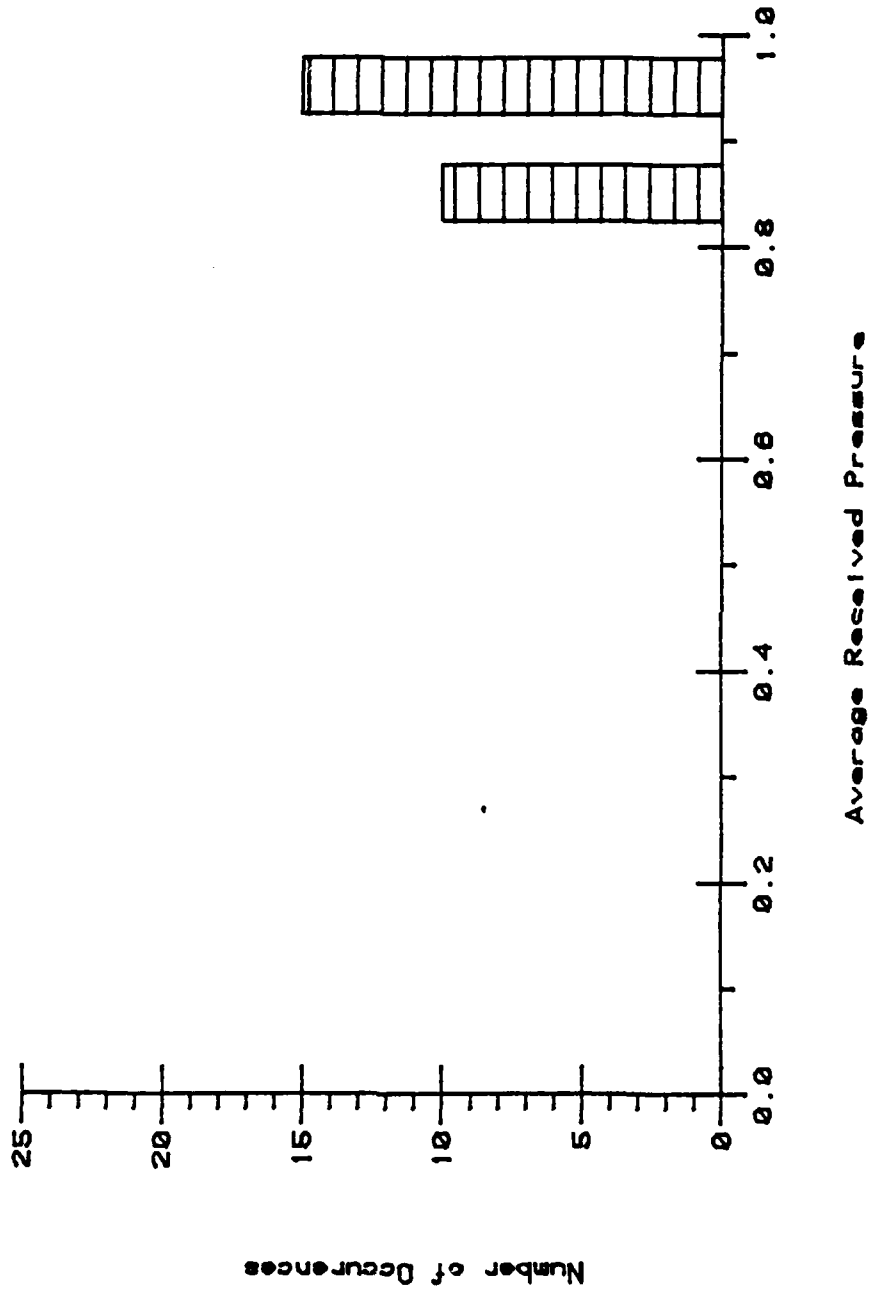

Figure 37. Average received pressure versus the number of occurrences for a single point scatterer at a range of 7.50 cm and aperture of .75 cm over 25 trials.

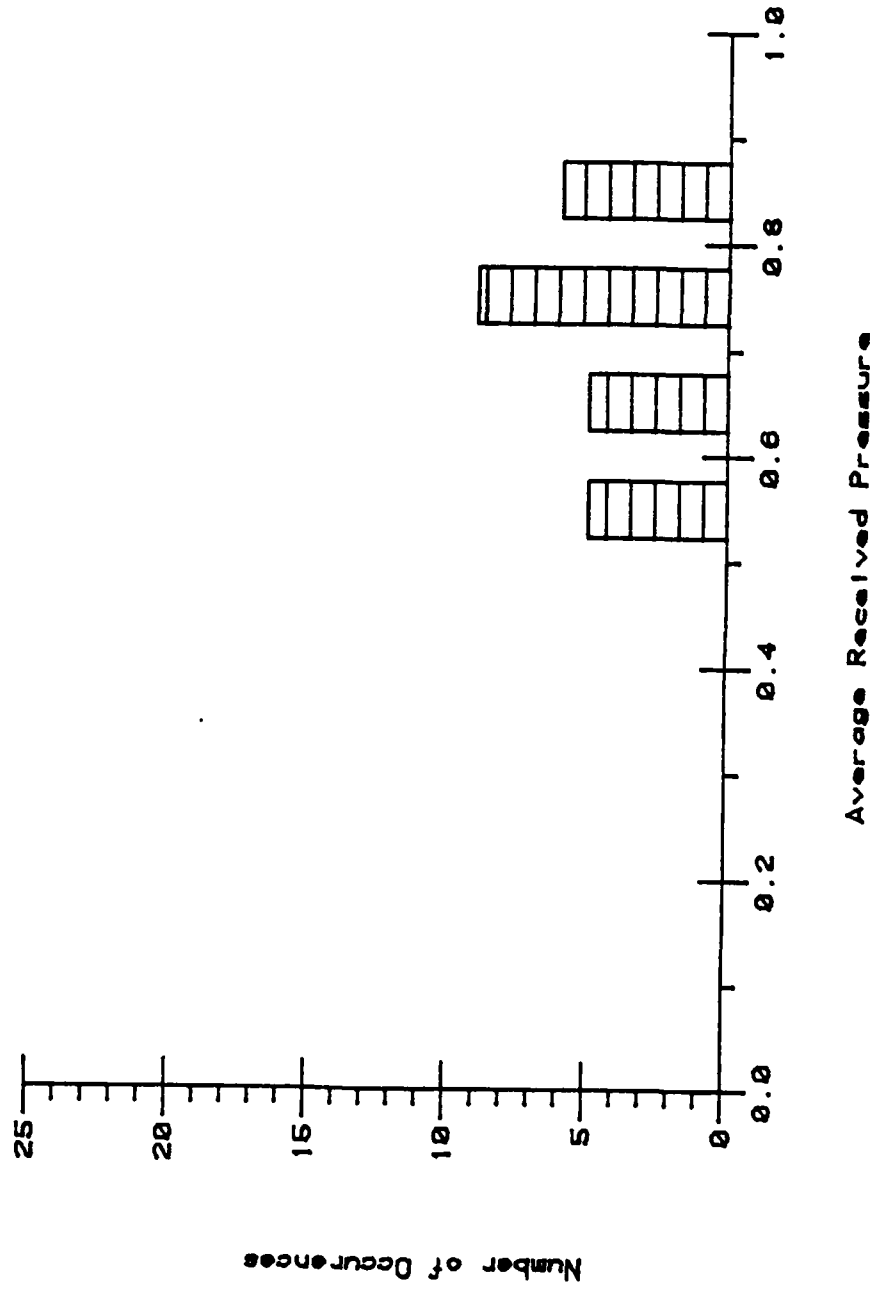

Figure 38. Average received pressure versus the number of occurrences for a single point scatterer at a range of 7.50 cm and aperture of 1.00 cm over 25 trials.

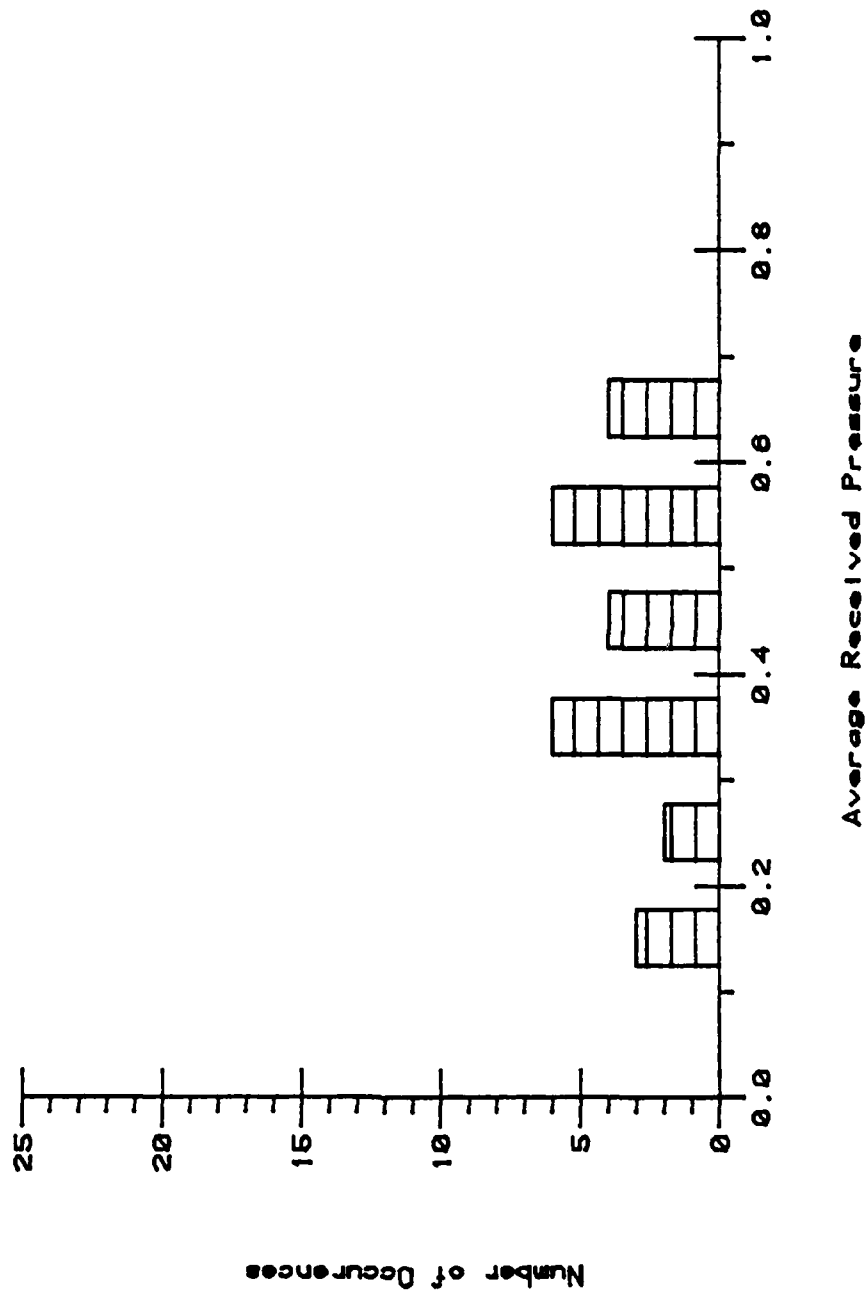

Figure 39. Average received pressure versus the number of occurrences for a single point scatterer at a range of 7.50 cm and aperture of 1.25 cm over 25 trials.

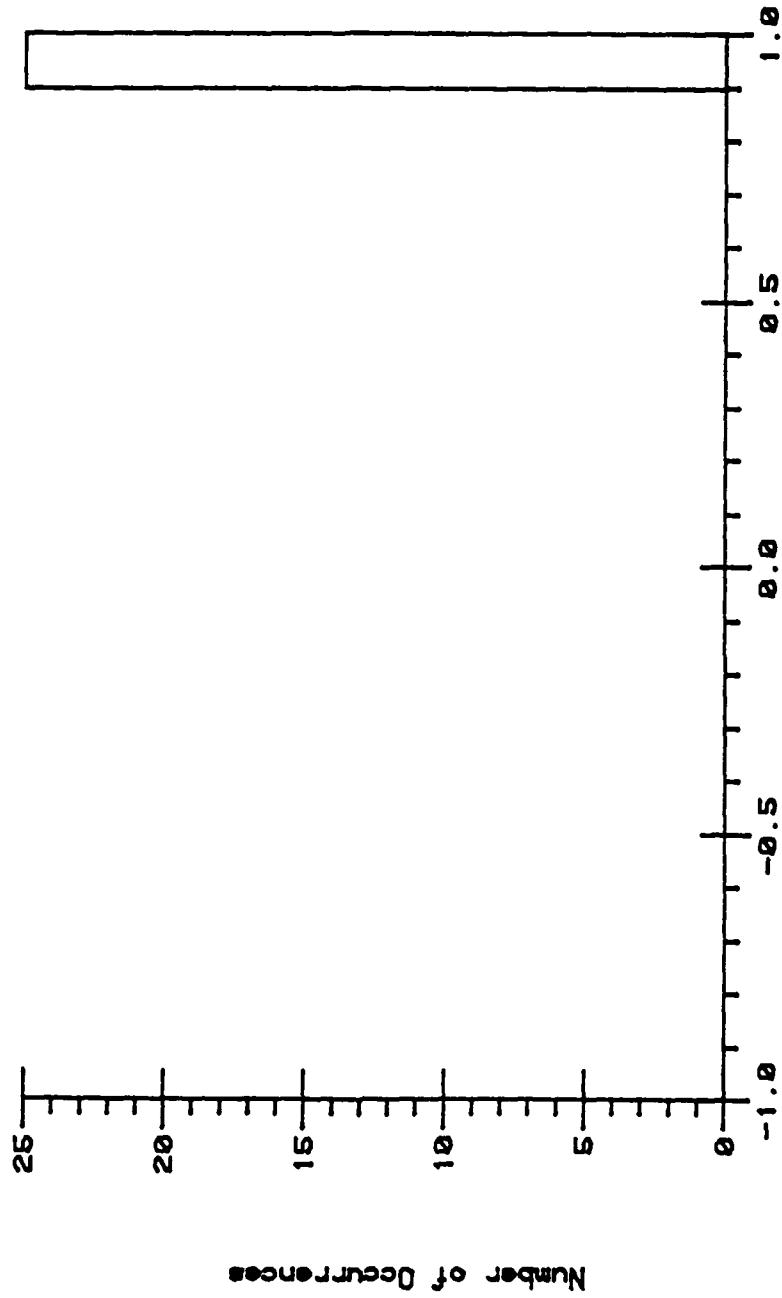
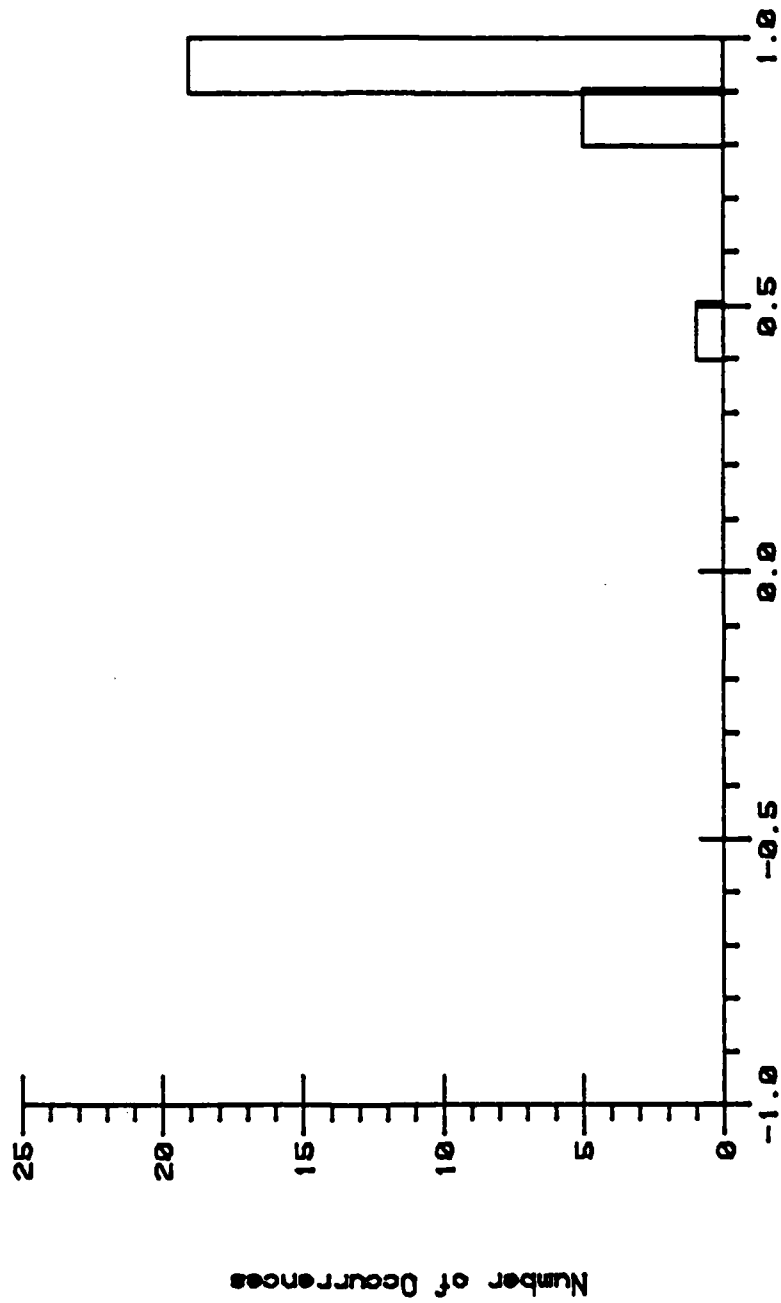
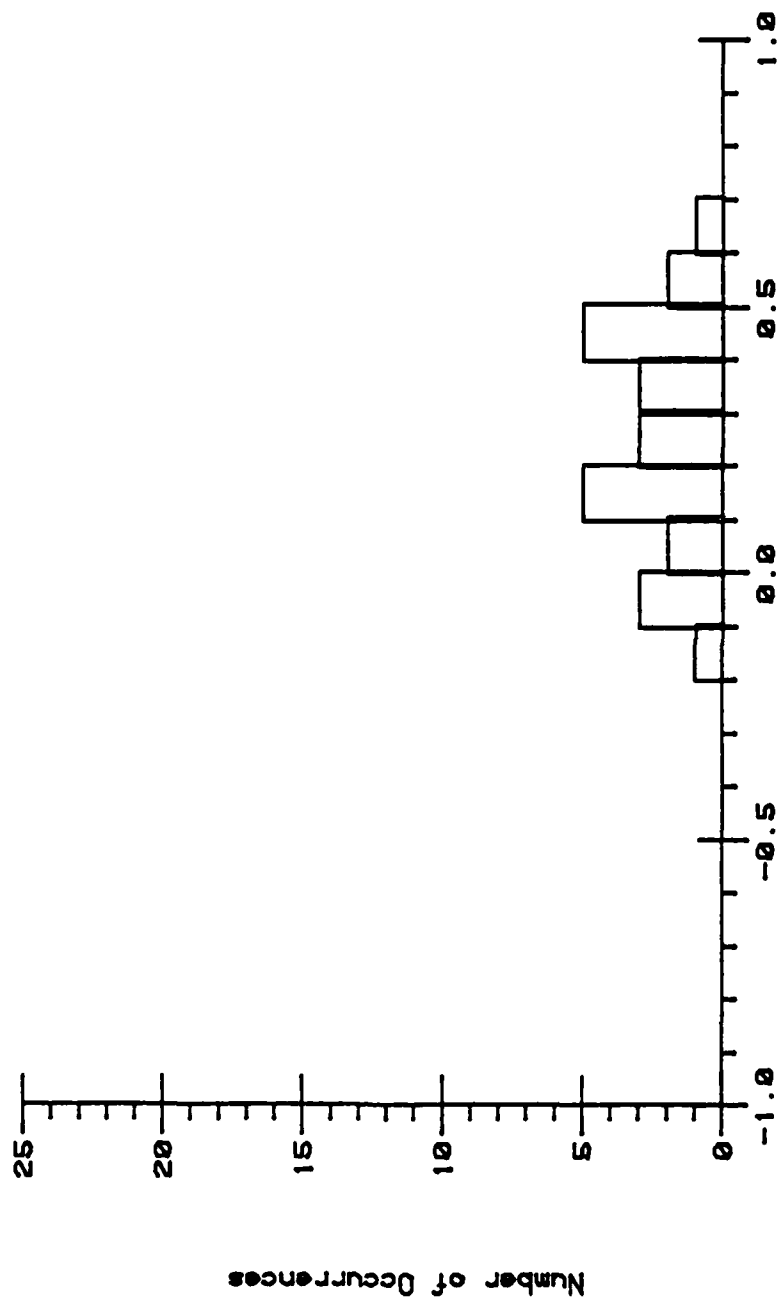

Figure 40. Average received pressure versus the number of occurrences for 200 scatterers at a range of 20.00 cm and aperture of .50 cm over 25 trials.



Average Received Pressure

Figure 41. Average received pressure versus the number of occurrences for 200 scatterers at a range of 20.00 cm and aperture of .75 cm over 25 trials.



Average Received Pressure

Figure 42. Average received pressure versus the number of occurrences for 200 scatterers at a range of 20.00 cm and aperture of 1.00 cm over 25 trials.

APPENDIX B

HOW TO USE THE COMPUTER PROGRAMS

The computer programs used in this simulation were written to allow maximum flexibility and accurate presentation of data generated in the modelling procedure. The author made extensive use of modular program construction so that other workers can clearly understand program execution and implement source code modification. The operating requirements and logic flow of each computer program are presented.

Phase

A FORTRAN program PHASE was developed for use in the computer simulation. This program allows the user to select the following scattering arrangements: a single point source, linear array, rectangular array, random planar array, and random volume. The user also specifies aperture, number of scatterers, range and frequency for calculations of received amplitude and phase distributions across the surface area of the ultrasonic transducer. Once the program PHASE has been loaded, the program will prompt the user for input parameters as shown by Figure 43. Initial calculations are displayed on the computer terminal for verification by the user. The resulting data calculated can be printed on paper and/or written to a disk file for plotting by PLT3D, CPLOT, or other available x-y plotting routines.

PHASE-CANCELLATION PROGRAM

SCATTERER ARRANGEMENT(L,O,R,V,A):
SPECIFY NUMBER OF SCATTERING PARTICLES:
ENTER DISTANCE FROM TRANSDUCER TO PARTICLES:
TRANSDUCER APERTURE:
PLEASE ENTER OPERATING FREQUENCY(MEGAHERTZ):
VARY RANGE, SCATTERERS, APERTURE, FREQUENCY(R,N,A,F):
ENTER STOP VALUE(REAL):
INCREMENT:
DO YOU WANT PLOTTING DATA WRITTEN TO DISK(Y/N):
PRINTED DATA WRITTEN TO DISK(Y/N):
IS ABOVE INPUT DATA CORRECT(Y/N):

Figure 43. Sample input to program PHASE.

```

C*****
C
C Bioengineering: Phase-Cancellation Studies
C
C SCATTERERING ARRANGEMENTS:
C 1) LINEAR
C 2) RECTANGULAR ARRAY
C 3) RANDOM ARRAY
C 4) RANDOM VOLUME
C 5) RANDOM ARRAY CONSTANT SCATTERING APERTURE
C
C*****

```

```

COMPLEX PRS(41,41)
COMMON /B/RANGE, NUM, APERT, FREQ, WAVEL, XK, PARRAD, NCOUNT, PCT, PSF,
1 DIV, XNEAR, IFLAG, IFLAG1, IFLAG2, IFLAG3, VELCTY, XKA, RFREQ(100),
2 TRANR, AMP(41,41), THETA(41,41), ASF, RPHASE(100), RREAL(100),
3 SCAT, CENTER, M, AMPMIN, AMPMAX, THEMIN, THEMAY, PIC(41,41), DIM,
4 RNUM(100), RPRS(100), RMAG(100), RIMAG(100), DAMP, DTHETA, RPCT(100),
5 TEMPRS, ANS, RAMP(100), STOP, XINC, SCTANS, XNUM, RVOL(100), ARPVOL, PRS

```

```

C
C MAIN PROGRAM

TYPE 1000
1000 FORMAT(26X, 'BIOENGINEERING PROGRAM', //)

CALL ASK
1005 CALL INIT
CALL CRUNCH
CALL WARN
CALL ARYPIC
CALL DECIDE
CALL VERIFY
CALL NORMAL
CALL STAT
CALL AVGPRS
CALL FILINC
CALL INCVAR

IF(IFLAG2.EQ.0) GOTO 1005
2050 TYPE 2055
2055 FORMAT('ODO YOU WISH TO CONTINUE(Y/N)? ', $)
CALL BELL
ACCEPT 2060, ANSWER
2060 FORMAT(A1)
IF(ANSWER.NE.'Y') GOTO 2070
CALL ASK
GOTO 1005
2070 CALL PARCNT
CALL SAVDAT
CALL VOLDAT
STOP
END

```



```

C*****
C
C  PRDAT: PRINT RESULTS OF AMPLITUDE AND PHASE CALCULATIONS
C
C*****

```

```

SUBROUTINE PRDAT(FNAME3,FNAME4)
DOUBLE PRECISION FNAME3,FNAME4
INTEGER ITHETA(41,41)

CALL OPEN(21,'FILE',FNAME3)
CALL OPEN(22,'FILE',FNAME4)
WRITE(21,2076)
2076 FORMAT(53X,'AMPLITUDE DATA')
WRITE(22,2077)
2077 FORMAT(58X,'PHASE DATA')
WRITE(21,2078)
2078 FORMAT(53X,14('-'),//)
WRITE(22,2079)
2079 FORMAT(58X,10('-'),//)

DO 2090 I =1,M
DO 2091 J =1,M
2091 ITHETA(I,J) = INT(THETA(I,J))
2090 CONTINUE
WRITE(21,2085)((AMP(I,J),J=9,33),I=9,33)
WRITE(22,2086)((ITHETA(I,J),J=9,33),I=9,33)
2085 FORMAT(25(F5.2))
2086 FORMAT(25(I4,1X))

WRITE(21,2081)
WRITE(22,2081)
2081 FORMAT(' ',///)
IF(SCTANS.EQ.'0') WRITE(21,2093) PCT,FREQ
IF(SCTANS.EQ.'0') GOTO 2094
2093 FORMAT(1X,'NUMBER:',F8.1,7X,'FREQUENCY:',F5.2,' MHZ')
WRITE(21,2082) NUM,FREQ
WRITE(22,2082) NUM,FREQ
2082 FORMAT(1X,'NUMBER:',I5,10X,'FREQUENCY:',F5.2,' MHZ')
2094 WRITE(21,2083) RANGE
WRITE(22,2083) RANGE
2083 FORMAT(1X,'DISTANCE FROM TRANSDUCER TO SCATTER:',F7.2,' CM')
WRITE(21,2084) APERT
WRITE(22,2084) APERT
2084 FORMAT(1X,'TRANSDUCER APERTURE:',F6.3,' CM')
WRITE(21,2088) DAMP
WRITE(22,2088) DTHETA
2088 FORMAT(1X,'DIFFERENCE:',F11.5)
WRITE(21,2092) TEMPRS
2092 FORMAT(1X,'AVERAGE RECEIVED PRESSURE:',F10.5)
CALL CLOSE(21)
CALL CLOSE(22)
RETURN
END

```

```

C*****
C
C  PRDAT: PRINT RESULTS OF AMPLITUDE AND PHASE CALCULATIONS
C
C*****

```

```

      SUBROUTINE PRDAT(FNAME3,FNAME4)
      DOUBLE PRECISION FNAME3,FNAME4
      INTEGER ITHETA(41,41)
      CALL OPEN(21,'FILE',FNAME3)
      CALL OPEN(22,'FILE',FNAME4)
      WRITE(21,2076)
2076  FORMAT(53X,'AMPLITUDE DATA')
      WRITE(22,2077)
2077  FORMAT(58X,'PHASE DATA')
      WRITE(21,2078)
2078  FORMAT(53X,14('-'),//)
      WRITE(22,2079)
2079  FORMAT(58X,10('-'),//)
      DO 2090 I =1,M
      DO 2091 J =1,M
2091  ITHETA(I,J) = INT(THETA(I,J))
2090  CONTINUE
      WRITE(21,2085)((AMP(I,J),J=9,33),I=9,33)
      WRITE(22,2086)((ITHETA(I,J),J=9,33),I=9,33)
2085  FORMAT(25(F5.2))
2086  FORMAT(25(I4,1X))

      WRITE(21,2081)
      WRITE(22,2081)
2081  FORMAT(' ',///)
      IF(SCTANS.EQ.'0') WRITE(21,2093) PCT,FREQ
      IF(SCTANS.EQ.'0') GOTO 2094
2093  FORMAT(1X,'NUMBER:',F8.1,7X,'FREQUENCY:',F5.2,' MHZ')
      WRITE(21,2082) NUM,FREQ
      WRITE(22,2082) NUM,FREQ
2082  FORMAT(1X,'NUMBER:',I5,10X,'FREQUENCY:',F5.2,' MHZ')
2094  WRITE(21,2083) RANGE
      WRITE(22,2083) RANGE
2083  FORMAT(1X,'DISTANCE FROM TRANSDUCER TO SCATTER:',F7.2)
      WRITE(21,2084) APERT
      WRITE(22,2084) APERT
2084  FORMAT(1X,'TRANSDUCER APERTURE:',F6.3,' CM')
      WRITE(21,2088) DAMP
      WRITE(22,2088) DTHETA
2088  FORMAT(1X,'DIFFERENCE:',F11.5)
      WRITE(21,2092) TEMPRS
2092  FORMAT(1X,'AVERAGE RECEIVED PRESSURE:',F10.5)
      CALL CLOSE(21)
      CALL CLOSE(22)
      RETURN
      END

```

```

C*****
C
C  AVGPRS: CALCULATE AVERAGE RECEIVED PRESSURE FOR THE TRANSDUCER
C
C*****

```

SUBROUTINE AVGPRS

```

      K = 0
      TEMPRS = 0.0
      DO 3005 I = 1,M
      DO 3000 J = 1,M
      IF(PIC(I,J).EQ.'-') GOTO 3000
      TEMPRS = TEMPRS + AMP(I,J)
      K = K + 1
3000  CONTINUE
3005  CONTINUE
      TEMPRS = TEMPRS/FLOAT(K)
      RPRS(NCOUNT) = TEMPRS
      AREA = 3.1415927 * (TRANR**2)
      APRESS = (TEMPRS/AREA)
      TYPE 3010,APRESS,TEMPRS
3010  FORMAT('OAVGPRS/AREA = ',F11.5,' AVGPRS = ',F11.5)
      IF(SCTANS.NE.'V') GOTO 3025
      VOLUME = 3.1415926 * (TRANR**2) * .1
      ARPVOL = TEMPRS/VOLUME
      RVOL(NCOUNT) = ARPVOL
3025  RETURN
      END

```

```

C*****
C
C  CRUNCH: CALCULATE SCALE FACTORS
C
C*****

```

SUBROUTINE CRUNCH

```

      NNUM = NUM
      IF(NUM.EQ.1) NNUM = NNUM + 1
      XNUM = FLOAT(NNUM)
      PSF = (APERT/(XNUM-1.0))
      CENTER = INT(M/2.0) + 1.0
      TRANR = (APERT/2.0)
      ASF = (APERT/(DIM-1.00))
      PARRAD = 6.0
      RETURN
      END

```

```

C*****
C
C INFO: WRITE INFORMATION TO DISK IN FILE INFXXX.DAT
C
C*****

      SUBROUTINE INFO(FNAME1,FNAME2)
      DOUBLE PRECISION FNAME1,FNAME2
      CALL OPEN(21,'FILE',FNAME2)
      WRITE(21,4000)
4000  FORMAT(26X,'INFORMATION FILE')
      WRITE(21,4005)
4005  FORMAT(26X,16('-'),///)
      WRITE(21,4010) FNAME1
4010  FORMAT(5X,'PLOTTING DATA FILE NAME: ',A10,/)
      WRITE(21,4015) NUM
4015  FORMAT(5X,'NUMBER OF SCATTERING PARTICLES:',I5,/)
      WRITE(21,4020) RANGE
4020  FORMAT(5X,'DISTANCE TRANSDUCER - SCATTERERS:',F7.2,1X,'CM',/)
      WRITE(21,4025) APERT
4025  FORMAT(5X,'APERATURE OF TRANSDUCER:',F8.3,1X,'CM',/)
      WRITE(21,4035) FREQ
4035  FORMAT(5X,'FREQUENCY:',F7.2,1X,'MEGAHERTZ',/)
      WRITE(21,4040) WAVEL
4040  FORMAT(5X,'WAVELENGTH:',F7.2,1X,'MILLIMETERS',/)
      WRITE(21,4045) XK
4045  FORMAT(5X,'WAVENUMBER K:',F10.2,' RAD/CM',/)
      WRITE(21,4050) PARRAD
4050  FORMAT(5X,'SCATTERER RADIUS:',F7.2,1X,'MICROMETERS',/)
      WRITE(21,4060) DIV
4060  FORMAT(5X,'ANGLE OF DIVERGENCE:',F7.2,1X,'DEGREES',/)
      WRITE(21,4065) XNEAR
4065  FORMAT(5X,'NEAR-FARFIELD BOUNDARY:',F7.2,1X,'CENTIMETERS',/)
      WRITE(21,4070) VELCTY
4070  FORMAT(5X,'WAVESPEED:',F8.2,1X,'METERS/SEC',/)
      WRITE(21,4075) XKA
4075  FORMAT(5X,'KA:',F8.5,/)
      WRITE(21,4080) SCAT
4080  FORMAT(5X,'SCATTERING PARTICLE COEFFICIENT:',F5.2,/)
      WRITE(21,4090) SCTANS
4090  FORMAT(5X,'SCATTERERING ARRANGEMENT: ',A1,/)
      WRITE(21,4100) TEMPRS
4100  FORMAT(5X,'AVERAGE RECEIVED PRESSURE =',F11.5,/)
      WRITE(21,4105) DAMP
4105  FORMAT(5X,'AMPLITUDE DIFFERENCE - TRANSDUCER = ',F11.6,/)
      WRITE(21,4110) DTHETA
4110  FORMAT(5X,'PHASE DIFFERENCE ACROSS TRANSUCER = ',F11.6,/)
      CALL CLOSE(21)
      RETURN
      END

```

```

C*****
C
C  VERIFY: DISPLAY INFORMATION ON TTY FOR VERIFERCATION
C
C*****

```

SUBROUTINE VERIFY

```

      TYPE 5000
5000  FORMAT('0  ')
      TYPE 5005
5005  FORMAT(26X,'INPUT DATA SUMMARY',/)
      TYPE 5010,NCOUNT,PCT
5010  FORMAT('ONCOUNT:',I6,25X,'NUMBER OF PARTICLES',F7.1)
      TYPE 5015,RANGE,APERT
5015  FORMAT('OLENGTH FACE TO PARTICLES',F7.2,7X,'APERATURE:',F8.3)
      TYPE 5020,WAVEL,XK
5020  FORMAT('OWAVELENGTH:',F7.2,20X,'WAVENUMBER:',F10.2,' RAD/CM')
      TYPE 5025,PARRAD,FREQ
5025  FORMAT('OPARTICLE RADIUS:',F7.2,15X,'FREQ:',F7.2,1X,'MHERTZ')
      TYPE 5030,DIV,XNEAR
5030  FORMAT('ODIVERGENCE:',F7.2,20X,'NEARFIELD BOUNDARY:',F7.2)
      RETURN
      END

```

```

C*****
C
C  INIT: INTIALIZE ULTRASONIC AND ARRAY PARAMETERS
C
C*****

```

SUBROUTINE INIT

```

      M = 41
      DIM = 23.0
      SCAT = 1.0
      VELCTY = 1500.00
      WAVEL = (VELCTY/(FREQ*1.0E03))
      XK = (2.0 * 3.14159)/(WAVEL/10.0)
      XNEAR = (APERT**2)/(0.40 * WAVEL)
      DIV = (ASIN((.122 * WAVEL)/APERT)) * 57.29578
      NCOUNT = NCOUNT + 1
      AMPMIN = 1000.00
      AMPMAX = -1000.00
      THEMIN = 1000.00
      THEMAX = -1000.00
      RETURN
      END

```

```

C*****
C
C SAVDAT: CREATE DATA FILE FOR PLOTTING OF AVERAGE AMPLITUDE
C VS. NUMBER OF SCATTERERS AND WRITE DATA SUMMARY FILE TO DISK
C
C*****

```

```

SUBROUTINE SAVDAT
DOUBLE PRECISION FNAME5, FNAME6

CALL NAME(FNAME5, FNAME6)
CALL OPEN(21, 'FILE', FNAME5)
CALL OPEN(22, 'FILE', FNAME6)
WRITE(22, 8010)
8010 FORMAT(35X, 'DATA SUMMARY')
WRITE(22, 8015)
8015 FORMAT(35X, 12('-', '/////'))
WRITE(22, 8016) SCTANS
8016 FORMAT(6X, 'SCATTERERING ARRANGEMENT: ', A1, '//)
IF(ANS.NE.'F') GOTO 8022
WRITE(22, 8021) RANGE, APERT, NUM
8021 FORMAT(6X, 'RANGE:', F7.2, ' CM APERT:', F6.3, ' CM NUM: ', I5, '//)
WRITE(22, 8026)
8026 FORMAT(5X, 'FRQ', 4X, 'AVG PRS', 4X, 'DIFF AMP', 4X, 'DIFF PHASE', 4X,
1 'REAL', 5X, 'IMAGINARY', 4X, 'MAGNITUDE')
GOTO 8002
8022 WRITE(22, 8020) RANGE, APERT, FREQ
8020 FORMAT(6X, 'RANGE:', F7.2, ' CM APERT:', F6.3, ' CM FREQ: ',
1 F5.2, ' MEGAHERTZ', '//)
WRITE(22, 8025)
8025 FORMAT(5X, 'NUM', 4X, 'AVG PRS', 4X, 'DIFF AMP', 4X, 'DIFF PHASE', 4X,
1 'REAL', 5X, 'IMAGINARY', 4X, 'MAGNITUDE')
8002 WRITE(22, 8030)
8030 FORMAT(5X, '---', 4X, 7('-'), 4X, 8('-'), 4X, 10('-'), 4X, '----', 5X,
1 9('-'), 4X, 9('-'), '//)
DO 8000 I = 1, NCOUNT
IF(ANS.NE.'F') GOTO 8001
WRITE(21, 8005) RFREQ(I), RPRS(I)
WRITE(22, 8040) RFREQ(I), RPRS(I), RAMP(I), RPHASE(I), RREAL(I),
1 RIMAG(I), RMAG(I)
GOTO 8000
8001 WRITE(21, 8005) RNUM(I), RPRS(I)
8035 WRITE(22, 8040) RNUM(I), RPRS(I), RAMP(I), RPHASE(I), RREAL(I),
1 RIMAG(I), RMAG(I)
8005 FORMAT(3X, F11.4, 2X, F11.7)
8040 FORMAT(3X, F6.0, 2X, F9.5, 3X, F7.3, 7X, F7.3, 4X, F7.3, 5X, F7.3, 5X, F7.3)
8000 CONTINUE
CALL CLOSE(21)
CALL CLOSE(22)
RETURN
END

```

```
C*****
C
C ARYPIC: INITIALIZE PICTATORIAL TRANSDUCER REPRESENTATION
C ROUTINE LOCATES PARTICLE SCATTERERS WITHIN TRANSDUCER BEAM
C
C*****
```

```
      SUBROUTINE ARYPIC
```

```
      DO 6005 I = 1,M
      DO 6000 J = 1,M
      PIC(I,J) = '-'
      AMP(I,J) = 0.0
6000  THETA(I,J) = 0.0
6005  CONTINUE
      RETURN
      END
```

```
C*****
C
C PLTDAT: WRITE PLOTTING DATA TO DISK
C
C*****
```

```
      SUBROUTINE PLTDAT(FNAME1)
      DOUBLE PRECISION FNAME1
```

```
      CALL OPEN(21,'FILE',FNAME1)
      WRITE(21,7000) M,AMPMIN,AMPMAX,THEMIN,THEMAX,SCTANS
7000  FORMAT(I3,1X,F11.5,1X,F11.5,1X,F11.5,1X,F11.5,1X,A1)
      WRITE(21,7005) NUM,TRANR,RANGE,FREQ,APERT,PCT
7005  FORMAT(I5,1X,F11.5,1X,F11.5,1X,F11.5,1X,F11.5,1X,F11.5)
      WRITE(21,7010)((AMP(I,J),J=1,M),I=1,M)
      WRITE(21,7010)((THETA(I,J),J=1,M),I=1,M)
7010  FORMAT(41(F11.6,1X))
      CALL CLOSE(21)
      RETURN
      END
```

```

C*****
C
C ASK: PROMPT USER FOR INPUT VARIABLES
C
C*****

      SUBROUTINE ASK
8000   IFLAG = 0
      IFLAG1 = 0
8002   TYPE 8003
8003   FORMAT('OSCATTERER ARRANGEMENT(L,O,R,V,A): ', $)
      ACCEPT 8055, SCTANS
      TYPE 8001
8001   FORMAT('OSPECIFY NUMBER OF SCATTERING PARTICLES: ', $)
      ACCEPT 8005, NUM
8005   FORMAT(I)
      TYPE 8010
8010   FORMAT('OENTER DISTANCE FROM TRANSDUCER TO PARTICLES: ', $)
      ACCEPT 8015, RANGE
8015   FORMAT(F)
      TYPE 8020
8020   FORMAT('OTRANSDUCER APERTURE: ', $)
      ACCEPT 8015, APERT
      TYPE 8030
8030   FORMAT('OPLEASE ENTER OPERATING FREQUENCY(MEGAHERTZ): ', $)
      ACCEPT 8015, FREQ
8045   TYPE 8050
8050   FORMAT('ORANGE, NUMBER SCATTERERS, APERTURE, FREQ(R,N,A,F): ', $)
      ACCEPT 8055, ANS
8055   FORMAT(A1)
      IF(ANS.NE.'R'.AND.ANS.NE.'N'.AND.ANS.NE.'A'.AND.ANS.NE.'F')
      1 GOTO 8045
      TYPE 8070
8070   FORMAT('OENTER STOP VALUE-REAL VALUE): ', $)
      ACCEPT 8015, STOP
      IF(STOP.NE.FLOAT(NUM)) GOTO 8074
      XINC = 1.0
      GOTO 8079
8074   TYPE 8075
8075   FORMAT('OINCREMENT OF VARIABLE-REAL VALUE): ', $)
      ACCEPT 8015, XINC
8079   TYPE 8080
8080   FORMAT('ODO YOU WANT PLOTTING DATA WRITTEN TO DISK(Y/N)? ', $)
      ACCEPT 8055, ANSWER
      IF(ANSWER.EQ.'N') IFLAG = 1
      TYPE 8085
8085   FORMAT('OPRINTED DATA WRITTEN TO DISK(Y/N)? ', $)
      ACCEPT 8055, ANSWER
      IF(ANSWER.EQ.'N') IFLAG1 = 1
      TYPE 8090
8090   FORMAT('OIS ABOVE INPUT DATA CORRECT(Y/N)? ', $)
      ACCEPT 8055, ANS1
      IF(ANS1.EQ.'N') GOTO 8000
      RETURN
      END

```



```

C*****
C
C  NORMAL: THIS SUBROUTINE NORMALIZES DATA AS OUTLINED.
C  1.  DETERMINE PHASE FROM COMPLEX PRESSURE ARRAY
C  2.  CALCULATE AMPLITUDE FROM MAGNITUDE*COS(PHASE)
C  3.  LOCATE AMPLITUDE AND PHASE MAXIMA AND MINIMA
C  4.  WRITE RESULTS TO ARRAYS
C
C*****

```

```

SUBROUTINE NORMAL
COMPLEX PRS(41,41),Z

```

```

Z = PRS(IFIX(CENTER),IFIX(CENTER))

```

```

DO 7005 I = 10,32
DO 7000 J = 10,32
IF(PIC(I,J).EQ.'-') GOTO 7000
PRS(I,J) = PRS(I,J)/Z
THETA(I,J)=57.295780*ATAN2(AIMAG(PRS(I,J)),REAL(PRS(I,J)))
AMP(I,J) = COSD(THETA(I,J))
IF(THETA(I,J).LT.0.0) THETA(I,J) = THETA(I,J) + 360.00
7005 CONTINUE
7000 CONTINUE

```

```

DO 7025 I =1,M
DO 7020 J =1,M
IF(PIC(I,J).EQ.'-') GOTO 7020
IF(AMP(I,J).GT.AMPMAX) AMPMAX = AMP(I,J)
IF(AMP(I,J).LT.AMPMIN) AMPMIN = AMP(I,J)
IF(THETA(I,J).GT.THEMAX) THEMAX = THETA(I,J)
IF(THETA(I,J).LT.THEMIN) THEMIN = THETA(I,J)
7020 CONTINUE
7025 CONTINUE

```

```

DAMP = AMPMAX - AMPMIN
DTHETA = THEMAX - THEMIN
RPCT(NCOUNT) = PCT
RPHASE(NCOUNT) = DTHETA
RAMP(NCOUNT) = DAMP
RNUM(NCOUNT) = FLOAT(NUM)
RMAG(NCOUNT) = CABS(Z)
RIMAG(NCOUNT) = AIMAG(Z)
RREAL(NCOUNT) = REAL(Z)
RFREQ(NCOUNT) = FREQ
RETURN
END

```

```

C*****
C
C RDNAPT: THIS SUBROUTINE RANDOMLY PLACES A POINT SCATTERER WITHIN A
C SURFACE AREA SPECIFIED IN VARIABLE SCTDIM. THE USER VARY APERTURE
C
C*****

```

```

SUBROUTINE RDNAPT
  COMPLEX C, PRS(41,41)

  PCT = FLOAT(NUM)
  SEED1 = .012345
  SEED2 = .543210
  SEED3 = .975310
  SEED4 = .013579
  SCTDIM = .75
  ASFSCT = SCTDIM/(DIM - 1.0)
  SCTRAD = SCTDIM/2.0
  DO 1010 I1 = 1,M
  DO 1005 J1 = 1,M
  XI1 = FLOAT(I1)
  XJ1 = FLOAT(J1)
  TEMP1 = ASF*SQRT((XI1-CENTER)**2 + (XJ1-CENTER)**2)
  IF(TEMP1.GT.TRANR) GOTO 1005
  C = (0.0,0.0)
  NUMBER = 0
  PIC(I1,J1) = 'X'
  DO 1000 I2 = 1,100000
  SIGN1 = 1.0
  SIGN2 = 1.0
  TEMP5 = RAN(SEED3)
  TEMP6 = RAN(SEED4)
  IF(TEMP5.LT..5000) SIGN1 = -1.0
  IF(TEMP6.LT..5000) SIGN2 = -1.0
  XRAND = SCTDIM * RAN(SEED1) * SIGN1
  YRAND = SCTDIM * RAN(SEED2) * SIGN2
  SEED1 = SEED1 + .13
  SEED2 = SEED2 + .133
  SEED3 = SEED3 + .1333
  SEED4 = SEED4 + .13333
  TEMP3 = XRAND/ASFCT
  TEMP4 = YRAND/ASFCT
  TEMP2 = ASFCT*SQRT((TEMP3+XI1-CENTER)**2 + (TEMP4+XJ1-CENTER)**2)
  IF(TEMP2.GT.SCTRAD) GOTO 1000
  NUMBER = NUMBER + 1
  XLEG2 = SQRT(XRAND**2 + YRAND**2)
  HYPO = SQRT(XLEG2**2 + RANGE**2)
  C = (SCAT/HYPO)*CEXP((0.0,1.0)*XK*(RANGE+HYPO)) + C
  IF(NUMBER.EQ.NUM) GOTO 1004
1000 CONTINUE
1004 PRS(I1,J1) = C
1005 CONTINUE
1010 CONTINUE
RETURN

```

```

C*****
C
C  VOLSC: THIS SUBROUTINE RANDOMLY PLACES A PARTICLE WITHIN A CYLINDER
C
C*****

```

```

SUBROUTINE VOLSC
  COMPLEX C, PRS(41,41)
  PCT = FLOAT(NUM)
  SEED1 = .012345
  SEED2 = .543210
  SEED3 = .975310
  SEED4 = .013579
  SEED5 = .024531
  DO 2010 I1 = 10, 32
  DO 2005 J1 = 10, 32
  TEMP1 = ASF * SQRT((FLOAT(I1)-CENTER)**2+(FLOAT(J1)-CENTER)**2)
  IF(TEMP1.GT.TRANR) GOTO 2005
  NUMBER = 0
  C = (0.0,0.0)
  PIC(I1,J1) = 'X'
  DO 2000 I2 =1,999999
  SIGN1 = 1.0
  SIGN2 = 1.0
  TEMP5 = RAN(SEED3)
  TEMP6 = RAN(SEED4)
  IF(TEMP5.LT..5000) SIGN1 = -1.0
  IF(TEMP6.LT..5000) SIGN2 = -1.0
  XRAND = APERT * RAN(SEED1) * SIGN1
  YRAND = APERT * RAN(SEED2) * SIGN2
  SEED1 = SEED1 + .13
  SEED2 = SEED2 + .133
  SEED3 = SEED3 + .1333
  SEED4 = SEED4 + .13333
  SEED5 = SEED5 + .133333
  TEMP3 = XRAND/ASF
  XI1 = FLOAT(I1)
  XJ1 = FLOAT(J1)
  TEMP4 = YRAND/ASF
  TEMP2 = ASF*SQRT((TEMP3+XI1-CENTER)**2+(TEMP4+XJ1-CENTER)**2)
  IF(TEMP2.GT.TRANR) GOTO 2000
  NUMBER = NUMBER + 1
  XLEG2 = SQRT(XRAND**2 + YRAND**2)
  DEPTH = (RAN(SEED5) * .1) + RANGE
  HYPO = SQRT(XLEG2**2 + DEPTH**2)
  C = (SCAT/HYPO)*CEXP((0.0,1.0)*XK*(DEPTH+HYPO)) + C
  IF(NUMBER.EQ.NUM) GOTO 2004
2000 CONTINUE
2004 PRS(I1,J1) = C
2005 CONTINUE
2010 CONTINUE
  RETURN
  END

```

```

C*****
C
C RDNSCT: THIS SUBROUTINE TAKES THE COORDINATE I1,J1 FROM THE TRANSDUCER
C FACE AND SUMS THE AMPLITUDE AND PHASE DUE TO EACH SCATTERER WITHIN
C THE BEAM PROFILE. ASSUME A PLANAR INCIDENT WAVE WITH A SPHERICAL
C REFLECTED WAVEFRONT
C 1) ASF = ARRAY SCALE FACTOR (CM/#BLOCKS FOR TRANSDUCER)
C 2) PRS = COMPLEX PRESSURE ARRAY
C 3) XRAND = RANDOM X COORDINATE (YRAND - Y COORDINATE)
C
C*****

```

```

SUBROUTINE RDNSCT
COMPLEX C,PRS(41,41)

```

```

PCT = FLOAT(NUM)
SEED1 = .012345
SEED2 = .543210
SEED3 = .975310
SEED4 = .013579
DO 3010 I1 = 1,M
DO 3005 J1 = 1,M
C = (0.0,0.0)
NUMBER = 0
XI1 = FLOAT(I1)
XJ1 = FLOAT(J1)
TEMP1 = ASF*SQRT((XI1-CENTER)**2 + (XJ1-CENTER)**2)
IF(TEMP1.GT.TRANR) GOTO 3005
PIC(I1,J1) = 'X'
DO 3000 I2 = 1,10000
SIGN1 = 1.0
SIGN2 = 1.0
TEMP5 = RAN(SEED3)
TEMP6 = RAN(SEED4)
IF(TEMP5.LT..5000) SIGN1 = -1.0
IF(TEMP6.LT..5000) SIGN2 = -1.0
XRAND = APERT * RAN(SEED1) * SIGN1
YRAND = APERT * RAN(SEED2) * SIGN2
SEED1 = SEED1 + .13
SEED2 = SEED2 + .133
SEED3 = SEED3 + .1333
SEED4 = SEED4 + .13333
TEMP3 = XRAND/ASF
TEMP4 = YRAND/ASF
TEMP2 = ASF*SQRT((TEMP3+XI1-CENTER)**2+(TEMP4+XJ1-CENTER)**2)
IF(TEMP2.GT.TRANR) GOTO 3000
NUMBER = NUMBER + 1
XLEG2 = SQRT(XRAND**2 + YRAND**2)
HYPO = SQRT(XLEG2**2 + RANGE**2)
C = (SCAT/HYPO)*CEXP((0.0,1.0)*XK*(RANGE+HYPO)) + C
IF(NUMBER.EQ.NUM) GOTO 3004
3000 CONTINUE
3004 PRS(I1,J1) = C
3005 CONTINUE
3010 CONTINUE

```

```

C*****
C
C  FILINC: INCREMENT DATA FILE NAMES & CALL INFO AND SAVDAT SUBROUTINES
C
C*****

```

```

      SUBROUTINE FILINC
      DOUBLE PRECISION FNAME1,FNAME2,FNAME3,FNAME4

```

```

C  FLAG OPERATIONS:
C    0 = PERFORM ROUTINE
C    1 = SKIP

```

```

      IF(IFLAG.EQ.1.AND.IFLAG1.EQ.1) GOTO 4005

```

```

      FNAME1 = 'PLT000.DAT'
      FNAME2 = 'AMPO00.DAT'
      FNAME3 = 'INFO00.DAT'
      FNAME4 = 'PHZ000.DAT'

```

```

C  ALLOW INCREMENT OF FILE NAMES DEPENDING UPON THE CHANGING VARIABLE

```

```

      IF(ANS.EQ.'A') ICOUNT = IFIX(APERT * 100.00)
      IF(ANS.EQ.'R') ICOUNT = IFIX(RANGE * 10.00)
      IF(ANS.EQ.'F') ICOUNT = IFIX(FREQ * 10.00)
      IF(ANS.EQ.'N') ICOUNT = NUM

```

```

      DO 4000 I = 1,ICOUNT
      CALL INCFIL(FNAME1)
      CALL INCFIL(FNAME2)
      CALL INCFIL(FNAME3)
4000  CALL INCFIL(FNAME4)

```

```

      IF(IFLAG.EQ.0) CALL PLTDAT(FNAME1)
      IF(IFLAG1.EQ.0) CALL PRTDAT(FNAME2,FNAME4)
      IF(IFLAG1.EQ.0) CALL INFO(FNAME1,FNAME3)

```

```

4005  RETURN
      END

```

```
C*****  
C  
C  INCVAR: INCREMENT COUNTER VARIABLES AND SET CONTROL FLAG 2  
C  
C*****
```

```
      SUBROUTINE INCVAR
```

```
      IFLAG2 = 0
```

```
      IF(ANS.NE.'N') GOTO 5000
```

```
      NUM = NUM + IFIX(XINC)
```

```
      ISTOP = IFIX(STOP)
```

```
      IF(NUM.GT.ISTOP) IFLAG2 = 1
```

```
      GOTO 5015
```

```
5000  IF(ANS.EQ.'A'.OR.ANS.EQ.'F') GOTO 5005
```

```
      RANGE = RANGE + XINC
```

```
      IF(RANGE.GT.STOP) IFLAG2 = 1
```

```
      GOTO 5015
```

```
5005  IF(ANS.EQ.'F') GOTO 5010
```

```
      APERT = APERT + XINC
```

```
      IF(APERT.GT.STOP) IFLAG2 = 1
```

```
      GOTO 5015
```

```
5010  FREQ = FREQ + XINC
```

```
      IF(FREQ.GT.STOP) IFLAG2 = 1
```

```
5015  RETURN
```

```
      END
```

```

C*****
C
C LINSCT: THIS SUBROUTINE TAKES EACH COORDINATE ON THE TRANSDUCER
C AND SUMS THE AMPLITUDE AND PHASE DISTRIBUTION DUE TO EACH SCATTER.
C THE SCATTERERS ARE ARRANGED IN A LINEAR (ONE-DIMENSIONAL) ARRAY.
C
C*****

```

```

SUBROUTINE LINSCT
COMPLEX C, PRS(41,41)

```

```

XEDGE = IFIX(CENTER) - INT(DIM/2.0)
YEDGE = CENTER
PCT = FLOAT(NUM)

```

```

DO 6020 I =1,M
DO 6015 J =1,M
XI = FLOAT(I)
XJ = FLOAT(J)
XTEMP = ASF*SQRT((XI-CENTER)**2 + (XJ-CENTER)**2)
IF(XTEMP.GT.TRANR) GOTO 6015
C = (0.0,0.0)
PIC(I,J) = 'X'
IF(NUM.NE.1) GOTO 6000
XLEG2 = SQRT((((ASF)*(XI-XEDGE)-(TRANR))**2) +
1 ((XJ-YEDGE)*(ASF))**2))
HYPO = SQRT(XLEG2**2 + RANGE**2)
C =(SCAT/HYPO)*CEXP((0.0,1.0) *XK*(RANGE+HYPO))
GOTO 6011

```

```

6000 DO 6010 I2 =1,NUM
XI2 = FLOAT(I2)
XLEG2 =SQRT(((ASF)*(XI-XEDGE)-(XI2-1.0)*(PSF))**2 +
1 ((XJ-YEDGE)*(ASF))**2)
HYPO = SQRT(XLEG2**2 + RANGE**2)
C = (SCAT/HYPO)*CEXP((0.0,1.0) * XK * (RANGE+HYPO)) + C
6010 CONTINUE
6011 PRS(I,J) = C
6015 CONTINUE
6020 CONTINUE
RETURN
END

```

```

C*****
C
C  PARCNT: LOADS PARTICLE COUNT ARRAY (RPCT) USED IN THE RECTANGULAR
C  SCATTERERING ARRANGEMENT IN THE NUMBER COUNT ARRAY (RNUM) FOR USE IN
C  SAVDAT SUBROUTINE.
C
C*****

```

SUBROUTINE PARCNT

```

C  SCTANS:
C    L,R,V,A = EXIT
C    O       = PERFORM TRANSFER

      T = SCTANS
      IF(T.EQ.'L'.OR.T.EQ.'R'.OR.T.EQ.'V'.OR.T.EQ.'A') GOTO 7010

      DO 7000 I = 1,NCOUNT
      RNUM(I) = RPCT(I)
7000  CONTINUE

      TYPE 7005
7005  FORMAT('ODATA TRANSFER FROM RPCT ARRAY TO RNUM COMPLETED!')
7010  RETURN
      END

```

```

C*****
C
C  DECIDE: THIS SUBROUTINE CALLS THE CORRECT SCATTERERING ROUTINE BASED
C  ON USER INPUT.
C
C*****

```

SUBROUTINE DECIDE

```

C  SCATTERER ROUTINE: USER DEFINED
C    L = LINEAR ARRAY
C    O = RECTANGULAR ARRAY
C    R = RANDOM ARRAY
C    V = RANDOM VOLUME
C    A = RANDOM ARRAY CONSTANT SCATTERING APERTURE

      IF(SCTANS.EQ.'L') CALL LINSCT
      IF(SCTANS.EQ.'O') CALL RCTSCT
      IF(SCTANS.EQ.'R') CALL RDNSCT
      IF(SCTANS.EQ.'V') CALL VOLSCCT
      IF(SCTANS.EQ.'A') CALL RDNAPT
      RETURN
      END

```



```

C*****
C
C  RCTSCT: BACKSCATTER ROUTINE FEATURING A RECTANGULAR ARRANGEMENT
C  OF PARTICLES WITHIN A TRANSDUCER BEAM PROFILE
C
C*****

```

```

      SUBROUTINE RCTSCT
      COMPLEX C,PRS(41,41)
      XEDGE = 10.0
      YEDGE = 10.0
      TEMP5 = FLOAT(NUM)/2.0
      TEMP2 = TEMP5 - INT(TEMP5)
      IF(TEMP2.NE.0.00) GOTO 3000
      PCNTR = TEMP5 + .5000
      GOTO 3005
3000  PCNTR = INT(TEMP5) + 1.0
3005  DO 3025 I1 = 10,32
      DO 3020 J1 = 10,32
      XI1 = FLOAT(I1)
      XJ1 = FLOAT(J1)
      TEMP1 = ASF*SQRT((XI1-CENTER)**2 + (XJ1-CENTER)**2)
      IF(TEMP1.GT.TRANR) GOTO 3020
      C = (0.0,0.0)
      PIC(I1,J1) = 'X'
      DO 3015 I2 = 1,NUM
      DO 3010 J2 = 1,NUM
      TEMP3=PSF*SQRT((FLOAT(I2)-PCNTR)**2+(FLOAT(J2)-PCNTR)**2)
      IF(TEMP3.GT.TRANR) GOTO 3010
      XLEG2=SQRT(((ASF)*(XI1-XEDGE)-(FLOAT(I2)-1.0)*(PSF))**2 +
      1 ((XJ1-YEDGE)*(ASF)-(FLOAT(J2)-1.0)*(PSF))**2)
      HYPO = SQRT(XLEG2**2 + RANGE**2)
      C =(SCAT/HYPO)*CEXP((0.0,1.0)*XK*(RANGE+HYPO)) + C
      IF(XJ1.NE.CENTER.OR.XI1.NE.CENTER) GOTO 3010
      IF(I2.NE.IFIX(PCNTR).OR.J2.NE.IFIX(PCNTR)) GOTO 3010
      PCT = 0.0
      DO 3007 I3 = 1,NUM
      DO 3006 J3 = 1,NUM
      TEMP4=PSF*SQRT((FLOAT(I3)-PCNTR)**2 + (FLOAT(J3)-PCNTR)**2)
      IF(TEMP4.LE.TRANR) PCT = PCT + 1
3006  CONTINUE
3007  CONTINUE
3010  CONTINUE
3015  CONTINUE
      PRS(I1,J1) = C
3020  CONTINUE
3025  CONTINUE
      RETURN
      END

```

```

C*****
C
C  WARN: CHECK PARAMETERS TO SEE IF DATA ASSUMPTIONS HOLD
C
C*****

```

SUBROUTINE WARN

```

4003  XKA = XK * PARRAD * 1.0E-04
      IF(XKA.GT.1.0) TYPE 4005
4005  FORMAT('***KA > 1.0  CHECK INITIAL CONDITIONS***')
      IF(RANGE.LT.XNEAR) TYPE 4010
4010  FORMAT('0***SCATTERERING ARRAY WITHIN NEARFIELD***')
      RETURN
      END

```

```

C*****
C
C  VOLDAT: WRITE AVERAGE RECEIVED PRESSURE PER VOLUME TO DISK
C
C*****

```

SUBROUTINE VOLDAT
DOUBLE PRECISION FNAME

```

      IF(SCTANS.NE.'V') GOTO 5015
      FNAME = 'VD000.DAT'
      ICOUNT = IFIX(APERT * 100.00)

      DO 5000 I =1, ICOUNT
5000  CALL INCFIL(FNAME)
      CALL OPEN(21, 'FILE', FNAME)
      DO 5005 I =1, NCOUNT
      WRITE(21, 5010) RNLM(I), RVOL(I)
5005  CONTINUE
5010  FORMAT(1X, F11.6, 1X, F11.6)
      CALL CLOSE(21)
5015  RETURN
      END

```

AD-A109 682

PENNSYLVANIA STATE UNIV UNIVERSITY PARK APPLIED RESE--ETC F/8 17/1
EFFECTS OF PHASE CANCELLATION ON THE SCATTERING MEASUREMENTS.(U)
JUL 81 J M DZIERZANOWSKI N00024-79-C-6043
ARL/PSU/TH-81-201 NL

UNCLASSIFIED

2 of 2
Pages



END
DATE
FILMED
DTIC

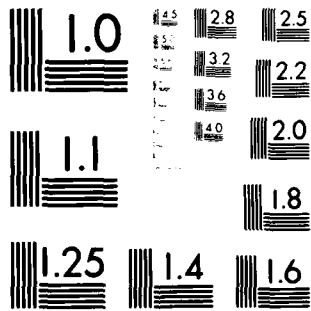

MICROCOPY RESOLUTION TEST CHART
NATIONAL BUREAU OF STANDARDS-1963-A

```

C*****
C
C ASKFEW: THIS SUBROUTINE IS USED WHEN A MACRO FILE CONTROLS EXECUTION
C
C*****

```

SUBROUTINE ASKFEW

```

      ACCEPT 8000,NUM
8000  FORMAT(I)
8005  FORMAT(F)
      XINC = 1.0
      STOP = 100.0
      APERT = .25
      FREQ = 5.0
      RANGE = 15.0
      IFLAG1 = 0
      ANS = 'N'
      IFLAG = 1
      SCTANS = 'V'
      RETURN
      END

```

```

C*****
C
C APPSTR: APPENDS ONE CHARACTER STRING TO ANOTHER
C 1) STRING - STRING TO BE EXTENDED
C 2) NCH - NUMBER OF CHARACTERS IN STRING UPON ENTRY
C 3) ADDTN - STRING TO BE APPENDED
C 4) NADD - NUMBER OF CHARACTERS TO BE APPENDED
C 5) I67 - CHARACTER TYPE : 6 = 6-BIT (FROM ASCPK)
C 7 = 7-BIT (STD. ASCII)
C
C*****

```

```

      SUBROUTINE APPSTR(STRING,NCH,ADDTN,NADD,I67)
      DIMENSION STRING(1)
      NBWD = (36/I67) * I67
      NBITS = NCH * I67
      NWD = NBITS/NBWD
      NBITR = NBITS - NWD * NBWD - 1
      NWD = NWD + 1

      CALL BPOINT(I67,STRING(NWD),NBITR,BPS)
      CALL BPOINT(I67,ADDTN,-1,BPA)
      DO 9000 I =1,NADD
      CALL ILDB(ICH,BPA)
      CALL IDPB(ICH,BPS)
9000  CONTINUE

      RETURN
      END

```

```

C*****
C
C STAT:  CALCULATE USING AMP(I,J) AND THETA(I,J) ARRAYS STATISTICAL
C        PARAMETERS - MEAN AND VARIANCE.
C
C*****

      SUBROUTINE STAT

      K = 0
      TEMPA = 0.0
      TEMPB = 0.0
      DO 1005 I = 1,M
         DO 1000 J = 1,M
            IF(PIC(I,J).EQ.'-') GOTO 1000
            TEMPA = TEMPA + AMP(I,J)
            TEMPB = TEMPB + THETA(I,J)
            K = K + 1
1000    CONTINUE
1005    CONTINUE

      AMEAN = TEMPA/FLOAT(K)
      PMEAN = TEMPB/FLOAT(K)

      K = 0
      TEMPA = 0.0
      TEMPB = 0.0
      DO 1015 I = 1,M
         DO 1010 J = 1,M
            IF(PIC(I,J).EQ.'-') GOTO 1010
            TEMPA = TEMPA + (AMP(I,J) - AMEAN)**2
            TEMPB = TEMPB + (THETA(I,J) - PMEAN)**2
            K = K + 1
1010    CONTINUE
1015    CONTINUE

      AVAR = TEMPA/(FLOAT(K) - 1.0)
      PVAR = TEMPB/(FLOAT(K) - 1.0)

      TYPE 1020,AMEAN,PMEAN
1020    FORMAT('OAMP MEAN AMPLITUDE = ',F11.6,' MEAN PHASE = ',F11.6)
      TYPE 1025,AVAR
1025    FORMAT('OAMP VARIANCE = ',F11.6)

      RETURN
      END

```

```
C*****  
C  
C NAME: CONSTRUCTS OUTPUT DATA FILE NAME USING USER SPECIFIED PARAMETERS  
C FIRST CHARACTER REFERS TO THE SCATTERING ARRANGEMENT AND THE  
C SECOND INDICATES WHICH PARAMETER IS BEING VARIED  
C  
C*****
```

```
SUBROUTINE NAME(FNAME5,FNAME6)  
DOUBLE PRECISION F1,FNAME5,FNAME6,S2
```

```
A2 = ANS  
S2 = SCTANS  
F1 = '0000.DAT'  
FNAME6 = 'TAB000.DAT'  
INAME = IFIX(APERT * 100.00)
```

```
CALL APPSTR(S2,1,A2,1,7)  
CALL APPSTR(S2,2,F1,4,7)
```

```
FNAME5 = S2
```

```
DO 2000 I = 1,INAME  
CALL INCFIL(FNAME5)  
CALL INCFIL(FNAME6)  
2000 CONTINUE
```

```
RETURN  
END
```

PLT3D

The graphics program, PLT3D, plots the three-dimensional amplitude and phase distributions across a transducer aperture. This program can be executed at installations supporting the TOPS-10 operating system and Tektronix AG-II graphics software. PLT3D operates in an interactive mode allowing flexible control of graphics parameters and subsequent plot generation. The main graphics subroutine, VISDO (Visualize Double Surfaces), requires data to be expressed in cartesian coordinates. VISDO plots an array of $M \times N$ elements, each array element having a distinct value. The user specifies the shear or rotation, relative elevation and span of the plot. The user may also specify the plot not to be cross-hatched, by including the subroutine TSPLT, meaning only lines in the left-to-right direction are drawn rather than left-to-right and front-to-back. The algorithm used by TSPLT accounts for hidden lines thus maintaining data integrity.

CPLLOT

The FORTRAN program CPLLOT constructs contour plots using data generated by PHASE. Once the amplitude and phase data have been read into program arrays, the number of contour levels must be specified. This parameter is used to determine how many contours of equivalence are drawn between the maximum and minimum data points. The contour subroutine PLTKP then drawn the final plot. This plot only shows the regularity of the data in one plane with no evidence of relative height between contours.

```

C*****
C
C PHASE-CANCELLATION STUDIES: 3D PLOTTING PROGRAM
C
C THIS PROGRAM USES DATA FILES CREATED BY PHASE.F4 AND CONSTRUCTS
C 3-D PLOTS. THE PROGRAM REQUESTS U AND V SHEAR DIRECTIONS
C EAST OR WEST ORIENTATION AND HAS FLEXIBLE CONTROL OVER SCALE
C AND COMPRESSION FACTORS.
C
C RUN COMMAND: PLT3D.F4,NUMBER.REL,@SYS:GRA3D,@SYS:GRALIB
C
C*****

```

```

DOUBLE PRECISION FNAME1
DIMENSION AMP(41,41),THETA(41,41)
EXTERNAL PLTCA

```

```

TYPE 1001
1001 FORMAT('0 ')
TYPE 1002
TYPE 1001
1000 TYPE 1005
1002 FORMAT(20X,'BIOENGINEERING: 3-D GRAPHICS PROGRAM')
1005 FORMAT('ENTER DATA FILE NAME: ',,$)
ACCEPT 1010,FNAME1
1010 FORMAT(A10)

```

```

C READ IN DATA FILE CREATED BY PHASE.F4

```

```

CALL OPEN(21,'FILE',FNAME1)
READ(21,1025) M,AMPMIN,AMPMAX,THEMIN,THEMAX,SCTANS
1025 FORMAT(I3,1X,F11.5,1X,F11.5,1X,F11.5,1X,F11.5,1X,A1)
READ(21,1026) NUM,TRANR,RANGE,FREQ,APERT,PCT
1026 FORMAT(I5,1X,F11.5,1X,F11.5,1X,F11.5,1X,F11.5,1X,F11.5)
READ(21,1027)((AMP(I,J),J=1,M),I=1,M)
READ(21,1027)((THETA(I,J),J=1,M),I=1,M)
1027 FORMAT(41(F11.6,1X))
CALL CLOSE(21)
CALL BELL

```

```

C MULTIPLY AMPLITUDE AND PHASE DATA BY XSIGN TO ACCOUNT FOR PLOTTING
C BY SUBROUTINE VISDO

```

```

XSIGN = -1.0
DO 1039 I =1,M
DO 1038 J =1,M
AMP(I,J) = XSIGN * AMP(I,J)
1038 THETA(I,J) = XSIGN * THETA(I,J)
1039 CONTINUE

```

C PROMPT USER FOR PLOTTING NAME AND SCALE FACTORS TO BE USED BY VISDO

```

1040 TYPE 1045
1045 FORMAT('OENTER PLOT NAME (5 CHARACTERS): ', $)
ACCEPT 1050, PNAME
1050 FORMAT(A5)
TYPE 1055
1055 FORMAT('O EAST/WEST VIEW (EAST = -1, WEST = +1): ', $)
ACCEPT 1060, LVIEW
1060 FORMAT(I)
TYPE 1065
1065 FORMAT('O ENTER U SHEAR (REAL 0.0 TO 1.0): ', $)
ACCEPT 1070, USHEAR
1070 FORMAT(F)
TYPE 1075
1075 FORMAT('O ENTER V SHEAR (REAL 0.0 - 1.0): ', $)
ACCEPT 1070, VSHEAR
TYPE 1080
1080 FORMAT('O ENTER COMPRESSION FACTOR: ', $)
ACCEPT 1070, COMP
TYPE 1085
1085 FORMAT('O ENTER SPAN COMPRESSION FACTOR: ', $)
ACCEPT 1070, SFACTR
ASPA1 = 1.0 * COMP
ASPA2 = -ASPA1
ASPA1 = ASPA1/SFACTR
TSPA1 = (THEMAX - THEM1N)*COMP
TSPA2 = -TSPA1
TSPA2 = TSPA2/SFACTR
1141 TYPE 1145
1145 FORMAT('ODO YOU WISH TO PLOT AMPLITUDE OR PHASE (A/P): ', $)
ACCEPT 1150, ANS
IF(ANS.NE.'A'.AND.ANS.NE.'P') GOTO 1141

```

C SET UP GRAPHIC LIBRARY AND CALL PLOTTING ROUTINES

```

CALL PLT00
CALL BELL
CALL FRAME
CALL PRT(ANS, PCT, TRANR, RANGE, FREQ, SCTANS)
CALL PLTLA(PNAME)
1150 FORMAT(A1)
IF(ANS.EQ.'P') GOTO 1155
CALL VISDO(ASPA1, AMP, AMP, ASPA2, M, M, M, M, USHEAR, VSHEAR,
1 LVIEW, -1, PLTCA)
GOTO 1160
1155 CALL VISDO(TSPA1, THETA, THETA, TSPA2, M, M, M, M, USHEAR, VSHEAR,
1 LVIEW, -1, PLTCA)
1160 CONTINUE
CALL BELL
STOP
END

```

```

C*****
C
C PRT: PRINT NUMERICAL INFORMATION ON GRAPH
C
C*****

```

```

SUBROUTINE PRT(ANS,PCT,TRANR,RANGE,FREQ,SCTANS)
DIMENSION A(6),B(5),C(5),D(2),E(2),F(3),G(4),H(3),I(3)
DATA(A(K),K=1,6)/'NORMALIZED RECEIVED AMPLITUDE'/
DATA(B(K),K=1,5)/'NORMALIZED RECEIVED PHASE'/
DATA(D(K),K=1,2)/'APERTURE: '/
DATA(E(K),K=1,2)/'DISTANCE: '/
DATA(F(K),K=1,3)/'RANDOM ARRAY'/
DATA(G(K),K=1,4)/'RECTANGULAR ARRAY'/
DATA(H(K),K=1,3)/'LINEAR ARRAY'/
DATA(I(K),K=1,3)/'RANDOM VOLUME'/
APERT =TRANR * 2.0
CALL CHRSET(21,33)
IF(ANS.EQ.'P') GOTO 2000
CALL JUSTFX(30,A,0,LEN,IOFS)
CALL MOVABS(512+IOFS,725)
CALL ANCHOS(A,LEN)
GOTO 2005
2000 CALL JUSTFX(25,B,0,LEN,IOFS)
CALL MOVABS(512+IOFS,725)
CALL ANCHOS(B,LEN)
2005 CALL CHRSET(14,22)
CALL MOVABS(100,655)
STR = 'NUM:'
NUM = IFIX(PCT)
CALL ANCHOS(STR,4)
CALL NUMBER(NUM,'15')
CALL MOVABS(100,630)
STRING = 'CM'
CALL JUSTFX(10,D,-1,LEN,IOFS)
CALL ANCHOS(D,LEN)
CALL NUMBER(APERT,'F6.2')
CALL ANCHOS(STRING,2)
CALL MOVABS(100,605)
CALL ANCHOS(E,9)
CALL NUMBER(RANGE,'F7.2')
CALL ANCHOS(STRING,2)
CALL MOVABS(100,580)
STR = 'FREQ:'
CALL ANCHOS(STR,5)
CALL NUMBER(FREQ,'F5.2')
STR = 'MHZ'
CALL ANCHOS(STR,3)
CALL MOVABS(100,555)
IF(SCTANS.EQ.'R'.OR.SCTANS.EQ.'L'.OR.SCTANS.EQ.'V') GOTO 2010
CALL JUSTFX(17,G,-1,LEN,IOFS)
CALL ANCHOS(G,LEN)
GOTO 2030

```

```
2010 IF(SCTANS.EQ.'R'.OR.SCTANS.EQ.'V') GOTO 2020
      CALL JUSTFX(12,H,-1,LEN,IOFS)
      CALL ANCHOS(H,LEN)
      GOTO 2030
2020 IF(SCTANS.EQ.'R') GOTO 2025
      CALL JUSTFX(13,I,-1,LEN,IOFS)
      CALL ANCHOS(I,LEN)
      GOTO 2030
2025 CALL JUSTFX(12,F,-1,LEN,IOFS)
      CALL ANCHOS(F,LEN)
2030 RETURN
      END
```

```
C*****
C
C FRAME: DRAW A FRAME AROUND THE PLOT. SET UP AN 8.5" X 11" FRAME
C INNER FRAME OF 1" INSIDE OF IT AND DEFINE THE ORIGIN PAGE CENTER
C
C*****
```

```
SUBROUTINE FRAME
CALL PLOT(0.0,0.0,3)
CALL PLOT(0.0,11.0,2)
CALL PLOT(8.5,11.0,1)
CALL PLOT(8.5,0.0,1)
CALL PLOT(0.0,0.0,1)
CALL PLOT(4.25,5.50,-3)
RETURN
END
```

```

C*****
C
C TSPLT: PLOT 3-D REPRESENTATION ON DATA WITHOUT CROSSHATCHING
C   U(K) - ARRAY FOR DISTANCE ALONG X COORDINATE
C   V(K) - ARRAY CONTAINING AMPLITUDE AT DISTANCE X
C   IX(J,I) - CONVERTS 2 DIMENSIONAL ARRAY INTO 1
C
C*****

```

```

SUBROUTINE TSPLT(ASPAN1,AMP,ASPAN2,N,M,USHEAR,VSHEAR,LV)
EXTERNAL PLTCA
DIMENSION AMP(1),U(501),V(501)

```

```

C FUNCTION STATEMENTS & CALL NULL INITIAL HORIZON FOR HIDDEN LINE

```

```

IX(J,I) = (I - 1) * M + J
AM(J,I) = ZS * (AMP(IX(J,I)) - ASPAN1)
CALL VISNH

```

```

C SET UP SCALE FACTORS USING SHEAR VALUES

```

```

MK = 501
ZS = (1.0 - VSHEAR)/(ASPAN2 - ASPAN1)
DELTAU = USHEAR/FLOAT(M - 1)
DELTAV = VSHEAR/FLOAT(M - 1)
DELTAS = (1.0 - USHEAR)/FLOAT(M - 1)
VE = 0.0

```

```

C SET UP DATA FOR VISUALIZE HORIZON ROUTINE VISHO

```

```

DO 1010 I = 1,M
  K = 0
  EU = USHEAR - (DELTAU * FLOAT(I))
  DO 1000 J = 1,M
    K = MINO(K+1,MK)
    U(K) = EU
    V(K) = VE + AM(J,I)
    EU = EU + DELTAS
1000  CONTINUE
      CALL VISHO(U,V,K,1,PLTCA)
      CALL VISHO(U,V,K,-1,PLTCA)
      VE = VE + DELTAV
1010  CONTINUE
      RETURN
      END

```

```

C*****
C
C PHASE-CANCELLATION STUDIES: CONTOUR PLOTTING PROGRAM
C
C THIS PROGRAM USES DATA CREATED FROM PHASE.F4 AND PLOTS USER
C SPECIFIABLE CONTOUR INTERVALS. USES 3DPLOT.F4 AS THE MAIN ROUTINE.
C
C LOAD CPLOT.F4,@SYS:CRA3D
C
C*****

      DOUBLE PRECISION FNAME1
      DIMENSION AMP(41,41),THETA(41,41)
      EXTERNAL PLTCA

      TYPE 1001
1000  TYPE 1005
1001  FORMAT(20X,'BIOENGINEERING: CONTOUR GRAPHICS PROGRAM')
1005  FORMAT('PLEASE ENTER PLOTTING DATA FILE: ',§)
      ACCEPT 1010,FNAME1
1010  FORMAT(A10)

C READ IN DATA FILE AS SPECIFIED BY USER

      CALL OPEN(21,'FILE',FNAME1)
      READ(21,1015) M,AMPMIN,AMPMAX,THEMIN,THEMAX,SCTANS
1015  FORMAT(I3,1X,F11.5,1X,F11.5,1X,F11.5,1X,F11.5,1X,A1)
      READ(21,1020) NUM,TRAMP,RANGE,FREQ,APERT,PCT
1020  FORMAT(I5,1X,F11.5,1X,F11.5,1X,F11.5,1X,F11.5,1X,F11.5)
      READ(21,1025)((AMP(I,J),J=1,M),I=1,M)
      READ(21,1025)((THETA(I,J),J=1,M),I=1,M)
1025  FORMAT(41(F11.6,1X))
      CALL CLOSE(21)

C SET UP PLOTTING PARAMETERS

1050  CINT1 = AMPMIN
      CINT2 = AMPMAX
      NUMX = M
      NUMY = M
      SUBX = 5.0
      SUBY = 5.0
      TYPE 1055
1055  FORMAT('ENTER PLOT NAME (MAX 5 CHARACTERS): ',§)
      ACCEPT 1060,FILNAM
1060  FORMAT(A5)
      TYPE 1065
1065  FORMAT('HOW MANY CONTOUR LEVELS (INTEGER): ',§)
      ACCEPT 1070,NLEVELS
1070  FORMAT(I)

C CALL GRAPHICS LIBRARY ROUTINES AND CALL CONTOUR ROUTINE PLTKP

      CALL PLTOO
      CALL PLTFR

```

```
CALL PLTLA(FILNAM)
CALL PLTKP(CINT1,AMP,CINT2,NLEVEL,SUBX,M,SUBY,M,PLTCA)
CALL BELL
TYPE 1035
1085 FORMAT('OREPEAT(Y/N): ',S)
ACCEPT 1080,ANS
IF(ANS.EQ.'Y') GOTO 1050
STOP
END
```

BATGEN

BATGEN is a FORTRAN program written to control the batch stream of the PDP-10 at the Hybrid Computer Laboratory. The program reads a parameter data file after each successful execution of PHASE. BATGEN then writes a new batch control file and resubmits PHASE to the batch controller for execution. The parameter data file, named PARAM.DAT, contains input values of aperture, frequency, range, and the number of scatterers. This file may also contain start, stop, and increment values if the user is changing one of the above parameters. The user must ensure that disk memory allocation is not exceeded when using the batch controller or program execution will fail.

```

C*****
C
C  BATCH CONTROL FILE GENERATOR - BATGEN.F4
C
C  PROGRAM DESCRIPTION: PARAM.DAT CONTAINS THE 8 INPUTS TO PHASE.F4
C  WHEN USING THE ASKFEW SUBROUTINE.  THE PROGRAM READS IN THE DATA
C  FILE AND REWRITES IT TO A CONTROL FILE NAMED RDN.CTL FOR BATCH USE.
C
C*****

```

```

      REAL PARAM(10,8)
      CALL OPEN(21,'FILE','PARAM.DAT')
      ILINE = 1
1000  READ(21,1005,END=1010)(PARAM(ILINE,J),J=1,8)
1005  FORMAT(8F)
      ILINE = ILINE + 1
      GOTO 1000
1010  CLOSE(UNIT=21,DISPOSE='DELETE')

```

```

C  NOW THAT THE DATA FILE HAS BEEN LOADED INTO PARAM ARRAY, CHECK
C  LAST OPERATION, REWRITE DATA BACK TO DISK OMITTING FIRST LINE

```

```

      NLINE = ILINE - 1
      IF(NLINE.EQ.1) GOTO 1025

```

```

      CALL OPEN(21,'FILE','PARAM.DAT')
      DO 1020 ILINE =2,NLINE
      WRITE(21,1015)(PARAM(ILINE,J),J=1,8)
1015  FORMAT(3F10.5)
1020  CONTINUE
      CALL CLOSE(21)

```

```

C  WRITE BATCH CONTROL FILE, CHANGE LOCATION 1 & 5 IN PARAM ARRAY TO
C  INTEGER VARIABLES FOR INPUT TO ASKFEW SUBROUTINE

```

```

1025  CALL OPEN(21,'FILE','RDN.CTL')
      IPAR1 = PARAM(1,1)
      IPAR5 = PARAM(1,5)
      WRITE(21,1030) IPAR1,PARAM(1,2),PARAM(1,3),PARAM(1,4),
1      IPAR5,PARAM(1,6),PARAM(1,7),PARAM(1,8)
1030  FORMAT(' .SET TIME 0',/,
1      '.SET HPQ 0',/,',.SET DSKPRI 0',/,',.RUN PHASE'/
2      '*',I/,'*',F/,'*',F/,'*',F/,'*Y',/
3      '*',I/,'*',F/,'*',F/,'*',F/,'*N')
      IF(NLINE.EQ.1) GOTO 1100
      WRITE(21,1035)
1035  FORMAT(' .RUN BATGEN'/,
1      '.SUBMIT RDN.CTL/RESTARTABLE/UNIQUE:0')
1100  CALL CLOSE(21)
      STOP
      END

```

C*****

C

C PHASE-CANCELLATION STUDIES: BIOENGINEERING

C

C CALCULATE HISTOGRAM OF AVERAGE RECEIVED PRESSURE DATA FOR A

C RANDOM PLANAR DISTRIBUTION OF SCATTERERS

C

C*****

DIMENSION AMP(41,41),THETA(41,41),PIC(41,41),AVGDAT(1/300)
COMPLEX PRS(41,41),C

C INPUT VARIABLES AND INITIALIZE ULTRASONIC PARAMETERS

TYPE 100

100 FORMAT('OPLEASE ENTER RANGE,APERT,NUM: ',S)

ACCEPT 105,RANGE,APERT,NUM

105 FORMAT(F,F,I)

FREQ = 5.00

M = 41

DIM = 23.0

SCAT = 1.0

VELCTY = 1500.00

WAVEL = (VELCTY/(FREQ*1.0E03))

XK = (2.0 * 3.14159)/(WAVEL/10.0)

CENTER = INT(M/2.0) + 1.0

TRANR = APERT/2.0

ASF = (APERT/(DIM-1.00))

DO 1005 I =1,M

DO 1000 J =1,M

1000 PIC(I,J) = '-'

1005 CONTINUE

C DETERMINE PARTICLE LOCATION IN UNITS OF BLOCKS AND SEE IF WITHIN BEAM

C THEN SEARCH TRANSDUCER COORDINATES - CHECK IT WITHIN BEAM ALSO -

C CALCULATE THE DISTANCE BETWEEN THE TWO SETS OF COORDINATES AND CONVERT

C CENTIMETERS - USE THIS VALUE IN THE GEOMETRY

DO 1045 I = 1,NUM

1010 SEED1 = SEED1 + .131

SEED2 = SEED2 + .1331

XCOOR = RAN(SEED1) * FLOAT(M)

YCOOR = RAN(SEED2) * FLOAT(M)

TEMP1 = ASF * SQRT((XCOOR-CENTER)**2 + (YCOOR-CENTER)**2)

IF(TEMP1.GT.TRANR) GOTO 1010

DO 1020 I1 = 1,M

DO 1015 J1 = 1,M

T=ASF*((I1-CENTER)**2 + (J1-CENTER)**2)

IF(T.GT.TRANR) GOTO 1015

PIC(I1,J1) = 'X'

DIST=ASF*SQRT((XCOOR-I1)**2 + (YCOOR-J1)**2)

HYPO=SQRT(DIST**2 + RANGE**2)

PRS(I1,J1)=(SCAT/HYPO)*CEXP((0.0,1.0)*XK*(RANGE+HYPO))

1015 CONTINUE

1020 CONTINUE

C LOCATE CENTER VALUE OF THE PRESSURE ARRAY AND ASSIGN TO C FOR
 C NORMALIZATION OF THE PRESSURE VALUES - CALCULATE THE AMPLITUDE AND
 C PHASE VALUES AT EACH LOCATION ON THE TRANSDUCER SURFACE AREA

```

    C = PRS(IFIX(CENTER),IFIX(CENTER))
    DO 1030 II = 10,32
    DO 1025 JJ = 10,32
        IF(PIC(II,JJ).EQ.'-') GOTO 1025
        PRS(II,JJ) = PRS(II,JJ)/C
        THETA(II,JJ)=57.29580*ATAN2(AIMAG(PRS(II,JJ)),
1      REAL(PRS(II,JJ)))
        AMP(II,JJ) = COSD(THETA(II,JJ))
1025  CONTINUE
1030  CONTINUE

    K = 0
    TEMP = 0.0
    DO 1040 II = 10,32
    DO 1035 JJ = 10,32
        IF(PIC(II,JJ).EQ.'-') GOTO 1035
        TEMP = TEMP + AMP(II,JJ)
        K = K + 1
1035  CONTINUE
1040  CONTINUE
    AVGDAT(I) = TEMP/FLOAT(K)
1045  CONTINUE

C END NUMBER LOOP AND CALCULATE MEAN AND VARIANCE OF AVGDAT ARRAY

    K = 0
    TEMP = 0.0
    DO 1050 I =1,NUM
        TEMP = TEMP + AVGDAT(I)
        K = K + 1
1050  CONTINUE
    AMEAN = TEMP/FLOAT(K)
    TEMP = 0.0
    DO 1055 I =1,NUM
        TEMP = TEMP + (AVGDAT(I)-AMEAN)**2
1055  CONTINUE
    AVAR = TEMP/(FLOAT(K)-1.0)
C WRITE RESULTS TO DISK IN FILE SUM.DAT
    CALL OPEN(21,'FILE','SUM.DAT')
    WRITE(21,1060) AMEAN,AVAR
1060  FORMAT(5X,'MEAN= ',F11.7,' VARIANCE = ',F11.7,/)
    WRITE(21,1061) RANGE,APERT,NUM
1061  FORMAT(5X,'RANGE = ',F7.2,' APERTURE = ',F6.2,' NUM = ',I3,/)
    DO 1070 I =1,NUM
    WRITE(21,1065) I,AVGDAT(I)
1065  FORMAT(5X,I3,3X,F11.5)
1070  CONTINUE
    CALL CLOSE(21)
    STOP
    END

```

DISTRIBUTION LIST FOR TM 81-201

Commander (NSEA 0342)
Naval Sea Systems Command
Department of the Navy
Washington, DC 20362

Copies 1 and 2

Commander (NSEA 9961)
Naval Sea Systems Command
Department of the Navy
Washington, DC 20362

Copies 3 and 4

Defense Technical Information Center
5010 Duke Street
Cameron Station
Alexandria, VA 22314

Copies 5 through 10

