

AD-A101 578

ARMY ENGINEER DISTRICT PHILADELPHIA PA

F/G 8/8

FLOOD PLAIN INFORMATION; MANTUA CREEK, GLOUCESTER COUNTY, NEW J--ETC(U)

NOV 72

UNCLASSIFIED

DAEN/NAP-82040/FPI23-72/1

NL

1 of 2  
AD A  
101578

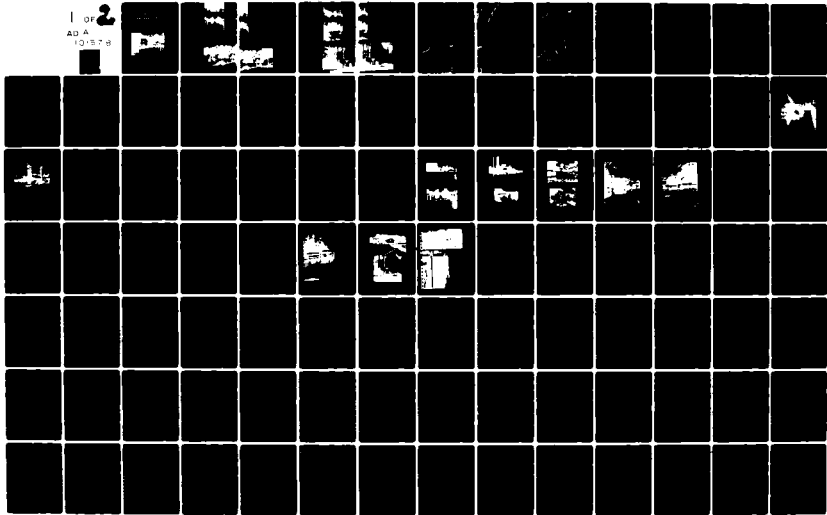

AD A101578

APPROPRIATE FOR PUBLIC RELEASE;  
DISTRIBUTION UNLIMITED.

# FLOOD PLAIN INFORMATION

①

II

MANTUA CREEK  
GLOUCESTER COUNTY, NEW JERSEY

CHESTNUT BRANCH and EDWARDS RUN

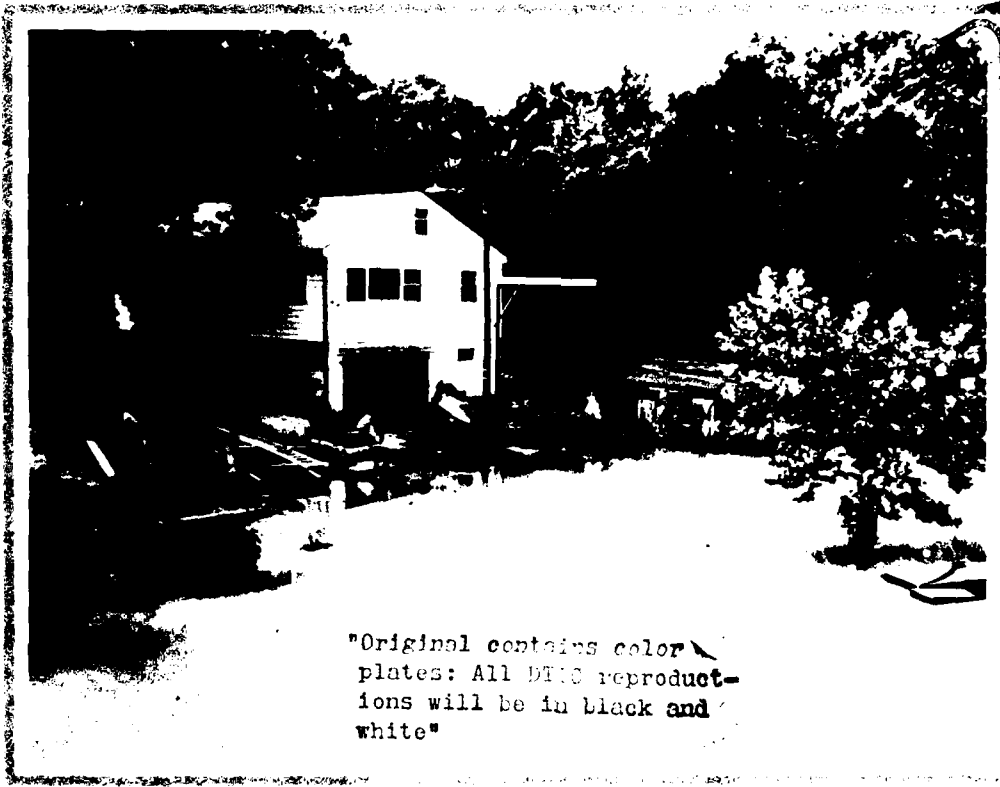

"Original contains color plates: All DTIC reproductions will be in black and white"

PREPARED FOR THE GLOUCESTER COUNTY PLANNING BOARD AND THE NEW JERSEY  
DEPARTMENT OF ENVIRONMENTAL PROTECTION BY THE DEPT. OF THE ARMY,  
PHILADELPHIA DISTRICT, CORPS OF ENGINEERS, PHILADELPHIA, PA.

NOVEMBER 1972

8 1 7 116

REPT. NO. DAEN/NAP - 82040/FPI 23-72/11

THIS FILE COPY

HIGHEST FLOODS RECORDED ON  
MANTUA CREEK, PITMAN, NEW JERSEY,  
GAUGING STATION

Elevation in Feet	Date of Crest
75.1	September 1, 1940
71.6	August 10, 1967
70.9	August 14, 1968
Mean Sea Level Datum	



ment of and sup-  
d Plain Information  
a Creek, Chestnut

NEW JERSEY  
S

## ACTION is needed

The flood plain of Mantua Creek is highly developed in the lower reaches and sparsely developed in the upper reaches. Expansion and redevelopment of industrial facilities can be expected in the future. The devastating effects of flooding will continue to increase unless action is taken.

Effective regulatory measures such as zoning ordinances and building codes can be designed to prevent increased flood damages. Flood proofing can reduce potential damages to properties already subject to flooding, and additional works to modify flooding can also be a part of the long-run solution.

The Mantua Creek communities are not the only ones with flooding problems. Flood plain information has already been provided for many of several thousand flood-plagued communities. Nearly 400 of those having FPI Reports by mid-1971 have adopted or strengthened regulations, while 700 others have them under study. An additional 600 communities have used the FPI Reports to establish interim land use control.

This folder has been prepared for the Gloucester County Planning Board by the U.S. Army Corps of Engineers from data in the report "Flood Plain Information, Mantua Creek, Chestnut Branch, and Edwards Run, Gloucester County, New Jersey." Copies of the report and this folder are available upon request from the Gloucester County Planning Board.



*First Avenue, Mantua Terrace, with flood waters of Mantua Creek; September, 1940*

Inside are sketches illustrating the horizontal and vertical relationship of flooded areas and a flood area map from the report showing the extent of the Floodway Design Flood (FDF) and Standard Project Flood (SPF).



FLO  
on MANTU  
NEW J



This folder is an announcement of and supplement to the "Flood Plain Information (FPI) Report, Mantua Creek, Chestnut Branch, and Edwards Run, Gloucester County, New Jersey." The report has been prepared to emphasize the importance of flood hazards in land

# FLOODS

ON MANTUA CREEK, NEW JERSEY



# FLOODS

## on MANTUA CREEK, NEW JERSEY

...ce, with flood waters of  
...ptember, 1940

...strating the horizon-  
...ionship of flooded  
...a map from the re-  
...ent of the Floodway  
...nd Standard Project



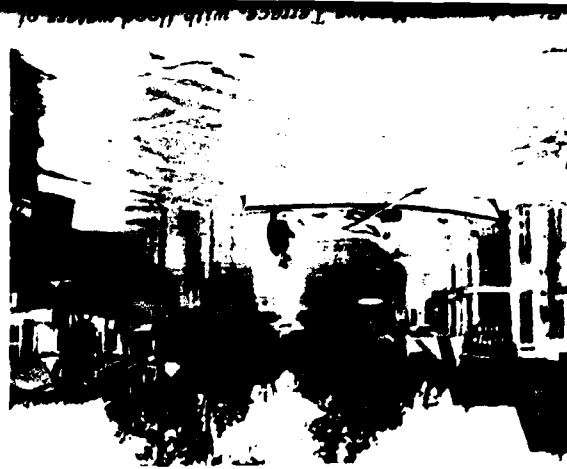
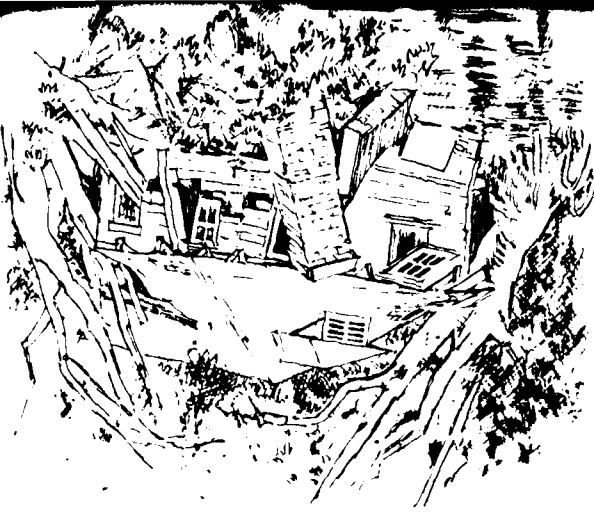

Increased flood damage to buildings can be avoided by measures such as zoning and flood insurance. Flood insurance will continue to be needed in the future. The development of industrial areas in the upper reaches and lower reaches and Mantua Creek is highly needed.

# FLOODS ON MANTUA CREEK, NEW JERSEY

This folder is an announcement of and supplement to the "Flood Plain Information (FPI) Report, Mantua Creek, Chestnut Branch, and Edwards Run, Gloucester County, New Jersey." The report has been prepared to emphasize the importance of flood potential and flood hazards in land use planning and to aid in management decisions concerning flood plain utilization.

Although areas along Mantua Creek, Chestnut Branch, and Edwards Run have suffered extensive damage from past floods, studies indicate that large floods may recur. Emphasis is given to future floods in the FPI Report. Maps, profiles, and cross sections have been included to illustrate the possible extent and severity of future floods.

Included in this folder is a photograph showing possible future flood heights at Mantua Terrace. The flood height shown for a large flood, the New Jersey Floodway Design Flood (NJFDF), is one that occurs once in 100 years on the average, although it could occur in any year. Also indicated is the flood height that would be reached if a very large, Standard Project Flood (SPF), should occur. The SPF represents a reasonable upper limit of expected flooding in the study area.

Possible future flood heights in Mantua Terrace.



Mantua Terrace-Flood of August, 1967.

HIGHEST FLOOD:  
MANTUA CREEK, PIT  
GAUGING

Date of Crest  
September 1, 1940  
August 10, 1967  
January 14, 1968

POSSIBLE FUTURE FLOODS:  
Large  
New Jersey Floodway  
Design Flood (NJFDF)  
100 Year  
New Jersey Floodway  
Design Flood (NJFDF)  
Very Large  
Standard Project Flood

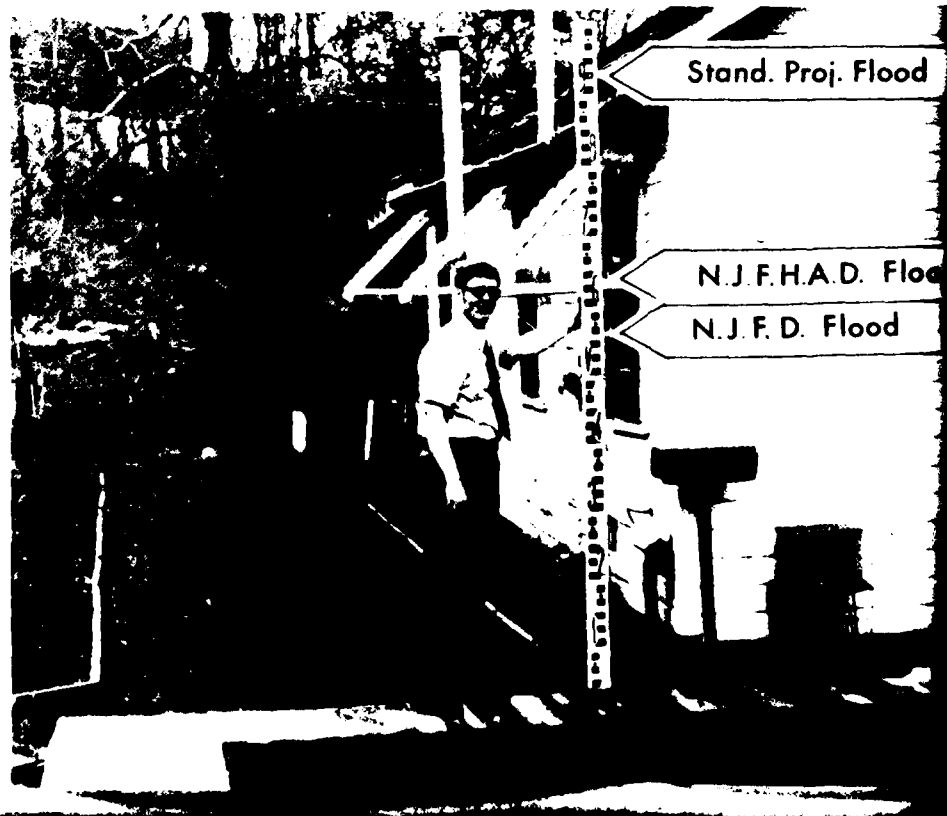

Effective regulatory measures such as zon-

to increase unless action is taken.  
devastating effects of flooding will continue  
facilities can be expected in the future. The  
Expansion and redevelopment of industrial  
sparsely developed in the upper reaches.  
developed in the lower reaches and  
The flood plain of Mantua Creek is highly

## ACTION is needed

### HIGHEST FLOODS RECORDED ON MANTUA CREEK, PITMAN, NEW JERSEY, GAUGING STATION

Date of Crest	Elevation in Feet Mean Sea Level Datum
September 1, 1940	75.1
August 10, 1967	71.6
January 14, 1968	70.9

### POSSIBLE FUTURE FLOODS FOR PLANNING

Large	
New Jersey Floodway Design Flood (NJFDF)	73.9
100 Year	
New Jersey Flood Hazard Area Design Flood (NJFHADF)	75.8
Very Large	
Standard Project Flood (SPF)	76.2



ood of August, 1967.

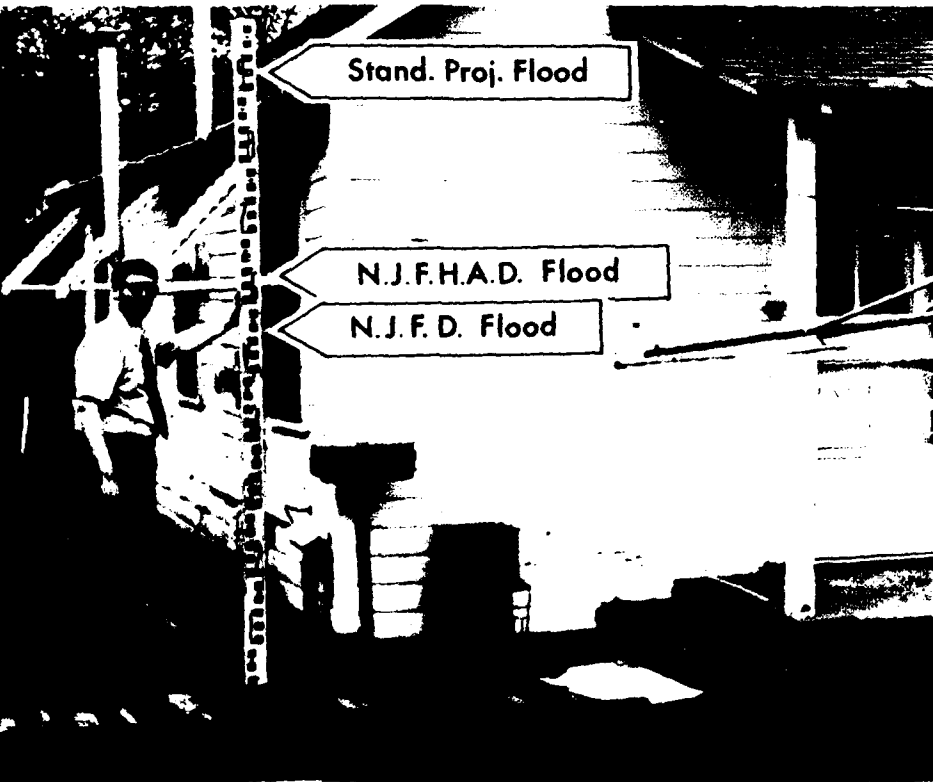

# BUILDING in the FLOOD PLAIN can make FLOODS WIDER and DEEPER

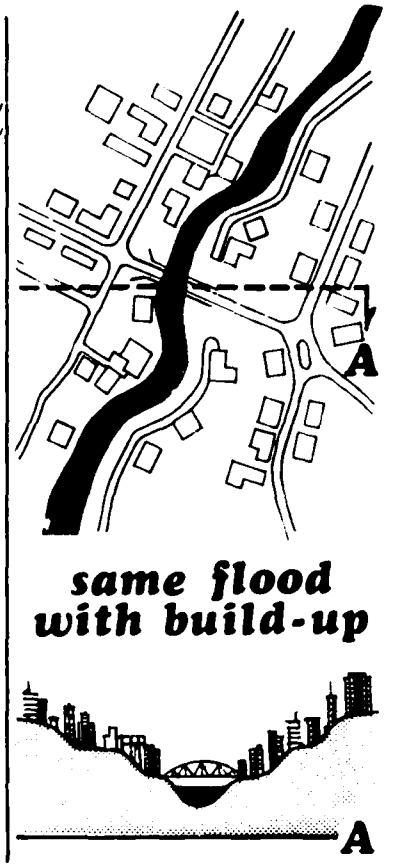
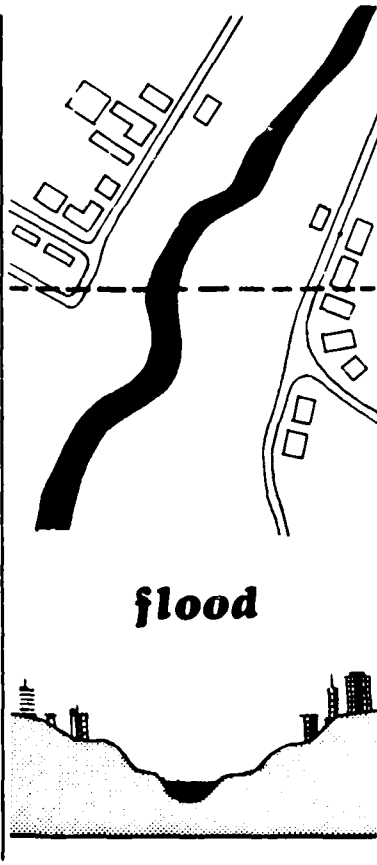
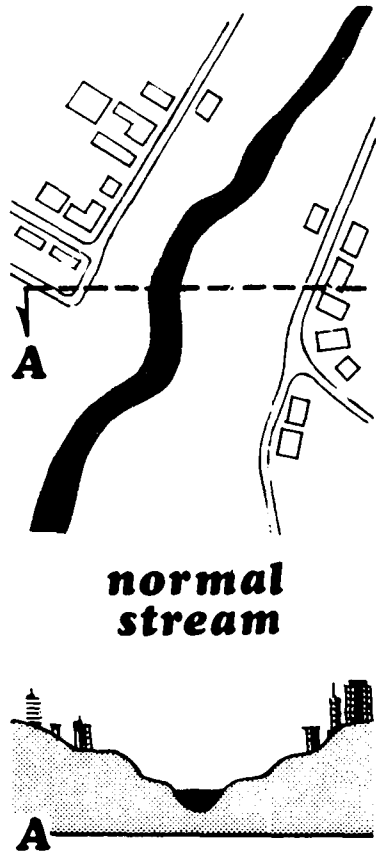

## TOOLS of FLOOD PLAIN MANAGEMENT for the reduction of Flood Damage and H

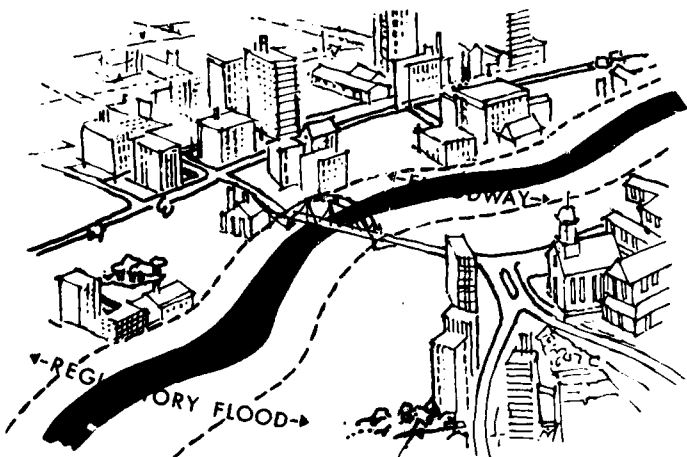

**MEASURES TO REDUCE VULNERABILITY TO FLOODS** provide for a future with more freedom from flood damage, often at minor cost and with little adverse effect on the environment . . . . .

### REGULATIONS

- (ZONING, BUILDING CODES, SUBDIVISION)
- FLOOD PROOFING • RELOCATIONS •
- URBAN RENEWAL •

**MEASURES TO MODIFY FLOODS** are often required to alleviate existing problems and sometimes to forestall future problems . . .

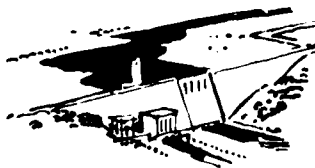

**DAMS & RESERVOIRS**

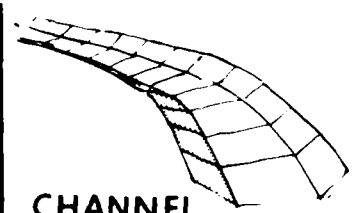

**CHANNEL ENLARGEMENT**

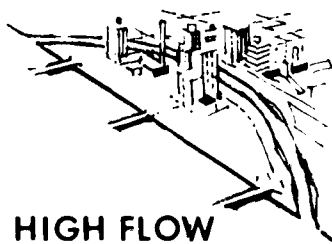

**HIGH FLOW DIVERSION**

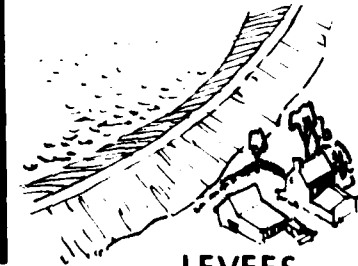

**LEVEES**

WEST DEPTFORD TWP.

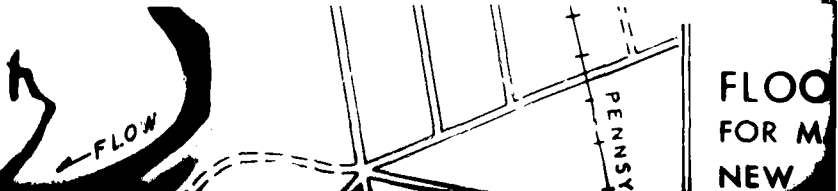

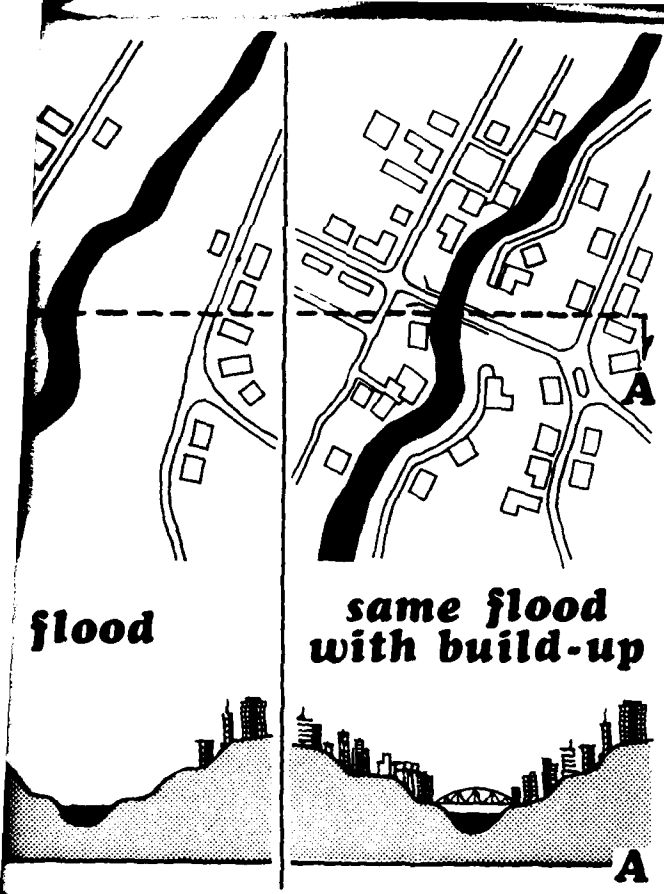

2

*this*  
**ENCROACHMENT**  
 can change  
 a  
**Small Flood**  
 into a  
**MAJOR**  
**FLOOD**

for the reduction of Flood Damage and Human Suffering

**MEASURES TO MODIFY FLOODS**  
 often required to alleviate existing problems and  
 sometimes to forestall future problems . . .

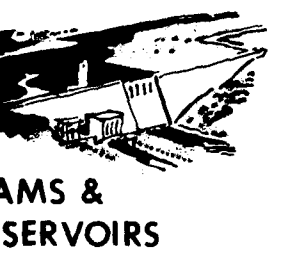

**DAMS &  
 RESERVOIRS**

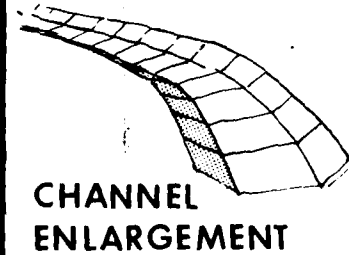

**CHANNEL  
 ENLARGEMENT**

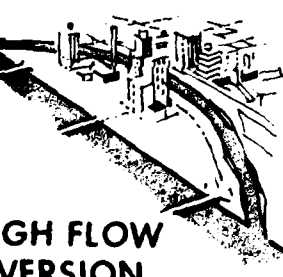

**HIGH FLOW  
 DIVERSION**

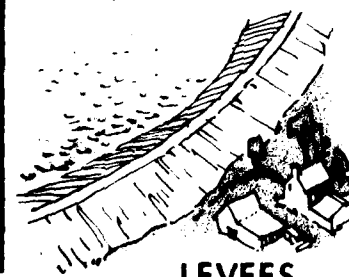

**LEVEES**

**OTHER  
 MEASURES**  
 aid the Flood Plain  
 occupant in coping  
 with floods . . .

- EDUCATION**
- TAX  
 ADJUSTMENTS**
- FLOOD  
 INSURANCE**
- WARNING &  
 EMERGENCY  
 PLANS**

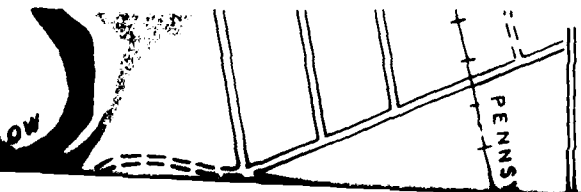

**FLOOD PATTERNS  
 FOR MANTUA CREEK  
 NEW JERSEY**



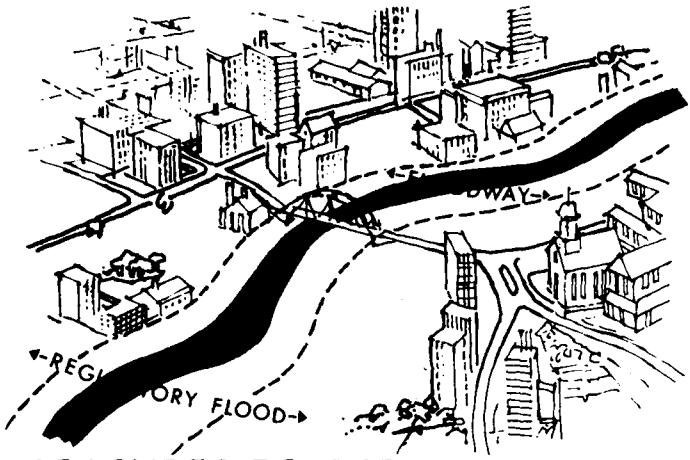

**MEASURES TO REDUCE VULNERABILITY TO FLOODS** provide for a future with more freedom from flood damage, often at minor cost and with little adverse effect on the environment . . . . .

- REGULATIONS**  
 (ZONING, BUILDING CODES, SUBDIVISION)  
 • FLOOD PROOFING • RELOCATIONS •  
 • URBAN RENEWAL •

**MEASURES TO MODIFY FLOODS** are often required to alleviate existing problems and sometimes to forestall future problems . . .

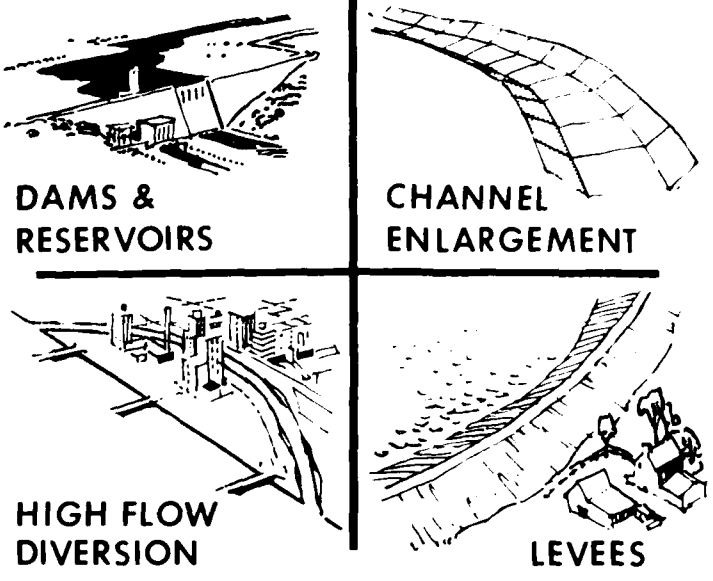

**WEST DEPTFORD TWP.**

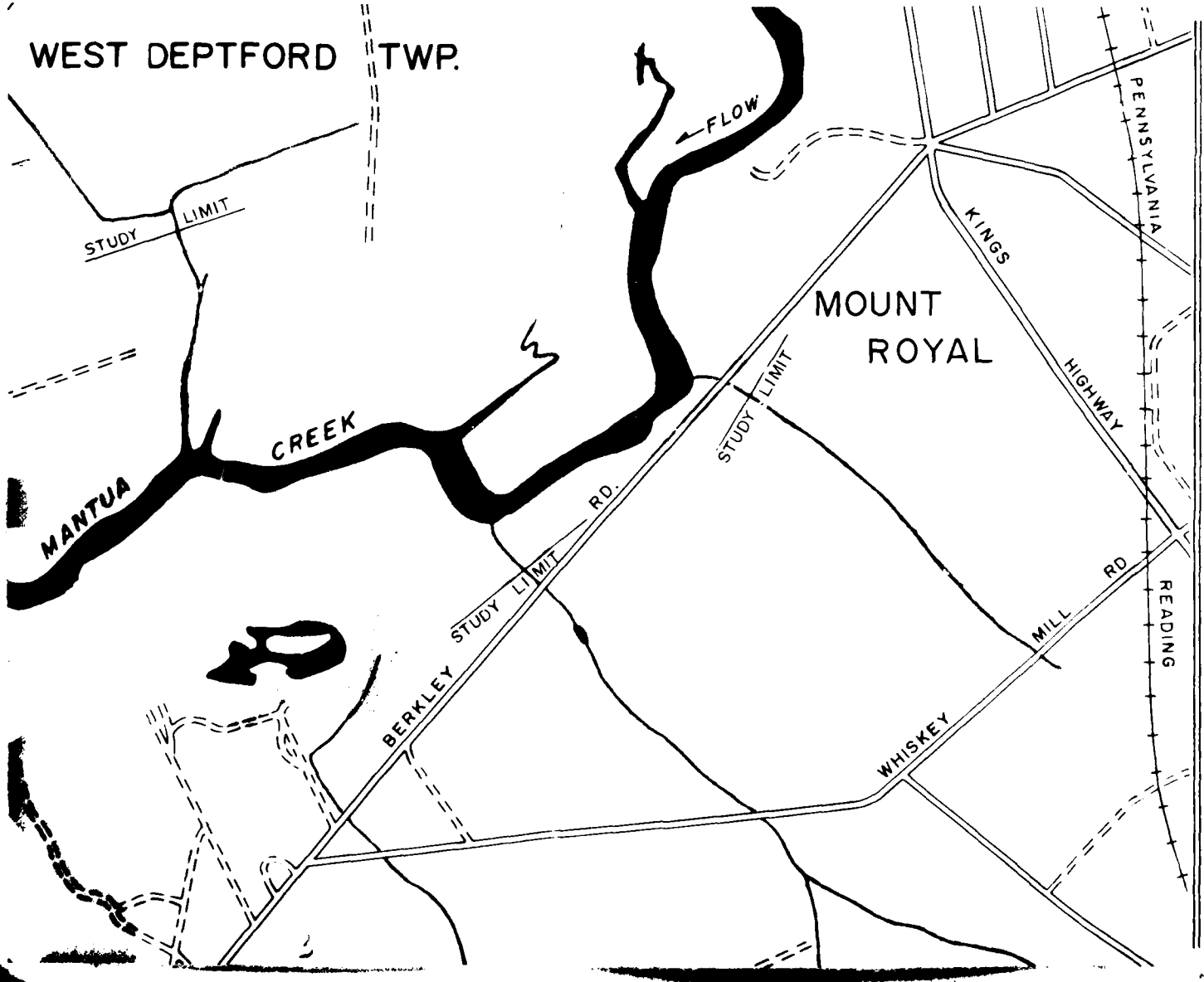

**FLOOD FOR MA NEW JE**

**LEGE**  
 appro of ove

**NORM**  
**N. J. DESI**  
**STAN**  
**FLOOR**

**PROFILES**  
 Flood Pl show of these fl for the

## WAYS TO MODIFY FLOODS

designed to alleviate existing problems and forestall future problems . . .

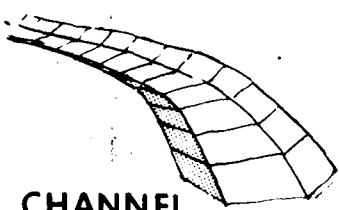

**CHANNEL ENLARGEMENT**

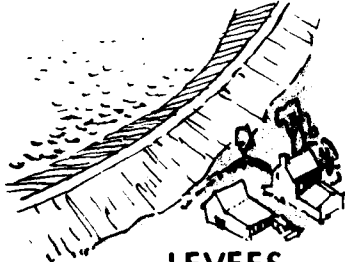
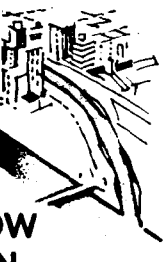

**LEVEES**

**OTHER MEASURES**  
aid the Flood Plain occupant in coping with floods . . .

*EDUCATION*

*TAX ADJUSTMENTS*

*FLOOD INSURANCE*

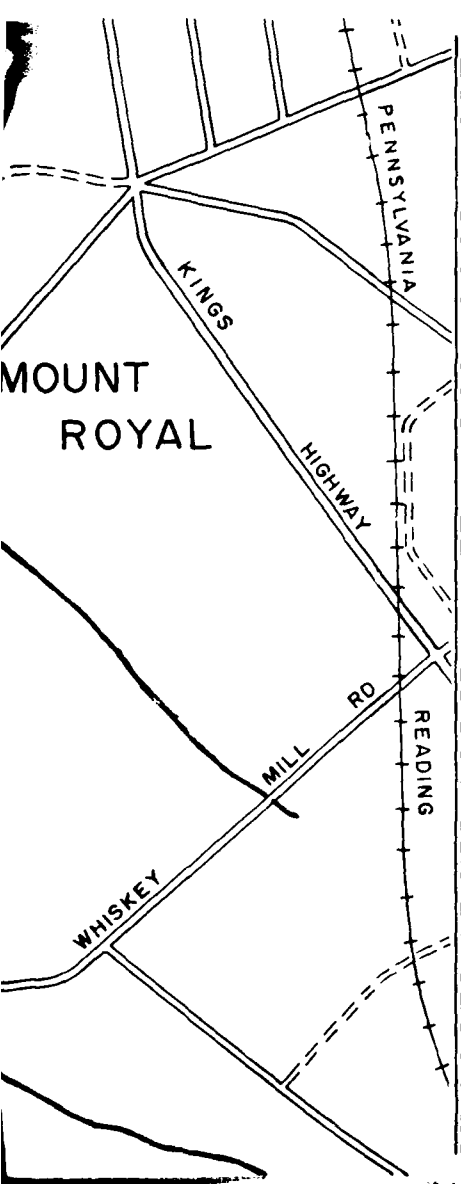

*WARNING & EMERGENCY PLANS*



**FLOOD PATTERNS FOR MANTUA CREEK NEW JERSEY**

### LEGEND

approximate limits of overflow

-  **NORMAL STREAM**
-  **N. J. FLOODWAY DESIGN FLOOD (NJDFD)**
-  **STANDARD PROJECT FLOOD (SPF)**

**PROFILES** in the *Flood Plain Information Report* show elevations of these floods for the entire study area

TO THE REQUESTOR:

This Flood Plain Information (FPI) Report was prepared by the Philadelphia District office of the U.S. Army Corps of Engineers, under the continuing authority of the 1960 Flood Control Act, as amended. The report contains valuable background information, discussion of flood characteristics and historical flood data for the study area. The report also presents through tables, profiles, maps and text, the results of engineering studies to determine the possible magnitude and extent of future floods, because knowledge of flood potential and flood hazards is important in land use planning and for management decisions concerning floodplain utilization. These projections of possible flood events and their frequency of occurrence were based on conditions in the study area at the time the report was prepared.

Since the publication of this FPI Report, other engineering studies or reports may have been published for the area. Among these are Flood Insurance Studies prepared by the Federal Insurance Administration of the Federal Emergency Management Agency, Flood Insurance Studies generally provide different types of flood hazard data (including information pertinent to setting flood insurance rates) and different types of floodplain mapping for regulatory purposes and in some cases provide updated technical data based on recent flood events or changes in the study area that may have occurred since the publication of this report.

It is strongly suggested that, where available, Flood Insurance Studies and other sources of flood hazard data be sought out for the additional, and, in some cases, updated flood plain information which they might provide. Should you have any questions concerning the preparation of, or data contained in this FPI Report, please contact:

U.S. Army Corps of Engineers  
Philadelphia District  
Custom House, 2nd and Chestnut Streets  
Philadelphia, PA 19106

ATTN: Flood Plain Mgt. Services Branch, NAPEN-M

Telephone number: (215) 597-4807

REPORT DOCUMENTATION PAGE		READ INSTRUCTIONS BEFORE COMPLETING FORM	
1. REPORT NUMBER DAEN/NAP-82040/FPI23-72/11 ✓	2. GOVT ACCESSION NO. AD-A101578	3. RECIPIENT'S CATALOG NUMBER	
4. TITLE (and Subtitle) Flood plain information Mantua Creek, Gloucester County, New Jersey, Chestnut Branch & Edwards Run.		5. TYPE OF REPORT & PERIOD COVERED Flood plain information	
7. AUTHOR(s)		6. PERFORMING ORG. REPORT NUMBER DAEN/NAP-82040/FPI23-72/11	
9. PERFORMING ORGANIZATION NAME AND ADDRESS U.S. Army Engineer District Philadelphia 2nd & Chestnut Sts. Philadelphia, PA 19106		8. CONTRACT OR GRANT NUMBER(s)	
11. CONTROLLING OFFICE NAME AND ADDRESS U.S. Army Engineer District Philadelphia 2nd & Chestnut Sts. Philadelphia, PA 19106		10. PROGRAM ELEMENT, PROJECT, TASK AREA & WORK UNIT NUMBERS	
14. MONITORING AGENCY NAME & ADDRESS (if different from Controlling Office)		12. REPORT DATE Nov. 1972	
		13. NUMBER OF PAGES 55	
		15. SECURITY CLASS. (of this report) UNCLASSIFIED	
		15a. DECLASSIFICATION/DOWNGRADING SCHEDULE	
16. DISTRIBUTION STATEMENT (of this Report)			
17. DISTRIBUTION STATEMENT (of the abstract entered in Block 20, if different from Report)			
18. SUPPLEMENTARY NOTES			
19. KEY WORDS (Continue on reverse side if necessary and identify by block number)			
Mantua Creek, NJ Gloucester County Planning Board NJ Dept. of Environmental Protection Flood forecasting		Floods Floodplains	
20. ABSTRACT (Continue on reverse side if necessary and identify by block number)			
This report covered the flood situation along Mantua Creek from its confluence with the Delaware River near Paulsboro, N.J. upstream to its headwaters near Glassboro, NJ and includes the Edwards Run and Chestnut Branch tributaries. The information included a history of flooding along the creek and identification of areas which may be subject to future flooding. Special emphasis was given to possible future floods thru maps, photographs, profiles and cross sections.			

Under authority of Section 206 of the 1960 Flood Control Act as amended the flood plain information was prepared by the U.S. Army Corps of Engineers Philadelphia District at the request of the Gloucester County Planning Board and the New Jersey Dept. of Environmental Protection. The information should be considered for its historical nature. Since the publication of this FPI report other Flood Insurance studies have been undertaken and should also be consulted for more current information.

NOTICE

THIS DOCUMENT HAS BEEN REPRODUCED FROM THE BEST COPY FURNISHED BY THE SPONSORING AGENCY. ALTHOUGH IT IS RECOGNIZED THAT CERTAIN PORTIONS ARE ILLEGIBLE, IT IS BEING RELEASED IN THE INTEREST OF MAKING AVAILABLE AS MUCH INFORMATION AS POSSIBLE.

APPROVED FOR PUBLIC RELEASE;  
DISTRIBUTION UNLIMITED.

X  
A

CONTENTS

	Page
PREFACE . . . . .	i
BACKGROUND INFORMATION . . . . .	1
Settlement . . . . .	1
The Stream and Its Valley . . . . .	1
Developments in the Flood Plain . . . . .	3
FLOOD SITUATION . . . . .	5
Sources of Data and Records . . . . .	5
Flood Season and Flood Characteristics . . . . .	5
Factors Affecting Flooding and Its Impact . . . . .	5
Obstructions to floodflows . . . . .	5
Flood damage reduction measures . . . . .	6
Other factors and their impacts . . . . .	9
Flood warning and forecasting . . . . .	9
Flood fighting and emergency evacuation plans . . . . .	9
Material storage on the flood plain. . . . .	10
PAST FLOODS . . . . .	11
Summary of Historical Floods . . . . .	11
Flood Records . . . . .	11
Flood Descriptions . . . . .	12
August 15, 1867; September 4, 1868; September 5, 1868; and September 24, 1882 . . . . .	12
June 28, 1938 . . . . .	12
September 1, 1940 . . . . .	12
July 22, 1945 . . . . .	13

CONTENTS (Continued)

	Page
September 12-13, 1960 . . . . .	14
August 10, 1967 . . . . .	14
<b>FUTURE FLOODS . . . . .</b>	<b>20</b>
Floodway Design Flood and Flood Hazard Area Design Flood . . . . .	20
Standard Project Flood . . . . .	21
Frequency . . . . .	22
Hazards of Large Floods . . . . .	22
Flooded areas and flood damages . . . . .	23
Obstructions . . . . .	23
Velocities of flow . . . . .	24
Rates of rise and duration of flooding . . . . .	26
Photographs, future flood heights . . . . .	26
<b>GLOSSARY . . . . .</b>	<b>30</b>

TABLES

<u>Table</u>		
1	Drainage Areas, Mantua Creek Watershed . . . . .	2
2	1970 Population, Gloucester County Municipalities . . . . .	4
3	Flood Crest Elevations (Mantua Creek at Pitman, New Jersey, Gauging Station) . . . . .	11
4	Peak Flows for Floodway Design, Flood Hazard Area Design and Standard Project Floods . . . . .	21
5	Comparison of Flood Elevations (Mantua Creek at Pitman, New Jersey, Gauging Station) . . . . .	22
6	Elevation Data (Bridges Across Mantua Creek, Chestnut Branch and Edwards Run) . . . . .	24
7	Maximum Average Velocities (Mantua Creek, Edwards Run and Chestnut Branch) . . . . .	25



CONTENTS (Continued)

<u>Plate</u>	<u>PLATES</u>	
1	General Map . . . . .	Opposite Page i
2	Index Map - Flooded Areas	
3- 14	Flooded Areas	
15 - 17	High Water Profiles (Mantua Creek)	
18	High Water Profile (Edwards Run)	
19	High Water Profiles (Edwards Run)	
20	High Water Profiles (Chestnut Branch and Plank Run)	
21	Selected Cross Sections (Mantua Creek)	
22	Selected Cross Sections (Edwards Run)	
23	Selected Cross Sections (Chestnut Branch)	
24	Discharge Hydrographs .	

At End of Report

FIGURES

<u>Figure</u>		<u>Page</u>
1	Debris along Mantua Creek . . . . .	7
2	Debris along Mantua Creek . . . . .	8
3- 4	Flooding in Mantua Terrace during the September 1, 1940, flood . . . . .	15
5	Woodbury Water Works at Sewell, September 1, 1940 . . . . .	16
6	Kressey Lake, East side of Pitman, September 1, 1940, storm . . . . .	16
7	Destruction caused by the September 1, 1940, flood at Alcyon Lake, Pitman . . . . .	17
8	Destruction caused by the September 1, 1940, flood at Mantua Terrace . . . . .	17
9	Homes downstream of Rt. 45 inundated by the flood of August 10, 1967 . . . . .	18

CONTENTS (Continued)

FIGURES (Continued)

<u>Figure</u>		<u>Page</u>
10	Homes upstream of Rt. 45 which were inundated by the flood of August 10, 1967 . . . . .	19
11	Future flood heights on Mantua Creek at Delsea Drive (N.J. Rt. 47) bridge . . . . .	27
12	Future flood heights on Mantua Creek at Mantua Terrace . . . . .	28
13	Future flood heights on Chestnut Branch at the Robbins Lumber Co., Pitman . . . . .	29

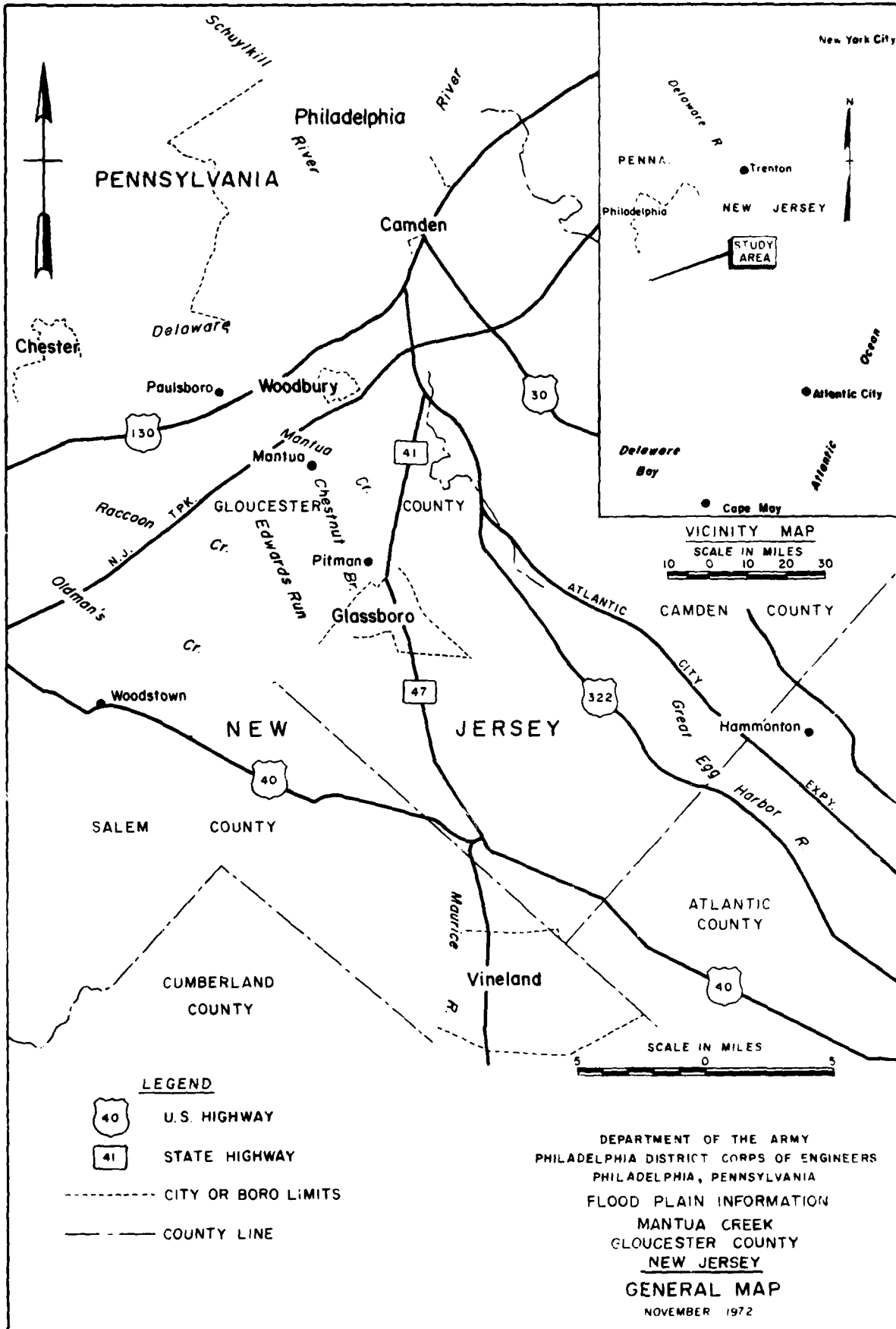

## PREFACE

*This report covers the flood situation along Mantua Creek from its confluence with the Delaware River near Paulsboro, New Jersey, upstream to its headwaters near Glassboro, New Jersey, and includes the Edwards Run and Chestnut Branch tributaries. The properties on the flood plain along the stream and its tributaries are primarily residential with few industries. Many properties suffered severe damages during past floods. Although large floods have occurred in the past, studies indicate that even larger floods are possible.*

*This report has been prepared to emphasize the importance of flood potential and flood hazards in land use planning and in making management decisions concerning flood plain utilization. It includes a history of flooding along Mantua Creek and identifies those areas that are subject to possible future flooding. Special emphasis is given to these possible future floods through maps, photographs, profiles, and cross sections. The report does not provide solutions to flood problems; however, it does furnish a suitable basis for the adoption of land use controls to guide flood plain development and thereby prevent intensification of the loss problems. It will also aid in the identification of areas where other flood damage reduction techniques such as works to modify flooding and adjustments including flood proofing might be embodied in an overall flood plain management (FPM) program. Other FPM program studies -- those of environmental attributes and the current and future land use role of the flood plain as part of its surroundings -- would also profit from this information.*

*Under the continuing authority provided in Section 206 of the 1960 Flood Control Act as amended, this report was prepared in response to the request of the Gloucester County Planning Board through the New Jersey Department of Environmental Protection. The Planning Board will make information available to all interested agencies and individuals. Upon further request, the Corps of Engineers, Philadelphia District Office, will provide technical assistance to planning agencies in the interpretation and use of the data presented as well as planning guidance and further assistance, including the development of additional technical information.*

## BACKGROUND INFORMATION

### Settlement

The early settlement of the Mantua Creek area of Gloucester County dates back to the time of the Lenni-Lenape Indians. The Indians valued the area for its abundance of fish and game, and utilized the creeks extensively for transportation. They helped the early white settlers to cope with the wild country and taught them how to cultivate corn and tobacco. The Indians had cleared many of the fertile areas and established their own settlements along many creeks in the Gloucester County area.

The Dutch became the first permanent settlers with the construction of Fort Nassau on the Delaware River in 1623. The fort provided security and a trading post from which to manage a profitable fur trade. The Dutch influence soon waned, however, yielding to the Swedes in 1638. The Swedes were determined to build homes in the New World and vigorously cleared the land for their settlements. With the arrival of William Penn in 1682, the English began to dominate the entire Delaware Valley, giving English names to many former Swedish and Dutch settlements.

The early industrial development of the area was comprised of saw and grist mills which could be found on many streams and creeks throughout the county. These early mills encouraged development of flood plain land and established a trend for development that continues today. Agriculture was also an important industry for the early settlers, and continues to be one of the major industries of the area.

### The Stream and Its Valley

Mantua Creek and its two major tributaries, Edwards Run and Chestnut Branch, drain a total of 50.9 square miles of Gloucester County, New Jersey. From its headwaters near Glassboro, Mantua Creek flows 18.6 miles in a northwestern direction to its confluence with the Delaware River at Paulsboro. In its upper reaches, Mantua Creek flows through gently rolling, wooded terrain marked by a number of small lakes. Further downstream, the creek flows through a relatively broad, flat flood plain and finally through low, tidal marshland from the New Jersey Turnpike to the confluence with the Delaware River. These low tidal areas are susceptible to flooding from high stages of the Delaware River as well as from runoff collected within the watershed. Over the study length of 18.6 miles, Mantua Creek's streambed falls approximately 144 feet for an average slope of 7.8 feet per mile.

Within the study area, Chestnut Branch, a major tributary of Mantua Creek, flows 7.2 miles from its origin at Glassboro to its confluence with Mantua Creek east of the town of Mantua. Chestnut Branch drains a total of 9.9 square miles and falls 109.5 feet for an average slope of 15.2 feet per mile.

Edwards Run, the second major tributary of Mantua Creek covered by this report, flows from its headwaters in Mantua Township 6.9 miles in a northern direction through East Greenwich Township before emptying into Mantua Creek near Mount Royal. Edwards Run has an average slope of 13.6 feet per mile and drains an area of 10.6 square miles. The portions of Mantua Creek, Chestnut Branch, and Edwards Run included in this study are shown on the general map. Drainage areas contributing to runoff at locations in the study area are listed in Table 1.

The climate of the area is moderate with temperatures averaging a little above freezing in the winter and above 73° F. in the summer. Annual rainfall averages about 44 inches and is generally well distributed throughout the year.

**TABLE 1  
DRAINAGE AREAS  
MANTUA CREEK WATERSHED**

Location	Mileage Above Mouth	Drainage Area	
		Tributary Sq. Mi.	Main Stream Sq. Mi.
<b><u>Mantua Creek</u></b>			
Confluence with Delaware River	0.0	---	50.9
Unnamed Tributary	3.7	0.4	---
Unnamed Tributary	5.3	1.2	---
Edwards Run	5.6	10.6	---
Above Edwards Run	5.6	---	34.1
Unnamed Tributary	8.3	1.2	---
Unnamed Tributary	9.2	0.8	---
Chestnut Branch	9.4	9.9	---
Above Chestnut Branch	9.4	---	19.4
Monongahela Branch	10.0	3.8	---
Bees Branch	12.0	1.2	---
Bethel Run	13.2	1.5	---
Porch Run	13.3	2.5	---
U.S.G.S. Gauge at Pitman, N.J.	15.4	---	6.0
Duffield Run	15.6	2.3	---
Above Duffield Run	15.6	---	3.5

**TABLE 1 (Continued)**  
**DRAINAGE AREAS**  
**MANTUA CREEK WATERSHED**

Location	Mileage Above Mouth	Drainage Area	
		Tributary Sq. Mi.	Main Stream Sq. Mi.
<b><u>Edwards Run</u></b>			
Confluence with Mantua Creek	0.0	---	10.6
Above New Jersey Turnpike Bridge	1.3	---	9.5
Above Heritage Road Bridge	3.9	---	5.7
Above Pitman-Jefferson Road Bridge	5.3	---	2.9
<b><u>Chestnut Branch</u></b>			
Confluence with Mantua Creek	0.0	---	9.9
Above Center Ave. Bridge	2.5	---	6.6
Above Lambs Road Bridge	5.0	---	3.3
Plank Run	6.4	1.0	---
Above Plank Run	6.4	---	1.3

#### **Developments in the Flood Plain**

A large part of the flood plain of Mantua Creek is rural, wooded and undeveloped. Many areas are devoted to farming but scattered residential structures can be found throughout the flood plain. Development is more concentrated near the town of Pitman and downstream of the confluence with Chestnut Branch, where Mantua Creek passes through developed areas of Deptford, West Deptford, and Mantua Townships. One area of residential development in West Deptford Township that has suffered damage from flooding is Mantua Terrace. The area was hardest hit by flooding that occurred along Mantua Creek following the storm of September 1940. Representative photographs of the record flooding that occurred in Mantua Terrace as a result of that storm may be found in Figures 3, 4, and 8 on Pages 15 and 17. Further downstream, development of the flood plain increases in the City of Paulsboro, where residential, commercial, and industrial development can be found on or near flood plain land. This development is in areas adjacent to low, tidal marshland that is susceptible to flooding from high flows of Mantua Creek as well as from high stages of the Delaware River.

The flood plains of Chestnut Branch and Edwards Run are also rural and largely undeveloped. Scattered residential and commercial development can be found on the flood plain of Chestnut Branch in the vicinity of Glassboro and Pitman. The flood plain of Edwards Run is wooded and adjacent areas are devoted mainly to farming.

In addition to the buildings situated on the flood plains of Mantua Creek, Chestnut Branch, and Edwards Run, streets, highways, railroads, utilities, and sewage treatment plants are subject to flooding. Census statistics for Gloucester County municipalities, given in Table 2, indicate that the areas adjacent to Mantua Creek and its tributaries are generally experiencing a substantial increase in population. Therefore, development in Gloucester County can certainly be expected to increase, resulting in additional pressures to utilize the flood plain of Mantua Creek and its tributaries.

**TABLE 2**  
**1970**  
**POPULATION**  
**GLOUCESTER COUNTY MUNICIPALITIES (a)**

Municipality	1970	1960	Percent Change
Deptford Township	24,232	17,878	35.5
Glassboro Borough	12,938	10,253	26.2
Mantua Township	9,643	7,991	20.7
Paulsboro Borough	8,084	8,121	- 0.5
Pitman Borough	10,257	8,644	18.7
Wenonah Borough	2,364	2,100	12.6
West Deptford Township	13,928	11,152	24.9

(a) All Figures taken from 1970 Census of Population-Advance Report



## FLOOD SITUATION

### Sources of Data and Records

The U.S. Geological Survey (U.S.G.S.) maintains a gauging station at Pitman, New Jersey. The gauge is located on the left abutment of Wadsworth Dam at Kressey Lake, 0.9 mile east of Pitman, New Jersey. The drainage area above the gauge is 6.04 square miles. This gauge has been in operation from April 1940 to the present time.

To supplement the records at the gauge, newspaper files, historical documents, and records were searched for information concerning past flooding. From these records, a knowledge of flooding on Mantua Creek and its two major tributaries has been developed.

Maps prepared for this report were based on U.S. Geological Survey quadrangle sheets entitled, "Woodbury, New Jersey, 1967", "Runnemede, New Jersey, 1967", and "Pitman East, New Jersey, 1966". Structural data on bridges and culverts were obtained by field surveys performed by Corps of Engineers, Philadelphia District, personnel.

### Flood Season and Flood Characteristics

*The main flood seasons for Mantua Creek, Chestnut Branch, and Edwards Run occur during the late summer and early fall. The worst flood as recorded occurred during September. However, flooding has occurred within the study area during all seasons of the year, usually resulting from heavy rains within the watershed. Stages can rise from normal flow to extreme flood peaks within twelve hours, with high velocities in the main stream channel. In addition to floods caused by runoff from general rainfall, Mantua Creek and its two tributaries are susceptible to hurricane activity and floods from snowmelt in combination with rainfall.*

### Factors Affecting Flooding and Its Impact

**Obstructions to floodflows** - Natural obstructions to floodflows include trees, brush, and other vegetation growing along the stream banks in floodway areas. Man-made encroachments on or over the streams, such as dams, bridges, and culverts, can also create more extensive flooding than would otherwise occur.

During floods, trees, brush, and other vegetation growing in floodways impede floodflows, thus creating backwater and increased flood heights. Trees and other debris may be washed away and carried downstream to collect on bridges and other obstructions to flow. As floodflows increase, masses of debris break loose and a wall of water and debris surges downstream until another obstruction is encountered. Debris may collect against a bridge

until the load exceeds its structural capacity and the bridge is destroyed. The limited capacity of obstructive bridges or culverts, debris plugs at the culvert mouth, or a combination of these factors retards floodflows and results in flooding upstream, erosion around the culvert entrance and bridge approach embankments, and possible damage to the overlying roadbed.

In general, obstructions restrict floodflows and result in overbank flows and unpredictable areas of flooding, destruction of or damage to bridges and culverts, and an increased velocity of flow immediately downstream. It is impossible to predict the degree or location of the accumulation of debris; therefore, for the purpose of this report, it was necessary to assume that there would be no accumulation of debris to clog any of the bridge or culvert openings in the development of the flood profiles. Representative photographs of obstructions to floodflows may be seen in Figures 1 and 2.

Four dams are located on Mantua Creek and its tributaries, Edwards Run and Chestnut Branch. They have no flood control capacities and will not seriously alter flow characteristics of flood waters. Mantua Creek, Edwards Run, and Chestnut Branch are spanned by 37 bridges. Pertinent information on all bridges can be found in Table 6 on Page 24. Many of these bridges are obstructive to floodflows.

**Flood damage reduction measures** - There are no existing, proposed, or authorized flood control or related measures in the study area or upstream in the watershed, nor are there any existing local flood plain zoning regulations in Gloucester County. However, the State of New Jersey enacted an encroachment law in 1929 which is essentially a preventive flood loss measure. The law is known as the "1929 Encroachment Law (RS 58:1-26)" and is administered by the Division of Water Policy and Supply of the Department of Environmental Protection. The law reads in part as follows:

"No structure within the natural and ordinary high water mark of any stream shall be made by any public authority or private person or corporation without notice to the (Division) and in no case without complying with such conditions as the (Division) may prescribe for preserving the channel and providing for the flow of water therein to safeguard the public against danger from the waters impounded or affected by such a structure and this prohibition shall apply to any renewal of existing structures."

Under the provision of this law, the Division issues permits for the construction of bridges, culverts, fills, walls, channel improvements, pipe crossings and other encroachments located within the natural and ordinary high water mark of the stream. Another New Jersey encroachment law (Chapter 229, Laws of 1938, amending a previous law known as RS 40:56-1), permits municipalities of the State to construct improvements, remove obstructions, define the location, establish widths, grades, and elevations of any stream and to prevent encroachments thereon -- subject to approval by the State of the flood carrying capacity to be provided.



FIGURE 1 Trees and brush along stream bank near the electricity substation upstream of Delsea Drive (N.J. Rt. 47) bridge.



**FIGURE 2-** Accumulated debris clogs the channel of Mantua Creek downstream of the East Holly Avenue bridge.

Under this law, counties in New Jersey are permitted to assist municipalities in local flood damage alleviation programs. The New Jersey Flood Plain Designation and Marking Law, enacted in 1962 [RS 58:16A (50-54)] empowers the Division of Water Policy and Supply to delineate and mark flood hazard areas, and coordinate effectively the development, dissemination, and use of information on floods and flood damage that may be available. The development of adequate flood plain information as furnished in this report will enable state and local authorities to further implement existing statutes and regulations.

In addition to the State regulation, Gloucester County is currently in the process of preparing a comprehensive plan for the county. This comprehensive plan consists of twelve basic elements, one of which is a master plan. Included in the master plan is a plan of proposed flood plain zoning recommendations.

**Other factors and their impacts** - The populated area most frequently inundated by Mantua Creek is Mantua Terrace in the vicinity of the New Jersey Route 45 bridge. Flooding at Mantua Terrace has resulted from high tides in the Delaware River and floodwaters from upstream sources. Flood damages may be reduced by efficient flood warning and forecasting systems and by implementing flood fighting and emergency evacuation plans. Damages may increase if materials stored in the flood plain are swept downstream at high velocities.

**Flood warning and forecasting** - The National Weather Service Branch of the National Oceanic and Atmospheric Administration (NOAA) maintains year-round surveillance of weather conditions at Trenton, New Jersey. Commercial radio stations receive information on hurricanes, tornadoes, and flash flood warnings from the National Weather Service and broadcast to the public through the Emergency Weather Network in cooperation with the New Jersey Civil Defense Disaster Control (CD-DC). The State CD-DC also receives the information directly from Trenton and disseminates the forecasts through its own communications system with area, county and local Civil Defense Offices. Tidal information is broadcast on public radio during the Delaware Bay Marine Forecast originating from the National Weather Service Philadelphia Office. Mantua Creek has no stream stage monitoring devices for flood forecasting purposes; residents must rely on National Weather Service "flood watches" for advanced warning.

**Flood fighting and emergency evacuation plans** - Although there are no formal flood fighting or emergency evacuation plans for the Mantua Creek area during a flood emergency, area residents are alerted through local communications media by the Gloucester County Civil Defense Office. This office maintains communications with the State Civil Defense Headquarters and coordinates flood fighting evacuation and rescue activities on a county-wide basis with local agencies.

**Material storage on the flood plain** - The flood plain along Mantua Creek in the study area is occupied mainly by residential properties and a few commercial and industrial establishments. The majority of floatable materials stored on the flood plain can be found in the *Paulsboro-Billingsport area*. Chestnut Branch and Edwards Run are occupied by residential and farming properties with some commercial properties. A lumber yard on Chestnut Branch below Alcyon Lake in Pitman could add floatable material to the stream during times of floods. In addition, the storage tanks and containers in the area may be unrestrained and buoyant. During times of floods, these floatable materials may be carried away by floodflows causing serious damage to structures downstream and clogging bridge openings creating more hazardous flooding problems.

## PAST FLOODS

### Summary of Historical Floods

Damaging floods have been reported in the study area of Mantua Creek and its tributaries as early as 1867 and 1868; however, little data is available concerning their severity. Floods causing significant damage have occurred in 1938, 1940, 1945, 1952, 1960, 1967, 1968, and 1971. Of these, the September 1, 1940, flood was the highest flood of record at the Pitman stream gauge station.

### Flood Records

Flood data for Mantua Creek was obtained from a stream gauging station maintained by the U.S. Geological Survey at Pitman, New Jersey. The gauge has been in operation from April 1940 to the present. High water marks of past floods were obtained, residents were interviewed, and newspaper files and historical documents were searched for information concerning past floods. Crest stages and discharges for known floods at the gauging station on Mantua Creek at Pitman, New Jersey, are shown in Table 3.

TABLE 3  
FLOOD CREST ELEVATIONS  
Mantua Creek at Pitman, New Jersey, Gauging Station

Date of Crest	Estimated Peak Discharge (cfs)	Stage (feet)	Elevation (a) feet - m.s.l.d.
September 1, 1940	4,200 (b)	6.6	75.1
August 10, 1967	668	3.1	71.6
January 14, 1968	359	2.4	70.9
September 12, 1960	240	2.1	70.6
August 10, 1952	233	2.1	70.6

(a) Gauge zero datum is 68.5 feet, mean sea level datum.  
(b) Estimated flow over dam and through break in earth dike.

### Flood Descriptions

The following four entries were taken from the Diary of John Cawman Eastlack of Mantua, New Jersey:

August 15, 1867 - A heavy rain. Nearly all the mill dams around are broken. Fifteen are gone and only two for several miles around were saved. Bridges and culverts carried.

September 4, 1868 - The great freshet of 1868. Very heavy rains caused freshet which destroyed most of the bridges and mill dams on Mantua, Raccoon, and Oldmans Creeks. The bridge at Mantua was destroyed.

September 5, 1868 - Empty barrel was nearly filled with water from direct rain.

September 24, 1882 - Several days of very heavy rain said to total 13 inches. Many dams and bridges carried away.

June 28, 1938 - This flood was the result of very heavy rain which began late Sunday night, June 26th, and continued into Tuesday. Most seriously damaged areas were Sewell and Mantua Terrace.

### EXCERPTS FROM THE PHILADELPHIA RECORD AND THE PHILADELPHIA EVENING PUBLIC LEDGER, JUNE 28, 1938

A record-breaking fall of rain continued unabated today over a tri-State area and sent more flood water swirling over farmlands and through lowland communities in southern New Jersey, Pennsylvania, and Delaware.

George S. Bliss, United States Weather Forecaster at the Philadelphia Bureau, announced at 8:30 A.M. today that a total of 4.70 inches of rain had fallen here since the unseasonal storm broke Sunday night, making it the third greatest rainstorm in the

history of the weather bureau.

More than 100 bungalows along Mantua Creek were inundated last night and some residents were marooned and others were forced to move to higher ground by way of canoes and rowboats. Alcyon Lake near Pitman also threatened to overflow its banks. The Creek receded rapidly today and occupants of summer homes returned. Traffic also resumed on the Glassboro road at Sewell which was closed last night by high water.

September 1, 1940 - This is the largest recorded flood at the Pitman gauging station. Its peak discharge was 4,200 cubic feet per second. The storm began in the late hours of August 31st. Rainfall measurements by local observers in Wenonah and Mantua ranged from 18.0 inches in Wenonah (container used - milk bottle) to 15.1 inches in Mantua (container used - flatbottom boat). According to the observers, the rain began at 12:30 a.m. on September 1st and was very heavy until 2:00 a.m. Fourteen inches of rain fell by 6:00 a.m. and the rain finally ended by 10:00 a.m. The most heavily damaged area along Mantua Creek was Mantua Terrace.



EXCERPTS FROM THE DAILY TIMES, WOODBURY, SEPTEMBER 3, 1940

## Storm Damage Expected To Reach Million Mark Over Fifty Families Left Homeless

Gloucester County today surveyed damage left in the wake of flood waters that inundated wide areas on Sunday, drove hundreds of persons from their homes, washed out bridges and highways, disrupted railroad and bus traffic facilities and caused property damage estimated at one million dollars.

Hardest hit in this county was Mantua Terrace and Mullica Hill. Mantua Creek overflowed driving more than fifty families from their homes. Huge washouts on the Camden-Millville electric line of the Pennsylvania-Reading Seashore lines occurred below Wenonah and Franklinville. The railroad bridge at Paulsboro was washed out.

The storm, beginning Sunday morning shortly after midnight, rapidly reached alarm-

ing proportions as lakes broke their dams or washed over their banks and creek water levels reached new highs. About 200 persons were made temporarily homeless at Mantua Terrace when the water in Mantua Creek overflowed and reached rooftops of about 100 homes along the Creek. Twelve of the homes were swept away by the raging water.

The bridge between Wenonah and Mantua, on Mantua Avenue, during the high tide on Sunday was blocked off when it was feared that it would be swept away. Alcyon Lake Dam gave way at Pitman and two bridges were broken through.

Woodbury Water Plant at Sewell was inundated by floodwaters which reached a depth of twelve feet along the Glassboro Road and over a ¼ mile area was out of operation on Sunday.

(Photographs of flooding that occurred as a result of the September 1, 1940, storm may be found in Figures 3 through 8 on Page 15 through 17.)

July 22, 1945 - At Wenonah, New Jersey, the rain started falling about 5:30 p.m., Sunday, July 22, and continued until about 7:00 p.m. It rained very hard for thirty-five to forty minutes near the middle of the storm. At times, the rain did not fall in drops but appeared as streams from a shower bath head. Residents of Mantua Terrace were forced to leave their homes and the Woodbury Water Plant was again flooded.

EXCERPTS FROM THE DAILY TIMES, WOODBURY, JULY 23, 1945

## Torrential Rains Flood Highways and Inundate Reservoir at City Pumping Plant, Users Asked to Conserve Water

## Bridge Washed Out of Pennsylvania-Reading Seashore Lines Below Wenonah--Storm Snarls Traffic From Shore Points--Normal Water Service Expected Tomorrow

The heaviest rainfall of the summer yesterday afternoon inundated highways,

flooded the reservoir at Woodbury's Water Plant, disrupted through train service on

the Camden-Millville Branch of the Pennsylvania-Reading Seashore Lines, and played havoc with traffic homeward bound from seashore resorts. Flooding on the reservoir at the city's pumping station on Glassboro Road, Sewell, forced the plant to stop pumping and resulted in city officials appealing to residents to use water only where it is necessary. Conservation of the city's reserve supply will prevent any possibility of a water famine.

A small trestle bridge over Monongahela Branch, below Wenonah, was washed out last night, halting train travel at that point.

County Engineer William Baum said that the County's worst washout occurred on the Glassboro Road, below Wenonah, where there is a serious washout at one end

of the bridge over the Monongahela Branch and the shoulders and fill beneath the concrete roadway has been washed out for a distance of about twenty feet. Traffic over this section has been halted.

Traffic was stalled on the Glassboro Road, at the Woodbury water plant, where the water swept across the highway at a depth of three feet at the height of the storm. The flood water and the tributary of Mantua Creek adjacent to the plant, overflowed into the reservoir at the plant, contaminating the supply there with dirt and refuse.

Residents along the creek at Mantua evacuated their homes at 1:30 A.M. today, but the water receded and the occupants returned this morning. Two automobiles were inundated at that spot.

#### EXCERPTS FROM THE DAILY TIMES, WOODBURY, SEPTEMBER 12-13, 1960

First reports of damages in the county came from the Mantua Township Area. State police at Mantua said drainage water undermined foundations and caved in a home.

In Mantua Terrace, West Deptford Township, about six families were forced to evacuate their homes along the creek front, near Route 45, when Mantua Creek overflowed its banks.

August 10, 1967 - This is the second largest recorded flood at the Pitman Gauging Station. Its peak discharge was 668 cubic feet per second with total rainfall for the period of August 10-11 measured at 4.99 inches. Based on observation of the flooded areas, it is estimated that in the Mantua Creek watershed, the flood of August 10th caused \$75,000 damage to highways and \$75,000 damage to residential property and commercial interests.

#### EXCERPTS FROM THE DAILY TIMES, WOODBURY, AUGUST 10, 1967

Flood emergency declared here -- Four families were forced to leave their homes in Mantua Terrace when flood waters from Mantua Creek rose as high as second story windows. The homes were located just before the Route 45 Bridge in Mantua. In Mantua Township, roads caved in on Route 45 near center city and Breakneck Road in Barnsboro.

The storm closed Lambs Road at Bethel Mill Road from Richwood to Hurffville in Washington Township.

As flood waters subsided, residents in the tri-county area began the big "mop-up" today. County officials began tallying the cost of yesterday's flood. It is expected to total tens of thousands of dollars.

(Photographs of flooding that occurred as a result of the August 1967 storm may be found in Figures 9 and 10 on Pages 18 and 19.)



**FIGURE 3 -** Floodwaters of Mantua Creek approach the rooftops of these homes in Mantua Terrace as flooding nears its crest during the September 1, 1940, storm.



**FIGURE 4 -** Floodwaters on First Avenue, Mantua Terrace, limit transportation to boats.



**FIGURE 5 -** This photo of the old Woodbury Water Works on Glassboro Road at Sewell was made September 1, 1940, after floodwaters had receded several feet. Car shown in center was completely submerged at the crest of flooding.



**FIGURE 6 -** View of Kressey Lake, East side of Pitman, taken on overflow side of dam looking southeast into lakebed. During the September 1, 1940, storm the concrete dam (far right) remained intact while the earth embankment (center) was washed away, flooding Delsea Drive.



**FIGURE 7** - Floodwaters from the storm of September 1, 1940, caused this damage at Alcyon Lake, Pitman. Fifty feet of embankment was washed out, allowing the water to flow under the roadbed and drain the lake. Photo was taken from a spot in the lakebed which is normally under fifteen feet of water.



**FIGURE 8** - This home in Mantua Terrace was badly damaged by floating debris during the flood of September 1, 1940.



**FIGURE 9** Floodwaters of Mantua Creek inundate these properties downstream of New Jersey, Route 46 during the August 10, 1967, storm.



**FIGURE 10** - Floodwaters recede from these properties along Mantua Creek upstream of New Jersey Route 45 following the August 10, 1967, storm. Note the high water mark on both buildings.

## FUTURE FLOODS

Floods of the same or larger magnitude as those that have occurred in the past could occur in the future. Large floods have also been experienced in the past on streams with similar geographical and physiographical characteristics as those found in the study area. Similar combinations of rainfall and runoff which caused the floods could occur in the study area. Therefore, to determine the flood potential of the study area, it was necessary to consider storms and floods that have occurred in regions of like topography, watershed cover, and physical characteristics. Discussion of the future floods in this report has been limited to those that have been designated as the Floodway Design Flood (FDF), the Flood Hazard Area Design Flood (FHADF), and the Standard Project Flood (SPF). The Standard Project Flood represents a reasonable upper limit of expected flooding in the study area, even though the expected Standard Project Flood discharge at the Pitman gauging station was surpassed by the floodflow of September 1940. The Floodway Design Flood and the Flood Hazard Area Design Flood may reasonably be expected to occur more frequently although they will not be as severe as the infrequent Standard Project Flood.

### **Floodway Design and Flood Hazard Area Design Floods**

The State of New Jersey defines "Floodway" as the channel and portion of the adjacent flood plain necessary to preserve the natural regimen of a stream for the reasonable passage of the Floodway Design Flood. The "Flood Hazard Area" includes the floodway and any additional portions of the flood plain inundated by the Flood Hazard Area Design Flood.

Both the Floodway Design Flood and the Flood Hazard Area Design Flood are used extensively by the State of New Jersey for flood plain management programs. Methods for the determination of these design floods are contained in "New Jersey Flood Hazard Report No. 1, Delineation of Flood Hazard Areas". The method applies "multiples" to the mean annual flood as determined by regional analysis prescribed in New Jersey Water Resources Circular No. 13, "Floods in New Jersey: Magnitude and Frequency". This circular was prepared in 1964 by the U.S. Geological Survey in cooperation with the State of New Jersey. Peak flows for both the Floodway Design Flood and the Flood Hazard Area Design Flood at selected locations are shown in Table 4. The relative water surface elevations for the Floodway Design Flood and the Flood Hazard Area Design Flood are shown on Plates 15 through 20.



### Standard Project Flood

The Standard Project Flood is defined as a major flood that can be expected to occur from a severe combination of meteorological and hydrological conditions that are considered reasonably characteristic of the geographical area in which the study area is located, excluding extremely rare combinations. The Corps of Engineers, in cooperation with NOAA, has made comprehensive studies and investigations based on the past records of experienced storms and floods and has developed generalized procedures for estimating the flood potential of streams. Peak discharges for the Standard Project Flood at selected locations in the study area are shown in Table 4. A discharge hydrograph for the Standard Project Flood at selected locations is shown on Plate 24. Relative water surface elevations for the Standard Project Flood are shown on Plates 15 through 20.

TABLE 4  
PEAK FLOWS FOR FLOODWAY DESIGN, FLOOD HAZARD AREA DESIGN AND  
STANDARD PROJECT FLOODS

Location	River Mile	Drainage Area Sq. Mi.	Floodway Design Flood Discharge cfs	Flood Hazard Area Design Flood Discharge cfs	Standard Project Flood Discharge cfs
<b><u>Mantua Creek</u></b>					
Confluence with Delaware River	0	50.9	7,200	9,000	11,800
Above Confluence with Edwards Run	5.6	34.1	5,500	6,900	9,700
Above Confluence with Chestnut Branch	9.4	19.4	3,600	4,500	6,200
U.S.G.S. Gauge at Pitman	15.4	6.0	1,300	1,700	3,000
<b><u>Edwards Run</u></b>					
Confluence with Mantua Creek	0	10.6	2,300	2,800	3,700
<b><u>Chestnut Branch</u></b>					
Confluence with Mantua Creek	0	9.9	2,100	2,700	3,250

Table 5 shows comparisons of flood elevations for the Floodway Design, Flood Hazard Area Design, and the Standard Project Floods with the highest recorded flood at the U.S.G.S. Gauge at Pitman, New Jersey.

**TABLE 5**  
**COMPARISON OF FLOOD ELEVATIONS**  
**Mantua Creek at Pitman, New Jersey, Gauging Station**

Flood	Elevation Feet-mean sea level datum
January 14, 1968	70.9
August 10, 1967	71.6
September 1, 1940	75.1 (a)
Floodway Design	73.9
Flood Hazard Area Design	75.8
Standard Project	76.2

(a) Although the discharge of the September 1, 1940, storm was greater than that of a Standard Project Storm, a dam break resulted in a lower water surface at the crest. See Figure 6 on Page 16.

#### **Frequency**

Regionalized frequency curves of peak flows were developed at selected stations along the main stream as well as Chestnut Branch and Edwards Run by methods prescribed in New Jersey Water Resources Circular No. 13, "Floods in New Jersey: Magnitude and Frequency."

The curves represent the frequency of floodflows up to a magnitude of once in 100 years (Floodway Design Flood). Frequencies of floods equivalent to the Standard Project Flood and larger can be obtained through extrapolation of the curve, but it is not practical to assign a frequency to such large flows as their occurrence is so extremely rare. The curves, which are available upon request, reflect the judgment of engineers who have studied the area and are familiar with the region; however, it must be regarded as approximate and should be used with caution in connection with any planning of flood plain use.

#### **Hazards of Large Floods**

The extent of damage caused by any flood depends on the topography of the area flooded, depth and duration of flooding, velocity of flow, rate of rise, and developments in the flood plain. A Floodway Design Flood, Flood Hazard Area Design Flood, or Standard Project Flood on Mantua Creek would result in the inundation of residential, commercial, and industrial properties in the study area. Deep floodwater flowing at high velocity and carrying floating debris would create conditions hazardous to persons and vehicles attempting to cross flooded areas. In general, floodwater three or more feet deep and flowing at a

velocity of three or more feet per second could easily sweep an adult person off his feet, thus creating definite danger of injury or drowning. Rapidly rising and swiftly flowing floodwater may trap persons in homes that are ultimately destroyed, or in vehicles that are ultimately submerged or floated. Water lines can be ruptured by deposits of debris and the force of floodwaters, thus creating the possibility of contaminated domestic water supplies. Damaged sanitary sewer lines and sewage treatment plants could result in the pollution of floodwaters creating health hazards. Isolation of areas by floodwater could increase dangers during medical, fire, or law enforcement emergencies.

**Flooded areas and flood damages** - The areas along Mantua Creek, Chestnut Branch, and Edwards Run that would be flooded by the Standard Project Flood are shown on Plate 2, which is also an index map to Plates 3 through 14. Areas that would be flooded by the Floodway Design Flood and the Standard Project Flood are shown in detail on Plates 3 through 14. Because of the small difference in elevation between the Flood Hazard Area Design Flood and the Floodway Design Flood, only the Floodway Design Flood and the Standard Project Flood are shown on these plates. The actual limits of these overflow areas may vary somewhat from those shown on the maps because the 20-foot contour interval and scale of the maps do not permit precise plotting of the flooded area. As may be seen from these plates, floodflows from the main stream of Mantua Creek, Chestnut Branch, and Edwards Run inundate sections of Pitman, Wenonah, Oak Valley, Paulsboro and other small communities adjacent to the streams. The areas that would be flooded by the various design floods include commercial, industrial, and residential properties, along with associated streets and roads.

Considerable damages to the facilities would occur during the Floodway Design and the Flood Hazard Area Design Floods. However, due to the wider extent, greater depths of flooding, higher velocity of flow and longer duration of flooding during a Standard Project Flood, damage would be more severe than during the Floodway Design and the Flood Hazard Area Design Floods. Plates 15 through 20 show water surface profiles for all three design floods. Depth of flow in the channel can be estimated from these illustrations. Typical cross sections at selected locations, together with the water surface elevation and lateral extent of the design floods, are shown on Plates 21 through 23.

**Obstructions** - During flooding conditions, debris can collect on bridges and culverts, thereby decreasing their carrying capacity and causing greater water depths (backwater effect) upstream of the structures. Since the occurrence and amount of debris are indeterminate factors, only the physical characteristics of the structures were considered in preparing profiles of the Floodway Design, Flood Hazard Area Design and Standard Project Floods. Similarly, the maps of flooded areas show the backwater effect of obstructive bridges and culverts, but do not reflect increased water surface elevation that could be caused

by debris collecting against the structures, or by deposition of silt in the stream channel under structures. As previously indicated, there are four dams within the study area that have no flood control capacities and will not seriously alter the flow characteristics of floodwaters. Of the thirty-seven bridges crossing Mantua Creek, Chestnut Branch, and Edwards Run, nineteen are obstructive to the Floodway Design Flood, while twenty-four are obstructive to the Standard Project Flood. Table 6 shows water surface elevations for all three design floods at the bridges.

**Velocities of flow** - Water velocities during floods depend largely on the size and shape of the stream's cross sections, conditions of the stream, and the bed slope, all of which vary on different streams and at different locations on the same stream. During the Floodway Design Flood, velocities in the main channel of Mantua Creek would be 3 to 10 feet per second. Water flowing at this rate is capable of causing severe erosion to stream banks and fill around bridge abutments and transporting large objects. Much higher velocities are encountered during the Standard Project Flood. Channel flows and overbank flows would reach maximum velocities of 12.0 feet per second and 3.8 feet per second, respectively, in some locations. Water flowing at 2 feet or less per second will deposit debris and silt. Table 7 lists the maximum velocities that could occur in the main channel and overbank areas at selected cross section locations of Mantua Creek, Edwards Run, and Chestnut Branch during the design floods.

**TABLE 6**  
**ELEVATION DATA**  
**BRIDGES ACROSS MANTUA CREEK, CHESTNUT BRANCH AND EDWARDS RUN**

Identification	Mileage Above Mouth	Undercl. Elevation feet-msld	Water Surface Elevation		
			Floodway Design Flood feet-msld	Flood Hazard Area Design Flood feet-msld	Standard Project Flood feet-msld
<b>Mantua Creek</b>					
Pennsylvania-Reading Seashore Line	1.40	4.0	9.7	9.7	14.5
N.J. Rt. 44 (Broad St.)	1.63	7.9	9.7	9.7	14.5
Interstate Rt. 295	2.84	28.5	9.7	9.7	14.5
County Rt. 551 (Kings Highway)	5.10	14.7	9.7	9.7	14.5
Pennsylvania-Reading Seashore Line	5.27	17.7	9.7	9.7	14.5
N. J. Turnpike	6.59	18.7	9.7	9.7	14.5
N. J. Rt. 45 (Mantua Pike)	8.40	15.0	11.5	12.6	14.8
W. Mantua Ave.	9.24	16.5	12.2	13.3	16.0
Pennsylvania-Reading Seashore Line	10.28	41.9	12.9	14.1	17.4
Glassboro Road	11.50	17.0	17.5	20.4	21.0
Center Avenue	11.76	19.3	22.6	24.5	25.6
Lambs Road	13.84	49.6	47.4	49.0	51.3
E. Holly Avenue	15.18	66.4*	69.5	69.9	70.6
N. J. Rt. 47 (Delsea Dr.)	15.30	62.0	69.9	70.5	71.4
Green Tree Road	16.52	90.6*	94.2	94.5	95.2
Fishpond Road	17.60	106.3*	111.4	111.6	111.8
Glassboro - Cross Keys Road	18.12	117.0*	120.4	120.7	121.1

**TABLE 6 (Continued)**  
**ELEVATION DATA**  
**BRIDGES ACROSS MANTUA CREEK, CHESTNUT BRANCH AND EDWARDS RUN**

Identification	Mileage Above Mouth	Undercl. Elevation feet-msld	Water Surface Elevation		
			Floodway Design Flood	Flood Hazard Area Design Flood	Standard Project Flood
			feet-msld	feet-msld	feet-msld
<b>Edwards Run</b>					
Berkley Road	0.28	10.4	9.7	9.7	14.5
N. J. Turnpike	1.26	22.5	12.4	14.0	16.8
Jessup Mill Road	2.27	16.4	16.3	18.0	21.7
N. J. Rt. 45 (Bridgeton Pike)	3.42	33.8	27.7	29.2	31.4
Heritage Road	3.86	35.5	34.7	36.1	36.3
Breakneck Road	4.69	47.2	48.0	49.2	51.7
Pitman-Jefferson Road	5.34	52.5	56.8	57.1	57.6
Jackson Road	6.04	67.5	67.9	68.8	71.0
Irrigation Pond - outlet pipe	6.64	83.6*	95.3	95.4	95.8
Private Road	6.74	89.9*	97.4	97.6	97.9
<b>Chestnut Branch</b>					
Mantua Blvd.	0.38	16.0	12.6	13.8	16.1
Center Avenue	2.50	35.6	30.0	30.3	30.6
Tylers Mills Rd.	3.44	45.7	48.3	49.1	49.3
Main Street	3.50	61.5	50.5	51.7	52.5
Lambs Road	5.03	70.6	74.2	76.5	78.3
West Holly Avenue	5.38	83.0	87.2	87.4	87.6
Carew Avenue	5.95	94.6	89.5	90.4	90.5
Private Bridge at Crossing Apts.	6.94	108.1*	108.6	109.3	109.6
Pennsylvania Reading Seashore Line	7.20	112.5*	113.4	114.6	115.2
Plank Run - U.S. Rt. 322	0.24	108.5	107.4	107.6	107.7

\* Culvert(s)

**TABLE 7**  
**MAXIMUM AVERAGE VELOCITIES<sup>(a)</sup>**  
**MANTUA CREEK, EDWARDS RUN AND CHESTNUT BRANCH**

Location	Mileage Above Mouth	Standard Project Flood		Flood Hazard Area Design Flood		Floodway Design Flood	
		Channel	Overbank <sup>(b)</sup>	Channel	Overbank <sup>(b)</sup>	Channel	Overbank <sup>(b)</sup>
		feet per second		feet per second		feet per second	
<b>Mantua Creek</b>							
Cross-section 10	6.85	2.7	1.0	2.2	0.8	2.0	0.7
Cross-section 11	8.14	4.3	1.6	3.7	1.3	3.4	1.2
Cross-section 13	8.69	3.2	1.3	2.7	1.0	2.5	0.9
Cross-section 14	9.71	3.5	1.5	2.6	1.1	2.5	1.1
Cross-section 15	10.47	2.8	1.2	2.8	1.1	2.7	1.1
Cross-section 21	14.73	5.7	2.8	5.2	2.6	5.0	2.5
Cross-section 23	15.24	1.3	0.5	1.1	0.4	1.0	0.4
Cross-section 24	15.35	2.1	0.7	1.8	0.6	1.6	0.5

**TABLE 7 (Continued)**  
**MAXIMUM AVERAGE VELOCITIES<sup>(a)</sup>**  
**MANTUA CREEK, EDWARDS RUN AND CHESTNUT BRANCH**

Location	Mileage Above Mouth	Standard Project Flood		Flood Hazard Area Design Flood		Floodway Design Flood	
		Channel	Overbank <sup>(b)</sup>	Channel	Overbank <sup>(b)</sup>	Channel	Overbank <sup>(b)</sup>
		feet per second		feet per second		feet per second	
<b>Edwards Run</b>							
Cross-section 4	1.86	2.1	0.9	2.4	1.0	2.6	1.1
Cross-section 5	2.23	4.1	1.5	5.0	1.8	5.8	2.0
Cross-section 9	4.22	10.9	3.1	9.8	2.5	9.6	2.0
Cross-section 11	5.30	3.1	1.3	4.4	1.7	5.3	1.9
Cross-section 14	6.26	2.3	1.0	3.0	1.3	3.6	1.4
<b>Chestnut Branch</b>							
Cross-section 6	2.46	7.3	2.0	5.5	1.6	6.3	1.5
Cross-section 7	2.85	8.1	2.5	8.0	2.4	8.2	2.1
Cross-section 13	5.24	2.0	0.7	2.8	1.0	4.6	1.2
Cross-section 14	5.37	5.3	1.7	5.9	2.6	6.3	4.2
Cross-section 15	5.98	7.9	2.5	7.1	2.3	6.1	1.9

(a) Velocities given are in reaches unaffected by bridges or other channel constrictions

(b) Value given is the greater of the left and right overbank velocity.

**Rates of rise and duration of flooding** - Intensive rainfall that accompanies severe storm fronts usually produces the floods which occur within the Mantua Creek Watershed. There is a time lag of several hours before overbank flooding occurs along the main stem. Chestnut Branch and Edwards Run, with small drainage areas, reach overbank flooding conditions much sooner. Floods generally rise slowly after reaching overbank and stay out of banks for long periods of time.

**Photographs, future flood heights** - The levels that the Floodway Design, Flood Hazard Area Design, and Standard Project Floods are expected to reach at various locations along Mantua Creek and Chestnut Branch are indicated on the following photographs.



FIGURE 11 - Future flood heights at Delsea Drive (N.J. Rt. 471) bridge on Mantua Creek

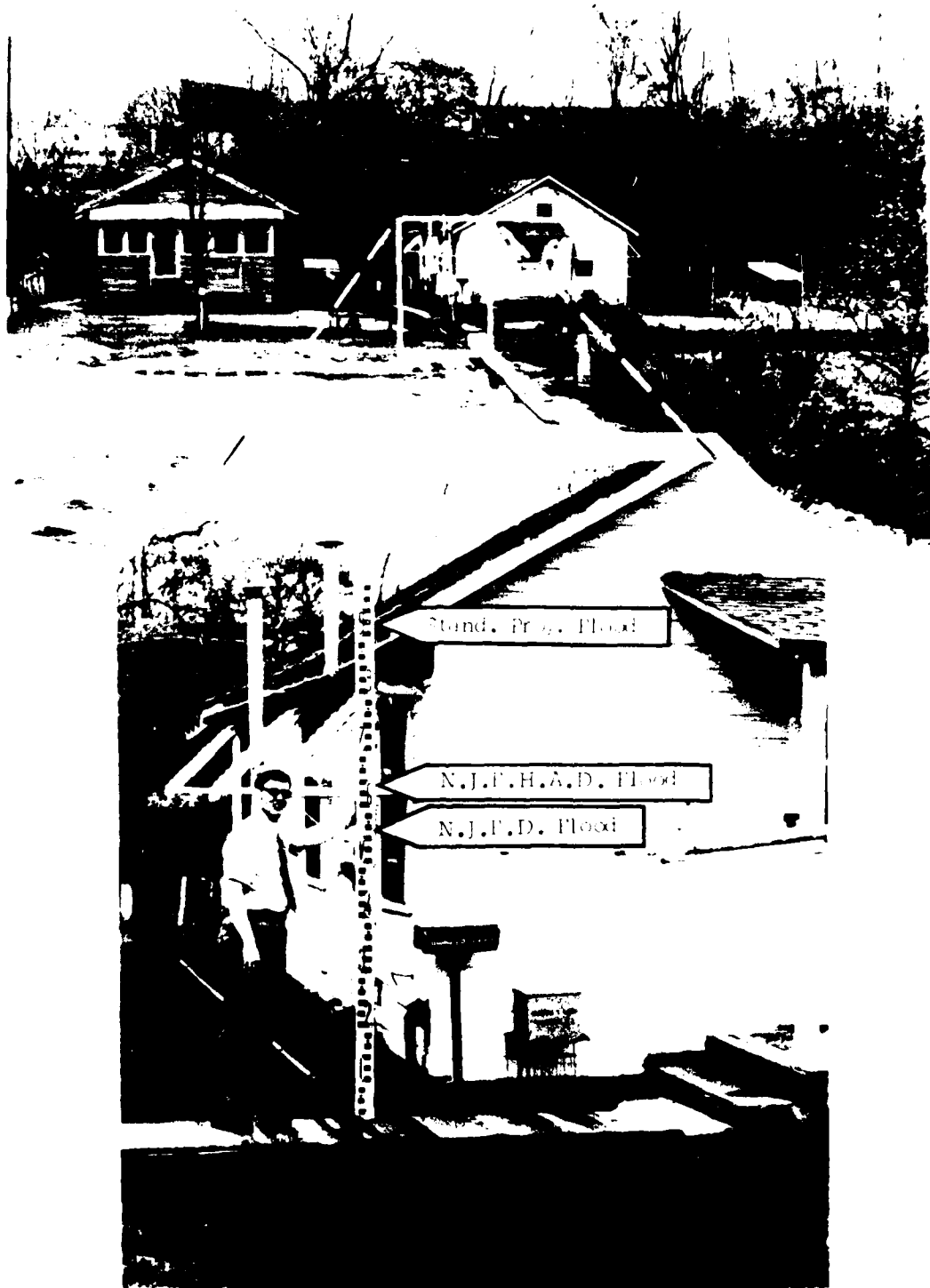

FIGURE 12- Future flood heights of Mantua Creek in Mantua Terrace.



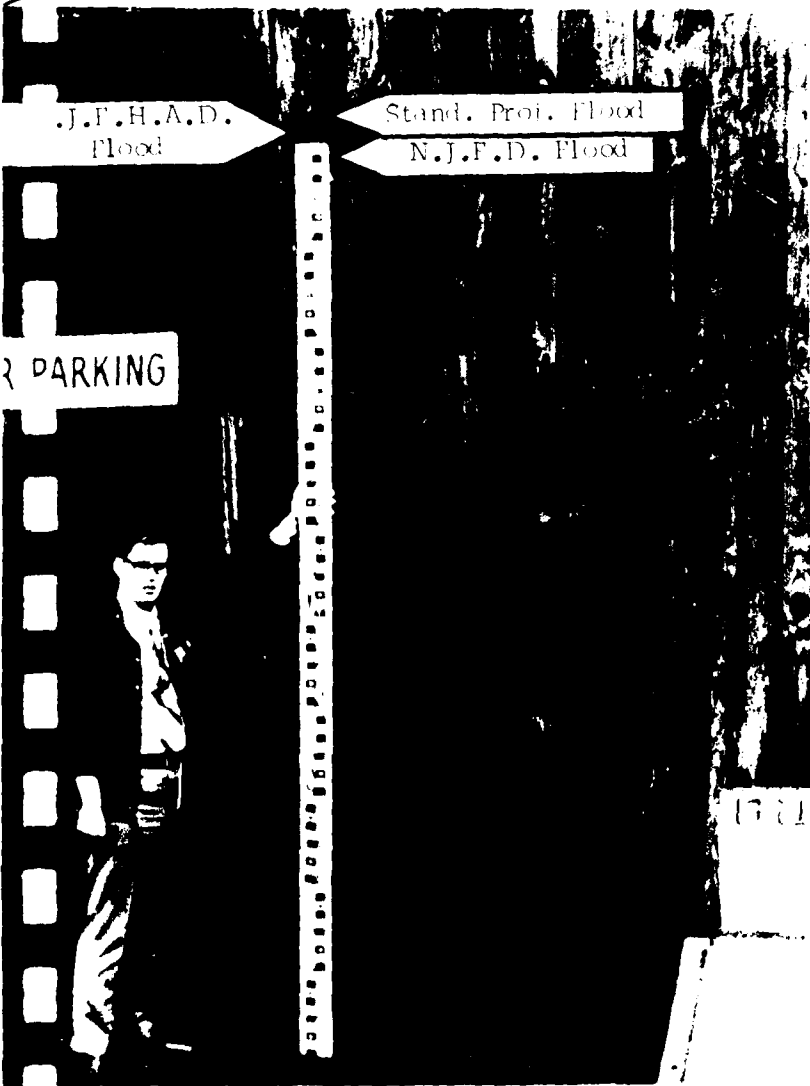
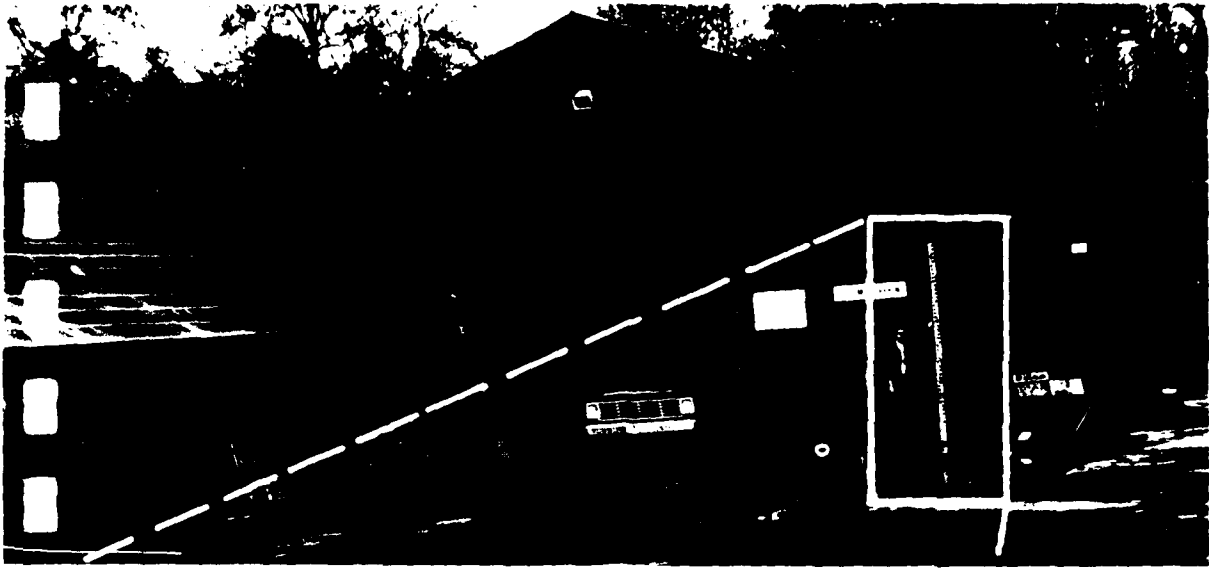

FIGURE 13 -  
Future flood height of Chestnut  
Branch at the Robbins Lumber  
Co., West Holly Ave., Patman

## GLOSSARY

**Backwater.** The resulting high water surface in a given stream due to a downstream obstruction or high stages in an intersecting stream.

**Flood.** An overflow of lands not normally covered by water and that are used or usable by man. Floods have two essential characteristics: The inundation of land is temporary; and the land is adjacent to and inundated by overflow from a river, stream, ocean, lake, or other body of standing water.

Normally a "flood" is considered as any temporary rise in streamflow or stage, but not the ponding of surface water, that results in significant adverse effects in the vicinity. Adverse effects may include damages from overflow of land areas, temporary backwater effects in sewers and local drainage channels, creation of unsanitary conditions or other unfavorable situations by deposition of materials in stream channels during flood recessions, rise of ground water coincident with increased streamflow, and other problems.

**Flood Crest.** The maximum stage or elevation reached by the waters of a flood at a given location.

**Flood Hazard Area Design Flood.** A flood greater than the Floodway Design Flood that inundates the Floodway and additional portions of the flood plain. This area is known as the Flood Hazard Area. The Floodway (see Floodway Design Flood) is an integral part of the Flood Hazard Area. This flood is also used extensively by the State of New Jersey for planning purposes.

**Flood Plain.** The areas adjoining a river, stream, watercourse, ocean, lake, or other body of standing water that have been or may be covered by floodwater.

**Flood Profile.** A graph showing the relationship of water surface elevation to location, the latter generally expressed as distance above mouth for a stream of water flowing in an open channel. It is generally drawn to show surface elevation for the crest of a specific flood, but may be prepared for conditions at a given time or stage.

**Flood Stage.** The stage or elevation at which overflow of the natural banks of a stream or body of water begins in the reach or area in which the elevation is measured.

**Floodway Design Flood.** A flood that inundates the channel and portions of the adjacent flood plain necessary for the reasonable passage of flood waters. This area is known as the Floodway and represents the minimum area of the flood plain required for passage of flood waters without aggravating flood conditions upstream or downstream. This flood is used extensively by the State of New Jersey for planning purposes (See also: Flood Hazard Area Design Flood).

**Hurricane.** An intense cyclonic windstorm of tropical origin in which winds tend to spiral inward in a counterclockwise direction toward a core of low pressure, with maximum surface wind velocities that equal or exceed 75 miles per hour (65 knots) for several minutes or longer at some points. Tropical storm is the term applied if maximum winds are less than 75 miles per hour.

**Hydrograph.** A graph showing flow values against time at a given point, usually measured in cubic feet per second. The area under the curve indicates total volume of flow.

**Left Bank.** The bank on the left side of a river, stream, or watercourse, looking downstream.

**Right Bank.** The bank on the right side of a river, stream, or watercourse, looking downstream.

**Standard Project Flood.** The flood that may be expected from the most severe combination of meteorological and hydrological conditions that are considered reasonably characteristic of the geographical area in which the drainage basin is located, excluding extremely rare combinations. Peak discharges for these floods are generally about 40-60 percent of the Probable Maximum Floods for the same basins. As used by the Corps of Engineers, Standard Project Floods are intended as practicable expressions of the degree of protection that should be sought in the design of flood control works, the failure of which might be disastrous.

**Underclearance Elevation.** The elevation at the top of the opening of a culvert, or other structure through which water may flow along a watercourse.

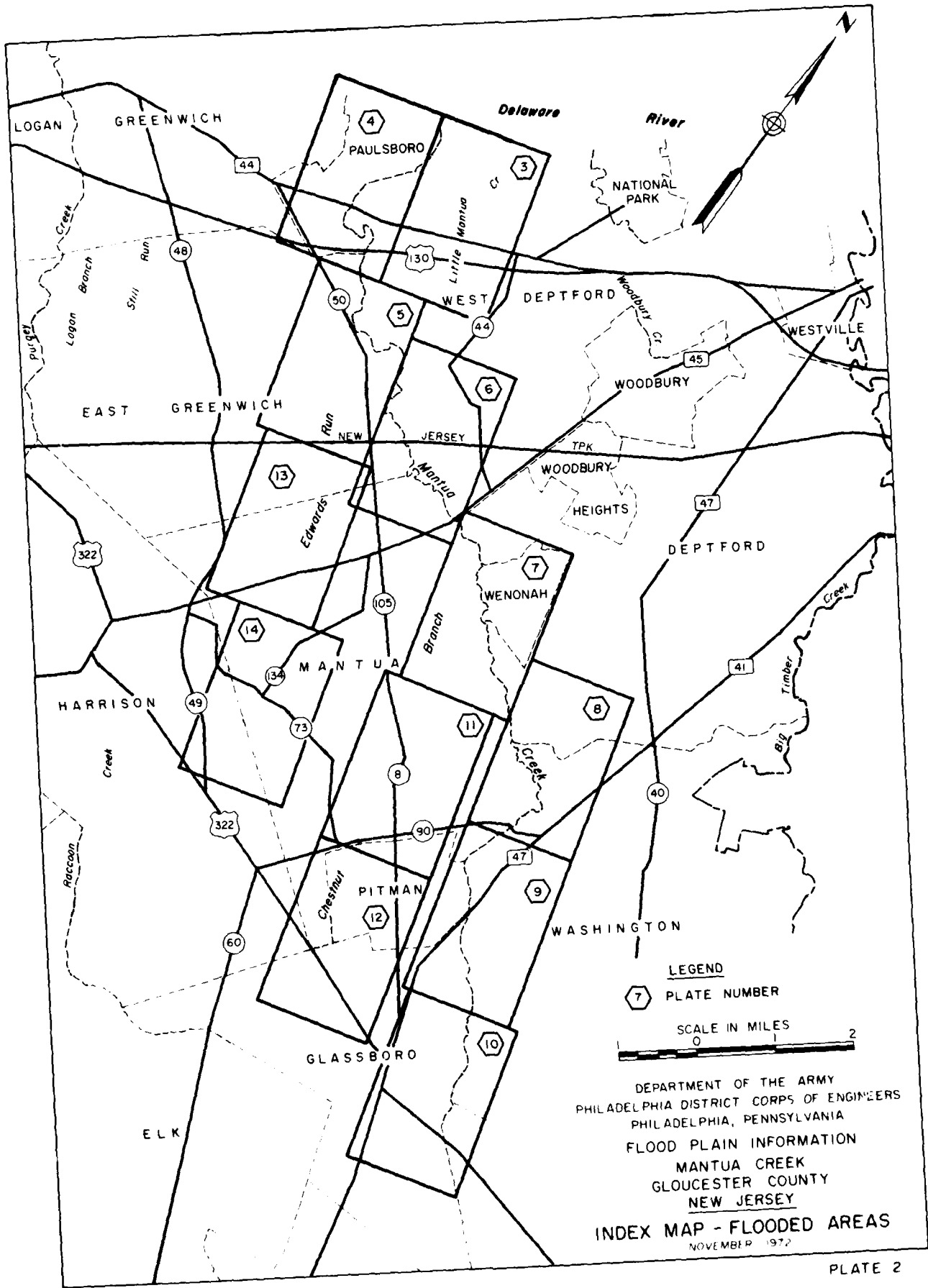

LEGEND  
 7 PLATE NUMBER

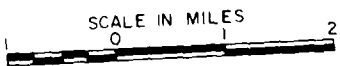

DEPARTMENT OF THE ARMY  
 PHILADELPHIA DISTRICT CORPS OF ENGINEERS  
 PHILADELPHIA, PENNSYLVANIA  
 FLOOD PLAIN INFORMATION  
 MANTUA CREEK  
 GLOUCESTER COUNTY  
 NEW JERSEY  
 INDEX MAP - FLOODED AREAS  
 NOVEMBER 1972

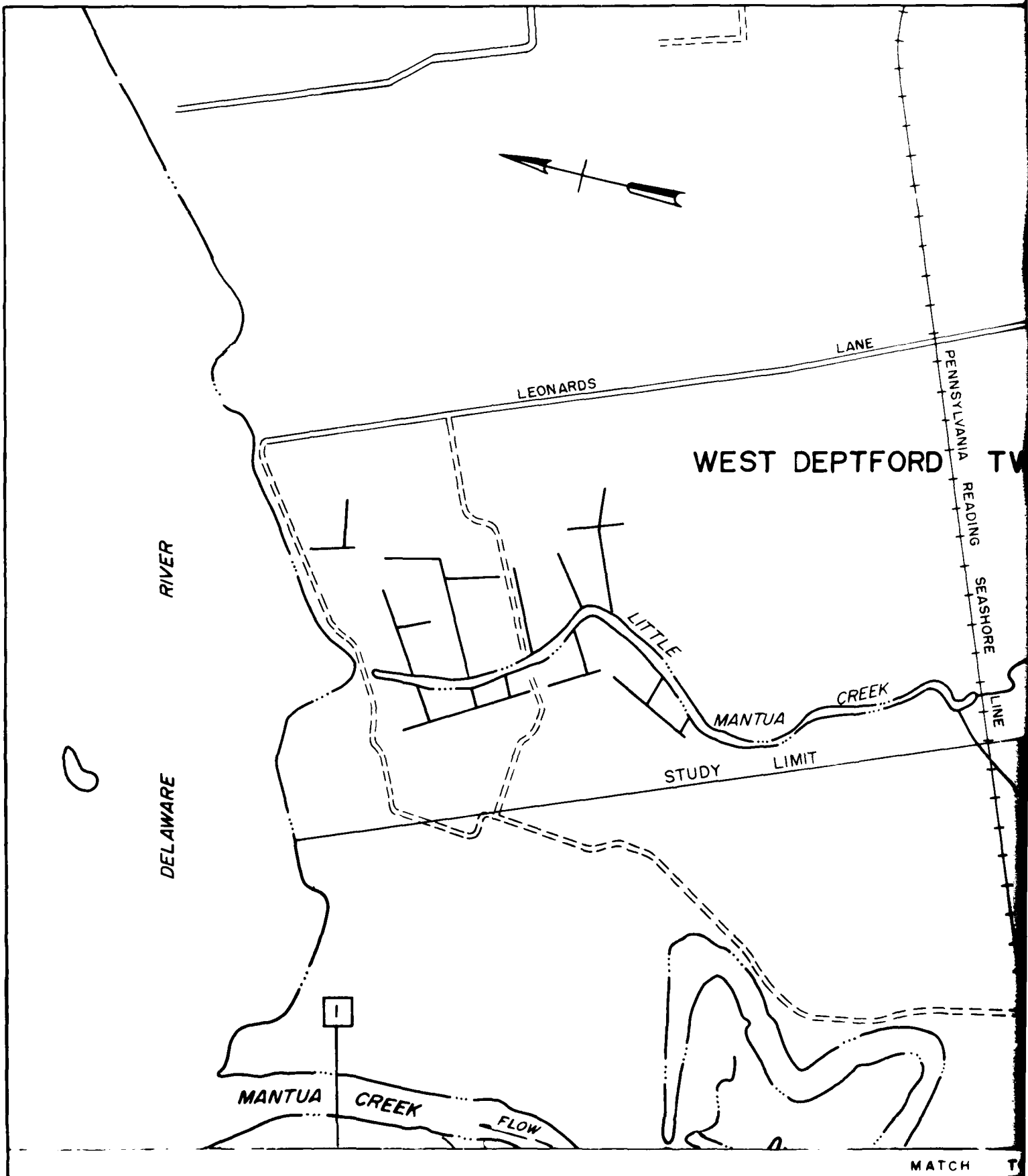

DELAWARE RIVER

DELAWARE

LEONARDS LANE

WEST DEPTFORD TWP

PENNSYLVANIA READING SEASHORE LINE

LITTLE CREEK

MANTUA CREEK

STUDY LIMIT

MANTUA CREEK

FLOW

MATCH

1

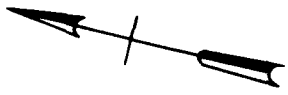

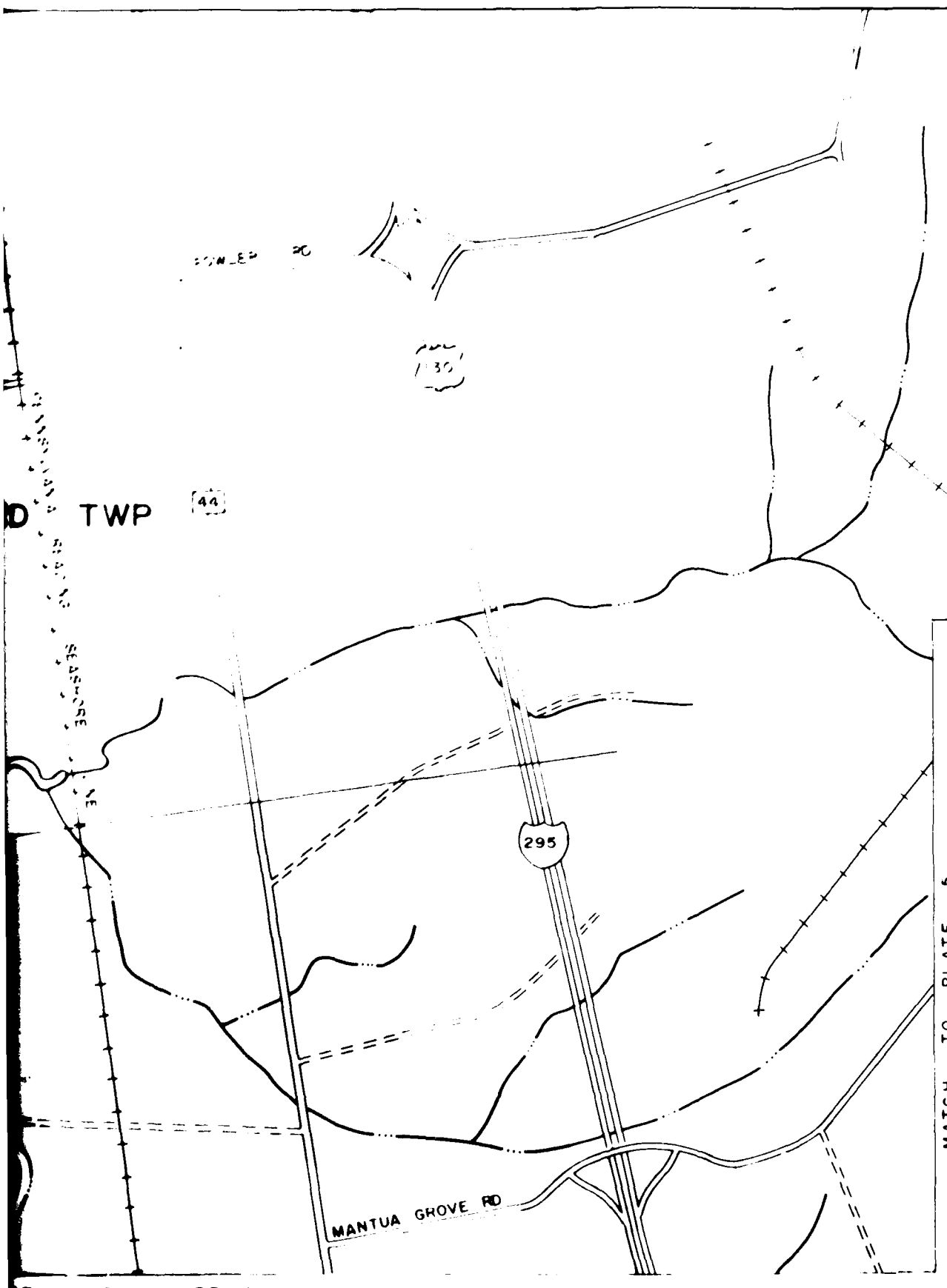

LEG  
 OVERFLOW  
 { N. FLO  
 DESIGN  
 FLOOD  
 M+O MILES AB  
 CROSS SE  
 GROUND E  
 G.S. 192  
 TOWNSHIP

- NOTES
1. MAP BASED ON U.S.G.S. WOODBURY RUNNEMEDE 1967. MINOR ADDITIONS MADE BY CORPS OF ENG.
  2. LIMITS OF OVERFLOW SHOWN ARE ACTUAL LOCATION ON GROUND IN THE REPORT.
  3. AREAS OUTSIDE THE FLOOD PLAIN ARE SUBJECT TO FLOODING.
  4. MINIMUM CONTOUR INTERVAL IS 5 FEET.

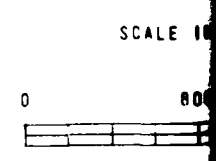

DEPARTMENT OF  
 PHILADELPHIA DISTRICT  
 PHILADELPHIA, PA.  
 FLOOD PLAIN  
 MANTUA  
 GLUCESTON  
 NEW  
 FLOODING  
 NOVEMBER 1967

MATCH TO PLATE 4

MATCH TO PLATE 5

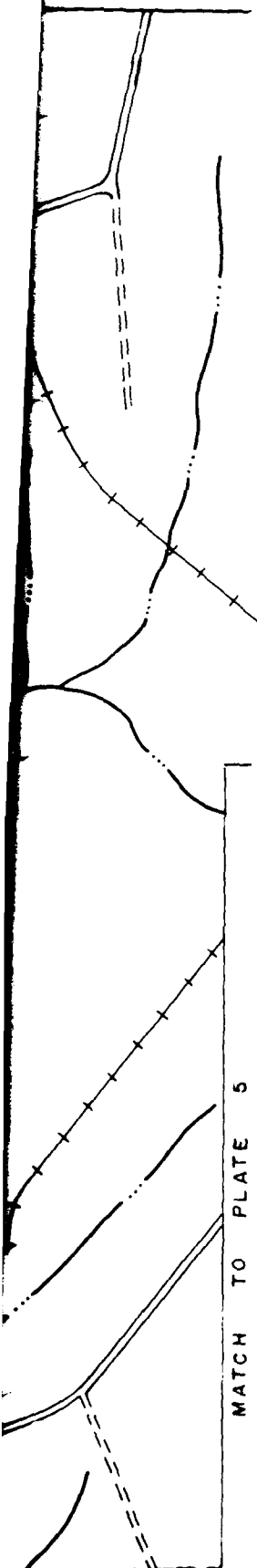

LEGEND

OVERFLOW LIMITS

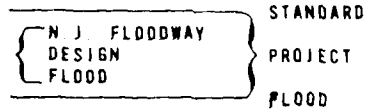

M+O MILES ABOVE MOUTH

1 CROSS SECTION

GROUND ELEVATION IN FEET (U.S.C.  
G.S. 1929 AD.) SEA LEVEL DATUM

TOWNSHIP OR BORD LIMITS

NOTES

1. MAP BASED ON U. S. G. S. 7.5 MIN. QUADRANGLES: WOODBURY, RUNNEMEDE & PITMAN E&W 1953 & 1967. MINOR ADDITIONS AND MODIFICATIONS MADE BY CORPS OF ENGINEERS.
2. LIMITS OF OVERFLOW SHOWN MAY VARY FROM ACTUAL LOCATION ON GROUND AS EXPLAINED IN THE REPORT.
3. AREAS OUTSIDE THE FLOOD PLAIN MAY BE SUBJECT TO FLOODING FROM LOCAL RUNOFF.
4. MINIMUM CONTOUR INTERVAL IS 20 FT.

SCALE IN FEET

0 800 1600

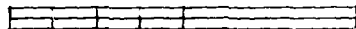

DEPARTMENT OF THE ARMY  
PHILADELPHIA DISTRICT, CORPS OF ENGINEERS  
PHILADELPHIA, PENNSYLVANIA

FLOOD PLAIN INFORMATION

MANTUA CREEK  
GLOUCESTER COUNTY  
NEW JERSEY

FLOODED AREAS

NOVEMBER 1972

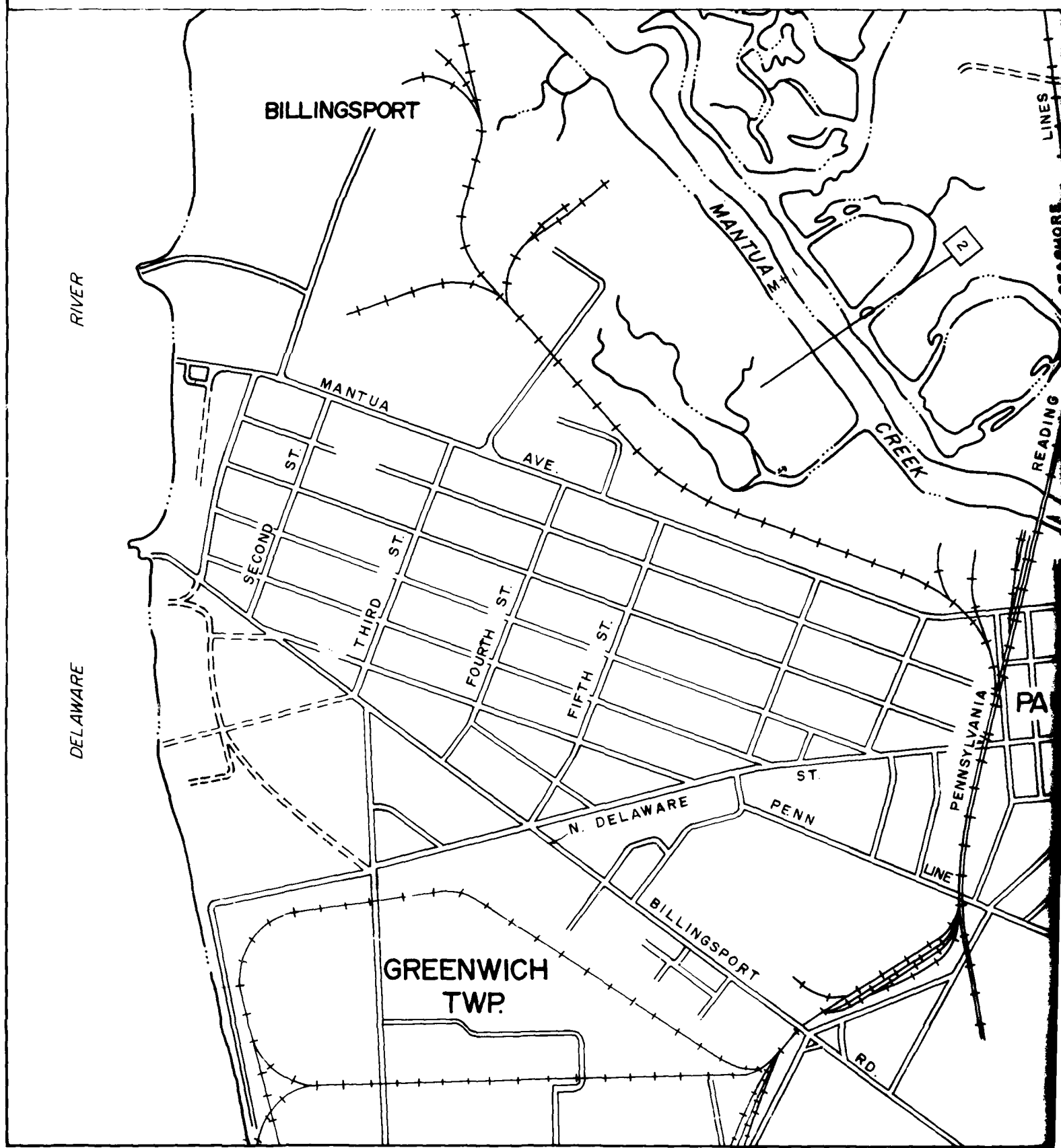



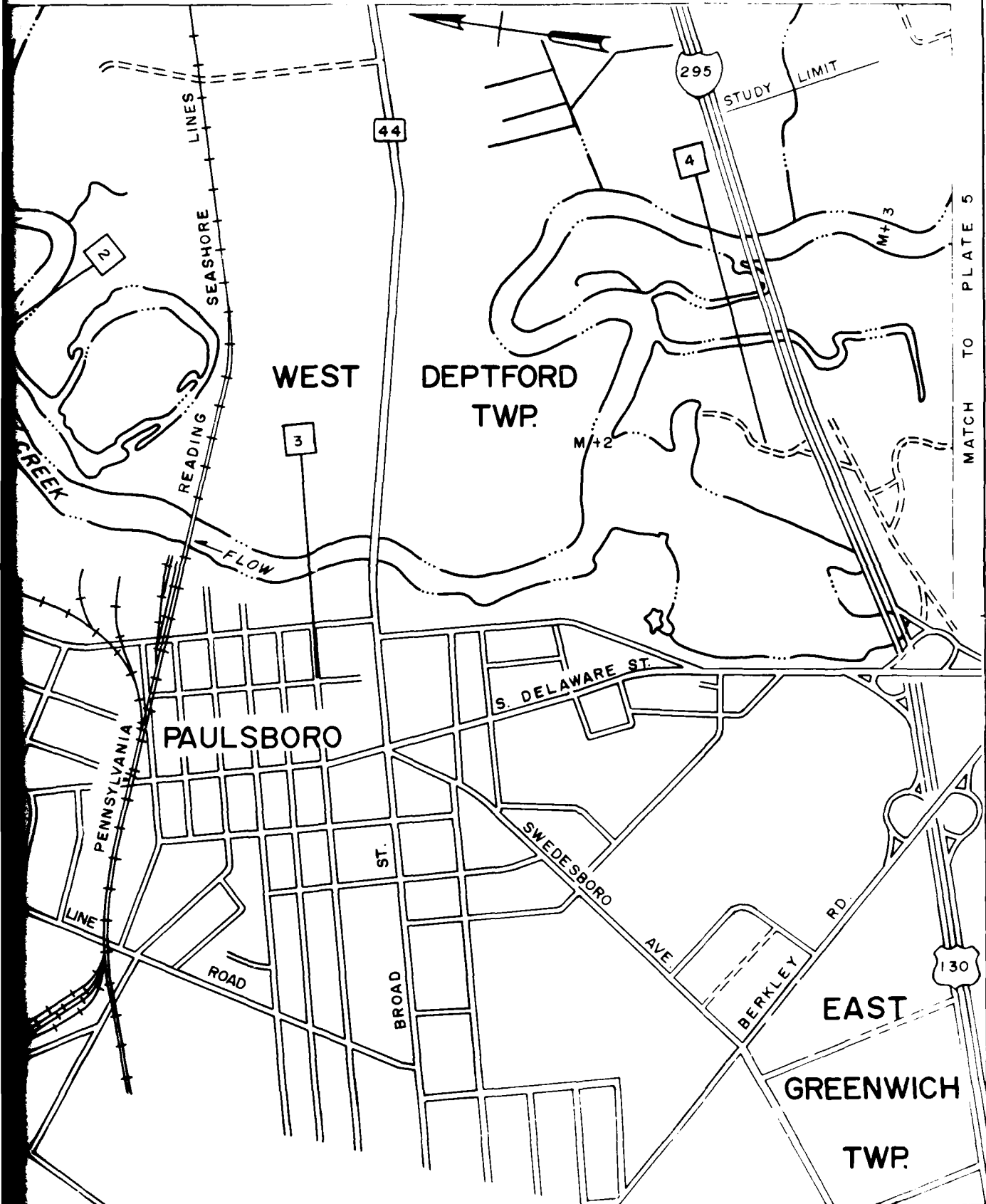

OV

N. DE. FL.

M+3 MI

2 CR

GR

G.

TO

NOTES

1. MAP BASED ON U WOODBURY, RUNN 1967. MINOR ADI MADE BY CORPS I
2. LIMITS OF OVER ACTUAL LOCATIO IN THE REPORT.
3. AREAS OUTSIDE SUBJECT TO FLO
4. MINIMUM CONTOU

S

0

DEPAI PHILADELPHIA D PHILADI FLOOD GLC FI

LEGEND

OVERFLOW LIMITS

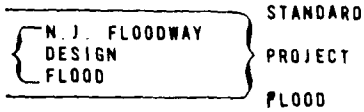

M+3 MILES ABOVE MOUTH

2 CROSS SECTION

GROUND ELEVATION IN FEET (U.S.C G.S. 1929 ADJ.) SEA LEVEL DATUM

TOWNSHIP OR BORO LIMITS

NOTES

1. MAP BASED ON U.S.G.S. 7.5 MIN. QUADRANGLES: WOODBURY, RUNNEMEDE & PITMAN E&W 1953 & 1967. MINOR ADDITIONS AND MODIFICATIONS MADE BY CORPS OF ENGINEERS.
2. LIMITS OF OVERFLOW SHOWN MAY VARY FROM ACTUAL LOCATION ON GROUND AS EXPLAINED IN THE REPORT.
3. AREAS OUTSIDE THE FLOOD PLAIN MAY BE SUBJECT TO FLOODING FROM LOCAL RUNOFF.
4. MINIMUM CONTOUR INTERVAL IS 20 FT.

SCALE IN FEET

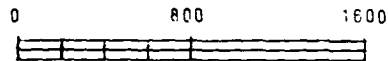

DEPARTMENT OF THE ARMY  
 PHILADELPHIA DISTRICT, CORPS OF ENGINEERS  
 PHILADELPHIA, PENNSYLVANIA

FLOOD PLAIN INFORMATION

MANTUA CREEK  
 GLUCESTER COUNTY  
 NEW JERSEY

FLOODED AREAS

NOVEMBER 1972

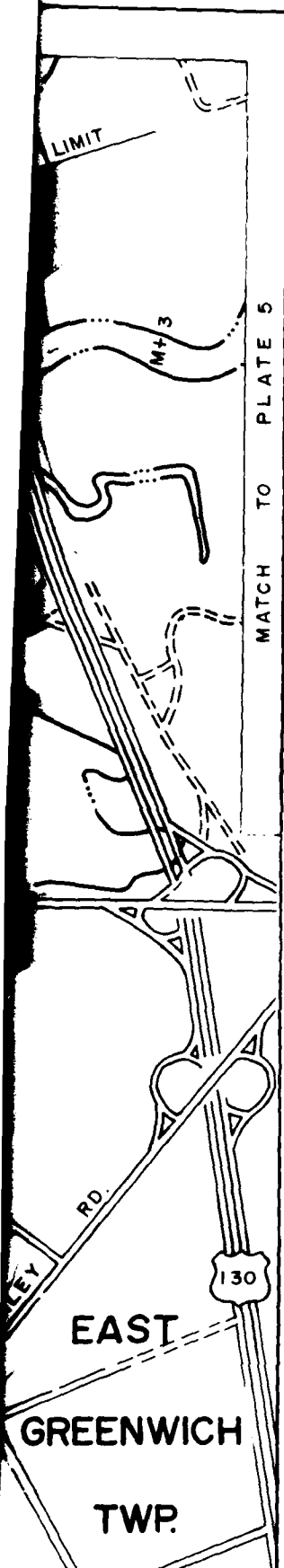

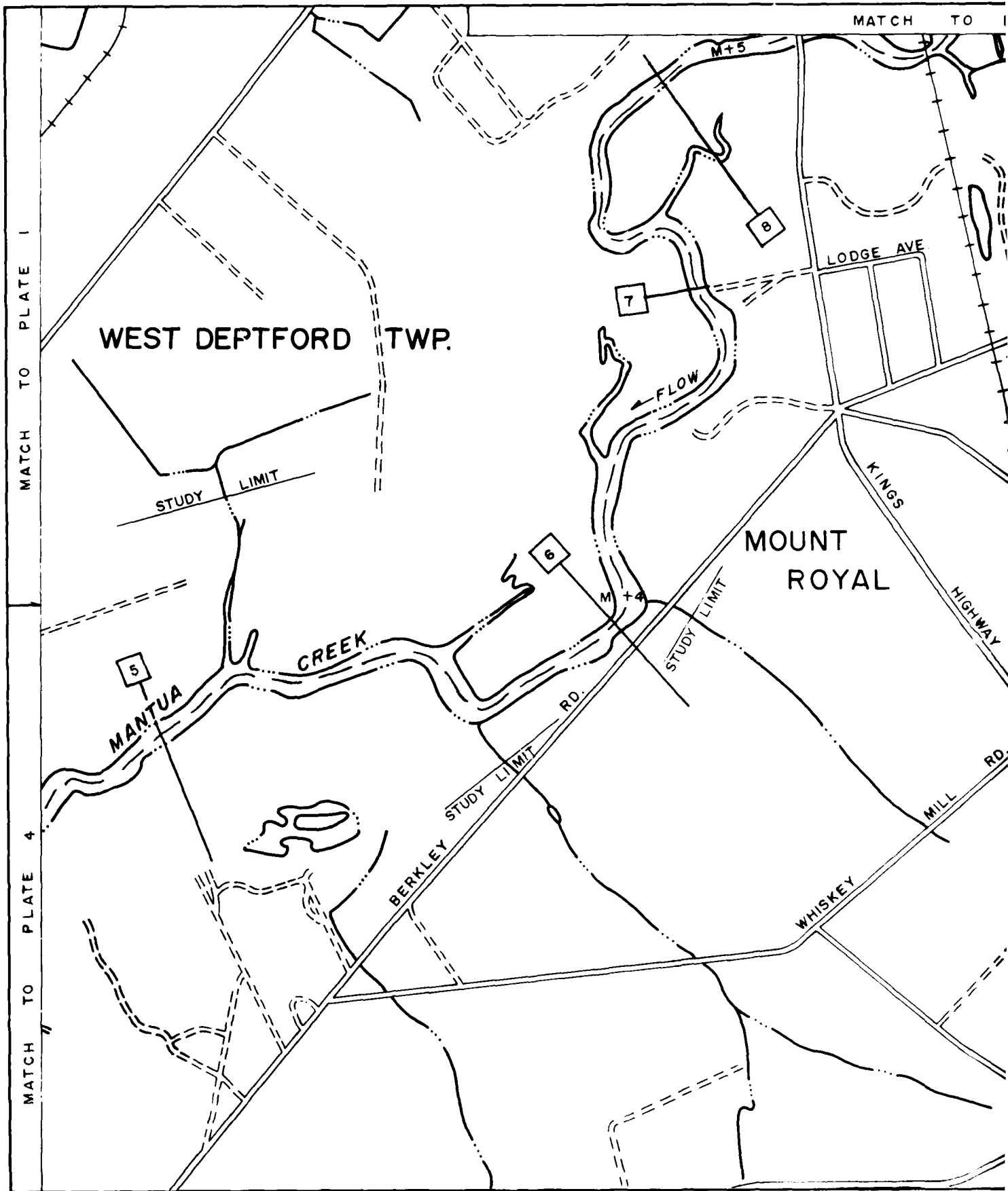

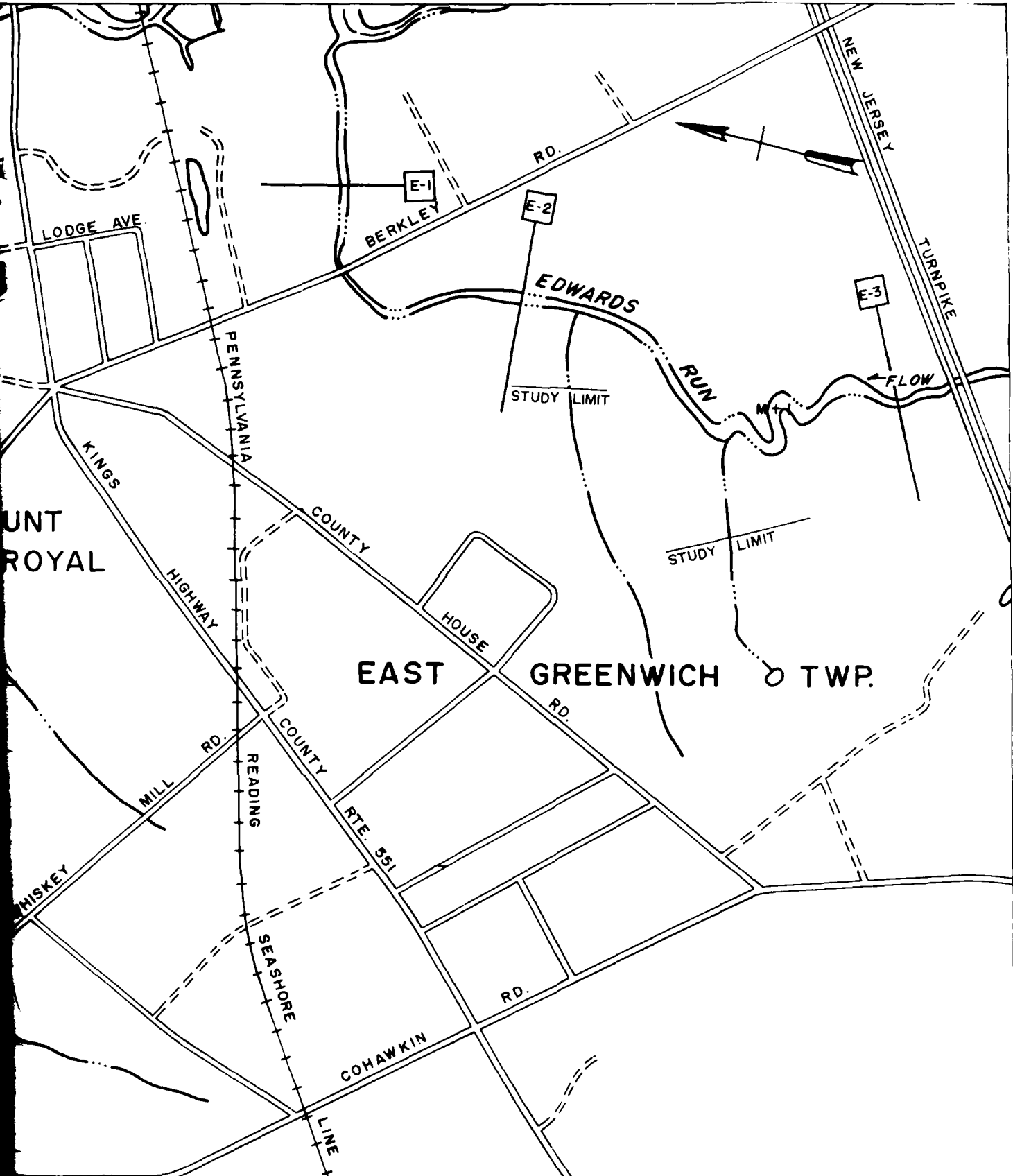

NOTES

- 1. MAI
- WOI
- 100
- MAI
- 2. LII
- AC'
- IN
- 3. ARI
- SUI
- 4. MII

MATCH TO PLATE 13

PHI

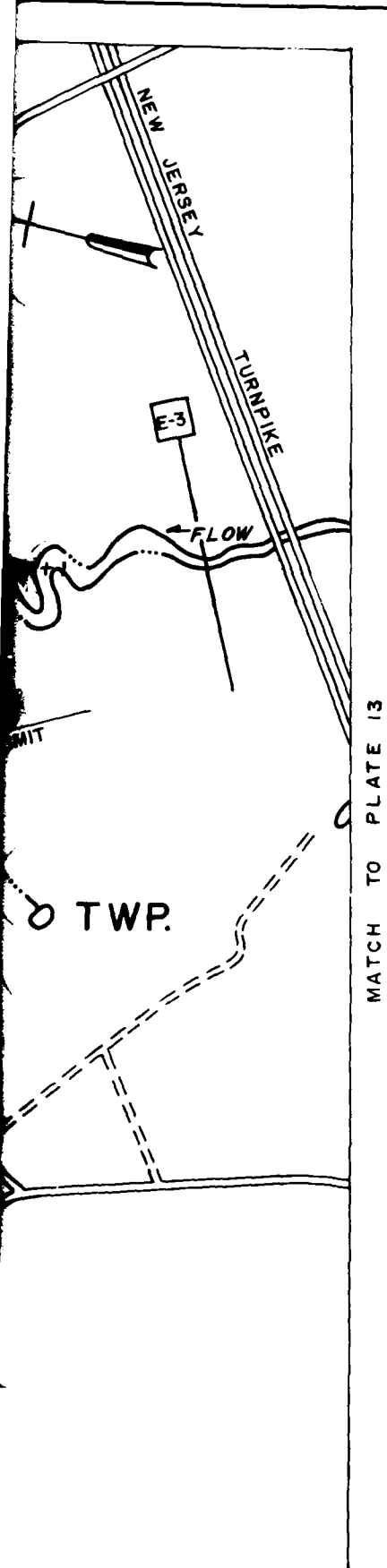

LEGEND

OVERFLOW LIMITS

N. J. FLOODWAY DESIGN FLOOD	STANDARD PROJECT FLOOD
-----------------------------------	------------------------------

M+4 MILES ABOVE MOUTH

5 CROSS SECTION

GROUND ELEVATION IN FEET (U.S.C  
G.S. 1929 ADJ.) SEA LEVEL DATUM

TOWNSHIP OR BORO LIMITS

NOTES

1. MAP BASED ON U.S.G.S. 7.5 MIN. QUADRANGLES: WOODBURY, RUNNEMEDE & PITMAN E&W 1953 & 1967. MINOR ADDITIONS AND MODIFICATIONS MADE BY CORPS OF ENGINEERS.
2. LIMITS OF OVERFLOW SHOWN MAY VARY FROM ACTUAL LOCATION ON GROUND AS EXPLAINED IN THE REPORT.
3. AREAS OUTSIDE THE FLOOD PLAIN MAY BE SUBJECT TO FLOODING FROM LOCAL RUNOFF.
4. MINIMUM CONTOUR INTERVAL IS 20 FT.

SCALE IN FEET

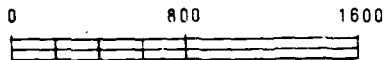

DEPARTMENT OF THE ARMY  
PHILADELPHIA DISTRICT, CORPS OF ENGINEERS  
PHILADELPHIA, PENNSYLVANIA

FLOOD PLAIN INFORMATION

MANTUA CREEK  
GLOUCESTER COUNTY  
NEW JERSEY

FLOODED AREAS

NOVEMBER 1972

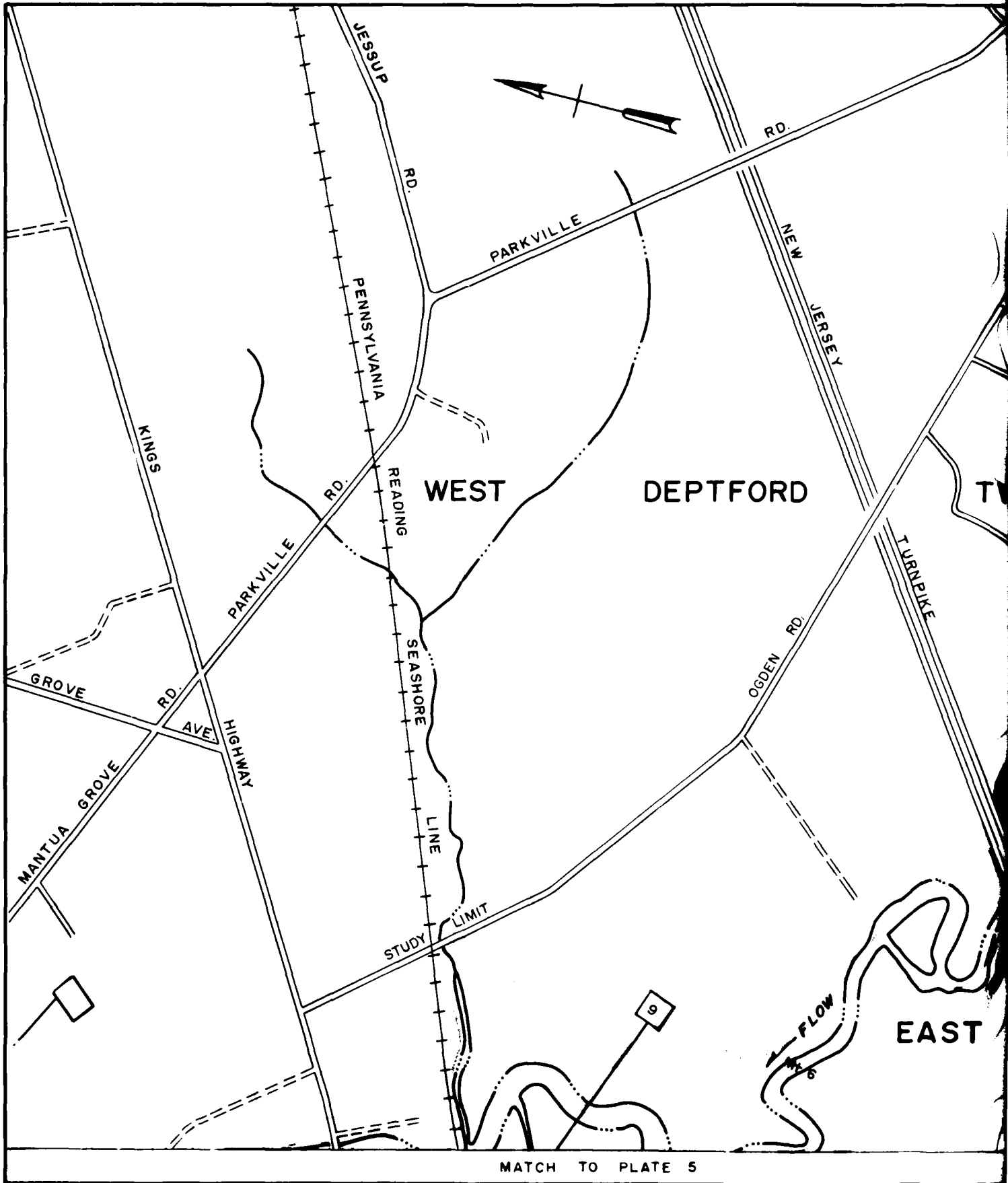

MATCH TO PLATE 5

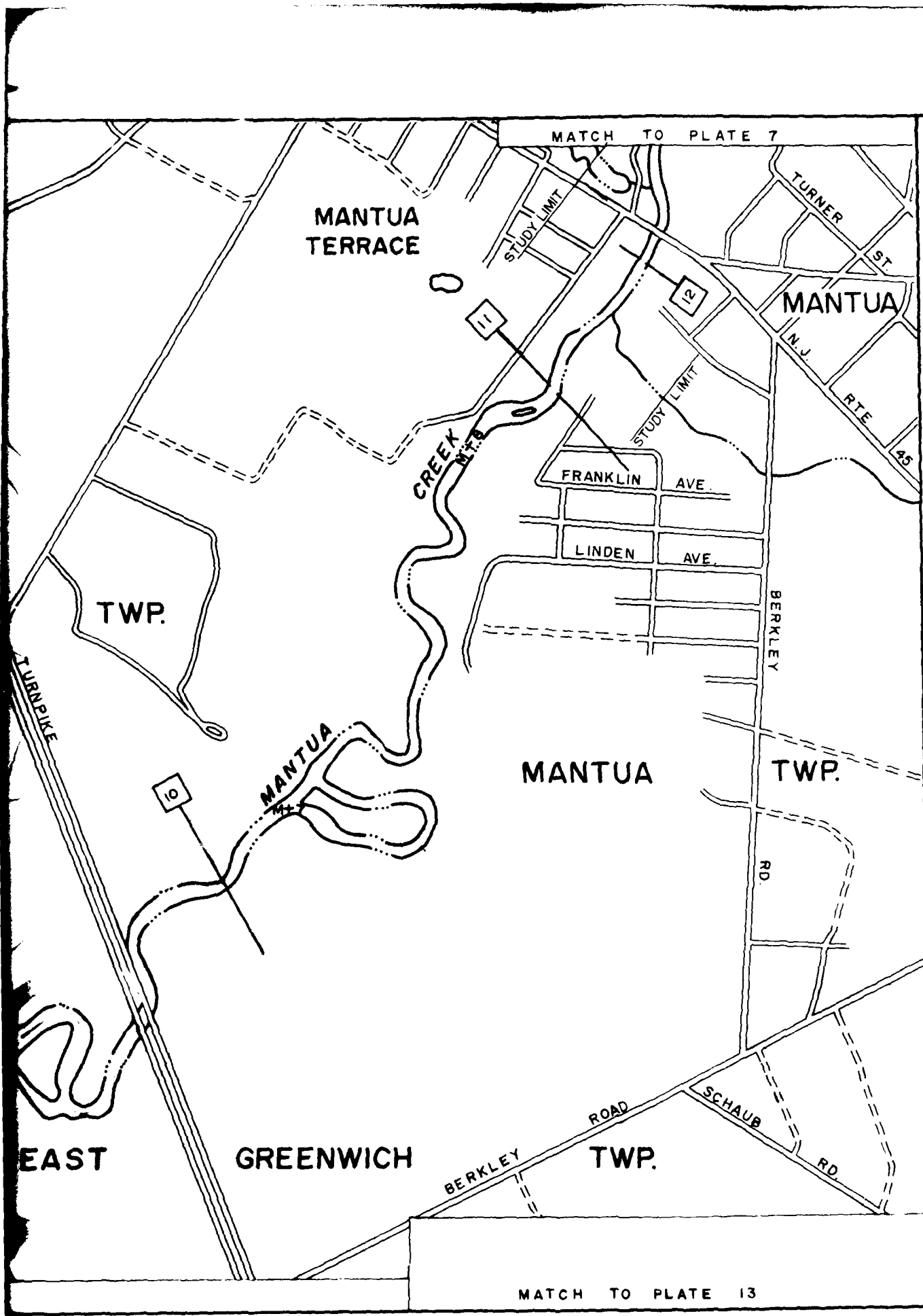

OVER

N. J. DESI FLOO

M+6 MILE

9 CROO

GROO

G.S.

TOWN

- NOTES
1. MAP BASED ON U.S. WOODBURY, RUNNER 1967. MINOR ADD MADE BY CORPS OF
  2. LIMITS OF OVERF ACTUAL LOCATION IN THE REPORT.
  3. AREAS OUTSIDE T SUBJECT TO FLOO
  4. MINIMUM CONTOUR

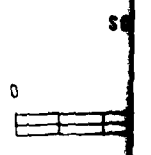

DEPA

PHILADELPHIA DE

PHILADE

FLOOD

GL

FU



**LEGEND**

**OVERFLOW LIMITS**

**N. J. FLOODWAY DESIGN FLOOD**

**STANDARD PROJECT FLOOD**

**M+6 MILES ABOVE MOUTH**

**CROSS SECTION**

**GROUND ELEVATION IN FEET (U.S.C. G.S. 1929 AD.) SEA LEVEL DATUM**

**TOWNSHIP OR BORO LIMITS**

**NOTES**

1. MAP BASED ON U.S.G.S. 7.5 MIN. QUADRANGLES: WOODBURY, RUNNEMEDE & PITMAN E&W 1953 & 1987. MINOR ADDITIONS AND MODIFICATIONS MADE BY CORPS OF ENGINEERS.
2. LIMITS OF OVERFLOW SHOWN MAY VARY FROM ACTUAL LOCATION ON GROUND AS EXPLAINED IN THE REPORT.
3. AREAS OUTSIDE THE FLOOD PLAIN MAY BE SUBJECT TO FLOODING FROM LOCAL RUNOFF.
4. MINIMUM CONTOUR INTERVAL IS 20 FT.

**SCALE IN FEET**

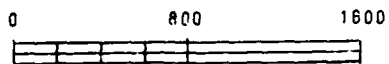

DEPARTMENT OF THE ARMY  
 PHILADELPHIA DISTRICT, CORPS OF ENGINEERS  
 PHILADELPHIA, PENNSYLVANIA

**FLOOD PLAIN INFORMATION**

**MANTUA CREEK  
 GLUCESTER COUNTY  
 NEW JERSEY**

**FLOODED AREAS**

**NOVEMBER 1972**



DEPTFORD

TWP.

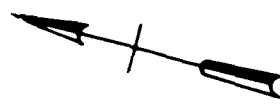

MONONGAHELA

MAPLE AVE.

E. MANTUA AVE.

MARION AVE.

WENONAH

DEPTFORD TWP.

STUDY LIMIT

LESLIE AVE.

JEFFERSON AVE.

OGDEN RD.

HOWARD AVE.

LINCOLN AVE.

JACKSON ST.

STUDY LIMIT

GARFIELD AVE.

PINE ACRES

HAYES AVE.

FLOW

C-1

OAK VALLEY

PURDIE AVE.

MANTUA

MANTUA

W MANTUA AVE.

MARYLAND AVE.

DARTMOUTH

DUKE DR.

MCCARTHY AVE.

UNION ST.

ELM AVE.

EVERGREEN

MARLE AVE.

WOODLAND DR.

WOODLAND AVE.

C-3

MATCH TO PLATE 6

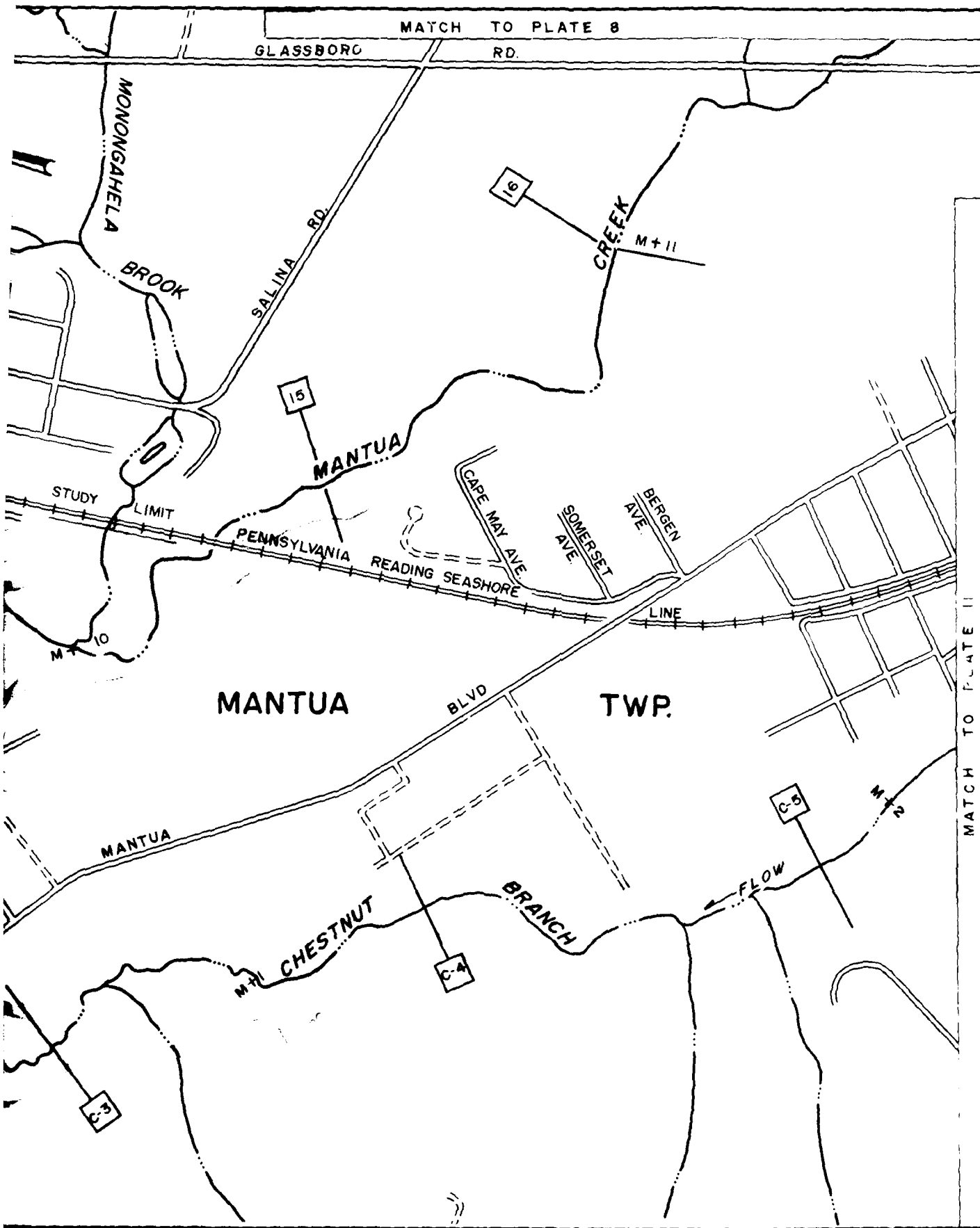

M+9

13

NOTES

1. MAP BASED  
WOODBURY,  
1867. MIN  
MADE BY C
2. LIMITS OF  
ACTUAL LO  
IN THE RE
3. AREAS OUT  
SUBJECT Y
4. MINIMUM C

MATCH TO PLATE 11

PHILADEL

LEGEND

OVERFLOW LIMITS

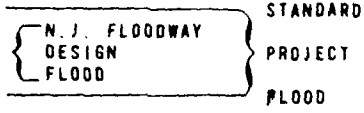

M+9 MILES ABOVE MOUTH

13 CROSS SECTION

GROUND ELEVATION IN FEET (U. S. C  
G. S. 1929 AD.) SEA LEVEL DATUM

TOWNSHIP OR BORO LIMITS

NOTES

1. MAP BASED ON U. S. G. S. 7.5 MIN. QUADRANGLES: WOODBURY, RUNNEMEDE & PITMAN E&W 1953 & 1967. MINOR ADDITIONS AND MODIFICATIONS MADE BY CORPS OF ENGINEERS.
2. LIMITS OF OVERFLOW SHOWN MAY VARY FROM ACTUAL LOCATION ON GROUND AS EXPLAINED IN THE REPORT.
3. AREAS OUTSIDE THE FLOOD PLAIN MAY BE SUBJECT TO FLOODING FROM LOCAL RUNOFF.
4. MINIMUM CONTOUR INTERVAL IS 20 FT.

SCALE IN FEET

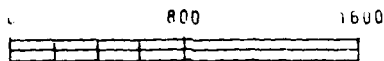

DEPARTMENT OF THE ARMY  
PHILADELPHIA DISTRICT, CORPS OF ENGINEERS  
PHILADELPHIA, PENNSYLVANIA

FLOOD PLAIN INFORMATION

MANTUA CREEK  
GLOUCESTER COUNTY  
NEW JERSEY

FLOODED AREAS

NOVEMBER 1972

MATCH TO PLATE II

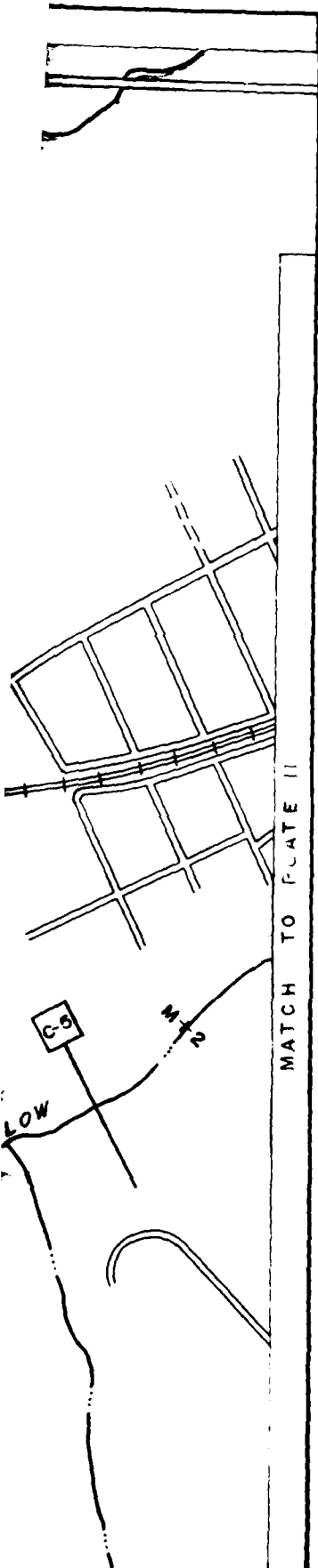

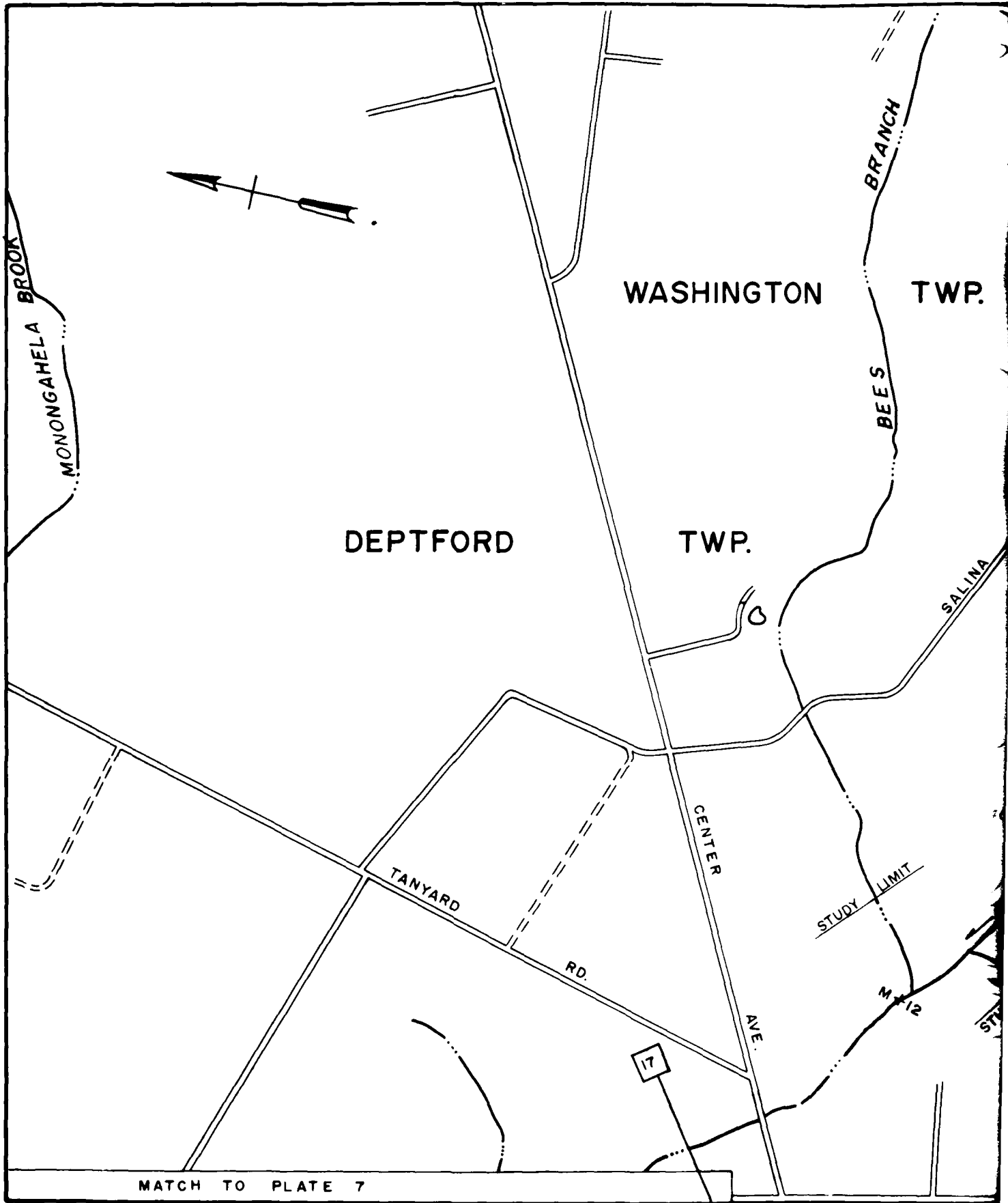

MATCH TO PLATE 7

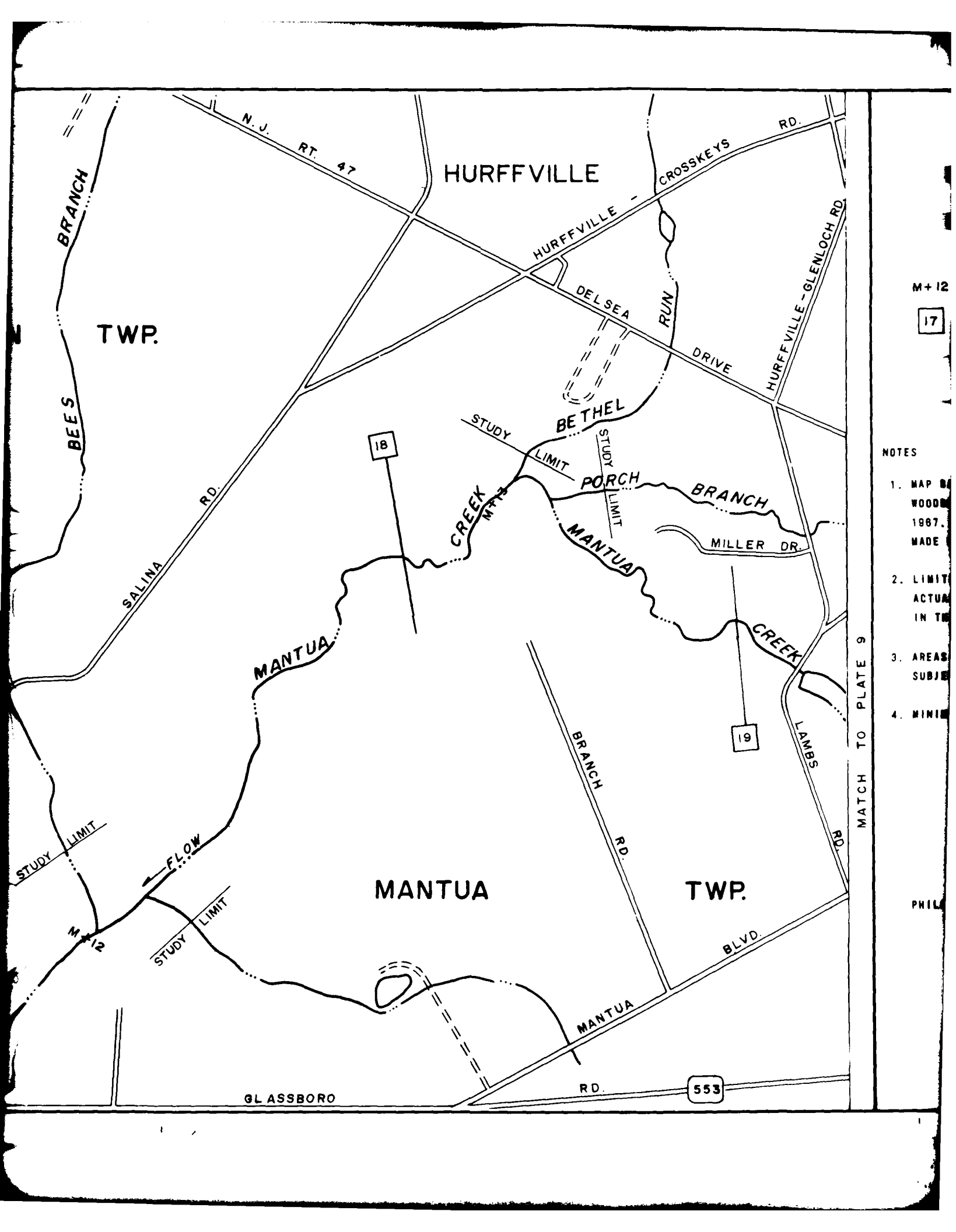

M+12  
17

- NOTES
1. MAP OF WOODS 1887. MADE
  2. LIMIT ACTUAL IN THE
  3. AREAS SUBJECT
  4. MINIMUM

MATCH TO PLATE 9

PHIL

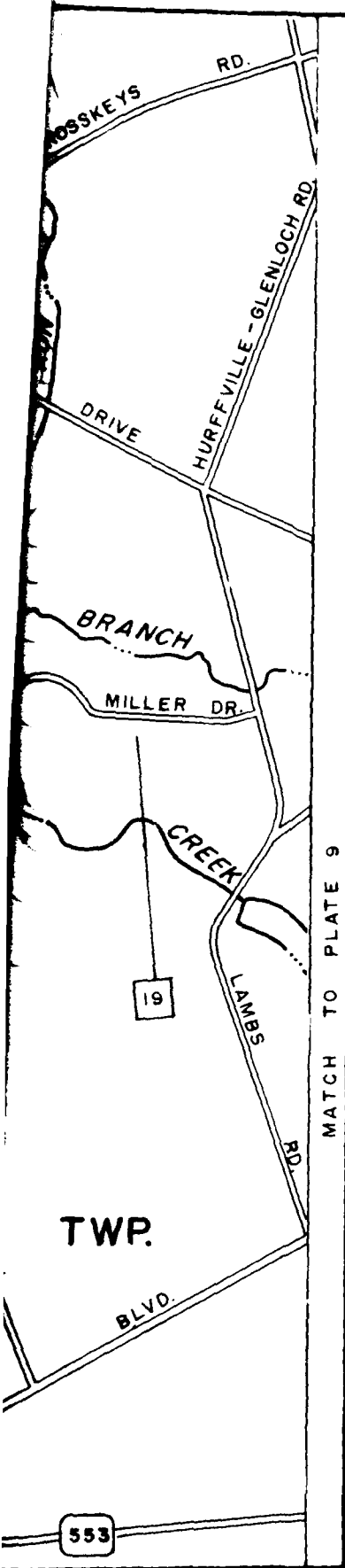

MATCH TO PLATE 9

LEGEND

OVERFLOW LIMITS

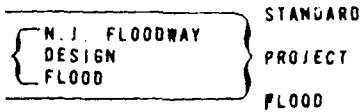

M+12      MILES ABOVE MOUTH

17      CROSS SECTION

GROUND ELEVATION IN FEET (U.S.C. G.S. 1929 AD.) SEA LEVEL DATUM

TOWNSHIP OR BORO LIMITS

NOTES

1. MAP BASED ON U.S.G.S. 7.5 MIN. QUADRANGLES: WOODBURY, RUNNEMEDE & PITMAN E&W 1953 & 1967. MINOR ADDITIONS AND MODIFICATIONS MADE BY CORPS OF ENGINEERS.
2. LIMITS OF OVERFLOW SHOWN MAY VARY FROM ACTUAL LOCATION ON GROUND AS EXPLAINED IN THE REPORT.
3. AREAS OUTSIDE THE FLOOD PLAIN MAY BE SUBJECT TO FLOODING FROM LOCAL RUNOFF.
4. MINIMUM CONTOUR INTERVAL IS 20 FT.

SCALE IN FEET

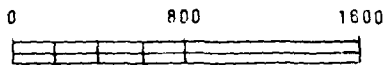

DEPARTMENT OF THE ARMY  
PHILADELPHIA DISTRICT, CORPS OF ENGINEERS  
PHILADELPHIA, PENNSYLVANIA

FLOOD PLAIN INFORMATION

MANTUA CREEK  
GLOUCESTER COUNTY  
NEW JERSEY

FLOODED AREAS

NOVEMBER 1972

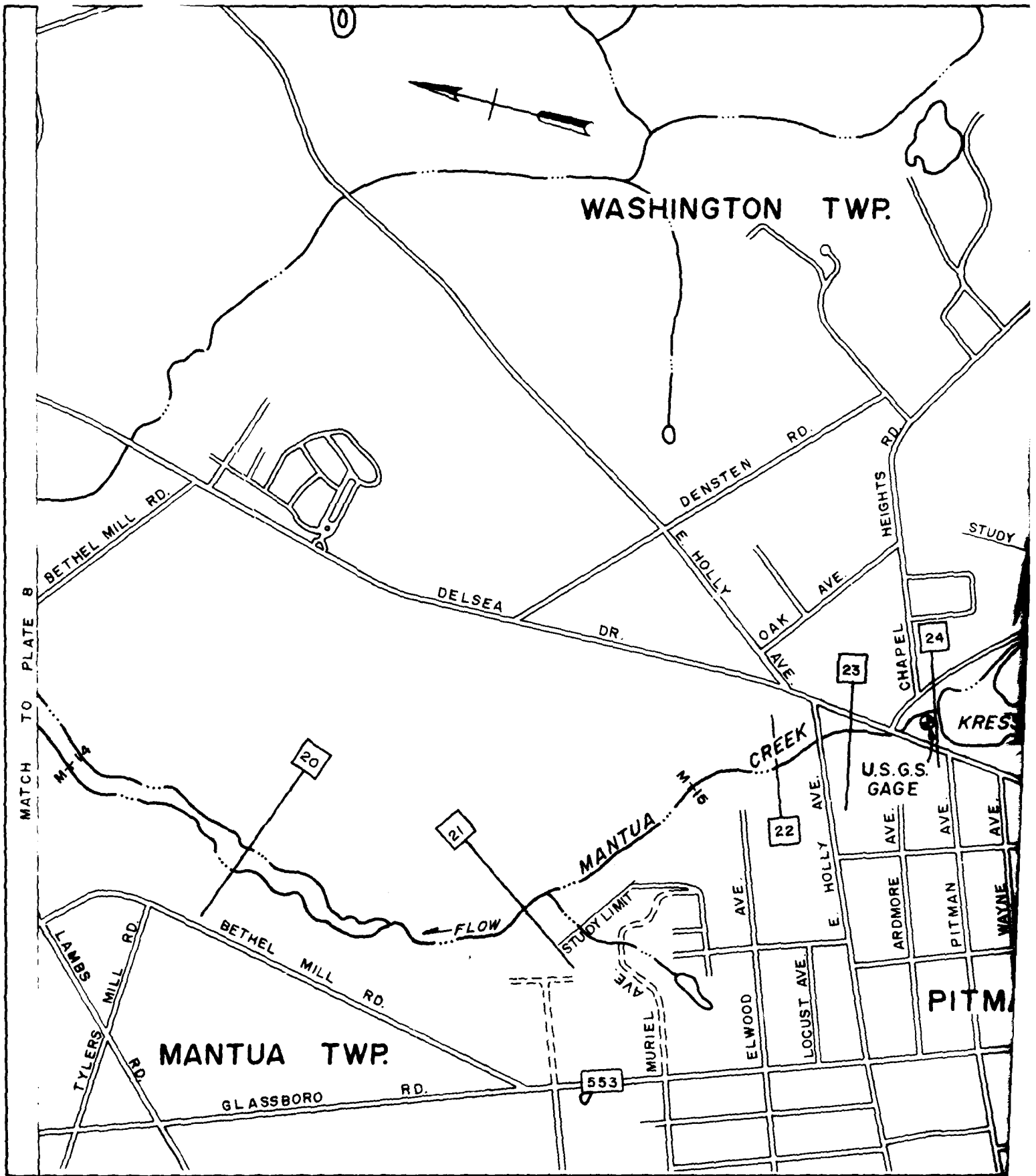

WASHINGTON TWP.

MANTUA TWP.

MATCH TO PLATE 8

STUDY

KRES

U.S.G.S. GAGE

PITM

0

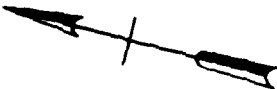

DELSEA DR.

DENSTEN RD.

HEIGHTS RD.

BETHEL MILL RD.

E. HOLLY AVE.

OAK AVE.

CHAPEL AVE.

TYLERS MILL RD.

BETHEL MILL RD.

GLASSBORO RD.

MANTUA CREEK

M-16

E. HOLLY AVE.

ARDMORE AVE.

PITMAN AVE.

WAYNE AVE.

ELWOOD AVE.

LOCUST AVE.

MURIEL AVE.

553

21

20

23

24

FLOW

STUDY LIMIT

WP.

M+14

20

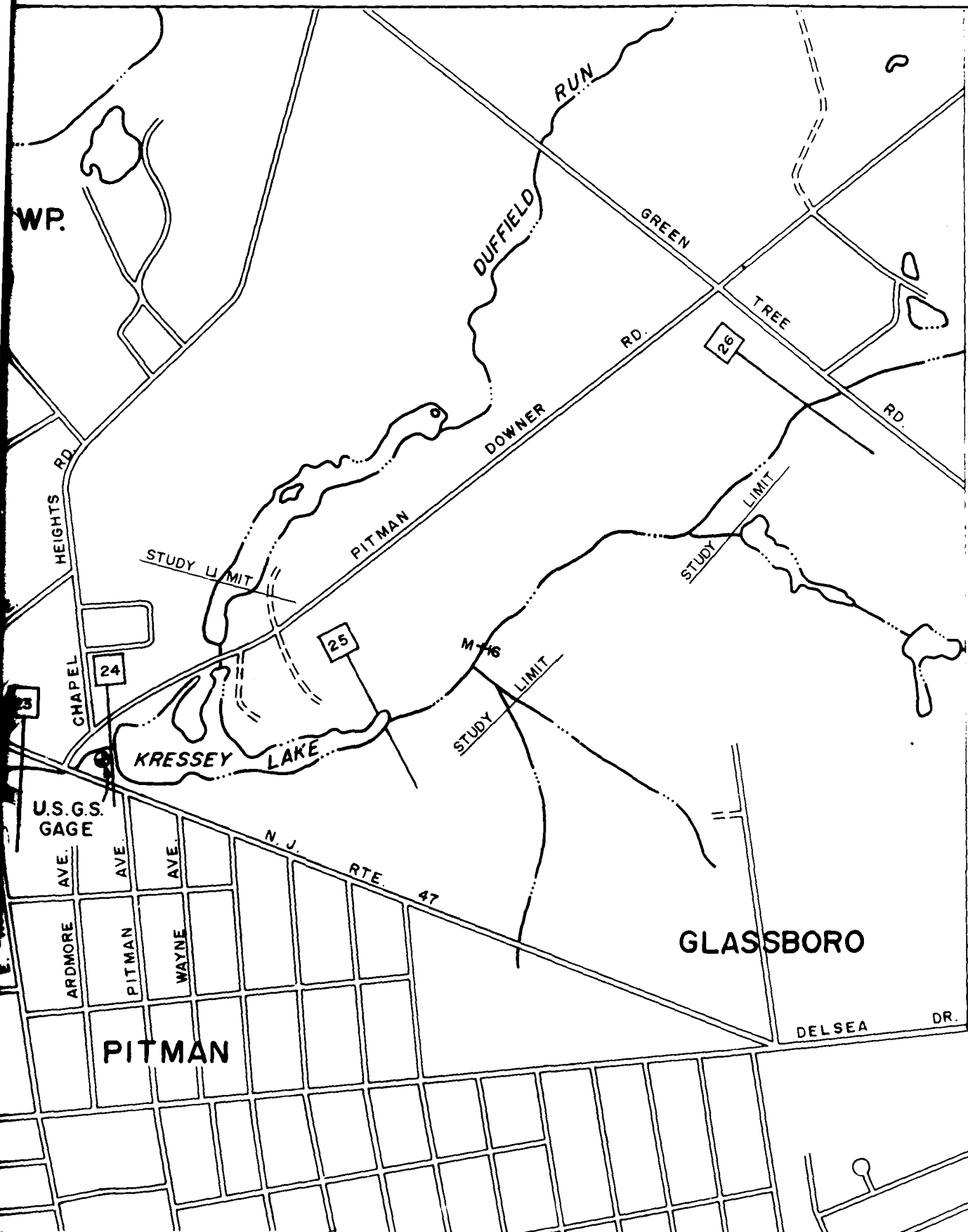

NOTES

1. MAP BASED WOODBURY, 1967. MIN MADE BY C
2. LIMITS OF ACTUAL LD IN THE RE
3. AREAS OUT SUBJECT T
4. MINIMUM C



PHILADELI



LEGEND

OVERFLOW LIMITS

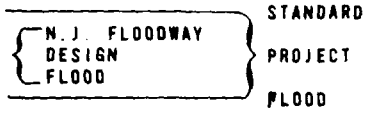

M+14 MILES ABOVE MOUTH

20 CROSS SECTION

GROUND ELEVATION IN FEET (U.S.C. G.S. 1929 ADJ.) SEA LEVEL DATUM

TOWNSHIP OR BORO LIMITS

NOTES

1. MAP BASED ON U.S.G.S. 7.5 MIN. QUADRANGLES: WOODBURY, RUNNEMEDE & PITMAN E&W 1953 & 1967. MINOR ADDITIONS AND MODIFICATIONS MADE BY CORPS OF ENGINEERS.
2. LIMITS OF OVERFLOW SHOWN MAY VARY FROM ACTUAL LOCATION ON GROUND AS EXPLAINED IN THE REPORT.
3. AREAS OUTSIDE THE FLOOD PLAIN MAY BE SUBJECT TO FLOODING FROM LOCAL RUNOFF.
4. MINIMUM CONTOUR INTERVAL IS 20 FT.

SCALE IN FEET

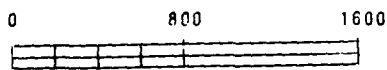

DEPARTMENT OF THE ARMY  
 PHILADELPHIA DISTRICT, CORPS OF ENGINEERS  
 PHILADELPHIA, PENNSYLVANIA

FLOOD PLAIN INFORMATION

MANTUA CREEK  
 GLOUCESTER COUNTY  
NEW JERSEY

FLOODED AREAS

NOVEMBER 1972

MATCH TO PLATE 10

RD.

ORO

DR.

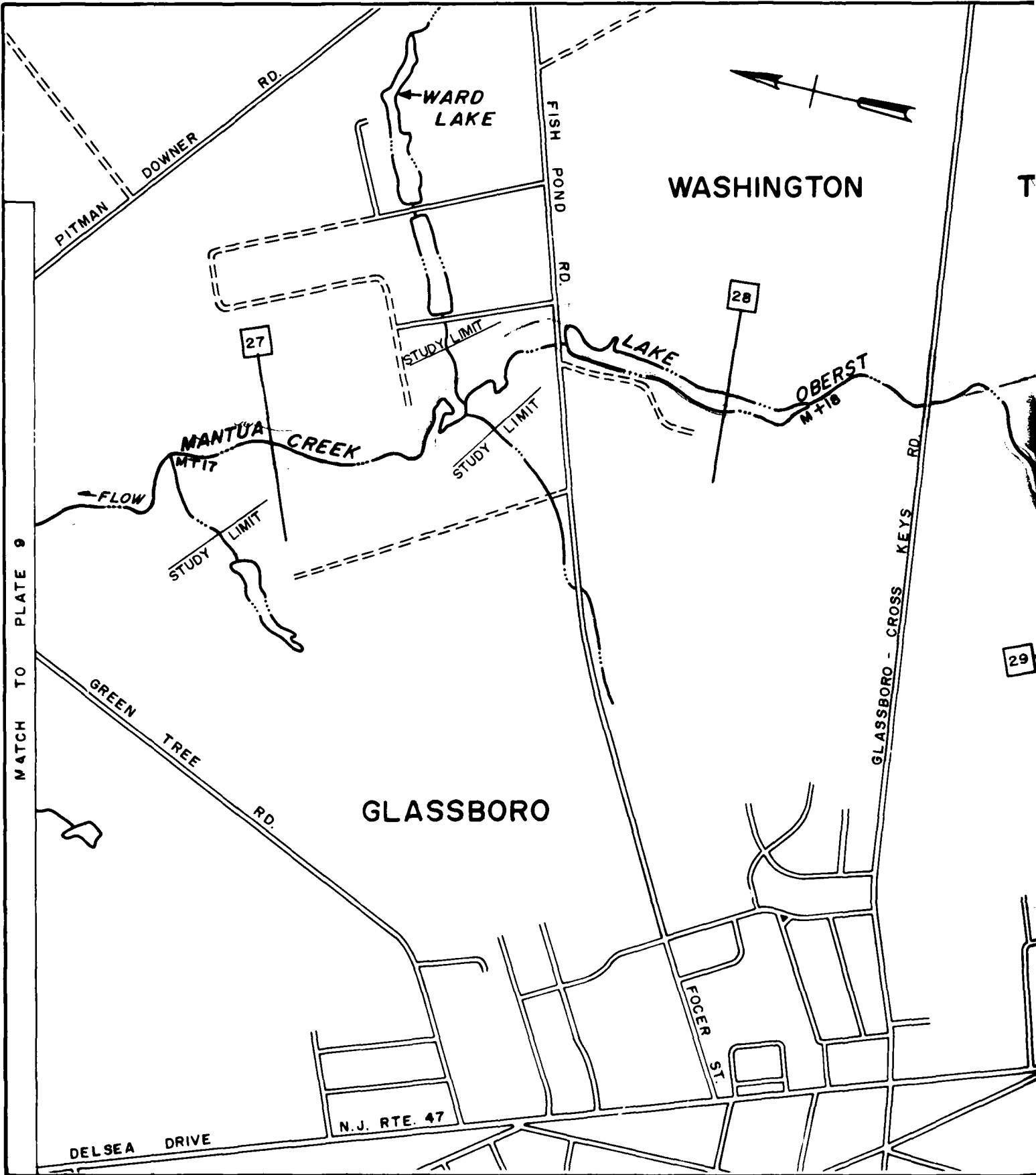

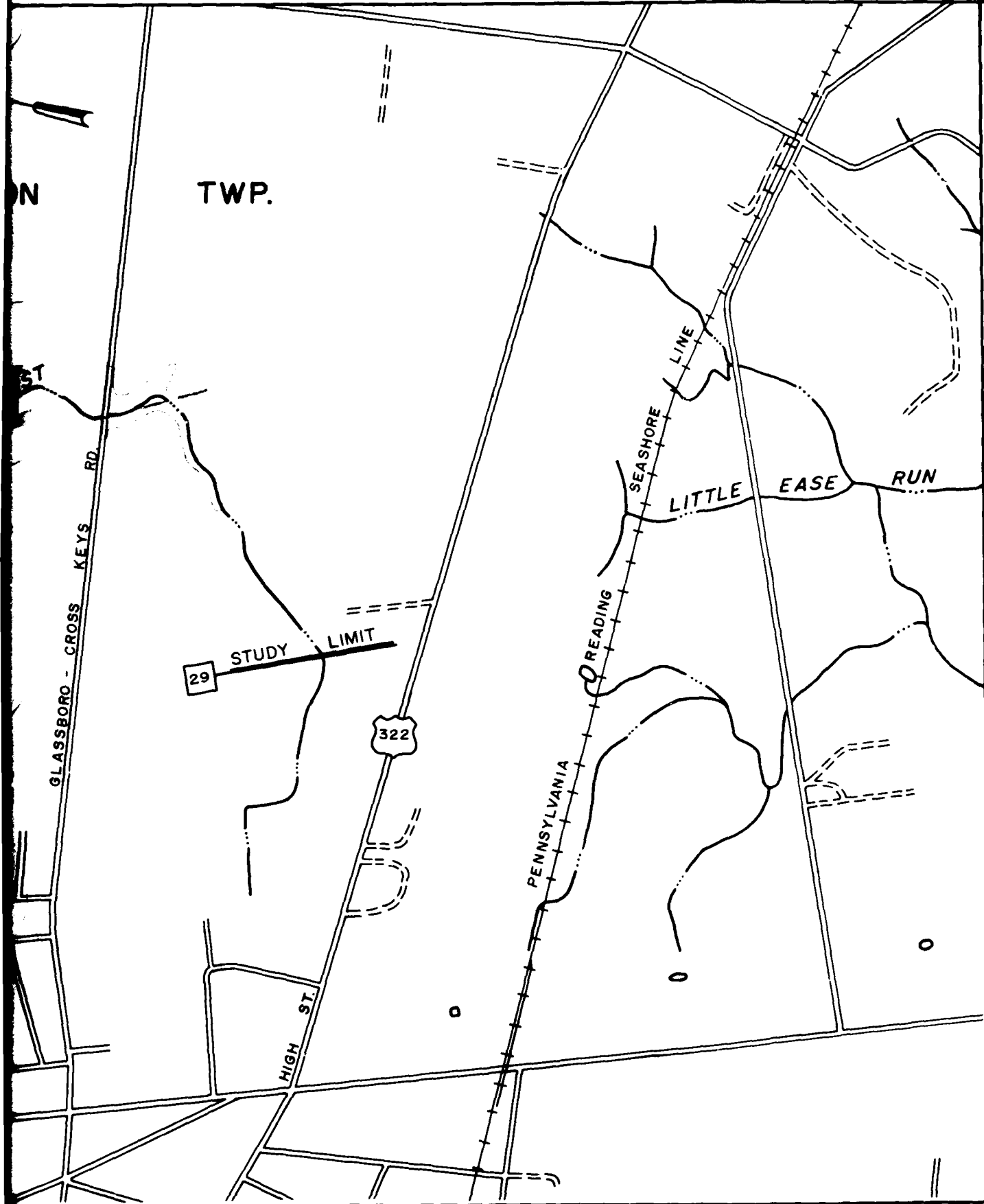

TWP.

M+ 17

27

NOTES

1. MAP BASED ON  
WOODBURY,  
1967. MINOR  
CHANGES MADE BY CO
2. LIMITS OF  
ACTUAL LOCATION  
IN THE RECORD
3. AREAS OUTSIDE  
SUBJECT TO
4. MINIMUM CO

PHILADELPHIA  
PLANNING  
FI

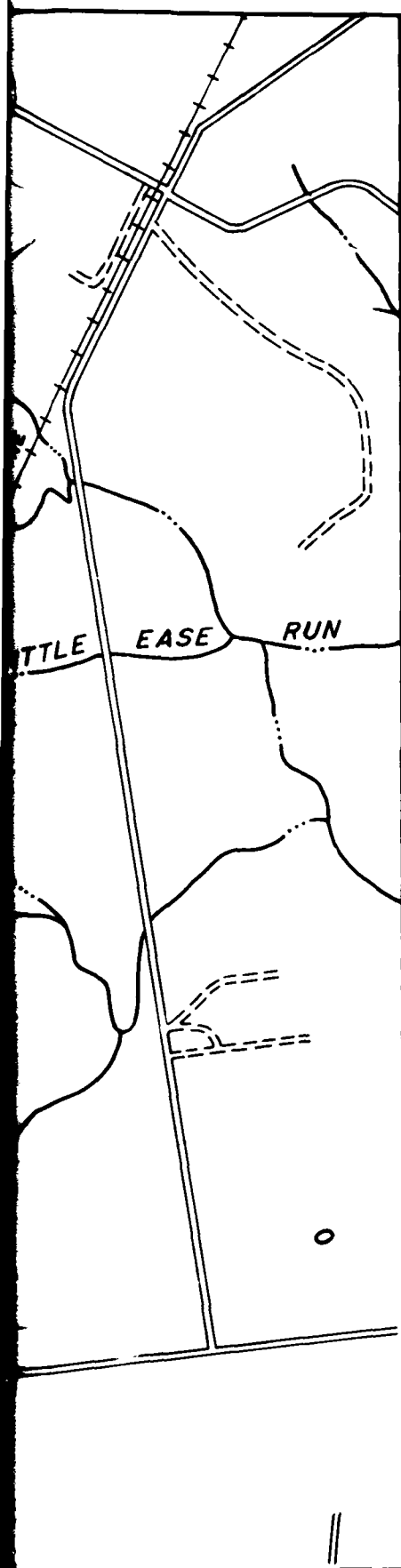

LEGEND

OVERFLOW LIMITS

N. J. FLOODWAY DESIGN FLOOD	STANDARD
	PROJECT
	FLOOD

M+ 17      MILES ABOVE MOUTH

27      CROSS SECTION

GROUND ELEVATION IN FEET (U.S.C  
G.S. 1929 ADJ.) SEA LEVEL DATUM

TOWNSHIP OR BORO LIMITS

NOTES

1. MAP BASED ON U.S.G.S. 7.5 MIN. QUADRANGLES: WOODBURY, RUNNEWEDE & PITMAN E&W 1953 & 1967. MINOR ADDITIONS AND MODIFICATIONS MADE BY CORPS OF ENGINEERS.
2. LIMITS OF OVERFLOW SHOWN MAY VARY FROM ACTUAL LOCATION ON GROUND AS EXPLAINED IN THE REPORT.
3. AREAS OUTSIDE THE FLOOD PLAIN MAY BE SUBJECT TO FLOODING FROM LOCAL RUNOFF.
4. MINIMUM CONTOUR INTERVAL IS 20 FT.

SCALE IN FEET

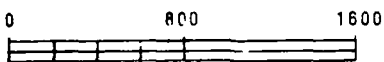

DEPARTMENT OF THE ARMY  
PHILADELPHIA DISTRICT, CORPS OF ENGINEERS  
PHILADELPHIA, PENNSYLVANIA

FLOOD PLAIN INFORMATION

MANTUA CREEK  
GLOUCESTER COUNTY  
NEW JERSEY

FLOODED AREAS

NOVEMBER 1972

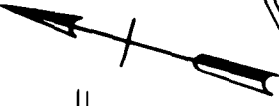
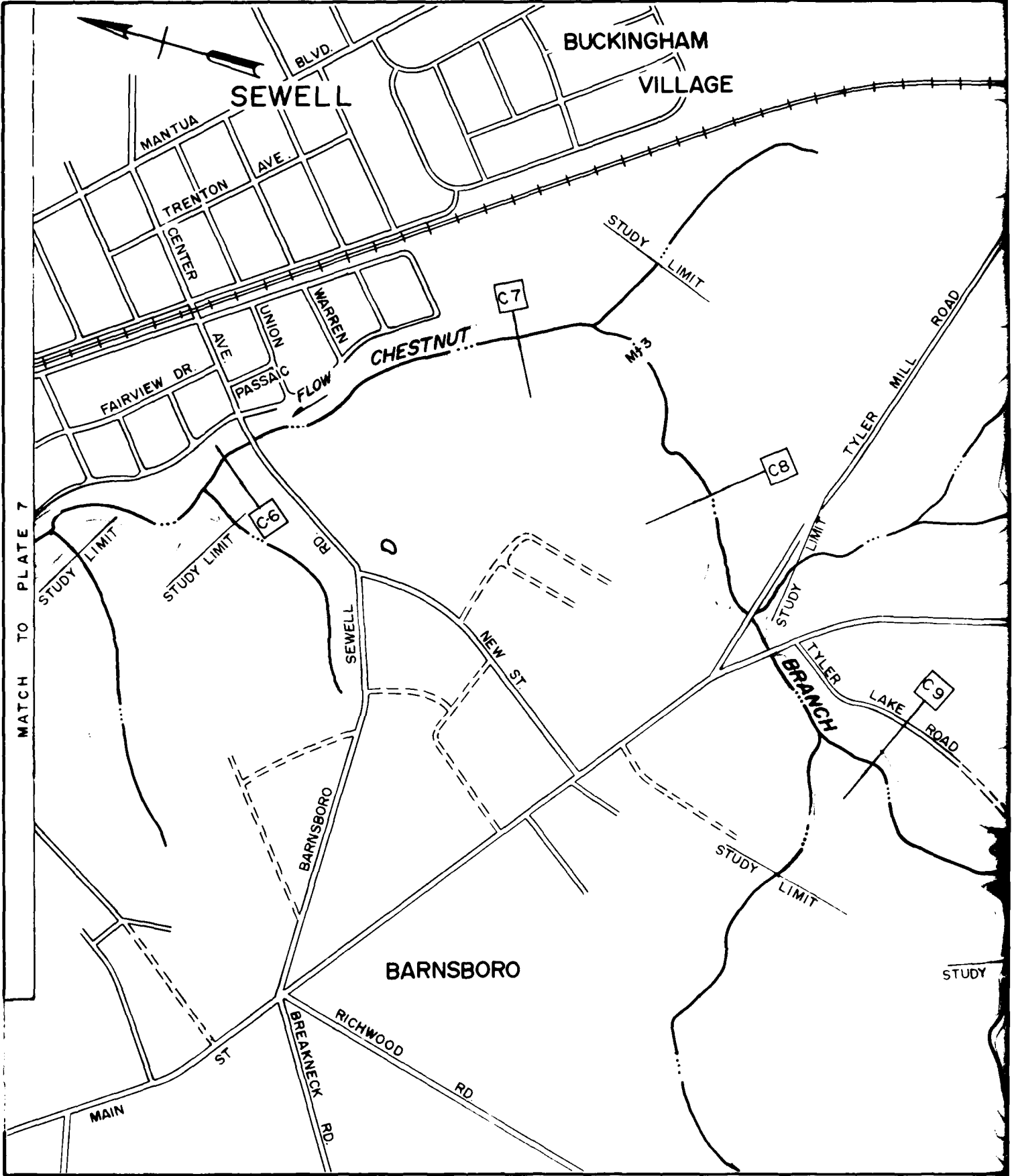

SEWELL

BUCKINGHAM VILLAGE

BLVD.

MANTUA

TRENTON AVE.

CENTER

WARREN

CHESTNUT

FAIRVIEW DR.

PASSAIC

LINCOLN AVE.

STUDY LIMIT

C7

MH-3

TYLER MILL ROAD

C8

MATCH TO PLATE 7

STUDY LIMIT

STUDY LIMIT

C6

SEWELL RD.

D

NEW ST

STUDY LIMIT

TYLER BRANCH

LAKE ROAD

C9

BARNSBORO

BARNSBORO

STUDY LIMIT

STUDY

MAIN

ST

BRAKNECK RD.

RICHWOOD

RD.

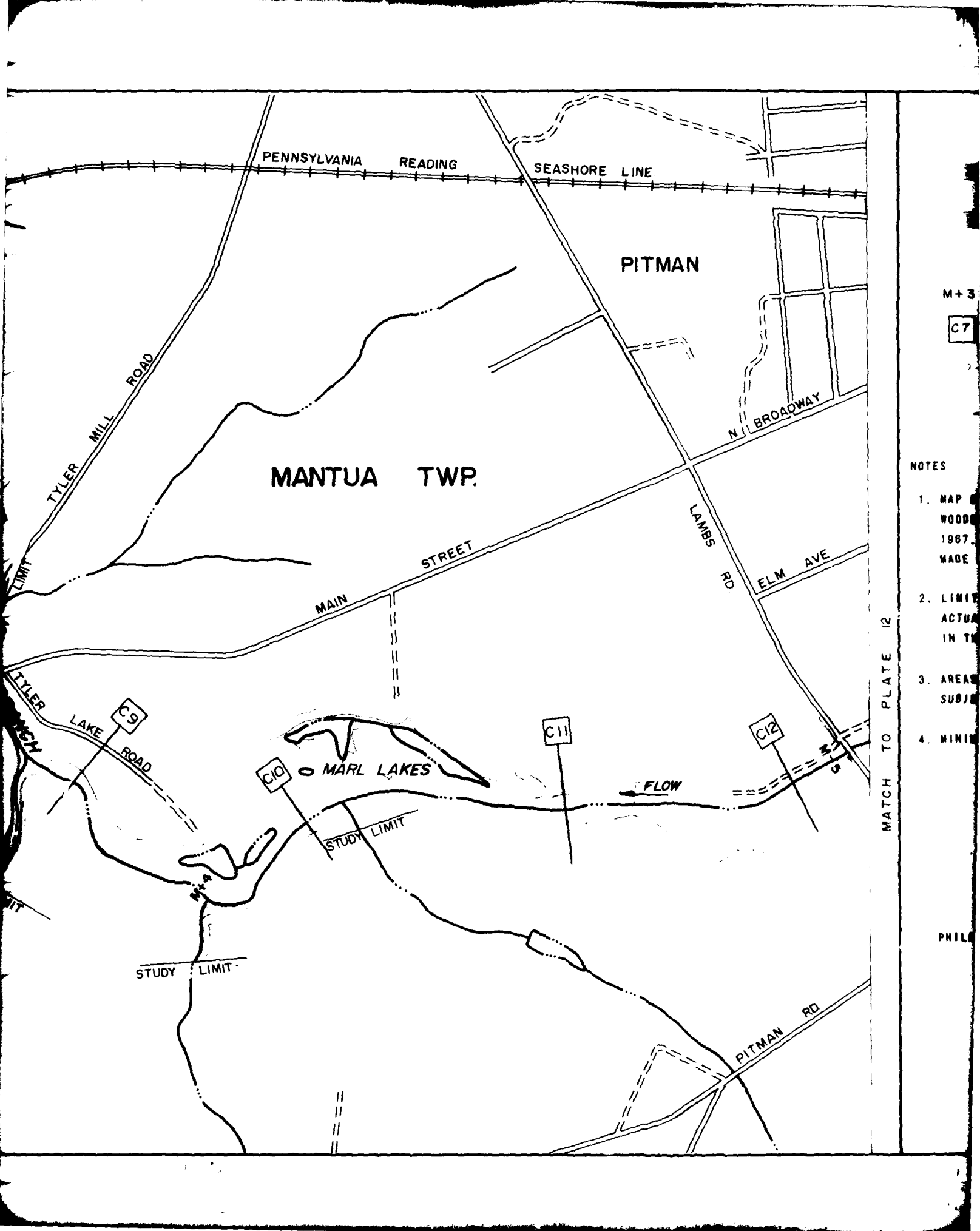

M+3

C7

NOTES

1. MAP WOOD 1987. MADE
2. LIMIT ACTUAL IN THE
3. AREAS SUBJECT
4. MINIMUM

MATCH TO PLATE 12

PHIL

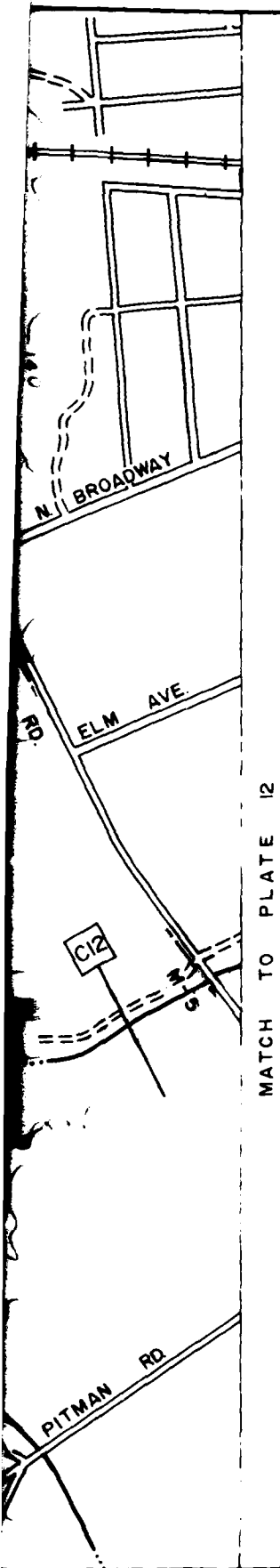

LEGEND

OVERFLOW LIMITS

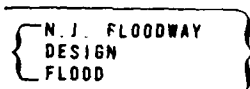
 N. J. FLOODWAY  
 DESIGN  
 FLOOD

STANDARD  
 PROJECT  
 FLOOD

M+3 MILES ABOVE MOUTH

 CROSS SECTION

GROUND ELEVATION IN FEET (U.S.C  
G.S. 1929 ADJ.) SEA LEVEL DATUM

TOWNSHIP OR BORO LIMITS

NOTES

1. MAP BASED ON U.S.G.S. 7.5 MIN. QUADRANGLES: WOODBURY, RUNNEMEDE & PITMAN E&W 1953 & 1967. MINOR ADDITIONS AND MODIFICATIONS MADE BY CORPS OF ENGINEERS.
2. LIMITS OF OVERFLOW SHOWN MAY VARY FROM ACTUAL LOCATION ON GROUND AS EXPLAINED IN THE REPORT.
3. AREAS OUTSIDE THE FLOOD PLAIN MAY BE SUBJECT TO FLOODING FROM LOCAL RUNOFF.
4. MINIMUM CONTOUR INTERVAL IS 20 FT.

SCALE IN FEET

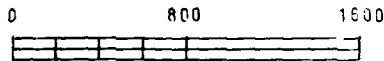

DEPARTMENT OF THE ARMY  
PHILADELPHIA DISTRICT, CORPS OF ENGINEERS  
PHILADELPHIA, PENNSYLVANIA

FLOOD PLAIN INFORMATION

MANTUA CREEK  
GLOUCESTER COUNTY  
NEW JERSEY

FLOODED AREAS

NOVEMBER 1972

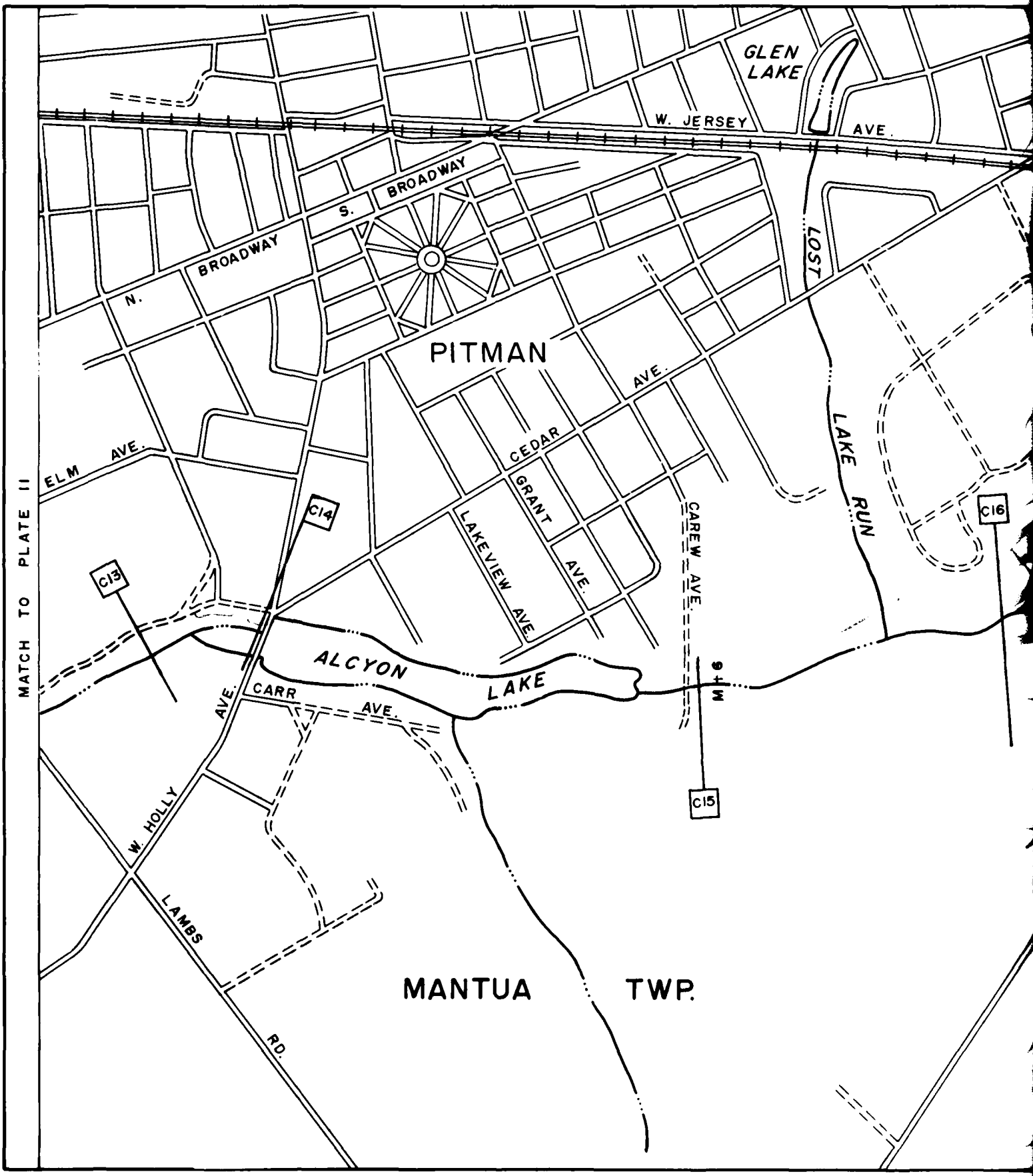

MATCH TO PLATE II

GLEN LAKE

W. JERSEY AVE.

BROADWAY

BROADWAY

N.

PITMAN

ELM AVE.

AVE.

CEDAR

GRANT

LAKEVIEW AVE.

CAREW AVE.

LOST

LAKE RUN

C13

C14

C16

ALCYON LAKE

CARR AVE.

S + M

C15

W. HOLLY

LAMBS

RD.

MANTUA

TWP.



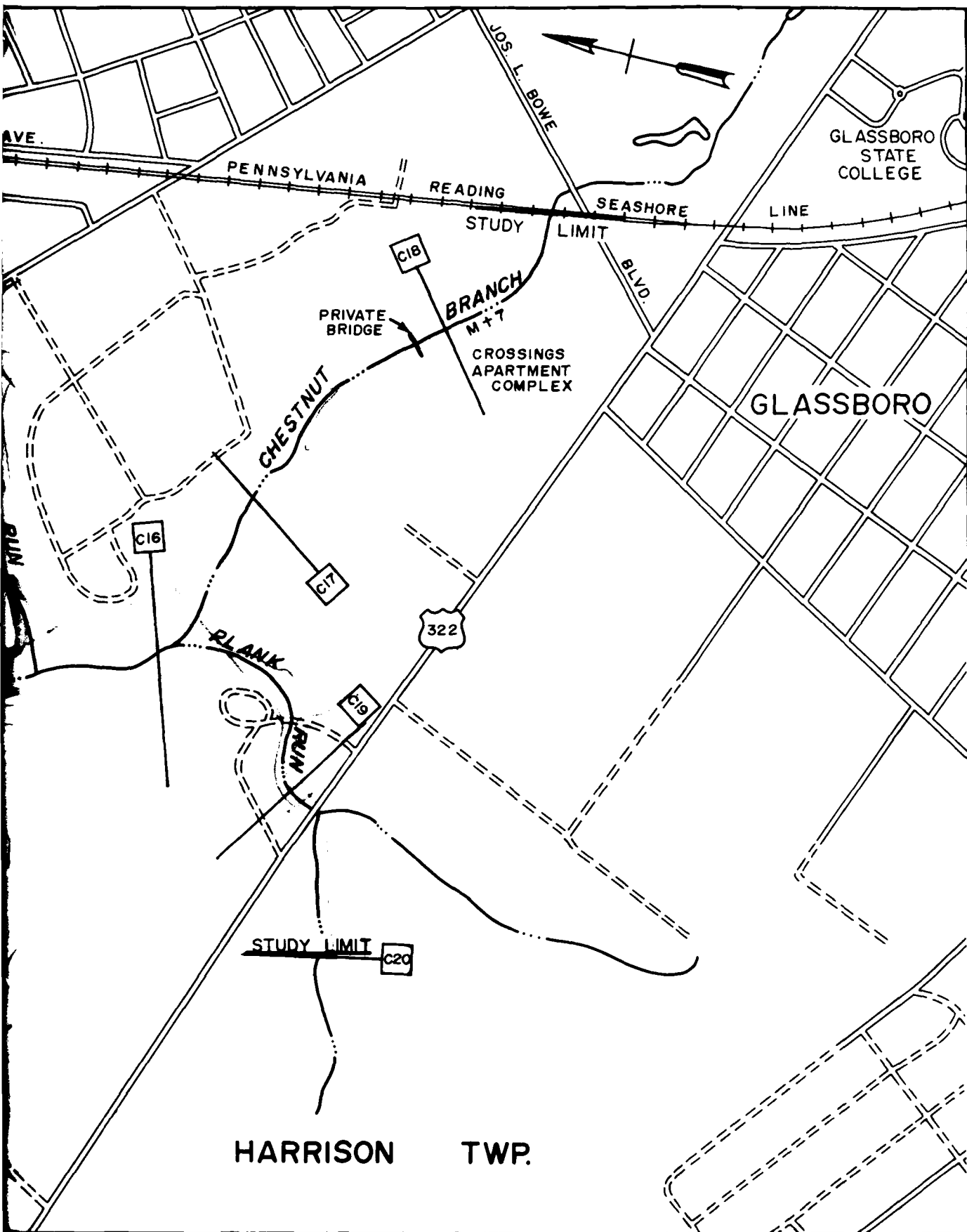

M+6

C13

NOTES

1. MAP BASED ON WOODBURY, RUN 1967. MINOR A MADE BY CORPS
2. LIMITS OF OVER ACTUAL LOCATI IN THE REPORT
3. AREAS OUTSIDE SUBJECT TO FL
4. MINIMUM CONTO

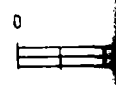

DEPT  
PHILADELPHIA  
PHILADELPHIA

FLOOD

GL

F

HARRISON TWP.

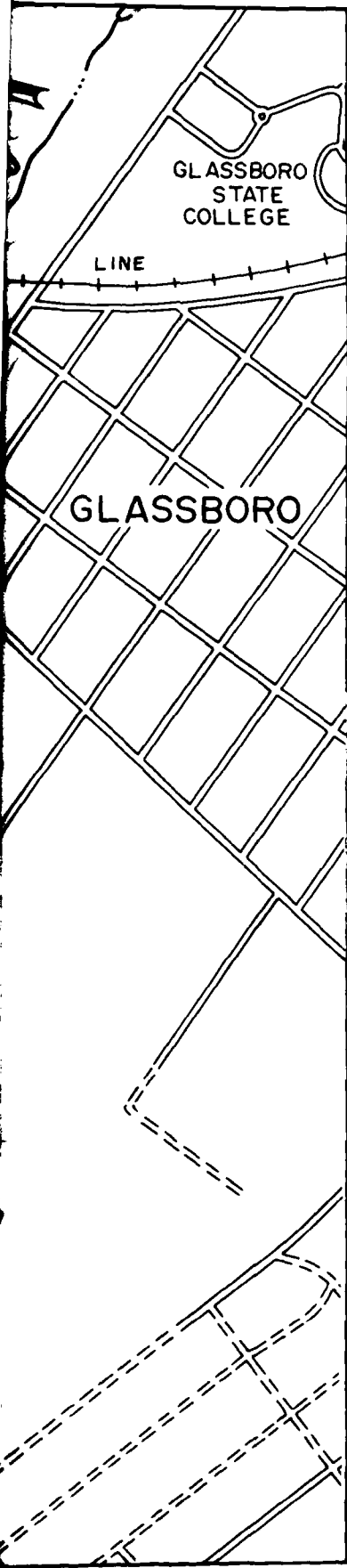

**LEGEND**

**OVERFLOW LIMITS**

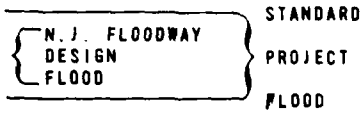

M+6 MILES ABOVE MOUTH

C13 CROSS SECTION

GROUND ELEVATION IN FEET (U.S.C  
G.S. 1929 ADJ.) SEA LEVEL DATUM

TOWNSHIP OR BORO LIMITS

**NOTES**

1. MAP BASED ON U.S.G.S. 7.5 MIN. QUADRANGLES: WOODBURY, RUNNEWEDE & PITMAN E&W 1953 & 1967. MINOR ADDITIONS AND MODIFICATIONS MADE BY CORPS OF ENGINEERS.
2. LIMITS OF OVERFLOW SHOWN MAY VARY FROM ACTUAL LOCATION ON GROUND AS EXPLAINED IN THE REPORT.
3. AREAS OUTSIDE THE FLOOD PLAIN MAY BE SUBJECT TO FLOODING FROM LOCAL RUNOFF.
4. MINIMUM CONTOUR INTERVAL IS 20 FT.

SCALE IN FEET

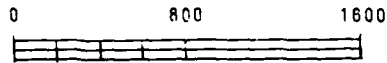

DEPARTMENT OF THE ARMY  
PHILADELPHIA DISTRICT, CORPS OF ENGINEERS  
PHILADELPHIA, PENNSYLVANIA

**FLOOD PLAIN INFORMATION**

MANTUA CREEK  
GLOUCESTER COUNTY  
NEW JERSEY

**FLOODED AREAS**

NOVEMBER 1972

MATCH TO PLATE 6

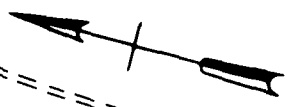

E4

E5

E6

STUDY LIMIT

STUDY LIMIT

STUDY LIMIT

MATCH TO PLATE 5

N.J. TURNPIKE

EAST GREENWICH TWP.

M+2

M+3

JESSUP MILL RD.

EDWARDS RUN

RD.

BOODYS MILL

COHAWKIN RD.

RD.

0

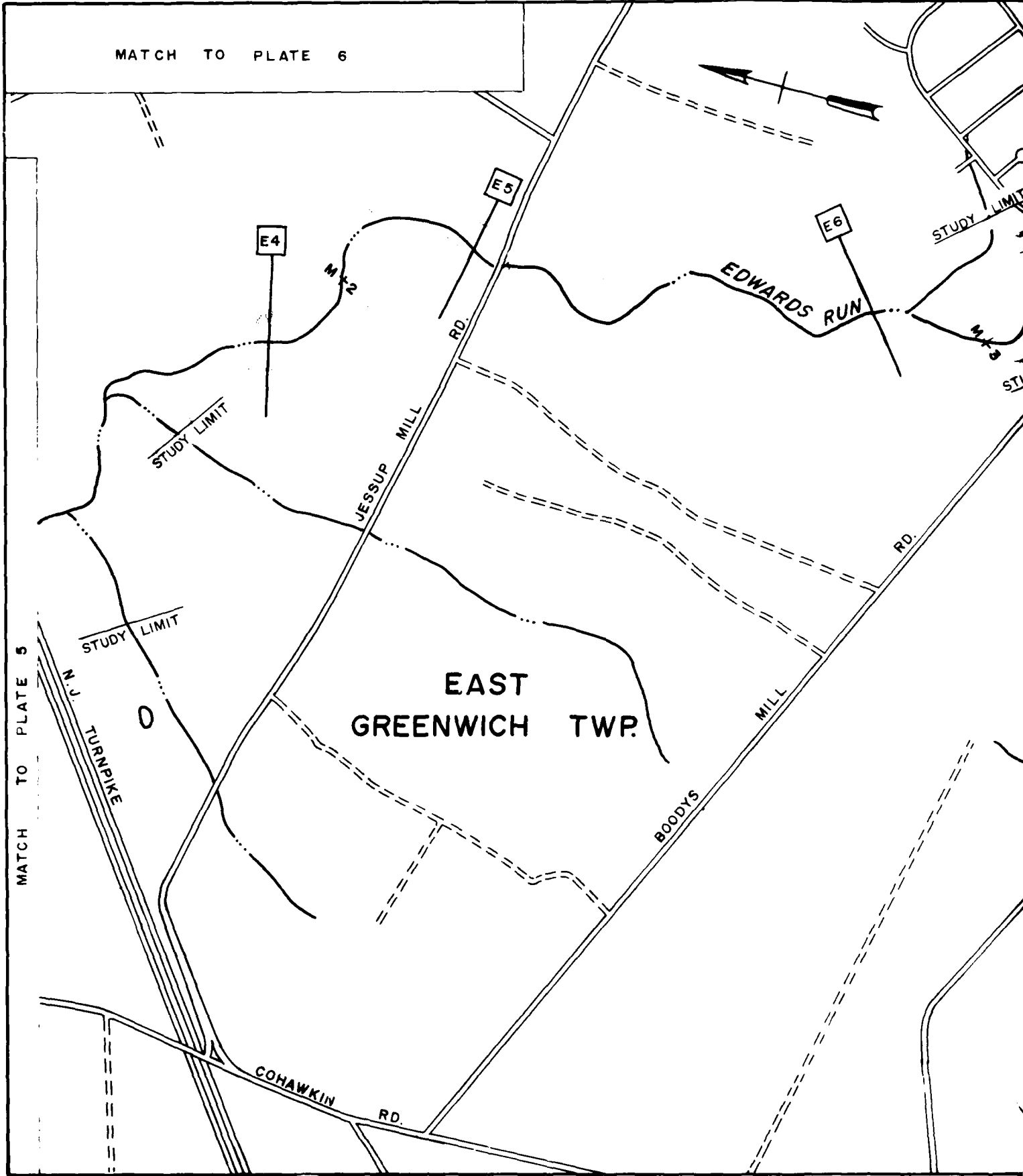

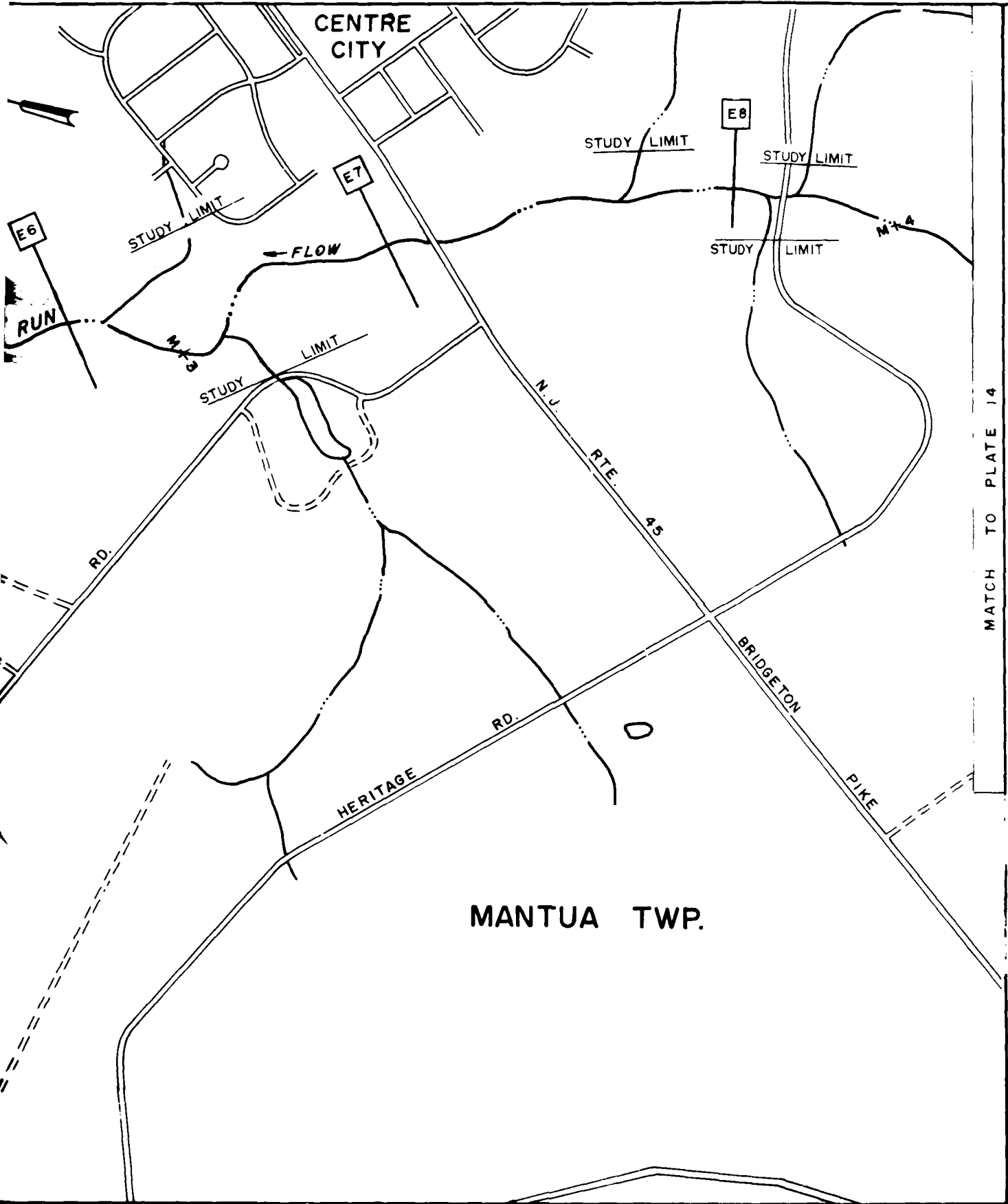

M+2

E4

MATCH TO PLATE 14

NOTES

1. MAP BY WOODBRIDGE 1867. MADE BY
2. LIMITS ACTUAL IN THE
3. AREAS SUBJECT
4. MINIMUM

PHILADELPHIA

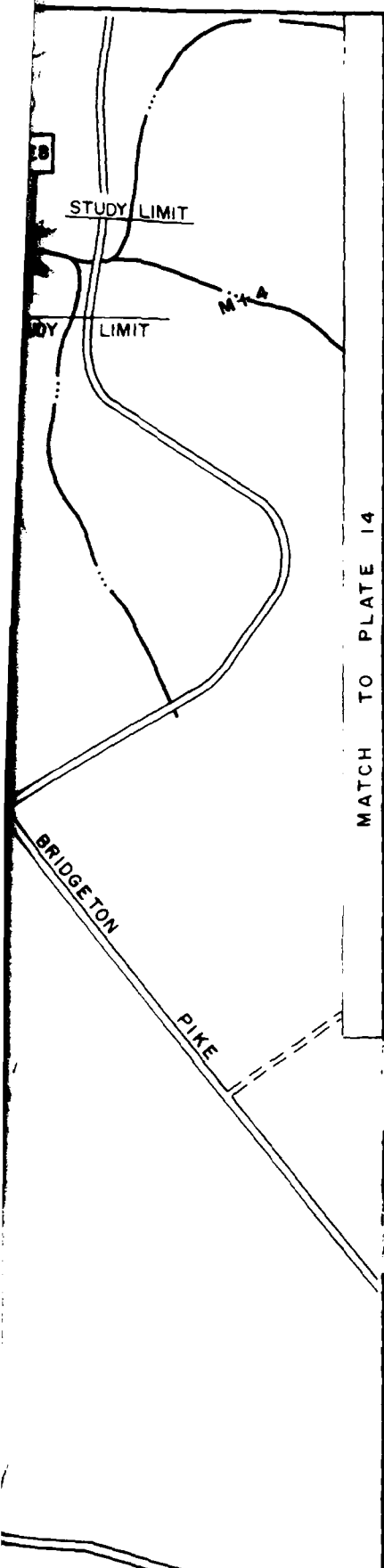

LEGEND

OVERFLOW LIMITS



M+2 MILES ABOVE MOUTH

**E4** CROSS SECTION

GROUND ELEVATION IN FEET (U.S.C  
G.S. 1929 ADJ.) SEA LEVEL DATUM

TOWNSHIP OR BORO LIMITS

NOTES

1. MAP BASED ON U.S.G.S. 7.5 MIN. QUADRANGLES: WOODBURY, RUNNEMEDE & PITMAN E&W 1953 & 1967. MINOR ADDITIONS AND MODIFICATIONS MADE BY CORPS OF ENGINEERS.
2. LIMITS OF OVERFLOW SHOWN MAY VARY FROM ACTUAL LOCATION ON GROUND AS EXPLAINED IN THE REPORT.
3. AREAS OUTSIDE THE FLOOD PLAIN MAY BE SUBJECT TO FLOODING FROM LOCAL RUNOFF.
4. MINIMUM CONTOUR INTERVAL IS 20 FT.

SCALE IN FEET

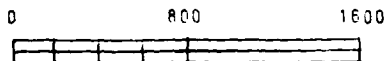

DEPARTMENT OF THE ARMY  
PHILADELPHIA DISTRICT, CORPS OF ENGINEERS  
PHILADELPHIA, PENNSYLVANIA

FLOOD PLAIN INFORMATION

MANTUA CREEK  
GLOUCESTER COUNTY  
NEW JERSEY

FLOODED AREAS

NOVEMBER 1972

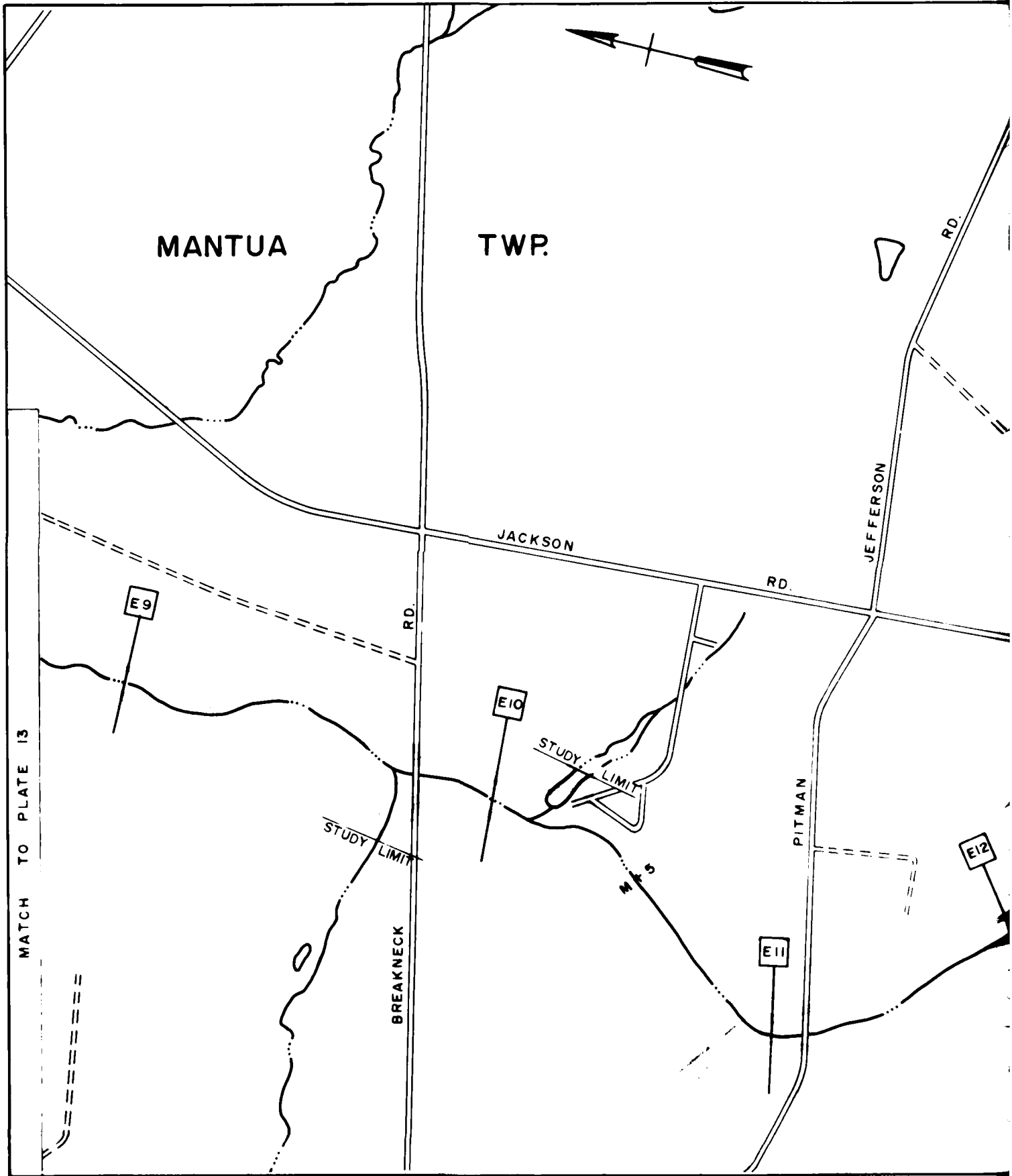

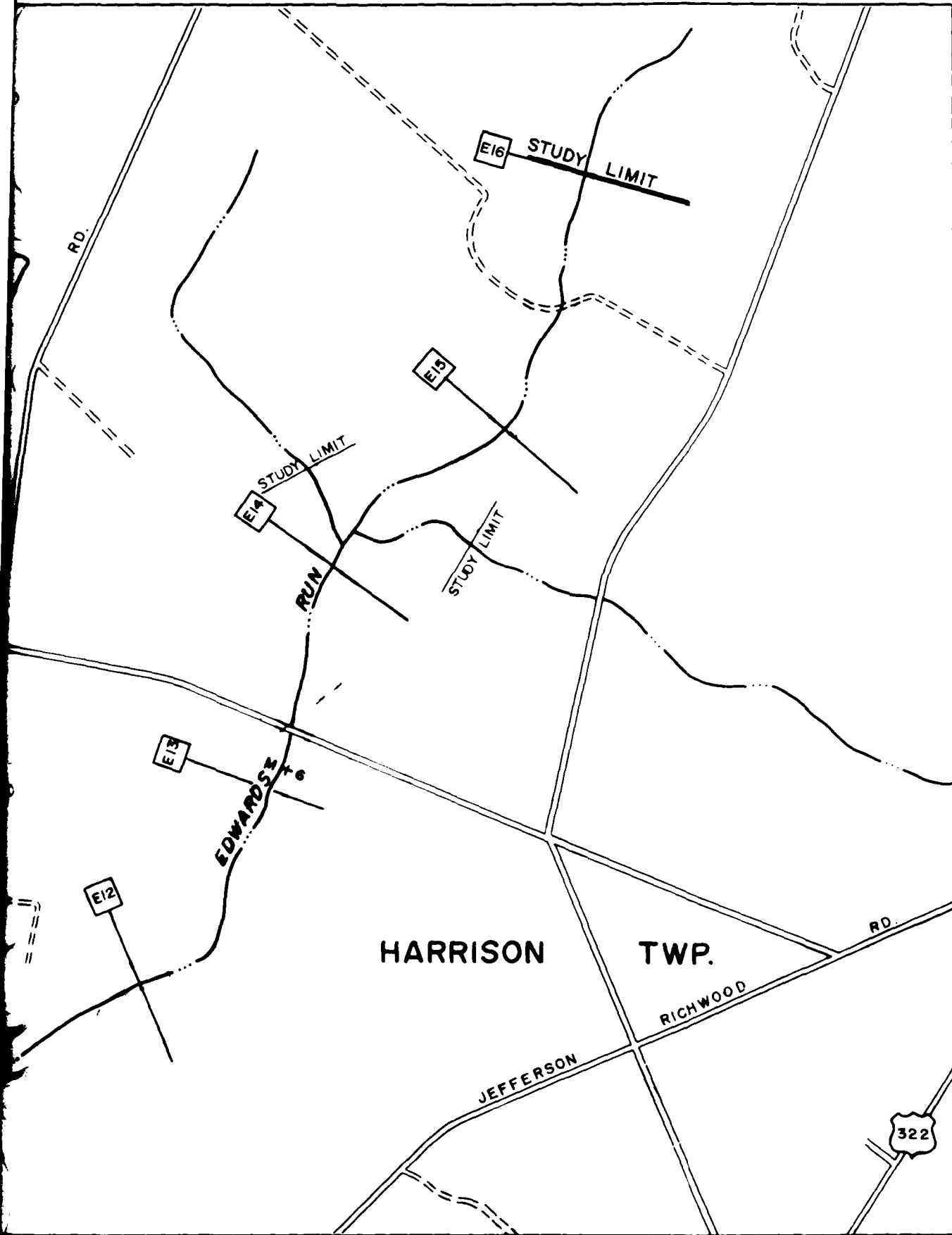

OVER  
 N. J.  
 DES  
 FLOO

M+5 MILI  
 E9 CRO  
 GRDI  
 G. S.  
 TOWN

NOTES

1. MAP BASED ON U. I. WOODBURY RUNNEE 1967 MINOR ADDI MADE BY CORPS OF
2. LIMITS OF OVERFI ACTUAL LOCATION IN THE REPORT.
3. AREAS OUTSIDE TI SUBJECT TO FLOO
4. MINIMUM CONTOUR

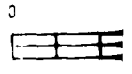

DEPAR  
 PHILADELPHIA DI  
 PHILADE

FLOOD

GLI

F

LEGEND

OVERFLOW LIMITS

 STANDARD  
PROJECT  
FLOOD

M+5 MILES ABOVE MOUTH

 CROSS SECTION

GROUND ELEVATION IN FEET (U.S.C  
G.S. 1929 ADJ.) SEA LEVEL DATUM

TOWNSHIP OR BORO LIMITS

NOTES

1. MAP BASED ON U.S.G.S. 7.5 MIN. QUADRANGLES:  
WOODBURY, RUNNEMEDE & PITMAN E&W 1953 &  
1967. MINOR ADDITIONS AND MODIFICATIONS  
MADE BY CORPS OF ENGINEERS
2. LIMITS OF OVERFLOW SHOWN MAY VARY FROM  
ACTUAL LOCATION ON GROUND AS EXPLAINED  
IN THE REPORT.
3. AREAS OUTSIDE THE FLOOD PLAIN MAY BE  
SUBJECT TO FLOODING FROM LOCAL RUNOFF
4. MINIMUM CONTOUR INTERVAL IS 20 FT

SCALE IN FEET

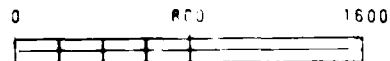

DEPARTMENT OF THE ARMY  
PHILADELPHIA DISTRICT, CORPS OF ENGINEERS  
PHILADELPHIA, PENNSYLVANIA

FLOOD PLAIN INFORMATION

MANTUA CREEK  
GLOUCESTER COUNTY  
NEW JERSEY

FLOODED AREAS

NOVEMBER 1972



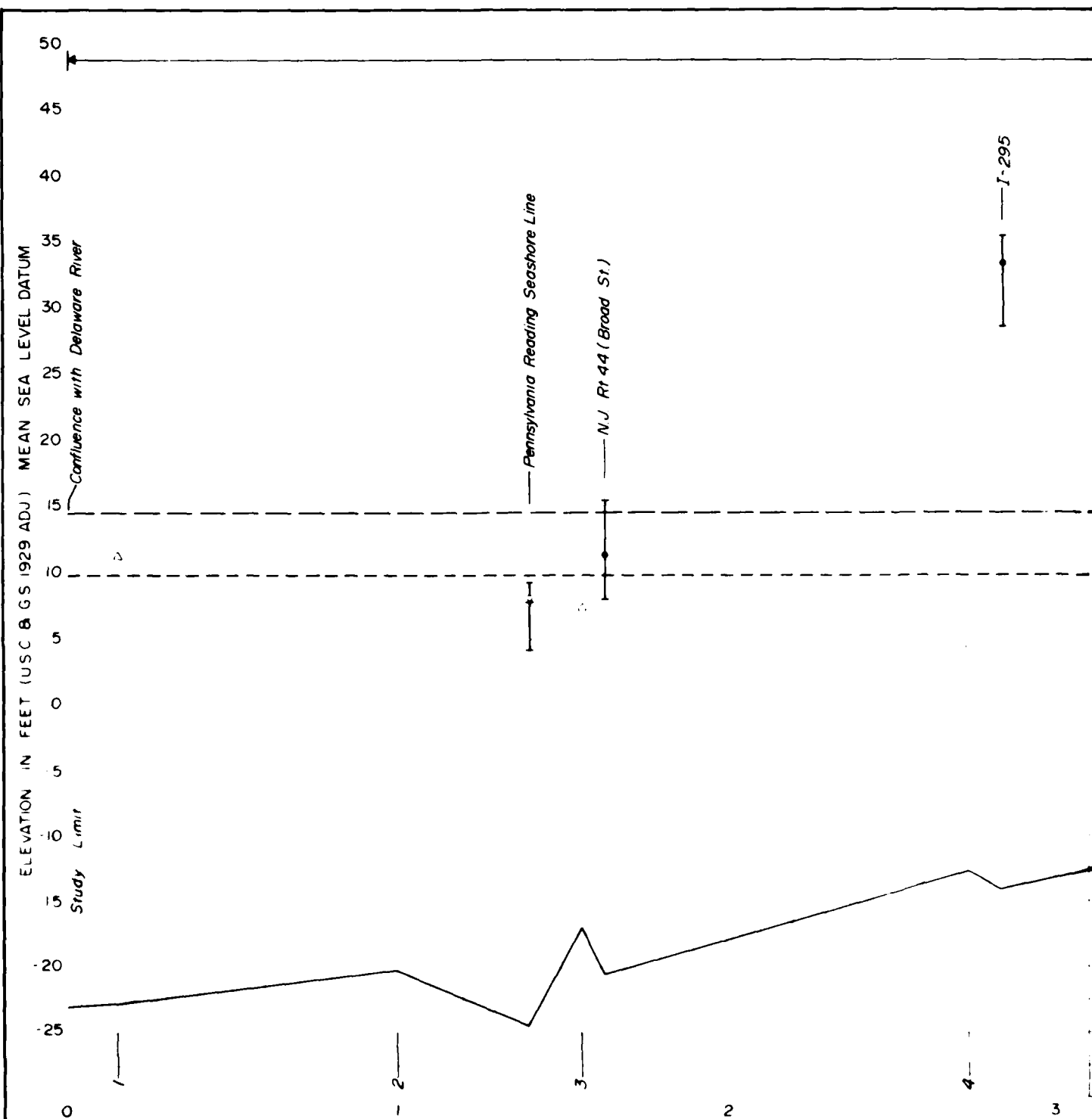

**LEGEND**

- Top of Bridge Railing
- Bridge Floor
- Underclearance
- Top of Rail (Railroad Bridge)
- Top of Low Bank

The N.J. Floodway Design Flood and the  
N.J. Flood Hazard Area Design Flood  
are approximately the same elevation

I-295

Kings Highway (County Rt. 551)

Pennsylvania - Reading  
Seashore Line

Edwards Run

Standard Project Flood

N.J. Floodway Design Flood

Streambed

4

3

5

6

4

7

8

5

9

MILES ABOVE MOUTH

Kings Highway (County Rt. 551)

Pennsylvania - Reading Seashore Line

Edwards Run

New Jersey Turnpike

MATCH LINE PLATE 16

N.J. Flood Hazard Area Design Flood



DEPARTMENT OF THE ARMY  
 PHILADELPHIA DISTRICT, CORPS OF ENGINEERS  
 PHILADELPHIA, PENNSYLVANIA  
 FLOOD PLAIN INFORMATION  
 MANTUA CREEK  
 GLOUCESTER COUNTY  
NEW JERSEY  
 HIGH WATER PROFILE  
 MANTUA CREEK

NOVEMBER 1972

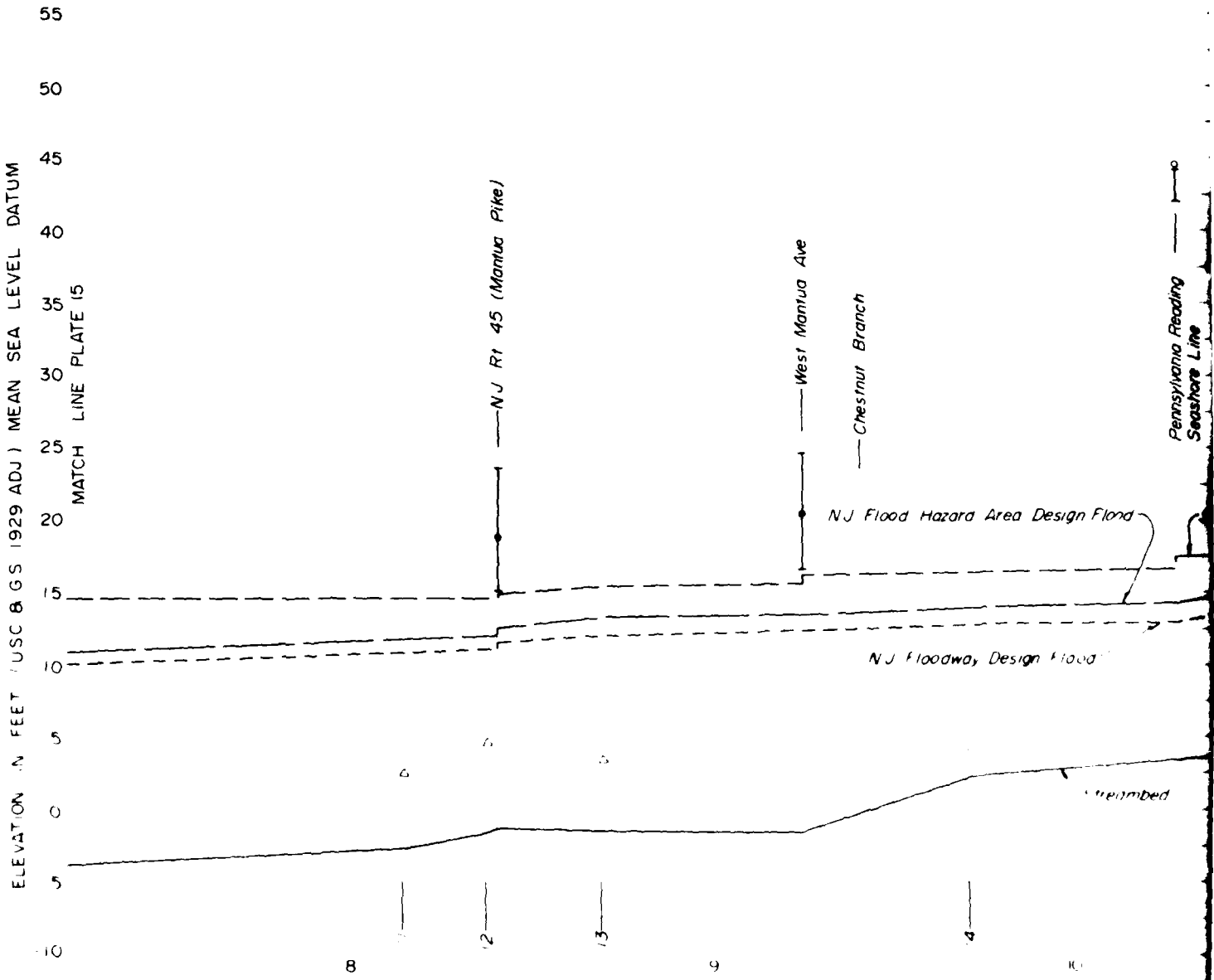

LEGEND

- | Top of Bridge Railing
- Bridge Floor
- | Underclearance
- Δ Top of Rail (Railroad Bridge)
- Δ Top of Low Bank

Pennsylvania Reading  
Seashore Line

- 19 SPF
- 18
- 17
- 16
- 15 NJFHADF
- 14
- 13 NJFDF
- 12
- 11
- 10
- 9
- 8
- 7
- 6
- 5
- 4
- 3 LOW BANK
- 2
- 1
- 0 STREAMBED

Glassboro Rd

Center Ave

Design Flood  
Standard Project Flood

Flood

Streambed



MILES ABOVE MOUTH

PHIL AD

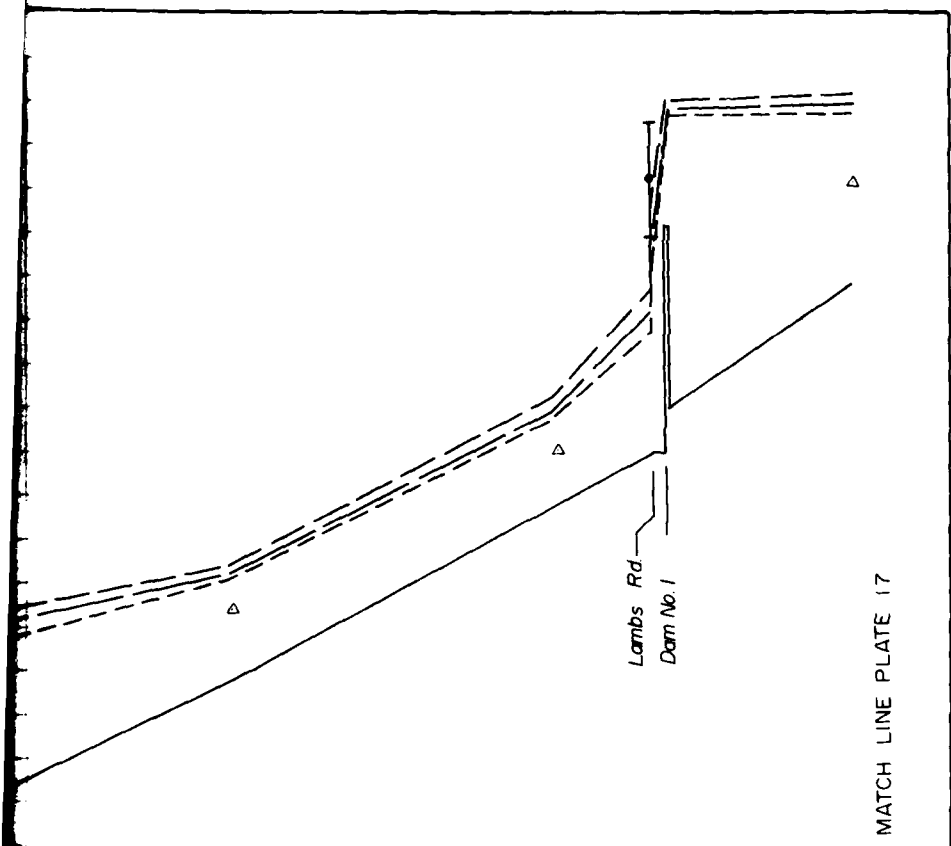

MATCH LINE PLATE 17

18  
13

19  
14

20

DEPARTMENT OF THE ARMY  
 PHILADELPHIA DISTRICT, CORPS OF ENGINEERS  
 PHILADELPHIA, PENNSYLVANIA  
 FLOOD PLAIN INFORMATION  
 MANTUA CREEK  
 GLOUCESTER COUNTY  
 NEW JERSEY  
 HIGH WATER PROFILE  
 MANTUA CREEK  
 NOVEMBER 1972

ELEVATION IN FEET (USC & G.S. 1929 ADJ.) MEAN SEA LEVEL DATUM  
 MATCH LINE PLATE 16

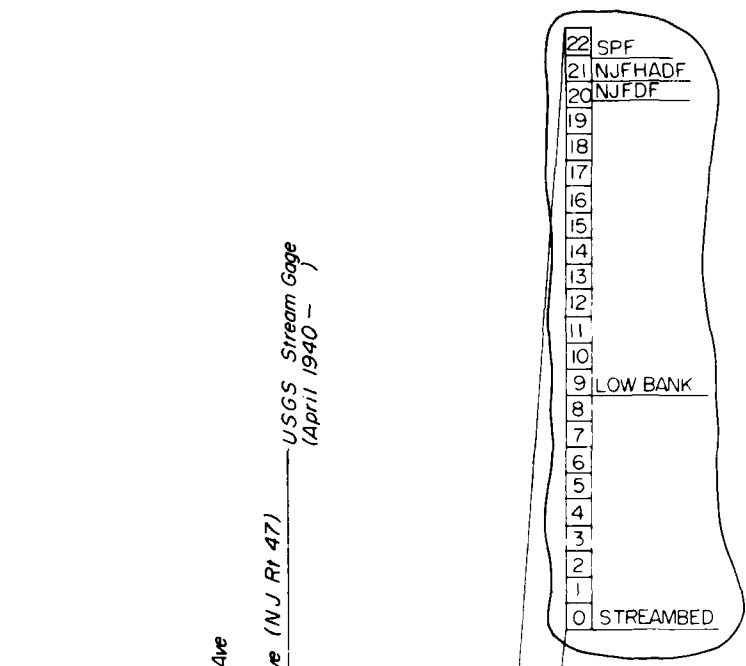

E Green Tree Rd.  
 NJ Flood Hazard Area Design  
 NJ Floodway Design Flood  
 Standard Project Flood  
 Streambed

USGS Stream Gage  
 (April 1940 - )  
 Delsea Drive (NJ Rt 47)  
 Dam No. 2  
 East Holly Ave

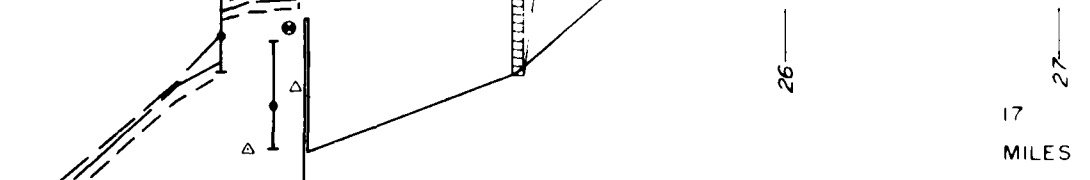

17  
 27  
 MILES ABOVE

- LEGEND**
- | Top of Bridge Railing
  - Bridge Floor
  - | Underclearance
  - ⊠ Top of Rail (Railroad Bridge)
  - △ Top of Low Bank

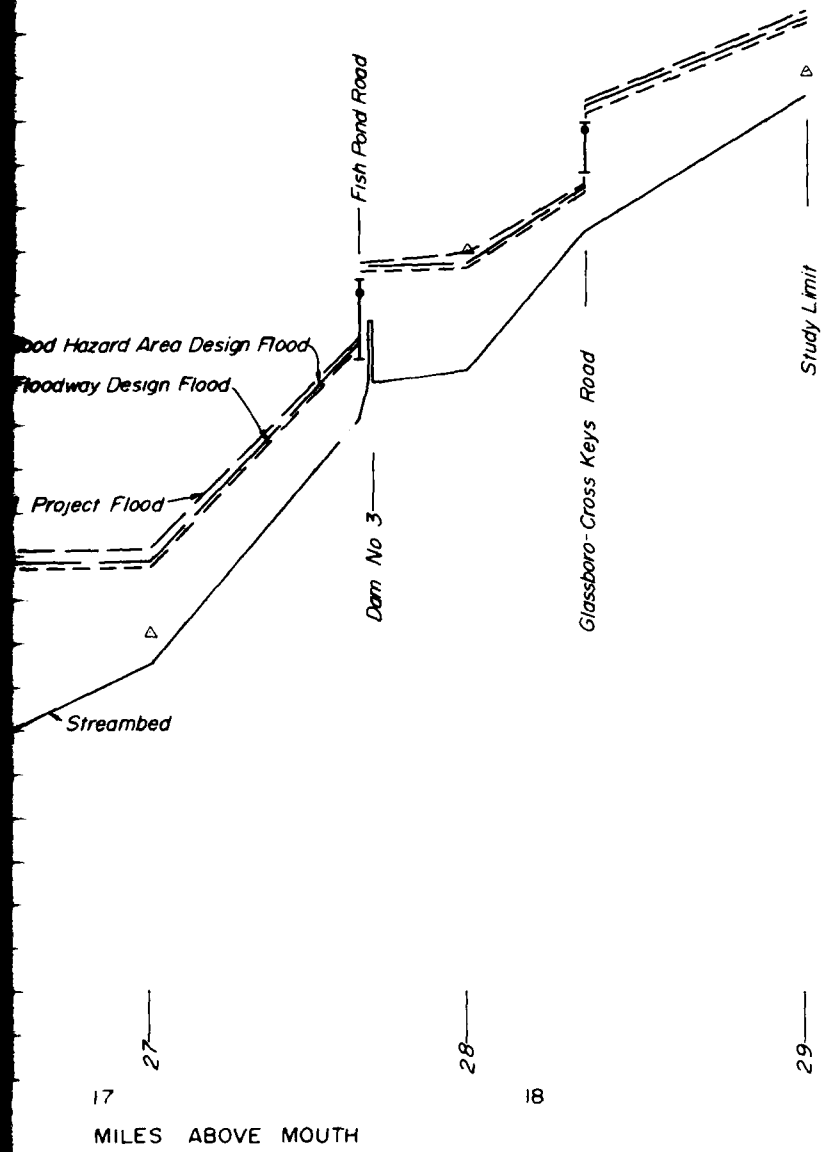

17  
MILES ABOVE MOUTH

18

29

Railing  
 (Railroad Bridge)  
 Bank

DEPARTMENT OF THE ARMY  
 PHILADELPHIA DISTRICT, CORPS OF ENGINEERS  
 PHILADELPHIA, PENNSYLVANIA  
 FLOOD PLAIN INFORMATION  
 MANTUA CREEK  
 GLOUCESTER COUNTY  
 NEW JERSEY  
 HIGH WATER PROFILE  
 MANTUA CREEK  
 NOVEMBER 1972



ELEVATION IN FEET (U.S.C. & G.S. 1929 ADJ.) MEAN SEA LEVEL DATUM

75  
70  
65  
60  
55  
50  
45  
40  
35  
30  
25  
20  
15  
10  
5  
0  
-5

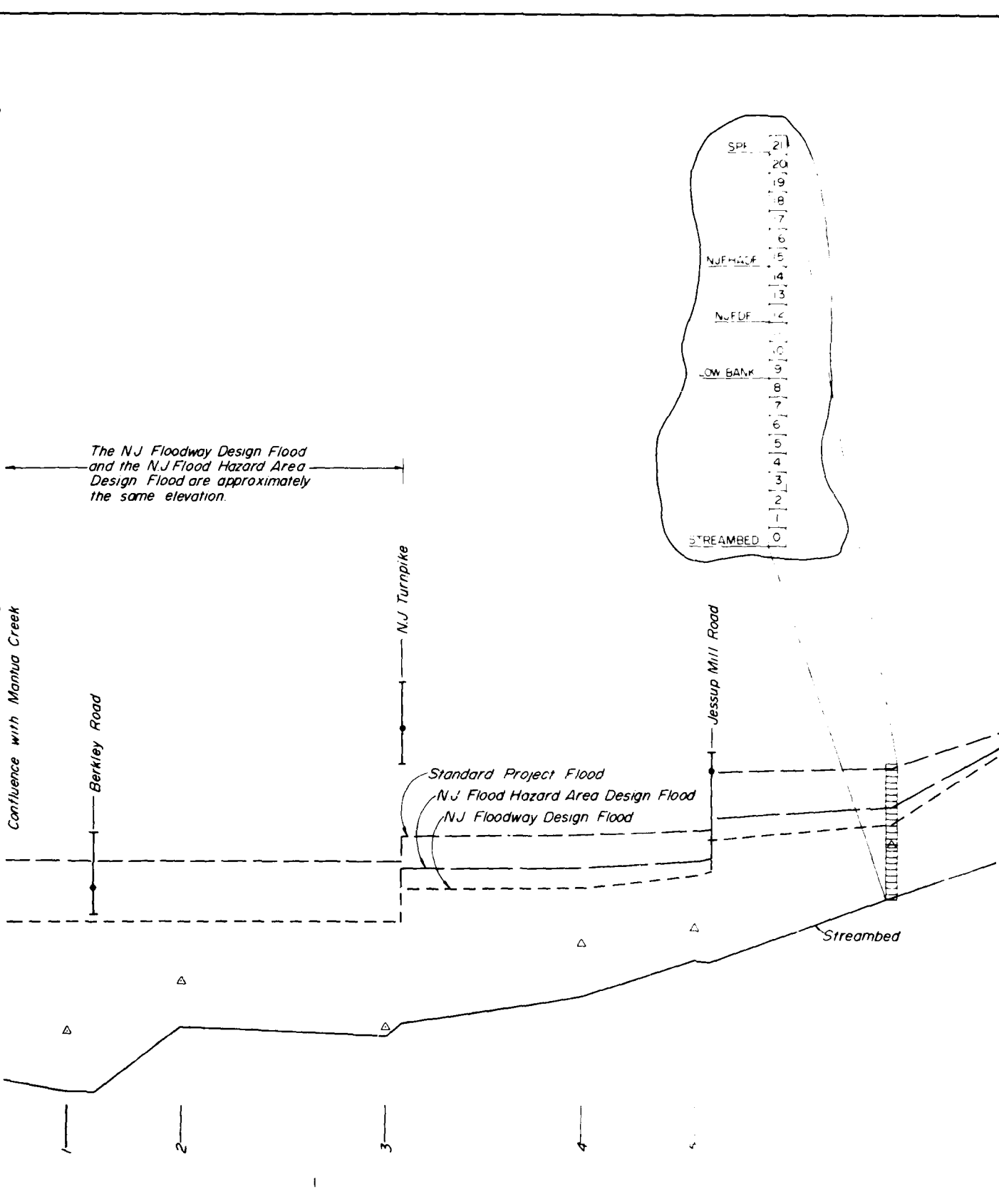

The NJ Floodway Design Flood and the NJ Flood Hazard Area Design Flood are approximately the same elevation.

SPF	21
	20
	19
	18
	17
	16
NJFHAF	15
	14
	13
NJFDF	12
	11
	10
LOW BANK	9
	8
	7
	6
	5
	4
	3
	2
	1
STREAMBED	0

Standard Project Flood  
NJ Flood Hazard Area Design Flood  
NJ Floodway Design Flood

Streambed

Berkley Road

NJ Turnpike

Jessup Mill Road

Confluence with Mantua Creek

1

2

3

4

5

AD-A101 578

ARMY ENGINEER DISTRICT PHILADELPHIA PA  
FLOOD PLAIN INFORMATION, MANTUA CREEK, GLOUCESTER COUNTY, NEW J--ETC(U)  
NOV 72

F/6 8/8

UNCLASSIFIED

DAEN/NAP-82040/FP123-72/1

NL

2 OF 2  
AD A  
C15 7 H



END  
DATE  
FILMED  
8-81  
DTIC

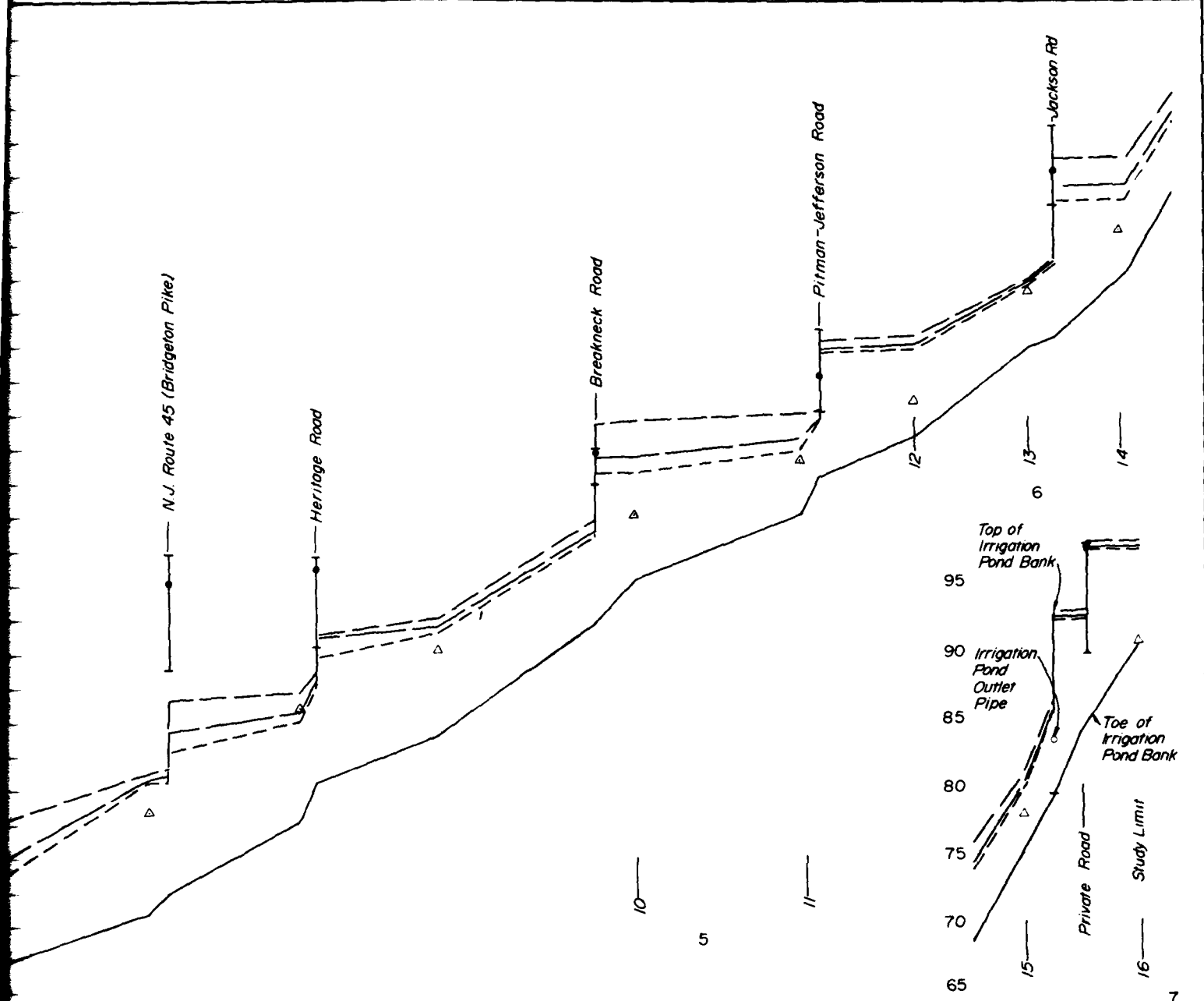

**LEGEND**

- ⌋ Top of Bridge Railing
- Bridge Floor
- ⌋ Underclearance
- ⌚ Top of Rail (Railroad Bridge)
- △ Top of Low Bank

DEPARTMENT OF THE ARMY  
 PHILADELPHIA DISTRICT, CORPS OF ENGINEERS  
 PHILADELPHIA, PENNSYLVANIA  
**FLOOD PLAIN INFORMATION**  
 MANTUA CREEK  
 GLOUCESTER COUNTY  
 NEW JERSEY  
 HIGH WATER PROFILE  
 EDWARDS RUN  
 NOVEMBER 1972

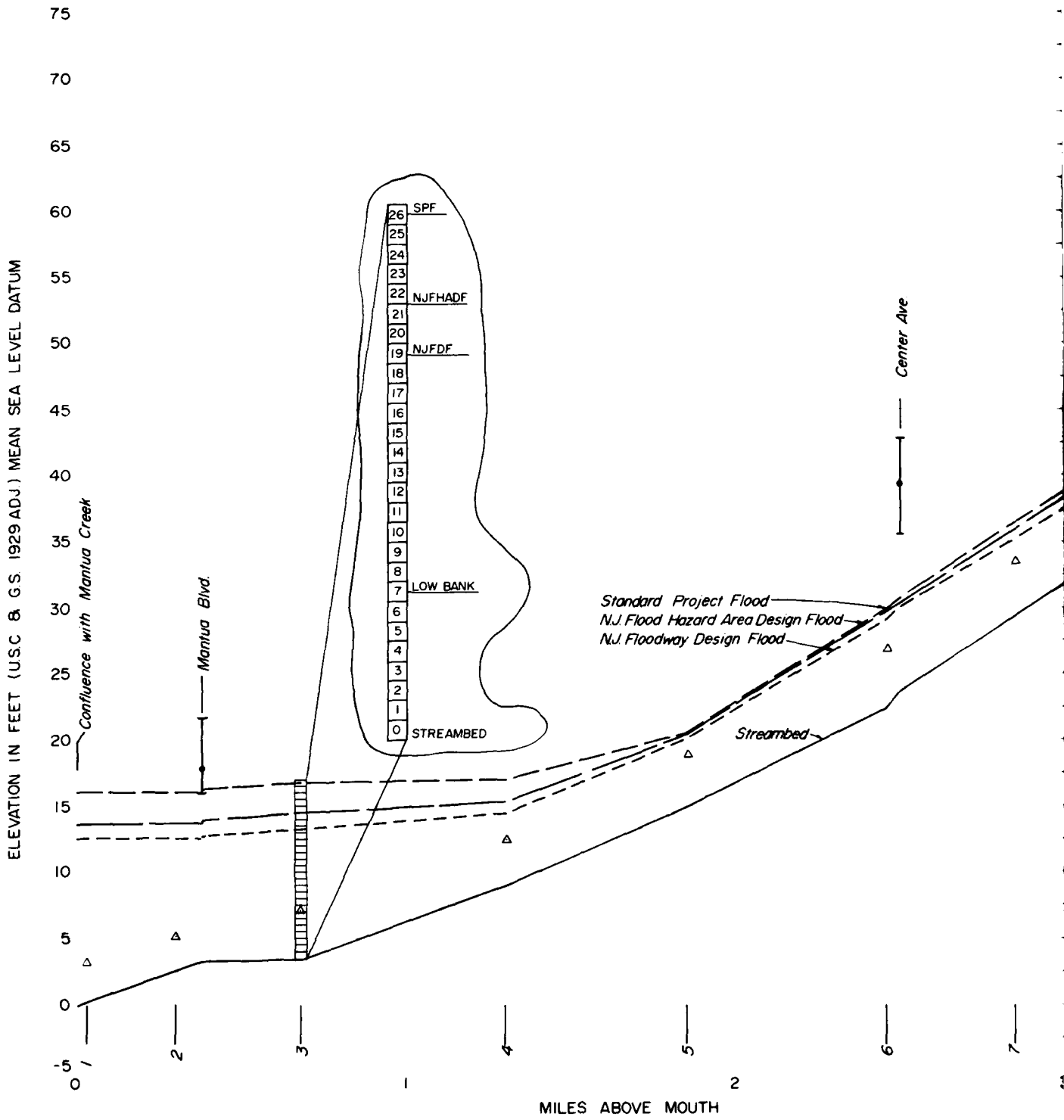

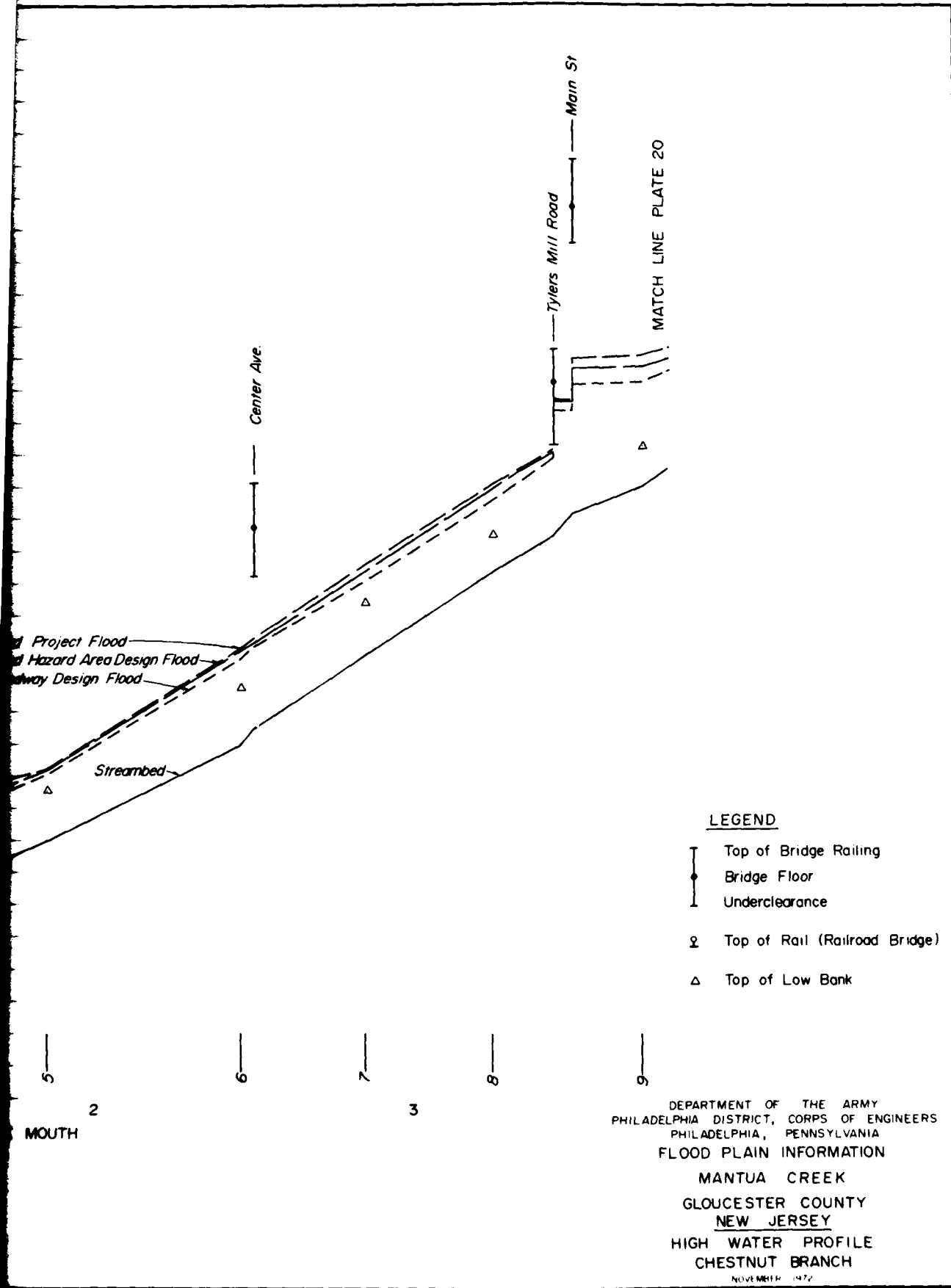

LEGEND

- | Top of Bridge Railing
- Bridge Floor
- | Underclearance
- ⊔ Top of Rail (Railroad Bridge)
- △ Top of Low Bank

DEPARTMENT OF THE ARMY  
 PHILADELPHIA DISTRICT, CORPS OF ENGINEERS  
 PHILADELPHIA, PENNSYLVANIA  
 FLOOD PLAIN INFORMATION  
 MANTUA CREEK  
 GLOUCESTER COUNTY  
 NEW JERSEY  
 HIGH WATER PROFILE  
 CHESTNUT BRANCH  
 NOVEMBER 1972

ELEVATION IN FEET (U.S. & G.S. 1929 ADJ.) MEAN SEA LEVEL DATUM  
MATCH LINE PLATE 19

12	SPF
11	NJFHADF
10	NJFDF
9	
8	
7	
6	
5	LOW BANK
4	
3	
2	
1	
0	STREAMBED

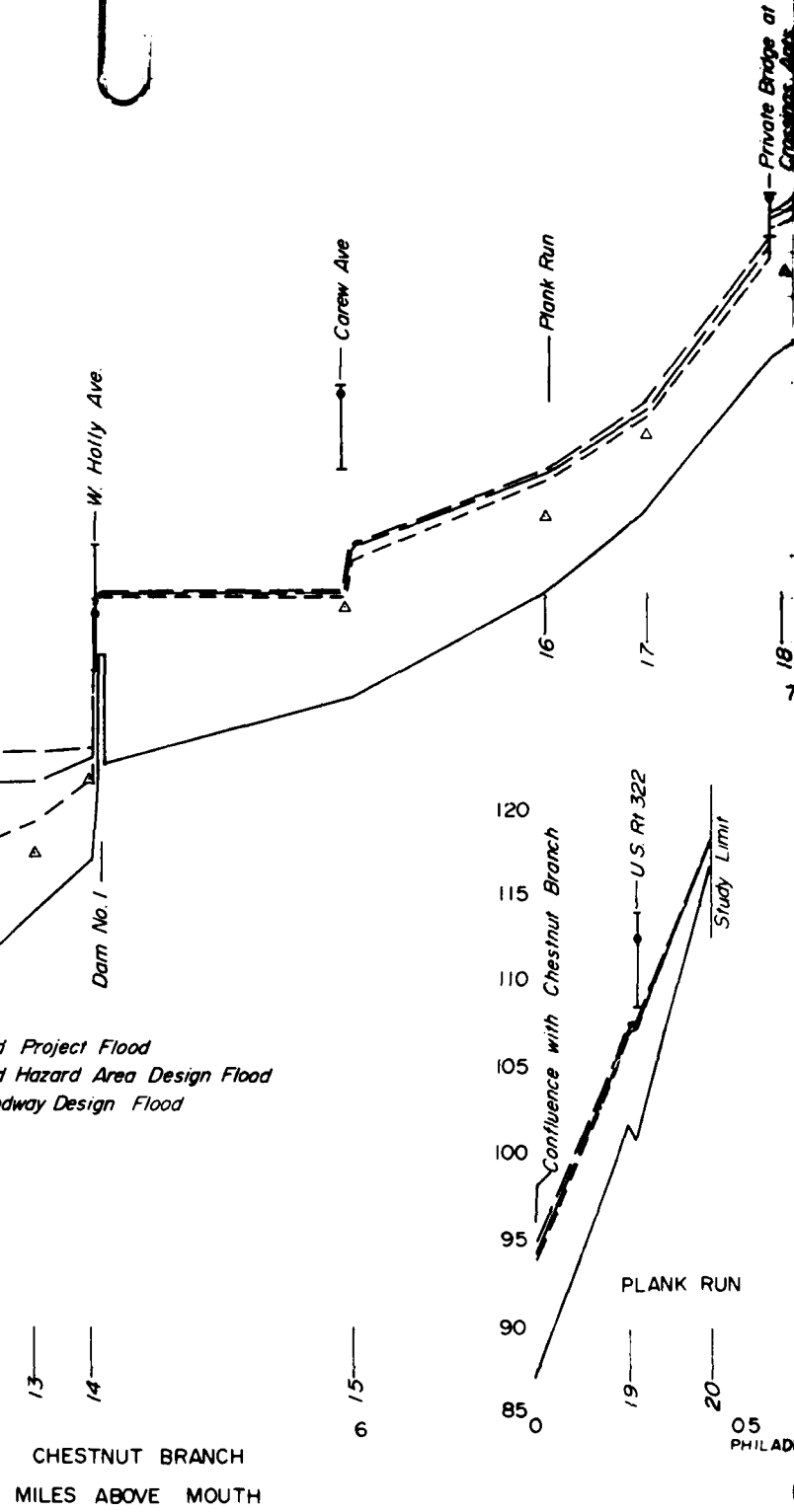

CHESTNUT BRANCH  
MILES ABOVE MOUTH

05  
PHILADE

CHE

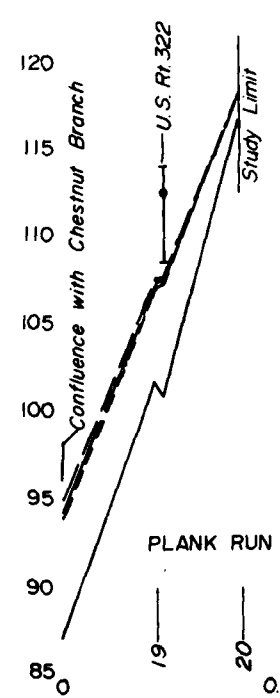
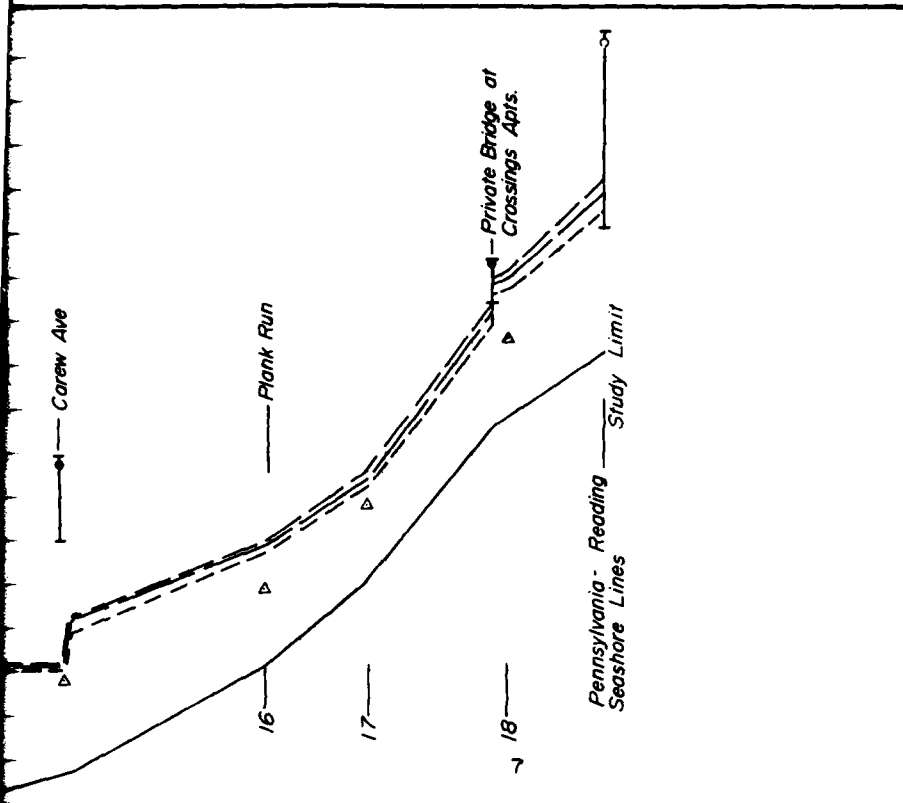

- LEGEND**
- |— Top of Bridge Railing
  - Bridge Floor
  - |— Underclearance
  - ⊕ Top of Rail (Railroad Bridge)
  - △ Top of Low Bank

0.5 DEPARTMENT OF THE ARMY  
 PHILADELPHIA DISTRICT, CORPS OF ENGINEERS  
 PHILADELPHIA, PENNSYLVANIA  
 FLOOD PLAIN INFORMATION  
 MANTUA CREEK  
 GLOUCESTER COUNTY  
 NEW JERSEY  
 HIGH WATER PROFILES  
 CHESTNUT BRANCH & PLANK RUN  
 NOVEMBER 1972

ELEVATION IN FEET (U.S.C. & G.S. 1929 ADJ.) MEAN SEA LEVEL DATUM.

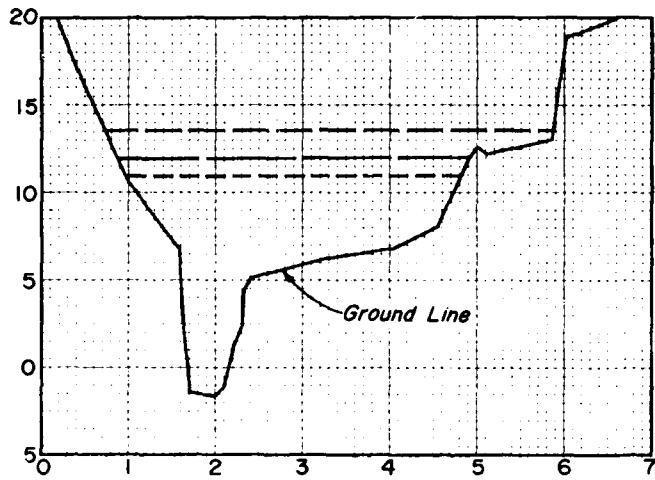

CROSS SECTION NO. 10  
MILE 6.85

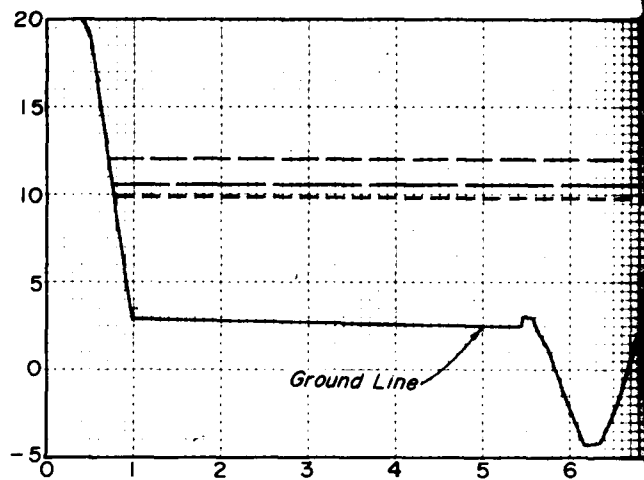

CROSS SECTION NO. 11  
MILE 8.14

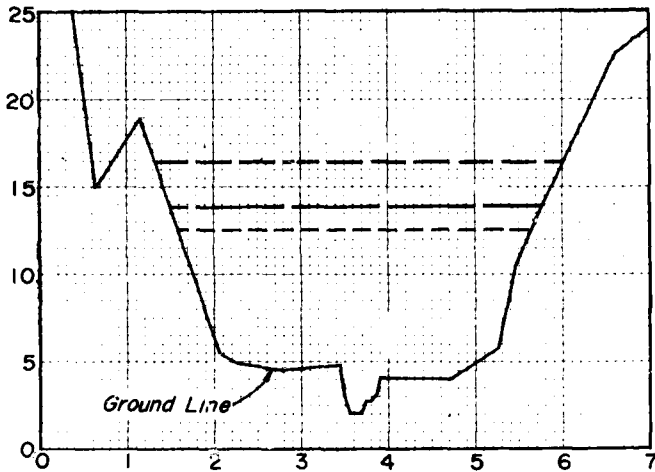

CROSS SECTION NO. 14  
MILE 9.71

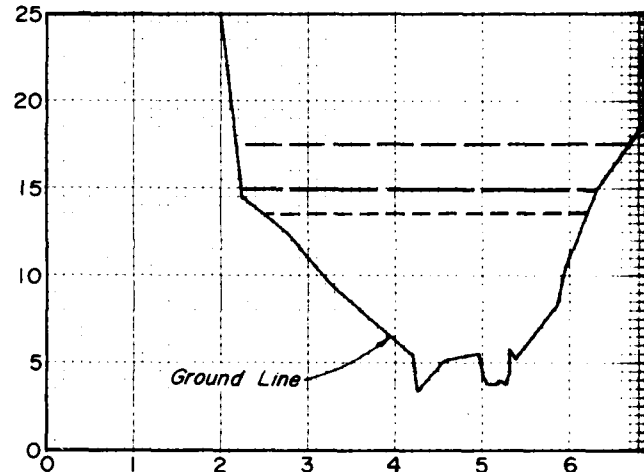

CROSS SECTION NO. 15  
MILE 10.47

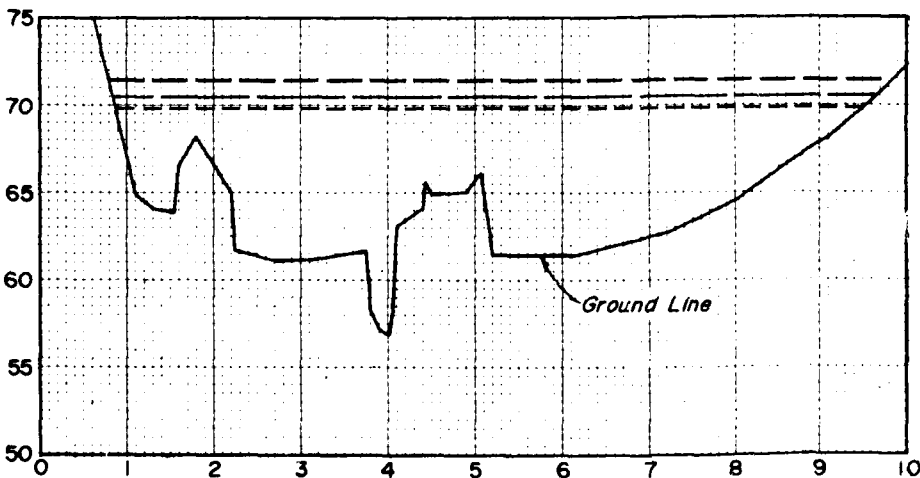

CROSS SECTION NO. 23  
MILE 15.24

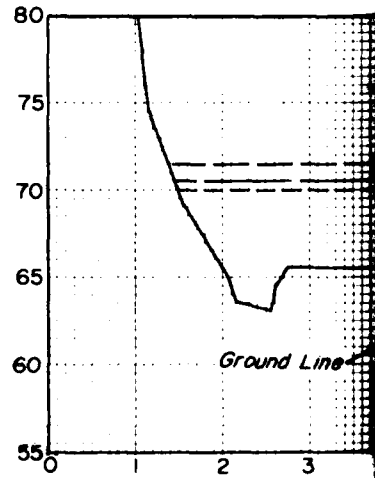

CROSS SECTION NO. 24  
MILE 16.00

HORIZONTAL DISTANCE IN HUNDREDS OF FEET



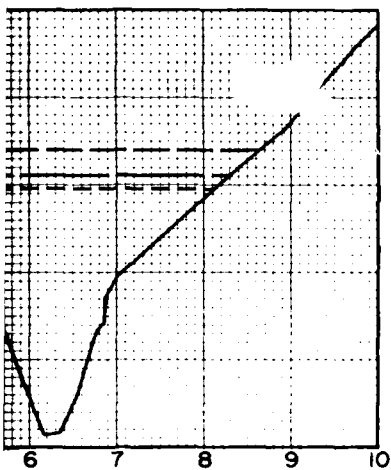

NO. 11

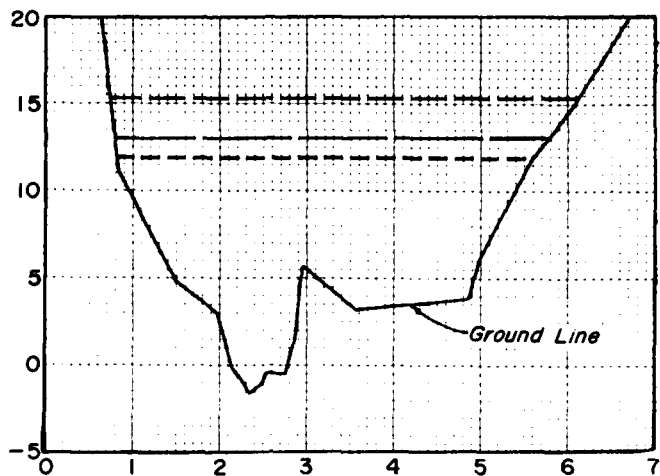

CROSS SECTION NO. 13  
MILE 8.69

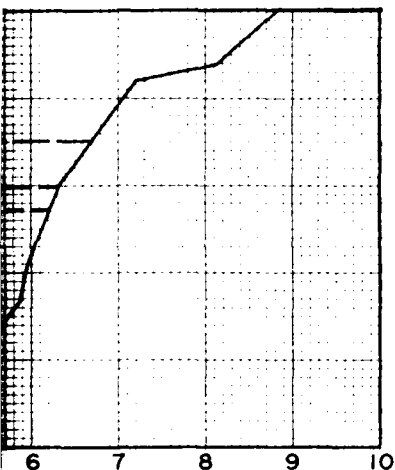

NO. 15

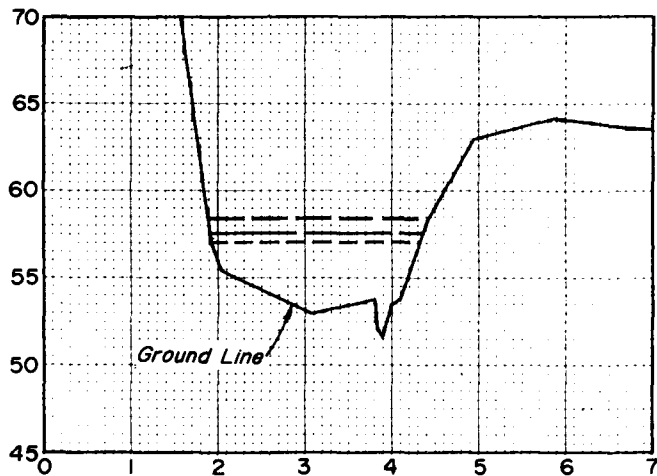

CROSS SECTION NO. 21  
MILE 14.73

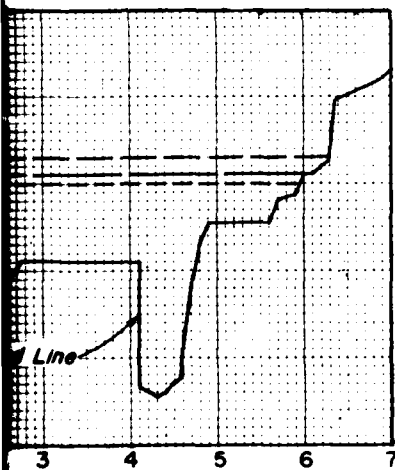

SECTION NO. 24  
MILE 15.35

**LEGEND**

- Standard Project Flood
- New Jersey Flood Hazard Area Design Flood
- - - New Jersey Floodway Design Flood

**NOTES:**

The 20 sections not shown in this report are on file at the Philadelphia District, Corps of Engineers and are available for inspection upon request. Cross sections taken looking downstream.

DEPARTMENT OF THE ARMY  
PHILADELPHIA DISTRICT, CORPS OF ENGINEERS  
PHILADELPHIA, PENNSYLVANIA  
FLOOD PLAIN INFORMATION  
MANTUA CREEK  
GLOUCESTER COUNTY  
NEW JERSEY  
SELECTED CROSS SECTIONS  
MANTUA CREEK

NOVEMBER 1972

ELEVATION IN FEET (U.S.C. & G.S. 1929 ADJ.) MEAN SEA LEVEL DATUM

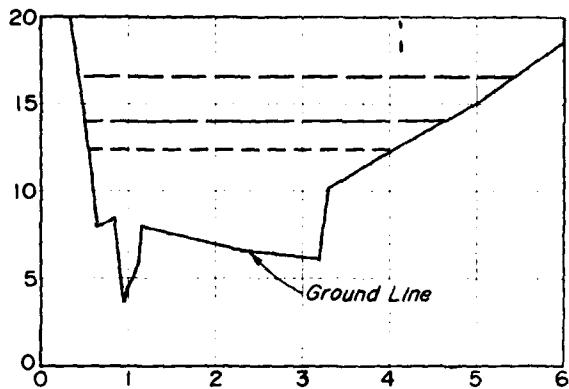

CROSS SECTION NO. 4  
MILE 1.86

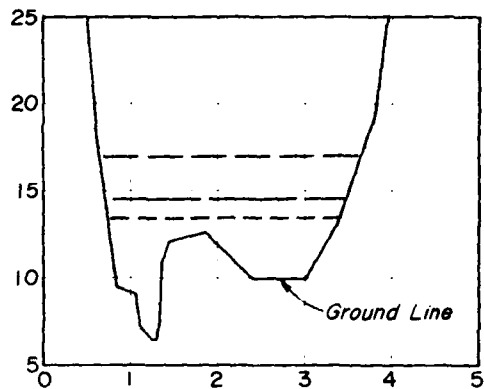

CROSS SECTION NO. 5  
MILE 2.23

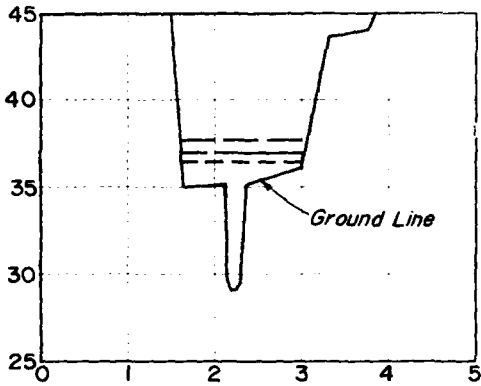

CROSS SECTION NO. 9  
MILE 4.22

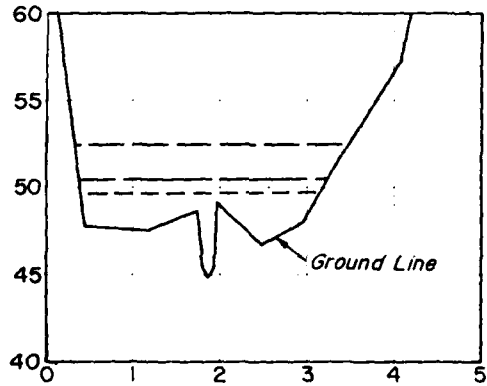

CROSS SECTION NO. 11  
MILE 5.30

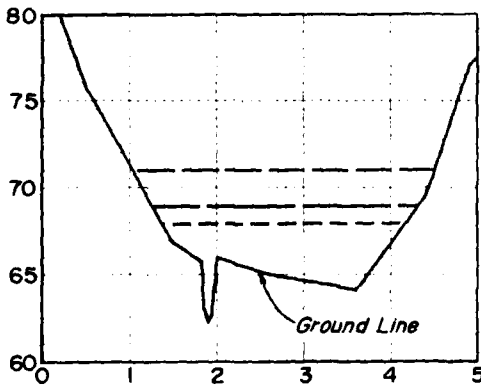

CROSS SECTION NO. 14  
MILE 6.26

HORIZONTAL DISTANCE IN HUNDREDS OF FEET

**LEGEND**

- Standard Project Flood
- New Jersey Flood Hazard Area Design Flood
- - - New Jersey Floodway Design Flood

**NOTES:**

The 11 sections not shown in this report are on file at the Philadelphia District, Corps of Engineers and are available for inspection upon request.

Cross sections taken looking downstream.

DEPARTMENT OF THE ARMY  
PHILADELPHIA DISTRICT, CORPS OF ENGINEERS  
PHILADELPHIA, PENNSYLVANIA

FLOOD PLAIN INFORMATION  
MANTUA CREEK

GLOUCESTER COUNTY

NEW JERSEY

SELECTED CROSS SECTIONS  
EDWARDS RUN

NOVEMBER 1972

ELEVATION IN FEET (U.S. & G.S. 1929 ADJ.) MEAN SEA LEVEL DATUM.

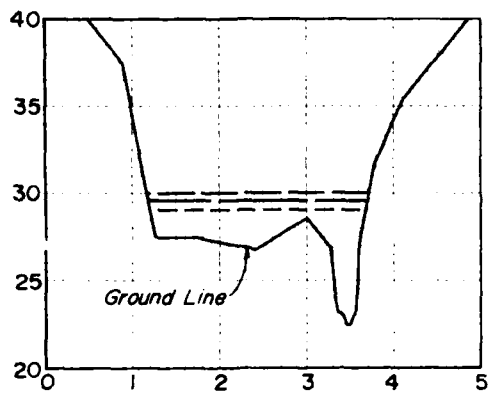

CROSS SECTION NO. 6  
MILE 2.46

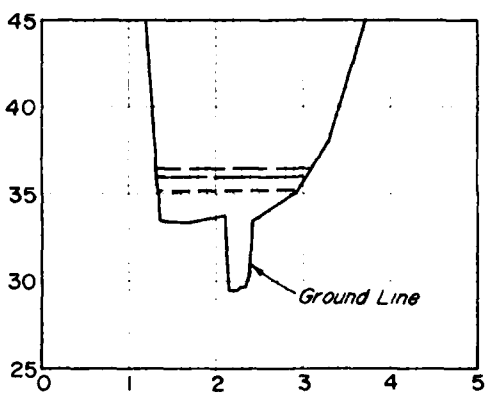

CROSS SECTION NO. 7  
MILE 2.85

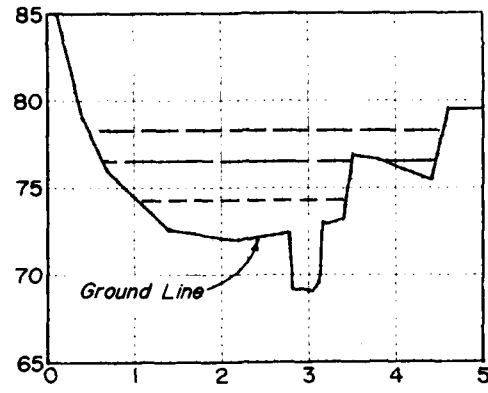

CROSS SECTION NO. 13  
MILE 5.24

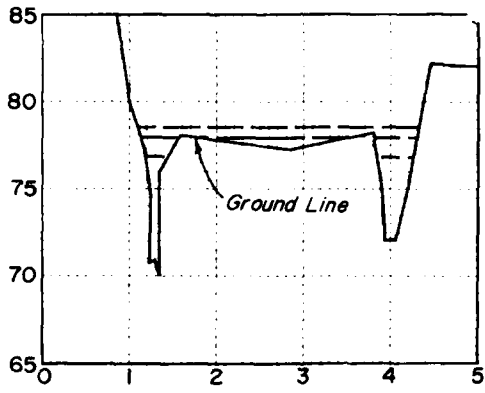

CROSS SECTION NO. 14  
MILE 5.37

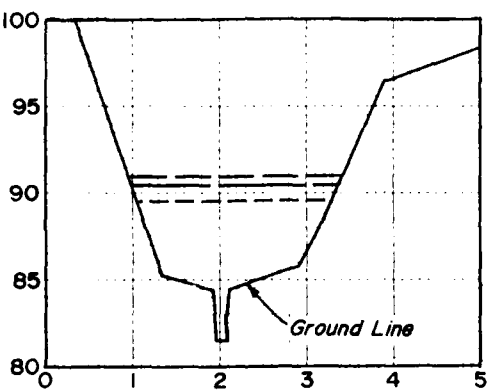

CROSS SECTION NO. 15  
MILE 5.98

HORIZONTAL DISTANCE IN HUNDREDS OF FEET

- LEGEND**
- Standard Project Flood
  - New Jersey Flood Hazard Area Design Flood
  - - - New Jersey Floodway Design Flood

**NOTES:**  
 The 13 sections not shown in this report are on file at the Philadelphia District, Corps of Engineers and are available for inspection upon request.  
 Cross sections taken looking downstream.

DEPARTMENT OF THE ARMY  
 PHILADELPHIA DISTRICT, CORPS OF ENGINEERS  
 PHILADELPHIA, PENNSYLVANIA  
 FLOOD PLAIN INFORMATION  
 MANTUA CREEK  
 GLOUCESTER COUNTY  
NEW JERSEY  
 SELECTED CROSS SECTIONS  
 CHESTNUT BRANCH  
 NOVEMBER 1972

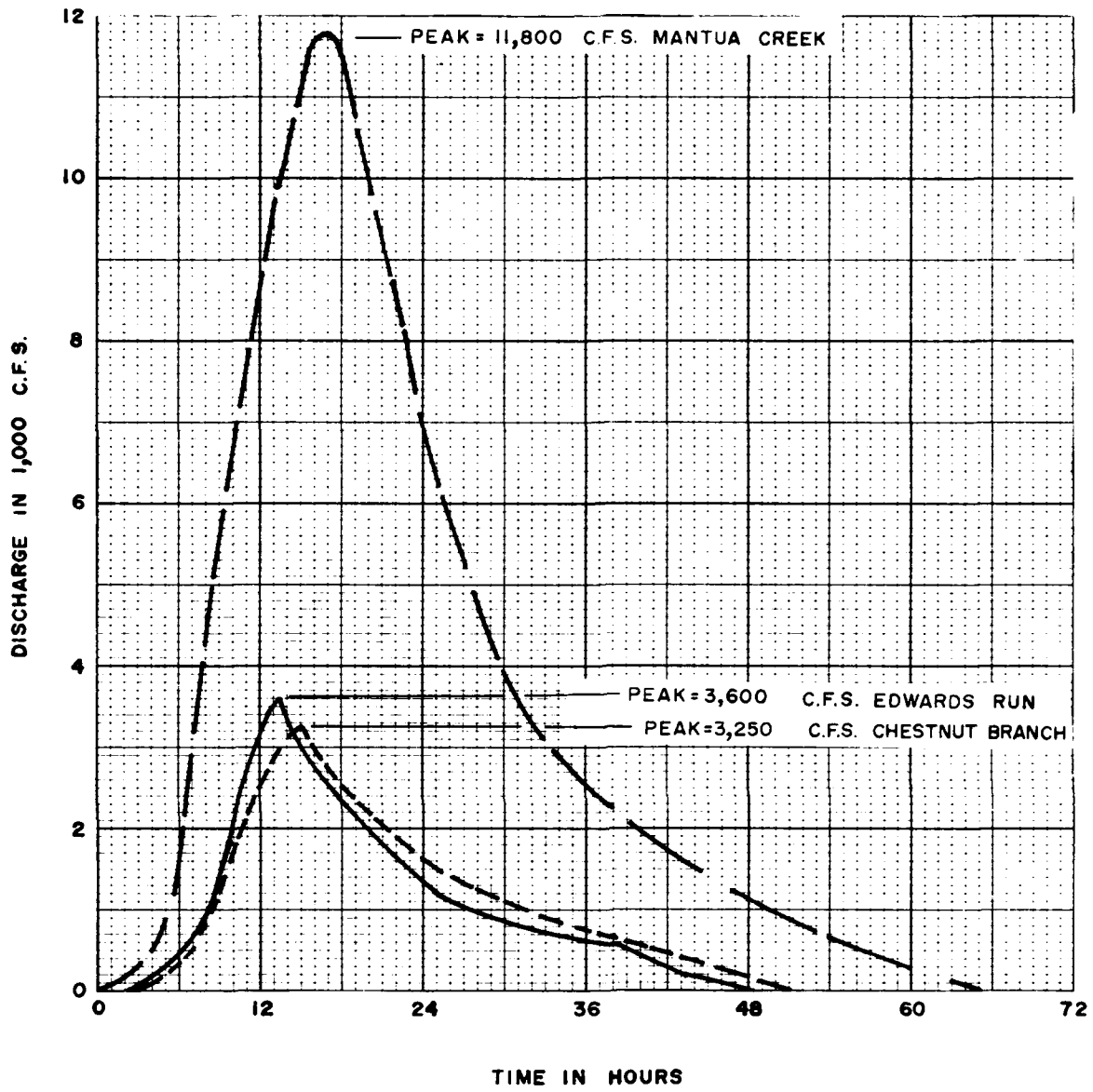

NOTES:

HYDROGRAPHS ARE AT MOUTHS:  
 DRAINAGE AREAS SQUARE MILES  
 MANTUA CREEK 50.9  
 EDWARDS RUN 10.6  
 CHESTNUT BRANCH 9.9

DEPARTMENT OF THE ARMY  
 PHILADELPHIA DISTRICT, CORPS OF ENGINEERS  
 PHILADELPHIA, PENNSYLVANIA  
 FLOOD PLAIN INFORMATION  
 MANTUA CREEK  
 GLOUCESTER COUNTY  
NEW JERSEY  
 STANDARD PROJECT FLOOD  
 HYDROGRAPHS

NOVEMBER 1972

END

DATE  
FILMED

8 - 8 - 1

DTIC