

AD-A101 212

ACKENHEIL AND ASSOCIATES INC PITTSBURGH PA
NATIONAL DAM INSPECTION PROGRAM. BUTLER'S LAKE DAM (NDI NUMBER --ETC(U)
MAY 81

F/G 13/13

DACW31-81-C-0027

UNCLASSIFIED

NL

For
AD 212



END
DATE
FILMED
8-8-81
DTIC

AD A101212

LEVEL

①

OHIO RIVER BASIN
DRENNEN BRANCH
ALLEGHENY COUNTY

PENNSYLVANIA

NDI No. PA 01067
PENN DER No. 2-29

BUTLER'S LAKE DAM

DTIC
JUL 10 1981

BUTLER'S GOLF COURSE
DAC W31-81-C-0027

PHASE I INSPECTION REPORT
NATIONAL DAM INSPECTION PROGRAM

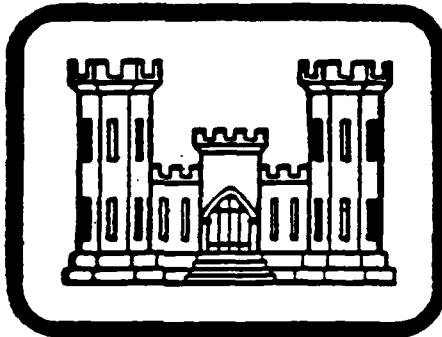

PREPARED FOR

DEPARTMENT OF THE ARMY
BALTIMORE DISTRICT, CORPS OF ENGINEERS
BALTIMORE, MARYLAND 21203

BY

ACKENHEIL & ASSOCIATES GEO SYSTEMS, INC.
CONSULTING ENGINEERS
1000 BANKSVILLE ROAD
PITTSBURGH, PENNSYLVANIA 15216

MAY 1981

DTIC FILE COPY
Original contains color
plates. All DTIC reproductions
will be in black and
white.

81 7 10 017

①

OHIO RIVER BASIN
BUTLER'S LAKE DAM
ALLEGHENY COUNTY, COMMONWEALTH OF PENNSYLVANIA
NDI NO. PA 01067
PennDER NO. 2-29

BUTLER'S GOLF COURSE

PHASE I INSPECTION REPORT
NATIONAL DAM INSPECTION PROGRAM,
Butler's Lake Dam (NDI Number PA-01067,
PennDER Number 2-29) Ohio River Basin,
Drennen Branch, Allegheny County,
Pennsylvania. Phase I Inspection Report.



Prepared for: DEPARTMENT OF THE ARMY
Baltimore District, Corps of Engineers
Baltimore, Maryland 21203

Prepared by: ACKENHEIL & ASSOCIATES GEO SYSTEMS, INC.
Consulting Engineers
1000 Banksville Road
Pittsburgh, Pennsylvania 15216

DACW31-81-C-0027

Date: 10 May 1981

41105

PREFACE

This report is prepared under guidance contained in the Recommended Guidelines for Safety Inspection of Dams for Phase I investigations. Copies of these guidelines may be obtained from the Department of the Army, Office of Chief of Engineers, Washington, D.C. 20314.

The purpose of a Phase I investigation is to identify expeditiously those dams which may pose hazards to human life or property. The assessment of the general condition of the dam is based upon visual observations and review of available data. Detailed investigations and analyses involving topographic mapping, subsurface investigations, materials testing, and detailed computational evaluations are beyond the scope of a Phase I investigation; however, the investigation is intended to identify the need for such studies which should be performed by the owner.

In reviewing this report, it should be realized that the reported condition of the dam is based on observations of field conditions at the time of inspection along with data available to the inspection team. In cases where the reservoir was lowered or drained prior to inspection, such action, while improving the stability and safety of the dam, removes the normal load on the structure and may obscure certain conditions which might otherwise be detectable if inspected under the normal operating environment of the structure.

It is important to note that the condition of the dam depends on numerous and constantly changing internal and external factors which are evolutionary in nature. It would be incorrect to assume that the present condition of the dam will continue to represent the condition of the dam at some time in the future. Only through frequent inspections can unsafe conditions be detected and only through continued care and maintenance can these conditions be prevented or corrected.

Phase I investigations are not intended to provide detailed hydrologic and hydraulic analyses. In accordance with the established Guidelines, the spillway design flood is based on the estimated "Probable Maximum Flood" (PMF) for the region (greatest reasonably possible storm runoff), or fractions thereof. The spillway design flood provides a measure of relative spillway capacity and serves as an aid in determining the need for more detailed hydrologic and hydraulic studies, considering the size of the dam, its general condition, and the downstream damage potential.

PHASE I INSPECTION REPORT
NATIONAL DAM INSPECTION PROGRAM

SYNOPSIS OF ASSESSMENT AND RECOMMENDATIONS

NAME OF DAM:	Butler's Lake Dam
STATE LOCATION:	Pennsylvania
COUNTY LOCATION:	Allegheny
STREAM:	Drennen Branch of Boyd's Hollow Run
DATE OF INSPECTION:	11 December 1980
COORDINATES:	Lat. 40°15'54" Long. 79°47'18"

ASSESSMENT

Based on a review of available information and visual observations of conditions as they existed on the date of the field inspection, the general condition of the Butler's Lake Dam is considered to be fair.

This assessment is based primarily on visual observations of embankment and spillway conditions.

Butler's Lake Dam is a "small" size, "high" hazard dam. Corps of Engineers guidelines recommend one-half to one times the Probable Maximum Flood (PMF) as the Spillway Design Flood for a "small" size, "high" hazard dam. The Butler's Lake Dam's Spillway Design Flood is one-half the Probable Maximum Flood. Spillway capacity is "inadequate" because the non-overtopping flood discharge was found, by using the HEC-1 computer program, to be 43 percent of the PMF. At one-half PMF, the embankment is overtopped by a maximum 0.54 foot for approximately 2.8 hours. In the opinion of the evaluating engineer, this amount of overtopping is not sufficient to cause failure of the embankment.

The Phase I investigation revealed several deficiencies and conditions which should be corrected or improved through implementation of the following recommended evaluation, remedial, monitoring and maintenance efforts.

RECOMMENDATIONS

1. Additional Investigations: It is recommended that the owner retain the services of a registered professional engineer, knowledgeable in the design and construction of earth dams, to study and make recommendations on the following:

SYNOPSIS OF ASSESSMENT AND RECOMMENDATIONS (CONT'D)
Butler's Lake Dam

a. Relocation or improvement of the spillway's downstream channel to provide adequate erosion protection for the embankment's downstream slope and toe area. Proposed modifications should provide for protection and maintenance of the spring discharge below the dam.

b. The necessity to increase reservoir/spillway capacity.

c. Evaluation of the operability and capacity of the outlet works facility.

d. Recommendations for removal of tree stumps and animal burrows from the downstream slope and regrading of the slope to a uniform condition.

2. Emergency Operation and Warning Plan: The owner should develop an Emergency Operation and Warning Plan including:

a. Guidelines for evaluating inflow during periods of heavy precipitation or runoff.

b. Procedures for around the clock surveillance during periods of heavy precipitation or runoff.

c. Procedures for drawdown of the reservoir under emergency conditions.

d. Procedures for notifying downstream residents and public officials, in case evacuation of downstream areas is necessary.

3. Remedial Work. The visual inspection disclosed other minor deficiencies which should be corrected or monitored. These are:

a. Improving the embankment crest to remove vehicle ruts and standing water, and provide adequate drainage and erosion protection.

a. Removal of reinforcing bars from the crest of the spillway weir.

c. Removal of brush piles from the downstream slope and toe areas.

d. Implementation of a regularly scheduled monitoring program to observe the spring discharge below the dam for changes in quantity and quality.

SYNOPSIS OF ASSESSMENT AND RECOMMENDATIONS (CONT'D)
Butler's Lake Dam

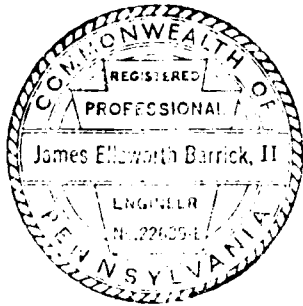

Samuel G. Mazzella 8 May 1981
Samuel G. Mazzella Date
Project Engineer

James P. Hannan 8 May 1981
James P. Hannan Date
Project Engineer

James E. Barrick 8 May 81
James E. Barrick, P.E. Date
PA Registration No. 022639-E

Approved by: James W. Peck
James W. Peck
Colonel, Corps of Engineers
District Engineer

22 May 1981
Date

Accession For	
NTIS CRA&I	<input checked="" type="checkbox"/>
DTIC TAB	<input type="checkbox"/>
Unannounced	<input type="checkbox"/>
Justification	<i>for 50 per free</i>
By	
Dist	
Availability Codes	
Dist	

A

BUTLER'S LAKE DAM



OVERVIEW

TABLE OF CONTENTS

	<u>Page</u>
PREFACE	i
SYNOPSIS OF ASSESSMENT AND RECOMMENDATIONS	ii
OVERVIEW PHOTOGRAPH	v
SECTION 1 - PROJECT INFORMATION	
1.1 General	1
1.2 Description of Project	1
1.3 Pertinent Data	3
SECTION 2 - ENGINEERING DATA	
2.1 Design	5
2.2 Construction	6
2.3 Modification/Repair	6
2.4 Operation	7
2.5 Evaluation	7
SECTION 3 - VISUAL INSPECTION	
3.1 Findings	8
3.2 Evaluation	12
SECTION 4 - OPERATIONAL FEATURES	
4.1 Procedure	14
4.2 Maintenance of Dam	14
4.3 Inspection of Dam	14
4.4 Warning System	14
4.5 Evaluation	14
SECTION 5 - HYDROLOGY AND HYDRAULICS	
5.1 Evaluation of Features	15
SECTION 6 - STRUCTURAL STABILITY	
6.1 Available Information	17
6.2 Evaluation	18
SECTION 7 - ASSESSMENT AND RECOMMENDATIONS	
7.1 Assessment	19
7.2 Recommendations	20

TABLE OF CONTENTS (cont'd)

	<u>Page</u>
APPENDIX A - VISUAL INSPECTION CHECKLIST	
Visual Observations Checklist I	A1
Field Sketch	A11
Field Profile and Section	A12
Weir Plan, Elevation and Spillway Profile	A13
APPENDIX B - ENGINEERING DATA CHECKLIST	
APPENDIX C - PHOTOGRAPHS	
Photo Key Map	C1
Photos 1 through 16	C2
Photo Descriptions	C6
APPENDIX D - HYDROLOGY AND HYDRAULICS ANALYSES	
Methodology	D1
Engineering Data	D3
HEC-1 Data Base	D4
Spillway Stage-Discharge Relationship	D5
Loss Rate and Base Flow Parameters	D8
Elevation-Area-Capacity Relationships	D8
Overtop Parameters	D9
Program Schedule	D9
HEC-1 Computer Analysis	D10
Hydrologic Performance Plot	D13
APPENDIX E - PLATES	
List of Plates	E1
Plates I through III	E2
APPENDIX F - GEOLOGY	
Geomorphology	F1
Stratigraphy	F1
Mining Activities	F1
Geologic Map	F2
Geologic Column	F3

PHASE I INSPECTION REPORT
NATIONAL DAM INSPECTION PROGRAM
BUTLER'S LAKE DAM
NATIONAL I. D. NO. PA 01067
PennDER No. 2-29

SECTION 1
PROJECT INFORMATION

1.1 GENERAL

a. Authority: The Phase I investigation was performed pursuant to authority granted by Public Law 92-367 (National Dam Inspection Act) to the Secretary of the Army, through the Corps of Engineers, to conduct inspections of dams throughout the United States.

b. Purpose: The purpose of the investigation is to make a determination on whether or not the dam constitutes a hazard to human life or property.

1.2 DESCRIPTION OF PROJECT

a. Dam and Appurtenances:

(1) Embankment: Butler's Lake Dam was designed and constructed as a earthfill structure with a foundation cutoff. The embankment is 435 feet long (excluding spillway), with a toe to crest height of 30.2 feet and a crest width of 12 feet. The embankment's upstream slope was observed to be 1.3H:1V above the waterline. The downstream slope was 1.8H:1V above a central bench and 1.9H:1V below the bench.

(2) Outlet Works: The outlet works facility consists of a 12 inch diameter cast iron pipe with a reinforced concrete control tower. The tower is located approximately 50 feet upstream from the crest of the dam.

(3) Principal (and Emergency) Spillway: The spillway is a concrete lined, open channel located at the junction of the embankment and left abutment. Flow control is by a concrete weir wall that has a 24.4 foot crest length. Flow over the weir is to a concrete slab discharge channel. A concrete slab bridge crosses the spillway.

(4) Freeboard Conditions: Freeboard between the spillway crest and the minimum observed elevation of the embankment was 3.1 feet on the date of the field inspection.

(5) Downstream Conditions: Boyd's Hollow Run, below Butler's Lake Dam, flows through a moderately steep sloped valley for about 1.8 miles to a confluence with the Youghiogheny River at Buena Vista, Pennsylvania. In the first 8,000 feet below the dam, at least 10 inhabited dwellings lie on the floodplain at elevations low enough to possibly be affected by high flows.

(6) Reservoir: Butler's Lake is about 1,300 feet long at the normal pool elevation and has a surface area of 7.3 acres. When the pool is at the crest of the dam, the reservoir length increases to 1,550 feet and the surface area is about 9.0 acres.

(7) Watershed: The watershed contributing to Butler's Lake, 192 acres, is predominately grassland and woodland with some residential development.

b. Location: Butler's Lake Dam is located in Elizabeth Township, Allegheny County, Pennsylvania, approximately 1.4 miles southwest of Buena Vista, Pennsylvania.

c. Size Classification: The dam has a maximum storage capacity of 94 acre-feet and a toe to crest height of 30.2 feet. Based on the Corps of Engineers guidelines, this dam is classified as an "small" size structure.

d. Hazard Classification: Butler's Lake Dam is classified as a "high" hazard dam. In the event of a dam failure, Legislative Route 02111 and at least ten inhabited dwellings on the floodplain below could be subjected to possible damage and loss of more than a few lives could result.

e. Ownership: Butler's Lake Dam is owned by the Butler's Golf Course. Correspondence can be addressed to:

Butler's Golf Course
800 Rock Run Road
Elizabeth, Pennsylvania 15037
Attention: Mr. Ralph Nill
(412) 751-4222

f. Purpose of Dam: Butler's Lake Dam was constructed as a water supply source.

g. Design and Construction History: The dam was designed by Alex. L. McVicker, Registered Engineer, Monongahela, Pennsylvania, in 1939. The contractor who constructed Butler's Lake Dam is unknown.

h. Normal Operating Procedure: Butler's Lake Dam was designed to operate as an uncontrolled structure. Under normal operating conditions, the pool level is maintained by the crest of the spillway. The spillway also provides capacity to pass flood flows.

1.3 PERTINENT DATA

a.	<u>Drainage Area</u>	0.30 sq. mi.
b.	<u>Discharge</u>	
	Maximum Flood at Dam	Unknown
	Principal (and Emergency) Spillway Capacity at Design Top of Dam	264 cfs
	Principal (and Emergency) Spillway Capacity at Current Top of Dam	231 cfs
c.	<u>Elevation (feet above MSL)</u>	
	Design Top of Dam	1010.8*
	Current Top of Dam (low point)	1010.2
	Principal (and Emergency) Spillway Overflow Crest	1007.1
	Normal Pool	1007.1
	Outlet Works Inlet Invert	Unknown
	Outlet Works Outlet Invert	980.0
	Toe of Embankment	980.0
d.	<u>Reservoir Length</u>	
	Length of Maximum Pool	1550 feet
	Length of Normal Pool	1300 feet
e.	<u>Reservoir Storage</u>	
	Design Top of Dam	100 acre-feet
	Current Top of Dam	94 acre-feet
	Principal (and Emergency) Spillway Crest	69 acre-feet
f.	<u>Reservoir Surface</u>	
	Design Top of Dam	9.4 acres
	Current Top of Dam	9.0 acres
	Principal (and Emergency) Spillway Crest	7.3 acres

g. Embankment

Type	Earth
Length	435 feet
Height	30.2 feet
Crest Width	12 feet
Slopes	
Downstream	1.8H:1V to 1.9H:1V
Upstream	1.3H:1V
Zoned Embankment	Yes*
Cutoff Provisions	Yes*

h. Principal (and Emergency) Spillway

Type	Rectangular Open Channel
Flow Control	Concrete Wall Weir
Location	Left Abutment
Overflow Crest Length	24.4 feet
Crest Elevation	1007.1

i. Outlet Works

Type	Reinforced Concrete Tower with 12 inch diameter C.I. pipe
Location	Near Center of Dam
Inlet Invert Elevation	Unknown
Outlet Invert Elevation	980.0
Trash Screen	Yes*
Conduit Length	96 feet*
Sluice Gate	Yes*
Anti-Seep Collars	Yes, 6*

*Taken or derived from available engineering drawings or reports.

SECTION 2
ENGINEERING DATA

2.1 DESIGN

a. Data Available: The following written information and data may be obtained from the Pennsylvania Department of Environmental Resources, Harrisburg, Pennsylvania. The information was reviewed for this study.

(1) Miscellaneous correspondence related to permit application requirements and approval conditions.

(2) Application, application reports and permit for construction of a dam by John W. Butler.

(3) Set of design drawings (2 sheets) by Alex. L. McVicker, Registered Engineer, dated June 1939.

(4) Specifications for dam construction prepared by Alex. L. McVicker, P.E., undated.

(5) Inspection reports by Department of Environmental Resources personnel dated 11 July 1941, 24 June 1952 and 19 March 1964.

(6) A calculation showing spillway capacity for various drainage areas prepared by Department of Forests and Waters personnel, dated 28 July 1964.

b. Design Features: The embankment and appurtenances were designed in accordance with Water and Power Resources Board criteria.

(1) Field Investigation: Six test pits were excavated prior to construction; the logs are presented on Design Drawing, Sheet 1 of 2 (Appendix E). They indicate a soil profile consisting of topsoil, loam, and fire clay which extends to bedrock consisting of limestone, sandstone and shale. State dam personnel recommended that the walls of the outlet riser and the piers of the spillway be founded on rock to reduce the possibility of settlement.

(2) Embankment: The embankment was designed as a compacted earthfill structure. The upstream portion was designated to receive "selected" material and downstream portion was to receive "common" material compacted in 6 inch lifts. A "main puddle trench" was to be constructed the length of the dam along the line of the spillway weir. The trench was to be constructed into impervious material or be at least one foot deep. The upstream face was to be riprapped with a good quality sandstone, one foot in depth placed on six inches of gravel.

(3) Outlet Works and Water Supply Pipeline: According to the design drawings, a 12 inch diameter cast iron outlet works conduit and an 8 inch diameter cast iron water supply pipeline pass through the embankment foundation. Both lines were to be placed on a concrete cradle 6 inches thick at the base with the concrete extending halfway up the pipe.

(4) Principal (and Emergency) Spillway: The spillway is a concrete lined open channel located at the left abutment. Flow control is by concrete wall weir which has a crest length of 24.4 feet and a height of three feet.

2.2 CONSTRUCTION

a. Contractors: The contractor who constructed Butler's Lake Dam is unknown.

b. Construction Period: The embankment and appurtenances were constructed between 1939 and 1941.

c. Field Changes: There are no records of any field changes during the construction of this dam.

d. Construction Inspection: On-site construction inspections were performed by representatives of the Commonwealth of Pennsylvania on 21 August 1940 and 27 June 1941.

2.3 MODIFICATION/REPAIR

The lower portion of the proposed wasteway (spillway) discharge channel was not constructed as designed.

A "leak" developed in an excavated hole in the wasteway channel in 1940. A grouting program by the owner was apparently not effective and he was advised by Division of Dams personnel to use a cement grout mixture.

There are no reports of any major repairs to this dam since its completion in 1941.

Flashboards and a fish screen were ordered removed from the spillway opening following the 19 June 1952 inspection by Division of Dams personnel.

The design drawings show a spillway weir wall height of 3 feet. Phase I field inspection measurements showed the wall to be 5.1 feet high. Based on dam inspection reports by state personnel, this modification must have been made after 1952.

A diversion pipe for filling the pond was observed to be obstructing the wasteway channel during a PennDER inspection on 19 March 1964. The pipe was not observed during the Phase I field inspection.

A new water intake and pump house was added to the facility recently. Its installation is not reported in the files of PennDER, Division of Dam Safety.

2.4 OPERATION

According to the Water and Power Resources Board, Butler's Golf Course is responsible for the operation of Butler's Lake Dam.

The principal (and emergency) spillway is uncontrolled and the dam does not require a dam tender.

Performance and operation records are not maintained and the outlet works is normally closed.

2.5 EVALUATION

a. Availability: Available design information and drawings were obtained from the Pennsylvania Department of Environmental Resources.

b. Adequacy: The available design information, supplemented by field inspection and engineering analyses presented in succeeding sections, is adequate for the purpose of this Phase I Inspection Report.

c. Validity: There appears to be no reason to question the validity of the available design information and drawings although some deviations from design conditions were observed.

The lack of an access bridge prevented examination of the outlet works intake structure.

SECTION 3
VISUAL INSPECTION

3.1 FINDINGS

a. General: The field inspection of the Butler's Lake Dam was performed on 11 December 1980, and consisted of:

(1) Visual observations of the embankment crest and slopes, groins and abutments;

(2) Visual observations of the principal (and emergency) spillway including approach and discharge channels and overflow crest;

(3) Visual observations of portions of the outlet works intake structure and conduit;

(4) Visual observations of the embankment's downstream toe area including drainage channels and surficial conditions;

(5) Visual observations of the reservoir shoreline, inlet stream channel, and watershed;

(6) Visual observations of downstream conditions and evaluation of the downstream hazard potential;

(7) Transit stadia surveys of relative elevations along the embankment crest centerline, spillway, and across the embankment slopes.

The visual observations were made during periods when the reservoir was at normal operating level. There was no defined tailwater.

The visual observations checklist, field sketch, profile and section, and weir plan, elevation and spillway profile containing the observations and comments of the field inspection team are contained in Appendix A. Specific observations are illustrated on photographs in Appendix C. Detailed findings of the field inspection are presented in the following sections.

b. Dam Configuration: Butler's Lake Dam is an earthen impounding embankment constructed across Drennen Branch of Boyd's Hollow Run, a tributary to the Youghiogeny River. The dam forms Butler's Lake. The principal (and emergency) spillway is a weir controlled concrete open channel on the left abutment. The concrete wall overflow crest of the spillway maintains the lake pool level at approximately Elevation 1007.1. Normal and storm flows are discharged through the spillway to the dam's left downstream groin.

c. Embankment:

(1) Crest: The crest of Butler's Lake Dam was somewhat higher toward the ends of the dam than at the center. There were no visible cracks or significant depressions observed in the crest. However, considerable wheel rutting was noted at both the left and right ends of the embankment. Many of the wheel ruts contained standing water. Crest vegetation was generally sparse.

The crest appeared to have proper horizontal alignment. No offsets or unusual conditions were observed that would indicate movement of the embankment.

(2) Upstream Slope: The upstream slope was covered with a layer of cobble sized sandstone riprap erosion protection. The slope was not uniform; but changes were gradual and gave no indication of instability, settlement or detrimental movement.

(3) Downstream Slope: The downstream face of the embankment was generally vegetated and had recently been cleared of small to moderate sized trees, particularly on the lower slope. Numerous stumps were observed, and diameters were measured to range from 2 to 6 inches.

The slope was locally bulgy and uneven. Close observation indicated that many of the bulges were diggings from animal burrows.

Portions of the downstream slope and toe area below the embankment were obscured by piles of recent tree cuttings.

The visual inspection revealed no strong indications of slope instability, high ground water levels within the embankment, or erosion of embankment slopes.

d. Abutments:

(1) Right: The right abutment was lightly to moderately wooded and was generally mild in slope. There were no indications of abutment instability or significant erosion above or below the dam.

The junction of the abutment and the embankment was generally vegetated and contained no indications of seepage or erosion.

(2) Left: The left abutment was generally grass covered and appeared to be well maintained. The abutment slope was mild to moderate. There were no indications of abutment erosion or instability either above or below the embankment.

The junction of the left abutment and the embankment was not well-defined but contained the spillway discharge channel and a portion of the downstream channel.

e. Principal (and Emergency) Spillway:

(1) Approach Channel: The spillway approach channel contained some debris immediately behind the overflow crest. No other obstructions were observed that would reduce the capacity of the spillway during high flows.

(2) Overflow Crest: The spillway overflow crest consists of a concrete wall weir structure located between concrete training walls beneath the spillway bridge. The concrete was in fair condition with only minor deterioration and leakage noted at and around construction joints.

Several rusted reinforcing bars protruded from the top of the concrete wall. Some of the bars contained minor amounts of debris.

(3) Discharge Channel: The discharge channel was in good condition. Only minor cracking and deterioration of concrete training walls and base slab were noted. Some minor undercutting was observed at the junction of the training walls and the base slab.

(4) Bridge: The spillway bridge was functional on the date of inspection. Some deterioration of concrete was noted at the downstream edge of the bridge slab, but it did not appear to reduce the structural integrity of the slab.

The slab surface could not be inspected because of a thick covering of mud.

The handrail contained surficial rust and appeared to be in good condition.

f. Outlet Works:

(1) Intake Structure: The outlet works intake is located in a concrete riser structure approximately 50 feet upstream of the embankment crest. No access bridge was available for inspection of the structure. No cracking and only minor deterioration of concrete surfaces were observed from the crest of the dam.

(2) Conduit: The outlet works conduit could not be observed except at the immediate downstream toe of the embankment. At this point, the conduit was 12 inch diameter cast iron and was partially clogged with fine soil materials.

(3) Discharge Channel: The outlet works discharge channel could not be observed because of a large brush pile immediately downstream of the conduit outlet point.

g. Reservoir:

(1) Slopes: The slopes above the reservoir shoreline were generally mild to moderately steep. The slopes were heavily wooded on the right side of the reservoir and generally grass covered on the left. There were no indications of shoreline instability anywhere along the perimeter of the reservoir.

(2) Inlet Stream: The inlet stream to the reservoir approaches through a natural channel that was heavily overgrown with brush and small trees.

(3) Sedimentation: The upper end of the reservoir contained a moderate amount of sediment.

(4) Watershed: The watershed was generally as indicated by the U.S.G.S. topographic map. There were no indications of significant new construction or mining activities in the watershed.

h. Downstream Conditions:

(1) Downstream Channel: The downstream channel below the spillway discharge channel is a partially riprap lined, open channel along the embankment groin. The channel has been cleared of trees and heavy brush for a distance of approximately 50 feet below the discharge channel. The channel then enters a narrow, steep, tree lined channel for approximately 150 feet where it enters a pond on the floodplain below the dam. Below the pond, the channel is narrow and densely vegetated with trees and brush for about 500 feet where it enters a culvert beneath Legislative Route 02111.

(2) Downstream Spring: A spring discharging an estimated 10 to 15 gallons per minute was observed in the downstream channel approximately 100 feet below the crest of the embankment. There was considerable iron staining in the vicinity of the spring, but no sediments or moving fine soil particles were observed.

(3) Floodplain Development: In the first 8,000 feet below the dam, there are at least ten inhabited dwellings that lie on the floodplain at elevations low enough to possibly be affected by high flows.

3.2 EVALUATION

The following evaluations are based on the visual inspection performed on 11 December 1980.

a. Embankment: The condition of the Butler's Lake Dam embankment was fair. Deficiencies of the embankment were observed, which included:

(1) A considerable number of animal burrows on the downstream face of the embankment.

(2) A considerable number of tree stumps in the lower portion of the downstream face of the embankment.

(3) Brush piles on and about the embankment that obscured observation of embankment and downstream conditions.

(4) Wheel rutting and barren areas on the embankment crest.

b. Principal (and Emergency) Spillway: The observed condition of the spillway was fair. This is based on observation of the following deficiencies:

(1) Alignment of the spillway discharge channel which could result in large spillway flows in or near the left groin of the embankment. The current alignment could result in erosion of the embankment under adverse flow conditions.

(2) Debris in the approach channel that might reduce the capacity of the spillway.

(3) Steel reinforcing bars protruding from the overflow crest that enhance the potential for clogging of the spillway.

(4) Minor leakage of the overflow crest wall and minor undercutting of the training walls at the junction with the base slab.

c. Outlet Works: The condition of the outlet works could not be determined. No access was available to the intake structure and it could not be determined if the flow control was operative. Discussions with the Owner indicated that the lake had never been drained.

The downstream end of the outlet works conduit was partially clogged and the discharge channel below could not be inspected because of a large brush pile.

d. Downstream Channel: The downstream channel immediately below the discharge channel of the spillway was in poor condition. This is based on observations that the channel lies in the groin of the embankment and abutment, and significant flows in the discharge channel for extended periods could imperil the toe of the embankment. The riprap lining on the base of the channel did not appear to be sufficient to withstand the erosive potential of high flows.

e. Downstream Spring: The origin of the spring in the downstream channel could not be determined, but it did not appear to present an immediate threat to the structure.

f. Hazard Potential: Based on the observed downstream floodplain conditions, Butler's Lake Dam was assigned a "high" hazard potential rating.

SECTION 4
OPERATIONAL FEATURES

4.1 PROCEDURE

Reservoir pool level is maintained at the elevation of the overflow crest of the principal (and emergency) spillway.

Normal operating conditions do not require a dam tender.

The outlet works is normally closed.

4.2 MAINTENANCE OF DAM

The embankment and appurtenances are maintained by Butler's Golf Course. Maintenance reportedly consists of periodically repairing eroded areas and making miscellaneous repairs as necessary.

4.3 INSPECTION OF DAM

Butler's Golf Course is required by the State of Pennsylvania to inspect the dam annually and make needed repairs.

4.4 WARNING SYSTEM

There is no warning system and no formal emergency procedure to alert or evacuate downstream residents upon threat of a dam failure.

4.5 EVALUATION

The maintenance program should be continued. However, there are no written operation, maintenance or inspection procedures, nor is there a warning system or formal emergency procedure for this dam. These procedures should be developed in the form of checklists and step by step instructions, and should be implemented as necessary.

SECTION 5
HYDROLOGY AND HYDRAULICS

5.1 EVALUATION OF FEATURES

a. Design Data: Butler's Lake Dam has a watershed of 192 acres, which is vegetated primarily by woodland, grassland and residential development. The watershed is about one mile long and one half mile wide and has a maximum elevation of 1,220 feet (MSL).

At the spillway crest elevation, the lake has a surface area of 7.3 acres and a storage capacity of 68.7 acre-feet. The spillway overflow crest has a recessed configuration with a total effective length of 24.4 feet. The spillway is located at the junction of the left abutment and the embankment.

Spillway capacity and embankment freeboard were made sufficient to accommodate at least 525 cubic feet per second, which was considered sufficient for this structure and watershed at the time of design.

No hydrologic calculations were found relating reservoir/spillway performance to the Probable Maximum Flood or fractions thereof.

b. Experience Data: Records are not kept of reservoir level or rainfall amounts. There is no record or report of the embankment ever being overtopped.

c. Visual Observations: On the date of the field inspection, no serious deficiencies were observed that would prevent the spillway from functioning. The pool elevation, at the time of the inspection, was about 3.3 feet below the crest of the dam.

The alignment of the spillway discharge channel directs spillway flows into or near the embankment's left groin. This could lead to detrimental erosion of the embankment under adverse flow conditions.

The stadia survey performed during the Phase I investigation indicated that the minimum elevation of the embankment crest was 1010.2. The benchmark elevation used for the embankment survey was the base of the emergency spillway weir (Elevation 1002.0 as indicated on Sheet No. 2 of the design drawings).

d. Overtopping Potential: Overtopping potential was investigated through the development of the Probable Maximum Flood (PMF) for the watershed and the subsequent routing of the PMF and fractions of the PMF through the reservoir and spillway. The Corps of Engineers guidelines recommend 0.5 to one times the Probable Maximum Flood (PMF) for "small" size, "high" hazard dams. Based on the dam's relatively small size and observed downstream conditions, Butler's Lake Dam's was assigned Spillway Design Flood (SDF) of one-half the PMF.

Hydrometeorological Report No. 33 indicates the adjusted 24 hour Probable Maximum Precipitation (PMP) for the subject site is 19.3 inches. No calculations are available to indicate whether the reservoir and spillway are sized to pass a flood corresponding to the runoff from 9.7 inches of rainfall in 24 hours. Consequently, an evaluation of the reservoir/spillway system was performed to determine whether the dam's spillway capacity is adequate under current Corps of Engineers guidelines.

The Corps of Engineers, Baltimore District, has directed that the HEC-1 Dam Safety Version computer program be utilized. The program was prepared by the Hydrologic Engineering Center (HEC), U.S. Army Corps of Engineers, Davis, California, July 1978. The major methodologies and key input data for this program are discussed briefly in Appendix D.

The peak inflow to Butler's Lake Dam was determined, by HEC-1, to be 910 cfs for a full PMF. The peak inflow for the SDF was 455 cfs.

An initial pool elevation of 1007.1 was assumed prior to commencement of the storm.

e. Spillway Adequacy: The capacity of the combined reservoir and spillway system was determined to be 43 percent of the PMF by HEC-1. According to Corps of Engineers' guidelines, Butler's Lake Dam spillway is "inadequate".

The maximum dam overtopping depth for the SDF was calculated by HEC-1 to be 0.54 foot. In the event of the occurrence of an SDF, overtopping would be limited to approximately 170 feet of the embankment crest near the left end of the dam. Duration of this overtopping would be approximately 2.8 hours. In the opinion of the evaluating engineer, this overtopping would not cause a failure of the embankment. This is based on the computed flow depth and duration, and observed soil conditions. An overtopping depth of at least one foot above the minimum elevation of the crest was judged by the engineer to be necessary to cause failure of the dam. Consequently, a breach analysis and downstream routing were not performed.

SECTION 6
STRUCTURAL STABILITY

6.1 AVAILABLE INFORMATION

a. Design and Construction Data: All available design documentation, calculations and other data received from the Pennsylvania Department of Environmental Resources were reviewed. The dam and appurtenances were designed by Alex. L. McVicker, Registered Engineer, of Monongahela, Pennsylvania, in 1939. There were no structural design calculations available for review. A detailed list of available information is found in Appendix B.

b. Operating Records: There are no written operating records or procedures for this dam.

c. Post-Construction Changes: Phase I investigation field measurements showed a spillway weir height of 5 feet as compared with a three foot weir height specified on the design drawings. A horizontal construction joint was visible in the weir wall at about 3 feet above the base slab. Review of data received from PennDER suggests that the weir was raised some time after 1952.

A water intake and pump house has been recently constructed on a peninsular fill placed on the upstream slope of the dam.

d. Visual Observations: The field inspection disclosed no evidence of potential instability of the embankment or its components, although non-uniformities in the embankment face were observed. The measured embankment slopes were found to be relatively steep by current design standards, but the overall downstream slope including bench was approximately 2H:1V. Also, the downstream slope contained numerous tree stumps and animal burrows at the time of the inspection.

There was no visible evidence of a high ground water level or seepage through or beneath the embankment.

e. Performance: There has been no indication or report of any problems associated with stability of the embankment or appurtenances over the 42 year life of the structure.

A spring was observed in the downstream channel approximately 100 feet below the crest of the dam. The discharging water was clear and no nearby sediment deposits were noted. PennDER records suggest that the spring has been in existence since 1941.

6.2 EVALUATION

a. Design Documents: The design documentation was, by itself, considered inadequate to evaluate the structure. No structural calculations were available for review.

b. Embankment: Based on results of the visual inspection that included observations of embankment slopes, materials, and seepage conditions, Butler's Lake Dam appeared to be stable.

c. Principal and (Emergency) Spillway: Based on results of the visual inspection, the principal and (emergency) spillway structure for Butler's Lake Dam appeared to be stable.

d. Seismic Stability: According to the Seismic Risk Map of the United States, Butler's Lake Dam is located in Zone 1 where damage due to earthquakes would most likely be minor.

A dam located in Seismic Zone 1 may be assumed to present no hazard from an earthquake provided static stability conditions are satisfactory and conventional safety margins exist. No calculations were developed to verify this assessment, however.

SECTION 7
ASSESSMENT AND RECOMMENDATIONS

7.1 ASSESSMENT

a. Evaluation:

(1) Embankment: Butler's Lake Dam's embankment is considered to be in fair condition. This is based on visual observations that revealed several deficiencies.

(2) Principal (and Emergency) Spillway: The condition of the spillway is considered to be fair. This is based on an "inadequate" capacity rating as determined using HEC-1, and visual observations of structural and alignment deficiencies.

The Spillway Design Flood, based on hazard classification and size, is one half the Probable Maximum Flood. The combined spillway/reservoir capacity was found to be 43% of the Probable Maximum Flood.

(3) Outlet Works: The outlet works facility could not be evaluated to determine its condition. Limited observations of the intake structure and discharge pipe, however, indicated a state of disrepair.

(4) Spring: The spring located in the downstream channel appeared to be stable in terms of quantity and quality of discharge.

(5) Emergency Plans: The lack of a documented emergency operation and warning plan is considered to be a deficiency.

b. Adequacy of Information: The information available on design, construction, operation and performance history in combination with visual observations and hydrology and hydraulic calculations was sufficient to evaluate the embankment and appurtenant structures in accordance with the Phase I investigation guidelines.

c. Urgency: The recommendations presented in Section 7.2 should be implemented immediately.

d. Necessity for Further Studies: Additional engineering information should be developed to improve the condition of the spillway's downstream channel and evaluate the condition of the outlet works facility.

7.2 RECOMMENDATIONS

a. Additional Investigations: It is recommended that the owner retain the services of a registered professional engineer, knowledgeable in the design and construction of earth dams, to study and make recommendations on the following:

(1) Relocation or improvement of the spillway's downstream channel to provide adequate erosion protection for the embankment's downstream slope and toe area. Proposed modifications should provide for protection and maintenance of the spring discharge below the dam.

(2) The necessity to increase reservoir/spillway capacity.

(3) Evaluation of the operability and capacity of the outlet works facility.

(4) Recommendations for removal of tree stumps and animal burrows from the downstream slope and regrading of the slope to a uniform condition.

b. Emergency Operation and Warning Plan: The owner should develop an Emergency Operation and Warning Plan including:

(1) Guidelines for evaluating inflow during periods of heavy precipitation or runoff.

(2) Procedures for around the clock surveillance during periods of heavy precipitation or runoff.

(3) Procedures for drawdown of the reservoir under emergency conditions.

(4) Procedures for notifying downstream residents and public officials, in case evacuation of downstream areas is necessary.

c. Remedial Work: The visual inspection disclosed other minor deficiencies which should be corrected or monitored. These are:

(1) Improving the embankment crest to remove vehicle ruts and standing water, and provide adequate drainage and erosion protection.

(2) Removal of reinforcing bars from the crest of the spillway weir.

(3) Removal of brush piles from the downstream slope and toe areas.

(4) Implementation of a regularly scheduled monitoring program to observe the spring in the downstream channel for changes in quantity and quality.

APPENDIX A
VISUAL INSPECTION CHECKLIST

VISUAL OBSERVATIONS CHECKLIST I
(NON-MASONRY IMPOUNDING STRUCTURE)

Name Dam Butler's Lake County Allegheny State Pennsylvania National ID # PA 01067

Type of Dam Earth Hazard Category High

Date of Inspection 11 December 1980 Weather Cloudy, cold, light snow Temperature 25°F

Pool Elevation at Time of Inspection 1006.9 (MSL)

Tailwater at Time of Inspection None

Inspection Personnel: J. E. Barrick, P.E. Ackenheil & Associates, Project Manager
and Hydrologist
J. P. Hannan Ackenheil & Associates, Geotechnical Engineer
S. G. Mazzella Ackenheil & Associates, Civil Engineer
C. A. Woodward Pennsylvania Department of Environmental Resources
R. Nill Owner

Recorder J. E. Barrick

GEO Project G80138-N
PENNDER I.D. No. 2-29

EMBANKMENT

VISUAL EXAMINATION OF	OBSERVATIONS	REMARKS OR RECOMMENDATIONS
SURFACE CRACKS	None observed.	
UNUSUAL MOVEMENT OR CRACKING AT OR BEYOND THE TOE	None observed.	
SLOUGHING OR EROSION OF EMBANKMENT AND ABUTMENT SLOPES	None observed.	
VERTICAL AND HORIZONTAL ALIGNMENT OF THE CREST	The crest was approximately level at the right center portion of the dam and appeared to rise towards both ends. The horizontal alignment appeared to be in accordance with design conditions. There were no offsets, indications of misalignment or indications of post-construction alignment changes.	
RIPRAP FAILURES	None observed.	
SETTLEMENT	None observed.	

EMBANKMENT (CONTINUED)

VISUAL EXAMINATION OF	OBSERVATIONS	REMARKS OR RECOMMENDATIONS
JUNCTION OF EMBANKMENT AND ABUTMENT	The junction of the embankment and the right abutment appeared to be in good condition, although it was heavily brush covered. There were no indications of erosion, seepage, or slope instability.	The junction of the embankment and the left abutment contained the spillway discharge and downstream channels.
JUNCTION OF EMBANKMENT AND SPILLWAY	The junction of the embankment and the spillway appeared to be in good condition. No erosion or seepage conditions were observed.	See <u>Principal (and Emergency) Spillway: Discharge Channel and Downstream Conditions</u> : Channel for further comments.
ANY NOTICEABLE SEEPAGE	A spring, discharging an estimated 10 to 15 gallons per minute, was observed in the spillway downstream channel approximately 100 feet below the crest of the dam. Considerable iron staining was observed in the vicinity of the spring, but no sediments or active erosion were noted.	
DRAINS	Two drains located in the spillway walls beneath the bridge were observed. The drain on the left wall was dry. The drain exiting the right wall was discharging a small amount of water (less than 1 gph).	
EROSION PROTECTION	The erosion protection on the embankment's upstream slope consisted of cobble sized sandstone rock that appeared to have been hand-placed. No erosion or displacement of the erosion protection blanket was observed. Considerable vegetation was growing through.	

EMBANKMENT (CONTINUED)

VISUAL EXAMINATION OF	OBSERVATIONS	REMARKS OR RECOMMENDATIONS
SURFICIAL CONDITIONS	<p>The crest of the embankment contained numerous barren areas and wheel ruts, many of which contained water. Wheel rutting and disturbance of the crest were particularly noticeable towards the left end of the embankment. No significant erosion of the crest was observed.</p>	
	<p>The upstream slope was somewhat uneven but appeared to be in good condition. No erosion or anomalous slope conditions were observed.</p>	
	<p>The downstream slope was moderately steep and contained a bench-like area at approximately mid-height. The upper portion of the slope was generally uniform but contained a considerable number of small lumps and bulges. Upon close observation, many of the lumps and bulges were found to be animal burrow diggings. The upper portion of the slope had recently been cleared of small trees and dense brush.</p>	
	<p>The bench and lower portion of the embankment's downstream slope contained numerous stumps of recently cut trees. Stump diameters ranged from 2 to 6 inches. The bench and lower slope were bulgy and lumpy, and contained numerous animal burrows. Three large brush piles consisting of recent tree cuttings were observed in the area immediately below the toe of the embankment. Four smaller brush piles were observed on the bench of the embankment.</p>	
	<p>No strong indications of embankment slope instability, high embankment ground water or embankment erosion were observed on or immediately below the downstream slope.</p>	

PRINCIPAL (AND EMERGENCY) SPILLWAY

<u>VISUAL EXAMINATION OF</u>	<u>OBSERVATIONS</u>	<u>REMARKS OR RECOMMENDATIONS</u>
APPROACH CHANNEL	<p>The approach channel to the spillway contained some floating debris immediately behind the overflow crest. Above this, the approach channel was free of obstructions that might reduce the discharge capacity of the spillway.</p>	
OVERFLOW CREST	<p>The spillway overflow crest appeared to be in functional condition. No significant cracking or concrete deterioration was observed. Some minor leakage was noted at the junction of the overflow crest wall and the spillway left training wall. Some concrete deterioration was noted at a construction joint approximately 2 feet below the crest of the wall. Several rusted reinforcing bars protruded from the top of the overflow crest and contained a small amount of debris and vegetal matter.</p>	
DISCHARGE CHANNEL	<p>The spillway discharge channel appeared to be in good condition. No significant cracking of walls or slab were noted and no significant deterioration of concrete surfaces was observed. The junction of both training walls and the discharge channel slab showed minor undercutting. Channel alignment directs flows into the left embankment groin.</p>	
BRIDGE AND PIERS	<p>The reinforced concrete bridge deck contained minor concrete cracking and deterioration but was of such a thickness that its structural capacity was not in question.</p> <p>Steel pipe handrails contained a layer of surface rust, but otherwise appeared to be in good condition.</p>	

OUTLET WORKS

<u>VISUAL EXAMINATION OF</u>	<u>OBSERVATIONS</u>	<u>REMARKS OR RECOMMENDATIONS</u>
INTAKE STRUCTURE	<p>The intake structure was observed in the lake approximately 50 feet upstream of the crest of the dam. Two steel rails extended from a concrete headwall on the upstream slope to the intake structure. However, no walkway was available to provide access to the structure.</p> <p>The concrete of the intake structure was observed to be in fair condition with some minor deterioration of concrete surfaces.</p>	
CONDUIT	<p>The outlet works conduit was observed only at the downstream toe of the embankment where it was measured to be 12 inch diameter cast iron pipe. The lower half of the pipe was silted in.</p>	
OUTLET STRUCTURE	<p>None observed.</p>	
DISCHARGE CHANNEL	<p>The outlet works discharge channel could not be observed because of a brush pile immediately downstream of the conduit outlet.</p>	

WATER SUPPLY FACILITY

VISUAL EXAMINATION OF	OBSERVATIONS	REMARKS OR RECOMMENDATIONS
INTAKE STRUCTURE	<p>The water supply facility intake structure and pump house is located on a small peninsula extending into the lake from the upstream slope of the embankment. The intake structure is housed in a concrete block building which was not entered.</p>	
PIPELINE	<p>The water supply facility pipeline was observed leaving the intake structure house and extending along the crest of the embankment to a point on the left abutment where it disappeared into the ground.</p> <p>The pipe was 9 inch diameter (O.D.) and passed through seven concrete thrust blocks between the intake structure house and the left abutment.</p>	

INSTRUMENTATION

<u>VISUAL EXAMINATION OF</u>	<u>OBSERVATIONS</u>	<u>REMARKS OR RECOMMENDATIONS</u>
MONUMENTATION/SURVEYS	None observed.	
OBSERVATION WELLS	None observed.	
WEIRS	The concrete weir overflow crest of the spillway could be used for low head flow measurements, if required.	
PIEZOMETERS	None observed.	

RESERVOIR

VISUAL EXAMINATION OF	OBSERVATIONS	REMARKS OR RECOMMENDATIONS
SLOPES	<p>The reservoir slopes varied from mild to moderately steep. The right shoreline was heavily wooded throughout its entire length. The left shoreline was wooded in the upper reach of the reservoir and grass covered in the lower reach of the reservoir.</p>	<p>No signs of significant erosion or reservoir slope instability were observed anywhere within the impoundment zone.</p>
INLET STREAM	<p>The inlet stream approached the reservoir through a natural channel. Considerable brush and small trees were growing along the inlet stream channel.</p>	
SEDIMENTATION	<p>A moderate amount of sediment was observed in the reservoir immediately below the inlet stream.</p>	

DOWNSTREAM CONDITIONS

VISUAL EXAMINATION OF CHANNEL (OBSTRUCTIONS, DEBRIS, ETC.)	OBSERVATIONS	REMARKS OR RECOMMENDATIONS
	<p>The downstream channel immediately below the spillway discharge channel is an irregular open channel with earthen bottom and sides. The channel bottom contains some rock riprap immediately below the spillway discharge channel and has been cleared of trees and debris for approximately 50 feet below the dam. The channel appears to be the left groin of the embankment in the reach immediately below the spillway.</p>	
	<p>Below this, the downstream channel is narrow, winding and tree lined to a point where it enters a small pond approximately 200 feet below the crest of the dam. Below this, the channel parallels Legislative Route 02111 and enters a culvert beneath the road.</p>	
APPROXIMATE NUMBER OF HOMES AND POPULATION	<p>The first 4,000 feet of downstream channel below the dam lies in a densely wooded, uninhabited valley. In the next 4,000 feet there are at least ten inhabited dwellings that lie on the floodplain at elevations low enough to possibly be affected by high flows.</p>	

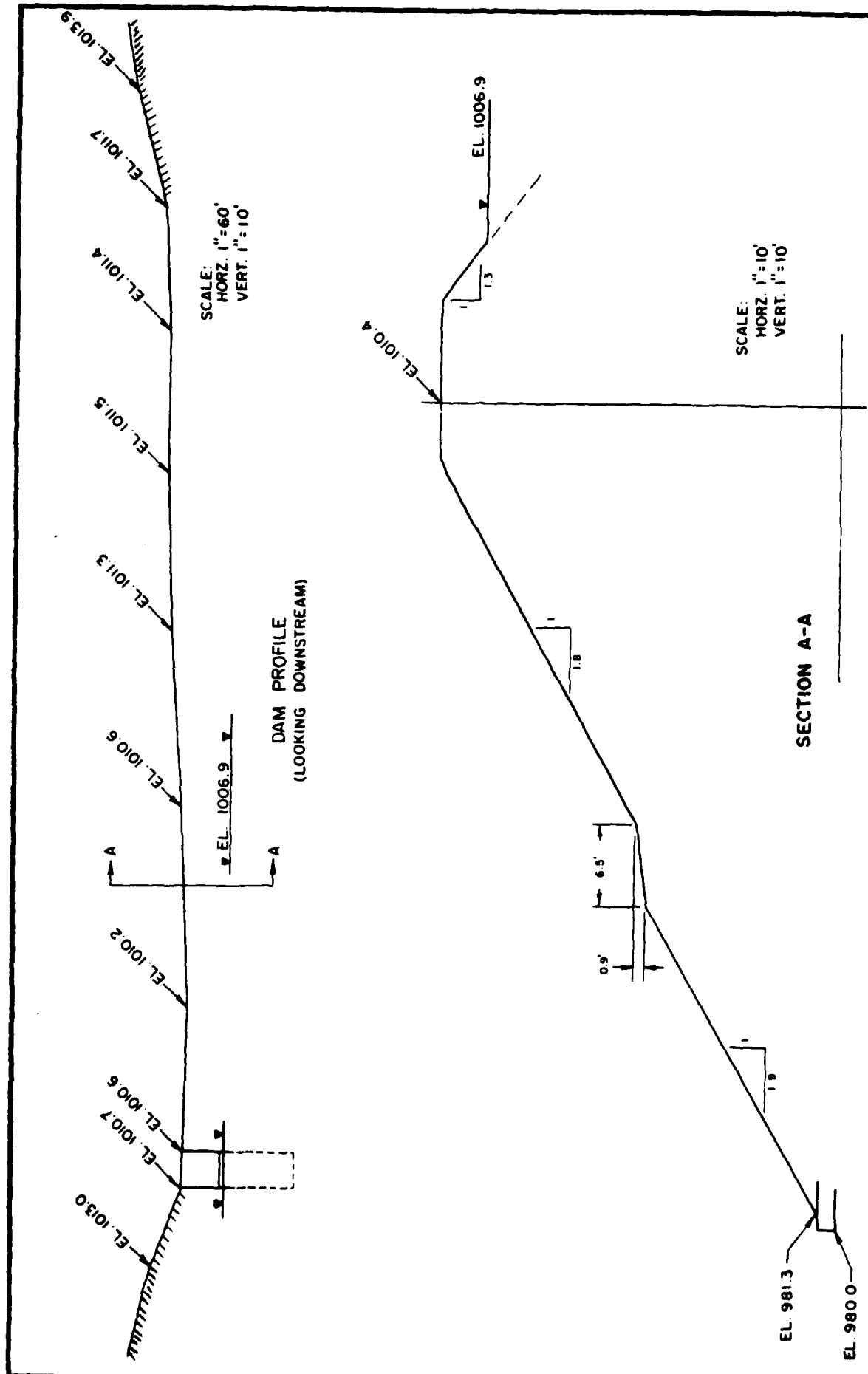

DATE: MAY 1981	BUTLER'S LAKE DAM		FIELD PROFILE and SECTION
SCALE: AS SHOWN	NATIONAL DAM INSPECTION PROGRAM		
DR: JF	CK: JEB	ACKENHEIL & ASSOCIATES CONSULTING	ENGINEERS
DWG. NO. 80138N-2	ORO SYSTEMS, INC.		
1000 BANKSVILLE RD./PITTSBURGH, PA. 15216			

L E G E N D

IMPOUNDING EMBANKMENT SLOPE

OTHER SLOPES

STREAM OR SHORELINE

EROSION PROTECTION

FENCE

PIPE

EROSION

CONCRETE

SPRING

BRUSH PILE

WHEEL RUTS

ANIMAL BURROW

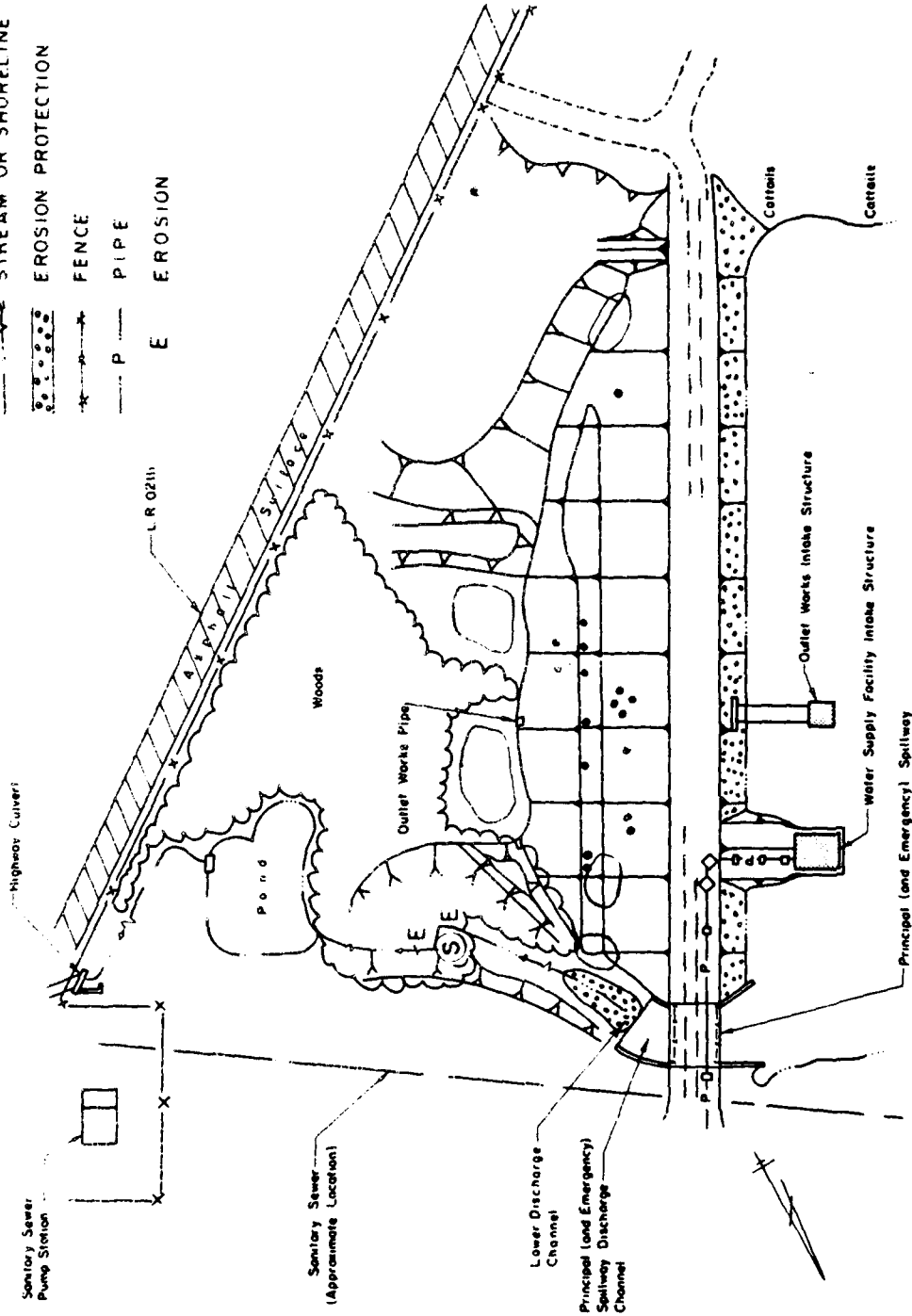

DATE: MAY 1981	BUTLER'S LAKE DAM
SCALE: NONE	NATIONAL DAM INSPECTION PROGRAM
DR: JF	ACKENHEIL & ASSOCIATES CONSULTING
DWG. NO. 80138 N-1	GEO SYSTEMS, INC. ENGINEERS

1000 BANKSVILLE RD. PITTSBURGH, PA. 15216	
FIELD SKETCH	

WEIR

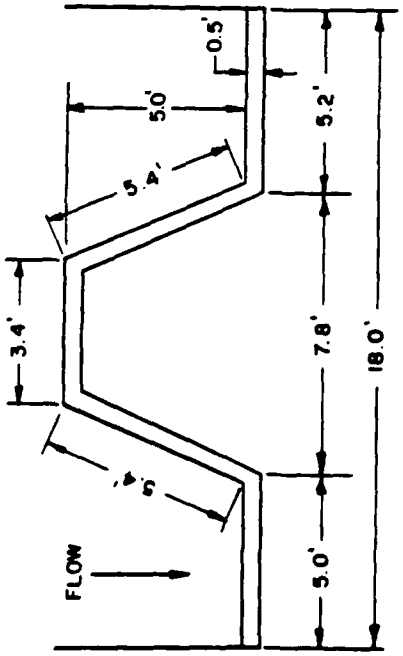

PLAN
1" = 5'

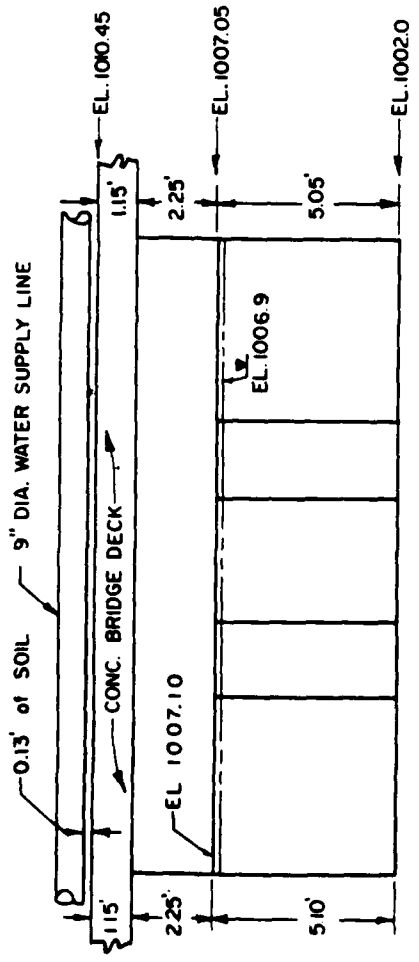

ELEVATION
(LOOKING UPSTREAM)
1" = 5'

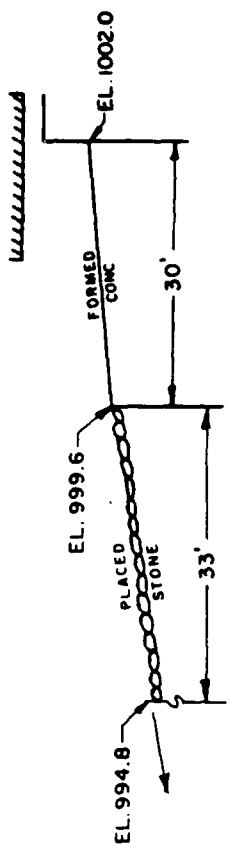

SPILLWAY PROFILE

SCALE:
HORZ. 1" = 20'
VERT. 1" = 20'

DATE: MAY 1981	BUTLER'S LAKE DAM NATIONAL DAM INSPECTION PROGRAM ACKENHEIL & ASSOCIATES CONSULTING ENGINEERS GEO SYSTEMS, INC. 1000 BANKSVILLE RD./PITTSBURGH, PA. 15216	WEIR PLAN, ELEVATION AND SPILLWAY PROFILE
SCALE: AS SHOWN		
DR: JF CK: JEB		
DWG. NO. 80138N-3		

APPENDIX B
ENGINEERING DATA CHECKLIST

CHECK LIST
ENGINEERING DATA
DESIGN, CONSTRUCTION, OPERATION
PHASE I

NAME OF DAM Butler's Lake Dam
NDI No. PA 01067

ITEM	REMARKS
*Design Drawings	Design drawings by Alex. L. McVicker, Registered Engineer, Monongahela, Pennsylvania including: Sheet No. 1 showing General Arrangement of Impounding Reservoir and Dam, Typical Section Through Dam, Intake Retaining Walls, Plan of Intake, and Sections Through Test Pits.** Sheet No. 2 showing Location Plan of Proposed Dam, General Plan, Longitudinal Section of Proposed Dam, Developed Elevations of Spillway, Plan of Spillway, and Sections.**
As-Built Drawings	None available.
Regional Vicinity Map	U.S.G.S. 7-1/2 Minute McKeesport, Pennsylvania Quadrangle Map.
*Construction History	Constructed between 1939 and 1941; Contractor not reported. Periodic progress reports available in PENNDR files by state personnel.
*Typical Sections of Dam	See Design Drawings.

ITEM	REMARKS
*Outlets-Plan Details Constraints Discharge Ratings	See Design Drawings.
Rain/Reservoir Records	None reported.
*Design Reports	"Report upon the Application of John W. Butler", dated 11 July 1939, prepared by the Chief of Dams for the Water and Power Resources Board. "Supplementary Report Upon the Application of John W. Butler" dated 29 August 1939 prepared by the Dam Engineer for the Water and Power Resources Board.
Geology Reports	None available.
Design Computations	None available.
Hydrology and Hydraulics	None available.
Dam Stability	None available.
Seepage Studies	None available.
*Materials Investigations, Boring Records, Laboratory, Field	Six test pits dug. See Plate II.

ITEM	REMARKS
Post-Construction Surveys of Dam	None available.
*Borrow Sources	On site and in vicinity.
Monitoring Systems	None reported.
Modifications	None reported.
High Pool Records	None reported.
Post-Construction Engineering Studies and Reports	None available.
Maintenance, Operation, Records	None available.
*Spillway-Plan Sections Details	See Design Drawings.
*Operating Equipment Plans and Details	See Design Drawings.
*Specifications	"Plans and Specifications, Impounding Reservoir or Lake, John W. Butler, Owner, McKeesport, PA." prepared by Alex. L. McVicker, P.E., undated

ITEM

REMARKS

***Miscellaneous**

A memorandum dated 31 July 1940 discussing a "leak" that was discharging to the wasteway channel. A recommendation was made by the investigating engineer to use a pure cement grout instead of the sawdust and sand mixture previously tried.

Application for permission to construct "a reservoir to impound waters in Drennen Branch of Boyd's Hollow Run . . ." filed with the Department of Forests and Waters, Water Resources Board, 14 June 1939.

Application for permission to appropriate water from Drennen Branch, filed with the Department of Forests and Waters, Water Resources Board, 14 June 1939.

"Permit" to construct a dam, across Drennen Branch, issued 8 September 1939 by the Water and Power Resources Board.

Dam inspection reports by Division of Dams personnel dated 24 June 1952 and 19 March 1964.

***Construction Reports**

Two construction reports by Water and Power Resources Board personnel, 21 August 1940 and 27 June 1941.

Prior Accidents or Failure of Dam Description Reports

None reported.

*Information and data may be obtained from the PennDER, Harrisburg, Pennsylvania
**Reduced size reproductions contained in Appendix E.

APPENDIX C
PHOTOGRAPHS

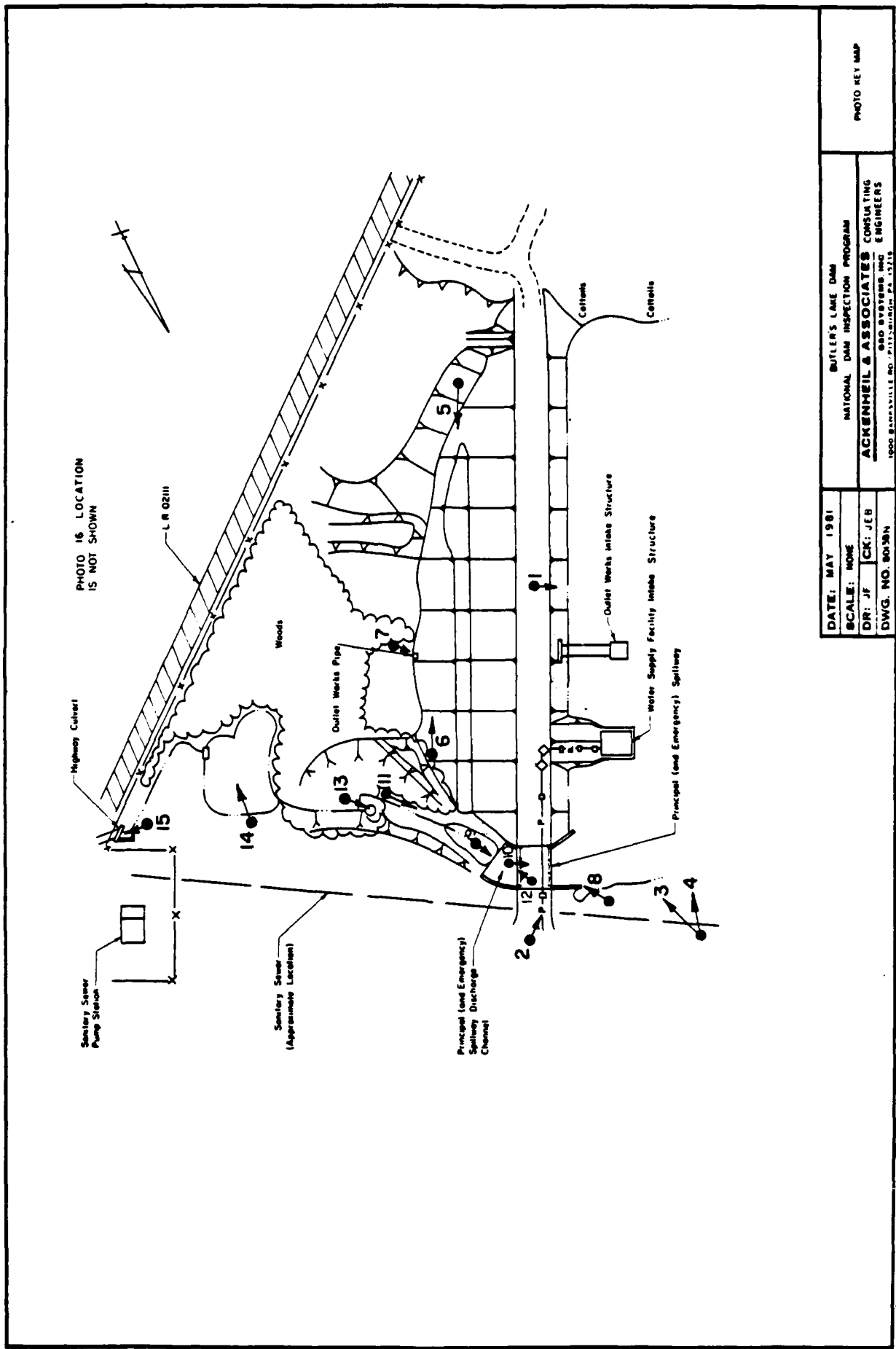

DATE: MAY 1981	BUTLER'S LAKE DAM
SCALE: NONE	NATIONAL DAM INSPECTION PROGRAM
DR: JF	CK: JEB
DWG. NO. 80-38N	ACKENHEIL & ASSOCIATES CONSULTING 880 SYSTEMS, INC ENGINEERS 1500 SANDHILL RD., PITTSTOWN, PA 15719

PHOTO KEY MAP

BUTLER'S LAKE DAM

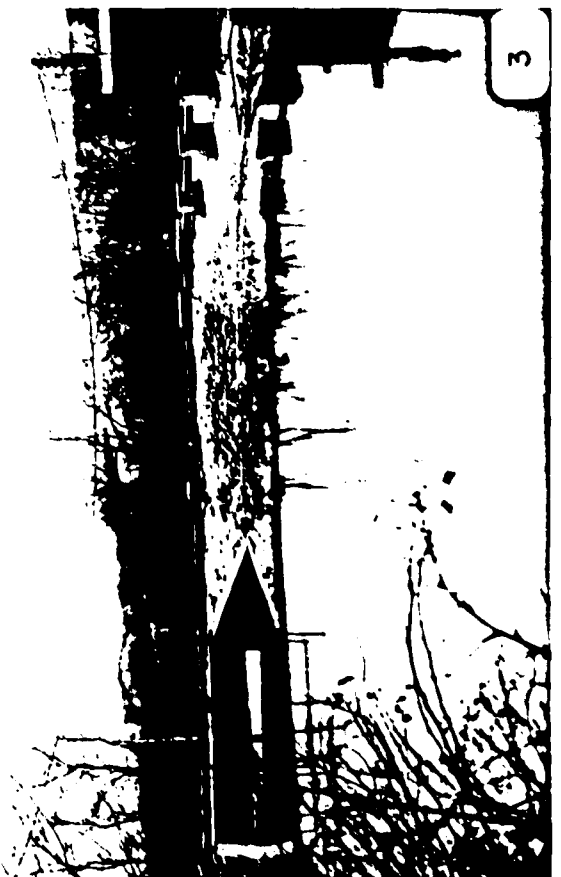
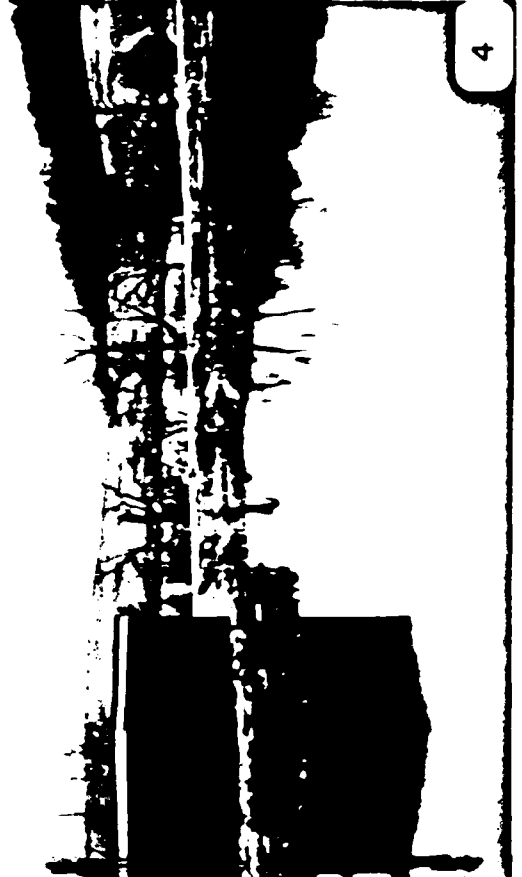
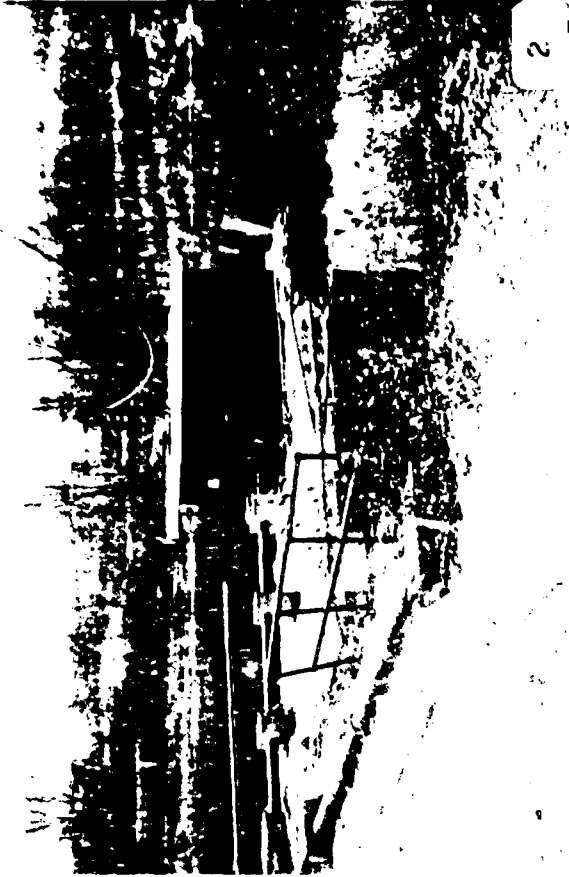

BUTLER'S LAKE DAM

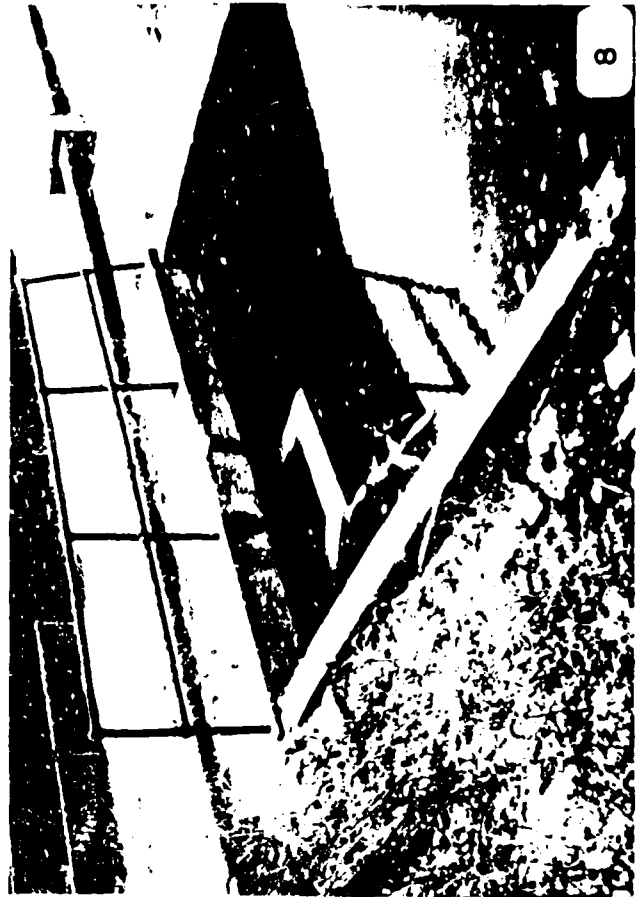

BUTLER'S LAKE DAM



10



12



9



11

BUTLER'S LAKE DAM

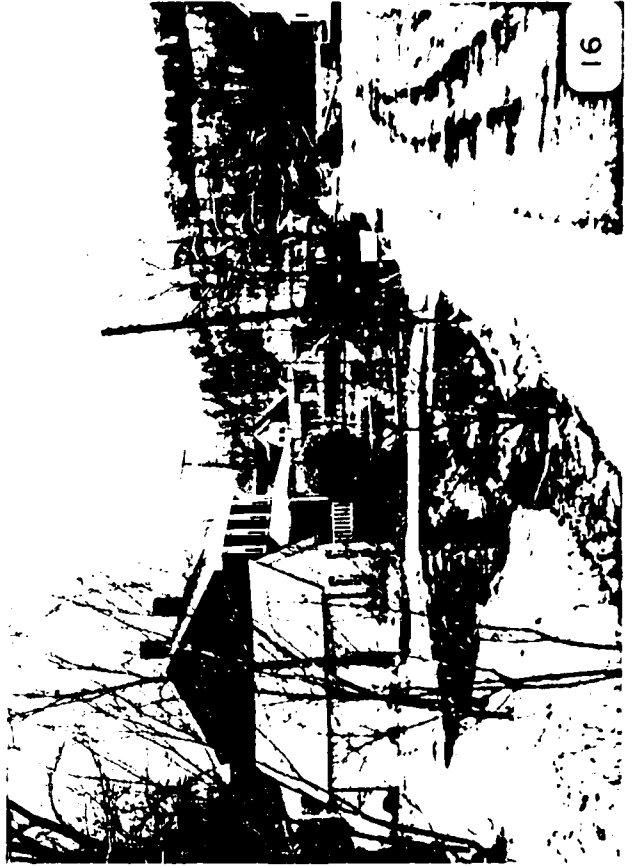

PHOTO DESCRIPTIONS

- Photo 1 Reservoir Overview taken from embankment crest.
- Photo 2 Water Supply Intake Structure showing pump house and pipeline. Note pipeline on deck of spillway bridge.
- Photo 3 Upstream Embankment Slope showing the spillway approach channel, bridge and water supply pipeline.
- Photo 4 Upstream Embankment Slope showing the water supply intake and outlet works intake structures.
- Photo 5 Downstream Embankment Slope taken from right abutment.
- Photo 6 Downstream Embankment Slope taken from the lower junction of the embankment and the spillway.
- Photo 7 Outlet Works Pipe.
- Photo 8 Principal (and Emergency) Spillway Approach Channel showing training walls and weir crest.
- Photo 9 Spillway Discharge Channel looking upstream.
- Photo 10 Spillway Overflow Crest; note reinforcing bars protruding from top of crest.
- Photo 11 Spillway Discharge Channel, Overview looking upstream.
- Photo 12 Spillway Discharge Channel, Overview looking downstream from spillway bridge.
- Photo 13 Spring located approximately 100 feet downstream of embankment crest.
- Photo 14 Pond approximately 200 feet downstream of the crest of the dam. Pond weir in center of photo does not function because flow is beneath the weir.
- Photo 15 Highway Culvert beneath Legislative Route 02111.
- Photo 16 Downstream Hazards approximately 1.6 miles downstream of embankment. Photo shows Boyd's Hollow Run and the intersection of Legislative Route 02111 and Greenock - Buena Vista Road.

APPENDIX D
HYDROLOGY AND HYDRAULICS
ANALYSES

APPENDIX D
HYDROLOGY AND HYDRAULICS
ANALYSES

Methodology: The dam overtopping analysis was accomplished using the systemized computer program HEC-1 (Dam Safety Version), July 1978, prepared by the Hydrologic Engineering Center, U.S. Army Corps of Engineers, Davis, California. A brief description of the methodology used in the analysis is presented below.

1. Precipitation: The Probable Maximum Precipitation (PMP) is derived and determined from regional charts prepared from past rainfall records including "Hydrometeorological Report No. 33" prepared by the U.S. Weather Bureau.

The index rainfall is reduced from 10% to 20% depending on watershed size by utilization of what is termed the HOP Brook adjustment factor. Distribution of the total rainfall is made by the computer program using distribution methods developed by the Corps.

2. Inflow Hydrograph: The hydrologic analysis used in development of the overtopping potential is based on applying a hypothetical storm to a unit hydrograph to obtain the inflow hydrograph for reservoir routing.

The unit hydrograph is developed using the Snyder method. This method requires calculation of several key parameters. The following list gives these parameters, their definition and how they were obtained for these analyses.

<u>Parameter</u>	<u>Definition</u>	<u>Where Obtained</u>
Ct	Coefficient representing variations of watershed	From Corps of Engineers*
L	Length of main stream channel	From U.S.G.S. 7.5 minute topographic map
Lca	Length on main stream to centroid of watershed	From U.S.G.S. 7.5 minute topographic map
Cp	Peaking coefficient	From Corps of Engineers*
A	Watershed size	From U.S.G.S. 7.5 minute topographic map

3. Routing: Reservoir routing is accomplished by using Modified Puls routing techniques where the flood hydrograph is routed through reservoir storage. Hydraulic capacities of the outlet works, spillways and the crest of the dam are used as outlet controls in the routing.

The hydraulic capacity of the outlet works can either be calculated and input or sufficient dimensions input and the program will calculate an elevation-discharge relationship.

Storage in the pool area is defined by an area-elevation relationship from which the computer calculates storage. Surface areas are either planimetered from available mapping or U.S.G.S. 7.5 minute series topographic maps or taken from reasonably accurate design data.

4. Dam Overtopping: Using given percentages of the PMF the computer program will calculate the percentage of the PMF which can be controlled by the reservoir and spillway without the dam overtopping.

*Developed by the Corps of Engineers on a regional basis for Pennsylvania.

HYDROLOGIC AND HYDRAULIC
ENGINEERING DATA

DRAINAGE AREA CHARACTERISTICS: Predominantly woodland,
grassland, and residential development.

ELEVATION-TOP NORMAL POOL (STORAGE
CAPACITY): 1007.1 (68.7 acre-feet)

ELEVATION-TOP FLOOD CONTROL POOL (STORAGE
CAPACITY): 1010.2 (94 acre-feet)

ELEVATION-MAXIMUM DESIGN POOL: 1007.1

ELEVATION-TOP DAM: Design-1010.8 (including settlement crown),
Observed Minimum-1010.2

OVERFLOW SECTION

- a. Elevation 1007.1
- b. Type Concrete Wall Weir
- c. Width 18 feet between training walls
- d. Weir Crest Length 24.4 feet
- e. Location Spillover Left Abutment
- f. Number and Type of Gates None

OUTLET WORKS

- a. Type 12 inch diameter cast iron pipe
- b. Location Through center of dam
- c. Entrance Invert Unknown
- d. Exit Invert 980.0

HYDROMETEOROLOGICAL GAGES

- a. Type None
- b. Location N/A
- c. Records None

MAXIMUM REPORTED NON-DAMAGING
DISCHARGE None reported

HEC-1 DAM SAFETY VERSION
 HYDROLOGY AND HYDRAULIC ANALYSIS
 DATA BASE

NAME OF DAM:	Butler's Lake Dam	NDI ID NO. PA 01067
Probable Maximum Precipitation (PMP)		24.1*
Drainage Area		0.3 sq. mi.
Reduction of PMP Rainfall for Data Fit		0.8 (24.1)
Reduce by 20%, therefore PMP rainfall =		19.3 inches
Adjustments of PMF for Drainage Area (Zone 7)		
6 hrs.		102%
12 hrs.		120%
24 hrs.		130%
48 hrs.		140%
Snyder Unit Hydrograph Parameters		
Zone		25**
C _p		0.4
C _t		1.0
L		1.0 mile
L _{ca}		0.5 mile
t _p = C _t (L · L _{ca}) ^{0.3} =		0.81 hours
Loss Rates		
Initial Loss		1.0 inch
Constant Loss Rate		0.05 inch/hour
Base Flow Generation Parameters		
Flow at Start of Storm	1.5 cfs/sq.mi=	0.45 cfs
Base Flow Cutoff		0.05 x Q peak
Recession Ratio		2.0
Overflow Section Data		
Crest Length		24.4 feet
Freeboard		3.1 feet
Discharge Coefficient		3.09 feet
Exponent		1.5
Discharge Capacity		231 cfs

* Hydrometeorological Report 33

**Hydrological zone defined by Corps of Engineers, Baltimore District, for determining Snyder's Coefficients (C_p and C_t).

ACKENHEIL & ASSOCIATES
 GEO Systems, Inc.
 1000 Banksville Road
 PITTSBURGH, PA. 15216
 (412) 531-7111

Job BUTLER'S LAKE DAM Job No 80138-N
 Subject DISCHARGE RATING DATA
 Made By SGM Date 15-DE-80 Checked KBR Date 1-14-80

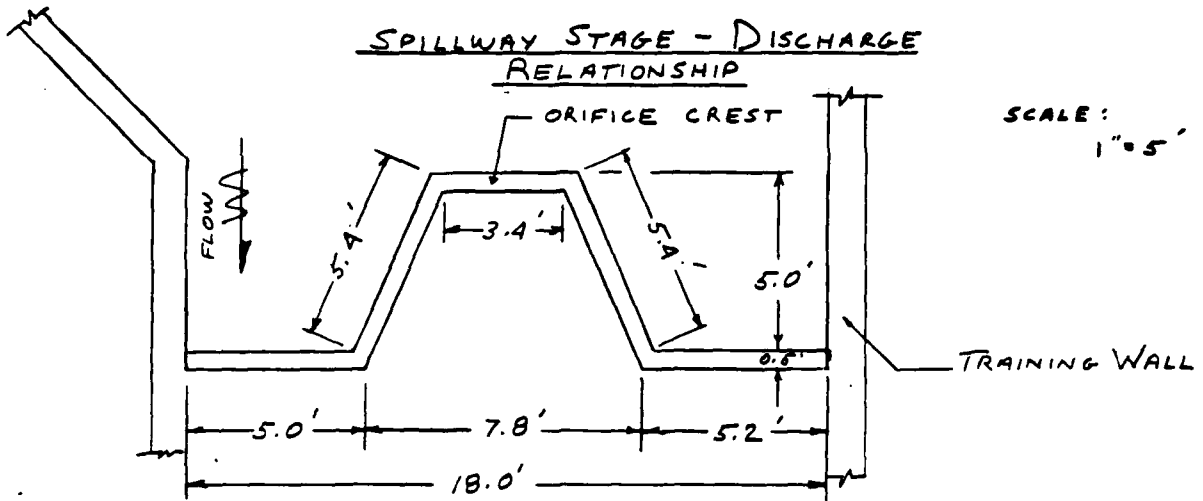

PLAN

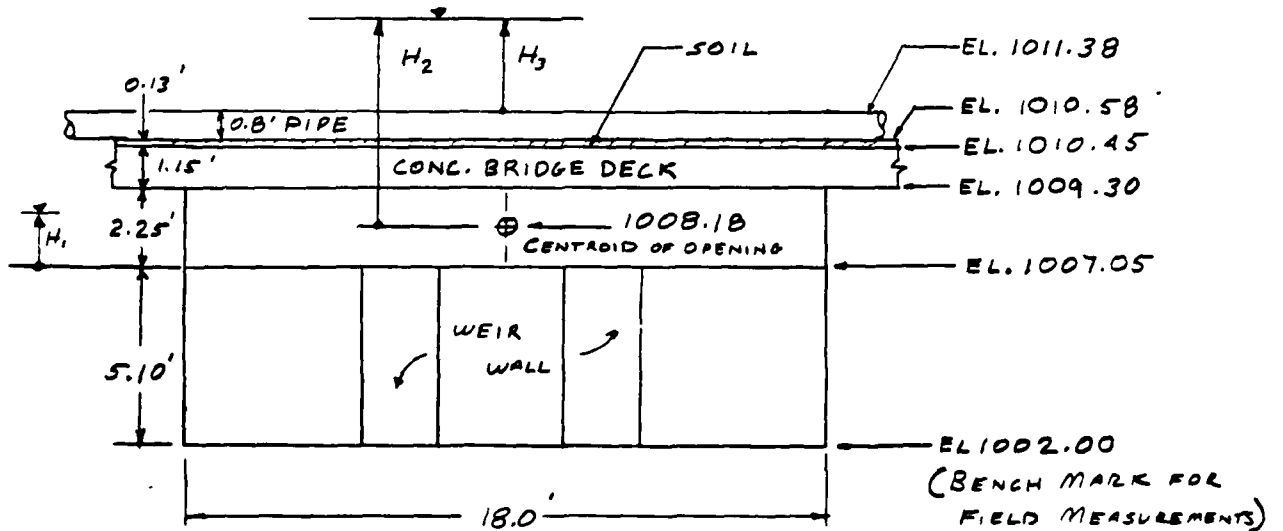

ELEVATION

ACKENHEIL & ASSOCIATES
 GEO Systems, Inc.
 1000 Banksville Road
 PITTSBURGH, PA. 15216
 (412) 531-7111

Job BUTLER'S LAKE DAM Job No 80138-N
 Subject DISCHARGE RATING CALCULATION
 Made By SGM Date 15 Dec 80 Checked KBR Date 1-14-80

$$L_{OVER} = 18.0'$$

$$L_{WEIR} = 5.0' + 5.4' + 5.4' + 3.4' + 5.2' = 24.4'$$

$$A = 2.25' \times 18.0' = 40.5 \text{ SQ. FT.}$$

$$Q_1 = C_1 L_{WEIR} H_1^{1.5} \quad \text{WHERE } C_1 = 3.1 \quad \& L_{WEIR} = 24.4'$$

$$Q_2 = C_2 A \sqrt{2g} H_2 \quad \text{WHERE } C_2 = 0.5 \quad \& A = 40.5 \text{ SQ. FT.}$$

$$Q_3 = C_3 L_{OVER} H_3^{1.5} \quad \text{WHERE } C_3 = 3.1 \quad \& L_{OVER} = 18.0'$$

WHERE H_1 , H_2 AND H_3 ARE AS SHOWN ON ELEVATION, PAGE D5

ELEV. (CFT.)	WEIR		ORIFICE		WEIR		DISCHARGE Q (CCFS)
	OVERFLOW CREST		H_2 (CFT.)	Q_2 (CCFS)	OVER BRIDGE DECK		
	H_1 (CFT.)	Q_1 (CCFS)			H_3 (CFT.)	Q_3 (CCFS)	
1007.05	0	0	-	-	-	-	0
1007.55	0.50	27	-	-	-	-	27
1008.05	1.00	76	-	-	-	-	76
1008.55	1.50	139	-	-	-	-	139
1009.05	2.00	214	-	-	-	-	214
1009.30	2.25	255	-	-	-	-	255
1009.80			1.62	207	-	-	207
1010.30			2.12	237	-	-	237
1010.45			2.27	245	-	-	245
1010.58			2.40	252	-	-	252
1011.08			2.90	277	-	-	277
1011.58			3.40	300	0.20	5	305
1012.08			3.90	321	0.70	33	354
1012.58			4.40	341	1.20	73	414
1013.08			4.90	360	1.70	124	484
1013.58			5.40	378	2.20	182	560
1014.08			5.90	395	2.70	248	643
1014.58			6.40	411	3.20	319	730
1015.08			6.90	427	3.70	397	824
1015.58			7.40	442	4.20	480	922

ACKENHEIL & ASSOCIATES
GEO Systems, Inc.
1000 Banksville Road
PITTSBURGH, PA 15216
(412) 531-7111

Job BUTLER'S LAKE DAM Job No 30234
Subject DISCHARGE RATING CURVE
Made By SGM Date 15 DEC. 80 Checked - PH Date 4/15/81

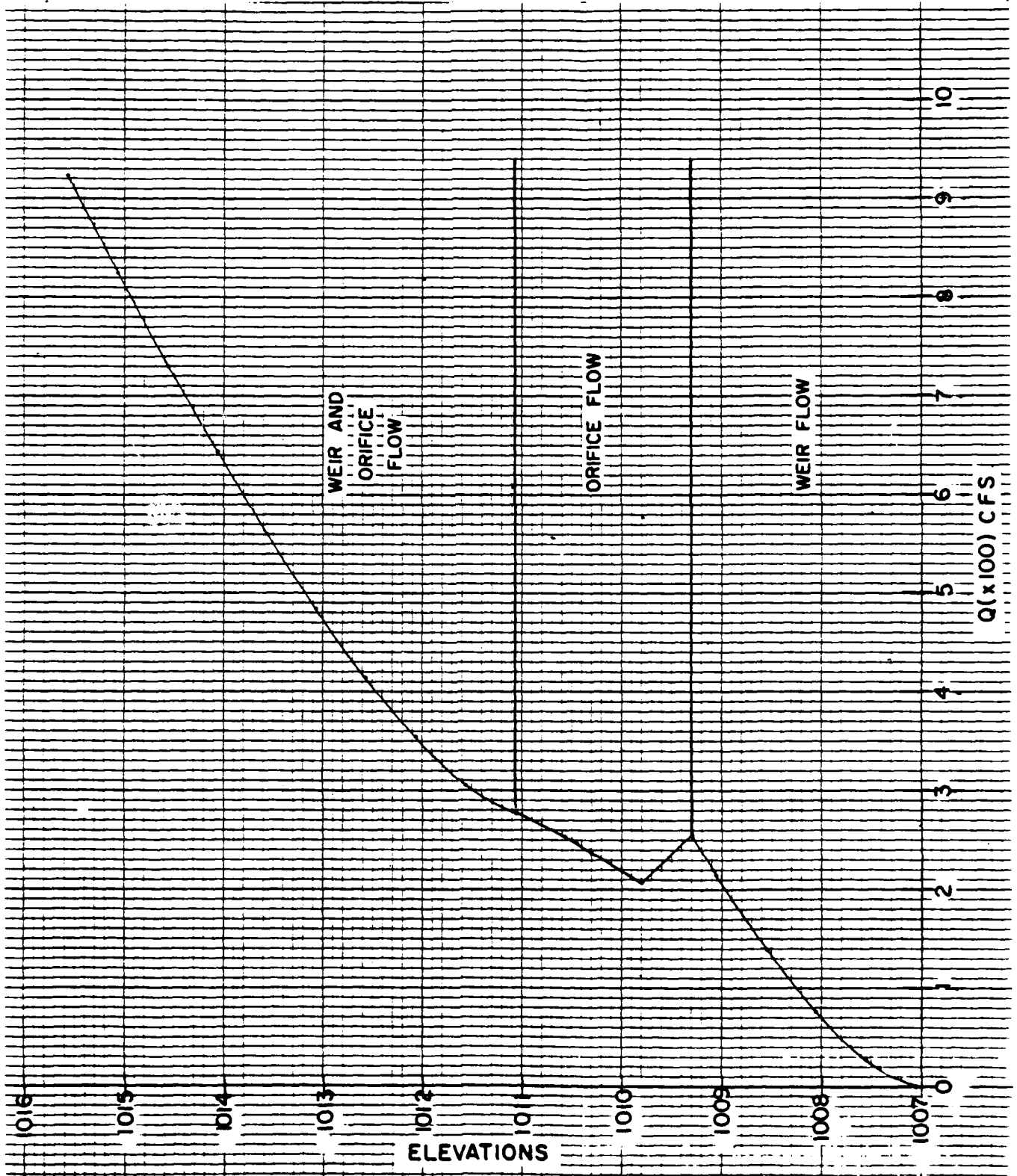

ACKENHEIL & ASSOCIATES
GEO Systems, Inc.
1000 Banksville Road
PITTSBURGH, PA 15216
(412) 531-7111

Job BUTLER'S LAKE DAM Job No B013BN
Subject DATA INPUT
Made By SGM Date 13 FEB 81 Checked JPH Date 4/15/81

LOSS RATE AND BASE FLOW PARAMETERS

AS RECOMMENDED BY CORPS OF ENGINEERS, BALTIMORE DISTRICT

STRTL = 1 INCH
CNSTL = 0.05 INCHES/HOUR
STRTO = 1.5 CFS/MI²
QRCSN = 0.05 (5% OF PEAK FLOW)
RTIOR = 2.0

ELEVATION-AREA-CAPACITY RELATIONSHIPS

FROM U.S.G.S. 7.5 MIN. QUAD., DESIGN DRAWINGS
AND FIELD INSPECTION DATA:

AT ELEVATION 1007.1

INITIAL STORAGE = 68.7 ACRE-Feet

POND SURFACE AREA = 7.3 ACRES

AT ELEVATION 1020 AREA = 15.6 ACRES

FROM THE CONIC METHOD OF RESERVOIR VOLUME
FLOOD HYDROGRAPH PACKAGE HEC-1
DAM SAFETY VERSION (USERS MANUAL)

$$H = \frac{3V}{A} = \frac{3(68.7)}{7.3} = 28.2$$

ELEVATION WHERE AREA EQUALS ZERO

$$1007.1 - 28.2 = 978.9$$

\$A	0	7.3	15.6
\$E	978.9	1007.1	1020

ACKENHEIL & ASSOCIATES
GEO Systems, Inc.
1000 Banksville Road
PITTSBURGH, PA. 15216
(412) 531-7111

Job BUTLER'S LAKE DAM Job No 80138N
Subject DATA INPUT
Made By SGM Date 13 FEB 81 Checked JPK Date 4/15/81

OVERTOP PARAMETERS

TOP OF DAM ELEVATION (MINIMUM) = 1010.2
LENGTH OF DAM (EXCLUDING SPILLWAY) = 435
COEFFICIENT OF DISCHARGE = 3.1
 $\$L_{max} = 535$ $\$V_{max} = 1014.0'$

PROGRAM SCHEDULE

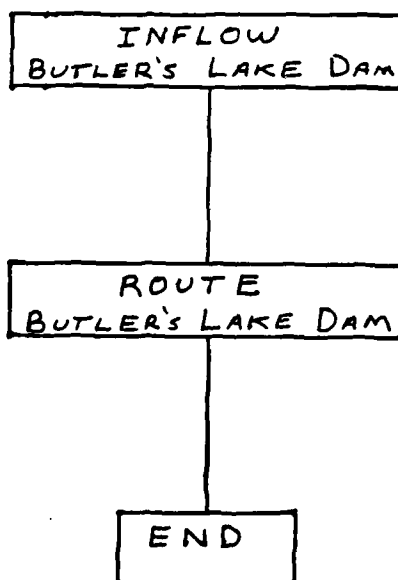

 FLOOD HYDROGRAPH PACKAGE (HEC-1)
 DAM SAFETY VERSION JULY 1978
 LAST MODIFICATION 26 FEB 79

1	A1	NATIONAL PROGRAM FOR THE INSPECTION OF NON FEDERAL DAMS									
2	A2	HYDROLOGIC AND HYDRAULIC ANALYSIS OF BUTLER LAKE DAM									
3	A3	PROBABLE MAXIMUM FLOOD PMF/UNIT HYDROGRAPH BY SNYDER'S METHOD									
4	B	300	0	10	0	0	0	0	0	-4	0
5	B1	5									
6	J	1	5	1							
7	J1	1.	.5	.3	.25	.2					
8	K	0	1					1			
9	K1	INFLOW HYDROGRAPH FOR BUTLER LAKE DAM									
10	M	1	1	0.3						1	
11	P		24.1	102	120	130	140				
12	T							1.0	.05		
13	W	0.81	0.40								
14	X	-1.5	-0.05	2.0							
15	K	1	2					1			
16	K1	ROUTING AT BUTLER LAKE DAM									
17	Y			1	1						
18	Y1	1					68.7	-1			
19	Y4	1007.1	1007.6	1008.1	1008.6	1009.1	1009.3	1009.8	1010.3	1010.5	1010.6
20	Y4	1011.1	1011.6	1012.1	1012.6	1013.1	1013.6	1014.1	1014.6	1015.1	1015.6
21	Y5	0.	27.	76.	139.	214.	255.	207.	237.	245.	252.
22	Y5	277.	305.	354.	414.	484.	560.	643.	730.	824.	922.
23	\$A	0.	7.3	15.6							
24	\$E	978.9	1007.1	1020.							
25	\$S	1007.1									
26	\$D	1010.2	3.1	1.5	435.						
27	\$L	26.	158.	247.	452.	478.	504.	521.	528.	535.	
28	\$V	1010.2	1010.5	1011.0	1011.5	1012.0	1012.5	1013.0	1013.5	1014.0	
29	K	99									
30	A										
31	A										
32	A										
33	A										
34	A										

PREVIEW OF SEQUENCE OF STREAM NETWORK CALCULATIONS

RUNOFF HYDROGRAPH AT 1
 ROUTE HYDROGRAPH TO 2
 END OF NETWORK

 FLOOD HYDROGRAPH PACKAGE (HEC-1)
 DAM SAFETY VERSION JULY 1978
 LAST MODIFICATION 26 FEB 79

RUN DATE: 29 APR 81
 RUN TIME: 12. 1. 2

NATIONAL PROGRAM FOR THE INSPECTION OF NON FEDERAL DAMS
 HYDROLOGIC AND HYDRAULIC ANALYSIS OF BUTLER LAKE DAM
 PROBABLE MAXIMUM FLOOD PMF/UNIT HYDROGRAPH BY SNYDER'S METHOD

JOB SPECIFICATION										
NQ	NHR	NMIN	IDAY	IHR	IMIN	METRC	IPLT	IPRT	NSTAN	
300	0	10	0	0	0	0	0	-4	0	
			JOPER	NWT	LROPT	TRACE				
			5	0	0	0				

MULTI-PLAN ANALYSES TO BE PERFORMED
 NPLAN= 1 NRTIO= 5 LRTIO= 1
 RTIOS= 1.00 0.50 0.30 0.25 0.20

SUB-AREA RUNOFF COMPUTATION

INFLOW HYDROGRAPH FOR BUTLER LAKE DAM

	ISTAQ	ICOMP	IECON	ITAPE	JPLT	JPRT	INAME	ISTAGE	LAUTO
	1	0	0	0	0	0	1	0	0

HYDROGRAPH DATA									
IHYDG	IUNG	TAREA	SNAP	TRSDA	TRSPC	RATIO	ISNOW	ISAME	LOCAL
1	1	0.30	0.0	0.30	0.0	0.0	0	1	0

PRECIP DATA									
SPFE	PMS	R6	R12	R24	R48	R72	R96		
0.0	24.10	102.00	120.00	130.00	140.00	0.0	0.0		

TRSPC COMPUTED BY THE PROGRAM IS 0.800

LOSS DATA										
LROPT	STRKR	DLTKR	RTIOL	ERAIN	STRKS	RTIOK	STRTL	CNSTL	ALSMX	RTIMP
0	0.0	0.0	1.00	0.0	0.0	1.00	1.00	0.05	0.0	0.0

UNIT HYDROGRAPH DATA
 TP= 0.81 CP=0.40 NTA= 0

RECESSION DATA										
STRTRQ= -1.50			QRCSN= -0.05			RTIOR= 2.00				
UNIT HYDROGRAPH 51 END-OF-PERIOD ORDINATES, LAG= 0.82 HOURS, CP= 0.40 VOL= 1.00										
8.	28.	56.	82.	95.	93.	83.	75.	67.	60.	
54.	48.	43.	39.	35.	31.	28.	25.	22.	20.	
18.	16.	14.	13.	11.	10.	9.	8.	7.	7.	
6.	5.	5.	4.	4.	3.	3.	3.	2.	2.	
2.	2.	2.	1.	1.	1.	1.	1.	1.	1.	
1.										

END-OF-PERIOD FLOW													
MO.DA	HR.MN	PERIOD	RAIN	EXCS	LOSS	COMP Q	MO.DA	HR.MN	PERIOD	RAIN	EXCS	LOSS	COMP Q
			SUM	26.99	24.57	2.42			28360.				
				(686.)	(624.)	(61.)			(803.07)				

HYDROGRAPH ROUTING

ROUTING AT BUTLER LAKE DAM

	ISTAQ	ICOMP	IECON	ITAPE	JPLT	JPRT	INAME	ISTAGE	LAUTO
	2	1	0	0	0	0	1	0	0

ROUTING DATA									
QLOSS	CLOSS	AVG	IRES	LSAME	IOPT	IPMP	LSTR		
0.0	0.0	0.0	1	1	0	0	0		

	NSTPS	NSTDL	LAG	AMSKK	X	TSK	STORA	ISPRAT	
	1	0	0	0.0	0.0	0.0	69.	-1	

STAGE	1007.10	1007.60	1008.10	1008.60	1009.10	1009.30	1009.80	1010.30
	1010.50	1010.60						
	1011.10	1011.60	1012.10	1012.60	1013.10	1013.60	1014.10	1014.60
	1015.10	1015.60						

FLOW	0.0	27.00	76.00	139.00	214.00	255.00	207.00	237.00
	245.00	252.00						
	277.00	305.00	354.00	414.00	484.00	560.00	643.00	730.00
	824.00	922.00						

SURFACE AREA=	0.	7.	16.						
CAPACITY=	0.	69.	213.						
ELEVATION=	979.	1007.	1020.						

	CREL	SPWID	COQW	EXPW	ELEVL	COQL	CAREA	EXPL
	1007.1	0.0	0.0	0.0	0.0	0.0	0.0	0.0

	DAM DATA								
	TOPEL 1010.2	COQD 3.1	EXPD 1.5	DAMWID 435.					
CREST LENGTH AT OR BELOW ELEVATION	26.	158.	247.	452.	478.	504.	521.	528.	535.
	1010.2	1010.5	1011.0	1011.5	1012.0	1012.5	1013.0	1013.5	1014.0
PEAK OUTFLOW IS	905.	AT TIME	40.50 HOURS						
PEAK OUTFLOW IS	394.	AT TIME	41.17 HOURS						
PEAK OUTFLOW IS	236.	AT TIME	41.17 HOURS						
PEAK OUTFLOW IS	194.	AT TIME	41.17 HOURS						
PEAK OUTFLOW IS	153.	AT TIME	41.17 HOURS						

PEAK FLOW AND STORAGE (END OF PERIOD) SUMMARY FOR MULTIPLE PLAN-RATIO ECONOMIC COMPUTATIONS
 FLOWS IN CUBIC FEET PER SECOND (CUBIC METERS PER SECOND)
 AREA IN SQUARE MILES (SQUARE KILOMETERS)

OPERATION	STATION	AREA	PLAN	RATIOS APPLIED TO FLOWS				
				RATIO 1 1.00	RATIO 2 0.50	RATIO 3 0.30	RATIO 4 0.25	RATIO 5 0.20
HYDROGRAPH AT	1	0.30	1	910.	455.	273.	228.	182.
	(0.78)	(25.78)	(12.89)	(7.73)	(6.44)	(5.16)
ROUTED TO	2	0.30	1	905.	394.	236.	194.	153.
	(0.78)	(25.64)	(11.15)	(6.69)	(5.49)	(4.34)

SUMMARY OF DAM SAFETY ANALYSIS

PLAN 1	ELEVATION	INITIAL VALUE	SPILLWAY CREST	TOP OF DAM				
	STORAGE	1007.11	1007.10	1010.20				
	OUTFLOW	69.	69.	94.				
		0.	0.	231.				
RATIO OF PMF	MAXIMUM RESERVOIR W.S.ELEV	MAXIMUM DEPTH OVER DAM	MAXIMUM STORAGE AC-FT	MAXIMUM OUTFLOW CFS	DURATION OVER TOP HOURS	TIME OF MAX OUTFLOW HOURS	TIME OF FAILURE HOURS	
1.00	1011.31	1.11	104.	905.	5.67	40.50	0.0	
0.50	1010.74	0.54	99.	394.	2.83	41.17	0.0	
0.30	1009.21	0.0	85.	236.	0.0	41.17	0.0	
0.25	1008.96	0.0	83.	194.	0.0	41.17	0.0	
0.20	1008.70	0.0	81.	153.	0.0	41.17	0.0	

ACKENHEIL & ASSOCIATES
GEO Systems, Inc.
1000 Banksville Road
PITTSBURGH, PA 15216
(412) 531-7111

Job BUTLER'S LAKE DAM Job No. 80138 N
Subject HYDROLOGIC PERFORMANCE PLOT
Made By SGM Date 16 APR. 81 Checked JFB Date 4/20/81

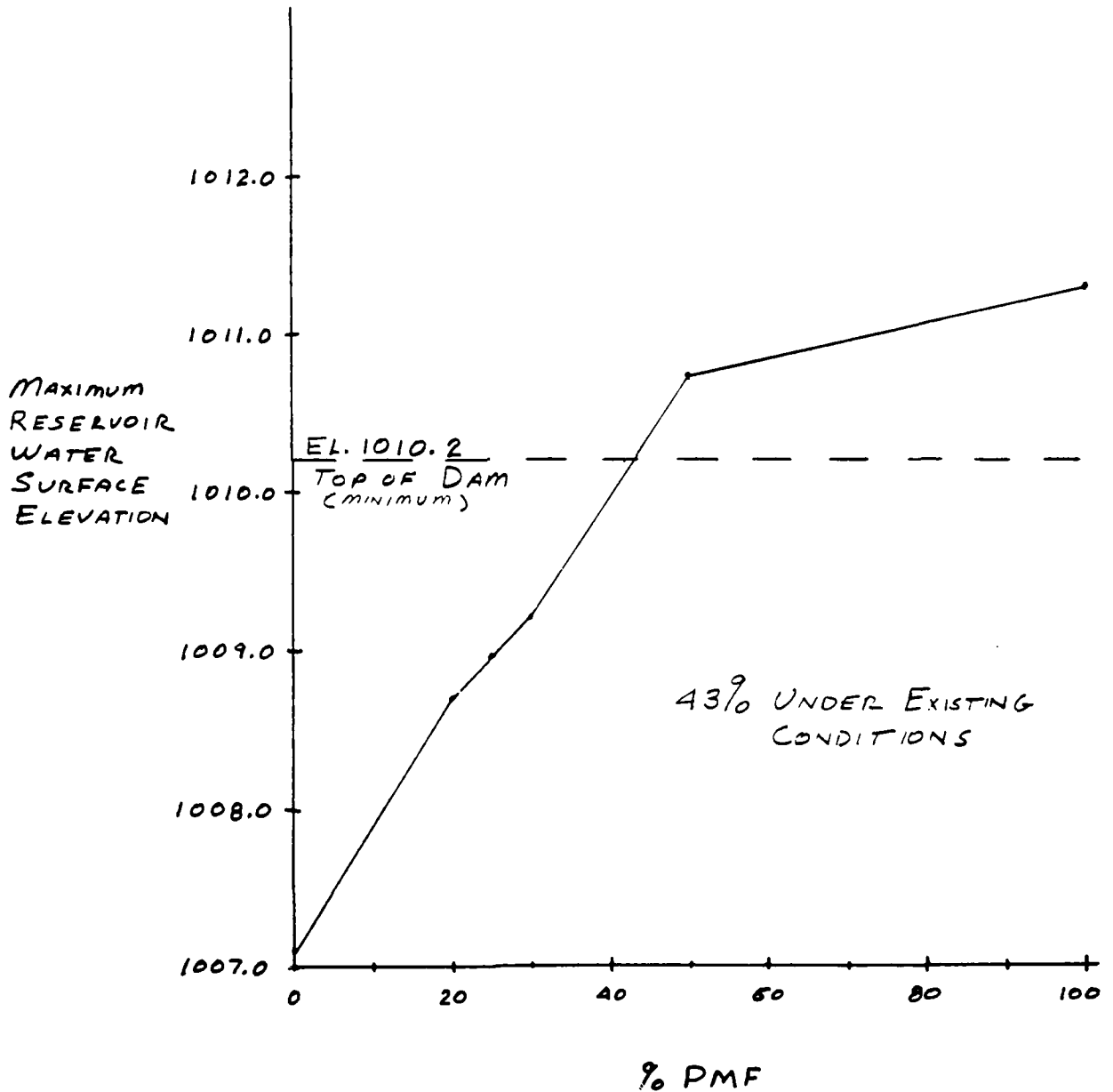

APPENDIX E

PLATES

LIST OF PLATES

- Plate I Regional Vicinity Map.
- Plate II Proposed Reservoir or Lake to be Situated on
the Headwaters of Boyds Run, Elizabeth Twp.,
Allegheny Co., PA, Sheet No. 1.
- Plate III Proposed Reservoir or Lake to be Situated on
the Headwaters of Boyds Run, Elizabeth Twp.,
Allegheny Co., PA, Sheet No. 2.

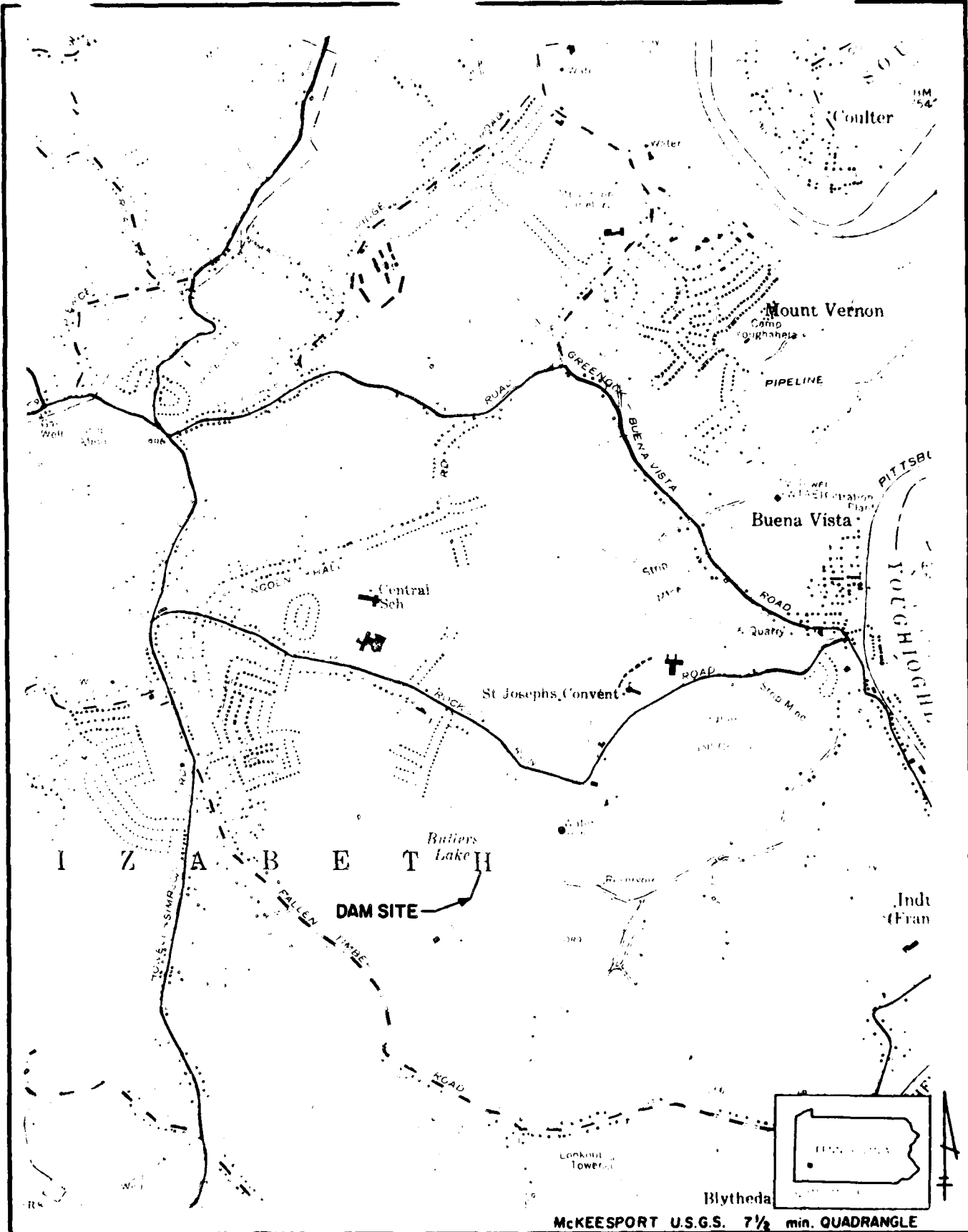

Blytheda
 McKEESPORT U.S.G.S. 7 1/2 min. QUADRANGLE

DATE: MAY 1981		BUTLER'S LAKE DAM NATIONAL DAM INSPECTION PROGRAM		REGIONAL VICINITY MAP
SCALE: 1" = 2000'				
DR: JF	CK:	ACKENHEIL & ASSOCIATES CONSULTING ENGINEERS GEO SYSTEMS, INC. 1000 BANKSVILLE RD./PITTSBURGH PA 15216		
PLATE I				

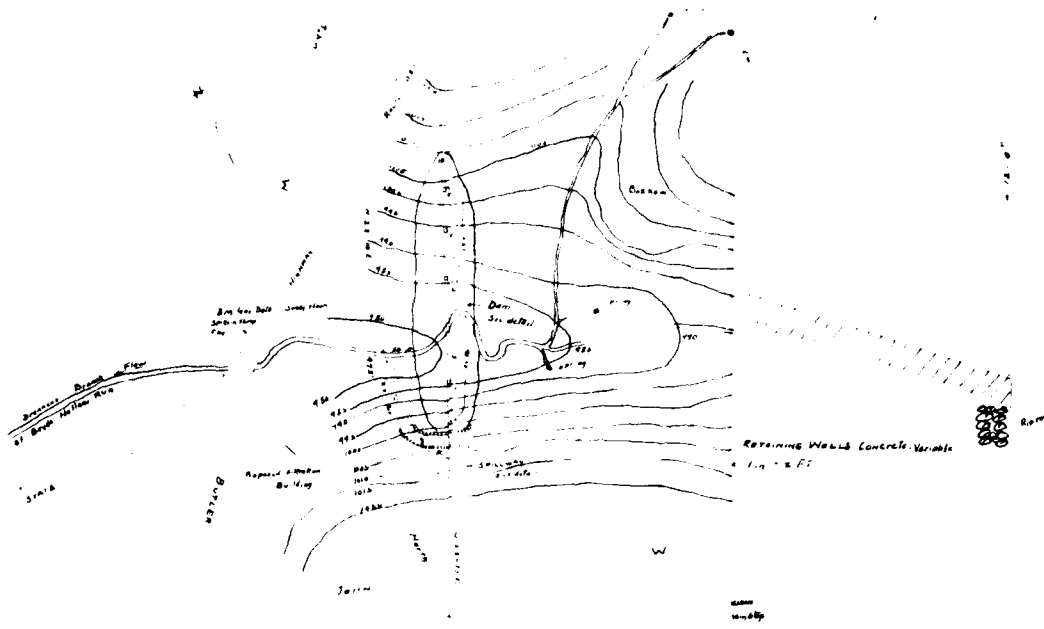

GENERAL ARRANGEMENT OF IMPOUNDING RESERVOIR & DAM
Scale 1" = 100'

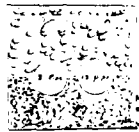

Cross Section of Dam
Concrete Core

1:50 ft

Common
Some is
Material

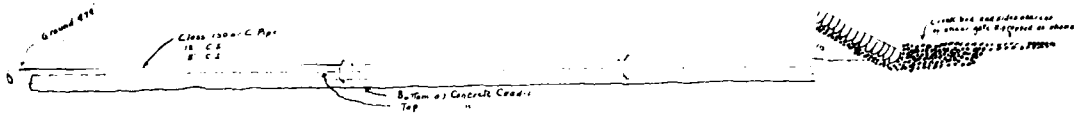

PLAN OF INTAKE
Scale 1/4" = 1'

in Sec East of Dam 5/8
in 1/5 ft vertical

1	LOAM	LOAM	5
2	SMALL SAND SLATE	FINE CLAY SAND	6
3	FINE CLAY SAND	FINE CLAY SAND	7
4	FINE CLAY SAND	FINE CLAY SAND	8
5	FINE CLAY SAND	FINE CLAY SAND	9
6	FINE CLAY SAND	FINE CLAY SAND	10
7	FINE CLAY SAND	FINE CLAY SAND	11
8	FINE CLAY SAND	FINE CLAY SAND	12
9	FINE CLAY SAND	FINE CLAY SAND	13
10	FINE CLAY SAND	FINE CLAY SAND	14

PROPOSED RESERVOIR OR LAKE SHEET No. 1
TO BE SITUATED ON THE
LATS OF BOYD RUN ELIZABETH TWP ALLEGHENY COUNTY PA
AND OWNED BY
JOHN W BUTLER

JUNE 1920
ALBY L. McVEIGH Reg. Engr. 822

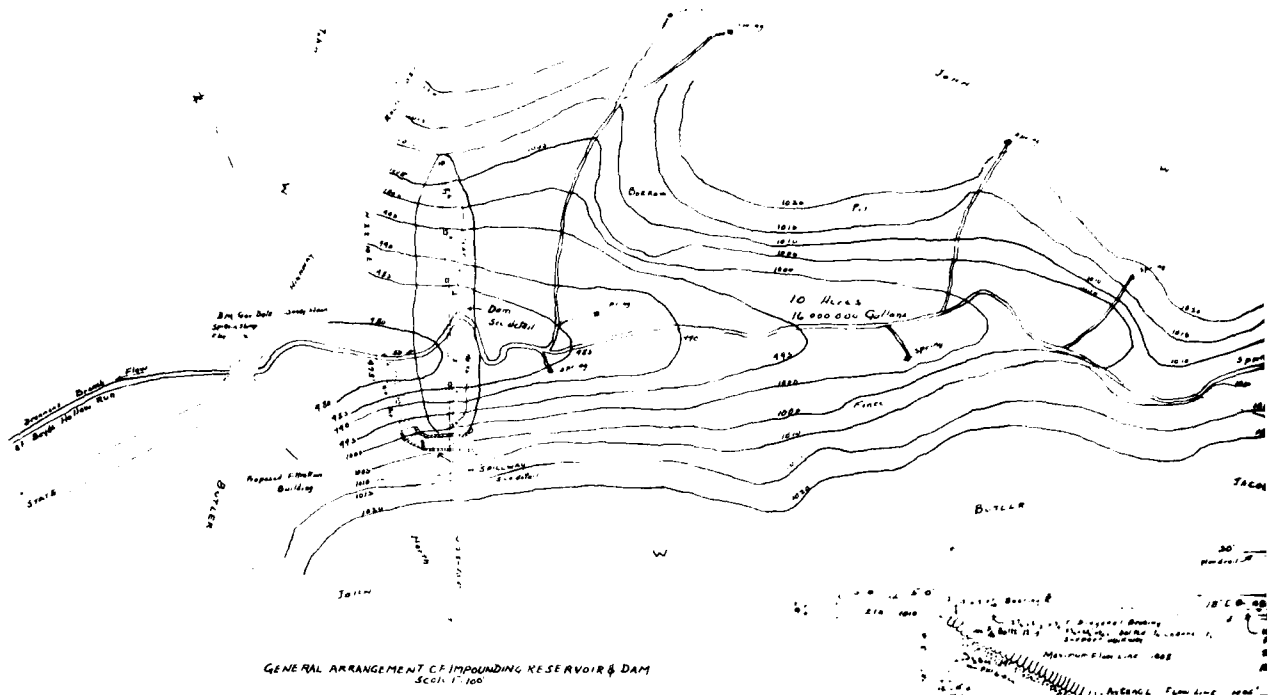

GENERAL ARRANGEMENT OF IMPOUNDING RESERVOIR & DAM
Scale 1/100



Cross Section of Dam
Concrete Grade C

Common Material called
Same as Selected
Material

Selected Material
Contract in place
as specified

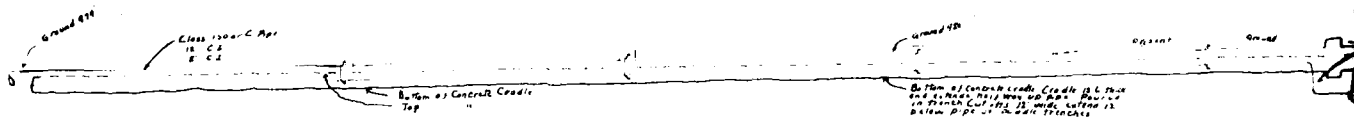

TYPICAL
SECTION THROUGH DAM
Scale 1/10

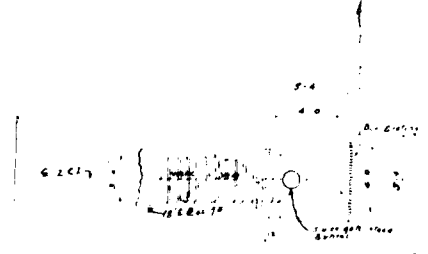

PLAN OF INTAKE
Scale 1/10

1	LOAM	LOAM	LOAM	LOAM	LOAM	YELLOW CLAY
2						
3						
4						
5						
6	SHALE AND SLATE	FINE CLAY SAND	FINE CLAY SAND	FINE CLAY SAND	FINE CLAY SAND	SHALE AND SLATE
7						
8						
9	FINE CLAY SAND	FINE CLAY SAND	FINE CLAY SAND	FINE CLAY SAND	FINE CLAY SAND	FINE CLAY SAND
10						

SECTIONS THROUGH TEST PILES
Scale 1/10

All Concrete to be
placed in place
if possible

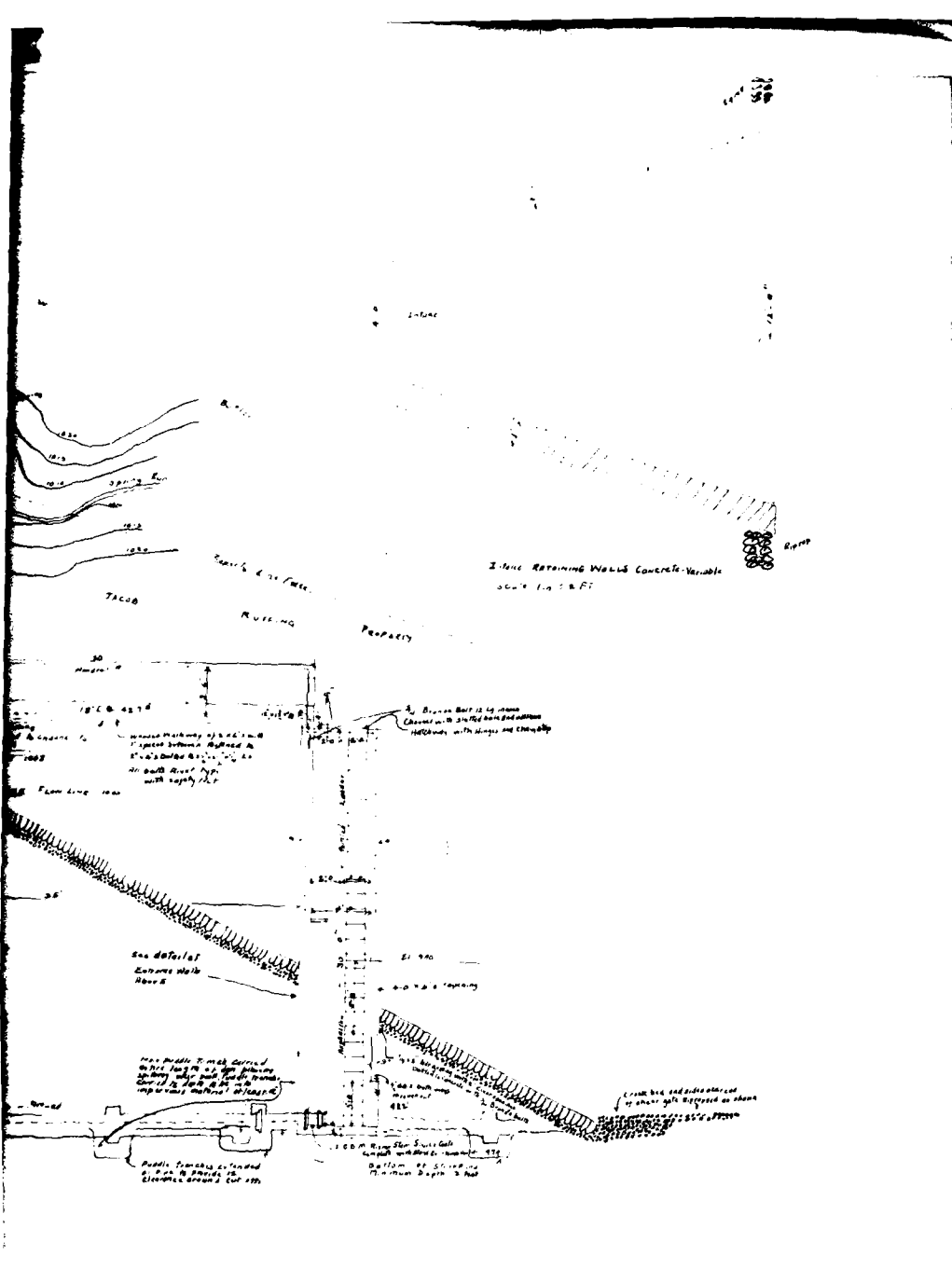

Section of Struck 500 East of Dam 612
 111 - 5 FT Vertical
 Good
 Limestone
 Good
 Sandstone
 Shale
 Breccia - Basalt

PROPOSED RESERVOIR OR LAKE SHEET No 1
 TO BE SITUATED ON THE
 HEADWATERS OF BRAYS RUN ELIZABETH TWP ALLEGHENY COUNTY PA
 AND OWNED BY
 JOHN W. BUTLER
 SCALE AS SHOWN
 JUNE 1939
 ALOY L. McVICKER Reg. Eng. #22

& Concrete & Co. 12 1/2 1911
 Best quality building stone is present and economical
 1 mile or more in interesting and picturesque

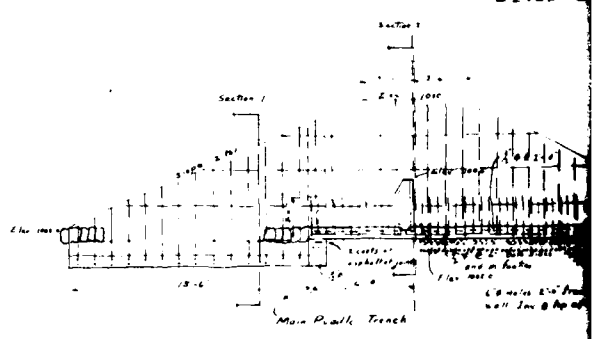
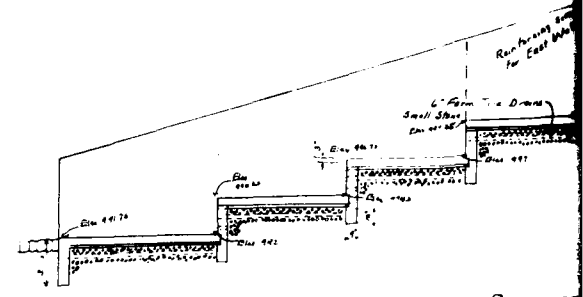
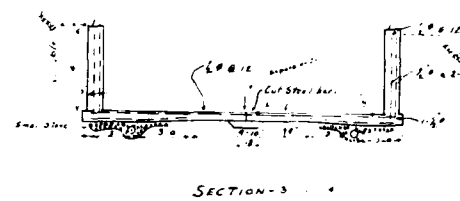
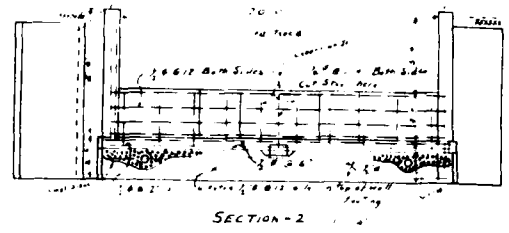
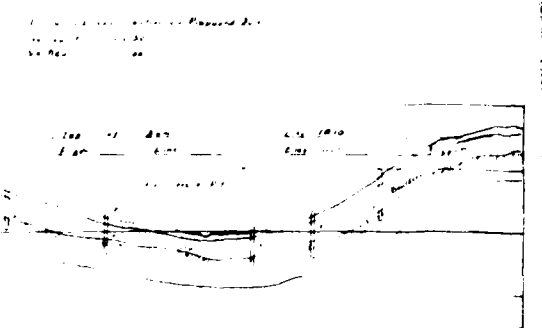
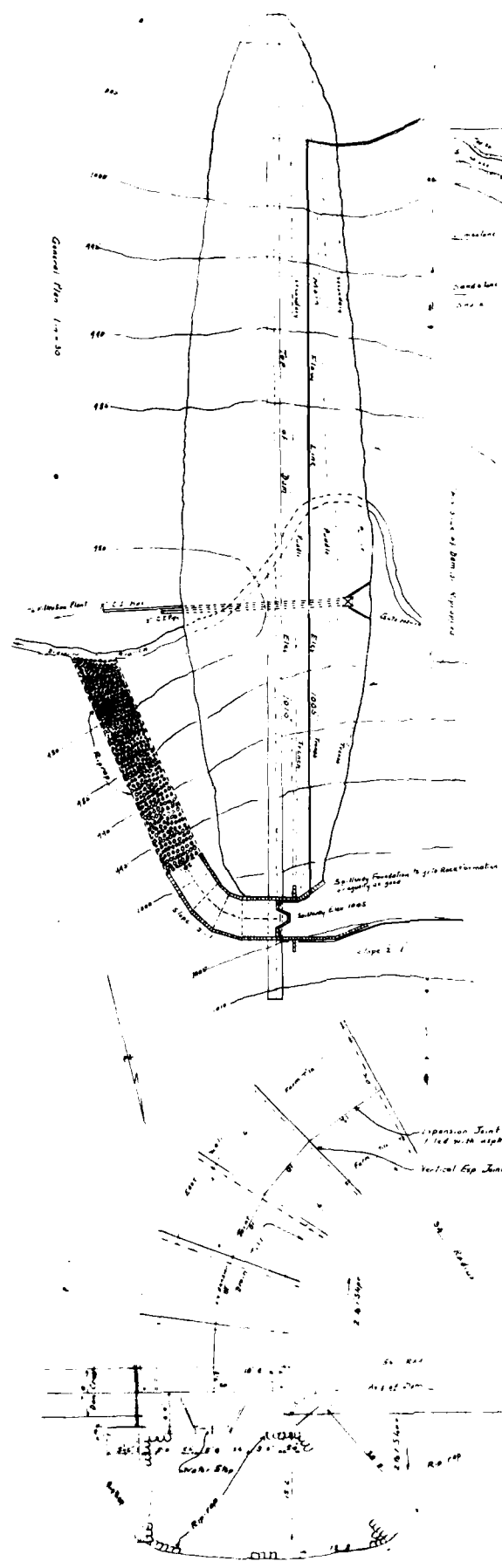

Plan of Spillway, See also, water
1 - 2 ft

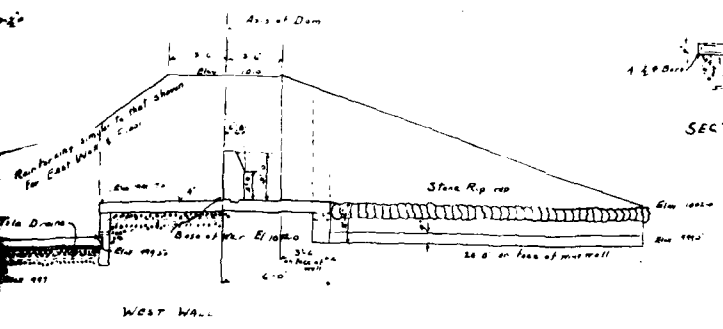
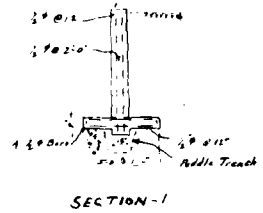
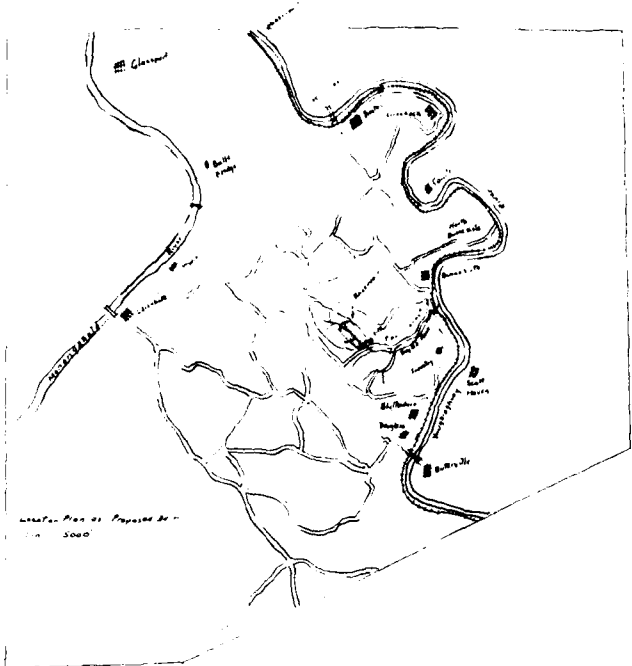

DEVELOPED ELEVATIONS OF SPILLWAY
Scale 1/4" = 1'-0"

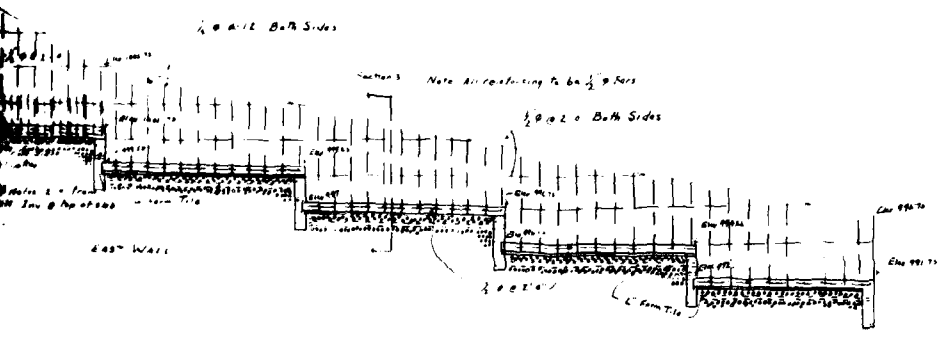

PROPOSED RESERVOIR OR LAKE. SHEET NO. 2
TO BE SITUATED ON THE
HEADWATER OF BASS RUN ELIZABETH TWP ALLEGHENY COUNTY PA.
AND OWNED BY
JOHN W. BUTLER
SCALE AS SHOWN
JUNE 1930

ALAN L. MCKAY, Eng. 505-086

APPENDIX F

GEOLOGY

GEOLOGY

Geomorphology

Butler's Lake Dam is located within the Pittsburgh Plateau section of the Appalachian Plateau Physiographic Province. This area is characterized by gently folded sedimentary rocks which have been incised by streams to form steep sided valleys. Slopes range from moderate to moderately steep, with the steeper slopes usually found adjacent to streams.

Stratigraphy

Butler's Lake Dam is located near the stratigraphic contact of the Monongahela Group of Pennsylvanian Age and the Dunkard Group of Permian Age. The Pittsburgh Formation, which makes up more than three-fourths of the Monongahela Group, contains two minable coals in this area, the Pittsburgh and Redstone seams. Other major rock types found in this formation include shale, sandstone, and limestone. Located stratigraphically above the Pittsburgh Formation is the Uniontown Formation which consists of sandstone and shale. The Waynesburg Coal Seam, which marks the stratigraphic boundary between the Monongahela and Dunkard Groups does not outcrop near the dam site. The Dunkard Group is poorly exposed in this area because it outcrops on hilltops rather than valleys. The main rock types found in this group are siltstones and shales.

Mining Activities

The Pittsburgh Coal Seam has been extensively deep-mined in this area in contrast to the Redstone Coal Seam, which has only been affected by small country banks.

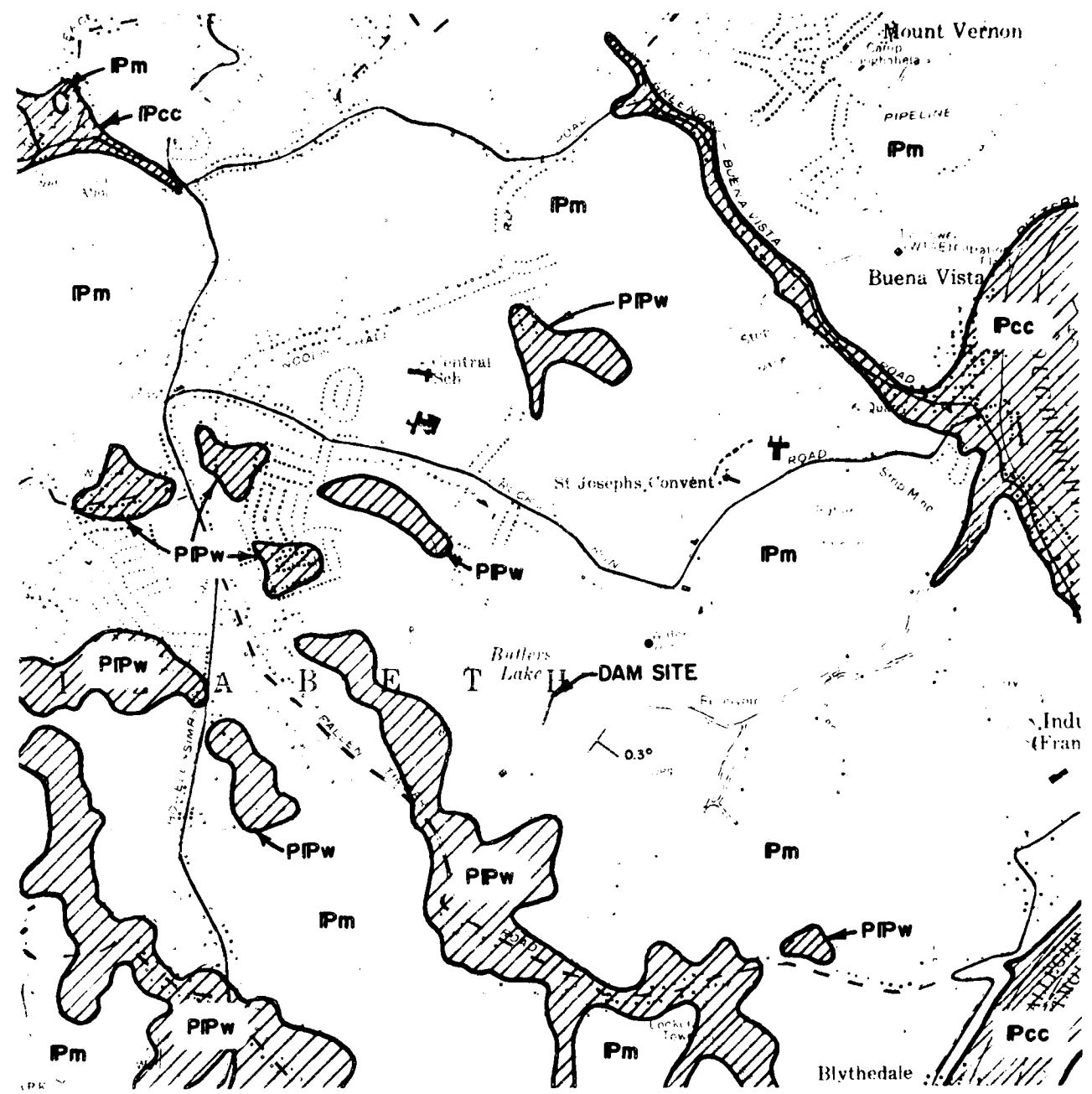

McKEESPORT QUADRANGLE, ALLEGHENY COUNTY, PENNSYLVANIA

SCALE:  1:24000
 CONTOUR INTERVAL 20 FT. DATUM IS MEAN SEA LEVEL
 ——— FORMATION CONTACT

DATA OBTAINED FROM PENNSYLVANIA TOPOGRAPHIC AND GEOLOGIC SURVEY GREATER PITTSBURGH REGION GEOLOGIC MAP AND CROSS SECTIONS, 1975 and GREATER PITTSBURGH REGION STRUCTURE CONTOUR MAP, 1975

DATE: MAY 1981		BUTLER'S LAKE DAM NATIONAL DAM INSPECTION PROGRAM	GEOLOGIC MAP
SCALE: 1"=200'			
DR: JF	CK:	ACKENHEIL & ASSOCIATES CONSULTING ENGINEERS GEO SYSTEMS, INC. 1000 BANKSVILLE RD./PITTSBURGH, PA. 15216	

AGE	VC OR G	Z-1E3 TH	COLUMNAR SECTION	PROMINENT BEDS
QUATERNARY		Q1		PLEISTOCENE GLACIAL OUTWASH, RIVER TERRACE DEPOSITS AND ALLUVIUM
PERMIAN	DUNKARD (P4)	WASHINGTON GREENE (P3)		UPPER WASHINGTON LIMESTONE
		WASHINGTON (P2)		WASHINGTON COAL
		WAYNESBURG (P1)		WAYNESBURG SANDSTONE
		WAYNESBURG (P1)		WAYNESBURG COAL
PENNSYLVANIAN	MORGANTOWN (P3)	UNIONTOWN (P2)		UNIONTOWN SANDSTONE
		UNIONTOWN (P2)		UNIONTOWN COAL
	CONEMAUGH (P2)	BENWOOD (P1)		BENWOOD LIMESTONE
		SEWICKLEY (P1)		SEWICKLEY COAL
		PITTSBURGH (P1)		PITTSBURGH SANDSTONE
		PITTSBURGH (P1)		PITTSBURGH COAL
	GLENSHAW (P1)	CONNELLSVILLE (P1)		CONNELLSVILLE SANDSTONE
		MORGANTOWN (P1)		MORGANTOWN SANDSTONE
	ALLEGHANY (P1)	AMES (P1)		AMES LIMESTONE
		PITTSBURGH (P1)		PITTSBURGH REDBEDS
SALTSBURGH (P1)			SALTSBURGH SANDSTONE	
MAHONING (P1)			MAHONING SANDSTONE	
POTTSVILLE (P1)	UPPER FREEPORT (P1)		UPPER FREEPORT COAL	
	UPPER KITTANNING (P1)		UPPER KITTANNING COAL	
	WORTHINGTON (P1)		WORTHINSTON SANDSTONE	
MERCER (P1)	LOWER KITTANNING (P1)		LOWER KITTANNING COAL	
	HOMERWOOD (P1)		HOMERWOOD SANDSTONE	
MERCER (P1)	MERCER (P1)		MERCER SANDSTONE, SHALE & COAL	
	CONNOQUENESSING (P1)		CONNOQUENESSING SANDSTONE	
	CONNOQUENESSING (P1)		CONNOQUENESSING SANDSTONE	
MISSISSIPPIAN	MALCOLM CHALK (M1)	BURGOON (M1)		BURGOON SANDSTONE
		CUYAHOGA (M1)		CUYAHOGA SHALE
		BEREA (M1)		BEREA SANDSTONE

DATE: MAY 1981		BUTLER'S LAKE DAM NATIONAL DAM INSPECTION PROGRAM	GEOLOGIC COLUMN
SCALE: 1" = 360'			
DR: JF	CK:	A. C. ACKENHEIL & ASSOCIATES, INC. CONSULTING ENGINEERS PITTSBURGH, PA., CHARLESTON, W. VA. & BALTIMORE, MD.	