

AD-A099 378 ARMY ENGINEER WATERWAYS EXPERIMENT STATION VICKSBURG MS F/G 13/2  
 REAERATION THROUGH GATED-CONDUIT OUTLET WORKS.(U)  
 MAR 81 S C WILHELMS; D R SMITH  
 UNCLASSIFIED WES/TR/E-81-5 NL

1 of 1  
 AD-A099 378

END  
 DATE  
 FILMED  
 DTIC

AD A099378

LEVEL

DTIC  
MAY 26 1981

6

Unclassified

SECURITY CLASSIFICATION OF THIS PAGE (When Data Entered)

REPORT DOCUMENTATION PAGE		READ INSTRUCTIONS BEFORE COMPLETING FORM	
1. REPORT NUMBER Technical Report E-81-5	2. GOVT ACCESSION NO. AD-A099378	3. RECIPIENT'S CATALOG NUMBER	
4. TITLE (and Subtitle) REAERATION THROUGH GATED-CONDUIT OUTLET WORKS.	5. TYPE OF REPORT & PERIOD COVERED Final report		
7. AUTHOR(s) Steven C. Wilhelms Dennis R. Smith	6. CONTRACT OR GRANT NUMBER(s)		
9. PERFORMING ORGANIZATION NAME AND ADDRESS U. S. Army Engineer Waterways Experiment Station Hydraulics Laboratory P. O. Box 631, Vicksburg, Miss. 39180		10. PROGRAM ELEMENT, PROJECT, TASK AREA & WORK UNIT NUMBERS CWIS No. 31402 EWQOS Work Unit 31604 (III A.1)	
11. CONTROLLING OFFICE NAME AND ADDRESS Office, Chief of Engineers, U. S. Army Washington, D. C. 20314		12. REPORT DATE Mar 81	13. NUMBER OF PAGES 78
14. MONITORING AGENCY NAME & ADDRESS (if different from Controlling Office) U. S. Army Engineer Waterways Experiment Station Environmental Laboratory P. O. Box 631, Vicksburg, Miss. 39180		15. SECURITY CLASS. (of this report) Unclassified	
16. DISTRIBUTION STATEMENT (of this Report)  Approved for public release; distribution unlimited.			
17. DISTRIBUTION STATEMENT (of the abstract entered in Block 20, if different from Report)			
18. SUPPLEMENTARY NOTES The effort was initiated under work unit CWIS 31402, "Methods of Enhancing Water Quality," of the Reservoir Water Quality Research Program sponsored by the Office, Chief of Engineers. This effort was completed and the report published within the Environmental & Water Quality Operational Studies (EWQOS).			
19. KEY WORDS (Continue on reverse side if necessary and identify by block number) Aeration                      Oxygen Conduits                      Temperature Hydraulic gates Outlet works			
20. ABSTRACT (Continue on reverse side if necessary and identify by block number) Dissolved oxygen and temperature data from twelve Corps of Engineers civil works projects were analyzed relative to oxygen uptake through the project's outlet structure. All the structures examined were similar gated-conduit outlet works. The Energy Dissipation Model (EDM) and Deficit Ratio Model (DRM) were evaluated for use in predicting reaeration through outlet works. Most of the structures reaerated their releases to 80-90 percent of saturation. The EDM appears more appropriate for use with structures than does the DRM.			

SECURITY CLASSIFICATION OF THIS PAGE(When Data Entered)

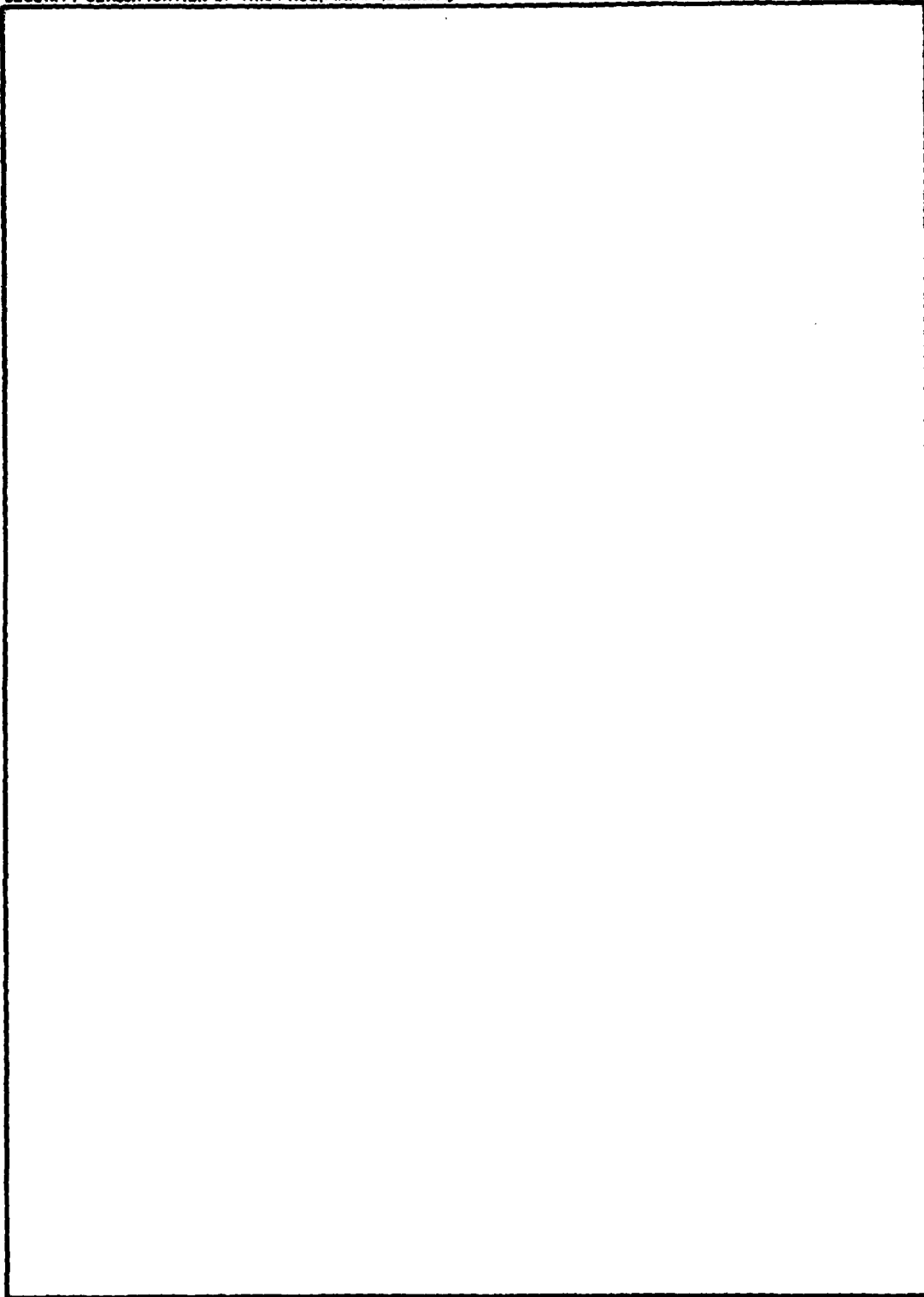

SECURITY CLASSIFICATION OF THIS PAGE(When Data Entered)

Preface

This analysis was conducted at the U. S. Army Engineer Waterways Experiment Station (WES), CE, Hydraulics Laboratory (HL), from September 1976 to December 1978. This effort was initiated under work unit CWIS 31402, "Methods of Enhancing Water Quality," of the Reservoir Water Quality Research Program sponsored by the Office, Chief of Engineers. The effort was completed and the report published within the Environmental and Water Quality Operational Studies (EWQOS) under EWQOS Work Unit 31604 (III A.1).

Dr. J. L. Mahloch was Program Manager for EWQOS. Messrs. H. B. Simmons, Chief of the HL, and J. L. Grace, Jr., Chief of the Hydraulic Structures Division, directed the effort. Mr. Steven C. Wilhelms conducted the study and prepared the text under the direct supervision of Mr. D. G. Fontane, former Chief of the Reservoir Water Quality Branch (Physical). Dr. D. R. Smith, Chief of the Reservoir Water Quality Branch, assisted in the preparation and review of this report. Mr. M. E. Neumann assisted in the mathematical analysis of the data. Data were furnished by Mr. Glenn Drummond and other personnel of the Ohio River Division and by personnel from the Vicksburg District, CE.

COL John L. Cannon, CE, and COL Nelson P. Conover, CE, were Commanders and Directors of WES during this effort. Mr. Fred R. Brown was Technical Director.

This report should be cited as follows:

Wilhelms, Steven C., and Smith, Dennis R. 1981.  
"Reaeration Through Gated-Conduit Outlet Works,"  
Technical Report E-81-5, U. S. Army Engineer Water-  
ways Experiment Station, CE, Vicksburg, Miss.

Accession For	
NTIS GSA&I	<input checked="" type="checkbox"/>
DTIC TAB	<input type="checkbox"/>
Unannounced	<input type="checkbox"/>
Justification	
By	
Distribution/	
Availability Codes	
Avail and/or	
Dist Special	
	A

Contents

	<u>Page</u>
Preface . . . . .	1
Conversion Factors, U. S. Customary Units to Metric (SI) Units of Measurement . . . . .	3
Introduction . . . . .	4
Objectives . . . . .	5
Scope . . . . .	5
Approach . . . . .	5
Energy Dissipation Model . . . . .	7
Deficit Ratio Model . . . . .	10
Results . . . . .	12
Conclusions . . . . .	15
Recommendations . . . . .	21
References . . . . .	26
Plates 1-38	
Appendix A: Hydraulic and Predicted Data . . . . .	A1
Appendix B: Example Case for Prediction of Reaeration for Gated-Conduit Outlet Works . . . . .	B1
Synopsis of Procedure . . . . .	B2
Example Case . . . . .	B3
Tables B1 and B2	
Appendix C: SELECT Example . . . . .	C1

Conversion Factors, U. S. Customary To Metric (SI)  
Units of Measurement

U. S. customary units of measurement used in this report can be converted to metric (SI) units as follows:

<u>Multiply</u>	<u>By</u>	<u>To Obtain</u>
cubic feet per second	0.02832	cubic metres per second
Fahrenheit degrees	5/9	Celsius degrees or Kelvins*
feet	0.3048	metres
foot-pounds (force)	1.355818	metre-newtons or joules
pounds (force)	4.44822	newtons
square feet	0.09290304	square metres

---

\* To obtain Celsius (C) temperature readings from Fahrenheit (F) readings, use the following formula:  $C = (5/9)(F - 32)$ . To obtain Kelvin (K) readings, use:  $K = (5/9)(F - 32) + 273.15$ .



## REAERATION THROUGH GATED-CONDUIT OUTLET WORKS

### Introduction

1. It is often possible to enhance the water quality of releases from reservoirs by employing outlet works that aerate the flow. This is especially important if the water entering the outlet works is low in dissolved oxygen (D.O.), since many kinds of aquatic life cannot survive in a low D.O. environment. To design structures that effectively aerate the release water, predictive techniques are required that quantify the gas transfer that results with flow through a particular structure of interest. Few predictive techniques have been developed or applied to hydraulic structures.

2. The development of generalized equations applicable to arbitrary structural designs is extremely difficult. Reaeration during flow through hydraulic structures depends upon molecular diffusion and the magnitude of dispersion due to turbulent mixing. In most instances, turbulence is the physical mechanism that dominates the rate of gas transfer. Numerical modeling of turbulence to accurately describe gas-transfer processes in self-aerated flows requires a data base and modeling techniques in excess of those currently available. Reaeration occurring during flow through hydraulic structures is currently predicted on a very limited basis by use of semiempirical or empirical mathematical models of the reaeration process. For any of these models, the coefficients must be determined experimentally and the models compared to determine the most applicable. Above all, the models should not be applied indiscriminately outside of the flow regime for which the coefficients were developed. It is imperative to investigate the adequacy of the respective models for predicting reaeration in hydraulic structures.

3. Two models were analyzed and evaluated regarding reaeration occurring through outlet works: (a) Energy Dissipation Model (EDM) (Tsivoglou and Wallace 1972) and (b) Deficit Ratio Model (DRM) (Holler 1970). These two were chosen because they are relatively simple mathematical models that predict the gas transfer as a function of the total energy dissipated.

### Objectives

4. The objectives of this study were as follows:
  - a. To analyze and document existing D.O. data for gated-conduit release structures.
  - b. To provide a qualitative and quantitative evaluation of the gas-transfer characteristics of existing structures of this type.
  - c. To test the applicability of the EDM and DRM for predicting oxygen uptake through reservoir outlet works.

### Scope

5. This report addresses reservoir outlet works consisting of intake structures, conduits, and stilling basins (Figure 1). Analysis of D.O. data from several U. S. Army Corps of Engineers projects is reported herein. Drawings of the projects are presented in Plates 1-12. All of these outlet works exhibited similar hydraulic conditions inasmuch as there was free-surface flow through the conduit and the outlet portal was not submerged by the tailwater.

### Approach

6. The data available for analysis were observed D.O. and temperature profiles in the lake and downstream D.O. and temperature (Plates 13-38). Prediction of the D.O. and temperature entering the structure was required. A generalized selective withdrawal technique (Bohan and Grace 1973), "SELECT," developed at the U. S. Army Engineer Waterways Experiment Station (WES), CE, was verified for applicability to the hydraulic structures by predicting release temperatures and comparing the predictions with the observed release temperatures. This was possible because there is negligible heat transfer between the release water and structure. SELECT was then used to predict D.O. content of the water entering the hydraulic structure. These predictions were used in a qualitative evaluation of the reaeration occurring through the

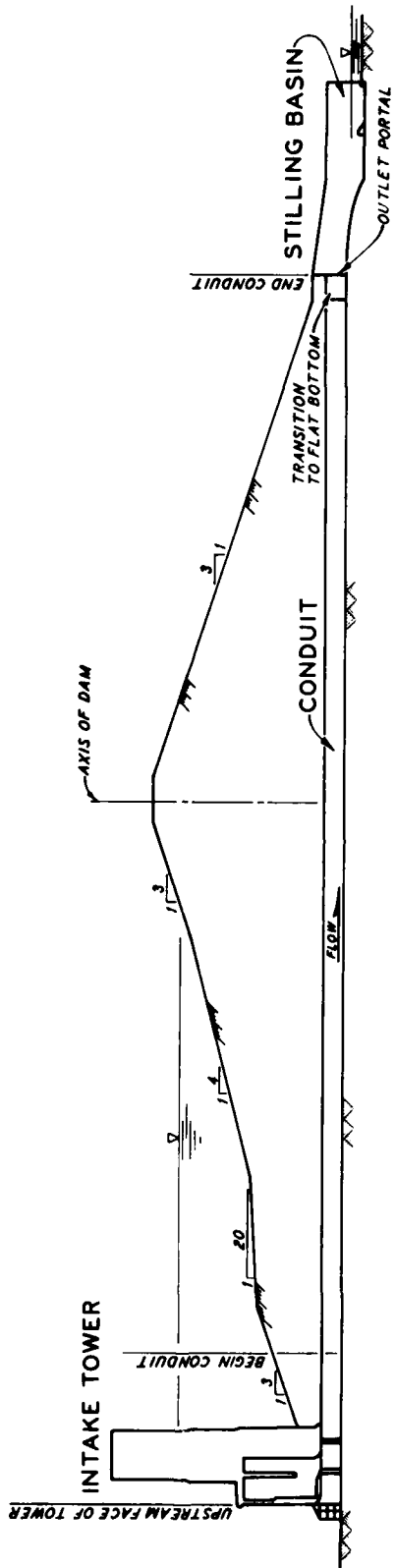

Figure 1. Intake structure, conduit, and stilling basin

structures and as input to the EDM and DRM (Appendix A).

### Energy Dissipation Model

7. The EDM, which was developed for streams, states that the reaeration rate coefficient is proportional to the rate of energy dissipation. The model is expressed mathematically as

$$K_2 = c \frac{\Delta E}{t_f} \quad (1)$$

where

$K_2$  = reaeration or gas-transfer coefficient, base e, per sec

$c$  = escape coefficient, per ft\* of energy loss

$\Delta E$  = energy expended from upstream point to downstream point, ft-lb per lb of water

$t_f$  = time of flow from upstream to downstream, sec

The total energy dissipated between upstream and downstream points is the sum of the irreversible losses in kinetic and potential energy, which can be expressed as

$$\Delta E = \frac{v_1^2 - v_2^2}{2g} + (H_1 + Z_1) - (H_2 + Z_2) \quad (2)$$

where the variables are defined by (Tsvoglou and Wallace 1972)

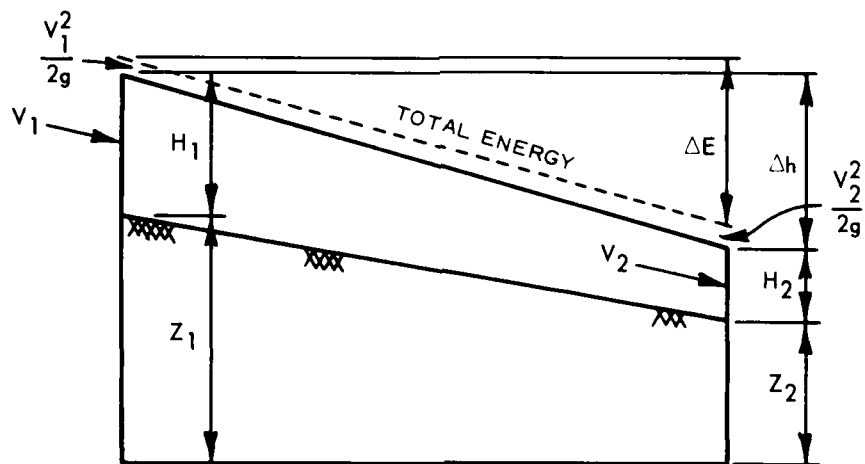

\* A table of factors for converting U. S. customary units of measurement to metric (SI) units is presented on page 3.

where

- $V_1, V_2$  = velocity at respective locations, ft/sec  
 $H_1, H_2$  = depth of flow at respective locations, ft  
 $Z_1, Z_2$  = elevation of respective locations above some datum, ft  
 $g$  = acceleration due to gravity, ft/sec<sup>2</sup>  
 $\Delta h$  = water surface elevation change from upstream to downstream, ft

In the hydraulic structures analyzed, the velocity in the lake  $V_1$  was approximately zero, and the velocity in the exit channel  $V_2$  was small relative to its contribution to total head. Thus, the term

$$\frac{V_1^2 - V_2^2}{2g}$$

is negligible when compared to the elevation difference. Therefore,  $\Delta E$  can be closely approximated by  $\Delta h$  the water surface elevation change from upstream to downstream expressed in feet:

$$\Delta E \approx \Delta h = (H_1 + Z_1) - (H_2 + Z_2) \quad (3)$$

8. Assuming no chemical or biological oxygen consumption during flow through the structure, the downstream D.O. concentration can be estimated from a first order reaction equation (Streeter and Phelps 1925)

$$D_f = D_i \exp(-K_2 t_f) \quad (4)$$

where  $D_f$ ,  $D_i$  equals D.O. deficit downstream and upstream, respectively, mg/l. The oxygen deficit is defined as

$$D = C_{\text{sat}} - C_{\text{act}}$$

where

- $D$  = D.O. deficit, mg/l  
 $C_{\text{sat}}$  = saturation concentration of D.O., mg/l  
 $C_{\text{act}}$  = actual concentration of D.O., mg/l

Combining Equations 1, 3, and 4 yields

$$D_f = D_i \exp(-c\Delta h) \quad (5)$$

the predictive EDM.

9. Tests on streams and rivers (Tsivoglou and Neel 1976) using a gaseous tracer (Tsivoglou et al. 1968) indicated that the escape coefficient for a particular reach was dependent on the streamflow rate. The stream observations were divided into groups according to discharge. The first group had discharges less than 10 cfs. The second group ranged in discharges up to 500-750 cfs. A third group was considered (>750 cfs), but insufficient data were available for analysis. This information implies that a single escape coefficient might be used to predict the D.O. uptake occurring in this type of structure by similar groupings of flow rates. Most flows in these projects were within the range of the second group, although a few were in the third group. None were in the first group.

10. The escape coefficient for gated-conduit structures was unknown, thus gas-transfer tests were conducted at the outlet works of Enid Lake, Mississippi,\* using a gaseous tracer technique (Tsivoglou et al. 1968). These tests indicated a value of 0.045 per ft as an overall escape coefficient for the Enid structure. This estimate of the escape coefficient, after adjustment for the ambient water temperatures by

$$c_T = c_{20} 1.022^{(T-20)}$$

where  $c_T$ ,  $c_{20}$  are escape coefficients at  $T^\circ\text{C}$  and  $20^\circ\text{C}$ , respectively, was used in the predictive EDM (Equation 5) to estimate oxygen uptake occurring in several hydraulic structures consisting of an intake structure, conduit, and stilling basin.

---

\* Unpublished data, C. H. Tate, Jr., August 1978, U. S. Army Engineer Waterways Experiment Station, Vicksburg, Mississippi.

### Deficit Ratio Model

11. Using the "two film" theory of mass transfer, the DRM can be expressed (Holler 1970)

$$r = \frac{D_i}{D_f} = \exp\left(\frac{k_l a t}{v}\right) \quad (6)$$

where

$r$  = deficit ratio

$k_l$  = liquid film coefficient

$a$  = air/liquid interface area

$t$  = time of contact

$v$  = volume of liquid

12. In a channel the average transit time can be approximated in terms of the channel volume and the average flow rate:

$$t = \frac{v}{Q}$$

where

$Q$  = flow rate

$t$  = time of flow

Substituting in Equation 6,

$$r = \exp\left(\frac{k_l a}{Q}\right) \quad (7)$$

Using a Maclaurin's series to expand Equation 7 gives

$$r = 1 + \sum_{n=1}^{\infty} \frac{\left(\frac{k_l a}{Q}\right)^n}{n!} \quad (8)$$

13. It has been theorized (Holler 1970) that the air liquid interface area  $a$  can be expressed as a function of momentum change occurring in a hydraulic jump or when a jet impinges on a surface. By substituting a momentum function for area and dropping higher order terms, Equation 8 can be expressed as

$$r = 1 + f(\Delta V)$$

where  $f(\Delta V)$  is some function of the velocity change. In Holler's (1970) work, the deficit ratio was experimentally related to  $\Delta V^2$  and yielded the DRM predictive model

$$r = 1 + \beta(\Delta V)^2 \quad (9)$$

where

$\Delta V$  = change in velocity, ft/sec

$\beta$  = coefficient,  $\text{sec}^2/\text{ft}^2$

For flow over a sharp-crested weir, kinematics can be used to relate the velocity of the jet to fall height by converting potential energy to kinetic energy KE of the jet.

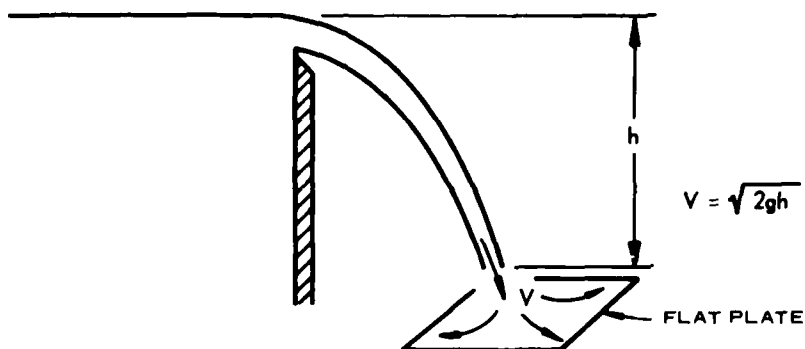

When the jet impinges on a flat plate, the momentum change is reflected in a velocity change. The velocity change along the axis of the jet is

$$\Delta V = V$$

since there is no velocity along the direction of the jet after impact. The potential energy is converted to kinetic energy and a large part of the KE is dissipated in the impact. Holler (1970) substituted  $h$  for  $\Delta V^2$  for the experimental work performed on sharp-crested weirs. In hydraulic structures, the change of potential energy to kinetic energy and subsequent dissipation is analogous, even though the energy



is not dissipated in a single impact. Thus,  $\Delta h$ , the difference in pool and tailwater elevations, was used as an estimate for  $\Delta V^2$  in Equation 9 with the constant  $2g$  taken into account in the coefficient  $\beta'$ .

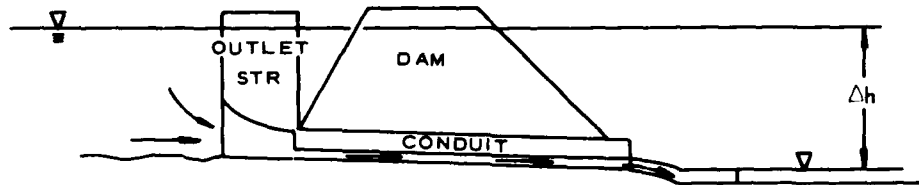

Holler determined experimentally that  $\beta'$  was 0.065 per ft for discharges over low-head submerged tainter gate spillway structures. Therefore,

$$r = 1 + 0.065\Delta h \quad (10)$$

Equation 10 was used to predict D.O. uptake through the same structures used in the EDM analysis. Observed D.O. data at the structures were compared to predicted D.O.

### Results

14. Plates 13-38 document the data used in this analysis of reaeration through selected outlet works. D.O. and temperature profiles for the lakes are plotted, and observed downstream D.O. and temperature measurements are given. The Beltzville data are documented in Hart and Wilhelms (1977). Other hydraulic and predicted data are presented in Appendix A. Release water temperatures were predicted with SELECT. Figure 2 shows the SELECT-predicted release temperature plotted against the observed release temperature. The standard deviation (Miller and Freund 1977) for SELECT-predicted temperatures was  $\pm 2.0^\circ\text{C}$ .

15. The data from all the projects indicated that reaeration through the structures was sufficient to raise the downstream D.O. to approximately 80-100 percent of saturation regardless of the flow and initial D.O. content. Figure 3 shows change of percent saturation plotted against initial saturation. The upstream deficit  $D_i$  was

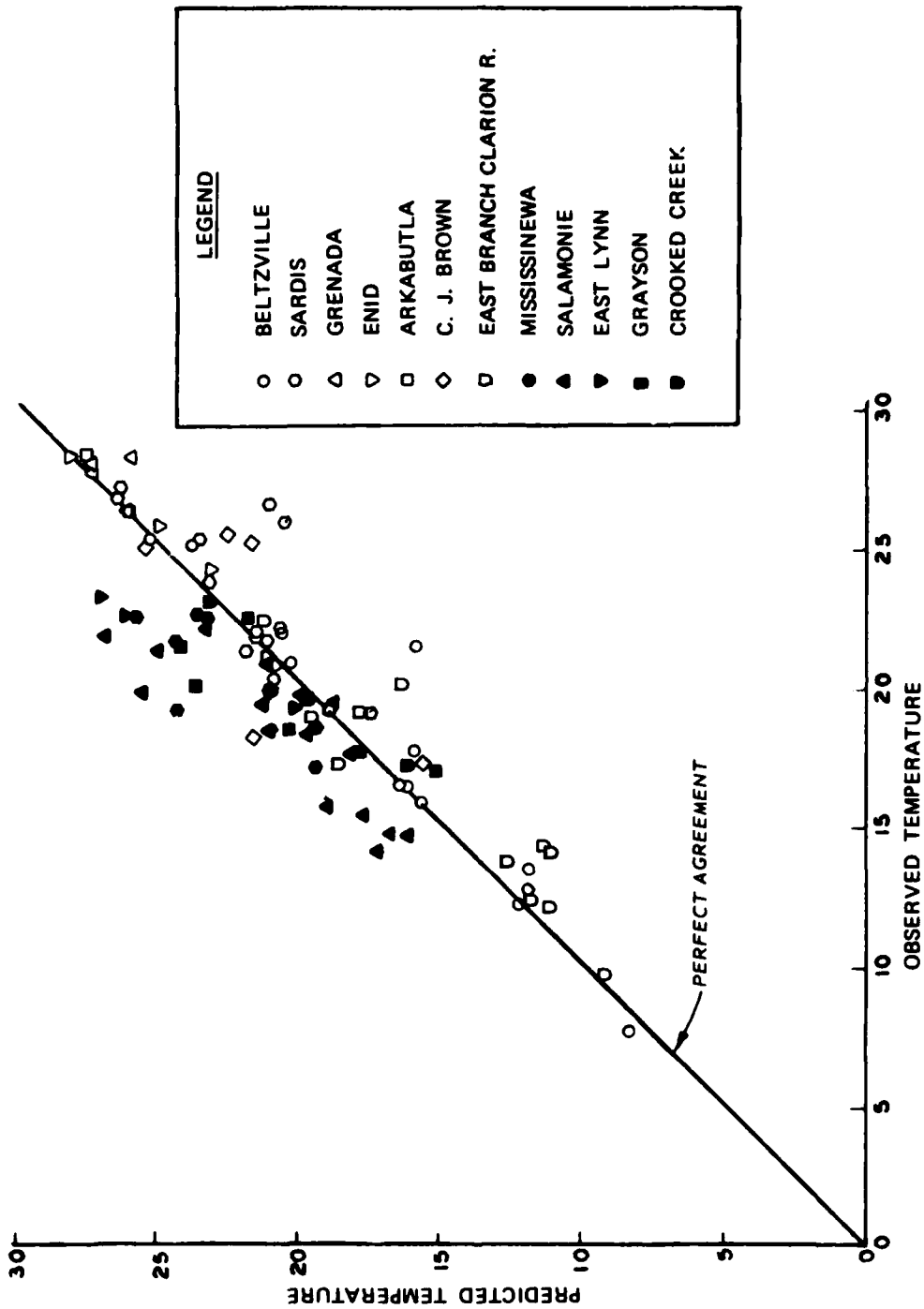
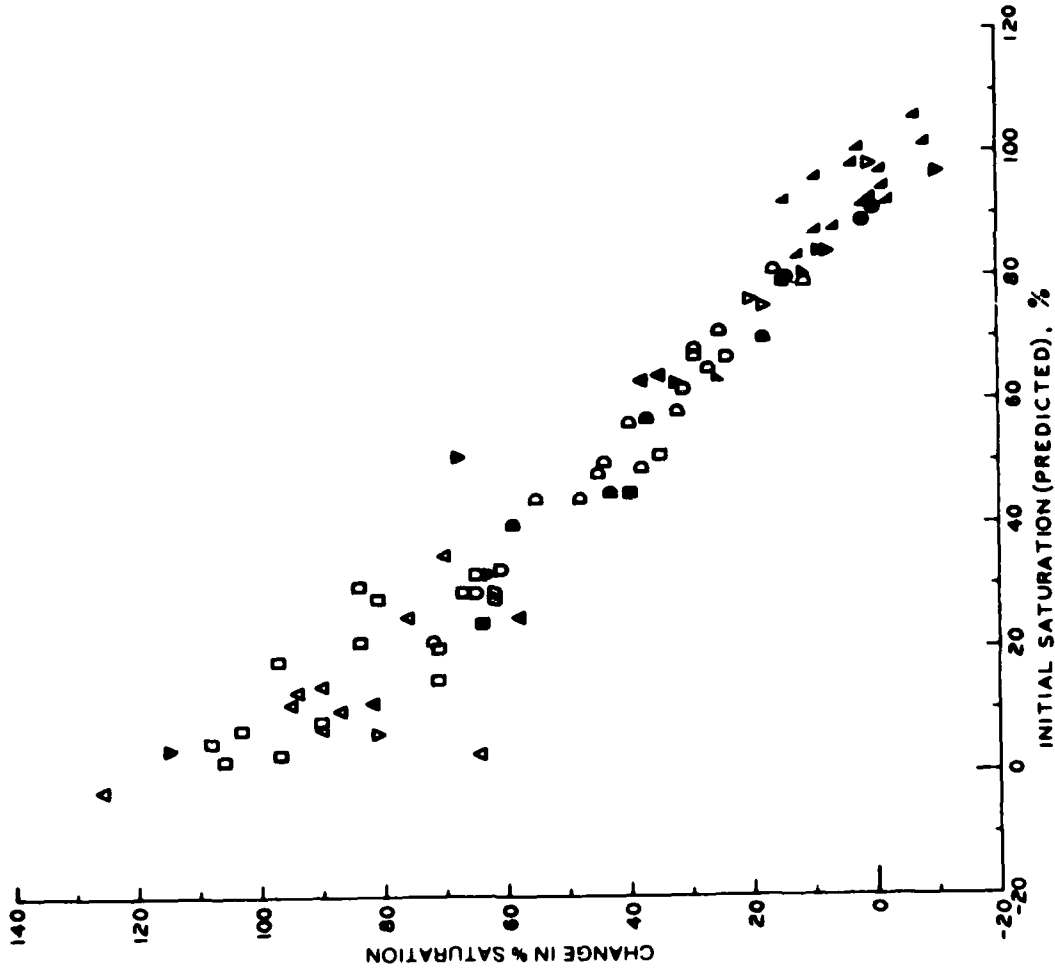

Figure 2. Predicted temperature versus observed temperature



**LEGEND**

▽	EAST BRANCH CLARION R.
□	SALAMONIE
△	MISSISSINIEWA
▽	GRAYSON
D	SARDIS
○	BELTZVILLE
●	EAST LYNN
■	ARKABUTLA
▲	ENID
▽	C J BROWN
●	GRENADA
▲	CROOKED CREEK

Figure 3. Change in D.O. saturation versus initial saturation

predicted with SELECT. Final saturation was computed from observed data.

16. The EDM predictive model was used to estimate the downstream deficit  $D_f$ . Predictions made with this model were compared to observed data (Figure 4). The predicted data varied with a standard error (Miller and Freund 1977) of  $\pm 0.7$  mg/l. D.O. predictions were also made with the DRM and were compared to observed downstream D.O. These comparisons are presented in Figure 5. Standard error for these predictions was  $\pm 0.9$  mg/l.

### Conclusions

17. All the projects analyzed indicated that releases re-aerated to approximately 90 percent of saturation. A common minimum release D.O. objective as established by some state standards is 5.0 mg/l. Data clearly indicated that these gated-conduit structures successfully met this standard.

18. Most D.O. predictions made with the EDM using an escape coefficient  $c_{20} = 0.045$  per ft compared favorably with observed D.O. The agreement between observed and predicted data was very good, considering the inherent variability in the data and the hydraulic differences among the structures. It is probable that the escape coefficients vary slightly from project to project and with flow for a particular structure because of differences in levels of turbulence, geometry, or other factors that affect the hydraulics and hydrodynamics of the flow through the structure.

19. Using a  $c_{20}$  of 0.045 per ft for gated-conduit structures with the range of flow rates investigated is consistent with river and stream investigations (Tsivoglou and Neal 1976), which have indicated an average  $c_{20}$  of 0.054 per ft for flow rates similar to those encountered in these projects. It was concluded from those studies that as the flow increases, the  $c_{20}$  should be adjusted downward toward a limiting value of approximately 0.025 to 0.030 per ft.

20. D.O. predictions made with the DRM (Figure 5) tend to be

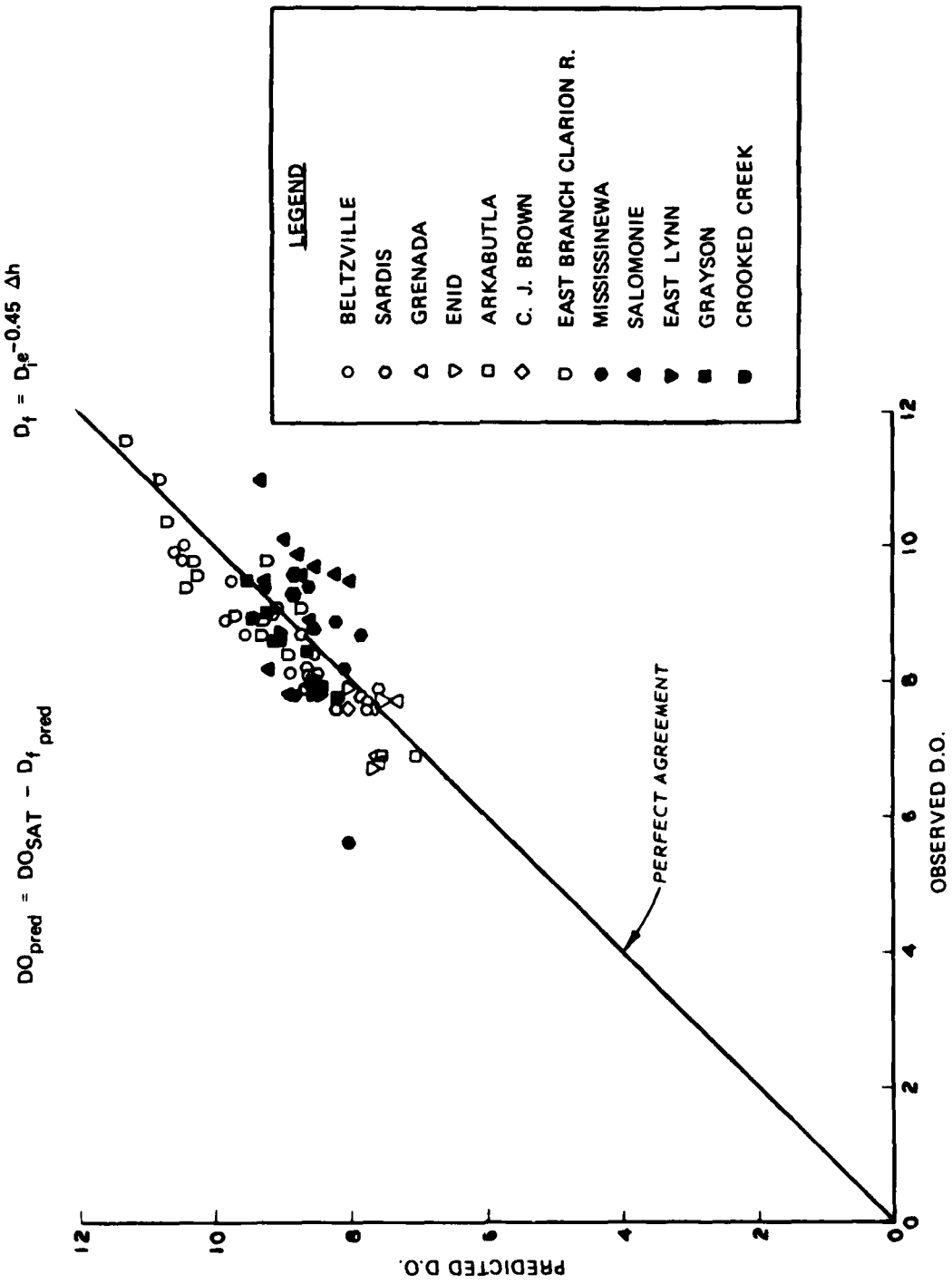

Figure 4. EDM-predicted D.O. versus observed D.O.

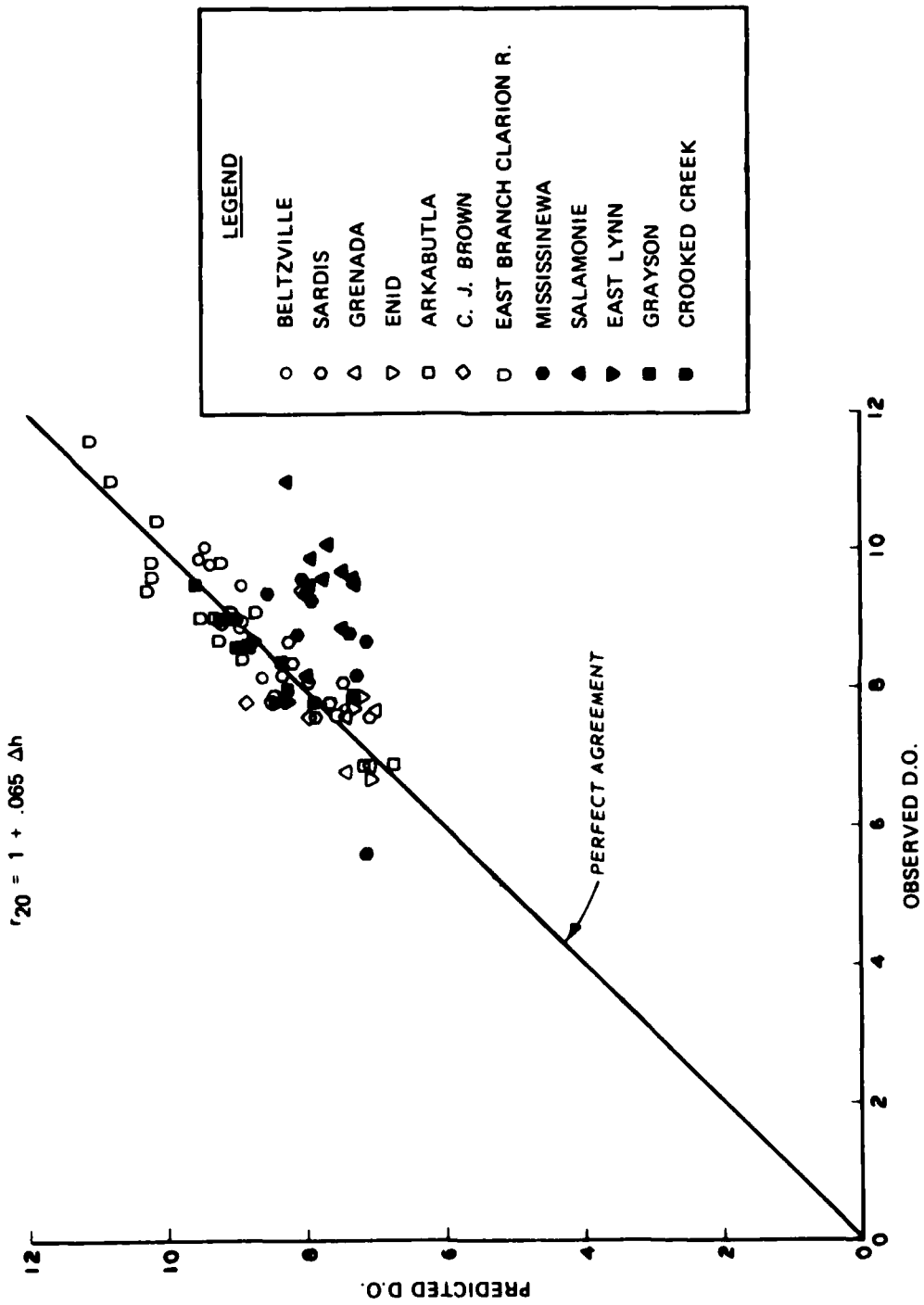

Figure 5. Holler's (1970) DRM-predicted D.O. versus observed D.O.

lower than observed D.O. levels. This implies that the coefficient  $\beta'$  in the DRM, which was developed for low heads, should be larger for high-head structures to increase predicted downstream D.O. concentration. The analysis of data obtained from the tracer studies at Enid Lake\* resulted in a  $\beta'$  coefficient of 0.200 per ft. Predictions made with the DRM with this coefficient are shown in Figure 6. The standard error (Miller and Freund 1977) of prediction was  $\pm 0.8$  mg/l as compared to 0.9 mg/l obtained with  $\beta'$  of 0.065 per ft developed for low-head structures.

21. The above results indicate that there is very little difference in the standard errors for the EDM model (calibrated with the Enid outlets work data), the DRM calibrated with low-head data, and the DRM calibrated with the Enid data. This implication is somewhat misleading, since there are fundamental differences in the models. The differences can be clearly delineated by comparing plots of the respective equations.

22. In Figure 7 the DRM developed by Holler (1970) for low-head submergible tainter gates can be compared with the EDM calibrated with the Enid data. The DRM has been inverted to provide consistency in the comparison. The models predict essentially identical deficit ratios for heads less than approximately 20 ft and consequently are equally valid. However, above 20 ft, the differences in predicted deficit ratios increase. The difference at larger heads is inherent in the derivation of the respective models. Both assume a first order process that is normally expressed mathematically as an exponential process. However, the DRM employs a truncated Maclaurin's series expansion to describe the exponential process. As a result, the DRM is mathematically valid only in the range of heads for which the truncated Maclaurin series approximates the exponential. The range for which it will be valid depends upon the range of heads over which the empirical coefficient was determined. Holler calibrated the DRM for low-head structures and consequently the model yields less accurate predictions for heads greater than 20 ft.

---

\* Unpublished data, C. H. Tate, Jr., August 1978, U. S. Army Engineer Waterways Experiment Station, Vicksburg, Mississippi.

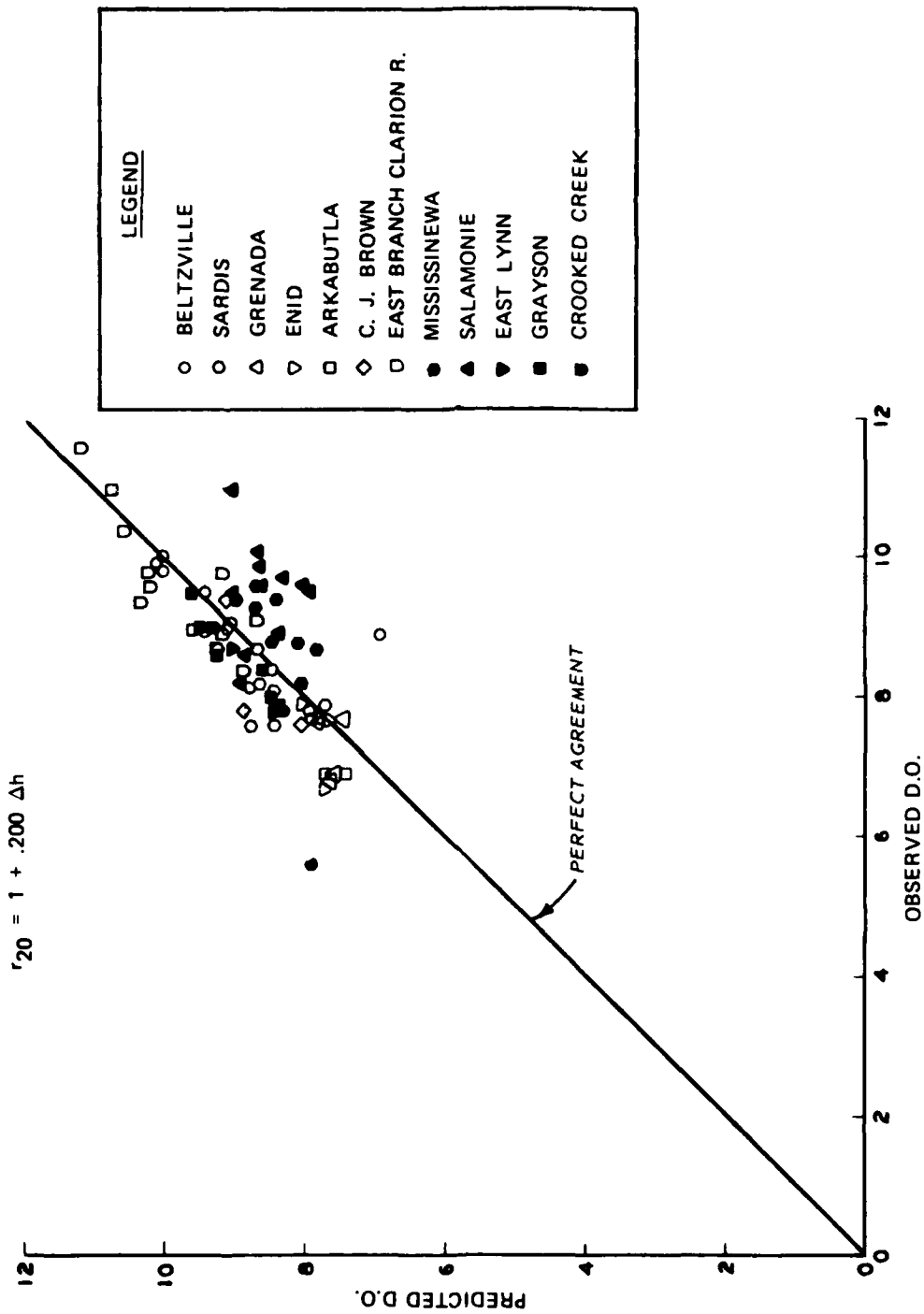

Figure 6. DRM-predicted D.O. versus observed D.O.



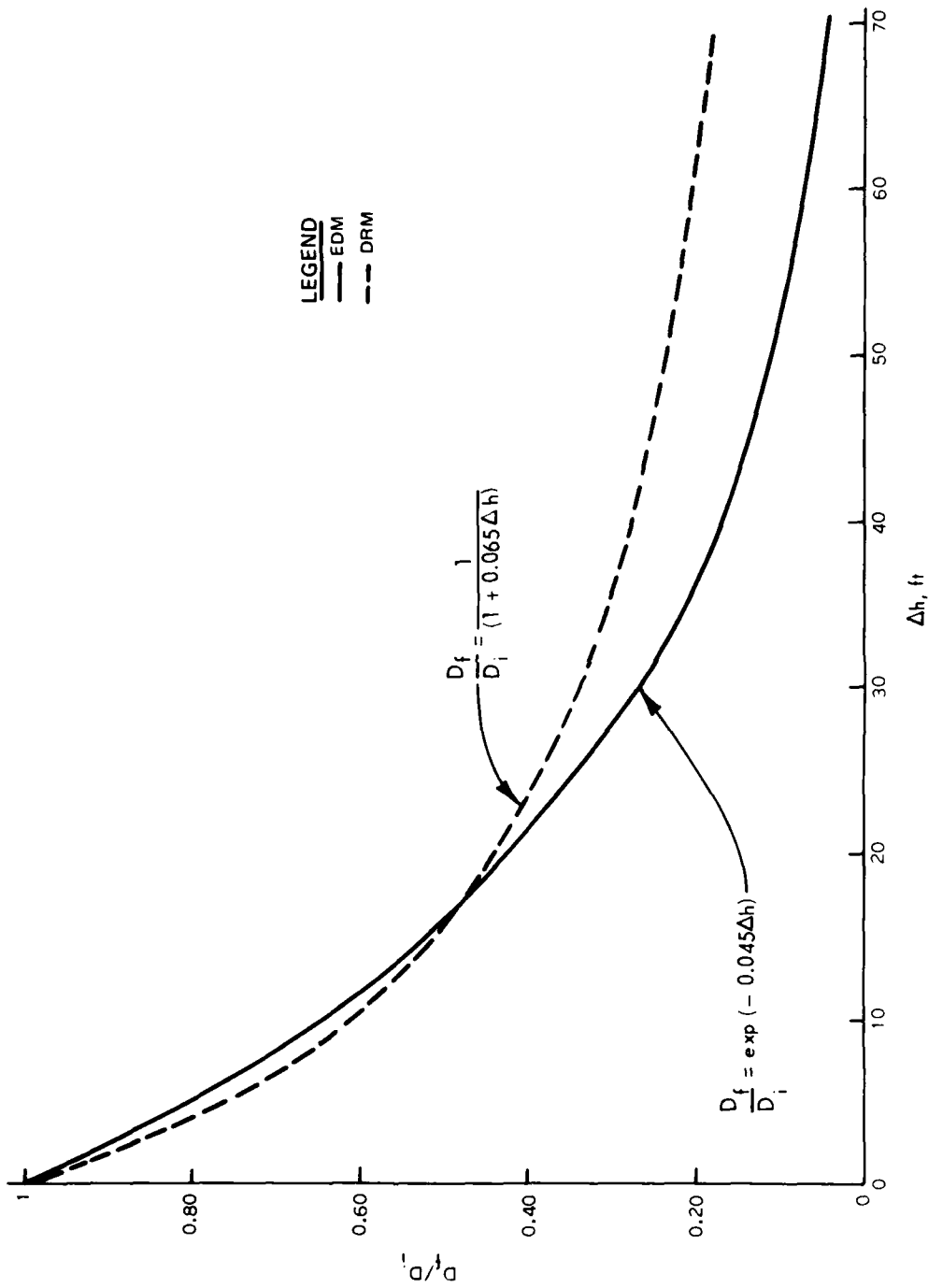

Figure 7. Comparison of Holler's (1970) DRM and EDM with coefficient determined from Enid Outlet Works

23. Although the DRM calibrated for low-head structures is not rigorously valid at high heads, large predictive errors will not necessarily result. As indicated in paragraph 16, the standard error of prediction with the DRM (calibrated for low-head structures) and the EDM (calibrated with Enid data) was 0.9 and 0.7 mg/l, respectively. This occurs because the final D.O. concentration asymptotically approaches saturation as the head is increased. Consequently, at large heads, the deficit ratios became small, which results in relative insensitivity of the final D.O. to the deficit ratio. The absolute error in D.O. prediction will be small; however, the DRM will tend to predict a lower final D.O. than actually exists. This result is clearly indicated by the plots in Figure 7 and is verified by the comparison of predicted and observed results in Figure 5.

24. It is possible to calibrate the DRM for large-head structures; however, large changes in the experimentally determined coefficient result. Calibrating the DRM with Enid data resulted in a  $\beta'$  of 0.200 per ft as compared to 0.065 per ft for low-head structures. As indicated in Figure 8, with this modification the DRM and EDM predict essentially equivalent results for heads of 50-70 ft. This is also reflected in Figures 4 and 6, which compare predicted and measured D.O. for the EDM and DRM, respectively. DRM, calibrated for large heads, should not be used for low-head structures. As indicated in Figure 7, very large errors would result.

#### Recommendations

25. The EDM should be used instead of the DRM to predict D.O. The EDM with an escape coefficient of 0.045 per ft predicts the deficit ratio for low-head structures as well as the DRM does. Additionally the EDM predicts D.O. for high heads (>25 ft) without modifying the experimentally determined coefficient. In comparison, large changes in the experimentally determined coefficient are required for the DRM to achieve equivalent accuracy. The assumptions upon which the DRM is based severely restrict the range of heads for which the equation is valid.

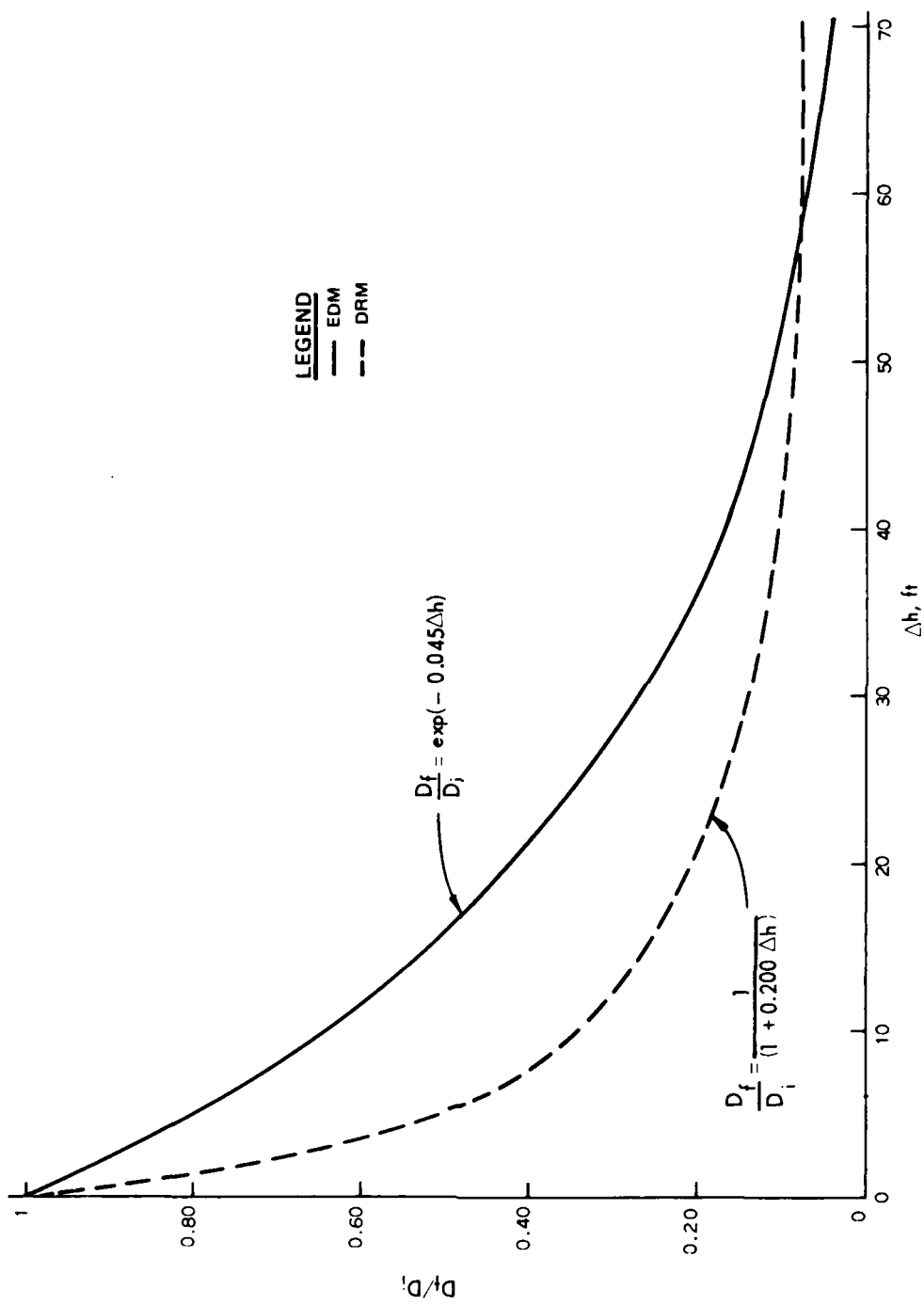

Figure 8. Comparison of DRM and EDM based upon coefficients determined from Enid Outlet Works

26. Additional research should be conducted to evaluate the effects of flow rate on gas transfer. Detailed studies of the hydraulics, turbulence, and energy dissipation related to gas transfer must be performed to clearly identify the cause and effect of structure design and gas exchange. Projects with outlet works similar to the structures examined but with other hydraulic conditions such as submerged outlet portals and full conduit flow should be examined to evaluate gas-transfer characteristics. Since reservoir outlet works are only a portion of the structures used to release water from man-made lakes, other types of structures, such as spillways, sluices, and hydropower structures (Figures 9 and 10), should also be investigated to evaluate appropriate models with these gas-transfer characteristics.

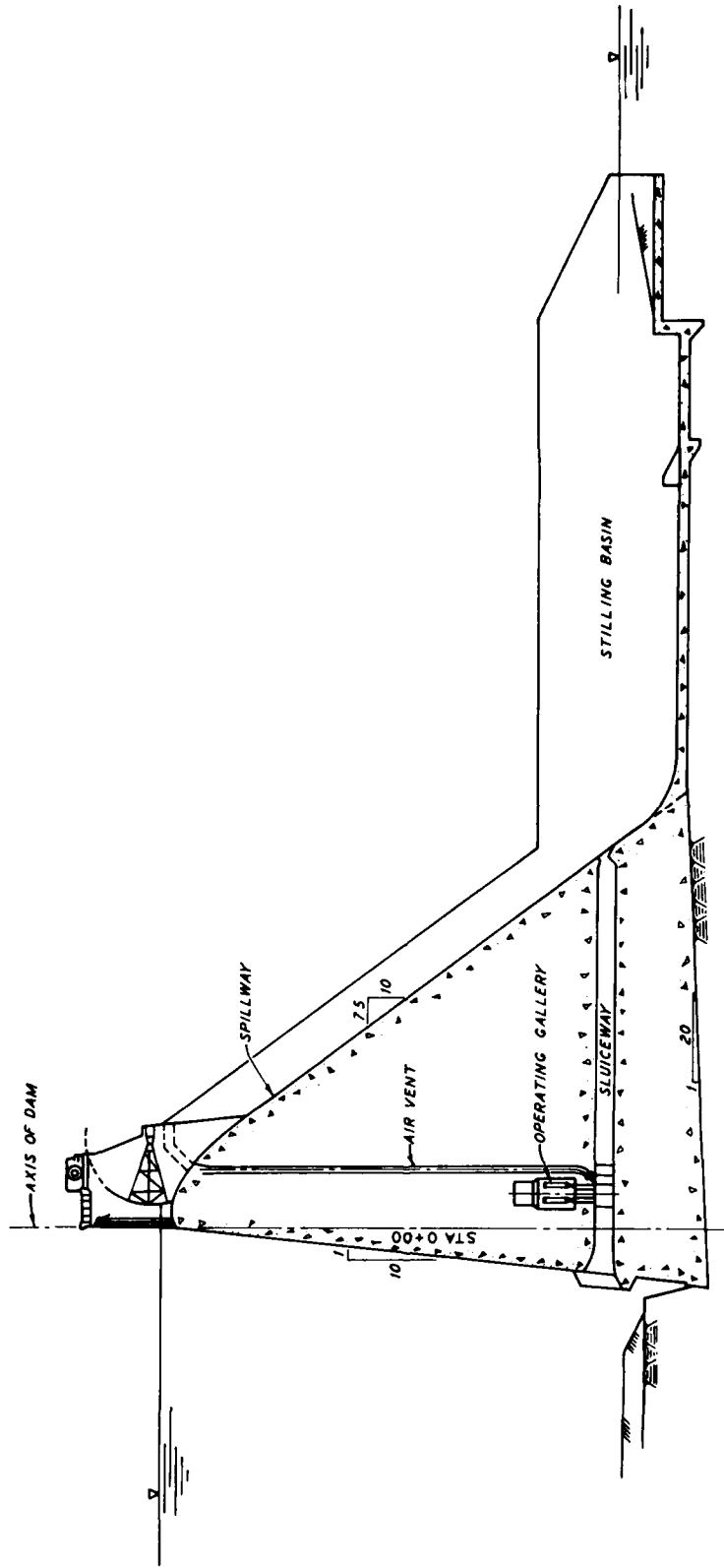

Figure 9. Spillway, sluiceway, and stilling basins

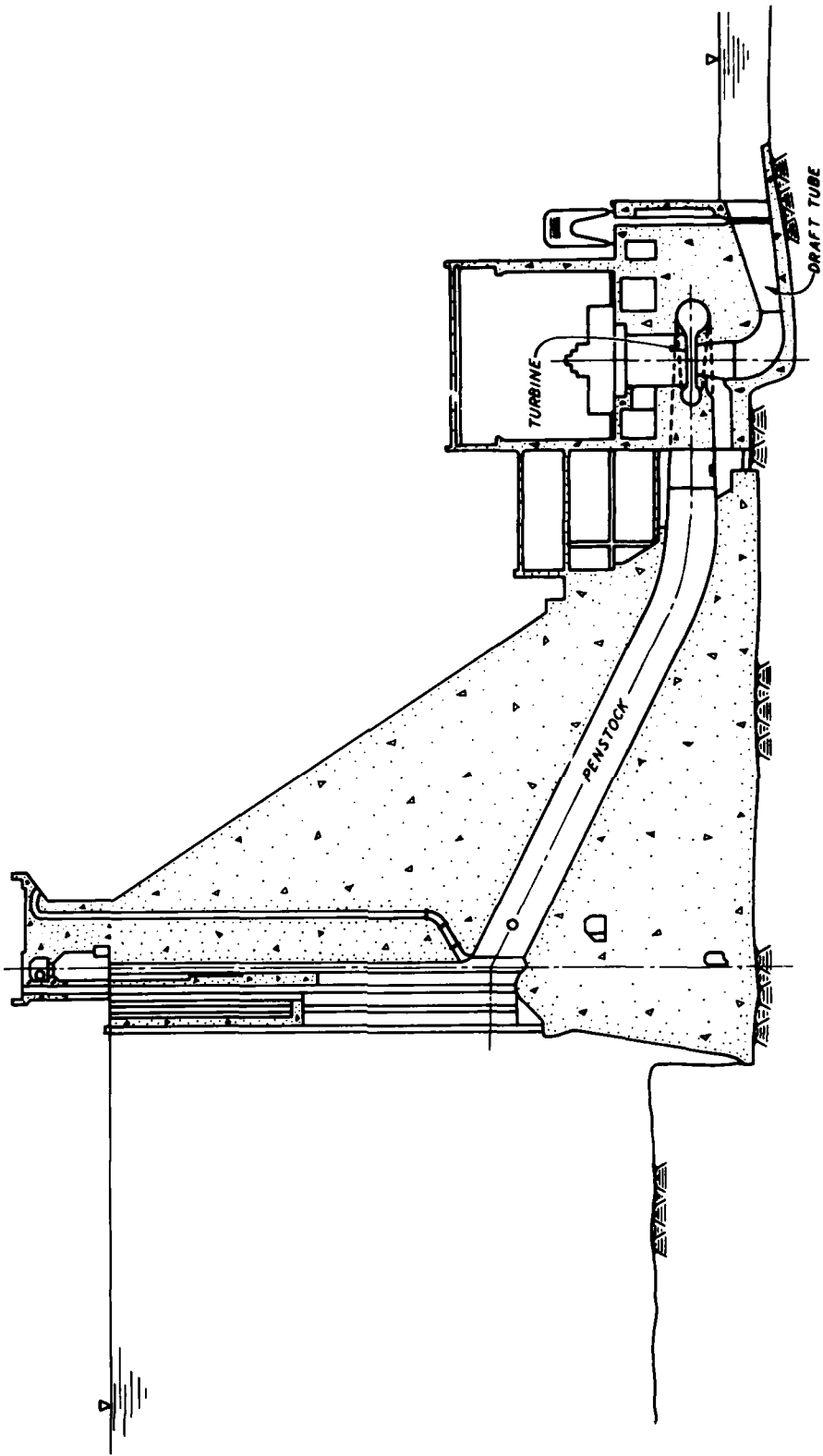
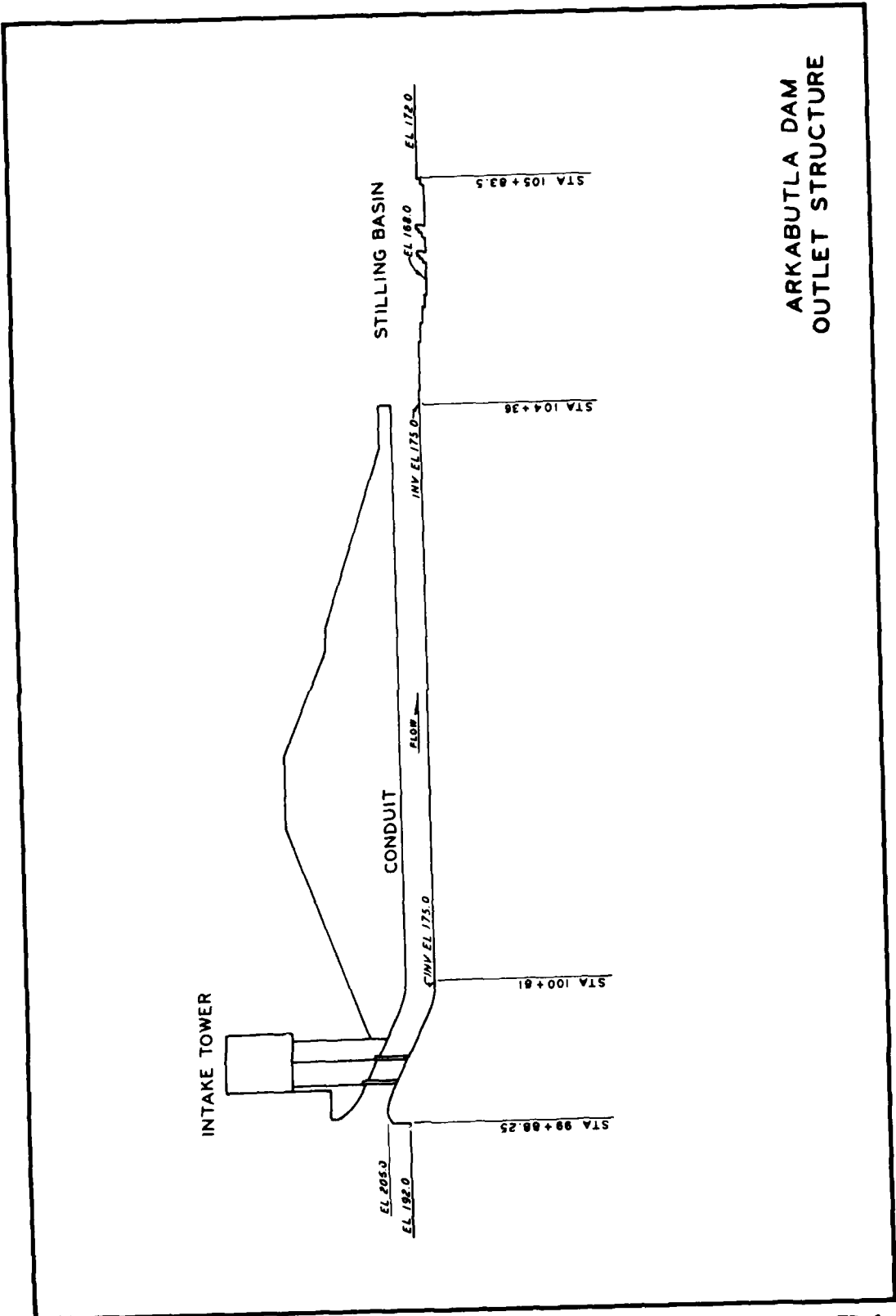

Figure 10. Power house

### References

- Bohan, J. P., and Grace, J. L., Jr. 1973. "Selective Withdrawal from Man-Made Lakes; Hydraulics Laboratory Investigation," Technical Report H-73-4, U. S. Army Engineer Waterways Experiment Station, CE, Vicksburg, Miss.
- Hart, E. D., and Wilhelms, S. C. 1977. "Reaeration Tests, Outlet Works, Beltzville Dam, Poho Poco Creek, PA," Technical Report H-77-14, U. S. Army Engineer Waterways Experiment Station, CE, Vicksburg, Miss.
- Holler, A. G. 1970. "Reaeration of Discharge Through Hydraulic Structures," U. S. Army Engineer Division, Ohio River, Cincinnati, Ohio.
- Loftis, B. (In press). "WESTEX--A Reservoir Simulation Model," U. S. Army Engineer Waterways Experiment Station, CE, Vicksburg, Miss.
- Miller, I., and Freund, J. E. 1977. Probability and Statistics for Engineers, 2d ed., Prentiss-Hall, Englewood Cliffs, N. J.
- Streeter, H. W., and Phelps, E. B. 1925. "A Study of the Pollution and Natural Purification of the Ohio River," U. S. Bulletin 146, Public Health Service.
- Tsivoglou, E. C., et al. 1968. "Tracer Measurement of Stream Reaeration: II. Field Studies," Journal of the Water Pollution Control Federation, Vol 40, No. 2.
- Tsivoglou, E. C., and Neal, L. A. 1976. "Tracer Measurement of Reaeration: III. Predicting the Reaeration Capacity of Inland Streams," Journal of the Water Pollution Control Federation, Vol 48, No. 12.
- Tsivoglou, E. C., and Wallace, J. R. 1972. "Characterization of Stream Reaeration Capacity," EPA-R3-72-012, U. S. Environmental Protection Agency, Washington, D. C.



ARKABUTLA DAM  
 OUTLET STRUCTURE

PLATE 1



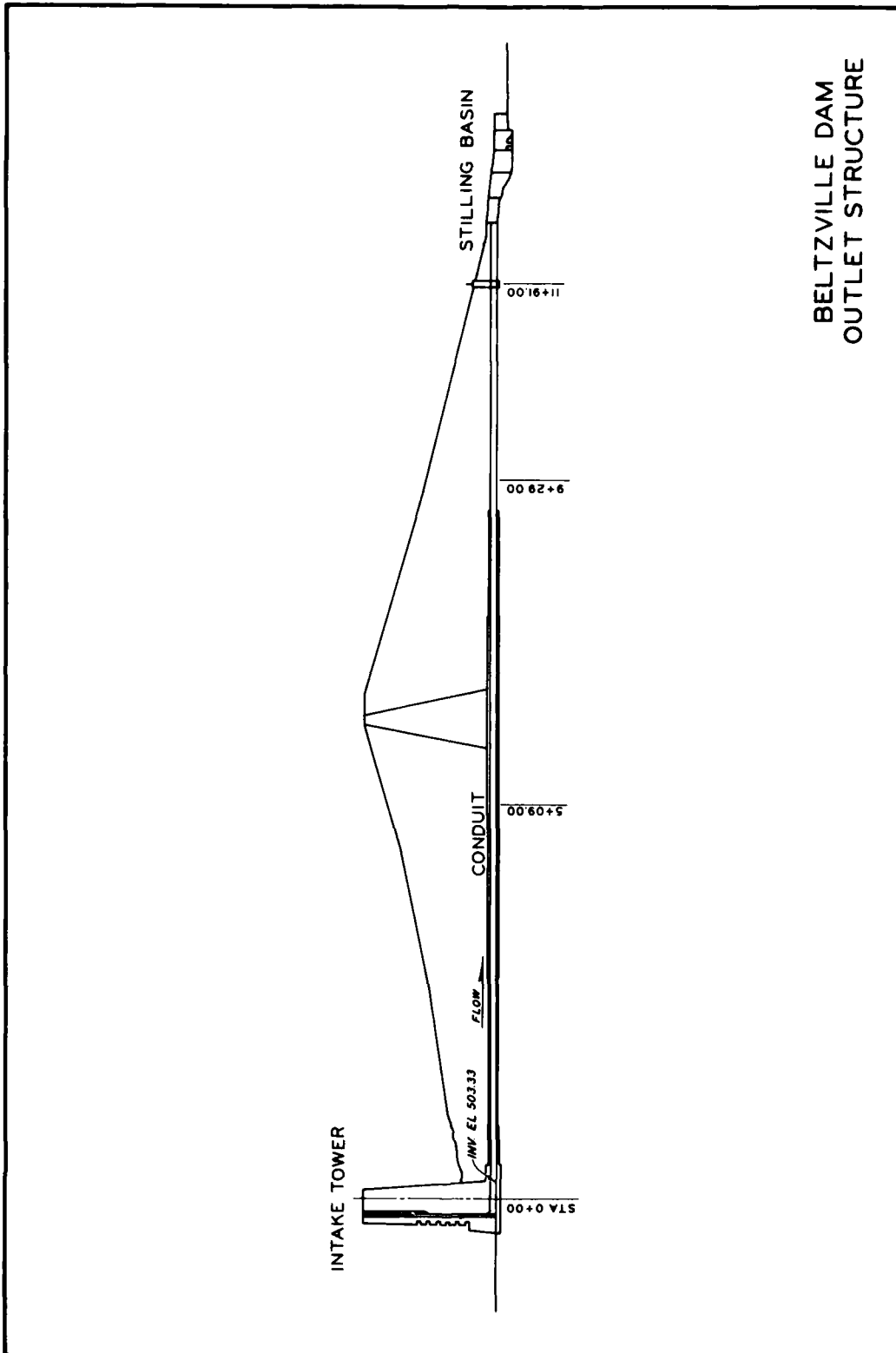

BELTZVILLE DAM  
OUTLET STRUCTURE

PLATE 2

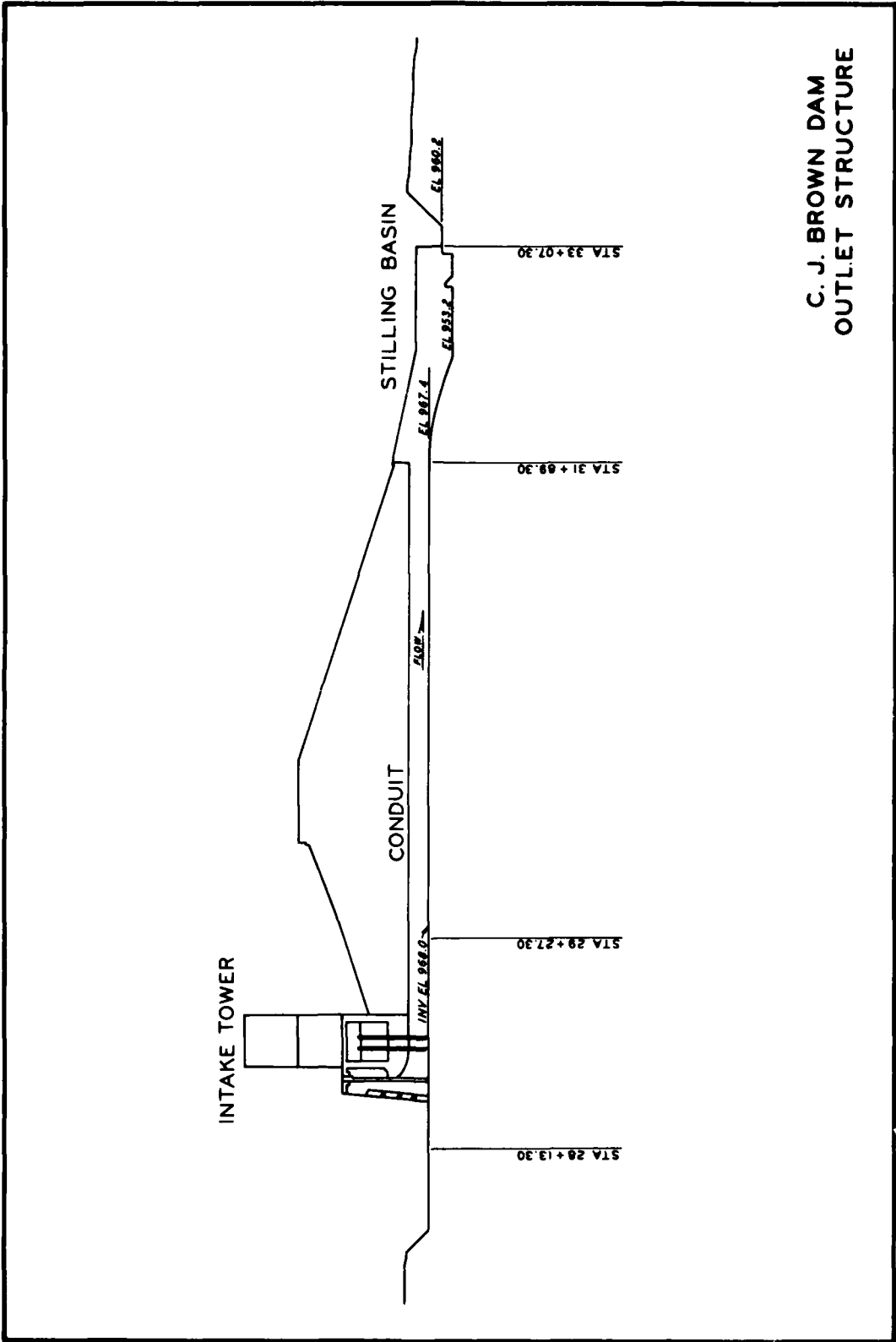

C. J. BROWN DAM  
OUTLET STRUCTURE

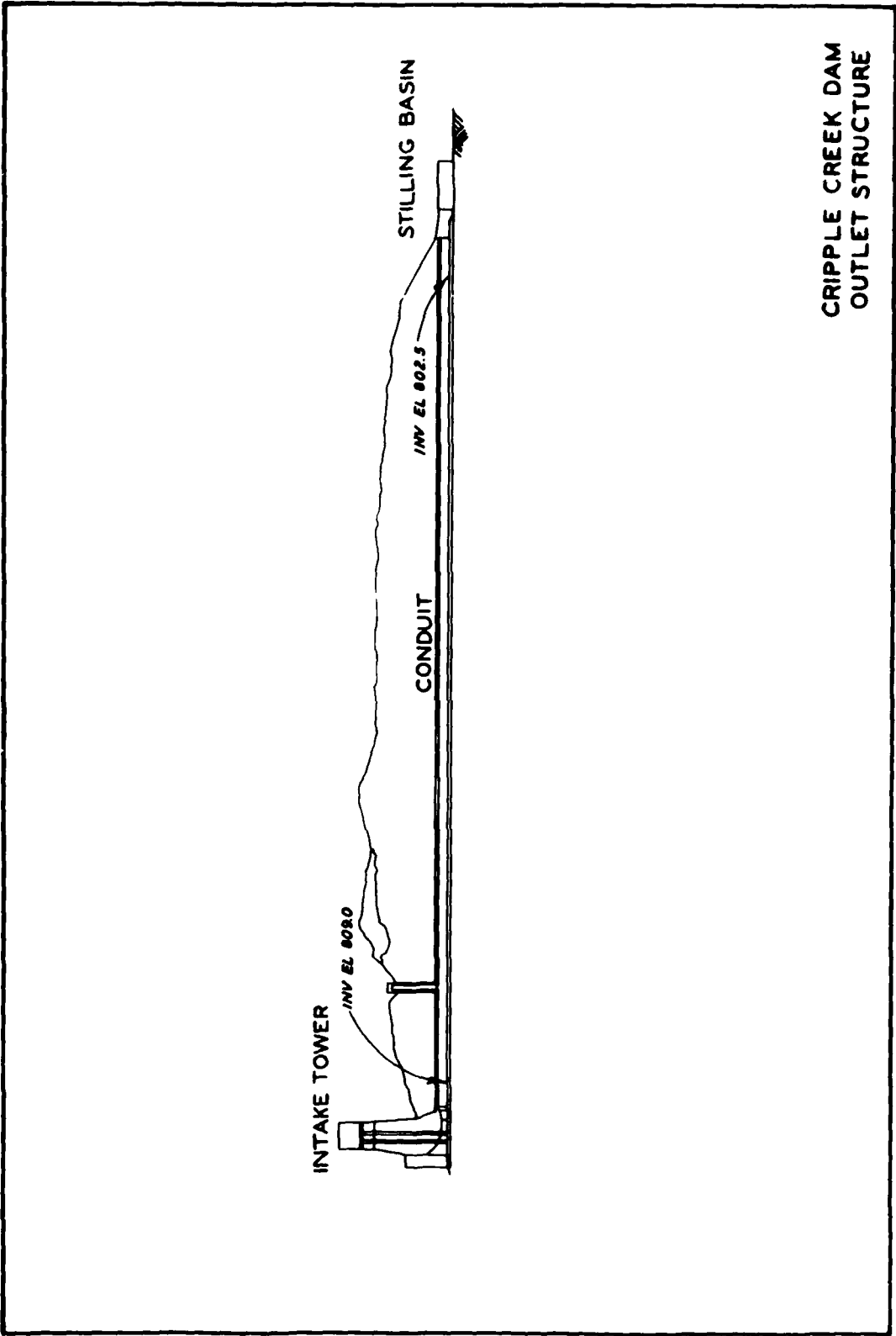

CRIPPLE CREEK DAM  
OUTLET STRUCTURE

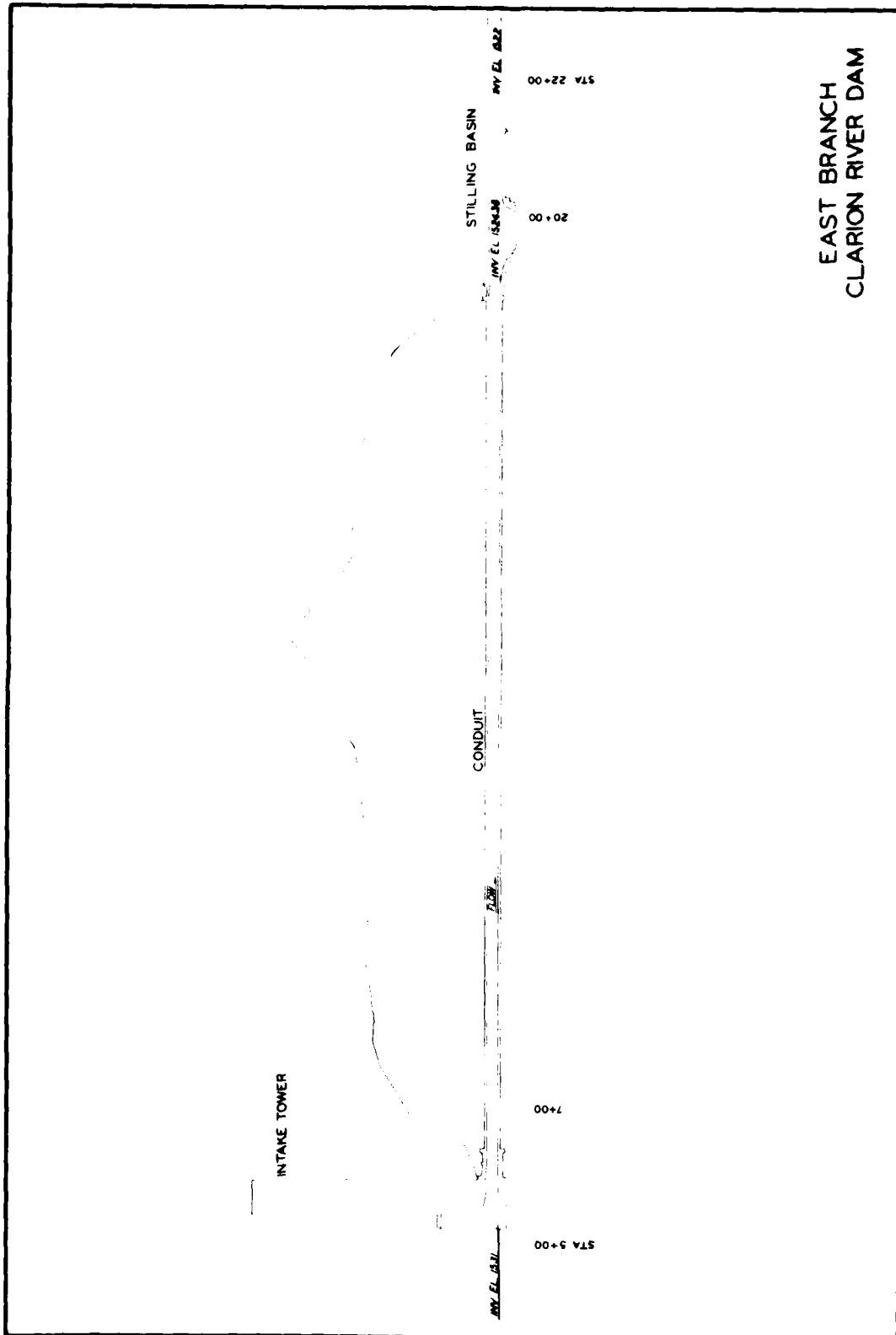

EAST BRANCH  
CLARION RIVER DAM

PLATE 5

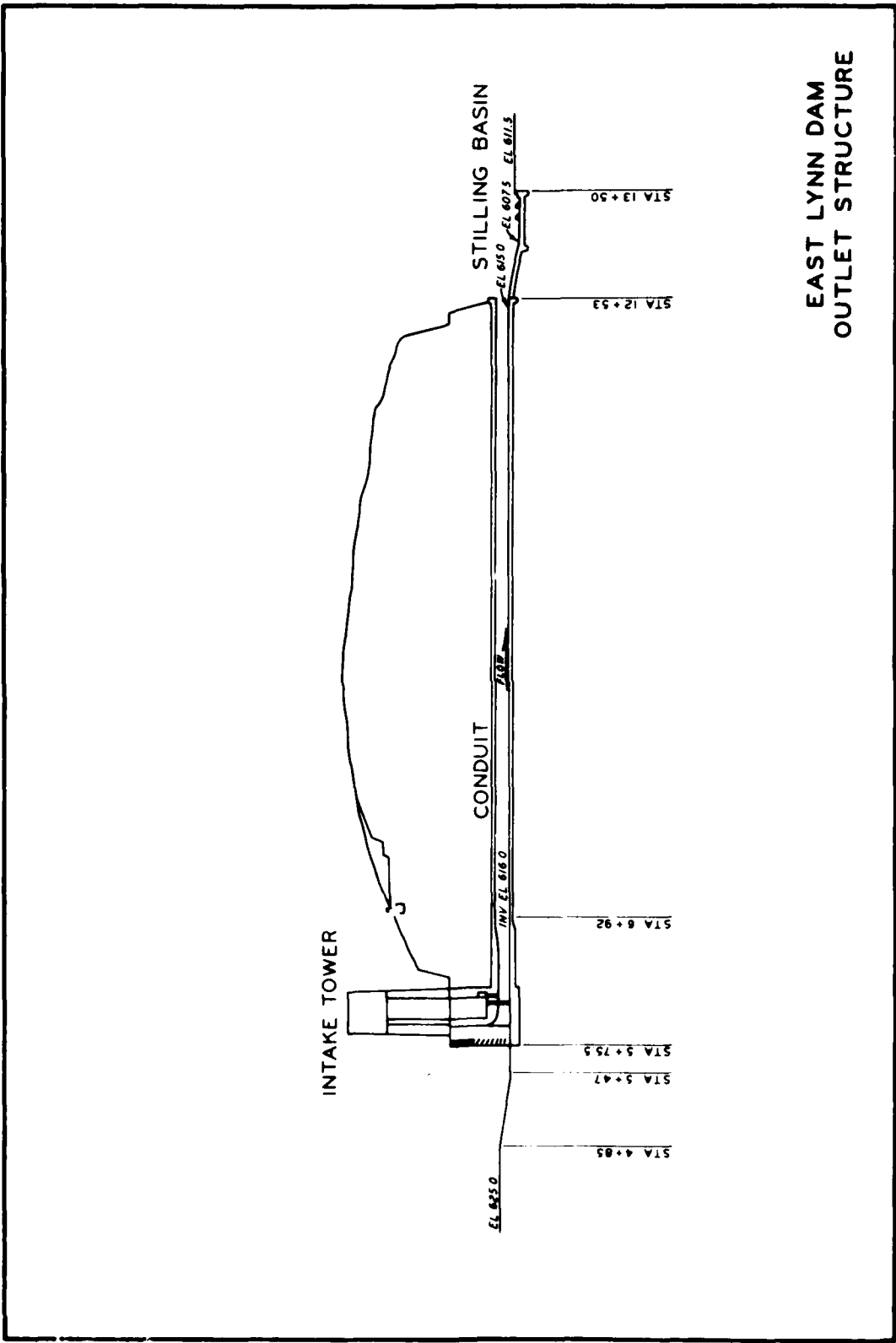

**EAST LYNN DAM  
OUTLET STRUCTURE**

PLATE 6

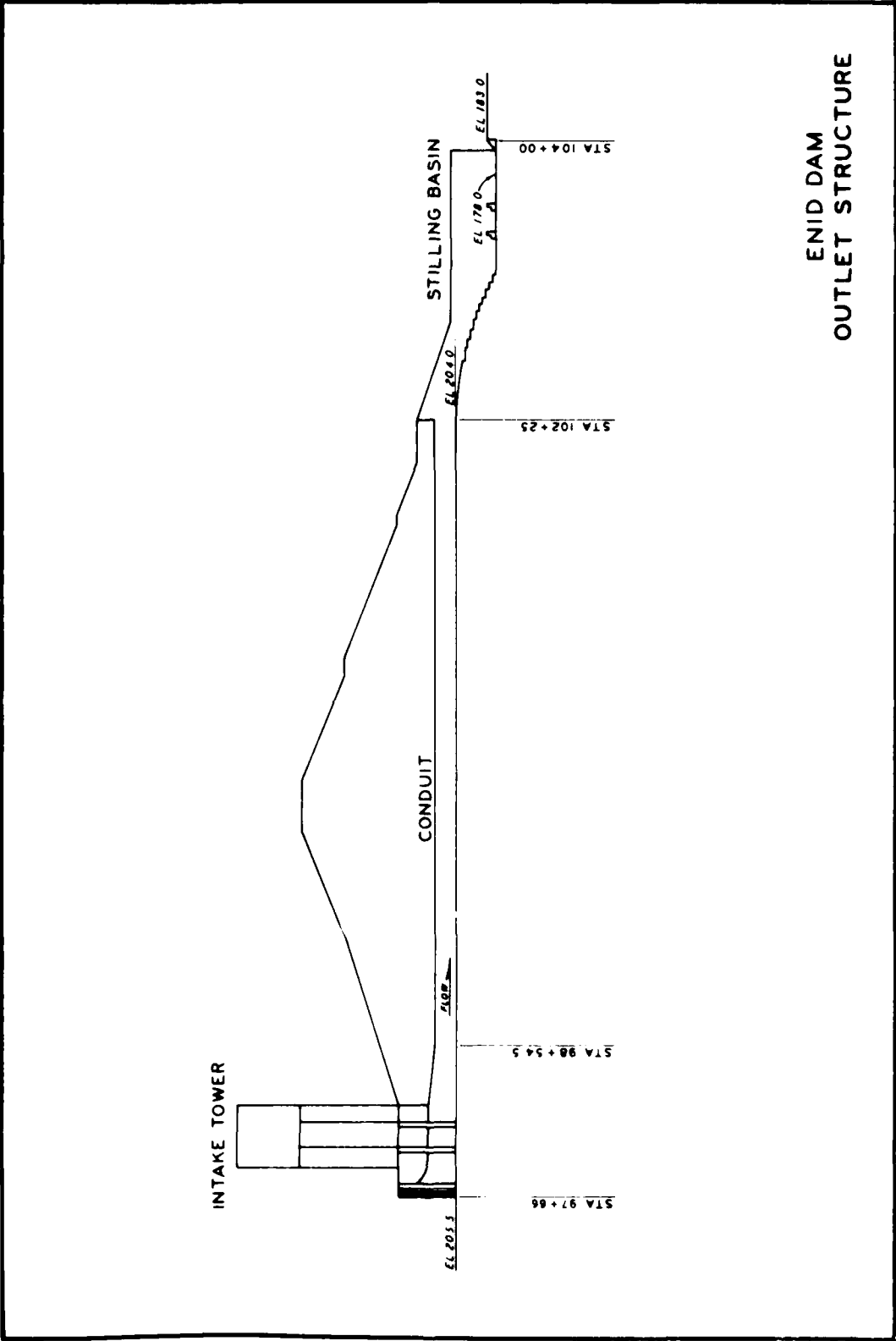

ENID DAM  
OUTLET STRUCTURE

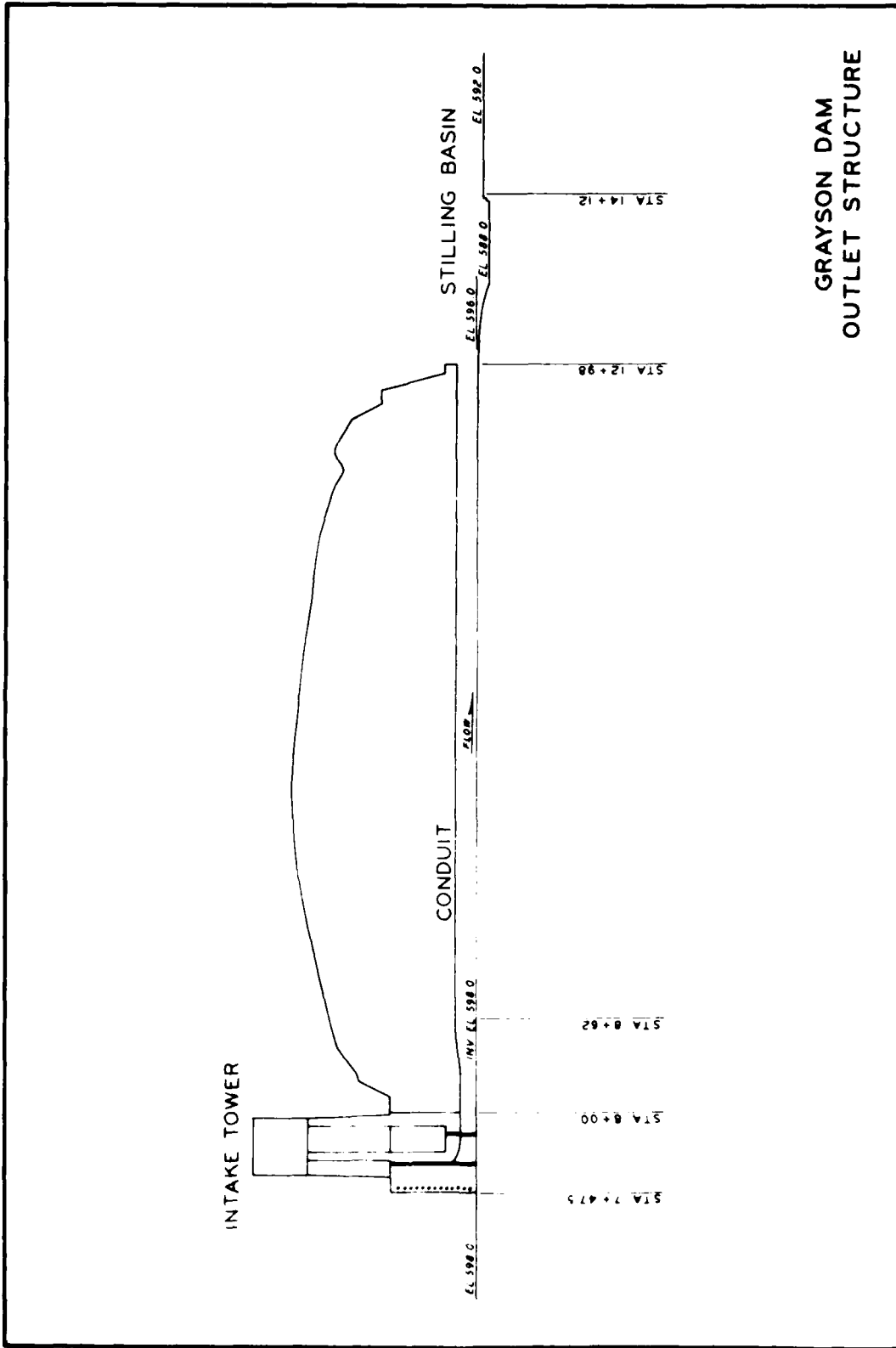
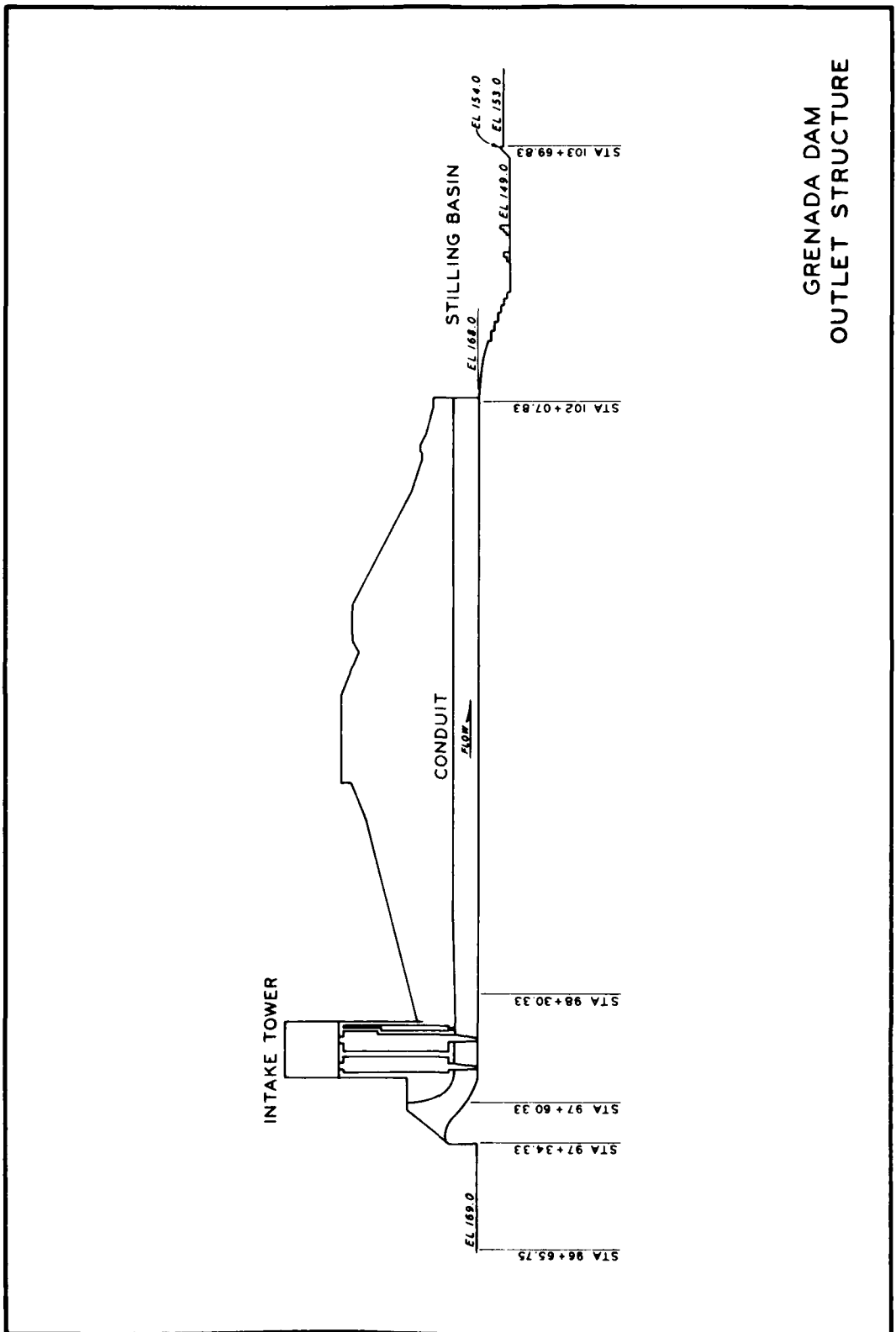
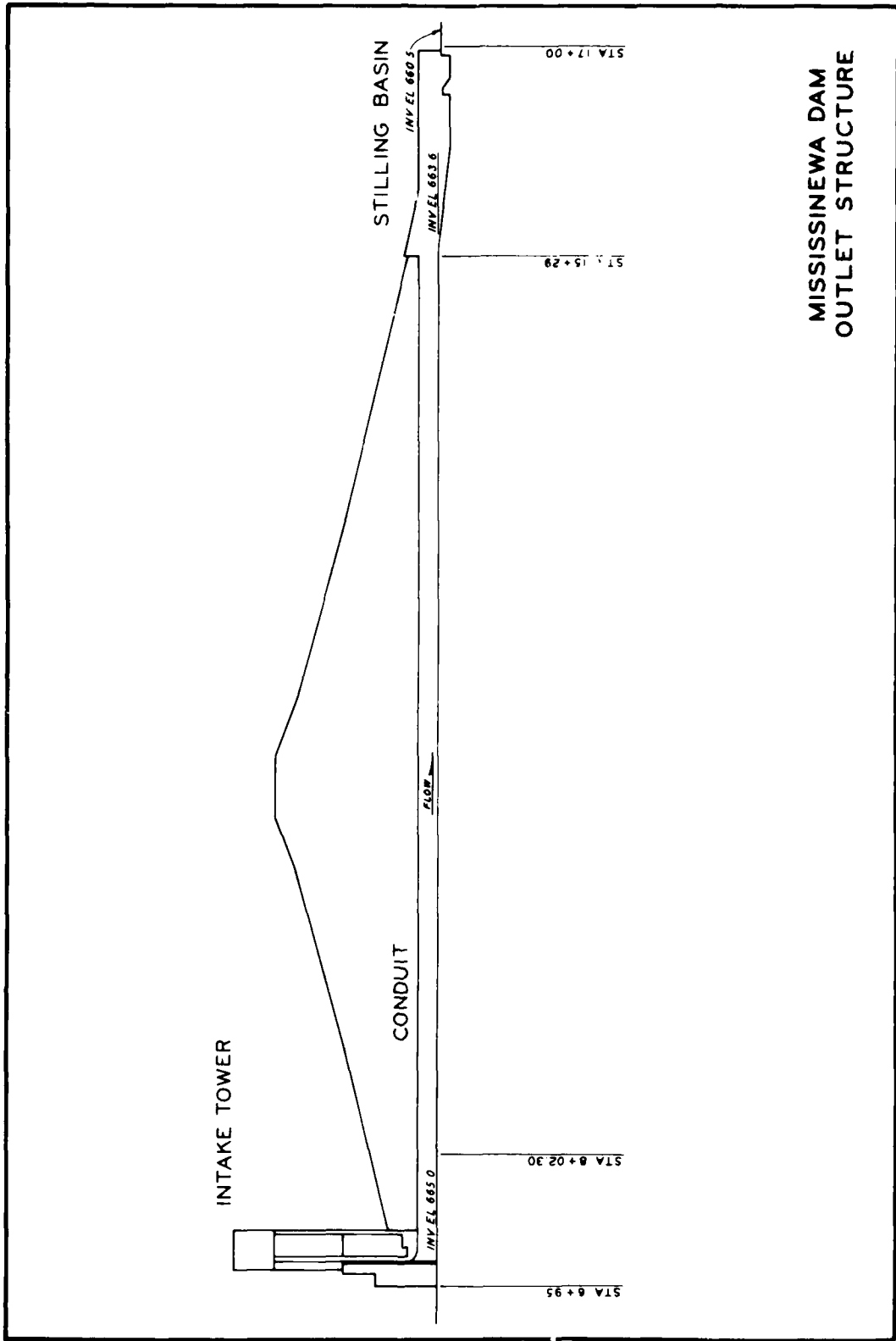

PLATE 8



GRENADA DAM  
OUTLET STRUCTURE





MISSISSINEWA DAM  
OUTLET STRUCTURE

PLATE 10

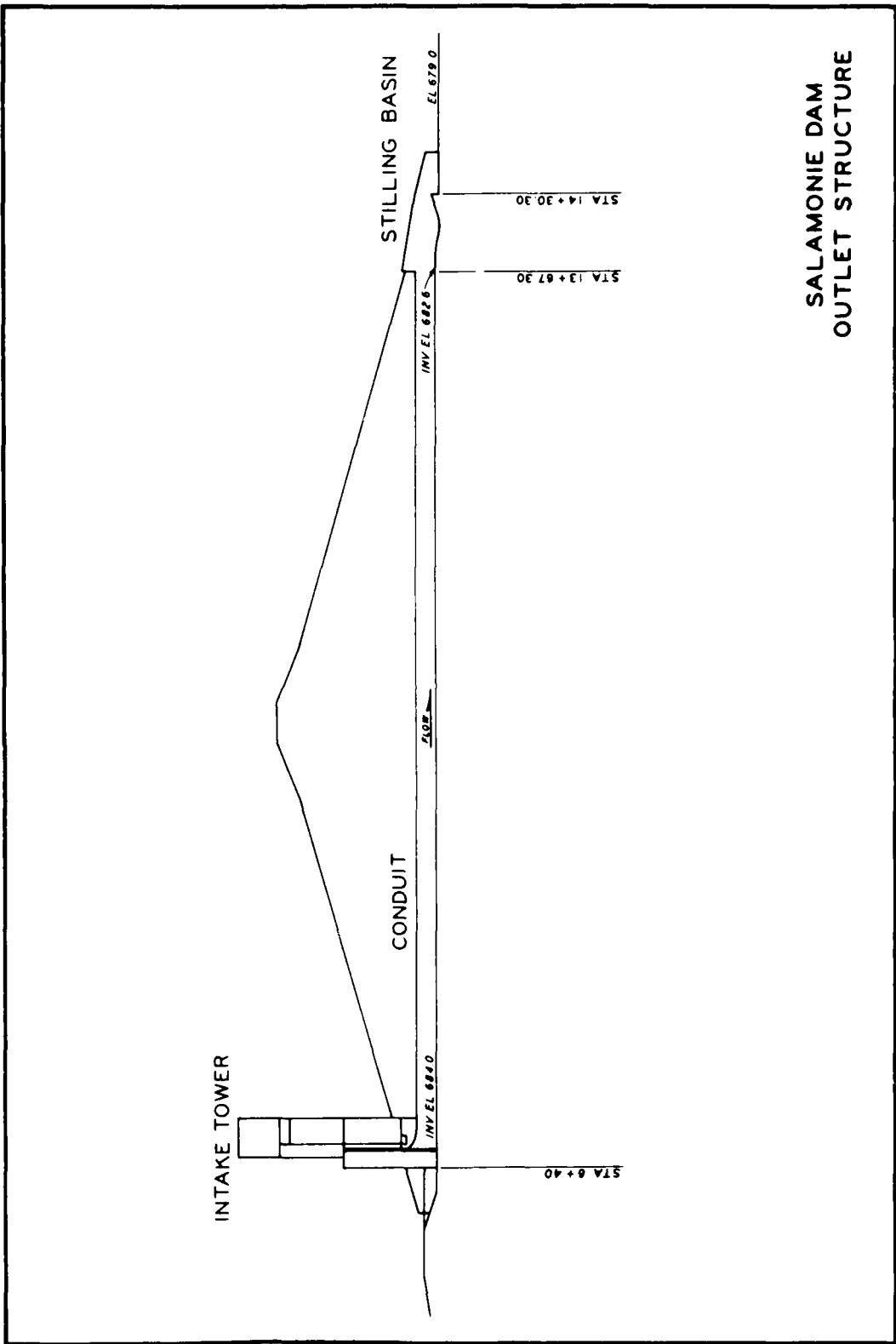

SALAMONIE DAM  
OUTLET STRUCTURE

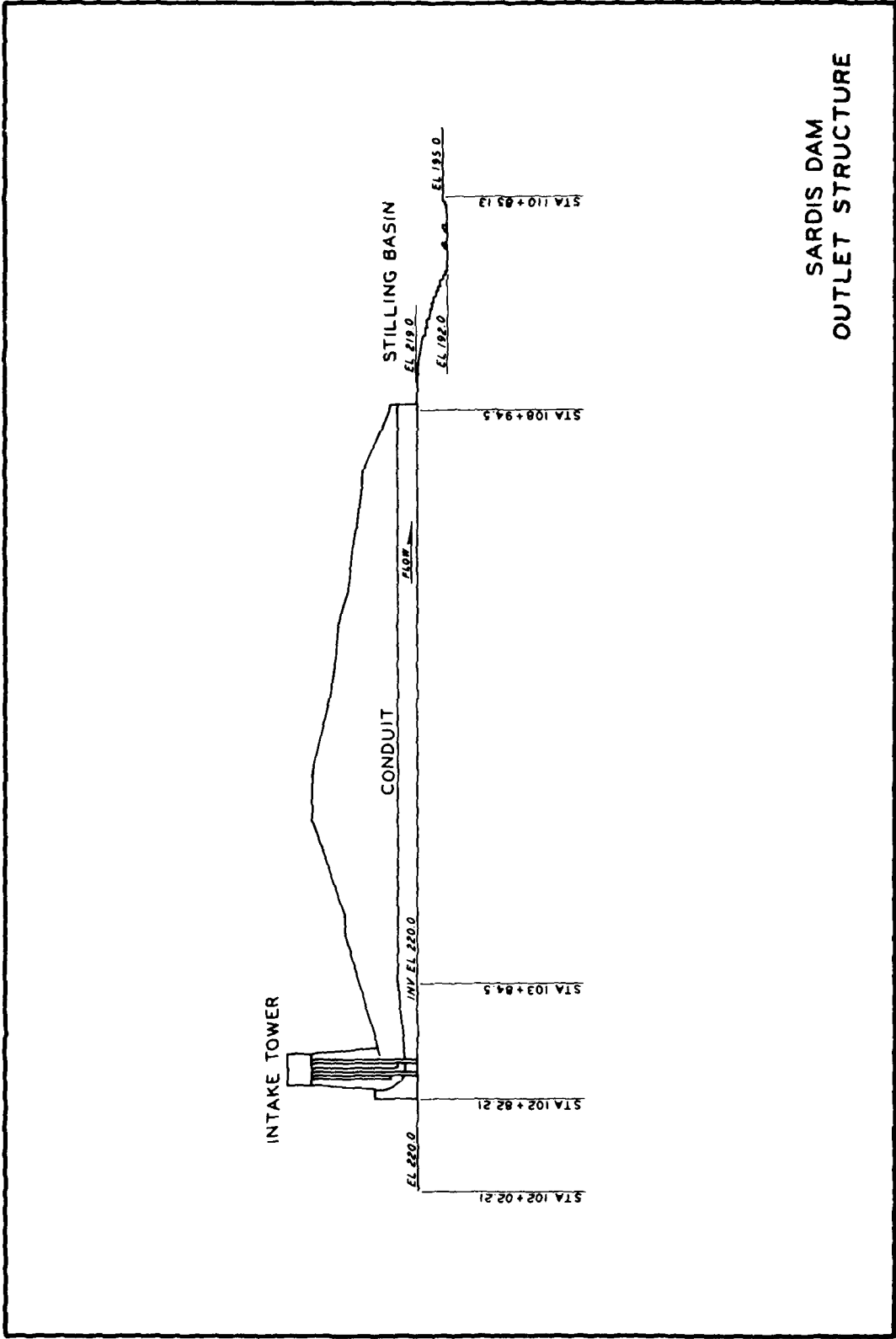

SARDIS DAM  
OUTLET STRUCTURE

PLATE 12

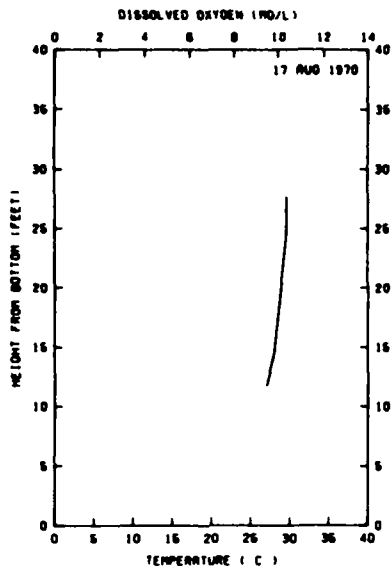

RELEASE TEMP. 26.3  
RELEASE D.O. NA

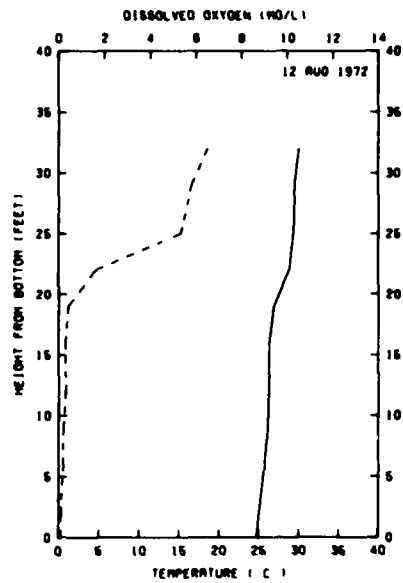

RELEASE TEMP. 28.3  
RELEASE D.O. 6.9

**LEGEND**

—— WATER TEMPERATURE  
- - - DISSOLVED OXYGEN

ARKABUTLA LAKE  
**TEMPERATURE AND  
DISSOLVED OXYGEN PROFILES**

17 AUG 1970-12 AUG 1972

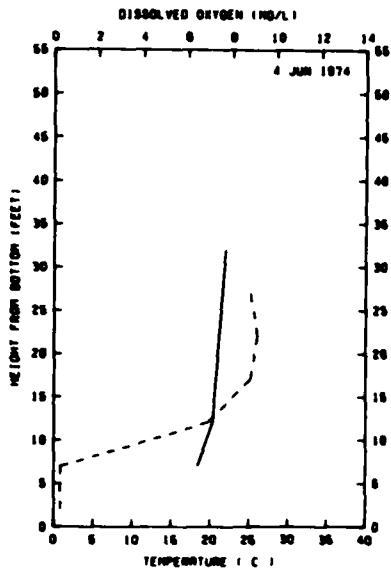

RELEASE TEMP. 20.8  
RELEASE D.O. 7.8

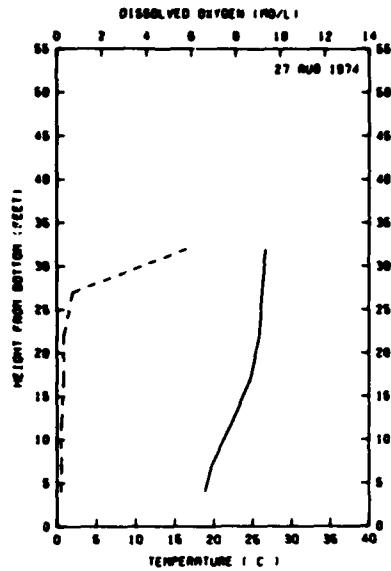

RELEASE TEMP. 21.7  
RELEASE D.O. 10.4

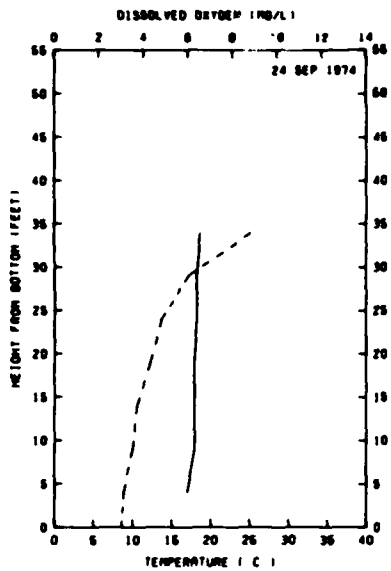

RELEASE TEMP. NA  
RELEASE D.O. 10.4

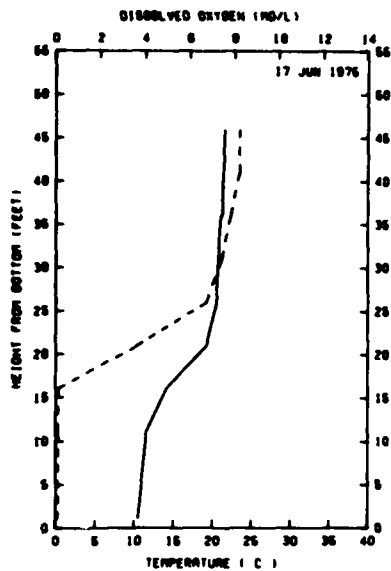

RELEASE TEMP. 15.6  
RELEASE D.O. 9.4

**LEGEND**

- WATER TEMPERATURE
- - - DISSOLVED OXYGEN

C. J. BROWN LAKE  
**TEMPERATURE AND  
DISSOLVED OXYGEN PROFILES**

4 JUN 1974-17 JUN 1975

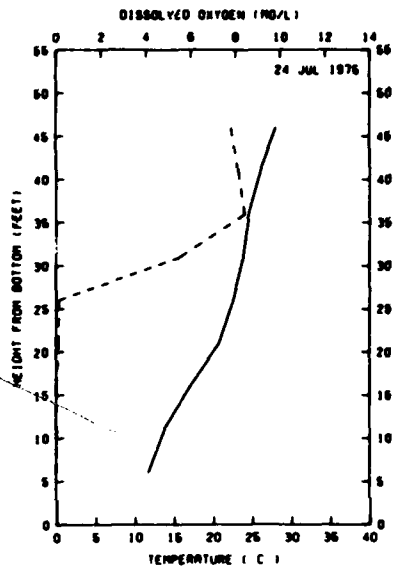

RELEASE TEMP. 22.6  
RELEASE D.O. 7.8

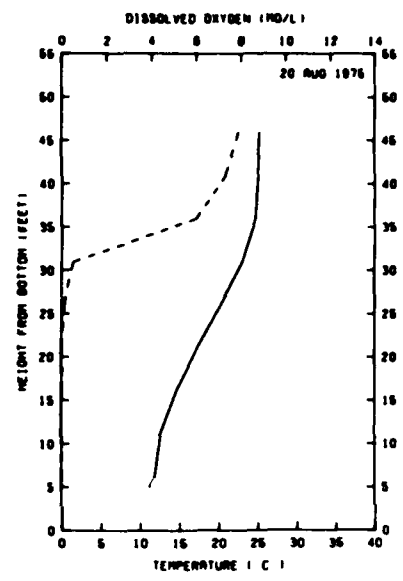

RELEASE TEMP. 25.5  
RELEASE D.O. 7.6

**LEGEND**

- WATER TEMPERATURE
- - - DISSOLVED OXYGEN

C. J. BROWN LAKE  
**TEMPERATURE AND  
DISSOLVED OXYGEN PROFILES**  
24 JUL 1975-20 AUG 1975

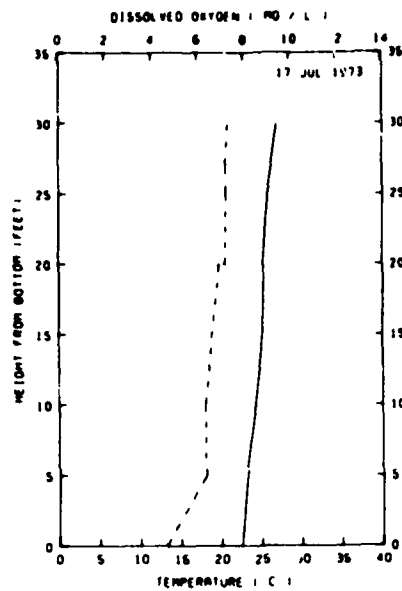

RELEASE TEMP. 23.0  
RELEASE D.O. 7.8

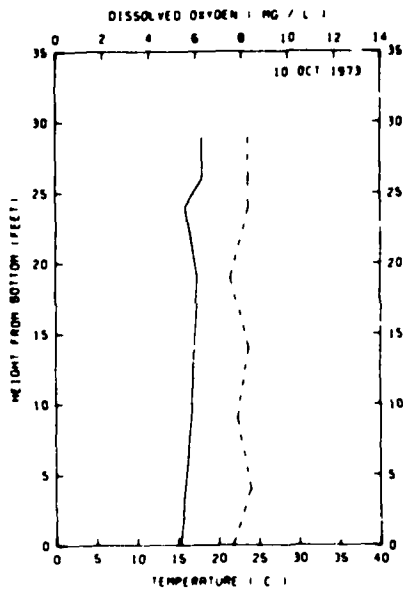

RELEASE TEMP. 17.1  
RELEASE D.O. 9.0

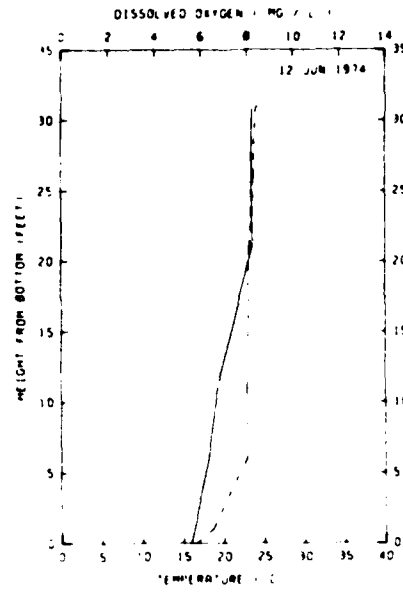

RELEASE TEMP. 17.6  
RELEASE D.O. 9.0

**LEGEND**

- WATER TEMPERATURE
- - - DISSOLVED OXYGEN

**CROOKED CREEK LAKE  
TEMPERATURE AND  
DISSOLVED OXYGEN PROFILES**

17 JUL 1973-12 JUN 1974

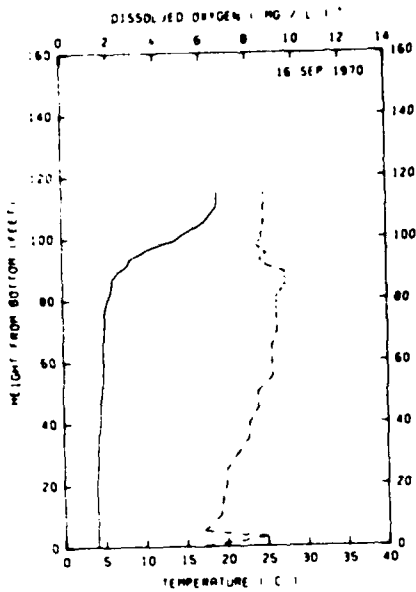

RELEASE TEMP. 17.2  
RELEASE D.O. 9.0

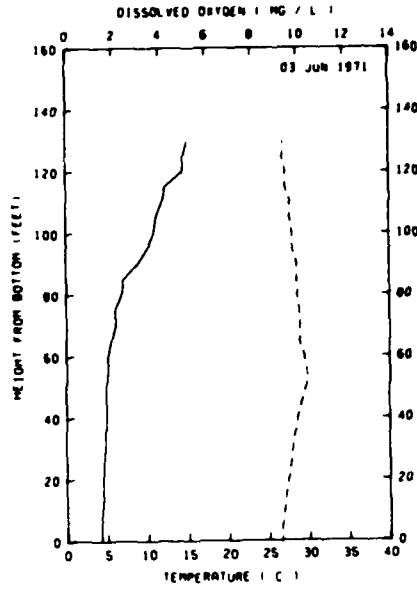

RELEASE TEMP. 14.0  
RELEASE D.O. 9.8

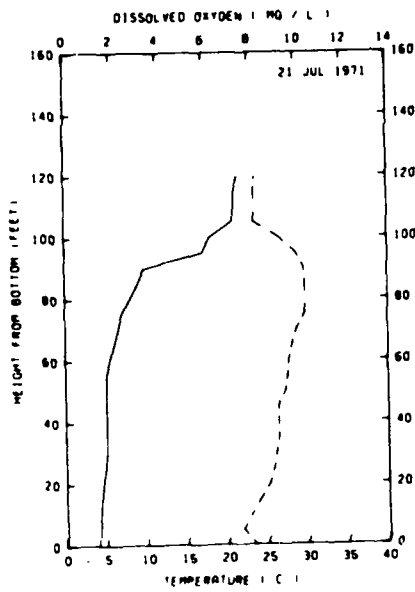

RELEASE TEMP. 18.9  
RELEASE D.O. 8.7

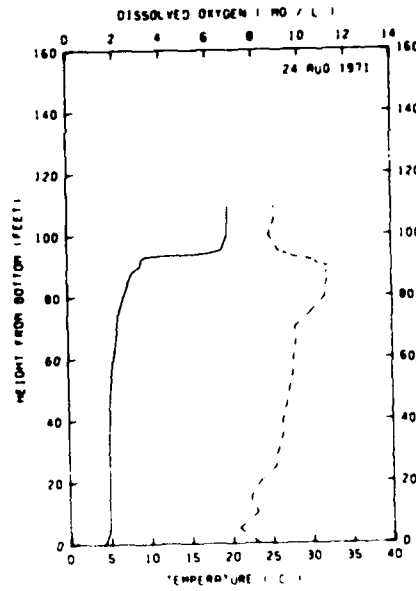

RELEASE TEMP. 19.5  
RELEASE D.O. 9.8

**LEGEND**

- WATER TEMPERATURE
- - - DISSOLVED OXYGEN

**EAST BRANCH LAKE  
TEMPERATURE AND  
DISSOLVED OXYGEN PROFILES**

16 SEP 1970-24 AUG 1971



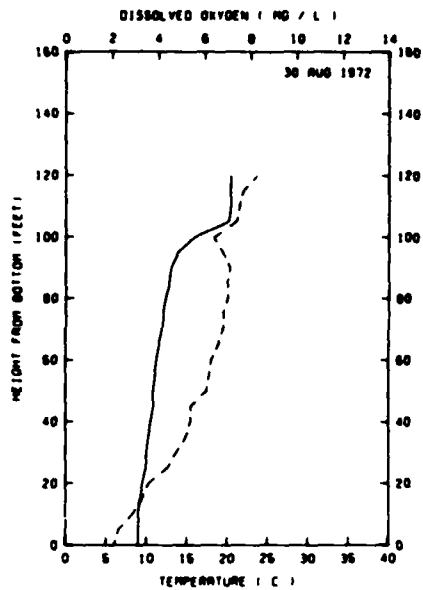

RELEASE TEMP. 19.2  
RELEASE D.O. 8.9

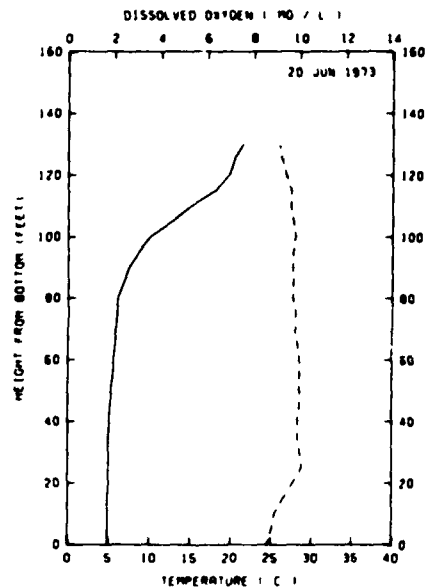

RELEASE TEMP. 13.6  
RELEASE D.O. 9.4

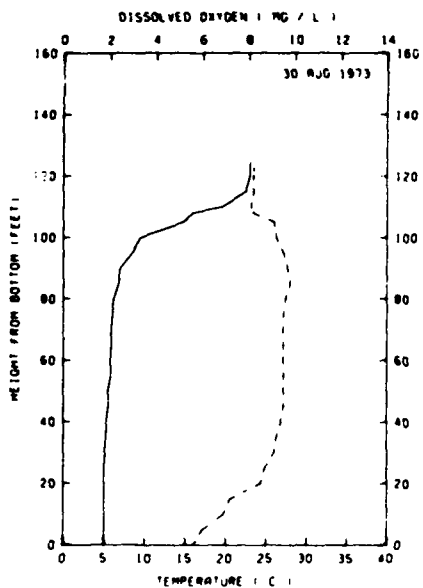

RELEASE TEMP. 21.0  
RELEASE D.O. 8.4

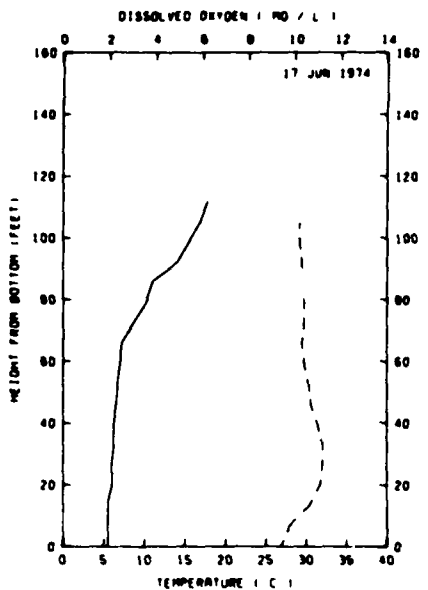

RELEASE TEMP. 14.3  
RELEASE D.O. 9.6

**LEGEND**

- WATER TEMPERATURE
- - - DISSOLVED OXYGEN

EAST BRANCH LAKE  
**TEMPERATURE AND  
DISSOLVED OXYGEN PROFILES**

30 AUG 1972-17 JUN 1974

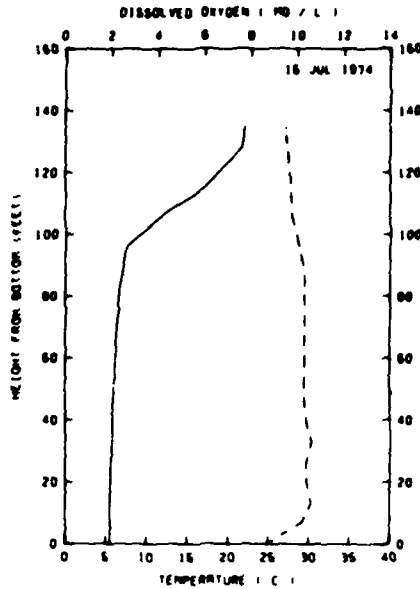

RELEASE TEMP. 20.0  
RELEASE D.O. 9.1

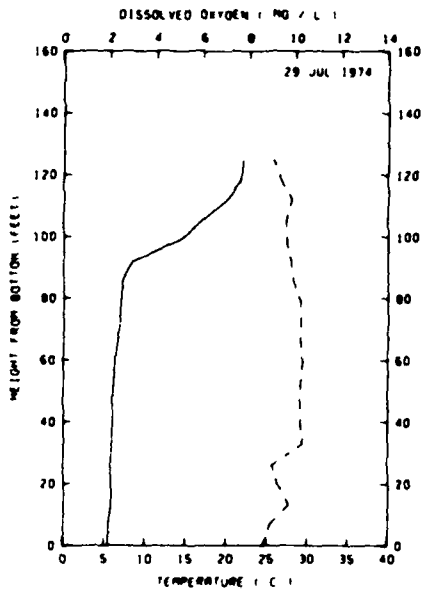

RELEASE TEMP. 19.0  
RELEASE D.O. 9.0

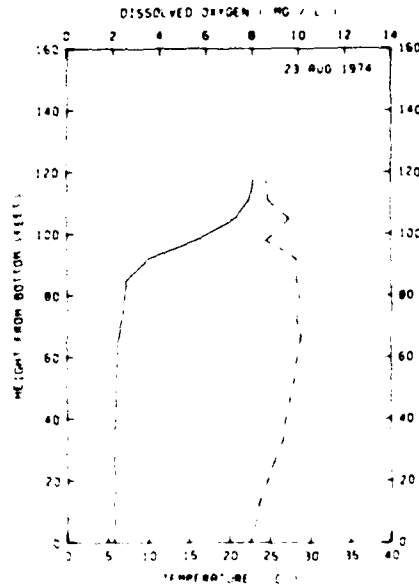

RELEASE TEMP. 22.3  
RELEASE D.O. 9.1

**LEGEND**

- WATER TEMPERATURE
- - - DISSOLVED OXYGEN

**EAST BRANCH LAKE  
TEMPERATURE AND  
DISSOLVED OXYGEN PROFILES**

15 JUL 1974-23 AUG 1974

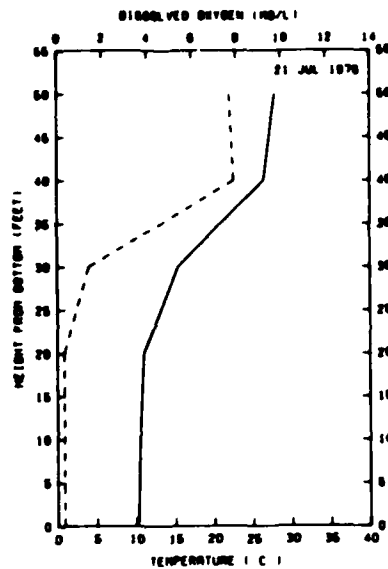

RELEASE TEMP. 23.2  
RELEASE D.O. 7.8

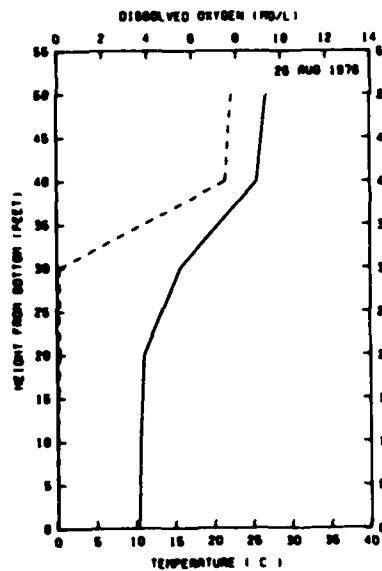

RELEASE TEMP. 22.5  
RELEASE D.O. 7.8

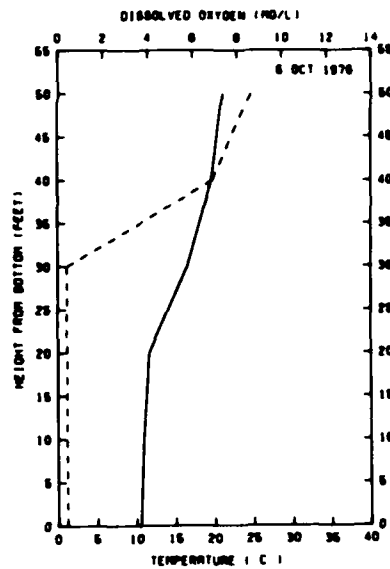

RELEASE TEMP. 19.3  
RELEASE D.O. 8.7

**LEGEND**

- WATER TEMPERATURE
- - - DISSOLVED OXYGEN

EAST LYNN LAKE  
**TEMPERATURE AND  
DISSOLVED OXYGEN PROFILES**

21 JUL 1976-6 OCT 1976

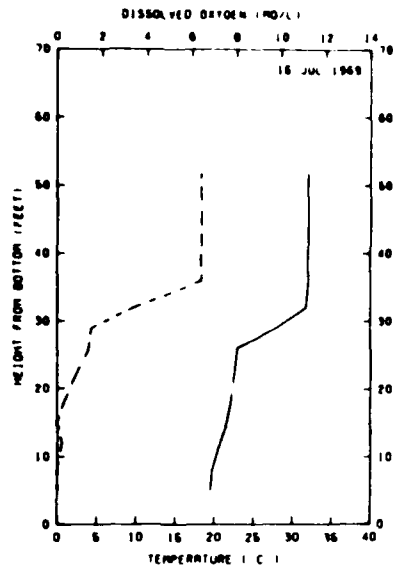

RELEASE TEMP 24.1  
RELEASE D.O. 7.9

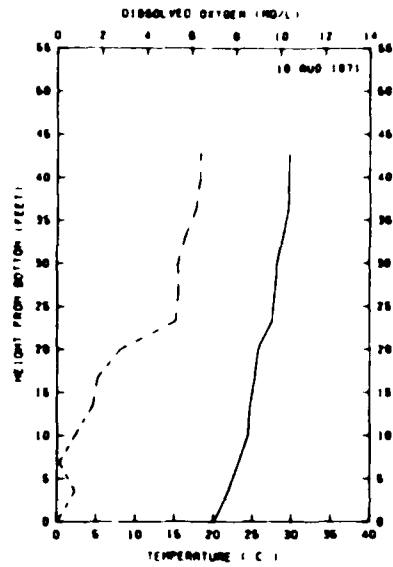

RELEASE TEMP 25.7  
RELEASE D.O. 6.8

**LEGEND**

—— WATER TEMPERATURE  
- - - DISSOLVED OXYGEN

ENID LAKE  
**TEMPERATURE AND  
DISSOLVED OXYGEN PROFILES**

16 JUL 1969-18 AUG 1971

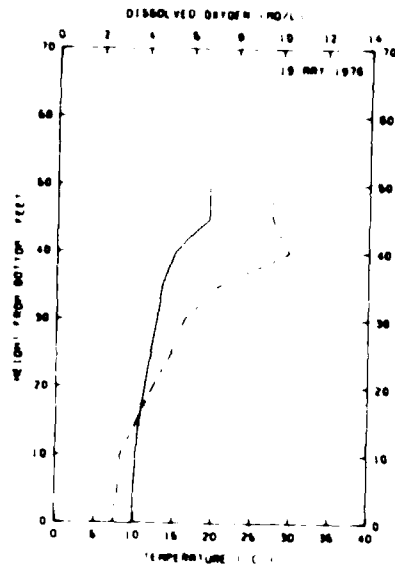

RELEASE TEMP 17.0  
RELEASE DO 9.5

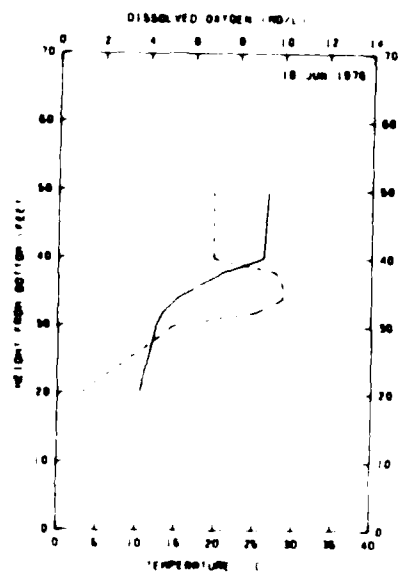

RELEASE TEMP 21.5  
RELEASE DO 10.4

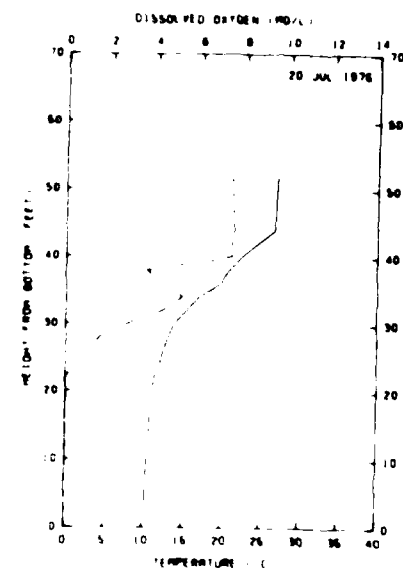

RELEASE TEMP 22.4  
RELEASE DO 10.0

**LEGEND**

- WATER TEMPERATURE
- - - DISSOLVED OXYGEN

**RAYSON LAKE  
TEMPERATURE AND  
DISSOLVED OXYGEN PROFILES**

19 MAY 1976 - 20 JUL 1976

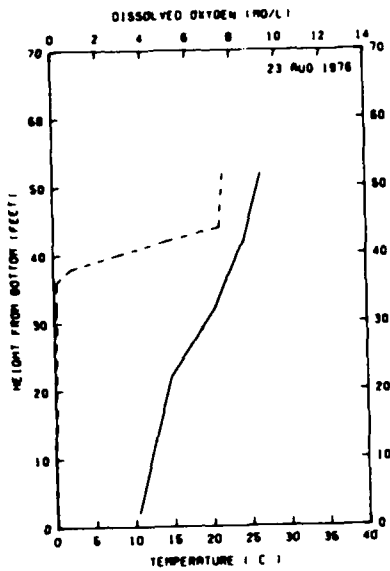

RELEASE TEMP. 20.0  
RELEASE D.O. 7.9

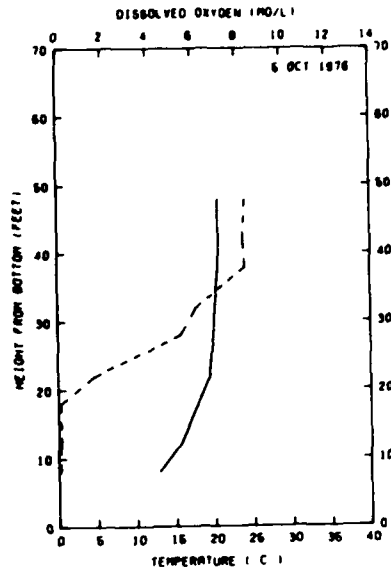

RELEASE TEMP. 18.4  
RELEASE D.O. 8.6

**LEGEND**

- WATER TEMPERATURE
- - - DISSOLVED OXYGEN

GRAYSON LAKE  
**TEMPERATURE AND  
DISSOLVED OXYGEN PROFILES**

23 AUG 1976-5 OCT 1976

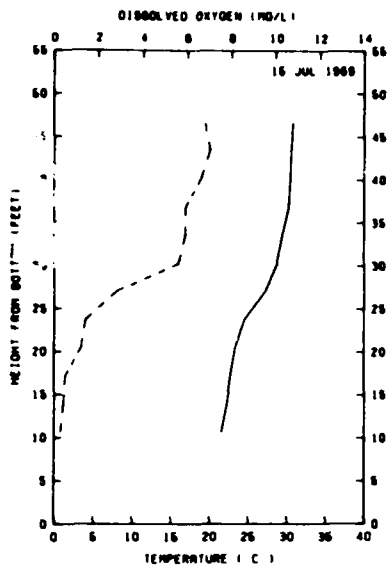

RELEASE TEMP. 28.2  
RELEASE D.O. 7.7

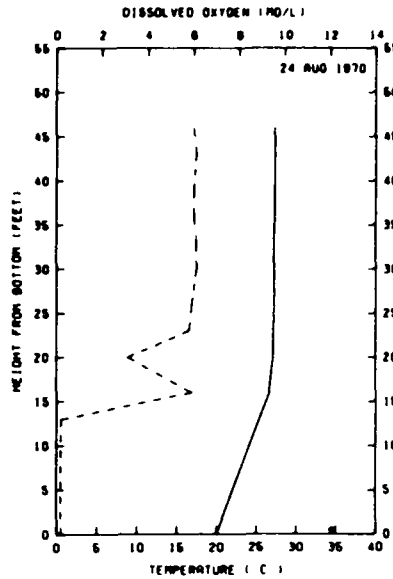

RELEASE TEMP. 26.3  
RELEASE D.O. 7.6

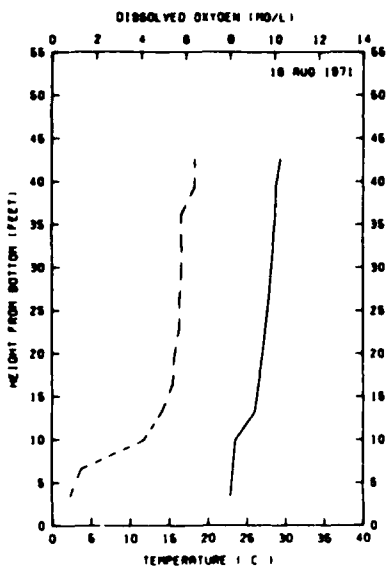

RELEASE TEMP. 27.9  
RELEASE D.O. 6.8

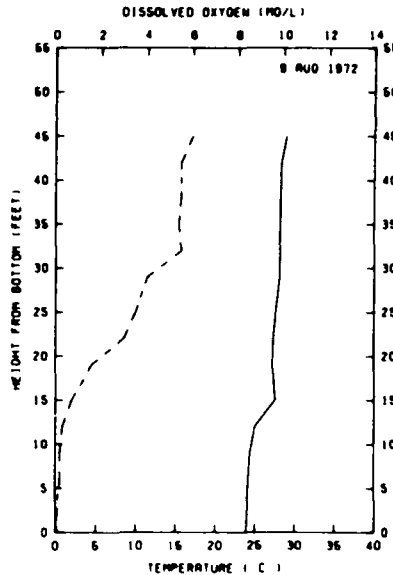

RELEASE TEMP. 27.6  
RELEASE D.O. 6.9

**LEGEND**

- WATER TEMPERATURE
- - - DISSOLVED OXYGEN

GRENADA LAKE  
**TEMPERATURE AND  
DISSOLVED OXYGEN PROFILES**

15 JUL 1969-9 AUG 1972

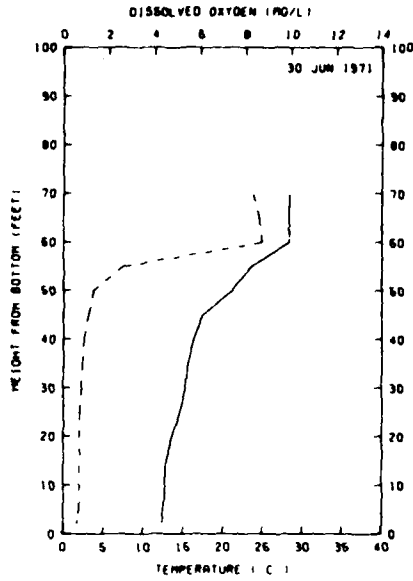

RELEASE TEMP. 17.0  
RELEASE D.O. 9.4

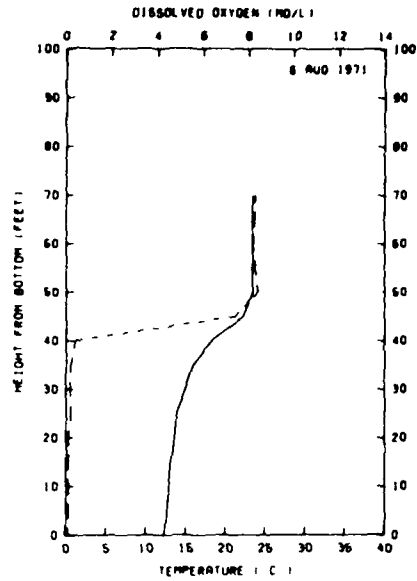

RELEASE TEMP. 15.0  
RELEASE D.O. NA

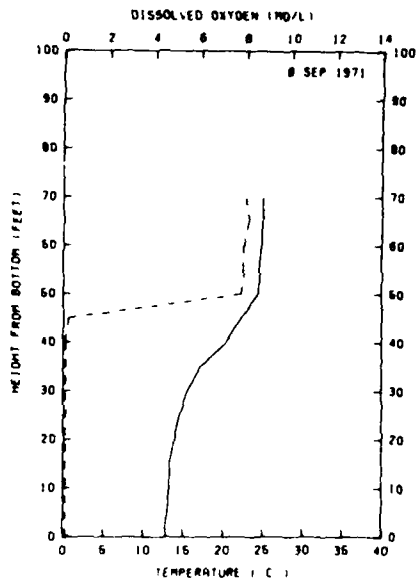

RELEASE TEMP. 21.1  
RELEASE D.O. 9.4

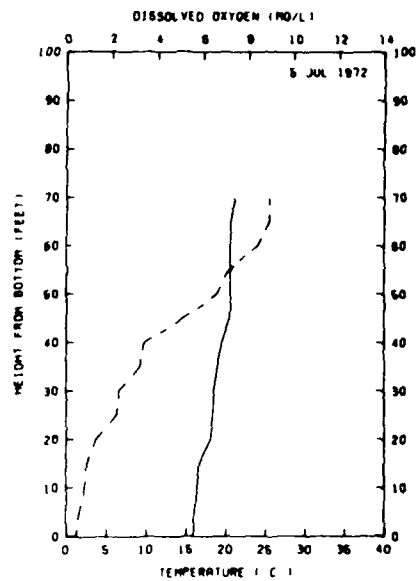

RELEASE TEMP. 19.4  
RELEASE D.O. 9.3

**LEGEND**

- WATER TEMPERATURE
- - - DISSOLVED OXYGEN

MISSISSINAWA LAKE  
**TEMPERATURE AND  
DISSOLVED OXYGEN PROFILES**

30 JUN 1971-5 JUL 1972



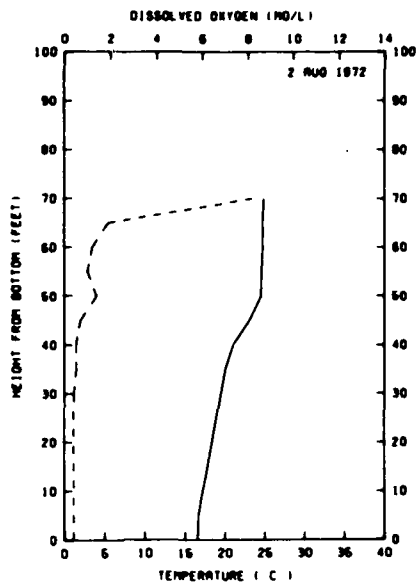

RELEASE TEMP. 23.9  
RELEASE D.O. NA

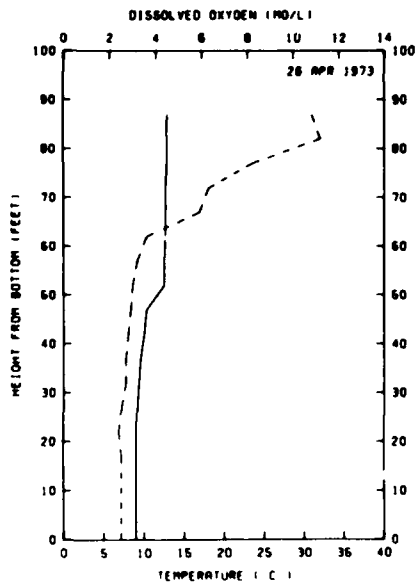

RELEASE TEMP. 9.2  
RELEASE D.O. 12.6

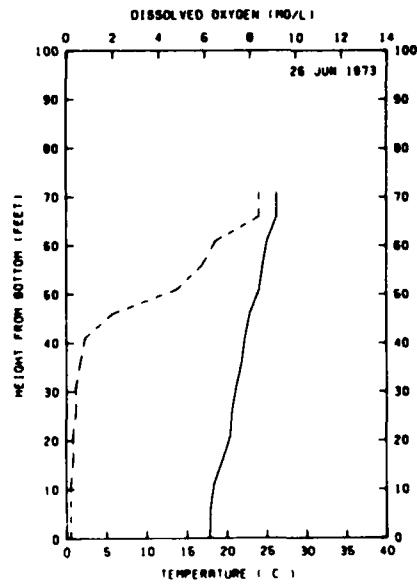

RELEASE TEMP. 24.4  
RELEASE D.O. 5.6

**LEGEND**

- WATER TEMPERATURE
- - - DISSOLVED OXYGEN

MISSISSINEWA LAKE  
**TEMPERATURE AND  
DISSOLVED OXYGEN PROFILES**

2 AUG 1972-26 JUN 1973

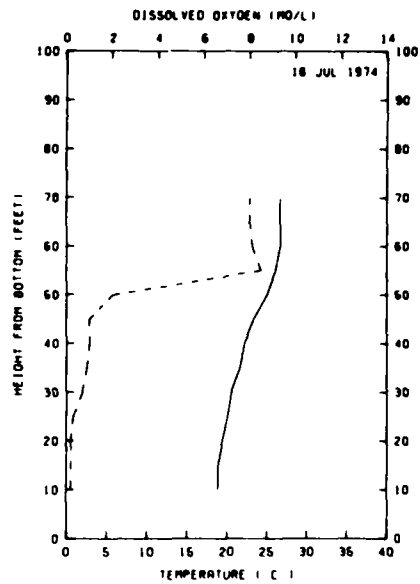
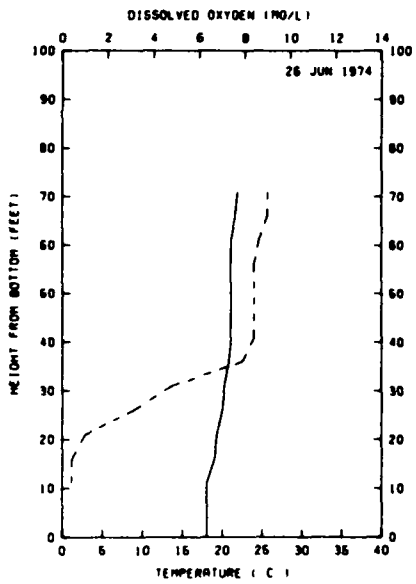
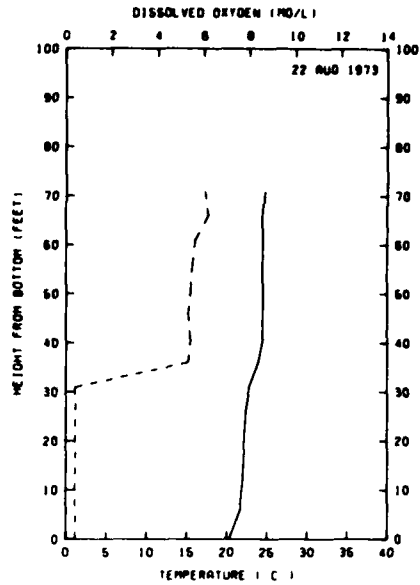
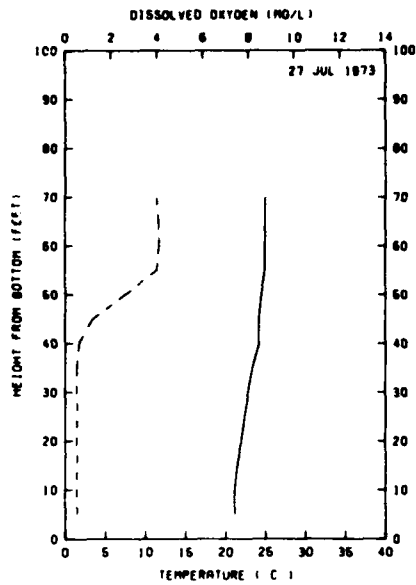

**LEGEND**

- WATER TEMPERATURE
- - - DISSOLVED OXYGEN

MISSISSINewa LAKE  
**TEMPERATURE AND  
DISSOLVED OXYGEN PROFILES**

27 JUL 1973-16 JUL 1974

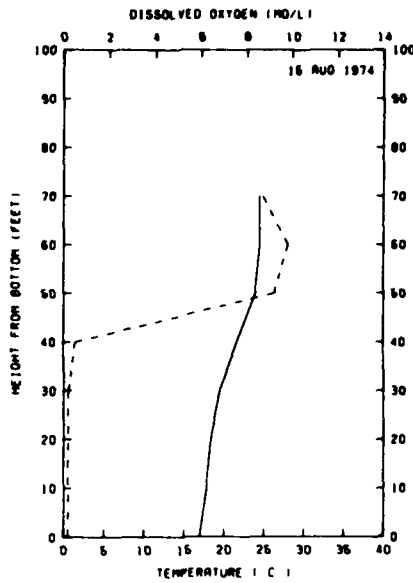

RELEASE TEMP. 24.4  
RELEASE D.O. 9.4

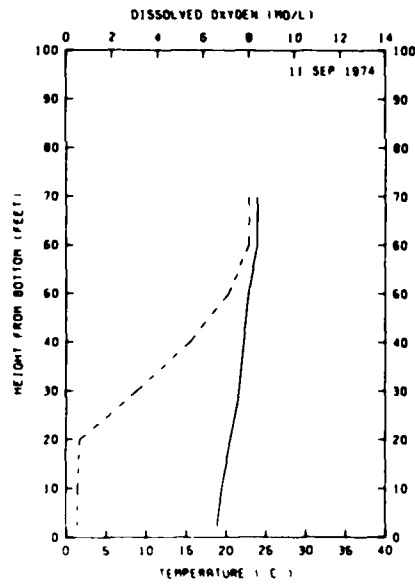

RELEASE TEMP. NA  
RELEASE D.O. 8.8

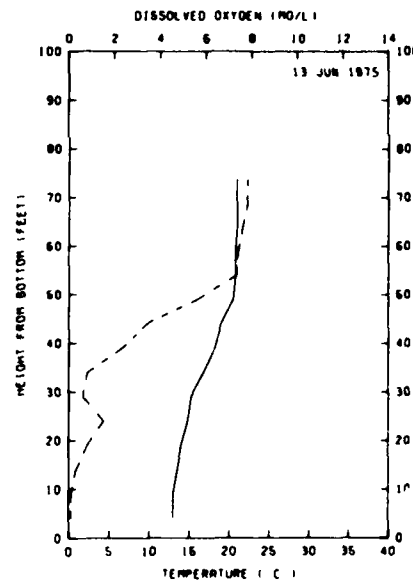

RELEASE TEMP. 19.4  
RELEASE D.O. 7.8

**LEGEND**

- WATER TEMPERATURE
- - - DISSOLVED OXYGEN

MISSISSINEWA LAKE  
**TEMPERATURE AND  
DISSOLVED OXYGEN PROFILES**

15 AUG 1974-13 JUN 1975

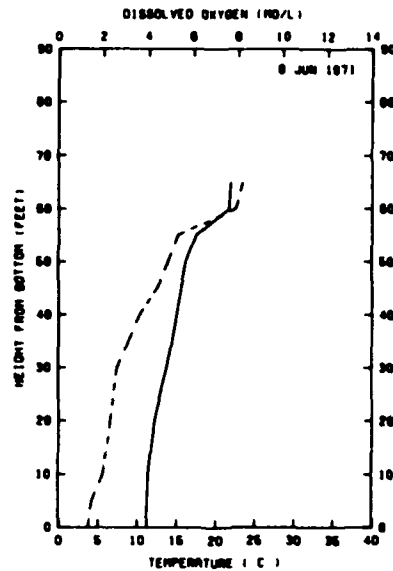

RELEASE TEMP. 17.2  
RELEASE D.O. 11.0

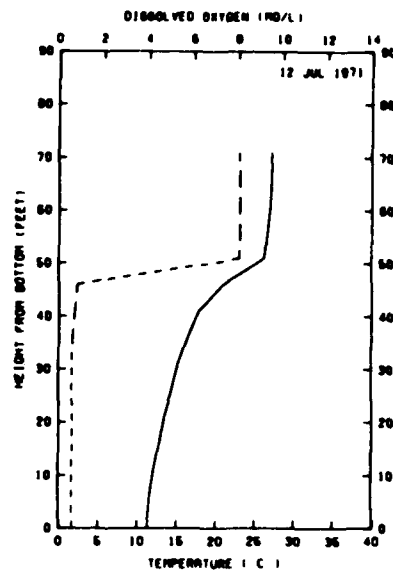

RELEASE TEMP. 16.7  
RELEASE D.O. 9.5

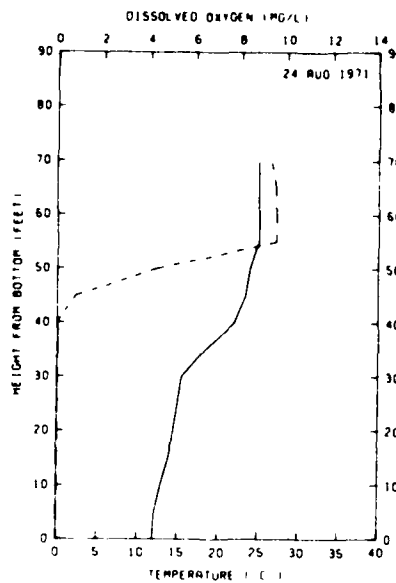

RELEASE TEMP. 17.9  
RELEASE D.O. 9.4

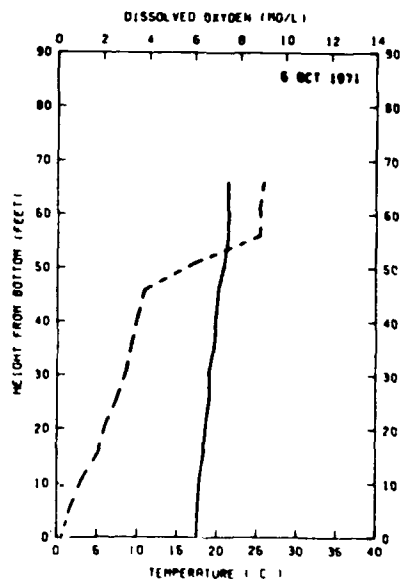

RELEASE TEMP. 19.7  
RELEASE D.O. 9.6

**LEGEND**

- WATER TEMPERATURE
- - - DISSOLVED OXYGEN

SALAMONIE LAKE  
**TEMPERATURE AND  
DISSOLVED OXYGEN PROFILES**

8 JUN 1971-5 OCT 1971

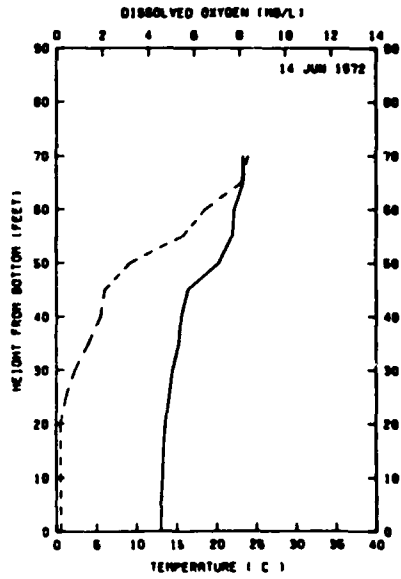

RELEASE TEMP. 17.7  
RELEASE D.O. 8.2

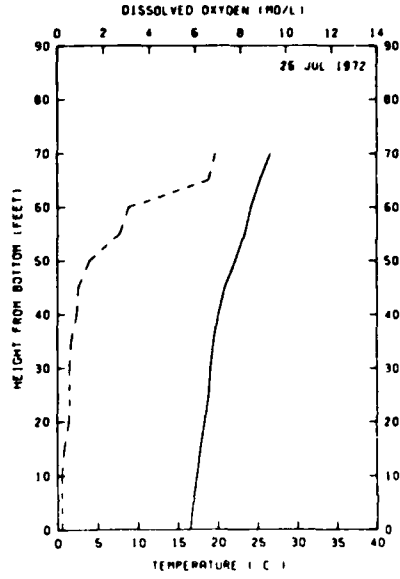

RELEASE TEMP. 21.3  
RELEASE D.O. 9.7

**LEGEND**

— WATER TEMPERATURE  
- - - DISSOLVED OXYGEN

SALAMONIE LAKE  
**TEMPERATURE AND  
DISSOLVED OXYGEN PROFILES**

14 JUN 1972-25 JUL 1972

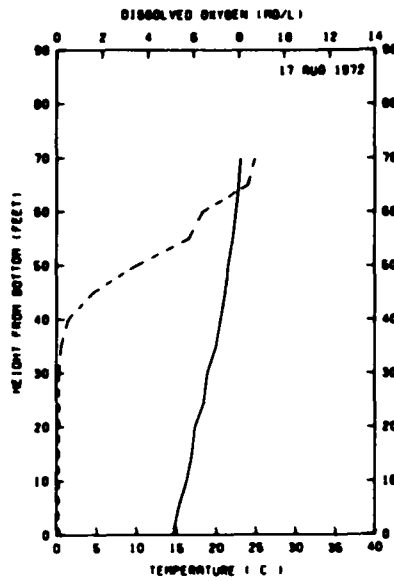

RELEASE TEMP. 18.7  
RELEASE D.O. 10.1

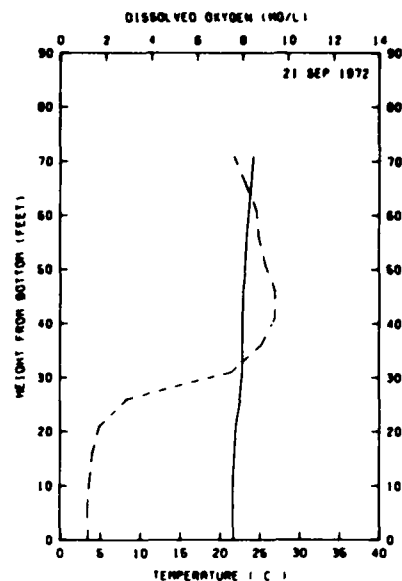

RELEASE TEMP. 18.9  
RELEASE D.O. 7.8

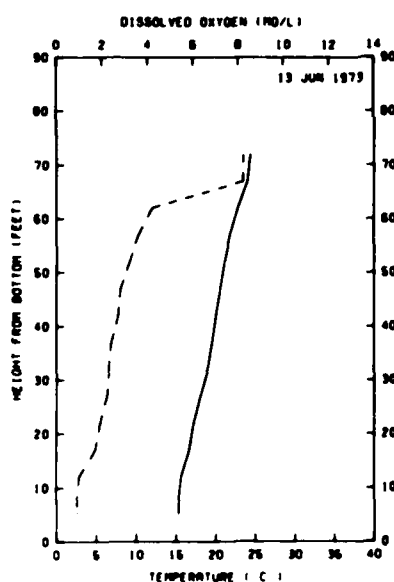

RELEASE TEMP. 18.3  
RELEASE D.O. 8.6

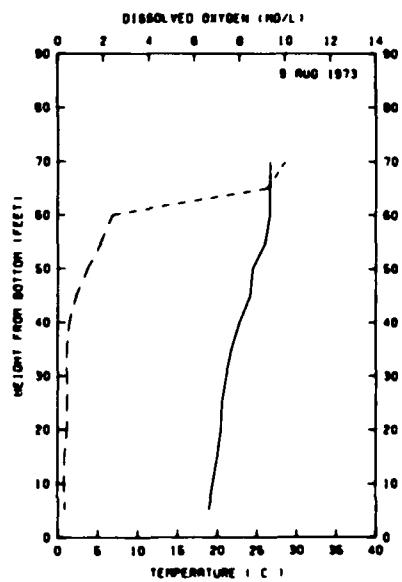

RELEASE TEMP. 22.4  
RELEASE D.O. NA

**LEGEND**

- WATER TEMPERATURE
- - - DISSOLVED OXYGEN

SALAMONIE LAKE  
**TEMPERATURE AND  
DISSOLVED OXYGEN PROFILES**  
17 AUG 1972-9 AUG 1973

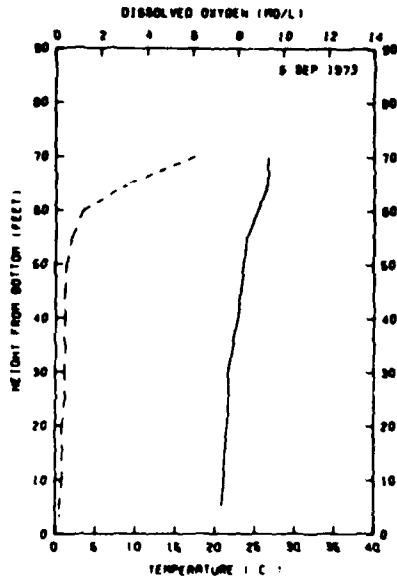

RELEASE TEMP. 23.3  
RELEASE D.O. 9.6

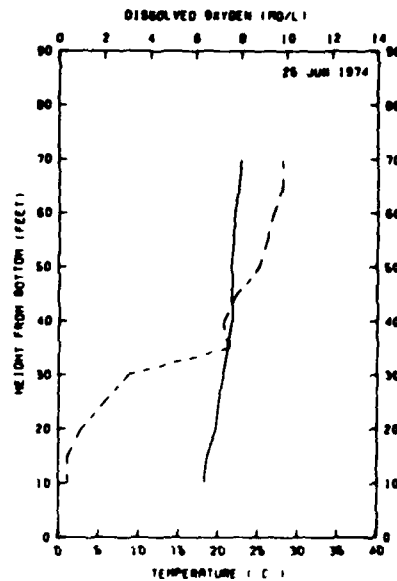

RELEASE TEMP. 20.0  
RELEASE D.O. 9.9

**LEGEND**

- WATER TEMPERATURE
- - - DISSOLVED OXYGEN

SALAMONIE LAKE  
**TEMPERATURE AND  
DISSOLVED OXYGEN PROFILES**

6 SEP 1973-25 JUN 1974

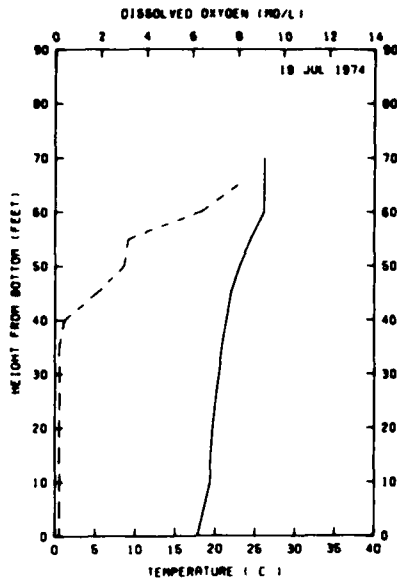

RELEASE TEMP. 21.0  
RELEASE D.O. 8.9

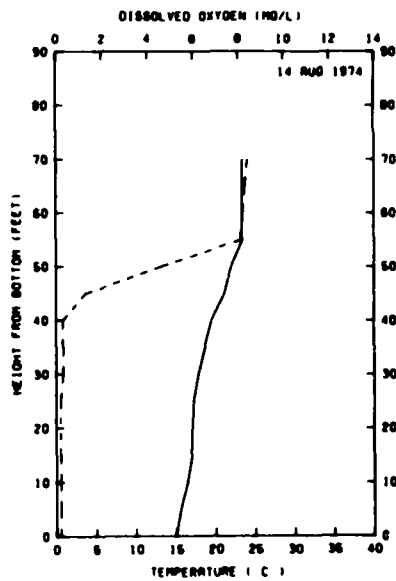

RELEASE TEMP. 21.1  
RELEASE D.O. NA

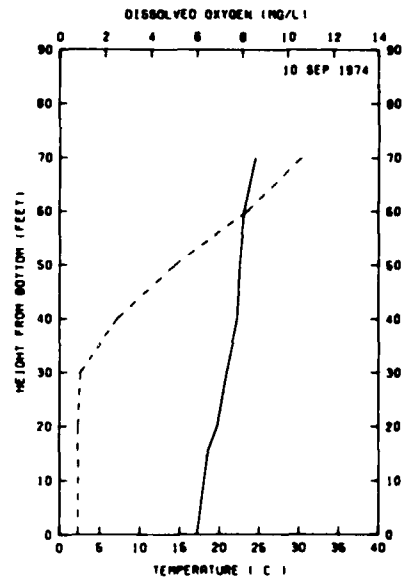

RELEASE TEMP. 21.1  
RELEASE D.O. 9.5

**LEGEND**

— WATER TEMPERATURE  
- - - DISSOLVED OXYGEN

SALAMONIE LAKE  
**TEMPERATURE AND  
DISSOLVED OXYGEN PROFILES**

19 JUL 1974-10 SEP 1974



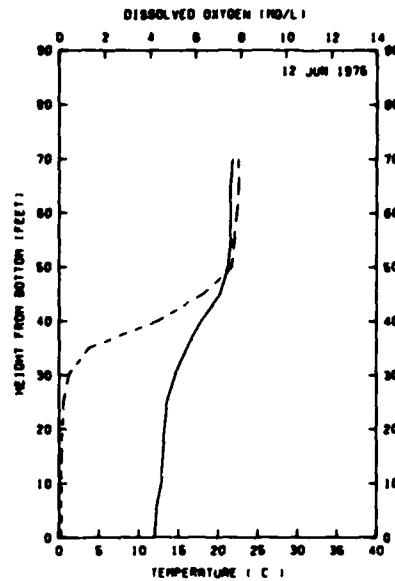

RELEASE TEMP. 19.0  
RELEASE D.O. NA

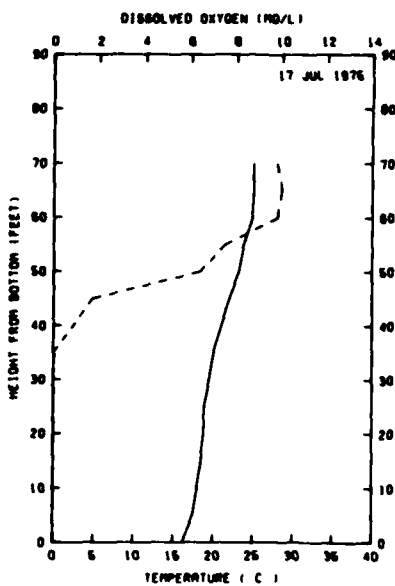

RELEASE TEMP. 25.6  
RELEASE D.O. NA

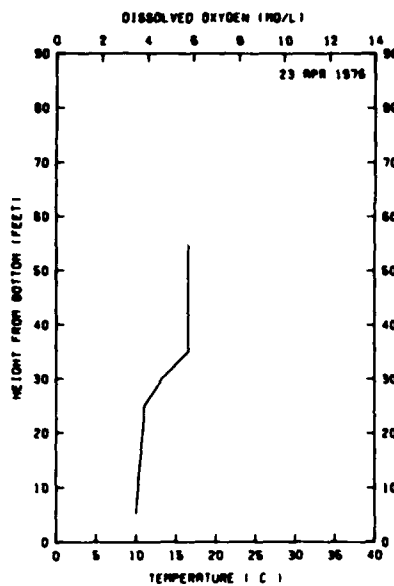

RELEASE TEMP. 16.22  
RELEASE D.O. NA

**LEGEND**

- WATER TEMPERATURE
- - - DISSOLVED OXYGEN

SALAMONIE LAKE  
**TEMPERATURE AND  
DISSOLVED OXYGEN PROFILES**  
12 JUN 1975-23 APR 1976

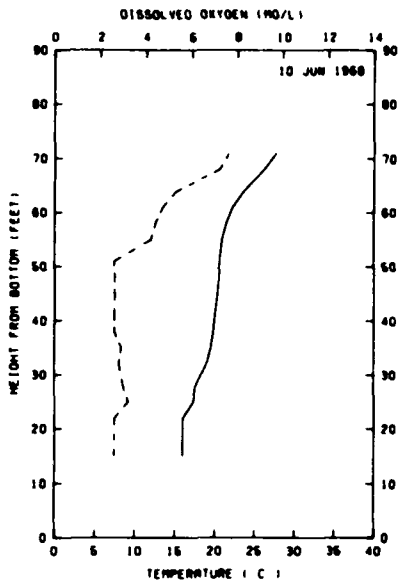

RELEASE TEMP. 21.8  
RELEASE D.O. 8.1

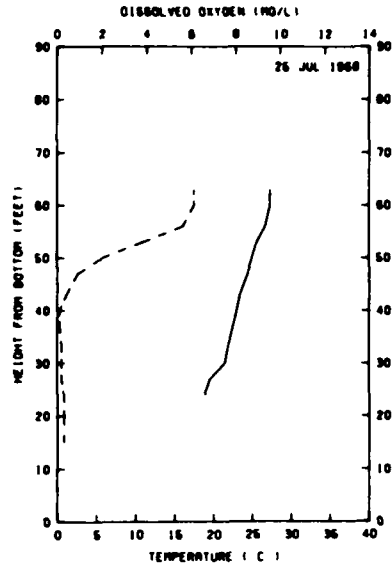

RELEASE TEMP. 25.2  
RELEASE D.O. 7.6

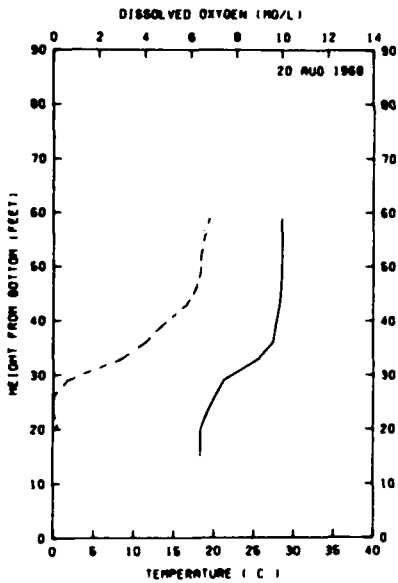

RELEASE TEMP. 26.7  
RELEASE D.O. 7.7

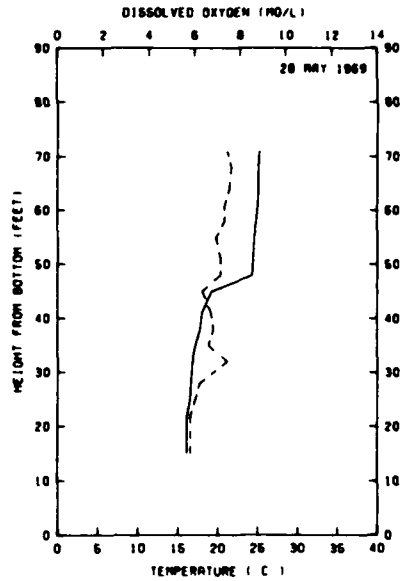

RELEASE TEMP. 21.9  
RELEASE D.O. 7.9

**LEGEND**

— WATER TEMPERATURE  
- - - DISSOLVED OXYGEN

SARDIS LAKE  
**TEMPERATURE AND  
DISSOLVED OXYGEN PROFILES**

10 JUN 1968-28 MAY 1969

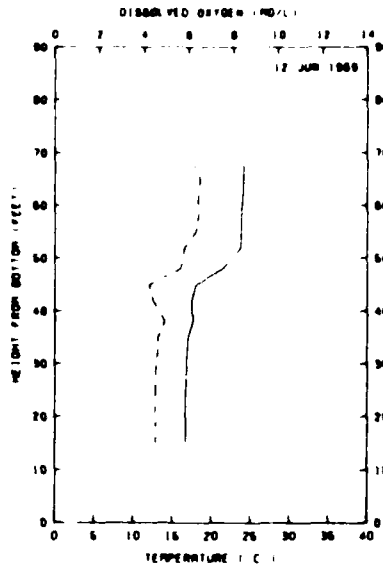

RELEASE TEMP 20.8  
RELEASE D.O. 8.7

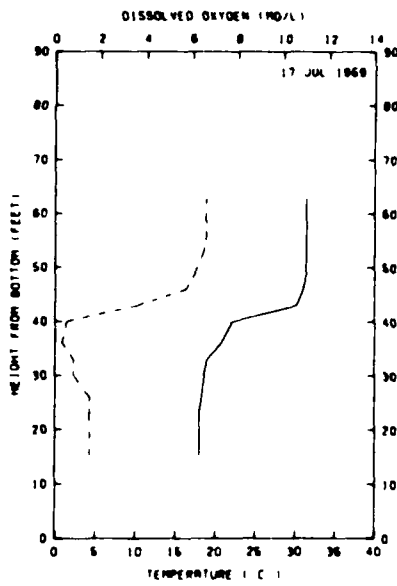

RELEASE TEMP 26.5  
RELEASE D.O. 7.9

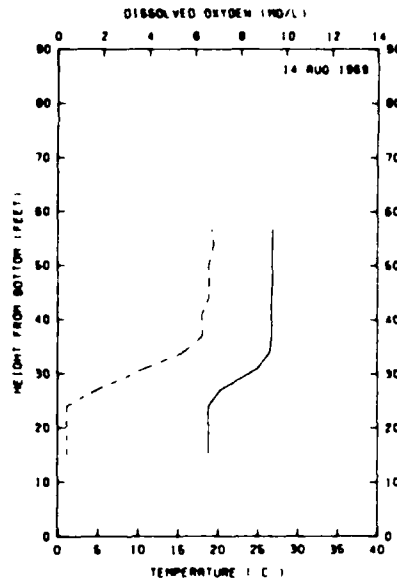

RELEASE TEMP. 25.9  
RELEASE D.O. 7.8

**LEGEND**

- WATER TEMPERATURE
- - - DISSOLVED OXYGEN

SARDIS LAKE  
**TEMPERATURE AND  
DISSOLVED OXYGEN PROFILES**

12 JUN 1969-14 AUG 1969

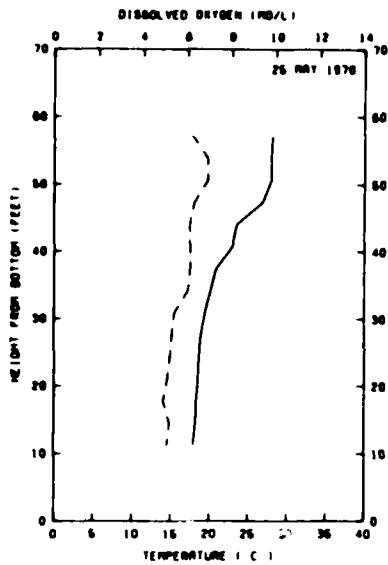

RELEASE TEMP 21.2  
RELEASE D.O. 8.2

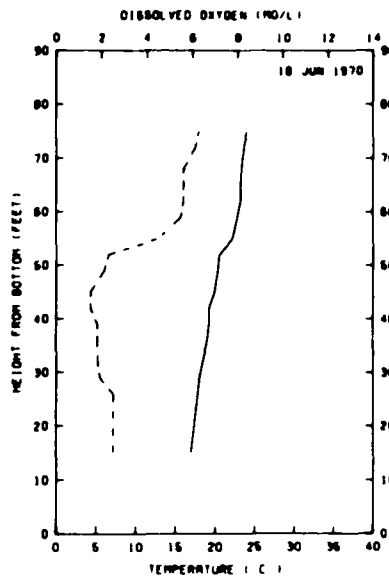

RELEASE TEMP 21.6  
RELEASE D.O. 8.1

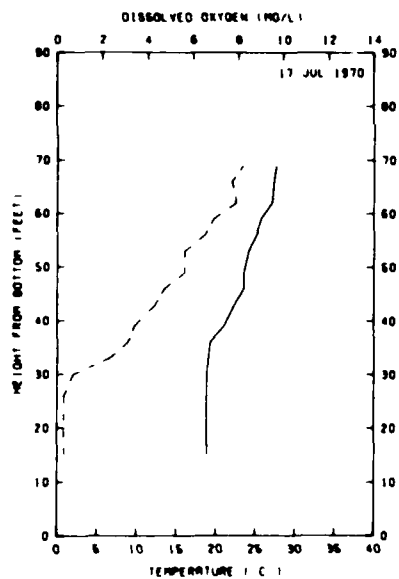

RELEASE TEMP 23.8  
RELEASE D.O. 7.6

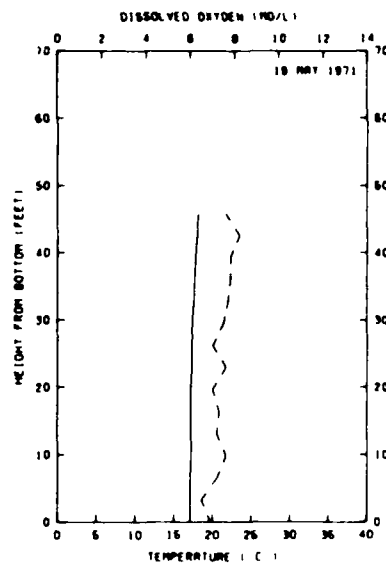

RELEASE TEMP 19.0  
RELEASE D.O. 9.0

**LEGEND**

- WATER TEMPERATURE
- - - DISSOLVED OXYGEN

SARDIS LAKE

**TEMPERATURE AND DISSOLVED OXYGEN PROFILES**

25 MAY 1970-19 MAY 1971

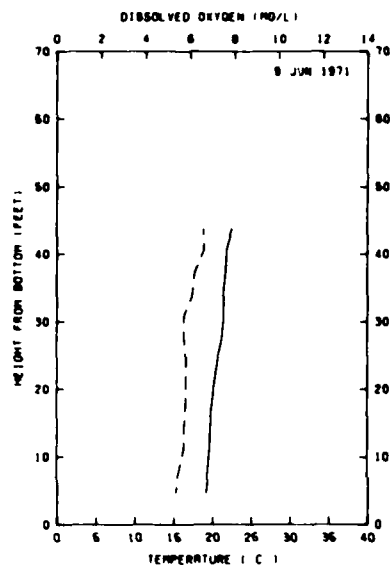

RELEASE TEMP. 22.0  
RELEASE D.O. 8.4

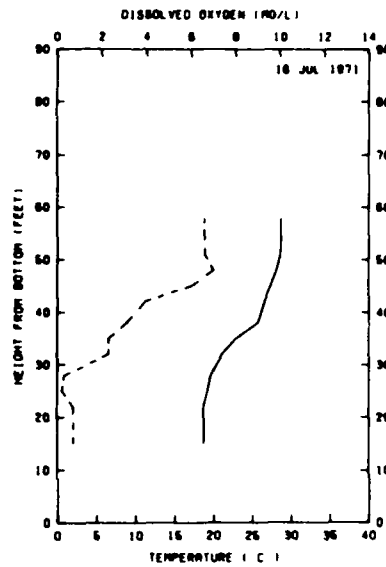

RELEASE TEMP. 25.3  
RELEASE D.O. 7.7

LEGEND

- WATER TEMPERATURE
- - - DISSOLVED OXYGEN

SARDIS LAKE

TEMPERATURE AND  
DISSOLVED OXYGEN PROFILES

9 JUN 1971-16 JUL 1971

Appendix A: Hydraulic and Predicted Data

Outlet Works Structures	Date	Release Temperature, °C		D.O., mg/l		Δh ft	Structure Discharge cfs	Structure Design Discharge cfs
		Observed	Predicted	Observed Downstream	Entering Outlet Works*			
Arkabutla	17 Aug 1970	26.3	26.3	NA	NA	46.88	1440	5000
	12 Aug 1972	28.3	27.6	6.90	1.9	49.60	1050	
C. J. Brown	4 Jun 1974	20.8	20.9	7.80	8.7	34.80	27	2500
	27 Aug 1974	21.7	25.1	10.4	0.3	34.70	40	
	24 Sep 1974	NA	18.0	10.4	4.4	36.70	40	
	17 Jun 1975	15.6	17.3	9.40	3.2	48.50	56	
	24 Jul 1975	22.6	25.5	7.80	7.8	48.60	50	
	20 Aug 1975	25.5	24.9	7.60	6.9	48.90	15	
Crooked Creek	17 Jul 1973	23.0	23.2	7.8	5.5	42.06	42	4500
	10 Oct 1973	17.1	16.1	9.0	8.0	40.05	205	
	12 Jun 1974	17.6	17.9	9.0	7.6	41.81	36	
East Branch	16 Sep 1970	17.2	18.5	9.0	8.7	128.64	49	4400
	3 Jun 1971	14.0	11.1	9.8	9.7	150.20	76	
	21 Jul 1971	18.9	19.6	8.7	8.7	140.47	185	
	29 Aug 1971	19.5	19.6	9.8	8.9	126.42	160	
	30 Aug 1972	19.2	20.2	8.9	7.6	129.92	170	
	20 Jun 1973	13.6	12.6	9.4	9.9	149.63	270	
	30 Aug 1973	21.0	21.3	8.4	8.2	133.37	195	
	17 Jun 1974	14.3	11.4	9.6	11.2	151.05	45	
	15 Jul 1974	20.0	16.4	9.1	10.5	143.32	245	
	29 Jul 1974	19.0	17.9	9.0	9.3	141.03	165	
23 Aug 1974	22.3	21.4	9.1	9.0	132.69	155		
East Lynn	21 Jul 1976	23.2	27.2	7.80	7.8	51.40	14	6900
	26 Aug 1976	22.5	26.2	7.80	7.7	51.32	17	
	6 Oct 1976	19.3	20.1	8.70	7.4	50.13	119	

(Continued)

\* Predicted by SELECT to be entering outlet works prior to reaeration.

Outlet Works Structures	Date	Release Temperature, °C		D.O., mg/l		Δh ft	Structure Discharge cfs	Structure Design Discharge cfs
		Observed	Predicted	Observed Downstream	Entering Outlet Works			
Enid	16 Jul 1969	24.1	23.2	7.90	0.9	56.65	1370	2400
	18 Aug 1971	25.7	25.0	6.80	2.0	59.61	684	
Grayson	19 May 1976	17.0	15.0	9.50	9.5	57.77	28	8600
	18 Jun 1976	21.8	24.3	8.40	9.7	57.80	26	
	20 Jul 1976	22.4	21.8	8.00	6.5	59.79	27	
	23 Aug 1976	20.0	23.7	7.90	0.5	58.94	118	
	5 Sep 1976	18.4	20.5	8.6	7.9	55.18	87	
Grenada	15 Jul 1969	28.2	26.0	7.70	3.1	52.61	2390	5100
	24 Aug 1970	26.3	26.2	7.60	4.6	50.98	2640	
	18 Aug 1971	27.9	27.4	6.80	5.5	49.90	3390	
	9 Aug 1972	27.6	27.4	6.90	3.5	50.15	2610	
Mississinewa	30 Jun 1971	17.0	17.0	9.40	1.0	74.87	130	9000
	6 Aug 1971	15.0	14.4	NA	0.2	74.90	110	
	8 Sep 1971	21.1	19.9	9.40	1.0	74.83	166	
	5 Jul 1972	19.4	18.1	9.30	2.3	70.46	1860	
	2 Aug 1972	23.9	23.9	NA	1.1	74.83	86	
	26 Apr 1973	9.2	9.2	12.6	2.6	89.71	542	
	26 Jun 1973	24.4	19.2	5.60	0.3	74.86	245	
	27 Jul 1973	23.6	22.6	8.20	0.6	72.37	835	
	22 Aug 1973	23.3	22.5	8.80	1.2	72.94	2030	
	26 Jun 1974	19.7	19.6	9.60	3.2	70.55	1862	
	16 Jul 1974	25.8	22.5	8.70	1.0	76.07	66	
	15 Aug 1974	24.4	21.6	9.40	2.1	76.02	66	
	11 Sep 1974	NA	22.3	8.80	5.5	75.84	104	
13 Jun 1975	19.4	17.1	7.80	2.1	72.62	670		
Salamonie	8 Jun 1971	17.2	14.1	11.00	2.9	69.73	26	9000
	12 Jul 1971	16.7	14.6	9.50	0.8	72.89	76	
	24 Aug 1971	17.9	17.7	9.4	0.0	74.70	28	

(Continued)

(Sheet 2 of 3)



Outlet Works Structures	Date	Release Temperature, °C		D.O., mg/l		Entering Outlet Works	Δh ft	Structure	Structure
		Observed	Predicted	Observed Downstream	Observed Downstream			Discharge cfs	Design Discharge cfs
Salamonie (Continued)	5 Oct 1971	19.7	18.3	9.60	1.9	67.94	495		
	14 Jun 1972	17.7	15.4	8.20	1.4	74.31	72		
	25 Jul 1972	21.3	19.4	9.70	0.6	73.04	232		
	17 Aug 1972	18.7	19.5	10.10	0.2	74.45	50		
	21 Sep 1972	18.9	22.3	7.80	4.7	71.94	1510		
	13 Jun 1973	18.3	17.6	8.60	1.9	72.63	1722		
	9 Aug 1973	22.4	21.7	NA	0.4	74.57	28		
	6 Sep 1973	23.3	22.0	9.60	0.4	74.38	50		
	25 Jun 1974	20.0	19.8	9.90	2.5	71.07	1922		
	19 Jul 1974	21.0	20.7	8.90	0.5	74.52	21		
	14 Aug 1974	21.1	18.5	NA	0.3	74.73	28		
	10 Sep 1974	21.1	21.2	9.5	0.5	73.62	116		
	12 Jun 1975	19.0	15.8	NA	1.8	73.49	116		
	17 Jul 1975	25.6	19.8	11.4	0.1	74.44	50		
	23 Apr 1976	16.2	14.6	NA	NA	59.97	22		
	Sardis	10 Jun 1968	21.8	21.6	8.10	4.2	65.72	4110	7500
		25 Jul 1968	25.2	23.6	7.60	1.7	58.99	3490	
20 Aug 1968		26.7	26.5	7.70	4.5	57.73	2000		
28 May 1969		21.9	21.5	7.90	6.9	66.93	3570		
12 Jun 1969		20.8	20.3	8.70	5.3	63.43	3740		
17 Jul 1969		26.5	26.1	7.90	3.5	58.00	3620		
14 Aug 1969		25.9	25.6	7.80	5.5	52.90	3250		
25 May 1970		21.2	21.9	8.20	5.8	72.05	4070		
18 Jun 1970		21.6	21.3	8.10	3.9	69.05	4570		
27 Jul 1970		23.8	23.2	7.60	4.9	64.12	4040		
19 May 1971	19.0	17.5	9.00	7.5	65.28	1030			
9 Jun 1971	22.0	20.7	8.40	5.9	60.74	2910			
16 Jul 1971	25.3	25.2	7.70	4.1	55.79	2450			

(Sheet 3 of 3)

Appendix B: Example Case for Prediction of Reaeration  
for Gated-Conduit Outlet Works

### Synopsis of Procedure

1. Based upon the analysis presented earlier, the D.O. released from gated conduits may be computed if the following conditions are satisfied:
  - a. Flow issued from under the bottom edge of the control gate.
  - b. The flow rates were such that free-surface flow existed in the conduit; i.e., the conduit was not flowing full.
  - c. The outlet portal of the conduit was not submerged by the tailwater.
  
2. The data required are the following:
  - a. Lake temperature and D.O. profiles.\*
  - b. Forebay and tailwater elevations.
  - c. Structure details, i.e., outlet configuration and location.
  - d. Discharge rate.
  - e. Upstream morphometry.
  
3. The recommended calculation sequence is as follows:
  - a. Predict the flow weighted average temperature and D O. entering the outlet works with the computer code SELECT (Bohan and Grace 1973).
  - b. Adjust the escape coefficient for the temperature with the equation

$$c_T = c_{20} 1.022^{T-20}$$

where

- $c_T$  = temperature-adjusted escape coefficient,  $\text{ft}^{-1}$   
 $T$  = Predicted release temperature,  $^{\circ}\text{C}$   
 $c_{20}$  = Escape coefficient at  $20^{\circ}\text{C}$  (or  $c_{20} = 0.045$  per foot)

---

\* Either observed or predicted with a numerical model such as WESTEX (Loftis, in press). (References mentioned in this Appendix are more fully identified in the References section at the end of the main text.)

- c. Compute the oxygen deficit  $D$  (mg/l) entering the outlet works by

$$D = C_{\text{sat}} - C_{\text{SEL}}$$

where

$C_{\text{sat}}$  = oxygen saturation concentration for predicted release temperature, mg/l

$C_{\text{SEL}}$  = D.O. entering outlet works prior to reaeration, predicted by SELECT, mg/l

- d. Calculate the difference in forebay and tailwater elevations,  $\Delta h$ , ft.
- e. Predict the final or release deficit from

$$D_f = D_i \exp(-c_T \Delta h)$$

where

$D_f$  = downstream deficit, mg/l

- f. Calculate the released D.O. concentration from

$$C_{\text{rel}} = C_{\text{sat}} - D_f$$

#### Example Case

4. An example case is presented below:
- a. The temperature and D.O. profiles and hydraulic data for Mystery Lake are presented in Tables B1 and B2.
- b. These data are input to SELECT (presented in Appendix C) and the following predictions are obtained:

$$T = 18.34 \text{ }^\circ\text{C}$$

$$C_{\text{SEL}} = 3.95 \text{ mg/l}$$

- c. The temperature-corrected escape coefficient is

$$c_T = 0.045 (1.022)^{(T-20)}$$

$$\begin{aligned}c_{18.34} &= 0.045 (1.022)^{(18.34-20)} \\ &= 0.043 \text{ ft}^{-1}\end{aligned}$$

and

$$\Delta h = 400 - 340 = 60 \text{ ft}$$

d. The upstream deficit is

$$\begin{aligned}D_i &= C_{\text{sat}} - 3.95 \\ &= 9.5 - 3.95 \\ &= 5.55 \text{ mg/l}\end{aligned}$$

e. The downstream deficit after reaeration is:

$$\begin{aligned}D_f &= D_i \exp(-c\Delta h) \\ &= 5.55 \exp[-0.043 (60)] \\ D_f &= 0.4 \text{ mg/l}\end{aligned}$$

f. Released D.O. after reaeration is

$$\begin{aligned}C_{\text{rel}} &= C_{\text{sat}} - D_f \\ &= 9.5 - 0.4 \\ &= 9.1 \text{ mg/l}\end{aligned}$$

Table B1  
Mystery Lake Profiles

<u>Elevation</u> ft	<u>Depth</u> ft	<u>Temperature</u> °C	<u>D.O.</u> mg/l
400	0	28.0	8.0
395	5	27.6	8.0
390	10	27.3	8.0
385	15	26.0	8.0
380	20	25.0	7.3
375	25	21.0	4.3
370	30	14.0	3.1
365	35	12.0	2.8
360	40	10.1	2.6
355	45	10.0	2.5
350	50	9.9	2.3

Table B2  
Hydraulic and Geometric Data

---

Discharge: 225 cfs  
 Port Location: Elevation 372 ft  
 Port Area: 16 ft<sup>2</sup>  
 Upstream Morphometry:

<u>Elevation, ft</u>	<u>Width, ft</u>
400	1500
390	1200
380	1900
370	800
360	600
350	100

Forebay Elevation: 400 ft  
 Tailwater Elevation: 340 ft

---

Appendix C: SELECT Example

```

1000 ***MYSTERY LAKE WITHDRAWAL
1010 ***FILES 05 06
1020 ***DATA SETS 1
1030 ***PRINT INPUT
1040 ***MYSTERY LAKE EXAMPLE CASE
1050 ***ENGLISH
1060 ***TABLES 1
1070 ***THICKNESS 2.0
1080 ***INTERVAL 2
1090 ***SURFACE 400.
1100 ***BOTTOM 350.
1110 ***NUMBER OF WIDTHS 6
1120 ***ELEVATION WIDTH
1130 *** 400. 1500.
1140 *** 390. 1200.
1150 *** 380. 1000.
1160 *** 370. 800.
1170 *** 360. 600.
1180 *** 350. 200.
1190 ***PORTS 1
1200 ***AREA 16.
1210 ***ELEVATION 372.
1220 ***FLOW 225.
1230 ***NUMBER OF TEMPS 11
1240 ***TEMPERATURE DEGREES CENTIGRADE
1250 ***DEPTH TEMP
1260 *** 0.0 28.0
1270 *** 5.0 27.8
1280 *** 10.0 27.3
1290 *** 15.0 26.0
1300 *** 20.0 25.0
1310 *** 25.0 21.0
1320 *** 30.0 14.0
1330 *** 35.0 12.0
1340 *** 40.0 10.1
1350 *** 45.0 10.0
1360 *** 50.0 9.9
1370 ***QUALITIES 1
1380 ***NUMBER OF DISSOLVED OXYGEN 11
1390 ***DEPTH DO
1400 *** 0.0 8.0
1410 *** 5.0 8.0
1420 *** 10.0 8.0
1430 *** 15.0 7.3
1440 *** 20.0 5.1
1450 *** 25.0 4.3
1460 *** 30.0 3.1
1470 *** 35.0 2.8
1480 *** 40.0 2.6
1490 *** 45.0 2.5
1500 *** 50.0 2.3
1510 ***STOP

```



MYSTERY LAKE WITHDRAWAL

MYSTERY LAKE EXAMPLE CASE

UNITS ARE FEET

PORT ELEVATION 372.000  
PORT AREA 16.000  
DISCHARGE, VOLUME FLOW PER SEC. 225.0000

TOTAL DISCHARGE, VOLUME PER SEC 225.0000

LOWER WITHDRAWAL LIMIT, HEIGHT ABOVE BOTTOM 4.469 ELEVATION 354.469  
UPPER WITHDRAWAL LIMIT, HEIGHT ABOVE BOTTOM 37.313 ELEVATION 387.313  
OUTFLOW DENSITY 0.99845 G/CC  
OUTFLOW TEMPERATURE 18.34  
OUTFLOW CONCENTRATION OF DISSOLVED OXYGEN 3.95

ELEVATION	DEPTH	WIDTH	DENSITY	VELOCITY	FLOW	TEMPERATURE	DISSOLVED OX
399.000	1.00	1470.0	0.99628	0.	0.	27.96	8.00
395.000	5.00	1350.0	0.99632	0.	0.	27.80	8.00
391.000	9.00	1230.0	0.99643	0.	0.	27.40	8.00
387.000	13.00	1140.0	0.99667	0.	0.	26.52	7.58
383.000	17.00	1060.0	0.99692	0.0029	6.0541	25.60	6.42
379.000	21.00	980.0	0.99728	0.0098	19.1980	24.20	4.94
375.000	25.00	900.0	0.99802	0.0180	32.4015	21.00	4.30
371.000	29.00	820.0	0.99907	0.0182	29.8503	15.40	3.34
367.000	33.00	740.0	0.99943	0.0115	16.9812	12.80	2.92
363.000	37.00	660.0	0.99961	0.0051	6.7425	11.24	2.72
359.000	41.00	560.0	0.99972	0.0010	1.1539	10.08	2.58
355.000	45.00	400.0	0.99973	0.0000	0.0000	10.00	2.50
351.000	49.00	240.0	0.99974	0.	0.	9.92	2.34

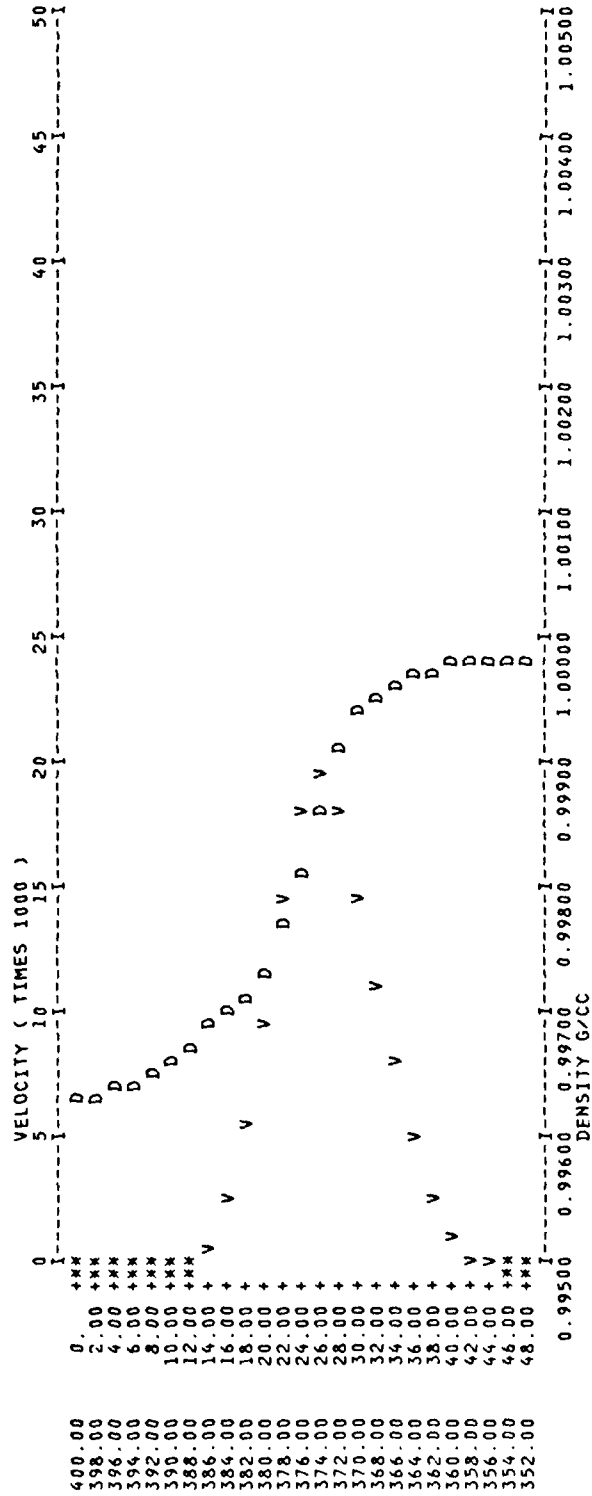

In accordance with letter from DAFN-RDC, FAEN-ASI dated 22 July 1977, Subject: Facsimile Catalog Cards for Laboratory Technical Publications, a facsimile catalog card in Library of Congress MARC format is reproduced below.

Wilhelms, Steven C.

Reaeration through gated-conduit outlet works : Final report / by Steven C. Wilhelms, Dennis R. Smith (Hydraulics Laboratory, U.S. Army Engineer Waterways Experiment Station) ; prepared for Office, Chief of Engineers, U.S. Army ; monitored by Environmental Laboratory, U.S. Army Engineer Waterways Experiment Station ; Springfield, Va. ; available from NTIS, 1981.

26, [14] p., [19] leaves of plates : ill. ; 27 cm. -- (Technical report / U.S. Army Engineer Waterways Experiment Station ; E-81-5)

Cover title.

"March 1981."

"Under CWIS No. 31402 (EWQOS Work Unit 31604 (III A.1))."

Bibliography: p. 26.

1. Hydraulic gates. 2. Oxygen. 3. Reservoirs -- Aeration. 4. Temperature. I. Smith, Dennis R. II. United States. Army. Corps of Engineers. Office

Wilhelms, Steven C.

Reaeration through gated-conduit outlet works : ... 1981.  
(Card 2)

of the Chief of Engineers. III. United States. Army Engineer Waterways Experiment Station. Hydraulics Laboratory. IV. United States. Army Engineer Waterways Experiment Station. Environmental Laboratory. V. Title VI. Series: Technical report (United States. Army Engineer Waterways Experiment Station) ; E-81-5. TA7.W34 no.E-81-5

