

AD-A099 298

NAVAL OCEAN SYSTEMS CENTER SAN DIEGO CA
NAVYLAND MICROWAVE SCANNING BEAM TESTS AT NOSC. THREE LANDING --ETC(U)
FEB 81 F E MORRIS

F/G 17/7

UNCLASSIFIED

NOSC/TR-646

NI

1 of 2

AD A
099 298

NOSC

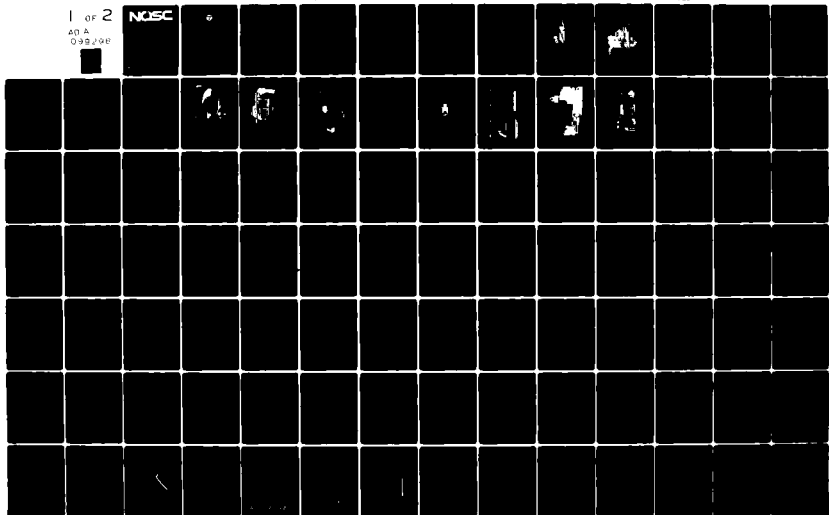

LEVEL II

12

NOSC

NOSC TR 646

NOSC TR 646

Technical Report 646

NAVTOLAND MICROWAVE SCANNING BEAM TESTS AT NOSC

Three landing guidance systems tested
in a specular multipath environment

FE Morris

February 1981

Interim Report: November 1980 - January 1981

Prepared for
Naval Air Systems Command

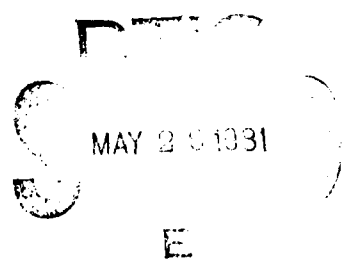

Approved for public release; distribution unlimited.

NAVAL OCEAN SYSTEMS CENTER
SAN DIEGO, CALIFORNIA 92152

81 5 26 019

AD A 099 298

DTIC FILE COPY



NAVAL OCEAN SYSTEMS CENTER, SAN DIEGO, CA 92152

A N A C T I V I T Y O F T H E N A V A L M A T E R I A L C O M M A N D

SL GUILLE, CAPT, USN
Commander

HL BLOOD
Technical Director

ADMINISTRATIVE INFORMATION

This work was performed under NOSC Project CT37 for Naval Air Systems Command (AIR Task A03P-03PA/003C/1W0570-002, Work Request IOR N00019-81-WR-11203, Program Element 63203N, subproject task W0570-SL) over the period November 1980 through January 1981. NAVAIR NAVTOLAND project engineers are TS Momiyama, ADPO-18, and RS Niemczyk, AIR-53355B. NOSC project manager is SK Miyashiro, Code 8216.

Released by
DR Wehner, Head
Tactical Sensors and Electronic
Warfare Division

Under authority of
JH Maynard, Head
Command Control Electronic Warfare
Systems and Technology Department

ACKNOWLEDGEMENTS

The author would like to thank Kenneth Sliegus and Wayland Carlson for their participation in the tests.

UNCLASSIFIED

SECURITY CLASSIFICATION OF THIS PAGE (When Data Entered)

REPORT DOCUMENTATION PAGE		READ INSTRUCTIONS BEFORE COMPLETING FORM
1. REPORT NUMBER NOSC Technical Report 646 (TR 646) /	2. GOVT ACCESSION NO. AD-A099298	3. RECIPIENT'S CATALOG NUMBER
4. TITLE (and Subtitle) NAVTO LAND MICROWAVE SCANNING BEAM TESTS AT NOSC. Three landing guidance systems tested in a specular multipath environment		5. TYPE OF REPORT & PERIOD COVERED 9 Interim report November 1980 - January 1981
7. AUTHOR(s) 10 14 Morris 14) V... / TR-...		6. PERFORMING ORG. REPORT NUMBER
9. PERFORMING ORGANIZATION NAME AND ADDRESS Naval Ocean Systems Center San Diego, CA 92152		8. CONTRACT OR GRANT NUMBER(s) 16... 70
11. CONTROLLING OFFICE NAME AND ADDRESS Naval Air Systems Command Washington, DC 20361		10. PROGRAM ELEMENT, PROJECT, TASK AREA & WORK UNIT NUMBERS 17 63203N, W0570-SL
		12. REPORT DATE February 1981
		13. NUMBER OF PAGES 119 12) ...
14. MONITORING AGENCY NAME & ADDRESS (if different from Controlling Office)		15. SECURITY CLASS. (of this report) Unclassified
		15a. DECLASSIFICATION DOWNGRADING SCHEDULE
16. DISTRIBUTION STATEMENT (of this Report) Approved for public release; distribution unlimited		
17. DISTRIBUTION STATEMENT (of the abstract entered in Block 20, if different from Report)		
18. SUPPLEMENTARY NOTES		
19. KEY WORDS (Continue on reverse side if necessary and identify by block number) Aircraft landing guidance NAVTO LAND VTOL aircraft Circular polarization Ku-Band transmission Specular multipath Pulse-coded scanning beam		
20. ABSTRACT (Continue on reverse side if necessary and identify by block number) Results of testing Ku-band pulse-coded microwave scanning guidance system concepts are reported. Three different systems were tested under conditions of severe specular multipath. It is concluded that Ku-Band antennas with elevation and azimuth scanning beamwidths as wide as 4 and 6 deg, respectively, are adequate for shipboard landing guidance systems and that circular polarization and an elevation scan technique at low-angle-beam cutoff and mathematical beamfitting are effective solutions to multipath problems expected for a Navy shipboard system. Additionally, 1- and 2-μs/deg coding was tested. No difference in accuracy was found.		

DD FORM 1473 1 JAN 73

EDITION OF 1 NOV 65 IS OBSOLETE
S. N. 0102-LF-014-6601

UNCLASSIFIED
SECURITY CLASSIFICATION OF THIS PAGE (When Data Entered)

UNCLASSIFIED

SECURITY CLASSIFICATION OF THIS PAGE (When Data Entered)



S N 0102-LF-014-6601

UNCLASSIFIED

SECURITY CLASSIFICATION OF THIS PAGE(When Data Entered)

CONTENTS

SUMMARY . . .	page 2
INTRODUCTION . . .	3
TRANSMITTER AND RECEIVING EQUIPMENT . . .	3
PACSCAN . . .	3
Tactical Landing System (TLS) . . .	5
TPN-30 . . .	6
AIL Receiver-Decoder . . .	6
TEST PROCEDURES . . .	6
TEST RESULTS . . .	6
Introduction . . .	6
Circular versus vertical polarization of elevation data . . .	8
Enhanced versus unenhanced elevation decoder . . .	8
PACSCAN-TPN-30 elevation angle data comparisons . . .	9
PACSCAN average elevation data corrections . . .	9
Azimuth data . . .	10
1- vs 2- μ s/deg Coding . . .	10
CONCLUSIONS . . .	11
APPENDICES	
A Elevation Angle Data . . .	51
B AIL Equipment (PACSCAN, TLS) . . .	81
C MRAALS TPN-30 . . .	95

Approved by	
Checked by	
Dist	
A	

SUMMARY

PROBLEM

Test and evaluate microwave scanning landing guidance system concepts in a specular multipath environment for application to vertical takeoff and landing systems aboard small ships. Specifically, evaluate circular polarization, relatively large-beamwidth antennas, and mathematical signal enhancement techniques.

APPROACH

Three different systems were tested at the NOSC range under severe, controlled multipath conditions and the results analyzed and compared.

CONCLUSIONS

1. Both circular polarization and low-elevation-angle enhancement techniques contribute to solving the problem of specular multipath.
2. Antennas with elevation and azimuth scanning beamwidths as wide as 4 and 6 deg, respectively, are adequate for a shipboard Ku-Band scanning beam landing guidance system. Existing Navy and Marine Corps Ku-Band scanning beam systems have beamwidths of 2 deg or less.
3. Comparative tests were run on 1- and 2- μ s/deg coding, and it was found that there was no significant difference in the accuracies of the two.

INTRODUCTION

During December 1980, tests were conducted on three different microwave scanning beam landing guidance transmitters at the test facility at Naval Ocean Systems Center (NOSC). These tests are a part of the testing which has been done for the Navy Vertical Takeoff and Landing (NAVTO LAND) Project. The test facility has an approximately 160- by 160-ft ground plane, over which controlled specular multipath conditions can be achieved.

The three transmitters that were tested were the Airborne Instrument Laboratories (AIL) PACSCAN Unit, a highly modified Tactical Landing System (TLS) elevation unit, and a Singer-Kearfott-produced AN/TPN-30 Marine Remote Area Approach and Landing Systems MRAALS) ground unit. All of these transmitters operate in the Ku-Band and are scanning beam devices that transmit coded pulse pairs in such a manner that they can be decoded in an airborne receiver to accurately determine the elevation and azimuth angle of the transmitter from the aircraft.

Three special features were available for testing in the AIL equipment: circular polarization of the signal; a special low-angle enhancement technique, patented by AIL; and the ability to change from 2- to 1- μ s/deg coding.

This report will describe the equipment tested and its special features, present the data that were obtained during the tests, and summarize and compare the various techniques and devices. Three appendixes are provided. Appendix A contains comprehensive plots of the test data, Appendix B presents a description of the AIL equipment, and Appendix C describes in detail the TPN-30.

TRANSMITTER AND RECEIVING EQUIPMENT

PACSCAN

The PACSCAN equipment (Fig 1) elevation angle coverage is from 0 to approximately 16 deg. The azimuth coverage is approximately 30 deg to either side of the center line. The beamwidth of the elevation antenna is approximately 4 deg at 3 dB down and the sidelobes down 25 dB. The azimuth antenna has a beamwidth of 6 deg at 3 dB down. The polarization was vertical for the tests, even though PACSCAN is normally horizontally polarized.

The PACSCAN equipment features a special, patented, low-angle enhancement mode of operation. In conventional scanning beam equipment, the elevation angle must be scanned at or near zero to be able to decode low-angle data. The AIL system employs a technique in which the elevation-angle transmitter is cut off at some value above zero and the airborne decoder determines angle position by means of mathematical beam fitting on the partial elevation beam received at low angles. Thus one is able to decode angles at elevation angles less than one-half the beamwidth of the transmitting antenna. In this prototype equipment the cutoff angle is variable in 0.5-deg steps from 0 to 6 deg. This provides a means of controlling the multipath reflections by eliminating them at low angles.

The update rate of the equipment is four times per second for the elevation and azimuth angle data.

The equipment can also be simply switched to provide coding of either 1 or 2 μ s/deg.

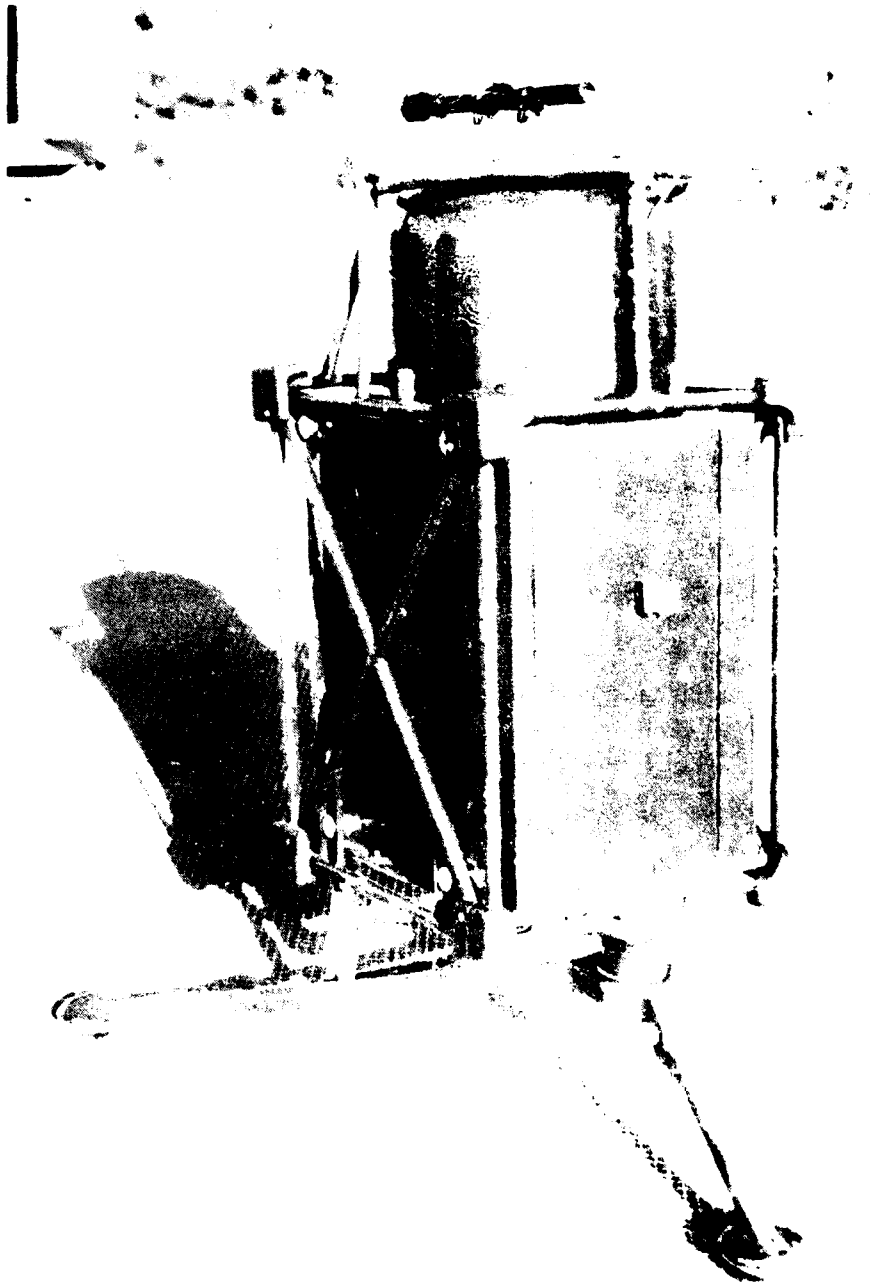

Figure 1. (a) (b) (c) (d) (e) (f) (g) (h) (i) (j) (k) (l) (m) (n) (o) (p) (q) (r) (s) (t) (u) (v) (w) (x) (y) (z)

TACTICAL LANDING SYSTEM - TELS

The TELS (Tactical Landing System) is a new type of aircraft landing gear system. It is designed to provide a safe and efficient landing for tactical aircraft. The system is currently being tested at NOSC.

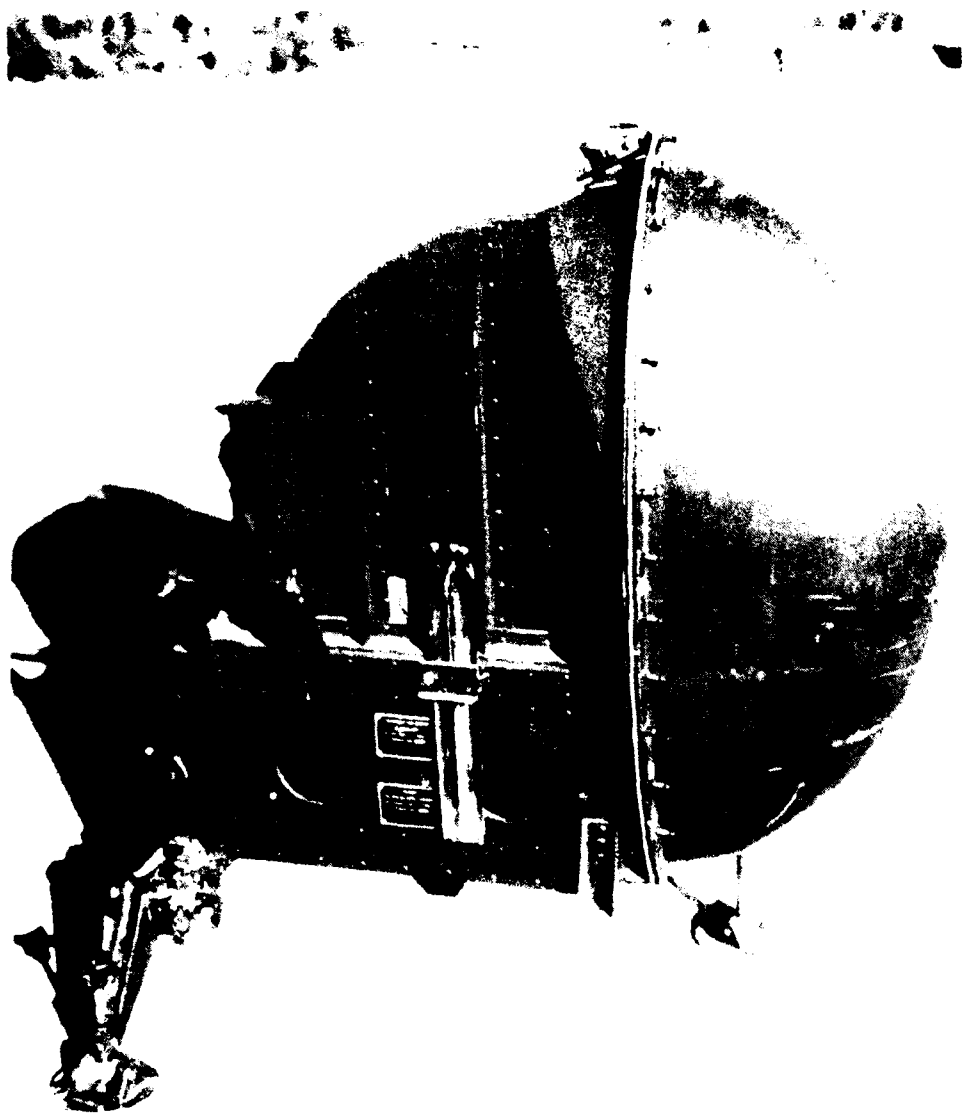

Figure 1. TELS (Tactical Landing System) component.

The TLS was equipped with a 4-deg beam, measured at the 3-dB points, and is circularly polarized. The scan rate of the antenna is 4 Hz. The system has a coding of $1 \mu\text{s/deg}$ and has selectable 0.5-deg cutoff up to 6 deg. Figure 3 is a photograph of the circularly polarized scanning beam antenna.

TPN-30

The Marine Remote Area Approach and Landing System (MRAALS) TPN-30 transmitter was developed by Singer-Kearfott for the Marine Corps. The unit has a 2-deg beamwidth in both elevation and azimuth. It provides elevation coverage from 0 to 20 deg and azimuth coverage of ± 20 deg. The scan rate is 7.5 Hz. The unit is shown in Fig 4, and descriptive information is presented in Appendix C.

AIL RECEIVER-DECODER

The receiver used in all the December tests was a modified ARQ-31 front end. The decoder is broken into two parts, one of which is the ARQ-31 interval tracker. The second part is a Texas Instruments SBP9900 microprocessor, which provides 2k by 16 bytes of scratch pad memory. The decoder provides both digital and analog outputs. Additionally it can do course softening and offset calculations. Figure 5 shows the unit on the vertical track.

TEST PROCEDURES

The tests were run at Building 372 at NOSC. Here there is a large wire screen (approximately 160 by 160 ft) ground plane. A track on a large vertical, wooden pole was used to obtain various elevation angles. Figure 6 is a drawing of the test range. A photograph of the range is shown in Fig 7.

Data were taken by raising the receiver-decoder to approximately 25 ft then lowering it in approximately 6-in. increments and taking data at each level until the data became unusable.

An interface unit provided by AIL permitted direct interface to an HP9825A computer. The raw data were placed on magnetic tape in the HP9825A, and plots of the smooth data were obtained from the HP9872 plotter. Figure 8 is a photograph of this data-taking equipment.

At each reference point, 100 samples of angular data were taken for elevation for all three transmitters and also 100 samples of azimuth data for the PACSCAN and the TPN-30. A mean and standard deviation were calculated using these samples.

The data were taken at a horizontal distance of approximately 150 ft. Each of the transmitters was either sitting directly on the ground plane or elevated 7 ft, 8 in. off the ground plane and sitting on a wooden box in the back of a stake truck. This setup is shown in Fig 9. A photograph of all three of the transmitters tested is shown in Fig 10.

TEST RESULTS

INTRODUCTION

Table 1 lists the runs made during this series of tests and summarizes the important factors in each run. Of the 31 runs, only Runs 9 and 10 were bad data, caused by an error in setting the equipment.

Run No.	Trans	Located	Cutoff, deg	Polar	Enhance	Tape	Comments
1	PACSCAN	On mat	3.5	Vert	Yes	No. 1 T0	Preliminary checkout
2	TLS	On mat	0	Vert	No	No. 1 T1	Compare unenhanced circular - vertical
3	TLS	On mat	2.5	Vert	Yes	No. 2 T0	Compare enhanced circular - vertical
4	TLS	On mat	2.5	Circ	Yes	No. 2 T1	Compare enhanced circular - vertical
5	TLS	On mat	2.5	Circ	Yes	No. 3 T0	Added aluminum screen
6	TLS	On mat	0	Circ	No	No. 3 T1	Compare unenhanced circular - vertical
7	TLS	On truck	0	Circ	Yes	No. 4 T0	Compare enhanced circular - vertical
8	TLS	On truck	0	Vert	Yes	No. 1 T1	Compare enhanced circular - vertical
9	TLS	On truck	-12	Vert	Yes	No. 5 T0	Equipment set wrong. Bad data
10	TLS	On truck	-12	Circ	Yes	No. 5 T1	Equipment set wrong. Bad data
11	TLS	On truck	-12	Circ	Yes	No. 6 T0	Negative angle compare enhanced circular - vertical
12	TLS	On truck	-12	Vert	Yes	No. 6 T1	Negative angle compare enhanced circular - vertical
13	TLS	On mat	0	Circ	Yes	No. 7 T0	Compare enhancement, 0 deg cutoff
14	TLS	On mat	0	Circ	No	No. 7 T1	Compare enhancement, 0 deg cutoff
15	PACSCAN	On mat	0	Vert	No	No. 8 T0	Compare enhanced and unenhanced, 0 deg cutoff
16	PACSCAN	On mat	0	Vert	Yes	No. 8 T1	Compare enhanced and unenhanced, 0 deg cutoff
17	PACSCAN	On mat	1	Vert	Yes	No. 9 T0	Testing cutoff values
18	PACSCAN	On mat	2	Vert	Yes	No. 0 T1	Testing cutoff values
19	PACSCAN	On mat	3	Vert	Yes	No. 10 T4	Testing cutoff values
20	PACSCAN	On mat	4	Vert	Yes	No. 10 T1	Testing cutoff values
21	PACSCAN	On mat	1	Vert	Yes	No. 11 T0	Testing cutoff values
22	PACSCAN	On mat	2.5	Vert	Yes	No. 11 T1	Testing cutoff values
23	PACSCAN	On truck	0	Vert	Yes	No. 12 T0	Elevated off mat compared run
24	PACSCAN	On truck	0	Vert	No	No. 12 T1	Elevated off mat compared run
25	PACSCAN	On truck	-9	Vert	No	No. 13 T0	Effects of negative cutoff angles
26	PACSCAN	On truck	-9	Vert	Yes	No. 13 T1	Effects of negative cutoff angles
27	TPN 30	On truck	0	Vert	No	No. 14 T0	Elevated TPN 30 Run.
28	TPN 30	On truck	0	Vert	No	No. 14 T1	Rerun of run 27
29	TPN 30	On mat	0	Vert	No	No. 15 T0	Azimuth at 0 deg
30	TPN 30	On mat	0	Vert	No	No. 15 T1	Left Azimuth at -5 deg left
31	TPN 30	On mat	0	Vert	No	No. 16 T0	Rerun of No. 3 because of high sigma

Table 1. Summary of Test Runs 1 through 31.

Appendix A contains plots for the elevation angle data for Runs 1 through 8 and 11 through 31 (Fig A-1 through A-29). These data are presented in the Appendix A for completeness. Some of the runs will be characterized in this section, as will be the composite data that present the results.

CIRCULAR VERSUS VERTICAL POLARIZATION OF ELEVATION DATA

The TLS was equipped with a special antenna that permitted testing circular versus vertical polarization. Figure 11 shows the average values plotted for Runs 2 and 6 that compare circular to vertical polarization with the TLS transmitter on the mat, a 0-deg cutoff, and with no enhancement. Figure 12 shows the standard deviations for the same runs. In these two figures there is no significant effect from the polarization. Figures 13 and 14 represent the average values and standard deviations for Runs 3 and 4. In these runs the transmitter was on the mat, the cutoff was set at 2.5 deg, and the signal was enhanced. Again one can see little difference in the two polarizations.

Figures 15 and 16 give the average and standard deviations, respectively, for Runs 7 and 8, in which the TLS was elevated 7 ft, 8 in. off the mat with a 0-deg cutoff in the enhanced mode. Again there is not a significant improvement.

In the next two tests (Runs 11 and 12 elevated at 7 ft, 8 in.) the TLS was pointed downward approximately 12 deg so that the signal was illuminating the mat. Again a run was taken using both vertical and circular polarization, and the results are shown in Fig 17 for the averages and in Fig 18 for the standard deviation. Here the difference between circular and vertical polarization is pronounced. The errors were completely off scale for the vertical polarization a majority of the run, whereas with the circular polarization the decoder was able to track. This is important, for it represents the case of negative angle coverage that will be necessary in the NAVTOLAND advanced development equipment.

ENHANCED VERSUS UNENHANCED ELEVATION DECODER

The AIL enhancement technique provides an algorithm that makes a best fit to the beam envelope sensed by the decoder. It permits obtaining a valid answer for elevation angles less than one-half a beamwidth above cutoff.

Figures 19 and 20 present the averages and the standard deviations for Runs 15 and 16. Both runs were identical and on the mat, the only difference being that one was enhanced while the other was not. A zero cutoff was used in both cases, and this is self-defeating since the primary object is to permit cutting off the beam at higher angles; but it was done here for completeness and standard deviation comparisons. One does not see any improvement in the average here. In fact it becomes worse at lower angles. However, there is a marked improvement in the standard deviation in Fig 20 of approximately two to one.

Runs 23 and 24 were used to again compare enhanced with unenhanced. Both these runs were taken with the transmitter elevated to 7 ft, 8 in. and the elevation at 0 deg cutoff. The results for the averages are shown in Fig 21 and for the standard deviations in Fig 22. Note that below 2 deg, the half-beamwidth for the PACSCAN, the unenhanced decoded angle slopes upward. This is caused by an increasingly larger portion of the beam being missing below 0 deg cutoff and the fact that the decoder averages what is received over the entire interval. The enhanced signal processor mathematically corrects for the missing beamwidth in the enhanced case and continues to track right down to 0 deg and below. A comparison of the standard deviations for these runs shows the strong improvement at higher angles, but it becomes worse at angles between 0 and 1 deg.

From these plots one can make a strong case for the enhancement techniques, and this will be illustrated further in the next section.

PACSCAN - TPN-30 ELEVATION ANGLE DATA COMPARISONS

In this section the plots compare the data taken with the three different transmitters. Both the PACSCAN and TLS have 4-deg elevation beamwidth, and the TPN-30 has a 2-deg beamwidth.

The average values for the three different transmitters are shown in Fig 23. The composite curve represents data from runs 2, 15 and 29. Cutoff was set at 0 deg for all three transmitters and the PACSCAN and TLS were not enhanced. Figure 24 gives the standard deviations for these same runs. The average for the TPN-30 is smoother than that for the PACSCAN and TLS. The standard deviations are approximately of the same magnitude, with the TPN-30 again being smoother. Figure 25 shows the average values for the three transmitters for Runs 13, 16, and 29. These runs are identical to the previous runs, except both the TLS and the PACSCAN are now in the enhanced mode. Figure 26 shows the standard deviation values for the runs.

A comparison of Fig 23 and 25 shows a slight degradation in the average values for TLS and PACSCAN, but comparison of Fig 24 and 26 shows a marked improvement in the standard deviation. Again it must be noted that to get the benefit of the enhancement technique, the cutoff should be set above 0 deg.

Figures 27 and 28 show the composite averages and standard deviations, respectively, for runs 8, 23, and 28. In all of these runs the transmitters were elevated 7 ft, 8 in. above the mat. One can see a marked improvement in the low-angle data for the PACSCAN and the TLS. Since both the PACSCAN and TLS are in the enhanced mode, they track well below the half-beamwidth (ie, 2-deg) value. The TPN-30, with a half-beamwidth value of 1 deg, shows a steady upward slope below that value. The standard deviations are approximately equal between 0 deg and 1 deg, and better by a factor of two at elevation values above 1 deg.

PACSCAN AVERAGE ELEVATION DATA CORRECTIONS

The algorithm used to enhance the PACSCAN was not complete when the unit was delivered for test. To complete the algorithm, a correction is needed to eliminate the upward slope in the data that occurs at angles approximately 1-2 deg below the transmitter elevation cutoff value. This was not the case for the TLS. It had been corrected.

Figures 29 through 33 show the plots for the average values of the enhanced PACSCAN data as they were taken in Runs 1, 18, 19, 20, and 22 and the same data after a correction was applied in the 9825A computer, before the data were plotted. The same correction was used in all five figures.

The corrected average is given by

$$\text{if } A_{\text{raw}} < E_{\text{cut}} - 0.5$$

$$\text{then } A_{\text{corr}} = A_{\text{raw}} - S (E_{\text{cut}} - 0.5 - A_{\text{raw}})$$

where:

A_{corr} = corrected average

A_{raw} = raw data average

S = slope constant

F_{cut} = transmitter cutoff angle

The slope used in all of the five figures was approximated from Fig 32 and is approximately 0.87. Examination of these figures shows that the average value was being tracked at approximately 0.5 deg elevation, which would be one-eighth of a beamwidth for the PACSCAN. This was not a dropout point but came about by the physical limitations of the test facility. Figure 33 illustrates the improvement obtained by using this correction.

AZIMUTH DATA

Figure 34 presents the azimuth angle data obtained for the PACSCAN in run 16. In the azimuth figures that will be presented in this section, the average bias offset from zero is not important since no attempt was made to obtain precise azimuth alignment. Figure 35 shows the average and standard deviation for the PACSCAN elevation, 7 ft, 8 in. In Fig 36 the PACSCAN was again elevated, and the zero-elevation reference was approximately -9 deg so that the signal was illuminating the mat. Here one sees a degradation of the average, but the standard deviation remains approximately the same.

Figures 37 and 38 show the azimuth angle data for the TPN-30 on the mat and elevated. Again one should note the bias offset of the average is merely a test alignment error and not an error in the equipment. Comparison of the PACSCAN and TPN-30 azimuth angle data shows both the average and standard deviation to be smoother. It is worth noting again that the TPN-30 is a 2-deg-beamwidth system and the PACSCAN a 6-deg system.

1- VS 2- μ s/deg CODING

Preliminary testing on the PACSCAN system was accomplished between 30 April and 14 May 1980 at the NOSC Test Range. During this period, the effect of changing the spacing of the angular encoding from 2 to 1 deg was tested, and the results were definite enough that the tests were not repeated during the November tests.

The results of these tests are shown in Fig 39 and 40, in which the averages for the runs with 1- and 2- μ s/deg coding are compared. The decoder was in the unenhanced mode, and the transmitter was on the mat. The standard deviations for the two runs are shown in Fig 40. Careful examination of the data shows no significant differences in either the averages or the standard deviations.

CONCLUSIONS

A. Where elevation angle coverage requirements make it necessary to illuminate a specular multipath reflector with the elevation beam, multipath is a severe problem, and some technique must be used to counter the problem. In these tests, circular polarization of the signal appears to be one adequate, as well as practical, solution to the problem.

B. Incorporating mathematical enhancement techniques to process the elevation data offers a distinct improvement in the presence of specular multipath.

C. Accurate angle data can be obtained using beamwidths of up to 4 deg and enhancement techniques, thus providing significant reductions in equipment size. Existing Ku-Band equipments, such as the AN/SPN-41 and the AN/TPN-30 MRAALS, have beamwidths of 2 deg or less.

D. There is no significant difference in accuracy between 1- and 2- μ s deg coding.



FIG. 3. (a) (b) (c) (d) (e) (f) (g) (h) (i) (j) (k) (l) (m) (n) (o) (p) (q) (r) (s) (t) (u) (v) (w) (x) (y) (z)

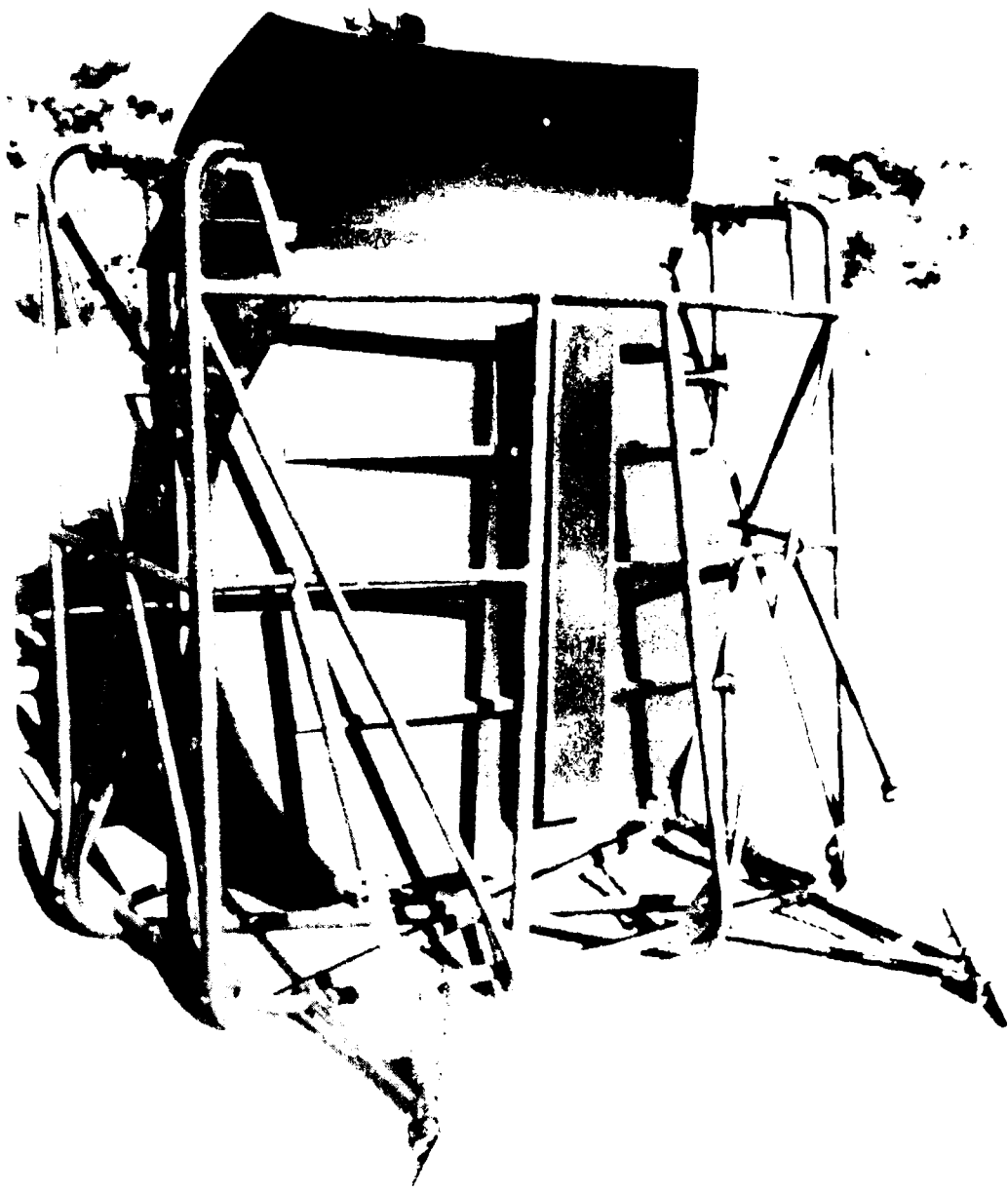

FIG. 1. (DN)



Figure 5 Receiver of cables of the vertical track

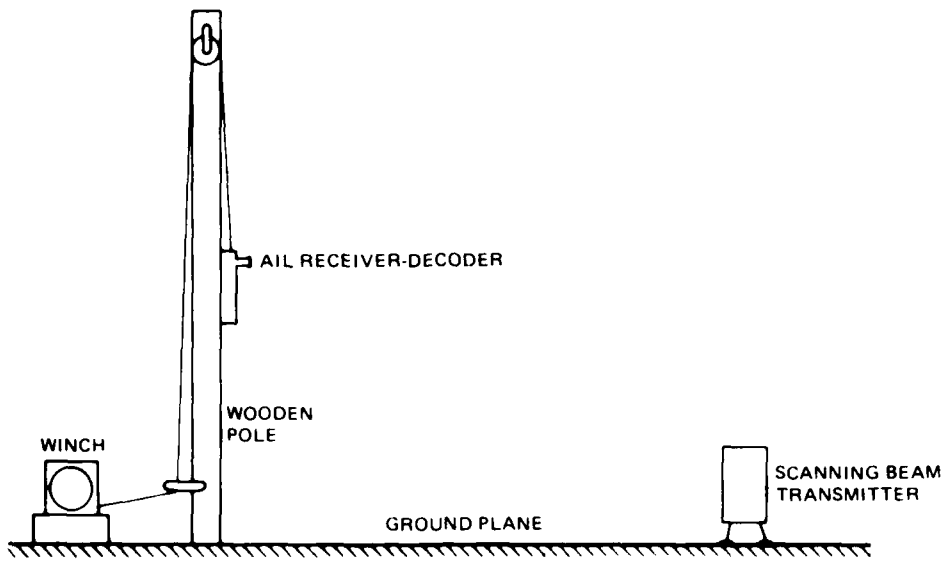

Figure 6. Test range layout.

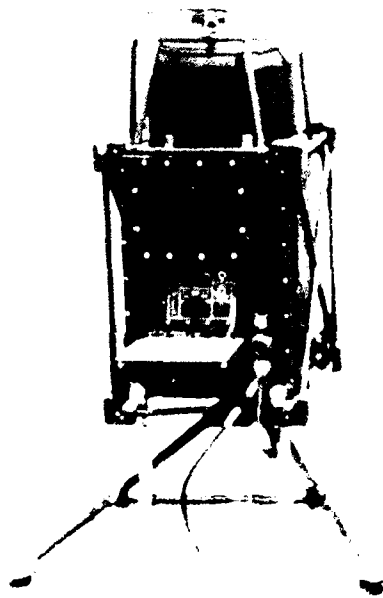

Figure 1. Aerial view of the building.



Figure 8 Data storage and plotting equipment

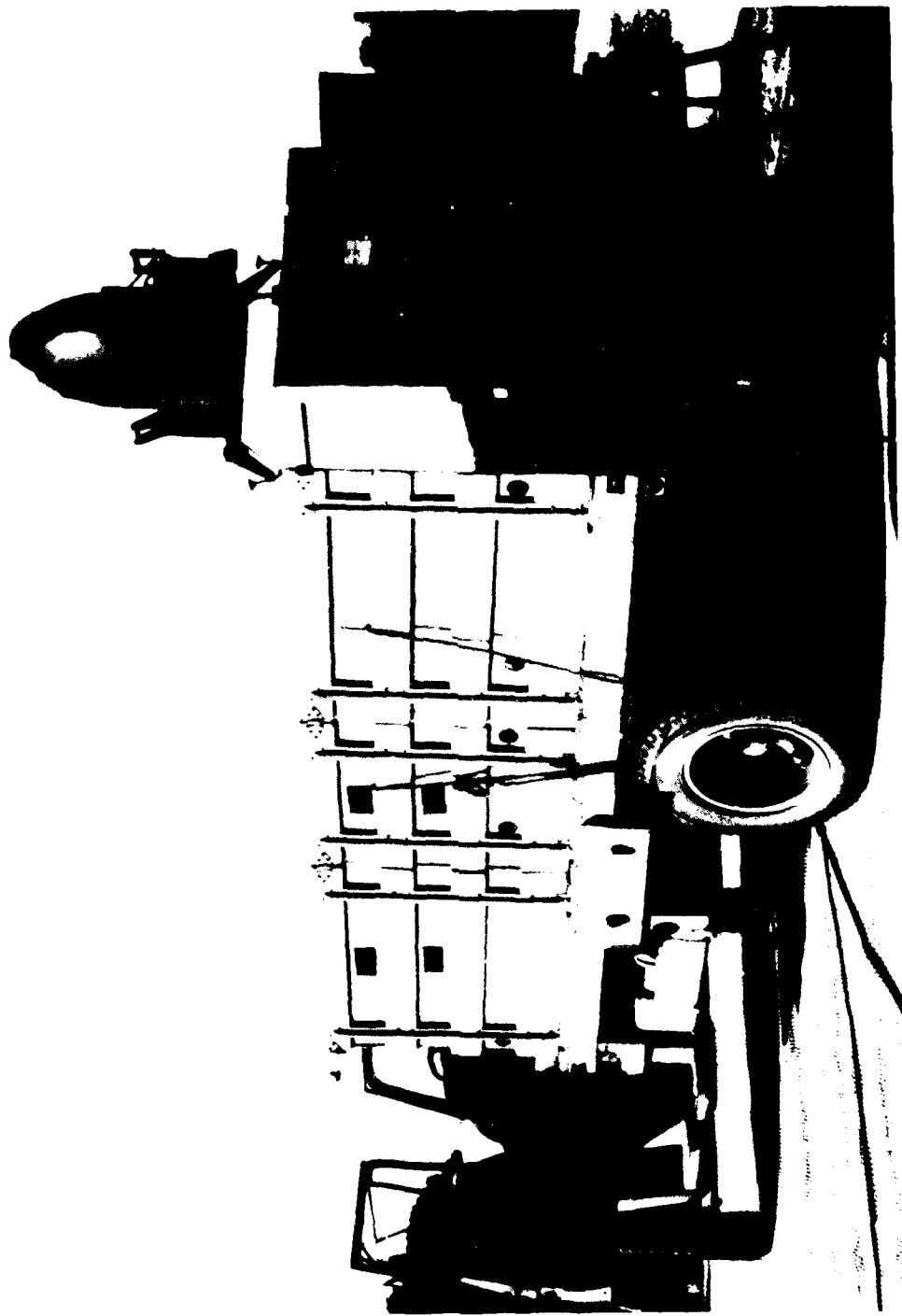

Figure 9. Test setup showing transmitter elevated above ground plane.

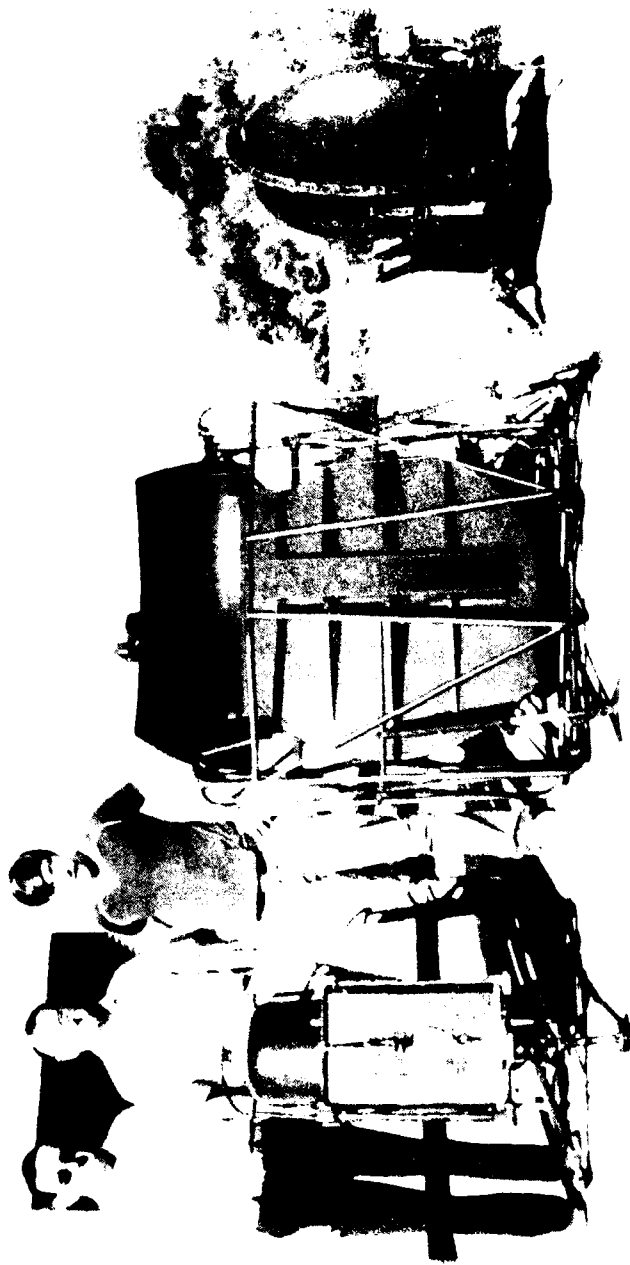

Figure 10 The three transmitters used in the tests

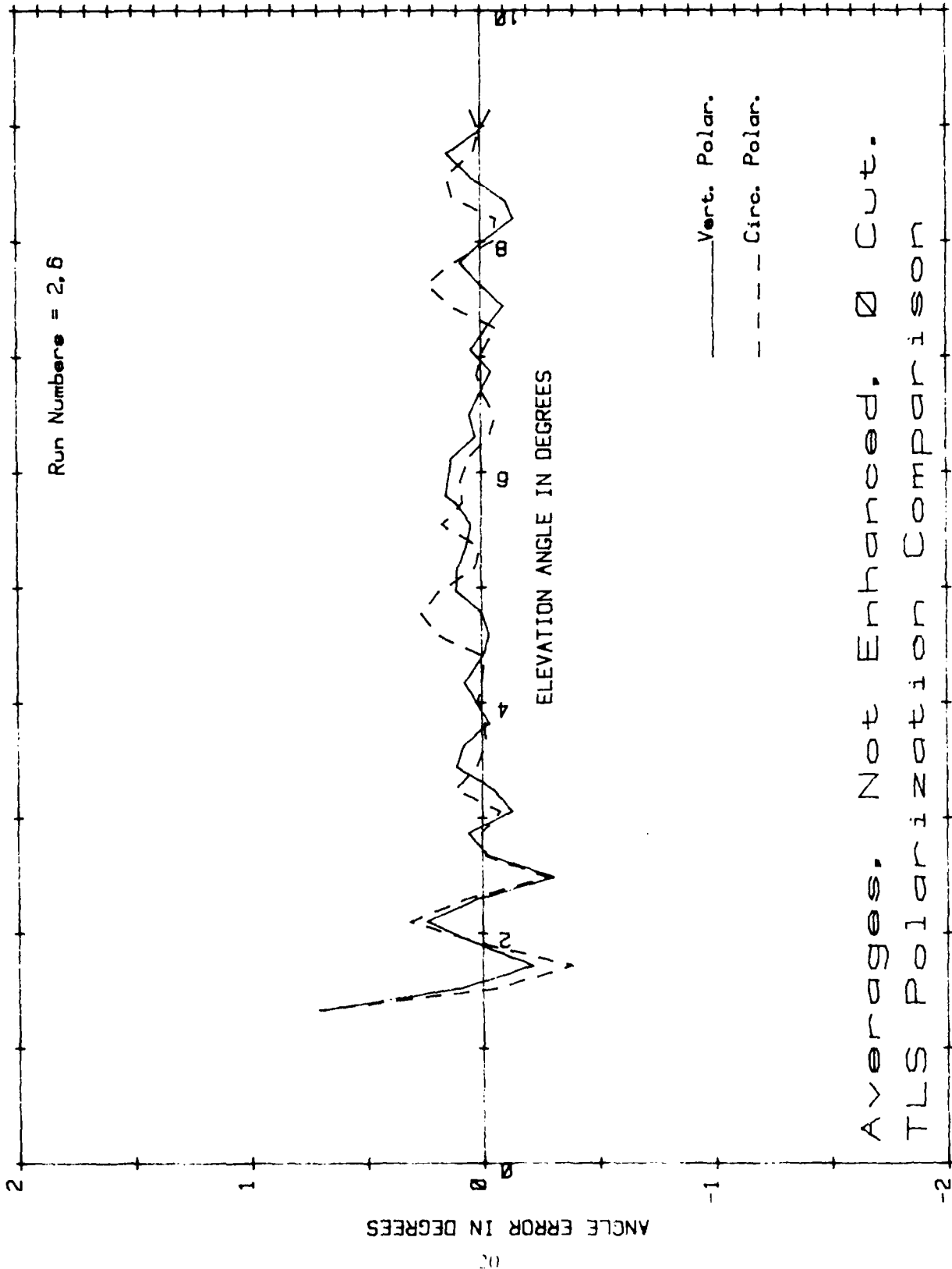

Figure 11. Average values for Runs 2 and 6.

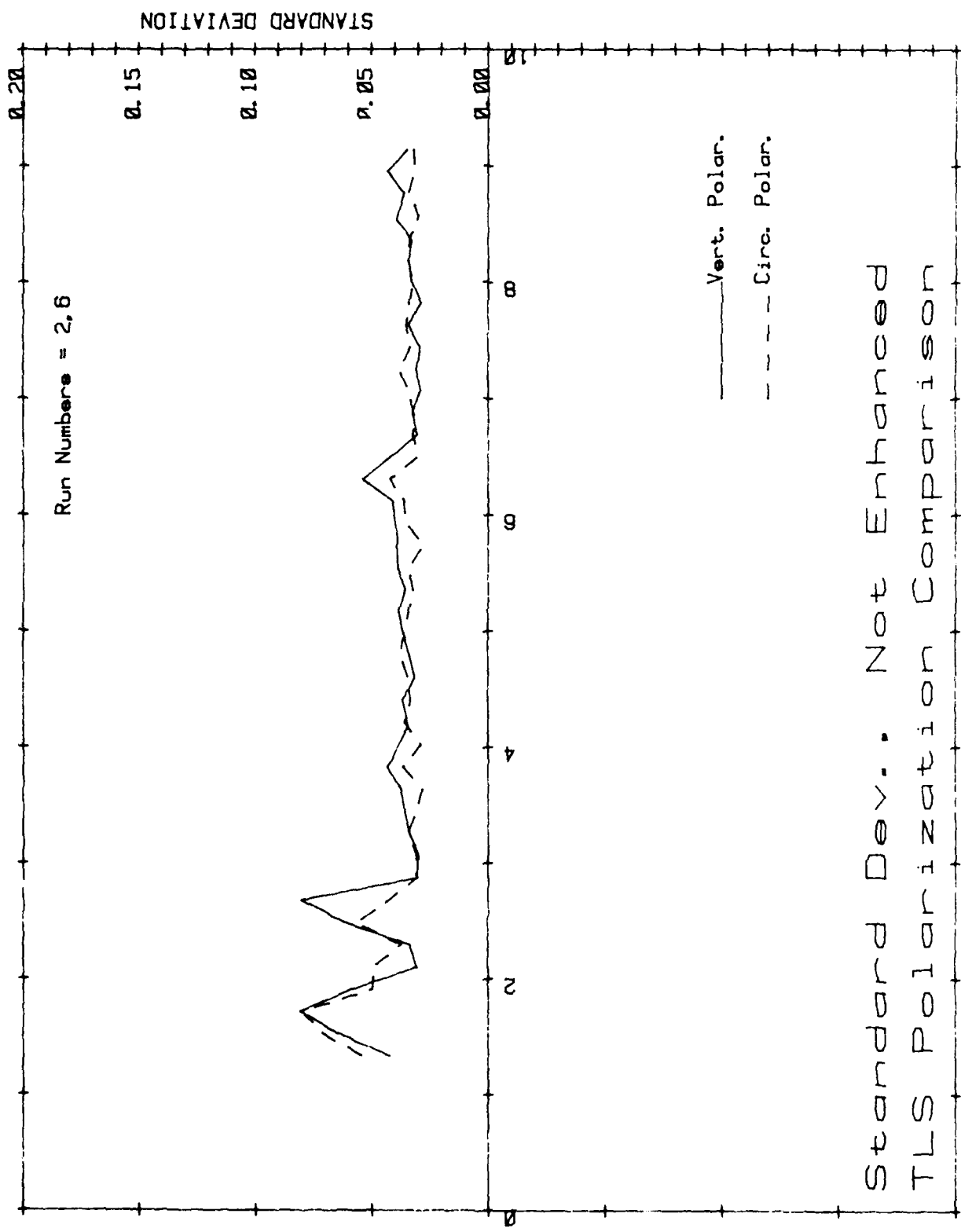

Figure 12. Standard deviations for Runs 2 and 6.

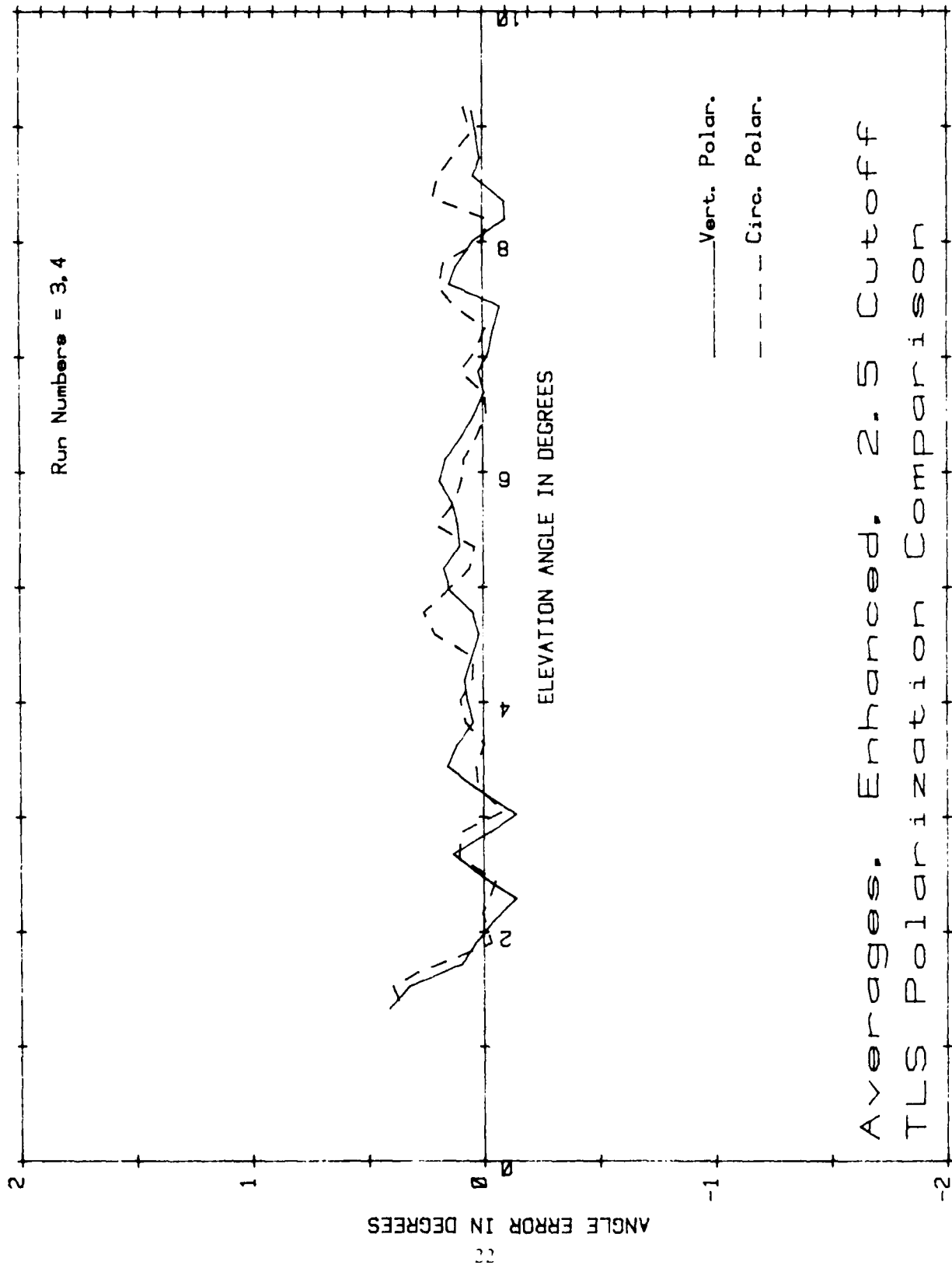

Figure 13. Average values for Runs 3 and 4.

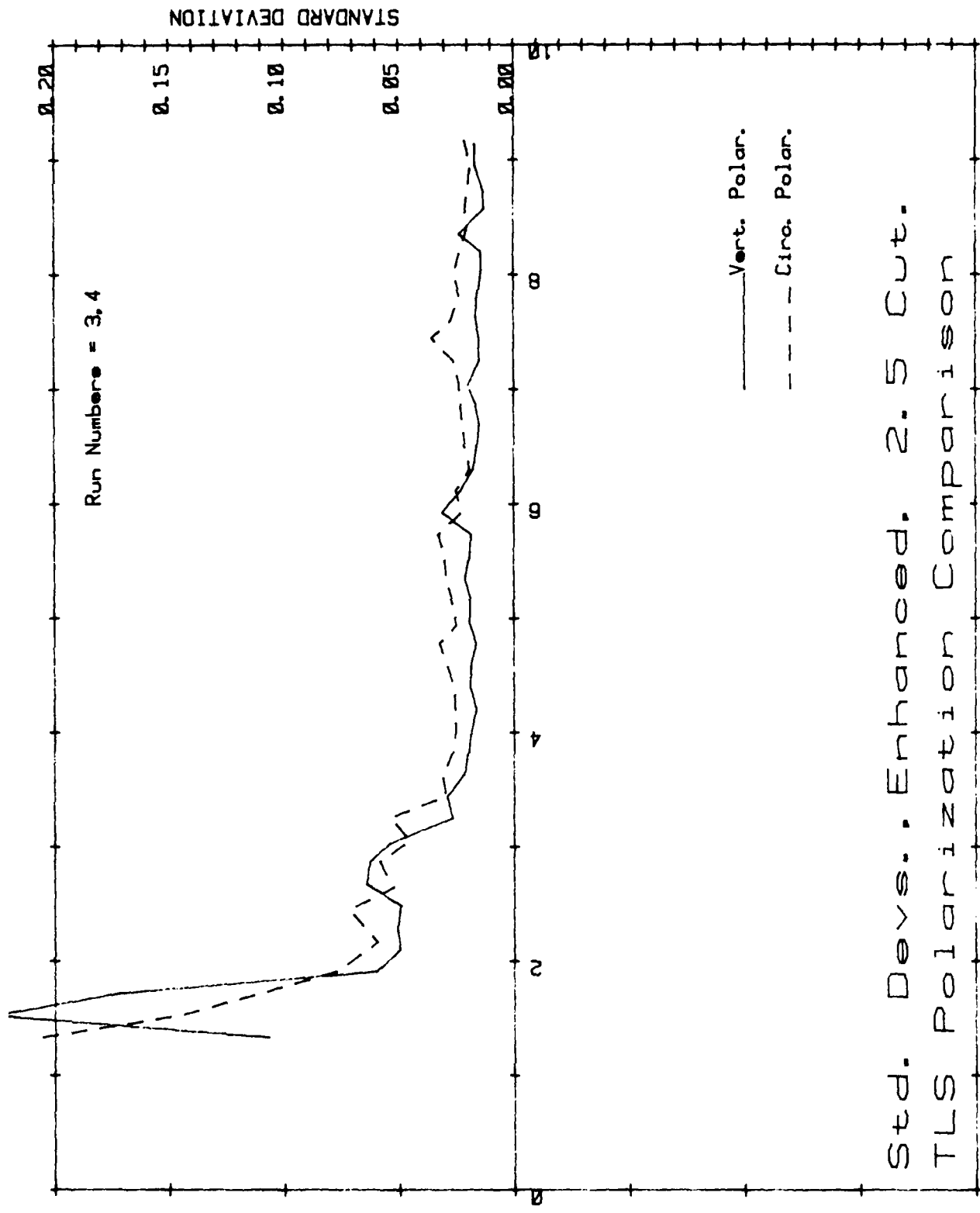

Figure 14. Standard deviations for Runs 3 and 4.

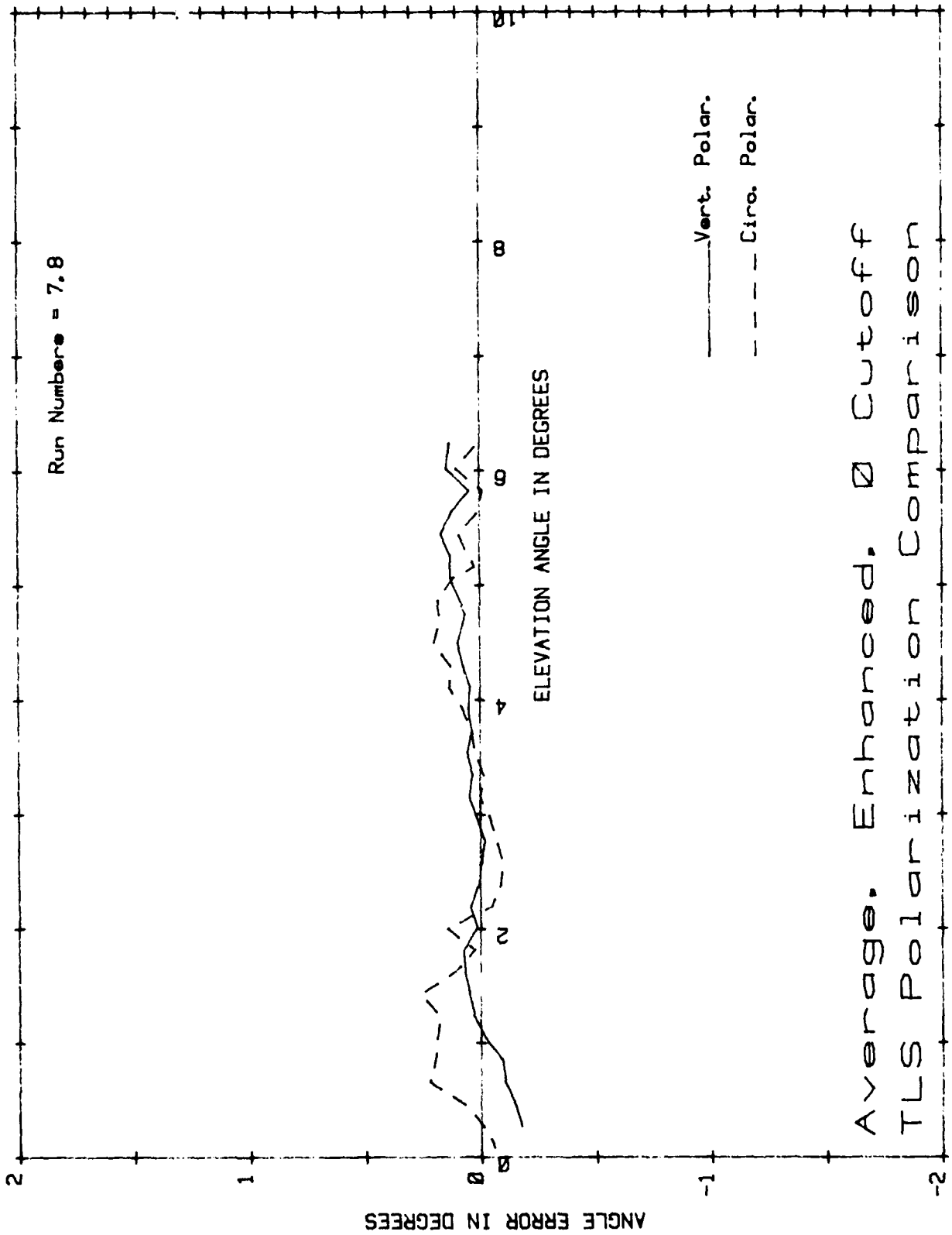
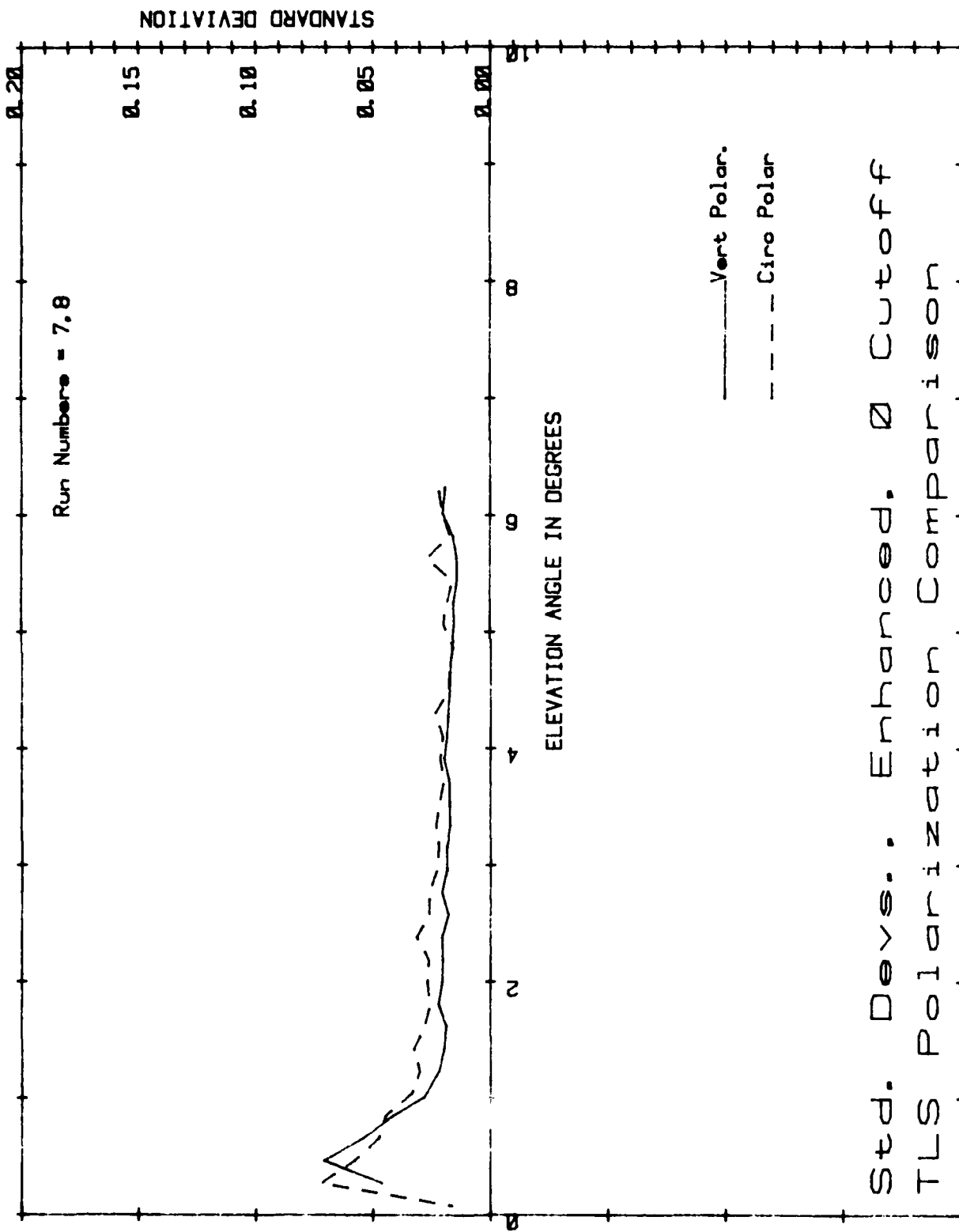

Figure 15. Average value for Runs 7 and 8.



Std. Devs.. Enhanced. \emptyset Cutoff
 TLS Polarization Comparison

Figure 16. Standard deviations for Runs 7 and 8.

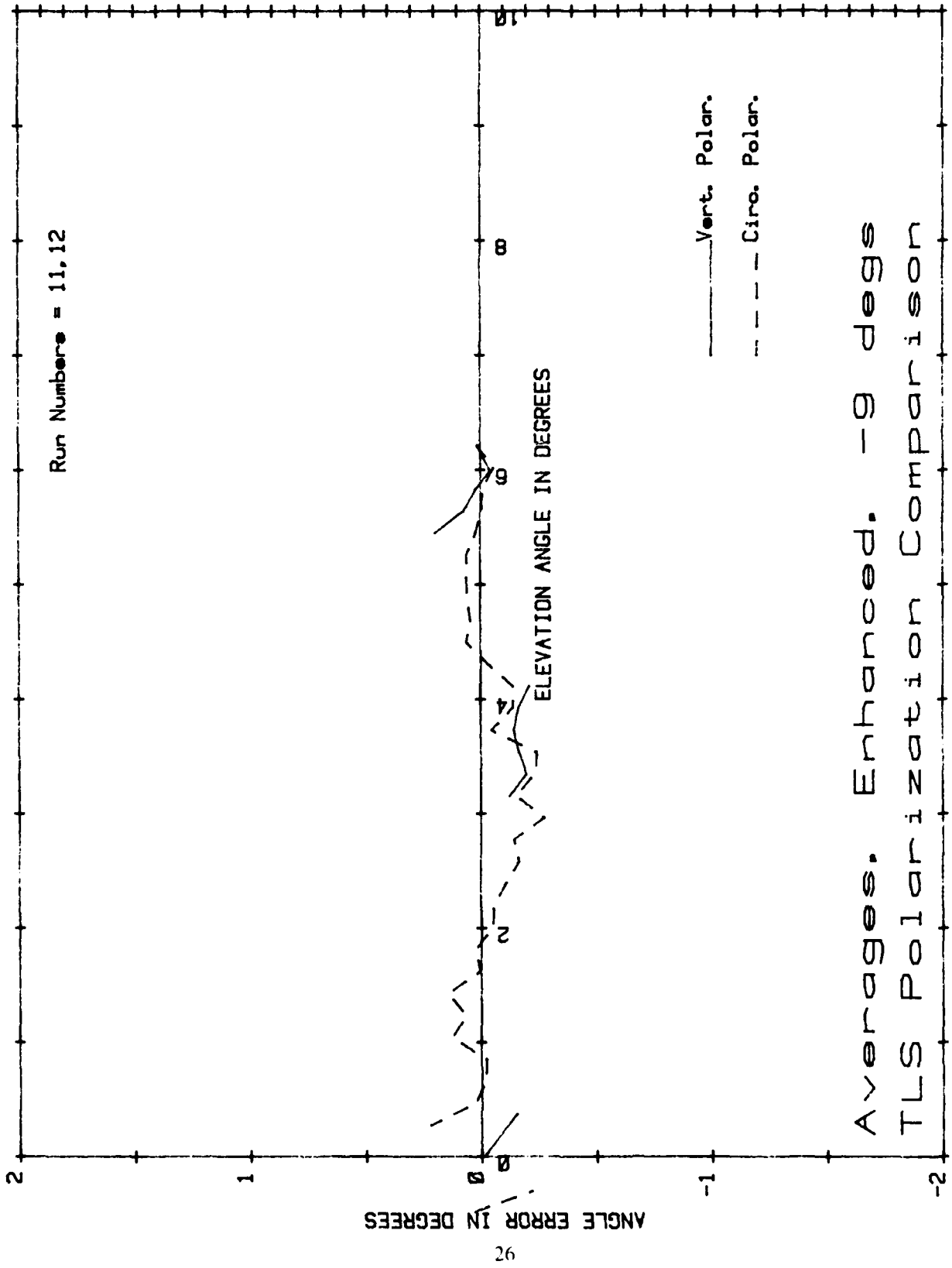
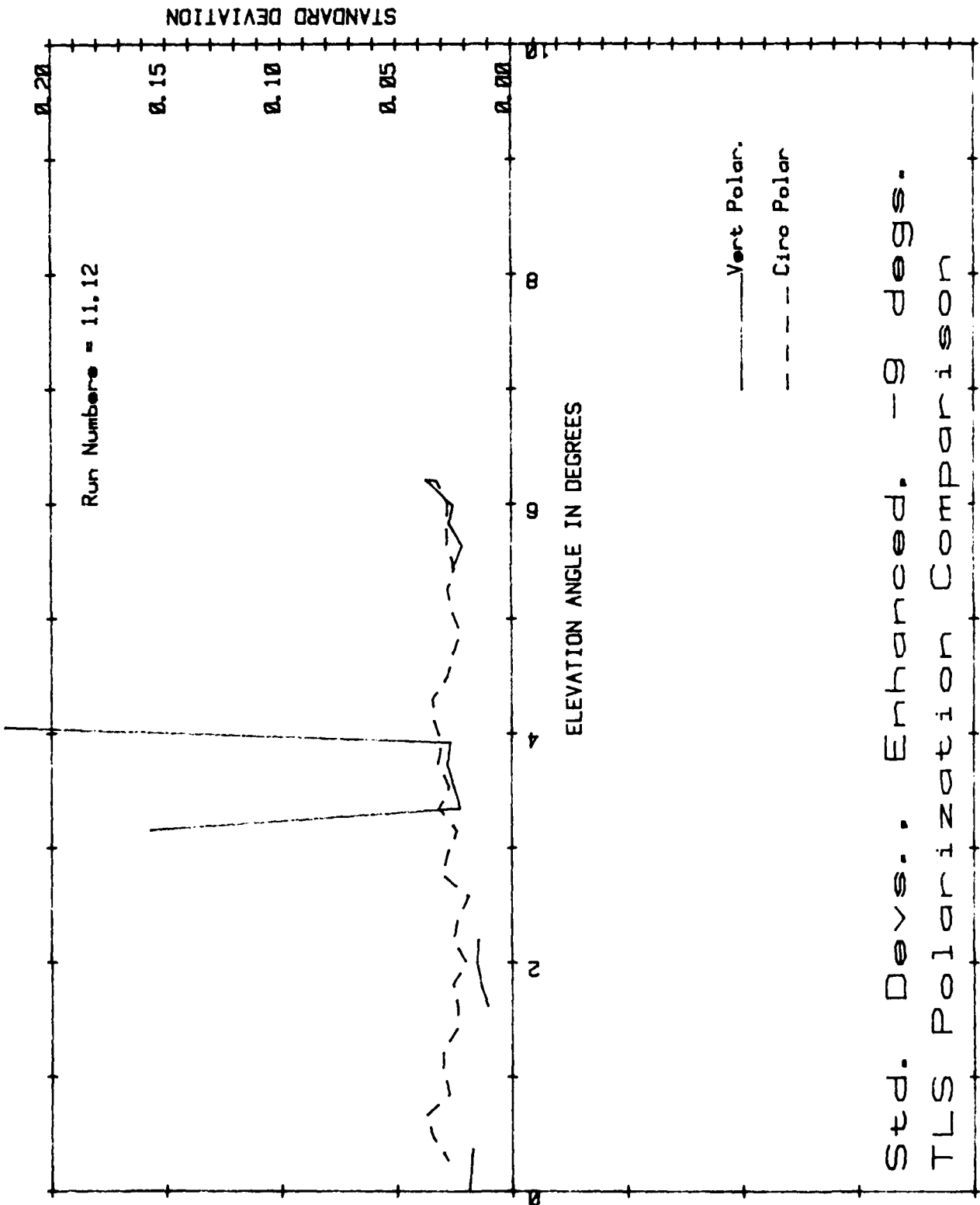

Figure 17. Average values for Runs 11 and 12.



Std. Devs. . Enhanced. -9 degs.
 TLS Polarization Comparison

Figure 18. Standard deviations for Runs 11 and 12.

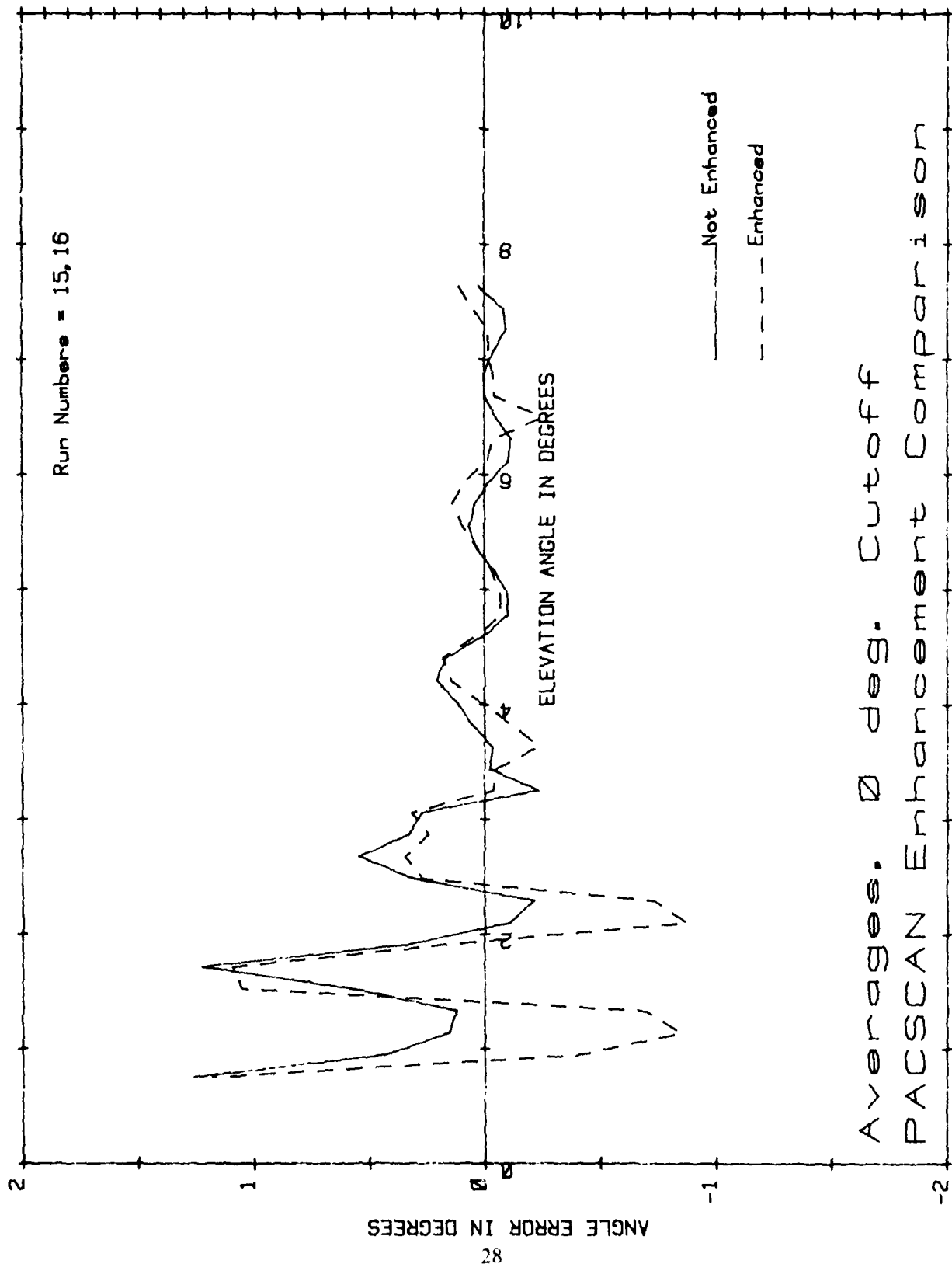

Figure 19. Average values for Runs 15 and 16.

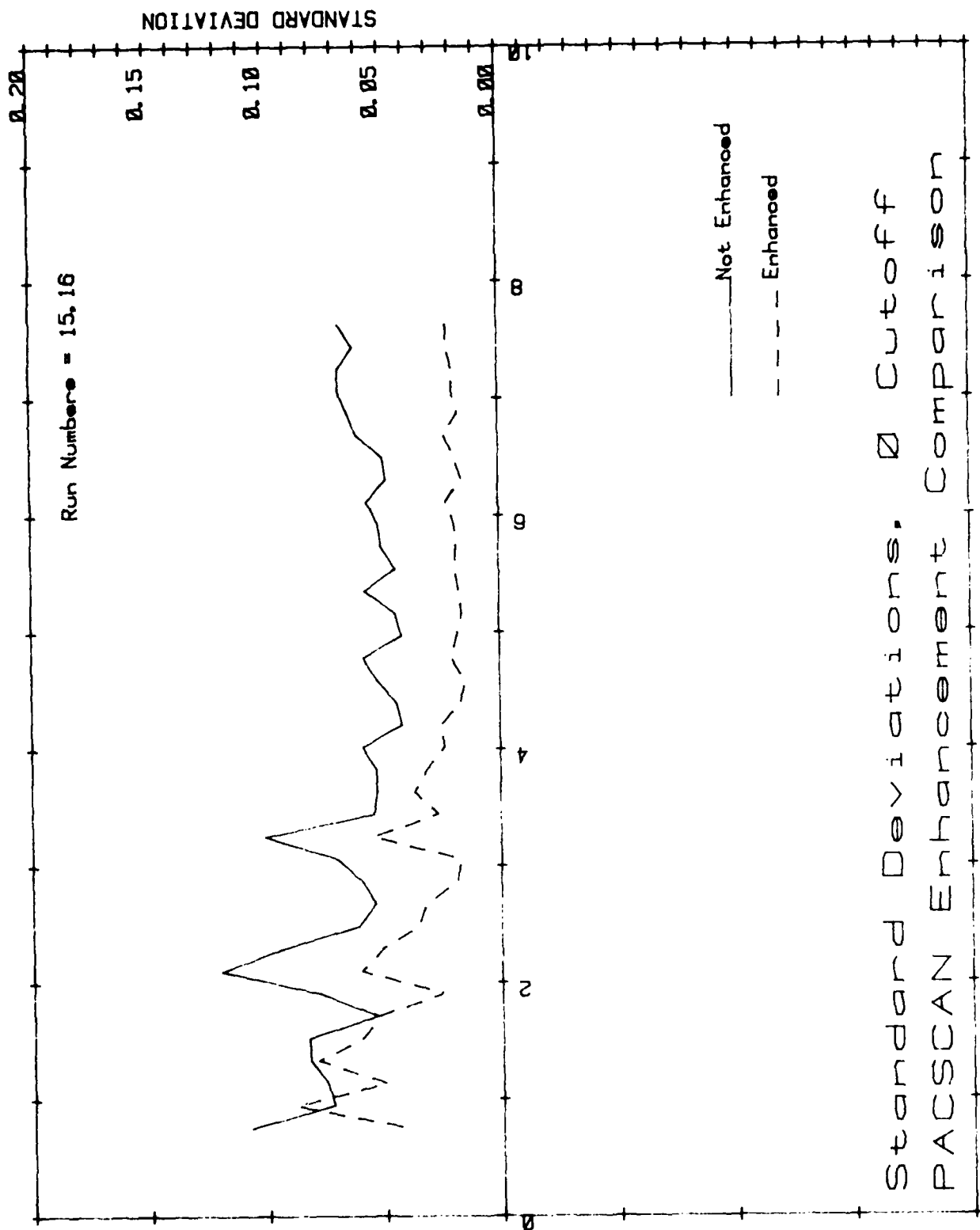
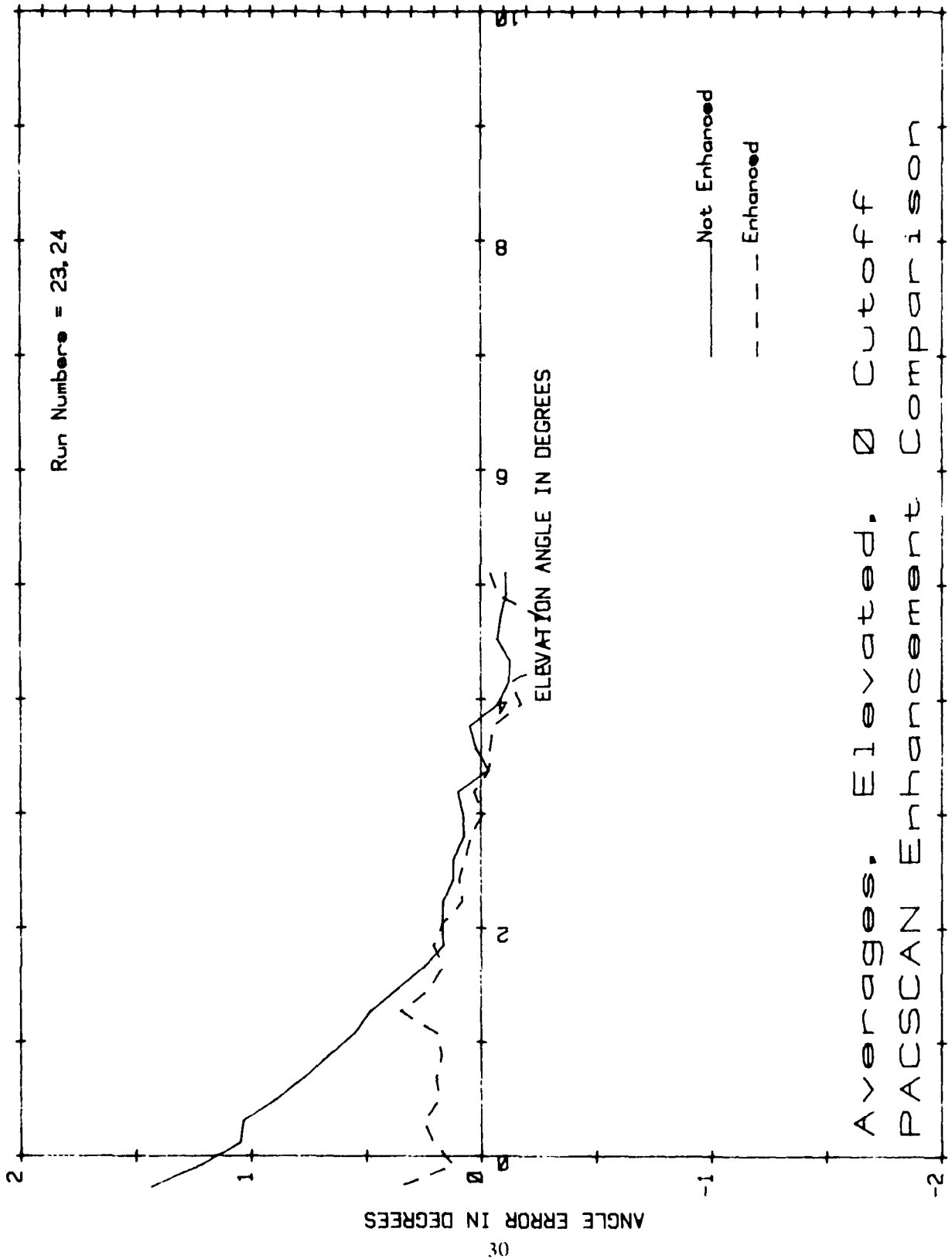
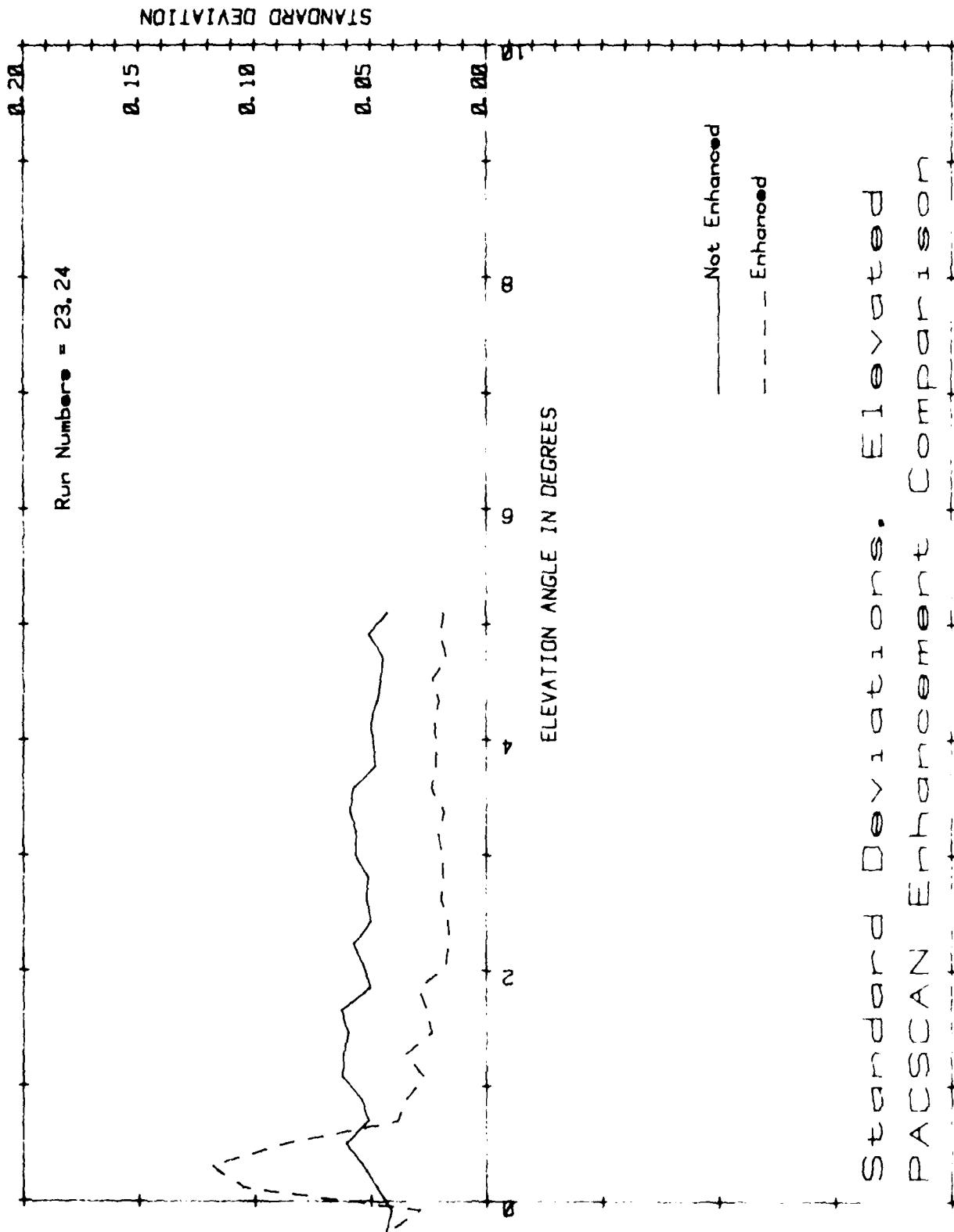

Figure 20. Standard deviations for Runs 15 and 16.



Averages. Elevated. \emptyset Cutoff
PACSCAN Enhancement Comparison

Figure 21. Average values for Runs 23 and 24.



Standard Deviations. Elevated
PACSCAN Enhancement Comparison

Figure 2 - Standard Deviations for Runs 23 and 24

Run Numbers = 2, 15, 29

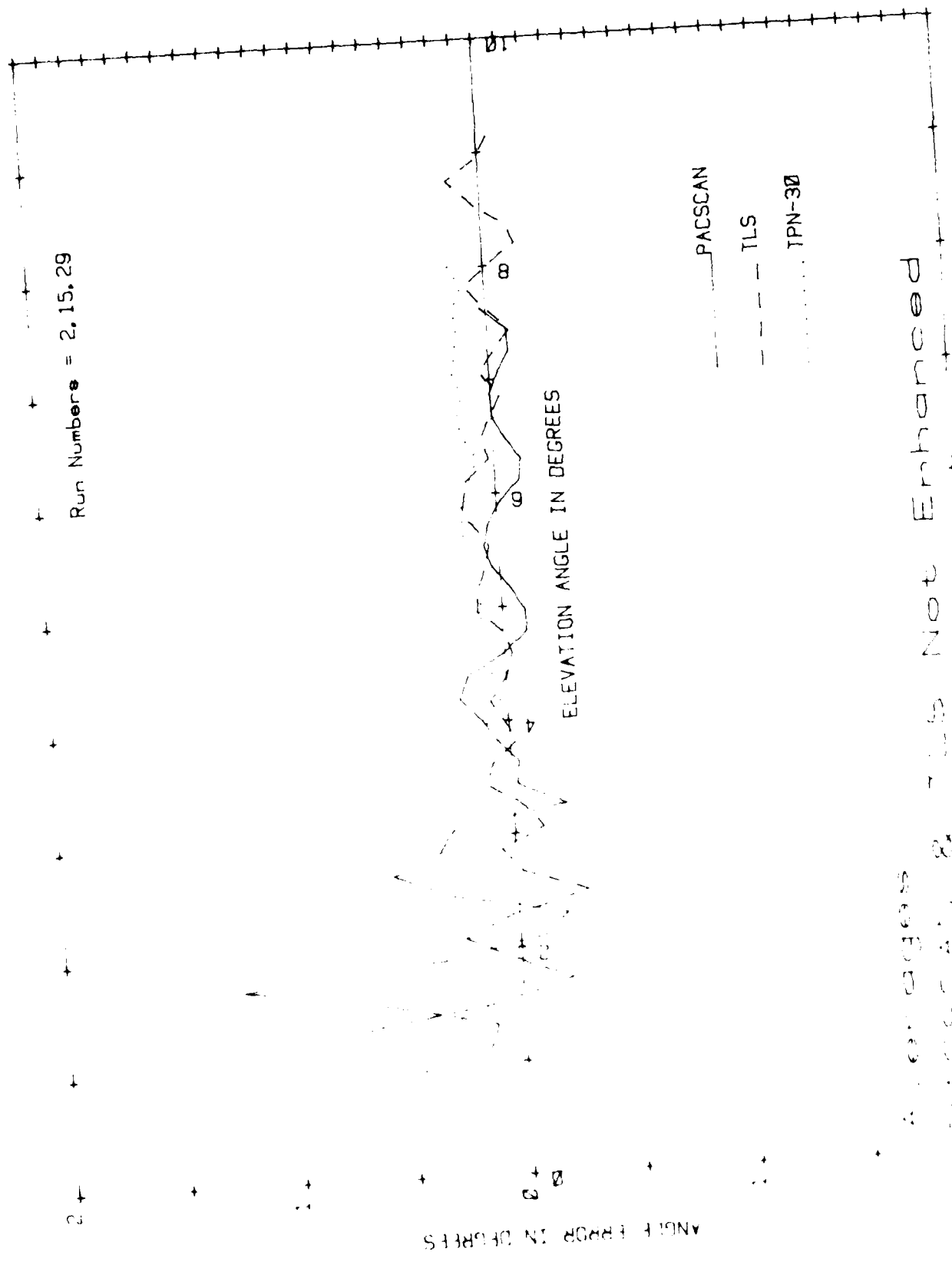

Average angle error for PACSCAN, TLS, and TPN-30. PACSCAN is the highest, TLS is in the middle, and TPN-30 is the lowest. Not Enhanced

Figure 24 Average values for Runs 2, 15, and 29.

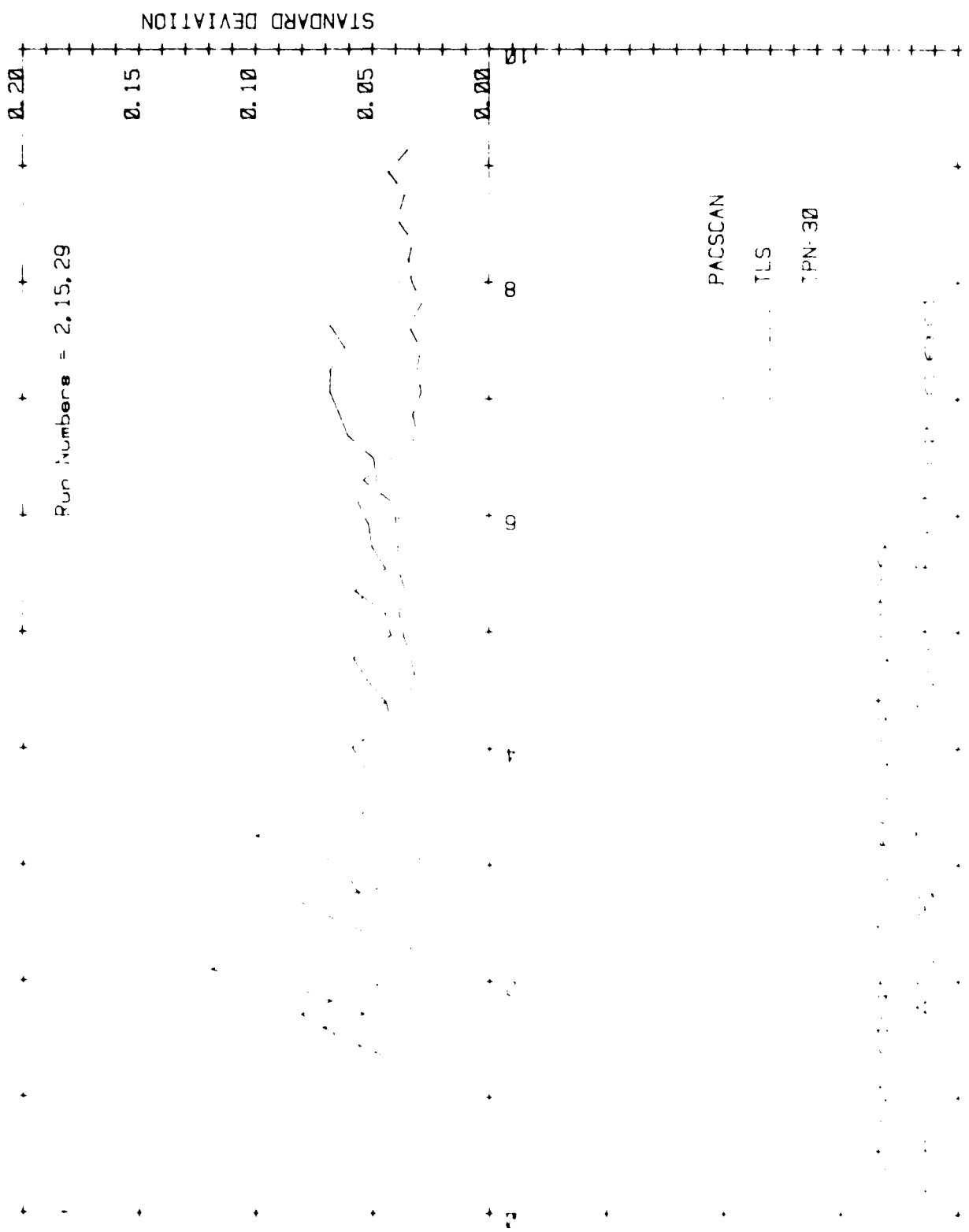

Run numbers = 2, 15, 29

PACSCAN
TLS
TPN-30

...

Run Numbers = 13, 16, 29

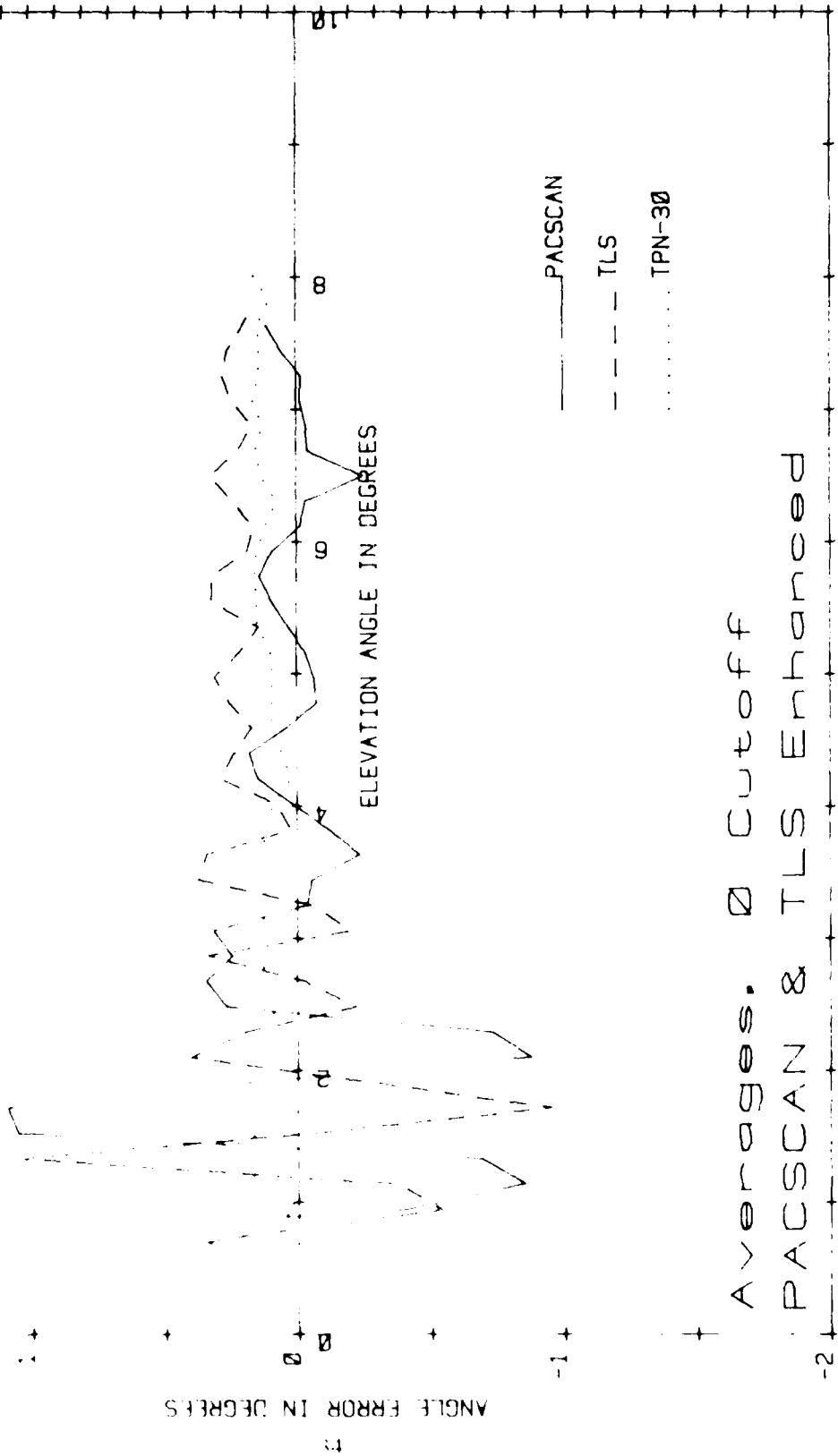

Averages. 0 Cutoff
PACSCAN & TLS Enhanced

Figure 25. Average values for Runs 13, 16, and 29.

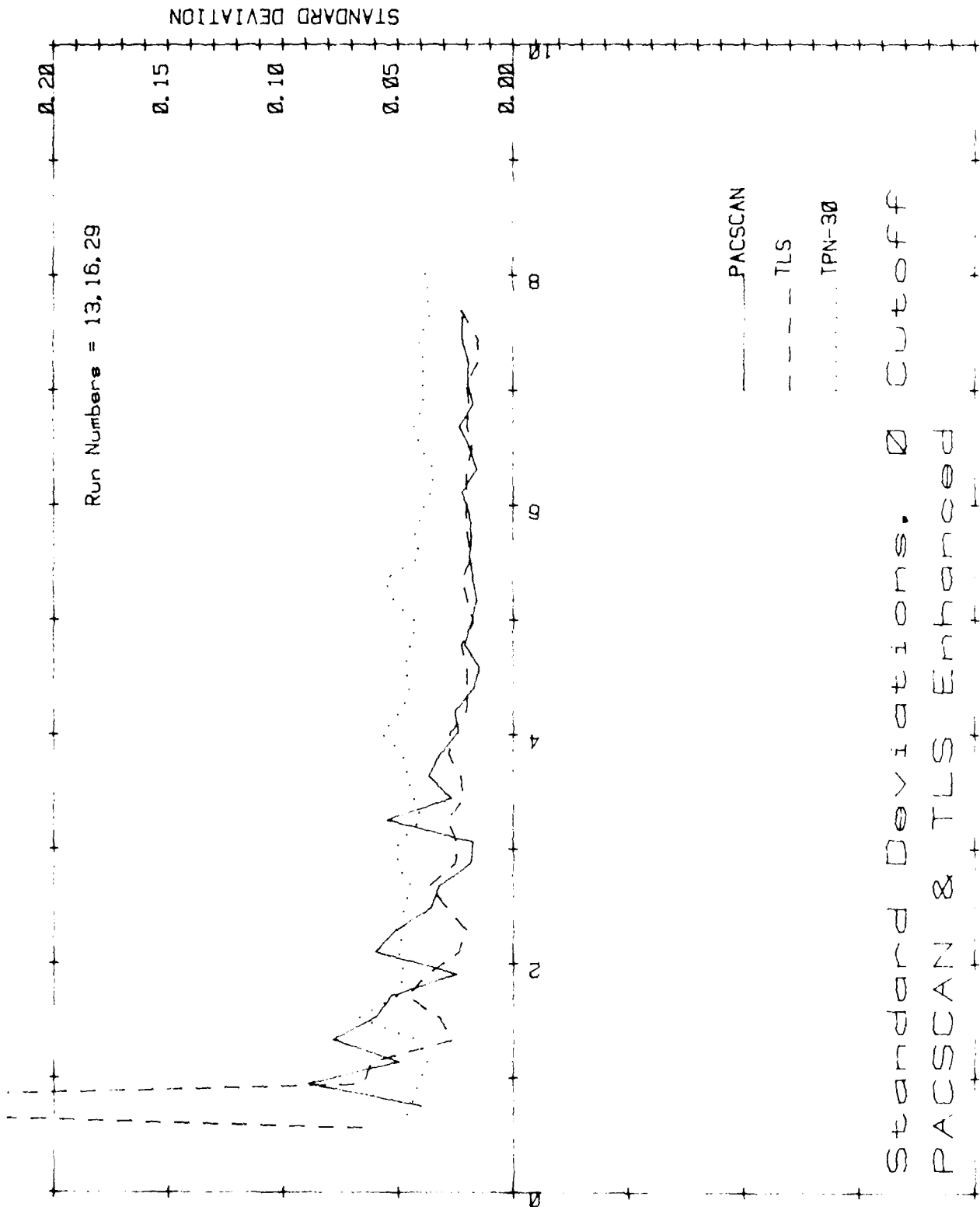

Figure 26. Standard deviations for Runs 13, 16, and 29.

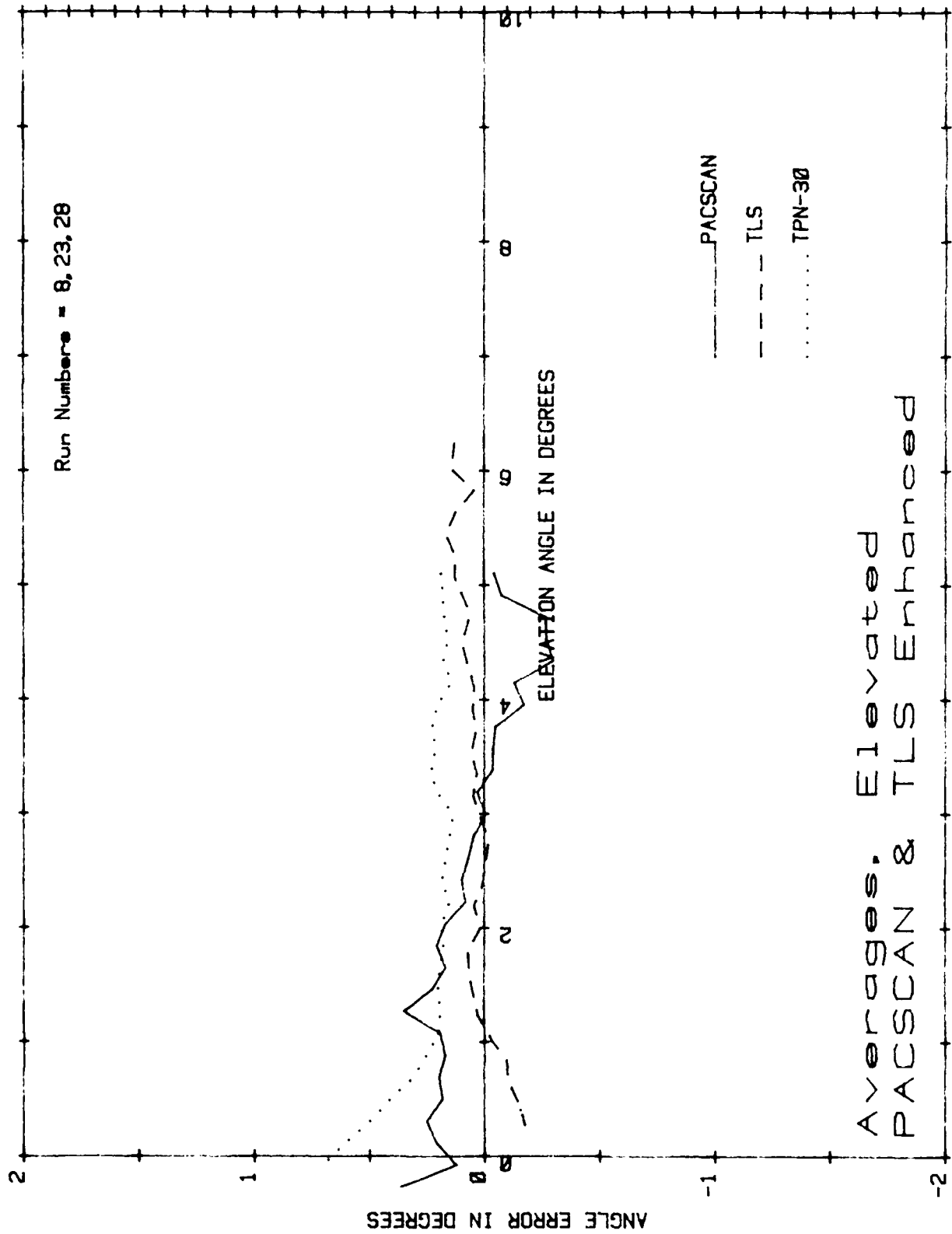

Figure 27. Average values for Runs 8, 23, and 28.

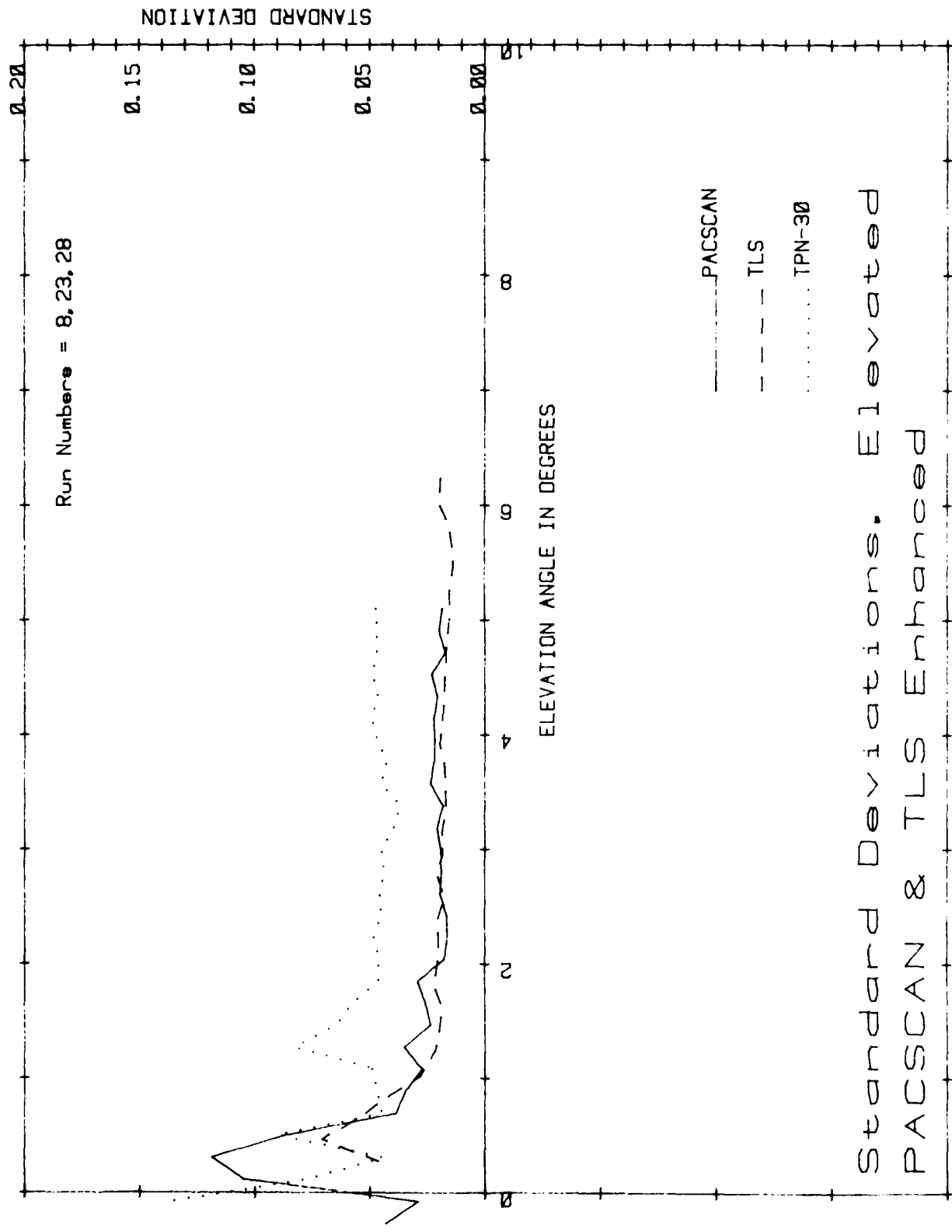

Figure 28. Standard deviations for Runs 8, 23, and 28.

Standard Deviations. Elevated
 PACSCAN & TLS Enhanced

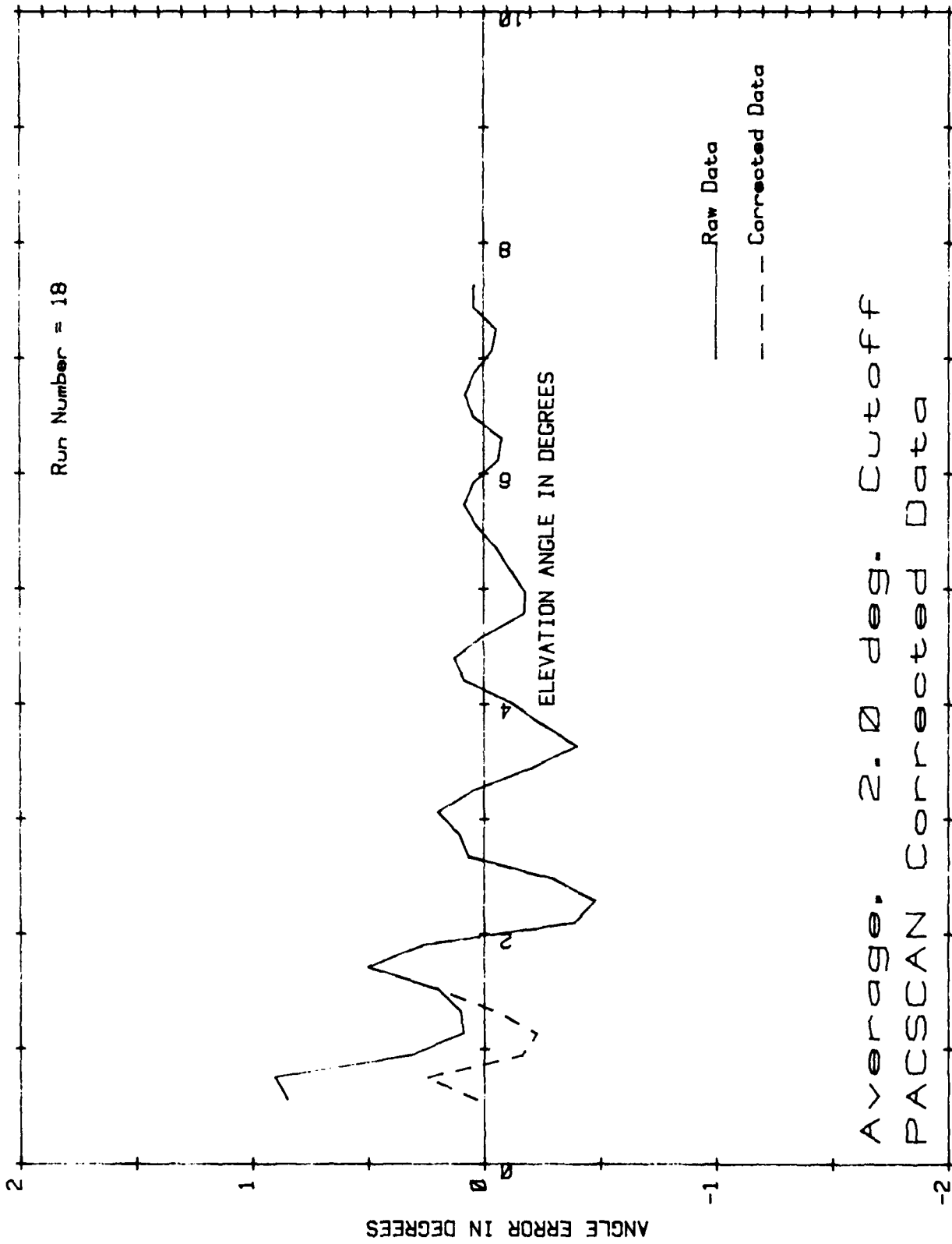

Figure 29. Average values for Run 18.

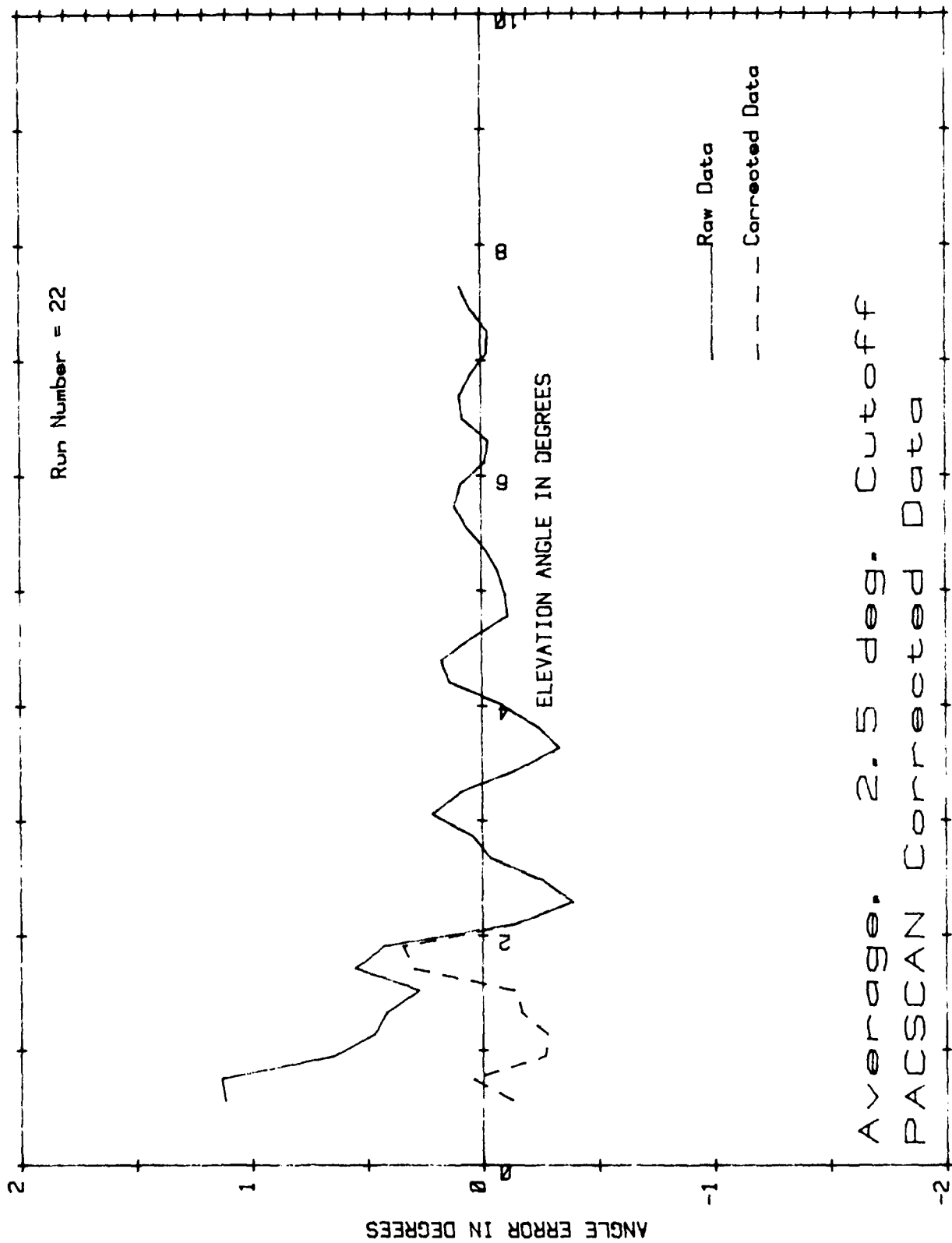

Figure 30. Average values for Run 22.

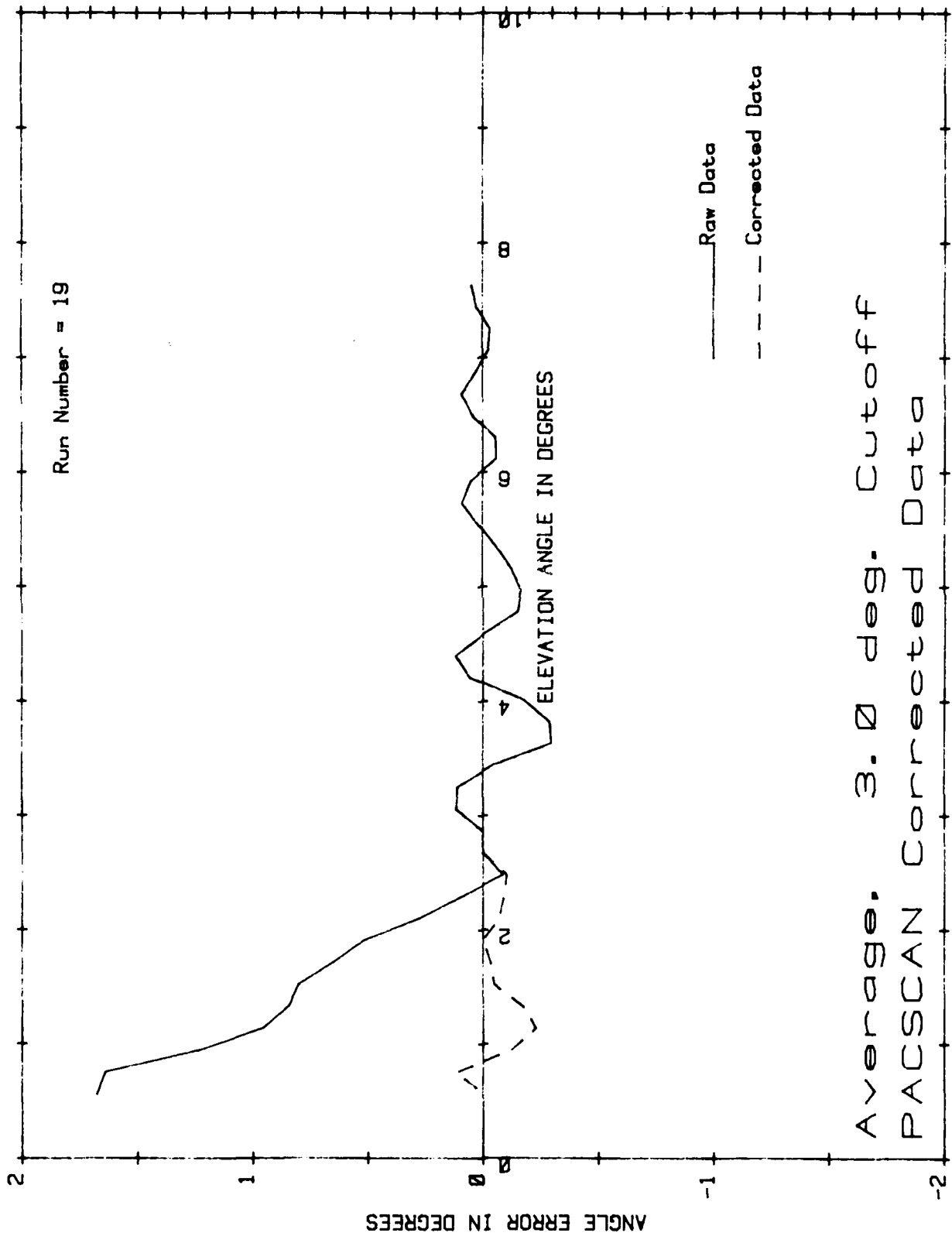
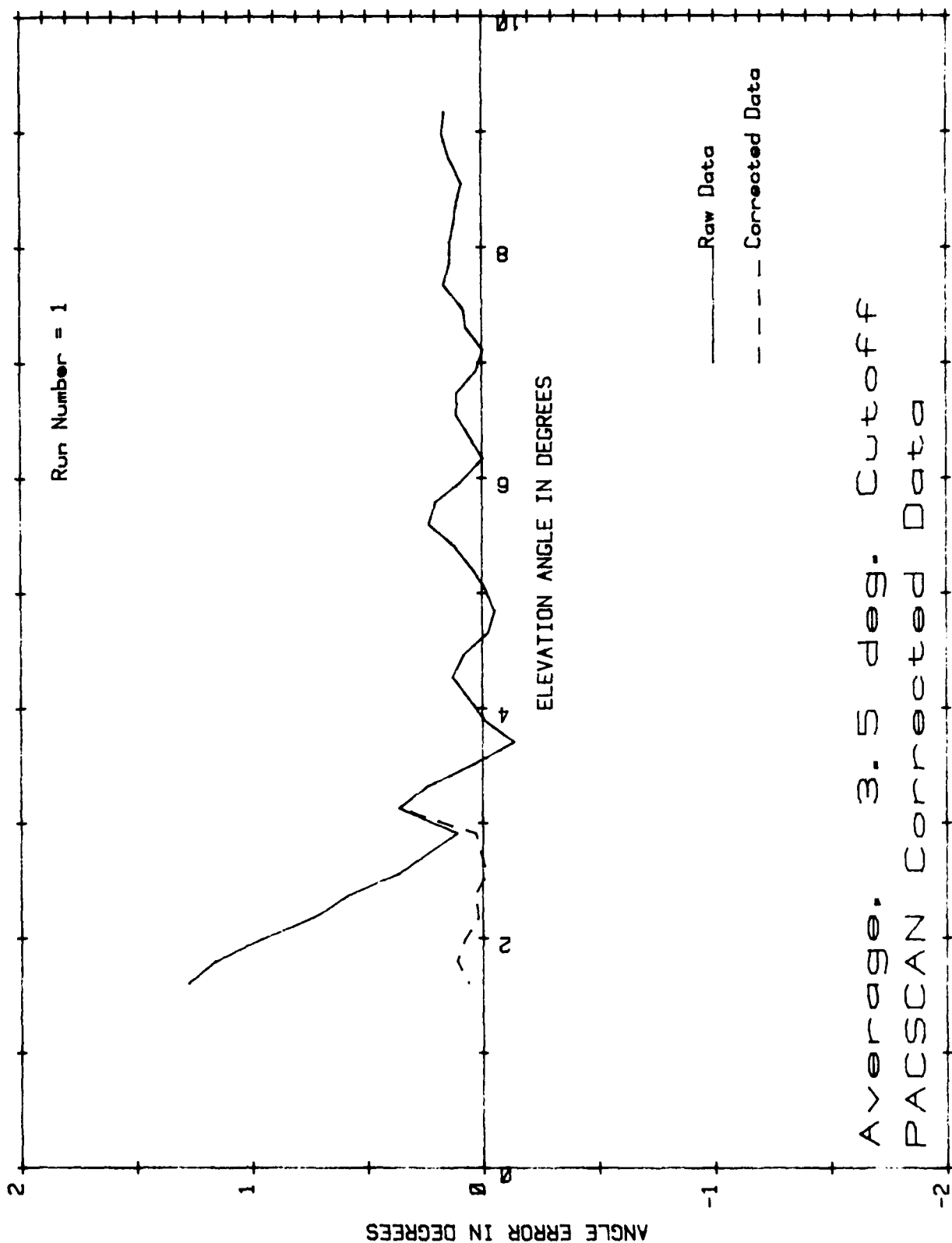

Figure 31. Average values for Run 19.



Average. 3.5 deg. Cutoff
PACSCAN Corrected Data

Figure 32. Average values for Run 1.

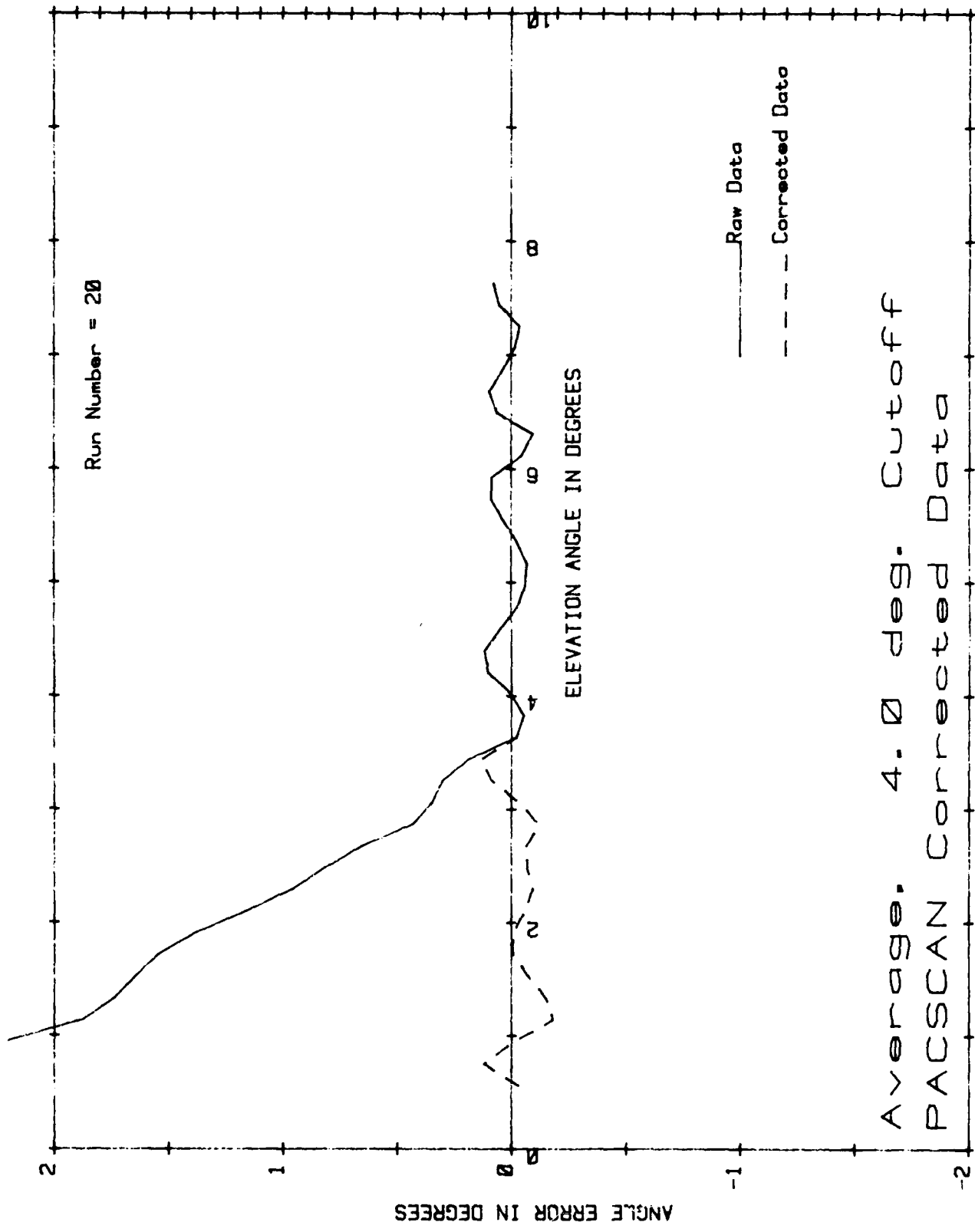

Figure 33. Average values for Run 20.

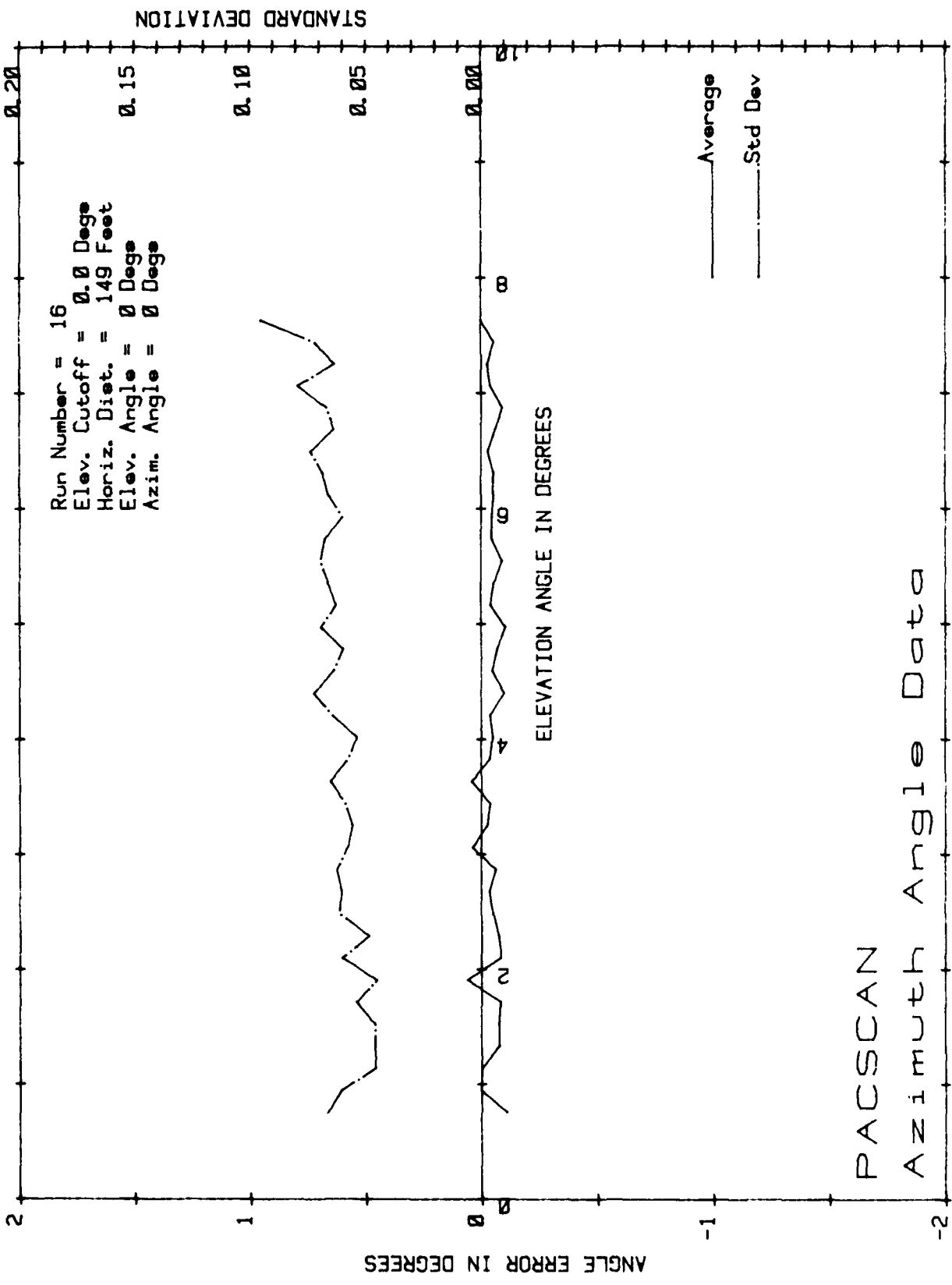

Figure 34. Azimuth angle data, Run 16.

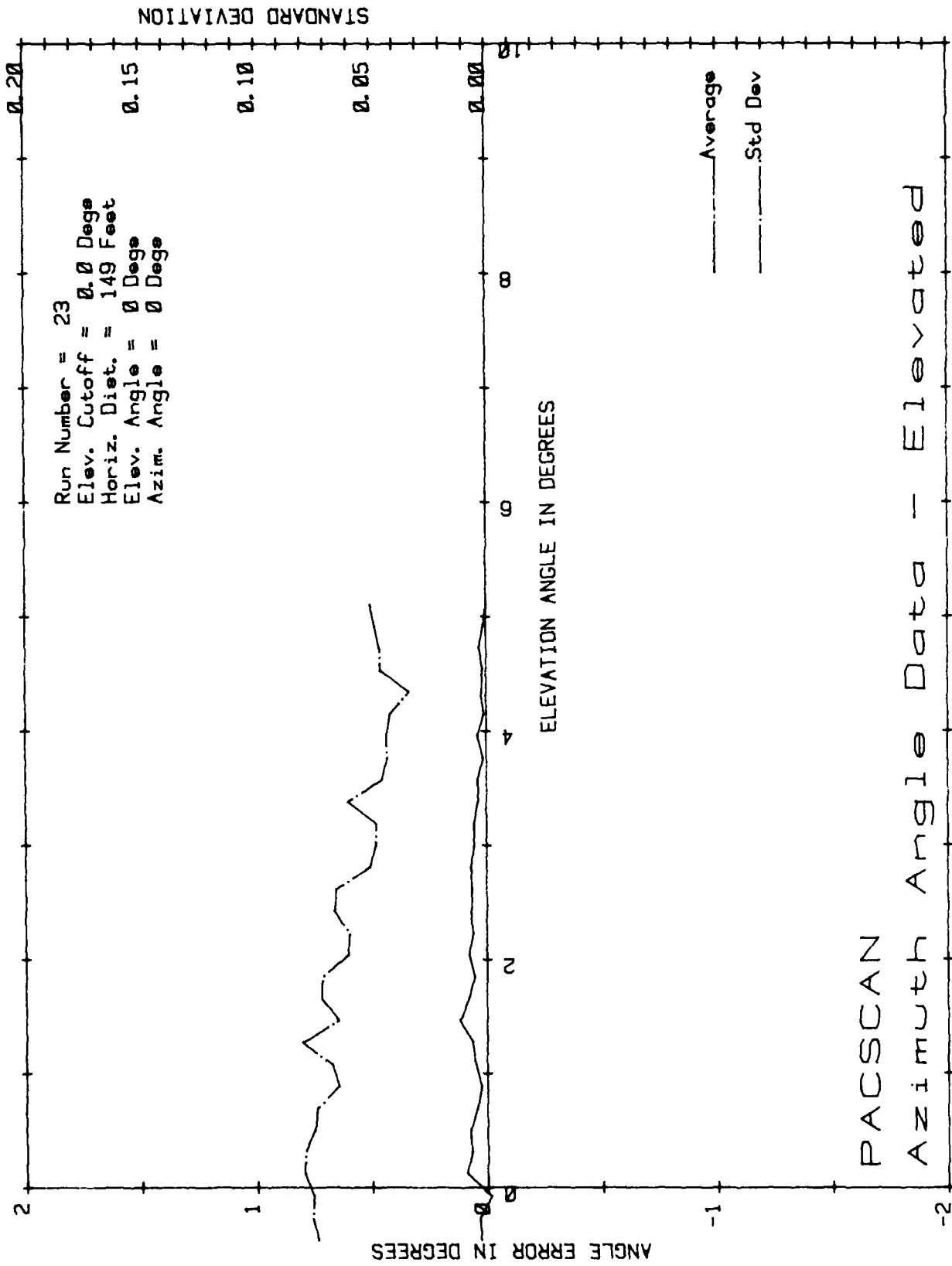

Figure 35. Azimuth angle data, Run 23.

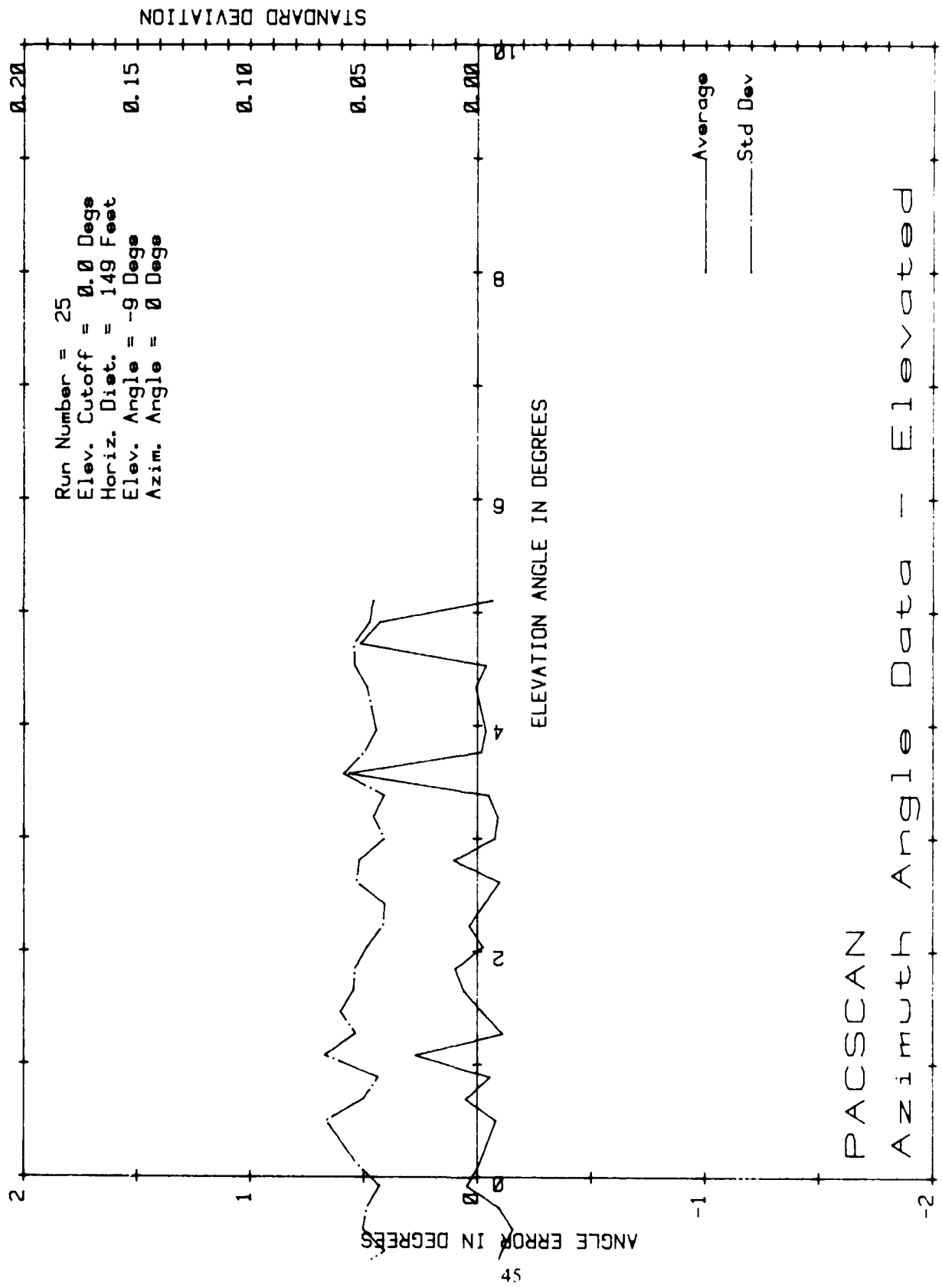

Figure 36. Azimuth angle data, Run 25.

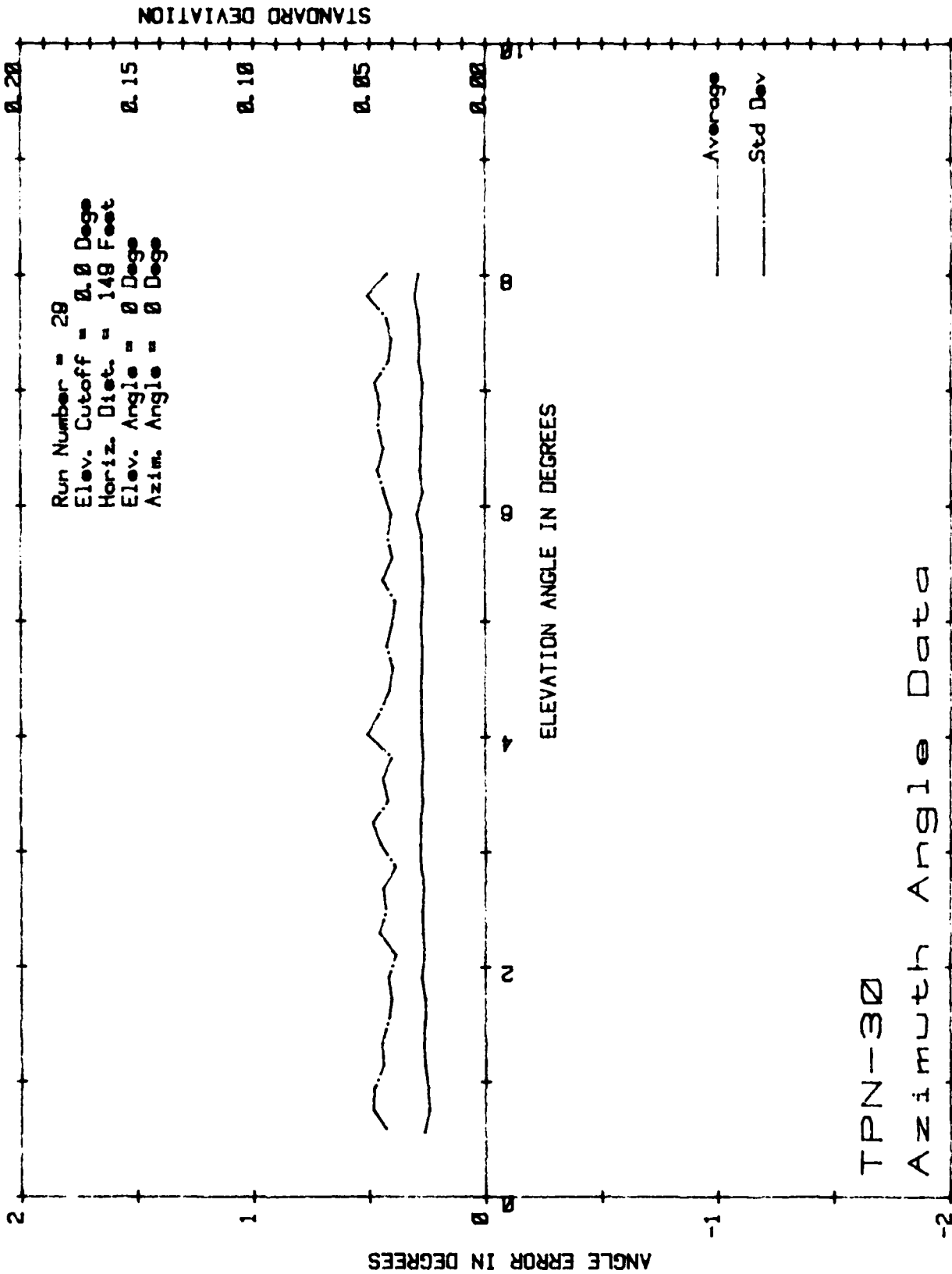
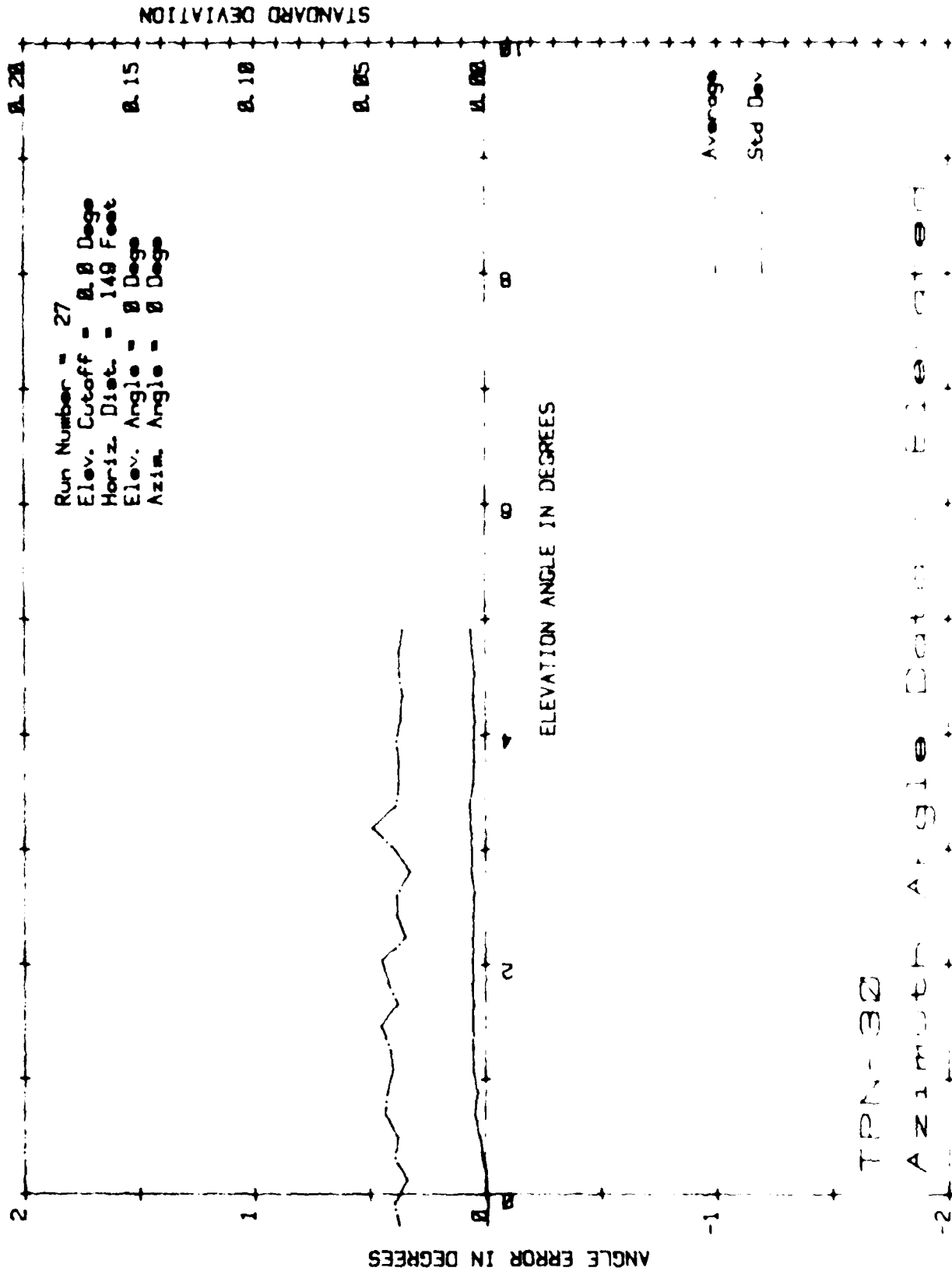

Figure 37. Azimuth angle data, Run 28.



Run Number = 27
 Elev. Cutoff = 0.0 Dege
 Horiz. Dist. = 149 Feet
 Elev. Angle = 0 Dege
 Azim. Angle = 0 Dege

TPN-30

Azimuth Angle Data is Elevation

Average
 Std Dev

EXPERIMENTAL DATA
EXPERIMENTAL DATA



ELEVATION ANGLE IN DEGREES

TWO MICROSEC PER DEG
ONE MICROSEC PER DEG

Experimental Data

Experimental Data

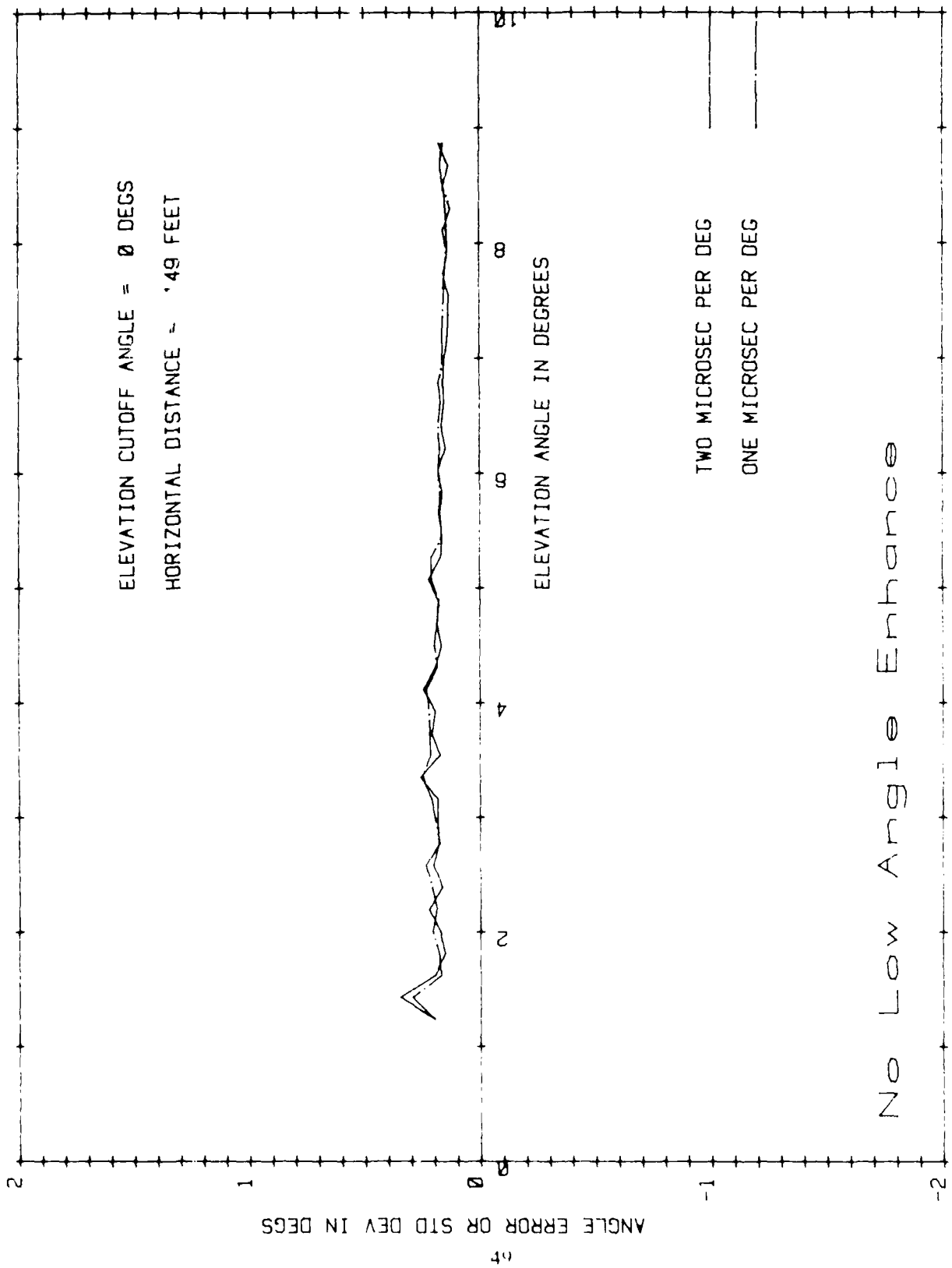

Figure 40. Comparison of standard deviations for different code spacings.

APPENDIX A
Elevation Angle Data

Figures A-1 through A-29 are the plots for test runs in order, except that runs 9 and 10 were not plotted since they have had data due to an error in setting the test equipment. Each figure shows the average value for 100 samples as well as the standard deviation. Significant parameters are contained on the plot.

PRECEDING PAGE BLANK-NOT FILLED

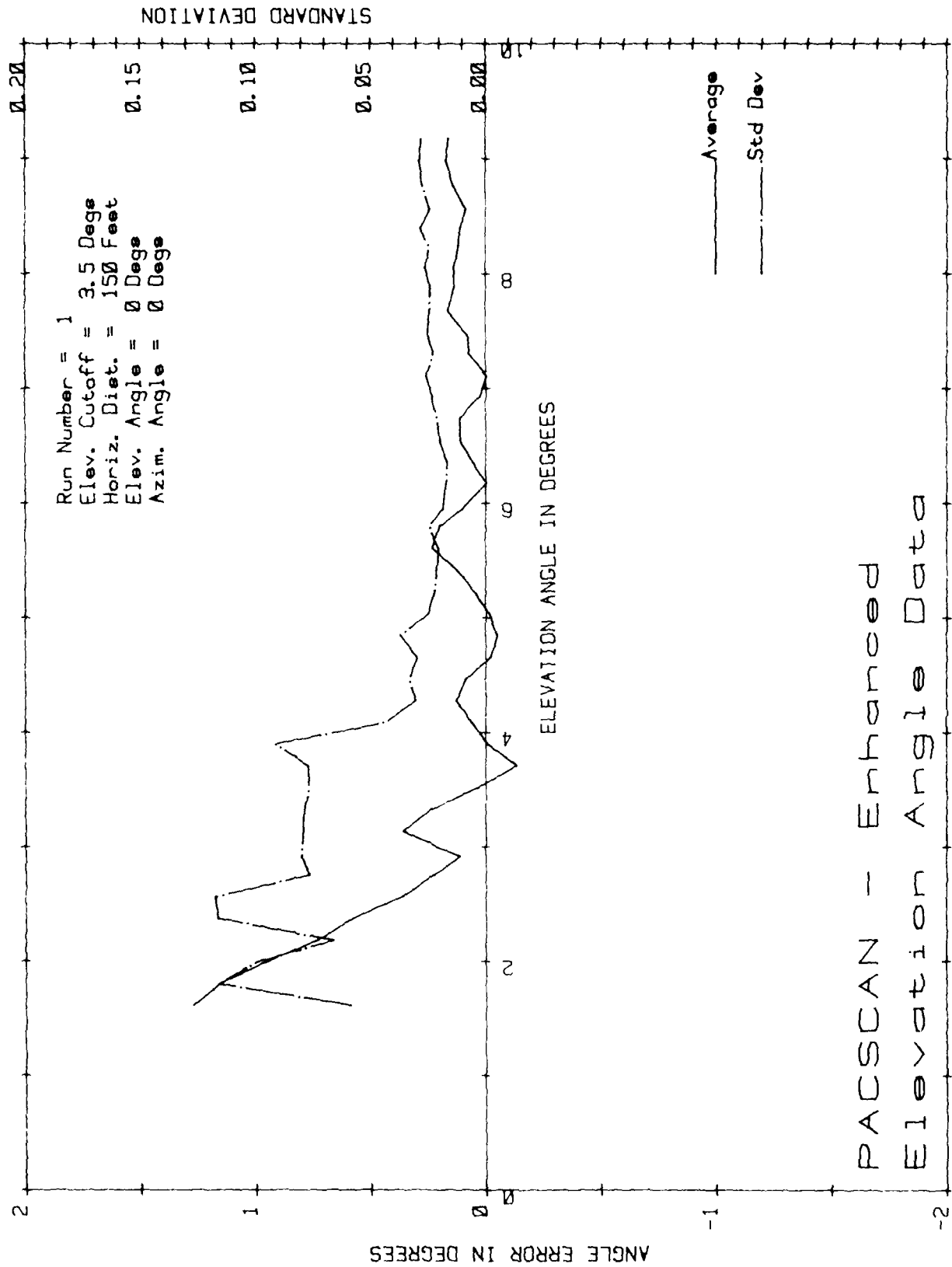

Figure A-1. PACSCAN enhanced.

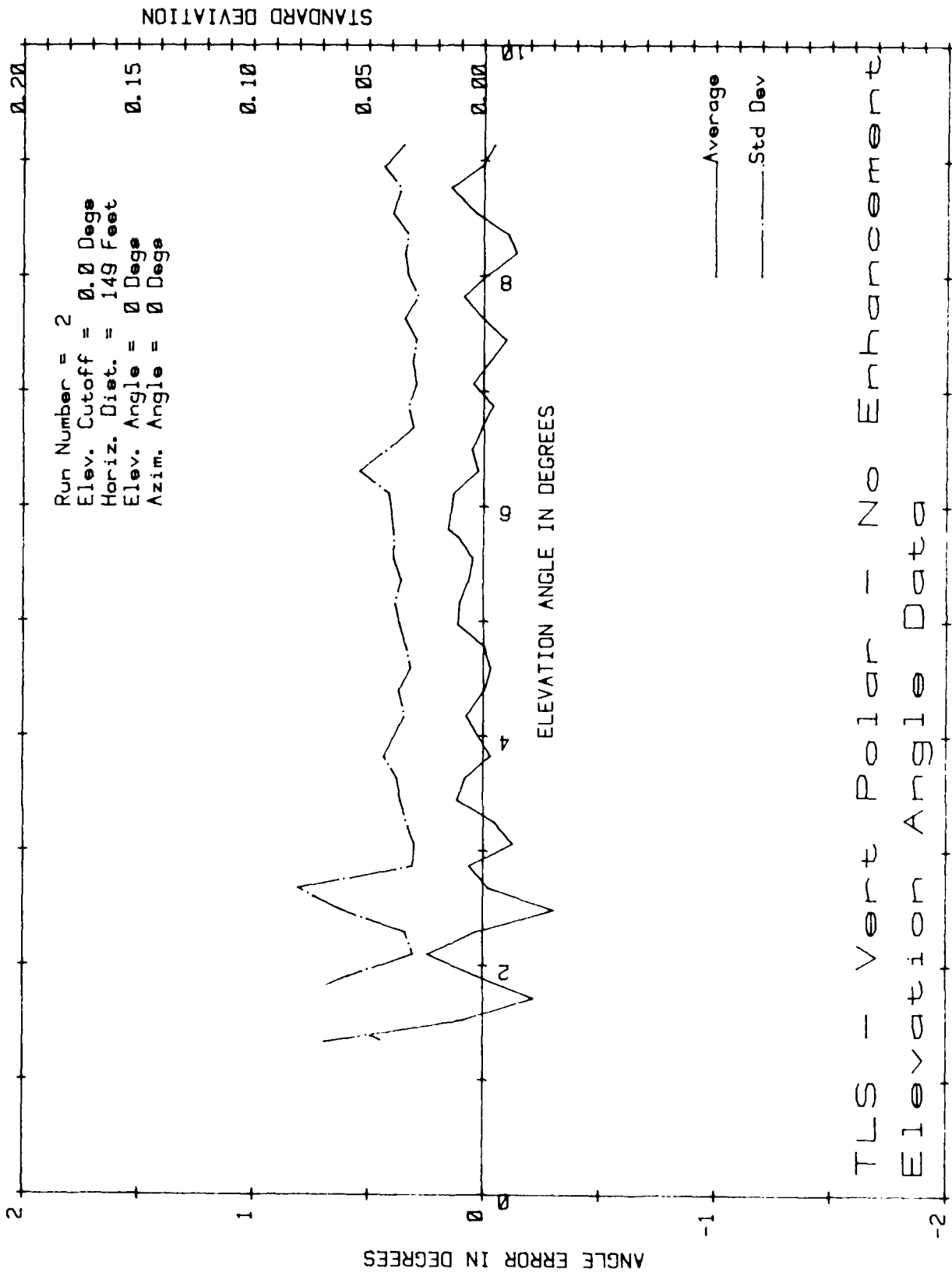

Figure A-2. TLS, vertical polarization, no enhancement.

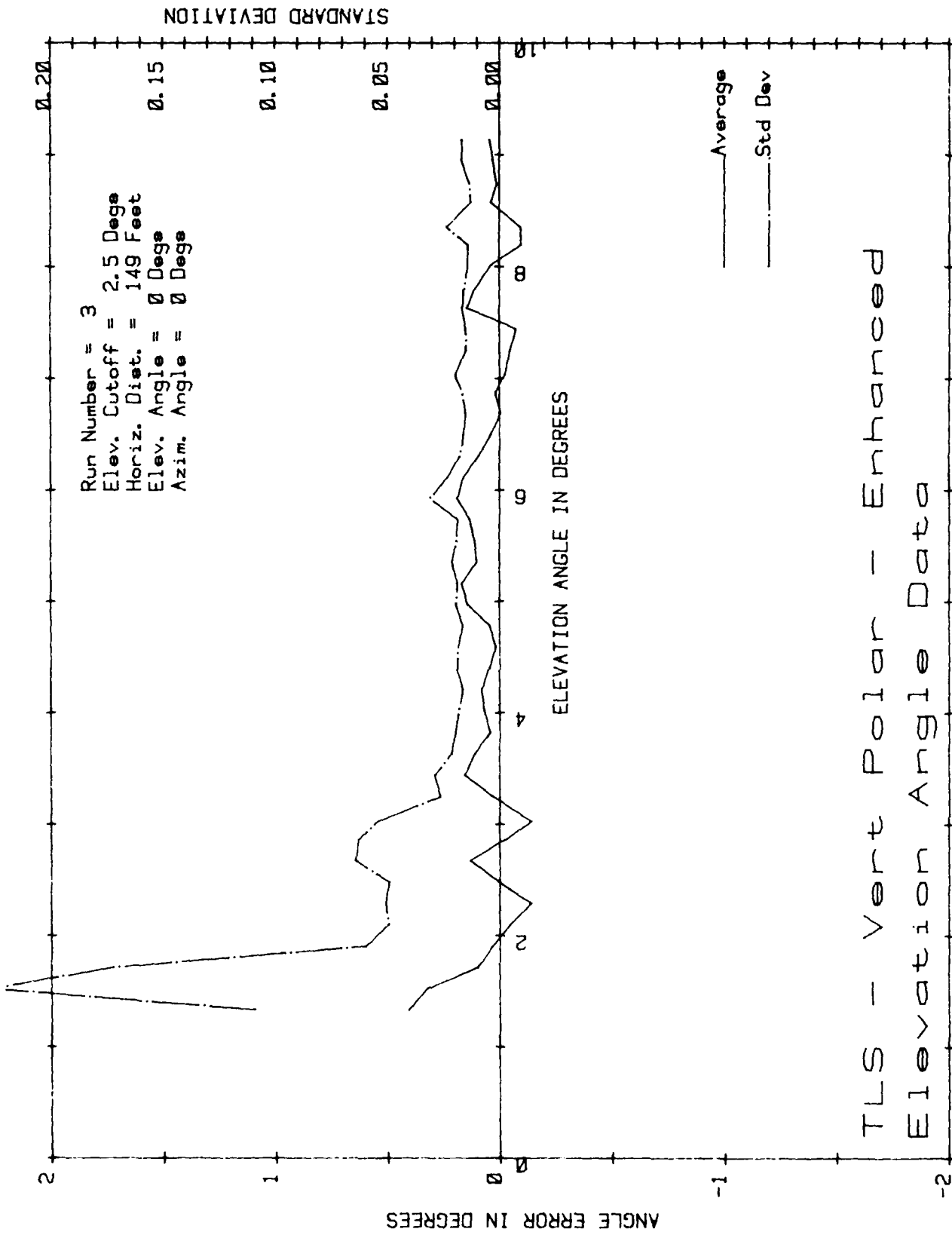
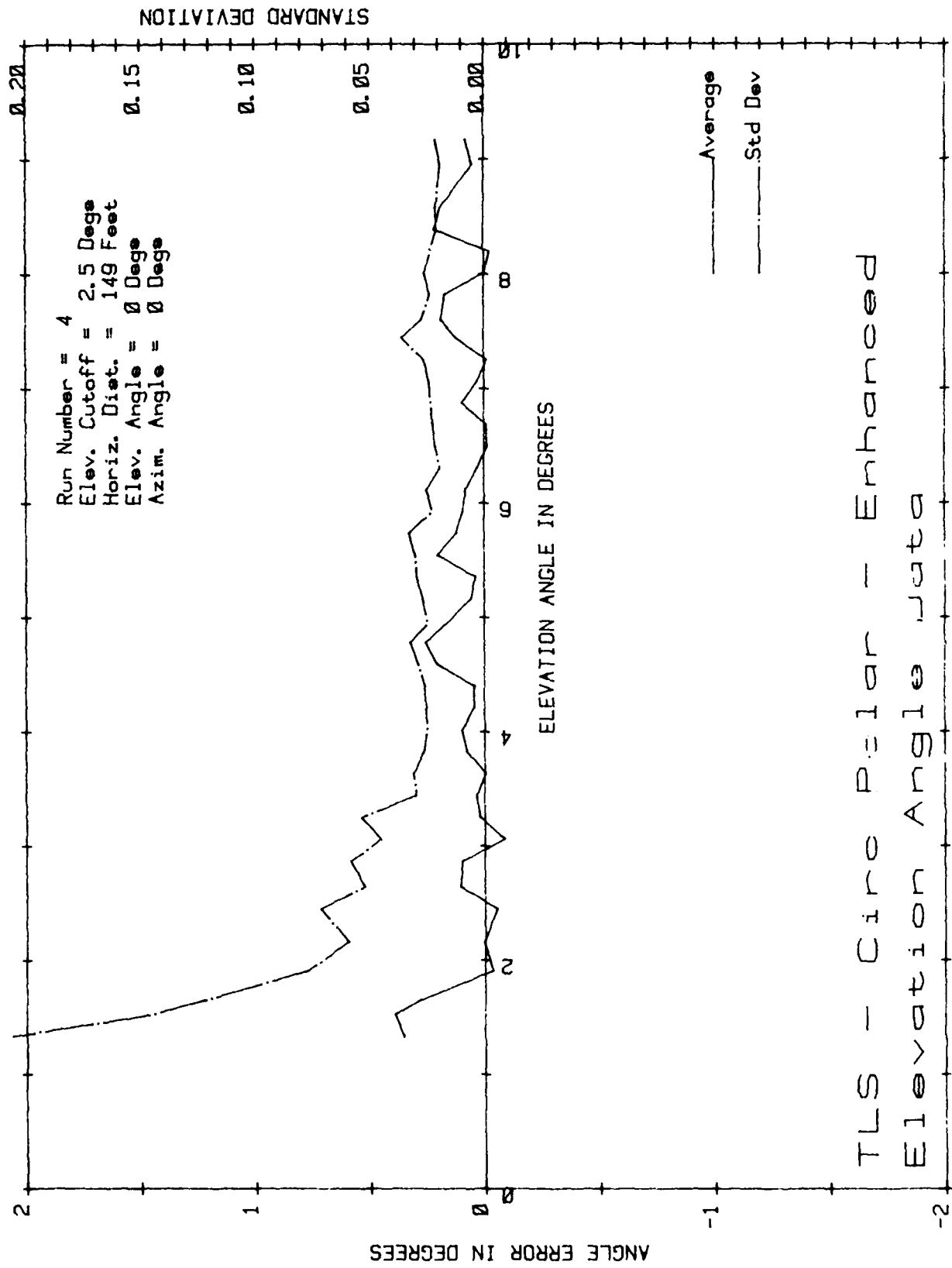

Figure A.3. TLS vertical polarization, enhanced.



TLS - Circle Polar - Enhanced
 Elevation Angle Data

Figure A-4: TLS circular polarization, enhanced.

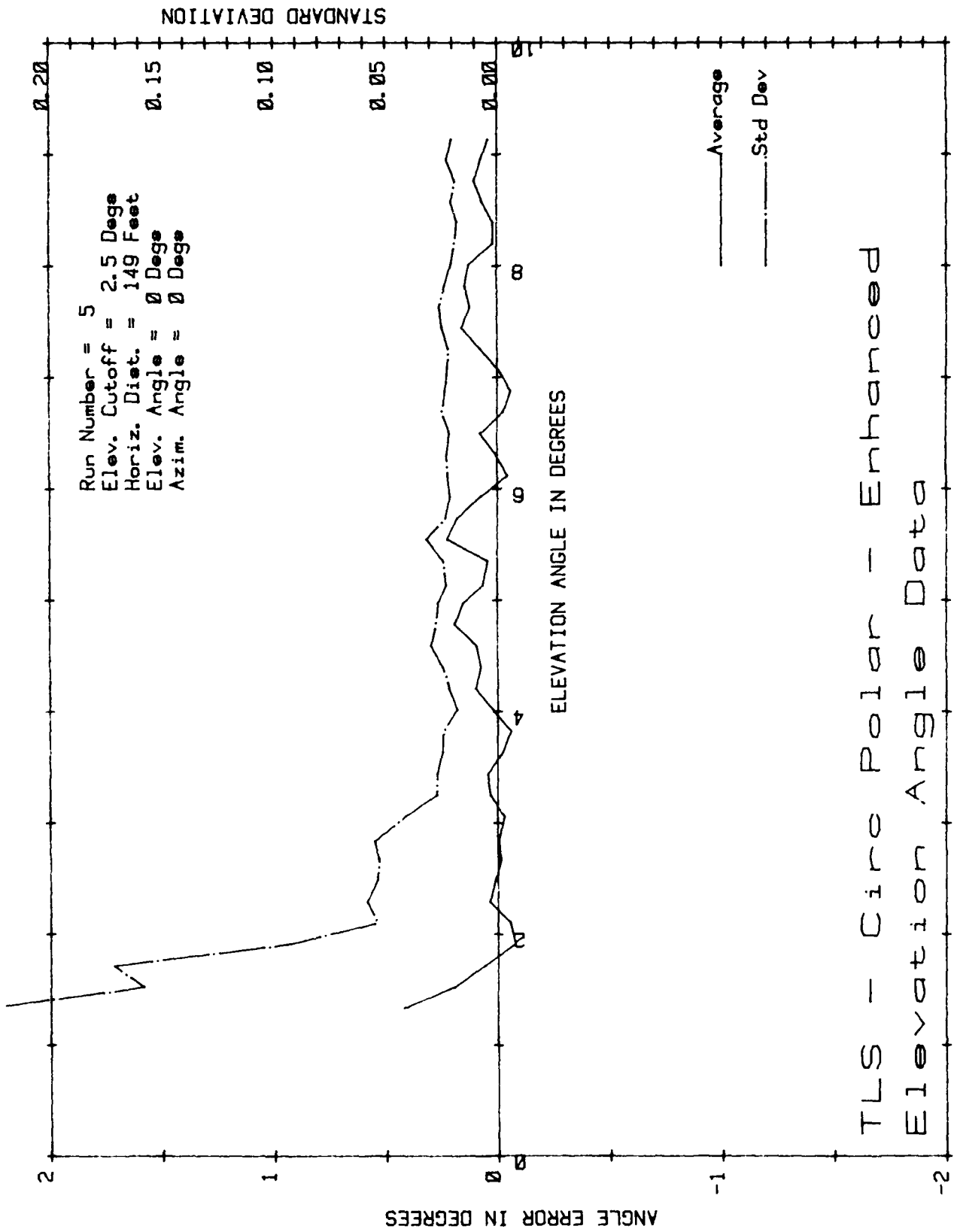

Figure A-5. TLS circular polarization, enhanced.

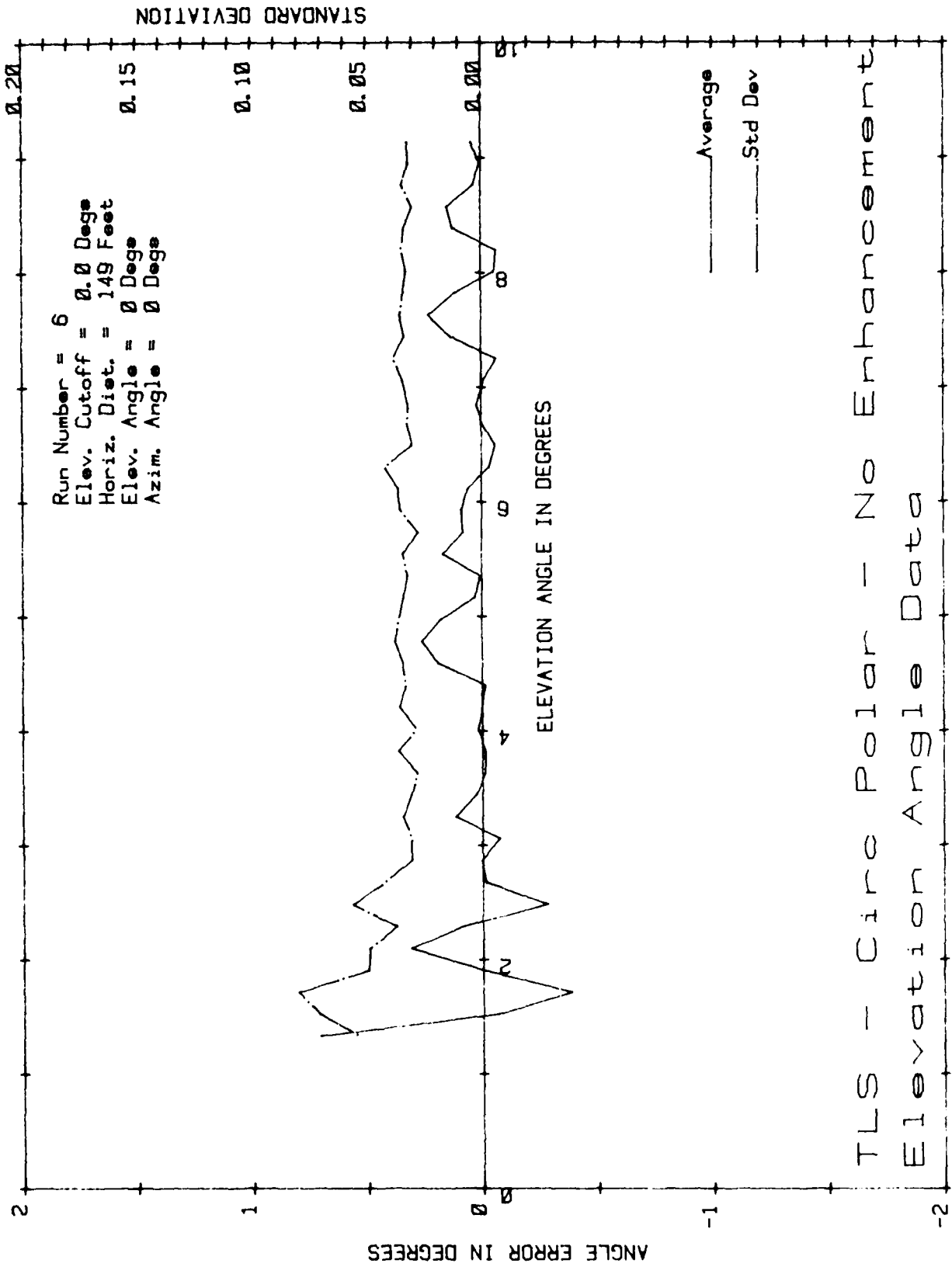

Figure A-6 TLS circular polarization, no enhancement.

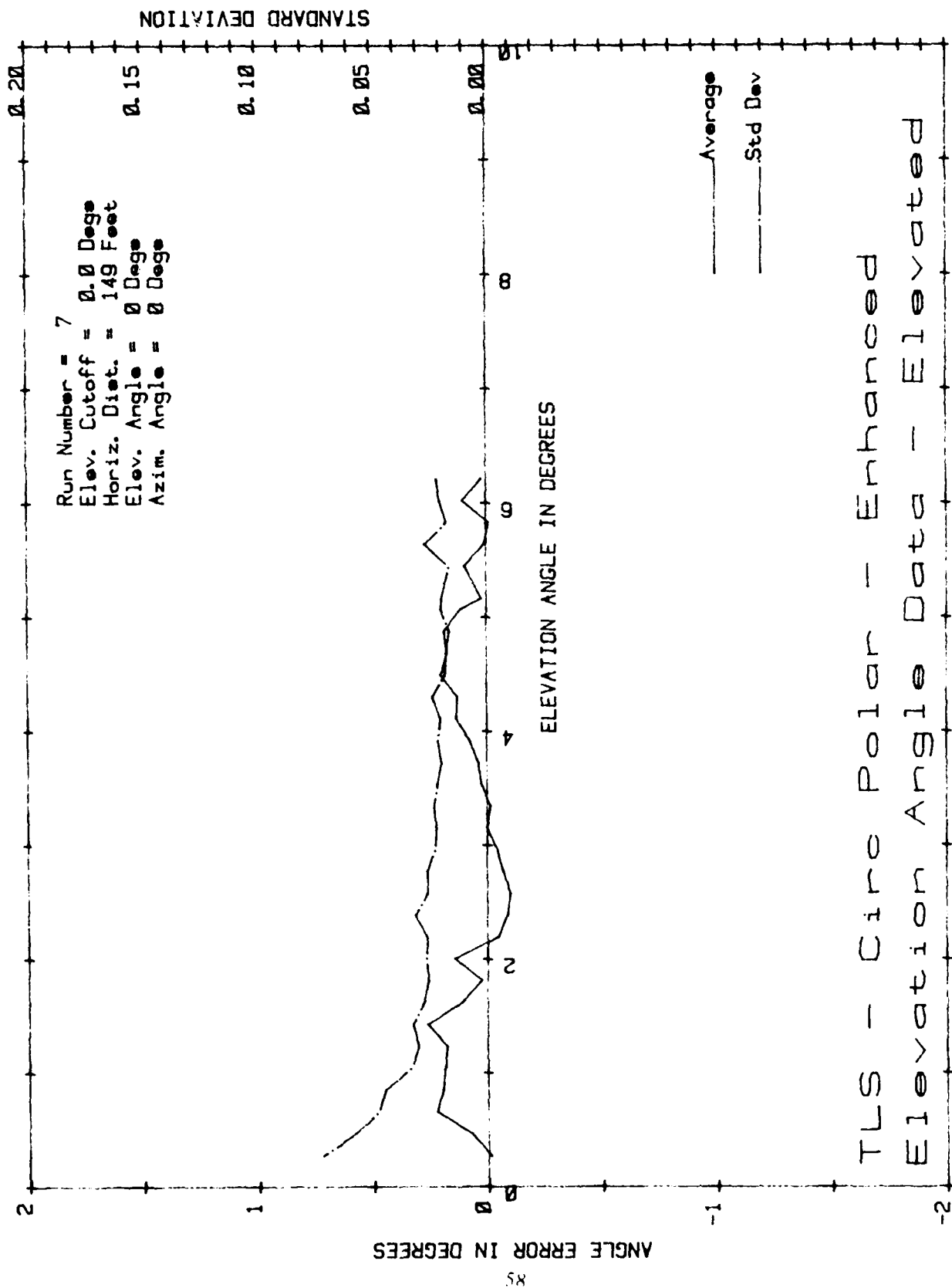
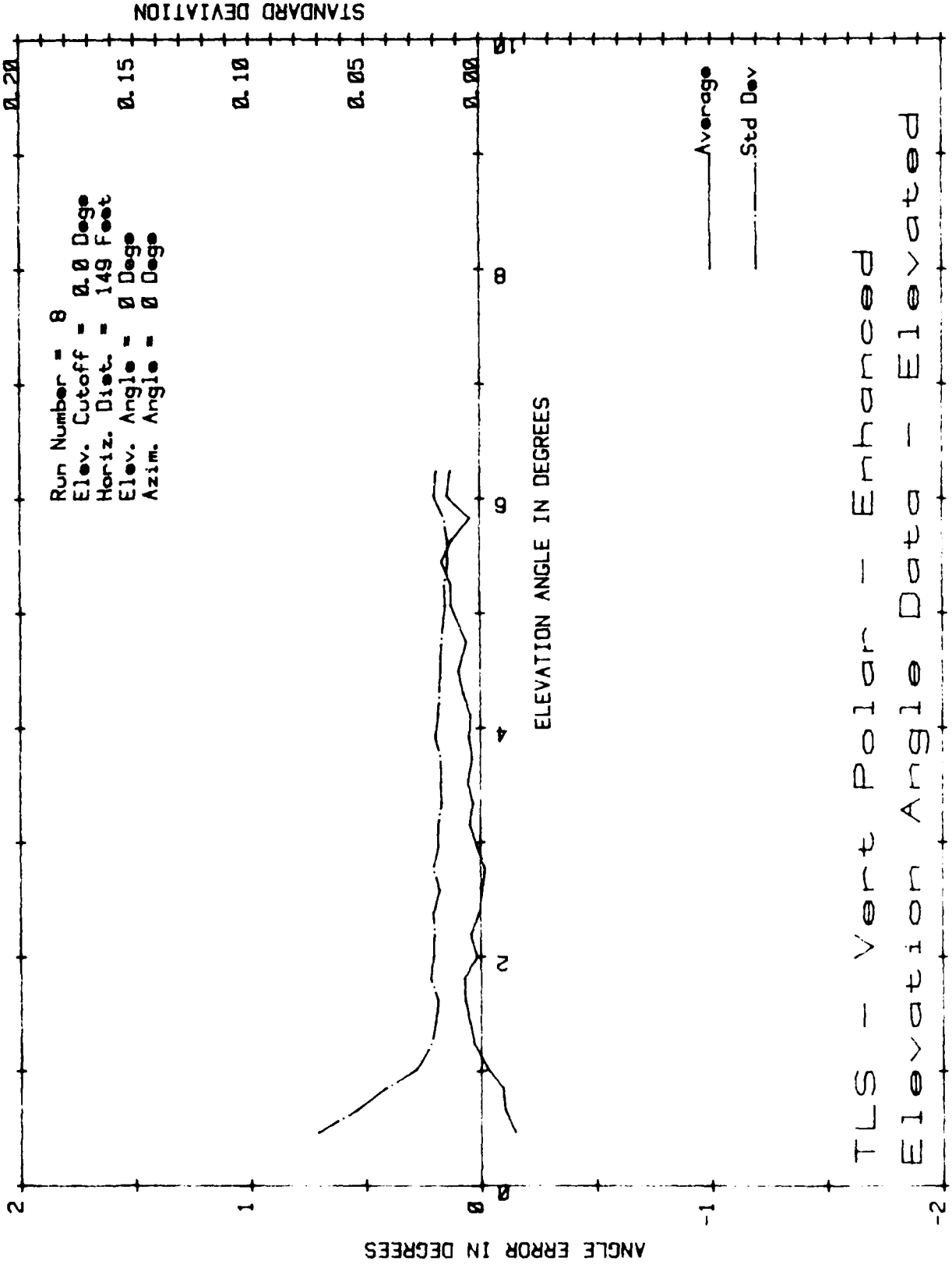
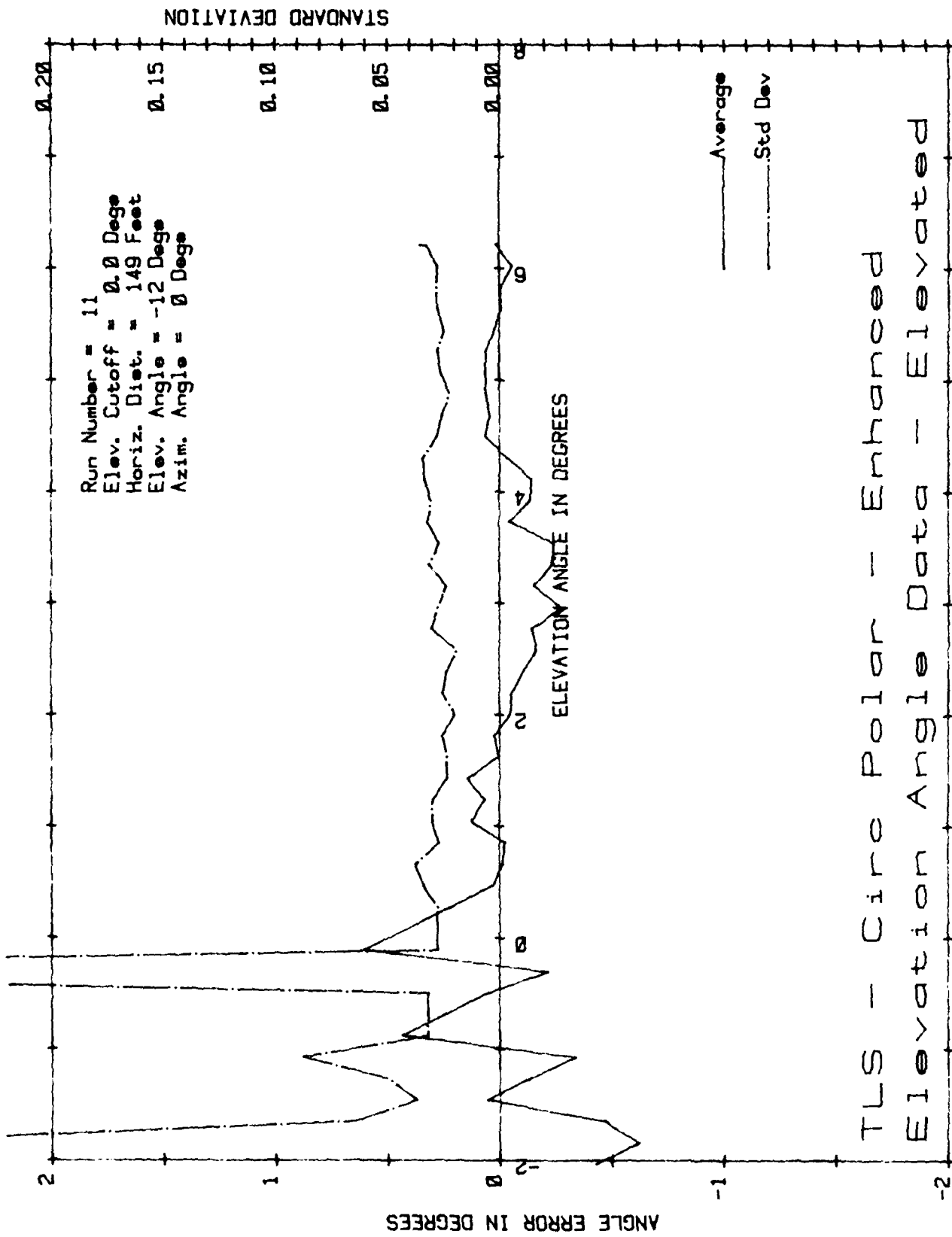

Figure A.7. TLS circular polarization enhanced.



TLS - Vert Polar - Enhanced
 Elevation Angle Data - Elevated

Figure A5 - TLS vertical polarization, enhanced.



TLS - Circ Polar - Enhanced
 Elevation Angle Data - Elevated

Figure A-9. TLS, circular polarization, enhanced.

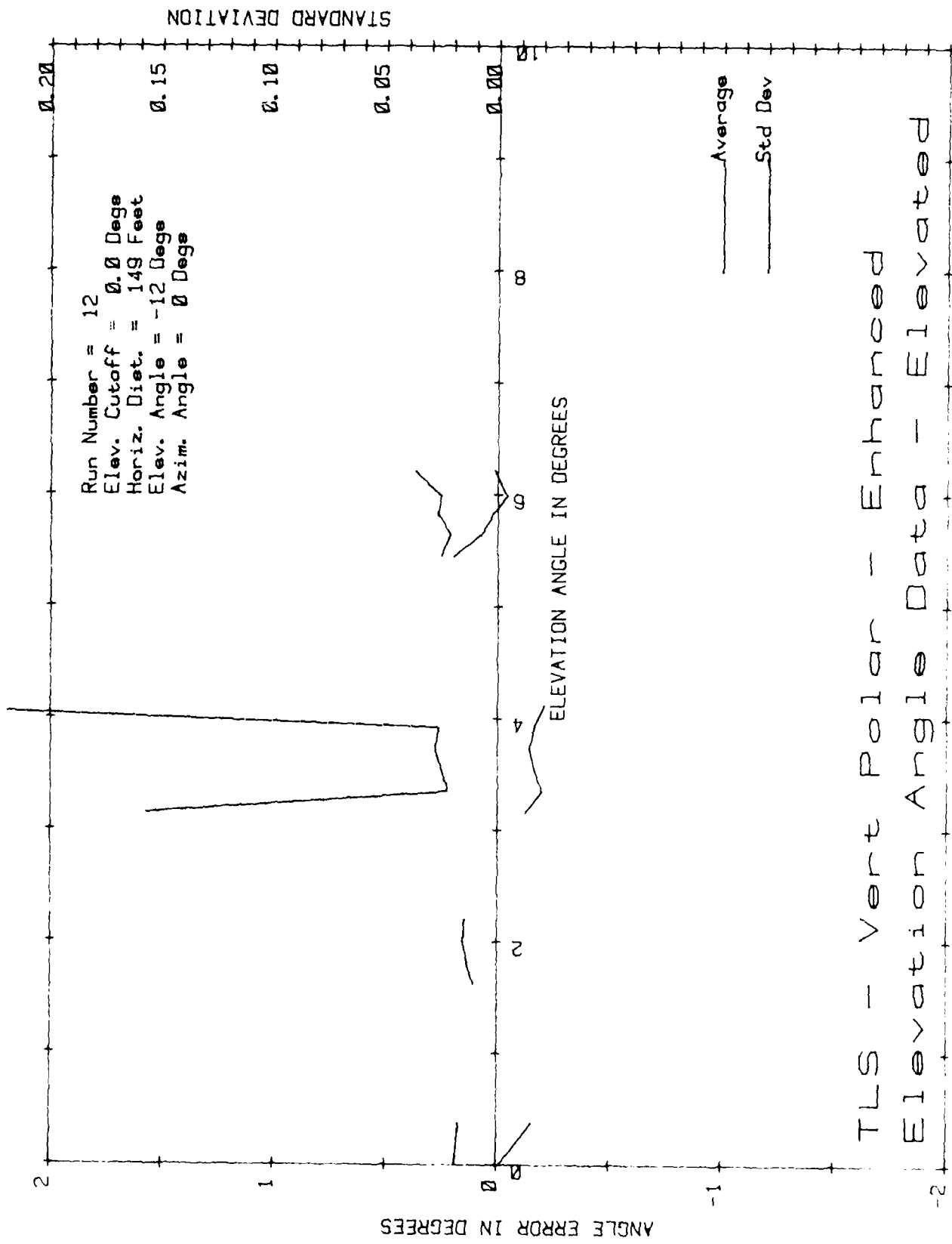

TLS - Vert Polar - Enhanced
 Elevation Angle Data - Elevated

Figure A-10. TLS, vertical polarization, enhanced.

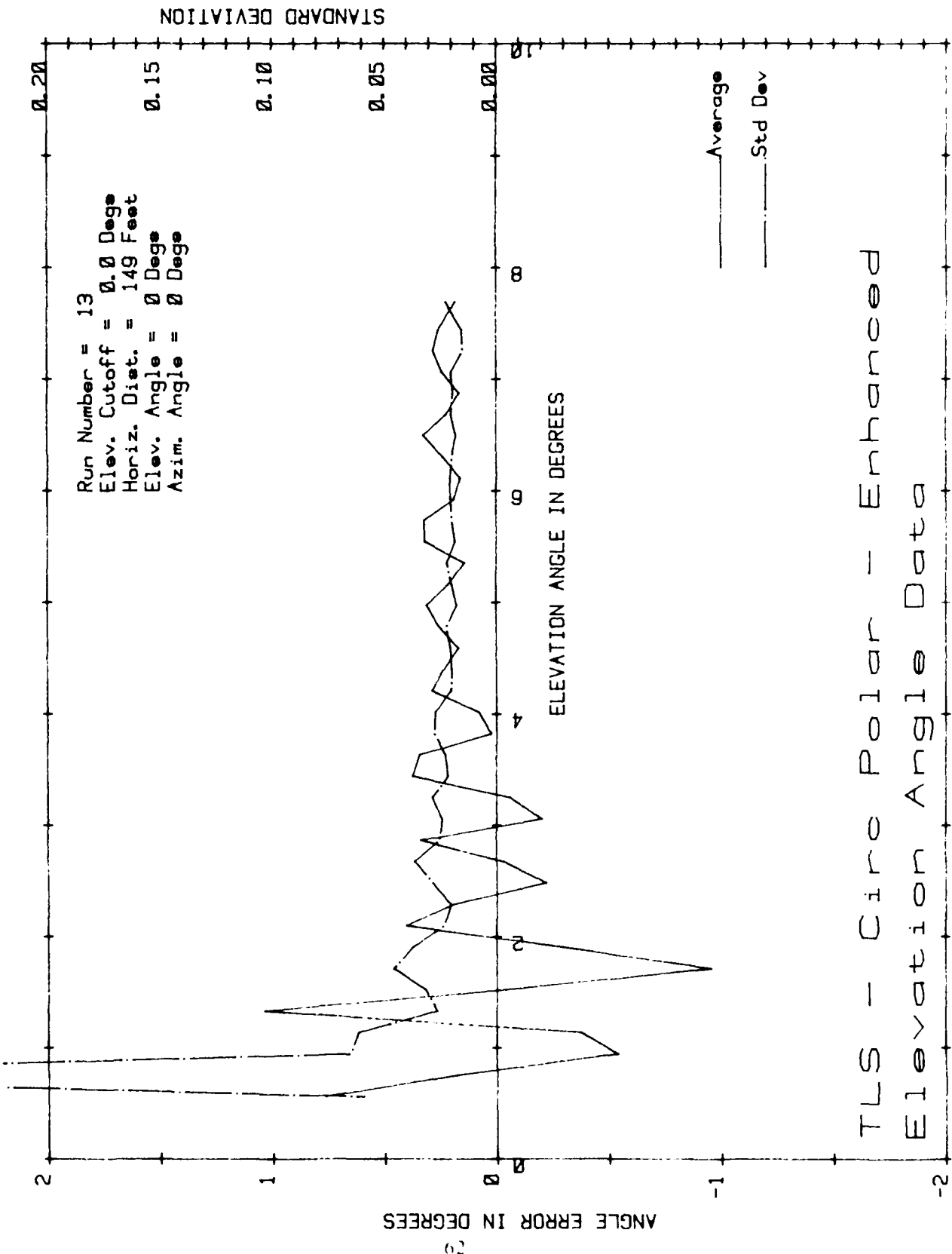

TLS - Circ Polar - Enhanced
 Elevation Angle Data

Figure A-11. TLS, circular polarization, enhanced.

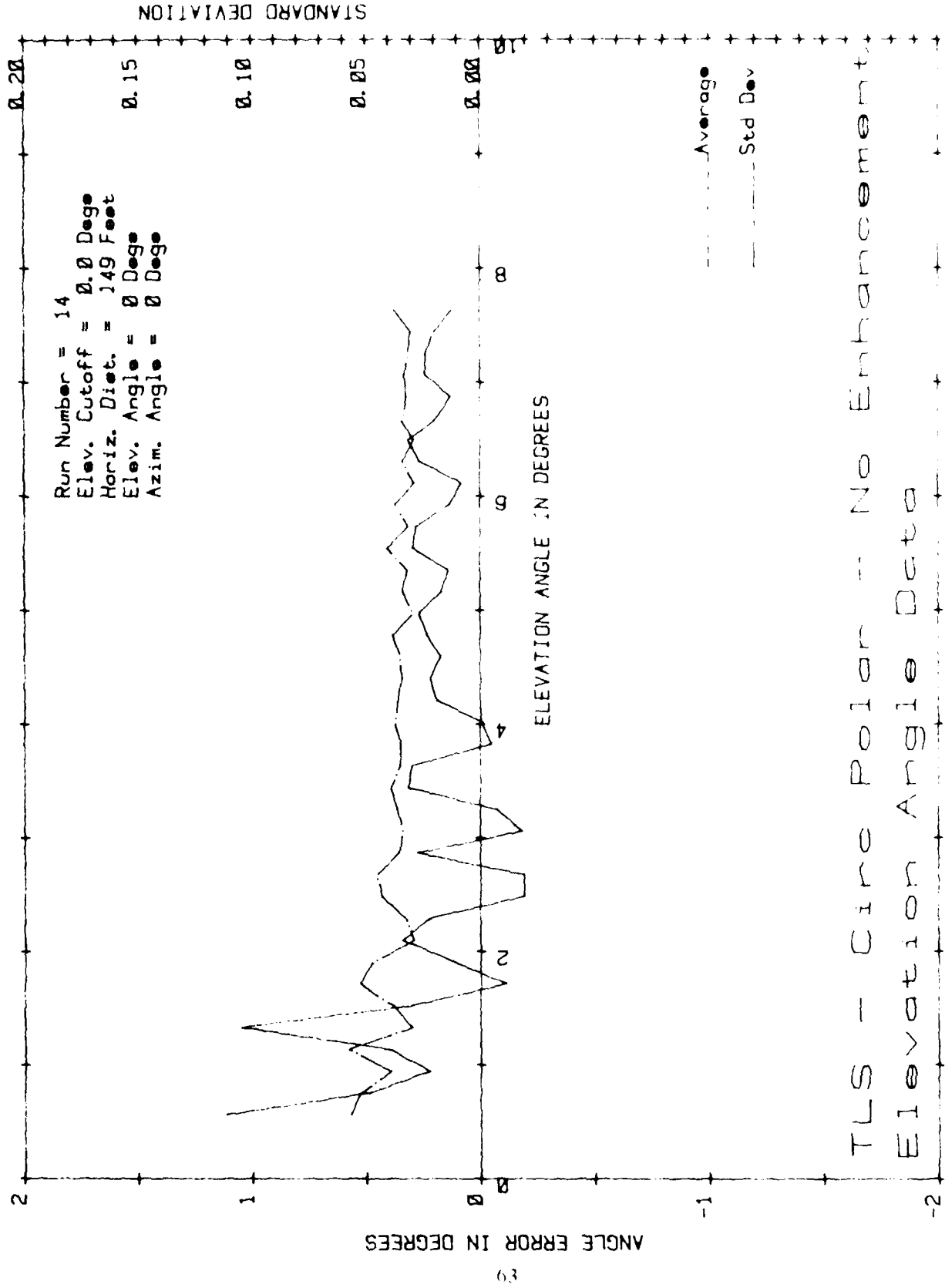

TLS - Circle Polar - No Enhancement
 Elevation Angle Data

Figure A.11 - TLS (circle polar) elevation angle data

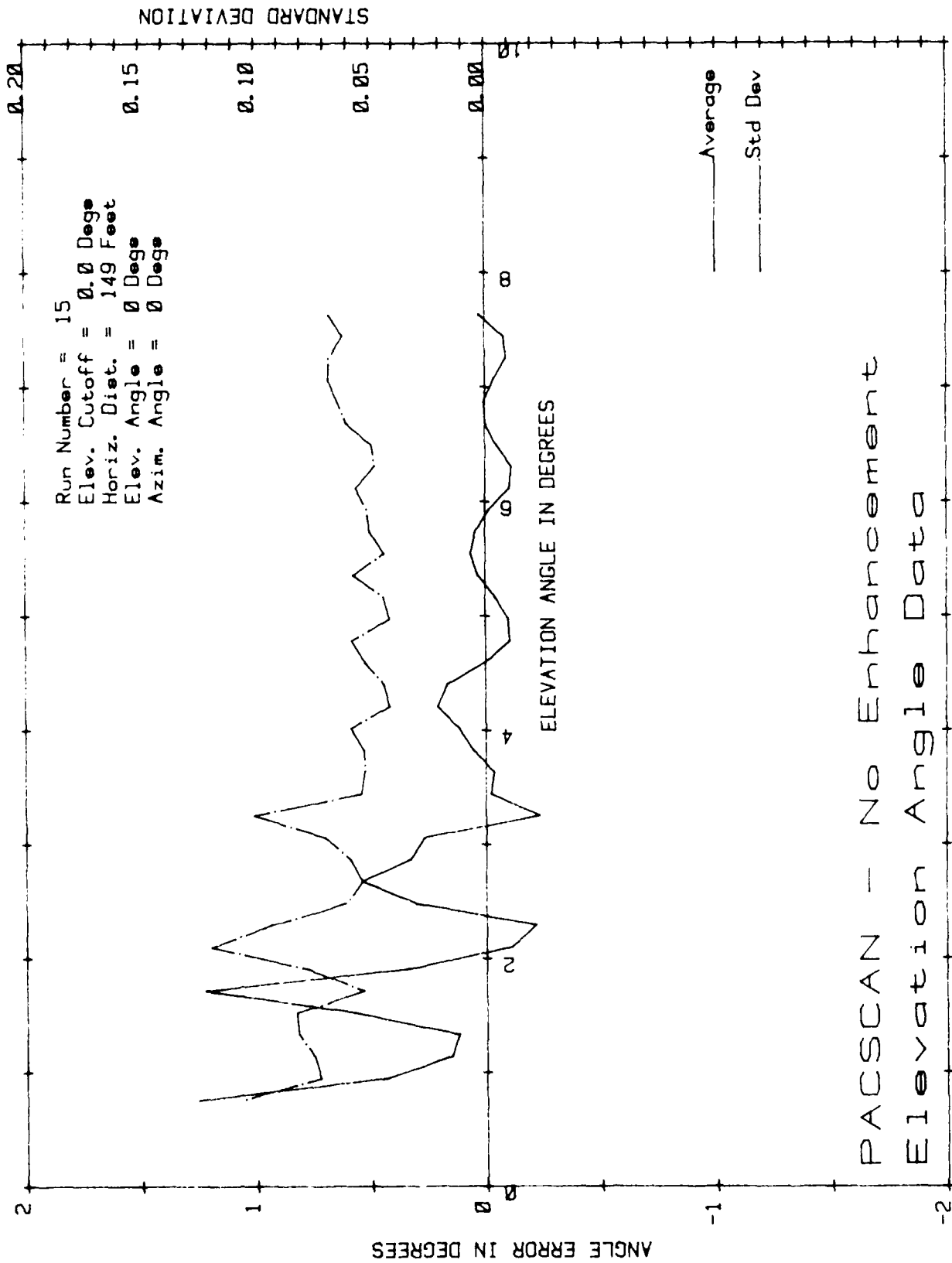

PACSCAN - No Enhancement
 Elevation Angle Data

Figure A-13. PACSCAN, no enhancement.

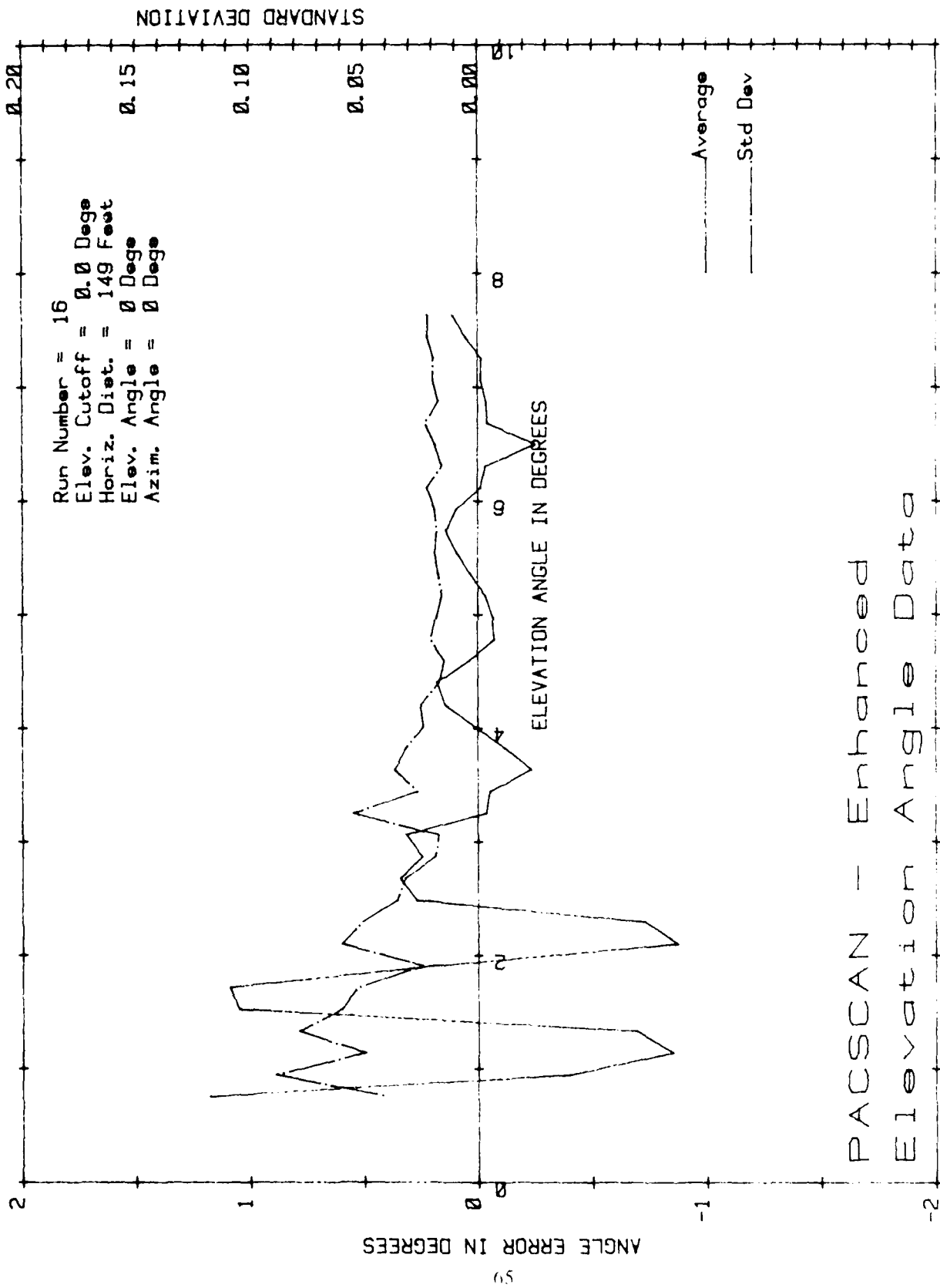

PACSCAN - Enhanced
 Elevation Angle Data

Figure A-14 - PACSCAN, enhanced

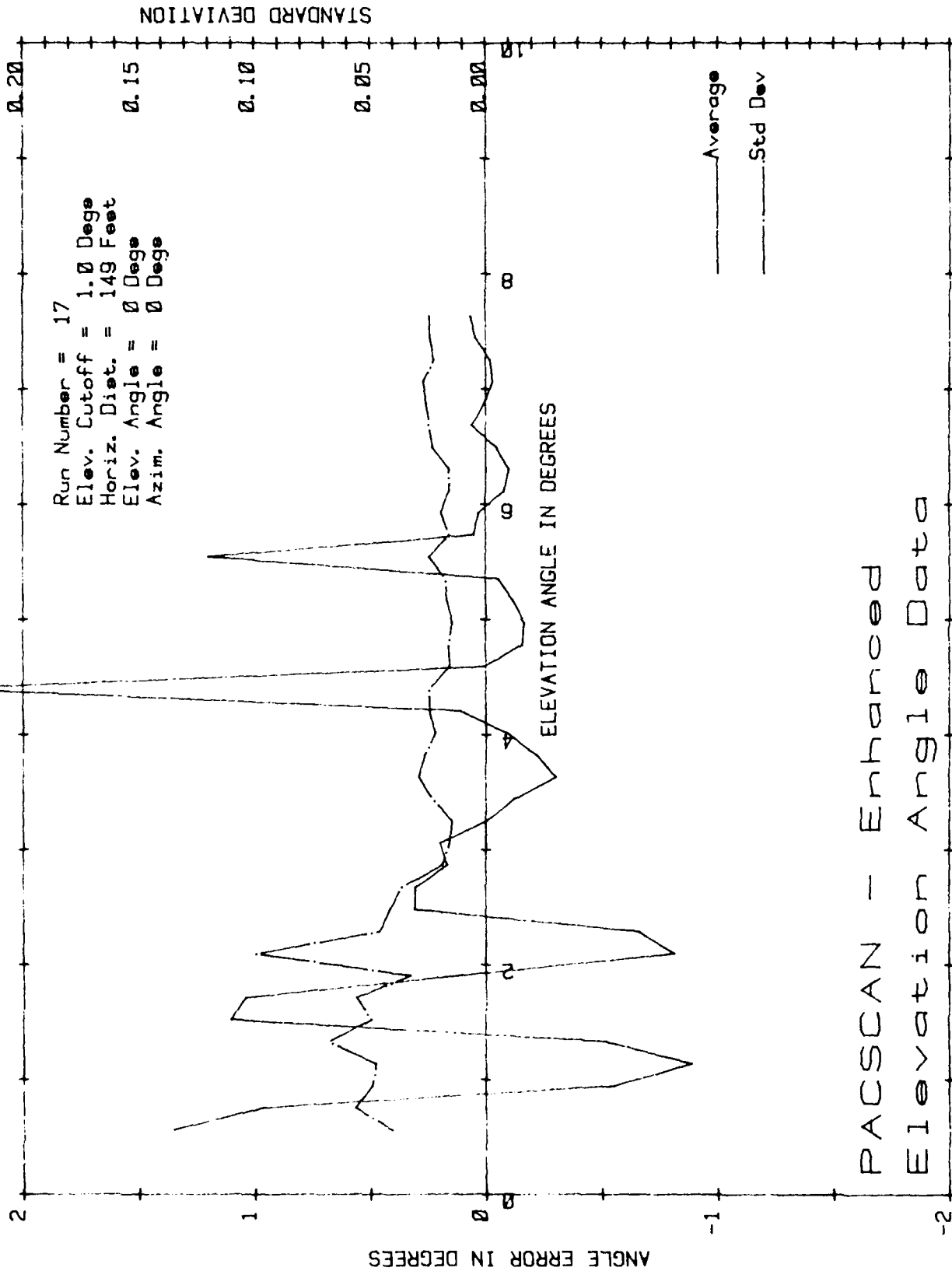
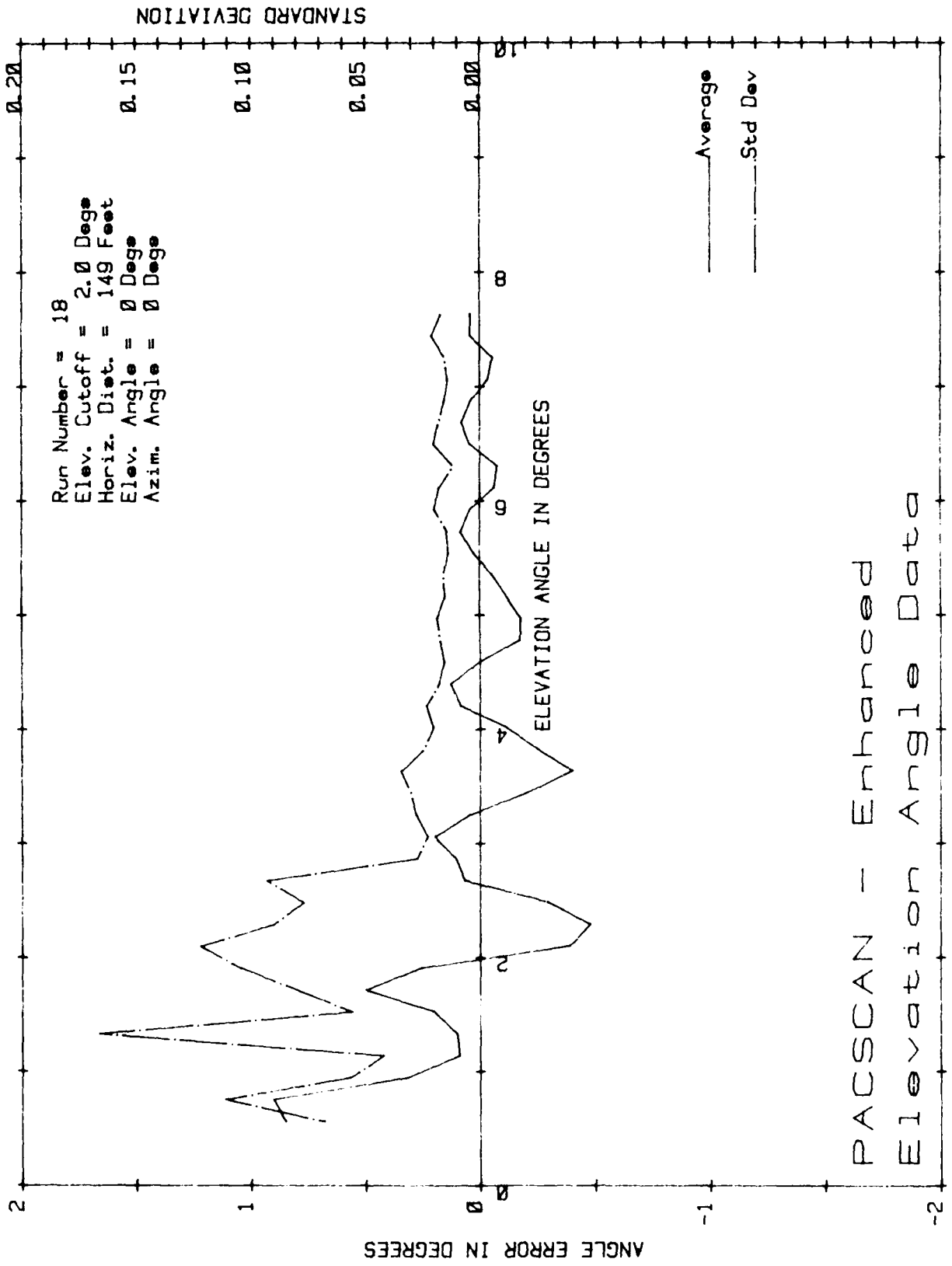
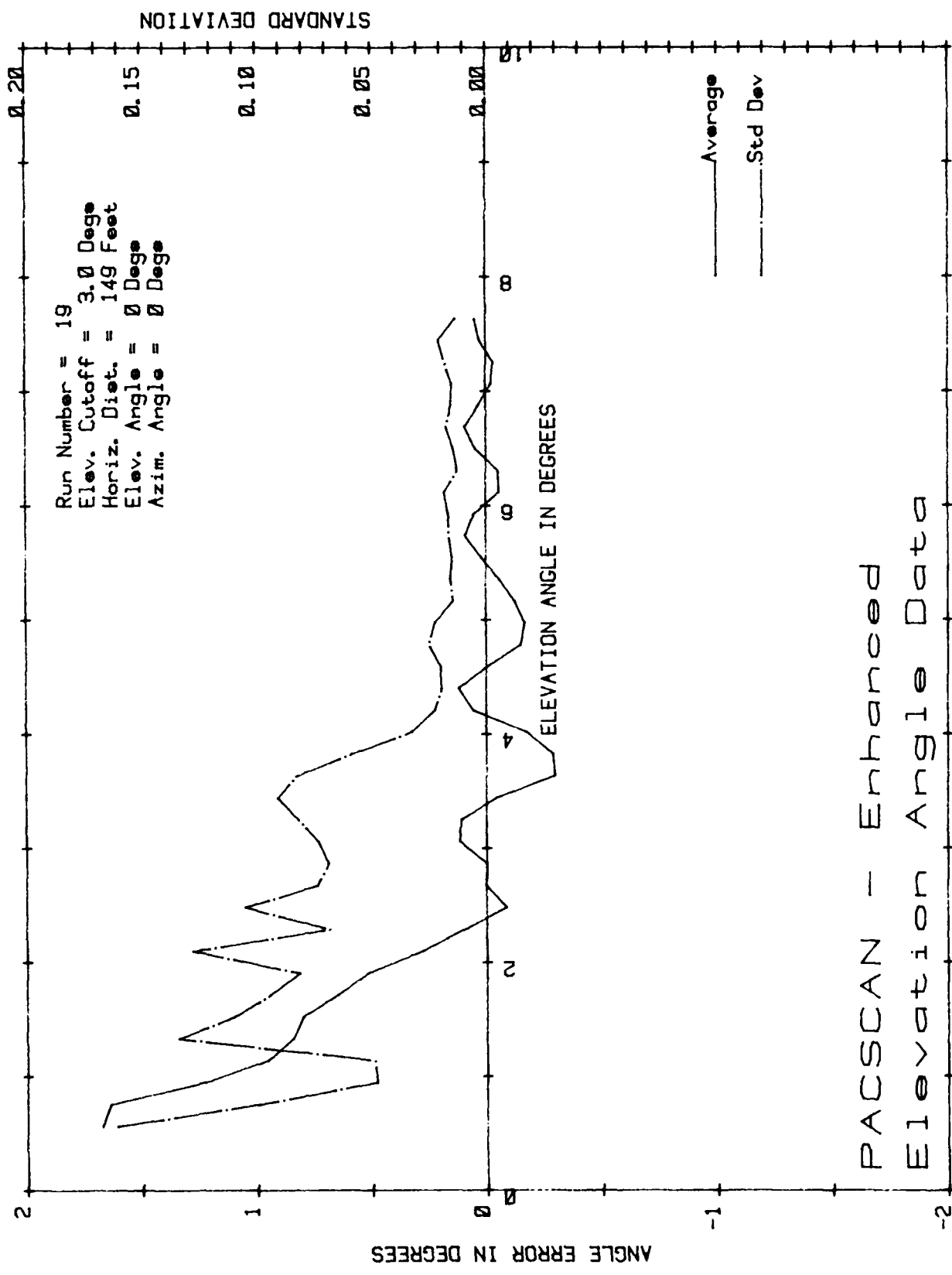

Figure A-15. PACSCAN, enhanced.



PACSCAN - Enhanced
 Elevation Angle Data

Figure A-16. PACSCAN, enhanced.



PACSCAN - Enhanced
 Elevation Angle Data

Figure A-17. PACSCAN, enhanced.

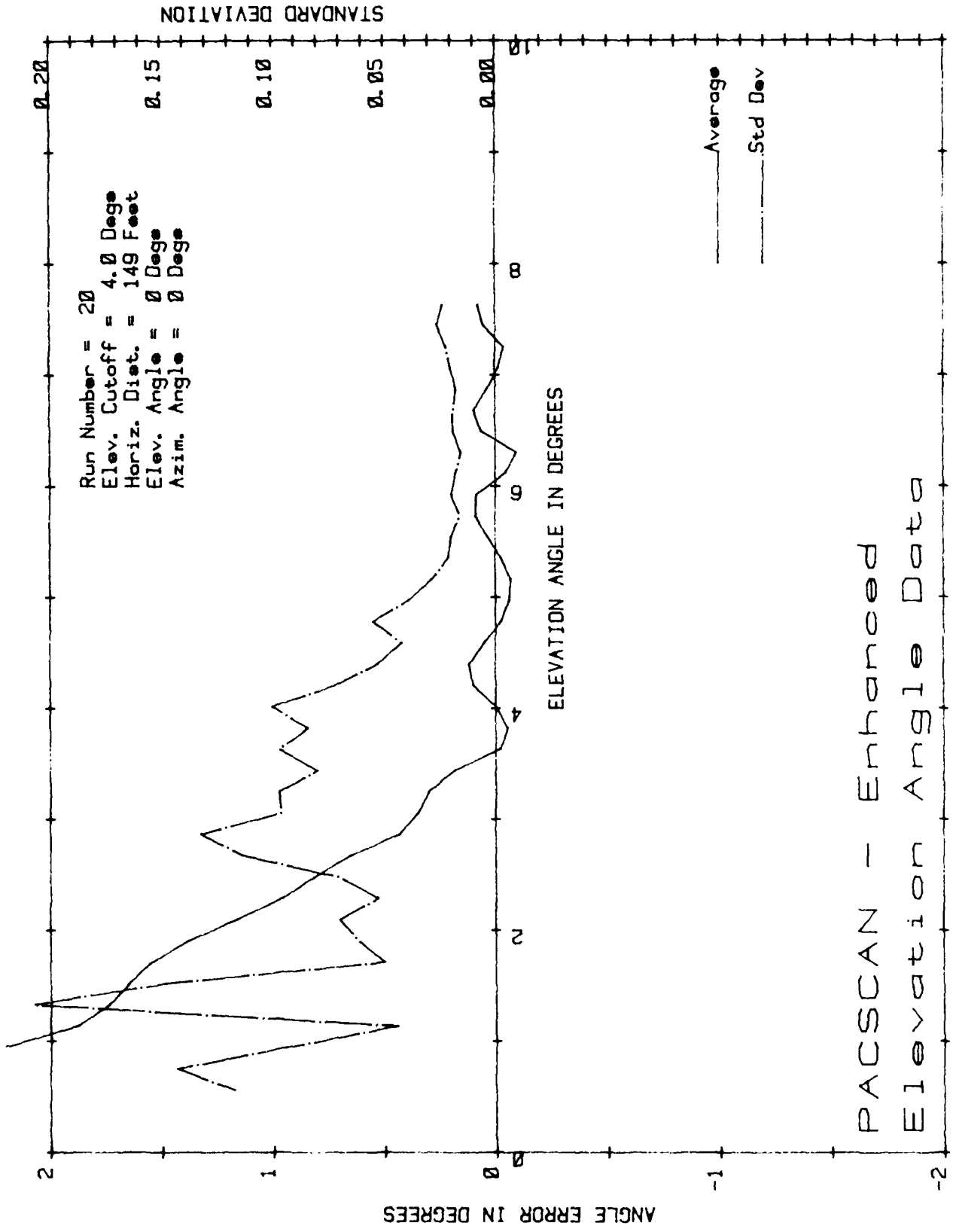
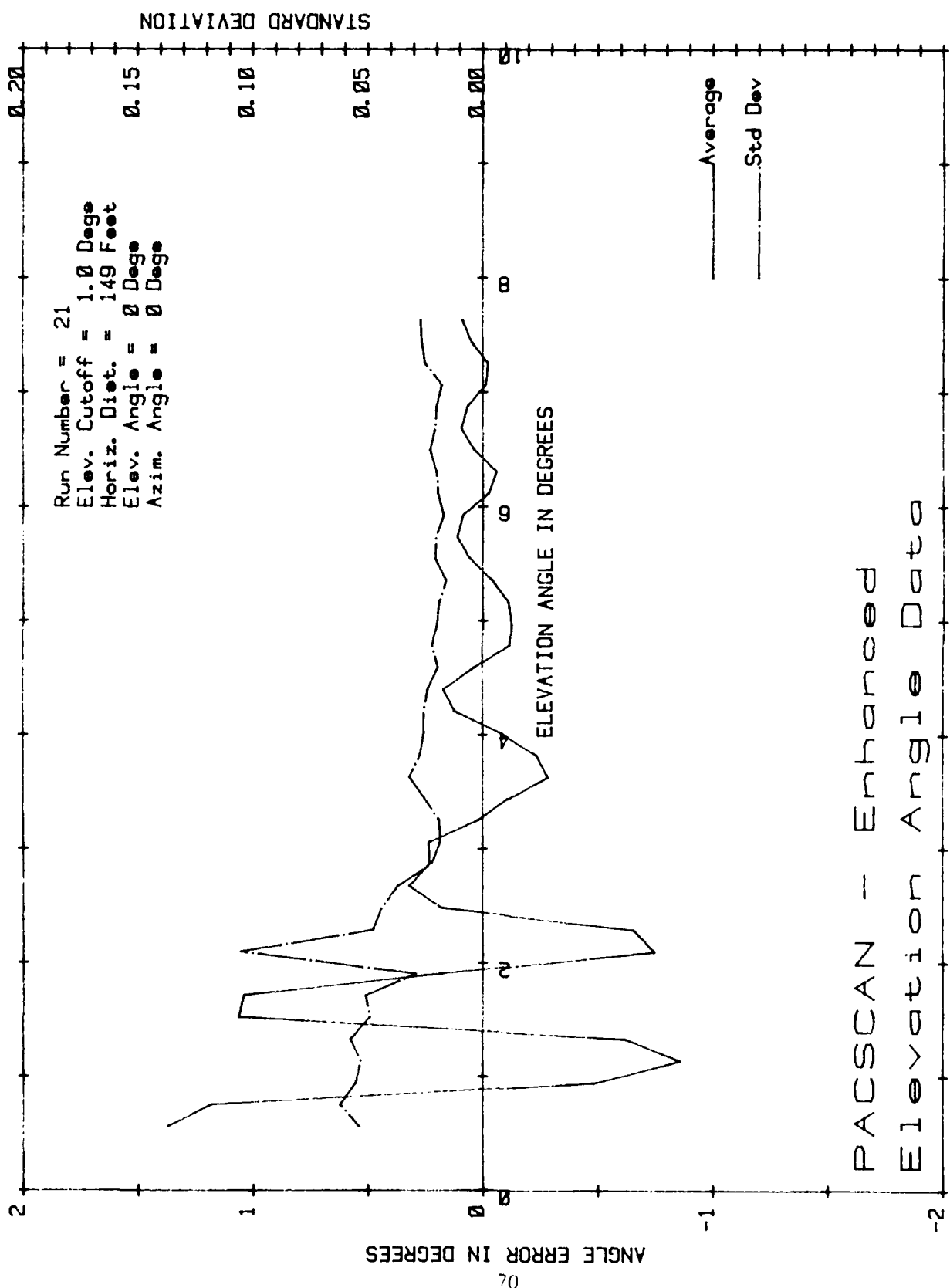

Figure A-18. PACSCAN, enhanced.

PACSCAN - Enhanced
 Elevation Angle Data



PACSCAN - Enhanced
 Elevation Angle Data

Figure A.19. PACSCAN, enhanced.

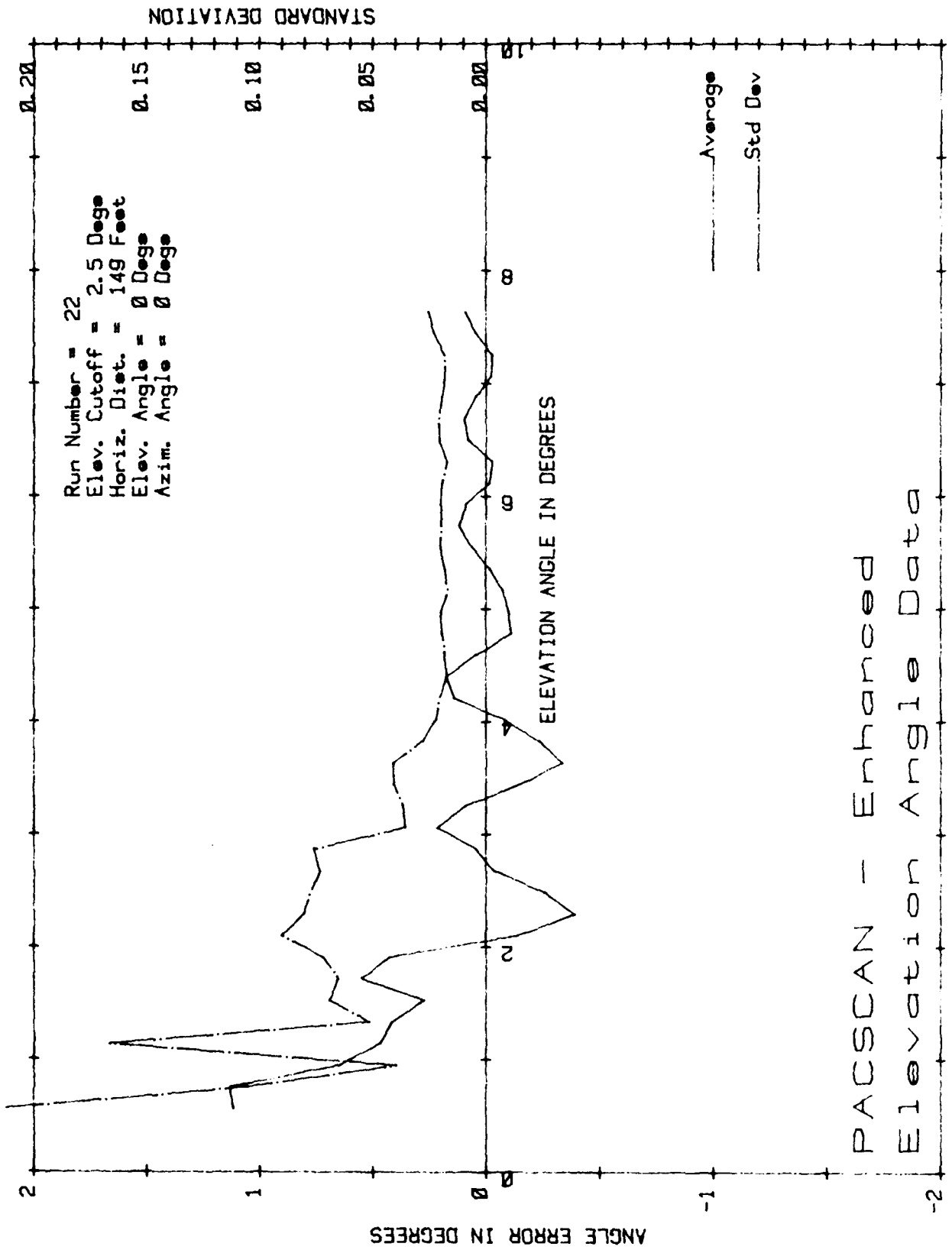

PACSCAN - Enhanced
 Elevation Angle Data

Figure A-20. PACSCAN, enhanced.

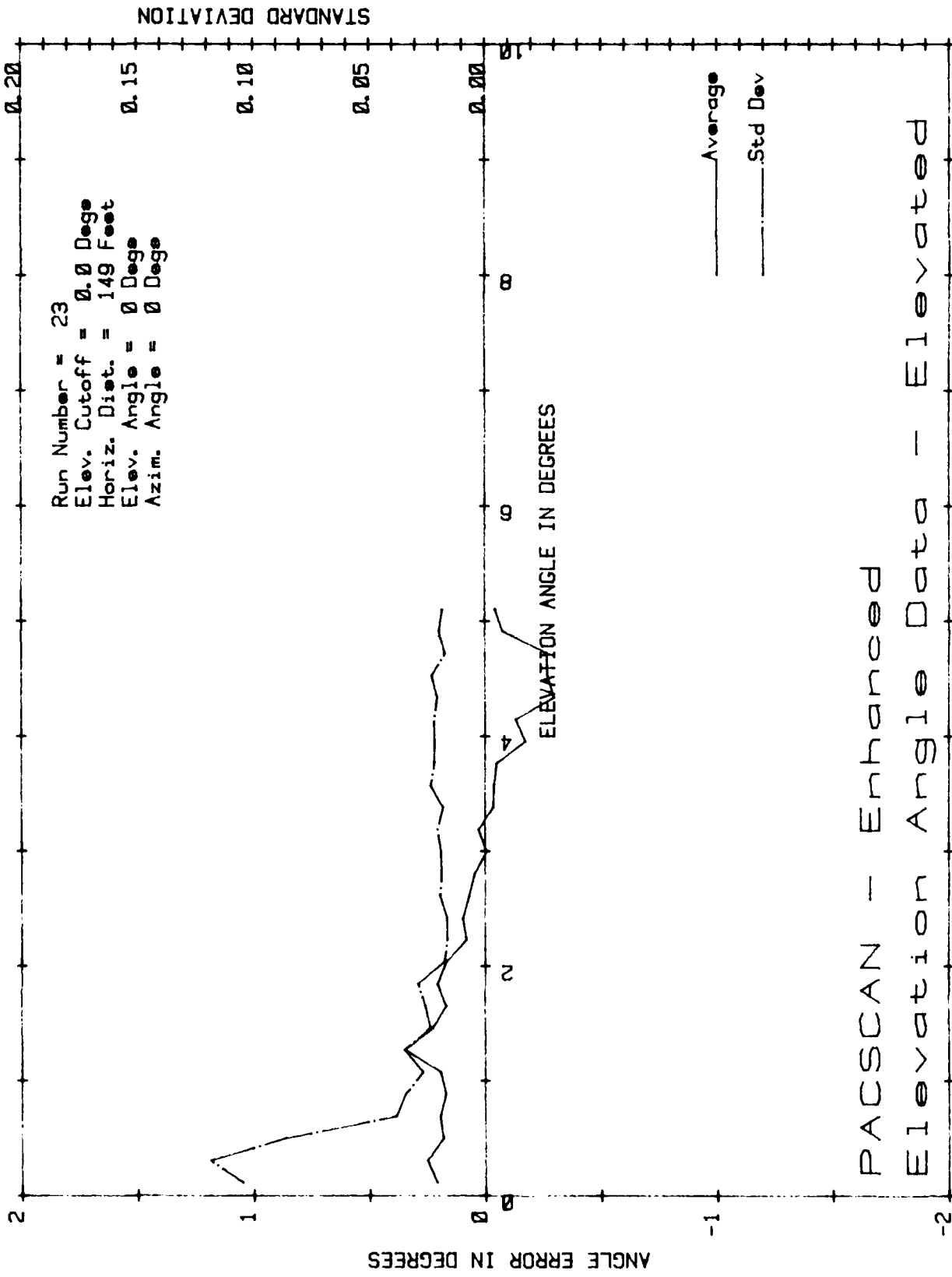
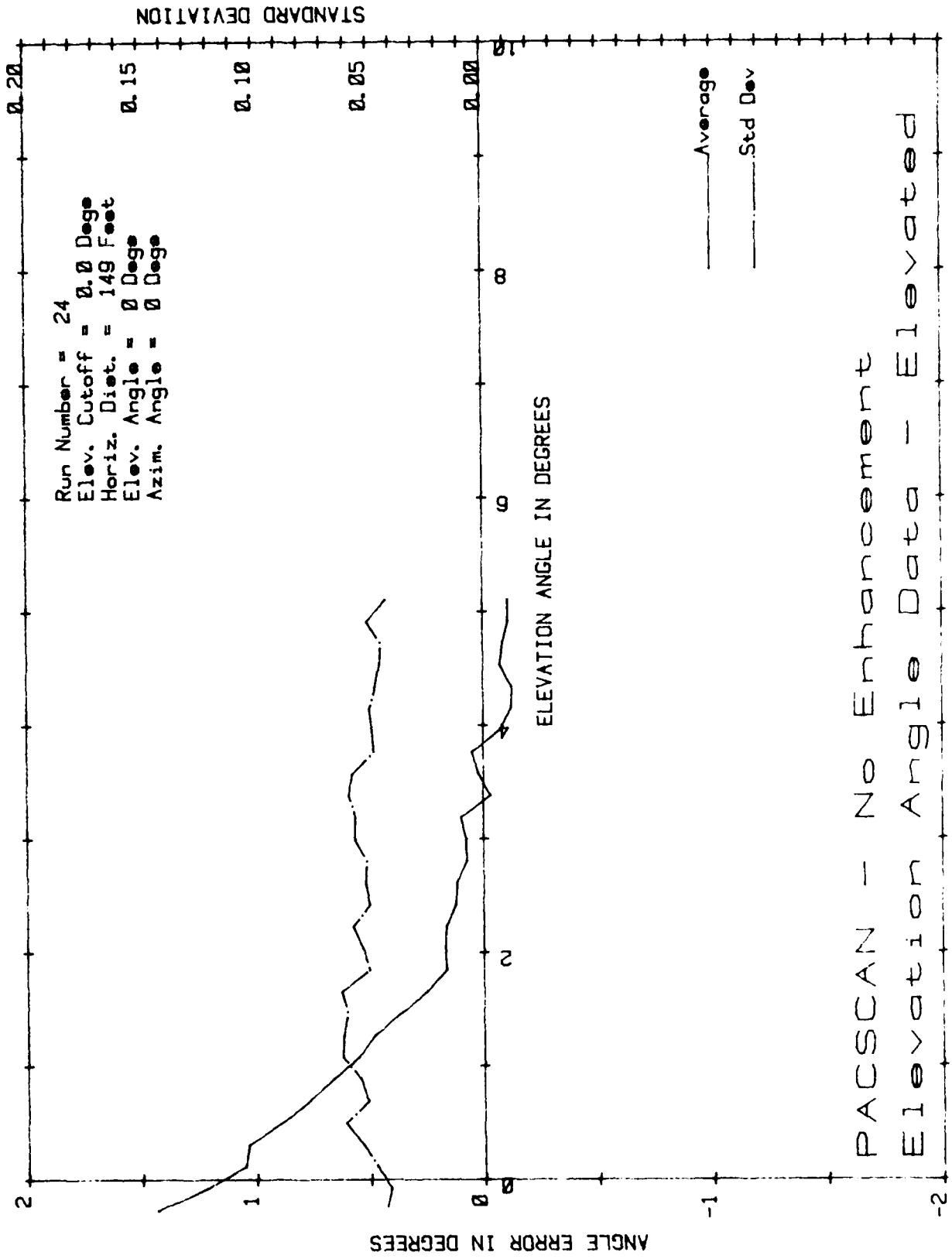
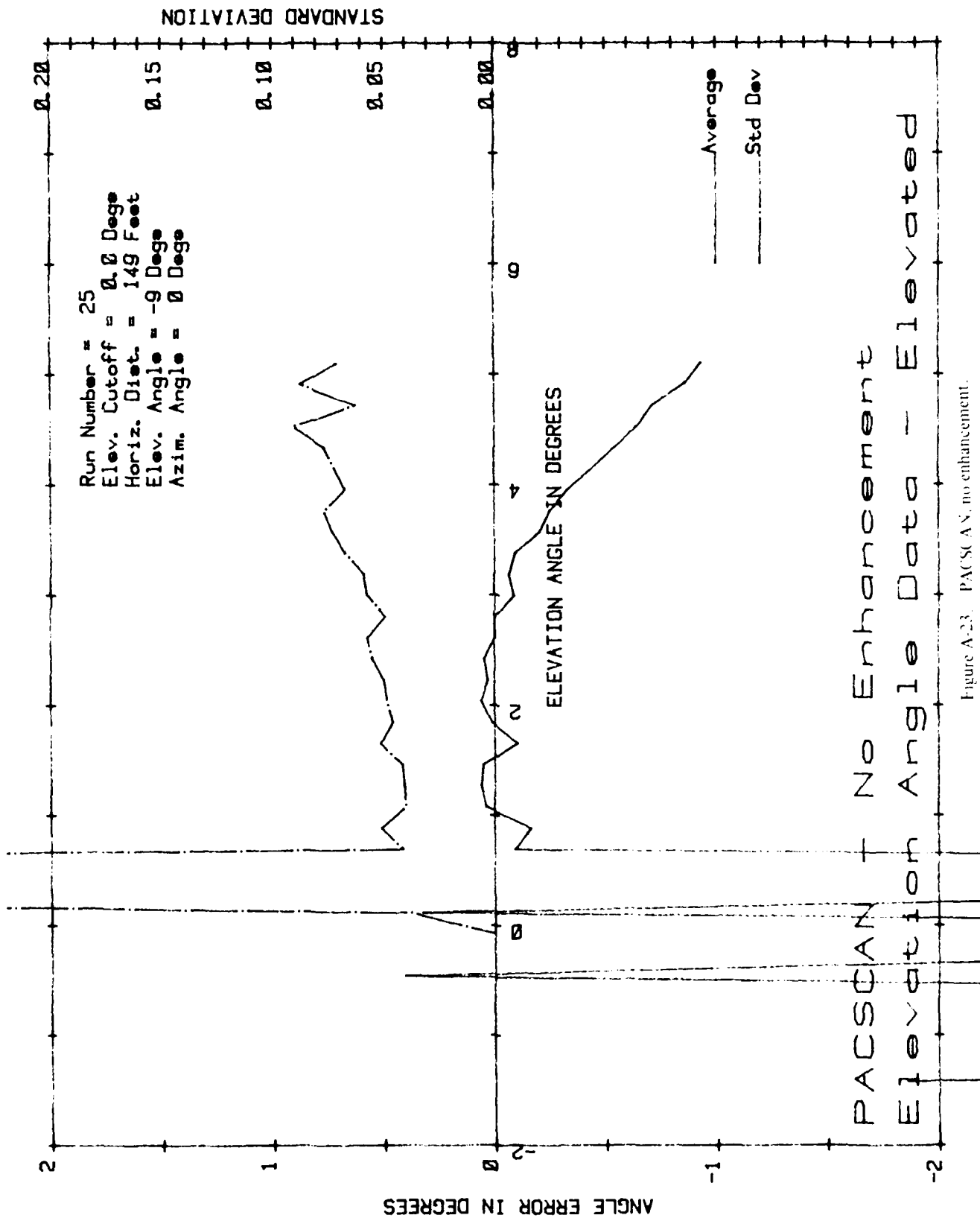

Figure A-21. PACSCAN, enhanced.



PACSCAN - No Enhancement
 Elevation Angle Data - Elevated

Figure A-22 PACSCAN no enhancement



PACSCAN - No Enhancement
 Elevation Angle Data - Elevated

Figure A-23. PACSCAN, no enhancement.

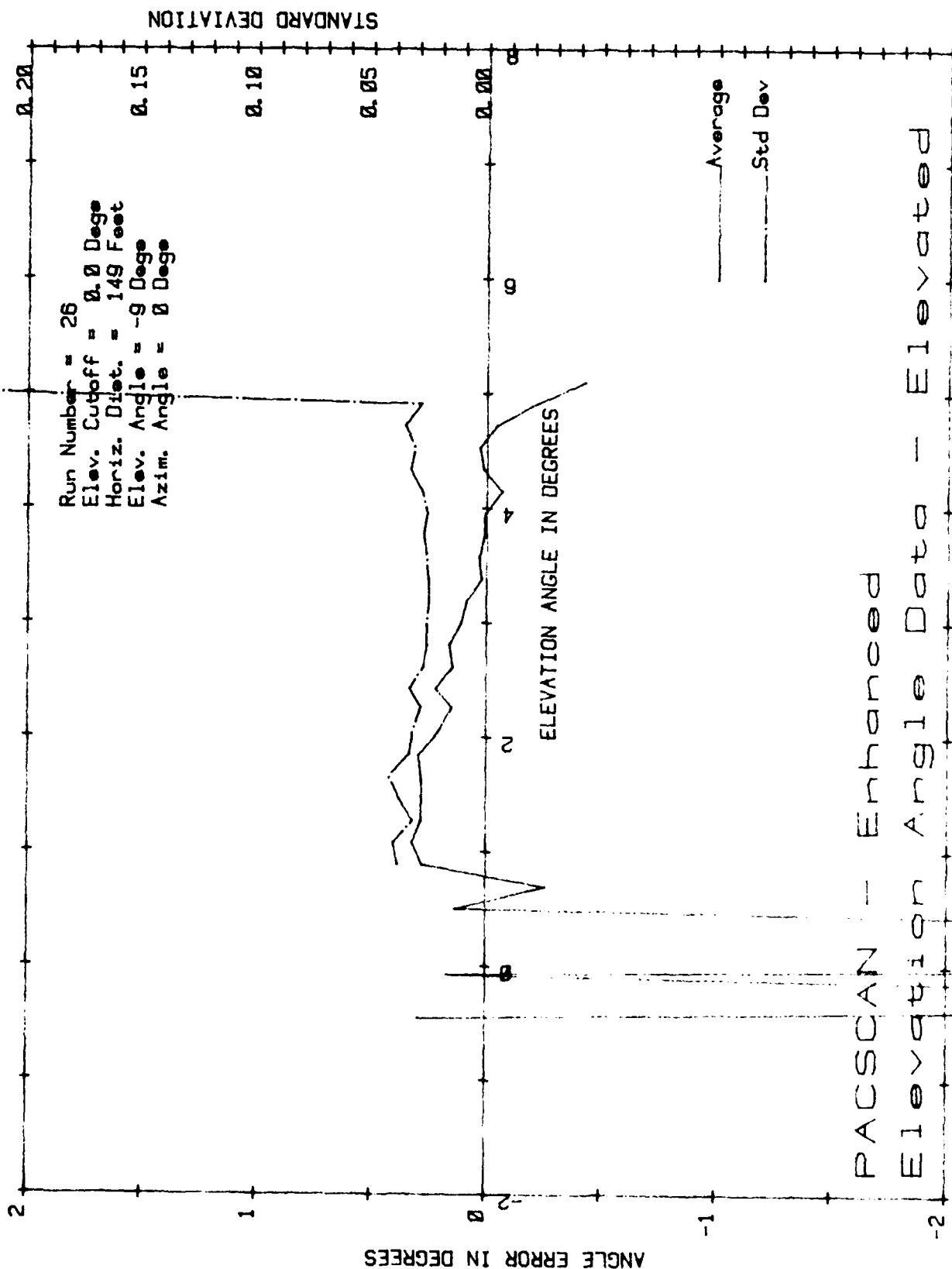

PACSCAN - Enhanced
 Elevation Angle Data - Elevated

Figure A-24 PACSCAN enhancement.

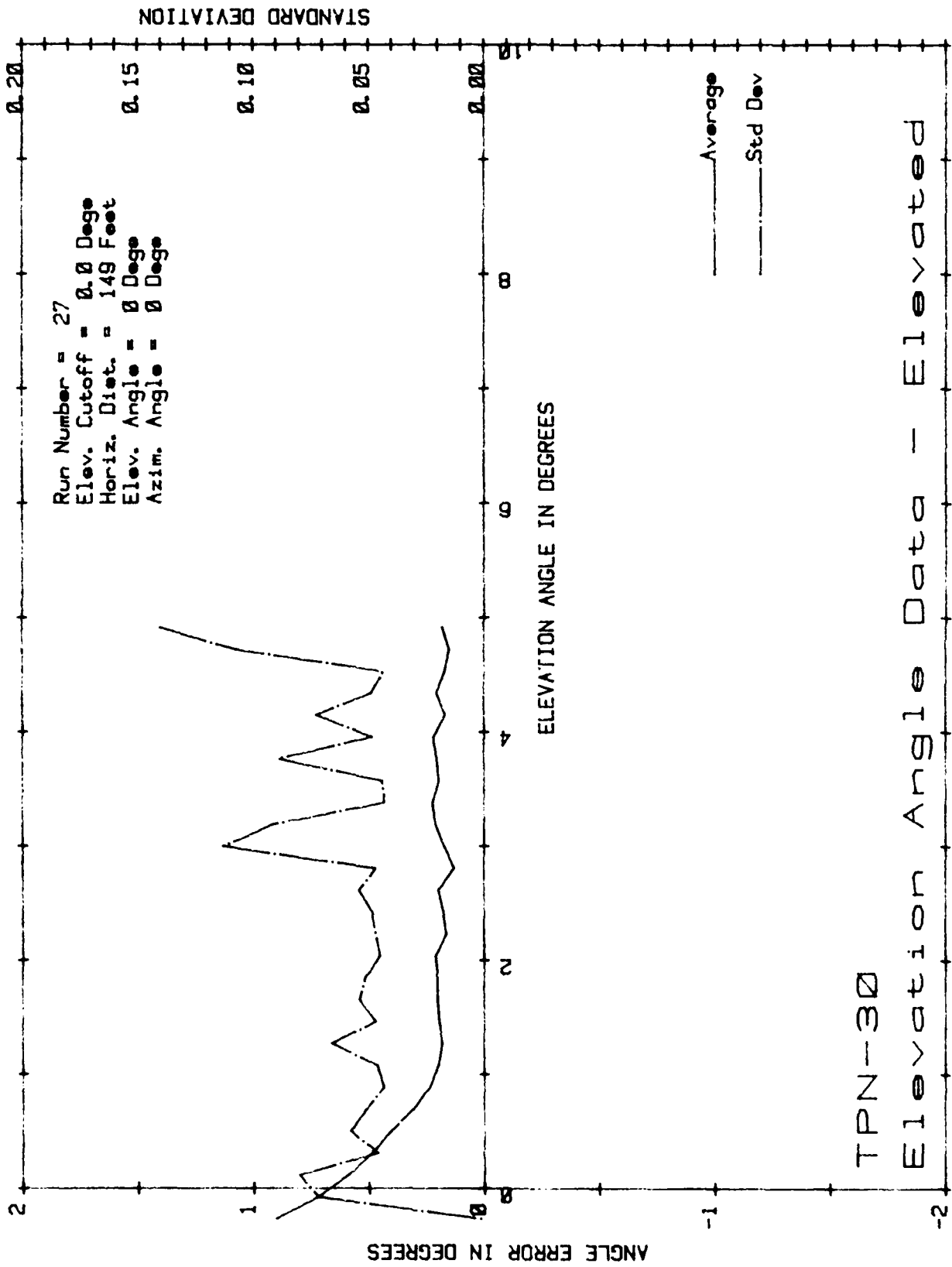

Figure A-25. TPN-30.

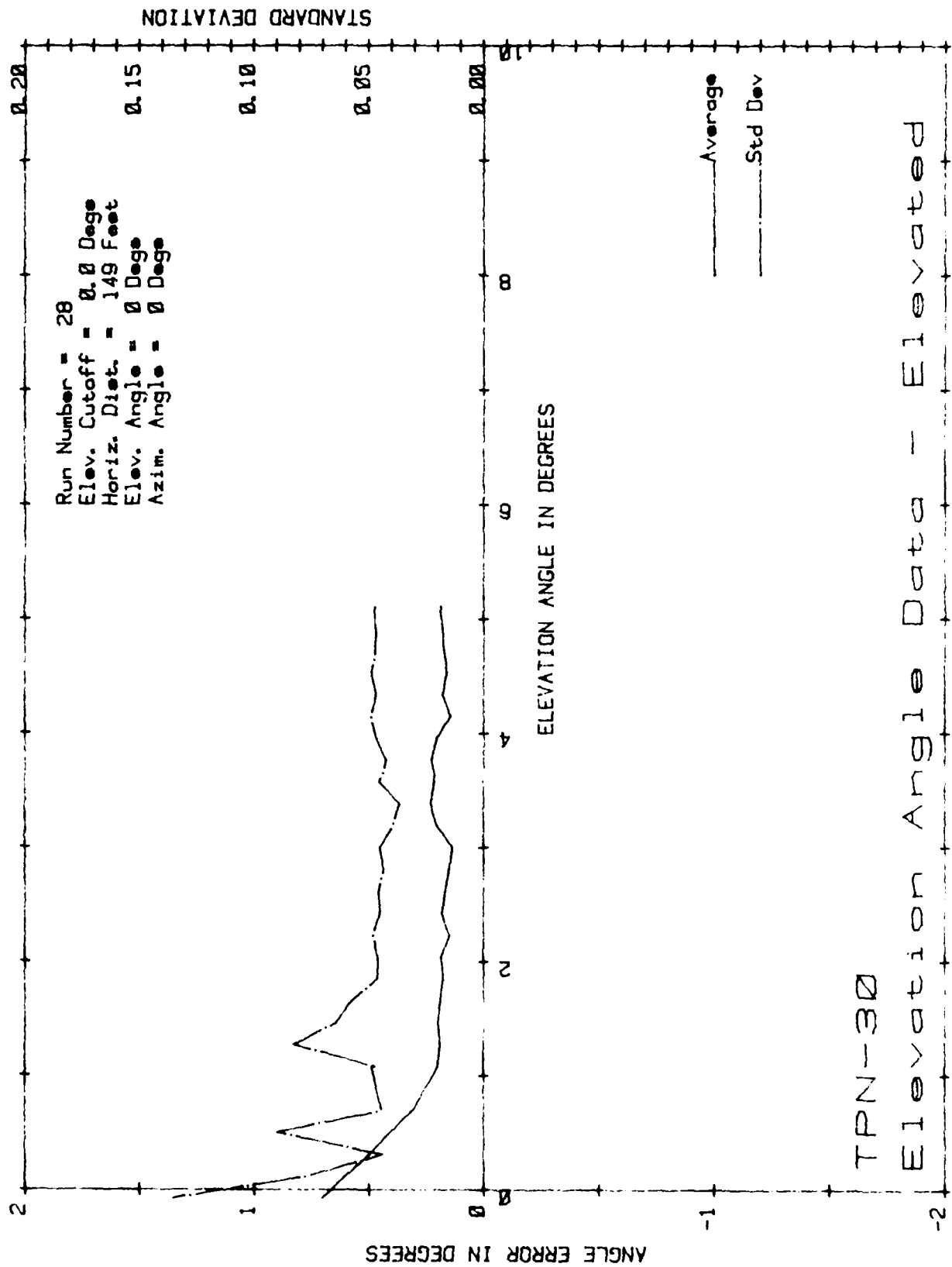

Figure A-26 TPN 30

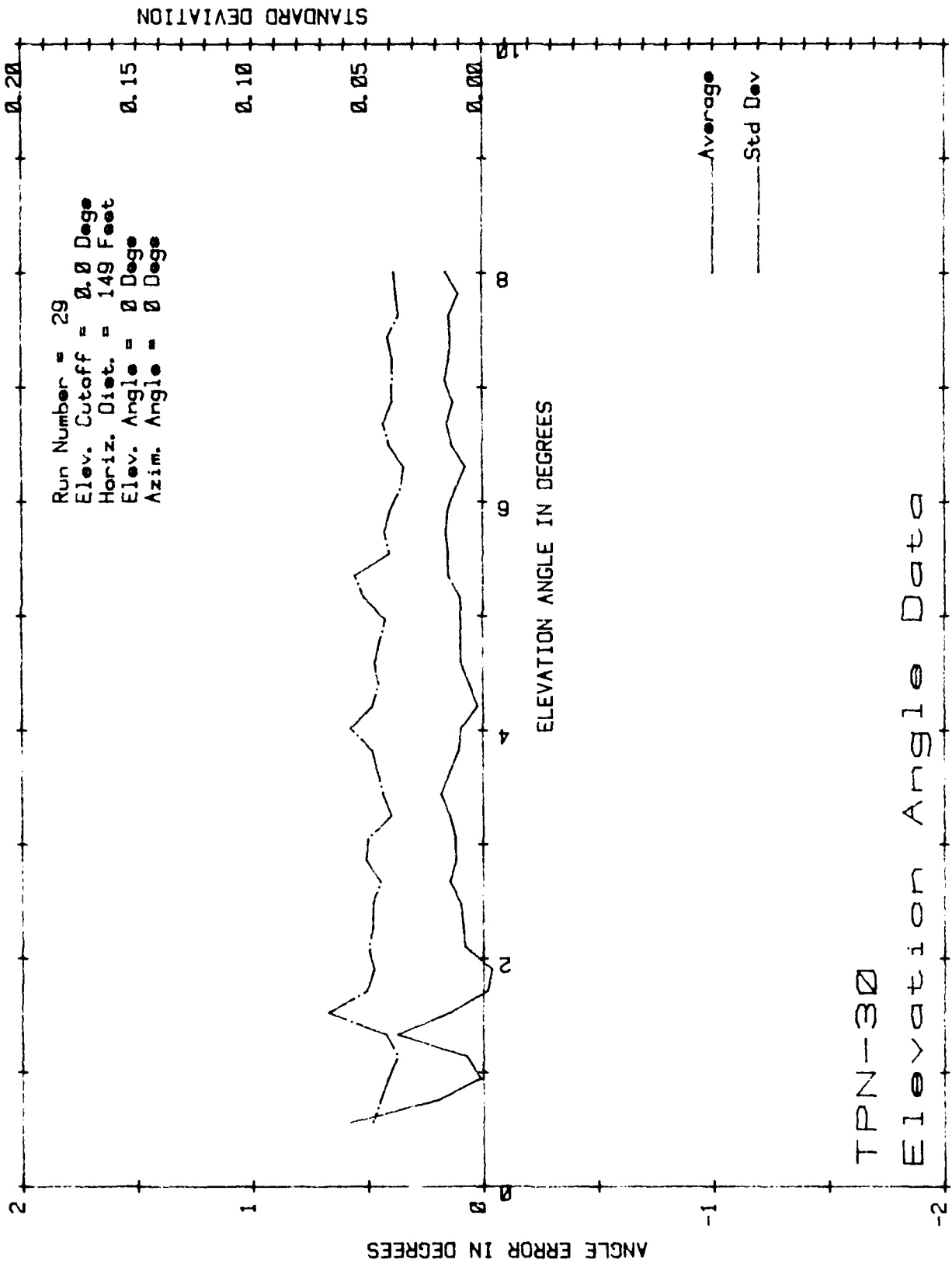

Figure A-27. TPN-30.

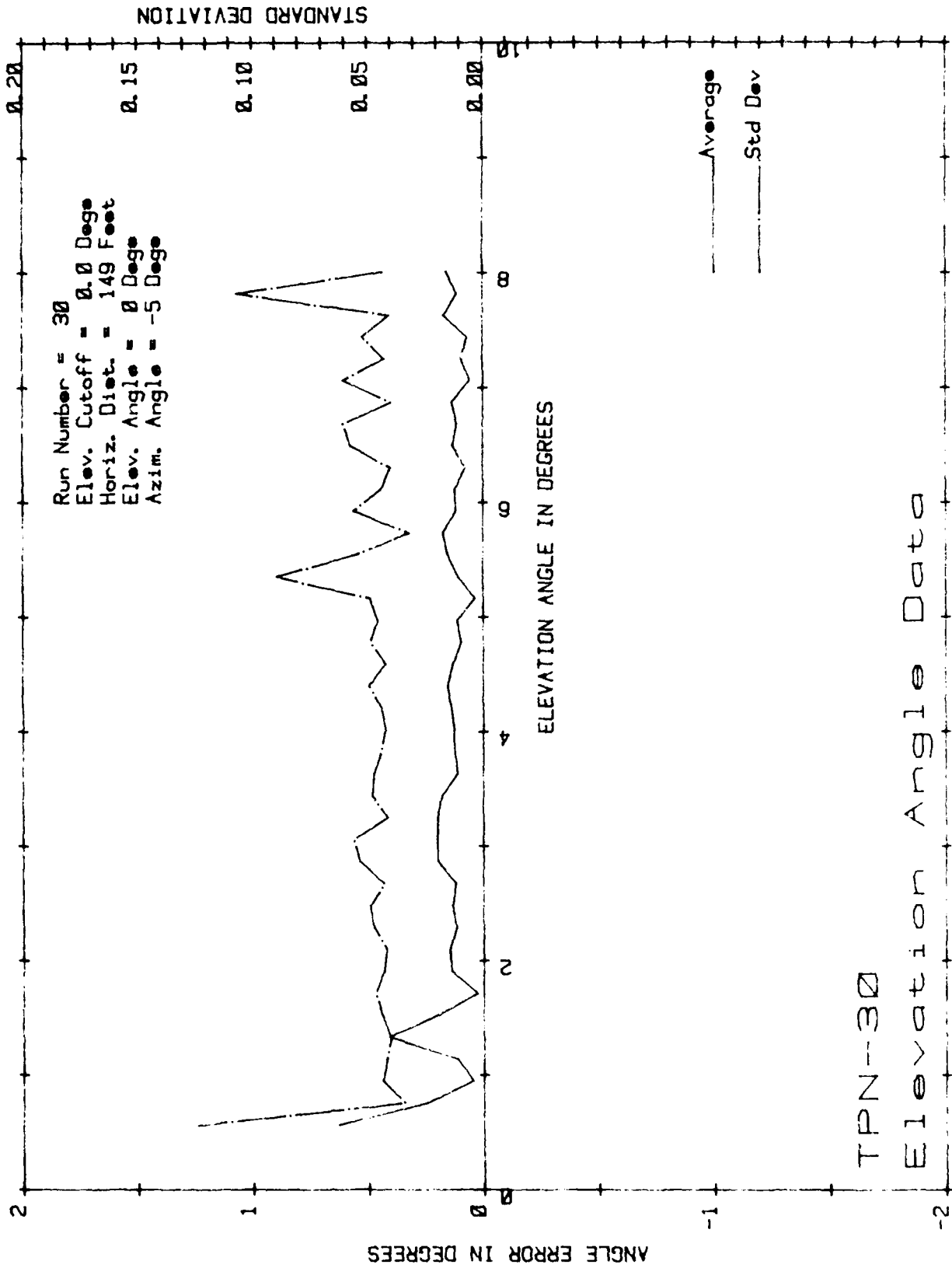
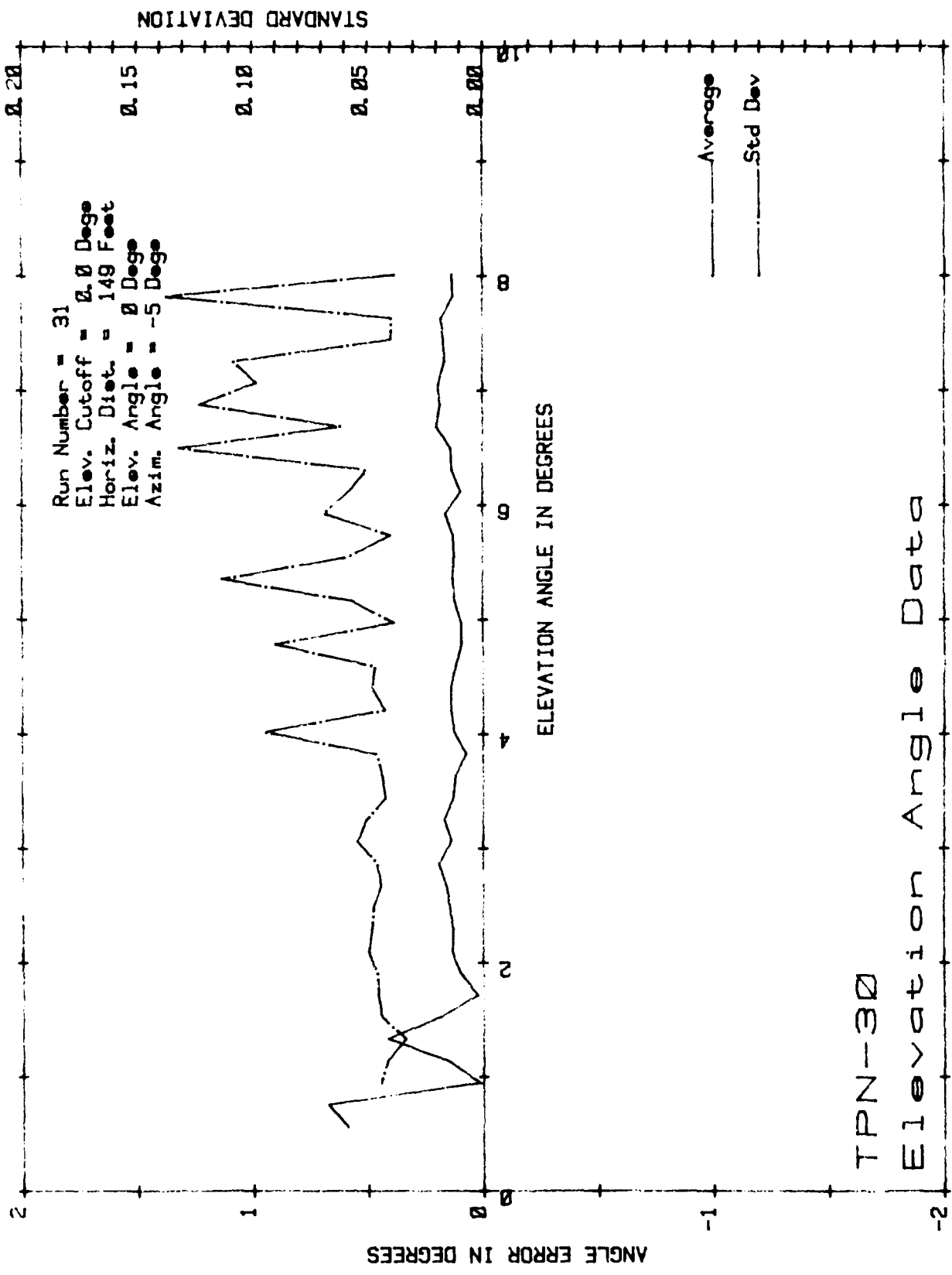

Figure A-28. TPN 30.



TPN-30
 Elevation Angle Data

Figure A-29. TPN-30.

APPENDIX B

AIR EQUIPMENT (PACSCAN, TLS)

BASIC ELEMENTS OF THE TLS

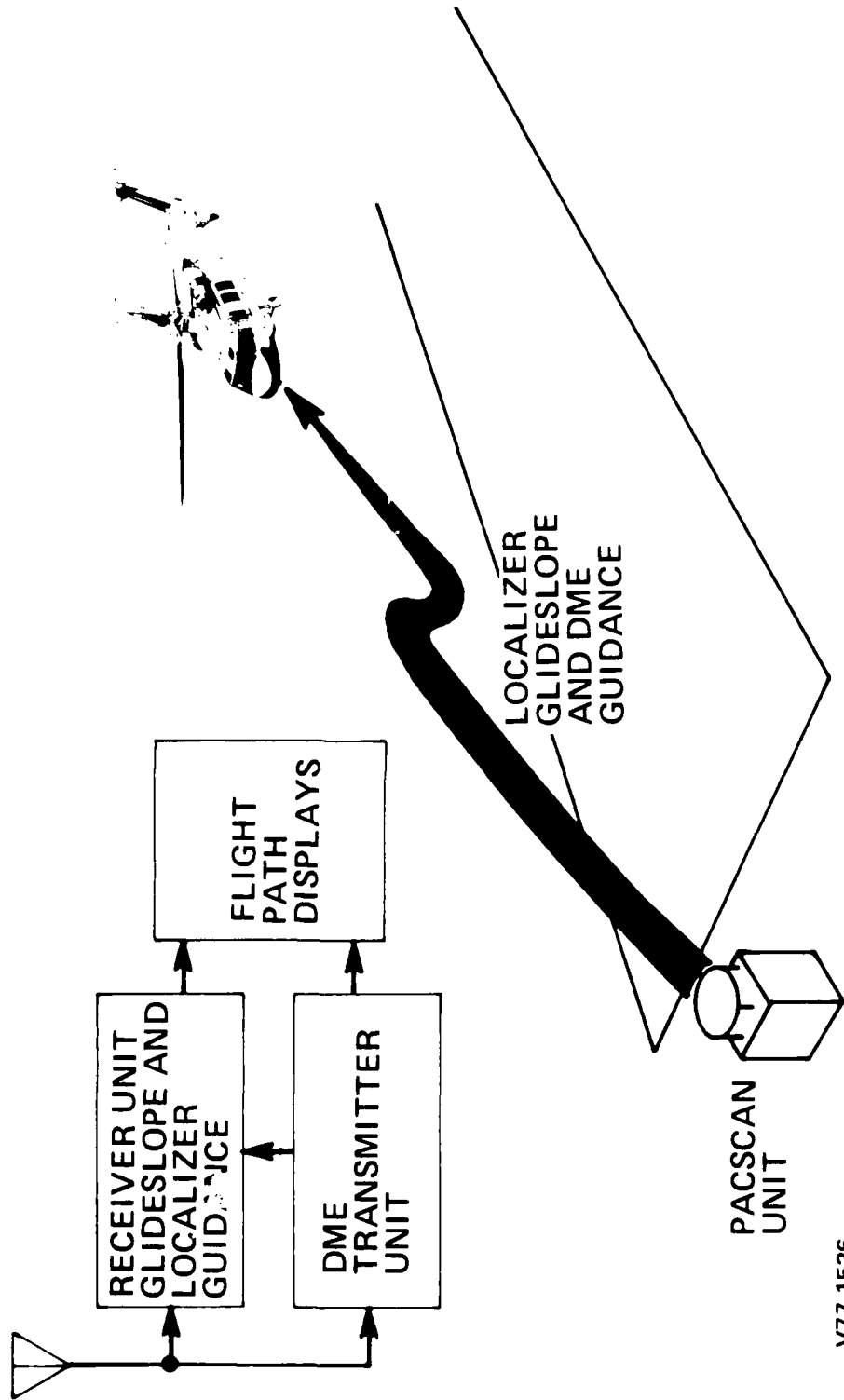

V77-1526

GROUND SET TECHNICAL CHARACTERISTICS

ELECTRONIC ASSEMBLY

- SIZE - 28" HIGH, 16" WIDE, 16" DEEP
- WEIGHT - 35 POUNDS
- PRIMARY POWER - 150 WATTS FROM 24-VOLT BATTERY OR OTHER SOURCES

TRIPOD ASSEMBLY

- SIZE-FOLDED - 7" HIGH, 7" WIDE, 25" LONG
- BATTERY
- AZIMUTH COVERAGE - $\pm 30^{\circ}$ PROPORTIONAL SECTOR
- ELEVATION COVERAGE - 0 TO 20°
- GLIDESLOPES FROM 6 TO 12°
- DME COVERAGE - ± 30 AZIMUTH, 20° ELEVATION
- RANGE - 10 NAUTICAL MILES
- AIRBORNE ACTIVATION OF GROUND EQUIPMENT (SERVICE REQUEST MODE)
- SETUP ACCURACY - BETTER THAN 0.5° ON AXIS - AUTOMATIC TILT MONITOR
- COMPONENT COMMONALITY WITH TLS AND TACSCAN
- TEST SET COMMONALITY WITH TLS TEST SETS - AN/TS-3381 AND AN/TS-3382

V77-1296

P A C - S C A N

GUIDANCE-PATH CHARACTERISTICS (WITH AN/ARQ-31)

GLIDESLOPE ANGLE DEGREES	GLIDESLOPE COURSE WIDTH** ±DEGREES FROM COURSE	LOCALIZER COURSE WIDTH** ±DEGREES FROM COURSE
6	2.0	3.0
7	2.25	3.25
8	2.75	3.75
9	3.0	4.0
10	3.25	4.25
11	3.75	4.75
12	4.0	5.0

*COMMON TO ALL EQUIPMENTS

**WIDTH IS ADJUSTABLE +100% (IN FOUR STEPS) AND -50% (IN TWO STEPS)
BY WIRED JUMPER CHANGES

V77-1302

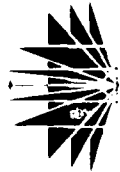

Microwave Landing System



SCANNING ANTENNA PATTERN

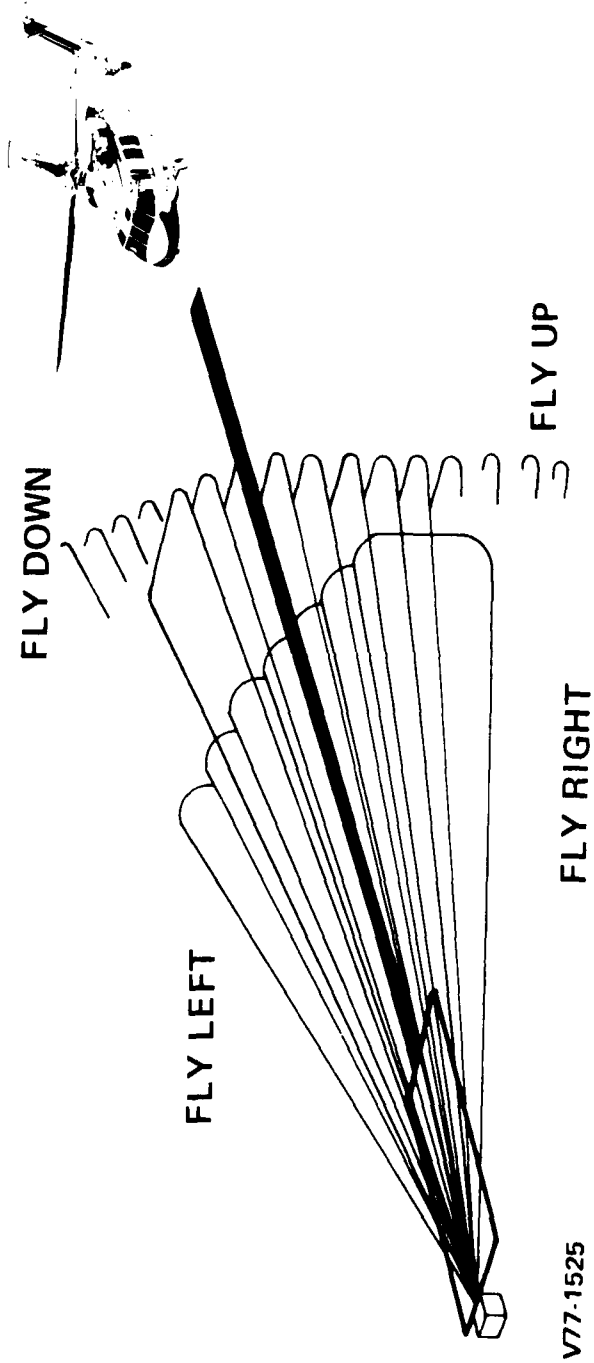

LOCALIZER ANGLE CODE SPACING AND COVERAGE

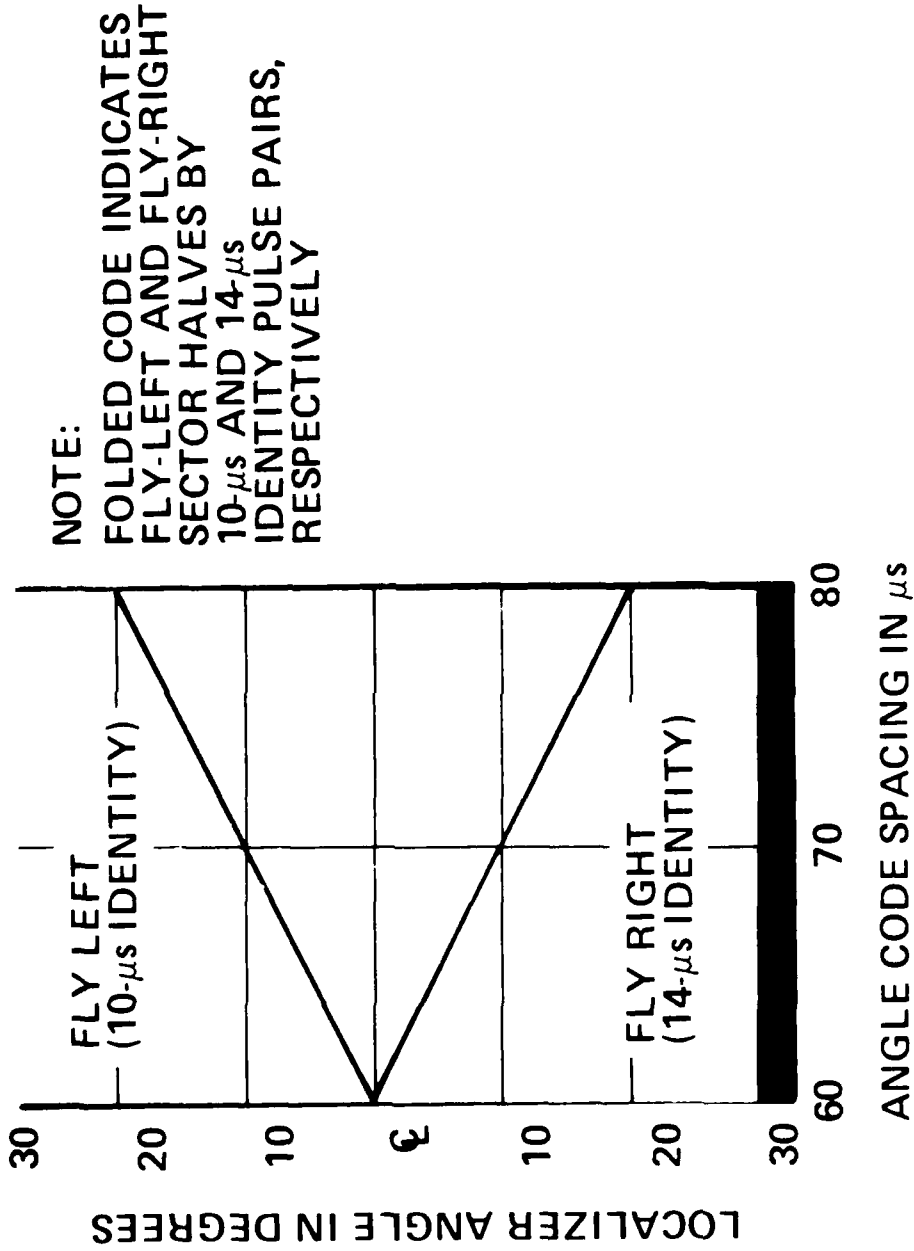

V77-1297

OPERATING CHANNELS*

<u>CHANNEL NUMBER</u>	<u>GROUND-TO-AIR FREQUENCY (GHZ)</u>	<u>INTERROGATION PULSE-PAIR SPACING (μs)</u>
1	15.412	11
2	15.436	13
3	15.484	15
4	15.508	17
5	15.532	19
6	15.568	21
7	15.592	23
8	15.616	25
9	15.664	27
10	15.688	29

DME AIR-TO-GROUND FREQUENCY IS 15.460 GHZ

*COMMON TO ALL EQUIPMENTS

V77-1299

GROUND SET FEATURES

- PRECISION, FAN-SHAPED MICROWAVE SCANNING BEAMS
- COMPATIBLE WITH OTHER ARMY SCANNING BEAM EQUIPMENTS
- SCANNING BEAM ACCURACY AND COURSE STABILITY
- FREE FROM SITING EFFECTS
- LIGHTWEIGHT MANPACK
- BATTERY OR AC OPERATED
- COMPLETELY SELF-CONTAINED
- INTERNALLY MONITORED
- INTEGRAL PRECISION DME

V77-1304

COVERAGE AND CODING

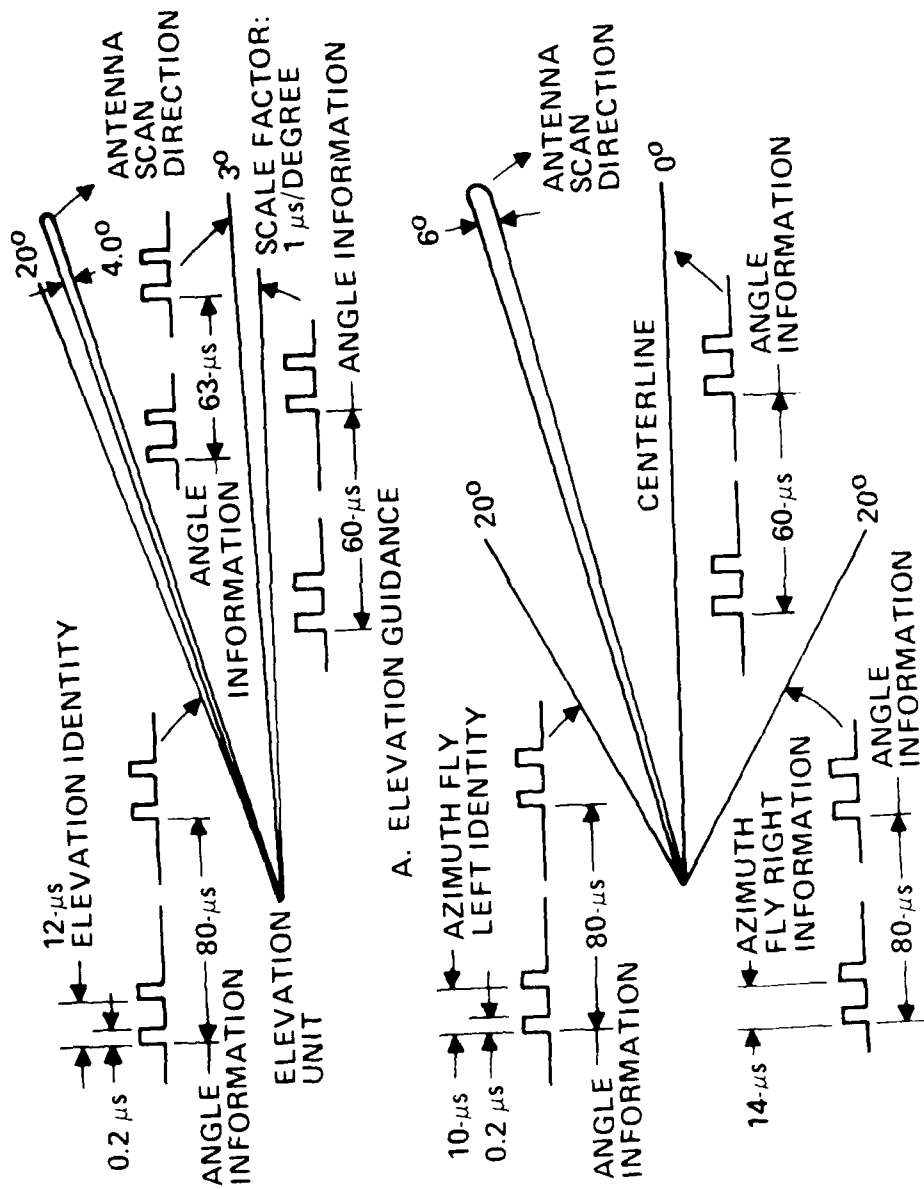

V77 1298

B. AZIMUTH GUIDANCE

BEAM MODULATION OF U.S. ARMY MICROWAVE

SCANNING BEAM
GUIDANCE FUNCTION IDENTITY
12 μs = GLIDESLOPE
10 AND 14 μs = LOCALIZER

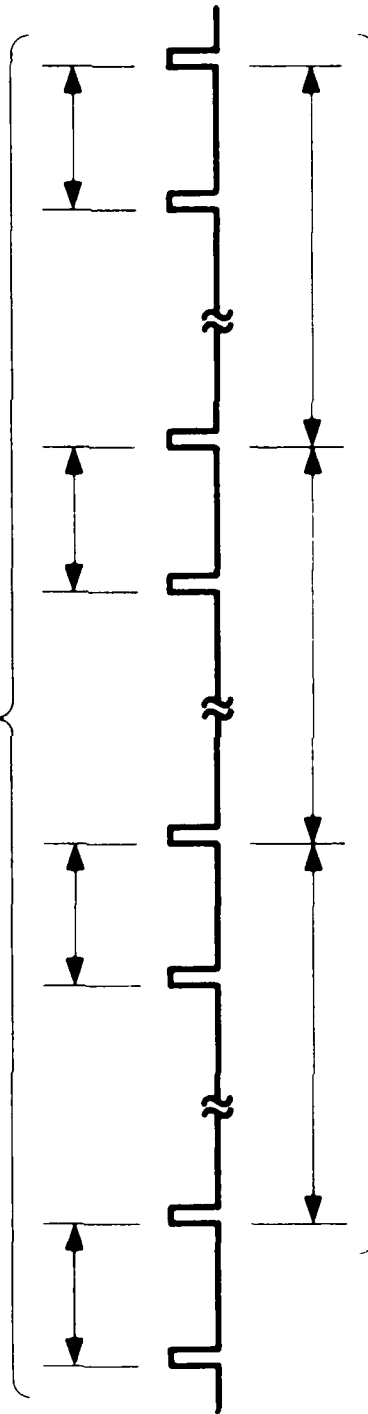

EACH SPACING REPRESENTS
THE INSTANTANEOUS ANGLE
OF THE SCANNING BEAM

V77-1301

DME FUNCTION AND CODING

A. SOLICIT INTERVAL - GROUND SET INITIATES DME PERIOD

- GROUND TRANSMISSION

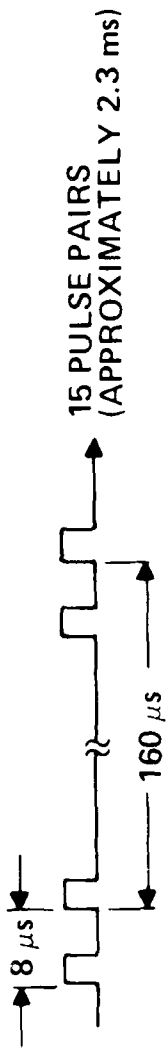

B. AIR SET INTERROGATES - GROUND SET REPLIES

- AIR TRANSMISSION

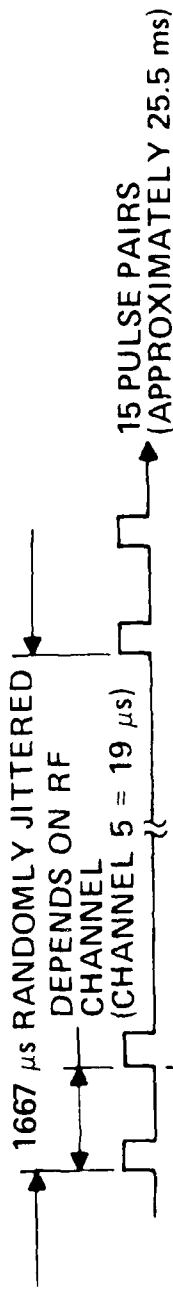

- GROUND REPLY

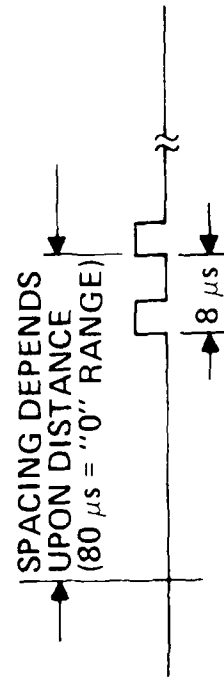

V77-1300

U.S. ARMY MICROWAVE LANDING SYSTEMS

- COMMON AIRBORNE UNIT - AN/ARQ-31
- A FAMILY OF GROUND UNITS TO MEET DIFFERENT OPERATIONAL SITUATIONS

TLS

SPLIT SITE
SERVE HELICOPTER AND FIXED WING
MAN TRANSPORTABLE (TWO MAN CARRY
PER UNIT)

TACSCAN

COLLOCATED
SERVE HELICOPTER AND FIXED WING
MAN TRANSPORTABLE (TWO MAN CARRY)

PACSCAN

COLLOCATED
SERVE HELICOPTER
MAN PORTABLE (BACK PACK)

V77-1306

TIME SHARING OF GUIDANCE SIGNALS

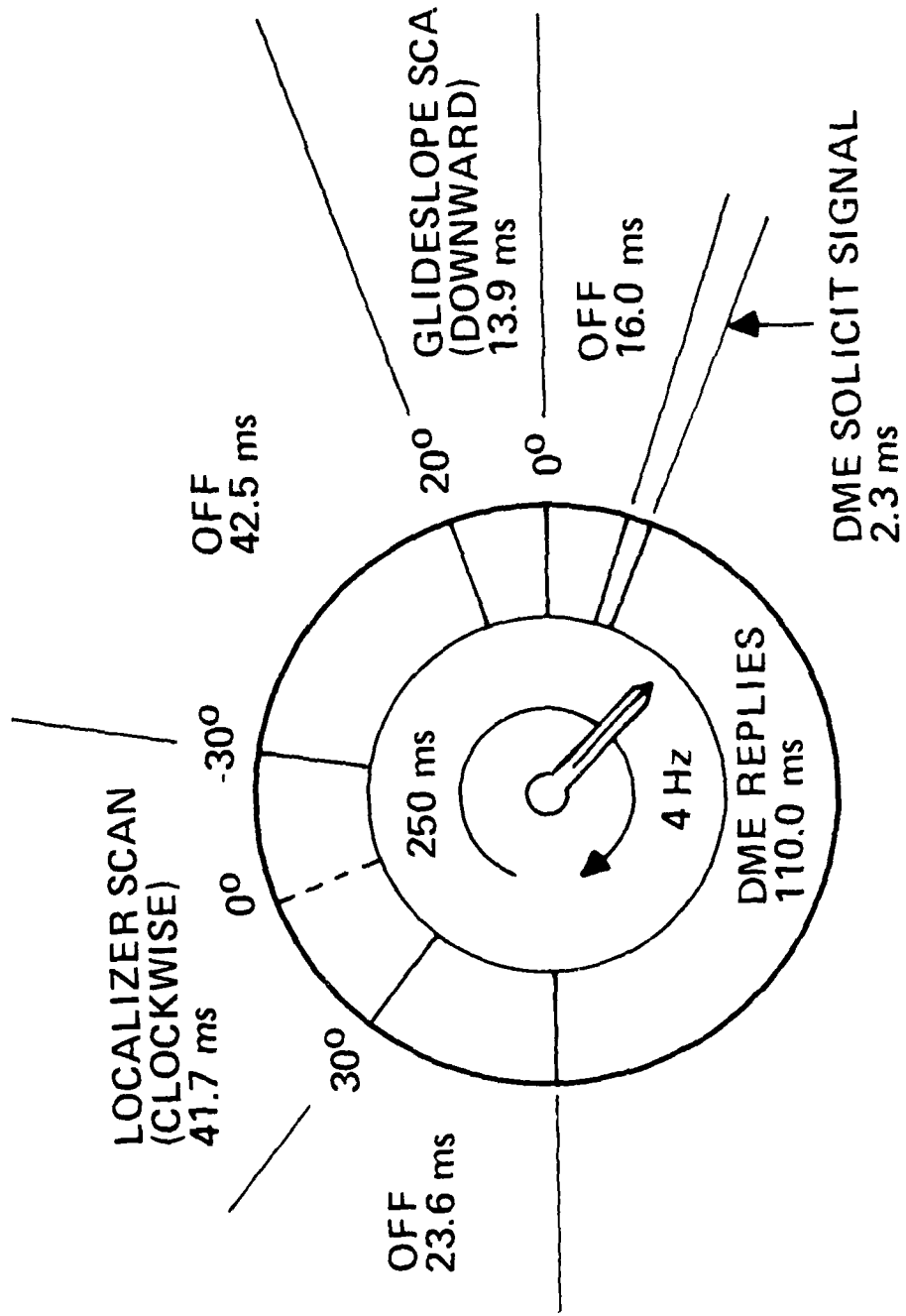

AD-A099 298

NAVAL OCEAN SYSTEMS CENTER SAN DIEGO CA
NAVYLAND MICROWAVE SCANNING BEAM TESTS AT NOSC. THREE LANDING --ETC(U)
FEB 81 F E MORRIS
NOSC/TR-646

F/G 17/7

UNCLASSIFIED

NI

2 of 2
AD A
099 298



END
DATE
FILMED
6-81
DTIC

TIME SHARING OF GUIDANCE SIGNALS

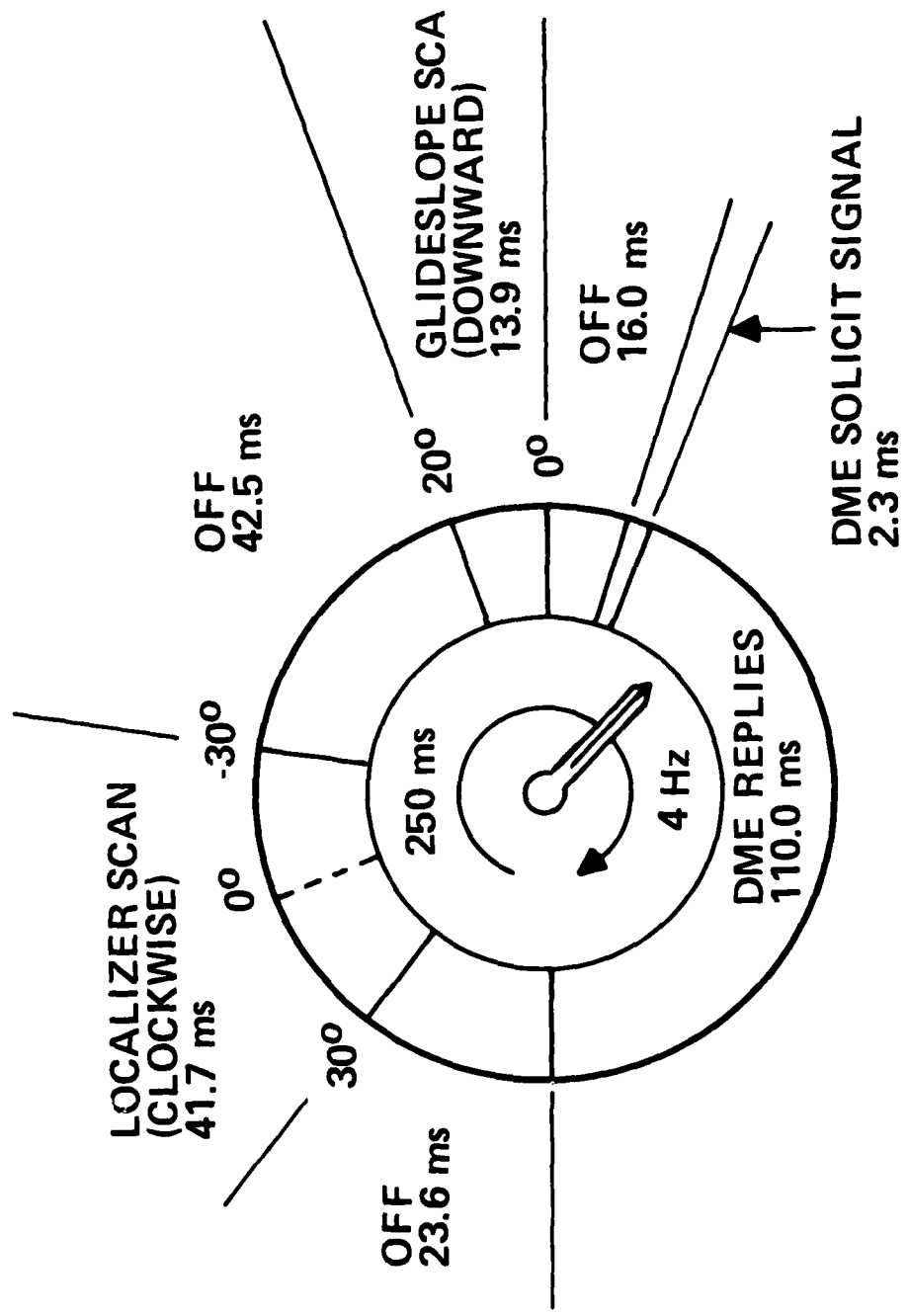

APPENDIX C

MRAALS TPN-30

MRAALS
MICROWAVE INSTRUMENT LANDING SYSTEM

Presentation Document PD-524

12 June 1975

KEARFOTT DIVISION
THE SINGER COMPANY
LITTLE FALLS, NEW JERSEY

INTRODUCTION

MICROWAVE LANDING SYSTEM EXPERIENCE

MRAALS is the fifth generation of microwave instrument landing systems designed and produced by Singer-Kearfott Division.

We are currently under contract with the U.S. Navy to furnish the Marine Corps with advanced scanning beam microwave landing systems.

S-KD developed and produced military tactical landing systems for USAF in 1967 as a result of TACLAND studies specified by ASNAG-67-24. Over 40 ground systems (AN/TRN-27) and 500 airborne systems (AN/ARN-97) were delivered to USAF.

S-KD landing systems are now in use by commercial air carriers with thousands of hours of satisfactory operation.

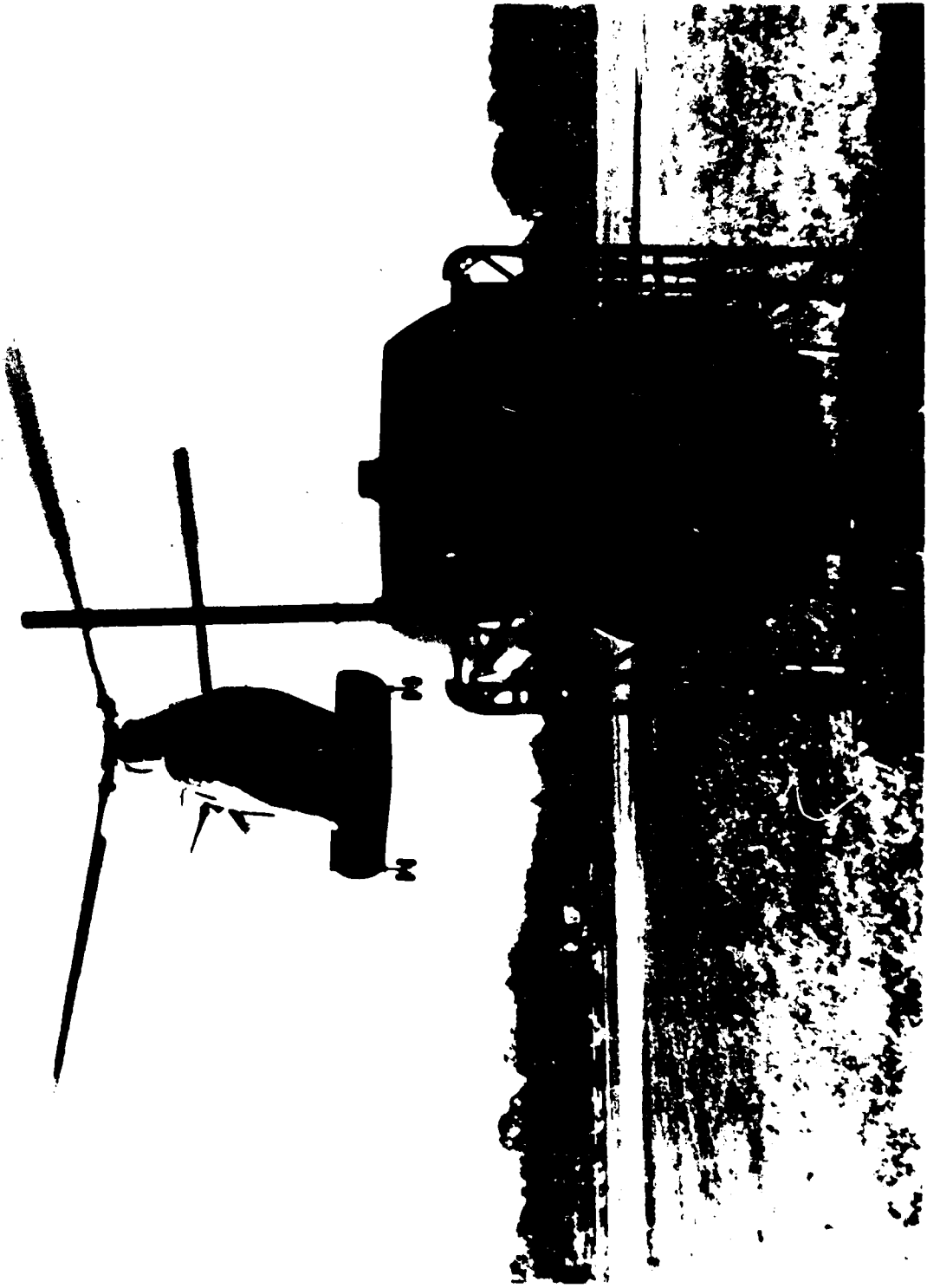

MRAALS SYSTEM REQUIREMENTS

- OPERATION
 - DAY - NIGHT
- RANGE
 - 10 MILES ANGLE, 40 MILES DME
- ADVERSE WEATHER
 - 25.4mm RAIN/HOUR (1 in/HOUR)
- VISIBILITY
 - 1/4 MILE, 100 ft ALTITUDE (CAT II)
- CLEARANCE
 - TERRAIN CLEARANCE
 - OBSTACLE CLEARANCE CODING
 - LOCALIZER BLANKING
 - ELEVATION BLANKING
- CHANNELS
 - 20 CHANNELS - ANGLE
 - 252 CHANNELS - DME

MRAALS

- AIR DERIVED SCANNING BEAM SYSTEM TO LAND AIRCRAFT
UNDER INSTRUMENT METEOROLOGICAL CONDITIONS (IMC)
- CO-LOCATED
 - 2-MAN PORTABLE
 - 10 MINUTE SET-UP TIME
 - LOCALIZER
 - GLIDE SCOPE
 - DME (DISTANCE MEASUREMENT EQUIPMENT)
- SPLIT SITE
 - REMOTE TOWER CONTROL

MRAALS GROUND SUBSYSTEM SPECIFICATIONS

CATEGORY II

- 1/4 nmi VISIBILITY
- 100 ft ALTITUDE

ANGLE ACCURACY

- LOCALIZER $\pm 0.1^\circ$
- GLIDE SLOPE $\pm 0.05^\circ$

RANGE ACCURACY

- ± 100 ft

RANGE RATE ACCURACY

- ± 10 KNOTS (17 ft/sec)

SET-UP TIME

- 10 MINUTES

OPERATIONAL WEIGHT

- 110 lb

GROUND SUBSYSTEM

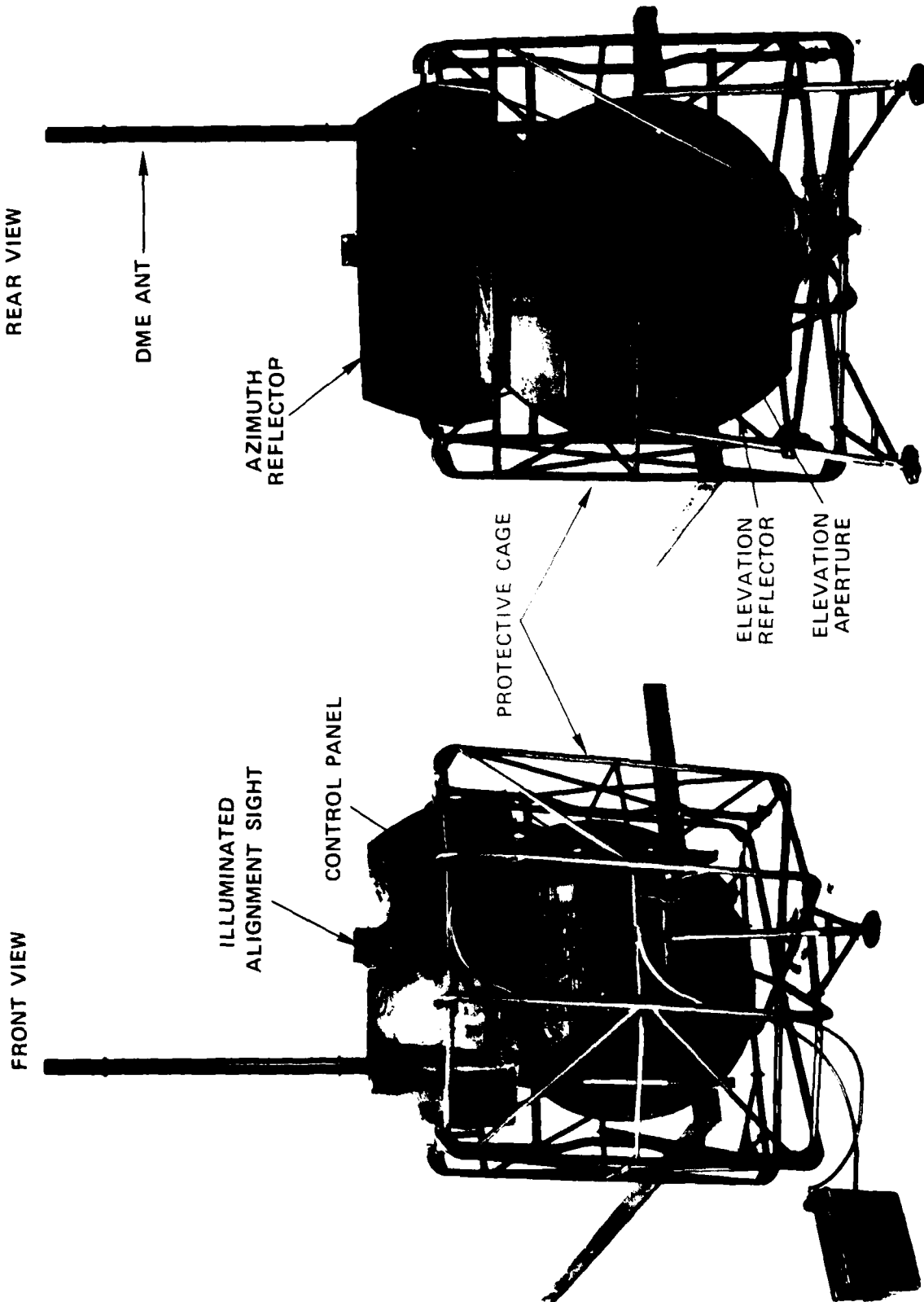

GROUND SUBSYSTEM COMPONENT LOCATION

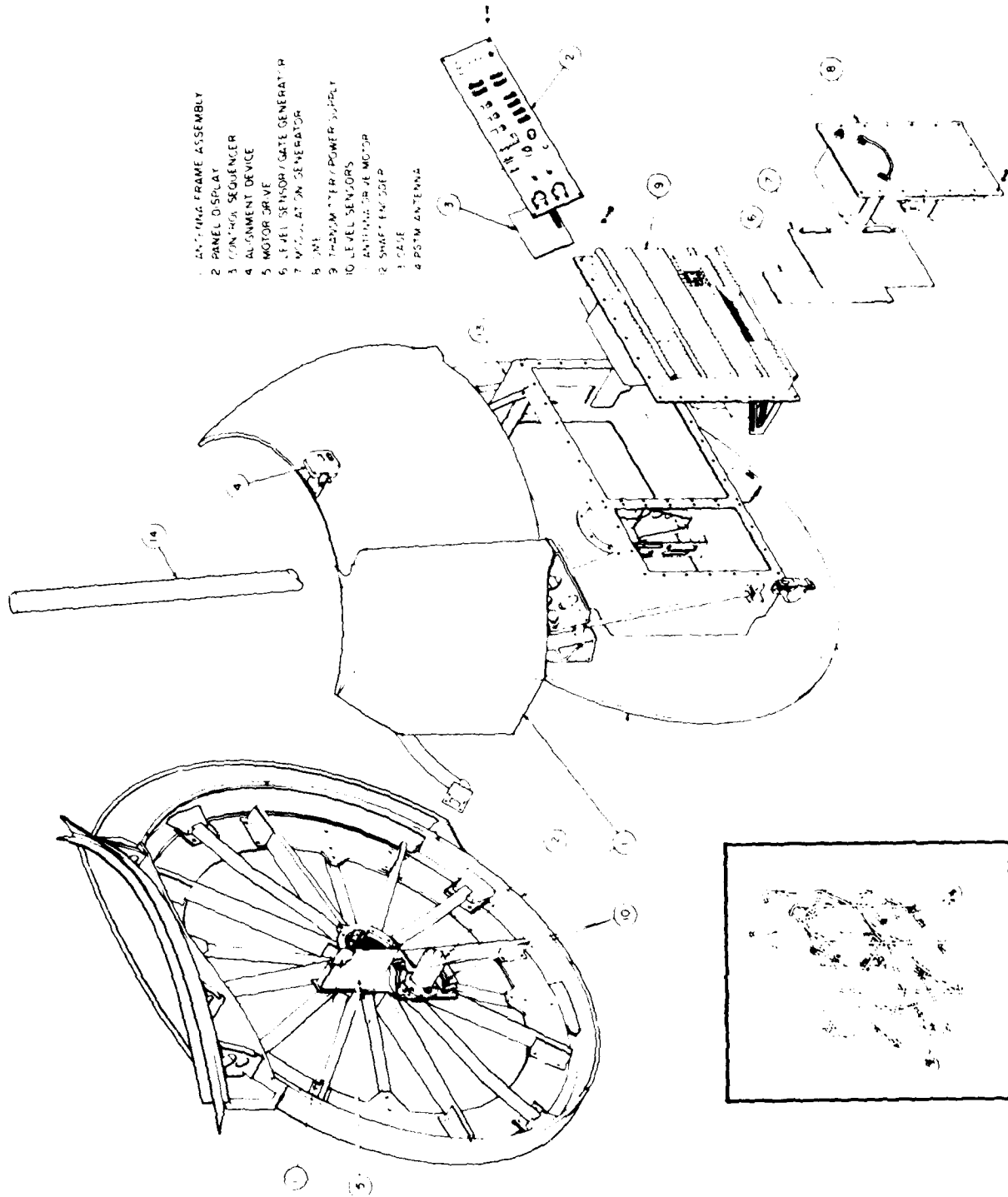

UNIQUE ANTENNA

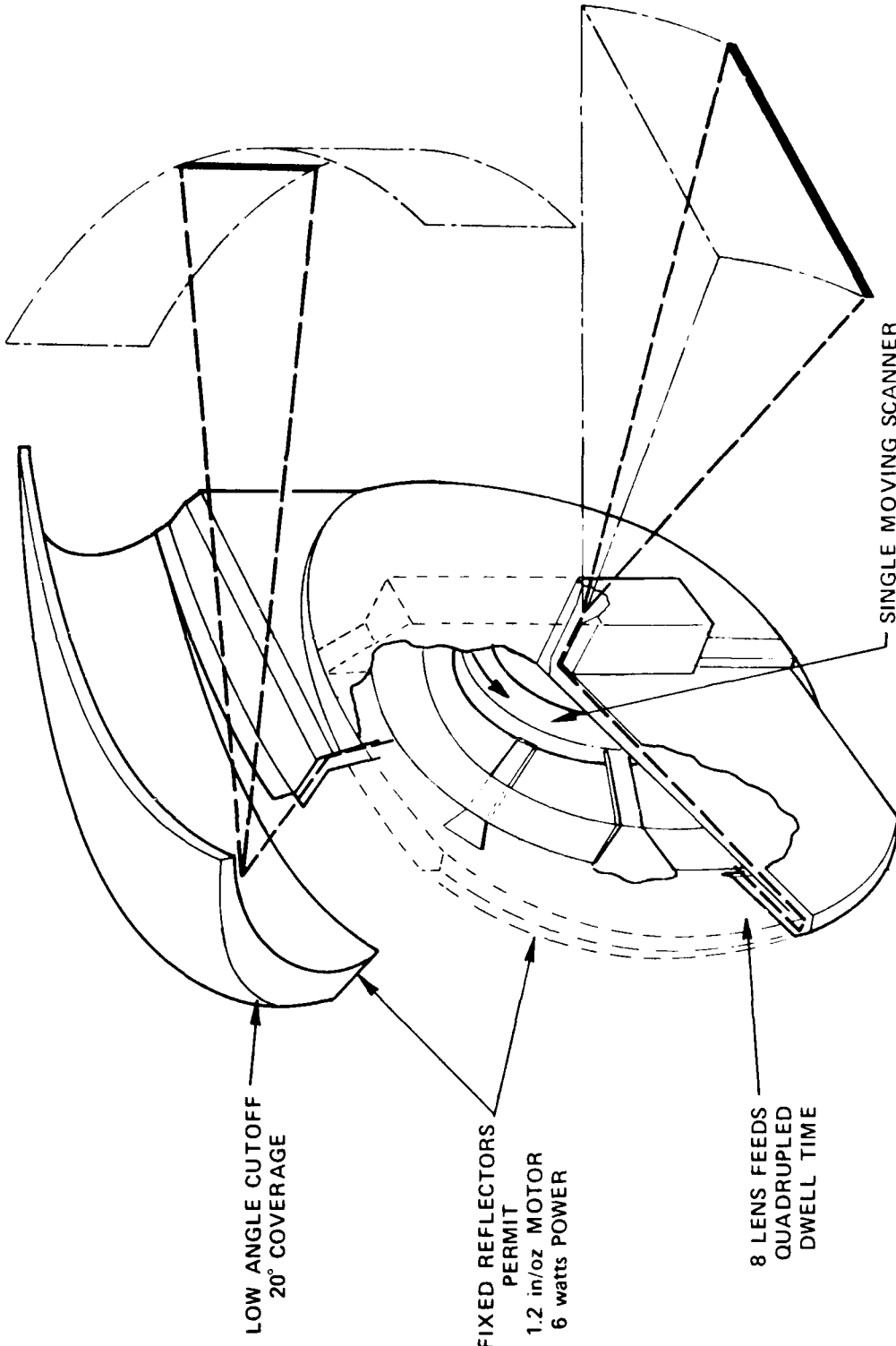

LOW ANGLE CUTOFF
20° COVERAGE

FIXED REFLECTORS
PERMIT
1.2 in/oz MOTOR
6 watts POWER

8 LENS FEEDS
QUADRUPLED
DWELL TIME

SINGLE MOVING SCANNER
AT
7.5 SCANS/SECOND
POSITIVE SYNCHRONISM

HAND CARRY TO OPERATIONAL SITE

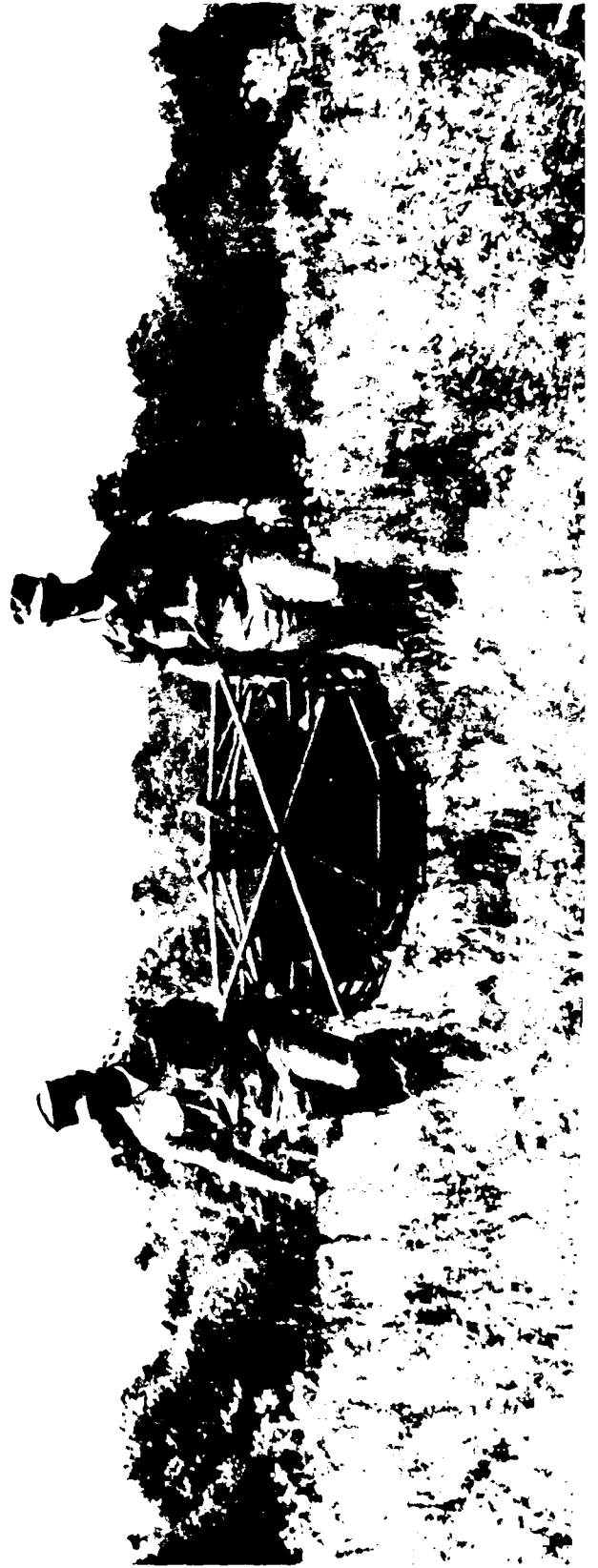

INITIAL SET-UP AT SITE

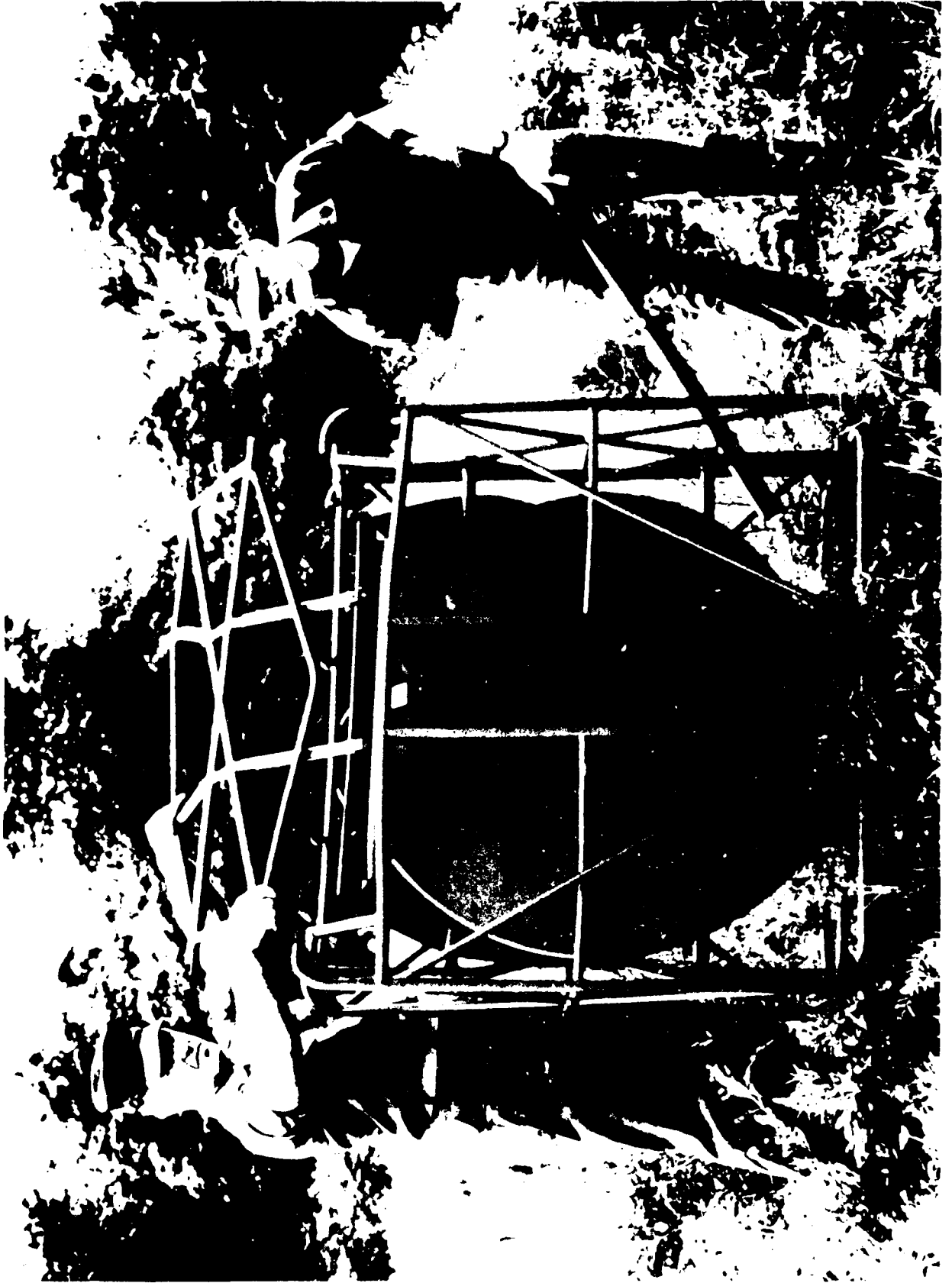



MRAALS AIRBORNE SUBSYSTEM SPECIFICATIONS

- AIR SELECTABLE GLIDE SLOPE
 - 3° - 12° IN 1° INCREMENTS
- GLIDE PATH & LOCALIZER COURSE WIDTH
 - AUTOMATIC COURSE SOFTENING PROVIDED AS FUNCTION OF RANGE AND GROUND CONFIGURATION
- RANGE - RANGE RATE
 - 360° AT 50 MILES (INDEPENDENT OF ANGLE)
- NUMBER OF A/C SERVICED (DME FUNCTION)
 - 100
- GUIDANCE COVERAGE
 - ±20° LOCALIZER
 - 0 - 20° GLIDE SLOPE
 - 10 MILES ANGLE
 - 40 MILES DME

COCKPIT DISPLAYS

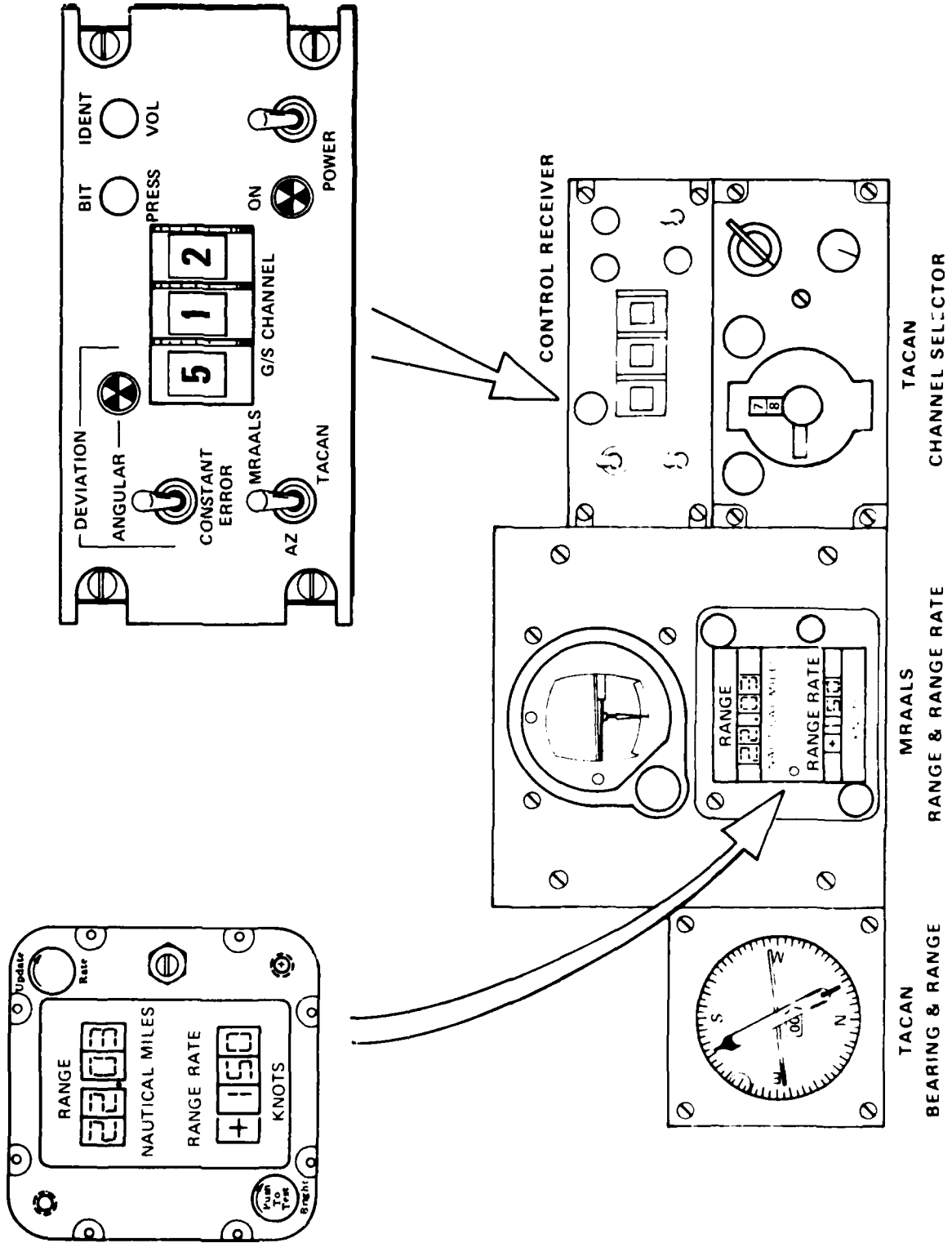

MRAALS COVERAGE

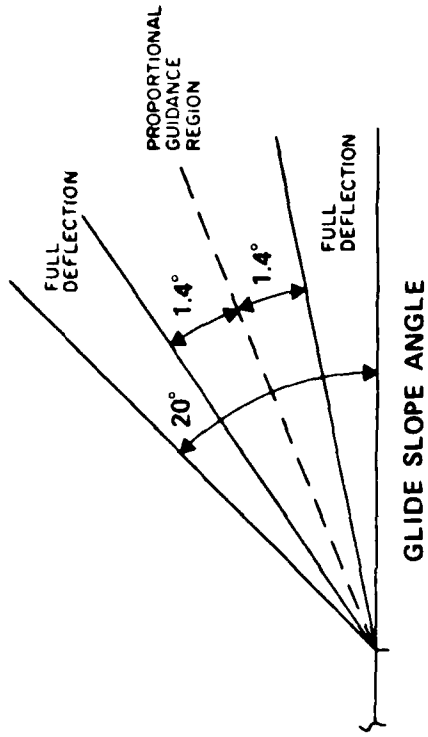
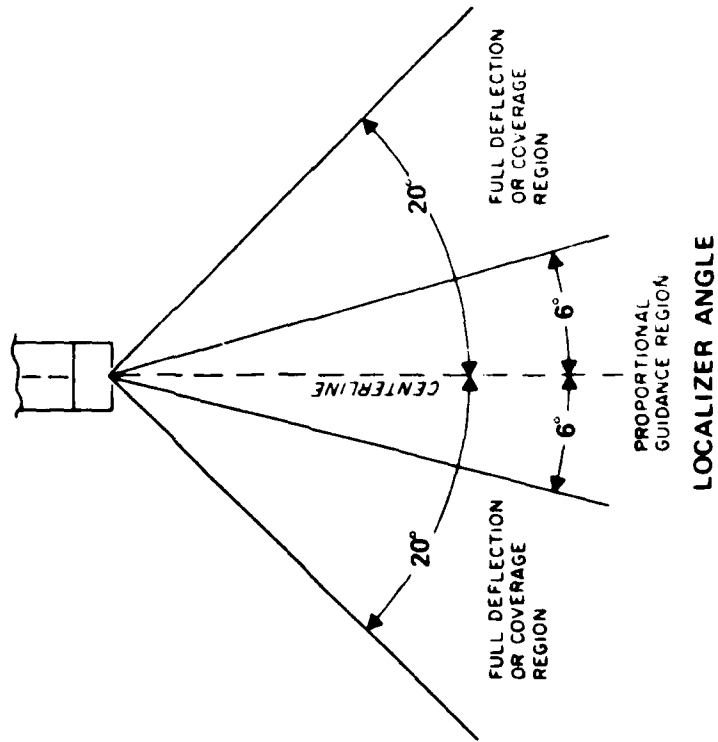

COLOCATED MRAALS

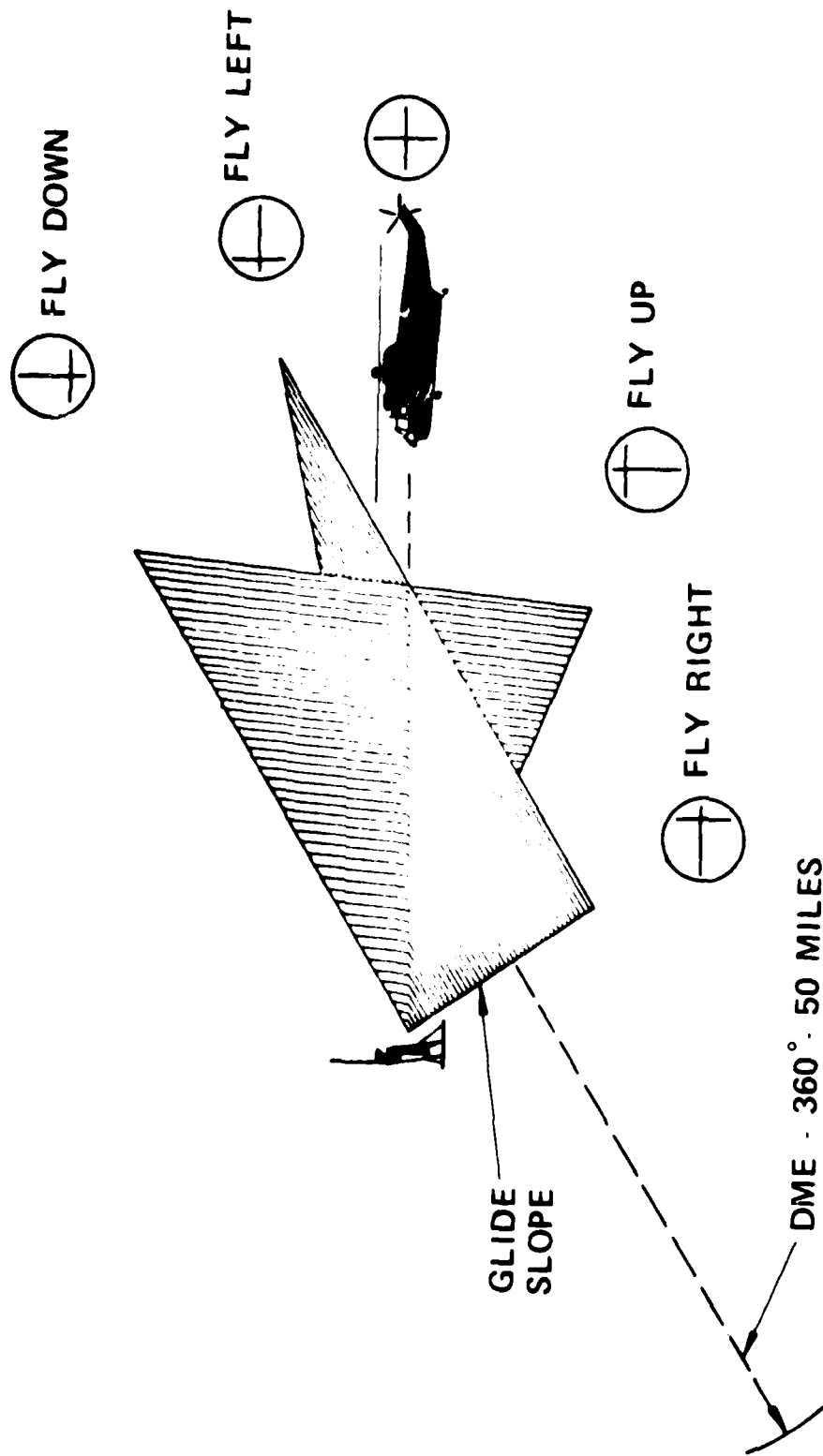

SPLIT SITE MRAALS

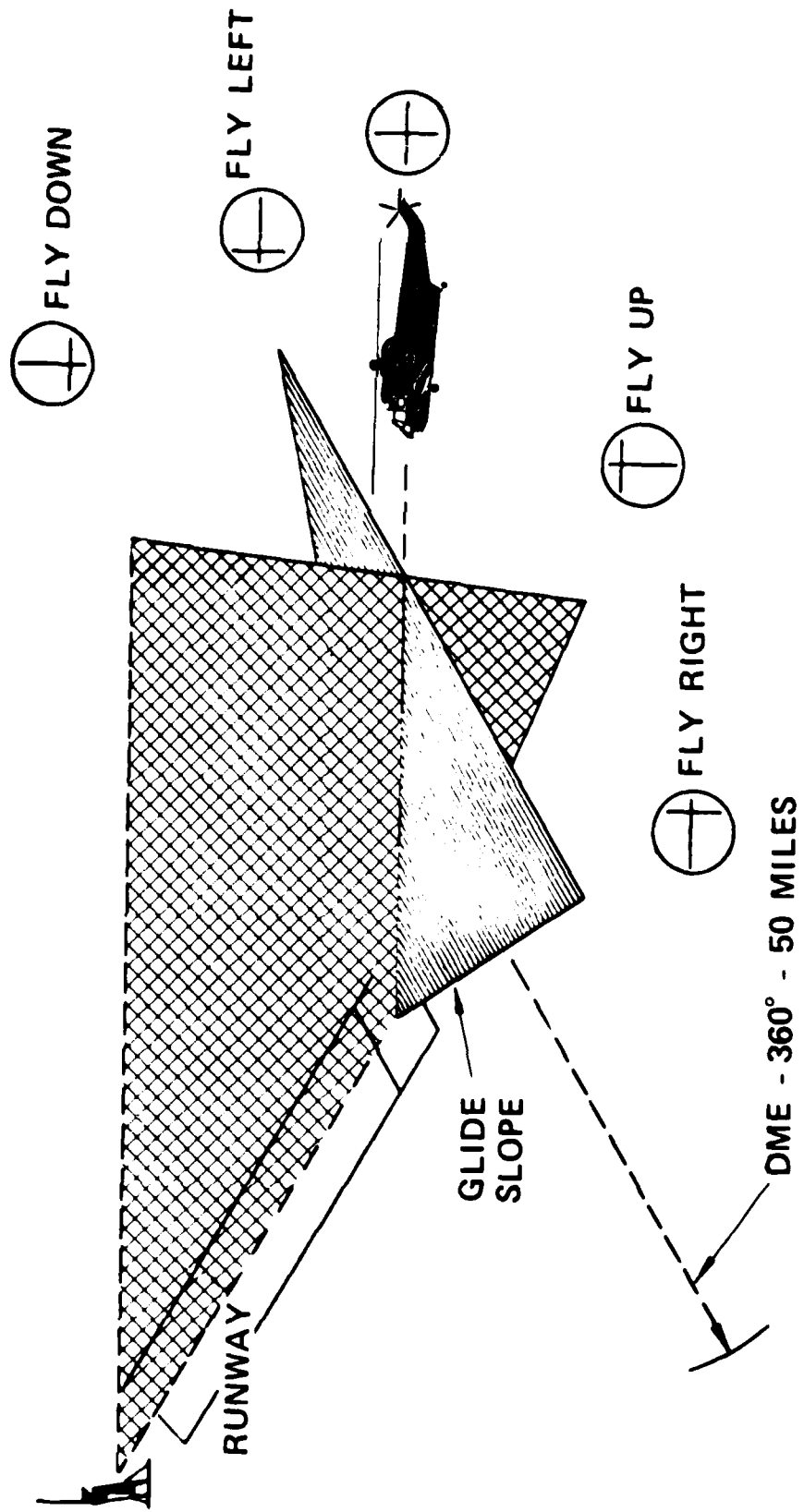

OBSTACLE CLEARANCE (ELEVATION)

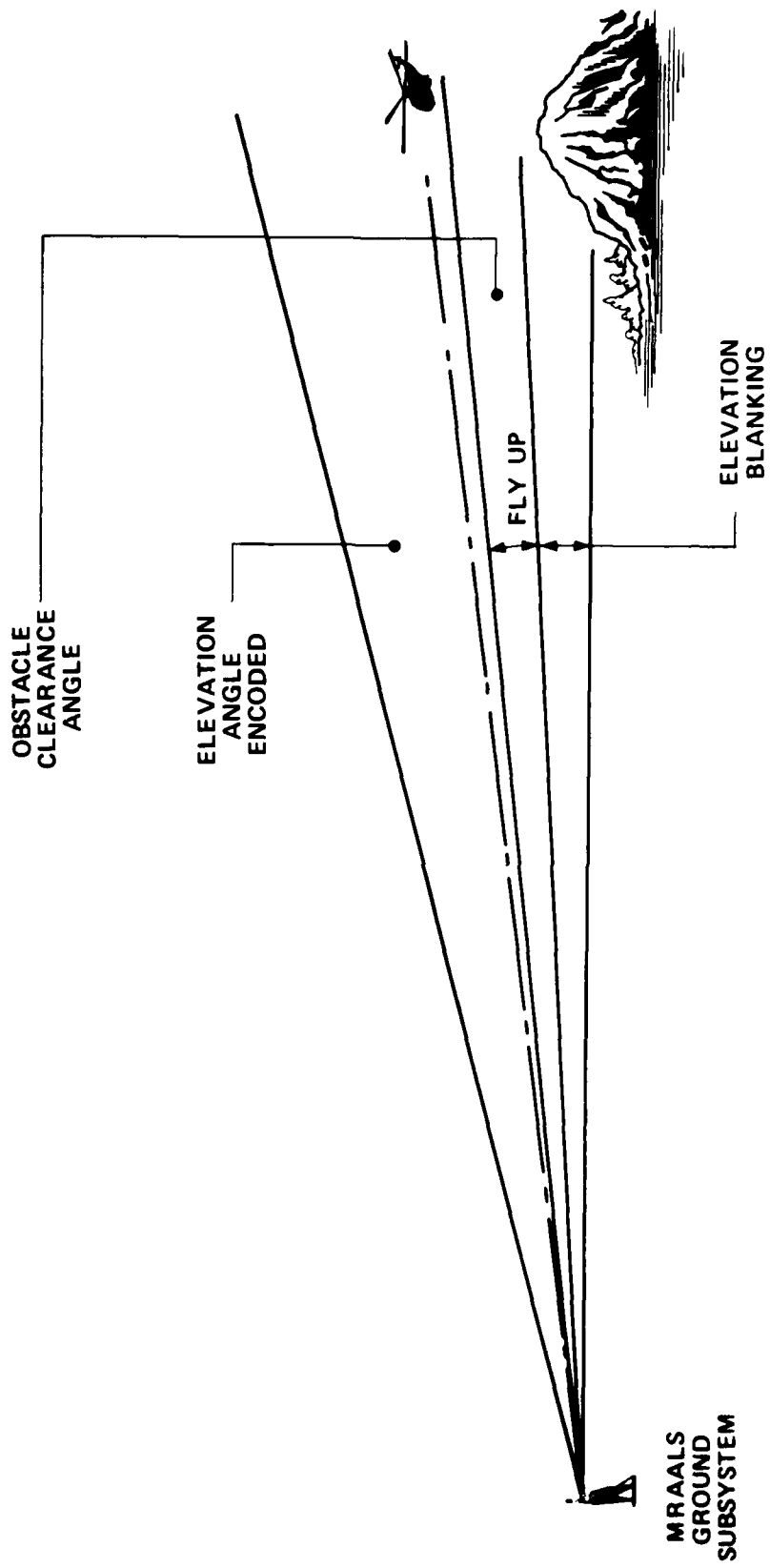

AZIMUTH BLANKING

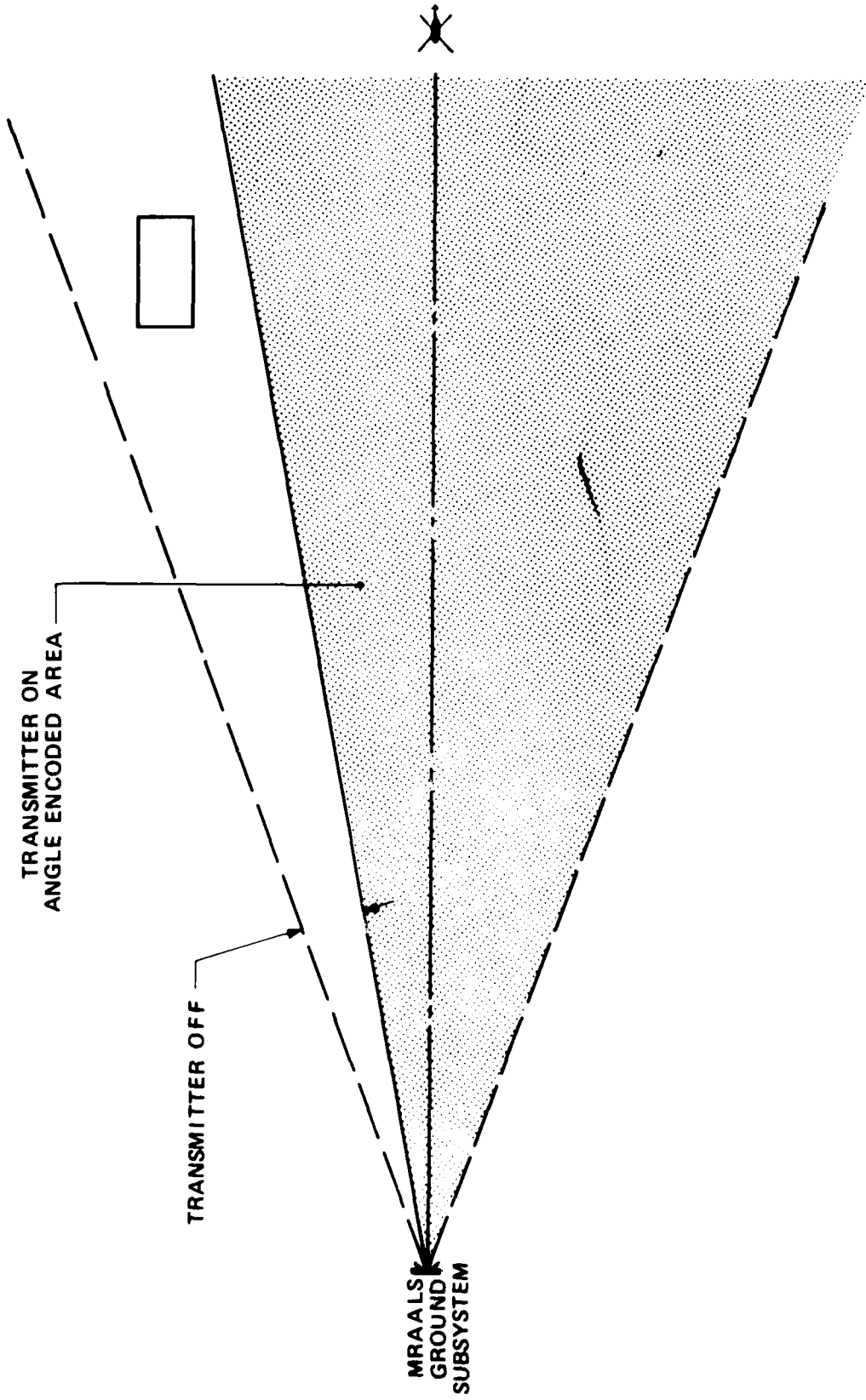

APPROACH PROCEDURE

- FLY DESIGNATED TACAN AZIMUTH TO INTERCEPT LANDING SYSTEM WINDOW
- SELECT TACAN CHANNEL FOR DME AT 60 - 50 MILES
SELECT ANGLE GUIDANCE CHANNEL
VERIFY WITH STATION IDENTIFICATION
- PRECISION RANGE DISPLAYS FROM 51 MILES, AT ANY AZIMUTH ANGLE
- CONFIRM AZIMUTH HEADING BY MAXIMIZING RANGE RATE
- * ● WHEN CROSSPOINTER ELEVATION FLAG HIDES, SELECT GLIDESLOPE ANGLE (GSA)
OBSERVING OBSTACLE CLEARANCE LIGHT TO ASSURE THAT A SAFE GSA HAS BEEN SELECTED
- * ● WHEN LOCALIZER FLAGS HIDE, THE AIRCRAFT SHOULD BE LINED UP ON AZIMUTH CENTERLINE USING VERTICAL NEEDLE
- CENTER BOTH NEEDLES UNTIL DECISION RANGE AND/OR ALTITUDE IS REACHED
- * ● MAY OCCUR IN REVERSE ORDER DEPENDING ON AIRCRAFT POSITION WITH RESPECT TO LOCALIZER AND GLIDESLOPE TRANSMITTER

SYSTEM ACQUISITION WITH 360° DME

1. FLY CONSTANT RANGE RATE TO INTERCEPT LOCALIZER
2. TURN IN WHEN LOCALIZER FLAGS HIDE
3. DECREASING RANGE INDICATES TURN TOWARD STATION

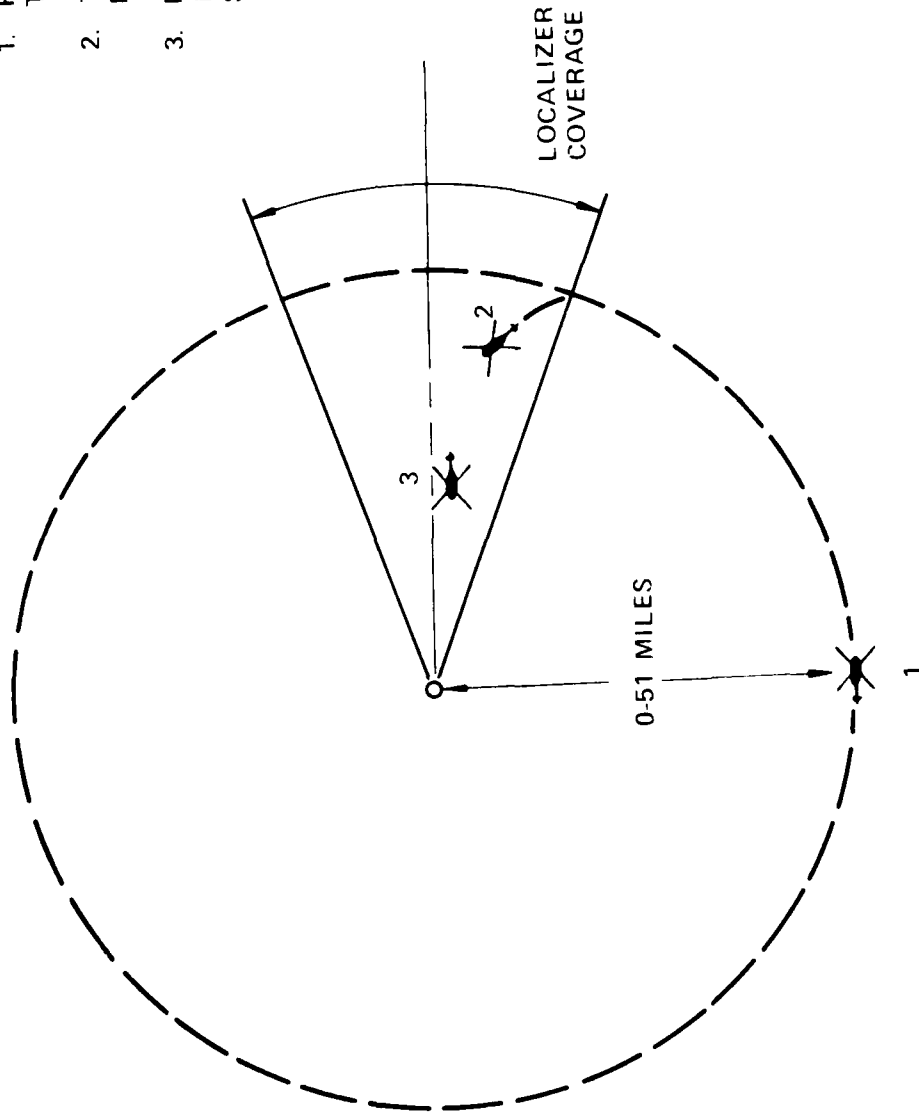

MRAALS RELIABILITY

GROUND

- MTBF = 2900 HOURS
- 1000 HOURS @ 90% CONFIDENCE
REQUIRES 2300 HOURS DEMO
- TEST +65°C

AIRBORNE

- MTBF = 1480 HOURS
- MIL-E-5400 CLASS II
 - 54° TO + 71°C
 - + 95° INTERMITTENT
- VIBRATION 10g HARD MOUNTED

MRAALS MAINTAINABILITY

- GROUND SUBSYSTEM
MTTR = 9.5 MINUTES
ONLY FIVE MODULES
MODULES IDENTIFIED BY CONTROL PANEL BITE AND TEST POINTS
- AIRBORNE SUBSYSTEM
MTTR = 21 MINUTES
BIT INDICATES LRU FAILURE
- TEST EQUIPMENT
STANDARD TEST EQUIPMENT (SCOPES, SIGNAL GENERATORS, COUNTERS)
INVENTORY TEST EQUIPMENT

ARA-63

TACAN

SUMMARY OF MRAALS FEATURES

- DAY-NIGHT OPERATION: 1/4 MILE VISIBILITY, 100 ft ALTITUDE
 - TWO-MAN TRANSPORTABLE: LIGHTWEIGHT, RUGGED CONSTRUCTION
 - 10 MINUTE SET-UP TIME: NO EXTERNAL BORE SIGHT REQUIRED
 - HIGH RELIABILITY
- LOW SPEED ANTENNA DESIGN WITH AUTOMATIC LOCALIZER AND GLIDE SLOPE SYNCHRONIZATION AND NO ELECTROMECHANICAL SWITCHING
- LOW POWER (170 WATTS)
- SINGLE ASSEMBLY CONTAINS LOCALIZER, GLIDE SLOPE, AND DME UNITS
- ONLY ONE MAGNETRON IN GROUND SUB-SYSTEM
- NO AIRBORNE MAGNETRON (CERAMIC TRIODE IN TACAN)
- L-BAND DME
 - 50 MILE PRECISION RANGE - CAN HANDLE MORE AIRCRAFT
 - BETTER RAIN PERFORMANCE THAN Ku BAND
 - SEPARATE FROM ANGLE SYSTEM - NO TIME SHARING OF Ku BAND SIGNAL
 - AUTOMATIC COURSE SOFTENING
 - ACCURACY: DME \pm 100 ft, GLIDE SLOPE \pm .05°, LOCALIZER \pm 0.1°
 - CONFORMS TO INTERIM MILITARY STANDARD FORMAT

INITIAL DISTRIBUTION

NAVAL AIR SYSTEMS COMMAND

ADPO-18 (5)
AIR-9500 (2)
AIR-53355B
AIR-53355C
AIR-53343 (2)

NAVAL ELECTRONIC SYSTEMS COMMAND

NELEX-520
NELEX-5403
NELEX-5203 (2)

NAVAL AIR DEVELOPMENT CENTER
CODE 6014

NAVAL AIR TEST CENTER
CODE SA-71
CODE SA-73

NAVAL ELECTRONIC SYSTEMS ENGINEERING
ACTIVITY, ST. INIGOES
CODE 022 (2)

NATIONAL AERONAUTICS AND SPACE ADMINISTRATION
AMES RESEARCH CENTER
MS210-0 (2)

NAVAL AIR ENGINEERING CENTER

CUTLER-HAMMER INC
A1L DIVISION
COMAC ROAD
DEER PARK, NY 17729

SINGER-KEARFOTT DIVISION
150 TOTOWA ROAD
WAYNE, NJ 07470

ANALYTICAL MECHANICS ASSOCIATION, INC.
MOUNTAIN VIEW, CA 94042

DEFENSE TECHNICAL INFORMATION CENTER (12)

DATE
FILMED
-18