

AD A099237



UNCLASSIFIED

SECURITY CLASSIFICATION OF THIS PAGE: (When Data Entered)

REPORT DOCUMENTATION PAGE		READ INSTRUCTIONS BEFORE COMPLETING FORM
1. REPORT NUMBER 14 HDL-TM-81-7 ✓	2. GOVT ACCESSION NO. AD-A099 237	3. RECIPIENT'S CATALOG NUMBER
4. TITLE (and Subtitle) Radio Frequency Interference Evaluation of a Single Skin S-280B Shelter.		5. TYPE OF REPORT & PERIOD COVERED Technical Memorandum
7. AUTHOR(s) Robert V. Garver Charles Brown Gichner Inc., York, PA		6. PERFORMING ORG. REPORT NUMBER
9. PERFORMING ORGANIZATION NAME AND ADDRESS Harry Diamond Laboratories 2800 Powder Mill Road Adelphi, MD 20783		8. CONTRACT OR GRANT NUMBER(s)
11. CONTROLLING OFFICE NAME AND ADDRESS U.S. Army Materiel Development and Readiness Command Alexandria, VA 22333		10. PROGRAM ELEMENT, PROJECT, TASK AREA & WORK UNIT NUMBERS Program El.: 6.21.20.A
14. MONITORING AGENCY NAME & ADDRESS (if different from Controlling Office)		12. REPORT DATE March 1981
		13. NUMBER OF PAGES 48
		15. SECURITY CLASS. (of this report) UNCLASSIFIED
		15a. DECLASSIFICATION/DOWNGRADING SCHEDULE
16. DISTRIBUTION STATEMENT (of this Report) Approved for public release; distribution unlimited.		
17. DISTRIBUTION STATEMENT (of the abstract entered in Block 20, if different from Report)		
18. SUPPLEMENTARY NOTES HDL Project: F389E1 DRCMS Code: 612120.H.250011 DA Project: 1L162120AH25		
19. KEY WORDS (Continue on reverse side if necessary and identify by block number) Shelter RFI shielding S-280B MIL-STD-285 EMP Radio frequency interference Electromagnetic pulse		
20. ABSTRACT (Continue on reverse side if necessary and identify by block number) An S-280B shelter was subjected to MIL-STD-285 radio frequency interference (RFI) tests in the normal configuration and with the curb-side and rear exterior skins removed. Although the shelter had been damaged before testing, it was repaired to bring its performance up to meet the MIL-STD-285 requirements of a new shelter. The measurements after the skin was removed showed a 20-dB reduction of shielding for electric (E-) field at the		

DD FORM 1 JAN 73 1473 EDITION OF 1 NOV 65 IS OBSOLETE

UNCLASSIFIED

SECURITY CLASSIFICATION OF THIS PAGE (When Data Entered)

UNCLASSIFIED

SECURITY CLASSIFICATION OF THIS PAGE(When Data Entered)

20. ABSTRACT (Cont'd)

higher frequencies and a 14-dB reduction of shielding for magnetic (H-) field at the lower frequencies. Sealing a gap between the interior wall and the door frame restored one-third of the low-frequency H-field shielding and about 10 dB of the high-frequency E-field shielding. The conclusion is that the leakage is dominated by the seams. An 80-dB single skin shelter must have either welded seams all the way around or equivalent or else multiple walls each having RFI shielding.

Accession For

SEARCHED	<input checked="" type="checkbox"/>
SERIALIZED	<input type="checkbox"/>
INDEXED	<input type="checkbox"/>
FILED	<input type="checkbox"/>

A

UNCLASSIFIED

SECURITY CLASSIFICATION OF THIS PAGE(When Data Entered)

CONTENTS

	<u>Page</u>
1. INTRODUCTION.....	5
2. TEST RESULTS.....	8
3. DISCUSSION.....	15
4. CONCLUSION.....	16
DISTRIBUTION.....	47
APPENDIX A.--DATA SHEETS FOR RFI SHIELDING OF S-280 SHELTER.....	17

FIGURES

1 Present S-280 shelter.....	5
2 Typical location of exterior RFI antenna.....	6
3 Measurements of S-280 shelter for RFI shielding.....	9
4 Measurement setup for 175-kHz magnetic field shielding per MIL-STD-285.....	9
5 Inner skin joints.....	11
6 S-280 shelter with outer skin removed from curb side.....	12
7 S-280 shelter with outer skin removed from rear and curb side.....	12
8 Interface of door frame and skin.....	13
9 Interface of door frame and inner skin with paint removed.....	14
10 Interface of door frame and inner skin with RFI tape.....	14
11 Theoretical attenuation of 0.030-in.-thick aluminum.....	16

TABLES

1 S-280 Shelter Drawings.....	8
2 Shielding of S-280 Shelter.....	10

1. INTRODUCTION

A hardened Army tactical shelter (HATS) is being developed by the U.S. Army to provide protection from air attacks, to enhance protection from nearby nuclear weapon detonations, and to provide protection to personnel from biological and chemical attacks. The initial design is to be a direct substitute for the basic Army S-280 shelter. It must satisfy the same size and radio frequency interference (RFI) shielding requirements. Because structural details are being forced by more stringent strength requirements on the walls of the HATS, the methods for deriving the minimum requirements for the RFI shielding of the walls must be more firmly defined.

The present S-280 (fig. 1) has two 0.030-in. (0.762-mm)-thick aluminum walls separated by 2 in. (5.08 cm) of insulating core material. The inner wall is carefully bonded electrically around most of the seams for continuous RFI shielding. The outer wall panels are riveted together, but sealed against only water and air. The shelter provides at least 60 dB of RFI shielding in accordance with MIL-STD-285¹ and often provides 80 dB or more.

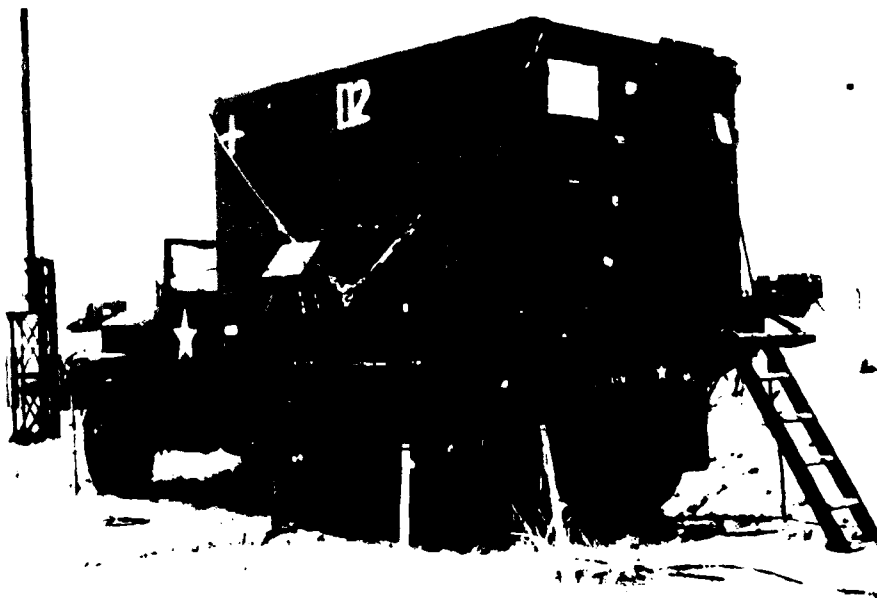

Figure 1. Present S-280 shelter.

¹Military Standard Attenuation Measurements for Enclosures, Electromagnetic Shielding, for Electronic Test Purposes, Methods of, MIL-STD-285 (25 June 1956).

This report evaluates how well an RFI shield can be made with a single skin by modifying an S-280 shelter. The test procedure was first to measure the RFI shielding of the shelter in its like-new configuration. Next, the outer skin on one side and the back was removed, and the residual shielding was measured. Then metal tape was applied to an electrically leaky seam around the door jamb to determine how much shielding could be obtained from the single skin. The measurements were much more stringent than required by MIL-STD-285. Normally, the shielding needs to be measured only once for each wall. For the test reported here, the outside antenna remained fixed for each wall (fig. 2) while the inside antenna was moved around the seam and the plane surface of each wall. This procedure permitted weak spots to be localized and provided comparison data in greater detail than the normal measurements did.

The shielding was measured at Gichner Inc., which also provided the shelter. The shelter had been used for other tests before the present one. These earlier tests had slightly damaged the shelter in these ways:

a. In accordance with MIL-S-55286B(EL), paragraph 4.19.1, Air Transport,² the simulated shelter had been suspended for 30 min by the four lifting eyes with 17,500 lb (7875 kg) of water in waterproof bags inside. The bags had leaked. In an effort to blow the residual water out of the shelter, the curb-side wall had bulged and had become delaminated. Three holes had been drilled in an unsuccessful relamination attempt.

b. A destruction test had been applied to the left (road-side) front lifting eye. This test may have disturbed the interior RFI sealing material, although the interior environmental seal showed no breaks or sign of severe stress.



Figure 2. Typical location of exterior RFI antenna.

²Military Specification, Shelter, Electrical Equipment, S-280()/G, MIL-S-55286B(EL) (22 September 1975).

c. At some time in handling or storage, a forklift tong had slit the left lower rear wall in two places.

Otherwise, the shelter appeared to be in perfect order. There were no cutouts in the ceiling, the walls, or the floor.

A continuous metal wall provides the best barrier to electromagnetic radiations such as RFI and electromagnetic pulse (EMP) from nuclear detonations. Continuously welded seams provide the best shielding. The shelter walls require insulation, and metal with insulation bonded to it cannot be welded without destroying the bond and the insulation. Therefore, practical assembly procedures call for overlapping metal surfaces at joints with closely spaced rivets. In some walls, the facing surfaces cannot be reached for riveting, so a conductive plastic material is injected between the surfaces. All joints are then sealed with an environmental (air and water barrier) plastic material such as an elastomer.

From drawings* and discussions with Gichner engineers, certain structural features have been identified that might influence the RFI response of the shelter (table 1).

a. The inner skin serves as the major barrier to RFI except for the door, for which the outer skin is the barrier.

b. There is a design fault in continuity at the juncture of the rear wall inner skin and the outer door jamb (dwg aa, zone 4B, "SEE NOTE 12"). (Drawing Z, note 12, calls out item 24 adhesive or item 25 sealer, neither of which is specified for RFI applications. App A sheet 1 calls out 44 rivets on the jamb side, 24 on the bottom, 16 on the top, and ~24 on the hinge side.)

c. The inner ceiling and floor are joined to the side walls by RFI sealer and rivets every 3 to 4-3/16 in. (7.62 to 10.64 cm) (dwg l and m, item 69, sealer). (Drawing h refers to note 15 for item 69; drawing g describes it as supplied by Chomerics Inc. of Arlington, MA. The rivet spacing is derived from drawing j, sect. G-G.)

d. The interior end walls are joined to the ceiling, walls, and floor by channels with the interior walls angled to come close to each other and form a V-groove channel that almost touches. This channel is filled first with Chomerics RFI sealer and then with environmental sealer (dwg m).

**The S-280B shelter drawing pile contains selected drawings required to track the RFI shielding of the structure. These drawings (table 1) are designated in this report alphabetically.*

e. The RFI sealer is petroleum based. It dries in time and does not adhere to the surfaces, causing a life problem. A silastic (conductive) sealer would give better life and should provide the environmental seal required. Injecting the Chomeric sealer into the V-groove channel is especially poor because the cavity behind the channel is relatively large and, to conserve expensive material, the sealer is injected so that it just touches the edges with no pressure behind it.

TABLE 1. S-280 SHELTER DRAWINGS

Reference	Drawing	Title	Sheet
a	SM-C-165306	Skin, Inner Floor and Roof	-
b	SM-C-165308	Skin, Inner Side Panel	-
c	SM-D-165400	Panel Assy--Roof	-
d	SM-D-165450	Panel Assy--Floor	-
e	SM-D-165455	Assy, Panel Side	-
f	SM-D-165456	Frame-Skin Assembly, Roof	-
g-m	SC-D-200131	Shelter, Electrical Equipment S-280B/G	1, 2, 8, 9, 10 11, 13 of 13
n-p	SC-D-200140	Door Latch Assenbly	1, 2, 3 of 3
q-s	SM-D-450461	Door Assembly	1, 3, 4 of 4
t, u	SM-D-450462	Panel Assembly, Emergency Exit	1, 2 of 2
v, w	SM-D-508738	Panel Assembly, Door	1, 2 of 2
x	SM-D-508739	Frame and Skin Assy Door Panel	-
y	SM-D-555523	Panel Assy, Front End	1 of 2
z, aa	SM-D-555525	Panel Assembly Door End	1, 2 of 2
bb, cc	SC-D-595099	Frame and Skin Assy (Door End)	1, 2 of 2

2. TEST RESULTS

The E-field, H-field, and plane waves were measured from 100 kHz to 10 GHz (fig. 3, 4). The receiver was tuned to the desired frequency, and the gain was adjusted for a noise level of 0 dB. Next, the oscillator was turned on, the antennas were set 25 in. (63.5 cm) apart,

and the reference on the receiver input attenuator was read. Then the door was closed, and the new receiver level attenuation was measured. The shielding is the difference in level between the two attenuation readings.

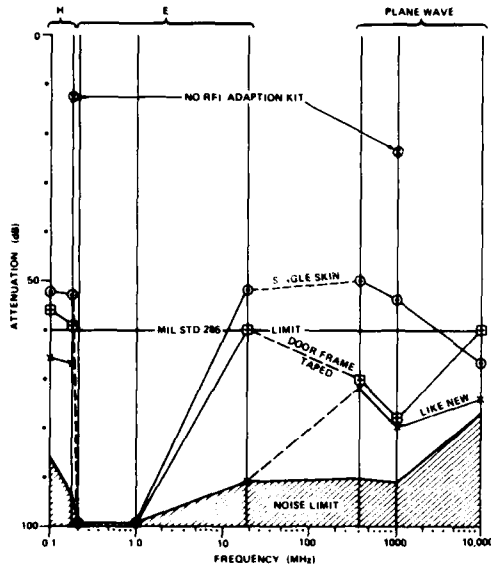

Figure 3. Measurements of S-280 shelter for RFI shielding; lines connect data points only for identification.

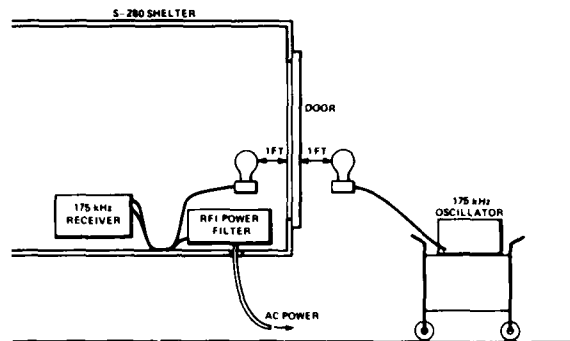

Figure 4. Measurement setup for 175-kHz magnetic field shielding per MIL-STD-285.

Preliminary readings were taken with the shelter slightly damaged and with no RFI adaption kit. The measurements showed 24 dB of shielding at 1 GHz and 13 dB at 175 kHz (app A, test sheet 1).

The standard RFI adaption kit for an S-280 shelter consists of a honeycomb door vent knockout panel in place of the louvered vent knockout panel and RFI gasket material around the edge of the knockout panel and the door. The honeycomb vent attenuates incident electromagnetic radiation, and the RFI gasket material provides electrical continuity between mating surfaces of doors and removable panels.

The RFI knockout panel was installed, the door RFI channel was cleaned, the gasket was installed, shims were installed on the door striker plates, and minor holes in the outer skin were cleaned and taped. Preliminary readings again showed 68 dB at 1 GHz and 58 dB at 175 kHz. Some leakage appeared to have come from the front roof seam,

so all inner seams were stripped of paint and taped with 2-in. (5.08-cm)-wide aluminum conducting tape. The addition of the tape improved the 175-kHz reading to 67 dB (92 to 25 dB) (app A, test sheet 3).

A complete series of tests was done (app A, test sheets 2 to 9). The worst case shielding levels were noted (table 2) and plotted (fig. 3, "LIKE NEW"). The front and back panels tended to leak more at the seams than did the side panels, probably because of the poorer construction of the front- and back-panel seams. The front and back inner walls are joined to the side walls and ceiling by the poorer V-groove channel (fig. 5, sect. C-C). The side inner walls are joined to the floor and the ceiling by the better method (fig. 5, sect. Y-Y). The two plane surfaces overlap, are bonded together with RFI sealing compound, and are riveted at 3- to 4-3/16-in. intervals.

TABLE 2. SHIELDING OF S-280 SHELTER

Frequency (MHz)	"Like new" references			"Like new"		Single skin		Door seam taped	
	Reference (dB)	Noise (dB)	Limit (dB)	Measurement (dB)	Shielding (dB)	Measurement (dB)	Shielding (dB)	Measurement (dB)	Shielding (dB)
Magnetic field									
0.1	86	0	86	20	66	34	52	30	56
0.175	93	0	93	30	63	39	53	34	59
Electric field									
0.2	99	0	99	<0	>99	<0	>100	<0	>100
1	99	0	99	<0	>99	<0	>95	<0	>100
18	91	0	91	<0	>91	38	52	30	60
Plane wave									
400	90	0	90	18	72	40	50	20	70
1,000	91	0	91	12	79	38	54	15	78
10,000	108	31	77	34	74	39	67	44	60

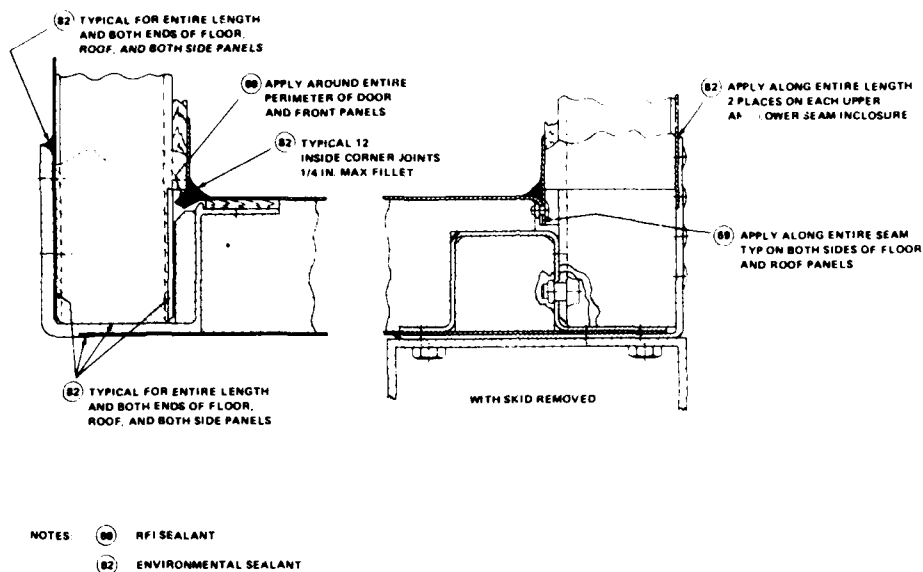

Figure 5. Inner skin joints (dwg m).

The highest leakage, at 400 MHz, occurred around the door latching bolts. The outside handle is a quarter wavelength at about 400 MHz, and the handle penetrates the door and is short-circuited only by bearing surfaces and thruster plates.

After those tests, the next step in the evaluation was to remove the outer skin from the curb side (fig. 6). There was an obvious source of radiation from the curb side, especially at 175 kHz (app A, test sheets 10 and 11).

The rear outer skin was removed next (fig. 7), and a complete run of data was taken (app A, test sheets 12 to 19; table 2 and fig. 3, "SINGLE SKIN"). The attenuation dropped from about ≥ 70 to 50 dB. The one weak spot in RFI shielding is the junction of the inner skin and door frame (fig. 8). The paint and some of the environmental sealer were stripped away (fig. 9). The end of the inner skin and the metal of the door frame are apart by about 1/4 in. (0.63 cm). The inner skin is isolated from the vertical aluminum structural member by a thin wood thermal barrier. The 1/4-in. gap is partly filled with bonding cement that joins the inner skin to the foam and wood core. The entire seam is then covered with weatherproof elastomer (fig. 9, seam detail with elastomer partly pulled away). Even if the rivets make good electrical contact with the inner skin and the aluminum structural member, there is a controlled gap between the metal surfaces of about 1/4 in. due to the thin wood thermal barrier.

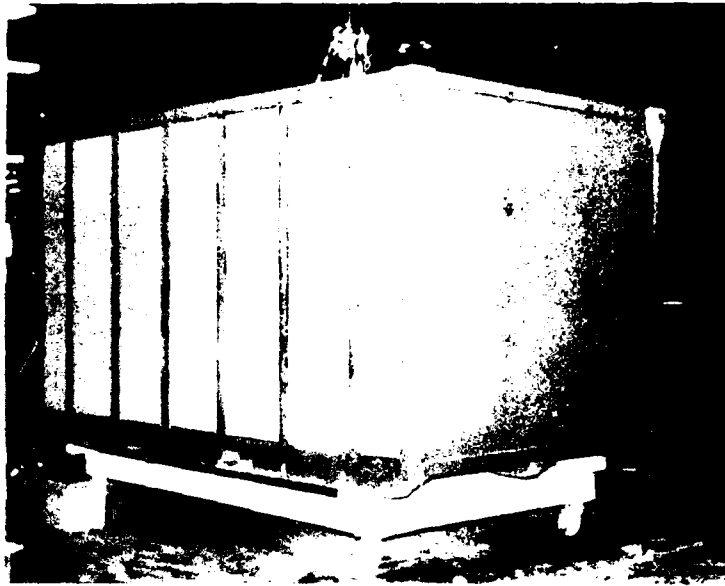

Figure 6. S-280 shelter with outer skin removed from curb side.

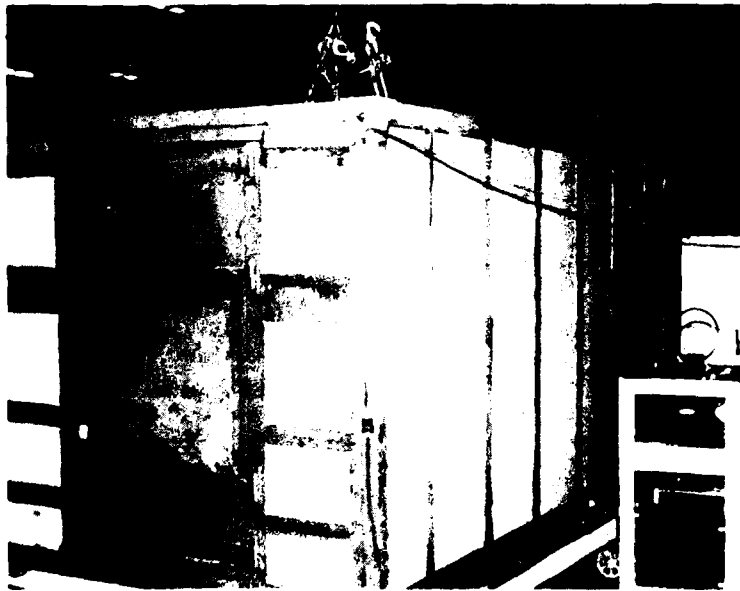
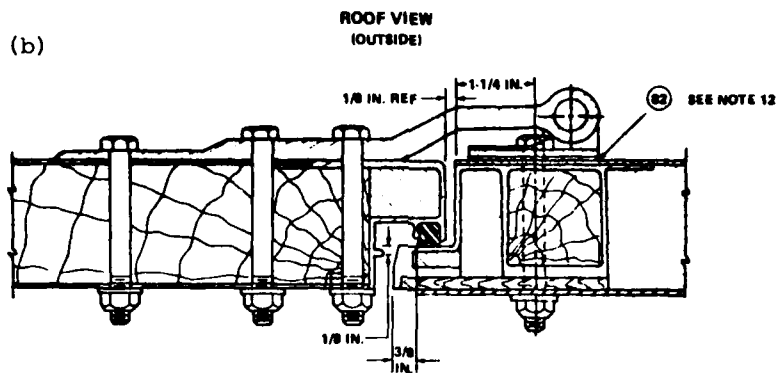
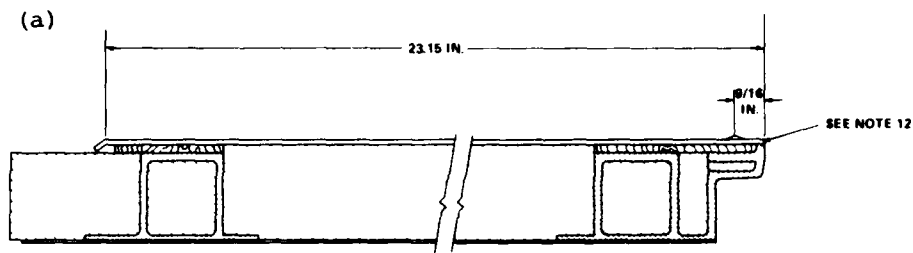

Figure 7. S-280 shelter with outer skin removed from rear and curb side.



NOTE: 82 ENVIRONMENTAL SEALANT

Figure 8. Interface of door frame and skin: (a) inner skin up and (b) inner skin down (dwg aa and k).

After the interface of the door frame and the inner skin was taped (fig. 10), the shielding data were taken again at all frequencies (app A, test sheets 20 to 27; table 2 and fig. 3, "DOOR FRAME TAPED"). The E-field isolation and the plane wave isolation of the shelter were restored enough to marginally pass the MIL-STD-285 limit. However, the H-field isolation failed.



Figure 9. Interface of door frame and inner skin with paint removed.

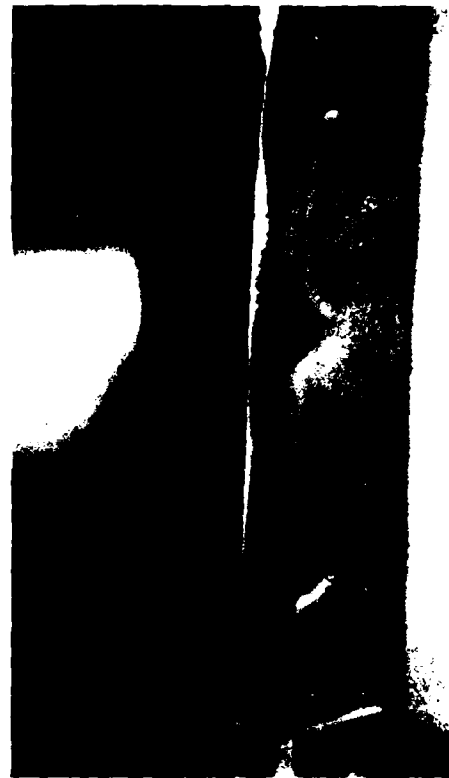

Figure 10. Interface of door frame and inner skin with RFI tape.

3. DISCUSSION

The MIL-STD-285 E- and H-field measurements are made with the source antenna 12 in. (30.48 cm) from the shelter wall. In agreement with Monroe³ and Getson et al,^{4,5} such measurements provide higher E-field attenuations and lower H-field attenuations at the lower frequencies than do plane waves. The theoretical attenuation of 0.030-in. aluminum over the frequency range is shown in figure 11. With the source antenna 12 in. from the surface at 0.1 MHz, the E-field attenuation is 178 dB, the H-field attenuation is 50 dB, and the plane wave attenuation is 114 dB. The measurement of 52 to 56 dB (table 2) may be attributed to the antenna's being more than 12 in. from the inner skin and to the additional aluminum vertical support structure's being present on the wall (fig. 6). Even though only 50 dB should be measured for a close H-field source, the shielding of the structure for most incident electromagnetic radiated energy will typically be much higher. Sources of RFI and EMP will normally be much farther than 12 in. and cause the incident energy to be like a plane wave and to experience more than 100-dB attenuation. Based on the attenuation of 0.030-in. aluminum (fig. 11), the E-field and plane wave measurements of MIL-STD-285 should be greater than 100 dB. When a lower attenuation is measured, it indicates imperfections in structural seams or door gaskets or leakage through the honeycomb of the ventilator aperture.

The shielding recorded in figure 3 indicates that the seams and the door gaskets appear to contribute to the lower level of isolation. If it is required that a single skin shelter have 80 dB with no cutouts, then a better construction system is needed such as welding all seams. If welded seams or their equivalent cannot be obtained, then multiple layers with all RFI joints should be used. Even though the outer skin on the shelter was not sealed against RFI, it contributed to the RFI isolation.

³Richard L. Monroe, *EMP Shielding Effectiveness and MIL-STD-285*, Harry Diamond Laboratories HDL-TR-1636 (July 1973), Defense Documentation Center AD 771 997.

⁴Eduardo Villaseca, Carl Davis, William Blackwood, and William Getson, *An Investigation of the Validity of Applying MIL-STD-285 to EMP Shielding Effectiveness*, Harris Corp., Melbourne, FL, contract with Defense Nuclear Agency DNA 4411F (15 April 1977), Defense Documentation Center AD A051 889.

⁵W. J. Getson, *Shielding Effectiveness Requirements of Enclosures to Harden Systems Against EMP*, Proc. DNA EMP Environments and Protection Implementation Seminar, Defense Nuclear Agency DNA 4565P-2(S) (October 1977), 265-278.

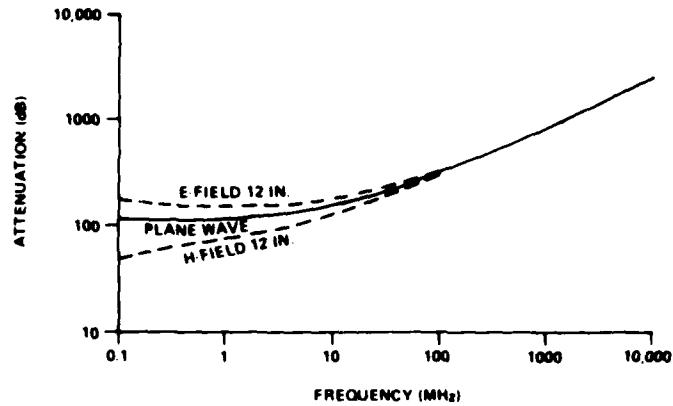

Figure 11. Theoretical attenuation of 0.030-in.-thick aluminum.

The shelter provides shielding over a broad range of frequencies including those of interest for high-altitude EMP (HEMP). Any HEMP should experience the same 60 dB or more attenuation characteristic of the E-field and plane wave measurements since the source of the HEMP is at a long distance.

4. CONCLUSION

The leakage observed in the measurement of the single skin S-280B shelter is dominated by the seams. An 80-dB shelter must have welded seams or their equivalent or be constructed of multiple layers, each one sealed against RFI by means similar to those for the S-280B shelter.

APPENDIX A.--DATA SHEETS FOR RFI SHIELDING OF S-280 SHELTER

APPENDIX A

This appendix contains the raw data taken in the MIL-STD-285¹ tests on a single skin S-280B shelter. The data are summarized in the main body of this report. Finer details of the shelter response can be derived from a close study of the data points.

These terms are used in the test sheets:

Frequency: Frequency at which measurements were made

KO panel Knockout panel (inlet louver assembly)

Like new Troublesome seams taped up, knockout panel redone, new radio frequency interference (RFI) gasket, and door latching plate shimmed

Ref Reference attenuation reading of signal generator when source antenna and receiver antenna are 2 ft apart with nothing between them

Zero Attenuation reading of signal generator when transmitter is turned off

¹Military Standard Attenuation Measurements for Enclosures, Electro-magnetic Shielding, for Electronic Test Purposes, Methods of, MIL-STD-285 (25 June 1956). [MIL-STD-285 states English Units.]

APPENDIX A

TEST SHEET 1. S-280B SHELTER

Special conditions	Frequency	Ref (dB)	Zero (dB)	Rear (dB)	Curb side (dB)	Front (dB)	Road side (dB)
No filter or gasket	1 GHz	86	0	62	50	44	53
	175 kHz	92	0	79	36	33	33
With filter and gasket	1 GHz	86	0	18 ^a	10 ^b	18 ^c	16 ^d
	175 kHz	92	0	22 ^e	14 ^f	34 ^g	14 ^h

^aAround door, knockout panel, and both vertical seams.

^bAll seams.

^cBoth vertical seams

^dFront vertical seam.

^eTop seam.

^fFront vertical seam.

^gRoad side vertical seam and bottom seam.

^hRear vertical seam.

APPENDIX A

TEST SHEET 2 S-2503 SHELTER
(ALL VIEWS FROM INSIDE)

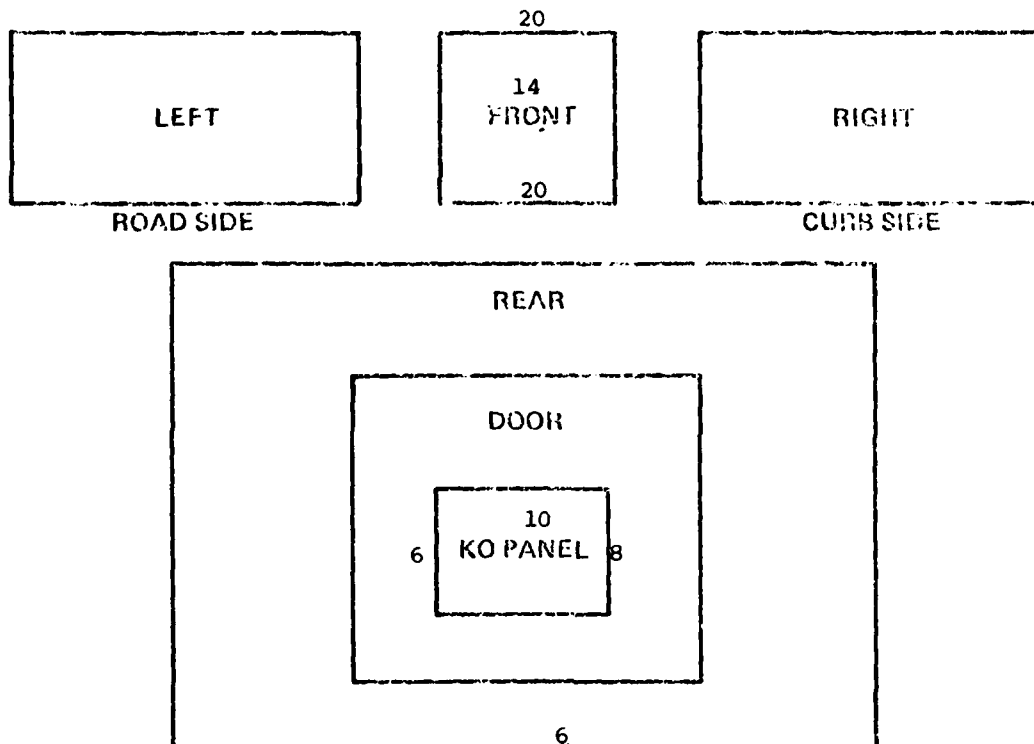

SPECIAL CONDITIONS Like new

FREQUENCY 100 kHz REF. 86 dB ZERO 0 dB

DATE 12 Sep 1979 TIME 0815

OBSERVERS Brown, Guise

APPENDIX A

TEST SHEET 3 S-280B SHELTER
(ALL VIEWS FROM INSIDE)

x moving outside to same location

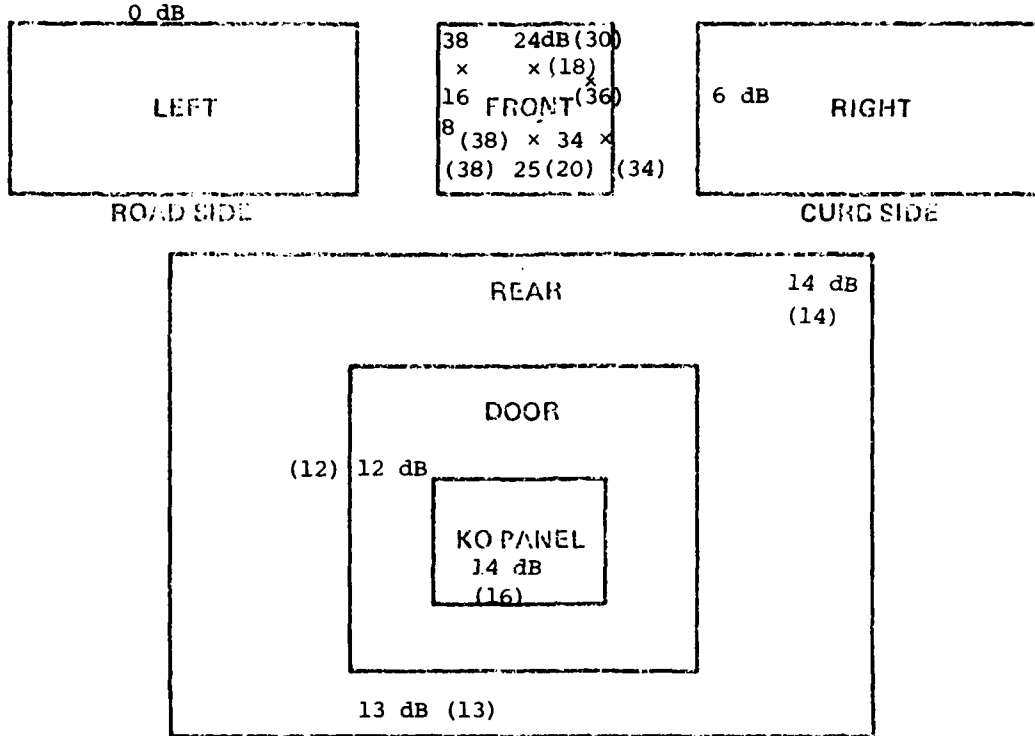

SPECIAL CONDITIONS Like new

FREQUENCY 175 kHz REF. 92 dB (93 dB) ZERO 0 dB

DATE 11 Sep 1979 (12 Sep 1979) TIME 1435 (0730)

OBSERVERS Guise, Brown, Garver

APPENDIX A

TEST SHEET 4 S-2803 SHELTER
(ALL VIEWS FROM INSIDE)

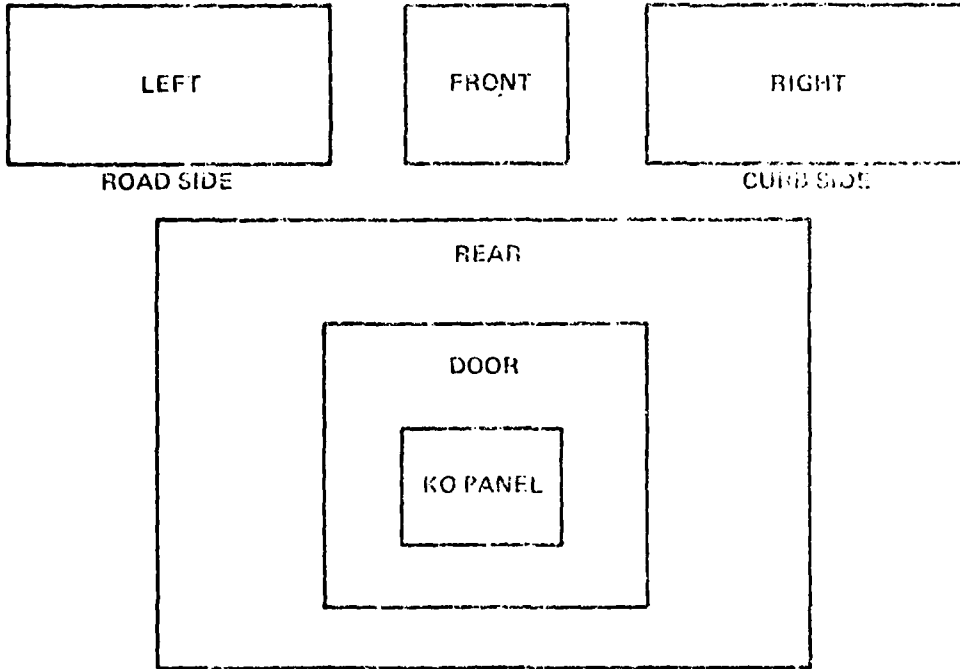

>99 dB attenuation all over

SPECIAL CONDITIONS Like new
FREQUENCY 200 kHz REF. 99 dB ZERO 0 dB
DATE 12 Sep 1979 TIME 0740
OBSERVERS Brown, Guise

APPENDIX A

TEST SHEET 5 C-2808 SHELTER
(ALL VIEWS FROM INSIDE)

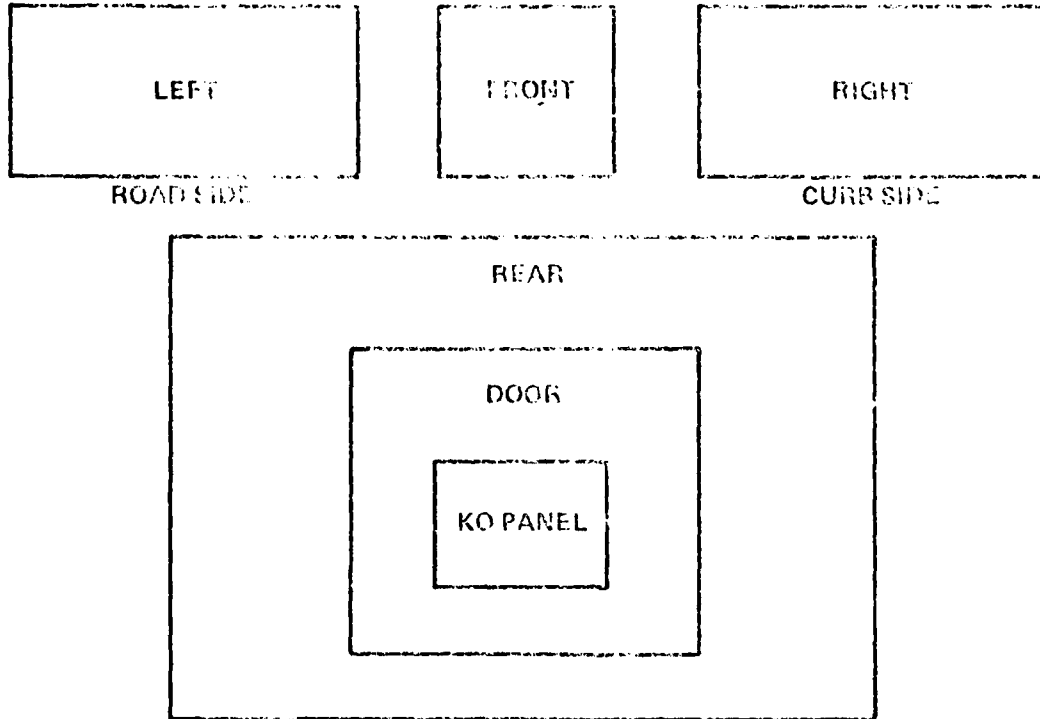

>99 dB attenuation all over

SPECIAL CONDITIONS Like new
FREQUENCY 1 MHz REF. 99 dB ZERO 0 dB
DATE 12 Sep 1979 TIME 0750
OBSERVERS Brown, Guise

APPENDIX A

TEST SHEET 6 S-2803 SHELTER
(ALL VIEWS FROM INSIDE)

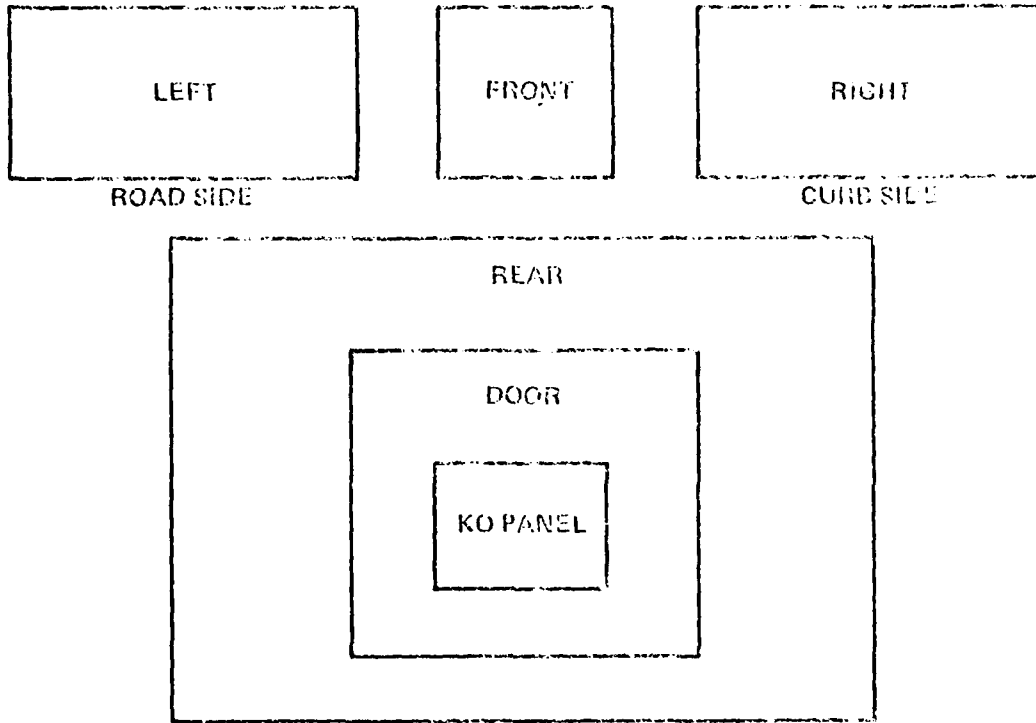

>91 dB attenuation all over

SPECIAL CONDITIONS Like new

FREQUENCY 18 MHz REF. 91 dB ZERO 0 dB

DATE 12 Sep 1979 TIME 0800

OBSERVERS Brown, Guise

APPENDIX A

TEST SHEET 7 3-280K SHELTER
(ALL VIEWS FROM INSIDE)

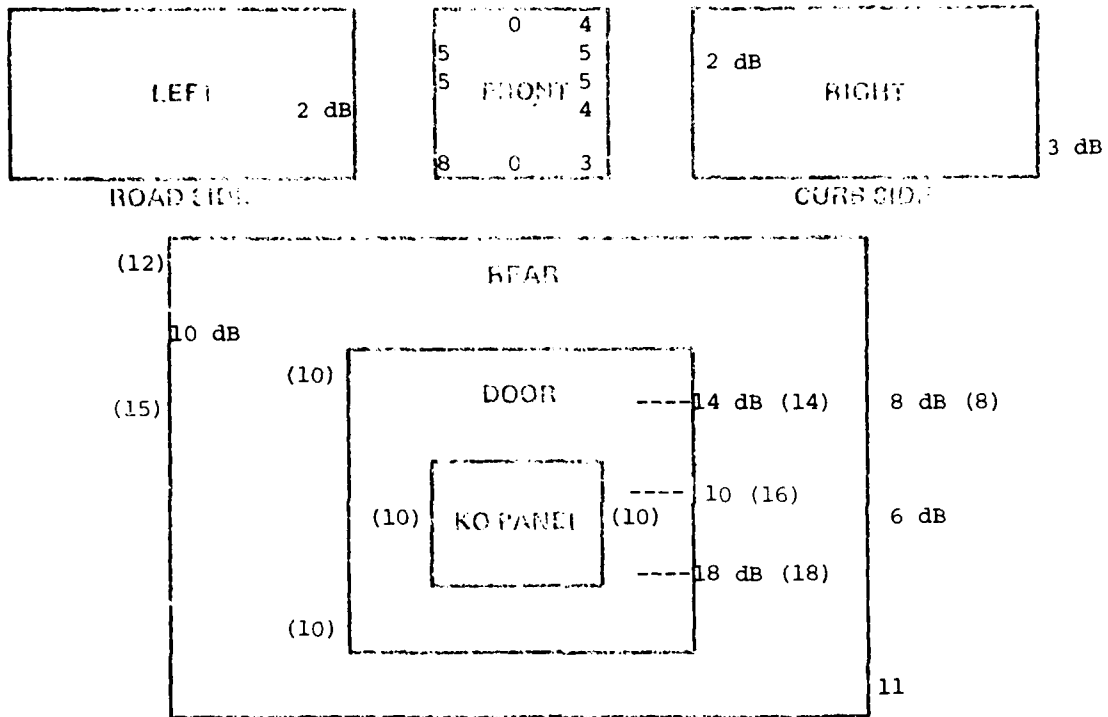

SPECIAL CONDITIONS Like new

FREQUENCY 400 MHz REF. 90 dB (92 dB) ZERO 0 dB

DATE 11 Sep 1979 (12 Sep 1979) TIME 1421 (0715)

OBSERVERS Guise, Brown, Garver

APPENDIX A

TEST SHEET ⁸ S-2803 SHELTER
(ALL VIEWS FROM INSIDE)

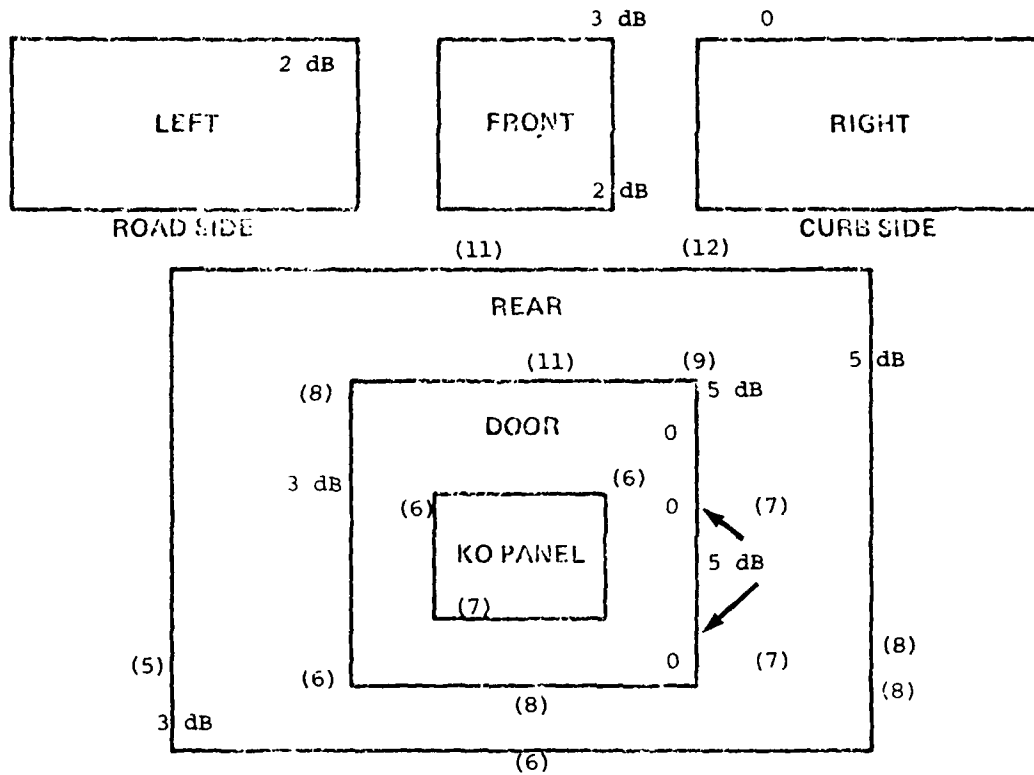

SPECIAL CONDITIONS Like new

FREQUENCY 1 GHz REF. 93 dB (91 dB) ZERO 0 dB

DATE 11 Sep 1979 (12 Sep 1979) TIME 1353 (0720)

OBSERVERS Guise, Brown, Garver

APPENDIX A

TEST SHEET 9 S-200B SHELTER
(ALL VIEWS FROM INSIDE)

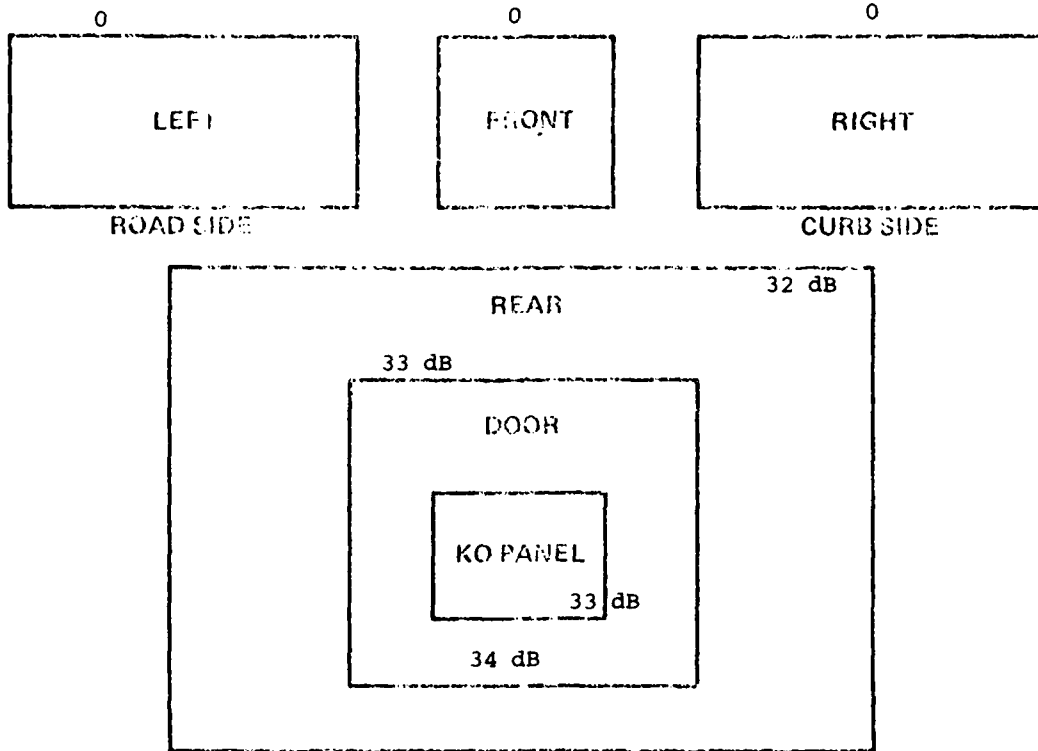

SPECIAL CONDITIONS Like new

FREQUENCY 10 GHz REF. 108 dB ZERO 31 dB

DATE 12 Sep 1979 TIME 0916

OBSERVERS Guise, Brown, Garver

APPENDIX A

TEST SHEET 10 S-280R SHELTER
(ALL VIEWS FROM INSIDE)

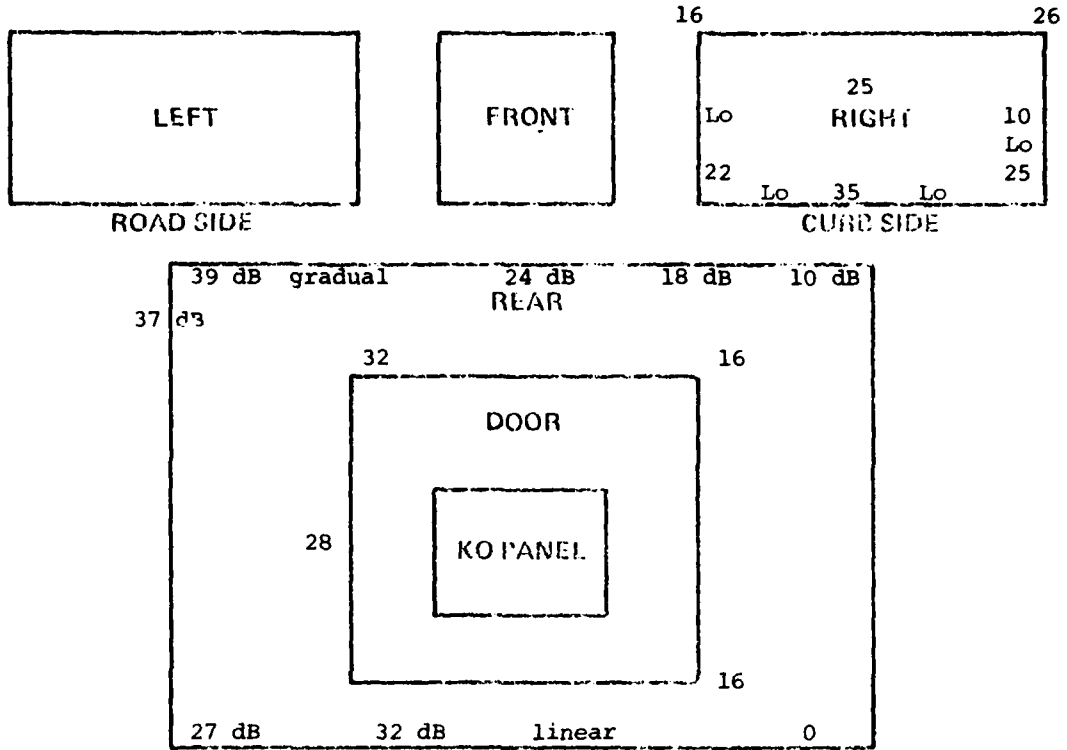

SPECIAL CONDITIONS Magnetic curb side exterior skin removed

FREQUENCY 175 kHz REF. 93 dB ZERO 0 dB

DATE 12 Sep 1979 TIME 1417

OBSERVERS Guise, Brown, Garver

APPENDIX A

TEST SHEET 11 S-2800 SHELTER
(ALL VIEWS FROM INSIDE)

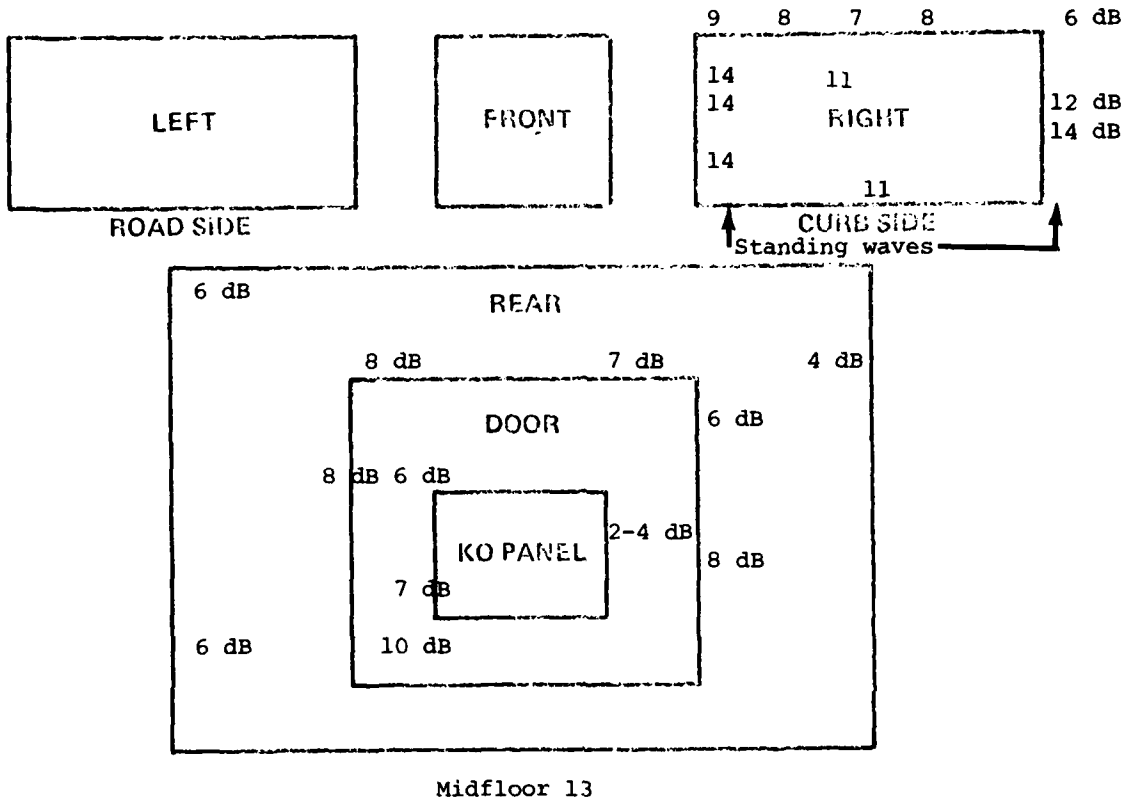

SPECIAL CONDITIONS Curb side exterior skin removed

FREQUENCY 1 GHz REF. 89 dB ZERO 0 dB

DATE 12 Sep 1979 TIME 1402

OBSERVERS Guise, Brown, Garver

APPENDIX A

TEST SHEET 13 S-2808 SHELTER
(ALL VIEWS FROM INSIDE)

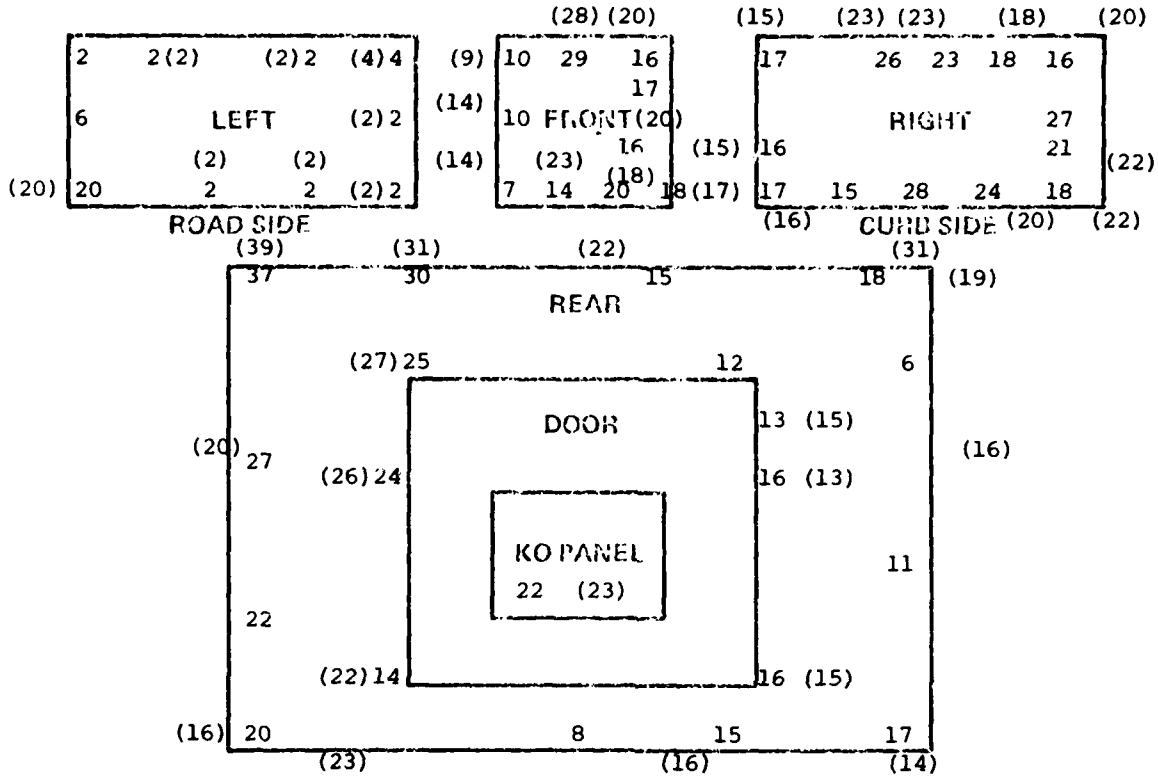

SPECIAL CONDITIONS Curb side and rear exterior skins removed

FREQUENCY 175 kHz REF. 92 dB (92 dB) ZERO 0 dB

DATE 13 Sep 1979 (13 Sep 1979) TIME 0850 (1245)

OBSERVERS Guise, Shirey

APPENDIX A

TEST SHEET 14 S-2808 SHELTER
(ALL VIEWS FROM INSIDE)

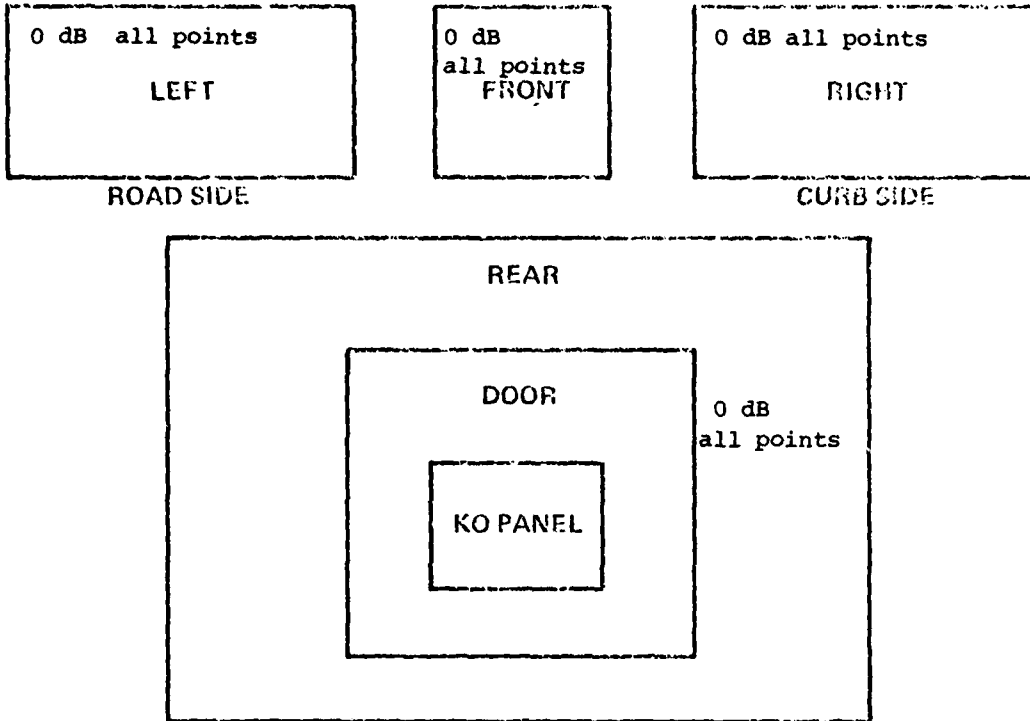

SPECIAL CONDITIONS Curb side and rear exterior skins removed

FREQUENCY 200 kHz REF. 100 dB ZERO 0 dB

DATE 13 Sep 1979 TIME 0910

OBSERVERS Guise, Shirey

APPENDIX A

TEST SHEET 15 0-280B SHELTER
(ALL VIEWS FROM INSIDE)

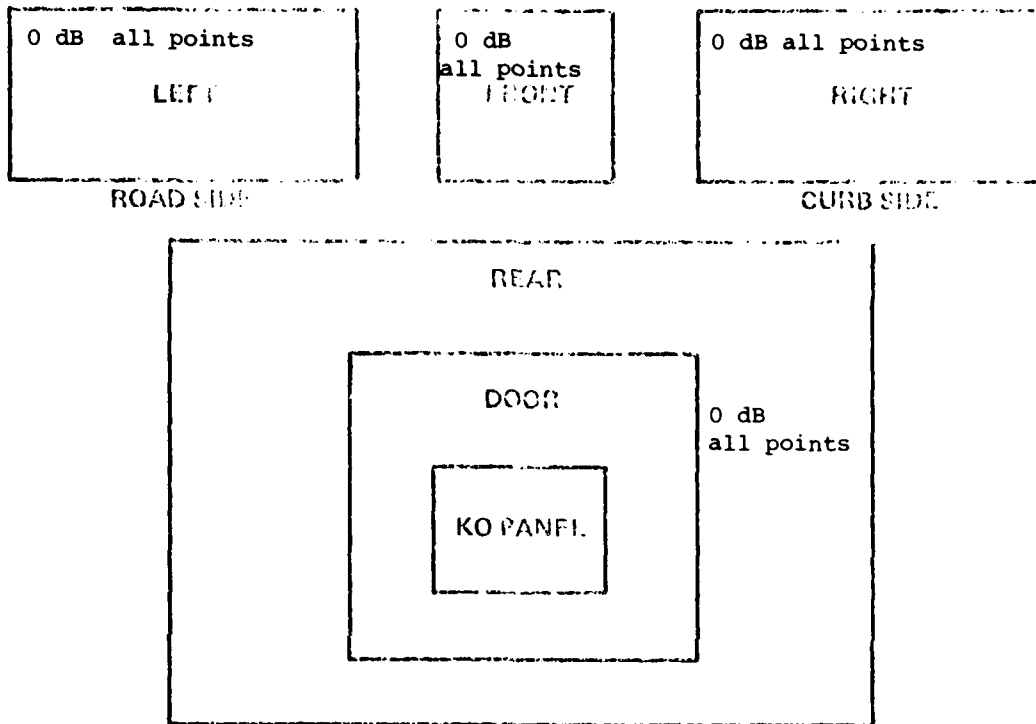

SPECIAL CONDITIONS Curb side and rear exterior skins removed

FREQUENCY 1.0 MHz REF. 95 dB ZERO 0 dB

DATE 13 Sep 1979 TIME 0920

OBSERVERS Guise, Shirey

APPENDIX A

TEST SHEET 16 S-200B SHELTER
(ALL VIEWS FROM INSIDE)

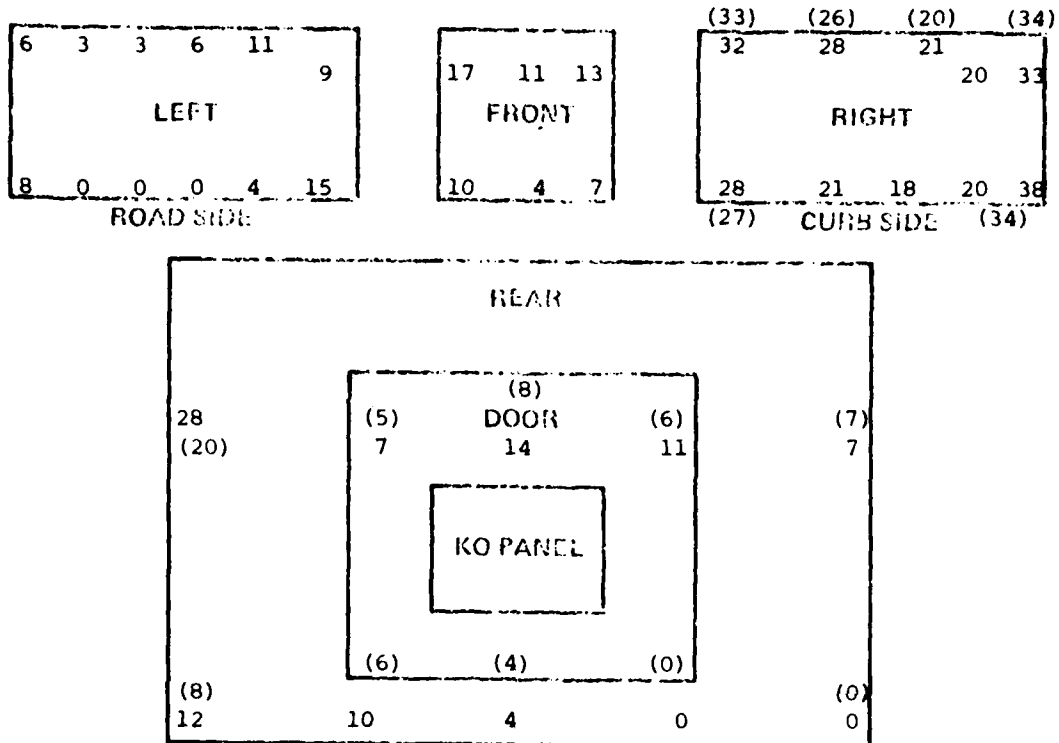

SPECIAL CONDITIONS Curb side and rear exterior skins removed

FREQUENCY 18 MHz REF. 90 dB ZERO 0 dB

DATE 13 Sep 1979 TIME 0930

OBSERVERS Guise, Shirey

APPENDIX A

TEST SHEET 17 G-2803 SHELTER
(ALL VIEWS FROM INSIDE)

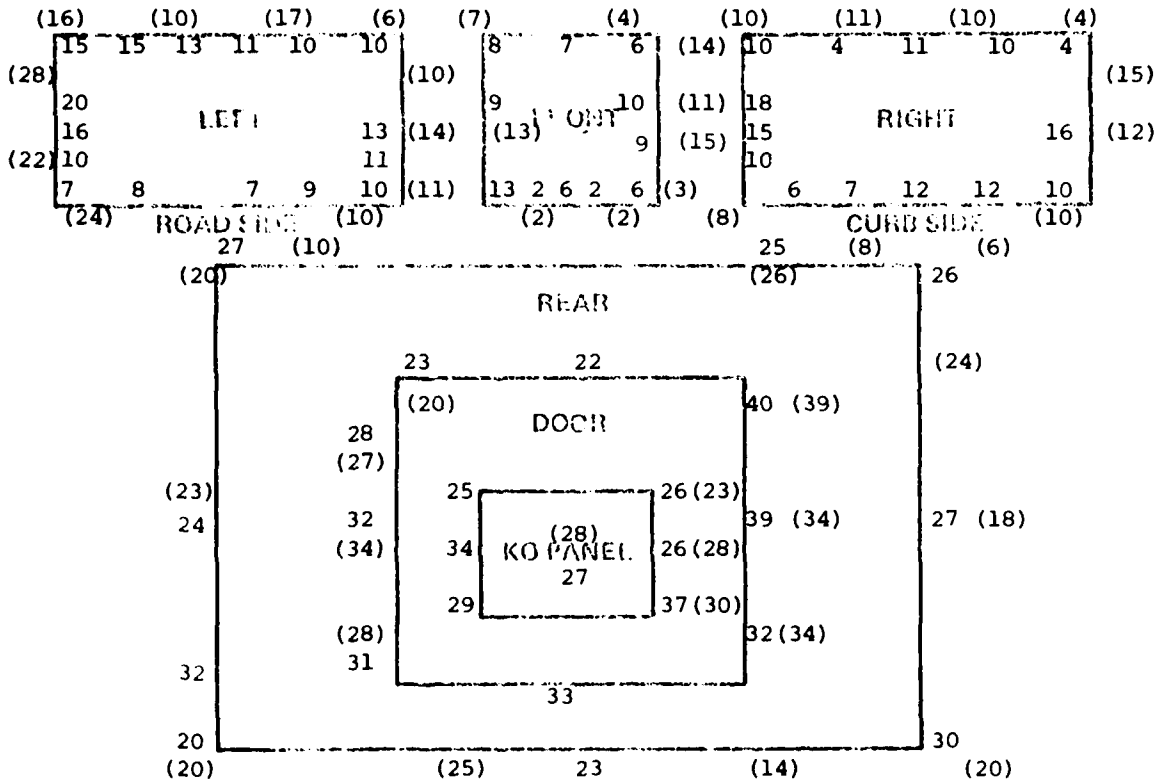

SPECIAL CONDITIONS Curb side and rear exterior skins removed

FREQUENCY 400 MHz REF 90 dB (90 dB) ZERO 0 dB

DATE 13 Sep 1979 (13 Sep 1979) TIME 0815 (1330)

OBSERVERS Guise, Shirey

APPENDIX A

TEST SHEET 19 S-200B SHELLER
(ALL VIEWS FROM INSIDE)

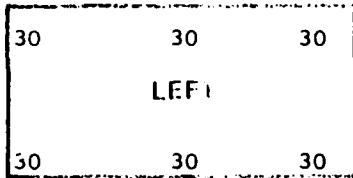

ROAD SIDE

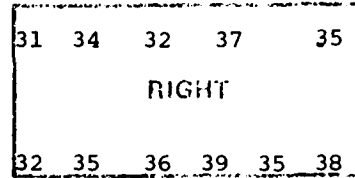
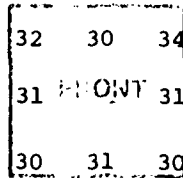

CURB SIDE

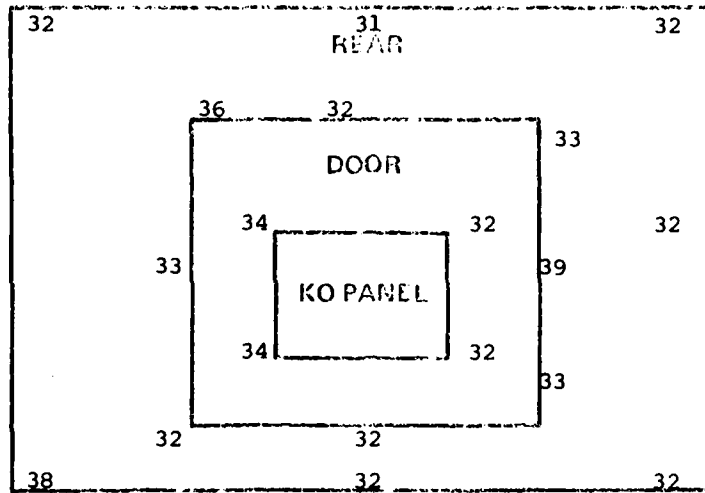

SPECIAL CONDITIONS Curb side and rear exterior skins removed

FREQUENCY 10 GHz REF. 106 dB ZERO 30 dB

DATE 13 Sep 1979 TIME 1500

OBSERVERS Guise, Shirey

APPENDIX A

TEST SHEET 20 S-220B SHELTER
(ALL VIEWS FROM INSIDE)

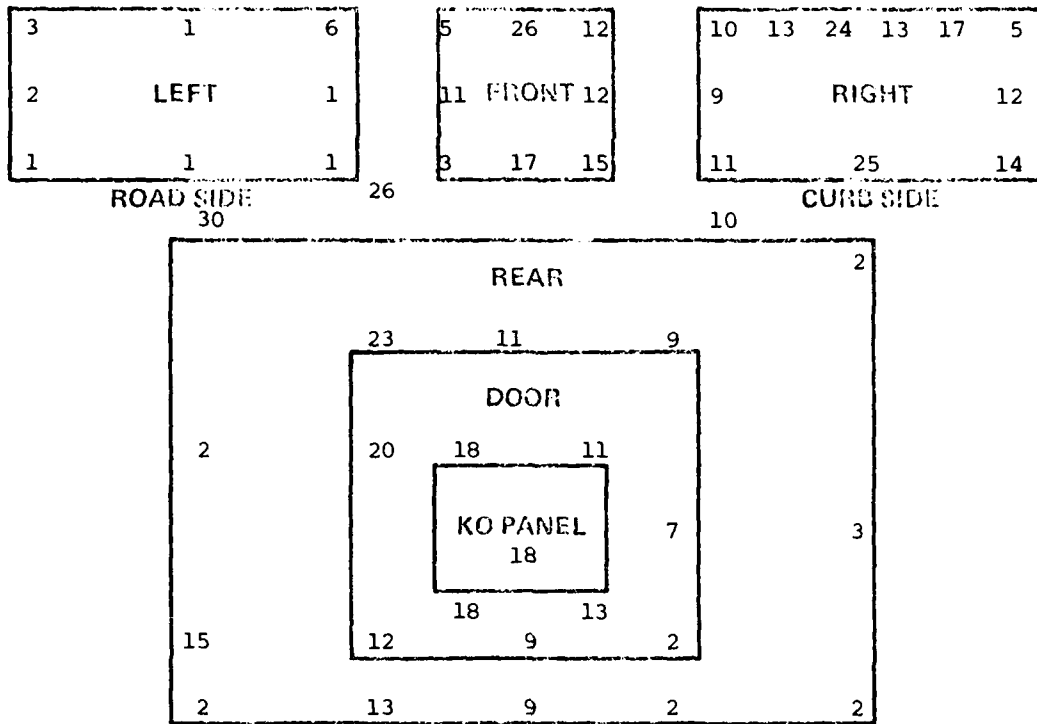

SPECIAL CONDITIONS Curb side and rear exterior skins removed (RFI tape around door frame)

FREQUENCY 100 kHz R.F.F. 86 dB ZERO 0 dB

DATE 14 Sep 1979 TIME 1300

OBSERVERS Guise, Shirey

APPENDIX A

TEST SHEET 21 S-2800 SHELTER
(ALL VIEWS FROM INSIDE)

9	0	8
7	LEFT	0
10	0	0

ROAD SIDE

20	31	22
6	FRONT	20
4	20	29

20	32	22	10
12	RIGHT		10
24	17	24	22

CURB SIDE

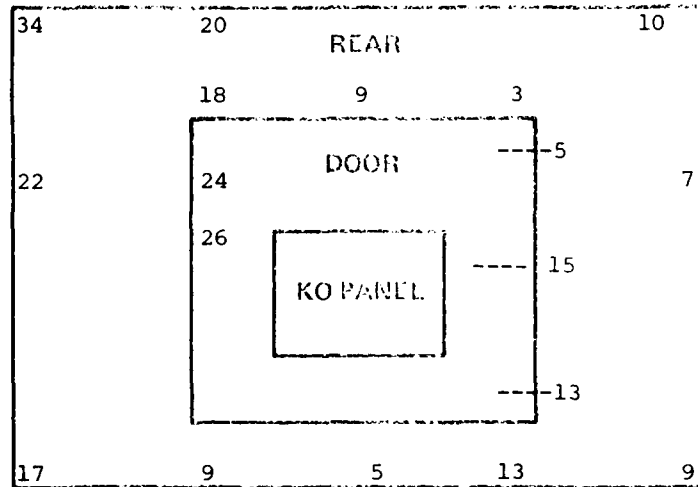

SPECIAL CONDITIONS Curb side and rear exterior skins removed (RFI tape around door frame)

FREQUENCY 175 kHz REF. 93 dB ZERO 0 dB

DATE 14 Sep 1979 TIME 1115

OBSERVERS Guise, Shirey

APPENDIX A

TEST SHEET 22 S- 2803 SHELTER
(ALL VIEWS FROM INSIDE)

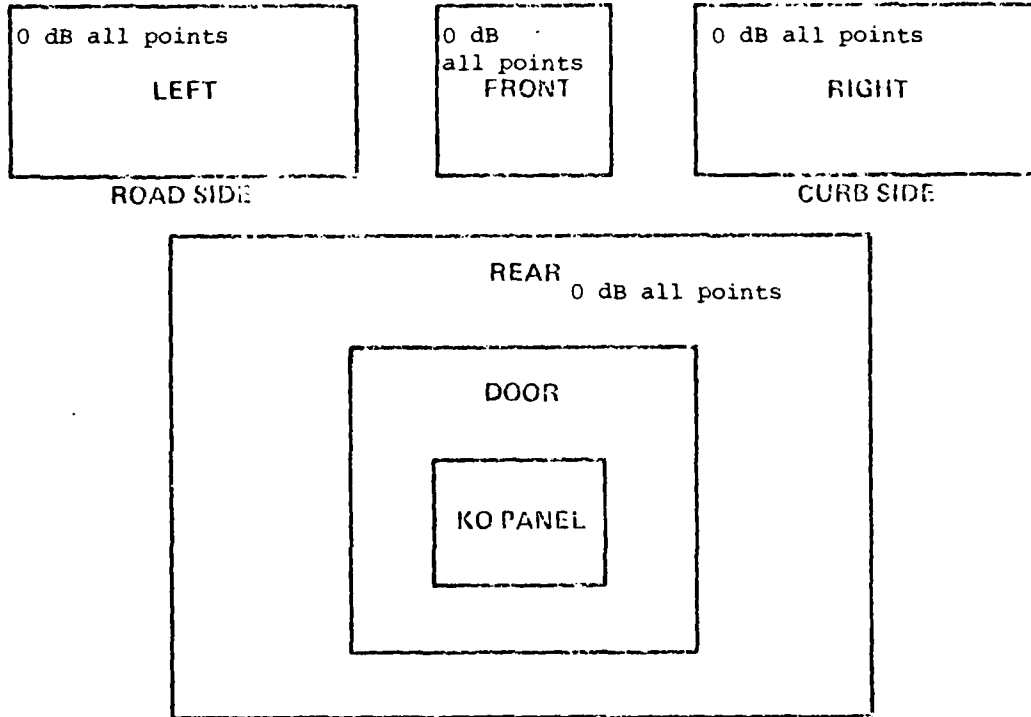

SPECIAL CONDITIONS Curb side and rear exterior skins removed (RFI tape around door frame)

FREQUENCY 200 kHz REF. 100 dB ZERO 0 dB

DATE 14 Sep 1979 TIME 1130

OBSERVERS Guise, Shirey

APPENDIX A

TEST SHEET 23S-2002 SHELTER
(ALL VIEWS FROM INSIDE)

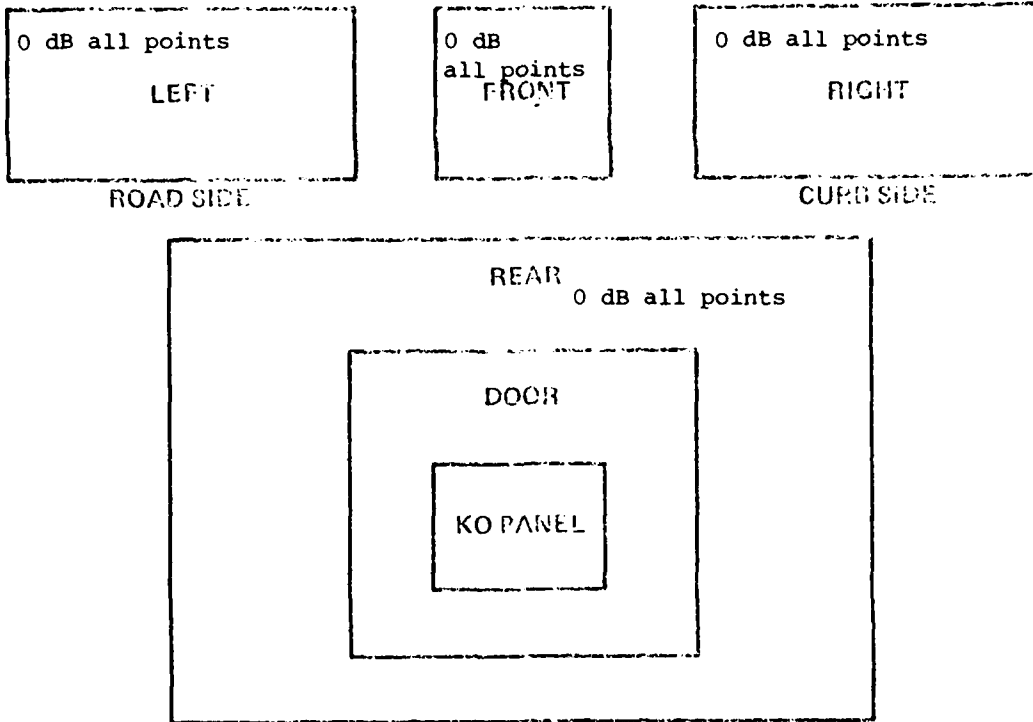

SPECIAL CONDITIONS Curb side and rear exterior skins removed (RFI tape
around door frame)

FREQUENCY 1.0 MHz REF. 95 dB ZERO 0 dB

DATE 14 Sep 1979 TIME 1140

OBSERVERS Guise, Shirey

APPENDIX A

TEST SHEET 24 S-2808 SHELTER
(ALL VIEWS FROM INSIDE)

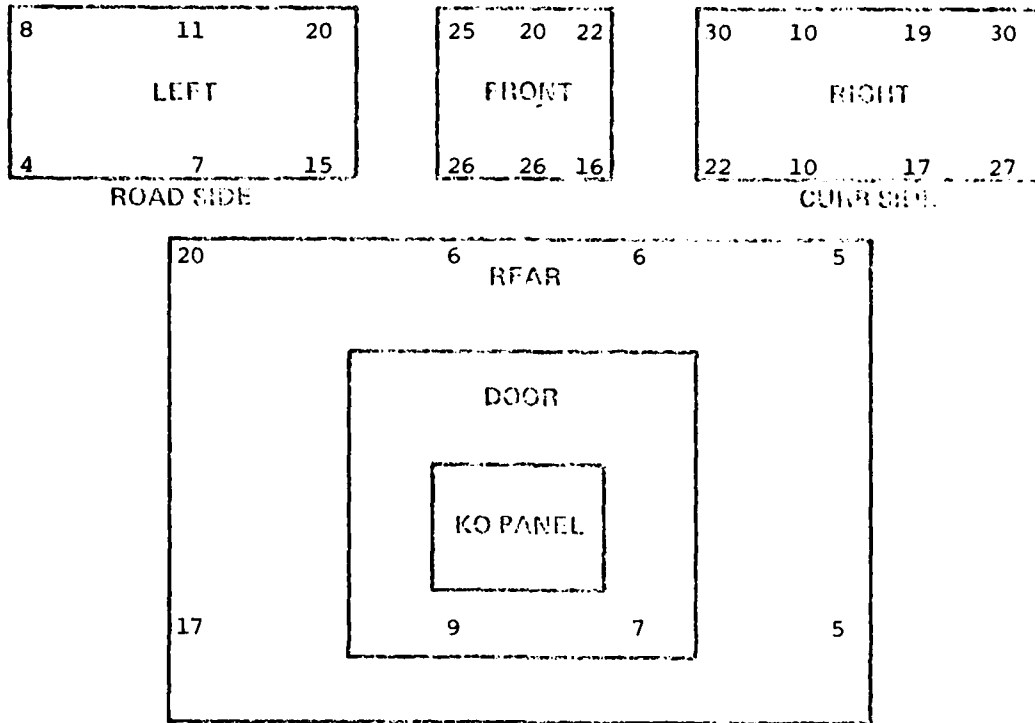

SPECIAL CONDITIONS Curb side and rear exterior skins removed (RFI tape around door frame)

FREQUENCY 18 MHz REF. 90 dB ZERO. 0 dB

DATE 14 Sep 1979 TIME 1250

OBSERVERS Guise, Shirey

APPENDIX A

TEST SHELTER 25 6-2608 SHELTER
(ALL VIEWS FROM INSIDE)

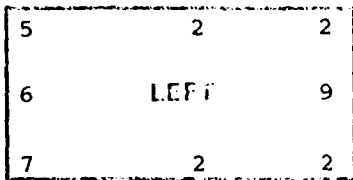

ROAD SIDE

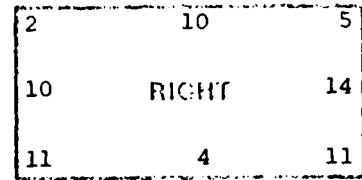
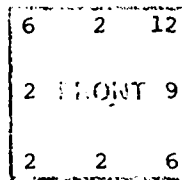

CURB SIDE

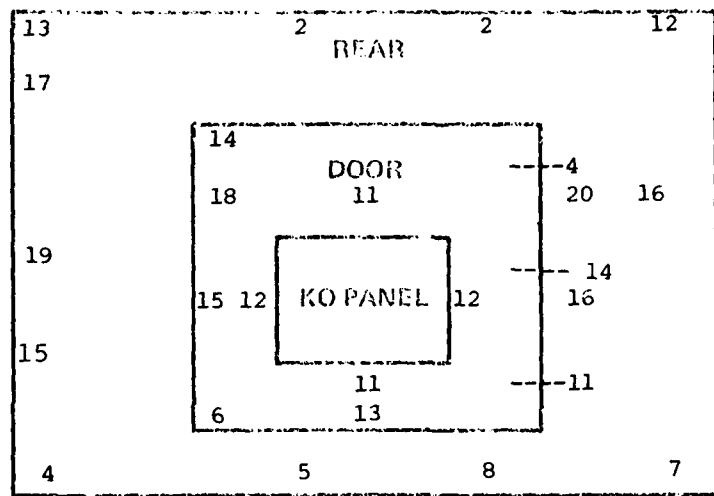

SPECIAL CONDITIONS Curb side and rear exterior skin removed (RFI tape around door frame)

FREQUENCY 400 MHz REF. 90 dB ZERO 0 dB

DATE 14 Sep 1979 TIME 1040

OBSERVERS Guise, Shirey

APPENDIX A

TEST SHEET 26 S-2803 SHELTER
(ALL VIEWS FROM INSIDE)

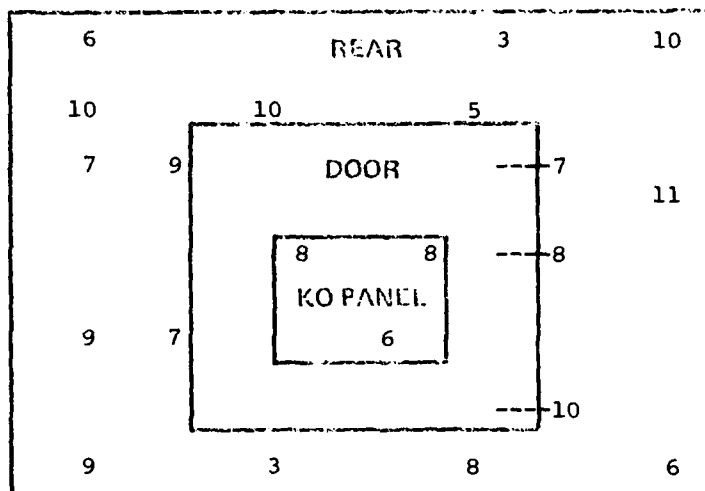
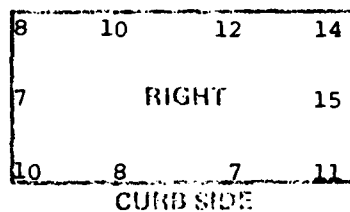
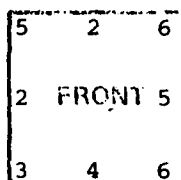
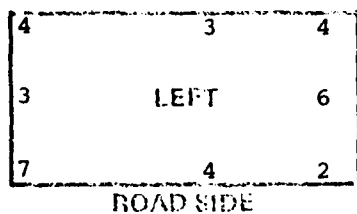

SPECIAL CONDITIONS Curb side and rear exterior skin removed (RFI tape around door frame)

FREQUENCY 1 GHz REF. 93 dB ZERO 0 dB

DATE 14 Sep 1979 TIME 1010

OBSERVERS Guise, Shirey

APPENDIX A

TEST SHEET 27 S-2093 SHELTER
(ALL VIEWS FROM INSIDE)

30	30	30
30	LEFT	30
30	30	30

ROAD SIDE

30	30	35
30	FRONT	30
30	32	30

32	33	33	42	33
32		RIGHT		32
34	33	37	44	33 37

CURB SIDE

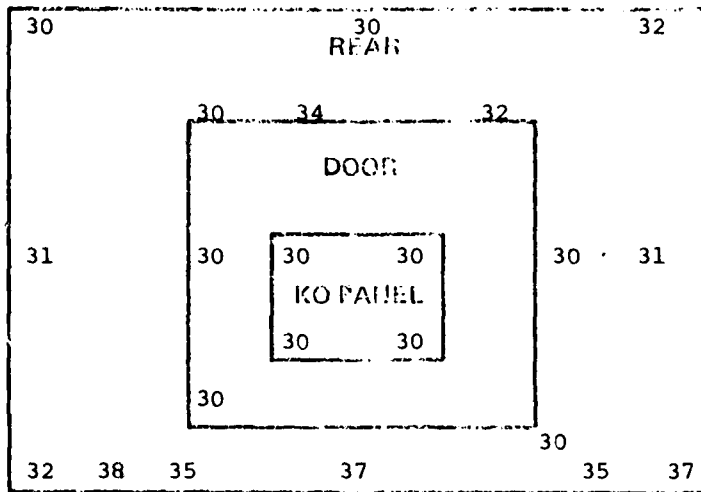

SPECIAL CONDITIONS Curb side and rear exterior skins removed (RFI tape around door frame)

FREQUENCY 10 GHz REF. 104 dB ZERO 30 dB

DATE 14 Sep 1979 TIME 1340

OBSERVERS Guise, Shirey

DISTRIBUTION

ADMINISTRATOR
DEFENSE TECHNICAL INFORMATION CENTER
ATTN DTIC-DDA (12 COPIES)
CAMERON STATION, BUILDING 5
ALEXANDRIA, VA 22314

COMMANDER
US ARMY RSCH & STD GP (EUR)
ATTN CHIEF, PHYSICS & MATH BRANCH
FPO NEW YORK 09510

COMMANDER
US ARMY ARMAMENT MATERIEL
READINESS COMMANBD
ATTN DRSAR-LEP-L, TECHNICAL LIBRARY
ROCK ISLAND, IL 61299

COMMANDER
US ARMY MISSILE & MUNITIONS
CENTER & SCHOOL
ATTN ATSK-CTD-F
REDSTONE ARSENAL, AL 35809

DIRECTOR
US ARMY MATERIEL SYSTEMS ANALYSIS
ACTIVITY
ATTN DRXSY-MP
ABERDEEN PROVING GROUND, MD 21005

DIRECTOR
US ARMY BALLISTIC RESEARCH LABORATORY
ATTN DRDAR-TSB-S (STINFO)
ABERDEEN PROVING GROUND, MD 21005

US ARMY ELECTRONICS TECHNOLOGY
AND DEVICES LABORATORY
ATTN DELET-DD
FORT MONMOUTH, NJ 07703

HQ USAF/SAMI
WASHINGTON, DC 20330

TELEDYNE BROWN ENGINEERING
CUMMINGS RESEARCH PARK
ATTN DR. MELVIN L. PRICE, MS-44
HUNTSVILLE, AL 35807

ENGINEERING SOCIETIES LIBRARY
345 EAST 47TH STREET
ATTN ACQUISITIONS DEPARTMENT
NEW YORK, NY 10017

DIRECTOR
DEFENSE NUCLEAR AGENCY
ATTN RAEV, ELECTRONICS
VULNERABILITY DIV
ATTN RAEE, EMP EFFECTS DIV
WASHINGTON, DC 20305

HEADQUARTERS, US ARMY COMMUNICATIONS
& ELECTRONICS MATERIEL READINESS
COMMAND AND FORT MONMOUTH
ATTN DRSEL-LE-SS, JULES SAGUI (5 COPIES)
FORT MONMOUTH, NJ 07703

COMMANDER
US ARMY MISSILE COMMAND
ATTN DRCPM-PE, PERSHING (B. JOHNSON)
REDSTONE ARSENAL, AL 35809

DIRECTOR
US ARMY SIGNALS WARFARE LABORATORY
VINT HILL FARMS STATION
ATTN DELSW-CE, COMMUNICATIONS/EW
DIVISION
WARRENTON, VA 22186

COMMANDER
US ARMY TRAINING AND DOCTRINE
COMMAND
ATTN ATCD-C, BATTLEFIELD SYS
INTEGRATION BR
ATTN ATCD-T, TEST & EVAL DIR
FORT MONROE, VA 23651

COMMANDER
WHITE SANDS MISSILE RANGE
DEPT OF THE ARMY
ATTN STEWS-CE, COMMUNICATIONS/
ELEC OFFICE
WHITE SANDS MISSILE RANGE, NM 88002

AEROSPACE CORP
PO BOX 92957
ATTN IRVING GARFUNKEL
LOS ANGELES, CA 90009

BOOZ-ALLEN & HAMILTON
776R SHREWSBURY AVE
ATTN STEPHEN TUZENELL
TINTON FALLS, NJ 07724

BRUNSWICK CORPORATION
325 BRUNSWICK LANE
ATTN MILES UNTIEDT
MARION, VA 24354

CHOMERICS
77 DRAGON COURT
ATTN IRA BARRY
WOBURN, MA 01801

CRAIG SYSTEMS CORPORATION
360 MERRIMACK STREET
ATTN JOHN FORD
LAWRENCE, MA 01842

DISTRIBUTION (Cont'd)

ELECTROMAGNETIC APPLICATION
PO BOX 26263
ATTN RAYNER ROSICH
DENVER, CO 80226

GICHNER MOBILE SYSTEMS
PO BOX B
ATTN WILLIAM W. CICCARELLI
DALLASTOWN, PA 17313

GOODYEAR AEROSPACE CORP
ATTN L. PAUL JOHNSON
LITCHFIELD PARK, AZ 85340

GTE PRODUCTS CORP
189B STREET
ATTN STAN MORAN
NEEDHAM, MA 02194

IRT CORP
PO BOX 80817
ATTN RICHARD STEWART
SAN DIEGO, CA 92138

KAMAN AVIDYNE
83 SECOND AVENUE
NW PARK
ATTN RAFFI P. YEGHIAYAN
BURLINGTON, MA 01803

MISSION RESEARCH CORP
1400 SAN MATEO BOULEVARD, SE
ATTN PAUL TRYBUS
ALBUQUERQUE, NM 87103

MITRE CORP
PO BOX 208
ATTN JOHN CALLIGEROS
BEDFORD, MA 01730

NORADAM
510 SOUTH LANSING
ATTN R. G. HOWSER
TULSA, OK 74120

OPE PRODUCTS CORP
GTE PRODUCTS
189B STREET
ATTN MEL DILL
NEEDHAM, MA 92194

ROCKWELL INT
3370 MIRALOMA AVE
ATTN JAMES LOCASSO
ANAHEIM, CA 92803

TECHNOLOGY DEVELOPMENT OF CA
624 SIX FLAGS DRIVE
SUITE 130
ATTN SAMUEL CLARK
ARLINGTON, TX 76011

TECKNIT
129 DERMODY STREET
ATTN WILL SCHOENLEBER
CRANFORD, NJ 07016

TRW - DSSG
10 NORTH SPACE PARK
ATTN CLYDE HALL
REDONDO BEACH, CA 90278

US ARMY ELECTRONICS RESEARCH
& DEVELOPMENT COMMAND
ATTN TECHNICAL DIRECTOR, DRDEL-CT

HARRY DIAMOND LABORATORIES
ATTN CO/TD/TSO/DIVISION DIRECTORS
ATTN RECORD COPY, 81200
ATTN HDL LIBRARY, 81100 (3 COPIES)
ATTN HDL LIBRARY, 81100 (WOODBRIDGE)
ATTN TECHNICAL REPORTS BRANCH, 81300
ATTN CHAIRMAN, EDITORIAL COMMITTEE
ATTN LEGAL OFFICE, 97000
ATTN CHIEF, 21000
ATTN CHIEF, 21100
ATTN CHIEF, 21200
ATTN CHIEF, 21300
ATTN CHIEF, 21400, (2 COPIES)
ATTN CHIEF, 21500
ATTN CHIEF, 22000
ATTN CHIEF, 22100
ATTN CHIEF, 22300
ATTN CHIEF, 22800
ATTN CHIEF, 22900
ATTN CHIEF, 20240
ATTN TOKARCIC, J., 47100
ATTN WHITTAKER, D., 22900
ATTN MEYER, O., 22300
ATTN GARVER, R., 21100 (5 COPIES)

DATE
ILMED
-8