

AD A 099 053

LEVEL III

2

DNA 5066F-2

RESPONSE OF BASIC STRUCTURAL ELEMENTS AND B-52 STRUCTURAL COMPONENTS TO SIMULATED NUCLEAR OVERPRESSURE

Volume II - Program Data (Basic Structural Elements)

Boeing Wichita Company
3801 South Oliver Street
Wichita, Kansas 67210

DTIC
SELECTED
MAY 18 1981
S D E

30 September 1979

Final Report for Period 1 June 1977-30 September 1979

CONTRACT No. DNA 001-77-C-0166

V4
B056 1714

APPROVED FOR PUBLIC RELEASE;
DISTRIBUTION UNLIMITED.

THIS WORK SPONSORED BY THE DEFENSE NUCLEAR AGENCY
UNDER RDT&E RMSS CODE B342078464 N99QAXAJ50202 H2590D.

Prepared for
Director
DEFENSE NUCLEAR AGENCY
Washington, D. C. 20305

DTIC FILE COPY

81 5 18 082

Destroy this report when it is no longer needed. Do not return to sender.

PLEASE NOTIFY THE DEFENSE NUCLEAR AGENCY,
ATTN: STTI, WASHINGTON, D.C. 20305, IF
YOUR ADDRESS IS INCORRECT, IF YOU WISH TO
BE DELETED FROM THE DISTRIBUTION LIST, OR
IF THE ADDRESSEE IS NO LONGER EMPLOYED BY
YOUR ORGANIZATION.



UNCLASSIFIED

SECURITY CLASSIFICATION OF THIS PAGE (When Data Entered)

19 REPORT DOCUMENTATION PAGE		READ INSTRUCTIONS BEFORE COMPLETING FORM
1. REPORT NUMBER DNA 5066F-2	2. GOVT ACCESSION NO. AD-A099	3. RECIPIENT'S CATALOG NUMBER 053
4. TITLE (and Subtitle) RESPONSE OF BASIC STRUCTURAL ELEMENTS AND B-52 STRUCTURAL COMPONENTS TO SIMULATED NUCLEAR OVERPRESSURE, Volume II - Program Data (Basic Structural Elements)		5. TYPE OF REPORT & PERIOD COVERED Final Report for Period 1 Jun 77 - 30 Sep 79
6. AUTHOR(s) Roger P. Syring Richard L. Grubb		6. PERFORMING ORG. REPORT NUMBER D3-11108-8, Vol II
9. PERFORMING ORGANIZATION NAME AND ADDRESS Boeing Wichita Company 3801 South Oliver Street Wichita, Kansas 67210		8. CONTRACT OR GRANT NUMBER(s) DNA 001-77-C-0166 NE
11. CONTROLLING OFFICE NAME AND ADDRESS Director Defense Nuclear Agency Washington, D.C. 20305		10. PROGRAM ELEMENT, PROJECT, TASK AREA & WORK UNIT NUMBERS Subtask N99QAXAJ502-02
14. MONITORING AGENCY NAME & ADDRESS (if different from Controlling Office) D3-11108-8-8-VOL-2		12. REPORT DATE 30 Sep 79
		13. NUMBER OF PAGES 262
		15. SECURITY CLASS (of this report) UNCLASSIFIED
		15a. DECLASSIFICATION/DOWNGRADING SCHEDULE
16. DISTRIBUTION STATEMENT (of this Report) Approved for public release; distribution unlimited.		
17. DISTRIBUTION STATEMENT (of the abstract entered in Block 20, if different from Report)		
18. SUPPLEMENTARY NOTES This work sponsored by the Defense Nuclear Agency under RDT&E RMSS Code B342078464 N99QAXAJ50202 H2590D.		
19. KEY WORDS (Continue on reverse side if necessary and identify by block number) Static Test Shock Load Test Shock Tube Nuclear Overpressure Structural Response Analysis NOVA-2 Aircraft Vulnerability Nuclear Hardness B-52 Components		
20. ABSTRACT (Continue on reverse side if necessary and identify by block number) This document reports on the following: (1) experimental determination of the response of 16 basic structural elements and 7 B-52 components to simulated nuclear overpressure environments (utilizing Sandia Corporation's Thunderpipe Shock Tube), (2) analysis of these test specimens utilizing the NOVA-2 computer program, and (3) correlation of test and analysis results.		

UNCLASSIFIED

SECURITY CLASSIFICATION OF THIS PAGE(When Data Entered)

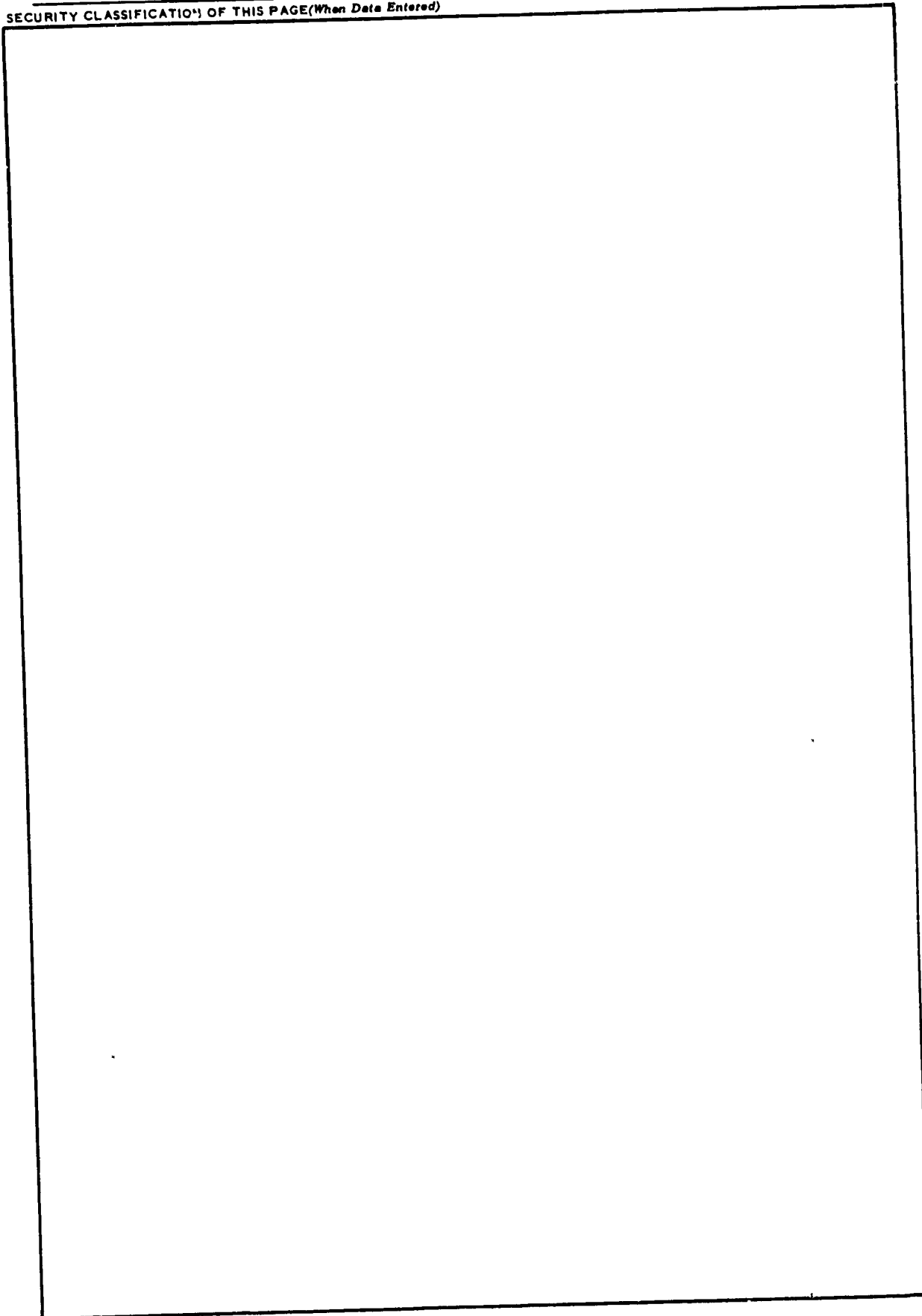

UNCLASSIFIED

SECURITY CLASSIFICATION OF THIS PAGE(When Data Entered)

Accession For	
NTIS GRA&I	<input checked="" type="checkbox"/>
DTIC TAB	<input type="checkbox"/>
Unannounced	<input type="checkbox"/>
Justification	
By _____	
Distribution/	
Availability Codes	
Dist	Avail and/or Special
A	

Conversion factors for U.S. customary to metric (SI) units of measurement.

To Convert From	To	Multiply By
degree (angle)	radian (rad)	1.745 329 X E -2
foot	meter (m)	3.048 000 X E -1
foot-pound-force	joule (J)	1.355 818
inch	meter (m)	2.540 000 X E -2
kip (1000 lbf)	newton (N)	4.448 222 X E +3
kip/inch ² (ksi)	kilo pascal (kPa)	6.894 757 X E +3
mil	meter (m)	2.540 000 X E -5
pound-force (lbf avoirdupois)	newton (N)	4.448 222
pound-force inch	newton-meter (N*m)	1.129 848 X E -1
pound-force/inch	newton/meter (N/m)	1.751 268 X E +2
pound-force/foot ²	kilo pascal (kPa)	4.788 026 X E -2
pound-force/inch ²	kilo pascal (kPa)	6.894 757
pound-mass (lbm avoirdupois)	kilogram (kg)	4.535 924 X E -1
pound-mass-foot ² (moment of inertia)	kilogram-meter ² (kg*m ²)	4.214 011 X E -2
pound-mass/foot ³	kilogram/meter ³ (kg/m ³)	1.601 846 X E +1

PREFACE

This report was prepared by the Boeing Wichita Company, a division of The Boeing Company, under Contract No. DNA 001-77-C-0166, P00002, and documents the overall program description, test specimens and procedures, test results, analysis results, observations, and conclusions. The work was funded by the Defense Nuclear Agency and the Aeronautical Systems Division and was performed under the following:

<u>Program Element</u>	<u>Project</u>	<u>Task Area</u>	<u>Work Unit</u>
NWED 62704H	N99QAXA	E502	08
NWED 62704H	N99QAXA	J502	02
NWED 62704H	Q56QAXA	J502	02

Inclusive dates of research and development as documented herein were June 1977 through September 1979.

Volumes I and II are associated with 16 basic structural elements. Volume I summarizes the program description, test specimens and procedures, test results, analysis results, and conclusions. Volume II contains photographs, listings of NOVA-2 analysis models, and measured test data.

Volumes III and IV are associated with seven B-52 structural components. Volume III summarizes the program description, test specimens and procedures, test results, analysis results, and conclusions. Volume III is classified SECRET. Volume IV contains photographs, listings of NOVA-2 analysis models, and measured test data.

Mr. Kenneth L. Roger was the Program Manager for this task. Principal investigator was Roger P. Syring.

Appreciation is expressed to Capt. Mike Rafferty (DNA/SPAS), Mr. Dudley Ward (ASD/ENFTV), and Mr. Gerald Campbell (AFWL/DYV) for their interest and support of this program.

TABLE OF CONTENTS (VOLUME II)

		<u>PAGE</u>
	NOMENCLATURE -----	5
1.0	TEST SPECIMENS 18-21 (PIN ENDED COLUMNS) -----	7
1.1	Description and Instrumentation -----	9
1.2	Spec Drawing -----	10
1.3	NOVA-2LT Analysis Model -----	11
1.4	Static Test Photos -----	12
1.5	Static Test Results -----	13
1.6	Shock Test Photos -----	15
1.7	Shock Test Results -----	16
2.0	TEST SPECIMENS 22-23 (PIN ENDED COLUMNS) -----	31
2.1	Description and Instrumentation -----	33
2.2	Spec Drawing -----	34
2.3	NOVA-2LT Analysis Model -----	35
2.4	Static Test Results -----	36
2.5	Shock Test Results -----	37
3.0	TEST SPECIMENS 24-25 (CLAMP ENDED COLUMNS) -----	49
3.1	Description and Instrumentation -----	51
3.2	Spec Drawing -----	52
3.3	NOVA-2LT Analysis Model -----	53
3.4	Static Test Photos -----	54
3.5	Static Test Results -----	55
3.6	Shock Test Results -----	57
4.0	TEST SPECIMENS 26-27 (PIN ENDED COLUMNS) -----	69
4.1	Description and Instrumentation -----	71
4.2	Spec Drawing -----	72
4.3	NOVA-2LT Analysis Model -----	73
4.4	Static Test Results -----	74
4.5	Shock Test Results -----	75
5.0	TEST SPECIMENS 28-29 (CLAMP ENDED COLUMNS) -----	83
5.1	Description and Instrumentation -----	85
5.2	Spec Drawing -----	86
5.3	NOVA-2LT Analysis Model -----	87
5.4	Static Test Results -----	88
5.5	Shock Test Results -----	90

		<u>PAGE</u>
6.0	TEST SPECIMEN 30 (FLAT PANEL) -----	95
6.1	Description and Instrumentation -----	97
6.2	Spec Drawing -----	98
6.3	NOVA-2LT Analysis Model -----	99
6.4	Static Test Results -----	100
6.5	Shock Test Photos -----	101
6.6	Shock Test Results -----	103
7.0	TEST SPECIMEN 31 (FLAT PANEL) -----	127
7.1	Description and Instrumentation -----	129
7.2	Spec Drawing -----	130
7.3	NOVA-2LT Analysis Model -----	131
7.4	Static Test Results -----	132
7.5	Shock Test Photos -----	133
7.6	Shock Test Results -----	135
8.0	TEST SPECIMEN 32 (SKIN/FRAME CYLINDER) -----	157
8.1	Description and Instrumentation -----	159
8.2	Spec Drawing -----	160
8.3	NOVA-2LT Analysis Model -----	161
8.4	Static Test Results -----	162
8.5	Shock Test Photos -----	163
8.6	Shock Test Results -----	166
9.0	TEST SPECIMEN 33 (SKIN/FRAME CYLINDER) -----	211
9.1	Description and Instrumentation -----	213
9.2	Spec Drawing -----	214
9.3	NOVA-2LT Analysis Model -----	215
9.4	Static Test Results -----	216
9.5	Shock Test Photos -----	217
9.6	Shock Test Results -----	220

NOMENCLATURE

AFWL	Air Force Weapons Laboratory
ASD	Aeronautical Systems Division
DNA	Defense Nuclear Agency
IN	Inches
LB	Pound
NO	Number
PSI	Pounds per square inch
SEC	Second
SPEC	Specimen

SPECIMEN NO. 18-21

PRECEDING PAGE BLANK-NOT FILMED

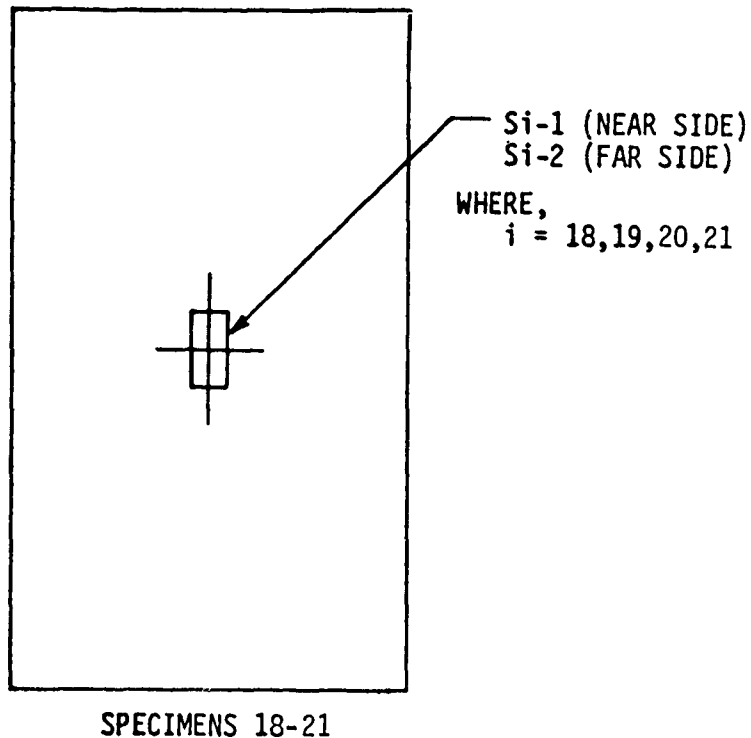

PIN-ENDED COLUMNS - 0.033 IN. THICK
10.0 IN. LONG
5.0 IN. WIDE

MATERIAL - 6061-T6 ALUMINUM ALLOY

DENSITY - 0.0002539 LB-SEC²/IN⁴

YIELD STRESS - 42,200 PSI

ULTIMATE STRESS - 47,360 PSI

MODULUS OF ELASTICITY - 10.1 x 10⁶ PSI

Figure 1. Description and Instrumentation - Specimens 18-21

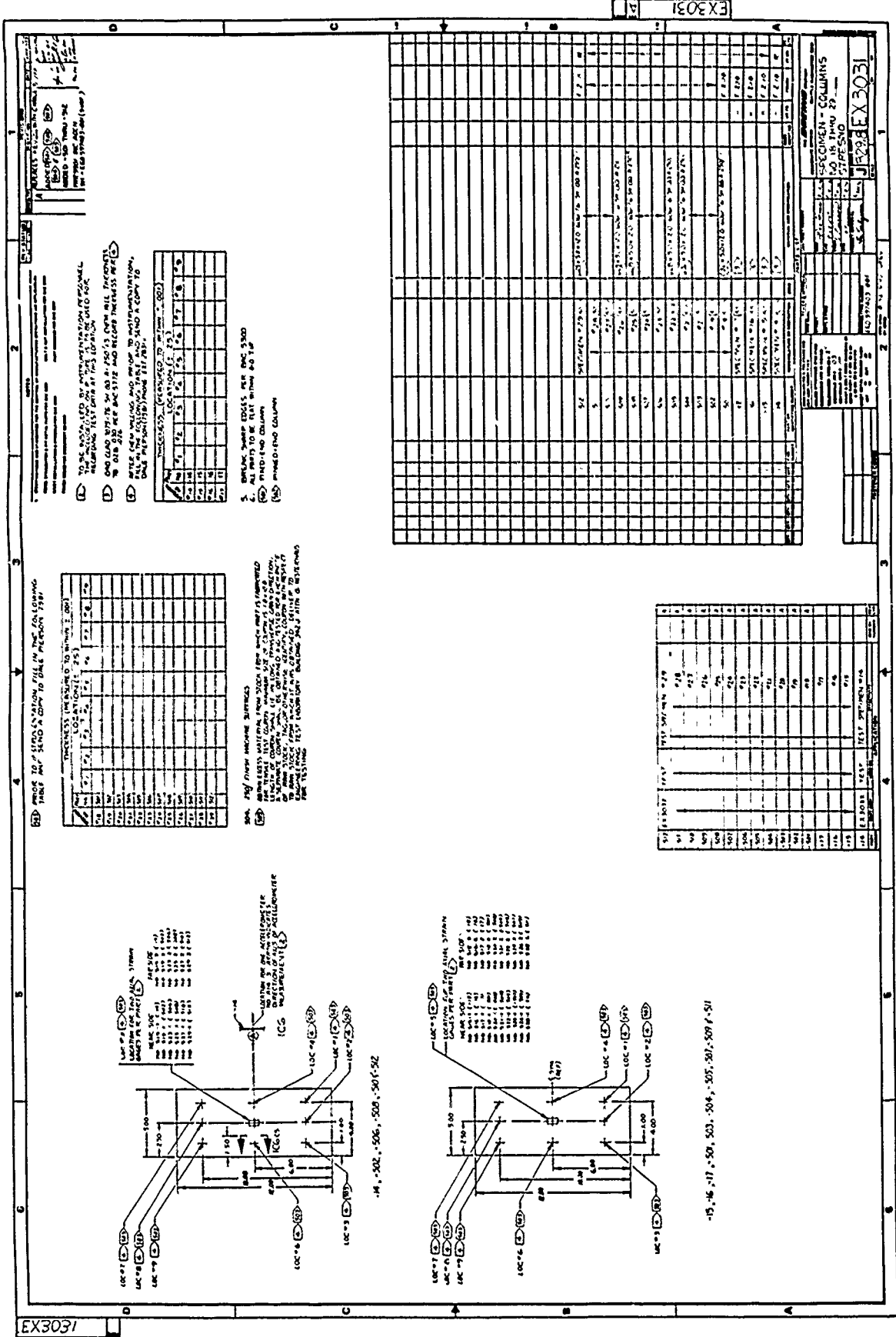

NOVA-2LT DATA DECK LISTING
 TEST SPECIMENS 18-21

	1						GP 1
* * *	NOVA-2LT DATA DECK FOR TEST SPECIMENS 18-21	* * *					
	1	10	100	2		1	GP 3
0.50							GP 4
	2	3	3	1		1	GPB 1
	20	1	6				GPB 2
-0.5							
0.0							
0.5							
1.0							
1.5							
2.0							
2.5							
3.0							
3.5							
4.0							
4.5							
5.0							
5.5							
6.0							
6.5							
7.0							
7.5							
8.0							
8.5							
9.0							
9.5							
10.0							
	0						GPB 8
	0						GPB 12
0.0002539							GPB 13
0.9818							GPB 14
0.033							GPB 15
5.0							GPB 16
	2						GPB 17
0.004178		42200.					GPB 18
0.1188		47360.					GPB 18
0.005							GPB 21
0.0		0.100	400.0				GPB 22
	4						GP 6



FIGURE 3. STATIC TEST SETUP - SPECIMENS 18-21

TABLE 1

STATIC TEST STRESS DATA - SPECIMENS 18-21

(STRESSES GIVEN IN PSI)

STRAIN GAUGE	LOAD (POUNDS)				
	13.0	16.0	16.75	16.95	17.15
S18-1	-141.	-10252.	-27543.	-32865.	-
S18-2	-61.	10595.	28048.	33522.	-
S19-1	-1183.	-11047.	-28254.	-32885.	-36037.
S19-2	960.	10996.	28825.	33691.	36995.
S20-1	-2376.	-11903.	-29147.	-	-39774.
S20-2	2071.	11783.	29136.	-	40156.
S21-1	-1012.	-9890.	-25788.	-	-32872.
S21-2	902.	9798.	25843.	-	33120.

TABLE 2

STATIC TEST DISPLACEMENT DATA - SPECIMENS 18-21 (VERTICAL DISPLACEMENT IS DISPLACEMENT OF PISTON PARALLEL TO COLUMN AXIS, AND LATERAL DISPLACEMENT IS MEASURED PERPENDICULAR TO COLUMN AT ITS CENTER)

	LOAD (POUNDS)				
	13.0	16.0	16.75	16.95	17.15
SPEC. 18 LATERAL	0.005	0.595	1.545	1.80	-
SPEC. 18 VERTICAL	0.0	0.095	0.610	0.850	-
SPEC. 19 LATERAL	0.055	0.580	1.555	1.770	1.930
SPEC. 19 VERTICAL	0.010	0.105	0.620	0.830	0.990
SPEC. 20 LATERAL	0.080	0.585	1.440	-	1.940
SPEC. 20 VERTICAL	0.005	0.100	0.450	-	1.020
SPEC. 21 LATERAL	0.055	0.590	1.550	-	1.940
SPEC. 21 VERTICAL	0.0	0.080	0.610	-	0.990

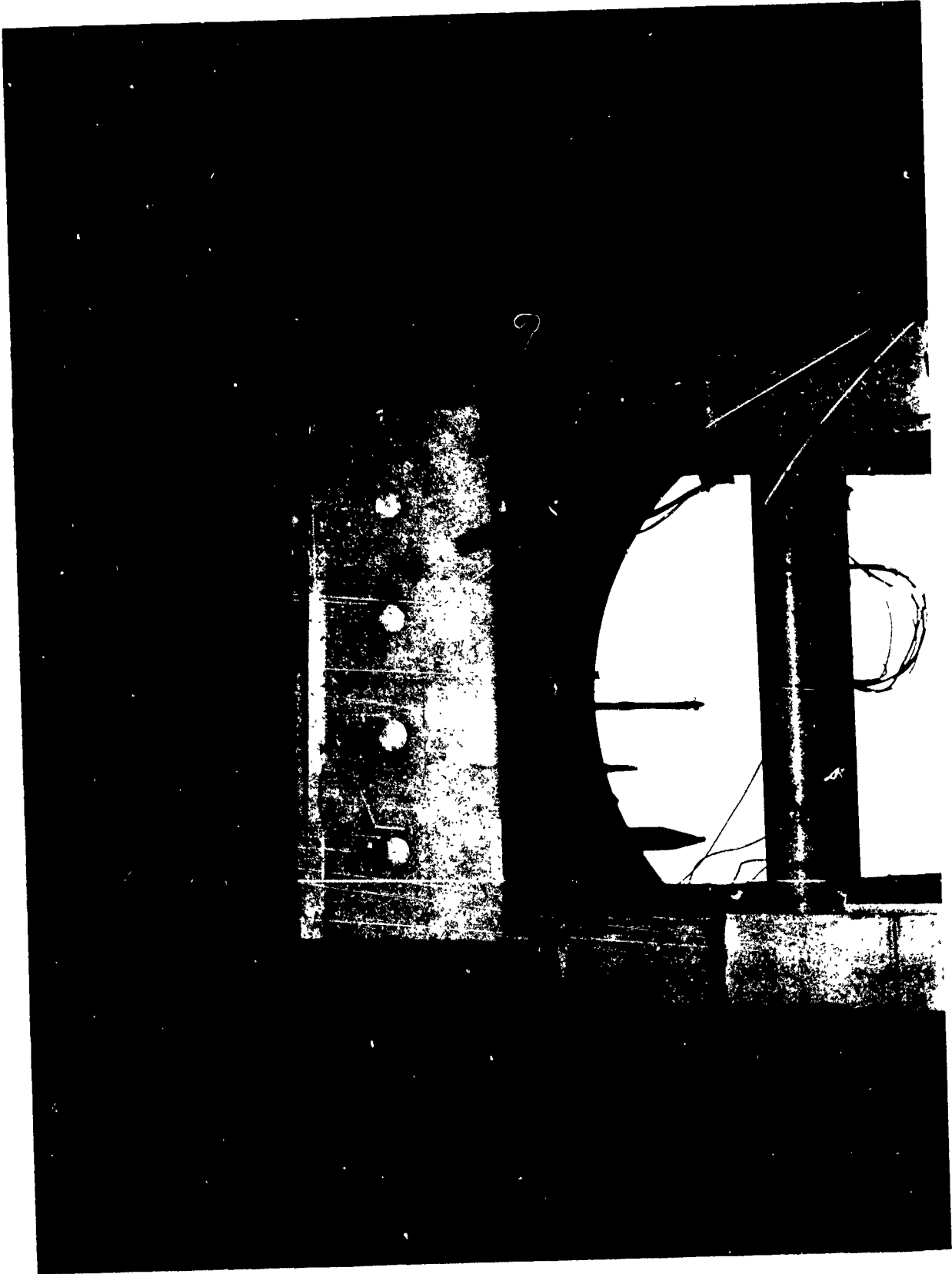

FIGURE 4. SHOCK TEST SETUP - SPECIMENS 18-21

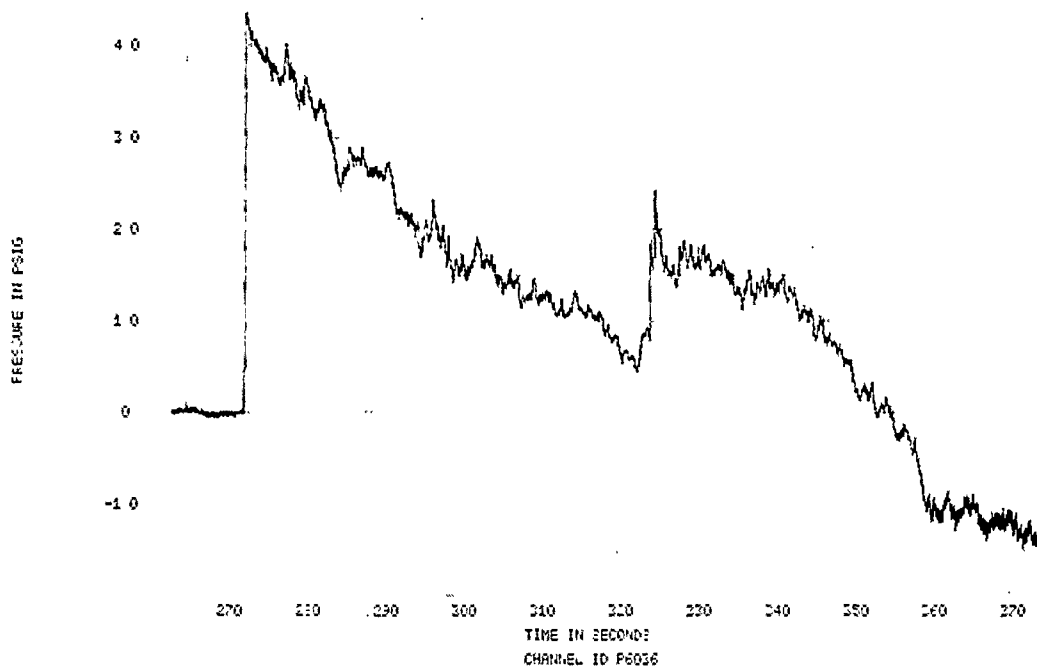

FIGURE 5. SPECIMENS 18-21, EVENT 78-298, TUNNEL WALL INCIDENT
 OVERPRESSURE TIME HISTORY

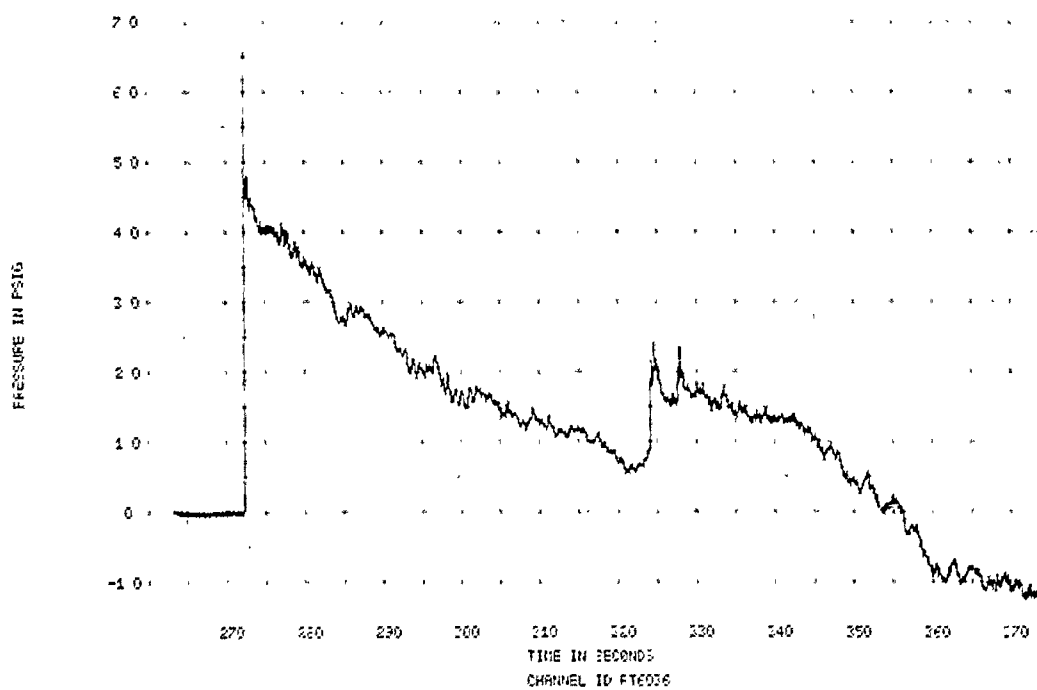

FIGURE 6. SPECIMENS 18-21, EVENT 78-298, TUNNEL WALL REFLECTED
 OVERPRESSURE TIME HISTORY

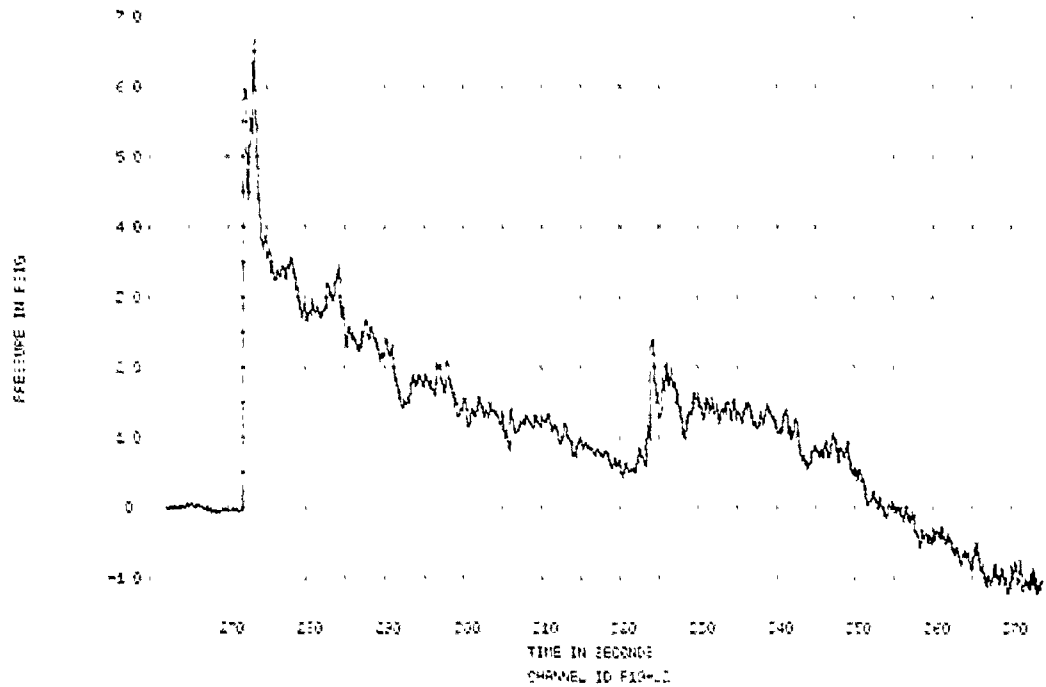

FIGURE 7. SPECIMENS 18-21, EVENT 78-298, SPECIMEN REFLECTED OVERPRESSURE TIME HISTORY

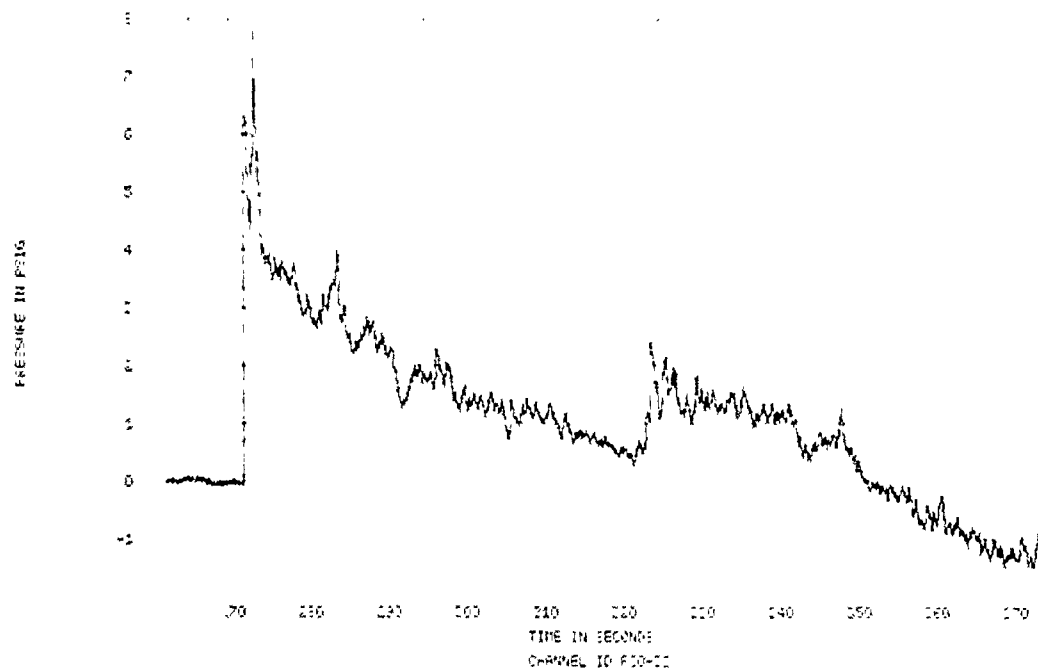

FIGURE 8. SPECIMENS 18-21, EVENT 78-298, SPECIMEN REFLECTED OVERPRESSURE TIME HISTORY

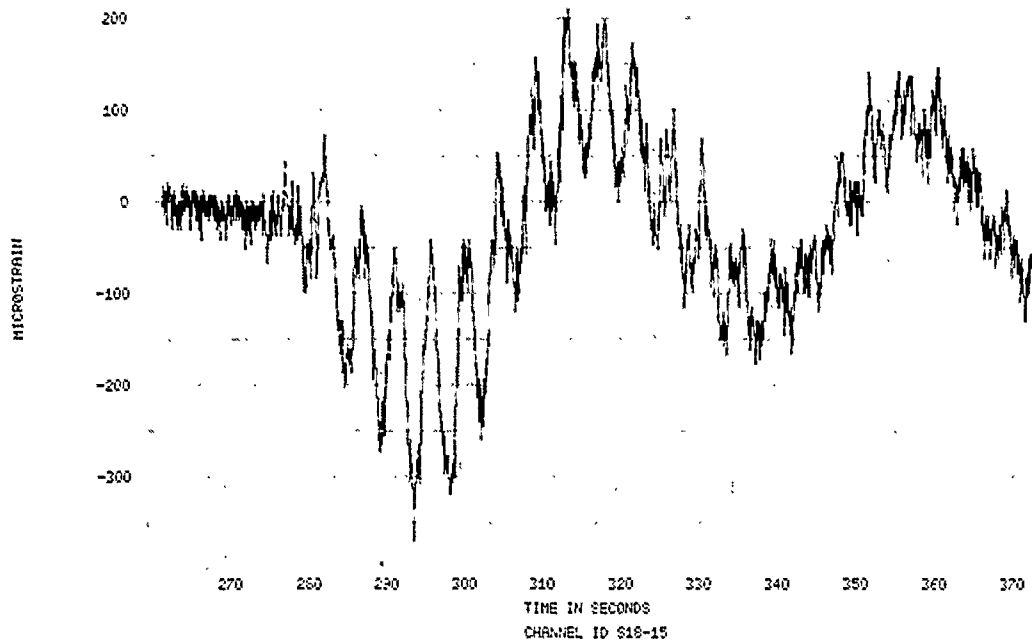

FIGURE 9. SPECIMEN 18, EVENT 78-298, STRAIN TIME HISTORY

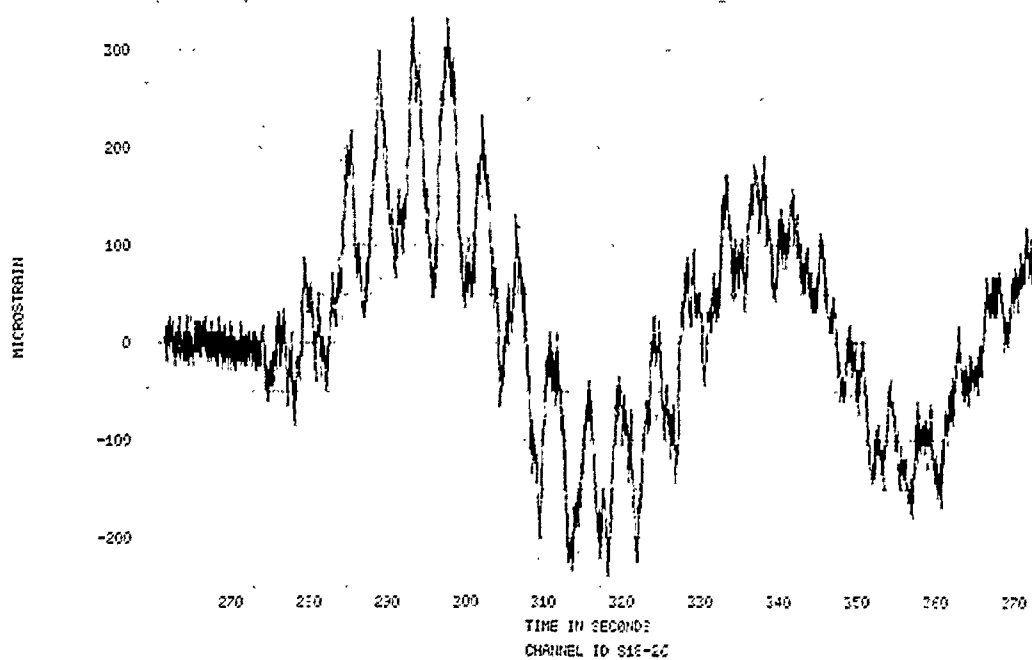

FIGURE 10. SPECIMEN 18, EVENT 78-298, STRAIN TIME HISTORY

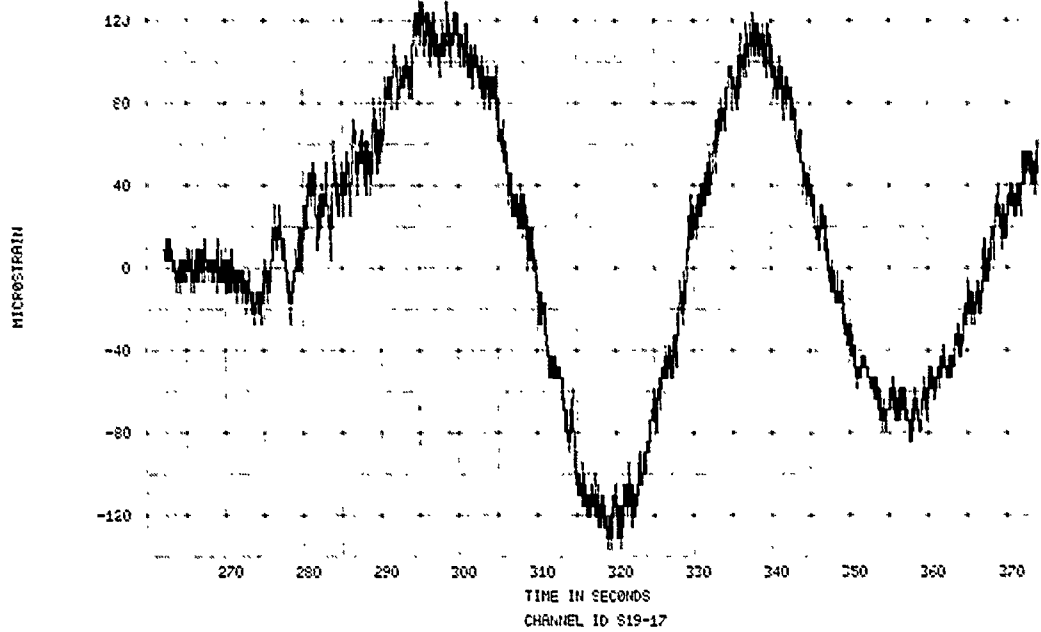

FIGURE 11. SPECIMEN 18, EVENT 78-296, STRAIN TIME HISTORY

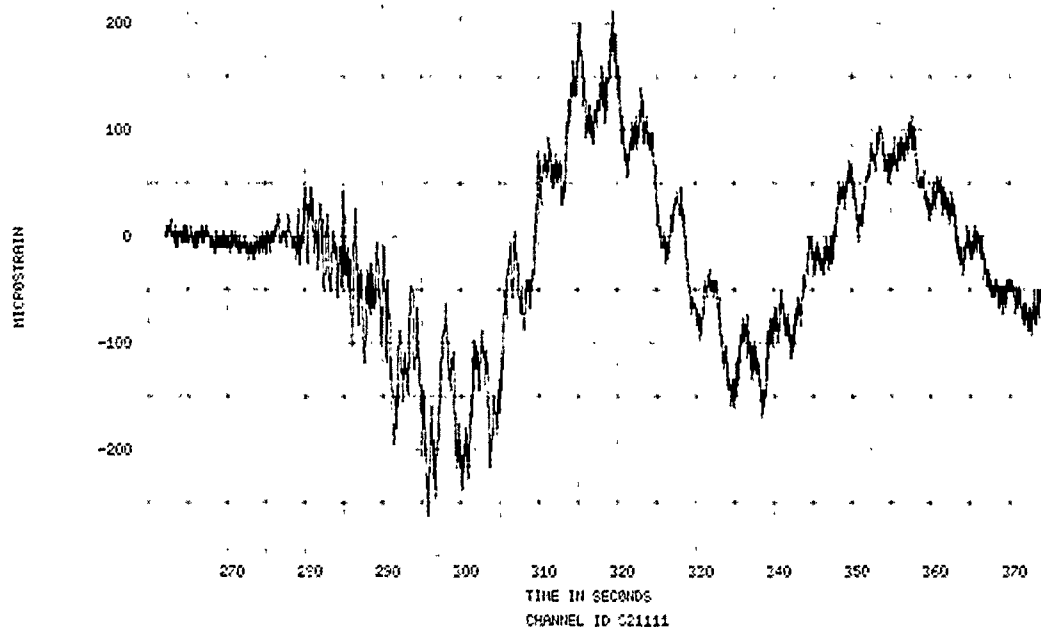

FIGURE 12. SPECIMEN 21, EVENT 78-296, STRAIN TIME HISTORY

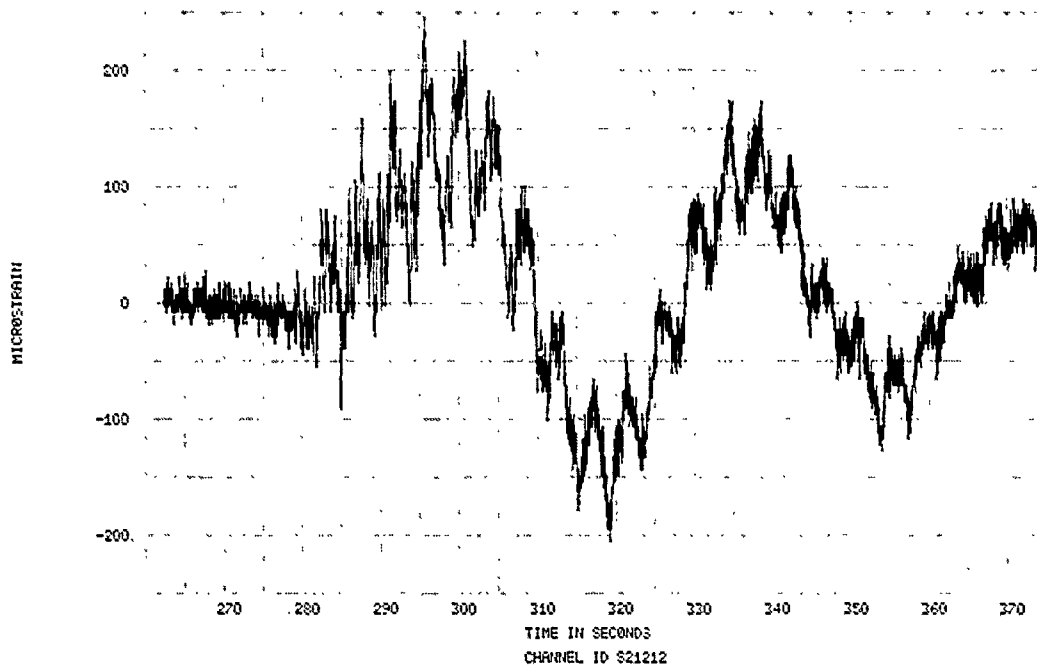

FIGURE 13. SPECIMEN 21, EVENT 78-298, STRAIN TIME HISTORY

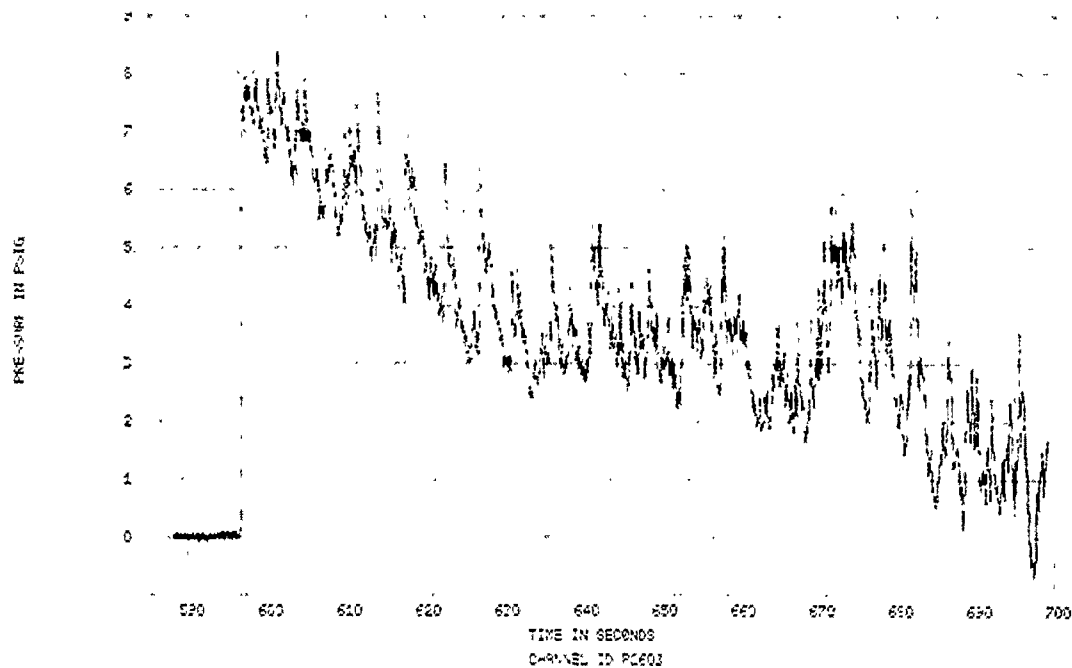

FIGURE 14. SPECIMENS 18-21, EVENT 78-352, TUNNEL WALL INCIDENT OVERPRESSURE TIME HISTORY

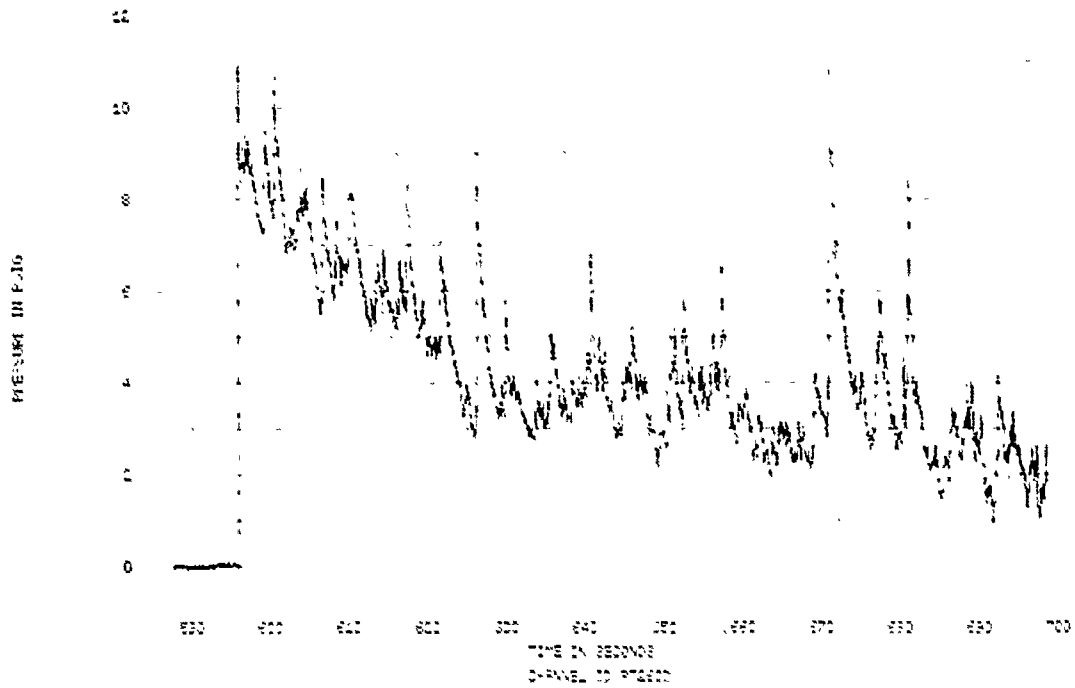

FIGURE 15. SPECIMENS 18-21, EVENT 78-352, TUNNEL WALL REFLECTED OVERPRESSURE TIME HISTORY

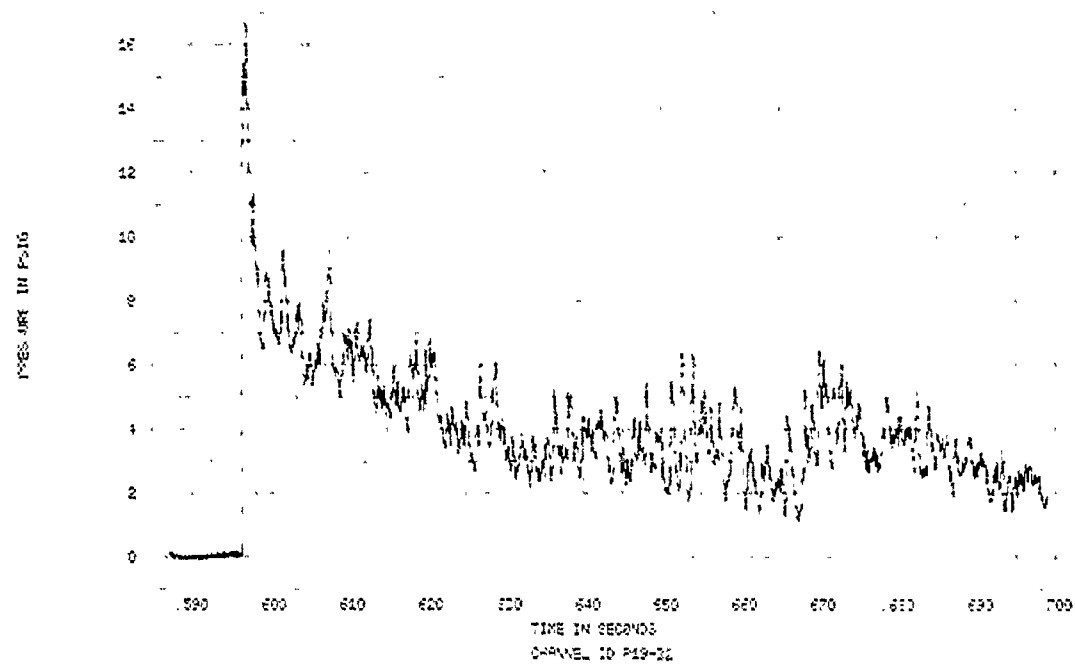

FIGURE 16. SPECIMENS 18-21, EVENT 78-352, SPECIMEN REFLECTED OVERPRESSURE TIME HISTORY

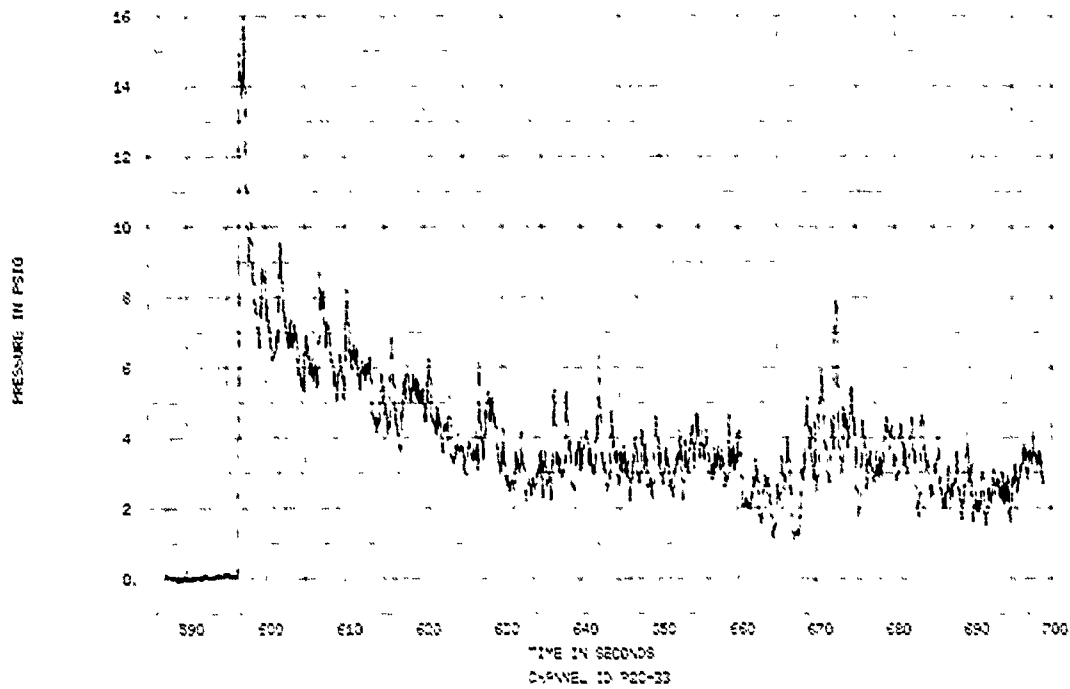

FIGURE 17. SPECIMENS 18-21, EVENT 78-382, SPECIMEN REFLECTED OVERPRESSURE TIME HISTORY

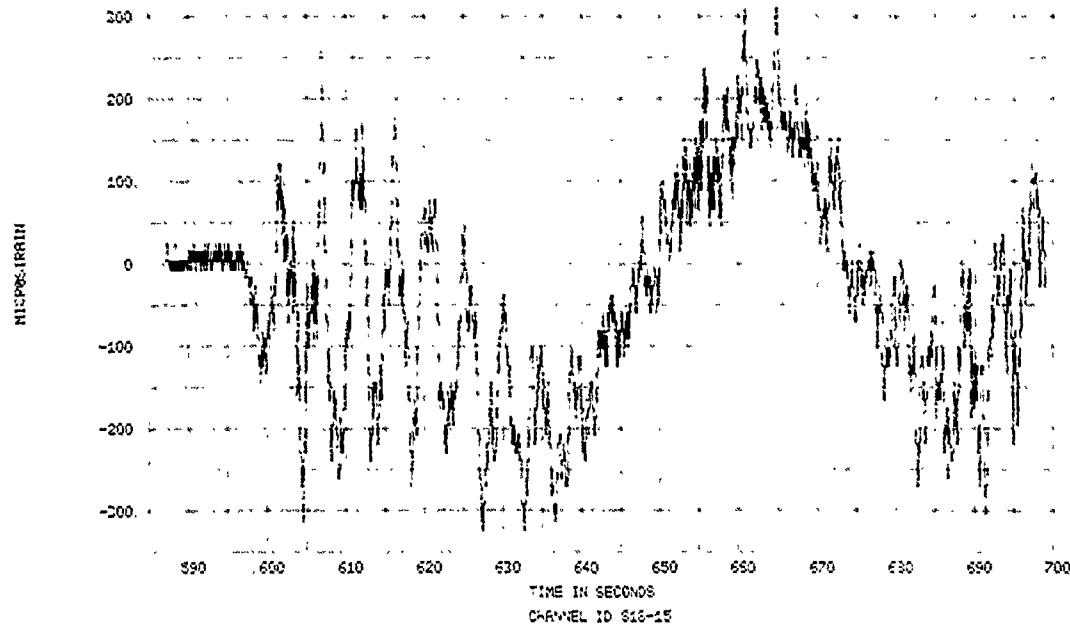

FIGURE 18. SPECIMEN 18, EVENT 78-382, STRAIN TIME HISTORY

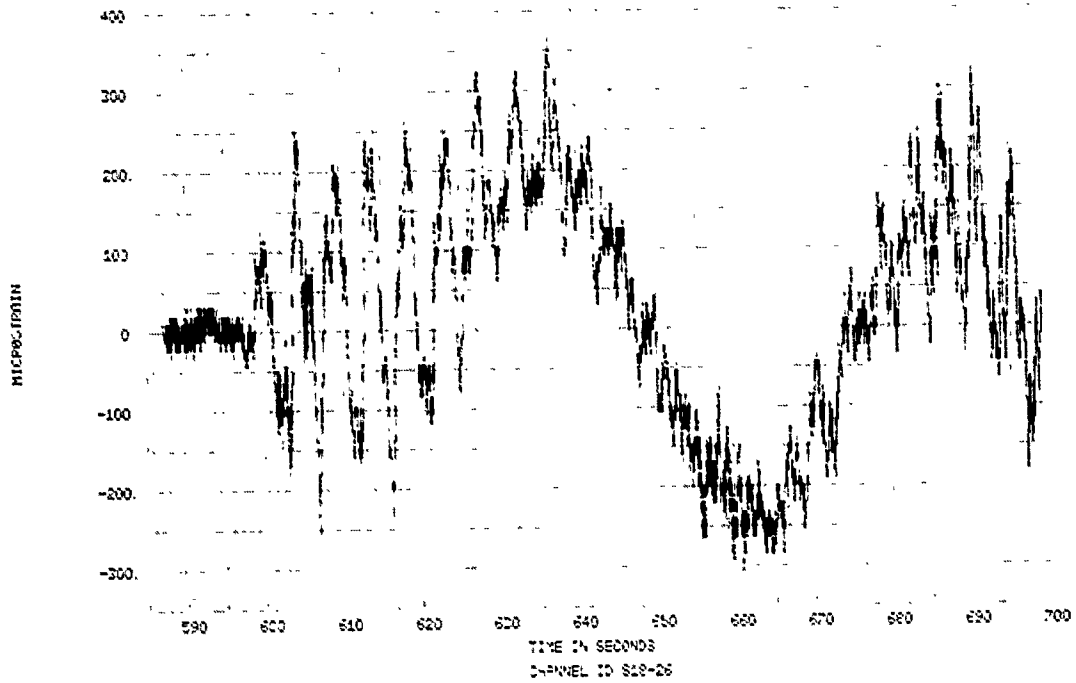

FIGURE 19. SPECIMEN 18, EVENT 78-352, STRAIN TIME HISTORY

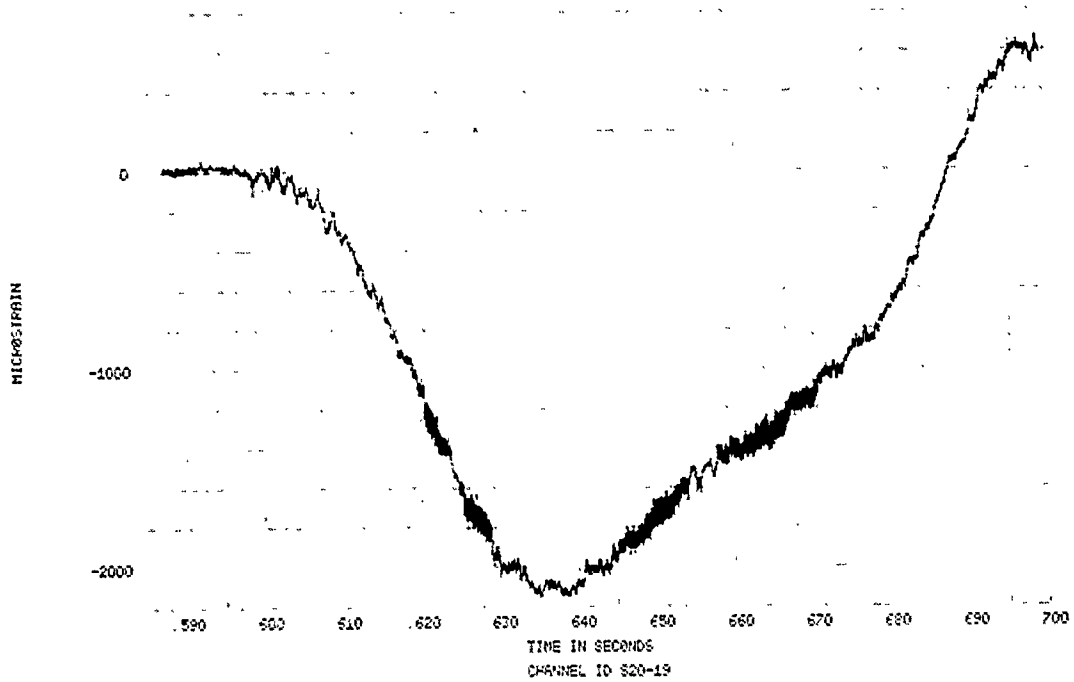

FIGURE 20. SPECIMEN 20, EVENT 78-352, STRAIN TIME HISTORY

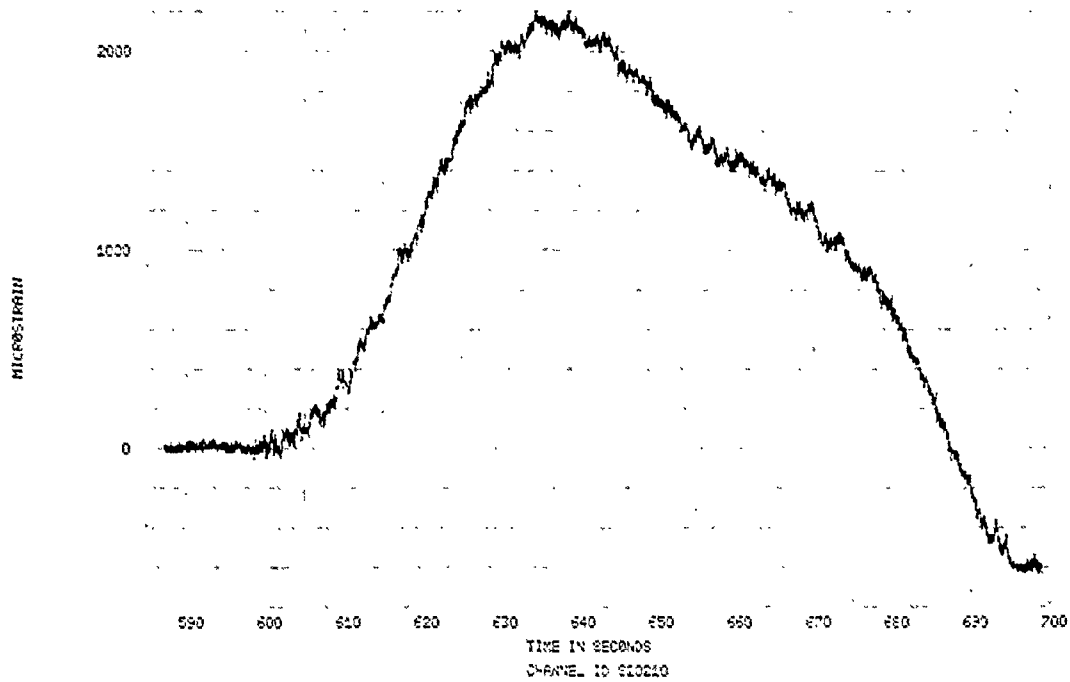

FIGURE 21. SPECIMEN 20, EVENT 78-352, STRAIN TIME HISTORY

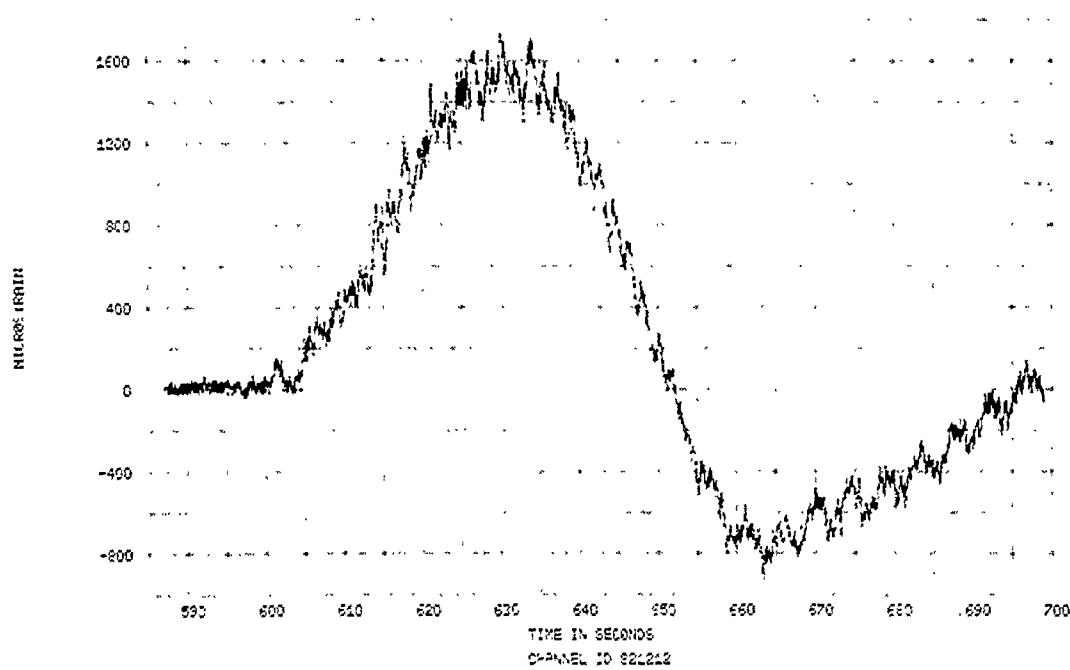

FIGURE 22. SPECIMEN 21, EVENT 78-352, STRAIN TIME HISTORY

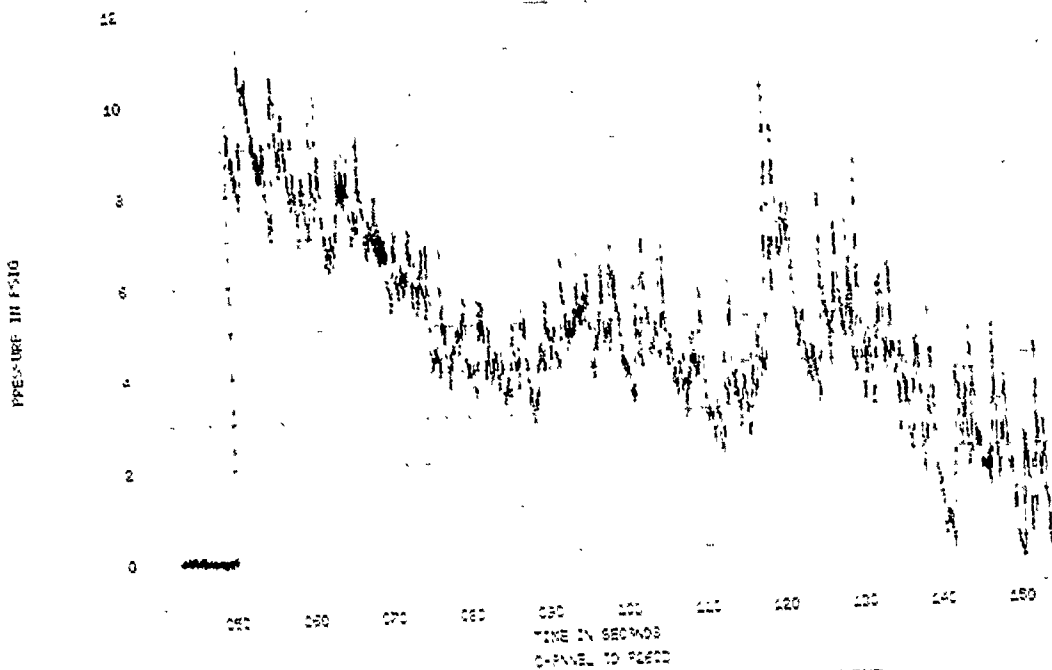

FIGURE 23. SPECIMENS 18-21, EVENT 78-353, TUNNEL WALL INCIDENT OVERPRESSURE TIME HISTORY

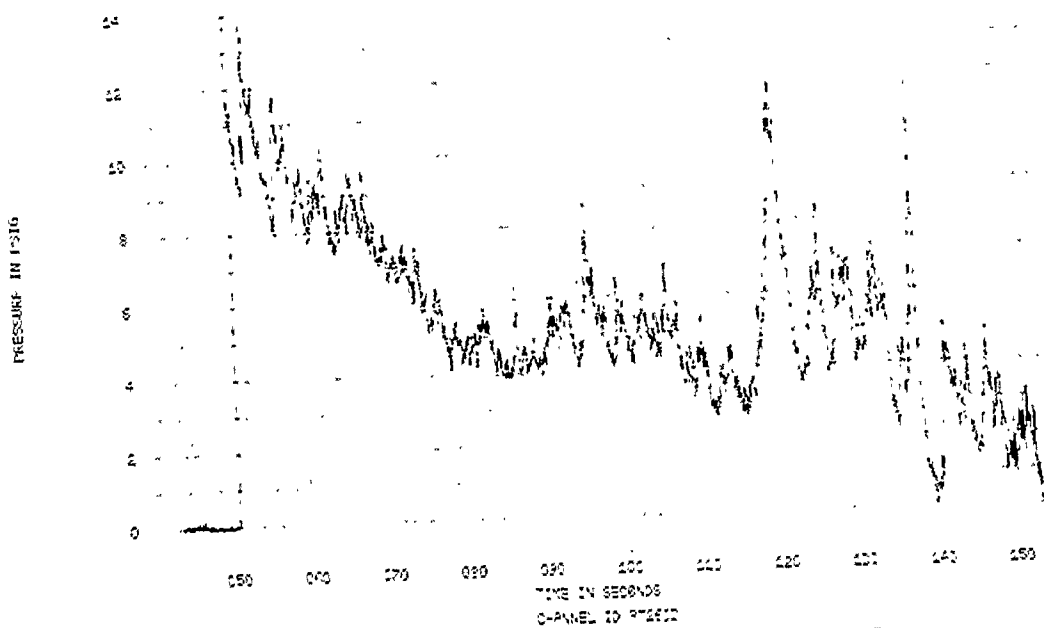

FIGURE 24. SPECIMEN 18-21, EVENT 78-353, TUNNEL WALL REFLECTED OVERPRESSURE TIME HISTORY

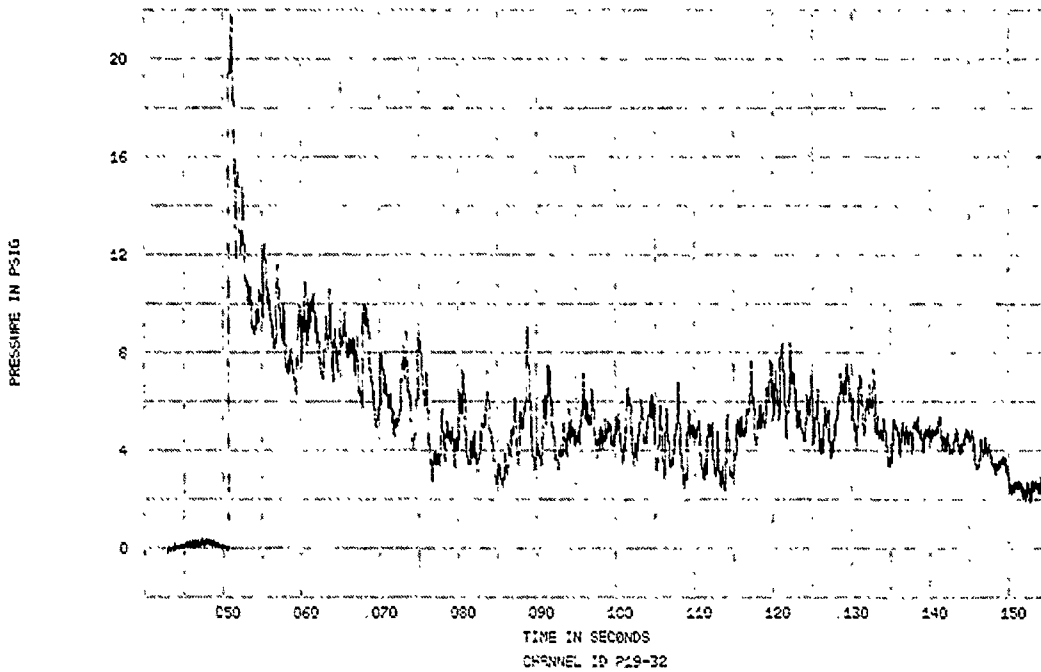

FIGURE 25. SPECIMENS 18-21, EVENT 78-353, SPECIMEN REFLECTED OVERPRESSURE TIME HISTORY

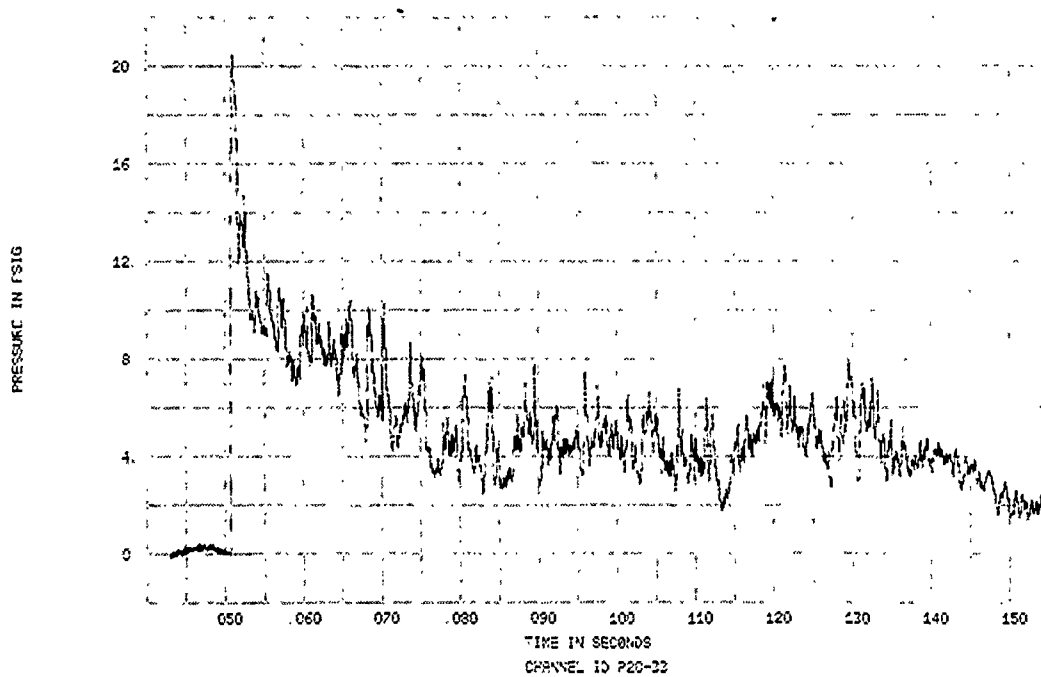

FIGURE 26. SPECIMENS 18-21, EVENT 78-353, SPECIMEN REFLECTED OVERPRESSURE TIME HISTORY

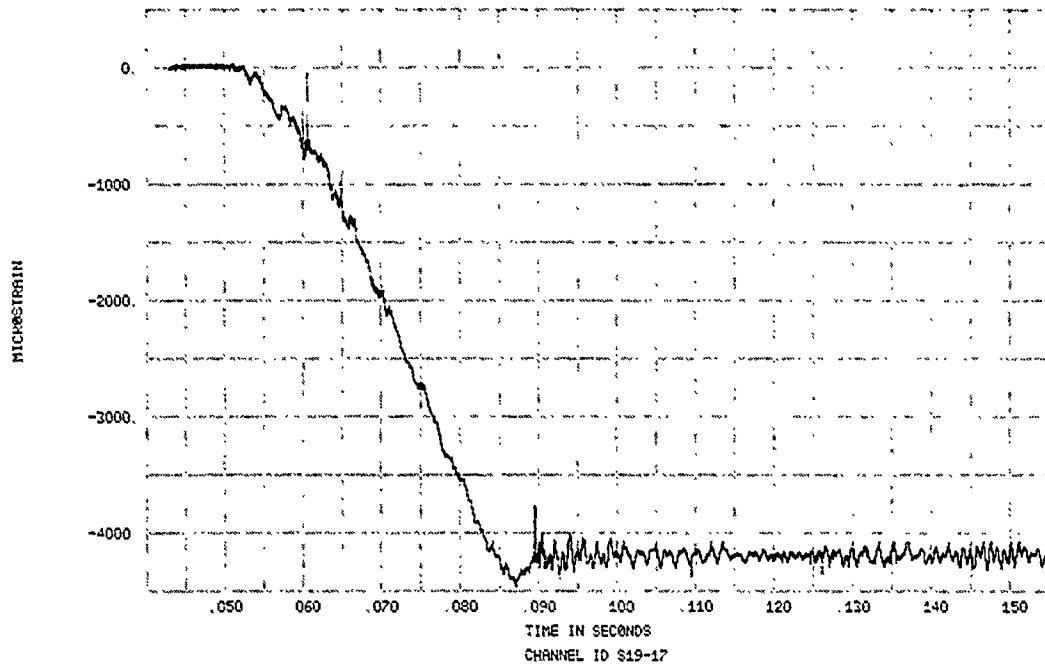

FIGURE 27. SPECIMEN 19, EVENT 78-363, STRAIN TIME HISTORY

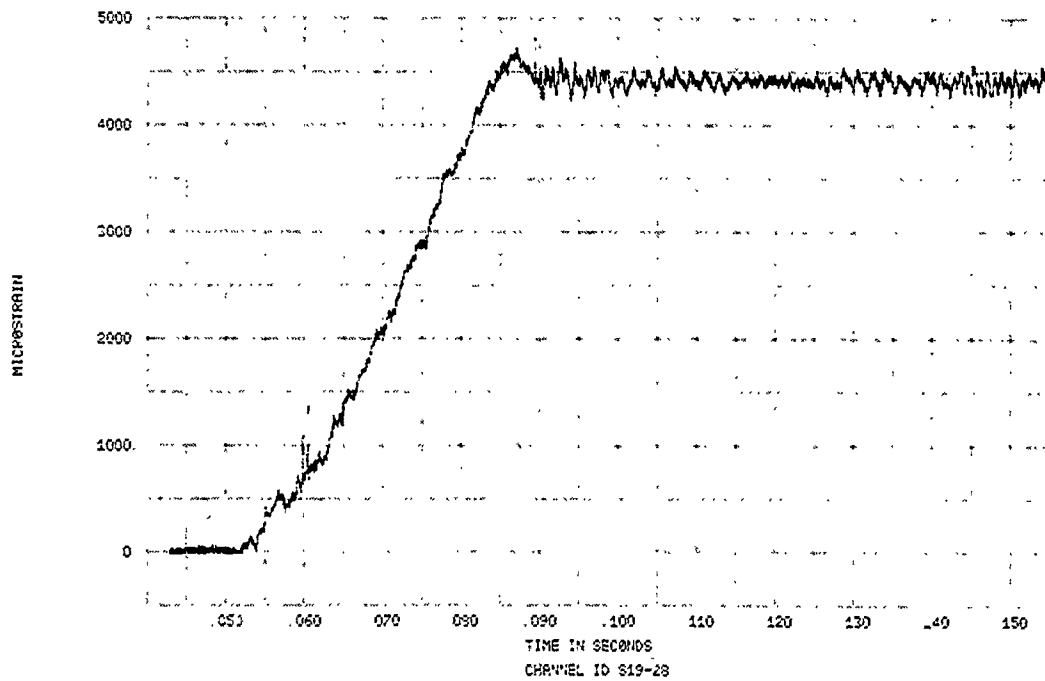

FIGURE 28. SPECIMEN 19, EVENT 78-363, STRAIN TIME HISTORY

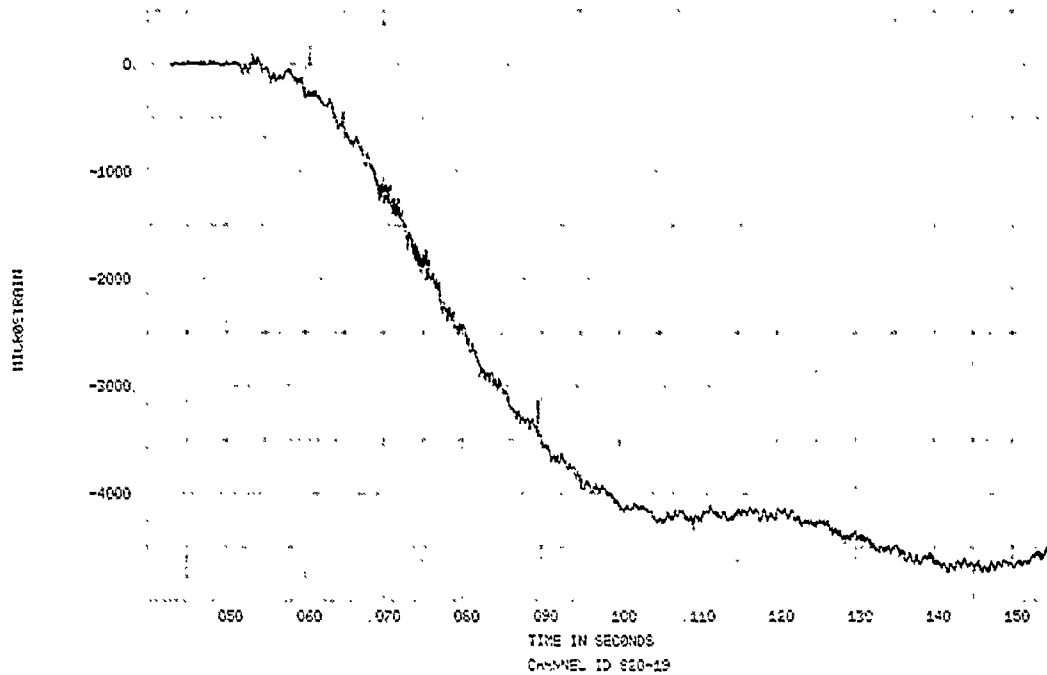

FIGURE 29. SPECIMEN 20, EVENT 78-353, STRAIN TIME HISTORY

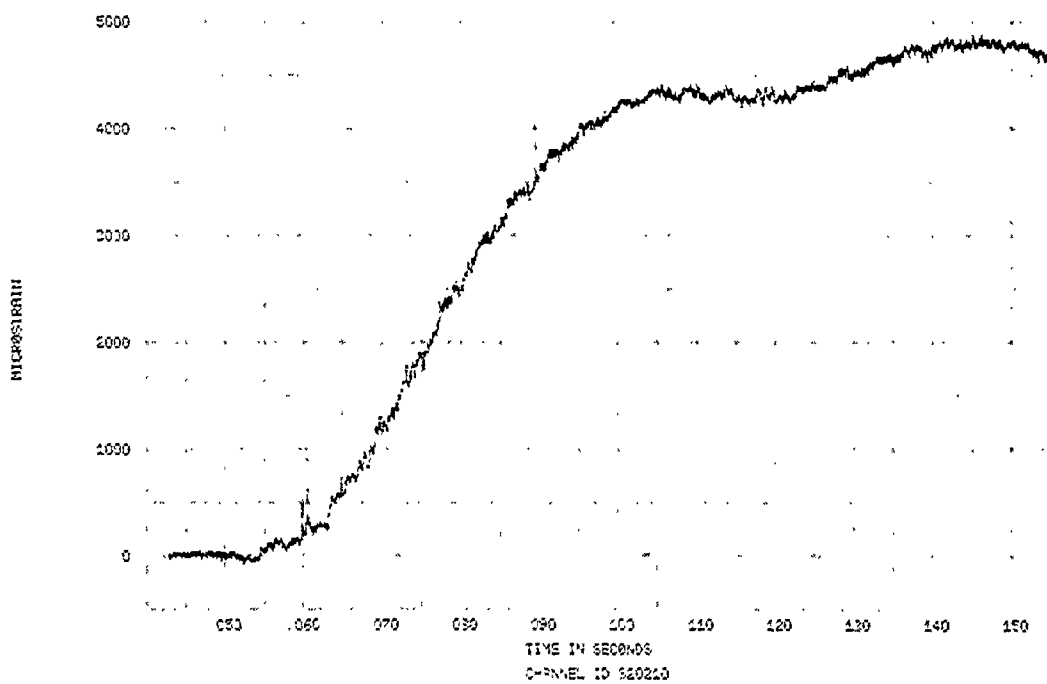

FIGURE 30. SPECIMEN 20, EVENT 78-353, STRAIN TIME HISTORY

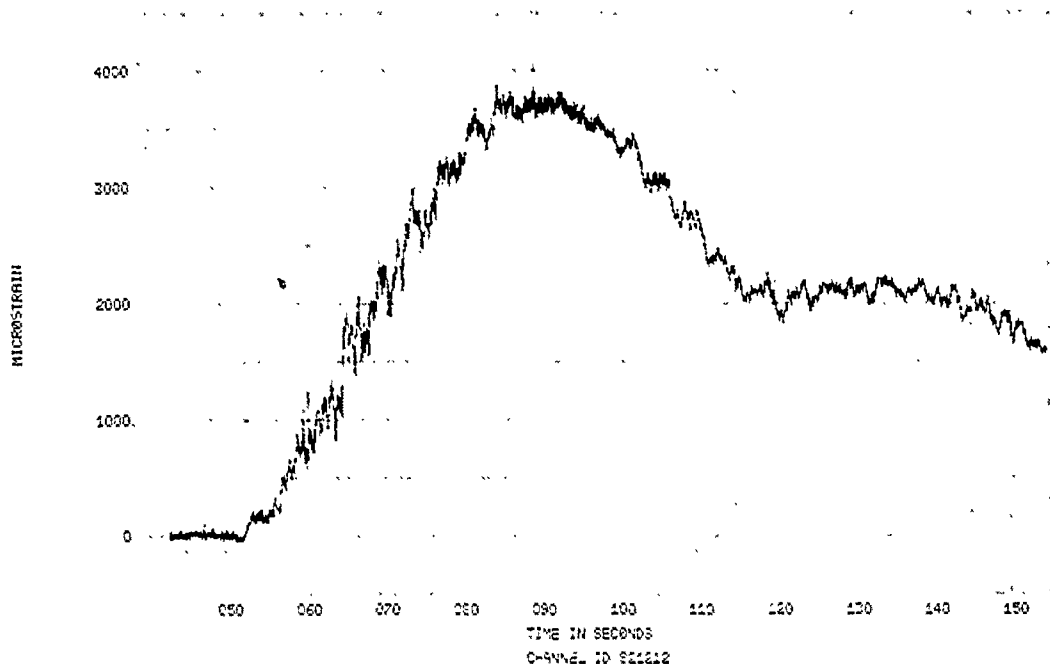
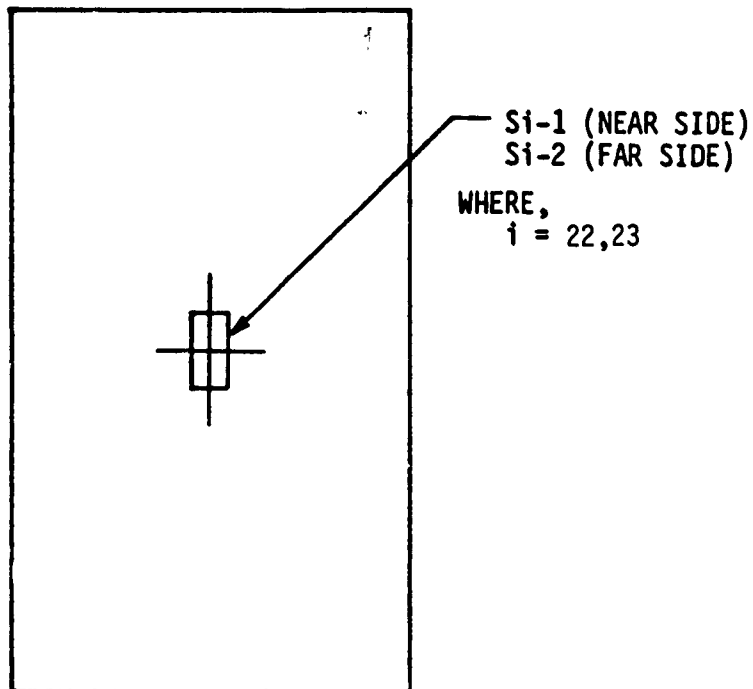

FIGURE 31. SPECIMEN 21, EVENT 78-353, STRAIN TIME HISTORY

30

SPECIMEN NO. 22-23

PRECEDING PAGE BLANK-NOT FILMED



SPECIMENS 22-23

PIN-ENDED COLUMNS - 0.028 IN. THICK
 10.0 IN. LONG
 5.0 IN. WIDE

MATERIAL - 6061-T6 ALUMINUM ALLOY

DENSITY - 0.0002539 LB-SEC²/IN⁴

YIELD STRESS - 41,180 PSI

ULTIMATE STRESS - 46,060 PSI

MODULUS OF ELASTICITY - 10.7 x 10⁶ PSI

Figure 32. Description and Instrumentation - Specimens 22-23

PRECEDING PAGE BLANK-NOT FILMED

NOVA-2LT DATA DECK LISTING
TEST SPECIMENS 22-23

	1					GP 1
*** NOVA-2LT DATA DECK FOR TEST SPECIMENS 22-23 ***	1	10	100	2	1	GP 3
0.50	2	3	3	1	1	GP 4
	20	1	6			GPB 1
-0.5						GPB 2
0.0						
0.5						
1.0						
1.5						
2.0						
2.5						
3.0						
3.5						
4.0						
4.5						
5.0						
5.5						
6.0						
6.5						
7.0						
7.5						
8.0						
8.5						
9.0						
9.5						
10.0						
	0					GPB 8
	0					GPB 12
0.0002539						GPB 13
0.9818						GPB 14
0.028						GPB 15
5.0						GPB 16
	2					GPB 17
0.003849		41180.				GPB 18
0.1150		46060.				GPB 18
0.010						GPB 21
0.0		0.100	400.0			GPB 22
	4					GP 6

TABLE 3
 STATIC TEST STRESS DATA - SPECIMENS 22-23
 (STRESSES GIVEN IN PSI)

STRAIN GAUGE	LOAD (POUNDS)				
	6.0	8.0	9.0	10.0	10.5
S22-1	-1498.	-4986.	-14991.	-38852.	-
S22-2	1391.	5179.	15526.	40211.	-
S23-1	396.	1252.	3445.	19196.	37899.
S23-2	-535.	-1477.	-3627.	-19185.	-37461.

TABLE 4
 STATIC TEST DISPLACEMENT DATA - SPECIMENS 22-23 (VERTICAL
 DISPLACEMENT IS DISPLACEMENT OF PISTON PARALLEL TO COLUMN
 AXIS, AND LATERAL DISPLACEMENT IS MEASURED PERPENDICULAR
 TO COLUMN AT ITS CENTER)

	LOAD (POUNDS)				
	6.0	8.0	9.0	10.0	10.5
SPEC. 22 LATERAL	0.090	0.310	0.915	2.180	-
SPEC. 22 VERTICAL	0.015	0.035	0.240	1.450	-
SPEC. 23 LATERAL	0.035	0.090	0.220	1.160	2.150
SPEC. 23 VERTICAL	0.003	0.010	0.015	0.355	1.295

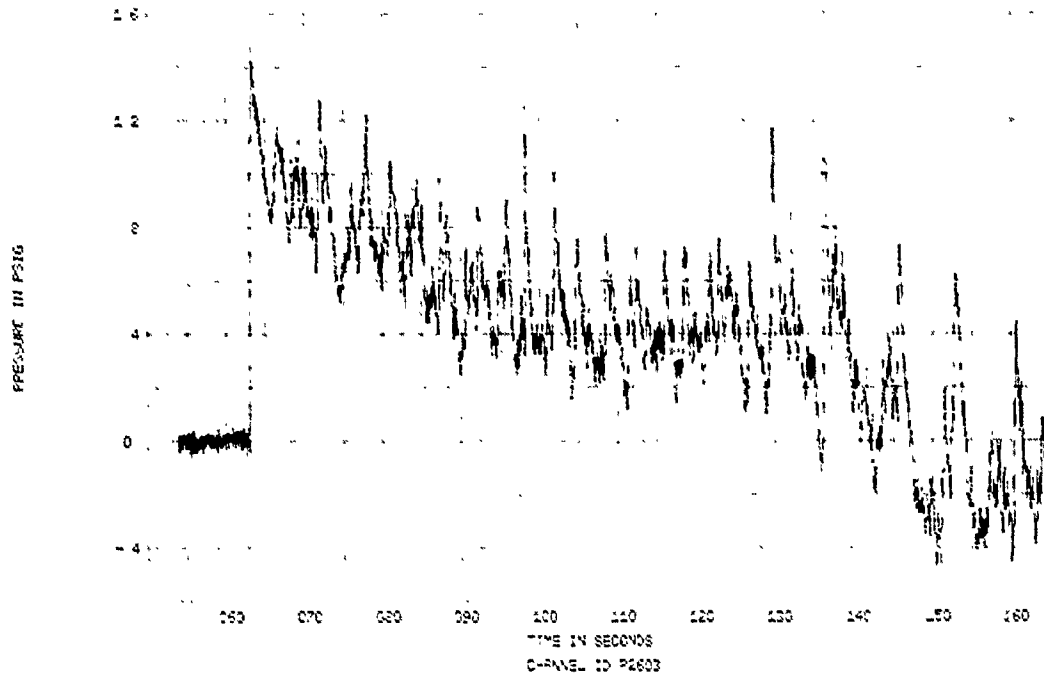

FIGURE 34. SPECIMENS 22-23, EVENT 78-349, TUNNEL WALL INCIDENT OVERPRESSURE TIME HISTORY

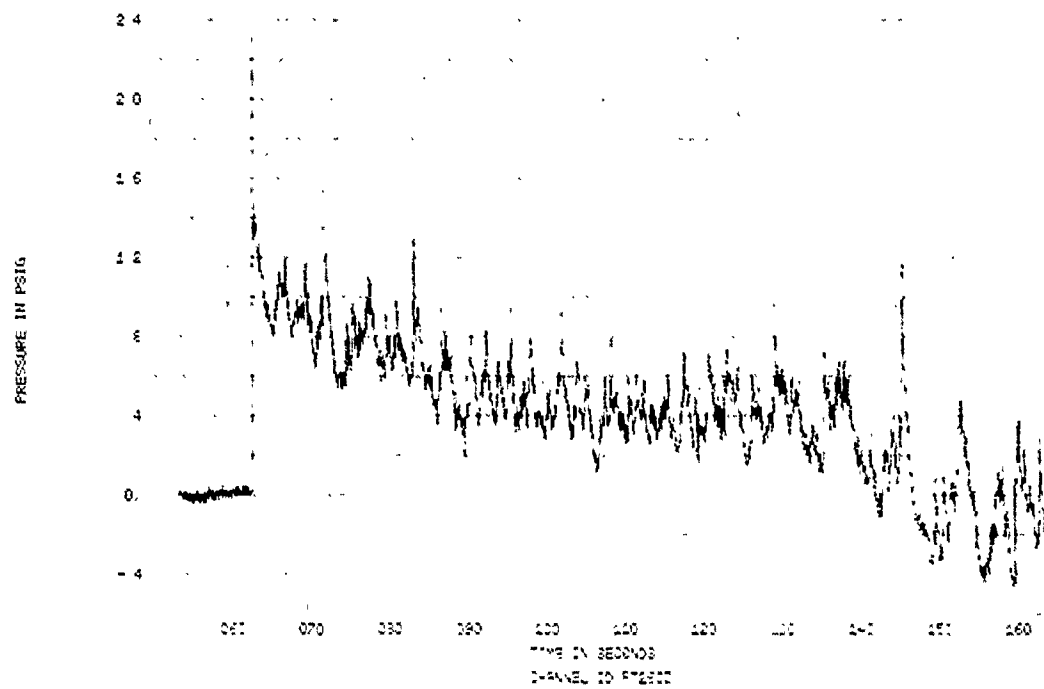

FIGURE 35. SPECIMENS 22-23, EVENT 78-349, TUNNEL WALL REFLECTED OVERPRESSURE TIME HISTORY

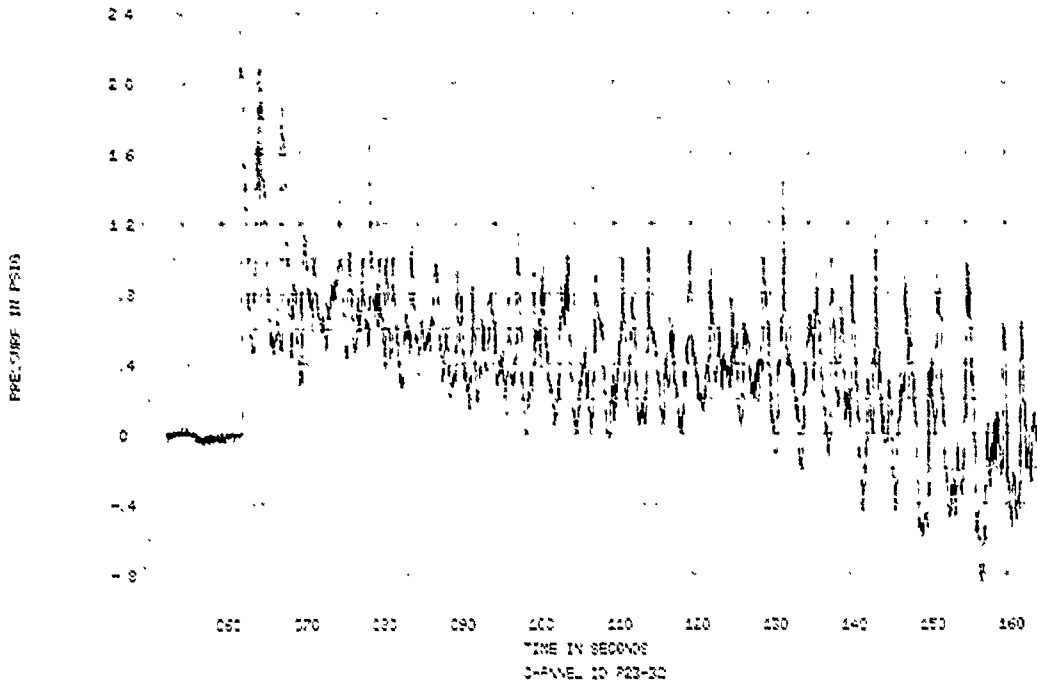

FIGURE 36. SPECIMENS 22-23, EVENT 78-349, SPECIMEN REFLECTED OVERPRESSURE TIME HISTORY

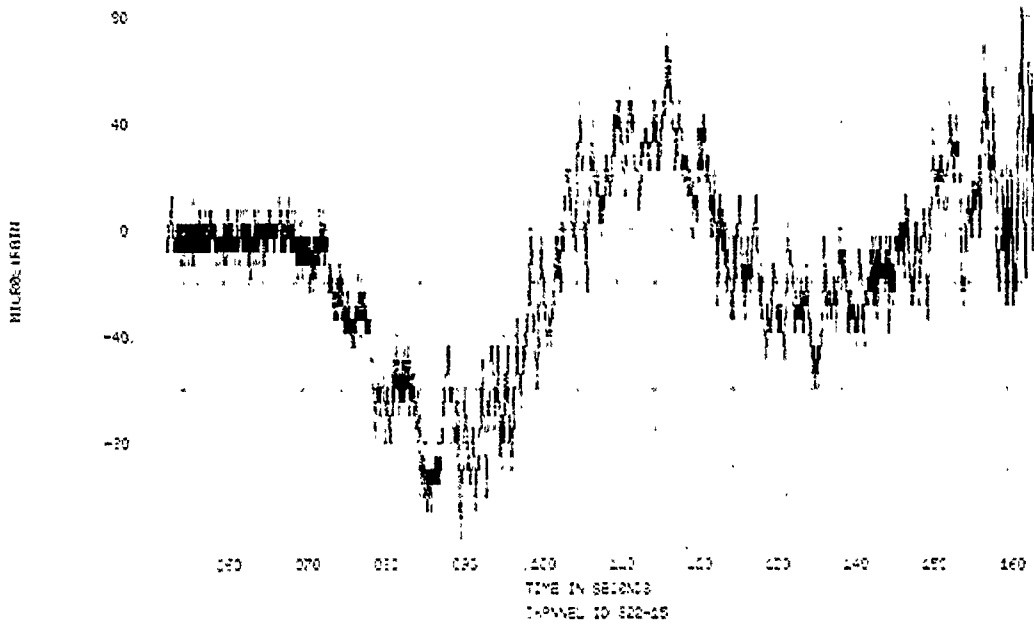

FIGURE 37. SPECIMEN 22, EVENT 78-349, STRAIN TIME HISTORY

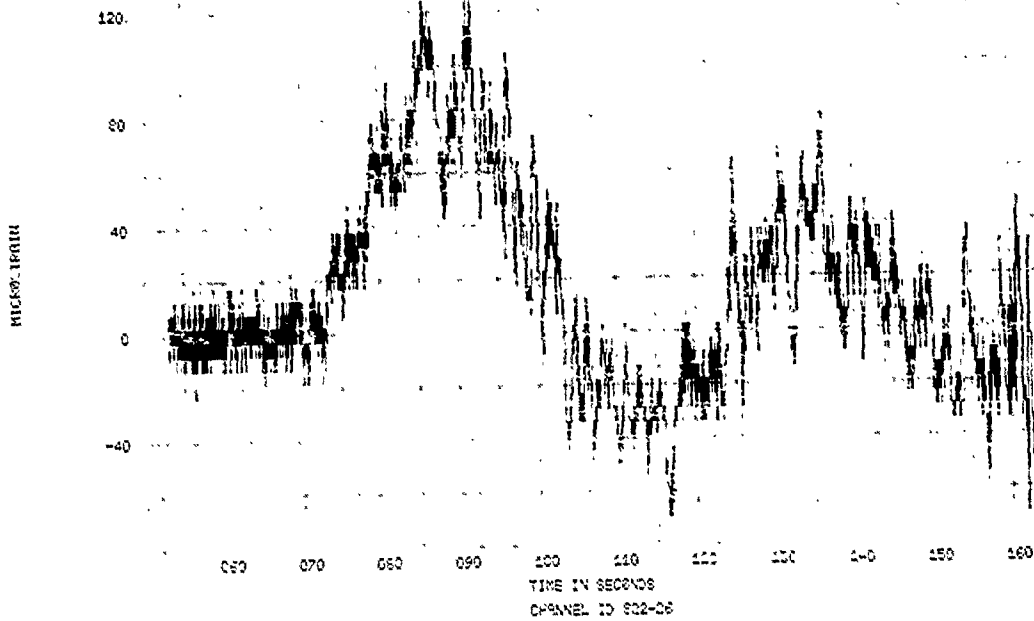

FIGURE 38. SPECIMEN 22, EVENT 78-349, STRAIN TIME HISTORY

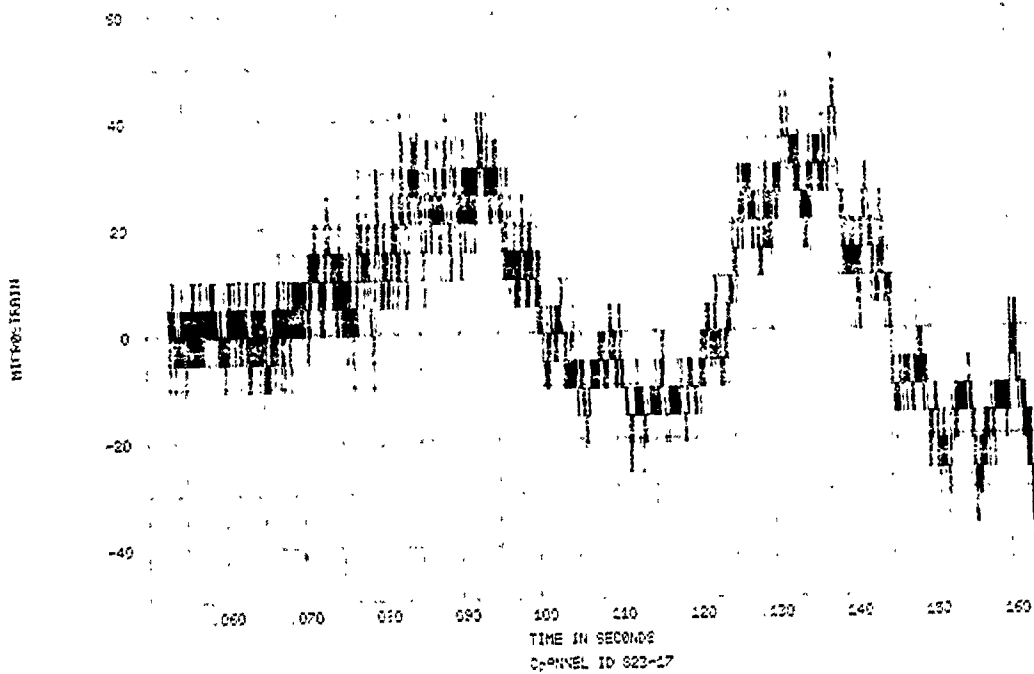

FIGURE 39. SPECIMEN 23, EVENT 78-349, STRAIN TIME HISTORY

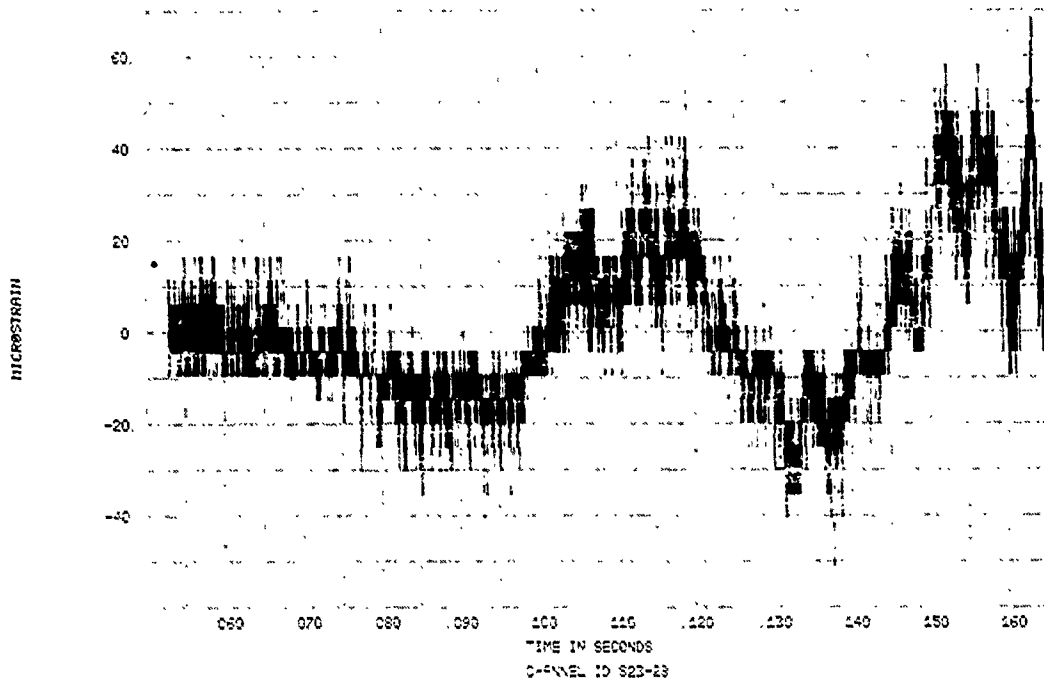

FIGURE 40. SPECIMEN 23, EVENT 78-348, STRAIN TIME HISTORY

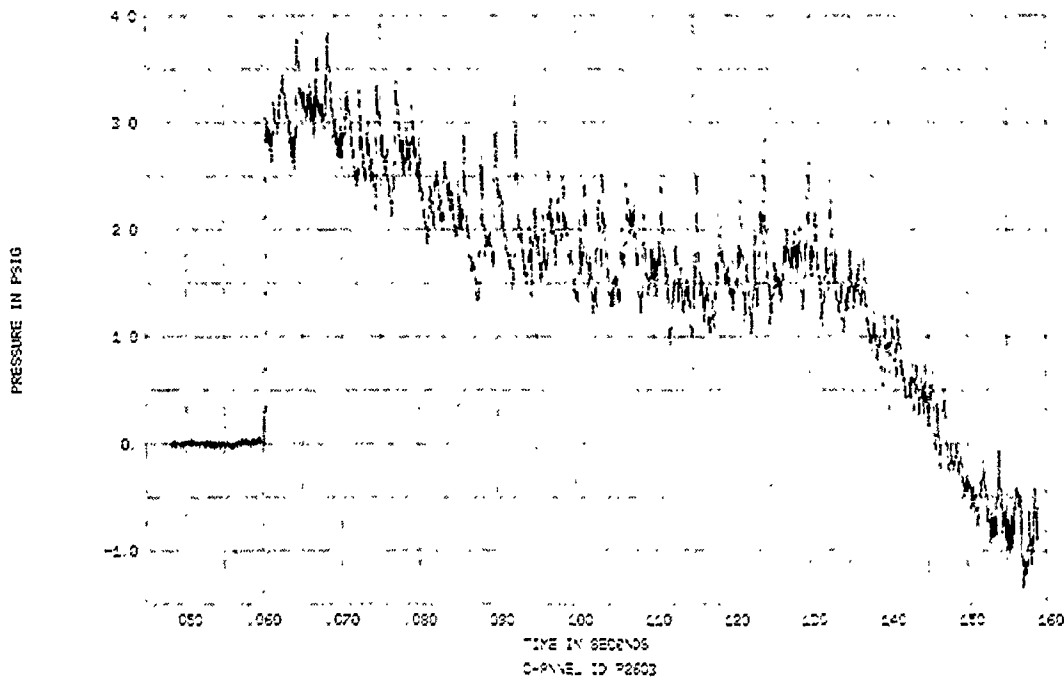

FIGURE 41. SPECIMENS 22-23, EVENT 78-350, TUNNEL WALL INCIDENT OVERPRESSURE TIME HISTORY

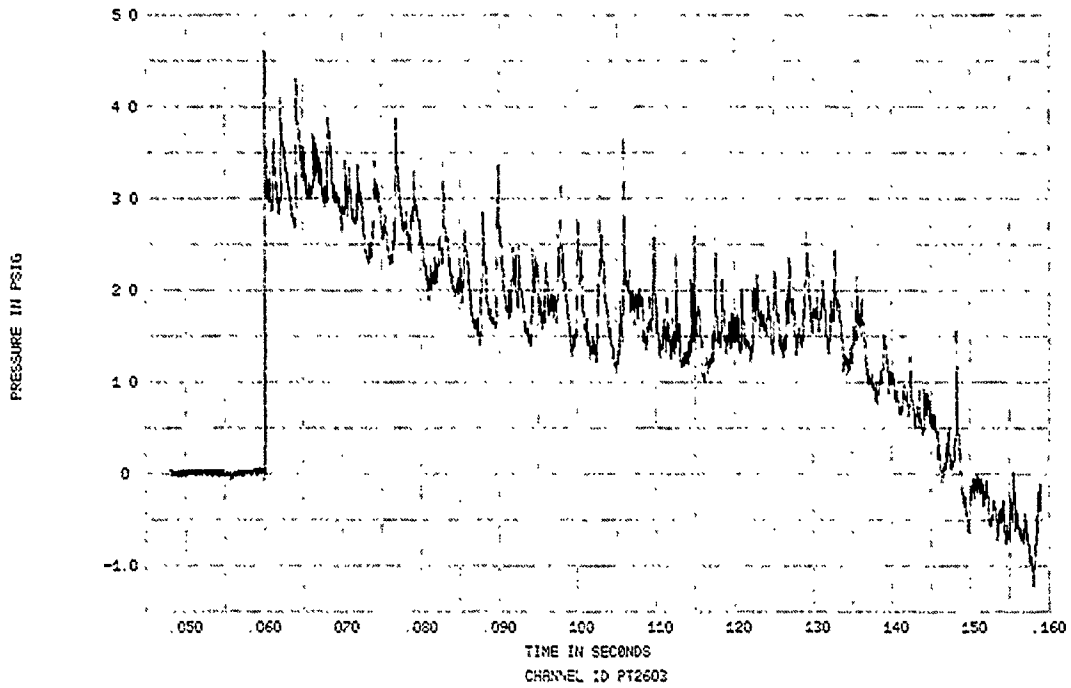

FIGURE 42. SPECIMENS 22-23, EVENT 78-350, TUNNEL WALL REFLECTED OVERPRESSURE TIME HISTORY

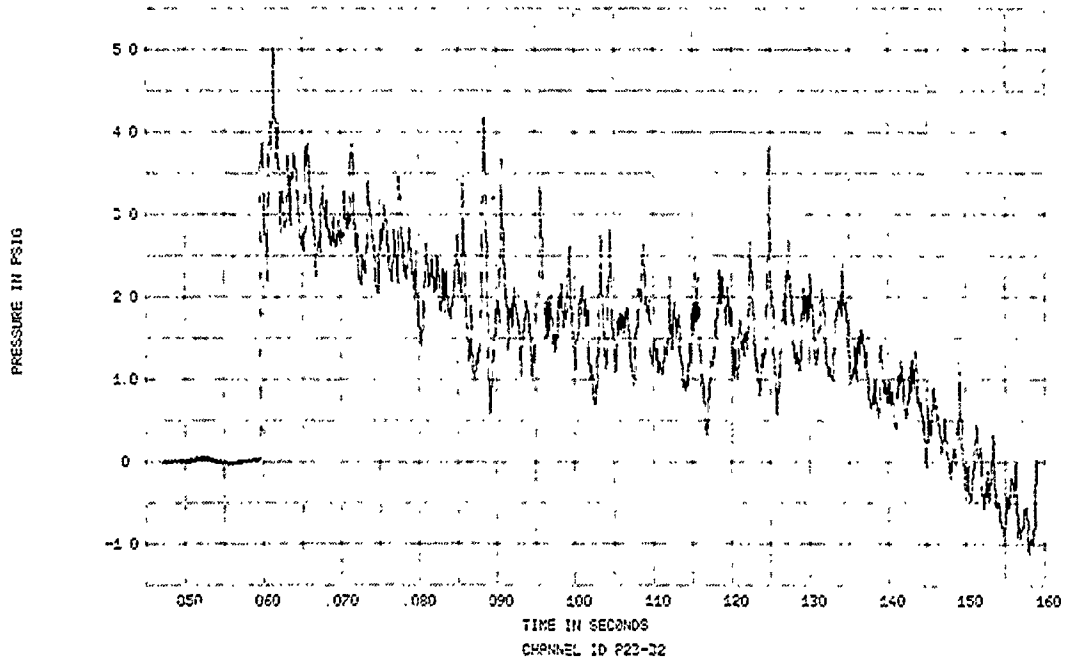

FIGURE 43. SPECIMENS 22-23, EVENT 78-350, SPECIMEN REFLECTED OVERPRESSURE TIME HISTORY

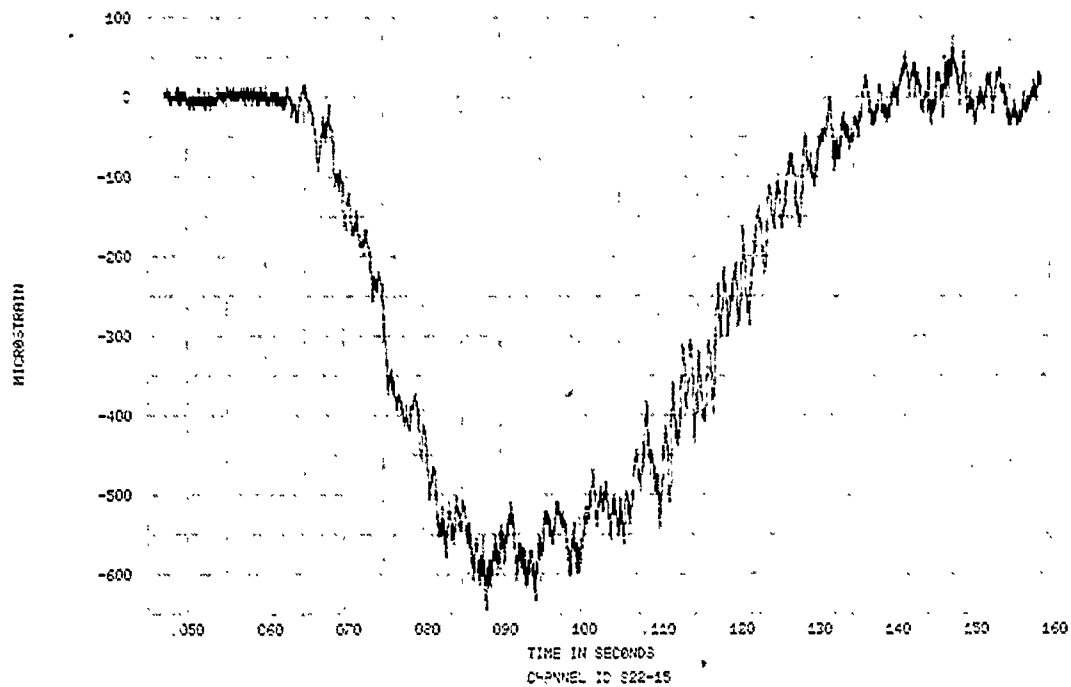

FIGURE 44. SPECIMEN 22, EVENT 78-350, STRAIN TIME HISTORY

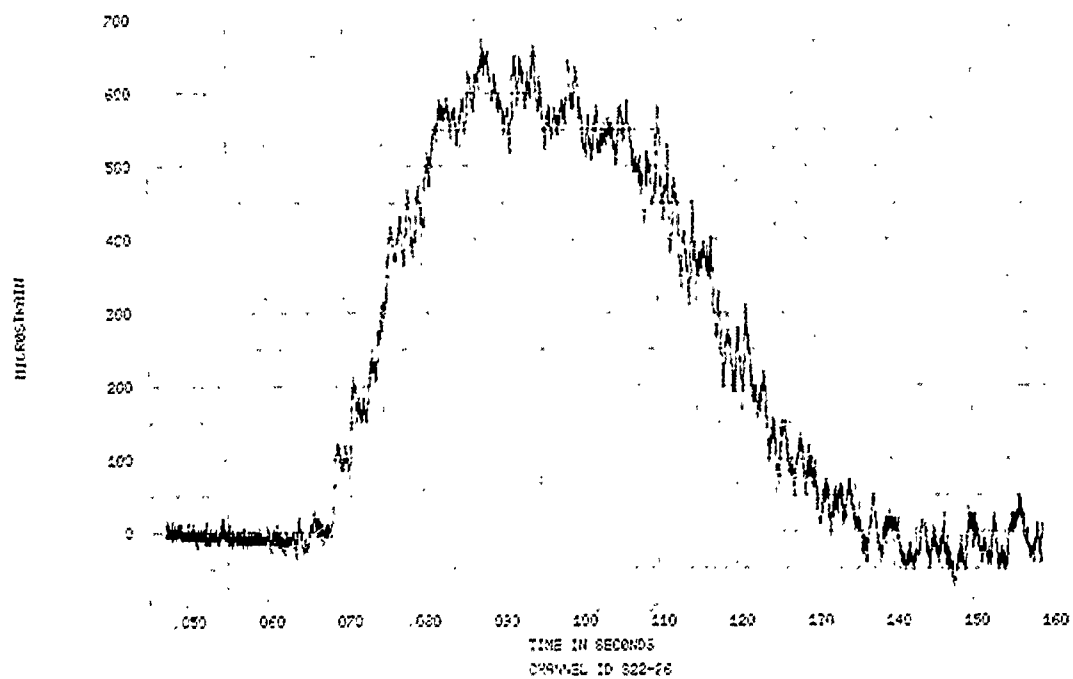

FIGURE 45. SPECIMEN 22, EVENT 78-350, STRAIN TIME HISTORY

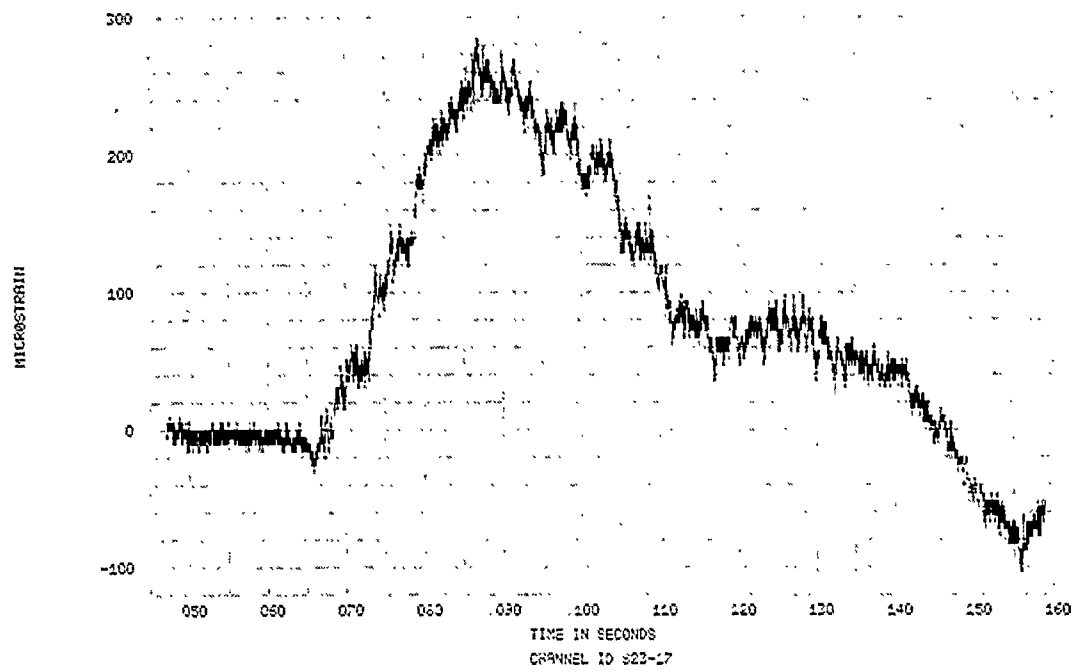

FIGURE 46. SPECIMEN 23, EVENT 78-350, STRAIN TIME HISTORY

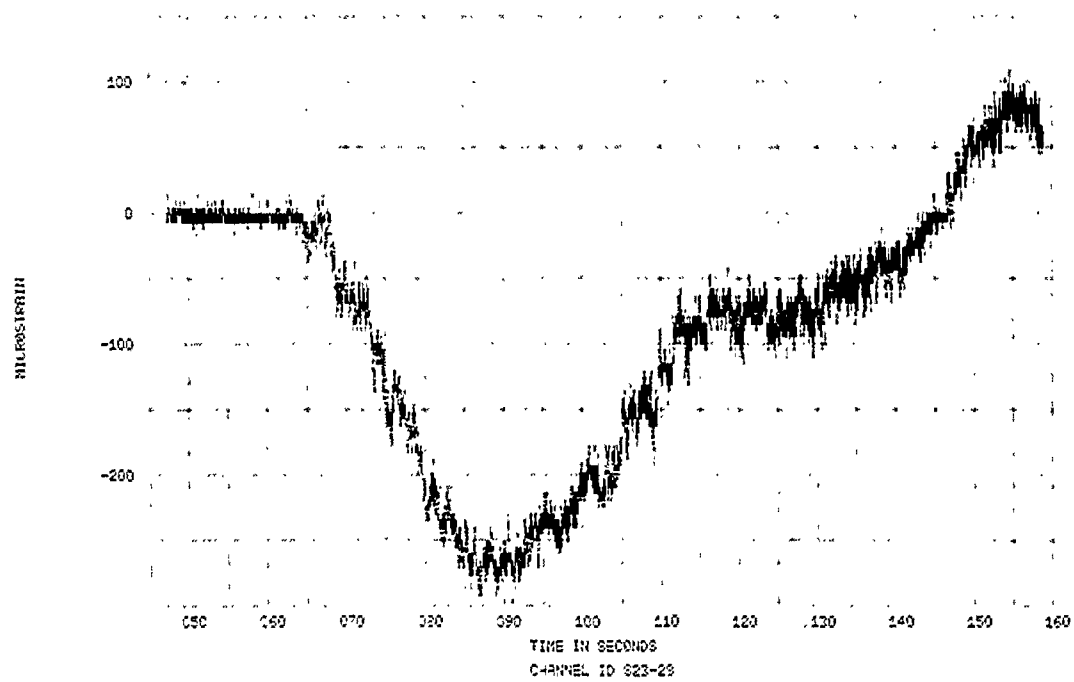

FIGURE 47. SPECIMEN 23, EVENT 78-350, STRAIN TIME HISTORY

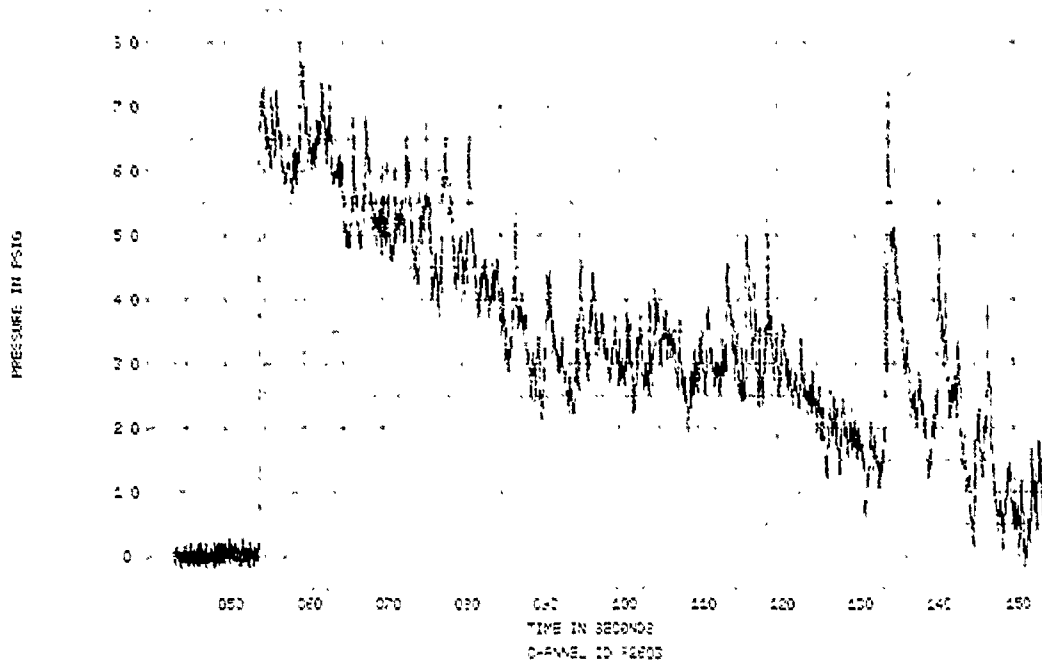

FIGURE 48. SPECIMENS 22-23, EVENT 78-351, TUNNEL WALL INCIDENT OVERPRESSURE TIME HISTORY

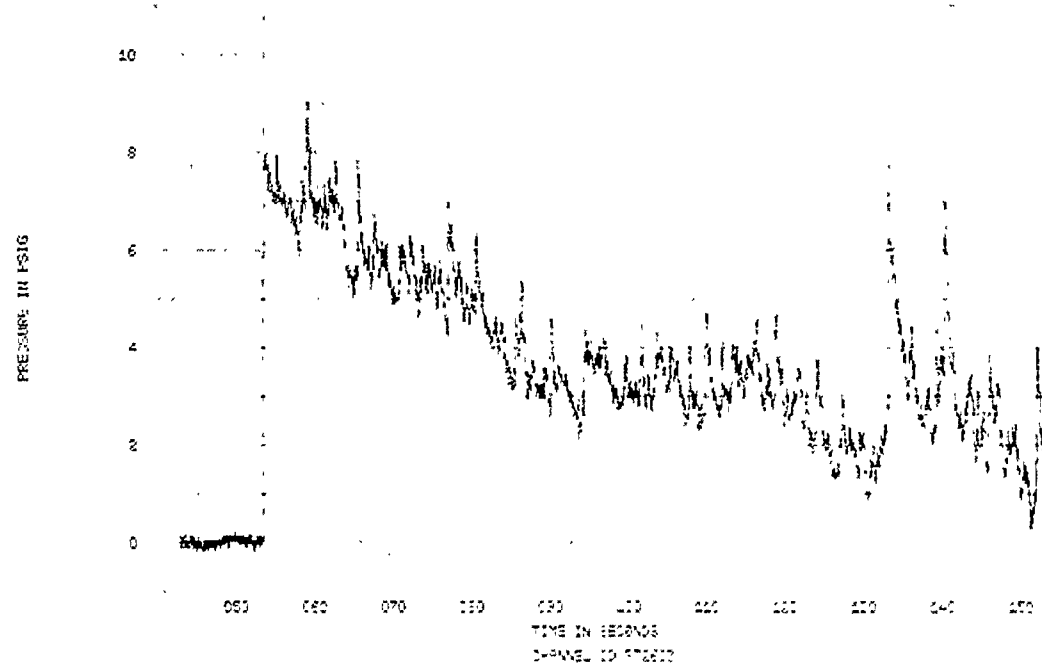

FIGURE 49. SPECIMENS 22-23, EVENT 78-351, TUNNEL WALL REFLECTED OVERPRESSURE TIME HISTORY

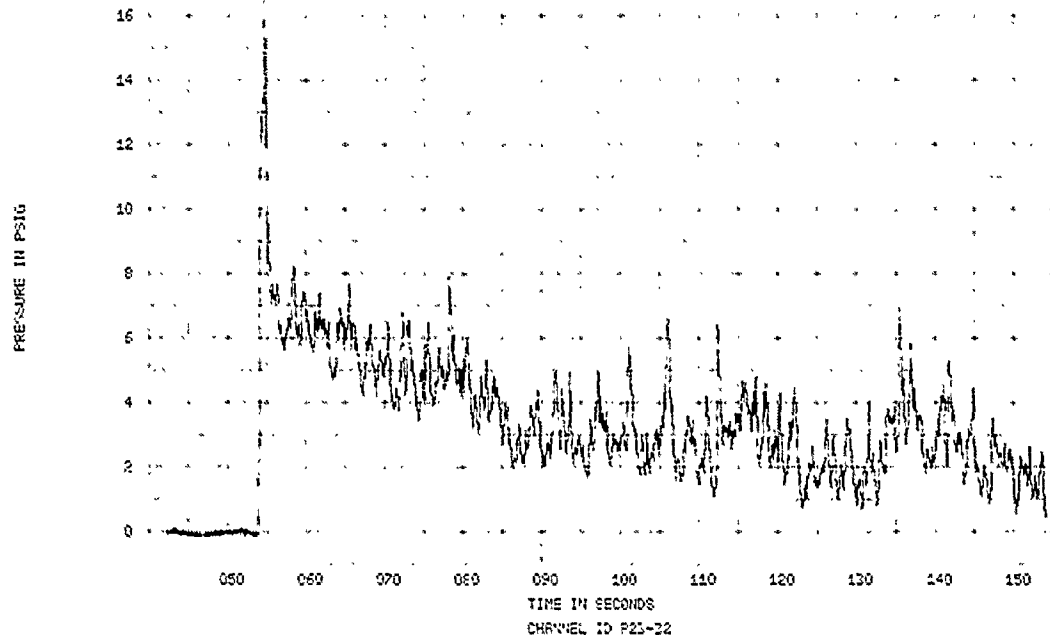

FIGURE 50. SPECIMENS 22-23, EVENT 78-351, SPECIMEN REFLECTED OVERPRESSURE TIME HISTORY

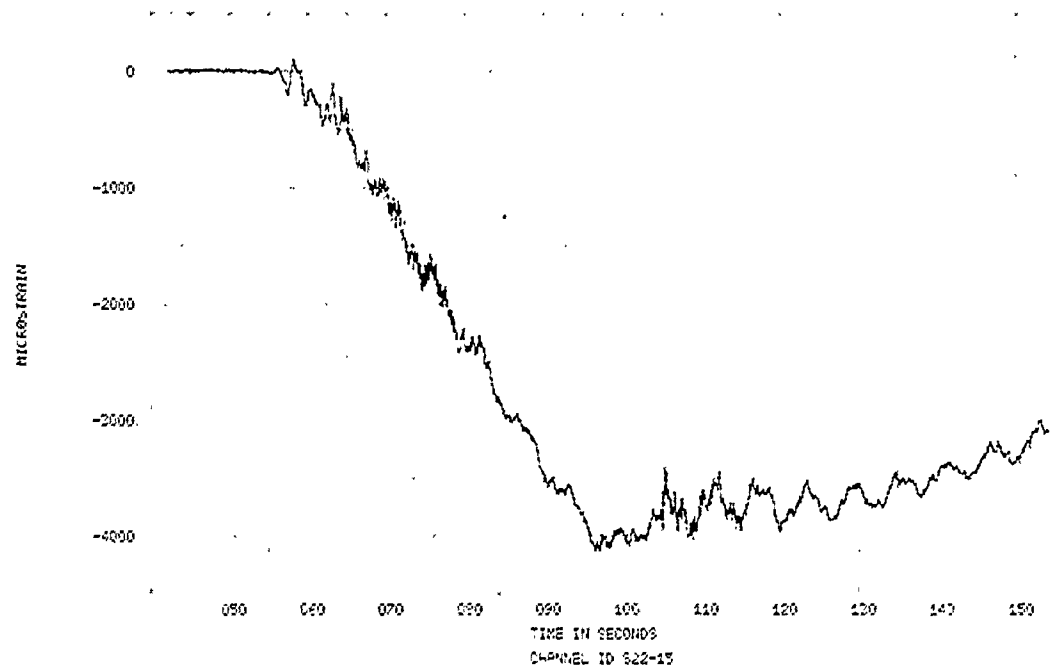

FIGURE 51. SPECIMEN 22, EVENT 78-351, STRAIN TIME HISTORY

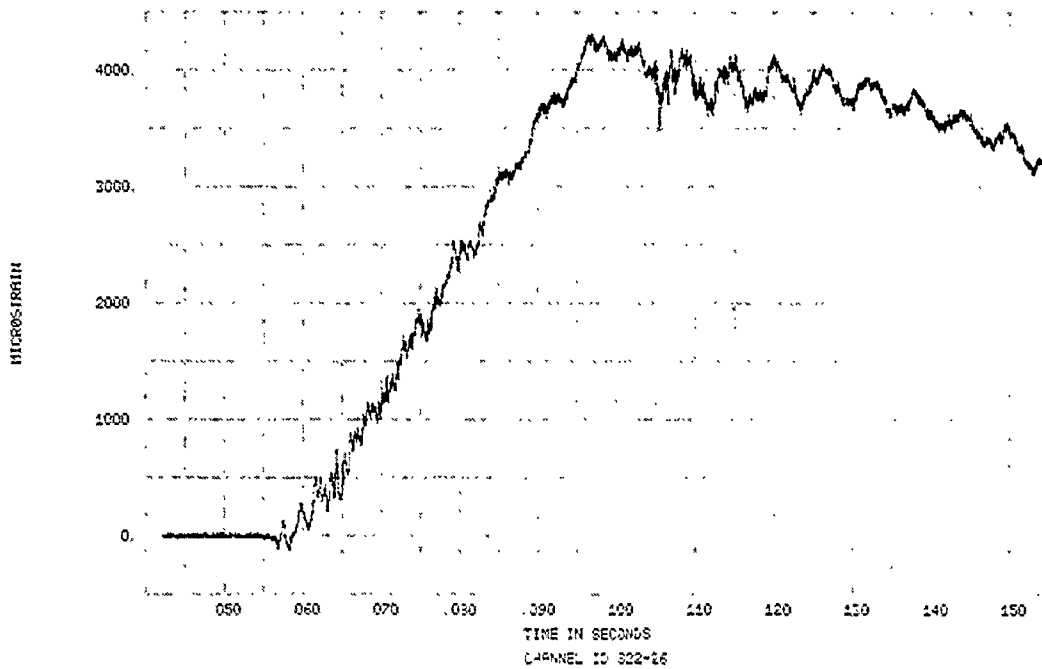

FIGURE 52. SPECIMEN 22, EVENT 78-351, STRAIN TIME HISTORY

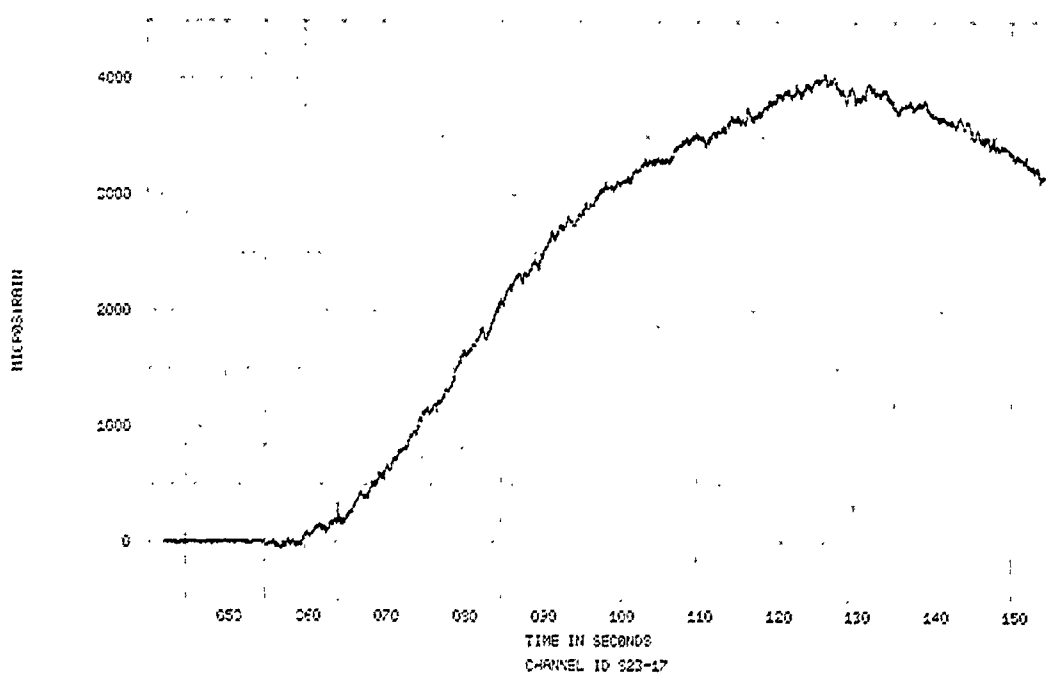

FIGURE 53. SPECIMEN 23, EVENT 78-351, STRAIN TIME HISTORY

PLOTTED OCT 19 1978 HBE 8261 906 LEE -8318 5899 HCL 4293 3828 LCL 3 3809
ANALOG TAPE 299009 TRACK NO 2 FILTER 10000HZ SAMPLE RATE 100000 CHARGE NO 78 351

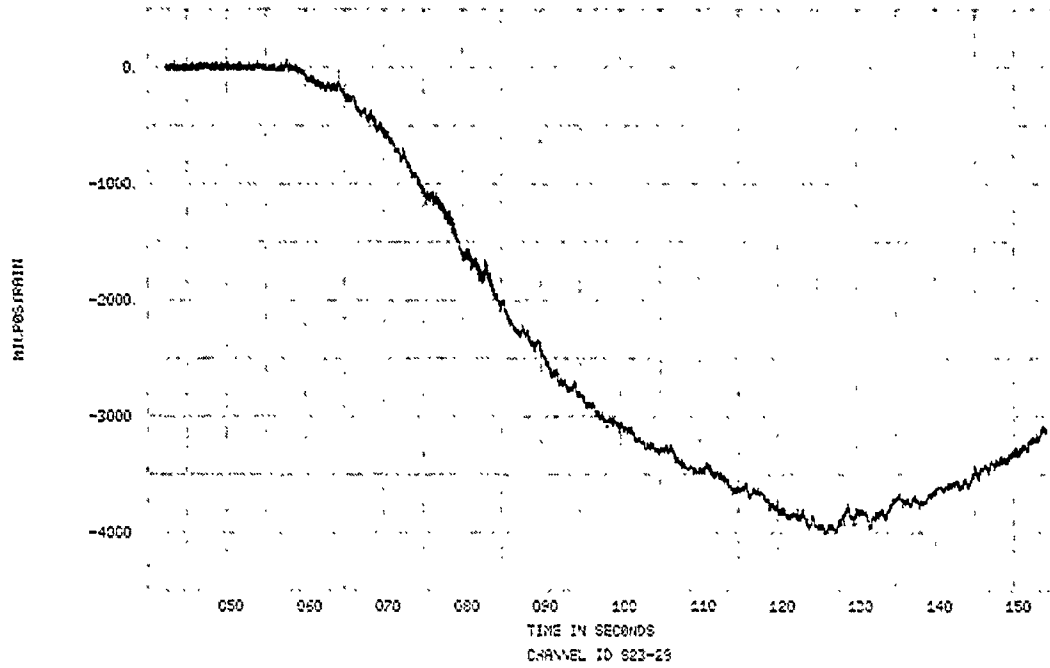
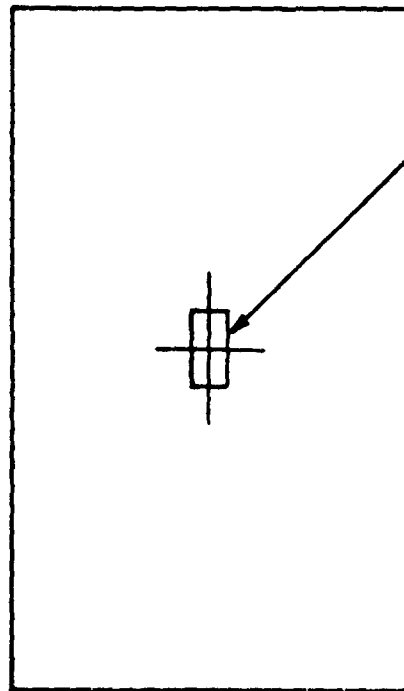

FIGURE 54. SPECIMEN 23, EVENT 78-351, STRAIN TIME HISTORY

SPECIMEN NO. 24-25

PRECEDING PAGE BLANK-NOT FILMED



Si-1 (NEAR SIDE)
Si-2 (FAR SIDE)

WHERE,
 $i = 24, 25$

SPECIMENS 24-25

CLAMP-ENDED COLUMNS - 0.028 IN. THICK
10.0 IN. LONG
5.0 IN. WIDE

MATERIAL - 6061-T6 ALUMINUM ALLOY

DENSITY - 0.0002539 LB-SEC²/IN⁴

YIELD STRESS - 41,180 PSI

ULTIMATE STRESS - 46,060 PSI

MODULUS OF ELASTICITY - 10.7×10^6 PSI

Figure 55. Description and Instrumentation - Specimens 24-25

PRECEDING PAGE BLANK-NOT FILMED

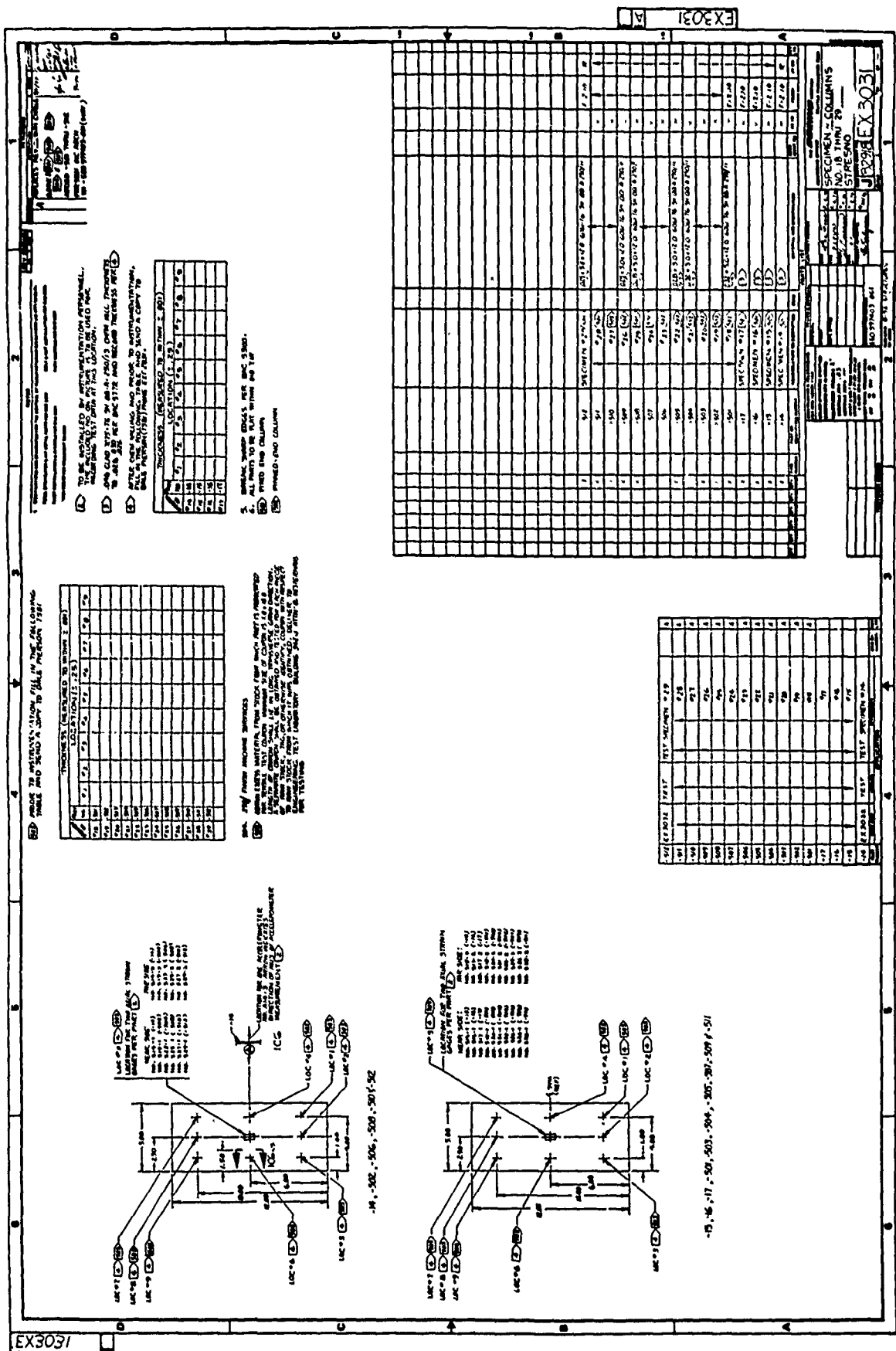

Figure 56. Spec Drawing - Specimens 24-25

NOVA-2LT DATA DECK LISTING
TEST SPECIMENS 24-25

* * * NOVA-2LT DATA DECK FOR TEST SPECIMENS 24-25 * * *						GP 1:
	1	10	100	2	1	GP 3:
0.50	1					GP 4:
	2	2	2	1	1	GPB 1:
	20	1	6			GPB 2:
0.0	-0.5					GPB 5:
0.0	0.0					GPB 6:
0.0	0.5					GPB 6:
0.0	1.0					GPB 6:
0.0	1.5					GPB 6:
0.0	2.0					GPB 6:
0.0	2.5					GPB 6:
0.0	3.0					GPB 6:
0.0	3.5					GPB 6:
0.0	4.0					GPB 6:
0.0	4.5					GPB 6:
0.0	5.0					GPB 6:
0.0	5.5					GPB 6:
0.0	6.0					GPB 6:
0.0	6.5					GPB 6:
0.0	7.0					GPB 6:
0.0	7.5					GPB 6:
0.0	8.0					GPB 6:
0.0	8.5					GPB 6:
0.0	9.0					GPB 6:
0.0	9.5					GPB 6:
0.0	10.0					GPB 7:
	0					GPB 8:
	0					GPB 12:
0.0002539						GPB 13:
0.9818						GPB 14:
0.028						GPB 15:
5.0						GPB 16:
	2					GPB 17:
0.003849	41180.					GPB 18:
0.1150	46060.					GPB 18:
0.010						GPB 21:
0.0	0.040	100.0				GPB 22:
	4					GP 6

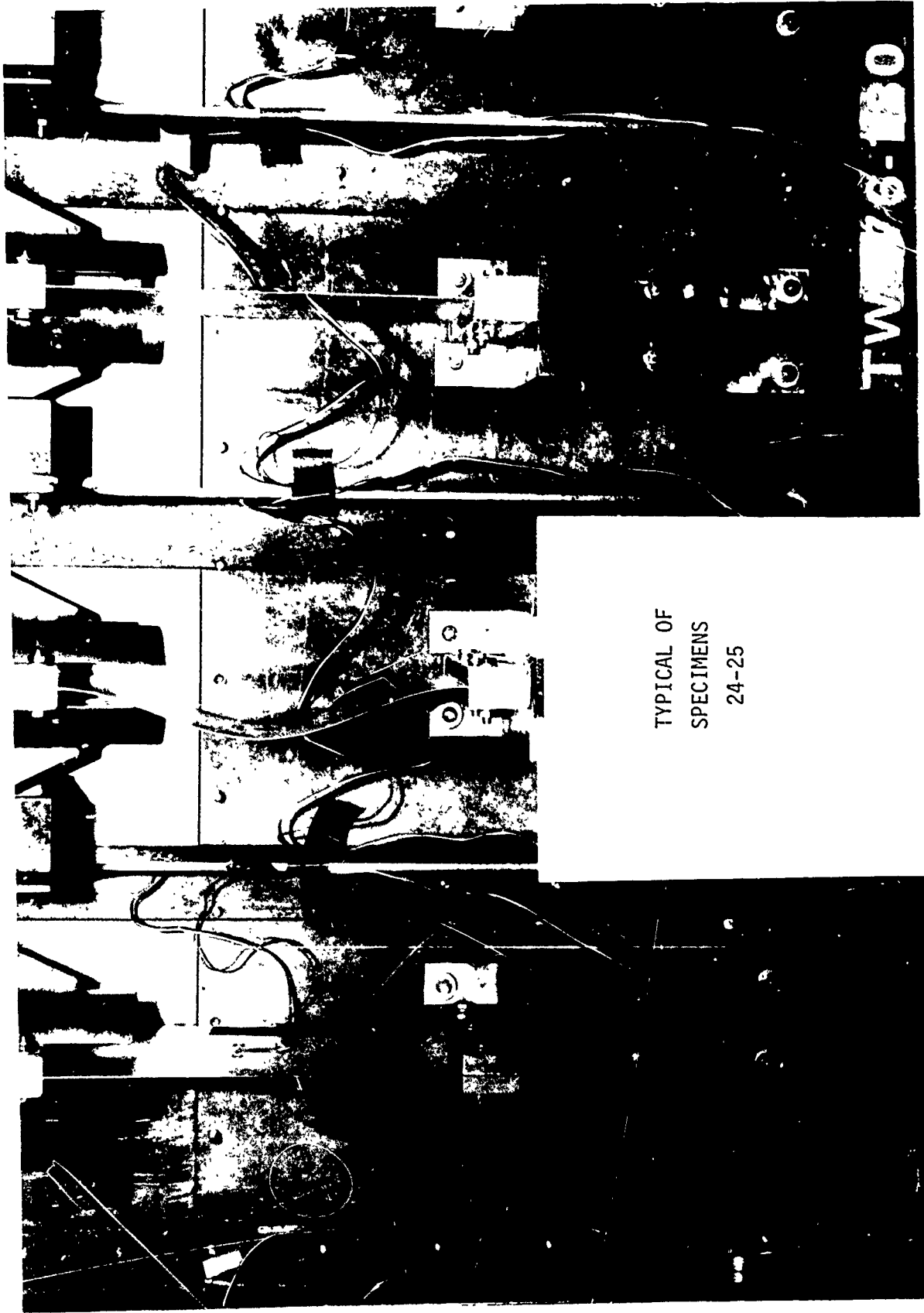

FIGURE 57. STATIC TEST SETUP - SPECIMENS 24-25

TABLE 5
 STATIC TEST STRESS DATA - SPECIMEN 24
 (STRESSES GIVEN IN PSI)

STRAIN GAUGE	LOAD (POUNDS)				
	4.5	11.5	18.5	22.5	24.0
S24-1	-2001.	-7608.	-16617.	-26397.	-30645.
S24-2	1926.	7244.	15911.	25402.	29554.

TABLE 6
 STATIC TEST DISPLACEMENT DATA - SPECIMEN 24 (VERTICAL
 DISPLACEMENT IS DISPLACEMENT OF PISTON PARALLEL TO
 COLUMN AXIS, AND LATERAL DISPLACEMENT IS MEASURED
 PERPENDICULAR TO COLUMN AT ITS CENTER)

	LOAD (POUNDS)				
	4.5	11.5	18.5	22.5	24.0
SPEC. 24 LATERAL	0.065	0.220	0.475	0.745	0.860
SPEC. 24 VERTICAL	0.015	0.070	0.185	0.350	0.440

TABLE 7
 STATIC TEST STRESS DATA - SPECIMEN 25
 (STRESSES GIVEN IN PSI)

STRAIN GAUGE	LOAD (POUNDS)				
	32.1	34.1	36.1	38.1	38.3
S25-1	856.	1423.	2878.	19677.	27413.
S25-2	-1434.	-2065.	-3563.	-20266.	-27948.

TABLE 8
 STATIC TEST DISPLACEMENT DATA - SPECIMEN 25 (VERTICAL
 DISPLACEMENT IS DISPLACEMENT OF PISTON PARALLEL TO
 COLUMN AXIS, AND LATERAL DISPLACEMENT IS MEASURED
 PERPENDICULAR TO COLUMN AT ITS CENTER)

	LOAD (POUNDS)				
	32.1	34.1	36.1	38.1	38.3
SPEC. 25 LATERAL	0.035	0.050	0.095	0.640	0.880
SPEC. 25 VERTICAL	0.003	0.005	0.007	0.105	0.195

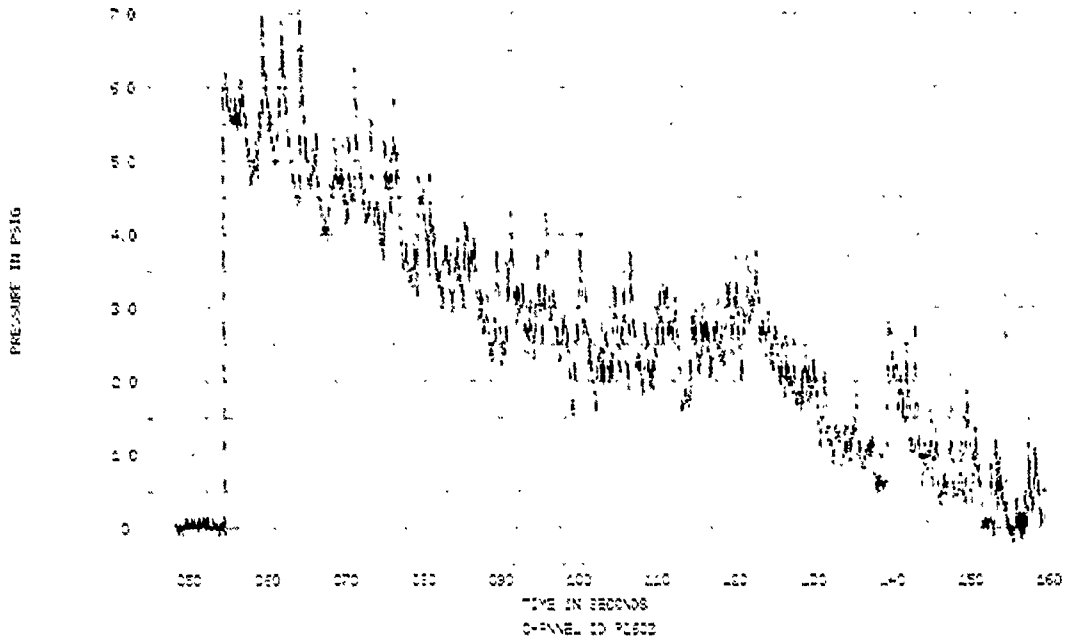

FIGURE 58. SPECIMENS 24-25, EVENT 78-355, TUNNEL WALL INCIDENT OVERPRESSURE TIME HISTORY

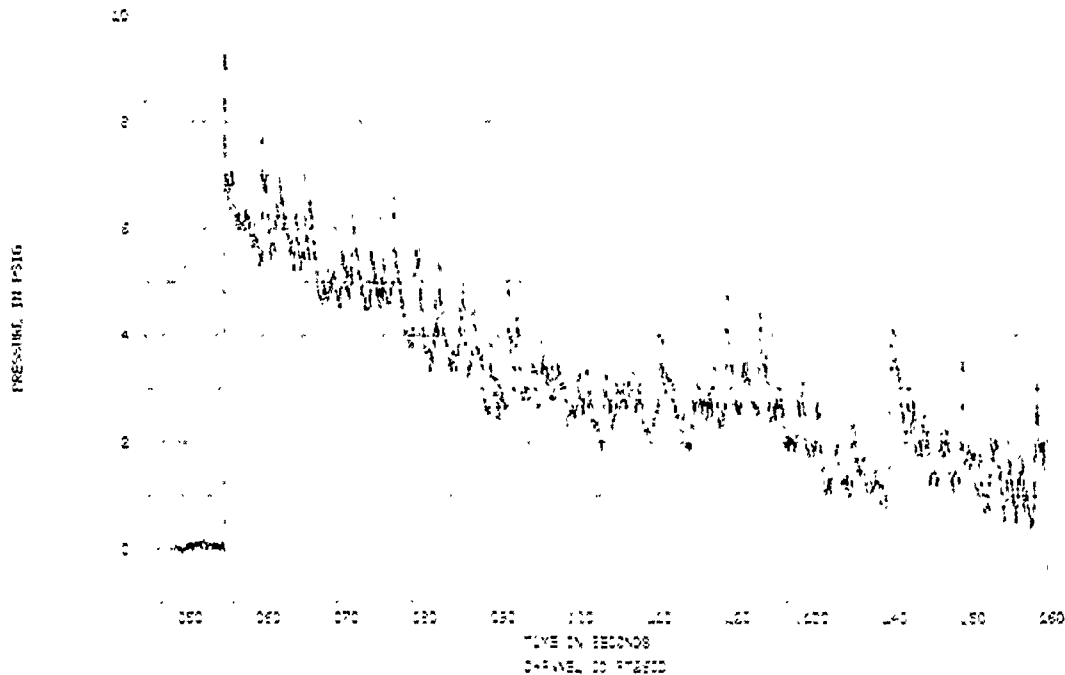

FIGURE 59. SPECIMENS 24-25, EVENT 78-355, TUNNEL WALL REFLECTED OVERPRESSURE TIME HISTORY

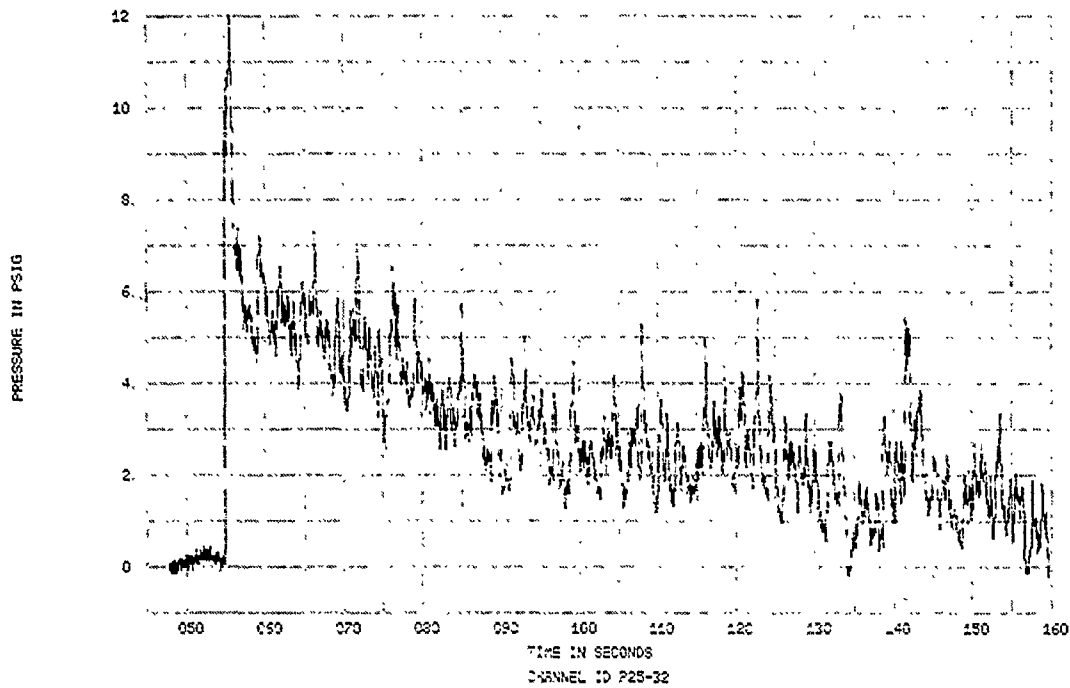

FIGURE 60. SPECIMENS 24-25, EVENT 78-355, SPECIMEN REFLECTED OVERPRESSURE TIME HISTORY

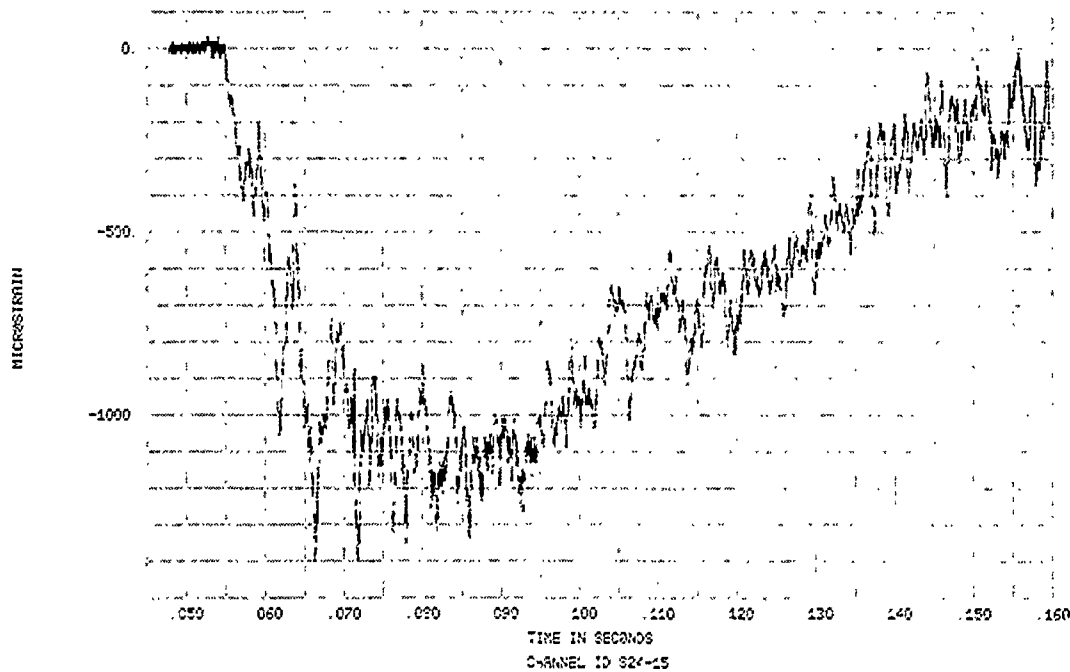

FIGURE 61. SPECIMEN 24, EVENT 78-355, STRAIN TIME HISTORY

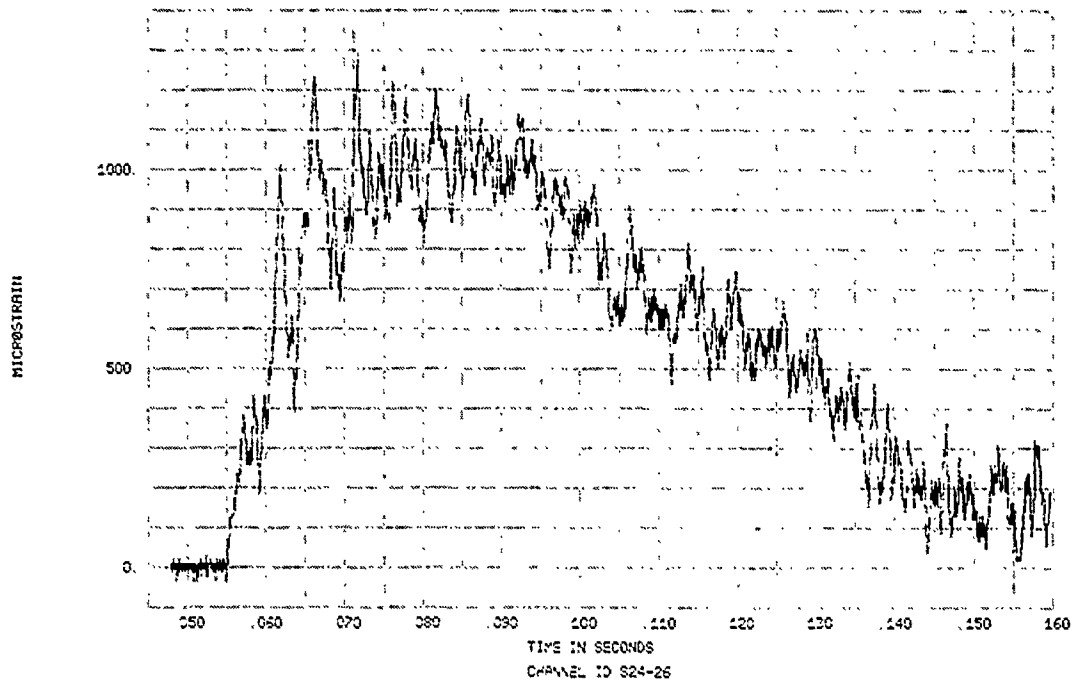

FIGURE 62. SPECIMEN 24, EVENT 78-355, STRAIN TIME HISTORY

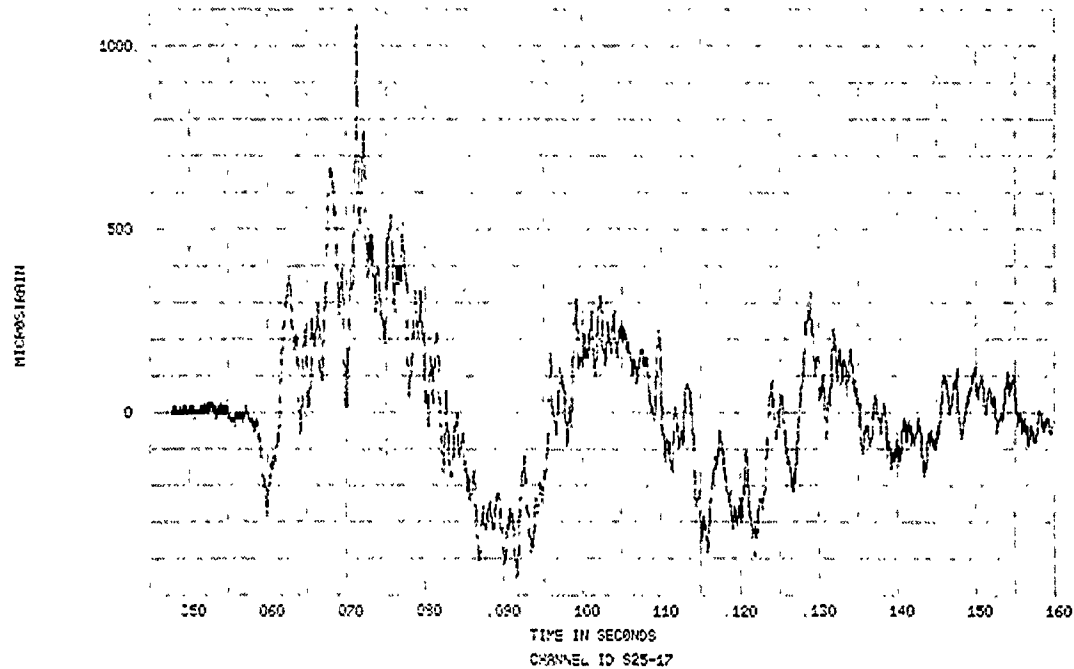

FIGURE 63. SPECIMEN 25, EVENT 78-355, STRAIN TIME HISTORY

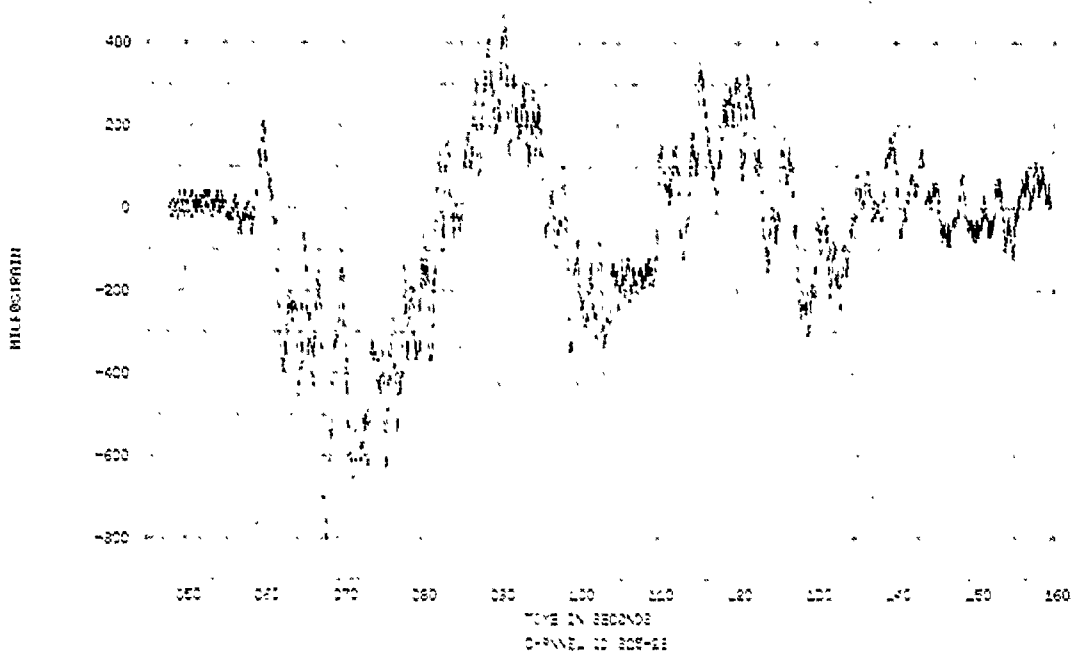

FIGURE 64. SPECIMEN 25, EVENT 78-355, STRAIN TIME HISTORY

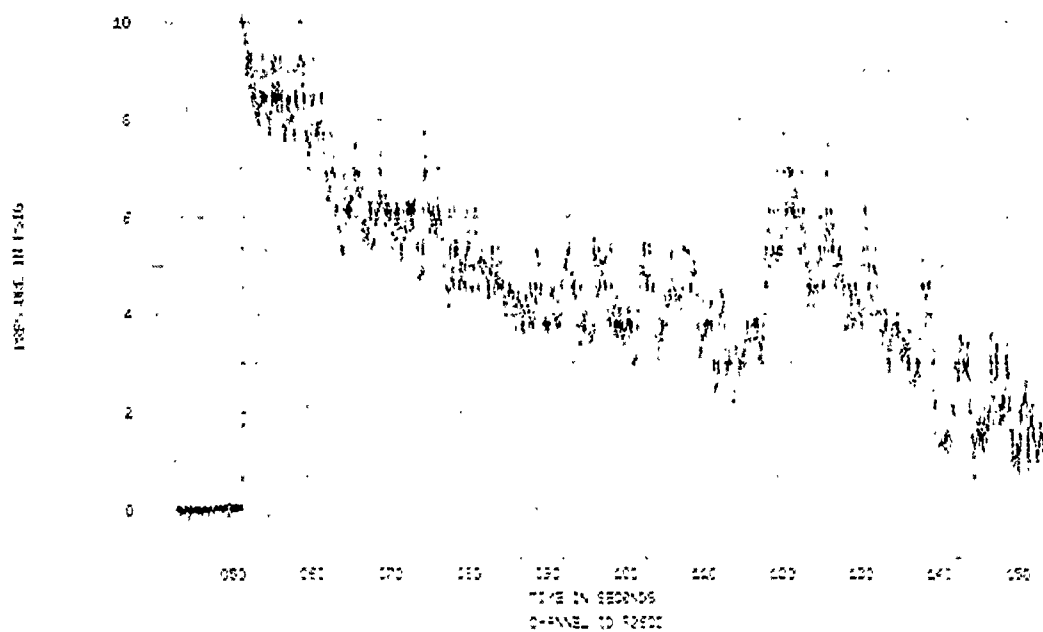

FIGURE 65. SPECIMENS 24-25, EVENT 78-357, TUNNEL WALL INCIDENT OVERPRESSURE TIME HISTORY

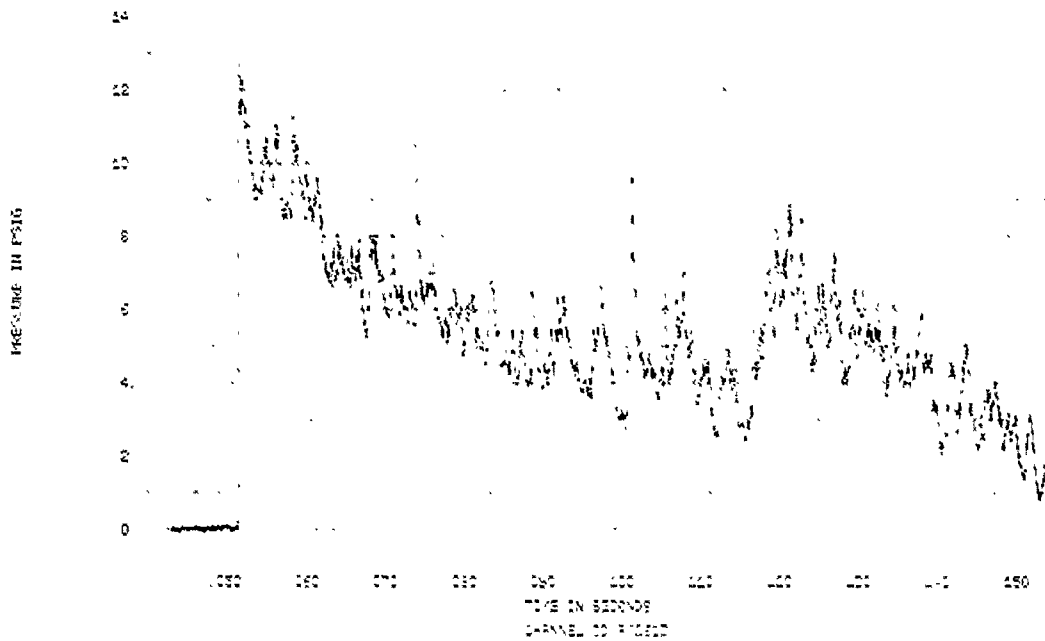

FIGURE 66. SPECIMENS 24-25, EVENT 78-357, TUNNEL WALL REFLECTED OVERPRESSURE TIME HISTORY

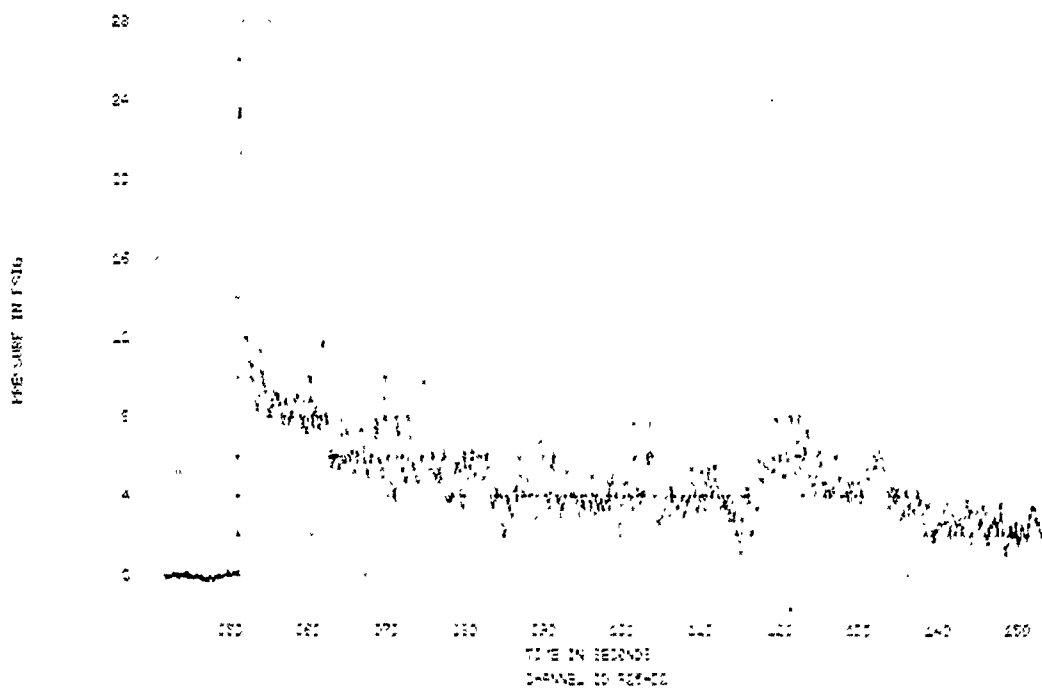

FIGURE 67. SPECIMENS 24-25, EVENT 78-357, SPECIMEN REFLECTED OVERPRESSURE TIME HISTORY

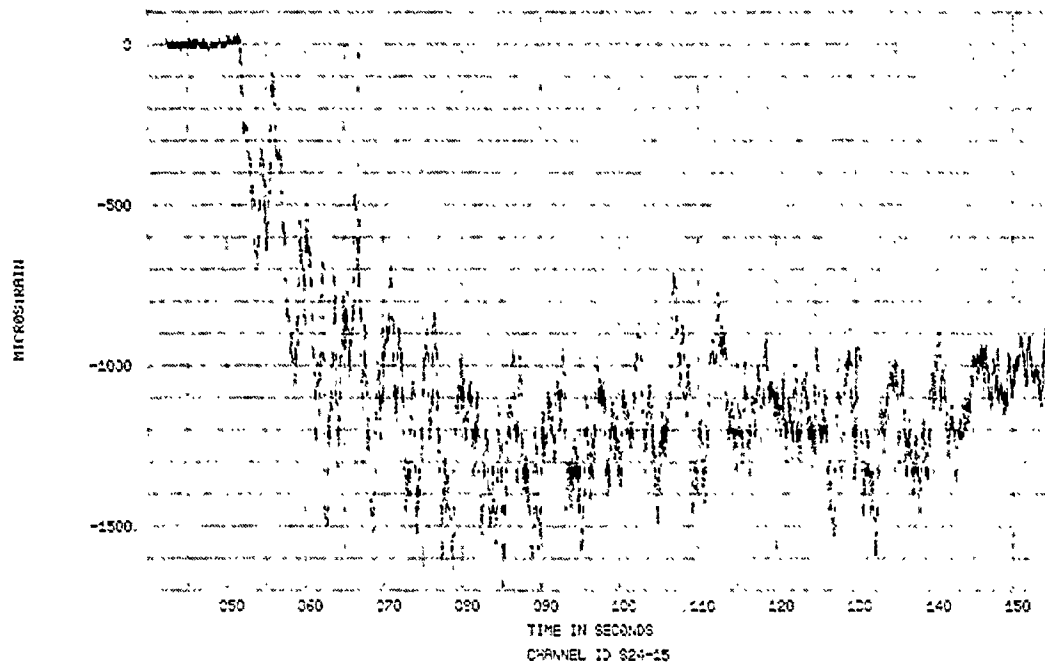

FIGURE 68. SPECIMEN 24, EVENT 78-357, STRAIN TIME HISTORY

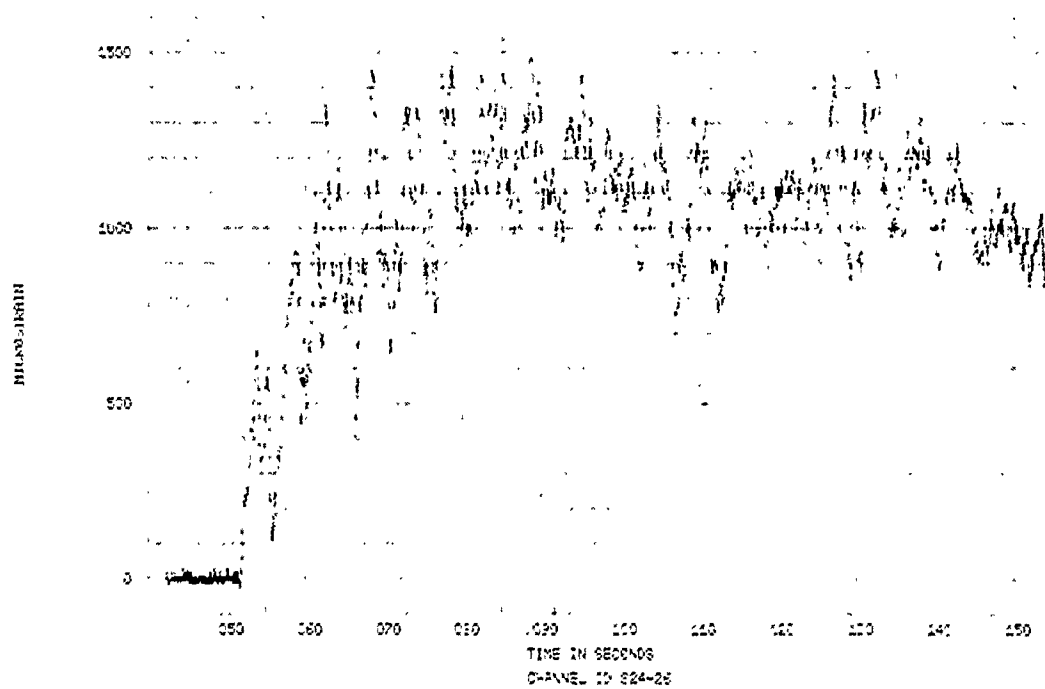

FIGURE 69. SPECIMEN 24, EVENT 78-357, STRAIN TIME HISTORY

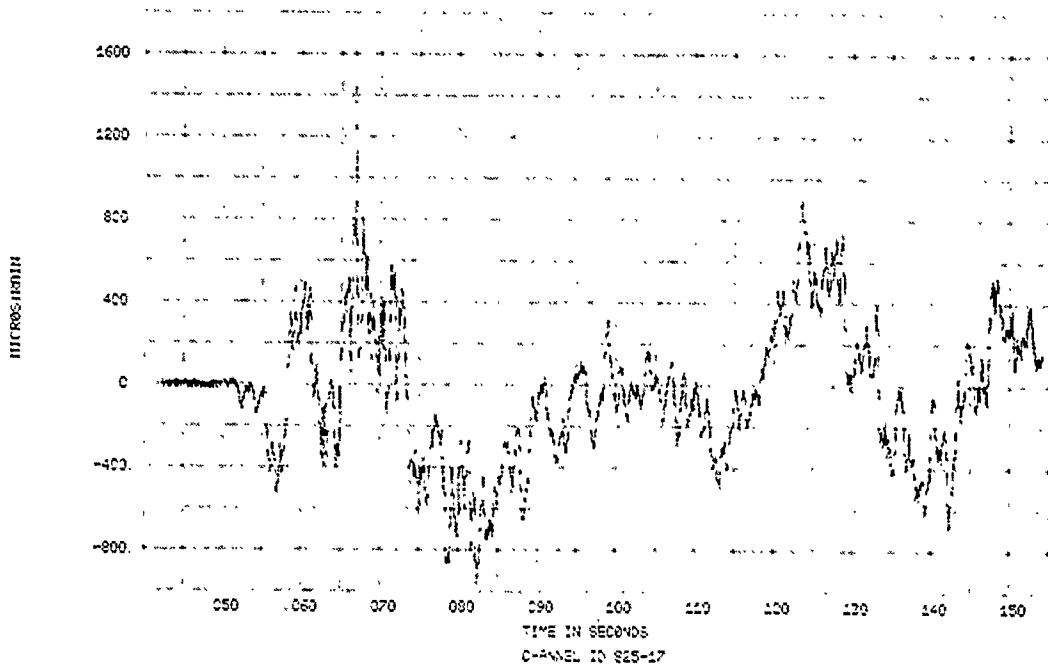

FIGURE 70. SPECIMEN 25, EVENT 70-357, STRAIN TIME HISTORY

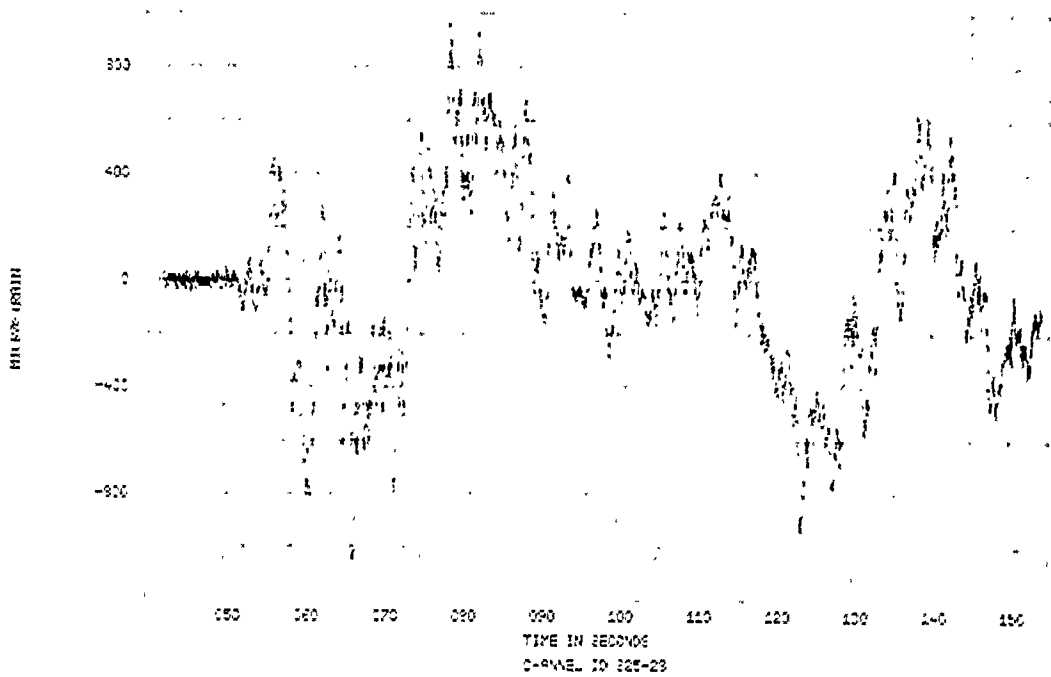

FIGURE 71. SPECIMEN 25, EVENT 70-357, STRAIN TIME HISTORY

(1)

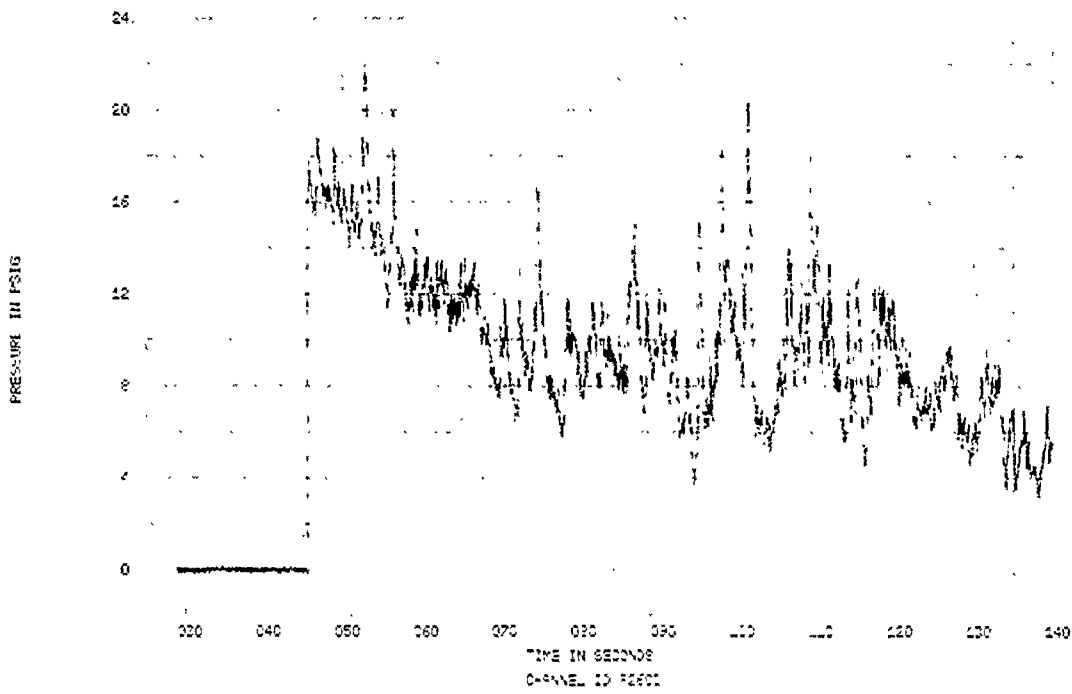

FIGURE 72. SPECIMENS 24-25, EVENT 78-358, TUNNEL WALL INCIDENT OVERPRESSURE TIME HISTORY

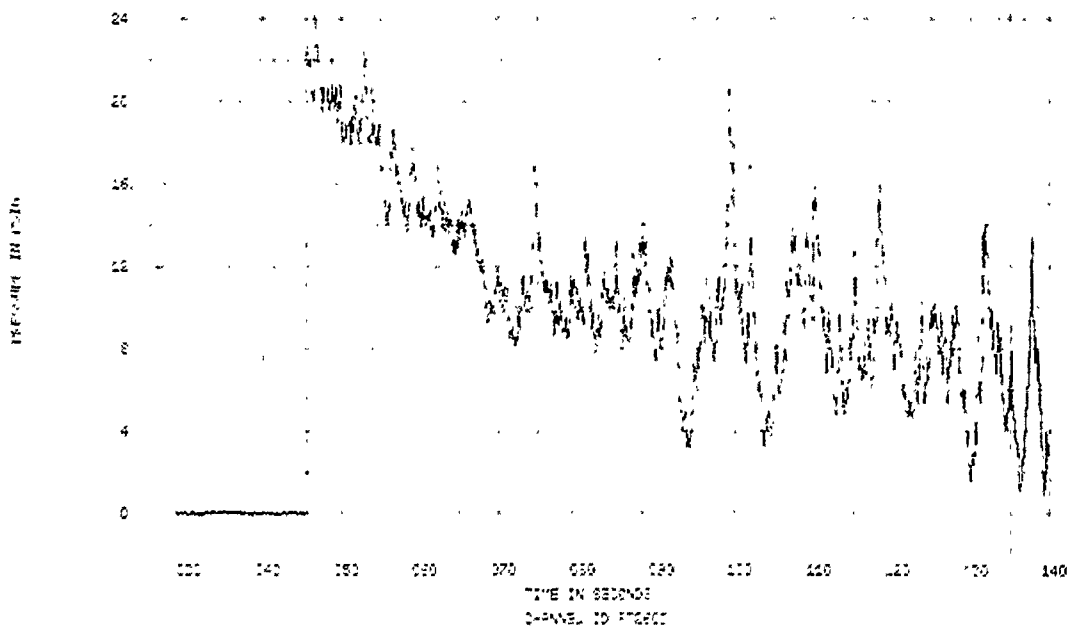

FIGURE 73. SPECIMENS 24-25, EVENT 78-358, TUNNEL WALL REFLECTED OVERPRESSURE TIME HISTORY

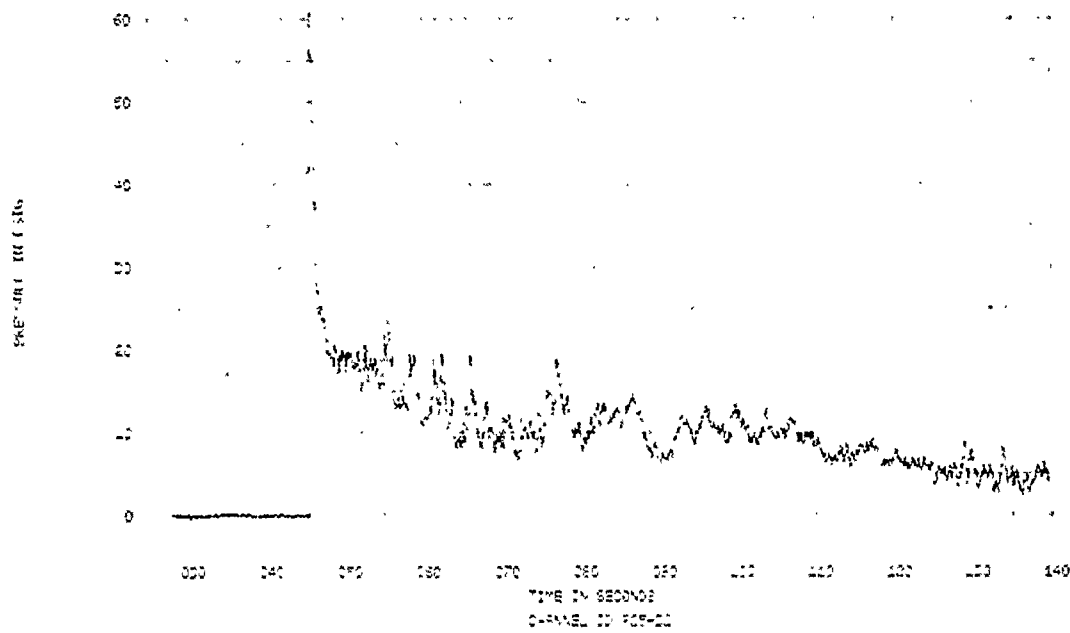

FIGURE 74. SPECIMENS 24-25, EVENT 78-358, SPECIMEN REFLECTED OVERPRESSURE TIME HISTORY

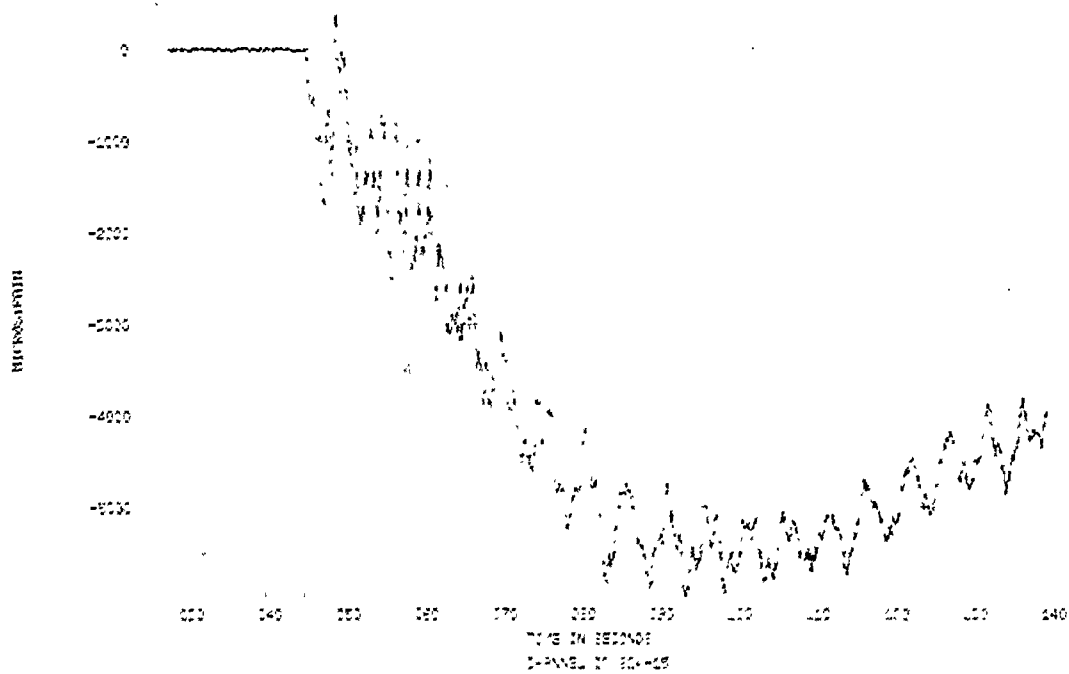

FIGURE 75. SPECIMEN 24, EVENT 78-358, STRAIN TIME HISTORY

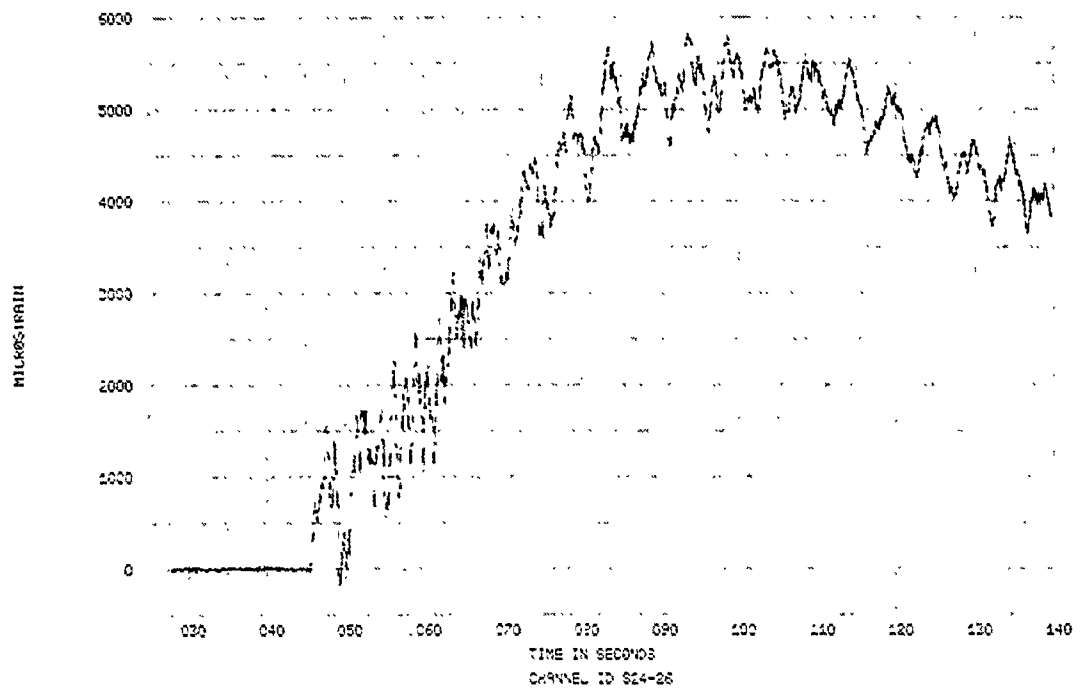

FIGURE 76. SPECIMEN 24, EVENT 78-358, STRAIN TIME HISTORY

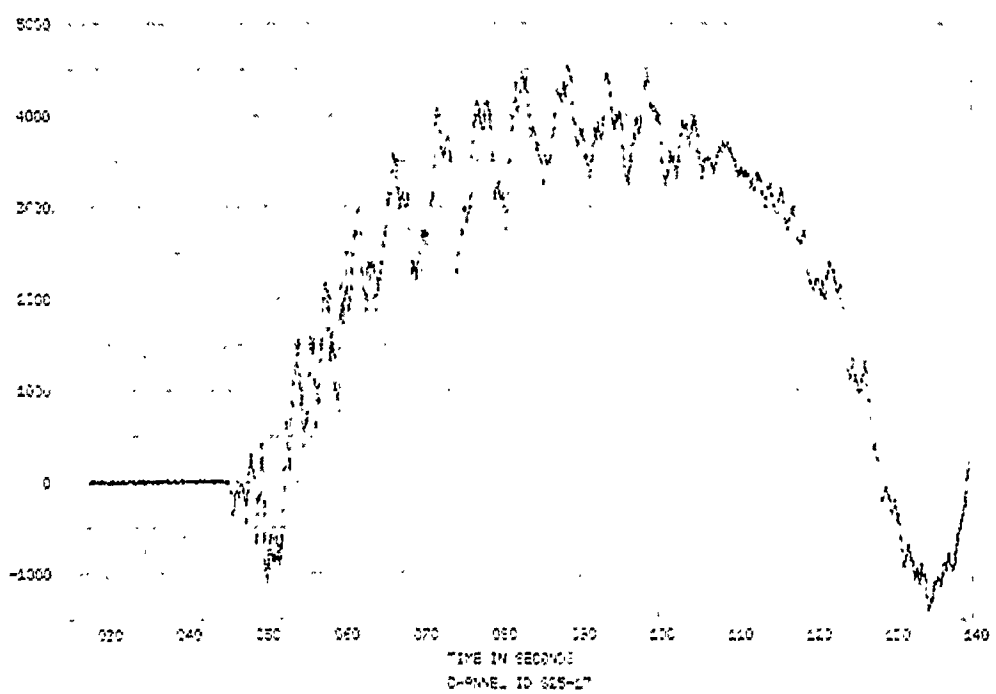

FIGURE 77. SPECIMEN 25, EVENT 78-358, STRAIN TIME HISTORY

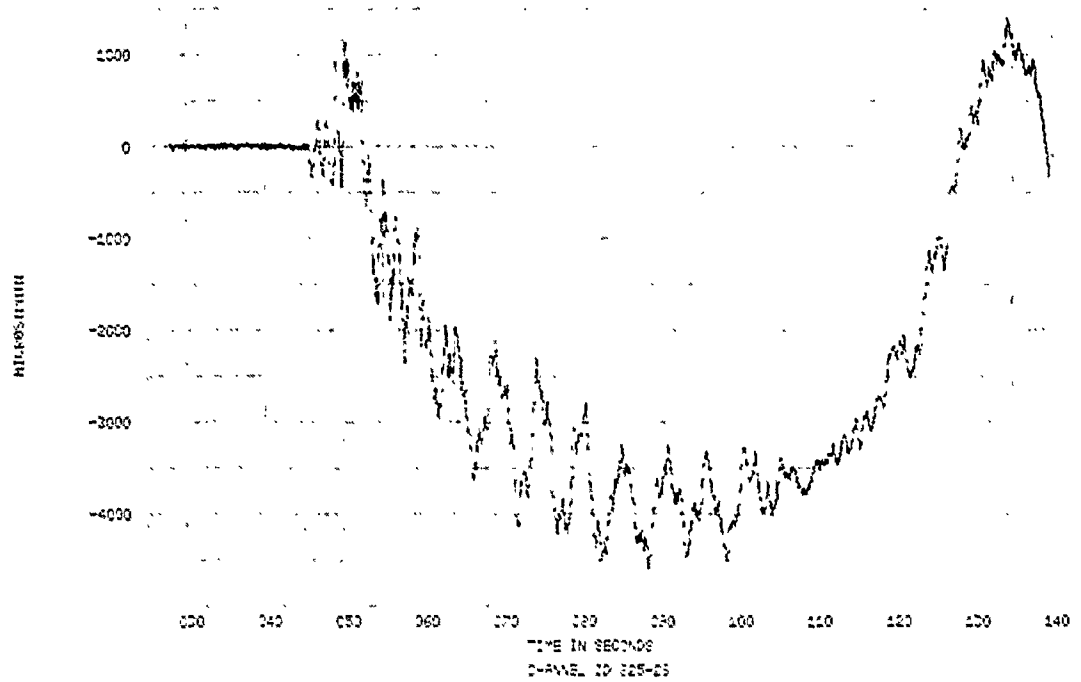
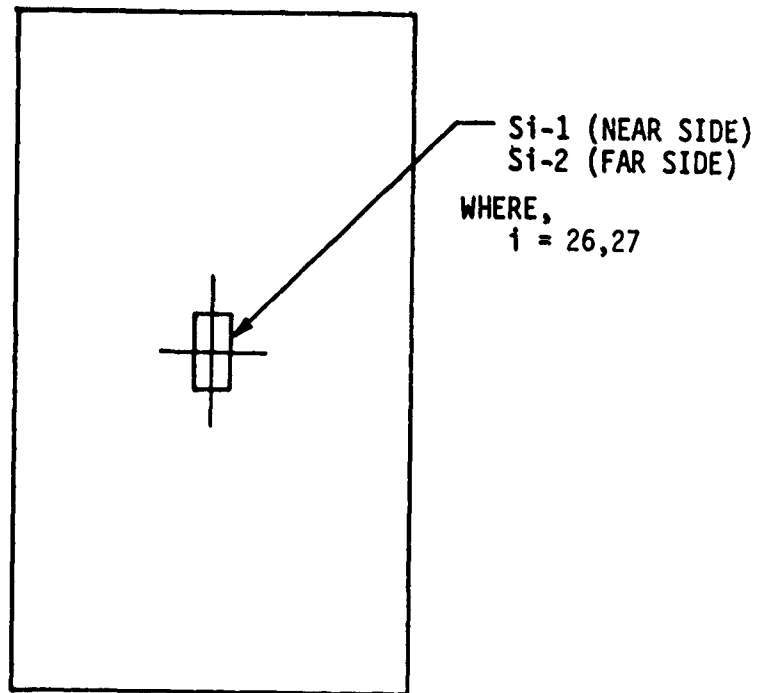

FIGURE 78. SPECIMEN 25, EVENT 79-358, STRAIN TIME HISTORY

SPECIMEN NO. 26-27



Si-1 (NEAR SIDE)
Si-2 (FAR SIDE)

WHERE,
i = 26,27

SPECIMENS 26-27

PIN-ENDED COLUMNS - 0.025 IN. THICK
10.0 IN. LONG
5.0 IN. WIDE

MATERIAL - 6061-T42 ALUMINUM ALLOY

DENSITY - 0.0002539 LB-SEC²/IN⁴

YIELD STRESS - 25,310 PSI

ULTIMATE STRESS - 38,760 PSI

MODULUS OF ELASTICITY - 10.85 x 10⁶ PSI

Figure 79. Description and Instrumentation - Specimens 26-27

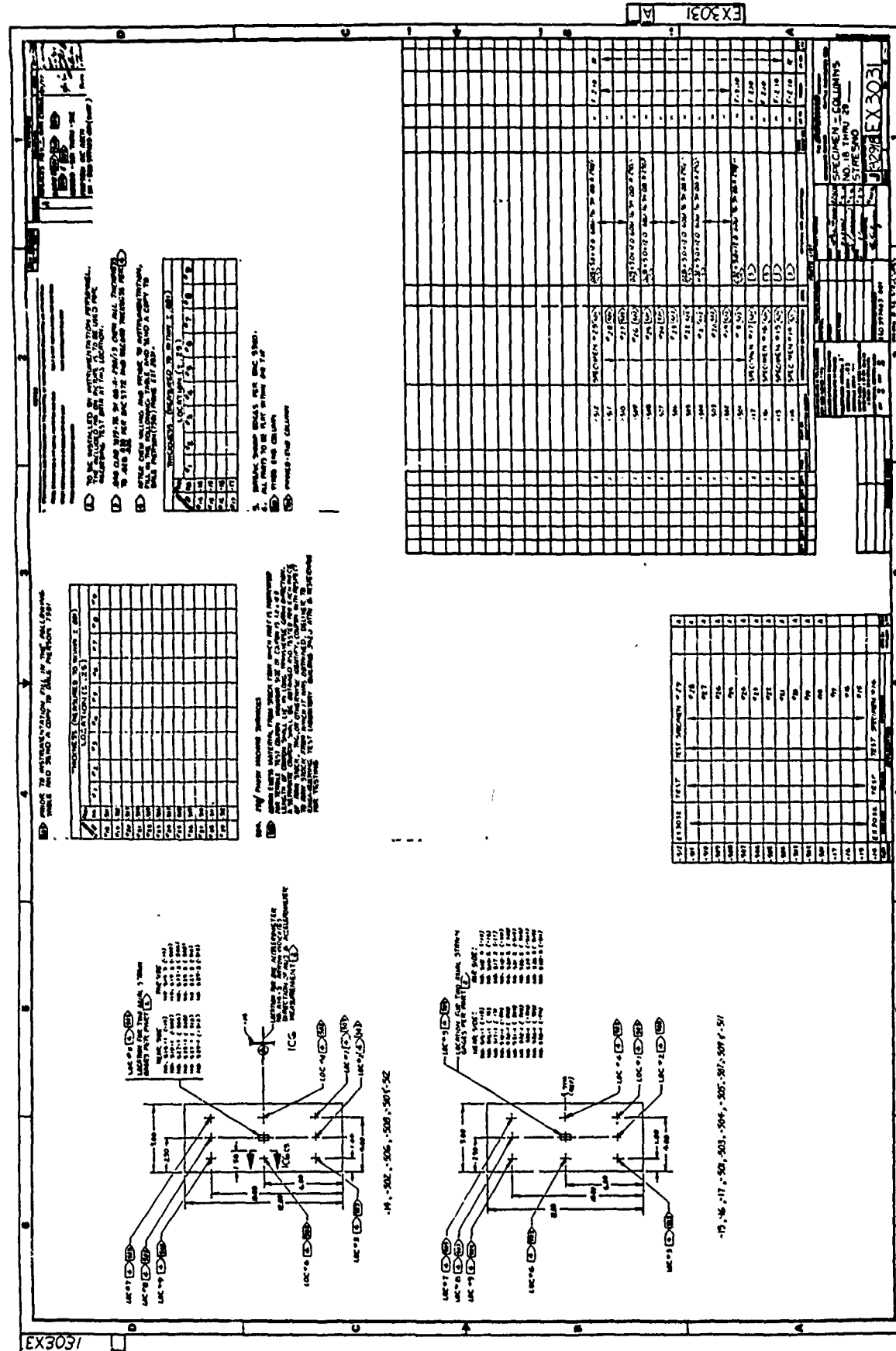

Figure 80. Spec Drawing - Specimens 26-27

NOVA-2LT DATA DECK LISTING
 TEST SPECIMENS 26-27

* * * NOVA-2LT DATA DECK FOR TEST SPECIMENS 26-27 * * *						GP 1
	1	10	100	2	1	GP 3
0.50	1					GP 4
	2	3	3	1	1	GPB 1
	20	1	6			GPB 2
-0.5						
0.0						
0.5						
1.0						
1.5						
2.0						
2.5						
3.0						
3.5						
4.0						
4.5						
5.0						
5.5						
6.0						
6.5						
7.0						
7.5						
8.0						
8.5						
9.0						
9.5						
10.0						
	0					GPB 8
	0					GPB 12
0.0002539						GPB 13
0.9818						GPB 14
0.025						GPB 15
5.0						GPB 16
	2					GPB 17
0.002333	25310.					GPB 18
0.200	38760.					GPB 18
0.002						GPB 21
0.0	0.100	400.0				GPB 22
	4					GP 6

TABLE 9
 STATIC TEST STRESS DATA - SPECIMENS 26-27
 (STRESSES GIVEN IN PSI)

STRAIN GAUGE	LOAD (POUNDS)				
	6.3	6.7	7.0	7.2	7.4
S26-1	1310.	3322.	11017.	13943.	41490.
S26-2	-1447.	-3255.	-10395.	-13232.	-40711.
S27-1	-208.	-396.	-312.	-604.	-21706.
S27-2	115.	270.	188.	447.	22132.

TABLE 10
 STATIC TEST DISPLACEMENT DATA - SPECIMENS 26-27
 (VERTICAL DISPLACEMENT IS DISPLACEMENT OF PISTON
 PARALLEL TO COLUMN AXIS, AND LATERAL DISPLACEMENT
 IS MEASURED PERPENDICULAR TO COLUMN AT ITS CENTER)

	LOAD (POUNDS)				
	6.3	6.7	7.0	7.2	7.4
SPEC. 26 LATERAL	0.085	0.210	0.695	0.870	2.310
SPEC. 26 VERTICAL	0.009	0.015	0.120	0.200	1.560
SPEC. 27 LATERAL	0.015	0.025	0.020	0.040	1.490
SPEC. 27 VERTICAL	0.0	0.0	0.0	0.0	0.555

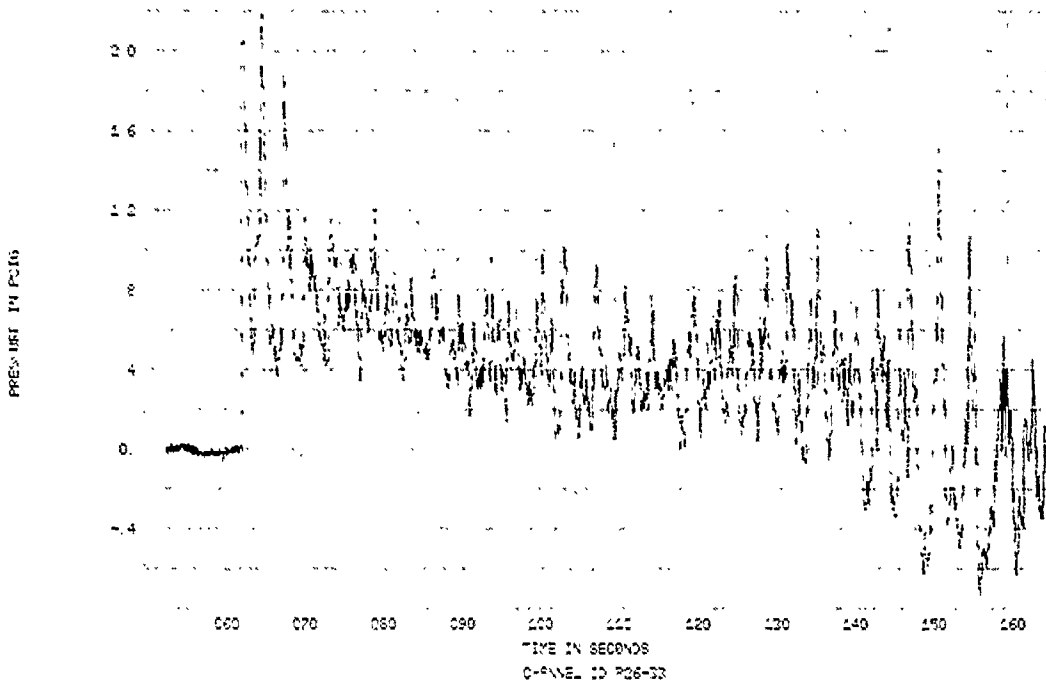

FIGURE 81. SPECIMENS 26-27, EVENT 78-349, SPECIMEN REFLECTED OVERPRESSURE TIME HISTORY

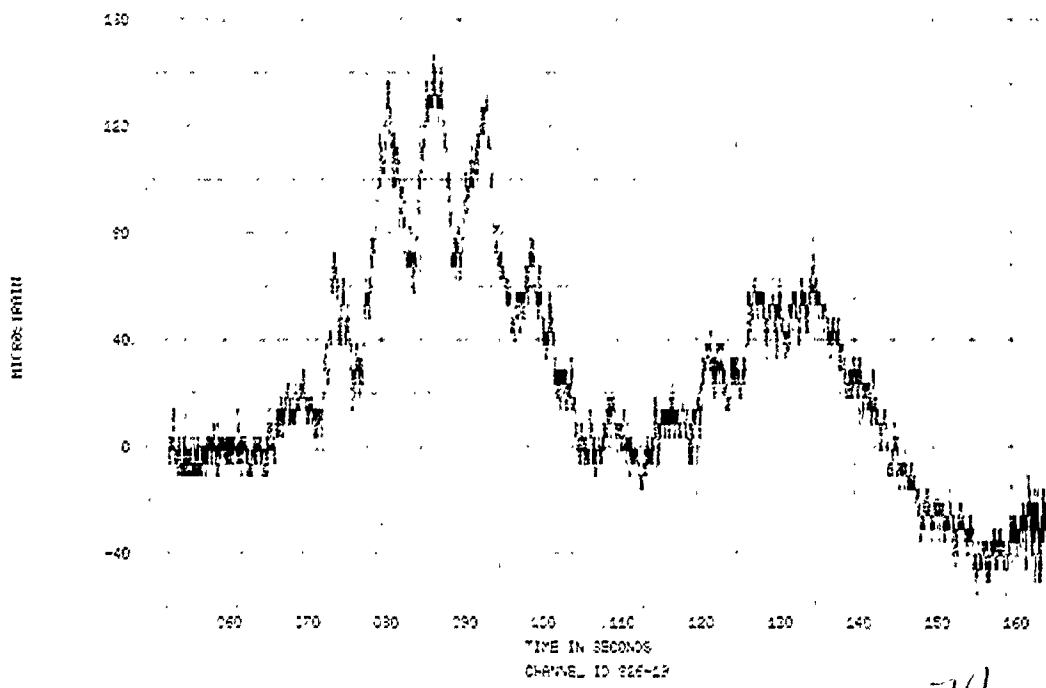

FIGURE 82. SPECIMEN 26, EVENT 78-349, STRAIN TIME HISTORY

70

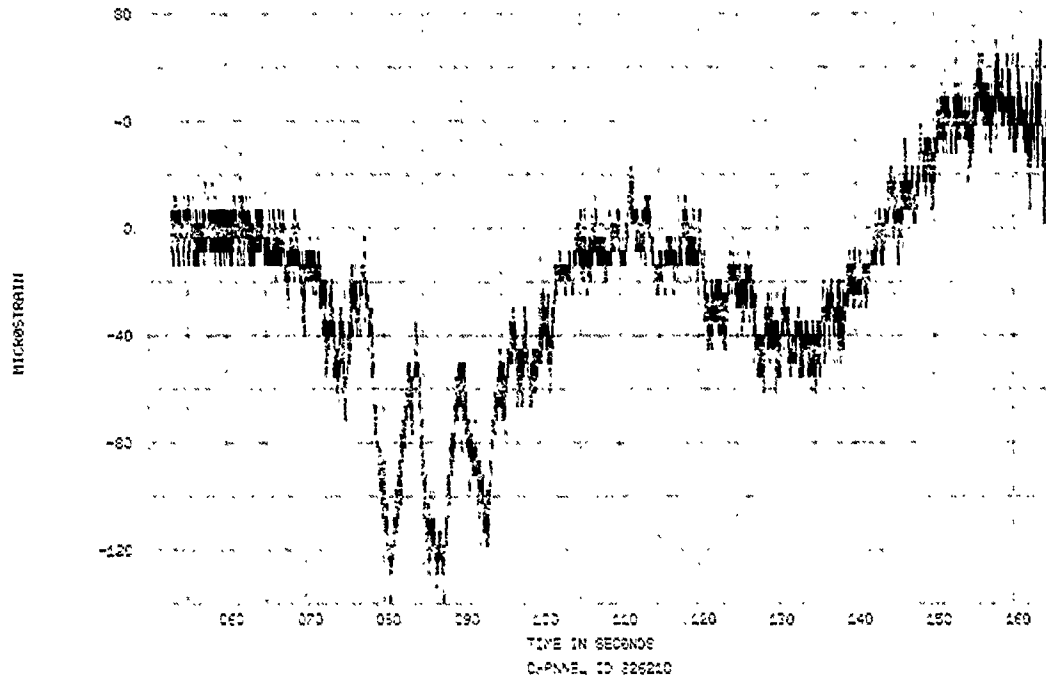

FIGURE 83. SPECIMEN 26, EVENT 78-349, STRAIN TIME HISTORY

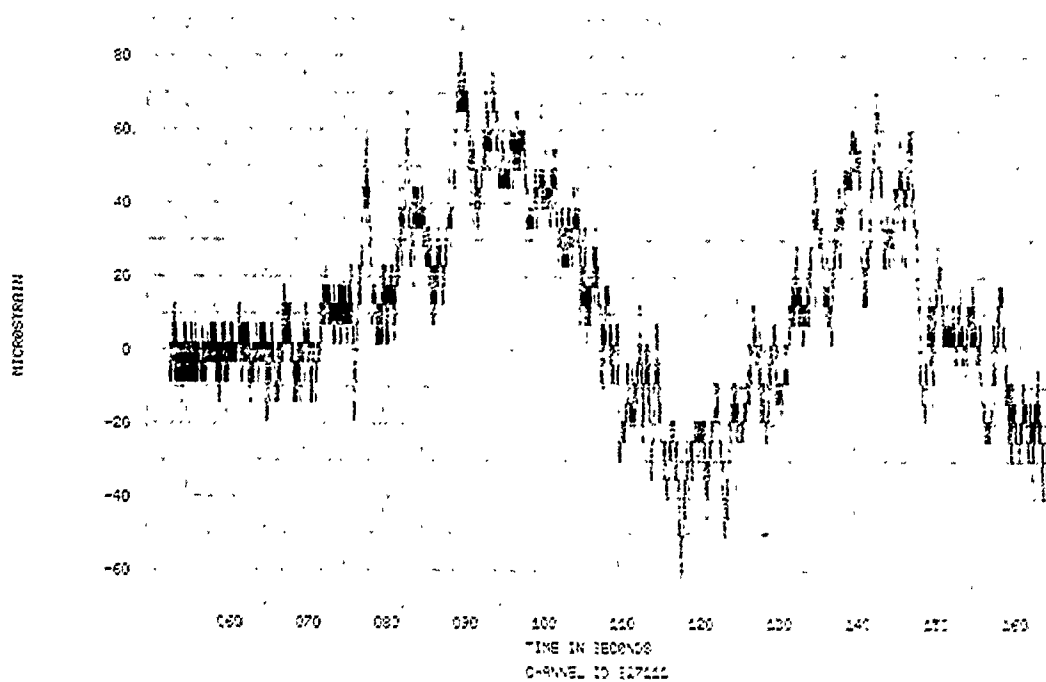

FIGURE 84. SPECIMEN 27, EVENT 78-349, STRAIN TIME HISTORY

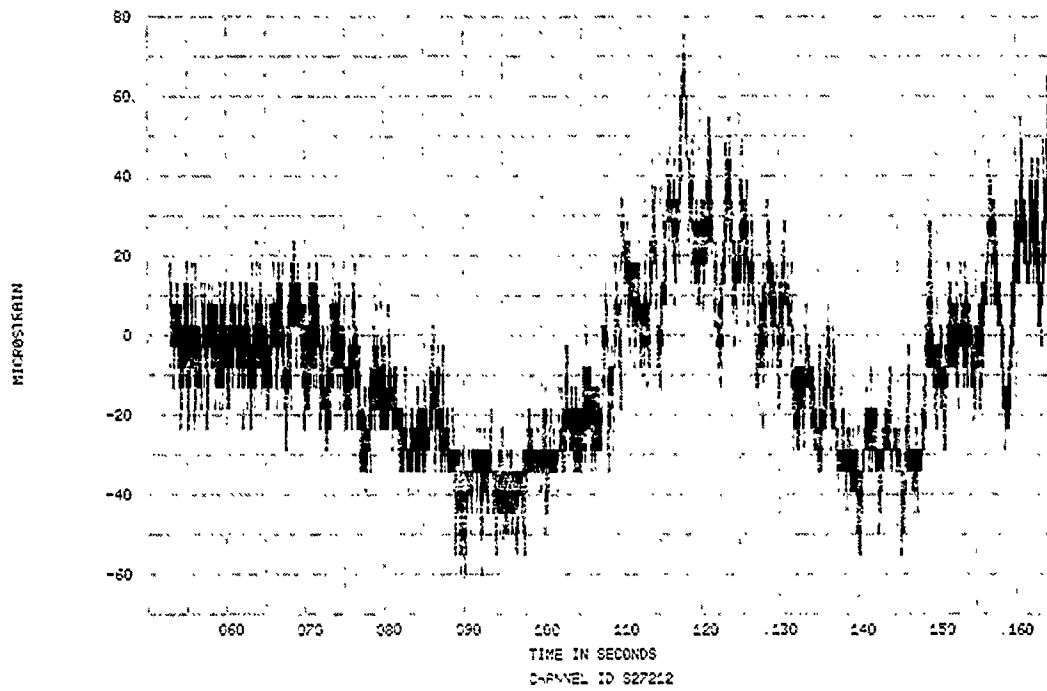

FIGURE 85. SPECIMEN 27, EVENT 78-349, STRAIN TIME HISTORY

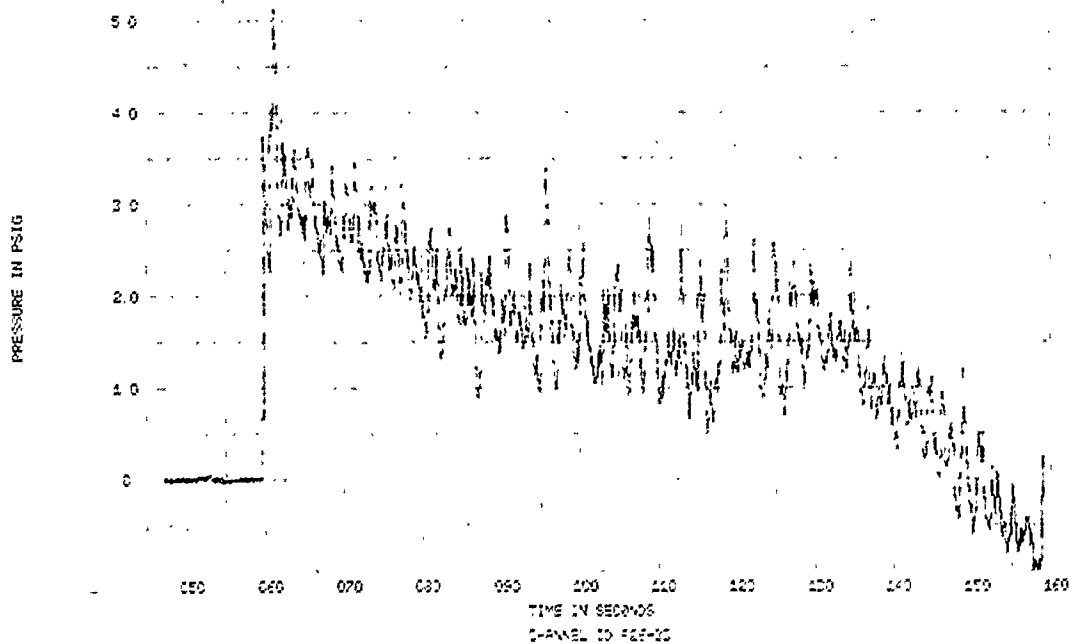

FIGURE 86. SPECIMENS 26-27, EVENT 78-350, SPECIMEN REFLECTED OVERPRESSURE TIME HISTORY

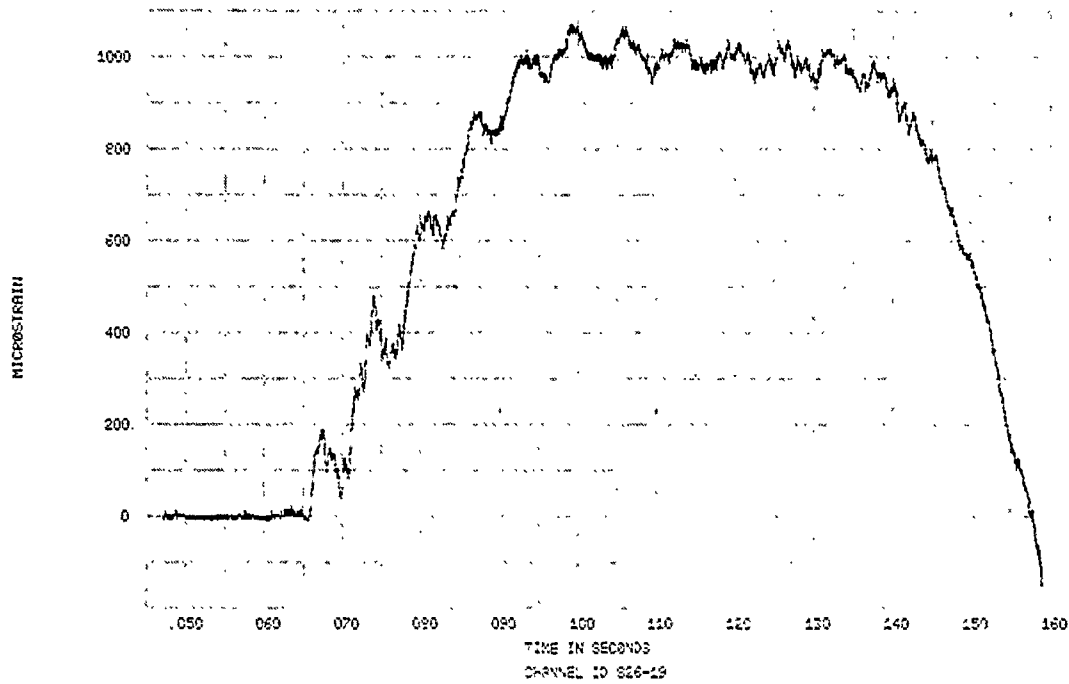

FIGURE 87. SPECIMEN 26, EVENT 78-350, STRAIN TIME HISTORY

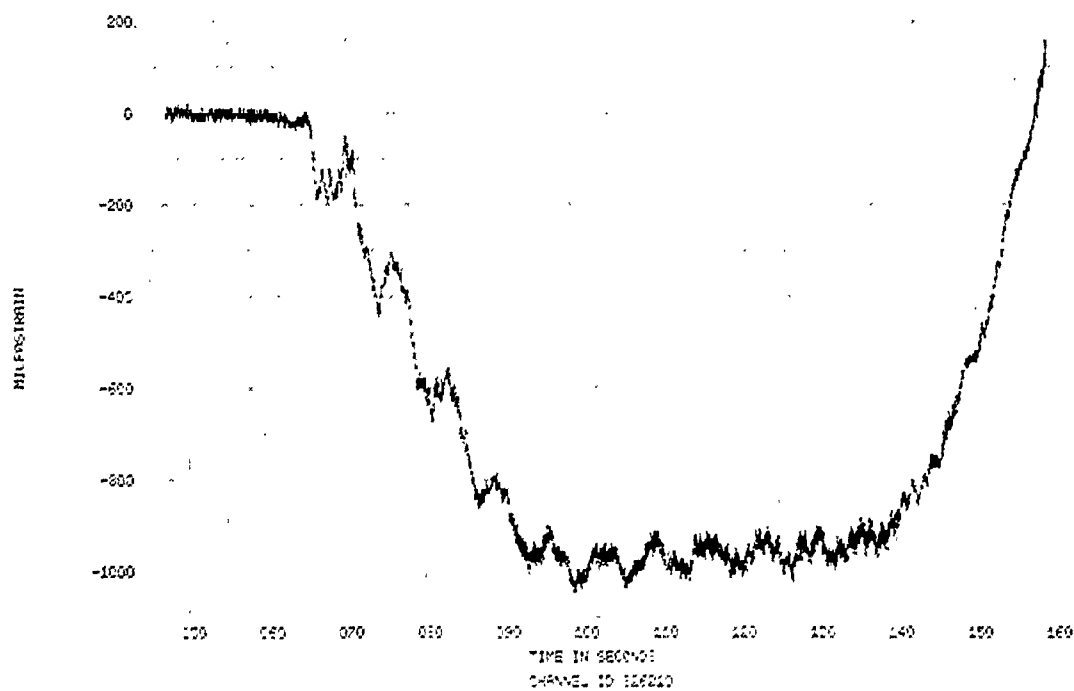

FIGURE 88. SPECIMEN 26, EVENT 78-350, STRAIN TIME HISTORY

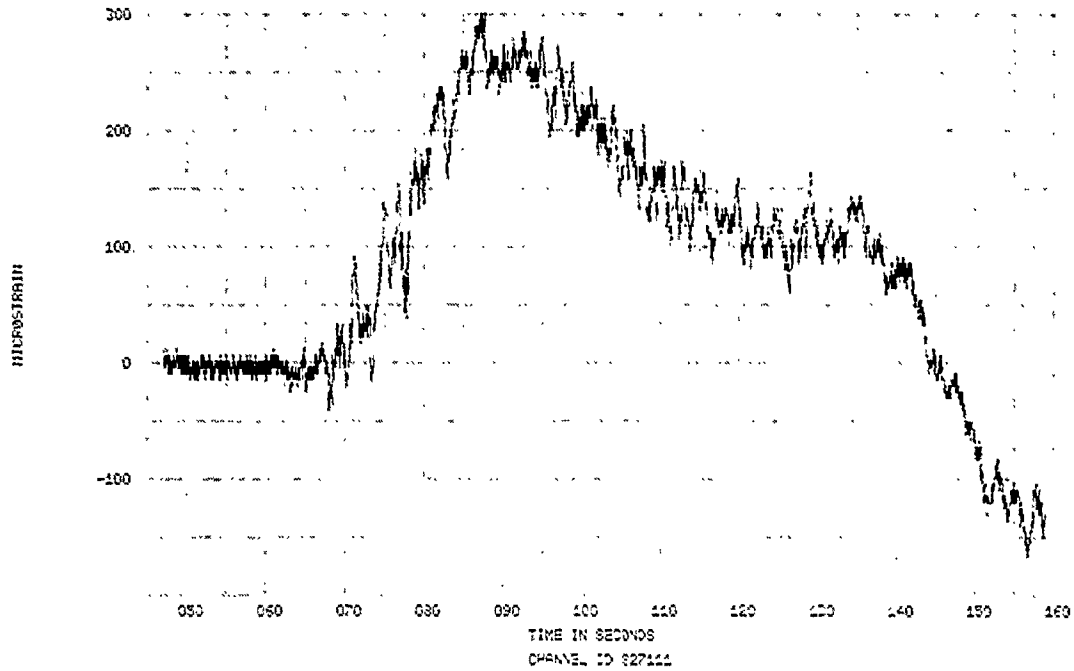

FIGURE 89. SPECIMEN 27, EVENT 78-350, STRAIN TIME HISTORY

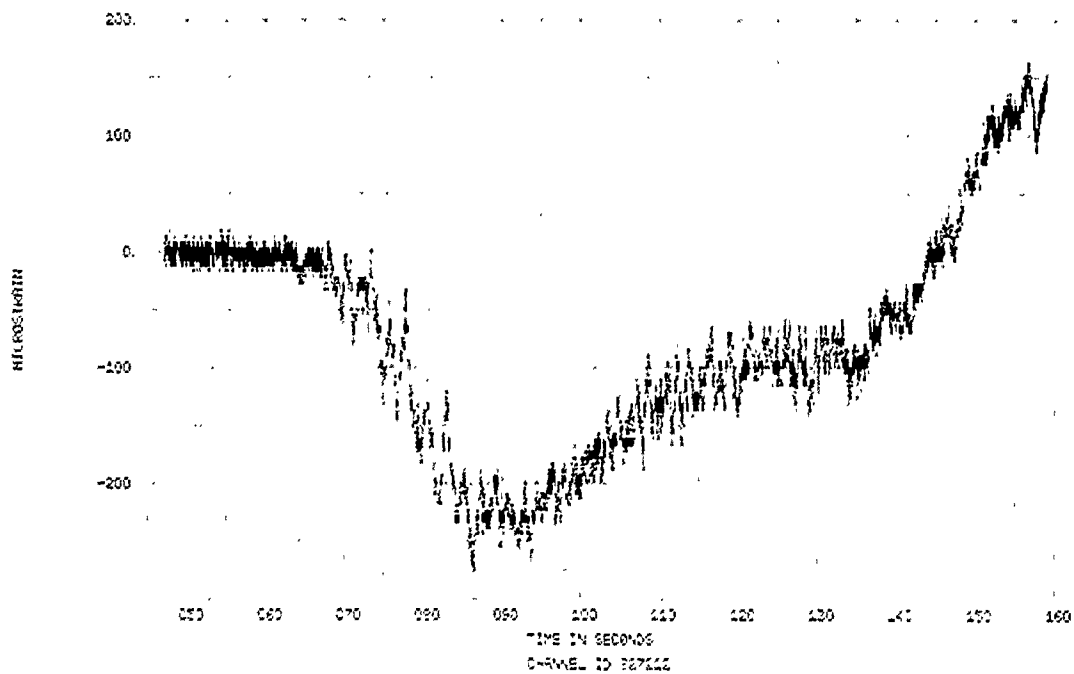

FIGURE 90. SPECIMEN 27, EVENT 78-350, STRAIN TIME HISTORY

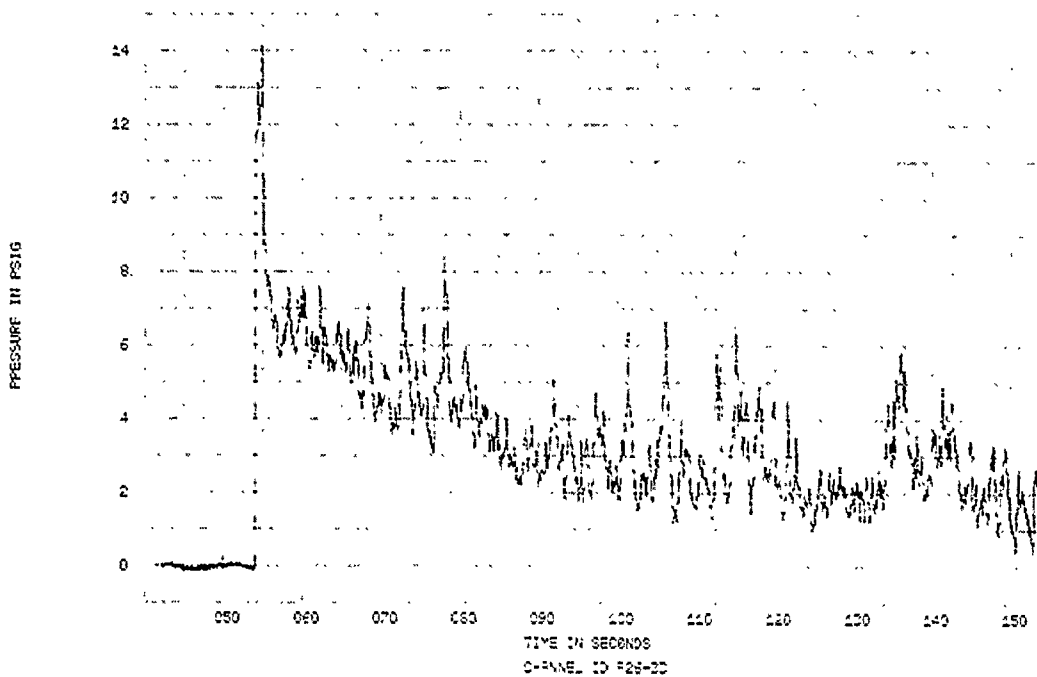

FIGURE 91. SPECIMENS 26-27, EVENT 78-351, SPECIMEN REFLECTED OVERPRESSURE TIME HISTORY

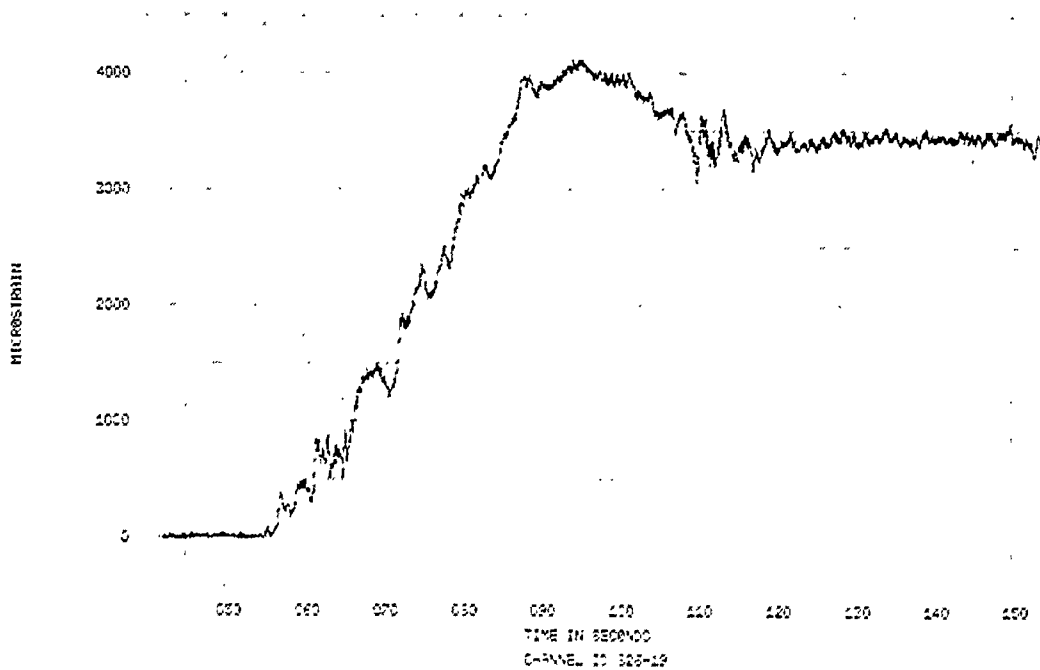

FIGURE 92. SPECIMEN 26, EVENT 78-351, STRAIN TIME HISTORY

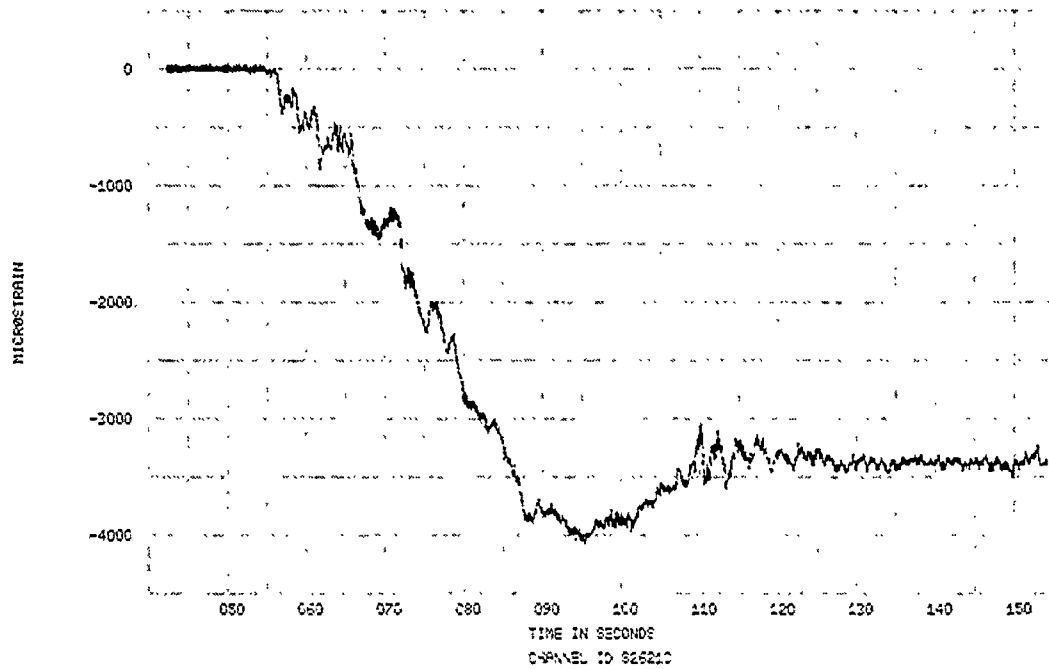

FIGURE 93. SPECIMEN 26, EVENT 78-351, STRAIN TIME HISTORY

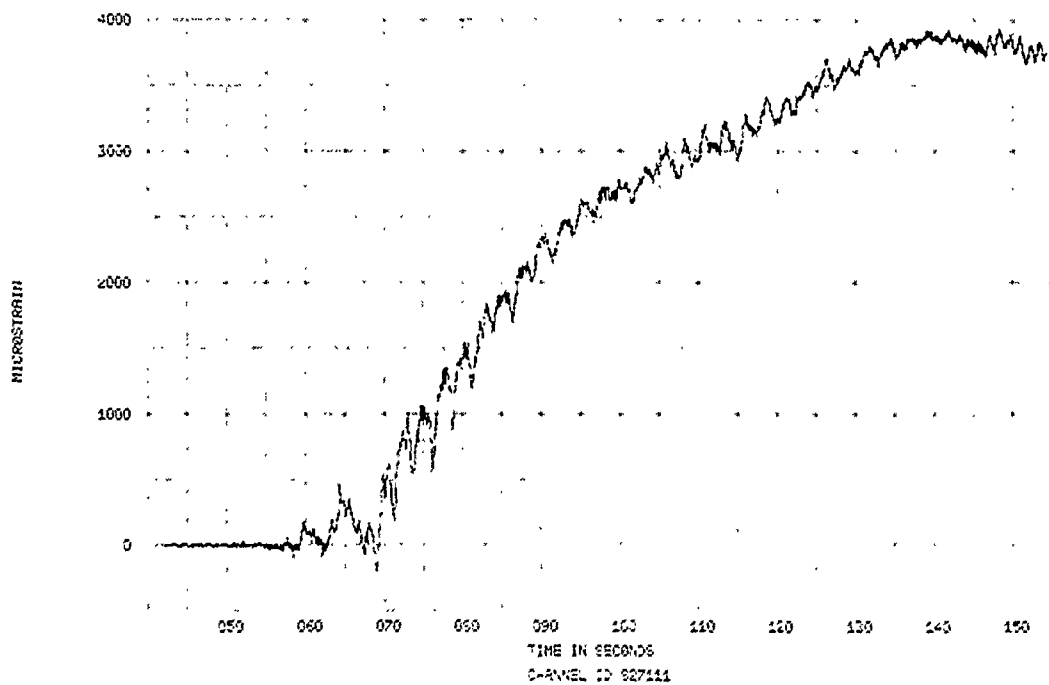

FIGURE 94. SPECIMEN 27, EVENT 78-351, STRAIN TIME HISTORY

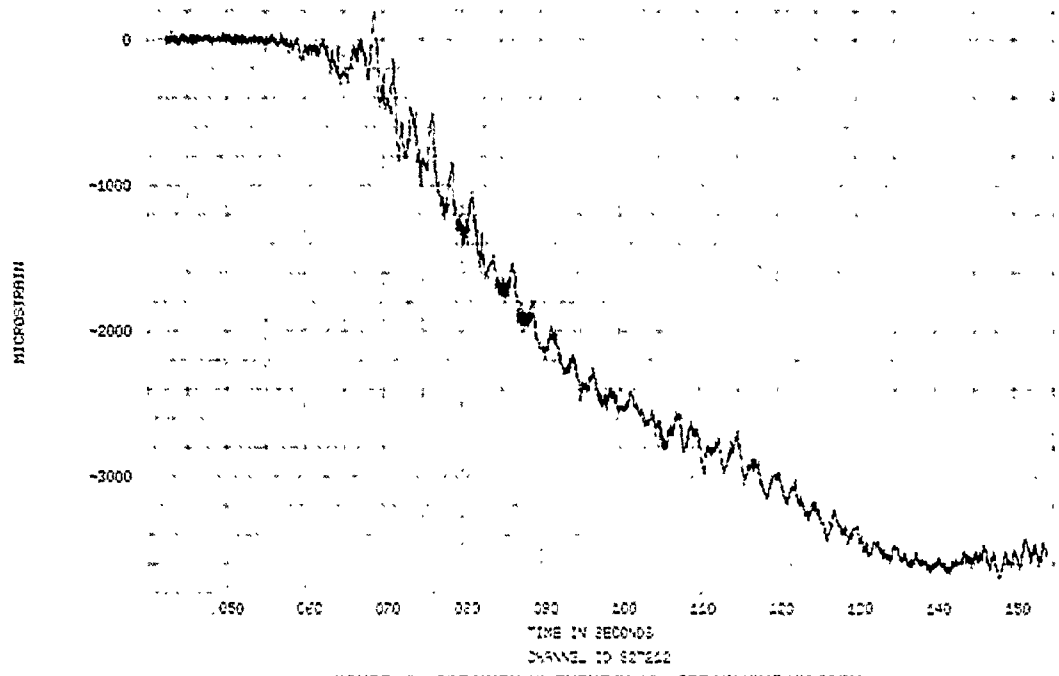
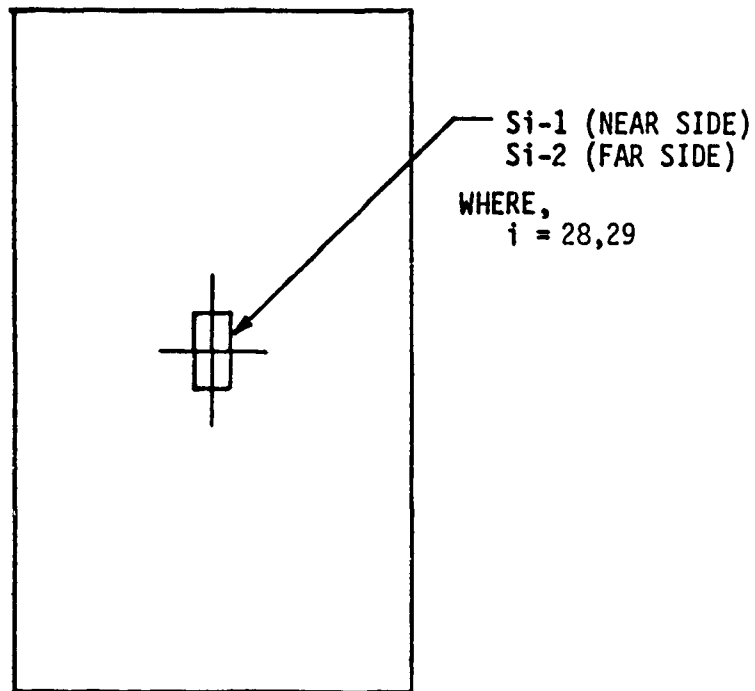

FIGURE 95. SPECIMEN 27, EVENT 78-351, STRAIN TIME HISTORY

SPECIMEN ON. 28-29



Si-1 (NEAR SIDE)
Si-2 (FAR SIDE)

WHERE,
i = 28,29

SPECIMENS 28-29

CLAMP-ENDED COLUMNS - 0.025 IN. THICK
10.0 IN. LONG
5.0 IN. WIDE

MATERIAL - 6061-T42 ALUMINUM ALLOY

DENSITY - 0.0002539 LB-SEC²/IN⁴

YIELD STRESS - 24,940 PSI

ULTIMATE STRESS - 38,685 PSI

MODULUS OF ELASTICITY - 10.25 x 10⁶ PSI

FIGURE 96. Description and Instrumentation - Specimens 28-29

PRECEDING PAGE BLANK-NOT FILMED

NOVA-2LT DATA DECK LISTING
TEST SPECIMENS 28-29

* * * NOVA-2LT DATA DECK FOR TEST SPECIMENS 28-29 * * *						GP 1
1	10	100	2	1	1	GP 3
0.50	1	10	100	2	1	GP 4
	2	2	2	1	1	GPB 1
	20	1	6			GPB 2
0.0	-0.5					GPB 5
0.0	0.0					GPB 6
0.0	0.5					GPB 6
0.0	1.0					GPB 6
0.0	1.5					GPB 6
0.0	2.0					GPB 6
0.0	2.5					GPB 6
0.0	3.0					GPB 6
0.0	3.5					GPB 6
0.0	4.0					GPB 6
0.0	4.5					GPB 6
0.0	5.0					GPB 6
0.0	5.5					GPB 6
0.0	6.0					GPB 6
0.0	6.5					GPB 6
0.0	7.0					GPB 6
0.0	7.5					GPB 6
0.0	8.0					GPB 6
0.0	8.5					GPB 6
0.0	9.0					GPB 6
0.0	9.5					GPB 6
0.0	10.0					GPB 7
	0					GPB 8
	0					GPB 12
0.0002539						GPB 13
0.9818						GPB 14
0.025						GPB 15
5.0						GPB 16
	2					GPB 17
0.002433	24940.					GPB 18
0.1950	38685.					GPB 18
0.003						GPB 21
0.0	0.040	100.0				GPB 22
	4					GP 6

TABLE 11
 STATIC TEST STRESS DATA - SPECIMEN 28
 (STRESSES GIVEN IN PSI)

STRAIN GAUGE	LOAD (POUNDS)				
	26.0	27.0	27.5	27.9	28.2
S28-1	1061.	3060.	9474.	15069.	20766.
S28-2	-1586.	-3454.	-9534.	-15049.	-20655.

TABLE 12
 STATIC TEST DISPLACEMENT DATA - SPECIMEN 28
 (VERTICAL DISPLACEMENT IS DISPLACEMENT OF PISTON
 PARALLEL TO COLUMN AXIS, AND LATERAL DISPLACEMENT
 IS MEASURED PERPENDICULAR TO COLUMN AT ITS CENTER)

	LOAD (POUNDS)				
	26.0	27.0	27.5	27.9	28.2
SPEC. 28 LATERAL	0.045	0.115	0.350	0.560	0.765
SPEC. 28 VERTICAL	0.005	0.010	0.030	0.075	0.140

TABLE 13
 STATIC TEST STRESS DATA - SPECIMEN 29
 (STRESSES GIVEN IN PSI)

STRAIN GAUGE	LOAD (POUNDS)				
	22.4	23.8	25.3	26.6	26.9
S29-1	2652.	3900.	7145.	15132.	21143.
S29-2	-3203.	-4472.	-7935.	-17025.	-23878.

TABLE 14
 STATIC TEST DISPLACEMENT DATA - SPECIMEN 29
 (VERTICAL DISPLACEMENT IS DISPLACEMENT OF PISTON
 PARALLEL TO COLUMN AXIS, AND LATERAL DISPLACEMENT
 IS MEASURED PERPENDICULAR TO COLUMN AT ITS CENTER)

	LOAD (POUNDS)				
	22.4	23.8	25.3	26.6	26.9
SPEC. 29 LATERAL	0.085	0.125	0.250	0.555	0.780
SPEC. 29 VERTICAL	0.005	0.008	0.010	0.075	0.150

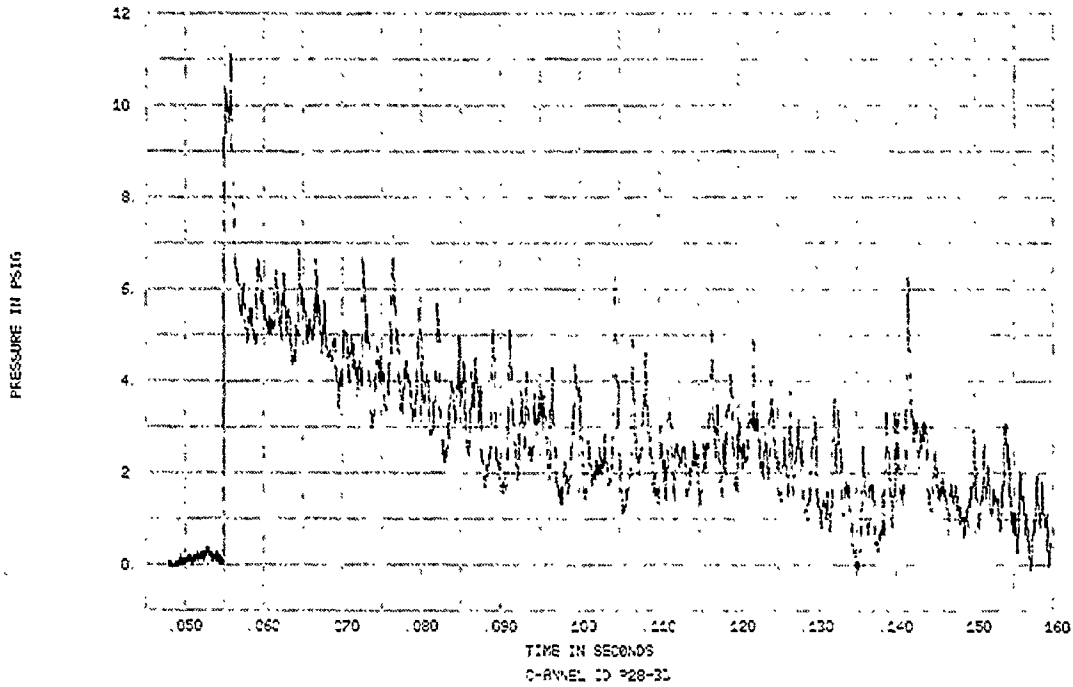

FIGURE 90. SPECIMENS 28-29, EVENT 78-355, SPECIMEN REFLECTED OVERPRESSURE TIME HISTORY

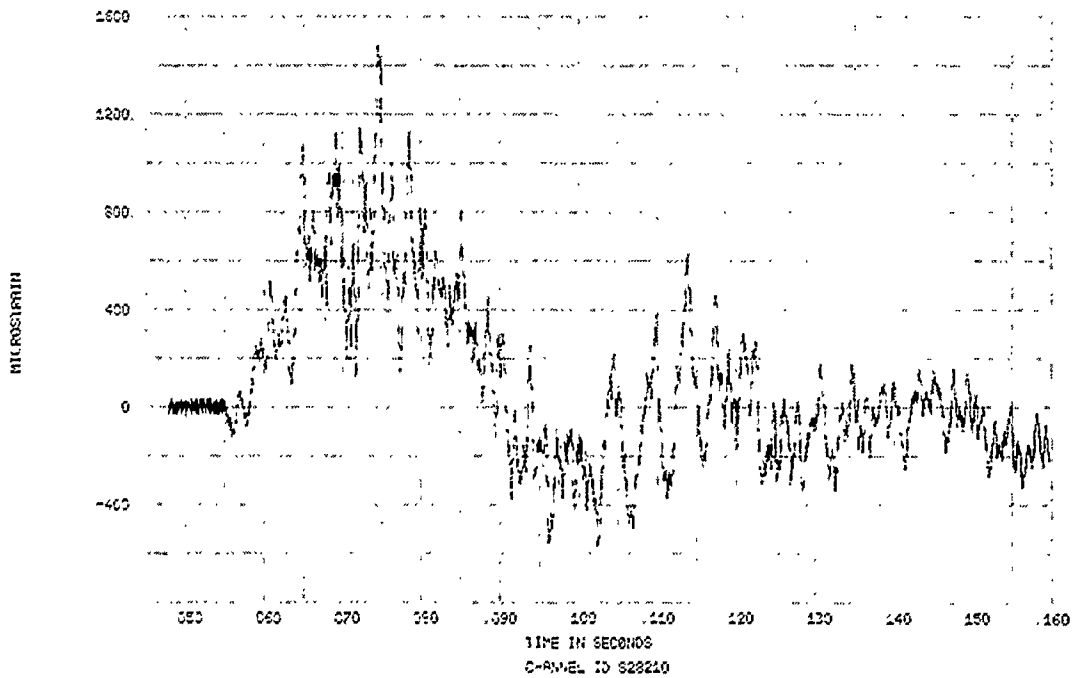

FIGURE 90. SPECIMEN 28, EVENT 78-355, STRAIN TIME HISTORY

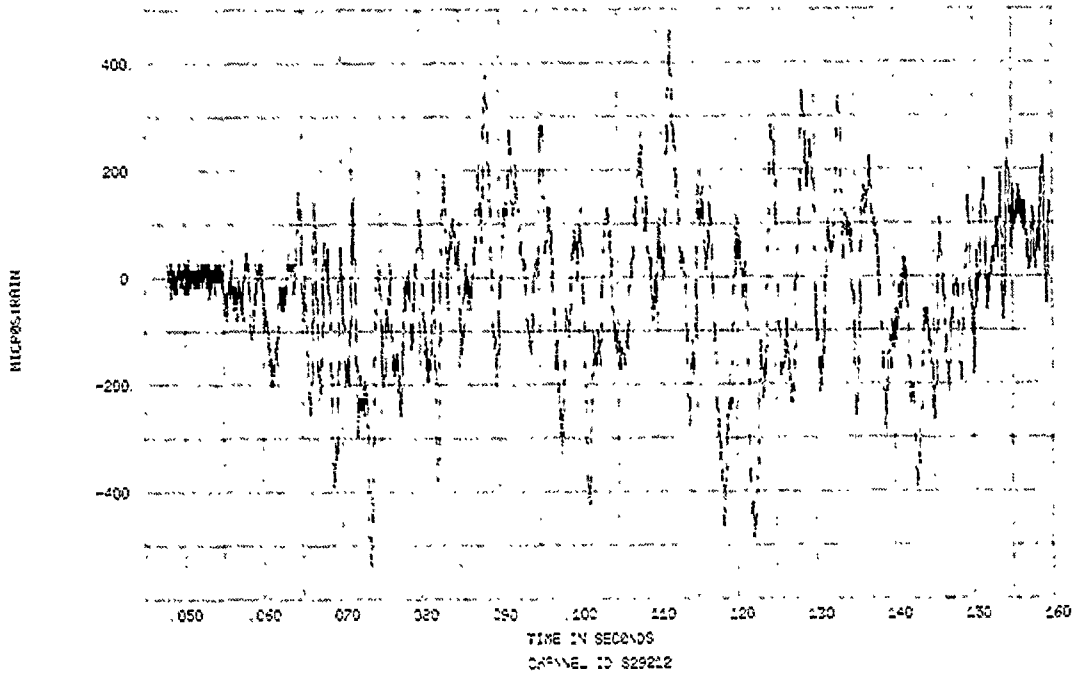

FIGURE 100. SPECIMEN 29, EVENT 78-355, STRAIN TIME HISTORY

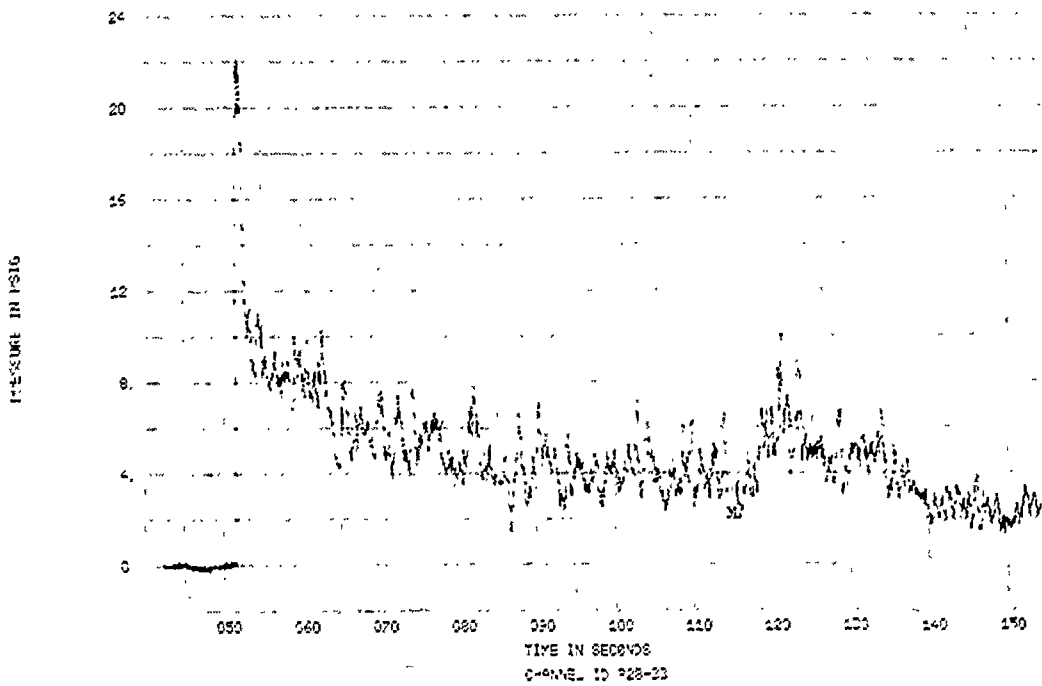

FIGURE 101. SPECIMENS 28-29, EVENT 78-357, SPECIMEN REFLECTED OVERPRESSURE TIME HISTORY

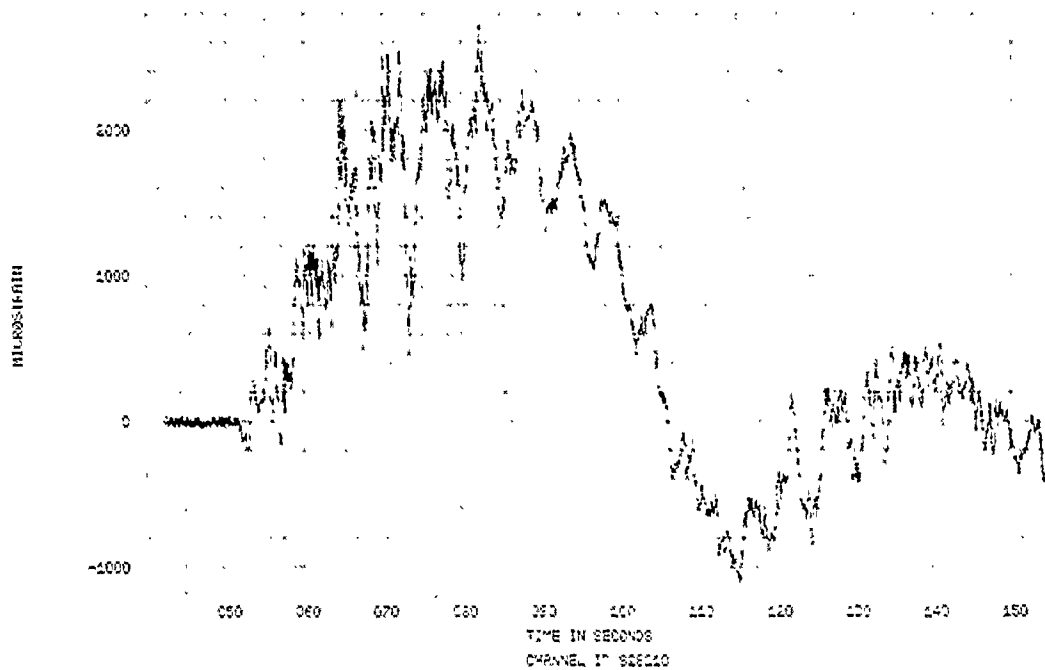

FIGURE 102. SPECIMEN 28, EVENT 78-357, STRAIN TIME HISTORY

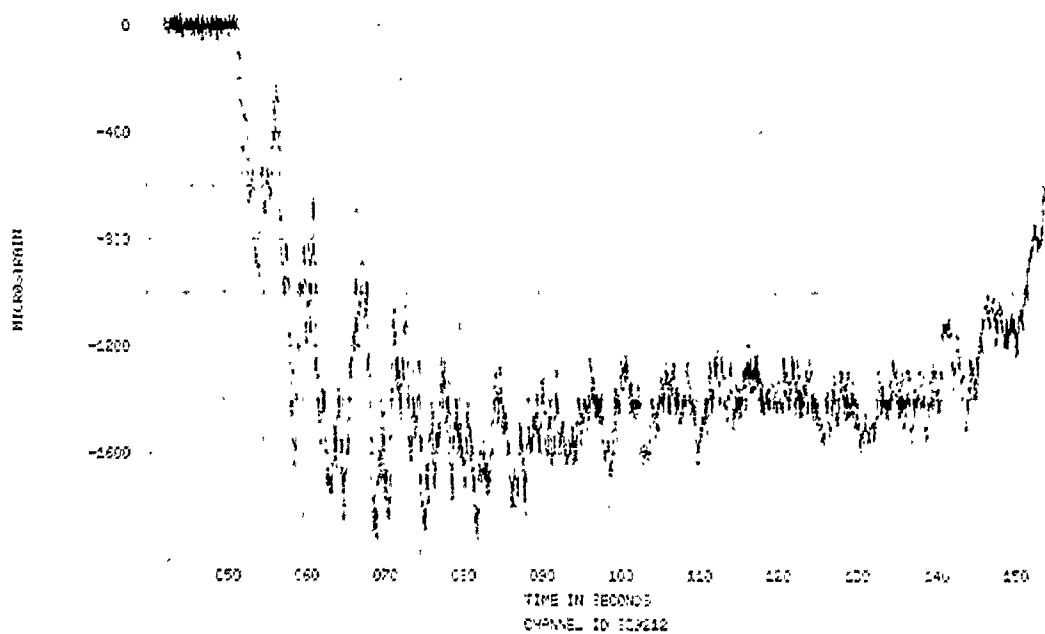

FIGURE 103. SPECIMEN 29, EVENT 78-357, STRAIN TIME HISTORY

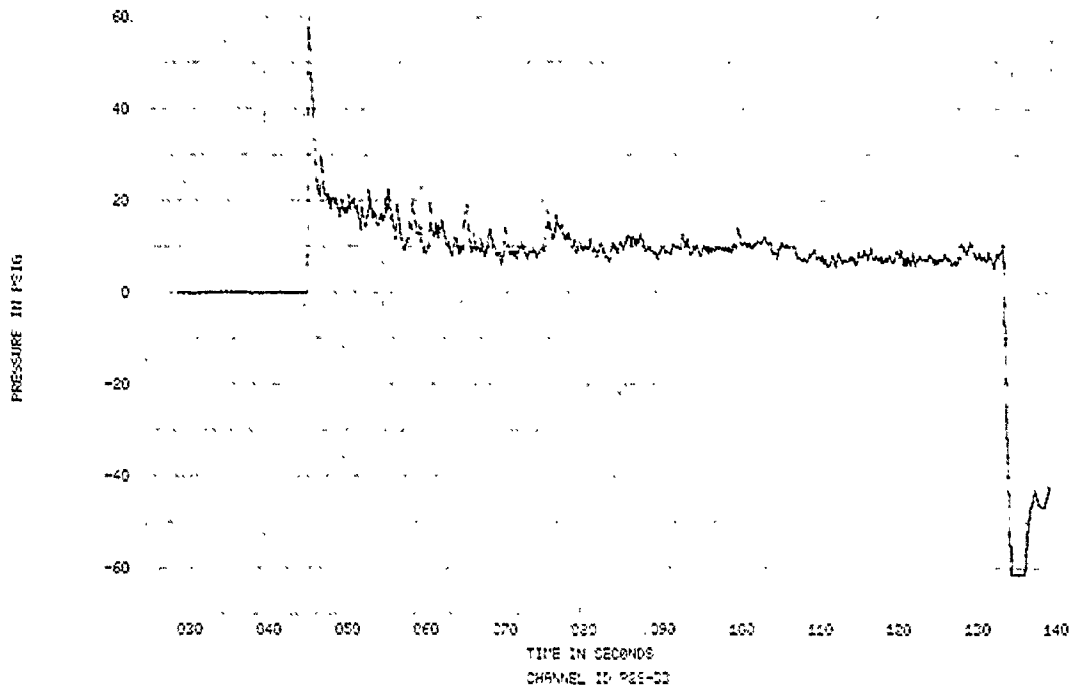

FIGURE 104. SPECIMENS 28-29, EVENT 78-358, SPECIMEN REFLECTED OVERPRESSURE TIME HISTORY

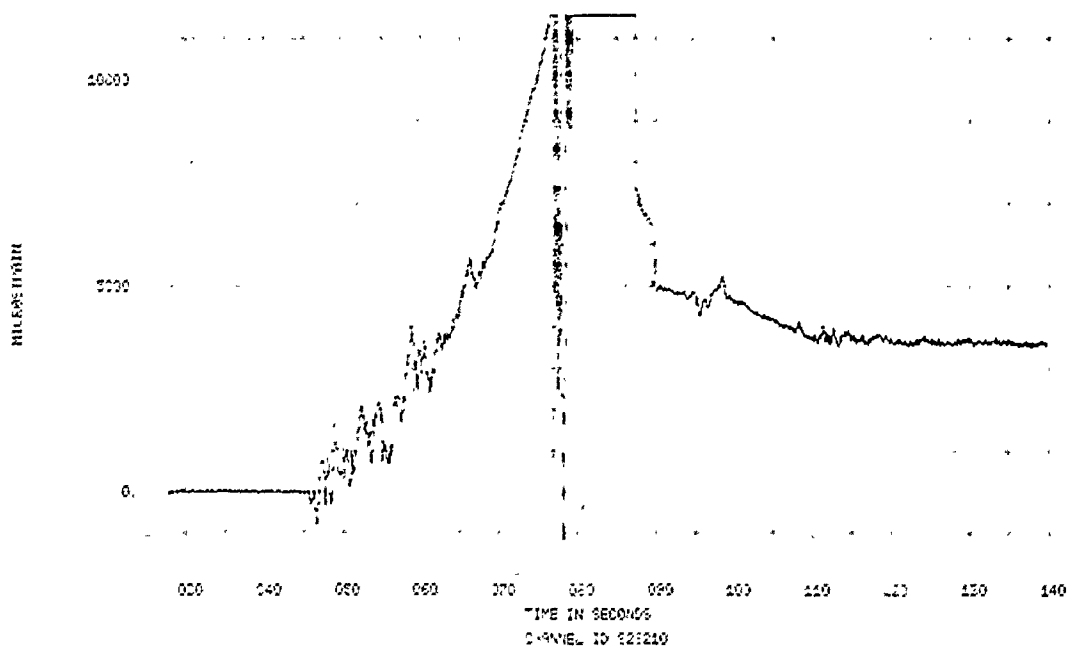

FIGURE 105. SPECIMEN 28, EVENT 78-358, STRAIN TIME HISTORY

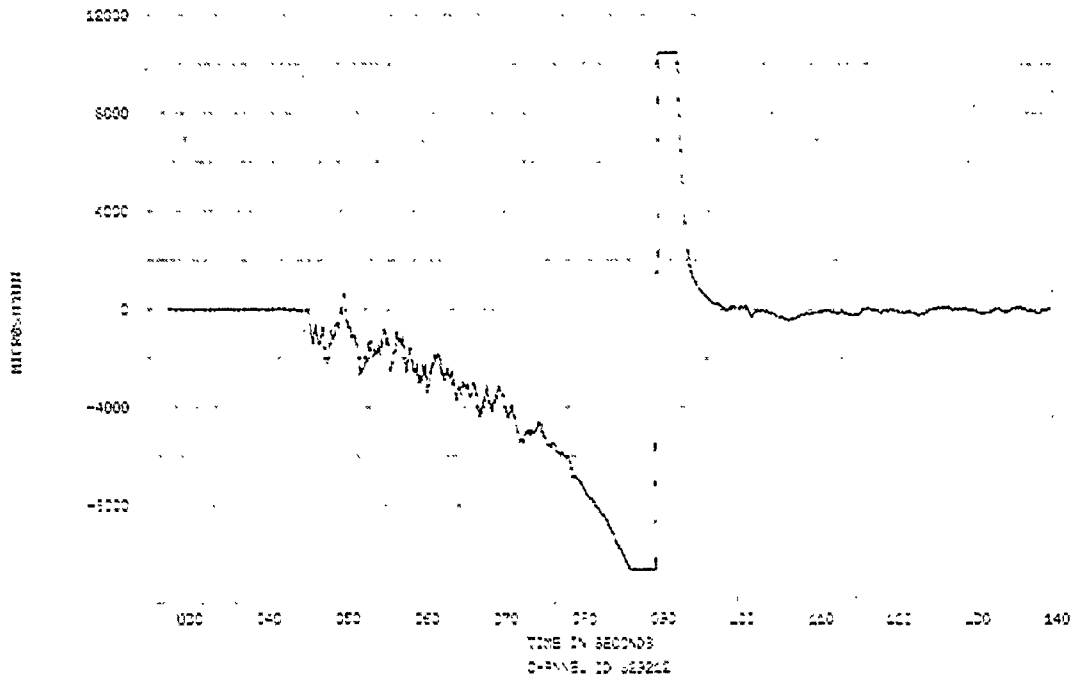
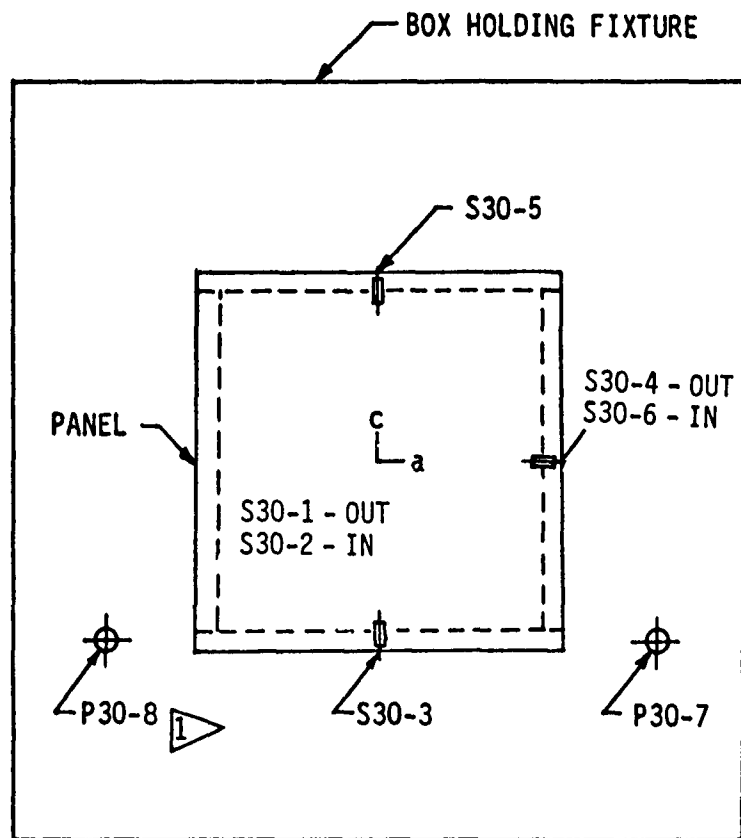

FIGURE 106. SPECIMEN 29, EVENT 78-358, STRAIN TIME HISTORY

SPECIMEN NO. 30



SPECIMEN NO. 30

1 BACK SIDE OF BOX HOLDING FIXTURE ONLY

FLAT UNSTIFFENED PANEL - 0.039 IN. THICK
22.0 IN. SQUARE

FOUR SIDES CLAMPED

MATERIAL - 6061-T6 ALUMINUM ALLOY

DENSITY - 0.0002539 LB-SEC²/IN⁴

POISSON'S RATIO - 0.33

MODULUS OF ELASTICITY - 11.7×10^6 PSI

SHEAR MODULUS - 3.8×10^6 PSI

YIELD STRESS - 38,360 PSI

ULTIMATE STRESS - 46,790 PSI

Figure 107. Description and Instrumentation - Specimen No. 30

PRECEDING PAGE BLANK-NOT FILMED

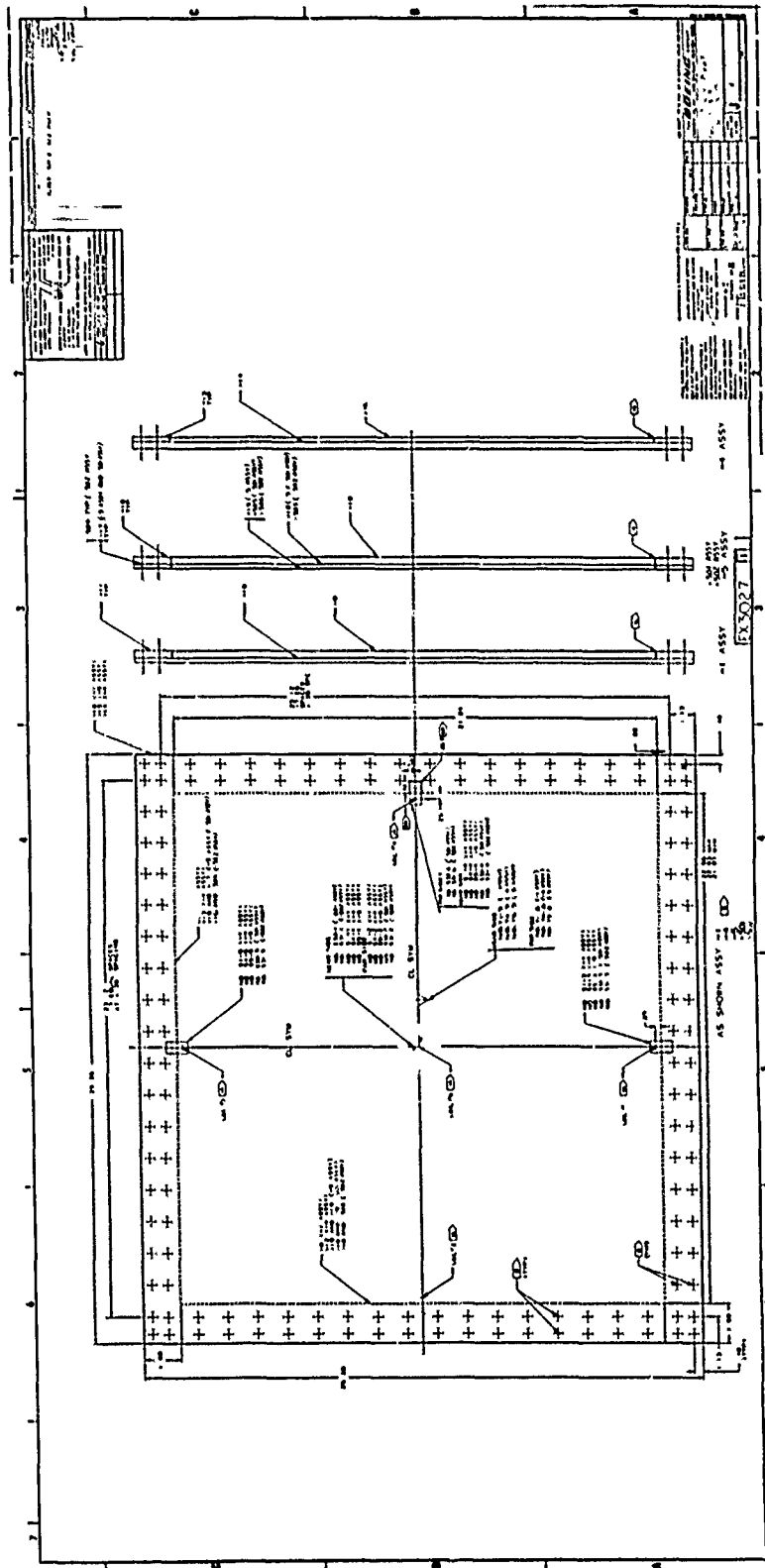

Figure 108. Spec Drawing - Specimen No. 30

NOVA-2LT DATA DECK LISTING
TEST SPECIMEN 30

* * * NOVA-2LT DATA DECK FOR TEST SPECIMEN 30 * * *						GP 1
	1					
	1	1	101	2		GP 3
0.50					2	GP 4
	7	7	15	15		GPP 1
	0	1	2			GPP 2
	24					GPP 3
	2	7				GPP 4
	3	5				GPP 4
	3	6				GPP 4
	3	7				GPP 4
	4	4				GPP 4
	4	5				GPP 4
	4	6				GPP 4
	4	7				GPP 4
	5	3				GPP 4
	5	4				GPP 4
	5	5				GPP 4
	5	6				GPP 4
	5	7				GPP 4
	6	3				GPP 4
	6	4				GPP 4
	6	5				GPP 4
	6	6				GPP 4
	6	7				GPP 4
	7	2				GPP 4
	7	3				GPP 4
	7	4				GPP 4
	7	5				GPP 4
	7	6				GPP 4
	7	7				GPP 4
	1					GPP 5
22.0	22.0					GPP 6
0.039	.0002539	11.7	E+06			GPP 11
0.33	38360.	6.48	E+040.15			GPP 12
0.0	0.0	0.0	0.0	0.0	0.0	GPP 13
0.0	0.0	0.0	0.0	0.0	0.0	GPP 13
0.0	0.0	0.0	0.0	0.0	0.0	GPP 13
0.0	0.0	0.0	0.0	0.0	0.0	GPP 13
0.0	0.0	0.0	0.0	0.0	0.0	GPP 13
0.0	0.0	0.0	0.0	0.0	0.0	GPP 13
0.0	0.0	0.0	0.0	0.0	0.0	GPP 13
0.0	0.0	0.0	0.0	0.0	0.0	GPP 13
0.0	0.0	0.0	0.0	0.0	0.0	GPP 13
0.0	0.005	25.0				GPP 14

TABLE 15
 STATIC TEST DATA - SPECIMEN 30
 (STRESSES GIVEN IN PSI)

STRAIN GAUGE	STATIC PRESSURE (PSI)		
	1.03	2.05	3.07
S30-1	1415.	3380.	5201.
S30-2	3725.	6405.	8802.
S30-3	18238.	30238.	40427.
S30-4	11357.	18369.	24107.
S30-5	19853.	32195.	42581.
S30-6	-7773.	-11725.	-14824.

TABLE 16
 STATIC TEST DISPLACEMENT DATA - SPECIMEN 30
 (DISPLACEMENT MEASURED AT CENTER OF PANEL)

	STATIC PRESSURE (PSI)		
	1.03	2.05	3.07
DISPLACEMENT (INCHES)	0.191	0.270	0.324

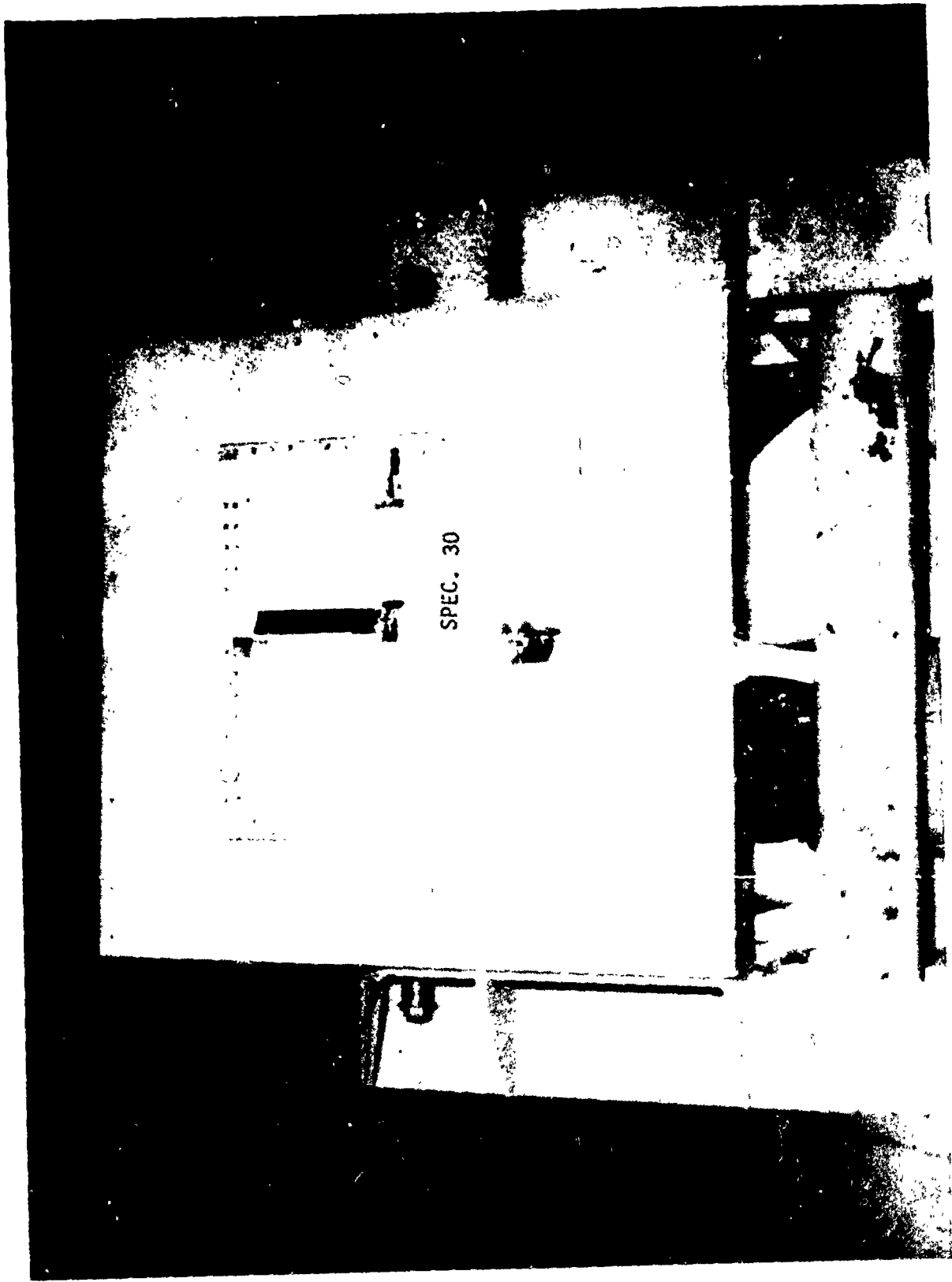

FIGURE 109. SHOCK TEST SETUP - SPECIMEN 30



FIGURE 110. CONDITION OF SPECIMEN 30 SUBSEQUENT TO SHOCK LOAD TEST

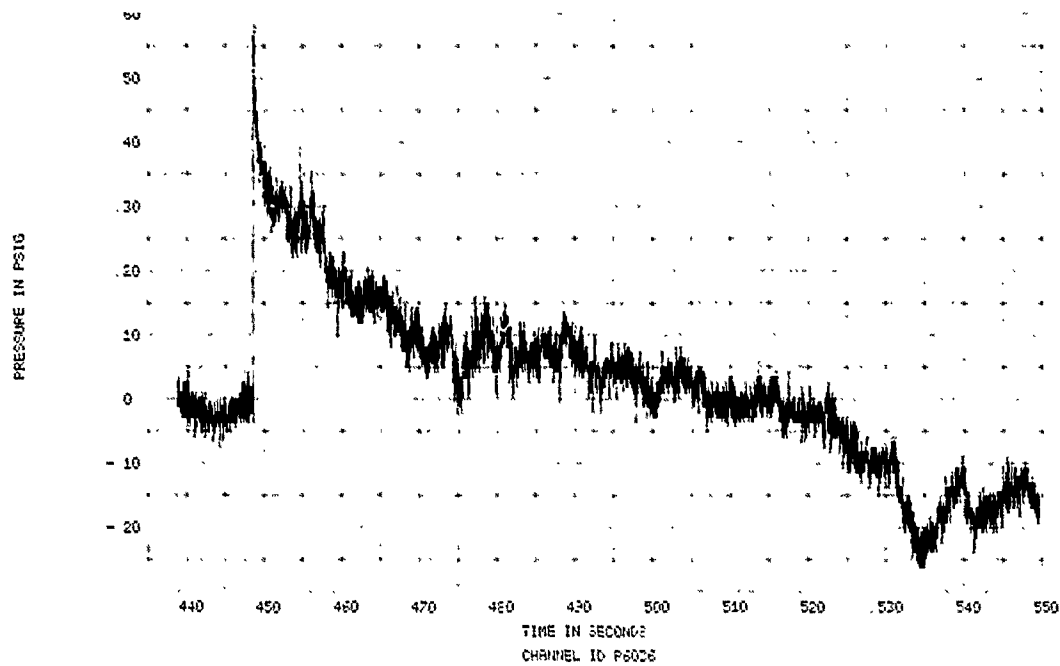

FIGURE 111. SPECIMEN 30, EVENT 78-334, TUNNEL WALL INCIDENT OVERPRESSURE TIME HISTORY

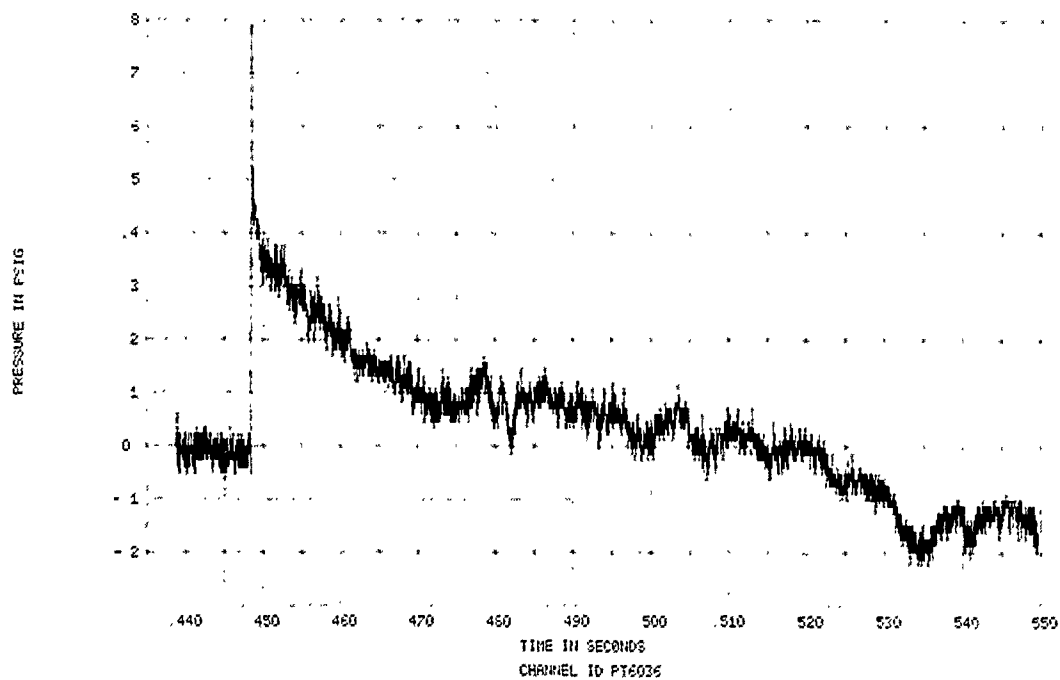

FIGURE 112. SPECIMEN 30, EVENT 78-334, TUNNEL WALL REFLECTED OVERPRESSURE TIME HISTORY

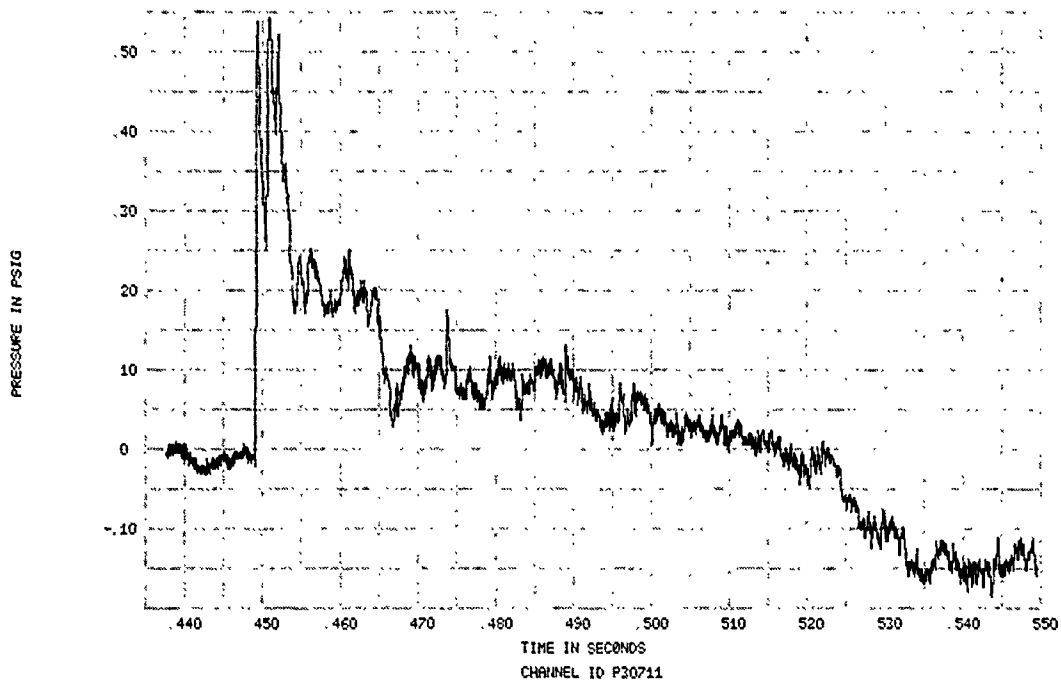

FIGURE 113. SPECIMEN 30, EVENT 78-334, SPECIMEN REFLECTED OVERPRESSURE TIME HISTORY

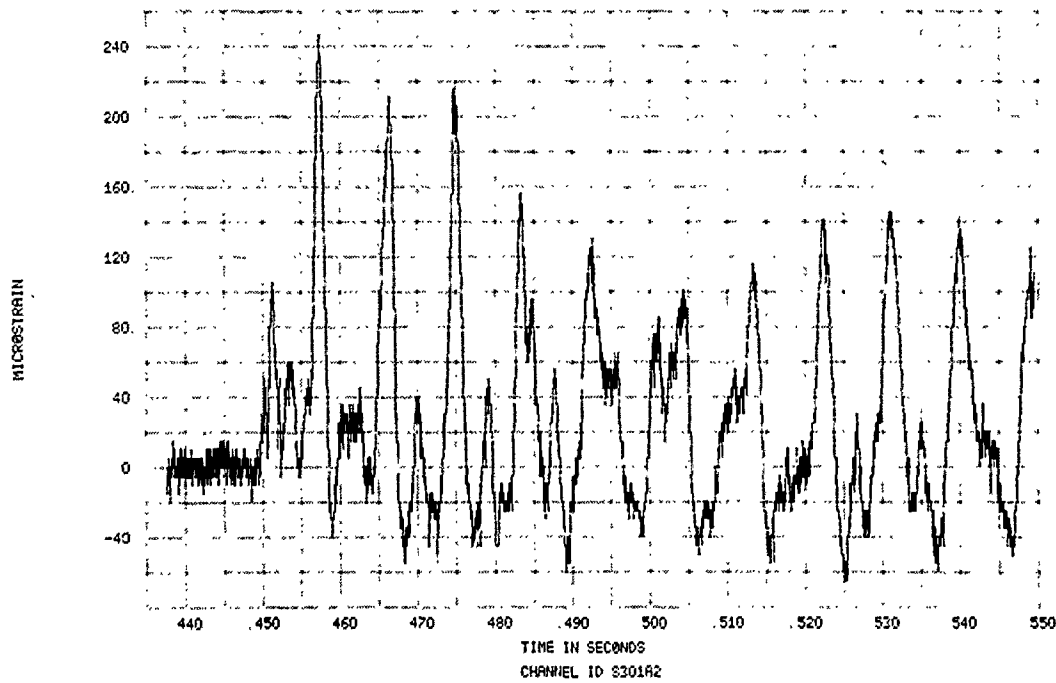

FIGURE 114. SPECIMEN 30, EVENT 78-334, STRAIN TIME HISTORY

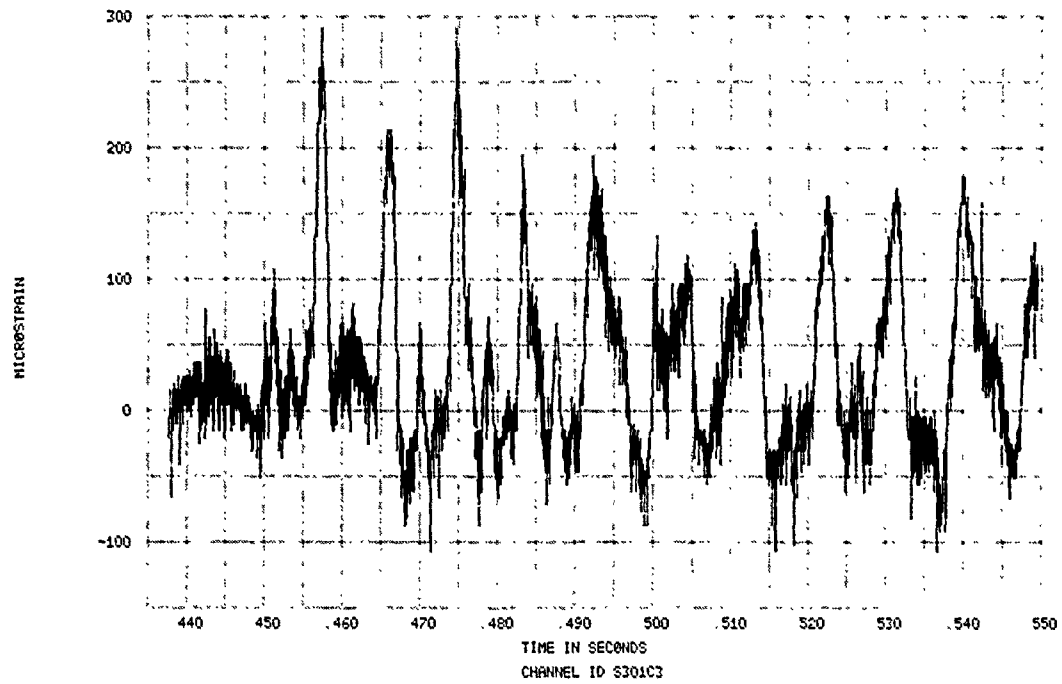

FIGURE 115. SPECIMEN 30, EVENT 78-334, STRAIN TIME HISTORY

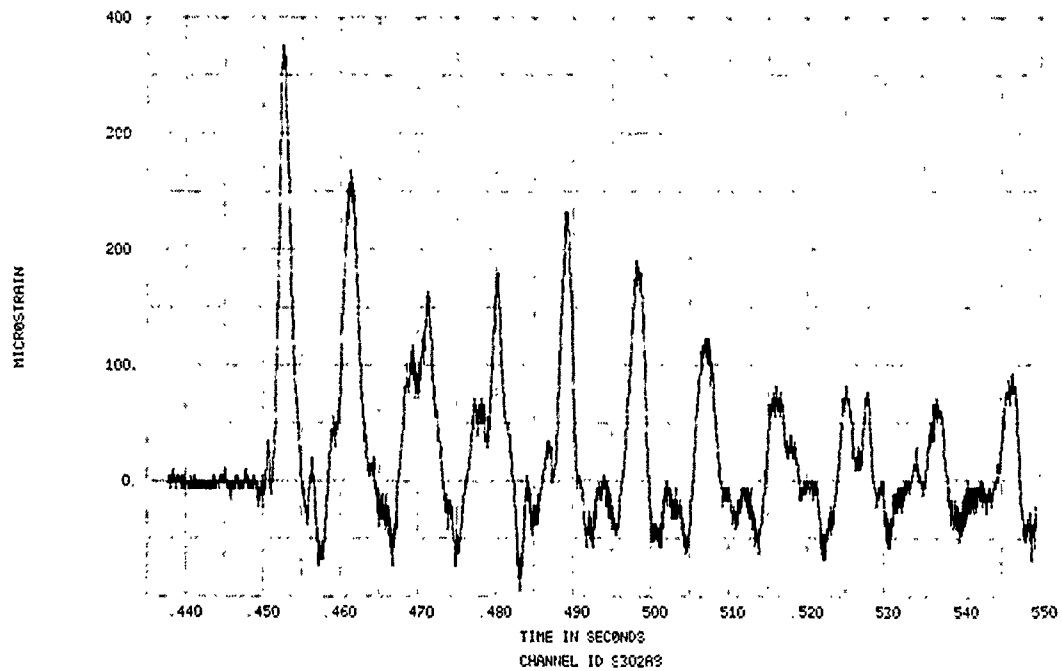

FIGURE 116. SPECIMEN 30, EVENT 78-334, STRAIN TIME HISTORY

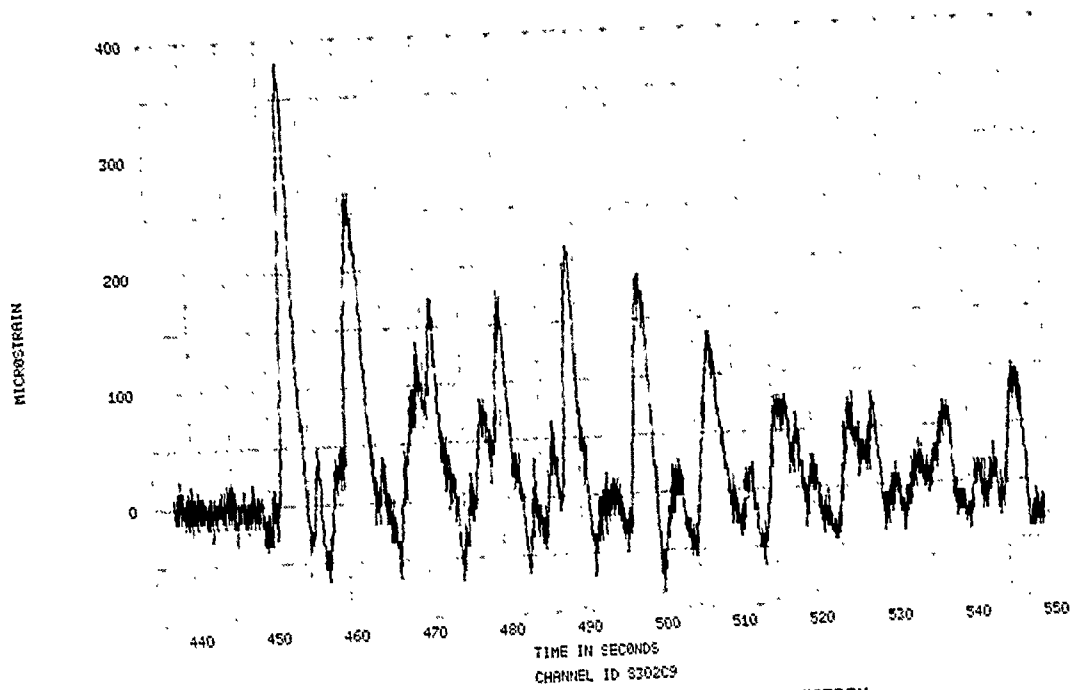

FIGURE 117. SPECIMEN 30, EVENT 78-334, STRAIN TIME HISTORY

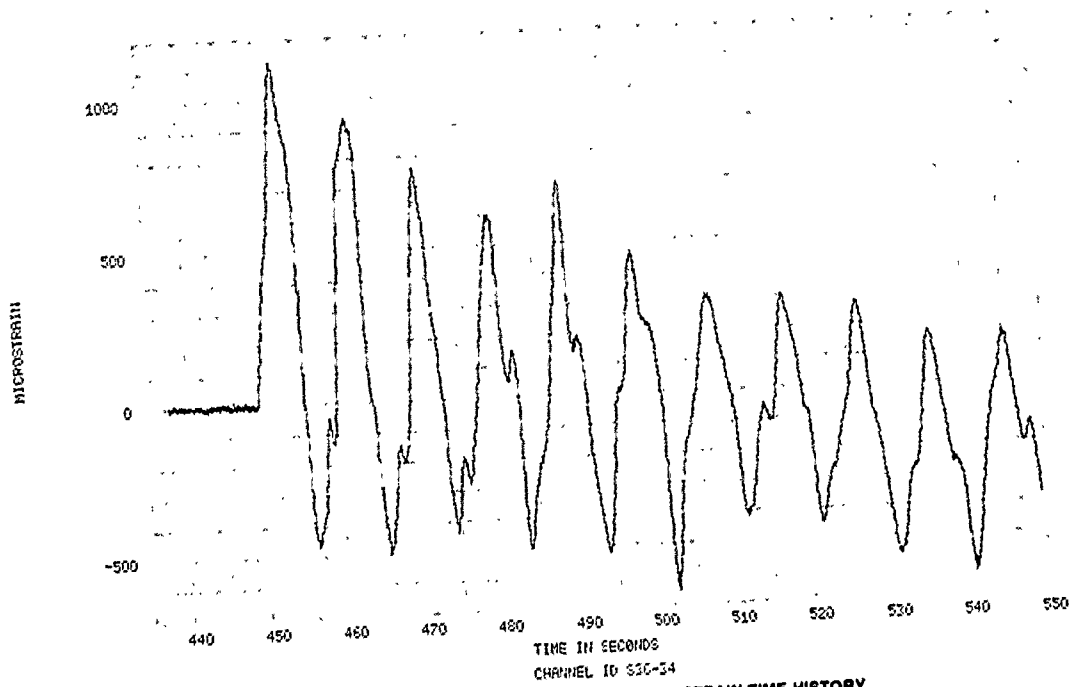

FIGURE 118. SPECIMEN 30, EVENT 78-334, STRAIN TIME HISTORY

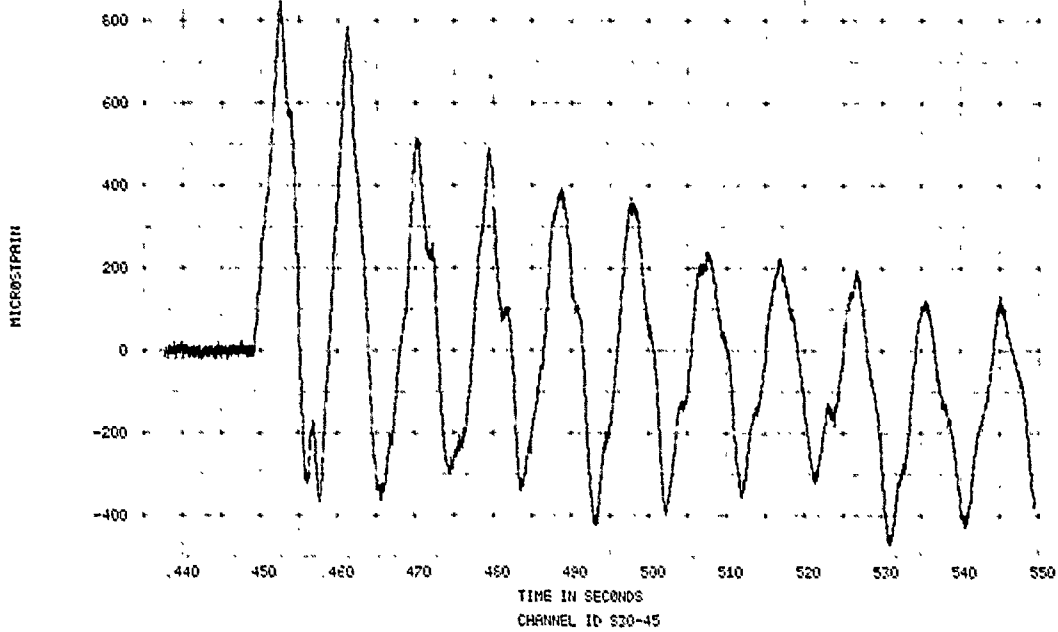

FIGURE 119. SPECIMEN 30, EVENT 78-334, STRAIN TIME HISTORY

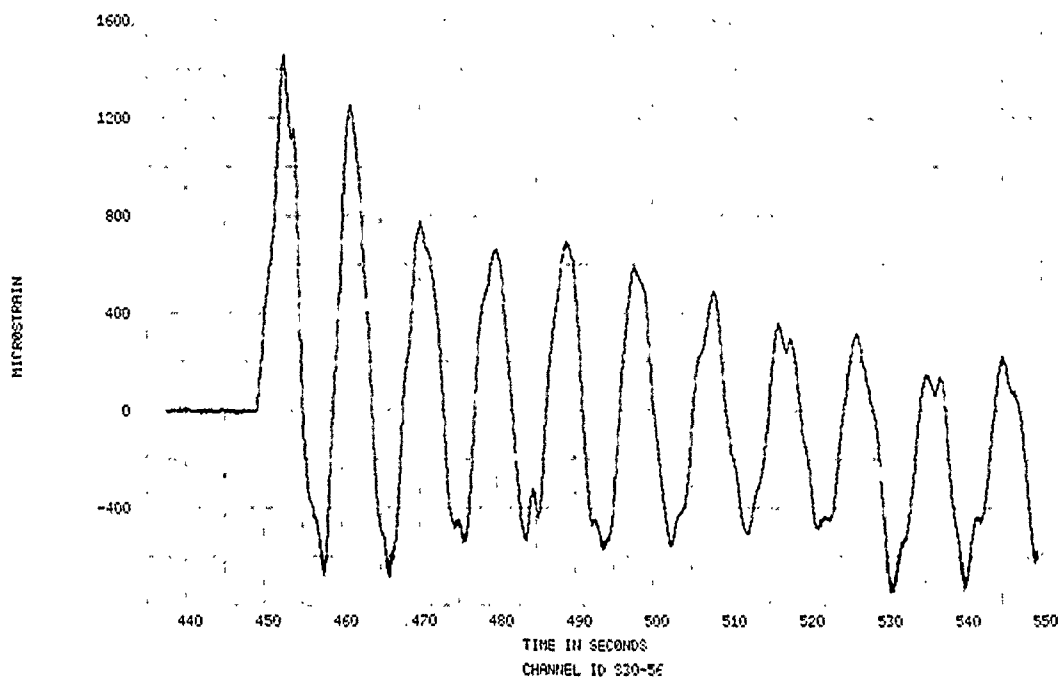

FIGURE 120. SPECIMEN 30, EVENT 78-334, STRAIN TIME HISTORY

100

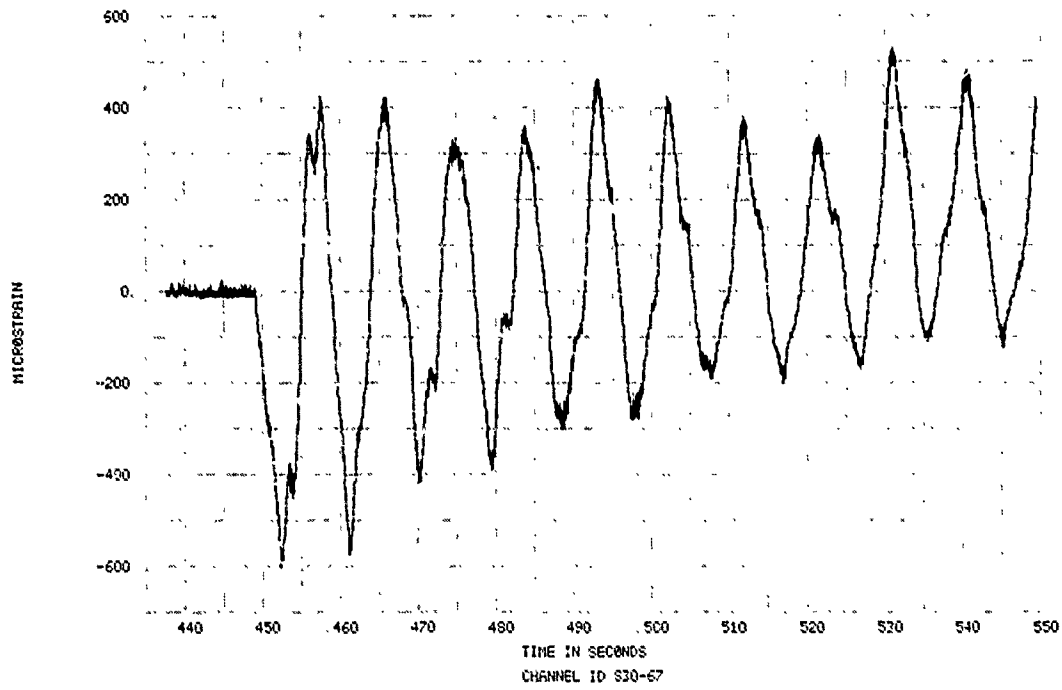

FIGURE 121. SPECIMEN 30, EVENT 78-334, STRAIN TIME HISTORY

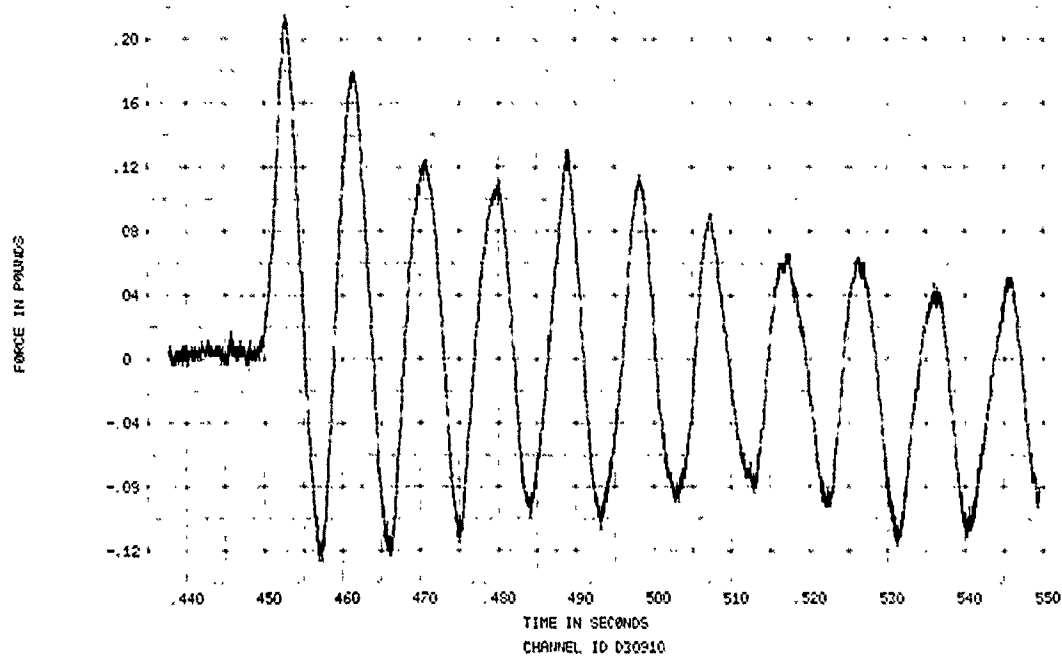

FIGURE 122. SPECIMEN 30, EVENT 78-334, DEFLECTION TIME HISTORY

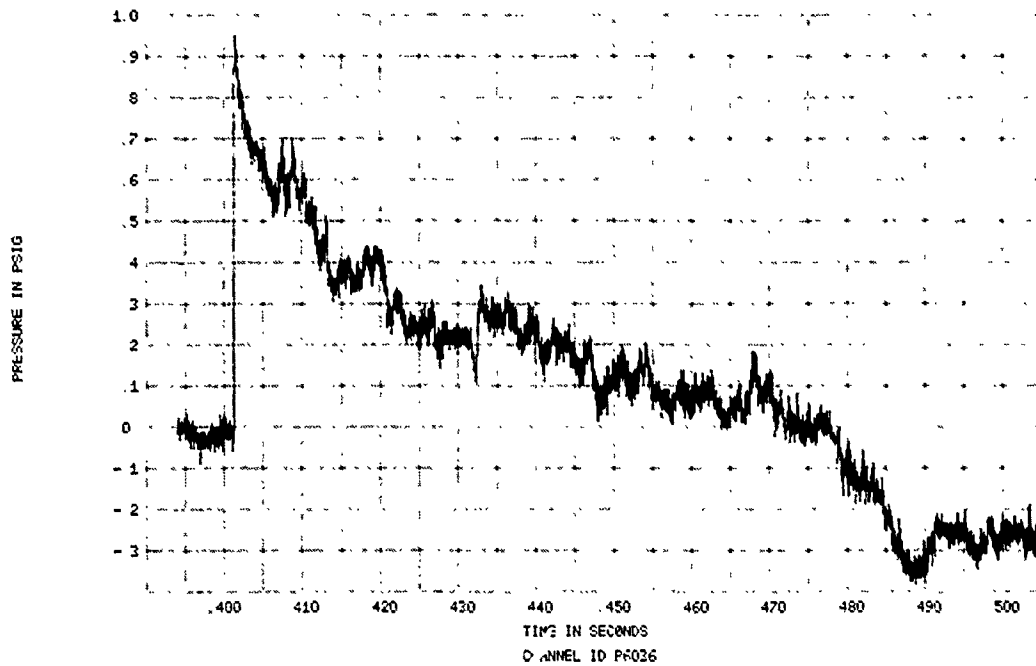

FIGURE 123. SPECIMEN 30, EVENT 78-335, TUNNEL WALL INCIDENT OVERPRESSURE TIME HISTORY

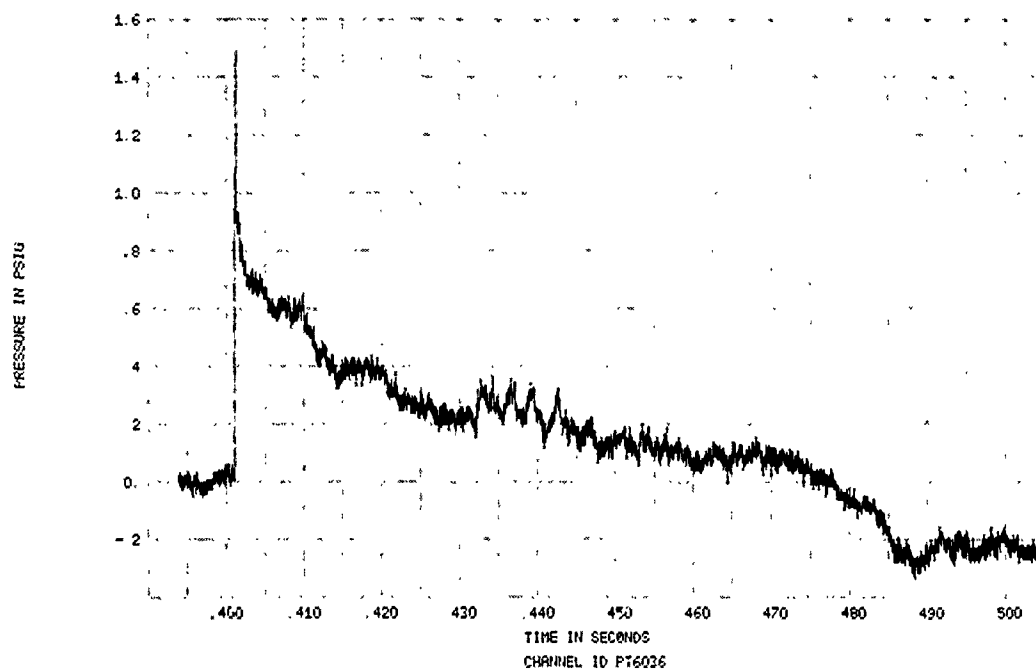

FIGURE 124. SPECIMEN 30, EVENT 78-335, TUNNEL WALL REFLECTED OVERPRESSURE TIME HISTORY

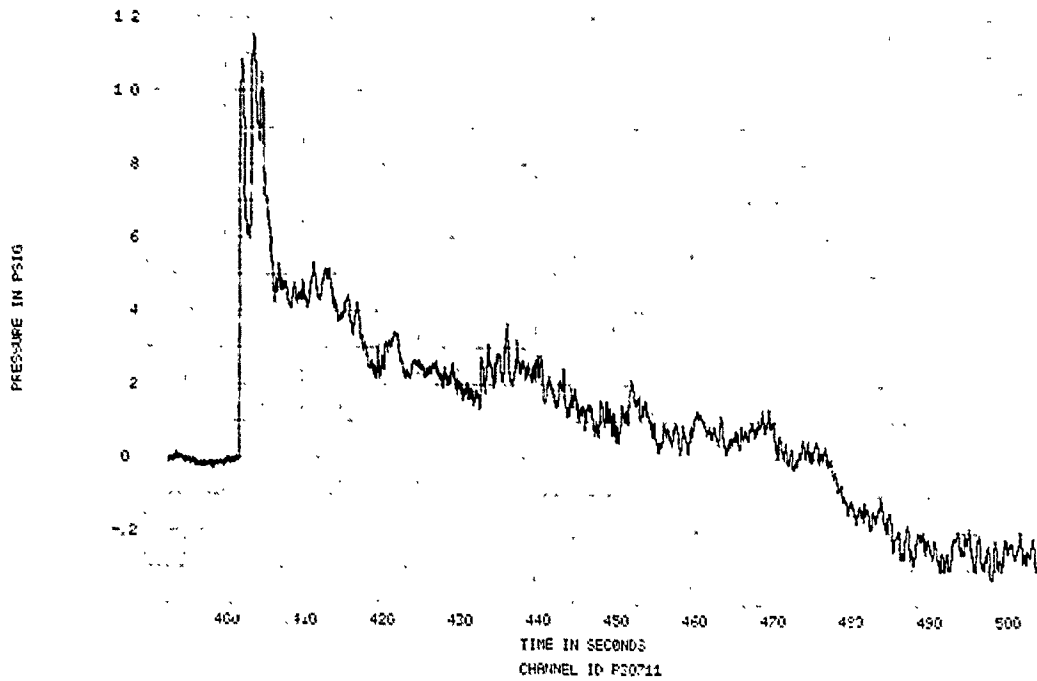

FIGURE 125. SPECIMEN 30, EVENT 78-335, SPECIMEN REFLECTED OVERPRESSURE TIME HISTORY

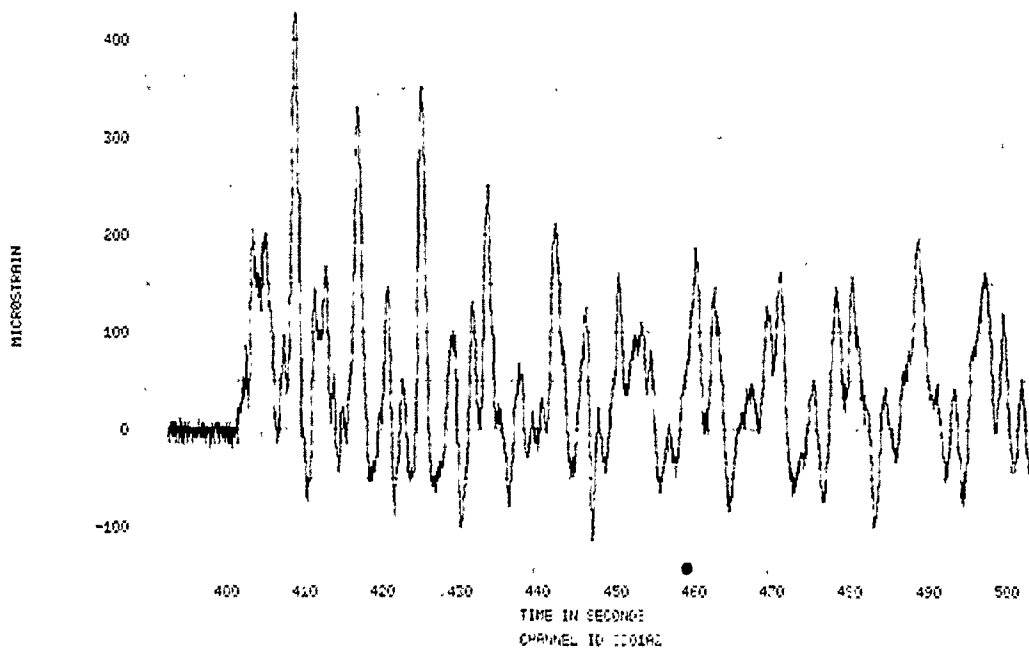

FIGURE 126. SPECIMEN 30, EVENT 78-335, STRAIN TIME HISTORY

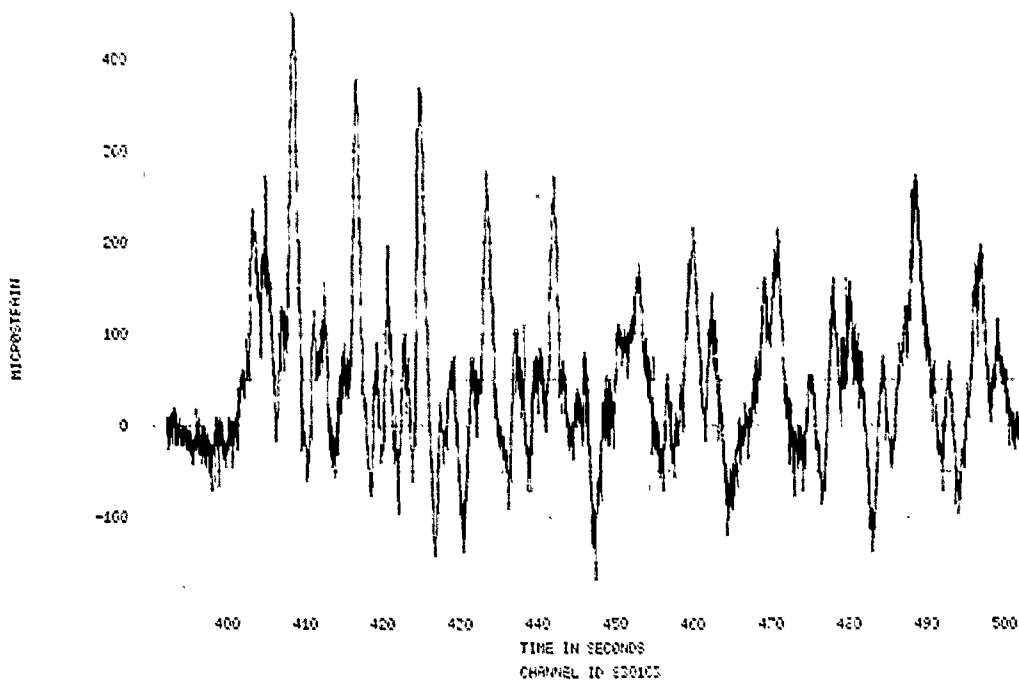

FIGURE 127. SPECIMEN 30, EVENT 78-335, STRAIN TIME HISTORY

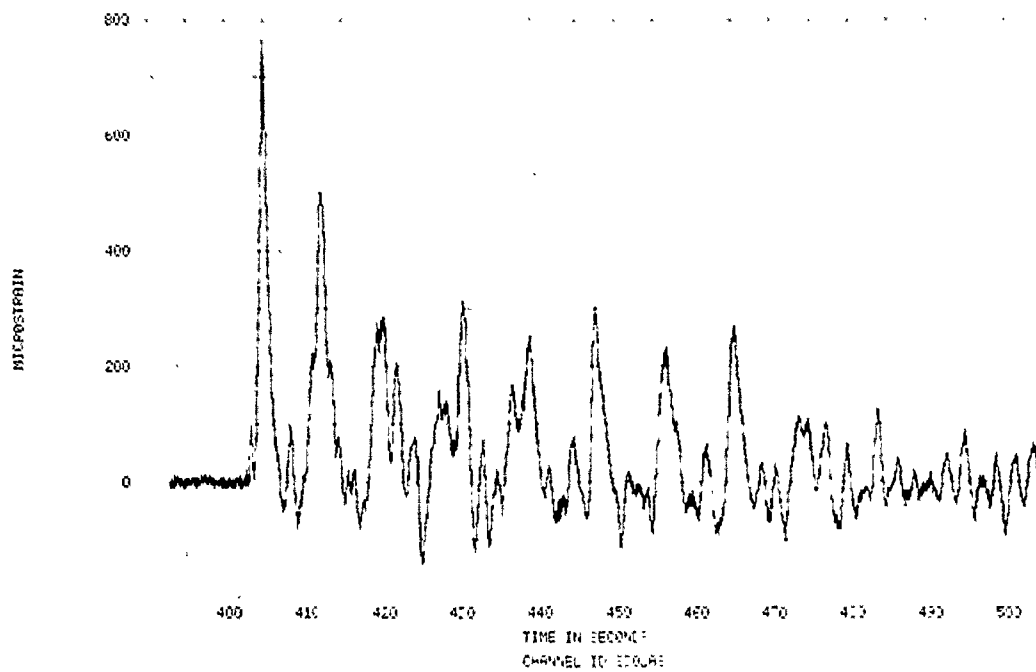

FIGURE 128. SPECIMEN 30, EVENT 78-335, STRAIN TIME HISTORY

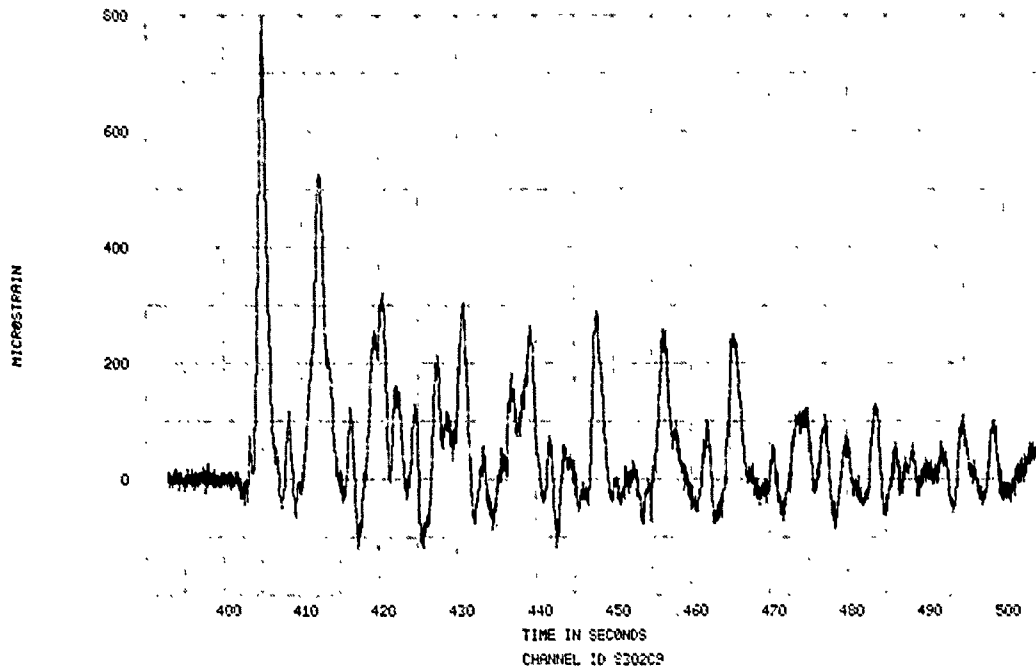

FIGURE 129. SPECIMEN 30, EVENT 78-335, STRAIN TIME HISTORY

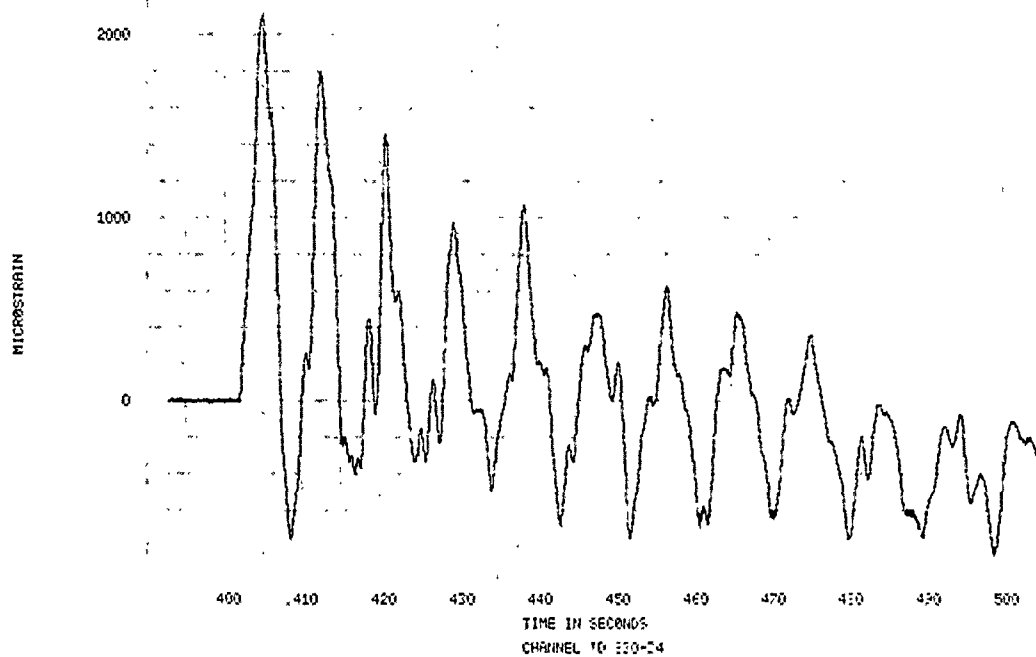

FIGURE 130. SPECIMEN 30, EVENT 78-335, STRAIN TIME HISTORY

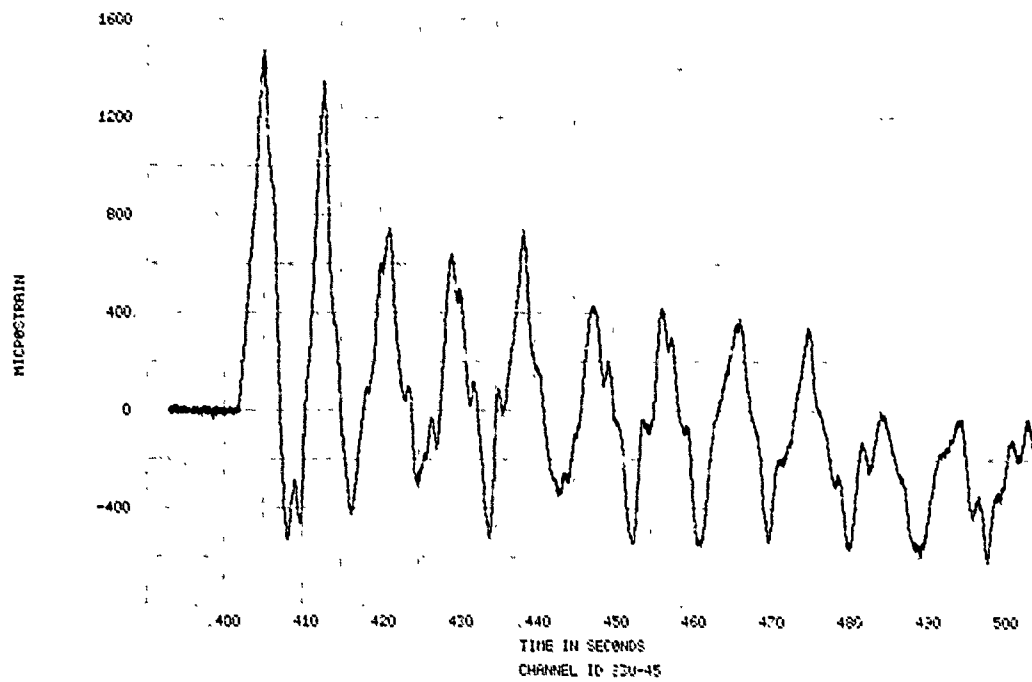

FIGURE 131. SPECIMEN 30, EVENT 78-335, STRAIN TIME HISTORY

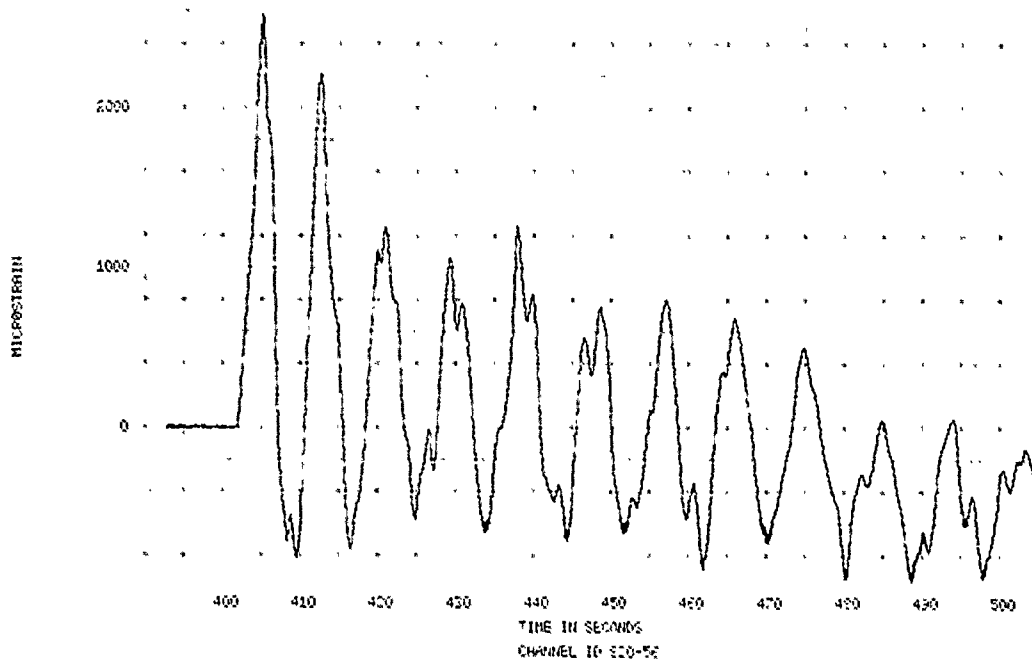

FIGURE 132. SPECIMEN 30, EVENT 78-335, STRAIN TIME HISTORY

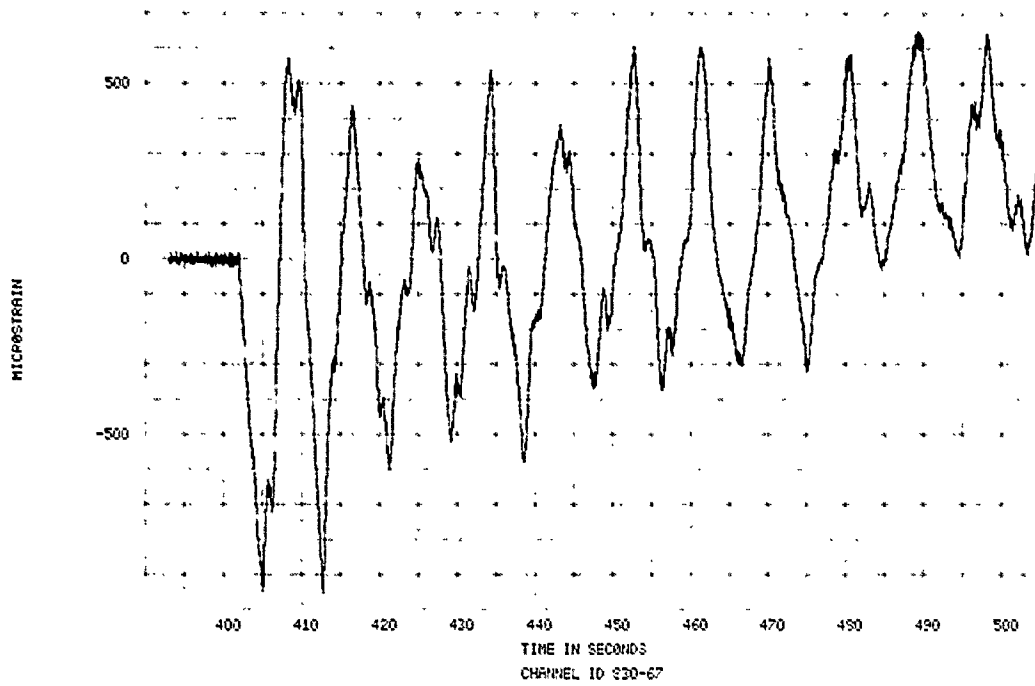

FIGURE 133. SPECIMEN 30, EVENT 78-335, STRAIN TIME HISTORY

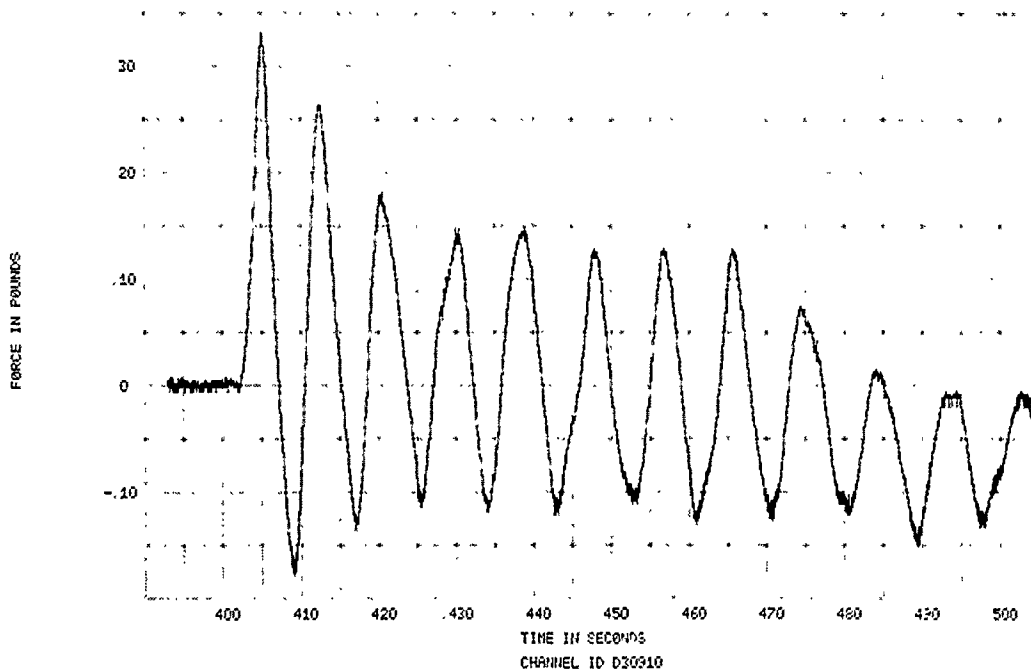

FIGURE 134. SPECIMEN 30, EVENT 78-335, DEFLECTION TIME HISTORY

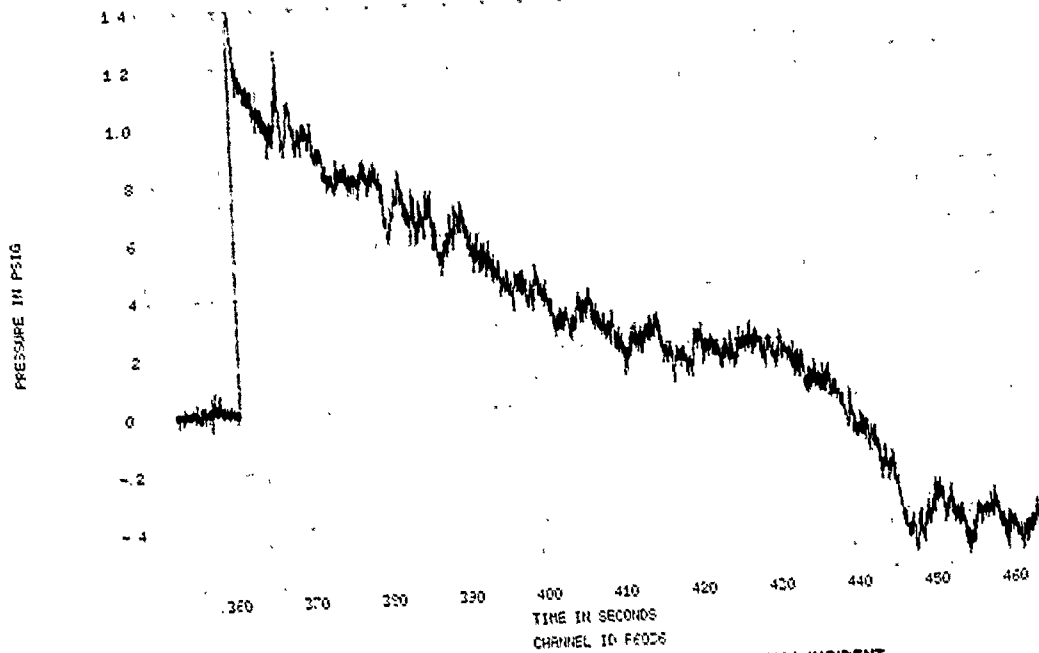

FIGURE 135. SPECIMEN 30, EVENT 78-336, TUNNEL WALL INCIDENT OVERPRESSURE TIME HISTORY

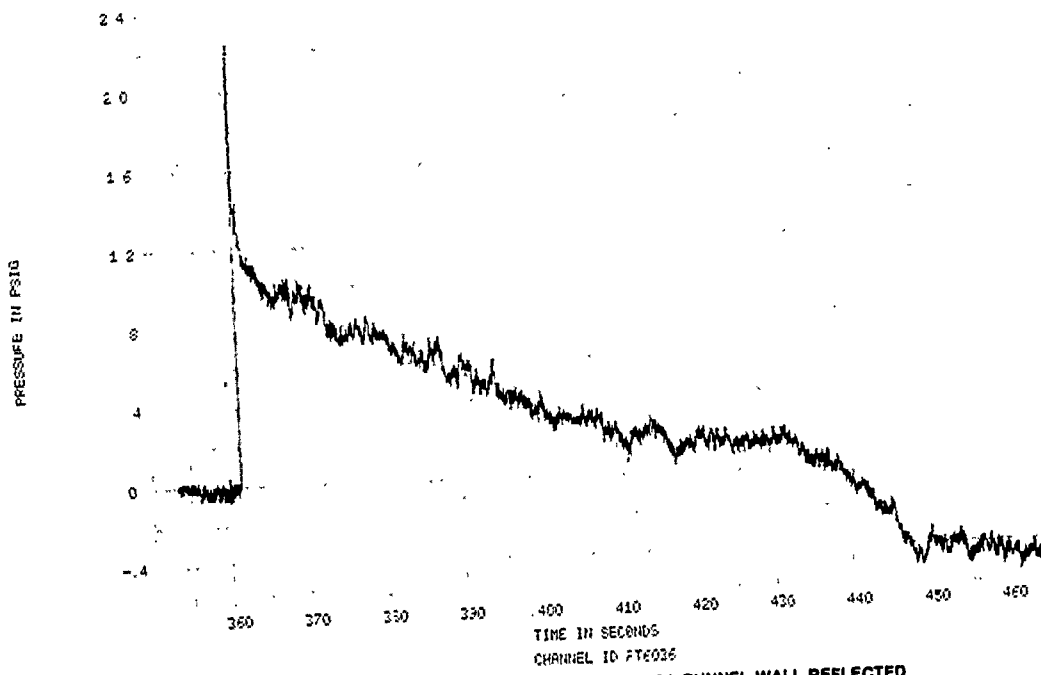

FIGURE 136. SPECIMEN 30, EVENT 78-336, TUNNEL WALL REFLECTED OVERPRESSURE TIME HISTORY

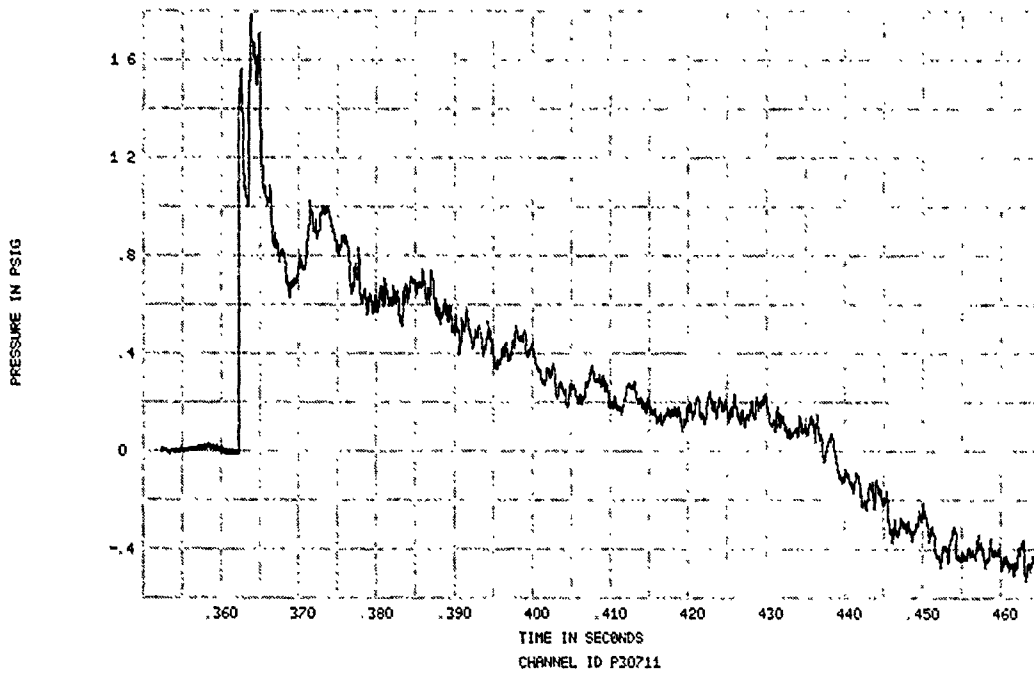

FIGURE 137. SPECIMEN 30, EVENT 78-336, SPECIMEN REFLECTED OVERPRESSURE TIME HISTORY

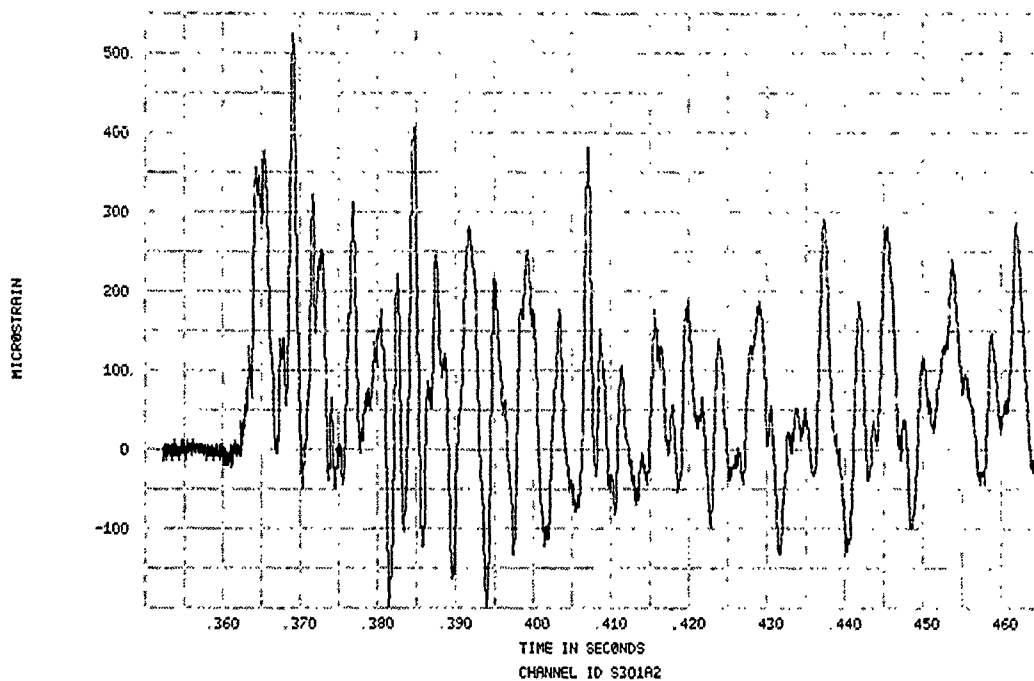

FIGURE 138. SPECIMEN 30, EVENT 78-336, STRAIN TIME HISTORY

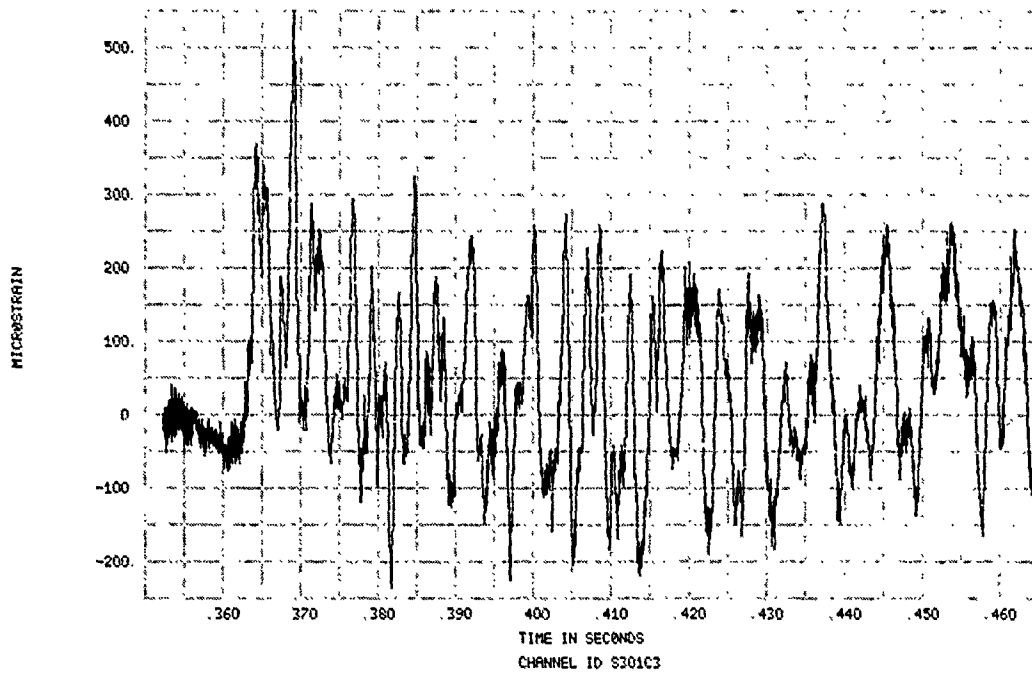

FIGURE 139. SPECIMEN 30, EVENT 78-336, STRAIN TIME HISTORY

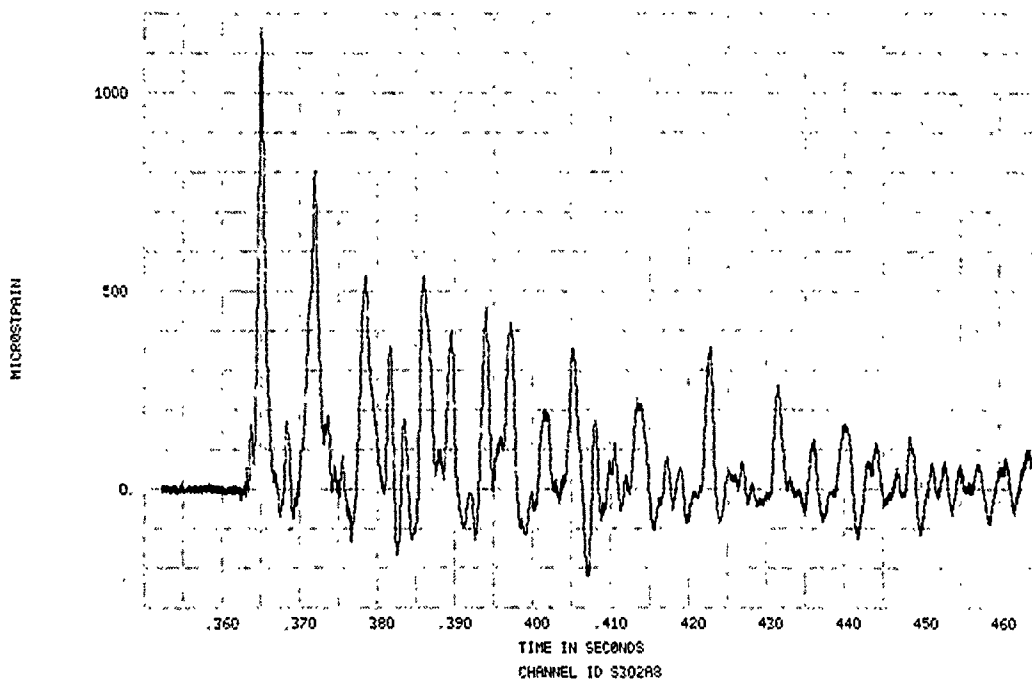

FIGURE 140. SPECIMEN 30, EVENT 78-336, STRAIN TIME HISTORY

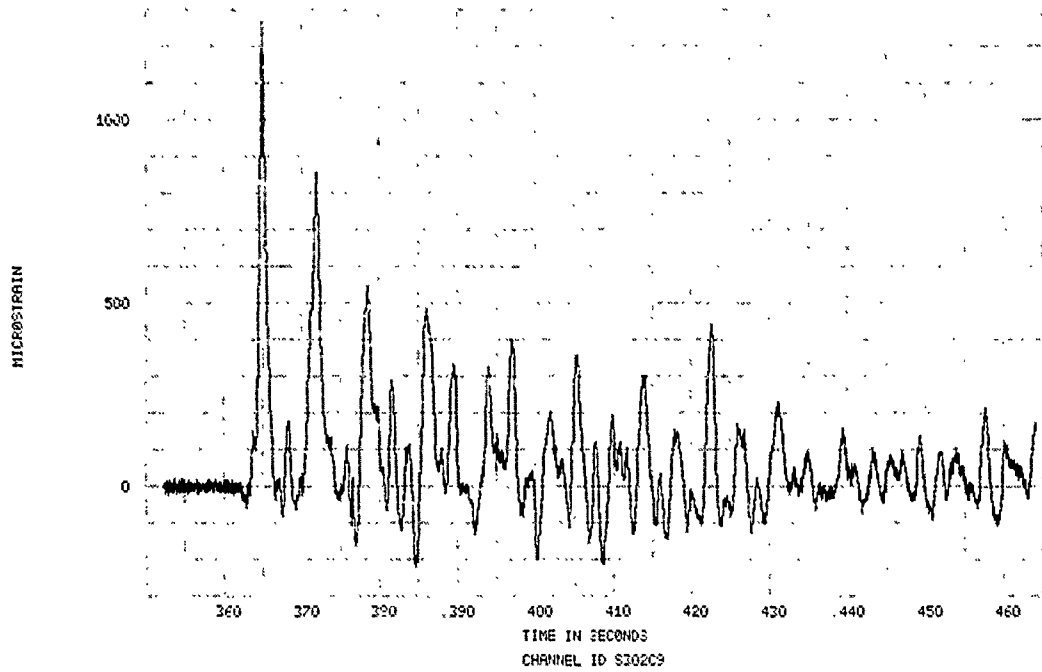

FIGURE 141. SPECIMEN 30, EVENT 78-336, STRAIN TIME HISTORY

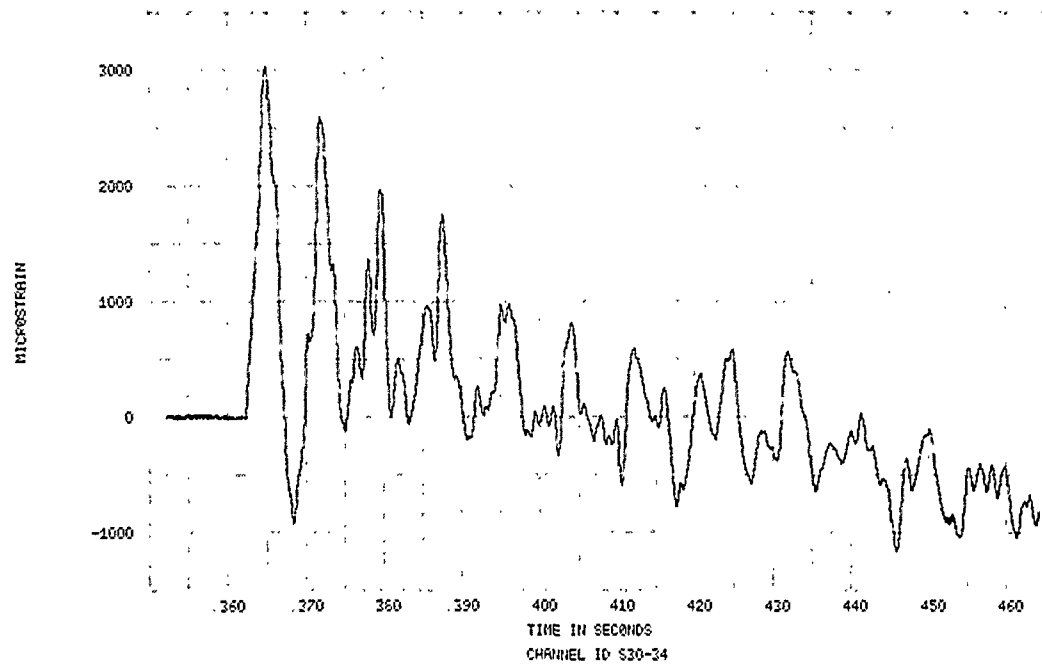

FIGURE 142. SPECIMEN 30, EVENT 78-336, STRAIN TIME HISTORY

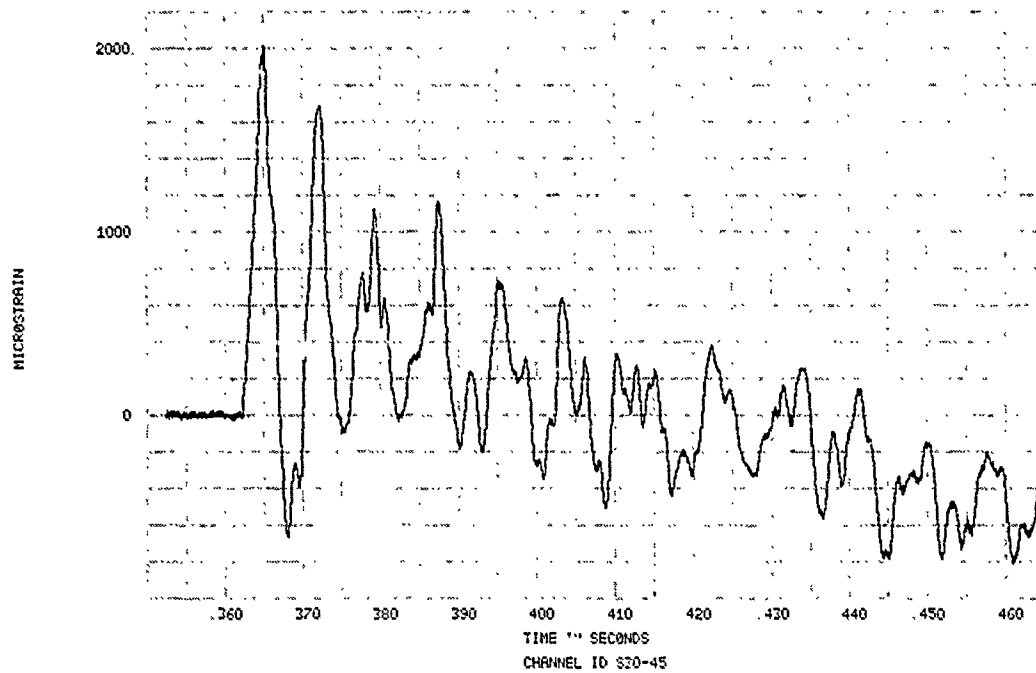

FIGURE 143. SPECIMEN 30, EVENT 78-336, STRAIN TIME HISTORY

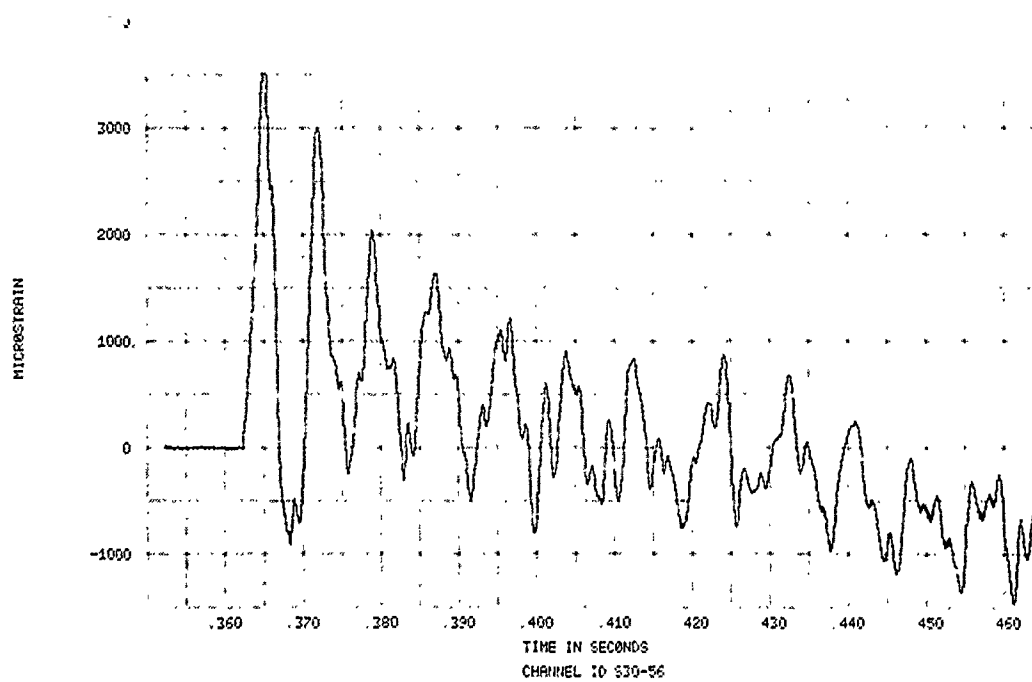

FIGURE 144. SPECIMEN 30, EVENT 78-336, STRAIN TIME HISTORY

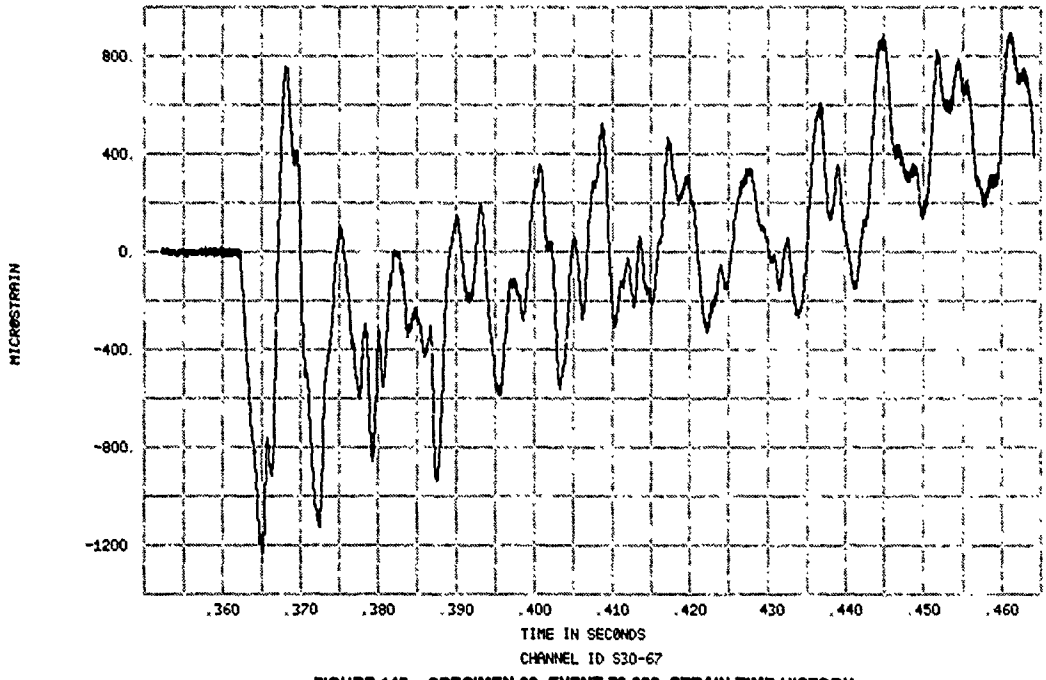

FIGURE 145. SPECIMEN 30, EVENT 70-336, STRAIN TIME HISTORY

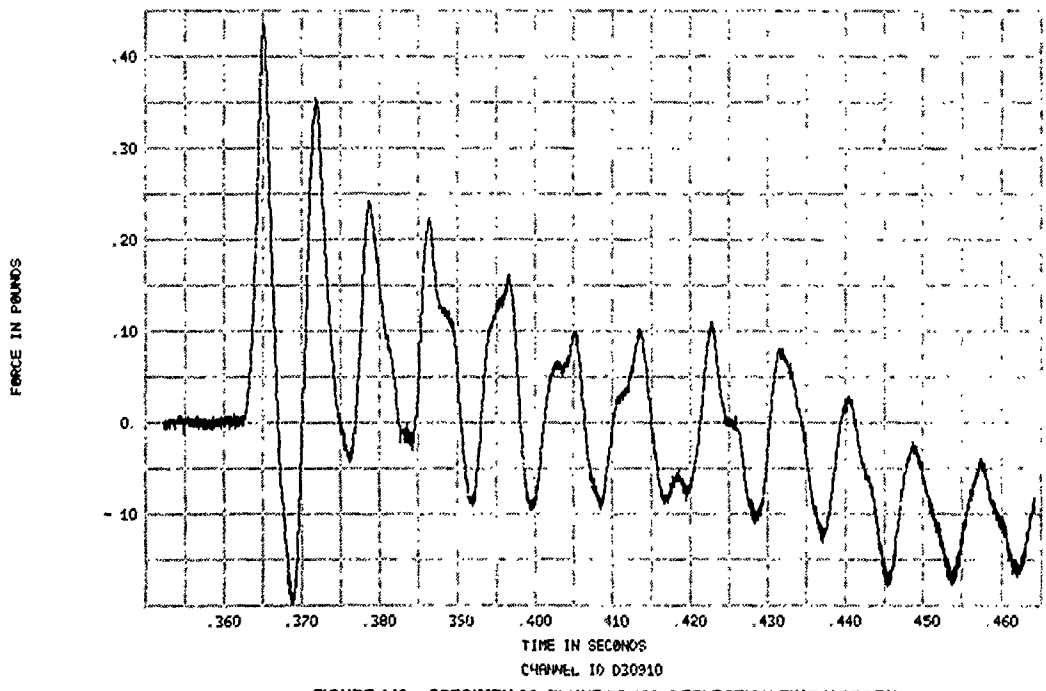

FIGURE 146. SPECIMEN 30, EVENT 70-336, DEFLECTION TIME HISTORY

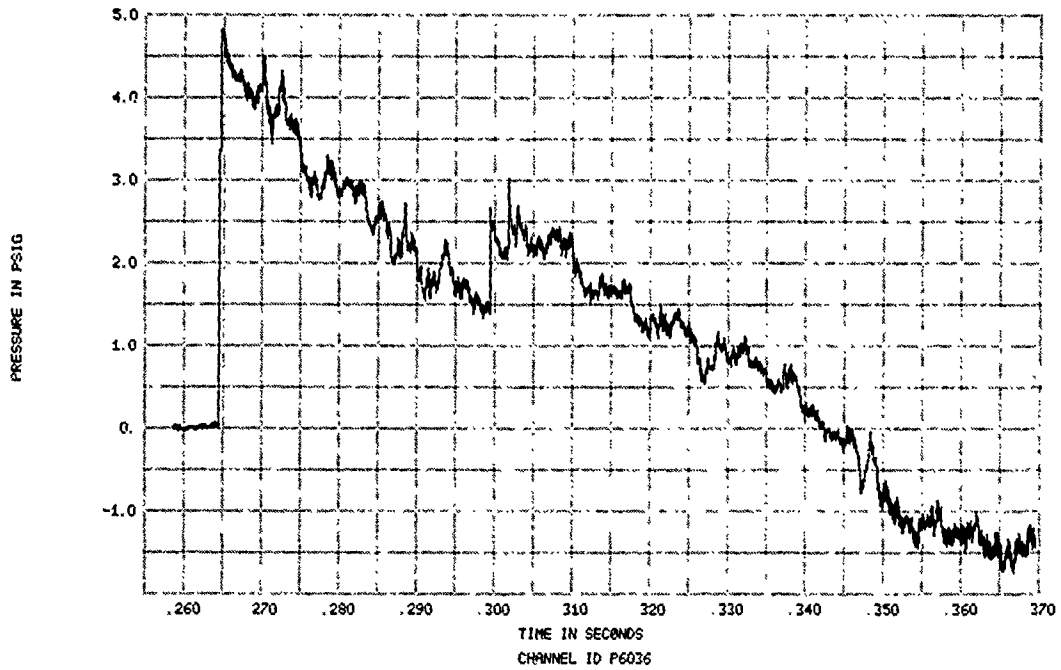

FIGURE 147. SPECIMEN 30, EVENT 78-338, TUNNEL WALL INCIDENT OVERPRESSURE TIME HISTORY

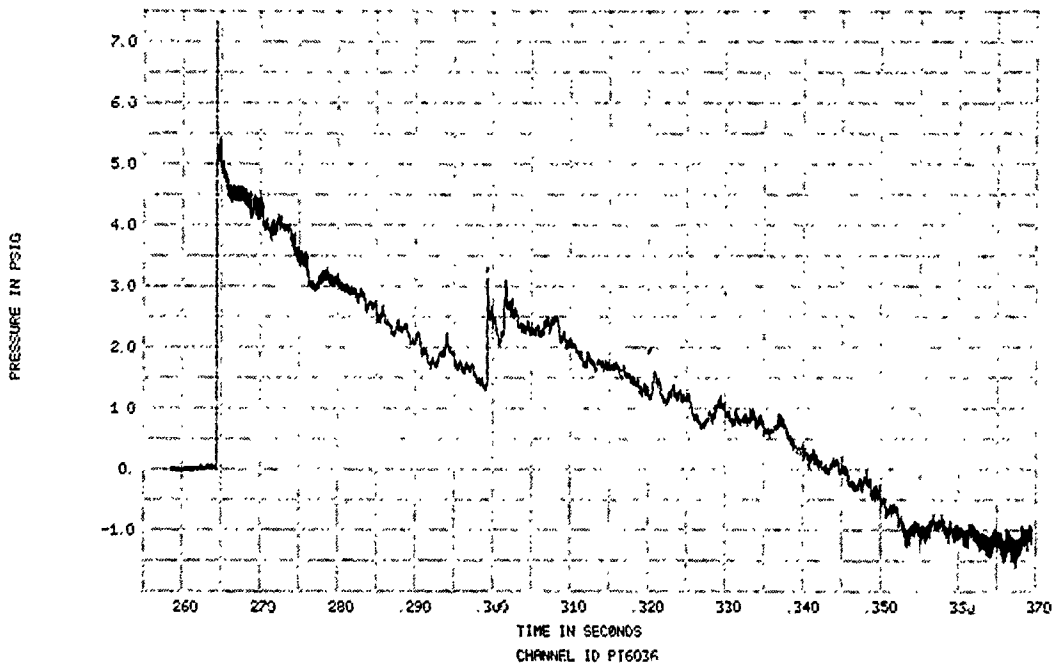

FIGURE 148. SPECIMEN 30, EVENT 78-338, TUNNEL WALL REFLECTED OVERPRESSURE TIME HISTORY

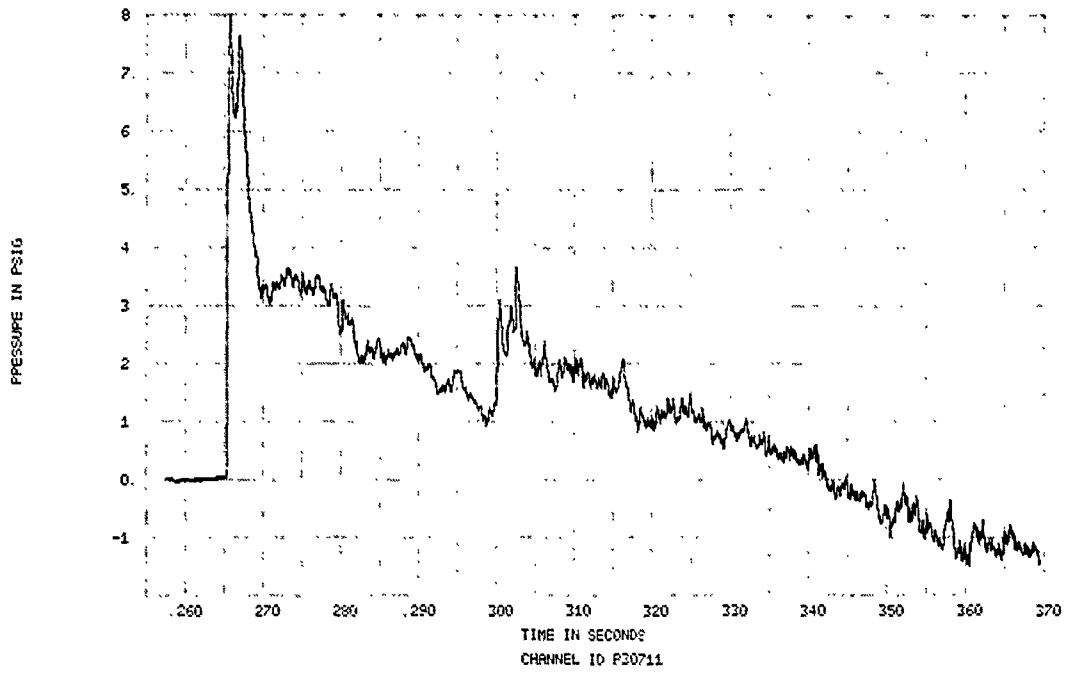

FIGURE 149. SPECIMEN 30, EVENT 78-338, SPECIMEN REFLECTED OVERPRESSURE TIME HISTORY

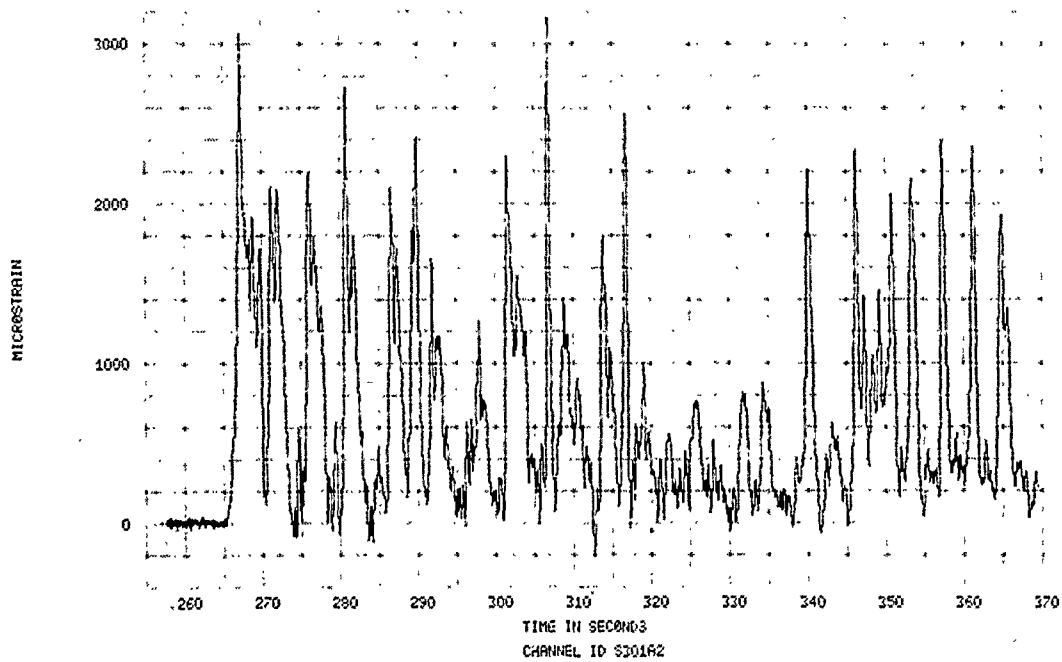

FIGURE 150. SPECIMEN 30, EVENT 78-338, STRAIN TIME HISTORY

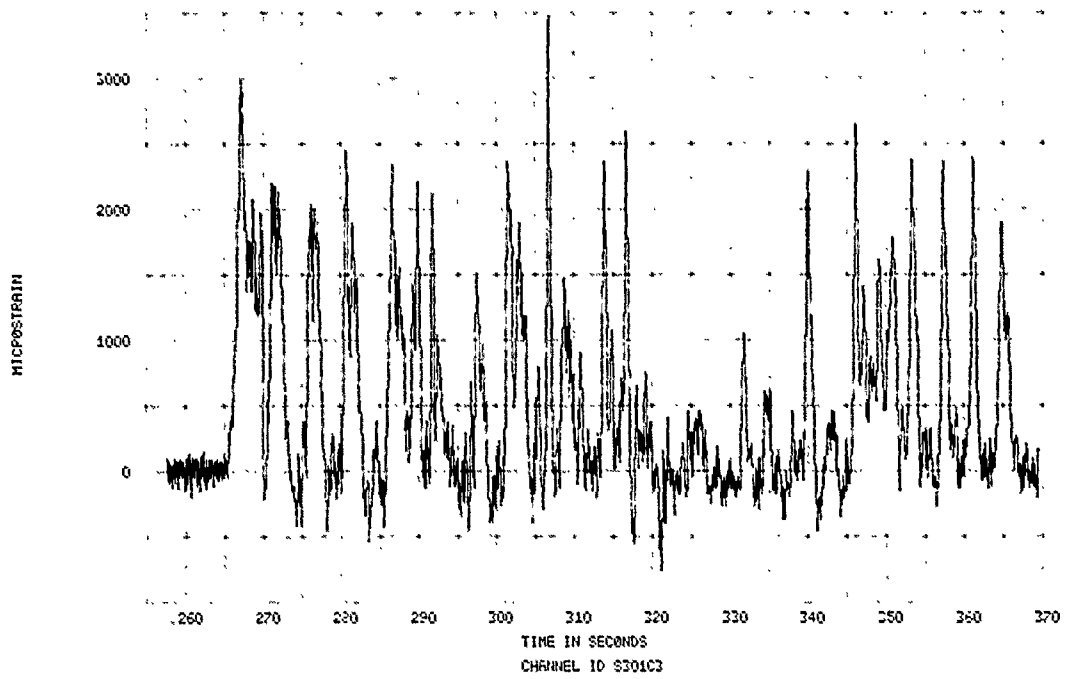

FIGURE 151. SPECIMEN 30, EVENT 78-338, STRAIN TIME HISTORY

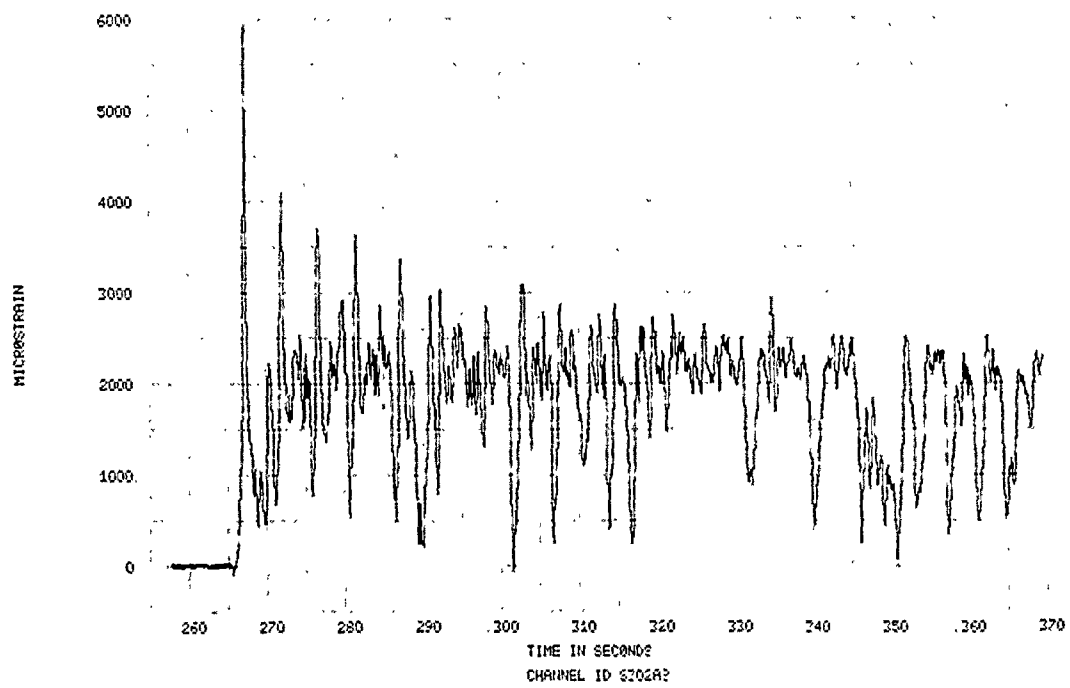

FIGURE 152. SPECIMEN 30, EVENT 78-338, STRAIN TIME HISTORY

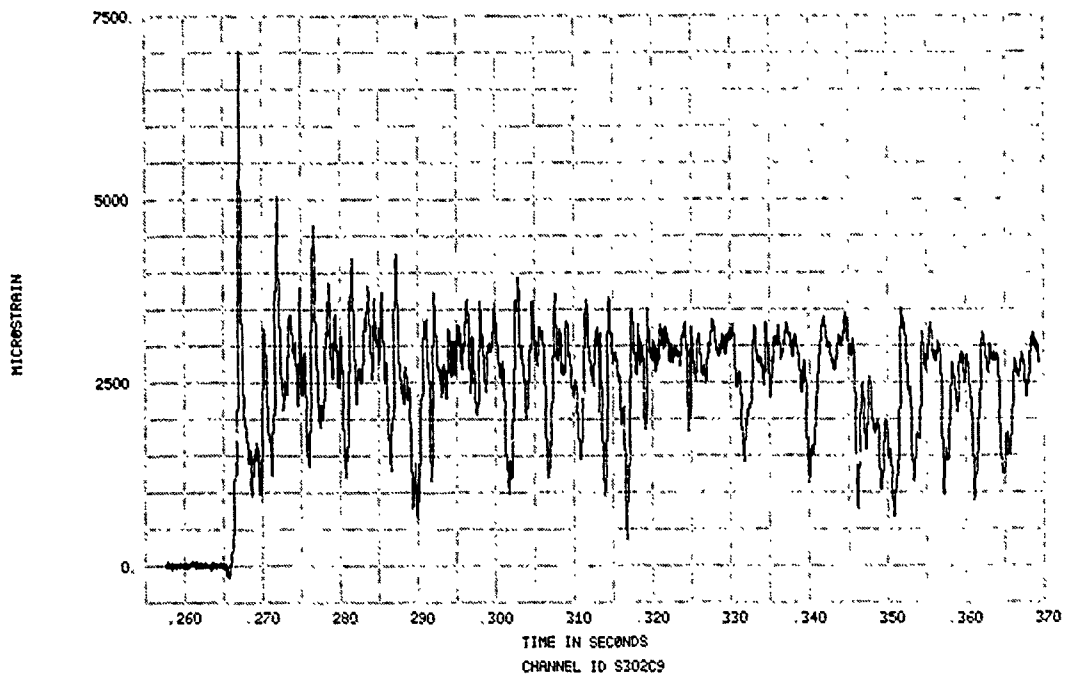

FIGURE 153. SPECIMEN 30, EVENT 70-338, STRAIN TIME HISTORY

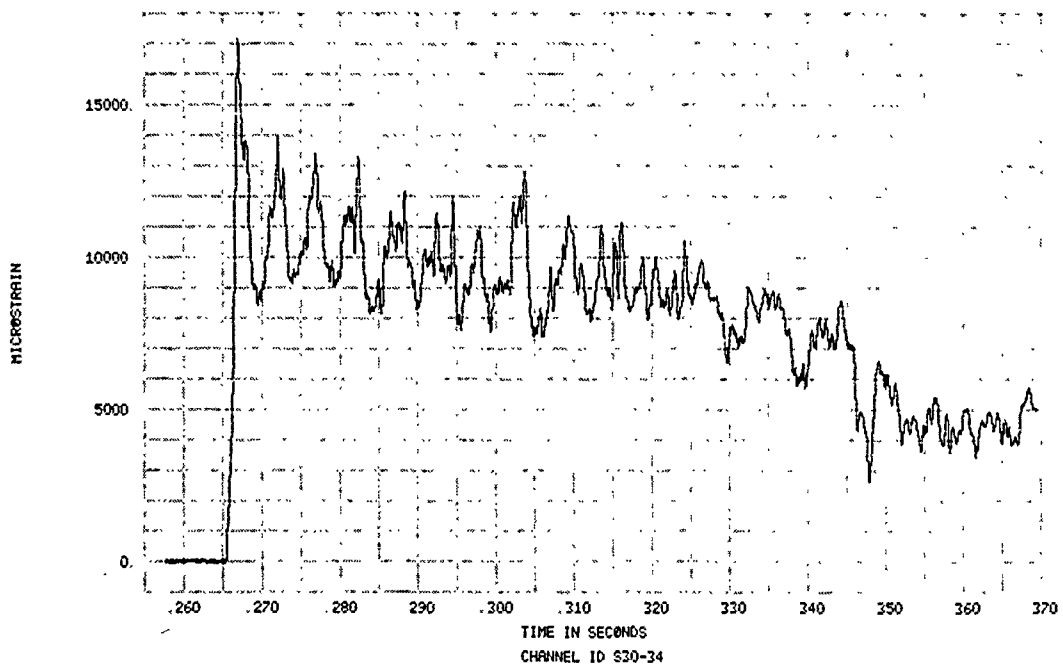

FIGURE 154. SPECIMEN 30, EVENT 70-338, STRAIN TIME HISTORY

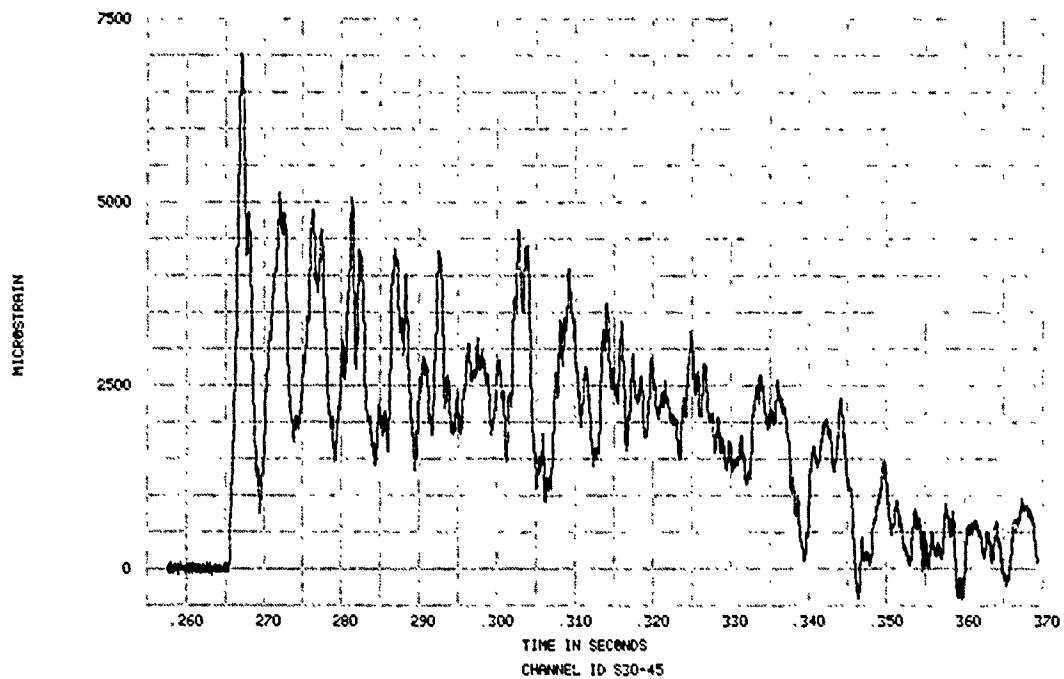

FIGURE 155. SPECIMEN 30, EVENT 70-338, STRAIN TIME HISTORY

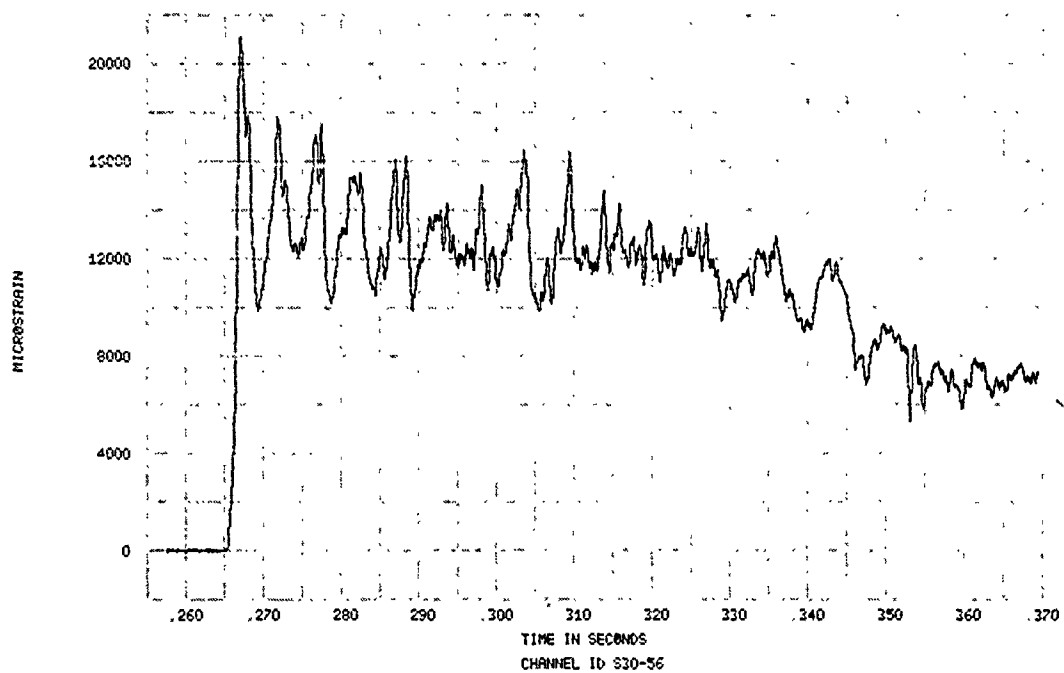

FIGURE 156. SPECIMEN 30, EVENT 70-338, STRAIN TIME HISTORY

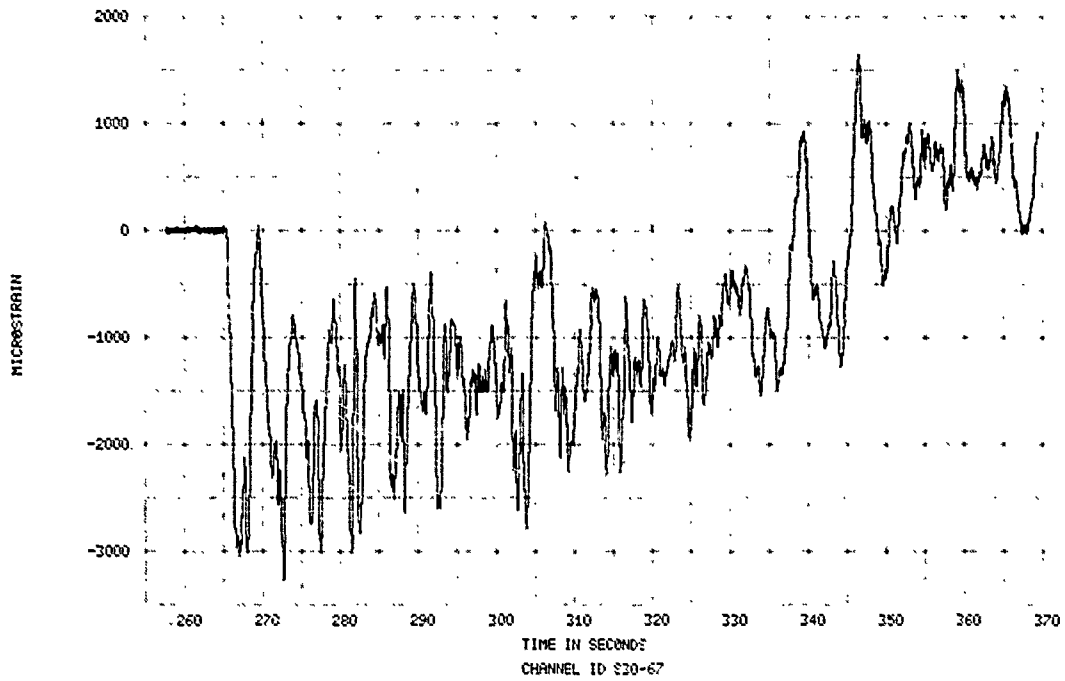
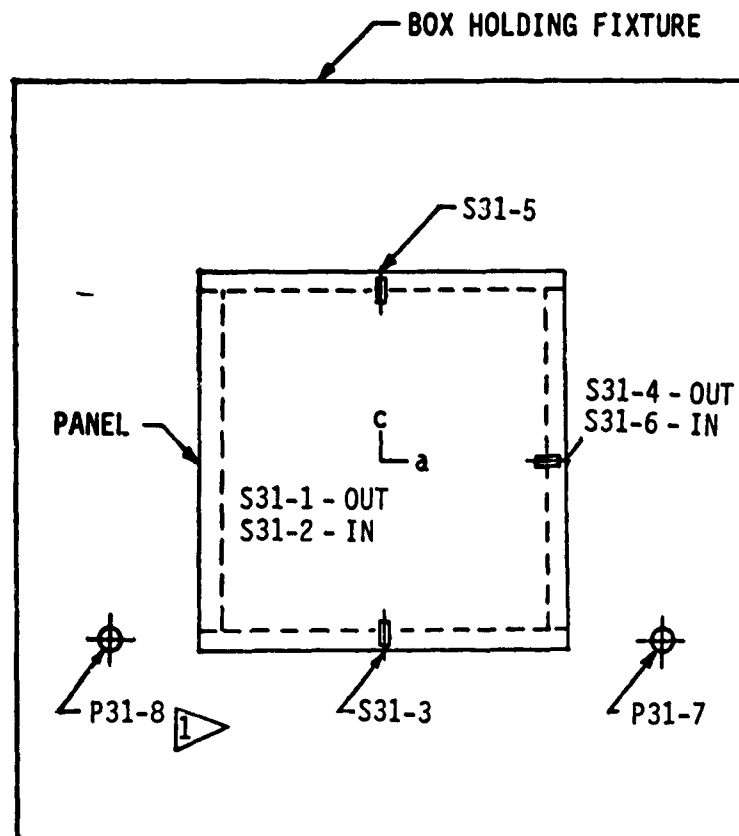

FIGURE 157. SPECIMEN 30, EVENT 76-338, STRAIN TIME HISTORY

SPECIMEN NO. 31



SPECIMEN NO. 31

1 BACK SIDE OF BOX HOLDING FIXTURE ONLY

FLAT UNSTIFFENED PANEL - 0.062 IN. THICK
22.0 IN. SQUARE

FOUR SIDES CLAMPED

MATERIAL - 6061-T6 ALUMINUM ALLOY

DENSITY - 0.0002539 LB-SEC²/IN⁴

POISSON'S RATIO - 0.33

MODULUS OF ELASTICITY - 10.6×10^6 PSI

SHEAR MODULUS - 3.8×10^6 PSI

YIELD STRESS - 42,330 PSI

ULTIMATE STRESS - 47,840 PSI

Figure 158. Description and Instrumentation - Specimen No. 31

PRECEDING PAGE BLANK-NOT FILLED

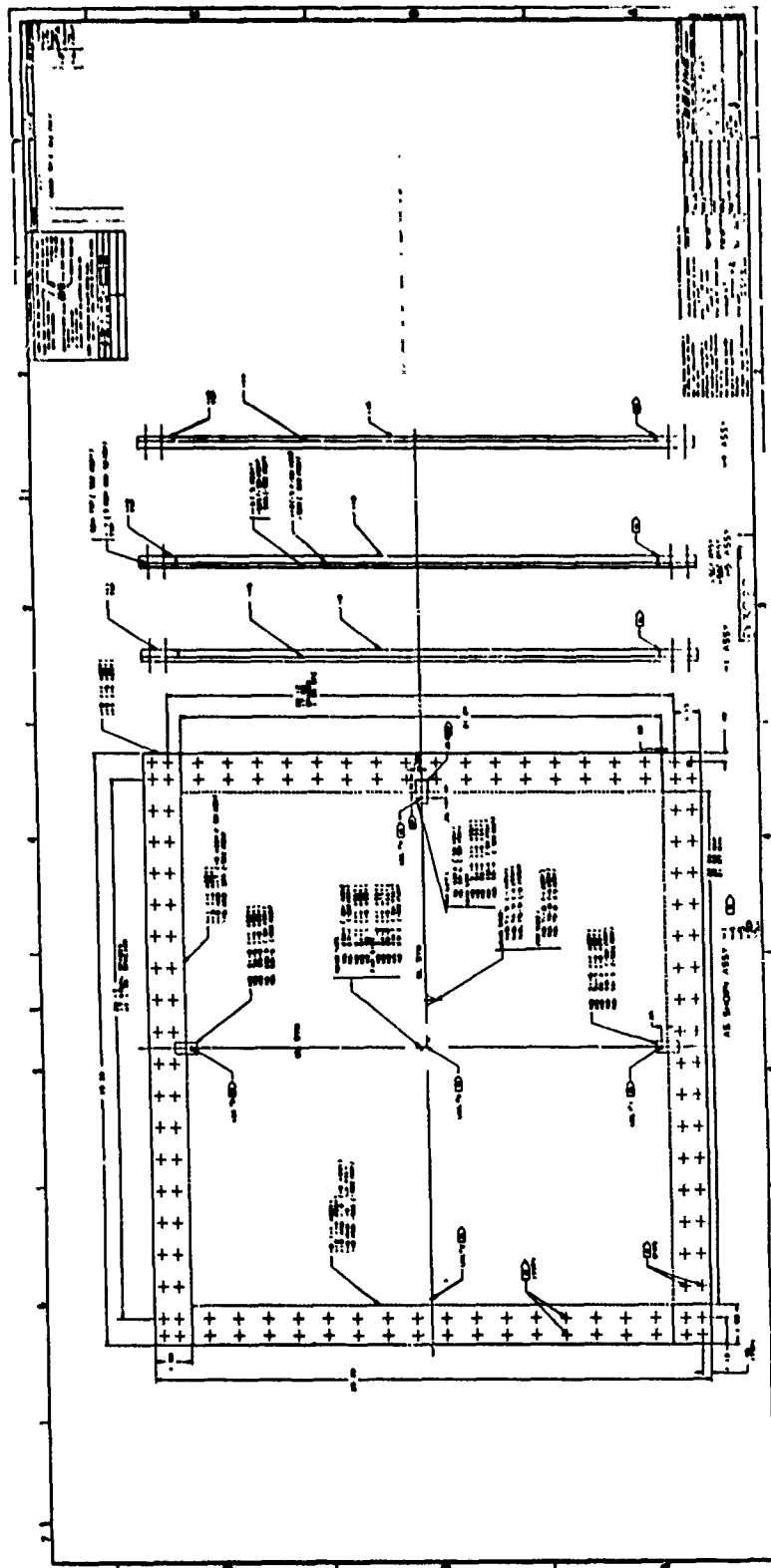

Figure 159. Spec Drawing - Specimen No. 31

NOVA-2LT DATA DECK LISTING
TEST SPECIMEN 31

* * * NOVA-2LT DATA DECK FOR TEST SPECIMEN 31 * * *							GP 1
1	1	101	2	0			GP 3
0.50	7	7	15	15	4		GP 4
	1	1	2				GPP 1
	24						GPP 2
	2	7					GPP 3
	3	5					GPP 4
	3	6					GPP 4
	3	7					GPP 4
	4	4					GPP 4
	4	5					GPP 4
	4	6					GPP 4
	4	7					GPP 4
	5	3					GPP 4
	5	4					GPP 4
	5	5					GPP 4
	5	6					GPP 4
	5	7					GPP 4
	6	3					GPP 4
	6	4					GPP 4
	6	5					GPP 4
	6	6					GPP 4
	6	7					GPP 4
	7	2					GPP 4
	7	3					GPP 4
	7	4					GPP 4
	7	5					GPP 4
	7	6					GPP 4
	7	7					GPP 4
	1						GPP 5
22.0	22.0						GPP 6
0.062	.0002539	10.6	E+06				GPP 11
0.33	42330.	5.51	E+04	0.12			GPP 12
0.0	0.0	0.0	0.0	0.0	0.0		GPP 13
0.0	0.0	0.0	0.0	0.0	0.0		GPP 13
0.0	0.0	0.0	0.0	0.0	0.0		GPP 13
0.0	0.0	0.0	0.0	0.0	0.0		GPP 13
0.0	0.0	0.0	0.0	0.0	0.0		GPP 13
0.0	0.0	0.0	0.0	0.0	0.0		GPP 13
0.0	0.0	0.0	0.0	0.0	0.0		GPP 13
0.0	0.0	0.0	0.0	0.0	0.0		GPP 13
0.0	0.0	0.0	0.0	0.0	0.0		GPP 13
0.0	0.005	25.0					GPP 14

TABLE 17
 STATIC TEST STRESS DATA - SPECIMEN 31
 (STRESSES GIVEN IN PSI)

STRAIN GAUGE	STATIC PRESSURE (PSI)					
	1.01	1.53	2.02	2.52	3.05	3.21
S31-1	718.	1343.	1909.	2472.	3026.	3160.
S31-2	3693.	4813.	5775.	6669.	7517.	7750.
S31-3	13864.	18493.	22455.	26180.	29738.	30726.
S31-4	10282.	13685.	16565.	19242.	21777.	22479.
S31-5	14994.	19909.	24098.	28036.	31761.	32785.
S31-6	-6450.	-8378.	-9984.	-11472.	-12852.	-13233.

TABLE 18
 STATIC TEST DISPLACEMENT DATA - SPECIMEN 31
 (DISPLACEMENT MEASURED AT CENTER OF PANEL)

	STATIC PRESSURE (PSI)					
	1.01	1.53	2.02	2.52	3.05	3.21
DISPLACEMENT (INCHES)	0.179	0.217	0.246	0.272	0.295	0.301

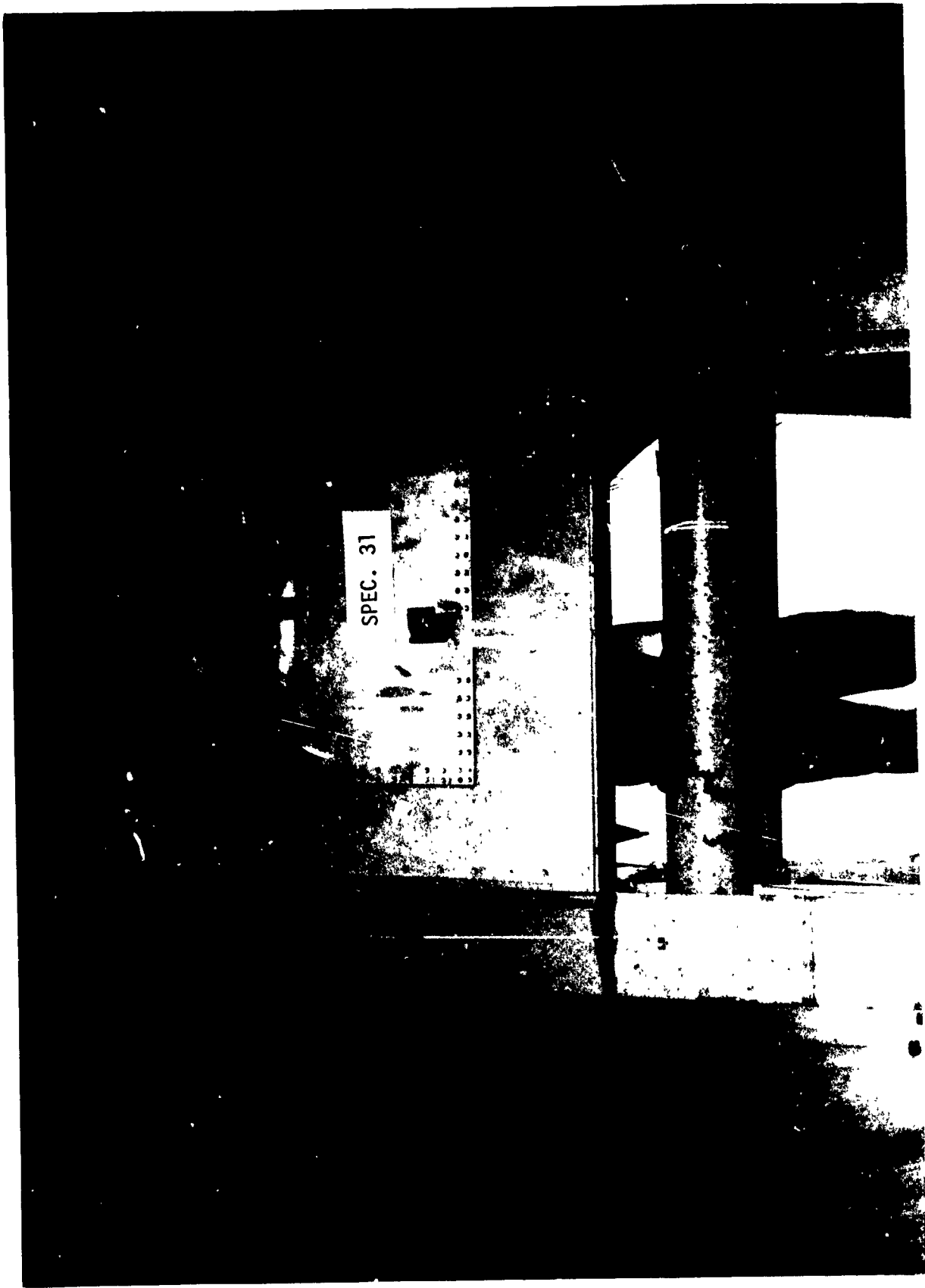

FIGURE 160. SHOCK TEST SETUP - SPECIMEN 31

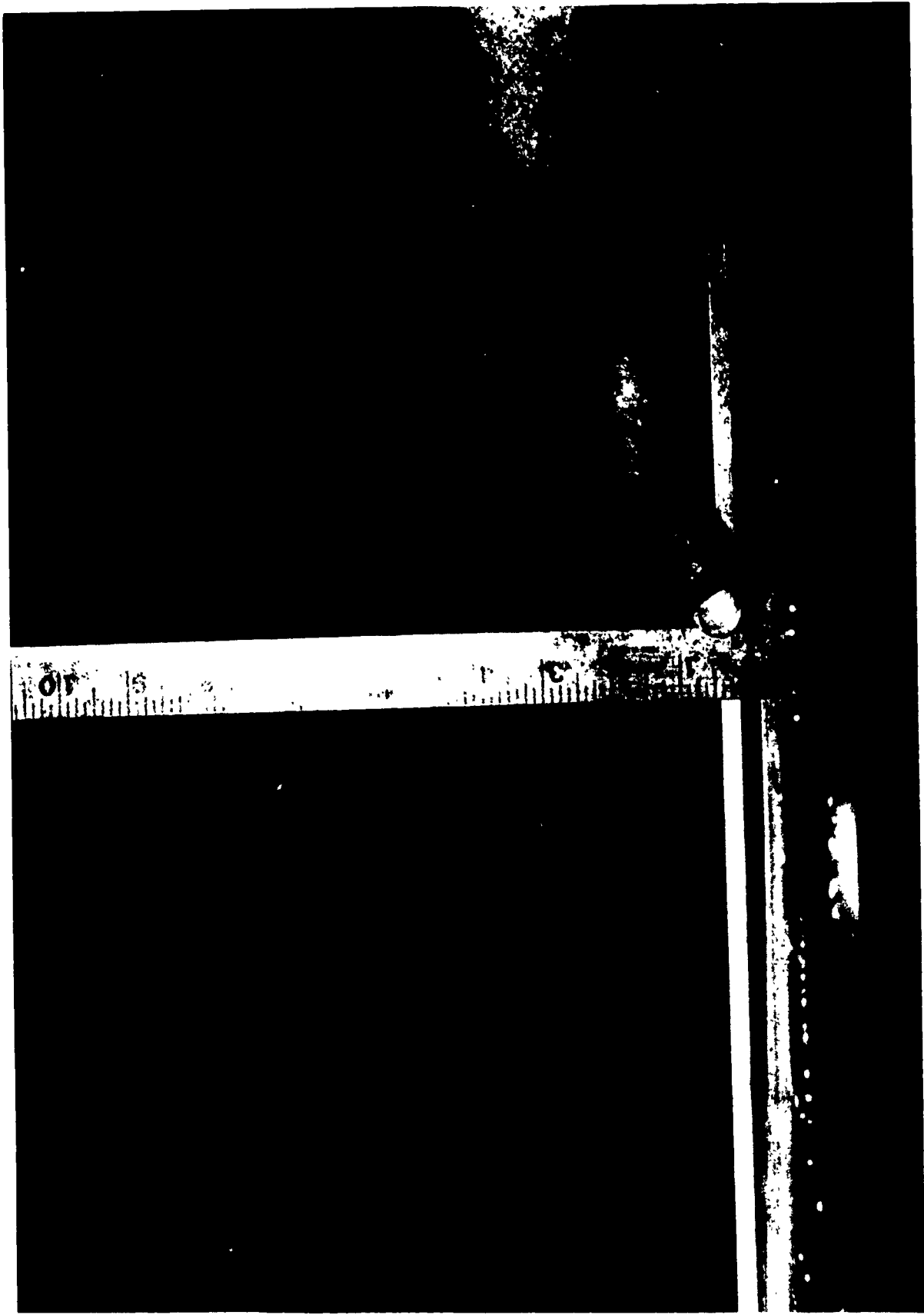

FIGURE 161. CONDITION OF SPECIMEN 31 SUBSEQUENT TO SHOCK LOAD TEST

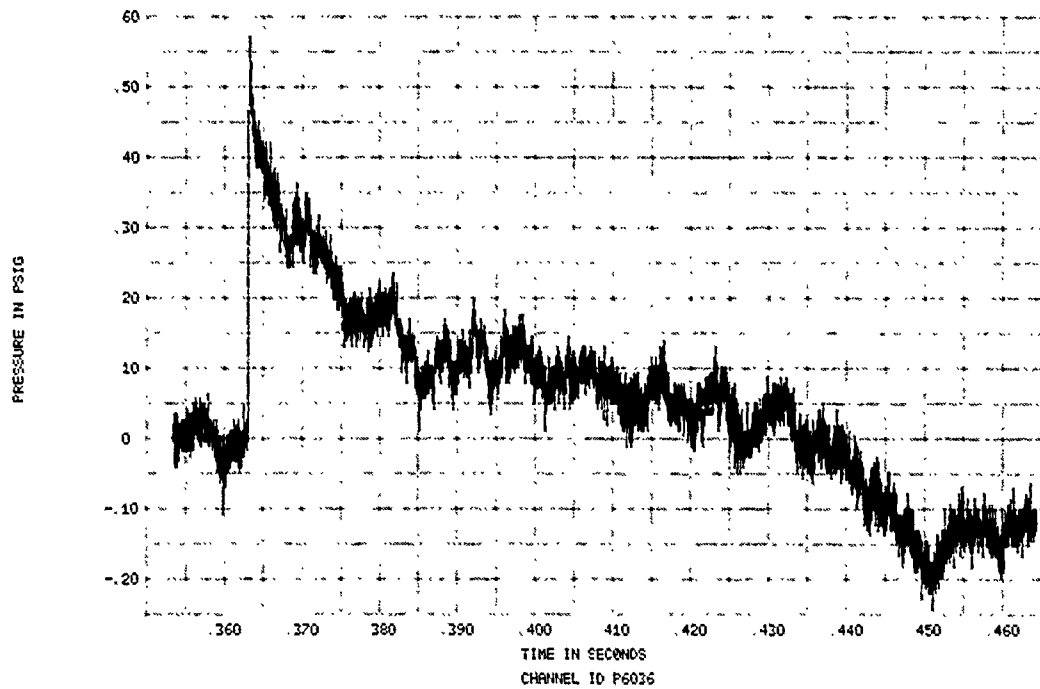

FIGURE 162. SPECIMEN 31, EVENT 78-339, TUNNEL WALL INCIDENT OVERPRESSURE TIME HISTORY

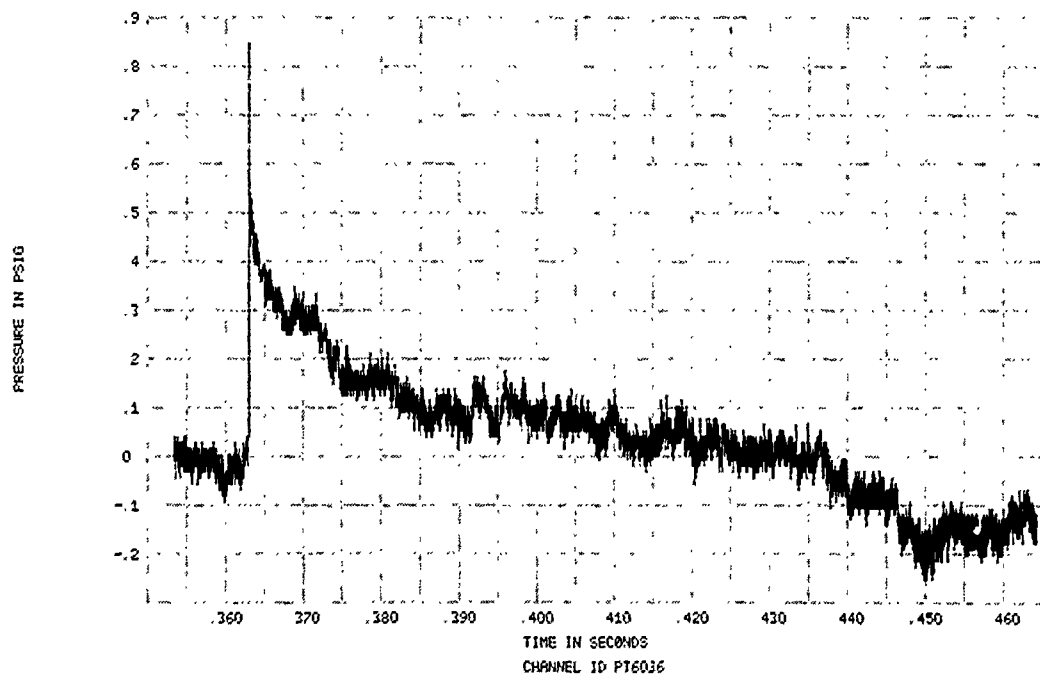

FIGURE 163. SPECIMEN 31, EVENT 78-339, TUNNEL WALL REFLECTED OVERPRESSURE TIME HISTORY

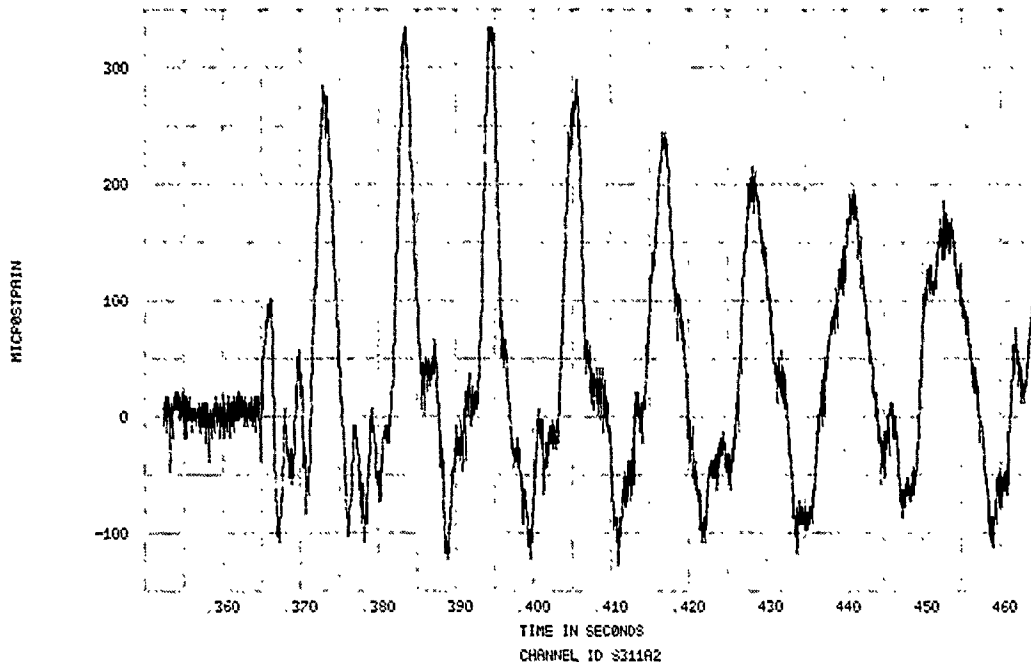

FIGURE 164. SPECIMEN 31, EVENT 78-339, STRAIN TIME HISTORY

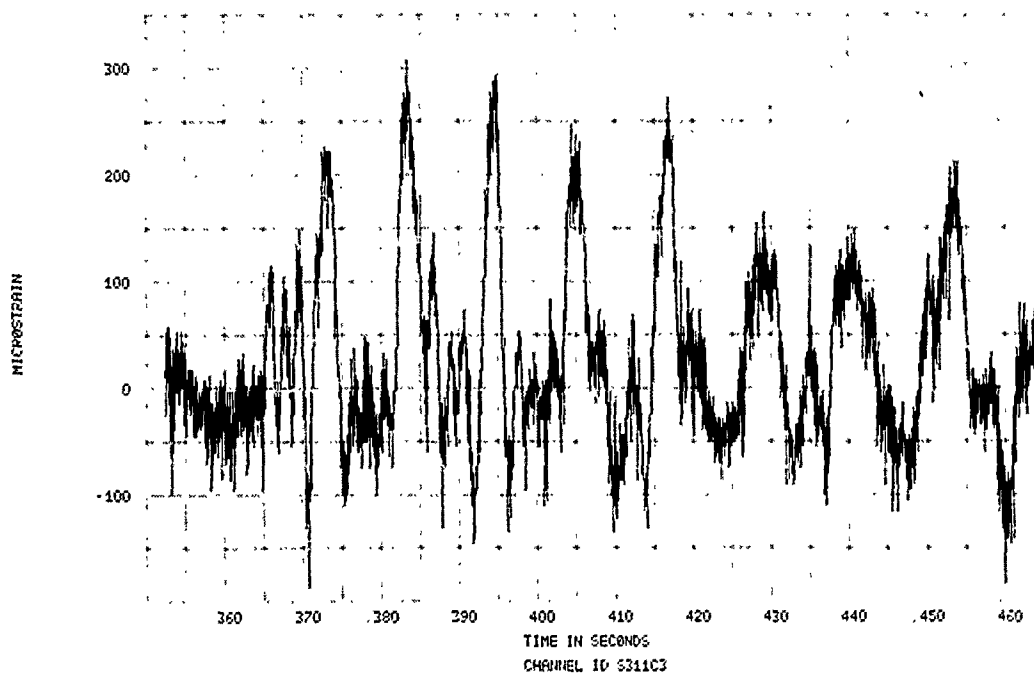

FIGURE 165. SPECIMEN 31, EVENT 78-339, STRAIN TIME HISTORY

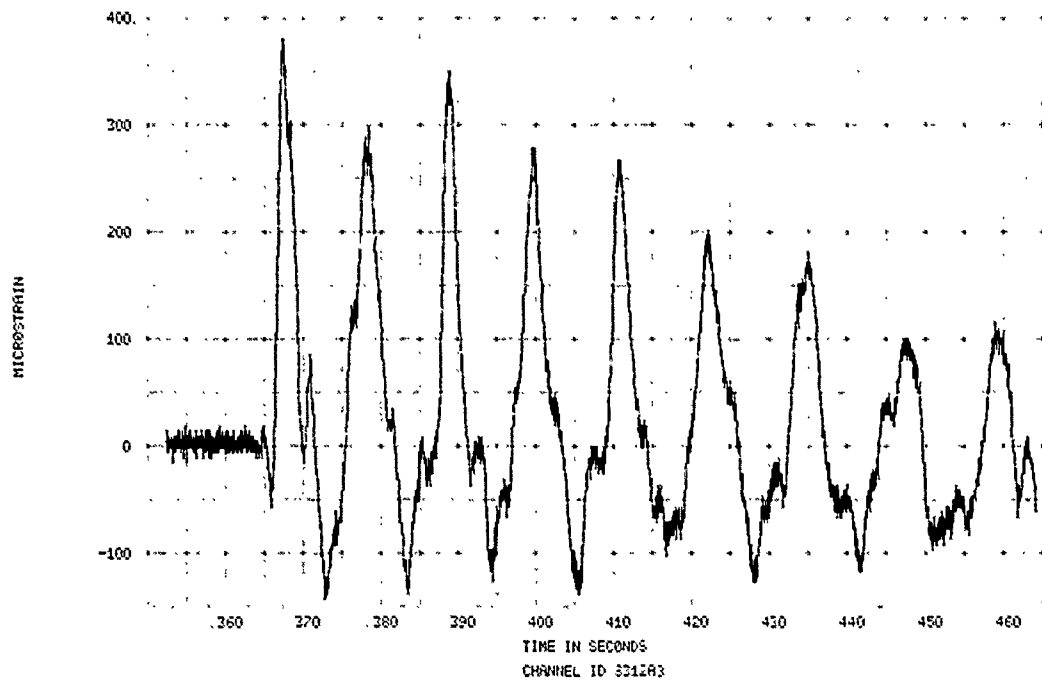

FIGURE 166. SPECIMEN 31, EVENT 78-339, STRAIN TIME HISTORY

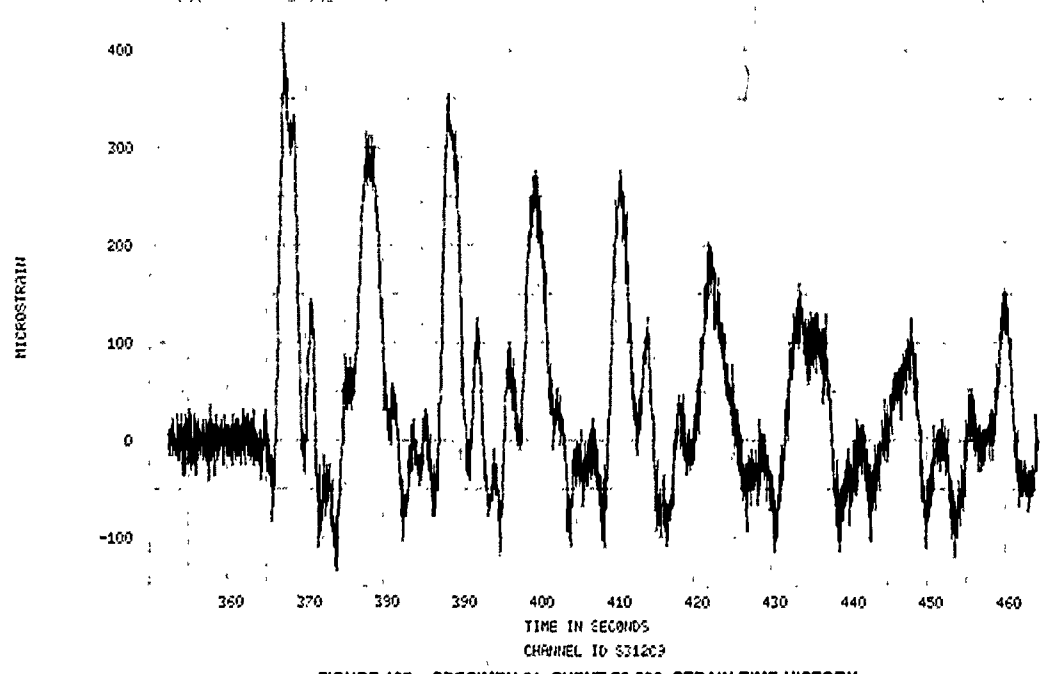

FIGURE 167. SPECIMEN 31, EVENT 79-339, STRAIN TIME HISTORY

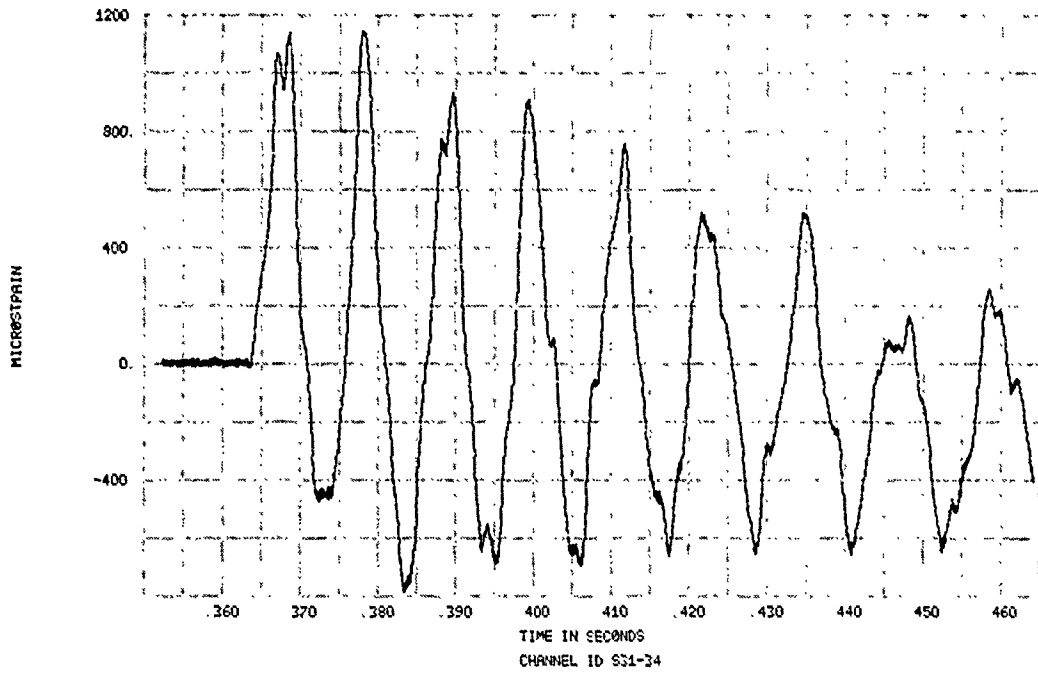

FIGURE 168. SPECIMEN 31, EVENT 78-339, STRAIN TIME HISTORY

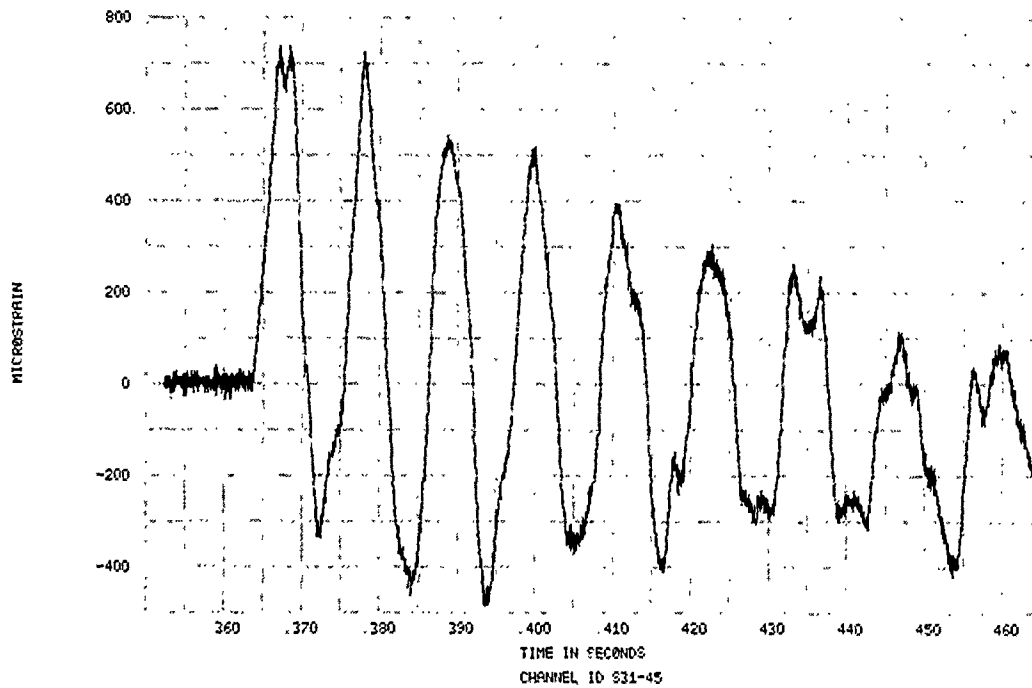

FIGURE 169. SPECIMEN 31, EVENT 78-339, STRAIN TIME HISTORY

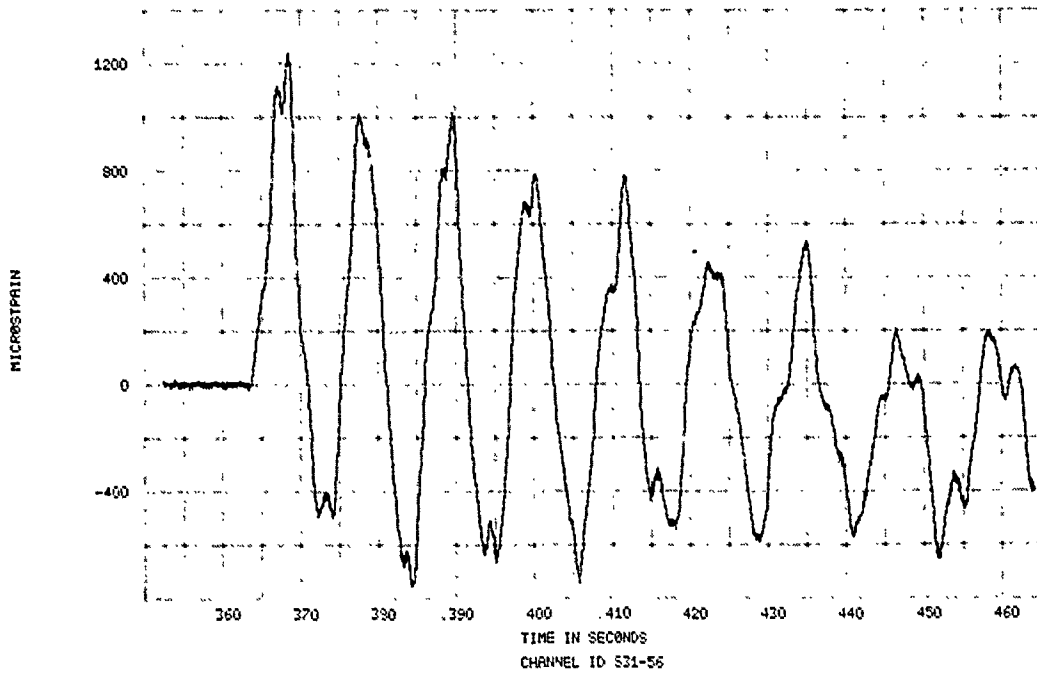

FIGURE 170. SPECIMEN 31, EVENT 78-339, STRAIN TIME HISTORY

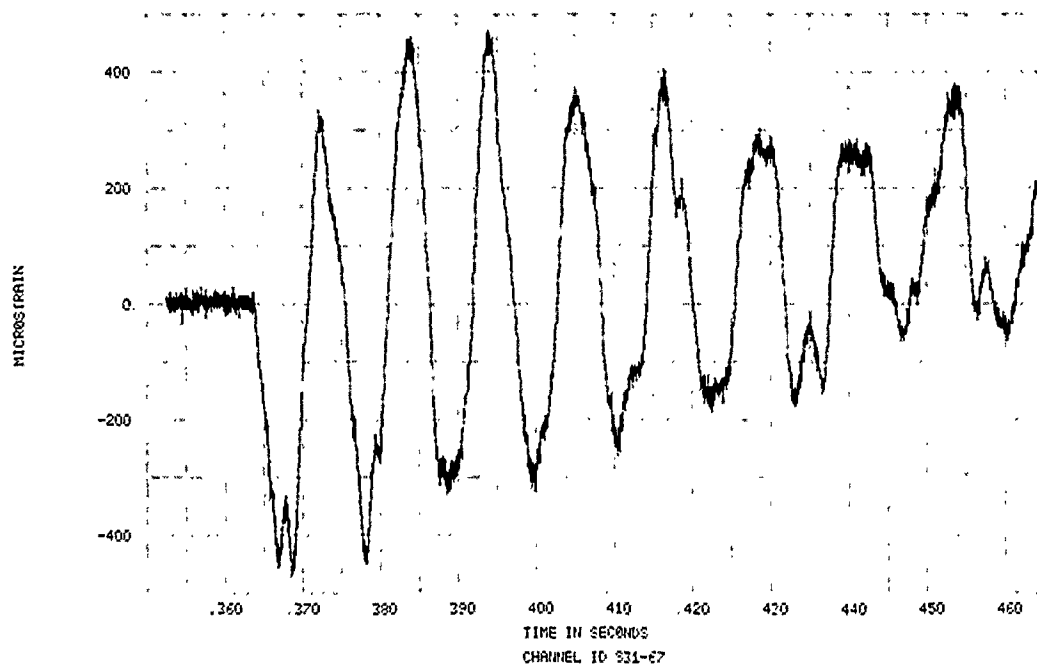

FIGURE 171. SPECIMEN 31, EVENT 78-339, STRAIN TIME HISTORY

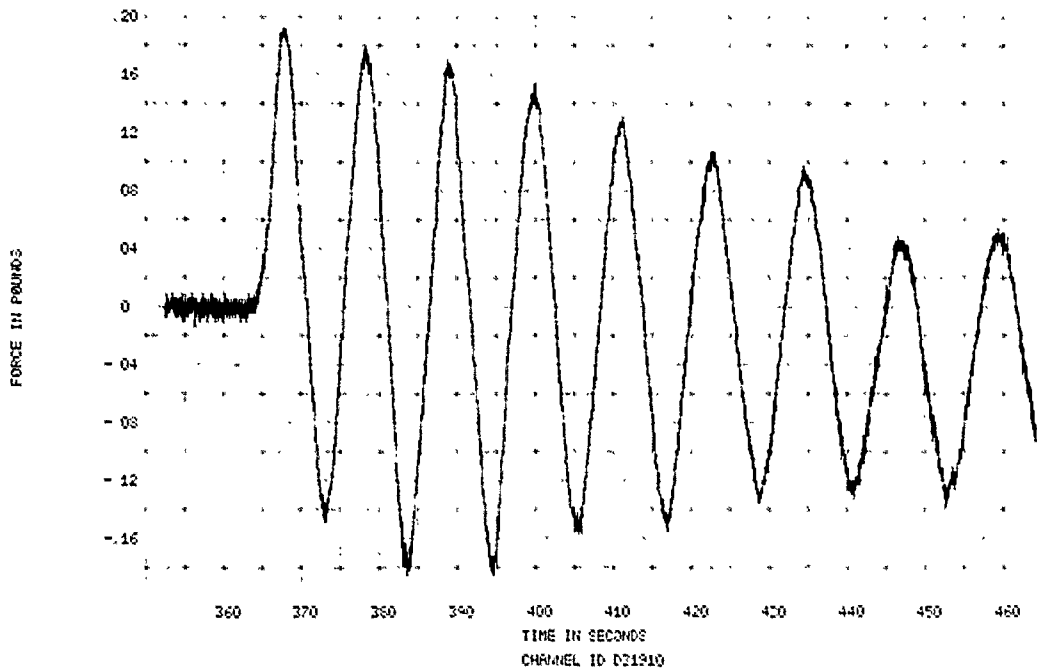

FIGURE 172. SPECIMEN 31, EVENT 78-339, DEFLECTION TIME HISTORY

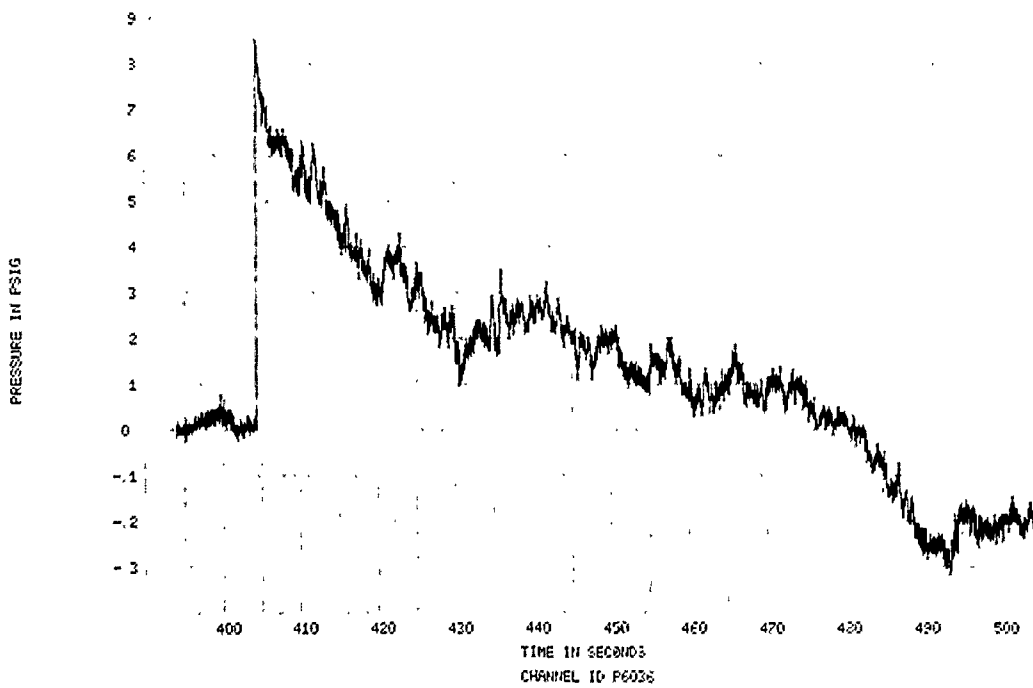

FIGURE 173. SPECIMEN 31, EVENT 78-342, TUNNEL WALL INCIDENT OVERPRESSURE TIME HISTORY

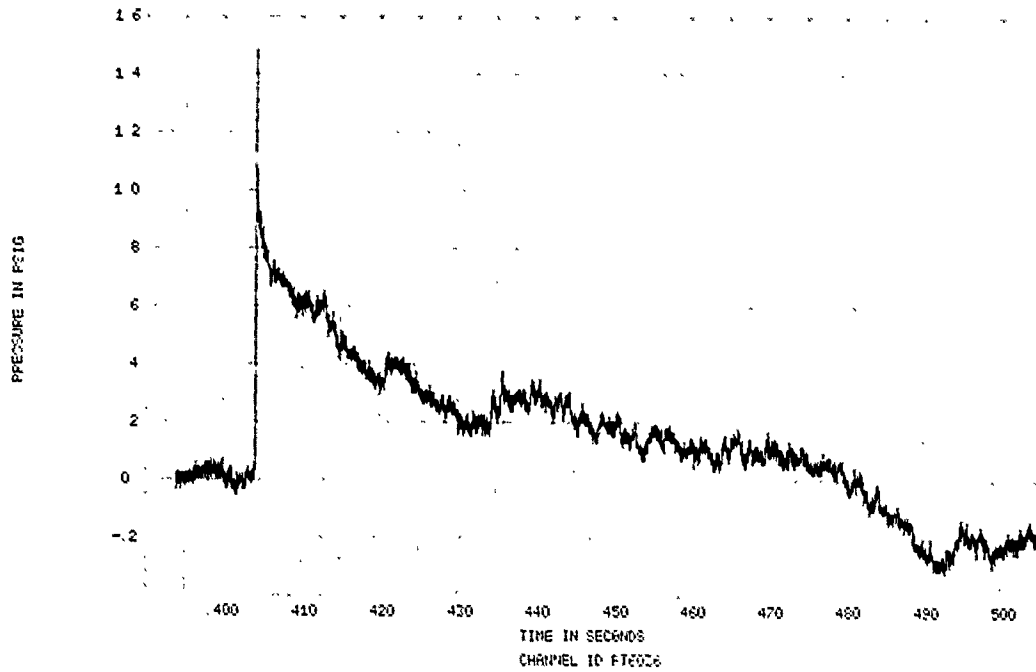

FIGURE 174. SPECIMEN 31, EVENT 78-342, TUNNEL WALL REFLECTED OVERPRESSURE TIME HISTORY

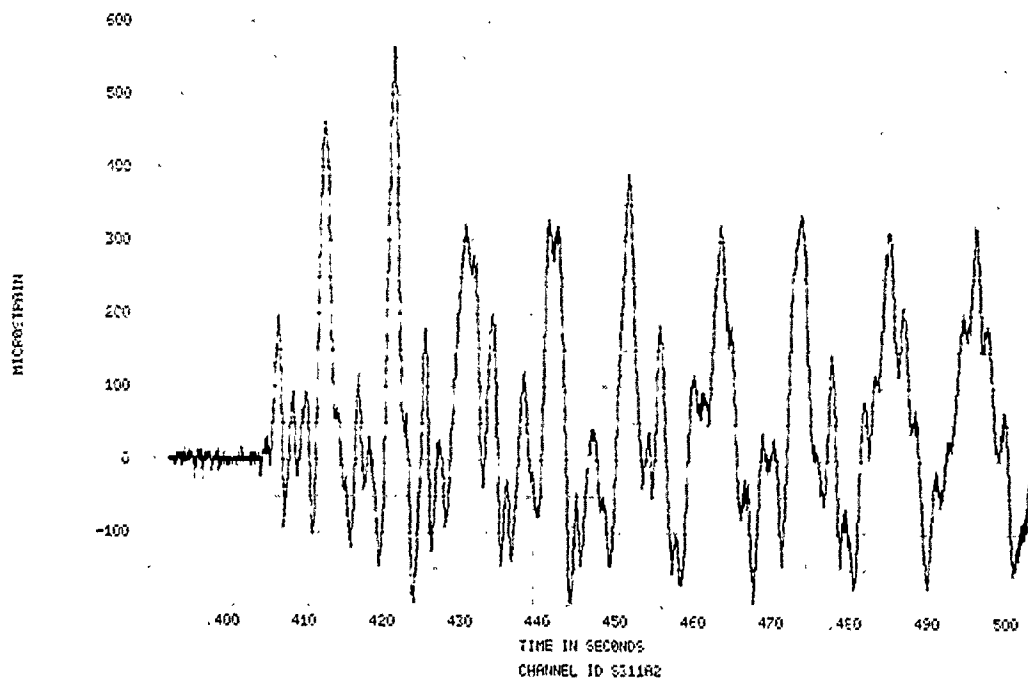

FIGURE 175. SPECIMEN 31, EVENT 78-342, STRAIN TIME HISTORY

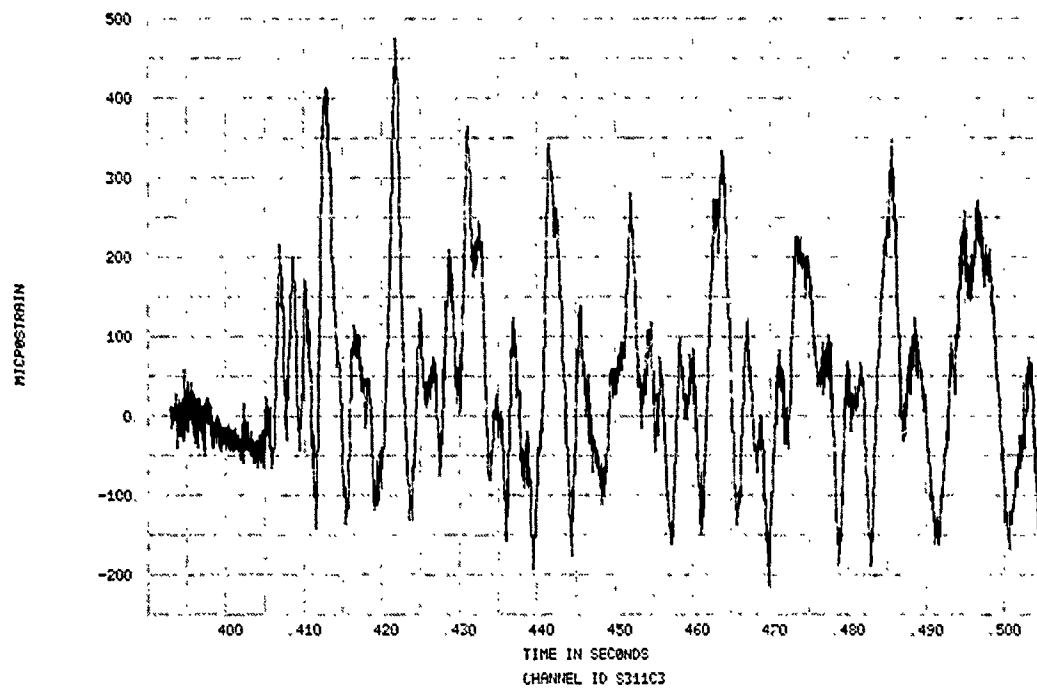

FIGURE 176. SPECIMEN 31, EVENT 78-342, STRAIN TIME HISTORY

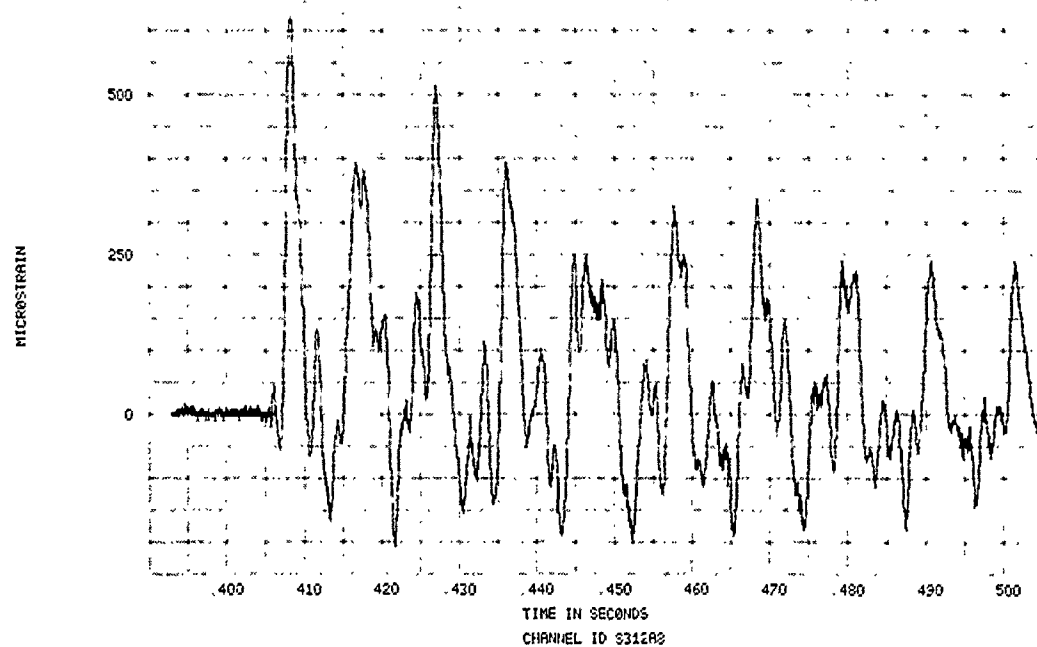

FIGURE 177. SPECIMEN 31, EVENT 78-342, STRAIN TIME HISTORY

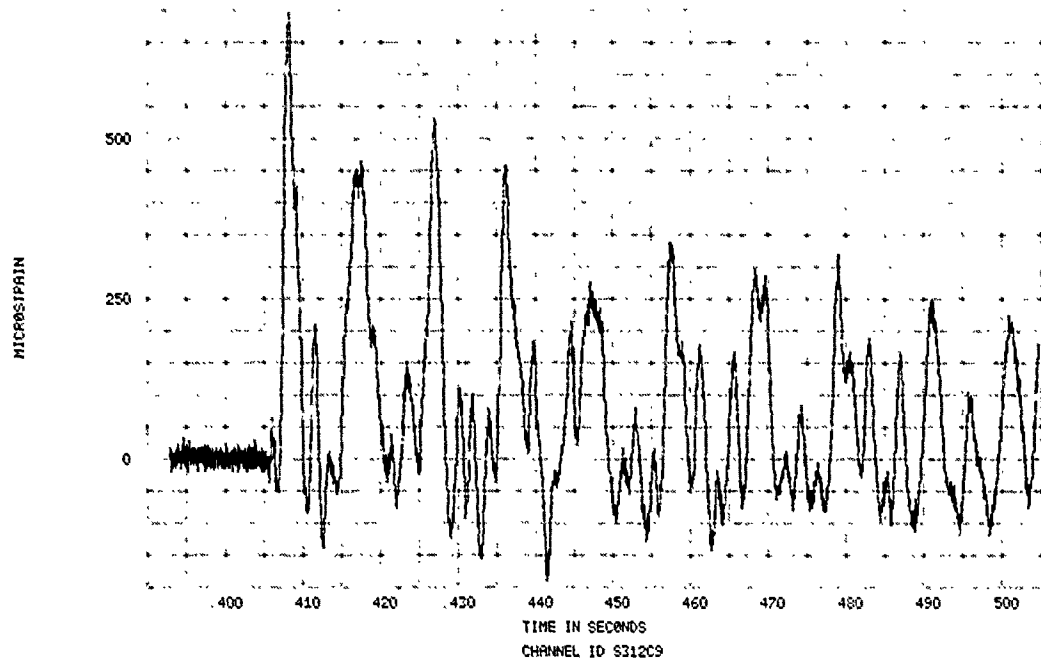

FIGURE 178. SPECIMEN 31, EVENT 78-342, STRAIN TIME HISTORY

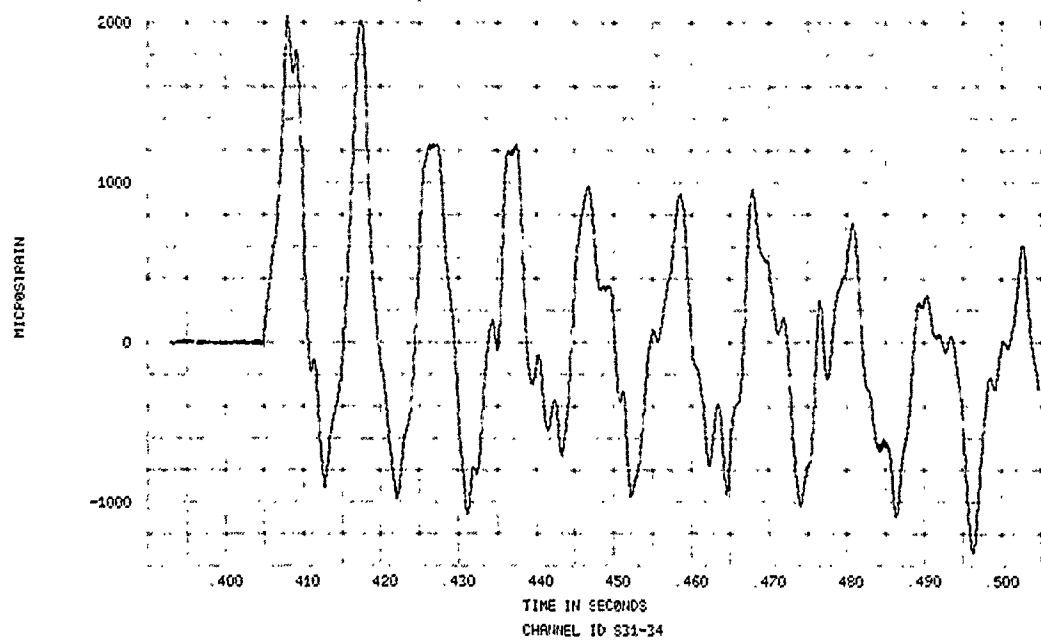

FIGURE 179. SPECIMEN 31, EVENT 78-342, STRAIN TIME HISTORY

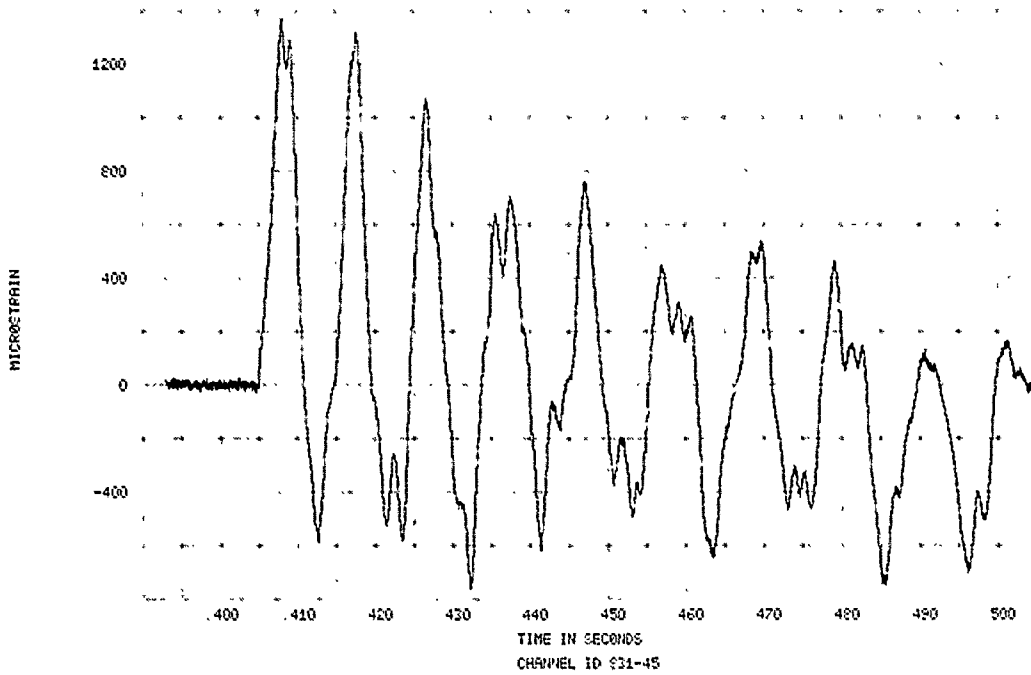

FIGURE 180. SPECIMEN 31, EVENT 78-342, STRAIN TIME HISTORY

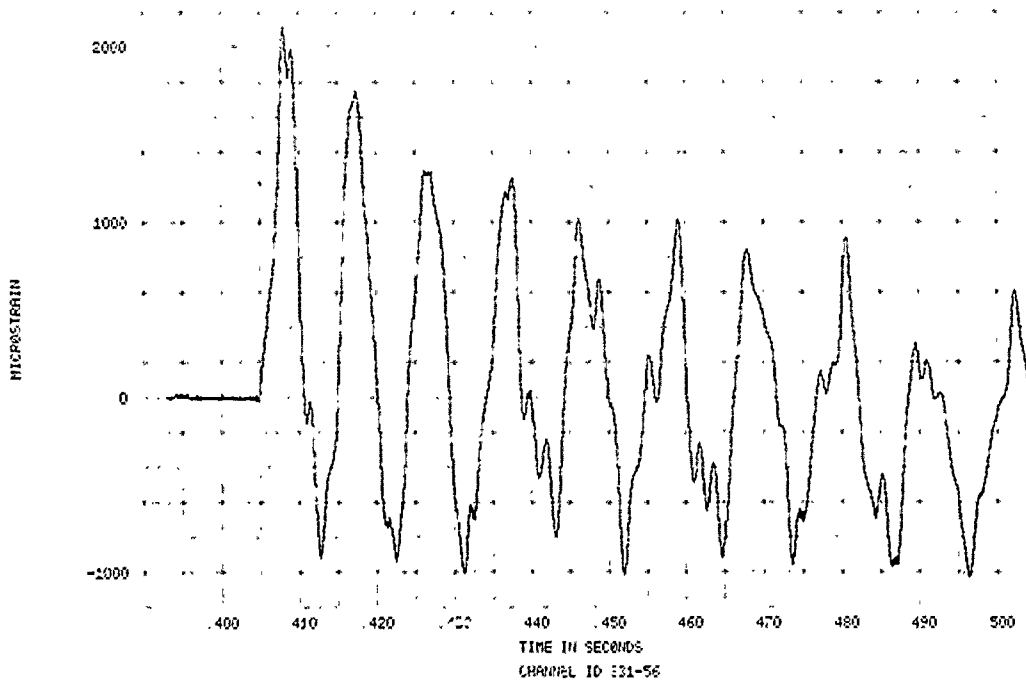

FIGURE 181. SPECIMEN 31, EVENT 78-342, STRAIN TIME HISTORY

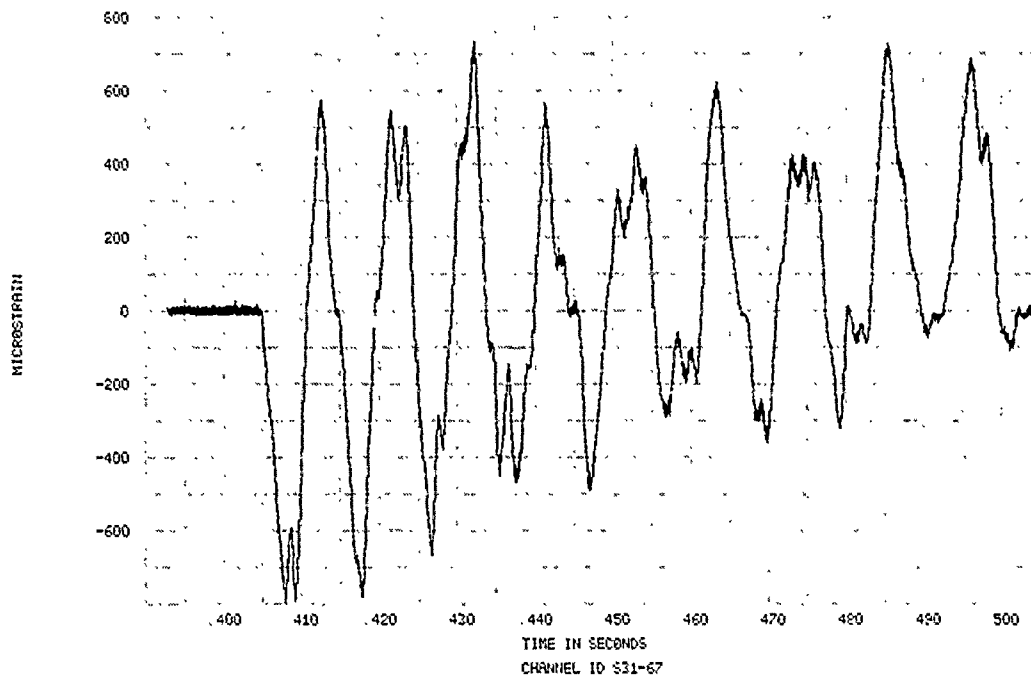

FIGURE 182. SPECIMEN 31, EVENT 78-342, STRAIN TIME HISTORY

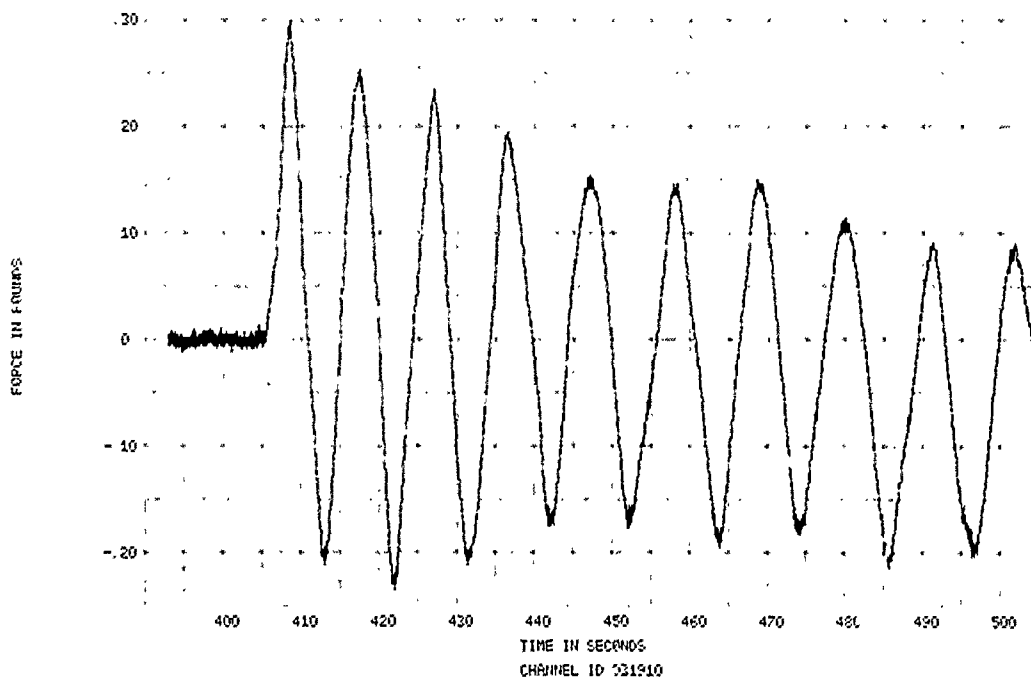

FIGURE 183. SPECIMEN 31, EVENT 78-342, DEFLECTION TIME HISTORY

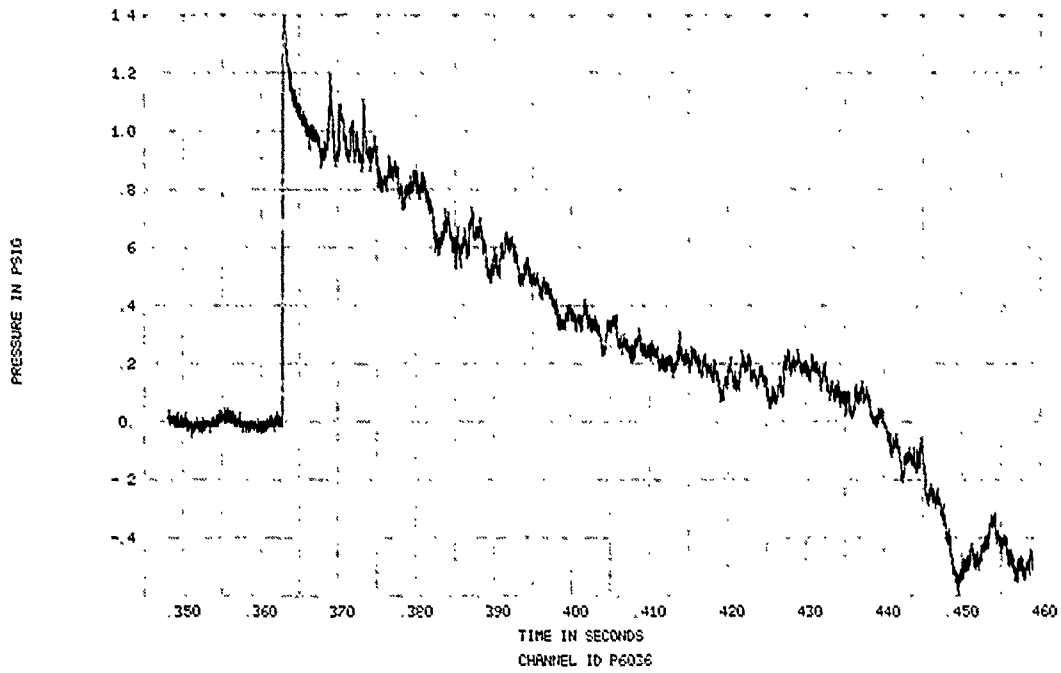

FIGURE 184. SPECIMEN 31, EVENT 78-343, TUNNEL WALL INCIDENT OVERPRESSURE TIME HISTORY

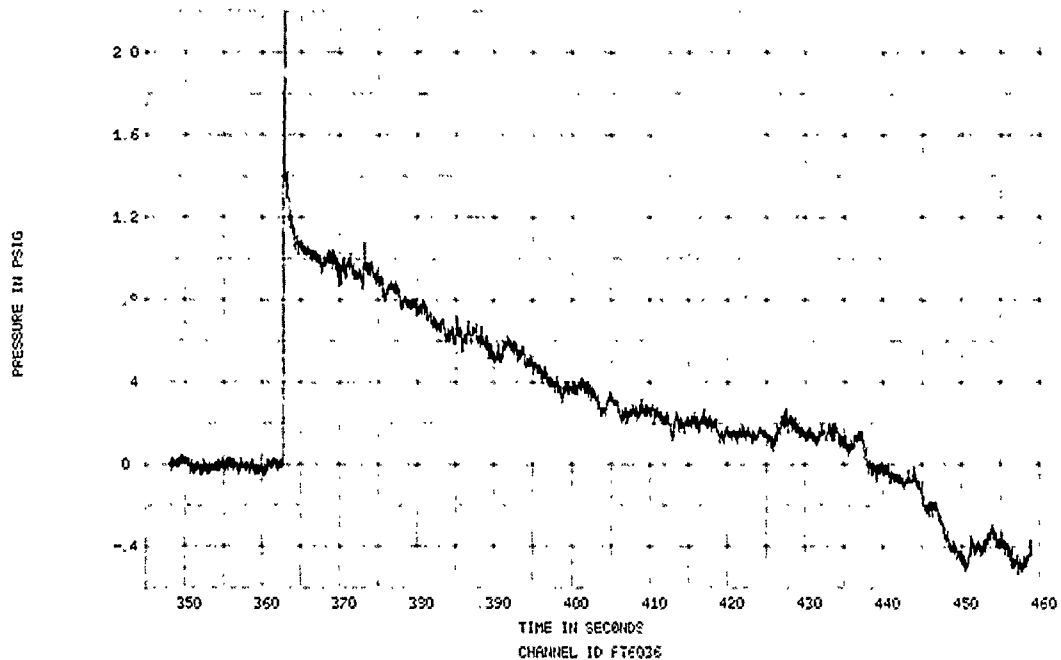

FIGURE 185. SPECIMEN 31, EVENT 78-343, TUNNEL WHALL REFLECTED OVERPRESSURE TIME HISTORY

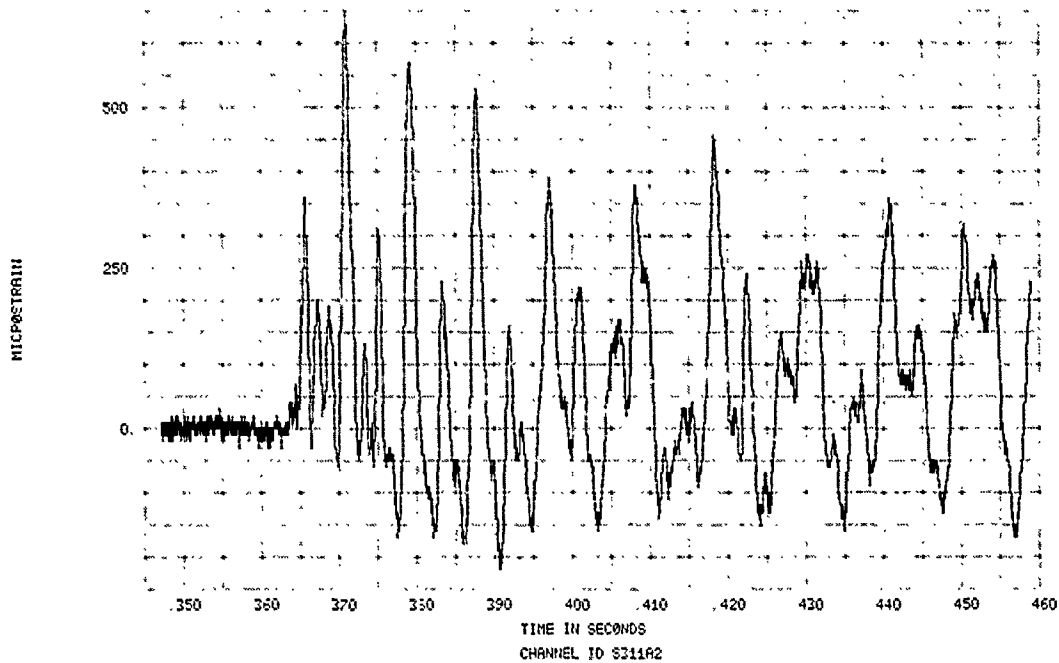

FIGURE 186. SPECIMEN 31, EVENT 78-343, STRAIN TIME HISTORY

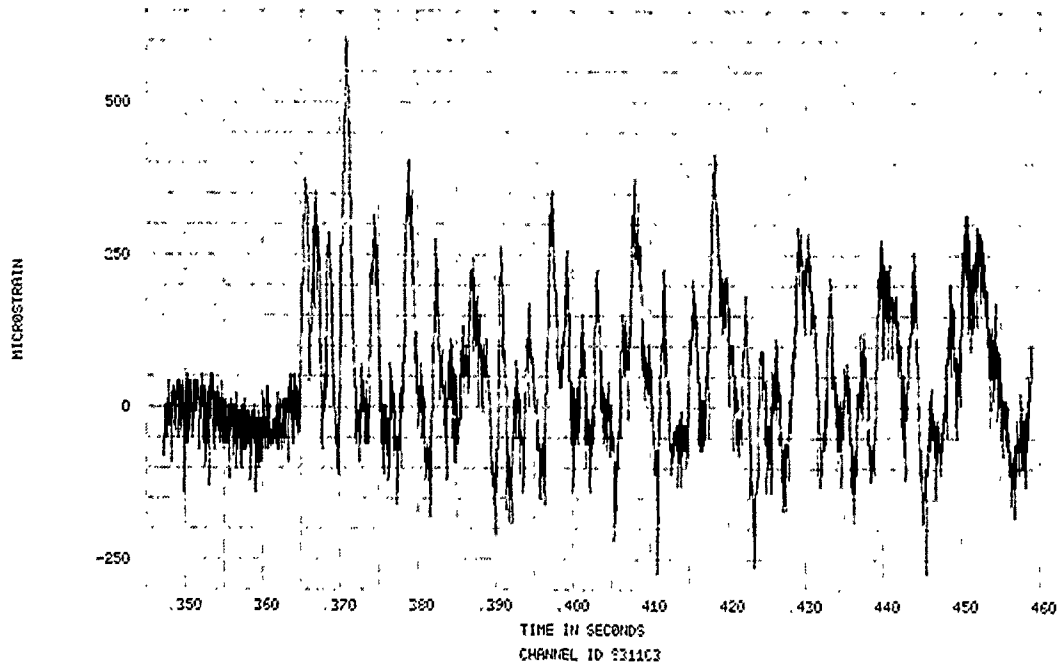

FIGURE 187. SPECIMEN 31, EVENT 78-343, STRAIN TIME HISTORY

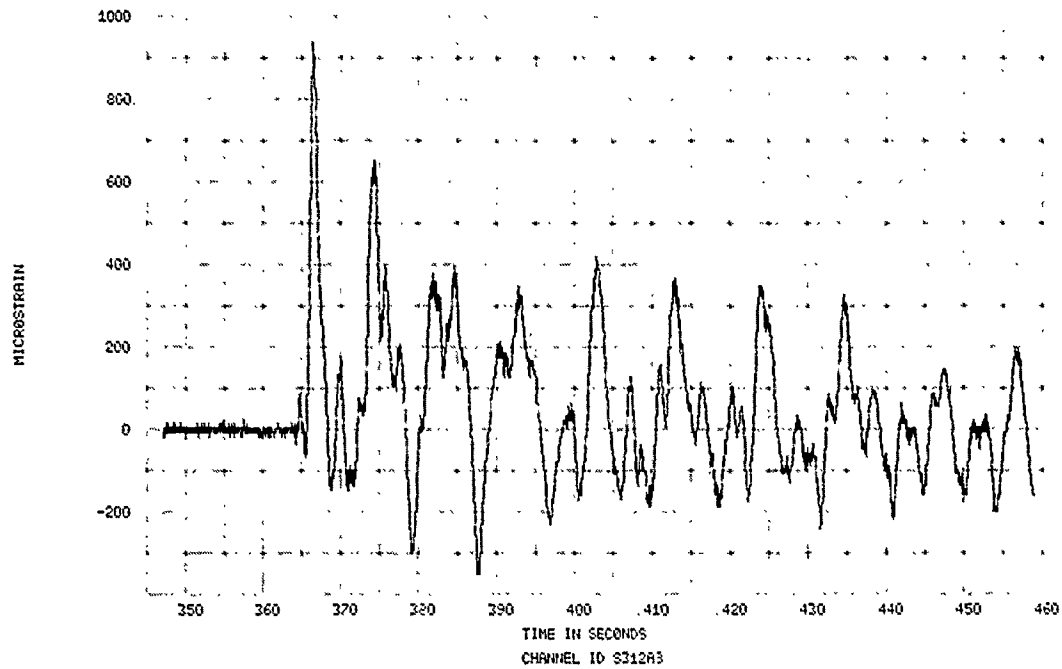

FIGURE 188. SPECIMEN 31, EVENT 78-343, STRAIN TIME HISTORY

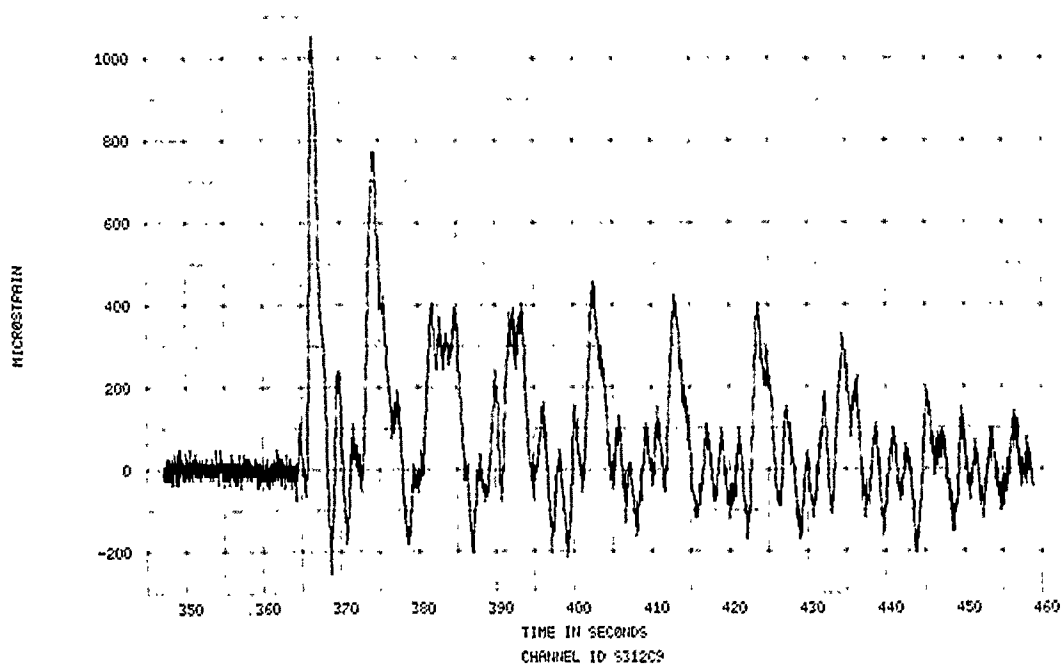

FIGURE 189. SPECIMEN 31, EVENT 78-343, STRAIN TIME HISTORY

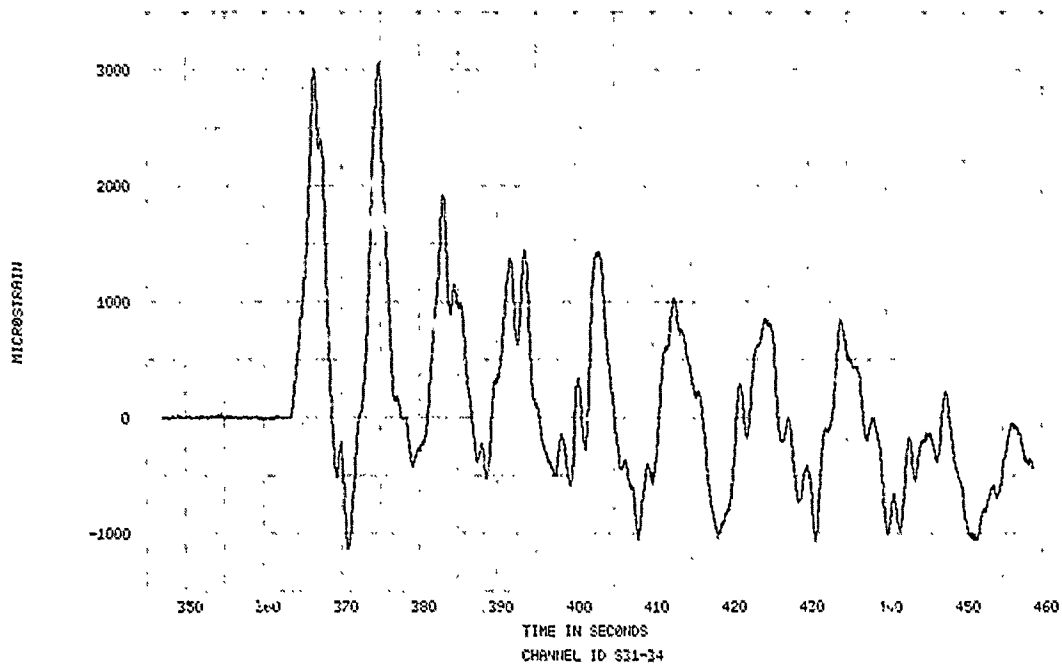

FIGURE 190. SPECIMEN 31, EVENT 78-343, STRAIN TIME HISTORY

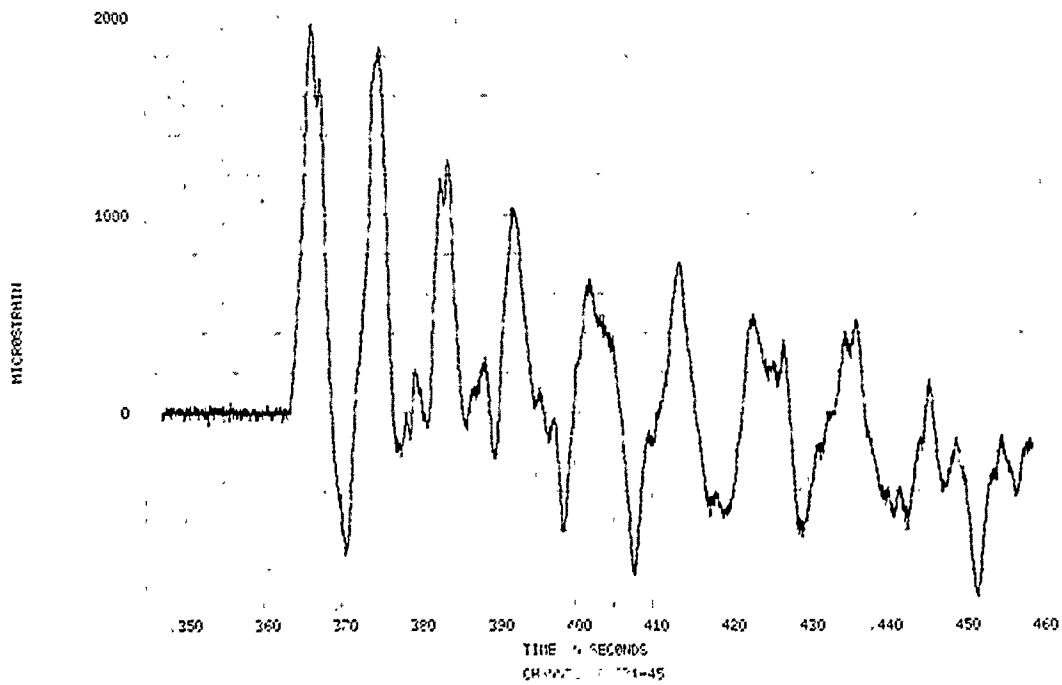

FIGURE 191. SPECIMEN 31, EVENT 78-343, STRAIN TIME HISTORY

141

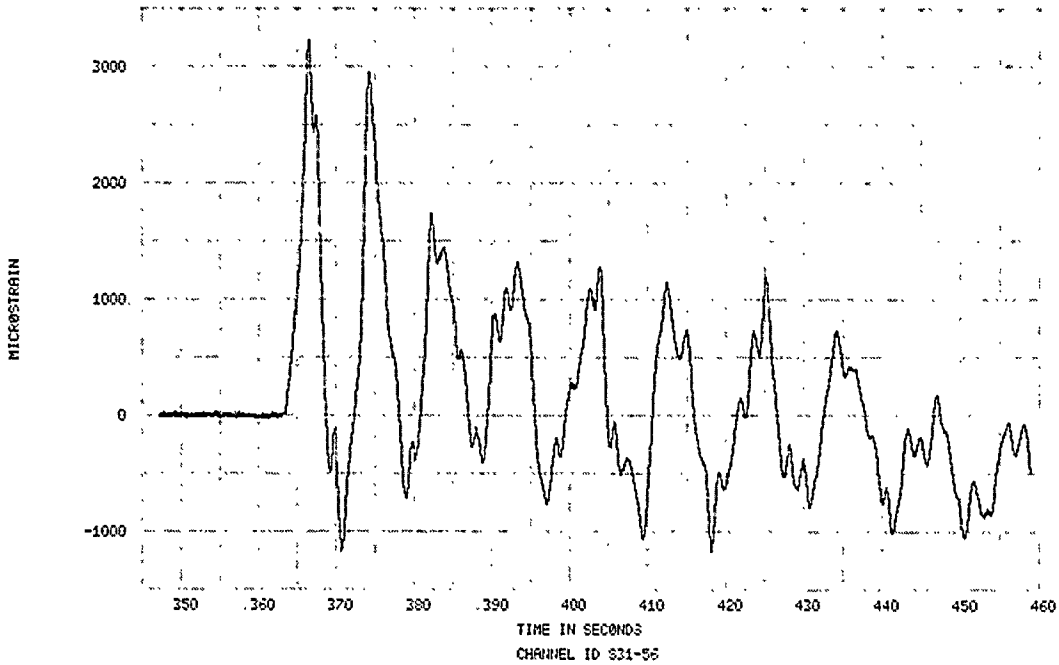

FIGURE 192. SPECIMEN 31, EVENT 78-343, STRAIN TIME HISTORY

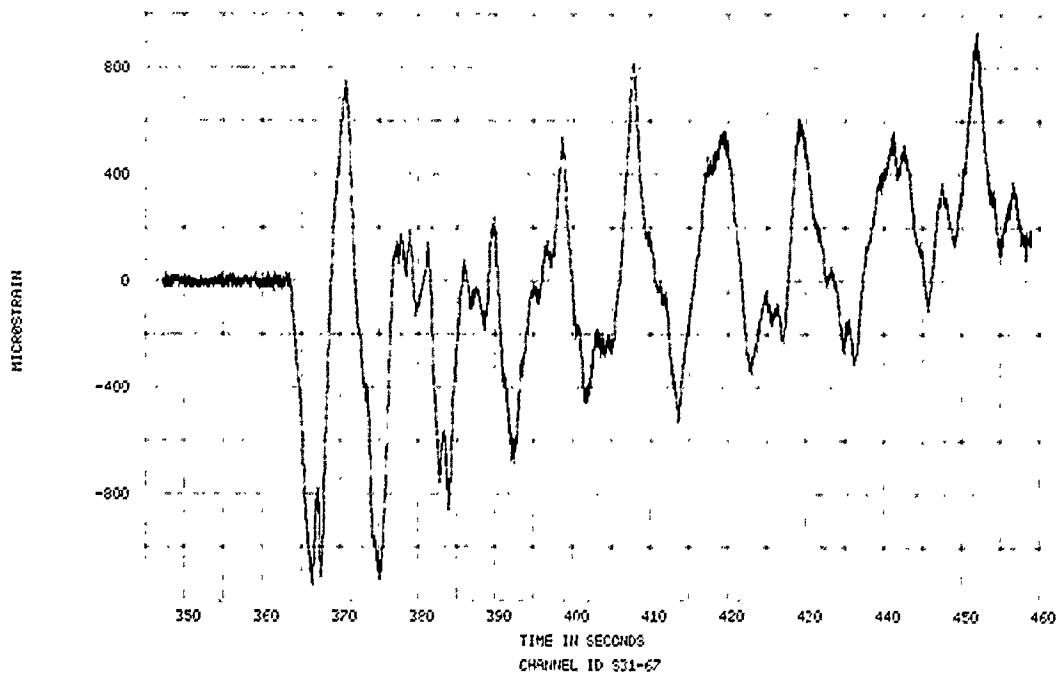

FIGURE 193. SPECIMEN 31, EVENT 78-343, STRAIN TIME HISTORY

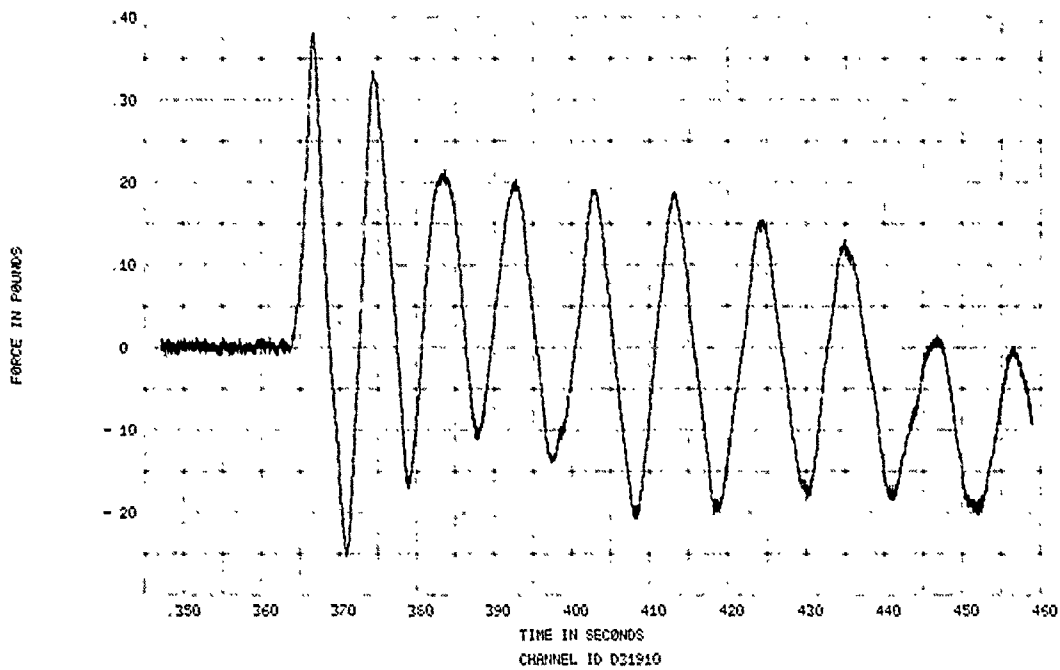

FIGURE 194. SPECIMEN 31, EVENT 78-343, DEFLECTION TIME HISTORY

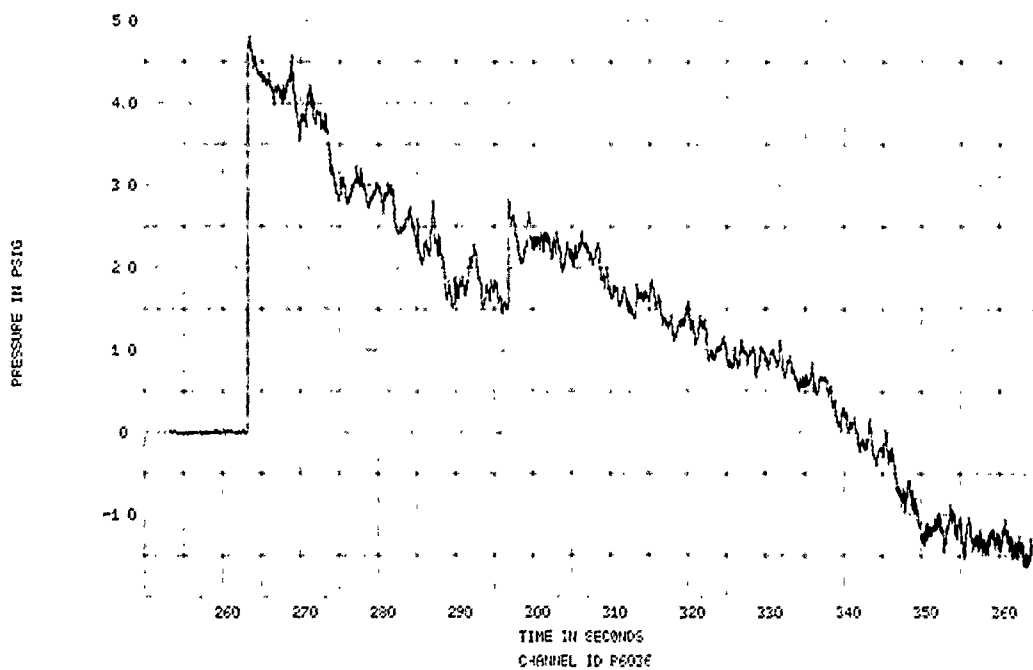

FIGURE 195. SPECIMEN 31, EVENT 78-344, TUNNEL WALL INCIDENT OVERPRESSURE TIME HISTORY

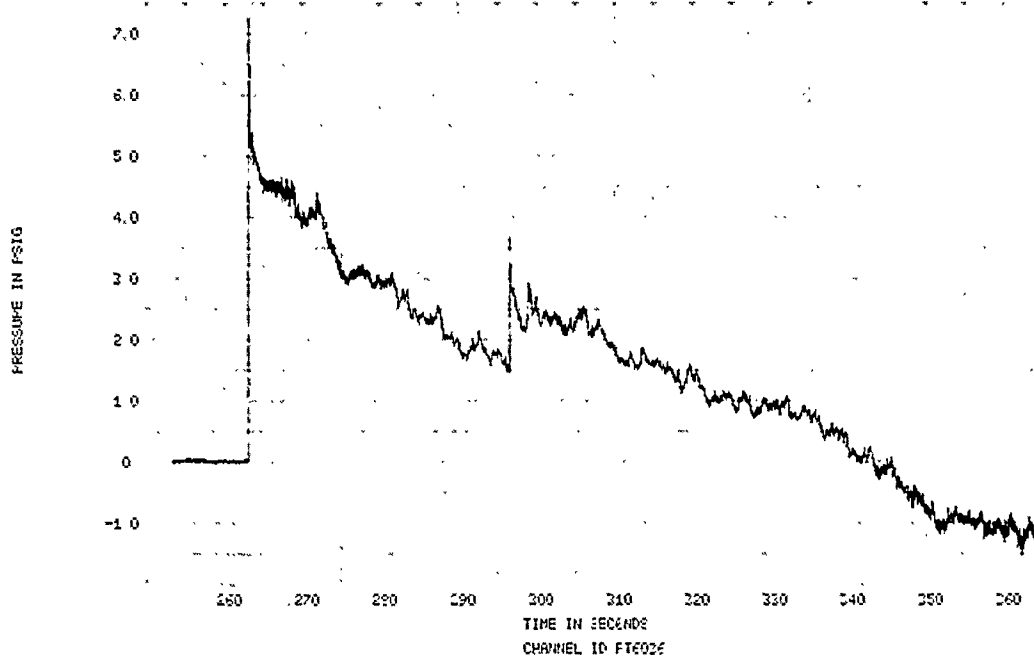

FIGURE 196. SPECIMEN 31, EVENT 78-344, TUNNEL WALL REFLECTED OVERPRESSURE TIME HISTORY

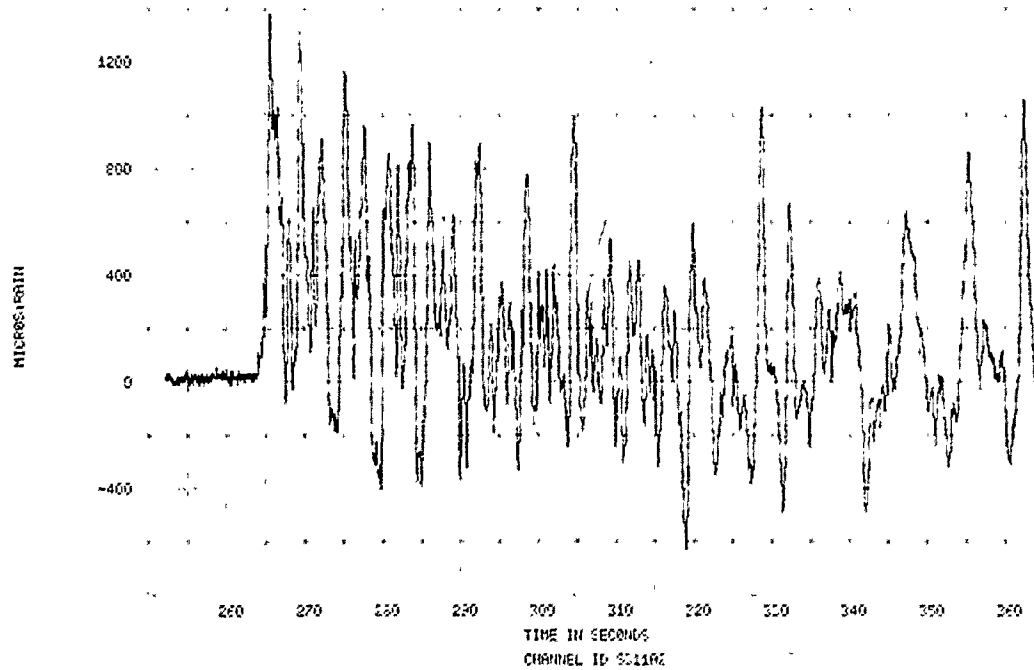

FIGURE 197. SPECIMEN 31, EVENT 78-344, STRAIN TIME HISTORY

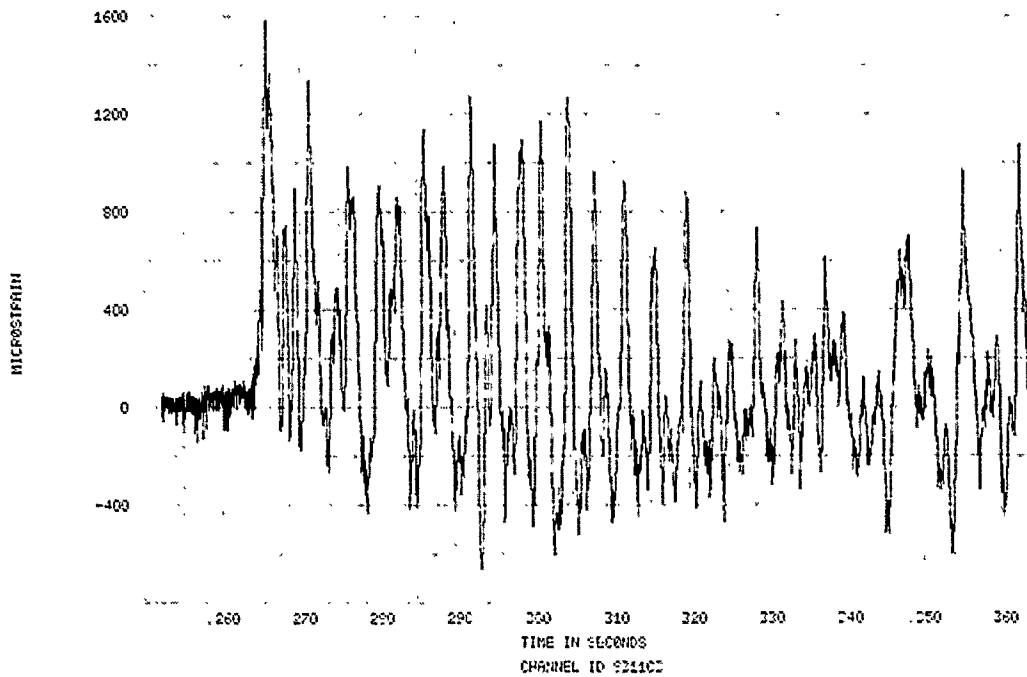

FIGURE 198. SPECIMEN 31, EVENT 78-344, STRAIN TIME HISTORY

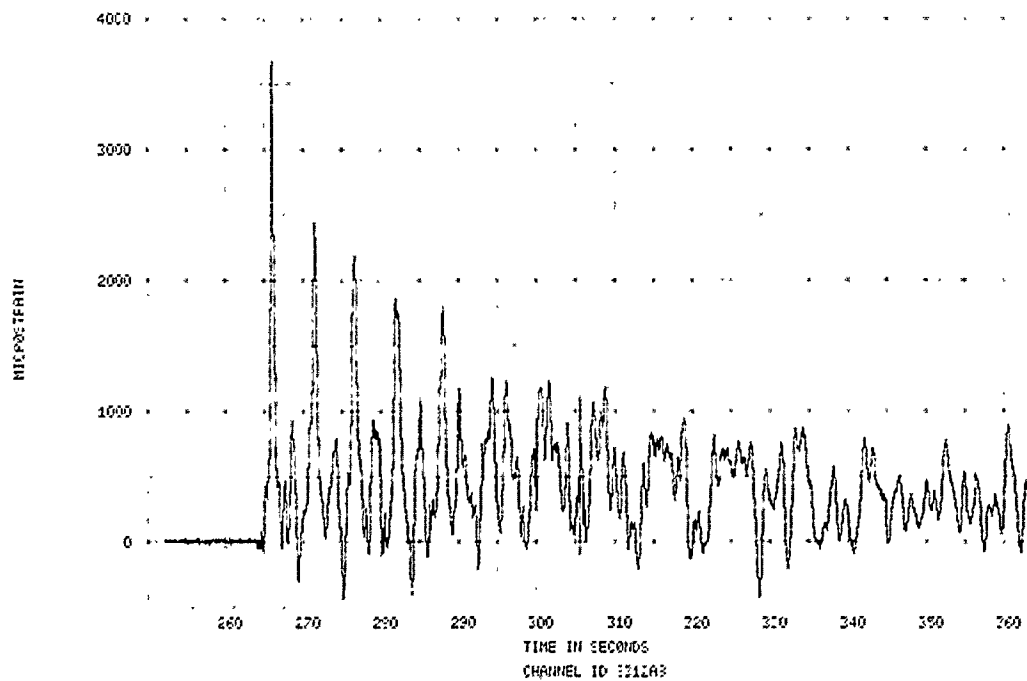

FIGURE 199. SPECIMEN 31, EVENT 78-344, STRAIN TIME HISTORY

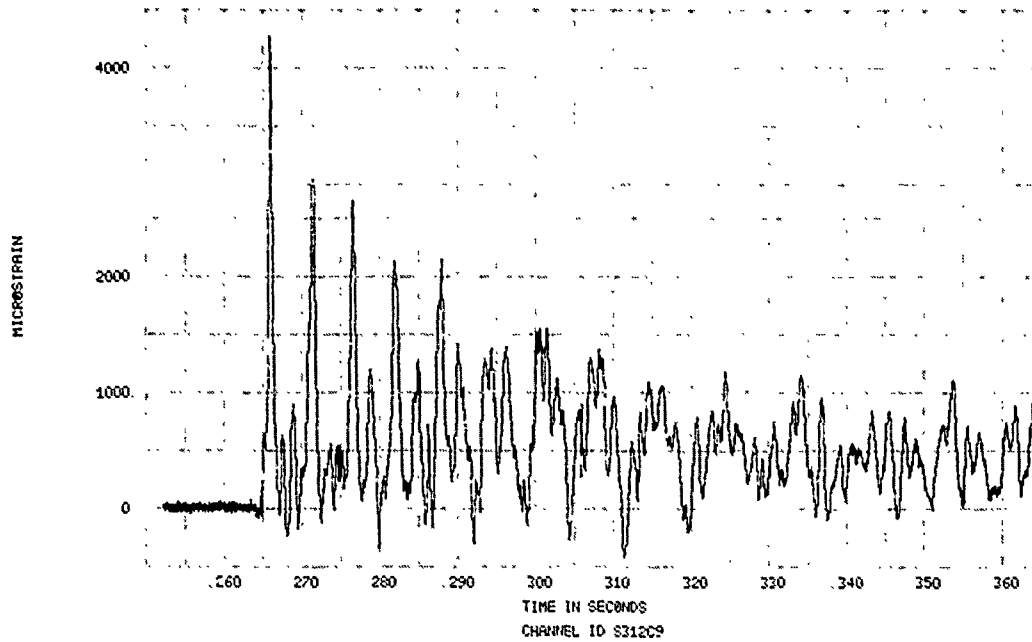

FIGURE 200. SPECIMEN 31, EVENT 78-344, STRAIN TIME HISTORY

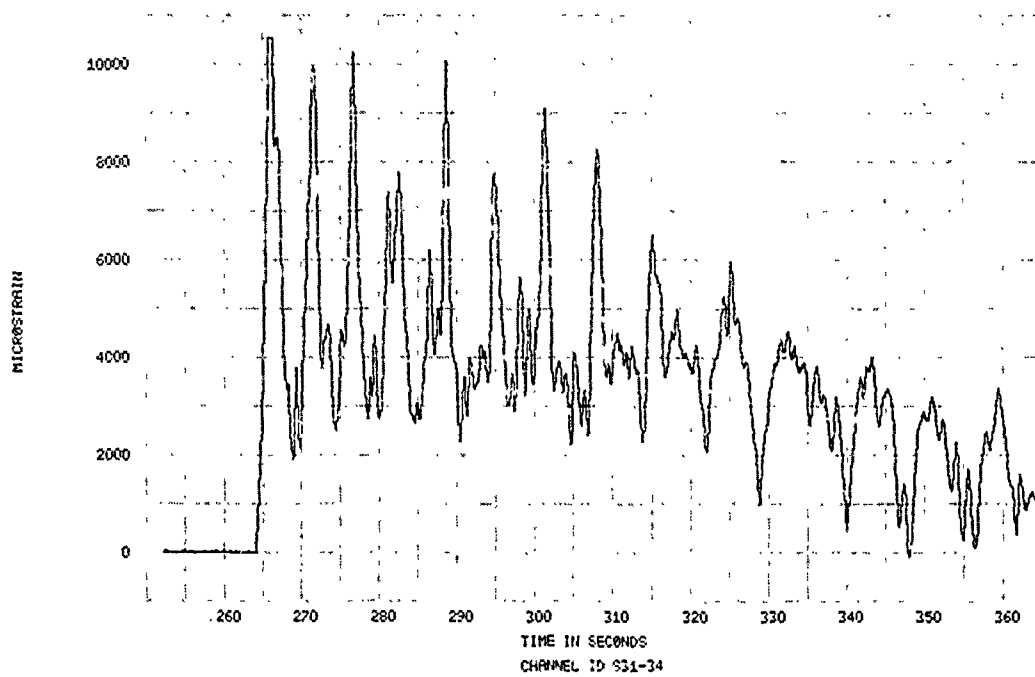

FIGURE 201. SPECIMEN 31, EVENT 78-344, STRAIN TIME HISTORY

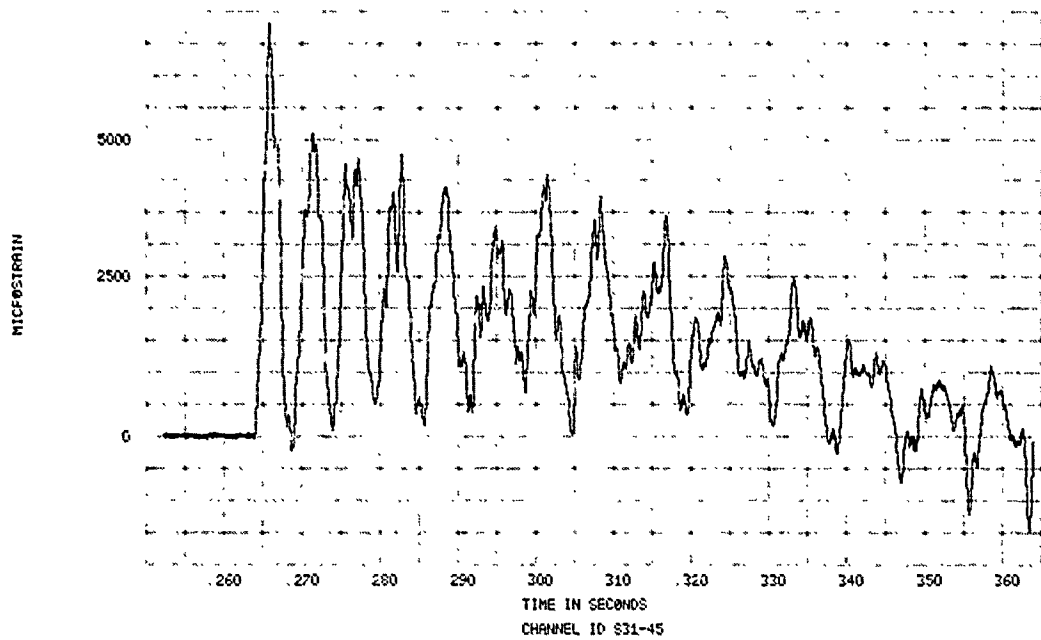

FIGURE 202. SPECIMEN 31, EVENT 78-344, STRAIN TIME HISTORY

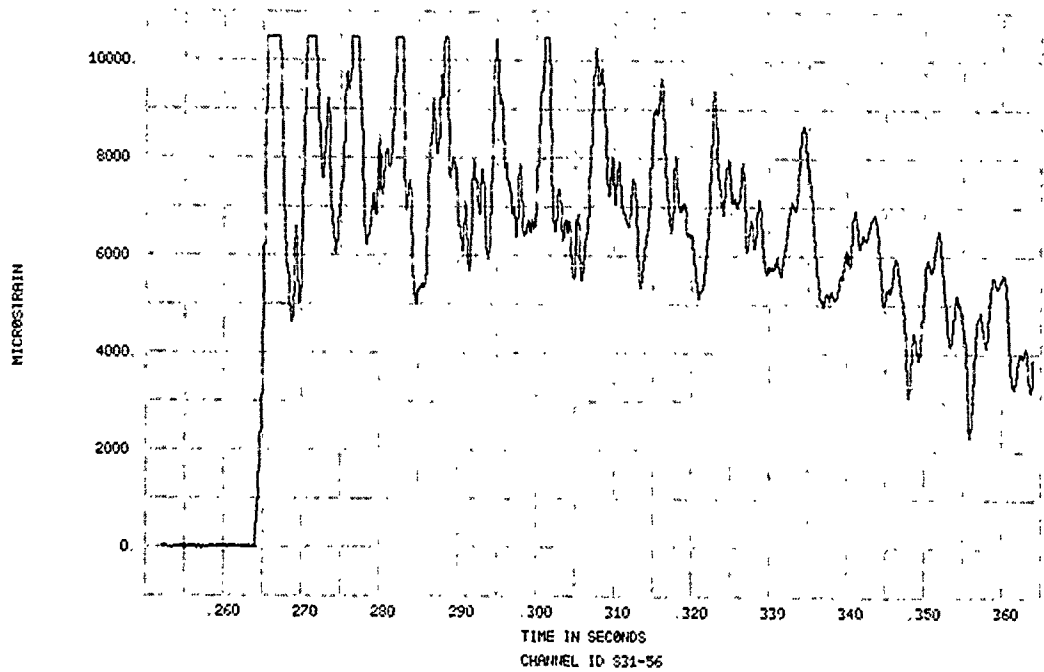

FIGURE 203. SPECIMEN 31, EVENT 78-344, STRAIN TIME HISTORY

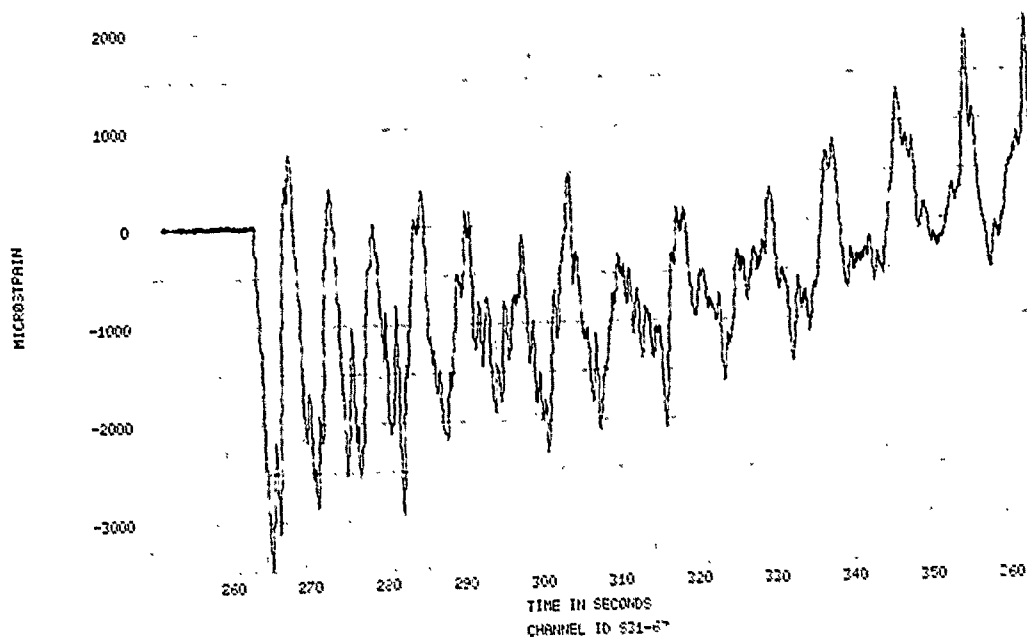
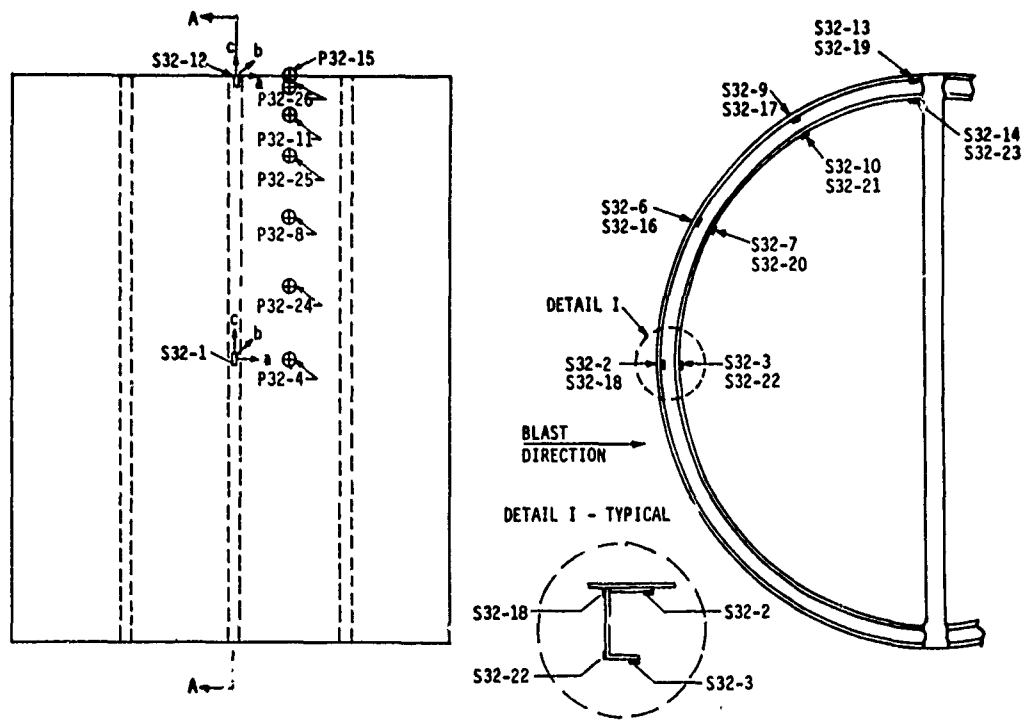

FIGURE 204. SPECIMEN 31, EVENT 78-344, STRAIN TIME HISTORY

SPECIMEN NO. 32



SPECIMEN NO. 32

SKIN/FRAME CYLINDER (24.0 IN. RADIUS)
 FRAME CLAMPED AT TWO DIAMETRICALLY OPPOSITE POINTS
 MATERIAL - 6061-T42 ALUMINUM ALLOY
 DENSITY - 0.0002539 LB-SEC²/IN⁴
 MODULUS OF ELASTICITY - 11.4×10^6 PSI
 YIELD STRESS - 19,990 PSI
 ULTIMATE STRESS - 38,470 PSI

The skin was bonded to the frame and was not included in the cross-section due to lack of shear transfer

Figure 205. Description and Instrumentation - Specimen No. 32

PRECEDING PAGE BLANK-NOT FILMED

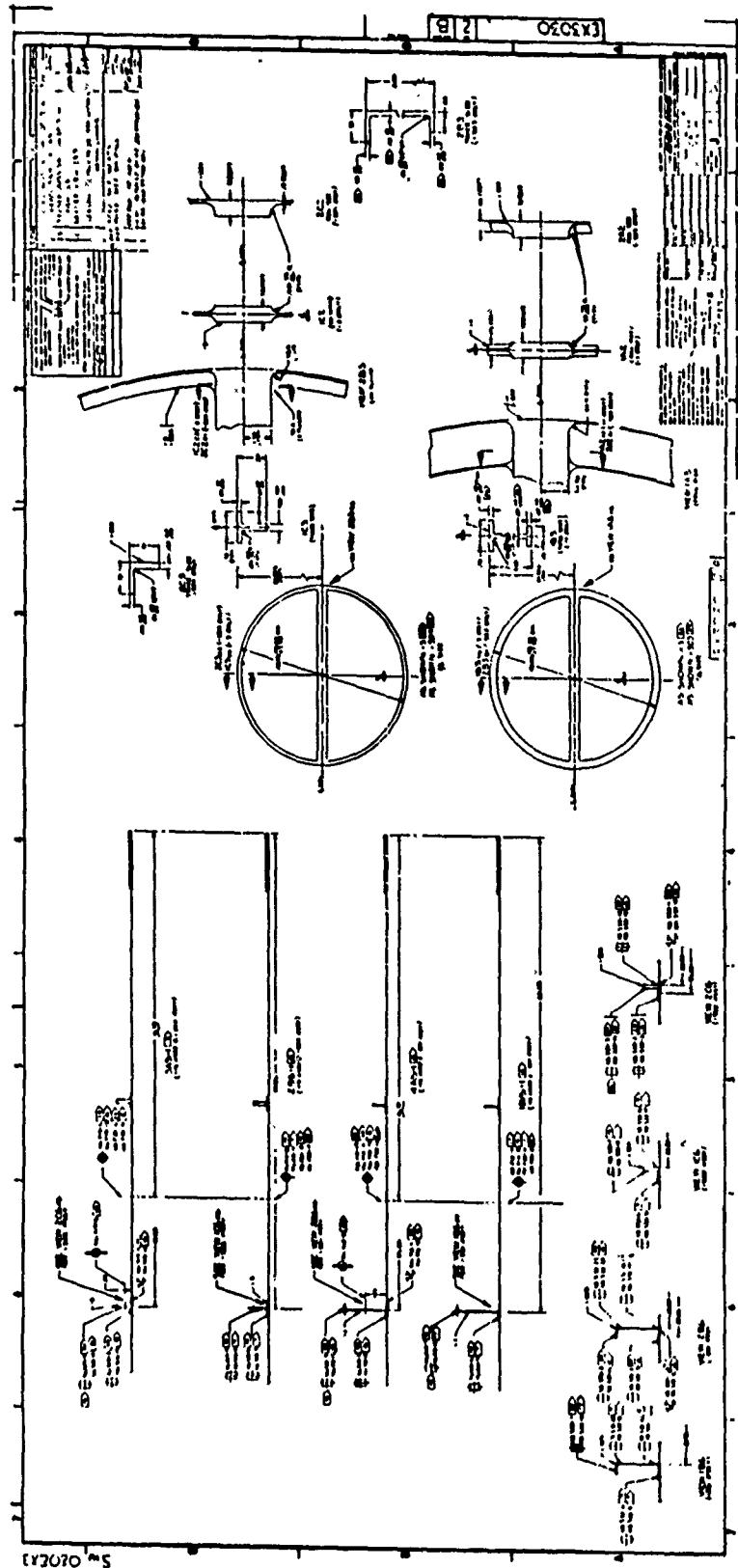

Figure 206. Spec Drawing - Specimen No. 32

NOVA-2LT DATA DECK LISTING
TEST SPECIMEN 32

*** NOVA-2LT DATA DECK FOR TEST SPECIMEN 32 ***						GP 1
1	7	100	2	1		GP 3
0.50	2	2	5	1	1	GP 4
	18	3	6			GPB 1
22.96	1.30					GPB 2
22.90	2.10					GPB 5
22.77	3.22					GPB 6
22.42	5.13					GPB 6
21.91	6.99					GPB 6
21.25	8.81					GPB 6
21.13	10.17					GPB 6
19.92	11.50					GPB 6
19.12	12.78					GPB 6
17.75	14.63					GPB 6
16.26	16.26					GPB 6
14.63	17.75					GPB 6
12.78	19.13					GPB 6
11.50	19.92					GPB 6
9.39	21.0					GPB 6
7.59	21.71					GPB 6
5.75	22.27					GPB 6
3.85	22.68					GPB 6
1.93	22.92					GPB 6
0.0	23.0					GPB 7
	0					GPB 8
.0002539	1	1	1			GPB 12
9.0	.0002539	.0002539				GPB 13
0.110						GPB 14
0.705						GPB 15
	2					GPB 16
0.001708	19464.					GPB 17
0.19474	37458.					GPB 18
	2					GPB 18
0.001754	19990.					GPB 19
0.200	38470.					GPB 20
1.787						GPB 20
0.106						GPB 15
	2					GPB 16
0.001708	19464.					GPB 17
0.19474	37458.					GPB 18
	2					GPB 18
0.001754	19990.					GPB 19
0.200	38470.					GPB 20
1.106						GPB 20
0.460						GPB 15
	2					GPB 16
0.001708	19464.					GPB 17
0.19474	37458.					GPB 18
	2					GPB 18
0.001754	19990.					GPB 19
0.200	38470.					GPB 20
0.000001	0.010	100.0				GPB 20
	4					GPB 22
						GP 6

TABLE 19
 STATIC TEST STRESS DATA - SPECIMEN 32
 (STRESSES GIVEN IN PSI)

STRAIN GAUGE	STATIC PRESSURE (PSI)									
	0.80	1.20	1.50	2.0	2.50	3.0	3.50	4.0		
S32-1	8776.	12713.	15426.	18793.	14752.	23749.	24393.	24312.		
S32-2	-1003.	-1288.	-1585.	-2314.	-2360.	-1767.	-2314.	-3181.		
S32-3	-673.	-1060.	-1322.	-1721.	-2143.	-2782.	-3374.	-3956.		
S32-6	-1699.	-2679.	-3557.	-5677.	-7763.	-9565.	-11172.	-11788.		
S32-7	80.	11.	-114.	-513.	-969.	-1721.	-2246.	-2633.		
S32-9	-2497.	-3773.	-4708.	-6270.	-6977.	-8014.	-8983.	-10123.		
S32-10	547.	718.	730.	342.	-217.	-832.	-1402.	-1881.		
S32-12	-3428.	-7418.	-8168.	-8474.	-8352.	-11989.	17828.	23929.		
S32-13	251.	946.	1208.	889.	410.	-125.	-730.	-1653.		
S32-14	-365.	-490.	-524.	-559.	-627.	-331.	-399.	-467.		
S32-16	251.	331.	467.	832.	1083.	1402.	1379.	889.		
S32-17	422.	536.	627.	695.	467.	490.	422.	410.		
S32-18	547.	627.	650.	627.	296.	-274.	-456.	-399.		
S32-19	684.	695.	638.	433.	239.	-399.	-638.	-707.		
S32-20	-194.	-308.	-445.	-730.	-935.	-1311.	-1345.	-1003.		
S32-21	638.	866.	912.	764.	707.	479.	376.	262.		
S32-22	-992.	-1448.	-1699.	-1892.	-1858.	-1858.	-1915.	-2006.		
S32-23	-1471.	-2120.	-2440.	-2907.	-3409.	-3602.	-4138.	-4788.		

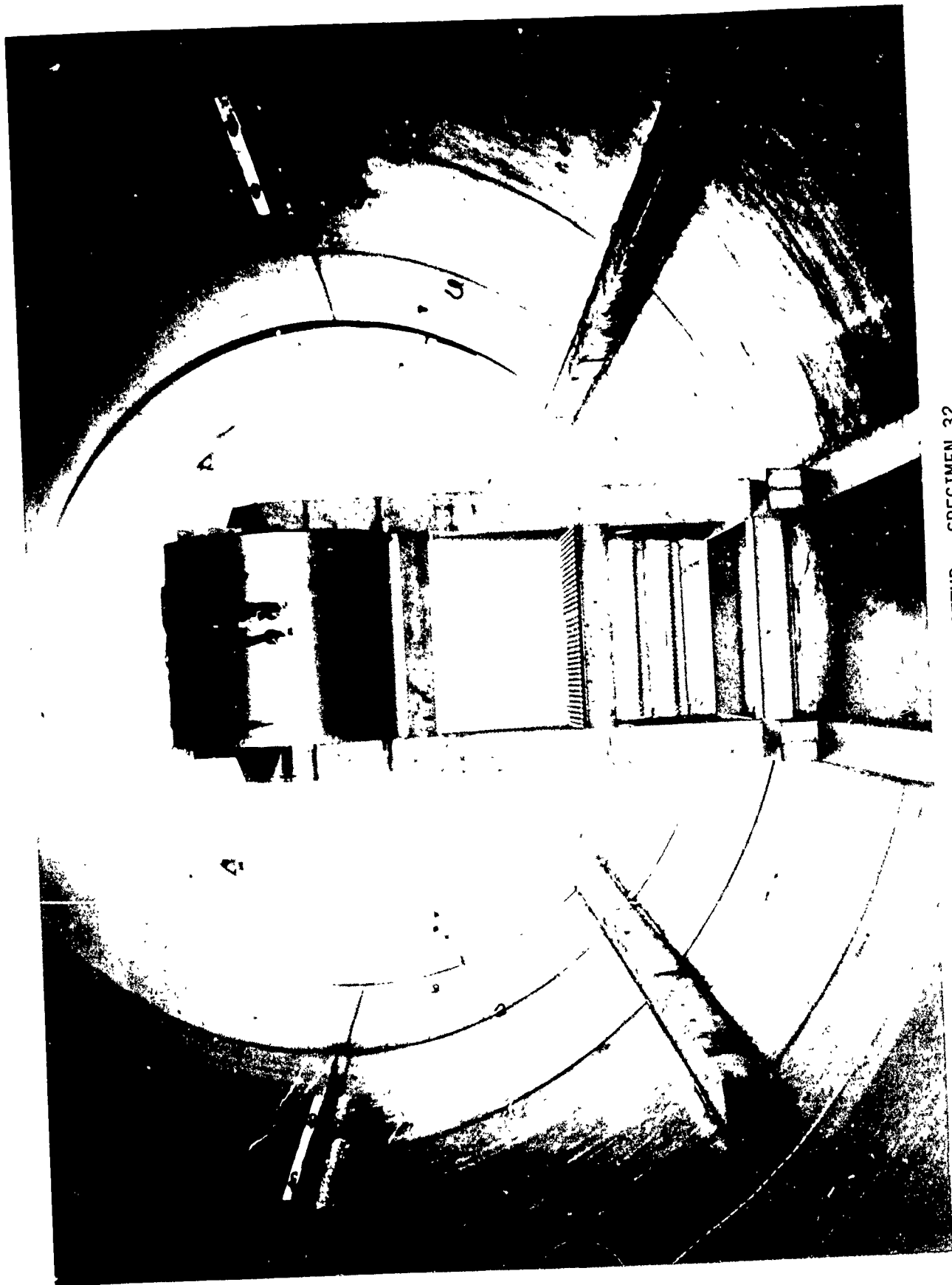

FIGURE 207. SHOCK TEST SETUP - SPECIMEN 32

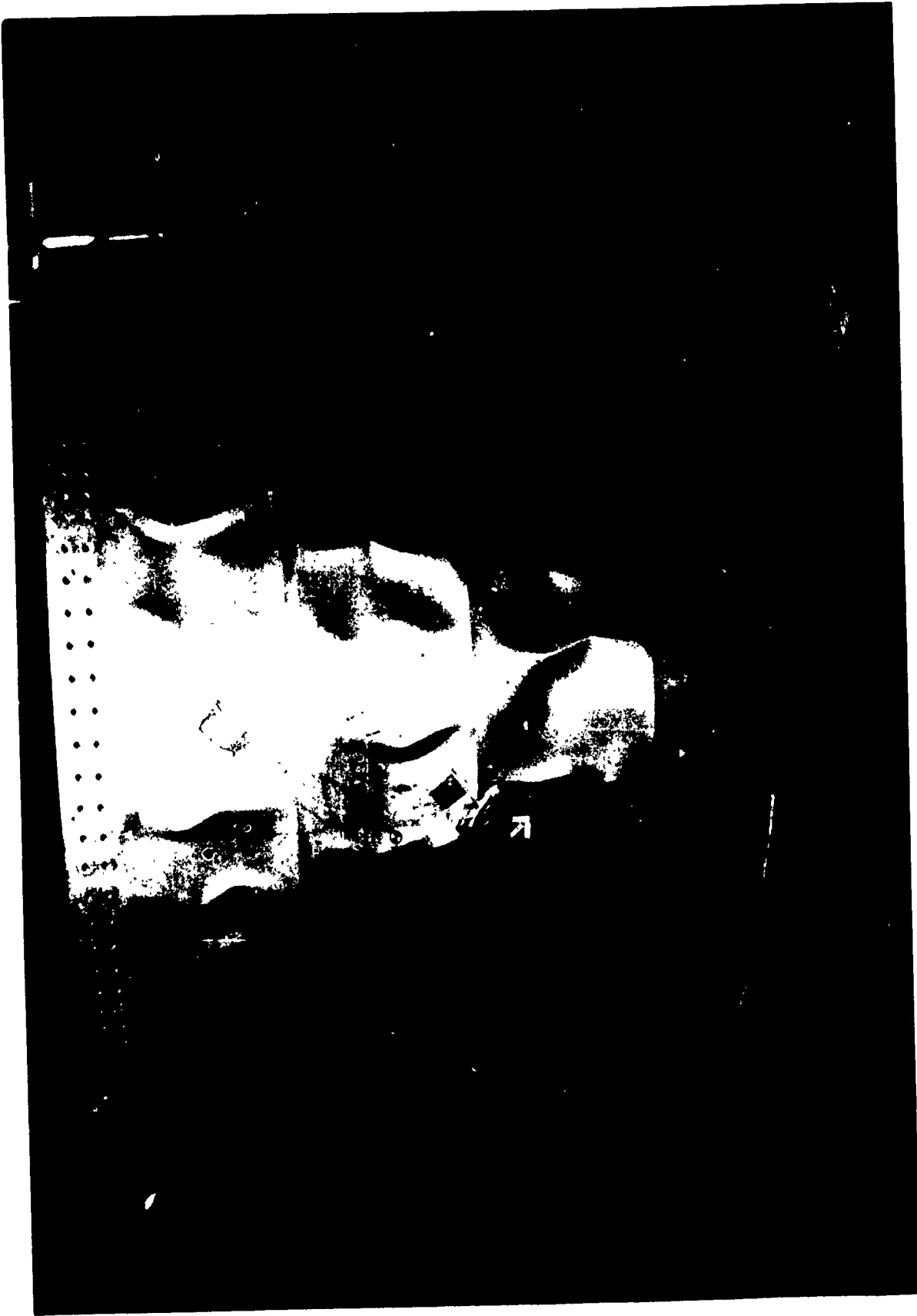

FIGURE 208. CONDITION OF SPECIMEN 32 SUBSEQUENT
TO SHOCK LOAD TEST



FIGURE 209. CONDITION OF SPECIMEN 32 SUBSEQUENT TO SHOCK LOAD TEST

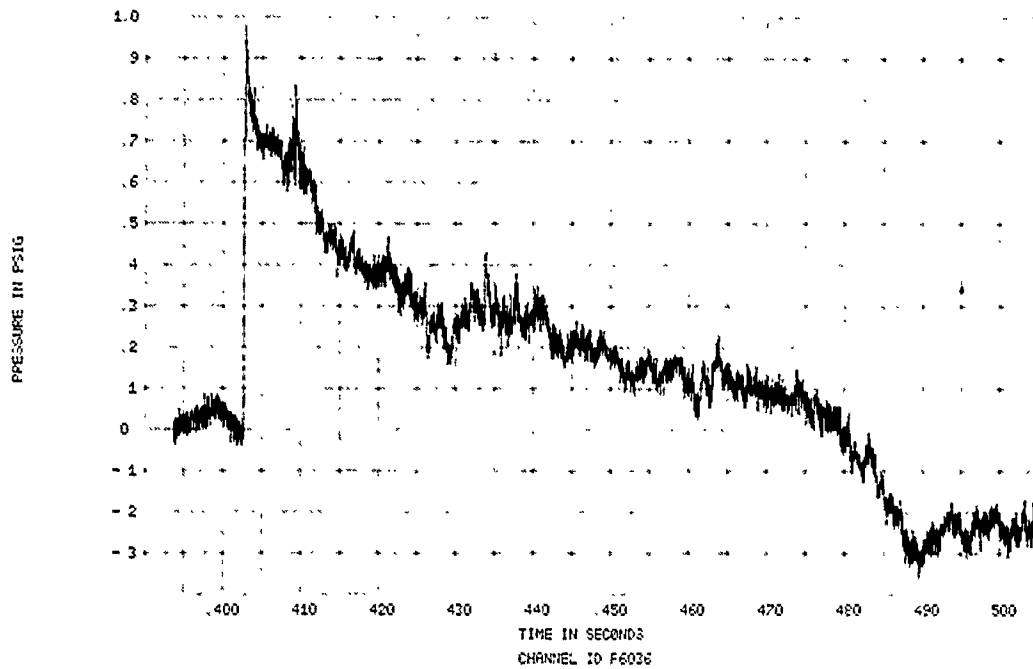

FIGURE 210. SPECIMEN 32, EVENT 78-345, TUNNEL WALL INCIDENT OVERPRESSURE TIME HISTORY

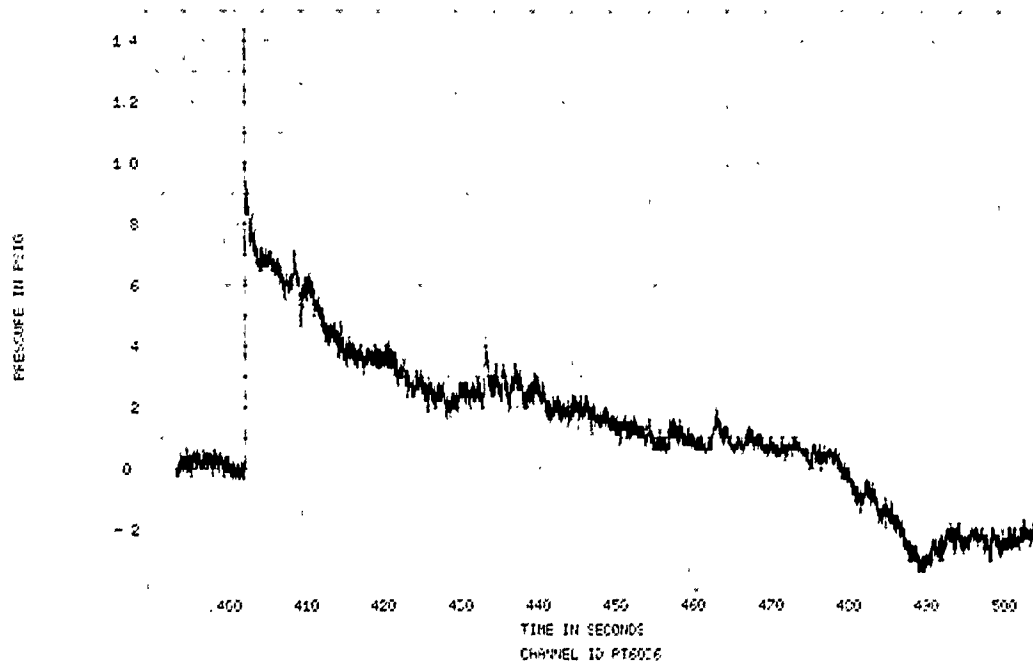

FIGURE 211. SPECIMEN 32, EVENT 78-345, TUNNEL WALL REFLECTED OVERPRESSURE TIME HISTORY

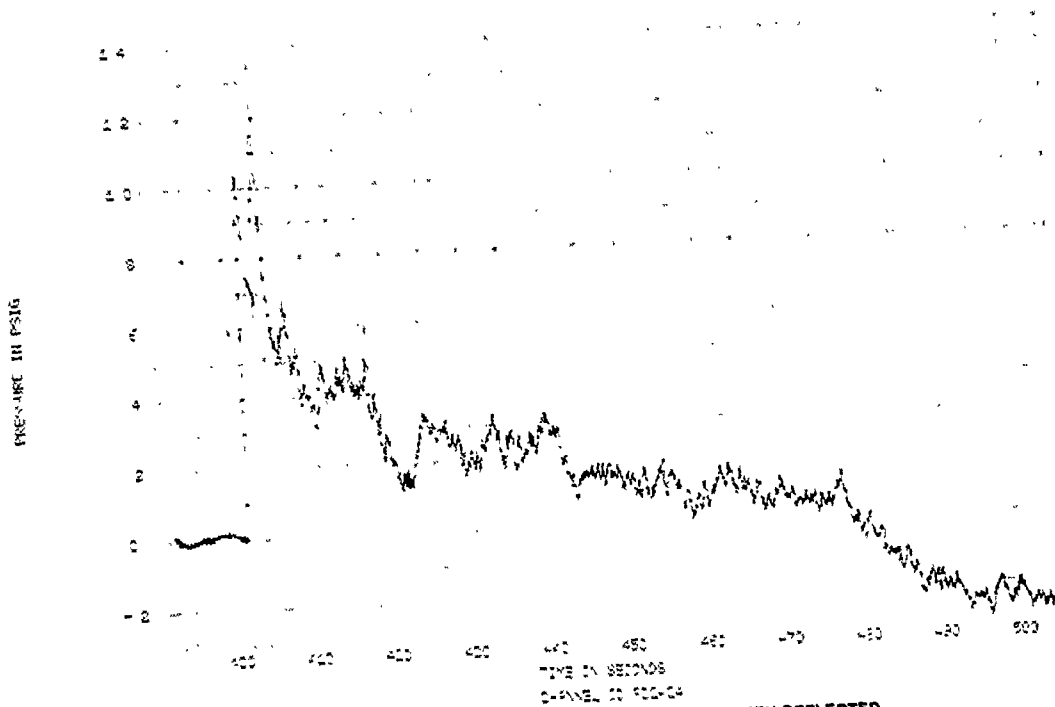

FIGURE 212. SPECIMEN 32, EVENT 78-345, SPECIMEN REFLECTED OVERPRESSURE TIME HISTORY

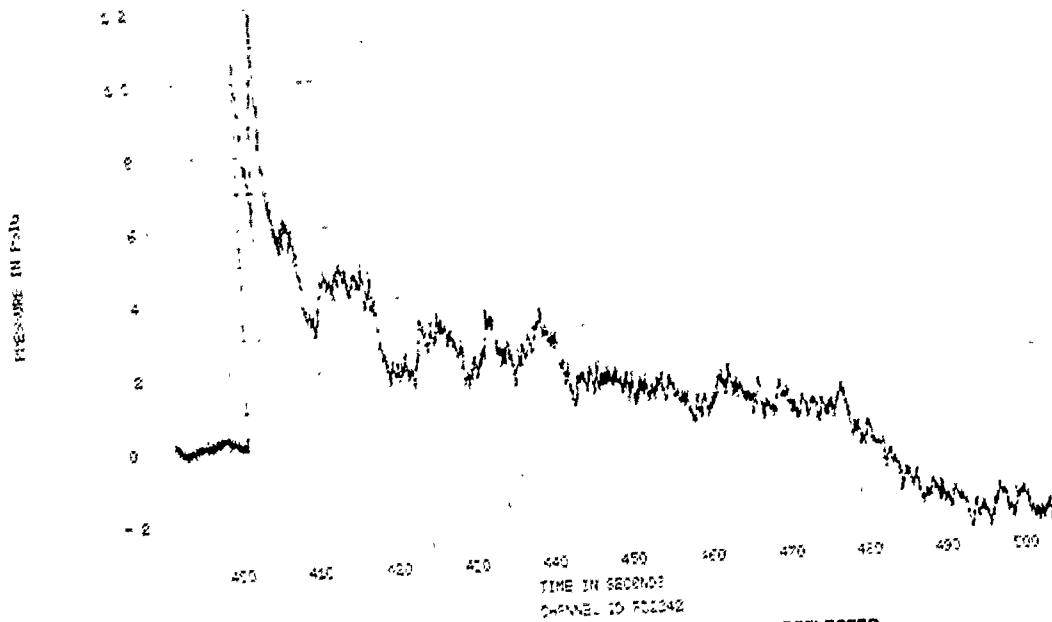

FIGURE 213. SPECIMEN 32, EVENT 78-345, SPECIMEN REFLECTED OVERPRESSURE TIME HISTORY

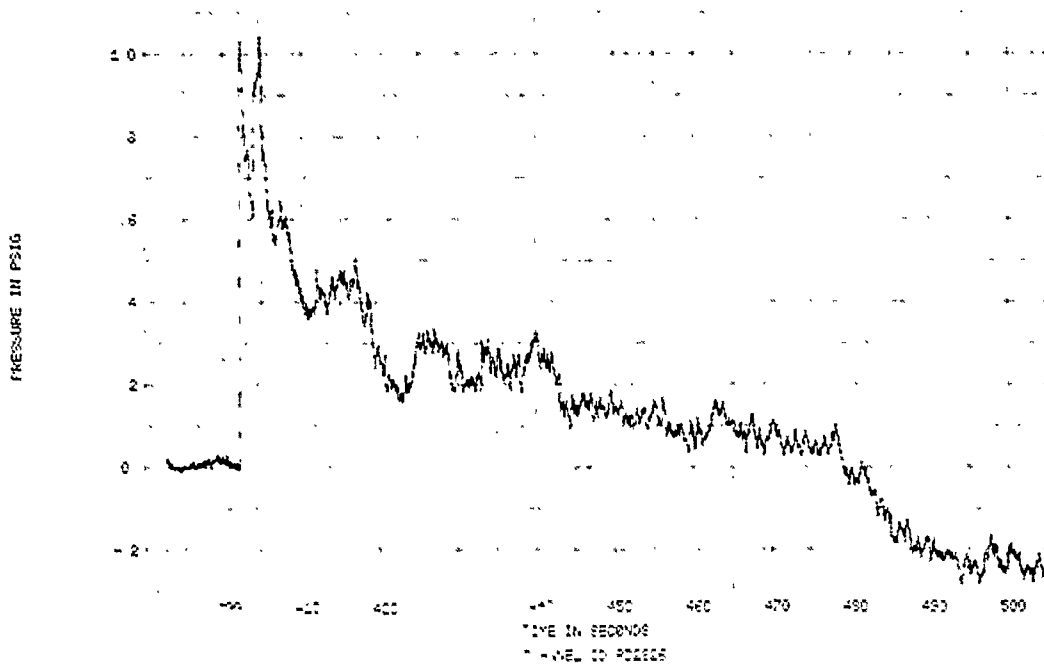

FIGURE 214. SPECIMEN 32, EVENT 78-345, SPECIMEN REFLECTED OVERPRESSURE TIME HISTORY

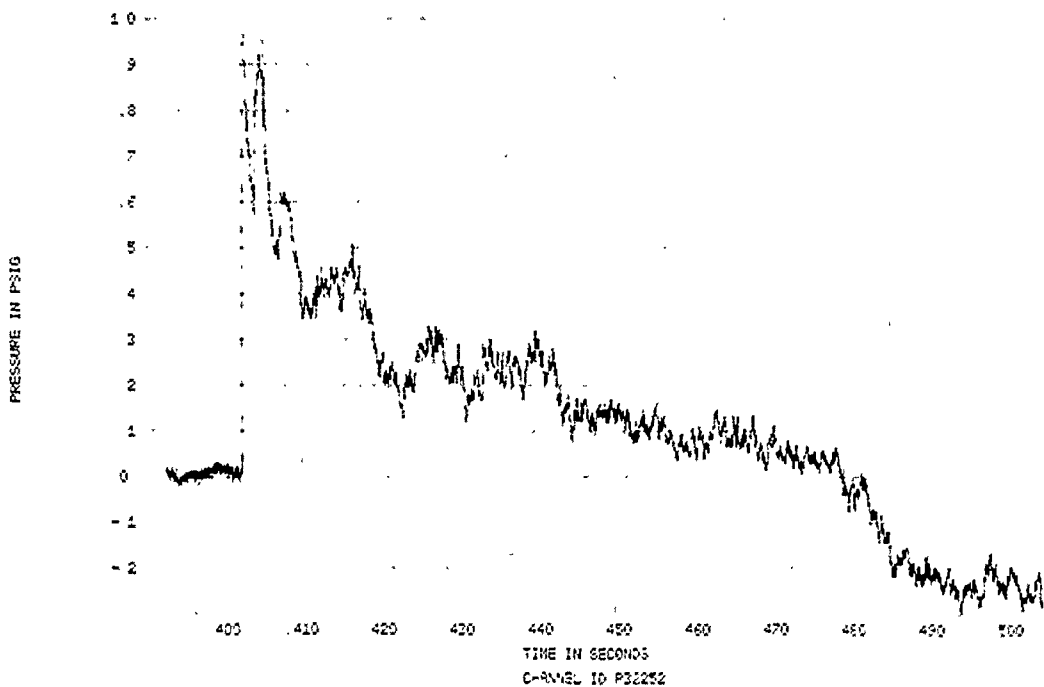

FIGURE 215. SPECIMEN 32, EVENT 78-345, SPECIMEN REFLECTED OVERPRESSURE TIME HISTORY

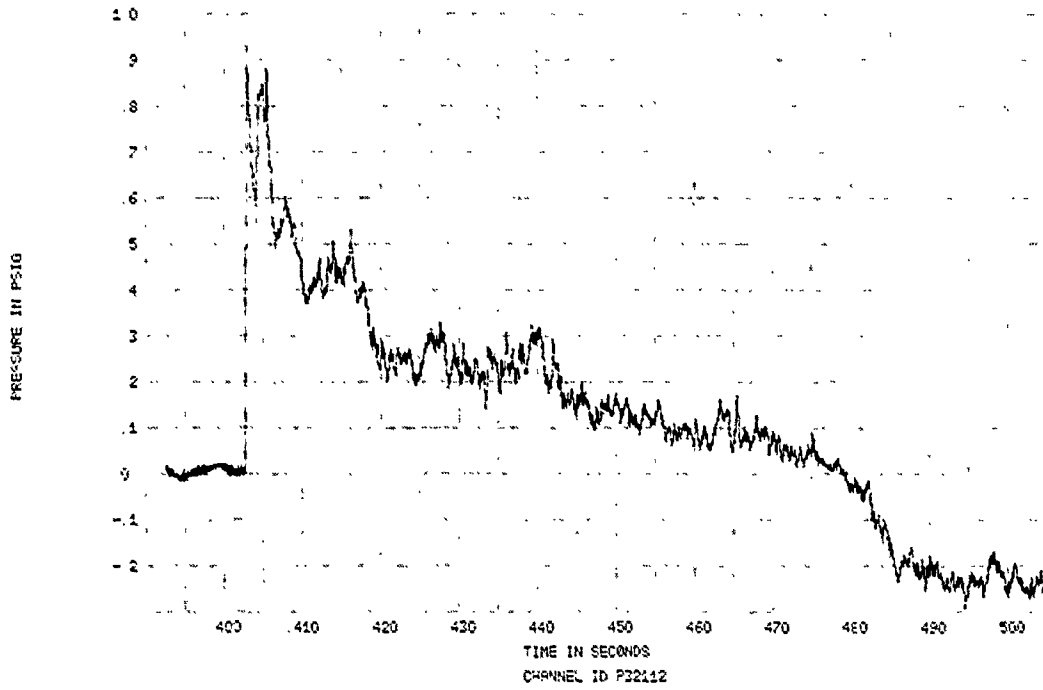

FIGURE 216. SPECIMEN 32, EVENT 78-345, SPECIMEN REFLECTED OVERPRESSURE TIME HISTORY

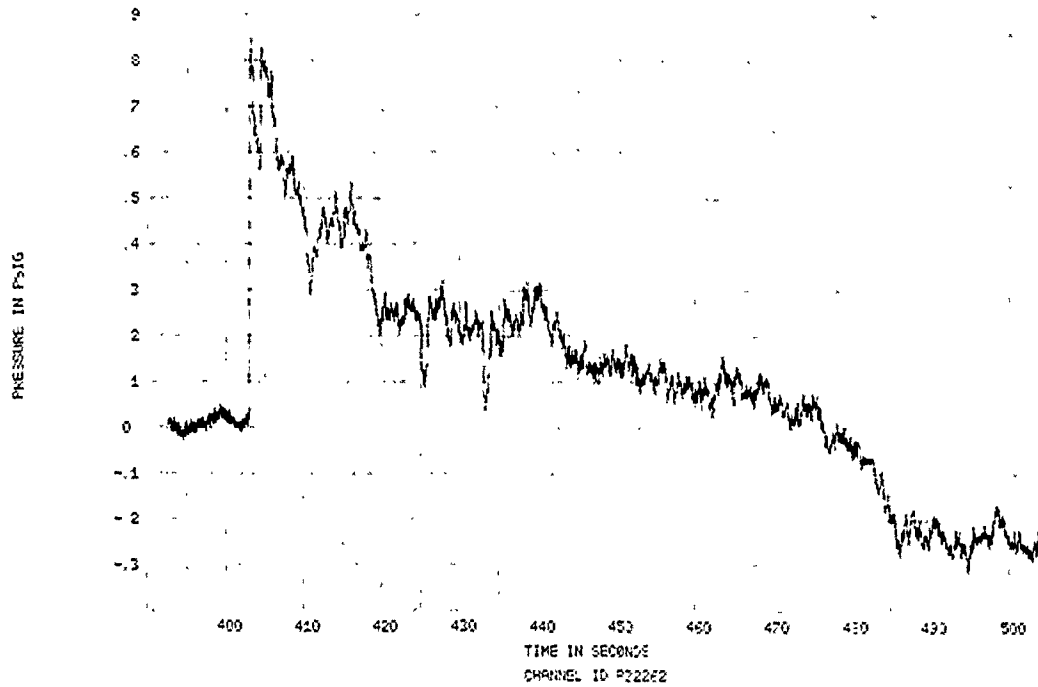

FIGURE 217. SPECIMEN 32, EVENT 78-345, SPECIMEN REFLECTED OVERPRESSURE TIME HISTORY

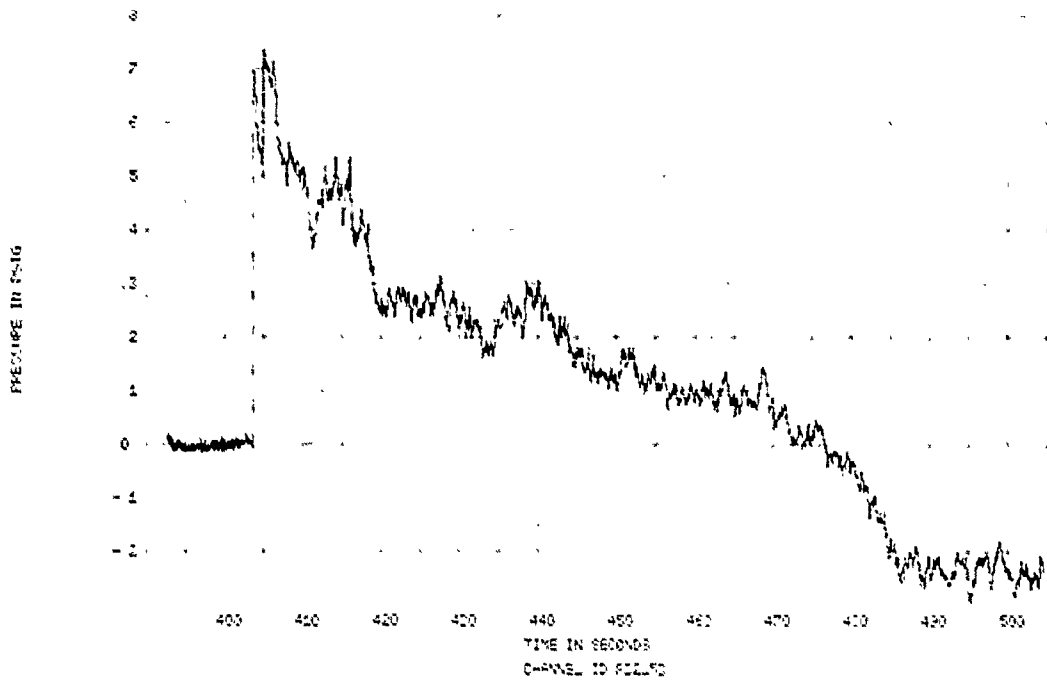

FIGURE 218. SPECIMEN 32, EVENT 78-345, SPECIMEN REFLECTED OVERPRESSURE TIME HISTORY

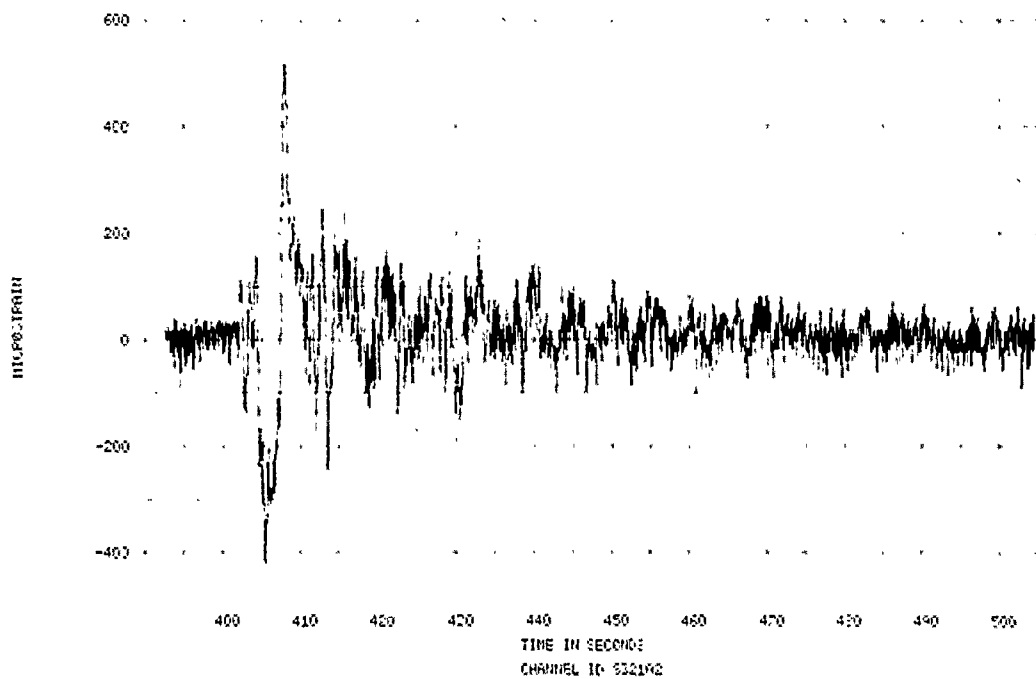

FIGURE 219. SPECIMEN 32, EVENT 78-345, STRAIN TIME HISTORY

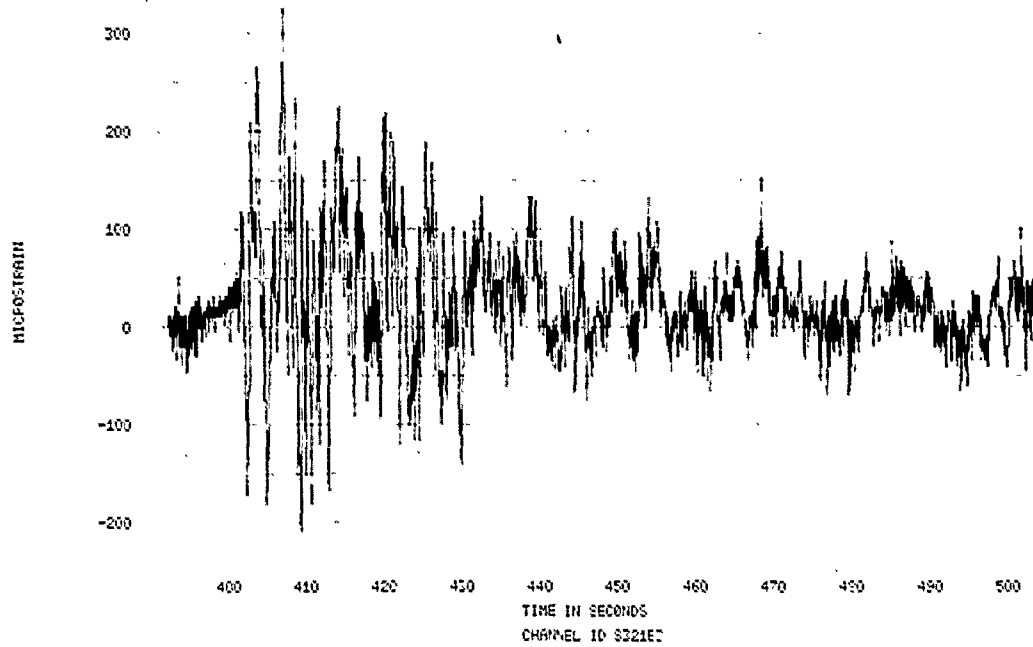

FIGURE 220. SPECIMEN 32, EVENT 78-345, STRAIN TIME HISTORY

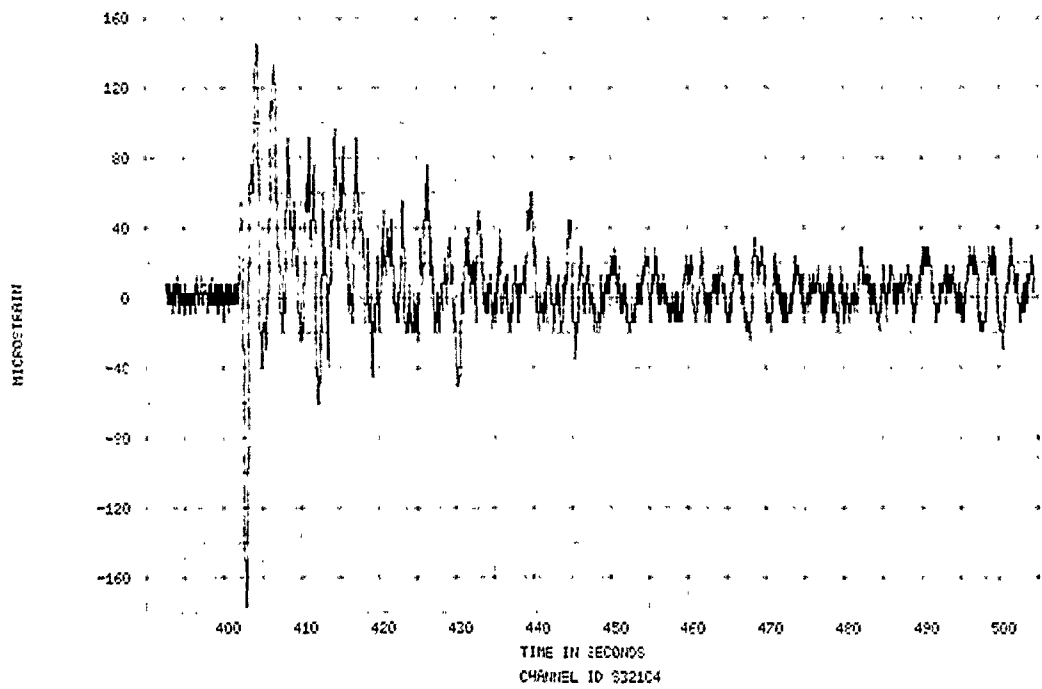

FIGURE 221. SPECIMEN 32, EVENT 78-345, STRAIN TIME HISTORY

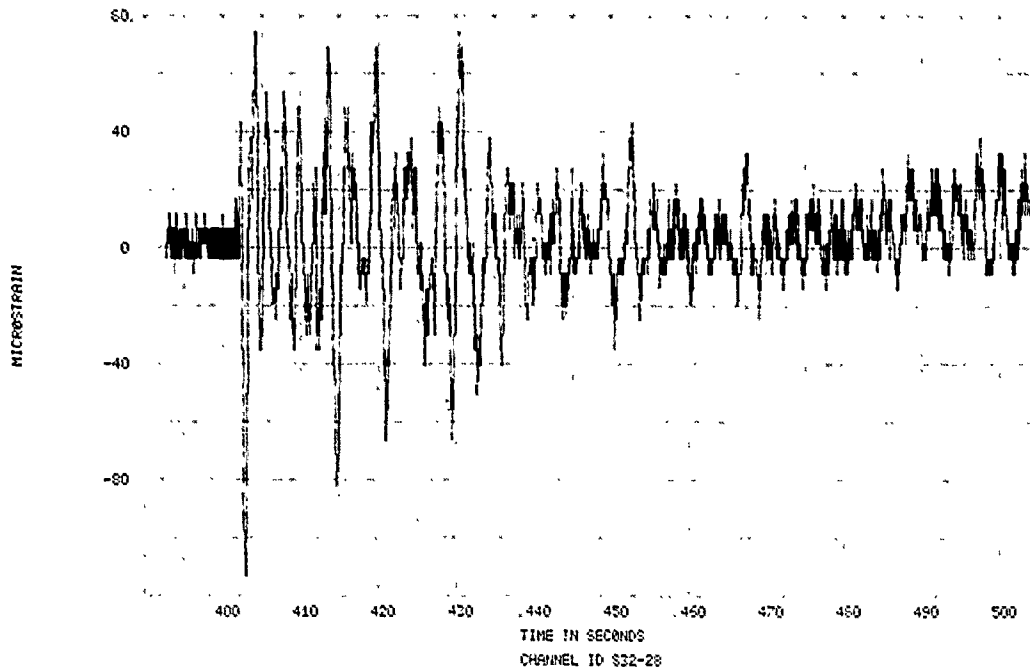

FIGURE 222. SPECIMEN 32, EVENT 78-345, STRAIN TIME HISTORY

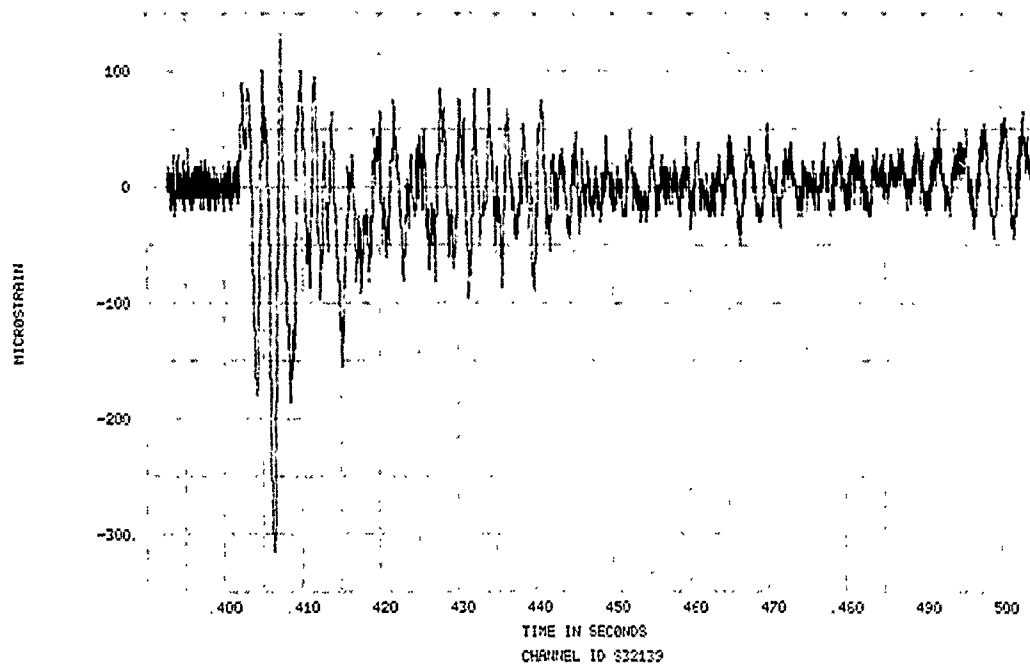

FIGURE 223. SPECIMEN 32, EVENT 78-345, STRAIN TIME HISTORY

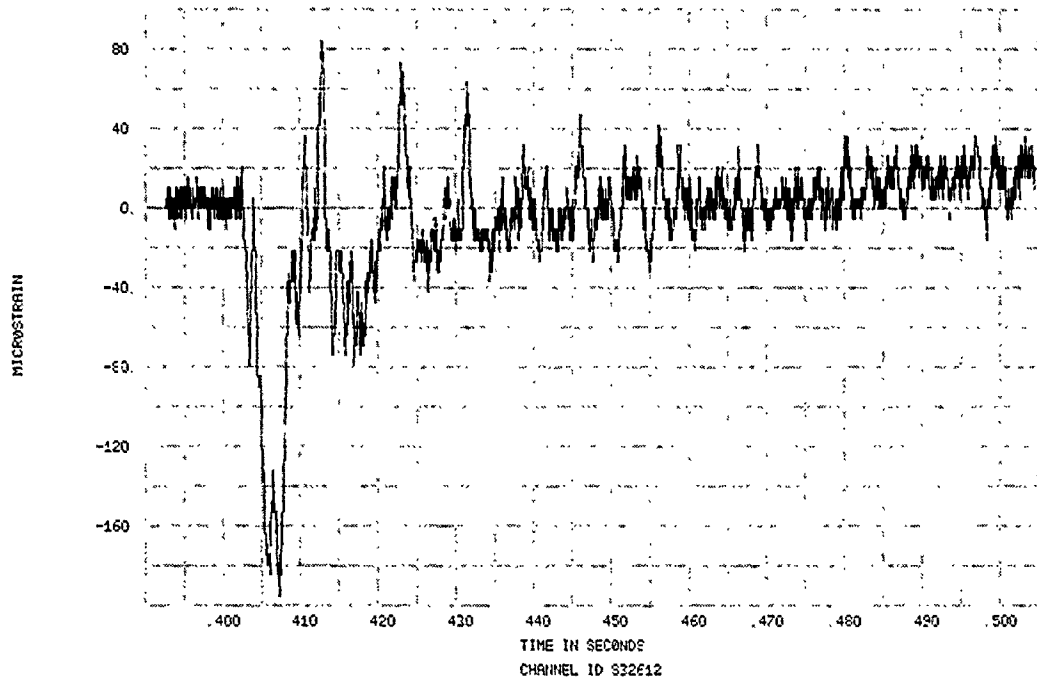

FIGURE 224. SPECIMEN 32, EVENT 78-345, STRAIN TIME HISTORY

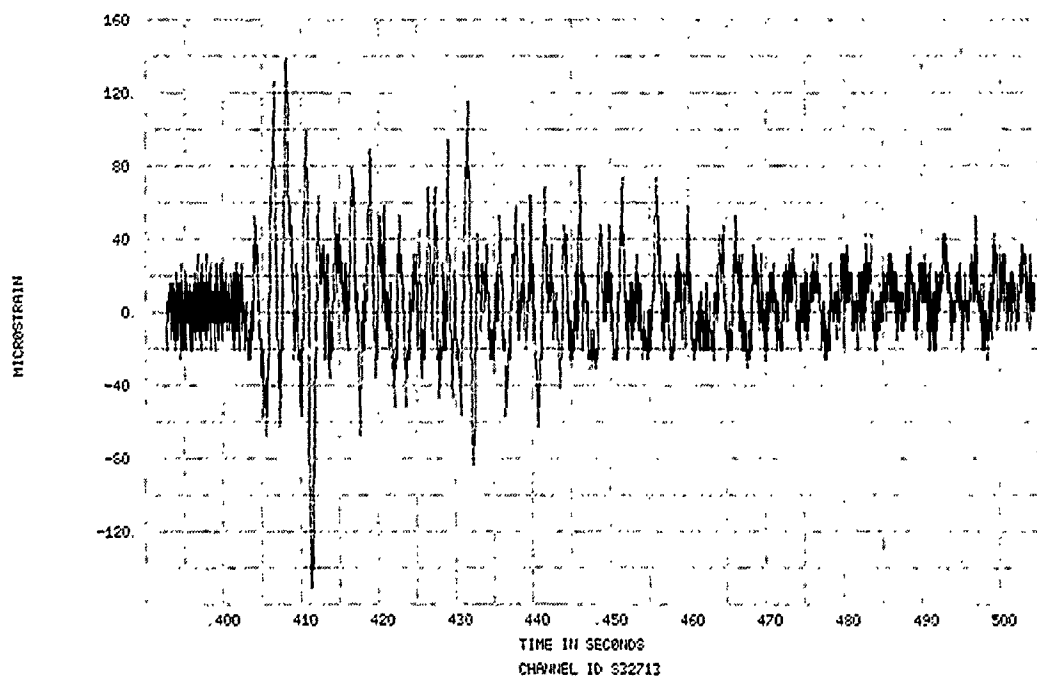

FIGURE 225. SPECIMEN 32, EVENT 78-345, STRAIN TIME HISTORY

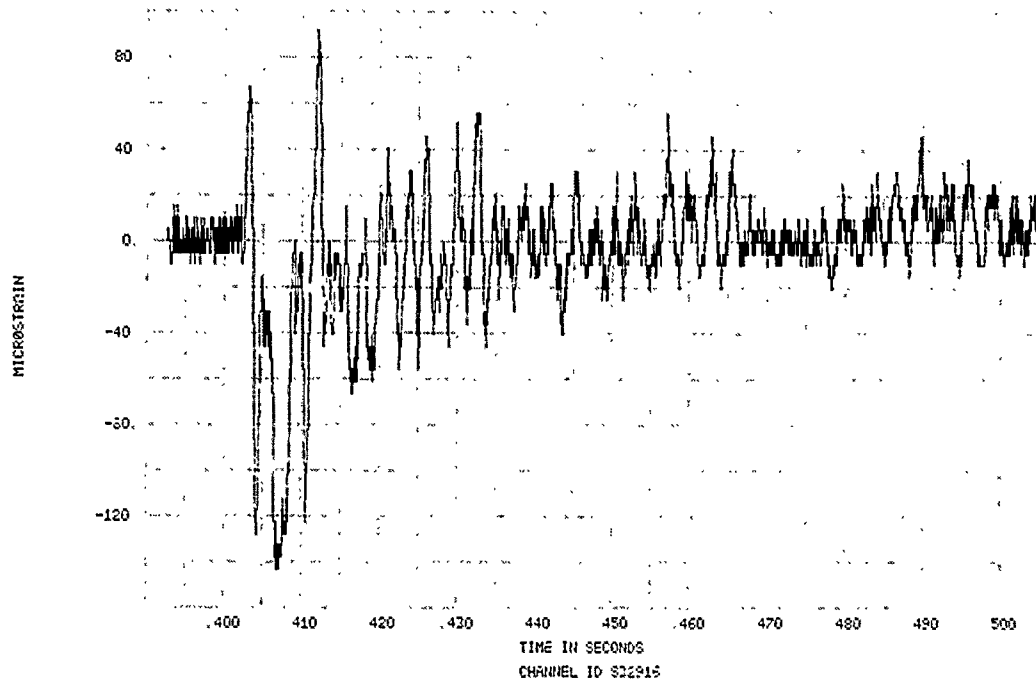

FIGURE 226. SPECIMEN 32, EVENT 78-345, STRAIN TIME HISTORY

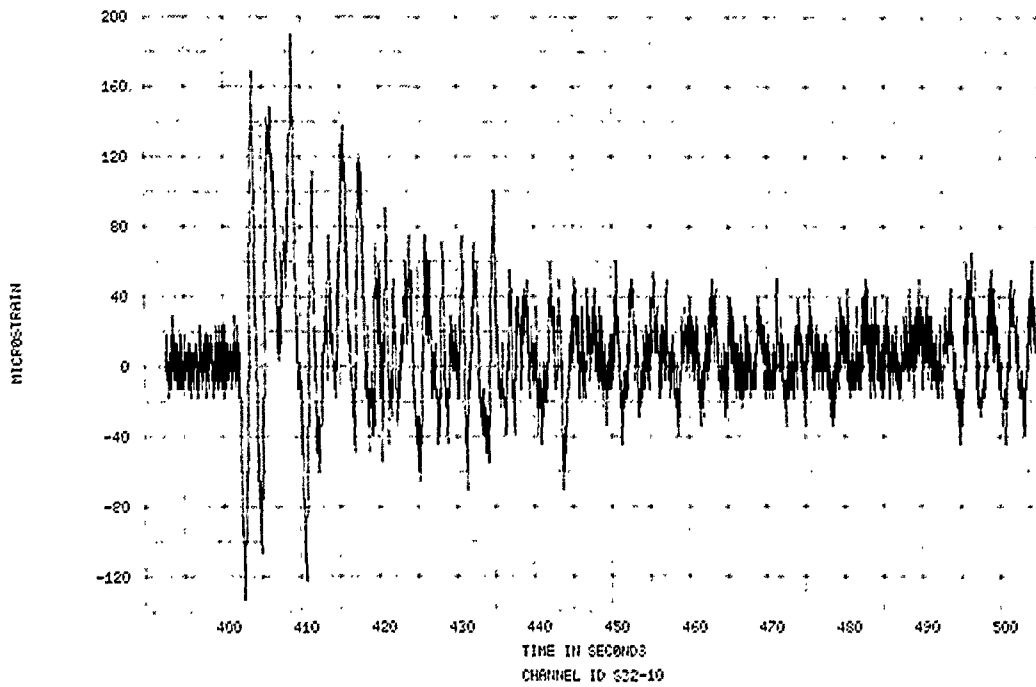

FIGURE 227. SPECIMEN 32, EVENT 78-345, STRAIN TIME HISTORY

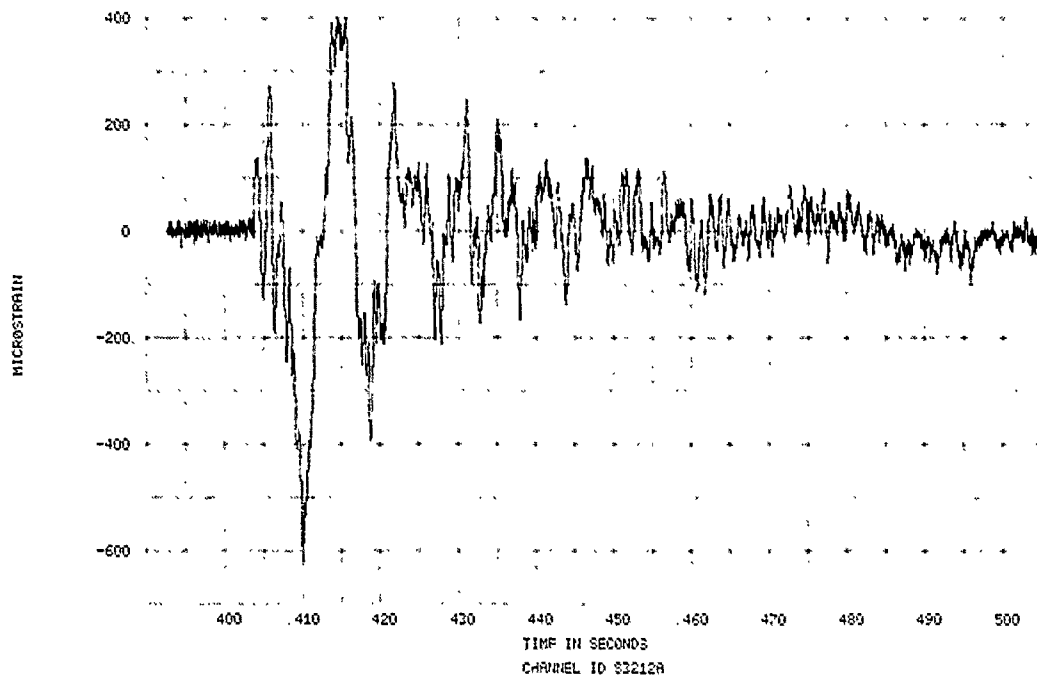

FIGURE 228. SPECIMEN 32, EVENT 78-345, STRAIN TIME HISTORY

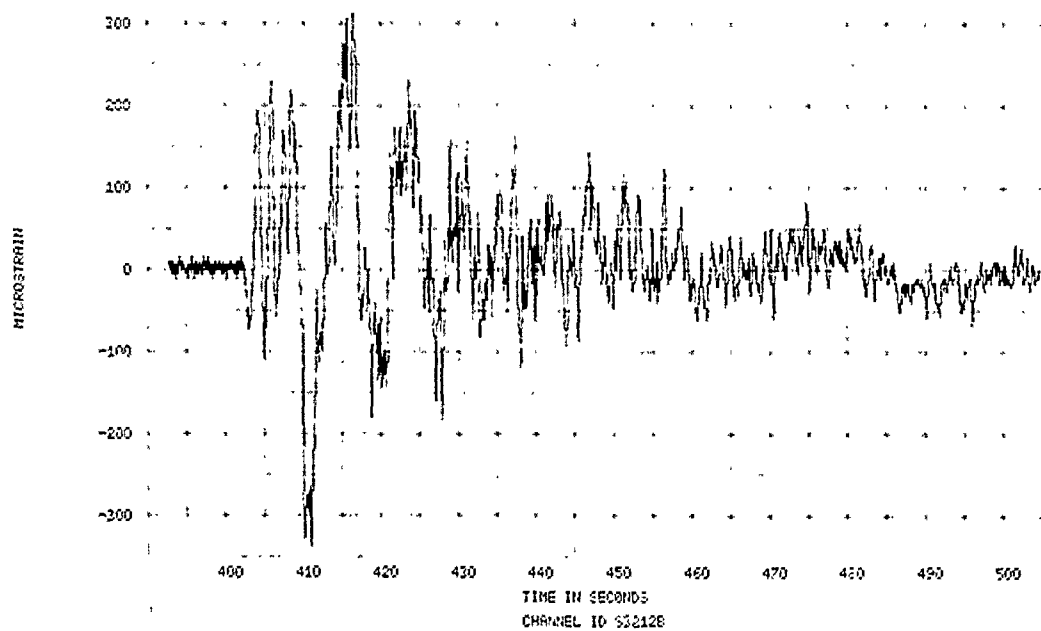

FIGURE 229. SPECIMEN 32, EVENT 78-345, S1RAIN TIME HISTORY

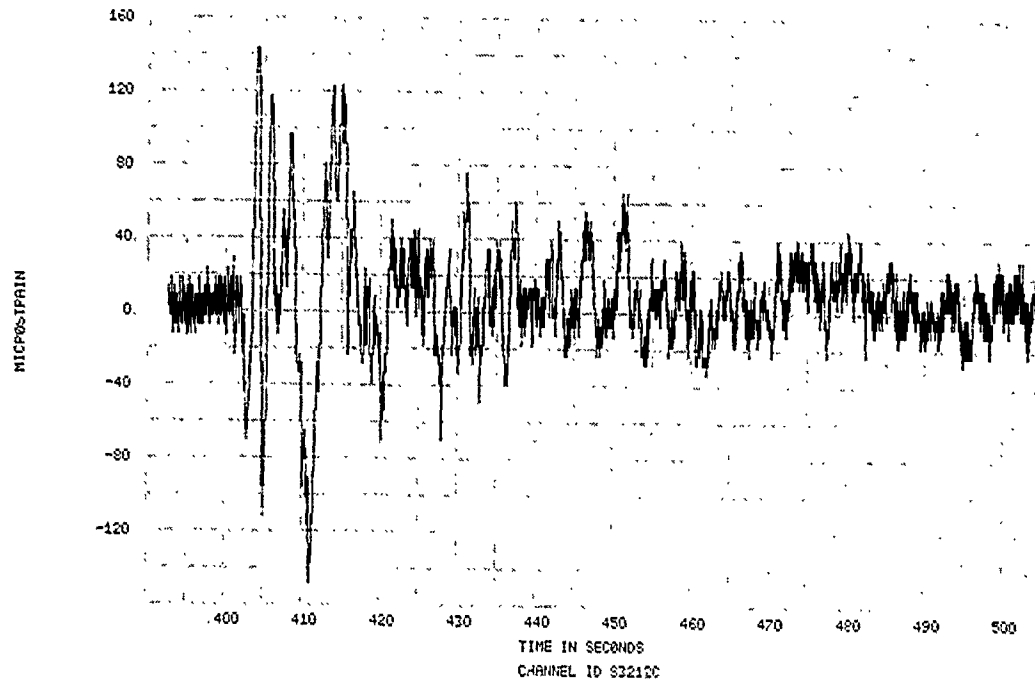

FIGURE 230. SPECIMEN 32, EVENT 78-345, STRAIN TIME HISTORY

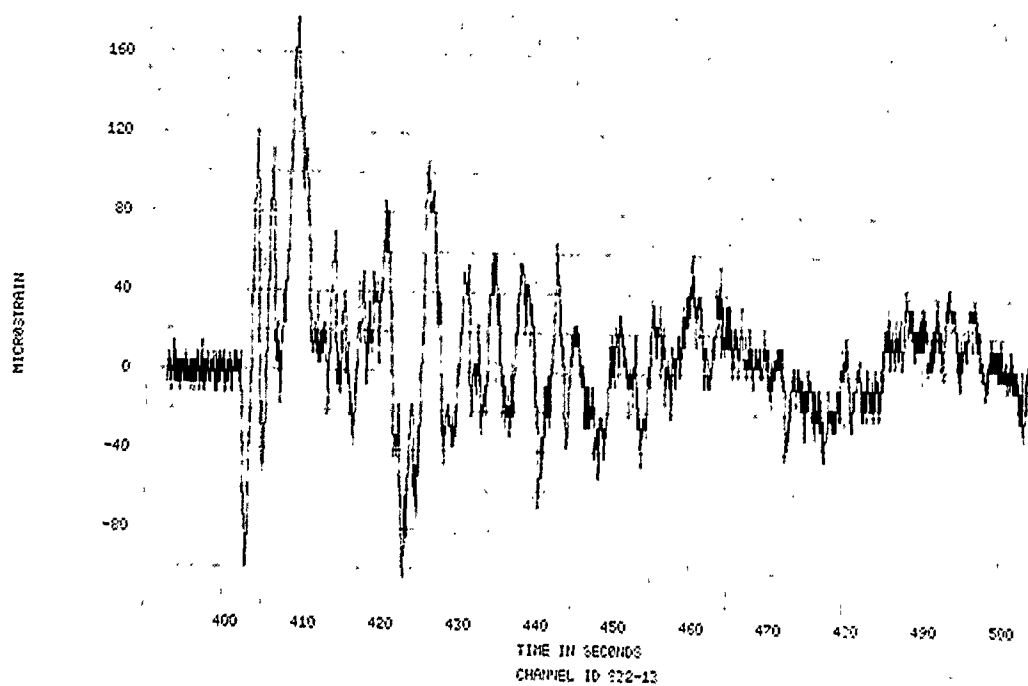

FIGURE 231. SPECIMEN 32, EVENT 78-345, STRAIN TIME HISTORY

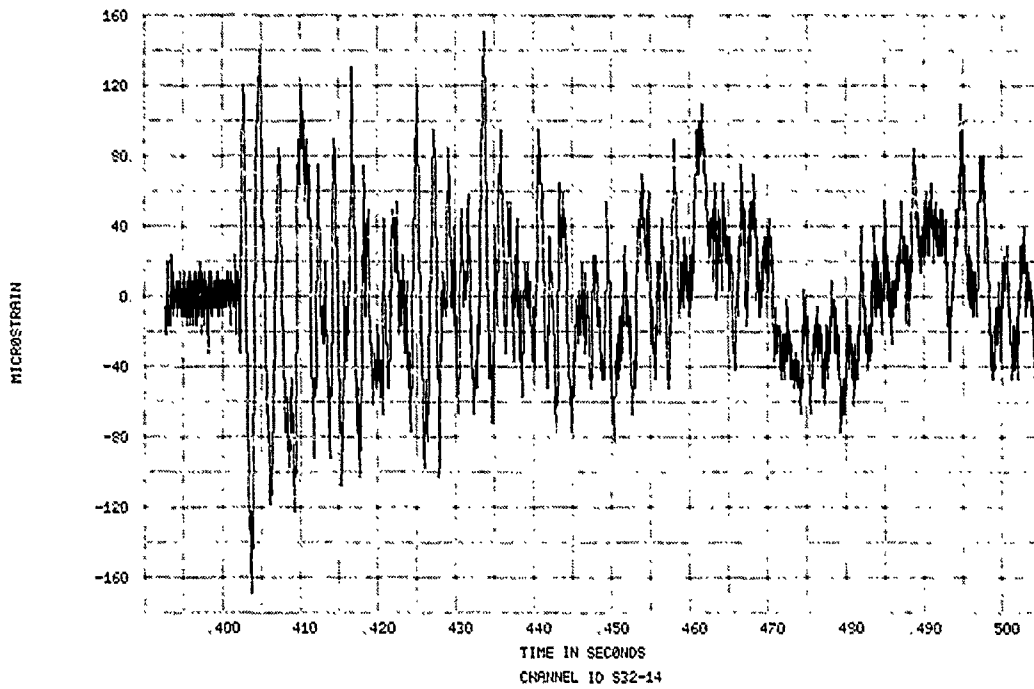

FIGURE 232. SPECIMEN 32, EVENT 78-345, STRAIN TIME HISTORY

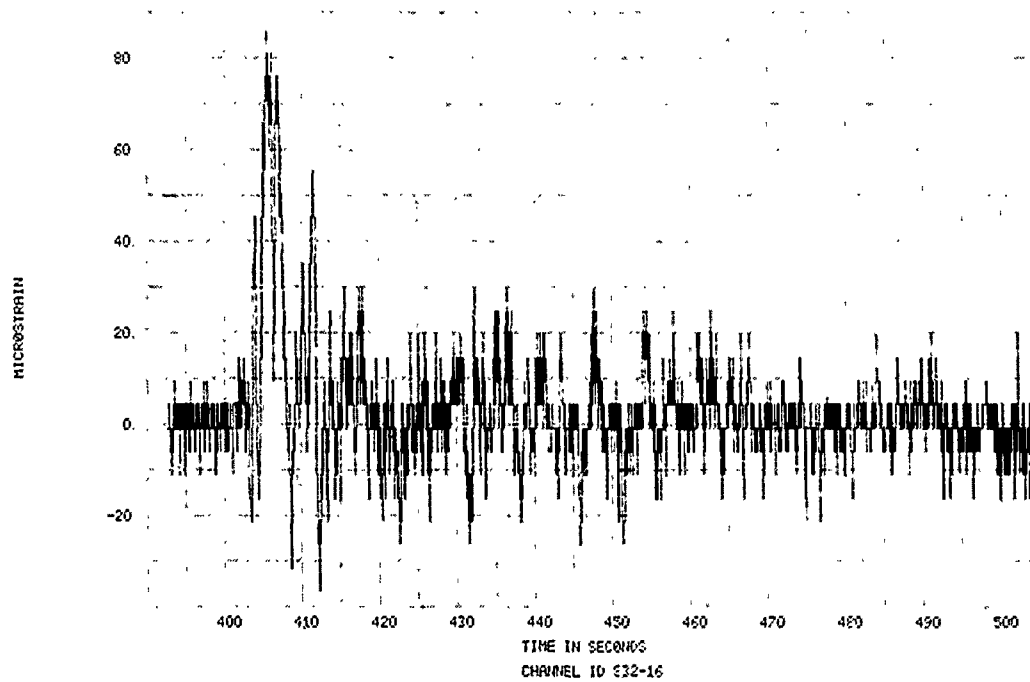

FIGURE 233. SPECIMEN 32, EVENT 78-345, STRAIN TIME HISTORY

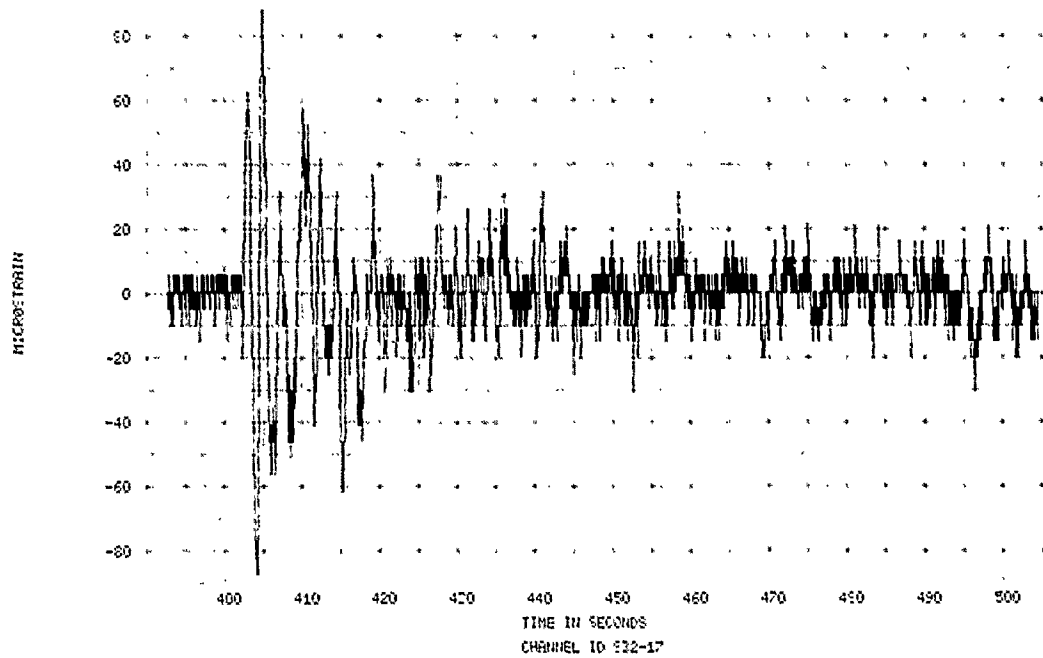

FIGURE 234. SPECIMEN 32, EVENT 78-345, STRAIN TIME HISTORY

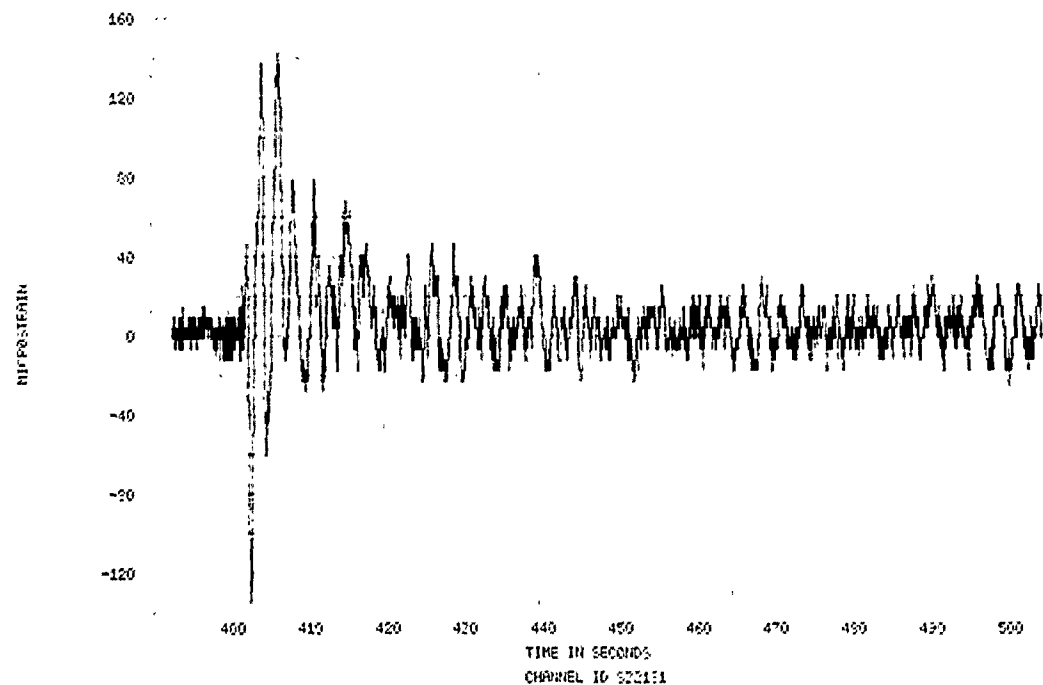

FIGURE 235. SPECIMEN 32, EVENT 78-345, STRAIN TIME HISTORY

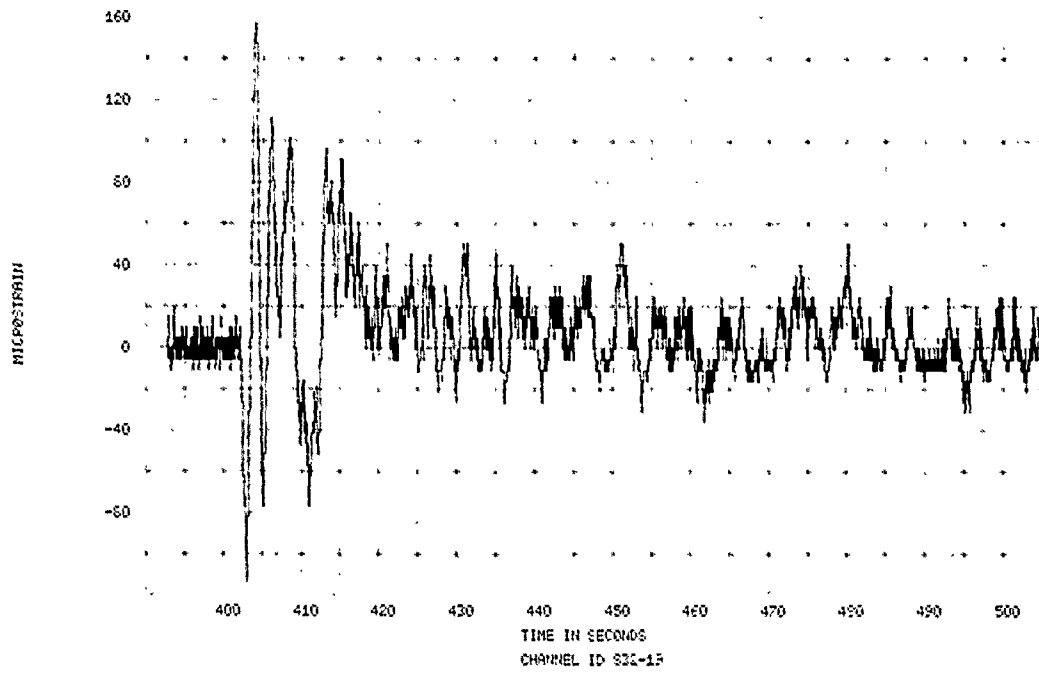

FIGURE 236. SPECIMEN 32, EVENT 78-345, STRAIN TIME HISTORY

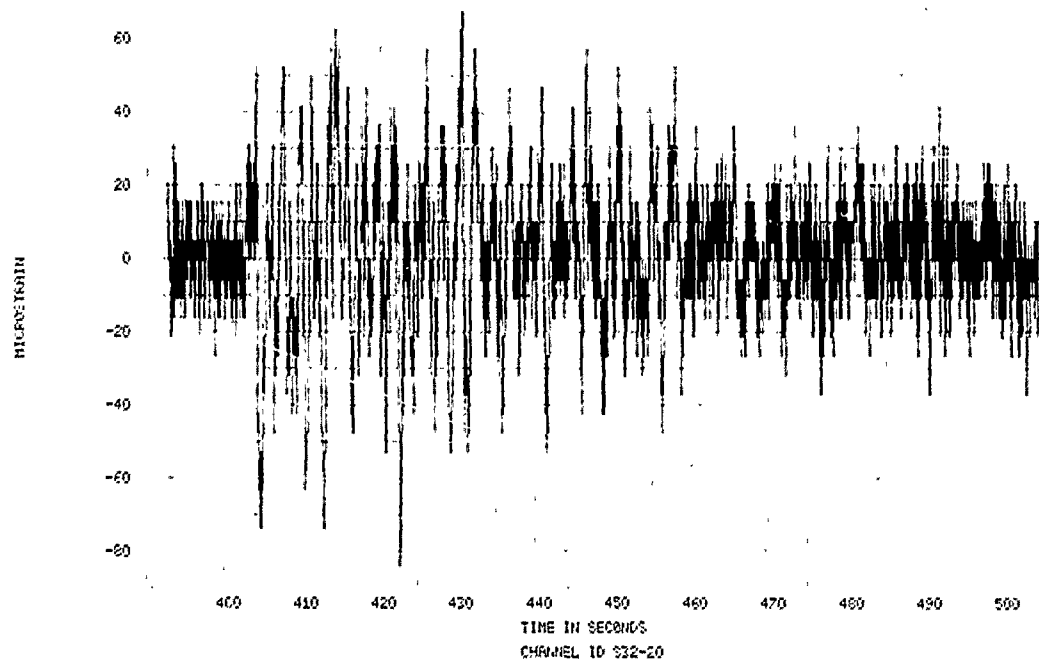

FIGURE 237. SPECIMEN 32, EVENT 78-345, STRAIN TIME HISTORY

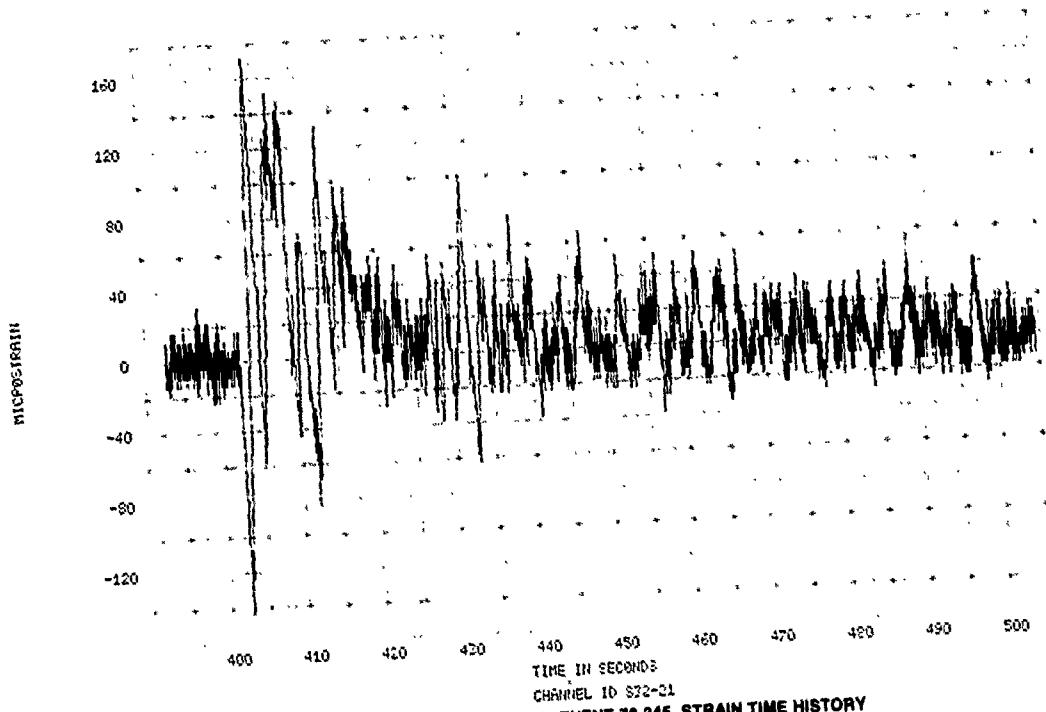

FIGURE 238. SPECIMEN 32, EVENT 78-345, STRAIN TIME HISTORY

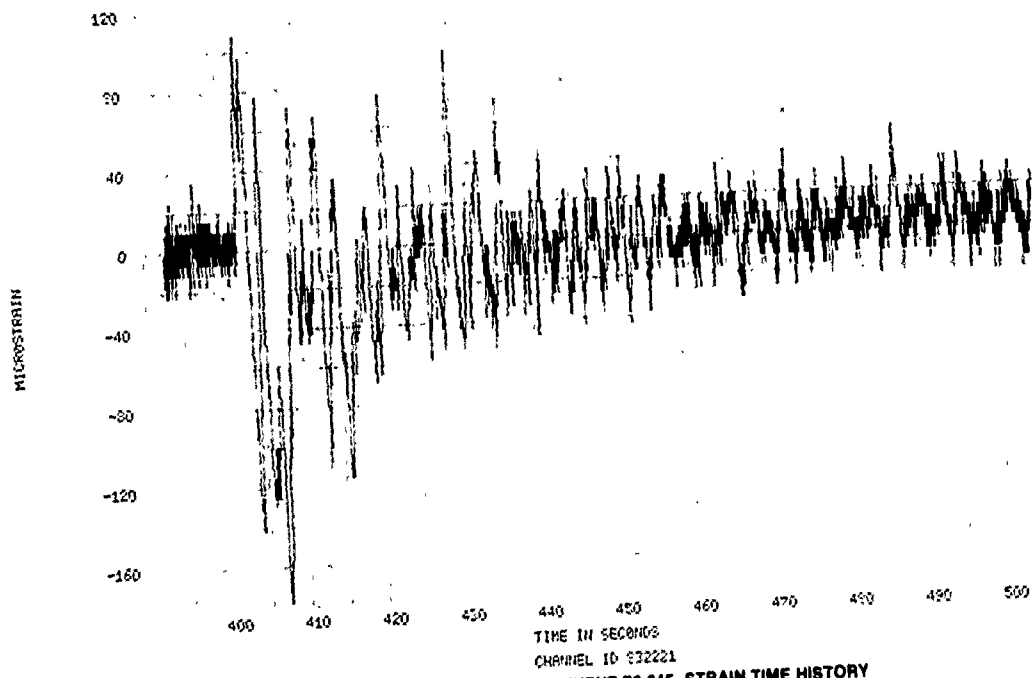

FIGURE 239. SPECIMEN 32, EVENT 78-345, STRAIN TIME HISTORY

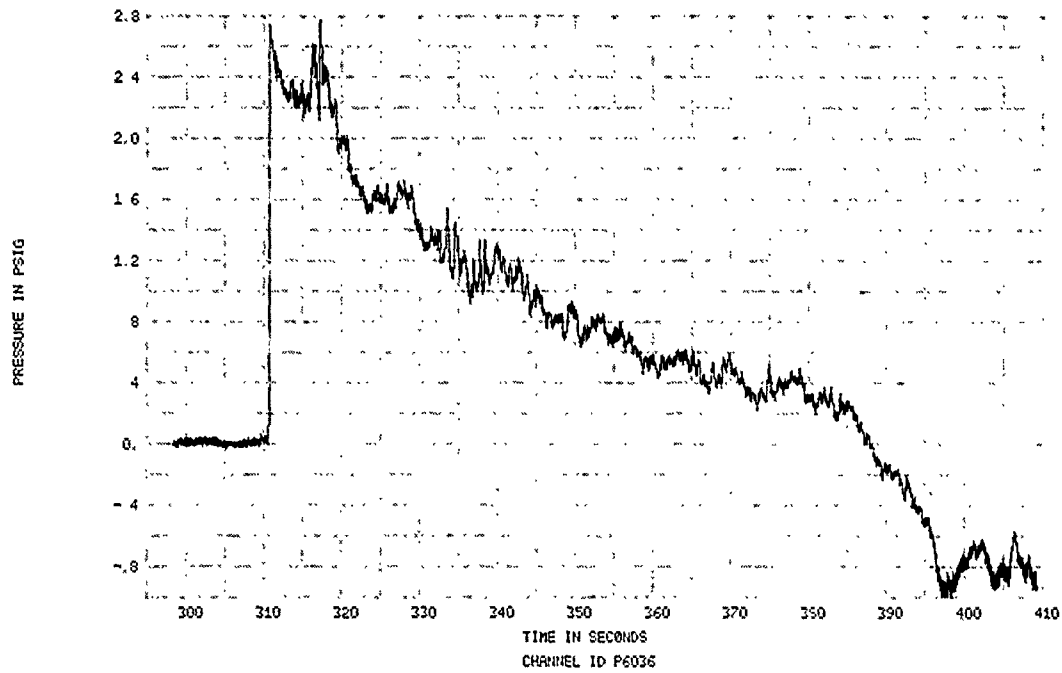

FIGURE 240. SPECIMEN 32, EVENT 78-347, TUNNEL WALL INCIDENT OVERPRESSURE TIME HISTORY

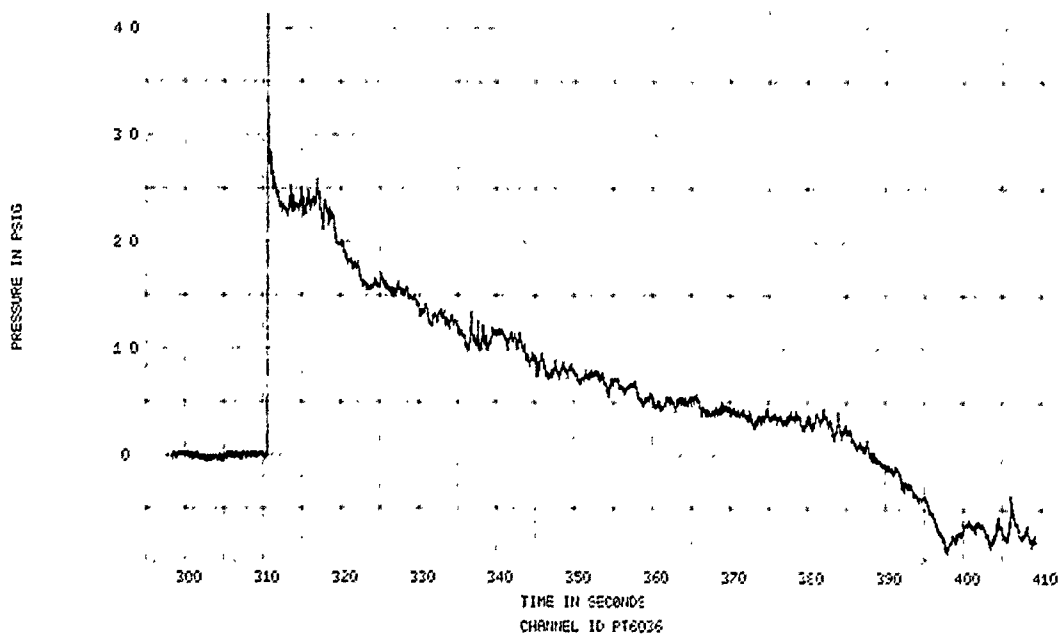

FIGURE 241. SPECIMEN 32, EVENT 78-347, TUNNEL WALL REFLECTED OVERPRESSURE TIME HISTORY

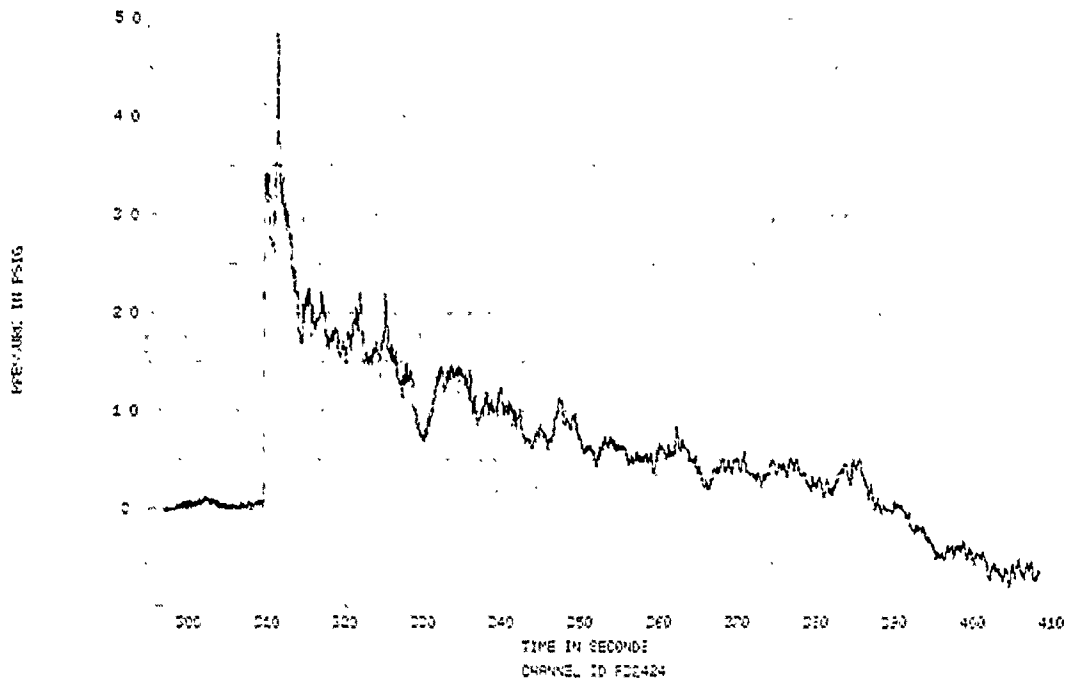

FIGURE 242. SPECIMEN 32, EVENT 78-347, SPECIMEN REFLECTED OVERPRESSURE TIME HISTORY

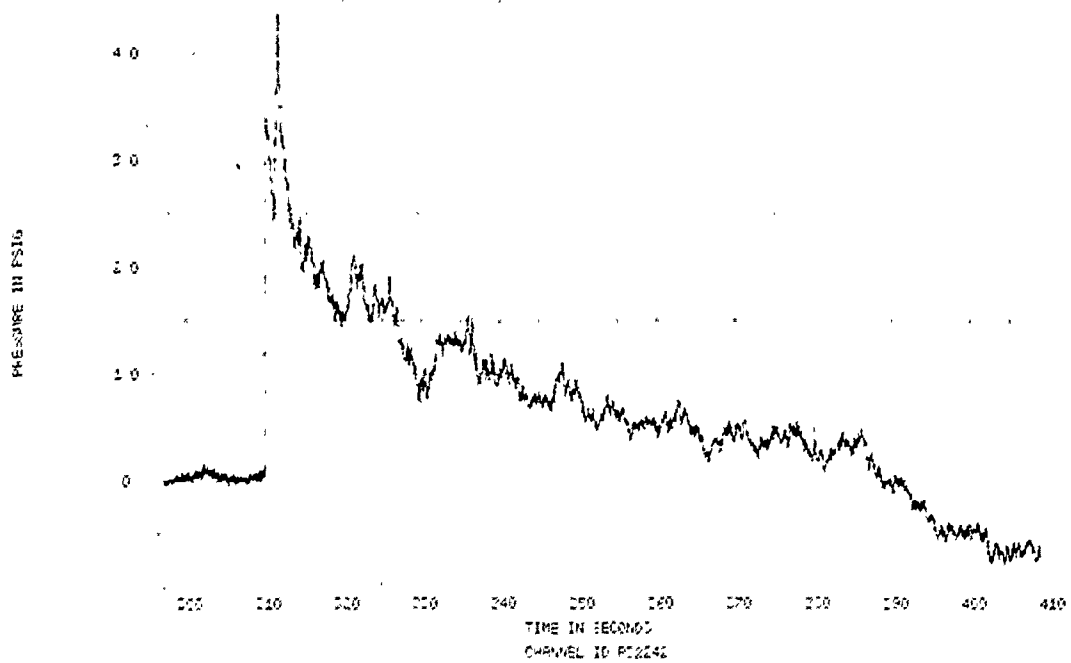

FIGURE 243. SPECIMEN 32, EVENT 78-347, SPECIMEN REFLECTED OVERPRESSURE TIME HISTORY

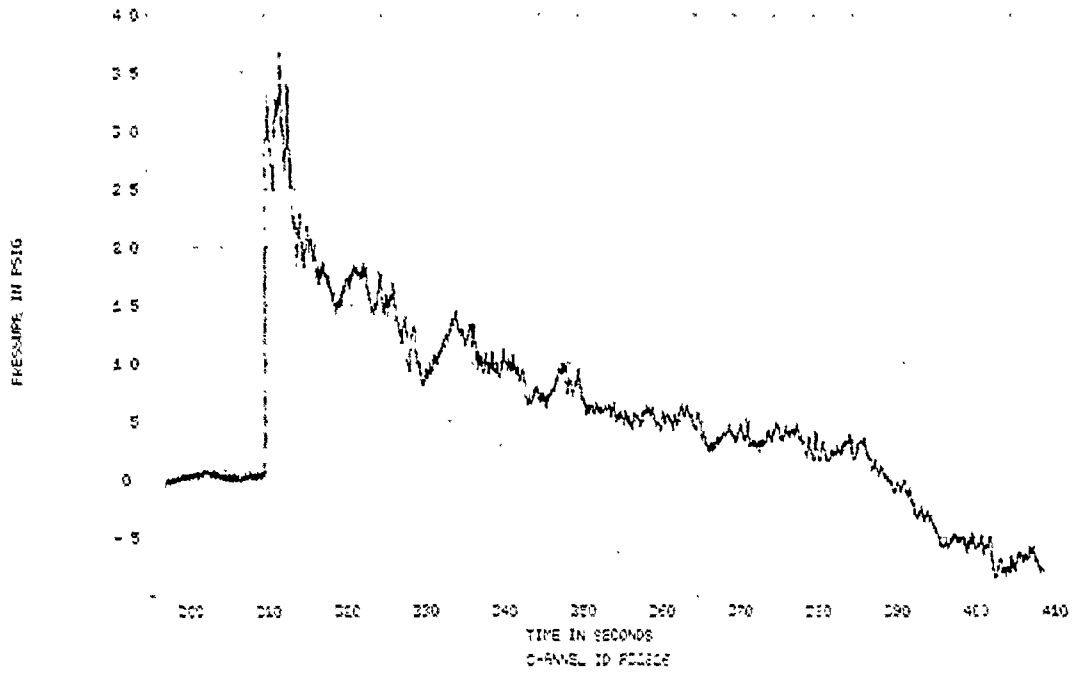

FIGURE 244. SPECIMEN 32, EVENT 78-347, SPECIMEN REFLECTED OVERPRESSURE TIME HISTORY

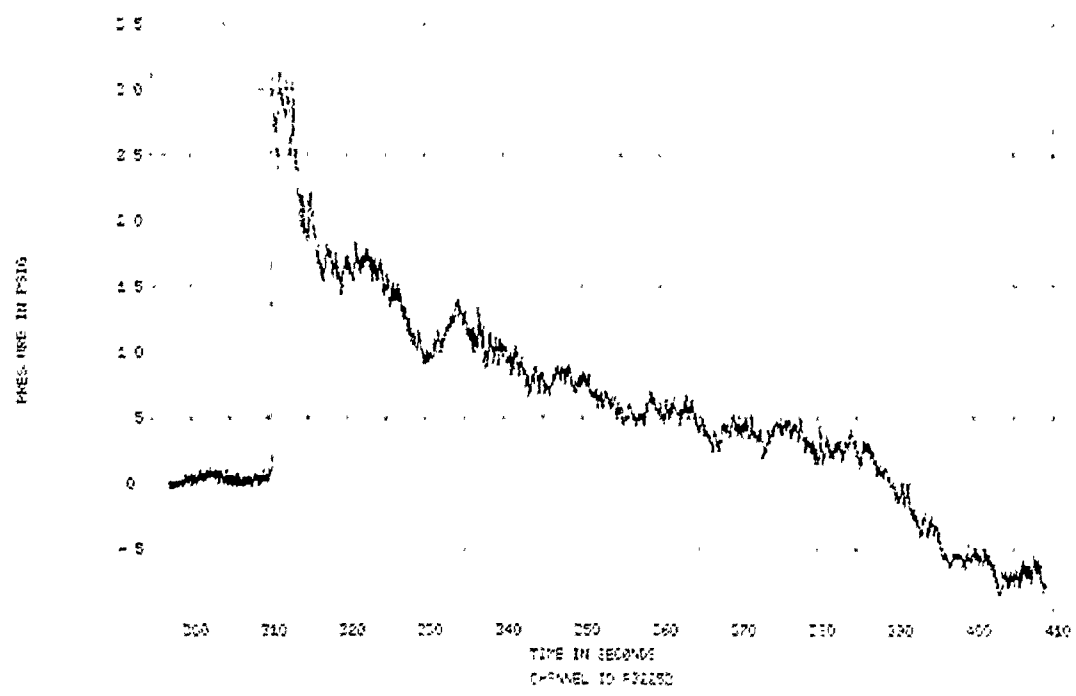

FIGURE 245. SPECIMEN 32, EVENT 78-347, SPECIMEN REFLECTED OVERPRESSURE TIME HISTORY

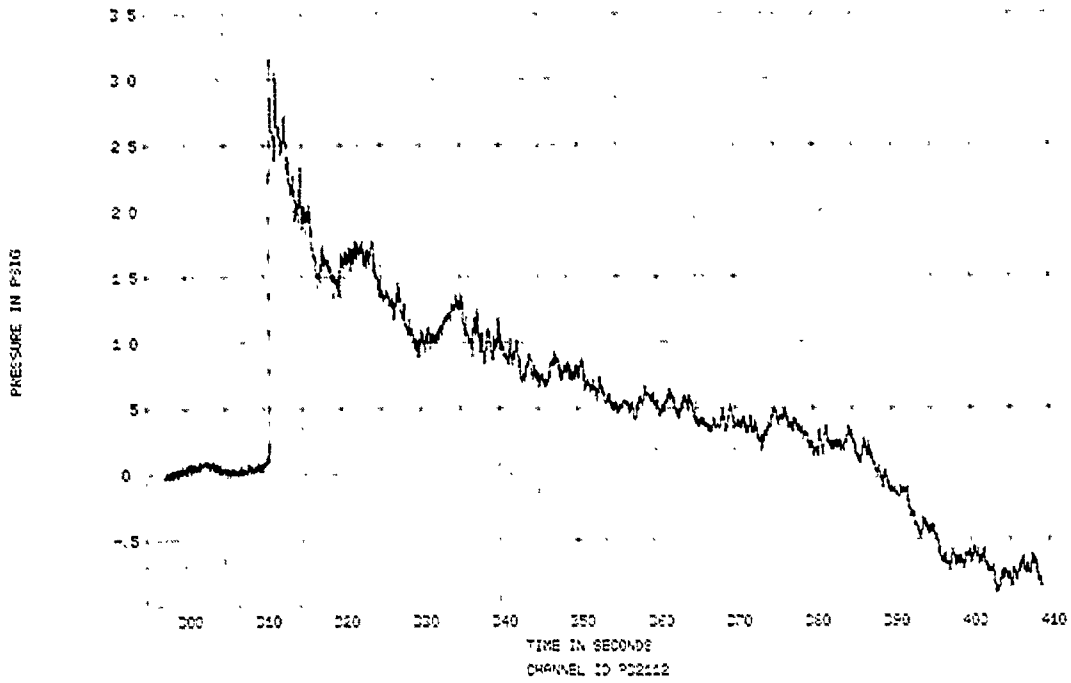

FIGURE 246. SPECIMEN 32, EVENT 78-347, SPECIMEN REFLECTED OVERPRESSURE TIME HISTORY

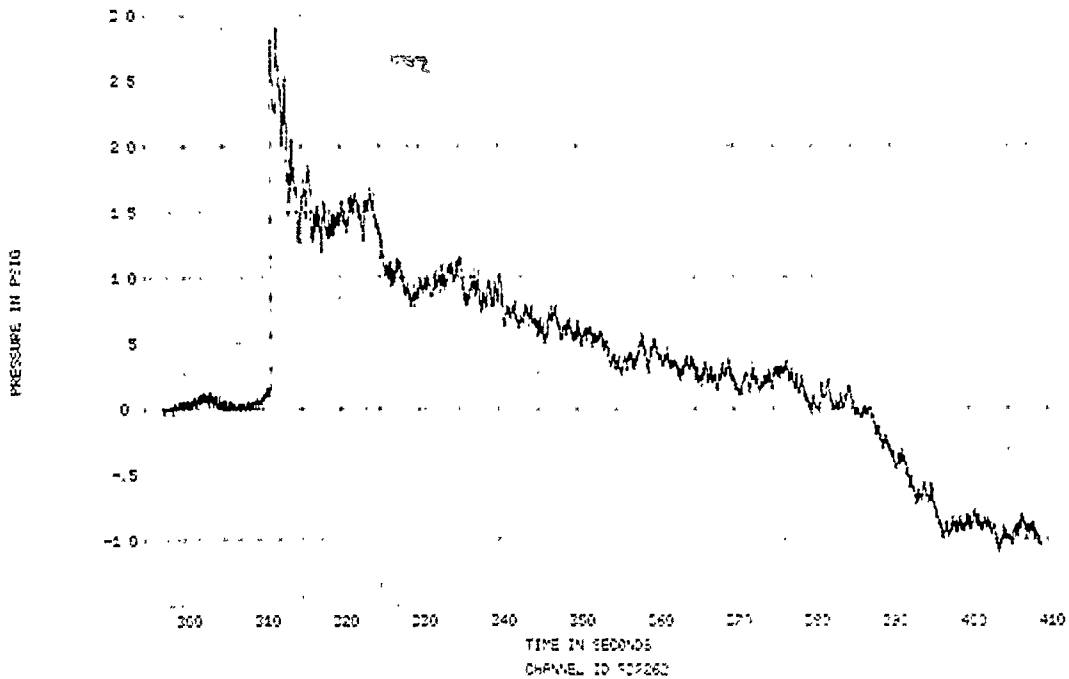

FIGURE 247. SPECIMEN 32, EVENT 78-347, SPECIMEN REFLECTED OVERPRESSURE TIME HISTORY

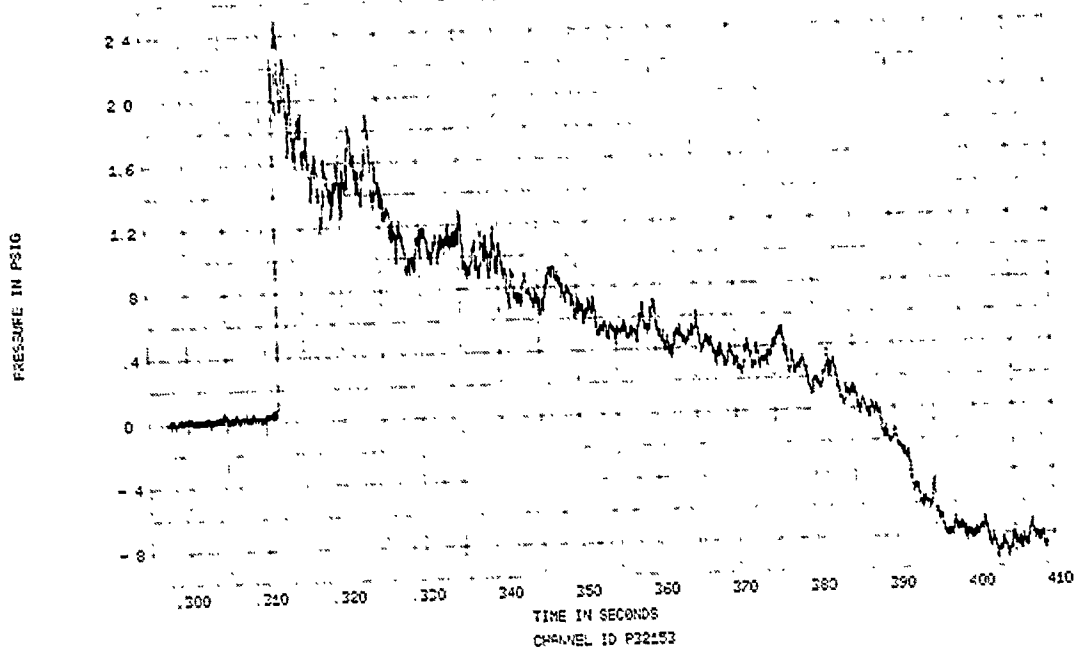

FIGURE 248. SPECIMEN 32, EVENT 78-347, SPECIMEN REFLECTED OVERPRESSURE TIME HISTORY

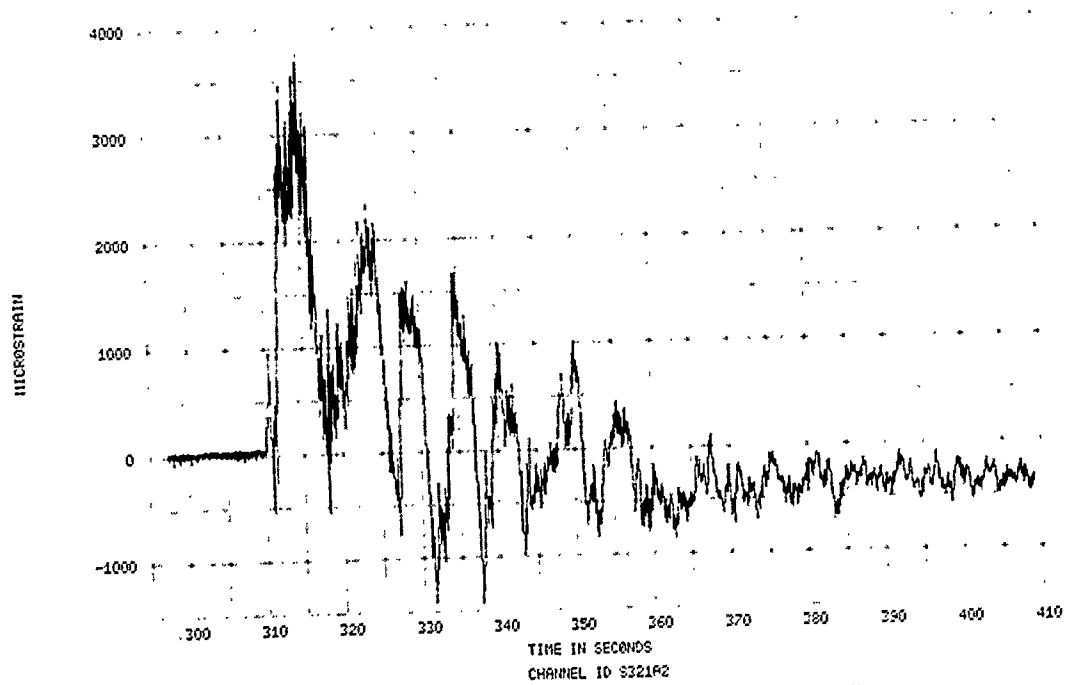

FIGURE 249. SPECIMEN 32, EVENT 78-347, STRAIN TIME HISTORY

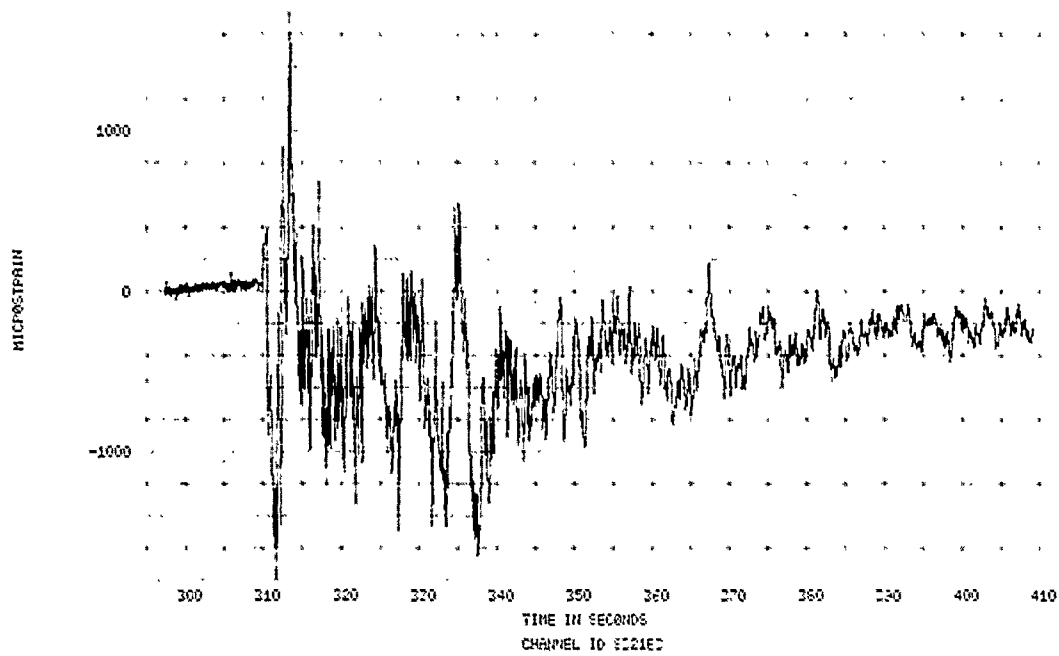

FIGURE 250. SPECIMEN 32, EVENT 70-347, STRAIN TIME HISTORY

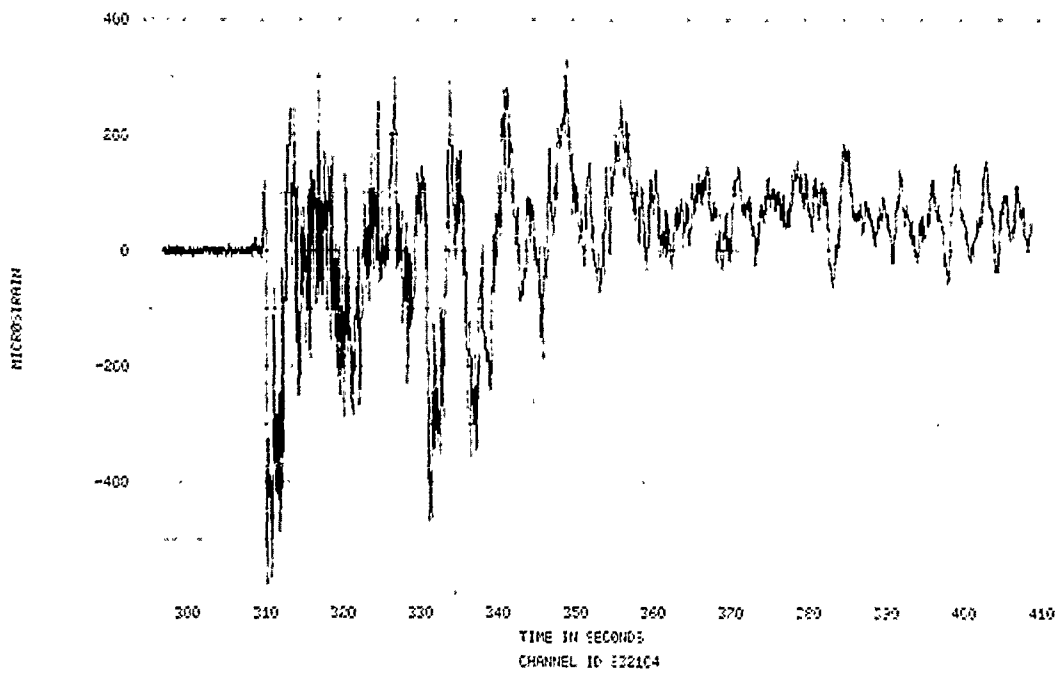

FIGURE 251. SPECIMEN 32, EVENT 70-347, STRAIN TIME HISTORY

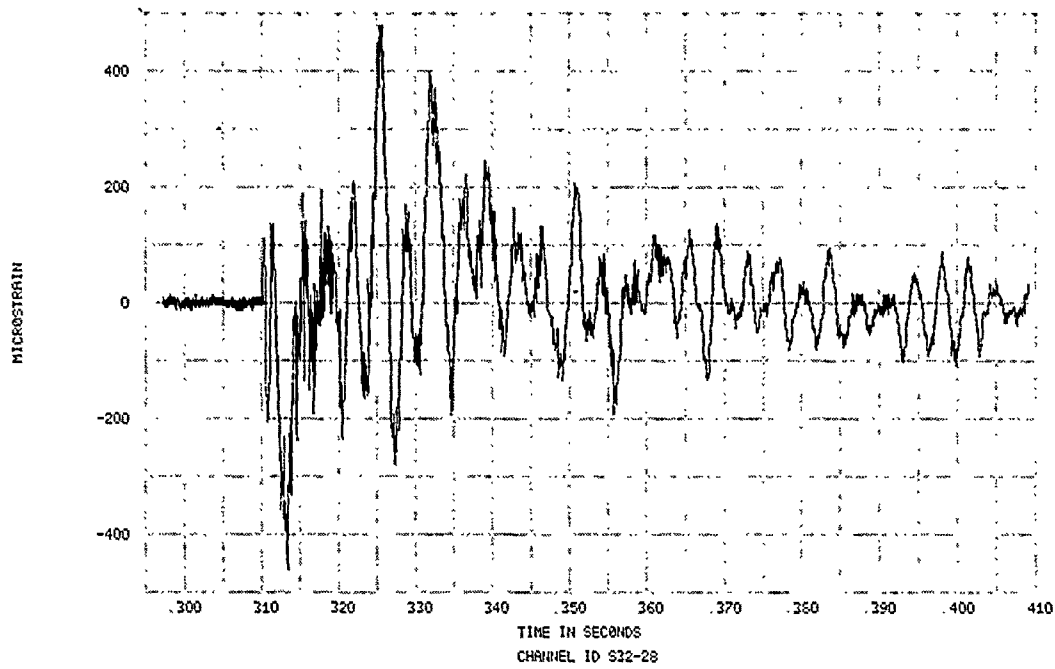

FIGURE 252. SPECIMEN 32, EVENT 78-347, STRAIN TIME HISTORY

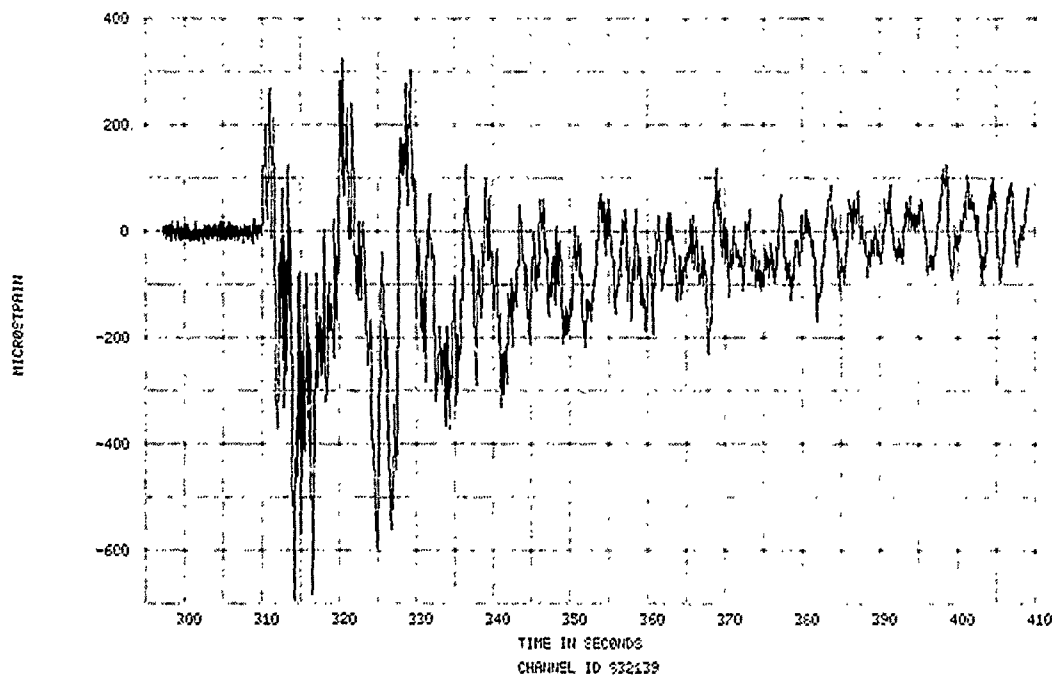

FIGURE 253. SPECIMEN 32, EVENT 78-347, STRAIN TIME HISTORY

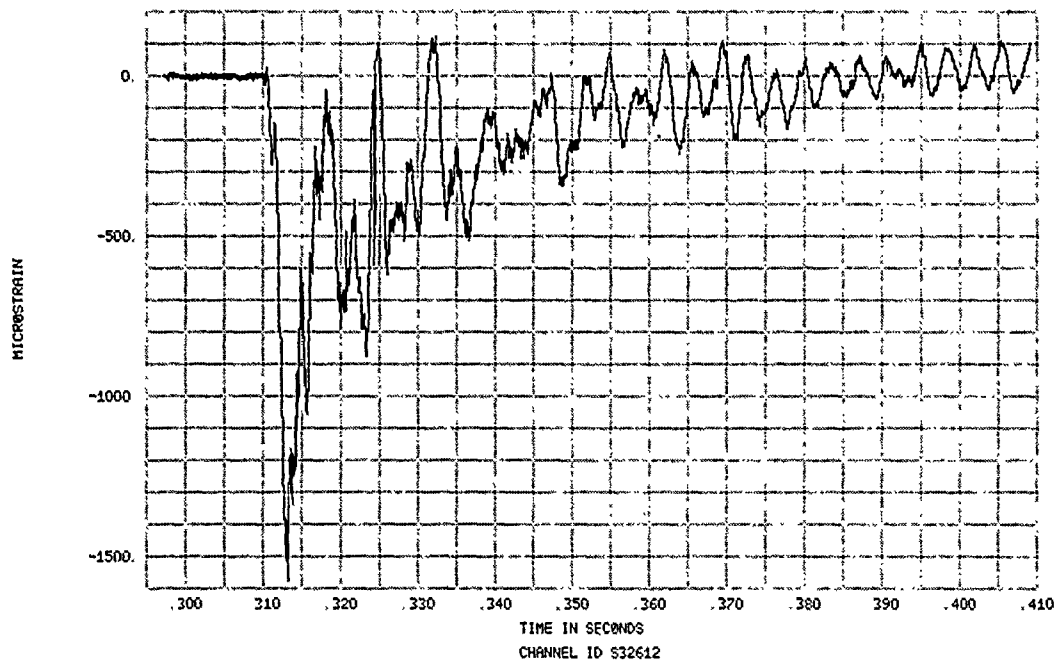

FIGURE 254. SPECIMEN 32, EVENT 78-347, STRAIN TIME HISTORY

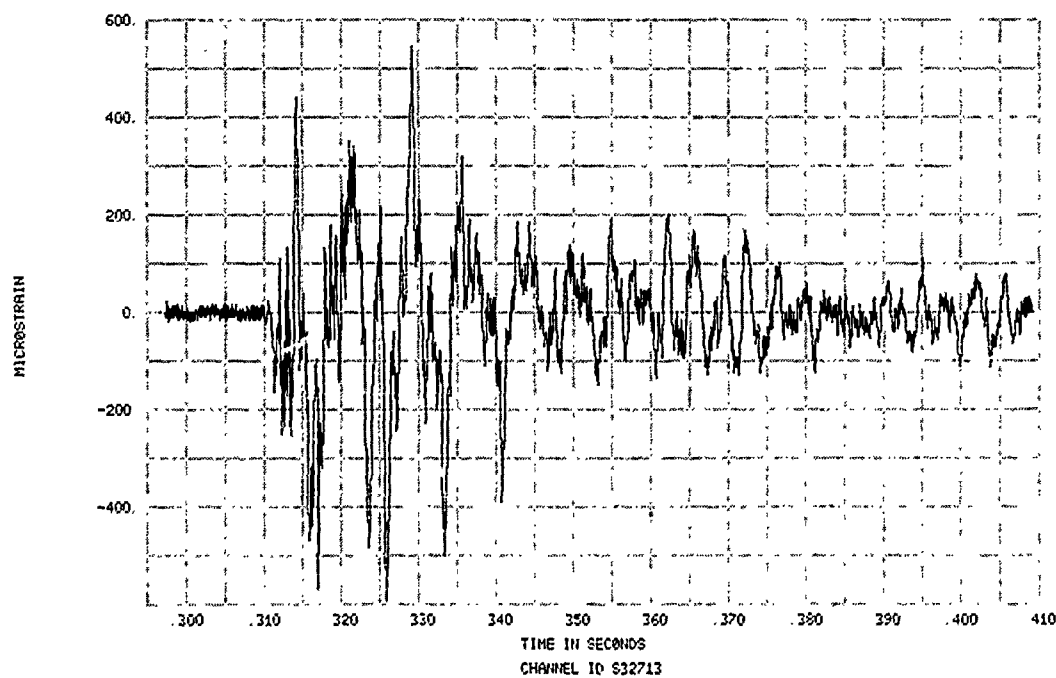

FIGURE 255. SPECIMEN 32, EVENT 78-347, STRAIN TIME HISTORY

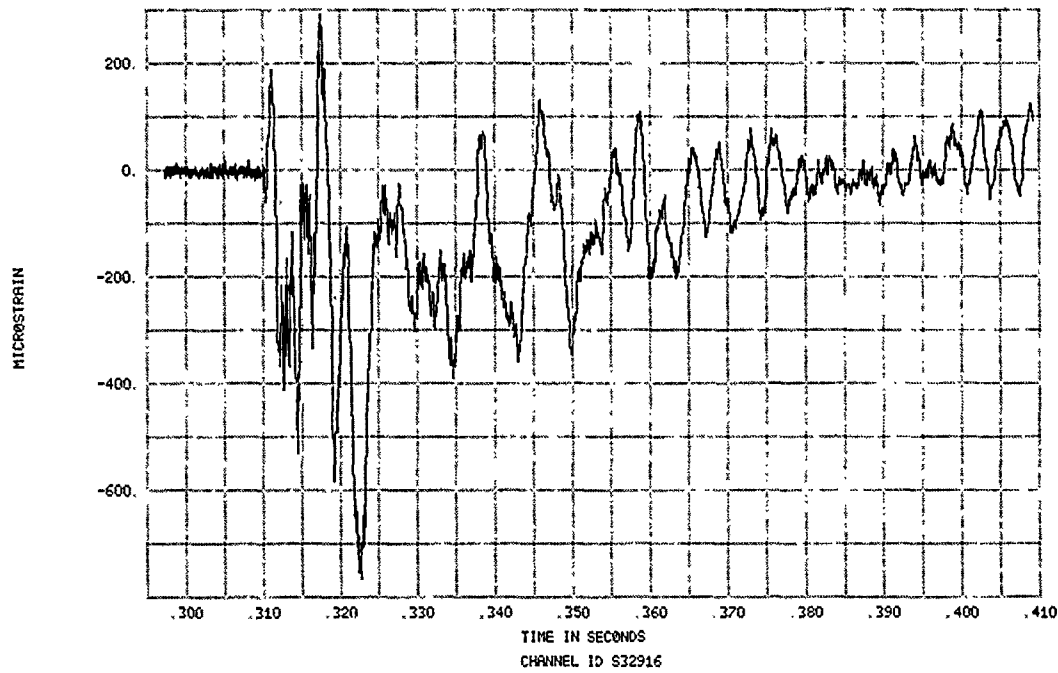

FIGURE 256. SPECIMEN 32, EVENT 78-347, STRAIN TIME HISTORY

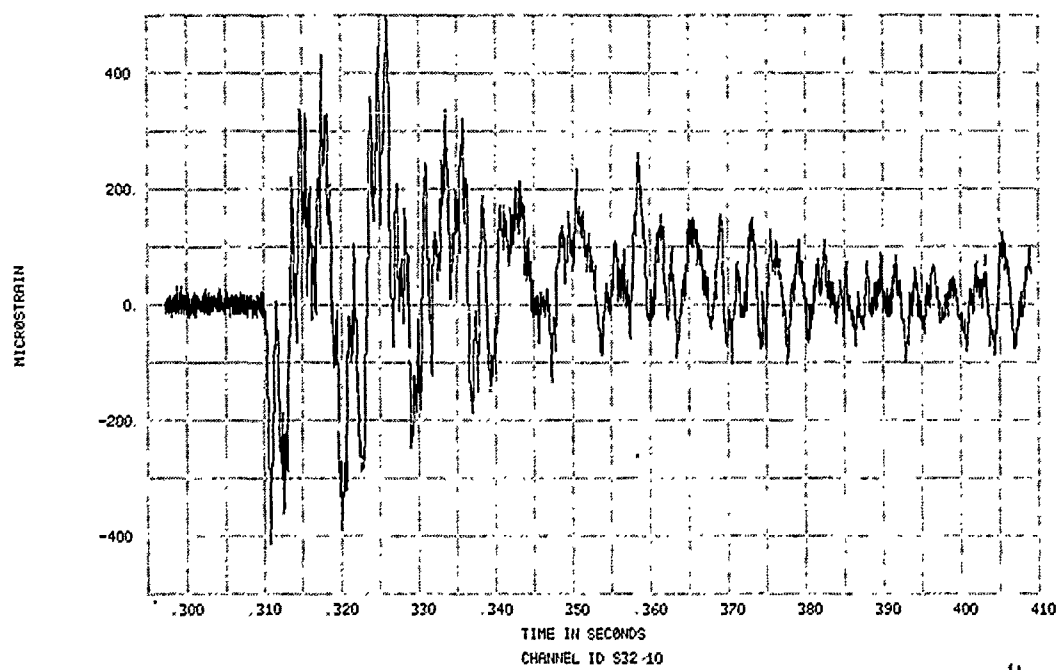

FIGURE 257. SPECIMEN 32, EVENT 78-347, STRAIN TIME HISTORY

1/10

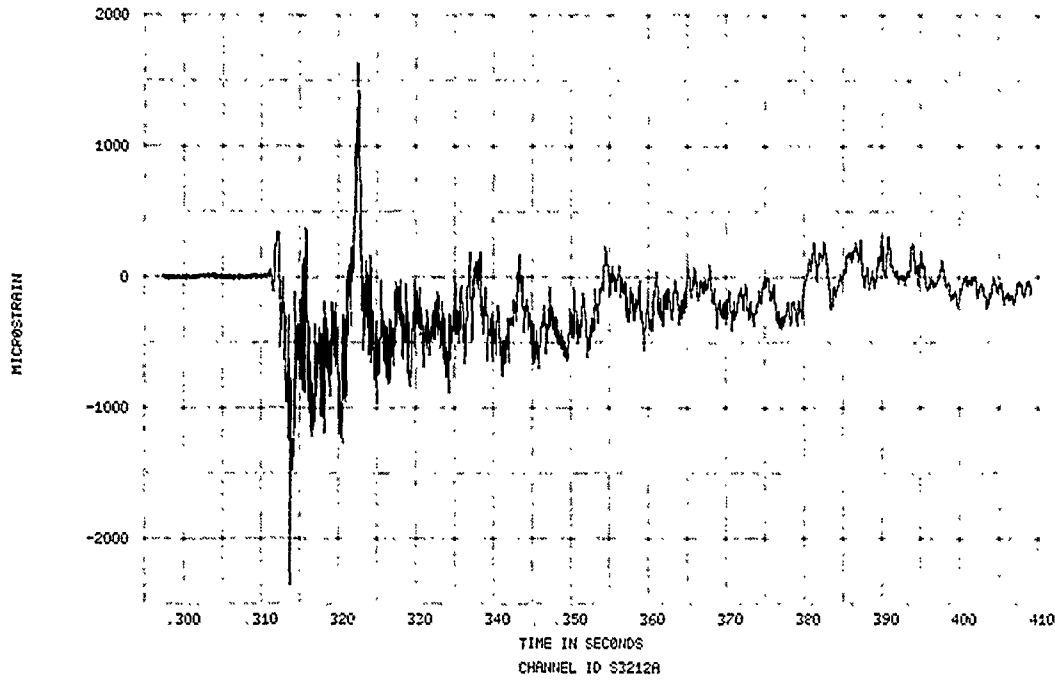

FIGURE 258. SPECIMEN 32, EVENT 78-347, STRAIN TIME HISTORY

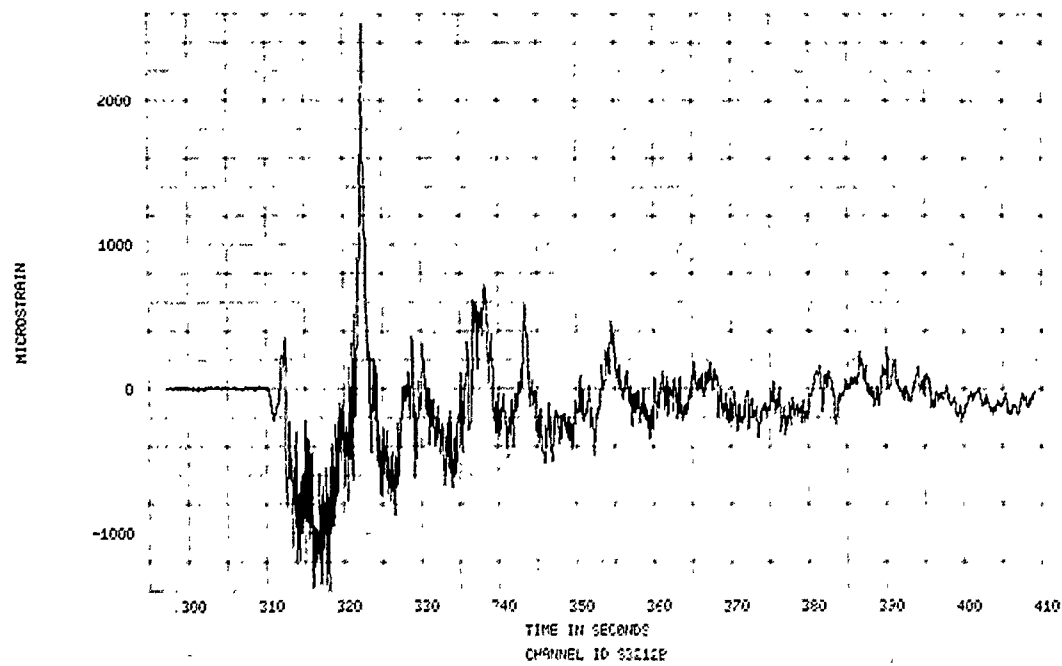

FIGURE 259. SPECIMEN 32, EVENT 78-347, STRAIN TIME HISTORY

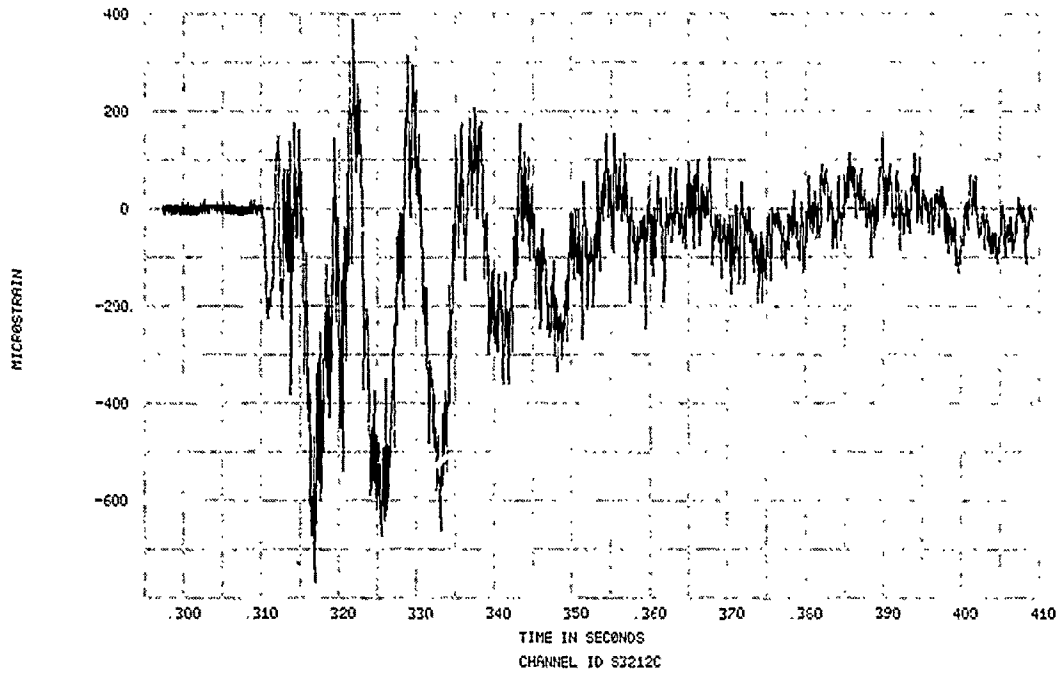

FIGURE 260. SPECIMEN 32, EVENT 78-347, STRAIN TIME HISTORY

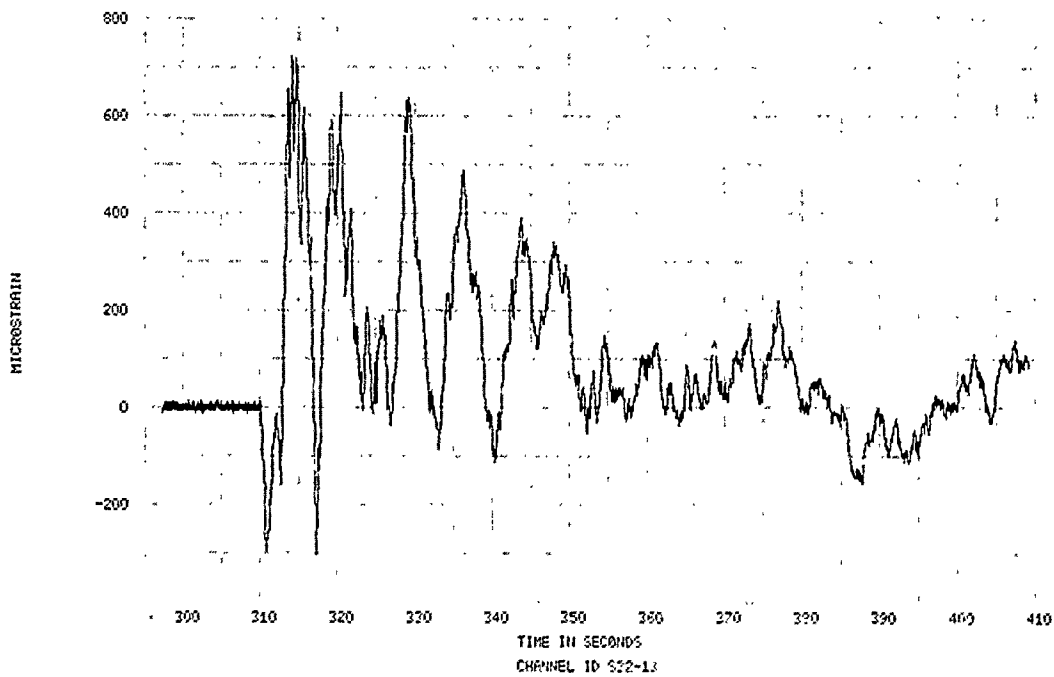

FIGURE 261. SPECIMEN 32, EVENT 78-347, STRAIN TIME HISTORY

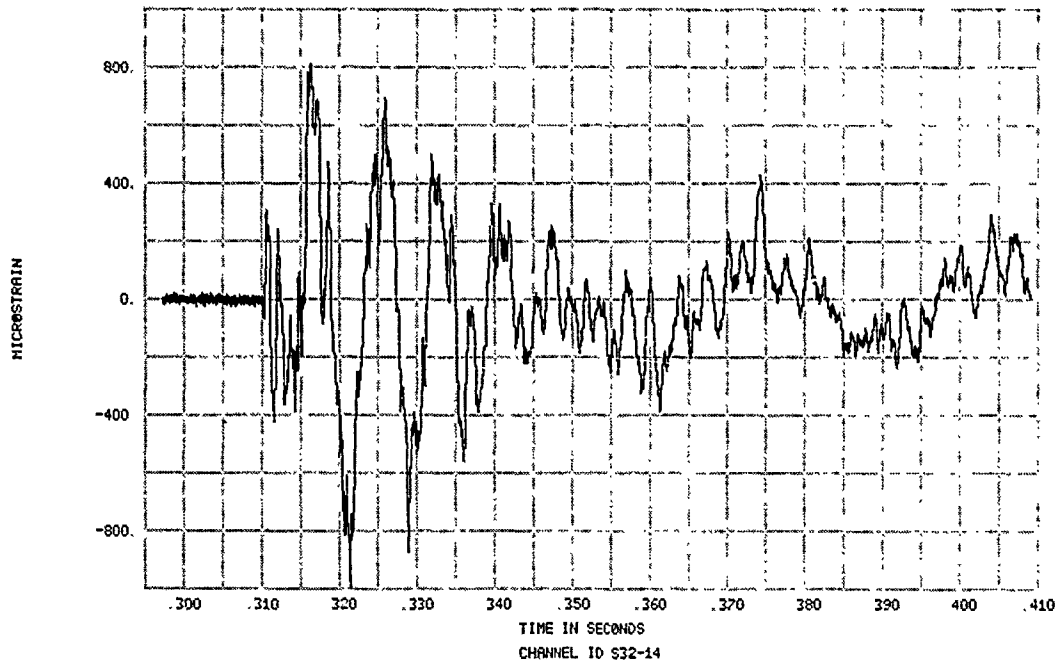

FIGURE 262. SPECIMEN 32, EVENT 78-347, STRAIN TIME HISTORY

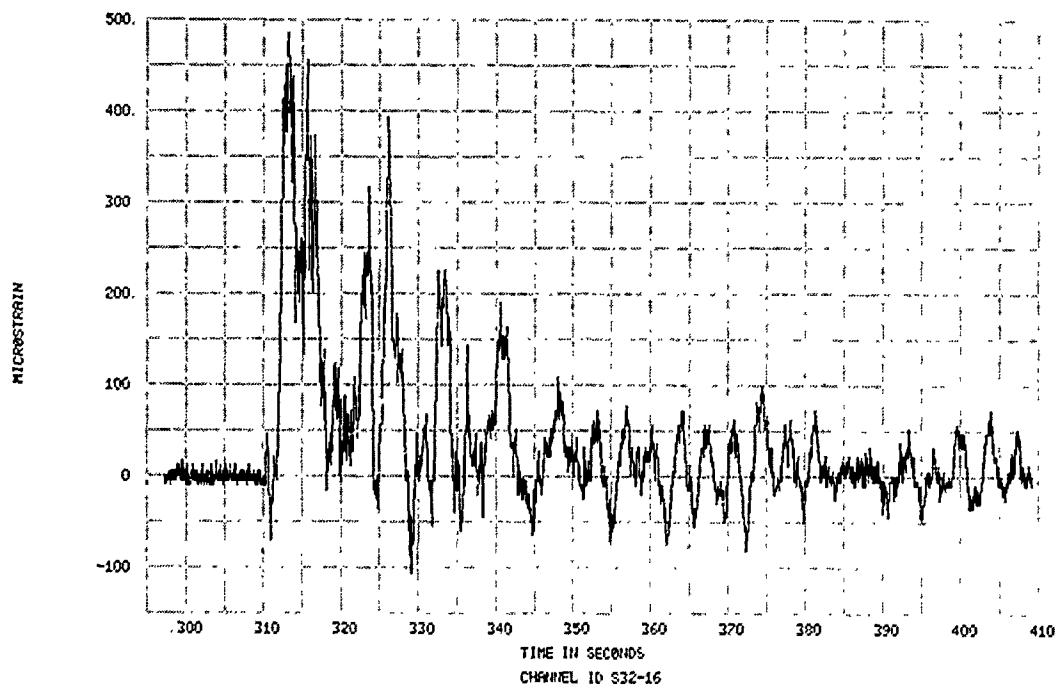

FIGURE 263. SPECIMEN 32, EVENT 78-347, STRAIN TIME HISTORY

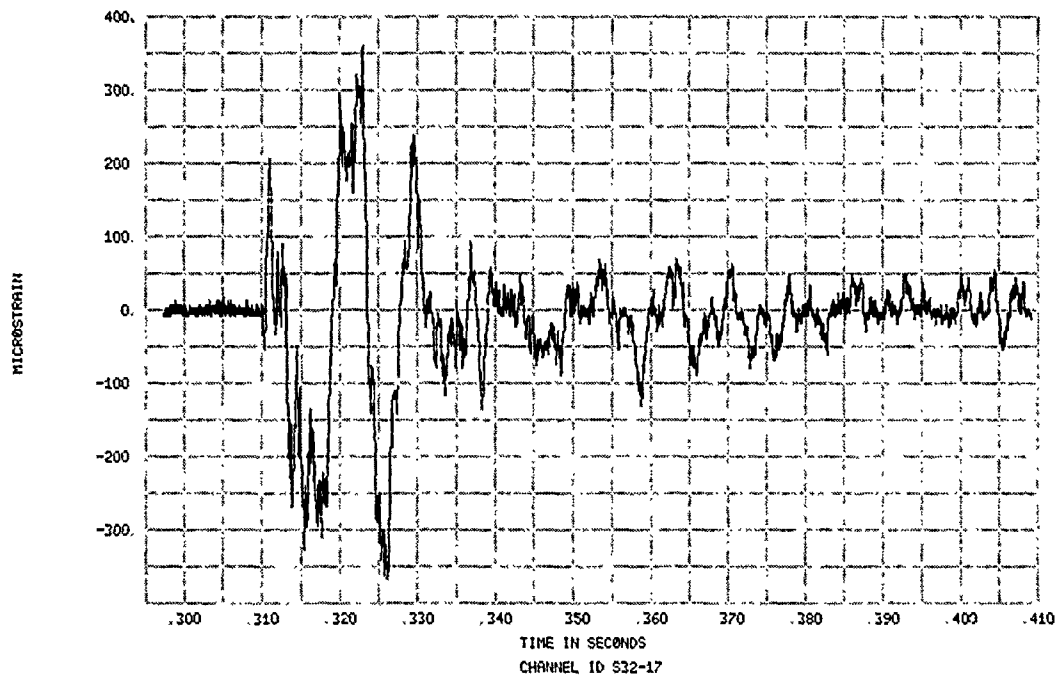

FIGURE 264. SPECIMEN 32, EVENT 78-347, STRAIN TIME HISTORY

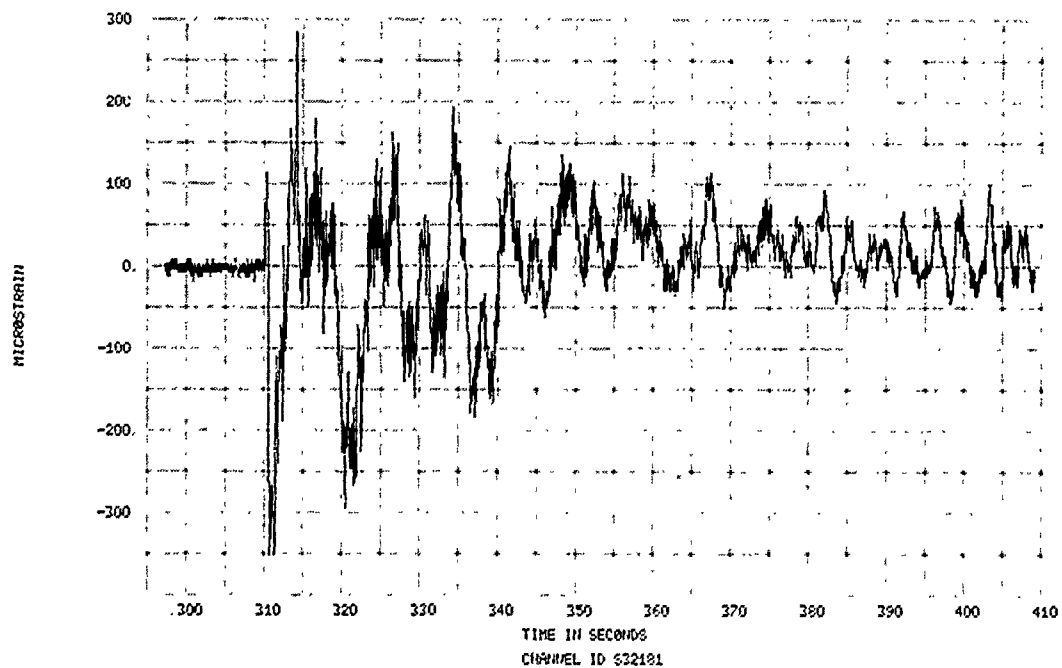

FIGURE 265. SPECIMEN 32, EVENT 78-347, STRAIN TIME HISTORY

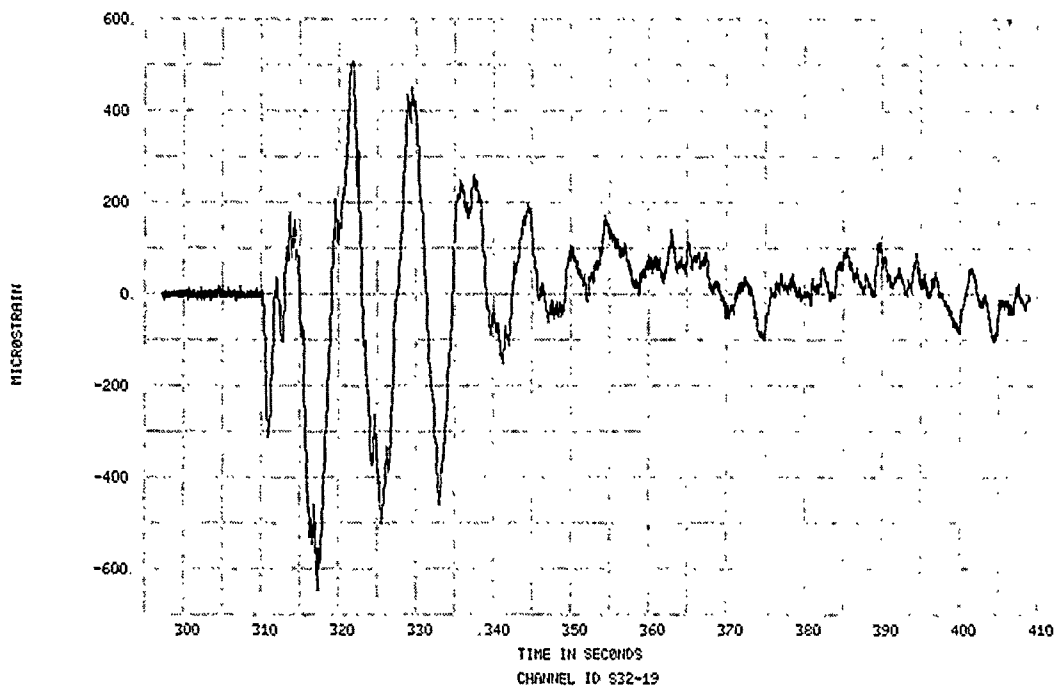

FIGURE 266. SPECIMEN 32, EVENT 78-347, STRAIN TIME HISTORY

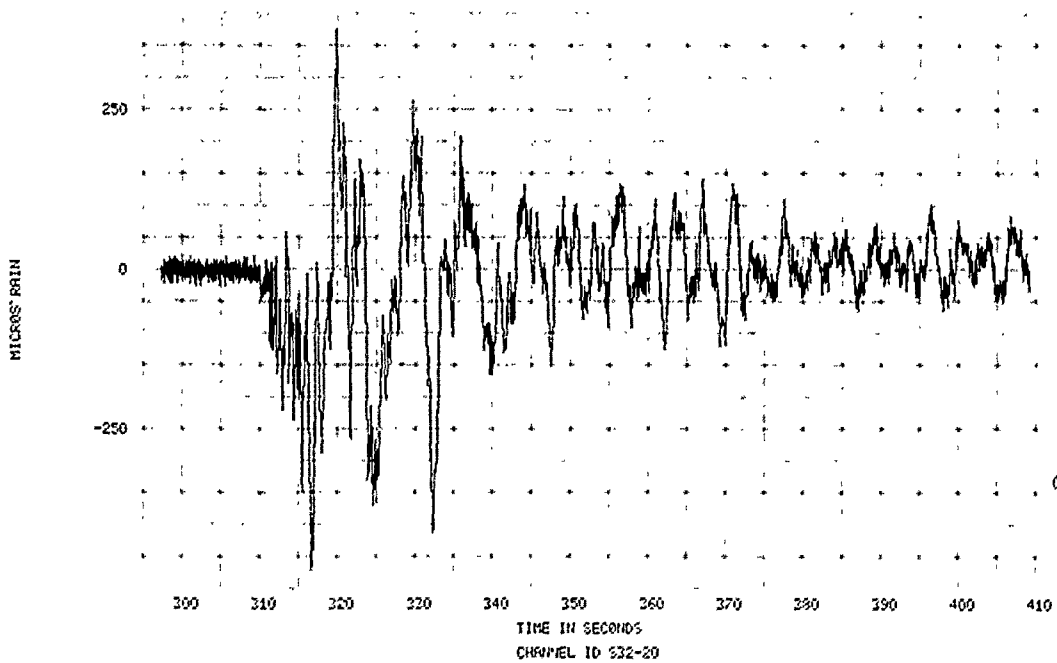

FIGURE 267. SPECIMEN 32, EVENT 78-347, STRAIN TIME HISTORY

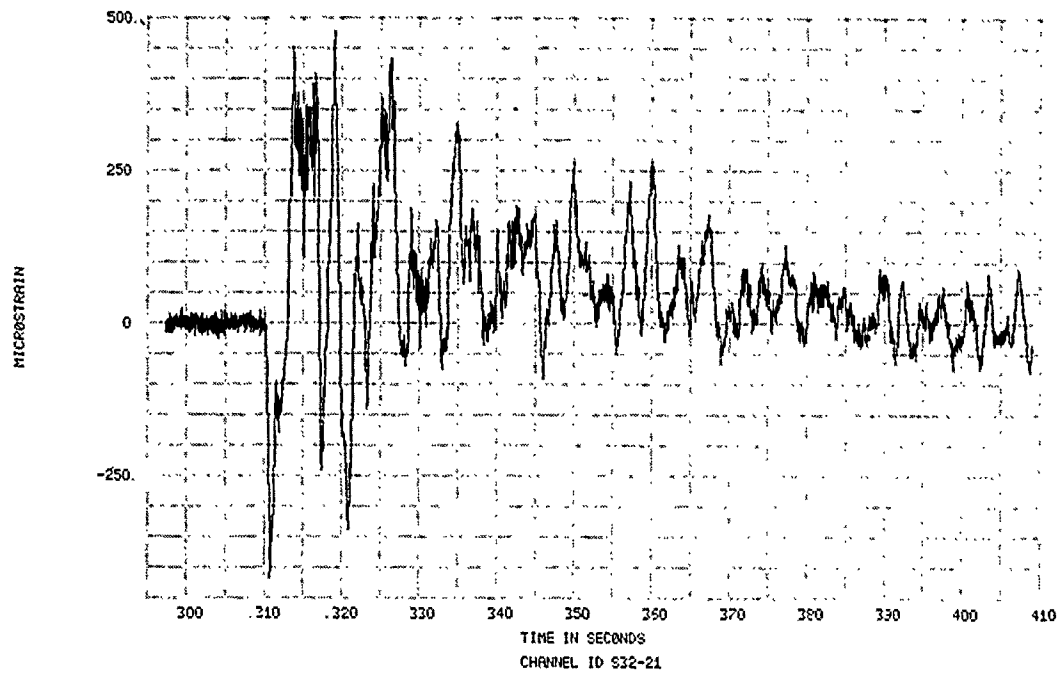

FIGURE 268. SPECIMEN 32, EVENT 78-347, STRAIN TIME HISTORY

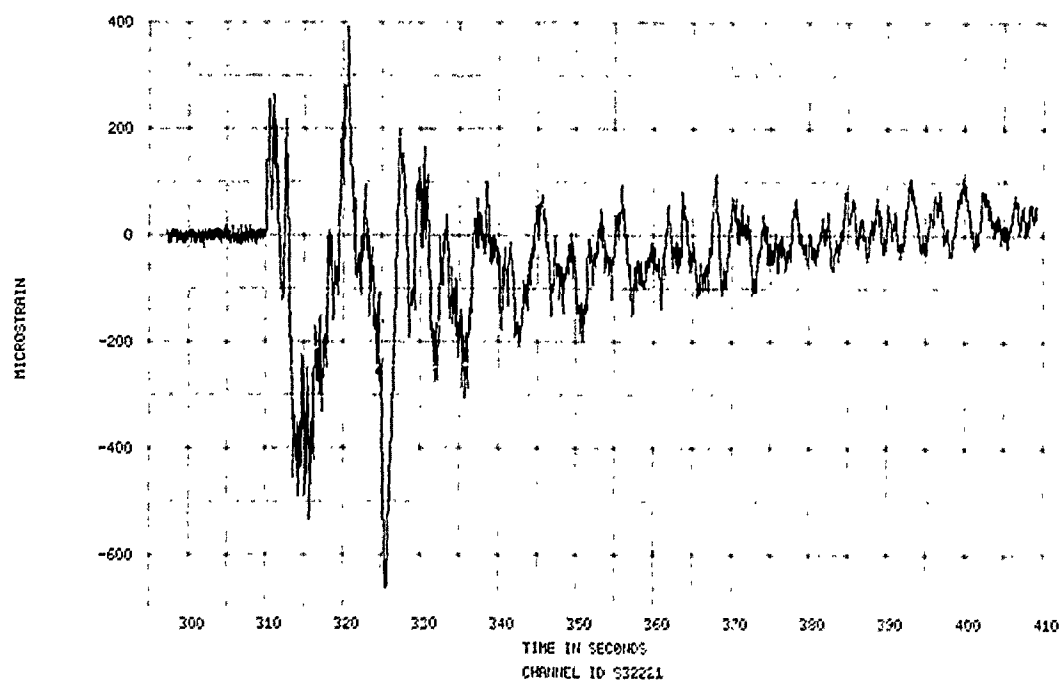

FIGURE 269. SPECIMEN 32, EVENT 78-347, STRAIN TIME HISTORY

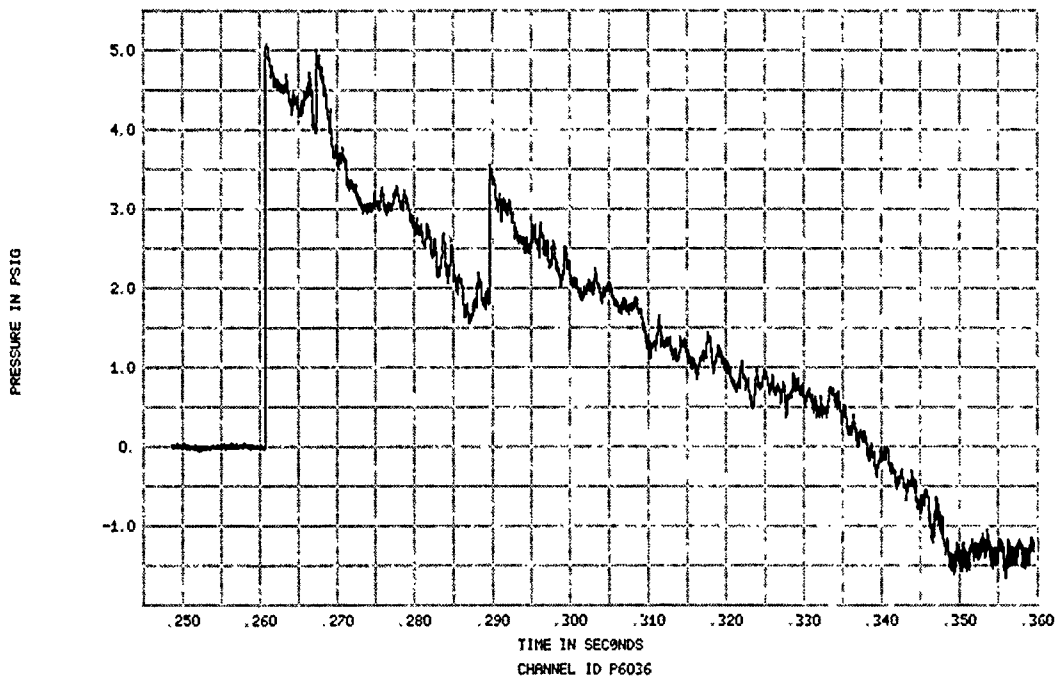

FIGURE 270. SPECIMEN 32, EVENT 78-348, TUNNEL WALL INCIDENT OVERPRESSURE TIME HISTORY

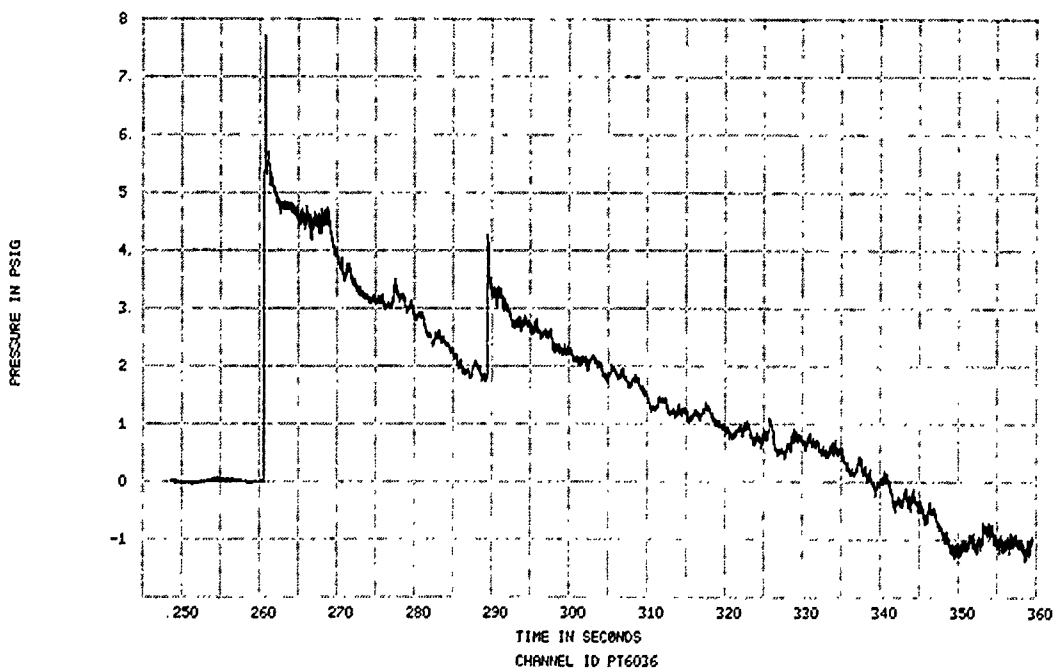
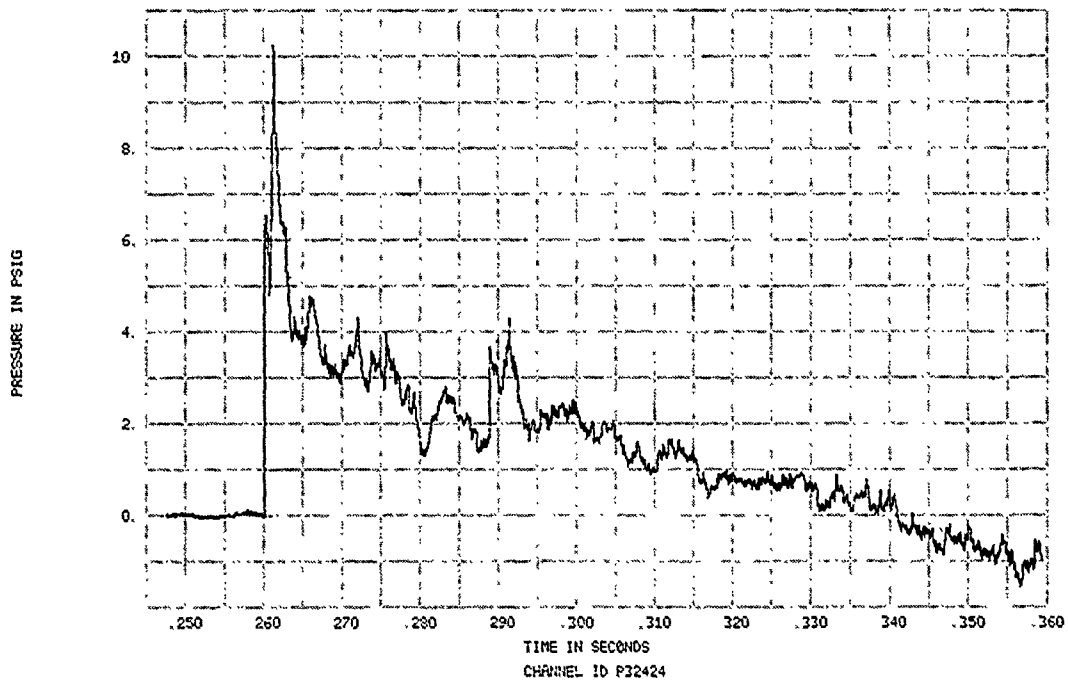
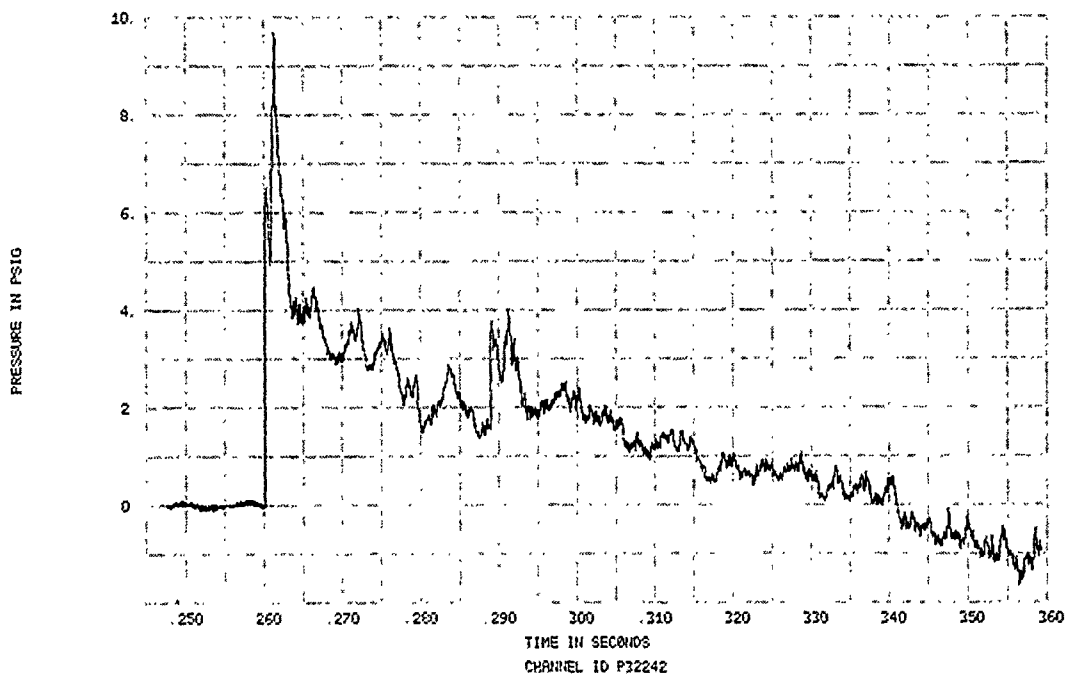

FIGURE 271. SPECIMEN 32, EVENT 78-348, TUNNEL WALL REFLECTED OVERPRESSURE TIME HISTORY



**FIGURE 272. SPECIMEN 32, EVENT 78-348, SPECIMEN REFLECTED
 OVERPRESSURE TIME HISTORY**



**FIGURE 273. SPECIMEN 32, EVENT 78-348, SPECIMEN REFLECTED
 OVERPRESSURE TIME HISTORY**

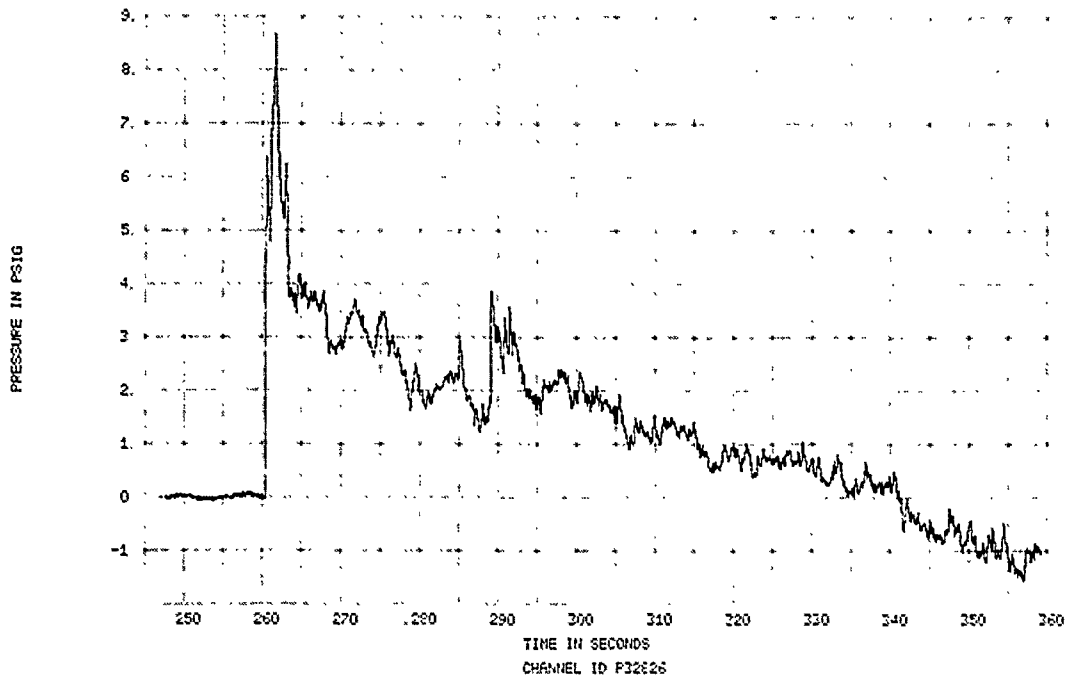

FIGURE 274. SPECIMEN 32, EVENT 78-348, SPECIMEN REFLECTED OVERPRESSURE TIME HISTORY

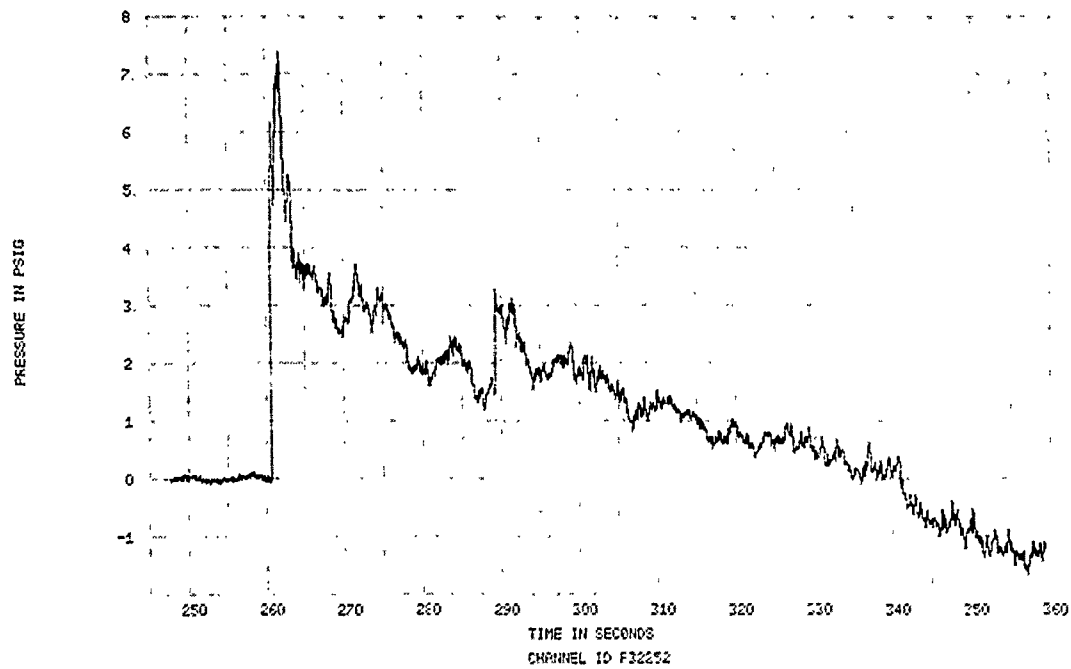

FIGURE 275. SPECIMEN 32, EVENT 78-348, SPECIMEN REFLECTED OVERPRESSURE TIME HISTORY

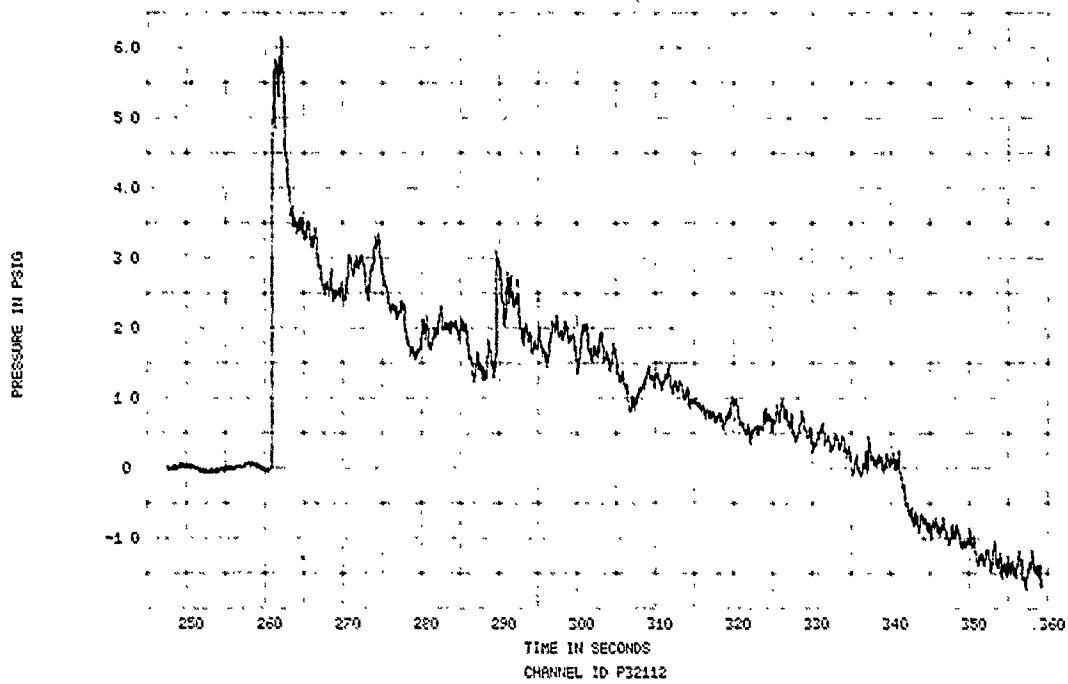

FIGURE 276. SPECIMEN 32, EVENT 78-348, SPECIMEN REFLECTED OVERPRESSURE TIME HISTORY

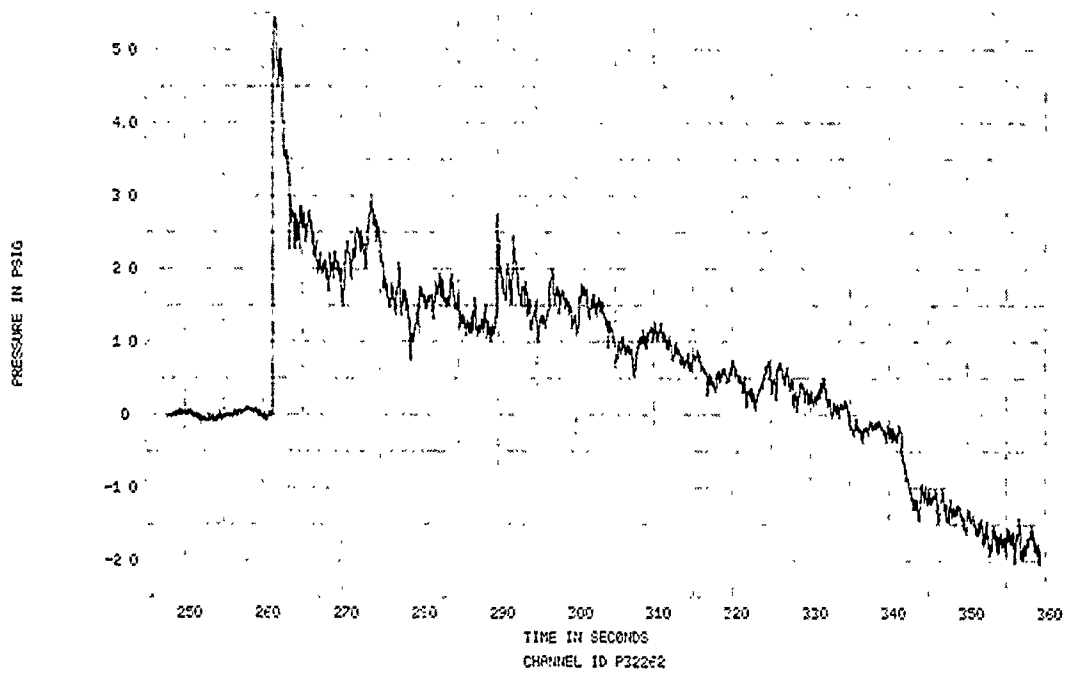

FIGURE 277. SPECIMEN 32, EVENT 78-348, SPECIMEN REFLECTED OVERPRESSURE TIME HISTORY

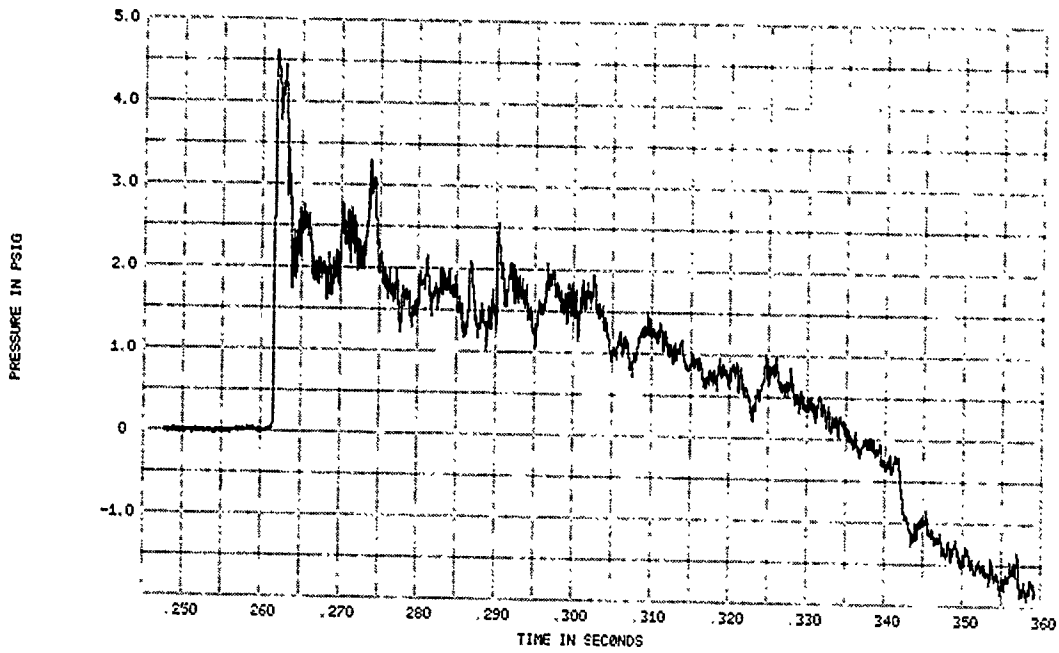

FIGURE 278. SPECIMEN 32, EVENT 78-348, SPECIMEN REFLECTED OVERPRESSURE TIME HISTORY

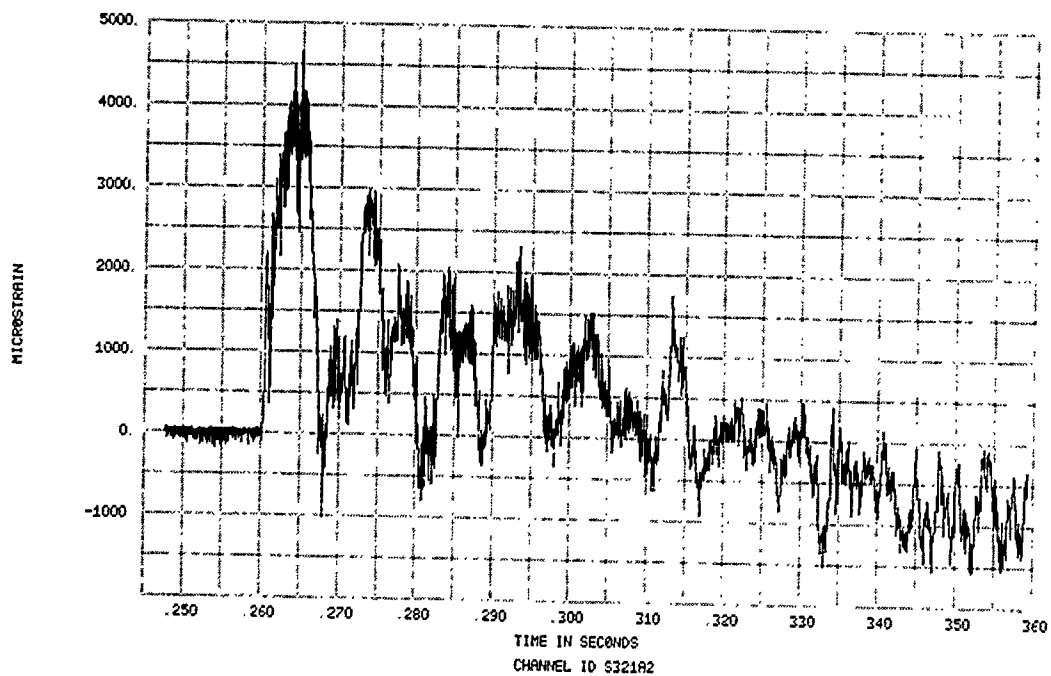

FIGURE 279. SPECIMEN 32, EVENT 78-348, STRAIN TIME HISTORY

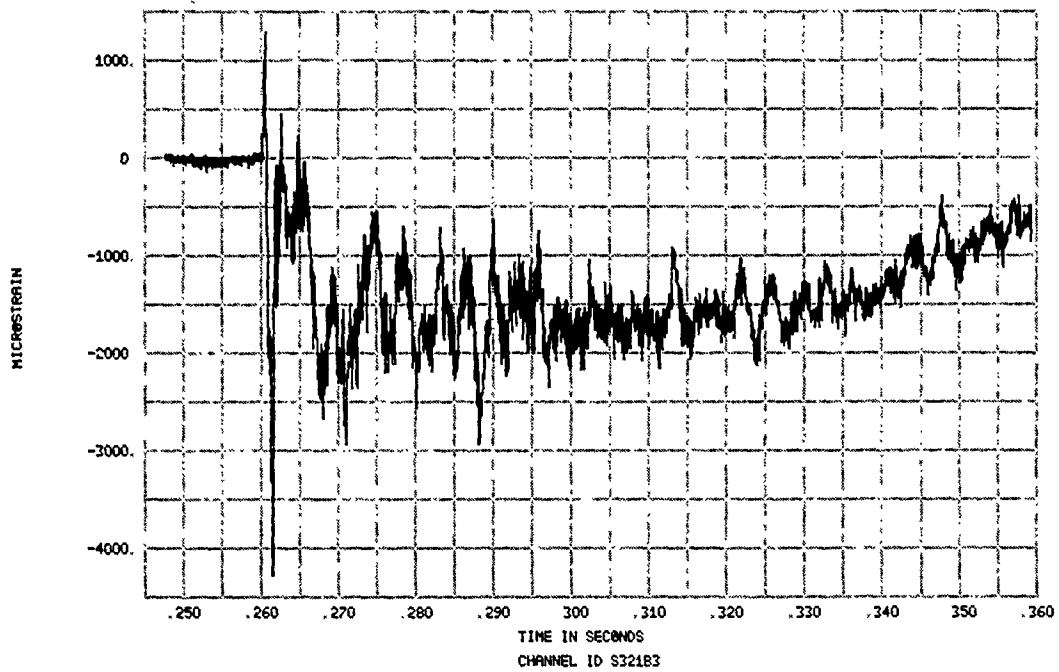

FIGURE 280. SPECIMEN 32, EVENT 78-348, STRAIN TIME HISTORY

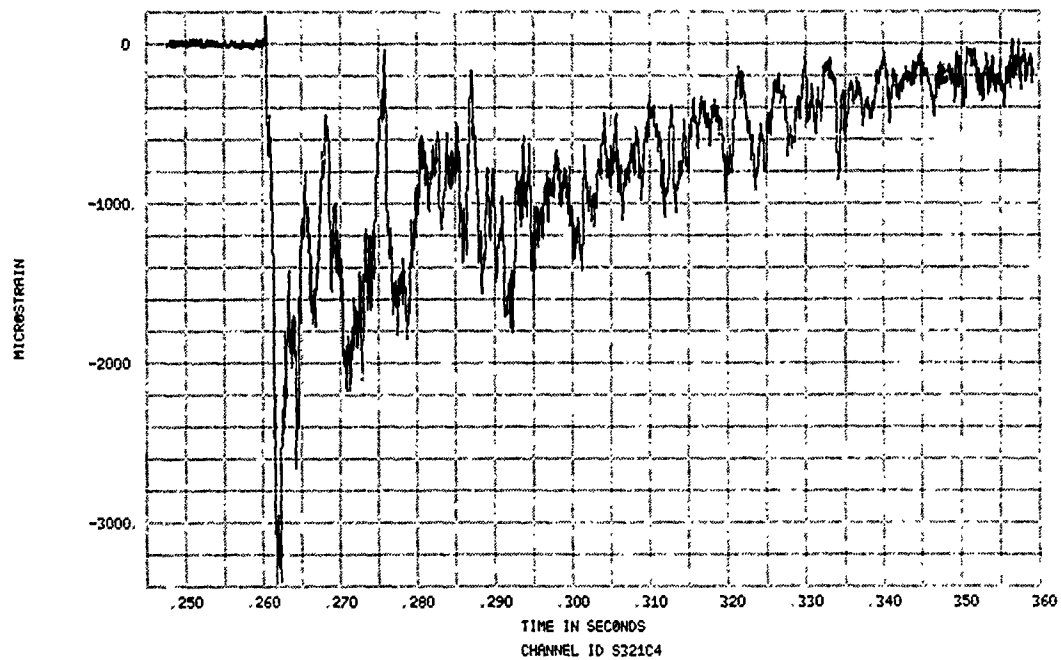

FIGURE 281. SPECIMEN 32, EVENT 78-348, STRAIN TIME HISTORY

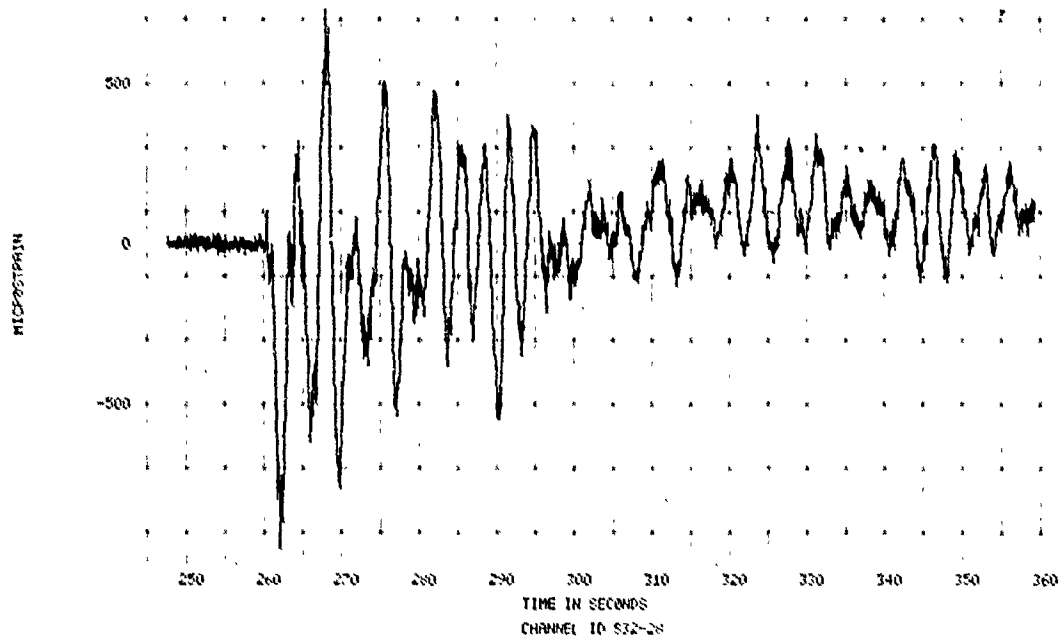

FIGURE 282. SPECIMEN 32, EVENT 78-348, STRAIN TIME HISTORY

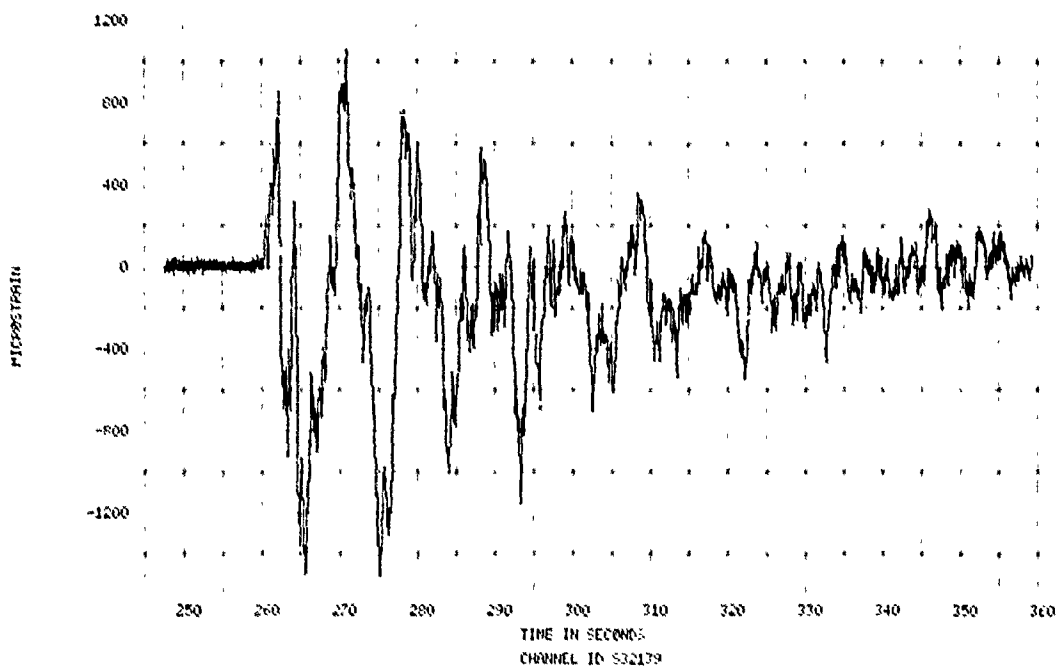

FIGURE 283. SPECIMEN 32, EVENT 78-348, STRAIN TIME HISTORY

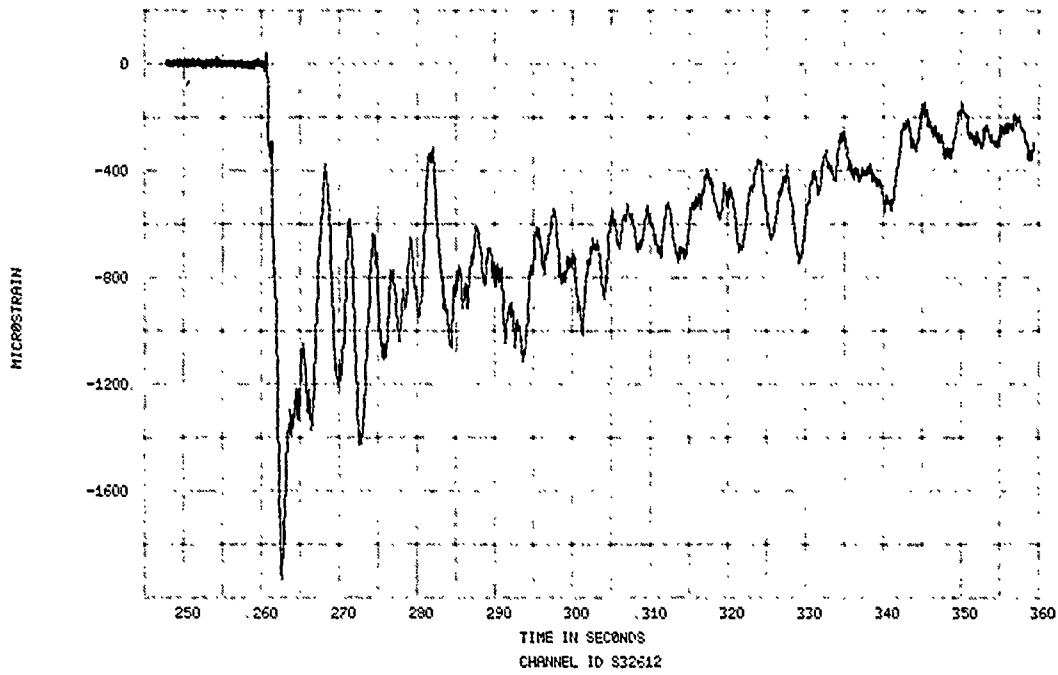

FIGURE 284. SPECIMEN 32, EVENT 78-348, STRAIN TIME HISTORY

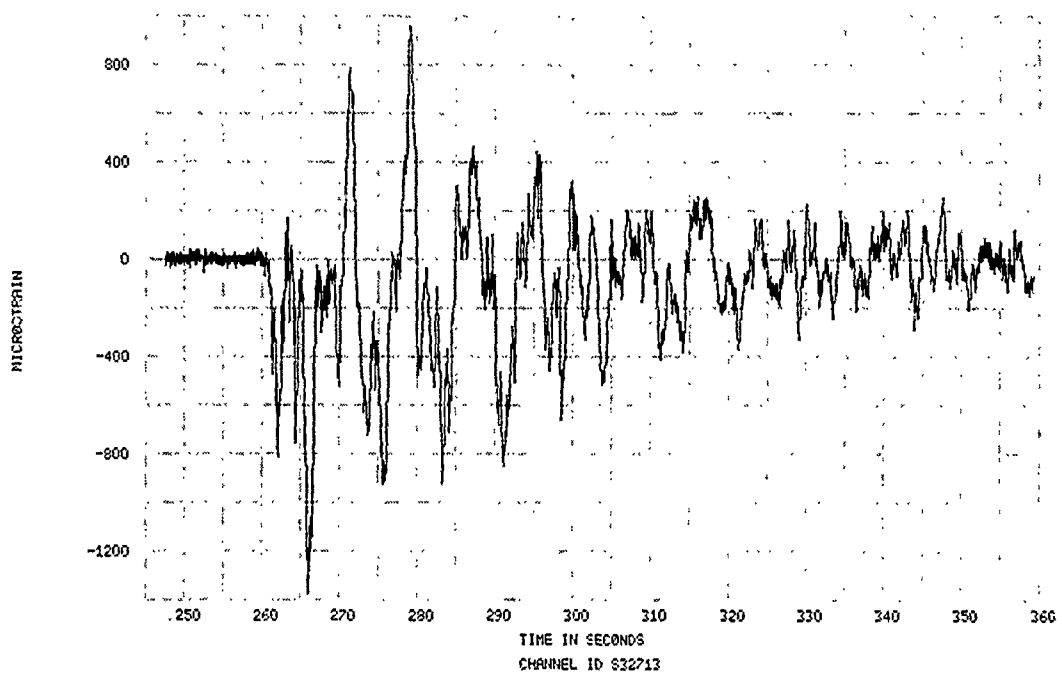

FIGURE 285. SPECIMEN 32, EVENT 78-348, STRAIN TIME HISTORY

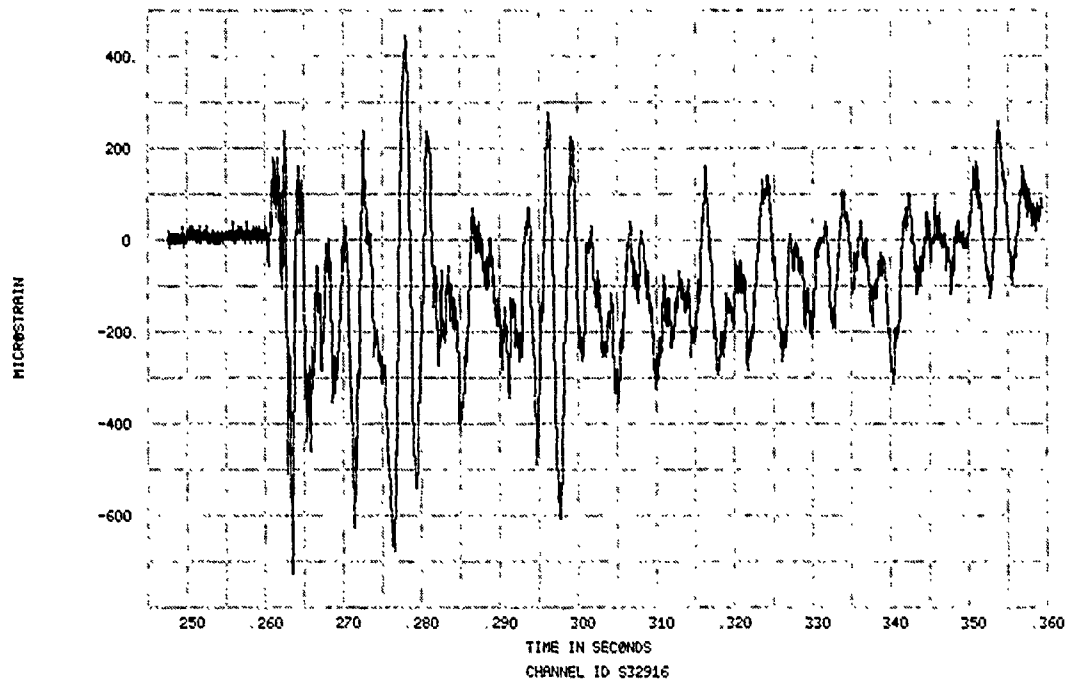

FIGURE 286. SPECIMEN 32, EVENT 78-348, STRAIN TIME HISTORY

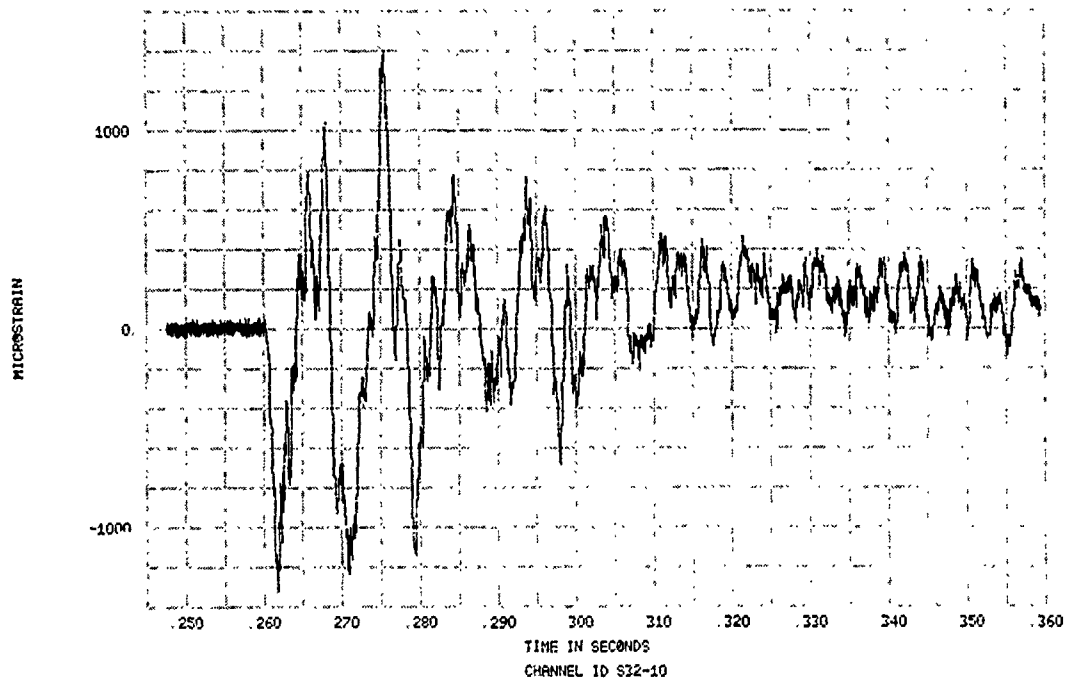

FIGURE 287. SPECIMEN 32, EVENT 78-348, STRAIN TIME HISTORY

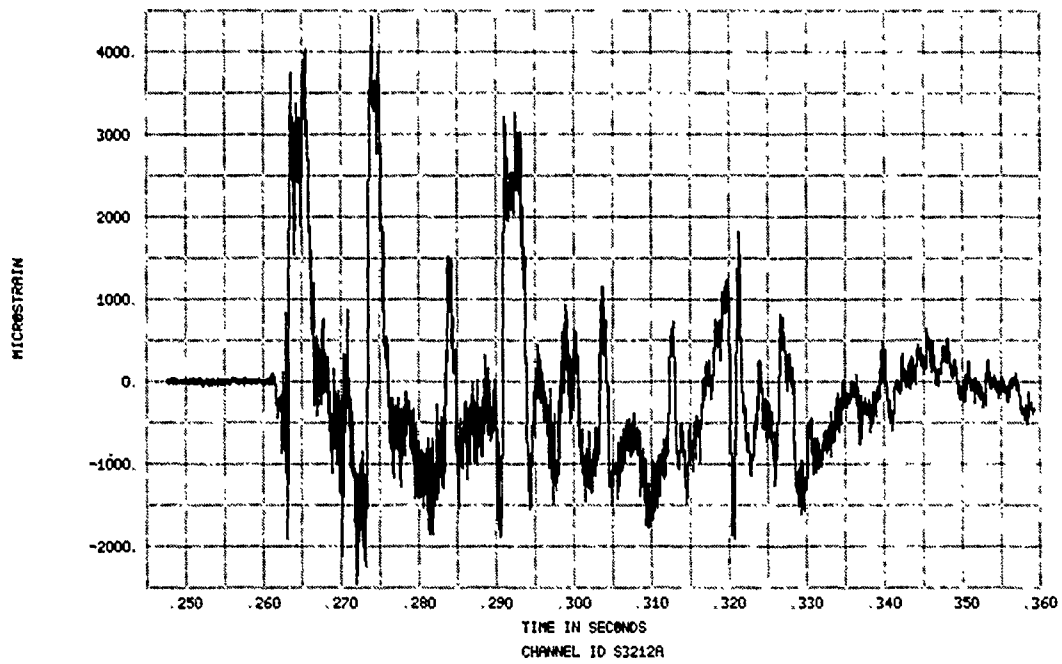

FIGURE 288. SPECIMEN 32, EVENT 78-348, STRAIN TIME HISTORY

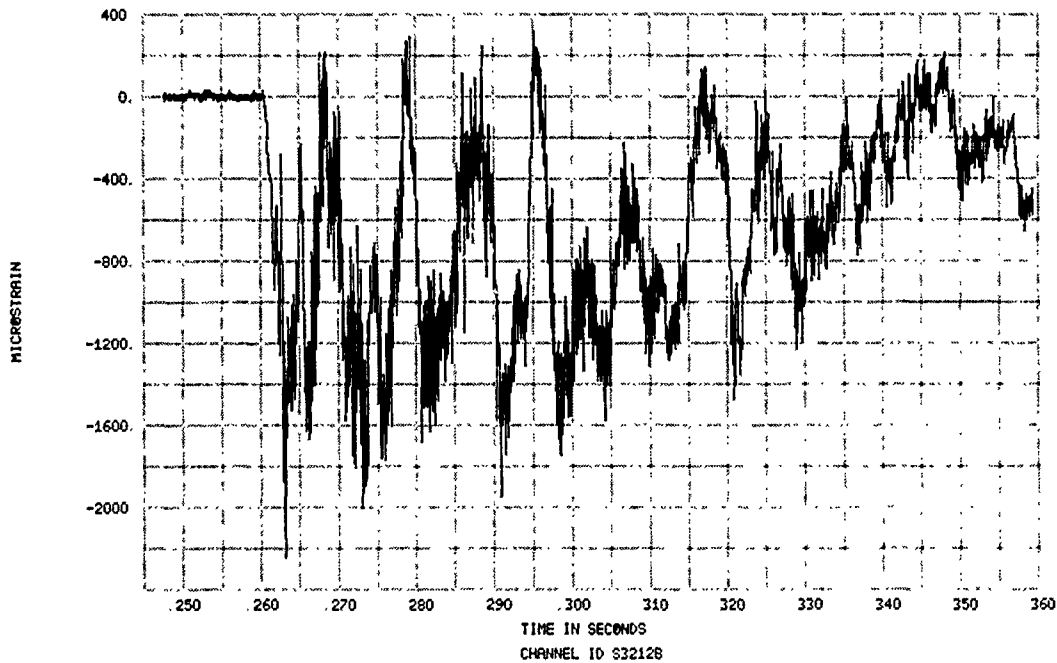

FIGURE 289. SPECIMEN 32, EVENT 78-348, STRAIN TIME HISTORY

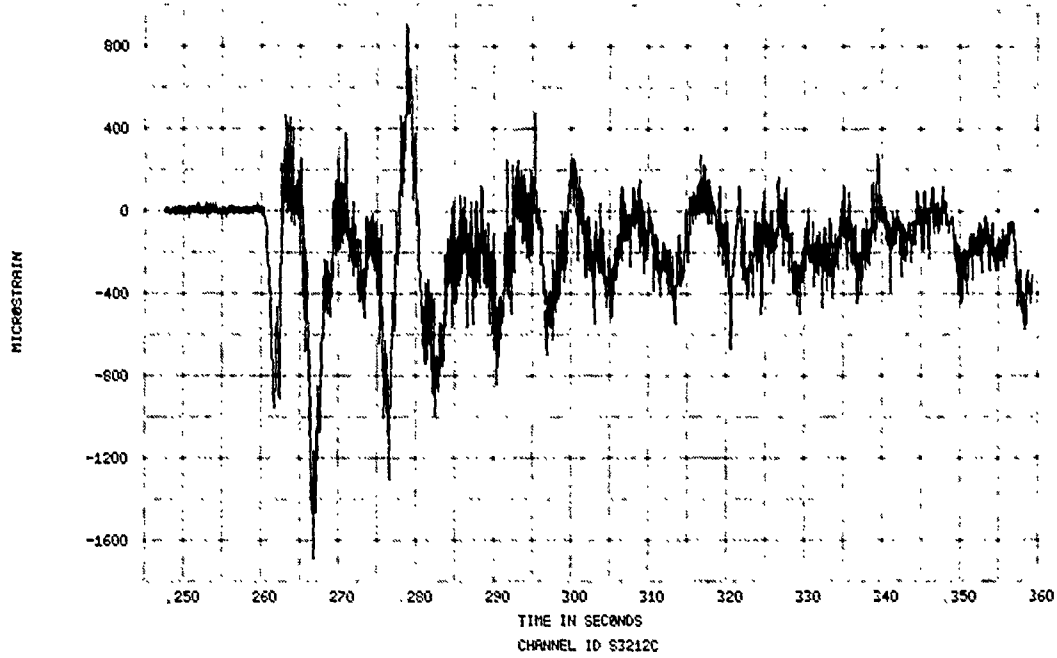

FIGURE 290. SPECIMEN 32, EVENT 78-348, STRAIN TIME HISTORY

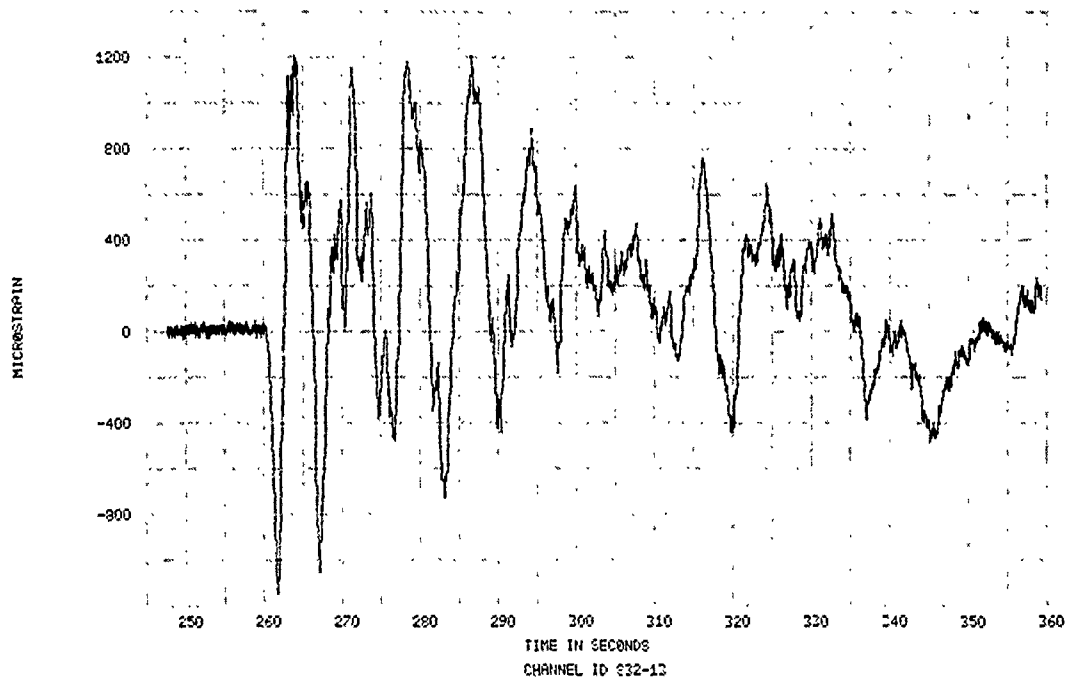

FIGURE 291. SPECIMEN 32, EVENT 78-348, STRAIN TIME HISTORY

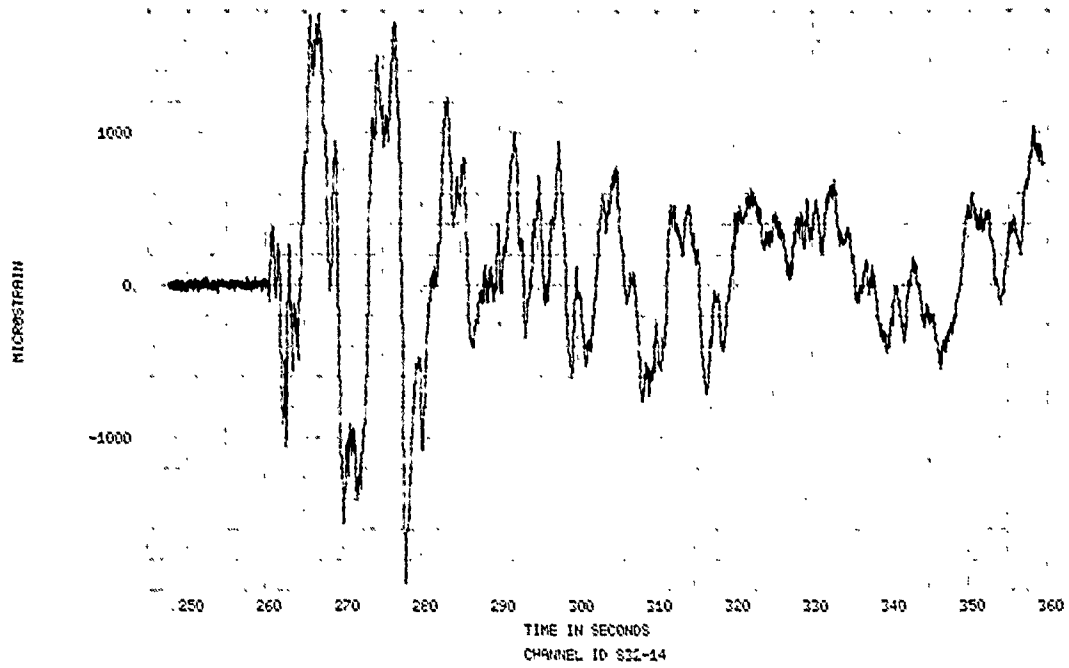

FIGURE 292. SPECIMEN 32, EVENT 78-348, STRAIN TIME HISTORY

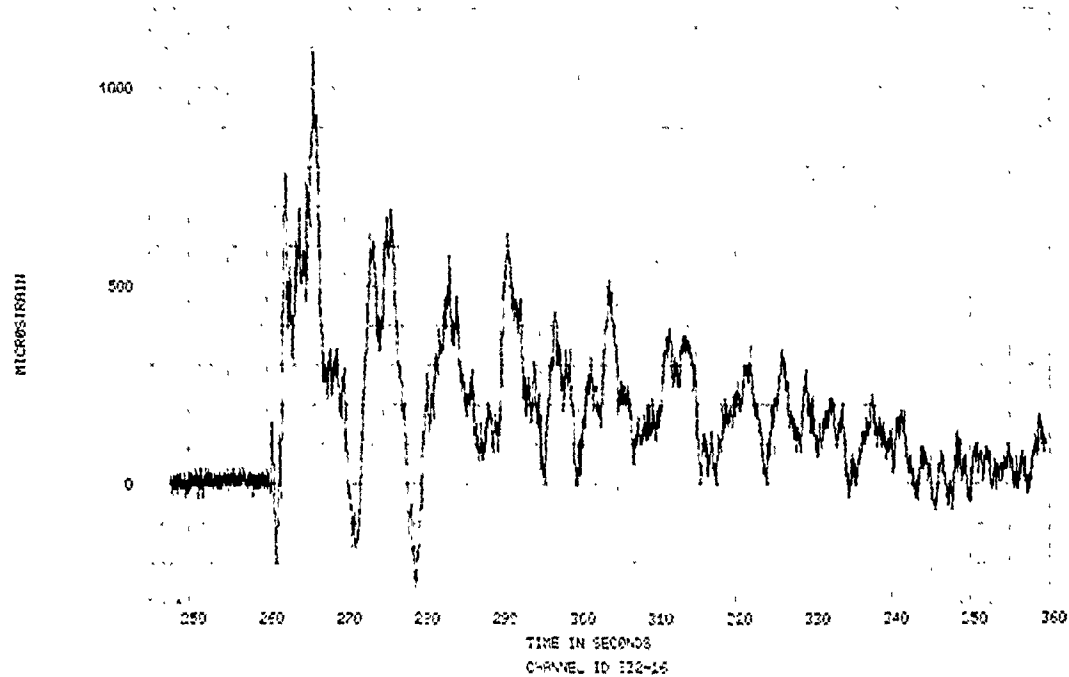

FIGURE 293. SPECIMEN 32, EVENT 78-348, STRAIN TIME HISTORY

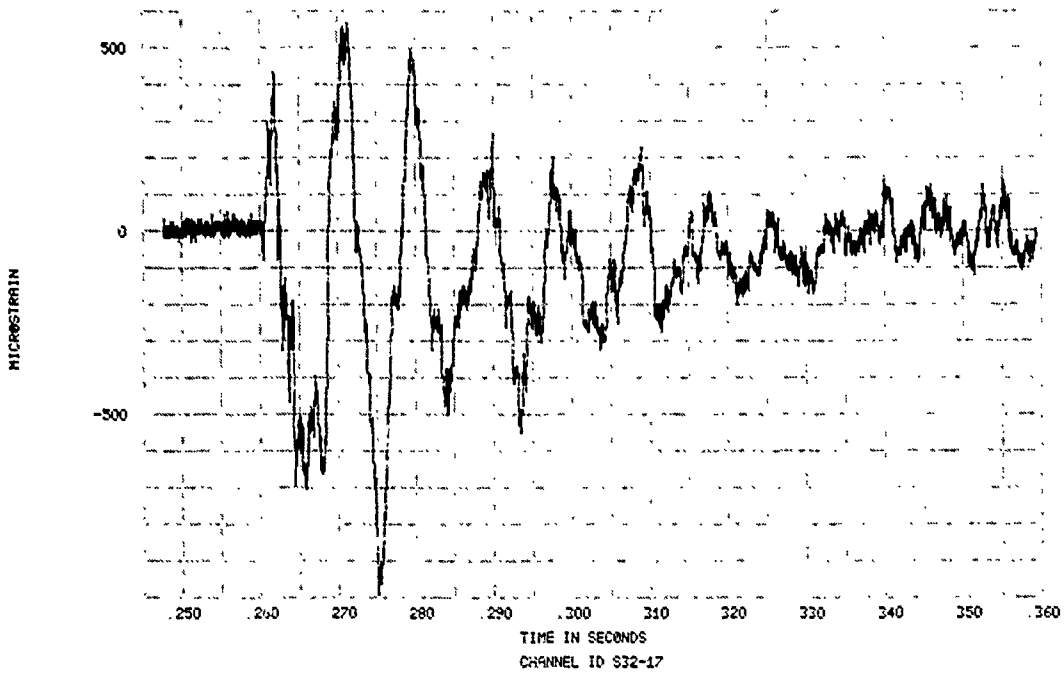

FIGURE 294. SPECIMEN 32, EVENT 78-348, STRAIN TIME HISTORY

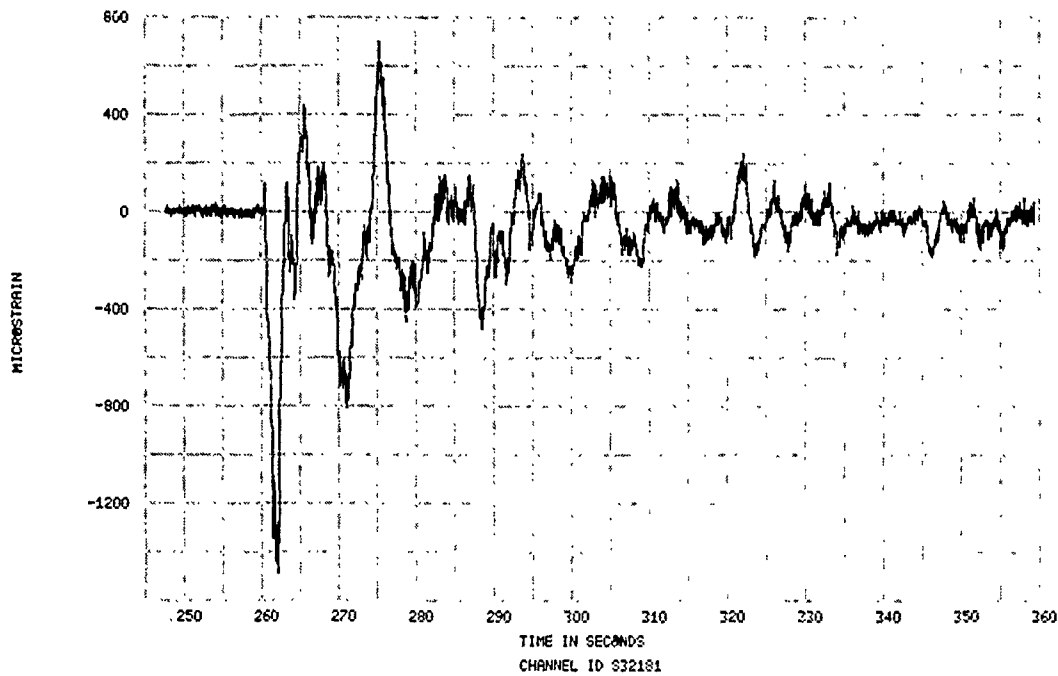

FIGURE 295. SPECIMEN 32, EVENT 78-348, STRAIN TIME HISTORY

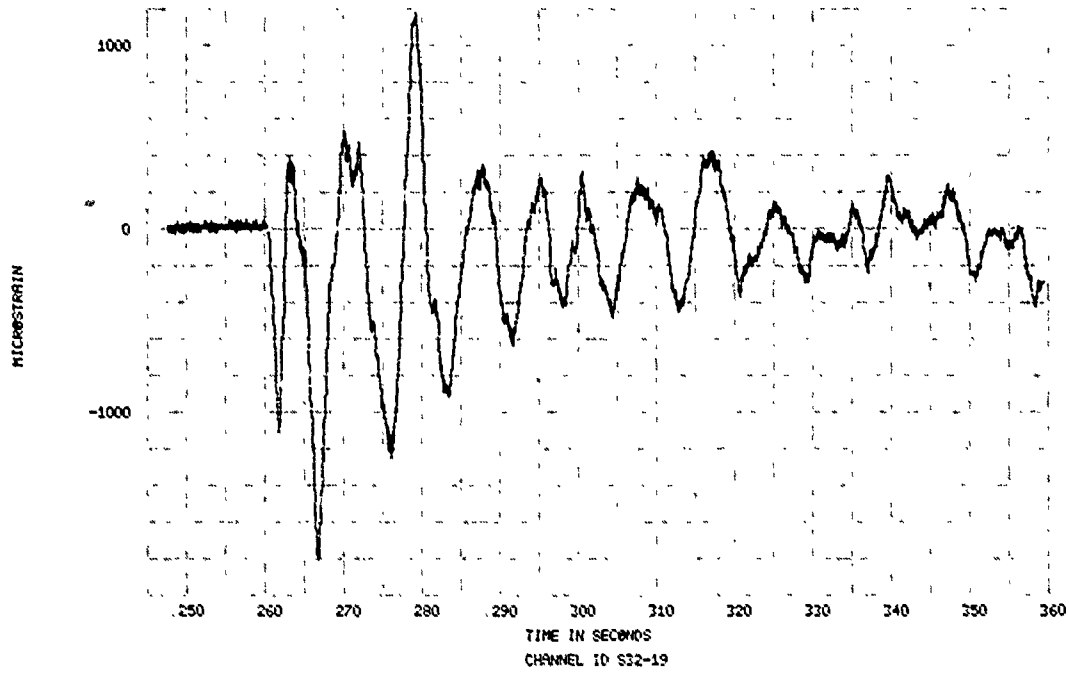

FIGURE 296. SPECIMEN 32, EVENT 78-348, STRAIN TIME HISTORY

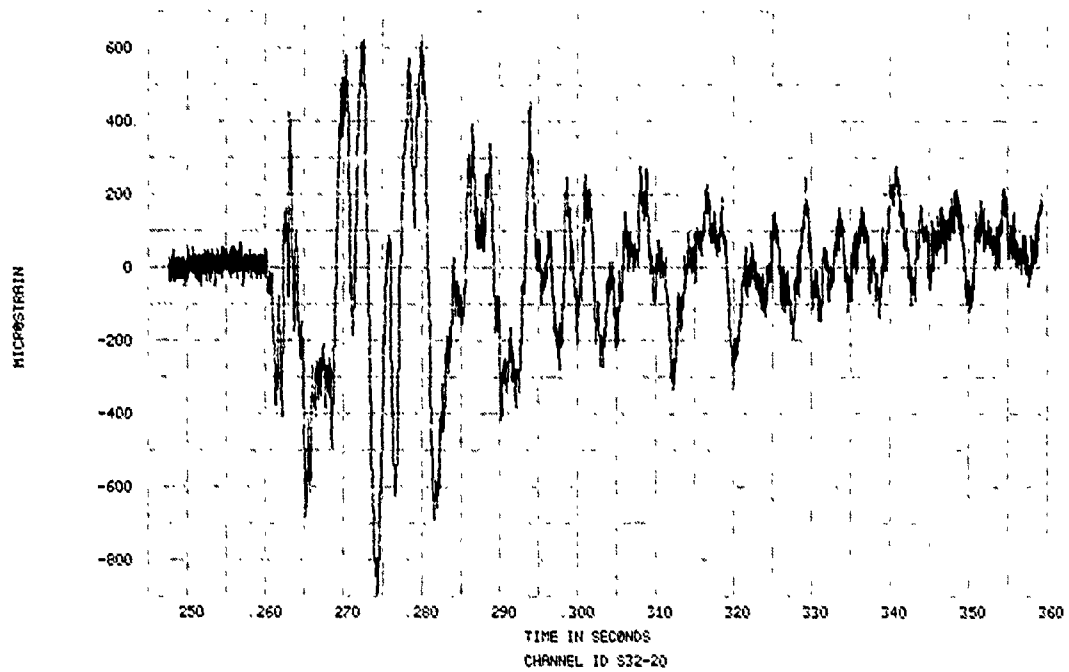

FIGURE 297. SPECIMEN 32, EVENT 78-348, STRAIN TIME HISTORY

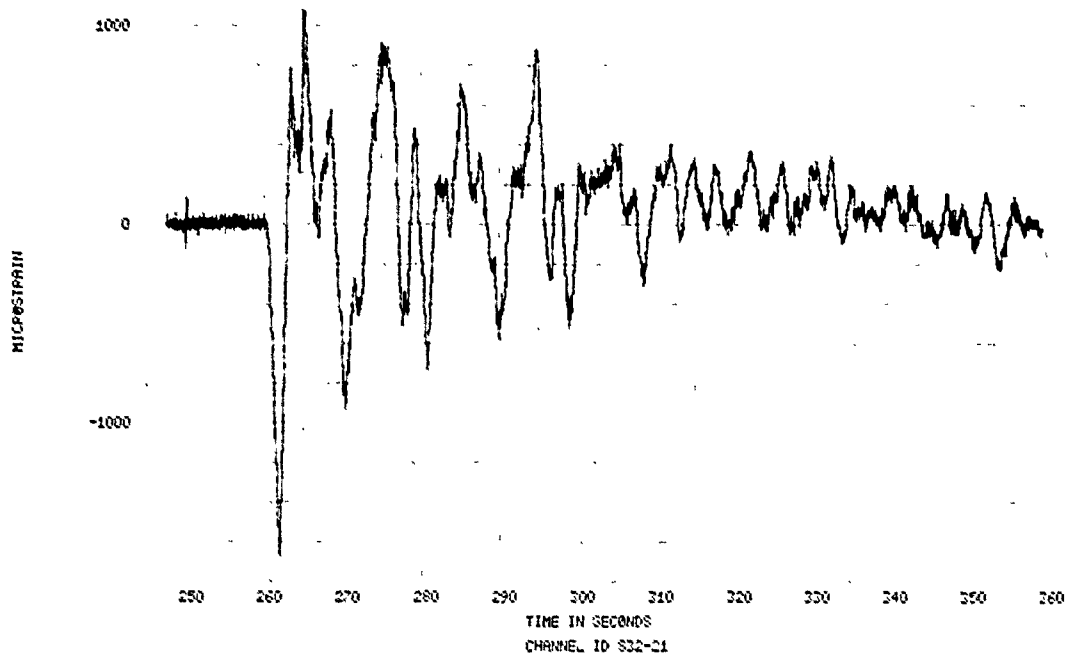

FIGURE 288. SPECIMEN 32, EVENT 78-348, STRAIN TIME HISTORY

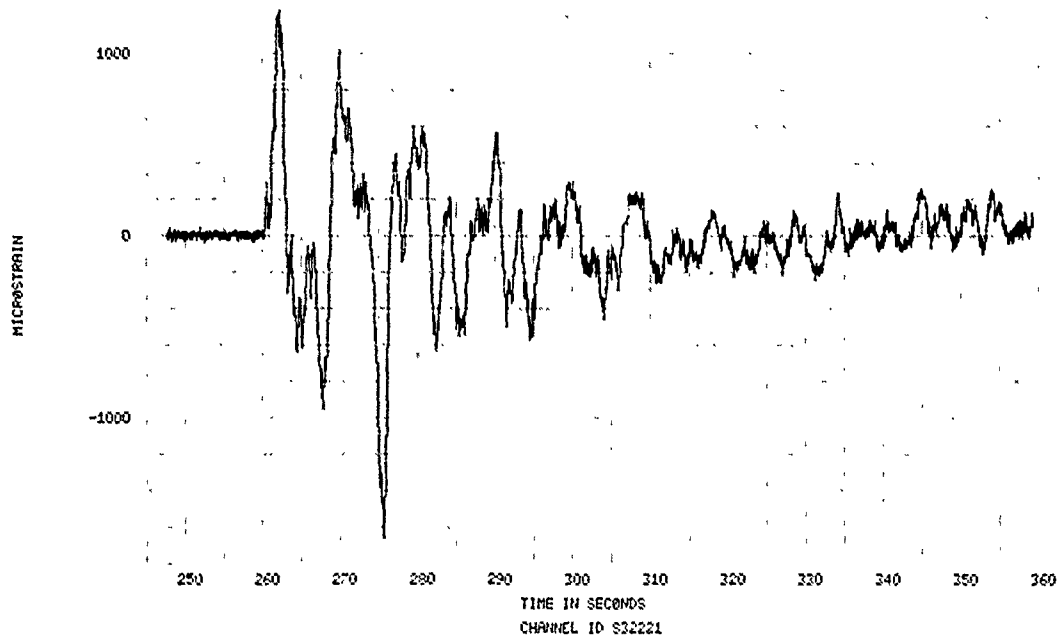
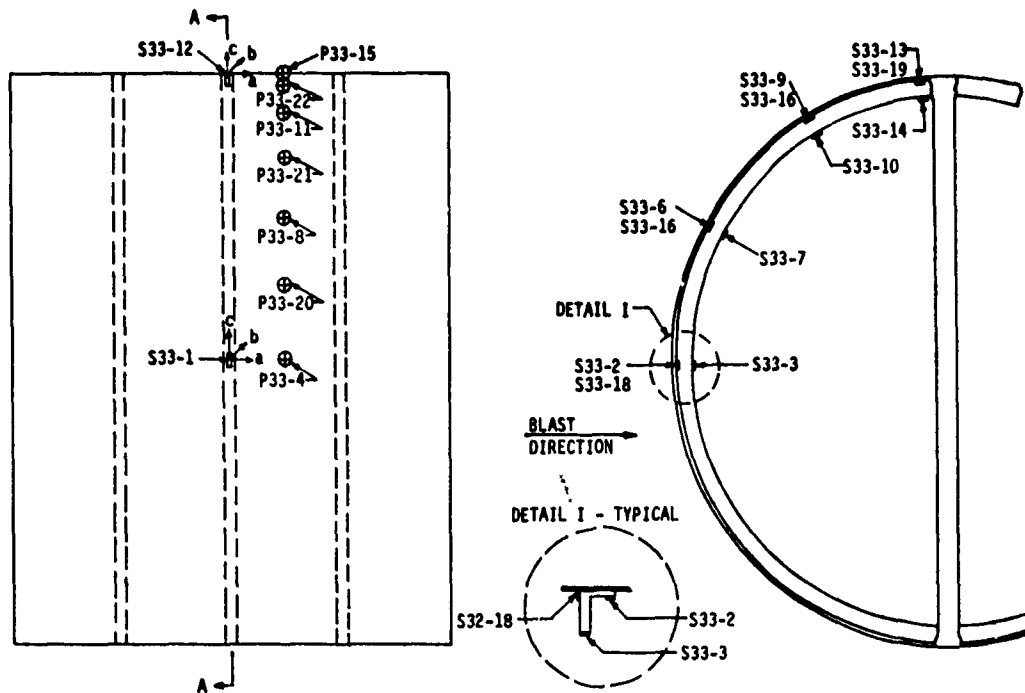

FIGURE 289. SPECIMEN 32, EVENT 78-348, STRAIN TIME HISTORY

SPECIMEN NO. 33

SPECIMEN NO. 33

PRECEDING PAGE BLANK-NOT FILMED



SPECIMEN NO. 33

SKIN/FRAME CYLINDER (24.0 IN. RADIUS)

FRAME CLAMPED AT TWO DIAMETRICALLY OPPOSITE POINTS

MATERIAL - 6061-T42 ALUMINUM ALLOY

DENSITY - 0.0002539 LB-SEC²/IN⁴

MODULUS OF ELASTICITY - 10.4 x 10⁶ PSI

YIELD STRESS - 20,480 PSI

ULTIMATE STRESS - 38,250 PSI

The skin was bonded to the frame and was not included in the cross-section due to lack of shear transfer

Figure 300. Description and Instrumentation - Specimen No. 33

PRECEDING PAGE BLANK-NOT FILMED

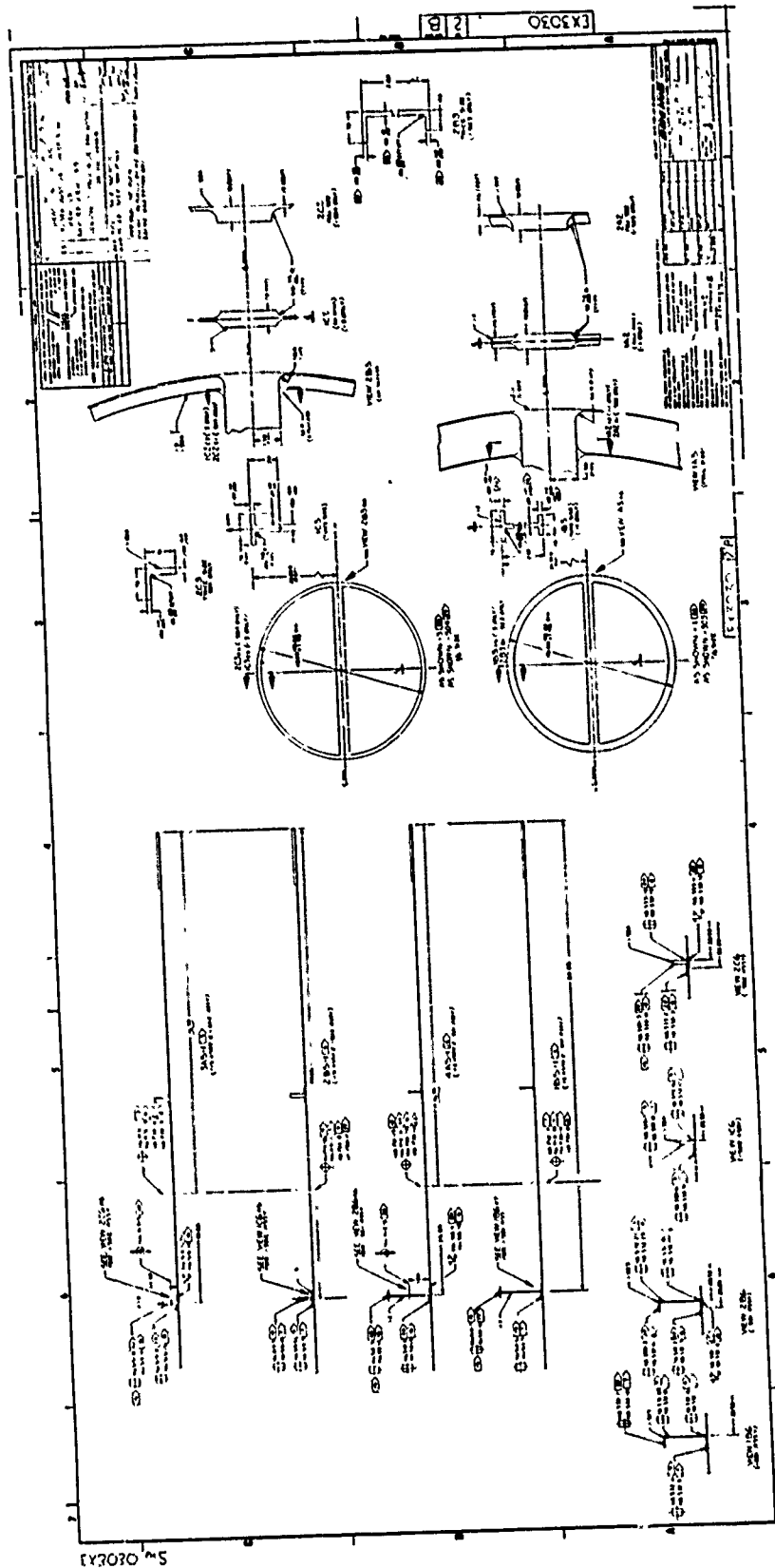

Figure 301. Spec Drawing - Specimen No. 33

NOVA-2LT DATA DECK LISTING
TEST SPECIMEN 33

* * * NOVA-2LT DATA DECK FOR TEST SPECIMEN 33 * * *						GP 1
1	7	101	2	1	1	GP 3
0.50	1					GP 4
	2	2	5	1	1	0 GPB 1
	18	2	6			GPB 2
23.61	1.34					GPB 5
23.55	2.16					GPB 6
23.41	3.31					GPB 6
23.05	5.27					GPB 6
22.53	7.19					GPB 6
21.85	9.06					GPB 6
21.73	10.46					GPB 6
20.48	11.82					GPB 6
19.66	13.14					GPB 6
18.25	15.04					GPB 6
16.72	16.72					GPB 6
15.04	18.25					GPB 6
13.14	19.67					GPB 6
11.82	20.48					GPB 6
9.66	21.59					GPB 6
7.80	22.32					GPB 6
5.91	22.90					GPB 6
3.96	23.32					GPB 6
1.98	23.57					GPB 6
0.0	23.65					GPB 7
	0					GPB 8
	1	1	1			GPB 12
.0002539	.0002539	.0002539				GPB 13
9.0						GPB 14
0.108						GPB 15
0.704						GPB 16
	2					GPB 17
0.001917	19941.					GPB 18
0.19961	37244.					GPB 18
	2					GPB 19
0.001969	20480.					GPB 20
0.2050	38250.					GPB 20
0.597						GPB 15
0.154						GPB 16
	2					GPB 17
0.001917	19941.					GPB 18
0.19961	37244.					GPB 18
	2					GPB 19
0.001969	20480.					GPB 20
0.2050	38250.					GPB 20
0.0	0.010	20.0				GPB 22
	4					GP 6

TABLE 20
 STATIC TEST STRESS DATA - SPECIMEN 33
 (STRESSES GIVEN IN PSI)

STRAIN GAUGE	STATIC PRESSURE (PSI)									
	0.80	1.60	2.40	2.80	3.20	3.60	3.80	4.0		
S33-1	11755.	17916.	22593.	24303.	25764.	27126.	27764.	28418.		
S33-2	-1487.	-3754.	-6105.	-7124.	-8133.	-9069.	-9537.	-10057.		
S33-3	1404.	2912.	3598.	3671.	3702.	3702.	3702.	3650.		
S33-6	385.	291.	-957.	-1674.	-2340.	-3026.	-3349.	-3713.		
S33-7	478.	801.	374.	-42.	-447.	-853.	-1040.	-1300.		
S33-9	-1414.	-4046.	-7405.	-8996.	-10494.	-11835.	-12438.	-13104.		
S33-10	-114.	42.	489.	416.	229.	62.	-21.	-104.		
S33-12	10667.	21368.	27566.	29268.	30740.	31926.	32475.	33024.		
S33-13	-1269.	-2746.	-4732.	-5710.	-6666.	-7634.	-8102.	-8622.		
S33-14	-645.	-2392.	-4087.	-4618.	-5075.	-5606.	-5886.	-6219.		
S33-16	-582.	-1446.	-2018.	-2309.	-2621.	-2933.	-3099.	-3266.		
S33-17	104.	291.	229.	198.	198.	114.	52.	-52.		
S33-18	-2090.	-4607.	-6687.	-7613.	-8424.	-9256.	-9641.	-9994.		
S33-19	374.	811.	1102.	1061.	1009.	1009.	1019.	1009.		

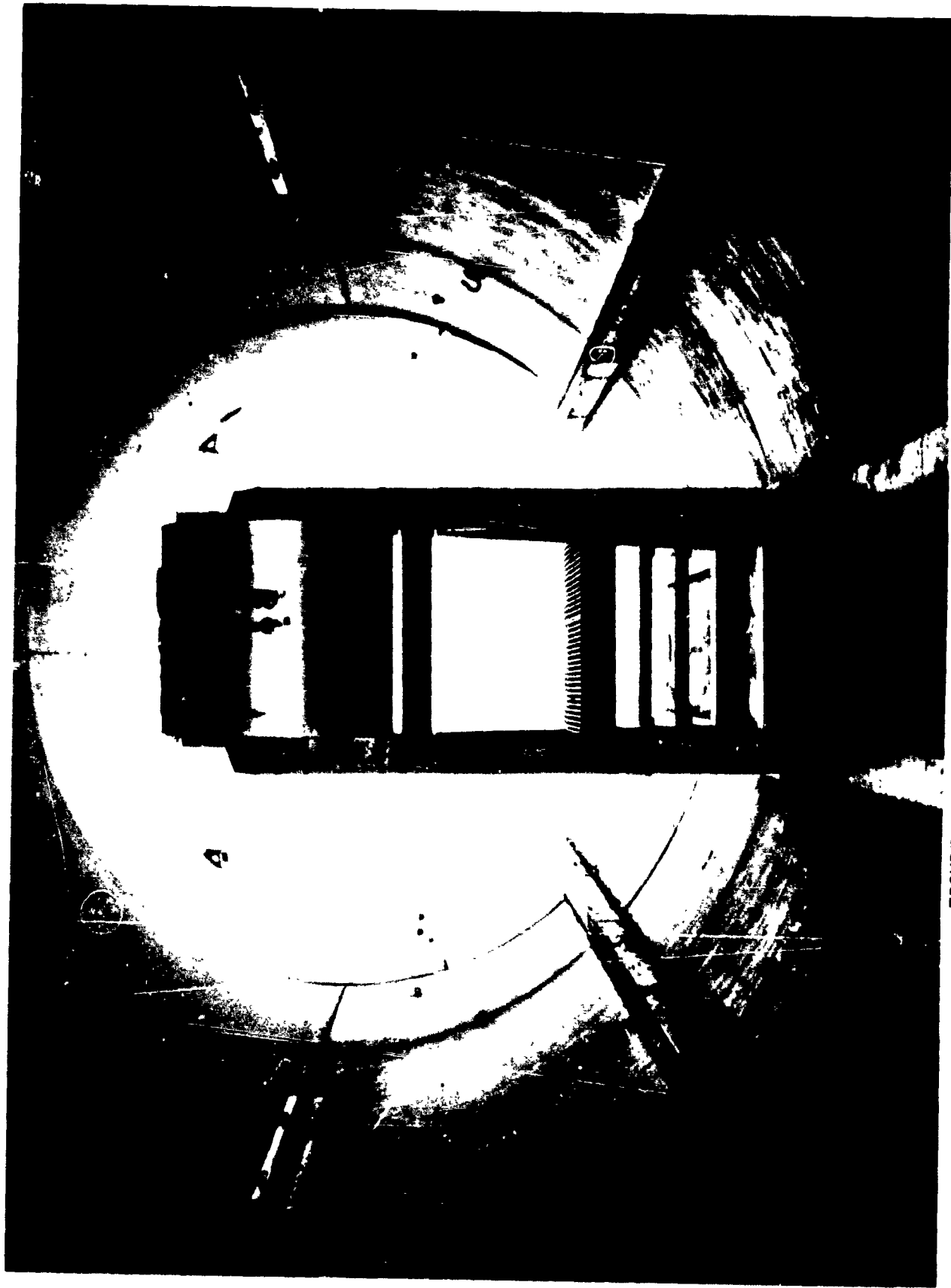

FIGURE 302. SHOCK TEST SETUP - SPECIMEN 33

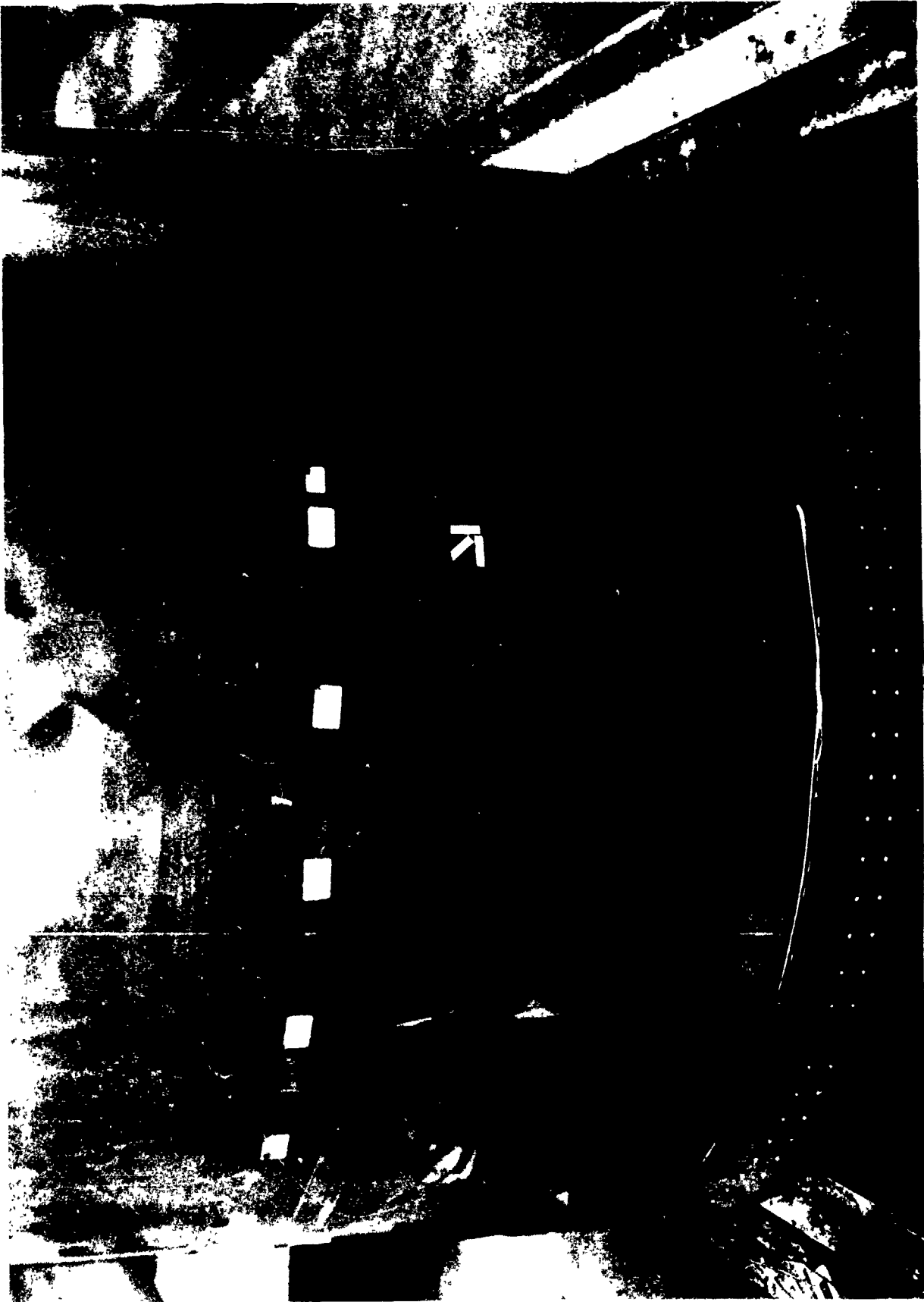

FIGURE 303. CONDITION OF SPECIMEN 33 SUBSEQUENT TO SHOCK LOAD TEST



FIGURE 304. CONDITION OF SPECIMEN 33 SUBSEQUENT TO SHOCK LOAD TEST

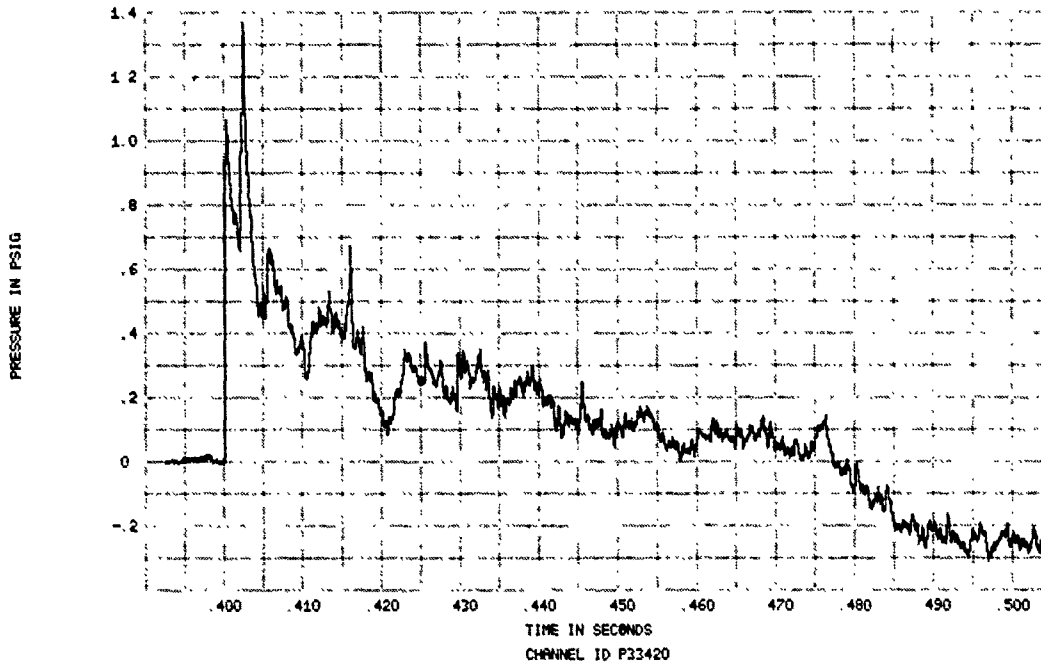

FIGURE 306. SPECIMEN 33, EVENT 78-328, SPECIMEN REFLECTED OVERPRESSURE TIME HISTORY

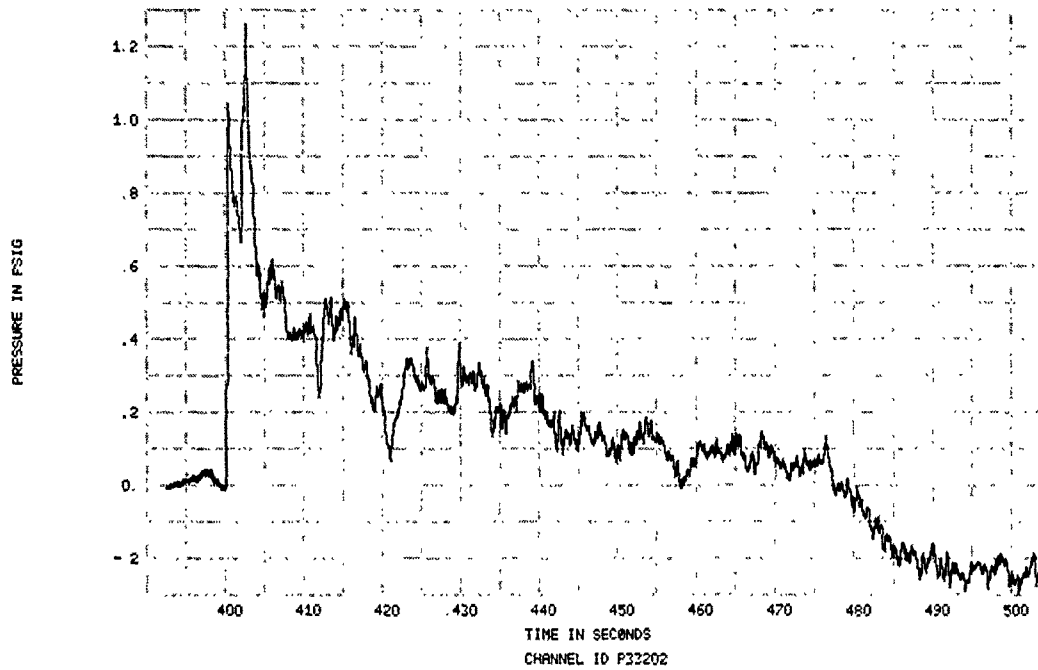

FIGURE 306. SPECIMEN 33, EVENT 78-328, SPECIMEN REFLECTED OVERPRESSURE TIME HISTORY

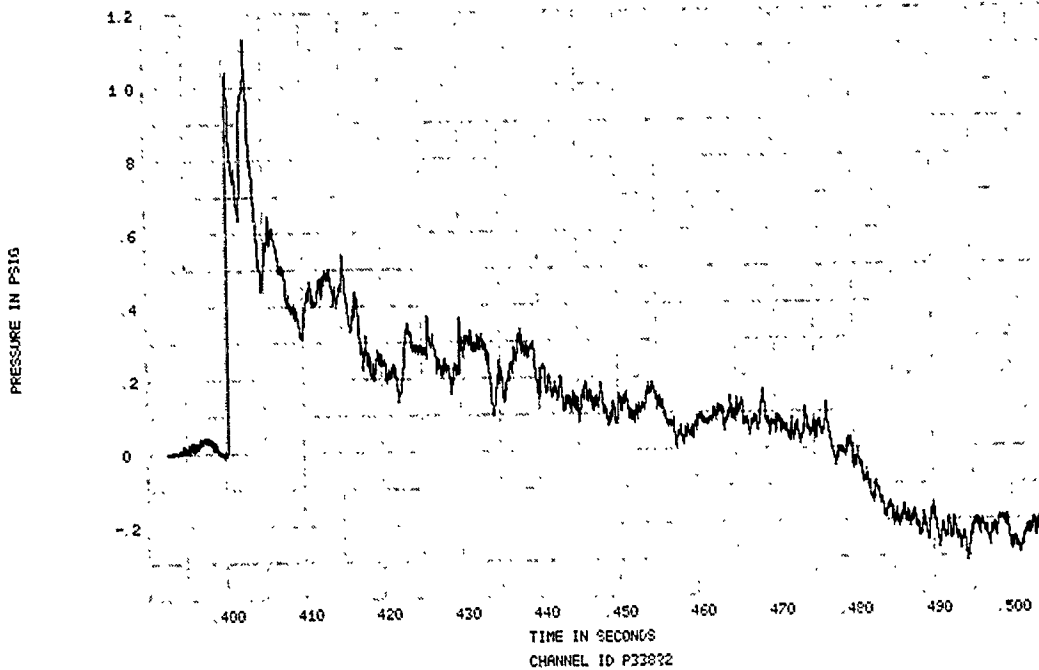

FIGURE 307. SPECIMEN 33, EVENT 78-328, SPECIMEN REFLECTED OVERPRESSURE TIME HISTORY

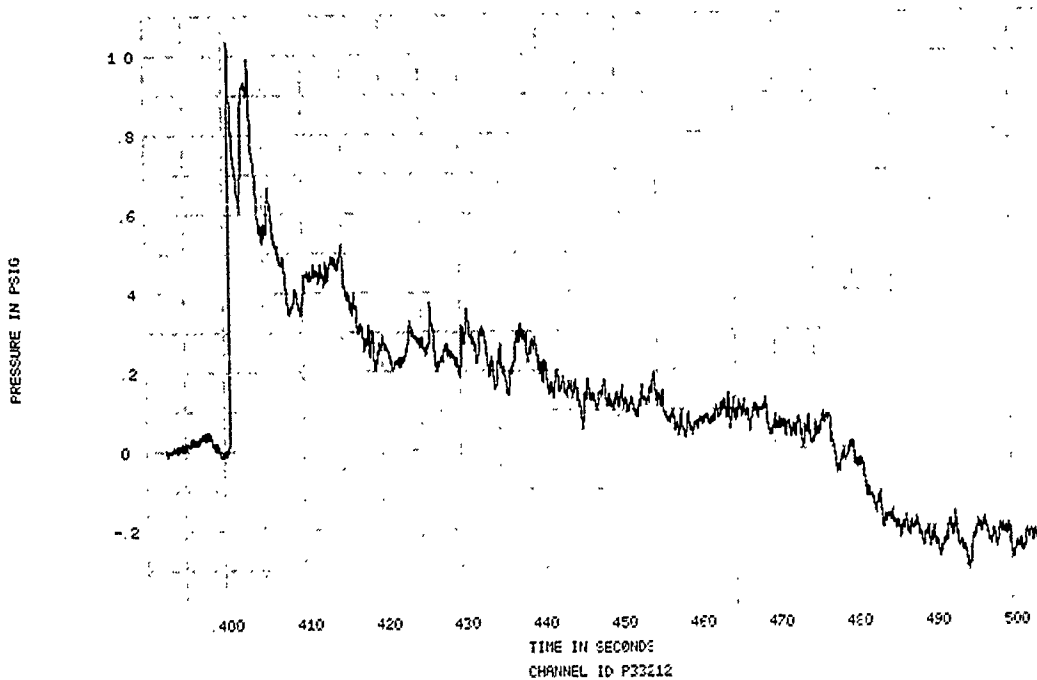

FIGURE 308. SPECIMEN 33, EVENT 78-328, SPECIMEN REFLECTED OVERPRESSURE TIME HISTORY

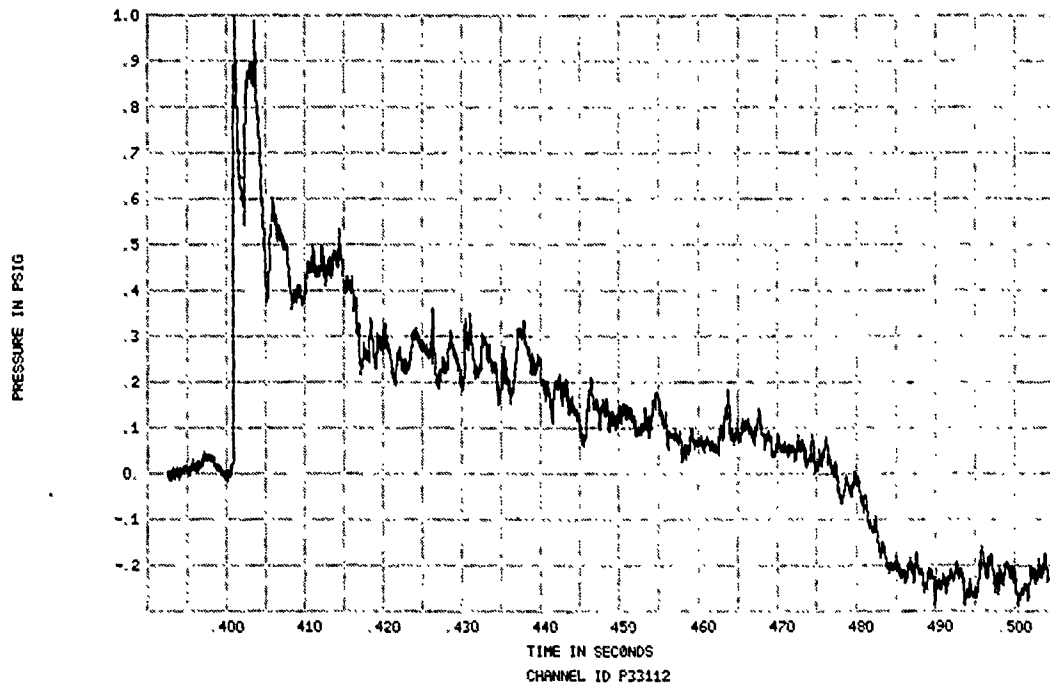

FIGURE 308. SPECIMEN 33, EVENT 78-328, SPECIMEN REFLECTED OVERPRESSURE TIME HISTORY

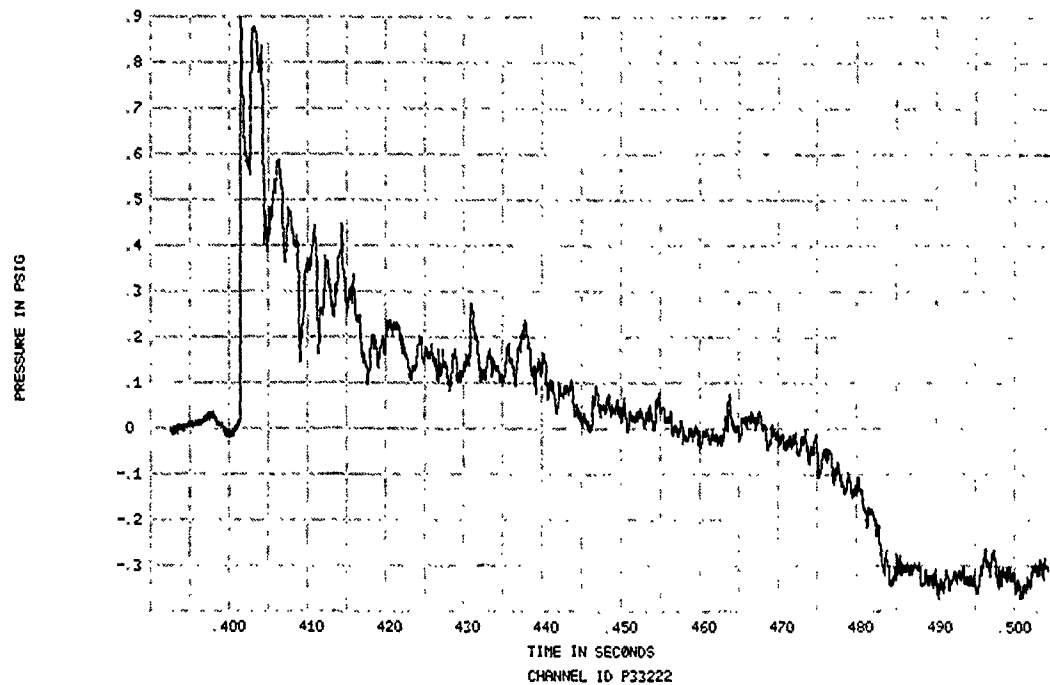

FIGURE 310. SPECIMEN 33, EVENT 78-328, SPECIMEN REFLECTED OVERPRESSURE TIME HISTORY

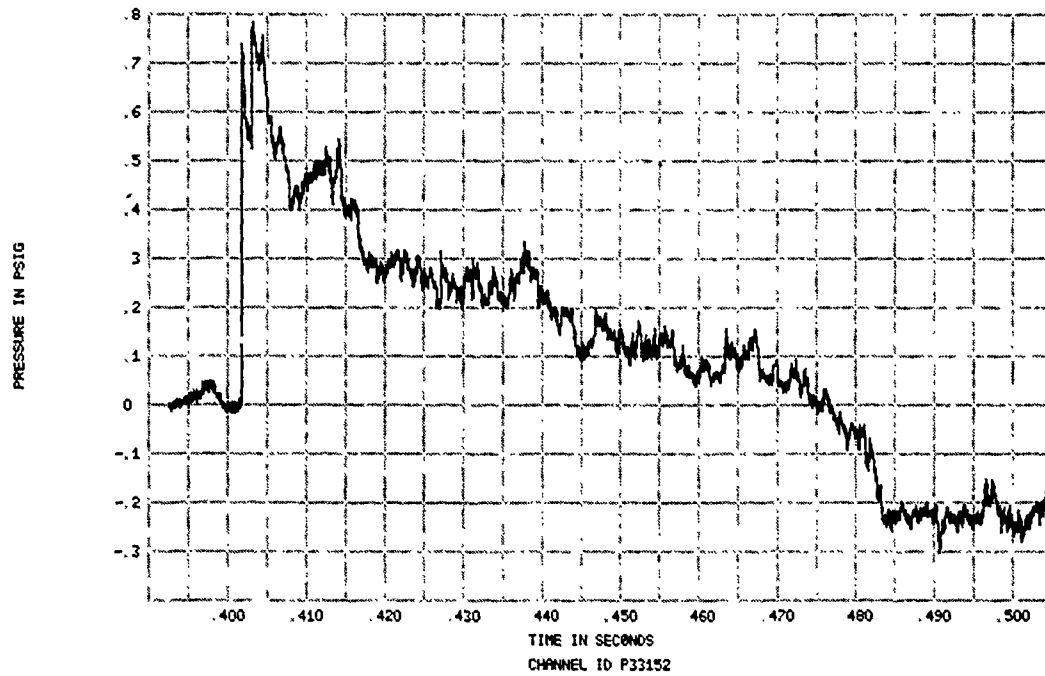

FIGURE 311. SPECIMEN 33, EVENT 78-328, SPECIMEN REFLECTED OVERPRESSURE TIME HISTORY

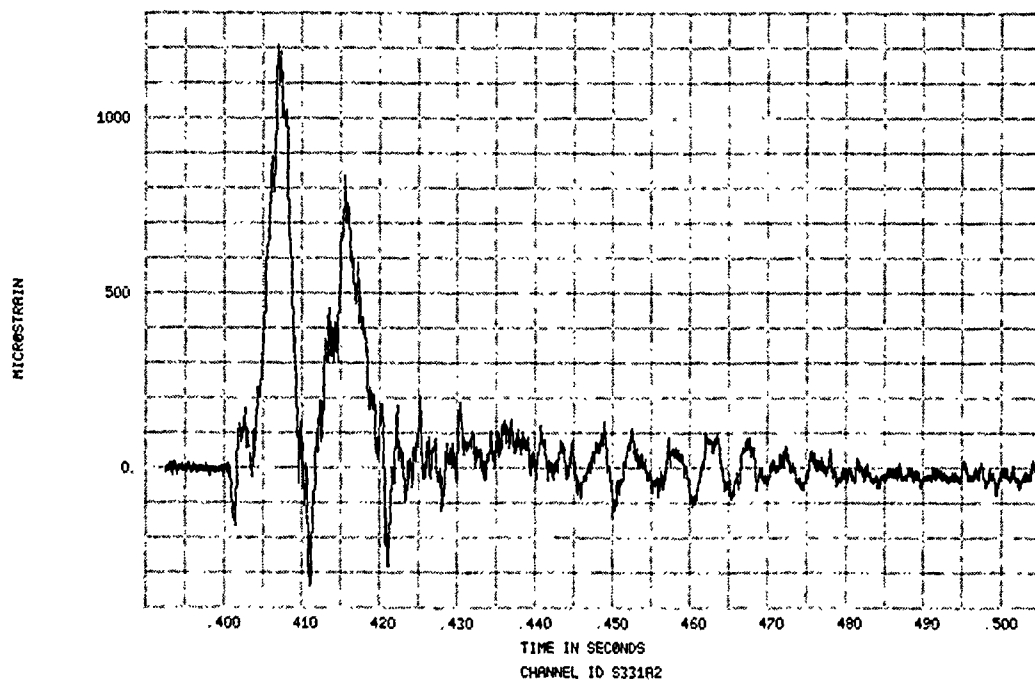

FIGURE 312. SPECIMEN 33, EVENT 78-328, STRAIN TIME HISTORY

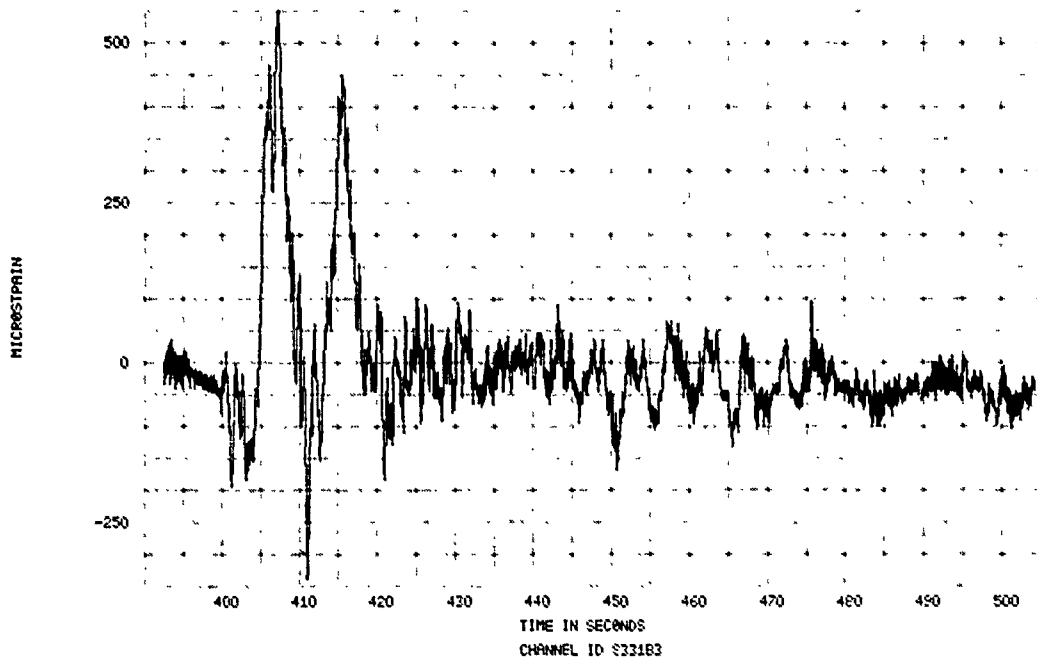

FIGURE 313. SPECIMEN 33, EVENT 78-328, STRAIN TIME HISTORY

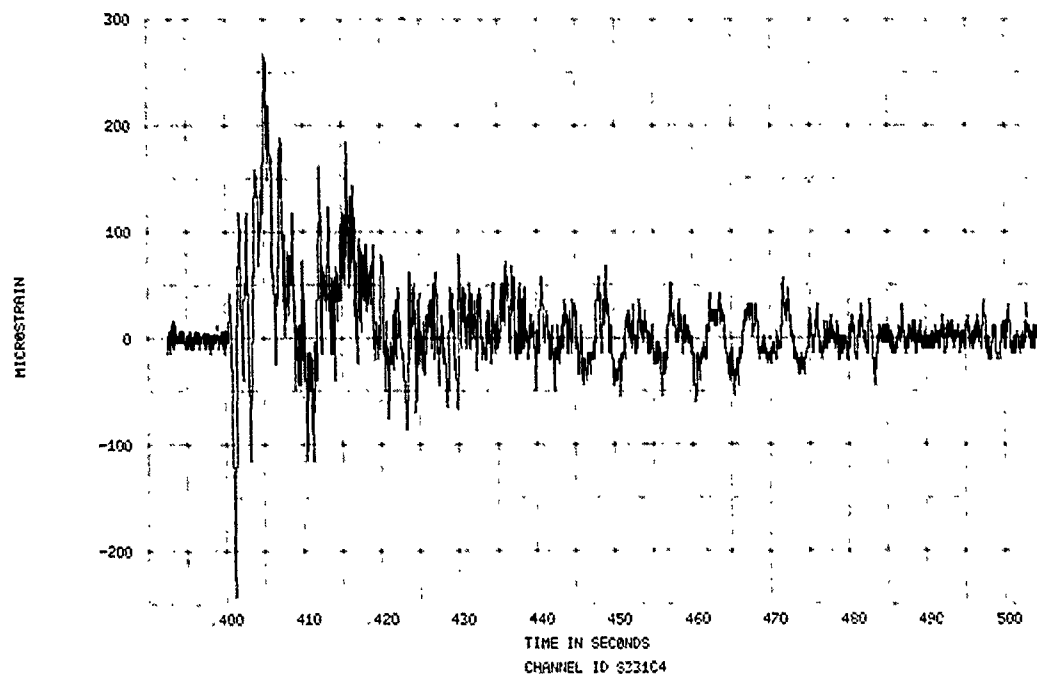

FIGURE 314. SPECIMEN 33, EVENT 78-328, STRAIN TIME HISTORY

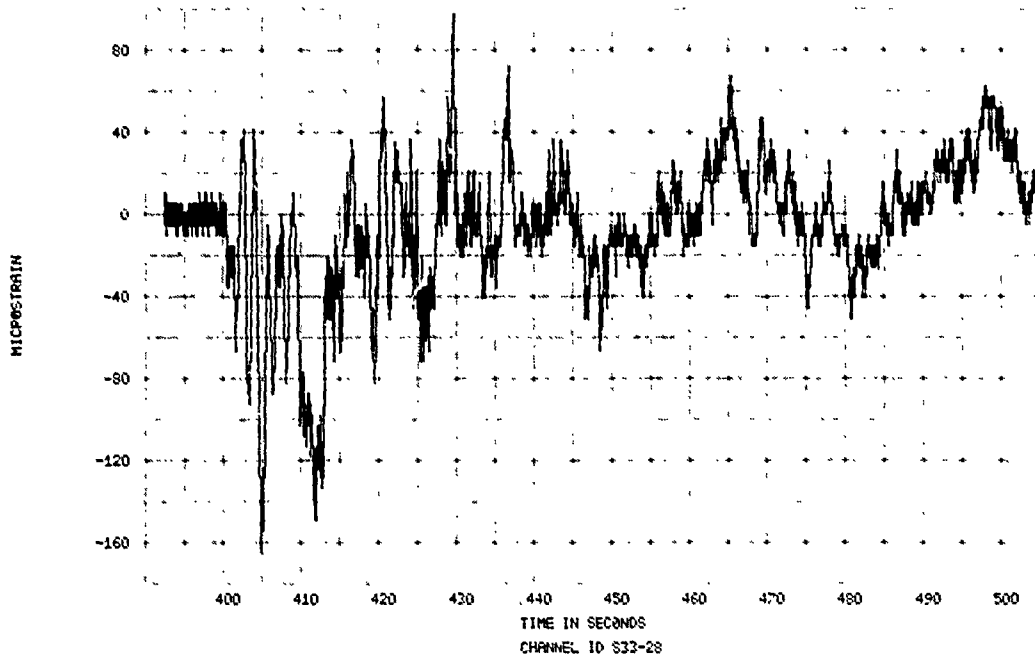

Figure 315. SPECIMEN 33, EVENT 78-328, STRAIN TIME HISTORY

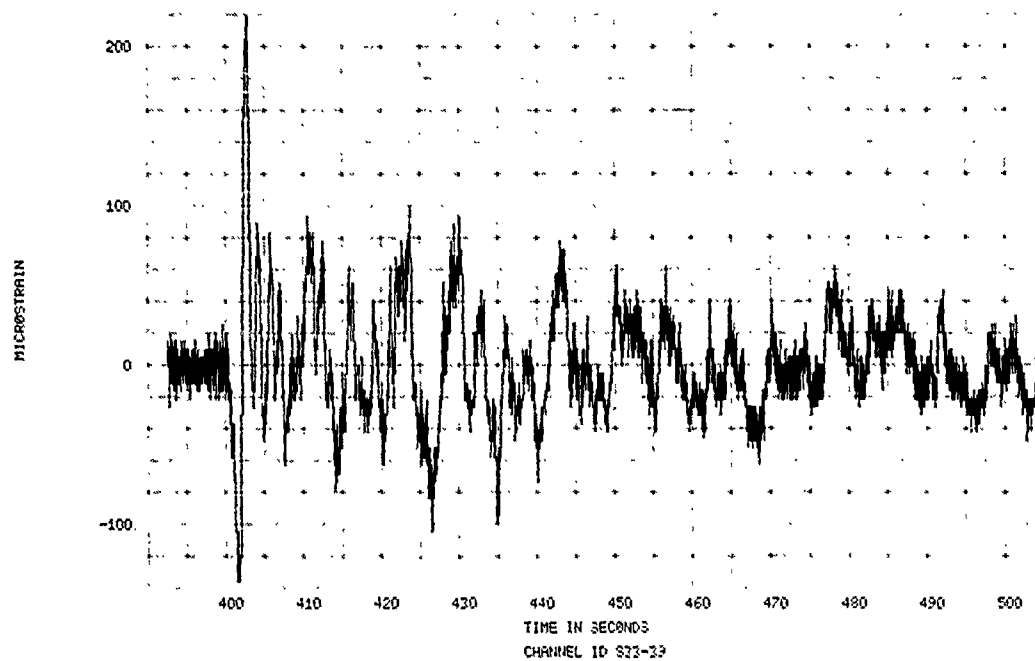

FIGURE 316. SPECIMEN 33, EVENT 78-328, STRAIN TIME HISTORY

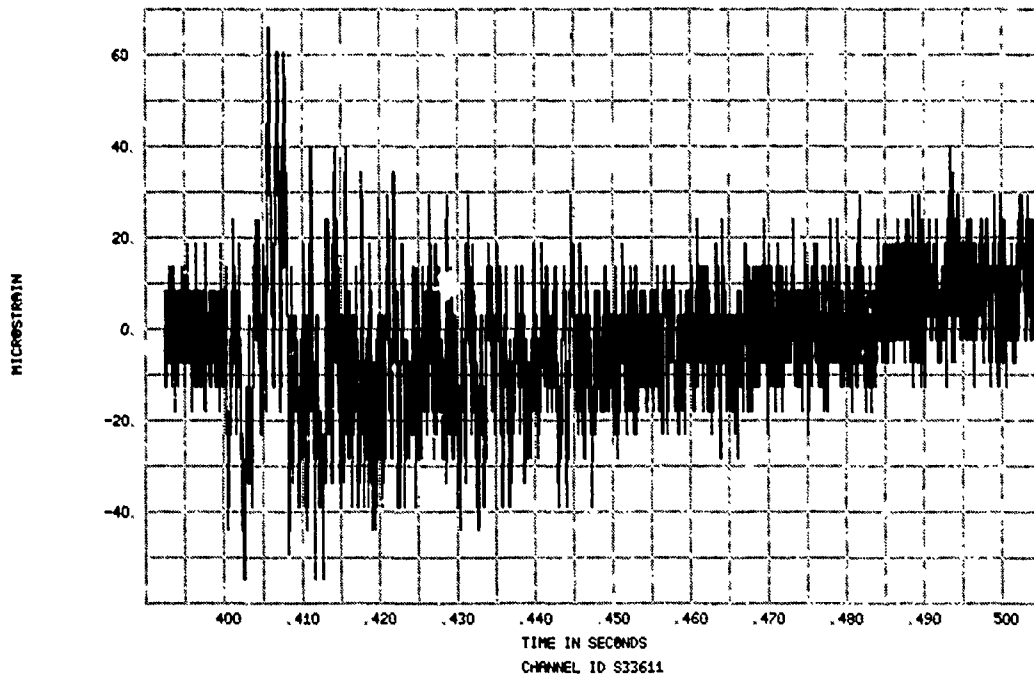

FIGURE 317. SPECIMEN 33, EVENT 78-328, STRAIN TIME HISTORY

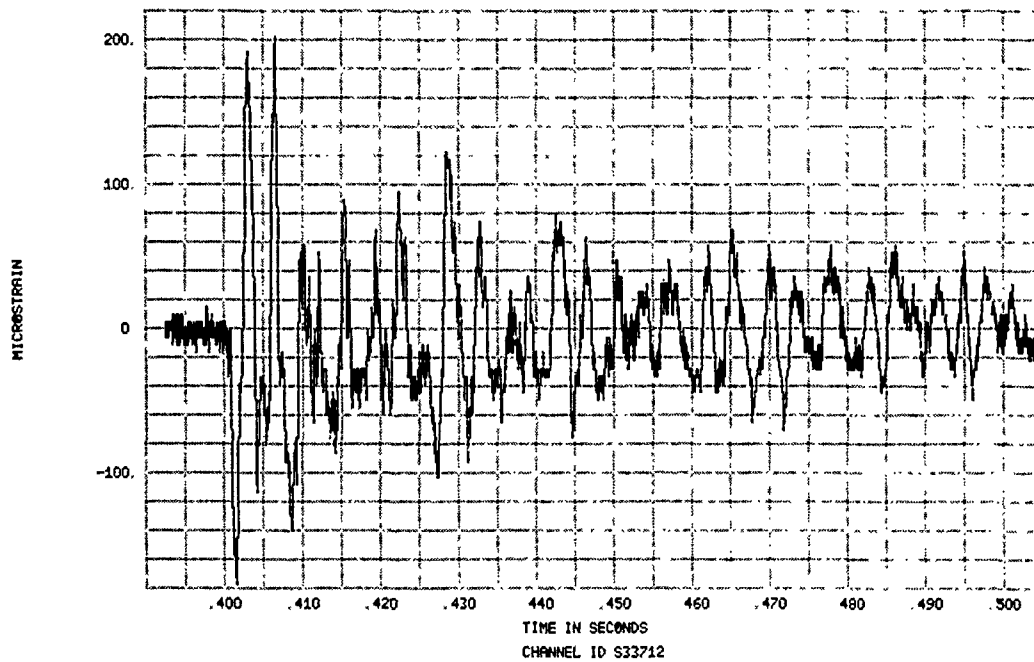

FIGURE 318. SPECIMEN 33, EVENT 78-328, STRAIN TIME HISTORY

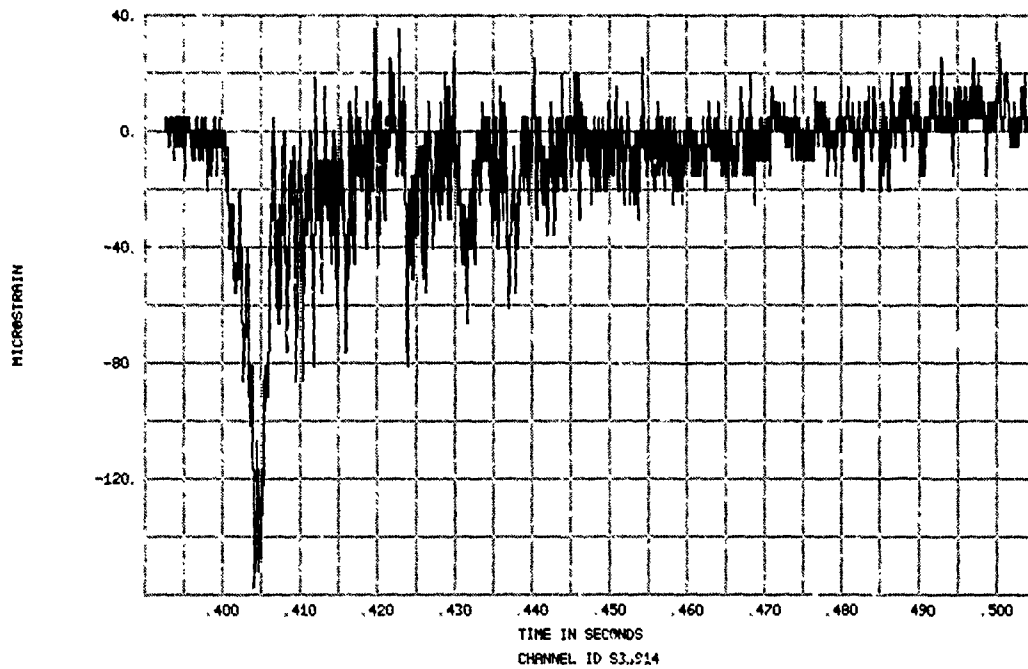

FIGURE 319. SPECIMEN 33, EVENT 78-328, STRAIN TIME HISTORY

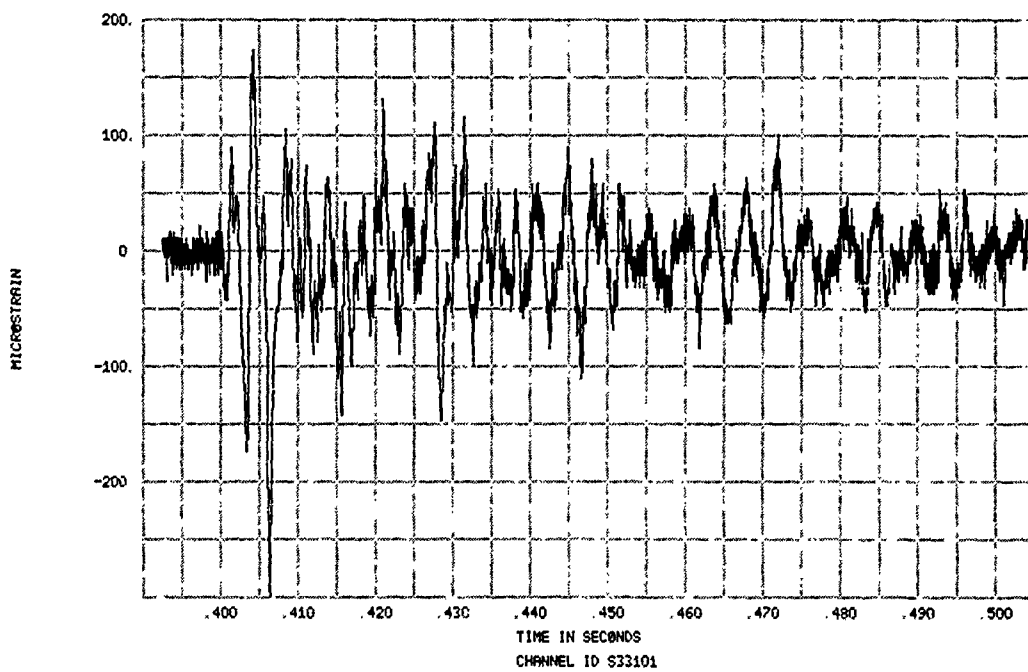

FIGURE 320. SPECIMEN 33, EVENT 78-328, STRAIN TIME HISTORY

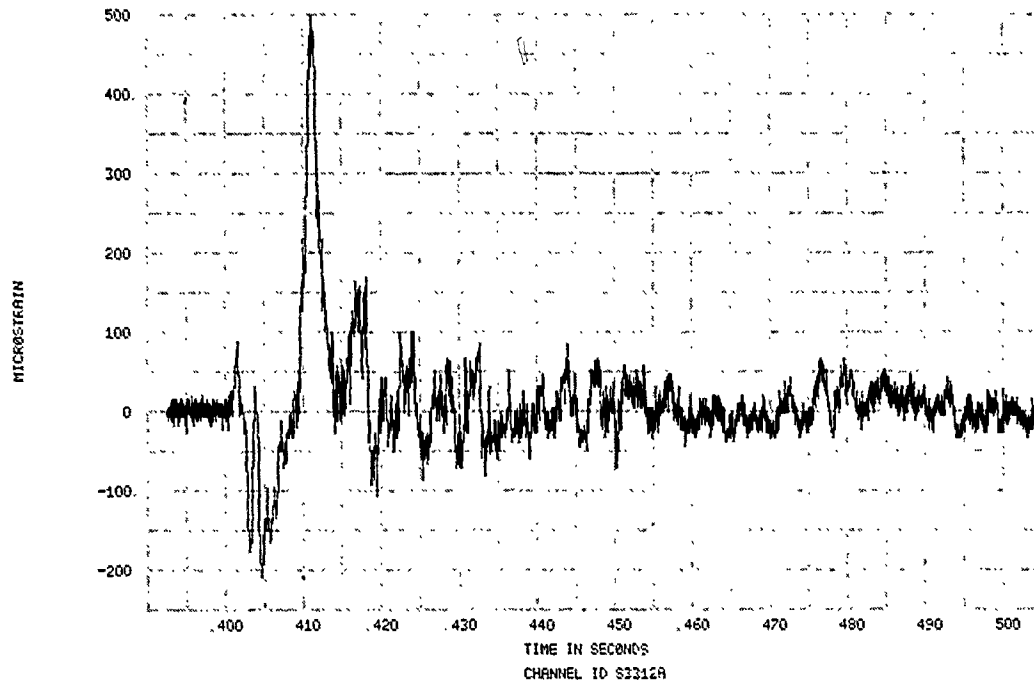

FIGURE 321. SPECIMEN 33, EVENT 78-328, STRAIN TIME HISTORY

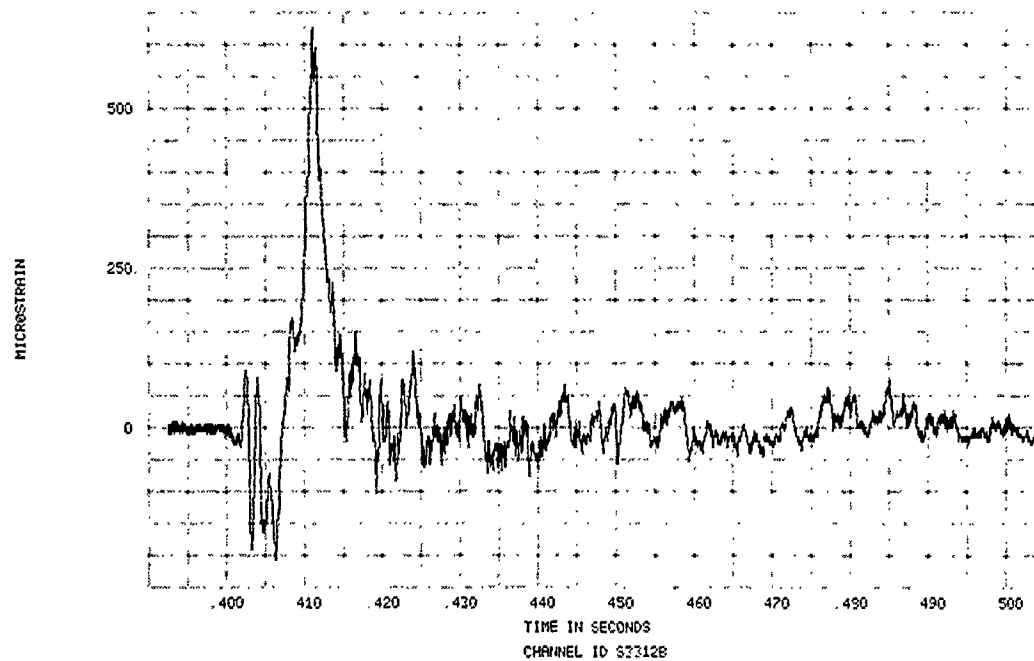

FIGURE 322. SPECIMEN 33, EVENT 78-328, STRAIN TIME HISTORY

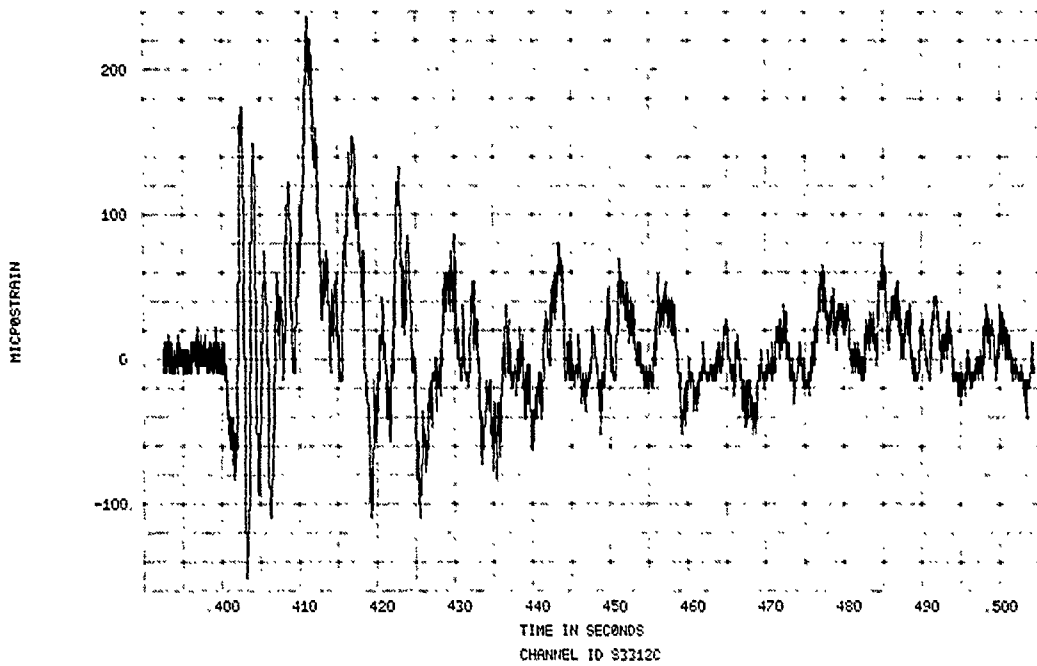

FIGURE 323. SPECIMEN 33, EVENT 78-328, STRAIN TIME HISTORY

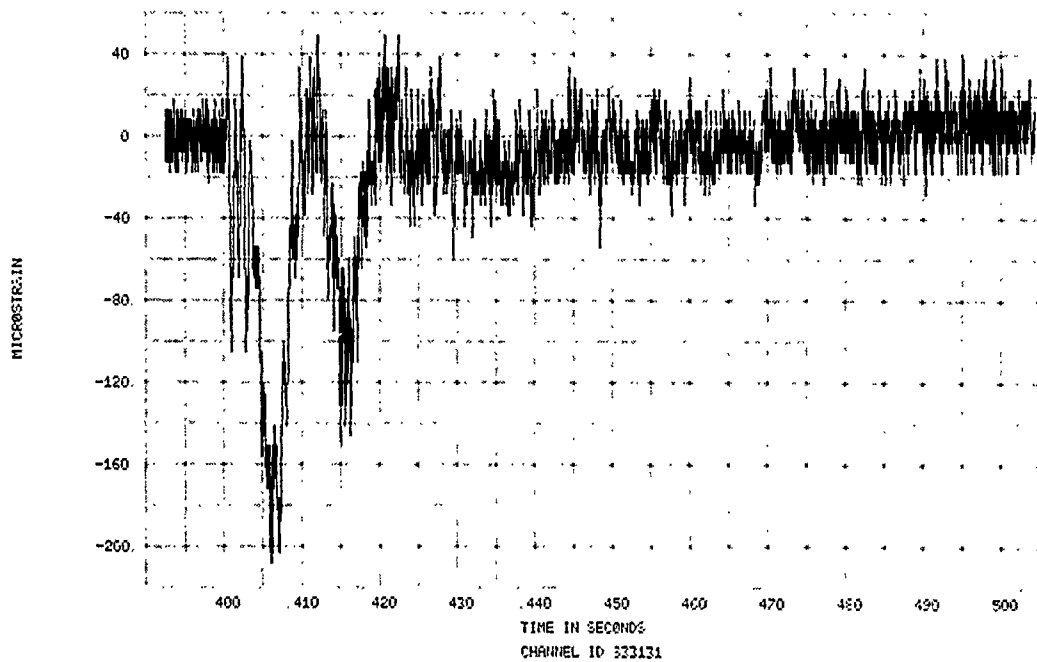

FIGURE 324. SPECIMEN 33, EVENT 78-328, STRAIN TIME HISTORY

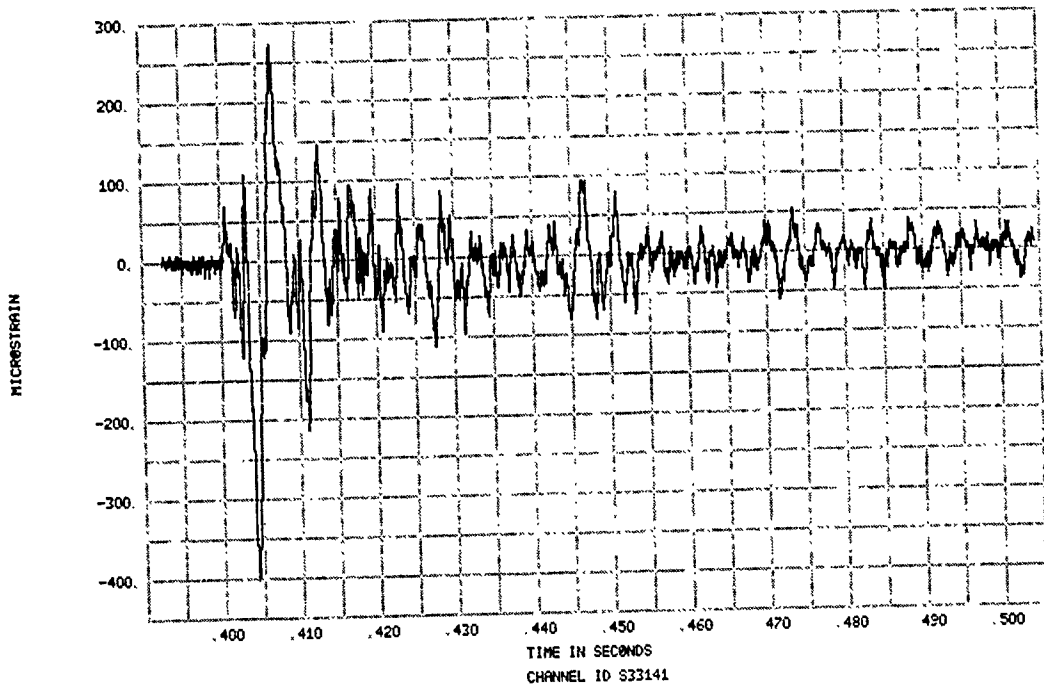

FIGURE 325. SPECIMEN 33, EVENT 78-328, STRAIN TIME HISTORY

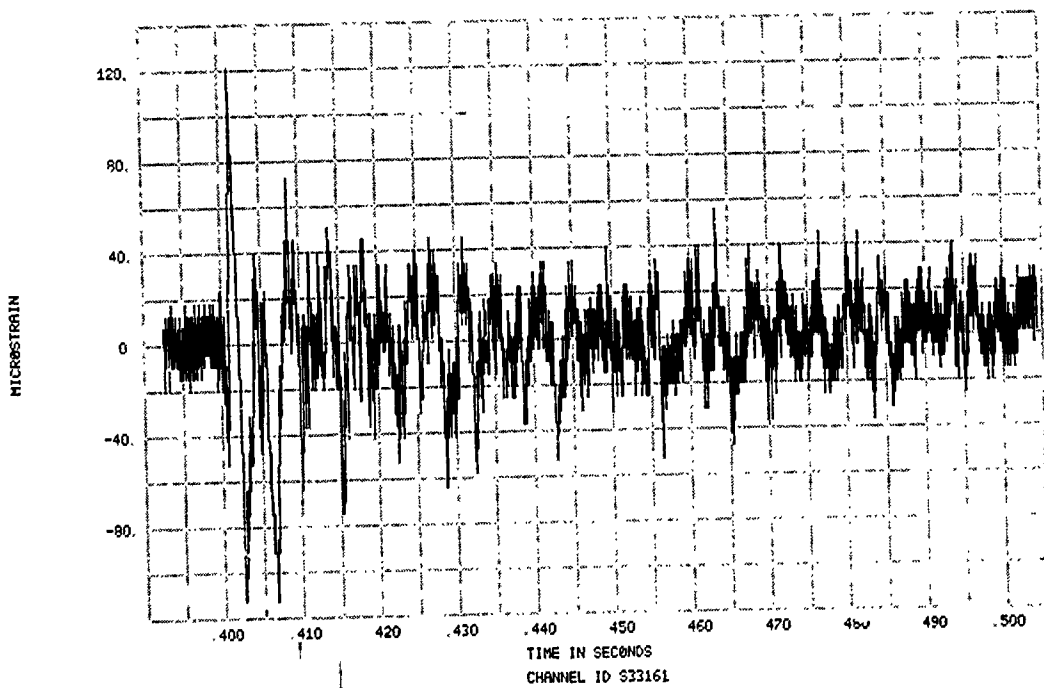

FIGURE 326. SPECIMEN 33, EVENT 78-328, STRAIN TIME HISTORY

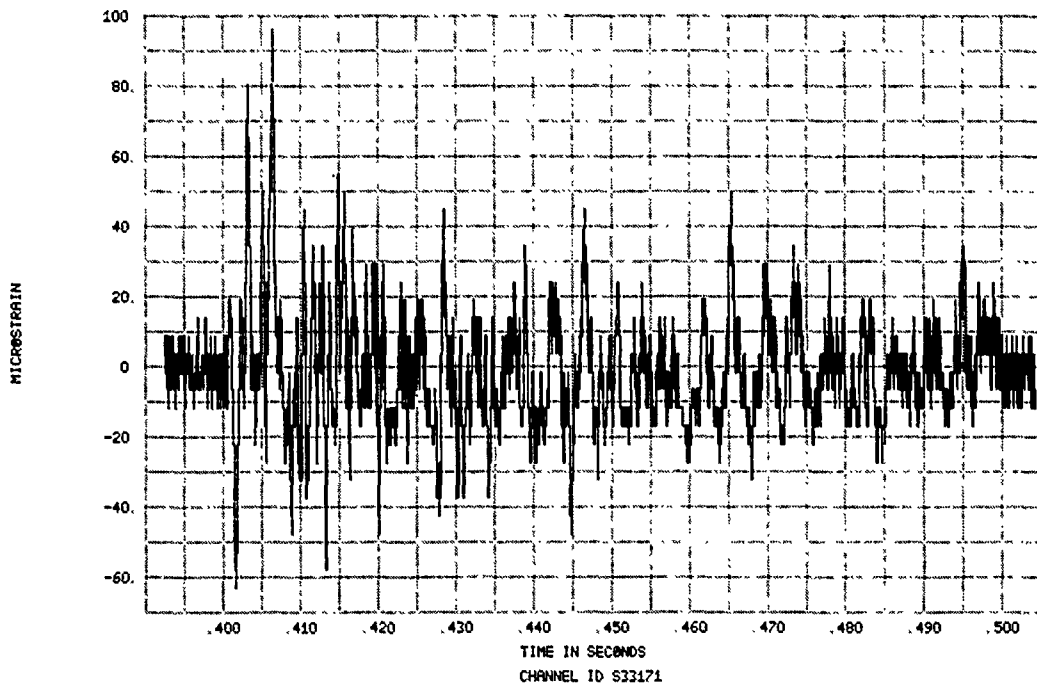

FIGURE 327. SPECIMEN 33, EVENT 78-328, STRAIN TIME HISTORY

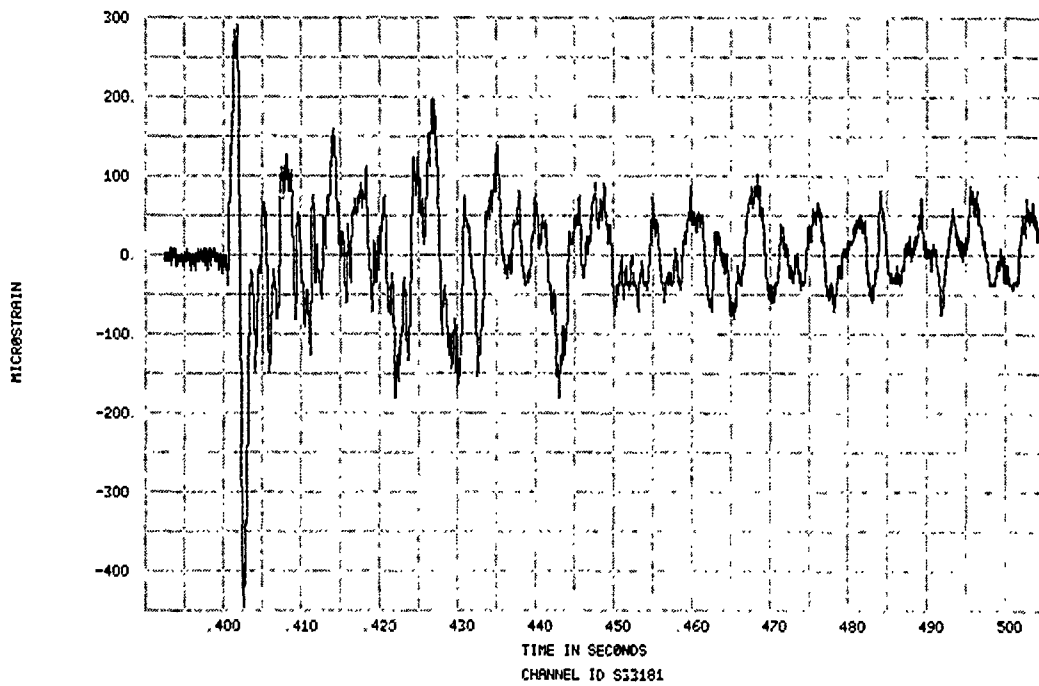

FIGURE 328. SPECIMEN 33, EVENT 78-328, STRAIN TIME HISTORY

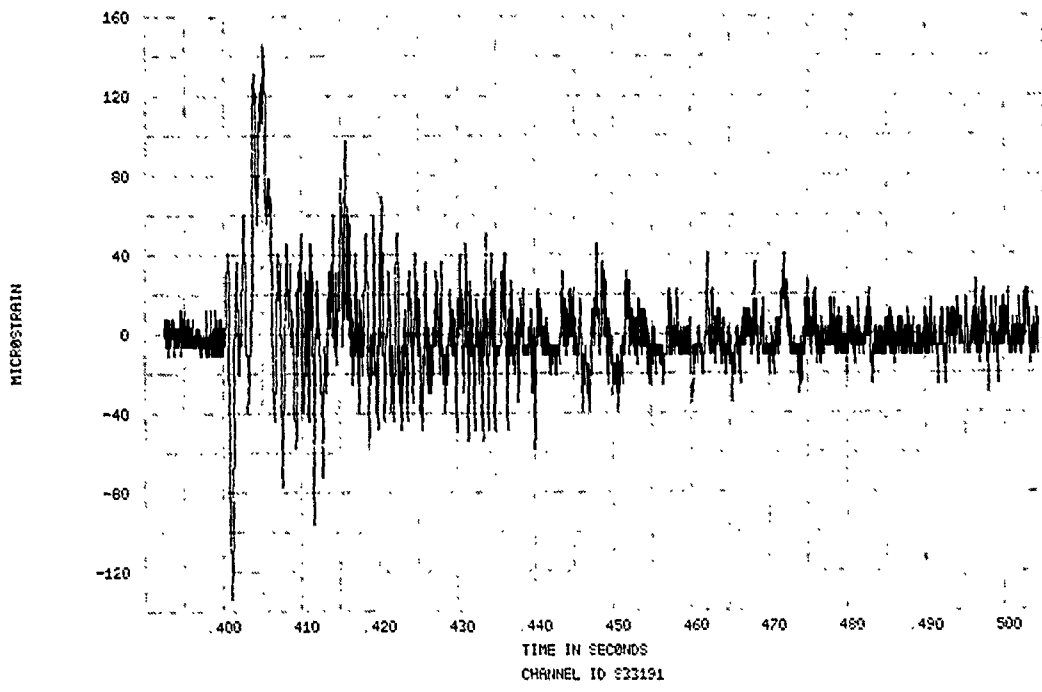

FIGURE 329. SPECIMEN 33, EVENT 78-328, STRAIN TIME HISTORY

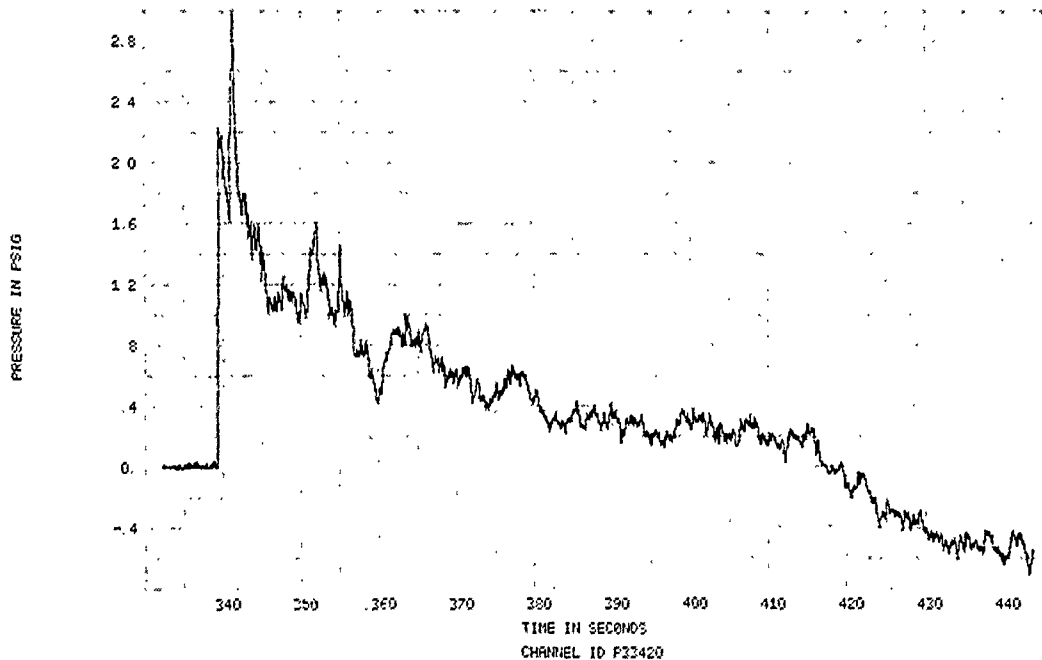

FIGURE 330. SPECIMEN 33, EVENT 78-330, SPECIMEN REFLECTED OVERPRESSURE TIME HISTORY

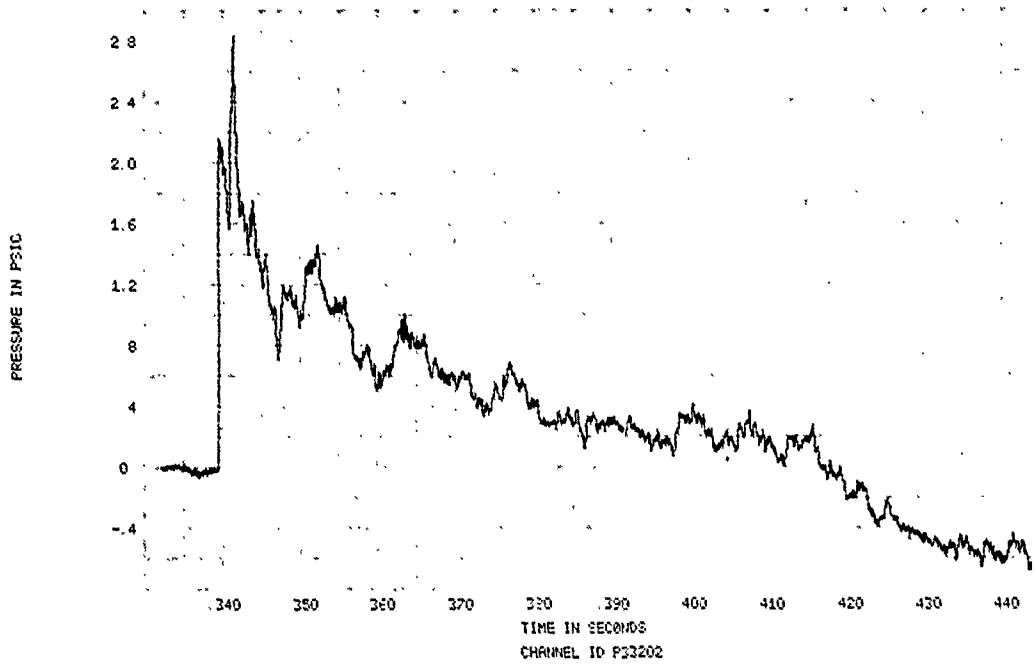

FIGURE 331. SPECIMEN 33, EVENT 70-330, SPECIMEN REFLECTED OVERPRESSURE TIME HISTORY

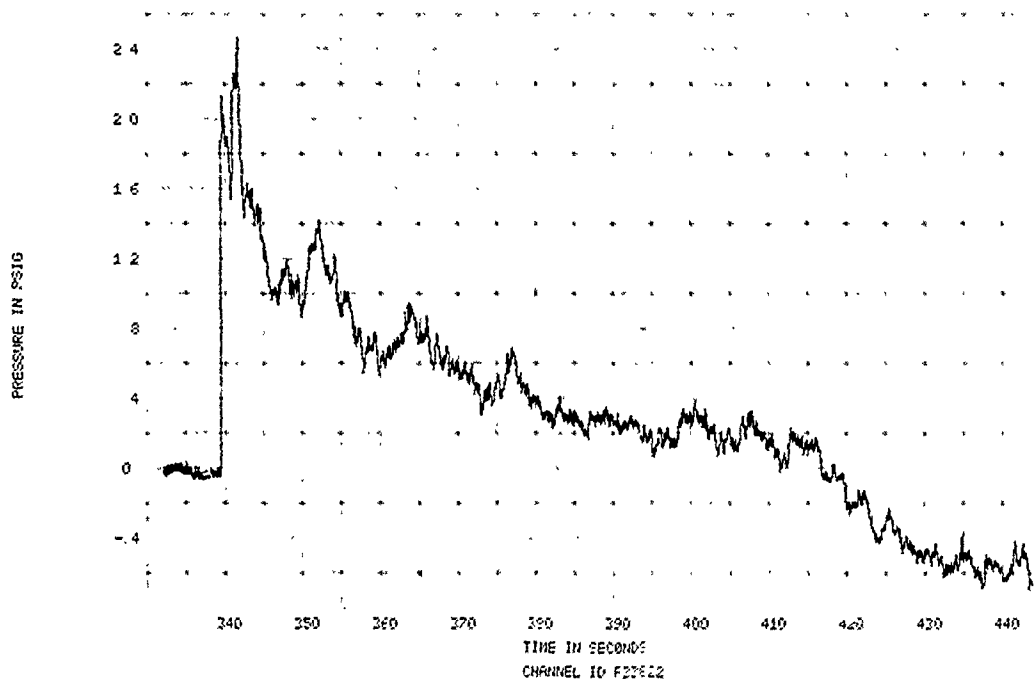

FIGURE 332. SPECIMEN 33, EVENT 70-330, SPECIMEN REFLECTED OVERPRESSURE TIME HISTORY

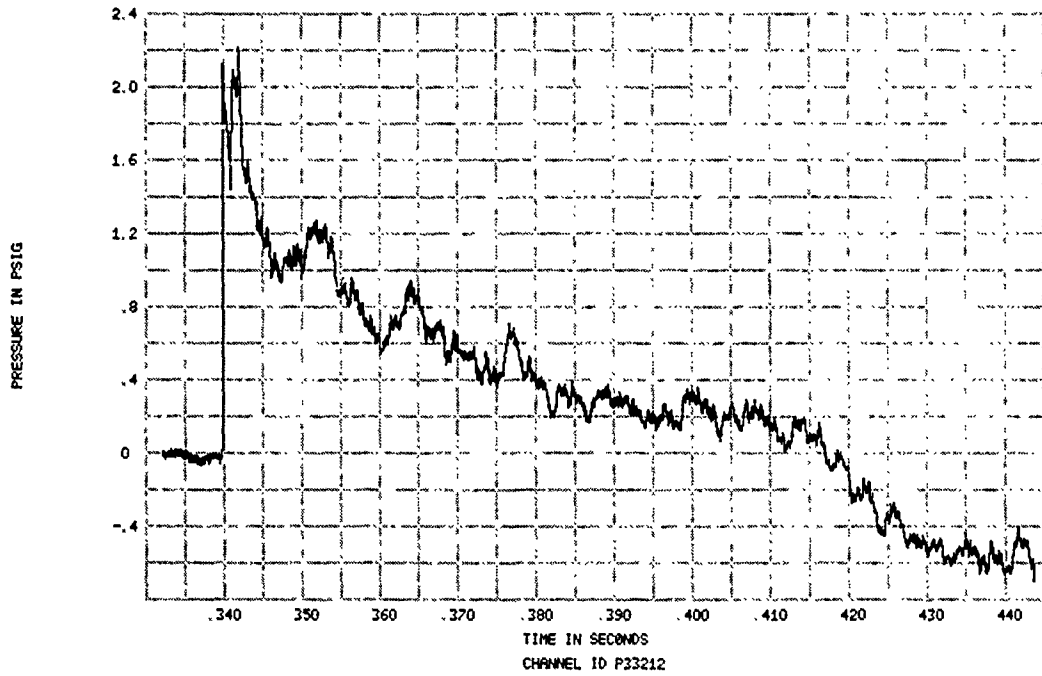

FIGURE 333. SPECIMEN 33, EVENT 78-330, SPECIMEN REFLECTED OVERPRESSURE TIME HISTORY

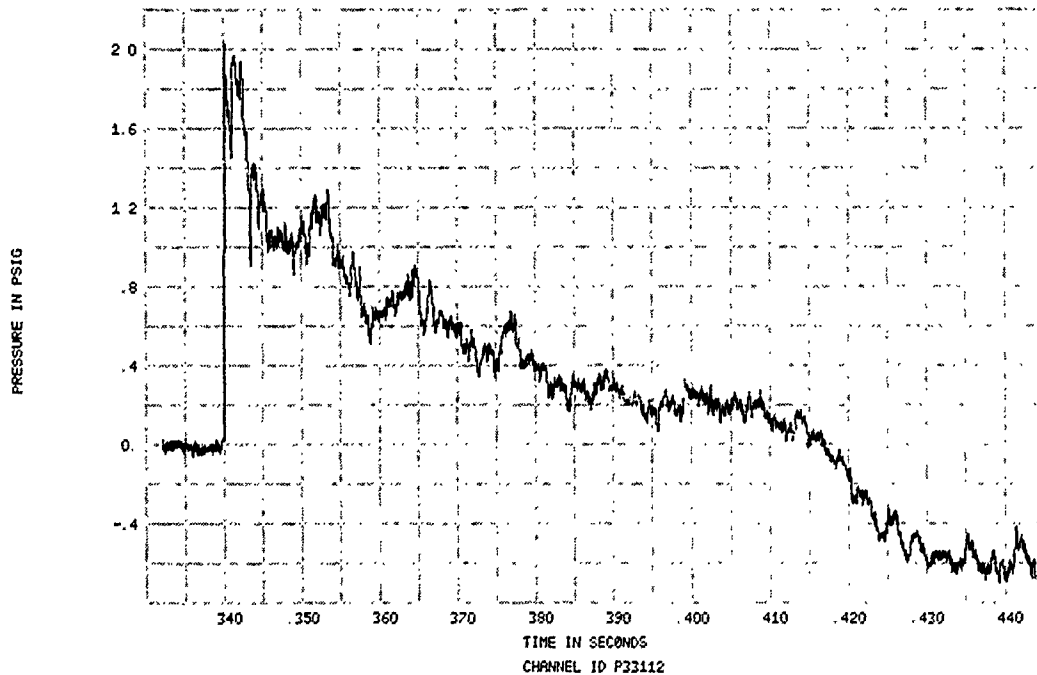

FIGURE 334. SPECIMEN 33, EVENT 79-330, SPECIMEN REFLECTED OVERPRESSURE TIME HISTORY

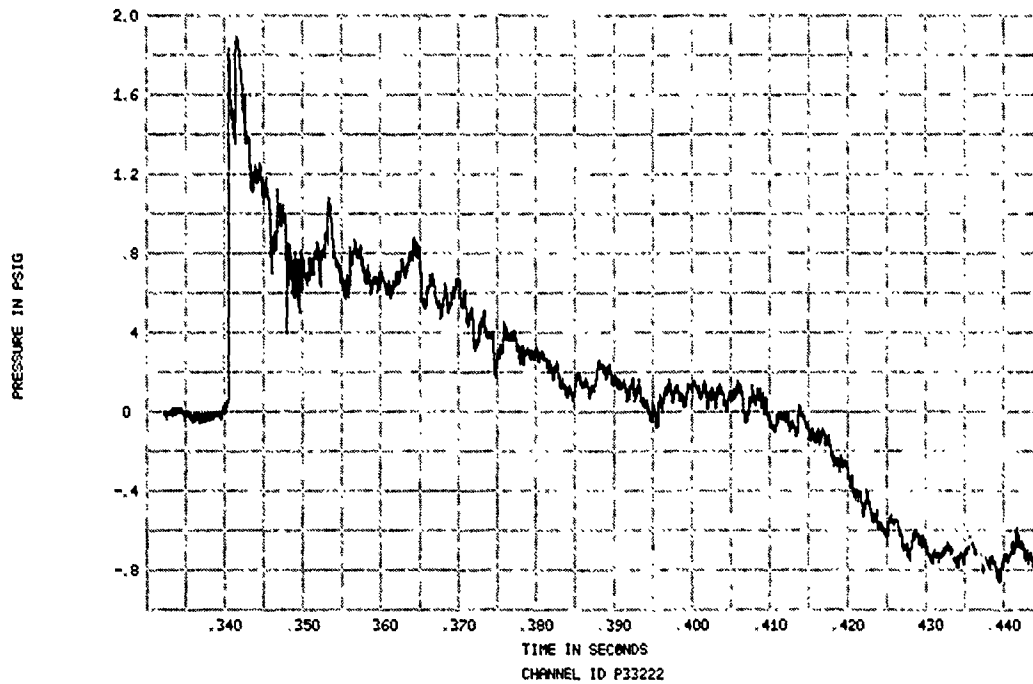

FIGURE 335. SPECIMEN 33, EVENT 70-330, SPECIMEN REFLECTED OVERPRESSURE TIME HISTORY

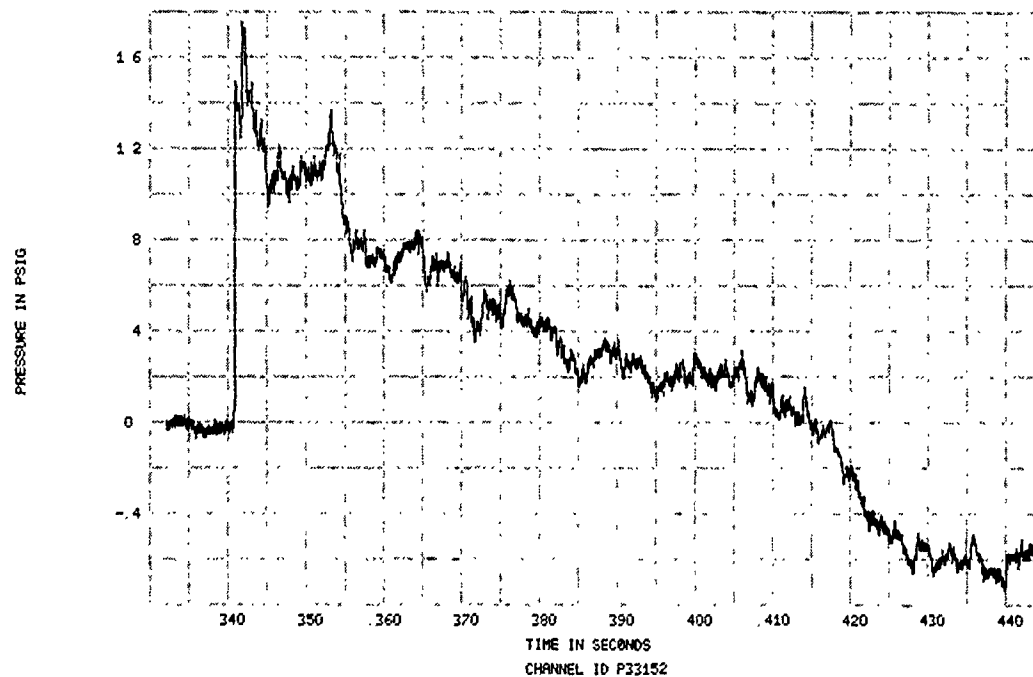

FIGURE 336. SPECIMEN 33, EVENT 70-330, SPECIMEN REFLECTED OVERPRESSURE TIME HISTORY

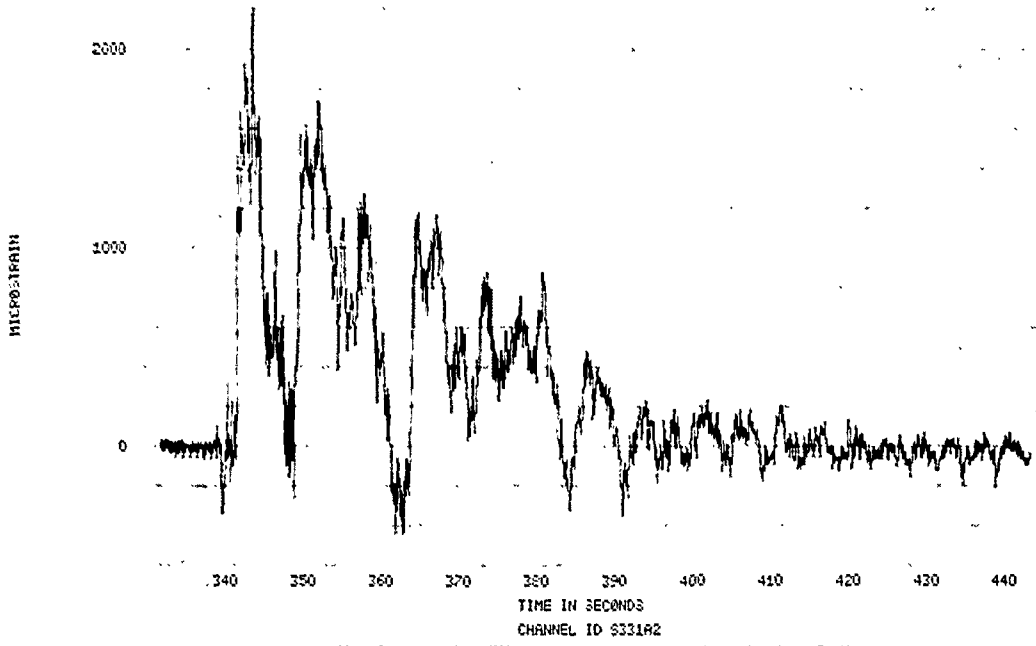

FIGURE 337. SPECIMEN 33, EVENT 78-330, STRAIN TIME HISTORY

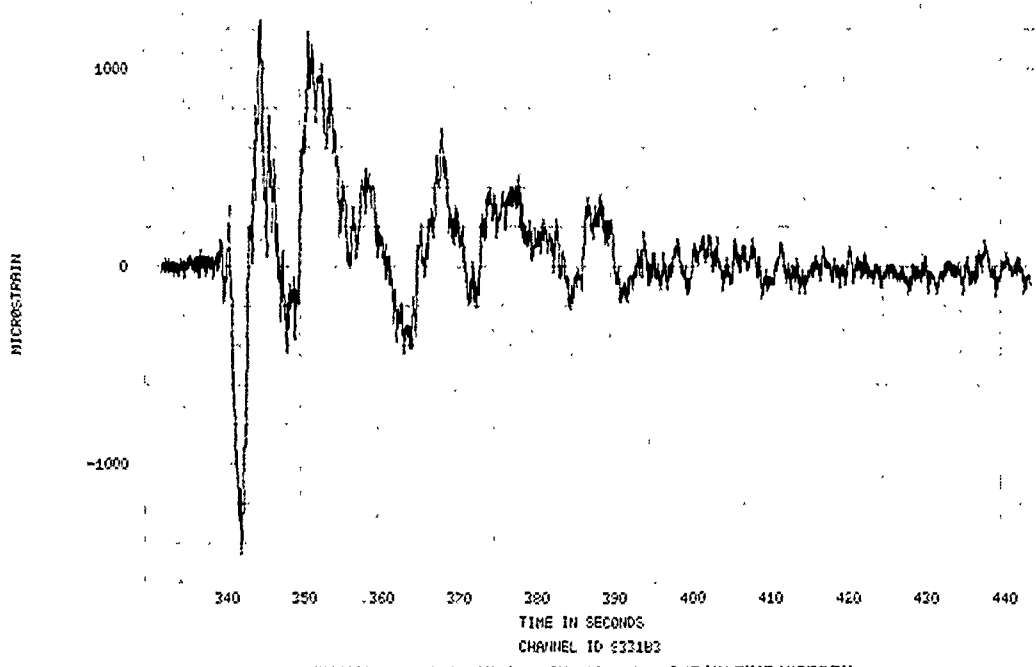

FIGURE 338. SPECIMEN 33, EVENT 78-330, STRAIN TIME HISTORY

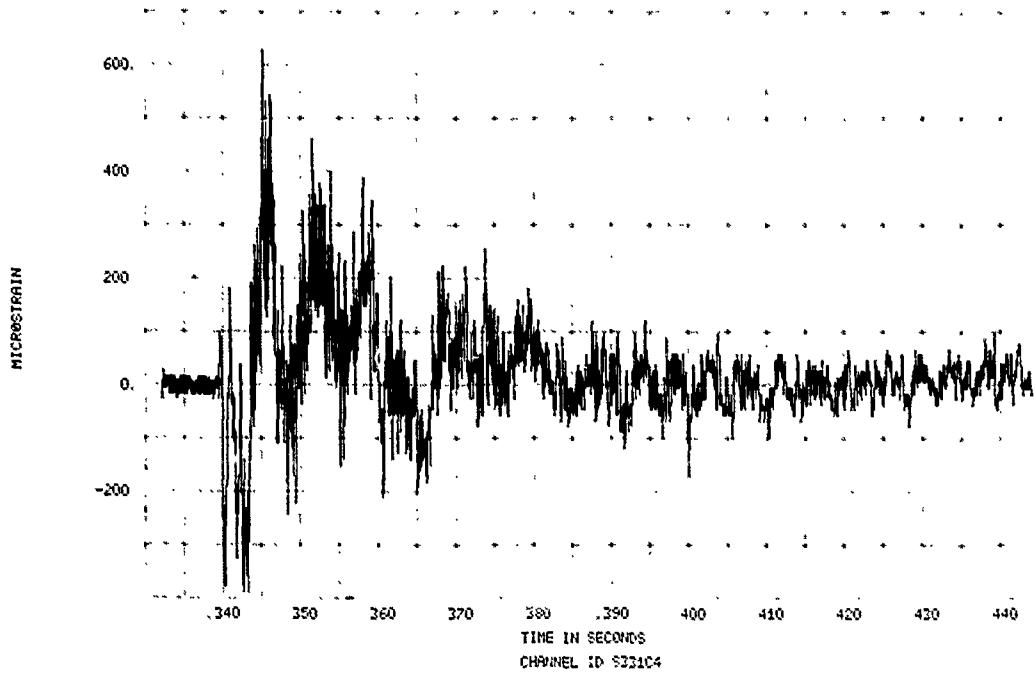

FIGURE 339. SPECIMEN 33, EVENT 78-330, STRAIN TIME HISTORY

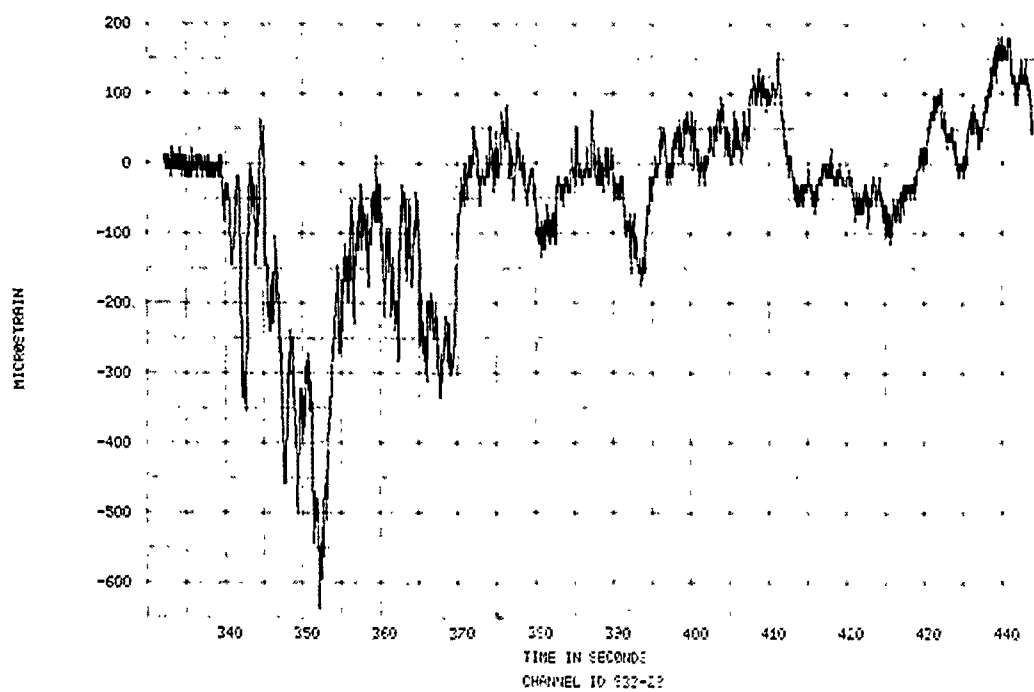

FIGURE 340. SPECIMEN 33, EVENT 78-330, STRAIN TIME HISTORY

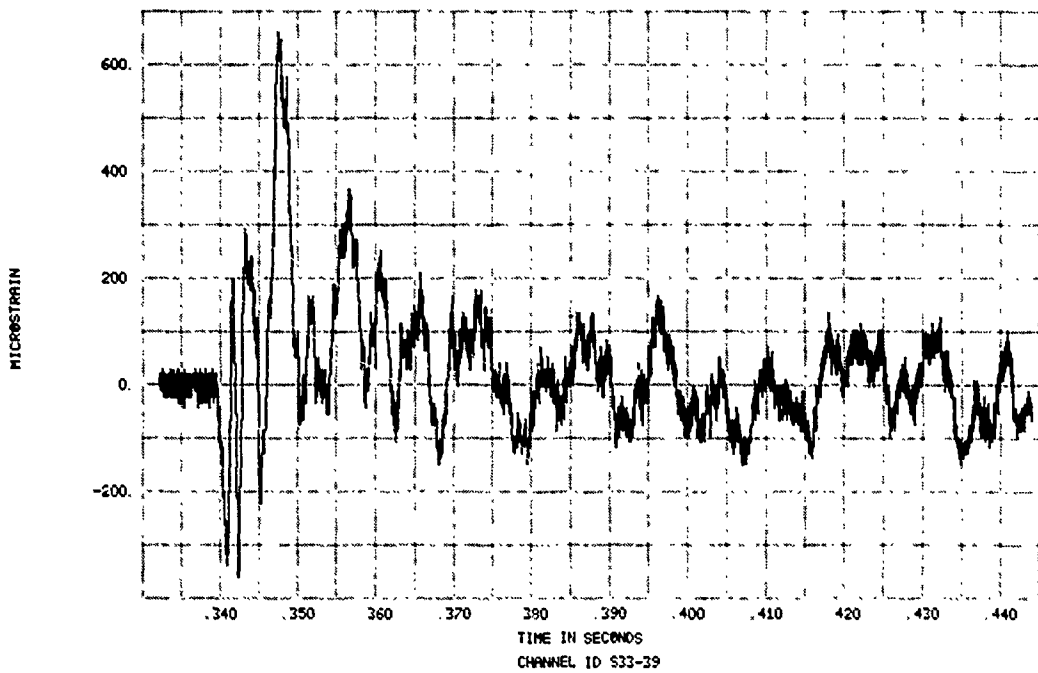

FIGURE 341. SPECIMEN 33, EVENT 78-330, STRAIN TIME HISTORY

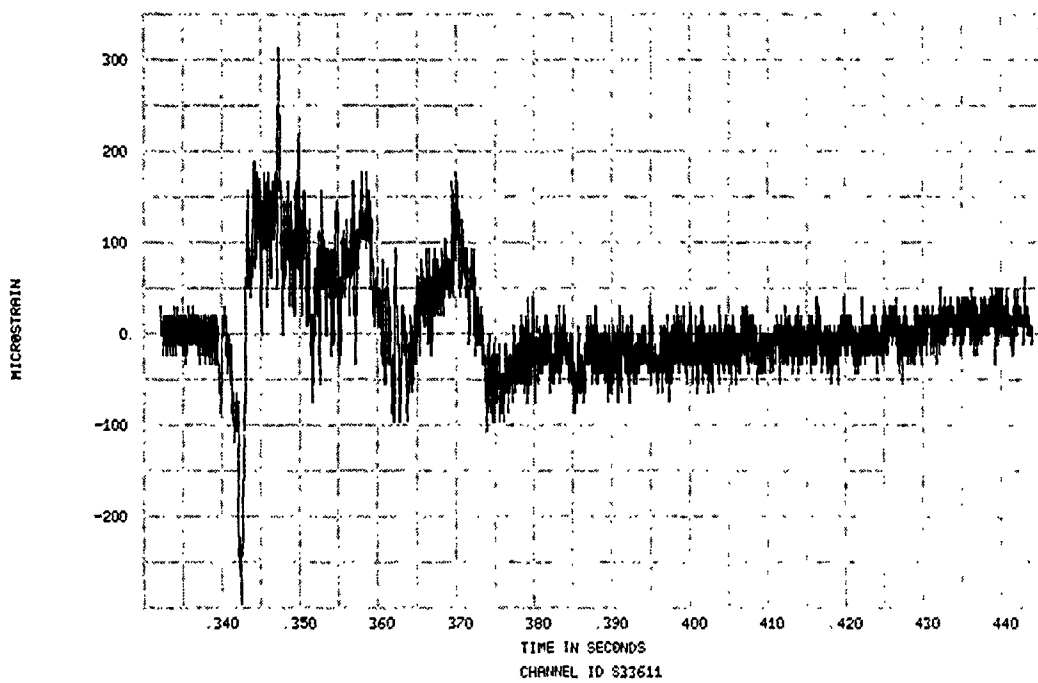

FIGURE 342. SPECIMEN 33, EVENT 78-330, STRAIN TIME HISTORY

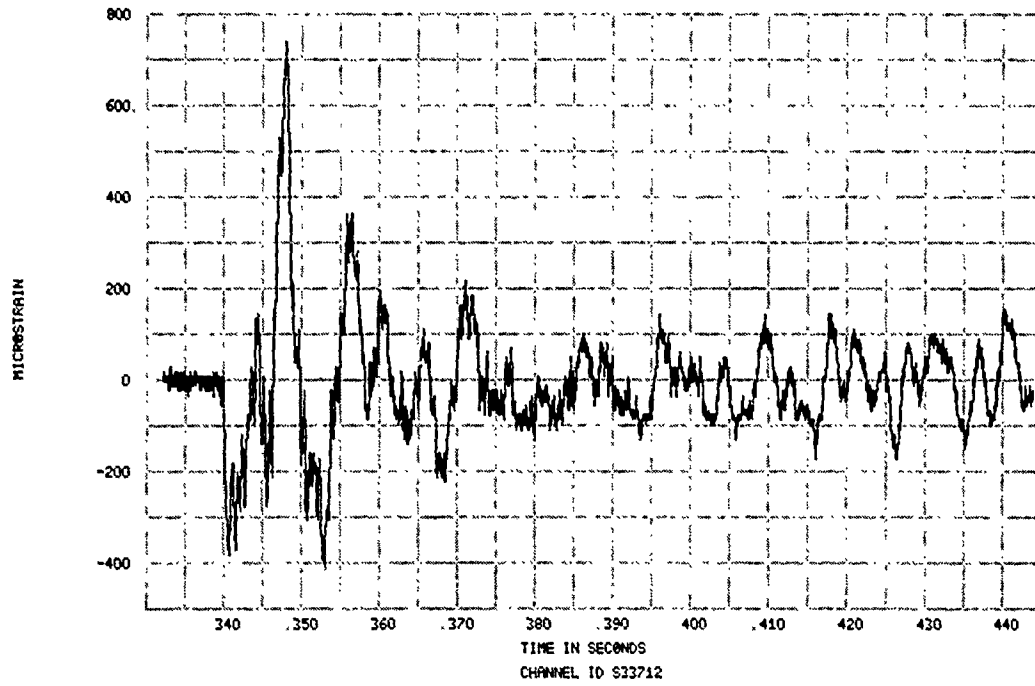

FIGURE 343. SPECIMEN 33, EVENT 78-330, STRAIN TIME HISTORY

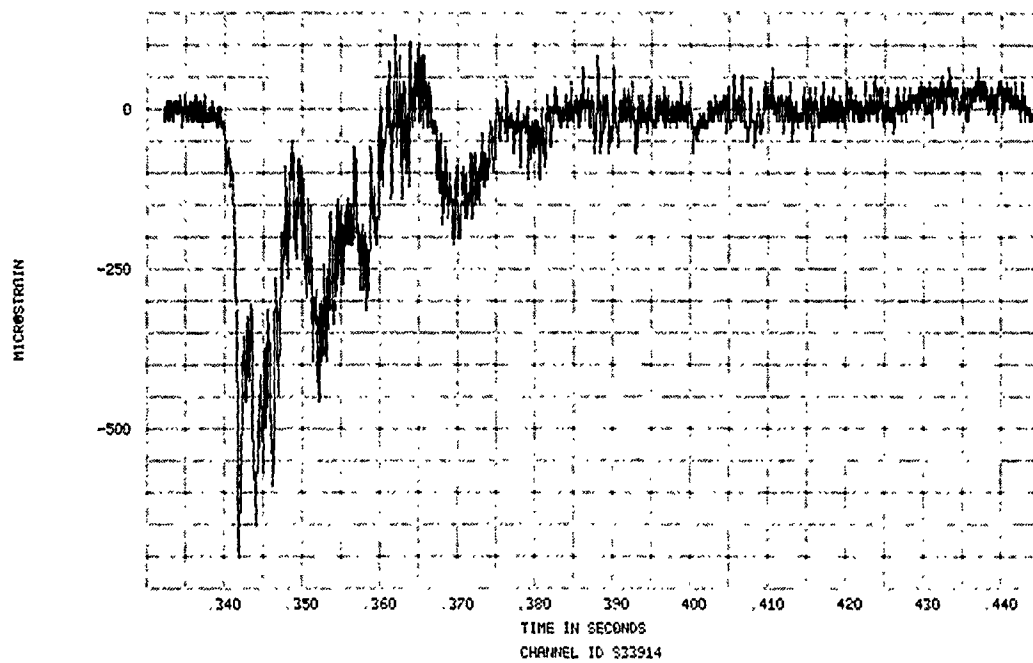

FIGURE 344. SPECIMEN 33, EVENT 78-330, STRAIN TIME HISTORY

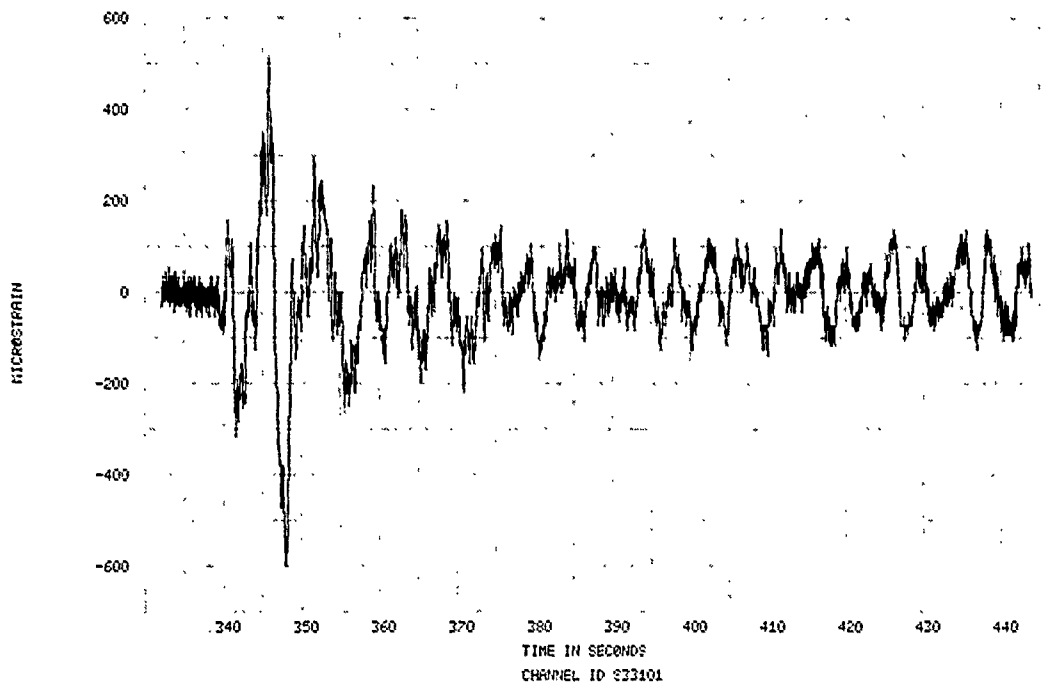

FIGURE 345. SPECIMEN 33, EVENT 78-330, STRAIN TIME HISTORY

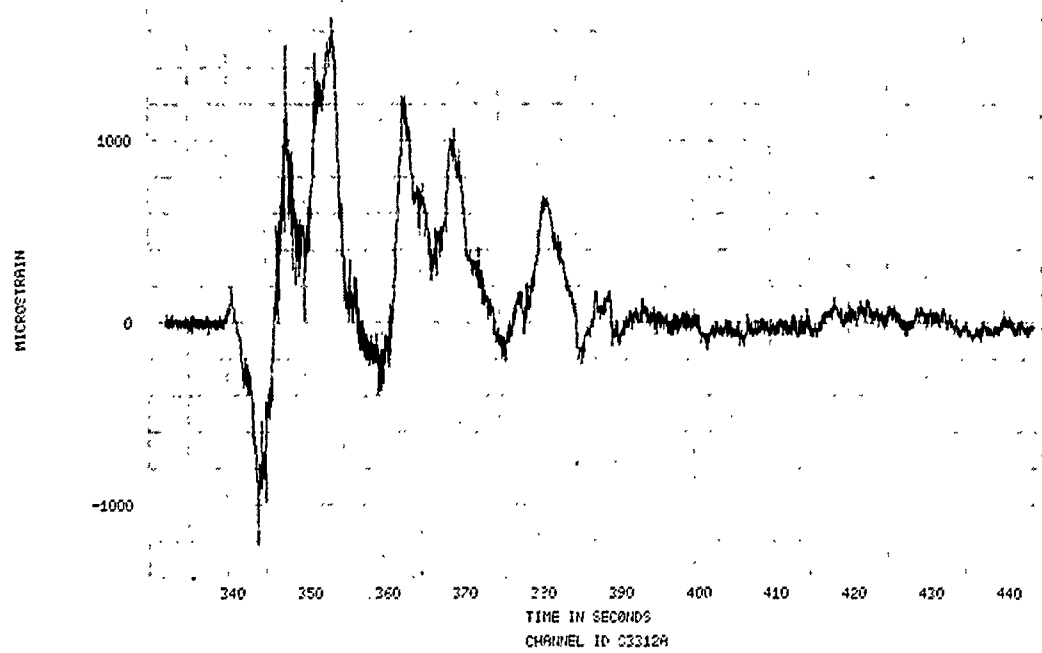

FIGURE 346. SPECIMEN 33, EVENT 78-330, STRAIN TIME HISTORY

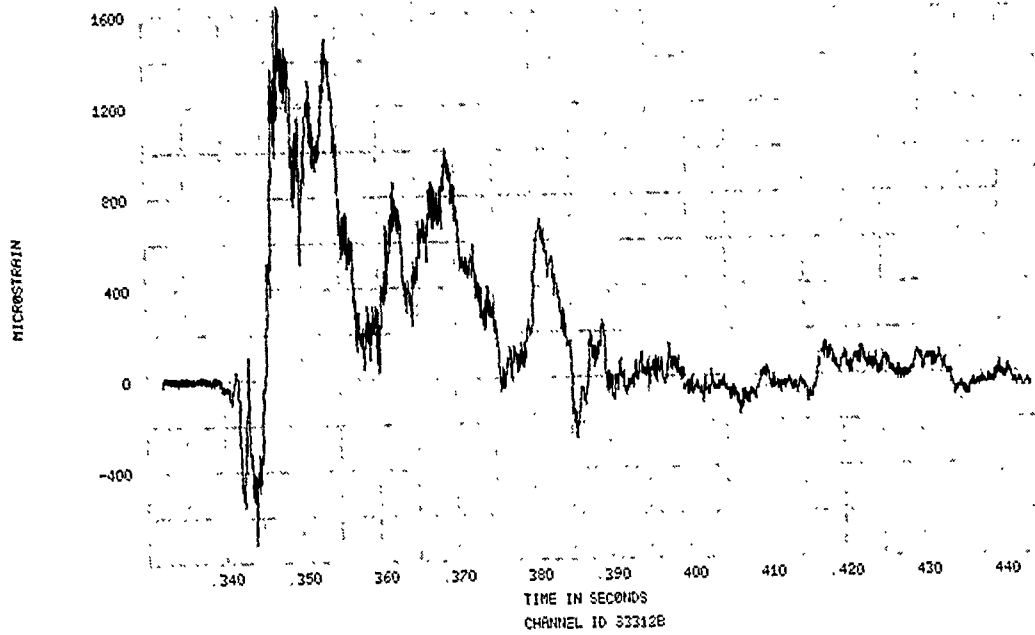

FIGURE 347. SPECIMEN 33, EVENT 78-330, STRAIN TIME HISTORY

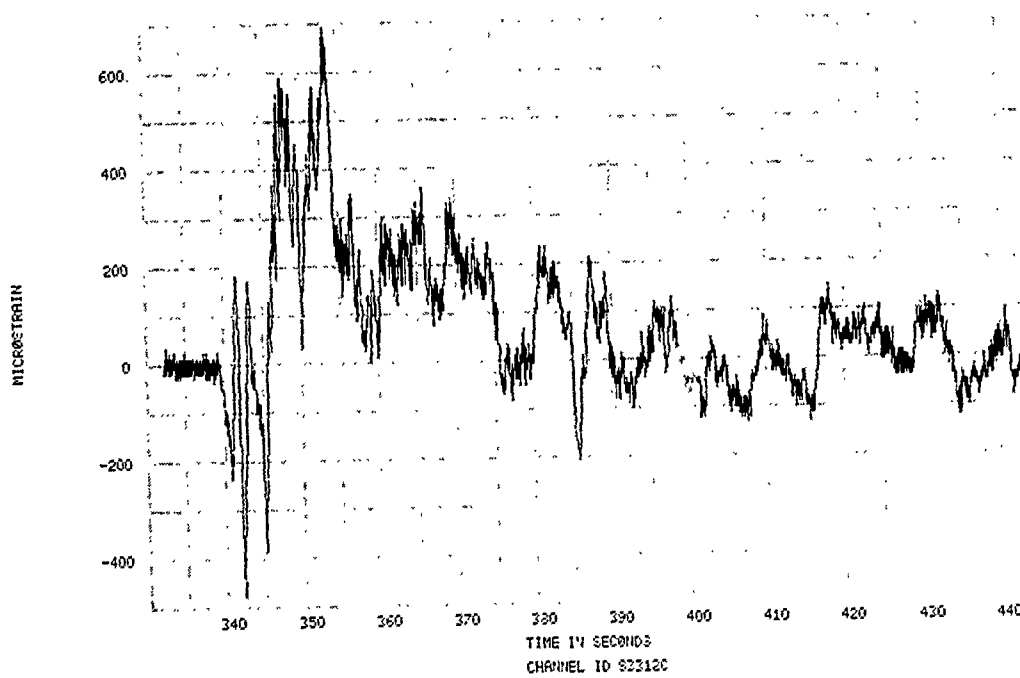

FIGURE 348. SPECIMEN 33, EVENT 78-330, STRAIN TIME HISTORY

1/31

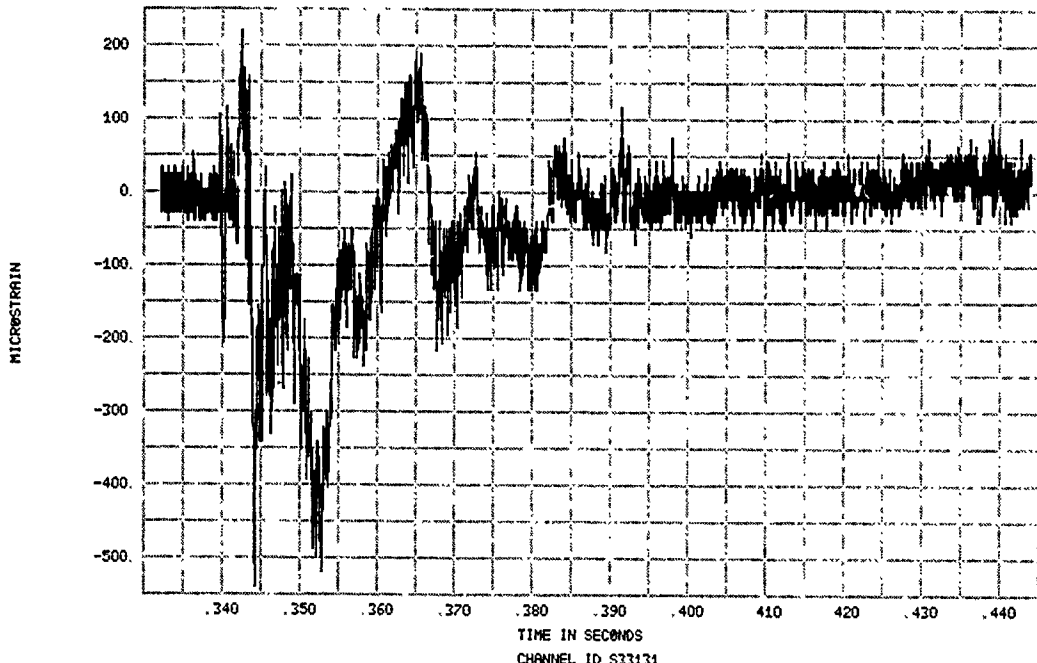

FIGURE 349. SPECIMEN 33, EVENT 78-330, STRAIN TIME HISTORY

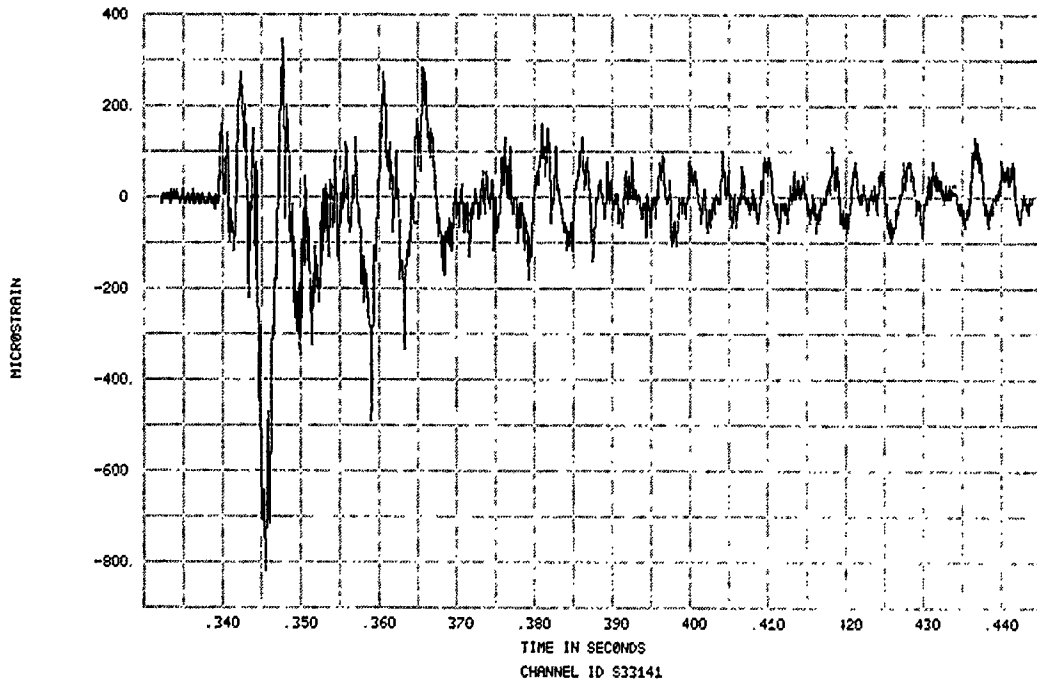

FIGURE 350. SPECIMEN 33, EVENT 78-330, STRAIN TIME HISTORY

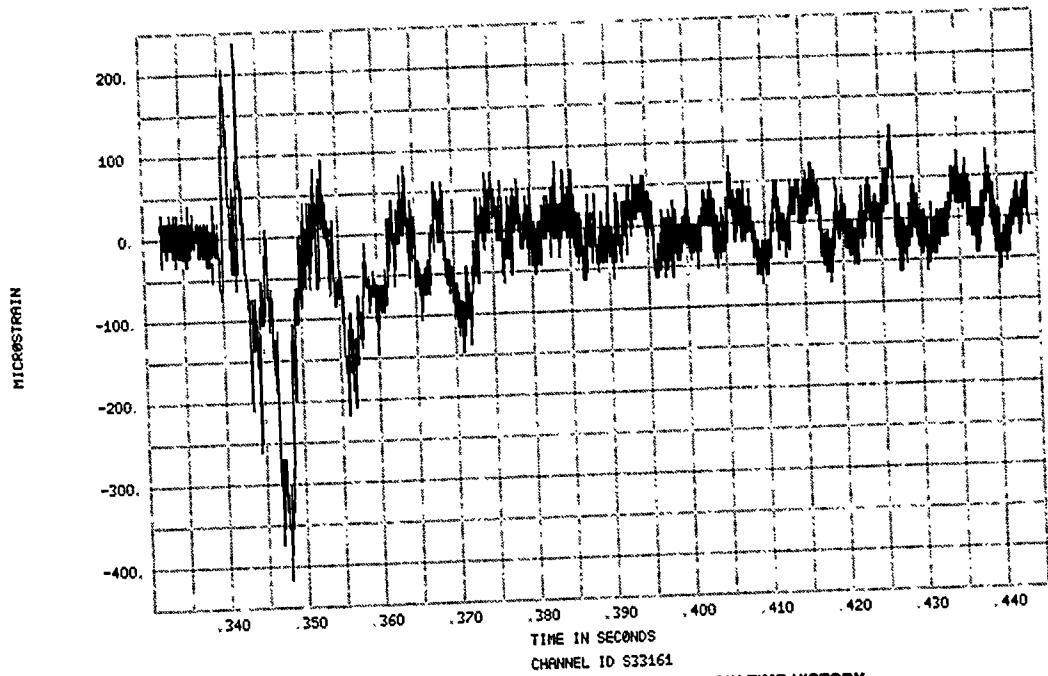

FIGURE 351. SPECIMEN 33, EVENT 78-330, STRAIN TIME HISTORY

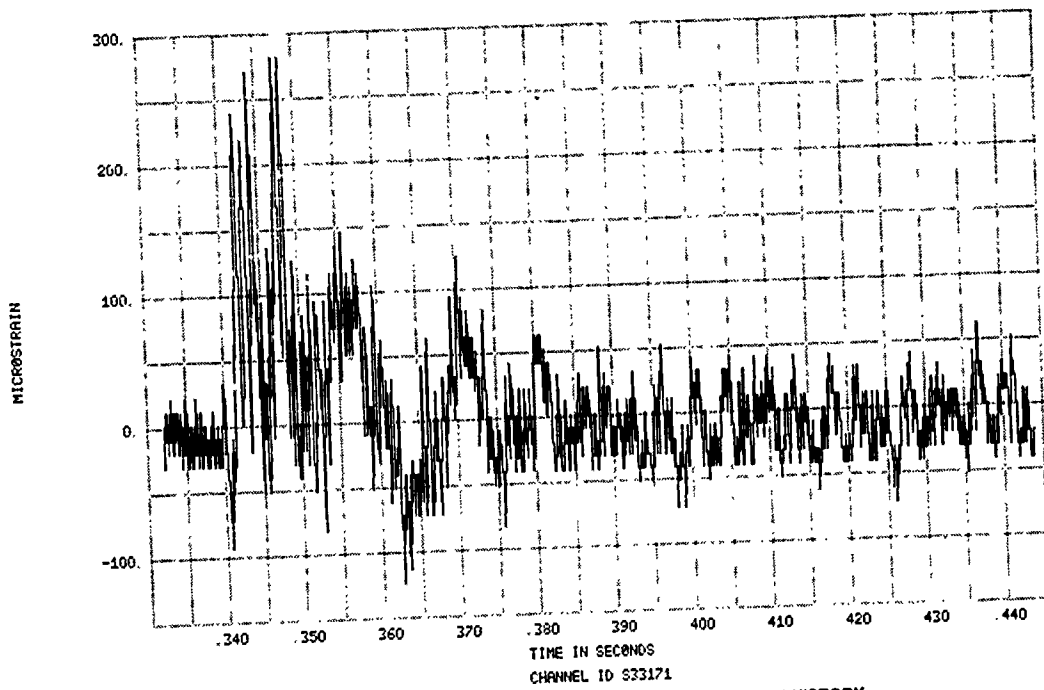

FIGURE 352. SPECIMEN 33, EVENT 78-330, STRAIN TIME HISTORY

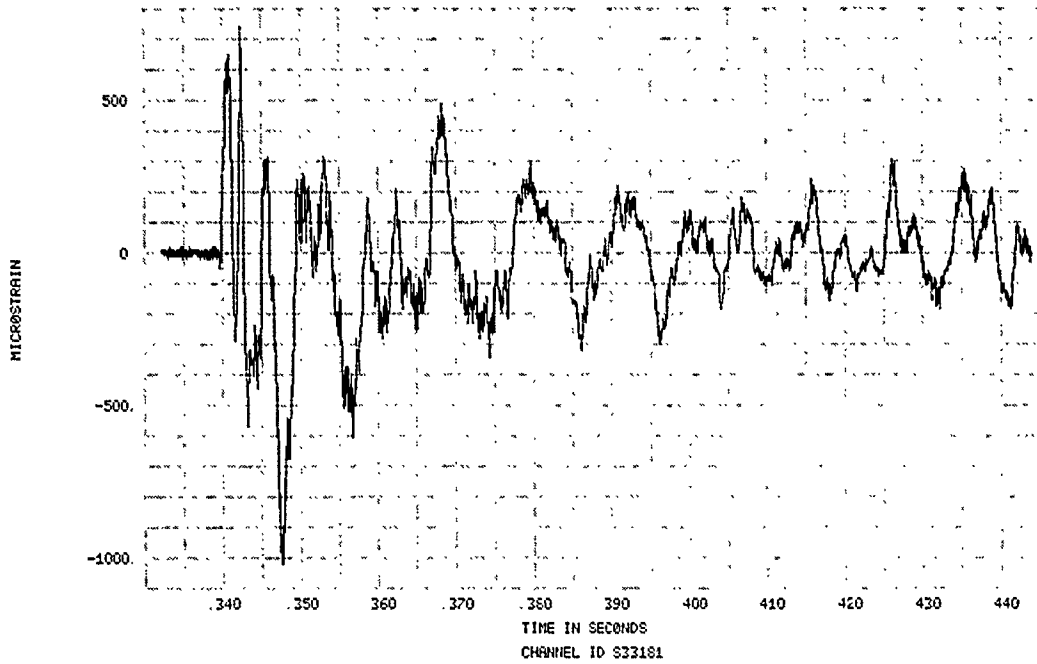

FIGURE 353. SPECIMEN 33, EVENT 78-330, STRAIN TIME HISTORY

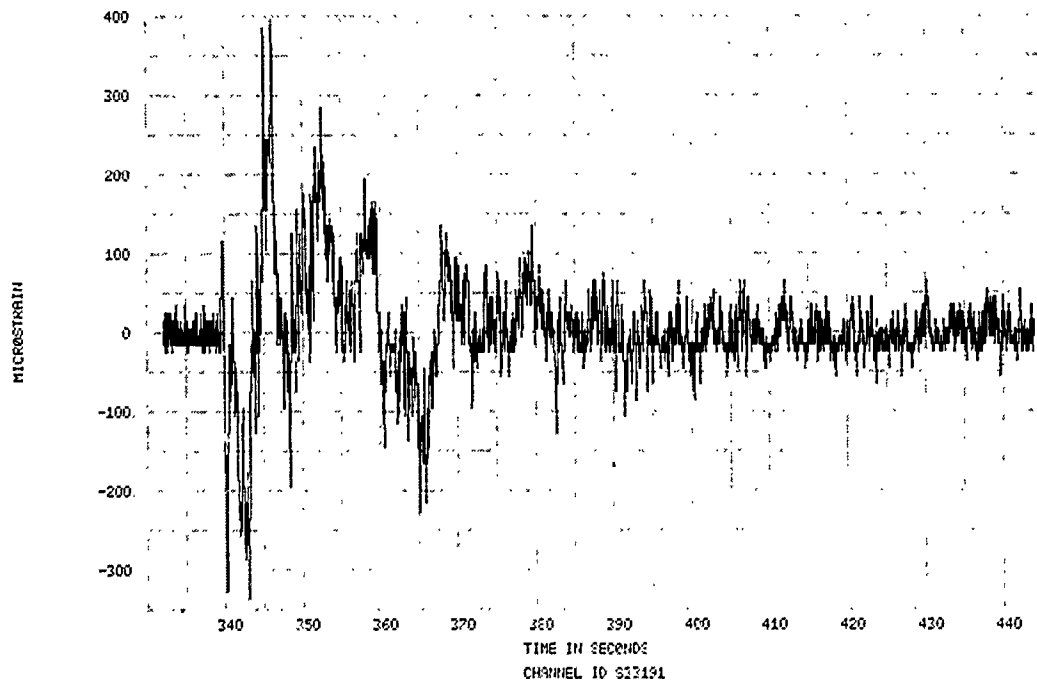

FIGURE 354. SPECIMEN 33, EVENT 78-330, STRAIN TIME HISTORY

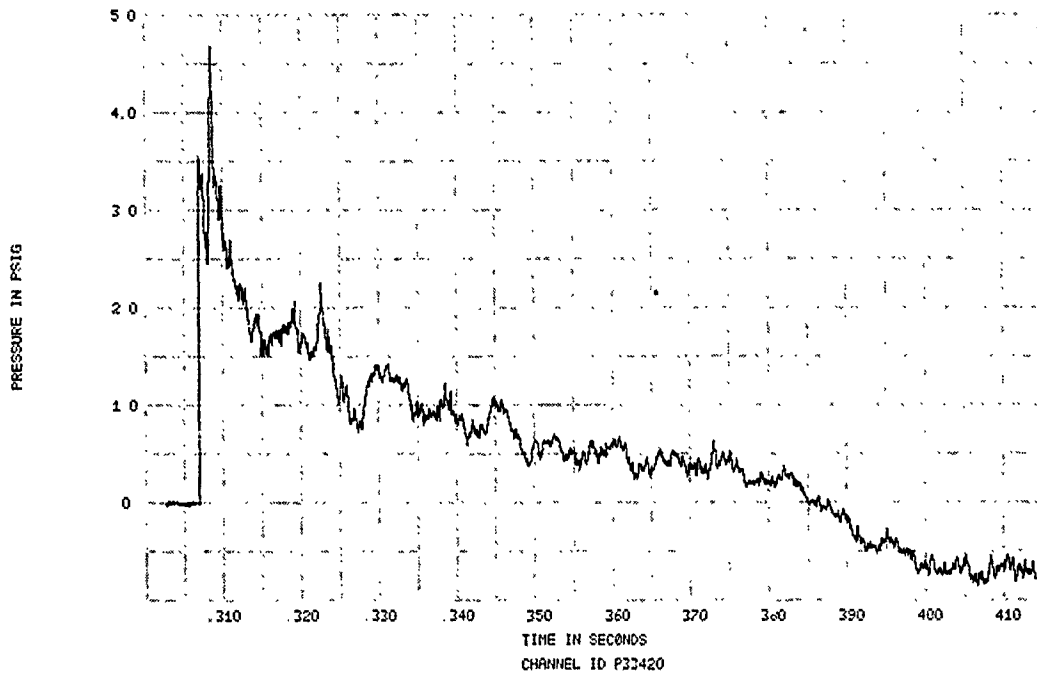

FIGURE 355. SPECIMEN 33, EVENT 78-331, SPECIMEN REFLECTED OVERPRESSURE TIME HISTORY

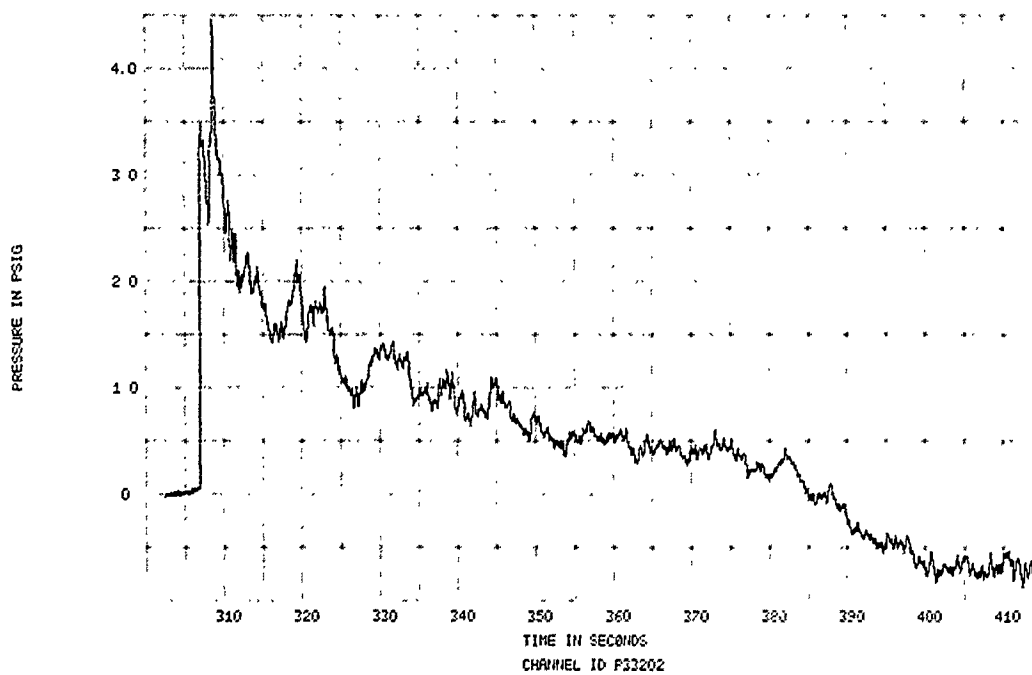

FIGURE 356. SPECIMEN 33, EVENT 78-331, SPECIMEN REFLECTED OVERPRESSURE TIME HISTORY

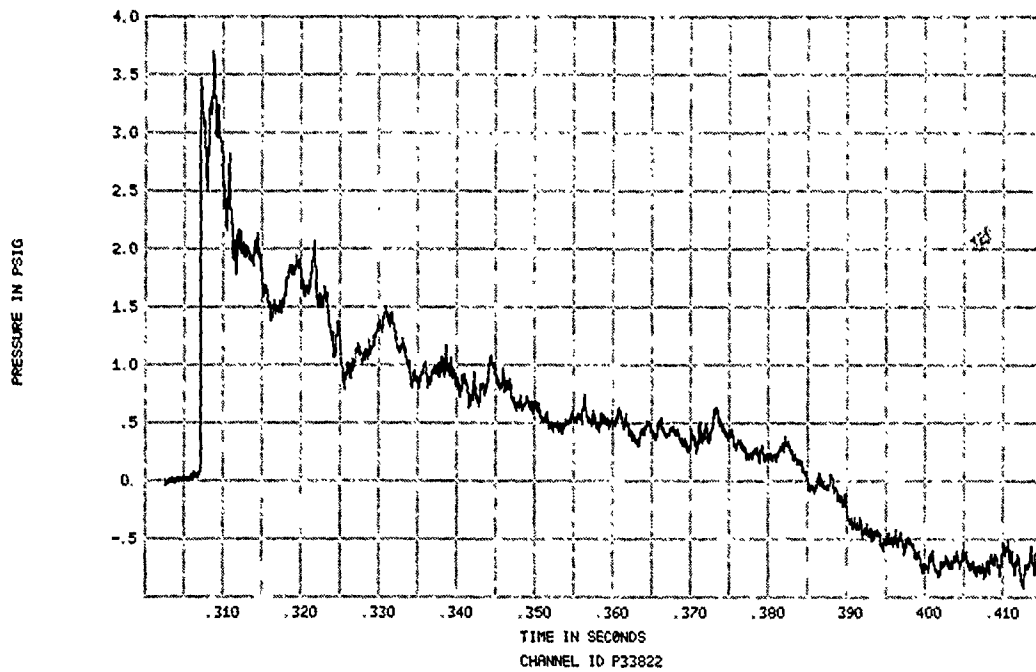

FIGURE 357. SPECIMEN 33, EVENT 78-331, SPECIMEN REFLECTED OVERPRESSURE TIME HISTORY

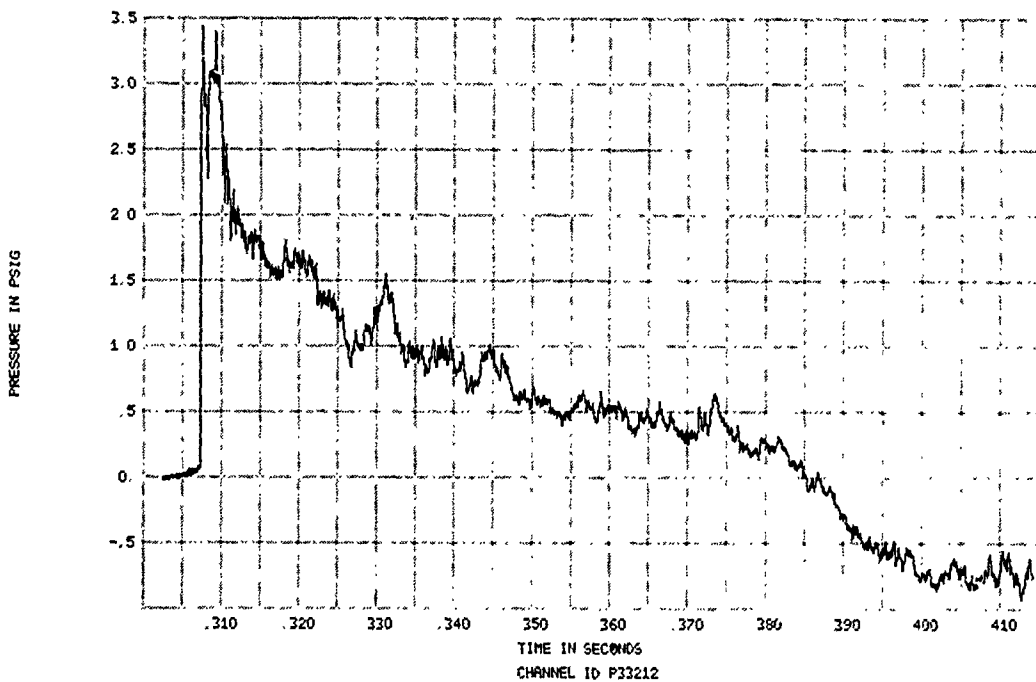

FIGURE 358. SPECIMEN 33, EVENT 78-331, SPECIMEN REFLECTED OVERPRESSURE TIME HISTORY

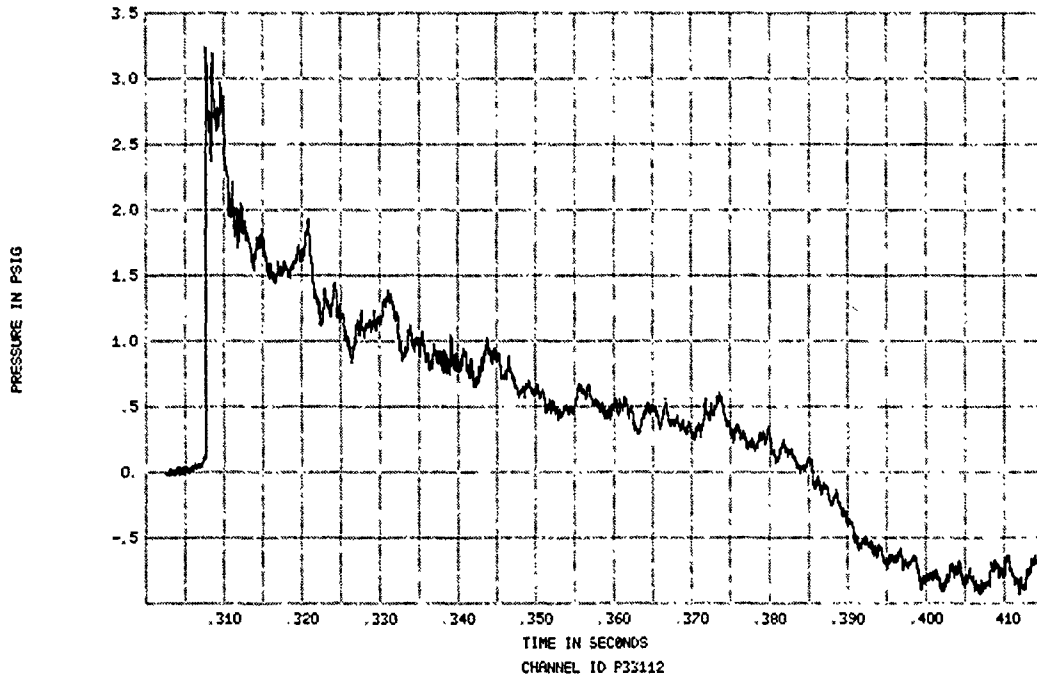

FIGURE 359. SPECIMEN 33, EVENT 78-331, SPECIMEN REFLECTED OVERPRESSURE TIME HISTORY

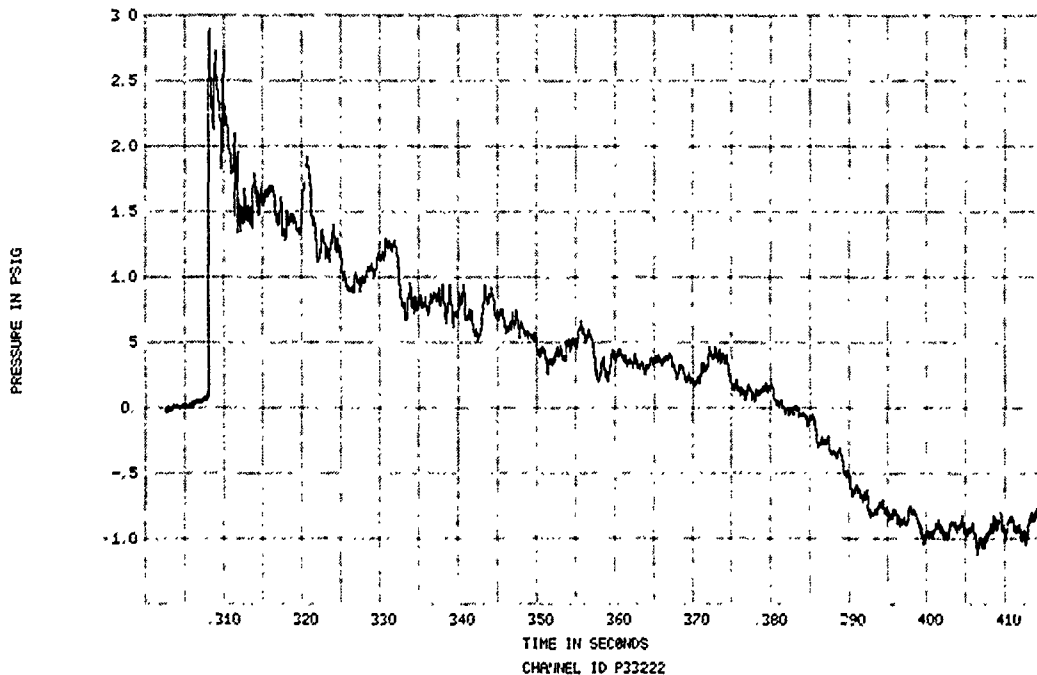

FIGURE 360. SPECIMEN 33, EVENT 78-331, SPECIMEN REFLECTED OVERPRESSURE TIME HISTORY

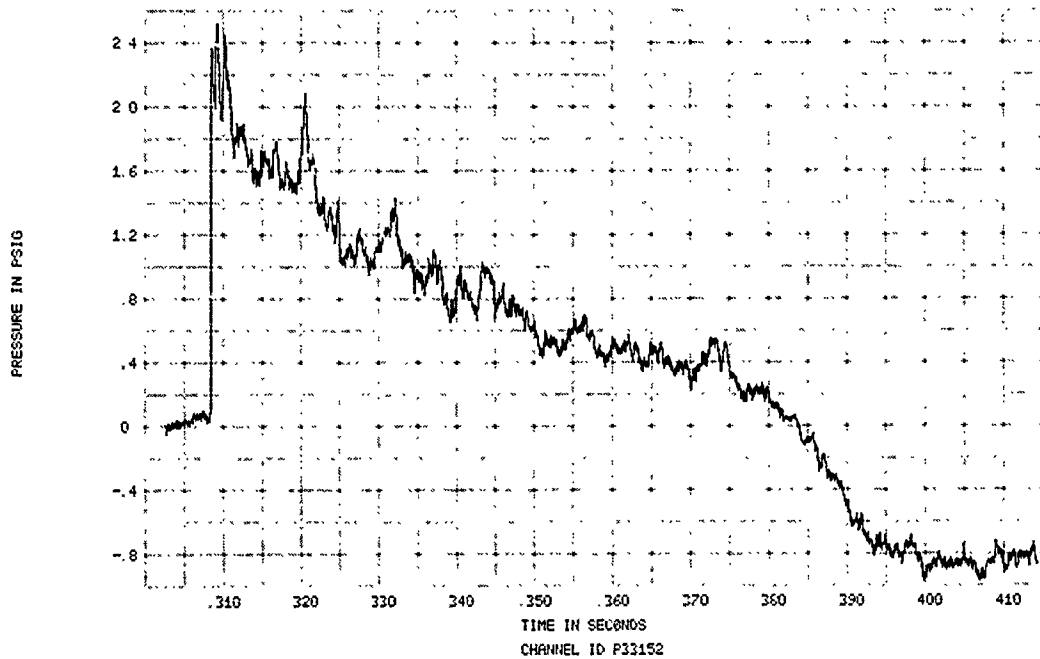

FIGURE 361. SPECIMEN 33, EVENT 78-331, SPECIMEN REFLECTED OVERPRESSURE TIME HISTORY

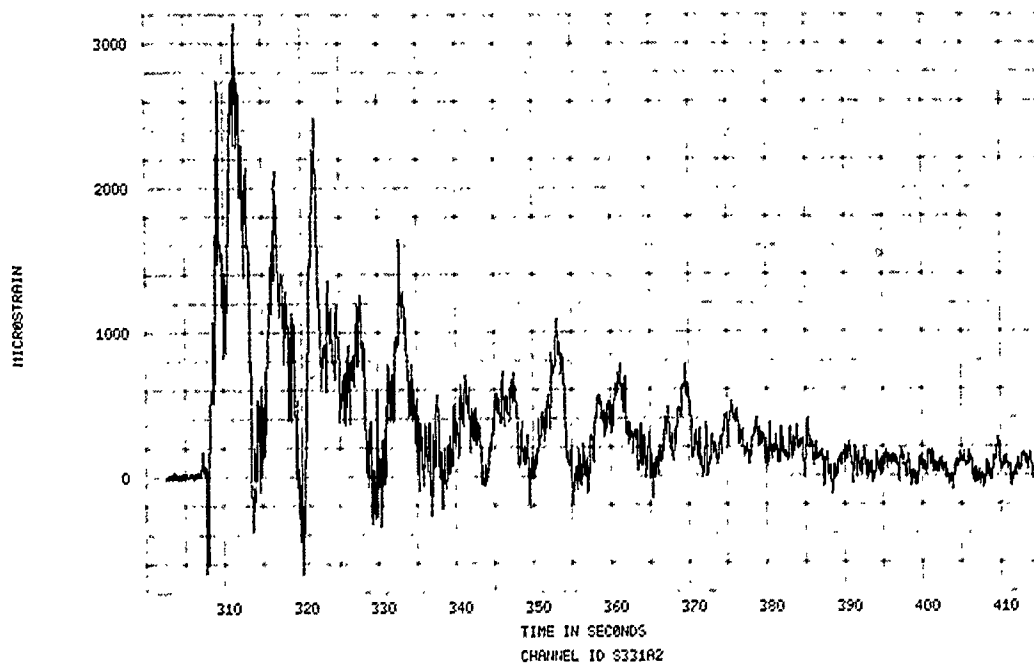

FIGURE 362. SPECIMEN 33, EVENT 78-331, STRAIN TIME HISTORY

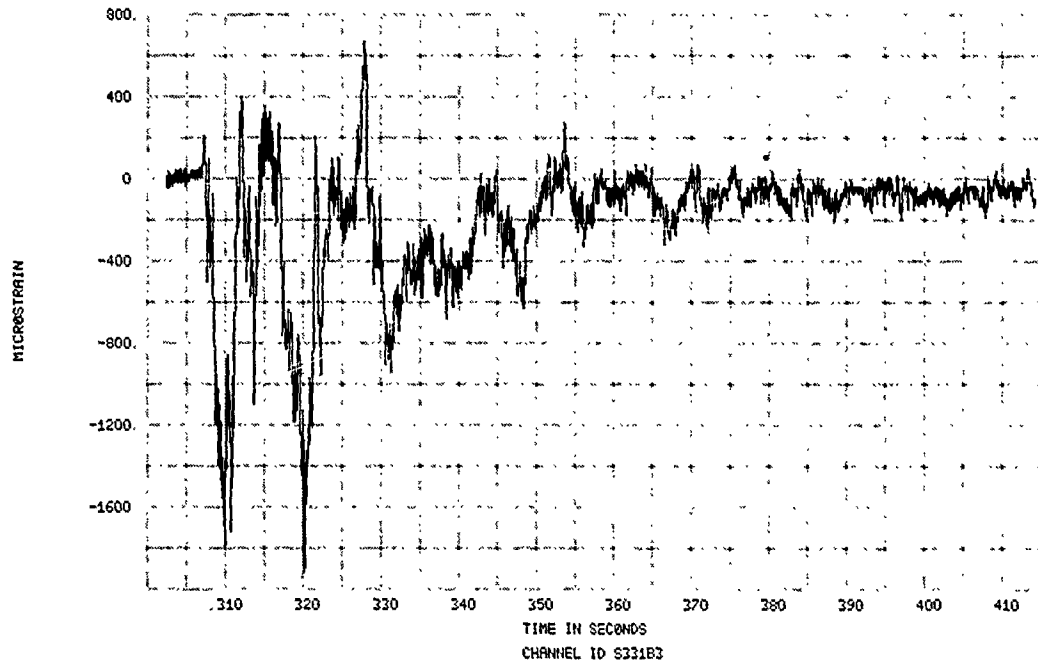

FIGURE 383. SPECIMEN 33, EVENT 78-331, STRAIN TIME HISTORY

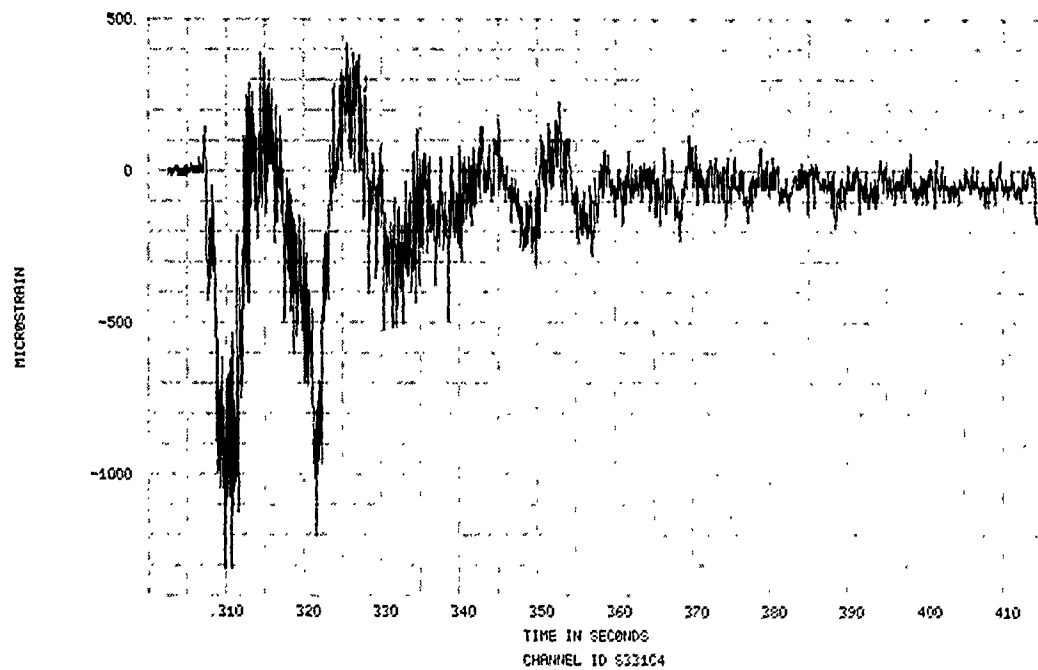

FIGURE 384. SPECIMEN 33, EVENT 78-331, STRAIN TIME HISTORY

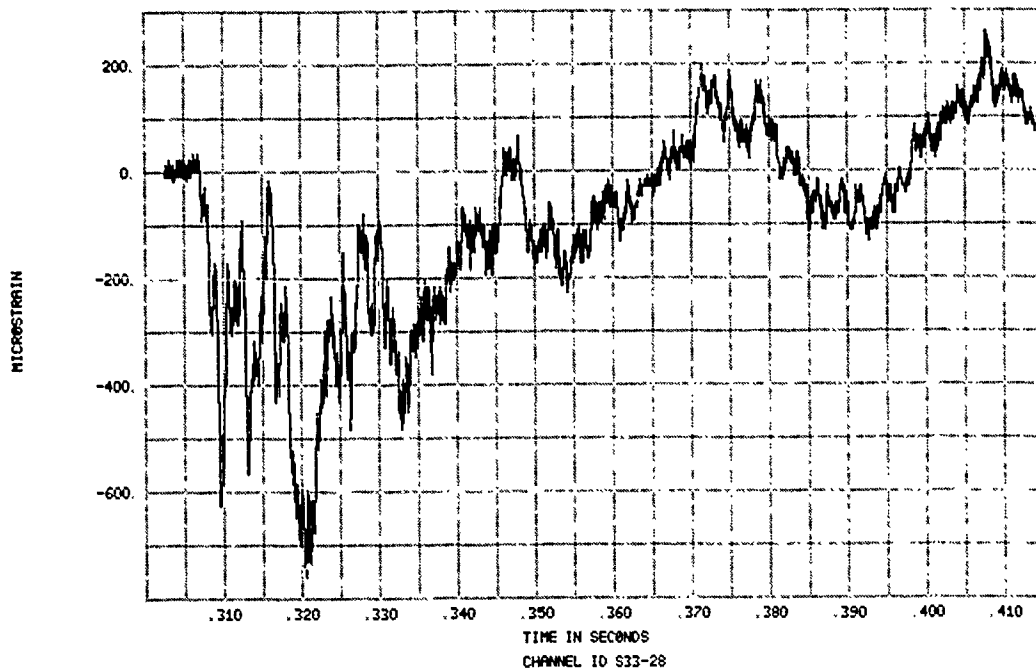

FIGURE 366. SPECIMEN 33, EVENT 78-331, STRAIN TIME HISTORY

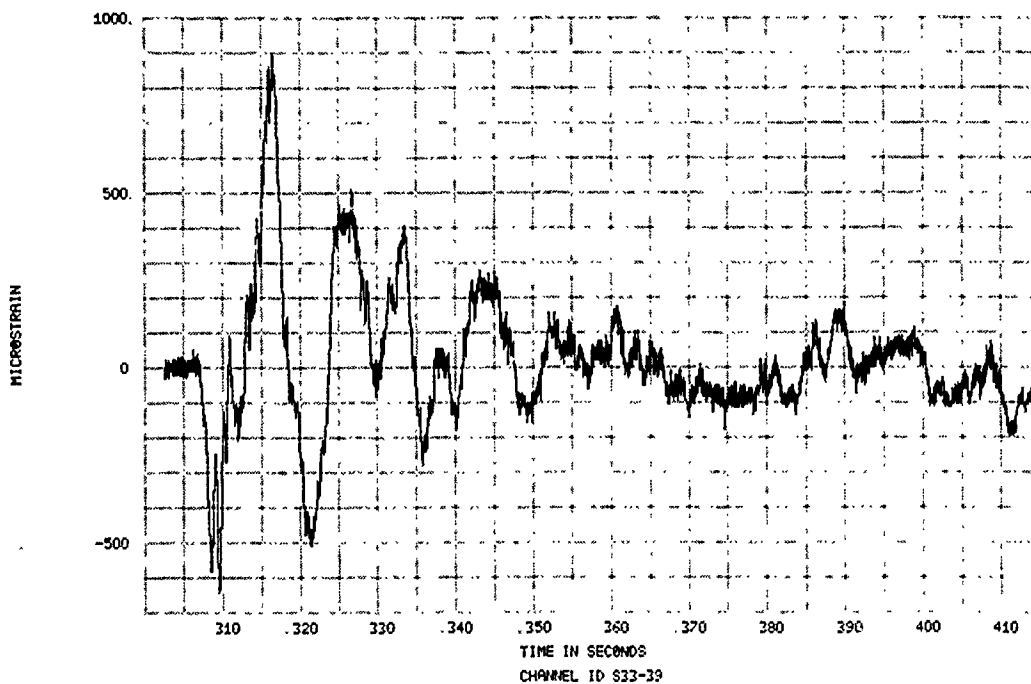

FIGURE 366. SPECIMEN 33, EVENT 78-331, STRAIN TIME HISTORY

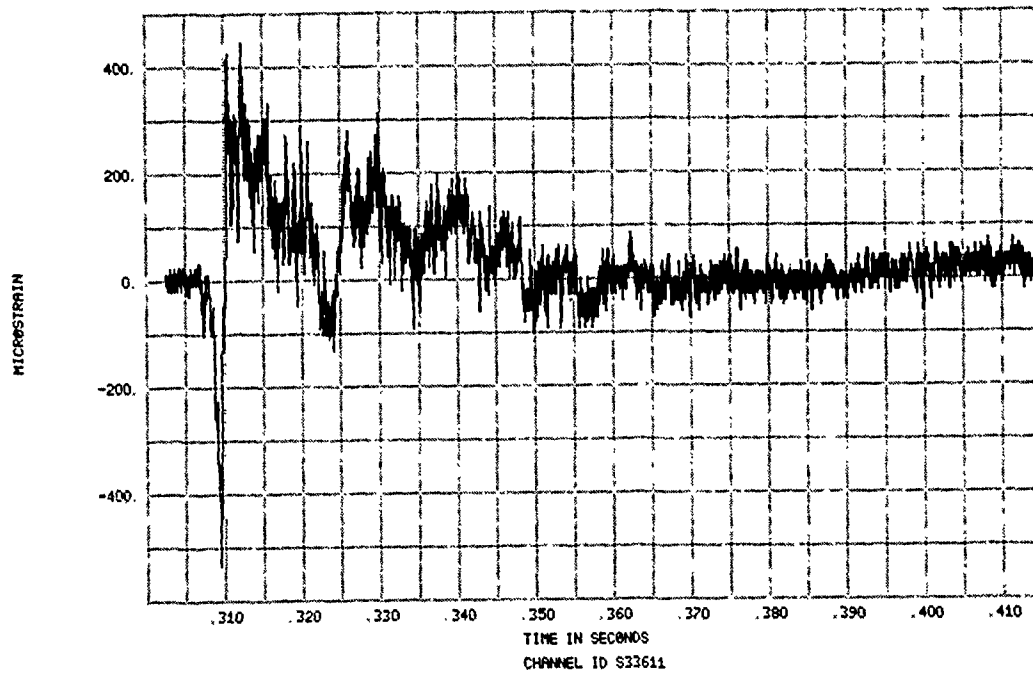

FIGURE 367. SPECIMEN 33, EVENT 78-331, STRAIN TIME HISTORY

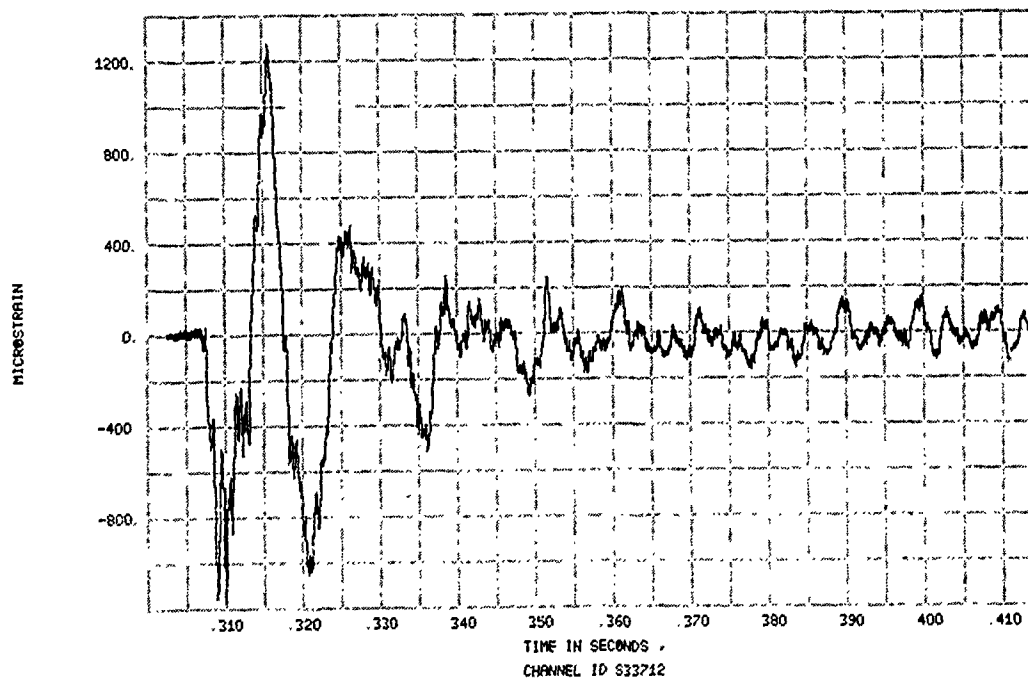

FIGURE 368. SPECIMEN 33, EVENT 78-331, STRAIN TIME HISTORY

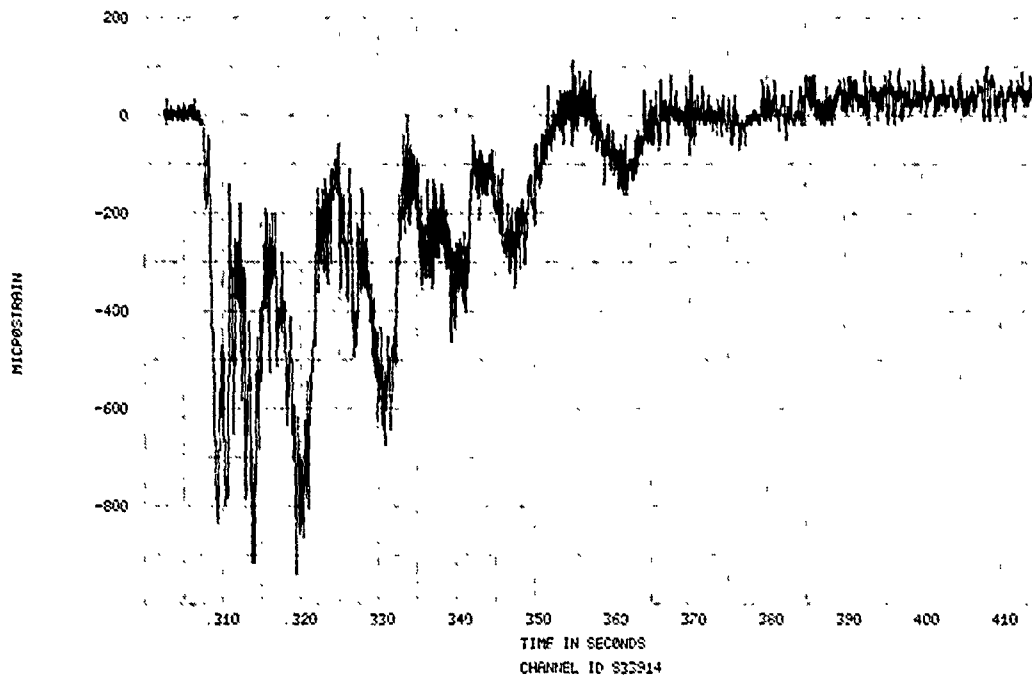

FIGURE 369. SPECIMEN 33, EVENT 78-331, STRAIN TIME HISTORY

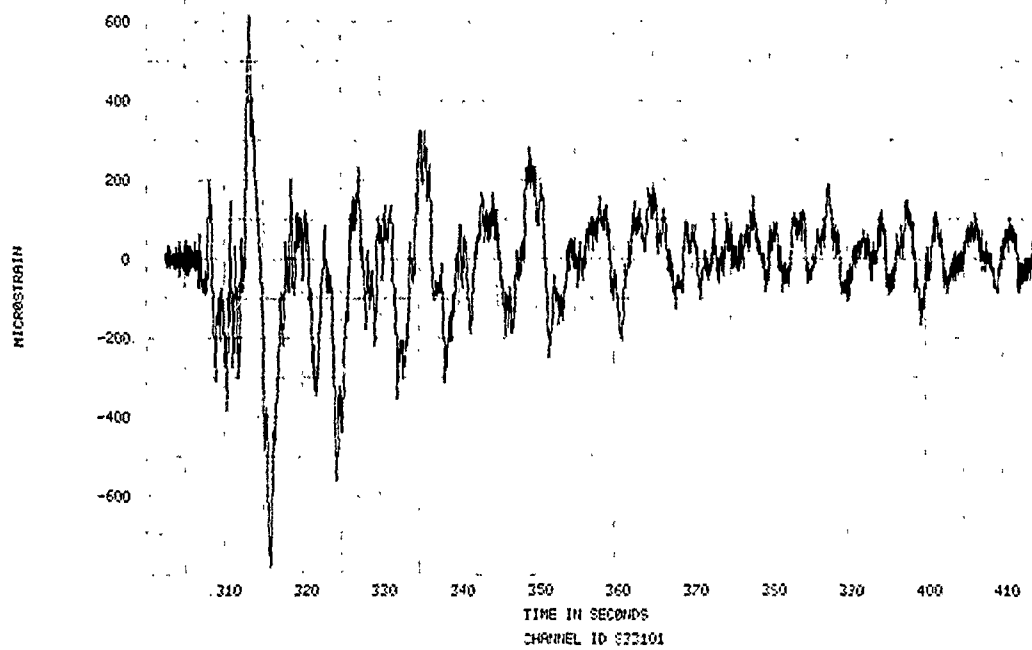

FIGURE 370. SPECIMEN 33, EVENT 78-331, STRAIN TIME HISTORY

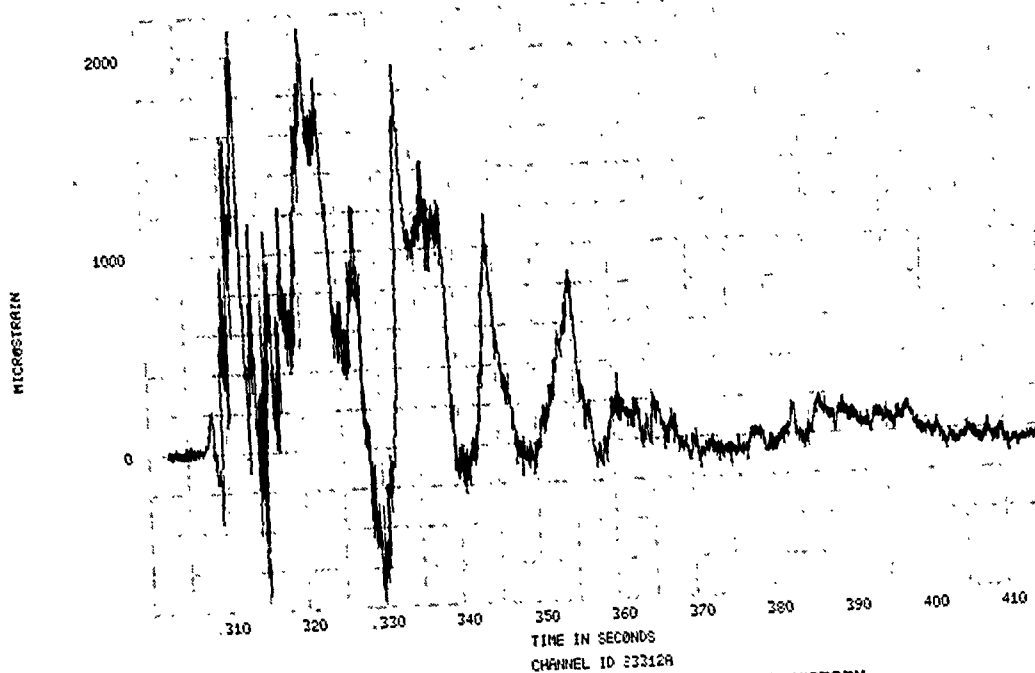

FIGURE 371. SPECIMEN 33, EVENT 78-331, STRAIN TIME HISTORY
CHANNEL ID 233128

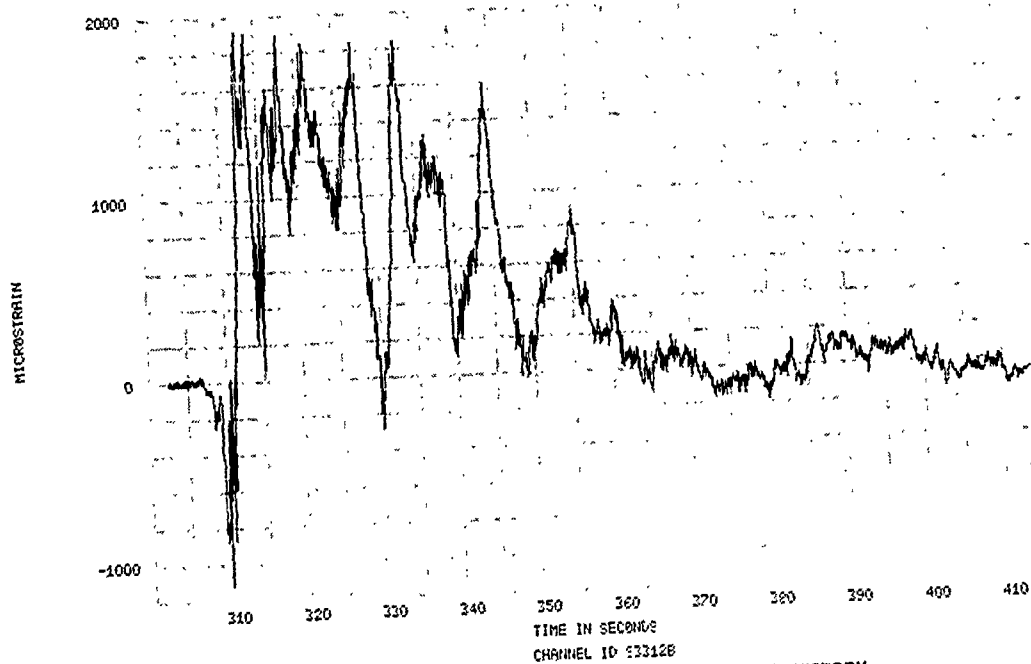

FIGURE 372. SPECIMEN 33, EVENT 78-331, STRAIN TIME HISTORY
CHANNEL ID 233128

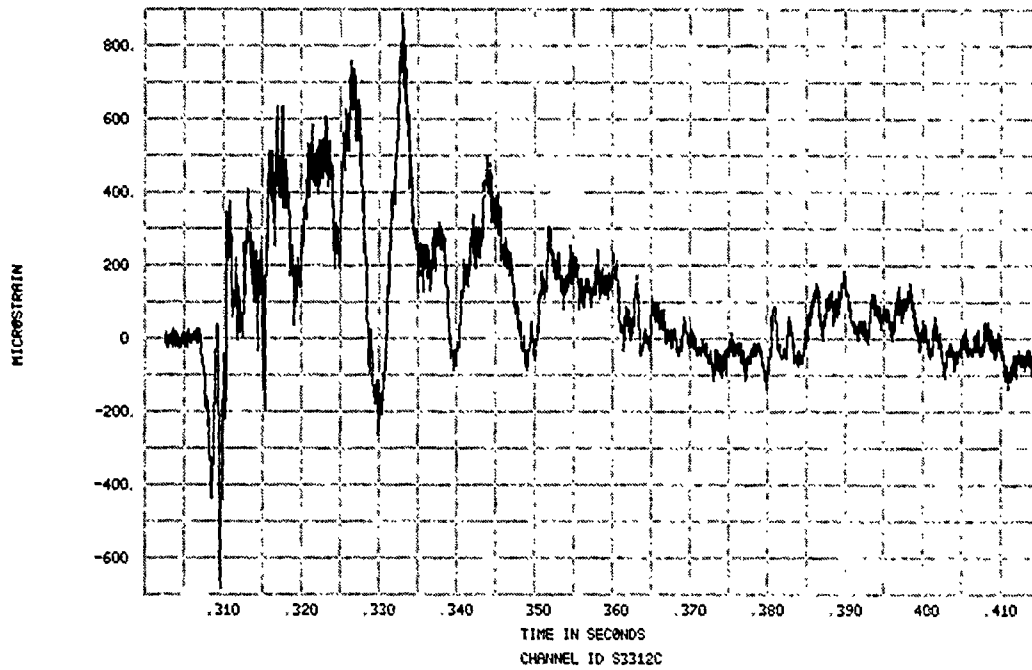

FIGURE 373. SPECIMEN 33, EVENT 78-331, STRAIN TIME HISTORY

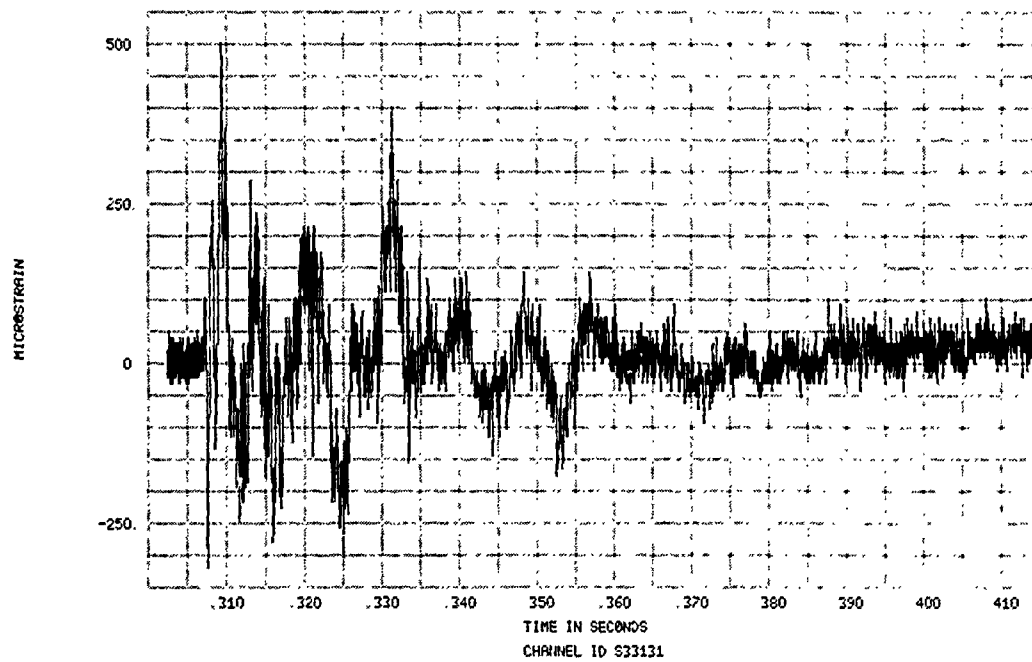

FIGURE 374. SPECIMEN 33, EVENT 78-331, STRAIN TIME HISTORY

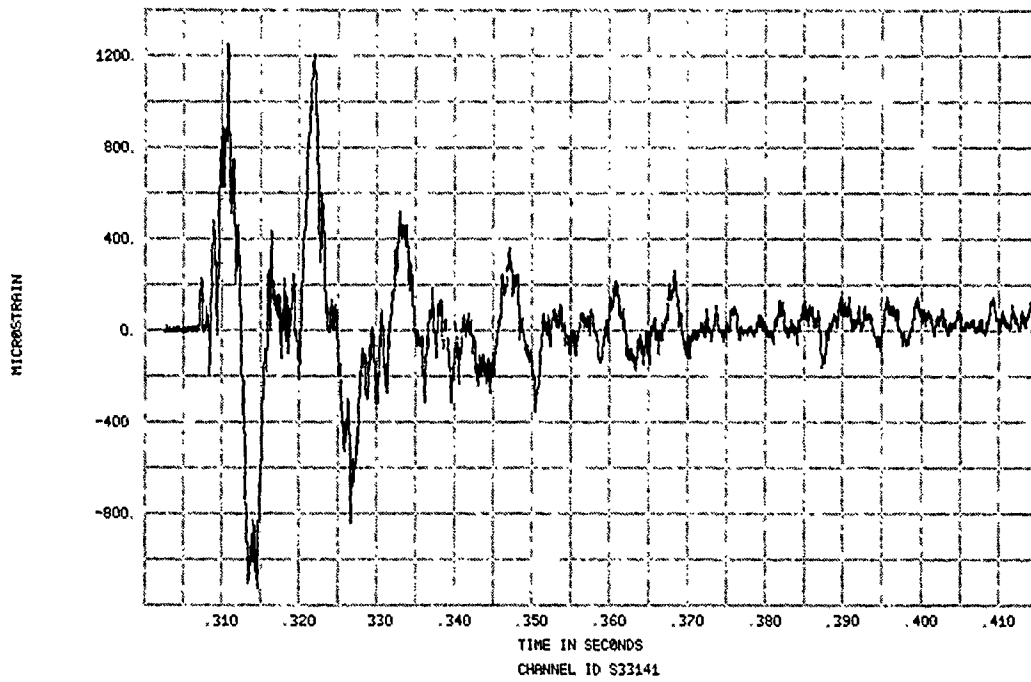

FIGURE 375. SPECIMEN 33, EVENT 78-331, STRAIN TIME HISTORY

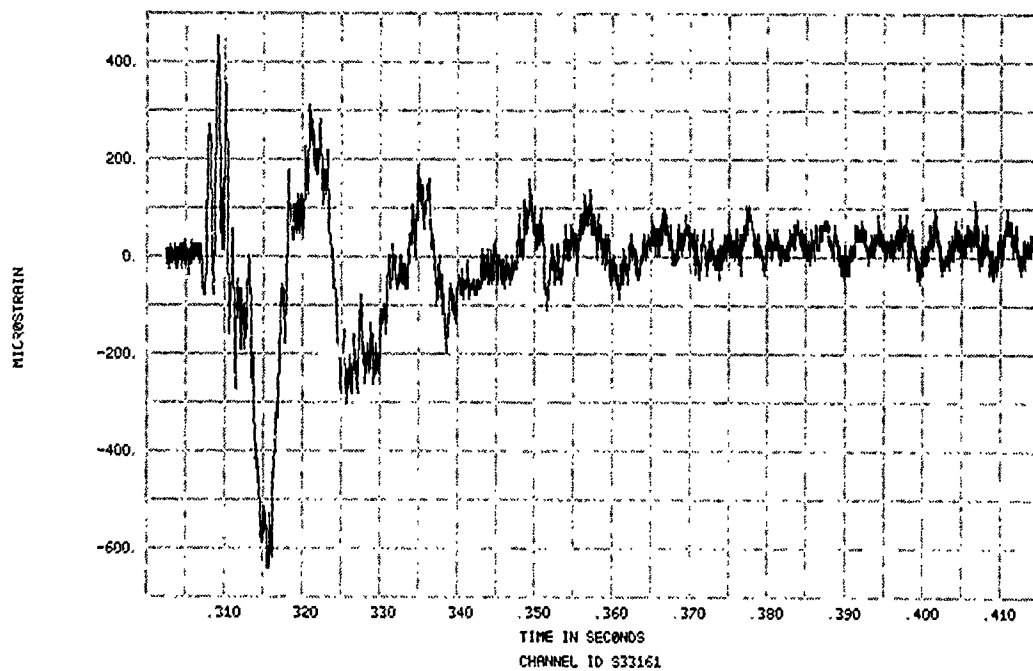

FIGURE 376. SPECIMEN 33, EVENT 78-331, STRAIN TIME HISTORY

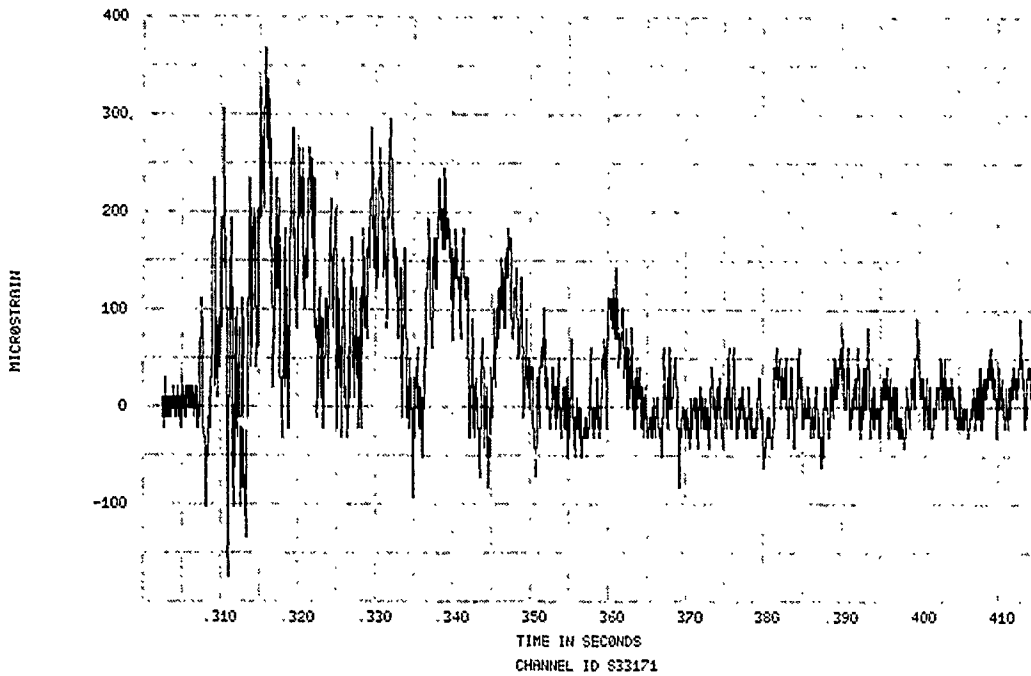

FIGURE 377. SPECIMEN 33, EVENT 78-331, STRAIN TIME HISTORY

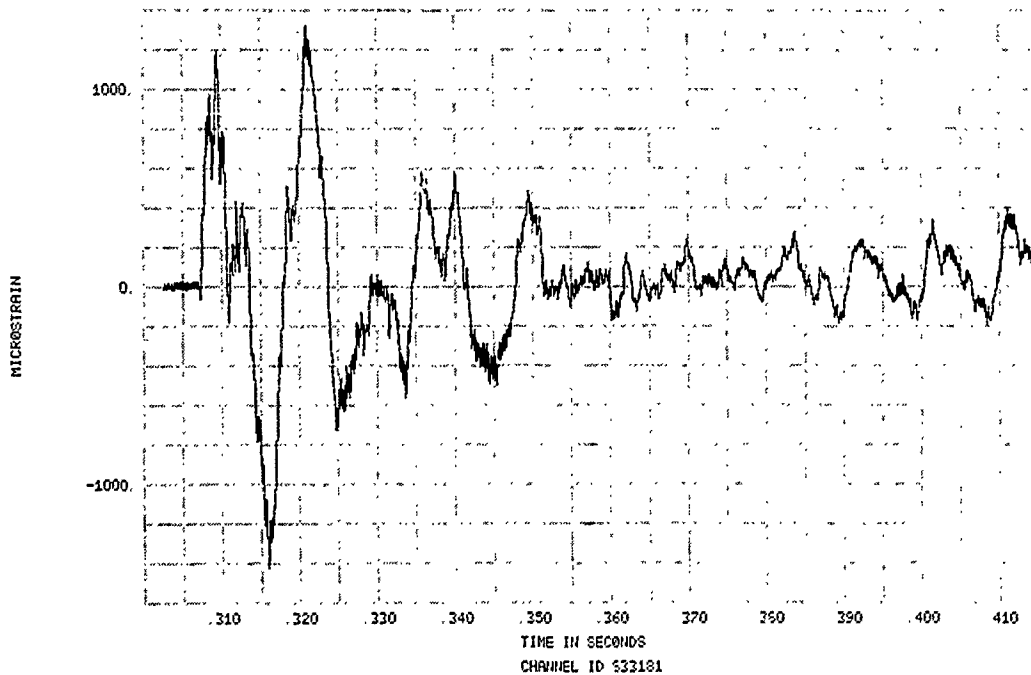

FIGURE 378. SPECIMEN 33, EVENT 78-331, STRAIN TIME HISTORY

PLOTTED OCT 16, '78 HBE 8170 945 LEE -8215 5625 HCL 4232 5594 LCL -1 1405
ANALOG TAPE 298009 TRACK NO 6 FILTER 10000HZ SAMPLE RATE 100000 CHARGE NO 78 331

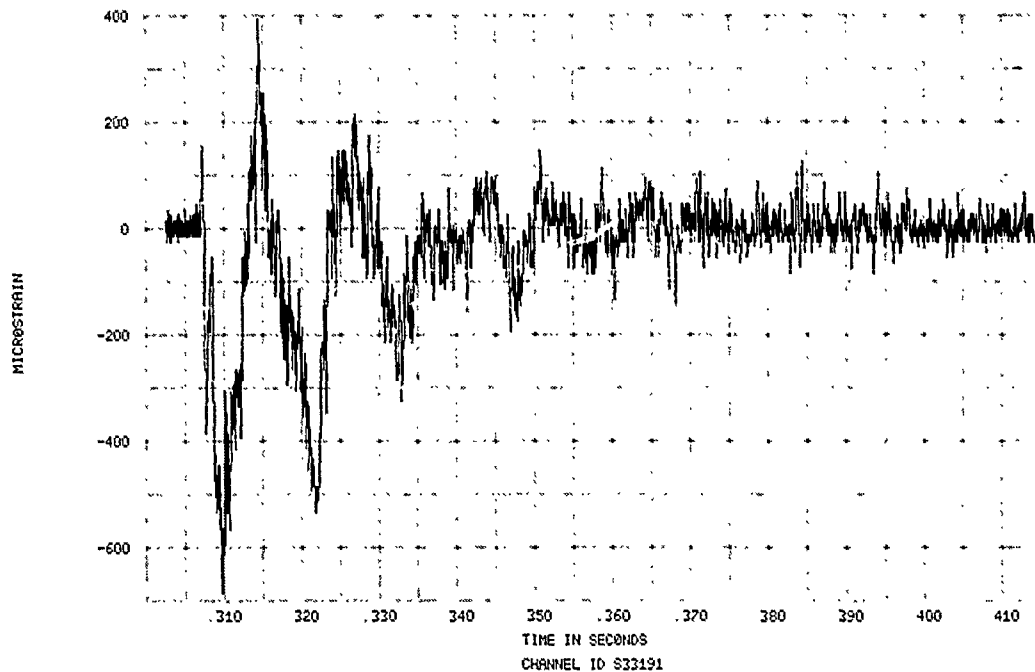

FIGURE 379. SPECIMEN 33, EVENT 78-331, STRAIN TIME HISTORY

DISTRIBUTION LIST

DEPARTMENT OF DEFENSE

Assistant to the Secretary of Defense
Atomic Energy
ATTN: Executive Assistant

Defense Intelligence Agency
ATTN: DB-4C, V. Fratzke

Defense Nuclear Agency
ATTN: SPAS
4 cy ATTN: TITL

Defense Technical Information Center
2 cy ATTN: DD

Field Command
Defense Nuclear Agency
Livermore Branch
ATTN: FCT, W. Tyler

Field Command
Defense Nuclear Agency
Livermore Branch
ATTN: FCPRL

Undersecretary of Def for Rsch & Engrg
ATTN: Strategic & Space Sys (OS)

DEPARTMENT OF THE ARMY

Harry Diamond Laboratories
Department of the Army
ATTN: DELHD-N-P, J. Gwaltney

U.S. Army Ballistic Research Labs
ATTN: DRDAR-BLT, J. Keefer
ATTN: DRDAR-BLT, W. Taylor

U.S. Army Materiel Dev & Readiness Cmd
ATTN: DRCDE-D, L. Flynn

U.S. Army Nuclear & Chemical Agency
ATTN: Library

DEPARTMENT OF THE NAVY

Naval Material Command
ATTN: MAT OBT-22

Naval Research Laboratory
ATTN: Code 1221 for Code 2627

Naval Surface Weapons Center
ATTN: Code F31, K. Caudle

Naval Weapons Evaluation Facility
ATTN: L. Oliver

Office of Naval Research
ATTN: Code 465

Strategic Systems Project Office
Department of the Navy
ATTN: NSP-272

DEPARTMENT OF THE AIR FORCE

Aeronautical Systems Division
Air Force Systems Command
ATTN: ASD/YYEF
ATTN: ASD/ENFT, R. Bachman
4 cy ATTN: ASD/ENFTV, D. Ward

Air Force Systems Command
ATTN: SDNI
ATTN: DLWB

Air Force Weapons Laboratory
Air Force Systems Command
ATTN: SUL
ATTN: NTYV, A. Sharp
ATTN: NT, D. Payton
ATTN: NTYV, G. Campbell
ATTN: NTYC (S/V Data Base)

Air Force Wright Aeronautical Laboratories
ATTN: MBL, G. Schmitt
ATTN: POTX, M. Stibich

Assistant Chief of Staff
Studies & Analyses
Department of the Air Force
ATTN: AF/SASB, R. Mathis
ATTN: AF/SASC, B. Adams

Deputy Chief of Staff
Research, Development, & Acq
Department of the Air Force
ATTN: AFRDQI, N. Alexandrow

Foreign Technology Division
Air Force Systems Command
ATTN: SDBF, S. Spring

Strategic Air Command
Department of the Air Force
ATTN: XPS
2 cy ATTN: XPFS, F. Tedesco

OTHER GOVERNMENT AGENCY

Central Intelligence Agency
ATTN: OSWR/NED

DEPARTMENT OF ENERGY CONTRACTOR

Sandia National Lab
ATTN: A. Lieber

DEPARTMENT OF DEFENSE CONTRACTORS

Boeing Co
ATTN: M/S 85/20, E. York
ATTN: M/S 40-19, R. Dahl

Boeing Wichita Co
ATTN: R. Syring

Calspan Corp
ATTN: M. Dunn

DEPARTMENT OF DEFENSE CONTRACTORS (Continued)

University of Dayton
ATTN: B. Wilt

Effects Technology, Inc
ATTN: R. Globus
ATTN: R. Parisse
ATTN: E. Bick

General Research Corp
ATTN: T. Stathacopoulos
ATTN: J. Cunningham

Kaman—TEMPO
ATTN: DASIAC

Kaman—TEMPO
ATTN: J. Moulton

Kaman Avidyne
ATTN: B. Lee
ATTN: E. Criscione
ATTN: N. Hobbs
ATTN: R. Ruetenik

DEPARTMENT OF DEFENSE CONTRACTORS (Continued)

Kaman Sciences Corp
ATTN: D. Sachs

Los Alamos Technical Associates, Inc
ATTN: P. Hughes

Pacific-Sierra Research Corp
ATTN: H. Brode

PDA Engineering
ATTN: J. McDonald
ATTN: H. Moody
ATTN: C. Thacker

R & D Associates
ATTN: F. Field
ATTN: J. Carpenter
ATTN: A. Kuhl
ATTN: P. Rausch
ATTN: P. Haas

Science Applications, Inc
ATTN: J. Cockayne