

AD-A091 172

OREGON STATE UNIV CORVALLIS SCHOOL OF OCEANOGRAPHY

F/G 8/10

TOWED THERMISTOR CHAIN OBSERVATIONS IN JASIN; (U)

JUL 80 R J BAUMANN, C A PAULSON, J WAGNER

N00014-76-C-0067

DATA-80

NL

UNCLASSIFIED

1 OF 3  
AD  
AC0872

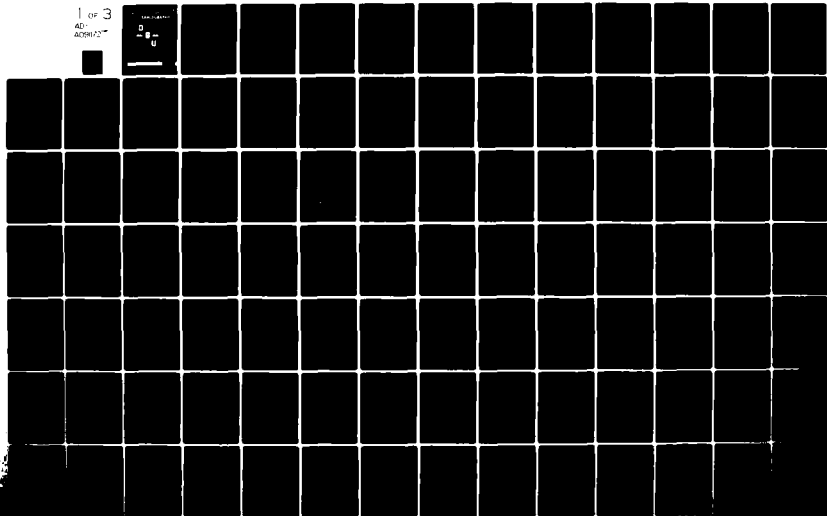

School of

LEVEL II

12

# OCEANOGRAPHY

AD A091172

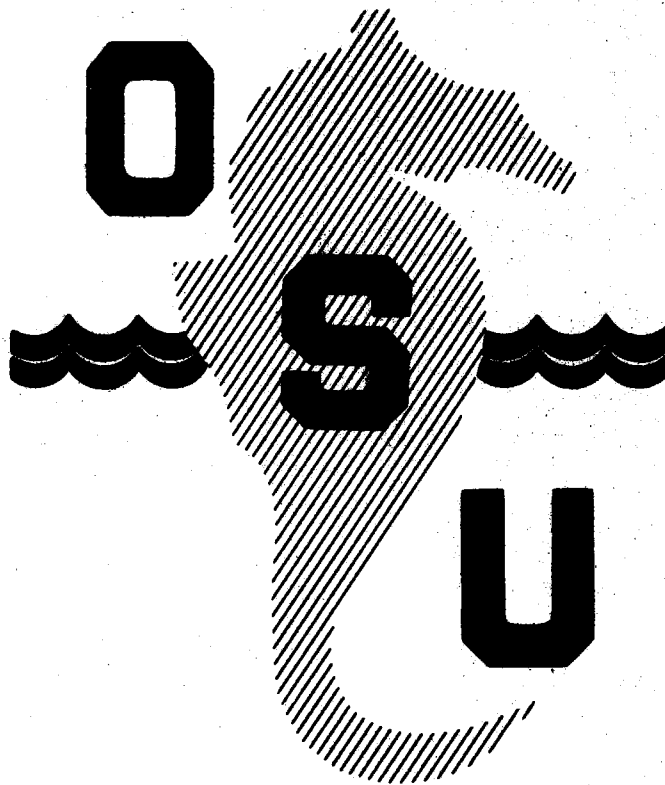

DTIC ELECTED  
NOV 03 1980  
E

DDC FILE COPY

**DISTRIBUTION STATEMENT A**

Approved for public release;  
Distribution Unlimited

Towed Thermistor Chain  
Observations in JASIN

by  
R. J. Baumann, C. A. Paulson  
and J. Wagner

Office of Naval Research  
N00014-76-C-0007  
N00014-76-C-0004  
NR 000-102

Reference 00-14  
July 1980  
Data Report 00

Reproduction in whole or in part is  
permitted for any purpose of the  
United States Government

OREGON STATE UNIVERSITY

80 10 17 068

Unclassified

SECURITY CLASSIFICATION OF THIS PAGE (When Data Entered)

REPORT DOCUMENTATION PAGE		READ INSTRUCTIONS BEFORE COMPLETING FORM
1. REPORT NUMBER 80-14 ✓	2. GOVT ACCESSION NO. AD A091172	3. RECIPIENT'S CATALOG NUMBER
4. TITLE (and Subtitle) TOWED THERMISTOR CHAIN OBSERVATIONS IN JASIN,		5. TYPE OF REPORT & PERIOD COVERED data
		6. PERFORMING ORG. REPORT NUMBER Data Report No. 80 ✓
7. AUTHOR(s) R. J./Baumann; C. A. Paulson, and J./Wagner		8. CONTRACT OR GRANT NUMBER(s) N00014-76-C-0067 ✓ N00014-79-C-0004
9. PERFORMING ORGANIZATION NAME AND ADDRESS School of Oceanography Oregon State University Corvallis, OR 97331		10. PROGRAM ELEMENT, PROJECT, TASK AREA & WORK UNIT NUMBERS NR 083-102
11. CONTROLLING OFFICE NAME AND ADDRESS Office of Naval Research Ocean Science and Technology Division Arlington, VA 22217		12. REPORT DATE 11 July 1980
14. MONITORING AGENCY NAME & ADDRESS (if different from Controlling Office)		13. NUMBER OF PAGES 207
16. DISTRIBUTION STATEMENT (of this Report)  Approved for public release; distribution unlimited		15. SECURITY CLASS. (of this report) unclassified
		15a. DECLASSIFICATION/DOWNGRADING SCHEDULE
17. DISTRIBUTION STATEMENT (of the abstract entered in Block 20, if different from Report)		
18. SUPPLEMENTARY NOTES		
19. KEY WORDS (Continue on reverse side if necessary and identify by block number)  Towed Thermistor Chain Horizontal Temperature Variability Isotherm Cross-sections Joint Air-Sea Interaction (JASIN) Experiment		
20. ABSTRACT (Continue on reverse side if necessary and identify by block number)  → Observations of temperature and pressure between 10 and 70 m depth were taken with a towed thermistor chain during late August and early September, 1978, about 400 km northwest of Scotland as a part of the JASIN Experiment. The chain was usually towed at a speed of 3 m/s around a 15-km square centered at 59°N, 12°30'W. On two occasions tows were made around five-km squares as part of coordinated observations involving several ships. The observations were averaged over sequential 30-second intervals and		

DD FORM 1473  
1 JAN 73

EDITION OF 1 NOV 65 IS OBSOLETE  
S/N 0102-014-6601

Unclassified

SECURITY CLASSIFICATION OF THIS PAGE (When Data Entered)

272268

Unclassified

SECURITY CLASSIFICATION OF THIS PAGE(When Data Entered)

isotherm depths were interpolated from the averaged observations. Cross-sections of temperature and isotherm depth are presented. Spectra of the depth of the lowest and highest isotherm of each cross-section are also presented.

Unclassified

SECURITY CLASSIFICATION OF THIS PAGE(When Data Entered)

TOWED THERMISTOR CHAIN

OBSERVATIONS IN JASIN

by

R. J. Baumann, C. A. Paulson  
and J. Wagner

School of Oceanography  
Oregon State University  
Corvallis, OR 97331

DATA REPORT

Office of Naval Research  
Contract N00014-76-C-0067  
and N00014-79-C-0067  
Project NR 083-102

Accession For	
NTIS	<input checked="" type="checkbox"/>
BDC TAB	<input type="checkbox"/>
Unannounced	<input type="checkbox"/>
Justification	<input type="checkbox"/>
By _____	
Disposal _____	
Special Access Codes	
Dist	Special
<b>A</b>	

Approved for public release, distribution unlimited

Data Report 80  
Reference 80-14  
July 1980

G. Ross Heath  
Dean

## ACKNOWLEDGMENTS

The design and construction of the thermistor chain were carried out by the Technical Planning and Development Group at Oregon State University under the direction of Rod Mesecar. We gratefully acknowledge the cooperation of the officers, crew and scientists aboard the R/V ATLANTIS II, David F. Casiles, commanding and Melbourne G. Briscoe, Chief Scientist. This research was supported by the Office of Naval Research through contracts N00014-76-C-0067 and N00014-79-C-0004 under project NR 083-102.

## TABLE OF CONTENTS

ACKNOWLEDGMENTS-----	i
INTRODUCTION-----	1
INSTRUMENTATION-----	1
OBSERVATIONS-----	2
ANALYSIS-----	6
REFERENCES-----	8
TOW TRACKS-----	9
TEMPERATURE CROSS-SECTIONS-----	23
ISOTHERM CROSS-SECTIONS-----	82
SPECTRA OF HIGHEST AND LOWEST ISOTHERMS-----	141
APPENDIX A. Configuration of the Chain Under Tow-----	192

## INTRODUCTION

This report presents measurements of temperature in the upper ocean obtained by use of a towed thermistor chain. The measurements were taken as part of the Joint Air-Sea Interaction (JASIN) Experiment conducted during the summer of 1978. A summary of the scientific and operational plans for JASIN has been given by Pollard (1978). More detailed accounts are given in documents published by the Royal Society (1977, 1978).

## INSTRUMENTATION

The thermistor chain consisted of sensors, electrical conductors, plastic fairing, a strain member and a 450 kg lead-filled depressor. The thermistors were manufactured by Thermometrics (Model P-85). They were molded into sections of fairing together with bridge/amplifiers. Power and signals were transmitted by electrical conductors running through the tail sections of the fairing. The thermistors were spaced at intervals of 2 m over a section of chain 50 m in length. Four pressure sensors were also installed on the chain at 15 m intervals. The pressure sensors were manufactured by Kulite and were installed in tail sections together with bridge/amplifiers in a fashion similar to the thermistor electronics. Signals from the sensors were recorded, processed and displayed by use of a minicomputer system manufactured by Digital Equipment Corporation (PDP 11/05). A more complete description of the thermistor chain system is given by Spoering and Paulson (1980).



## OBSERVATIONS

The thermistor chain was towed by the R/V ATLANTIS II in an area about 400 km northwest of Scotland. The locations of the tows are tabulated and plotted in the section entitled Tow Tracks. A summary of the tow parameters is given in Table 1. The first digit of the run number designates the number of the deployment of the chain. With the exception of the first deployment, the chain was always towed counterclockwise around a square. The letter following the deployment number designates the side of the square, i.e. N indicates a tow leg toward the west on the north side of the box. The digits following the dash in the run number designates the leg, one leg per side of the square except for the first deployment. The first deployment was separated into three legs. The middle leg contained a front which separated regions of nearly constant thermal properties. The square around which tows were made was usually 15 km on a side surrounding the Fixed Intensive Array. However, on two occasions tows were conducted in cooperation with other ships. The first occasion was around a five-km square containing the drifting buoy P1 and the second occasion was around a five-km square containing the mooring H2. The instrumented section of the chain extended from about 20 to 70 m depth in all tows except the last which was 10 m shallower. The tow speed was usually about 3 m/s. The tow speeds tabulated in Table 1 were determined from LORAN C and satellite navigational fixes.

TABLE 1. Thermistor chain tows during JASIN-78.

<u>Run</u>	<u>Date</u>	<u>Start time (GMT)</u>	<u>Tow speed (m/s)</u>	<u>Duration</u>	
				<u>Time (min)</u>	<u>Distance (km)</u>
1-1	24-AUG-78	1611	3.36	128.0	25.8
1-2	"	1819	3.07	64.0	11.8
1-3	"	1923	3.19	128.0	24.5
2W-1	25-AUG-78	1213	2.95	75.0	13.3
2S-2	"	1331	2.93	72.5	12.7
2E-3	"	1446	2.88	91.0	15.7
2N-4	"	1620	3.41	73.0	14.9
2W-5	"	1738	2.99	72.5	13.0
2S-6	"	1853	3.07	80.0	14.7
2E-7	"	2016	2.74	85.0	14.0
2N-8	"	2145	3.01	70.0	12.6
3N-1	27-AUG-78	1215	2.97	73.0	13.0
3W-2	"	1332	2.89	85.0	14.7
3S-3	"	1459	2.97	77.5	13.8
3E-4	"	1620	2.93	77.5	13.6
3N-5	"	1742	3.21	77.0	14.8
3W-6	"	1902	3.22	67.5	13.0
3S-7	"	2012	3.02	78.5	14.2
3E-8	"	2133	3.10	72.5	13.5

Run	Date	Start time (GMT)	Tow speed (m/s)	Duration	
				Time (min)	Distance (km)
4N-1	29-AUG-78	1209	3.04	37.5	6.8
4W-2	"	1249	2.92	28.5	5.0
4S-3	"	1320	2.91	26.5	4.6
4E-4	"	1349	3.02	27.5	5.0
Computer failure		1433	----	72.0	---
4E-5	"	1545	3.09	23.5	4.4
4N-6	"	1611	2.93	25.5	4.5
4W-7	"	1639	2.86	27.5	4.7
4S-8	"	1709	2.64	28.5	4.5
4E-9	"	1740	3.00	25.5	4.6
4N-10	"	1807	2.76	27.5	4.6
4W-11	"	1837	2.90	27.5	4.8
4S-12	"	1907	2.77	27.5	4.6
4E-13	"	1937	2.70	27.5	4.5
4N-14	"	2007	2.86	27.5	4.7
4W-15	"	2037	2.85	29.5	5.0
4S-16	"	2109	2.84	27.5	4.7
4E-17	"	2139	2.66	23.5	3.8
4N-18	"	2210	2.91	30.5	5.3
4W-19	"	2243	3.00	26.5	4.8
4S-20	"	2312	2.91	27.5	4.8
4E-21	"	2342	2.70	27.5	4.5
4N-22	30-AUG-78	0012	2.78	29.5	4.9
4W-23	"	0044	2.79	27.5	4.6
4S-24	"	0114	2.85	27.5	4.7
4E-25	"	0144	2.73	27.5	4.5
4N-26	"	0214	2.78	28.5	4.8
4W-27	"	0245	2.70	27.5	4.5
4S-28	"	0315	2.83	27.5	4.7
4E-29	"	0345	2.78	29.5	4.9
4N-30	"	0417	2.61	27.5	4.3
5N-1	31-AUG-78	1153	3.02	72.0	13.0
5W-2	"	1308	3.16	69.5	13.2
5S-3	"	1419	3.19	78.5	15.0
5E-4	"	1540	2.89	86.0	14.9
5N-5	"	1710	3.03	90.0	16.4
5W-6	"	1843	3.04	72.5	13.2
5S-7	"	1958	2.86	85.5	14.7
5E-8	"	2126	2.97	84.5	15.1

<u>Run</u>	<u>Date</u>	<u>Start time (GMT)</u>	<u>Tow speed (m/s)</u>	<u>Duration</u>	
				<u>Time (min)</u>	<u>Distance (km)</u>
6W-1	2-SEP-78	1139	2.73	28.5	4.7
6S-2	"	1212	2.50	32.5	4.9
6E-3	"	1247	2.74	27.5	4.5
6N-4	"	1317	2.53	29.5	4.5
6W-5	"	1349	2.39	28.5	4.1
6S-6	"	1420	2.96	27.5	4.9
6E-7	"	1451	2.52	24.5	3.7
6N-8	"	1518	2.46	32.5	4.8
6W-9	"	1553	2.74	27.5	4.5
6S-10	"	1624	2.69	25.5	4.1
6E-11	"	1653	2.66	26.5	4.2
6N-12	"	1722	2.40	36.5	5.3
6W-13	"	1801	2.87	27.0	4.6
6S-14	"	1832	2.86	26.0	4.5
6E-15	"	1901	2.46	31.5	4.6
6N-16	"	1935	2.51	34.5	5.2
6W-17	"	2012	2.84	23.5	4.0
6S-18	"	2038	2.71	27.5	4.5
6E-19	"	2109	2.31	31.5	4.4
6N-20	"	2143	2.68	30.5	4.9
6W-21	"	2217	2.57	20.5	3.2
6S-22	"	2240	2.45	33.5	4.9
6E-23	"	2316	2.38	31.5	4.5
6N-24	"	2356	2.98	20.0	3.6
6W-25	3-SEP-78	0019	2.80	22.5	3.8
6S-26	"	0044	2.58	33.5	5.2
6E-27	"	0120	2.55	26.5	4.1
6N-28	"	0148	2.59	28.5	4.4
6W-29	"	0218	2.52	29.5	4.5
6S-30	"	0250	2.71	30.5	5.0
6E-31	"	0324	2.84	21.5	3.7
6N-32	"	0348	2.69	29.5	4.8
6W-33	"	0421	2.60	31.5	4.9
6S-34	"	0455	2.80	28.5	4.8
6E-35	"	0526	2.58	28.5	4.4
7S-1	4-SEP-78	0803	3.23	64.0	12.4
7E-2	"	0910	3.03	74.5	13.5
7N-3	"	1027	2.86	93.5	16.0
7W-4	"	1203	3.27	68.5	13.4
7S-5	"	1314	2.93	85.0	14.9
7E-6	"	1443	2.85	81.0	13.9
7N-7	"	1607	3.29	70.5	13.9
7W-8	"	1719	2.74	81.0	13.3

## ANALYSIS

The temperature observations were low-pass filtered by computing sequential 30 s averages. Filtering removes variations caused by surface gravity waves and ship heave. The filtered observations are shown in the section entitled Temperature Cross-Sections.

Isotherm depths were determined by linear interpolation between the filtered temperature observations. The depths of isotherms in intervals of 0.2°C are shown in the section entitled Isotherm Cross-Sections.

Spectra of the shallowest and deepest isotherm on each leg were computed and are presented in the section entitled Spectra of Highest and Lowest Isotherms.

Spectra of the depth of the thermistor chain at three locations on the chain are shown in Figure 1. The spectra were computed from low-pass filtered (30 s averages) measurements of pressure during Run 1-1. The magnitude of vertical oscillations of the chain is usually greatest near the bottom. The magnitude of the spectra can be compared with spectra of isotherm depth shown in the section entitled Isotherm Cross-Sections. The magnitude of the isotherm spectra are usually more than two orders of magnitude greater than spectra of depth. We therefore conclude that variations in depth of the chain have a negligible effect on spectra of isotherm depth determined from the low-pass filtered temperature measurements.

More details on analysis procedures can be found in Spoering and Paulson (1980).

RUN 1-1 24-AUG-78  
PRESSURE SPECTRA

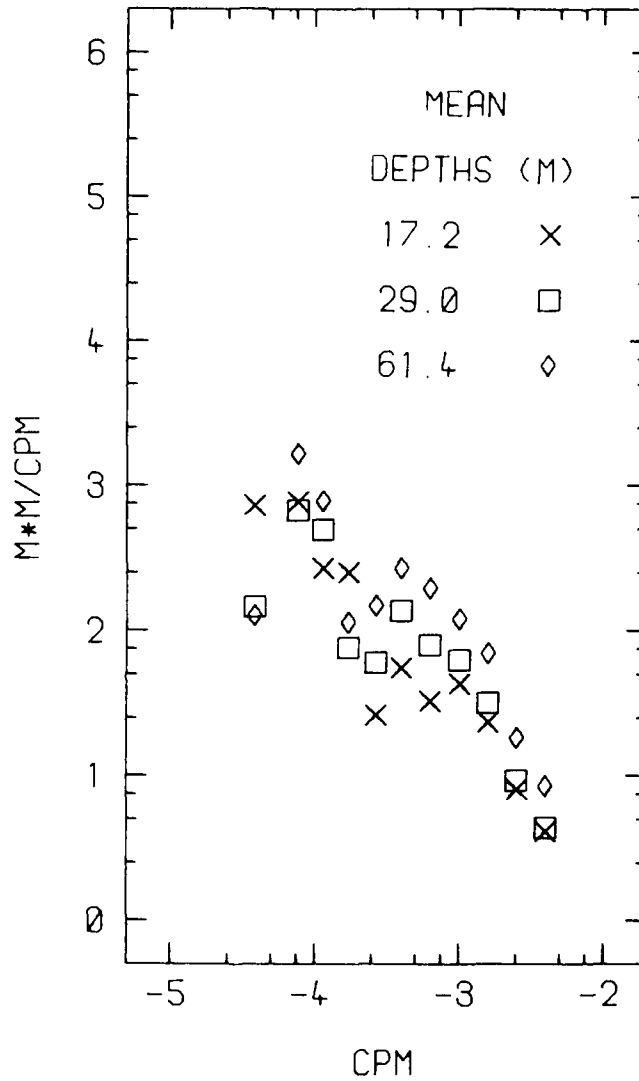

Figure 1. Spectra of depth measured at three locations on the towed thermistor chain during Run 1-1. The mean depths of the pressure sensors are indicated. The pressure records were low-pass (30 s averages) filtered prior to computing spectra.

## REFERENCES

- Batchelor, G. K., 1967: An Introduction to Fluid Dynamics. Cambridge University Press, Cambridge, 615 pp.
- Pollard, R. T., 1978: The Joint Air-Sea Interaction Experiment--JASIN 1978. Bull. Amer. Meteor. Soc., 59, 1310-1318.
- Royal Society, 1978: Air-Sea Interaction Project, Operational Plans for 1978. London, 225 pp.
- Royal Society, 1977: Air-Sea Interaction Project, Scientific Plans for 1977 and 1978. London, 208 pp.
- Sokolnikoff, J. S. and R. M. Redheffer, 1958: Mathematics of Physics and Modern Engineering, McGraw-Hill, New York, 810 pp.
- Spoering, T. J. and C. A. Paulson, 1980: Towed observations of internal waves in the upper ocean. (Submitted to J. Phys. Oceanog.).

## TOW TRACKS

On the following pages there is a tabulation of positions during each of the tows followed by plots, one for each run. The tabulated positions are plotted (x) on the plots. The positions were determined by use of LORAN C and navigational satellite. The local coordinates, x and y, are in kilometers north and east, respectively, of a point at the center of the Fixed Intensive Array (59°N, 12.5°W). The locations of moorings B1, B2, B3 and H2 are shown in several plots.



## RUN 1 24-AUG-78

TIME	LATITUDE		LONGITUDE		LOCAL COORDINATES	
	DEG	MIN	DEG	MIN	X	Y
1609	59	3.80	12	26.09	3.75	7.05
1635	59	3.54	12	31.76	-1.69	6.57
1655	59	3.37	12	35.48	-5.25	6.26
1701	59	3.26	12	36.84	-6.55	6.05
1727	59	3.04	12	42.42	-11.90	5.64
1811	59	2.74	12	51.71	-20.80	5.09
1840	59	2.67	12	58.21	-27.02	4.96
1904	59	2.52	13	2.87	-31.49	4.68
1934	59	2.45	13	8.48	-36.86	4.55
2006	59	2.22	13	14.56	-42.69	4.12
2041	59	1.98	13	21.52	-49.35	3.68
2101	59	1.88	13	25.52	-53.19	3.49
2120	59	1.77	13	29.63	-57.12	3.29

## RUN 2 25-AUG-78

TIME	LATITUDE		LONGITUDE		LOCAL COORDINATES	
	DEG	MIN	DEG	MIN	X	Y
1203	59	4.09	12	40.60	-10.15	7.59
1221	59	2.48	12	40.25	-9.82	4.60
1304	58	58.32	12	39.54	-9.14	-3.12
1331	58	55.75	12	38.80	-8.43	-7.89
1447	58	55.60	12	24.68	5.10	-8.17
1520	58	58.68	12	24.80	4.98	-2.45
1547	59	1.20	12	25.11	4.68	2.23
1620	59	4.26	12	25.53	4.28	7.91
1652	59	3.58	12	32.08	-1.99	6.65
1731	59	3.46	12	40.05	-9.63	6.42
1733	59	3.46	12	41.05	-10.59	6.42
1741	59	2.89	12	41.19	-10.72	5.37
1755	59	1.36	12	41.21	-10.74	2.53
1815	58	59.50	12	40.72	-10.27	-0.93
1853	58	55.75	12	40.28	-9.85	-7.89
2016	58	56.44	12	24.38	5.38	-6.61
2118	59	1.82	12	24.26	5.50	3.38
2145	59	4.31	12	24.81	4.97	8.00
2255	59	4.79	12	37.99	-7.65	8.89

## RUN 3 27-AUG-78

TIME	LATITUDE		LONGITUDE		LOCAL COORDINATES	
	DEG	MIN	DEG	MIN	X	Y
1209	59	3.97	12	22.69	7.00	7.37
1254	59	4.01	12	31.33	-1.27	7.45
1317	59	4.00	12	35.60	-5.36	7.43
1332	59	3.91	12	38.14	-7.80	7.26
1404	59	1.05	12	37.80	-7.47	1.95
1434	58	58.11	12	37.44	-7.13	-3.51
1459	58	55.82	12	36.80	-6.51	-7.76
1520	58	55.96	12	32.82	-2.70	-7.50
1549	58	56.01	12	27.15	2.73	-7.41
1620	58	56.38	12	21.75	7.90	-6.72
1651	58	59.38	12	22.10	7.57	-1.15
1743	59	4.22	12	22.93	6.77	7.80
1837	59	3.48	12	33.49	-3.34	6.46
1900	59	3.18	12	38.30	-7.95	5.91
1910	59	2.20	12	38.23	-7.88	4.08
1934	58	59.57	12	37.90	-7.57	-0.80
2009	58	56.01	12	37.53	-7.21	-7.41
2011	58	55.81	12	37.27	-6.96	-7.78
2032	58	55.74	12	33.54	-3.39	-7.91
2059	58	55.74	12	28.31	1.62	-7.91
2133	58	55.79	12	21.65	8.00	-7.82
2218	59	0.16	12	21.61	8.04	0.30
2252	59	3.69	12	21.89	7.77	6.85

## RUN 4 29.30-AUG-78

TIME	LATITUDE		LONGITUDE		LOCAL COORDINATES	
	DEG	MIN	DEG	MIN	X	Y
1126	58	53 91	12	20 44	9 16	-11 31
1142	58	53 88	12	17 20	12 26	-11 36
1148	58	54 26	12	16 91	12 54	-10 66
1210	58	56 08	12	17 42	12 05	-7 28
1246	58	55 86	12	24 27	5 49	-7 69
1250	58	55 75	12	24 52	5 25	-7 89
1318	58	52 84	12	24 30	5 46	-13 29
1330	58	52 72	12	22 14	7 53	-13 52
1348	58	52 82	12	18 83	10 70	-13 33
1404	58	54 29	12	18 98	10 56	-10 60
1417	58	55 65	12	19 10	10 44	-8 08
1545	58	53 02	12	19 49	10 07	-12 96
1609	58	55 42	12	19 60	9 96	-8 50
1637	58	55 63	12	24 72	5 06	-8 11
1653	58	54 16	12	24 95	4 84	-10 84
1706	58	52 95	12	24 83	4 95	-13 09
1735	58	52 89	12	20 00	9 58	-13 20
1740	58	53 04	12	19 27	10 28	-12 92
1754	58	54 41	12	19 44	10 12	-10 38
1803	58	55 31	12	19 50	10 06	-8 71
1807	58	55 65	12	19 53	10 03	-8 08
1835	58	55 85	12	24 36	5 40	-7 71
1904	58	53 13	12	24 40	5 36	-12 75
1934	58	53 10	12	19 20	10 35	-12 81
2004	58	55 71	12	18 95	10 59	-7 96
2034	58	55 89	12	24 31	5 45	-7 63
2106	58	52 94	12	24 13	5 62	-13 11
2136	58	52 77	12	18 81	10 72	-13 42
2207	58	55 41	12	18 05	11 45	-8 52
2240	58	55 42	12	24 07	5 68	-8 50
2309	58	52 61	12	24 07	5 68	-13 72
2339	58	52 40	12	18 61	10 91	-14 11
2409	58	55 01	12	18 23	11 28	-9 26
2441	58	55 21	12	23 78	5 96	-8 89
2511	58	52 51	12	24 17	5 58	-13 91
2541	58	52 22	12	18 85	10 68	-14 44
2611	58	54 86	12	18 42	11 09	-9 54
2642	58	55 18	12	23 78	5 96	-8 95
2712	58	52 57	12	24 10	5 65	-13 79
2742	58	52 49	12	18 78	10 75	-13 94
2814	58	55 36	12	18 47	11 05	-8 61
2844	58	55 63	12	23 34	6 38	-8 11

TIME	LATITUDE		LONGITUDE		LOCAL COORDINATES	
	DEG	MIN	DEG	MIN	X	Y
1152	59	3.79	12	23.91	5.83	7.04
1223	59	3.54	12	29.68	0.31	6.57
1308	59	3.05	12	38.19	-7.85	5.66
1419	58	55.81	12	37.60	-7.28	-7.78
1537	58	55.67	12	22.01	7.65	-8.04
1709	59	4.23	12	20.82	8.79	7.85
1841	59	3.41	12	38.19	-7.85	6.33
1956	58	55.96	12	37.72	-7.40	-7.50
2124	58	55.58	12	21.96	7.70	-8.21
2254	59	4.21	12	21.69	7.96	7.82

TIME	LATITUDE		LONGITUDE		LOCAL COORDINATES	
	DEG	MIN	DEG	MIN	X	Y
1121	59	26.90	12	28.08	1.84	49.94
1138	59	26.90	12	31.56	-1.49	49.94
1147	59	26.19	12	31.62	-1.55	48.62
1208	59	24.25	12	31.62	-1.55	45.02
1244	59	24.06	12	26.00	3.83	44.67
1314	59	26.72	12	25.93	3.90	49.61
1346	59	27.01	12	30.97	-0.93	50.15
1421	59	24.31	12	30.96	-0.92	45.13
1447	59	24.46	12	26.14	3.70	45.41
1515	59	26.72	12	25.62	4.20	49.61
1550	59	27.05	12	30.97	-0.93	50.22
1620	59	24.39	12	31.04	-1.00	45.28
1649	59	24.39	12	26.16	3.68	45.28
1720	59	27.00	12	25.16	4.64	50.13
1759	59	27.01	12	31.02	-0.98	50.15
1831	59	24.04	12	31.02	-0.98	44.63
1900	59	24.20	12	25.83	3.99	44.93
1933	59	26.81	12	25.38	4.43	49.78
2010	59	26.66	12	31.18	-1.13	49.50
2036	59	24.27	12	31.17	-1.12	45.06
2106	59	23.94	12	26.12	3.72	44.45
2141	59	26.54	12	25.60	4.22	49.27
2213	59	26.36	12	30.95	-0.91	48.94
2237	59	24.39	12	31.51	-1.45	45.28
2313	59	23.97	12	26.05	3.78	44.50
2347	59	26.58	12	25.92	3.91	49.35
2417	59	26.59	12	31.51	-1.45	49.37
2442	59	24.33	12	31.73	-1.66	45.17
2518	59	24.33	12	25.92	3.91	45.17
2547	59	26.72	12	26.15	3.69	49.61
2617	59	26.90	12	31.00	-0.96	49.94
2650	59	24.22	12	31.24	-1.19	44.97
2721	59	24.46	12	26.00	3.83	45.41
2746	59	26.75	12	25.82	4.00	49.66
2818	59	27.13	12	31.17	-1.12	50.37
2853	59	24.19	12	31.22	-1.17	44.91
2924	59	24.38	12	25.79	4.03	45.26
2955	59	26.95	12	25.23	4.57	50.04

RUN 7 4-SEP-78

TIME	LATITUDE		LONGITUDE		LOCAL COORDINATES	
	DEG	MIN	DEG	MIN	X	Y
754	58	55.88	12	37.00	-6.71	-7.65
907	58	56.49	12	22.26	7.41	-6.52
1024	59	3.99	12	20.85	8.77	7.41
1200	59	3.55	12	38.00	-7.66	6.59
1311	58	56.05	12	78.31	-7.96	-7.33
1439	58	56.13	12	22.17	7.50	-7.18
1604	59	3.93	12	23.20	6.51	7.30
1718	59	3.99	12	38.45	-8.09	7.41
1847	58	56.10	12	38.40	-8.05	-7.24

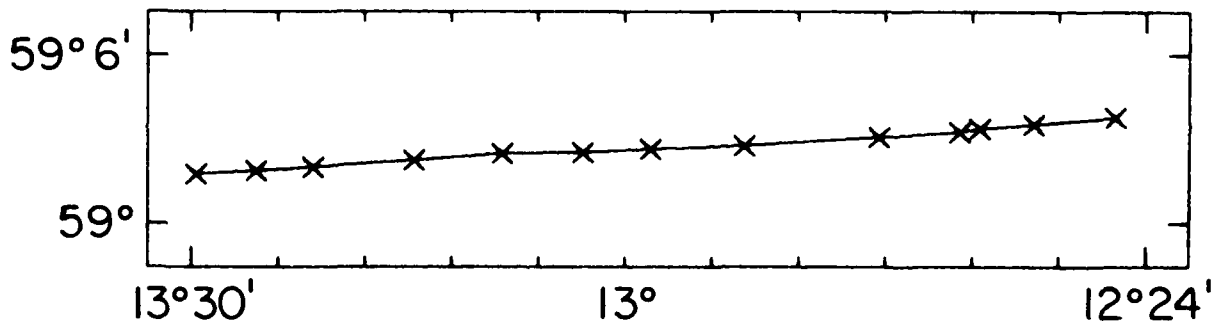

TOW TRACK RUN 1 24-AUG-78

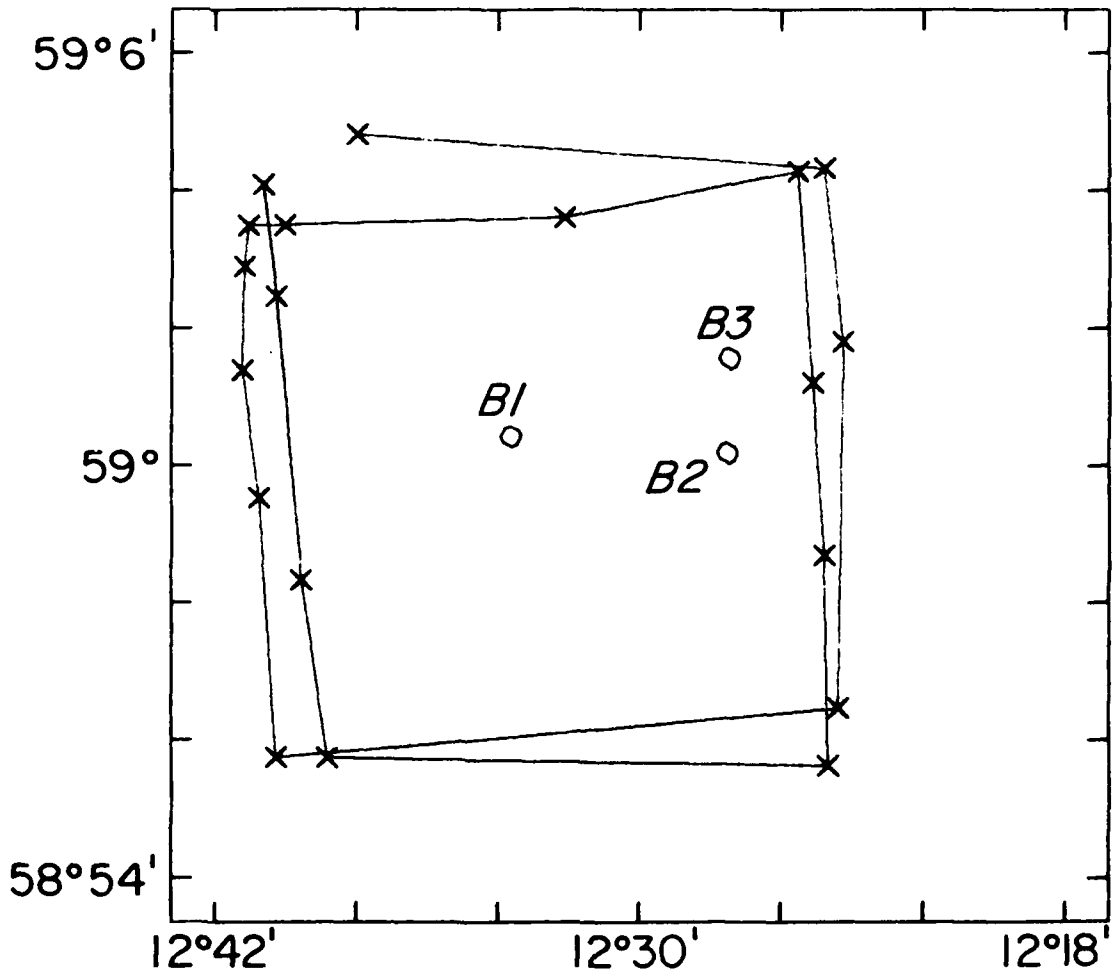

TOW TRACK RUN 2 25-AUG-78



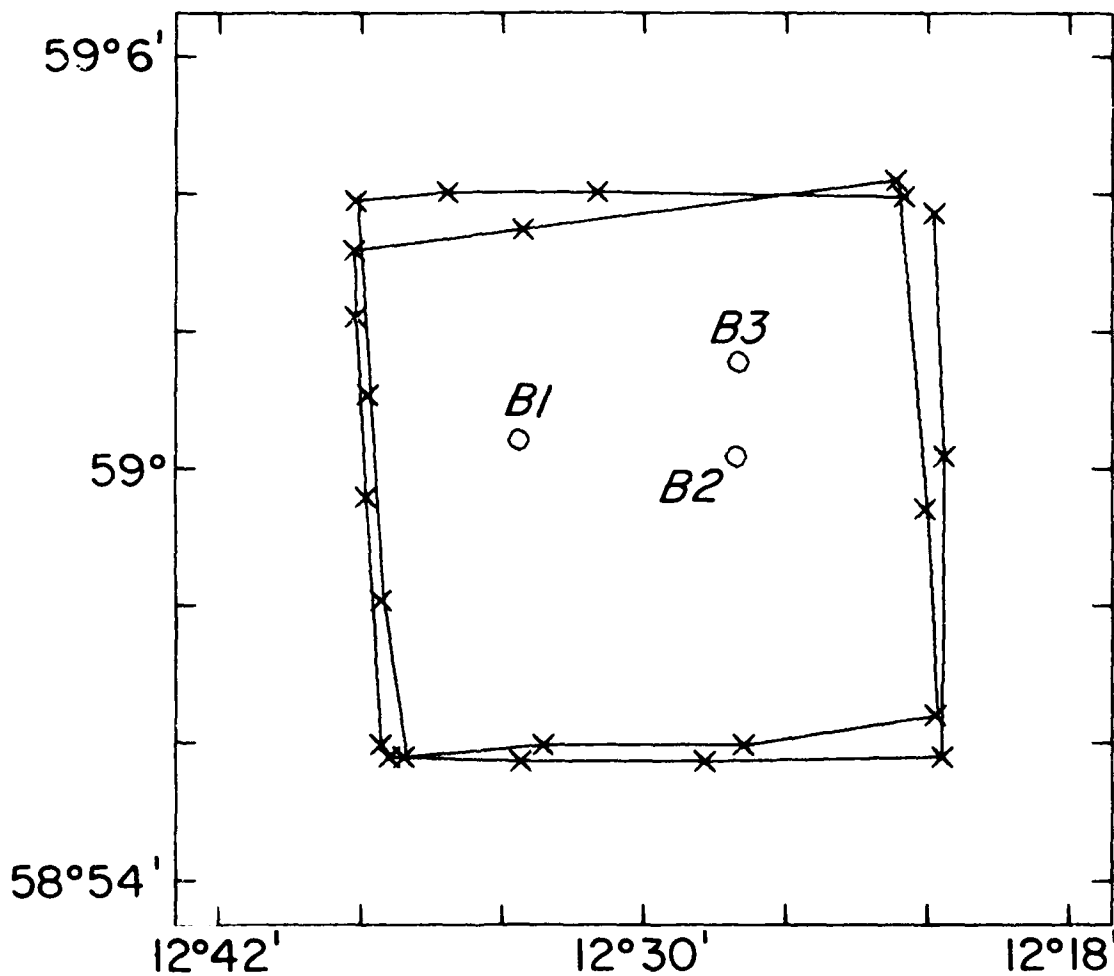

TOW TRACK RUN 3 27-AUG-78

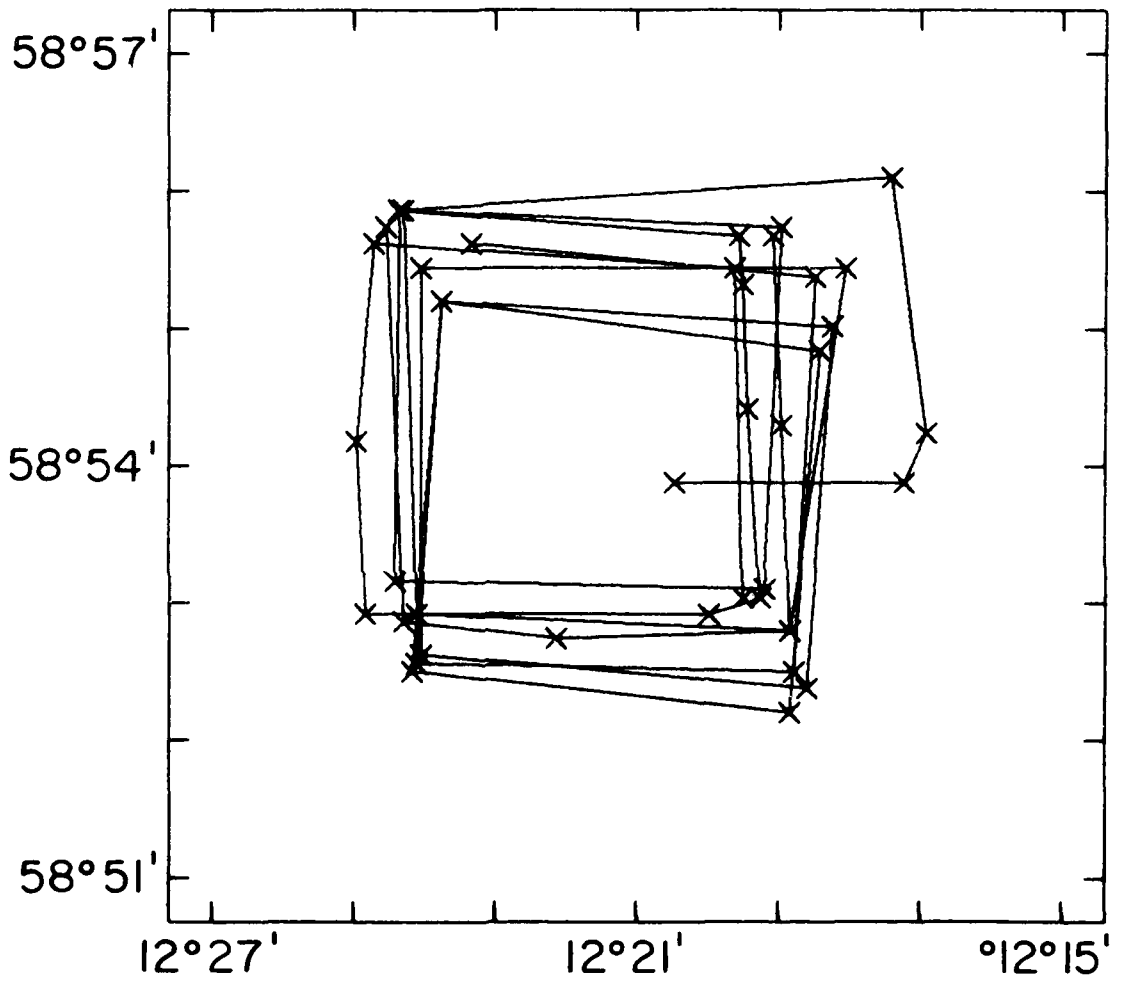

TOW TRACK RUN 4 29,30-AUG-78

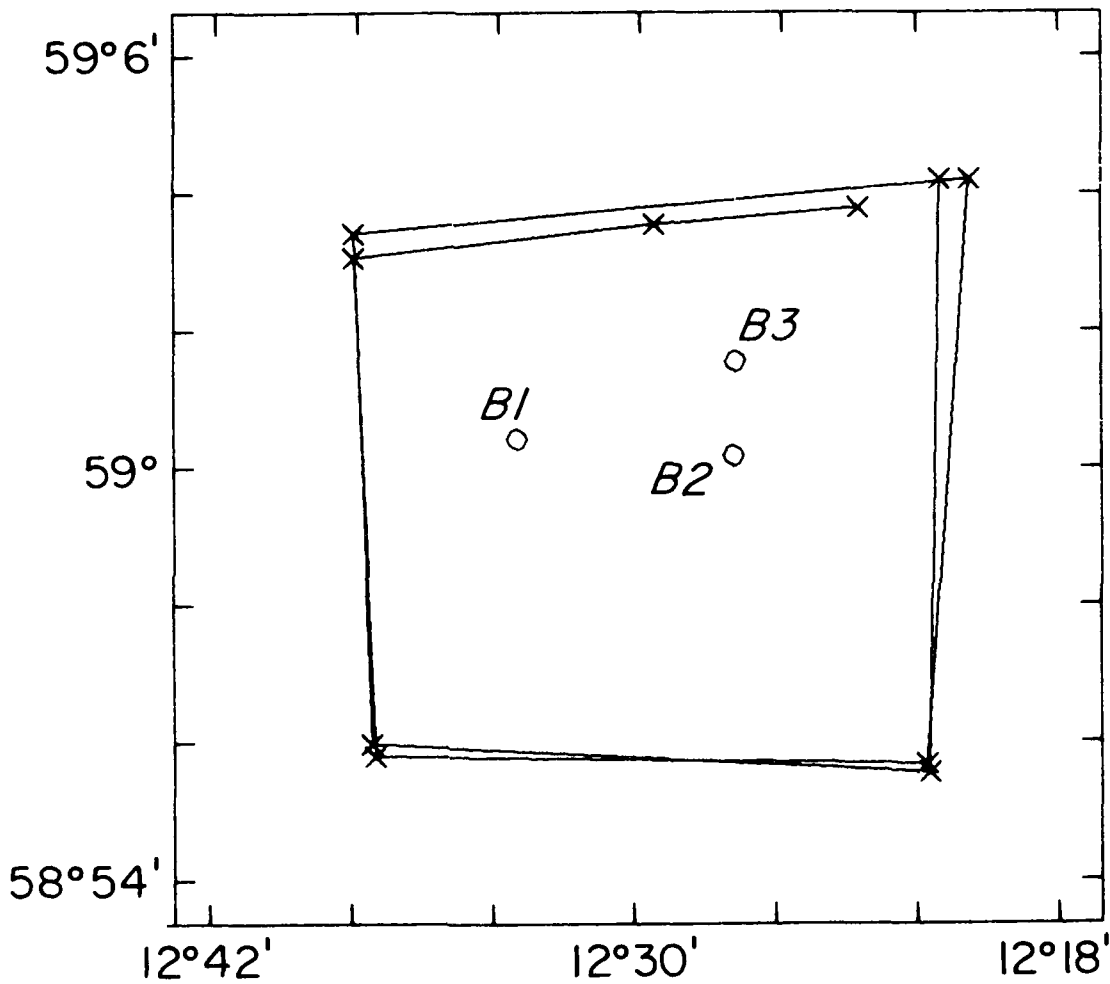

TOW TRACK RUN 5 31-AUG-78

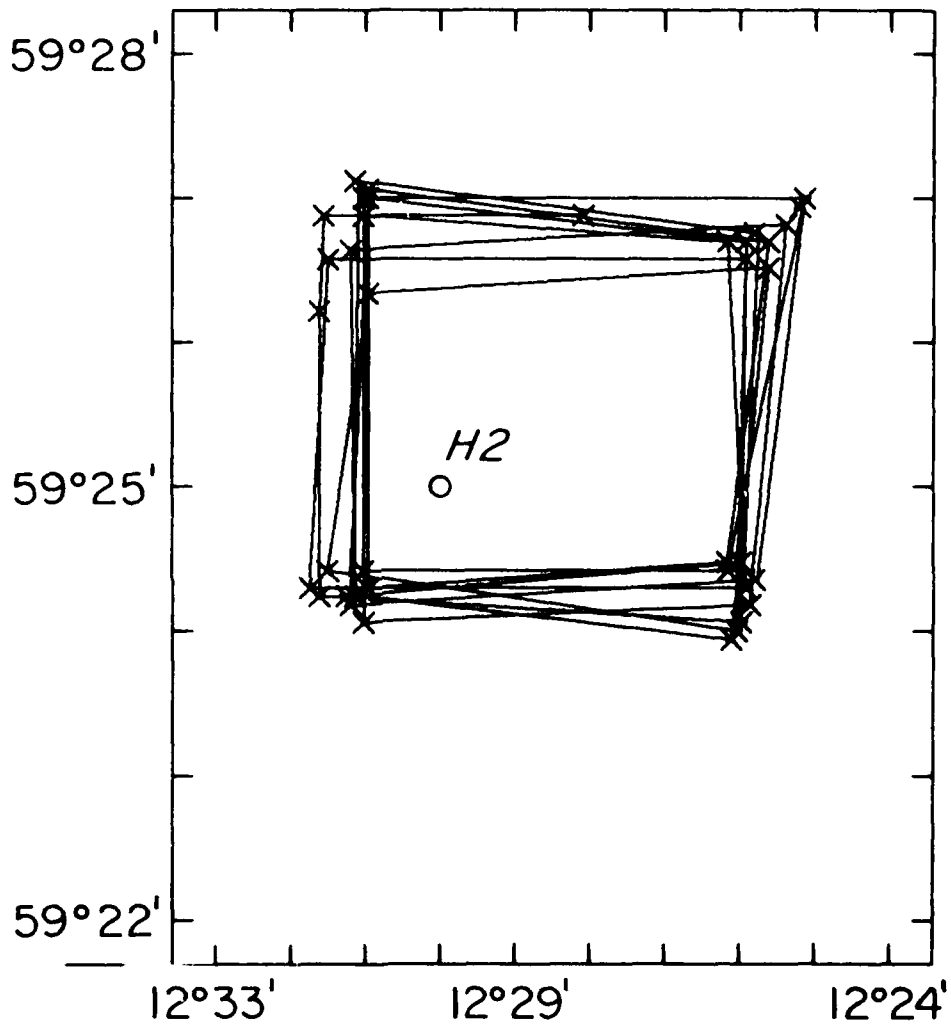

TOW TRACK RUN 6 2.3-SEP-78

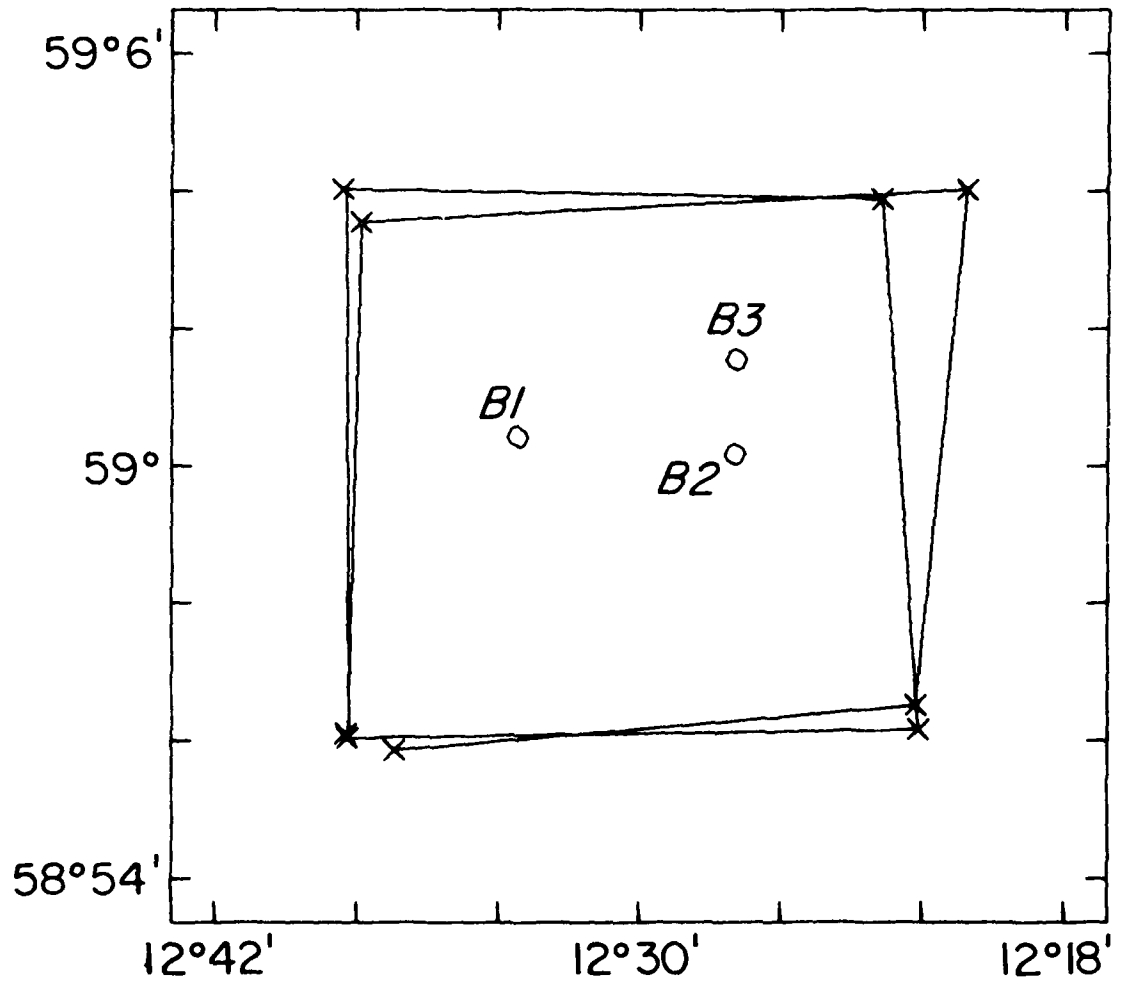

TOW TRACK RUN 7 4-SEP-78

## TEMPERATURE CROSS-SECTIONS

On the following pages there are plots, one for each leg, of low-pass filtered temperature as a function of time and distance along the leg. The filtering was accomplished by computing sequential 30 s averages. The mean depth of each sensor is given.

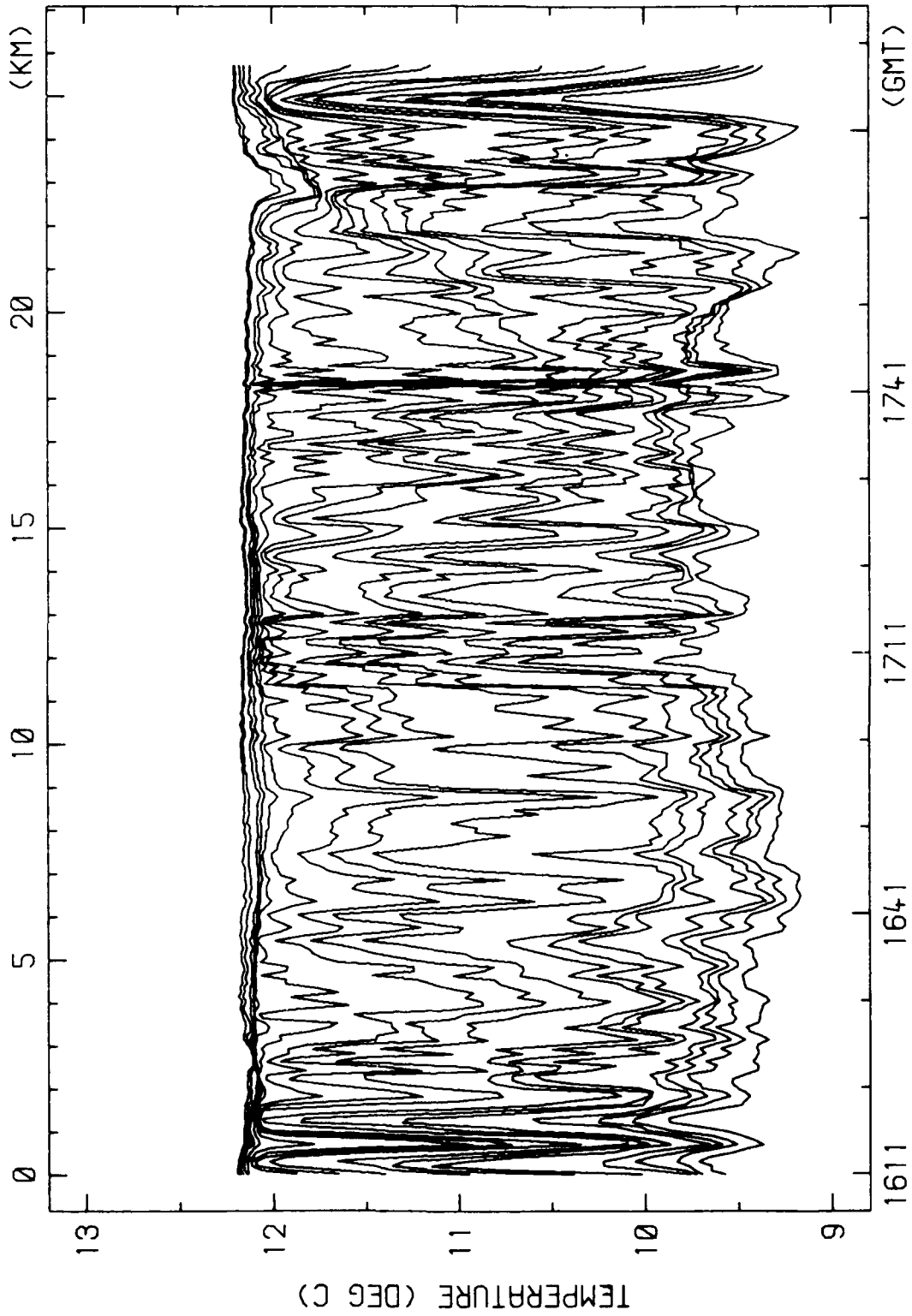

RUN 1-1 24-AUG-78 TEMPERATURE VS TIME/DISTANCE  
DEPTHS (M) 18.2, 20.2, 26.0, 28.0, 32.0, 36.0, 40.0  
42.0, 44.0, 48.1, 50.1, 52.1, 56.2, 58.3, 60.3, 64.5

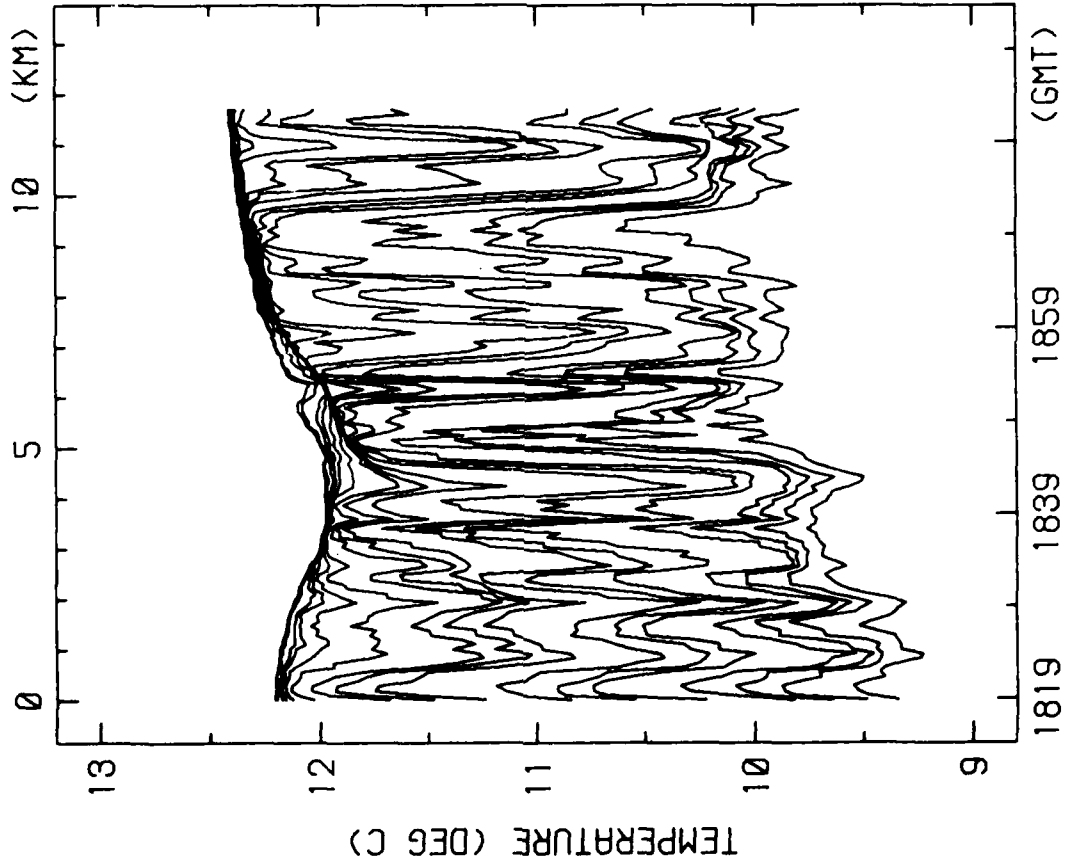

RUN 1-2 24-AUG-78 TEMPERATURE VS TIME/DISTANCE  
DEPTHS (M) 18.2, 20.2, 26.0, 28.0, 32.0, 36.0, 40.0  
42.0, 44.0, 48.1, 50.1, 52.1, 56.2, 58.3, 60.3, 64.5



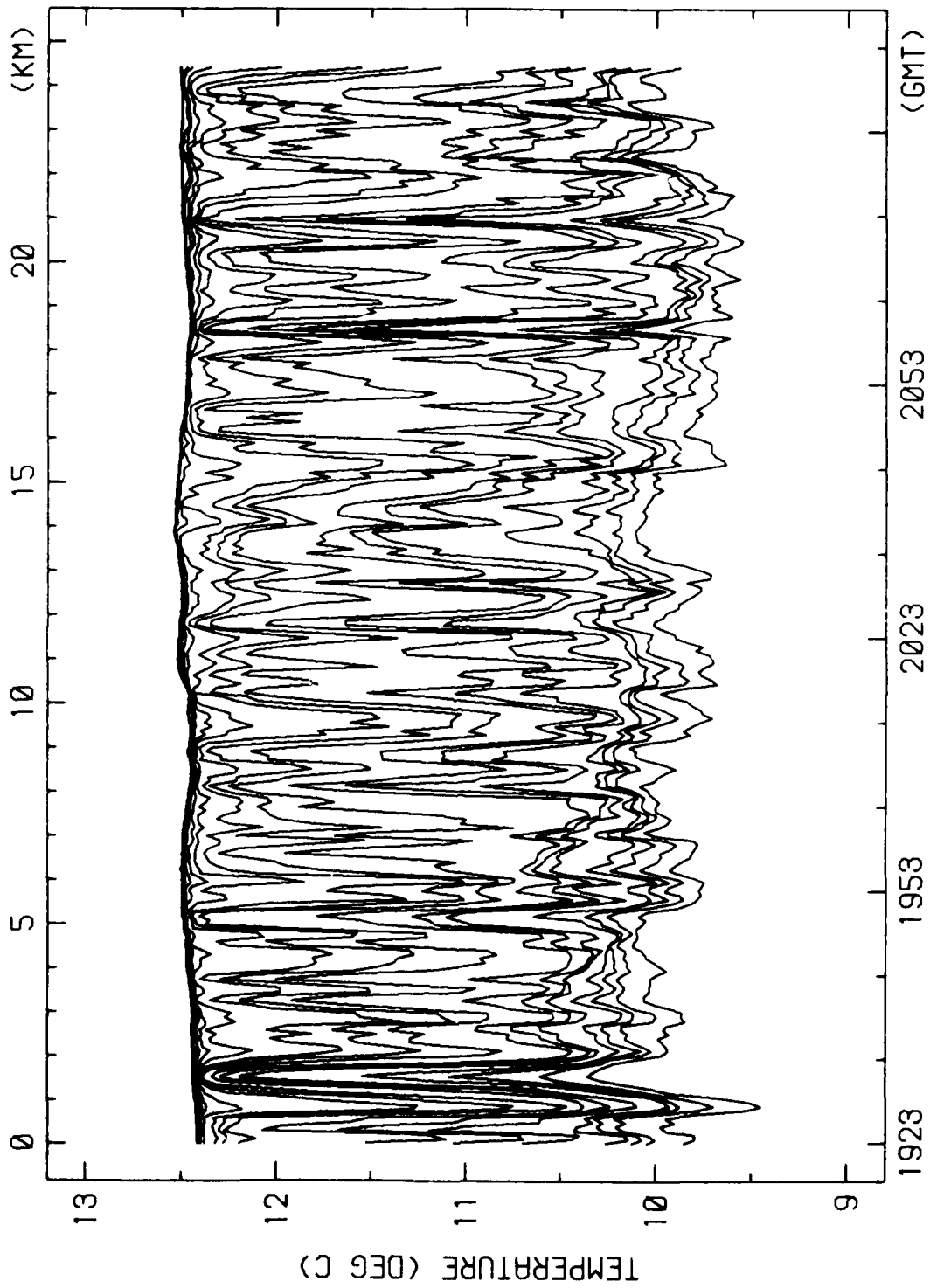

RUN 1-3 24-AUG-78 TEMPERATURE VS TIME/DISTANCE  
DEPTHS (M) 18.2, 20.2, 26.0, 28.0, 32.0, 36.0, 40.0,  
42.0, 44.0, 48.1, 50.1, 52.1, 56.2, 58.3, 60.3, 64.5

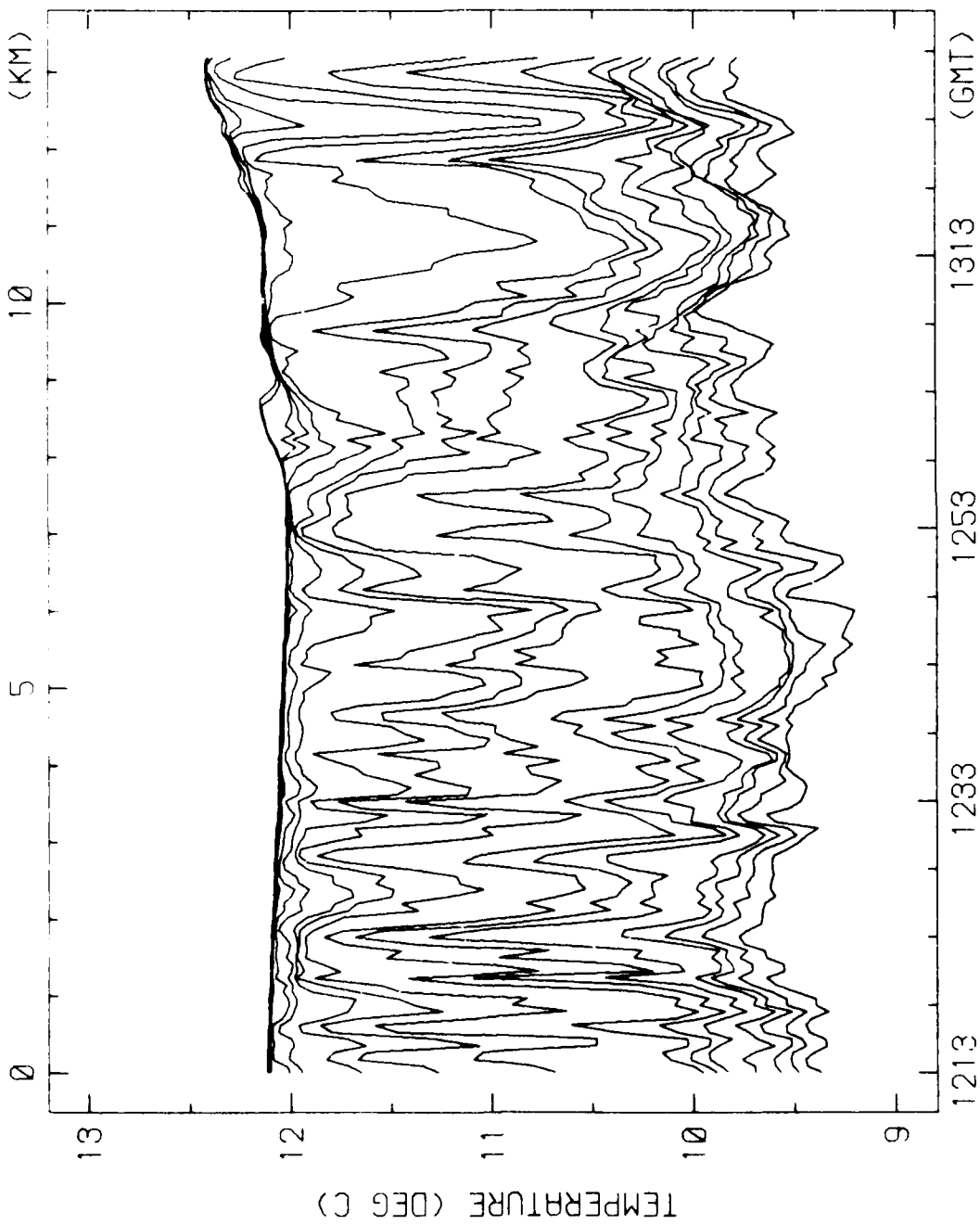

RUN 2W-1 25-AUG-78 TEMPERATURE VS TIME/DISTANCE  
DEPTHS (M) 18 6,20 5,26 5,28 5,32 5,36 5,40 6  
42 6,44 6,48 7,50 7,52 8,56 9,59 0,61 0,65 2

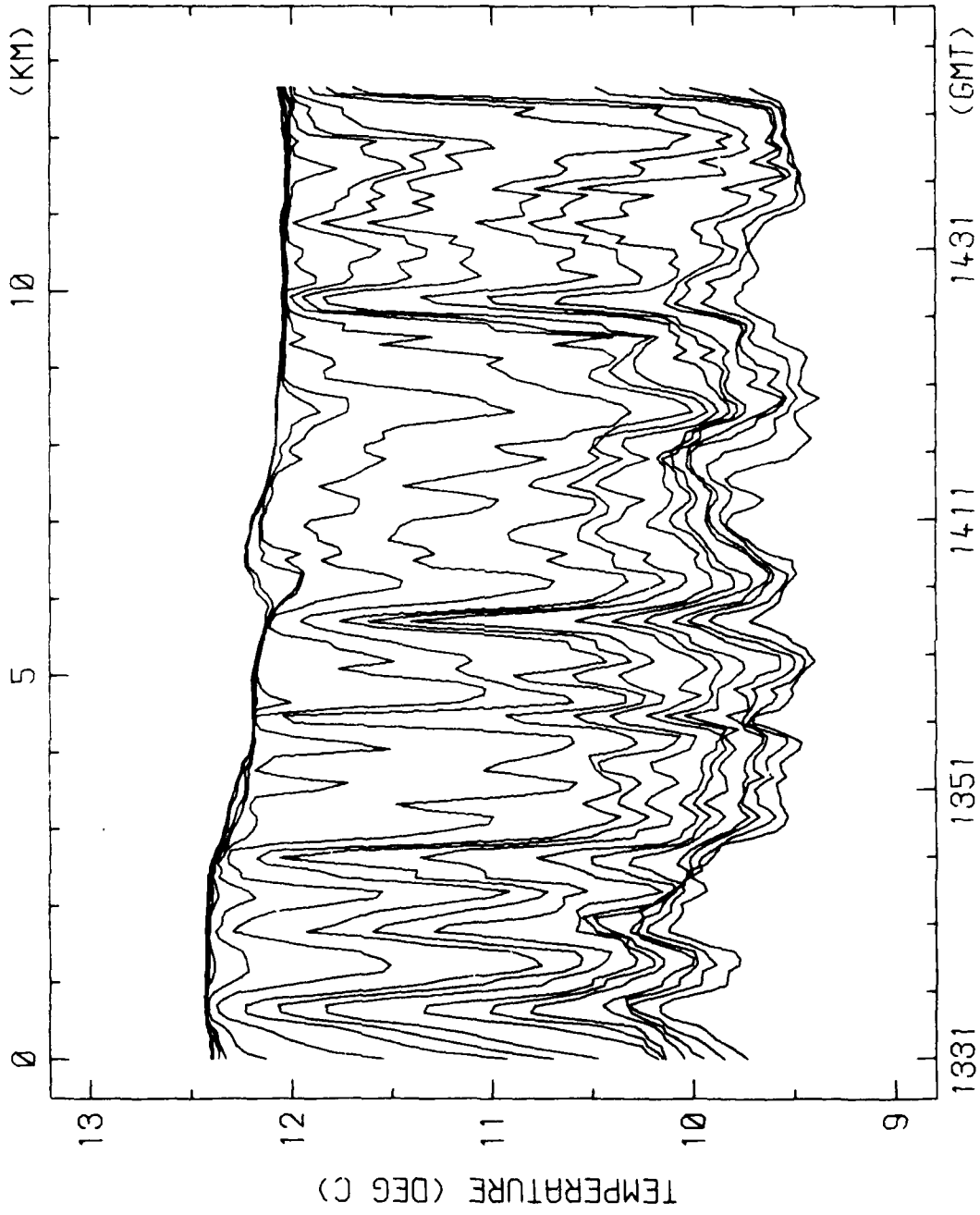

RUN 2S-2 25-AUG-78 TEMPERATURE VS TIME/DISTANCE  
 DEPTHS (M) 18 6,20 5,26 5,28 5,32 5,36 5,40 6  
 42 6,44 6,48 7,50 7,52 8,56 9,59 0,61 0,65 2

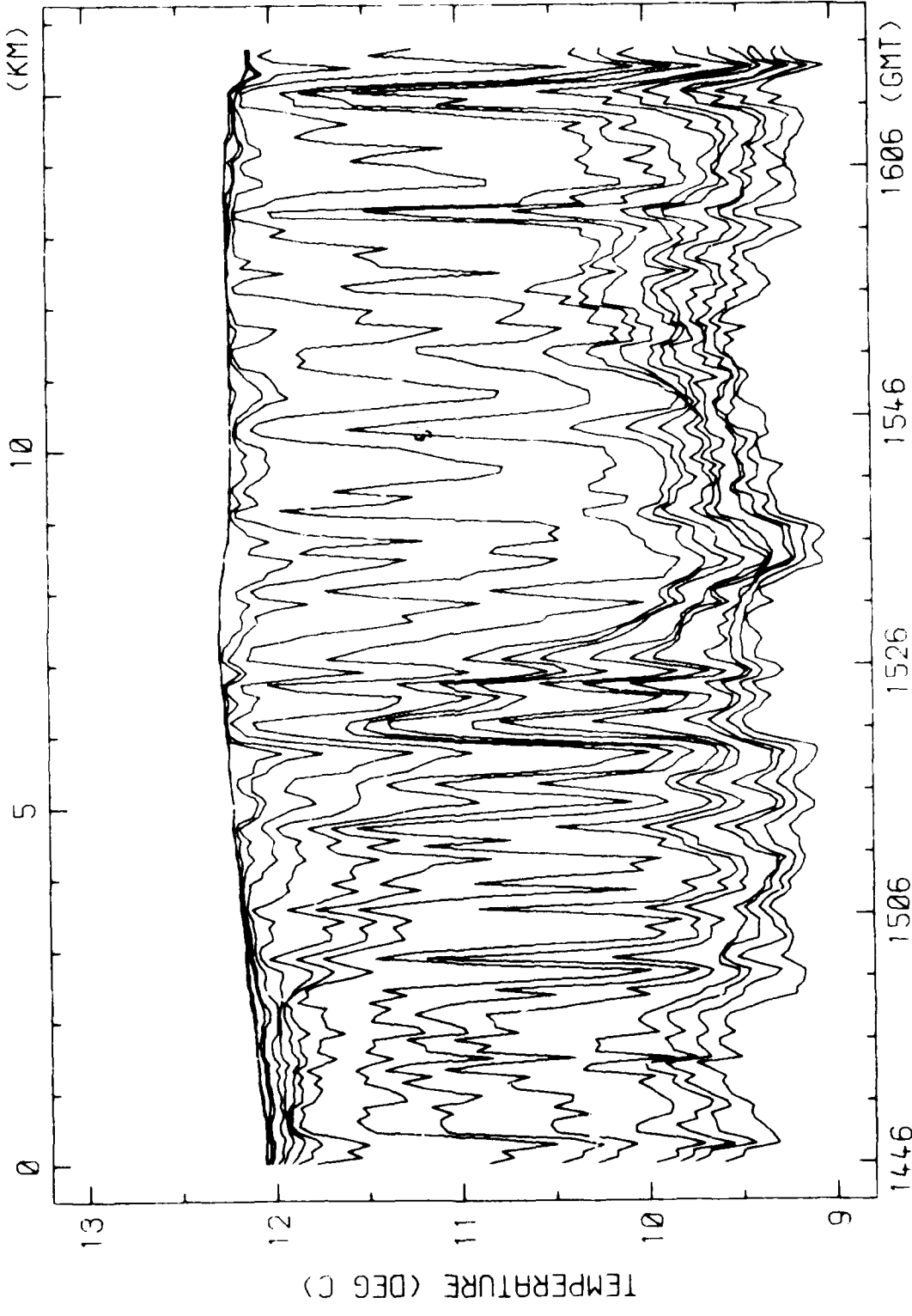

RUN 2E-3 25-AUG-78 TEMPERATURE VS TIME/DISTANCE  
DEPTHS (M) 18 6.20 5.26 5.28 5.32 5.36 5.40 6  
42 6.44 6.48 7.50 7.52 8.56 9.59 0.61 0.65 2

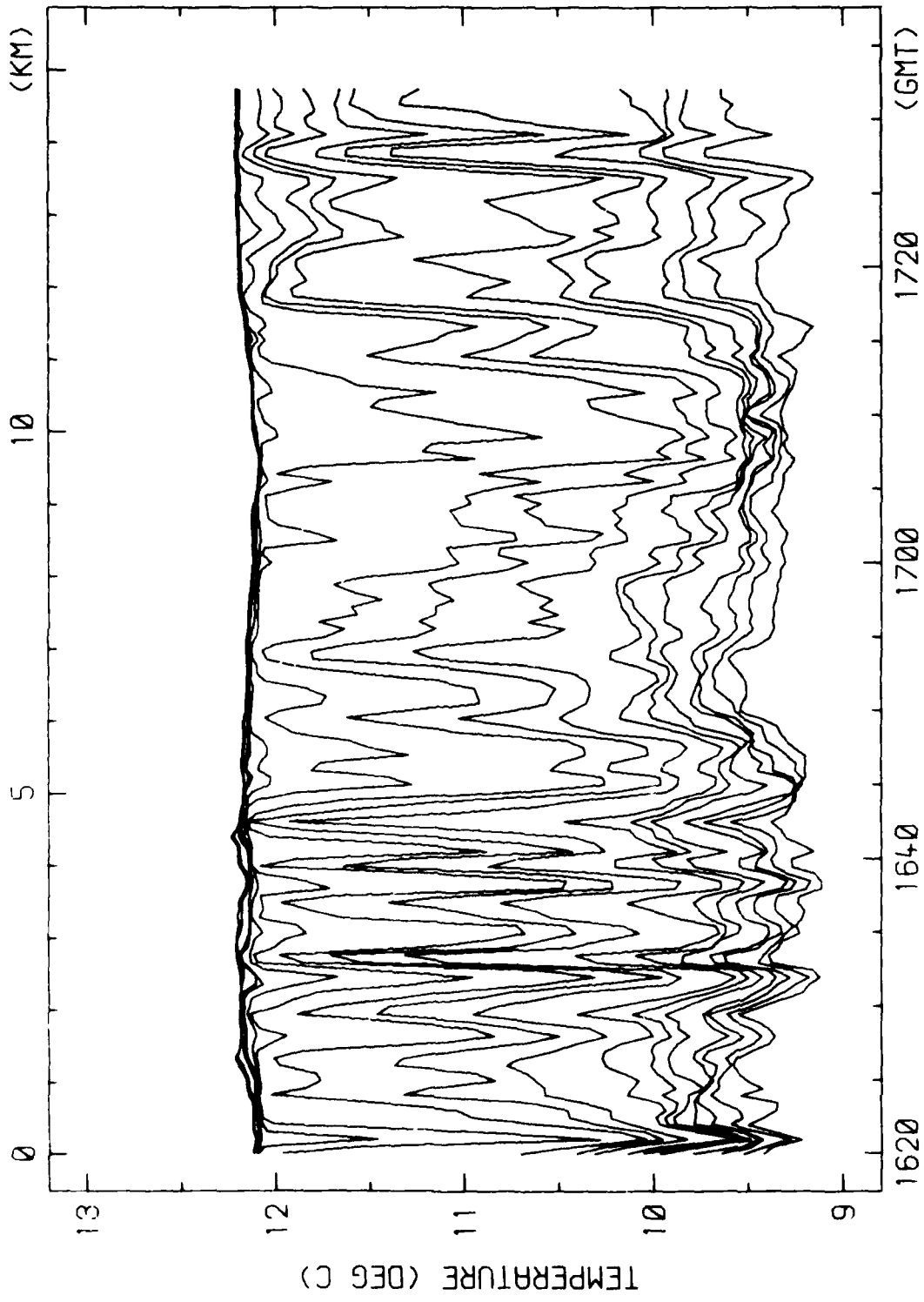

RUN 2N-4 25-AUG-78 TEMPERATURE VS TIME/DISTANCE  
DEPTHS (M) 18.6, 20.5, 26.5, 28.5, 32.5, 36.5, 40.6  
42.6, 44.6, 48.7, 50.7, 52.8, 56.9, 59.0, 61.0, 65.2

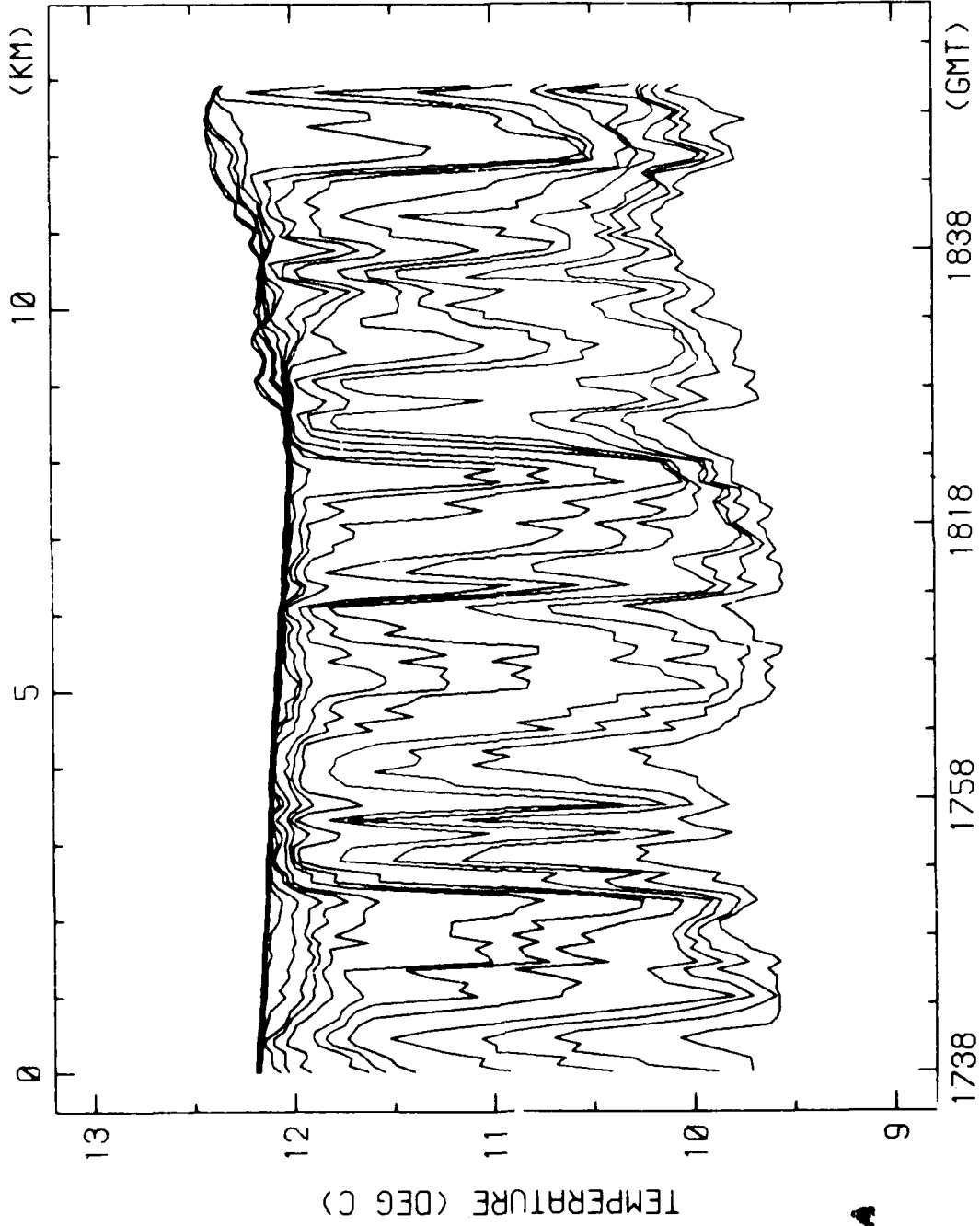

RUN 2W-5 25-AUG-78 TEMPERATURE VS TIME/DISTANCE  
DEPTHS(M) 18.6,20.5,26.5,28.5,32.5,36.5,40.6  
42.6,44.6,48.7,50.7,52.8,56.9,59.0,61.0,65.2

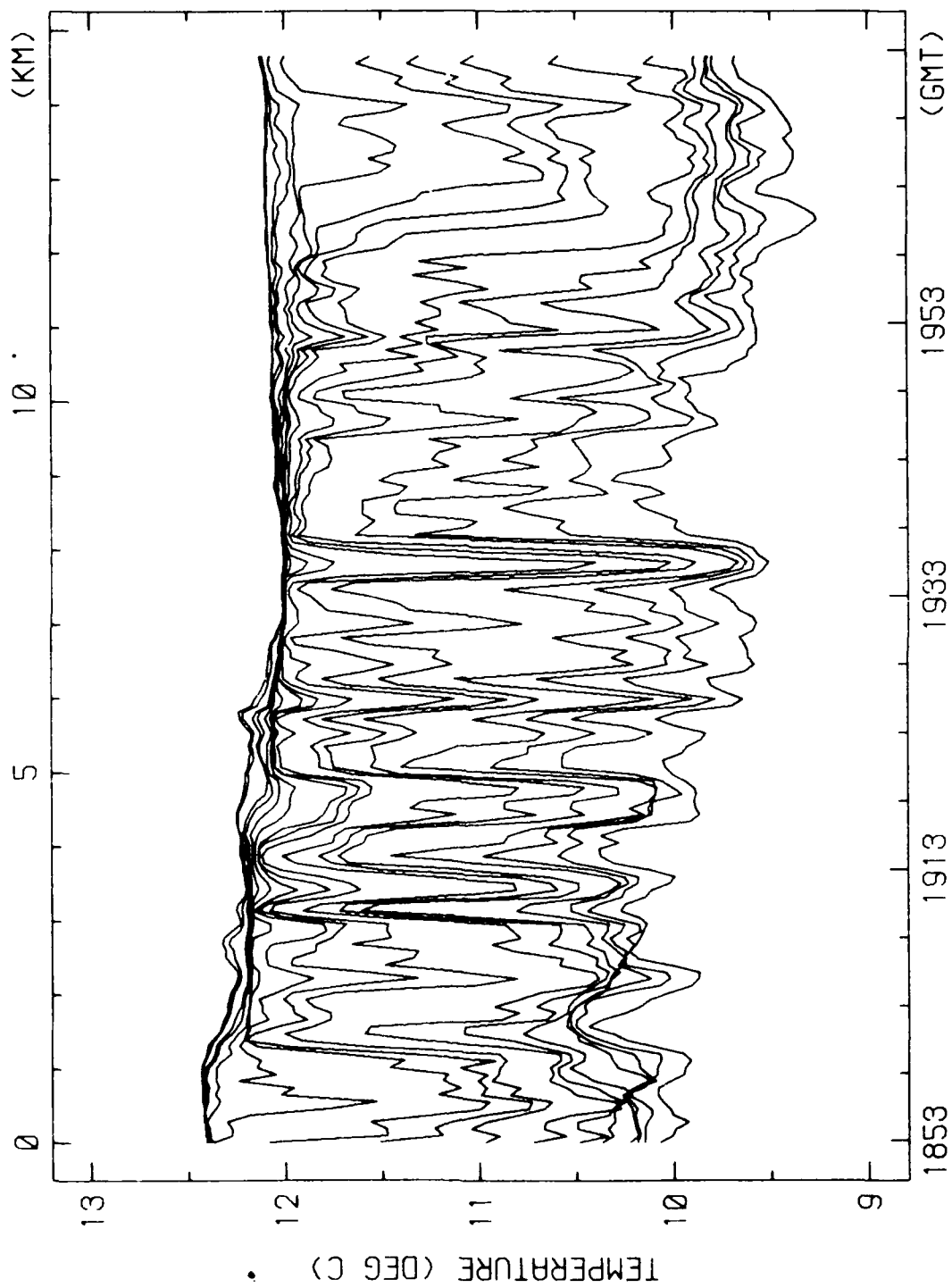

RUN 2S-6 25-AUG-78 TEMPERATURE VS TIME/DISTANCE

DEPTHS(M) 18.6, 20.5, 26.5, 28.5, 32.5, 36.5, 40.6,  
42.6, 44.6, 48.7, 50.7, 52.8, 56.9, 59.0, 61.0, 65.2

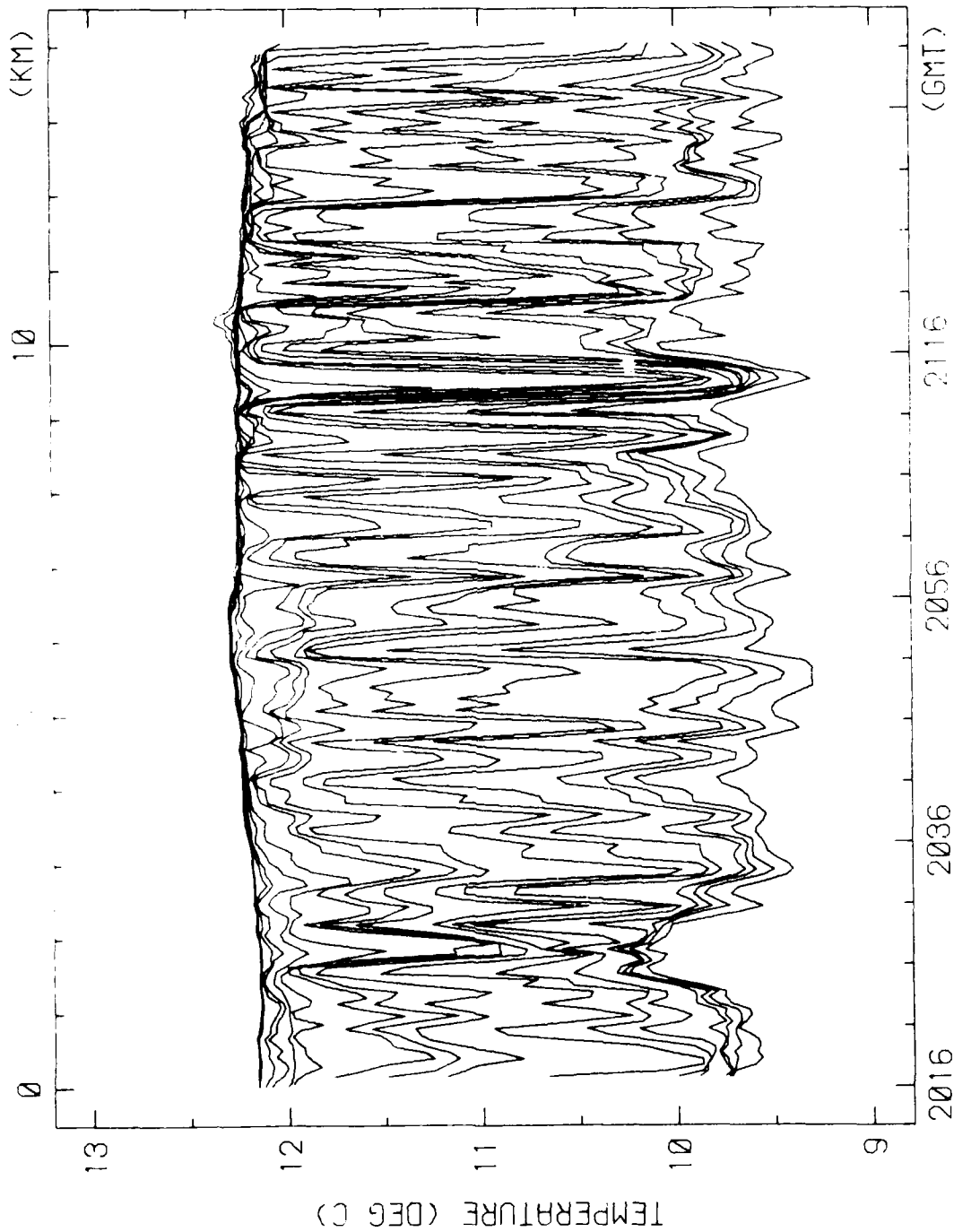

RUN 2E-7 25-AUG-78 TEMPERATURE VS TIME/DISTANCE

DEPTHS(M) 18 6,20 5,26 5,28 5,32 5,36 5,40 6  
42 6,44 6,48 7,50 7,52 8,56 9,58 0,61 0,65 1,2



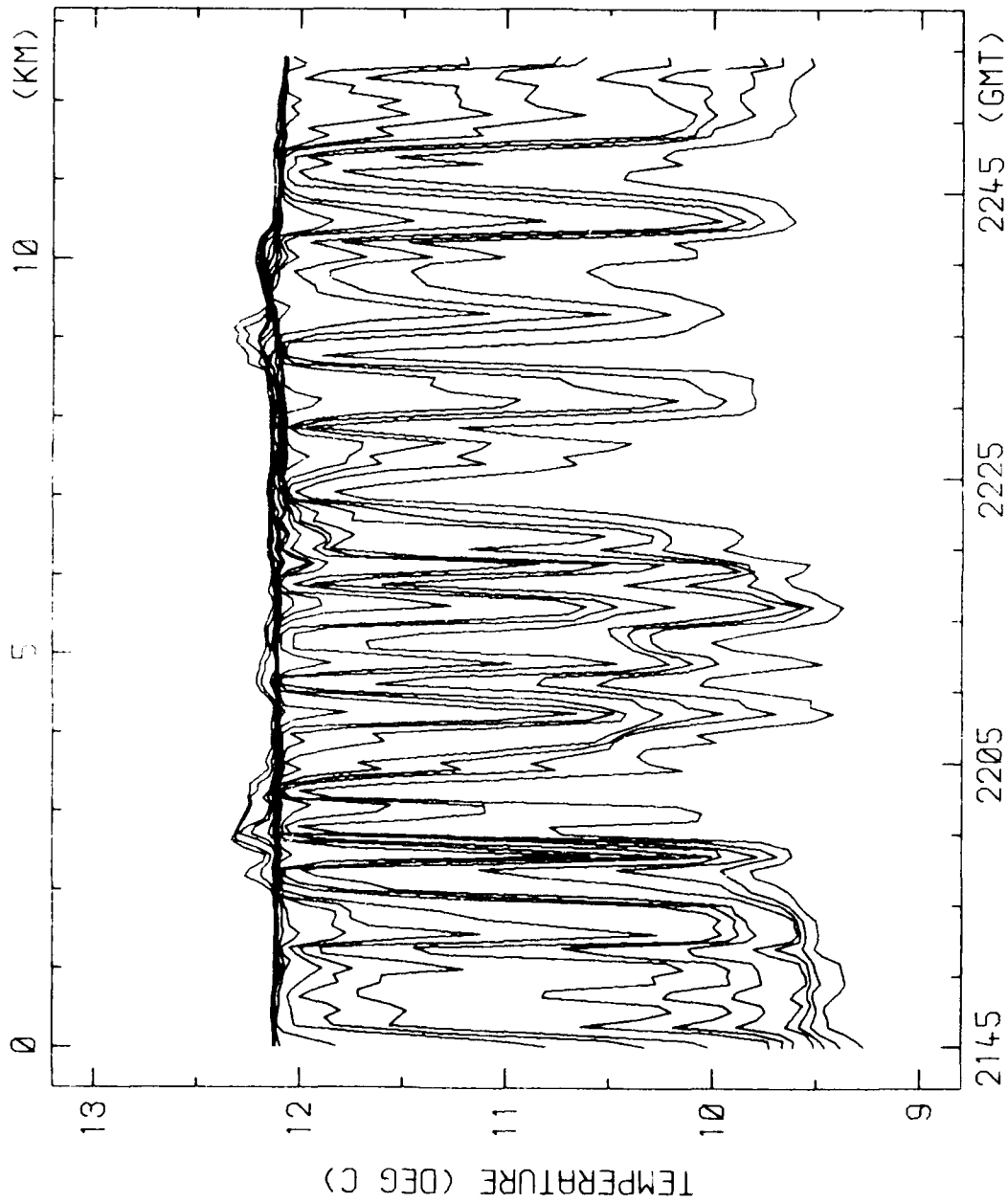

RUN 2N-8 25-AUG-78 TEMPERATURE VS TIME/DISTANCE  
DEPTHS(M) 18 6, 20 5, 26 5, 28 5, 32 5, 36 5, 40 6  
42 6, 44 6, 48 7, 50 7 52 8, 56 9, 59 0, 61 0, 65 2

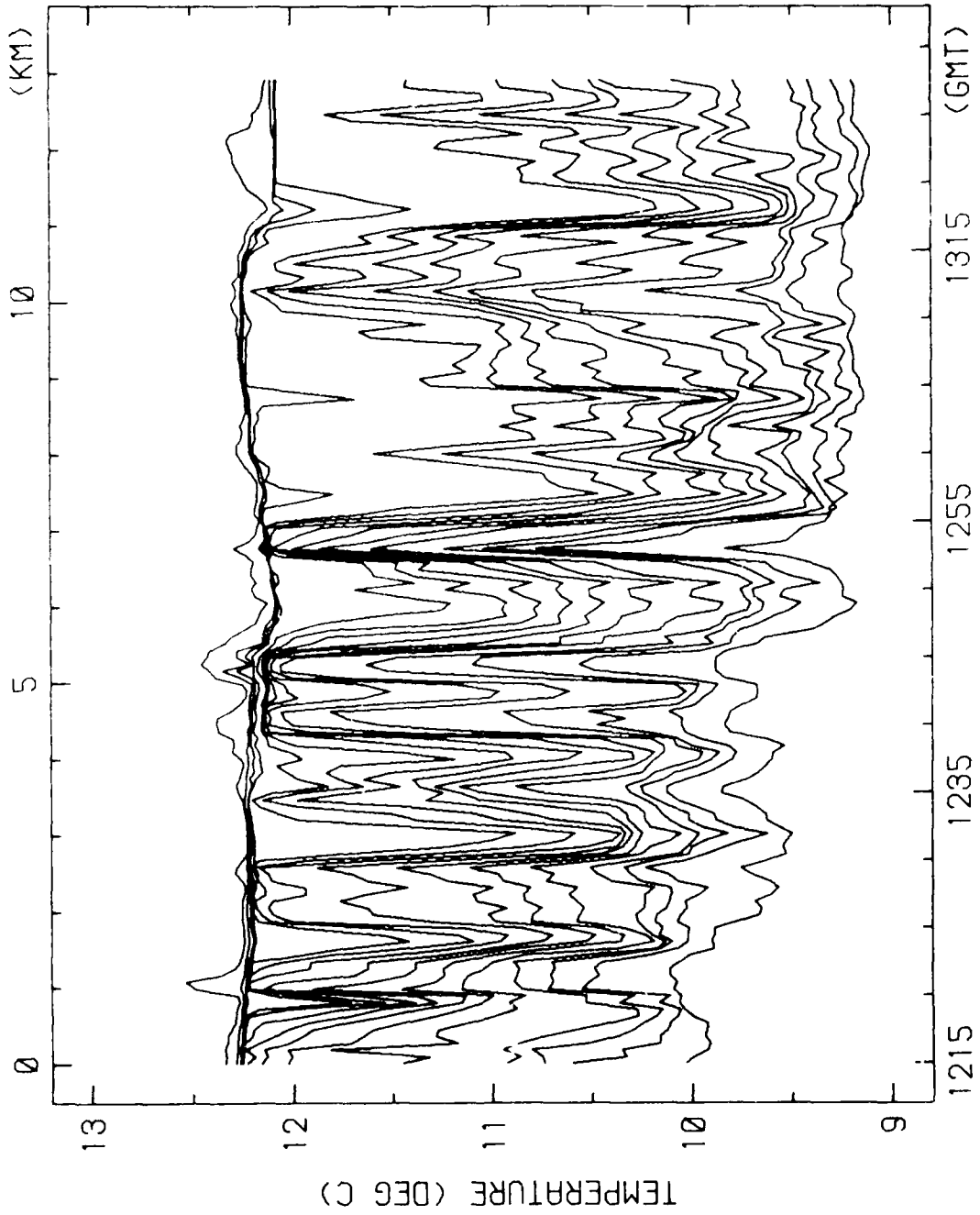

RUN 3N-1 27-AUG-78 TEMPERATURE VS TIME/DISTANCE  
DEPTHS (M) 18.6, 26.5, 28.5, 32.5, 40.6, 42.6  
44.6, 46.7, 48.7, 50.7, 52.8, 56.9, 59.0, 61.0, 69.3

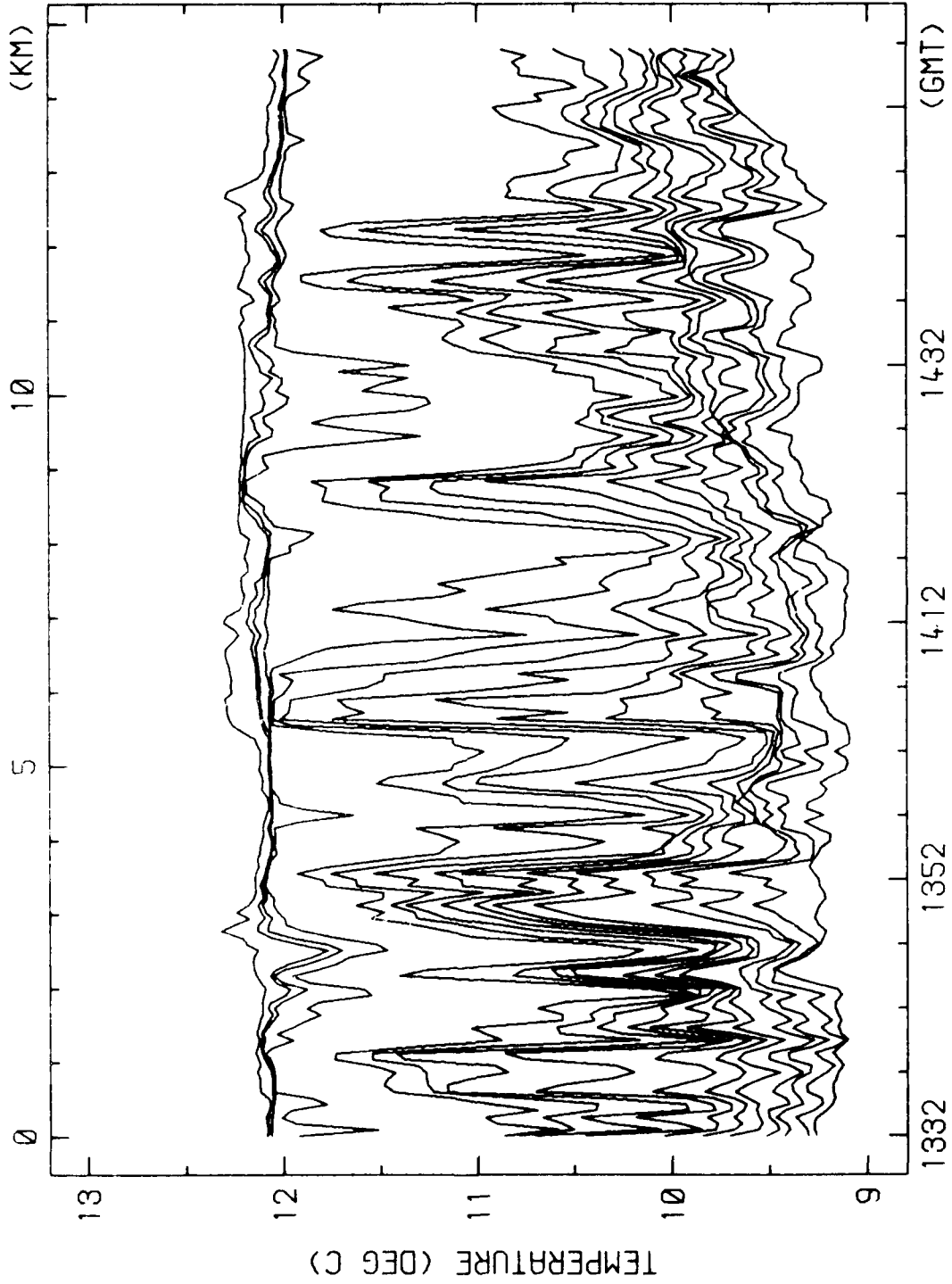

RUN 3W-2 27-AUG-78 TEMPERATURE VS TIME/DISTANCE

DEPTHS (M) 18.6, 26.5, 28.5, 32.5, 40.6, 42.6

44.6, 46.7, 48.7, 50.7, 52.8, 56.9, 59.0, 61.0, 69.3

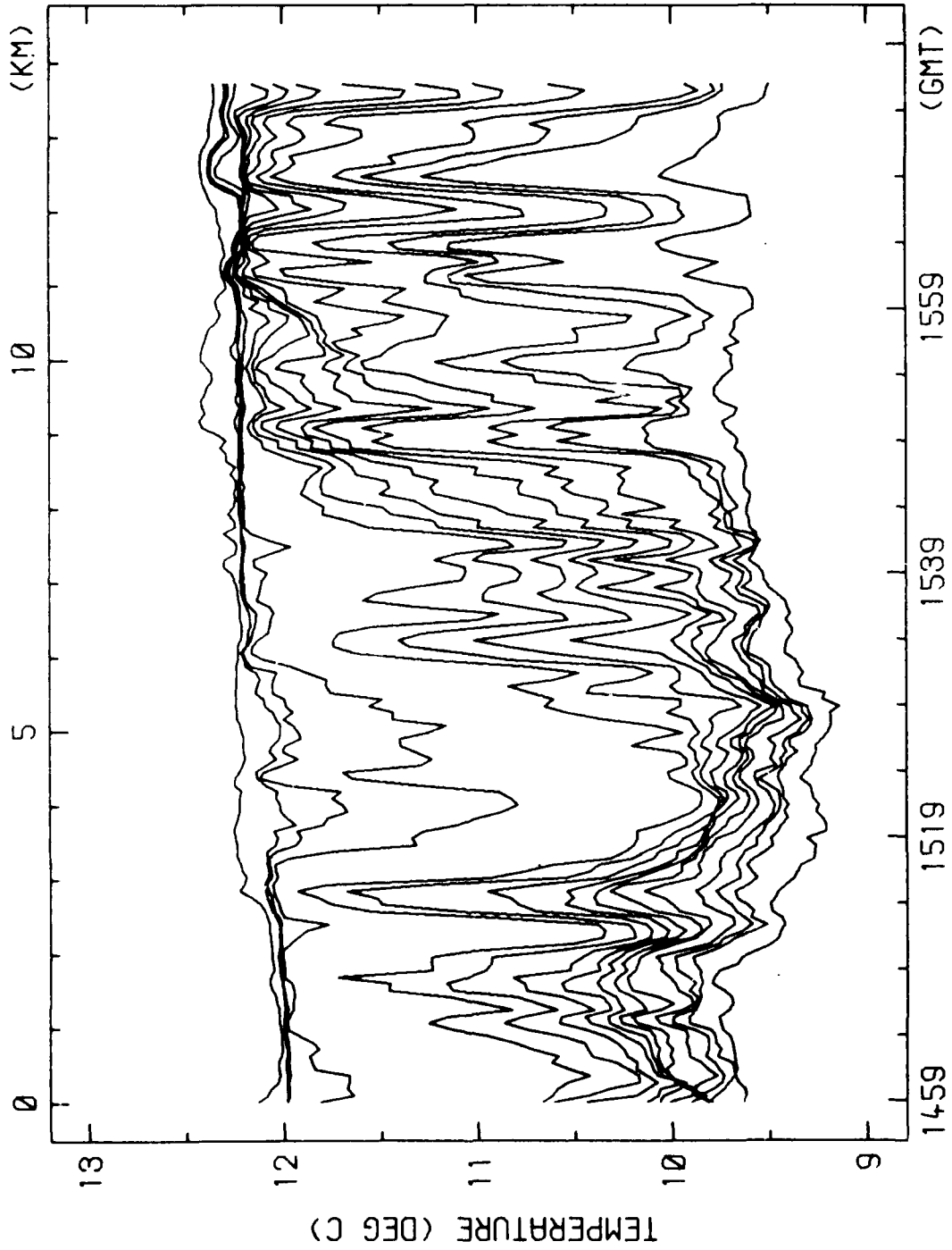

RUN 3S-3 27-AUG-78 TEMPERATURE VS TIME/DISTANCE

DEPTHS (M) 18.6, 26.5, 28.5, 32.5, 40.6, 42.6

44.6, 46.7, 48.7, 50.7, 52.8, 56.9, 59.0, 61.0, 69.3

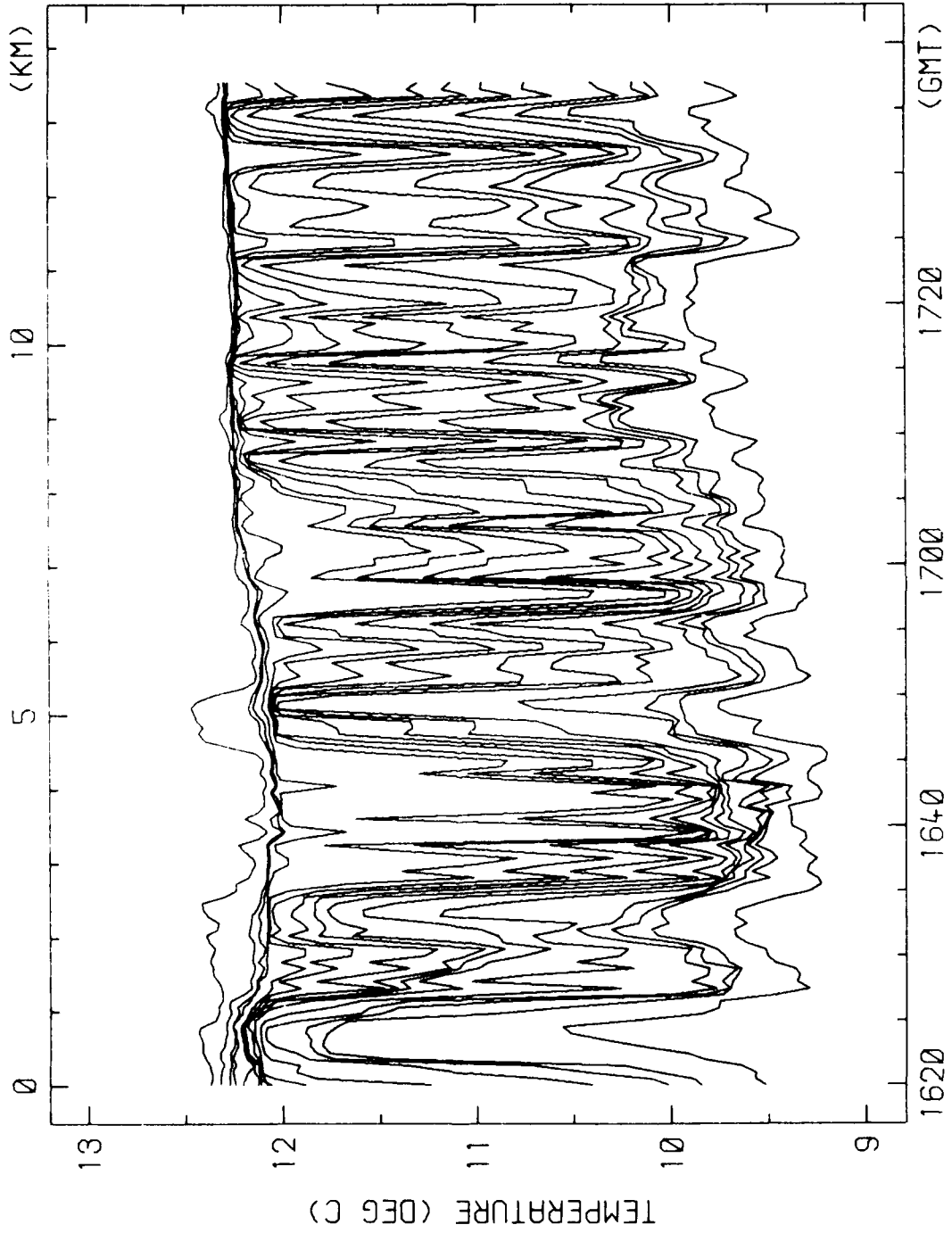

RUN 3E-4 27-AUG-78 TEMPERATURE VS TIME/DISTANCE

DEPTHS (M) 18 6, 26, 5, 28, 5, 32, 5, 40, 6, 42, 6

44, 6, 46, 7, 48, 7, 50, 7, 52, 8, 56, 9, 59, 0, 61, 0, 69, 3

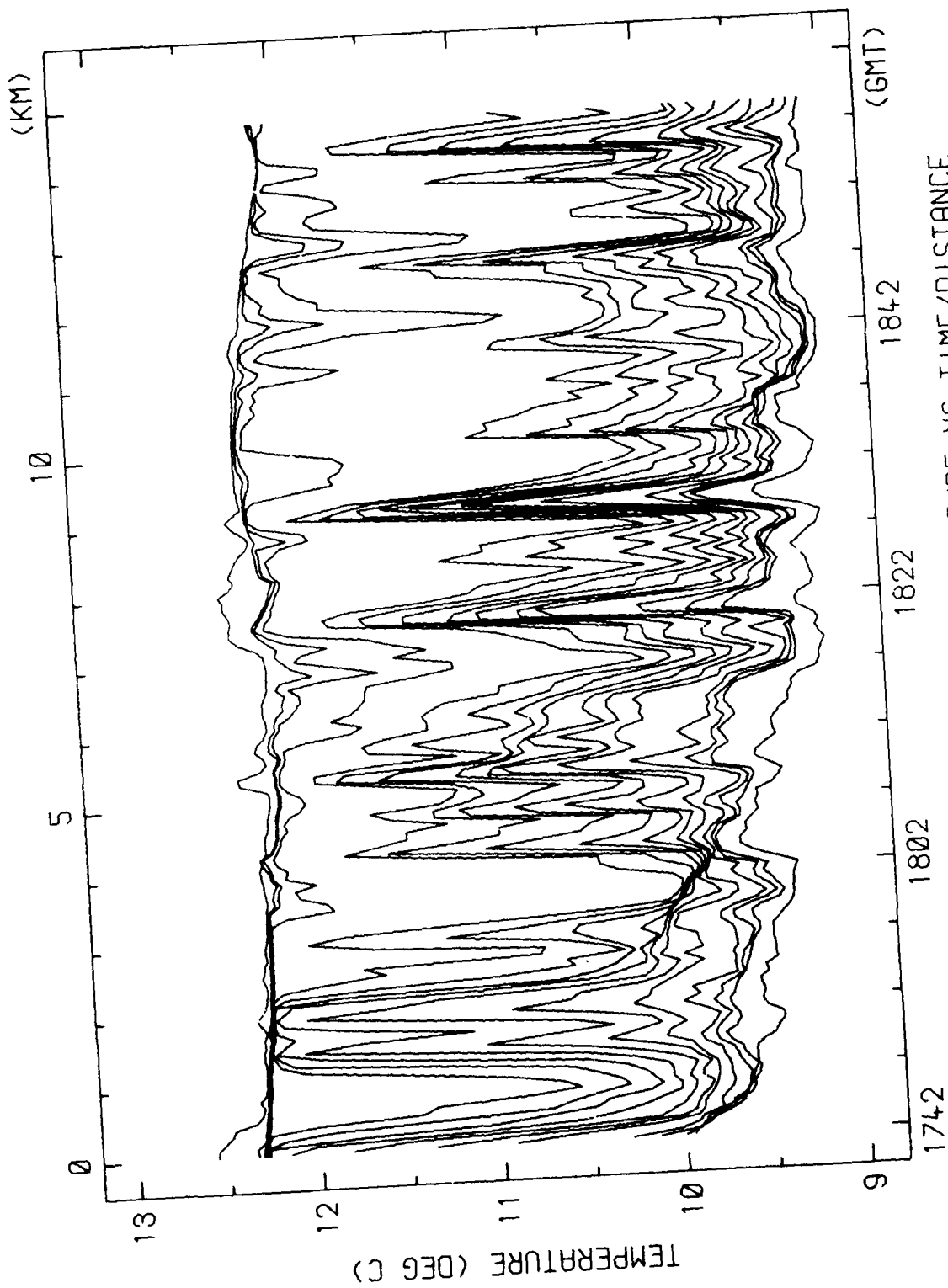

RUN 3N-5 27-AUG-78 TEMPERATURE VS TIME/DISTANCE  
DEPTHS (M) 18.6, 26.5, 28.5, 32.5, 40.6, 42.6  
44.6, 46.7, 48.7, 50.7, 52.8, 56.9, 59.0, 61.0, 69.3

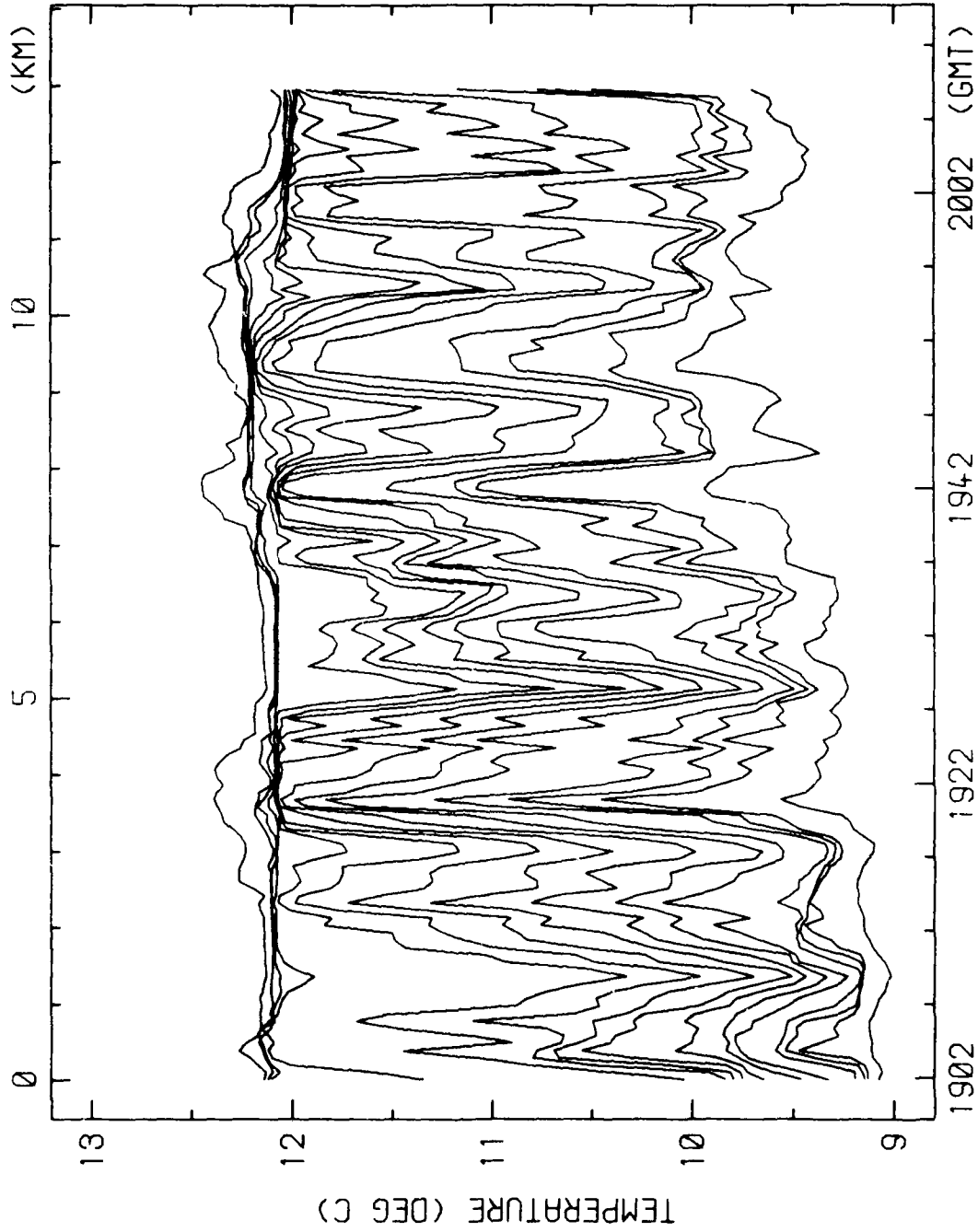

RUN 3W-6 27-AUG-78 TEMPERATURE VS TIME/DISTANCE  
DEPTHS (M) 18.6, 26.5, 28.5, 32.5, 40.6, 42.6  
44.6, 46.7, 48.7, 50.7, 52.8, 56.9, 59.0, 61.0, 69.3

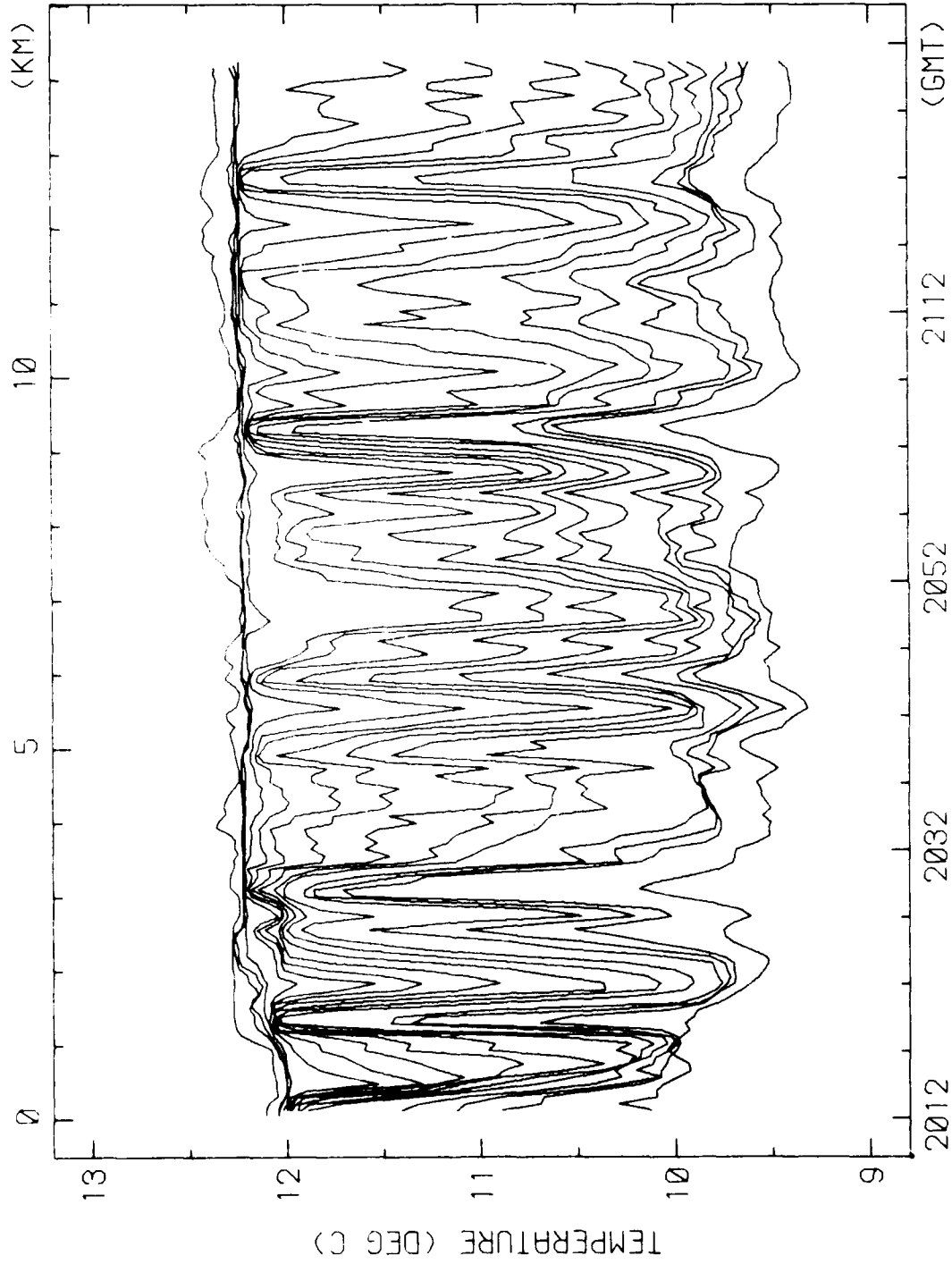

RUN 3S-7 27-AUG-78 TEMPERATURE VS TIME/DISTANCE  
DEPTHS (M) 18.6, 26.5, 28.5, 32.5, 40.6, 42.6  
44.6, 46.7, 48.7, 50.7, 52.8, 56.9, 59.0, 61.0, 65.8



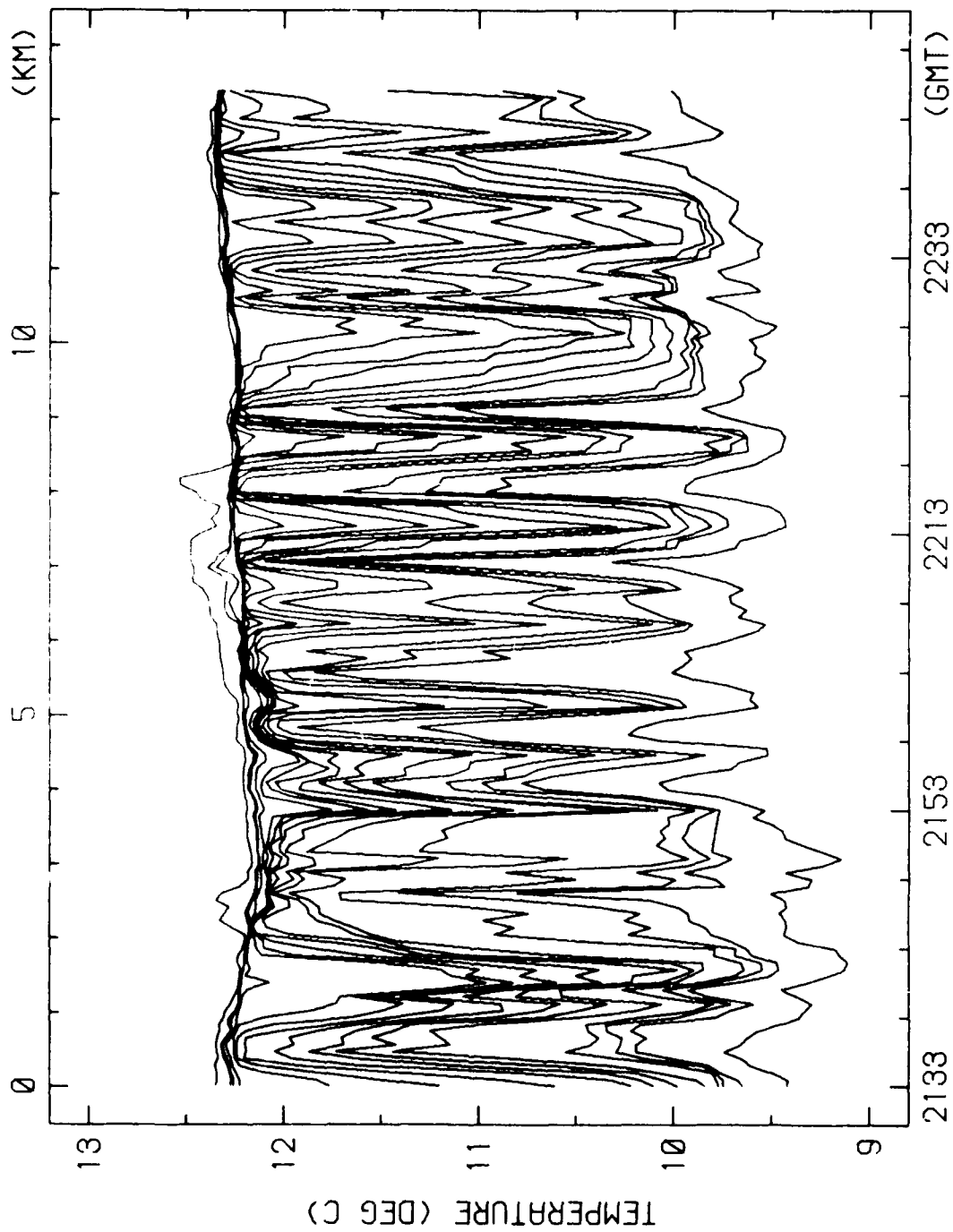

RUN 3E-8 27-AUG-78 TEMPERATURE VS TIME/DISTANCE

DEPTHS (M) 18.6, 26.5, 28.5, 32.5, 40.6, 42.6

44.6, 46.7, 48.7, 50.7, 52.8, 56.9, 59.0, 61.0, 69.3

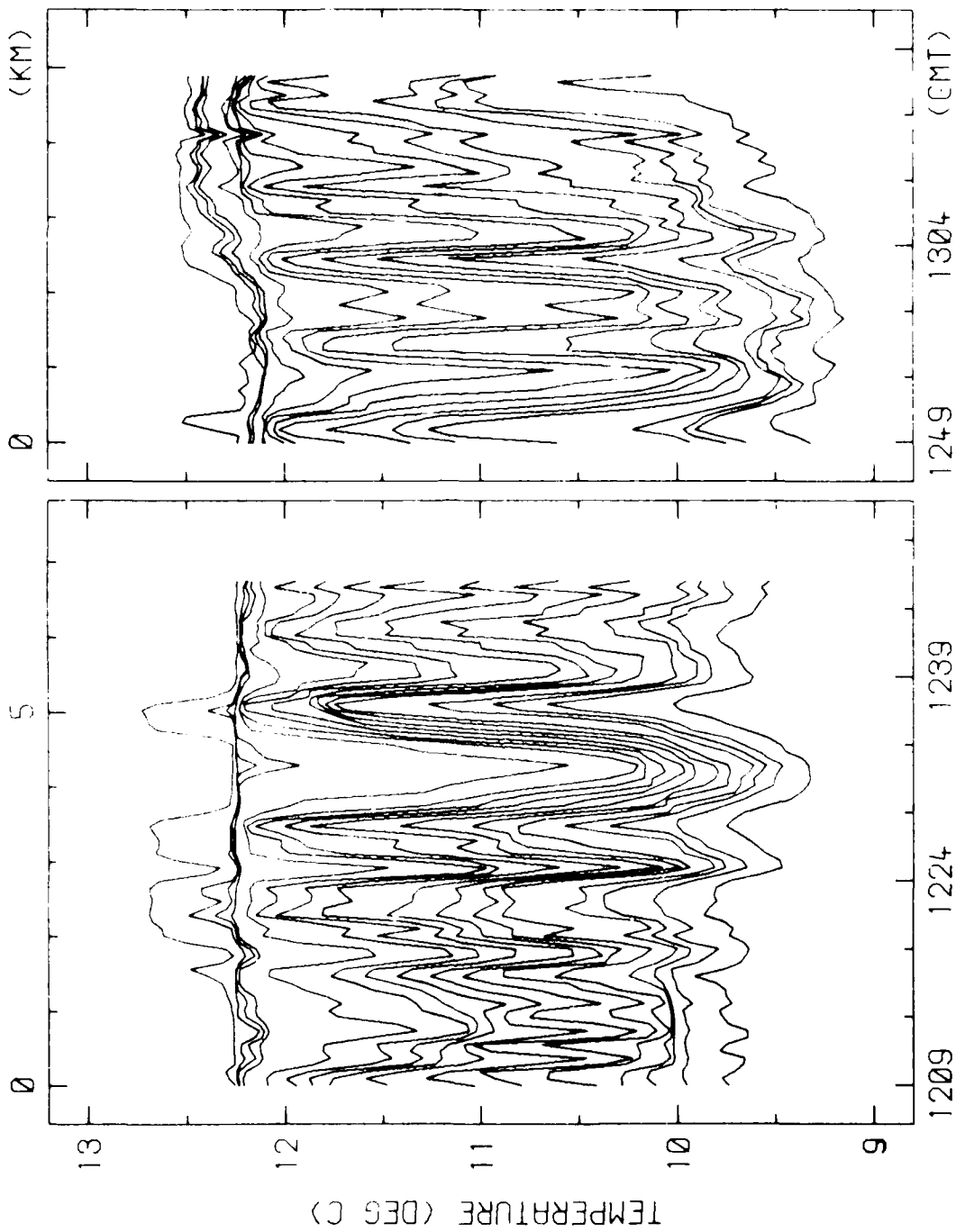

RUNS 4N-1, 4W-2 29-AUG-78 TEMPERATURE VS TIME/DISTANCE

DEPTHS (M) 18 9, 24 9, 26 9, 28 9, 37 0, 41 1, 43 1  
45 1, 47 2, 49 2, 51 3, 53 4, 57 5, 59 5, 61 6, 69 9

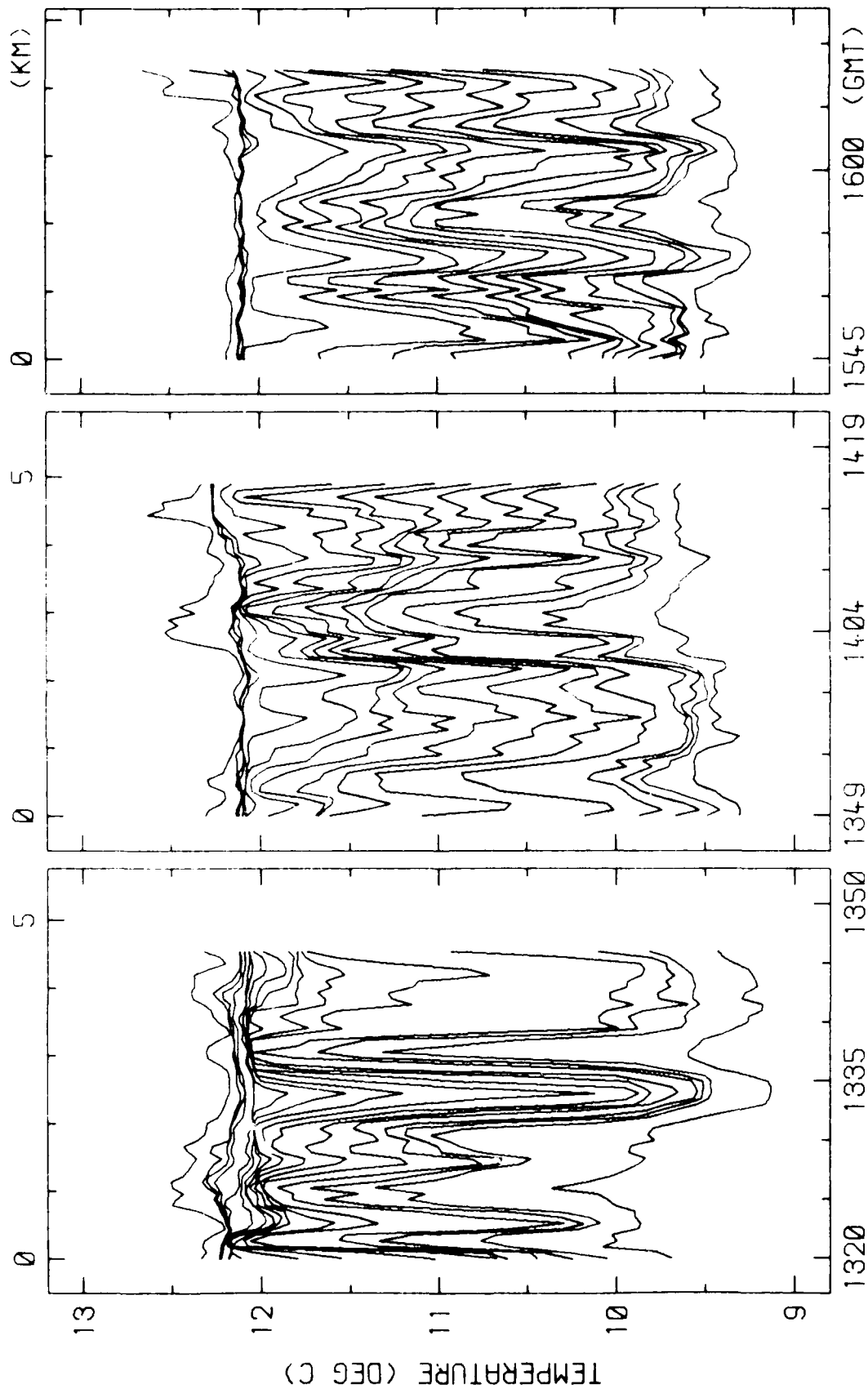

RUNS 4S-3, 4E-4, 4E-5 29-AUG-78 TEMPERATURE VS TIME/DISTANCE

DEPTHS (M) 18.9, 24.9, 26.9, 28.9, 37.0, 41.1, 43.1  
45.1, 47.2, 49.2, 51.3, 53.4, 57.5, 59.5, 61.6, 69.9

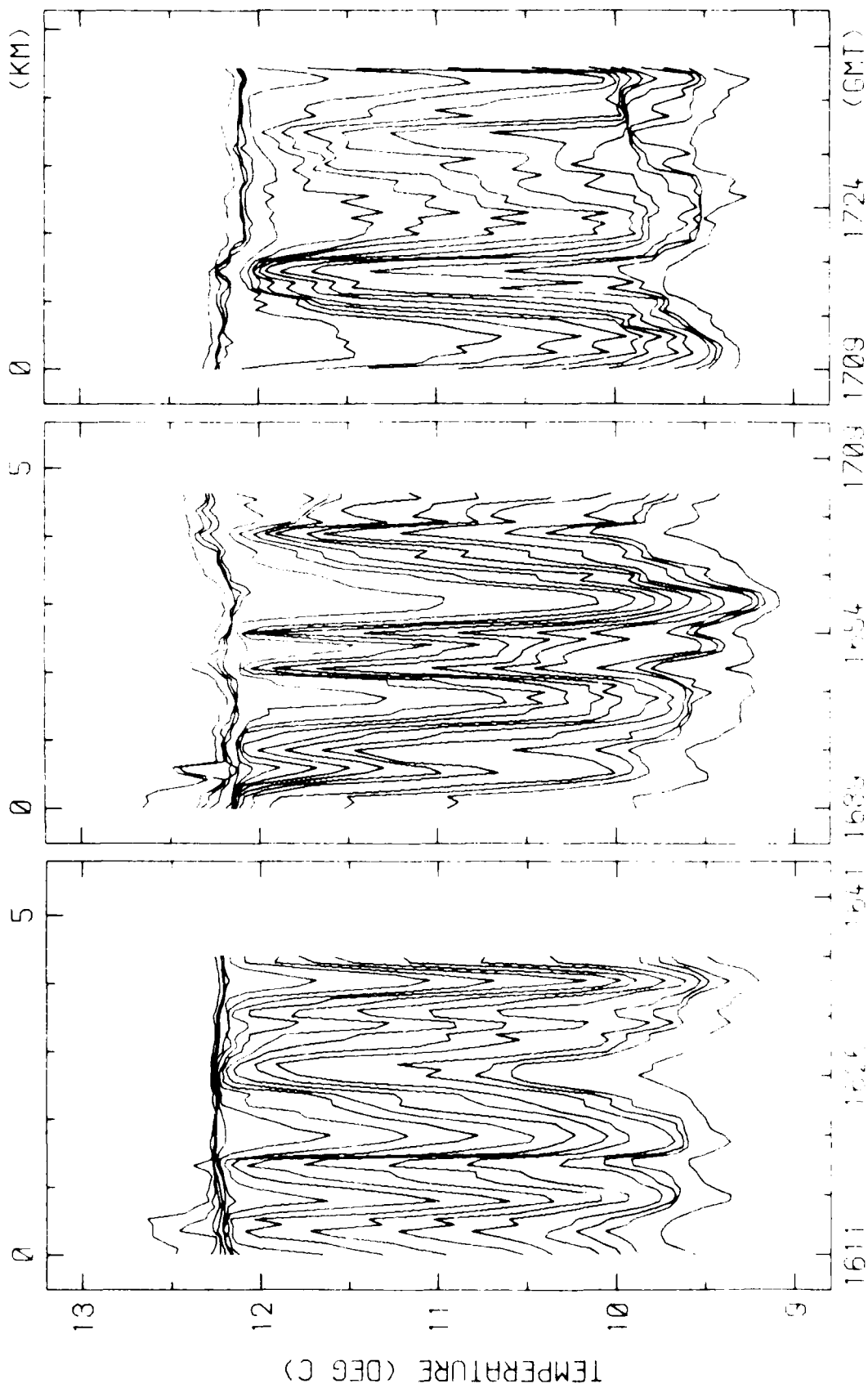

RUNS 4N-6, 4N-7, 4N-8 29-AUG-78 TEMPERATURE VS TIME/DISTANCE  
 DEPTHS (M) 18 9,24 9,26 9,28 9,37 0,41 1,43 1  
 45 1,47 2,48 2,51 3,53 4,57 5,58 5,61 6,65 3

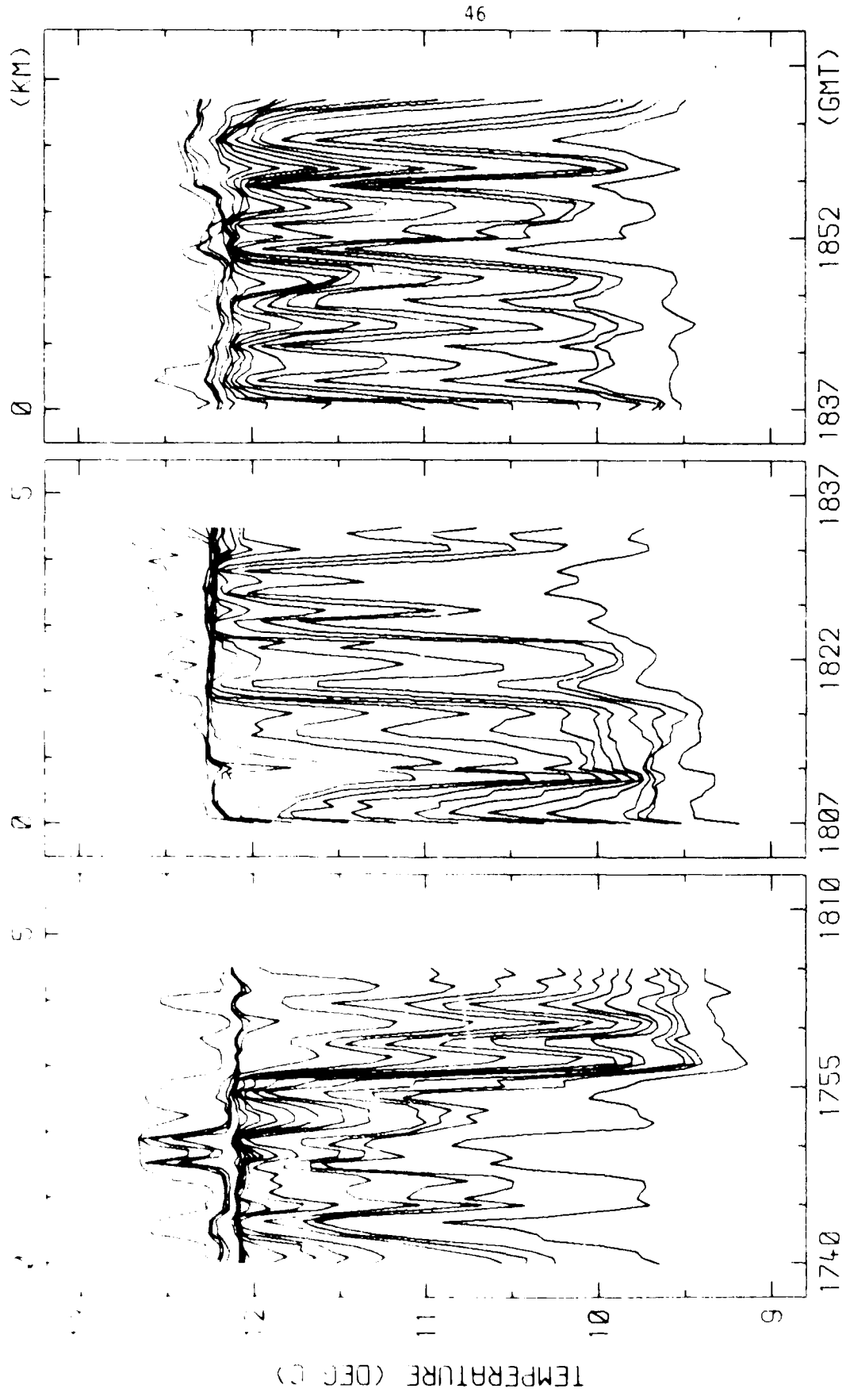

RUNS 4E-9, 4N-10, 4W-11 29-AUG-78 TEMPERATURE VS TIME/DISTANCE  
 DEPTHS (M) 18.9, 24.9, 26.9, 28.9, 37.0, 41.1, 43.1  
 45.1, 47.2, 49.2, 51.3, 53.4, 57.5, 59.5, 61.6, 69.9

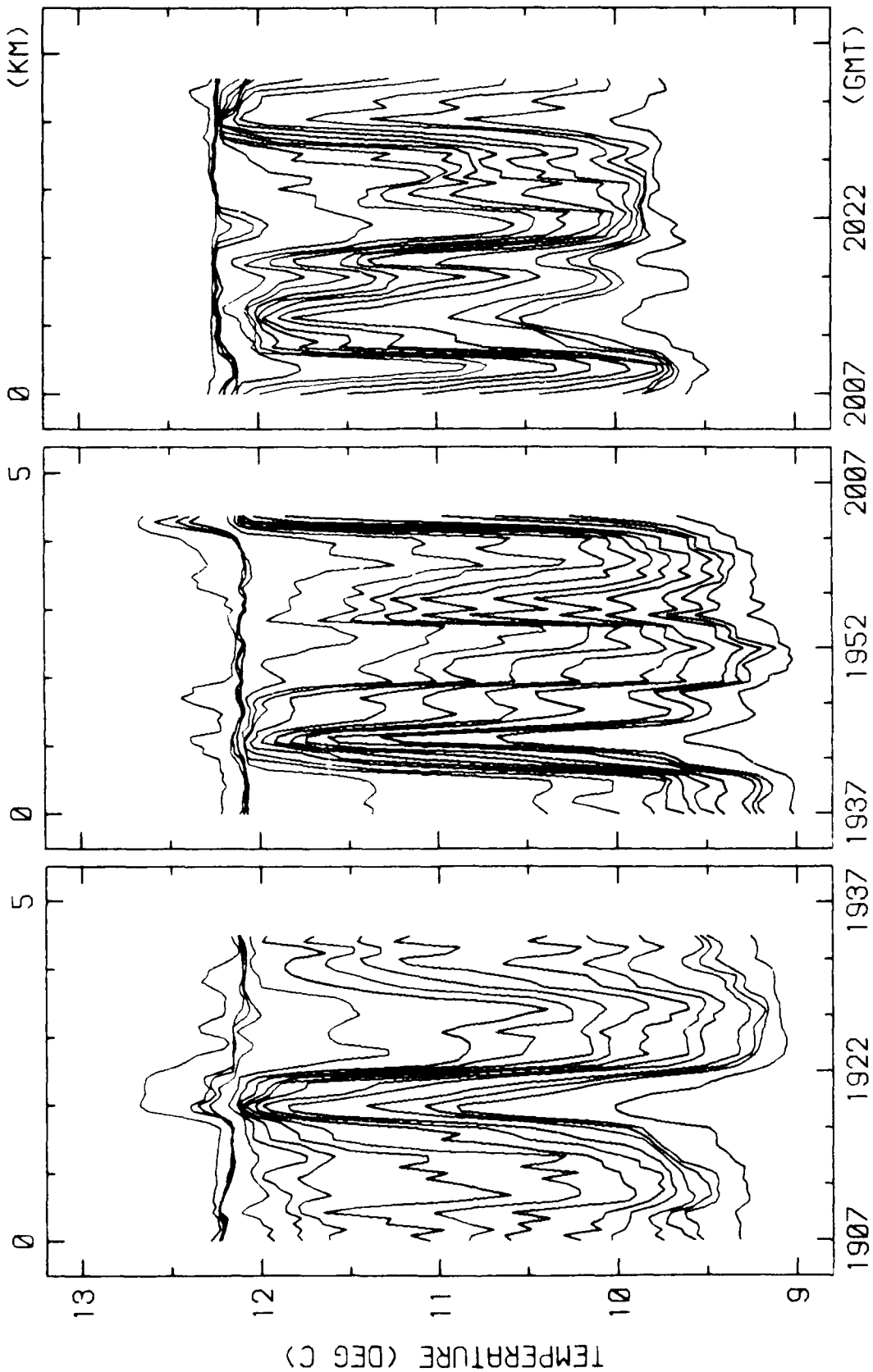

RUNS 4S-12, 4E-13, 4N-14 29-AUG-78 TEMPERATURE VS TIME/DISTANCE  
DEPTHS (M) 18.9,24.9,26.9,28.9,37.0,41.1,43.1  
45.1,47.2,49.2,51.3,53.4,57.5,59.5,61.6,69.9

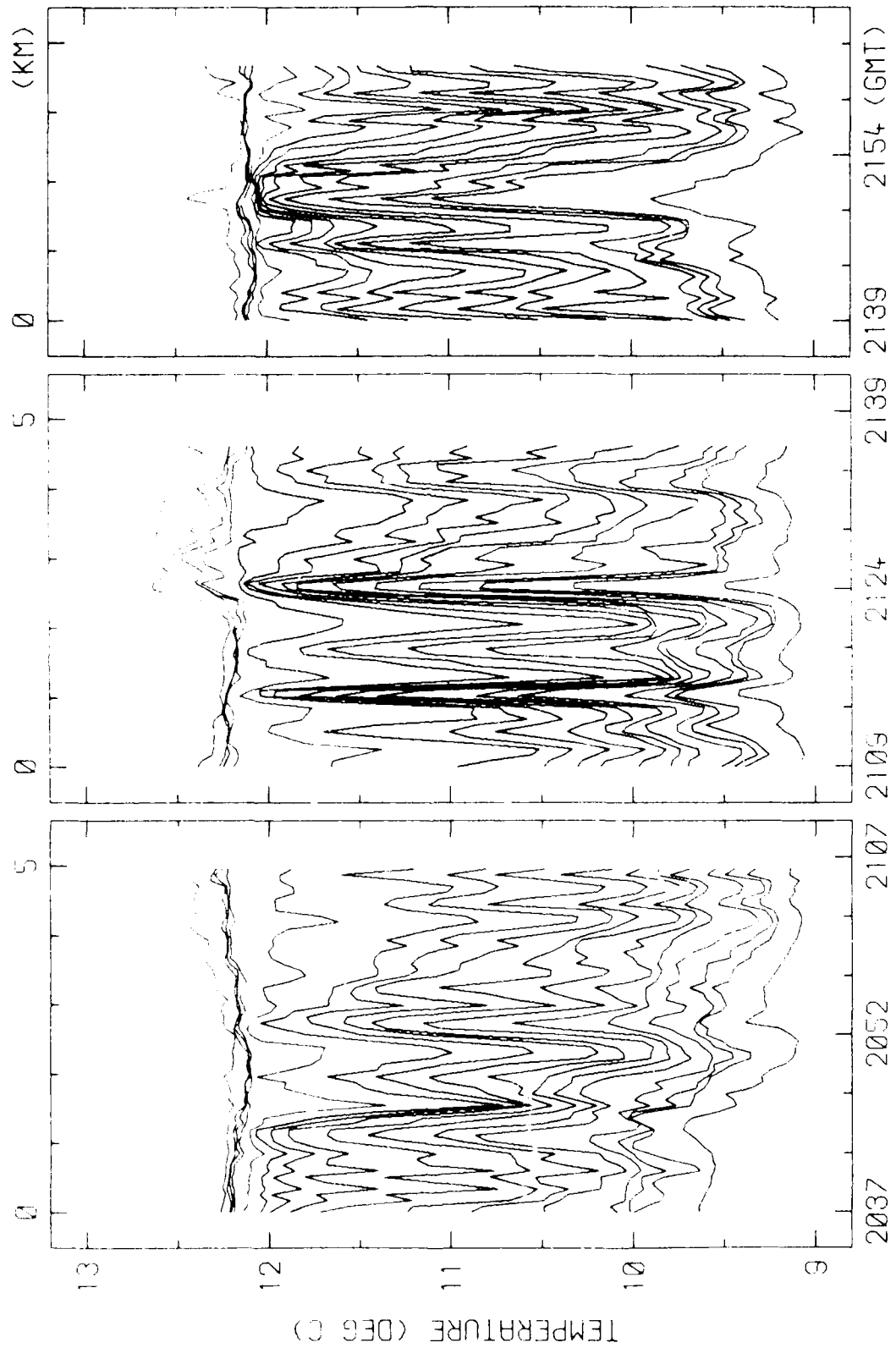

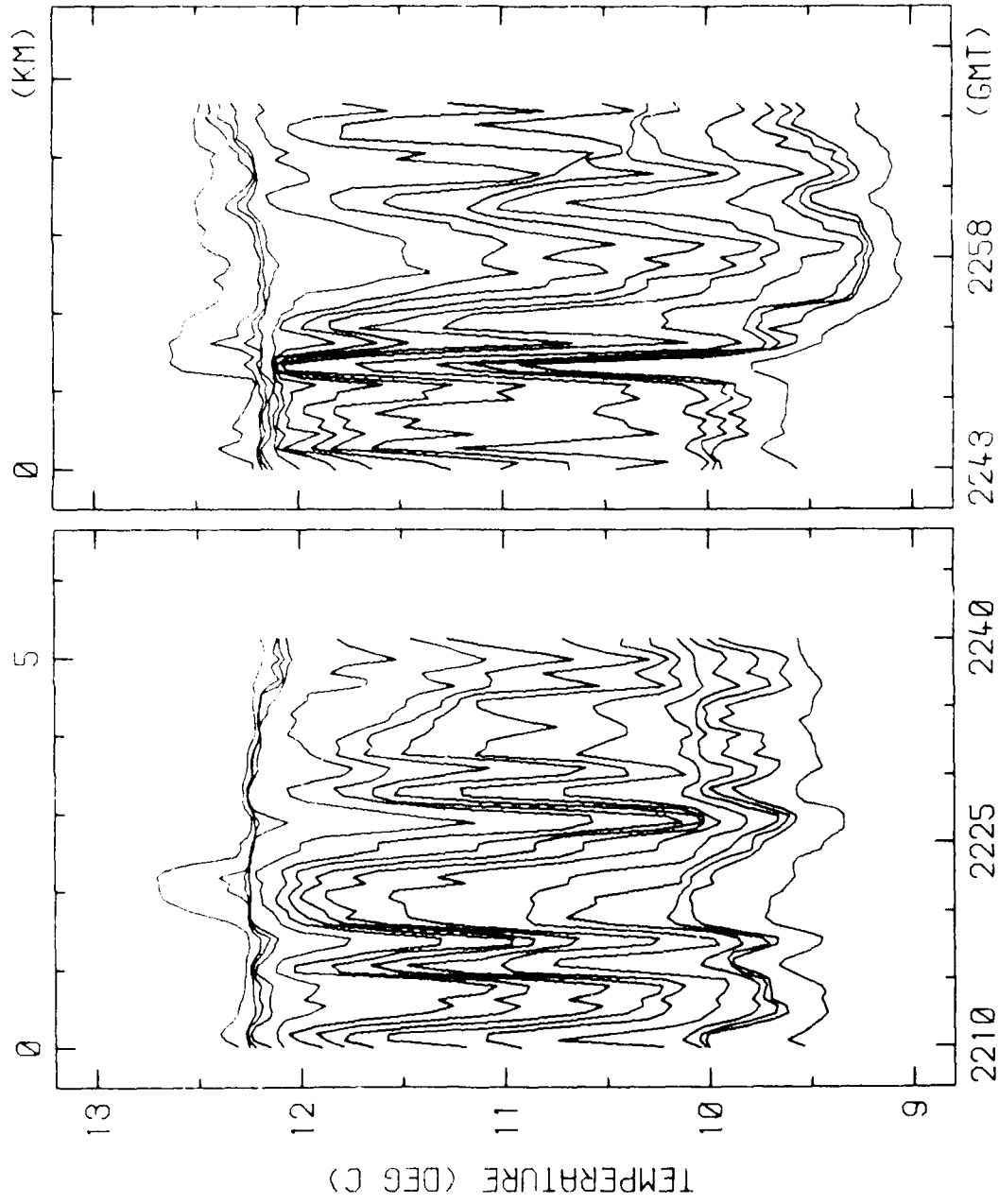

RUNS 4N-18, 4W-19 29-AUG-78 TEMPERATURE VS TIME/DISTANCE  
DEPTHS (M) 18, 9, 24, 9, 26, 9, 28, 9, 37, 0, 41, 1, 43, 1  
45, 1, 47, 2, 49, 2, 53, 4, 57, 5, 59, 5, 61, 6, 69, 9



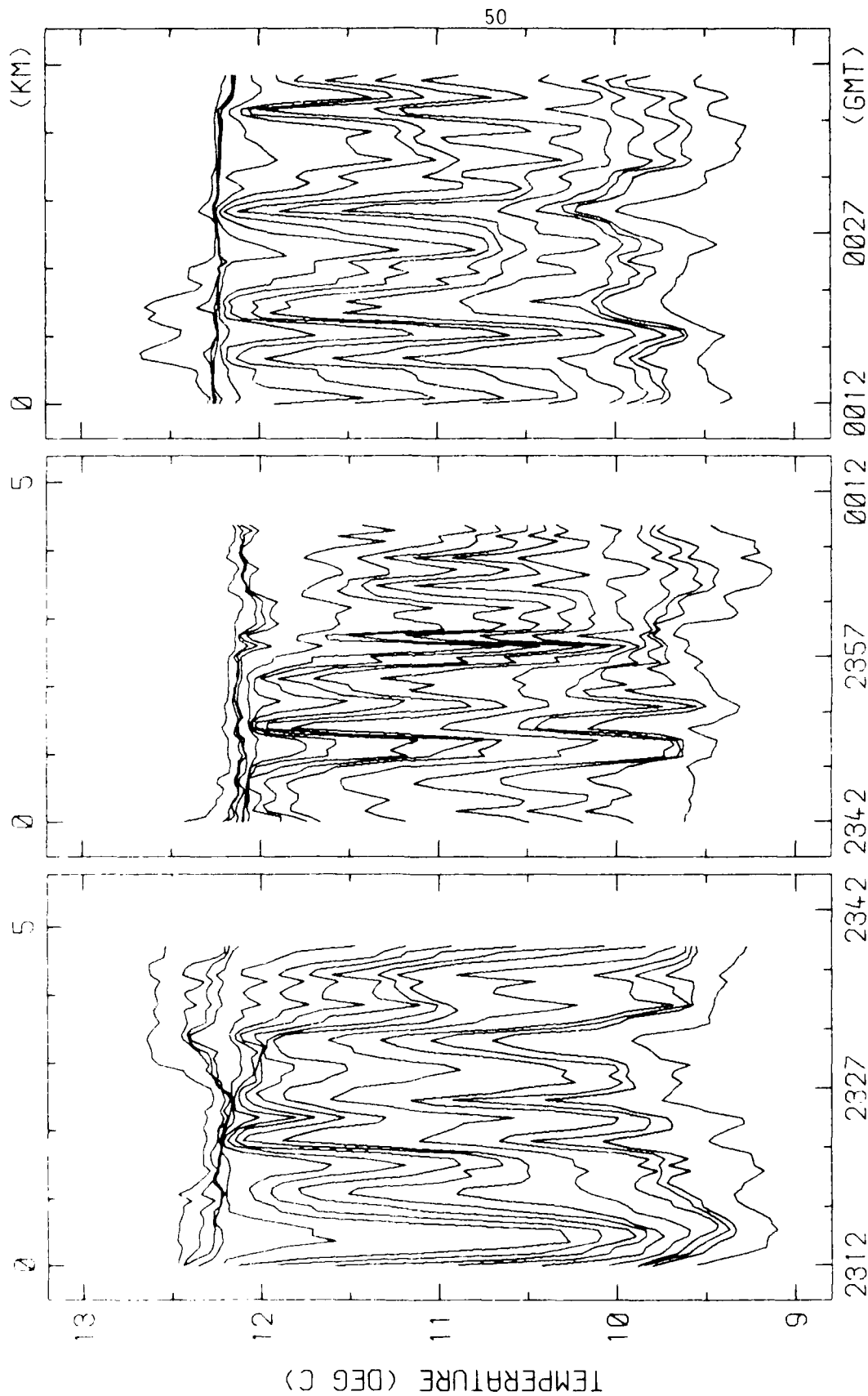

RUNS 4S-20, 4E-21, 4N-22 29,30-AUG-78 TEMPERATURE VS TIME/DISTANCE  
 DEPTHS (M) 18 9,24 9,26 9,28 9,37 0,41 1,43 1  
 45 1,47 2,49 2,53 4,57 5,59 5,61 6,69 9

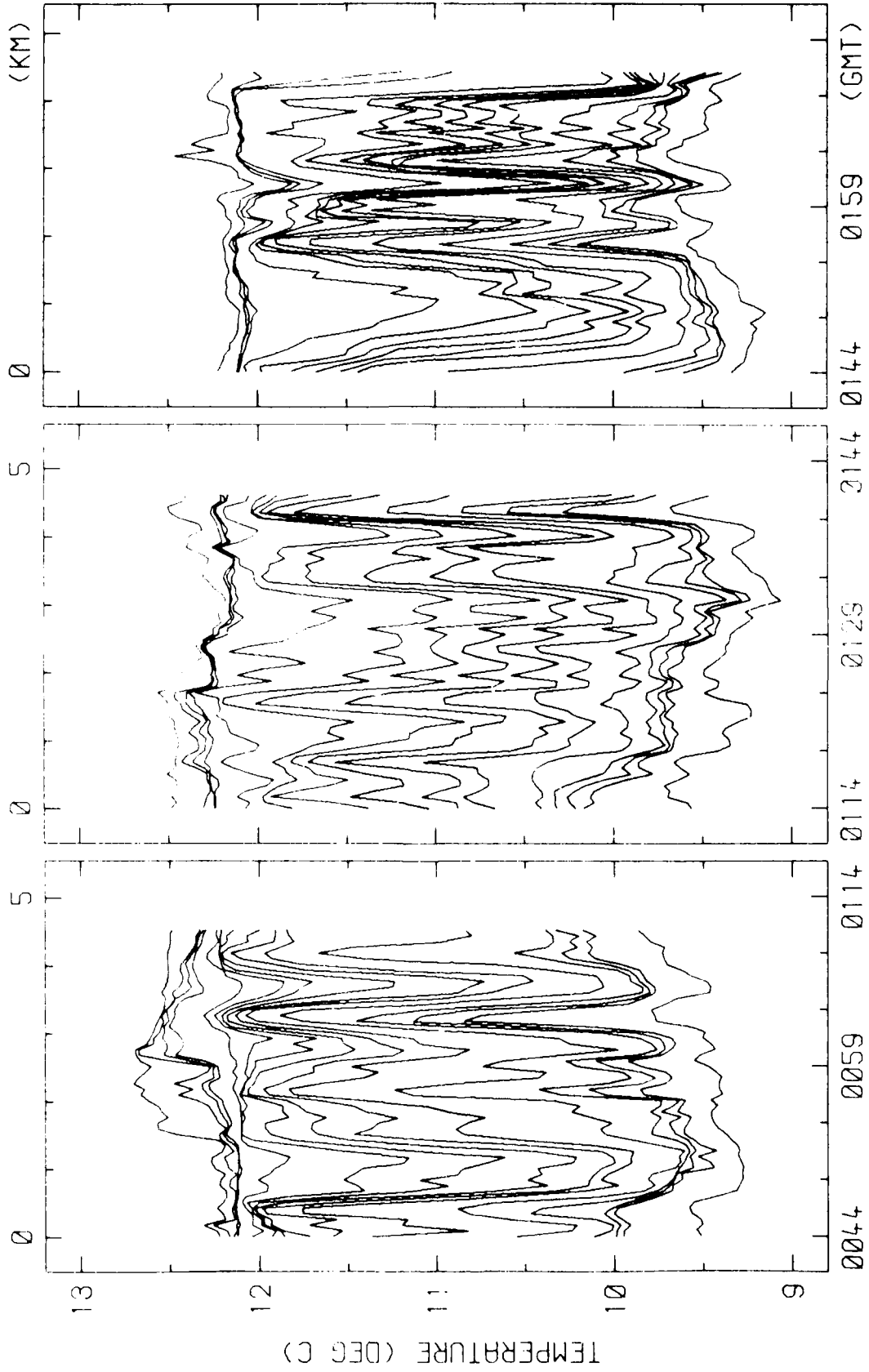

RUNS 4W-23, 4S-24, 4E-25 30-AUG-78 TEMPERATURE VS TIME/DISTANCE  
 DEPTHS (M) 18 9, 24 9, 26 9, 28 9, 37 0, 41 1, 43 1  
 45 1, 47 2, 49 2, 53 4, 57 5, 59 5, 61 6, 69 9

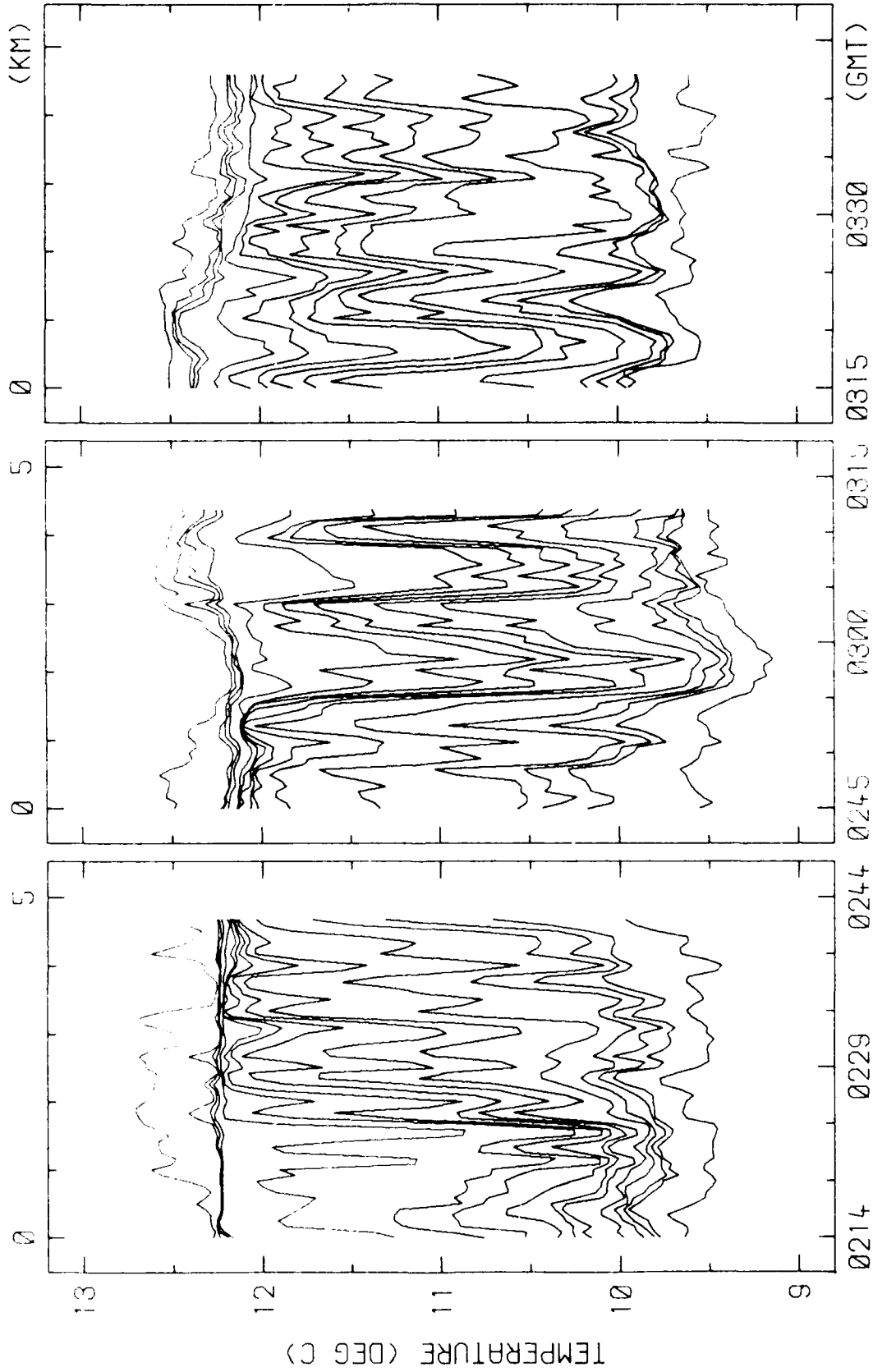

RUNS 4N-26, 4W-27, 4S-28 30-AUG-78 TEMPERATURE VS TIME/DISTANCE  
DEPTHS (M) 18.9, 24.9, 26.9, 28.0, 37.0, 41.1, 43.1  
45.1, 47.2, 49.2, 53.4, 57.5, 59.6, 61.6, 69.9

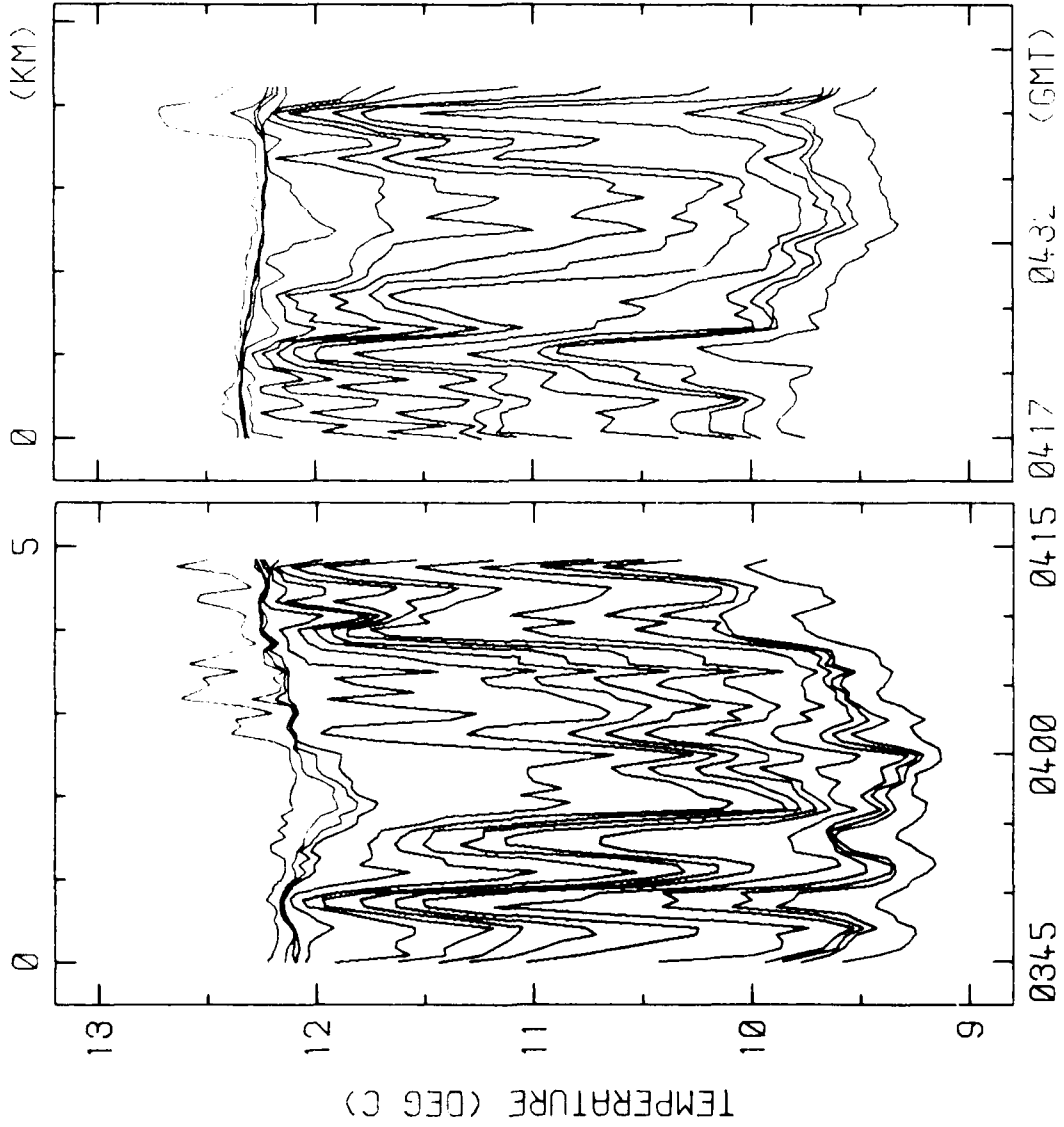

RUNS 4E-29, 4N-30 30-AUG-78 TEMPERATURE VS TIME/DISTANCE  
 DEPTHS (M) 18.9, 24.9, 26.9, 28.9, 37.0, 41.1, 43.1  
 45.1, 47.2, 48.2, 53.4, 57.5, 59.5, 61.6, 69.9

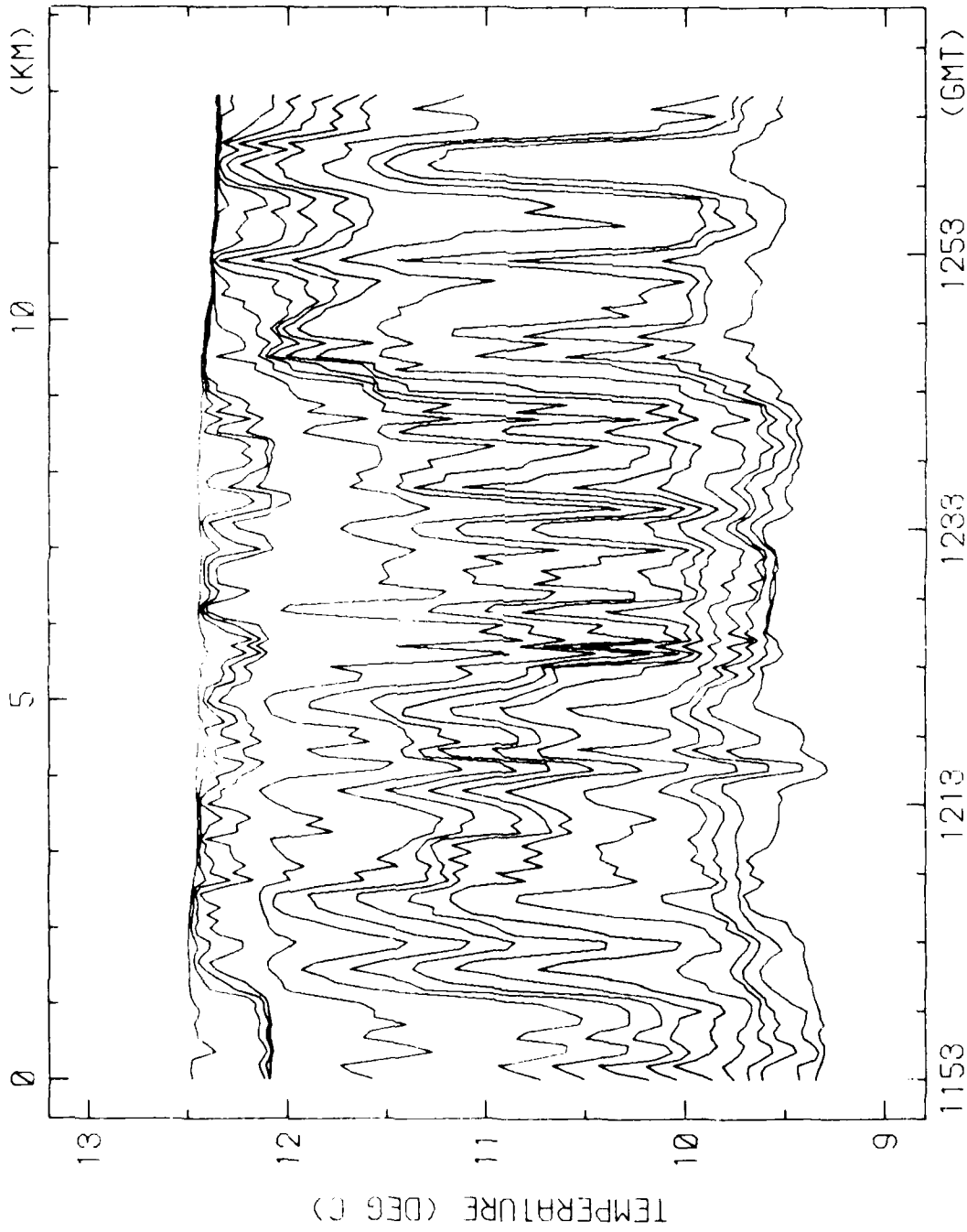

RUN 5N-1 31-AUG-78 TEMPERATURE VS TIME/DISTANCE

DEPTHS (M) 18 6,24 5,26 5,28 5,36 5,40 6,42 6

44 6,46 7,48 7,52 8,56 9,59 0,61 0,69 8

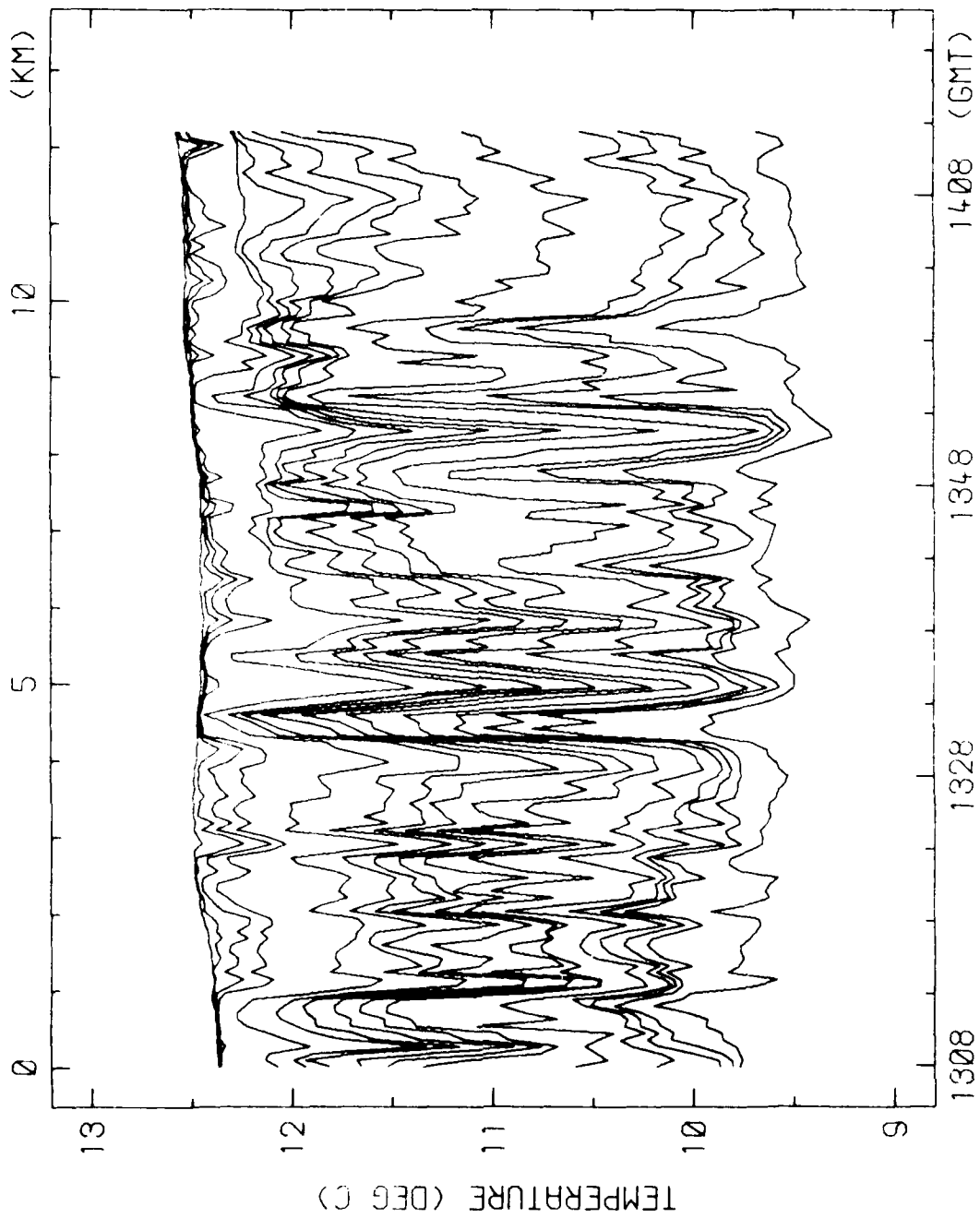

RUN 5W-2 31-AUG-78 TEMPERATURE VS TIME/DISTANCE

DEPTHS (M) 18.6, 24.5, 26.5, 28.5, 36.5, 40.6, 42.6

44.6, 46.7, 48.7, 52.8, 56.9, 59.0, 61.0, 65.3

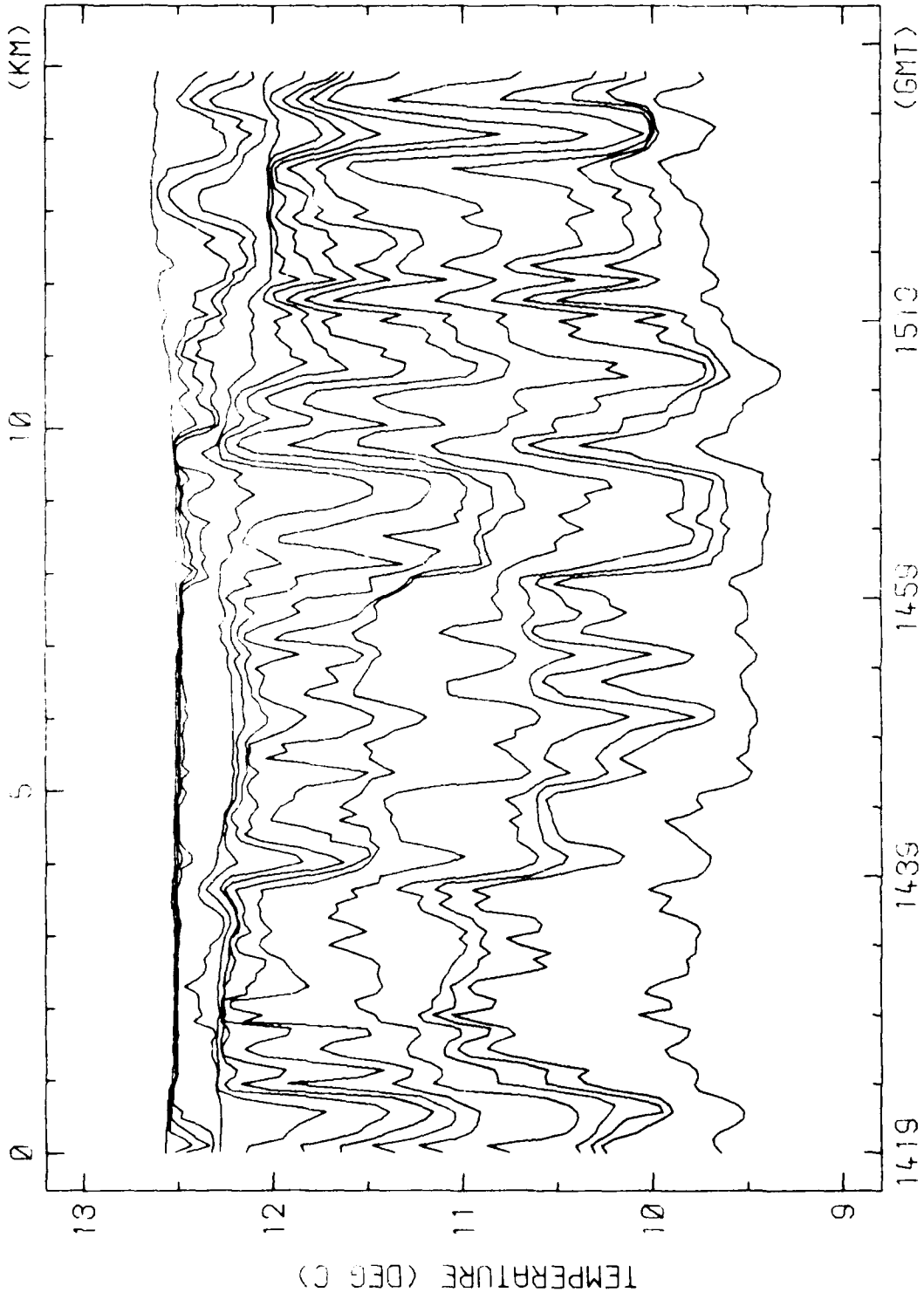

RUN 55-3 31-AUG-78 TEMPERATURE VS TIME/DISTANCE

DEPTHS (M) 18 6, 24 5, 26 3, 28 5, 36 5, 40 6, 42 6

44 6, 46 7, 48 7, 52 8, 56 9, 58 10, 61 10, 69 8

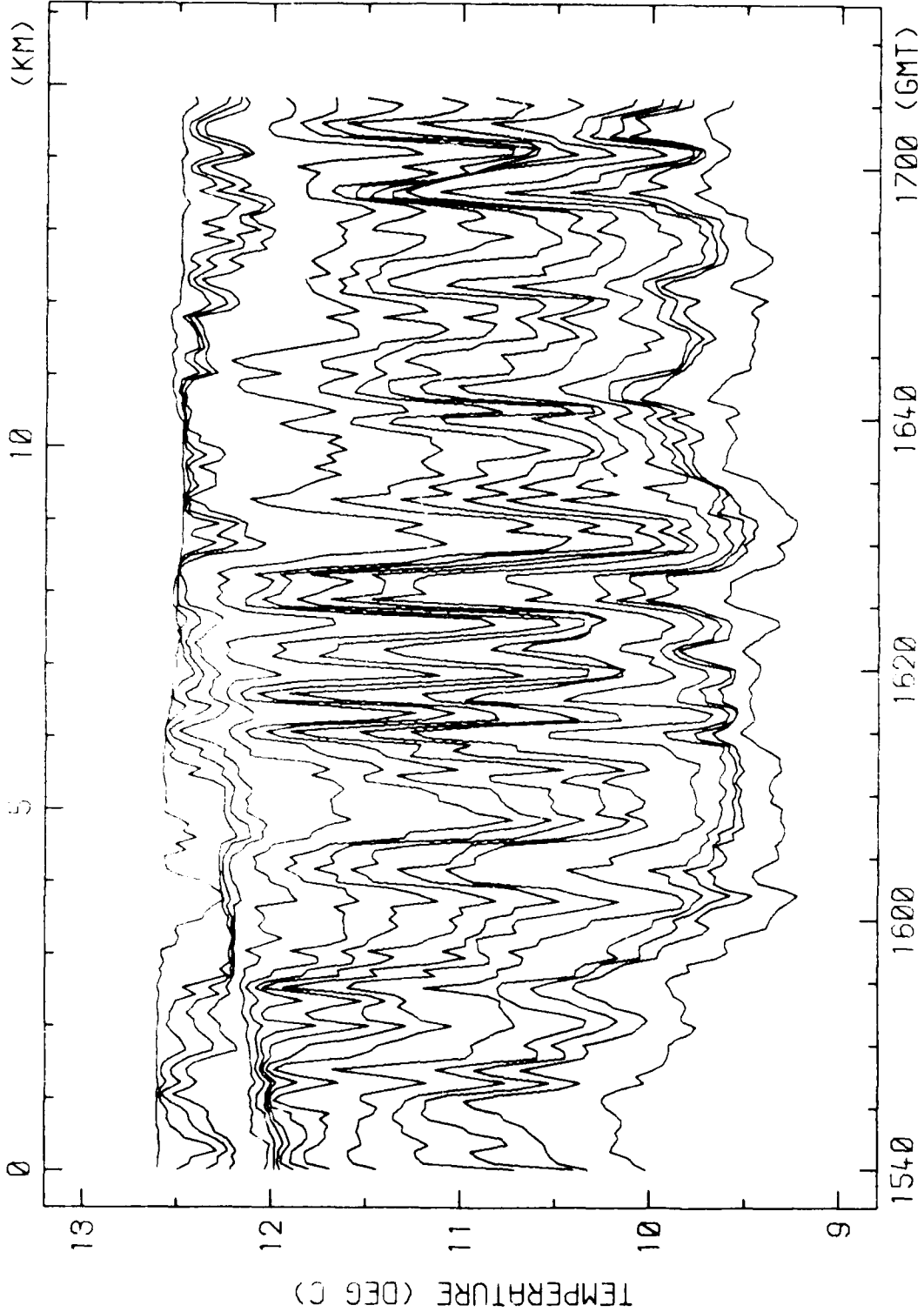

RUN SE-4 31-AUG-78 TEMPERATURE VS TIME/DISTANCE  
DEPTHS (M) 18, 6, 24, 5, 26, 5, 28, 5, 36, 5, 40, 6, 42, 6  
44, 6, 46, 7, 48, 7, 52, 8, 56, 9, 59, 10, 61, 10, 69, 13



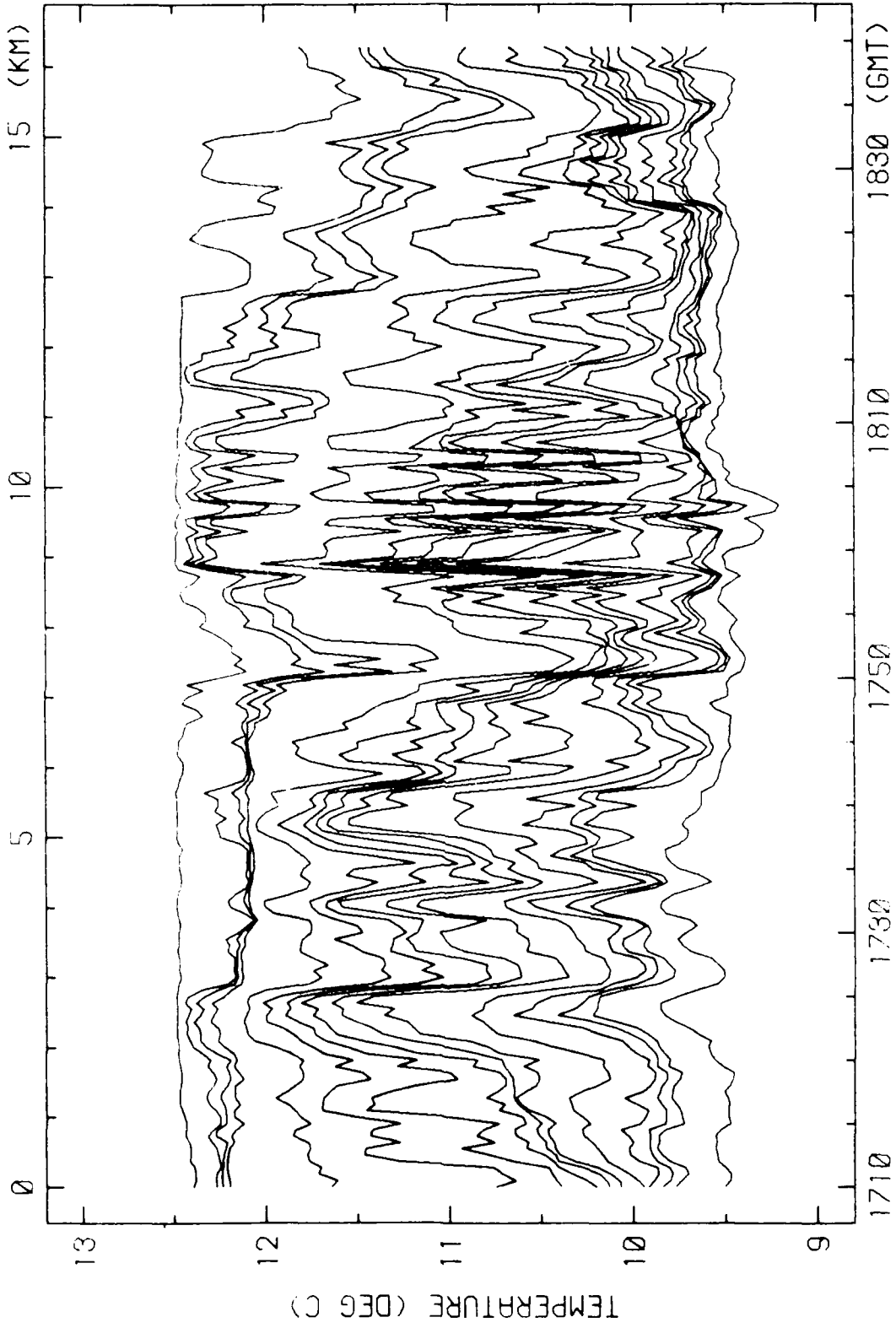

RUN 5N-5 31-AUG-78 TEMPERATURE VS TIME/DISTANCE  
DEPTHS (M) 18.6,24 5.26 5.28 5.36 5.40 6.42.6  
44 5.46 7.48 7.52 8.56 9.59 0.61 0.69.8

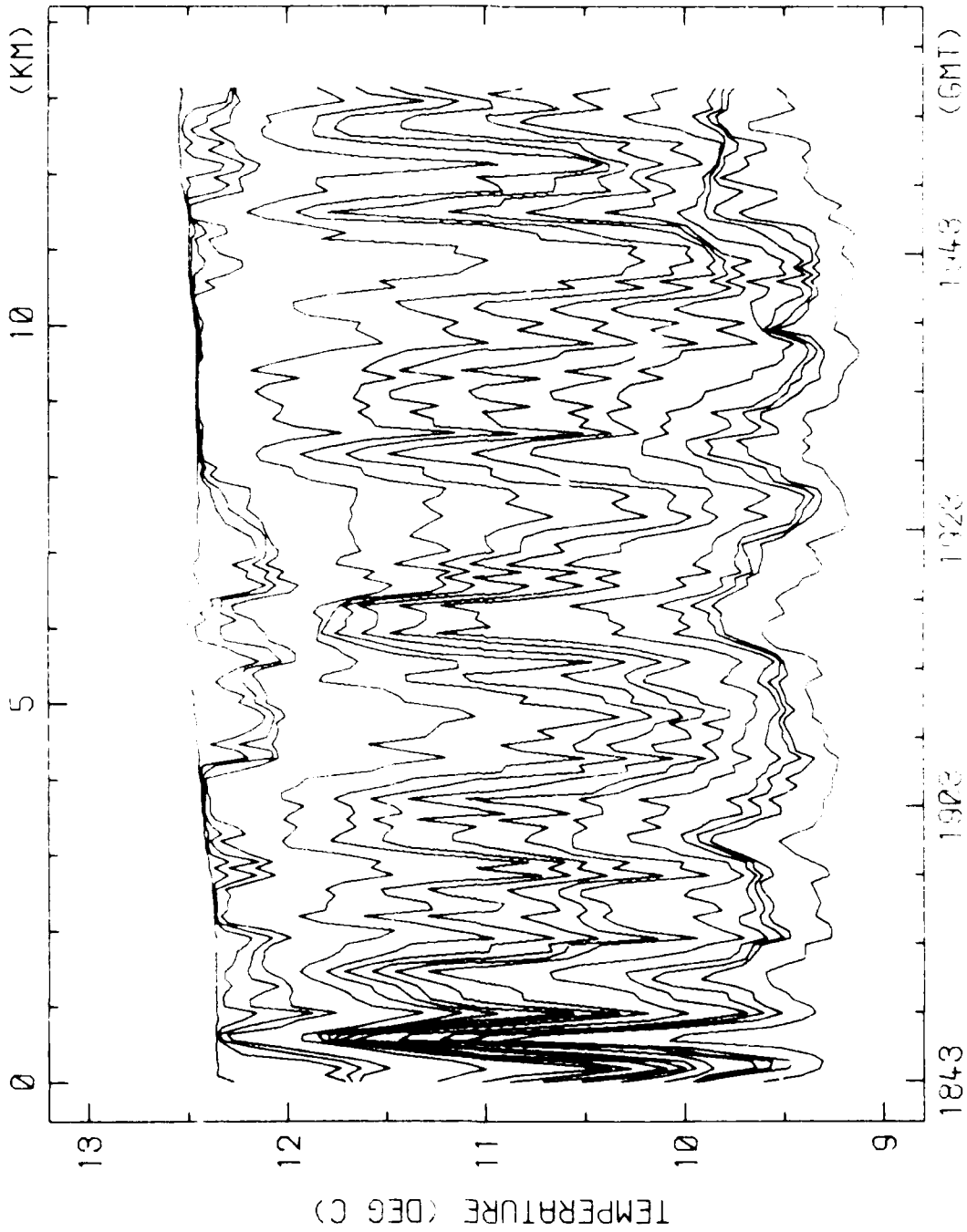

RUN SW-6 31-HUG-78 TEMPERATURE VS. TIME (CONTINUED)  
DEPTHS (M) 18 6.74 5.28 5.28 5.28 5.28 5.28 5.28 5.28  
44 6.46 7.42 7.52 8.58 8.58 8.58 8.58 8.58

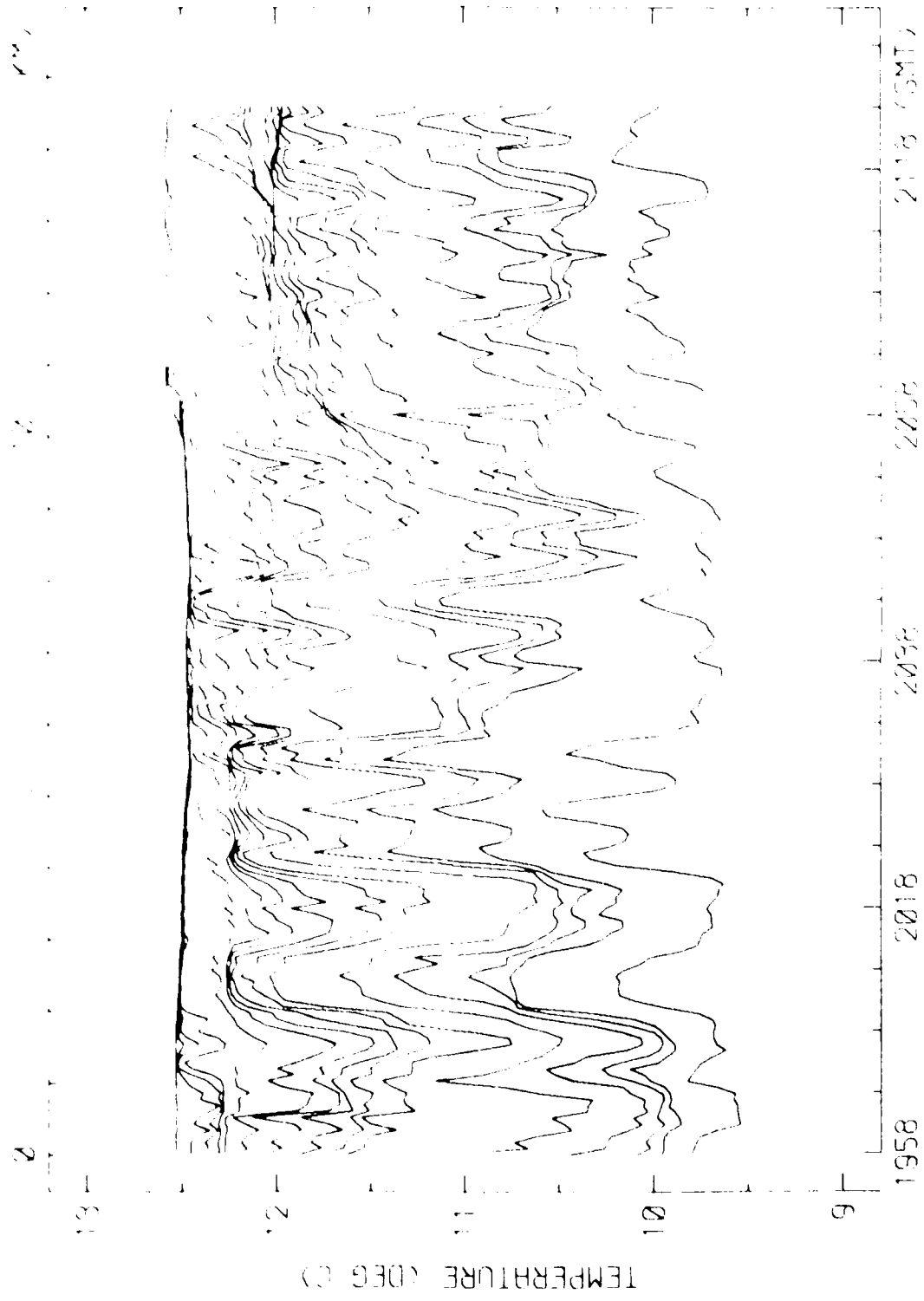

RUN 55-7 31-AUG-78 TEMPERATURE VS TIME/DISTANCE  
 DEPTHS (M) 18 6.24 5.26 5.28 5.36 5.40 6.42 6  
 44 6.46 7.48 7.52 8.56 9.59 0.61 0.69 3

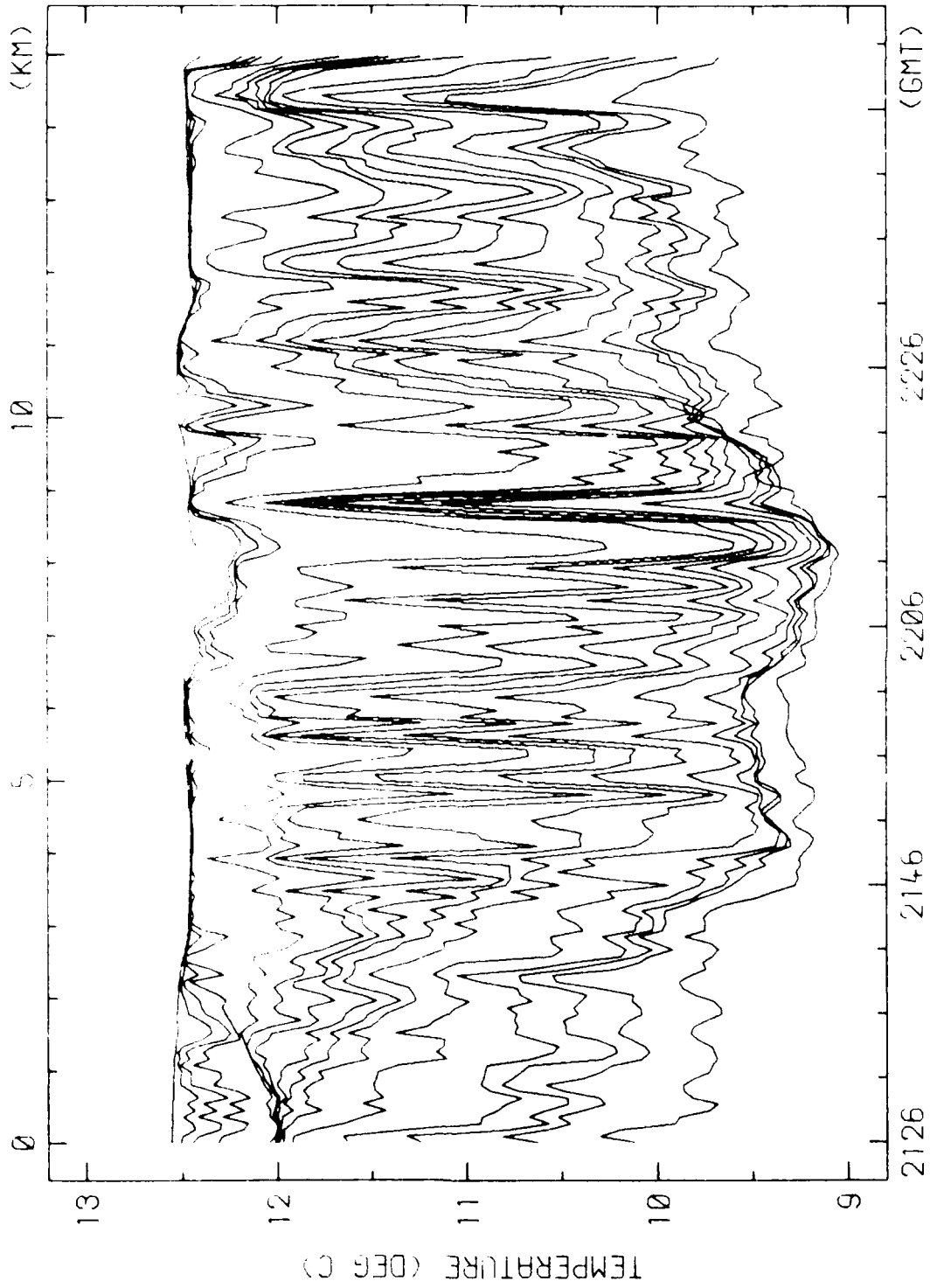

RUN SE-8 31-AUG-78 TEMPERATURE VS TIME/DISTANCE  
DEPTHS (M) 18, 6, 24, 5, 26, 5, 28, 5, 36, 5, 40, 6, 42, 6  
44, 6, 46, 7, 48, 7, 52, 8, 56, 9, 59, 0, 61, 0, 69, 3

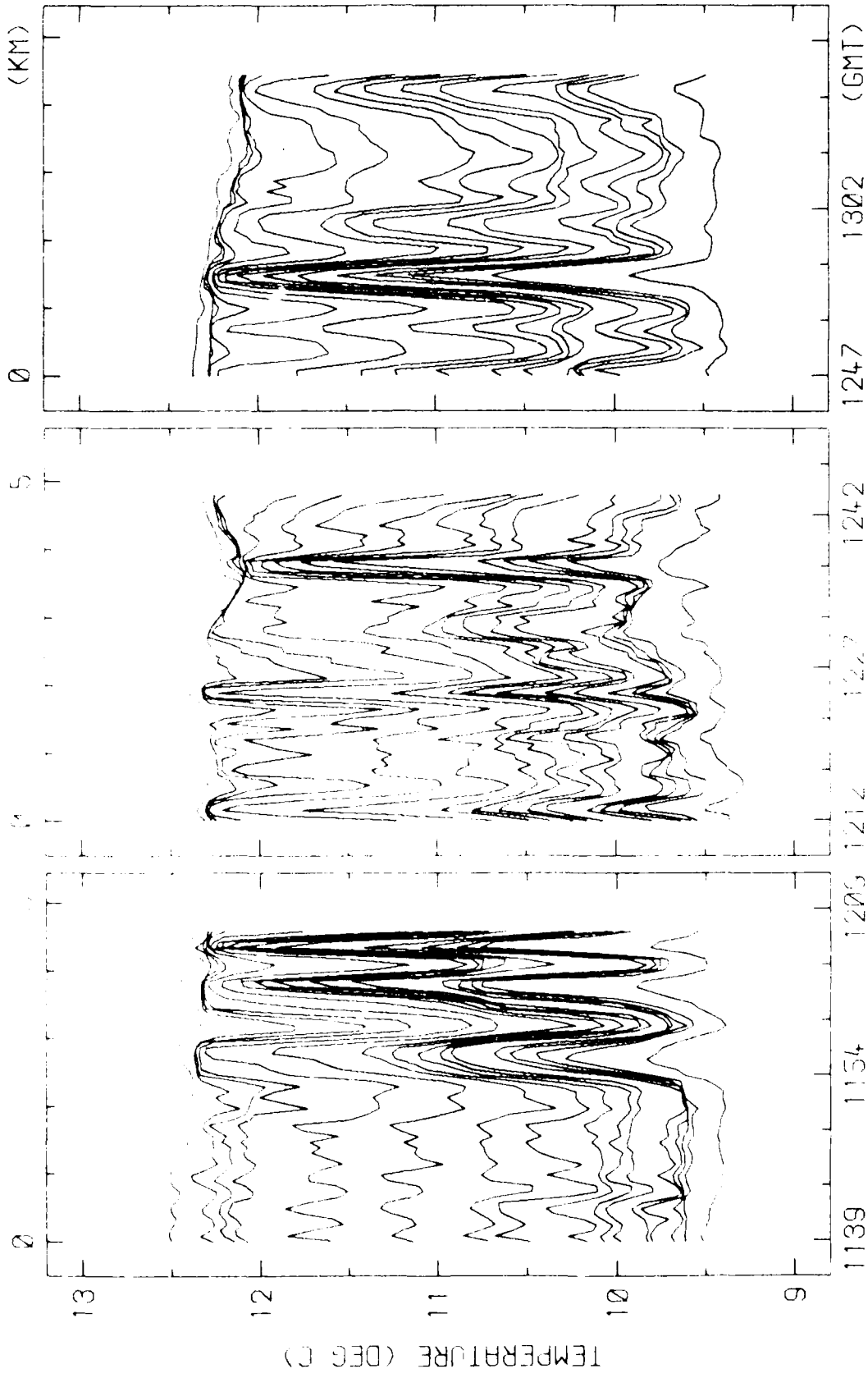

RUNS 6W-1, 6S-2, 6E-3 2-SEP-78 TEMPERATURE VS TIME/DISTANCE  
 DEPTH (M) 19 1,25 2,27 2,29 2,33 3,37 4,41 5  
 43 5,45 6,47 6,49 7,53 8,55 9,58 0,60 0,70 4

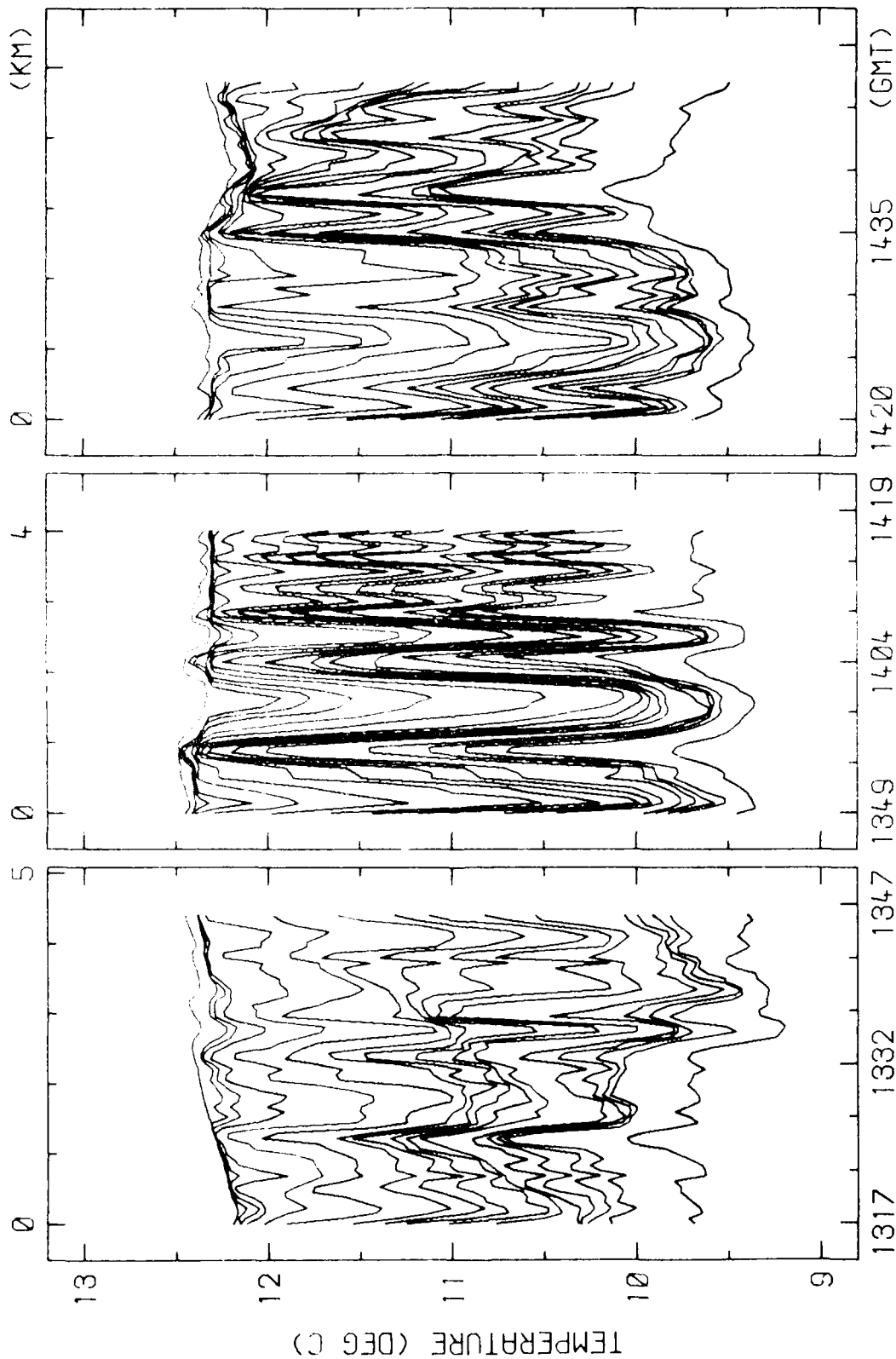

RUNS 6N-4, 6W-5, 6S-6 2-SEP-78 TEMPERATURE VS TIME/DISTANCE

DEPTHS (M) 19.1, 25.2, 27.2, 29.2, 33.3, 37.4, 41.5  
43.5, 45.6, 47.6, 49.7, 53.8, 55.9, 58.0, 60.0, 70.4

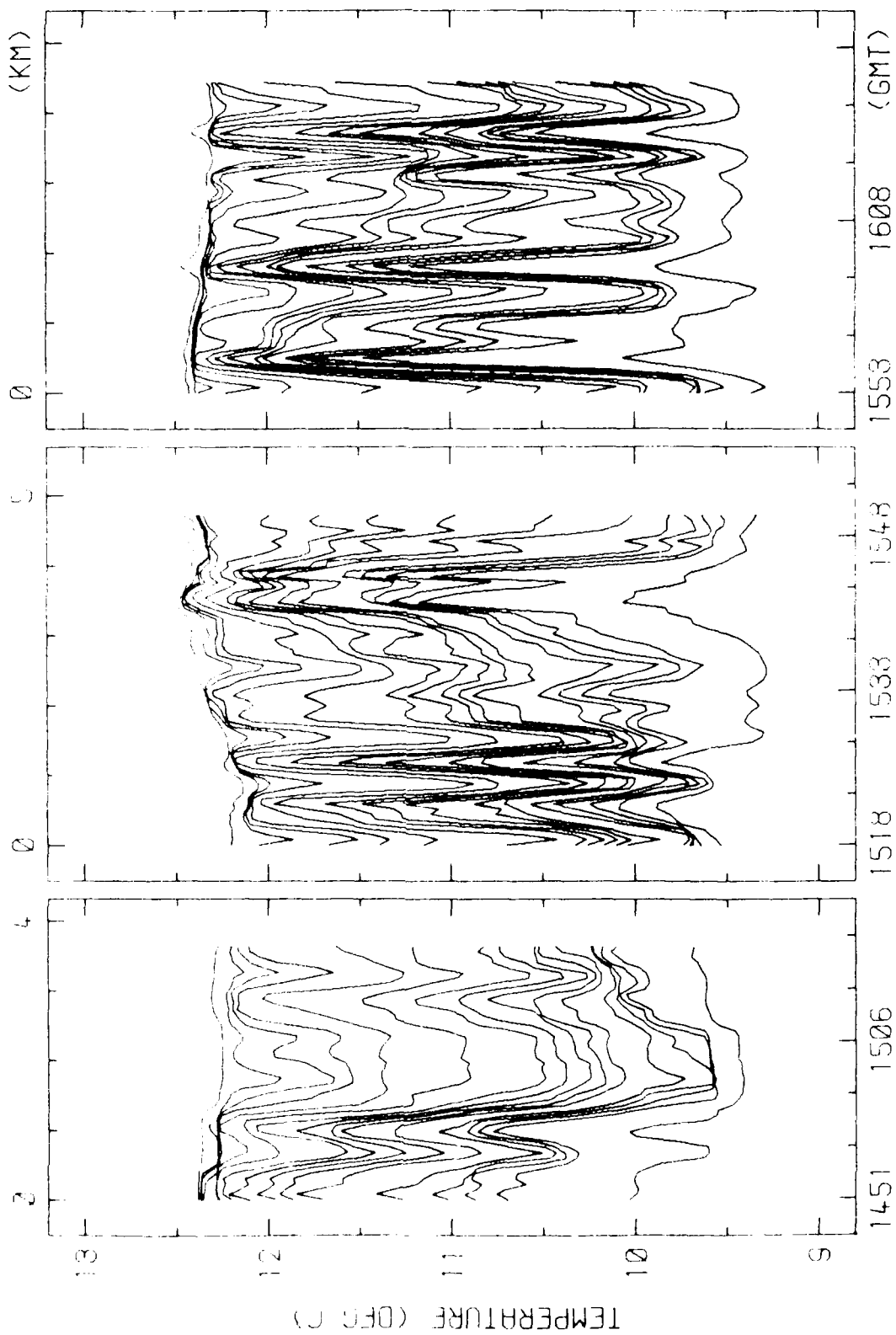

RUNS 6E-7, 6N-8, 6W-9 2-SEP-78 TEMPERATURE VS TIME/DISTANCE  
 DEPTHS (M) 19 1.25 2.27 2.29 2.38 3.37 4.41 5  
 43 5.45 6.47 6.49 7.53 8.55 9.58 0.60 0.70 4

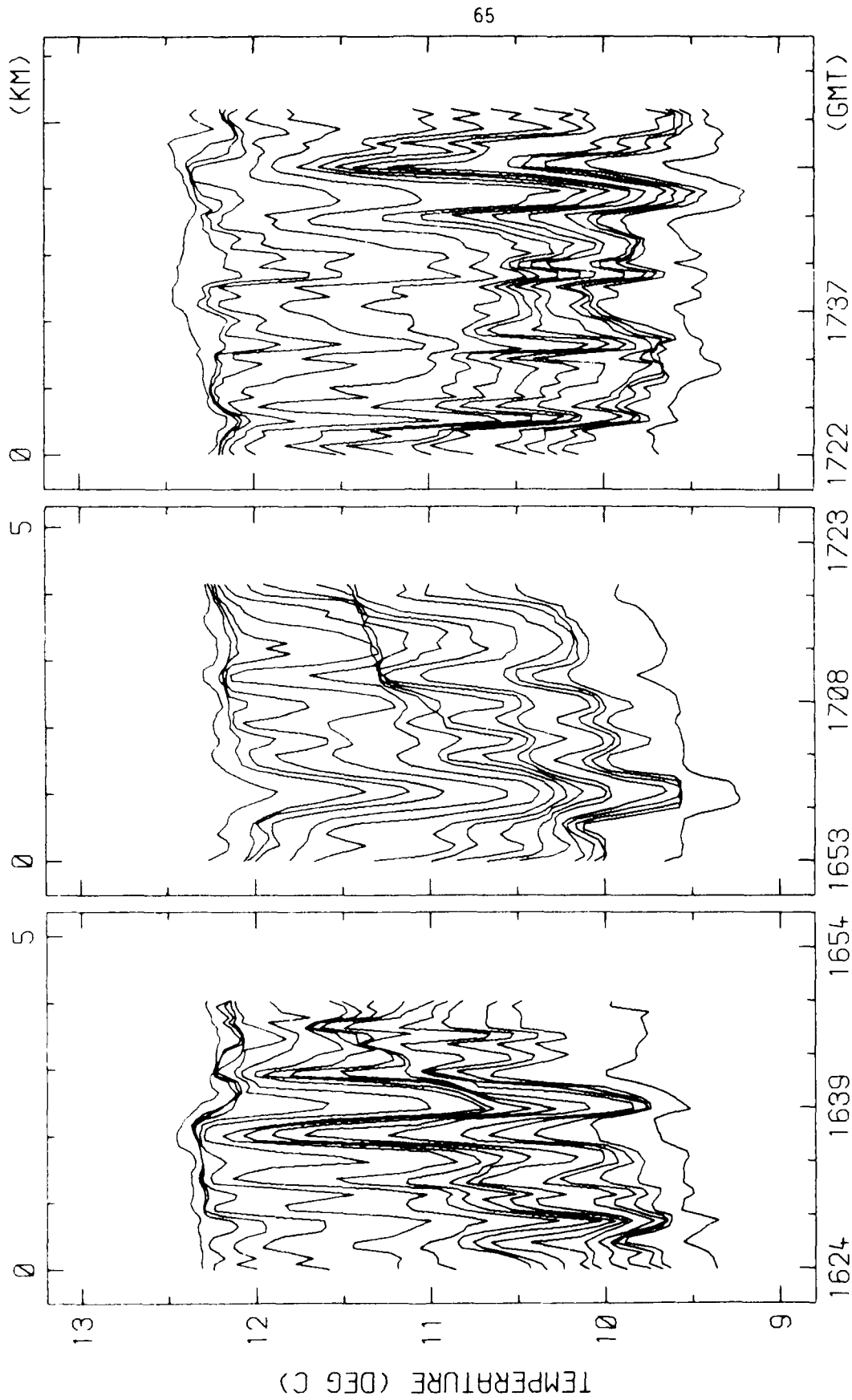

RUNS 6S-10, 6E-11, 6N-12 2-SEP-78 TEMPERATURE VS TIME/DISTANCE  
 DEPTHS (M) 19 1.25 2.27 2.29 2.33 3.37 4.41 5  
 43 5.45 6.47 6.49 7.53 8.55 9.58 0.60 0.70 4



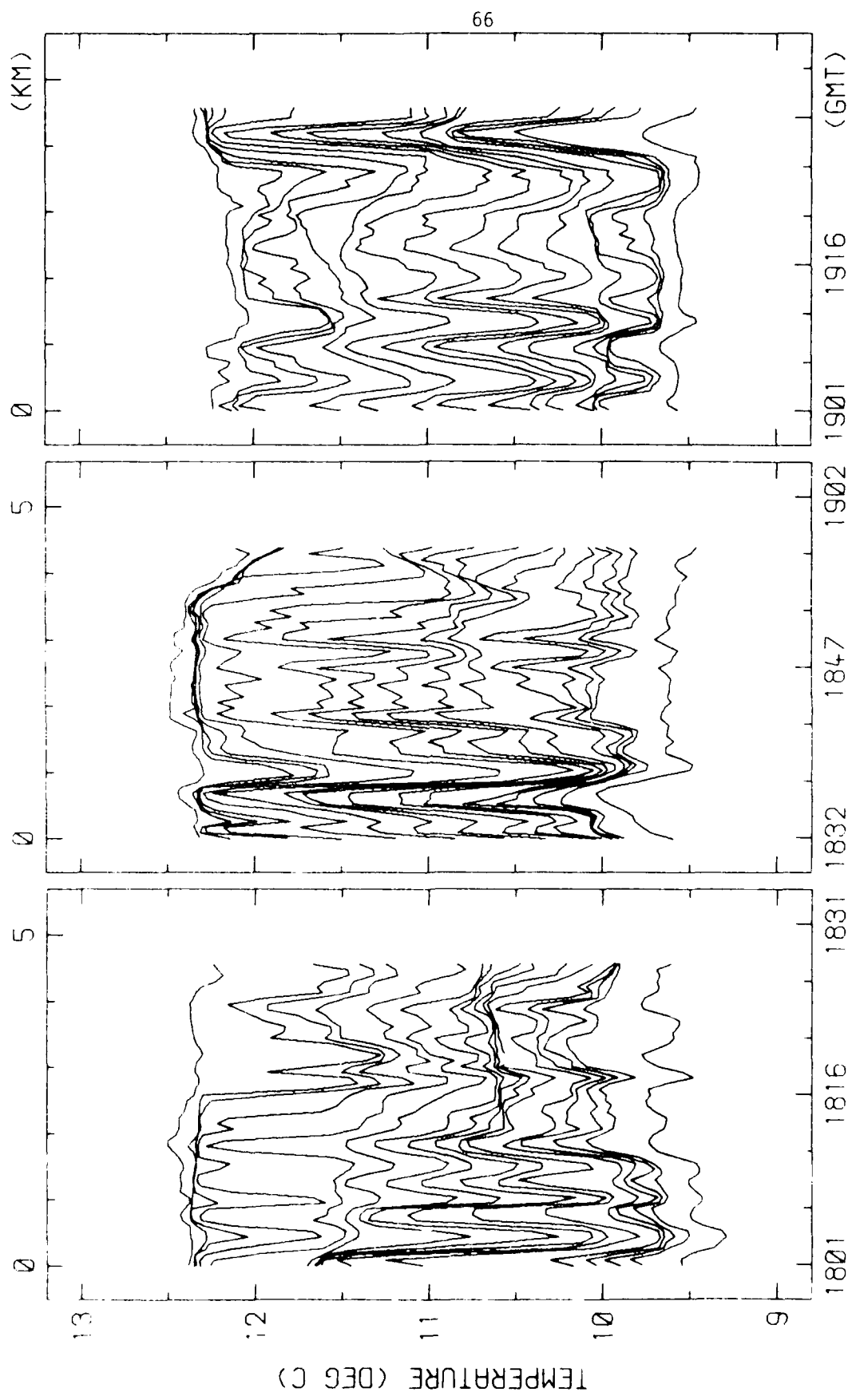

RUNS 6W-13, 6S-14, 6E-15 2-SEP-78 TEMPERATURE VS TIME/DISTANCE  
 DEPTHS (M) 19 1,25 2,27 2,29 2,33 3,37 4,41 5  
 43 5,45 6,47 6,49 7,53 8,55 9,58 0,60 0,70 4

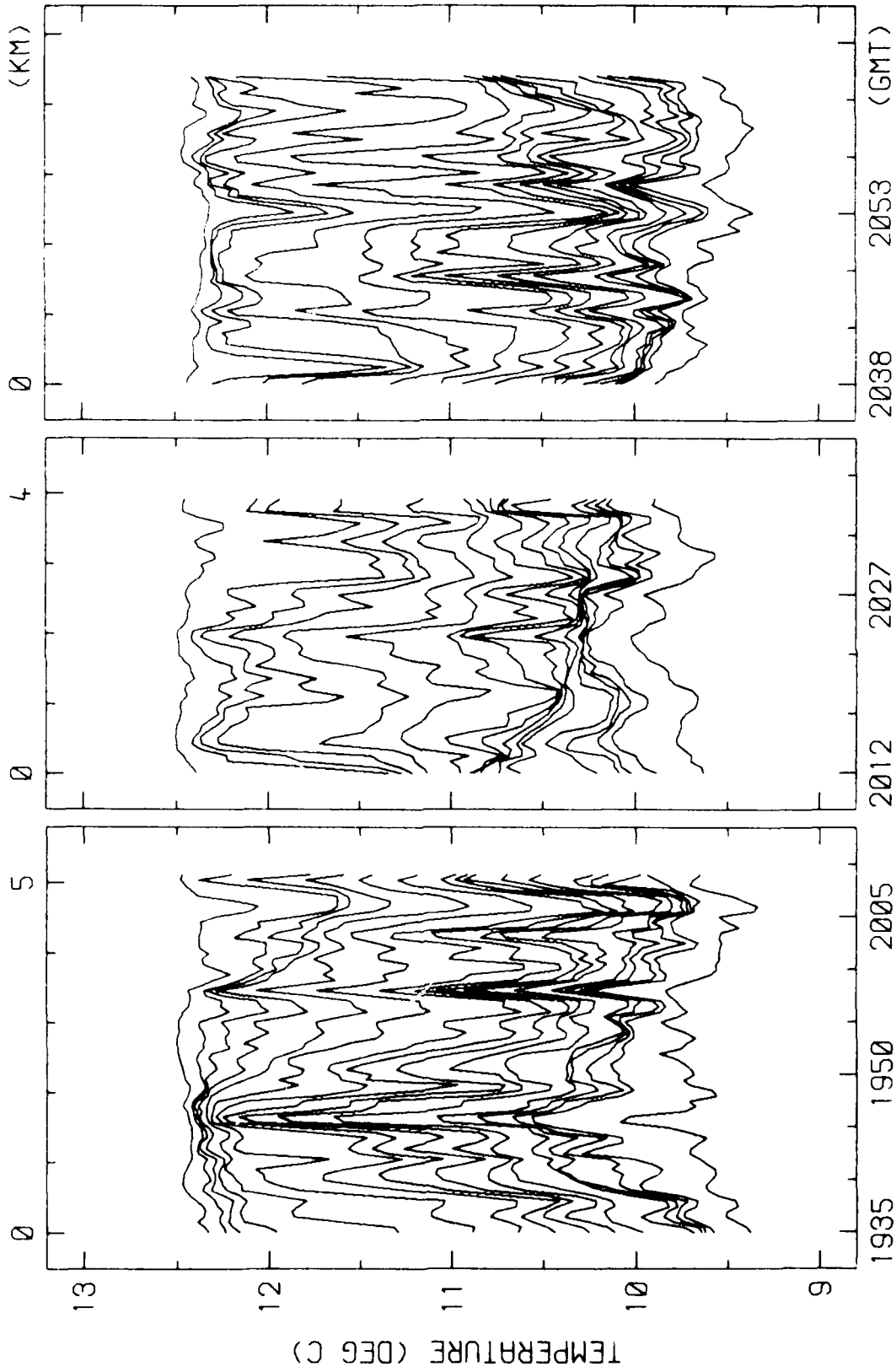

RUNS 6N-16, 6W-17, 6S-18 2-SEP-78 TEMPERATURE VS TIME/DISTANCE  
DEPTHS (M) 19 1,25 2,27 2,29 2,33 3,37 4,41 5  
43 5,45 6,47 6,49 7,53 8,55 9,58 0,60 0,70 4

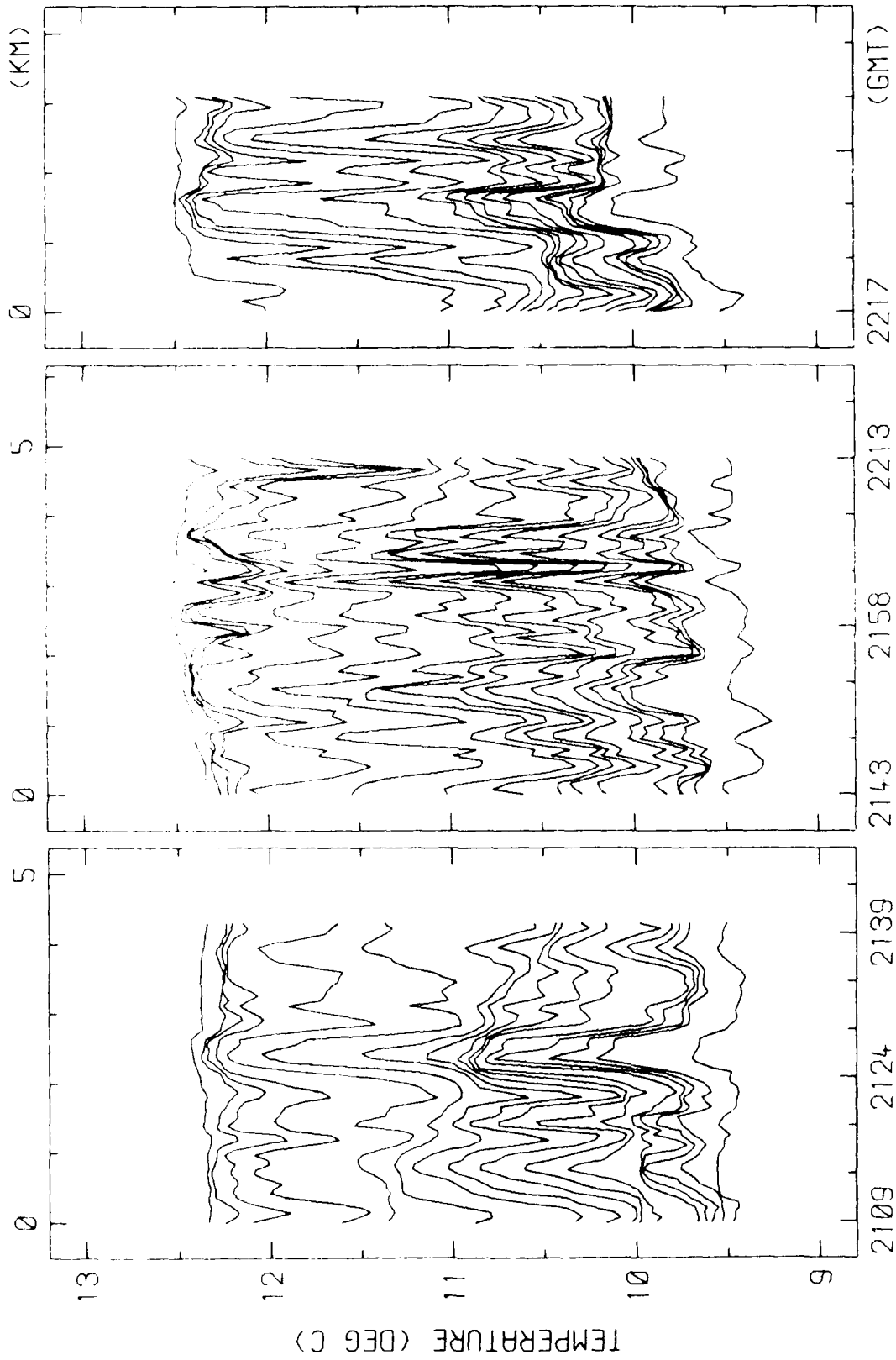

RUNS 6E-19, 6N-20, 6W-21 2-SEP-78 TEMPERATURE VS TIME/DISTANCE  
DEPTHS (M) 19 1.25 2.27 2.29 2.33 3.37 4.41 5  
43 5.45 6.47 6.49 7.53 8.55 9.58 0.60 0.70 4

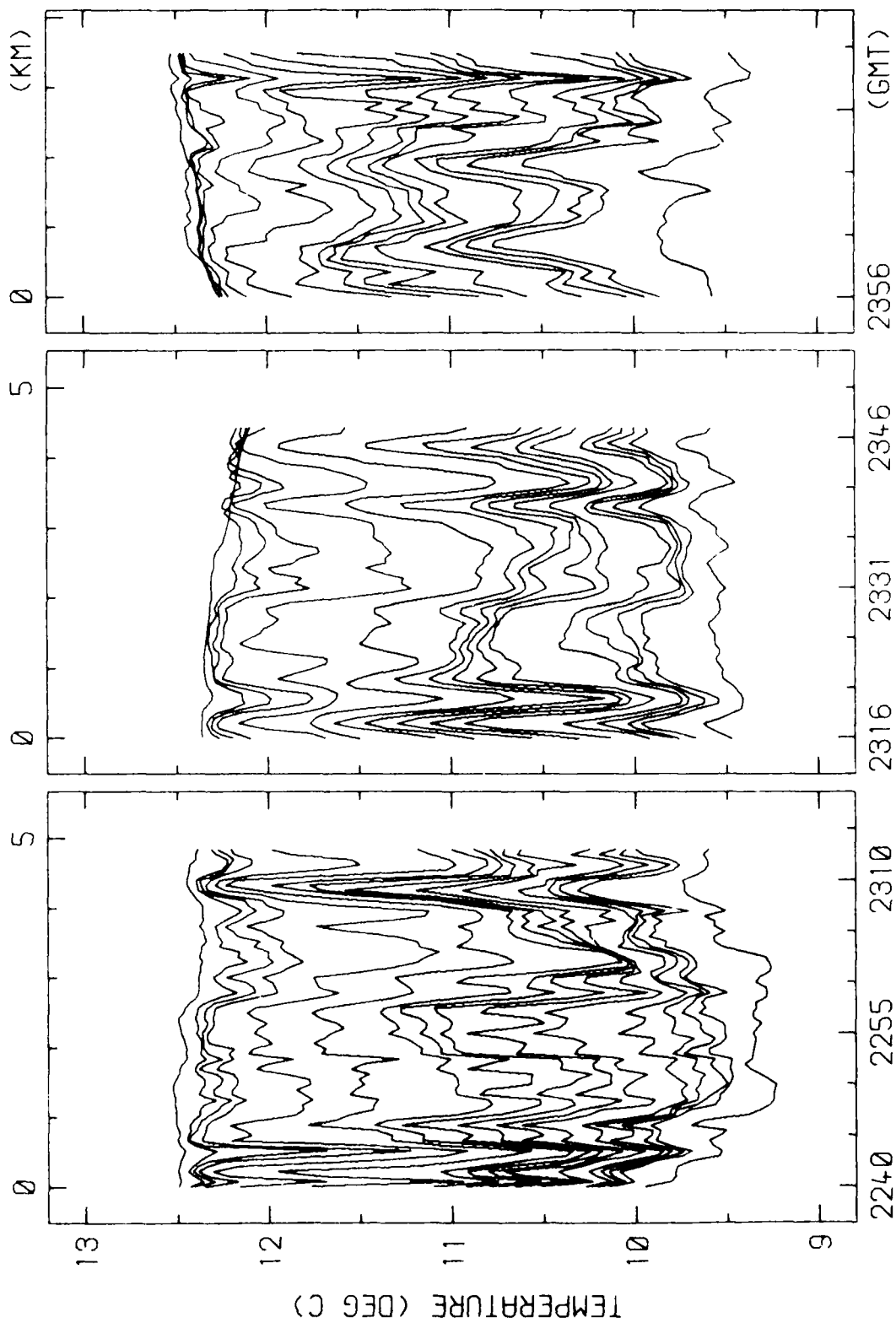

RUNS 6S-22, 6E-23, 6N-24 2-SEP-78 TEMPERATURE VS TIME/DISTANCE  
 DEPTHS (M) 19.1, 25 2, 27 2, 29 2, 33 3, 37 4, 41 5  
 43 5, 45 6, 47 6, 49 7, 53 8, 55 9, 58 0, 60 0, 70 4

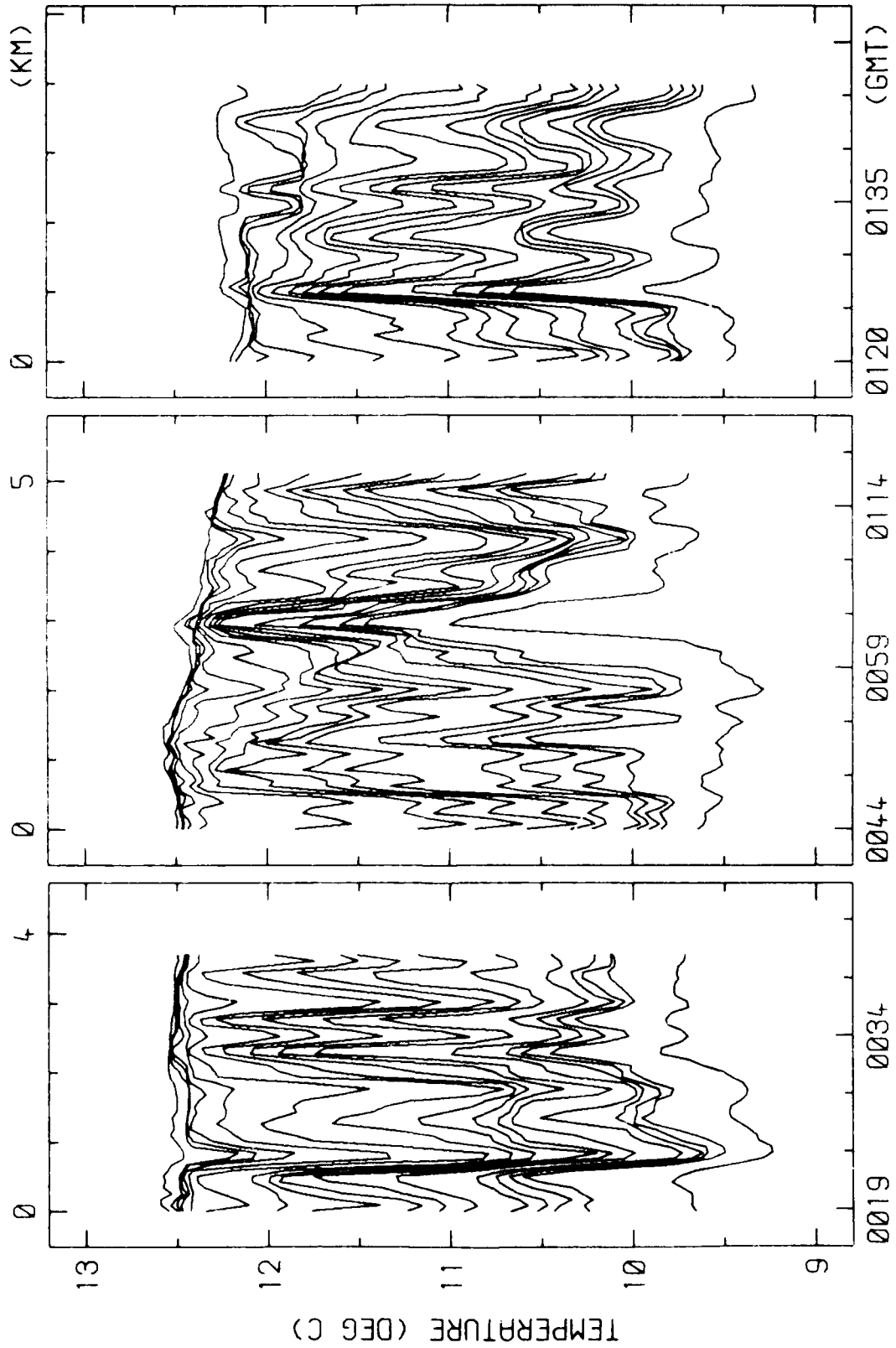

RUNS 6W-25, 6S-26, 6E-27 3-SEP-78 TEMPERATURE VS TIME/DISTANCE  
DEPTHS (M) 19.1, 25 2, 27 2, 29 2, 33 3, 37 4, 41.5  
43 5, 45 6, 47 6, 49 7, 53 8, 55 9, 58 0, 60 0, 70 4

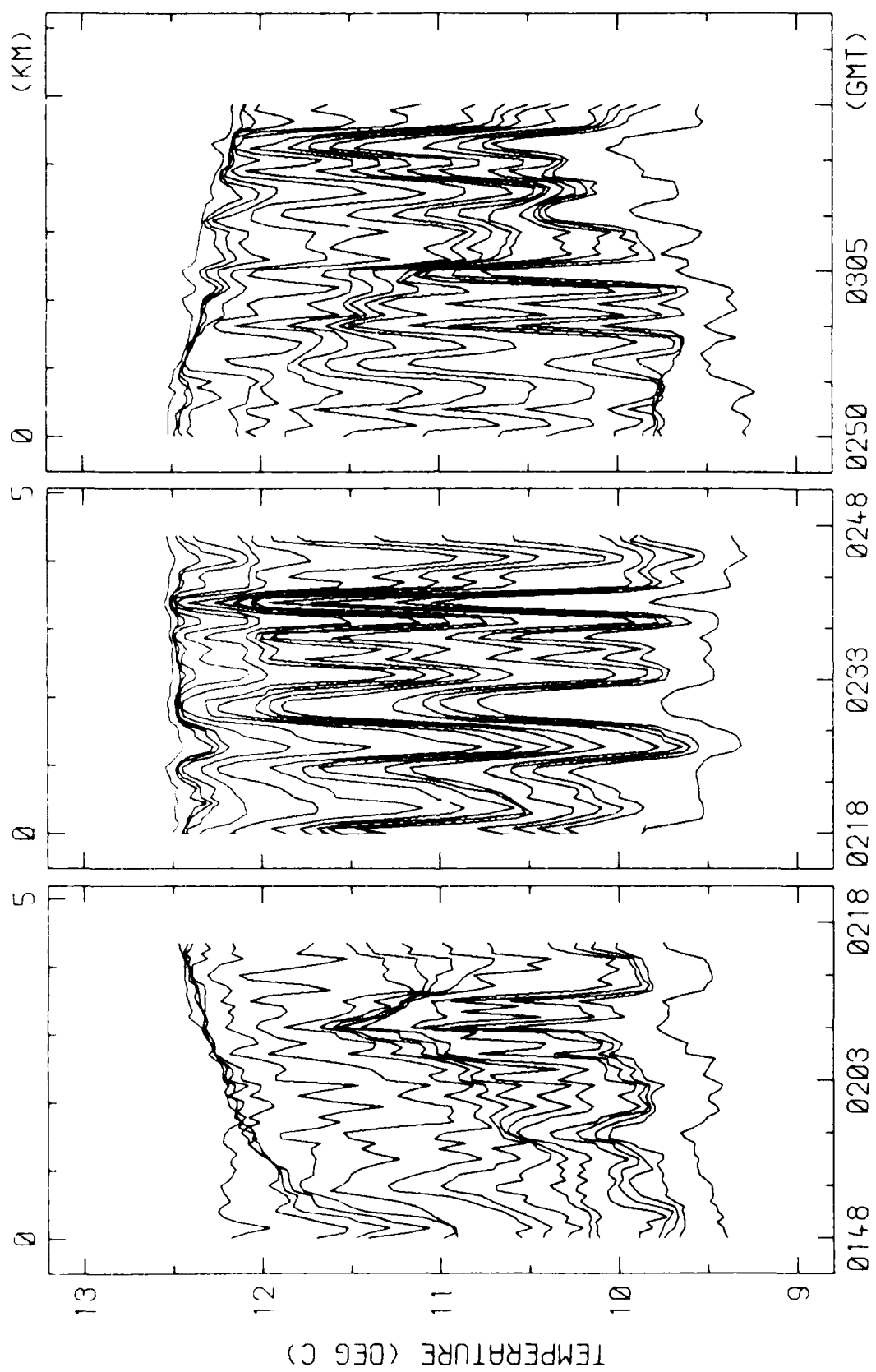

RUNS 6N-28, 6W-29, 6S-30 3-SEP-78 TEMPERATURE VS TIME/DISTANCE  
 DEPTHS (M) 19 1,25 2,27 2,29 2,33 3,37 4,41 5  
 43 5,45 6,47 6,49 7,53 8,55 9,58 0,60 0,70 4

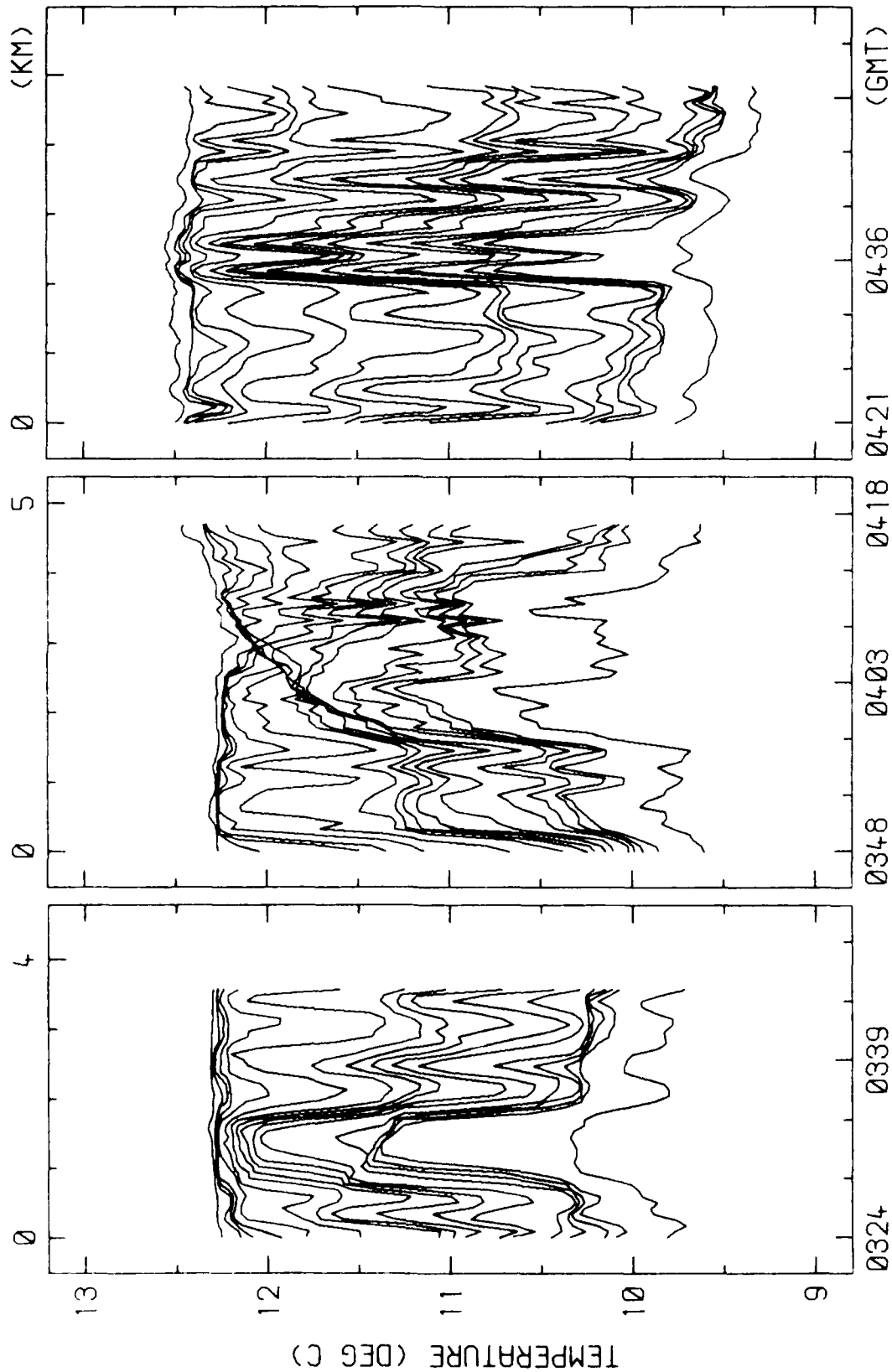

RUNS 6E-31, 6N-32, 6W-33 3-SEP-78 TEMPERATURE VS TIME/DISTANCE  
DEPTHS (M) 19.1, 25.2, 27.2, 29.2, 33.3, 37.4, 41.5  
43.5, 45.6, 47.6, 49.7, 53.8, 55.9, 58.0, 60.0, 70.4

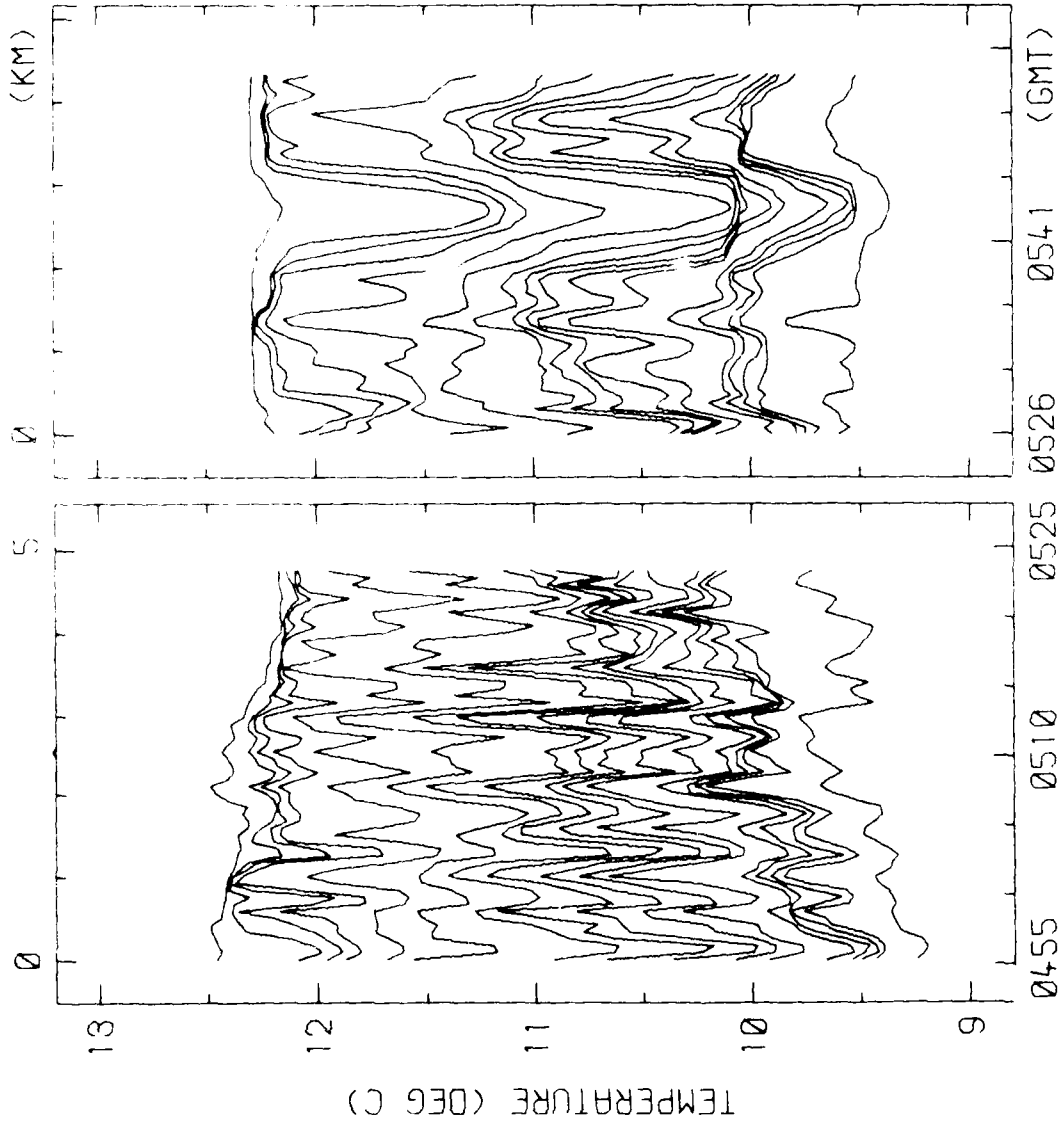

RUNS 6S-34, 6E-35 3-SEP-78 TEMPERATURE VS TIME/DISTANCE  
 DEPTHS (M) 19 1.25 2.27 2.29 2.38 3.37 4.41 5  
 43 5.45 6.47 6.49 7.53 8.55 9.58 0.60 0.70 4



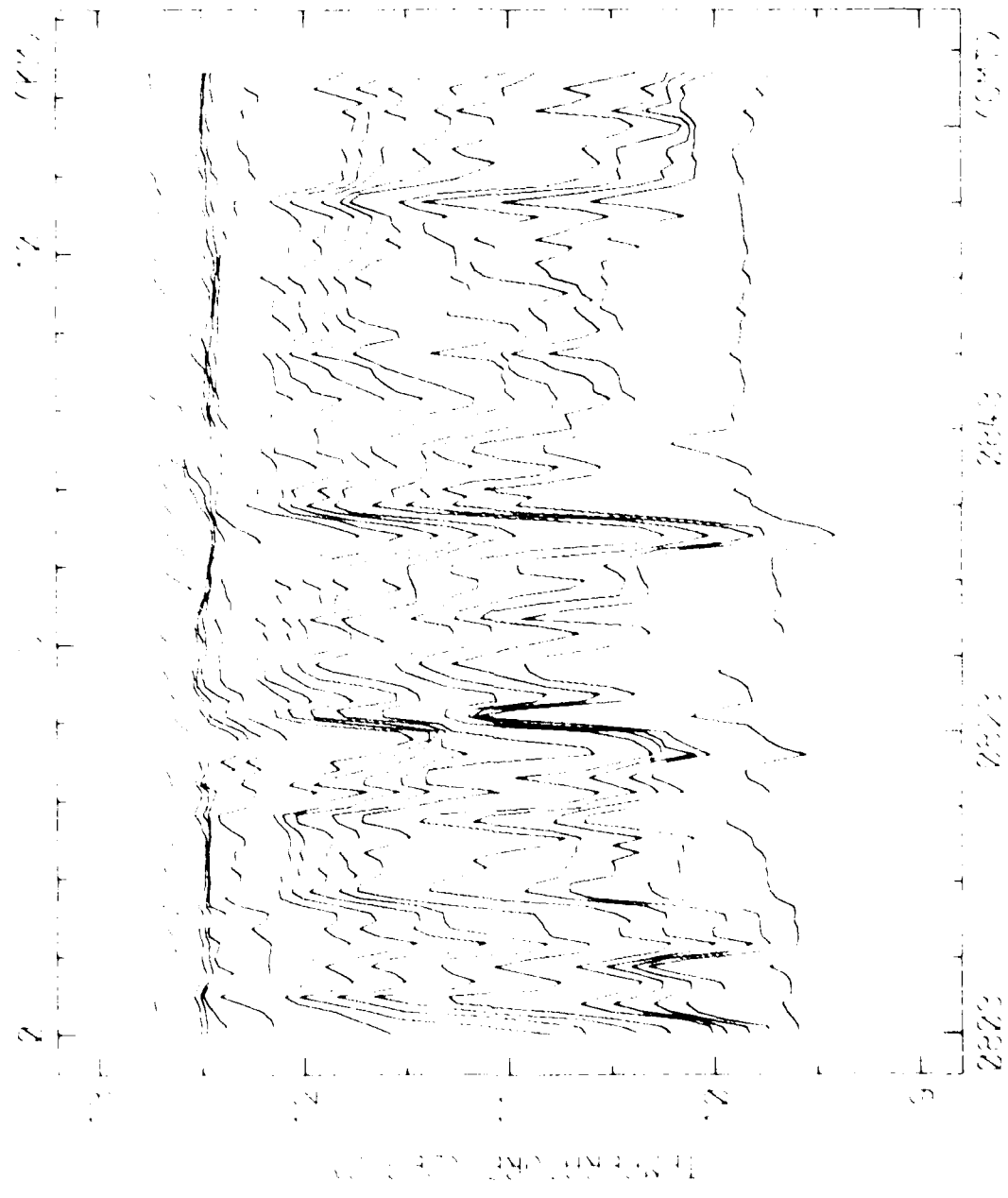

JULY 75: 4-SEP-78 TEMPERATURE IN METERS  
 34 2.36 2.38 2.42 1.44 2.48 2.48 2.48  
 35 2.36 2.38 2.42 1.44 2.48 2.48 2.48

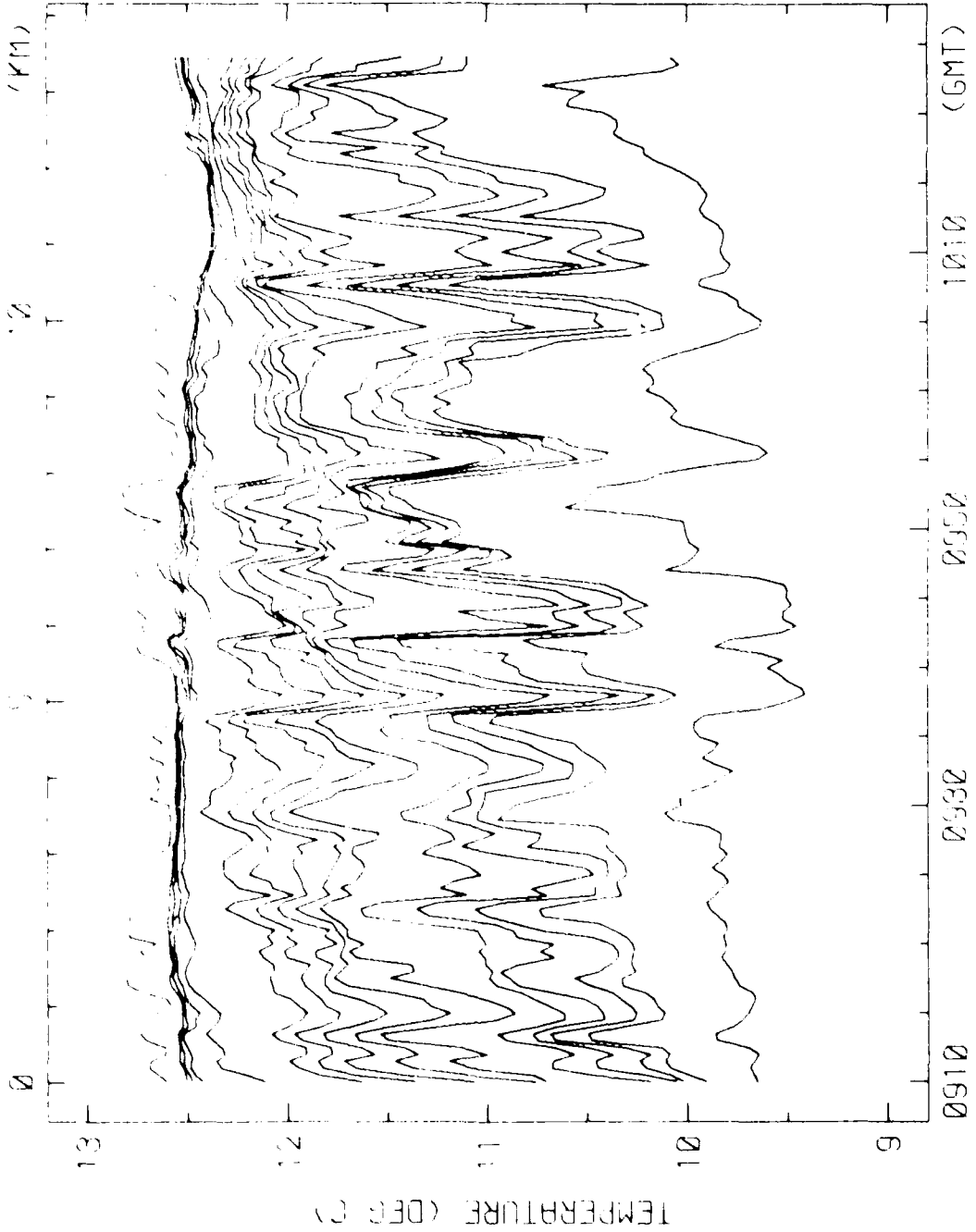

RUN 7E-2 4-SEP-78 TEMPERATURE VS TIME, DISTANCE

DEPTHS (M) 7, 13, 18, 27, 37, 47, 57, 67, 77, 87, 97, 107, 117, 127, 137, 147, 157, 167, 177, 187, 197, 207, 217, 227, 237, 247, 257, 267, 277, 287, 297, 307, 317, 327, 337, 347

34 0.36 0.38 0.42 1.44 2.45 2.48 3.58 6

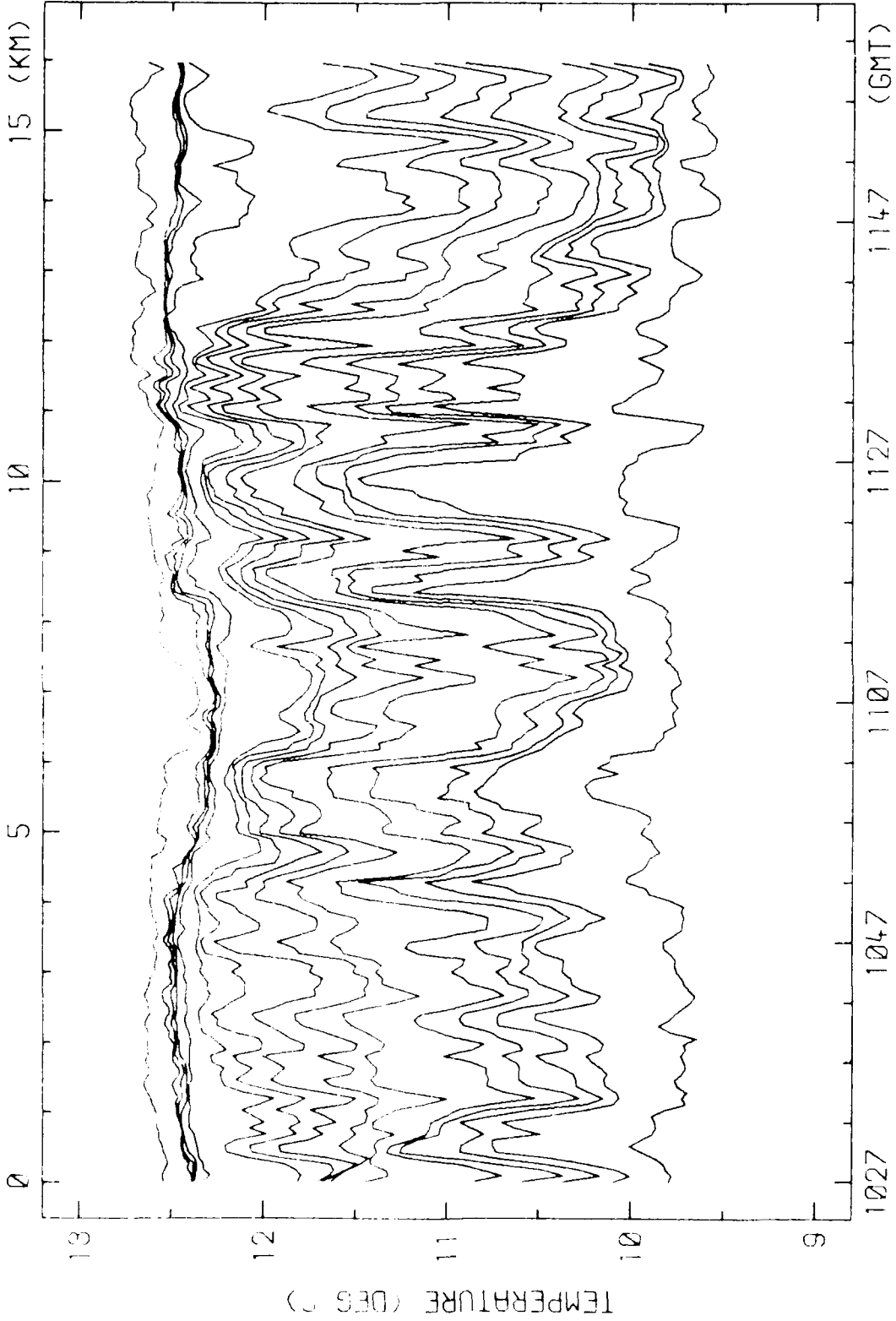

RUN 7N-3 4-SEP-78 TEMPERATURE VS TIME/DISTANCE  
DEPTHS (M) 7.9, 13.8, 15.8, 17.8, 21.8, 29.9, 31.9  
34.0, 36.0, 38.0, 42.1, 44.2, 46.2, 48.3, 58.6

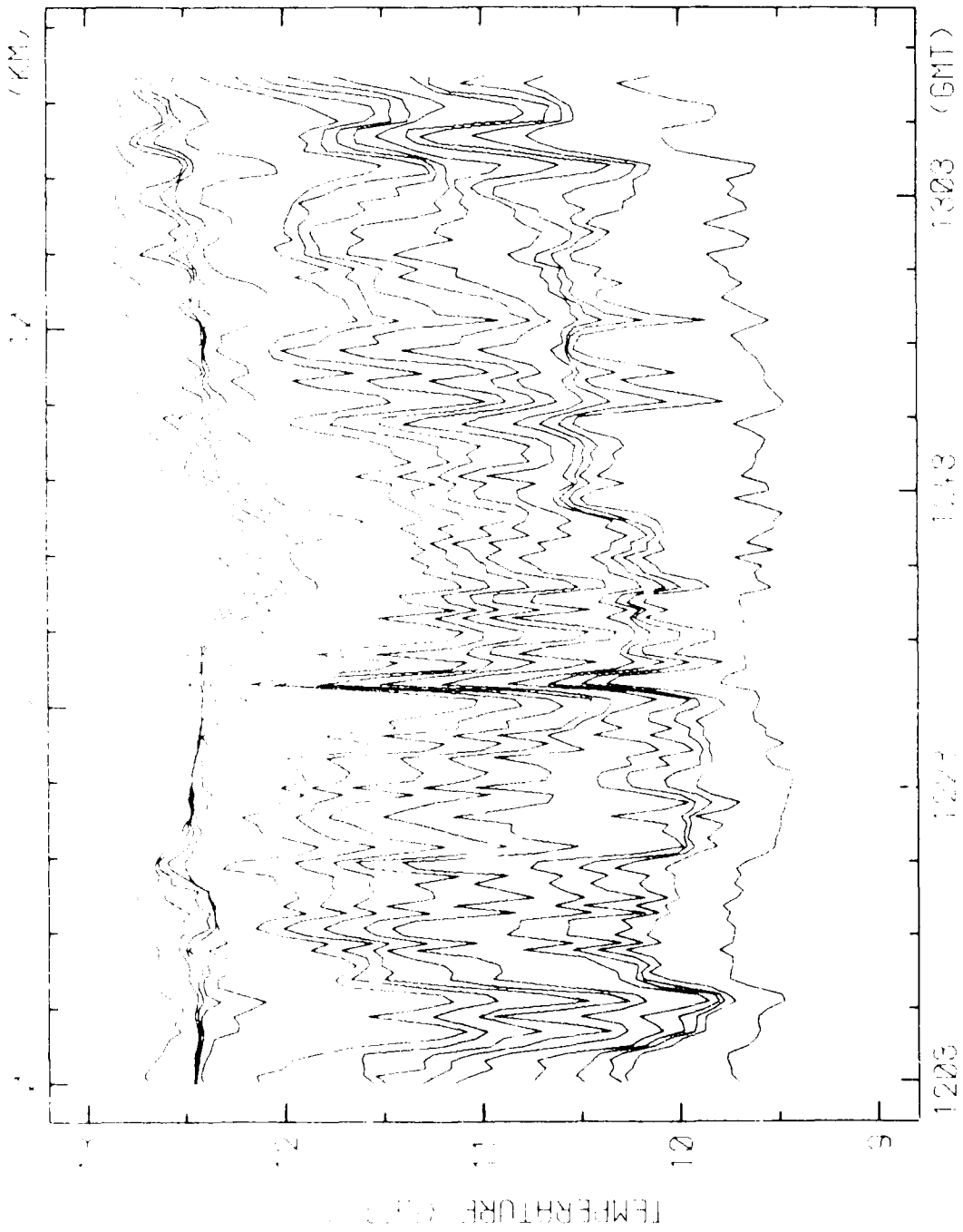

RUN 7W-4 4-SEP-78 TEMPERATURE VS TIME/DISTANCE  
DEPTHS (M) 7, 3, 13, 8, 15, 8, 17, 8, 21, 8, 29, 9, 31, 9  
34 0, 36 0, 38 0, 42 1, 44 2, 46 2, 48 2, 50 4

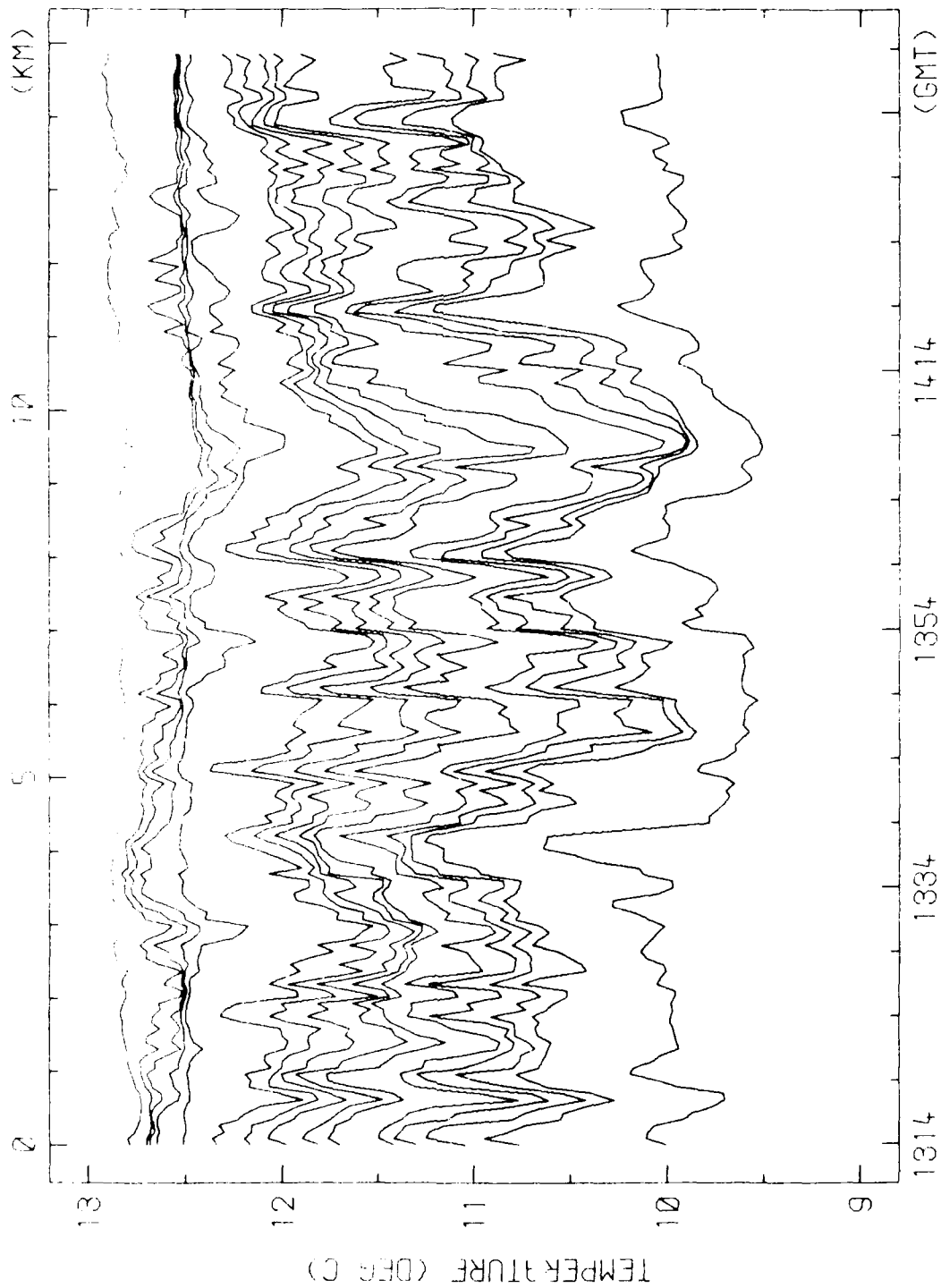

RUN 7S-5 4-SEP-78 TEMPERATURE VS TIME/DISTANCE  
DEPTHS (M) 7 9, 13, 8, 15, 8, 17, 8, 21, 8, 29, 9, 31, 9  
34 0, 36, 0, 38, 0, 42, 1, 44, 2, 46, 2, 48, 3, 56, 6

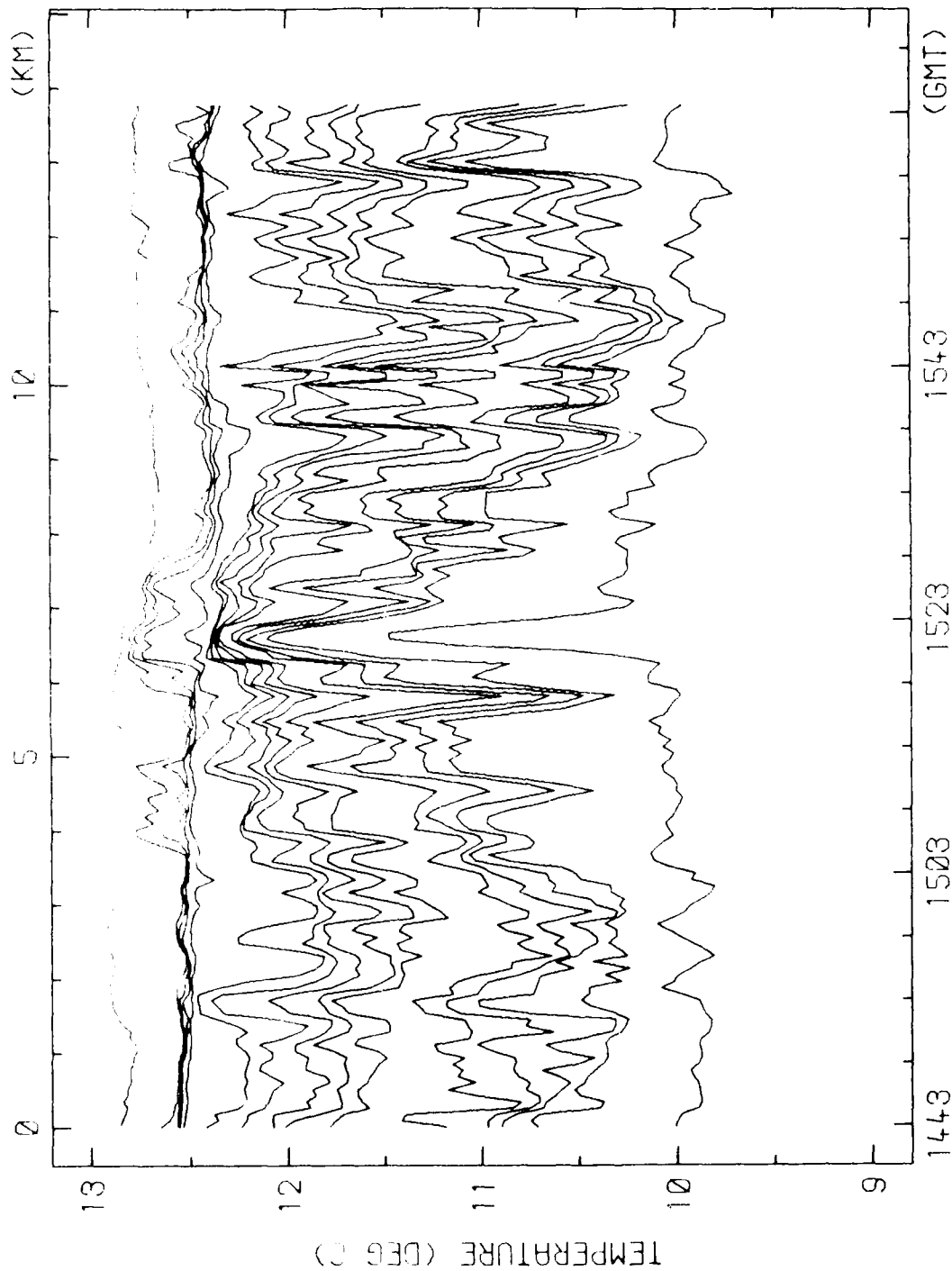

RUN 7E-6 4-SEP-78 TEMPERATURE VS TIME/DISTANCE  
DEPTHS (M) 7.9, 13.8, 15.8, 17.8, 21.8, 29.9, 31.9  
34.0, 36.0, 38.0, 42.1, 44.2, 46.2, 48.3, 58.6

1443 1503 1523 1543 (GMT)

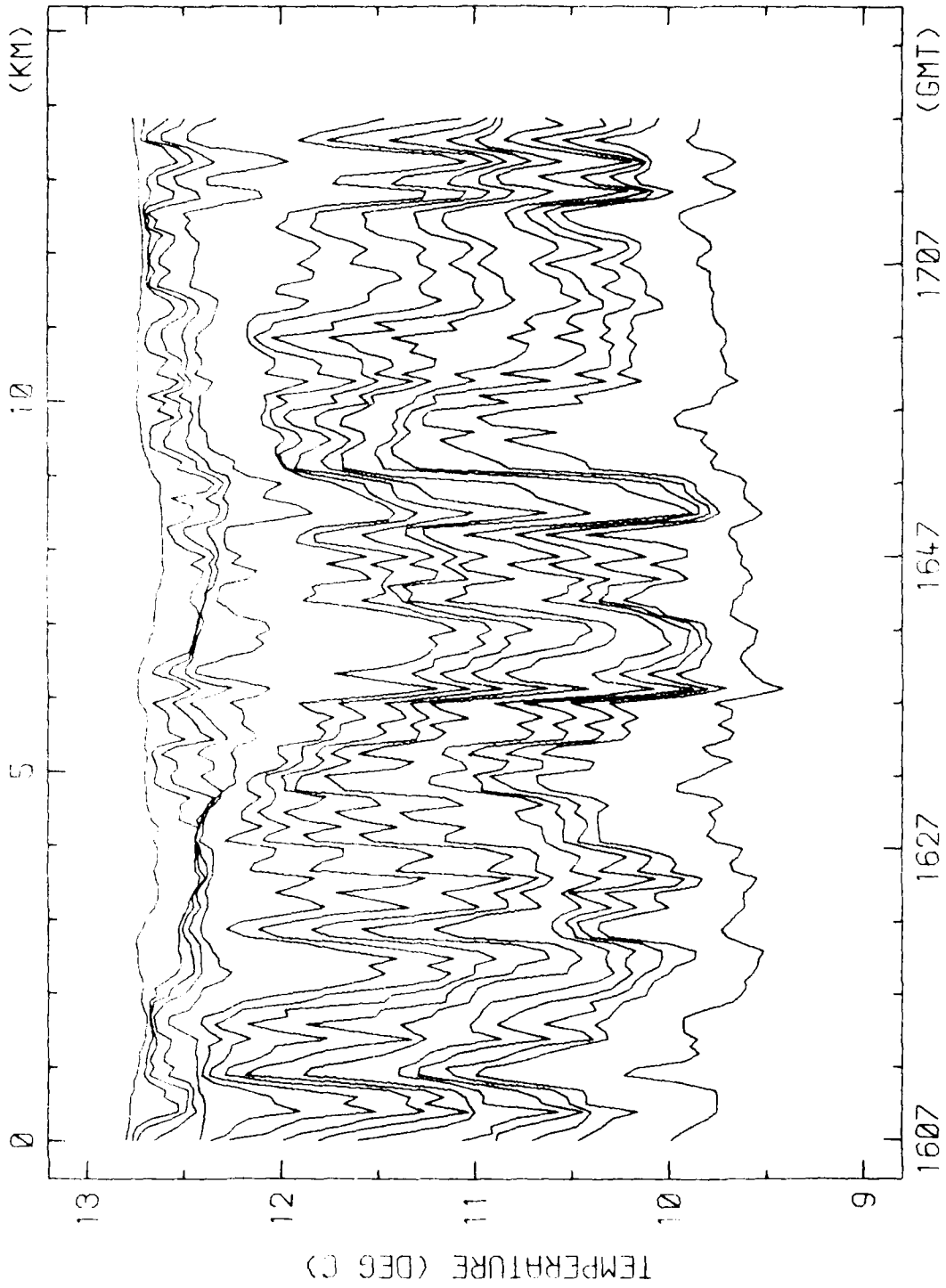

RUN 7N-7 4-SEP-78 TEMPERATURE VS TIME/DISTANCE  
DEPTHS (M) 7.9, 13.8, 15.8, 17.8, 21.8, 29.9, 31.9  
34.0, 36.0, 38.0, 42.1, 44.2, 46.2, 48.3, 58.6

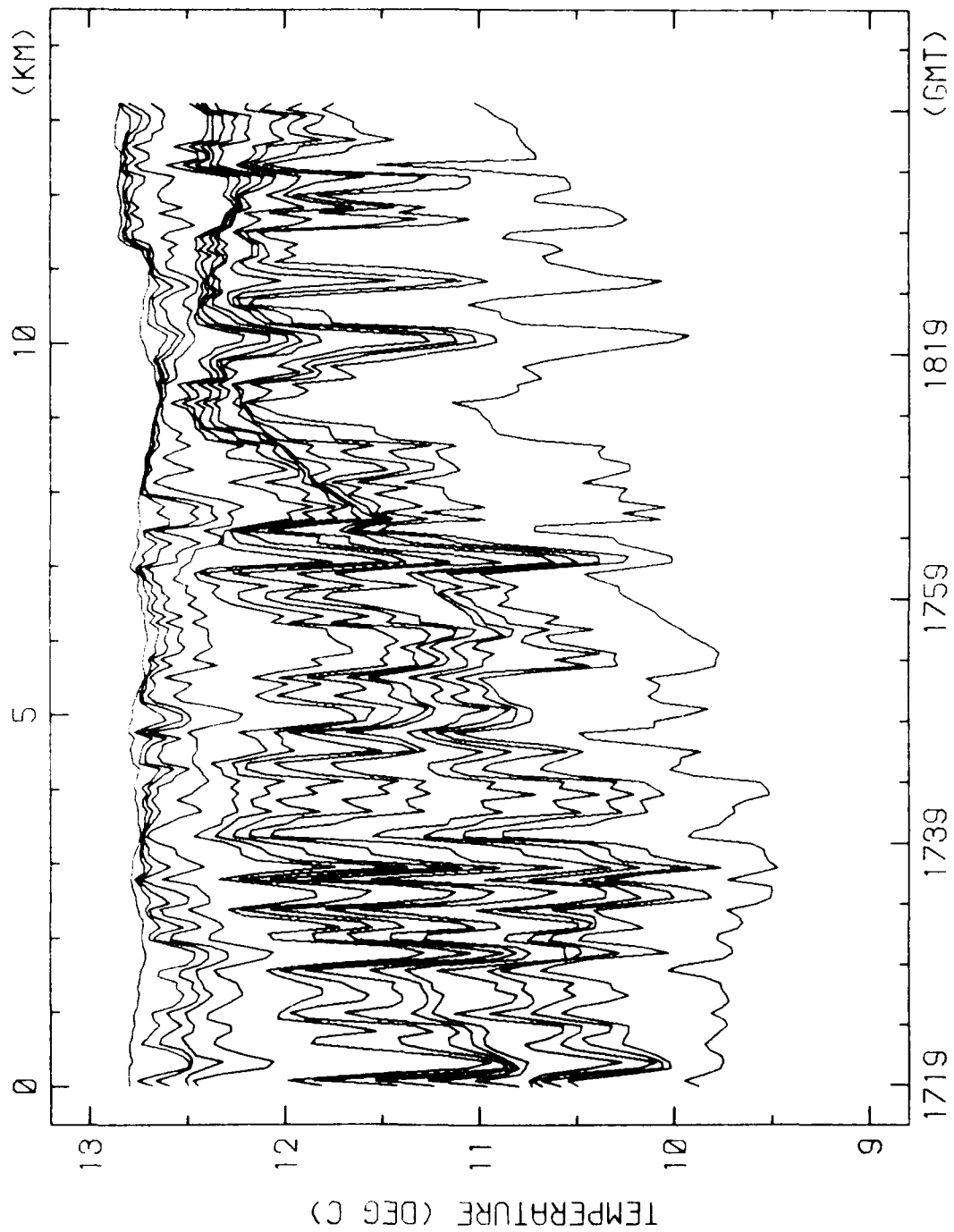

RUN 7W-8 4-SEP-78 TEMPERATURE VS TIME/DISTANCE  
DEPTHS (M) 7, 9, 13, 8, 15, 8, 17, 8, 21, 8, 29, 9, 31, 9



## ISOTHERM CROSS-SECTIONS

On the following pages there are plots of isotherms at 0.2°C intervals which were obtained by linear interpolation between the low-pass filtered temperature observations shown in the previous section. Isotherms which were not at least 80% complete were not plotted. Isotherms which were incomplete, but had no more than 20% of the record missing, were completed by linear extrapolation from adjacent isotherms.

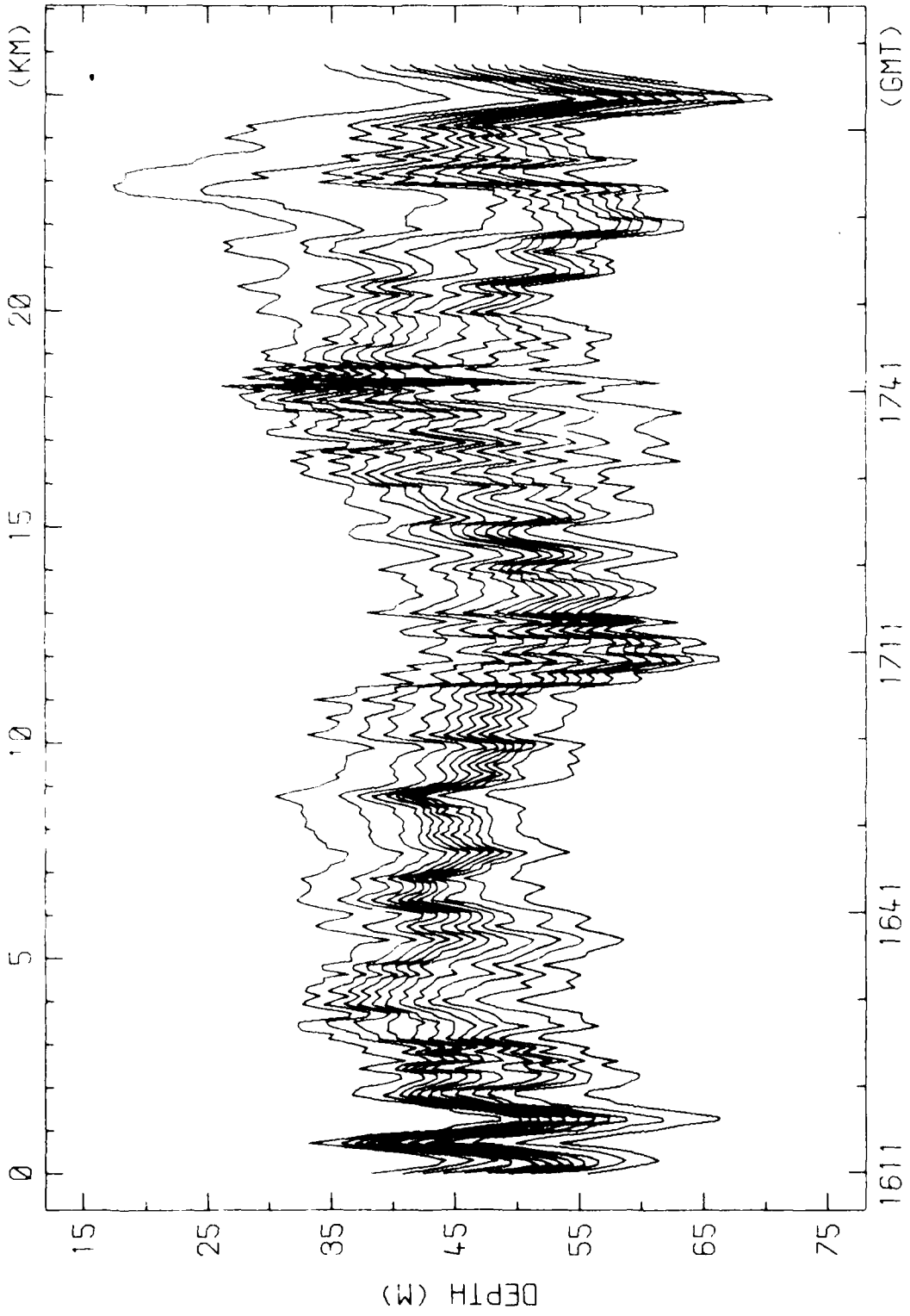

RUN 1-1 24-AUG-78 EDITED ISOTHERM DEPTH VS TIME/DISTANCE  
ISOTHERMS (DEG C) 12 0,11 8,11 6,11 4,11 2  
11 0,10 8,10 6,10 4,10 2,10 0,9 8

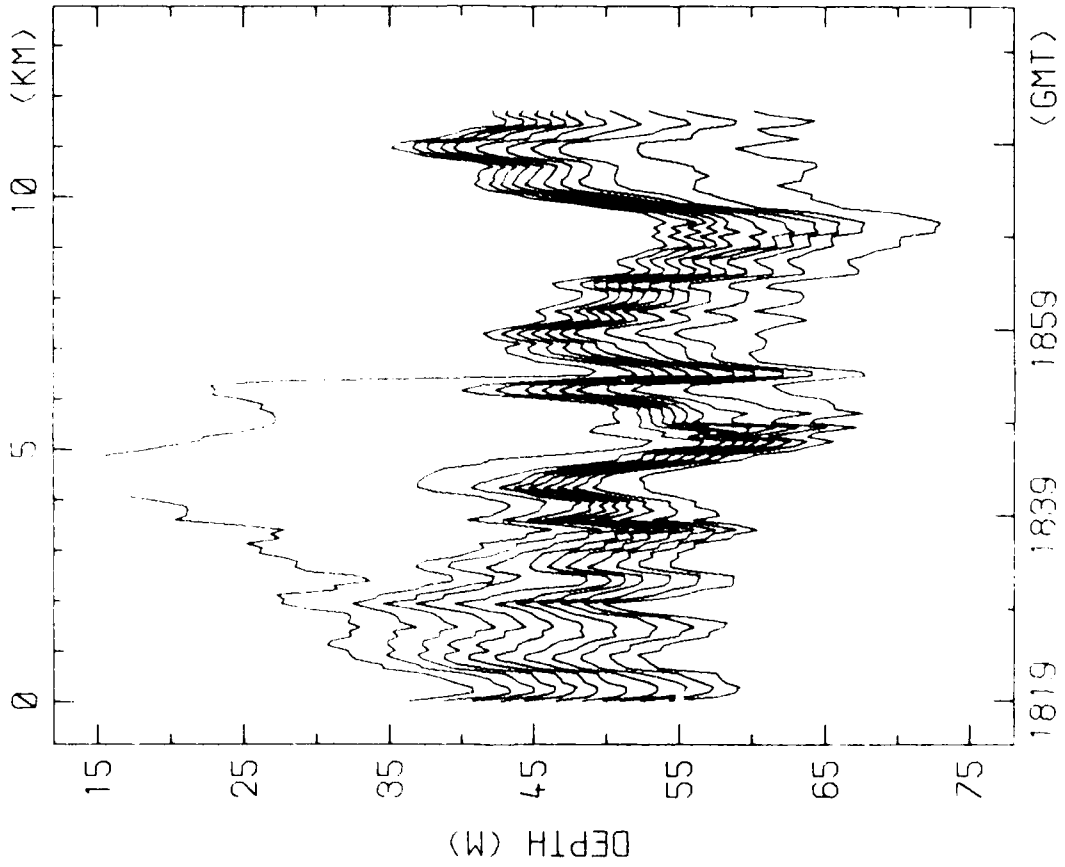

RUN 1-2 24-AUG-78 EDITED ISOTHERM DEPTH VS TIME/DISTANCE  
ISOTHERMS (DEG C) 12 0,11 3,11 6,11 4,11 2  
11 0,10 8,10 6,10 4,10 2,10 0

1819 1839 1859 (GMT)

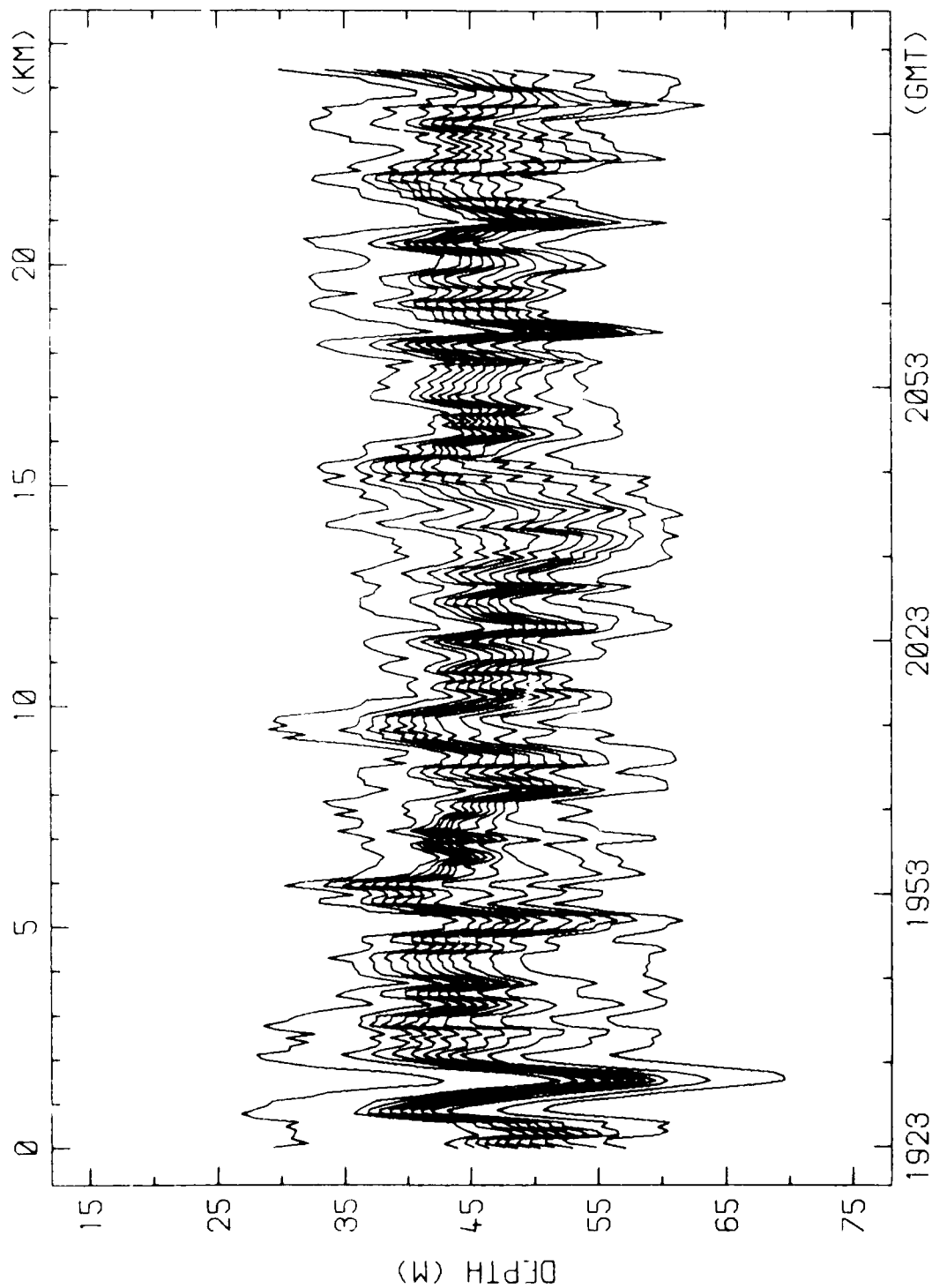

RUN 1-3 24-AUG-78 EDITED ISOTHERM DEPTH VS TIME/DISTANCE  
ISOTHERMS (DEG C) 12.4, 12.2, 12.0, 11.8, 11.6  
11.4, 11.2, 11.0, 10.8, 10.6, 10.4, 10.2

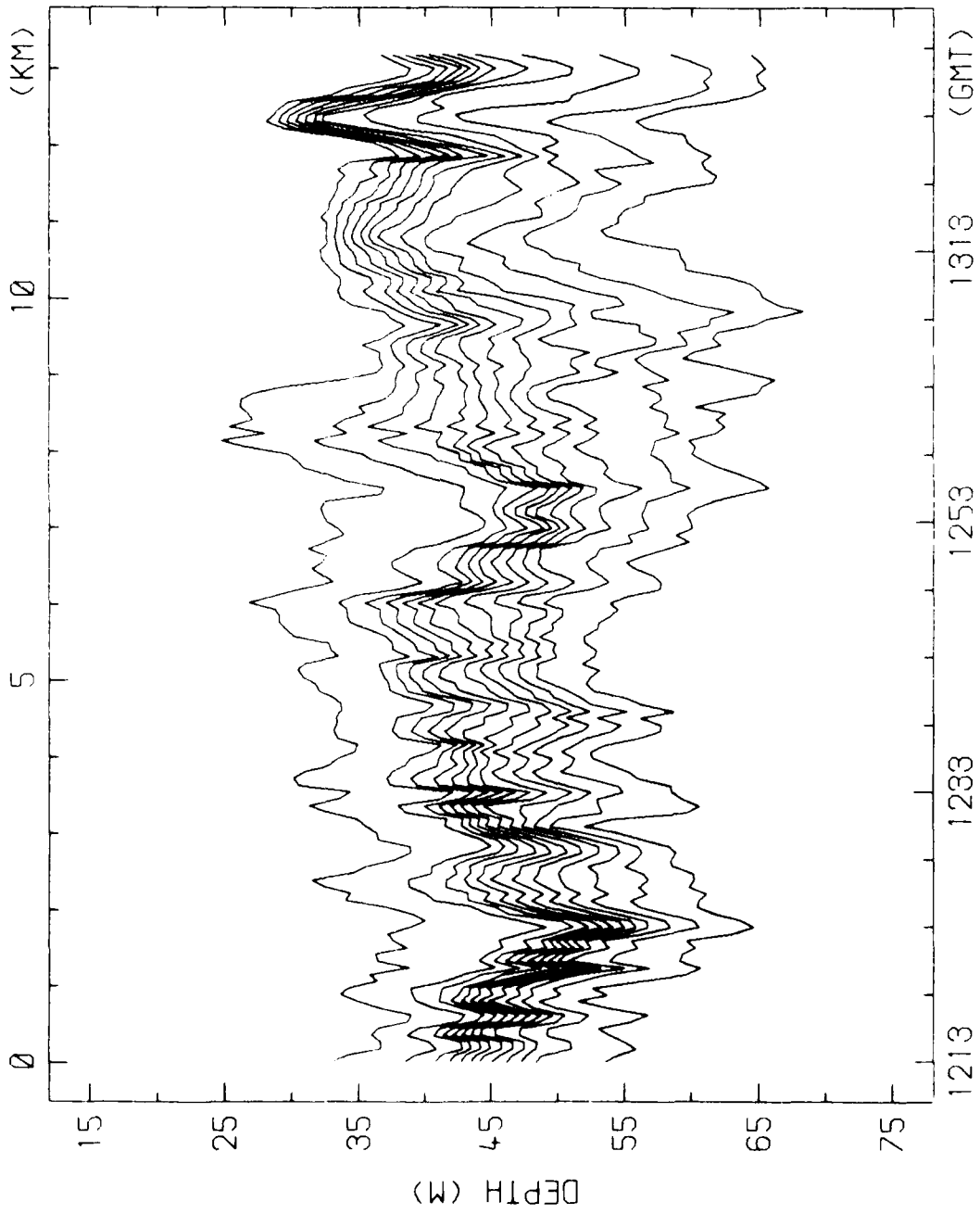

RUN 2W-1 25-AUG-78 EDITED ISOTHERM DEPTH VS TIME/DISTANCE  
 ISOTHERMS (DEG C) 12 0,11 8,11 6,11 4,11 2  
 11 0,10 8,10 6,10 4,10 2,10 0,9 8

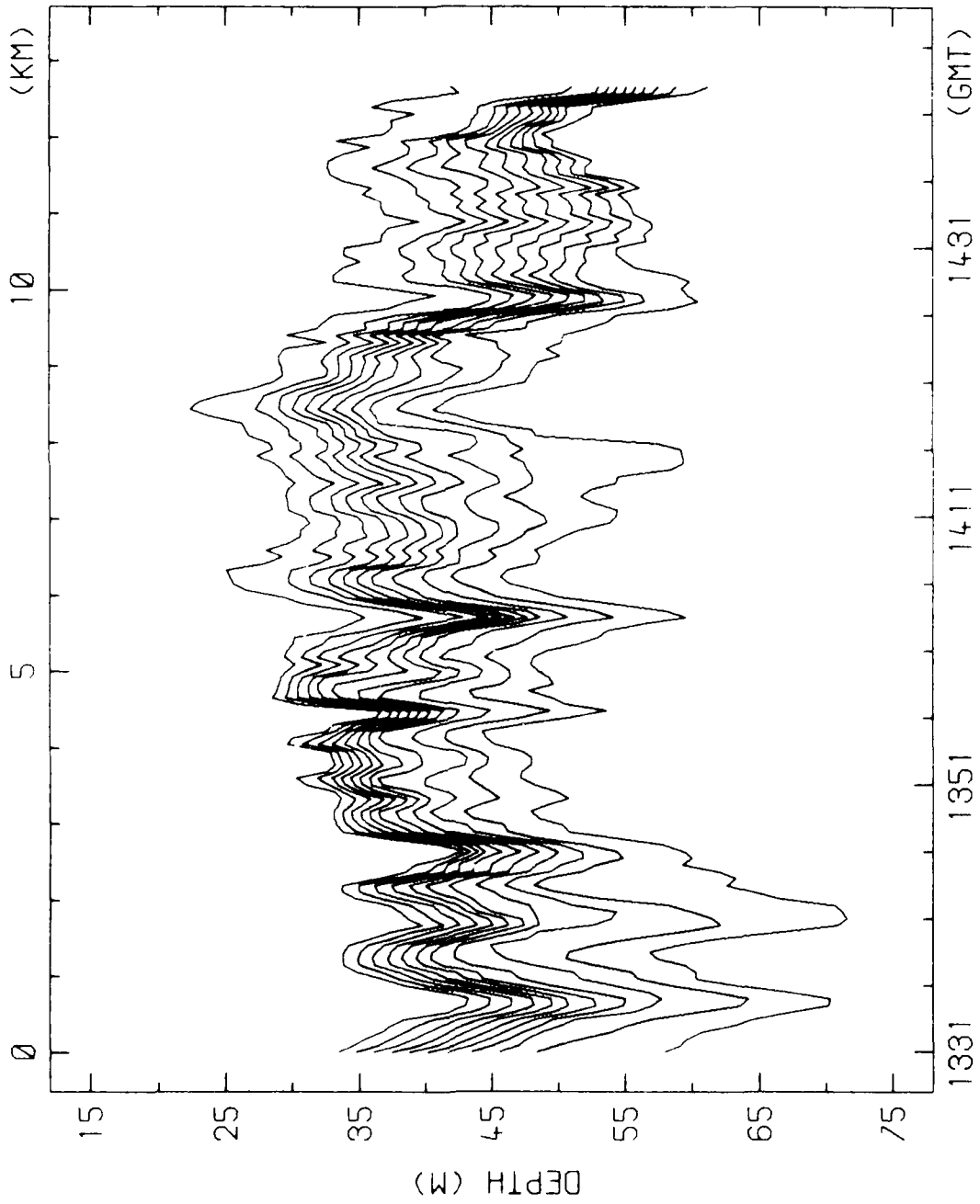

RUN 2S-2 25-AUG-78 EDITED ISOTHERM DEPTH VS TIME/DISTANCE  
ISOTHERMS (DEG C) 12 0,11 8,11 6,11 4,11 2  
11 0,10 8,10 6,10 4,10 2,10 0



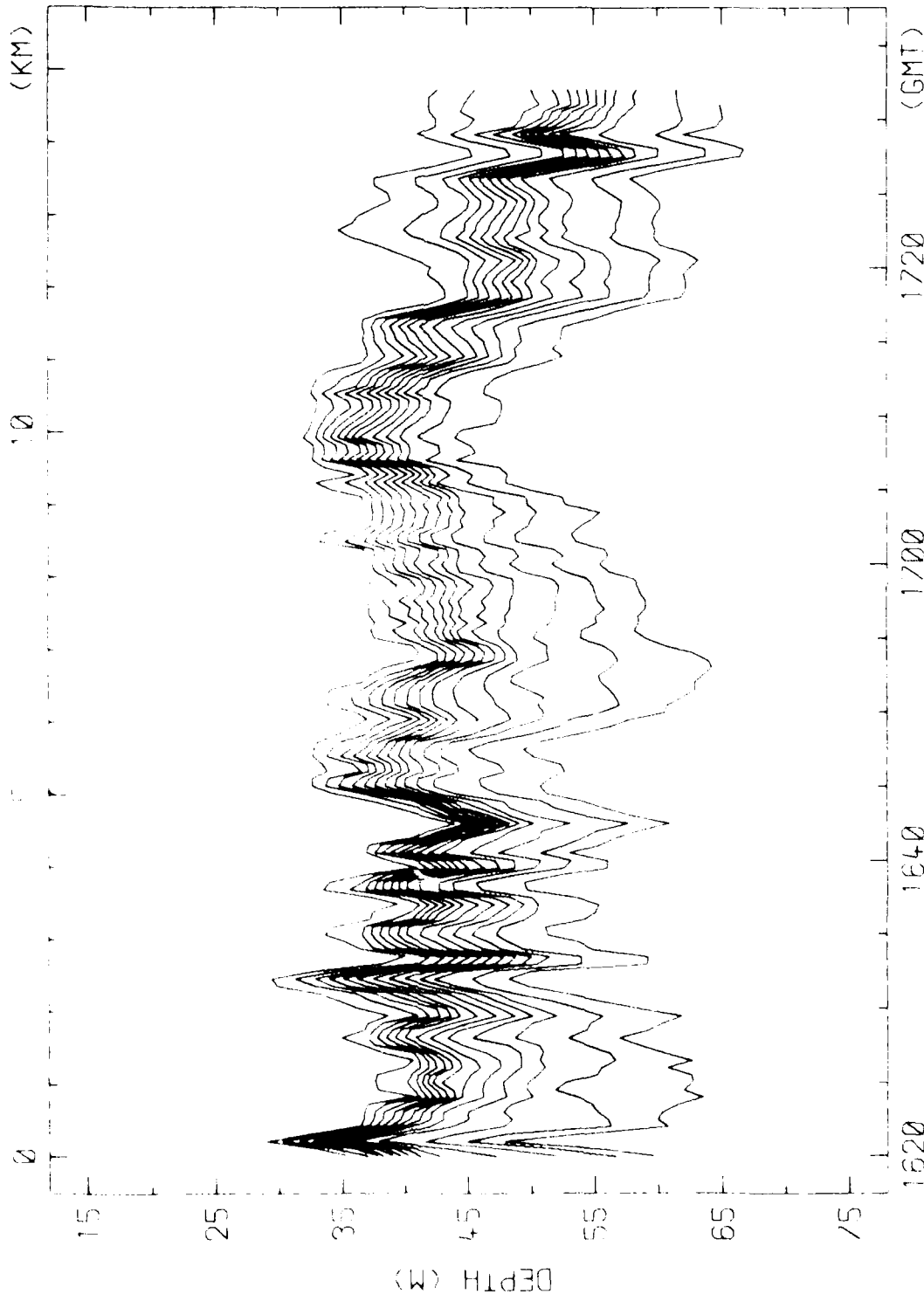

RUN 2N-4 25-AUG-78 EDITED ISOTHERM DEPTH VS TIME/DISTANCE  
ISOTHERMS (DEG C) 12 0,11 8,11 6,11 4,11 2  
11 0,10 8,10 6,10 4,10 2,10 0,9 8,9 6



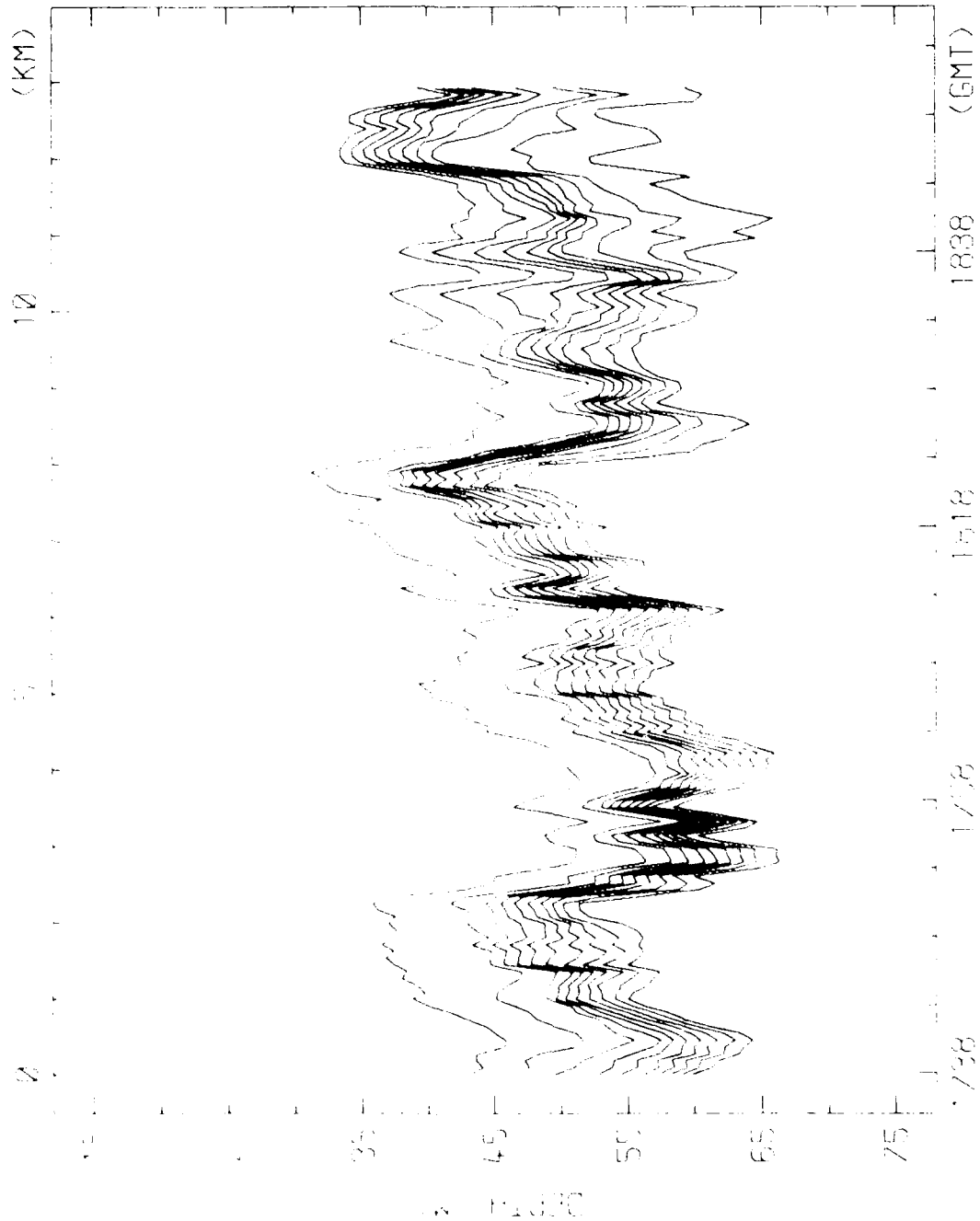

PLN 24-5 25-AUG-78 EDITED ISOTHERM DEPTH VS TIME/DISTANCE  
ISOTHERMS (C) 12 2.11 8.11 6.11 4  
11 2.11 4.10 8.10 4.10 2



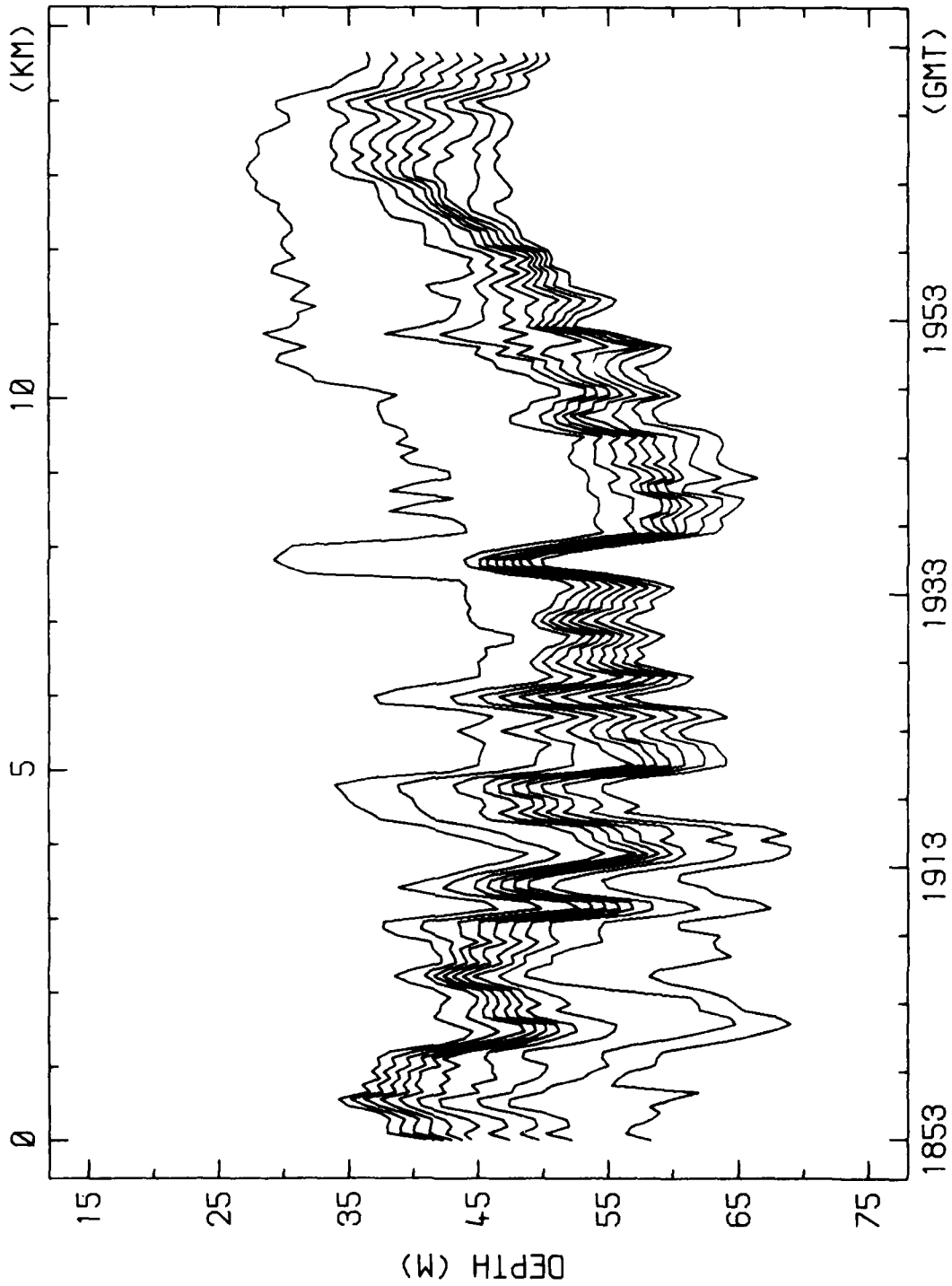

1853 1913 1933 1953 (GMT)

RUN 2S-6 25-AUG-78 EDITED ISOTHERM DEPTH VS TIME/DISTANCE  
 ISOTHERMS (DEG C) 12.0, 11.8, 11.6, 11.4  
 11.2, 11.0, 10.8, 10.6, 10.4, 10.2

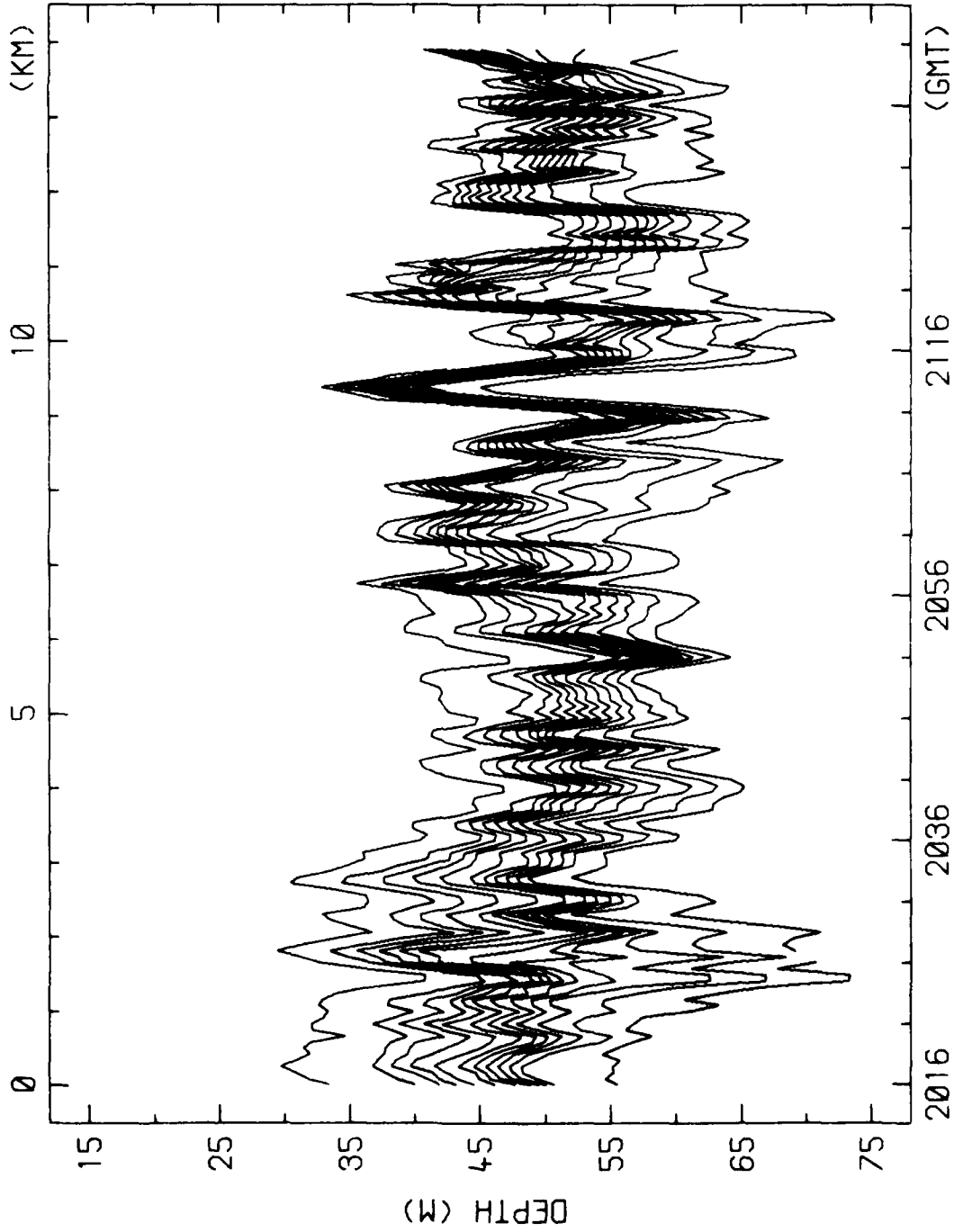

RUN 2E-7 25-AUG-78 EDITED ISOTHERM DEPTH VS TIME/DISTANCE  
ISOTHERMS (DEG C) 12.0, 11.8, 11.6, 11.4  
11.2, 11.0, 10.8, 10.6, 10.4, 10.2, 10.0, 9.8

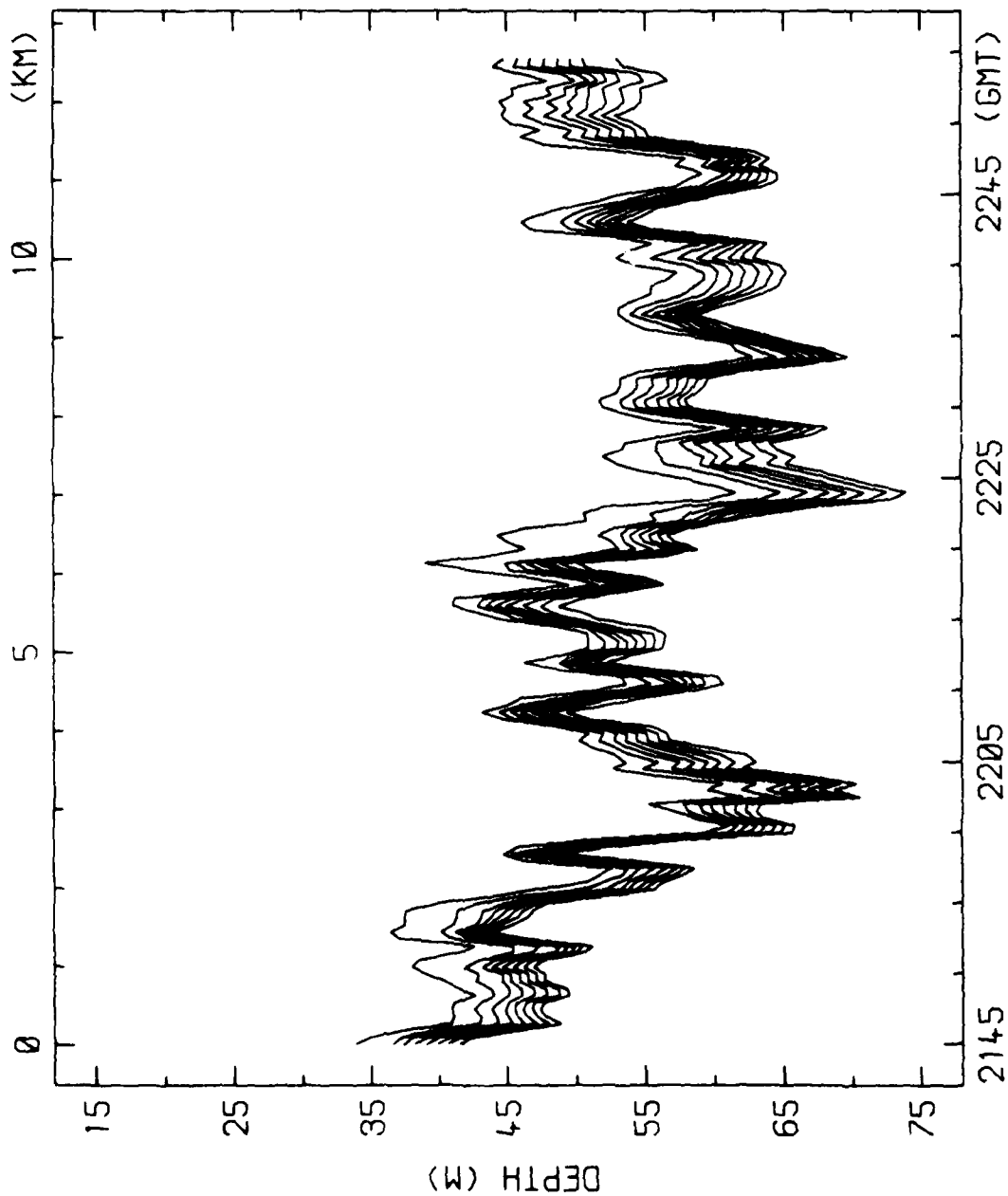

RUN 2N-8 25-AUG-78 EDITED ISOTHERM DEPTH VS TIME/DISTANCE  
ISOTHERMS (DEG C) 12.0,11.8,11.6,11.4  
11.2,11.0,10.8,10.6

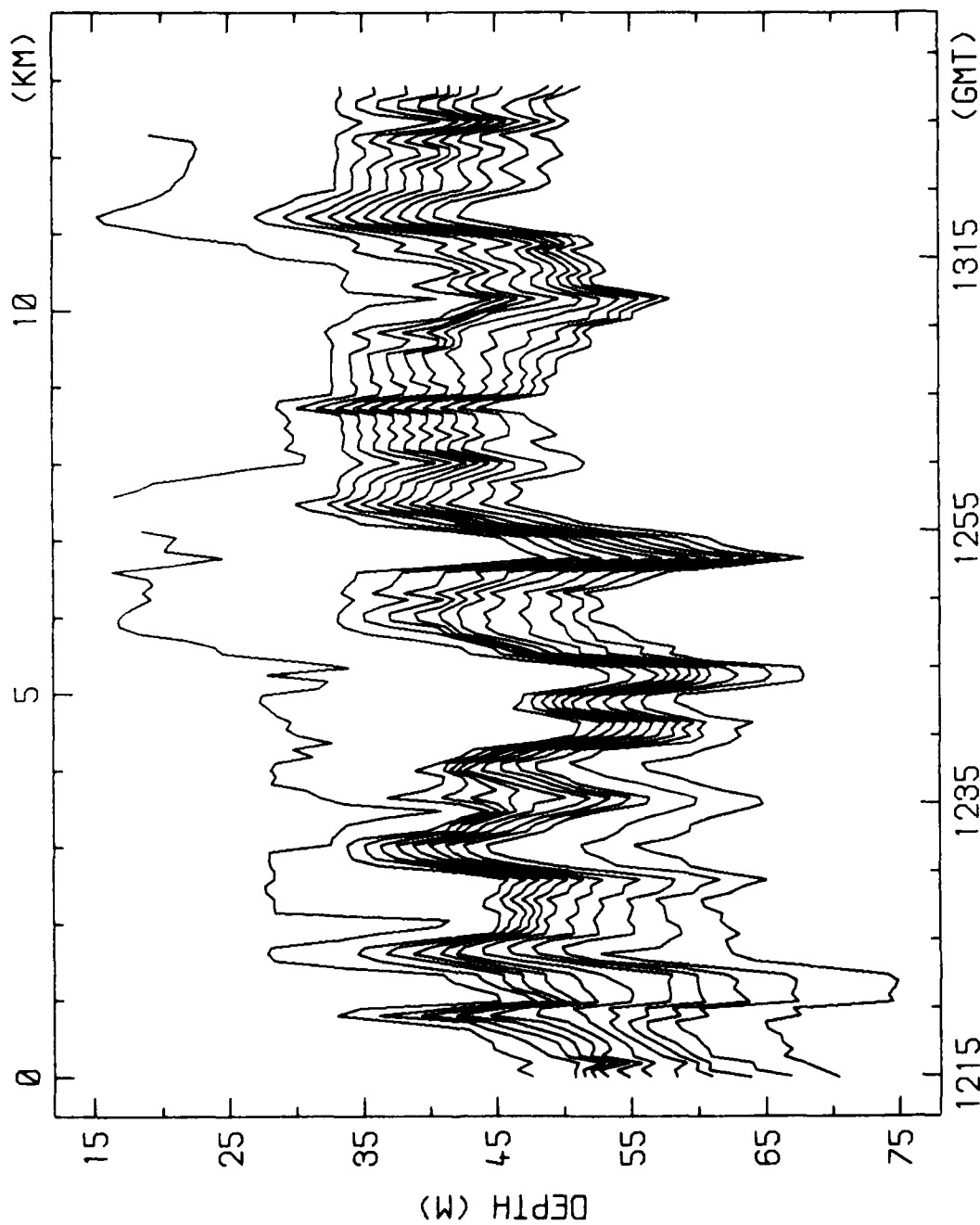

RUN 3N-1 27-AUG-78 EDITED ISOTHERM DEPTH VS TIME/DISTANCE  
ISOTHERMS (DEG C) 12.2,12.0,11.8,11.6,11.4  
11.2,11.0,10.8,10.6,10.4,10.2,10.0

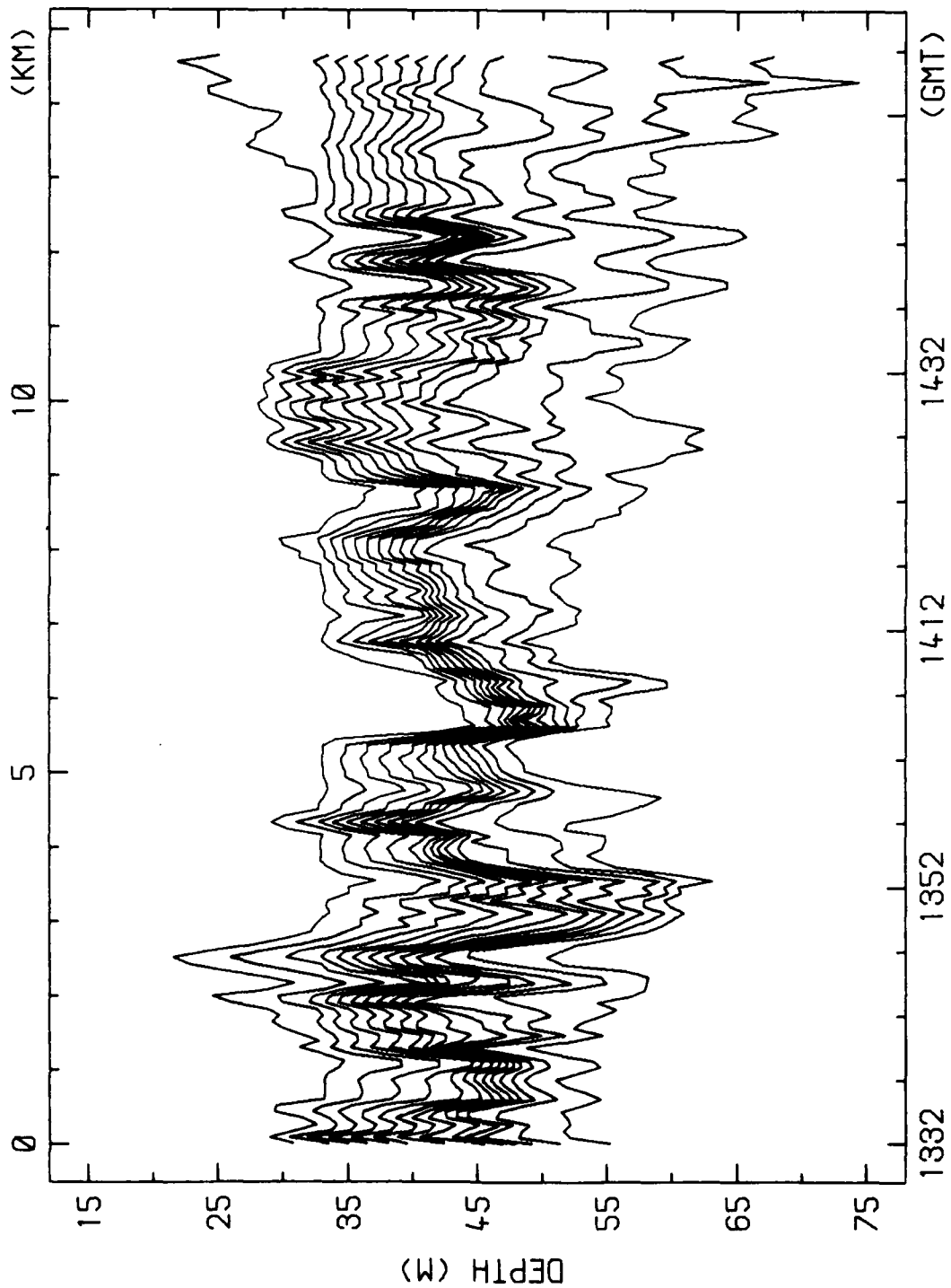

RUN 3W-2 27-AUG-78 EDITED ISOTHERM DEPTH VS TIME/DISTANCE  
ISOTHERMS (DEG C) 12.0, 11.8, 11.6, 11.4, 11.2  
11.0, 10.8, 10.6, 10.4, 10.2, 10.0, 9.8, 9.6

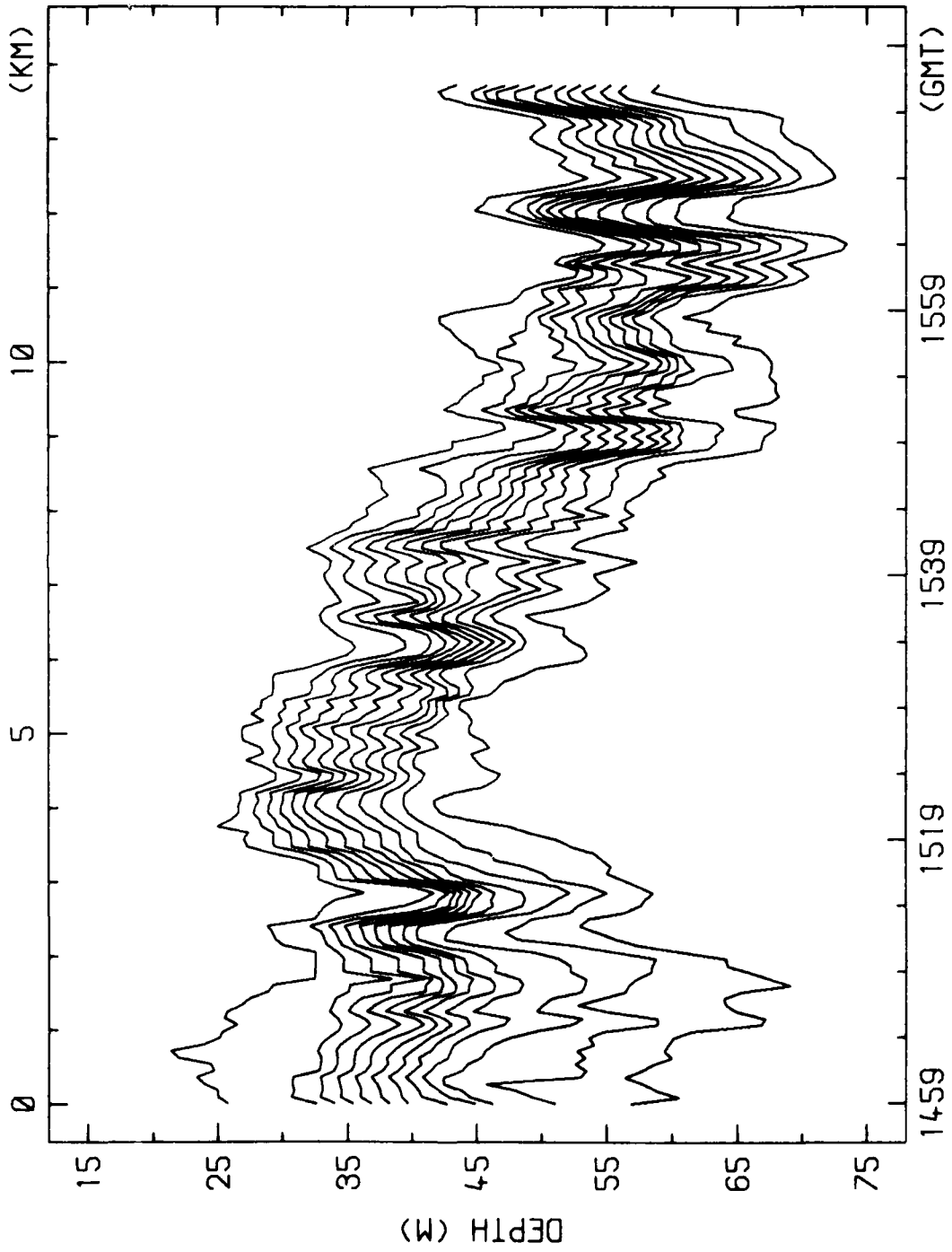

RUN 3S-3 27-AUG-78 EDITED ISOTHERM DEPTH VS TIME/DISTANCE  
ISOTHERMS (DEG C) 12.0,11.8,11.6,11.4,11.2  
11.0,10.8,10.6,10.4,10.2,10.0,9.8



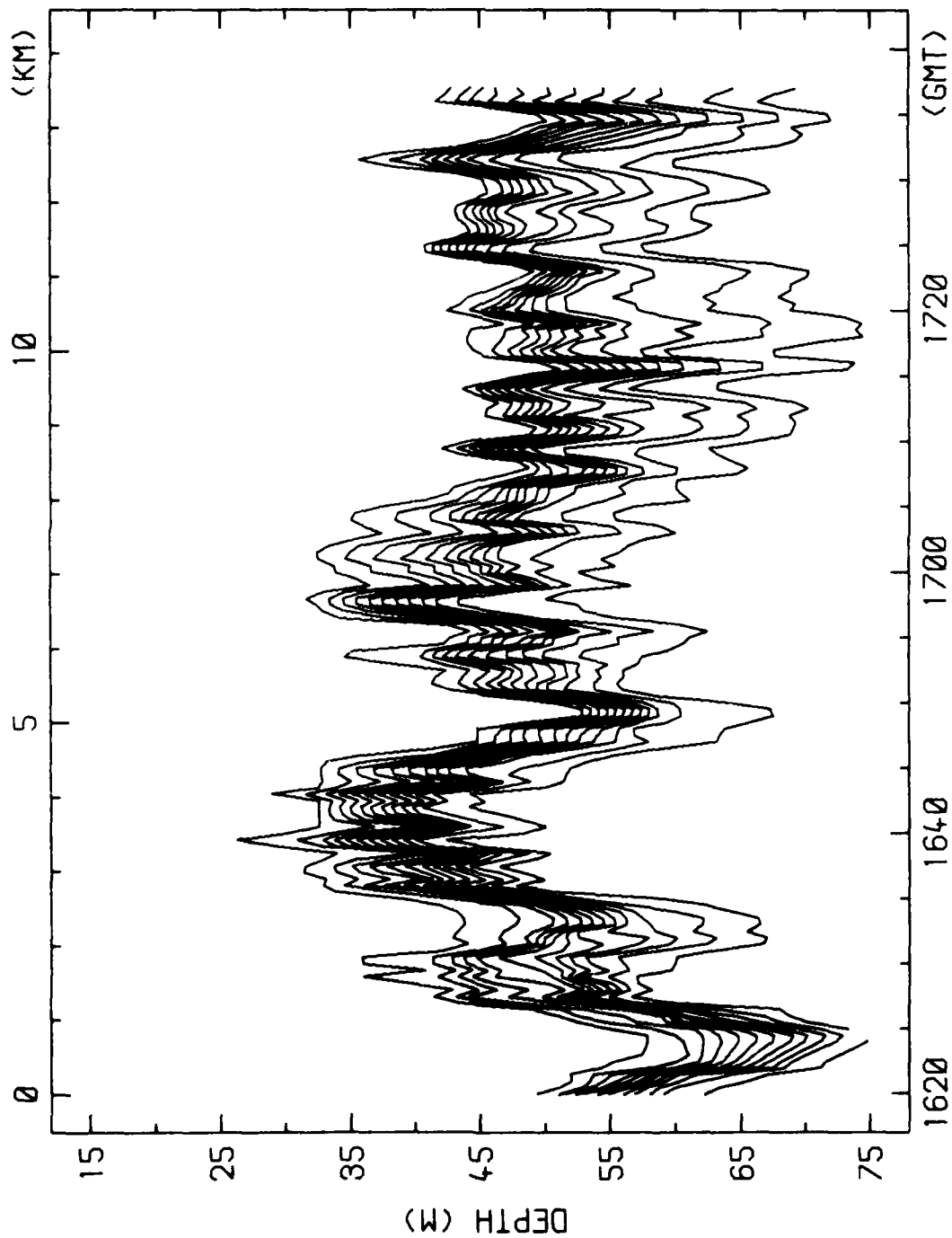

RUN 3E-4 27-AUG-78 EDITED ISOTHERM DEPTH VS TIME/DISTANCE

ISOTHERMS (DEG C) 12.0, 11.8, 11.6, 11.4, 11.2

11.0, 10.8, 10.6, 10.4, 10.2, 10.0, 9.8

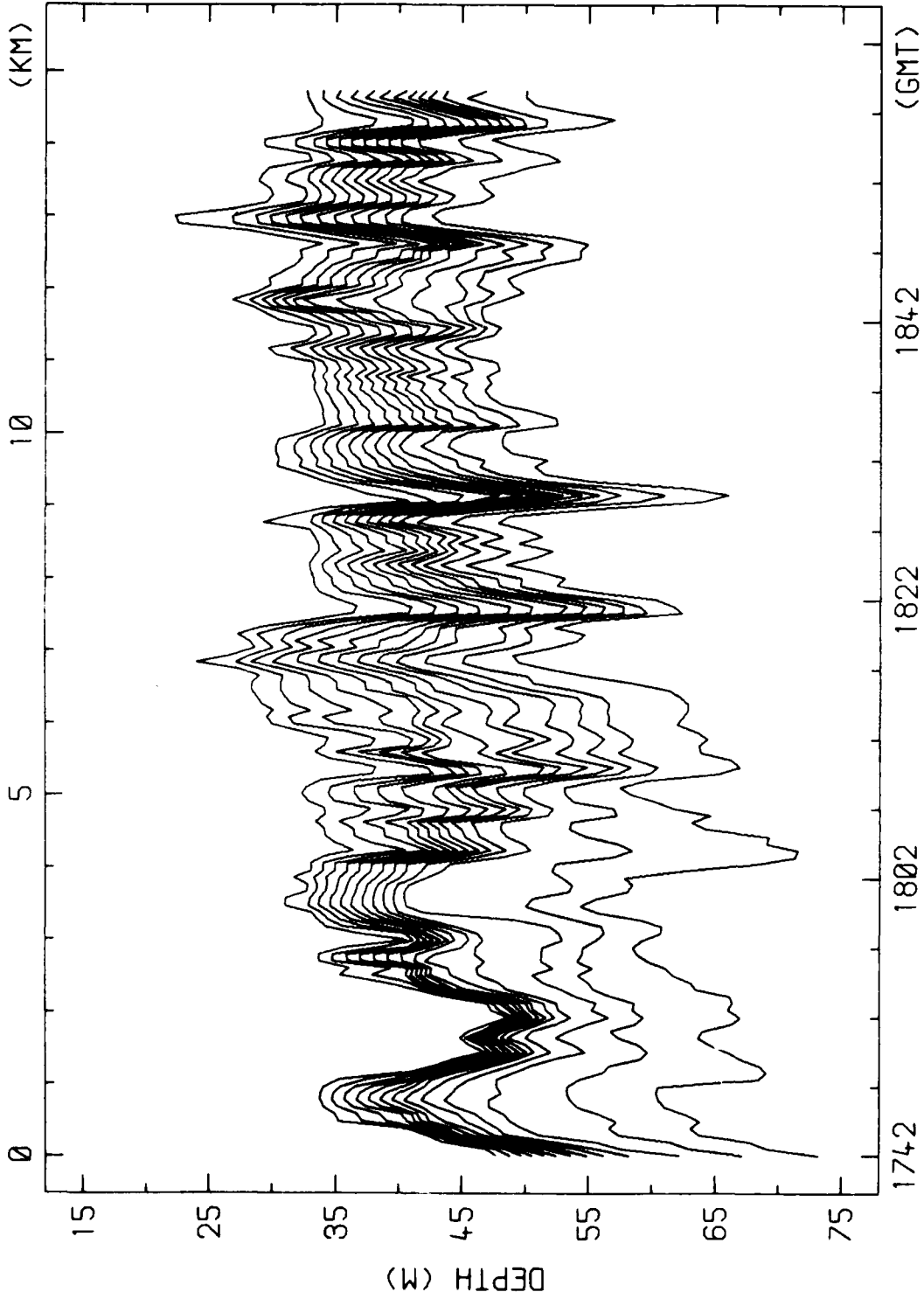

RUN 3N-5 27-AUG-78 EDITED ISOTHERM DEPTH VS TIME/DISTANCE  
ISOTHERMS (DEG C) 12.0, 11.8, 11.6, 11.4, 11.2  
11.0, 10.8, 10.6, 10.4, 10.2, 10.0, 9.8, 9.6

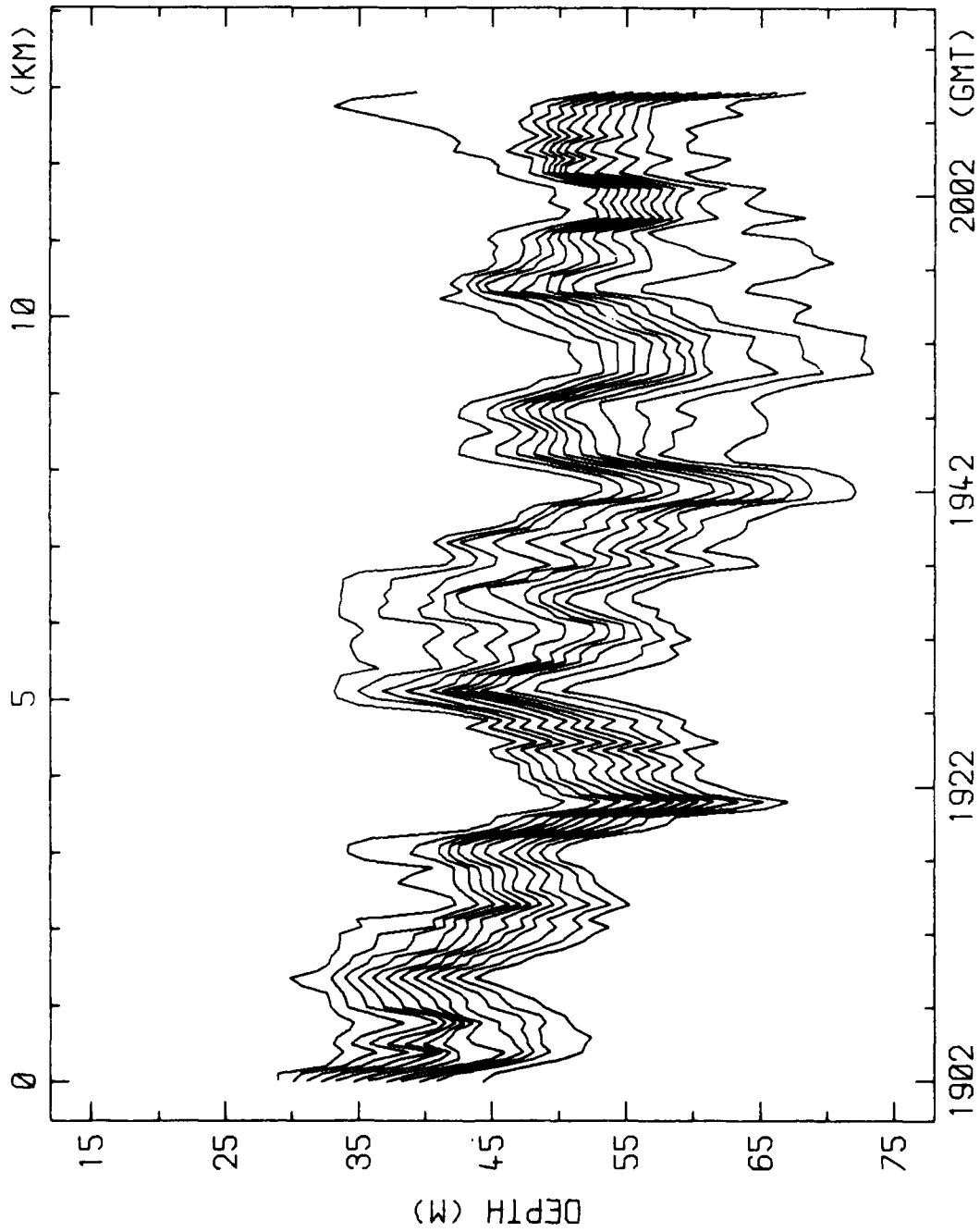

RUN 3W-6 27-AUG-78 EDITED ISOTHERM DEPTH VS TIME/DISTANCE  
ISOTHERMS (DEG C) 12.0, 11.8, 11.6, 11.4, 11.2  
11.0, 10.8, 10.6, 10.4, 10.2, 10.0, 9.8

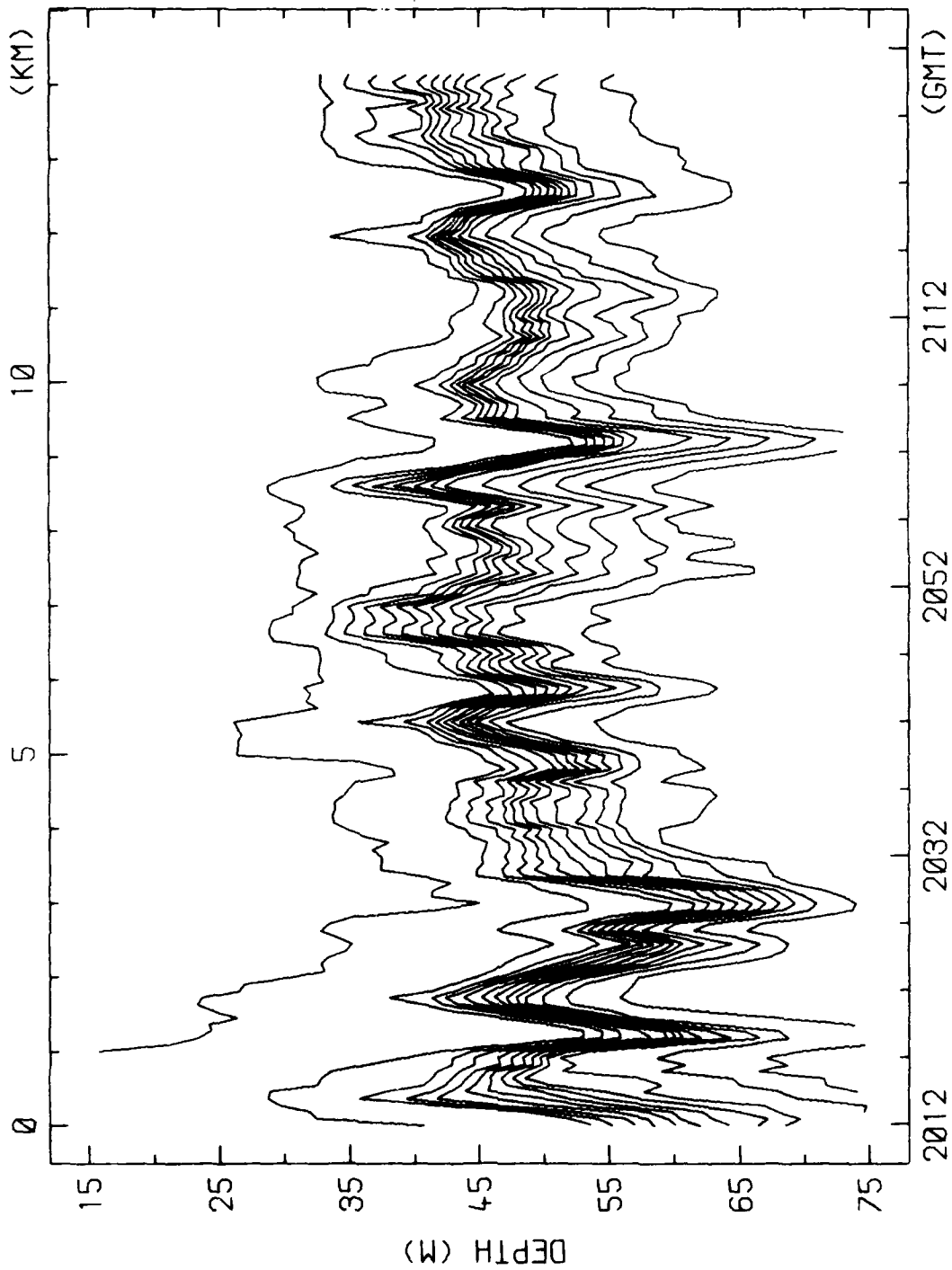

RUN 3S-7 27-AUG-78 EDITED ISOTHERM DEPTH VS TIME/DISTANCE  
ISOTHERMS (DEG C) 12.2,12.0,11.8,11.6,11.4,11.2  
11.0,10.8,10.6,10.4,10.2,10.0,9.8

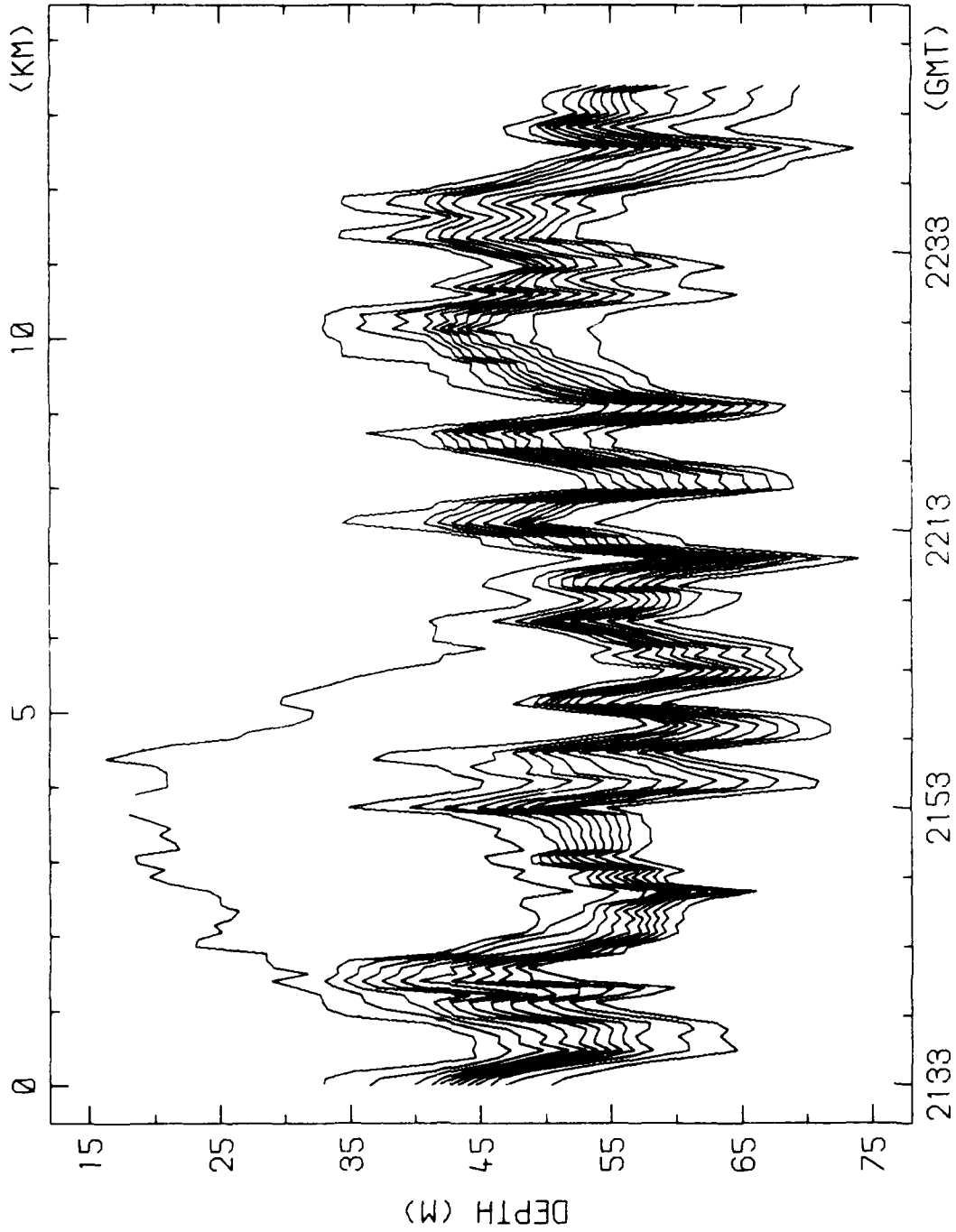

RUN 3E-8 27-AUG-78 EDITED ISOTHERM DEPTH VS TIME/DISTANCE  
ISOTHERMS (DEG C) 12.2,12.0,11.8,11.6,11.4,11.2  
11.0,10.8,10.6,10.4,10.2,10.0

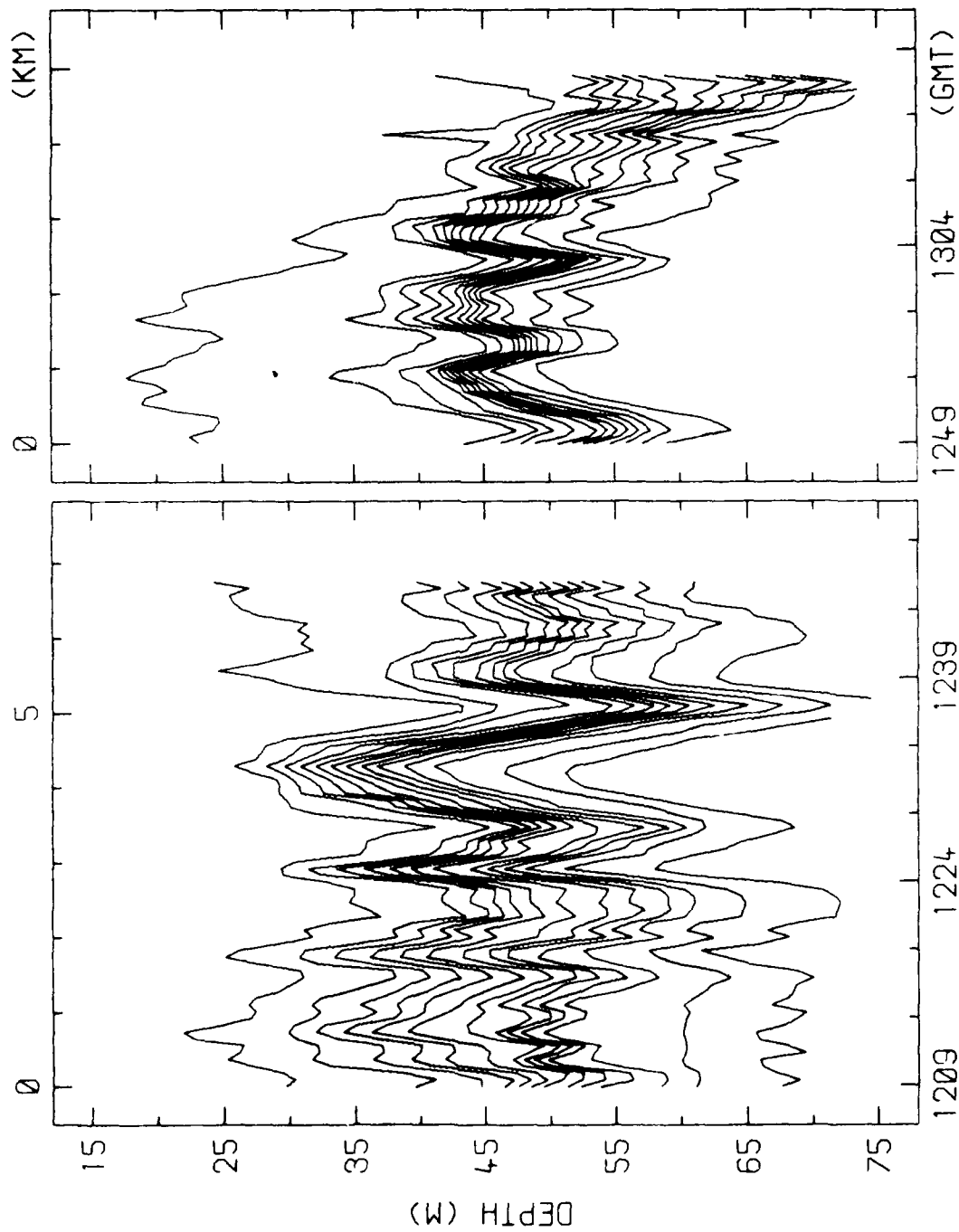

RUNS 4N-1, 4W-2 29-AUG-78  
EDITED ISOTHERM DEPTH VS TIME/DISTANCE ISOTHERMS (DEG C)  
4N-1 12 2 TO 9.8; 4W-2 12.2 TO 9.8

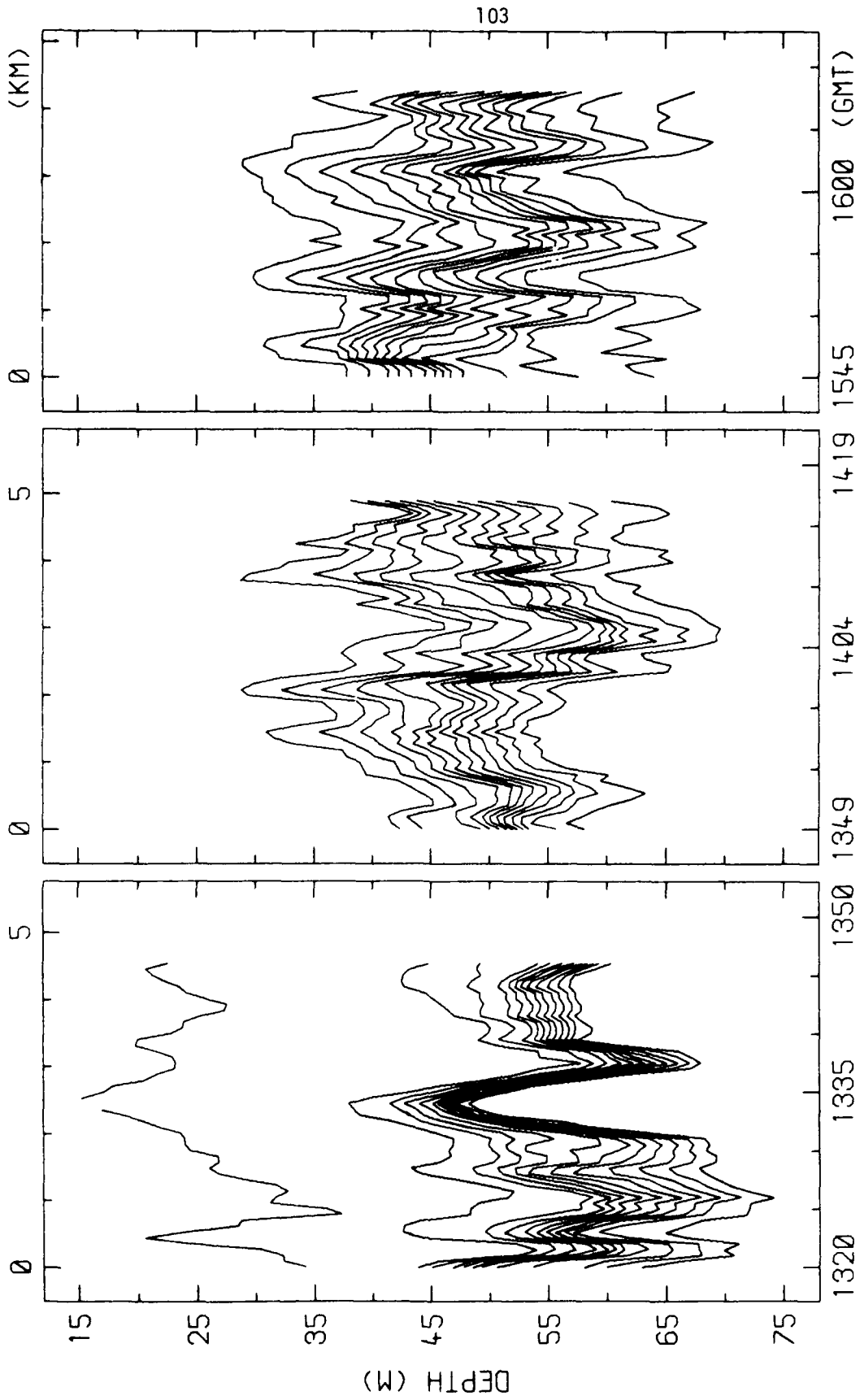

RUNS 4S-3, 4E-4, 4E-5 29-AUG-78  
 EDITED ISOTHERM DEPTH VS TIME/DISTANCE ISOTHERMS (DEG C)  
 4S-3 12.2 TO 10.0; 4E-4 12.0 TO 9.8; 4E-5 12.0 TO 9.6

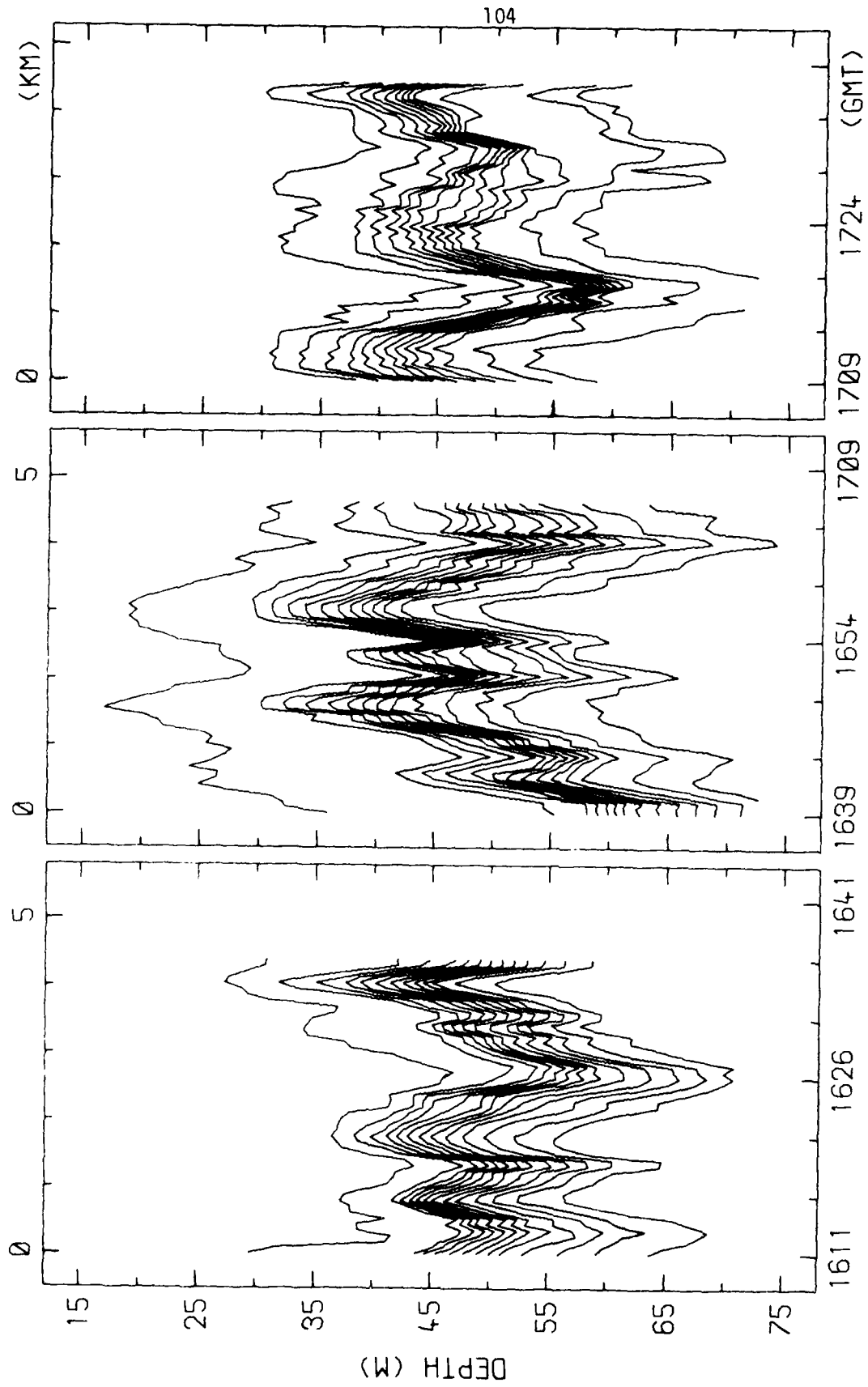

RUNS 4N-6, 4W-7, 4S-8 29-AUG-78  
 EDITED ISOTHERM DEPTH VS TIME/DISTANCE ISOTHERMS (DEG C)  
 4N-6 12.2 TO 9.8; 4W-7 12.2 TO 9.6; 4S-8 12.0 TO 9.6



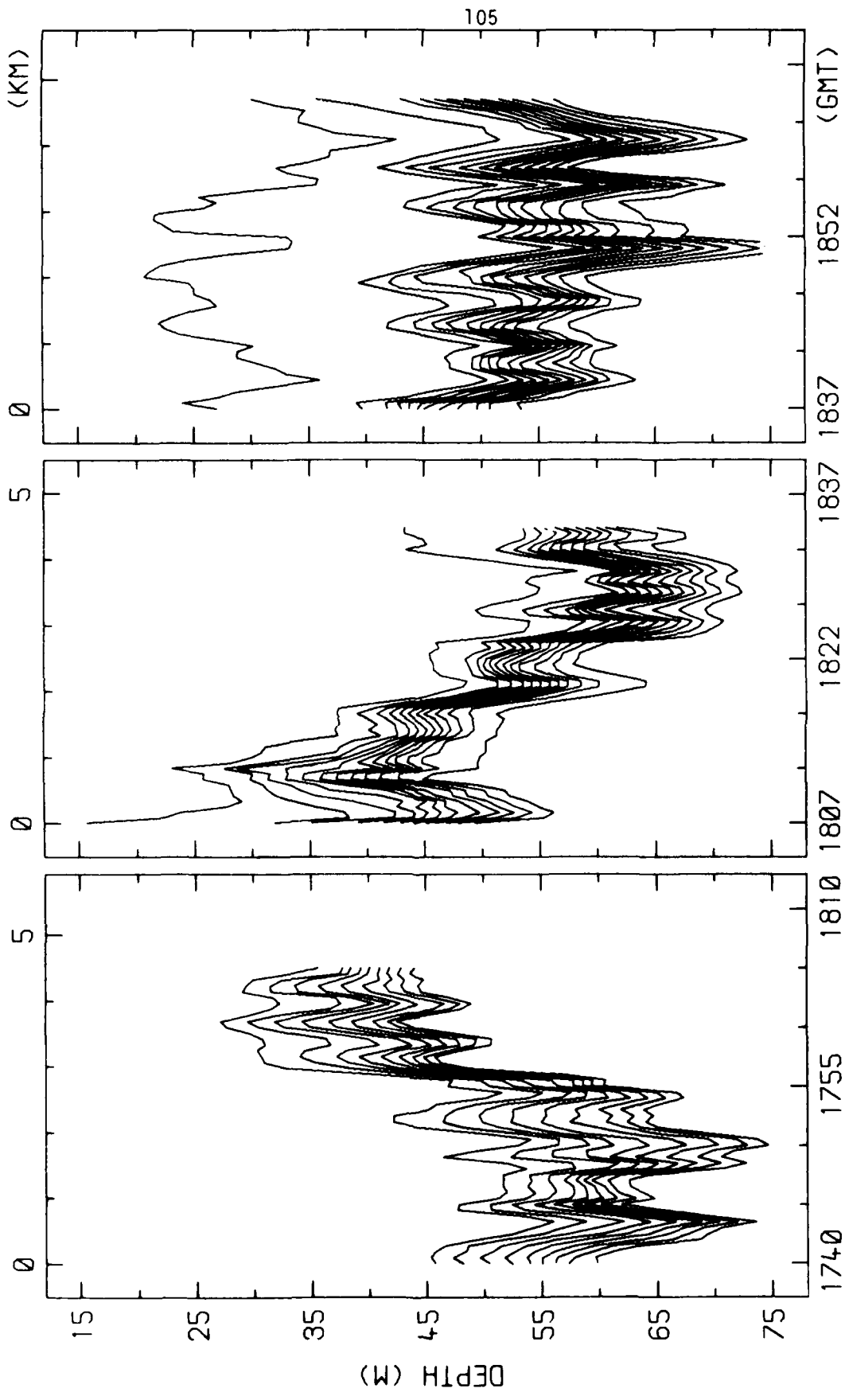

RUNS 4E-9, 4N-10, 4W-11 29-AUG-78  
 EDITED ISOTHERM DEPTH VS TIME/DISTANCE ISOTHERMS (DEG C)  
 4E-9 12.0 TO 10.4; 4N-10 12.2 TO 10.0; 4W-11 12.2 TO 10.0

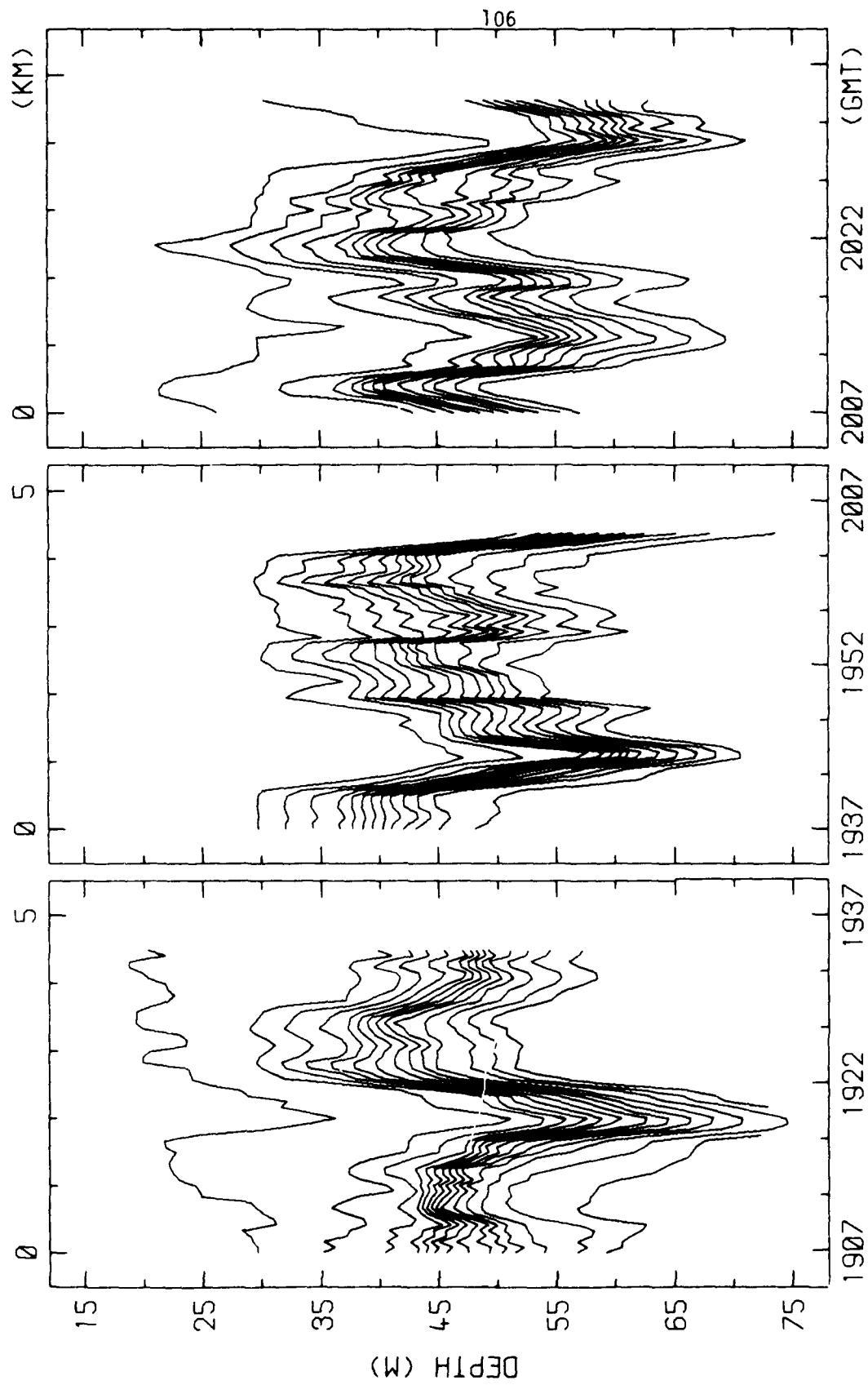

RUNS 4S-12, 4E-13, 4N-14 29-AUG-78  
 EDITED ISOTHERM DEPTH VS TIME/DISTANCE ISOTHERMS (DEG C)  
 4S-12 12 2 TO 9 6; 4E-13 12 0 TO 9 6; 4N-14 12 2 TO 10 0

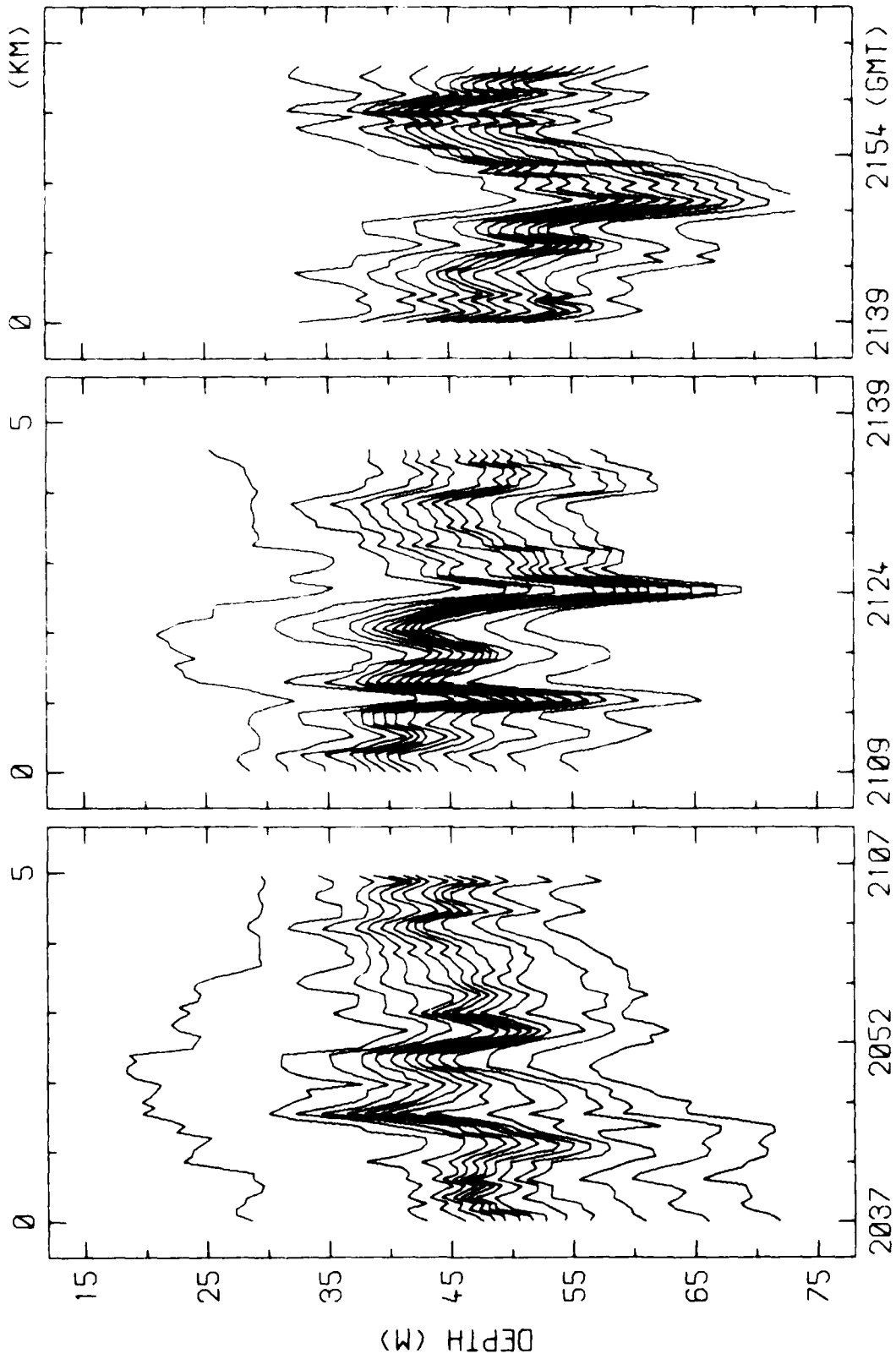

RUNS 4W-15, 4S-16, 4E-17 29-AUG-78  
 EDITED ISOTHERM DEPTH VS TIME/DISTANCE ISOTHERMS (DEG C)  
 4W-15 12 2 TO 9 6, 4S-16 12 2 TO 9 6, 4E-17 12 0 TO 9 6

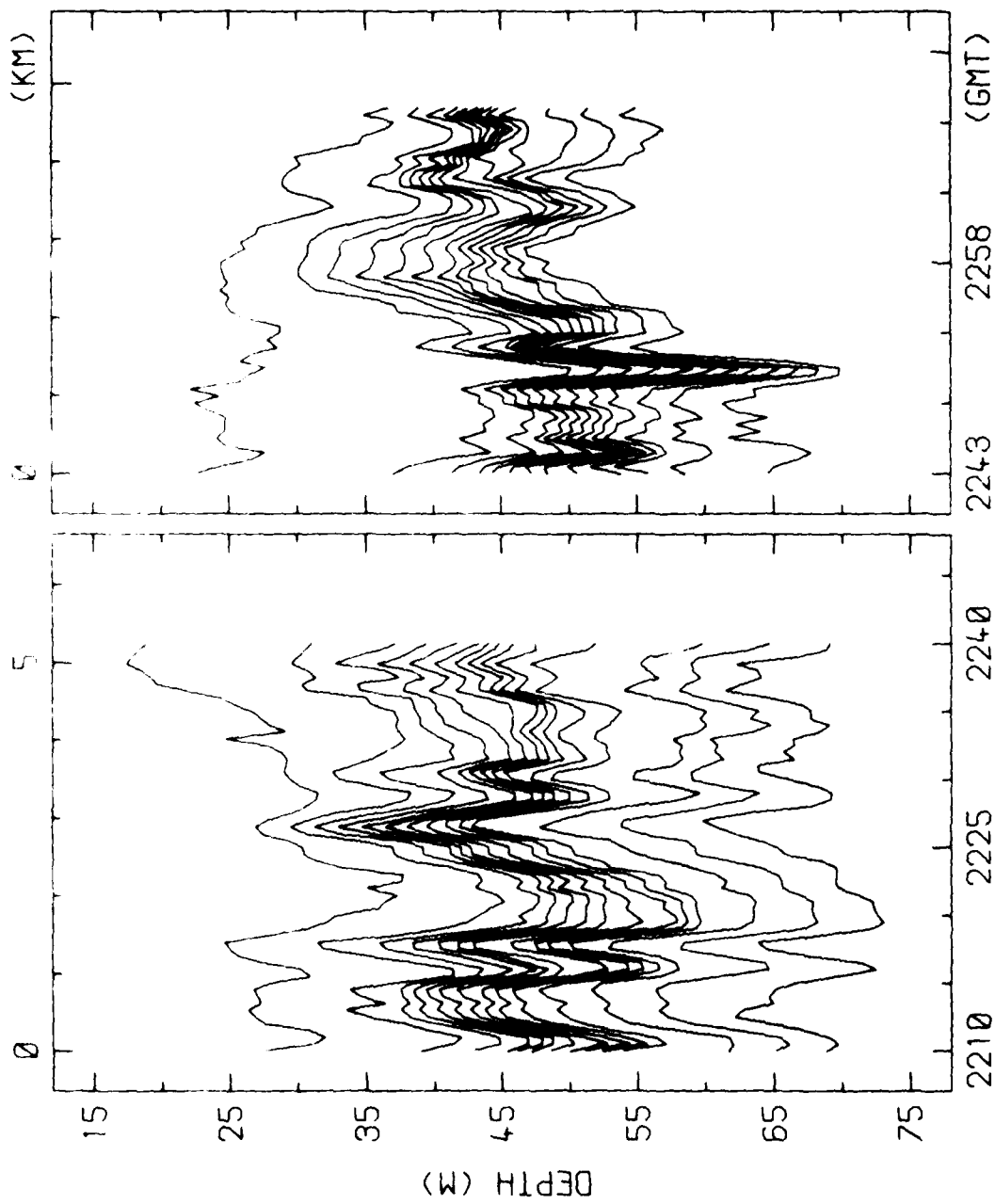

RUNS 4N-18, 4W-19 29-AUG-78  
EDITED ISOTHERM DEPTH VS TIME/DISTANCE ISOTHERMS (DEG C)  
4N-18 12.2 TO 9.6; 4W-19 12.2 TO 9.8

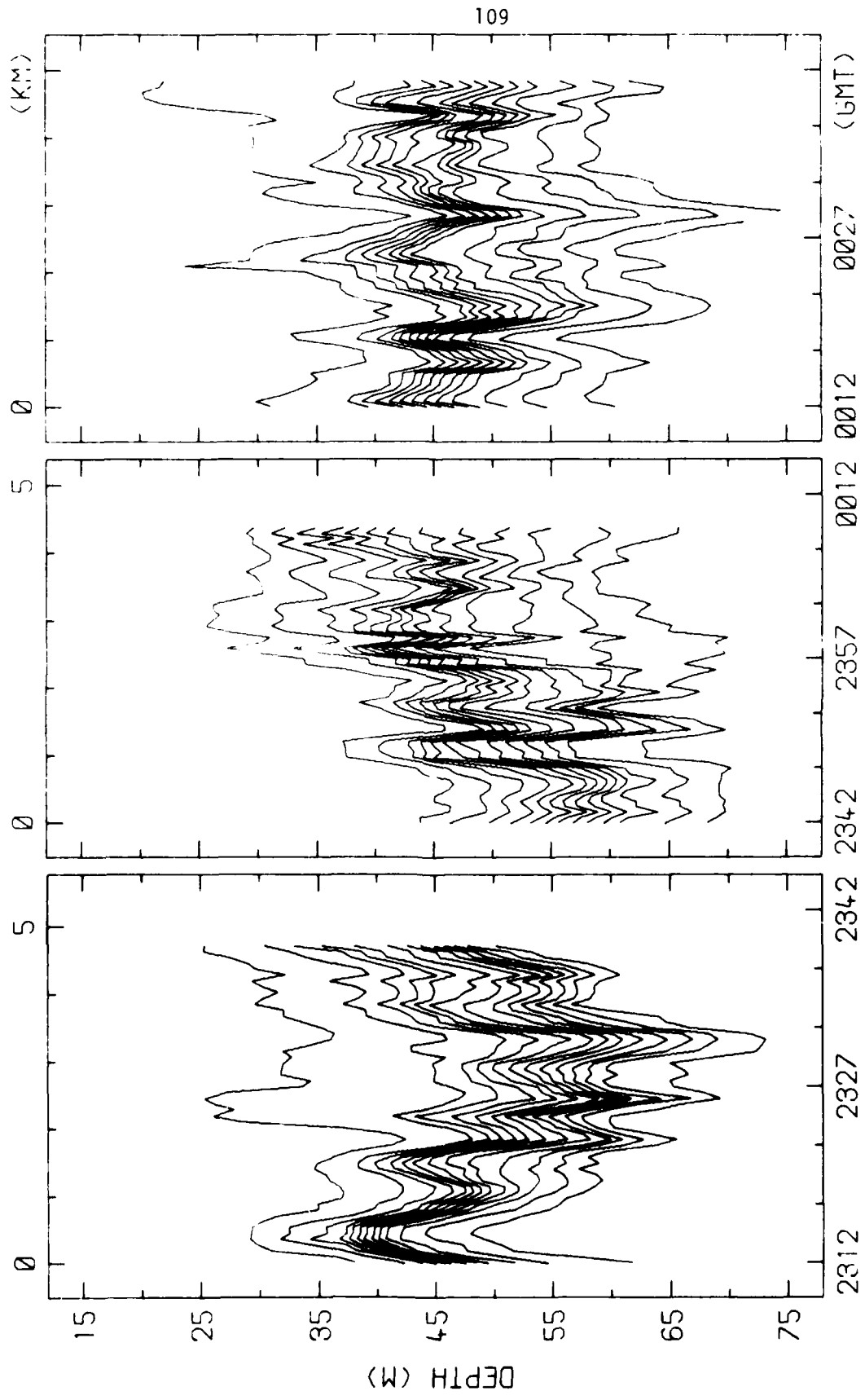

RUNS 4S-20, 4E-21, 4N-22 29.30-AUG-78  
 EDITED ISOTHERM DEPTH VS TIME/DISTANCE ISOTHERMS (DEG C)  
 4S-20 12.2 TO 9.8; 4E-21 12.0 TO 9.6; 4N-22 12.2 TO 9.8

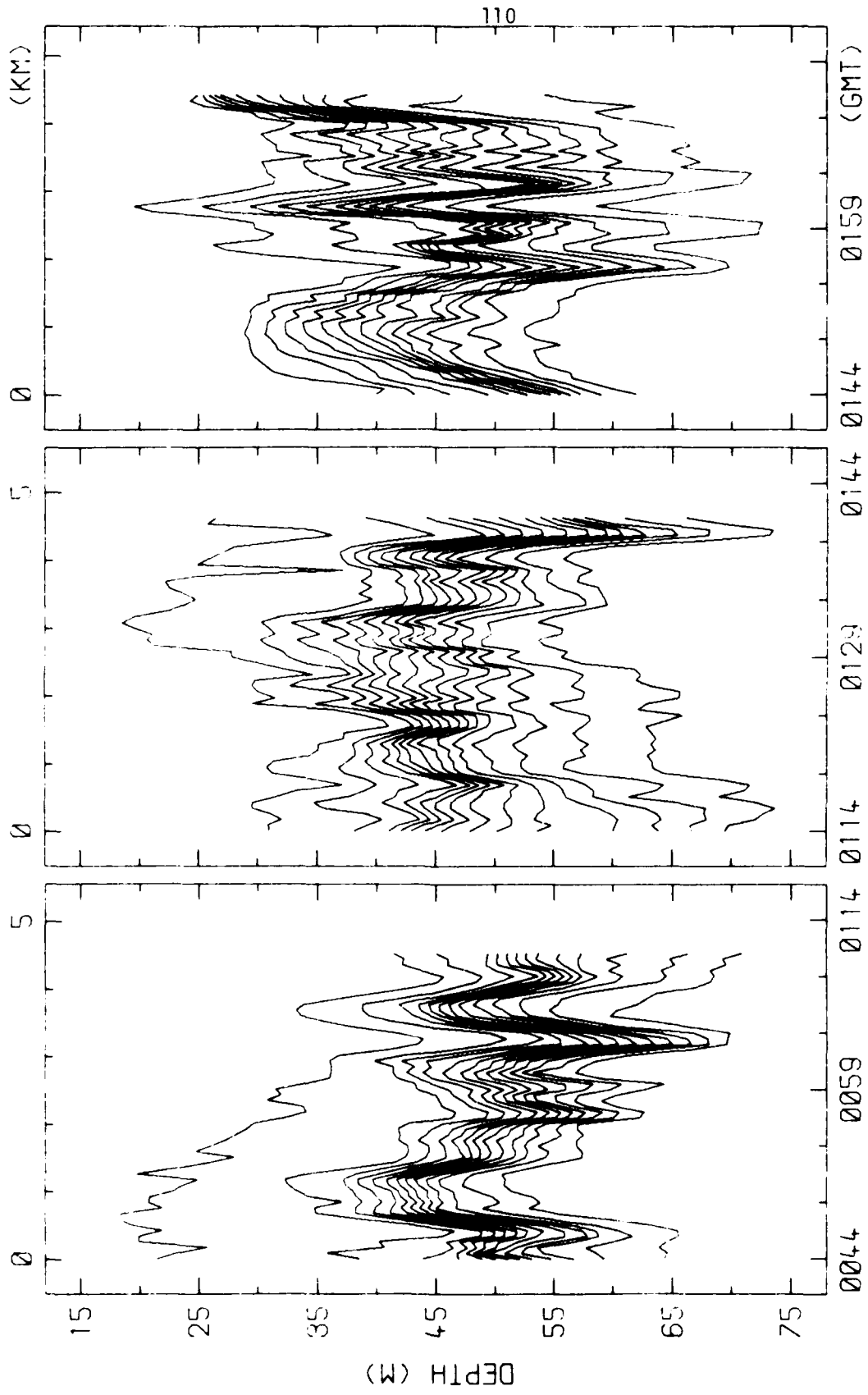

RUNS 4W-23, 4S-24, 4E-25 30-AUG-78  
 EDITED ISOTHERM DEPTH VS TIME/DISTANCE ISOTHERMS (DEG C)  
 4W-23 12 2 TO 9 8; 4S-24 12 2 TO 9 6; 4E-25 12 0 TO 9 6

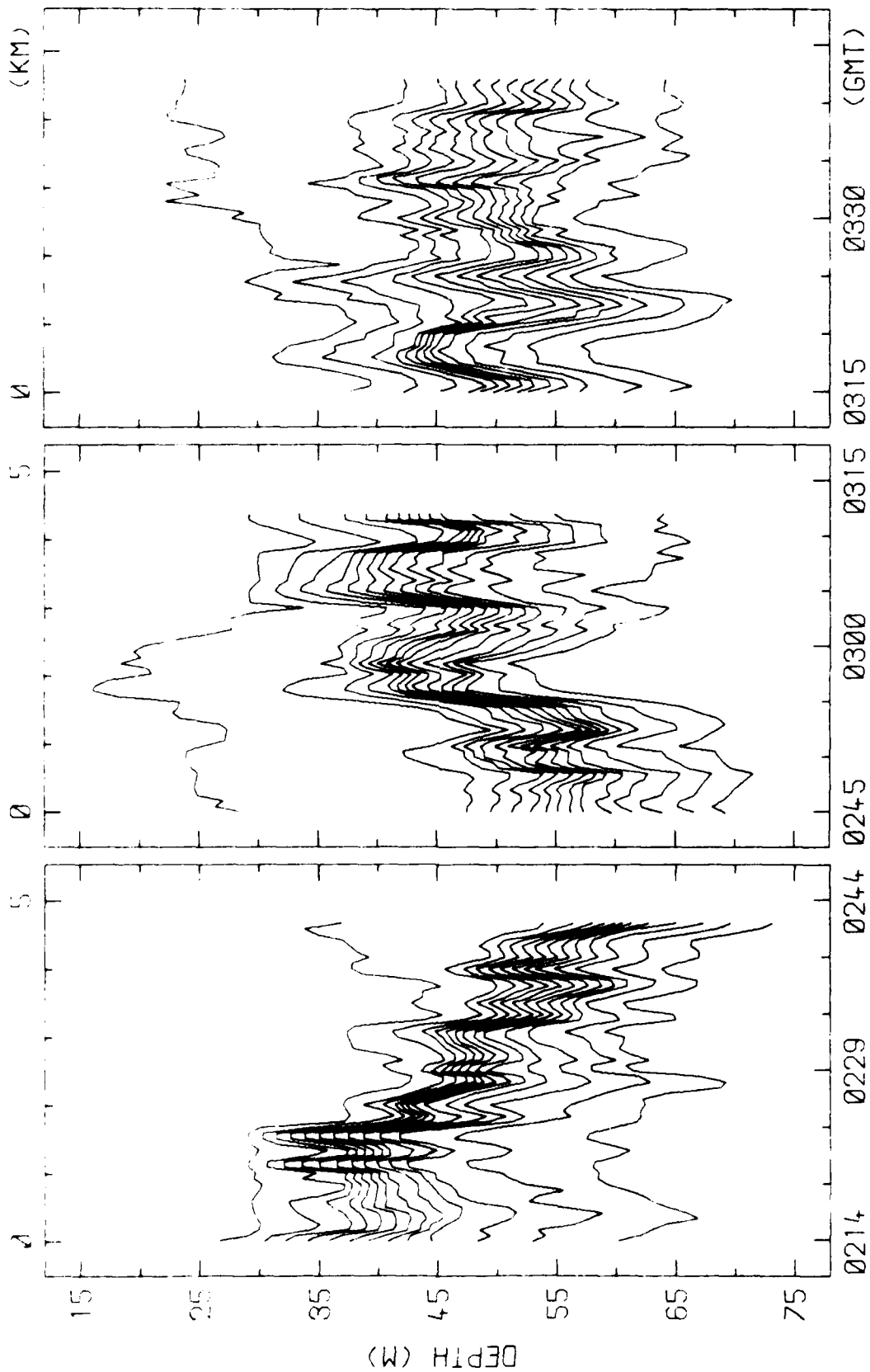

RUNS 4N-26, 4W-27, 4S-28 30-AUG-78  
EDITED ISOTHERM DEPTH VS TIME/DISTANCE ISOTHERMS (DEG C)  
4N-26 12.2 TO 9.8; 4W-27 12.2 TO 9.6; 4S-28 12.2 TO 9.8

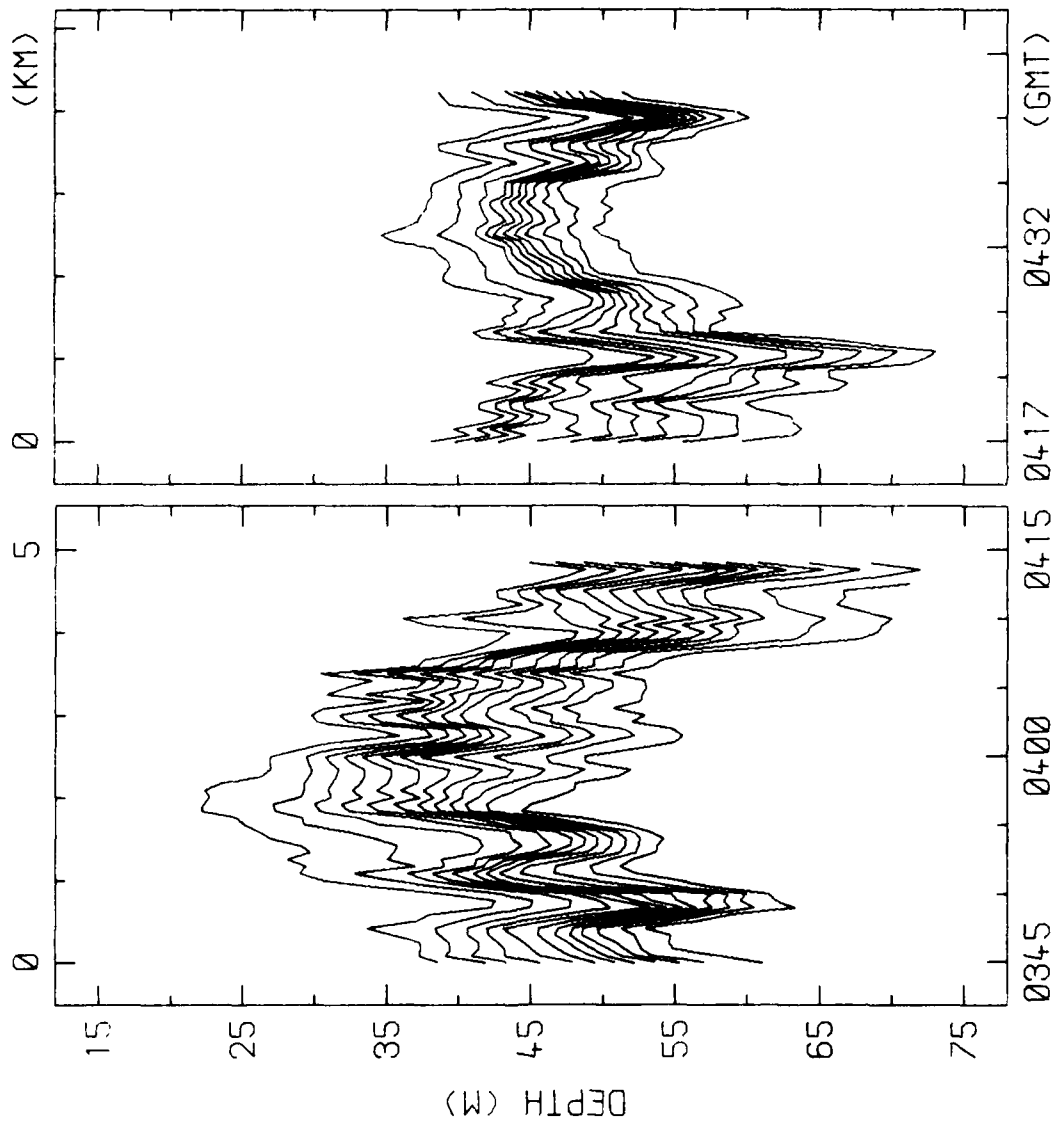

RUNS 4E-29, 4N-30 30-AUG-78  
EDITED ISOTHERM DEPTH VS TIME/DISTANCE ISOTHERMS (DEG C)  
4E-29 12.0 TO 9.8; 4N-30 12.0 TO 10.0



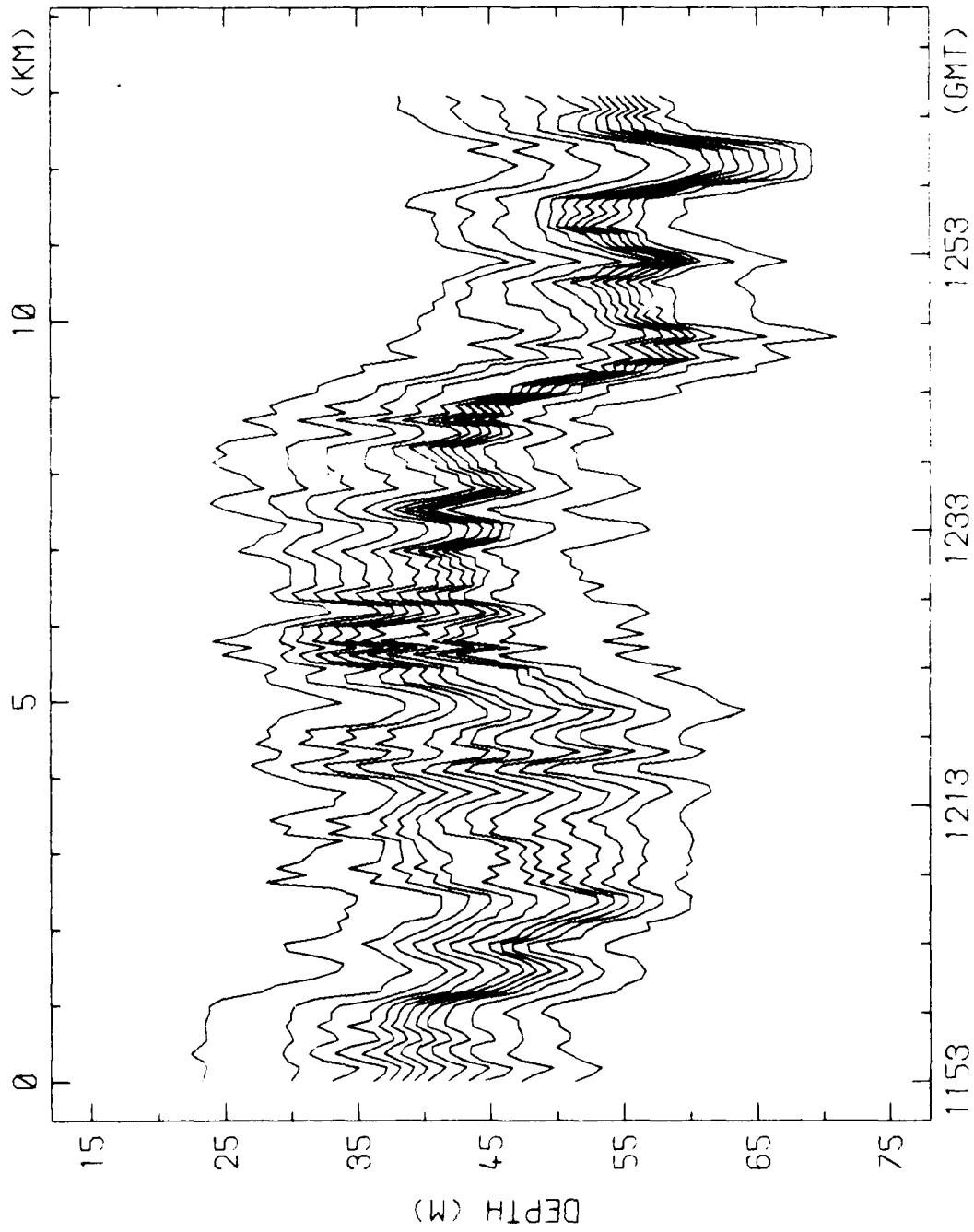

RUN 5N-1 31-AUG-78 EDITED ISOTHERM DEPTH VS TIME/DISTANCE  
ISOTHERMS (DEG C) 12 2,12 0,11 8,11 6,11 4  
11 2,11 0,10 8,10 6,10 4,10 2,10 0,9 8

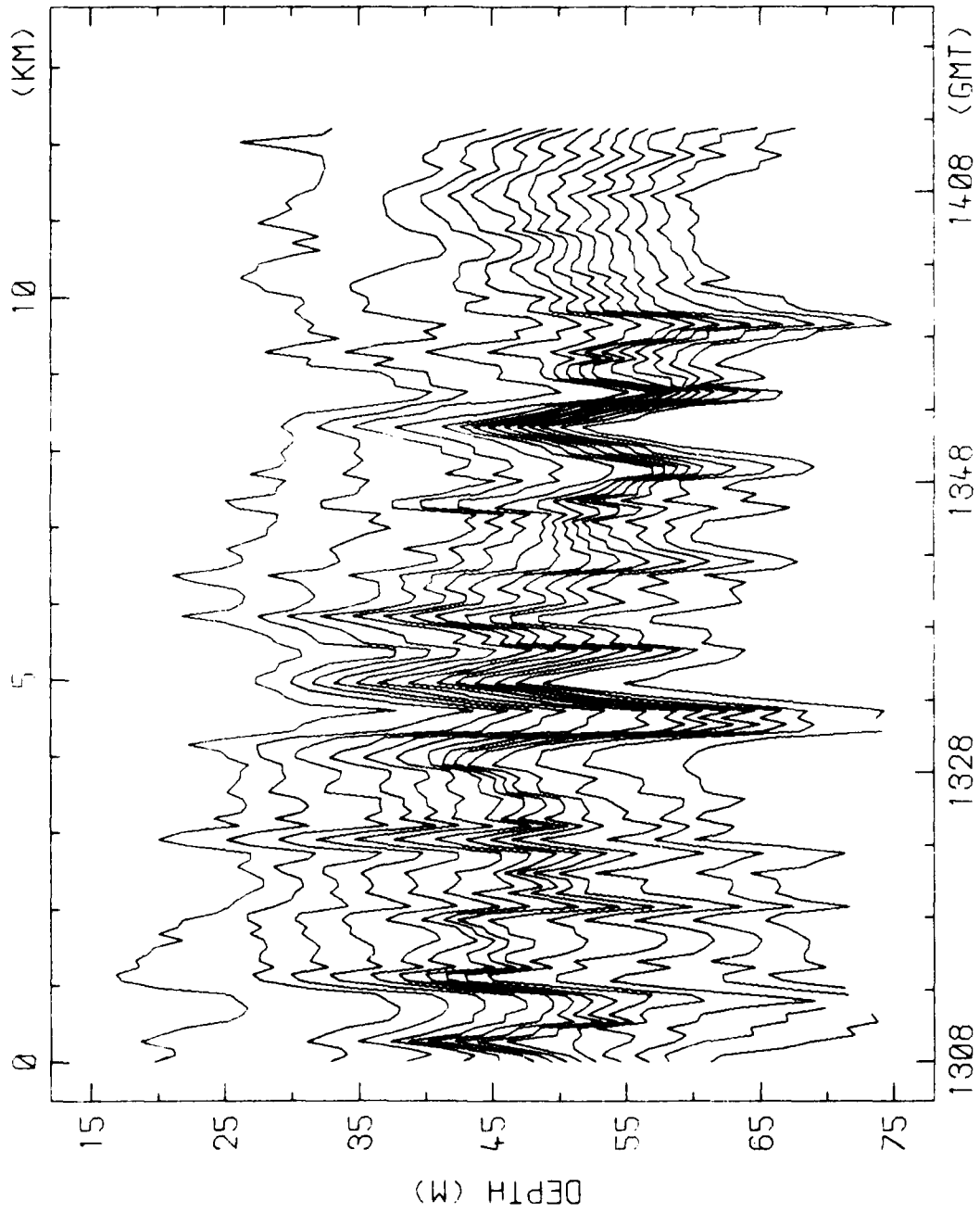

RUN SW-2 31-AUG-78 EDITED ISOTHERM DEPTH VS TIME/DISTANCE  
 ISOTHERMS (DEG C) 12.4,12.2,12.0,11.8,11.6,11.4  
 11.2,11.0,10.8,10.6,10.4,10.2,10.0,9.8

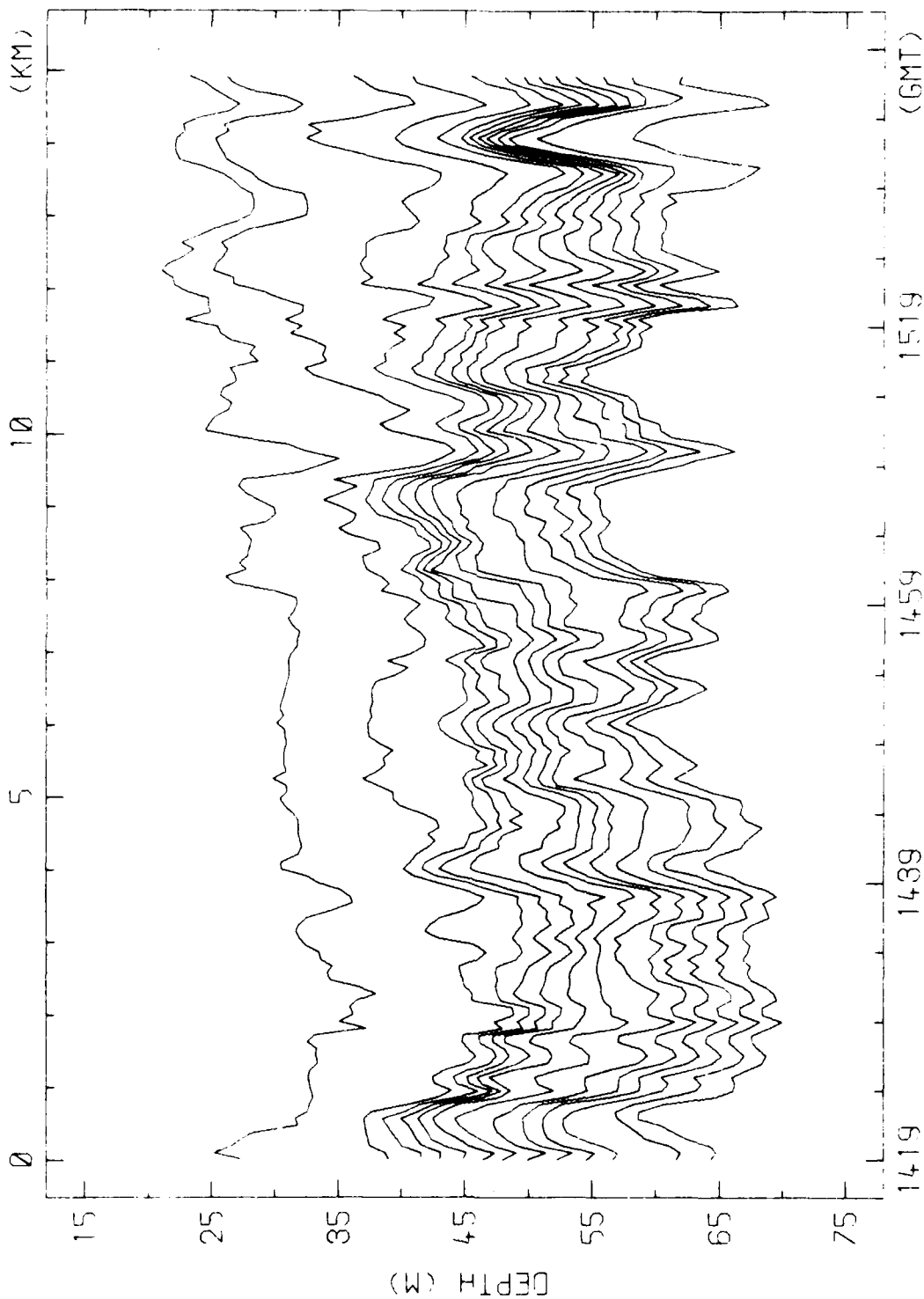

RUN 5S-3 31-AUG-78 EDITED ISOTHERM DEPTH VS TIME/DISTANCE  
ISOTHERMS (DEG C) 12, 4, 12, 2, 12, 0, 11, 8, 11, 6, 11, 4  
11, 2, 11, 0, 10, 8, 10, 6, 10, 4, 10, 2, 10, 0

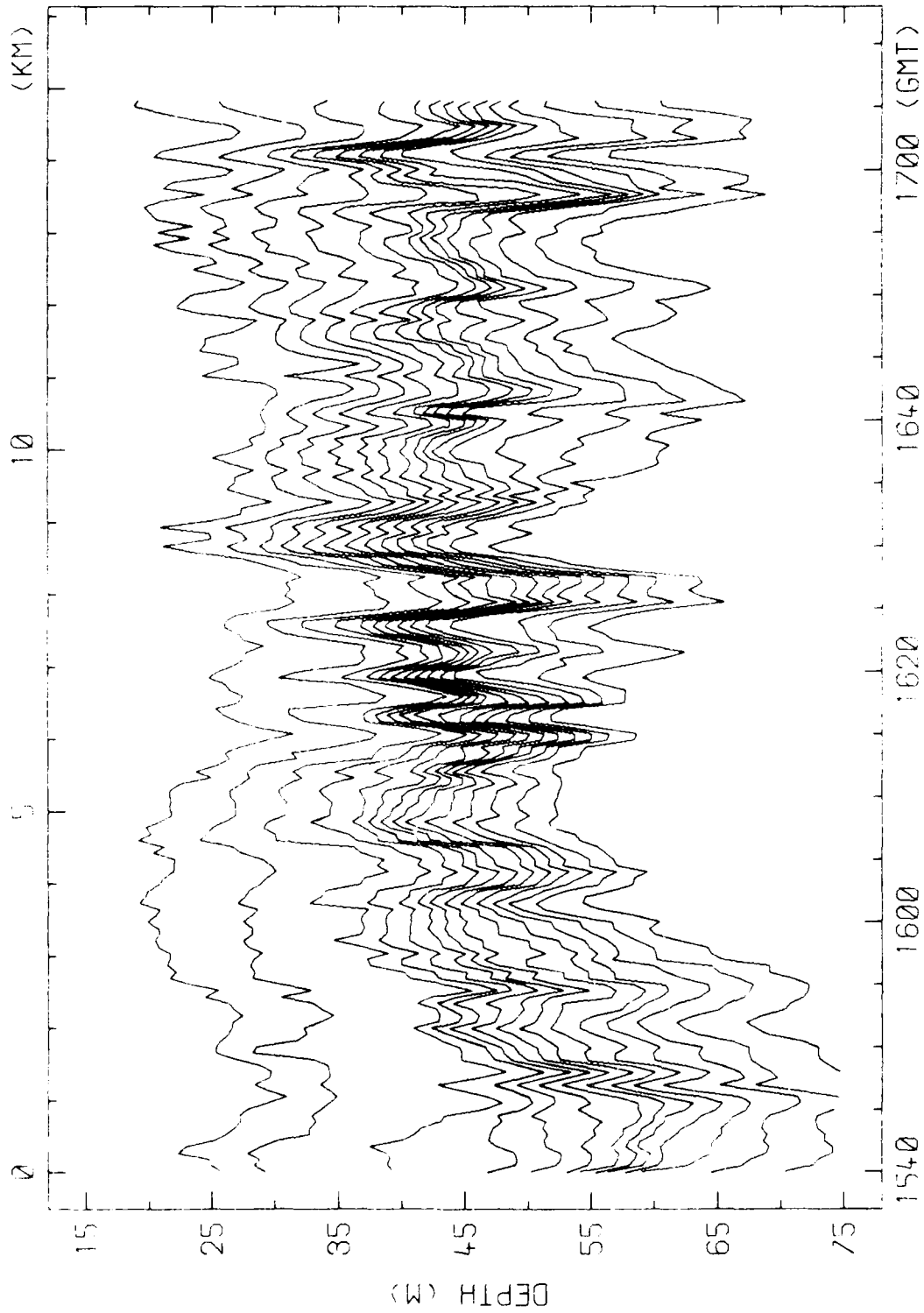

RUN SE-4 31-AUG-78 EDITED ISOTHERM DEPTH VS TIME/DISTANCE  
 ISOTHERMS (DEG C) 12 4,12 2,12 0,11 8,11 6,11.4  
 11 2,11 0,10 8,10 6,10 4,10 2,10 0,9.8

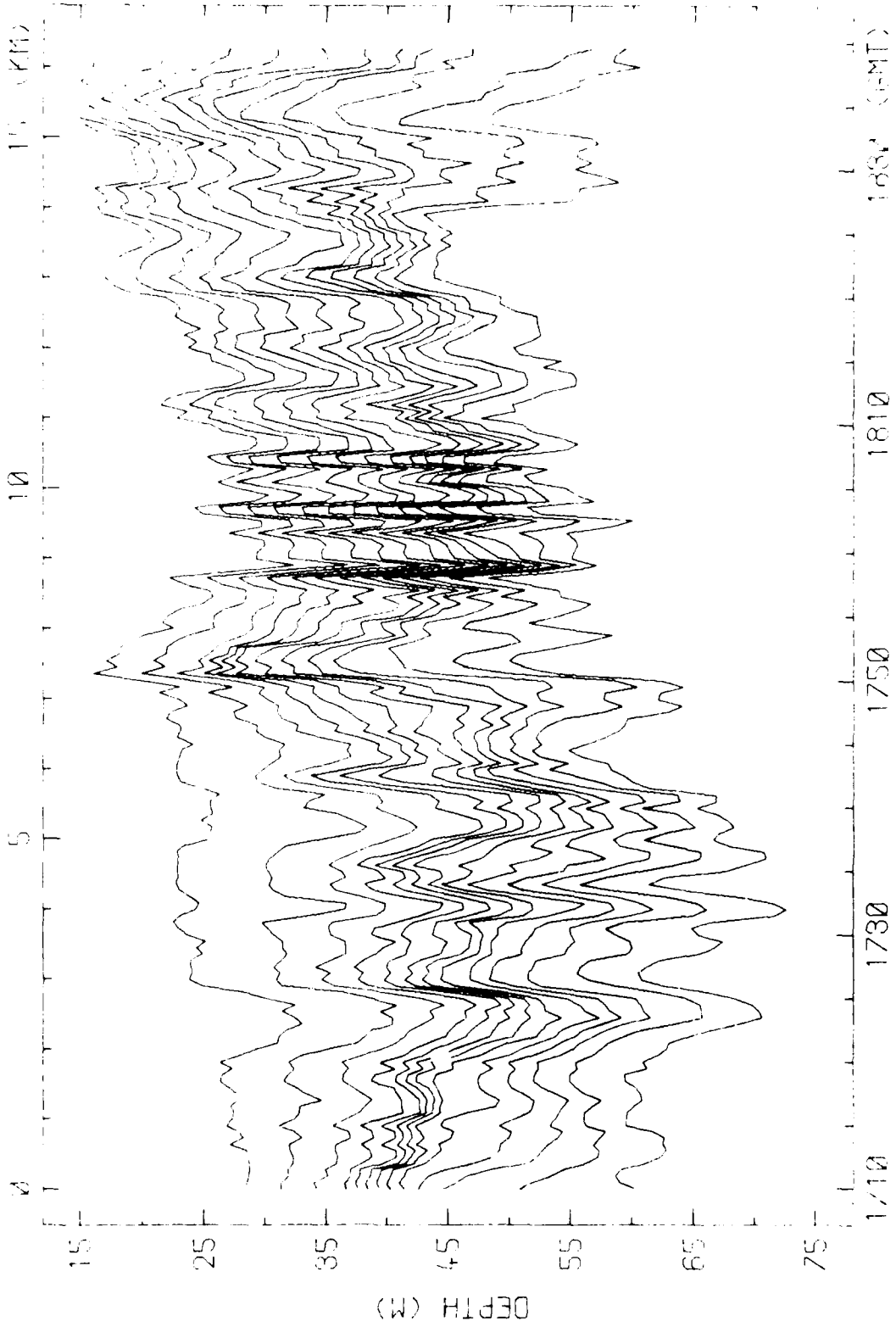

RUIN SN-5 31-AUG-78 EDITED ISOTHERM DEPTH VS. TIME/L. CONTINUED  
ISOTHERMS (DEG C) 12 2,12 0,11 8,11 6,11 4  
11,2,11 0,10 8,10 6,10 4,10 2,10 0,9 F

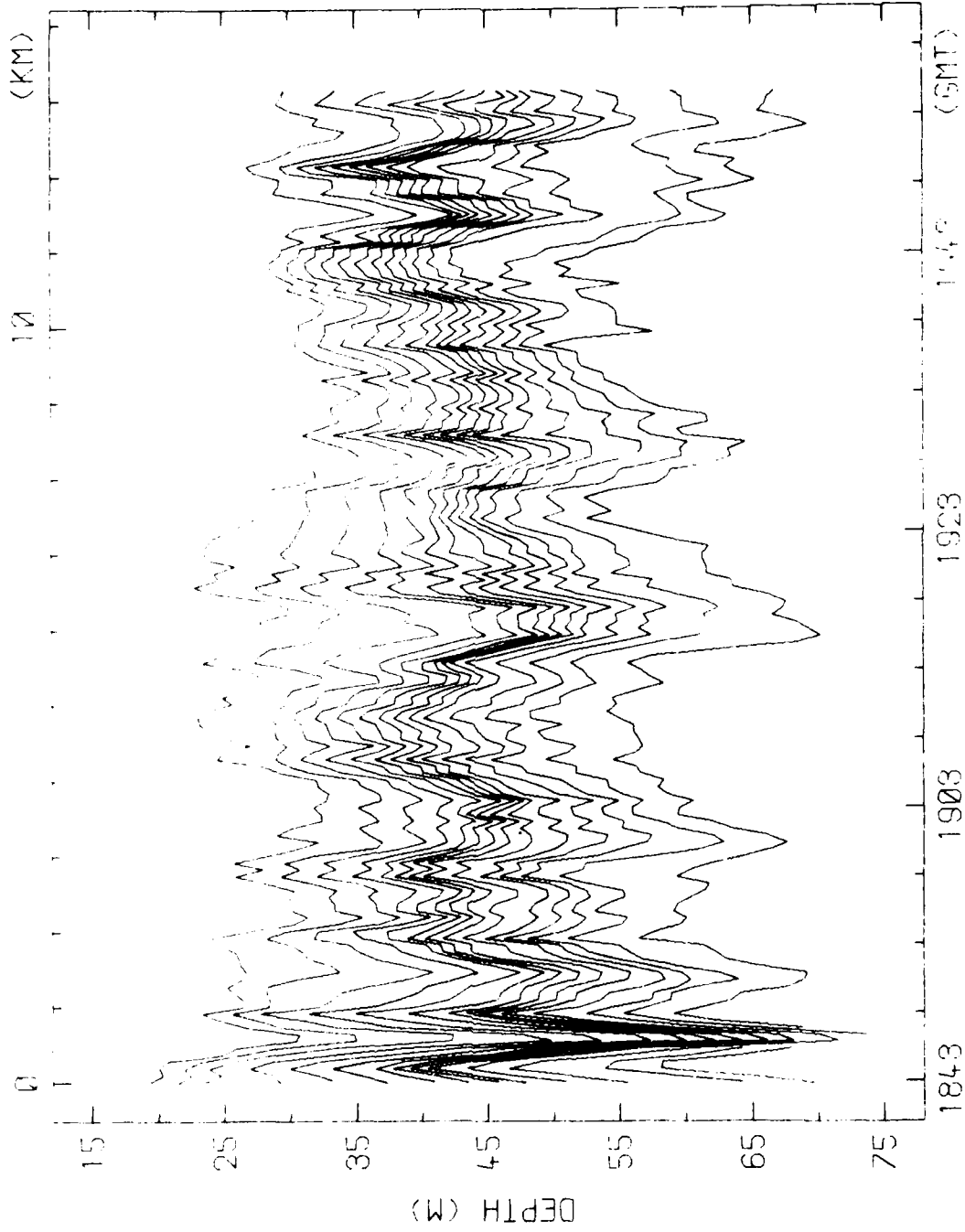

RUN 5W-6 31-AUG-78 EDITED ISOTHERM DEPTH VS TIME/DISTANCE  
ISOTHERMS (DEG C) 12, 2, 12, 0, 11, 8, 11, 6, 11, 4  
11, 2, 11, 0, 10, 8, 10, 6, 10, 4, 10, 2, 10, 0, 9, 8, 9, 6

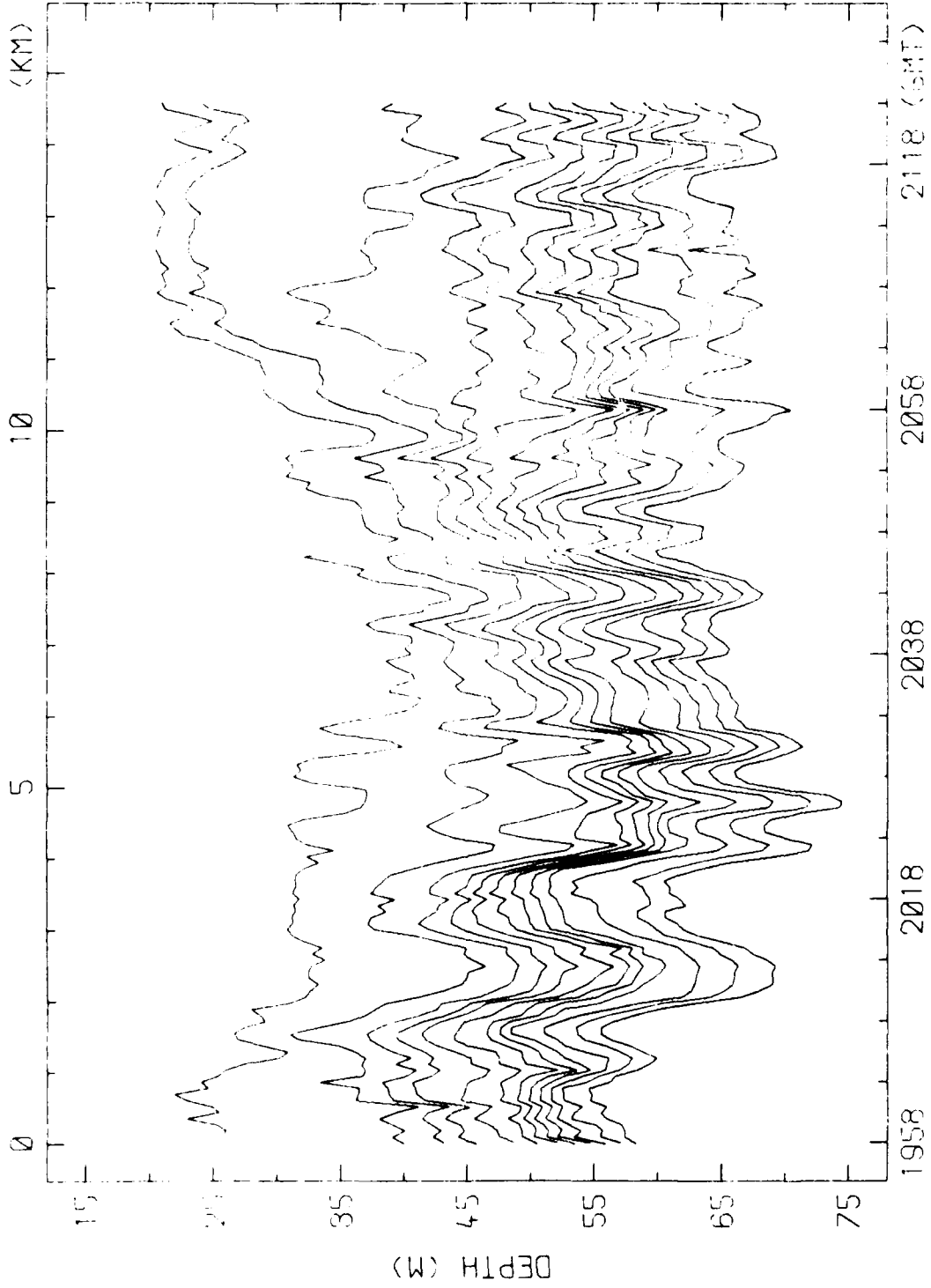

RUN 55-7 31-AUG-78 EDITED ISOTHERM DEPTH VS TIME/DISTANCE  
ISOTHERMS (DEG C) 12.4, 12.2, 12.0, 11.8, 11.6  
11.4, 11.2, 11.0, 10.8, 10.6, 10.4, 10.2

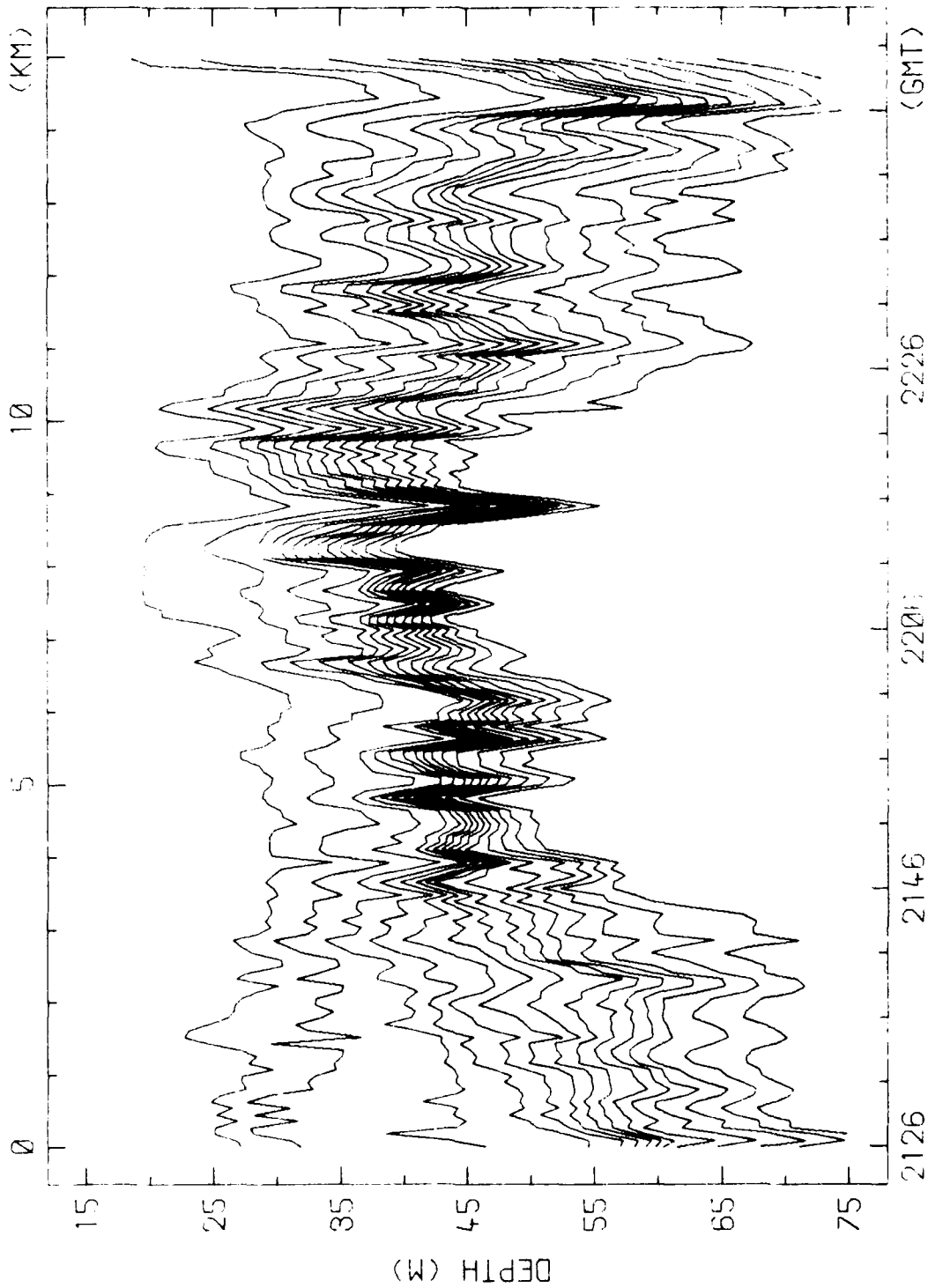

RUN 5E-8 31-AUG-78 EDITED ISOTHERM DEPTH VS TIME/DISTANCE

ISOTHERMS (DEG C) 12.4, 12.2, 12.0, 11.8, 11.6, 11.4

11.2, 11.0, 10.8, 10.6, 10.4, 10.2, 10.0, 9.8



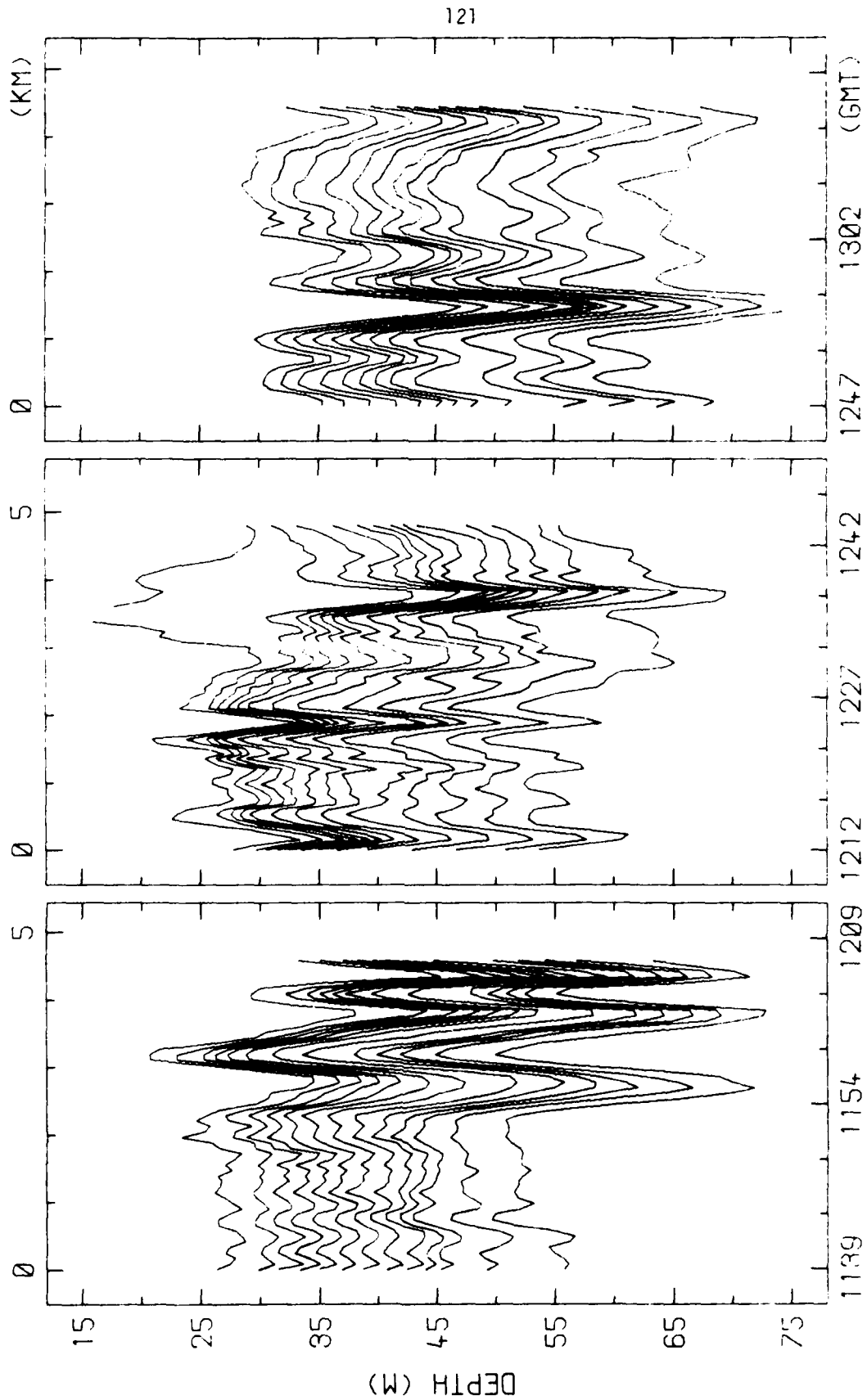

RUNS 6W-1, 6S-2, 6E-3 2-SEP-78 EDITED ISOTHERM DEPTH VS TIME (HOURS) ISOTHERMS (DEG C) 6W-1 12.2 TO 9.8, 6S-2 12.2 TO 9.8, 6E-3 12.2 TO 9.8

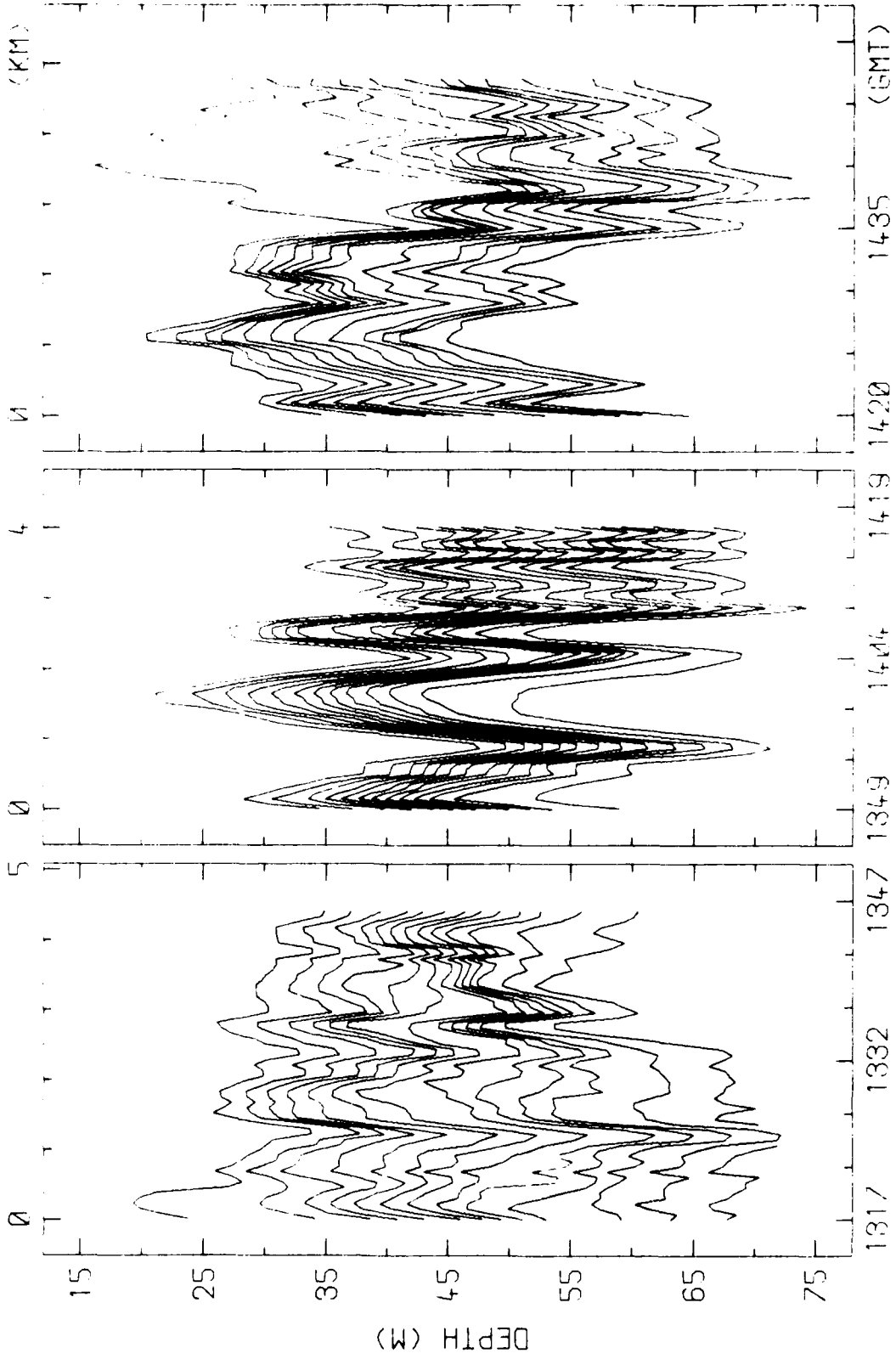

RUNS 6N-4, 6W-5, 6S-6 2-SEP-78 EDITED ISOTHERM DEPTH VS TIME/DISTANCE  
ISOTHERMS (DEG C) 6N-4 12.2 TO 9.8, 6W-5 12.2 TO 9.8, 6S-6 12.2 TO 10.0

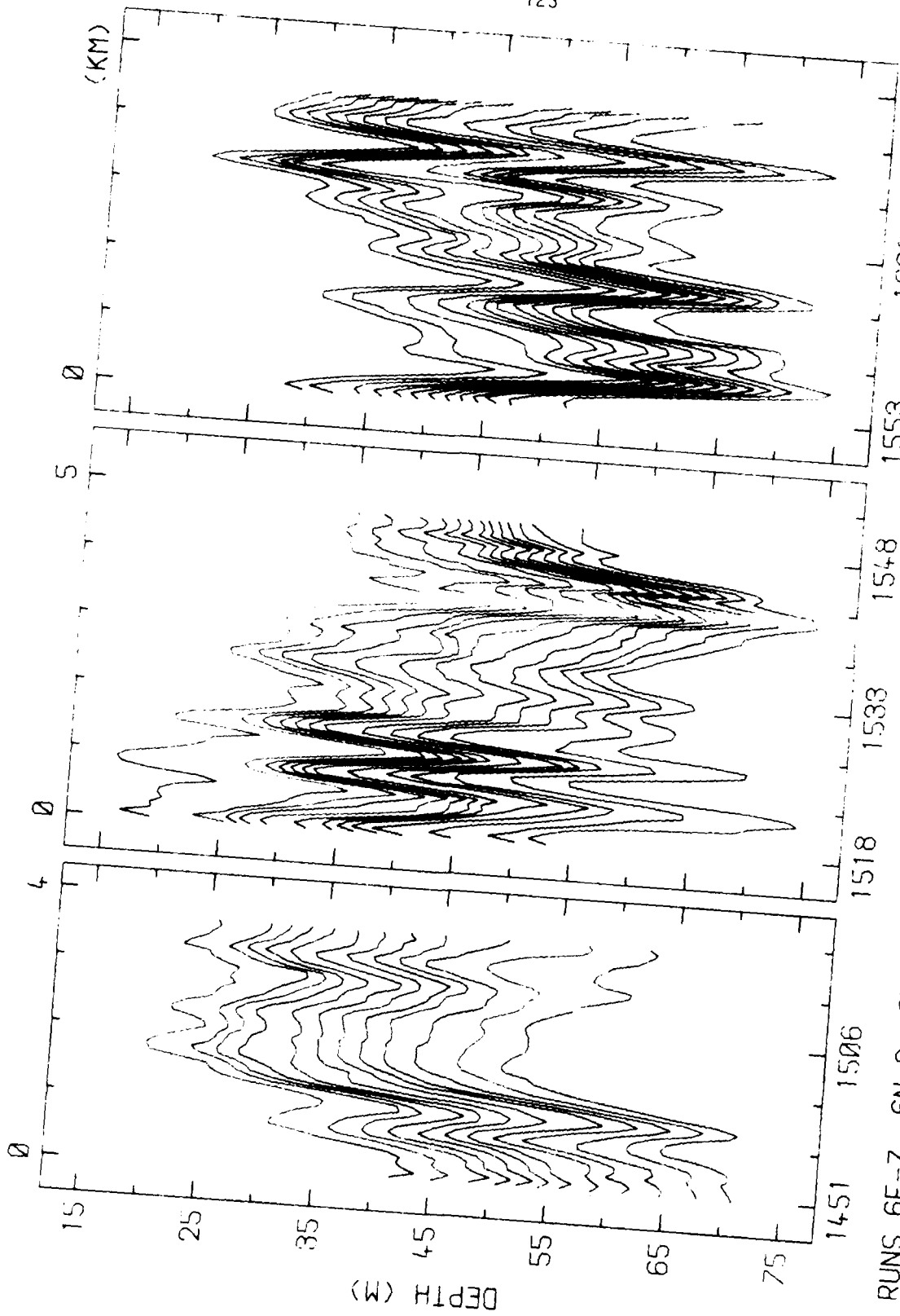

RUNS 6E-7, 6N-8, 6W-9 2-SEP-78 EDITED ISOTHERM DEPTH VS TIME/LATITUDE  
ISOTHERMS (DEG C) 6E-7 12.2 TO 10.0; 6N-8 12.2 TO 9.8; 6W-9 12.2 TO 9.8

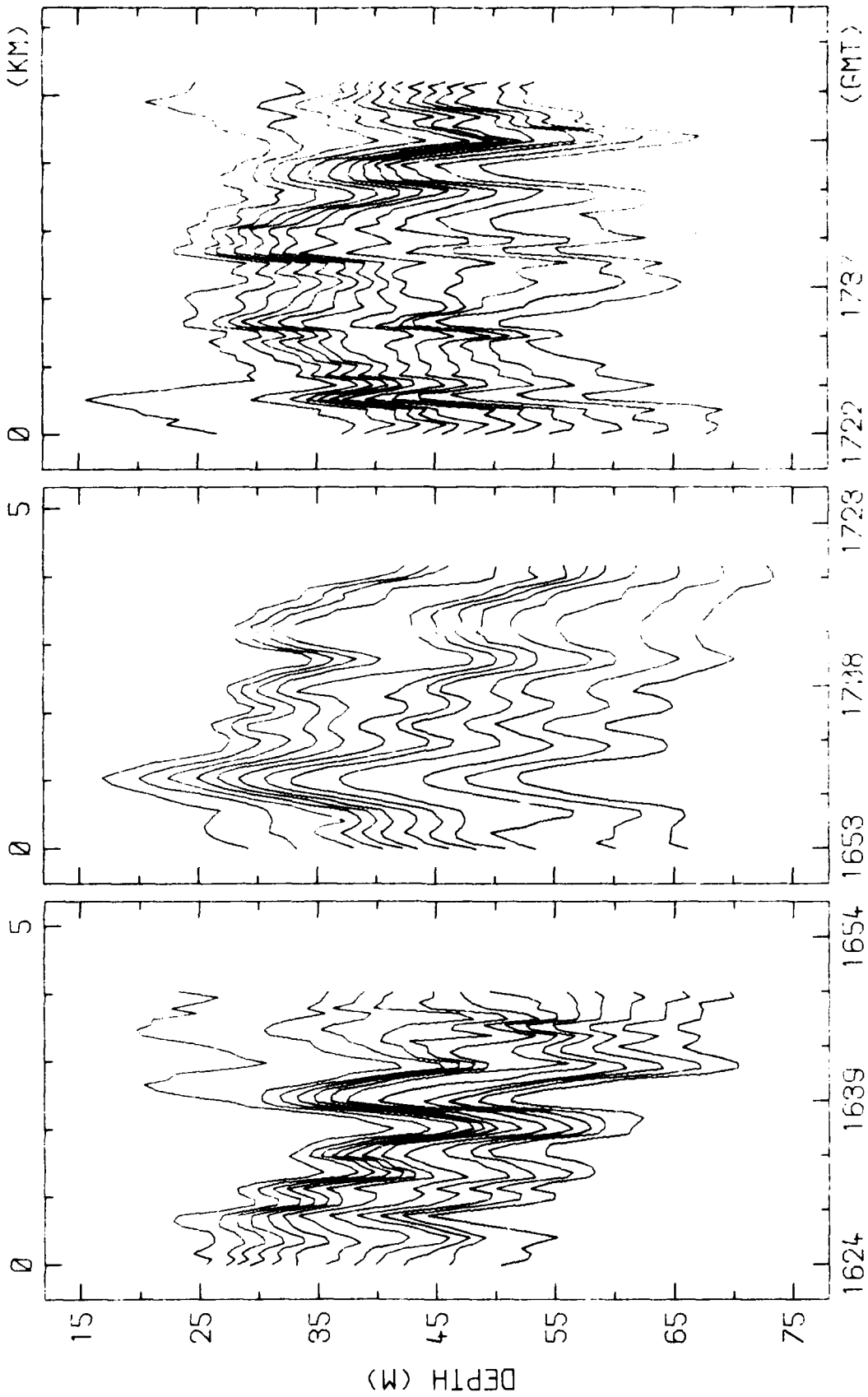

RUNS 6S-10, 6E-11, 6I-12, 2-SEP-78  
EDITED ISOTHERM DEPTH VS TIME/DISTANCE    ISOTHERM    (DEPTH)  
6S-10 12 2 TO 10 0; 6E-11 12 0 TO 9 8; 6I-12 12 2 TO 10 0

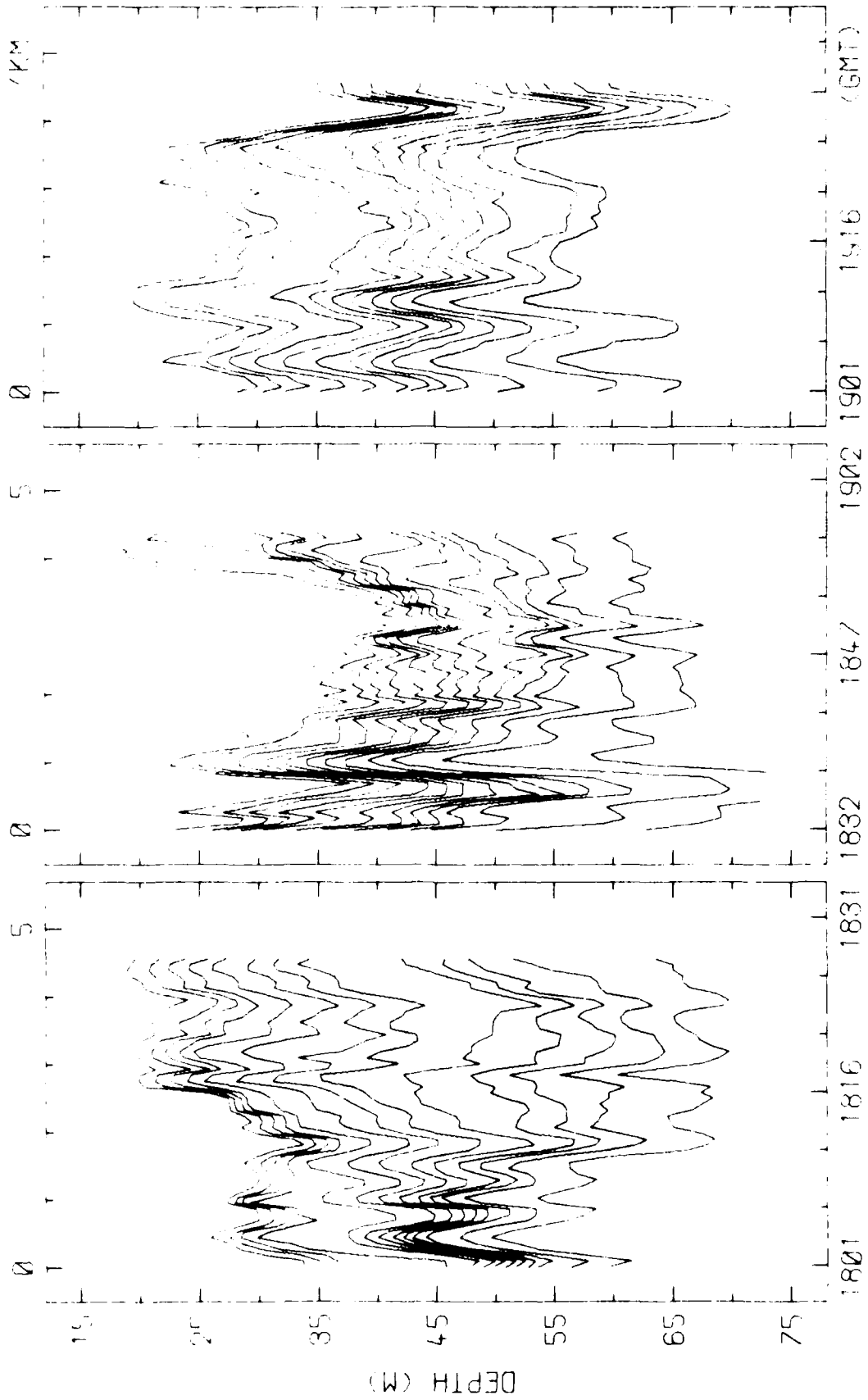

RUNS 6W-13, 6W-14, 6W-15 2 SEP 78  
EDITED ISOTHERM DEPTH VS. TIME/DISTANCE ISOTHERMS (TEMPERATURE)  
6W-13 1, 2, 10, 15, 20, 25, 30, 35, 40, 45, 50, 55, 60, 65, 70, 75, 80, 85, 90, 95, 100

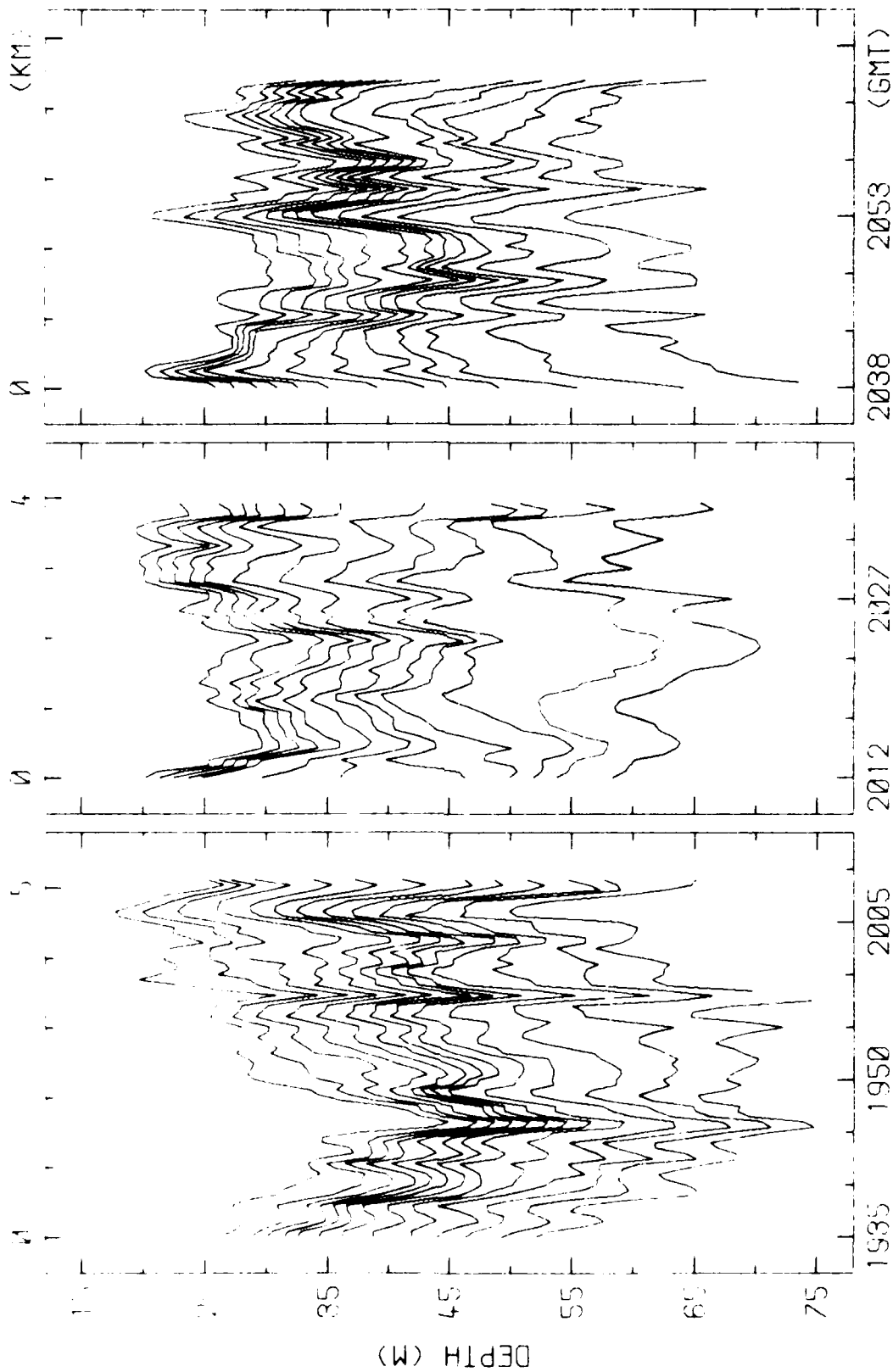

RUNS 6N-16, 6W-17, 6S-18 2-SEP-78  
EDITED ISOTHERM DEPTH VS TIME/DISTANCE ISOTHERMS (DEG C)  
6N-16 12.2 TO 9.8, 6W-17 12.2 TO 10.0, 6S-18 12.2 TO 9.8

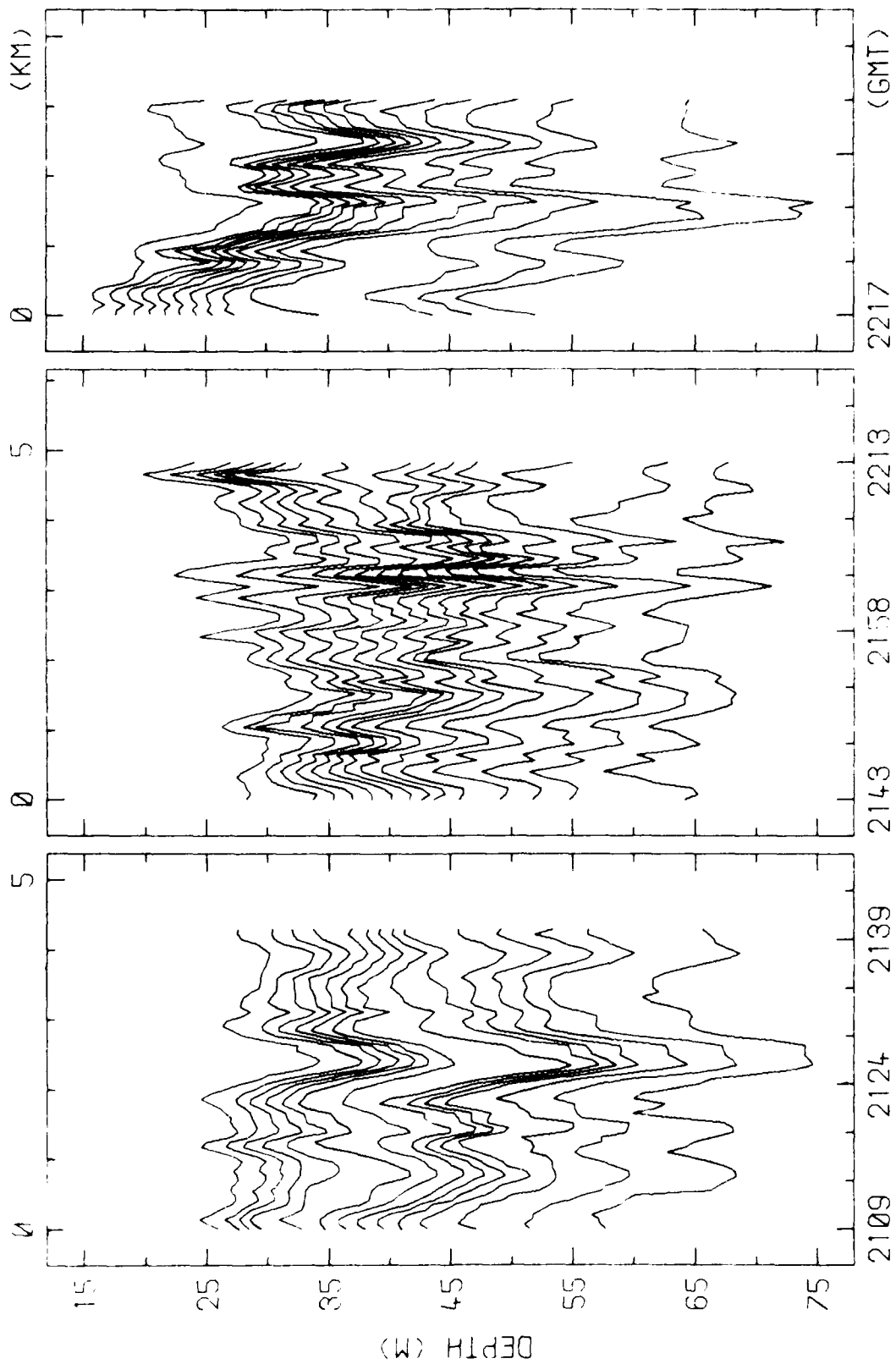

RUNS 6E-19, 6N-20, 6W-21 2-SEP-78  
EDITED ISOTHERM DEPTH VS TIME/DISTANCE ISOTHERMS (DEG C)  
6E-19 12.2 TO 9.6; 6N-20 12.2 TO 9.6; 6W-21 12.4 TO 10.0

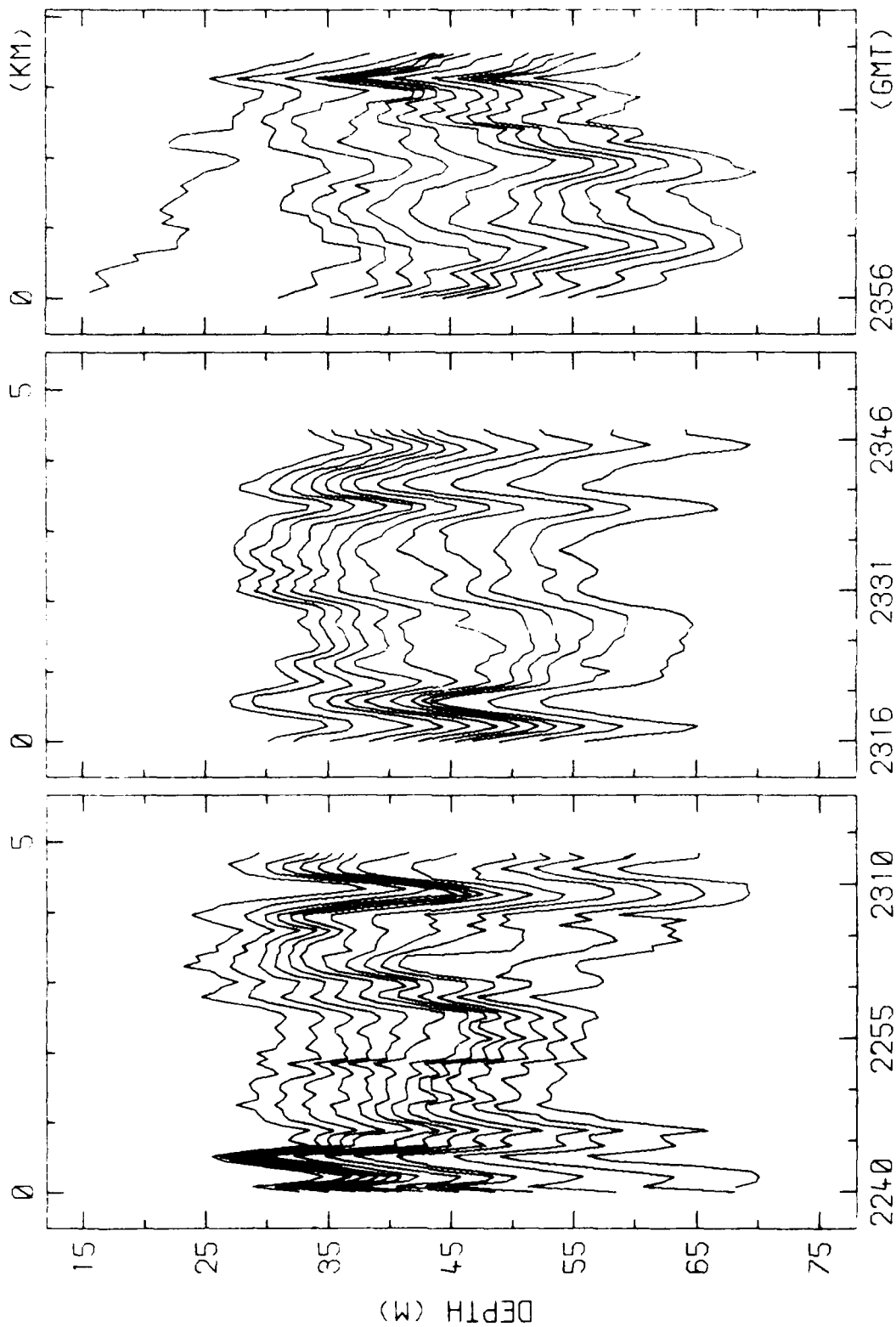

RUNS 65-22, 6E-23, 6N-24 2-SEP-78  
EDITED ISOTHERM DEPTH VS TIME/DISTANCE ISOTHERMS (DEG C)  
65-22 12.2 TO 9.8, 6E-23 12.0 TO 9.8, 6N-24 12.4 TO 10.0



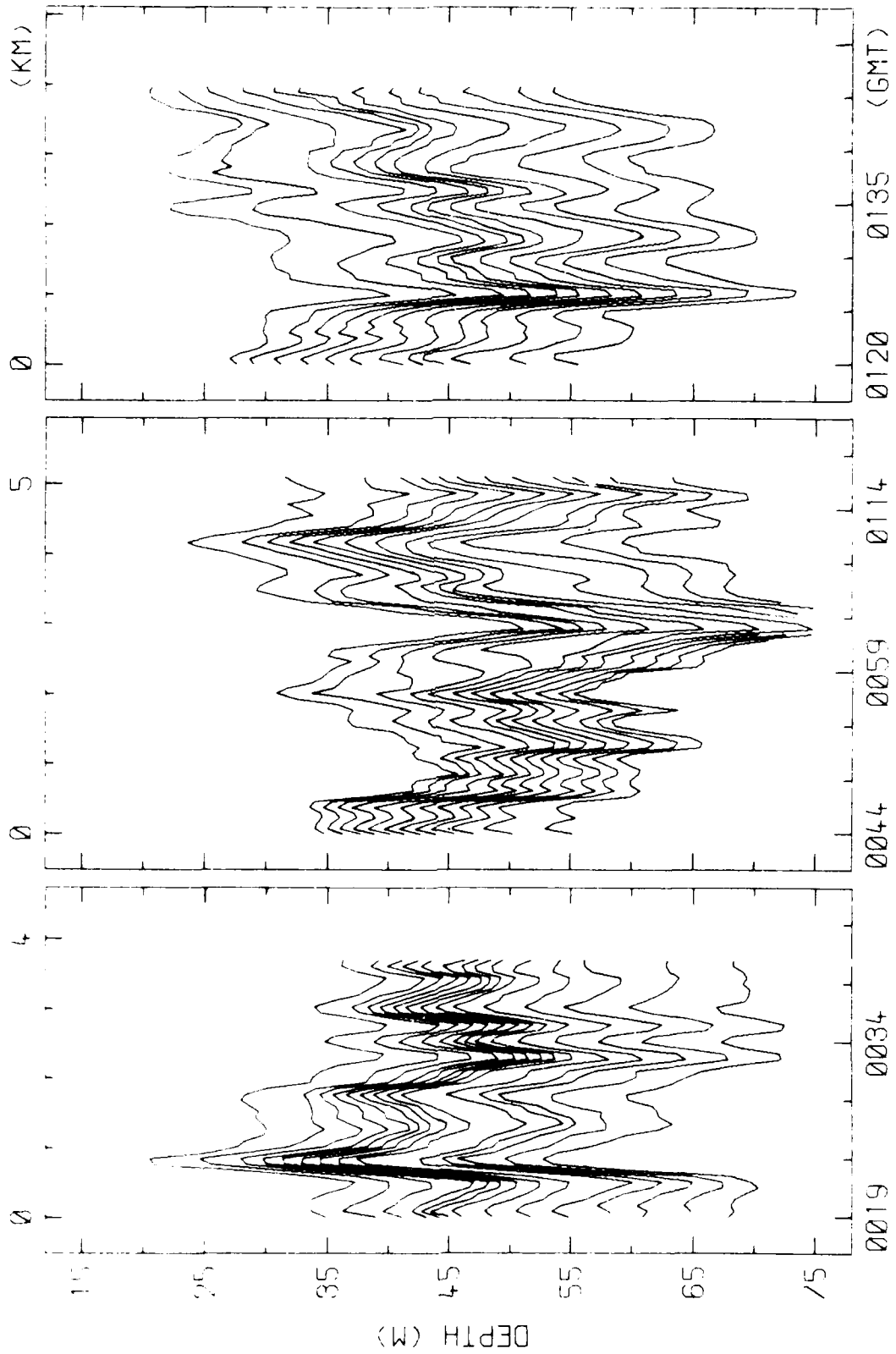

RUNS 6W-25, 6S-26, 6E-27 3-SEP-78  
EDITED ISOTHERM DEPTH VS TIME/DISTANCE ISOTHERMS (DEG C)  
6W-25 12 4 TO 9.8; 6S-26 12 2 TO 10.0; 6E-27 12.0 TO 9.8

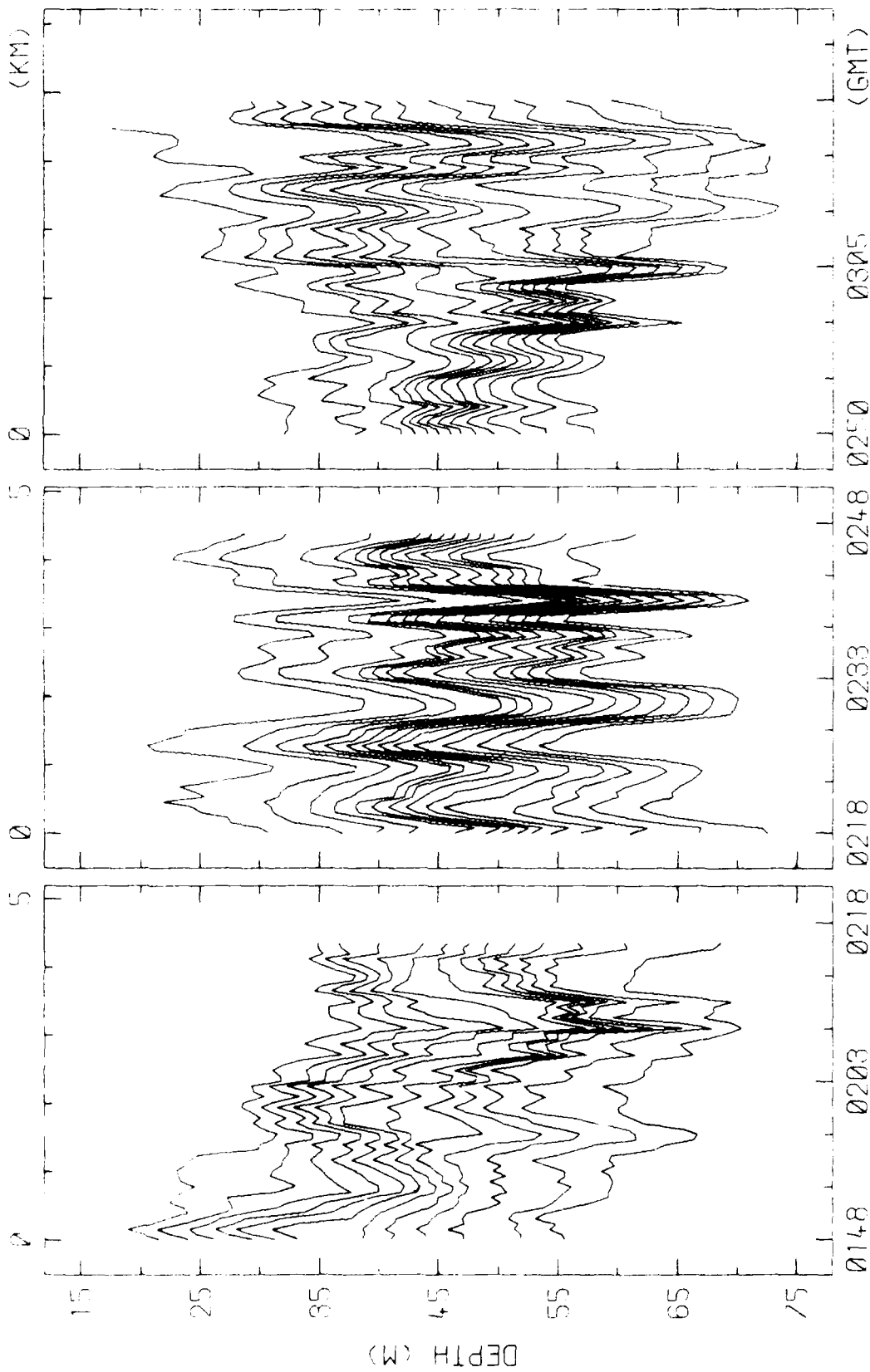

RUNS 6N-28, 6W-29, 6S-30 3-SEP-78  
EDITED ISOTHERM DEPTH VS TIME/DISTANCE ISOTHERMS (DEG C)  
6N-28 12 0 TO 4 8. 6W-29 12 4 TO 9 8. 6S-30 12 2 TO 9 8

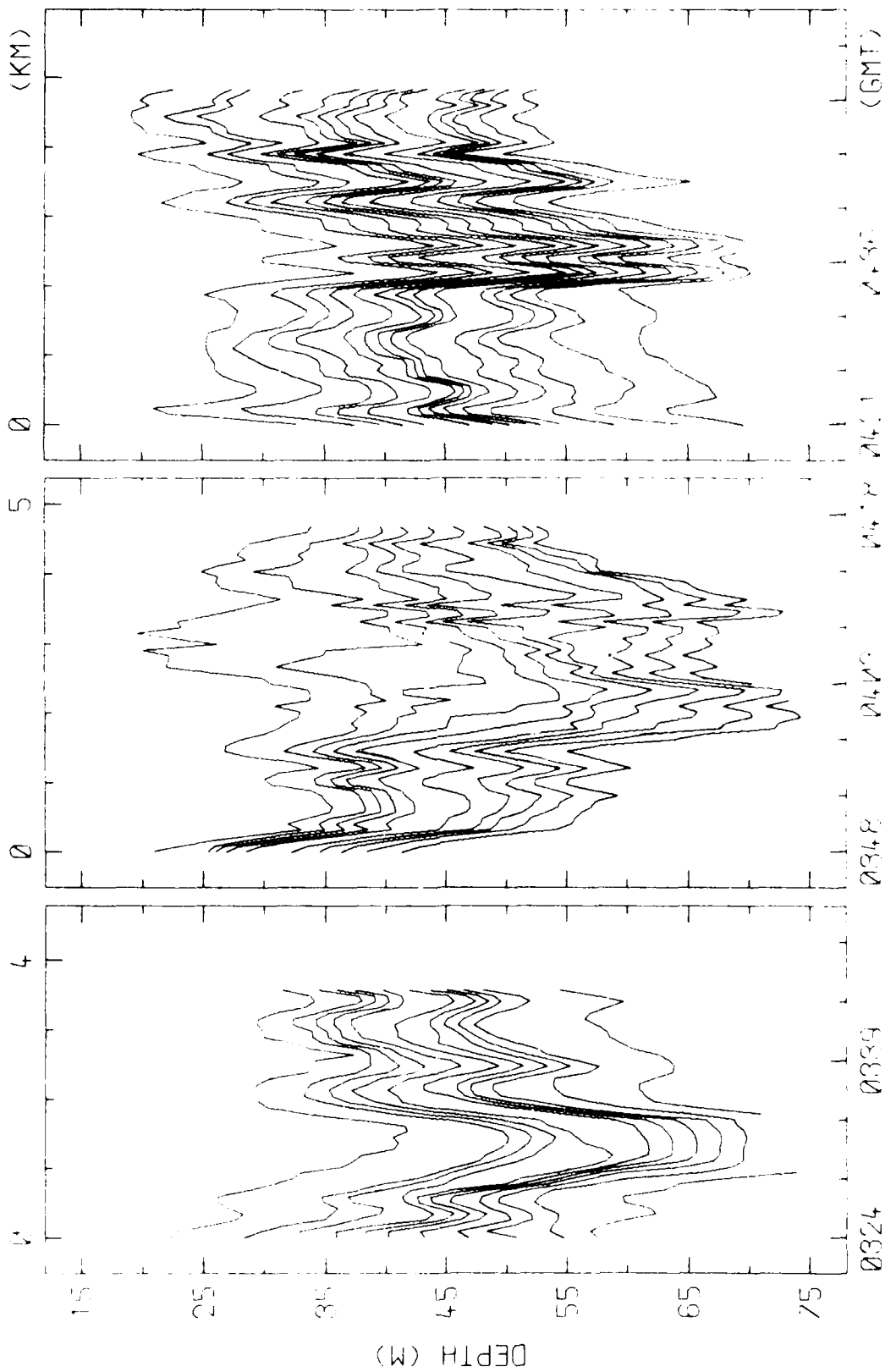

RUNS SE 31 ON 08/24/81  
EDITED ISOTHERM DEPTH VS. TIME AND STATION DISTANCES (DEP. IS  
SE-81 12 2 TO 10 2) RUNS 11 1 TO 10 1, 12 4 TO 10 4

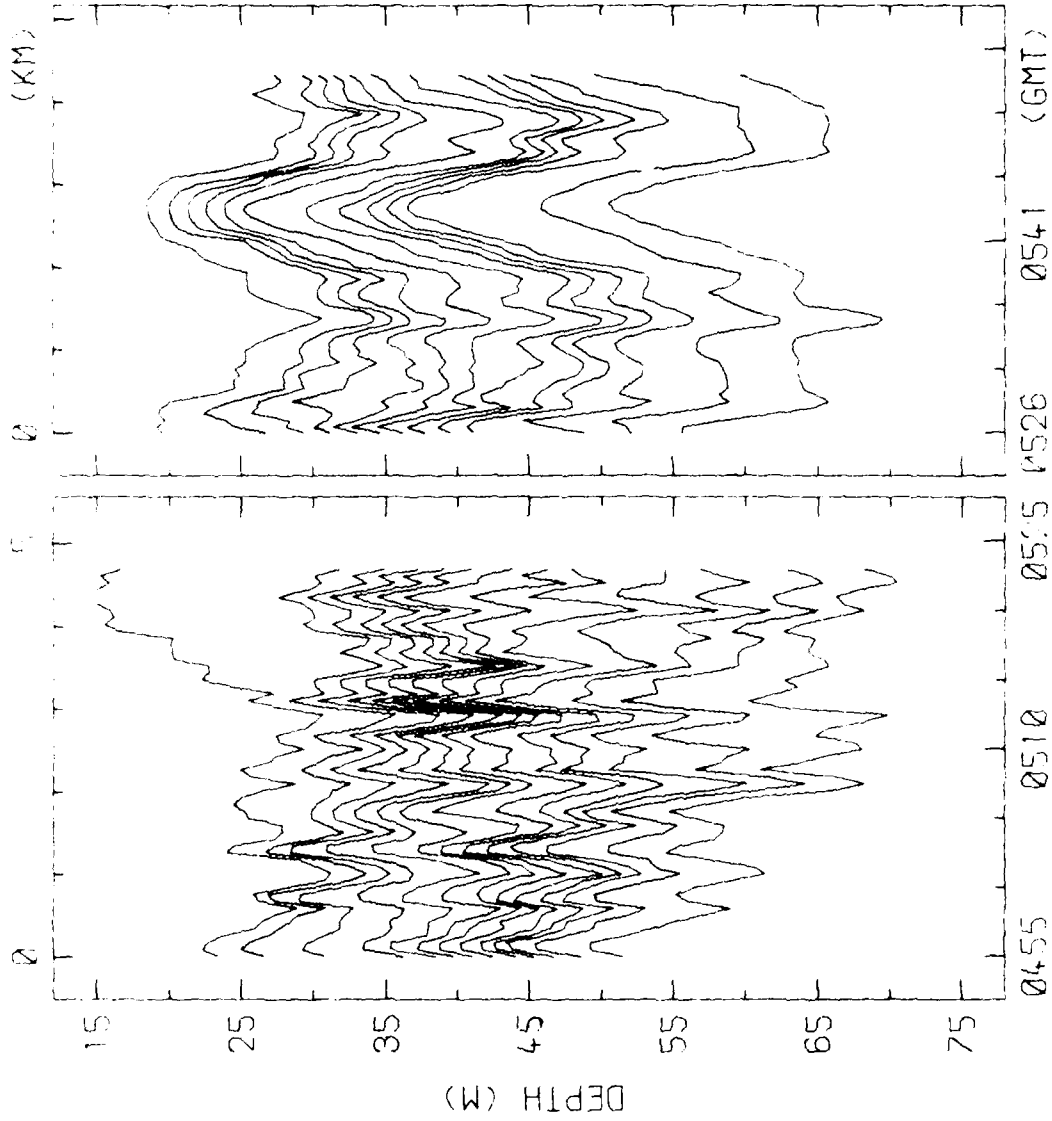

RUNS 6S-84, 6E-85 3-SEP-78  
EDITED ISOTHERM DEPTH VS TIME/DISTANCE ISOTHERMS (DEG C)  
6S-84 12 2 TO 4 8. 6E-85 12 2 TO 9 8

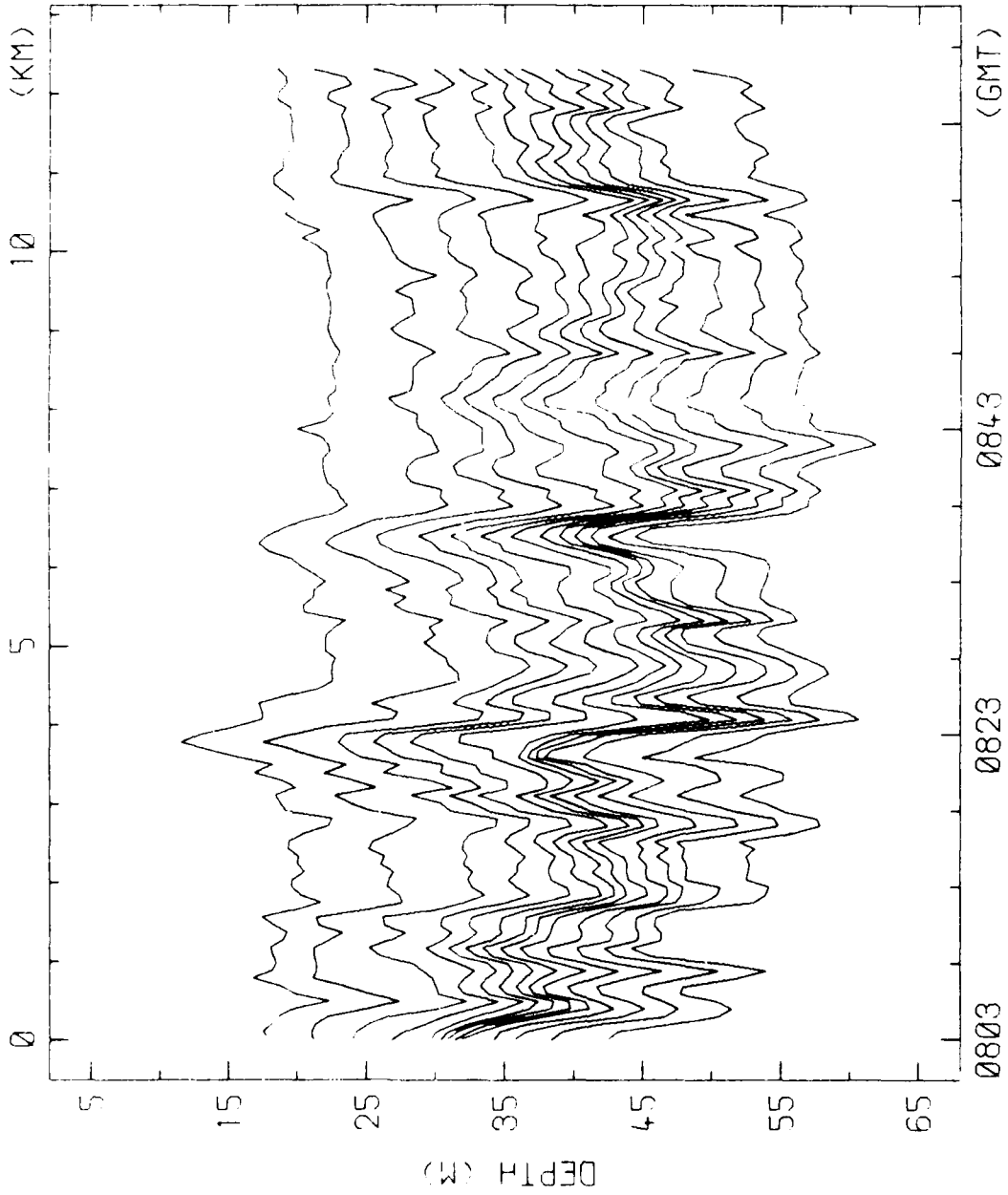

0803 0823 0843 (GMT)

RUN 7S-1 4-SEP-78 EDITED ISOTHERM DEPTH VS TIME/DISTANCE  
ISOTHERMS (DEG C) 12 4,12 2,12 0,11 8,11 6  
11 4,11 2,11 0,10 8,10 6,10 4,10 2,10 0

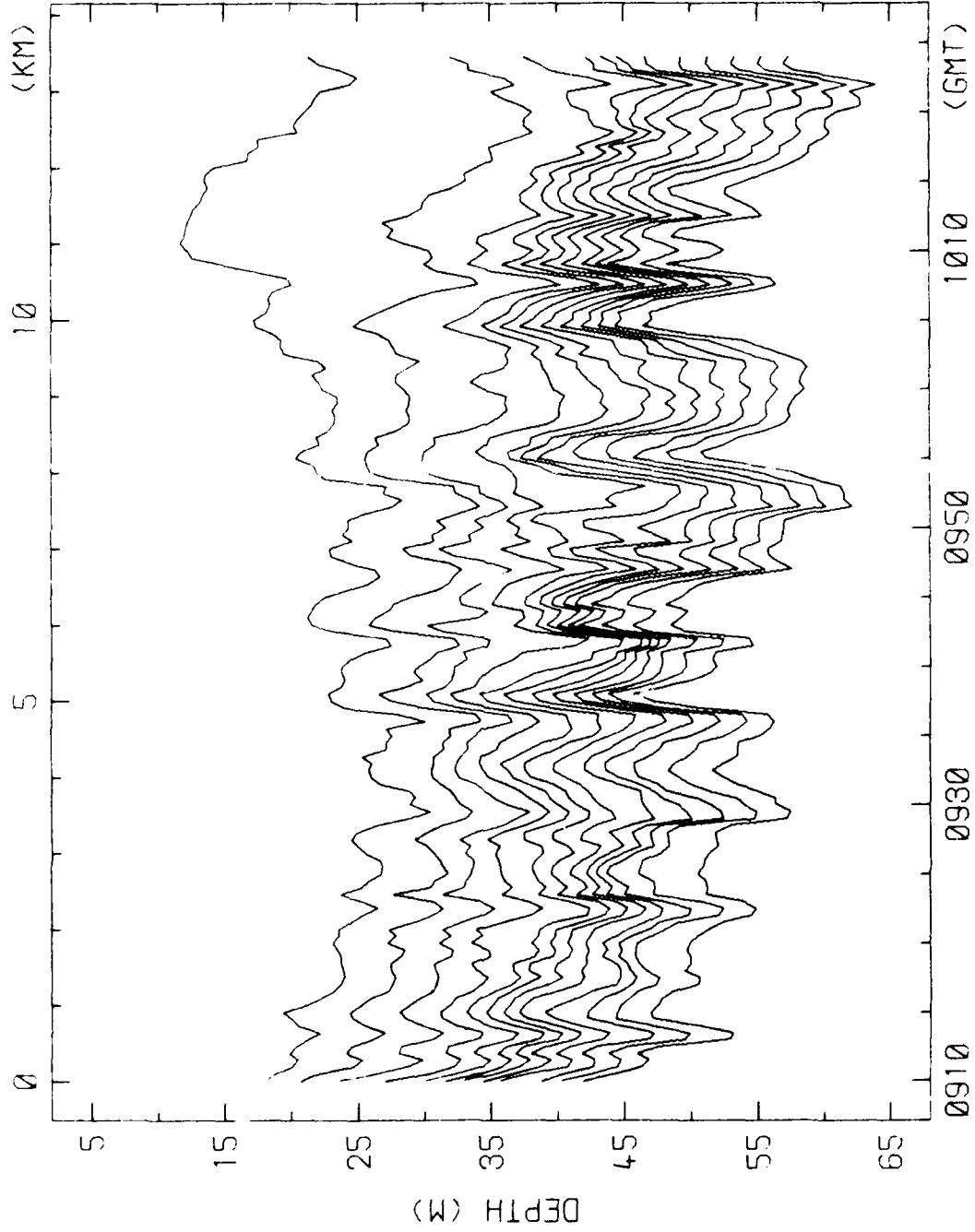

0910 0930 0950 1010 (GMT)

RUN 7E-2 4-SEP-78 EDITED ISOTHERM DEPTH VS TIME/DISTANCE  
ISOTHERMS (DEG C) 12.4, 12.2, 12.0, 11.8, 11.6  
11.4, 11.2, 11.0, 10.8, 10.6, 10.4, 10.2

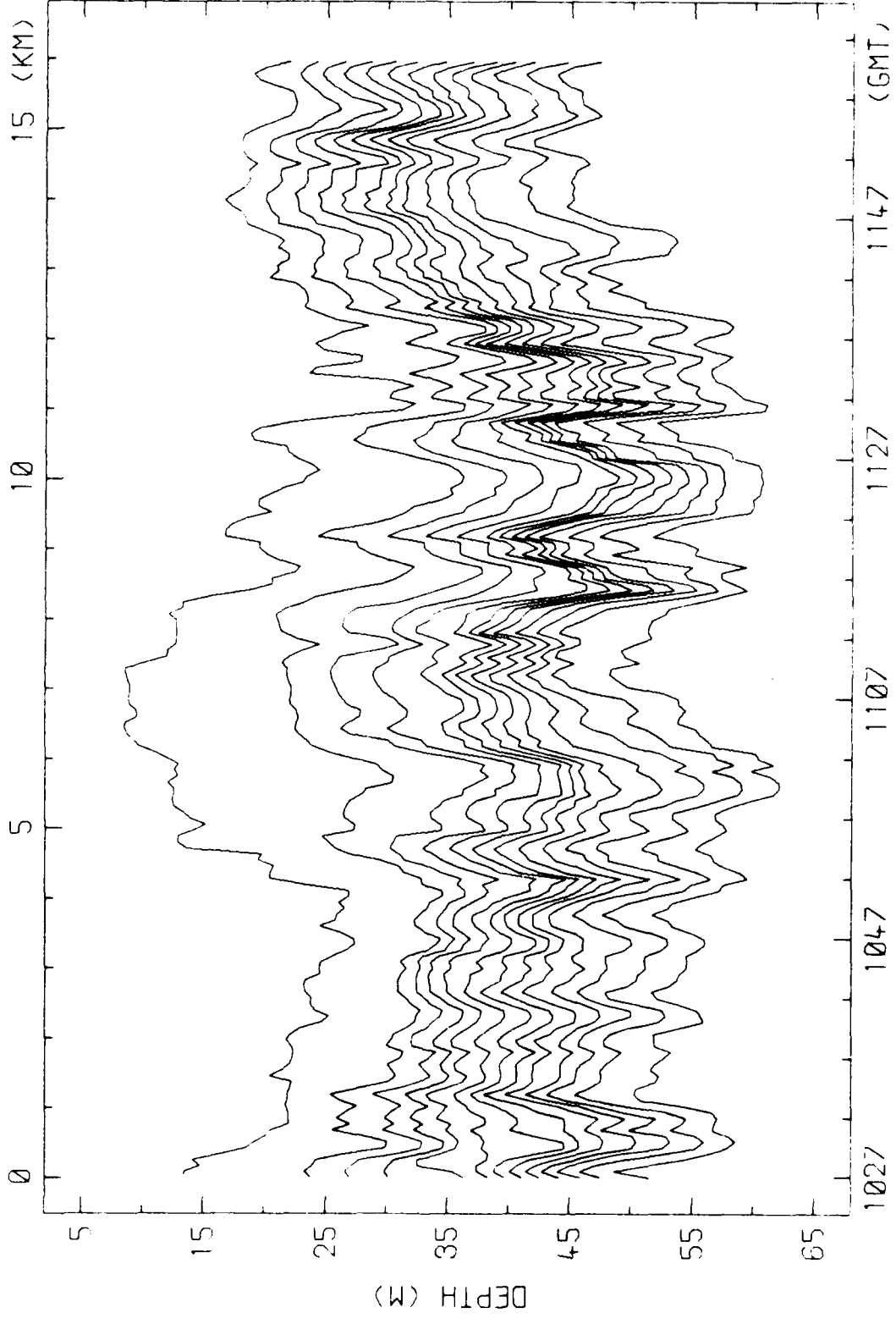

RUN 7N-3 4-SEP-78 EDITED ISOTHERM DEPTH VS TIME/DISTANCE  
ISOTHERMS (DEG C) 12.4, 12.2, 12.0, 11.8, 11.6  
11.4, 11.2, 11.0, 10.8, 10.6, 10.4, 10.2, 10.0

1027 1047 1107 1127 1147 (GMT)

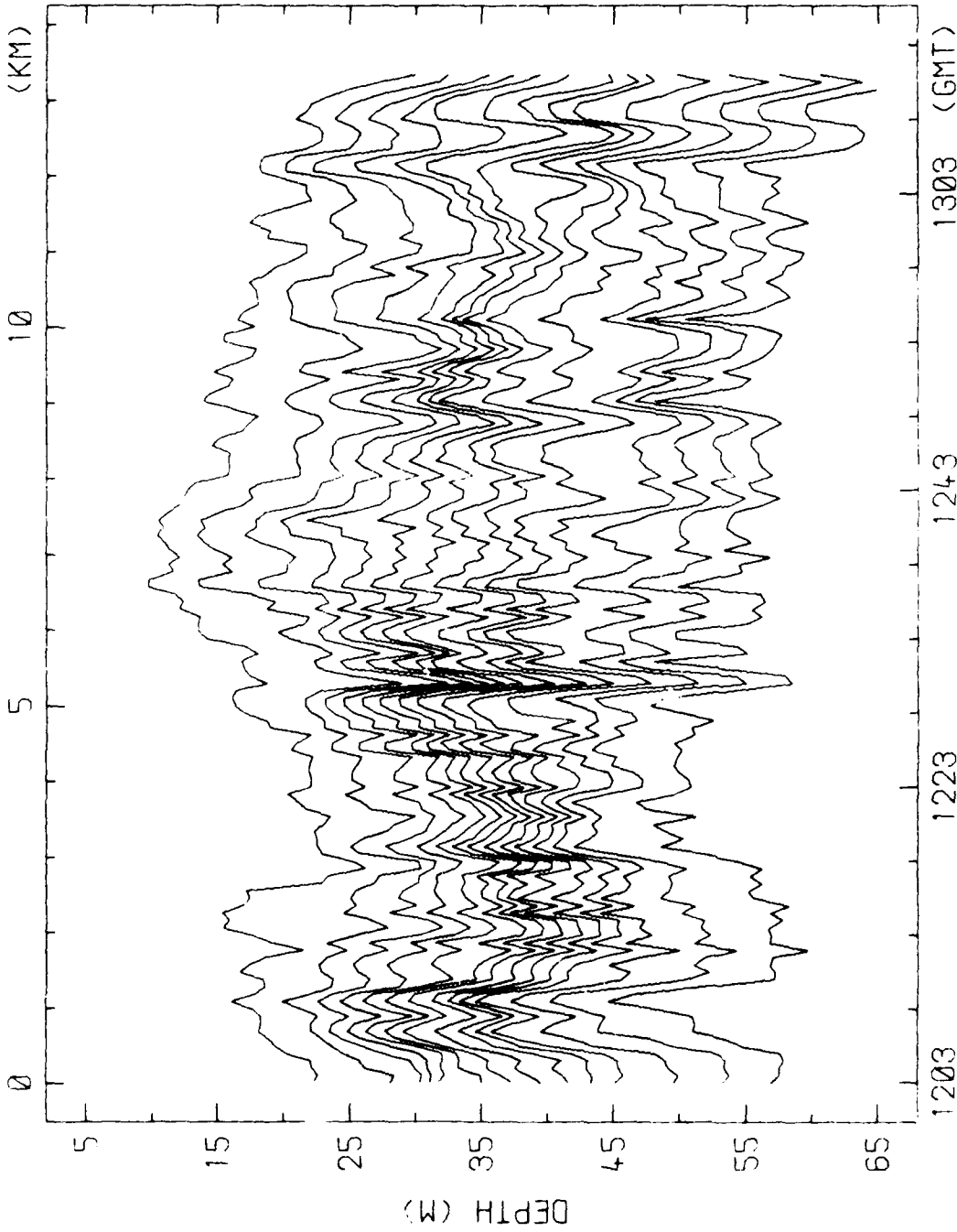

1208 1223 1243 1303 (GMT)

RUN /W-4 4-SEP-78 EDITED ISOTHERM DEPTH VS TIME/DISTANCE  
ISOTHERMS (DEG C) 12 4,12 2,12 0,11 8,11 6  
11 4,11 2,11 0,10 8,10 6,10 4,10 2,10 0,9 8



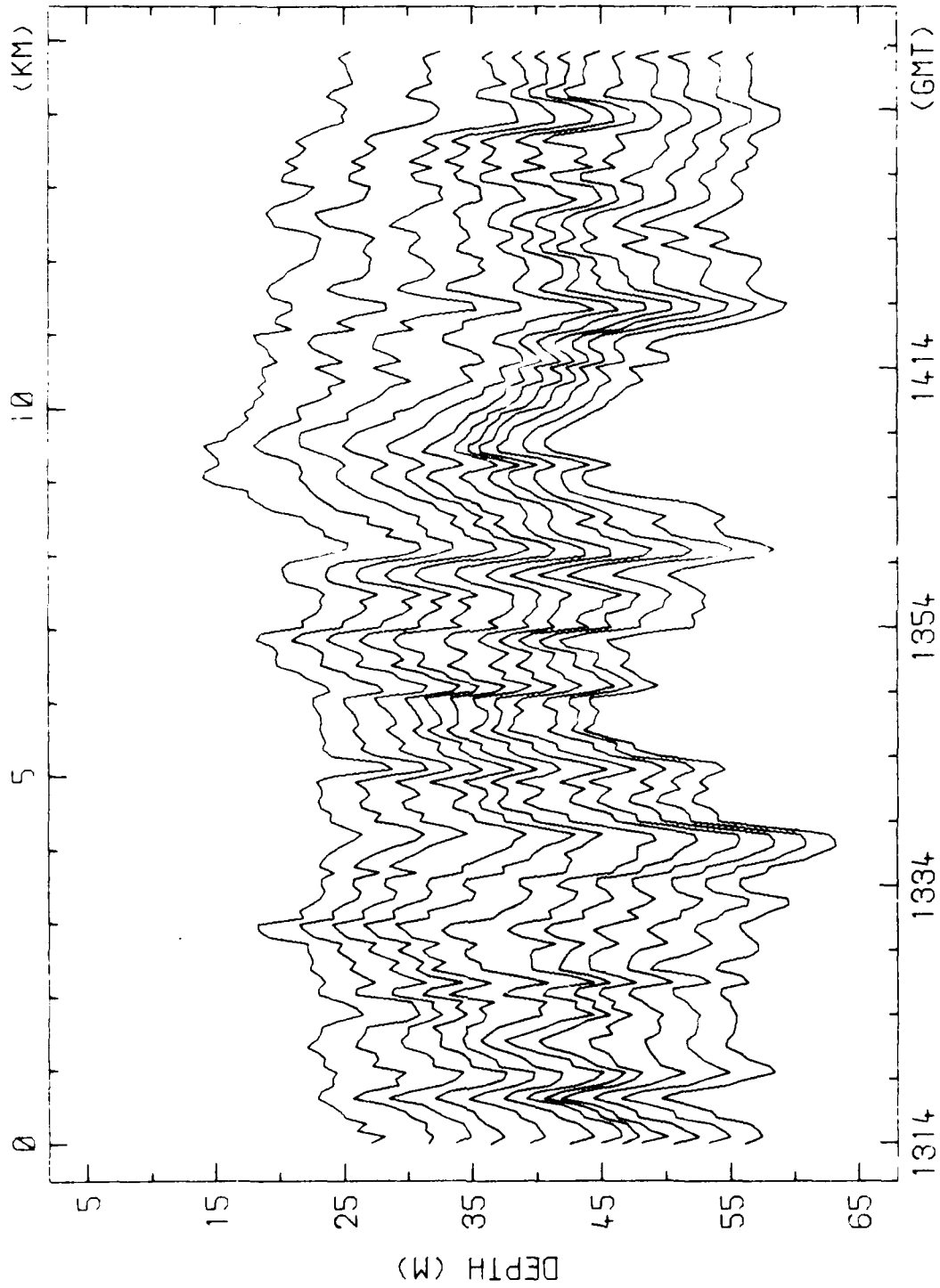

RUN 7S-5 4-SEP-78 EDITED ISOTHERM DEPTH VS TIME/DISTANCE

ISOTHERMS (DEG C) 12.4, 12.2, 12.0, 11.8, 11.6

11.4, 11.2, 11.0, 10.8, 10.6, 10.4, 10.2

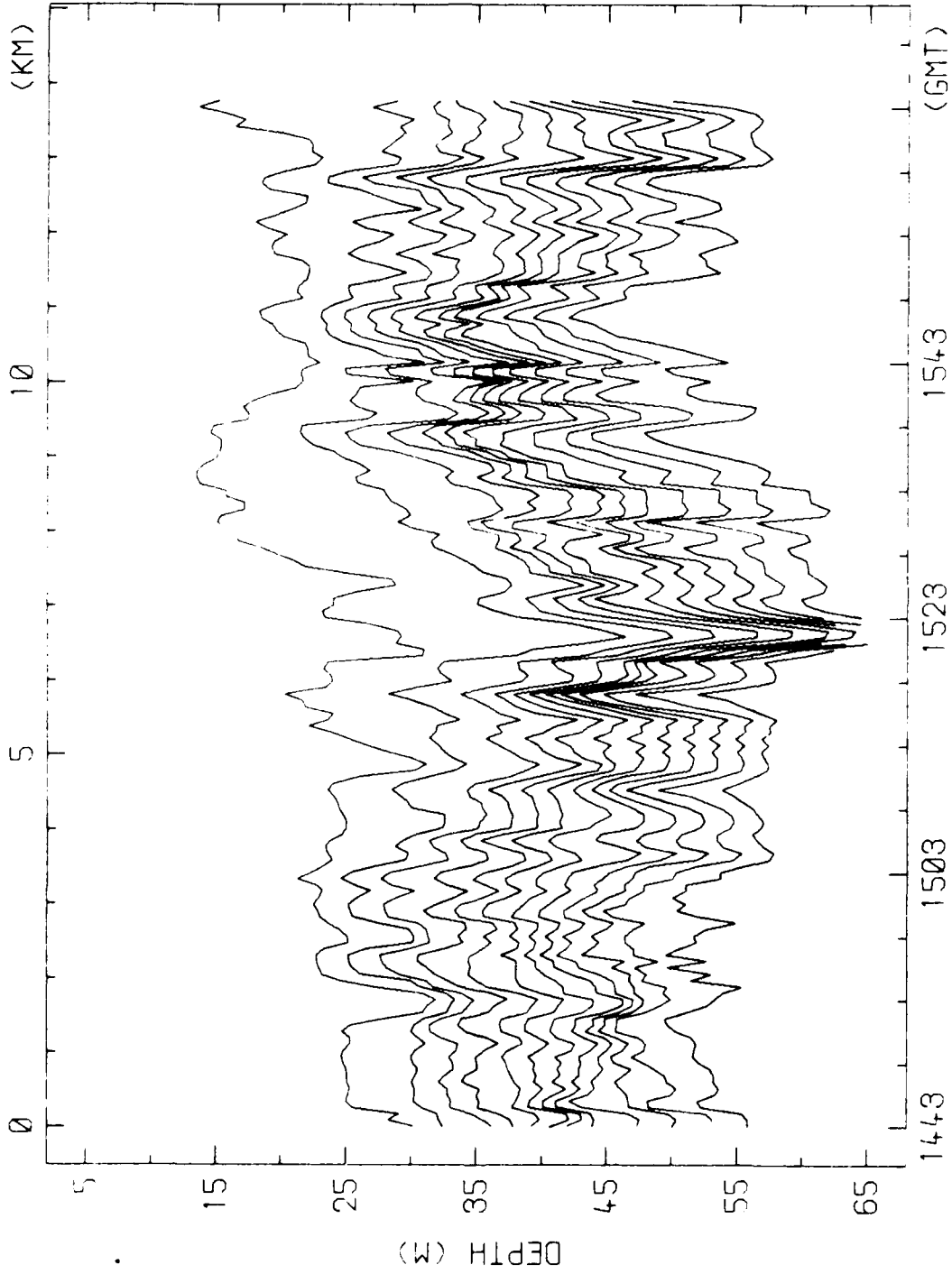

RUN 7E-6 4-SEP-78 EDITED ISOTHERM DEPTH VS TIME/DISTANCE  
 ISOTHERMS (DEG C) 12 4,12 2,12 0,11 8,11 6  
 11 4,11 2,11 0,10 8,10 6,10 4,10 2

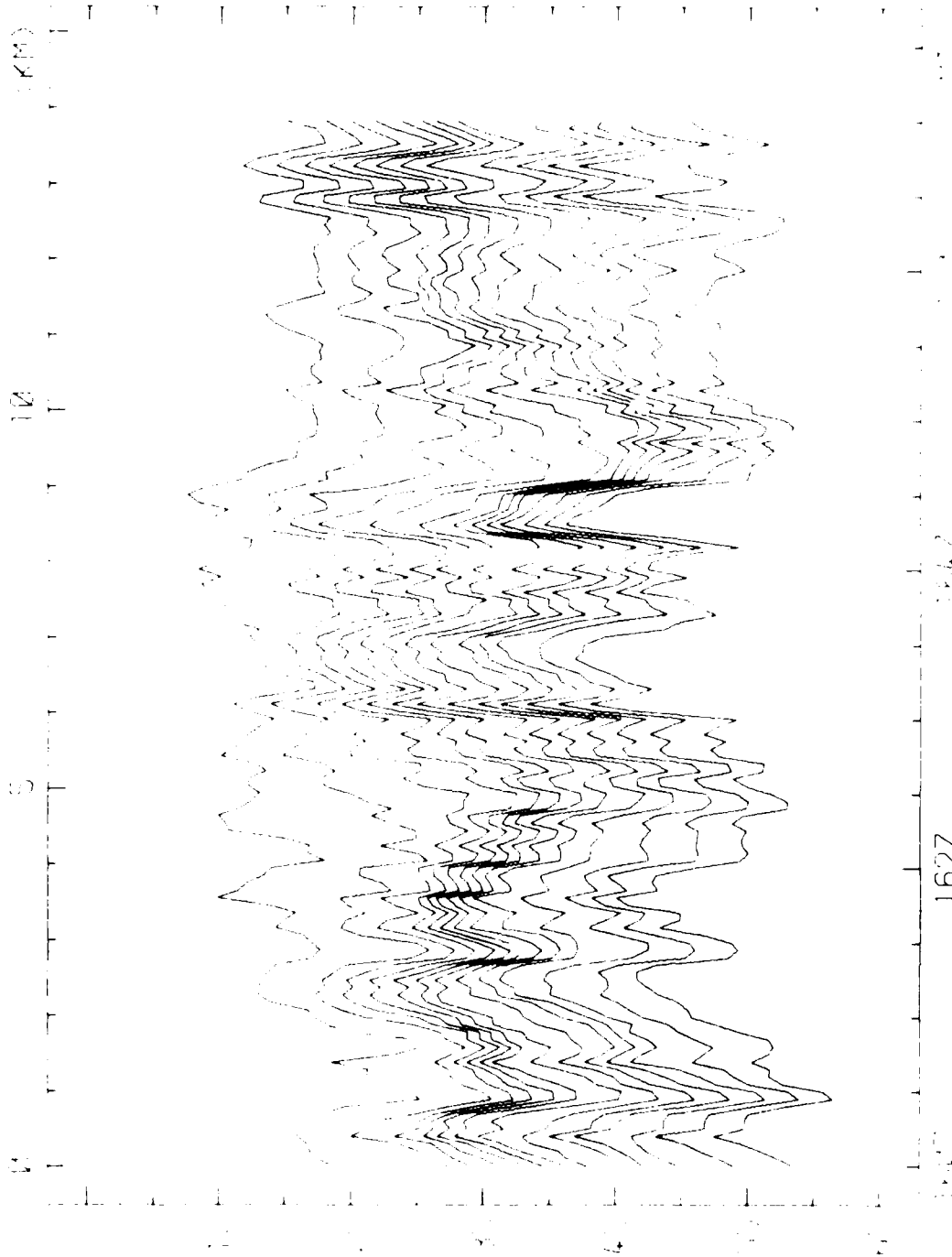

FORM 7N-7 4-SEP-78 EDITED (CONTINUED) 1627

ISOTHERMS (DEPTH) 1000 FT

11 5.11 2.11 1.11 0.11

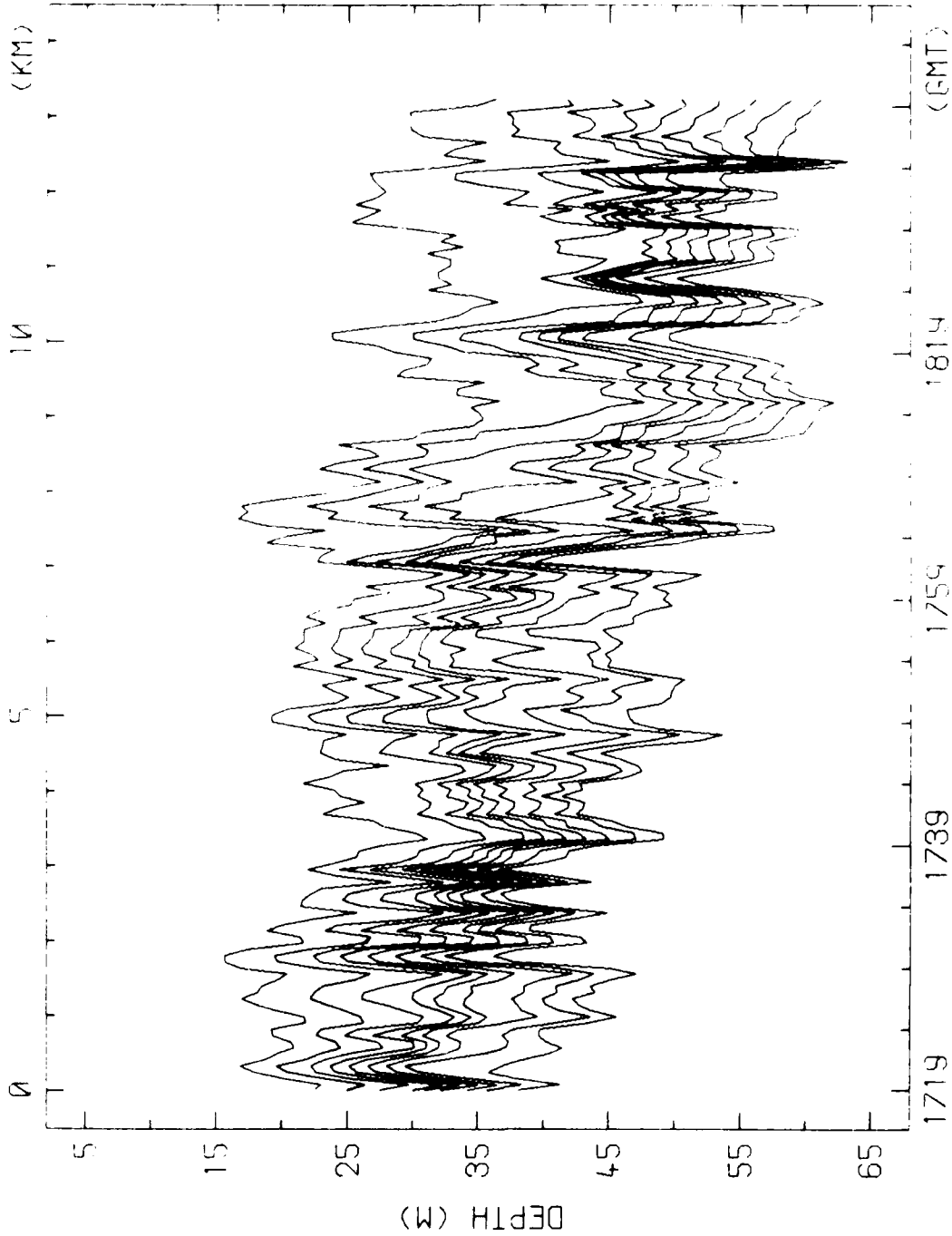

RUN 7W-8 4-SEP-78 EDITED ISOTHERM DEPTH VS TIME/DISTANCE  
ISOTHERMS (DEG C) 12 4,12 2,12 0,11 8,11 6  
11 4,11 2,11 0,10 8

## SPECTRA OF HIGHEST AND LOWEST ISOTHERMS

Spectra of the depth of the shallowest and deepest isotherms from each leg are plotted on the following pages. The symbol x designates the shallowest isotherm (highest temperature) and □ designates the deepest isotherm. The time-series of low-pass filtered isotherm depth were prewhitened by taking first differences prior to computing Fourier coefficients. The spectra were then recolorized and smoothed by averaging over non-overlapping frequency bands, five per decade, equally spaced on a logarithmic scale.

RUN 1-2 24-AUG-78  
ISOTHERMS (DEG C) 12 0, 10 0

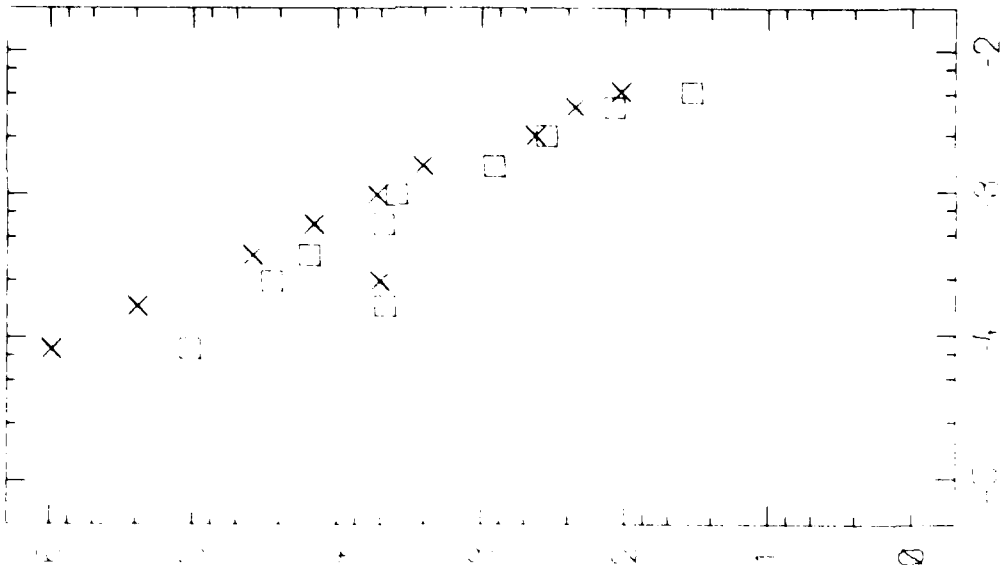

12.0

RUN 1-2 24-AUG-78  
ISOTHERMS (DEG C) 12 0, 10 0

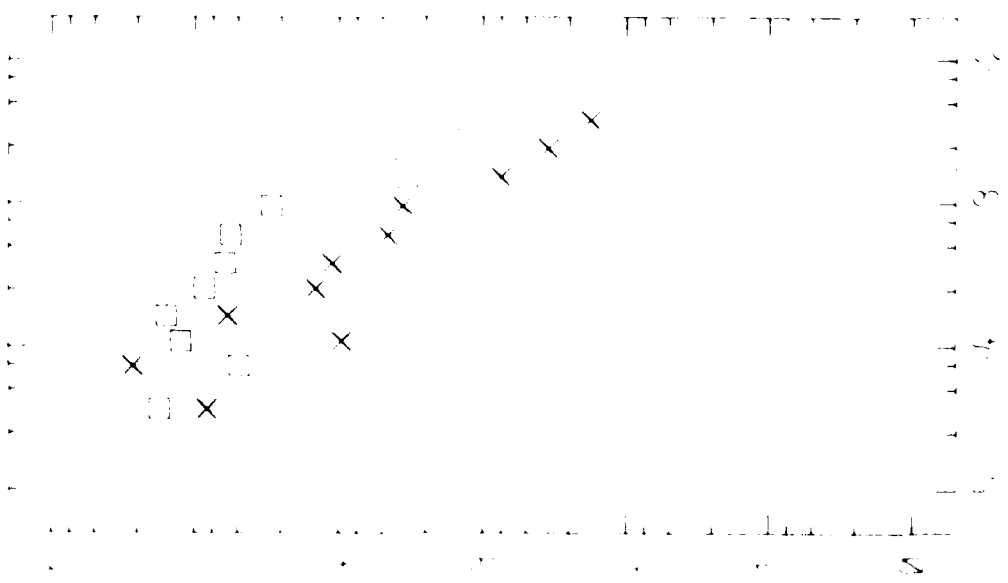

12.0

RUN 2W-1 25-AUG-78  
ISOTHERMS (DEG C) 12.0, 9.8

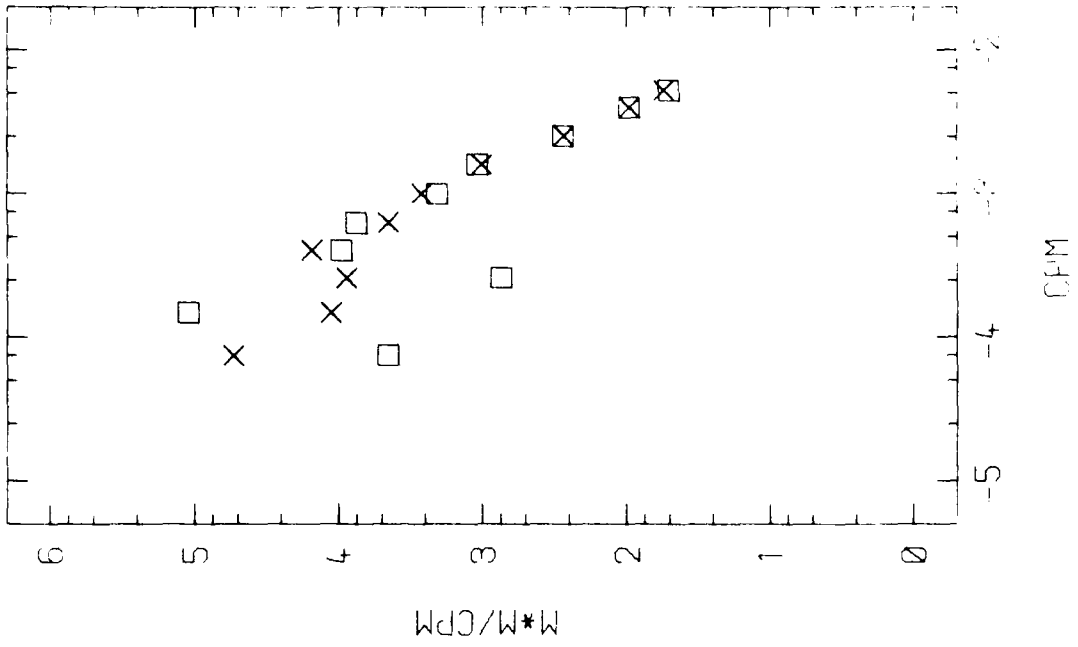

RUN 1-3 24-AUG-78  
ISOTHERMS (DEG C) 12.4, 10.2

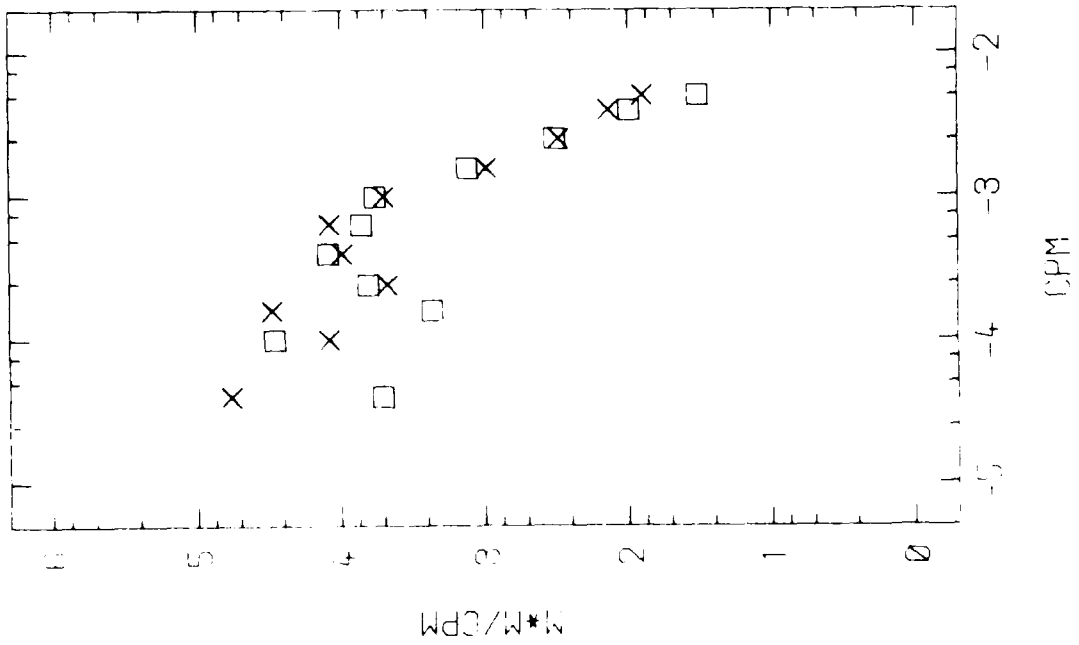

RUN 2E-3 25-AUG-78  
ISOTHERMS (DEG C) 12 0, 9.6

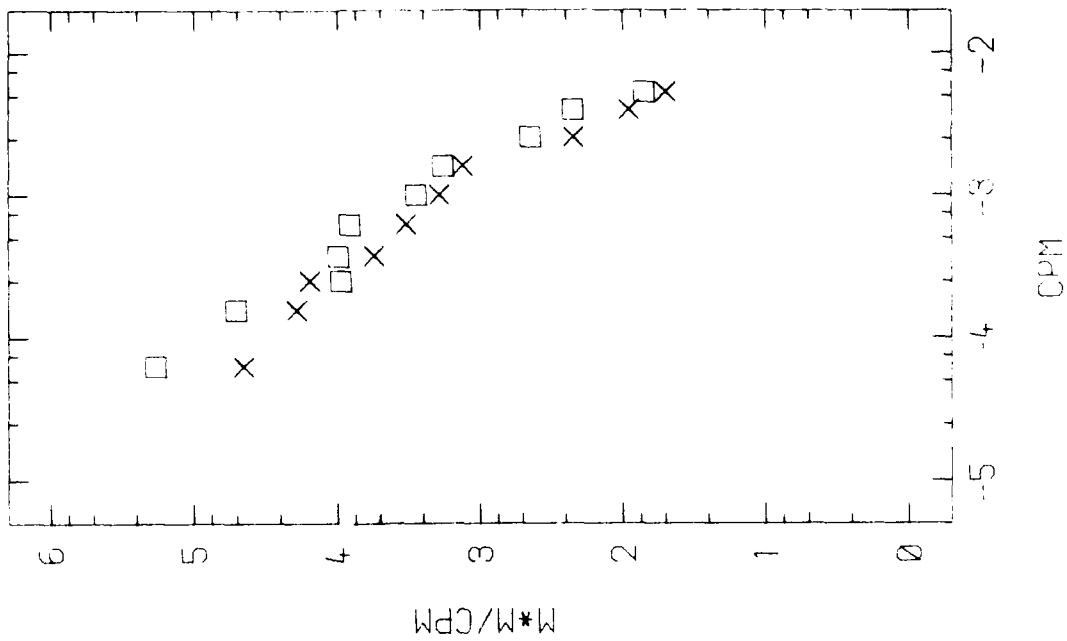

RUN 2E-2 25-AUG-78  
ISOTHERMS (DEG C) 12 0, 10.0

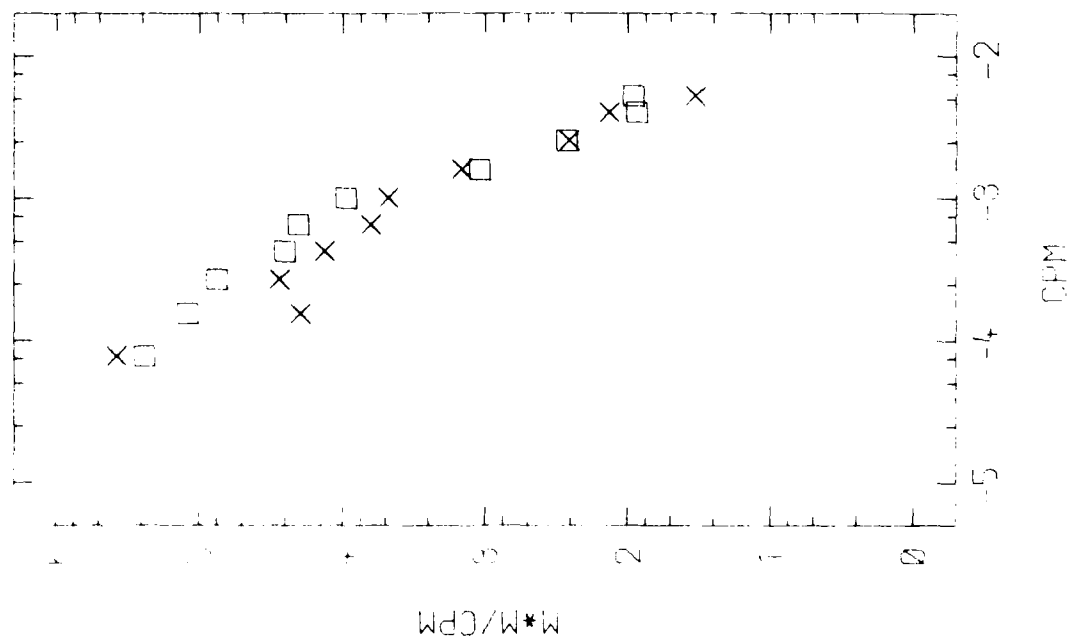



RUN 2W-5 25-AUG-78  
ISOTHERMS (DEG C) 12 0, 10 2

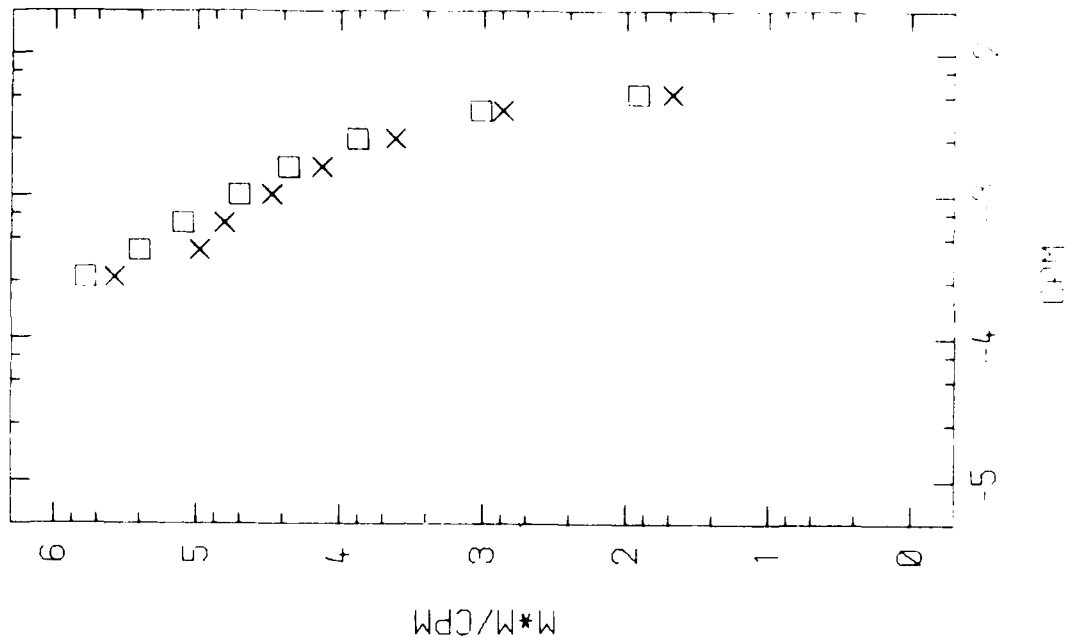

RUN 2N-4 25-AUG-78  
ISOTHERMS (DEG C) 12 0, 9 6

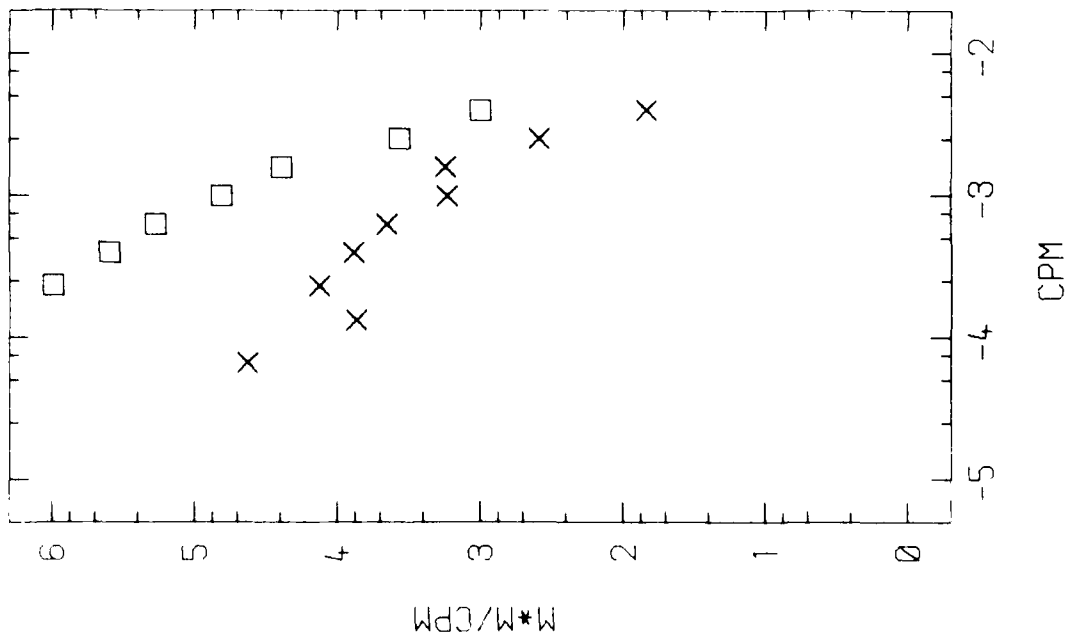

RUN 2E-7 25-AUG-78  
ISOTHERMS (DEG C) 12.0, 9.8

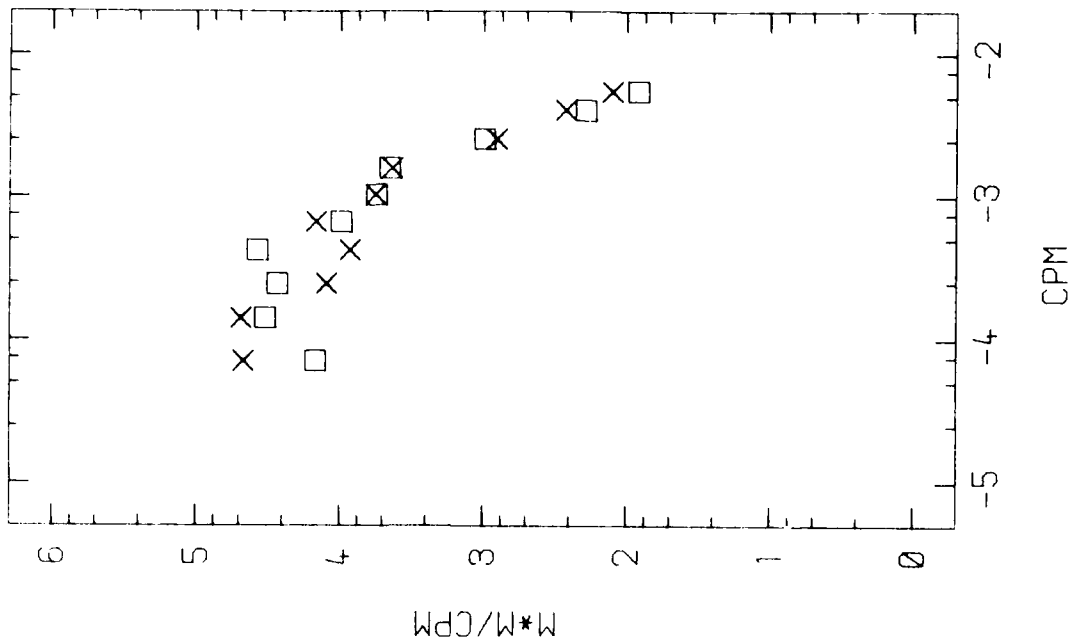

RUN 2S-6 25-AUG-78  
ISOTHERMS (DEG C) 12.0, 10.2

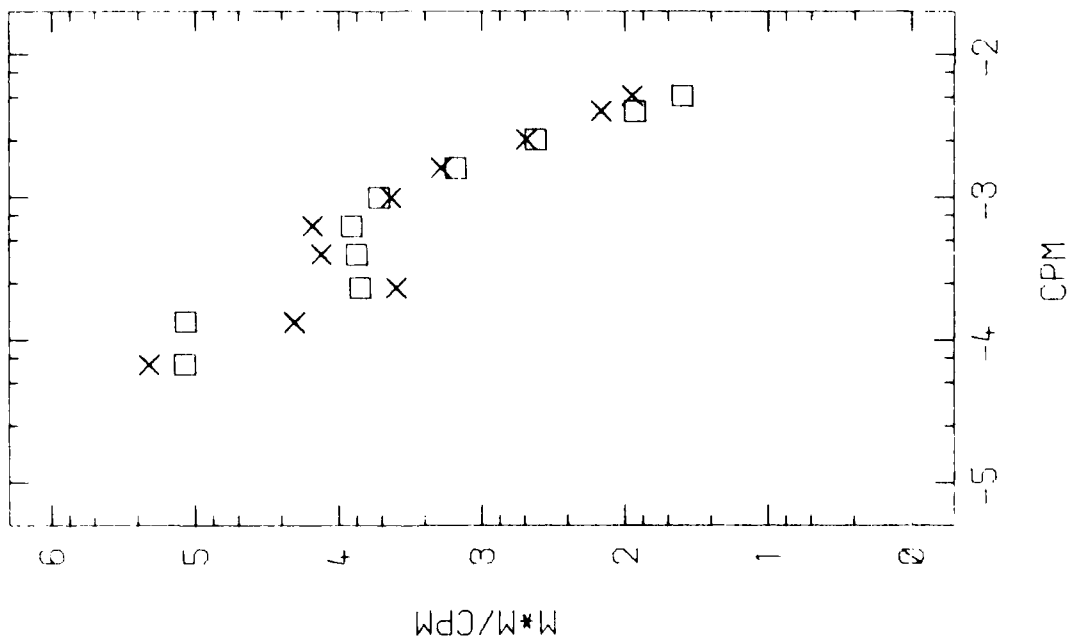

RUN 3N-1 27-AUG-78  
ISOTHERMS (DEG C) 12.2, 10.0

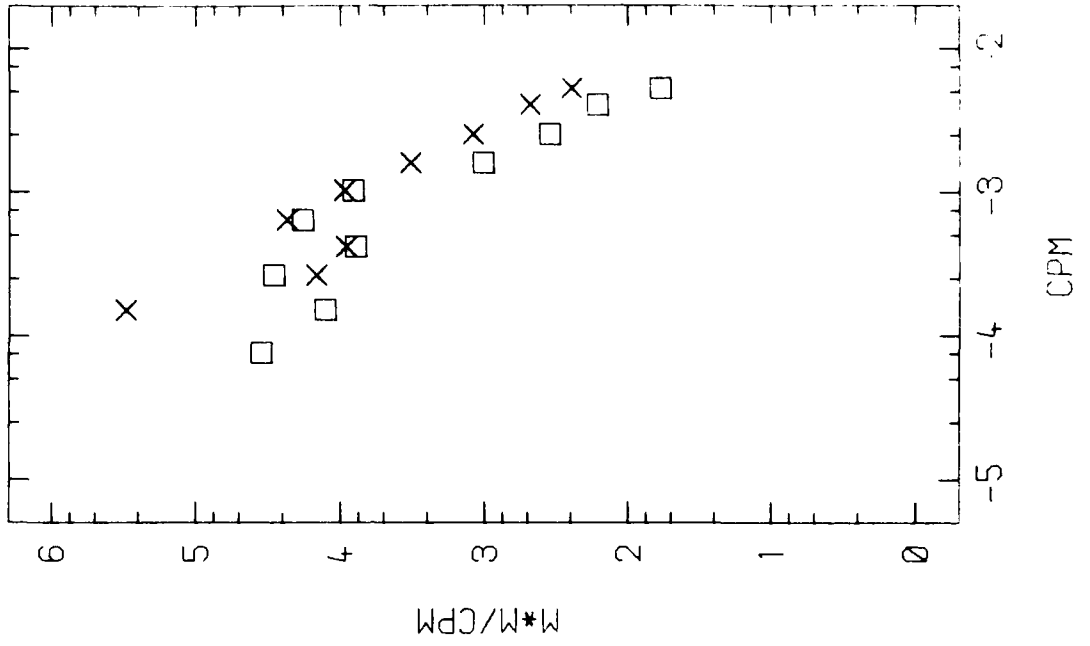

RUN 2N-8 25-AUG-78  
ISOTHERMS (DEG C) 12.0, 10.6

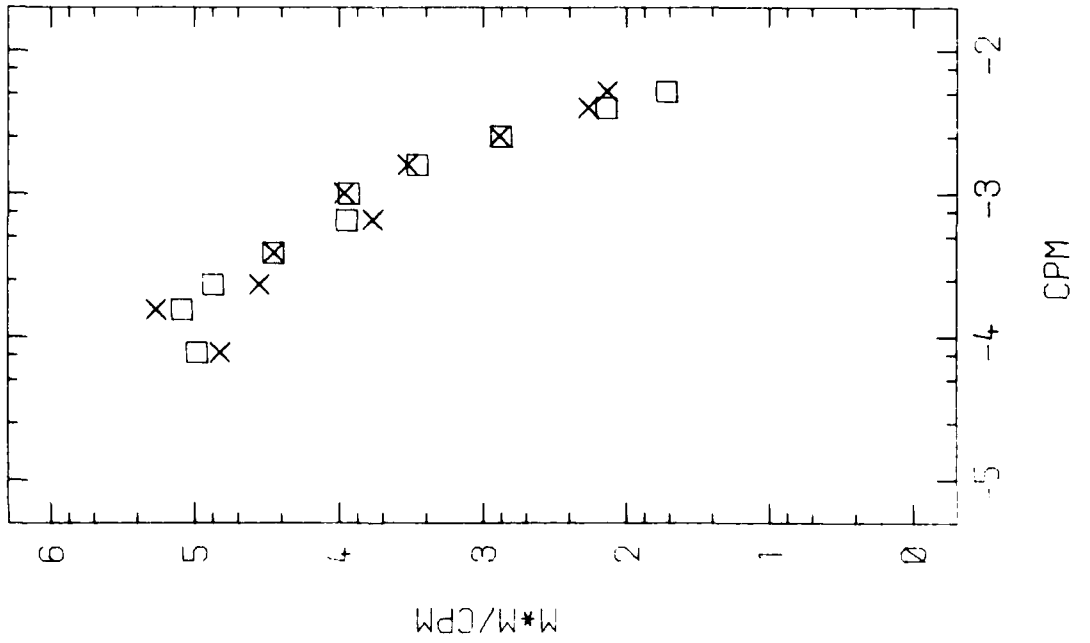

RUN 35-3 27-AUG-78  
ISOTHERMS (DEG C) 12 0, 9 8

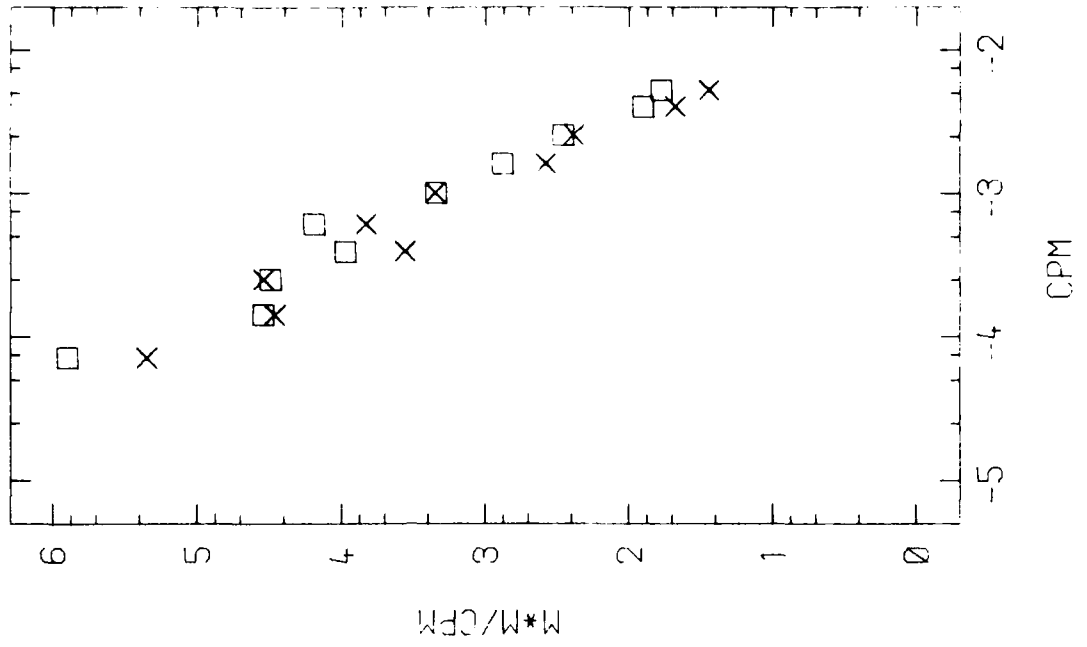

RUN 3W-2 27-AUG-78  
ISOTHERMS (DEG C) 12 0, 9 6

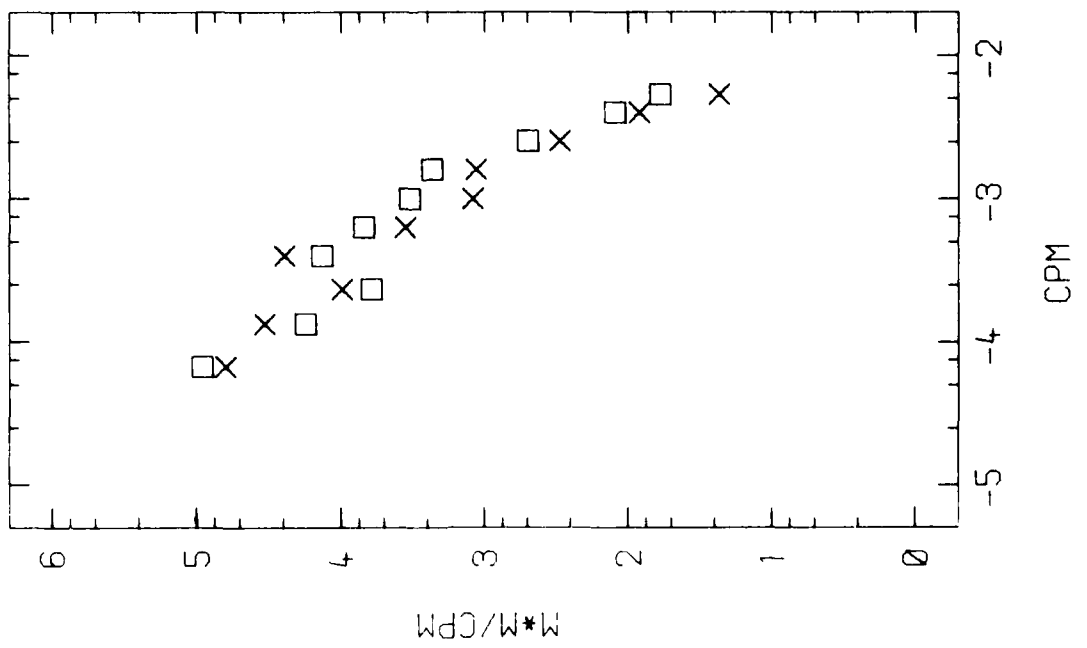

RUN 3N-5 27-AUG-78  
ISOTHERMS (DEG C) 12.0, 9.6

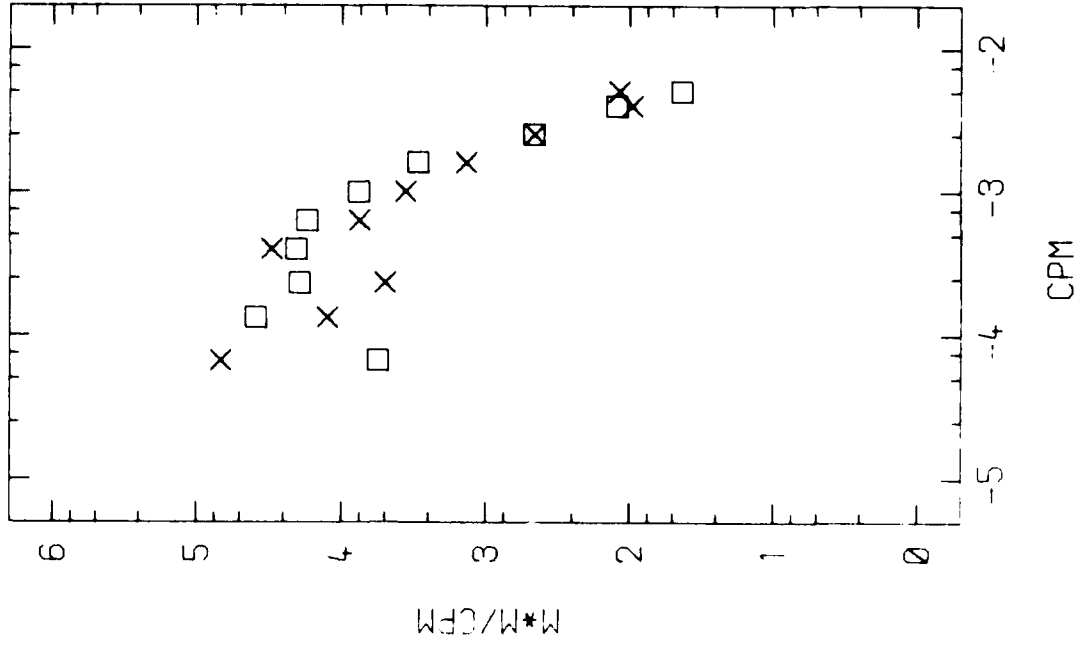

RUN 3E-4 27-AUG-78  
ISOTHERMS (DEG C) 12.0, 9.8

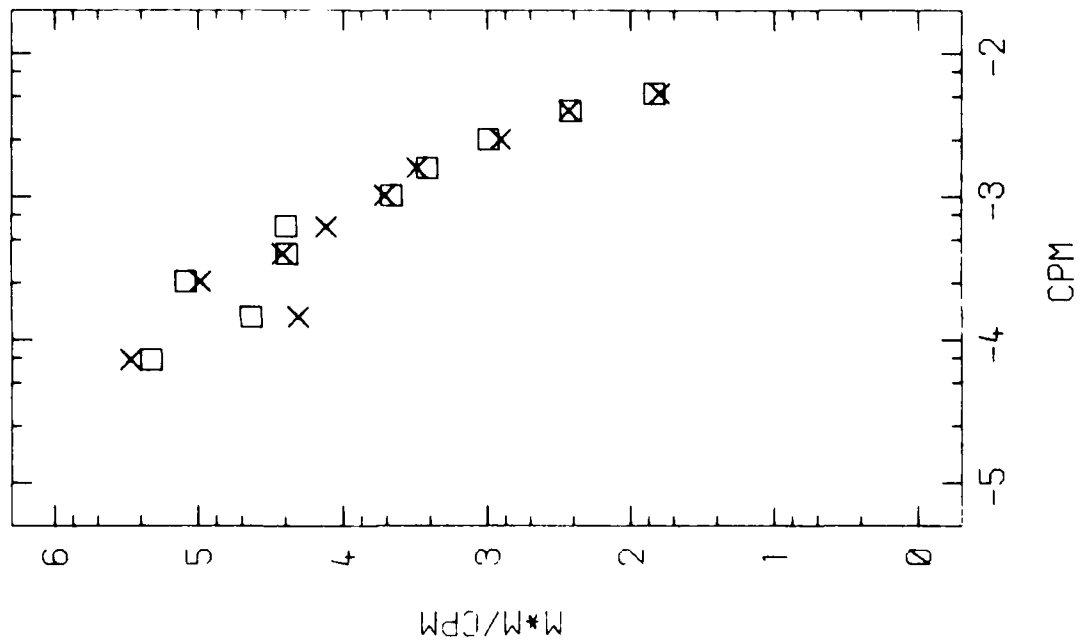

RUN 3W-6 27-AUG-78  
ISOTHERMS (DEG C) 12.0, 9.8

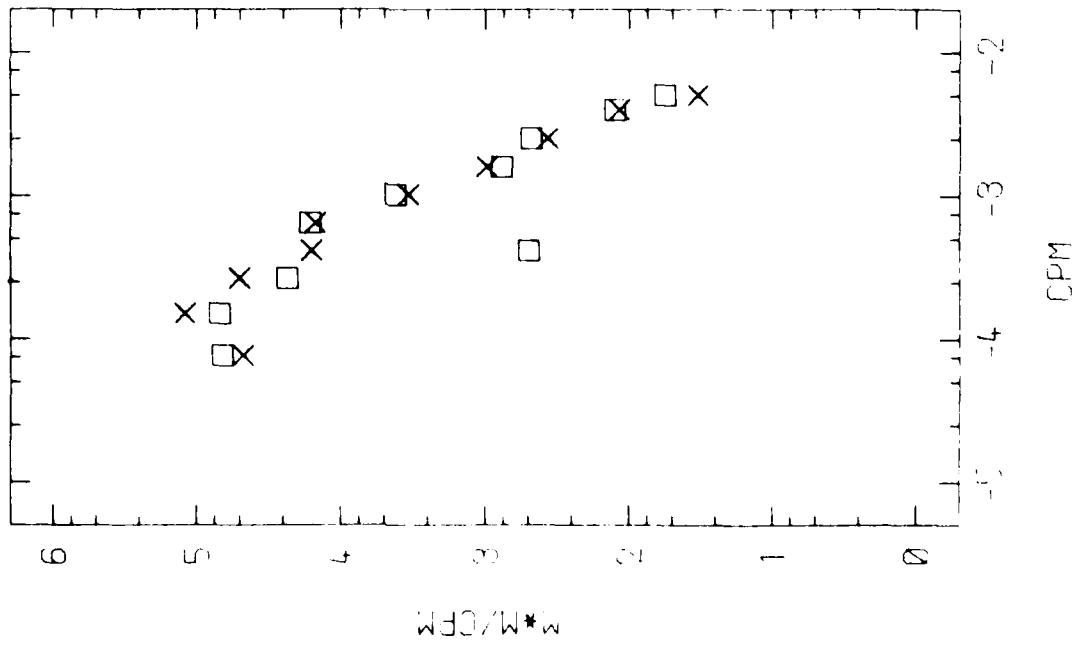

RUN 3S-7 27-AUG-78  
ISOTHERMS (DEG C) 12.2, 9.8

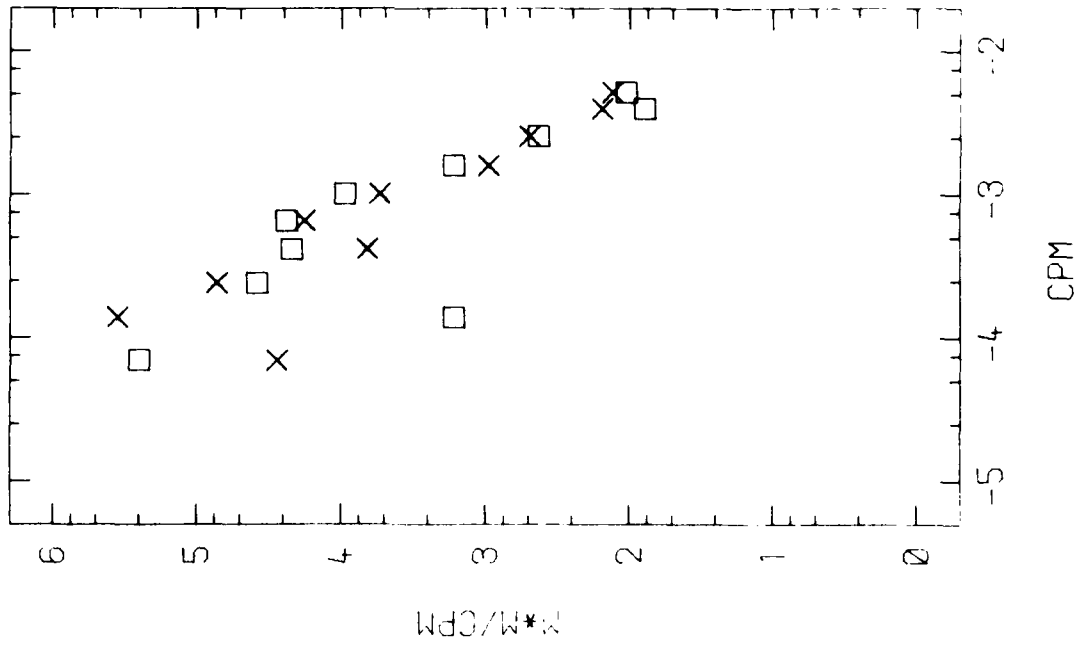

RUN 4N-1 29-AUG-78  
ISOTHERMS (DEG C) 12.2, 9.8

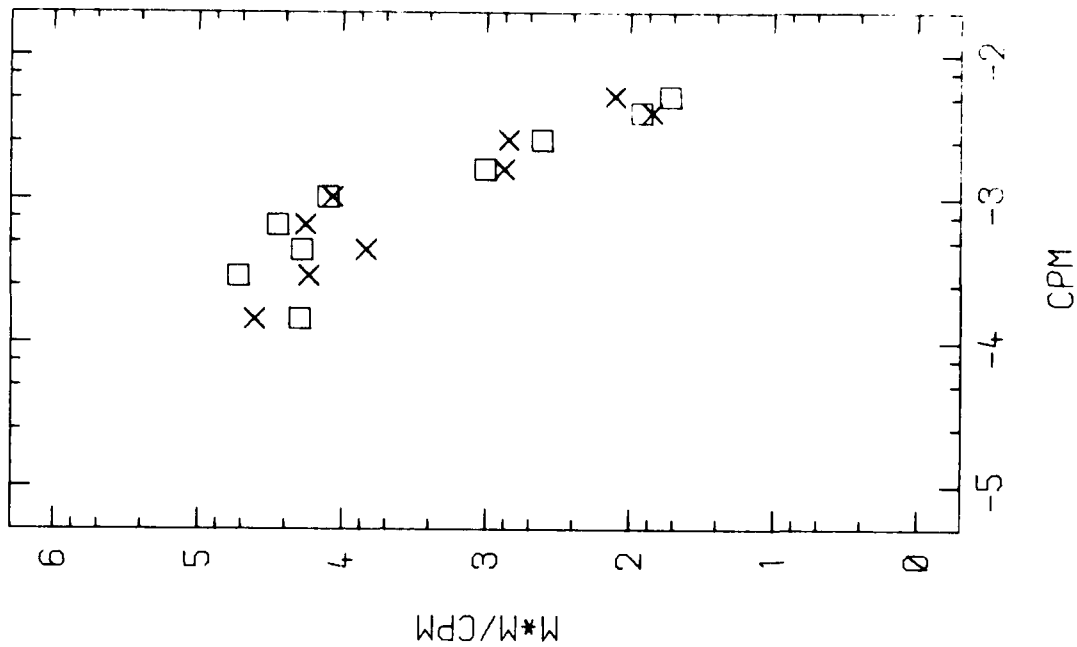

RUN 3E-8 27-AUG-78  
ISOTHERMS (DEG C) 12.2, 10.0

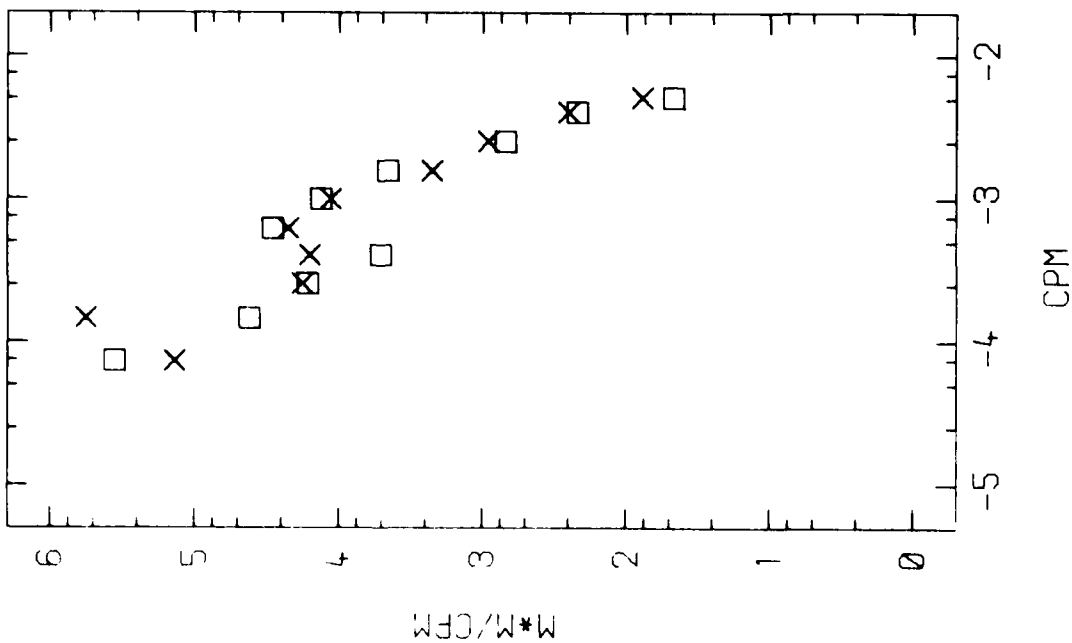

RUN 4S-3 29--AUG--78  
ISOTHERMS (DEG C) 12 2, 10 0

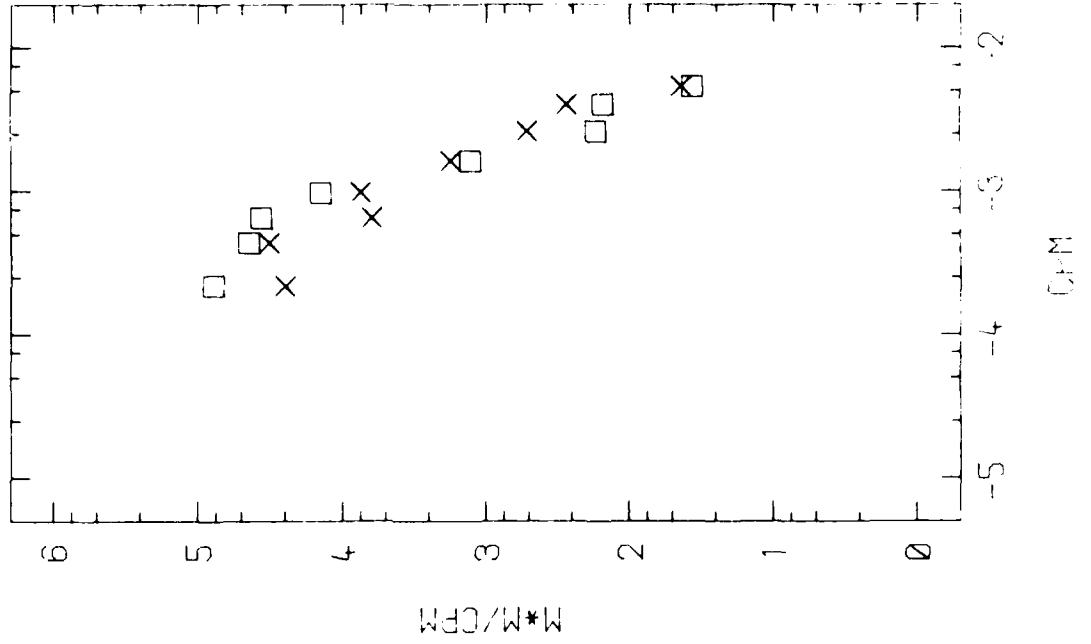

RUN 4W-2 29--AUG--78  
ISOTHERMS (DEG C) 12 2, 9.8

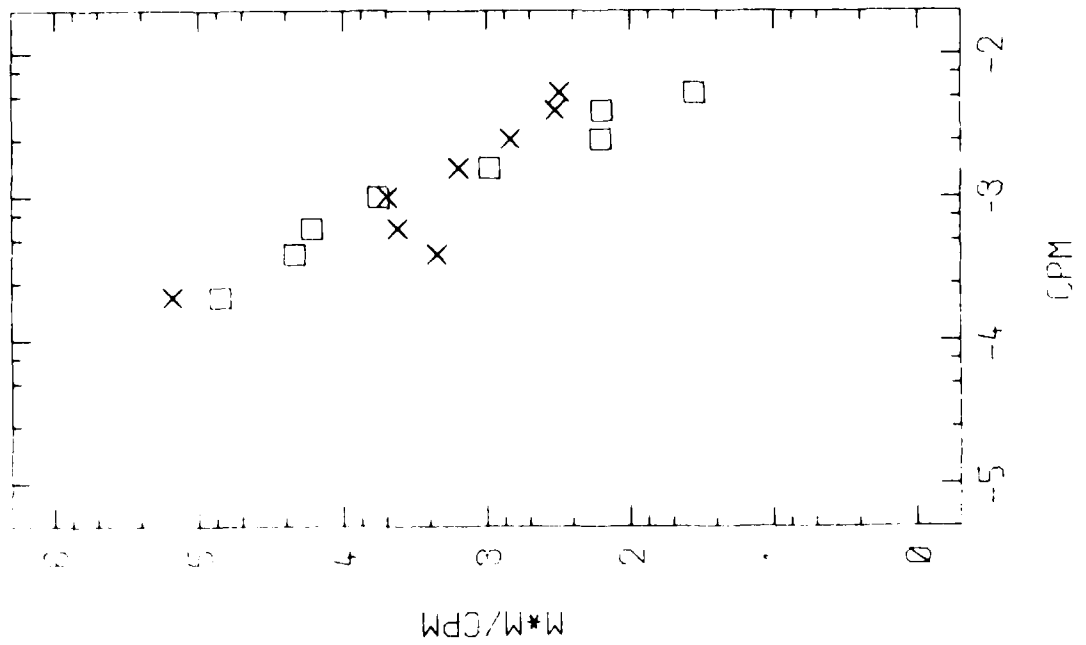



RUN 4E-5 29-AUG-78  
ISOTHERMS (DEG C) 12.0, 9.6

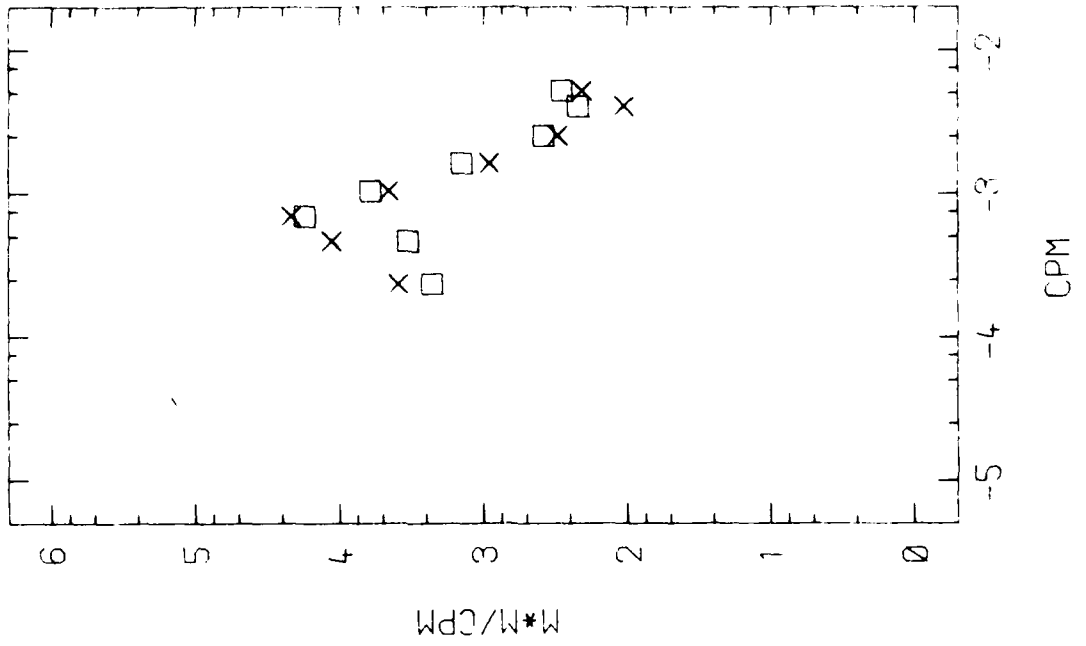

RUN 4E-4 29-AUG-78  
ISOTHERMS (DEG C) 12.0, 9.8

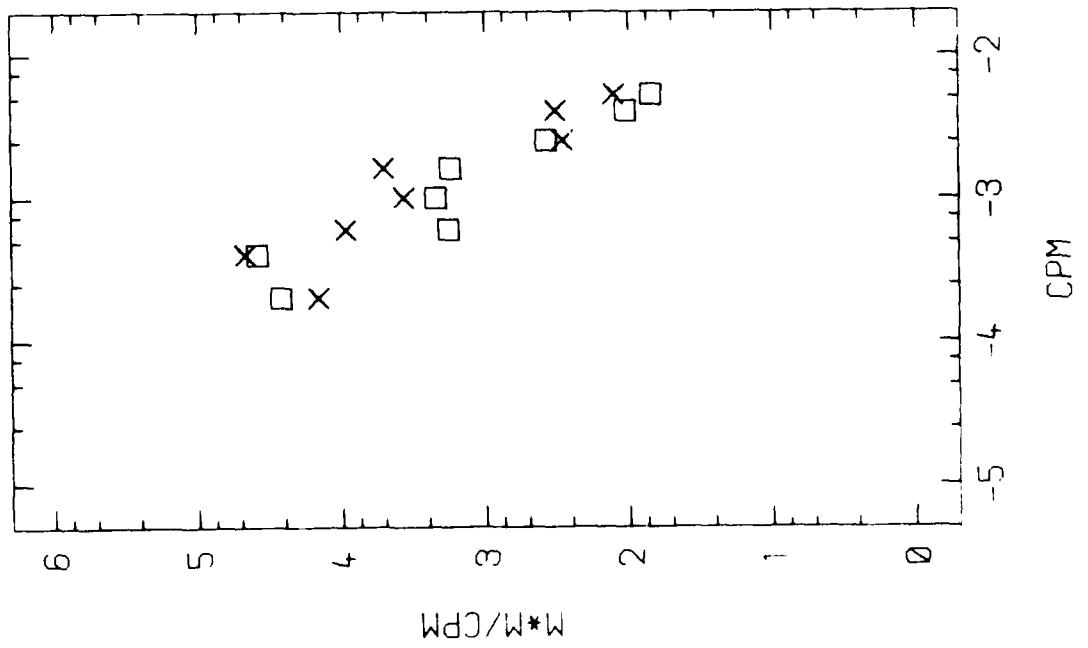

RUN 4W-7 29-AUG-78  
ISOTHERMS (DEG C) 12.2, 9.6

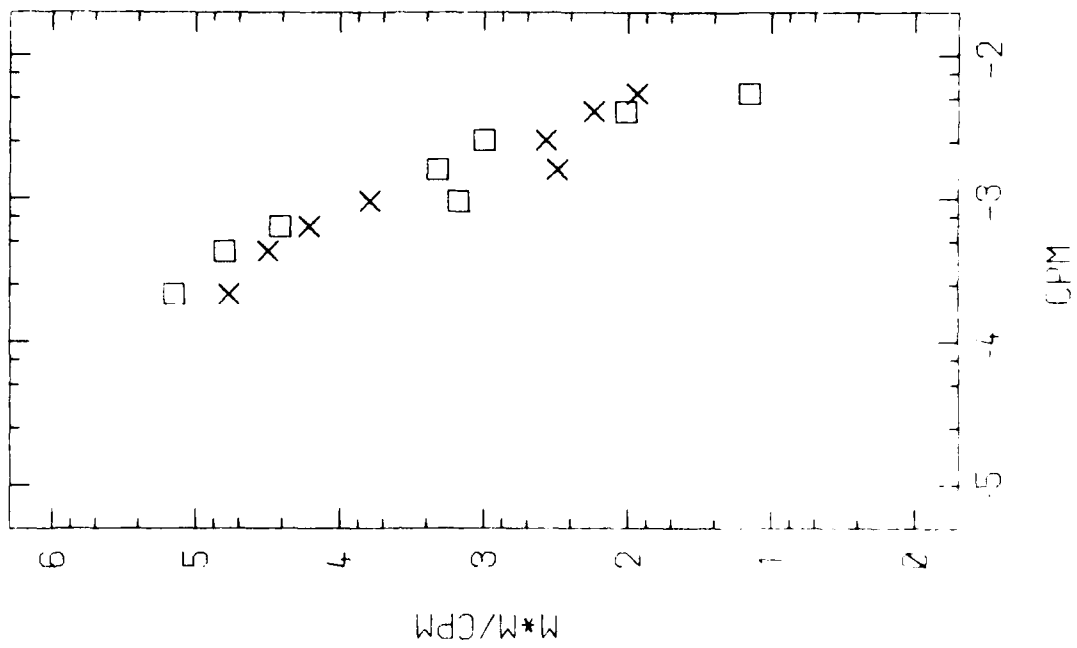

RUN 4N-6 29-AUG-78  
ISOTHERMS (DEG C) 12.2, 9.8

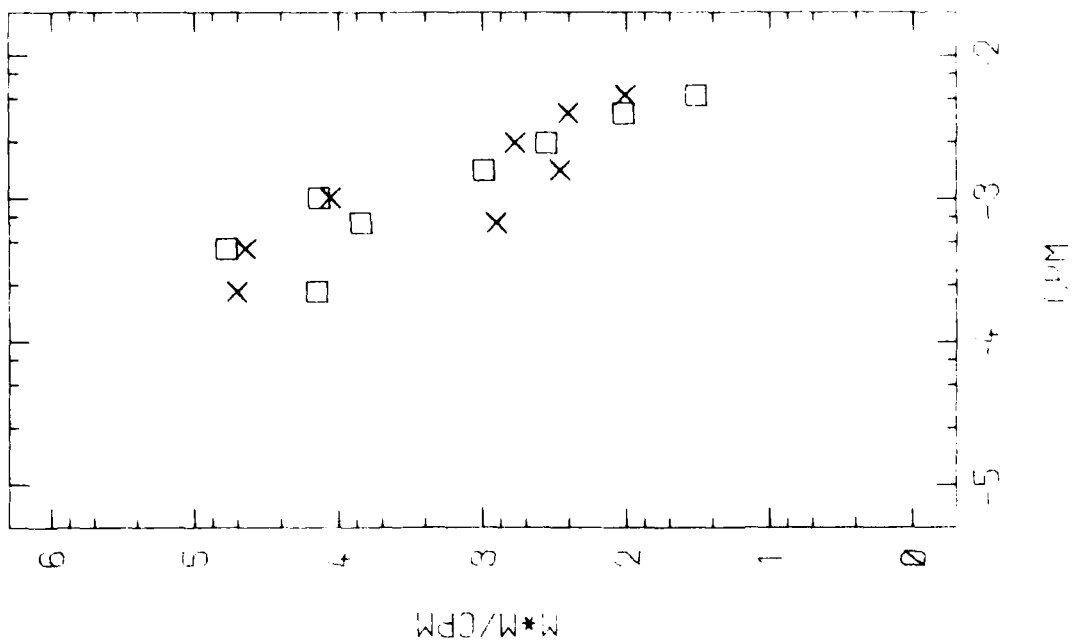

RUN 4E-9 29-AUG-78  
ISOTHERMS (DEG C) 12 0, 10 4

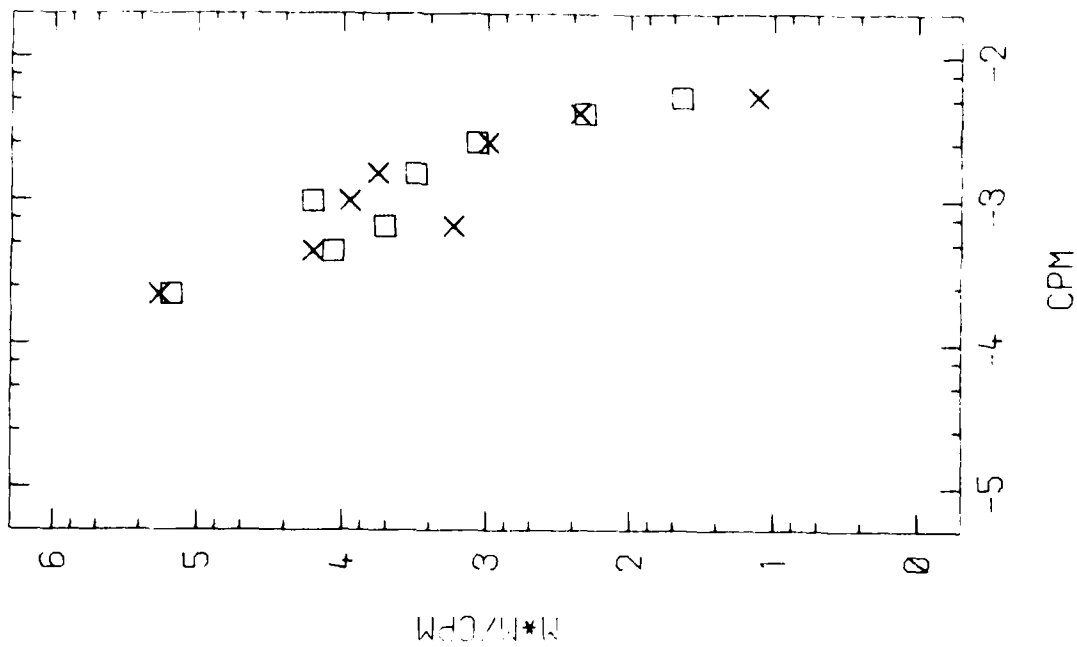

RUN 4S-8 29-AUG-78  
ISOTHERMS (DEG C) 12 0, 9 6

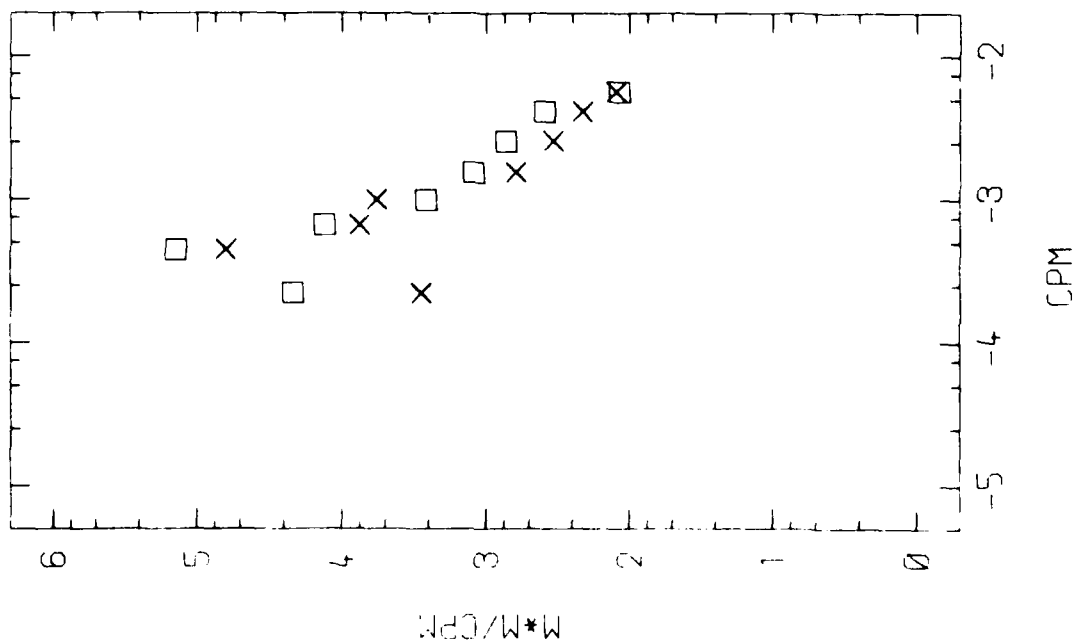

RUN 4N-10 29-AUG-78  
OTHERMS (DEG C) 12 21 30 40 50

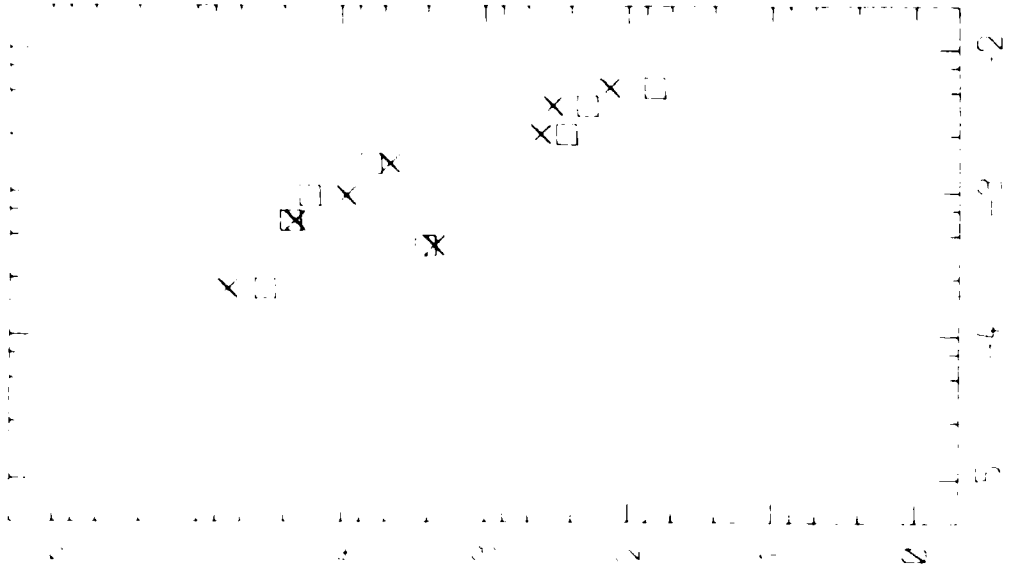

RUN 4N-10 29-AUG-78  
OTHERMS (DEG C) 12 21 30 40 50

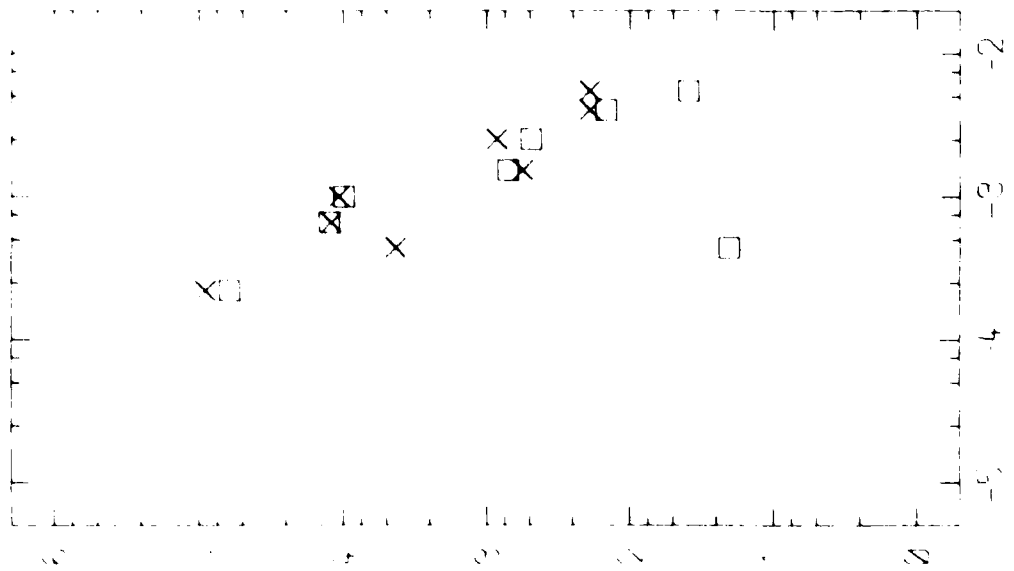

MAN CPM

CPM

CPM

RUN 4E-13 29-AUG-78  
ISOTHERMS (DEG C) 12 0, 9 6

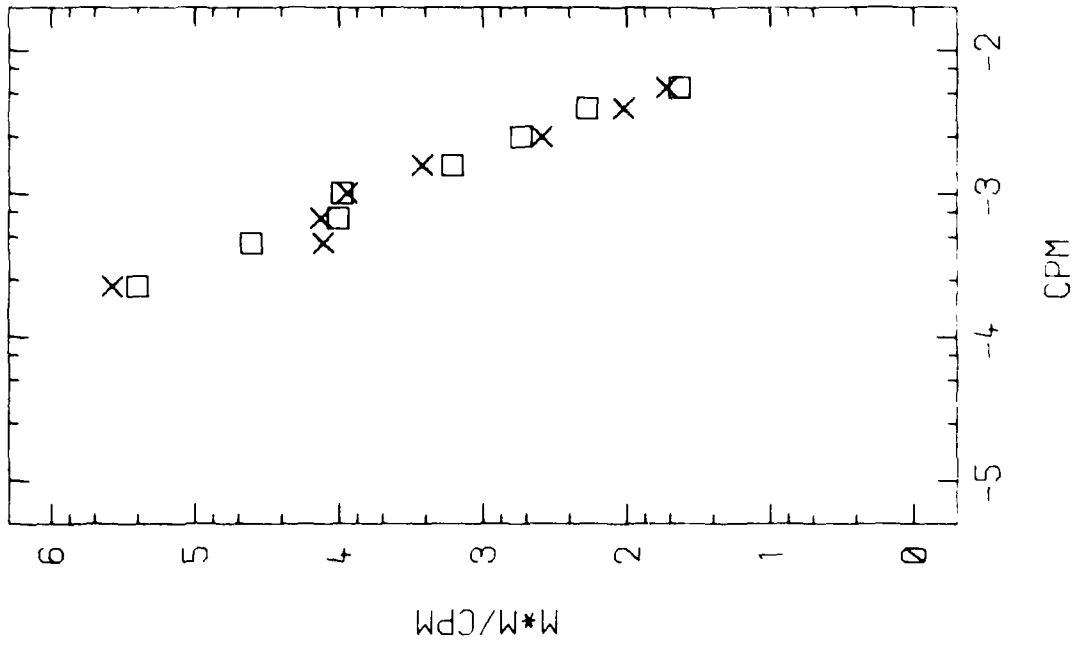

RUN 4S-12 29-AUG-78  
ISOTHERMS (DEG C) 12 2, 9 6

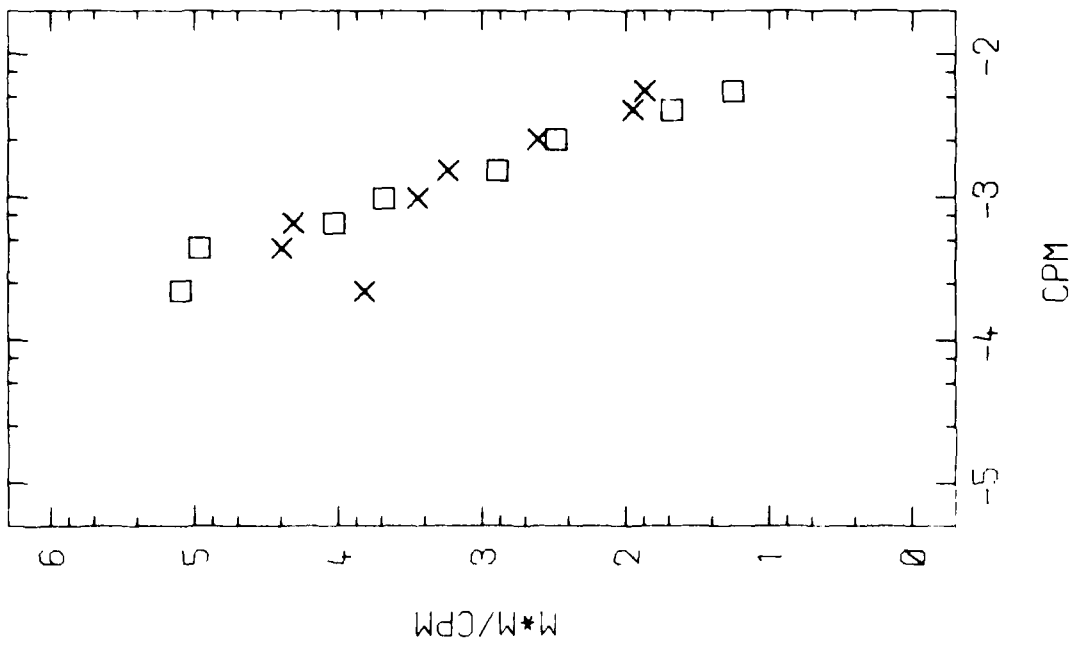

RUN 4W-15 29-AUG-78  
ISOTHERMS (DEG C) 12 2, 9.6

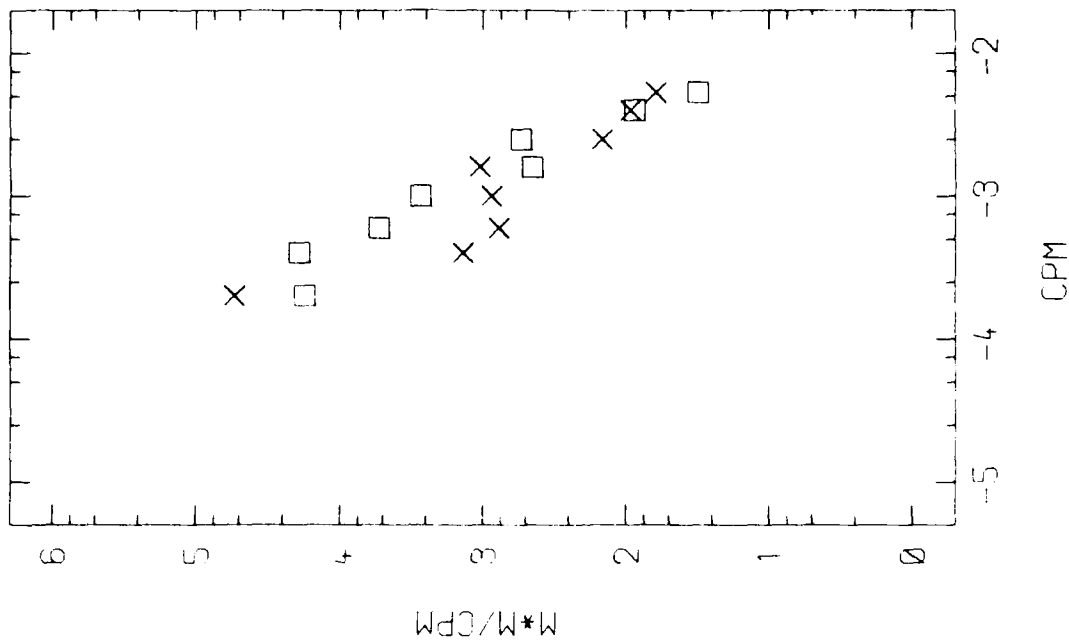

RUN 4N-14 29-AUG-78  
ISOTHERMS (DEG C) 12 2, 10 0

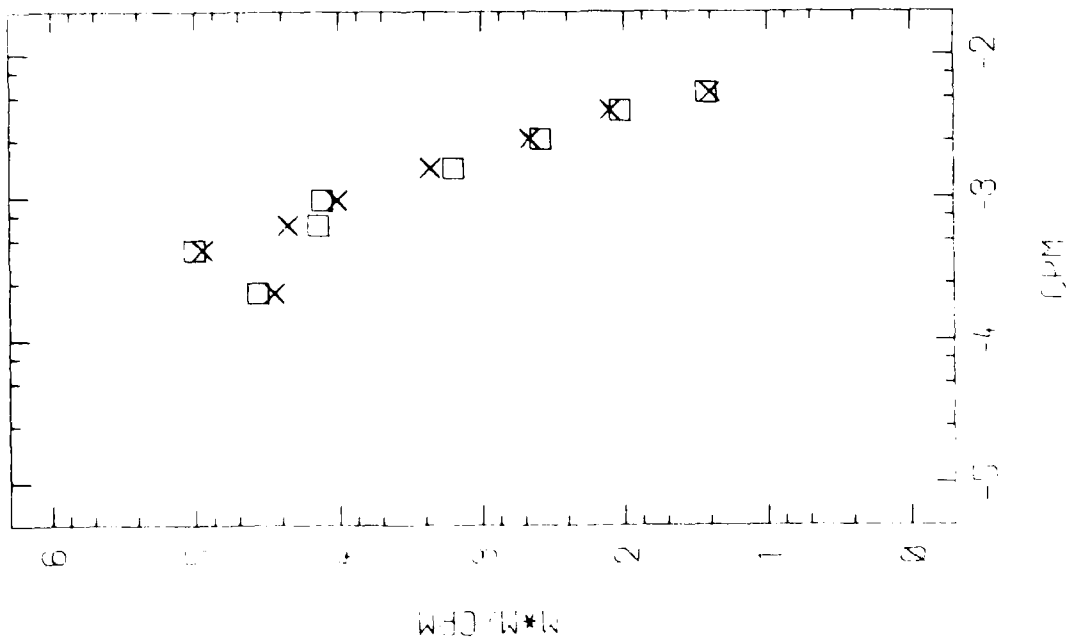

RUN 4E-17 29-AUG-78  
ISOTHERMS (DEG C) 12.0, 9.6

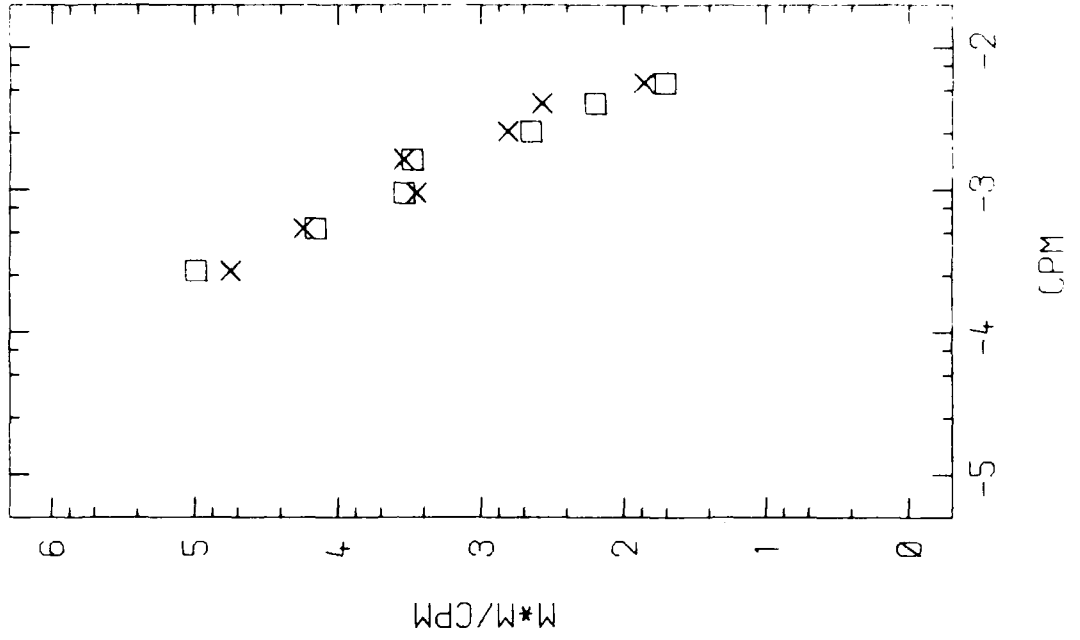

RUN 4S-16 29-AUG-78  
ISOTHERMS (DEG C) 12.2, 9.6

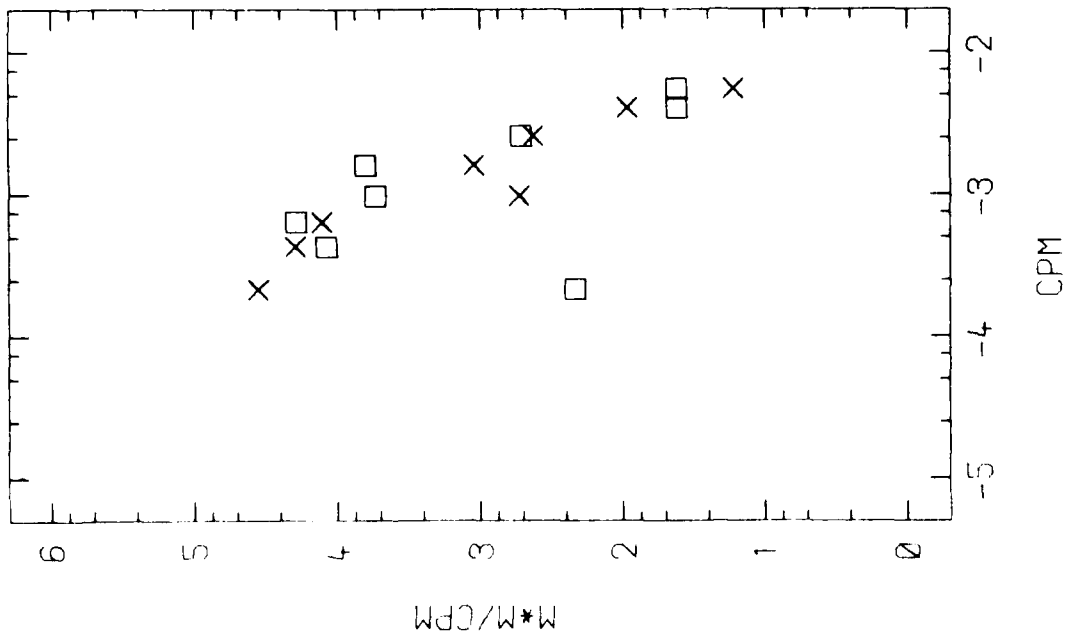

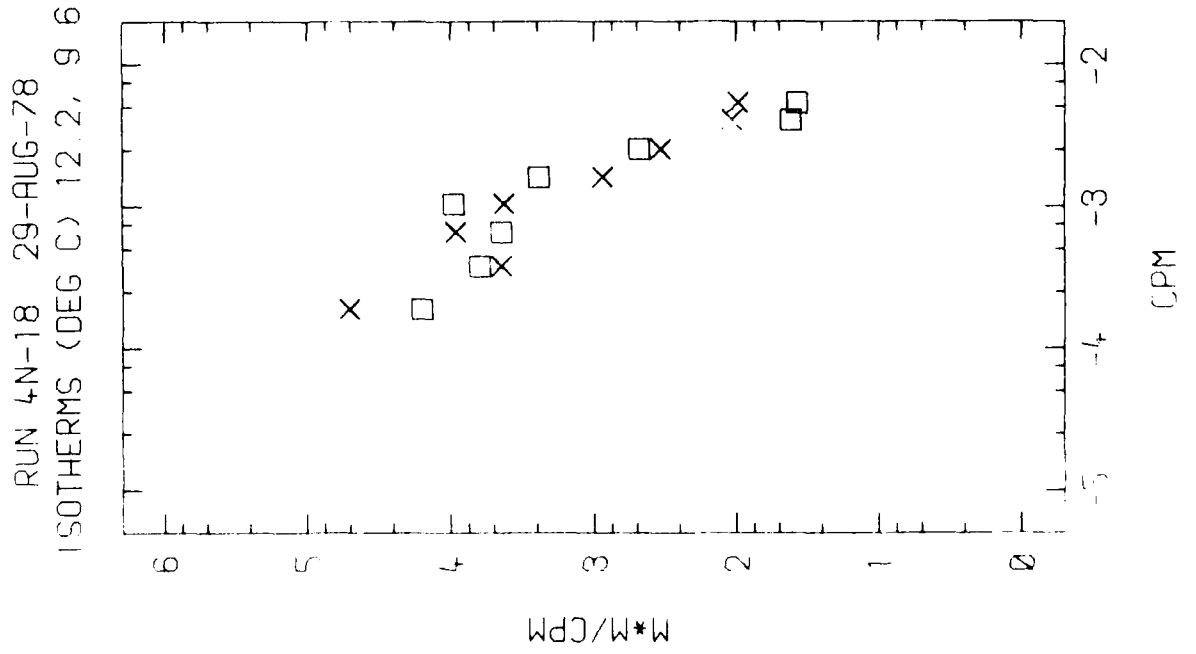
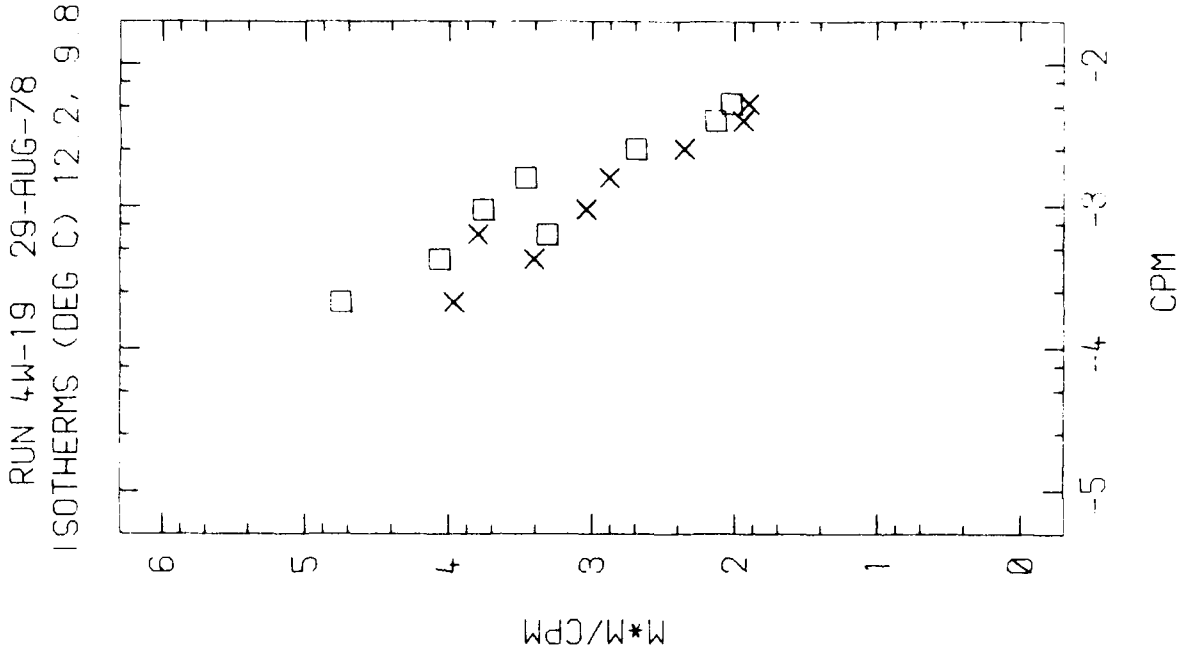



RUN 4E-21 29-AUG-78  
ISOTHERMS (DEG C) 12.0, 9.6

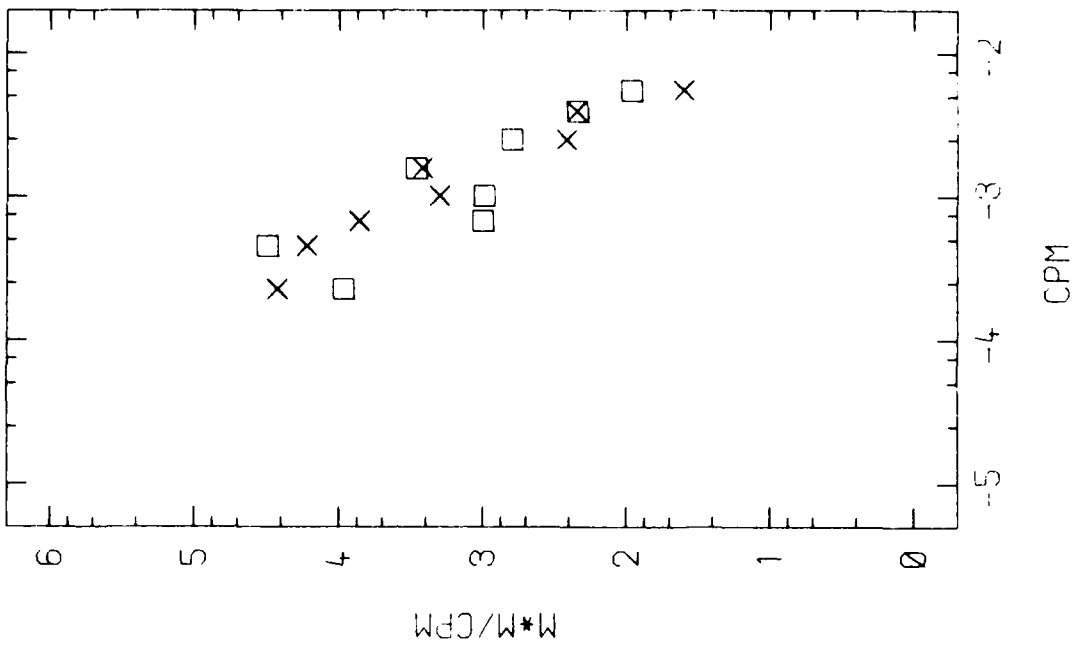

RUN 4S-20 29-AUG-78  
ISOTHERMS (DEG C) 12.2, 9.8

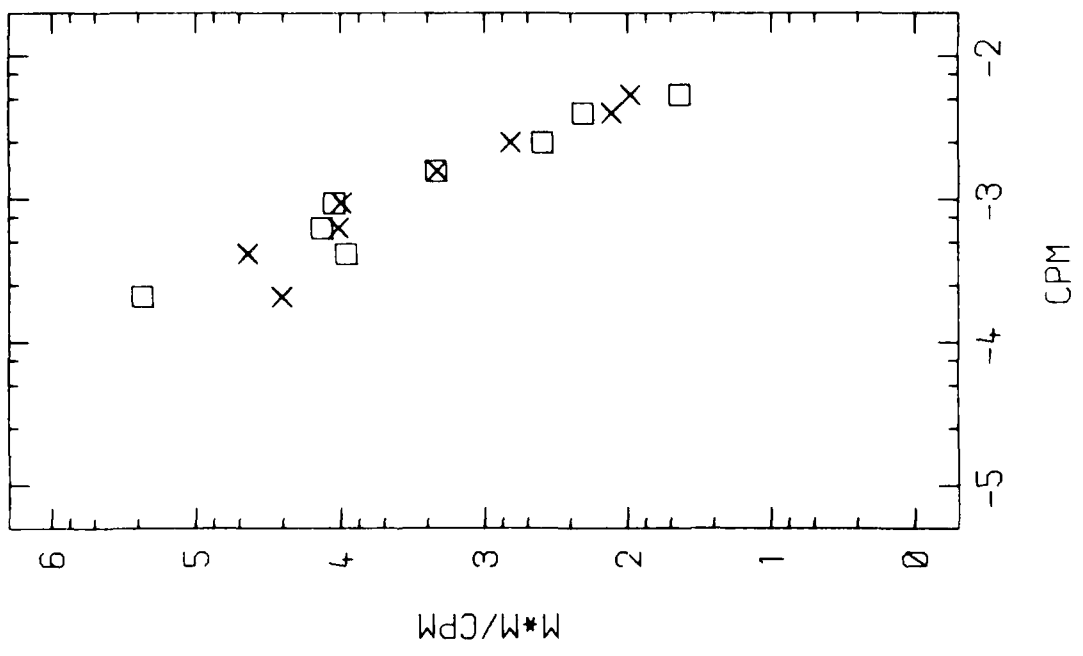

RUN 4W-23 29-AUG-78  
ISOTHERMS (DEG C) 12.2, 9.8

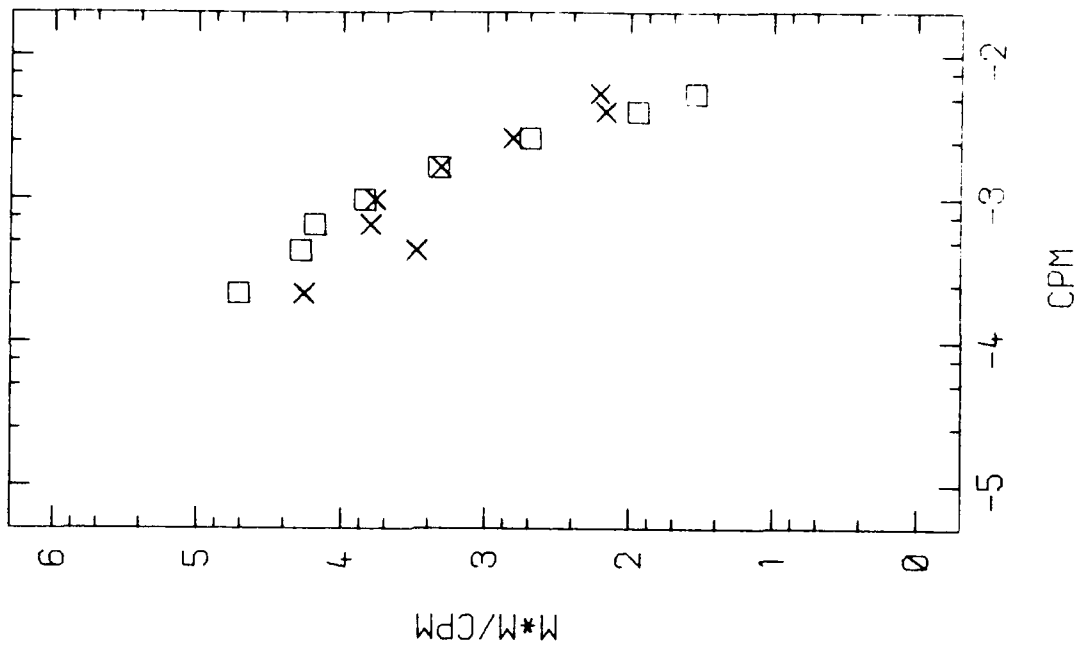

RUN 4N-22 29-AUG-78  
ISOTHERMS (DEG C) 12.2, 9.8

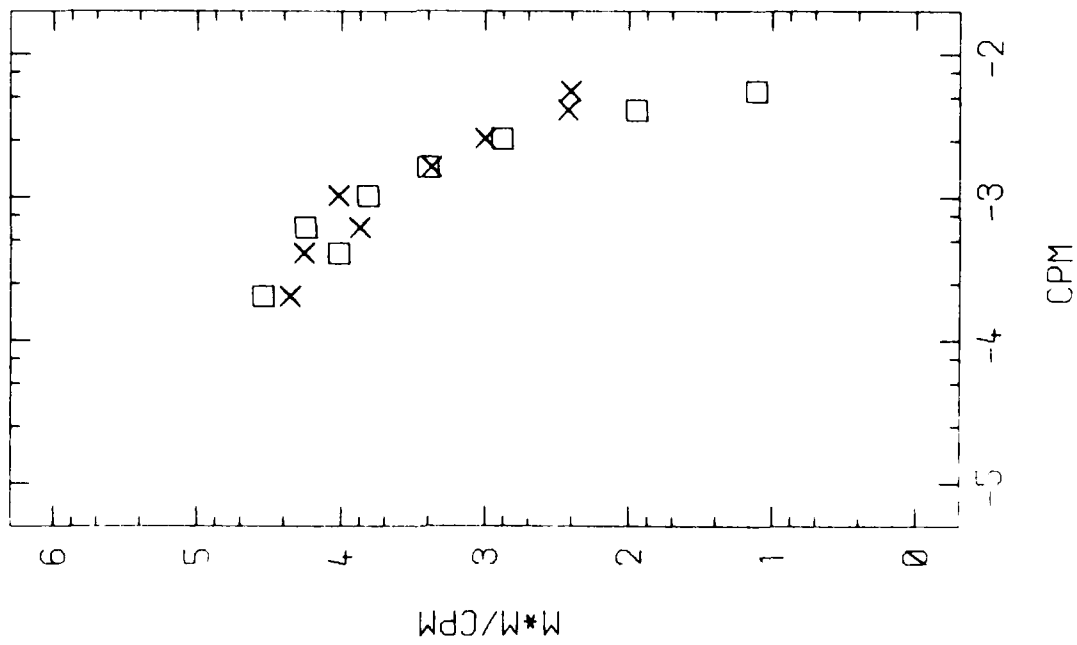

RUN 4E-25 30-AUG-78  
ISOTHERMS (DEG C) 12.0, 9.6

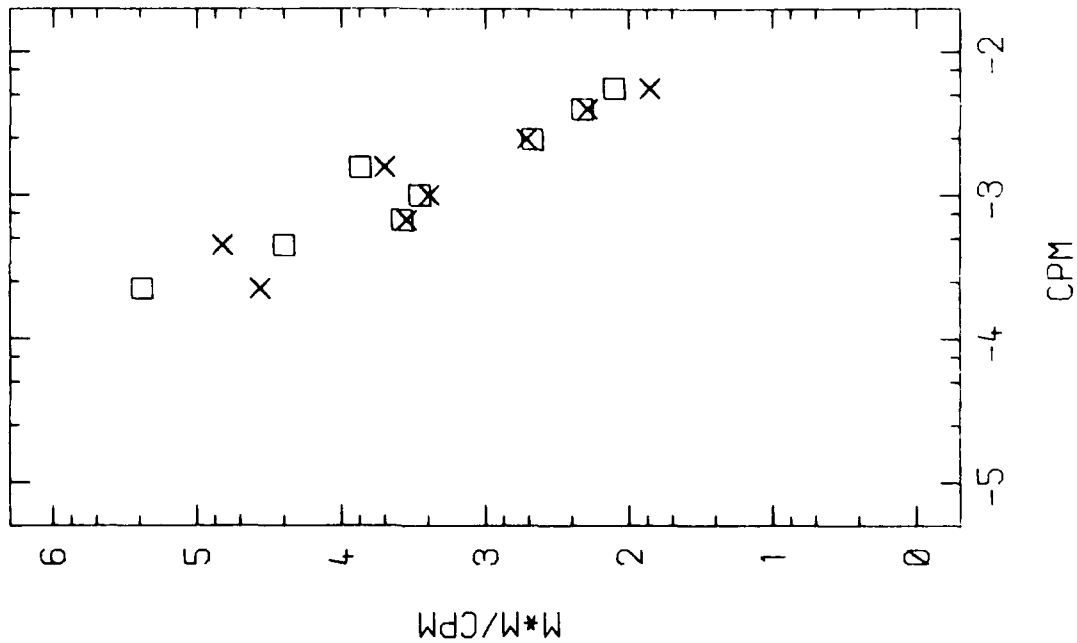

RUN 4S-24 30-AUG-78  
ISOTHERMS (DEG C) 12.2, 9.6

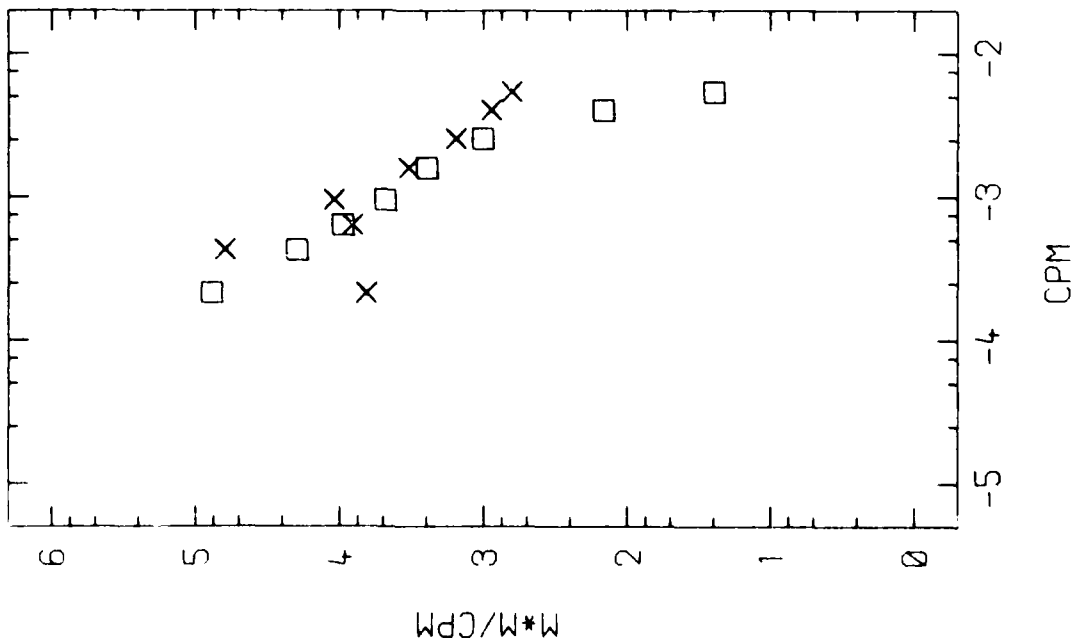

RUN 4W-27 30-AUG-78  
ISOTHERMS (DEG C) 12.2, 9.6

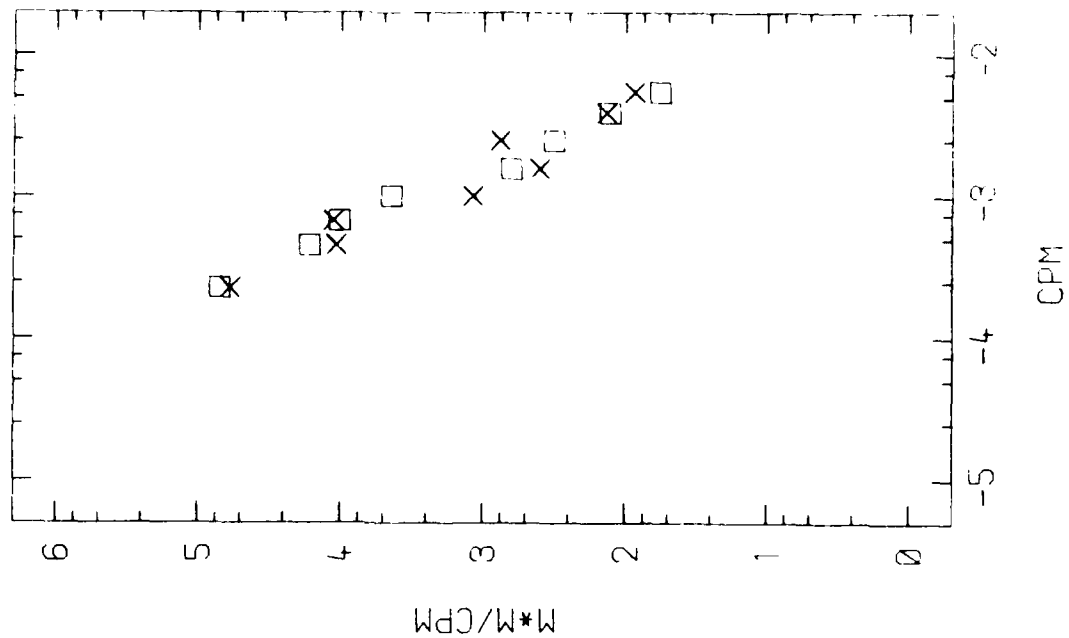

RUN 4N-26 30-AUG-78  
ISOTHERMS (DEG C) 12.2, 9.8

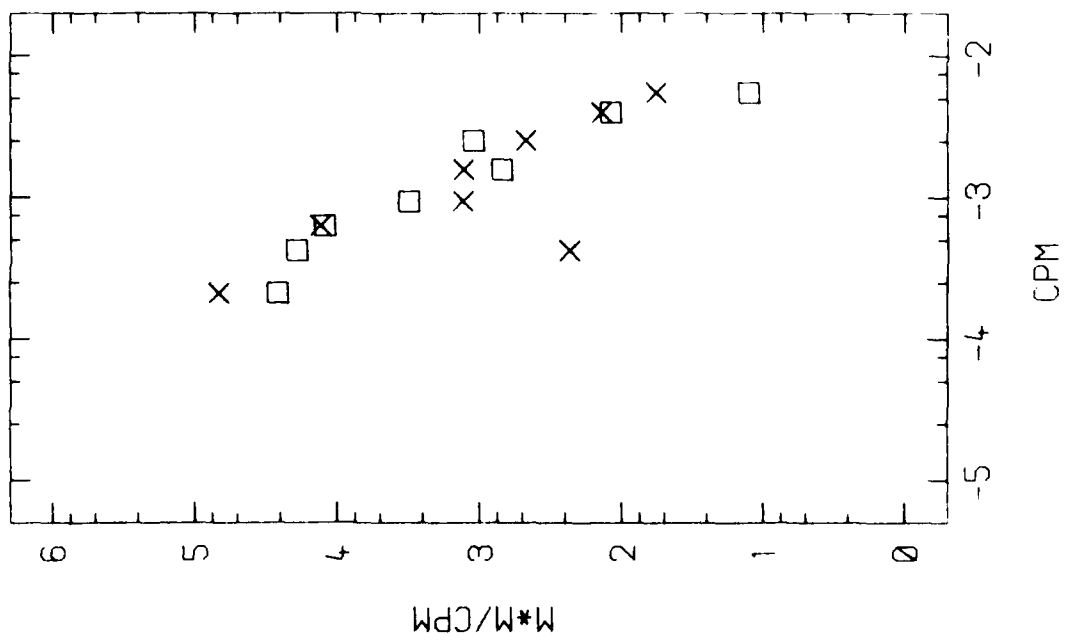

RUN 4E-29 30-AUG-78  
ISOTHERMS (DEG C) 12.0, 9.8

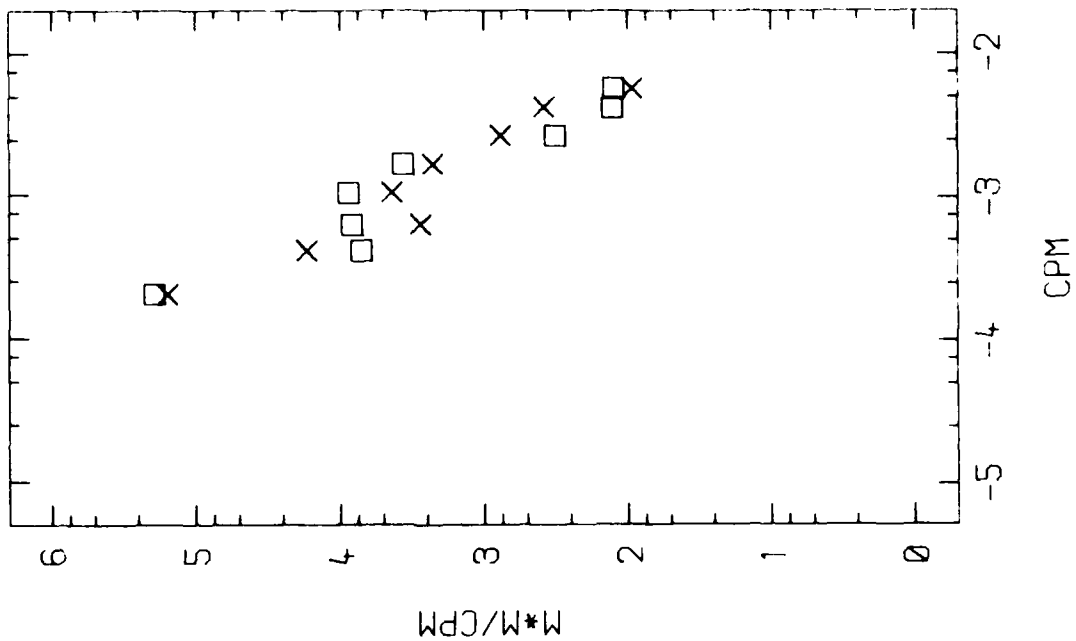

RUN 4S-28 30-AUG-78  
ISOTHERMS (DEG C) 12.2, 9.8

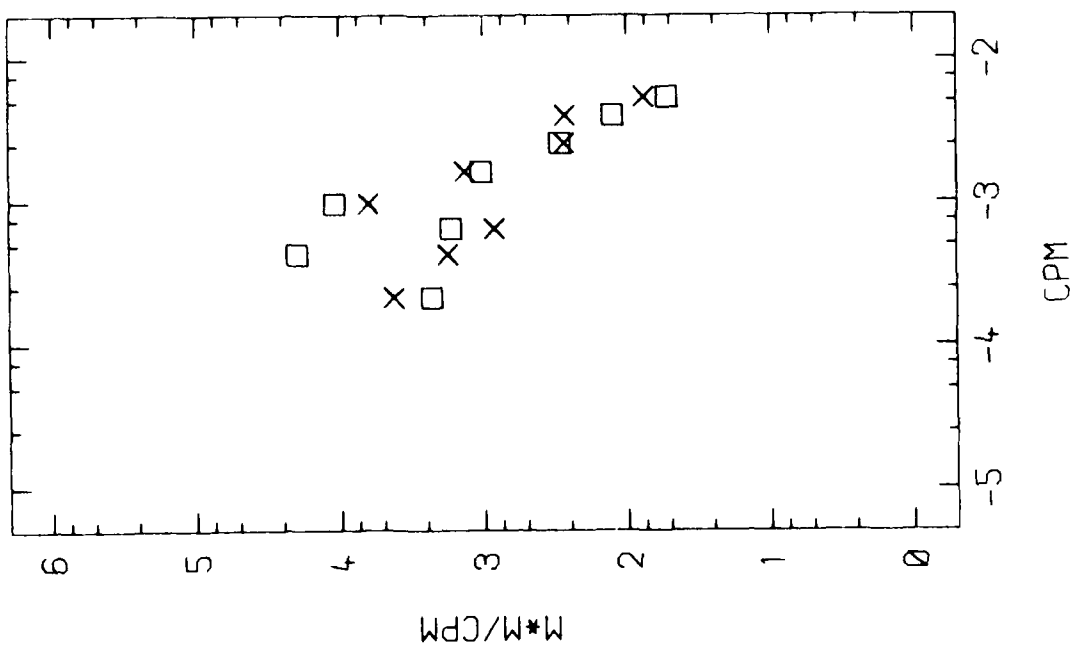

RUN 5N-1 31-AUG-78  
ISOTHERMS (DEG C) 12 2, 9 8

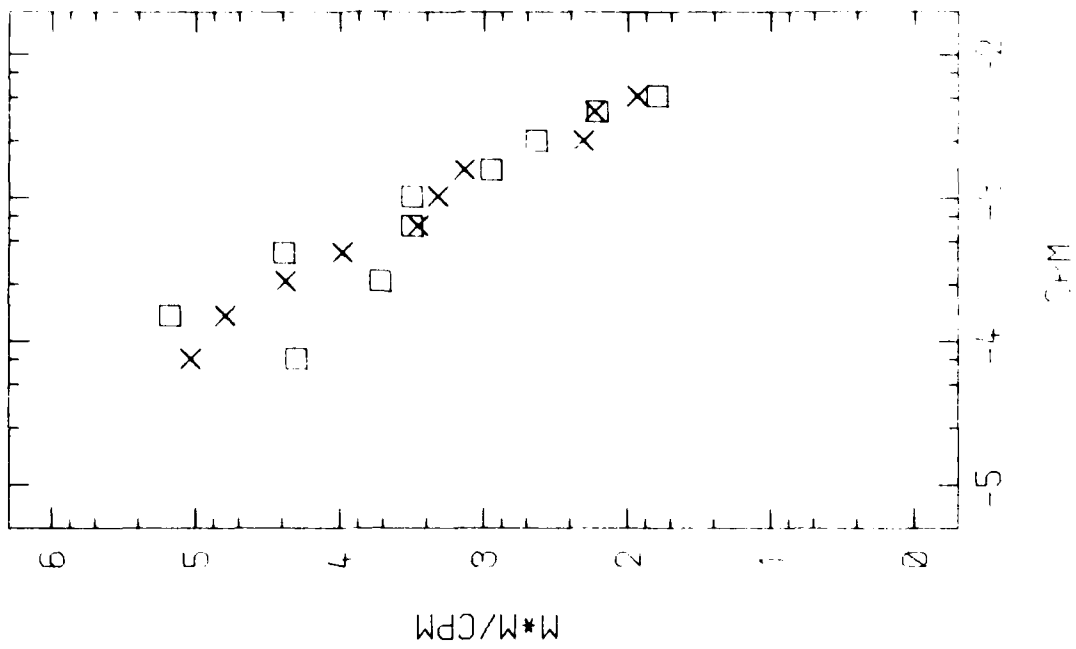

RUN 4N-30 30-AUG-78  
ISOTHERMS (DEG C) 12 0, 10 0

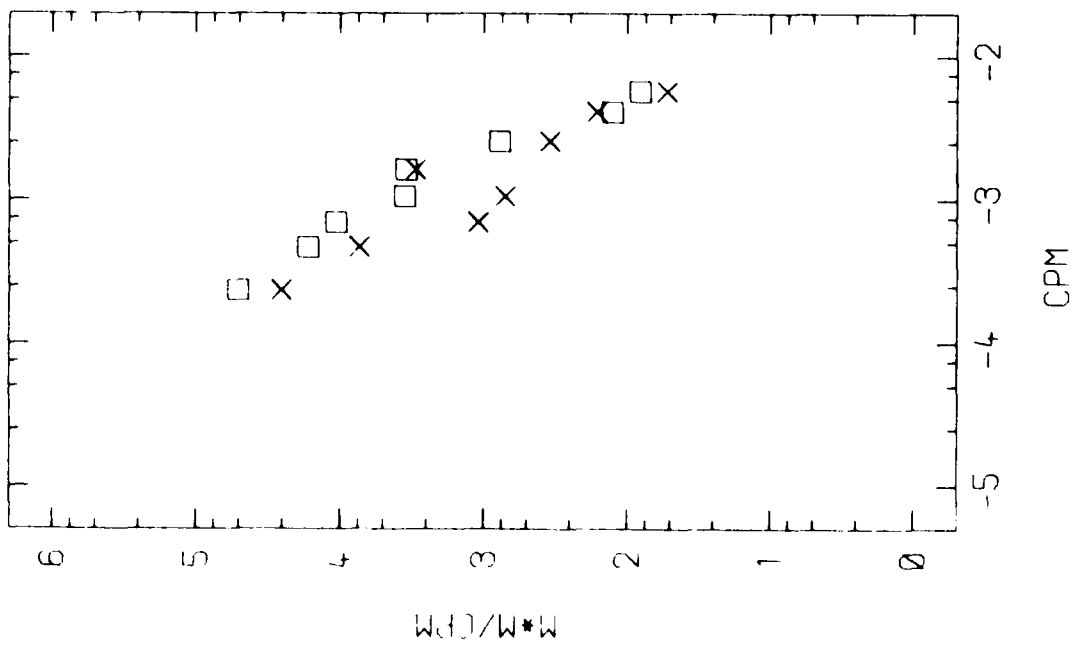

RUN 5S-3 31-AUG-78  
ISOTHERMS (DEG C) 12.4, 10.0

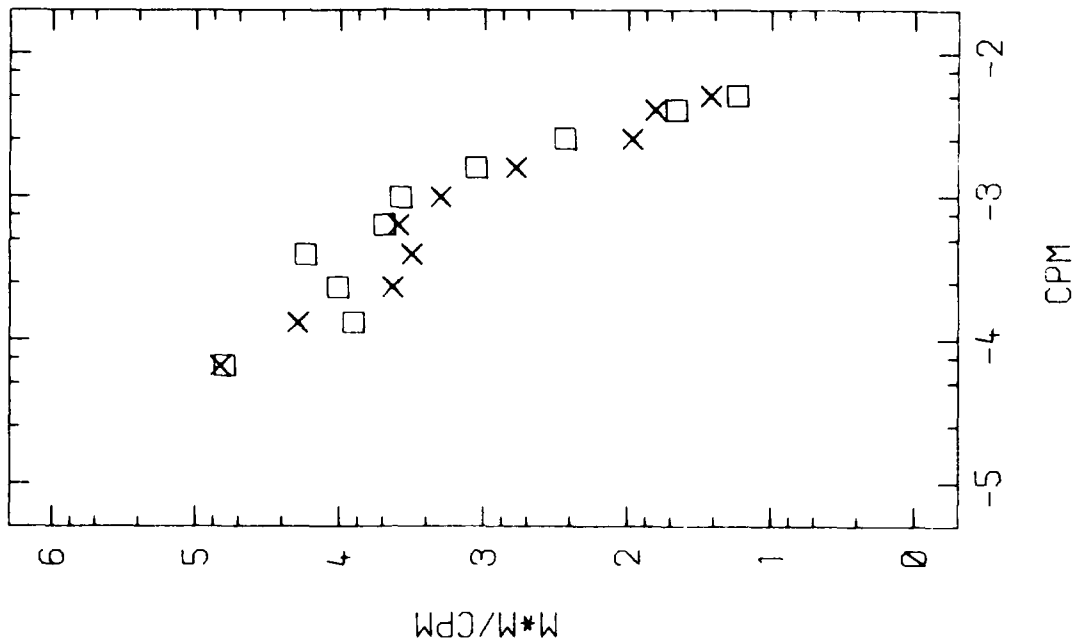

RUN 5W-2 31-AUG-78  
ISOTHERMS (DEG C) 12.4, 9.8

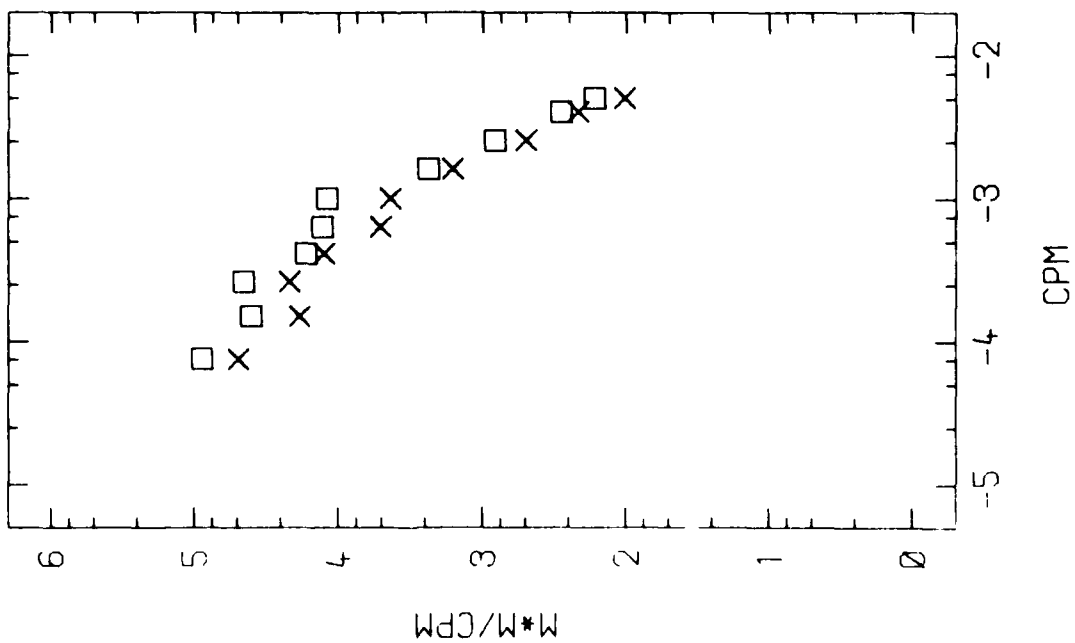

RUN 5N-5 31-AUG-78  
ISOTHERMS (DEG C) 12 2, 9 8

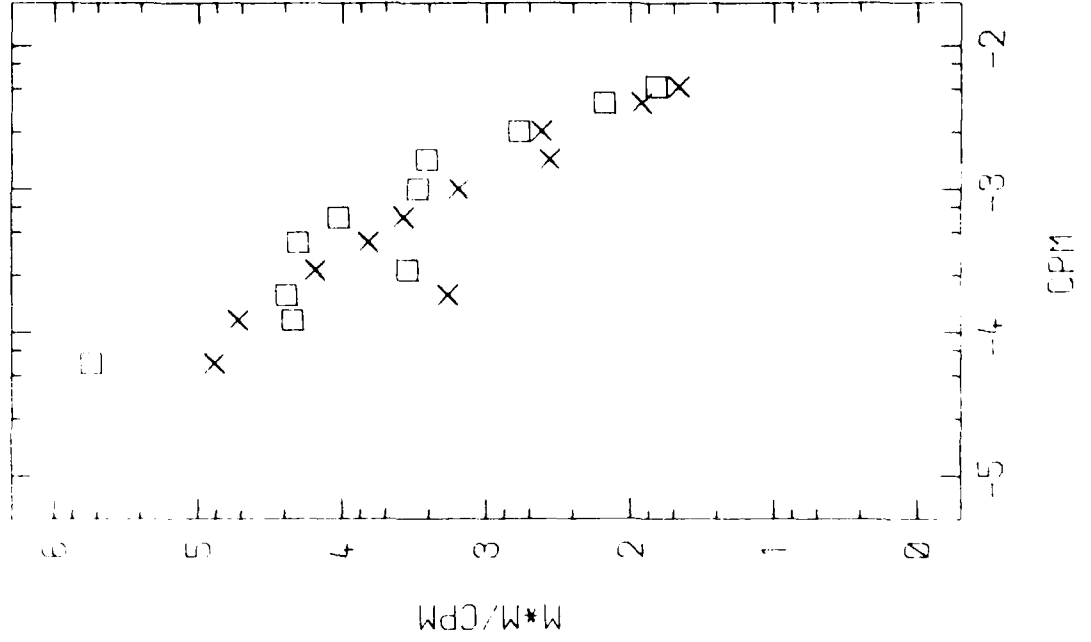

RUN 5E-4 31-AUG-78  
ISOTHERMS (DEG C) 12 4, 9 8

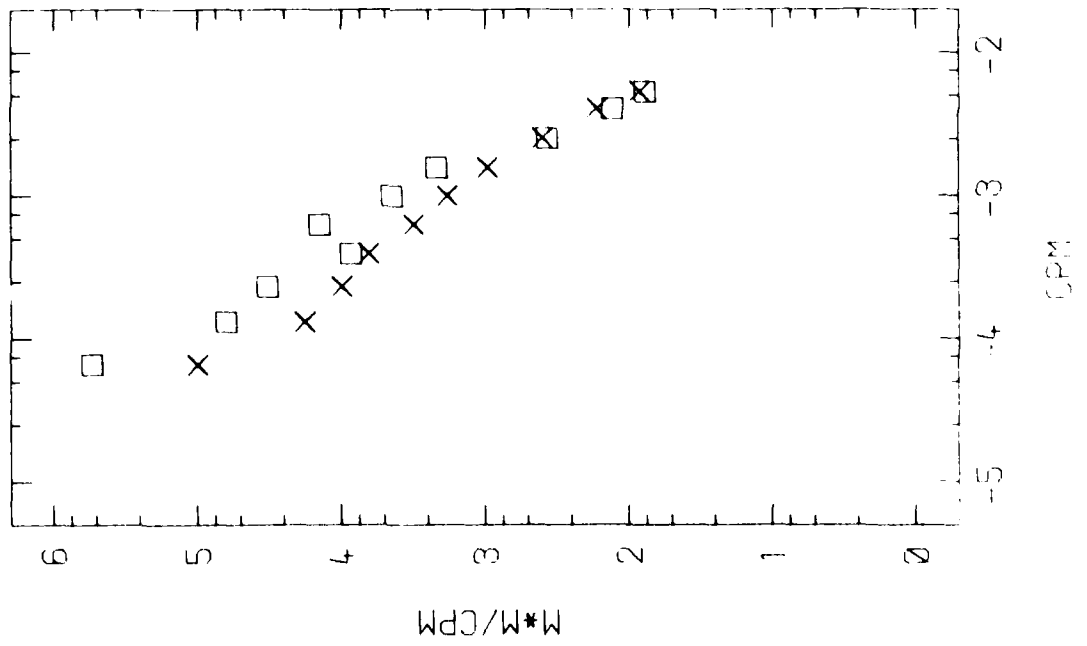



RUN 5S-7 31-AUG-78  
ISOTHERMS (DEG C) 12.4, 10.2

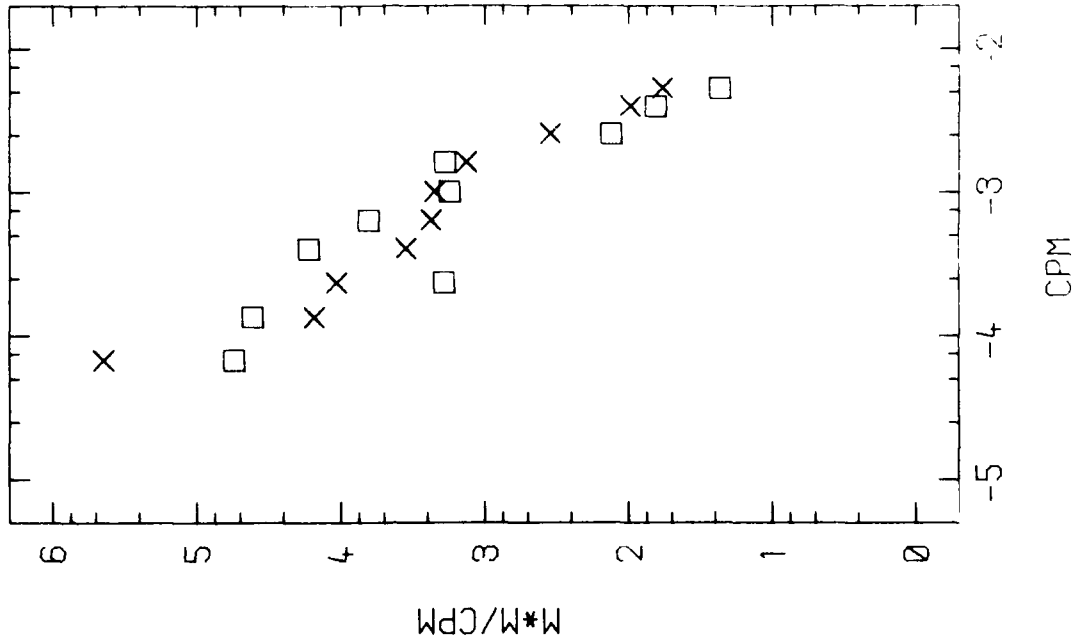

RUN 5W-6 31-AUG-78  
ISOTHERMS (DEG C) 12.2, 9.6

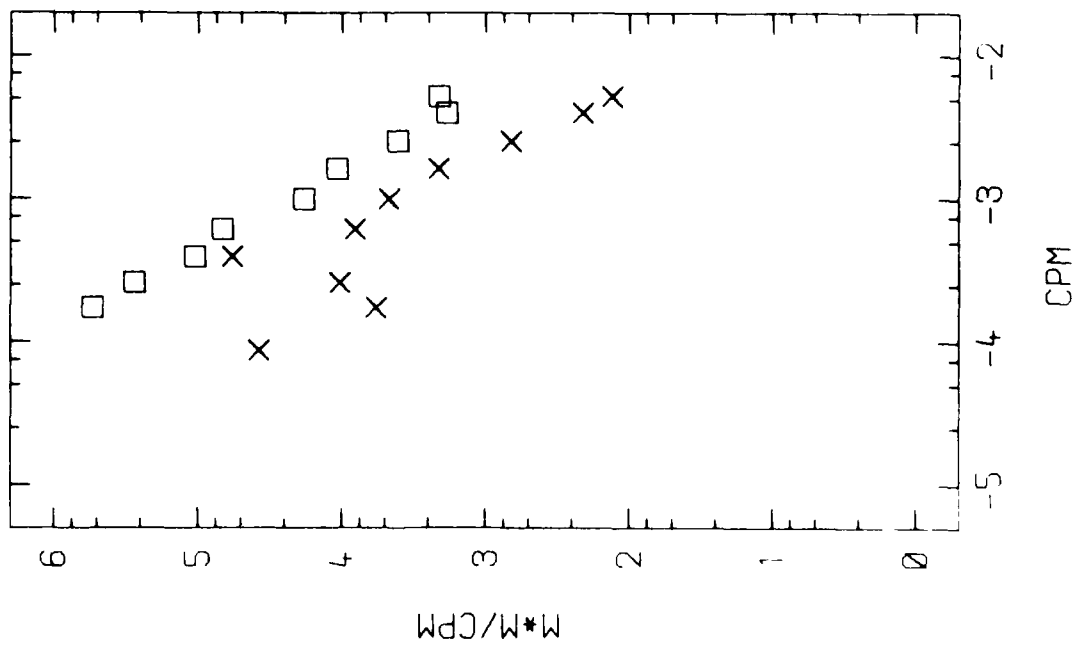



RUN 6E-3 2-SEP-78  
ISOTHERMS (DEG C) 12 0, 9 6

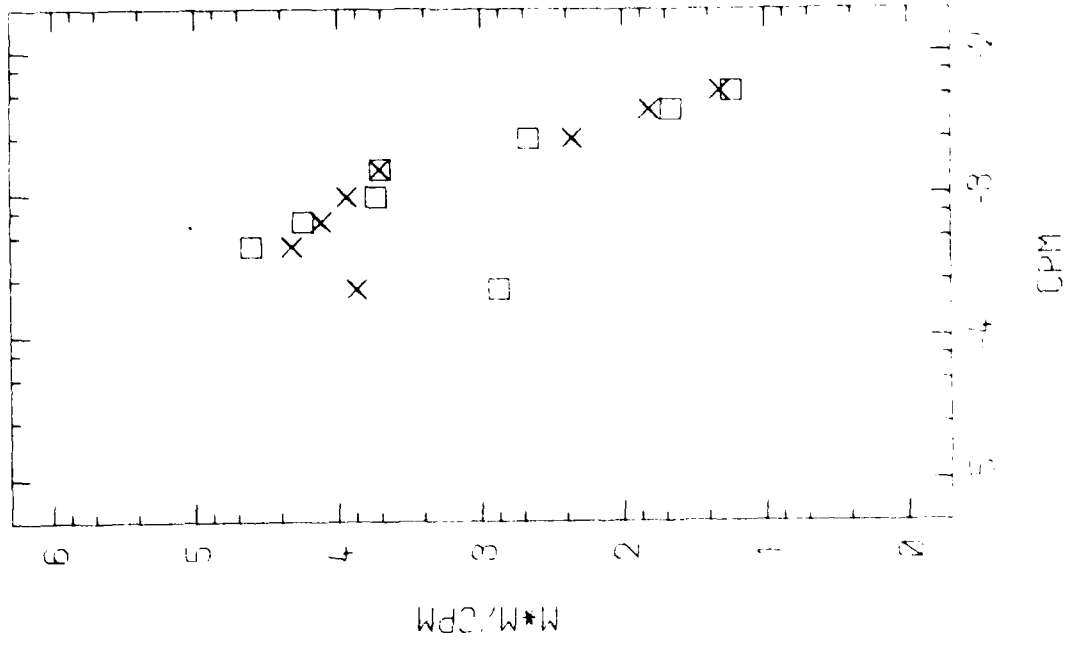

RUN 6S-2 2-SEP-78  
ISOTHERMS (DEG C) 12 2, 9 8

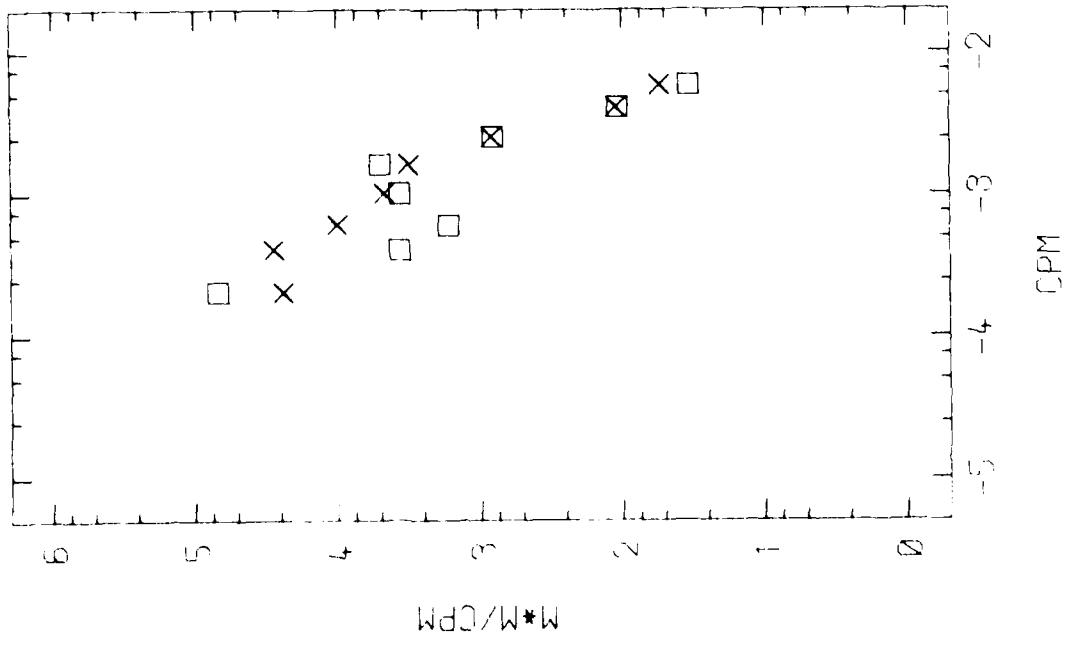

2 SEP 68  
 12 20 9 B

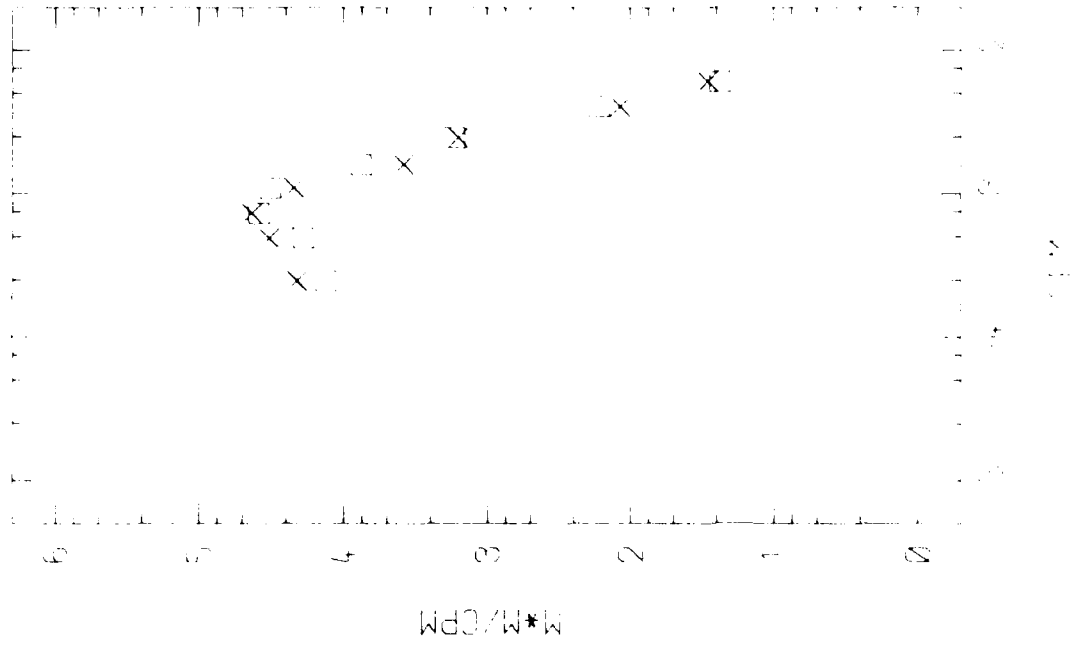

2 SEP 68  
 12 20 9 B

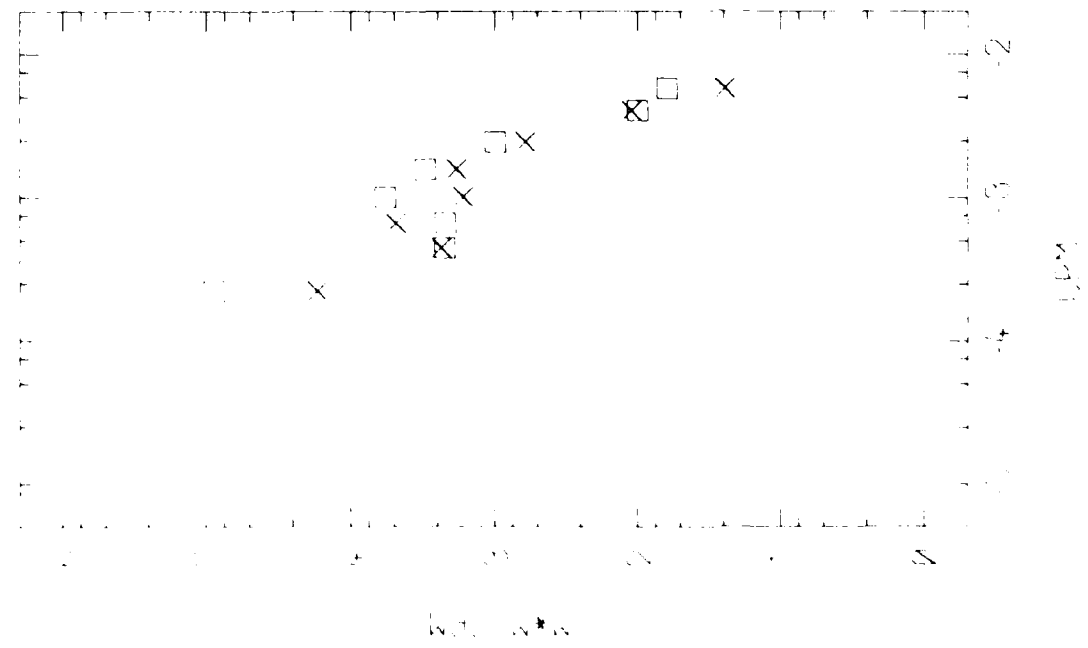

RUN 6E-7 2-SEP-78  
ISOTHERMS (DEG C) 12 2, 10 0

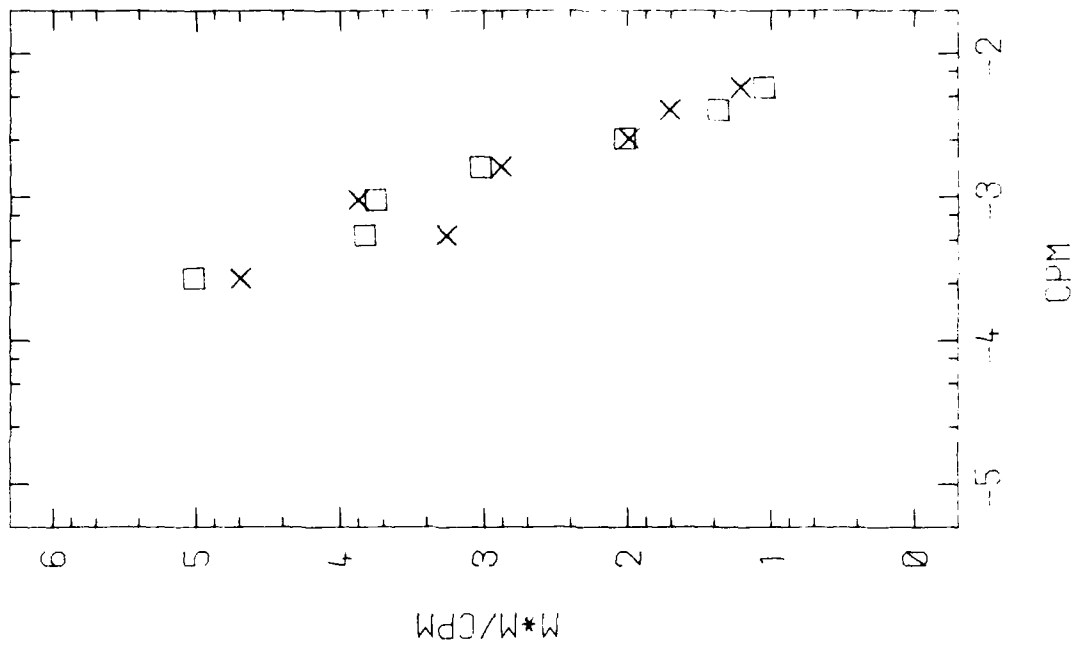

RUN 6S-6 2-SEP-78  
ISOTHERMS (DEG C) 12 2, 10 0

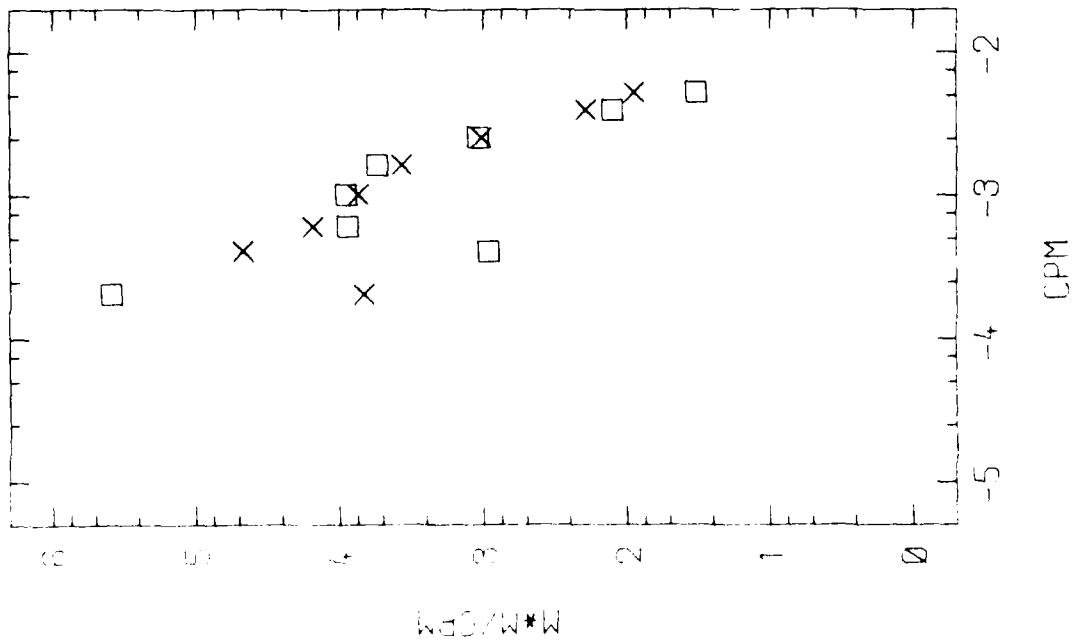

RUN 64. 8 2-SEP-78  
ISOTHERMS (DEG C) 12 2, 9 8

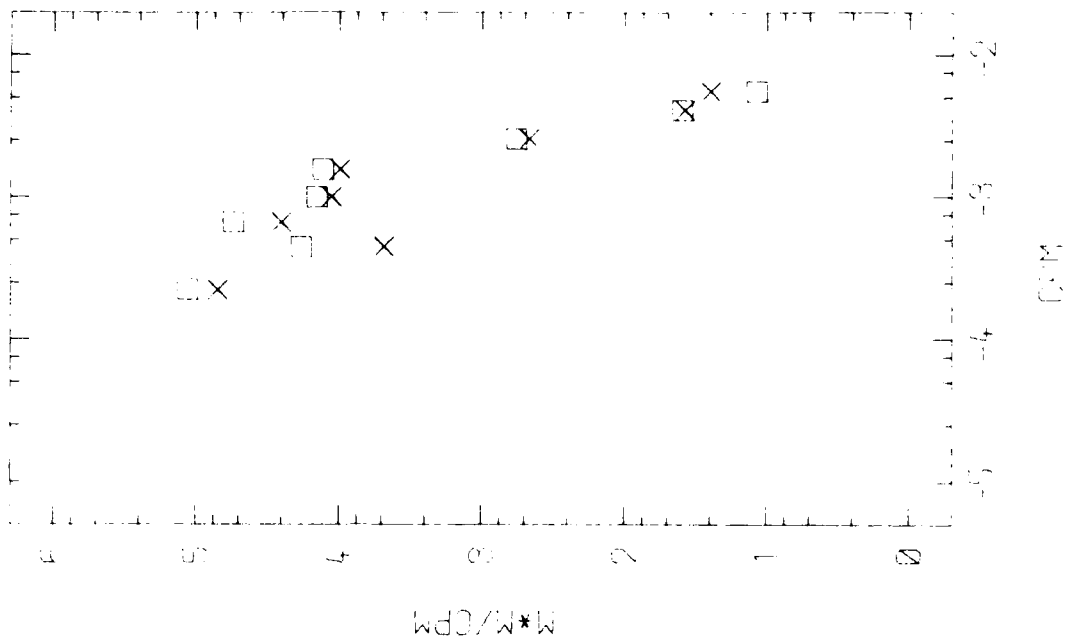

RUN 64. 8 2-SEP-78  
ISOTHERMS (DEG C) 12 2, 9 8

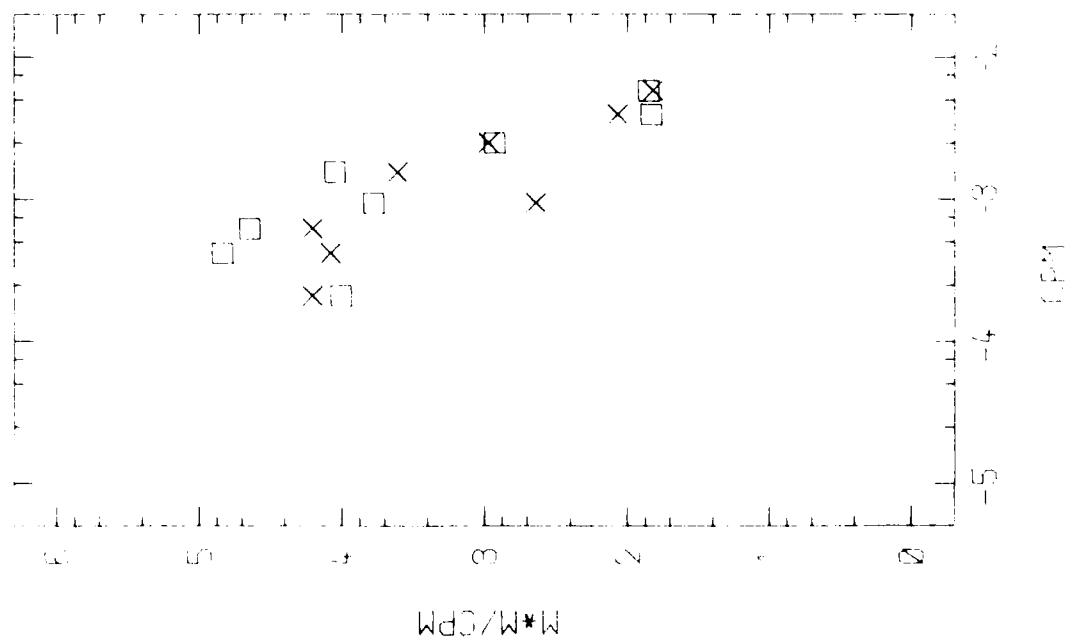

RIJN 6E 11 2 SEP /78  
ISOTHERMS (DEG C) 12.0, 9.8

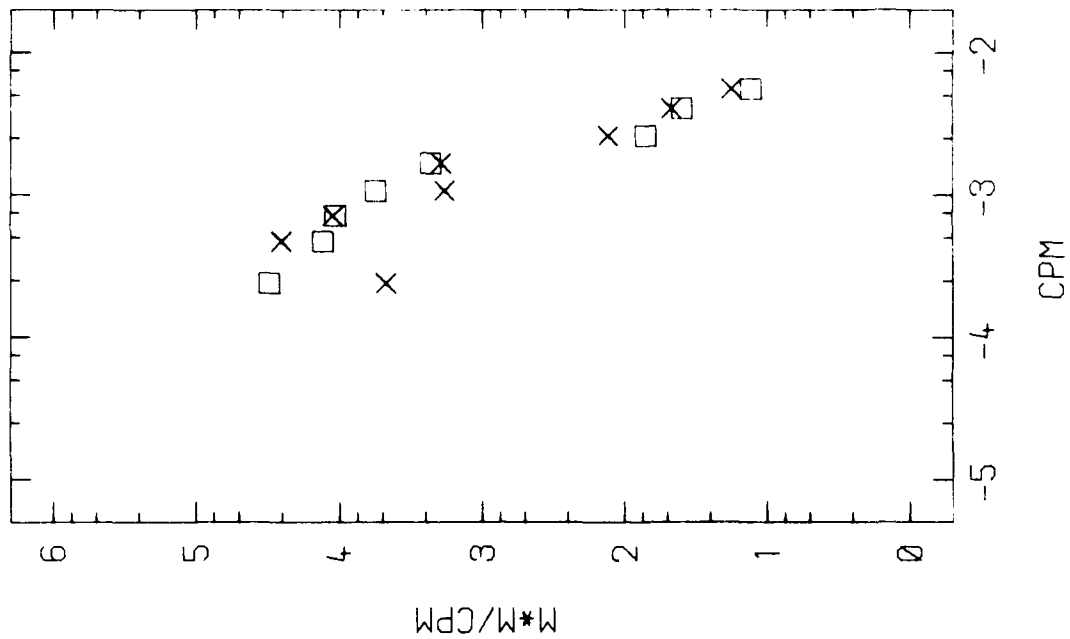

RIJN 6C 10 2-SEP-78  
ISOTHERMS (DEG C) 12.2, 10.0

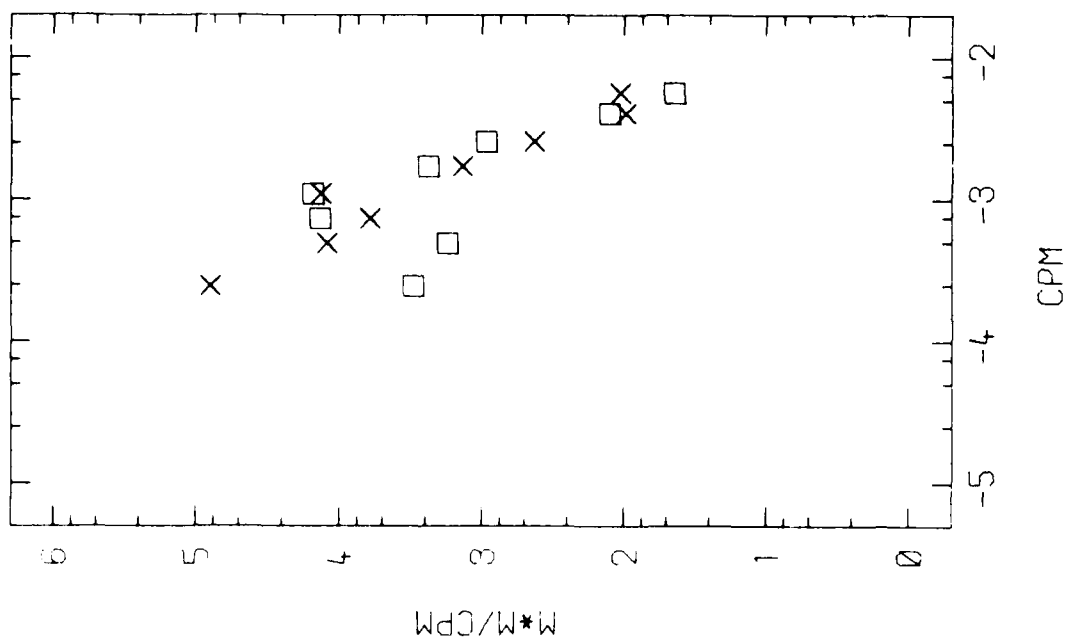

RUN 6W-13 2 SEP 78  
ISOTHERMS (DEG C) 12 2, 9 8

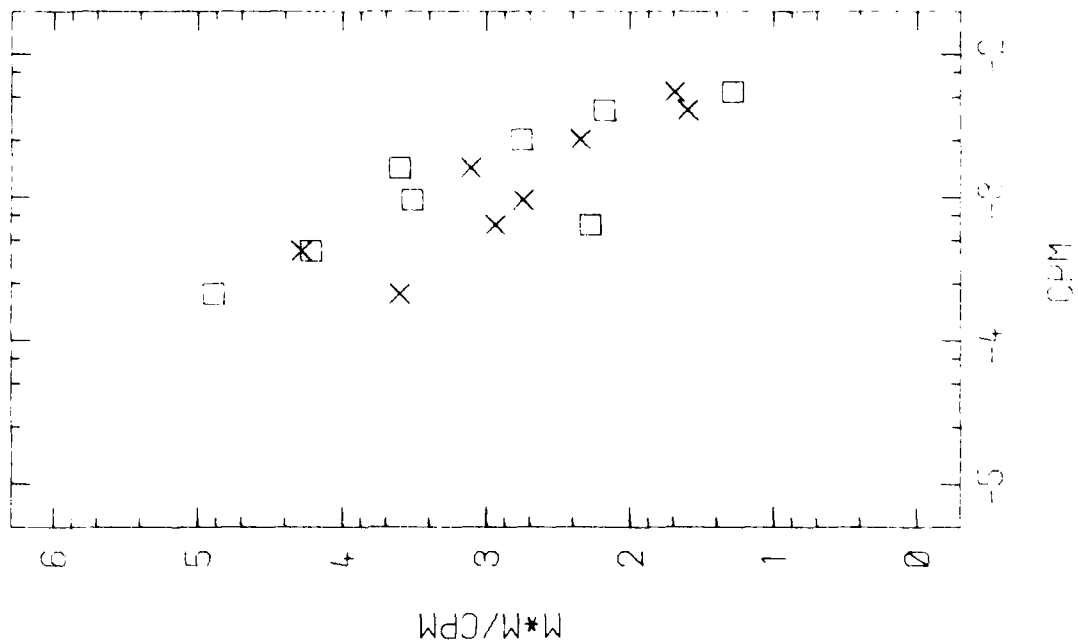

RUN 6N-12 2-SEP-78  
ISOTHERMS (DEG C) 12 2, 9 8

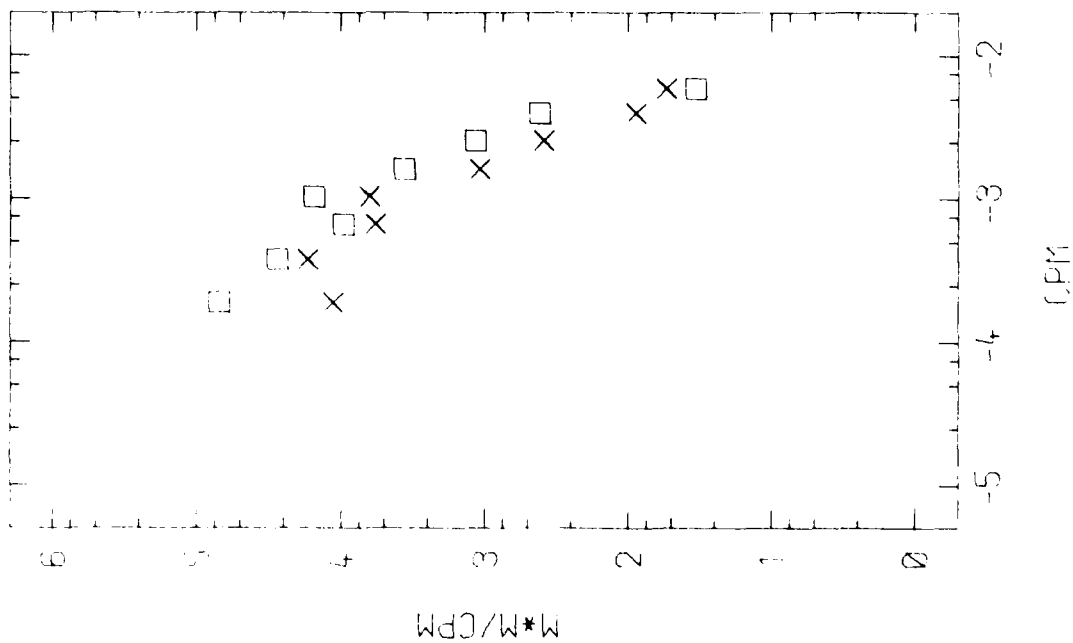



RUN 6E-15 2-SEP-78  
ISOTHERMS (DEG C) 12.0, 9.8

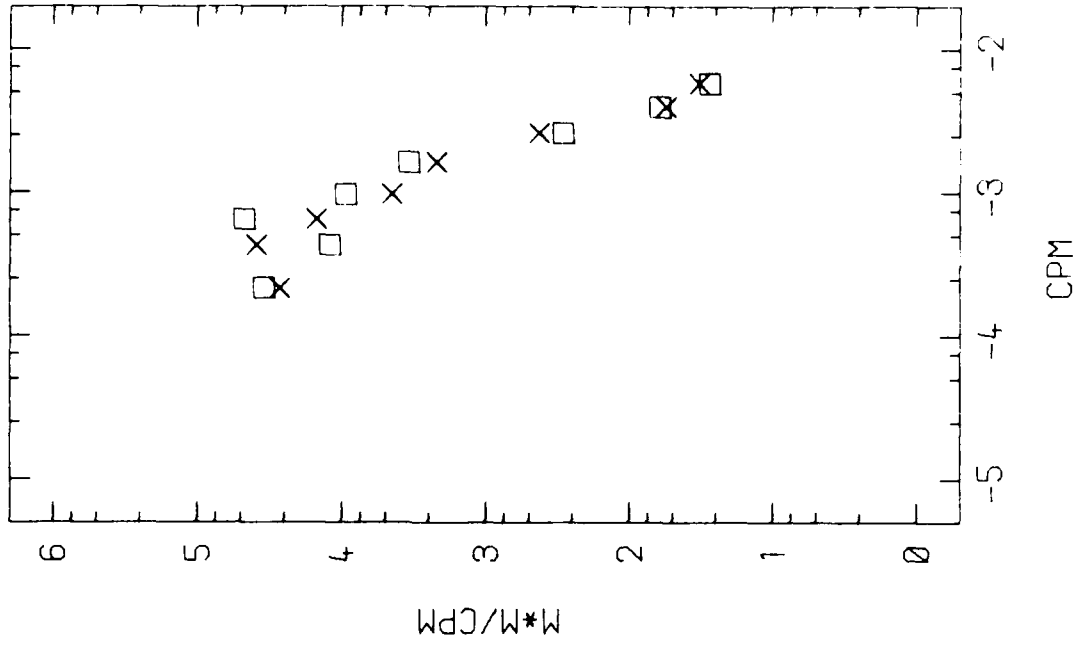

RUN 6S-14 2-SEP-78  
ISOTHERMS (DEG C) 12.2, 9.8

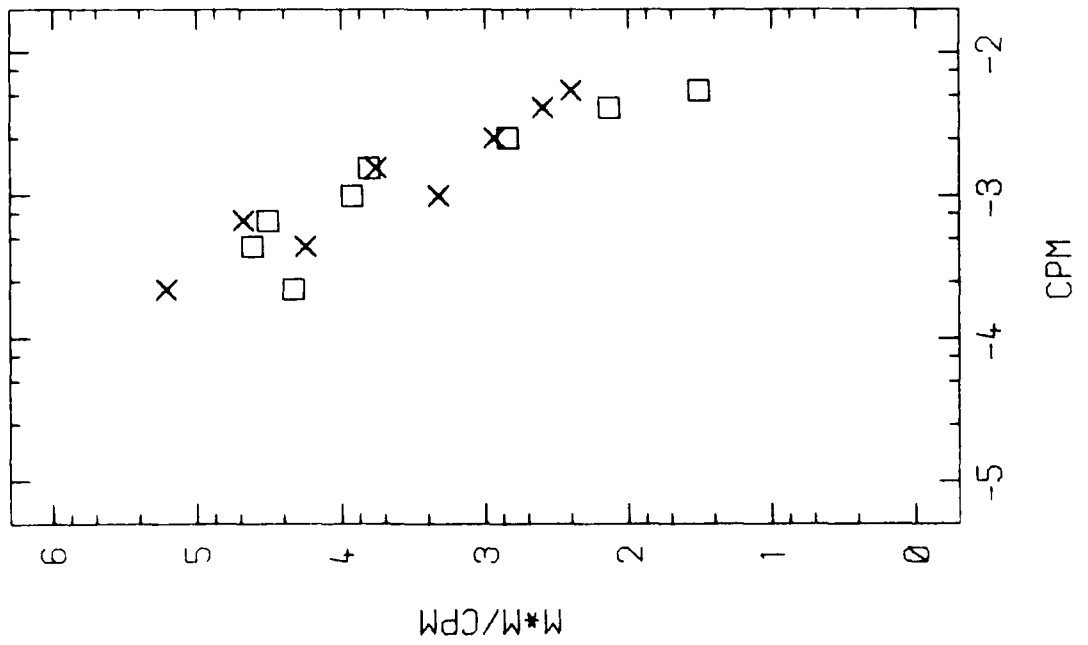

RUN 6W-17 2-SEP-78  
ISOTHERMS (DEG C) 12 2, 10 0

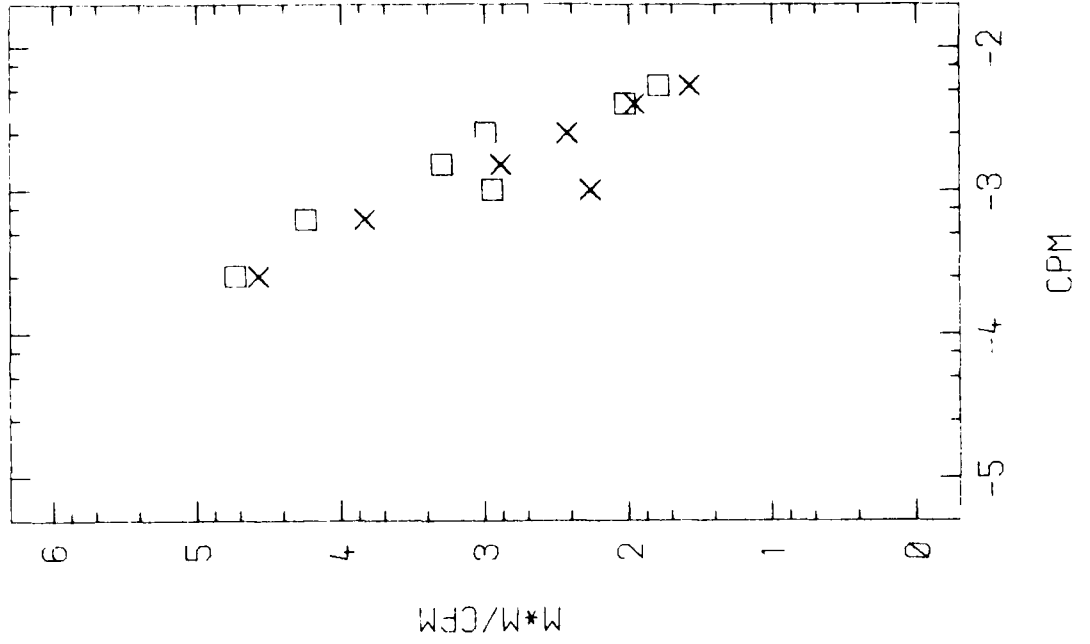

RUN 6N-16 2-SEP-78  
ISOTHERMS (DEG C) 12 2, 9 8

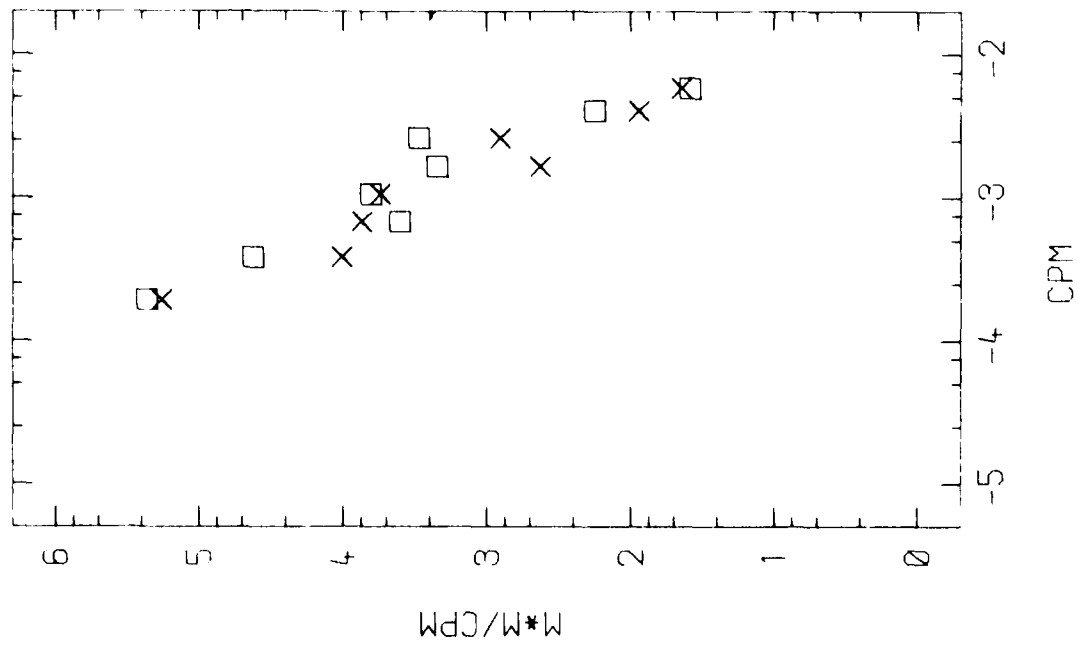

RUN 6E-19 2-SEP-78  
ISOTHERMS (DEG C) 12.2, 9.6

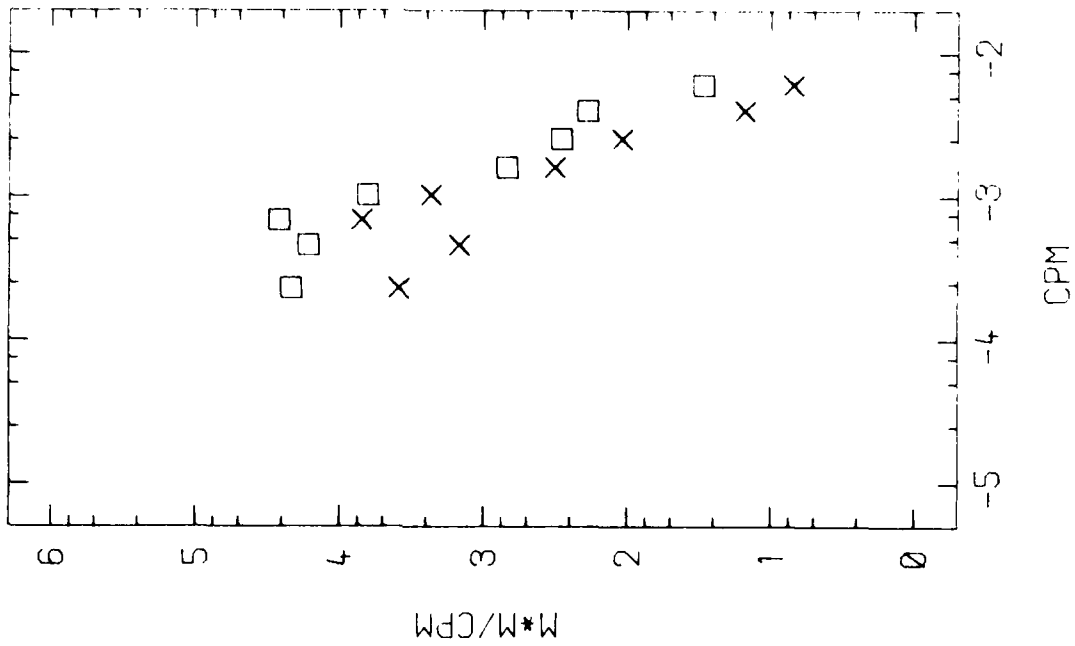

RUN 6S-18 2-SEP-78  
ISOTHERMS (DEG C) 12.2, 9.8

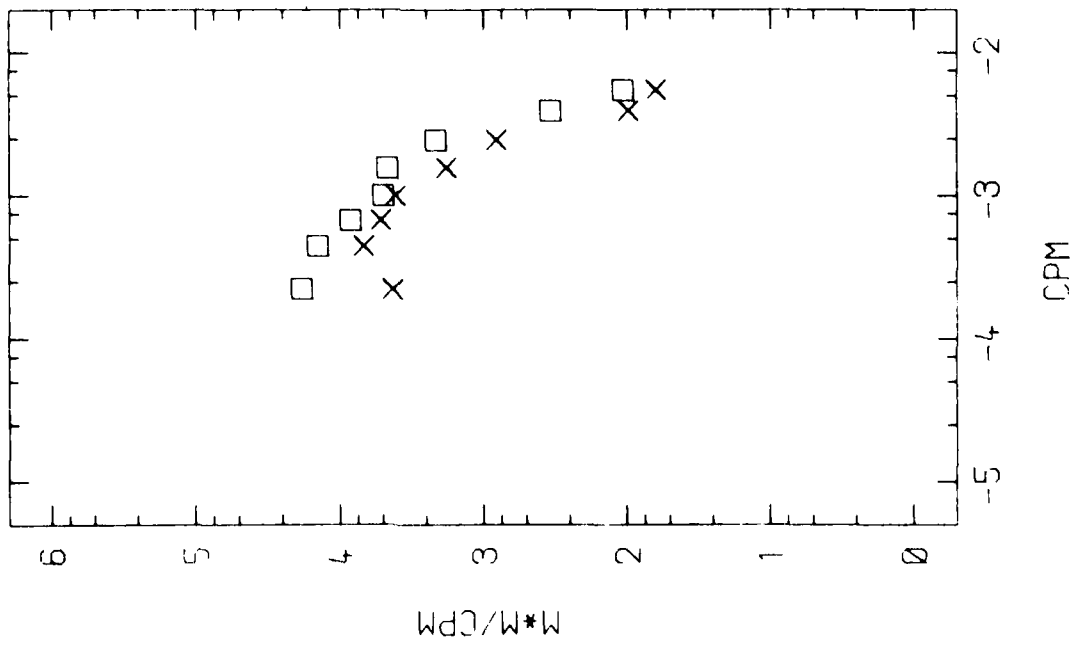

RUN 6N-20 2-SEP-78  
ISOTHERMS (DEG C) 12 2, 9.5

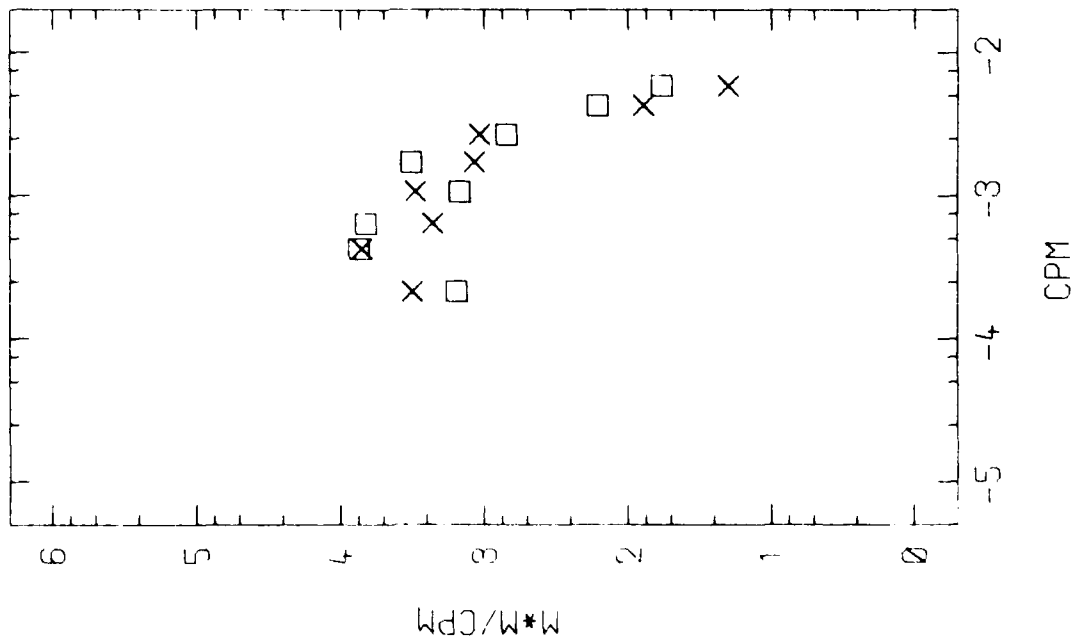

RUN 6W-21 2-SEP-78  
ISOTHERMS (DEG C) 12 4, 10 0

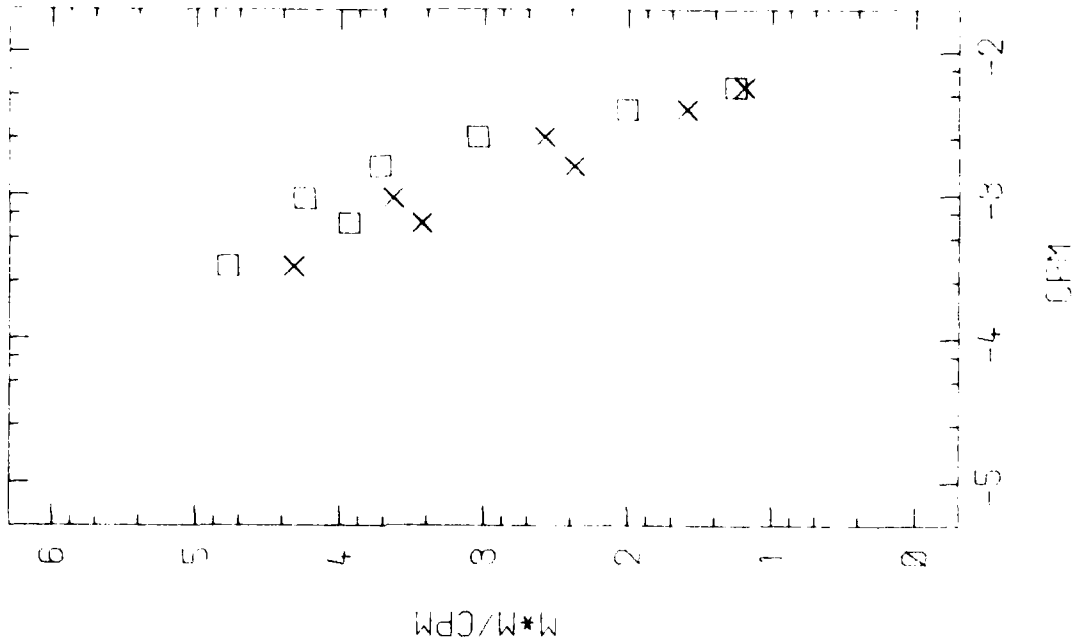

RUN 6E-23 2-SEP-78  
ISOTHERMS (DEG C) 12 0, 9 8

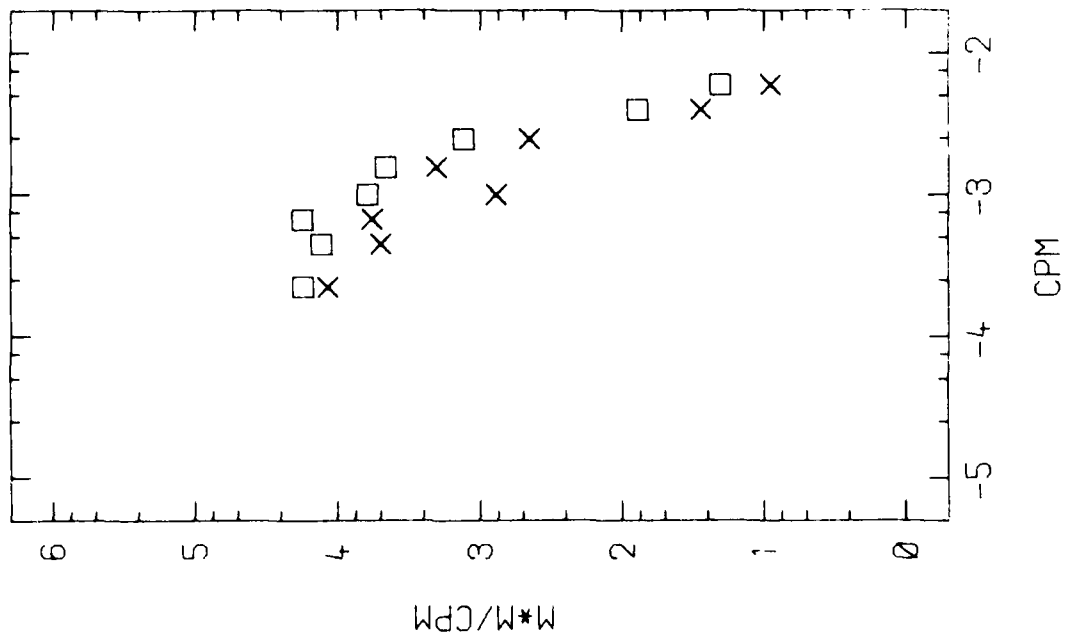

RUN 6S-22 2-SEP-78  
ISOTHERMS (DEG C) 12.2, 9.8

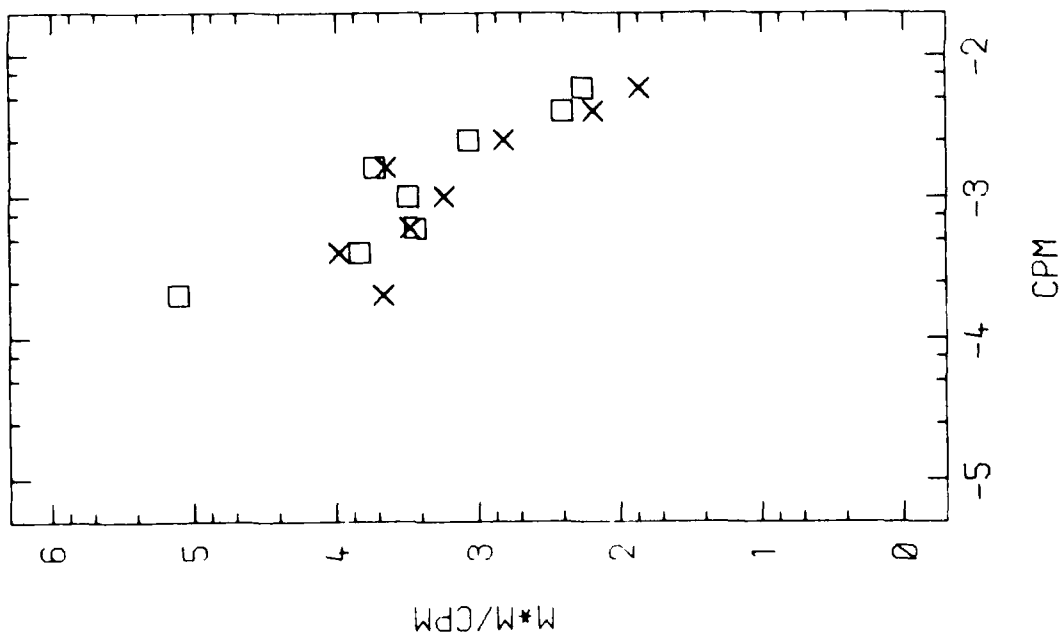

RUN 6W-25 3-SEP-78  
ISOTHERMS (DEG C) 12.4, 9.8

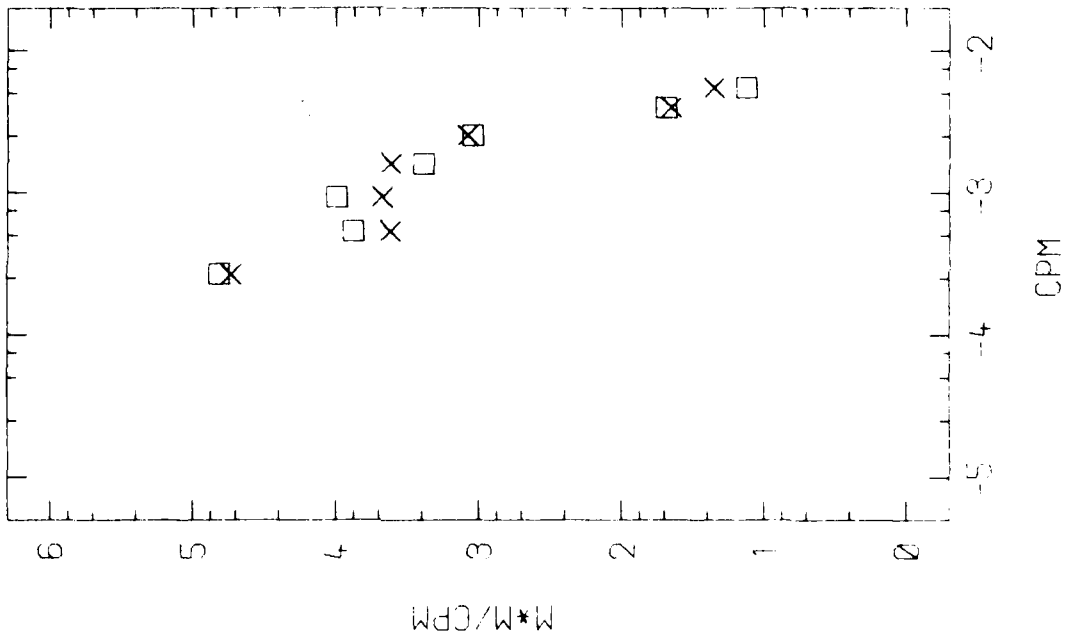

RUN 6N-24 2-SEP-78  
ISOTHERMS (DEG C) 12.4, 10.0

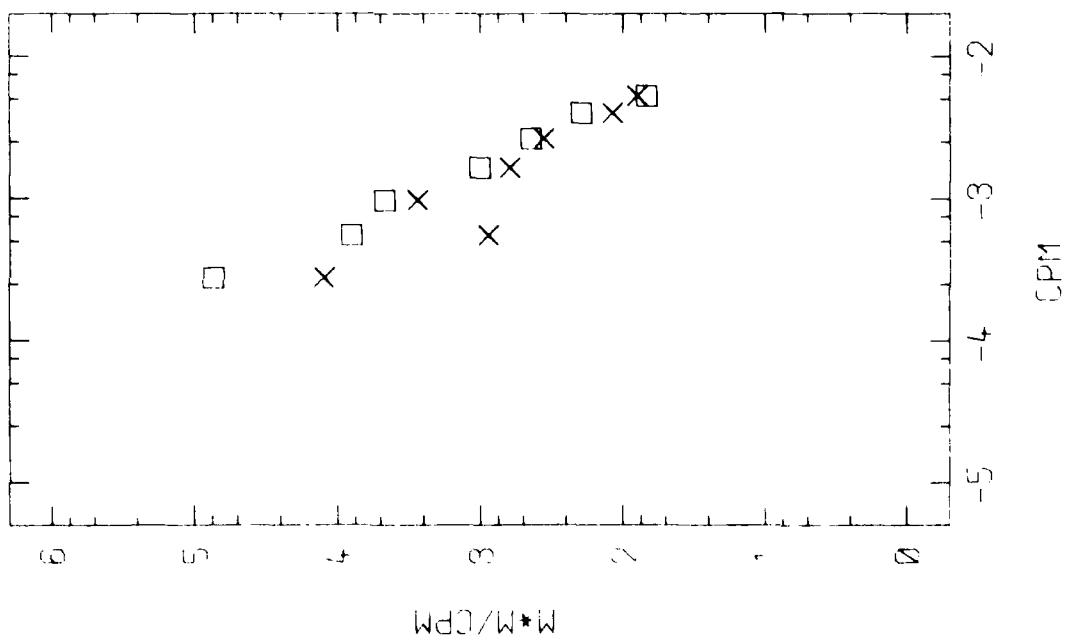

RUN 6E-27 3-SEP-78  
ISOTHERMS (DEG C) 12.0, 9.8

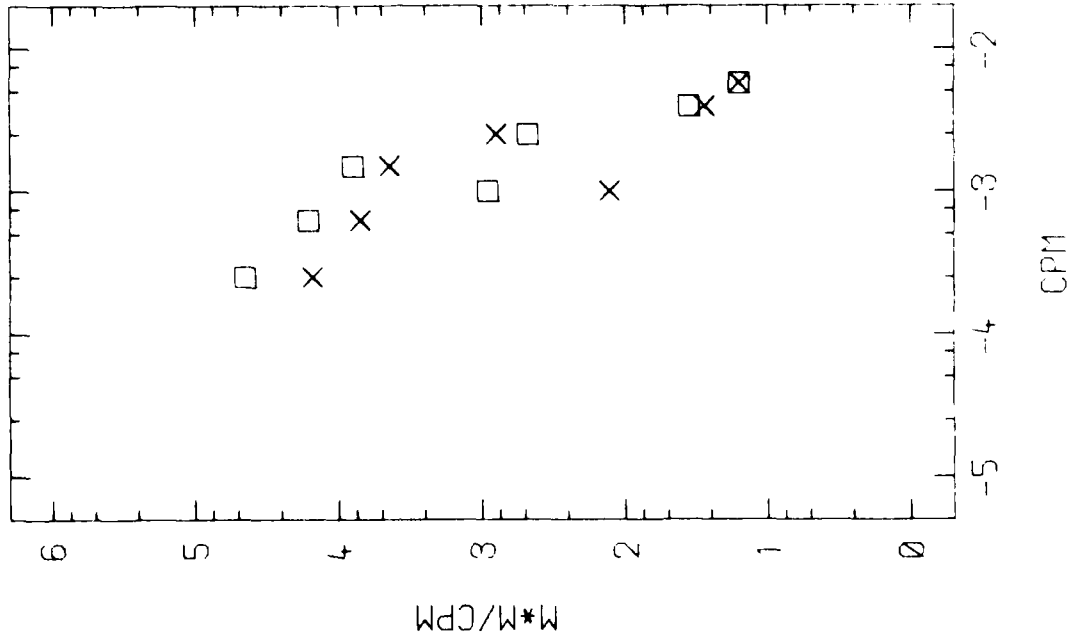

RUN 6S-26 3-SEP-78  
ISOTHERMS (DEG C) 12.2, 10.0

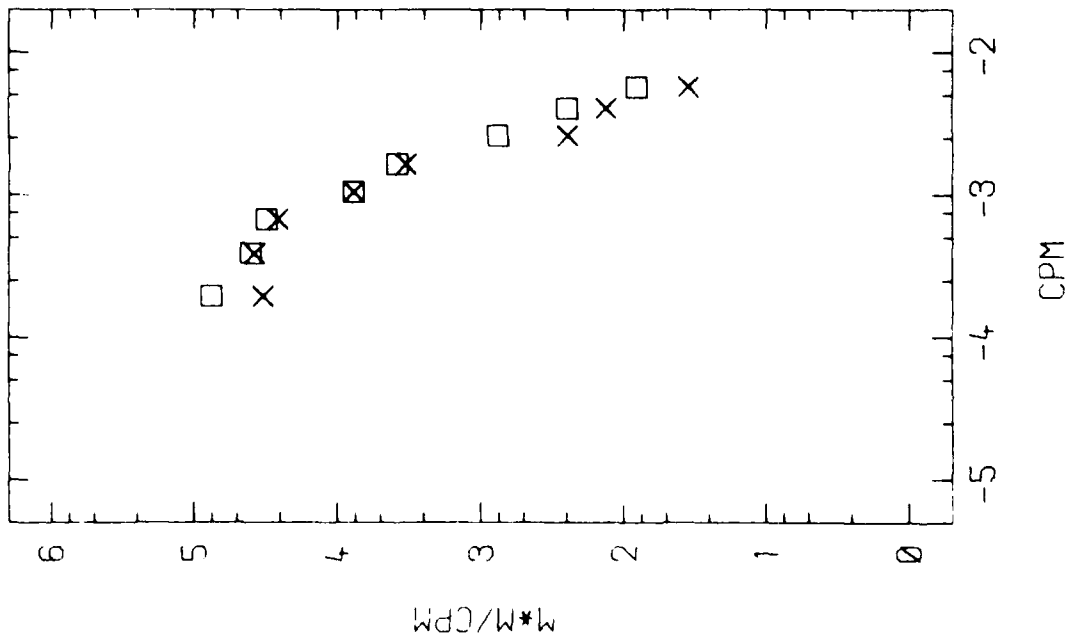

Run 50-29 3-SEP-78  
 THERMS (DEG C) 12 4, 9 8

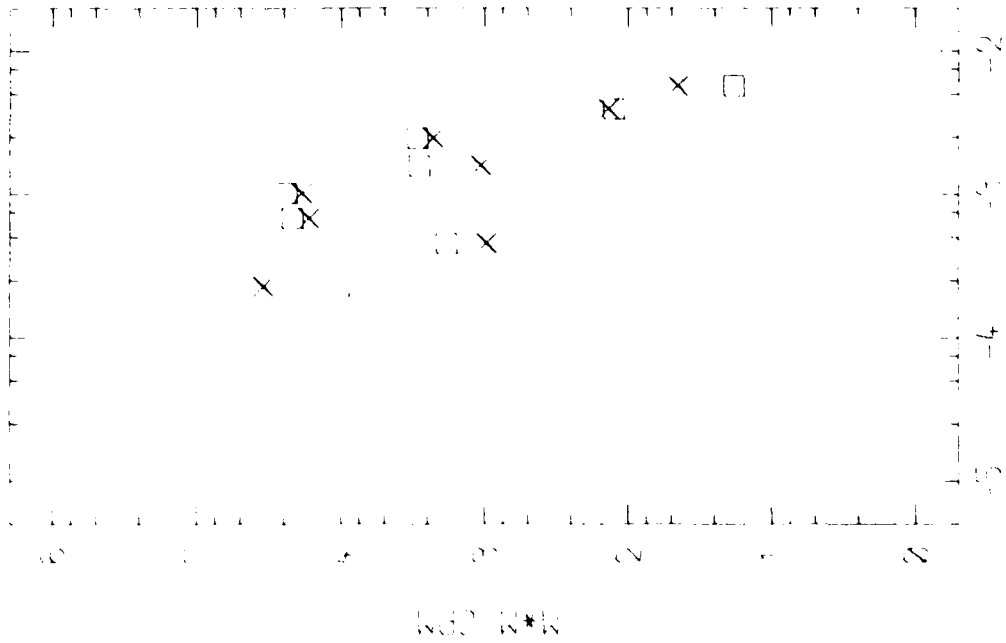

TEMP

Run 50-28 3-SEP-78  
 THERMS (DEG C) 12 0, 9 8

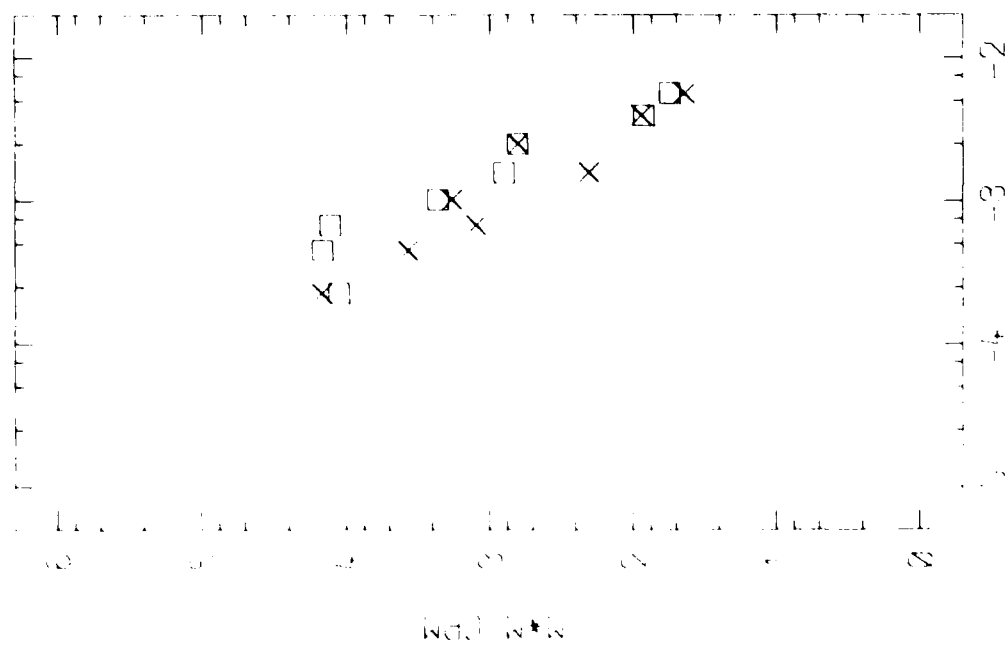

TEMP



RUN 6E-31 3-SEP-78  
ISOTHERMS (DEG C) 12 2, 10 2

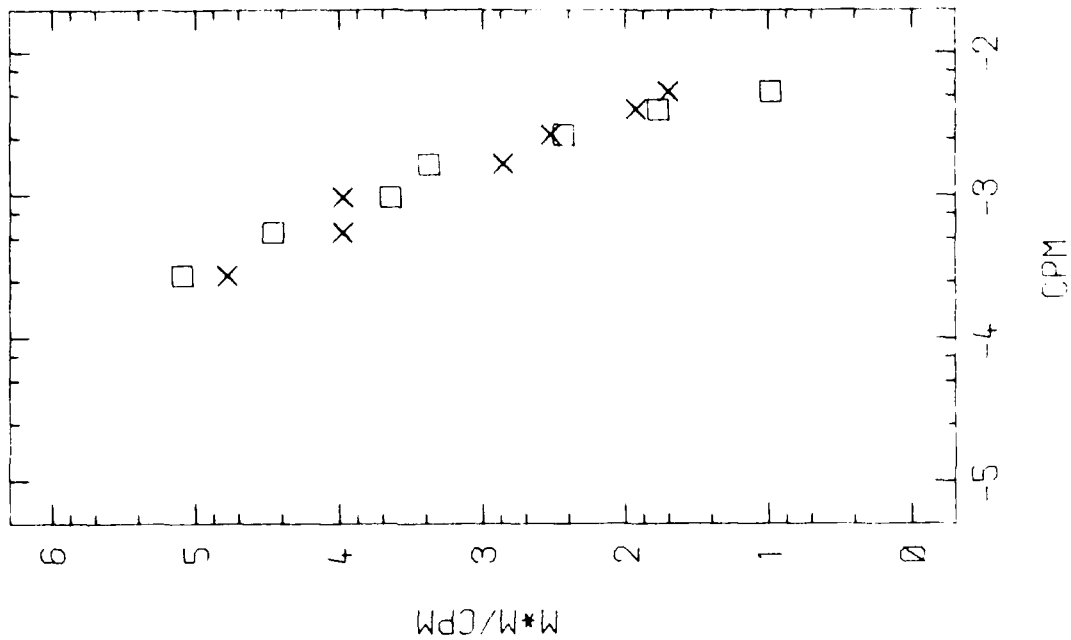

RUN 6S-30 3-SEP-78  
ISOTHERMS (DEG C) 12 2, 9 8

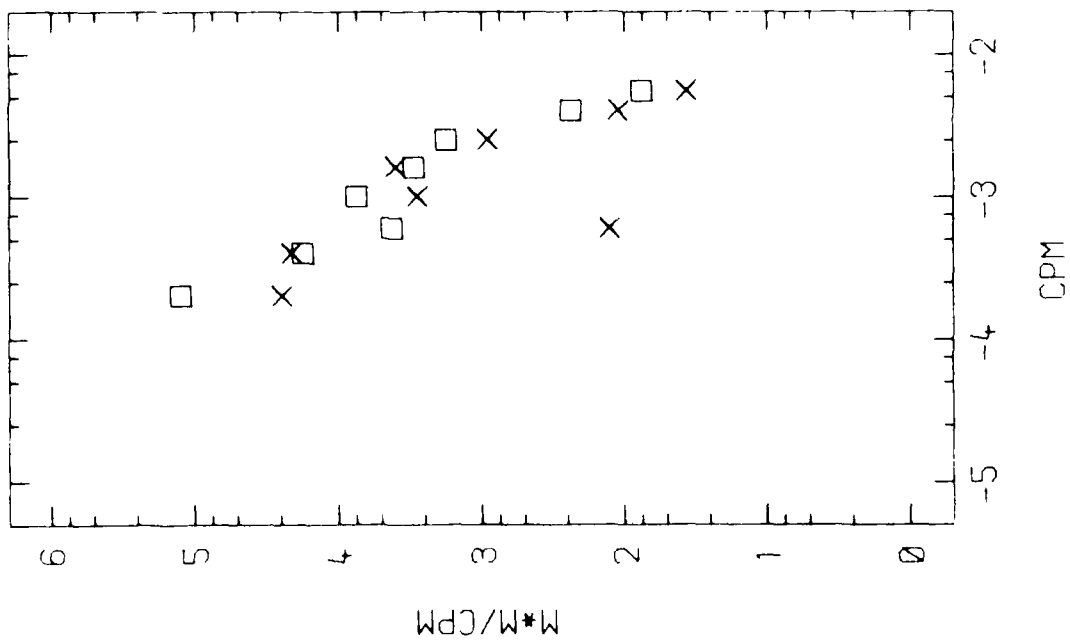



AD-A091 172

OREGON STATE UNIV CORVALLIS SCHOOL OF OCEANOGRAPHY

F/G 8/10

TOWED THERMISTOR CHAIN OBSERVATIONS IN JASIN, (U)

JUL 80 R J BAUMANN, C A PAULSON, J WAGNER

N00014-76-C-0067

DATA-80

NL

UNCLASSIFIED

3 OF 3  
AD  
A091172



END  
DATE  
FILMED  
12 80  
DTIC

RUN 6E-35 3-SEP-78  
ISOTHERMS (DEG C) 12.2, 9.8

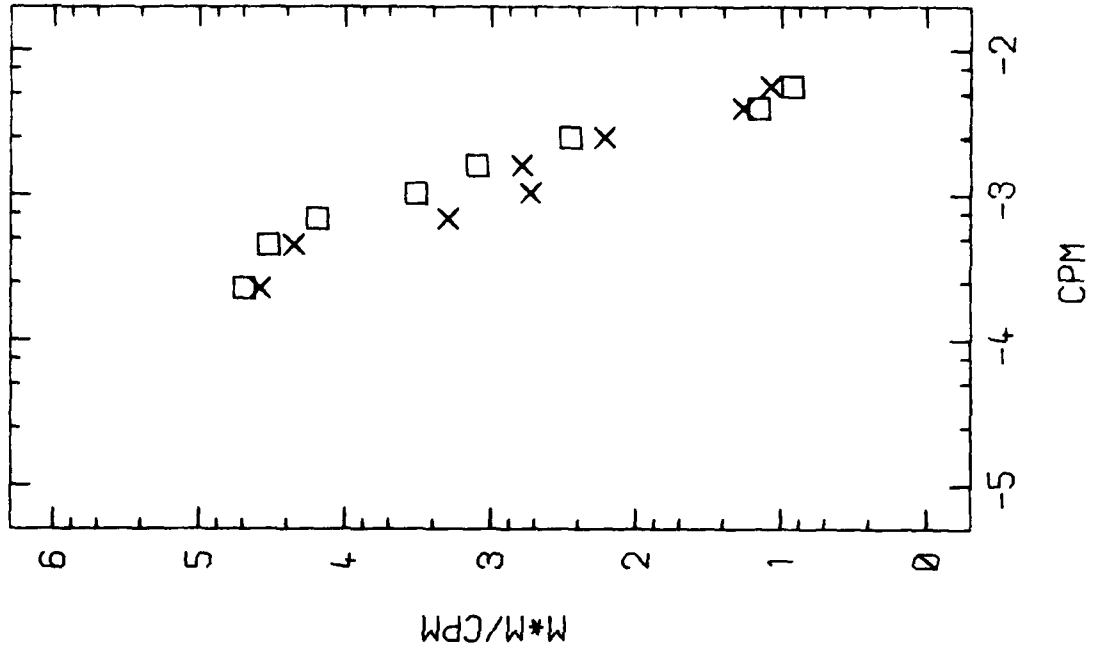

RUN 6S-34 3-SEP-78  
ISOTHERMS (DEG C) 12.2, 9.8

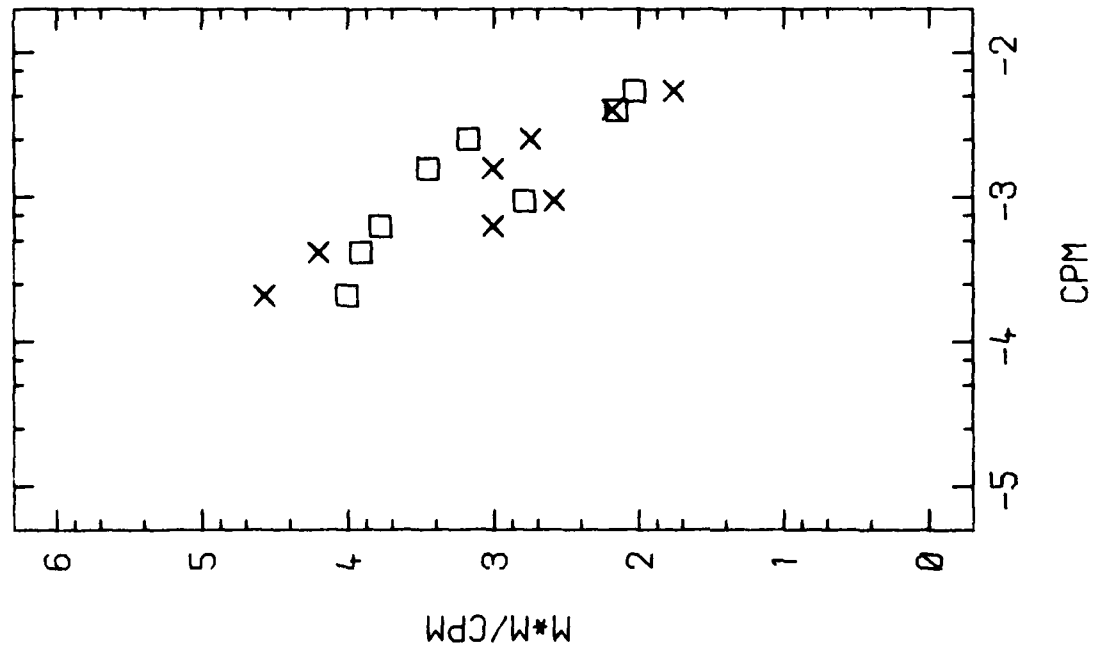

RUN 7E-2 4-SEP-78  
ISOTHERMS (DEG C) 12.4, 10.2

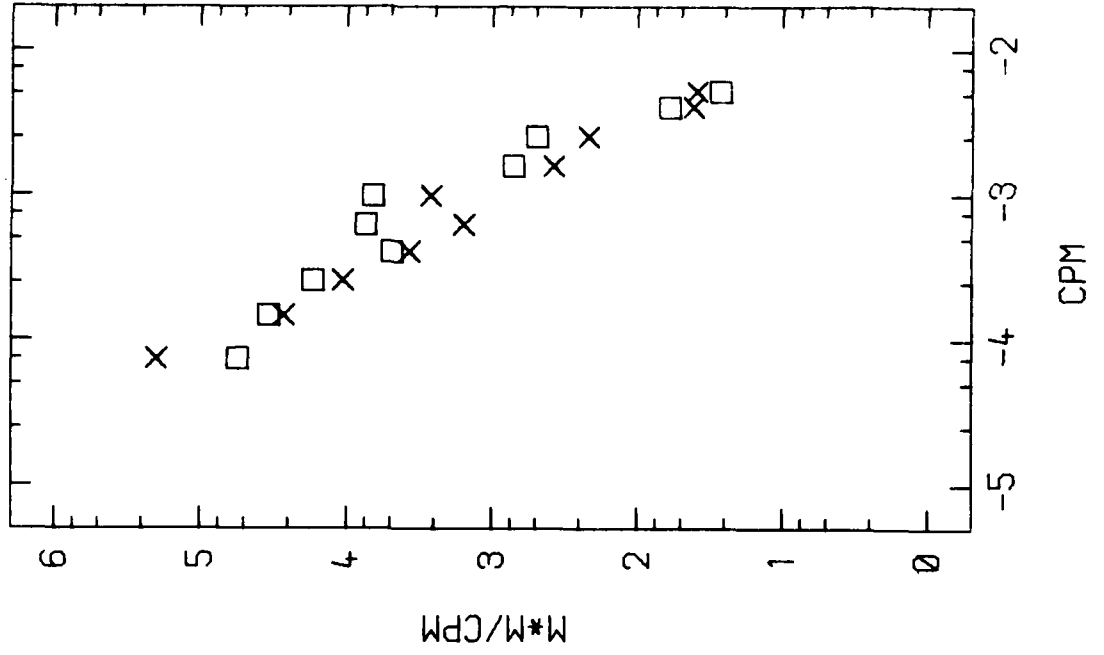

RUN 7S-1 4-SEP-78  
ISOTHERMS (DEG C) 12.4, 10.0

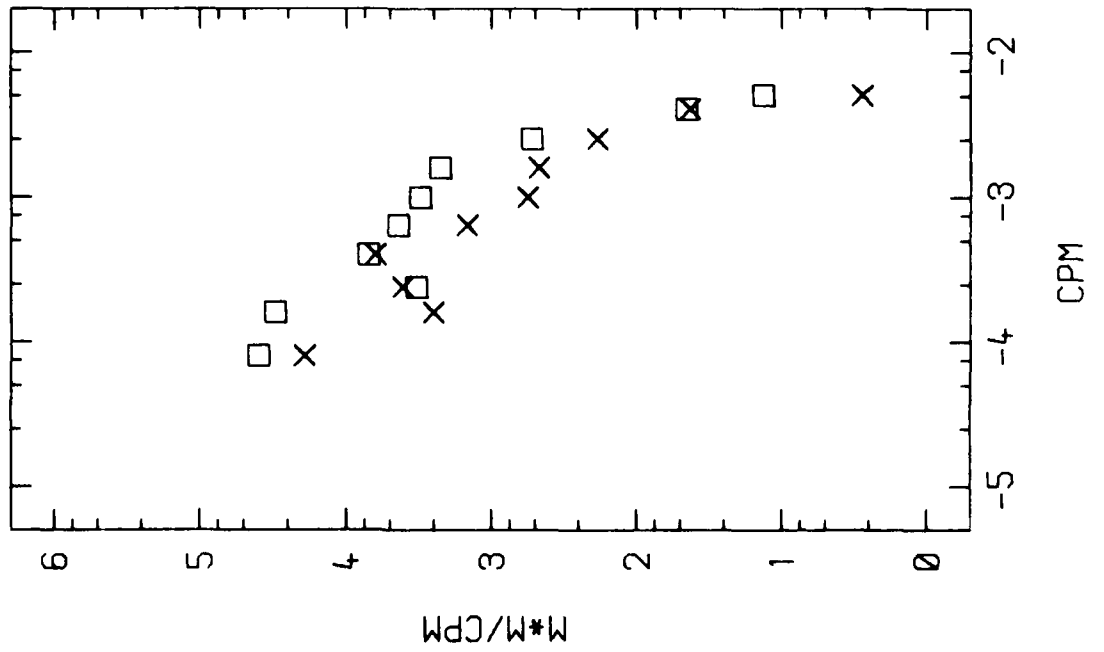

RUN 7W-4 4-SEP-78  
ISOTHERMS (DEG C) 12.4, 9.8

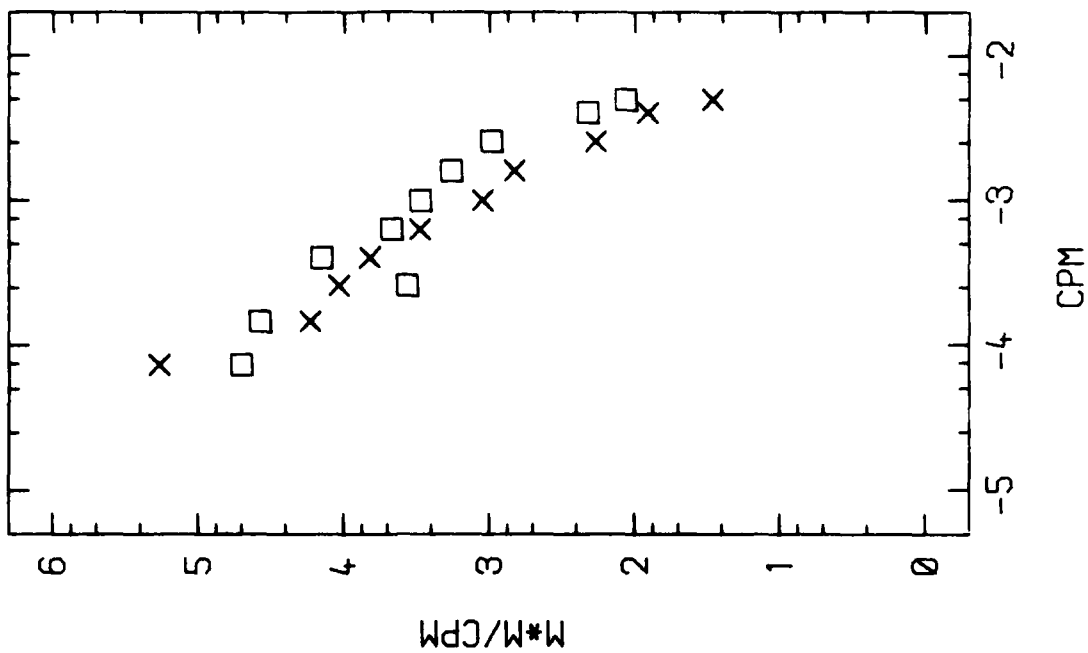

RUN 7N-3 4-SEP-78  
ISOTHERMS (DEG C) 12.4, 10.0

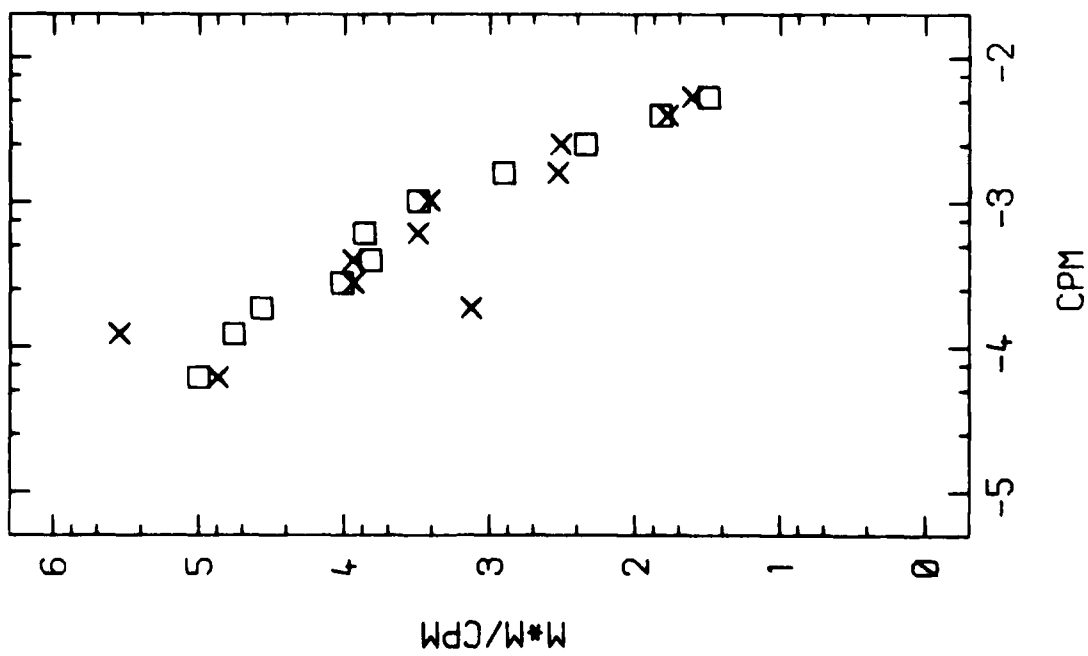

RUN 7E-6 4-SEP-78  
ISOTHERMS (DEG C) 12.4, 10.2

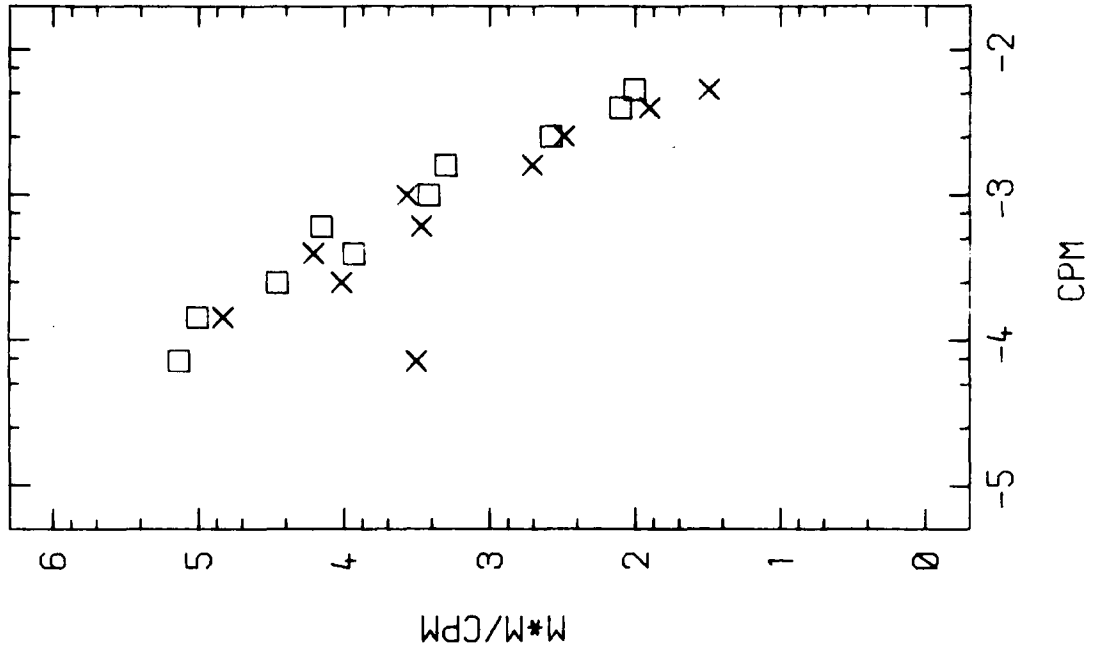

RUN 7S-5 4-SEP-78  
ISOTHERMS (DEG C) 12.4, 10.2

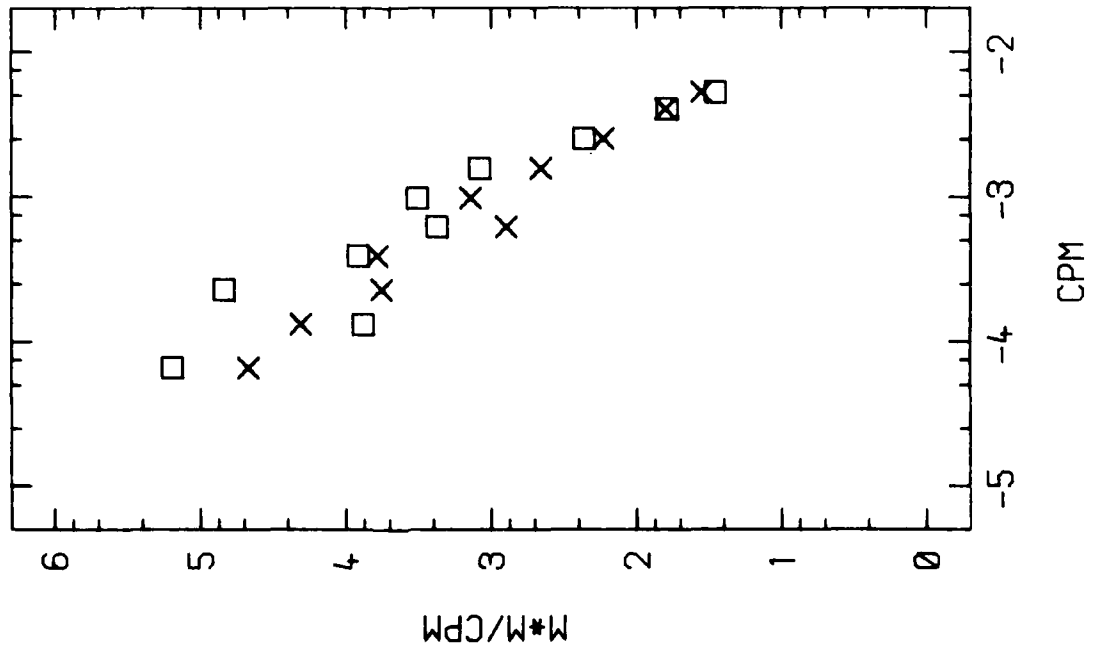

RUN 7W-8 4-SEP-78  
ISOTHERMS (DEG C) 12.4, 10.8

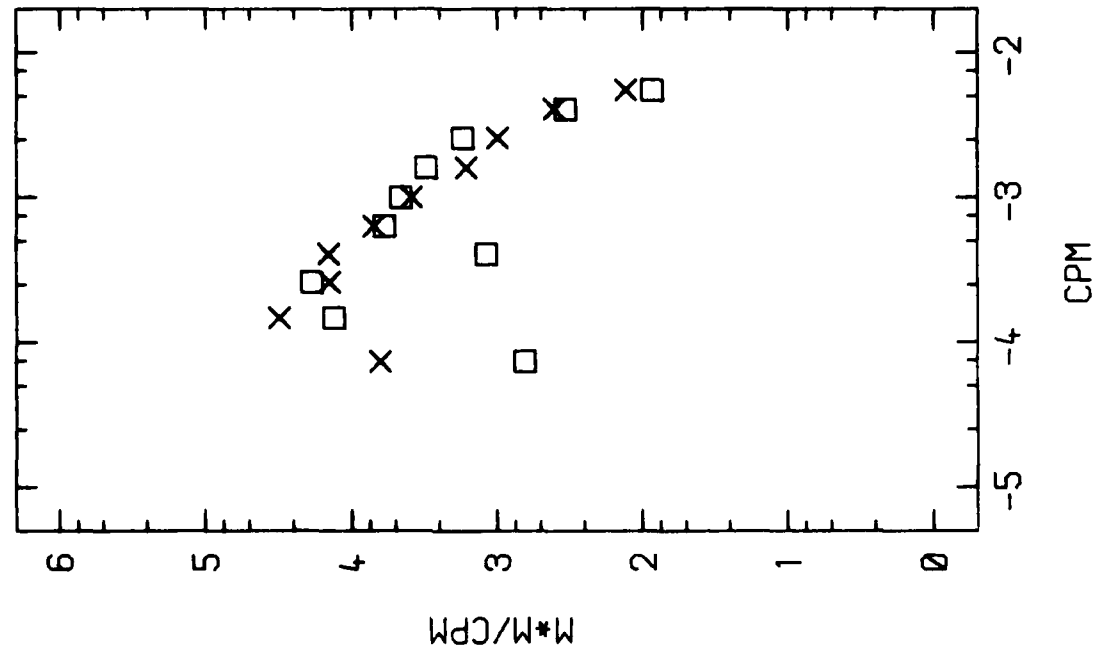

RUN 7N-7 4-SEP-78  
ISOTHERMS (DEG C) 12.4, 10.0

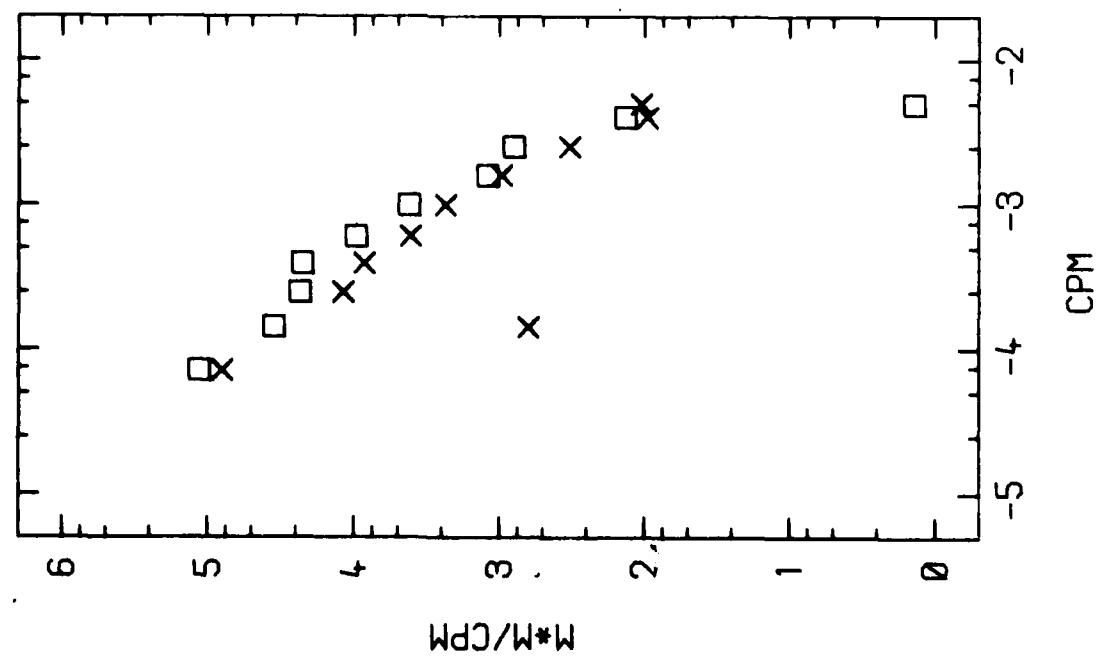



APPENDIX A

Configuration of the Chain Under Tow

The purpose of this Appendix is to derive an expression for the shape of the chain under tow. The derived shape serves as the basis for interpolating the depths of the sensors between pressure measurements and for smoothing variations in the pressure records caused by errors in the measurements.

We simplify the problem by considering the equilibrium case in which accelerations are neglected and the shape is independent of time. The problem then becomes similar to the problem of the "hanging chain", treatments of which are given in many textbooks (e.g., Sokolnikoff and Redheffer, 1958, pp. 40-42).

A schematic diagram of the chain under tow is shown in Figure A1. The  $x$ - $z$  coordinate system has its origin at the bottom of the chain in the center of the dead-weight depressor (bomb). The forces acting on the chain at  $x = z = 0$  are  $G_B$ , the gravitational force on the bomb;  $D_B$ , the drag force on the bomb;  $T(s = 0)$ , the upward tension in the chain, where  $s$  is the distance along the chain from  $x = z = 0$ . The forces acting on an element of the chain,  $\delta s$ , at an arbitrary point  $s$  on the chain are:  $W(s)\delta s$ , the gravitational force, where  $W(s)$  has dimensions of force per unit length;  $D(s)\delta s$ , the drag force, where  $D(s)$  also has dimensions of force per unit length;  $T(s + \delta s/2)$  the upward tensile force; and  $T(s - \delta s/2)$ , the downward tensile force. The buoyancy forces are incorporated into the gravitational forces,  $G_B$  and  $W$ . The tensile force may be decomposed into vertical and horizontal components as shown where  $\theta(s)$  is the angle between the chain and the horizontal.

If the chain is in equilibrium, we may, as shown in Figure A1, separately equate the horizontal and vertical forces acting on the chain at any point along the chain:

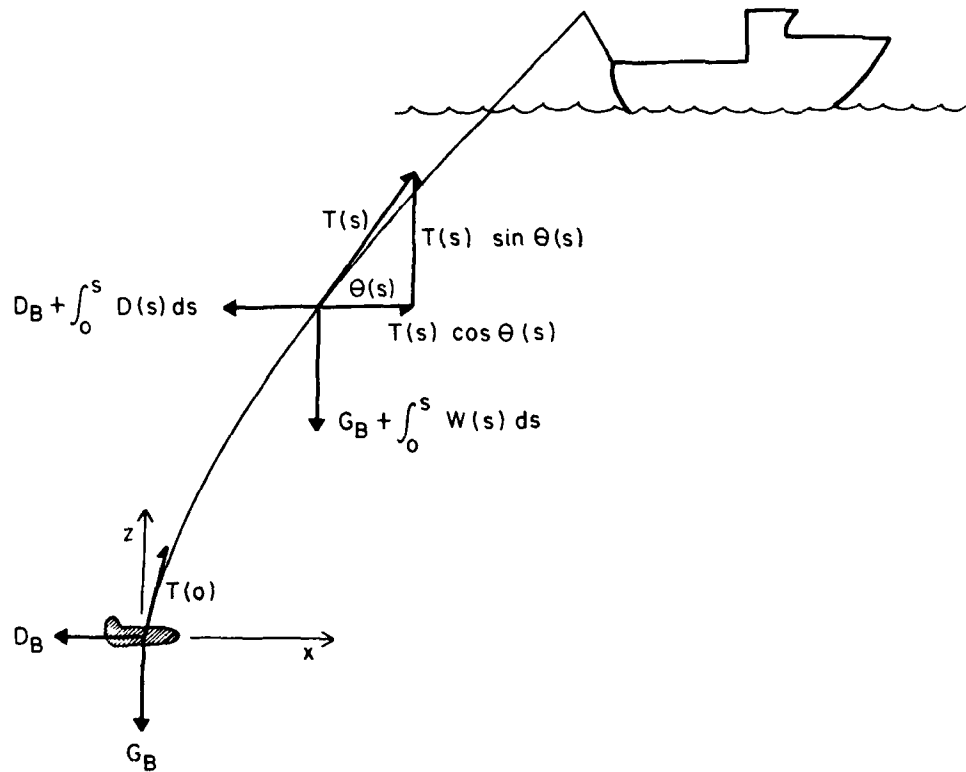

Figure A1. Schematic diagram illustrating the forces acting on the towed thermistor chain.

$$D_B + \int_0^s D(s) ds = T(s) \cos \theta(s) \quad (A1)$$

$$G_B + \int_0^s W(s) ds = T(s) \sin \theta(s)$$

We now assume that  $D(s)$  and  $W(s)$  are independent of  $s$ . This is essentially true for  $W(s)$  and is approximately true for  $D(s)$  providing  $\theta(s)$  does not differ too far from  $90^\circ$ . The equations (A1) are then integrated to obtain:

$$D_B + sD = T(s) \cos \theta(s) \quad (A2)$$

$$G_B + sW = T(s) \sin \theta(s) \quad (A3)$$

$T(s)$  can be eliminated from (A2) to obtain:

$$\tan \theta(s) = \frac{G_B + sW}{D_B + sD}$$

It is now possible to solve for  $\theta(s)$ ,  $x(s)$  and  $z(s)$ .  $\theta(s)$  is obtained directly from (A3) and  $x(s)$  and  $z(s)$  are given by:

$$x(s) = \int_0^s \cos \theta(s') ds' \quad (A4)$$

$$z(s) = \int_0^s \sin \theta(s') ds'$$

Consider first the expression for  $z(s)$ . Substituting from (A3) into (A4) yields:

$$z(s) = \int_0^s \frac{(G_B + s'W) ds'}{[(G_B + s'W)^2 + (D_B + s'D)^2]^{\frac{1}{2}}}$$

which can be rewritten

$$z(s) = \int_0^s \frac{(G_B + s'W) ds'}{(a + bs' + cs'^2)^{\frac{1}{2}}} \quad (A5)$$

where

$$a = G_B^2 + D^2$$

$$b = 2G_B W + 2 D_B D$$

$$c = W^2 + D^2$$

Integrating (A5) yields:

$$z(s) = \left( \frac{G_B}{\sqrt{c}} - \frac{bW}{2c^{3/2}} \left[ \sinh^{-1} \left( \frac{2cs + b}{\sqrt{d}} \right) - \sinh^{-1} \left( \frac{b}{\sqrt{d}} \right) \right] \right. \\ \left. + \frac{W}{c} [(A + bs + cs^2)^{1/2} - \sqrt{a}] \right) \quad (A7)$$

where

$$d = 4ac - b^2$$

An expression for  $x(s)$  can be obtained by a procedure similar to that used to obtain (A7). From (A3) and (A4) we obtain

$$x(s) = \int_0^s \frac{(D_B + s'D) ds'}{(a + b s' + c s'^2)^{1/2}} \quad (A8)$$

where  $a$ ,  $b$  and  $c$  have the definitions given in (A6). If one replaces  $G_B$  and  $W$  in (A5) with  $D_B$  and  $D$  respectively, the equation becomes identical to (A8). The integration of (A8) therefore yields an expression of the same form as (A7) with  $G_B$  and  $W$  replaced by  $D_B$  and  $D$ :

$$x(s) = \left( \frac{D_B}{\sqrt{c}} - \frac{bD}{2c^{3/2}} \left[ \sinh^{-1} \left( \frac{2cs + b}{\sqrt{d}} \right) - \sinh^{-1} \left( \frac{b}{\sqrt{d}} \right) \right] \right. \\ \left. + \frac{D}{c} [(a + bs + cs^2)^{1/2} - \sqrt{a}] \right) \quad (A9)$$

The drag forces,  $D_B$  and  $D$ , are assumed to be proportional to  $\rho U^2$  where  $\rho$  is the density of the water and  $U$  is the tow velocity:

$$D_B = C_B A_B \rho U^2 \quad (A10)$$

$$D = C A \rho U^2$$

where  $C_B$  and  $C$  are the drag coefficients for the depressor and the faired chain, respectively.  $A_B$  and  $A$  are the corresponding cross-sectional areas where  $A$  has dimensions of area per unit length.

The drag coefficient for the depressor was assumed equal to one. This value can be compared with the value for a circular disk equal 0.55 in the range of Reynolds numbers likely to be encountered (Batchelor, 1967, p. 341). A larger value was assumed for the depressor because, although it is streamlined, it has protruding fins, cable attachments and handling rings and may at times present a larger cross-sectional area to the flow than assumed. It turns out that the shape of the chain is not critically dependent on the assumed value of  $C_B$ . If one decreases  $C_B$  by 50% at a tow speed of 3 m/s, the computed change in depth 95 m below the surface is only 0.3 m. The Reynolds number for the bomb at a tow speed of 3 m/s is  $6.7 \times 10^5$ .

The drag coefficient for the faired chain was taken equal to 0.13 as suggested by the manufacturer. For comparison, bluff bodies have drag coefficients about equal 0.5. The value  $C = 0.13$  yielded chain shapes in good agreement with the pressure measurements on the chain. The uncertainties of the calculated depths of the thermistors are estimated not to exceed  $\pm 1$  m. The Reynolds number for the fairing is  $6 \times 10^4$  at a tow speed of 3 m/s.

Chain shapes calculated by use of (A7) and (A9) are shown in Figure A2. For a given tow speed, the shape depends only the the distance along the chain from the depressor. The parameters used to obtain the curves shown

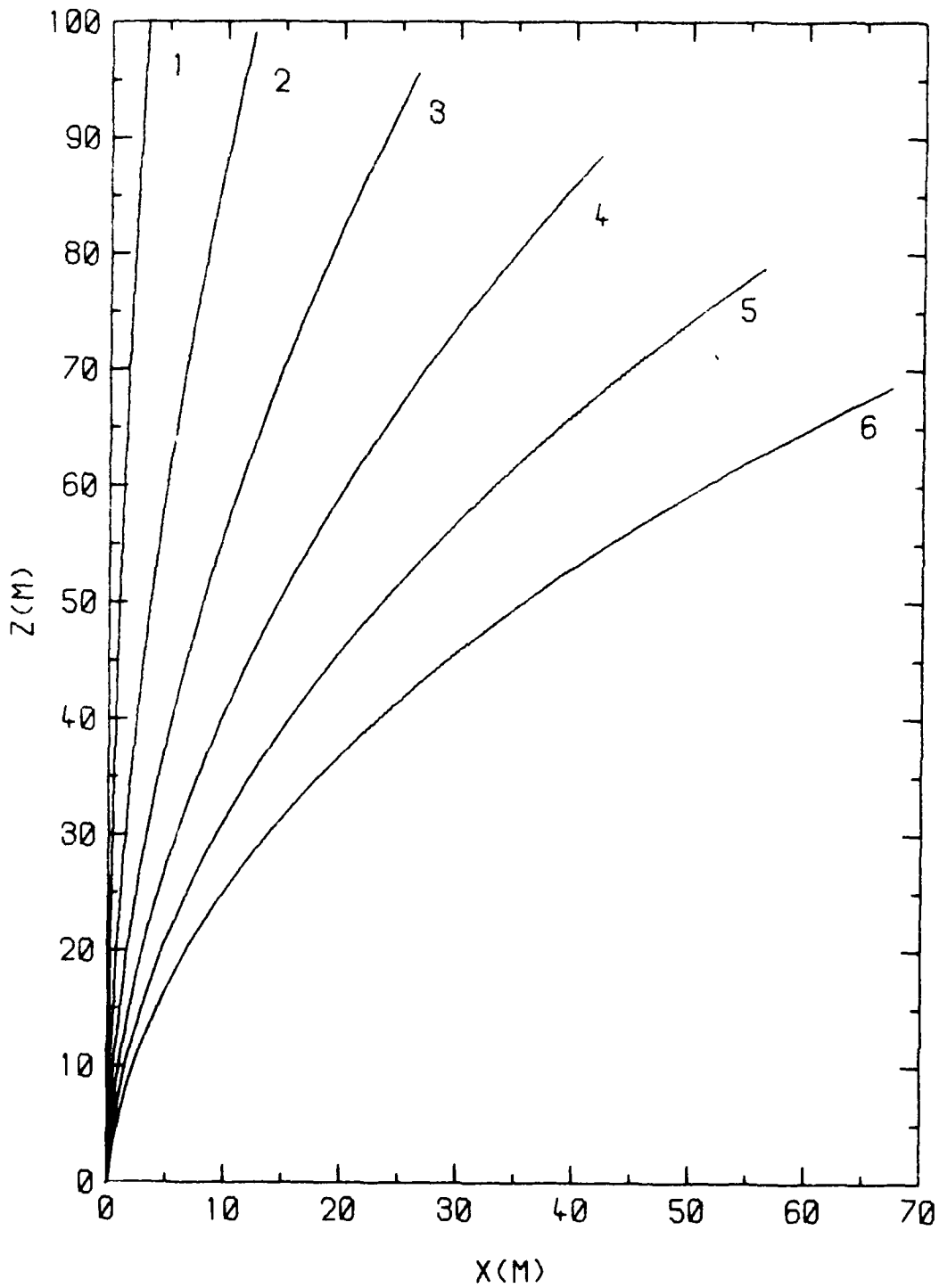

Figure A2. The shape of a towed thermistor chain, 100 m in length, for tow speeds ranging from 1 to 6 m/s. The drag force on the chain is assumed proportional to  $s$ , the distance along the chain.

in Figure A2 were:

$$\begin{aligned}
 G_B &= 4,120 \text{ Newtons} \\
 W &= 7 \text{ Newtons/m} \\
 C_B A_B \rho &= 12.3 \text{ Newtons/m}^2 \text{s}^{-2} \\
 CA\rho &= 2.6 \text{ Newtons/m}^3 \text{s}^{-2}
 \end{aligned}
 \tag{A11}$$

The above parameters are the best estimates for the chain.

An additional model for the shape of the chain was developed to compare two different assumptions for the drag force on the chain. In the previous development we assumed the drag,  $D$ , proportional to  $s$ , the distance along the chain from the depressor. Alternatively, we assume that  $D$  is proportional to  $z$ , the vertical space coordinate. The equation corresponding to (A3) is:

$$\frac{dz}{dx} = \tan \theta(s) = \frac{G_B + sW}{D_B + zD}
 \tag{A12}$$

To ease the integration of (A12) we assume that  $W$  is negligible, from which follows:

$$x = (D_B + \frac{D}{2} z) \frac{z}{G_B}
 \tag{A13}$$

We may also derive  $s(z)$  as follows:

$$\begin{aligned}
 \frac{dz}{ds} &= \sin \theta(s) \\
 s &= \int_0^z \frac{1}{\sin \theta(s)} dz' \\
 s &= \int_0^z \frac{[G_B^2 + (D_B + Dz')^2]^{\frac{1}{2}}}{G_B} dz' \\
 s &= \int_0^z (e + fz' + gz'^2)^{\frac{1}{2}} dz'
 \end{aligned}$$

where



$$e = 1 + \frac{D_B^2}{G_B^2}, \quad f = \frac{2D_B D}{G_B^2}, \quad g = \frac{D^2}{G_B^2}$$

Integrating we obtain:

$$s = \frac{(2gz + f) \sqrt{z} - f\sqrt{e}}{4g} + \frac{1}{2k\sqrt{g}} \left[ \sinh^{-1} \left( \frac{2gz+f}{\sqrt{q}} \right) - \sinh^{-1} \left( \frac{f}{\sqrt{q}} \right) \right]$$

where

$$Z = e + fz + gz^2$$

$$q = 4eg - f^2$$

$$k = \frac{4g}{q}$$

The two models are compared in Figures A3 and A4. In Figure A3 the shape of the chain given by the second model ( $D \propto z$ ) is plotted for various tow speeds. In Figure A4 the shape of the chain given by the first model ( $D \propto s$ ) is plotted for the same tow speeds. The parameters used in constructing the curves shown in Figures A3 and A4 are identical to those used in generating the curves shown in Figure A2 except that  $W$ , the gravitational minus buoyancy force, is assumed zero in Figures A3 and A4. The difference between the two models for a tow speed of 3 m/s amounts to only 0.3 m difference in  $z$  at  $s = 70$  m. We therefore conclude that the calculated shape of the chain is not critically dependent on the model for the tow speeds employed in JASIN. For faster tow speeds the differences may become significant. For example, at a tow speed of 5 m/s the difference in  $z$  when  $s = 100$  m is 4 m.

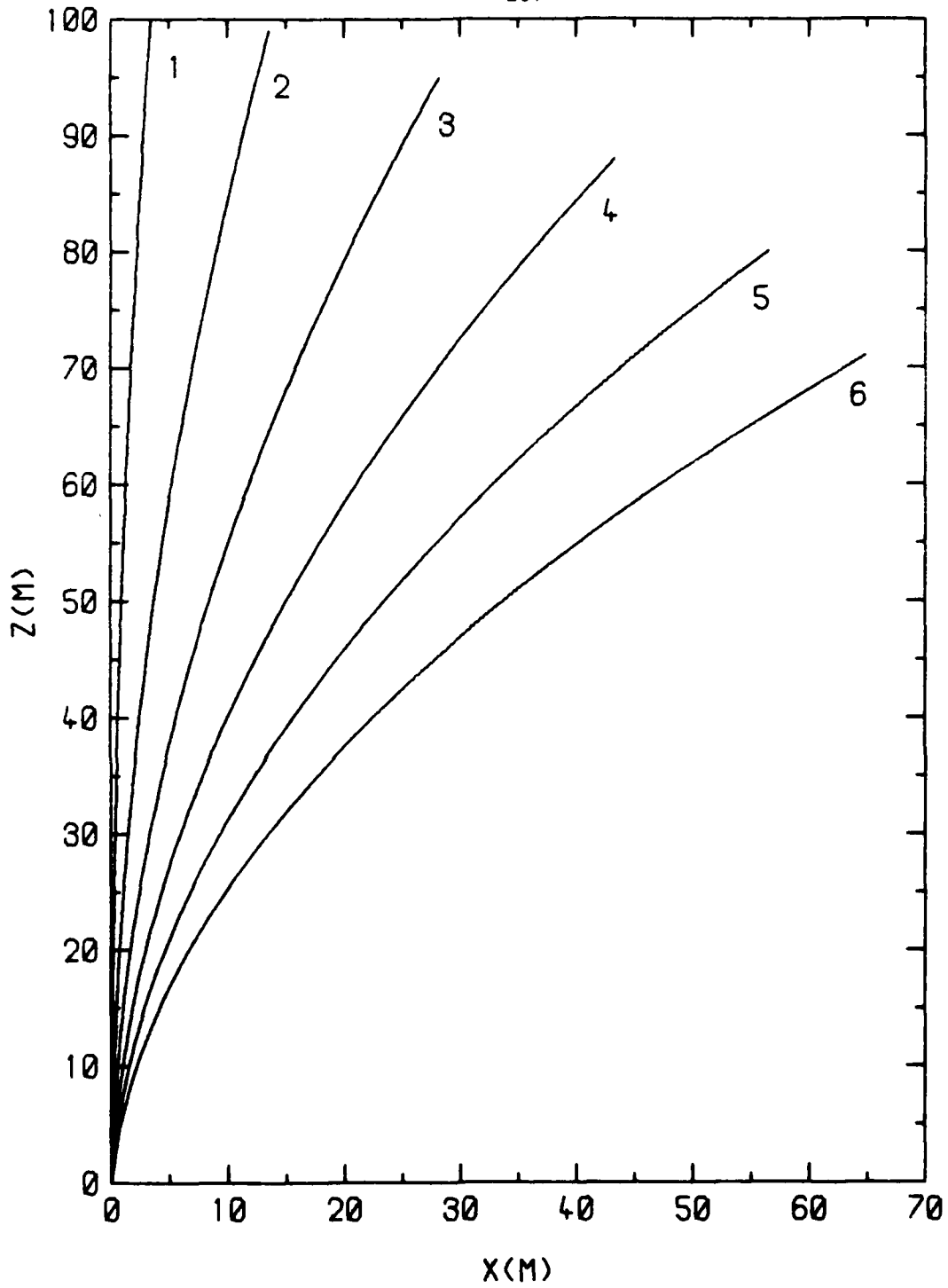

Figure A3. The shape of a towed thermistor chain, 100 m in length, for tow speeds ranging from 1 to 6 m/s. The chain is assumed to be weightless in water and the drag force is assumed proportional to  $z$ .

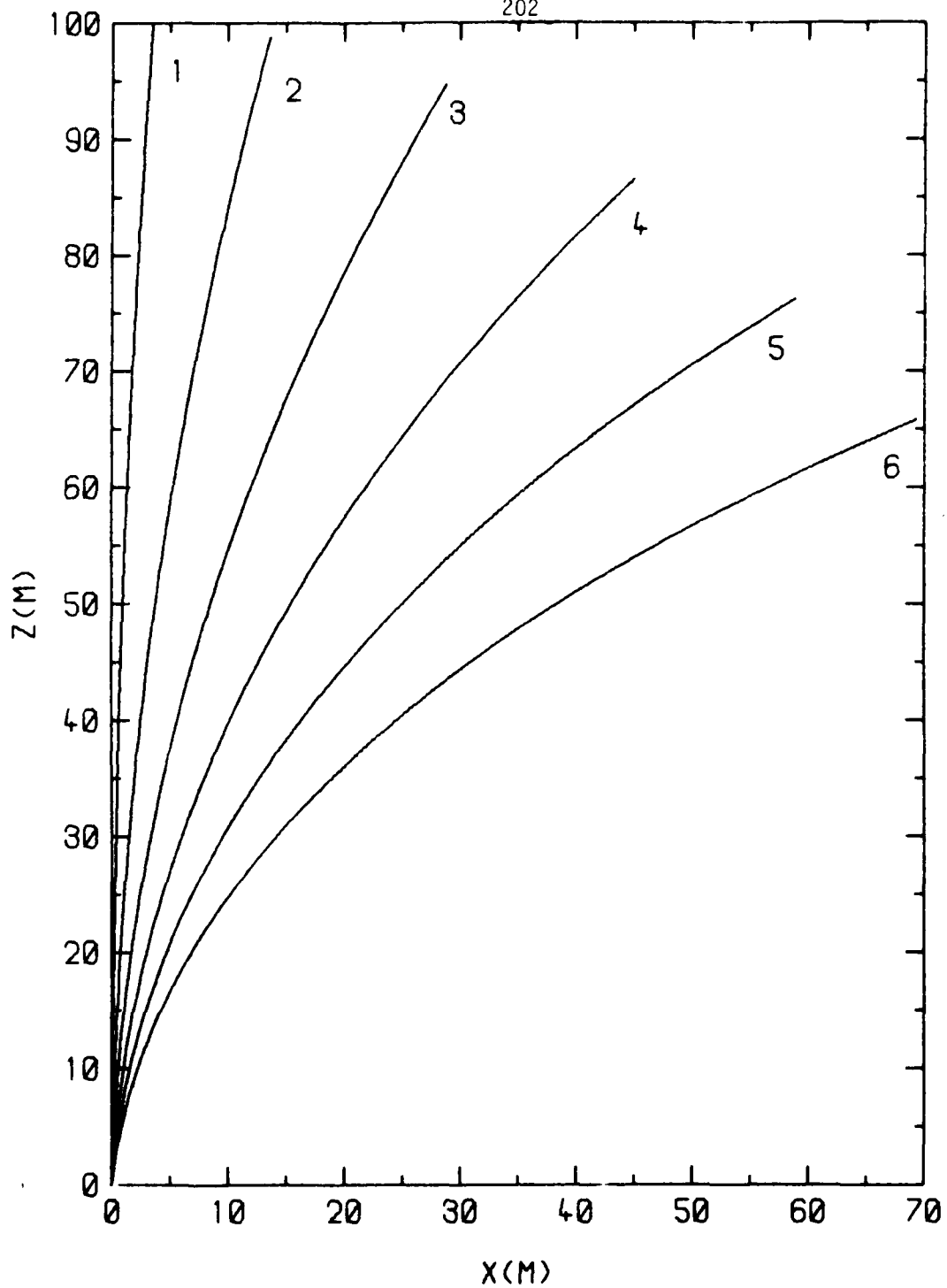

Figure A4. The shape of a towed thermistor chain, 100 m in length, for tow speeds ranging from 1 to 6 m/s. The chain is assumed to be weightless in water and the drag force is assumed proportional to  $s$ , the distance along the chain.