

SECURITY CLASSIFICATION OF THIS PAGE (When Data Entered)

REPORT DOCUMENTATION PAGE

READ INSTRUCTIONS
BEFORE COMPLETING FORM

| | | |
|--|--|--|
| 1. REPORT NUMBER | 2. GOVT ACCESSION NO. AD-A091137 | 3. RECIPIENT'S CATALOG NUMBER |
| 4. TITLE (and Subtitle) Phase I Inspection Report Conewango Creek Watershed Project Site 33 Allegheny River Basin, Chautauqua County, New York Inventory No. 581 | | 5. TYPE OF REPORT & PERIOD COVERED Phase I Inspection Report National Dam Safety Program |
| 7. AUTHOR(s) Bent L. Thomsen Gary L. Wood | | 6. PERFORMING ORG. REPORT NUMBER |
| 9. PERFORMING ORGANIZATION NAME AND ADDRESS Thomsen Associates 105 Corona Avenue Groton, NY 13073 | | 8. CONTRACT OR GRANT NUMBER(s) DACW-51-79-C-0001 |
| 11. CONTROLLING OFFICE NAME AND ADDRESS New York State Department of Environmental Conservation 50 Wolf Road Albany, NY 12233 | | 10. PROGRAM ELEMENT, PROJECT, TASK AREA & WORK UNIT NUMBERS |
| 14. MONITORING AGENCY NAME & ADDRESS (if different from Controlling Office) Department of the Army 26 Federal Plaza New York District, CofE New York, NY 10287 | | 12. REPORT DATE 10 September 1980 |
| | | 13. NUMBER OF PAGES |
| | | 15. SECURITY CLASS. (of this report) UNCLASSIFIED |
| | | 15a. DECLASSIFICATION/DOWNGRADING SCHEDULE |

LEVEL

16. DISTRIBUTION STATEMENT (of this Report)

Approved for public release; Distribution unlimited.

17. DISTRIBUTION STATEMENT (of the abstract entered in Block 20, if different from 16)

Original contains color plates; All DTIC reproductions will be in black and white

DTIC
NOV 5 1980

18. SUPPLEMENTARY NOTES

THIS DOCUMENT IS UNCLASSIFIED
THE COPY FURNISHED TO DDC CONTAINED A
SIGNIFICANT NUMBER OF PAGES WHICH DO NOT
REPRODUCE LEGIBLY.

19. KEY WORDS (Continue on reverse side if necessary and identify by block number)
Dam Safety
National Dam Safety Program
Visual Inspection
Hydrology, Structural Stability

Conewang Creek
Chautauqua
Allegheny

20. ABSTRACT (Continue on reverse side if necessary and identify by block number)

This report provides information and analysis on the physical condition of the dam as of the report date. Information and analysis are based on visual inspection of the dam by the performing organization.

The examination of available engineering documents and visual inspection of the Conewango Creek Watershed Project - Site 33 dam did not disclose conditions which constitute a hazard to downstream.

AD A 091 137

DDC FILE COPY

human life or property.

The total discharge capacity of the combined principal and auxiliary spillways is adequate to impound and safely discharge the floodwater resulting from the Probable Maximum Flood (PMF).

A number of minor deficiencies were noted on this structure. These deficiencies include: debris around the trash racks of the orifice in the riser intake structure, debris (logs) on the lower half of the upstream slope as measured from the crest to the normal pool elevation, slight erosion along abutment-embankment contacts on lower third of downstream slope, damaged internal drainage pipes above plunge pool, small animal burrow on downstream slope just above riprap around the principal spillway outlet pipe, wet areas beyond downstream toe in waste area along east side of outlet channel and natural flood plain on the west side of the outlet channel. These deficiencies should be corrected within 6 months of the date of notification of the owner. A warning system and evacuation plan for notification of downstream residents and proper authorities in the case of impending downstream flooding within 6 months should also be developed and implemented.

ALLEGHENY RIVER BASIN

**CONEWANGO CREEK WATERSHED PROJECT
SITE 33**

**CHAUTAUQUA COUNTY, NEW YORK
INVENTORY NO. N.Y. 581**

**PHASE I INSPECTION REPORT
NATIONAL DAM SAFETY PROGRAM**

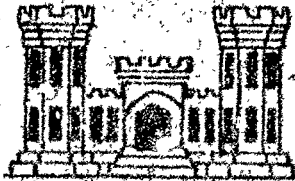

Prepared by
**THOMSEN ASSOCIATES
105 CORONA AVE. GROTON, N.Y.**

Prepared for
**DEPARTMENT OF THE ARMY
NEW YORK DISTRICT, CORPS OF ENGINEERS
NEW YORK, NEW YORK
JULY 1980**

DISCLAIMER NOTICE

THIS DOCUMENT IS BEST QUALITY PRACTICABLE. THE COPY FURNISHED TO DTIC CONTAINED A SIGNIFICANT NUMBER OF PAGES WHICH DO NOT REPRODUCE LEGIBLY.

PREFACE

This report is prepared under guidance contained in the Recommended Guidelines for Safety Inspection of Dams, for Phase I Investigations. Copies of these guidelines may be obtained from the Office of Chief of Engineers, Washington, D.C. 20314. The purpose of a Phase I Investigation is to identify expeditiously those dams which may pose hazards to human life or property. The assessment of the general condition of the dam is based upon available data and visual inspections. Detailed investigation, and analyses involving topographic mapping, subsurface investigations, testing, and detailed computational evaluations are beyond the scope of a Phase I Investigation; however, the investigation is intended to identify any need for such studies.

In reviewing this report, it should be realized that the reported condition of the dam is based on observations of field conditions at the time of inspection along with data available to the inspection team. In cases where the reservoir was lowered or drained prior to inspection, such action, while improving the stability and safety of the dam, removes the normal load on the structure and may obscure certain conditions which might otherwise be detectable if inspected under the normal operating environment of the structure.

It is important to note that the condition of a dam depends on numerous and constantly changing internal and external conditions, and is evolutionary in nature. It would be incorrect to assume that the present condition of the dam will continue to represent the condition of the dam at some point in the future. Only through frequent inspections can unsafe conditions be detected and only through continued care and maintenance can these conditions be prevented or corrected.

Phase I inspections are not intended to provide detailed hydrologic and hydraulic analyses. In accordance with the established Guidelines, the Spillway Test flood is based on the estimated "Probable Maximum Flood" for the region (greatest reasonably possible storm runoff), or fractions thereof. Because of the magnitude and rarity of such a storm event, a finding that a spillway will not pass the test flood should not be interpreted as necessarily posing a highly inadequate condition. The test flood provides a measure of relative spillway capacity and serves as an aide in determining the need for more detailed hydrologic and hydraulic studies, considering the size of the dam, its general condition and the downstream damage potential.

| | |
|---------------|-------------------------------------|
| Accession No. | |
| NTIS | <input checked="" type="checkbox"/> |
| DTIC TAB | |
| Unannounced | |
| Justification | |
| By | |
| Distribution | |
| Availability | |
| Dist | 122 |

10 Bent L. Thomsen
Gary L. Wood

11 10 Sep 80

12 190

PHASE I INSPECTION REPORT

NATIONAL DAM SAFETY PROGRAM

CONEWANGO CREEK WATERSHED PROJECT

SITE 33 Inventory Number NY 581

L.D. NO. N.Y. 581

ALLEGHENY RIVER BASIN

CHAUTAUQUA COUNTY, NEW YORK

Phase I Inspection Report

TABLE OF CONTENTS

PAGE NO.

| | | |
|-----|--------------------------------------|----|
| - | ASSESSMENT | - |
| - | OVERVIEW PHOTOGRAPH | - |
| 1 | PROJECT INFORMATION | 1 |
| 1.1 | GENERAL | 1 |
| 1.2 | DESCRIPTION OF PROJECT | 2 |
| 1.3 | PERTINENT DATA | 4 |
| 2 | ENGINEERING DATA | 7 |
| 2.1 | GEOTECHNICAL DATA | 7 |
| 2.2 | DESIGN RECORDS | 9 |
| 2.3 | CONSTRUCTION RECORDS | 9 |
| 2.4 | OPERATION RECORDS | 9 |
| 2.5 | EVALUATION OF DATA | 9 |
| 3 | VISUAL INSPECTION | 10 |
| 3.1 | FINDINGS | 10 |
| 3.2 | EVALUATION | 13 |
| 4 | OPERATION AND MAINTENANCE PROCEDURES | 14 |
| 4.1 | PROCEDURE | 14 |
| 4.2 | MAINTENANCE OF DAM | 14 |
| 4.3 | WARNING SYSTEM IN EFFECT | 14 |
| 4.4 | EVALUATION | 14 |
| 5 | HYDROLOGIC/HYDRAULIC | 15 |
| 5.1 | DRAINAGE AREA CHARACTERISTICS | 15 |
| 5.2 | ANALYSIS CRITERIA | 15 |
| 5.3 | SPILLWAY CAPACITY | 15 |
| 5.4 | RESERVOIR CAPACITY | 16 |
| 5.5 | FLOODS OF RECORD | 16 |
| 5.6 | OVERTOPPING POTENTIAL | 16 |
| 5.7 | EVALUATION | 16 |

15
DACW 51-79-C-0001

393970

| | <u>PAGE NO.</u> |
|--|-----------------|
| 6 STRUCTURAL STABILITY | 17 |
| 6.1 EVALUATION OF STRUCTURAL STABILITY | 17 |
| 7 ASSESSMENT/RECOMMENDATIONS | 19 |
| 7.1 ASSESSMENT | 19 |
| 7.2 RECOMMENDED REMEDIAL MEASURES | 19 |

APPENDICES

- Appendix A - Photographs
- Appendix B - Visual Inspection Checklist
- Appendix C - Hydrologic/Hydraulic Engineering Data and Computations
- Appendix D - Operation and Maintenance Inspection Reports
- Appendix E - Design Folder
- Appendix F - Drawings

PHASE I INSPECTION REPORT
NATIONAL DAM SAFETY PROGRAM

NAME OF DAM: Conewango Creek Watershed Project
Site 33, Inventory No. N.Y. 581

STATE LOCATED: New York

COUNTY: Chautauqua

RIVER BASIN: Allegheny

WATERSHED: Conewango Creek

STREAM: Unnamed

DATE OF INSPECTION(s): May 6 and 21, 1980
See Vicinity Map & Topographic Map,
Appendix F

ASSESSMENT

The examination of available engineering documents and visual inspection of the Conewango Creek Watershed Project - Site 33 dam did not disclose conditions which constitute a hazard to downstream human life or property.

The total discharge capacity of the combined principal and auxiliary spillways is adequate to impound and safely discharge the floodwater resulting from the Probable Maximum Flood (PMF).

A number of minor deficiencies were noted on this structure. These deficiencies include: debris around the trash racks of the orifice in the riser intake structure, debris (logs) on the lower half of the upstream slope as measured from the crest to the normal pool elevation, slight erosion along abutment-embankment contacts on lower third of downstream slope, damaged internal drainage pipes above plunge pool, small animal burrow on downstream

slope just above riprap around the principal spillway outlet pipe, wet areas beyond downstream toe in waste area along east side of outlet channel and natural flood plain on the west side of the outlet channel. These deficiencies should be corrected within 6 months of the date of notification of the owner. A warning system and evacuation plan for notification of downstream residents and proper authorities in the case of impending downstream flooding within 6 months should also be developed and implemented.

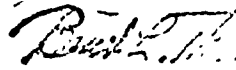

Bent L. Thomsen, P. E.
Thomsen Associates
N. Y. License #40553

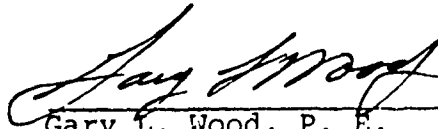

Gary L. Wood, P. E.
Thomsen Associates
N. Y. License #44504

APPROVED BY

14 SEP 1980

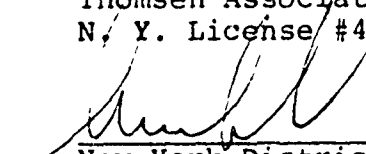

New York District Engineer
Colonel W. M. Smith, Jr.



View of reservoir and
surrounding slopes

PHASE I INSPECTION REPORT
NATIONAL DAM SAFETY PROGRAM
CONEWANGO CREEK WATERSHED PROJECT
SITE 33
I. D. No. N.Y. 581
ALLEGHENY RIVER BASIN
CHAUTAUQUA COUNTY, NEW YORK

SECTION 1: PROJECT INFORMATION

1.1 GENERAL

a. Authority

This Phase I Inspection Report was authorized by the New York State Department of Environmental Conservation by Contract No. D 201458. This study was performed in accordance with the terms of the above contract and the Recommended Guideline for Safety Inspection of Dams prepared by Department of the Army; Office of the Chief of Engineers to fulfill the requirements of the National Dam Inspection Act, Public Law 92-327.

b. Purpose of Inspection

This inspection was conducted to obtain available data concerning design and construction of the dam, to evaluate that data, to visually inspect existing conditions at the dam, to identify and evaluate deficiencies and/or hazardous conditions, if any, which may threaten life and property of the residents downstream of the dam and to recommend remedial measure to mitigate such deficiencies and hazardous conditions.

1.2 DESCRIPTION OF PROJECT

a. Description of Dam

The Conewango Creek Watershed Project Site 33 consists of an earth dam, with a principal spillway outlet pipe passing through the embankment and an auxiliary spillway passing around the western abutment of the dam.

The dam consists of a zoned compacted earth embankment which is 57 feet high, having a crest width of 18 feet and crest length of 325 feet. The upstream slope is 1 vertical on 3 horizontal and the downstream slope is 1 vertical on 2.5 horizontal. The crest, downstream slope and upper two-thirds of the upstream slope between the normal pool elevation and the crest are grass covered. The lower third of the upstream slope is not vegetated. There is a cutoff trench under the centerline of the dam which presumably was excavated to bedrock in accordance with the recommendations of the Design Report. Typical sections of this cutoff are shown on Sheet 4 of the As-Built Drawings, Appendix F.

The principal spillway includes the following components: a rectangular reinforced concrete riser structure with an orifice at elevation 1483.7 and riser crest at elevation 1509.1, a 36 inch I.D. reinforced concrete pressure pipe outlet and a riprap lined plunge pool cut into bedrock at the outlet end of the pipe. The reservoir drain is a 10 inch diameter cast iron pipe extending 40 feet into the reservoir from the base of the riser structure. A manually operated vertical slide gate mechanism mounted on the top of the riser structure controls the flow through the reservoir drain. The auxiliary spillway is in a cut section and has a bottom width of 50 feet.

The internal drainage system consists of drain trenches cut into the foundation material. The drain trenches are filled with a two-zone filter material and roughly parallel the abutment-embankment contact. Seepage from the drain trenches is collected in two 8 inch diameter perforated asbestos cement pipes which are surrounded by the filter materials and are parallel to the dam axis some 114 feet downstream from the dam centerline. The perforated sections terminate near the principal spillway outlet pipe where solid 8 inch diameter asbestos cement pipe bends 90 degrees and outlets to the plunge pool parallel to and either side of the principal spillway outlet pipe.

b. Location

The Conewango Creek Watershed Project Site 33 is located east of Pickup Hill Road approximately 1.2 miles (via public roads) southwest of the Village of Cherry Creek, New York.

c. Size Classification

The dam is 57 feet high and has a maximum storage capacity (normal pool to top of dam) of 128.3 acre-feet. Therefore, the dam is in the intermediate size category by virtue of its height as defined in the Recommended Guidelines for Safety Inspection of Dams.

d. Hazard Classification

The dam is classified as a "high" hazard due to the presence of a number of homes along the downstream channel and the crossing of a State Route 83 in the Village of Cherry Creek.

e. Ownership

The dam is owned, operated and maintained by the Conewango Creek Watershed District. The contracting officer is Mr. Richard Shield of R.D. #1, Box 334, Kennedy, New York 14747. His telephone number is 716-267-4801.

f. Purpose of Dam

The dam is an uncontrolled floodwater retarding structure.

g. Design and Construction History

Design of the dam was performed by the U.S. Department of Agriculture, Soil Conservation Service (SCS), Syracuse, New York. Construction was under the inspection of the SCS and the General Contractor was W. W. Kimmons Company of Buffalo, New York. The dam was completed in 1974 and the as-built drawings (portions of which are attached in Appendix F) are dated December 9, 1974. The Syracuse office of SCS has a design folder containing hydrologic, hydraulic, geologic information, as well as soil laboratory test data and slope stability analyses; in addition, as-built drawings and contract documents are maintained by the Syracuse SCS office.

h. Normal Operation Procedures

Normal flows are discharged through an orifice in the intake riser structure then through the principal spillway. The orifice is the primary control when the reservoir is between elevation 1483.7 and 1509.1. Reservoir levels between elevation 1509.1 and 1511.6 are discharged through the orifices and over the intake riser crest. The reservoir has sufficient capacity to store and discharge 8 percent of the Probable Maximum Flood without discharge occurring in the auxiliary spillway.

1.3

PERTINENT DATA

| | |
|--|-----|
| <u>a. Drainage Area</u> (Areas) | 350 |
| <u>b. Discharge at Damsite</u> (cfs) | |
| Reservoir Drain at Orifice Crest | 6 |
| Orifice at Riser Crest | 30+ |
| Principal Spillway at Auxiliary Spillway Crest | 155 |
| Principal Spillway at Design High Water | 156 |
| Auxiliary Spillway at Design High Water | 500 |
| Total Spillway Capacity at Design High Water | 656 |

c. Elevation (ft above MSL, taken from Design Report)

| | |
|---|--------|
| Top of Dam | 1519.9 |
| Design Maximum High Water | 1513.8 |
| Auxiliary Spillway Crest | 1511.6 |
| Normal Pool and Orifice Crest | 1483.7 |
| Intake Riser Crest (Principal Spillway) | 1509.1 |
| Reservoir Drain Invert | 1472.1 |
| Streambed at Dam Centerline | 1462.0 |

d. Reservoir (ft)

| | |
|--------------------------|------------|
| Length of Drainage Basin | 1.21 miles |
| Length of Normal Pool | 300 feet + |

e. Storage (acre-feet)

| | |
|---|-------|
| Normal Pool (Taken from Design Report) | 3.3 |
| Crest of Riser (Flood Storage Above Normal Pool) | 64.8 |
| Design High Water (Flood Storage Above Normal Pool) | 87.7 |
| Top of Dam (Flood Storage Above Normal Pool) | 128.3 |

f. Reservoir Surface (acres)

| | |
|-------------------|-----|
| Normal Pool | 0.7 |
| Crest of Riser | 4.4 |
| Design High Water | 5.4 |
| Top of Dam | 7.9 |

g. Dam (Taken from Design Report)

Type: 2 zone earth embankment with keyed earth cutoff trench and toe drains parallel to dam centerline

| | |
|-----------------------------|-------|
| Length: (ft) | 325 |
| Height: (ft) | 57 |
| Top Width: (ft) | 18 |
| Side Slopes: Upstream (V:H) | 1:3 |
| Downstream (V:H) | 1:2.5 |

Zone 1: Interior Section of Dam, material contains more than 20%, by weight, finer than #200 sieve size

Zone 2: Exterior sections, material contains less than 20%, by weight, finer than #200 sieve

Cutoff: Earth Cutoff Trench with Zone 1 material

Grout Curtain: None

h. Principle Spillway (Taken from Design Report,
see Sheet 10 of Drawings,
Appendix F)

Type: 30 inch I.D. Outlet Pipe a 2.5' x 7.5' I.D.
reinforced concrete riser structure rising 41.92'
above the base (outlet invert) elevation 1469.1

| | |
|------------------|--------------|
| Length of Weir: | 15.0 ft |
| Crest Elevation: | 1509.1 |
| Gates: | Uncontrolled |

i. Auxiliary Spillway (Taken from Design Report)

Type: Channel cut into soil, trapezoidal cross-section
with "bench" at mid-height, grass lined (see
revised cross section, Sheet 4 of Drawings,
Appendix F)

| | |
|------------------------------------|-----|
| Bottom Width: (ft) | 50 |
| Side Slopes: (V:H) | 1:3 |
| Length of Level or Control Section | 50 |
| Entrance Slope (%) | 2 |
| Exit Slope (%) | 3 |

j. Reservoir Drain (Taken from Design Report)

Type: 10 inch diameter cast iron pipe
Length: (ft) 40
Control: Manually operated vertical slide gate
mounted on the top of the intake riser
structure

SECTION 2: ENGINEERING DATA

2.1 GEOTECHNICAL DATA

a. General Geology

The Conewango damsite 33 is located southwest of the Village of Cherry Creek, in Chautauqua County, New York on the northern rim of the Appalachian Uplands physiographic province. This province is characterized by the sharp topographic relief associated with dissection of a broad plateau; namely, steep hills rising to elevations of over 2000 feet which are isolated by deep, narrow valleys.

Local bedrock consists of interbedded shales and siltstones of Upper Devonian age which are essentially horizontally bedded. The area is considered geologically stable seismically, and no major or active faults have been revealed by geologic field work. However, the area is within Zone 3 on the seismic map included with the Recommended Guidelines.

This particular area illustrates the diverse range of effects of Wisconsin continental glaciation. Uplands are comprised of ground moraine, largely basal till associated with glacial advances; major valleys such as the Conewango Creek valley contain deposits of silt and clay formed in proglacial lake basins when they were dammed by the ice, with resulting impoundment of meltwater and temporary existence of proglacial lakes. Present and former meltwater drainage channels are marked by the presence of sand and gravel outwash material deposited both during final glacial retreat and as more recent alluvium.

b. Subsurface Investigation

The subsurface investigation conducted by the SCS consisted of a total of 10 test borings and 24 test pit excavations. Overburden sampling in the test borings was accomplished by

driving a standard 2 inch O.D. split spoon sampler into the undisturbed material, beneath the casing, with a 140 pound weight falling 30 inches. Bedrock was cored with a double tube core barrel and NX size cores were recovered.

A total of 3 of the test borings and 4 of the test pit excavations were made along the dam centerline. The investigation for the principal spillway and outlet channel included advancing 3 test borings and 4 test pits. Three test pit excavations were made along the reservoir drain line. In the auxiliary spillway channel 4 test borings and 8 test pit excavations were advanced. An additional 5 test pit excavations were advanced between the dam and Pickup Hill Road because of the need for supplemental borrow material.

c. Subsurface Conditions

The subsurface investigation revealed the overburden soils at the dam site are quite variable in terms of composition and geologic origin. In general, alluvial gravels overlay glacial till soils in the flood plain.

Along the west abutment ice-contact stratified drift, glacial outwash sands and glacio-lacustrine silts and clays were encountered. At the steep east abutment shale and siltstone outcrop or was overlain by a thin veneer of topsoil. The bedrock exposed in the lower part of east abutment and along the drain line was highly weathered.

Seeps were present along the steep right abutment slopes at numerous locations and were encountered in the test pit excavations. Although seeps were not encountered in the test pit excavations for the auxiliary spillway investigation several were encountered during construction. Groundwater levels in the test pit-excavations and bore-holes appear to be controlled by the creek level.

2.2 DESIGN RECORDS

The dam was designed by the Soil Conservation Service, who prepared a design report, contract specifications and engineering drawings. Portions of the design folder have been included with this report as Appendix E. In addition a number of as-built drawings prepared by SCS have been included in Appendix F of this report.

2.3 CONSTRUCTION RECORDS

Construction inspection was performed by SCS and the construction documents are also available at the SCS office in Syracuse, New York. Changes from original design are noted on the as-built plans in Appendix F. The most notable change was the relocation of the principal spillway outlet pipe a distance of 20 feet east.

2.4 OPERATION RECORDS

Since the dam was designed as an uncontrolled, floodwater retarding structure no operating records are maintained regarding reservoir level or spillway discharge. During periods of heavy runoff it is reported the structure is monitored periodically by SCS personnel and representatives of the Conewango Watershed Commission.

2.5 EVALUATION OF DATA

The data presented in this report has been compiled from information obtained from the Soil Conservation Service, Conewango Creek Watershed Commission and the files of the New York State Department of Environmental Conservation. The information reviewed in connection with the Phase I inspection was considered adequate and reliable.

SECTION 3: VISUAL INSPECTION

3.1 FINDINGS

a. General

The visual inspection of the dam was conducted on May 6, 1980. The weather at the time of the inspection was cloudy with temperatures in the seventies. The reservoir level was at the crest of the orifice elevation 1483.7. On May 21, 1980 the site was revisited for the purpose of inspecting the principal spillway outlet pipe. On this date, the reservoir level had been drawn down, by opening the reservoir drain to approximately elevation 1478.

b. Embankment

In general the embankment was in good condition. No evidence of misalignment, sloughing, seepage, or cracking were observed. However, seepage was emerging from the natural valley wall at the abutment-embankment contacts on the upstream side of the dam. Also, the upstream slope of the embankment was not vegetated between elevation 1483.7 and about elevation 1496. Debris in the form of logs was laying on the upstream slope between elevations 1483.7 and 1500.0. Along the downstream abutment-embankment contact a slight amount of erosion has occurred in the lower third of the slope. Surface water runoff is concentrated along these contacts and has eroded a channel approximately 12 inches wide and deep. In general, these contacts are unlined except for some small stones (2" ± maximum size) which were removed during the seeding operation and placed in this area. An animal burrow was observed in the embankment near the toe of the dam just upslope of the riprap and to the right or east of the principal spillway outlet pipe.

The internal drainage system consists of drain trenches near the toe of the dam along the abutment. The drain trenches are cut into the foundation materials and filled with filter material. Seepage is collected and diverted from the drainage trenches into 8 inch diameter perforated asbestos cement pipe surrounded by filter material. The perforated sections are parallel to the axis of the dam and located 114 feet downstream from the dam centerline. The toe drains bend 90 degrees and outlet along either side of the principal spillway outlet pipe into the plunge pool as solid 8 inch diameter asbestos cement pipe. Between May 6 and May 21, 1980 the asbestos pipes had been broken off by vandals where they daylight above the plunge pool. No discharge was observed from the drains on the inspection dates noted above.

c. Principal Spillway

The principal spillway consists of a reinforced concrete riser structure with a 6 inch high by 9 inch wide orifice at elevation 1483.7 and the riser crest at elevation 1509.1. One 30 inch I.D. reinforced concrete pressure pipe bedded on a non-reinforced concrete cradle transports reservoir water from the riser structure to the plunge pool and outlet channel. This outlet pipe is provided with 9 reinforced concrete anti-seep collars at approximately 25 foot spacings starting 90 feet from the outlet to the riser structure. The components observed were in satisfactory condition.

d. Auxiliary Spillway

The auxiliary spillway for this structure is located at the west end of the dam. The spillway is cut into glacial derived soils consisting of: ice contact stratified drift and glacial outwash sands and gravels, glacio-lacustrine sands, silts and clays, and glacial till. Although the majority of the auxiliary spillway is in a cut area it

was necessary to construct a levee or dike along the east side of the spillway extending from just south of the dam axis north a distance of 135 feet. The levee section has a maximum height above existing ground surface of about 2.5 feet. Seeps encountered in the west side of the auxiliary spillway during construction are drained using 4 inch heavy duty perforated plastic pipe bedded in a trench 2 foot wide by 2 foot deep and surrounded by No. 2 stone. Areas in the cut slope which experienced sloughing were overexcavated and filled with No. 2 stone. Following earthwork the auxiliary spillway was lined with topsoil and seeded and now supports a healthy grass cover.

e. Reservoir Drain

The reservoir is drained by a 10 inch cast iron pipe and manually operated slide gate with the gate handle situated on the top of the riser structure. The slide gate is in operable condition.

f. Downstream of Toe

The waste area downstream of the dam along the east side of the outlet channel and the natural floodplain along west side of channel both exhibited ponded water and wet surficial soils.

g. Downstream Channel

The plunge pool is cut through a sequence of 5 feet of alluvial silt, sand and gravel underlain by 3 feet of silt and clay and terminates at the base 4 feet below the bedrock surface. A 2 foot layer of riprap lines the entire plunge pool and extended to elevation 1462.0 at the toe of the dam. Beyond the plunge pool the outlet channel area has been cleared and graded downstream a distance of about 135 feet from the outlet pipe. Beyond

the cleared and graded outlet channel the discharge is into the natural stream creek which is tree lined.

h. Reservoir Area

The area surrounding the reservoir is wooded with slopes ranging from 1 vertical to 4 horizontal to 1 vertical to 2 horizontal. No signs of slope instability were observed, however, seepage was emerging from the east reservoir slope.

3.2 EVALUATION

The visual inspection of this dam revealed the following deficiencies:

- 1) Debris buildup around orifice trash racks
- 2) Debris buildup along lower half of upstream embankment slope
- 3) Slight erosion along lower third of downstream slope at embankment-abutment contacts
- 4) Broken toe drain pipes and missing animal guards above plunge pool
- 5) An animal burrow on downslope above riprap lined plunge pool
- 6) Wet areas downstream of dam located east of outlet channel in waste area and west of outlet channel in flood plain
- 7) Unvegetated lower third of upstream slope
- 8) Evidence was observed that riprap around plunge pool has been thrown into plunge pool

SECTION 4: OPERATION AND MAINTENANCE

4.1 PROCEDURES

The normal reservoir level is controlled by the crest elevation of the orifice in the riser structure.

Downstream flow is controlled by the three outlet devices; first the orifice, then the riser crest and, finally the auxiliary spillway. The riser can discharge up to 155 cfs without discharges occurring in the auxiliary spillway.

4.2 MAINTENANCE OF DAM

The dam is maintained by the owner, Conewango Creek Watershed Commission. Normal maintenance should include mowing the grass from the embankment and auxiliary spillway; removal of debris from upstream embankment slope, reservoir slopes and around orifice trash rack; as well as repair or replacement of damaged or inoperative structures. The structure is inspected annually by a representative of SCS and the Owner's Contracting Officer. The resulting Inspection Report Forms from July 1975 through September 1979 are attached as Appendix D.

4.3 WARNING SYSTEM IN EFFECT

There is no warning system in effect, however, the dam is reportedly monitored during periods of heavy runoff by representatives of the SCS and Owner.

4.4 EVALUATION

The operation procedure for this structure is satisfactory. Increased maintenance is required to correct what appears to be reoccurring deficiencies noted during the visual inspection and review of Operation and Maintenance Inspection Records.

SECTION 5: HYDROLOGIC/HYDRAULIC

5.1 DRAINAGE AREA CHARACTERISTICS

Delineation of the watershed draining into the reservoir pool area was accomplished using the USGS 7.5 minute quadrangles for Hamlet and Cherry Creek, New York. The drainage area measures 350 acres and consists primarily of woodlands and open fields. The relief in the area consists of a continuous, moderately steep hill that forms into a gorge near the reservoir. The average slope of the drainage basin is approximately 10 percent.

5.2 ANALYSIS CRITERIA

The analysis of the floodwater retarding capability of this dam was performed using the Corps of Engineers HEC-1 computer program, Dam Safety Version. This program develops an inflow hydrograph based upon the "Snyder Synthetic Unit Hydrograph" and then uses the "Modified Puls" flood routing procedure. The spillway design flood selected for analysis was the PMF in accordance with the recommended guidelines of the U.S. Army Corps of Engineers.

5.3 SPILLWAY CAPACITY

The principal spillway of the dam is a drop inlet structure consisting of a two-stage reinforced concrete riser and a 30 inch diameter concrete pipe. The auxiliary spillway is an excavated outlet channel. Principal spillway discharge is controlled by the orifice and the riser up to the stage of 1511.7. Above this stage, the principal spillway discharge is controlled by the 30 inch diameter outlet pipe. The emergency spillway channel is of trapezoidal section with a bottom width of 50 feet and side slope of 3 horizontal to 1 vertical. Discharge through the emergency spillway was calculated assuming a depth of flow at the control section as critical depth.

The spillway appears to have adequate capacity for discharging the peak outflow for the Probable Maximum Flood (PMF). For the PMF, the peak inflow is 2035 cfs and the peak outflow is 2029 cfs. The calculated spillway capacity for a water surface elevation at the top of dam is 5113 cfs.

5.4 RESERVOIR CAPACITY

Storage capacity of the reservoir between the auxiliary spillway crest and the top of dam is 51.9 acre-feet, which is equivalent to a runoff depth of 1.95 inches over the drainage area. The total flood storage capacity of the dam is 128.3 acre-feet.

5.5 FLOODS OF RECORD

Due to the lack of reliable information no attempt was made to estimate the discharge for the flood of record.

5.6 OVERTOPPING POTENTIAL

Analysis using the PMF indicates that the dam would not be overtopped. For a PMF peak outflow of 2029 cfs the computed water surface elevation would still be 3.8 feet below the crest of the dam.

5.7 EVALUATION

At the PMF, flow discharge through the auxiliary spillway is 4.5 above the control section. The maximum discharge velocity and duration of flow through the auxiliary spillway are within normally accepted limits for grass-lined spillways.

SECTION 6: STRUCTURAL STABILITY

6.1 EVALUATION OF STRUCTURAL STABILITY

a. Visual Observations

No signs of instability were observed in connection with this structure.

b. Design and Construction Data

A total of 7 slope stability analyses were performed by the SCS for the embankment during the design phase. The soil strength parameters utilized in these analyses were based on consolidated-undrained triaxial shear tests without pore pressure measurements. The tests were conducted on remolded specimens of the proposed embankment materials compacted to at least 94.2 percent of the maximum dry density attainable through the Standard Proctor Compaction Method (ASTM D-698). The shear strength parameters used in the analyses are as follows:

| <u>Material Description</u> | <u>ϕ</u> <u>degrees</u> | <u>c</u> <u>psf</u> |
|-----------------------------|--|------------------------|
| Silty Gravel (GM) | 28.5 | 375 |
| Low Plasticity Silt (ML) | 26.5 | 800 |

We note the tests were conducted on remolded materials having a gradation less than the No. 4 sieve size.

The stability analyses were based on a modified Swedish circle method for both the upstream and downstream slopes under varying conditions. Of the 7 failure arcs investigated, the minimum factor of safety computed was 1.72 for the upstream slope under the following conditions: rapid drawdown from a reservoir level at elevation 1511.6, no berm, the failure arc confined within the embankment material, with $\phi = 28.5$ degrees and $c = 375$ psf.

The results of the stability analyses are contained with the Design Folder included in Appendix E. We note that all trial arcs are confined within the embankment.

A review of the stability analyses indicates the study was cursory in nature based on the minimal number of trial failure arcs investigated, as well as the seepage and loading conditions considered. However, the embankment slopes are flatter than is normally required for adequate safety factors in a zoned earth embankment.

We note that medium stiff silts and clay form a portion of the embankment foundation, yet no stability analyses failure arc penetrated the foundation. However, this does not appear to be a problem since any excess pore pressures generated within this material during and after embankment construction would have dissipated and the material would be stronger than at the end of construction.

Design of the crest width and longitudinal camber for settlement considerations as well as the cutoff trench width and depth are in accordance with standard engineering practice. The construction of the internal drainage system is of conventional design for zoned earth embankment dams.

c. Seismic Stability

No seismic stability analyses were performed as part of the dam design.

SECTION 7: ASSESSMENT/RECOMMENDATIONS

7.1 ASSESSMENT

a. Safety

The Phase I inspection of the Conwango Creek Watershed Project Site 33 dam did not reveal conditions which constitute a hazard to human life or property. The earth embankment is considered stable based on the available engineering data and visual observations. The dam and spillways are capable of retarding and safely discharging floodwaters resulting from the Probable Maximum Flood (PMF).

b. Adequacy of Information

The information reviewed was adequate for Phase I Inspection Reports.

c. Need for Additional Investigation

No additional investigations are required for this structure.

d. Urgency

All remedial measures should be completed within 6 months from the time of approval of this report. An emergency preparedness plan for notification and evacuation of downstream residents in the event of large auxiliary spillway discharge should be implemented within 6 months.

7.2 RECOMMENDED REMEDIAL MEASURES

- a. Remove debris from around orifice trash racks, embankment upstream slope.
- b. Remove dead brush and trees from reservoir slopes.
- c. Provide increased maintenance.
- d. Provide a procedure for periodic inspections including operations and lubrication of slide gate mechanisms.
- e. Re-establish riprap in and around plunge pool to as-built condition.

- f. Repair and re-establish asbestos cement drain pipe to as-built condition (including animal screens).
- g. Revegetate or otherwise protect the lower third of upstream embankment slope.
- h. Line abutment-embankment contact in eroded areas with non-erodable material such as stone, corrugated metal pipe, asphaltic pavement.
- i. Treat animal burrow by digging out and replacing with compacted embankment material.
- j. Consideration should be given to installing a fence along Pickup Hill Road to discourage vandals from entering property and cause further damage.
- k. Develop and implement a warning system and evacuation plan for downstream residents in the event of large auxiliary spillway discharge.

APPENDIX A

PHOTOGRAPHS



View of dam crest and top of intake structure.

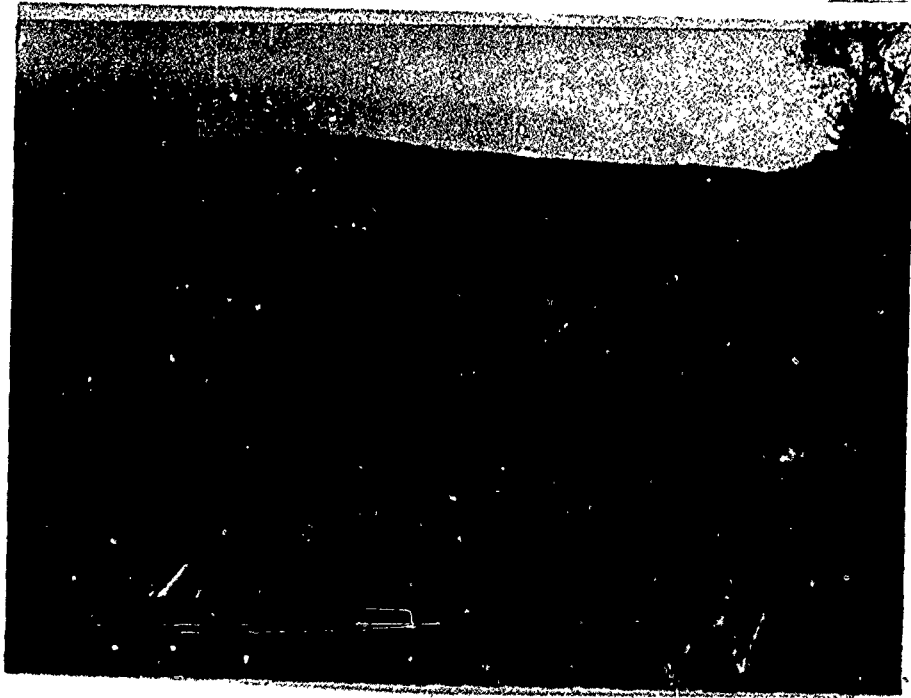

View of upstream embankment slope and intake structure from west abutment.



View of upstream slope from the embankment--note erosion along toe of embankment and resulting "delta" formation in the reservoir near picture center.

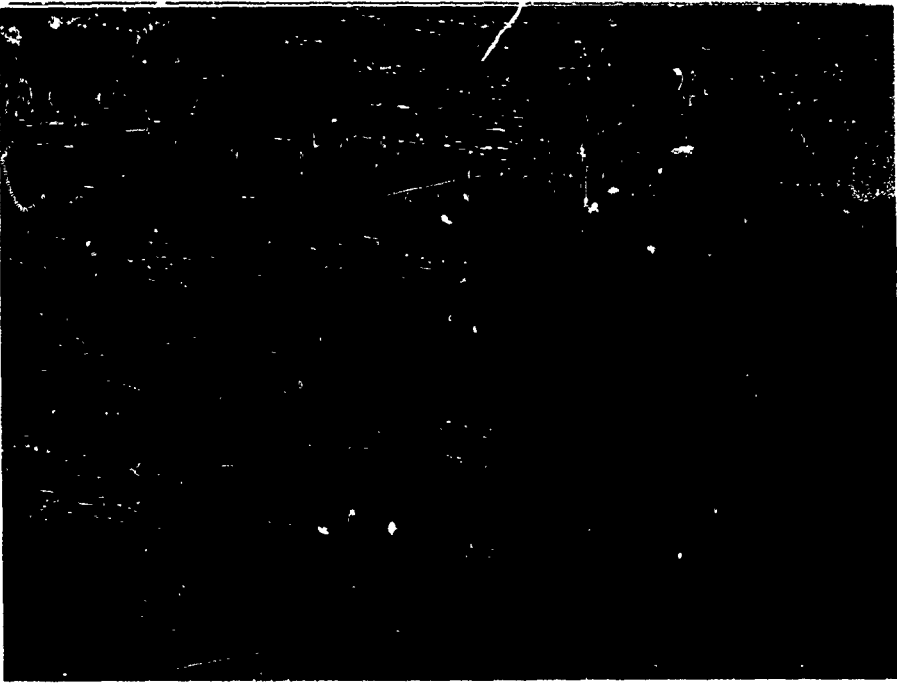

View of the upstream slope taken from the embankment above the intake structure.

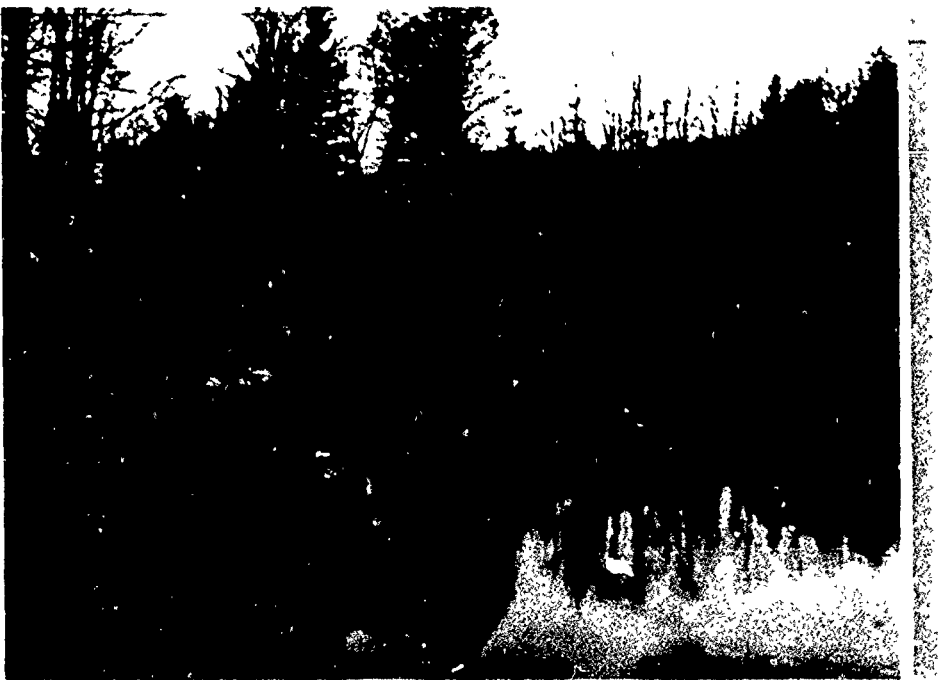

View of reservoir and intake structure from atop the reservoir--note trees within the reservoir.

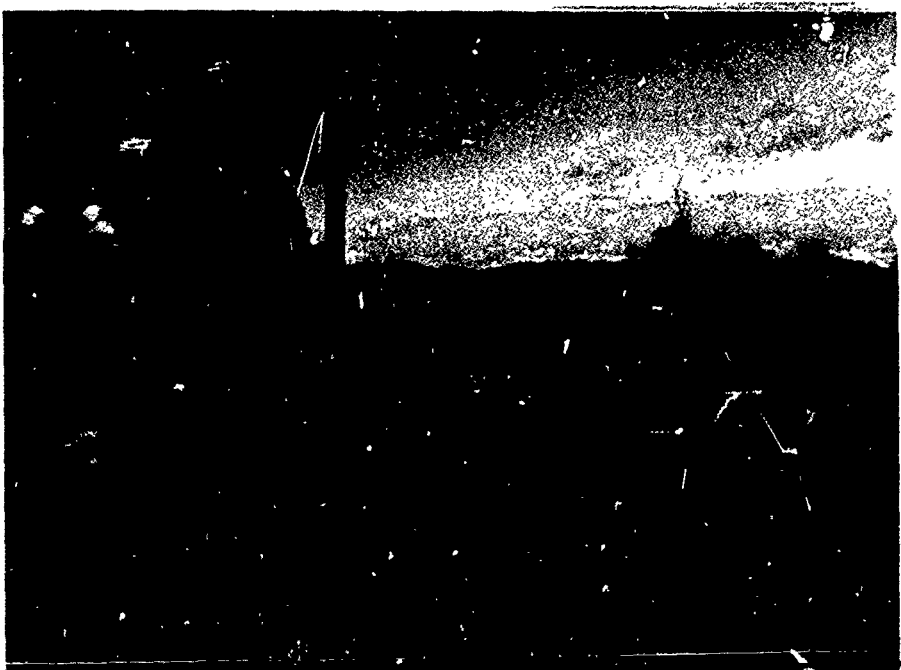

View of downstream embankment slope and outlet pipe from west side of downstream channel--note erosion along the abutment-embankment contact at left side of photo.



View of the outlet pipe, plunge pool and downstream channel from the crest of the embankment.



View of auxiliary spillway looking upstream--note the gravel underdrain.



View of auxiliary spillway looking downstream.



View of reservoir and surrounding slopes.

APPENDIX B

VISUAL INSPECTION CHECKLIST

THOMSEN ASSOCIATES
CONSULTING GEOTECHNICAL ENGINEERS & GEOLOGISTS

VISUAL INSPECTION CHECKLIST

1) Basic Data

a. General

Name of Dam Conewango Creek - Site 33
Fed. I.D. # 72-3917 DEC. Dam No. NY 581
River Basin Allegheny
Location: Town Cherry Creek County West Augusta
U.S.G.S. Quadrangle Cherry Creek
Stream Name Unnamed tributary
Tributary of Cherry Creek
Latitude (N) 42° 17' 10" Longitude (W) 79° 06' 51"
Type of Dam Zoned Earth Dam
Hazard Category High
Date(s) of Inspection 5/6/80, 5/2/82
Weather Conditions Cloudy
Reservoir Level at Time of Inspection 1483.70 *Controlled by Oriskany*
Tailwater Level at Time of Inspection 1454.1 *Inlets structure*

b. Inspection Personnel Charles T. Gagner II - Thomsen Associates

Paul Ehrenberg - H&I, Don Lake & Harry Heisk - SCS
Richard Shields - Conewango Creek Watershed Commission

c. Persons Contacted (Including Address & Phone No.)

Don Lake & Harry Heisk - SCS - Syracuse Office - 315-423-5503
Richard Shields - Contracting Office - Kennedy, N.Y. - 716-267-4801
Robert Warriner - DEC - Albany, NY - 518-457-5557

d. History: As Bilt 12/9/74
Date Constructed 1974 Date(s) Reconstructed NONE

Designe. Soil Conservation Service
Constructed by W W Kimmons Co. Buffalo, NY
Owner Conewango Creek Watershed Commission

e. Seismic Zone Zone 3

THOMSEN ASSOCIATES
CONSULTING GEOTECHNICAL ENGINEERS & GEOLOGISTS

VISUAL INSPECTION CHECKLIST

2) Embankment

a. Characteristics

- 1) Embankment Material 2-Zone Dam, Central Core composed of Material w/ >20% Passing #200 sieve, Upstream & Downstream Slopes composed of material w/ <20% Passing #20 sieve
- 2) Cutoff Type Cutoff Trench
- 3) Impervious Core Glacial Till, Glacifluvial, Glaciolacustrine >20% Pass. #200 sieve
- 4) Internal Drainage System Dr. Trench - 4:1 w/ 12" Dia. Gr. Dr. Pipe (9" diam) within Dr. Trench 2' from toe
- 5) Miscellaneous _____

b. Crest

- 1) Vertical Alignment OK
- 2) Horizontal Alignment OK
- 3) Surface Cracks NONE
- 4) Miscellaneous _____

c. Upstream Slope

- 1) Slope (Estimate) (V:H) 1:3
- 2) Undesirable Growth or Debris, Animal Burrows Debris (V. L. debris), lower part of slope
- 3) Sloughing, Subsidence or Depressions NONE

THOMSEN ASSOCIATES

CONSULTING GEOTECHNICAL ENGINEERS & GEOLOGISTS

VISUAL INSPECTION CHECKLIST

4) Slope Protection NONE (Lower 1/3 Bare, Middle 1/3 Reed Canary, Top 1/3 Grass)

5) Surface Cracks or Movement at Toe NONE, Note: Natural Seepage from Abutments toward Reservoir, Left Abutment - Embankment Contact is lined with 1" Max. Washed Gravel

d. Downstream Slope

1) Slope (Estimate - V:H) 1:2.5

2) Undesirable Growth or Debris, Animal Burrows See

Animal Burrow Noted below around outlet pipe.

3) Sloughing, Subsidence or Depressions NONE

4) Surface Cracks or Movement at Toe NONE

5) Seepage NONE

6) External Drainage System (Ditches, Trenches; Blanket)

SWALE BETWEEN TOE + ABUTMENT

GRASS COVERED, EROSION NOTED Lower 1/3 of slope 1' wide 1" Deep

7) Condition Around Outlet Structure SMALL ANIMAL

BURROW IN UPSLOPE SIDE OF RIPRAP AROUND OUTLET PIPE

8) Seepage Beyond Toe YES, SEE AS BUILT MAPS

GENERAL WASTE AREA RIGHT SIDE OF OUTLET CHANNEL IN NATURAL FLOOD PLAIN LEFT OF OUTLET CHANNEL

e. Abutments-Embankment Contact

THOMSEN ASSOCIATES
CONSULTING GEOTECHNICAL ENGINEERS & GEOLOGISTS

VISUAL INSPECTION CHECKLIST

1) Erosion at Contact Both Right and Left Sides -
EROSION ALONG DRAINAGE SWALE 1' WIDE 1' DEEP AT LOWER END
OF Slope

2) Seepage Along Contact NONE

3) Drainage System

a. Description of System Drain Trench with Filter Material
FOR toe along DOWNHILL TO PARALLEL DRAIN TRENCH
WITH 8" ϕ Asbestos Cement Drain Pipe Located 114' from
Dam & Animal Guards at Drain Pipe Outlet

b. Condition of System Only Outlet Drain Pipes Exposed
5-21-80 Vandal's have Broken off \approx 2' of outlet drain pipes
when they daylight from embankment

c. Discharge from Drainage System NONE

4) Instrumentation (Monumentation/Surveys, Observation Wells, Weirs, Piezometers, Etc.)

Horizontal & Vertical Control, 2 monuments
along ϕ outside of Dam

West Side in Pickup Hill Road Horizontal Control ϕ
Sta. 0+05.13 RR ispike in Road ϕ for Dam ϕ .

East Side ϕ Dam Monument Sta. 7+18.85 Elev. 1527.76

THOMSEN ASSOCIATES
CONSULTING GEOTECHNICAL ENGINEERS & GEOLOGISTS

VISUAL INSPECTION CHECKLIST

5) Reservoir

- a. Slopes Right Side 1:1.5 Left Side better
10% + 1:2
- b. Sedimentation slight exposed on lower 1/2 of upstream
face less than 1" 5-21-80 Est. Sedimentation with reservoir
nearly drained is 1/4"-5"
- c. Unusual Conditions Which Affect Dam Fallen Trees
along Reservoir Slopes

6) Area Downstream of Dam

- a. Downstream Hazard (No. of Homes, Highways, etc.) High
Many Homes in Cherry Creek, N.Y., downstream channel crosses secondary
roads at several locations.
- b. Seepage, Unusual Growth See POND MAPS on file
with POND
- c. Evidence of Movement Beyond Toe of Dam None
- d. Condition of Downstream Channel cleared ≈ 135' from
outlet works the into natural tree lined channel

7) Spillway(s) (Including Discharge Conveyance Channel)

- Concrete Riser Intake Structure with 36" ϕ Reinforced
Concrete Pressure Pipe to Plunge Pool on Downstream Side
- a. General Drifts control on pool @ Elev 1483.7
Riser Crest Elev. 1509.1
- b. Condition of Service Spillway Debris needs to be
cleaned around drifts trash rocks

THOMSEN ASSOCIATES
CONSULTING GEOTECHNICAL ENGINEERS & GEOLOGISTS

VISUAL INSPECTION CHECKLIST

- c. Condition of Auxiliary Spillway Good *Nbk: Seeps disclosed (during construction) in Cut Slope along West side of Spillway, AREA is treated w/ Gravel & Drained by 4" ϕ perforated plastic pipe, no flow has ever been observed from pipe outlet.*
GRASS LINED, Max. Elevation 1511.6
- d. Condition of Discharge Conveyance Channel _____

8) Reservoir Drain/Outlet

Type: Pipe Conduit _____ Other _____
Material: Concrete _____ Metal Cast Iron Other _____
Size: 10" ϕ Nominal Length 40.0'
Invert Elevations: Entrance 1472.1 Exit 1470.1 *in Riser structure*
Physical Condition (Describe): _____ Unobservable
Material: _____
Joints: _____ Alignment _____
Structural Integrity: _____
Hydraulic Capability: _____
Means of Control: Gate Valve _____ Uncontrolled _____
Operation: Operable Inoperable _____ Other _____
Present Condition (Describe): _____

Riser Crest Elevation 1509.1
No Warning System or Evacuation Plan

THOMSEN ASSOCIATES

CONSULTING GEOTECHNICAL ENGINEERS & GEOLOGISTS

9) Structural

a. Concrete Surfaces Good - Concrete Pipe Intake Structure

b. Structural Cracking NONE

c. Movement - Horizontal & Vertical Alignment (Settlement)

NONE

d. Junctions with Abutments or Embankments

N/A

e. Drains - Foundation, Joint, Face Outlet of Drain Pipes

(8" ϕ Asbestos Cement) had been broken off between
5/6/80 & 5/21/80 by Vandal's

f. Water Passages, Conduits, Sluices

g. Seepage or Leakage N/A

THOMSEN ASSOCIATES

CONSULTING GEOTECHNICAL ENGINEERS & GEOLOGISTS

h. Joints - Construction, etc. Tight

i. Foundation _____

j. Abutments _____

k. Control Gates Riser Stem Gate on Reservoir Drain

l. Approach & Outlet Channels Outlet pipe was to be

inspected on 5/21/80, Reservoir level had been drawn down below orifice but local contracting officer was not present to close drain at pre-arranged time to facilitate inspection of outlet pipe

m. Energy Dissipators (Plunge Pool, etc.) _____

n. Intake Structures Concrete Riser Structure - Good Condition

Some debris around trash racks @ orifice

o. Stability _____

p. Miscellaneous _____

APPENDIX C

HYDROLOGIC/HYDRAULIC ENGINEERING
DATA AND COMPUTATIONS

THOMSEN ASSOCIATES
 CONSULTING GEOTECHNICAL ENGINEERS & GEOLOGISTS

**CHECK LIST FOR DAMS
 HYDROLOGIC AND HYDRAULIC
 ENGINEERING DATA**

AREA-CAPACITY DATA:

| | <u>Elevation</u> (ft.) | <u>Surface Area</u> (acres) | <u>Storage Capacity</u> (acre-ft.) |
|--|---------------------------|--------------------------------|---------------------------------------|
| 1) Top of Dam | <u>1519.9</u> | <u>7.9</u> | <u>137.9</u> |
| 2) Design High Water (Max. Design Pool) | <u>1513.8</u> | <u>5.4</u> | <u>97.3</u> |
| 3) Auxiliary Spillway Crest | <u>1511.6</u> | <u>4.9</u> | <u>96.0</u> |
| 4) Pool Level with Flashboards | <u>N.A.</u> | <u>N.A.</u> | <u>N.A.</u> |
| 5) Service Spillway Crest | <u>1509.1</u> | <u>4.4</u> | <u>74.4</u> |
| 6) <i>Orifice Crest</i> <u>DISCHARGES</u> | <u>1493.7</u> | <u>0.7</u> | <u>9.6</u> |

| | <u>Volume</u> (cfs) |
|---|------------------------|
| 1) Average Daily | <u>Unknown</u> |
| 2) Spillway @ Maximum High Water (TOD OF DAM) | <u>163</u> |
| 3) Spillway @ Design High Water | <u>156</u> |
| 4) Spillway @ Auxiliary Spillway Crest Elevation | <u>148</u> |
| 5) Low Level Outlet <i>at Normal Pool</i> | <u>5</u> |
| 6) Total (of all facilities) @ Maximum High Water | <u>513</u> |
| 7) Maximum Known Flood | <u>Unknown</u> |

THOMSEN ASSOCIATES
CONSULTING GEOTECHNICAL ENGINEERS & GEOLOGISTS

CREST: _____ ELEVATION: 1519.9

Type: Zoned Earth Embankment

Width: 18 Length: 317 feet

Spillover Concrete Riser Structure & Auxiliary Spillway

Location Riser Structure on Upstream Embankment Slope near Maximum section of Dam, Auxiliary Spillway at West End of DAM

SPILLWAY:

PRINCIPAL

EMERGENCY

Orifice Crest - 1483.7
Riser Crest - 1509.1
Concrete Riser Structure w/ orifice

Elevation 1511.6
Type Gross lined Earthen Channel
Width 50 feet

Type of Control

Yes Uncontrolled Yes

Controlled:

Type _____
(Flashboards; gate)

Number _____

Size/Length _____

Invert Material Tessell over generally fine grained silt, sand & clay

Anticipated Length of operating service 17 hours at PAF event

295.2 (Pipe length) Chute Length 50' @ Level Control Section

Not Applicable Height Between Spillway Crest & Approach Channel Invert (Weir Flow) 2% Entrance Slope

THOMSEN ASSOCIATES
CONSULTING GEOTECHNICAL ENGINEERS & GEOLOGISTS

OUTLET STRUCTURES/EMERGENCY DRAWDOWN FACILITIES:

Type: Gate Sluice Conduit Penstock
Shape: Circular (Cast Iron Pipe)
Size: 10"
Elevations: Entrance Invert 1472.1
Exit Invert 1470.1
Tailrace Channel: Elevation Not Applicable

HYDROMETEROLOGICAL GAGES:

Type: NONE KNOWN TO BE IN THE AREA
Location: _____
Records:
Date - _____
Max. Reading - _____

FLOOD WATER CONTROL SYSTEM:

Warning System: None

Method of Controlled Releases (mechanisms):
Reservoir Drain with Manually operated slide gate

THOMSEN ASSOCIATES
CONSULTING GEOTECHNICAL ENGINEERS & GEOLOGISTS

DRAINAGE AREA: 350 Acres (0.53 sq miles)

DRAINAGE BASIN RUNOFF CHARACTERISTICS:

Land Use - Type: Wooded

Terrain - Relief: Moderate to Steep

Surface - Soil: Varies between glacio-kustaine silt & clay to dense glacial till

Runoff Potential (existing or planned extensive alterations to existing surface or subsurface conditions)

None Planned

Potential Sedimentation problem areas (natural or man-made; present or future)

Normal Pool is designed as a 50 year Sediment Pool

Potential Backwater problem areas for levels at maximum storage capacity including surcharge storage:

None

Dikes - Floodwalls (overflow & non-overflow) - Low reaches along the Reservoir perimeter:

Location: None

Elevation: _____

McFarland-Johnson Engineers, Inc.
171 Front Street
BINGHAMTON, NEW YORK 13905

JGB _____
SHEET NO _____ OF _____
CALCULATED BY P. S. DATE 2/5/70
CHECKED BY _____ DATE _____
SCALE _____

Drainage Area = 0.53 sq. mile

Estimation of Lag Time (t_p)

$$t_p = C_t (.955) (L.L_c)^3 + .25 t_r = 1.1 (.955) (1.21 \times .6)^3 + .25 (.20) \\ = 1.00 \text{ hr.}$$

$$\text{Slope of the basin} = \frac{1950 - 1500}{4200} \times 100 = 10.7\%$$

Check of Lag time

Using Linsley, Kohler & Paulhus Equations

$$\text{Lag } (t_p) = 0.72 \left(\frac{L.L_c}{.5} \right)^{.38} = 0.72 \left(\frac{1.21 \times .6}{.5} \right)^{.38} \\ = 0.97 \text{ hr.}$$

In HEC-1 input $t_p = 1 \text{ hr.}$ & $C_p = 0.63$ were used to develop synthetic unit hydrographs.

Probable Maximum Precipitation

From Hydrometeorological Report # 33, Probable Maximum Precipitation = 22.6 inches (For 200 sq. mile - 24 hr. duration.)

Depth - Area - Duration Relationship (Zone 2)

6 hr. - 116%
12 hr. - 127%
24 hr. - 141%

McFarland-Johnson Engineers, Inc.
 171 Front Street
 BINGHAMTON, NEW YORK 13905

JOB HYDROLOGIC STUDY DAM # NY 581
 SHEET NO _____ OF _____
 CALCULATED BY P.C. DATE 6/5/80
 CHECKED BY _____ DATE _____
 SCALE _____

STAGE - STORAGE DATA

| ELEVATION (ft.) | Surface Area (Acres) | Avg. Area (Acres) | Incremental Storage (Acree-ft) | Total Storage (Acree-ft) | Remarks |
|--------------------|-------------------------|----------------------|--------------------------------------|-----------------------------|--|
| 1483.7 | 0.7 | | | 0 | Surface Areas are directly taken from S.C.S. design report since they are computed with better contour maps. |
| 1509.1 | 4.4 | 2.55 | 64.8 | 64.8 | |
| 1511.6 | 4.9 | 4.65 | 11.6 | 76.4 | |
| 1513.8 | 5.4 | 5.15 | 11.3 | 87.7 | |
| 1519.9 | 7.9 | 6.65 | 40.6 | 128.3 | |

NOTE: Storage for other stages for HEC-1 input were interpolated from stage-storage curve.

McFarland-Johnson Engineers, Inc.
171 Front Street
BINGHAMTON, NEW YORK 13905

JOB HYDROLOGIC STUDY DAM # NY 221
SHEET NO _____ OF _____
CALCULATED BY T.K. DATE 6/5/90
CHECKED BY P.S. DATE 6/19/90
SCALE _____

STAGE-DISCHARGE COMPUTATION

Normal Pool Elevation - 1493.7
Elev. of crest of riser - 1509.1
Emergency spillway Elvn. - 1511.6
Elevn. of top of dam - 1519.9
Elevn. of Tail water - 1454.1

Size of orifice - 0.75' x 0.5'
Size of outlet pipe - 30" ϕ . $S_o = 0.03$
Length of pipe - 295.2'. $n = 0.12$
EL. @ inlet of pipe - 1469.1
Riser opening - 7.5' x 1.25' (2')

Assumptions:

- ① A constant coefficient of discharge of 0.7 was assumed to compute discharge through orifice.
- ② To compute the discharge through the riser, weir flow equation was used for reservoir stage below the top of riser. For all reservoir stage above the top of the riser orifice flow equation was used.
- ③ Coefficient of Weir = 3.1
- ④ Bureau of Public Roads Hydraulic Engineering Chart #2 was used to compute headwater from the pipe assuming inlet and outlet control. Long hand calculations were made to compute headwater beyond the limit of the chart.
- ⑤ In computing discharge through emergency spillway, approach velocity and friction loss were ignored.
- ⑥ Tailwater Elevation was ignored since the outlet pipe is discharging into a plunge pool.

McFarland-Johnson Engineers, Inc.
 171 Front Street
 BINGHAMTON, NEW YORK 13905

JOB HYDROLOGIC STUDY DAM # 1.0.2.21
 SHEET NO _____ OF _____
 CALCULATED BY T.K. DATE 6/15/57
 CHECKED BY V.S. DATE 2/2/58
 SCALE _____

STAGE-DISCHARGE COMPUTATIONS (CONTD.)

| ELEV. ft | STAGE ft | ORIFICE DISCHARGE C.F.S. | INLET CONTROL | | OUTLET CONTROL | | | CONTROL RISE & PIPE | | | EMERG. SPILLWAY DISCHARGE C.F.S. | TOTAL DISCHARGE C.F.S. |
|-------------|-------------|--------------------------------|---------------|-----------|------------------------|----------|-----------|---------------------|----------|---------------------|--|------------------------------|
| | | | HW/D | HW ft. | $\frac{d+H}{2}$ ft. | H ft. | HW ft. | HW ft. | H ft. | DISCHARGE C.F.S. | | |
| 1483.7 | 0 | | | | | | | | | | | 0 |
| 1485.7 | 2 | 2.8 | - | - | | | | | | | | 2.8 |
| 1487.7 | 4 | 4.0 | - | - | | | | | | | | 4.0 |
| 1489.7 | 6 | 5.0 | - | - | | | | | | | | 5.0 |
| 1491.7 | 8 | 5.9 | - | - | | | | | | | | 5.9 |
| 1493.7 | 10 | 6.6 | - | - | | | | | | | | 6.6 |
| 1495.7 | 12 | 7.2 | - | - | | | | | | | | 7.2 |
| 1497.7 | 14 | 7.8 | 0.52 | 1.30 | | | | | | | | 7.8 |
| 1499.7 | 16 | 8.4 | 0.53 | 1.32 | | | | | | | | 8.4 |
| 1501.7 | 18 | 8.9 | 0.57 | 1.42 | | | | | | | | 8.9 |
| 1503.7 | 20 | 9.4 | 0.58 | 1.45 | | | | | | | | 9.4 |
| 1505.7 | 22 | 9.8 | 0.59 | 1.47 | | | | | | | | 9.8 |
| 1507.7 | 24 | 10.3 | 0.6 | 1.5 | 1.8 | - | - | 1.5 | | | | 10.3 |
| 1509.7 | 26 | 10.7 | 1.4 | 3.5 | 2.15 | 2.4 | - | 3.5 | 0.6 | 21.6 | | 32.3 |
| 1511.7 | 28 | 3.1 | | 31.2 | 2.5 | 49.5 | 41.05 | 41.05 | 1.97 | 147.8 | 4.9 | 155.7 |

Pipe Control

McFarland-Johnson Engineers, Inc.
 171 Front Street
 BINGHAMTON, NEW YORK 13905

JOB: HYDROLOGIC STUDY DAM # NY 2-1
 SHEET NO. _____ OF _____
 CALCULATED BY: T.K. DATE: 6/15/71
 CHECKED BY: P.S. DATE: 6/17/71
 SCALE: _____

STAGE-DISCHARGE COMPUTATIONS (CONTD.)

| ELEV. ft. | STAGE ft. | ORIFICE DISCHARGE C.F.S. | INLET CONTROL | | OUTLET CONTROL | | | CONTROL | RISER & PIPE | | EMER. SPILLWAY | TOTAL |
|--------------|--------------|--------------------------------|---------------|----|------------------------|----------|-----------|-----------|--------------|---------------------|---------------------|---------------------|
| | | | HW/D | HW | $d \frac{H}{d}$ ft. | H ft. | HW ft. | HW ft. | H ft. | DISCHARGE C.F.S. | DISCHARGE C.F.S. | DISCHARGE C.F.S. |
| 1513.7 | 30 | | | - | 2.5 | 53.5 | 44.6 | 44.6 | 44.6 | 156 | 500 | 656 |
| 1515.7 | 32 | | | - | 2.5 | 55.5 | 46.6 | 46.6 | 46.6 | 157 | 1500 | 1657 |
| 1517.7 | 34 | | | - | 2.5 | 57.5 | 48.6 | 48.6 | 48.6 | 160 | 2900 | 3060 |
| 1519.7 | 36 | | | - | 2.5 | 59.5 | 50.6 | 50.6 | 50.6 | 162 | 4800 | 4962 |
| 1519.9 | 36.2 | | | - | 2.5 | 59.7 | 50.8 | 50.8 | 50.8 | 163 | 4950 | 5113 |

SAMPLE CALCULATIONS

ORIFICE DISCHARGE

Stage @ 1501.7

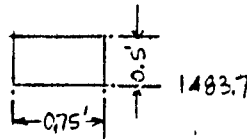

$$Q = CA \sqrt{2gH} = 0.7 \times 0.75 \times 0.5 \sqrt{64.4 \times 17.75}$$

$$= 8.9 \text{ c.f.s.}$$

RISER DISCHARGE

Stage @ 1511.7

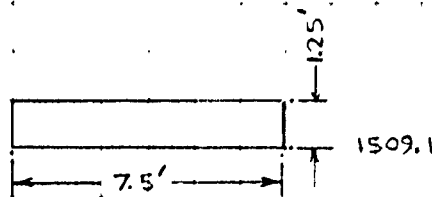

$$Q = CA \sqrt{2gH}$$

$$= 0.7 \times 7.5 \times 1.25 \sqrt{64.4 \times 1.98}$$

$$= 148.2 \text{ c.f.s.}$$

Computed head with $Q = 148.2$ c.f.s. indicates that the orifice will be submerged. Therefore, the orifice discharge will be greatly reduced. By trial & error, the total combined discharge through orifice & riser was computed. Total discharge of 151 c.f.s. was assumed and head water H₂O (outlet & spillway control) were computed.

Controlling H₂O (Outlet Control) = 40.4 ft.

Water Surface El. in the riser box = 1469.1 + 41.05 = 1510.15

Discharge thru orifice,

$$Q = CA \sqrt{2gAH}$$

$$= 0.7 \times 0.75 \sqrt{64.4 \times 1.55}$$

$$= 2.6 \text{ c.f.s.}$$

$$AH = 1511.7 - 1510.15 = 1.55$$

Total discharge thru riser & orifice = 148.2 + 2.6 = 150.8 c.f.s.

Discharge through Emergency spillway

$$Q = CLH^{3/2} = 3.1(50)(1.1)^{3/2} = 4.9 \text{ c.f.s.}$$

Total Discharge @ 1511.7 = 150.8 + 4.9 = 155.7 c.f.s.

PIPE CONTROL

At stage of 1513.7 the computed headwater with combined discharge (orifice and spillway) was more than the stage. Therefore, it was assumed pipe controls and it is outlet control.

$$HW = 1513.7 - 1469.1 = 44.6$$

$$HW = H_{tho} - LSO \quad H = 44.6 - 2.5 + 11.4 = 53.5$$

$$H = \left(1 + K_e + \frac{29n^2L}{R^{4/3}}\right) \frac{V^2}{2g}$$

$$53.5 = \left(1 + .1 + \frac{29(.012)^2 \times 295}{(1.62)^{4/3}}\right) \frac{V^2}{2g}, \quad 53.5 = 3.4 \frac{V^2}{2g}$$

$$V = 31.8' / \text{sec} \quad Q = A \times V = 4.908 \times 31.8 = 156 \text{ c.f.s.}$$

EMERGENCY SPILLWAY

Discharge thru Emergency Spillway.

$$H = 1513.7 - 1511.6 = 2.10$$

Neglecting approach velocity and friction loss.

$$H = d_c + \frac{V_c^2}{2g}$$

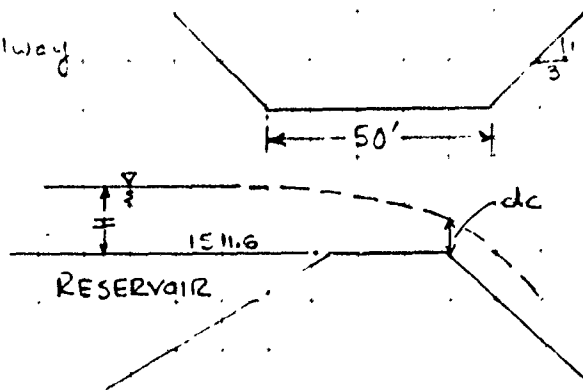

Computations involve assuming a discharge through the spillway and calculate d_c & $V_c^2/2g$ to balance two sides of the equation.

Table 8-5 of King & Brater "Handbook of Hydraulics" was used to compute d_c .

assume $Q = 500 \text{ c.f.s.}$ $K_c = .028$ $d_c/b = .029$

$$\therefore d_c = .029(50) = 1.45', \quad V_c = 500/70.8 = 6.34' / \text{sec} \quad V_c^2/2g = 0.62$$

$$\therefore d_c + V_c^2/2g = 1.45 + 0.62 = 2.07 = 2.1$$

$$\therefore \text{Total Discharge @ 1513.7} = 156 + 500 = 656 \text{ c.f.s.}$$

Site 33 Stage vs. Storage

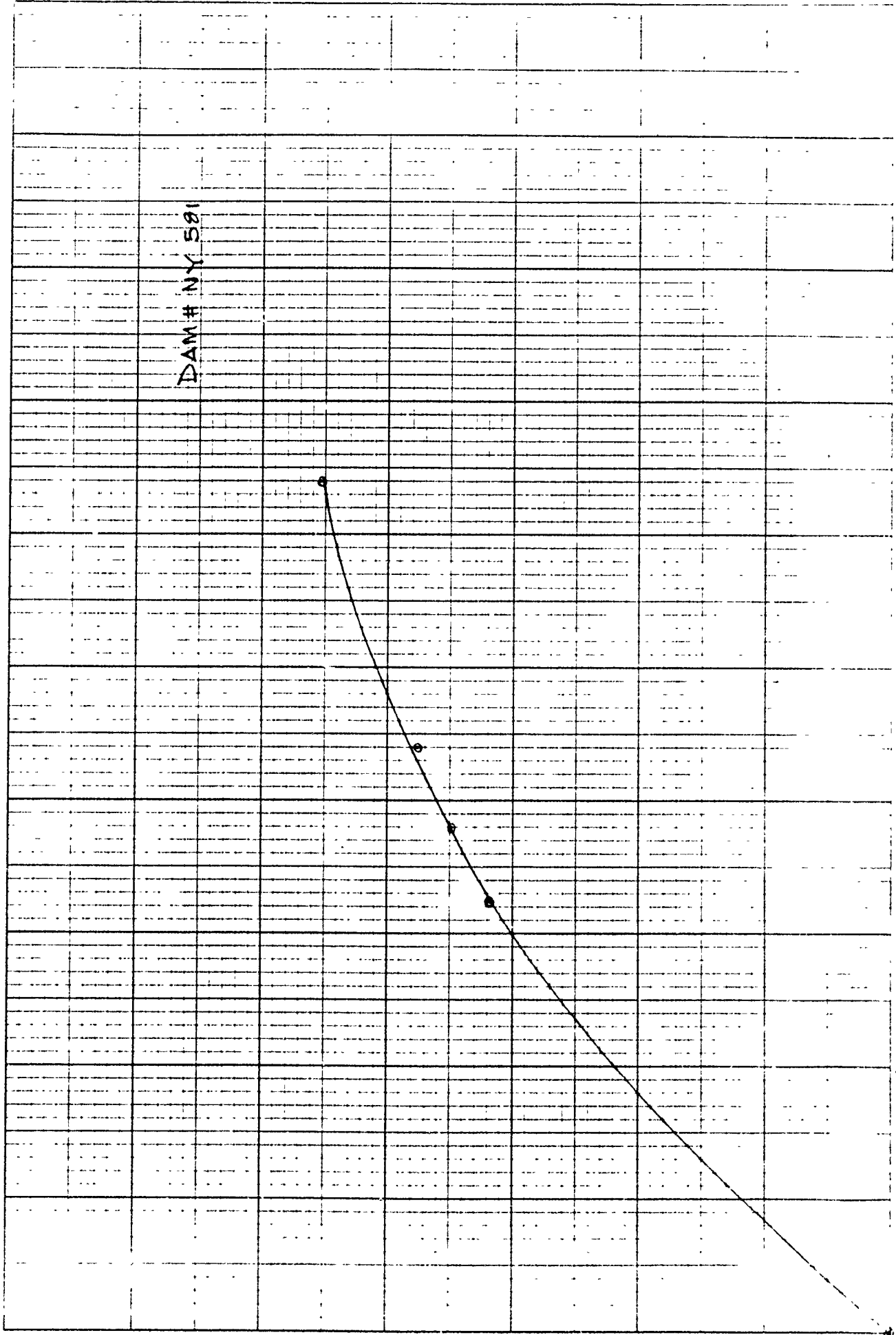

40 (Assult.)

40

4837

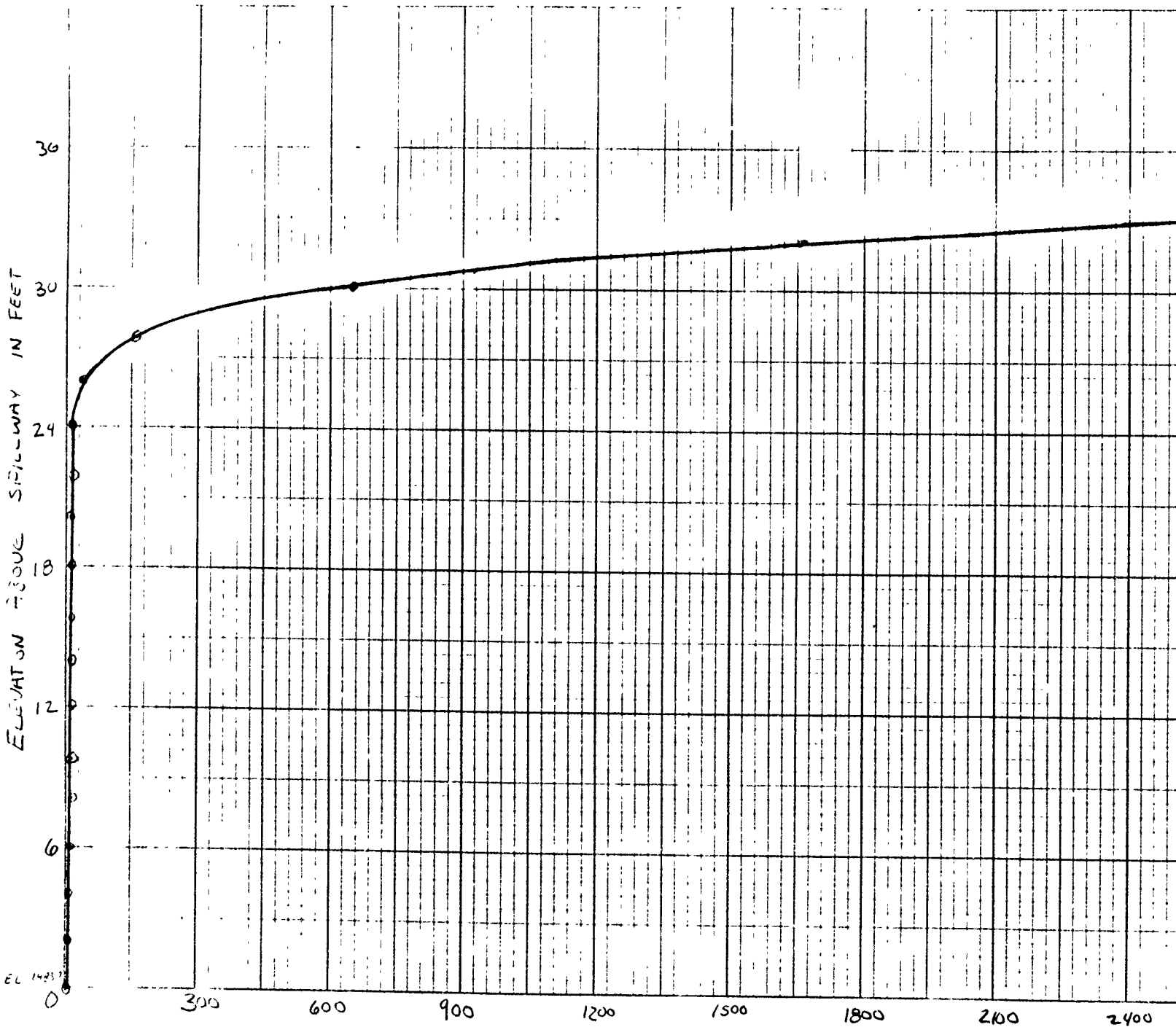

EL 1425.7

DISCHARGE IN C.F.S.

46 0782

7

KEUFFEL & ESSER CO. MADE IN U.S.A.
 10 X 10 TO THE INCH • 2 1/2 INCHES

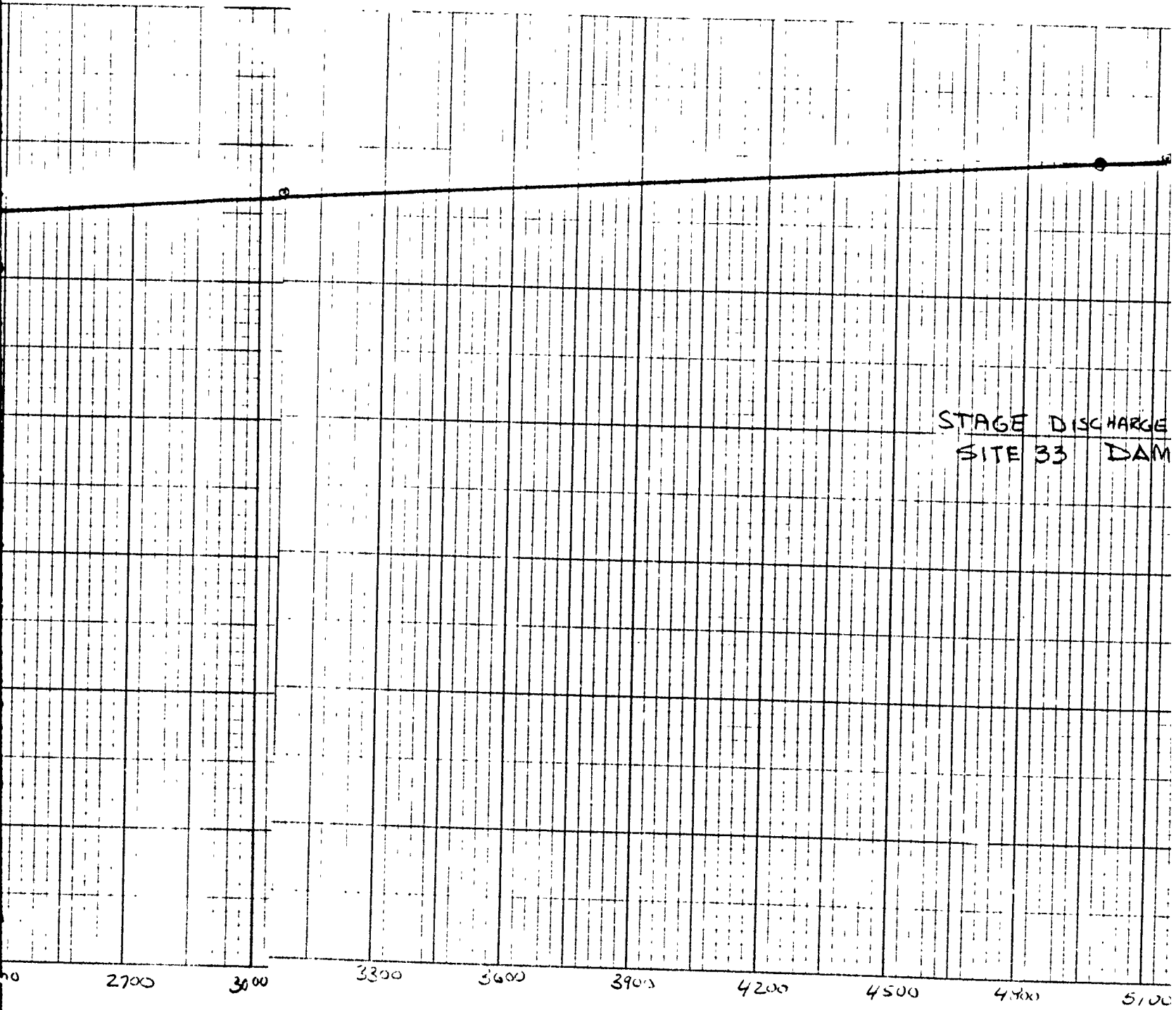

STAGE DISCHARGE
SITE 33 DAM

2

46 0782

STAGE DISCHARGE CURVE
SITE 33 DAM # NY 581

0050 0015 0004 0054 0020 0035 0030

46 0782

KEUFFEL & ESSER CO. MADE IN U.S.A.
10 X 10 THE INCH • 7 X 10 INCHES

3

 FLOOD HYDROGRAPH PACKAGE (HEC-1)
 DAM SAFETY VERSION JULY 1978
 LAST MODIFICATION 26 FEB 79

| ANALYSIS OF DAM OVERTOPPING USING RATIOS OF PMF HYDROLOGIC-HYDRAULIC ANALYSIS OF SAFETY OF NY 501 RATIOS OF PMF ROUTED THROUGH THE RESERVOIR | | | | | | | | | | |
|--|----|----------------------------------|------|-----|------|------|------|-----|------|------|
| 1 | A1 | | | | | | | | | |
| 2 | A2 | | | | | | | | | |
| 3 | A3 | | | | | | | | | |
| 4 | B | 150 | 0 | 12 | 0 | 0 | 0 | 0 | 0 | 0 |
| 5 | B1 | 5 | | | | | | | | |
| 6 | J | 1 | 6 | 1 | | | | | | |
| 7 | J1 | .2 | .35 | .50 | .65 | .80 | 1 | | | |
| 8 | K | 0 | 1 | 0 | 0 | 0 | 0 | 1 | | |
| 9 | K1 | CALCULATION OF INFLOW HYDROGRAPH | | | | | | | | |
| 10 | M | 1 | 1 | .53 | 0 | .53 | 0 | 0 | 0 | 0 |
| 11 | P | | 22.6 | 116 | 127 | 141 | 0 | 0 | 0 | 0 |
| 12 | T | 0 | 0 | 0 | 0 | 0 | 0 | 1 | .1 | 0 |
| 13 | W | 1.00 | .63 | | | | | | | |
| 14 | X | -2 | -.1 | 2 | | | | | | |
| 15 | K | 1 | 2 | 0 | 0 | 0 | 0 | 1 | 0 | 0 |
| 16 | K1 | ROUTING OF INFLOW HYDROGRAPH | | | | | | | | |
| 17 | Y | 0 | 0 | 0 | 1 | 1 | | | | |
| 18 | Y1 | 1 | 0 | 0 | 0 | 0 | 0 | -1 | | |
| 19 | Y2 | 0 | 12.5 | 31 | 47.5 | 60 | 67.8 | 76 | 85.5 | 96 |
| 20 | Y2 | 126 | 128 | | | | | | | |
| 21 | Y3 | 0 | 5 | 7.8 | 9.4 | 10.3 | 32.3 | 155 | 654 | 1657 |
| 22 | Y3 | 4962 | 5113 | | | | | | | 3060 |
| 23 | K | 99 | | | | | | | | |



PREVIEW OF SEQUENCE OF STREAM NETWORK CALCULATIONS

| | |
|----------------------|---|
| RUNOFF HYDROGRAPH AT | 1 |
| ROUTE HYDROGRAPH TO | 2 |
| END OF NETWORK | |



 FLOOD HYDROGRAPH PACKAGE (HEC-1)
 DAM SAFETY VERSION JULY 1978
 LAST MODIFICATION 26 FEB 79

TIME OF EXECUTION 30-JUL-80 11:33:50

ANALYSIS OF DAM OVERTOPPING USING RATIOS OF PMF
 HYDROLOGIC-HYDRAULIC ANALYSIS OF SAFETY OF NY 581
 RATIOS OF PMF ROUTED THROUGH THE RESERVOIR

JOB SPECIFICATION
 NQ NHR NMIN IDAY IHR IMIN METRC IPLT IPRT NSTAN
 150 0 12 0 0 0 0 0 0 0
 JOPER NWT LROPT TRACE
 5 0 0 0

MULTI-PLAN ANALYSES TO BE PERFORMED
 NPLAN= 1 NRTIO= 6 LRTIO= 1
 RTIOS= 0.20 0.35 0.50 0.65 0.80 1.00

SUB-AREA RUNOFF COMPUTATION

CALCULATION OF INFLOW HYDROGRAPH

ISTAG ICOMP IECON ITAPE JPLT JPRT INAME ISTAGE IAUTO
 1 0 0 0 0 0 1 0 0

HYDROGRAPH DATA
 IHYDG IUHG TAREA SNAP TRSDA TRSPC RATIO ISNOW ISAME LOCAL
 1 1 0.53 0.00 0.53 0.00 0.000 0 0 0

PRECIP DATA
 SPFE PMS R6 R12 R24 R48 R72 R96
 0.00 22.60 116.00 127.00 141.00 0.00 0.00 0.00

TRSPC COMPUTED BY THE PROGRAM IS 0.800

LOSS DATA
 LROPT STRKR DLTKR RTIOL ERAIN STRKS RTIOK SIRIL CNSTL ALSMX RTIMP
 0 0.00 0.00 1.00 0.00 0.00 1.00 1.00 0.10 0.00 0.00

UNIT HYDROGRAPH DATA
 TP= 1.00 CP=0.63 NTA= 0

RECESSION DATA
 STRTO= -2.00 QRCSN= -0.10 RTIOR= 2.00
 APPROXIMATE CLARK COEFFICIENTS FROM GIVEN SNYDER CP AND TP ARE IC= 5.82 AND K= 4.39 INTERVALS

UNIT HYDROGRAPH 27 END-OF-PERIOD ORDINATES, LAG= 0.99 HOURS, CP= 0.63 VOL= 1.00
 18. 64. 125. 181. 214. 214. 183. 146. 116. 92.
 73. 58. 46. 37. 29. 23. 19. 15. 12. 9.
 7. 6. 5. 4. 3. 2. 2.

McFARLAND-JOHNSON ENGINEERS INC

| MO. DA | HR. MN | PERIOD | RAIN | EXCS | LOSS | COMP Q | MO. DA | HR. MN | PERIOD | RAIN | EXCS | LOSS | COMP Q |
|--------|--------|--------|------|------|------|--------|--------|--------|--------|------|------|------|--------|
| 1.01 | 0.12 | 1 | 0.03 | 0.00 | 0.03 | 1. | 1.01 | 15.12 | 76 | 0.80 | 0.78 | 0.02 | 875. |
| 1.01 | 0.24 | 2 | 0.03 | 0.00 | 0.03 | 1. | 1.01 | 15.24 | 77 | 1.43 | 1.41 | 0.02 | 932. |
| 1.01 | 0.36 | 3 | 0.03 | 0.00 | 0.03 | 1. | 1.01 | 15.36 | 78 | 3.98 | 3.96 | 0.02 | 1066. |
| 1.01 | 0.48 | 4 | 0.03 | 0.00 | 0.03 | 1. | 1.01 | 15.48 | 79 | 1.28 | 1.26 | 0.02 | 1313. |
| 1.01 | 1.00 | 5 | 0.03 | 0.00 | 0.03 | 1. | 1.01 | 16.00 | 80 | 0.64 | 0.62 | 0.02 | 1615. |
| 1.01 | 1.12 | 6 | 0.03 | 0.00 | 0.03 | 1. | 1.01 | 16.12 | 81 | 0.59 | 0.57 | 0.02 | 1883. |
| 1.01 | 1.24 | 7 | 0.03 | 0.00 | 0.03 | 1. | 1.01 | 16.24 | 82 | 0.59 | 0.57 | 0.02 | 2035. |
| 1.01 | 1.36 | 8 | 0.03 | 0.00 | 0.03 | 1. | 1.01 | 16.36 | 83 | 0.59 | 0.57 | 0.02 | 2027. |
| 1.01 | 1.48 | 9 | 0.03 | 0.00 | 0.03 | 1. | 1.01 | 16.48 | 84 | 0.59 | 0.57 | 0.02 | 1888. |
| 1.01 | 2.00 | 10 | 0.03 | 0.00 | 0.03 | 1. | 1.01 | 17.00 | 85 | 0.59 | 0.57 | 0.02 | 1711. |
| 1.01 | 2.12 | 11 | 0.03 | 0.00 | 0.03 | 0. | 1.01 | 17.12 | 86 | 0.46 | 0.44 | 0.02 | 1558. |
| 1.01 | 2.24 | 12 | 0.03 | 0.00 | 0.03 | 0. | 1.01 | 17.24 | 87 | 0.46 | 0.44 | 0.02 | 1429. |
| 1.01 | 2.36 | 13 | 0.03 | 0.00 | 0.03 | 0. | 1.01 | 17.36 | 88 | 0.46 | 0.44 | 0.02 | 1317. |
| 1.01 | 2.48 | 14 | 0.03 | 0.00 | 0.03 | 0. | 1.01 | 17.48 | 89 | 0.46 | 0.44 | 0.02 | 1217. |
| 1.01 | 3.00 | 15 | 0.03 | 0.00 | 0.03 | 0. | 1.01 | 18.00 | 90 | 0.46 | 0.44 | 0.02 | 1129. |
| 1.01 | 3.12 | 16 | 0.03 | 0.00 | 0.03 | 0. | 1.01 | 18.12 | 91 | 0.05 | 0.03 | 0.02 | 1046. |
| 1.01 | 3.24 | 17 | 0.03 | 0.00 | 0.03 | 0. | 1.01 | 18.24 | 92 | 0.05 | 0.03 | 0.02 | 958. |
| 1.01 | 3.36 | 18 | 0.03 | 0.00 | 0.03 | 0. | 1.01 | 18.36 | 93 | 0.05 | 0.03 | 0.02 | 858. |
| 1.01 | 3.48 | 19 | 0.03 | 0.00 | 0.03 | 0. | 1.01 | 18.48 | 94 | 0.05 | 0.03 | 0.02 | 744. |
| 1.01 | 4.00 | 20 | 0.03 | 0.00 | 0.03 | 0. | 1.01 | 19.00 | 95 | 0.05 | 0.03 | 0.02 | 625. |
| 1.01 | 4.12 | 21 | 0.03 | 0.00 | 0.03 | 0. | 1.01 | 19.12 | 96 | 0.05 | 0.03 | 0.02 | 512. |
| 1.01 | 4.24 | 22 | 0.03 | 0.00 | 0.03 | 0. | 1.01 | 19.24 | 97 | 0.05 | 0.03 | 0.02 | 418. |
| 1.01 | 4.36 | 23 | 0.03 | 0.00 | 0.03 | 0. | 1.01 | 19.36 | 98 | 0.05 | 0.03 | 0.02 | 342. |
| 1.01 | 4.48 | 24 | 0.03 | 0.00 | 0.03 | 0. | 1.01 | 19.48 | 99 | 0.05 | 0.03 | 0.02 | 282. |
| 1.01 | 5.00 | 25 | 0.03 | 0.00 | 0.03 | 0. | 1.01 | 20.00 | 100 | 0.05 | 0.03 | 0.02 | 234. |
| 1.01 | 5.12 | 26 | 0.03 | 0.00 | 0.03 | 0. | 1.01 | 20.12 | 101 | 0.05 | 0.03 | 0.02 | 201. |
| 1.01 | 5.24 | 27 | 0.03 | 0.00 | 0.03 | 0. | 1.01 | 20.24 | 102 | 0.05 | 0.03 | 0.02 | 187. |
| 1.01 | 5.36 | 28 | 0.03 | 0.00 | 0.03 | 0. | 1.01 | 20.36 | 103 | 0.05 | 0.03 | 0.02 | 175. |
| 1.01 | 5.48 | 29 | 0.03 | 0.00 | 0.03 | 0. | 1.01 | 20.48 | 104 | 0.05 | 0.03 | 0.02 | 163. |
| 1.01 | 6.00 | 30 | 0.03 | 0.01 | 0.03 | 0. | 1.01 | 21.00 | 105 | 0.05 | 0.03 | 0.02 | 152. |
| 1.01 | 6.12 | 31 | 0.07 | 0.05 | 0.02 | 1. | 1.01 | 21.12 | 106 | 0.05 | 0.03 | 0.02 | 142. |
| 1.01 | 6.24 | 32 | 0.07 | 0.05 | 0.02 | 5. | 1.01 | 21.24 | 107 | 0.05 | 0.03 | 0.02 | 132. |
| 1.01 | 6.36 | 33 | 0.07 | 0.05 | 0.02 | 11. | 1.01 | 21.36 | 108 | 0.05 | 0.03 | 0.02 | 124. |
| 1.01 | 6.48 | 34 | 0.07 | 0.05 | 0.02 | 19. | 1.01 | 21.48 | 109 | 0.05 | 0.03 | 0.02 | 115. |
| 1.01 | 7.00 | 35 | 0.07 | 0.05 | 0.02 | 29. | 1.01 | 22.00 | 110 | 0.05 | 0.03 | 0.02 | 108. |
| 1.01 | 7.12 | 36 | 0.07 | 0.05 | 0.02 | 39. | 1.01 | 22.12 | 111 | 0.05 | 0.03 | 0.02 | 100. |
| 1.01 | 7.24 | 37 | 0.07 | 0.05 | 0.02 | 47. | 1.01 | 22.24 | 112 | 0.05 | 0.03 | 0.02 | 94. |
| 1.01 | 7.36 | 38 | 0.07 | 0.05 | 0.02 | 54. | 1.01 | 22.36 | 113 | 0.05 | 0.03 | 0.02 | 87. |
| 1.01 | 7.48 | 39 | 0.07 | 0.05 | 0.02 | 59. | 1.01 | 22.48 | 114 | 0.05 | 0.03 | 0.02 | 82. |
| 1.01 | 8.00 | 40 | 0.07 | 0.05 | 0.02 | 63. | 1.01 | 23.00 | 115 | 0.05 | 0.03 | 0.02 | 76. |
| 1.01 | 8.12 | 41 | 0.07 | 0.05 | 0.02 | 66. | 1.01 | 23.12 | 116 | 0.05 | 0.03 | 0.02 | 71. |
| 1.01 | 8.24 | 42 | 0.07 | 0.05 | 0.02 | 69. | 1.01 | 23.24 | 117 | 0.05 | 0.03 | 0.02 | 66. |
| 1.01 | 8.36 | 43 | 0.07 | 0.05 | 0.02 | 71. | 1.01 | 23.36 | 118 | 0.05 | 0.03 | 0.02 | 62. |
| 1.01 | 8.48 | 44 | 0.07 | 0.05 | 0.02 | 73. | 1.01 | 23.48 | 119 | 0.05 | 0.03 | 0.02 | 58. |
| 1.01 | 9.00 | 45 | 0.07 | 0.05 | 0.02 | 74. | 1.02 | 0.00 | 120 | 0.05 | 0.03 | 0.02 | 54. |
| 1.01 | 9.12 | 46 | 0.07 | 0.05 | 0.02 | 75. | 1.02 | 0.12 | 121 | 0.00 | 0.00 | 0.00 | 52. |
| 1.01 | 9.24 | 47 | 0.07 | 0.05 | 0.02 | 76. | 1.02 | 0.24 | 122 | 0.00 | 0.00 | 0.00 | 50. |
| 1.01 | 9.36 | 48 | 0.07 | 0.05 | 0.02 | 77. | 1.02 | 0.36 | 123 | 0.00 | 0.00 | 0.00 | 46. |
| 1.01 | 9.48 | 49 | 0.07 | 0.05 | 0.02 | 77. | 1.02 | 0.48 | 124 | 0.00 | 0.00 | 0.00 | 43. |
| 1.01 | 10.00 | 50 | 0.07 | 0.05 | 0.02 | 78. | 1.02 | 1.00 | 125 | 0.00 | 0.00 | 0.00 | 40. |
| 1.01 | 10.12 | 51 | 0.07 | 0.05 | 0.02 | 78. | 1.02 | 1.12 | 126 | 0.00 | 0.00 | 0.00 | 38. |
| 1.01 | 10.24 | 52 | 0.07 | 0.05 | 0.02 | 78. | 1.02 | 1.24 | 127 | 0.00 | 0.00 | 0.00 | 35. |
| 1.01 | 10.36 | 53 | 0.07 | 0.05 | 0.02 | 78. | 1.02 | 1.36 | 128 | 0.00 | 0.00 | 0.00 | 33. |
| 1.01 | 10.48 | 54 | 0.07 | 0.05 | 0.02 | 78. | 1.02 | 1.48 | 129 | 0.00 | 0.00 | 0.00 | 31. |
| 1.01 | 11.00 | 55 | 0.07 | 0.05 | 0.02 | 79. | 1.02 | 2.00 | 130 | 0.00 | 0.00 | 0.00 | 29. |
| 1.01 | 11.12 | 56 | 0.07 | 0.05 | 0.02 | 79. | 1.02 | 2.12 | 131 | 0.00 | 0.00 | 0.00 | 27. |
| 1.01 | 11.24 | 57 | 0.07 | 0.05 | 0.02 | 79. | 1.02 | 2.24 | 132 | 0.00 | 0.00 | 0.00 | 25. |
| 1.01 | 11.36 | 58 | 0.07 | 0.05 | 0.02 | 79. | 1.02 | 2.36 | 133 | 0.00 | 0.00 | 0.00 | 23. |
| 1.01 | 11.48 | 59 | 0.07 | 0.05 | 0.02 | 79. | 1.02 | 2.48 | 134 | 0.00 | 0.00 | 0.00 | 22. |

McGILLAND-JOHNSON ENGINEERS, INC.

| | | | | | | | | | | | | | |
|------|-------|----|------|------|------|------|------|------|-----|------|------|------|-----|
| 1.01 | 12.00 | 60 | 0.07 | 0.05 | 0.02 | 79. | 1.02 | 3.00 | 135 | 0.00 | 0.00 | 0.00 | 20. |
| 1.01 | 12.12 | 61 | 0.42 | 0.40 | 0.02 | 85. | 1.02 | 3.12 | 136 | 0.00 | 0.00 | 0.00 | 19. |
| 1.01 | 12.24 | 62 | 0.42 | 0.40 | 0.02 | 108. | 1.02 | 3.24 | 137 | 0.00 | 0.00 | 0.00 | 18. |
| 1.01 | 12.36 | 63 | 0.42 | 0.40 | 0.02 | 152. | 1.02 | 3.36 | 138 | 0.00 | 0.00 | 0.00 | 16. |
| 1.01 | 12.48 | 64 | 0.42 | 0.40 | 0.02 | 216. | 1.02 | 3.48 | 139 | 0.00 | 0.00 | 0.00 | 15. |
| 1.01 | 13.00 | 65 | 0.42 | 0.40 | 0.02 | 291. | 1.02 | 4.00 | 140 | 0.00 | 0.00 | 0.00 | 14. |
| 1.01 | 13.12 | 66 | 0.50 | 0.48 | 0.02 | 368. | 1.02 | 4.12 | 141 | 0.00 | 0.00 | 0.00 | 13. |
| 1.01 | 13.24 | 67 | 0.50 | 0.48 | 0.02 | 438. | 1.02 | 4.24 | 142 | 0.00 | 0.00 | 0.00 | 12. |
| 1.01 | 13.36 | 68 | 0.50 | 0.48 | 0.02 | 500. | 1.02 | 4.36 | 143 | 0.00 | 0.00 | 0.00 | 12. |
| 1.01 | 13.48 | 69 | 0.50 | 0.48 | 0.02 | 556. | 1.02 | 4.48 | 144 | 0.00 | 0.00 | 0.00 | 11. |
| 1.01 | 14.00 | 70 | 0.50 | 0.48 | 0.02 | 606. | 1.02 | 5.00 | 145 | 0.00 | 0.00 | 0.00 | 10. |
| 1.01 | 14.12 | 71 | 0.63 | 0.61 | 0.02 | 652. | 1.02 | 5.12 | 146 | 0.00 | 0.00 | 0.00 | 9. |
| 1.01 | 14.24 | 72 | 0.63 | 0.61 | 0.02 | 696. | 1.02 | 5.24 | 147 | 0.00 | 0.00 | 0.00 | 9. |
| 1.01 | 14.36 | 73 | 0.63 | 0.61 | 0.02 | 741. | 1.02 | 5.36 | 148 | 0.00 | 0.00 | 0.00 | 8. |
| 1.01 | 14.48 | 74 | 0.63 | 0.61 | 0.02 | 786. | 1.02 | 5.48 | 149 | 0.00 | 0.00 | 0.00 | 8. |
| 1.01 | 15.00 | 75 | 0.63 | 0.61 | 0.02 | 831. | 1.02 | 6.00 | 150 | 0.00 | 0.00 | 0.00 | 7. |

SUM 25.65 22.84 2.81 39843.
(652.)(580.)(71.)(1128.23)

| | PEAK | 6-HOUR | 24-HOUR | 72-HOUR | TOTAL VOLUME |
|------------|-------|--------|---------|---------|--------------|
| CFS | 2035. | 1084. | 332. | 266. | 39835. |
| CMS | 58. | 31. | 9. | 8. | 1128. |
| INCHES | | 19.03 | 23.30 | 23.31 | 23.31 |
| MM | | 483.46 | 591.78 | 591.96 | 591.96 |
| AC-FT | | 536. | 658. | 658. | 658. |
| THOUS CU M | | 663. | 812. | 812. | 812. |

HYDROGRAPH AT STA 1 FOR PLAN 1, RT10 1

| | | | | | | | | | |
|------|------|------|------|------|------|------|------|------|------|
| 0. | 0. | 0. | 0. | 0. | 0. | 0. | 0. | 0. | 0. |
| 0. | 0. | 0. | 0. | 0. | 0. | 0. | 0. | 0. | 0. |
| 0. | 0. | 0. | 0. | 0. | 0. | 0. | 0. | 0. | 0. |
| 0. | 1. | 2. | 4. | 6. | 8. | 9. | 11. | 12. | 13. |
| 13. | 14. | 14. | 15. | 15. | 15. | 15. | 15. | 15. | 16. |
| 16. | 16. | 16. | 16. | 16. | 16. | 16. | 16. | 16. | 16. |
| 17. | 22. | 30. | 43. | 58. | 74. | 88. | 100. | 111. | 121. |
| 130. | 139. | 148. | 157. | 166. | 175. | 186. | 213. | 263. | 323. |
| 377. | 407. | 405. | 378. | 342. | 312. | 286. | 263. | 243. | 226. |
| 209. | 192. | 172. | 149. | 125. | 102. | 84. | 68. | 56. | 47. |
| 40. | 37. | 35. | 33. | 30. | 28. | 26. | 25. | 23. | 22. |
| 20. | 19. | 17. | 16. | 15. | 14. | 13. | 12. | 12. | 11. |
| 10. | 10. | 9. | 9. | 8. | 8. | 7. | 7. | 6. | 6. |
| 5. | 5. | 5. | 4. | 4. | 4. | 4. | 3. | 3. | 3. |
| 3. | 2. | 2. | 2. | 2. | 2. | 2. | 2. | 2. | 1. |

| | PEAK | 6-HOUR | 24-HOUR | 72-HOUR | TOTAL VOLUME |
|------------|------|--------|---------|---------|--------------|
| CFS | 407. | 217. | 66. | 53. | 7967. |
| CMS | 12. | 6. | 2. | 2. | 226. |
| INCHES | | 3.81 | 4.66 | 4.66 | 4.66 |
| MM | | 96.69 | 118.36 | 118.39 | 118.39 |
| AC-FT | | 108. | 132. | 132. | 132. |
| THOUS CU M | | 133. | 162. | 162. | 162. |

HYDROGRAPH AT STA 1 FOR PLAN 1, RT10 2

| | | | | | | | | | |
|----|----|----|----|----|----|----|----|----|----|
| 0. | 0. | 0. | 0. | 0. | 0. | 0. | 0. | 0. | 0. |
| 0. | 0. | 0. | 0. | 0. | 0. | 0. | 0. | 0. | 0. |

McFARLAND-JOHNSON ENGINEERS, INC

| | | | | | | | | | |
|------|------|------|------|------|------|------|------|------|------|
| 0. | 2. | 4. | 7. | 10. | 14. | 16. | 19. | 21. | 22. |
| 23. | 24. | 25. | 25. | 26. | 26. | 27. | 27. | 27. | 27. |
| 27. | 27. | 27. | 27. | 28. | 28. | 28. | 28. | 28. | 28. |
| 30. | 38. | 53. | 75. | 102. | 129. | 153. | 175. | 195. | 212. |
| 228. | 244. | 259. | 275. | 291. | 306. | 326. | 373. | 459. | 565. |
| 659. | 712. | 709. | 661. | 599. | 545. | 500. | 461. | 426. | 395. |
| 366. | 335. | 300. | 260. | 219. | 179. | 146. | 120. | 99. | 82. |
| 70. | 66. | 61. | 57. | 53. | 50. | 46. | 43. | 40. | 38. |
| 35. | 33. | 31. | 29. | 27. | 25. | 23. | 22. | 20. | 19. |
| 18. | 17. | 16. | 15. | 14. | 13. | 12. | 11. | 11. | 10. |
| 9. | 9. | 8. | 8. | 7. | 7. | 6. | 6. | 5. | 5. |
| 5. | 4. | 4. | 4. | 4. | 3. | 3. | 3. | 3. | 2. |

| | PEAK | 6-HOUR | 24-HOUR | 72-HOUR | TOTAL VOLUME |
|------------|------|--------|---------|---------|--------------|
| CFS | 712. | 380. | 116. | 93. | 13942. |
| CMS | 20. | 11. | 3. | 3. | 395. |
| INCHES | | 6.66 | 8.15 | 8.16 | 8.16 |
| MM | | 169.21 | 207.12 | 207.19 | 207.19 |
| AC-FT | | 188. | 230. | 230. | 230. |
| THOUS CU M | | 232. | 284. | 284. | 284. |

| HYDROGRAPH AT STA | | | | 1 FOR PLAN 1, RTIO 3 | | | | | |
|-------------------|-------|-------|------|----------------------|------|------|------|------|------|
| 0. | 0. | 0. | 0. | 0. | 0. | 0. | 0. | 0. | 0. |
| 0. | 0. | 0. | 0. | 0. | 0. | 0. | 0. | 0. | 0. |
| 0. | 0. | 0. | 0. | 0. | 0. | 0. | 0. | 0. | 0. |
| 1. | 2. | 5. | 10. | 15. | 19. | 24. | 27. | 29. | 31. |
| 33. | 34. | 36. | 36. | 37. | 38. | 38. | 38. | 39. | 39. |
| 39. | 39. | 39. | 39. | 39. | 39. | 39. | 39. | 39. | 39. |
| 43. | 54. | 76. | 108. | 146. | 184. | 219. | 250. | 278. | 303. |
| 326. | 348. | 370. | 393. | 416. | 438. | 466. | 533. | 656. | 808. |
| 942. | 1017. | 1013. | 944. | 856. | 779. | 714. | 658. | 608. | 564. |
| 523. | 479. | 429. | 372. | 312. | 256. | 209. | 171. | 141. | 117. |
| 100. | 94. | 87. | 82. | 76. | 71. | 66. | 62. | 58. | 54. |
| 50. | 47. | 44. | 41. | 38. | 35. | 33. | 31. | 29. | 27. |
| 26. | 25. | 23. | 22. | 20. | 19. | 18. | 16. | 15. | 14. |
| 13. | 12. | 12. | 11. | 10. | 9. | 9. | 8. | 8. | 7. |
| 7. | 6. | 6. | 5. | 5. | 5. | 4. | 4. | 4. | 4. |

| | PEAK | 6-HOUR | 24-HOUR | 72-HOUR | TOTAL VOLUME |
|------------|-------|--------|---------|---------|--------------|
| CFS | 1017. | 542. | 166. | 133. | 19918. |
| CMS | 29. | 15. | 5. | 4. | 564. |
| INCHES | | 9.52 | 11.65 | 11.65 | 11.65 |
| MM | | 241.73 | 295.89 | 295.98 | 295.98 |
| AC-FT | | 269. | 329. | 329. | 329. |
| THOUS CU M | | 332. | 406. | 406. | 406. |

| HYDROGRAPH AT STA | | | | 1 FOR PLAN 1, RTIO 4 | | | | | |
|-------------------|-------|-------|-------|----------------------|------|------|------|------|-------|
| 1. | 1. | 1. | 1. | 0. | 0. | 0. | 0. | 0. | 0. |
| 0. | 0. | 0. | 0. | 0. | 0. | 0. | 0. | 0. | 0. |
| 0. | 0. | 0. | 0. | 0. | 0. | 0. | 0. | 0. | 0. |
| 1. | 3. | 7. | 12. | 19. | 25. | 31. | 35. | 38. | 41. |
| 43. | 45. | 46. | 47. | 48. | 49. | 49. | 50. | 50. | 50. |
| 51. | 51. | 51. | 51. | 51. | 51. | 51. | 51. | 51. | 51. |
| 55. | 70. | 99. | 140. | 189. | 239. | 285. | 325. | 361. | 394. |
| 424. | 453. | 481. | 511. | 540. | 569. | 606. | 693. | 853. | 1050. |
| 1224. | 1323. | 1317. | 1184. | 1066. | 933. | 829. | 856. | 791. | 734. |
| 680. | 623. | 557. | 484. | 406. | 333. | 271. | 222. | 183. | 152. |

McORLAND-JOBSON ENGINEERS, INC.

| | | | | | | | | | |
|------|------|------|------|-----|-----|-----|-----|-----|-----|
| 130. | 122. | 114. | 106. | 99. | 92. | 86. | 80. | 75. | 70. |
| 65. | 61. | 57. | 53. | 49. | 46. | 43. | 40. | 37. | 35. |
| 34. | 32. | 30. | 28. | 26. | 24. | 23. | 21. | 20. | 19. |
| 17. | 16. | 15. | 14. | 13. | 12. | 11. | 11. | 10. | 9. |
| 9. | 8. | 8. | 7. | 7. | 6. | 6. | 5. | 5. | 5. |

| | PEAK | 6-HOUR | 24-HOUR | 72-HOUR | TOTAL VOLUME |
|------------|-------|--------|---------|---------|--------------|
| CFS | 1323. | 705. | 216. | 173. | 25893. |
| CMS | 37. | 20. | 6. | 5. | 733. |
| INCHES | | 12.37 | 15.14 | 15.15 | 15.15 |
| MM | | 314.25 | 384.66 | 384.78 | 384.78 |
| AC-FT | | 350. | 428. | 428. | 428. |
| THOUS CU M | | 431. | 528. | 528. | 528. |

HYDROGRAPH AT STA 1 FOR PLAN 1, RTIO 5

| | | | | | | | | | |
|-------|-------|-------|-------|-------|-------|-------|-------|-------|-------|
| 1. | 1. | 1. | 1. | 1. | 1. | 1. | 0. | 0. | 0. |
| 0. | 0. | 0. | 0. | 0. | 0. | 0. | 0. | 0. | 0. |
| 0. | 0. | 0. | 0. | 0. | 0. | 0. | 0. | 0. | 0. |
| 1. | 4. | 8. | 15. | 23. | 31. | 38. | 43. | 47. | 50. |
| 53. | 55. | 57. | 58. | 59. | 60. | 61. | 61. | 62. | 62. |
| 62. | 62. | 63. | 63. | 63. | 63. | 63. | 63. | 63. | 63. |
| 68. | 86. | 121. | 172. | 233. | 295. | 350. | 400. | 445. | 485. |
| 522. | 557. | 593. | 629. | 665. | 700. | 745. | 853. | 1050. | 1292. |
| 1507. | 1628. | 1621. | 1510. | 1369. | 1246. | 1143. | 1053. | 973. | 903. |
| 837. | 766. | 686. | 595. | 500. | 410. | 334. | 274. | 225. | 187. |
| 161. | 150. | 140. | 130. | 122. | 114. | 106. | 99. | 92. | 86. |
| 80. | 75. | 70. | 65. | 61. | 57. | 53. | 49. | 46. | 43. |
| 41. | 40. | 37. | 35. | 32. | 30. | 28. | 26. | 24. | 23. |
| 21. | 20. | 19. | 17. | 16. | 15. | 14. | 13. | 12. | 11. |
| 11. | 10. | 9. | 9. | 8. | 8. | 7. | 7. | 6. | 6. |

| | PEAK | 6-HOUR | 24-HOUR | 72-HOUR | TOTAL VOLUME |
|------------|-------|--------|---------|---------|--------------|
| CFS | 1628. | 868. | 265. | 212. | 3186P. |
| CMS | 46. | 25. | 8. | 6. | 902. |
| INCHES | | 15.23 | 18.64 | 18.64 | 18.64 |
| MM | | 386.77 | 473.42 | 473.57 | 473.57 |
| AC-FT | | 430. | 527. | 527. | 527. |
| THOUS CU M | | 531. | 650. | 650. | 650. |

HYDROGRAPH AT STA 1 FOR PLAN 1, RTIO 6

| | | | | | | | | | |
|-------|-------|-------|-------|-------|-------|-------|-------|-------|-------|
| 1. | 1. | 1. | 1. | 1. | 1. | 1. | 1. | 1. | 1. |
| 0. | 0. | 0. | 0. | 0. | 0. | 0. | 0. | 0. | 0. |
| 0. | 0. | 0. | 0. | 0. | 0. | 0. | 0. | 0. | 0. |
| 1. | 5. | 11. | 19. | 29. | 39. | 47. | 54. | 59. | 63. |
| 66. | 69. | 71. | 73. | 74. | 75. | 76. | 77. | 77. | 78. |
| 78. | 78. | 78. | 78. | 79. | 79. | 79. | 79. | 79. | 79. |
| 85. | 108. | 152. | 216. | 291. | 368. | 438. | 500. | 556. | 606. |
| 652. | 696. | 741. | 786. | 831. | 875. | 932. | 1066. | 1313. | 1615. |
| 1883. | 2035. | 2027. | 1888. | 1711. | 1558. | 1429. | 1317. | 1217. | 1129. |
| 1046. | 958. | 858. | 744. | 625. | 512. | 418. | 342. | 282. | 234. |
| 201. | 187. | 175. | 163. | 152. | 142. | 132. | 124. | 115. | 108. |
| 100. | 94. | 87. | 82. | 76. | 71. | 66. | 62. | 58. | 54. |
| 52. | 50. | 46. | 43. | 40. | 38. | 35. | 33. | 31. | 29. |
| 27. | 25. | 23. | 22. | 20. | 19. | 18. | 16. | 15. | 14. |
| 13. | 12. | 12. | 11. | 10. | 9. | 9. | 8. | 8. | 7. |

McFARLAND-JOHNSON ENGINEERS INC



| | | | | | |
|------------|-------|--------|--------|--------|--------|
| CFS | 2035. | 1084. | 332. | 266. | 39835. |
| CMS | 58. | 31. | 9. | 8. | 1128. |
| INCHES | | 19.03 | 23.30 | 23.31 | 23.31 |
| MM | | 483.46 | 591.78 | 591.96 | 591.96 |
| AC-FT | | 538. | 658. | 658. | 658. |
| THOUS CU M | | 663. | 812. | 812. | 812. |

HYDROGRAPH ROUTING

ROUTING OF INFLOW HYDROGRAPH

| | ISTAQ | ICOMP | IECON | ITAPE | JPLT | JPRT | INAME | ISTAGE | IAUTO |
|---------|--------------|---------|-------|-------|-------|-------|--------|--------|---------|
| | 2 | 1 | 0 | 0 | 0 | 0 | 1 | 0 | 0 |
| | ROUTING DATA | | | | | | | | |
| | QLOSS | CLOSS | AVG | IRES | ISAME | IOPT | IPMP | LSTR | |
| | 0.0 | 0.000 | 0.00 | 1 | 1 | 0 | 0 | 0 | |
| | NSIPS | NSIDL | LAG | AMSKK | X | TSK | STORA | ISPRAT | |
| | 1 | 0 | 0 | 0.000 | 0.000 | 0.000 | -1. | 0 | |
| STORAGE | 0.00 | 12.50 | 31.00 | 47.50 | 60.00 | 67.80 | 76.00 | 85.50 | 96.00 |
| | 126.00 | 128.00 | | | | | | | |
| OUTFLOW | 0.00 | 5.00 | 7.80 | 9.40 | 10.30 | 32.30 | 155.00 | 654.00 | 1657.00 |
| | 4962.00 | 5113.00 | | | | | | | |

STATION 2, PLAN 1, RTIO 1

| OUTFLOW | | | | | | | | | |
|---------|------|------|------|------|------|------|------|------|------|
| 0. | 0. | 0. | 0. | 0. | 0. | 0. | 0. | 0. | 0. |
| 0. | 0. | 0. | 0. | 0. | 0. | 0. | 0. | 0. | 0. |
| 0. | 0. | 0. | 0. | 0. | 0. | 0. | 0. | 0. | 0. |
| 0. | 0. | 0. | 0. | 0. | 0. | 0. | 0. | 0. | 0. |
| 1. | 1. | 1. | 1. | 1. | 1. | 1. | 1. | 1. | 1. |
| 2. | 2. | 2. | 2. | 2. | 2. | 2. | 2. | 2. | 2. |
| 2. | 3. | 3. | 3. | 3. | 4. | 4. | 5. | 5. | 5. |
| 6. | 6. | 6. | 7. | 7. | 8. | 8. | 8. | 9. | 9. |
| 10. | 10. | 17. | 41. | 111. | 166. | 246. | 263. | 257. | 244. |
| 228. | 211. | 193. | 173. | 154. | 145. | 133. | 121. | 108. | 96. |
| 84. | 74. | 66. | 59. | 53. | 48. | 43. | 39. | 36. | 33. |
| 32. | 31. | 31. | 30. | 29. | 29. | 28. | 27. | 27. | 26. |
| 25. | 25. | 24. | 23. | 23. | 22. | 21. | 21. | 20. | 19. |
| 19. | 18. | 17. | 17. | 16. | 16. | 15. | 15. | 14. | 14. |
| 13. | 13. | 12. | 12. | 11. | 11. | 10. | 10. | 10. | 10. |
| STOR | | | | | | | | | |
| 0. | 0. | 0. | 0. | 0. | 0. | 0. | 0. | 0. | 0. |
| 0. | 0. | 0. | 0. | 0. | 0. | 0. | 0. | 0. | 0. |
| 0. | 0. | 0. | 0. | 0. | 0. | 0. | 0. | 0. | 0. |
| 0. | 0. | 0. | 1. | 1. | 1. | 1. | 1. | 1. | 1. |
| 2. | 2. | 2. | 2. | 2. | 3. | 3. | 3. | 3. | 4. |
| 3. | 4. | 4. | 5. | 5. | 5. | 5. | 5. | 6. | 6. |
| 6. | 6. | 7. | 7. | 8. | 9. | 10. | 12. | 14. | 15. |
| 17. | 20. | 22. | 22. | 22. | 22. | 32. | 35. | 39. | 44. |
| 50. | 56. | 62. | 68. | 73. | 76. | 78. | 78. | 78. | 78. |

McBRIDE - JOHNSON ENGINEERS, INC.

| | | | | | | | | | |
|-----|-----|-----|-----|-----|-----|-----|-----|-----|-----|
| 77. | 77. | 77. | 76. | 76. | 75. | 75. | 74. | 73. | 72. |
| 71. | 71. | 70. | 70. | 69. | 69. | 69. | 68. | 68. | 68. |
| 68. | 67. | 67. | 67. | 67. | 67. | 66. | 66. | 66. | 66. |
| 65. | 65. | 65. | 65. | 64. | 64. | 64. | 64. | 63. | 63. |
| 63. | 63. | 63. | 62. | 62. | 62. | 62. | 62. | 61. | 61. |
| 61. | 61. | 61. | 60. | 60. | 60. | 60. | 60. | 60. | 60. |

| STAGE | | | | | | | | | |
|-------|-----|-----|-----|-----|-----|-----|-----|-----|-----|
| 0.0 | 0.0 | 0.0 | 0.0 | 0.0 | 0.0 | 0.0 | 0.0 | 0.0 | 0.0 |
| 0.0 | 0.0 | 0.0 | 0.0 | 0.0 | 0.0 | 0.0 | 0.0 | 0.0 | 0.0 |
| 0.0 | 0.0 | 0.0 | 0.0 | 0.0 | 0.0 | 0.0 | 0.0 | 0.0 | 0.0 |
| 0.0 | 0.0 | 0.0 | 0.0 | 0.0 | 0.0 | 0.0 | 0.0 | 0.0 | 0.0 |
| 0.0 | 0.0 | 0.0 | 0.0 | 0.0 | 0.0 | 0.0 | 0.0 | 0.0 | 0.0 |
| 0.0 | 0.0 | 0.0 | 0.0 | 0.0 | 0.0 | 0.0 | 0.0 | 0.0 | 0.0 |
| 0.0 | 0.0 | 0.0 | 0.0 | 0.0 | 0.0 | 0.0 | 0.0 | 0.0 | 0.0 |
| 0.0 | 0.0 | 0.0 | 0.0 | 0.0 | 0.0 | 0.0 | 0.0 | 0.0 | 0.0 |
| 0.0 | 0.0 | 0.0 | 0.0 | 0.0 | 0.0 | 0.0 | 0.0 | 0.0 | 0.0 |
| 0.0 | 0.0 | 0.0 | 0.0 | 0.0 | 0.0 | 0.0 | 0.0 | 0.0 | 0.0 |
| 0.0 | 0.0 | 0.0 | 0.0 | 0.0 | 0.0 | 0.0 | 0.0 | 0.0 | 0.0 |
| 0.0 | 0.0 | 0.0 | 0.0 | 0.0 | 0.0 | 0.0 | 0.0 | 0.0 | 0.0 |
| 0.0 | 0.0 | 0.0 | 0.0 | 0.0 | 0.0 | 0.0 | 0.0 | 0.0 | 0.0 |
| 0.0 | 0.0 | 0.0 | 0.0 | 0.0 | 0.0 | 0.0 | 0.0 | 0.0 | 0.0 |
| 0.0 | 0.0 | 0.0 | 0.0 | 0.0 | 0.0 | 0.0 | 0.0 | 0.0 | 0.0 |
| 0.0 | 0.0 | 0.0 | 0.0 | 0.0 | 0.0 | 0.0 | 0.0 | 0.0 | 0.0 |
| 0.0 | 0.0 | 0.0 | 0.0 | 0.0 | 0.0 | 0.0 | 0.0 | 0.0 | 0.0 |
| 0.0 | 0.0 | 0.0 | 0.0 | 0.0 | 0.0 | 0.0 | 0.0 | 0.0 | 0.0 |
| 0.0 | 0.0 | 0.0 | 0.0 | 0.0 | 0.0 | 0.0 | 0.0 | 0.0 | 0.0 |
| 0.0 | 0.0 | 0.0 | 0.0 | 0.0 | 0.0 | 0.0 | 0.0 | 0.0 | 0.0 |
| 0.0 | 0.0 | 0.0 | 0.0 | 0.0 | 0.0 | 0.0 | 0.0 | 0.0 | 0.0 |
| 0.0 | 0.0 | 0.0 | 0.0 | 0.0 | 0.0 | 0.0 | 0.0 | 0.0 | 0.0 |

| | PEAK | 6-HOUR | 24-HOUR | 72-HOUR | TOTAL VOLUME |
|------------|------|--------|---------|---------|--------------|
| CFS | 263. | 117. | 37. | 29. | 4391. |
| CMS | 7. | 3. | 1. | 1. | 124. |
| INCHES | | 2.06 | 2.57 | 2.57 | 2.57 |
| MM | | 52.20 | 65.17 | 65.25 | 65.25 |
| AC-FT | | 58. | 72. | 73. | 73. |
| THOUS CU M | | 72. | 89. | 90. | 90. |

MAXIMUM STORAGE = 78.

STATION 2, PLAN 1, RTIO 2

| OUTFLOW | | | | | | | | | |
|---------|------|------|------|------|------|------|------|------|------|
| 0. | 0. | 0. | 0. | 0. | 0. | 0. | 0. | 0. | 0. |
| 0. | 0. | 0. | 0. | 0. | 0. | 0. | 0. | 0. | 0. |
| 0. | 0. | 0. | 0. | 0. | 0. | 0. | 0. | 0. | 0. |
| 0. | 0. | 0. | 0. | 0. | 0. | 1. | 1. | 1. | 1. |
| 1. | 1. | 1. | 2. | 2. | 2. | 2. | 2. | 2. | 3. |
| 3. | 3. | 3. | 3. | 3. | 3. | 4. | 4. | 4. | 4. |
| 4. | 4. | 5. | 5. | 5. | 6. | 6. | 6. | 7. | 7. |
| 8. | 8. | 9. | 9. | 9. | 10. | 10. | 18. | 49. | 151. |
| 424. | 582. | 663. | 682. | 642. | 600. | 553. | 509. | 469. | 434. |
| 402. | 371. | 339. | 303. | 265. | 225. | 187. | 155. | 145. | 133. |
| 120. | 109. | 99. | 90. | 82. | 76. | 69. | 64. | 59. | 55. |
| 51. | 47. | 44. | 41. | 38. | 35. | 33. | 32. | 31. | 31. |
| 30. | 30. | 29. | 29. | 28. | 27. | 27. | 26. | 25. | 25. |
| 24. | 23. | 23. | 22. | 21. | 21. | 20. | 19. | 19. | 18. |
| 17. | 17. | 16. | 16. | 15. | 15. | 14. | 14. | 13. | 13. |

| STOR | | | | | | | | | |
|------|----|----|----|----|----|----|----|----|----|
| 1. | 1. | 1. | 1. | 1. | 1. | 1. | 1. | 1. | 1. |
| 1. | 1. | 1. | 1. | 1. | 1. | 1. | 1. | 1. | 1. |
| 1. | 1. | 1. | 1. | 1. | 1. | 1. | 1. | 1. | 1. |

McFARLAND - JOHNSON ENGINEERS INC



| | | | | | | | | | |
|-----|-----|-----|-----|-----|-----|-----|-----|-----|-----|
| 3. | 3. | 4. | 4. | 4. | 5. | 5. | 6. | 6. | 6. |
| 7. | 7. | 9. | 8. | 8. | 9. | 9. | 10. | 10. | 10. |
| 11. | 11. | 12. | 13. | 14. | 16. | 18. | 21. | 24. | 27. |
| 31. | 34. | 38. | 43. | 47. | 52. | 57. | 63. | 69. | 76. |
| 81. | 84. | 86. | 86. | 85. | 84. | 84. | 83. | 82. | 81. |
| 81. | 80. | 79. | 79. | 78. | 77. | 77. | 76. | 75. | 75. |
| 74. | 73. | 72. | 72. | 71. | 71. | 70. | 70. | 70. | 69. |
| 69. | 69. | 69. | 68. | 68. | 68. | 68. | 68. | 67. | 67. |
| 67. | 67. | 67. | 66. | 66. | 66. | 66. | 66. | 65. | 65. |
| 65. | 65. | 64. | 64. | 64. | 64. | 63. | 63. | 63. | 63. |
| 63. | 62. | 62. | 62. | 62. | 62. | 61. | 61. | 61. | 61. |

| STAGE | | | | | | | | | |
|-------|-----|-----|-----|-----|-----|-----|-----|-----|-----|
| 0.0 | 0.0 | 0.0 | 0.0 | 0.0 | 0.0 | 0.0 | 0.0 | 0.0 | 0.0 |
| 0.0 | 0.0 | 0.0 | 0.0 | 0.0 | 0.0 | 0.0 | 0.0 | 0.0 | 0.0 |
| 0.0 | 0.0 | 0.0 | 0.0 | 0.0 | 0.0 | 0.0 | 0.0 | 0.0 | 0.0 |
| 0.0 | 0.0 | 0.0 | 0.0 | 0.0 | 0.0 | 0.0 | 0.0 | 0.0 | 0.0 |
| 0.0 | 0.0 | 0.0 | 0.0 | 0.0 | 0.0 | 0.0 | 0.0 | 0.0 | 0.0 |
| 0.0 | 0.0 | 0.0 | 0.0 | 0.0 | 0.0 | 0.0 | 0.0 | 0.0 | 0.0 |
| 0.0 | 0.0 | 0.0 | 0.0 | 0.0 | 0.0 | 0.0 | 0.0 | 0.0 | 0.0 |
| 0.0 | 0.0 | 0.0 | 0.0 | 0.0 | 0.0 | 0.0 | 0.0 | 0.0 | 0.0 |
| 0.0 | 0.0 | 0.0 | 0.0 | 0.0 | 0.0 | 0.0 | 0.0 | 0.0 | 0.0 |
| 0.0 | 0.0 | 0.0 | 0.0 | 0.0 | 0.0 | 0.0 | 0.0 | 0.0 | 0.0 |
| 0.0 | 0.0 | 0.0 | 0.0 | 0.0 | 0.0 | 0.0 | 0.0 | 0.0 | 0.0 |
| 0.0 | 0.0 | 0.0 | 0.0 | 0.0 | 0.0 | 0.0 | 0.0 | 0.0 | 0.0 |
| 0.0 | 0.0 | 0.0 | 0.0 | 0.0 | 0.0 | 0.0 | 0.0 | 0.0 | 0.0 |
| 0.0 | 0.0 | 0.0 | 0.0 | 0.0 | 0.0 | 0.0 | 0.0 | 0.0 | 0.0 |
| 0.0 | 0.0 | 0.0 | 0.0 | 0.0 | 0.0 | 0.0 | 0.0 | 0.0 | 0.0 |
| 0.0 | 0.0 | 0.0 | 0.0 | 0.0 | 0.0 | 0.0 | 0.0 | 0.0 | 0.0 |
| 0.0 | 0.0 | 0.0 | 0.0 | 0.0 | 0.0 | 0.0 | 0.0 | 0.0 | 0.0 |
| 0.0 | 0.0 | 0.0 | 0.0 | 0.0 | 0.0 | 0.0 | 0.0 | 0.0 | 0.0 |

| | PEAK | 6-HOUR | 24-HOUR | 72-HOUR | TOTAL VOLUME |
|------------|------|--------|---------|---------|--------------|
| CFS | 682. | 300. | 86. | 69. | 10315. |
| CMS | 19. | 8. | 2. | 2. | 292. |
| INCHES | | 5.26 | 6.03 | 6.03 | 6.03 |
| MM | | 133.67 | 153.14 | 153.29 | 153.29 |
| AC-FT | | 149. | 170. | 170. | 170. |
| THOUS CU M | | 183. | 210. | 210. | 210. |

MAXIMUM STORAGE = 86.

STATION 2, PLAN 1, RRIO 3

| OUTFLOW | | | | | | | | | |
|---------|------|-------|------|------|------|------|------|------|------|
| 0. | 0. | 0. | 0. | 0. | 0. | 0. | 0. | 0. | 0. |
| 0. | 0. | 0. | 0. | 0. | 0. | 0. | 0. | 0. | 0. |
| 0. | 0. | 0. | 0. | 0. | 0. | 0. | 0. | 0. | 0. |
| 2. | 2. | 2. | 1. | 1. | 1. | 1. | 1. | 1. | 1. |
| 4. | 4. | 4. | 2. | 2. | 3. | 3. | 3. | 3. | 4. |
| 5. | 6. | 6. | 5. | 5. | 5. | 5. | 5. | 5. | 5. |
| 9. | 10. | 10. | 6. | 6. | 7. | 7. | 8. | 8. | 9. |
| 45. | 964. | 1009. | 14. | 32. | 117. | 252. | 402. | 519. | 648. |
| 570. | 528. | 483. | 982. | 909. | 828. | 756. | 695. | 645. | 609. |
| 143. | 133. | 124. | 433. | 378. | 321. | 268. | 221. | 181. | 153. |
| 70. | 65. | 61. | 115. | 107. | 100. | 93. | 87. | 81. | 75. |
| 35. | 33. | 32. | 57. | 53. | 49. | 46. | 43. | 40. | 37. |
| 27. | 27. | 26. | 32. | 31. | 31. | 30. | 29. | 29. | 28. |
| 21. | 20. | 19. | 25. | 25. | 24. | 23. | 23. | 22. | 21. |
| | | | | | | 17. | 16. | 16. | 15. |

McLARD-JOHNSON ENGINEERS, INC

| STOR | | | | | | | | | |
|------|-----|-----|-----|-----|-----|-----|-----|-----|-----|
| 1. | 1. | 1. | 1. | 1. | 1. | 1. | 1. | 1. | 1. |
| 1. | 1. | 1. | 1. | 1. | 1. | 1. | 1. | 1. | 1. |
| 1. | 1. | 1. | 1. | 1. | 1. | 1. | 1. | 1. | 1. |
| 1. | 1. | 1. | 1. | 1. | 2. | 2. | 2. | 3. | 3. |
| 4. | 4. | 5. | 6. | 6. | 7. | 7. | 8. | 8. | 9. |
| 10. | 10. | 11. | 11. | 12. | 12. | 13. | 14. | 14. | 15. |
| 15. | 16. | 17. | 18. | 20. | 23. | 26. | 30. | 34. | 39. |
| 44. | 49. | 55. | 61. | 68. | 73. | 78. | 81. | 83. | 85. |
| 88. | 89. | 89. | 89. | 88. | 87. | 87. | 86. | 85. | 85. |
| 84. | 83. | 82. | 81. | 80. | 79. | 78. | 77. | 77. | 76. |
| 75. | 75. | 74. | 73. | 73. | 72. | 72. | 71. | 71. | 71. |
| 70. | 70. | 70. | 69. | 69. | 69. | 69. | 69. | 68. | 68. |
| 68. | 68. | 68. | 68. | 67. | 67. | 67. | 67. | 67. | 66. |
| 66. | 66. | 66. | 65. | 65. | 65. | 65. | 64. | 64. | 64. |
| 64. | 63. | 63. | 63. | 63. | 63. | 62. | 62. | 62. | 62. |

| STAGE | | | | | | | | | |
|-------|-----|-----|-----|-----|-----|-----|-----|-----|-----|
| 0.0 | 0.0 | 0.0 | 0.0 | 0.0 | 0.0 | 0.0 | 0.0 | 0.0 | 0.0 |
| 0.0 | 0.0 | 0.0 | 0.0 | 0.0 | 0.0 | 0.0 | 0.0 | 0.0 | 0.0 |
| 0.0 | 0.0 | 0.0 | 0.0 | 0.0 | 0.0 | 0.0 | 0.0 | 0.0 | 0.0 |
| 0.0 | 0.0 | 0.0 | 0.0 | 0.0 | 0.0 | 0.0 | 0.0 | 0.0 | 0.0 |
| 0.0 | 0.0 | 0.0 | 0.0 | 0.0 | 0.0 | 0.0 | 0.0 | 0.0 | 0.0 |
| 0.0 | 0.0 | 0.0 | 0.0 | 0.0 | 0.0 | 0.0 | 0.0 | 0.0 | 0.0 |
| 0.0 | 0.0 | 0.0 | 0.0 | 0.0 | 0.0 | 0.0 | 0.0 | 0.0 | 0.0 |
| 0.0 | 0.0 | 0.0 | 0.0 | 0.0 | 0.0 | 0.0 | 0.0 | 0.0 | 0.0 |
| 0.0 | 0.0 | 0.0 | 0.0 | 0.0 | 0.0 | 0.0 | 0.0 | 0.0 | 0.0 |
| 0.0 | 0.0 | 0.0 | 0.0 | 0.0 | 0.0 | 0.0 | 0.0 | 0.0 | 0.0 |
| 0.0 | 0.0 | 0.0 | 0.0 | 0.0 | 0.0 | 0.0 | 0.0 | 0.0 | 0.0 |
| 0.0 | 0.0 | 0.0 | 0.0 | 0.0 | 0.0 | 0.0 | 0.0 | 0.0 | 0.0 |
| 0.0 | 0.0 | 0.0 | 0.0 | 0.0 | 0.0 | 0.0 | 0.0 | 0.0 | 0.0 |
| 0.0 | 0.0 | 0.0 | 0.0 | 0.0 | 0.0 | 0.0 | 0.0 | 0.0 | 0.0 |
| 0.0 | 0.0 | 0.0 | 0.0 | 0.0 | 0.0 | 0.0 | 0.0 | 0.0 | 0.0 |
| 0.0 | 0.0 | 0.0 | 0.0 | 0.0 | 0.0 | 0.0 | 0.0 | 0.0 | 0.0 |
| 0.0 | 0.0 | 0.0 | 0.0 | 0.0 | 0.0 | 0.0 | 0.0 | 0.0 | 0.0 |

| | PEAK | 6-HOUR | 24-HOUR | 72-HOUR | TOTAL VOLUME |
|------------|-------|--------|---------|---------|--------------|
| CFS | 1009. | 478. | 135. | 108. | 16256. |
| CMS | 29. | 14. | 4. | 3. | 460. |
| INCHES | | 8.38 | 9.50 | 9.51 | 9.51 |
| MM | | 212.94 | 241.36 | 241.56 | 241.56 |
| AC-FT | | 237. | 268. | 269. | 269. |
| THOUS CU M | | 292. | 331. | 331. | 331. |

MAXIMUM STORAGE = 89.

STATION 2, PLAN 1, RTIO 4

| OUTFLOW | | | | | | | | | |
|---------|-------|-------|-------|-------|-------|------|------|------|------|
| 1. | 1. | 1. | 1. | 1. | 1. | 1. | 1. | 1. | 1. |
| 1. | 1. | 1. | 1. | 1. | 1. | 1. | 1. | 1. | 1. |
| 1. | 1. | 1. | 1. | 1. | 1. | 1. | 1. | 1. | 1. |
| 1. | 1. | 1. | 1. | 1. | 1. | 1. | 1. | 2. | 2. |
| 2. | 2. | 3. | 3. | 3. | 3. | 4. | 4. | 4. | 5. |
| 5. | 5. | 5. | 5. | 5. | 6. | 6. | 6. | 6. | 6. |
| 6. | 6. | 6. | 7. | 7. | 8. | 6. | 9. | 9. | 10. |
| 10. | 23. | 84. | 210. | 401. | 494. | 551. | 610. | 734. | 926. |
| 1112. | 1254. | 1312. | 1277. | 1182. | 1076. | 983. | 903. | 833. | 771. |
| 714. | 659. | 616. | 564. | 512. | 460. | 348. | 287. | 236. | 195. |

W. S. AND JOHNSON, ENGINEERS INC.

| | | | | | | | | | |
|-----|-----|-----|-----|-----|-----|-----|-----|-----|-----|
| 89. | 83. | 78. | 73. | 68. | 63. | 59. | 55. | 52. | 48. |
| 45. | 43. | 40. | 38. | 35. | 33. | 32. | 32. | 31. | 31. |
| 30. | 29. | 29. | 28. | 27. | 27. | 26. | 25. | 25. | 24. |
| 23. | 23. | 22. | 21. | 21. | 20. | 19. | 19. | 18. | 17. |

| | | | | | | | | | |
|------|-----|-----|-----|-----|-----|-----|-----|-----|-----|
| STOR | | | | | | | | | |
| 2. | 2. | 2. | 2. | 2. | 2. | 2. | 2. | 2. | 2. |
| 2. | 2. | 2. | 2. | 2. | 2. | 2. | 2. | 2. | 2. |
| 2. | 2. | 1. | 1. | 1. | 1. | 1. | 1. | 1. | 1. |
| 1. | 1. | 2. | 2. | 2. | 2. | 3. | 3. | 4. | 4. |
| 5. | 6. | 7. | 7. | 8. | 9. | 9. | 10. | 11. | 12. |
| 12. | 13. | 14. | 15. | 16. | 16. | 17. | 18. | 19. | 19. |
| 20. | 21. | 22. | 24. | 27. | 30. | 34. | 39. | 45. | 51. |
| 57. | 64. | 71. | 77. | 81. | 82. | 84. | 85. | 86. | 88. |
| 90. | 92. | 92. | 92. | 91. | 90. | 89. | 88. | 87. | 87. |
| 86. | 86. | 85. | 84. | 82. | 81. | 80. | 79. | 78. | 77. |
| 76. | 76. | 75. | 75. | 74. | 74. | 73. | 73. | 72. | 72. |
| 72. | 71. | 71. | 70. | 70. | 70. | 70. | 69. | 69. | 69. |
| 69. | 68. | 68. | 68. | 68. | 68. | 68. | 68. | 67. | 67. |
| 67. | 67. | 67. | 66. | 66. | 66. | 66. | 65. | 65. | 65. |
| 65. | 64. | 64. | 64. | 64. | 63. | 63. | 63. | 63. | 63. |

| | | | | | | | | | |
|-------|-----|-----|-----|-----|-----|-----|-----|-----|-----|
| STAGE | | | | | | | | | |
| 0.0 | 0.0 | 0.0 | 0.0 | 0.0 | 0.0 | 0.0 | 0.0 | 0.0 | 0.0 |
| 0.0 | 0.0 | 0.0 | 0.0 | 0.0 | 0.0 | 0.0 | 0.0 | 0.0 | 0.0 |
| 0.0 | 0.0 | 0.0 | 0.0 | 0.0 | 0.0 | 0.0 | 0.0 | 0.0 | 0.0 |
| 0.0 | 0.0 | 0.0 | 0.0 | 0.0 | 0.0 | 0.0 | 0.0 | 0.0 | 0.0 |
| 0.0 | 0.0 | 0.0 | 0.0 | 0.0 | 0.0 | 0.0 | 0.0 | 0.0 | 0.0 |
| 0.0 | 0.0 | 0.0 | 0.0 | 0.0 | 0.0 | 0.0 | 0.0 | 0.0 | 0.0 |
| 0.0 | 0.0 | 0.0 | 0.0 | 0.0 | 0.0 | 0.0 | 0.0 | 0.0 | 0.0 |
| 0.0 | 0.0 | 0.0 | 0.0 | 0.0 | 0.0 | 0.0 | 0.0 | 0.0 | 0.0 |
| 0.0 | 0.0 | 0.0 | 0.0 | 0.0 | 0.0 | 0.0 | 0.0 | 0.0 | 0.0 |
| 0.0 | 0.0 | 0.0 | 0.0 | 0.0 | 0.0 | 0.0 | 0.0 | 0.0 | 0.0 |
| 0.0 | 0.0 | 0.0 | 0.0 | 0.0 | 0.0 | 0.0 | 0.0 | 0.0 | 0.0 |
| 0.0 | 0.0 | 0.0 | 0.0 | 0.0 | 0.0 | 0.0 | 0.0 | 0.0 | 0.0 |
| 0.0 | 0.0 | 0.0 | 0.0 | 0.0 | 0.0 | 0.0 | 0.0 | 0.0 | 0.0 |
| 0.0 | 0.0 | 0.0 | 0.0 | 0.0 | 0.0 | 0.0 | 0.0 | 0.0 | 0.0 |
| 0.0 | 0.0 | 0.0 | 0.0 | 0.0 | 0.0 | 0.0 | 0.0 | 0.0 | 0.0 |
| 0.0 | 0.0 | 0.0 | 0.0 | 0.0 | 0.0 | 0.0 | 0.0 | 0.0 | 0.0 |
| 0.0 | 0.0 | 0.0 | 0.0 | 0.0 | 0.0 | 0.0 | 0.0 | 0.0 | 0.0 |
| 0.0 | 0.0 | 0.0 | 0.0 | 0.0 | 0.0 | 0.0 | 0.0 | 0.0 | 0.0 |
| 0.0 | 0.0 | 0.0 | 0.0 | 0.0 | 0.0 | 0.0 | 0.0 | 0.0 | 0.0 |
| 0.0 | 0.0 | 0.0 | 0.0 | 0.0 | 0.0 | 0.0 | 0.0 | 0.0 | 0.0 |
| 0.0 | 0.0 | 0.0 | 0.0 | 0.0 | 0.0 | 0.0 | 0.0 | 0.0 | 0.0 |

| | | | | | |
|------------|-------|--------|---------|---------|--------------|
| | PEAK | 6-HOUR | 24-HOUR | 72-HOUR | TOTAL VOLUME |
| CFS | 1312. | 652. | 185. | 148. | 22206. |
| CMS | 37. | 18. | 5. | 4. | 629. |
| INCHES | | 11.45 | 12.98 | 12.99 | 12.99 |
| MM | | 290.87 | 329.72 | 379.99 | 329.99 |
| AC-FT | | 324. | 367. | 367. | 367. |
| THOUS CU M | | 399. | 452. | 453. | 453. |

MAXIMUM STORAGE = 92.

STATION 2, PLAN 1, RTIU 5

| | | | | | | | | | |
|---------|----|----|----|----|----|----|----|----|----|
| OUTFLOW | | | | | | | | | |
| 1. | 1. | 1. | 1. | 1. | 1. | 1. | 1. | 1. | 1. |
| 1. | 1. | 1. | 1. | 1. | 1. | 1. | 1. | 1. | 1. |
| 1. | 1. | 1. | 1. | 1. | 1. | 1. | 1. | 1. | 1. |
| 1. | 1. | 1. | 1. | 1. | 1. | 1. | 2. | 2. | 2. |
| 3. | 5. | 3. | 3. | 5. | 5. | 5. | 5. | 5. | 5. |
| 5. | 6. | 6. | 6. | 6. | 6. | 6. | 7. | 7. | 7. |

McFARLAND - JOHNSON ENGINEERS, INC

| | | | | | | | | | |
|-------|-------|-------|-------|-------|-------|-------|-------|-------|-------|
| 7. | 7. | 7. | 8. | 8. | 8. | 9. | 9. | 10. | 18. |
| 71. | 209. | 430. | 540. | 605. | 652. | 714. | 789. | 932. | 1143. |
| 1369. | 1544. | 1615. | 1572. | 1455. | 1325. | 1210. | 1111. | 1025. | 948. |
| 879. | 811. | 736. | 653. | 589. | 508. | 426. | 352. | 290. | 239. |
| 200. | 173. | 156. | 151. | 145. | 139. | 133. | 126. | 119. | 113. |
| 106. | 100. | 94. | 88. | 83. | 77. | 72. | 68. | 63. | 59. |
| 55. | 52. | 49. | 46. | 43. | 41. | 38. | 36. | 33. | 32. |
| 32. | 31. | 31. | 30. | 29. | 29. | 28. | 27. | 27. | 26. |
| 25. | 25. | 24. | 23. | 23. | 22. | 21. | 21. | 20. | 19. |

| | | | | | | | | | |
|------|-----|-----|-----|-----|-----|-----|-----|-----|-----|
| STDR | | | | | | | | | |
| 2. | 2. | 2. | 2. | 2. | 2. | 2. | 2. | 2. | 2. |
| 2. | 2. | 2. | 2. | 2. | 2. | 2. | 2. | 2. | 2. |
| 2. | 2. | 2. | 2. | 2. | 2. | 2. | 2. | 2. | 2. |
| 2. | 2. | 2. | 2. | 2. | 3. | 3. | 4. | 5. | 5. |
| 6. | 7. | 6. | 9. | 10. | 11. | 12. | 13. | 14. | 14. |
| 15. | 16. | 17. | 18. | 19. | 20. | 21. | 22. | 23. | 24. |
| 25. | 26. | 28. | 30. | 33. | 37. | 43. | 49. | 55. | 63. |
| 70. | 77. | 81. | 83. | 85. | 85. | 86. | 87. | 88. | 91. |
| 93. | 95. | 96. | 95. | 94. | 93. | 91. | 90. | 89. | 89. |
| 88. | 87. | 86. | 85. | 84. | 83. | 81. | 80. | 79. | 78. |
| 77. | 76. | 76. | 76. | 75. | 75. | 75. | 74. | 74. | 73. |
| 73. | 72. | 72. | 72. | 71. | 71. | 70. | 70. | 70. | 70. |
| 69. | 69. | 69. | 69. | 69. | 68. | 68. | 68. | 68. | 68. |
| 68. | 67. | 67. | 67. | 67. | 67. | 66. | 66. | 66. | 66. |
| 65. | 65. | 65. | 65. | 64. | 64. | 64. | 64. | 63. | 63. |

| | | | | | | | | | |
|-------|-----|-----|-----|-----|-----|-----|-----|-----|-----|
| STAGE | | | | | | | | | |
| 0.0 | 0.0 | 0.0 | 0.0 | 0.0 | 0.0 | 0.0 | 0.0 | 0.0 | 0.0 |
| 0.0 | 0.0 | 0.0 | 0.0 | 0.0 | 0.0 | 0.0 | 0.0 | 0.0 | 0.0 |
| 0.0 | 0.0 | 0.0 | 0.0 | 0.0 | 0.0 | 0.0 | 0.0 | 0.0 | 0.0 |
| 0.0 | 0.0 | 0.0 | 0.0 | 0.0 | 0.0 | 0.0 | 0.0 | 0.0 | 0.0 |
| 0.0 | 0.0 | 0.0 | 0.0 | 0.0 | 0.0 | 0.0 | 0.0 | 0.0 | 0.0 |
| 0.0 | 0.0 | 0.0 | 0.0 | 0.0 | 0.0 | 0.0 | 0.0 | 0.0 | 0.0 |
| 0.0 | 0.0 | 0.0 | 0.0 | 0.0 | 0.0 | 0.0 | 0.0 | 0.0 | 0.0 |
| 0.0 | 0.0 | 0.0 | 0.0 | 0.0 | 0.0 | 0.0 | 0.0 | 0.0 | 0.0 |
| 0.0 | 0.0 | 0.0 | 0.0 | 0.0 | 0.0 | 0.0 | 0.0 | 0.0 | 0.0 |
| 0.0 | 0.0 | 0.0 | 0.0 | 0.0 | 0.0 | 0.0 | 0.0 | 0.0 | 0.0 |
| 0.0 | 0.0 | 0.0 | 0.0 | 0.0 | 0.0 | 0.0 | 0.0 | 0.0 | 0.0 |
| 0.0 | 0.0 | 0.0 | 0.0 | 0.0 | 0.0 | 0.0 | 0.0 | 0.0 | 0.0 |
| 0.0 | 0.0 | 0.0 | 0.0 | 0.0 | 0.0 | 0.0 | 0.0 | 0.0 | 0.0 |
| 0.0 | 0.0 | 0.0 | 0.0 | 0.0 | 0.0 | 0.0 | 0.0 | 0.0 | 0.0 |
| 0.0 | 0.0 | 0.0 | 0.0 | 0.0 | 0.0 | 0.0 | 0.0 | 0.0 | 0.0 |
| 0.0 | 0.0 | 0.0 | 0.0 | 0.0 | 0.0 | 0.0 | 0.0 | 0.0 | 0.0 |
| 0.0 | 0.0 | 0.0 | 0.0 | 0.0 | 0.0 | 0.0 | 0.0 | 0.0 | 0.0 |
| 0.0 | 0.0 | 0.0 | 0.0 | 0.0 | 0.0 | 0.0 | 0.0 | 0.0 | 0.0 |
| 0.0 | 0.0 | 0.0 | 0.0 | 0.0 | 0.0 | 0.0 | 0.0 | 0.0 | 0.0 |
| 0.0 | 0.0 | 0.0 | 0.0 | 0.0 | 0.0 | 0.0 | 0.0 | 0.0 | 0.0 |
| 0.0 | 0.0 | 0.0 | 0.0 | 0.0 | 0.0 | 0.0 | 0.0 | 0.0 | 0.0 |

| | | | | | |
|------------|-------|--------|---------|---------|--------------|
| | PEAK | 6-HOUR | 24-HOUR | 72-HOUR | TOTAL VOLUME |
| CFS | 1615. | 828. | 235. | 188. | 28163. |
| CMS | 46. | 23. | 7. | 5. | 798. |
| INCHES | | 14.54 | 16.46 | 16.48 | 16.48 |
| MM | | 369.29 | 418.19 | 418.52 | 418.52 |
| AC-FT | | 411. | 465. | 466. | 466. |
| THOUS CU M | | 507. | 574. | 574. | 574. |

MAXIMUM STORAGE = 96.

STATION 2, PLAN 1, RTID 6

McFARLAND JOHNSON ENGINEERS INC



| | | | | | | | | | |
|-------|-------|-------|-------|-------|-------|-------|-------|-------|-------|
| 1. | 1. | 1. | 1. | 1. | 1. | 1. | 1. | 1. | 1. |
| 1. | 1. | 1. | 1. | 1. | 1. | 1. | 1. | 1. | 1. |
| 1. | 1. | 1. | 1. | 1. | 1. | 2. | 2. | 2. | 3. |
| 3. | 4. | 4. | 4. | 5. | 5. | 5. | 5. | 6. | 6. |
| 6. | 6. | 6. | 7. | 7. | 7. | 7. | 7. | 7. | 8. |
| 8. | 8. | 8. | 8. | 9. | 9. | 10. | 13. | 53. | 194. |
| 458. | 589. | 674. | 753. | 802. | 847. | 897. | 987. | 1165. | 1429. |
| 1718. | 1955. | 2029. | 1959. | 1802. | 1639. | 1510. | 1389. | 1281. | 1186. |
| 1099. | 1013. | 920. | 815. | 700. | 606. | 521. | 435. | 361. | 298. |
| 249. | 216. | 195. | 179. | 166. | 155. | 151. | 146. | 140. | 134. |
| 127. | 121. | 114. | 107. | 101. | 95. | 89. | 84. | 78. | 73. |
| 69. | 65. | 61. | 58. | 54. | 51. | 48. | 45. | 42. | 39. |
| 37. | 34. | 32. | 32. | 31. | 31. | 30. | 30. | 29. | 28. |
| 28. | 27. | 26. | 26. | 25. | 24. | 24. | 23. | 22. | 21. |

| | | | | | | | | | |
|------|-----|-----|-----|-----|-----|-----|-----|-----|-----|
| STOR | | | | | | | | | |
| 2. | 2. | 2. | 2. | 2. | 2. | 2. | 2. | 2. | 2. |
| 2. | 2. | 2. | 2. | 2. | 2. | 2. | 2. | 2. | 2. |
| 2. | 2. | 2. | 2. | 2. | 2. | 2. | 2. | 2. | 2. |
| 2. | 2. | 2. | 3. | 3. | 4. | 4. | 5. | 6. | 7. |
| 8. | 9. | 10. | 11. | 12. | 13. | 15. | 16. | 17. | 18. |
| 19. | 20. | 22. | 23. | 24. | 25. | 26. | 28. | 29. | 30. |
| 31. | 33. | 35. | 38. | 42. | 47. | 53. | 61. | 69. | 77. |
| 82. | 84. | 86. | 87. | 87. | 88. | 88. | 89. | 91. | 94. |
| 97. | 99. | 99. | 99. | 97. | 96. | 94. | 93. | 92. | 91. |
| 90. | 89. | 88. | 87. | 86. | 85. | 83. | 81. | 80. | 79. |
| 78. | 77. | 77. | 76. | 76. | 76. | 76. | 75. | 75. | 75. |
| 74. | 74. | 73. | 73. | 72. | 72. | 72. | 71. | 71. | 71. |
| 70. | 70. | 70. | 69. | 69. | 69. | 69. | 69. | 68. | 68. |
| 68. | 68. | 68. | 68. | 67. | 67. | 67. | 67. | 67. | 66. |
| 66. | 66. | 66. | 65. | 65. | 65. | 65. | 64. | 64. | 64. |

| | | | | | | | | | |
|-------|-----|-----|-----|-----|-----|-----|-----|-----|-----|
| STAGE | | | | | | | | | |
| 0.0 | 0.0 | 0.0 | 0.0 | 0.0 | 0.0 | 0.0 | 0.0 | 0.0 | 0.0 |
| 0.0 | 0.0 | 0.0 | 0.0 | 0.0 | 0.0 | 0.0 | 0.0 | 0.0 | 0.0 |
| 0.0 | 0.0 | 0.0 | 0.0 | 0.0 | 0.0 | 0.0 | 0.0 | 0.0 | 0.0 |
| 0.0 | 0.0 | 0.0 | 0.0 | 0.0 | 0.0 | 0.0 | 0.0 | 0.0 | 0.0 |
| 0.0 | 0.0 | 0.0 | 0.0 | 0.0 | 0.0 | 0.0 | 0.0 | 0.0 | 0.0 |
| 0.0 | 0.0 | 0.0 | 0.0 | 0.0 | 0.0 | 0.0 | 0.0 | 0.0 | 0.0 |
| 0.0 | 0.0 | 0.0 | 0.0 | 0.0 | 0.0 | 0.0 | 0.0 | 0.0 | 0.0 |
| 0.0 | 0.0 | 0.0 | 0.0 | 0.0 | 0.0 | 0.0 | 0.0 | 0.0 | 0.0 |
| 0.0 | 0.0 | 0.0 | 0.0 | 0.0 | 0.0 | 0.0 | 0.0 | 0.0 | 0.0 |
| 0.0 | 0.0 | 0.0 | 0.0 | 0.0 | 0.0 | 0.0 | 0.0 | 0.0 | 0.0 |
| 0.0 | 0.0 | 0.0 | 0.0 | 0.0 | 0.0 | 0.0 | 0.0 | 0.0 | 0.0 |
| 0.0 | 0.0 | 0.0 | 0.0 | 0.0 | 0.0 | 0.0 | 0.0 | 0.0 | 0.0 |
| 0.0 | 0.0 | 0.0 | 0.0 | 0.0 | 0.0 | 0.0 | 0.0 | 0.0 | 0.0 |
| 0.0 | 0.0 | 0.0 | 0.0 | 0.0 | 0.0 | 0.0 | 0.0 | 0.0 | 0.0 |
| 0.0 | 0.0 | 0.0 | 0.0 | 0.0 | 0.0 | 0.0 | 0.0 | 0.0 | 0.0 |
| 0.0 | 0.0 | 0.0 | 0.0 | 0.0 | 0.0 | 0.0 | 0.0 | 0.0 | 0.0 |
| 0.0 | 0.0 | 0.0 | 0.0 | 0.0 | 0.0 | 0.0 | 0.0 | 0.0 | 0.0 |
| 0.0 | 0.0 | 0.0 | 0.0 | 0.0 | 0.0 | 0.0 | 0.0 | 0.0 | 0.0 |
| 0.0 | 0.0 | 0.0 | 0.0 | 0.0 | 0.0 | 0.0 | 0.0 | 0.0 | 0.0 |
| 0.0 | 0.0 | 0.0 | 0.0 | 0.0 | 0.0 | 0.0 | 0.0 | 0.0 | 0.0 |
| 0.0 | 0.0 | 0.0 | 0.0 | 0.0 | 0.0 | 0.0 | 0.0 | 0.0 | 0.0 |

| | | | | | |
|------------|-------|--------|---------|---------|--------------|
| | PEAK | 6-HOUR | 24-HOUR | 72-HOUR | TOTAL VOLUME |
| CFS | 2029. | 1059. | 301. | 241. | 36115. |
| CMS | 57. | 30. | 9. | 7. | 1023. |
| INCHES | | 18.60 | 21.11 | 21.13 | 21.13 |
| MM | | 472.33 | 536.27 | 536.68 | 536.68 |
| AC-FT | | 525. | 596. | 597. | 597. |
| THOUS CU M | | 648. | 736. | 736. | 736. |



PEAK FLOW AND STORAGE (END OF PERIOD) SUMMARY FOR MULTIPLE PLAN-RATIO ECONOMIC COMPUTATIONS
 FLOWS IN CUBIC FEET PER SECOND (CUBIC METERS PER SECOND)
 AREA IN SQUARE MILES (SQUARE KILOMETERS)

| OPERATION | STATION | AREA | PLAN | RATIOS APPLIED TO FLOWS | | | | | |
|---------------|---------|-------|------|-------------------------|-----------------|-----------------|-----------------|-----------------|-----------------|
| | | | | RATIO 1 0.20 | RATIO 2 0.35 | RATIO 3 0.50 | RATIO 4 0.65 | RATIO 5 0.80 | RATIO 6 1.00 |
| HYDROGRAPH AT | 1 | 0.53 | 1 | 407. | 712. | 1017. | 1323. | 1628. | 2035. |
| | (| 1.37) | (| 11.52)(| 20.16)(| 28.81)(| 37.45)(| 46.09)(| 57.61)(|
| ROUTED TO | 2 | 0.53 | 1 | 263. | 682. | 1009. | 1312. | 1615. | 2029. |
| | (| 1.37) | (| 7.46)(| 19.33)(| 28.58)(| 37.16)(| 45.73)(| 57.47)(|



APPENDIX D

OPERATION & MAINTENANCE
INSPECTION REPORT

NY-AS-17
4-28-71
(File Code AS-12-5)

U. S. Department of Agriculture
Soil Conservation Service

OPERATION AND MAINTENANCE INSPECTION REPORT
FOR STRUCTURES

Watershed Congwango Inspection: Special Date: Sept. 21, 1972
 Annual
Site No. 23

Name of Sponsoring Local Organization(s) having Operation and Maintenance Responsibility: Congwango Watershed Commission

Structure operation satisfactory: X Unsatisfactory:

| Item | Condition | | Describe maintenance and needed repairs | Esti- mated Costs | Agreed date repairs to be compld. |
|--------------|----------------|------------------|---|-------------------|-----------------------------------|
| | Satis- factory | Unsatis- factory | | | |
| 1 Vegetation | X | | | | |
| Principal | | | | | |
| 2 Spillway | X | | | | |
| 3 Fences | X | | | | |
| Emergency | | | | | |
| 4 Spillway | X | | | | |
| 5 Embankment | X | | | | |
| Reservoir | | | | | |
| 6 Area | X | | | | |
| Outlet | | | | | |
| 7 Channel | X | | | | |
| 8 Other | | | | | |

Remarks: Hard work involving replacing of rocks under toe drain outlet done during inspection.

[Signature]
SCS Representative

Richard L. Shields, Contracting Officer
Sponsoring Local Organization Rep

Distribution: Orig. - Sponsor with O&M responsibility
3 - SCS District Conservationist (1 forwarded to State Office, 1 forwarded to Area Conservationist)
1 - Each of other sponsors of watershed project
1 - N. Y. Department of Environmental Conservation

Report due - 10 days after inspection

(Check list on reverse side)

NY-AS-17
4-28-71
(File Code AS-12-5)

U. S. Department of Agriculture
Soil Conservation Service

OPERATION AND MAINTENANCE INSPECTION REPORT
FOR STRUCTURES

Watershed Conewango Inspection: Special Date: July 10, 1978
 Annual
Site No. 33

Name of Sponsoring Local Organization(s) having Operation and
Maintenance Responsibility: Conewango Watershed Commission

Structure operation satisfactory: X Unsatisfactory: _____

| Item | Condition | Describe maintenance and needed repairs | Estimated Costs | Agreed date repairs to be compld. |
|--------------|--------------|---|-----------------|-----------------------------------|
| | Satisfactory | Unsatisfactory | | |
| 1 Vegetation | X | | | |
| Principal | | | | |
| 2 Spillway | X | | | |
| 3 Fences | X | | | |
| Emergency | | | | |
| 4 Spillway | X | | | |
| 5 Embankment | X | | | |
| Reservoir | | | | |
| 6 Area | X | | | |
| Outlet | | | | |
| 7 Channel | X | | | |
| 8 Other | | | | |

Remarks: Remove 3 or 4 broken limbs and tree trunks from the pool area.

Toe drains need rocks under them for support at the outlet ends.

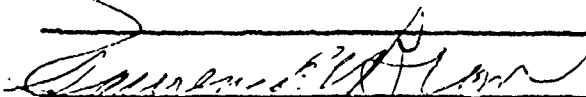
SCS Representative

Sponsoring Local Organization Rep.

Distribution: Orig. - Sponsor with O&M responsibility
3 - SCS District Conservationist (1 forwarded to State Office, 1 forwarded to Area Conservationist)
1 - Each of other sponsors of watershed project
1 - N. Y. Department of Environmental Conservation

Report due - 10 days after
inspection

(Check list on reverse side)

The below is collected by Jesse Elwick from
7-1-77 & sent to me received 7-5-77 - sent on to Dale Clark
on 7-5-77 J.E.

Site 6

Internal drains broken on ends
Remove debris upstr. dam

Site 19

Gullying along downstr. left abutment

Site 1

Dead tree to be removed on upstr.
side of dam

Site 3

Remove log upstr. of dam

Cap internal drain exit pipe back
and replace small animal guard (^{the pipe} ~~is~~ broken)

Site 33

9A. fasten low stage trash rack.

NY-AS-17
4-28-71
(File Code AS-12-5)

U. S. Department of Agriculture
Soil Conservation Service

OPERATION AND MAINTENANCE INSPECTION REPORT
FOR STRUCTURES

Watershed Conewango Inspection: Special Date: May 3, 1976
 Annual
Site No. 33

Name of Sponsoring Local Organization(s) having Operation and Maintenance Responsibility: Conewango Watershed Commission

Structure operation satisfactory: x Unsatisfactory: _____

| Item | Condition | Describe maintenance and needed repairs | Estimated Costs | Agreed date repairs to be compld. |
|--------------|--------------|---|-----------------|-----------------------------------|
| | Satisfactory | Unsatisfactory | | |
| 1 Vegetation | x | | | |
| Principal | | | | |
| 2 Spillway | x | | | |
| 3 Fences | | x | | |
| Emergency | | | | |
| 4 Spillway | x | | | |
| 5 Embankment | x | | | |
| Reservoir | | | | |
| 6 Area | x | | | |
| Outlet | | | | |
| 7 Channel | x | | | |
| 8 Other | -- | | | |

Remarks: Removal of debris from high water needed. Three rills to

be filled with stone picked from the site. Serious consideration should be given to establishing a fence parallel to pickup hill road to eliminate damage from vehicles which are now running over the site.

[Signature]
SCS Representative

[Signature] Contracting Officer
Sponsoring Local Organization Rep.

Distribution: Orig. - Sponsor with O&M responsibility
3 - SCS District Conservationist (1 forwarded to State Office, 1 forwarded to Area Conservationist)
1 - Each of other sponsors of watershed project
1 - N. Y. Department of Environmental Conservation

Report due - 10 days after inspection

(Check list on reverse side)

APPENDIX E

DESIGN FOLDER

CONEWANGO CREEK
WATERSHED PROTECTION PROJECT

DESIGN REPORT

SITE 33

NY-2173

CHAUTAUQUA COUNTY, NEW YORK
U.S. DEPARTMENT OF AGRICULTURE
SOIL CONSERVATION SERVICE

FEBRUARY 1971

DESIGN SECTION, SYRACUSE, N.Y.

Sheet 1 of 6

This is a two stage, single purpose flood control structure located in Chautauqua County, New York. approximately 1-1/4 miles southwest of Cherry Creek. Sheet 4 of this report, together with the Cherry Creek quadrangle published by the U. S. Geological Survey, may be used to locate the structure.

A summary of pertinent information is given on Sheet 3 of this report.

Criteria and procedures used in this design are given in Soil Conservation Service publications.

This is one of 20 proposed floodwater retarding dams in the Conewango Creek Watershed designed to reduce floodwater damage. It will retard a 100 year frequency storm without discharge occurring in the emergency spillway.

The structure consists of a zoned compacted earth fill of glacial till, alluvial gravel and clay. The foundation is underlain with weathered bedrock covered with alluvial gravel and glacial tills. Bed rock was encountered in right abutment, and at a lower level in the left abutment.

A drainage system is located under the downstream portion of the earth fill to control the phreatic surface and to provide a safe outlet for foundation seepage. A cutoff trench is located at the dam centerline to reduce seepage.

The principal spillway is a drop inlet structure consisting of a two stage reinforced concrete riser, 30" diameter concrete water pipe and an excavated outlet channel.

A vegetated earth excavated spillway is located on the left abutment.

U.S. DEPARTMENT OF AGRICULTURE - SOIL CONSERVATION SERVICE

| ELEMENT OF STRUCTURE | DETERMINING FACTOR | ELEV. ACRES | SURFACE AREA | | STORAGE | | INFLOW | | PEAK OUTFLOW CFS |
|-----------------------|---|-------------|--------------|--------|-----------------|----------|--------|------|------------------|
| | | | AC. FT. | INCHES | VOLUME * INCHES | RATE CFS | | | |
| Invert of Orifice | 50-year submerged sediment accumulation | 1483.7 | 0.7 | 0.13 | 3.3 | 0.13 | --- | --- | --- |
| Crest of Riser | 2.28" of storage | 1509.1 | 4.4 | 2.28 | 56.9 | 2.28 | --- | --- | --- |
| Crest of Emer. Spill. | Elev. necessary to prime prin spill controlled. | 1511.6 | 4.9 | 2.74 | 68.4 | 2.74 | --- | --- | 154 |
| Design High Water | ES-1020 Sh. 4 of 5 | 1513.8 | 5.4 | 3.19 | 79.8 | 3.19 | 6.10 | 1145 | 351 |
| Top of Dam | ES-1020 Sh. 5 of 5 | 1519.9 | 7.9 | 4.83 | 120.8 | 4.83 | 21.04 | 3841 | 3675 |

* Volume expressed in inches of runoff from controlled watershed area of 300 Ac.
 ** Refer to hydrologic criteria in National Engineering Memo #27

- 1/ Does not include 6.3 Ac. Ft. of sediment allocated to flood pool.
- 2/ Does not include 9.6 Ac. Ft. of sediment.
- 3/ Established in planning phase to provide desired level of protection.
- 4/ Flow does not reach E_e during the routing of the principal spillway hydrograph.

--DESIGN SECTION, SYRACUSE NY--

DESIGN REPORT SUMMARY

I. Watershed data

| | |
|---|------------------|
| A. Structure class | <u>6</u> ✓ |
| B. Drainage area | <u>300</u> Ac. |
| C. Time of concentration - T_c | <u>0.53</u> Hrs. |
| D. Hydrologic curve number - C_n Moisture Condition II | <u>77</u> ✓ |

II. Principal spillway

| | |
|------------------------------|----------------------|
| A. Conduit | |
| 1. Size (I.D.) | <u>30</u> In. |
| 2. Length | <u>220</u> Ft. |
| B. Riser | |
| 1. Size | <u>2.5 x 7.5</u> Ft. |
| 2. Height (floor to crest) | <u>15</u> Ft. |
| C. Weir length | <u>15</u> Ft. ✓ |
| D. Reservoir drain size | <u>10</u> In. |
| E. Type of energy dissipator | <u>PLUNGE POOL</u> ✓ |

III. Emergency spillway

| | |
|--|---------------------|
| A. Width | <u>50</u> Ft. |
| B. Side slopes | <u>3:1</u> |
| C. Length of level section | <u>50</u> Ft. |
| D. Exit slope | <u>0.03</u> Ft./Ft. |
| E. Maximum velocity - in exit section (ESH) | <u>6.6</u> Ft./Sec. |
| F. Duration of flow (ESH) through emergency spillway | <u>3.53</u> Hrs. |
| G. Frequency of use | <u>< 1%</u> ✓ |

IV. Earth fill

| | |
|---------------|------------------------|
| A. Height | <u>57</u> Ft. |
| B. Volume | <u> </u> C.Y. |
| C. Compaction | <u>Class A & C</u> |

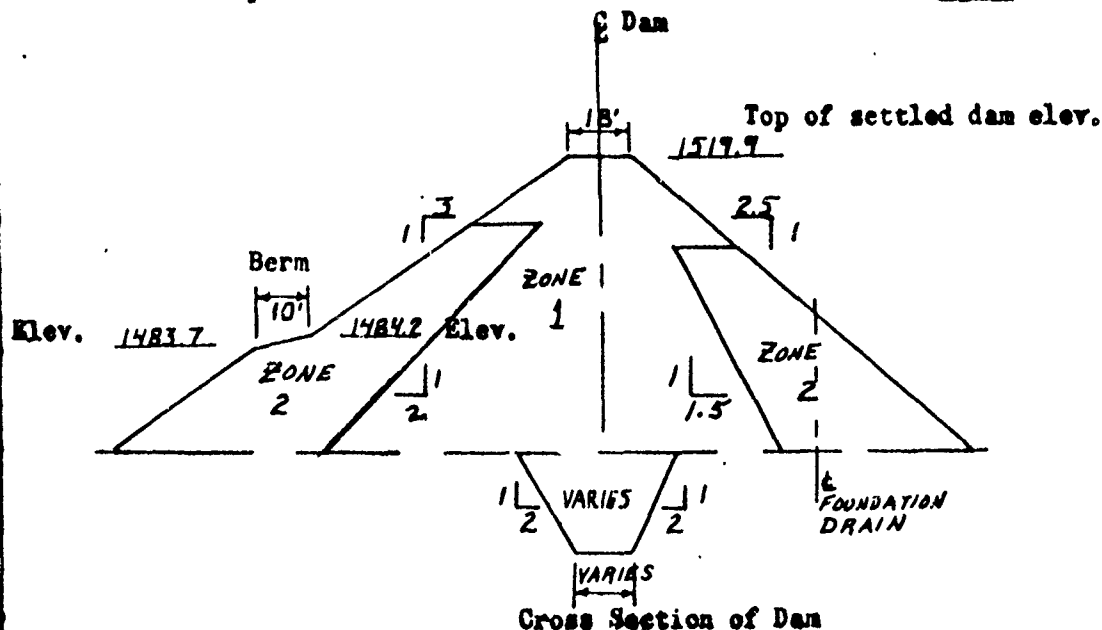

REVISIONS SHEET SITE 33

| | | | | |
|--|---------------------|----------------------|--------------------|----------------------------------|
| By <u>L.S.K.</u> | Date <u>1-16-69</u> | Checked By <u>CC</u> | Date <u>2-9-70</u> | Job No <u>NY-2173-D</u> |
| Subject <u>WORK PLAN - DESIGN COMPARISON</u> | | | | Sheet <u> </u> of <u> </u> |

| ITEM | UNIT | WORK PLAN | DESIGN | COMMENTS |
|------------------------------------|---------|---------------|-------------------|---|
| <u>DRAINAGE AREA</u> | SQ. MI. | <u>.47</u> | <u>.47</u> | |
| <u>STORAGE CAPACITY</u> | | | | |
| SEDIMENT (INC AERATED) | AC. FT. | <u>15</u> | <u>9.6</u> | |
| BENEFICIAL | AC. FT. | <u>0</u> | <u>0</u> | |
| RETARDING | AC. FT. | <u>78</u> | <u>68.4</u> | |
| TOTAL | AC. FT. | <u>93</u> | <u>78.0</u> | |
| BETWEEN HIGH & LOW S. | AC. FT. | <u>25</u> | <u>55.9</u> | <u>EXCLUDING AERATED SEDIMENT</u> |
| <u>SURFACE AREA</u> | | | | |
| NORMAL POOL | ACRE | <u>1</u> | <u>0.7</u> ✓ | |
| RETARDING POOL | ACRE | <u>5</u> | <u>4.92</u> | |
| DESIGN HIGH WATER | ACRE | | <u>5.44</u> | |
| <u>VOLUME OF FILL</u> | CU. YD. | <u>47924</u> | <u>54,100</u> | |
| <u>TOP OF DAM ELEV</u> | FEET | <u>1520.0</u> | <u>1519.9</u> | |
| <u>MAX HEIGHT OF DAM</u> | FEET | <u>60</u> | <u>56.9</u> ✓ | |
| <u>EMERGENCY SPILLWAY</u> | | | | |
| CREST ELEVATION | FEET | <u>1514.5</u> | <u>1511.6</u> ✓ | <u>EM SPWY CREST SET HIGH TO PRIME PRIN. SPWY.</u> |
| BOTTOM WIDTH | FEET | <u>200</u> | <u>50</u> | |
| TYPE | — | <u>VEG</u> | <u>VEG</u> | |
| PERCENT CHANCE OF USE | — | <u>1</u> | <u><1</u> ✓ | |
| AVE. CURVE NO COND. II | — | <u>77</u> | <u>77</u> ✓ | |
| <u>EM. SP. HYDROGRAPH</u> | | | | |
| STORM RAINFALL - 6 HR. | IN. | <u>15.70</u> | <u>8.9</u> | |
| STORM RUNOFF | IN. | <u>12.61</u> | <u>6.10</u> ✓ | |
| VELOCITY OF FLOW-V | FPS | <u>7.00</u> | <u>6.6</u> ✓ | |
| PEAK DISCHARGE RATE | CFS | <u>2320</u> | <u>351</u> | |
| MAX. WATER SURFACE EL. | FEET | <u>1517.4</u> | <u>1513.8</u> | |
| <u>FREEBOARD HYDROGRAPH</u> | | | | |
| STORM RAINFALL - 6 HR. | IN. | <u>24.30</u> | <u>24.30</u> | |
| STORM RUNOFF | IN. | <u>21.04</u> | <u>21.04</u> | |
| VELOCITY OF FLOW-V | FPS | <u>8.5</u> | | |
| PEAK DISCHARGE RATE | CFS | <u>3785</u> | <u>3731</u> | |
| MAX. WATER SURFACE EL. | FEET | <u>1518.4</u> | <u>1519.9</u> ✓ | |
| <u>PRINCIPAL SPILLWAY</u> | | | | |
| RISER SIZE | FT. | | <u>25 X 7.5</u> | |
| MAX. LOW STAGE FLOW | CFS | <u>10.4</u> | <u>9.0</u> | <u>LOW STAGE FLOW RE-SET AT 9.0 CFS BY PLANNING PARTY - NO RESTRICTION. SET FOR HIGH STAGE FLOW</u> |
| ORIFICE SIZE | FT. | | <u>0.5 X 0.75</u> | |
| MAX. HIGH STAGE FLOW | CFS | <u>21.2</u> | <u>1.54</u> | |
| PIPE SIZE | DIA. | | <u>30"</u> ✓ | |
| <u>CAPACITY EQUIVALENTS</u> | | | | |
| TOTAL SEDIMENT VOL. | IN. | <u>0.60</u> | <u>0.38</u> ✓ | |
| RETARDING STORAGE | IN. | <u>3.20</u> | <u>2.74</u> ✓ | |
| EM. SPILLWAY STORAGE TO TOP OF DAM | IN. | <u>1.32</u> | <u>2.10</u> ✓ | |
| <u>CLASS OF STRUCTURE</u> | — | <u>C</u> | <u>C</u> | |
| <u>CONSTRUCTION COSTS</u> | | | | |

CONEWANGO CREEK WATERSHED
SITE 33 NY-2173-D

DESIGN CRITERIA

1. Structure Classification: Class c
2. Purpose: Single Purpose flood retarding structure.
3. Principal Spillway:
 - a. Riser:
 - (1) Two stage with crest of orifice set at the 50 yr. submerged sediment pool elevation.
 - (2) Crest of riser is set by routing the 100 yr. evaluation storm thru low stage orifice.
 - b. Release Rates:

Capacity 1st stage - max. release rate 20. cfs.

Capacity 2nd stage - max release rate
4. Hydrographs:
 - a. Principal Spillway Hydrographs -

Use the 100 yr. frequency rainfall.
 - b. Emergency Spillway and Freeboard Hydrographs:

Use the point rainfall from rainfall map (ES-1020) for Class c structures.
5. Top of Dam Elevation:

Determined by the most severe of the following conditions:

 - (1) the passage of the freeboard hydrograph, (2) the passage of the emergency spillway hydrograph, plus the necessary freeboard required for frost conditions,
 - (3) the passage of the emergency spillway hydrograph, plus the necessary freeboard required for wave action,
 - or (4) the elevation of the emergency spillway crest plus 3 feet.

CONEWANGO CREEK WATERSHED
SITE 33 NY-2173-D

DESIGN CRITERIA

6. Emergency Spillway:
 - a. Length of level section: 50 ft.
 - b. Inlet channel: $S = 0.020$
 - c. Side slopes: 3:1

7. Earth Fill:
 - a. Top Width: Determine by $W = \frac{H+35}{5}$
 - b. Side Slopes: Upstream 3:1; Downstream $2\frac{1}{2}$:1
(Pending Soils Lab recommendation)
 - c. Berm: 10 ft. width set at orifice

CONEWANGO CREEK WATERSHED
SITE 33 NY-2173-D

By: CSK 1-27-70
Ck: ~~DCE~~ ^{cto} 2-2-70
~~DCE~~

DESIGN DATA

| Item | Unit | Quantity |
|---|-----------|--------------------------|
| Site Location: Latitude | 42°17'10" | |
| Longitude | 79°06'51" | |
| Drainage Area: | Sq.Mi. | 0.47 |
| | Acres | 300 |
| Class of structure: | | c |
| Principal Spillway: | | |
| Pipe Size (inside diameter) | Inches | 30 |
| Riser Size | Ft. | 2.5x7.5 |
| Pipe Length (approx.) | Ft. | 222 |
| Orifice Invert Elev. | Ft. | 1483.7 |
| Orifice Size | Ft. | .5x.75 |
| Riser Crest Elev. | Ft. | 1509.1 |
| Pipe Outlet Invert Elev. | Ft. | 1459.4 1457.7 |
| Emergency Spillway: | | |
| Bottom Width | Ft. | 50 |
| Level Section Length | Ft. | 50 |
| Entrance Length (approx.) | Ft. | 200 |
| Entrance Slope | Percent | 2 |
| Chance of Use | Percent | 1 - |
| Roughness Coefficient (Manning) | --- | .040 |
| Crest Elev. | Ft. | 1511.6 |
| Exit Slope | Percent | 3 |
| Storages: | | |
| Low Stage (V_{sl}) | In. | .13 |
| Retarding (Min. V_{sp}) | In. | 2.48 |
| Releases: | | |
| Peak Low Stage (Q_{ol}) | c.f.s. | 8.5 |
| Peak High Stage (Q_{fh}) | c.f.s. | 153.7 |
| Emergency Spillway Hydrograph (E_w) | Elev. | 1513.8 |
| Freeboard Hydrograph (E_w) | Elev. | 1519.9 |
| Top of Dam | Elev. | 1519.9 |

3-2

CONEWANGO CREEK WATERSHED

SITE 33

N.Y.-2173-D.

STAGE-STORAGE CURVE - EXPANDED SCALE

BY: C.S.K. 9-26-69 CK: W&D 9-26-69

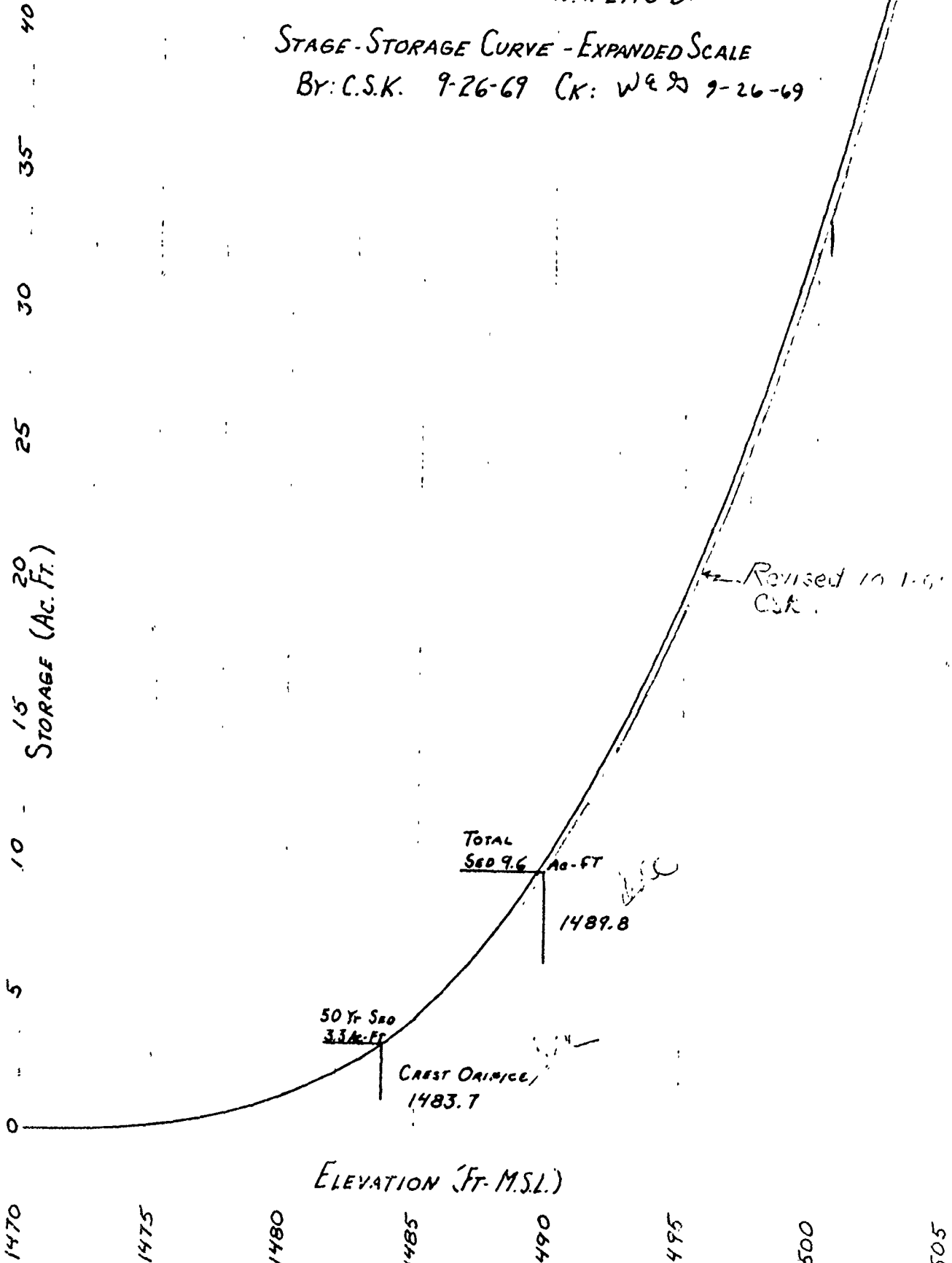

CONEWANGO CREEK WATERSHED
SITE 33 NY-2173-D
STAGE STORAGE CURVE

By: C.S.K. 1-13-70

CK: DCC 1-28-70

180
160
140
120
100
80
60
40
20

STORAGE (Ac-Ft)

1470
1480
1490
1500
1510
1520

ELEVATION



DATE PLOTTED: 1-28-70

CONEWANGO CREEK WATERSHED
SITE 33 NY-2173-D
STAGE STORAGE CURVE
EXPANDED

By: C.S.K. 1-13-70
CK DOC 1-28-70

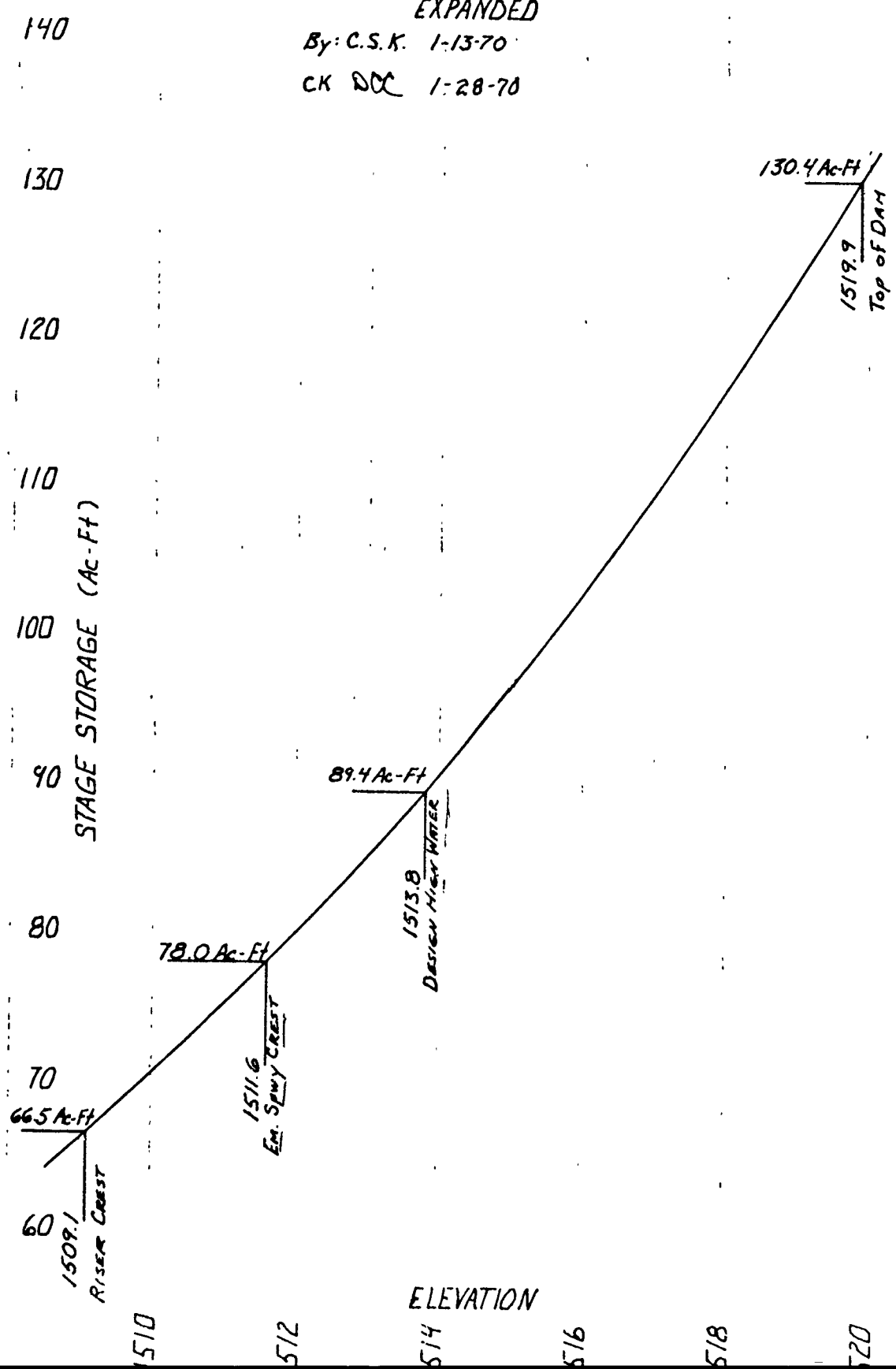

CONEWANGO CREEK WATERSHED
SITE 33 NY-2173-D
STAGE AREA CURVE

By: C.S.K. 1-13-70
CK: WCC. 1-29-70

8
7
6
5
4
3
2
1

AREA (Acres)

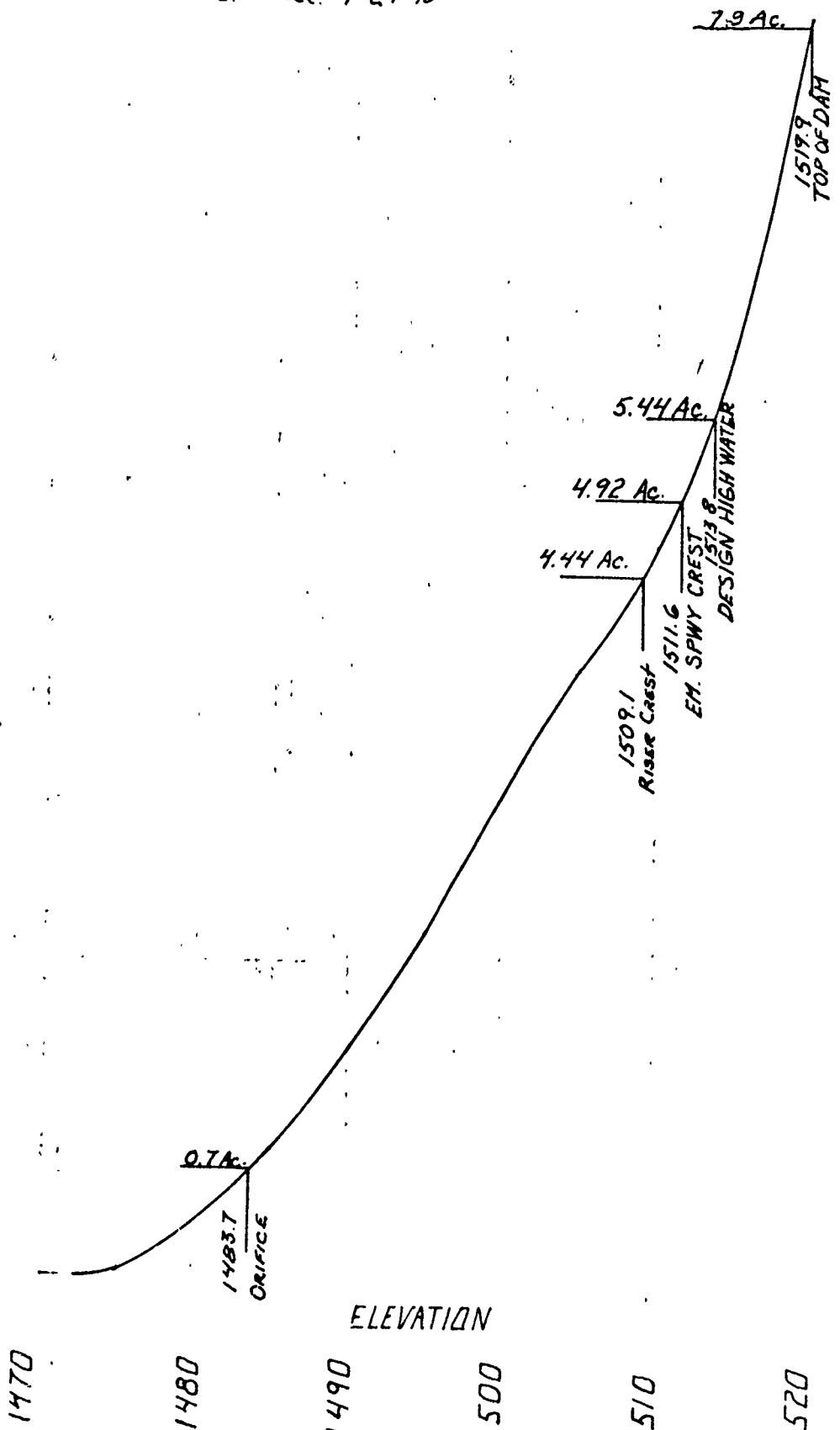

ELEVATION

1470 1480 1490 1500 1510 1520

GEOLOGY REPORT

JAN. 1959

SITE #33
CONEWANGO WATERSHED
CHAUTAUQUA COUNTY S&WCD
NEW YORK

APPROVAL:

Richard L. Phillips
Richard L. Phillips
State Conservation Engineer
Acting

PREPARED BY:

D. Bruce Champeon
D. Bruce Champeon
Geologist

REVIEWED BY:

B. S. Ellis
Bernard S. Ellis
Senior Staff Geologist

REFERENCE:

U. S. DEPARTMENT OF AGRICULTURE
SOIL CONSERVATION SERVICE

DRAWING NO.

NY-2173

SHEET 1 OF 1

17-59

DETAILED GEOLOGIC INVESTIGATION OF DAM SITES

GENERAL

Cherry Creek 7½ min. quadrangle

State New York County Chautauqua; _____, _____, Sec. _____, T. _____ R. _____; Watershed Conewango CreekSubwatershed Cherry Creek Fund class WP-08-2 Site number 33 Site group 1 Structure class c
(FP-2, WP-1, etc.)Investigated by Bruce Champeon, Geol. Equipment used See general information Date 11/17-12/18/69
(signature and title) (Type, size, make, model, etc.)

SITE DATA

Drainage area size .47 sq. mi, 300 acres. Type of structure Earth Fill Dam Purpose Floodwater retardingDirection of valley trend (downstream) north Maximum height of fill 57 feet. Length of fill 320 feet.Estimated volume of compacted fill required 41,700 yards; excavation from spillway, 17,050 c.y.

STORAGE ALLOCATION

| | Volume (ac. ft.) | Surface Area (acres) | Depth at Dam (feet) |
|----------------|------------------|----------------------|---------------------|
| 50-yr Sediment | <u>3.3</u> | <u>0.7</u> | <u>15.7</u> |
| Floodwater | <u>89.4</u> | <u>5.44</u> | <u>45.8</u> |

SURFACE GEOLOGY AND PHYSIOGRAPHY

Physiographic description Allegheny Plateau Topography rolling Attitude of beds: Dip 1% SW Strike NW essentially horizontalSteepness of abutments: Left 30-68 percent; Right 47-190 percent. Width of floodplain at centerline of dam 65 feetGeneral geology of site: The site is located on an unnamed tributary of Cherry Creek approximately 4,900 feet southwest of the center of the village of Cherry Creek. The stream is approximately 330 feet east of Pickup Hill Road.Bedrock is the Northeast shale, a medium gray shale with some interbedded medium gray siltstone, and is of upper Upper Devonian age.During the last glaciation (Wisconsin) the small stream-cut valley was slightly widened and deepened by ice. As the ice sheet waned, valley-flanking kame terrace deposits of the Findley recessional moraine formed between the valley walls and the glacier in the large Conewango valley. Later, the remaining ice of the highlands stagnated leaving the major part of the region mantled with the Kent ground moraine deposits.Site 33 is wholly within the area of Kent ground moraine, but is less than 1000' from the area mapped as kame terrace deposits.The materials at the site seem to belong to both areas and may represent a transitional zone between the two, or more likely they represent minor fluctuations of the locally stationary margin of the ice sheet.Modern alluvial gravel is found in the flood plain.

The supplemental borrow area east of Pickup Hill Road contains SM and ML glacial tills, GM glacial outwash gravel and some ML glacio-lacustrine sediments. Topsoil covers the area to about an average depth of one foot. The upper part of the left abutment where it is less steep has topsoil over glacial till and glacio-lacustrine CL-ML's and ML's. The steeper part of the left abutment as you approach the stream has a few feet of glacial till over very highly weathered bedrock. The steepest portion has no till, just badly weathered bedrock over fairly sound shales and siltstones. Topsoil is continuous over this whole abutment.

The flood plain is thinly mantled with topsoil over 4-6 feet of dirty alluvial gravel in the GM-CP-GW range. This gravel covers 4-5 feet of either gray or brown often silty till. Bedrock is at approximately a 10 foot depth underneath the flood plain.

Topsoil covers the entire right abutment except for the extremely steep 190% slope adjacent to the stream. Bedrock on the right abutment is very highly weathered to a depth of from 1-6 feet. Beyond that it is fairly sound. The upper part of the right abutment has 6-10 feet of glacial till over bedrock.

The right emergency spillway area contains an assortment of glacial tills, glacial outwash sands and gravels, and glacio-lacustrine CL-ML's and ML's. Bedrock in the emergency spillway is found at depths of 4-20 feet.

GENERAL INFORMATION

Backhoe work began November 17, 1969 and was finished on November 20, 1969. Twenty pits were dug with a Schield-Bantam, crawler-type, cable operated backhoe with a maximum digging depth of approximately twenty feet. Large bag samples were collected and processed in the soils laboratory in the Syracuse State Office; also several were shipped to the SML in Lincoln for further testing.

Drilling work began December 5, 1969 and was finished December 18, 1969. Holes were drilled with one trailer-mounted Acker Hillbilly rotary drill rig and one truck-mounted Acker power auger. A small John Deere bulldozer was used for mobilization between holes. Samples were obtained with a 2" O.D. split spoon sampler in conjunction with standard penetration tests, mostly of a 2' drive. Holes were advanced with casing and roller bits. Recovery was logged and stored in sealed wide-mouthed Mason jars. Bedrock was cored with an NX double-tube core barrel with diamond bit. The core was logged and stored in standard NX wooden core boxes. Water pressure tests were conducted in three holes along the centerline of dam.

Because the hazard classification was changed from class "b" to class "c" and bedrock was quite shallow in the emergency spillway, it was decided to investigate a supplemental borrow area on the left hand side of the dam between the dam and the road. Five additional pits were dug on December 17 with a rubber-tired John Deere backhoe and loader. These pits were also sampled and the materials processed in the soils lab in Syracuse.

BRIEF MATERIAL DESCRIPTIONS

CONEWANGO 33

- A** Glacial outwash and stream channel gravel, found in the borrow area, emergency spillway, and flood plain. 50-70% gravel, 10-20% slightly-moderately plastic fines. Not highly permeable. GP-GM-GW
- B** Road fill gravel, much like A, but with many roots, logs and much brush. GM
- C** Glacial outwash sand found only in one drill hole in the emergency spillway (DH 254) SM
- D** Mostly brown glacial till (sand and silt) found in the borrow area, top of both abutments, emergency spillway, and above rock in the flood plain. Ranges from SC-SM to CL-ML.
- E** Grayish glacial till, more clayey than D, and found only in the flood plain.
- F** Highly weathered bedrock found mostly on the steep abutment slopes. Ranges from SC-SM to CL-ML, rips easily.
- G** Glacio-lacustrine CL-ML found in the upper part of the left abutment and in the emergency spillway.
- H** Weathered glacial till found beneath topsoil in borrow area, upper part of both abutments, and the emergency spillway. Non-plastic ML.
- I** Glacio-lacustrine ML found in the borrow area, upper part of the left abutment, and the emergency spillway. Non-plastic.
- J** Topsoil covering the area except for the steepest part of the right abutment.
- K** Thinly bedded shale and limestone bedrock found everywhere but the borrow area. Usually weathered in the top few feet. Hopefully rippable in most cases.

DETAILED GEOLOGIC INVESTIGATION OF DAM SITES

FEATURE Centerline of Dam

(CENTERLINE OF DAM, PRINCIPAL SPILLWAY, EMERGENCY SPILLWAY, THE STREAM CHANNEL, INVESTIGATIONS FOR DRAINAGE OF STRUCTURE, BORROW AREA, RESERVOIR BASIN, ETC.)

DRILLING PROGRAM

| EQUIPMENT USED | NUMBER OF HOLES | | NUMBER OF SAMPLES TAKEN | | |
|----------------|-----------------|----------|-------------------------|-----------|--------|
| | EXPLORATION | SAMPLING | UNDISTURBED | DISTURBED | |
| | | | (STATE TYPE) | LARGE | SMALL |
| Backhoe | 4 | 2 | 0 | 3 bag | 0 |
| Drill Rig | 3 | 3 | 3 NX Core | 0 | 16 jar |
| | | | | | |
| | | | | | |
| | | | | | |
| TOTAL | 7 | 5 | 3 NX Core | 3 bag | 16 jar |

SUMMARY OF FINDINGS
(INCLUDE ONLY FACTUAL DATA)

Topsoil averages about 0.8' under the embankment except the very steep 190% slope on the right abutment. Subsoil (weathered till H, ML) underlies topsoil on the upper slopes with brown till D, CL-ML to GC-GM, under subsoil. Some areas of glacio-lacustrine silts and clays and outwash sands and gravels are found high upon the abutments.

On the steeper slopes weathered bedrock F, (CL-ML) covers shale and siltstone bedrock.

In the floodplain alluvial and road-fill gravels cover gray and brown tills which rest on bedrock. Logs and brush are found along the bottom of the road fill which is found between the stream and the right abutment.

The steep slopes weep water nearly everywhere. In the flood plain water levels are at 1463 ± 0.5' in all holes along the centerline.

Bedrock recovery was acceptable in most cases, however, the RQD was low.

No areas of critically low blow counts occur anywhere below the first couple of feet.

Permeability is highest in the alluvial gravel but is not excessive.

Pressure tests were run in three holes. Results are tabulated in the summary sheet near the end of the narrative section of the report.

DETAILED GEOLOGIC INVESTIGATION OF DAM SITES

FEATURE Drain Line

(CENTERLINE OF DAM, PRINCIPAL SPILLWAY, EMERGENCY SPILLWAY, THE STREAM CHANNEL, INVESTIGATIONS FOR DRAINAGE OF STRUCTURE, BORROW AREA, RESERVOIR BASIN, ETC.)

DRILLING PROGRAM

| EQUIPMENT USED | NUMBER OF HOLES | | NUMBER OF SAMPLES TAKEN | | |
|----------------|-----------------|----------|-----------------------------|-------|-------|
| | EXPLORATION | SAMPLING | UNDISTURBED (STATE TYPE) | LARGE | SMALL |
| Backhoe | 3 | 2 | 0 | 2 bag | 0 |
| | | | | | |
| | | | | | |
| | | | | | |
| | | | | | |
| TOTAL | 3 | 2 | 0 | 2 bag | 0 |

SUMMARY OF FINDINGS
(INCLUDE ONLY FACTUAL DATA)

The drain line profile is essentially the same as the centerline of dam file except that the till D is found on the right side only and does not occur under the whole flood plain.

Seepage occurs all along the steep banks. Water levels were 1460.8 in TP 502 and 1459.0 in TP 303.

Bedrock was at 1356 ± 0.5' in the two holes near the stream, and is slightly shallower than at the centerline.

DETAILED GEOLOGIC INVESTIGATION OF DAM SITES

FEATURE Principal Spillway and Outlet Channel

(CENTERLINE OF DAM, PRINCIPAL SPILLWAY, EMERGENCY SPILLWAY, THE STREAM CHANNEL, INVESTIGATIONS FOR DRAINAGE OF STRUCTURE, BORROW AREA, RESERVOIR BASIN, ETC.)

DRILLING PROGRAM

| EQUIPMENT USED | NUMBER OF HOLES | | NUMBER OF SAMPLES TAKEN | | |
|----------------|-----------------|----------|-----------------------------|-------|--------|
| | EXPLORATION | SAMPLING | UNDISTURBED (STATE TYPE) | LARGE | SMALL |
| Backhoe | 4 | 0 | 0 | 0 | 0 |
| Drill Rig | 3 | 3 | 3 NX Core | 0 | 18 jar |
| | | | | | |
| | | | | | |
| | | | | | |
| TOTAL | 7 | 3 | 3 NX Core | 0 | 18 jar |

SUMMARY OF FINDINGS
(INCLUDE ONLY FACTUAL DATA)

Topsoil is from 0.4-0.8' thick in all holes.

The general sequence of materials is a road fill gravel (B), GM, over alluvial gravel (A), GM-GW, which covers either gray or brown till (E or D) CL-ML, resting on bedrock (K).

The road fill has logs and brush near the bottom and the alluvial gravel is the most permeable material, but not excessively so.

Bedrock hovers around 1456' in the upper 2/3 of the spillway and drops to around 1450' in the lower 1/3.

Water levels are apparently controlled by the creek in most cases.

Blow counts range from 13-140, but most are from 20-55.

DH 352 was pressure tested and the results tabulated in the summary sheet near the end of the narrative.

Bedrock recovery was good, but the RQD was low.

DETAILED GEOLOGIC INVESTIGATION OF DAM SITES

FEATURE Emergency Spillway

(CENTERLINE OF DAM, PRINCIPAL SPILLWAY, EMERGENCY SPILLWAY, THE STREAM CHANNEL, INVESTIGATIONS FOR DRAINAGE OF STRUCTURE, BORROW AREA, RESERVOIR BASIN, ETC.)

DRILLING PROGRAM

| EQUIPMENT USED | NUMBER OF HOLES | | NUMBER OF SAMPLES TAKEN | | |
|----------------|-----------------|----------|-------------------------|-----------|--------|
| | EXPLORATION | SAMPLING | UNDISTURBED | DISTURBED | |
| | | | (STATE TYPE) | LARGE | SMALL |
| Backhoe | 8 | 3 | 0 | 6 bag | 0 |
| Drill Rig | 4 | 4 | 4 NX Core | 0 | 20 jar |
| | | | | | |
| | | | | | |
| TOTAL | 12 | 7 | 4 NX Core | 6 bag | 20 jar |

SUMMARY OF FINDINGS
(INCLUDE ONLY FACTUAL DATA)

Topsoil covers the spillway area to about 0.6' in depth. Beneath this is from of subsoil, weathered till H (ML).

Glacial till D and outwash gravel A make up most of the remaining material. However, smaller areas of glacio-lacustrine silts and clays occur also, the most noticeable being an apparently continuous layer of I, (ML) along the outer profile.

Bedrock elevations are fairly consistent except near the steeper slopes.

Blow counts range from 12-40, discounting those near bedrock and near the surface.

Water is usually absent, except for a couple of minor seeps.

No pressure tests were run in the spillway holes.

DETAILED GEOLOGIC INVESTIGATION OF DAM SITES

FEATURE Borrow Area

(CENTERLINE OF DAM, PRINCIPAL SPILLWAY, EMERGENCY SPILLWAY, THE STREAM CHANNEL, INVESTIGATIONS FOR DRAINAGE OF STRUCTURE, BORROW AREA, RESERVOIR BASIN, ETC.)

DRILLING PROGRAM

| EQUIPMENT USED | NUMBER OF HOLES | | NUMBER OF SAMPLES TAKEN | | |
|----------------|-----------------|----------|-------------------------|-----------|-------|
| | EXPLORATION | SAMPLING | UNDISTURBED | DISTURBED | |
| | | | (STATE TYPE) | LARGE | SMALL |
| Backhoe | 5 | 4 | 0 | 4 bag | 0 |
| _____ | _____ | _____ | _____ | _____ | _____ |
| _____ | _____ | _____ | _____ | _____ | _____ |
| _____ | _____ | _____ | _____ | _____ | _____ |
| TOTAL | 5 | 4 | 0 | 4 bag | 0 |

SUMMARY OF FINDINGS
(INCLUDE ONLY FACTUAL DATA)

The pits were dug between the dam and Pickup Hill road to the west. No graphic information was available, so they were not surveyed and plotted. They cover the entire field and show about 1.0' of topsoil over 1.5-3.5' of subsoil H.

Two pits show material A, alluvial or outwash gravel to 10'. Of the other three two show till D and the other glacic-lacustrine CL-M, I.

Only one pit (104) showed minor seepage.

INTERPRETATIONS AND CONCLUSIONS

CONEWANGO 33

Centerline of Dam

The upper part of the left abutment around TP 1 is glacial till (D and H), with areas of glacio-lacustrine silts and clays (G and I). Bedrock is fairly shallow (6.5') in DH 51 and comes closer to the surface as you go down the slope towards the stream. The steep part of the slope is highly weathered bedrock (F) over shales and siltstones (K). Topsoil (J) covers the abutment to an average depth of about 0.8'.

The flood plain shows road fill (B) and alluvial gravel (A) over glacial tills (D and E) which cover bedrock (K). Topsoil (J) is thin. Bedrock is at about 9' across the flood plain.

The lower part of the right abutment is highly weathered bedrock (F) over shallow shales and siltstone (K). The upper part has tills (D and H) over bedrock (K).

Water is apparent only in the flood plain where the creek controls the water table and on the steep slopes which are constantly weeping because of slowly draining bedrock. This made these slopes extremely slippery all the time of the investigation.

Blow counts are adequate over the entire site. No consolidation or differential settlement should occur because of soft foundations.

I would suggest removal of all of the old road fill material (B), since it contains large amounts of brush and logs, apparently used to protect the road bed from stream erosion. This amounts to about 1200 c.y. of material to be removed.

If we adhere to what seems to have become the standard practice of flattening abutment slopes to 2:1, this means cutting the right abutment back 24 to 40' horizontally, depending upon the elevation of the bottom of the cutoff or principal spillway trench.

Looking at the centerline of dam profile, it appears that a positive cutoff could be achieved by bottoming in the glacial till (D and E). However, the till doesn't extend across the flood plain along the drain line. Since the possibility exists that the interpretation on the centerline may be incorrect and that the till may not extend completely across the flood plain, I suggest that the cutoff extend to sound rock, which should be around the 12' depth.

Consideration should be given to either stripping the material on the abutment down to sound rock or providing a cutoff through weathered materials and into sound rock.

The abutments wept continuously and were always wet and slippery, probably due to ground water carrying silt and clay from the weathering bedrock in the abutments. This condition probably will persist after construction and may keep the embankment-abutment interface wetter than normal. I suggest considering some type of drainage to handle this water.

Centerline of Dam (cont'd)

Pressure tests of rock core holes showed losses of about 1 to 13 fpd at various pressures and depths. This leakage should be either cutoff or a drain provided to intercept it.

Some type of pump and trench system will be needed to keep the principal spillway cutoff and drain line trenches dry during excavation and construction.

The gravel in the flood plain is not extremely stable on steep slopes so some caving and sloughing should be expected. It should be more stable when the water table is lowered.

The steepness of the abutments and the relief involved (about 90') indicates that the ramps (haul roads) from the spillway and borrow area will have to be quite long to reduce the slope to a workable grade during the earlier stages of construction. That is, these roads will extend quite a ways up and down the valley; therefore the construction limits on the land rights maps should reflect this.

Embankment

Several materials will be available for the embankment: alluvial gravel A, outwash sand C, glacial till D and E, highly weathered bedrock F, glacio-lacustrine silts and clays G and I, weathered till H, topsoil J, and bedrock K. I suggest spoiling road fill B because of the large amount of brush mixed in with it.

Amounts of C and G are small and represent only a minor part of the spillway excavation.

Analysis of the grain size curves shows three general groups. I suggest placement of these grouped materials as follows: fine grained materials G, H, and I in an impervious central core; coarse, cleaner gravel A in the outer parts of the dam; and materials C, D, E, F in the area between the other two.

Normal side slopes probably will suffice.

There are no soft areas in the foundation that will contribute to differential settlement. However, the steepness of the right abutment results in having a section of fill at least 57' high only 8' away from a section that is 38' high. More settlement will occur in the higher section than the lower and cracking due to differential consolidation within the embankment could result. The materials are not highly susceptible to cracking though.

Establishing vegetation should not present any problem.

Drain Line

Rotten, highly weathered bedrock F occurs on both abutments. The flood plain shows alluvial gravel A and road fill B over bedrock. Some till D is found under the ditch on the right side of the flood plain.

I suggest carrying the drain to sound bedrock over its entire length, since rock is shallow anyway. The drain should extend beyond permanent pool elevation to pick up any seepage that comes through the abutment unless it is cutoff by the core trench.

Drain Line (cont'd)

The drain will be in contact with materials A (502.1) and F (501.1), as well as the embankment materials. The grain size curves show representative samples of each material.

No natural filter material is available at the site.

Principal Spillway

There were no alternate locations considered because the valley is so narrow anyway.

Thin topsoil covers road fill B. Beneath this alluvial gravel A over tills D or E and bedrock.

Since I have previously suggested removing all the road fill material, I don't believe any further excavation is necessary. This way we could kill two birds with one stone by removing an undesirable material and excavating the spillway trench at the same time. However, it appears that the present location is too close to the steep right abutment. I suggest that the spillway be moved roughly 25' left and possibly cocked a little to more nearly conform with the alignment of the present channel. Backfill with good till D.

A lot of water will have to be removed while the trench is open, so probably some kind of pump and trench system would be best.

Camber should be minimal because there are no soft materials present.

Outlet Channel

The outlet channel will be constructed mostly in alluvial gravel A. Presently this is subject to erosion during flood flows, but after the dam is constructed, the proposed outlet discharges and velocities should not erode the natural alluvial gravels.

If the channel needs to be very deep, some sloughing and caving should be expected.

There might be enough large siltstone flags ripped out to serve as riprap, but the low RQD indicates that probably the rock would not pass the soundness or LA abrasion tests. Also the flaggy shape would not be well suited for riprap, since the thickness of the flags would be only 2-4".

Emergency Spillway

Estimated quantities of available excavation are as follows: A - 1820 c.y., GHI - 5280 c.y., CDEF - 4485 c.y., J - 1020 c.y., K - 2130 c.y.

The RQD of cores seems to indicate that the bedrock will be rippable, at least for the most part. The one tough spot might be near TP 208, where there is over 8' of rock above grade.

Emergency Spillway (cont'd)

Silt I and sand C will be exposed on the cut slope. These might be a bit unstable under wet conditions, - which were not observed. Most pits were quite dry and showed little or no seepage.

Oversize (+6") waste material can be placed on the outer slope of the embankment near the downstream toe.

Borrow Area

The lack of topographic information in the borrow area makes it difficult to accurately portray borrow area profiles and quantities. On a basis of ten-foot deep holes over an approximate area of 1 1/2 acres we have the following quantities: of available borrow: A - 6140 c.y., D - 6335 c.y., HI - 8470 c.y., J - 2420 c.y.

This leaves us a little short of material but I expect we can go the knob just north of the borrow area and can excavate to a depth greater than ten feet. I don't expect to find anything there we haven't seen yet someplace.

Probably the natural moisture is a bit below optimum since most pits don't show any seepage.

GEOLOGY REPORT

JAN. 1959

SITE #33
CONEWANGO WATERSHED
CHAUTAUQUA COUNTY S&WCD
NEW YORK

SUPPLEMENTAL REPORT
LEFT EMERGENCY SPILLWAY

APPROVAL:

Richard L. Phillips
Richard L. Phillips
State Conservation Engineer

PREPARED BY:

D. Bruce Champeon
D. Bruce Champeon
Geologist

REVIEWED BY:

B. S. Ellis
Bernard S. Ellis
Senior Staff Geologist

REFERENCE:

U. S. DEPARTMENT OF AGRICULTURE
SOIL CONSERVATION SERVICE

DRAWING NO.
NY-2173(A)

SHEET 1 OF 15

DATE 2/9/71

GENERAL INFORMATION

Since a large quantity of bedrock was present in the proposed right emergency spillway excavation, it was decided to fully investigate the feasibility of moving the emergency spillway to the left side of the embankment. Five pits had been dug in the general area of the left spillway, but they were not located in the right places to give the needed information. Also, these pits were only ten feet deep because they were intended as borrow area pits.

Eight backhoe pits were dug with a Schield-Bantam, crawler type, cable-operated backhoe with a maximum digging depth of about twenty feet. Six large bag samples were collected and processed in Syracuse.

Four drill holes were drilled with a truck-mounted CME rotary drill rig. Samples were obtained with a 2" OD split-spoon sampler in conjunction with standard penetration tests, mostly of a 2' drive. Holes were advanced with 6" OD hollow stem flight augers. Recovery was logged and stored in sealed wide-mouth Mason type jars. Five jar samples were processed for correlation purposes.

All field work was done from 12/21/70 to 12/23/70.

The present design shows 35,500 c.y. of spillway excavation available and 46,500 c.y. of embankment fill needed, leaving 11,000 c.y. to be obtained from a borrow area, probably in the area of the old right spillway.

The initial report was prepared in March 1970 and covered all aspects of the site. This report adds a discussion of the new left emergency spillway and revises the borrow and embankment discussions. This report must be used in conjunction with the original. The material designations remain the same as the old ones.

DETAILED GEOLOGIC INVESTIGATION OF DAM SITES

FEATURE Left Emergency Spillway

(CENTERLINE OF DAM, PRINCIPAL SPILLWAY, EMERGENCY SPILLWAY, THE STREAM CHANNEL, INVESTIGATIONS FOR DRAINAGE OF STRUCTURE, BORROW AREA, RESERVOIR BASIN, ETC.)

DRILLING PROGRAM

| EQUIPMENT USED | NUMBER OF HOLES | | NUMBER OF SAMPLES TAKEN | | |
|------------------|-----------------|-----------|-----------------------------|---------------|---------------|
| | | | UNDISTURBED (STATE TYPE) | DISTURBED | |
| | | | | LARGE | SMALL |
| EXPLORATION | SAMPLING | | | | |
| <u>Backhoe</u> | <u>13</u> | <u>9</u> | <u>0</u> | <u>10 bag</u> | <u>0</u> |
| <u>Drill Rig</u> | <u>4</u> | <u>4</u> | <u>0</u> | <u>0</u> | <u>38 jar</u> |
| | <u>17</u> | <u>13</u> | <u>0</u> | <u>10 bag</u> | <u>38 jar</u> |
| | | | | | |
| | | | | | |
| | | | | | |
| TOTAL | | | | | |

SUMMARY OF FINDINGS
 (INCLUDE ONLY FACTUAL DATA)

Topsoil "J" averages 0.9', but ranges in thickness from 0.3' to 1.5'. Beneath topsoil "J" lies from 1.0' to 3.5' of weathered ablation till subsoil "H" (ML). No material "H" was found in TP215.

Three other types of materials are present:

- 1) Poorly stratified, ice-contact, glaciofluvial gravel or sand "A" that may classify as any of the following (GP-GM, SC-SM, CC-GM, SM, GM). Has less than 20% fines.
- 2) Sandy, ice-contact glacial till "D" that may classify as SM, SC-SM, or CL-ML. Has 40-55% fines.
- 3) Glaciofluvial sands and silts "C" interbedded with glaciolacustrine sands, silts, and clays "G" and "I".

Glacial till "D" is found mainly beneath "H" but above grade in the upper part of the inlet section, level section, and upper part of the outlet section. This material ranges from 3-15' thick and may be lensed or interbedded with other materials.

The gravel "A" is found mainly in the outlet section beneath "H" all the way to and below grade. It also extends beneath "D" near the level section and is still at and below grade.

DETAILED GEOLOGIC INVESTIGATION OF DAM SITES

FEATURE Left Emergency Spillway (cont'd)

(CENTERLINE OF DAM, PRINCIPAL SPILLWAY, EMERGENCY SPILLWAY, THE STREAM CHANNEL, INVESTIGATIONS FOR DRAINAGE OF STRUCTURE, BORROW AREA, RESERVOIR BASIN, ETC.)

DRILLING PROGRAM

| EQUIPMENT USED | NUMBER OF HOLES | | NUMBER OF SAMPLES TAKEN | | |
|----------------|-----------------|----------|-----------------------------|-------|-------|
| | EXPLORATION | SAMPLING | UNDISTURBED (STATE TYPE) | LARGE | SMALL |
| _____ | _____ | _____ | _____ | _____ | _____ |
| _____ | _____ | _____ | _____ | _____ | _____ |
| _____ | _____ | _____ | _____ | _____ | _____ |
| _____ | _____ | _____ | _____ | _____ | _____ |
| _____ | _____ | _____ | _____ | _____ | _____ |
| _____ | _____ | _____ | _____ | _____ | _____ |
| TOTAL | _____ | _____ | _____ | _____ | _____ |

SUMMARY OF FINDINGS
(INCLUDE ONLY FACTUAL DATA)

Most of the finer glaciofluvial sands and silts "C" and the glaciolacustrine materials "G" and "I" are found above and below grade at the level section and the inlet section. Minor amounts of "C" are found scattered elsewhere.

Bedrock "K" was found 21' below grade in DH258.

Water levels indicate that the gravel is well drained since little water was observed in these pits or holes. The inlet section holes showed fairly high water levels or seepage levels, mostly in till or the sands and glaciolacustrine fine grained materials.

Blow counts range from 9-67 discounting topsoil and the one blow count near bedrock. Most are above 20.

INTERPRETATIONS AND CONCLUSIONS

Left Emergency Spillway

Estimated quantities of excavation are as follows:

A-20,000 c.y., CD-8800 c.y., HI-4200 c.y., J topsoil)-1800 c.y. Approximately 700 c.y. of +6" material is excluded from the above figures.

All materials will be exposed at one place or another on the cutslope. The vast majority of grade will fall in material "A" and the rest will be in "C" except for very minor areas that will be in "I".

Some special consideration may need to be given to seeding the spillway, since the fines content is below 16% in gravel "A", and the area is generally dry. The inlet section is wetter and in till or lacustrines with plenty of fines.

I should point out that the profiles as shown probably present a more simplified story of deposition than really exists. The following quote should show why - "Ice-contact stratified drift shows, through details of form or internal character, that is accumulated in contact with glacier ice. Internally, three general characteristics distinguish it from outwash: (1) extreme range and abrupt changes in grain size, (2) included bodies of till, and (3) deformation. Whether accumulation takes place upon, against, or underneath the wasting terminal zone of the glacier, it is likely to be sporadic and irregular, with no intervening distance to smooth out diurnal and seasonal differences in rate of melting and release of sediment. The same site may successively see a rushing stream, a quiet pool, a small avalanche of boulders, and actual over-riding by ice, folding or faulting the layers of sediment or smearing till on them In such a place anything can happen, and it usually does."¹

Borrow Area

Most of the old right emergency spillway above rock will probably be used as additional borrow. The estimated quantities of excavation available are as follows: A-1800 c.y., CD-4500 c.y., CHI-5300 c.y. Approximately 200 c.y. of +6" material is excluded from the above figures.

The present land rights map may be a bit restrictive if the borrow area has to be expanded. Some consideration should be given to enlarging the land rights if necessary. As far as materials are concerned, there is no reason this area can not be expanded.

This area is also generally dry. Little seepage was observed.

Embankment

Every material will be available for use in the embankment, with the possible exceptions of bedrock K, which might not be excavated, and road fill B, which should be spoiled because of the large amount of brush in it. Only minor amounts of E and F will be available.

¹Flint, Richard Foster, 1957, Glacial and Pleistocene Geology, John Wiley & Sons, London, p. 146.

x

Analysis of the grain size curves shows three general groups. I suggest placement of these grouped materials as follows: fine grained GHI in the impervious central core; coarse, clean gravel A in the outer parts of the dam; and CD in the area between the other two.

It may be necessary to add moisture to the gravel "A" to get it up to optimum moisture.

Establishing vegetation may require a seed mix set up for low moisture and few fines, since the gravel "A" will be on the outside of the embankment.

UNITED STATES DEPARTMENT OF AGRICULTURE
SOIL CONSERVATION SERVICE - Soil Mechanics Laboratory

800 "J" Street, Lincoln, Nebraska 68508

SUBJECT: ENG 22-5, New York WP-08, Conewango Creek
Site No. 33 (Chautauqua County)

DATE: September 14, 1970

TO: Richard L. Phillips, State Conservation Engineer
SCS, Syracuse, New York

ATTACHMENTS

1. Form SCS-354, Soil Mechanics Laboratory Data, 2 sheets.
2. Form SCS-355A, Triaxial Shear Test Data, 2 sheets.
3. Form SCS-352, Compaction and Penetration Resistance, 4 sheets.
4. Form SCS-372A & B, Placement of Earth Fill Materials, 3 sheets.
5. Form SCS-357, Summary - Slope Stability Analysis, 2 sheets.
6. Form SCS-130, Drain Materials, 1 sheet.
7. Investigational Plans and Profiles.

INTRODUCTION

Proposed Site 33 is located in the Allegheny Plateau physiographic area where the topography is described as rolling. This is a class "c" dam with a maximum height of 57' and will contain approximately 41,700 cubic yards of fill.

DISCUSSION OF DATA

FOUNDATION MATERIALS

- A. Bedrock. Bedrock on this site is a medium gray shale with some interbedded gray siltstone and occasional limy sandstone beds. The shale is Northeast shale of Upper Devonian age. The shale is usually very weathered in the top few feet.
- B. Classification. The upper part of the left abutment has glacial till and glacio-lacustrine CL-ML's and ML's underneath the topsoil. Samples 1.1 and 1.2 from this area were tested at the Syracuse lab. Sample 1.1 classified as a CL (LL = 31, PI = 11) with 82% fines. Sample 1.2 classified as a nonplastic ML with 92% fines.

The steeper part of the left abutment has a few feet of glacial till overlying very highly weathered bedrock. The glacial till disappears at about the permanent pool elevation.

Across the floodplain about 4' to 6' of dirty alluvial gravels are present. These soils were logged as GM, GP, and GW. About 4' to 5' of silty till underlie the alluvium and serve as the bedrock contact. Sample 502.1 from the alluvium classified as a GW-GM with 68% gravel and only 8% fines.

Topsoil covers the entire right abutment except for the extremely steep slope adjacent to the stream channel. Bedrock on the right abutment is very highly weathered to a depth of 1' to 6'. The upper portion of this abutment has about 6' to 10' of glacial till over bedrock. Sample 4.1 from the weathered bedrock classified as a CL-ML (LL = 26, PI = 7) with 50% fines. Emergency spillway samples 206.1 through 206.4 represent the glacial till and classified as GP-GM, GM, and ML soils.

- C. Dry Density and Blow Count. Standard penetration tests were made in several holes. Blow counts were relatively high and ranged from 9 to 153.
- D. Consolidation. Settlement in the foundation materials is expected to be very minor based on blow counts and classifications.
- E. Permeability. Field pressure tests were made at three locations in the bedrock materials. In DH-51 in the left abutment, the permeability rate varied from 2.3 to 5.5 ft/day. In DH-302 in the floodplain, the rate was between 0.8 and 3.0 ft/day. In DH-53 in the right abutment, the permeability rate ranged from 4.1 to 13.2 ft/day. The alluvial gravels are expected to have at least moderate permeability rates.
- F. Shear Strength. No undisturbed samples were submitted from the foundation for shear testing. Based on the information available, the shear strength of the foundation materials was assumed to be no weaker than the embankment materials.

EMBANKMENT MATERIALS

- A. Classification. There are about seven types of materials available to construct the dam. These are summarized in the following tabulation:

| Type | Description | Location | Class |
|------|--------------------------|--------------------------------|----------------------------|
| G | Glacio-lacustrine | £ dam, E. Spwy. | CL-ML, CL |
| H | Glacial till | Borrow, E. Spwy. | ML |
| I | Glacio-lacustrine | £ dam, Borrow, E. Spwy. | ML |
| C | Outwash | E. Spwy. | SM |
| D | Glacial till | Borrow, E. Spwy. | GM, SM, SC, CL-ML |
| F | Highly weathered bedrock | £ dam, Drain Line | CL-ML, ML |
| A | Outwash and alluvium | Borrow, E. Spwy, Drain Line | GP-GC, GC, GP-GM, GW-GM |

Subj: New York WP-08, Conewango Creek, Site No. 33

- B. Compacted Dry Densities. Four large samples were submitted to the Laboratory for testing. The results are shown below for Standard Proctor effort on the minus No. 4 fraction:

| Field No. | Laboratory No. | Type | Class | Max. γ_d pcf | w_o % |
|-----------|----------------|------|-------|------------------------|------------|
| 101.1 | 71W46 | A | GC | 122.0 | 12.0 |
| 102.1 | 71W47 | D | GM | 122.0 | 10.5 |
| 103.1 | 71W48 | H | ML | 107.5 | 16.0 |
| 104.1 | 71W49 | I | ML | 111.0 | 13.5 |

- C. Consolidation. An average consolidation potential of 1.5% is estimated for Types G, H, and I materials. Settlement in the embankment materials was estimated to be 0.9' at the maximum section.
- D. Permeability. Type A materials are expected to be the most permeable embankment soils and are suggested for placement in the outer zones of the fill.
- E. Shear Strength. Consolidated undrained triaxial shear tests were made on Samples 102.1 (71W47) and 103.1 (71W48). The 1.4" test specimens were remolded to 95% of maximum D-698-A dry density at close to optimum moisture content. The specimens were allowed to soak to saturation and then tested. The results are shown below:

| Field Sample | Class | Type | Test γ_d (pcf) | % Saturation | ϕ (Deg.) | c (psf) |
|--------------|-------|------|--------------------------|--------------|------------------|--------------|
| 102.1 | GM | D | 116.5 | 91 | 28.5 | 375 |
| 103.1 | ML | H | 102.0 | 94 | 26.5 | 800 |

SLOPE STABILITY ANALYSIS

A modification of the Swedish circle method was used to check the slope stability analysis of the dam. Refer to Form SCS-357 (2 sheets) for a detailed summary of the analysis. No unusual conditions were encountered and the proposed slopes are adequate.

CONCLUSIONS AND RECOMMENDATIONS

- A. Cutoff. A cutoff extending to sound bedrock across the floodplain is recommended. It should also extend up the abutments to approximate elevation 1485'. From there to the top of the dam, a depth sufficient

Richard L. Phillips
Subj: New York WP-08, Conewango Creek, Site No. 33

4

to remove any loose surface disturbances, roots, etc., should be satisfactory. A 20' wide bottom with 2:1 side slopes is suggested.

Backfilling with Types G, H, or I soils compacted to 95% of D-698-A dry density is also suggested.

The SML also concurs in the geologist's suggestion to remove all of the old road fill material (Type B). This fill contains a large amount of old brush and logs. Only 1200 cubic yards of this material are involved.

- B. Principal Spillway. The proposed alignment crosses the centerline of dam near the base of the right abutment. Topsoil, old road fill, alluvial gravel, and tills in that order overlie bedrock. As previously discussed, removal of the road fill is recommended. This leaves only about 5' to 7' of alluvium and till under the maximum section. Settlement was estimated as 0.2' based on the limited foundation information available. No joint gap problems are anticipated.

Consideration should be given to moving the conduit closer to the stream channel and away from the steep right abutment.

A camber of 0.2' is suggested.

An effective ϕ angle of 30° is recommended for conduit loading computations.

- C. Drainage. In order to control seepage through the foundation materials, it is recommended that a pipe and filter trench drain be installed across the floodplain and up the abutments to approximate elevation 1500'. Locate the trench at a c/b ratio of 0.7. The trench should extend down to bedrock at all locations except between elevations 1490' and 1500' in the left abutment. Bottoming the trench in the SM soils (Type D) between these elevations should be adequate.

Refer to Form SCS-130 for a satisfactory gradation of the filter materials. The coarse filter shown should be satisfactory for use against Type A & B foundation soils and Type A embankment soils. However, a finer filter such as ASTM C33 is needed against Type F foundation materials.

- D. Embankment Design.

1. Placement of Materials. Refer to Forms SCS-372A & B (3 sheets) for recommended placement and control of the embankment materials.
2. Slopes. The proposed 3:1 slopes upstream with a 10' wide berm at elevation 1483.7' are satisfactory. The proposed 2½:1 slopes downstream are also satisfactory.

Richard L. Phillips
Subj: New York WP-08, Conewango Creek, Site No. 33

5

3. Overflow. An overflow of 1.1' is suggested across the floodplain to allow for residual settlement of the foundation and embankment.
- E. Shaping of the Right Abutment. In order to reduce the possibilities of harmful differential settlement in the area near the base of the right abutment, it is recommended the slopes be flattened to 2:1.

Prepared by:

Charles H. McElroy

Reviewed and Approved by:

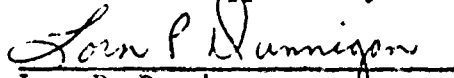
Lorn P. Dunnigan
Head
Soil Mechanics Laboratory

Attachments

cc:
Richard L. Phillips (1)
Bernard S. Ellis, Geologist, Syracuse, N. Y.
J. S. Wicks, Little Valley, N. Y.
N. F. Bogner, Upper Darby, Pa.

41,000 cu yd Floodwater Retarding

CONSERVATION SERVICE

| DESIGNATION PILE NUMBER | FIELD NUMBER | NEW YORK LOCATION AND DESCRIPTION | DEPTH | FIELD CLASS- IFICATION | MECHANICAL ANALYSIS GRAIN SIZE DISTRIBUTION EXPRESSED AS PERCENT FINER BY WEIGHT | | | | | | | | | | | | | | | | | ATTERBERG LIMITS | | | | |
|-------------------------------|-----------------|--|---------|------------------------------|---|------|-----|-----|-----|------|-----|-----|-----|-----|--------|------|------|----|--------|----|----|---------------------|----|--|--|--|
| | | | | | FINES | | | | | SAND | | | | | GRAVEL | | | | | | | LL | PI | | | |
| | | | | | 0.075 | 0.15 | 0.3 | 0.6 | 200 | #10 | #60 | #20 | #10 | #4 | 3/8" | 1/2" | 3/4" | 1" | 1 1/2" | 2" | 3" | | | | | |
| | | | | | 0.075 | 0.15 | 0.3 | 0.6 | 200 | #10 | #60 | #20 | #10 | #4 | 3/8" | 1/2" | 3/4" | 1" | 1 1/2" | 2" | 3" | | | | | |
| 71W | | Conewango Creek Site: 33 | | | | | | | | | | | | | | | | | | | | | | | | |
| 46 | 101.1 | Borrow A material L. Bag | 4-10' | GM-GP | 5 | 8 | 12 | 15 | 17 | 18 | 17 | 22 | 29 | 40 | 51 | 57 | 73 | 72 | 75 | 23 | 9 | | | | | |
| | | A Material; Alluvial gravel | | | | | | | | | | | | | | | | | | | | | | | | |
| | | 7,960 c.y. | | | | | | | | | | | | | | | | | | | | | | | | |
| | | Gradation from Syracuse Lab | | | | | | | 9 | 10 | 10 | 12 | 14 | 23 | 35 | 44 | 49 | 57 | 64 | 73 | 87 | 30 | 8 | | | |
| | | *Corrected for 13% + 3" | | | | | | | | | | | | | | | | | | | | | | | | |
| 47 | 102.1 | Borrow D material L. Bag | 3-10' | SM | 7 | 12 | 22 | 34 | 40 | 44 | 57 | 55 | 59 | 64 | 69 | 75 | 77 | 77 | 82 | 84 | 18 | 2 | | | | |
| | | D Material; Glacial Till | | | | | | | | | | | | | | | | | | | | | | | | |
| | | 9,970 c.y. | | | | | | | | | | | | | | | | | | | | | | | | |
| | | Gradation from Syracuse Lab | | | | | | | | | | | | | | | | | | | | | | | | |
| | | *Corrected for 10% + 5" | | | | | | | | | | | | | | | | | | | | | | | | |
| 48 | 103.1 | Borrow H material L. Bag | 1-3' | ML | 11 | 17 | 23 | 37 | 47 | 49 | 52 | 55 | 59 | 64 | 69 | 73 | 75 | 75 | 77 | 81 | 25 | 3 | | | | |
| | | H Material; Glacial Till | | | | | | | | | | | | | | | | | | | | | | | | |
| | | 7,050 c.y. | | | | | | | | | | | | | | | | | | | | | | | | |
| | | Gradation from Syracuse Lab | | | | | | | | | | | | | | | | | | | | | | | | |
| | | *Corrected for 10% + 5" | | | | | | | | | | | | | | | | | | | | | | | | |
| 49 | 104.1 | Borrow I material L. Bag | 4.5-10' | ML | 11 | 17 | 41 | 72 | 90 | | | | | 100 | | | | | | | 20 | 2 | | | | |
| | | I Material; Glauis = loesslike silt & clays | | | | | | | | | | | | | | | | | | | | | | | | |
| | | 4,020 c.y. | | | | | | | | | | | | | | | | | | | | | | | | |
| | | Gradation from Syracuse Lab | | | | | | | | | | | | | | | | | | | | | | | | |
| | | *Corrected for 10% + 5" | | | | | | | | | | | | | | | | | | | | | | | | |



arding

| MECHANICAL ANALYSIS GRAIN SIZE DISTRIBUTION EXPRESSED AS PERCENT FINER BY DRY WEIGHT | | | | | | | | | | | | | | | | | | ATTERBERG LIMITS | | UNIFIED CLASSIFICATION | SOLUBLE SALTS % | DISPERSION % | MOISTURE - DENSITY RELATIONSHIPS | | | | UNDISTURBED SAMPLE DATA | SPECIFICATIONS | | | | | | | | | | | | | | | | | | | | | | | | | | | | | | | |
|---|-----|-----|------|------|------|-----|------|------|--------|-----|------|------|------|-----|----------------------|----------------------|------|------------------|------|------------------------|-----------------|--------------|----------------------------------|----------------|--------|-------|-------------------------|----------------|---------------------|-----|----------------|--------|-------|-----|---------------------|-----|--|--|--|--|--|--|--|--|--|--|--|--|--|--|--|--|--|--|--|--|--|--|--|
| FINES | | | SAND | | | | | | GRAVEL | | | | | | | | | LL | PI | | | | Dry Density < No. 4 | G _s | Gravel | WAT % | | w % | Z _d g/cc | w % | G _s | Gravel | WAT % | w % | Z _d g/cc | w % | | | | | | | | | | | | | | | | | | | | | | | |
| #20 | #40 | #60 | #100 | #200 | #425 | #60 | #100 | #200 | #425 | #60 | #100 | #200 | #425 | #60 | #100 | #200 | #425 | | | | | | | | | | | | | | | | | | | | | | | | | | | | | | | | | | | | | | | | | | |
| 3 | 12 | 15 | 17 | 17 | 17 | 22 | 29 | 40 | 51 | 70 | 72 | 75 | 23 | 7 | GC | 13 | 12.0 | 12.0 | | | | | | | | | | | | | | | | | | | | | | | | | | | | | | | | | | | | | | | | | |
| * Corrected for 13% + 3" | | | | | | | | | | | | | | | | | | | | | | | | | | | | | | | | | | | | | | | | | | | | | | | | | | | | | | | | | | | |
| 6 | 9 | 10 | 10 | 12 | 14 | 23 | 35 | 44 | 49 | 57 | 64 | 73 | 87 | 30 | 8 | GP GC (Field Tested) | | | | | | | | | | | | | | | | | | | | | | | | | | | | | | | | | | | | | | | | | | | |
| * Corrected for 13% + 3" | | | | | | | | | | | | | | | | | | | | | | | | | | | | | | | | | | | | | | | | | | | | | | | | | | | | | | | | | | | |
| 17 | 22 | 34 | 44 | 51 | 55 | 59 | 64 | 69 | 75 | 87 | 93 | 98 | 100 | 18 | 2 | SL | 43 | 12.5 | 10.5 | | | | | | | | | | | | | | | | | | | | | | | | | | | | | | | | | | | | | | | | |
| * Corrected for 10% + 5" | | | | | | | | | | | | | | | | | | | | | | | | | | | | | | | | | | | | | | | | | | | | | | | | | | | | | | | | | | | |
| 13 | 23 | 38 | 41 | 48 | 56 | 59 | 63 | 67 | 72 | 77 | 85 | 88 | 90 | 5 | NP SL | (Field Tested) | | | | | | | | | | | | | | | | | | | | | | | | | | | | | | | | | | | | | | | | | | | |
| * Corrected for 10% + 5" | | | | | | | | | | | | | | | | | | | | | | | | | | | | | | | | | | | | | | | | | | | | | | | | | | | | | | | | | | | |
| 17 | 33 | 72 | 77 | 82 | 85 | 87 | 90 | 93 | 95 | 97 | 97 | 100 | | 25 | 3 | CL | 24 | 16.5 | 16.0 | | | | | | | | | | | | | | | | | | | | | | | | | | | | | | | | | | | | | | | | |
| * Corrected for 10% + 5" | | | | | | | | | | | | | | | | | | | | | | | | | | | | | | | | | | | | | | | | | | | | | | | | | | | | | | | | | | | |
| 20 | 44 | 70 | 77 | 79 | 81 | 82 | 85 | 87 | 90 | 93 | 94 | 93 | 100 | | NP ML (Field Tested) | | | | | | | | | | | | | | | | | | | | | | | | | | | | | | | | | | | | | | | | | | | | |
| * Corrected for 10% + 5" | | | | | | | | | | | | | | | | | | | | | | | | | | | | | | | | | | | | | | | | | | | | | | | | | | | | | | | | | | | |
| 7 | 41 | 76 | 90 | | | | | | | | | 100 | | 20 | 2 | CL | 24 | 11.5 | 13.5 | | | | | | | | | | | | | | | | | | | | | | | | | | | | | | | | | | | | | | | | |
| * Corrected for 10% + 5" | | | | | | | | | | | | | | | | | | | | | | | | | | | | | | | | | | | | | | | | | | | | | | | | | | | | | | | | | | | |
| 7 | 31 | 30 | 90 | 95 | | | | | | 73 | 98 | 97 | | | NP ML (Field Tested) | | | | | | | | | | | | | | | | | | | | | | | | | | | | | | | | | | | | | | | | | | | | |

2

SOIL CONSERVATION SERVICE

| LABORATORY SAMPLE NUMBER | FIELD NUMBER | New York LOCATION AND DESCRIPTION | DEPTH | FIELD CLASSIFICATION | MECHANICAL ANALYSIS GRAIN SIZE DISTRIBUTION EXPRESSED AS PERCENT FINER BY DRY WEIGHT | | | | | | | | | | | | | | | | | ATTERBERG LIMITS | | U.C.I. | |
|--------------------------|--------------|---|-----------|----------------------|---|-------|-------|-------|-------|------|------|-----|------|------|--------|-------|-------|-------|------|------|-------|------------------|---------|---------|-------|
| | | | | | FINES | | | | | SAND | | | | | GRAVEL | | | | | | | LL | PI | | |
| | | | | | 0.075 | 0.075 | 0.075 | 0.425 | 0.850 | 2.0 | 4.75 | 9.5 | 19.0 | 37.5 | 75.0 | 150.0 | 300.0 | 600.0 | 1.18 | 0.25 | 0.425 | | | | 0.850 |
| | | | | | % | % | % | % | % | % | % | % | % | % | % | % | % | % | % | % | % | % | % | | |
| - | 1.1 | E Dam } G Conewango Creek, Site 33 6.1-6.10 1.2-6.10 strata | 4'-8" | | 32 | 44 | 64 | 77 | 82 | 84 | 85 | 89 | 90 | 91 | 93 | 94 | 94 | 95 | 95 | 97 | 100 | 31 | 11 | C | |
| - | 203.1 | F. Spwy. } | 4.5' | | 15 | 23 | 41 | 57 | 63 | 66 | 72 | 76 | 80 | 85 | 91 | 95 | 97 | 99 | 100 | | | | | 5 | C |
| - | 103.1 | Borrow } H Glacial Till | 1'-3' | ✓ | 14 | 20 | 44 | 70 | 77 | 79 | 81 | 82 | 85 | 87 | 90 | 93 | 94 | 95 | 99 | 100 | | | NP | M | |
| - | 206.1 | E. Spwy. } | 3.2' | | 10 | 16 | 45 | 73 | 80 | 81 | 83 | 85 | 87 | 90 | 93 | 96 | 97 | 99 | 100 | | | | | NP | M |
| - | 1.2 | E Dam } I Glacio-Locustine | 8'-13' | | 19 | 25 | 46 | 85 | 92 | 96 | 98 | 98 | 99 | 99 | 100 | | | | | | | | | NP | M |
| - | 104.1 | Borrow } | 4.5-10' | ✓ | 12 | 17 | 38 | 80 | 90 | 95 | 98 | 98 | 98 | 99 | 99 | | | | 100 | | | | | NP | M |
| - | 206.4 | E. Spwy. } | 12' | | 6 | 9 | 22 | 50 | 66 | 77 | 92 | 93 | 94 | 95 | 96 | 97 | 99 | 99 | 100 | | | | | NP | M |
| - | 254.5b | F. Spwy. } C Outwash | 26'-12.5' | | 17 | 24 | 27 | 37 | 39 | 58 | 81 | 93 | 97 | 98 | 99 | 100 | | | | | | | | NP | S |
| - | 102.1 | Borrow } D Glacial Till | 3'-10' | ✓ | 14 | 25 | 42 | 53 | 58 | 66 | 70 | 74 | 80 | 86 | 87 | 92 | 94 | 98 | 100 | | | | | NP | S |
| - | 205.1 | E. Spwy. } | 8'-11" | | 12 | 16 | 33 | 42 | 46 | 49 | 56 | 60 | 64 | 68 | 76 | 82 | 85 | 90 | 92 | 96 | 100 | 21 | 13 | S | |
| - | 206.3 | E. Spwy. } | 9' | | 16 | 22 | 37 | 52 | 55 | 53 | 62 | 65 | 68 | 74 | 81 | 87 | 90 | 94 | 95 | 98 | 100 | 24 | 5 | CL M | |
| - | 4.1 | E Dam } F Highly org. bedst. | 8' | | 17 | 24 | 43 | 43 | 50 | 51 | 55 | 58 | 61 | 65 | 75 | 82 | 85 | 90 | 92 | 97 | 100 | 26 | 7 | CL M | |
| - | 501.1 | Drain } | 0.7-3' | | 13 | 22 | 43 | 58 | 62 | 63 | 64 | 64 | 65 | 67 | 68 | 72 | 74 | 78 | 83 | 89 | 100 | 30 | 6 | M | |
| - | 101.1 | Borrow } A Outwash | 4'-10' | ✓ | 6 | 9 | 10 | 10 | 11 | 13 | 16 | 21 | 27 | 34 | 43 | 51 | 57 | 64 | 72 | 80 | 100 | 33 | 3 | CL M | |
| - | 206.3 | E. Spwy. } | 6' | | 6 | 10 | 11 | 11 | 12 | 13 | 16 | 27 | 34 | 51 | 64 | 72 | 79 | 85 | 90 | 100 | 34 | 9 | CL M | | |
| - | 502.1 | Drain } | 3' | | | | | 8 | 8 | 10 | 10 | 14 | 23 | 32 | 41 | 46 | 56 | 64 | 90 | 100 | 42 | 12 | CL M | | |
| | | * Tested at Syracuse | | | | | | | | | | | | | | | | | | | | | | | |

| MECHANICAL ANALYSIS GRAIN SIZE DISTRIBUTION EXPRESSED AS PERCENT FINER BY DRY WEIGHT | | | | | | | | | | | | | | | | | | | ASTERBERG LIMITS | | UNIFIED CLASS- IFICATION | SOLUBLE SALTS % | DIS- PERSION % | WATER - DENSITY RELATIONSHIPS | | | UNDISTURBED SAMPLE DATA | | SPECIAL TESTS | | | | | | | | | |
|---|------|------|------|-----|-----|-----|-------|------|--------|------|-----|--------|-----|-----|-----|-----|-----|----|---------------------|-----------|--------------------------------|--------------------|----------------------|----------------------------------|----|---------------------------------|----------------------------|------------------------|---------------|----------------|----|---|-----------|----|--|--|--|--|
| FINES | | | SAND | | | | | | GRAVEL | | | | | | | | | | LL | PI | | | | | | MAX Z _d p.c.t. | % | T _d g/cc | % | G _c | | | | | | | | |
| #200 | #140 | #100 | #60 | #40 | #20 | #10 | #4.75 | 3/8" | 1/2" | 3/4" | 1" | 1 1/2" | 2" | | | | | | | | | | | | | | | | | | | | | | | | | |
| 44 | 66 | 77 | 82 | 86 | 89 | 90 | 91 | 93 | 94 | 95 | 100 | 100 | 100 | 100 | 100 | 100 | 100 | 31 | 11 | CL | | | | | | | | | | | | | | | | | | |
| 23 | 41 | 57 | 63 | 66 | 70 | 76 | 80 | 85 | 91 | 95 | 97 | 100 | | | | | | 31 | 5 | CL- ML | | | | | | | | | | | | | | | | | | |
| 20 | 44 | 70 | 77 | 79 | 81 | 82 | 85 | 87 | 90 | 93 | 96 | 98 | 100 | | | | | 11 | P | ML | | | | | | | | | | | | | | | | | | |
| 16 | 45 | 73 | 80 | 81 | 83 | 85 | 87 | 90 | 93 | 96 | 97 | 99 | 100 | | | | | 11 | P | ML | | | | | | | | | | | | | | | | | | |
| 25 | 46 | 85 | 92 | 96 | 98 | 98 | 99 | 99 | 100 | | | | | | | | | NP | | ML | | | | | | | | | | | | | | | | | | |
| 17 | 38 | 80 | 90 | 95 | 98 | 98 | 98 | 99 | 99 | | | 100 | | | | | | NP | | ML | | | | | | | | | | | | | | | | | | |
| 9 | 22 | 50 | 66 | 77 | 92 | 93 | 94 | 95 | 96 | 97 | 98 | 99 | 100 | | | | | NP | | ML | | | | | | | | | | | | | | | | | | |
| 17 | 24 | 27 | 39 | 35 | 58 | 31 | 93 | 97 | 98 | 99 | 100 | | | | | | | 11 | P | SM | | | | | | | | | | | | | | | | | | |
| 14 | 25 | 42 | 50 | 57 | 65 | 70 | 74 | 80 | 86 | 87 | 92 | 93 | 100 | | | | | 11 | P | SM | | | | | | | | | | | | | | | | | | |
| 16 | 33 | 42 | 46 | 49 | 56 | 60 | 64 | 68 | 76 | 82 | 85 | 90 | 92 | 96 | 100 | | | 21 | 13 | SC | | | | | | | | | | | | | | | | | | |
| 22 | 37 | 52 | 55 | 53 | 62 | 65 | 68 | 74 | 81 | 87 | 90 | 94 | 95 | 98 | 100 | | | 24 | 5 | CL- ML | | | | | | | | | | | | | | | | | | |
| 34 | 43 | 48 | 50 | 51 | 55 | 58 | 61 | 65 | 75 | 82 | 87 | 90 | 92 | 97 | 100 | | | 26 | 7 | CL- ML | | | | | | | | | | | | | | | | | | |
| 22 | 43 | 58 | 62 | 63 | 64 | 64 | 65 | 67 | 68 | 72 | 77 | 78 | 83 | 89 | 100 | | | 30 | 6 | ML | | | | | | | | | | | | | | | | | | |
| 6 | 9 | 10 | 10 | 11 | 13 | 14 | 15 | 16 | 17 | 21 | 27 | 31 | 40 | 51 | 57 | 64 | 70 | 77 | 83 | 87 | 90 | 92 | 93 | 94 | 95 | 96 | 97 | 98 | 99 | 100 | 33 | 8 | SP- GC | SC | | | | |
| 6 | 10 | 11 | 11 | 12 | 13 | 16 | 27 | 36 | 51 | 64 | 70 | 79 | 85 | 92 | 100 | | | 34 | 9 | GM | | | | | | | | | | | | | | | | | | |
| | | | 8 | 8 | 10 | 10 | 14 | 23 | 32 | 41 | 46 | 56 | 64 | 80 | 100 | | | 42 | 12 | SP- GM | | | | | | | | | | | | | | | | | | |

1

2

MATERIALS TESTING REPORT U. S. DEPARTMENT of AGRICULTURE
SOIL CONSERVATION SERVICE **TRIAxIAL SHEAR TEST**

PROJECT and STATE: INDIANA COSEK SITE 33 NEW YORK SAMPLE LOCATION: INDIAN CONSERVATION

FIELD SAMPLE NO: 152.1 DEPTH: 5-10' GEOLOGIC ORIGIN: Glacial Till

TYPE OF SAMPLE: COMPIGATED TESTED AT: SML-LINCOLN APPROVED BY: CAME DATE: 9/70

| INDEX TEST DATA | | SPECIMEN DATA | | TYPE OF TEST |
|--|----------------------------|---|-----------------------|---|
| USCS <u>GM</u> | LL <u>18</u> ; PI <u>2</u> | HEIGHT <u>3.0</u> " | DIAMETER <u>1.4</u> " | UU <input type="checkbox"/> CU <input checked="" type="checkbox"/> CU <input type="checkbox"/> CD <input type="checkbox"/> |
| % FINER (mm): 0.002 <u>7</u> ; 0.005 <u>12</u> ; 0.074 (#200) <u>40</u> | | MATERIALS TESTED PASSED <u>#4</u> SIEVE | | |
| G _s (-#4) <u>2.70</u> ; G _s (+#4) _____ | | METHOD OF PREPARATION <u>STRIKED IN 3 LIFT (COMPIGATED)</u> | | |
| STANDARD: Y _d MAX. <u>132.0</u> pcf; w _o <u>10.5</u> % | | MOLDING MOISTURE <u>13.2</u> % | | |
| MODIFIED: Y _d MAX. _____ pcf; w _o _____ % | | MOLDED AT <u>72</u> % OF Y _d MAXIMUM | | |

| DRY DENSITY | | MOISTURE CONTENT, % | | | TIME OF CONSOLIDATION (hrs) | MINOR PRINCIPAL STRESS σ ₃ (psi) | DEVIATOR STRESS σ ₁ - σ ₃ (psi) | AXIAL STRAIN AT FAILURE, ε (%) |
|---|--|---------------------|------------------------------|-------------|-----------------------------|---|---|--------------------------------|
| INITIAL pcf <input checked="" type="checkbox"/> g/cc <input type="checkbox"/> | CONSOLIDATED pcf <input checked="" type="checkbox"/> g/cc <input type="checkbox"/> | START OF TEST | DEG. OF SAT AT START OF TEST | END OF TEST | | | | |
| 11.7 | 11.2 | 14.7 | 89.6 | 14.0 | 16.18 | 10 | 36.5 | 3.0 |
| 115.5 | 119.1 | 15.8 | 72.9 | 14.2 | 16.42 | 25 | 55.6 | 5.0 |
| 117.3 | 120.3 | 14.5 | 89.5 | 13.2 | 16.20 | 40 | 61.4 | 7.0 |

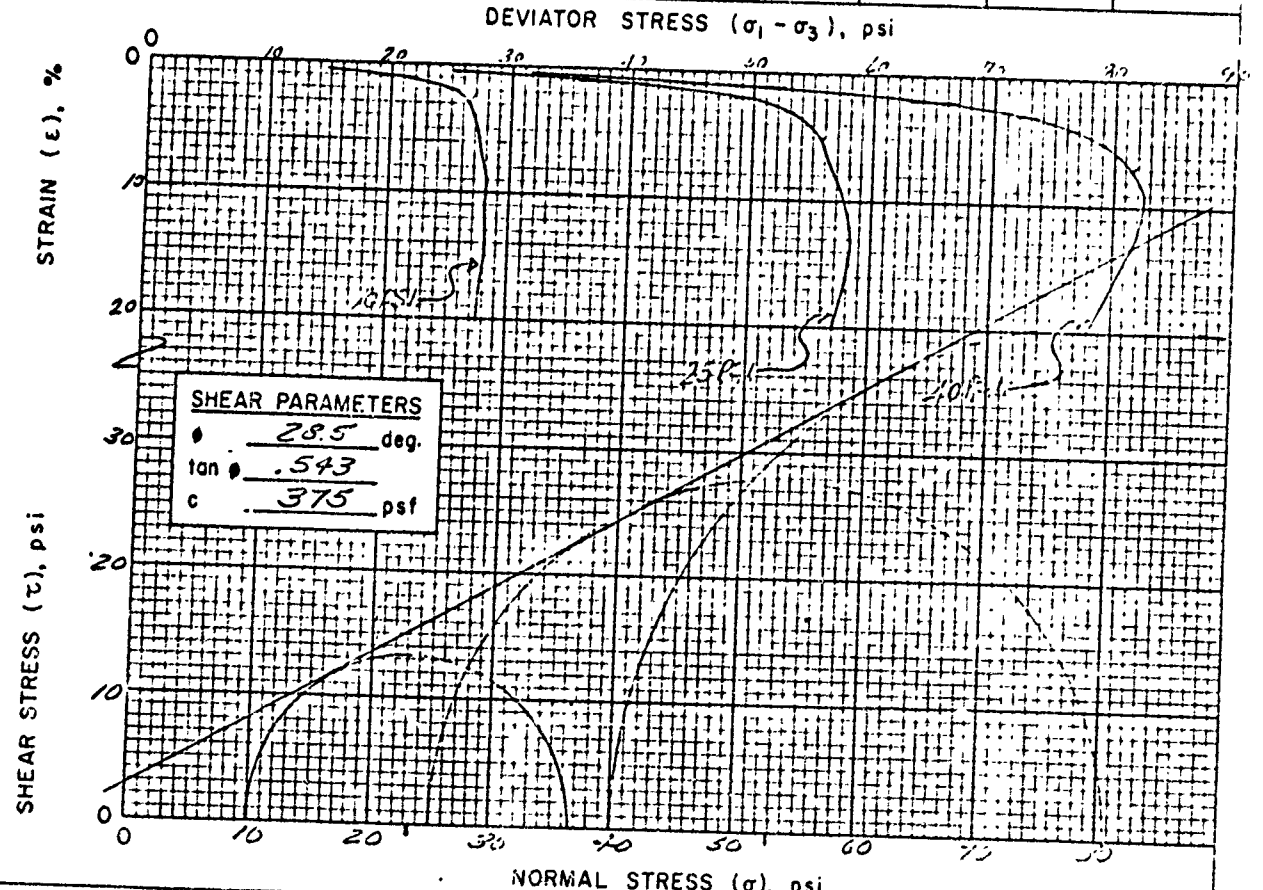

REMARKS

C.F. King

MATERIALS TESTING REPORT U. S. DEPARTMENT of AGRICULTURE SOIL CONSERVATION SERVICE TRIAXIAL SHEAR TEST

PROJECT and STATE WINDY CREEK STA 33 NEW YORK SAMPLE LOCATION East end of material

FIELD SAMPLE NO 12.1 DEPTH 1-3' GEOLOGIC ORIGIN Glacial Till

TYPE OF SAMPLE COMPOSITE TESTED AT SMIL-LINCOLN APPROVED BY CHMC DATE 9/70

| INDEX TEST DATA | | SPECIMEN DATA | | TYPE OF TEST |
|--|----------------------------|---|-----------------------|---|
| USCS <u>ML</u> | LL <u>25</u> ; PI <u>3</u> | HEIGHT <u>3.0</u> " | DIAMETER <u>1.4</u> " | UU <input type="checkbox"/> CU <input checked="" type="checkbox"/> CU <input type="checkbox"/> CD <input type="checkbox"/> |
| % FINER (mm): 0.002 <u>11</u> ; 0.005 <u>17</u> ; | | MATERIALS TESTED PASSED <u>#4</u> SIEVE | | |
| 0.074 (*200) <u>77</u> | | METHOD OF PREPARATION <u>STATIC</u> | | |
| G _s (-#4) <u>2.69</u> ; G _s (+#4) _____ | | <u>NUMBER OF SPECIMENS (3)</u> | | |
| STANDARD: γ_d MAX. <u>107.5</u> pcf; w _o <u>16.0</u> % | | MOLDING MOISTURE <u>18.1</u> % | | |
| MODIFIED: γ_d MAX. _____ pcf; w _o _____% | | MOLDED AT <u>94.8</u> % OF γ_d MAXIMUM | | |

| DRY DENSITY | | MOISTURE CONTENT, % | | | TIME OF CONSOLIDATION (hrs) | MINOR PRINCIPAL STRESS σ_3 (psi) | DEVIATOR STRESS $\sigma_1 - \sigma_3$ (psi) | AXIAL STRAIN AT FAILURE, ϵ (%) |
|---|--|---------------------|-------------------------------|-------------|-----------------------------|---|---|---|
| INITIAL pcf <input checked="" type="checkbox"/> g/cc <input type="checkbox"/> | CONSOLIDATED pcf <input checked="" type="checkbox"/> g/cc <input type="checkbox"/> | START OF TEST | DEG. OF SAT. AT START OF TEST | END OF TEST | | | | |
| 102.4 | 103.2 | 22.7 | 95.4 | 22.2 | 16.27 | 10 | 34.0 | 3.0 |
| 101.7 | 103.7 | 22.8 | 92.2 | 21.7 | 16.15 | 25 | 58.5 | 7.0 |
| 102.0 | 104.9 | 22.7 | 93.8 | 21.0 | 15.82 | 100 | 82.7 | 7.0 |

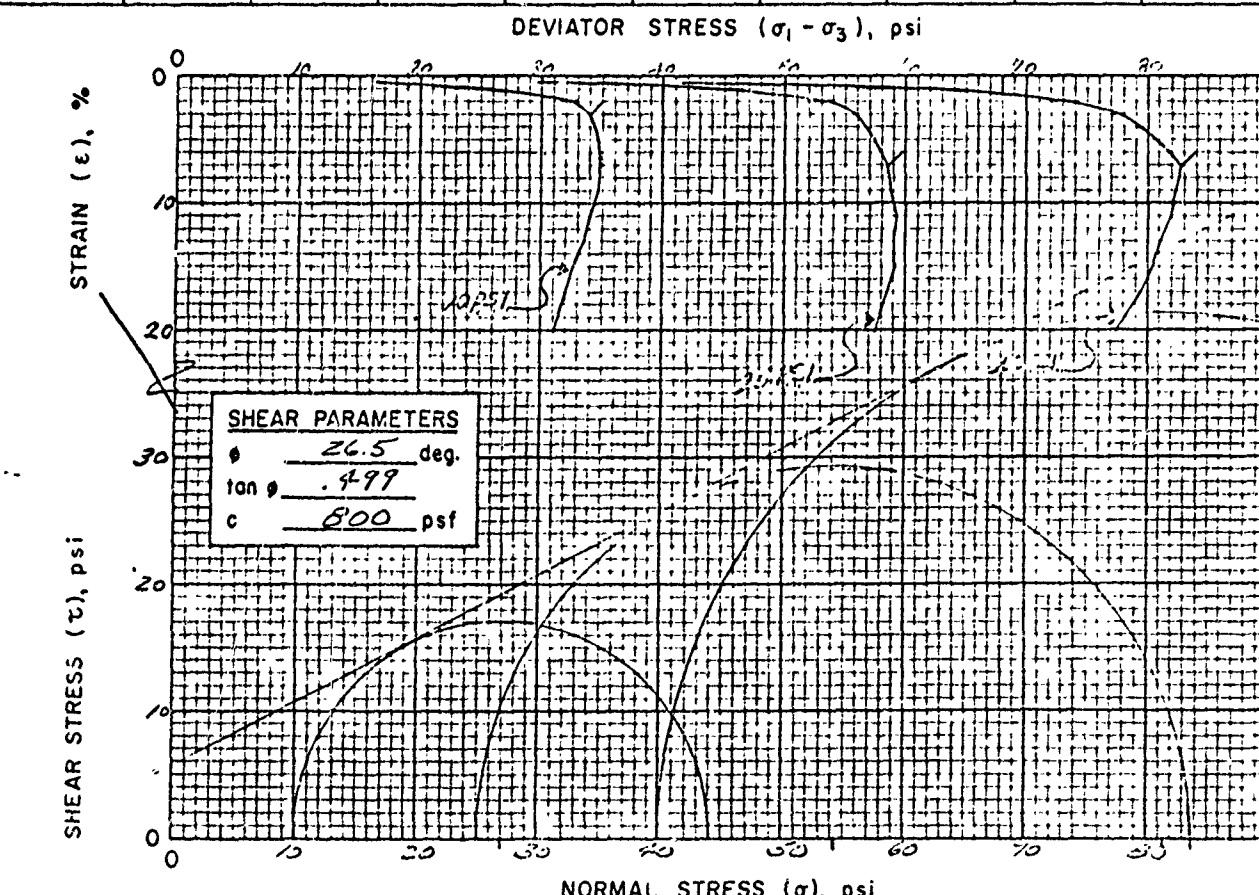

REMARKS TESTED @ 74.9% STD

MATERIALS TESTING REPORT U. S. DEPARTMENT of AGRICULTURE SOIL CONSERVATION SERVICE COMPACTION AND PENETRATION RESISTANCE

PROJECT AND STATE Conowango Creek # 33, New York

FIELD SAMPLE NO 101.1 LOCATION Borrow A Material DEPTH 4-10'

GEOLOGIC ORIGIN Glacial outwash TESTED AT SML-LINCOLN APPROVED BY CIIM DATE 9/70

CLASSIFICATION GC LL 28 PI 9 CURVE NO. 1 OF 4

MAX. PARTICLE SIZE INCLUDED IN TEST <#4 STD (ASTM D-698) ; METHOD A

SPECIFIC GRAVITY (G_s) { MINUS NO. 4: 2.72 PLUS NO. 4: 2.65 MOD. (ASTM D-1557) ; METHOD OTHER TEST (SEE REMARKS)

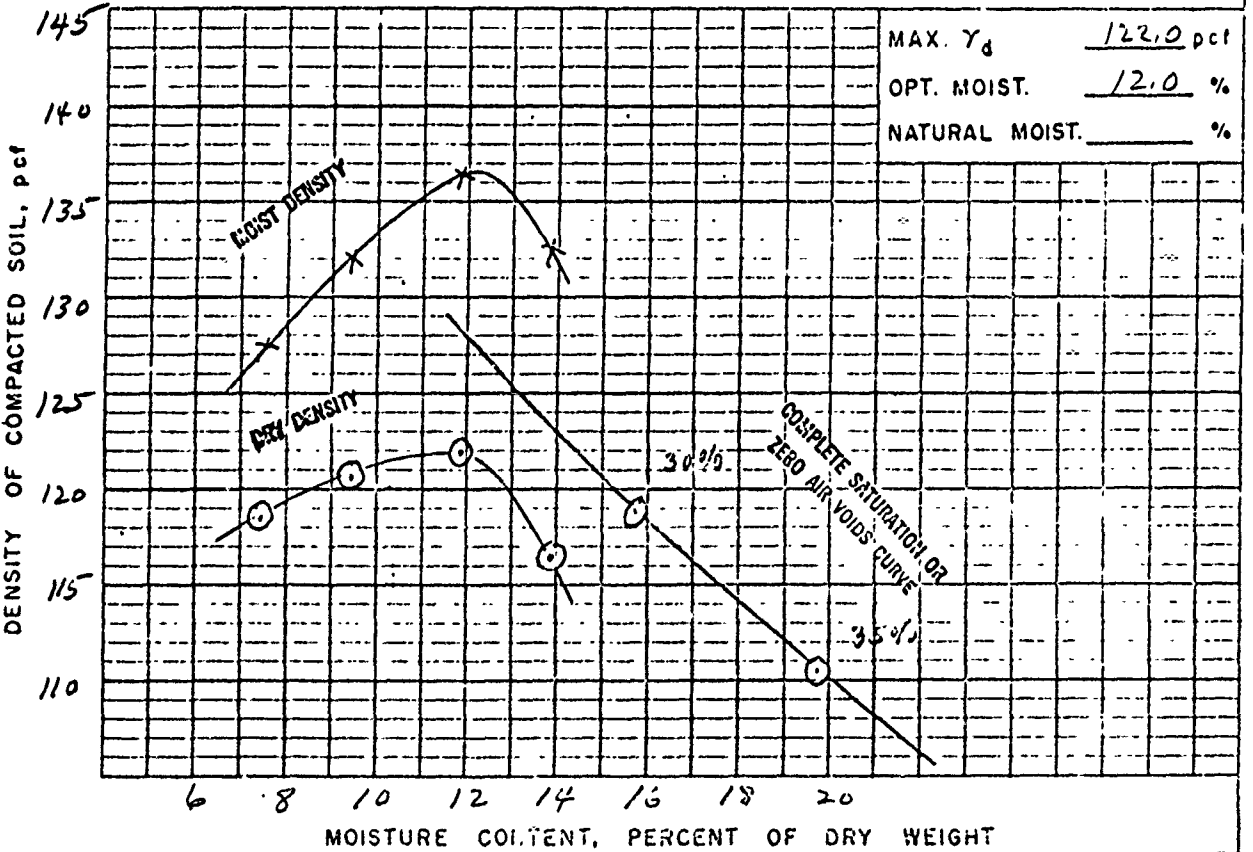
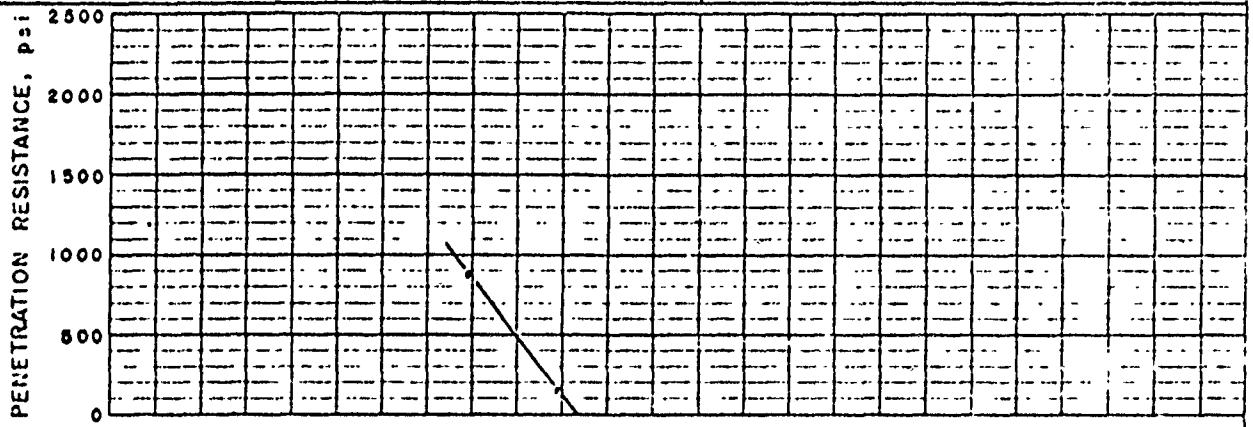

MAX. γ_d 122.0 pcf
OPT. MOIST. 12.0 %
NATURAL MOIST. %

REMARKS CURVE IS FOR THE MINUS NO. 4 FRACTION GRADATION OF TOTAL SAMPLE

MATERIALS TESTING REPORT U.S. DEPARTMENT of AGRICULTURE SOIL CONSERVATION SERVICE COMPACTION AND PENETRATION RESISTANCE

PROJECT AND STATE Cornwago Creek # 33, New York.

FIELD SAMPLE NO. 152.1 LOCATION Borrow D Material DEPTH 3-10'

GEOLOGIC ORIGIN Glacial Till TESTED AT SML-LINCOLN APPROVED BY CHMc DATE 5/70

CLASSIFICATION GM LL 18 PI 2 CURVE NO. 2 OF 4

MAX. PARTICLE SIZE INCLUDED IN TEST < #4 STD. (ASTM D-698) ; METHOD A

SPECIFIC GRAVITY (G_s) { MINUS NO. 4 2.70 MOD. (ASTM D-1557) ; METHOD _____
PLUS NO. 4 2.64 OTHER TEST (SEE REMARKS)

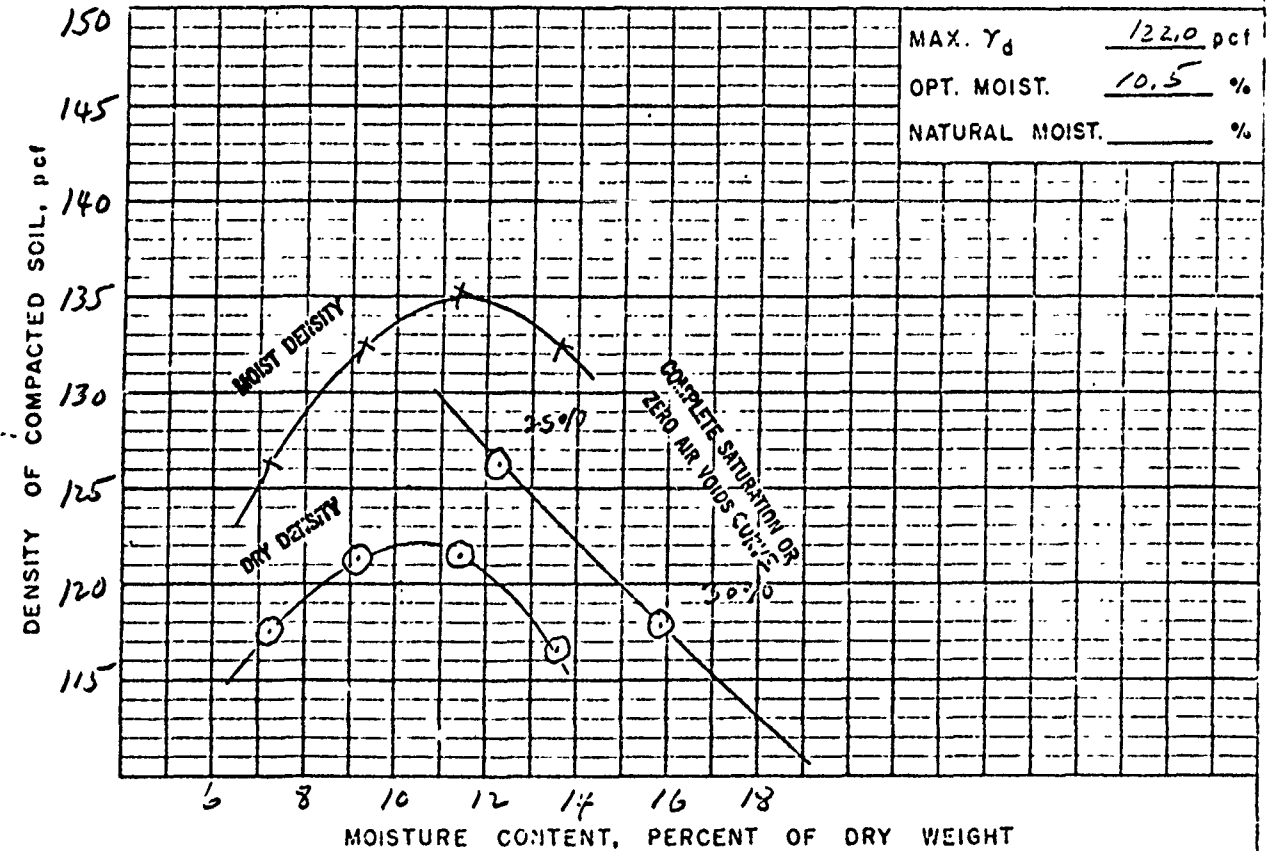
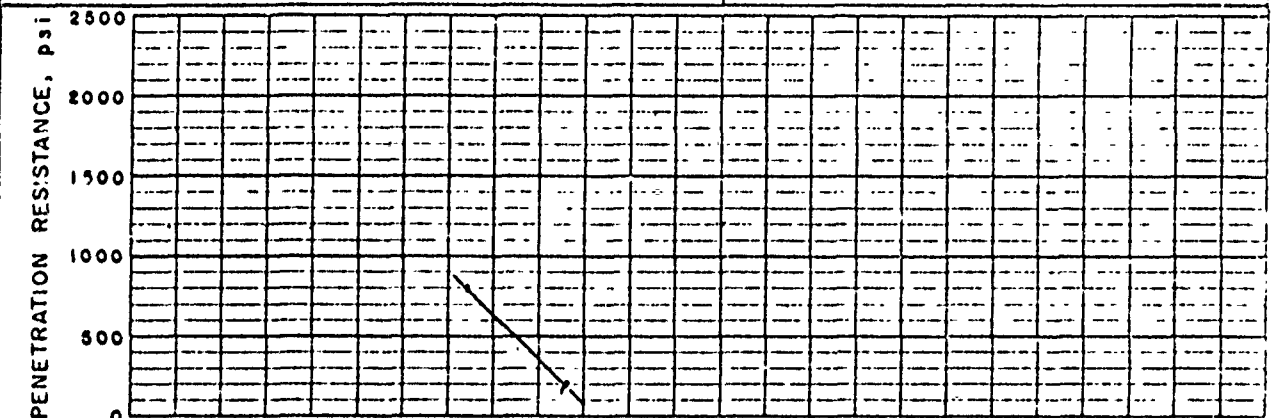

REMARKS CURVE IS FOR THE MINUS NO. 4 FRACTION GRADATION OF TEST SAMPLE
Max. γ_d = 122.0 pcf at 10.5% moisture

MATERIALS TESTING REPORT U. S. DEPARTMENT OF AGRICULTURE SOIL CONSERVATION SERVICE COMPACTION AND PENETRATION RESISTANCE

PROJECT AND STATE Conewango Creek, New York.

FIELD SAMPLE NO. 103.1 LOCATION Borrow H Material. DEPTH 1-3'

GEOLOGIC ORIGIN Glacial Till TESTED AT SML-LINCOLN APPROVED BY CLM/c DATE 5/70

CLASSIFICATION ML LL 25 PI 3 CURVE NO. 3 OF 4

MAX. PARTICLE SIZE INCLUDED IN TEST < #4 " STD. (ASTM D-698) METHOD A

SPECIFIC GRAVITY (G_s) { MINUS NO. 4 2.67 PLUS NO. 4 2.64 MOD (ASTM D-1557) METHOD _____ OTHER TEST (SEE REMARKS)

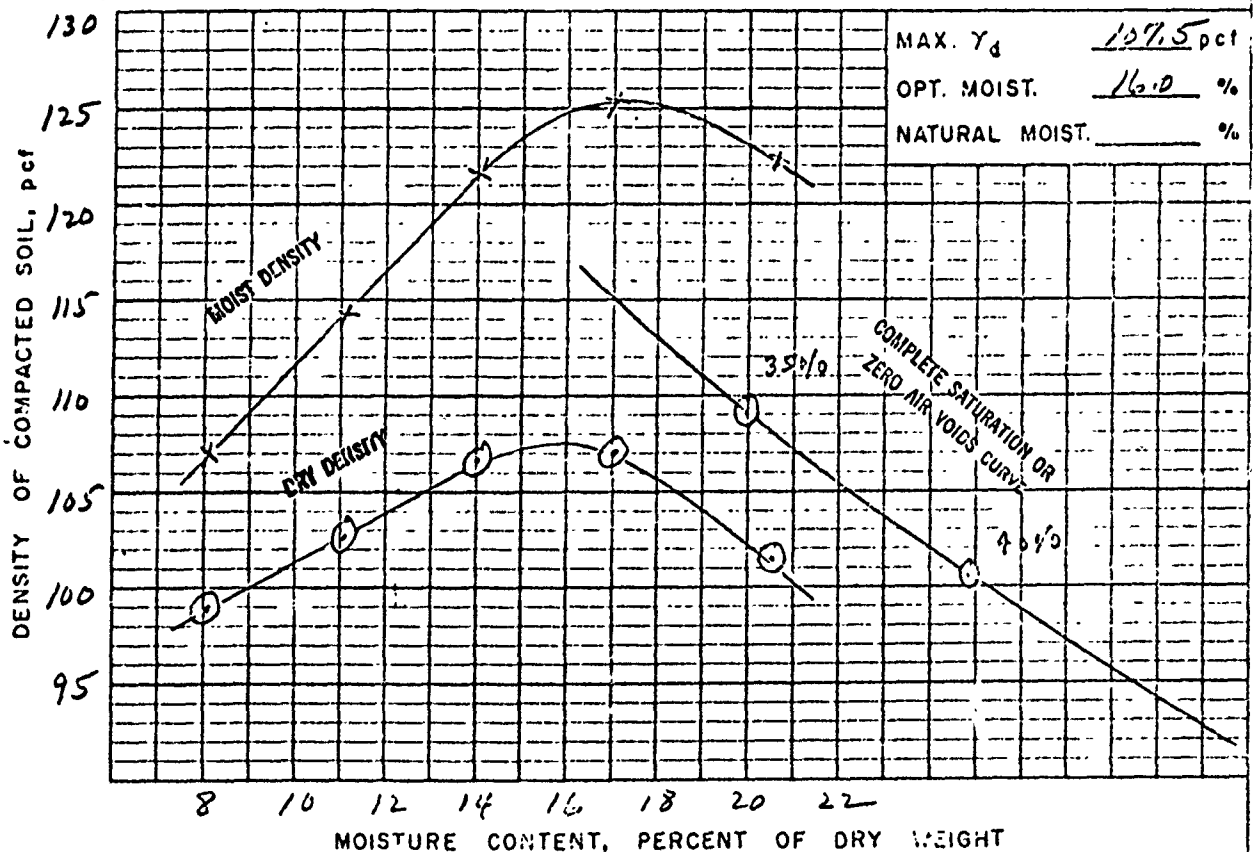
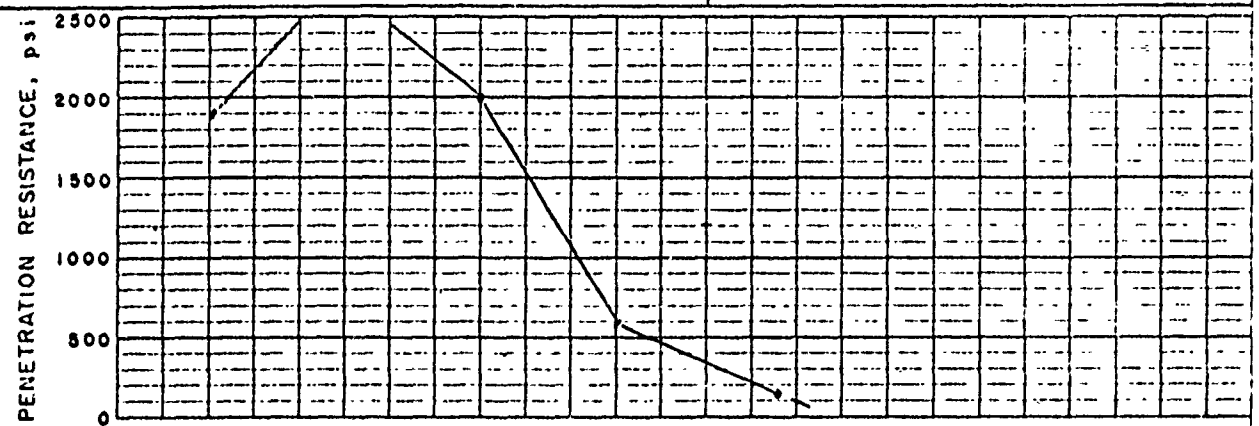

REMARKS
 CURVE IS FOR THE MINUS NO. 4 FRACTION
 GRADATION OF TOTAL SAMPLE
< NO. 200 77% ; < NO. 4 90% ; < 1/2 IN. 100%

MATERIALS U. S. DEPARTMENT OF AGRICULTURE COMPACTION AND
TESTING REPORT SOIL CONSERVATION SERVICE PENETRATION RESISTANCE

PROJECT AND STATE Conaway's Creek # 33, New York

FIELD SAMPLE NO 104.1 LOCATION Borrow I Material DEPTH 4.5-10'

GEOLOGIC ORIGIN Glacio-Lacustrine TESTED AT SML-LINCOLN APPROVED BY CHMc DATE 9/10

CLASSIFICATION ML LL 20 PI 2 CURVE NO. 4 OF 4

MAX. PARTICLE SIZE INCLUDED IN TEST < #4 " STD (ASTM D-698) ; METHOD A

SPECIFIC GRAVITY (G_s) { MINUS NO. 4 2.72 MOD (ASTM D-1557) ; METHOD _____
PLUS NO. 4 _____ OTHER TEST (SEE REMARKS)

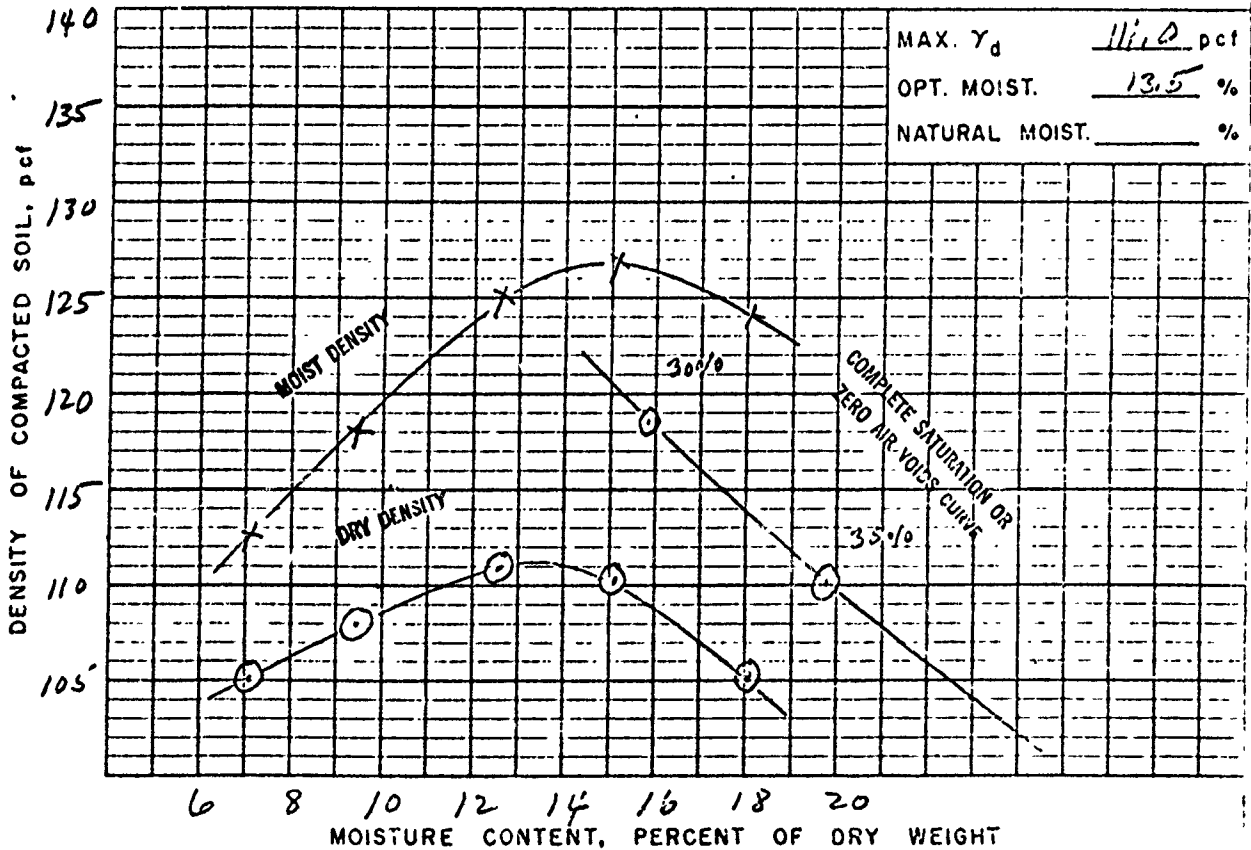
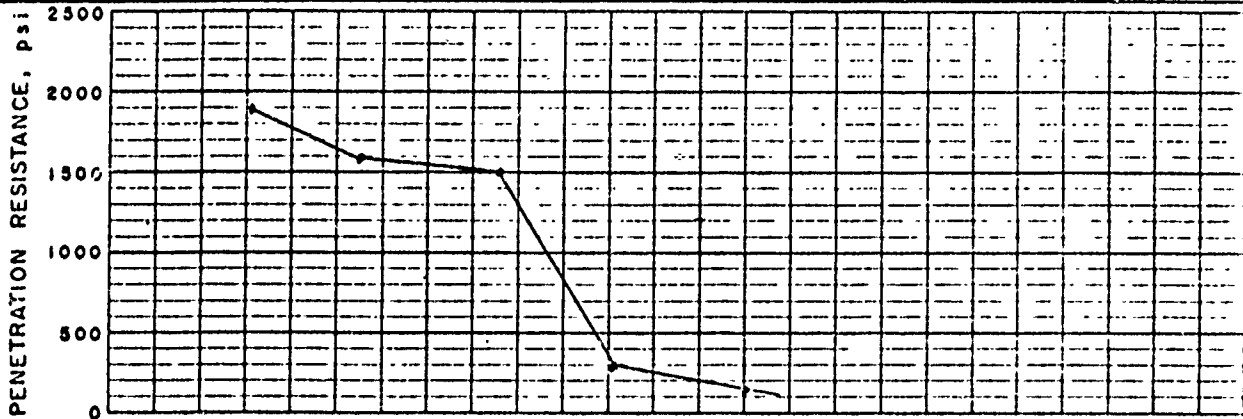

MAX. γ_d 111.0 pcf
OPT. MOIST. 13.5 %
NATURAL MOIST. _____ %

REMARKS

MATERIALS TESTING REPORT U. S. DEPARTMENT of AGRICULTURE SOIL CONSERVATION SERVICE PLACEMENT OF EARTH FILL MATERIALS

PROJECT and STATE

Conevango Creek, Site 33, N.Y.

BY

CHMc

DATE

9/70

| Embankment Zone No. | FILL MATERIALS | | RECOMMENDED COMPACTION REQUIREMENTS | | | | REFERENCE COMPACTION TEST | | | | |
|---------------------|----------------|----------|-------------------------------------|--|-------|--------------------------|---------------------------|------------------|------------|----------------------|-----------------------|
| | Type | Location | Average Depth (ft.) | Description (Origin, Group No., Hardness, Classification, etc) | Class | Degree of Compaction (%) | Moisture Limits (%) | Control Test | Sample No. | Optimum Moisture (%) | |
| | | | From | To | | From | To | ASTM Designation | Field | Lab. | Maximum Density (pcf) |
| 1 | G | ♀ Dam | 4 | CL; Glacio-Lacustrine; clay; moderately plastic | A | 95 | -2 | + D-692 A | 1-1 | - | - |
| 1 | G | E. Spwy | 4.5 | CL-ML; Glacio-Lacustrine; sandy-silty clay; slightly plastic | A | 95 | -1 | + D-692 A | 203.1 | - | - |
| 1 | H | Borrow | 1 | ML; Glacial Till; silt; non-plastic to slightly plastic; Curve ③ | A | 95 | opt. | + D-698 A | 103.1 | 48 | 107.5 |
| 1 | H | E. Spwy. | 3.2 | ML; (same) | A | 95 | opt. | + D-698 A | 206.1 | - | - |
| 1 | I | ♀ Dam | 8 | ML; Glacio-Lacustrine; silt; non-plastic | A | 95 | opt. | + D-698 A | 1-2 | - | - |
| 1 | I | Borrow | 4.5 | ML; Glacio-Lacustrine; silt; non-plastic to sl. plastic; Curve ② | A | 95 | opt. | + D-698 A | 104.1 | 49 | 111.0 |
| 1 | I | E. Spwy. | 12 | ML; Glacio-Lacustrine; silt; nonplastic | A | 95 | opt. | + D-698 A | 206.4 | - | - |
| 2 | C | E. Spwy. | 7.6 | SM; Outwash; silty sand; nonplastic | A | 95 | opt. | + D-698 A | 254.5 | - | - |
| 2 | D | Borrow | 3 | GM; Glacial Till; silty sandy gravel; nonplastic to sl. plastic; Curve ② | A | 95 | opt. | + D-698 A | 102.1 | 47 | 122.0 |

REMARKS

MATERIALS TESTING REPORT U. S. DEPARTMENT of AGRICULTURE SOIL CONSERVATION SERVICE PLACEMENT OF EARTH FILL MATERIALS

PROJECT and STATE *Conewango Creek, Site 33, N.Y.* BY *CHMc* DATE *9/70*

| Embankment Zone No. | Type | Location | Average Depth (ft.) | | Description (Origin, Group No., Hardness, Classification, etc.) | RECOMMENDED COMPACTION REQUIREMENTS | | | | REFERENCE COMPACTION TEST | | | | |
|---------------------|------|------------|---------------------|----|--|-------------------------------------|---------------------|--------------|-------------|---------------------------|-------|---------------|----------------------|------|
| | | | From | To | | Degree of Compaction (%) | Moisture Limits (%) | Control Test | Designation | Method | Class | Density (pcf) | Optimum Moisture (%) | |
| 2 | D | E. Spry. | 8 | 11 | SC; Glacial Till; clayey sand; moderately plastic | 95 | opt + | A | D-693 | A | 205.1 | 71W | - | - |
| 2 | D | F. Spry. | 9 | | CL-ML; Glacial Till; Silty, sandy clay; slightly plastic | 95 | opt + | A | D-692 | A | 206.3 | - | - | - |
| 2 | F | & Dam | 8 | | SC-SM; Highly wea. bedrock; slightly plastic | 95 | opt + | A | D-693 | A | 4.1 | - | - | - |
| 2 | F | Drain Line | 0.7 | 3 | ML; (same) | 95 | opt + | A | D-693 | A | 501.1 | - | - | - |
| 3 | A | Borrow | 4 | 10 | SP; Outwash; Clayey-silty gravel; slightly plastic; (same) | | | * | | | 101.1 | 46 | 122.0 | 12.0 |
| 3 | A | E. Spry | 6' | | SP-GM; Outwash; slightly plastic; | | | * | | | 206.2 | - | - | - |
| 3 | A | Drain Line | 3' | | SP-GM; Alluvium; relatively clean silty gravel; moderately plastic | | | * | | | 502.1 | - | - | - |

EMARKS
* Use a method specification that will produce a minimum mass density equalled to 95% D-693A dry density corrected for 40% rock.

MATERIALS TESTING REPORT U. S. DEPARTMENT of AGRICULTURE
SOIL CONSERVATION SERVICE **SUMMARY - SLOPE STABILITY ANALYSIS**

PROJECT and STATE: **CONEWANGO CREEK SITE 33 NEW YORK** DATE: **8-17-70**
METHOD OF ANALYSIS: **SWEDISH CIRCLE** ANALYZED AT: **SML LINCOLN** APPROVED BY: _____

| TRIAL NO. | SLOPE | SOURCE AND USE OF MATERIALS | CLASSIFICATION | ADOPTED DESIGN DATA | | | | | | REMARKS | F _s | |
|-----------|--------|-----------------------------|----------------|----------------------|----------------------|------------------------|------------------------|---------|-------|---------|---|---------|
| | | | | γ _d (pcf) | γ _m (pcf) | γ _{sat} (pcf) | γ _{sub} (pcf) | φ (deg) | tan φ | | | c (psf) |
| 1 | UP 3:1 | EMBANKMENT | GM | 124.0 | 134.5 | 140.5 | 78.0 | 28.5 | .543 | 375 | CORRECTED FOR 5% W _{max} CORRECTED FOR 10% W _{max} | 1.72 |
| 2 | UP 3:1 | EMBANKMENT | ML | 105.0 | 121.0 | 128.5 | 66.0 | 26.5 | .499 | 800 | | 2.2 |
| 3 | | | | | | | | | | | | 1.79 |
| 4 | | | | | | | | | | | | 1.76 |
| 5 | | | | | | | | | | | | 1.92 |
| 6 | | | | | | | | | | | | 2.0 |
| 7 | | | | | | | | | | | | 2.1 |
| 8 | | | | | | | | | | | | |
| | | | | | | | | | | | | |
| | | | | | | | | | | | | |
| | | | | | | | | | | | | |
| | | | | | | | | | | | | |
| | | | | | | | | | | | | |
| | | | | | | | | | | | | |
| | | | | | | | | | | | | |
| | | | | | | | | | | | | |
| | | | | | | | | | | | | |
| | | | | | | | | | | | | |
| | | | | | | | | | | | | |
| | | | | | | | | | | | | |
| | | | | | | | | | | | | |

CONDITIONS

MAXIMUM SECTION
 FULL DRAWDOWN - NO BERM - ARC CUT FROM OPPOSITE
 SLOPE THRU EMB. (28.5° - 375) ONLY
 FULL DRAWDOWN - NO BERM - ARC CUT FROM OPPOSITE
 SLOPE THRU EMB. (26.5° - 800) ONLY
 SAME CONDITIONS AS TRIAL #1
 SAME CONDITIONS AS TRIAL #1
 DRAIN @ 1/6 = 0.5 - NO BERM - ARC CUT FROM OPPOSITE
 SLOPE THRU EMB. (28.5° - 375) ONLY
 SAME CONDITIONS AS TRIAL #1
 SAME CONDITIONS AS TRIAL #1

MATERIALS TESTING REPORT

U. S. DEPARTMENT of AGRICULTURE
SOIL CONSERVATION SERVICE

DRAIN MATERIALS

PROJECT and STATE

Conewango Creek, Site 33, New York

DESIGNED AT

SML - Lincoln

BY

CHMc

DATE

9/70

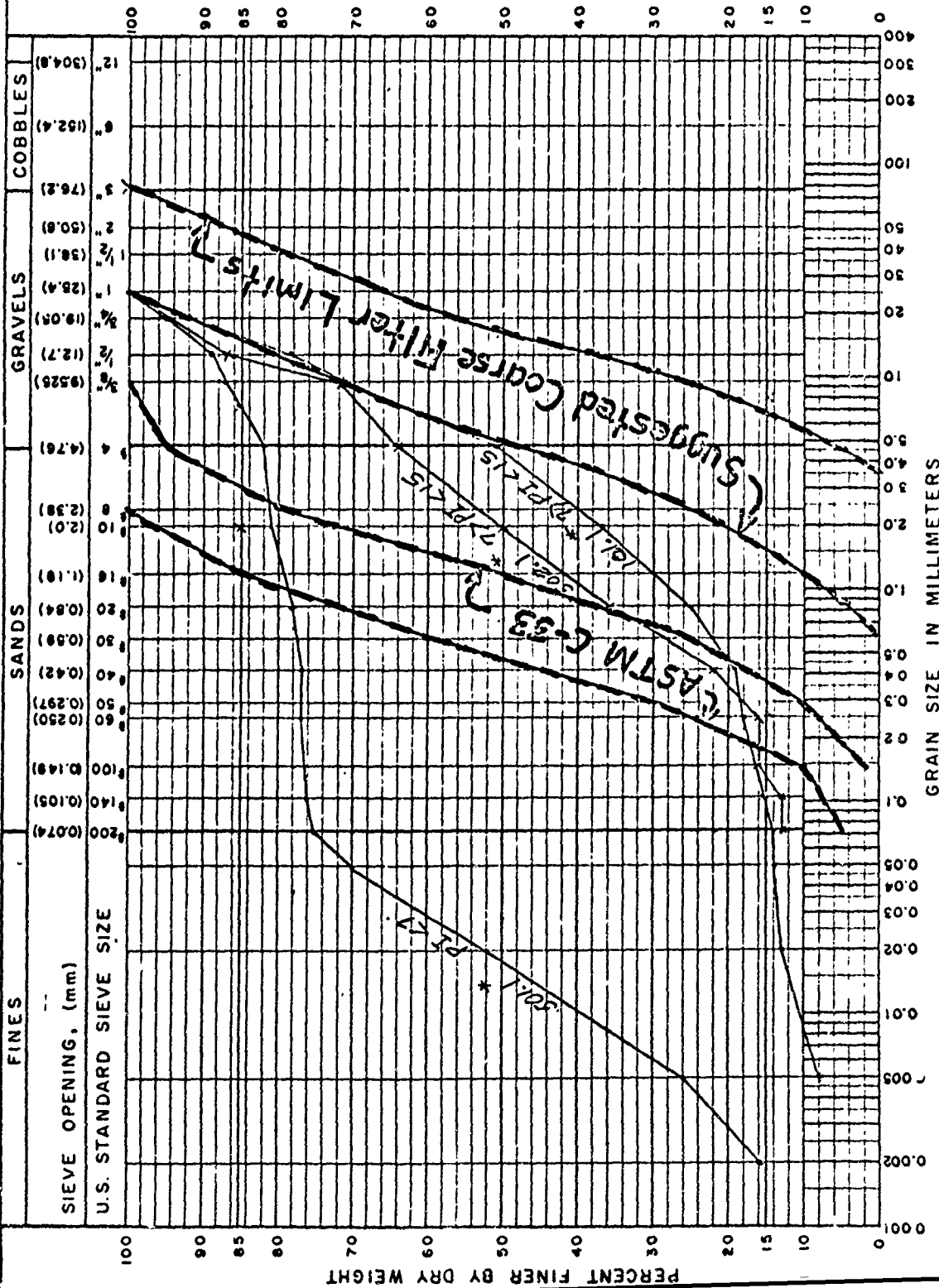

REMARKS * Regraded to minus 1"

SITE 13

NEW YORK MAXIMUM SECTION

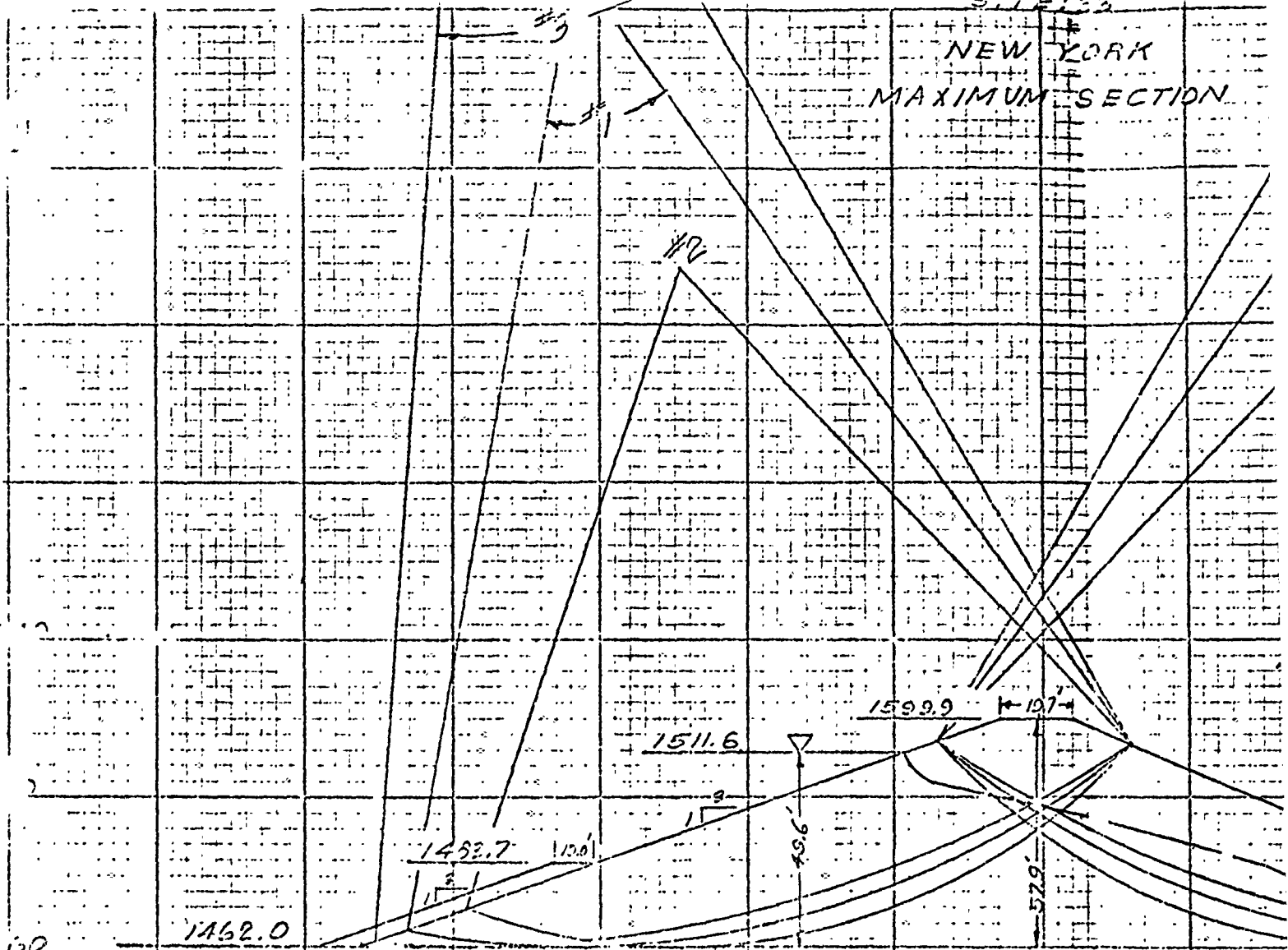

SCALE: 1" = 40'

DRAWN

DESIGNED

CHECKED

DATE

2

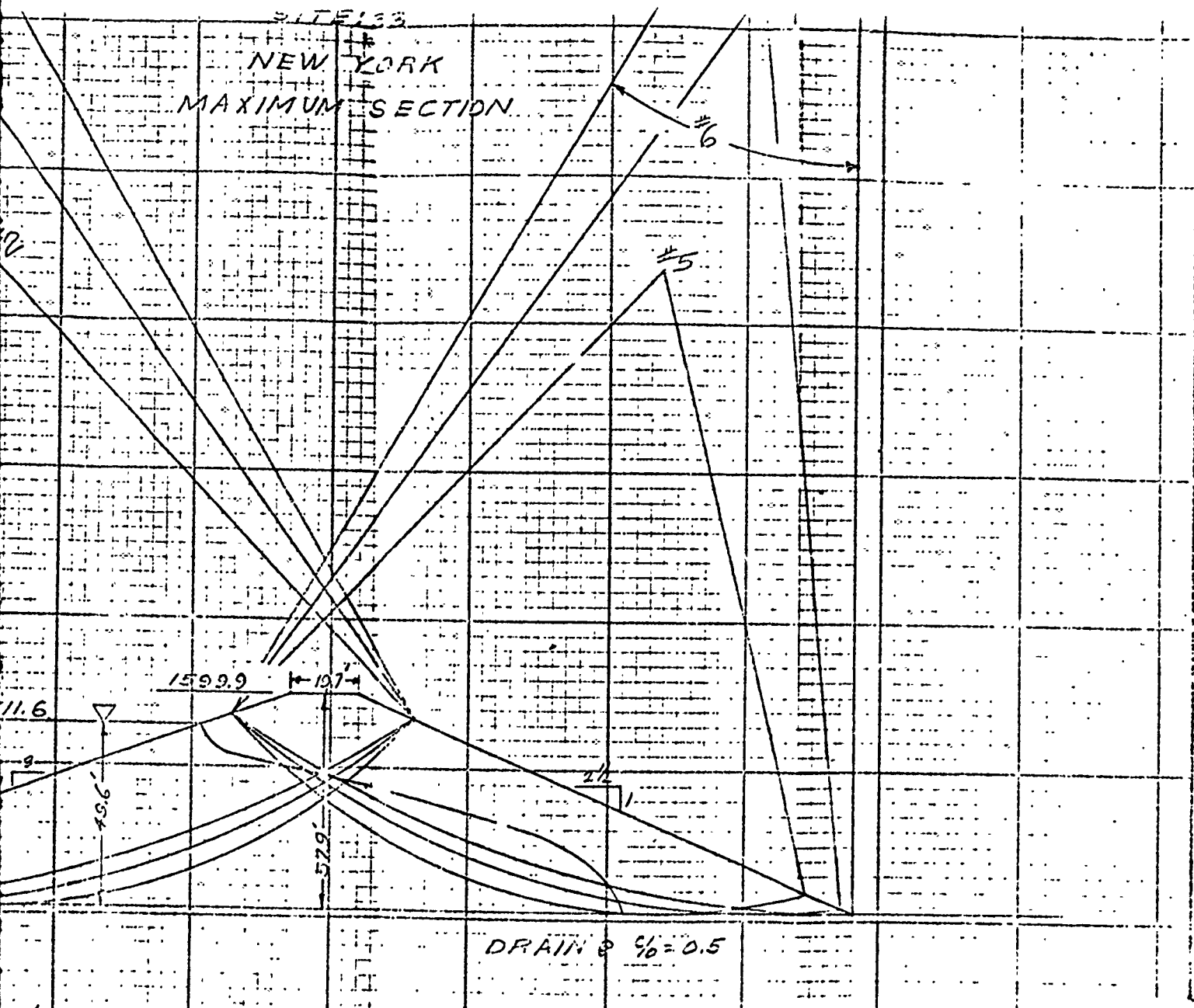

| | |
|--|---------------------------------|
| U. S. DEPARTMENT OF AGRICULTURE SOIL CONSERVATION SERVICE | |
| DESIGNED BY <i>R D L</i> | APPROVED |
| CHECKED BY <i>A. W. L.</i> | DRAWING NO. <i>FORM SCS 357</i> |
| DATE <i>9-17-70</i> | SHEET <i>2</i> OF <i>2</i> |

2

1

2

APPENDIX F

AS-BUILT DRAWINGS

DAM LOCATION

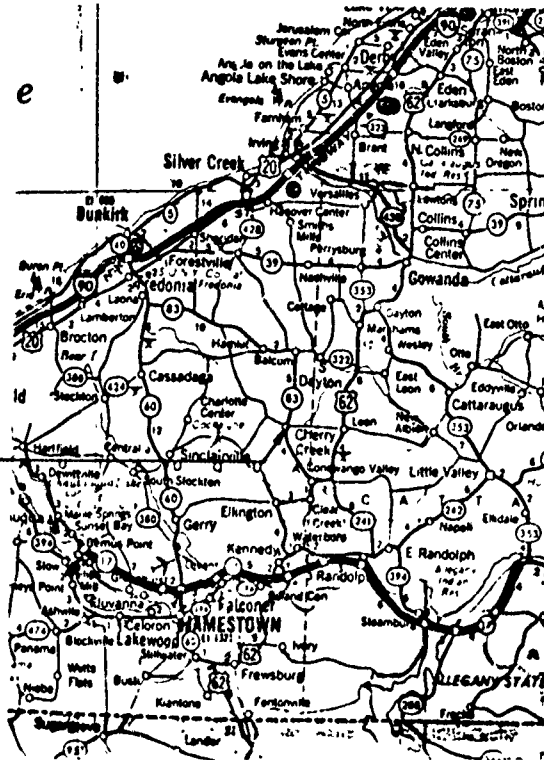

VICINITY MAP
CONEWANGO WATERSHED PROJECT
SITE 33
I.D. NO. N.Y. 581

DAM LOCATION

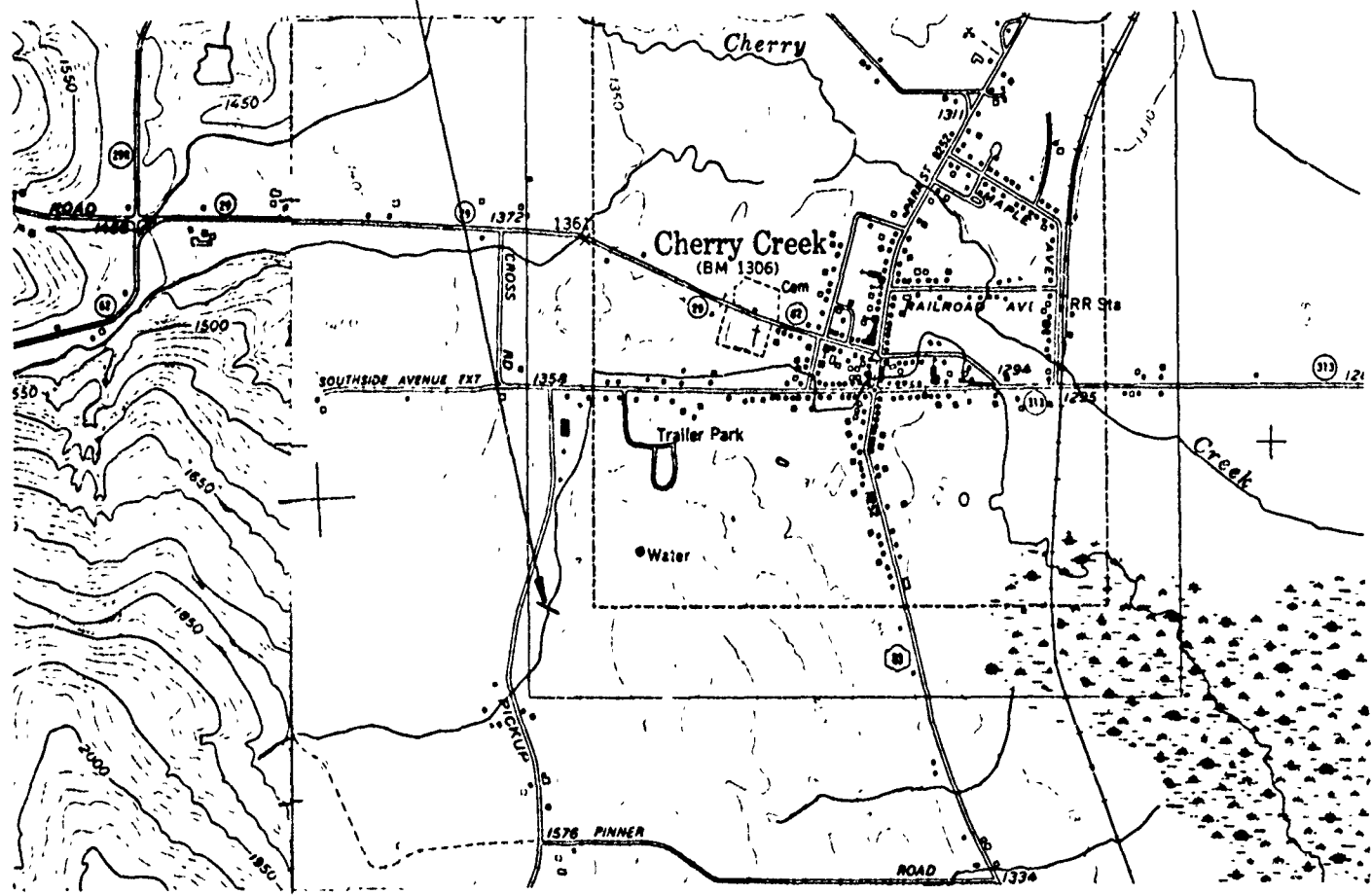

**TOPOGRAPHIC MAP
CONEWANGO WATERSHED PROJECT
SITE 33
I.D. NO. N.Y. 581**

CONEWANGO CREEK WATERSHED PROJECT

FLOODWATER RETARDING DAM

SITE 33 AS BUILT

| | |
|--|-------------------------------------|
| DRAINAGE AREA | 300 Acres |
| FLOOD STORAGE (TO EMERGENCY SPILLWAY CREST) | 68 Ac.Ft. |
| WATER SURFACE AREA (SEDIMENT POOL) | 0.7 Acres |
| HEIGHT OF DAM | 57 Feet |
| VOLUME OF FILL | 54,100 Cu.Yds. 50,676 |

BUILT UNDER THE WATERSHED PROTECTION AND
FLOOD PREVENTION ACT

BY

CONEWANGO CREEK WATERSHED COMMISSION

WITH THE ASSISTANCE OF THE
SOIL CONSERVATION SERVICE

OF THE

U. S. DEPARTMENT OF AGRICULTURE

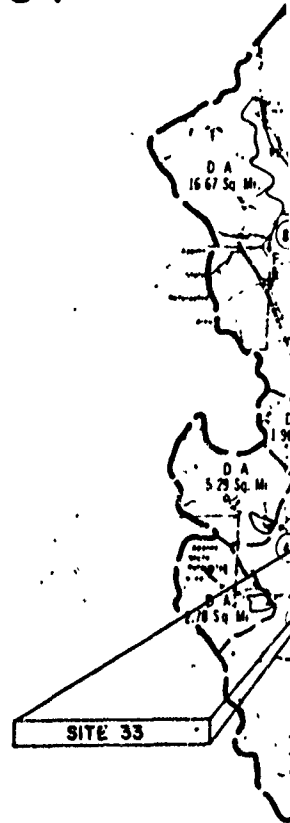

INDEX

| | |
|----------|--|
| SHEET 1 | COVER SHEET |
| SHEET 2 | PLAN OF STORAGE AREA |
| SHEET 3 | PLAN OF STRUCTURAL WORKS |
| SHEET 4 | CUTOFF TRENCH EXCAVATION |
| SHEET 5 | EMERGENCY SPILLWAY |
| SHEET 6 | FILL PLACEMENT AND PRINCIPAL SPILLWAY EXCAVATION |
| SHEET 7 | DRAINAGE SYSTEM DETAILS |
| SHEET 8 | DRAINAGE SYSTEM DETAILS |
| SHEET 9 | PLAN PROFILE OF PRINCIPAL SPILLWAY |
| SHEET 10 | RISER STRUCTURAL DETAILS |
| SHEET 11 | RISER STRUCTURAL DETAILS |
| SHEET 12 | RISER STRUCTURAL DETAILS |
| SHEET 13 | RISER STRUCTURAL DETAILS |
| SHEET 14 | RISER TRASH RACKS |
| SHEET 15 | CONDUIT DETAILS |
| SHEET 16 | END BENT AND CRADLE DETAILS |
| SHEET 17 | RESERVOIR DRAIN INLET DETAILS |
| SHEET 18 | FENCING DETAILS |
| SHEET 19 | LOGS OF TEST HOLES |
| SHEET 20 | LOGS OF TEST HOLES |
| SHEET 21 | LOGS OF TEST HOLES |
| SHEET 22 | LOGS OF TEST HOLES |
| SHEET 23 | LOGS OF TEST HOLES |

AS BUILT

AS BUILT

WATERSHED PROJECT

FLOODWATER RETARDING DAM

AS BUILT

300 Acres

68 Ac.Ft.

0.7 Acres

57 Feet

~~54,000~~ Cu.Yds.
50,676

PROTECTION AND
FACT

COMMISSION

OF THE
SERVICE

CULTURE

SPILLWAY EXCAVATION

WAY

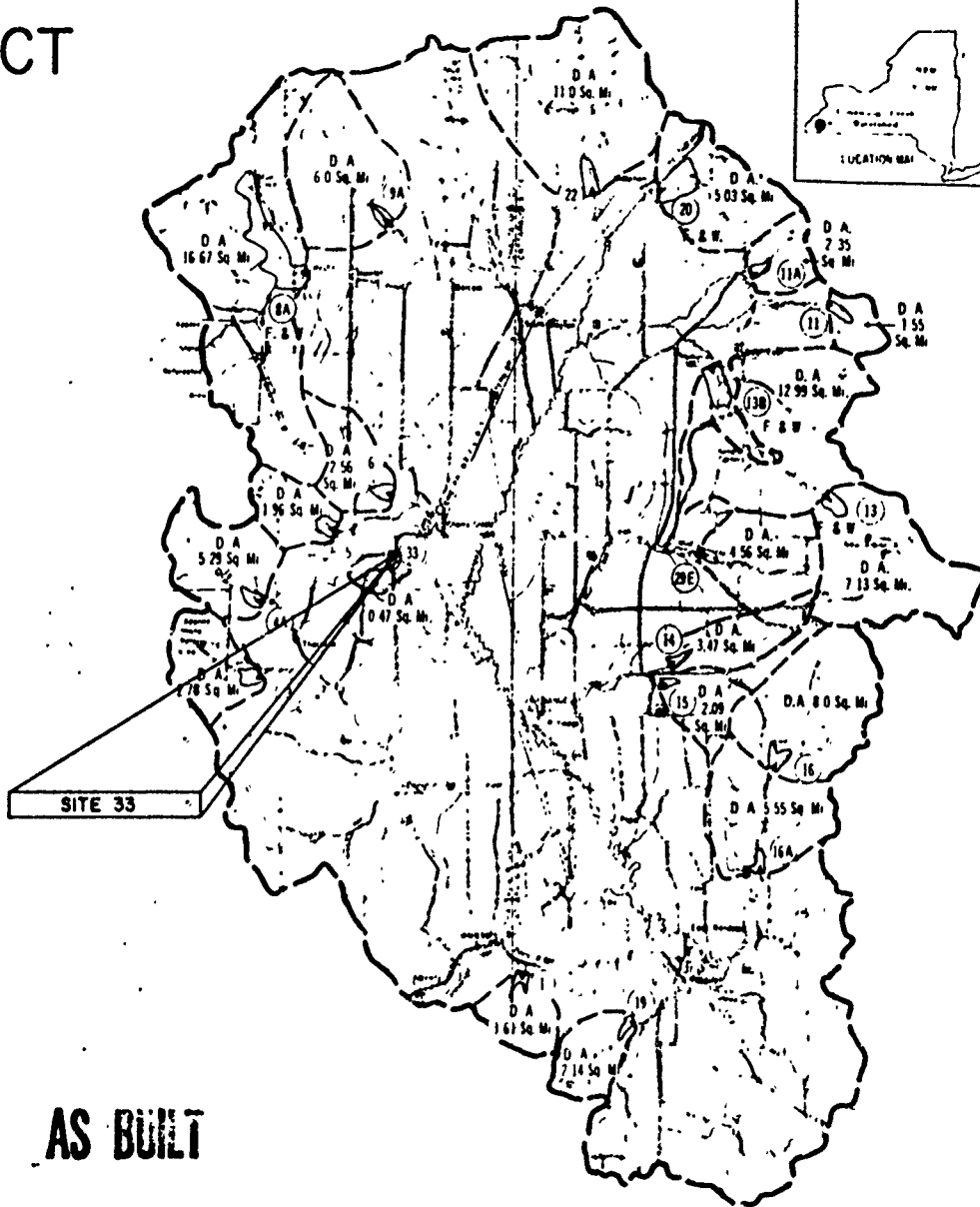

AS BUILT

AS BUILT

AS BUILT
12/9/74

| | |
|--|--|
| CONEWANGO CREEK WATERSHED PROJECT SITE 33 FLOODWATER RETARDING DAM CHAUTAUGUA COUNTY, NEW YORK COVER SHEET | |
| U. S. DEPARTMENT OF AGRICULTURE SOIL CONSERVATION SERVICE | |
| Designed W.A. RIEGEL 12/70 Drawn Traced Checked <i>San Beck</i> | Date 12/70 Approved by <i>State Conservation Engineer</i> <i>Sam E. Stuck</i> HEAD, ENG. & M/S PLAN. DIV. NY-2173-P 35-32 |

2

CONSTRUCTION DETAILS

1. AREAS UNDER THE DAM (INCLUDING 15 FEET OUTSIDE THE UPSTREAM AND DOWNSTREAM TOES), AND SEDIMENT BASIN AND EMERGENCY SPILLWAY (INCLUDING 15 FEET OUTSIDE THE CUT SLOPE) AND BORROW AREA TO BE CLEARED AND GRUBBED. LIMITS OF AREA TO BE CLEARED AND GRUBBED SHALL BE STAKED IN THE FIELD BY THE ENGINEER.
2. DEPTHS AND LIMITS OF BORROW EXCAVATION SHALL BE DETERMINED IN THE FIELD BY THE ENGINEER AS REQUIRED. AT THE COMPLETION OF EARTHFILL OPERATION, THE BORROW AREA SHALL BE LEFT GENTLY SLOPING, GENERALLY SMOOTH AND FREE DRAINING.
3. AREAS UPSTREAM FROM DAM AND BELOW ELEVATION 1485.0 SHALL BE CLEARED. ALSO THE AREA 50.0' WIDE ON THE LEFT ABUTMENT BORDERED BY ELEVATION 1485.0 AND THE INLET CHANNEL OF THE EMERGENCY SPILLWAY (EXTENDED) IS TO BE CLEARED. LIMITS OF AREA TO BE CLEARED SHALL BE STAKED IN THE FIELD BY THE ENGINEER. AREA OUTSIDE OF CLEARING AND GRUBBING LIMITS SHALL BE LEFT UNDISTURBED. MATERIAL DEPOSITED OUTSIDE THESE LIMITS BY THE CONSTRUCTION OPERATIONS WILL BE REMOVED BY THE CONTRACTOR.
4. BOTTOM SECTION OF THE EMERGENCY SPILLWAY IS TO BE COVERED WITH 8" OF TOP SOIL FROM STATION 1+50 TO APPROXIMATELY 5+80.
5. WASTE AREAS SHALL BE GRADED TO BE FREE DRAINING AND GENERALLY SMOOTH.
6. THE CONTRACTOR SHALL CONSTRUCT TEMPORARY BRIDGES, INSTALL CULVERTS, OR USE OTHER METHODS APPROVED BY THE ENGINEER WHERE HAUL ROADS CROSS LIVE STREAMS TO REDUCE POLLUTION OF THE AIR.
7. THE CONTRACTOR SHALL SPRINKLE OR APPLY DUST SUPPRESSORS ON HAUL ROADS AND AT THE SITE, AS NECESSARY, TO REDUCE POLLUTION OF THE AIR.
8. ALL CHEMICALS, FUELS, AND LUBRICANTS SHALL BE LOCATED, STORED, AND DISPOSED OF IN SUCH A MANNER AS TO PREVENT THEIR ENTRY INTO STREAMS, WELLS, OR SPRINGS.
9. SANITARY FACILITIES SHALL BE LOCATED IN SUCH A MANNER AS TO PREVENT POLLUTION OF SPRINGS, WELLS, AND STREAMS.

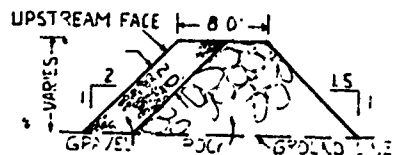
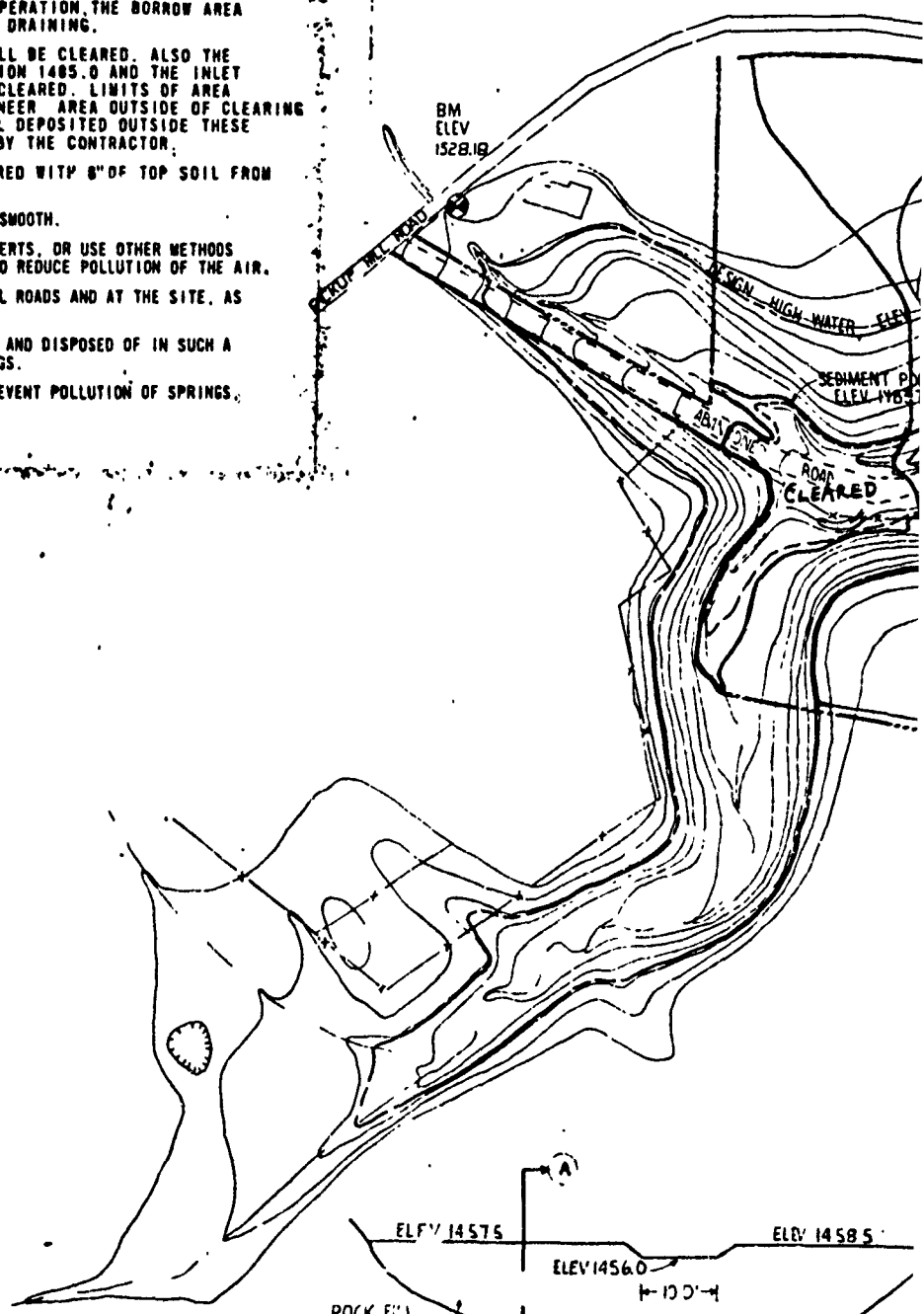

SECTION A-A

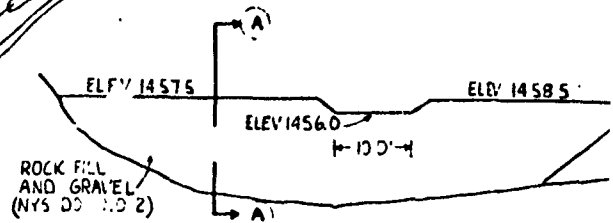

PROFILE ALONG C OF SEDIMENT BASIN
(SEE PLAN FOR LOCATION)

SEDIMENT BASIN CONSTRUCTION DETAILS

1. SEDIMENT BASIN LOCATION AND LENGTH AS SHOWN ON SHEET 5-A SHALL BE STAKED IN THE FIELD BY THE ENGINEER.
2. EARTH FILL COMPACTION SHALL BE MADE BY A MINIMUM OF ONE PASS OF VEHICLE USED FOR PACKING MATERIAL.
3. SOURCE OF EARTH FILL USED FOR SEDIMENT BASIN WILL BE DETERMINED IN THE FIELD BY THE ENGINEER.

LEGEND

- CONSTRUCTION LIMITS
- CONTOUR LINES
- - - - - CENTER OF STREAM
- - - - - SEDIMENT POOL
- - - - - DESIGN HIGH WATER
- ⊙ BENCH MARK

ES)
UT
AND
E
E
LEARNING
SE
FROM
AIR.

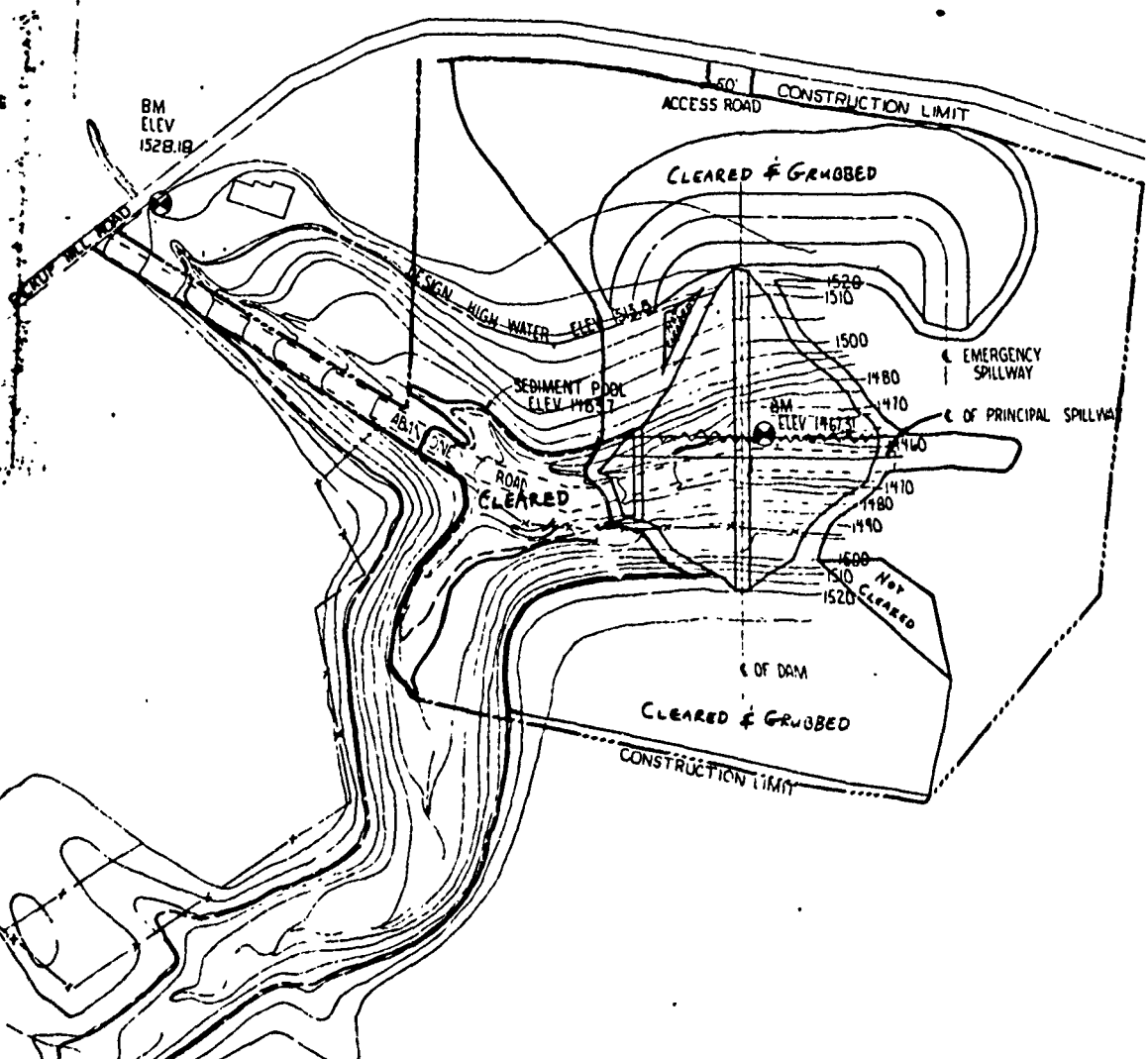

5' CONTOUR INTERVAL
0 50 100 200
SCALE IN FEET

AS BUILT 12/1/74

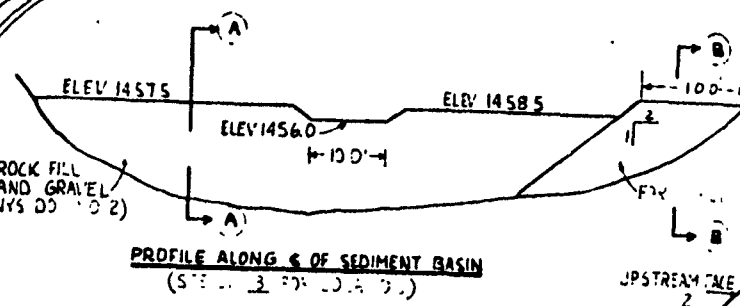

PROFILE ALONG C OF SEDIMENT BASIN
(SEE PLAN FOR LOCATION)

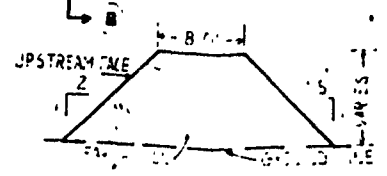

SECTION B-B

QUANTITIES

| | |
|-----------------------|-------|
| COARSE ROCK FILL | 10 CY |
| 1/2" TO 1 1/2" GRAVEL | 60 CY |
| EARTH FILL | 30 CY |

SEDIMENT BASIN CONSTRUCTION DETAILS

1. SEDIMENT BASIN LOCATION AND LENGTH AS SHOWN ON SHEET 33 SHALL BE MAINTAINED AND WILL BE STAKED IN THE FIELD BY THE ENGINEER.
2. EARTH FILL COMPACTION SHALL BE MADE BY A MINIMUM OF ONE PASS OF ROLLER USED FOR PLACING WATER AL.
3. SOURCE OF EARTH FILL USED FOR SEDIMENT BASIN WILL BE DETERMINED IN THE FIELD BY THE ENGINEER.

| DATE | ITEM | APP'D |
|--|------------------------|-----------|
| APRIL 72 | SEDIMENT BASIN DETAILS | |
| | REVISION | |
| CONEWANGO CREEK WATERSHED PROJECT SITE 33 FLOODWATER RETARDING DAM CHAUTAUQUA COUNTY, NEW YORK PLAN OF STORAGE AREA | | |
| U. S. DEPARTMENT OF AGRICULTURE SOIL CONSERVATION SERVICE | | |
| WA RIEGEL | 2-71 | |
| W GRAJKO JR | 11/69 | |
| D.M.C | 6/69 | |
| | 2 | NY-2173-P |

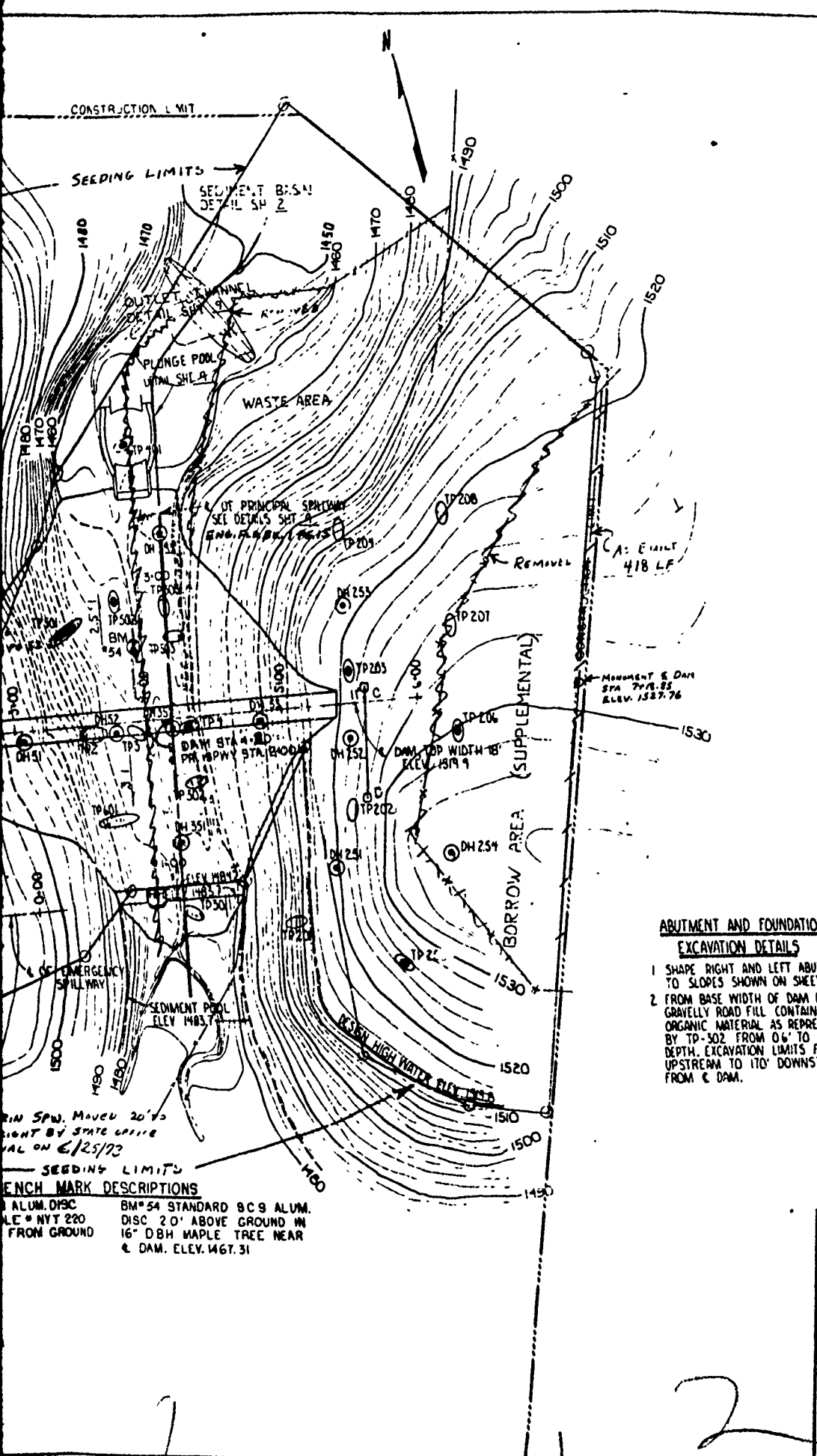

LEGEND

- CONTOUR LINE
- STREAM
- FENCE LINE
- BENCHMARK
- DESIGN HIGH WATER
- SEDIMENT POOL
- HUB
- FENCE LINE (EXISTING)
- ROAD
- TEST PIT (LOGGED ONLY)
- TEST PIT (LOGGED & SAMPLED)
- DRILL HOLE (LOGGED & SAMPLED)
- CONSTRUCTION LIMIT
- FENCE LINE (PLANNED)
- CLEARING LIMIT
- DESIGN HIGH WATER

CURVE I LAYOUT DATA

| | |
|------------|-----------|
| Δ = 40°00' | T = 100.0 |
| R = 100.0 | E = 41.92 |
| D = 57°18' | M = 24.29 |
| L = 157.0 | |

| STA | DEFLECT | CHORD DIST |
|------|---------|------------|
| 2+00 | 0°00' | — |
| 1+15 | 7°10' | 24.94 |
| 1+50 | 14°19' | 24.94 |
| 1+25 | 21°29' | 24.94 |
| 1+00 | 28°39' | 24.94 |
| 0+75 | 35°49' | 24.94 |
| 0+45 | 42°58' | 24.94 |

CURVE II LAYOUT DATA

| | |
|-------------|-----------|
| Δ = 85°57' | T = 46.57 |
| R = 50.0 | E = 18.33 |
| D = 114°36' | M = 13.41 |
| L = 15.0 | |

| STA | DEFLECT | CHORD DIST |
|------|---------|------------|
| 4+15 | 0°00' | — |
| 4+40 | 14°20' | 24.74 |
| 4+65 | 28°39' | 24.74 |
| 4+90 | 42°58' | 24.74 |

**ABUTMENT AND FOUNDATION
EXCAVATION DETAILS**

1. SHAPE RIGHT AND LEFT ABUTMENTS TO SLOPES SHOWN ON SHEET 1.
2. FROM BASE WIDTH OF DAM REMOVE GRAVELLY ROAD FILL CONTAINING ORGANIC MATERIAL AS REPRESENTED BY TP-302 FROM 0.6' TO 3.0' DEPTH. EXCAVATION LIMITS FROM 60' UPSTREAM TO 170' DOWNSTREAM FROM C. DAM.

SOILS DETAILS

SEE SHEETS 18, 19, 20, 21 FOR DESCRIPTION OF TEST PITS AND DRILL HOLES.

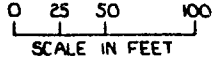

2' CONTOURS
AS BUILT 12/9/74

BENCHMARK DESCRIPTIONS

- BM#54 STANDARD 8C9 ALUM. DISC 20" ABOVE GROUND IN 16" DBH MAPLE TREE NEAR C. DAM. ELEV. 1467.31
- BM# NY 220 FROM GROUND

**CONEWANGO CREEK WATERSHED PROJECT
SITE 33
FLOODWATER RETARDING DAM
CHAUTAUQUA COUNTY, NEW YORK
PLAN OF STRUCTURAL WORKS**

**U. S. DEPARTMENT OF AGRICULTURE
SOIL CONSERVATION SERVICE**

| | |
|-----------------|-------|
| W. A. RIEGL | 12-10 |
| W. P. WILSON | 1-31 |
| J. DE VITA, III | 6-69 |

NY-2173-P

2

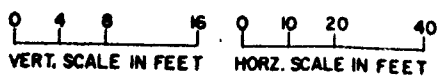
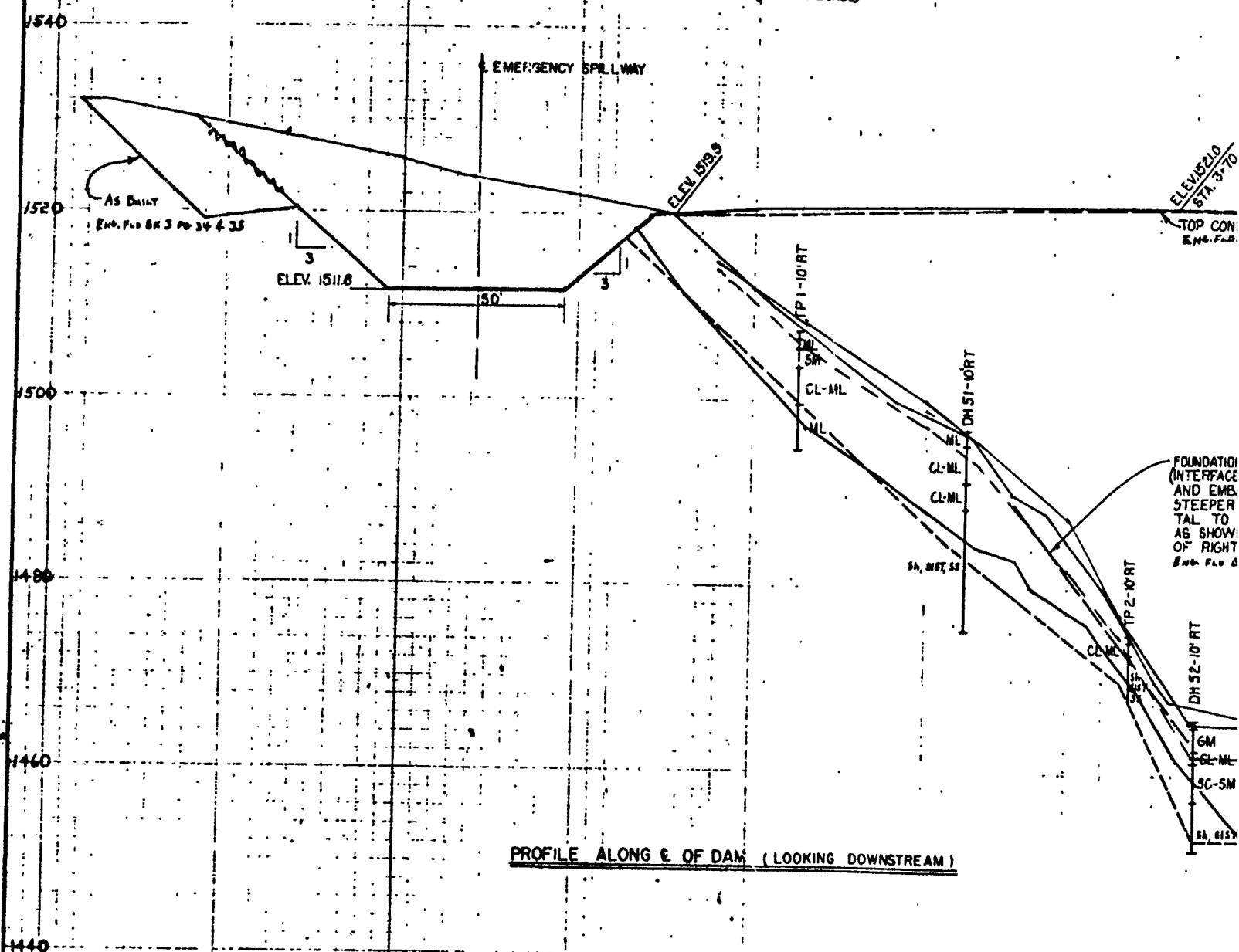
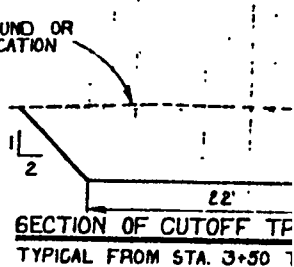
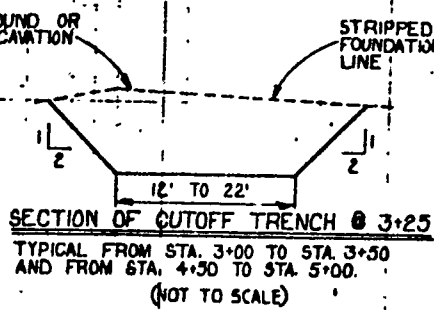
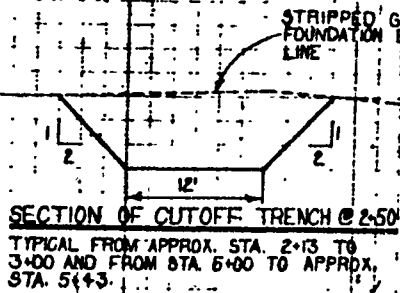

STRIPPED GROUND OR
FOUNDATION EXCAVATION
LINE

SECTION OF CUTOFF TRENCH @ 3+25

FROM STA. 3+00 TO STA. 3+50
STA. 4+30 TO STA. 5+00.
(NOT TO SCALE)

SECTION OF CUTOFF TRENCH @ 4+00

TYPICAL FROM STA. 3+50 TO STA. 4+50

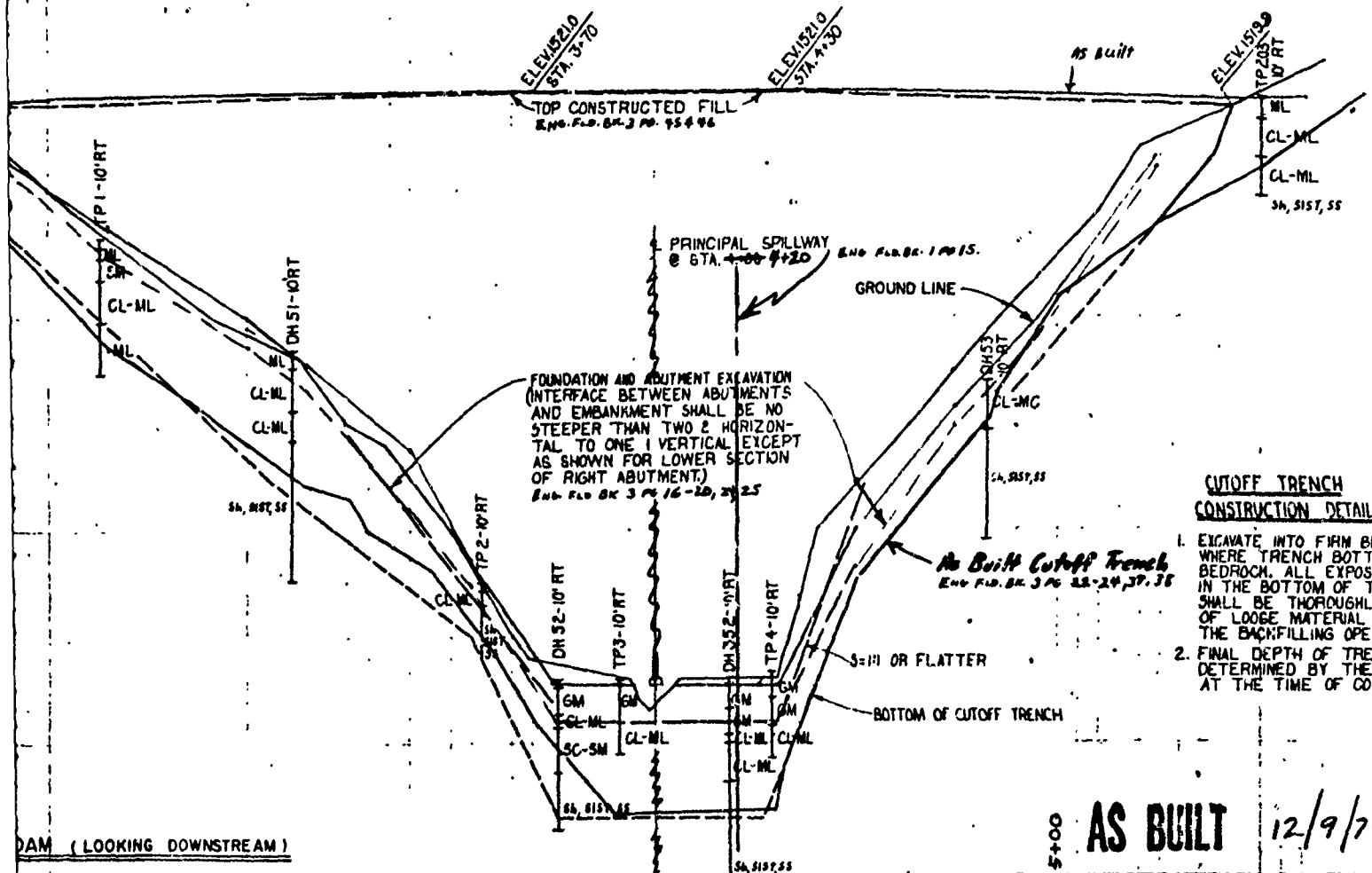

**CUTOFF TRENCH
CONSTRUCTION DETAILS**

1. EXCAVATE INTO FIRM BEDROCK WHERE TRENCH BOTTOMS ON BEDROCK. ALL EXPOSED ROCK IN THE BOTTOM OF TRENCH SHALL BE THOROUGHLY CLEANED OF LOOSE MATERIAL PRIOR TO THE BACKFILLING OPERATION.
2. FINAL DEPTH OF TRENCH TO BE DETERMINED BY THE ENGINEER AT THE TIME OF CONSTRUCTION.

AS BUILT 12/9/74

DAM (LOOKING DOWNSTREAM)

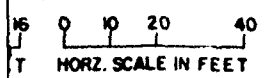

| | | | |
|---|------------------------------|---|---|
| <p>CONEWANGO CREEK WATERSHED PROJECT SITE 33 FLOODWATER RETARDING DAM CHAUTAQUA COUNTY, NEW YORK CUTOFF TRENCH EXCAVATION</p> | | | |
| <p>U. S. DEPARTMENT OF AGRICULTURE SOIL CONSERVATION SERVICE</p> | | | |
| <p>Drawn by W.A. RIEGEL</p> | <p>Date 11/70</p> | <p>Approved by</p> | <p>Checked by D. BURDICK</p> |
| <p>Checked by W.A.R.</p> | <p>Date 2/71</p> | <p>Project No. NY-2173-P</p> | <p>Sheet No. 23</p> |

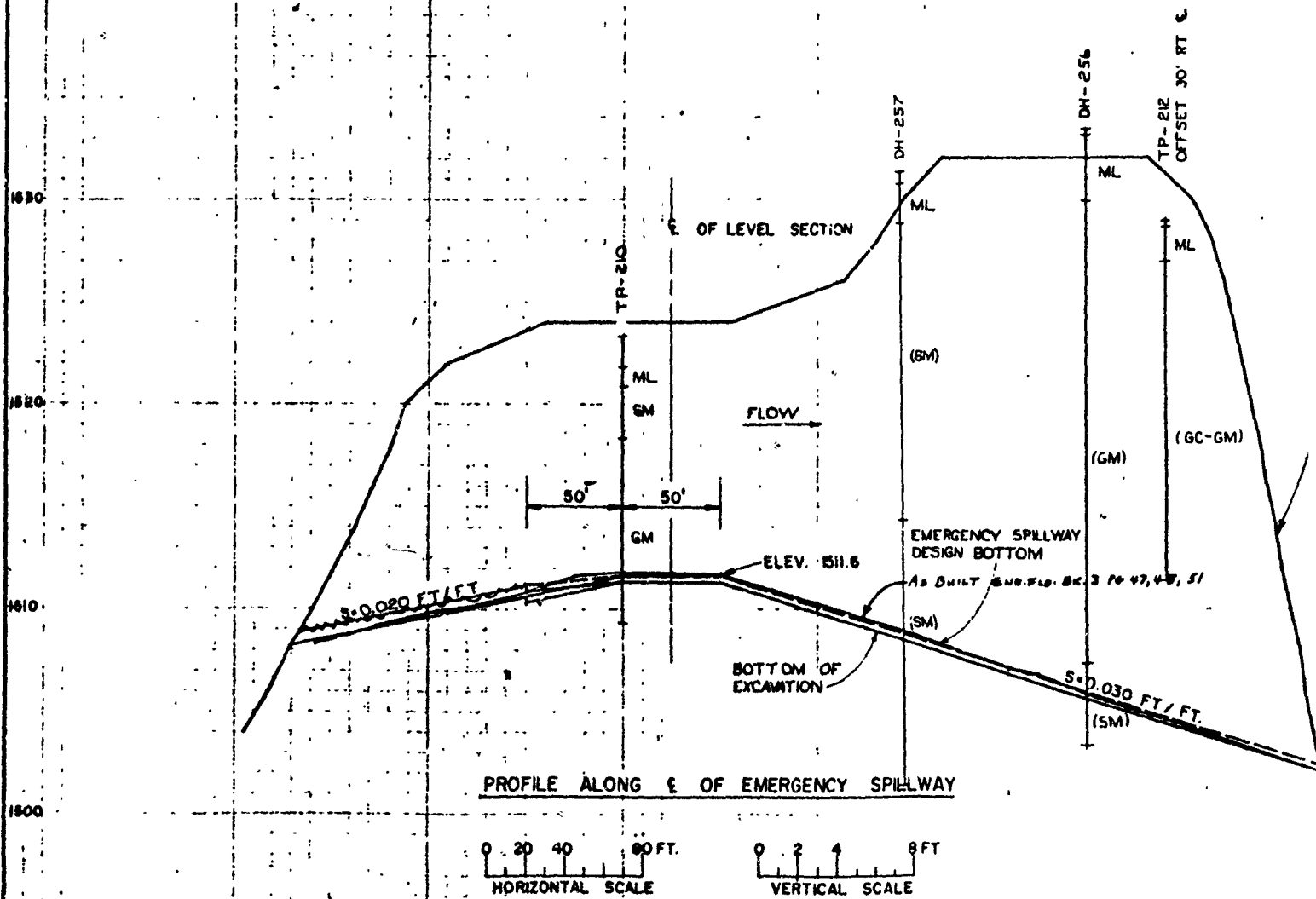
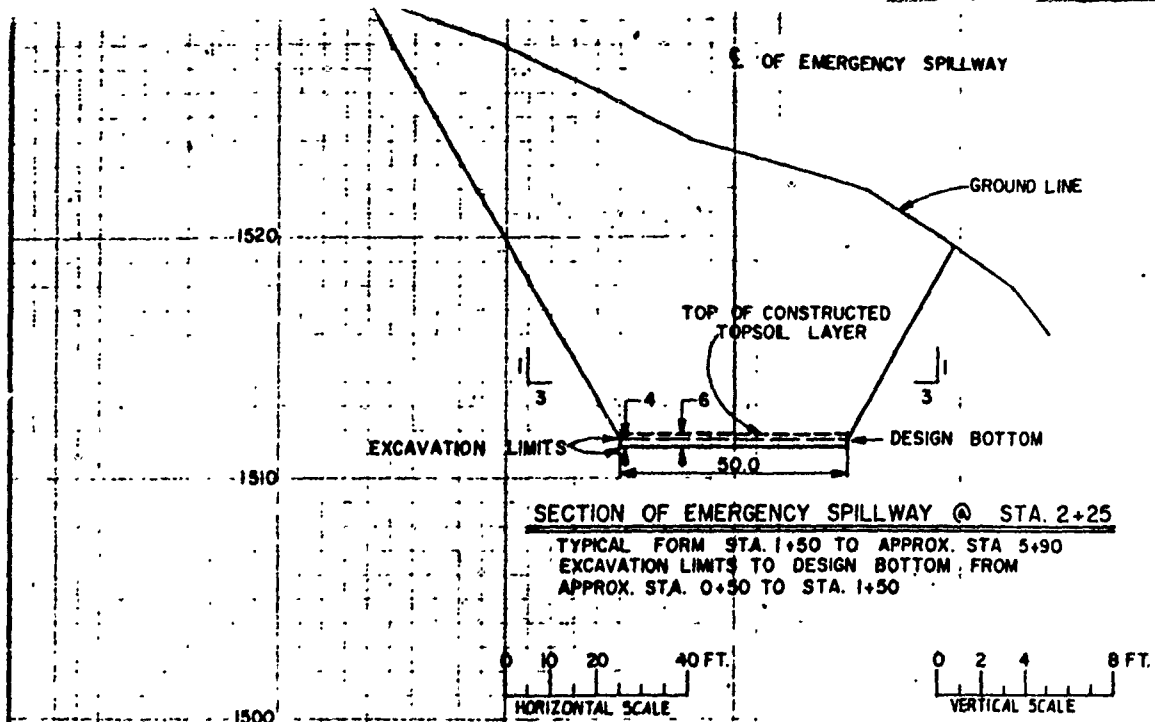

3+00 3+100 3+200 3+300 3+400 3+500

EMERGENCY SPILLWAY
GROUND LINE

DESIGN BOTTOM

SECTION @ STA. 2+25
PROX. STA. 5+90
FROM

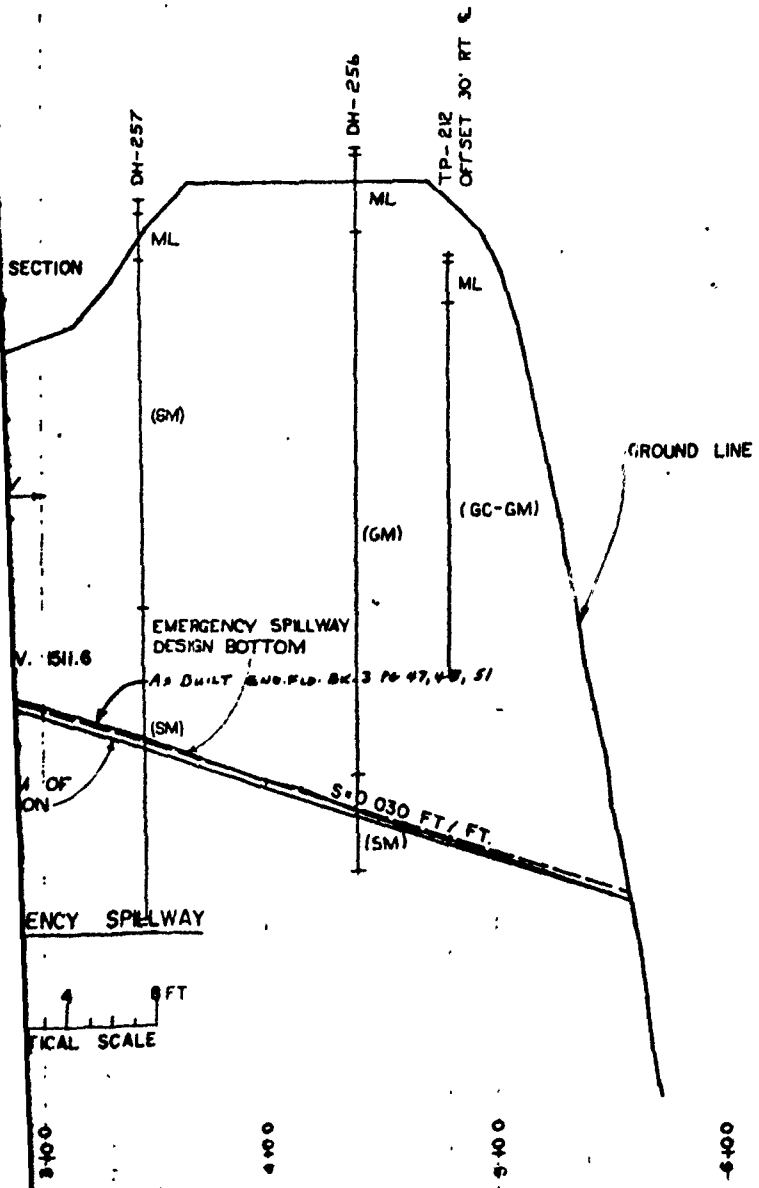

AS BUILT 12/9/74

CONEWANGO CREEK WATERSHED PROJECT
 SITE 33
 FLOODWATER RETARDING DAM
 CHAUTAUGUA COUNTY, NEW YORK
 EMERGENCY SPILLWAY
 U.S. DEPARTMENT OF AGRICULTURE
 SOIL CONSERVATION SERVICE

WA. RIEGEL 12/70
 W. MAVINS 12/70

5 NY-2173-P
 23
 3332

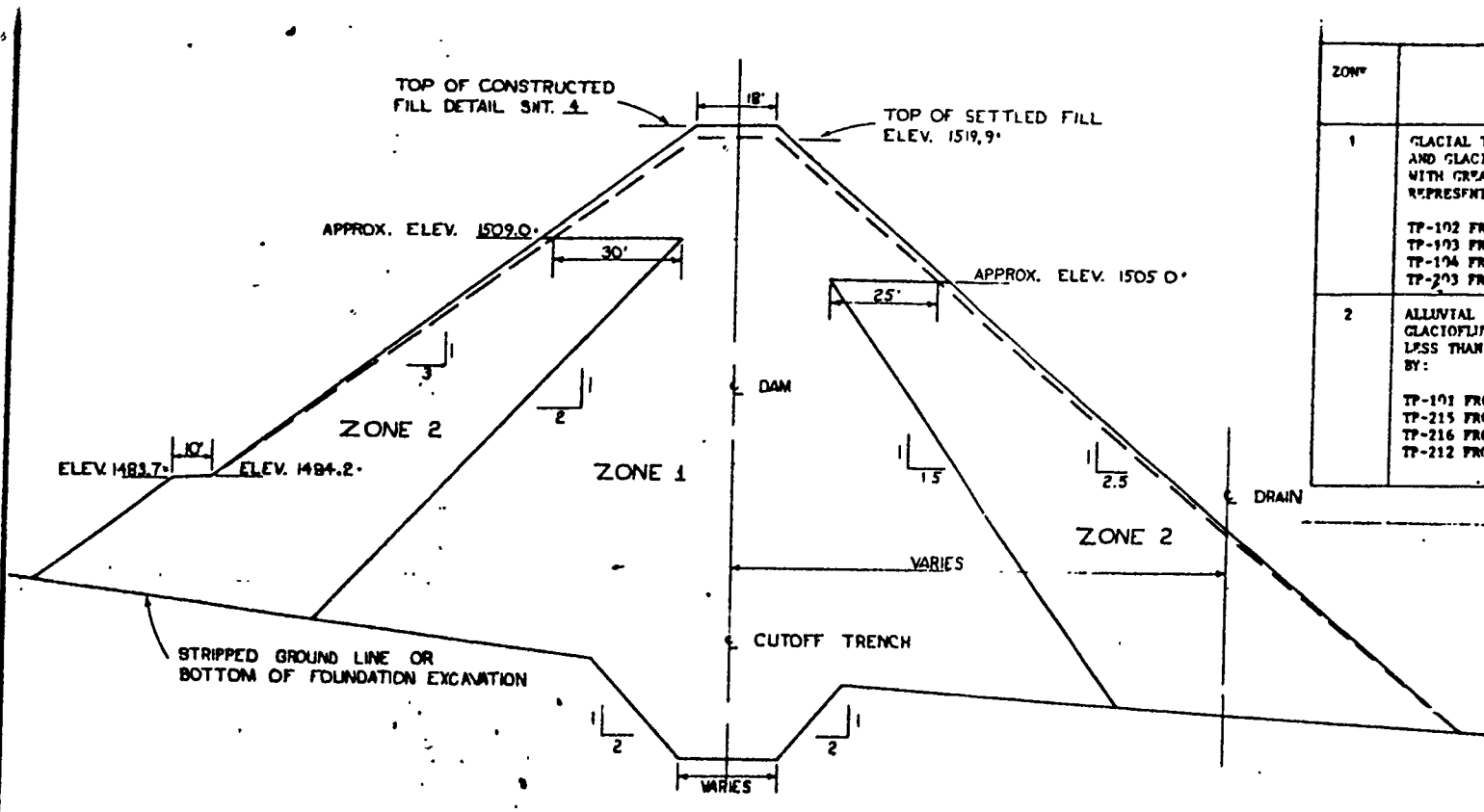

| ZONE | DESCRIPTION |
|------|--|
| 1 | GLACIAL T AND GLACI WITH GRA REPRESENT TP-102 FR TP-103 FR TP-104 FR TP-203 FR |
| 2 | ALLUVIAL (GLACIOFLU) LESS THAN BY: TP-101 FR TP-215 FR TP-216 FR TP-212 FR |

SECTION OF DAM AT STATION 4+25. (NOT TO SCALE)
TYPICAL FROM APPROX. STA. 2+30 TO APPROX. STA. 5+40

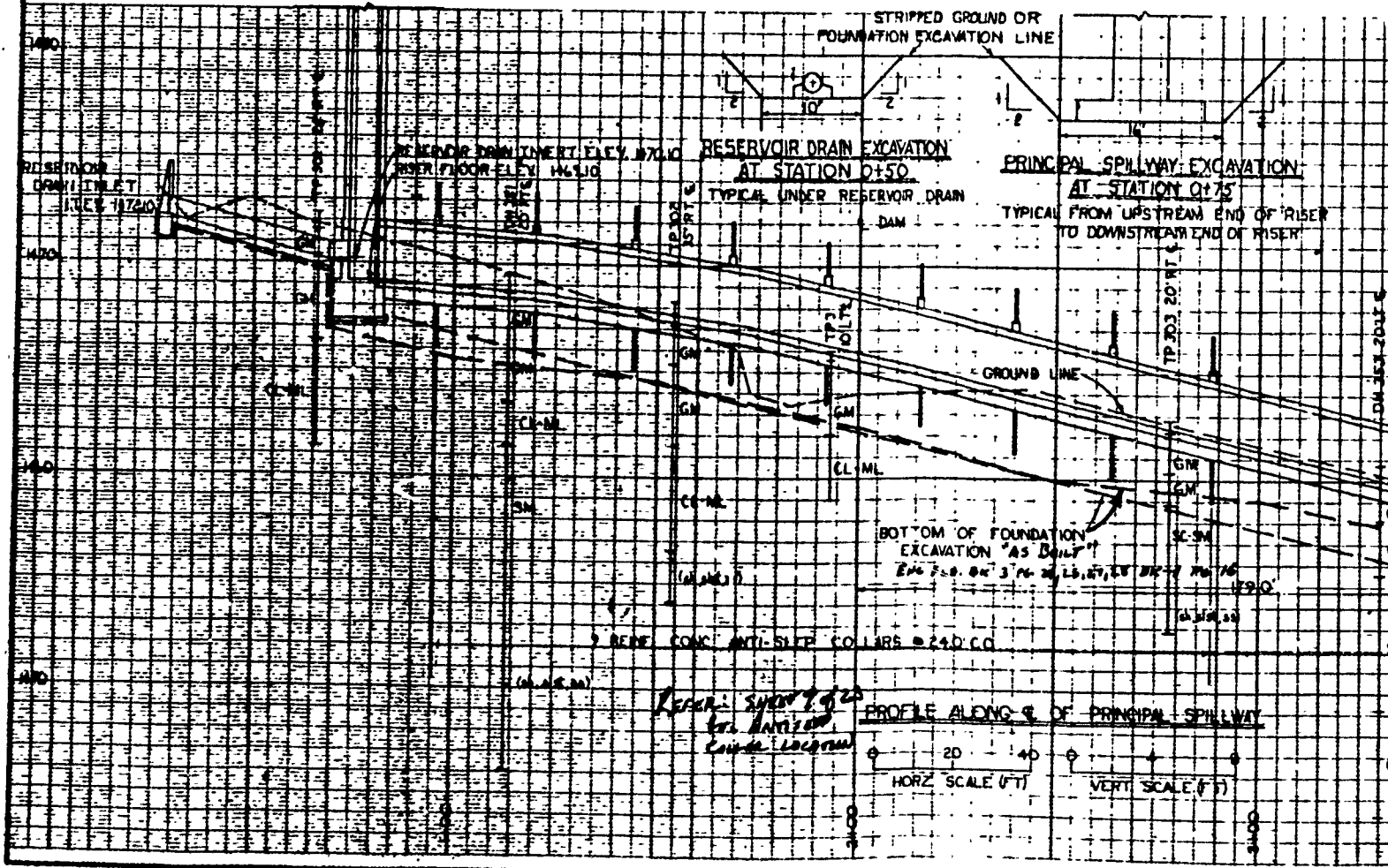

Refer: Spillway for Antislip Collar Location

PROFILE ALONG $\frac{1}{2}$ OF PRINCIPAL SPILLWAY
 20 40
 HORIZ SCALE (FT) VERT SCALE (FT)

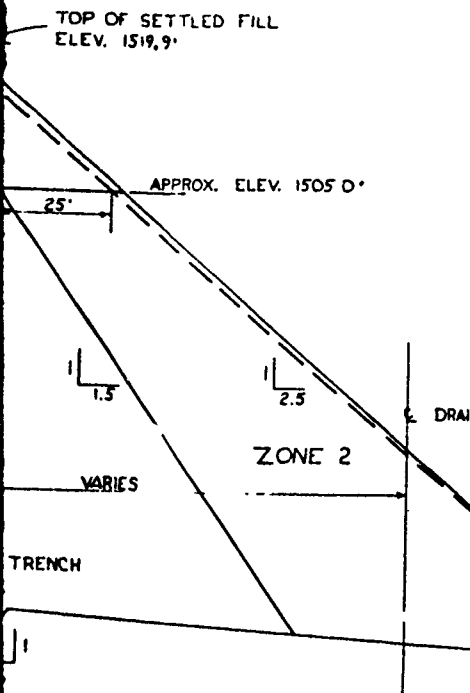

| ZONE | MATERIAL | MAX. ROCK SIZE | MAX. LIFT THICKNESS | MIN. REQUIRED WATER CONTENT | COMPACTION | |
|------|---|----------------|---------------------|-----------------------------------|------------|--|
| | | | | | CLASS | DEFINITION |
| 1 | GLACIAL TILL, GLACIOFLUVIAL, AND GLACIOLACUSTRINE MATERIALS WITH GREATER THAN 20% FINES REPRESENTED BY: TP-102 FROM 1.0' TO 10.0' TP-193 FROM 1.0' TO 9.5' TP-194 FROM 1.0' TO 10.0' TP-203 FROM 0.6' TO 5.5' | 6" | 9" | 2 PERCENTAGE POINTS BELOW OPTIMUM | A | 95% STANDARD DENSITY BY ASTM D-698 METHOD A |
| 2 | ALLUVIAL OR ICE-CONTACT GLACIOFLUVIAL MATERIALS WITH LESS THAN 20% FINES REPRESENTED BY: TP-101 FROM 4.0' TO 10.0' TP-215 FROM 7.0' TO 16.5' TP-216 FROM 3.6' TO 16.5' TP-212 FROM 2.0' TO 17.5' | 6" | 9" | WET 5/ | C | FOUR PASSES PER LAYER OF FILL BY A SMOOTH WHEEL VIBRATING ROLLER AT LEAST 72" WIDE, WEIGHING AT LEAST ONE TON (STATIC SERVICE WEIGHT) PER FOOT OF WIDTH AND CAPABLE OF EXERTING A DYNAMIC IMPACT OF AT LEAST 20,000 POUNDS AT THE RATE OF AT LEAST 1,200 TIMES PER MINUTE. |

- 1/ THE PLACEMENT TABLE INDICATES ESTIMATED USE OF MATERIALS.
- 2/ MAXIMUM ROCK SIZE PLACED IN BACKFILL COMPACTED BY MEANS OF HAND TAMPING OR MANUALLY DIRECTED POWER TAMPERS OR PLATE VIBRATORS SHALL BE 3".
- 3/ MAXIMUM LIFT THICKNESS PRIOR TO COMPACTION.
- 4/ WATER CONTENT AT TIME OF COMPACTION.
- 5/ THOROUGHLY WET BUT:
 - a. NOT MORE THAN 14% MOISTURE CONTENT ON THE MATERIAL PASSING THE #4 SIEVE UNLESS MODIFIED BY THE ENGINEER AT THE TIME OF CONSTRUCTION.
 - b. NOT SO WET AS TO CAUSE ADHERENCE OF THE SOIL TO THE WHEELS OR TRACKS OF EQUIPMENT, NOR TO CAUSE BOGGING DOWN OF EQUIPMENT.
- 6/ FOR TYPICAL COMPACTION CURVES SEE SHEET 22

CONSTRUCTION DETAILS

- 1. ZONE 2 BOUNDARIES INDICATED ARE APPROXIMATE. ADJUSTMENTS WILL BE MADE BY THE ENGINEER TO PERMIT THE CONTRACTOR TO UTILIZE ALL COARSE MATERIAL (LESS THAN 20% FINES) FROM REQUIRED EXCAVATIONS, WITHIN THE HEAT LINES OF THE EMBANKMENT.
- 2. TOPSOIL THAT IS SUITABLE FOR USE AND NOT USED ON THE SPECIFIED AREA OF THE EMERGENCY SPILLWAY SHALL BE INCORPORATED WITHIN THE SLOPES OF THE EARTH FILL AS DIRECTED BY THE ENGINEER.

STATION 4+25 (NOT TO SCALE)
TO APPROX STA 5+40

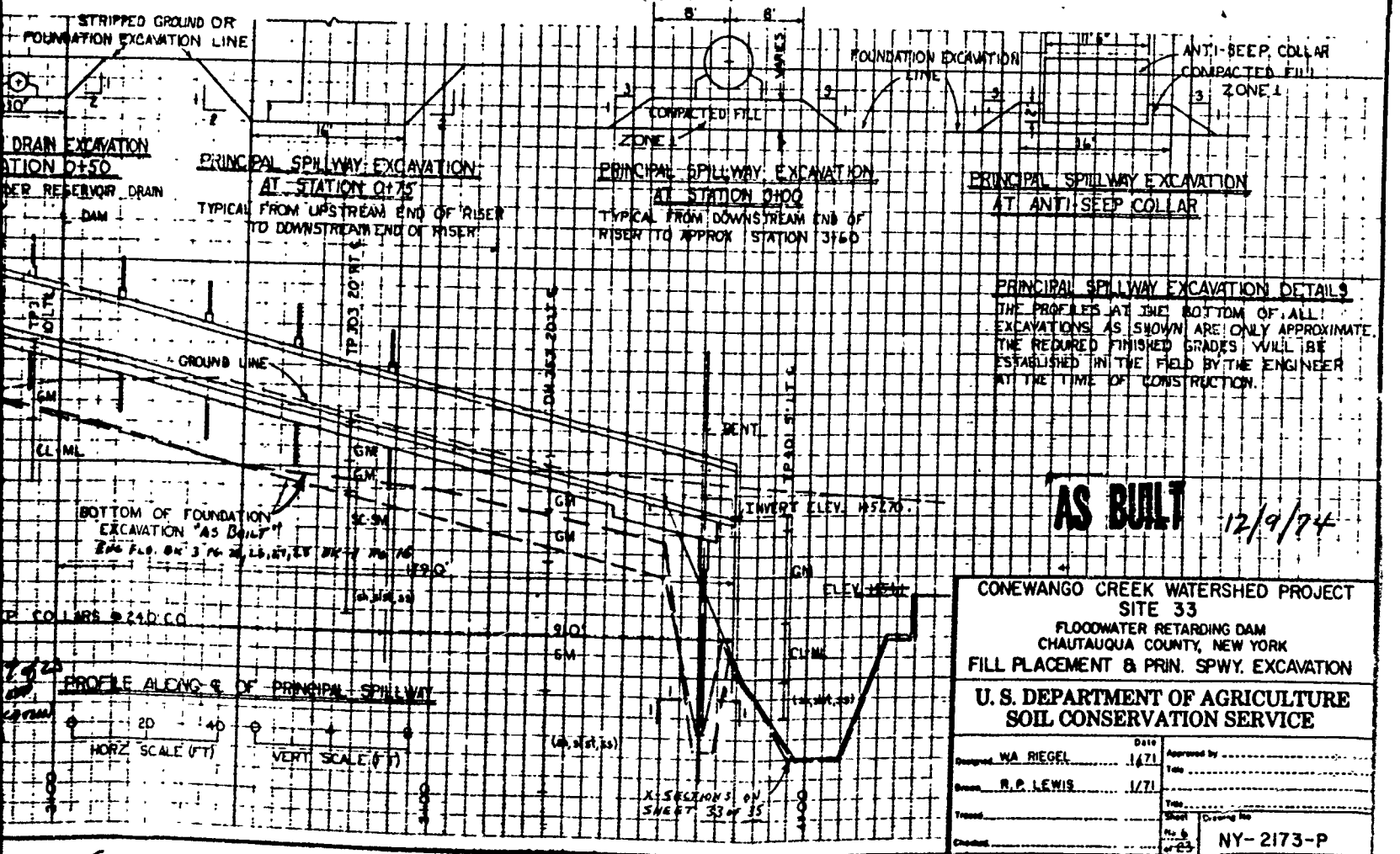

CONEWANGO CREEK WATERSHED PROJECT
SITE 33
 FLOODWATER RETARDING DAM
 CHAUTAUQUA COUNTY, NEW YORK
FILL PLACEMENT & PRIN. SPWY. EXCAVATION
U. S. DEPARTMENT OF AGRICULTURE
SOIL CONSERVATION SERVICE

Designed: WA RIEGEL Date: 1/71
 Approved by: _____
 Drawn: R.P. LEWIS Date: 1/71
 Title: _____
 Sheet: _____
 Drawing No: NY-2173-P
 Checked: _____
 Date: 12/9/74

1

2

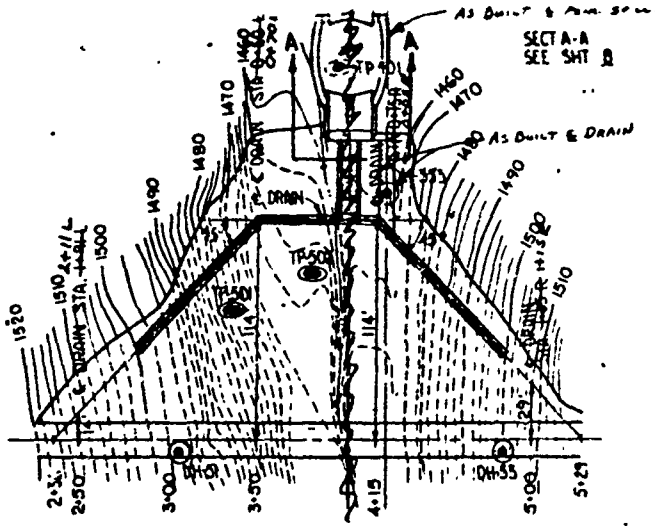

PLAN VIEW
 0 25 50 100
 SCALE IN FEET

GRAIN SIZE DISTRIBUTION TABLE FOR DRAIN FILL

| DRAIN FILL I (FINE) | | DRAIN FILL II (COARSE) | |
|---------------------|-----------|------------------------|-----------|
| SIEVE NO | % PASSING | SIEVE NO | % PASSING |
| 3" | | 3" | 100 |
| 1 1/2" | | 1 1/2" | 87-100 |
| 3/8" | 100 | 1" | 77-100 |
| #4 | 44-100 | 3/4" | 70-98 |
| #8 | 80-100 | 3/8" | 42-76 |
| #16 | 50-85 | #4 | 15-50 |
| #30 | 25-60 | #8 | 0-22 |
| #50 | 10-30 | #16 | 0-3 |
| #100 | 0-10 | | |
| #200 | 0-3 | | |

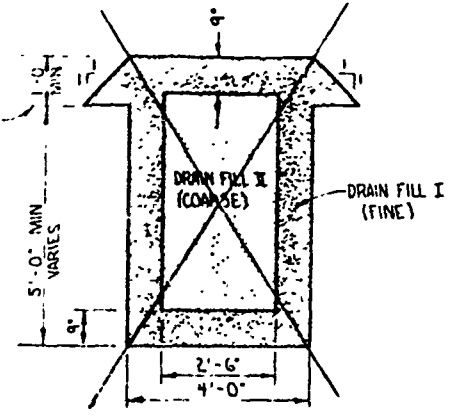

SECTION BB & GG
 TYPICAL SECTION WHERE BEDROCK IS NOT ENCOUNTERED IN ABUTMENTS (NOT TO SCALE)

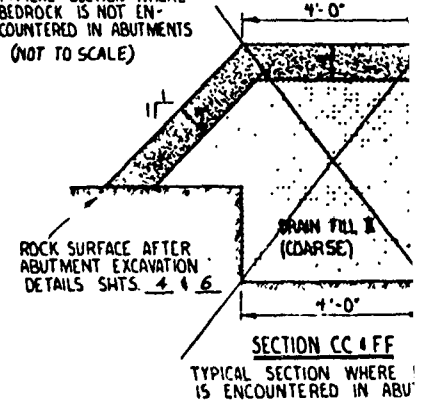

SECTION CC & FF
 TYPICAL SECTION WHERE IS ENCOUNTERED IN ABUT

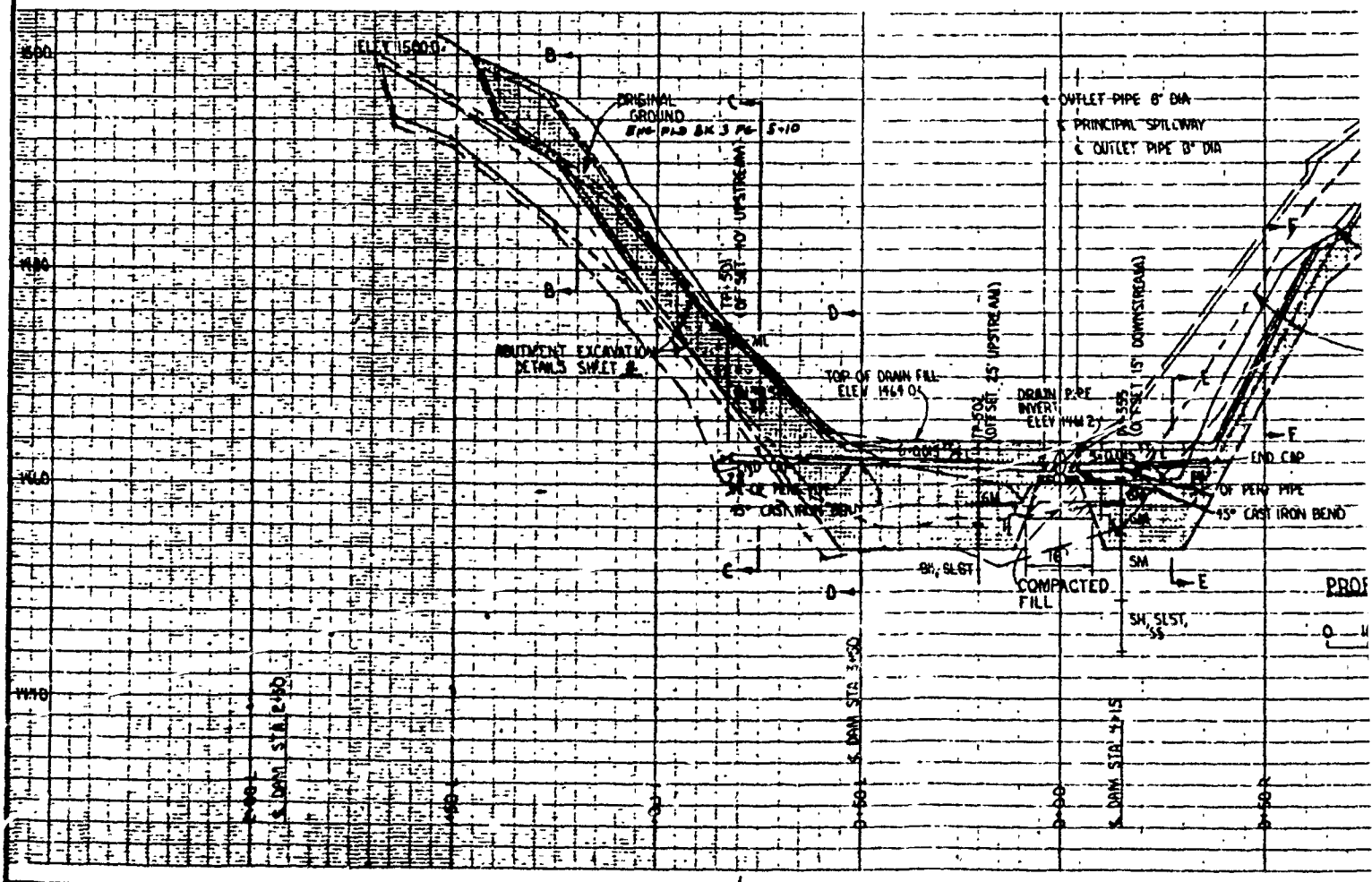

DRAINAGE SYSTEM DETAILS

- 1 ASBESTOS CEMENT DRAIN PIPE SHALL CONFORM TO SPECIFICATION 545 AND SHALL BE 8" DIA PRESSURE PIPE CLASS 200, TYPE II
- 2 THE PROFILES AT THE BOTTOM OF ALL EXCAVATIONS AS SHOWN ARE ONLY APPROXIMATE. THE REQUIRED FINISHED GRADES WILL BE ESTABLISHED IN THE FIELD BY THE ENGINEER AT THE TIME OF CONSTRUCTION

QUANTITY SUMMARY

- 191 ~~160~~ CU YDS DRAIN FILL I (FINE)
- 418 ~~250~~ CU YDS DRAIN FILL II (COARSE)
- 182 ~~172~~ LIN FT STRAIGHT SECTION OF 8" DIA PERFORATED ASBESTOS CEMENT PIPE
- 26 LIN FT STRAIGHT SECTION OF 8" DIA NON-PERFORATED ASBESTOS CEMENT PIPE
- 2 END CAPS
- 2 45° BEND - 8" DIA CAST IRON
- 1 90° BEND - 8" DIA CAST IRON

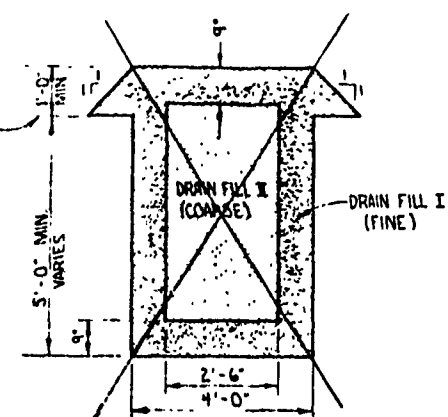

SECTION BB & GG
TYPICAL SECTION WHERE BEDROCK IS NOT ENCOUNTERED IN ABUTMENTS (NOT TO SCALE)

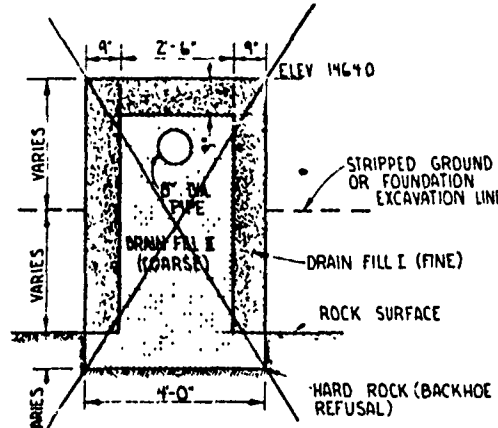

SECTION DD & EE
NOT TO SCALE

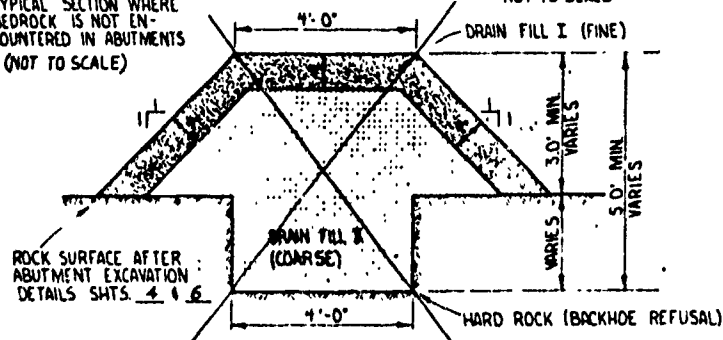

SECTION CC & FF
TYPICAL SECTION WHERE BEDROCK IS ENCOUNTERED IN ABUTMENTS

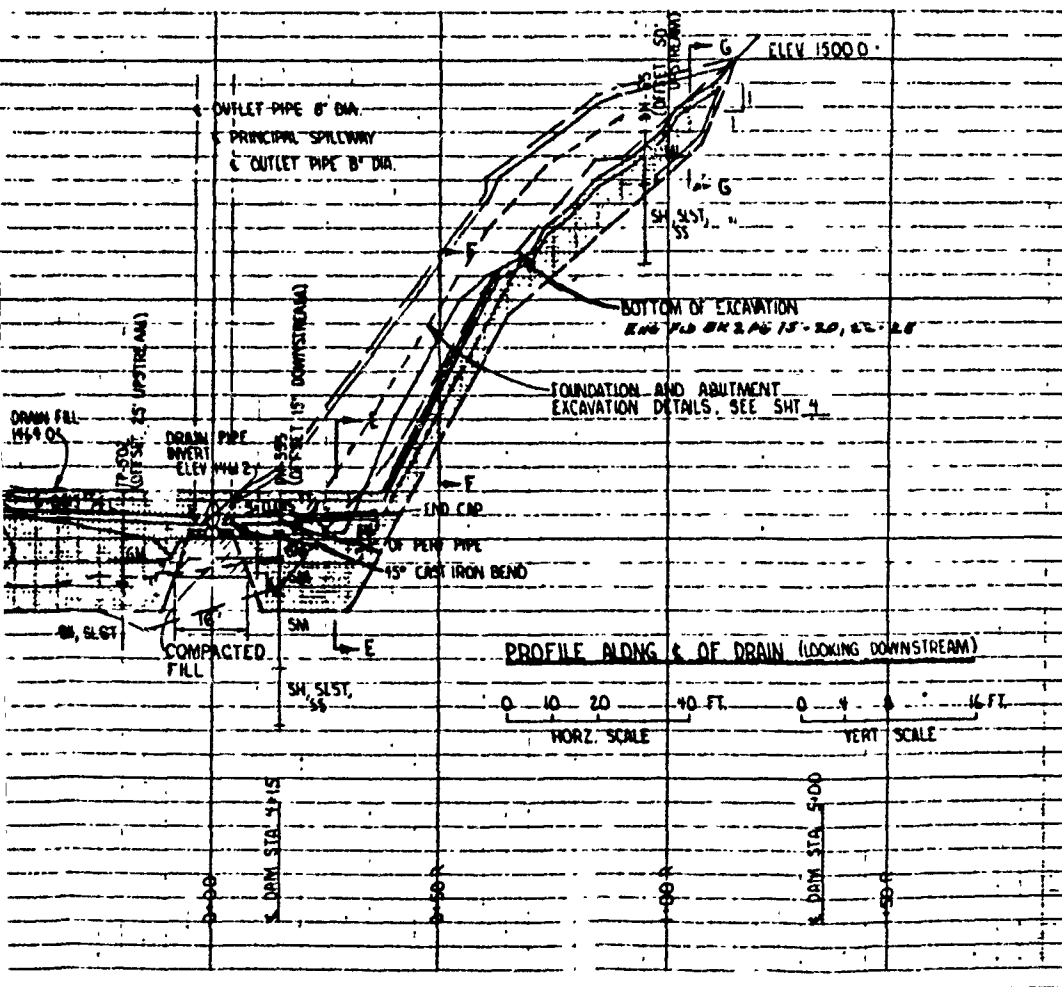

AS BUILT
12/9/74

CONEWANGO CREEK WATERSHED PROJECT
SITE 33
FLOODWATER RETARDING DAM
CHAUTAUQUA COUNTY, NEW YORK
DRAINAGE SYSTEM DETAILS

U.S. DEPARTMENT OF AGRICULTURE
SOIL CONSERVATION SERVICE

| | | | | | |
|-------------------|--------|------|-----------------------|-------------|--|
| Designed | W.A.R. | Date | 12-70 | Approved by | |
| Drawn | W.E.G. | Date | 1-71 | Title | |
| Traced | | | | | |
| Checked | | | | | |
| Sheet No. 7 of 23 | | | Drawing No. NY-2173-P | | |

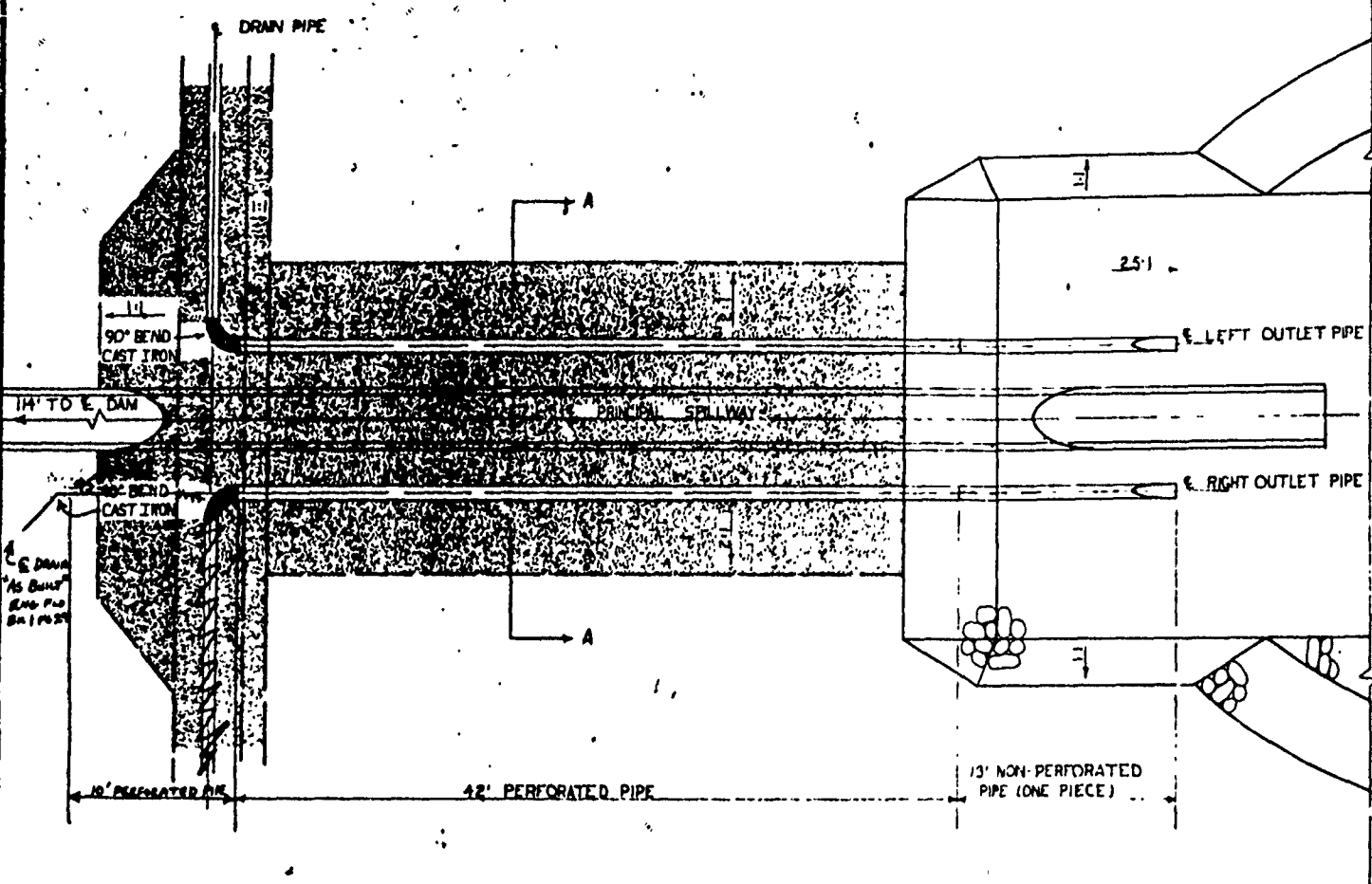

PLAN OF DRAIN OUTLETS

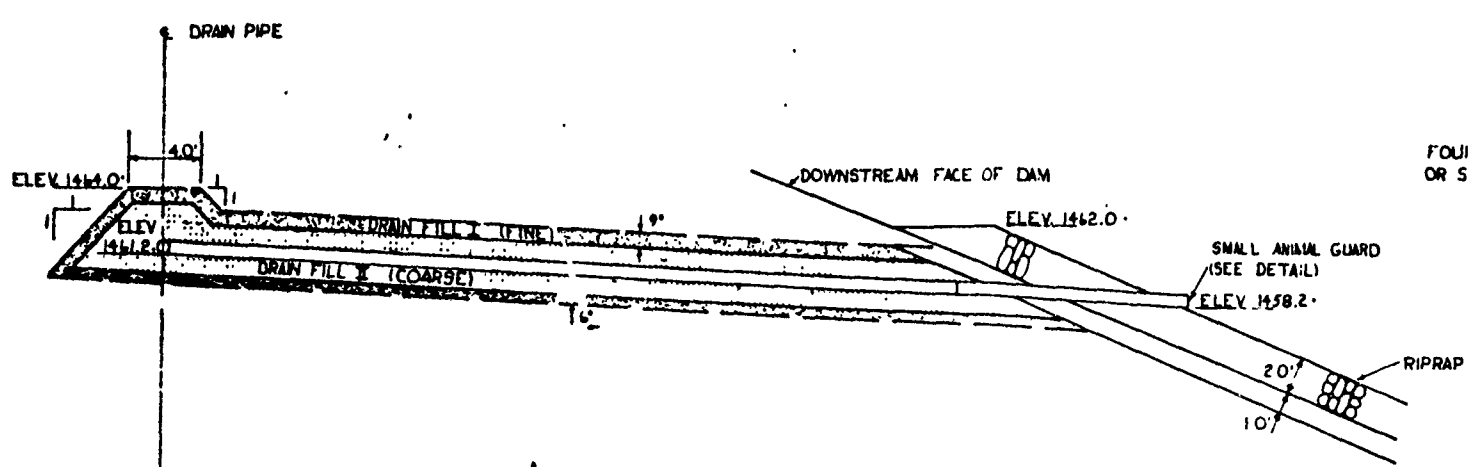

PROFILE ALONG DRAIN OUTLETS

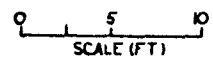

FOUR OR S

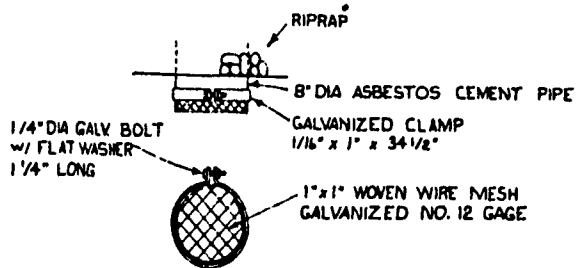
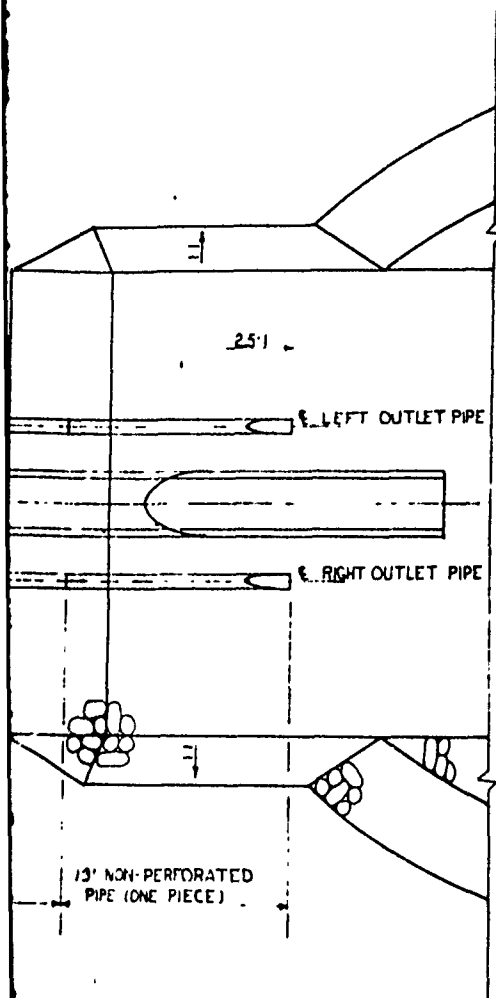

SMALL ANIMAL GUARD DETAILS

2-REQUIRED

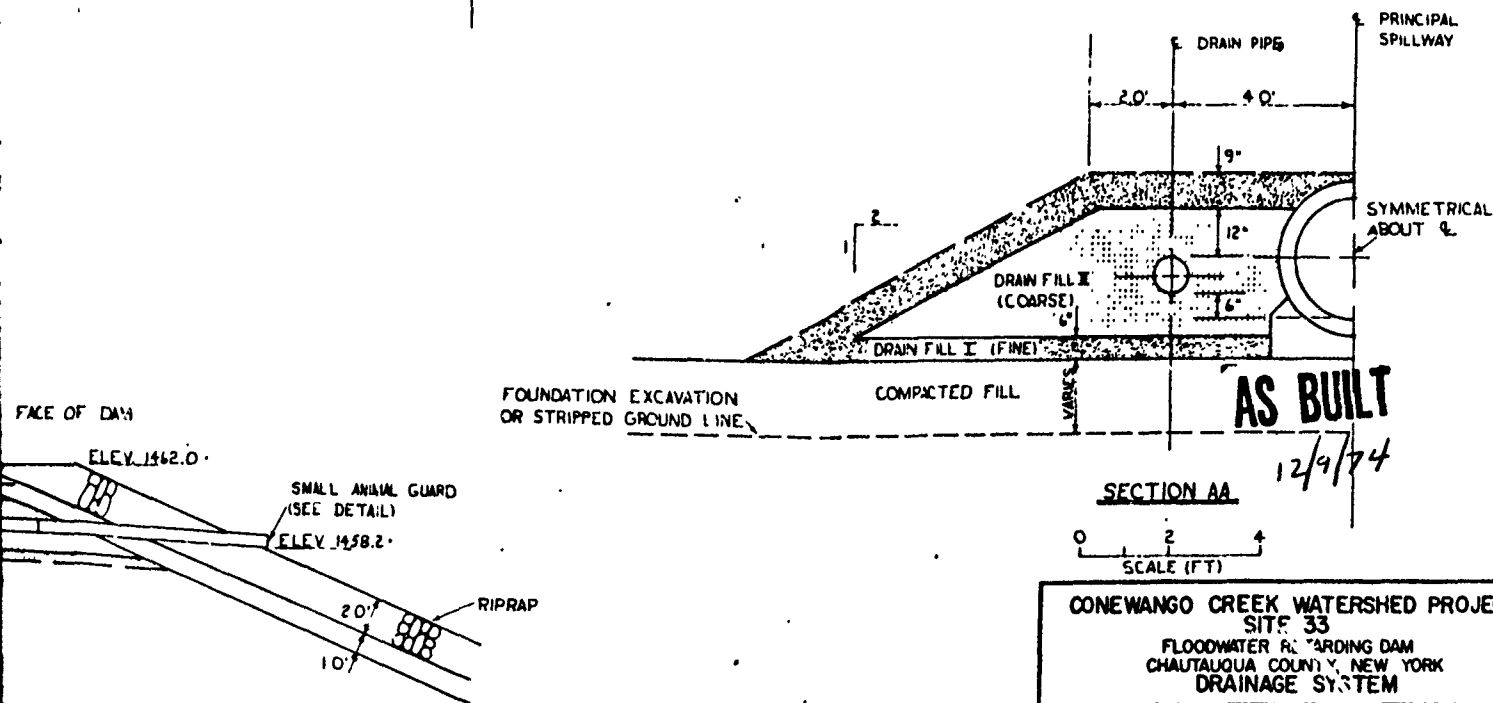

CONEWANGO CREEK WATERSHED PROJECT
SITE 33
FLOODWATER RETARDING DAM
CHAUTAUQUA COUNTY, NEW YORK
DRAINAGE SYSTEM

U. S. DEPARTMENT OF AGRICULTURE
SOIL CONSERVATION SERVICE

| Name | Date |
|-------------|------|
| W.A. RIEGEL | 1/71 |
| R.P. LEWIS | 1/71 |
| W.A.R. | 2/71 |

NY-2173-P

2

RESERVOIR DRAIN PIPE DETAIL 9

USE STANDARD MECHANICAL JOINTS
 PIPE SHALL CONFORM TO SPEC. 300
 AND SHALL BE 10" DIA CLASS 50
 THICKNESS DESIGNATION 22. 40.0'
 TYPE III AND A 5' SECTION WITH
 A CAST OR SCREWED ASA 125 FLANGE.
 TOTAL LENGTH OF PIPE = 45.0'

8' OF INLET CHANNEL
 BOTTOM WIDTH = 4.0'
 SIDE SLOPE = 2:1
 BOTTOM SLOPE = 0.00 FT/FT

40.0' OF STRAIGHT
 PIPE (CAST IRON)

ONE 5.0' LENGTH
 WITH FLANGE
 DETAIL SHT. 10

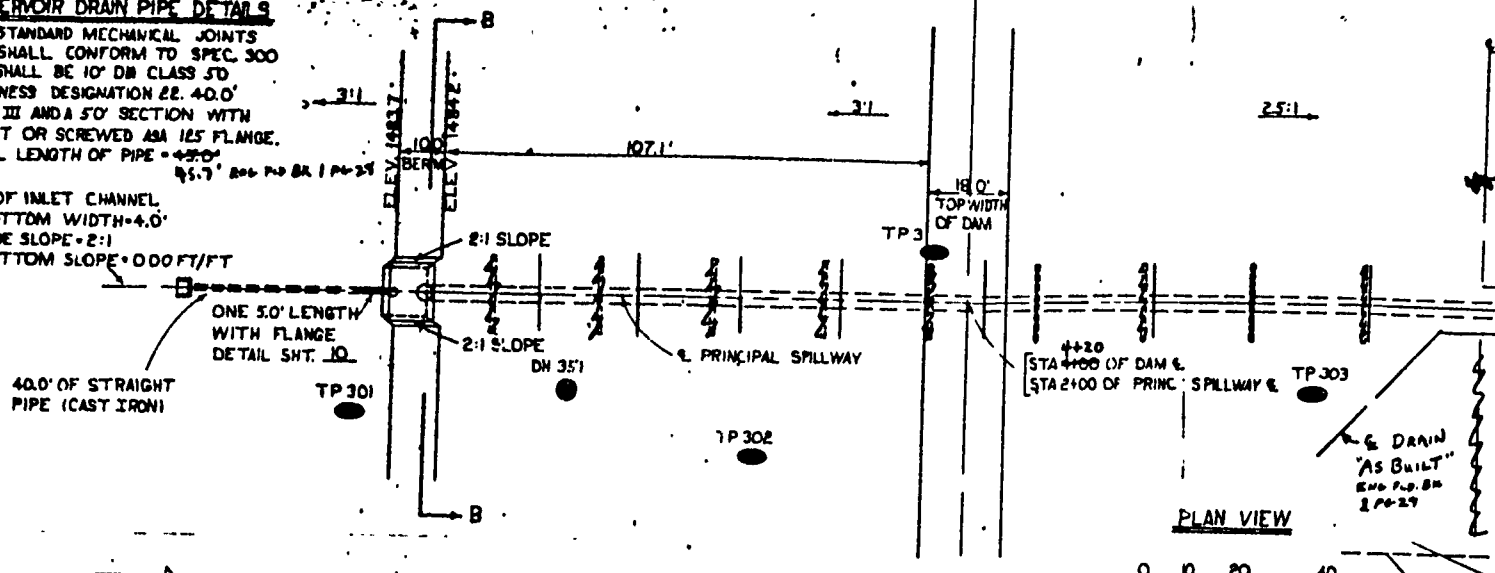

PLAN VIEW

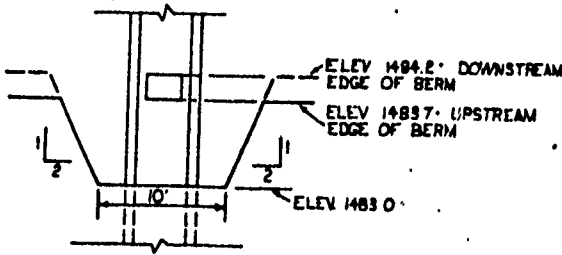
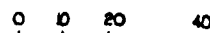

SECTION BB
(NOT TO SCALE)

RIPRAP DETAIL 3

LOOSE ROCK RIPRAP SHALL BE (A MAXIMUM SIZE OF 24" TO A MAXIMUM OF 20% SHALL BE LESS THAN 6" (10 LBS) AND A MAXIMUM SHALL BE LESS THAN 12" (40 LBS)
 BEDDING 3
 GRADATION I
 II (COARSE)

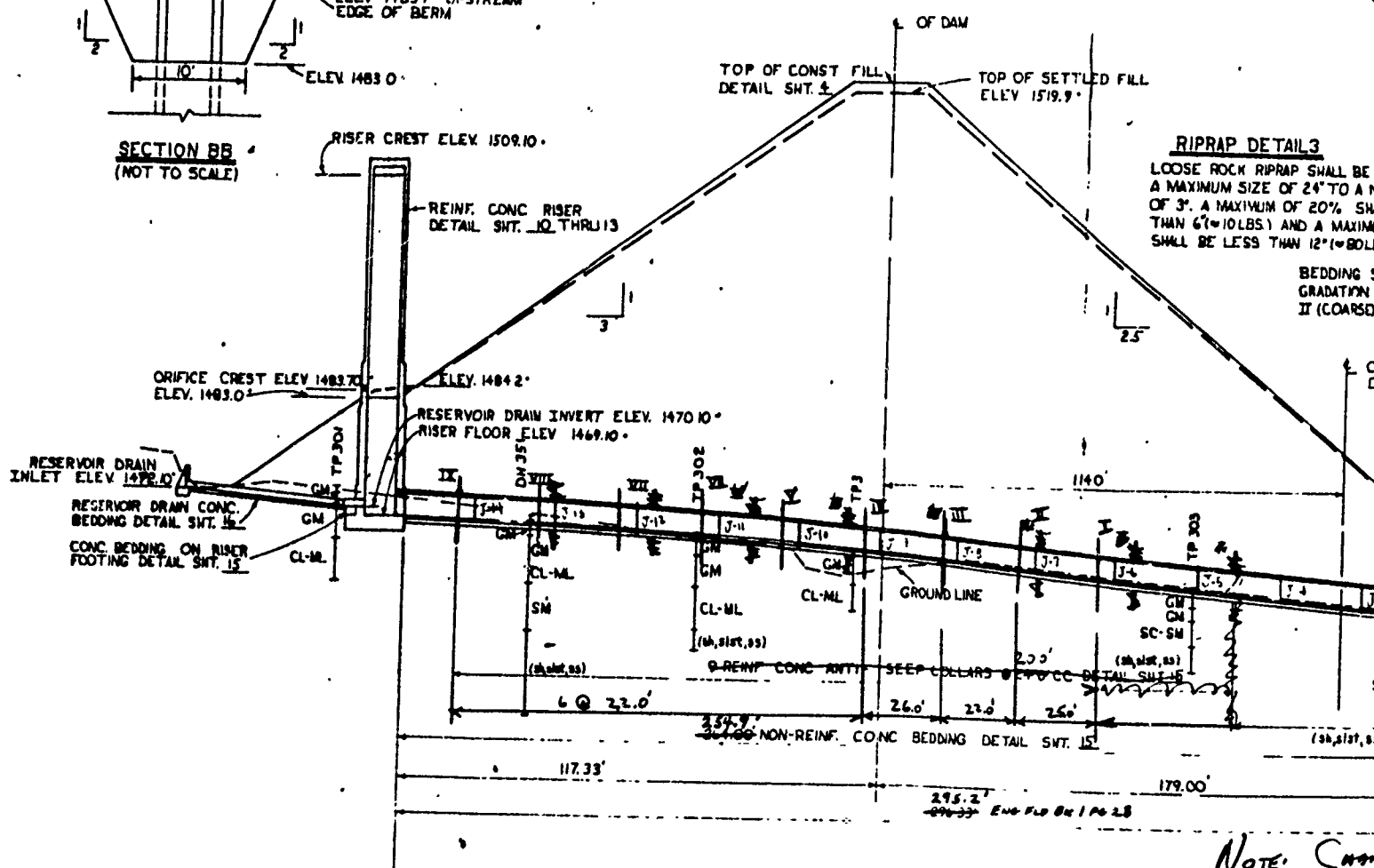

PROFILE ALONG E. OF PRINCIPAL SPILLWAY



NOTE: Check All

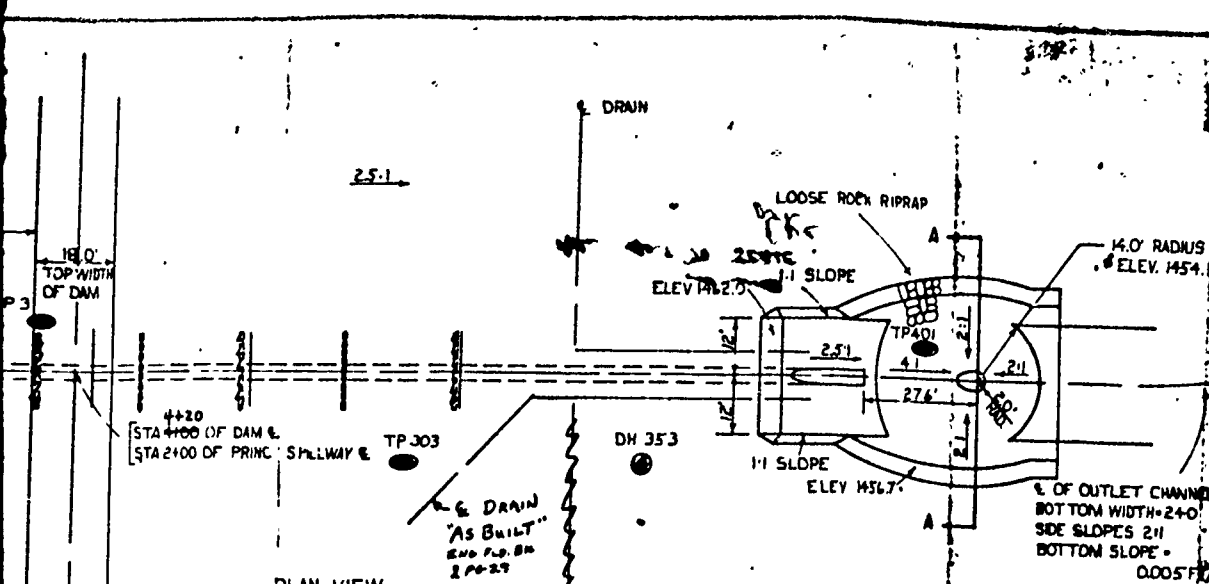

| COLLAR | DIST. FROM OUTLET | INVERT OF 90° DIA. PIPE | INVERT OF 30" DIA. PIPE |
|--------|-------------------|-------------------------|-------------------------|
| OUTLET | 0 | 1457.70 | 1457.70 |
| J-1 | 20 | 1458.68 | |
| J-2 | 40 | 1459.66 | 0.0005 |
| J-3 | 60 | 1460.64 | |
| J-4 | 80 | 1461.62 | |
| J-5 | 100 | 1462.57 | |
| J-6 | 120 | 1463.47 | |
| J-7 | 140 | 1464.33 | |
| J-8 | 160 | 1465.13 | |
| J-9 | 180 | 1465.89 | VAR. 65 |
| J-10 | 200 | 1466.57 | |
| J-11 | 220 | 1467.25 | |
| J-12 | 240 | 1467.85 | |
| J-13 | 260 | 1468.41 | |
| J-14 | 280 | 1468.91 | |
| J-15 | 296 | 1469.10 | |

PLAN VIEW

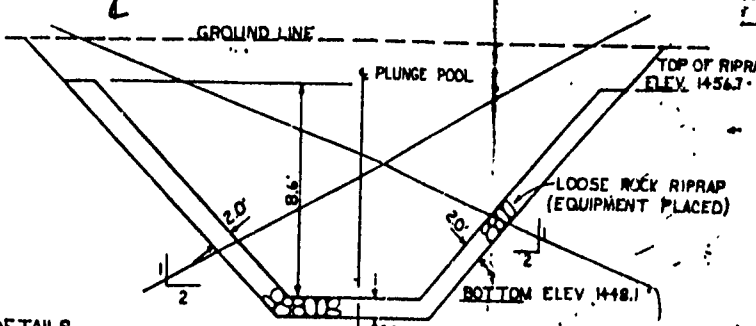
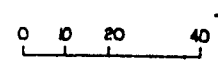

SECTION AA (NOT TO SCALE)

RIPRAP DETAILS

LOOSE ROCK RIPRAP SHALL BE GRADED FROM A MAXIMUM SIZE OF 24" TO A MINIMUM SIZE OF 3". A MAXIMUM OF 20% SHALL BE LESS THAN 6" (10 LBS) AND A MAXIMUM OF 60% SHALL BE LESS THAN 12" (60 LBS).

BEDDING SHALL MEET THE GRADATION REQUIREMENTS FOR DRAIN FILL II (COARSE) AS SHOWN ON SHEET 7.

ABOVE DIMENSIONS FOR LENGTHS OF PIPE ARE BASED ON NOMINAL LENGTHS AND DO NOT INCLUDE CREEP.

| COLLAR | DIST. FROM OUTLET | INVERT OF 90° DIA. PIPE | INVERT OF 30" DIA. PIPE |
|--------|-------------------|-------------------------|-------------------------|
| I | 98.90 | 1469.96 | 62.10 |
| II | 146.115 | 1469.02 | 63.24 |
| III | 159.137 | 1468.35 | .20 |
| IV | 163 | 1468.78 | .24 |
| V | 209.125 | 1466.26 | .07 |
| VI | 216.207 | 1467.88 | 66.82 |
| VII | 238.229 | 1467.92 | .52 |
| VIII | 239.251 | 1468.92 | .16 |
| IX | 288.273 | 1468.92 | .74 |

WHEN PIPE IS SUPPLIED IN LENGTHS OTHER THAN SHOWN, THE ENGINEER WILL PROVIDE THE CONTRACTOR WITH A REVISION OF THIS SHEET.

MOVEMENT OF ANTISEEP COLLARS NECESSARY DUE TO CHANGE FROM 16 FT. PIPE LENGTHS TO 20 FT LENGTHS. ARE.

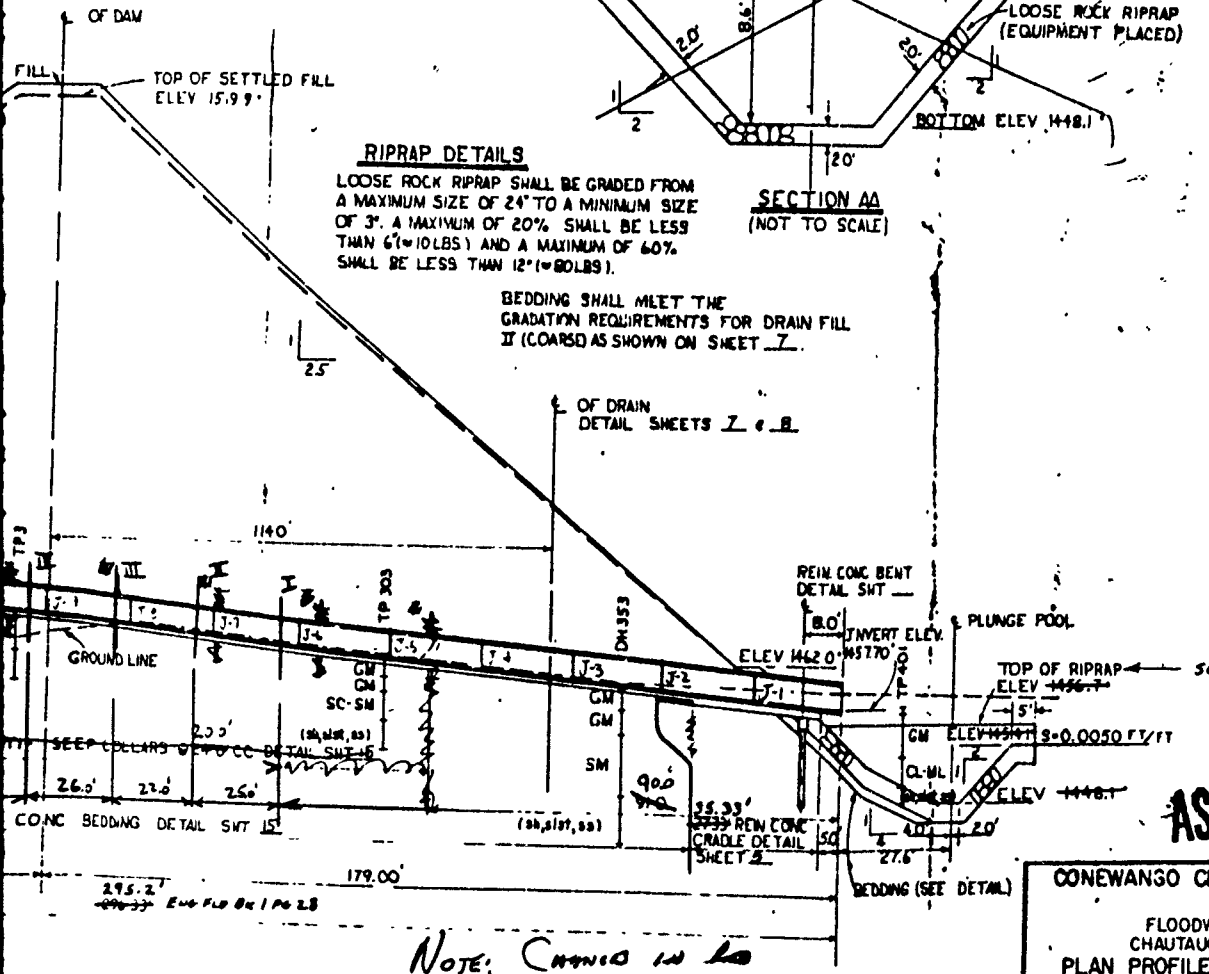

AS BUILT 12/9/74

NOTE: CHANNEL IN 10 ARE NOT TO SCALE *dlr*

CONEWANGO CREEK WATERSHED PROJECT
SITE 33
 FLOODWATER RETARDING DAM
 CHAUTAQUA COUNTY, NEW YORK
 PLAN PROFILE OF PRINCIPAL SPILLWAY

U. S. DEPARTMENT OF AGRICULTURE
SOIL CONSERVATION SERVICE

| | | | | | |
|----------|---------------|------|------|-------------|-----------|
| Designed | WA RIEGEL | Date | 1/71 | Approved by | |
| Drawn | R.P. LEWIS | Date | 1/71 | Title | |
| Checked | J.E. POLULECH | Date | 1/71 | Sheet No | 9 |
| | | | | Drawing No | NY-2173-P |

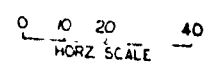

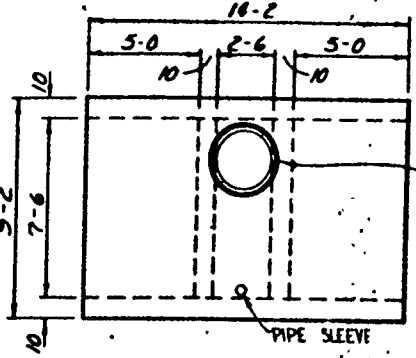

PLAN-TOP

"C" TYPE WALL THIMBLE 8" DEEP 10" DIA BOLTED TO FLANGE SEE DETAIL I

Manhole Frame

MANHOLE ASSEMBLY DETAILS
 CIRCULAR MANHOLE ASSEMBLY
 MIN CLEAR OPENING 30" NEENAH
 FOUNDRY CO. MODEL R-616-HH
 W/ STAINLESS CAP SCREWS OR
 APPROVED EQUIVALENT.

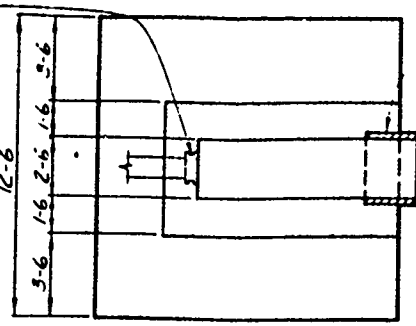

SECTION B-B

Specify Wall Thickness
 DETAIL SHEET 10



CONSTR. JOINT

1/4" x 6" Carbon steel plate,
 to conform to Spec 581
 Continuous thru constr. joint.
 Splices shall be either:
 1. Butt welded
 2. Lapped 3" and bolted
 3. Lapped 3" and fillet welded

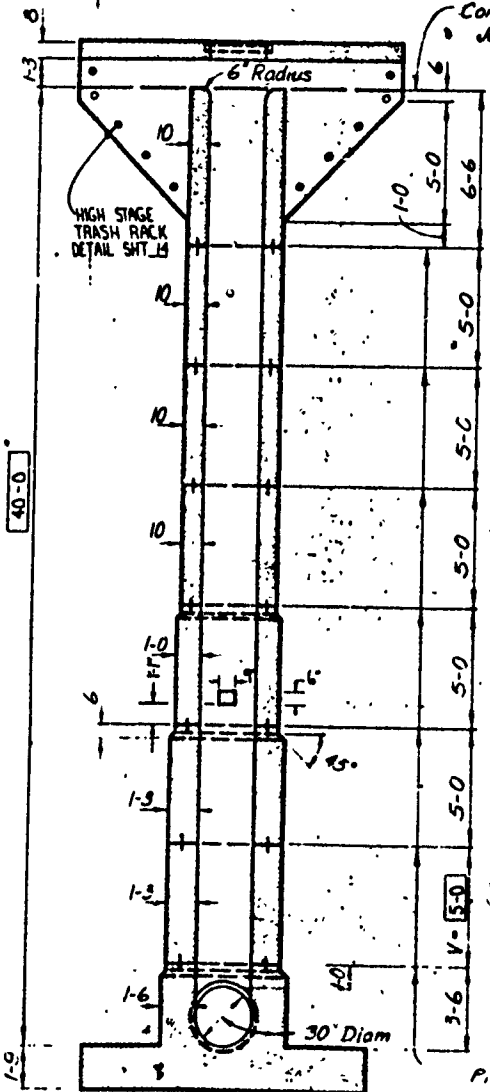

SECTION A-A

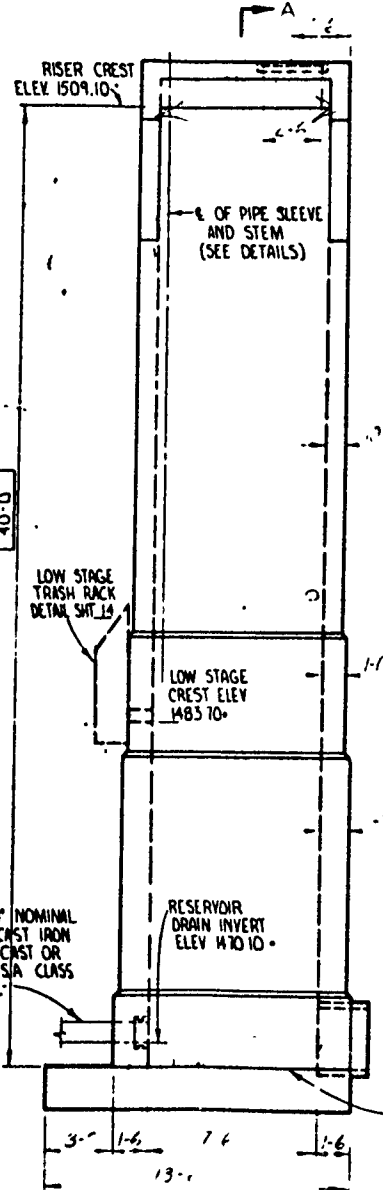

SIDE ELEVATION

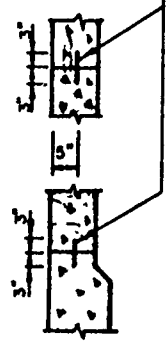
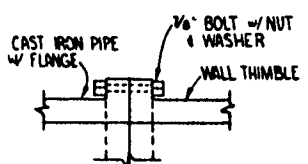

PLATE CONSTR. JOINT



DETAIL I (NOT TO SCALE)

SLIDE GATE DETAILS

- 1 10" DIA FLAT FRAME SLIDE GATE
- 2 CLASS 0-41
- 3 SLIDE GATE TO CONFORM TO SPEC 573 AND SHALL BE TYPE MMS-1.
- 4 "C" TYPE WALL THIMBLE 8" DEEP
- 5 RISER STEM, STEM GUIDES AND LIFTING DEVICE SHALL BE SIZED AND SPACED ACCORDING TO MANUFACTURER'S RECOMMENDATIONS.
- 6 HOLES DRILLED IN BACK FLANGE OF WALL THIMBLE BY GATE MANUFACTURER ACCORDING TO A S A CLASS 125 FLANGE SPECIFICATIONS
 DIA OF BOLT CIRCLE 14 1/4"
 DIA OF BOLT HOLES 1"
 NO OF BOLT HOLES 12

Steel

| | | | | | | | | | |
|--------------|-----|-----|--------|--------|-----|-----|------|------|-----|
| # 4 Bars | --- | --- | 520.0 | Lin Ft | --- | --- | 347 | Lbs | |
| # 5 Bars | --- | --- | 4007.0 | Lin Ft | --- | --- | 4180 | Lbs | |
| # 6 Bars | --- | --- | 2712.9 | Lin Ft | --- | --- | 4075 | Lbs | |
| # 7 Bars | --- | --- | 413.4 | Lin Ft | --- | --- | 845 | Lbs | |
| Total | | | | | | | --- | 9247 | Lbs |

Total Concrete = (4743) + (1.16 V) = (4743) + (1.16 x 5.0) = 552 Cu Yds

- 1 SPECIFIED BY ALL BENDS.
- 2 RADIUS OF BENT TO OR LESS FOR "B AND
- 3 THE 2" AND CLEAR DISTANCE STEEL PLACE HAVE A MINIMUM IN CONCRETE CLEAR COVER
- 4 ALL EXPOSED UNLESS OTHERWISE

20' x 20' Wall & 10' x 10'
DETAIL SHEET 12

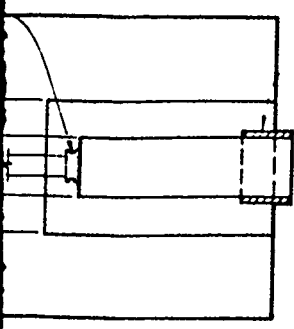

CONSTR JOINT

1/4" x 6" Carbon steel plate,
to conform to Spec 581
Continuous thru constr. joint.
Splices shall be either:
1. Bolt welded
2. Lapped 3" and bolted
3. Lapped 3" and fillet welded

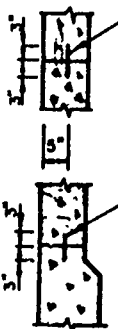
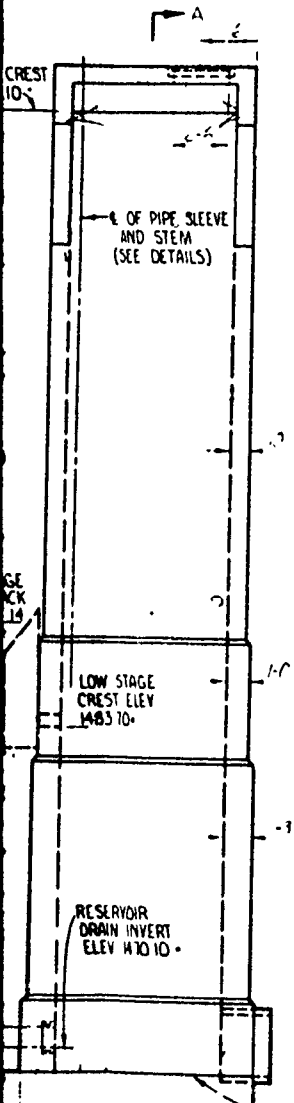
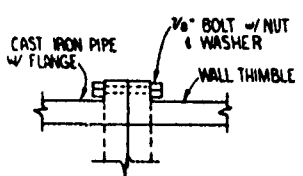

PLATE CONSTR JOINT



DETAIL I
(NOT TO SCALE)

CAST IRON PIPE
W/ FLANGE

1/2" BOLT W/ NUT
& WASHER

WALL THIMBLE

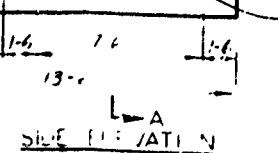

| | | | |
|-------|-----|------|-----|
| FT | --- | 347 | Lbs |
| FF | --- | 4180 | Lbs |
| FP | --- | 4075 | Lbs |
| FF | --- | 845 | Lbs |
| total | --- | 9247 | Lbs |

$3) + (1.16 \times 5.0) = [532] \text{ Cu Yds}$

STEEL SCHEDULE

| Mark | Size | Quantity | Length | Type | B | C | Total Length | Mark | Size | Quantity | Length | Type | B | C | Total Length |
|------|------|----------|--------|------|----------|----------|--------------|------|------|----------|--------|------|-----|-----|--------------|
| B1 | #6 | 14 | 12-0 | 1 | | | 168-0 | R29 | #5 | 20 | 6-9 | 1 | | | 135-0 |
| B2 | #6 | 13 | 13-6 | 1 | | | 169-0 | R30 | #5 | 20 | 8-0 | 21 | 2-9 | 5-3 | 160-0 |
| B3 | #7 | 40 | 8-0 | 21 | 3-8 | 4-4 | 320-0 | | | | | | | | |
| B4 | #6 | 14 | 13-0 | 1 | | | 182-0 | | | | | | | | |
| B5 | #6 | 16 | 12-0 | 1 | | | 192-0 | | | | | | | | |
| B6 | #6 | 4 | 5-3 | 1 | | | 21-0 | | | | | | | | |
| B7 | #6 | 7 | 5-3 | 21 | 1-0 | 4-3 | 36-9 | | | | | | | | |
| B8 | #6 | 19 | 7-9 | 21 | 1-0 | 6-9 | 167-3 | | | | | | | | |
| B9 | #6 | 10 | 8-6 | 1 | | | 85-0 | | | | | | | | |
| B10 | #6 | 5 | 3-6 | 1 | | | 17-6 | | | | | | | | |
| B11 | #6 | 3 | 2-9 | 1 | | | 8-3 | T1 | #5 | 18 | 6-0 | 1 | | | 108-0 |
| B12 | #6 | 2 | 2-9 | 1 | | | 5-6 | T2 | #5 | 6 | 8-0 | 1 | | | 48-0 |
| B13 | #6 | 6 | 4-4 | 1 | | | 26-0 | T3 | #5 | 4 | 4-9 | 1 | | | 19-0 |
| B14 | #7 | 20 | 4-8 | 1 | | | 93-4 | T4 | #5 | 4 | 3-6 | 1 | | | 14-0 |
| B15 | #5 | 10 | 7-0 | 21 | 1-1 | 5-11 | 70-0 | T5 | #5 | 4 | 2-3 | 1 | | | 9-0 |
| B16 | #5 | 14 | 9-3 | 21 | 3-4 1/2 | 5-10 1/2 | 129-6 | T6 | #5 | 4 | 9-0 | 19 | 2-0 | 7-0 | 36-0 |
| B17 | #5 | 4 | 8-9 | 21 | 3-1 1/2 | 5-7 1/2 | 35-0 | T7 | #5 | 12 | 8-3 | 1 | | | 99-0 |
| | | | | | | | | T8 | #5 | 2 | 3-3 | 1 | | | 6-6 |
| | | | | | | | | T9 | #5 | 2 | 5-9 | 1 | | | 11-6 |
| | | | | | | | | T10 | #5 | 2 | 10-9 | 1 | | | 21-6 |
| | | | | | | | | T11 | #5 | 2 | 13-3 | 1 | | | 26-6 |
| | | | | | | | | T12 | #5 | 14 | 6-3 | 1 | | | 87-6 |
| | | | | | | | | T13 | #5 | 6 | 8-0 | 1 | | | 48-0 |
| | | | | | | | | T14 | #5 | 4 | 6-0 | 1 | | | 24-0 |
| R1 | #6 | 22 | 11-9 | 1 | | | 258-6 | T15 | #5 | 4 | 4-9 | 1 | | | 19-0 |
| R2 | #5 | 20 | 8-6 | 1 | | | 170-0 | T16 | #5 | 4 | 3-6 | 1 | | | 14-0 |
| R3 | #6 | 10 | 3-6 | 1 | | | 35-0 | T17 | #5 | 4 | 2-3 | 1 | | | 9-0 |
| R4 | #6 | 28 | 9-9 | 1 | | | 273-0 | T18 | #5 | 4 | 9-0 | 19 | 2-0 | 7-0 | 36-0 |
| R5 | #6 | 40 | 9-3 | 21 | 3-4 | 5-11 | 370-0 | T19 | #5 | 24 | 8-0 | 21 | 2-9 | 5-3 | 192-0 |
| R6 | #6 | 20 | 8-6 | 1 | | | 170-0 | T20 | #5 | 2 | 3-3 | 1 | | | 6-6 |
| R7 | #6 | 10 | 3-6 | 1 | | | 35-0 | T21 | #5 | 2 | 5-9 | 1 | | | 11-6 |
| R8 | #6 | 26 | 4-0 | 1 | | | 104-0 | T22 | #5 | 2 | 8-3 | 1 | | | 16-6 |
| R9 | #5 | 36 | 8-9 | 21 | 3-1 1/2 | 5-7 1/2 | 315-0 | T23 | #5 | 2 | 10-9 | 1 | | | 21-6 |
| R10 | #5 | 4 | 8-3 | 21 | 2-10 1/2 | 5-4 1/2 | 35-0 | T24 | #5 | 2 | 13-3 | 1 | | | 26-6 |
| R11 | #5 | 22 | 6-9 | 1 | | | 140-6 | T25 | #5 | 4 | 13-9 | 1 | | | 55-0 |
| R12 | #6 | 14 | 8-3 | 1 | | | 115-6 | T26 | #5 | 4 | 15-9 | 1 | | | 55-0 |
| R13 | #5 | 10 | 3-6 | 1 | | | 35-0 | T27 | #5 | 18 | 8-3 | 1 | | | 115-6 |
| R14 | #5 | 26 | 4-6 | 1 | | | 117-0 | T28 | #5 | 2 | 4-9 | 1 | | | 9-6 |
| R15 | #5 | 20 | 3-8 | 1 | | | 73-4 | T29 | #5 | 7 | 13-9 | 1 | | | 96-3 |
| R16 | #6 | 36 | 8-9 | 21 | 3-1 | 5-8 | 315-0 | T30 | #5 | 4 | 5-3 | 1 | | | 21-0 |
| R17 | #6 | 4 | 8-3 | 21 | 2-10 1/2 | 5-4 1/2 | 33-0 | T31 | #5 | 24 | 6-3 | 21 | 1-6 | 5-3 | 162-0 |
| R18 | #5 | 20 | 11-9 | 1 | | | 235-0 | T32 | #5 | 2 | 6-6 | 21 | 1-6 | 5-0 | 13-0 |
| R19 | #6 | 14 | 8-3 | 1 | | | 115-6 | T33 | #5 | 2 | 2-6 | 21 | 1-6 | 1-0 | 5-0 |
| R20 | #5 | 8 | 3-3 | 1 | | | 26-0 | T34 | #5 | 7 | 13-9 | 1 | | | 96-3 |
| R21 | #5 | 20 | 11-0 | 1 | | | 235-0 | T35 | #5 | 4 | 5-3 | 1 | | | 21-0 |
| R22 | #5 | 40 | 8-0 | 21 | 2-9 | 5-3 | 320-0 | | | | | | | | |
| R23 | #5 | 10 | 8-3 | 1 | | | 82-6 | | | | | | | | |
| R24 | #5 | 8 | 3-3 | 1 | | | 26-0 | | | | | | | | |
| R25 | #5 | 28 | 8-0 | 21 | 2-9 | 5-3 | 228-0 | | | | | | | | |
| R26 | #5 | 20 | 6-9 | 1 | | | 155-0 | | | | | | | | |
| R27 | #5 | 8 | 8-3 | 1 | | | 66-0 | | | | | | | | |
| R28 | #5 | 8 | 3-3 | 1 | | | 26-0 | | | | | | | | |

BAR TYPES

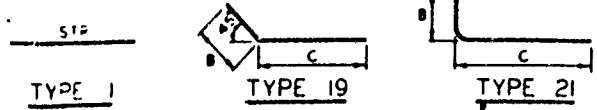

AS BUILT 0 2 4 6
12/19/74 Scale in Feet

CONSTRUCTION DETAILS

- SPECIFIED BAR DIMENSIONS ARE MEASURED TO OUTSIDE EDGE OF ALL BENDS
- RADIUS OF BENDS EQUALS 3 BAR DIAMETERS FOR SIZES EQUAL TO OR LESS THAN #7 RADIUS OF BENDS EQUALS 4 BAR DIAMETERS FOR #8 AND #9 BARS
- THE 2" AND 3" DISTANCE FROM SPECIFIED CONCRETE SURFACES ARE CLEAR DISTANCES WHERE NOT OTHERWISE SPECIFIED ALL REINFORCING STEEL PLACED IN CONCRETE POURED AGAINST THE GROUND SHALL HAVE A MINIMUM OF 3" COVER ALL REINFORCING STEEL PLACED IN CONCRETE POURED IN FORMS SHALL HAVE A MINIMUM OF 2" CLEAR COVER
- ALL EXPOSED EDGES OF CONCRETE TO HAVE A 3/4" CHAMFER UNLESS OTHERWISE NOTED

CONEWANGO CREEK WATERSHED PROJECT
SITE 33
FLOODWATER RETARDING DAM
CHAUTAUQUA COUNTY, NEW YORK
RISER STRUCTURAL DETAILS

U. S. DEPARTMENT OF AGRICULTURE
SOIL CONSERVATION SERVICE

| | | | |
|----------|--------------|-------------|-----------|
| Adopted | W. A. RIEGEL | Date | 12-70 |
| Drawn | | Title | |
| Checked | | Date | |
| Reviewed | J. E. P. | Date | 12-70 |
| | | Sheet | 10 of 20 |
| | | Drawing No. | NY-2173-P |

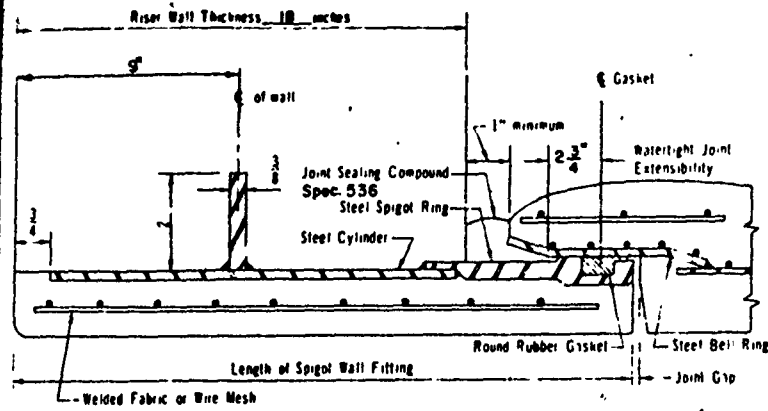

DETAIL A
 SUPPLY ONE (1) SPIGOT RING WALL FITTING FOR 18" WALL.

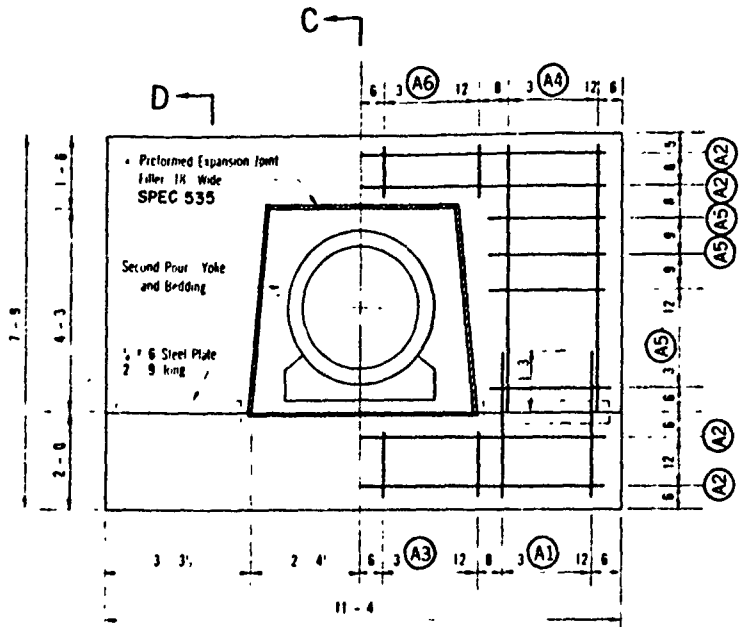

DETAIL OF ANTI-SEEP COLLAR (9 REQ'D)
 Yoke steel not shown

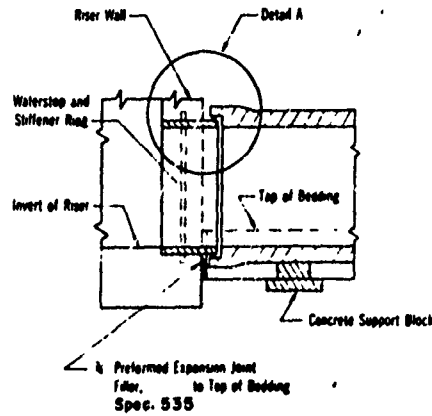

DETAIL OF SPIGOT WALL FITTING

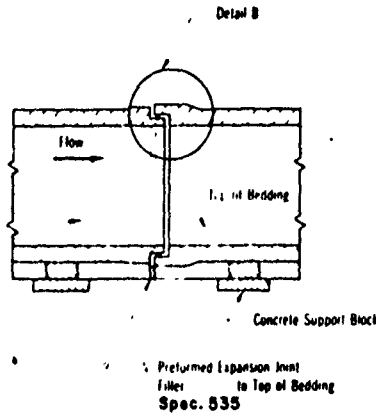

DETAIL OF PIPE JOINT

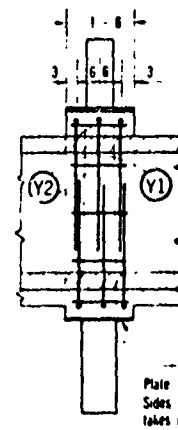

SECTION C-C

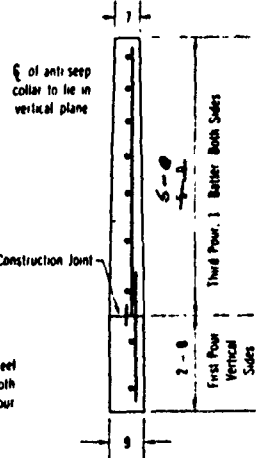

SECTION D-D

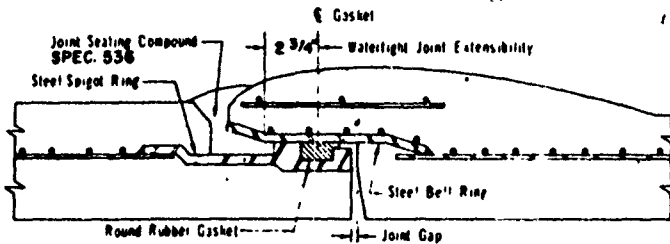

DETAIL B

| JOINT REQUIREMENTS | | | | |
|--------------------|------------------------------|------------------------------|---------------------------------------|---------------------------------------|
| No. Pipe Sections | Length of Pipe Section, feet | Minimum Joint Length, inches | Minimum Joint Limiting Angle, radians | Minimum Joint Limiting Angle, degrees |
| 18 | 16.0' | 4 1/2" | .0720 | 4° 07' |
| 1 | 8.0' | 4 1/2" | .0720 | 4° 07' |

Cost Outside Of Spigot Ring With Concrete On One 16.0' Section

For pipe length other than shown, joint requirements will be determined by the Engineer.

Where pipes of different length are connected, adjoining pipes shall meet the requirements of the longer pipe.

Prior to delivery of pipe, the pipe joint detail proposed for use shall be submitted to the Engineer for approval.

| STRENGTH R | |
|---------------------------------|----------------------|
| Inside Diameter of Pipe, inches | Internal Load |
| | Hydrostatic Pressure |
| 30.0 | 55.0 |

The outside diameter of pipe where the pipe furnished has assumed in design the three-furnished must not be less than strength multiplied by the the pipe furnished to the outs

| | |
|--|--------------|
| STANDARD CONDUIT DETAILS | |
| FOR REINFORCED CONCRETE PRESSURE PIPE PRINCIPAL SPILLWAY | |
| STANDARD DWG NO. ES-5030-BE | |
| DATE 2-70 | SHEET 1 OF 1 |

Joint length equals watertight joint extensibility plus joint gap.

The pipe shall be drawn together so that the maximum joint gap does not exceed 1/8 inch for pipe laid on a straight line. For cambered pipe or pipe laid on a curved line, the joint gap at the closest point shall not exceed 1/8 inch.

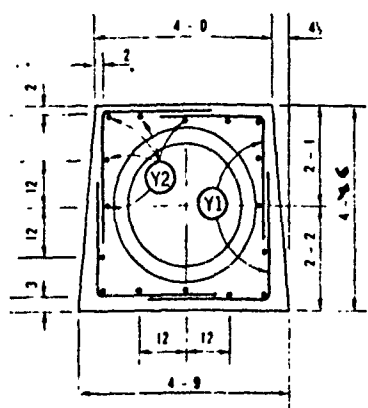
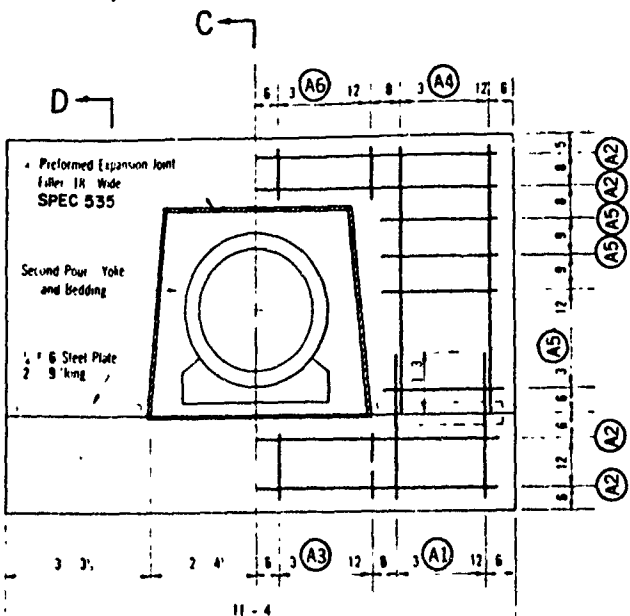

DETAIL OF ANTI-SEEP
COLLAR YOKE



| STEEL SCHEDULE | | | | | | |
|--------------------------------------|------|---------------------|--------|------|----------------|--------------|
| Anti-seep Collar and Yoke 9 Required | | | | | | |
| Mark | Size | Quantity per Collar | Length | Type | Total Quantity | Total Length |
| A1 | 4 | 6 | 3-9 | 1 | 54 | 162-0 |
| A2 | 4 | 4 | 18-10 | 1 | 36 | 390-0 |
| A3 | 4 | 6 | 1-6 | 1 | 54 | 81-0 |
| A4 | 4 | 6 | 5-6 | 1 | 84 | 297-0 |
| A5 | 4" | 10 | 2-9 | 1 | 90 | 247-6 |
| A6 | 4 | 6 | 1-0 | 1 | 84 | 54-0 |
| Y1 | 4 | 12 | 5-2 | 21 | 108 | 558-0 |
| Y2 | 4 | 16 | 1-2 | 1 | 144 | 168-0 |

| QUANTITIES | |
|---|-----------|
| Concrete | Cu Yds |
| Anti-seep Collar including Yoke (REINFORCED) | |
| Total | 10.7 20.0 |
| Bedding (NON-REINFORCED) | |
| Total | 8.6 12.2 |
| Steel | Pounds |
| Anti-seep Collar including Yoke | 1957-6" |
| Total | 1308 |

Concrete quantities are based on an outside diameter of pipe of 38.76 inches
Steel quantities do not change with outside diameter of pipe

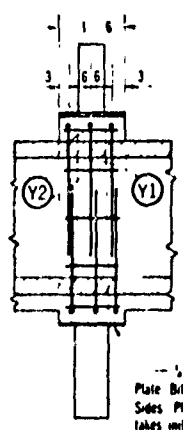

SECTION C-C

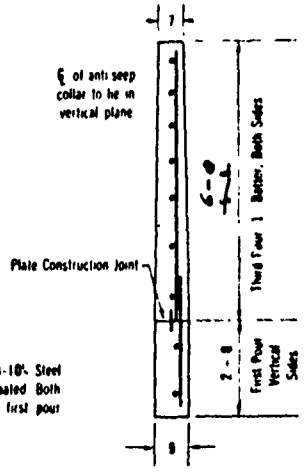

SECTION D-D

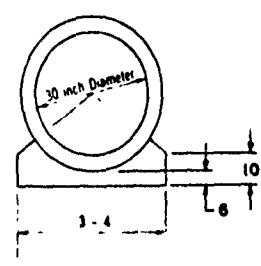

DETAIL OF BEDDING

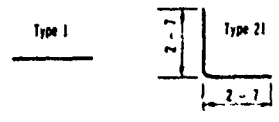

BAR TYPES

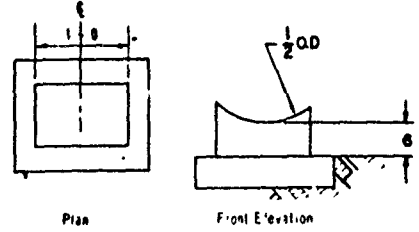

SUGGESTED SUPPORT BLOCKS

Sufficient blocks shall be provided to support required line and grade. The contractor shall determine the number and size required. Wedges may be used as an alternate.

AS BUILT

12/9/74

| JOINT REQUIREMENTS | | | |
|------------------------------|------------------------------|------------------------------|--------|
| Length of Pipe Section, feet | Minimum Joint Length, inches | Minimum Joint Limiting Angle | |
| 16-0' | 4 1/2 | .0720 radians | 4° 07' |
| 8-0' | 4 1/2 | .0720 radians | 4° 07' |

Of Spigot Ring With Concrete On One 16-0' Section

For pipe length other than shown, joint requirements will be determined by the Engineer.

Where pipes of different length are connected, adjoining pipes shall meet the requirements of the longer pipe.

Prior to delivery of pipe, the pipe joint detail proposed for use shall be submitted to the Engineer for approval.

| Inside Diameter of Pipe, inches | STRENGTH REQUIREMENTS | |
|---------------------------------|--|--|
| | Internal Load | External Load |
| | Hydrostatic Pressure | Minimum 3 Edge Bearing Strength in Pounds per Linear Foot of Pipe Applicable Standard Specification ASMA C-301 |
| Head of Water | Load to produce 0.001 inch crack one foot long | |
| 30.0 | 550 | 19,146 Lbs. |

The outside diameter of pipe assumed in design is 38.76 inches. Where the pipe furnished has an outside diameter greater than assumed in design, the three-edge bearing strength of the pipe furnished must not be less than the specified three-edge bearing strength multiplied by the ratio of the outside diameter of the pipe furnished to the outside diameter assumed in design.

CONEWANGO CREEK WATERSHED PROJECT
SITE 33
FLOODWATER RETARDING DAM
CHAUTAUQUA COUNTY NEW YORK
CONDUIT DETAILS

U.S. DEPARTMENT OF AGRICULTURE
SOIL CONSERVATION SERVICE

Adapted by: W.A. RIEGEL Date: 3/71 Approved by: [Signature]

Drawn by: [Signature] Title: [Blank]

Traced by: [Signature] Title: [Blank]

Checked by: SCV. Sheet No. 15 of 23 Drawing No. NY-2173-P

3531

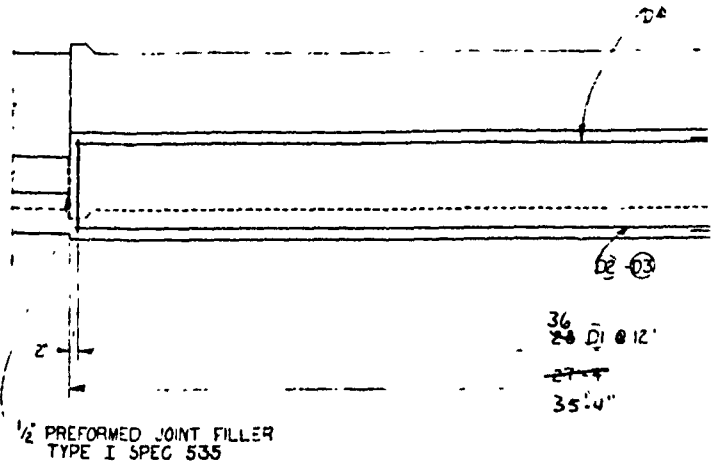
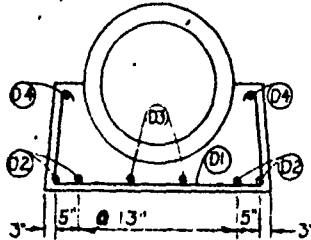
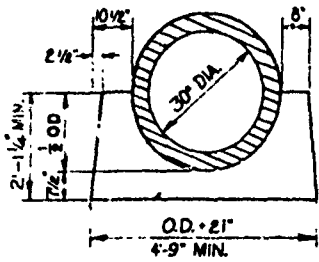

REINFORCED CONCRETE CRADLE DETAILS

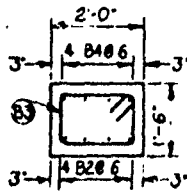
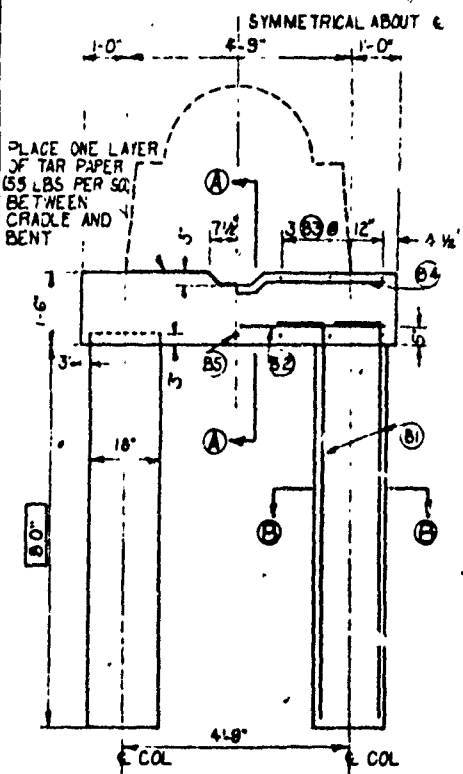
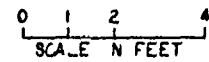

SECTION A-A



SECTION B-B

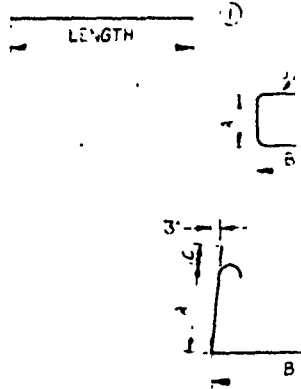

BAR TYPES

REINFORCED CONCRETE BENT DETAILS

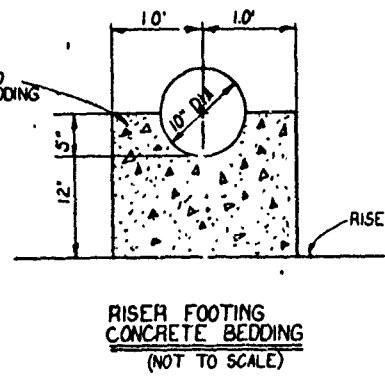
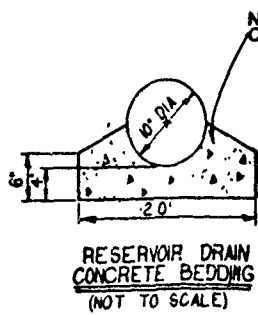

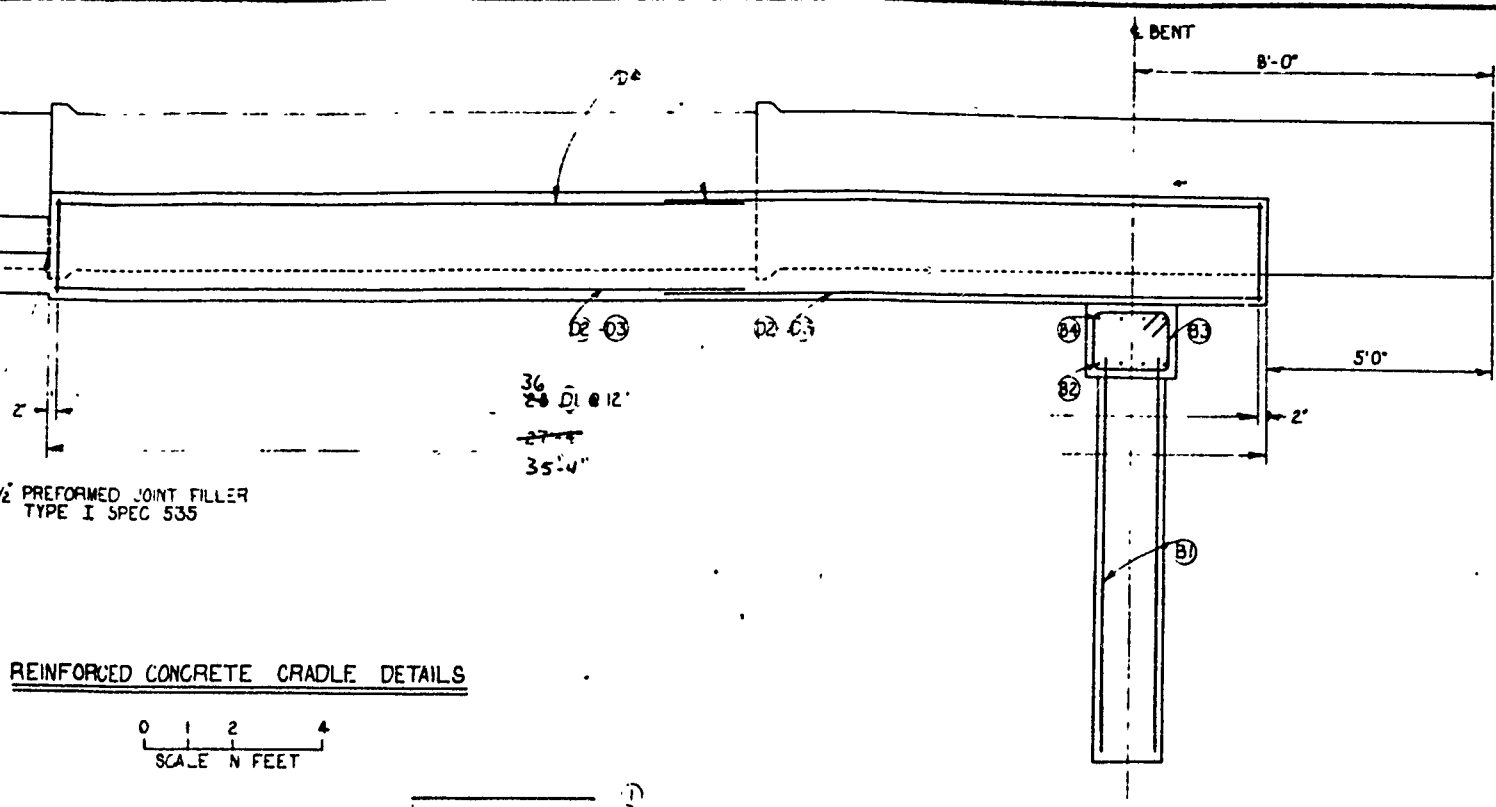

ADDITIONAL STEEL & CONCRETE NECESSARY DUE TO CHANGE FROM 16 FT PIPE LENGTHS TO 20 FT LENGTHS *RRC*

| STEEL SCHEDULE | | | | | | | | | |
|----------------|----------|------|------|--------|------|-----|-----|-----|--------------|
| Mark | Location | Quan | Size | Length | Type | A | B | C | Total Length |
| B-1 | Bent | 8 | 5 | 9-0 | 13 | 1-0 | 8-0 | | 72-0 |
| B-2 | | 4 | 8 | 6-3 | 1 | | | | 25-0 |
| B-3 | | 6 | 4 | 6-4 | 3 | 1-1 | 1-7 | 0-6 | 38-0 |
| B-4 | | 4 | 5 | 6-8 | 14 | 2-3 | 0-4 | 1-6 | 26-8 |
| B-5 | | 1 | 4 | 5-10 | 3 | 0-0 | 1-7 | 0-6 | 5-10 |
| D-1 | Cradle | 80 | 4 | 8-5 | 12 | 1-8 | 4-3 | 0-5 | 800-0 = 303 |
| D-2 | | 8 | 8 | 14-11 | 1 | | | | 118-8 = 162 |
| D-3 | | 4 | 7 | 14-2 | 1 | | | | 56-8 = 75 |
| D-4 | | 4 | 7 | 14-3 | 1 | | | | 56-8 = 79 |

QUANTITIES (THIS SHEET ONLY)

| STEEL | QUANTITY | WEIGHT |
|--------------|----------|----------------|
| NO 4 BAR | 536 | 325 LBS |
| NO 5 BAR | 98 | 103 LBS |
| NO 7 BAR | 68 | 158 LBS |
| NO 8 BAR | 25 | 87 LBS |
| NO 9 BAR | 10 | 58 LBS |
| TOTAL | | 631 LBS |

| CONCRETE | QUANTITY | WEIGHT |
|----------------|----------|------------|
| REINFORCED | 11.2 | 1.5 CY YDS |
| NON-REINFORCED | 1.5 | 1.5 CY YDS |

AS BUILT 12/4/74

CONSTRUCTION DETAILS SEE SHT 10

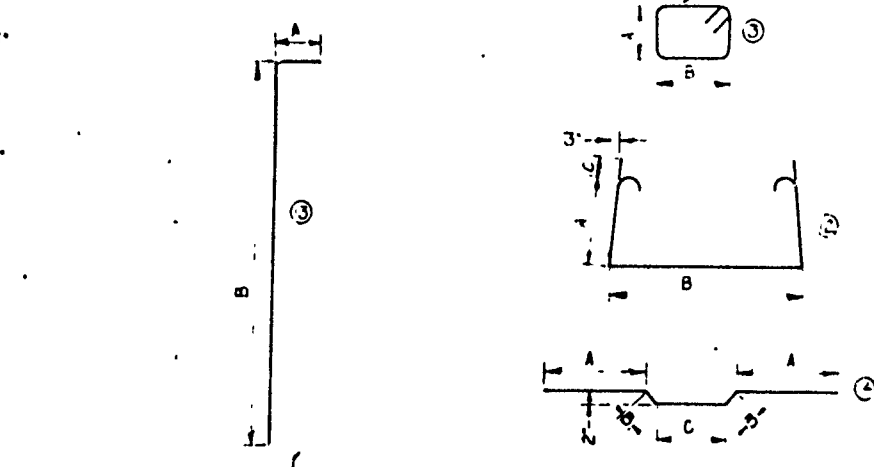

BAR TYPES

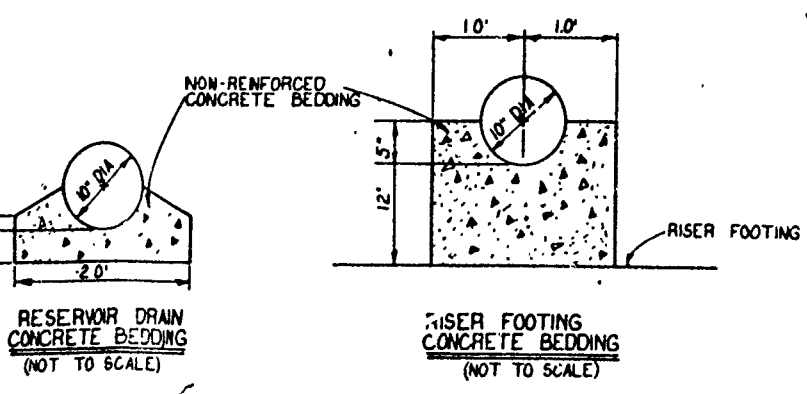

CONEWANGO CREEK WATERSHED PROJECT
SITE 33
 FLOODWATER RETARDING DAM
 CHAUTAUGUA COUNTY, NEW YORK
END BENT AND CRADLE DETAILS
 U. S. DEPARTMENT OF AGRICULTURE
 SOIL CONSERVATION SERVICE

Approved: W. A. RIEGEL 3/71
 D. BURDICK 3/71
 S.C.Y.

NY-2173-P
 APRIL 1971

2

MAGNUM PIT LOGS

TP #1, C/A Dam, 11/20/69, DBC, 1467.7

- 0.0 - 1.0 Topsoil
- 1.0 - 2.0 Silt, sandy
Max. size < 3"
Approx. 35% gravel, 20% sand, and 75% non-plastic fines.
Orange-brown; moist, slightly permeable; soft; till; ML
- 2.0 - 4.0 Sand, silty, gravelly
Max. size 10" - flaggy siltstones
Approx. 15% +6", 7% 3-6", 90% matrix (which is approx. 25% gravel, 30% sand, and 4% slightly plastic fines).
Brown; moist, very slightly permeable; very stiff; till; SM.
- 4.0 - 8.0 Silt & Clay, sandy
Max. size < 3"
Approx. 10% gravel, 20% sand, and 70% moderately plastic fines.
Brown; moist; very slightly permeable; hard; glacio-lacustrine; CL-ML. P.S. 1.1 (CL-M)
- 8.0 - 13.0+ Silt, w/sand
Max. size < 3"
Approx. 35% gravel, 10% sand, and 8% non-plastic fines.
Brown; moist; slightly permeable; medium density; interbedded; glacio-lacustrine. (ML) P.S. 1.2 (ML)
Note: No seepage observed.

TP #2 Bank, C/A Dam, 11/18/69, DBC, 1477.

- 0.0 - 0.7 Topsoil
- 0.7 - 2.0 Clayey silt, sandy, gravelly
Max. size 10" - flaggy siltstone
Approx. 15% +6", 4% 3-6", 95% matrix (which is approx. 20% gravel, 20% sand, and 60% moderately plastic fines).
Light brown; wet, very slightly permeable; very stiff; flat-lying flags; very highly weathered bedrock, "C" horizon, CL-ML
- 2.0 - 2.0+ Bedrock
Clay shale & siltstone; highly weathered, olive-brown; soft; laminated; highly fractured, filled w/CL-ML; essentially horizontal; northeast shale; upper Upper Devonian.
Note: Water seeping from practically everywhere.

TP #3 Fl. Pl., C/A Dam, 11/18/69, DBC, 1466.0

- 0.0 - 1.0 Topsoil
- 1.0 - 4.0 Gravel, silty, sandy
Max. size 18" - flaggy siltstone
Approx. 10% +6", 15% 3-6", and 75% matrix (which is approx. 50% gravel, 30% sand, and 20% slightly/moderately plastic fines).
Brown; moist-wet @ 3.4'; slightly permeable; very stiff-hard; flat-lying flags; alluvial-colluvial; GM.
- 4.0 - 4.0+ Bedrock
Clay shale & siltstone; highly weathered, olive-brown; soft; laminated; highly fractured, filled w/CL-ML; essentially horizontal; northeast shale; upper Upper Devonian.
Note: Gravel quite silty. Water @ creek level, 3.4'

TP #3, C/A Dam, 11/18/69, DBC, 1466.0

- 0.0 - 0.5 Topsoil
- 0.5 - 4.0 Gravel, sandy w/silt
Max. size 18" - flaggy SR siltstones
Approx. 10% +6", 15% 3-6", 75% matrix (which is approx. 60% gravel, 25% sand, and 15% slightly plastic fines).
Brown; moist-wet @ 2.5'; slightly permeable; very stiff; flat-lying flags; alluvial; GM
- 4.0 - 7.0+ Silt & Clay, gravelly, sandy
Max. size 8" - varies
Approx. 15% +6", 4% 3-6", 95% matrix (which is approx. 25% gravel, 20% sand, and 55% moderately plastic fines).
Gray-brown; wet; very slightly permeable; hard; till; CL-ML
Note: Water @ creek level, 2.5'

TP #4 Bank, C/A Dam, 11/18/69, DBC, 1465.0

- 0.0 - 1.0 Topsoil
- 1.0 - 11.0 Clayey silt, gravelly, sandy
Max. size 9" - flaggy siltstones
Approx. 15% +6", 4% 3-6", 95% matrix (which is approx. 25% gravel, 20% sand, and 55% moderately plastic fines).
Light brown; wet; very slightly permeable; very stiff; very highly weathered bedrock, "C" horizon; CL-ML. P.S. 1.3 (CL-M)
- 11.0 - 22.0+ Silt & Clay, gravelly, sandy
Max. size 8" - flaggy SR siltstone
Approx. 15% +6", 4% 3-6", 95% matrix (which is approx. 25% gravel, 20% sand, and 55% moderately plastic fines).
Gray w/brown; wet; very slightly permeable; hard; till; CL-ML
Note: Bed rock is not over till; the side of the pit slopes less steep than the bank. Water seeping @ 1.3'.

TP #4 Fl. Pl., C/A Dam, 11/18/69, DBC, 1465.0

- 0.0 - 0.5 Topsoil
- 0.5 - 2.3 Gravel, sandy, silty
Max. size 10" - flaggy siltstones
Approx. 10% +6", 15% 3-6", 75% matrix (which is approx. 50% gravel, 30% sand, and 20% slightly plastic fines).
Gray-brown; moist-wet @ 1.0', slightly permeable, very stiff; road fill, GM.
- 2.3 - 5.0 Gravel, sandy, silty
Max. size 10" - flaggy siltstones
Approx. 10% +6", 15% 3-6", 75% matrix (which is approx. 60% gravel, 25% sand, and 15% slightly plastic fines).
Brown; wet; slightly permeable; very stiff; flat-lying flags; alluvial; GM
- 5.0 - 8.0+ Silt & Clay, gravelly, sandy
Max. size 6"
Approx. 15% 3-6", and 95% matrix (which is approx. 25% gravel, 20% sand, and 55% moderately plastic fines).
Gray-brown; wet; very slightly permeable; hard; till; CL-ML
Note: Seeps everywhere. Many old trees, logs, brush, etc. around the 2.3' level. Served as base for road fill.

TP #101, Borrow Area, 12/17/69, DBC.

- 0.0 - 1.0 Topsoil
- 1.0 - 4.0 Silt, sandy
Max. size 5"
Approx. 25% 3-6", 90% matrix (which is approx. 10% gravel, 15% sand, and 75% very slightly plastic fines).
Orange-brown; moist; slightly permeable; soft; till; ML
- 4.0 - 10.0+ Gravel, sandy w/silt
Max. size 15" - mostly siltstone flags, few SR bed. cobbles
Approx. 6% +6", 9% 3-6", 85% matrix (which is approx. 60% gravel, 25% sand, and 15% slightly plastic fines).
Brown; moist; slightly-wet; moderately permeable; medium density; poorly stratified; outwash, GM. P.S. 101.1 (GM-GP)
Note: No seepage

TP #102, Borrow Area, 12/17/69, DBC

- 0.0 - 1.0 Topsoil
- 1.0 - 3.0 Silt, sandy
Max. size 4"
Approx. 15% 3-6", 99% matrix (which is approx. 10% gravel, 15% sand, and 75% very slightly plastic fines).
Orange-brown; moist; slightly permeable; soft; till; ML
- 3.0 - 10.0+ Sand, silty, gravelly
Max. size 8" - flaggy siltstones
Approx. 3% +6", 7% 3-6", 90% matrix (which is approx. 25% gravel, 30% sand, and 45% slightly plastic fines).
Brown; moist; slightly permeable; medium density; till; SM. P.S. 102.1 (SM)
Note: No seepage

TP #103, Borrow Area, 12/17/69, DBC

- 0.0 - 1.0 Topsoil
- 1.0 - 2.0 Silt, sandy
Max. size 5"
Approx. 25% 3-6", 98% matrix (which is approx. 10% gravel, 15% sand, and 75% very slightly plastic fines).
Orange-brown; moist; slightly permeable; soft; till; ML. P.S. 103.1 (ML)
- 3.0 - 9.0+ Sand, silty, gravelly
Max. size 8" - flaggy siltstones
Approx. 3% +6", 7% 3-6", 90% matrix (which is approx. 25% gravel, 30% sand, and 45% slightly plastic fines).
Brown; moist; slightly permeable; medium density; till; SM.
Note: No seepage

TP #104, Borrow Area, 12/17/69, DBC

- 0.0 - 1.0 Topsoil
- 1.0 - 4.5 Silt, sandy
Max. size 4"
Approx. 15% 3-6", 99% matrix (which is approx. 10% gravel, 15% sand, and 75% very slightly plastic fines).
Orange-brown; moist; slightly permeable; soft; till; ML
- 4.5 - 10.0+ Silt, w/sand
Max. size < 3"
Approx. 35% gravel, 10% sand, and 85% non-plastic fines.
Brown; moist-wet @ 5'; slightly permeable; medium density; very poorly stratified; glacio-lacustrine, ML. P.S. 104.1 (ML)
Note: Seepage @ 5'

TP #105, Borrow Area

- 0.0 - 1.0
- 1.0 - 2.5
- 2.5 - 10.0+
- TP #201, Borrow Area
- 0.0 - 0.4
- 0.4 - 2.0

TP #202, Borrow Area

- 2.0 - 5.0
- 5.0 - 5.0+

TP #202, Borrow Area

- 0.0 - 0.4
- 0.4 - 1.5

TP #202, Borrow Area

- 1.5 - 3.8

TP #202, Borrow Area

- 3.8 - 5.8

TP #202, Borrow Area

- 5.8 - 8.0

TP #202, Borrow Area

- 8.0 - 9.0

TP #202, Borrow Area

- 9.0 - 9.0+

CC
U.
Laggs
Tood

TP #9 Fl. Pl. C/A Dam, 11/28/69, DBC, 1466.0

- 0.0 - 0.5 Topsoil
- 0.5 - 2.3 Gravel, sandy, silty
Max. size 10" - flaggy siltstones
Approx. 10% +6", 15% 3-6", 75% matrix (which is approx. 50% gravel, 30% sand, and 20% slightly plastic fines).
Gray-brown; moist-wet @ 1.0'; slightly permeable; very stiff; road fill, CM.
- 2.3 - 5.0 Gravel, sandy, silty
Max. size 16" - flaggy siltstones
Approx. 10% +6", 15% 3-6", 75% matrix (which is approx. 40% gravel, 25% sand, and 15% slightly plastic fines).
Brown; wet; slightly permeable; very stiff; flat-lying flags; alluvial; CM.
- 5.0 - 8.0 + Silt & Clay, gravelly, sandy
Max. size 6"
Approx. 5% 3-6", and 95% matrix (which is approx. 25% gravel, 20% sand, and 55% moderately plastic fines).
Gray-brown; wet; very slightly permeable; hard; till; CL-ML

Note: Seeps everywhere. Many old trees, logs, brush, etc. around the 2.3' level. Served as base for road fill.

TP #10, Borrow Area, 12/17/69, DBC,

- 0.0 - 1.0 Topsoil
- 1.0 - 4.0 Silt, sandy
Max. size 3"
Approx. 25% 3-6", 90% matrix (which is approx 10% gravel, 15% sand, and 75% very slightly plastic fines).
Orange-brown; moist; slightly permeable; soft; till; ML
- 4.0 - 10.0 + Gravel, sandy w/silt
Max. size 15" - mostly siltstone flags, few SR sed. cobbles
Approx. 6% +6", 9% 3-6", 85% matrix (which is approx. 60% gravel, 25% sand, and 15% slightly plastic fines).
Brown; moist; slightly-moderately permeable; medium density; poorly stratified; outwash, CM. P.S. 101.1 (CM-GP)

Note: No seepage

TP #102, Borrow Area, 12/17/69, DBC

- 0.0 - 1.0 Topsoil
- 1.0 - 3.0 Silt, sandy
Max. size 4"
Approx. 1' 3-6", 99% matrix (which is approx. 10% gravel, 15% sand, and 75% very slightly plastic fines).
Orange-brown; moist; slightly permeable; soft; till; ML
- 3.0 - 10.0 + Sand, silty, gravelly
Max. size 8" - flaggy siltstones
Approx. 3% +6", 7% 3-6", 90% matrix (which is approx. 25% gravel, 30% sand, and 45% slightly plastic fines).
Brown; moist; slightly permeable; medium density, till; CM. P.S. 102.1 (SM)

Note: No seepage

TP #103, Borrow Area, 12/17/69, DBC

- 0.0 - 1.0 Topsoil
- 1.0 - 3.0 Silt, sandy
Max. size 3"
Approx. 25% 3-6", 90% matrix (which is approx. 10% gravel, 15% sand, and 75% very slightly plastic fines).
Orange-brown; moist; slightly permeable; soft; till; ML P.S. 103.1 (ML)
- 3.0 - 9.0+ Sand, silty, gravelly
Max. size 8" - flaggy siltstones
Approx. 3% +6", 7% 3-6", 90% matrix (which is approx. 25% gravel, 30% sand, and 45% slightly plastic fines).
Brown; moist; slightly permeable; medium density; till; ML

Note: No seepage

TP #104, Borrow Area, 12/17/69, DBC

- 0.0 - 1.0 Topsoil
- 1.0 - 4.5 Silt, sandy
Max. size 4"
Approx. 15% 3-6", 99% matrix (which is approx. 10% gravel, 15% sand, and 75% very slightly plastic fines).
Orange-brown; moist; slightly permeable; soft; till; ML
- 4.5 - 10.0 + Silt, w/sand
Max. size < 3"
Approx. 5% gravel, 10% sand, and 85% non-plastic fines.
Brown; moist-wet @ 5'; slightly permeable, medium density; very poorly stratified, glacio-lacustrine, ML P.S. 104.1 (ML)

Note: Seepage @ 5'

TP #105, Borrow Area, 12/17/69, DBC

- 0.0 - 1.0 Topsoil
- 1.0 - 2.5 Silt, sandy
Max. size 5"
Approx. 15% 3-6", 99% matrix (which is approx. 10% gravel, 15% sand, and 75% very slightly plastic fines).
Orange-brown; moist; slightly permeable; soft; till; ML
- 2.5 - 10.0 + Gravel, sandy w/silt
Max. size 16" - mostly flaggy siltstones, few SR sed. cobbles
Approx. 5% +6", 10% 3-6", 85% matrix (which is approx. 50% gravel, 30% sand, and 20% slightly plastic fines).
Brown; moist; slightly-moderately permeable; medium density; poorly stratified; outwash, CM

Note: No seepage. More gravel w/depth.

TP #201, Bear Spwy, 11/20/69, DBC, 1502.1

- 0.0 - 0.4 Topsoil
- 0.4 - 2.0 Silt, sandy
Max. size 3"
Approx. 25% 3-6", 99% matrix (which is approx. 10% gravel, 15% sand, and 75% very slightly plastic fines).
Orange-brown; moist; slightly permeable; medium density; till; ML
- 2.0 - 5.0 Silt & Clay, gravelly
Max. size 8" - Broken shale and siltstone flags
Approx. 15% +6", 4% 3-6", 81% matrix (which is approx. 30% gravel, 15% sand, and 55% moderately plastic fines).
Brown; wet; very slightly permeable; hard; shows bedding; very highly weathered bedrock, "C" horizon; CL-ML

- 5.0 - 5.0+ Bedrock
Clay shale & siltstone; highly weathered, olive-brown, soft; laminated; highly fractured, filled w/CL-ML; essentially horizontal; northeast shale; upper Upper Devonian.

Note: Pit dug from top of bank. No "C" horizon on lower end of pit, just topsoil over poor bedrock. Water seeping @ 1.7'

TP #202, Bear Spwy, 11/20/69, DBC, 1523.6

- 0.0 - 0.4 Topsoil
- 0.4 - 1.5 Silt, sandy
Max. size < 3"
Approx. 10% gravel, 15% sand, and 75% slightly plastic fines)
Orange-brown; moist; slightly permeable; soft; till; ML
- 1.5 - 3.8 Silt & Clay, sandy w/gravel
Max. size 15" - flaggy siltstones
Approx. 3% +6", 7% 3-6", 90% matrix (which is approx. 20% gravel, 25% sand, and 55% slightly-moderately plastic fines).
Lt. olive-gray; moist; very slightly permeable; hard, till; CL-ML
- 3.8 - 5.8 Gravel, sandy w/silt
Max. size 10" - various, mostly SR siltstones
Approx. 3% +6", 7% 3-6", 90% matrix (which is approx. 50% gravel, 15% sand, and 15% slightly plastic fines).
Brown; moist; slightly-moderately permeable; medium density; outwash; CM
- 5.8 - 8.0 Silt, w/sand
Max. size < 3"
Approx. 5% gravel, 10% sand, and 85% non-plastic fines.
Brown; moist; slightly permeable; medium density; glacio-lacustrine, ML.
- 8.0 - 9.0 Siltstone, flags
Max. size 30"
Approx. 50% +6", 20% 3-6", 30% matrix (which is approx. 15% gravel, 25% sand, and 60% moderately plastic fines).
Lt. brown; moist; very slightly permeable, very dense; bedrock, CL-ML

- 9.0 - 9.0+ Bedrock
Clay shale & siltstone; moderately weathered, gray-brown; soft to moderately hard; thin bedded; fractured; filled w/CL-ML; essentially horizontal; northeast shale; upper Upper Devonian

Note: No seepage. Pit from 8.0-9.0 is bedrock w/fracture fillings, but ripped up w/backhoe in up to 30' flags.

AS BUILT
12/9/74

CONEWANGO CREEK WATERSHED PROJECT
SITE 33
FLOODWATER RETARDING DAM
CHAUTAQUA COUNTY, NEW YORK
LOGS OF TEST HOLES

U. S. DEPARTMENT OF AGRICULTURE
SOIL CONSERVATION SERVICE

| | | | |
|--------|-------------|---------|-----------|
| Logged | B. CHAMPEON | Date | 11/12/69 |
| Drawn | J. H. ... | Checked | |
| Typed | B. CHAMPEON | Date | 11/14/69 |
| | | | NY-2173-G |

TP #203. Bur. Surv. 11/16/52. DEC. 1512.2

- 0.0 - 0.4 Topsoil
- 0.4 - 2.0 Silt, sandy
Max. size 5"
Approx. 25 3-6", 90% matrix (which is approx. 10% gravel, 20% sand, and 70% slightly plastic fines)
Lt. brown; moist; slightly permeable; soft; till; ML
- 2.0 - 3.5 Silt & Clay, sandy
Max. size 8" - few SR siltstones
Approx. 25 3-6", 90% matrix (which is approx. 10% gravel, 20% sand, and 60% moderately plastic fines)
Lt. brown; moist; very slightly permeable; hard; glacio-lacustrine; CL-ML. R.S. 203.1 (CL-ML)
- 3.5 - 9.0 Siltstone flags
Max. size 48"
Approx. 40% 4", 10% 3-6", 90% matrix (which is approx. 10% gravel, 25% sand, and 60% moderately plastic fines)
Lt. brown; moist; very slightly permeable; very dense; bedrock; CL-ML
- 9.0 - 9.0+ Bedrock
Clay shale & siltstone; moderately weathered; gray-brown; soft to moderately hard; thin bedded; fractured, filled w/CL-ML; essentially horizontal; Northeast shale, upper Upper Devonian.

Note: No seepage. Zone from 2.5-9.0' is bedrock w/fracture fillings, but ripped out w/backhoe in up to 48" flags.

TP #204. Bur. Surv. 11/18/52. DEC. 1512.2

- 0.0 - 0.4 Topsoil
- 0.4 - 1.3 Silt, sandy
Max. size 5"
Approx. 15 3-6", 90% matrix (which is approx. 10% gravel, 20% sand, and 60% slightly plastic fines)
Orange-brown; dry; slightly permeable; medium density; till; ML
- 1.3 - 3.5 Gravel, silty clayey, sandy
Max. size 20" - Flaggy siltstones
Approx. 15% 4", 25 3-6", 90% matrix (which is approx. 10% gravel, 25% sand, and 45% slightly-moderately plastic fines)
Lt. brown; dry; slightly permeable; hard; till; OC-GM
- 3.5 - 3.5+ Bedrock
Clay shale & siltstone; highly weathered; olive-brown; soft; laminated; highly fractured, filled w/CL-ML; essentially horizontal; Northeast shale; upper Upper Devonian.

Note: No seepage

TP #205. Bur. Surv. 11/20/52. DEC. 1526.2

- 0.0 - 0.5 Topsoil
- 0.5 - 2.0 Silt, sandy
Max. size 3"
Approx. 10% gravel, 20% sand, and 70% slightly plastic fines
Lt. brown; moist; slightly permeable; soft; till; ML
- 2.0 - 4.0 Silt & Clay, sandy, gravally
Max. size 8" - Flaggy siltstones
Approx. 15 4", 45 3-6", 95% matrix (which is approx. 20% gravel, 25% sand, and 55% slightly-moderately plastic fines)
Lt. brown; moist; very slightly permeable; very stiff; till; CL-ML
- 4.0 - 6.0 Gravel, sandy
Max. size 14" - varies - mostly SR siltstone
Approx. 25 4", 75 3-6", 90% matrix (which is approx. 4% gravel, 40% sand, and 15% slightly plastic fines)
Brown; moist; moderately permeable; medium density; very poorly stratified; outwash; GM
- 6.0 - 8.0 Silt, sandy
Max. size 3"
Approx. 10% gravel, 20% sand, and 60% non-plastic fines.
Brown; moist; slightly permeable; medium density; irreg. stratified; glacio-lacustrine; ML
- 8.0 - 11.0 Silt, sandy gravally
Max. size 10" - Flaggy siltstones
Approx. 15 4", 45 3-6", 95% matrix (which is approx. 20% gravel, 25% sand, and 45% slightly plastic fines)
Brown; moist; slightly permeable; very stiff; till; ML R.S. 205.1 (OC-ML)
- 11.0 - 12.5 Siltstone flags
Max. size 36"
Approx. 50% 4", 20% 3-6", 90% matrix (which is approx. 15% gravel, 25% sand, and 60% moderately plastic fines)
Brown; moist; very slightly permeable; very dense; bedrock; CL-ML
- 12.5 - 12.5+ Bedrock
Clay shale & siltstone; moderately weathered; gray-brown; soft to moderately hard; thin bedded; fractured, filled w/CL-ML; essentially horizontal; Northeast shale; upper Upper Devonian.

Note: No seepage. Zone from 11.0-12.5' is bedrock w/fracture fillings, ML was ripped up w/backhoe in up to 36" flags.

TP #206. Bur. Surv. 11/16/52. DEC. 1511.4

- 0.0 - 0.4 Topsoil
- 0.4 - 3.5 Silt, sandy
Max. size 3"
Approx. 10% gravel, 20% sand, and 70% slightly plastic fines.
Lt. brown; moist; slightly permeable; soft; till; ML. R.S. 206.1 (ML)
- 3.5 - 7.3 Gravel, sandy w/silt
Max. size 12" - varies - mostly SR siltstones
Approx. 25 4", 75 3-6", 90% matrix (which is approx. 4% gravel, 40% sand, and 15% very slightly plastic fines)
Brown; moist; slightly-moderately permeable; medium density; very poorly stratified; outwash; GM. R.S. 206.2 (GM-SP)
- 7.3 - 10.5 Silt & Clay, sandy, gravally
Max. size 14" - Flaggy siltstones
Approx. 15 4", 45 3-6", 90% matrix (which is approx. 25% gravel, 20% sand, and 55% moderately plastic fines)
Lt. olive-gray; moist; very slightly permeable; hard; till; CL-ML. R.S. 206.3 (CL-ML)

- 10.5 - 13.3 Silt, sandy
Max. size 3"
Approx. 10% gravel, 20% sand, and 60% non-plastic fines.
Brown; moist; slightly permeable; medium density; irregularly stratified; glacio-lacustrine; ML. R.S. 206.4 (ML)

- 13.3 - 14.3 Gravel, sandy, silty
Max. size 10" - varies - mostly SR siltstones
Approx. 25 4", 75 3-6", 90% matrix (which is approx. 4% gravel, 35% sand, and 20% very slightly plastic fines)
Brown; moist; slightly-moderately permeable; medium density; very poorly stratified; outwash; GM
- 14.3 - 16.0 Gravel, silty, sandy
Max. size 20" - Flaggy siltstones
Approx. 25 4", 10% 3-6", 85% matrix (which is approx. 30% gravel, 25% sand, and 45% moderately plastic fines)
Brown; moist; very slightly permeable; hard; till; GM

- 16.0 - 16.0+ Bedrock
Clay shale & siltstone; moderately weathered; gray-brown; soft to moderately hard; thin bedded; fractured, filled w/CL-ML; essentially horizontal; Northeast shale, upper Upper Devonian.

Note: Very slight seep @ 6'

TP #207. Bur. Surv. 11/19/52. DEC. 1526.3

- 0.0 - 0.4 Topsoil
- 0.4 - 3.3 Silt, sandy
Max. size 5"
Approx. 25 3-6", 90% matrix (which is approx. 15% gravel, 25% sand, and 60% slightly plastic fines)
Lt. brown; moist; slightly permeable; soft; till; ML
- 3.3 - 7.0 Gravel, sandy w/silt
Max. size 14" - varies - mostly SR siltstone
Approx. 25 4", 75 3-6", 90% matrix (which is approx. 30% gravel, 35% sand, and 15% very slightly plastic fines)
Brown; moist; slightly-moderately permeable; medium density; very poorly stratified; outwash; GM
- 7.0 - 11.5 Silt, sandy
Max. size 3"
Approx. 10% gravel, 20% sand, and 60% non-plastic fines.
Brown; moist; slightly permeable; irregularly stratified; glacio-lacustrine; ML
- 11.5 - 11.5+ Bedrock
Clay shale & siltstone; moderately weathered; gray-brown; soft to moderately hard; thin bedded; fractured, filled w/CL-ML; essentially horizontal; Northeast shale, upper Upper Devonian.

Note: No seepage

TP #208. Bur. Surv. 11/19/52. DEC. 1520.4

- 0.0 - 0.4 Topsoil
- 0.4 - 1.8 Silt, sandy
Max. size 3"
Approx. 15% gravel, 25% sand, and 60% slightly plastic fines.
Orange-brown; moist; slightly permeable; soft; till; ML.
- 1.8 - 4.0 Gravel, silty, clayey, sandy
Max. size 16" - Flaggy siltstones
Approx. 10% 4", 55 3-6", 85% matrix (which is approx. 30% gravel, 25% sand, and 45% slightly-moderately plastic fines)
Lt. brown; dry, slightly permeable, hard, till; OC-GM.
- 4.0 - 4.0+ Bedrock
Clay shale & siltstone, highly weathered, olive-brown, soft; laminated, highly fractured, filled w/CL-ML, essentially horizontal, Northeast shale, upper Upper Devonian.

Note: No seepage.

TP #208. Price

- 0.0 - 0.4
- 0.4 - 2.0

- 2.0 - 6.0

- 6.0 - 11.0+

TP #202 Bur. 1

- 0.0 - 1.0

- 1.0 - 10.5

- 10.5 - 15.8

- 15.8 - 18.0+

TP #202 PL. PL.

- 0.0 - 0.6

- 0.6 - 3.0

- 3.0 - 6.8

- 6.8 - 11.8

- 11.8 - 14.2+

TP #301, Prin. Smv. 11/18/69, D.C. 1471.4

- 0.0 - 0.5 Topsoil
- 0.5 - 2.0 Gravel, sandy, silty
Max. size 8" - Flaggy siltstones
Approx. 10% +6", 15% 3-6", 75% matrix (which is approx. 50% gravel, 30% sand, and 20% slightly plastic fines)
Gray-brown; moist; slightly permeable; very stiff; road fill; CM
- 2.0 - 6.0 Gravel, sandy, silty
Max. size 20" - Flaggy siltstones
Approx. 10% +6", 15% 3-6", 75% matrix (which is approx. 60% gravel, 25% sand, and 15% slightly plastic fines)
Brown; moist-wet @ 3.8'; slightly permeable; very stiff; flat lying flags; alluvial; CM
- 6.0 - 11.0+ Silt & Clay, gravelly, sandy
Max. size 6"
Approx. 5% 3-6", 95% matrix (which is approx. 25% gravel, 20% sand, and 55% moderately plastic fines)
Gray; wet; very slightly permeable; hard; till; CL-MU

Note: Moderate seepage @ 5.8'. Little brush @ ± 2.0'

TP #302, Bank, Prin. Smv. 11/18/69, D.C. 1471

- 0.0 - 2.0 Topsoil
- 2.0 - 10.5 Clayey silt, gravelly, sandy
Max. size 8" - Flaggy siltstones
Approx. 15% +6", 4% 3-6", 95% matrix (which is approx. 25% gravel, 20% sand, and 55% moderately plastic fines)
Lt. brown; wet; very slightly permeable; very stiff; very highly weathered bedrock, "c" horizon; CL-MU
- 10.5 - 15.8 Silt & Clay, gravelly, sandy
Max. size 7" - Flaggy SR siltstones
Approx. 15% +6", 4% 3-6", 95% matrix (which is approx. 25% gravel, 20% sand, and 55% moderately plastic fines)
Gray w/brown; wet; very slightly permeable; hard; till; CL-MU
- 15.8 - 18.0+ Bedrock
Clay shale & siltstone, moderately weathered; gray-brown; soft to moderately hard; thin bedded; fractured, filled w/CL-MU; essentially horizontal; Northeast shale, upper Upper Devonian.

Note: Water level @ 16.3'. Difficult digging in 15.8-18' zone.

TP #303, Fl. Cr., Prin. Smv. 11/18/69, D.C. 1471.3

- 0.0 - 0.6 Topsoil
- 0.6 - 3.0 Gravel, sandy, silty
Max. size 8" - Flaggy siltstones
Approx. 10% +6", 15% 3-6", 75% matrix (which is approx. 50% gravel, 30% sand, and 20% slightly plastic fines)
Gray-brown; moist; slightly permeable; very stiff; road fill; CM
- 3.0 - 6.8 Gravel, sandy, silty
Max. size 16" - Flaggy siltstones
Approx. 10% +6", 15% 3-6", 75% matrix (which is approx. 60% gravel, 25% sand, and 15% slightly plastic fines)
Brown; moist-wet @ 4.5'; slightly permeable; very stiff; flat lying flags; alluvial; CM
- 6.8 - 11.0 Silt & Clay, gravelly, sandy
Max. size 8" - Flaggy siltstones
Approx. 15% +6", 4% 3-6", 95% matrix (which is approx. 25% gravel, 20% sand, and 55% moderately plastic fines)
Gray; wet; very slightly permeable; hard; till; CL-MU
- 11.0 - 14.2+ Bedrock
Clay shale & siltstone; moderately weathered, gray-brown; soft to moderately hard, thin bedded; fractured, filled w/CL-MU; essentially horizontal; Northeast shale, upper Upper Devonian

Note: Moderate seepage @ 4.3'. Difficult digging below 12'. Brush & logs @ ± 3'

TP #304, Prin. Smv. 11/18/69, D.C. 1471.5

- 0.0 - 0.5 Topsoil
- 0.5 - 2.5 Gravel, sandy, silty
Max. size 15" - Flaggy siltstones
Approx. 10% +6", 15% 3-6", 75% matrix (which is approx. 60% gravel, 20% sand, and 20% slightly plastic fines)
Gray-brown; moist; slightly permeable; very stiff; road fill; CM
- 2.5 - 4.0 Gravel, sandy, silty
Max. size 18" - Flaggy siltstones
Approx. 10% +6", 15% 3-6", 75% matrix (which is approx. 60% gravel, 25% sand, and 15% slightly plastic fines)
Brown; moist; slightly permeable; very stiff; flat lying flags; alluvial; CM
- 4.0 - 7.0 Sand, silty, gravelly
Max. size 10" - Flaggy siltstones
Approx. 25% +6", 6% 3-6", 92% matrix (which is approx. 25% gravel, 20% sand, and 45% moderately plastic fines)
Brown; wet; very slightly permeable; hard; till; SC-SM.
- 7.0 - 10.0+ Bedrock
Clay shale & siltstone; moderately weathered; gray-brown; soft to moderately hard; thin bedded; fractured, filled w/CL-MU; essentially horizontal; Northeast shale, upper Upper Devonian.

Note: Moderate seepage @ 3.8'. This till slightly sandier and less plastic than gray till. Hard digging beyond 8.3'. Many logs and branches in 0.6-2.5'.

TP #305, Stream Channel, 11/18/69, D.C. 1471.1

- 0.0 - 0.2 Topsoil
- 0.2 - 5.3 Gravel, sandy, silty
Max. size 15" - Flaggy siltstones
Approx. 10% +6", 15% 3-6", 75% matrix (which is approx. 60% gravel, 25% sand, and 15% slightly plastic fines)
Brown; wet; slightly-moderately permeable; very stiff; flat lying flags; alluvial; CM
- 5.3 - 8.2 Silt & Clay, gravelly, sandy
Max. size 8" - Flaggy siltstones
Approx. 15% +6", 4% 3-6", 95% matrix (which is approx. 25% gravel, 20% sand, and 55% moderately plastic fines)
Gray-brown; wet; very slightly permeable; hard; till; CL-MU
- 8.2 - 10.0 Bedrock
Clay shale & siltstone; moderately weathered; gray-brown; soft to moderately hard; thin bedded; fractured, filled w/CL-MU; essentially horizontal; Northeast shale, upper Upper Devonian

Note: Water @ creek level, 0.8'

TP #306, Drain Line, 11/18/69, D.C. 1471.2

- 0.0 - 0.7 Topsoil
- 0.7 - 3.2 Silt & Clay, gravelly, sandy
Max. size 7" - Flaggy shale and siltstone
Approx. 4% +6", 11% 3-6", 85% matrix (which is approx. 30% gravel, 15% sand, and 55% moderately plastic fines)
Light brown; wet; very slightly permeable; very stiff; very highly weathered bedrock, "c" horizon; CL-MU
P.S. 301.1 (CL-MU)
- 3.0 - 3.0+ Bedrock
Clay shale & siltstone; highly weathered; olive-brown; soft; laminated; highly fractured, filled w/CL-MU; essentially horizontal; Northeast shale, upper Upper Devonian.

Note: Bedrock @ 3' @ top of pit and @ 6' @ bottom of pit. Seepage @ 0.7'

AS BUILT
12/9/74

**CONEWANGO CREEK WATERSHED PROJECT
SITE 33
FLOODWATER RETARDING DAM
CHAUTAQUA COUNTY, NEW YORK
LOGS OF TEST HOLES**

**U. S. DEPARTMENT OF AGRICULTURE
SOIL CONSERVATION SERVICE**

Date: 11-12-69
 State: NY
 Engineer: B. CHAMPEIN
 Project: 201
 File: 201
 NY-2173-G

TP #502. Brain line. 11/28/69. DEC. 1482.3

0.0 - 0.4 Topsoil
 0.4 - 6.0 Gravel, sandy, silty
 Max. size 1 1/2" - Flaggy siltstone
 Approx. 10% 1/4", 15% 1/2", 75% matrix (which is approx. 60% gravel, 25% sand, and 15% slightly plastic fines).
 Brown; moist-wet @ 1.0'; slightly permeable; very stiff-hard; flat-lying flags; alluvial; GN. P.S. 302.1 (GN-8)
 6.0 - 6.0+ Bedrock
 Clay shale & siltstone; moderately weathered; gray-brown; soft to moderately hard; thin bedded; fractured; filled w/CL-MI; essentially horizontal; Northeast shale, upper Upper Devonian.

Note: Water @ creek level, 1.5'

TP #503 Brain. Brain line. 11/28/69. DEC. 1474.1

0.0 - 1.0 Topsoil
 1.0 - 1.8 Clayey silt, gravely, sandy
 Max. size 3/4" - Flaggy siltstone
 Approx. 15% 1/4", 45% 1/2", 85% matrix (which is approx. 25% gravel, 25% sand, and 50% moderately plastic fines).
 Light brown; moist-wet @ 1.2'; very slightly permeable; very stiff; very highly weathered bedrock, "C" horizon; CL-MI
 1.8 - 1.8+ Bedrock
 Clay shale & siltstone; highly weathered; olive-brown; soft; laminated; highly fractured, filled w/CL-MI; essentially horizontal; Northeast shale; upper Upper Devonian.

Note: Bedrock is @ 3.3' in bottom of pit. Seepage @ 1.2'

TP #504 Ditch. Brain line. 11/28/69. DEC. 1461

0.0 - 3.5 Silt & Clay, gravely, sandy
 Max. size 3/4" - Flaggy siltstone
 Approx. 15% 1/4", 45% 1/2", 85% matrix (which is approx. 25% gravel, 25% sand, and 50% moderately plastic fines).
 Brown; moist-wet; very slightly permeable; hard; till; CL-MI
 3.5 - 3.5+ Bedrock
 Clay shale & siltstone; highly weathered; olive-brown; soft; laminated; highly fractured, filled w/CL-MI; essentially horizontal; Northeast shale; upper Upper Devonian.

Note: No topsoil. Water in ditch.

TP #505 Brain. Other. 11/28/69. DEC. 1482

0.0 - 0.7 Topsoil
 0.7 - 1.6 Clayey silt, sandy, gravely
 Max. size 3/4" - Flaggy siltstone
 Approx. 15% 1/4", 45% 1/2", 85% matrix (which is approx. 25% gravel, 25% sand, and 50% moderately plastic fines).
 Light brown; wet; very slightly permeable; very stiff; flat-lying flags; very highly weathered bedrock, "C" horizon; CL-MI
 1.6 - 1.6+ Bedrock
 Clay shale & siltstone; highly weathered; olive-brown; soft; laminated; highly fractured, filled w/CL-MI; essentially horizontal; Northeast shale; upper Upper Devonian.

Note: Water seeping from practically everywhere.

TP #506 FA. FA. Other. 11/28/69. DEC. 1470.4

0.0 - 1.0 Topsoil
 1.0 - 4.0 Gravel, silty, sandy
 Max. size 2 1/2" - Flaggy siltstone
 Approx. 10% 1/4", 15% 1/2", 75% matrix (which is approx. 50% gravel, 30% sand, and 20% slightly/moderately plastic fines).
 Brown; moist-wet @ 1.0'; slightly permeable; very stiff-hard; flat-lying flags; alluvial-alluvial; GN.
 4.0 - 4.0+ Bedrock
 Clay shale & siltstone; highly weathered; olive-brown; soft; laminated; highly fractured, filled w/CL-MI; essentially horizontal; Northeast shale; upper Upper Devonian.

Note: Gravel is siltier than usual. Water @ creek level, 3.4'

DRILL HOLE LOGS

CONDAMACO 33

Pressure test results
10.0-15.0

| | | |
|---------------------------------------|---|------|
| M 51 C/A Run. 12/4-11/69. DEC. 1427.7 | | 0.0 |
| 2 Topsoil | | 1.0 |
| 11 | Silt, sandy Approx. 5% gravel, 20% sand, 75% non-plastic fines Orange-brown; moist; slightly permeable, stiff, M=11; till; MI | 2.5 |
| 9 26 | Sand, silty, gravely Approx. 25% gravel, 30% sand, 4% slightly/moderately plastic fines Gray-brown; moist; very slightly permeable, stiff-very stiff, M=9-24; till; CL-MI | 6.5 |
| 153 113/3 | Clayey silt, sandy, gravely Approx. 20% gravel, 20% sand, 60% moderately plastic fines Lt. brown; wet; very slightly permeable; hard, M=133; very highly weathered bedrock, "C" horizon, CL-MI | 9.3 |
| NX NX NX NX | Bedrock - interbedded shale and siltstone w/few r. limy sandstone zones w/occ. biotite mica; silty clayey texture, occ. sandy, moderately weathered, cc. high down to 14' then essentially non-weathered below 14'; weathered zones are olive green to olive brown, rest is gray except for lighter limy parts, mod. soft to very hard; mostly laminated, few thin beds, occ. massive shale on limy sandstone; some highly weathered clay and silt seams; highly fractured to 4 1/2", mod below that; essentially horizontal, regional dip and strike, Northeast shale, upper Upper Devonian. | 22.5 |

Note: @ 12' on 12/11/69, 6' @ 12/15/69, @ surface on 12/18/69.

| | | |
|-----------------|----------|--------|
| Run 1 8.2-12.6' | 100% Rec | OK RND |
| 2 12.8-16.5' | 100% | 14' |
| 3 16.5-17.5' | 70% | 0' |
| 4 17.5-22.2' | 100% | 50' |

Largest whole core piece, 8"

| Pressure test results | | |
|-----------------------|--------|-------------|
| 17.5-22.5 | 30 psi | 4.17 fpd 1/ |
| | 20 psi | 1.49 fpd 2/ |
| | 10 psi | 2.37 fpd 1/ |
| 12.5-17.5 | 20 psi | 5.52 fpd |
| | 10 psi | 2.98 fpd |

1/ 1 qt. loss up outer pipe in 27 sec.
2/ 37 sec.
3/ 83 sec.

| | | |
|--|--|------|
| M 52 C/L Run. 12/16-17/69. DEC. 1458.9 | | 0.0 |
| Topsoil | | 0.7 |
| 20 24 | Gravel, sandy, silty Approx. 50% gravel, 30% sand, 20% slightly plastic fines Brown; moist-wet @ 2.8'; slightly permeable; very stiff, M=20-24; alluvial-colluvial, GN | 3.2 |
| 28 | Silt and clay, gravely, sandy Approx. 25% gravel, 20% sand, 55% moderately plastic fines Gray; wet; very slightly permeable, very stiff, M=28; till; CL-MI | 4.3 |
| 38 41 57/3 | Sand, silty gravely Approx. 25% gravel, 30% sand, 4% moderately plastic fines Brown; wet; very slightly permeable, hard, M=38-41; till; SC-5A | 8.5 |
| M M | Bedrock - interbedded shale and siltstone, not limy; silty and clayey texture; moderately weathered; olive green-slate gray; moderately soft-hard, breaks along bedding planes; laminated, few thin beds w/occasional clay and silt seams; fractures into 1/4"-1" pieces, some staining; core very fragmental; essentially horizontal; regional strike and dip; Northeast shale upper Upper Devonian. | 14.0 |
| Notes: @ 3.8' on 12/18/69 Run 1 8.0-14.0' 50% rec. OK RND Largest whole core piece, 3" | | |
| M 53 C/L Run. 12/23/69. DEC. 1494.0 | | 0.0 |
| 30 49 119 | Clayey silt, gravely sandy Approx. 25% gravel, 20% sand, 55% moderately plastic fines Lt. brown; wet; very slightly permeable; stiff-hard, M=10-119; very highly weathered bedrock, "C" horizon; CL-MI | 4.5 |
| 74/3 M M | Bedrock - interbedded shale and siltstone, w/few fine-gr. limy sandstone zones w/occ. biotite mica; silty clayey texture, occ. sandy; moderately weathered to 8', then essentially non-weathered below 8'; weathered zones are olive green-brown, rest is gray except for lighter limy parts; moderately soft-very hard; mostly laminated, few thin beds, occ. massive, some cross-bedding; mostly tight fractures, some staining on fracture surfaces, only 1 or 2 small CL-MI seams; fracture frequency 0.5" to 3.5", regional strike and dip, essentially horizontal; Northeast shale, upper Upper Devonian. | 15.0 |

Note: @ 7' on 12/15/69, @ 6' on 12/16/69.
Run 1 5.0-10.0' 62% Rec. OK RND
2 10.0-15.0' 100% Rec. OK RND

5.0-10.0

4/ Leaking badly around o
5/

Initial encounter w/water

| | | |
|-------------------------------------|--|--|
| M 251 Dmr. Solvay. 12/18/69. DEC. 1 | | |
| Topsoil | | |
| 2 | Silt, sandy Approx. 10% gravel, 15% s. Lt. brown to orange brown M=2, till; MI | |
| 40 39 | Silt and clay, sandy w/gr Approx. 20% gravel, 25% s. fines Brown-gray; moist; very s. till; CL-MI | |
| M | Bedrock - sandy siltstone, then, poor shale and silt; silty texture; moderate-w weathered in lower zone, ; moderately soft; laminated 8.5'; good rock breaks in horizontal, regional strike Upper Devonian. | |

Note: No water.

Run 1 5.5-10.5'
Largest whole core
No return water, U

| | | |
|--|---|--|
| M 252 Dmr. Solvay. 12/17-18/69. DEC | | |
| Topsoil | | |
| 6 15 | Silt, sandy Approx. 10% gravel, 15% s. Lt. brown; moist; slight; till; MI | |
| 12 30 | Silt, sandy, gravely Approx. 20% gravel, 25% s Brown, moist; very slight till; MI | |
| M M M | Bedrock - sandy siltstone uncompacted shale and silt to silty texture; incompo weathering, others essent olive brown; moderately s few thin beds, ecc. massi silt seams @ 10-11'; core is fractured into 1/2-2" essentially horizontal; M | |
| Notes: Run 1 8.0-11.0 2 11.0-16.0 3 16.0-18.0 | | |
| Largest whole core Lost drilling water short to get good | | |

| | | |
|-------------------------------------|--|--|
| M 253 Dmr. Solvay. 12/17/69. DEC. 1 | | |
| Topsoil | | |
| 4 20 | Silt, sandy Approx. 15% gravel, 20% s Lt. brown-orange brown; s stiff, M=4-20; till; MI | |
| 95/8 | Gravel, silty, sandy Approx. 20% gravel, 25% s Mottled brown; moist; al till; GN | |
| M | Bedrock - clay shale and highly/moderately weathe laminated bedding; many dip and strike, essentia Upper Devonian. | |

Note: Run 1 5.0-10.0'
Largest whole core
w/ water

LOGS

33

Pressure test results
10.0-15.0 30 psi 4.13 fpd
20 psi 4.58 fpd
10 psi 5.40 fpd
3.0-10.0 20 psi 12.1 fpd 4/
10 psi 13.2 fpd 2/

75% non-plastic fines
slightly permeable; stiff, M=11;

4.5% slightly-moderately
slightly permeable, stiff-very

6% moderately plastic
slightly permeable; hard, M=133, very
"C" horizon; CL-ML

sand siltstone w/few r.
biotite mica; silty clayey
tally weathered, cc. high
non-weathered yellow 14";
rest is silty brown, rest is
y parts; mod. soft to very
thin beds, ecc. massive
highly weathered clay
beds to 13", mod below
1, regional dip and strike,
Devonian.

6' on 12/15/69, @ surface on

DOF Rec. 5% R/D
DOF 5%
DOF 5%
DOF 5%

face, 8"

4.17 fpd 1/
3.49 fpd 2/
2.37 fpd 3/
3.52 fpd
2.90 fpd

or pipe in 27 sec.
37 sec.
83 sec.

4, 20% slightly plastic fines
slightly permeable; very stiff,
all, GM

55% moderately plastic fines
permeable; very stiff, M=28;

4% moderately plastic fines
permeable; hard, M=6-81;

and siltstone, not lime;
moderately weathered; silty
soft-hard, breaks along
few thin beds w/occasional
into 1/4-3" pieces, some
tal, essentially horizontal;
theast shale, upper upper

rec. OK R/D
in 3"

55% moderately plastic fines
slightly permeable; stiff-hard; M=10-119;
rock, "C" horizon; CL-ML

and siltstone, w/few fine-gr. limy
biotite mica; silty clayey texture, ecc.
to 8", then essentially non-weathered
are olive green-brown, rest is gray
parts; moderately soft-very hard; mostly
ecc massive, some cross-bedding; mostly
hing on fracture surfaces, only 1 or 2
frequency 0.5" to 3.5"; regional strike
ental; Northeast shale, upper upper

6' on 12/16/69
2% Rec. OK R/D
OK Rec. OK R/D
piece, 3.5"

Initial encounter w/water @ 4.5'

NH 251 Amer. Solvay, 12/18/69, DPC, 1519.0

Topsoil 0.0

2 Silt, sandy
Approx. 10% gravel, 15% sand, 75% slightly plastic fines
Lt. brown to orange brown; moist; slightly permeable; soft,
M=2; till; ML

40 Silt and clay, sandy w/gravel
Approx. 20% gravel, 25% sand, 55% slightly-moderately plastic
fines.
Brown-gray; moist; very slightly permeable; hard, M=39-40;
till; CL-ML

39 Bedrock - sandy siltstone, no lime, w/occ. biotite mica to 8.5',
then poor shale and siltstone from 8.5-10.5'; fine-grained to
silty texture; moderate-non weathered in upper zone, then highly
weathered in lower zone, grayish-tan; very hard to 8.5'; then
moderately soft; laminated to thin bedded, mostly CL-ML below
8.5'; good rock breaks in 3/4" to 2" fragments; essentially
horizontal, regional strike and dip; Northeast shale, upper
Upper Devonian.

Notes: No water.
Run 1 3.5-10.5' 62% Rec. OK R/D
Largest whole core piece, 2"
No return water, casing loose on bottom.

NH 252 Amer. Solvay, 12/17-18/69, DPC, 1522.0

Topsoil 0.0

6 Silt, sandy
Approx. 10% gravel, 15% sand, 75% slightly plastic fines
Lt. brown; moist; slightly permeable, medium-stiff; M=6-15,
till; ML

15 Silt, sandy, gravelly
Approx. 20% gravel, 25% sand, 55% slightly plastic fines
Brown; moist; very slightly permeable; stiff-hard; M=12-36;
till; ML.

12 Bedrock - sandy siltstone, no lime, ecc. biotite mica;
uncompacted shale and siltstone zone 10-12.5'; fine-grained to
silty texture; incompetent beds show high-moderate
weathering, others essentially non-weathered; grayish tan to
olive brown; moderately soft to very hard; mostly laminated
few thin beds, ecc. massive; ecc. highly weathered clay and
silt seams @ 10-11'; core is good 9-10', very poor 10-11'; rest
is fractured into 1/2-2" chunks; regional strike and dip,
essentially horizontal; Northeast shale, upper Upper Devonian.

Notes: Run 1 8.0-11.0 77% Rec. 35% R/D
2 11.0-16.0 60% Rec. OK R/D
3 16.0-18.0 100% Rec. "C" R/D
Largest whole core piece, 5"
Lost drilling water at start because casing a bit too
short to get good seating.

NH 253 Amer. Solvay, 12/17/69, DPC, 1519.1

Topsoil 0.0

4 Silt, sandy
Approx. 15% gravel, 20% sand, 65% slightly plastic fines
Lt. brown-orange brown; moist; slightly permeable, medium-very
stiff, M=4-20; till; ML

20 Gravel, silty, sandy
Approx. 20% gravel, 25% sand, 45% slightly plastic fines
Mottled brown; moist; slightly permeable; hard, M=95/8;
till; GM

Bedrock - clay shale and siltstone; clayey - silty texture,
highly-moderately weathered; olive brown; soft-medium soft;
laminated bedding; many CL-ML seams; very poor core; regional
dip and strike, essentially horizontal; Northeast shale, upper
Upper Devonian.

Notes: Run 1 5.0-10.0' 36% rec. OK R/D
Largest whole core piece, 3/4"
No water

Topsoil 0.0

8 Silt, sandy
Approx. 15% gravel, 20% sand, 65% slightly plastic fines
Lt. brown-orange brown; moist; slightly permeable; stiff-
very stiff, M=6-24, till; ML

24 Gravel, silty, sandy
Approx. 30% gravel, 25% sand, 45% slightly plastic fines
Mottled brown; moist; slightly permeable; very stiff, M=17-29;
till; GM

19 Sand, silty
Approx. 5% gravel, 70% sand, 25% non-plastic fines
Brown; moist; moderately permeable; medium density, M=18;
poorly stratified outwash; SM

13 Silt, sandy
Approx. 5% gravel, 15% sand, 80% non-plastic fines
Brown; moist; slightly permeable; medium density, M=12-20;
glacio-lacustrine; ML

29 Gravel, silty, sandy
Approx. 30% gravel, 25% sand, 45% slightly plastic fines
Mottled brown; moist; slightly permeable, very stiff, M=29;
till; GM

Bedrock - sandy siltstone, no lime, ecc. biotite mica, fine
grained to silty texture; essentially non-weathered; grayish
tan; very hard; thin bedded, shows some cross-bedding, ecc.
laminae of darker silts; usually tight fractures on 2-4"
spacing; little staining, core fresh looking, not fragmented;
regional strike and dip, essentially horizontal; Northeast
shale, upper Upper Devonian.

Notes: Run 1, 20.0-25.0', 90% Rec. OK R/D
Lost water from the start. Driller says 6" void
@ 24.0-24.5'. No water table.
Largest whole core piece, 4"

NH 351 Frig. Solvay, 12/11-12/69, DPC, 1492.5

Topsoil 0.0

40 Gravel, sandy, silty
Approx. 50% gravel, 30% sand, 20% slightly plastic fines
Gray-brown; moist; slightly permeable; hard, M=40; road fill;
GM

28 Gravel, sand, silty
Approx. 60% gravel, 25% sand, 15% slightly plastic fines
Brown; moist-wet @ 3'; slightly permeable, very stiff, M=20-25,
alluvial; GM

34 Silt and clay, gravelly, sandy
Approx. 25% gravel, 20% sand, 55% moderately plastic fines
Gray; wet; very slightly permeable; hard, M=34; till, CL-ML

55 Sand, silty, gravelly
Approx. 25% gravel, 30% sand, 45% slightly plastic fines
Brown; wet; very slightly permeable; very stiff, M=55-140;
till; SM

125 Bedrock - interbedded shale and siltstone; silty-clayey texture,
mostly moderately weathered; olive brown above 18', gray below,
moderately soft to very hard; mostly laminated some thin beds;
few highly weathered clay and silt seams; fractures into
1/2-2" blocks along bedding planes; regional strike and dip,
essentially horizontal; Northeast shale, upper Upper Devonian

Notes: Run 1, 13.5-18.5', 70% Rec., OK R/D
2, 18.5-23.5, 70% Rec., OK R/D
Largest whole core piece, 3"
Water @ 4.5', 12/12/69 and @ 3.0', 12/18/69.
Brush at bottom of road fill.

AS BUILT
12/7/74

CONEWANGO CREEK WATERSHED PROJECT
SITE 33
FLOODWATER RETARDING DAM
CHAUTAUQUA COUNTY, NEW YORK
LOGS OF TEST HOLES

U. S. DEPARTMENT OF AGRICULTURE
SOIL CONSERVATION SERVICE

6170
B. CHAMPEON 11/2/69
STATE CONS ENGINEER

11/11/74
B. CHAMPEON 11/16/74
NY-2173-G

32-32

EM 152 Prin. Spher. 11/22-11/26, REC. 1464.1

| | | |
|----|---|------|
| | Topsoil | 0.0 |
| 23 | Gravel, sandy silty Approx. 50% gravel, 20% sand, 20% slightly plastic fines Gray-brown; moist; slightly permeable; very stiff; N-60; road fill; GM | 2.0 |
| 22 | Gravel, sandy, silty Approx. 60% gravel, 20% sand, 10% slightly plastic fines Brown; moist-wet 0.2'; slightly permeable; very stiff; N-61; alluvial; GM | 2.2 |
| 19 | Silt and clay, gravelly, sandy Approx. 25% gravel, 20% sand, 20% moderately plastic fines Gray-brown; wet; very slightly permeable; stiff; N-63; till; CL-MI | 6.0 |
| 20 | Silt and clay, gravelly, sandy Approx. 25% gravel, 20% sand, 20% moderately plastic fines Gray; wet; very slightly permeable; very stiff; N-60-64; till; CL-MI | 6.0 |
| 21 | Bedrock - interbedded shale and siltstone, light areas of fine grained limy sandstone w/occ. biotite mica; silty and clayey texture, occ. sandy; moderately weathered, occ. high; essentially non-weathered from 13' down; weathered areas olive green, rest is gray except for white limy parts; moderately soft to very hard; mostly laminated, few thin beds, occ. massive, nearly cyclic shales on 8" thick limy beds; occ. highly weathered CL-MI beds; highly fractured in places, much improvement near bottom; regional dip and strike, essentially horizontal; Northeast shale, upper Devonian. | 25.6 |

Notes: Run 1 10.6-15.6 70% Rec. OK RSD
 2 15.6-20.6 90% Rec. OK RSD
 3 20.6-25.6 80% Rec. OK RSD
 Largest whole core piece, 13'
 Water at 3.0', 12/11/69, and at 2.0, 12/15/69.
 Some brush around 2.8'

EXPERIMENTAL DATA

| | | |
|-----------|--------|----------|
| 20.0-25.0 | 40 psi | 1.86 fpd |
| | 30 psi | 2.34 fpd |
| | 20 psi | 1.60 fpd |
| 15.0-20.0 | 10 psi | 1.78 fpd |
| | 30 psi | 0.78 fpd |
| | 80 psi | 0.72 fpd |
| 10.0-15.0 | 10 psi | 0.76 fpd |
| | 25 psi | 2.12 fpd |
| | 15 psi | 2.41 fpd |

EM 153 Prin. Spher. 12/15/69, REC. 1460.7

| | | |
|----|---|------|
| | Topsoil | 0.0 |
| 24 | Gravel, sandy silty Approx. 30% gravel, 30% sand, 20% slightly plastic fines Gray-brown; moist; slightly permeable; very stiff; N-64; road fill; GM | 2.6 |
| 17 | Gravel, sandy, silty Approx. 60% gravel, 20% sand, 10% slightly plastic fines Brown; moist-wet 0.2'; slightly permeable; very stiff; N-67-70; alluvial; GM | 2.2 |
| 23 | Sand, silty, gravelly Approx. 25% gravel, 20% sand, 45% slightly plastic fines Brown; wet; very slightly permeable; hard; N-63-65; till; SM | 11.5 |
| 21 | Bedrock - interbedded shale and siltstone, lighter limy areas in fine-grained sandstone w/occ. biotite mica; silty and clayey texture; moderately weathered; olive brown; moderately soft to hard; mostly laminated, some thin beds; occ. thin highly weathered CL-MI seams; most fractures are 1/4-1/2" in spacing, with little filling; regional strike and dip, essentially horizontal; Northeast shale, upper Upper Devonian. | 16.5 |

Notes: Run 1, 11.5-16.5', 50% Rec., OK RSD
 Largest whole core piece, 13'
 Water @ 5.3', 12/15/69
 Small amount of brush at ± 2.6'

WEIGHT OF COMPACTED SOIL IN LBS / CU. FT.

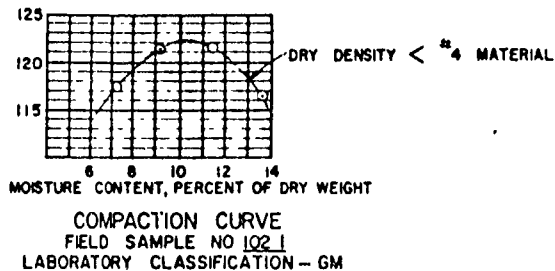

WEIGHT OF COMPACTED SOIL IN LBS / CU FT

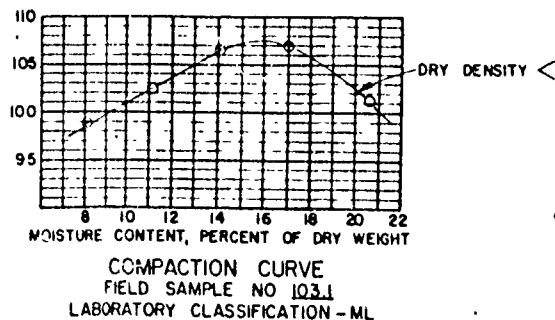

WEIGHT OF COMPACTED SOIL IN LBS / CU FT

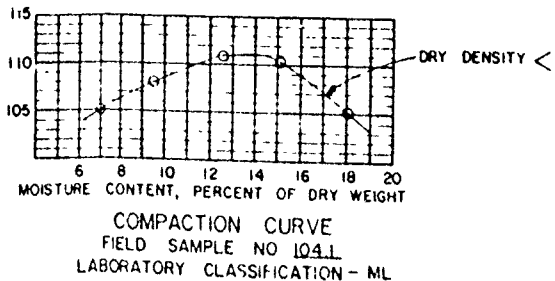

LEGEND
TEST HOLE NUMBERING SYSTEM

| | Test Pit (TP) | Drill Hole (DH) |
|--------------------|---------------|-----------------|
| Centerline of dam | 1-49 | 1-49 |
| Borrow Area | 101-149 | 101-149 |
| Emergency Spillway | 201-249 | 201-249 |
| Centerline of | | |
| Outlet Structure | 301-349 | 301-349 |
| Outlet Channel | 401-449 | 401-449 |
| Drain Line | 501-549 | 501-549 |
| Other | 601-649 | 601-649 |

UNIFIED SOIL CLASSIFICATION SYSTEM (USCS) SYMBOLS

- GW Well graded gravels; gravel-sand mixtures
- GP Poorly graded gravels
- GM Silty gravels; gravel-sand mixtures
- GC Clayey gravels; gravel-sand-clay mixtures
- SW Well graded sands; sand-gravel mixtures
- SP Poorly graded sands
- SM Silty sands; sand-silt mixtures
- SC Clayey sands; sand-clay mixtures
- ML Silts; silty, fine sands; sandy or clayey silts
- CL Clays of low to medium plasticity; silty, sandy or gravelly clays
- CH Clays of high plasticity; fat clays
- MH Elastic silts; micaceous or fibrous silts
- OL Organic silts and organic silty clays of low plasticity
- OH Organic clays or silts of high to medium plasticity

Note: Classifications shown in the logs are based on lab tests of samples representative of that material (ASTM D2487-66T). Significant deviations from normal are noted in the logs.

Key to Drill Hole (DH) Logs

| N | h | Material (USCS) | Depth (ft) |
|-----|-----|--|------------|
| 1 | 0-1 | Material description | 0-1 |
| 21 | 1-2 | Material description | 1-2 |
| 21 | 2-3 | Material description | 2-3 |
| DBS | | Dry air oven test | |
| RB | | Roller off to determine water content | |
| 64 | | | |
| AUG | | Hole advanced by auger | |
| NX | | Rock core, 1" diameter | |
| RR | | Percent rock core recovery, each drill run | |
| | | Permeability test (psi) | |

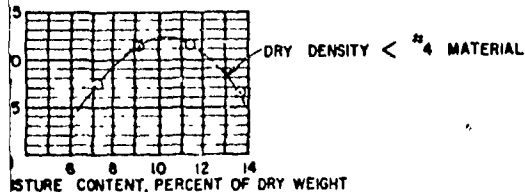

MOISTURE CONTENT, PERCENT OF DRY WEIGHT

COMPACTION CURVE
FIELD SAMPLE NO 102.1
LABORATORY CLASSIFICATION - GM

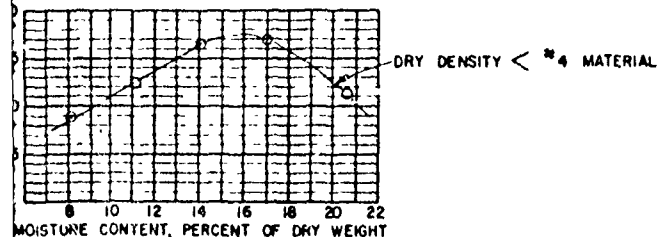

MOISTURE CONTENT, PERCENT OF DRY WEIGHT

COMPACTION CURVE
FIELD SAMPLE NO 103.1
LABORATORY CLASSIFICATION - ML

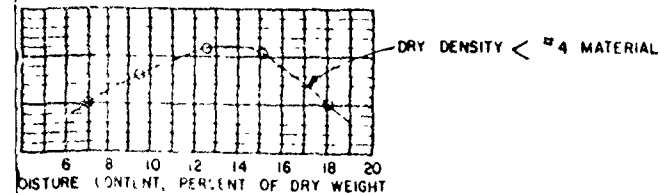

MOISTURE CONTENT, PERCENT OF DRY WEIGHT

COMPACTION CURVE
FIELD SAMPLE NO 104.1
LABORATORY CLASSIFICATION - ML

AS BUILT

12/9/74

CONEWANGO CREEK WATERSHED PROJECT
SITE 33
FLOODWATER RETARDING DAM
CHAUTAUQUA COUNTY, NEW YORK
LOGS OF TEST HOLES

U. S. DEPARTMENT OF AGRICULTURE
SOIL CONSERVATION SERVICE

LOGGED BY B. CHAMPEON 11/2/69
CHECKED BY W. MAXINS
DRAWN BY J. DUDLEY 3/1/70
DATE 3/14/70
PROJECT NO. NY-2173-G

WELL 222 1000

CONTINUED

TP #209, Bear River, 11/21/70, EC, 1314.8

- 0.0 - 1.0 Topsoil - average - varies 0.5 - 1.3'.
 1.0 - 3.3 Silt, sandy, gravelly
 Max. size 10" - SR Sed. Chls
 Approx. 25% +, 15% 3-4", 90% matrix (which is approx. 10% gravel, 30% sand and 60% very slightly plastic fines)
 Mottled gray-brown; moist; slightly permeable; medium density; homogeneous; weathered till; M.
 3.3 - 14.1 Sand and silt w/gravel
 Max. size 12" - SA Flaggy, Sed. Chls
 Approx. 15% +, 15% 3-4", 90% matrix (which is approx. 3% gravel, 60% sand and 37% non-plastic fines)
 Brown; moist-wet; slightly-moderately permeable; medium density; Interbeds of glacio-lacustrine; SM, SF, coarse M.
 14.1 - 14.7 Silt & Clay, sandy w/gravel
 Max. size 4" - SR-SA Sed. Chls
 Approx. 15% 3-4", 90% matrix (which is approx. 20% gravel, 20% sand and 70% moderately plastic fines)
 Brown and gray; wet; very slightly permeable; hard density; Interbeds of glacio-lacustrine; SM, M & CL

NOTE: Scoops and pipes in cleaner sands. Occasional till-like layers lensed in sands. Apt to seep at any depth below 3.3'. Pit has fairly smooth sides. Caves in coarser layers. No representative sample of 3.3-14.1 possible.

TP #210, Bear River, 11/21/70, EC, 1313.1

- 0.0 - 1.5 Topsoil
 1.5 - 3.3 Silt, sandy, w/gravel
 Max. size 5" - SR Sed. Chls
 Approx. 15% 3-4", 90% matrix (which is approx. 10% gravel, 20% sand and 70% slightly plastic fines)
 Orange-brown; moist; slightly permeable; soft density; homogeneous; weathered till; M.
 3.3 - 9.0 Sand, silty, gravelly
 Max. size 8" - SA Flaggy, Sed. Chls
 Approx. 15% +, 15% 3-4", 90% matrix (which is approx. 10% gravel, 40% sand and 40% very slightly plastic fines)
 Brown; moist; slightly permeable; medium density; homogeneous; till; SM
 9.0 - 14.0 Gravel, sandy, silty
 Max. size 14" - SR Sed. Chls & Eldrs
 Approx. 25% +, 25% 3-4", 90% matrix (which is approx. 20% gravel, 30% sand and 20% non-plastic fines)
 Brown; moist-wet; slightly-moderately permeable; medium density; lensed; mixed till and glacio-fluvial; GM

NOTE: Scoops slightly nearly everywhere below 5' but no marked seepage zones. Caves in cleaner zones. Extraneously mixed-up area. Sides of pit quite rough.

TP #211, Bear River, 11/22/70, EC, 1323.1

- 0.0 - 0.9 Topsoil
 0.9 - 2.0 Silt, gravelly, sandy
 Max. size 10" - SR Sed. Chls
 Approx. 15% +, 25% 3-4", 90% matrix (which is approx. 20% gravel, 30% sand and 60% slightly plastic fines)
 Orange-brown; moist; slightly permeable; soft density; homogeneous; weathered till; M.
 2.0 - 14.4 Gravel, sandy, silty
 Max. size 8" - SR Sed. Chls
 Approx. 25% +, 25% 3-4", 90% matrix (which is approx. 40% gravel, 15% sand and 20% very slightly plastic fines)
 Brown; moist-wet @ 11'; moderately permeable; loose-medium density; lensed; glacio-fluvial; GM
 R.S. 211.1 @ 12'. (GC-SM)

NOTE: Heavy seepage @ 11' from uphill side. Birtler in 3-4' zone, est. 40-30-30%. Caves.

TP #212, Bear River, 11/22/70, EC, 1322.8

- 0.0 - 0.3 Topsoil, very thin and sticky.
 0.3 - 3.0 Silt, sandy, gravelly
 Max. size 10" - SR Sed. Chls
 Approx. 25% +, 25% 3-4", 90% matrix (which is approx. 20% gravel, 30% sand and 60% slightly plastic fines)
 Orange-brown; moist; slightly permeable; soft density; homogeneous; weathered till; M.
 3.0 - 17.3 Gravel, sandy, silty
 Max. size 24" - SR-SA Sed. Chls & Eldrs
 Approx. 25% +, 25% 3-4", 90% matrix (which is approx. 50% gravel, 35% sand and 15% very slightly plastic fines)
 Brown; moist; moderately permeable; medium density; lensed; glacio-fluvial; GM
 R.S. 212.1 @ 9'. (GC-CP)

NOTE: No water. Caves.

TP #213, Bear River, 11/21/70, EC, 1314.5

- 0.0 - 1.0 Topsoil
 1.0 - 2.4 Silt, sandy w/gravel
 Max. size 5" - SA Sed. Chls
 Approx. 25% +, 25% 3-4", 90% matrix (which is approx. 10% gravel, 30% sand and 70% slightly plastic fines)
 Orange-brown; moist; slightly permeable; soft density; homogeneous; weathered till; M.
 2.4 - 16.3 Gravel, sandy, silty
 Max. size 18" - SR-SA Sed. Chls & Eldrs
 Approx. 25% +, 25% 3-4", 90% matrix (which is approx. 40% gravel, 30% sand and 10% very slightly plastic fines)
 Brown; moist; moderately permeable; medium density; lensed; glacio-fluvial; GM

NOTE: No water. Caves. Fewer +3' than 212.

TP #214, Bear River, 11/22/70, EC, 1326.3

- 0.0 - 1.0 Topsoil.
 1.0 - 4.0 Silt, sandy, w/gravel
 Max. size 5" - SA Sed. Chls
 Approx. 25% 3-4", 90% matrix (which is approx. 10% gravel, 20% sand and 70% slightly plastic fines)
 Orange-brown; moist; moderately permeable; soft density; homogeneous; weathered till; M.
 R.S. 214.1 @ 3'. (GM)
 4.0 - 7.8 Gravel, sandy, silty
 Max. size 10" - SR Sed. Chls
 Approx. 25% +, 25% 3-4", 90% matrix (which is approx. 40% gravel, 30% sand and 20% very slightly plastic fines)
 Brown; moist; slightly permeable; medium density; very poorly stratified; glacio-fluvial; GM
 7.8 - 9.3 Sand, silty w/gravel
 Max. size 7" - SR Sed. Chls
 Approx. 15% +, 25% 3-4", 90% matrix (which is approx. 10% gravel, 60% sand and 30% very slightly plastic fines)
 Brown; moist-wet @ 8'; slightly permeable; medium density; Interbeds of glacio-lacustrine; SM and M.
 9.3 - 16.4 Silt & Clay, sandy w/gravel
 Max. size 4"
 Approx. 15% 3-4", 90% matrix (which is approx. 10% gravel, 15% sand and 75% slightly-moderately plastic fines)
 Gray; wet; very slightly permeable; stiff density; interbeds of glacio-lacustrine; CL and M.
 R.S. 214.2 @ 12'. (CL-M)

NOTE: Moderate seepage @ 8'. Sand from 7.8-9.3 pipes readily. Caves a bit, but not too badly.

TP #215, Bear River, 11/22/70, EC, 1333.8

- 0.0 - 1.0 Topsoil
 1.0 - 7.0 Sand, silty, gravelly
 Max. size 8" - SA-SR sed. Chls
 Approx. 25% +, 25% 3-4", 90% matrix (which is approx. 20% gravel, 35% sand and 45% very slightly plastic fines)
 Mottled brown; moist; slightly permeable; medium density; homogeneous; till; SM
 7.0 16.3 Gravel, sandy, silty
 Max. size 18" - SR Sed Chls & Eldrs
 Approx. 25% +, 25% 3-4", 90% matrix (which is approx. 40% gravel, 35% sand and 20% non-plastic fines)
 Brown; moist; moderately permeable; medium density; very poorly stratified and interbedded; glacio-fluvial; GM
 R.S. 215.1 @ 9'. (SM)

NOTE: No seepage. Caves a bit.

TP #216, Bear River, 11/22/70, EC, 1333.8

- 0.0 - 1.0 Topsoil
 1.0 - 2.3 Silt, sandy, gravelly
 Max. size 5" - SA Sed. Chls
 Approx. 25% 3-4", 90% matrix (which is approx. 20% gravel, 20% sand and 60% slightly plastic fines)
 Mottled brown; moist; slightly permeable; soft density; homogeneous; weathered till; M.
 2.3 - 3.6 Sand, silty w/gravel
 Max. size 3"
 Approx. 100% matrix (which is approx. 10% gravel, 60% sand and 20% non-plastic fines)
 Brown; moist; moderately permeable; medium density; stratified; glacio-fluvial; SM

- 3.6 - 16.3 Gravel, sandy w/silt
 Max. size 20" - SR Sed Chls & Eldrs
 Approx. 25% +, 25% 3-4", 90% matrix (which is approx. 60% gravel, 30% sand and 10% very slightly plastic fines)
 Brown; moist; rapidly permeable; medium density; very poorly stratified; glacio-fluvial; GM-CP
 R.S. 216.1 @ 9'. (GC-CP)

NOTE: Oversize increases w/depth. Caves. No water.

WELL 1

CONCR.

SH #215, Left Bear River, 11/21/70.

| | |
|---------|--|
| | Brown topsoil |
| 6 Aug | Silt, sandy w/gravel - fines; orange-brown; no weathered glacial till; |
| 12 Aug | Gravel, sandy, silty - plastic fines; brown to slightly to moderately M-12-120; very poorly stratified; GM to SM |
| 41 Aug | |
| 85 Aug | |
| 57 Aug | |
| 51 Aug | |
| 102 Aug | |

SH #216, Left Bear River, 11/22-23/70

| | |
|--------|---|
| | Brown topsoil |
| 5 Aug | Silt, sandy, w/gravel - fines; light brown; moist weathered glacial till; |
| 37 Aug | Gravel, sandy, silty - slightly plastic fines; slightly to moderately poorly stratified; GM to SM R.S. 216.4 (GM) |
| 20 Aug | |
| 43 Aug | |
| 49 Aug | |
| 40 Aug | |
| 66 Aug | |
| 39 Aug | Sand, silty - est. 25% gr brown; moist; moderately stratified ice-contact g. R.S. 216.9 (SM) |

SH #217, Left Bear River, 11/22/70, EC

| | |
|--------|--|
| | Brown topsoil |
| 5 Aug | Silt, sandy, w/gravel - plastic fines; orange-br M-6; weathered glacial t |
| 14 Aug | Sand, silty, gravelly - plastic fines; brown; moist; slight contact glacial till; SM |
| 10 Aug | |
| 15 Aug | |
| 20 Aug | Gravel, sandy, silty - plastic fines; brown to gray; slightly to moderately poorly stratified; ice-contact glaciofluvial |
| 30 Aug | |
| 63 Aug | |
| 34 Aug | |
| 25 Aug | |
| 32 Aug | |

SH #218, Left Bear River, 11/21/70, EC.

| | |
|--------|--|
| | Brown topsoil |
| 9 Aug | Silt, sandy w/gravel - est fines; light brown; moist; weathered glacial till; M |
| 9 Aug | Sand, silty, gravelly - plastic fines; brown; moist stiff, M-9-22; occasional glacial till; M |
| 22 Aug | |
| 4 Aug | |
| 46 Aug | Silt, sandy - est. 5% gray; wet, slightly permeable; very poorly stratified ice-contact SM interbeds; M R.S. |
| 28 Aug | |
| 4 Aug | |
| 32 Aug | Sand, silty - est. 5% gray brown; moist; moderately poorly stratified glaciofluvial g |

Cals
 94% matrix (which is approx. 10% gravel, slightly plastic fines)
 lightly permeable; soft density; homo-till; ML

Cals & Elders
 92% matrix (which is approx. and 1% very slightly plastic fines)
 permeable; medium density; lensed;

Fewer +3" than 222.

Cals
 trix (which is approx. 10% gravel, slightly plastic fines)
 moderately permeable; soft density; till; ML

Cals
 94% matrix (which is approx. and 20% very slightly plastic fines)
 permeable; medium density; very fine-fluvial; GM

Cals
 87% matrix (which is approx. and 10% very slightly plastic fines)
 slightly permeable; medium density; lacustrine; GM and ML

Cals
 trix (which is approx. 10% gravel, slightly-plastic fines)
 permeable; stiff density; interbeds CL and ML

Sand from 7.8-8.5 pipes bit, but not too badly.

Cals
 87% matrix (which is approx. and 4% very slightly plastic fines)
 slightly permeable; medium density;

Cals & Elders
 90% matrix (which is approx. and 20% non-plastic fines)
 permeable; medium density; very interbedded; glacio-fluvial; GM

a bit.

Cals
 trix (which is approx. 20% gravel, slightly plastic fines)
 slightly permeable; soft density; till; ML

is approx. 10% gravel, 6% sand permeable; medium density; stratified;

Cals & Elders
 90% matrix (which is approx. and 20% very slightly plastic fines)
 permeable, medium density; very fine-fluvial; GM-CP

v/depth. Caves No water.

| DRILL HOLE LOGS | |
|--|--|
| CONWANGO 33 | |
| BH #233, Left Bear Smcr. 12/21/70. EC. 1522.3 0.0 | |
| | Brown topsoil 0.5 |
| 8 Aug | Silt, sandy w/gravel - est. 10% gravel, 20% sand, 70% non-plastic fines; orange-brown; moist; slightly permeable; soft, M=0; weathered glacial till; ML 4.0 |
| 12 Aug 41 | Gravel, sandy, silty - est. 45% gravel, 40% sand, 15% non-plastic fines; brown to gray-brown; moist; drier w/depth; slightly to moderately permeable; medium to very dense, M=12-128; very poorly stratified ice-contact glaciofluvial deposits; GM to SM |
| 85 | |
| 57 Aug | |
| 51 Aug | |
| 67 | |
| 103 Aug 128 | |
| BH #234, Left Bear Smcr. 12/22-23/70. EC. 1533.4 0.0 | |
| | Brown topsoil 0.5 |
| 5 Aug | Silt, sandy, w/gravel - est. 10% gravel, 20% sand, 70% non-plastic fines; light brown; moist; slightly permeable; soft, M=0; weathered glacial till; ML 3.8 |
| 37 Aug 20 | Gravel, sandy, silty - est. 50% gravel, 35% sand, 15% very slightly plastic fines; brown to gray-brown; moist; drier w/depth; slightly to moderately permeable; medium to very dense, M=20-66; very poorly stratified ice-contact glaciofluvial deposits; GM to SM E.S. 236.4 (SM) |
| 43 Aug | |
| 49 Aug | |
| 24 Aug 46 | |
| 39 Aug 47 | |
| 30.0 | |
| BH #242, Left Bear Smcr. 12/22/70. EC. 1531.3 0.0 | |
| | Brown topsoil 0.6 |
| 5 Aug | Silt, sandy, w/gravel - est. 10% gravel, 20% sand, 70% non-plastic fines; orange-brown; moist; slightly permeable; soft, M=0; weathered glacial till; ML 2.5 |
| 14 Aug 10 | Sand, silty, gravelly - est. 20% gravel, 55% sand, 25% non-plastic fines; brown; moist; slightly permeable; stiff, M=10-15; ice-contact glacial till; SM E.S. 237.2 (SM) |
| 15 Aug | |
| 16 0' | |
| 20 Aug 30 | Gravel, sandy, silty - est. 45% gravel, 40% sand, 15% non-plastic fines; brown to gray-brown; moist but drier w/depth; slightly to moderately permeable; medium to very dense, M=40-43; ice-contact glaciofluvial deposits; GM E.S. 237.8 (SM) |
| 62 Aug 34 | |
| 25 Aug 30 | |
| 32 Aug | |
| 30.0 | |
| BH #250, Left Bear Smcr. 12/21/70. EC. 1523.9 0.0 | |
| | Brown topsoil 0.4 |
| 9 Aug | Silt, sandy w/gravel - est. 10% gravel, 20% sand, 70% non-plastic fines; light brown; moist; slightly permeable; stiff, M=0; weathered glacial till; ML 2.0 |
| 9 Aug 22 | Sand, silty, gravelly - est. 30% gravel, 55% sand, 25% non-plastic fines; brown; moist; slightly permeable; stiff to very stiff, M=9-22; occasional ML and CL-ML interbeds; ice contact glacial till; SM 33.0 |
| 22 Aug | |
| 46 Aug 28 | Silt, sandy - est. 5% gravel, 35% sand, 60% non-plastic fines; grey, wet; slightly permeable; very stiff to hard, M=28-46; very poorly stratified ice-contact glaciolacustrine deposits; some SM interbeds; ML E.S. 238.4 (ML) |
| 28 Aug | |
| 32 Aug | Sand, silty - est. 5% gravel, 60% sand, 35% non-plastic fines; brown, moist; moderately permeable; dense, M=32; poorly stratified ice-contact glaciofluvial deposits; SM 30.0 |

| BH #234, Left Bear Smcr. 12/21/70. EC. 1522.3 (cont'd) | |
|--|--|
| 30 Aug 134 | Silt and clay, sandy - est. 15% gravel, 15% sand, 70% slightly to moderately plastic fines; gray; moist; very slight permeability; hard, M=30; stratified ice-contact glaciolacustrine deposits; some SM interbeds; CL-ML 33.7 |
| Aug | Bedrock - shale and siltstone - moderately weathered (not cored). (sh & silt) 37.0 |

AS BUILT
 12/9/74

CONEWANGO CREEK WATERSHED PROJECT
 SITE 33
 TEST PIT AND DRILL HOLE LOGS
 U. S. DEPARTMENT OF AGRICULTURE
 SOIL CONSERVATION SERVICE

Logged by *B. Chapman* 12/70
 Typed by *B. Whalley* 1-71

23
 STATE CONS ENGR.
 NY-2173-G

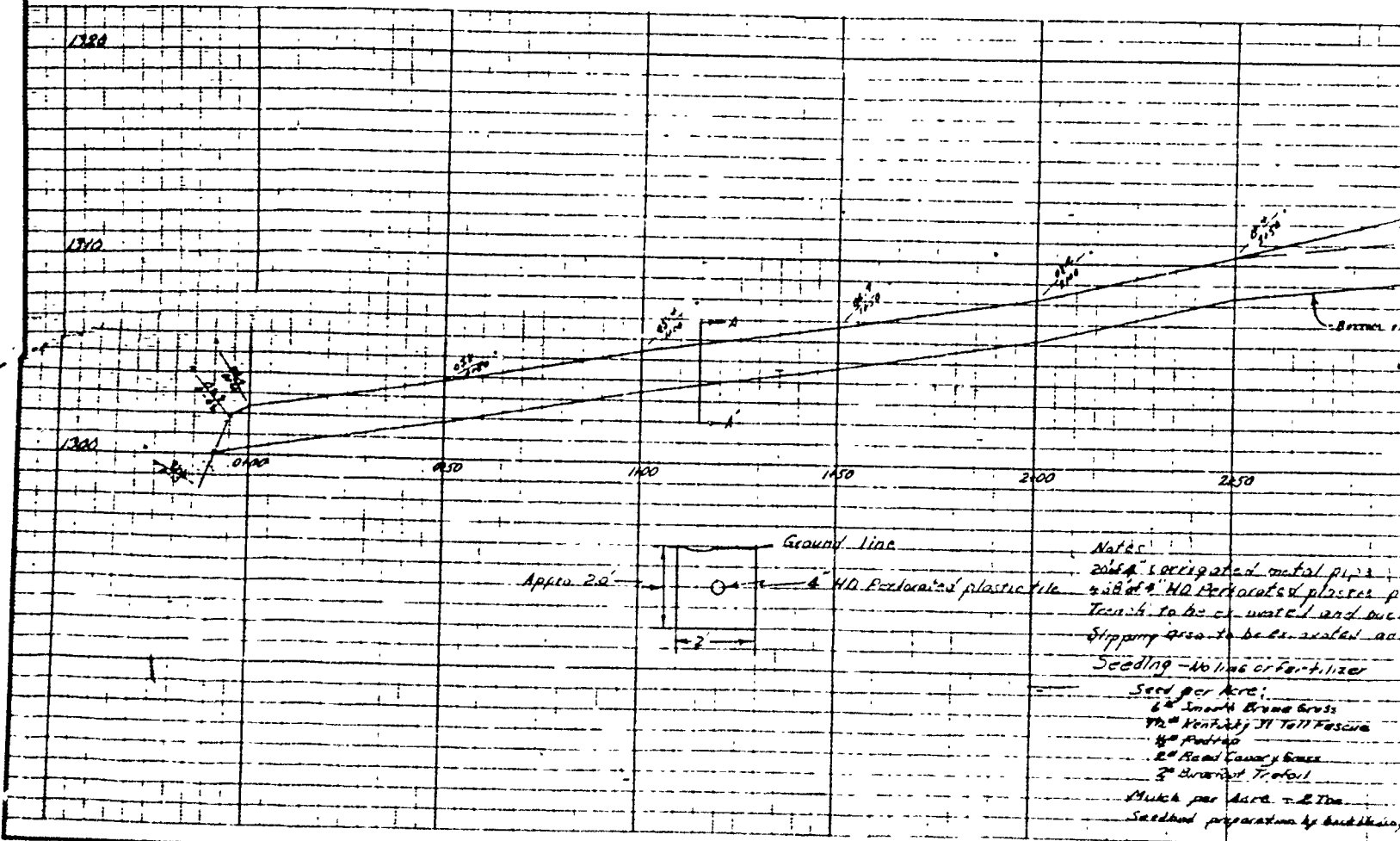
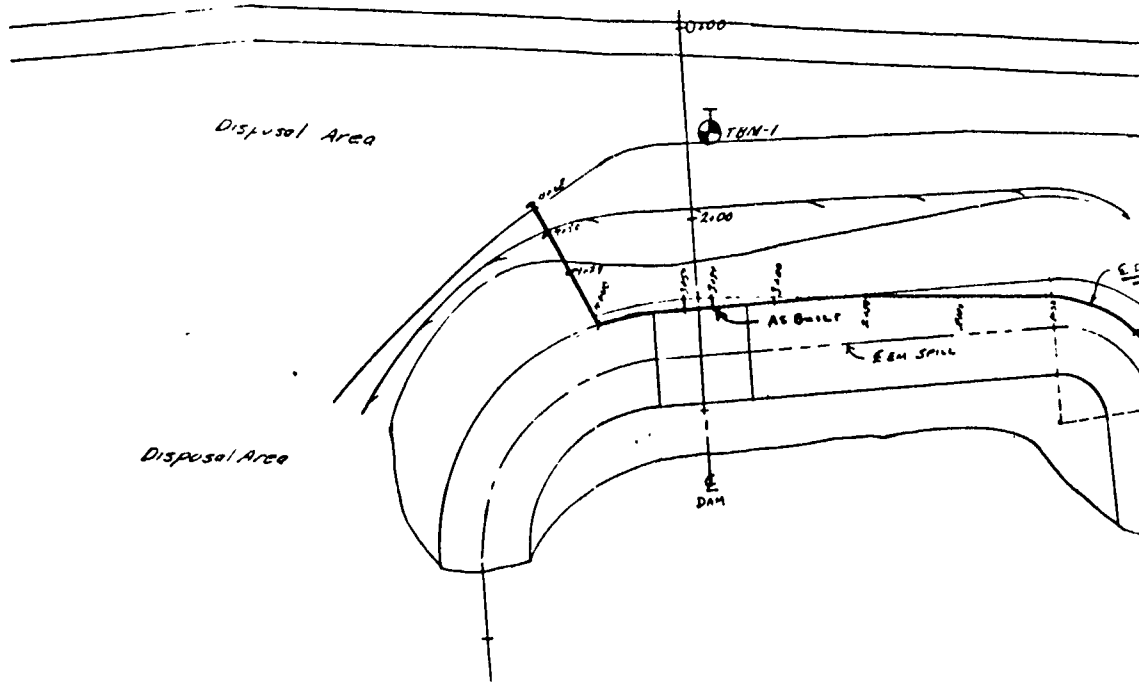

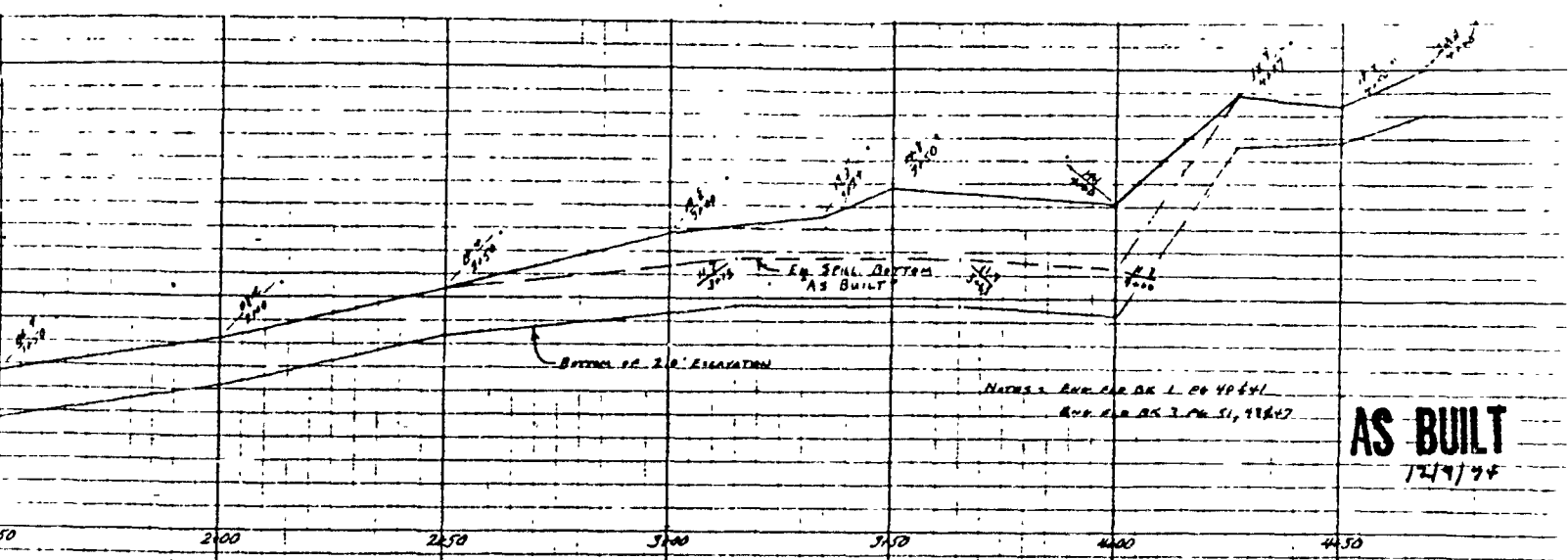
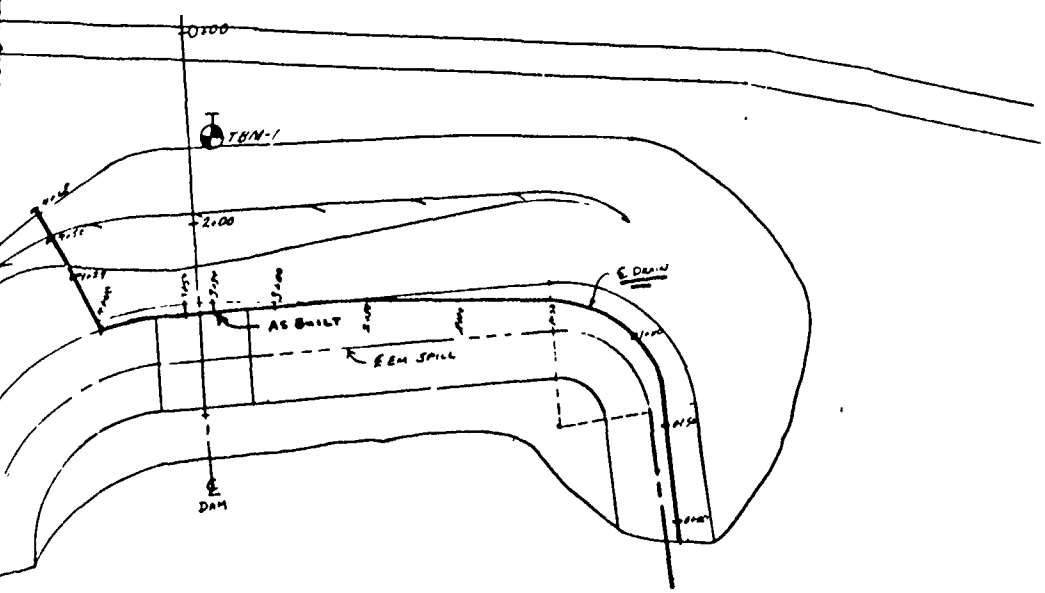

AS BUILT
1/27/74

line
 HD Perforated plastic tile
 Notes
 200# corrugated metal pipe
 460# of #10 Perforated plastic pipe
 Trench to be excavated and backfilled with 2' stone
 Slipping area to be excavated and filled with 2' stone
 Seeding - No lime or fertilizer
 Seed per acre:
 6# Smooth Bromegrass
 12# Kentucky 31 Tall Fescue
 4# Parrot
 2# Broad Canary Grass
 2# Burroughs Trifolium
 Muck per acre - 2 Tons
 Seedbed preparation by hand hoeing

COVERWANGU CREEK WATERSHED
 SITE 33
 E. Drain; Spilling Tile Drain

U.S. DEPARTMENT OF AGRICULTURE
 SOIL CONSERVATION SERVICE

| | | |
|----------|------|----------------|
| Designed | Date | Approved by |
| Drawn | | Title |
| Traced | | Title |
| Checked | | Sheet no. 30 |
| | | Drawing no. 32 |

1/27/74