

AD-A090 937

NEW YORK STATE DEPT OF ENVIRONMENTAL CONSERVATION ALBANY F/6 13/13  
NATIONAL DAM SAFETY PROGRAM. WARNER DAM, CHAUTAUGUA LAKE OUTLET--ETC(U)  
SEP 80 B L THOMSEN, G L WOOD DACW51-79-C-0001

UNCLASSIFIED

NL

1 of 2

4/2/81



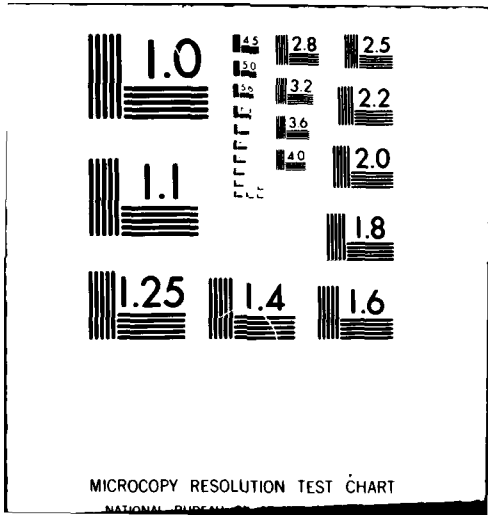

MICROCOPY RESOLUTION TEST CHART

NATIONAL BUREAU OF STANDARDS-1963-A

SECRET # JBS

SECURITY CLASSIFICATION OF THIS PAGE (When Data Entered)

REPORT DOCUMENTATION PAGE		READ INSTRUCTIONS BEFORE COMPLETING FORM
1. REPORT NUMBER	2. GOVT ACCESSION NO. AD-A090 937	3. RECIPIENT'S CATALOG NUMBER
4. TITLE (and Subtitle) Phase I Inspection Report Warrer Dam-Chautauqua Lake Outlet Allegheny River Basin, Chautauqua County, New York Inventory No. 750		5. TYPE OF REPORT & PERIOD COVERED Phase I Inspection Report National Dam Safety Program
7. AUTHOR(s) Bent L. Thomsen  Gary L. Wood		6. PERFORMING ORG. REPORT NUMBER
9. PERFORMING ORGANIZATION NAME AND ADDRESS Thomsen Associates 105 Corona Avenue Groton, NY 13073		8. CONTRACT OR GRANT NUMBER(s)  ✓ DACW-51-79-C-0001
11. CONTROLLING OFFICE NAME AND ADDRESS New York State Department of Environmental Conservation 50 Wolf Road Albany, NY 12233		10. PROGRAM ELEMENT, PROJECT, TASK AREA & WORK UNIT NUMBERS
14. MONITORING AGENCY NAME & ADDRESS (if different from Controlling Office) Department of the Army 26 Federal Plaza New York District, CofE New York, NY 10287		12. REPORT DATE 30 September 1980
		13. NUMBER OF PAGES
		15. SECURITY CLASS. (of this report)  UNCLASSIFIED
		15a. DECLASSIFICATION/DOWNGRADING SCHEDULE
16. DISTRIBUTION STATEMENT (of this Report)  Approved for public release; Distribution unlimited.		
17. DISTRIBUTION STATEMENT (of the abstract entered in Block 20, if different from Report)		
18. SUPPLEMENTARY NOTES  THIS DOCUMENT IS BEST QUALITY PRACTICABLE. THE COPY FURNISHED TO DDC CONTAINED A SIGNIFICANT NUMBER OF PAGES WHICH DO NOT REPRODUCE LEGIBLY.		
19. KEY WORDS (Continue on reverse side if necessary and identify by block number) Dam Safety National Dam Safety Program Visual Inspection Hydrology, Structural Stability		
Chadakoin River Warner Dam Chautauqua Lake Chautauqua County Allegheny River		
20. ABSTRACT (Continue on reverse side if necessary and identify by block number)  This report provides information and analysis on the physical condition of the dam as of the report date. Information and analysis are based on visual inspection of the dam by the performing organization.  Examination of available documents and a visual inspection of the dam did not reveal conditions which constitute an immediate hazard to human life or property. However, the dam has some		

AD A 090937

DDC FILE COPY

DTIC  
ELEMENT  
OCT 30 1980  
A

393970

deficiencies which require further investigation and remedial action.

Using the Corps of Engineers screening criteria for review of spillway adequacy, it has been determined that the dam would be overtopped for all storms exceeding approximately 75 percent of the PMF. The spillway is, therefore, considered to be "inadequate".

A review of the structural stability analysis performed by the designer indicated calculated safety factors against sliding to be less than recommended minimum value. A more detailed analysis which was performed as a part of this Phase I investigation produces a similar conclusion.

Therefore, it is recommended that within 6 months of notification to the owner a detailed field investigation and monitoring program be undertaken to determine the actual hydrostatic uplift pressures along the base of the dam and that further detailed structural stability analyses be performed using this information.

A warning system and evacuation plan should be developed and implemented within 3 months of notification to the owner.

In addition, the maintenance program which presently exists should be communicated to the dam operator for implementation within 3 months of notification to the owner.

Debris should be removed from the upstream face of the dam as part of the routine maintenance program.

Finally, leakage along the south side of the south tainter gate should be monitored on a daily basis with these observations documented in the dam operator's log book.

6 ALLEGHENY RIVER BASIN  
National Dam Safety Program  
WARNER DAM,  
CHAUTAUQUA LAKE OUTLET  
(Inventory Number NY-750) ←  
CHAUTAUQUA COUNTY, NEW YORK.  
INVENTORY NUMBER 750  
PHASE I INSPECTION REPORT.  
NATIONAL DAM SAFETY PROGRAM



10) Brent L. Thomsen  
Gary L. Wood

Prepared by  
THOMSEN ASSOCIATES  
105 CORONA AVE. GROTON, N.Y.

11) 14 Sep 80  
12) 163

Prepared for  
DEPARTMENT OF THE ARMY  
NEW YORK DISTRICT, CORPS OF ENGINEERS  
NEW YORK, NEW YORK

SEPTEMBER 1980

15) DACW 51-79-C-4441

APPROVED FOR PUBLIC RELEASE;  
DISTRIBUTION UNLIMITED  
CONTRACT NO. DACW-51-79-0001

392971 80 10 29 015

## **DISCLAIMER NOTICE**

**THIS DOCUMENT IS BEST QUALITY PRACTICABLE. THE COPY FURNISHED TO DTIC CONTAINED A SIGNIFICANT NUMBER OF PAGES WHICH DO NOT REPRODUCE LEGIBLY.**

PREFACE

This report is prepared under guidance contained in the Recommended Guidelines for Safety Inspection of Dams, for Phase I Investigations. Copies of these guidelines may be obtained from the Office of Chief of Engineers, Washington, D.C. 20314. The purpose of a Phase I Investigation is to identify expeditiously those dams which may pose hazards to human life or property. The assessment of the general condition of the dam is based upon available data and visual inspections. Detailed investigation, and analyses involving topographic mapping, subsurface investigations, testing, and detailed computational evaluations are beyond the scope of a Phase I Investigation; however, the investigation is intended to identify any need for such studies.

In reviewing this report, it should be realized that the reported condition of the dam is based on observations of field conditions at the time of inspection along with data available to the inspection team. In cases where the reservoir was lowered or drained prior to inspection, such action, while improving the stability and safety of the dam, removes the normal load on the structure and may obscure certain conditions which might otherwise be detectable if inspected under the normal operating environment of the structure.

It is important to note that the condition of a dam depends on numerous and constantly changing internal and external conditions, and is evolutionary in nature. It would be incorrect to assume that the present condition of the dam will continue to represent the condition of the dam at some point in the future. Only through frequent inspections can unsafe conditions be detected and only through continued care and maintenance can these conditions be prevented or corrected.

Phase I inspections are not intended to provide detailed hydrologic and hydraulic analyses. In accordance with the established Guidelines, the Spillway Test flood is based on the estimated "Probable Maximum Flood" for the region (greatest reasonably possible storm runoff), or fractions thereof. Because of the magnitude and rarity of such a storm event, a finding that a spillway will not pass the test flood should not be interpreted as necessarily posing a highly inadequate condition. The test flood provides a measure of relative spillway capacity and serves as an aide in determining the need for more detailed hydrologic and hydraulic studies, considering the size of the dam, its general condition and the downstream damage potential.

1. Distribution/Availability Codes	
Dist	Special
A	23

PHASE I INSPECTION REPORT  
NATIONAL DAM SAFETY PROGRAM  
WARNER DAM  
I.D. NO. N.Y. 750  
ALLEGHENY RIVER BASIN  
CHAUTAUQUA COUNTY, NEW YORK

TABLE OF CONTENTS

	<u>Page No.</u>
- ASSESSMENT	
- OVERVIEW PHOTOGRAPH	
1 PROJECT INFORMATION	1
1.1 GENERAL	1
1.2 DESCRIPTION OF PROJECT	1
1.3 PERTINENT DATA	3
2 ENGINEERING DATA	6
2.1 GEOTECHNICAL DATA	6
2.2 DESIGN RECORDS	7
2.3 CONSTRUCTION RECORDS	7
2.4 OPERATION RECORDS	7
2.5 EVALUATION OF DATA	8
3 VISUAL INSPECTION	9
3.1 FINDINGS	9
3.2 EVALUATION	10
4 OPERATION AND MAINTENANCE PROCEDURES	11
4.1 PROCEDURE	11
4.2 MAINTENANCE OF DAM	12
4.3 WARNING SYSTEM IN EFFECT	12
4.4 EVALUATION	12
5 HYDROLOGIC/HYDRAULIC	13
5.1 DRAINAGE AREA CHARACTERISTICS	13
5.2 ANALYSIS CRITERIA	13
5.3 SPILLWAY CAPACITY	14
5.4 RESERVOIR CAPACITY	15
5.5 FLOODS OF RECORD	15
5.6 OVERTOPPING POTENTIAL	15
5.7 EVALUATION	16



	<u>Page No.</u>
6 STRUCTURAL STABILITY	17
6.1 EVALUATION OF STRUCTURE	17
7 ASSESSMENT/RECOMMENDATIONS	20
7.1 ASSESSMENT	20
7.2 RECOMMENDED REMEDIAL MEASURE	21

APPENDICES

Appendix A - Photographs

Appendix B - Visual Inspection Checklist

Appendix C - Hydrologic/Hydraulic Engineering Data and Computations

Appendix D - Structural Stability Analyses

Appendix E - Operation Plans

Appendix F - Available Documents

Appendix G - Drawings

PHASE I INSPECTION REPORT  
NATIONAL DAM SAFETY PROGRAM

NAME OF DAM: Warner Dam-Chautauqua Lake Outlet  
Inventory No. N.Y. 750

STATE LOCATED: New York

COUNTY: Chautauqua

WATERSHED: Allegheny River

STREAM: Chadakoin River

DATE OF INSPECTION: May 21, 1980  
See Vicinity Map and Topographic Map  
Appendix G

ASSESSMENT

Examination of available documents and a visual inspection of the dam did not reveal conditions which constitute an immediate hazard to human life or property. However, the dam has some deficiencies which require further investigation and remedial action.

Using the Corps of Engineers screening criteria for review of spillway adequacy, it has been determined that the dam would be overtopped for all storms exceeding approximately 75 percent of the PMF. The spillway is, therefore, considered to be "inadequate".

A review of the structural stability analysis performed by the designer indicated calculated safety factors against sliding to be less than recommended minimum value. A more detailed analysis which was performed as a part of this Phase I investigation produces a similar conclusion.

Therefore, it is recommended that within 6 months of notification to the owner a detailed field investigation and monitoring program be undertaken to determine the actual hydrostatic uplift pressures along the base of the dam and that further detailed structural stability analyses be performed using this information.

A warning system and evacuation plan should be developed and implemented within 3 months of notification to the owner.

In addition, the maintenance program which presently exists should be communicated to the dam operator for implementation within 3 months of notification to the owner.

Debris should be removed from the upstream face of the dam as part of the routine maintenance program.

Finally, leakage along the south side of the south tainter gate should be monitored on a daily basis with these observations documented in the dam operator's log book.

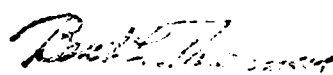
  
Bent L. Thomsen, P. E.  
Thomsen Associates  
N. Y. License #40553

  
Gary C. Wood, P. E.  
Thomsen Associates  
N. Y. License #44504

APPROVED BY:

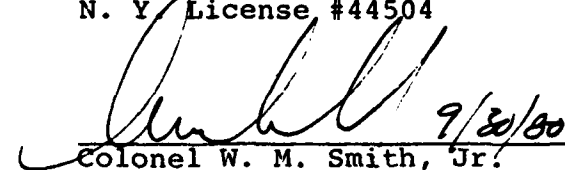
  
Colonel W. M. Smith, Jr.  
New York District Engineer



View of Downstream  
face of Dam.

PHASE I INSPECTION REPORT  
NATIONAL DAM SAFETY PROGRAM  
WARNER DAM  
I.D. NO. N.Y. 750  
ALLEGHENY RIVER BASIN  
CHAUTAUQUA COUNTY, NEW YORK

SECTION 1: PROJECT INFORMATION

1.1 GENERAL

a. Authority

This Phase I Inspection Report was authorized by the New York State Department of Environmental Conservation by Contract No. D-201458. This study was performed in accordance with the terms of the above contract and the Recommended Guidelines for Safety Inspection of Dams prepared by the Department of Army, Office of the Chief of Engineers to fulfill the requirements of the National Dam Inspection Act, Public Law 92-327.

b. Purpose of Inspection

This inspection was conducted to obtain available data concerning design and construction of the dam, to evaluate that data, to visually inspect existing conditions at the dam, to identify and evaluate deficiencies and/or hazardous conditions which, if present, may threaten life and property of the residents downstream of the dam and to recommend remedial measures to mitigate such deficiencies and hazardous conditions.

1.2 DESCRIPTION OF PROJECT

a. Description of Dam

The Warner Dam is a reinforced concrete gravity dam with three (3) tainter gates having a total clear span of 80 feet.

The dam is located approximately 60 feet downstream of a former concrete gravity dam having the same structural elevations and hydraulic capacity of the new dam. The existing dam was intended by the designer to be a

"replacement in kind" type of project of the former concrete dam.

Control of underseepage and potential scour downstream of the dam is provided by steel sheet piling.

b. Location

The Warner Dam is located in the city of Jamestown, New York on the Chadakoin River approximately 3.3 miles downstream of Chautauqua Lake and about 700 feet upstream from the Main Street Bridge.

c. Size Classification

The dam has a maximum height of 11.5 feet above the stream bed at elevation 1300.0. However, this structure regulates the level of Chautauqua Lake, with its enormous storage capacity of 236,000 acre-feet between the stream bed and the top of the dam, and, therefore, is assigned the large size classification.

d. Hazard Classification

The dam is classified a high hazard structure due to the number of homes, businesses and bridges along the downstream channel.

e. Ownership

The dam is owned by the New York State Department of Environmental Conservation and operated by the city of Jamestown, Board of Public Utilities. Mr. Arthur Olsen, dam operator and superintendent of the city-owned electrical generating plant was contacted as part of the Phase I Inspection. Mr. Olsen's address is Board of Public Utilities, City of Jamestown, New York, 14701 and his telephone is 716-661-2309.

f. Purpose of Dam

The primary purpose of the dam is to maintain the level of Chautauqua Lake for recreational and fishery resources during low flow periods of the year, while ensuring that

minimum release (discharge) objectives are met for the Chadakoin River to satisfy water quality management.

g. Design and Construction History

In 1976 a report was prepared by Konski Engineers of Syracuse, New York entitled "Inspection and Analysis, Warner Dam, Jamestown, N.Y." which evaluated the condition of the former concrete gravity dam constructed in 1919. Based on the finding of that report, it was decided to replace the old concrete dam.

The firm of Erdman, Anthony, Associates was retained by the New York State Department of Environment Conservation to furnish professional services for assessing the environmental impact of replacing the old dam, and preparing detailed design documents and construction supervision of the new dam.

The dam was constructed primarily in 1979 by Herbert F. Darling, Contractors of Williamsville, New York and was placed in operation on October 11, 1979.

h. Normal Operation Procedure

In order to meet the objectives of the dams purpose an operation plan was developed by the New York State Department of Environmental Conservation. Included in Appendix E are two figures (No. 1 & No. 2) which depict the original operation plan for the dam. This operation plan has since been modified according to the operator and the present objective as of May 21, 1980 is shown on Figure No. 3 of Appendix E.

1.3

PERTINENT DATA

a. Drainage Area

187.2 sq.mi.

b. Discharge at Damsite (cfs)

Total spillway capacity at maximum pool elevation 6629

c. Elevation (ft. above MSL)

Steamed at centerline of dam and spillway crest 1300.00

Chautauqua Lake summer pool (also pool at dam) 1308.25

Top of dam and maximum design pool 1311.50

d. Storage (acre-feet) (Based on Corps of Engineers study in 1965)

Chautauqua Lake at spillway crest  
(Elevation 1300.0 ) 205,000

Chautauqua Lake summer pool  
(Elevation 1308.25) 305,000

Chautauqua Lake at flood pool  
(Elevation 1310.00) 325,000

Chautauqua Lake at Elevation 1317.32 441,000  
(This corresponds to top of dam Elev.1311.5)

e. Reservoir Surface (acres)  
(Based on Corps of Engineers Study - 1965)

Spillway crest (Elev. 1300.0) 8050

Design high water (Elev. 1310.0) 15,500

Top of dam (Elev. 1311.5) 15,750

f. Dam

Type: Concrete gravity - Tainter Gate Dam

Length: (ft.) 96.0

Height: (ft.) 11.5

Top Width: (ft.) 9.0

Cutoff: Steel Sheet Piling

Grout Curtain: None

g. Spillway

Length of Weir: 80 ft.

Crest Elevation: 1300.0

Gates: 3-Tainter Gates 26'8" each in width



The data referred to above and in Section 5 which was obtained from the following publication of the Corps of Engineers:

"Lake Chautauqua and Chadakoin River, Jamestown, New York, Local Flood Protection, General Design Memorandum, Vol. II - Appendices", U. S. Army Engineer District - Pittsburgh, Corps of Engineers, dated March 1965.

## SECTION 2: ENGINEERING DATA

### 2.1 GEOTECHNICAL DATA

#### a. General Geology

The dam on the Chautauqua Lake outlet (Chadakoin River) is located at the south end of Chautauqua Lake in Jamestown, New York.

This area lies within the Appalachian Uplands physiographic province, characterized by steep-sloped hills rising to elevations of 1600 feet or more and isolated by narrow ravine-like valleys.

Bedrock in the region consists of Upper Devonian shales, siltstones and sandstones which have been uplifted and dissected, but are essentially flat-lying. No active faults are known in the area. The city of Jamestown is situated in a region classified as Zone 3 seismicity, as shown on Figure No. 1 of the Recommended Guidelines for Safety Inspection of Dams.

The southwestern portion of New York State was the scene of repeated advances and recessions of continental ice during the Wisconsin Stage of the Pleistocene; glacial till deposits on uplands in the Jamestown vicinity represent the terminal moraine of one such advance. Lowlands comprise part of the Chautauqua Lake basin and the lake itself is the remnant of a larger body created when ice dammed the outlet. Following final ice retreat, present and former meltwater channels were filled with granular outwash material deposited by streams emanating from the downwasting glacier.

#### b. Subsurface Conditions

The subsurface material reportedly encountered at the dam site is composed of some 15 feet of random man-placed fill underlain by a dense sand and gravel. The bedrock surface is on the order of 140 feet deep based on water well logs from the surrounding area.

2.2 DESIGN RECORDS

The dam was designed by Erdman, Anthony, Associates of Rochester, New York who prepared a "Environmental Assessment, Warner Dam Replacement, City of Jamestown, New York" as well as structural stability analysis, engineering drawings and contract specification for the construction. Appendix F contains the above referenced report while selected engineering drawings are included in Appendix G. The structural stability analysis performed by the designer is contained in Appendix D. According to the designer, no formal hydrologic analysis was performed. Hydraulic analysis of the tainter gate capacity was performed, the results of which are contained as gate rating curves in Appendix C.

2.3 CONSTRUCTION RECORDS

Construction supervision was provided by both Erdman, Anthony, Associates and New York State Department of Environment Conservation, (NYSDEC). Extensive construction documentation is available in the files of NYSDEC, at 50 Wolf Road, Albany, New York. A Mr. Russell Wege of NYSDEC maintains the construction records and was contacted for certain information as part of the Phase I Inspection.

2.4 OPERATION RECORDS

Detailed operation records are maintained by Mr. Arthur Olsen of the Board of Public Utilities in Jamestown, New York. These records include, at the least, a daily observation of the stage: (lake level) at the U.S.G.S. Gauging Station at Bemus Point, New York, and recording of the pool elevation just upstream of the dam from a staff gauge. In addition, flow or discharge is obtained from the U.S.G.S. Gauging Station at Dow Street in the village of Falconer which is downstream of the dam, as well as which gate(s) is in operation and the total height of the gate(s) opening.

2.5

EVALUATION OF DATA

The data presented in this report has been compiled from information obtained from the city of Jamestown, the files of the New York State Department of Environmental Conservation, the Corps of Engineers office in Pittsburgh, Pennsylvania and the designer, Erdman, Anthony, Associates. The data reviewed is considered adequate and reliable.

## SECTION 3: VISUAL INSPECTION

### 3.1 FINDINGS

#### a. General

A visual inspection of the dam was conducted on May 21, 1980. The weather at the time of the inspection was cloudy and rainy. The pool elevation upstream of the dam was 1307.41 with the tailwater at elevation 1300.1.

#### b. Dam

On the date of inspection only the middle tainter gate was in operation and discharging an estimated 240 cfs. The dam appeared to be in excellent condition. All concrete surfaces were in excellent condition, all mechanical parts appeared to be well lubricated and all gates were operated using the primary electrically driven motors.

No evidence of misalignment, structural cracking or seepage were detected. A slight amount of leakage was occurring along the south side of the southerly most tainter gate.

Debris had accumulated along the upstream face of the dam.

#### c. River Channel

The river banks for a distance of about 40 feet upstream of the dam are reinforced with an anchored bulkhead using steel sheet piling as the bulkhead wall and deadman. Upstream of the sheet piling the river bank is reinforced with the concrete abutments from the former concrete gravity dam. The concrete abutments were refaced and recapped. This concrete section ends approximately 135 feet upstream of the dam.

Downstream of the dam the anchored bulkhead system is utilized for erosion protection and river bank stabilization for a distance of 25 feet along the north bank to 50 feet along the south bank.

Downstream of the anchored bulkhead section, the north river bank is reinforced with a masonry wall for a distance of about 140 feet. This wall although, deteriorated, appeared to be stable.

Downstream of the anchored bulkhead along the south river bank, the bank has been provided with a laid-up stone protection (or stone paving) on a slope of about 2 horizontal to 1 vertical. This stone paving extends downstream, beyond the bulkhead, a distance of about 50 feet.

Some 700 feet downstream of the dam is the first structure which crosses the river. The structure, the Main Street Bridge is masonry stone arch bridge. Water passes through the two arches which span the river and based on the size of the arches, the structure would significantly constrict the flow during periods of large discharge.

### 3.2

#### EVALUATION

The visual inspection of this dam revealed that a slight amount of debris has collected along the upstream face of the dam.

Also, the dam operator had not been instructed on how to operate the tainter gates using the mechanical back-up system.

Finally, leakage was occurring along the seal between the concrete abutment and the south tainter gate.

## SECTION 4: OPERATION AND MAINTENANCE PROCEDURE

### 4.1 PROCEDURE

The normal upstream pool and Chautauqua Lake level are controlled by the operation of the gates for this dam. Downstream flow, likewise is limited by the flow over the spillway. At low flow, the elevation of the pool just upstream of the dam matches that of Chautauqua Lake. However, due to head loss in the channel between the outlet of Chautauqua Lake and the dam, the elevation between Chautauqua Lake and the pool upstream of the dam varies depending on the discharge through the tainter gates. Based on historical records of the former dam the relationships were established for lake levels up to elevation 1310.0.

All gates are exercised regularly on a random basis. The dam operator maintains detailed records of which gate(s) is in use and the corresponding discharge.

All gates are operated with individually controlled electrically driven motors and each gate has a mechanical back-up system. The mechanical system has a gear reduction ratio of 2000:1 and can be operated using a battery powered hand drill.

The initial operation plan for this dam required a minimum release (discharge) rate of 60 cfs for the summer-fall period and 40 cfs for the winter-spring season. In addition, it was determined in the Chautauqua Lake-Chadakoin River Regulation Plan as prepared by the NYSDEC, that the water needs for the Jamestown Municipal Power Plant (located upstream of the dam) could be satisfied by maintaining the 60 cfs flow during the summer months.

4.2 MAINTENANCE OF DAM

The responsibility for maintaining the dam is, as near as can be determined, the city of Jamestown. Since the dam went into service in the fall of 1979 no maintenance as yet has taken place.

A formal maintenance program exists for this structure and is contained in the Operation Plan prepared by the NYSDEC. However, the dam operator was not aware of any maintenance program at the time of this investigation.

4.3 WARNING SYSTEM IN EFFECT

There is no warning system or evacuation plan in effect. The dam is closely monitored and the gates operated in accordance with the current operation plan during periods of heavy runoff.

4.4 EVACUATION

The operation procedure for this structure is satisfactory for periods when electrical power is available to operate the gates. However, provisions should be made to have the dam operator(s) knowledgeable in the operation of the gates when electrical power outages occur. In addition, the dam operator should be made aware of the existing maintenance program and this program should be implemented to ensure proper operation of all mechanical and electrical systems.



## SECTION 5: HYDROLOGY/HYDRAULIC

### 5.1 DRAINAGE AREA CHARACTERISTICS

The Chautauqua Lake/Chadekoin River Basin in which the dam is located is situated in the southwestern portion of New York State and is a tributary to the Allegheny River in the Ohio River Basin. The entire drainage area encompasses an area of 187.2 square miles. Of this total, the lake area is 20.6 square miles, while the surrounding land area contains 166.6 square miles.

Lake Chautauqua extends in a northwest, southeast direction for the majority of its 18 mile drainage basin length. Tributary inflow results from numerous small streams that range from 3 to 8 miles in length which enter around the lake periphery. The lake outflow occurs at its southeastern extremity and is controlled by Warner Dam located approximately 3.3 miles downstream on the Chadakoin River.

The area within the Lake Chautauqua Basin consists of rounded intervalley ridges that rise gradually from graded valley floors. The local ground relief varies from approximately 200 to 400 feet, maximum relief is only about 550 feet between the normal level of the lake, elevation 1308 and the western basin divide in the Goose Creek Headwaters, where an elevation of 1863 feet above sea level is attained.

### 5.2 ANALYSIS CRITERIA

The hydrologic analysis of this dam was performed using the Corps of Engineers HEC-1 computer program, Dam Safety Version. The spillway design flood selected for analysis was the PMF in accordance with the Recommended Guidelines of the U. S. Army Corps of Engineers.

A synthetic 6 hour unit hydrograph developed by U. S. Army Corps of Engineers, Pittsburgh District was used to compute the Probable Maximum Flood (PMF) hydrograph. The PMF

hydrograph was then routed through Chautauqua Lake and Warner Dam by the "Modified Puls" flood routing procedure to obtain the outflow hydrograph. It was assumed that all three tainter gates will be fully opened when the lake level exceeds elevation 1310.0.

### 5.3 SPILLWAY CAPACITY

The Warner Dam spillway structure consists of three (3) tainter gates, each being identical in size and each having a length of 26'-8" for a total spillway length of 80 feet. The elevation of the sill of the tainter gates is at 1300. The elevation of the top of the upstream wall on both ends of the dam is at 1311.5.

The spillway discharge rate is closely regulated for lake elevations under 1310.0. The maximum release rates at such elevations were taken from the Chautauqua Lake Maximum Release Rate Curve for Warner Dam. At lake elevations above 1310.0 all three gates are assumed to be fully opened and the corresponding spillway discharges were computed as weir flow with a discharge coefficient of 3.4. The discharges were adjusted to consider the effect of the submergence of the crest due to high tailwater elevation.

The spillways do not have sufficient capacity for discharging the peak outflow for the PMF but will pass one-half the PMF. For the PMF, the peak inflow is 190,189 cfs and the peak outflow is 8,740 cfs. For one-half the PMF, the peak inflow is 95,094 cfs and the peak outflow is 4,164 cfs. The computed spillway capacity for a water surface elevation at the top of the dam (elevation 1311.5) is 6,629 cfs.

We note, the Pittsburgh District Corps of Engineer computed the inflow and outflow for the Probable Maximum Precipitation. Their results indicate an inflow of 160,000 cfs and an outflow of 9700 cfs which reasonably matches the results obtained from our analysis. The loss rates

used by the Corps of Engineers was not published in their report of 1965, as these values may account for the difference in the two analyses.

5.4 RESERVOIR CAPACITY

The reservoir at normal pool impounded by this dam lies primarily within the limits of Chautauqua Lake and the existing channel of the Chadakoin River. The stage-storage curve for Chautauqua Lake was developed by the Pittsburgh District Corps of Engineers. The storage capacity of the reservoir at normal pool elevation is 305,000 acre feet. Within the normal range of lake storage, a one-foot change will accomodate about 1.3 inches of basin runoff.

5.5 FLOODS OF RECORD

The maximum elevation for Chautauqua Lake occurred on March 28, 1946 when the lake reached an elevation of 1311.8 above mean sea level. The highest known discharge recorded at the U.S.G.S. Gauging Station in Falconer, approximately 3 miles downstream of Warner Dam, was 2070 cfs on March 5, 1976.

5.6 OVERTOPPING POTENTIAL

The hydrologic analysis indicates that the dam has sufficient spillway capacity to discharge one-half the PMF, but does not have sufficient capacity to discharge the full PMF. For the PMF peak outflow of 8740 cfs the wall on both ends of the dam would be overtopped. For the peak outflow from one-half the PMF, the computed water surface elevation would be 2.45 feet below the elevation of the top of the dam. The dam would be overtopped by all storm events exceeding 75% of PMF. The elevation of the water surface can not be evaluated for discharges in excess of 75% of the PMF because the channel walls are overtopped.

5.7

EVALUATION

The spillway capacity of this structure is sufficient to discharge 75 percent of the PMF and is, therefore, judged to be inadequate.

## SECTION 6: STRUCTURAL STABILITY

### 6.1 EVALUATION OF STRUCTURE

#### a. Visual Observations

The dam and reinforced river banks both upstream and downstream of the dam appeared to be in excellent condition with no sign of instability.

#### b. Design and Construction Data

The firm of Erdman, Anthony, Associates provided the structural stability analysis performed as part of the design phase for this structure. The structural stability analysis considered both static and seismic loading conditions (inertial force only) with the upstream pool at elevation 1311.0 and the downstream pool at elevation 1297.0. This structural stability analysis indicated adequate safety factors against overturning for both static and seismic loading conditions. However, the computed sliding safety factors of 1.56 for static loads and 1.38 for static and seismic loads combined are both below the recommended minimum value of 3.0 and 1.5, respectively. Furthermore, this analysis was based on the assumption that the sheet piling below the dam is 100 percent effective in reducing hydrostatic uplift. Conversely, shear resistance along the abutments was not taken in account.

Since this design analysis indicated safety factors against sliding below the recommended minimum, a more detailed structural stability analysis was performed as part of this Phase I inspection.

The original design analysis followed by our critique thereof; along with the additional stability analysis which were performed in conjunction with this inspection, are all included in Appendix D. Our analysis considered only those loading conditions for normal winter pool conditions. A structural stability analysis at 1/2 PMF or PMF is not considered appropriate as all tainter gates

would be open and the forces on the dam would be less than with the gates closed, as is the case in our analysis. Our analysis indicates that under the condition of maximum ice load the structure is stable, however, the factor of safety against sliding is 2.30 which is below the minimum recommended value of 3.0.

The sliding resistance computed assumed no shear resistance due to the embedded sheet piling as this would only be mobilized when the dam moves, which is considered failure. In addition, the analysis assumed the sheet piling below the spillway dam is completely ineffective and, therefore, full hydrostatic uplift pressure is applied along the upstream face with the typical triangular distribution to the downstream tailwater elevation.

An effective sheet pile cut-off wall would significantly reduce the hydrostatic uplift pressures along the base of the dam as can be demonstrated readily through construction of a flow net. However, although this approach is valid in designing a dam, it is not rational in our opinion for a study of this nature to make an assumption regarding its effectiveness unless it can be so determined through actual field data.

Therefore, we recommend piezometers be installed and monitored to determine the actual magnitude and distribution of the hydrostatic uplift pressures below the dam and additional structural stability analysis be performed.

#### c. Seismic Stability

The designer's seismic stability analysis was based on criteria not presently recommended for a structure in Seismic Zone 3. For this reason a seismic structural stability analysis was performed as part of the Phase I inspection. Our analysis was performed using the Zanger

hydrodynamic pressure distribution which is similar to the Westergaard distribution recommended by the Corps of Engineers guidelines. Our analysis indicates adequate safety factors against sliding and overturning for the combined seismic and static loads analyzed.

## SECTION 7: ASSESSMENT/RECOMMENDATIONS

### 7.1 ASSESSMENT

#### a. Safety

The Phase I Inspection of the Warner Dam did not reveal conditions which constitute an immediate hazard to human life and property of the downstream residents.

From the available data the total spillway capacity is capable of discharging 75 percent of the PMF without flow overtopping the upstream reinforced river banks. This spillway is, therefore, judged to be inadequate.

The structural stability analysis performed as part of this investigation indicates the dam has safety factors against sliding under maximum ice loading below that recommended by the Corps of Engineers Guidelines.

Since the designer's structural stability computations performed as part of the design phase indicates safety factors below those recommended and our analysis indicates potential stability problems, we recommend that field investigations and monitoring be performed to determine and monitor hydrostatic uplift pressures during the life of the structure.

#### b. Adequacy of Information

The information reviewed for this Phase I inspection is considered adequate.

#### c. Need for Additional Investigation

As discussed above, the structural stability analysis indicates a potentially unstable condition under maximum ice loading.

Therefore, a field investigation and monitoring program should be initiated within 6 months from the time of notification to the owner to determine the actual magnitude and distribution of hydrostatic uplift pressures at



the base of the dam. From the results of this investigation, a detailed structural stability analysis should be performed.

7.2 RECOMMENDED REMEDIAL MEASURE

- 1) The revised stability analyses should be performed within three months after installation of the piezometers and whatever corrective measures may be dictated by the results initiated as soon as practical thereafter.
- 2) Develop and implement within 3 months, a warning system, and an evacuation plan for downstream residents in the event of large discharge. In addition, the dam operator should be provided with thorough instruction and the necessary equipment for operation of the mechanical tainter gate hoisting system.
- 3) The responsibility for providing routine and preventive maintenance should be clearly established and the appropriate parties notified and the maintenance program implemented within 3 months.
- 4) Remove debris from the upstream face of the dam within 3 months.
- 5) Leakage through the seal along the south tainter gate should be monitored on a daily basis and documented in the daily log book maintained by the dam operator so that it can be corrected if it becomes worse.

APPENDIX A

PHOTOGRAPHS



View of retaining structures along north side of upstream channel. (Note concrete in center is part of old masonry dam)



Continuation of photo above. View of upstream face of dam.



View of downstream face of dam



Continuation of photo  
above. View of downstream  
face of dam.



View of downstream channel  
from dam.



View of pin pedestal and  
attachment of tainter gate  
arm to concrete pier.



View of electric motor,  
control panel and covered  
drive shaft for controlling  
tainter gate.

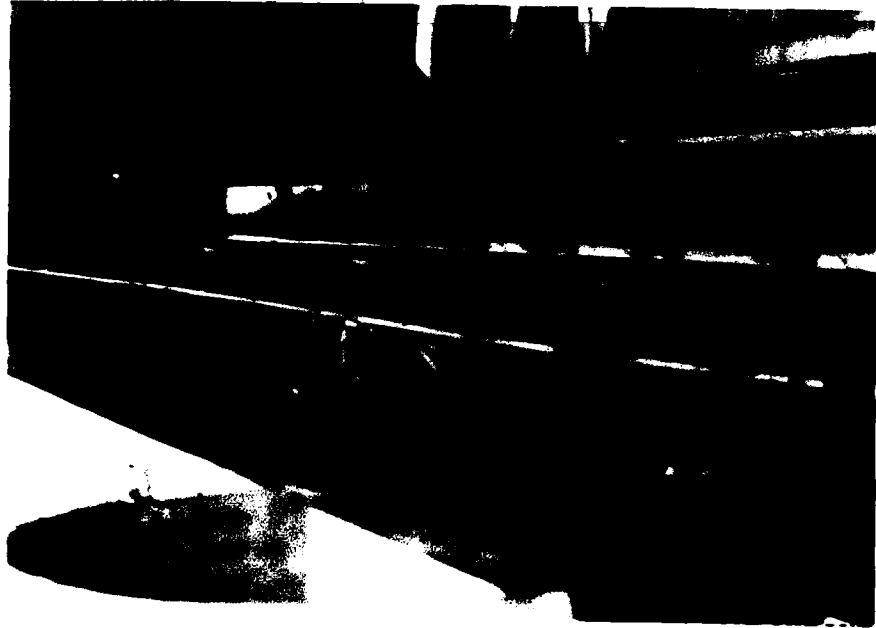

View of trash behind (up-  
stream side) tainter gate.

IST

**APPENDIX B**

**VISUAL INSPECTION CHECKLIST**

**THOMSEN ASSOCIATES**  
CONSULTING GEOTECHNICAL ENGINEERS & GEOLOGISTS

VISUAL INSPECTION CHECKLIST

1) Basic Data

a. General

Name of Dam Werner Dam (Christy, 1974)  
I.D. # 92-164 DEC. Dam No. NY 75  
River Basin Alaska  
Location: Town Theriot County Yukon  
U.S.G.S. Quadrangle Theriot  
Stream Name Chadka River (Christy)  
Tributary of Alaska River  
Latitude (N) 42° 25' Longitude (W) 79° 14'  
Type of Dam Concrete Gravity Dam  
Hazard Category C  
Date(s) of Inspection 5/2/79  
Weather Conditions Clear  
Reservoir Level at Time of Inspection 1000 ft  
Tailwater Level at Time of Inspection 1300 ft

b. Inspection Personnel Herbert F. Lashless - Thomsen Associates  
Charles E. Hain - Thomsen Associates

c. Persons Contacted (Including Address & Phone No.)  
State Dept. - Bureau of Reclamation - Dam Division, Bureau of  
Public Utilities, Anchorage, Alaska, N/14721 Telephone # 716-32  
2309

d. History:  
Date Constructed 1974-1979 Date(s) Reconstructed \_\_\_\_\_

Designer Edging & Anderson Associates, Prince Rupert  
Constructed by Herbert F. Lashless (Thomsen Associates)  
Owner NY State Department of Environmental Conservation

e. Seismic Zone Zone 2

**THOMSEN ASSOCIATES**  
CONSULTING GEOTECHNICAL ENGINEERS & GEOLOGISTS

VISUAL INSPECTION CHECKLIST

2) Embankment

a. Characteristics

1) Embankment Material Not Applicable

2) Cutoff Type \_\_\_\_\_

3) Impervious Core \_\_\_\_\_

4) Internal Drainage System \_\_\_\_\_

5) Miscellaneous \_\_\_\_\_

b. Crest

1) Vertical Alignment Good

2) Horizontal Alignment Good

3) Surface Cracks None

4) Miscellaneous \_\_\_\_\_

c. Upstream Slope

1) Slope (Estimate) (V:H) N.A.

2) Undesirable Growth or Debris, Animal Burrows \_\_\_\_\_

3) Sloughing, Subsidence or Depressions \_\_\_\_\_



**THOMSEN ASSOCIATES**  
CONSULTING GEOTECHNICAL ENGINEERS & GEOLOGISTS

VISUAL INSPECTION CHECKLIST

4) Slope Protection \_\_\_\_\_  
\_\_\_\_\_  
\_\_\_\_\_

5) Surface Cracks or Movement at Toe \_\_\_\_\_  
\_\_\_\_\_

d. Downstream Slope

1) Slope (Estimate - V:H) N.A. \_\_\_\_\_

2) Undesirable Growth or Debris, Animal Burrows \_\_\_\_\_  
\_\_\_\_\_

3) Sloughing, Subsidence or Depressions \_\_\_\_\_  
\_\_\_\_\_  
\_\_\_\_\_

4) Surface Cracks or Movement at Toe \_\_\_\_\_  
\_\_\_\_\_

5) Seepage \_\_\_\_\_  
\_\_\_\_\_  
\_\_\_\_\_

6) External Drainage System (Ditches, Trenches; Blanket) \_\_\_\_\_  
\_\_\_\_\_  
\_\_\_\_\_

7) Condition Around Outlet Structure \_\_\_\_\_  
\_\_\_\_\_

8) Seepage Beyond Toe \_\_\_\_\_  
\_\_\_\_\_

e. Abutments-Embankment Contact

N.A. \_\_\_\_\_  
\_\_\_\_\_

**THOMSEN ASSOCIATES**  
CONSULTING GEOTECHNICAL ENGINEERS & GEOLOGISTS

VISUAL INSPECTION CHECKLIST

1) Erosion at Contact \_\_\_\_\_  
\_\_\_\_\_

2) Seepage Along Contract \_\_\_\_\_  
\_\_\_\_\_  
\_\_\_\_\_  
\_\_\_\_\_

3) Drainage System

a. Description of System None \_\_\_\_\_  
\_\_\_\_\_  
\_\_\_\_\_

b. Condition of System \_\_\_\_\_  
\_\_\_\_\_

c. Discharge from Drainage System \_\_\_\_\_  
\_\_\_\_\_  
\_\_\_\_\_

4) Instrumentation (Monumentation/Surveys, Observation Wells, Weirs, Piezometers, Etc.) Instrumentation & Surveys, Observation Wells, Weirs, Piezometers \_\_\_\_\_  
\_\_\_\_\_  
\_\_\_\_\_  
\_\_\_\_\_  
\_\_\_\_\_  
\_\_\_\_\_  
\_\_\_\_\_  
\_\_\_\_\_

**THOMSEN ASSOCIATES**  
CONSULTING GEOTECHNICAL ENGINEERS & GEOLOGISTS

VISUAL INSPECTION CHECKLIST

- 5) Reservoir Upstream Pool
- a. Slopes Very gentle to nearly level
  - b. Sedimentation None Suspected due to recent construction of this structure
  - c. Unusual Conditions Which Affect Dam Intake Pipe for City Generation Plant upstream of dam requires upstream pool to be maintained at least above Elev. 1306.0
- 6) Area Downstream of Dam
- a. Downstream Hazard (No. of Homes, Highways, etc.) Minor Homes & Businesses along Downstream Channel
  - b. Seepage, Unusual Growth NONE
  - c. Evidence of Movement Beyond Toe of Dam NONE
  - d. Condition of Downstream Channel Good; Bridge downstream of Dam appears to be a constriction.
- 7) Spillway(s) (Including Discharge Conveyance Channel)
- a. General Tombra Gate Dam with 3 Gate <sup>each</sup> 26' 9" wide separated by concrete piers. Gates are electrically linked with a mechanical backup system.
  - b. Condition of Service Spillway Excellent

**THOMSEN ASSOCIATES**  
CONSULTING GEOTECHNICAL ENGINEERS & GEOLOGISTS

VISUAL INSPECTION CHECKLIST

c. Condition of Auxiliary Spillway None  
\_\_\_\_\_  
\_\_\_\_\_

d. Condition of Discharge Conveyance Channel Good. 104  
Bridge Downstream of Structure appears to be a  
restriction in the channel  
\_\_\_\_\_  
\_\_\_\_\_

8) Reservoir Drain/Outlet None  
Type: Pipe \_\_\_\_\_ Conduit \_\_\_\_\_ Other \_\_\_\_\_  
Material: Concrete \_\_\_\_\_ Metal \_\_\_\_\_ Other \_\_\_\_\_  
Size: \_\_\_\_\_ Length \_\_\_\_\_  
Invert Elevations: Entrance \_\_\_\_\_ Exit \_\_\_\_\_  
Physical Condition (Describe): \_\_\_\_\_ Unobservable \_\_\_\_\_  
Material: \_\_\_\_\_  
Joints: \_\_\_\_\_ Alignment \_\_\_\_\_  
Structural Integrity: \_\_\_\_\_  
\_\_\_\_\_  
Hydraulic Capability: \_\_\_\_\_  
\_\_\_\_\_  
Means of Control: Gate \_\_\_\_\_ Valve \_\_\_\_\_ Uncontrolled \_\_\_\_\_  
Operation: Operable \_\_\_\_\_ Inoperable \_\_\_\_\_ Other \_\_\_\_\_  
Present Condition (Describe): \_\_\_\_\_  
\_\_\_\_\_  
\_\_\_\_\_

**Additional Remarks and/or Observations:**  
No Warning System  
Dam is monitored on a nearly continuous basis  
during heavy precipitation  
Daily Routine Operations are maintained by  
Dam Operator  
\_\_\_\_\_  
\_\_\_\_\_  
\_\_\_\_\_

# THOMSEN ASSOCIATES

CONSULTING GEOTECHNICAL ENGINEERS - 1922 L STREET, N.W.

## 9) Structural

a. Concrete Surfaces Excellent

b. Structural Cracking None Observed

c. Movement - Horizontal & Vertical Alignment (Settlement)

None Observed

d. Junctions with Abutments or Embankments

Excellent

e. Drains - Foundation, Joint, Face

None

f. Water Passages, Conduits, Sluices

Down spill is  
the only water passage

g. Seepage or Leakage

Slight amount of leakage  
along south side of South transfer gate

# THOMSEN ASSOCIATES

CONSULTING ENGINEERS AND ARCHITECTS

- h. Joints - Construction, etc. Excellent
- i. Foundation Unobservable
- j. Abutments
- k. Control Gates 3 Tainter Gates each 26'8" wide  
by 11' high. Primary Control - Electric Driven Hoisting  
Secondary Control - Mechanical Driven Hoisting Cables
- l. Approach & Outlet Channels Unobservable
- m. Energy Dissipators (Plunge Pool, etc.) None
- n. Intake Structures NA
- o. Stability Appeared Satisfactory
- p. Miscellaneous All gates operated electrically at  
date of inspection. Back up mechanical  
system not operated as shown operation is  
not consistent with the procedure

APPENDIX C

HYDROLOGIC/HYDRAULIC ENGINEERING  
DATA AND COMPUTATIONS

**THOMSEN ASSOCIATES**  
 CONSULTING GEOTECHNICAL ENGINEERS & GEOLOGISTS

**CHECK LIST FOR DAMS  
 HYDROLOGIC AND HYDRAULIC  
 ENGINEERING DATA**

AREA-CAPACITY DATA:

	<u>Elevation</u> (ft.)	<u>Surface Area</u> (acres)	<u>Storage Capacity</u> (acre-ft.)
1) Top of Dam	<u>1311.5</u>	<u>15,750</u>	<u>441,000</u>
2) Design High Water (Max. Design Pool)	<u>1310.0*</u>	<u>15,500</u>	<u>412,000</u>
3) Auxiliary Spillway Crest	<u>N.A.</u>	<u>—————→</u>	<u>—————</u>
4) Pool Level with Flashboards	<u>N.A.</u>	<u>—————→</u>	<u>—————</u>
5) Service Spillway Crest	<u>1300.0</u>	<u>20,000</u>	<u>200,000</u>

\* Maximum Design Elevation of Chautauque Lake

DISCHARGES

	<u>Volume</u> (cfs)
1) Average Daily	<u>343*</u>
2) Spillway @ Maximum High Water (Top of Dam)	<u>6600?</u>
3) Spillway @ Design High Water (Elev. 1310.0)	<u>233?</u>
4) Spillway @ Auxiliary Spillway Crest Elevation	<u>N.A.</u>
5) Low Level Outlet	<u>N.A.</u>
6) Total (of all facilities) @ Maximum High Water	<u>6600?</u>
7) Maximum Known Flood	<u>2070*</u>

March 5, 1976

\* - Based on Records of the USGS Gauging Station at Falconer, N.Y. from 1935 to 1976 for Chautauque River flows



**THOMSEN ASSOCIATES**  
CONSULTING GEOTECHNICAL ENGINEERS & GEOLOGISTS

OUTLET STRUCTURES/EMERGENCY DRAWDOWN FACILITIES: NONE

Type: Gate \_\_\_\_\_ Sluice \_\_\_\_\_ Conduit \_\_\_\_\_ Penstock \_\_\_\_\_

Shape: \_\_\_\_\_

Size: \_\_\_\_\_

Elevations: Entrance Invert \_\_\_\_\_  
Exit Invert \_\_\_\_\_

Tailrace Channel: Elevation \_\_\_\_\_

**HYDROMETEROLOGICAL GAGES:**

Type: \_\_\_\_\_

Location: Township Airport

Records:

Date - \_\_\_\_\_

Max. Reading - \_\_\_\_\_

**FLOOD WATER CONTROL SYSTEM:**

Warning System: NONE

**Method of Controlled Releases (mechanisms):**

Electrically Controlled Hoisting Equipment with a  
Mechanical Backup System

**THOMSEN ASSOCIATES**  
CONSULTING GEOTECHNICAL ENGINEERS & GEOLOGISTS

CREST: Top of Side Wall ELEVATION: 137.5

Type: Tainter Gate Dam - Concrete Spillway

Width: 47' Length: 96'

Spillover: Concrete Spillway

Location: Spillover occurs in 90% of the 96 foot length, separated only by concrete piers

**SPILLWAY:**

**PRINCIPAL**

**EMERGENCY**

1300.00 Elevation None

Type \_\_\_\_\_

80 feet Width \_\_\_\_\_

Type of Control

Uncontrolled \_\_\_\_\_

Controlled:

Tainter Gates Type \_\_\_\_\_  
(Flashboards; gate)

3 Number \_\_\_\_\_

26'8" wide by 11' high Size/Length \_\_\_\_\_

Invert Material \_\_\_\_\_

Anticipated Length of operating service \_\_\_\_\_

Chute Length \_\_\_\_\_

The same Height Between Spillway Crest & Approach Channel Invert (Weir Flow) \_\_\_\_\_  
Elevation 1300.0

**THOMSEN ASSOCIATES**  
CONSULTING GEOTECHNICAL ENGINEERS & GEOLOGISTS

DRAINAGE AREA: 190 sq. miles

**DRAINAGE BASIN RUNOFF CHARACTERISTICS:**

Land Use - Type: Ranging from recreational to agricultural and forested  
Terrain - Relief: Ranges from nearly level to steep  
Surface - Soil: Highly variable ranging from glacio-lacustrine silt and clay to very dense glacial till deposits  
Runoff Potential (existing or planned extensive alterations to existing surface or subsurface conditions)

Runoff Potential is not expected to change significantly because of the size of the drainage area

Potential Sedimentation problem areas (natural or man-made; present or future)

Considered minimal

Potential Backwater problem areas for levels at maximum storage capacity including surcharge storage:

Chautauque Lake levels above Elevation 1312.0 would cause inundation of many residences surrounding the lake shore

Dikes - Floodwalls (overflow & non-overflow) - Low reaches along the Reservoir perimeter: None

Location: \_\_\_\_\_

Elevation: \_\_\_\_\_

**McFarland-Johnson Engineers, Inc.**  
 171 Front Street  
 BINGHAMTON, NEW YORK 13905

JOB Waste Water Hy. Study - Hydraulic Computations

SHEET NO. \_\_\_\_\_ OF \_\_\_\_\_

CALCULATED BY R. Weist DATE 9/3/50

CHECKED BY \_\_\_\_\_ DATE \_\_\_\_\_

SCALE \_\_\_\_\_

Stage - Discharge Computation

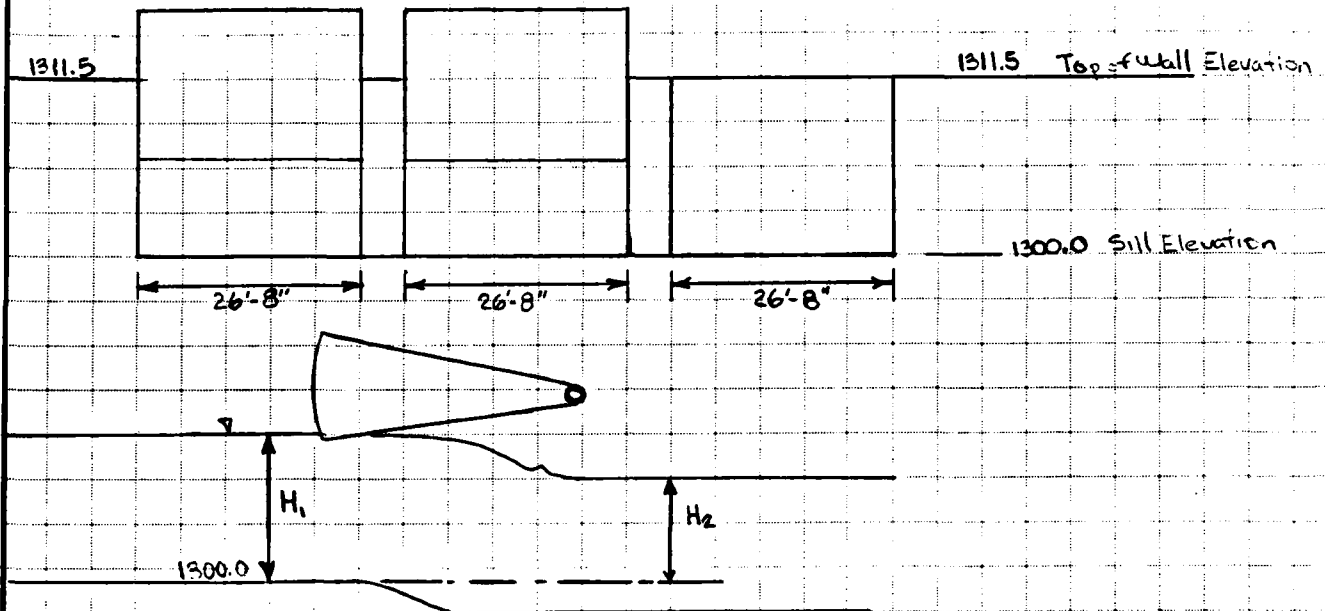

$C = 3.4, L = 80'$

Lake Elevation	ELEV. @ DAM	H.	Free Discharge Q.	$H_2$	$(\frac{H_2}{H_1})^{4.5}$	$\frac{Q}{Q_0}$	Q (submerged)
1314.15	1308.5	8.5	6740	7.40	.81	.53	3570
1314.67	1309.0	9.0	7314	7.65	.78	.56	4112
1315.20	1309.5	9.5	7964	7.96	.76	.57	4539
1315.74	1310.0	10.0	8601	8.25	.75	.58	4988
1316.27	1310.5	10.5	9254	8.58	.74	.59	5457
1316.79	1311.0	11.0	9923	8.81	.72	.62	6152
1317.32	1311.5	11.5	10,607	9.10	.70	.625	6629

**McFarland-Johnson Engineers, Inc.**  
 171 Front Street  
 BINGHAMTON, NEW YORK 13905

JOB Chattanooga Dam Hydrologic Engineering  
 SHEET NO \_\_\_\_\_ OF \_\_\_\_\_  
 CALCULATED BY R. W. JET DATE 9/2/80  
 CHECKED BY \_\_\_\_\_ DATE \_\_\_\_\_  
 SCALE \_\_\_\_\_

Stage-Discharge Data

<u>Lake Elevation</u>	<u>Elevation Upstream of Dam</u>	<u>Tailwater Elevation</u>	<u>Discharge (cfs)</u>
1308.25	1308.25		950
1314.15	1303.5	1307.40	3570
1314.67	1309.0	1307.65	4112
1315.20	1309.5	1307.96	4539
1315.74	1310.0	1308.25	4988
1316.27	1310.5	1308.58	5459
1316.79	1311.0	1308.81	6152
1317.32	1311.5	1309.10	6629

Assumptions:

- ① All 3 gates will be opened when Lake Elevations exceed 1310.0. At Lake Elevations under 1310.0 the Discharge was obtained from the Chattanooga Lake-Chadakoin River Maximum Release Rate vs. Lake Elevation Curve.
- ② The discharge for each gate was determined by the weir-flow formula  $Q = CLH^{3/2}$  where  $C = 3.4$ . In cases where the tailwater elevation submerges the crest of the dam (elevation 1300.0) a discharge for a submerged weir condition was computed utilizing the method developed on page 5-18 of the Handbook of Hydraulics by King & Brater.

Stage - Storage Data

<u>Lake Elevation</u>	<u>Elevation at Dam (Upstream)</u>	<u>(Acre-ft.) Storage Volume</u>
1308.25	1308.25	305,000
1314.25	1308.5	390,000
1314.67	1309.0	397,000
1315.20	1309.5	405,000
1315.74	1310.0	412,000
1316.27	1310.5	420,000
1316.79	1311.0	430,000
1317.32	1311.5	441,000

Normal Pool Elevation - 1308.25

Assumptions

- ① Elevation @ Warner Dam and at Lake Chautaugua are approximately equal at the Normal Pool Elevation of 1308.25
- ② At Lake elevations above normal pool (1308.25) the elevation at the dam is lower than Lake elevation. This is due to the head loss through the distance from the Lake to the Dam when the outlet gates of the Dam are opened. To approximate this differential at higher Lake Stages, historical Lake vs. Dam Elevations were plotted against each other and a best-fit line showing their relationship was extrapolated to a top of dam elevation of 1311.5. (see Graph Warner Dam Elevations Corresponding Lake)
- ③ At Lake elevations above 1310.0 all 3 gates are assumed to be open. The historical dam vs. Lake Chautaugua Elevations that were utilized to determine the dam-Lake elevation differential all met this condition.

**McFarland-Johnson Engineers, Inc.**  
171 Front Street  
BINGHAMTON, NEW YORK 13905

JOB Wassers Cove Hydrologic Study

SHEET NO. \_\_\_\_\_ OF \_\_\_\_\_

CALCULATED BY R. Heidt DATE 7/2/80

CHECKED BY \_\_\_\_\_ DATE \_\_\_\_\_

SCALE \_\_\_\_\_

Stage-Storage Data (cont.)

- ④ Stage-Storage Relations were taken from the Stage-Storage Curve for Lake Chautaugus - Chautaugus River prepared by the U.S. Army Corps of Engineers, Pittsford District. Note that for each stage at the Dam a corresponding Lake Elevation was used to determine the storage.

**McFarland-Johnson Engineers, Inc.**  
171 Front Street  
BINGHAMTON, NEW YORK 13905

JOB Warner Dam Hydraulic Study  
SHEET NO \_\_\_\_\_ OF \_\_\_\_\_  
CALCULATED BY R. Wright DATE 7/2/80  
CHECKED BY \_\_\_\_\_ DATE \_\_\_\_\_  
SCALE \_\_\_\_\_

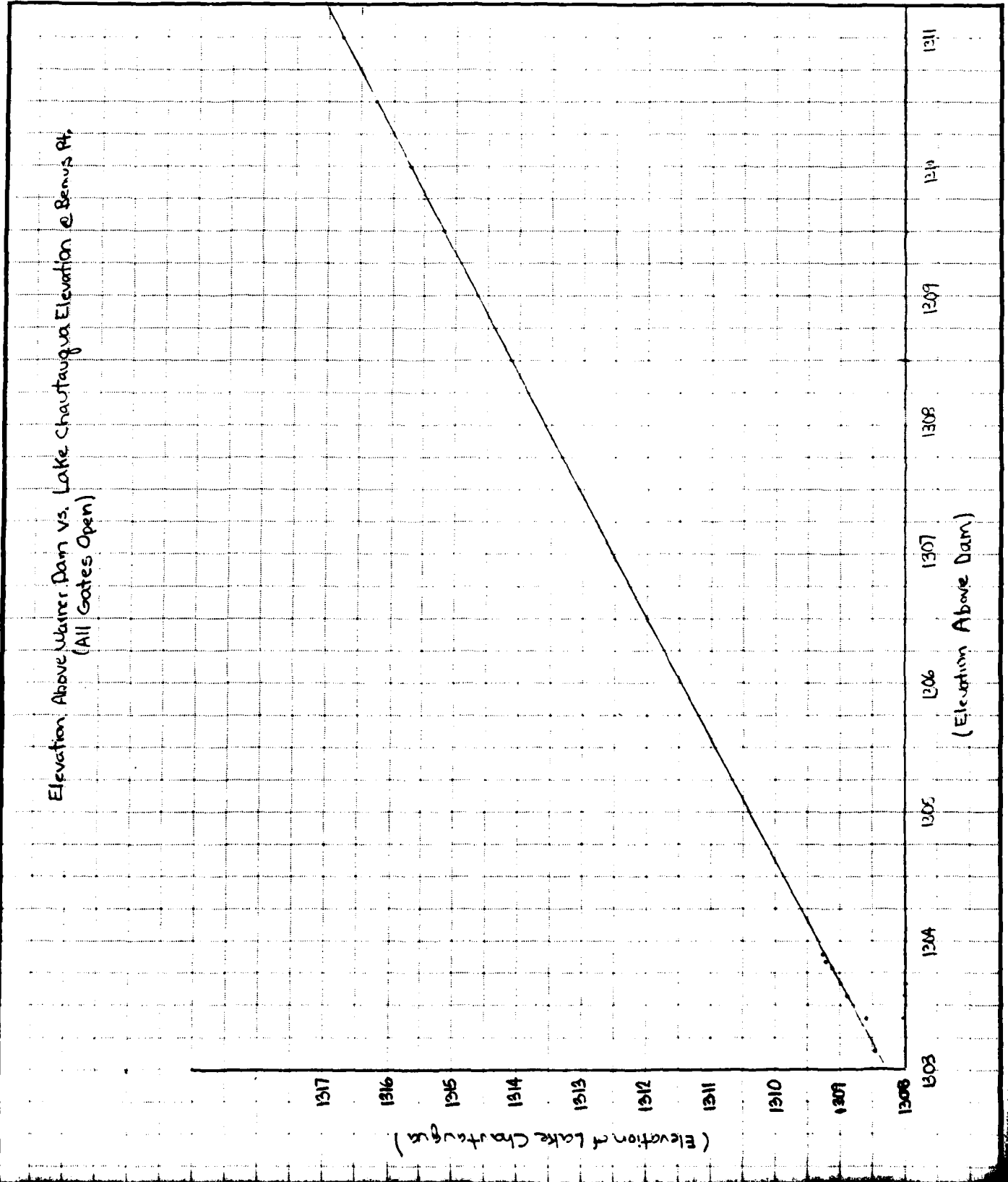



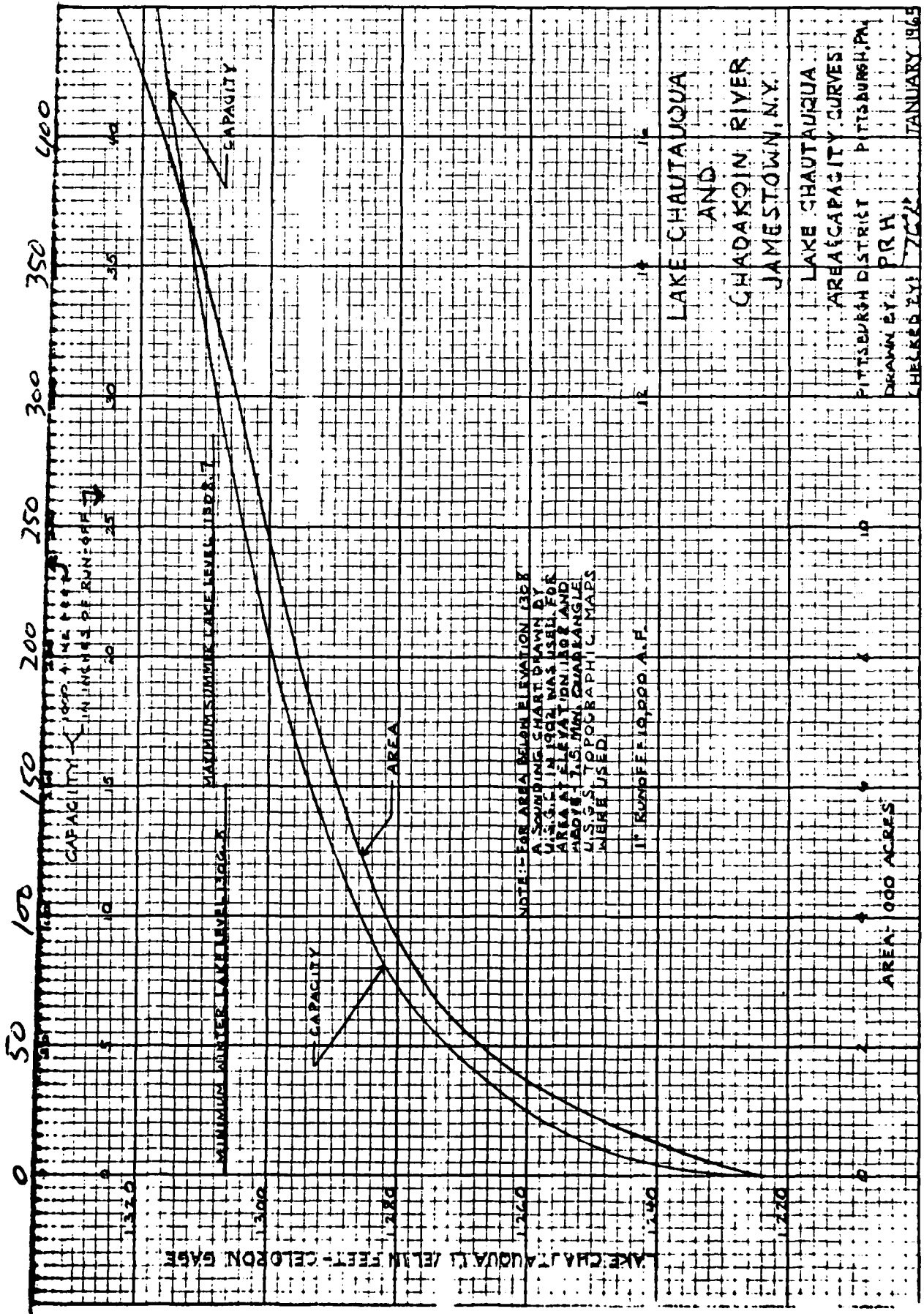

TAILWATER RATING CURVE  
WARNER DAM

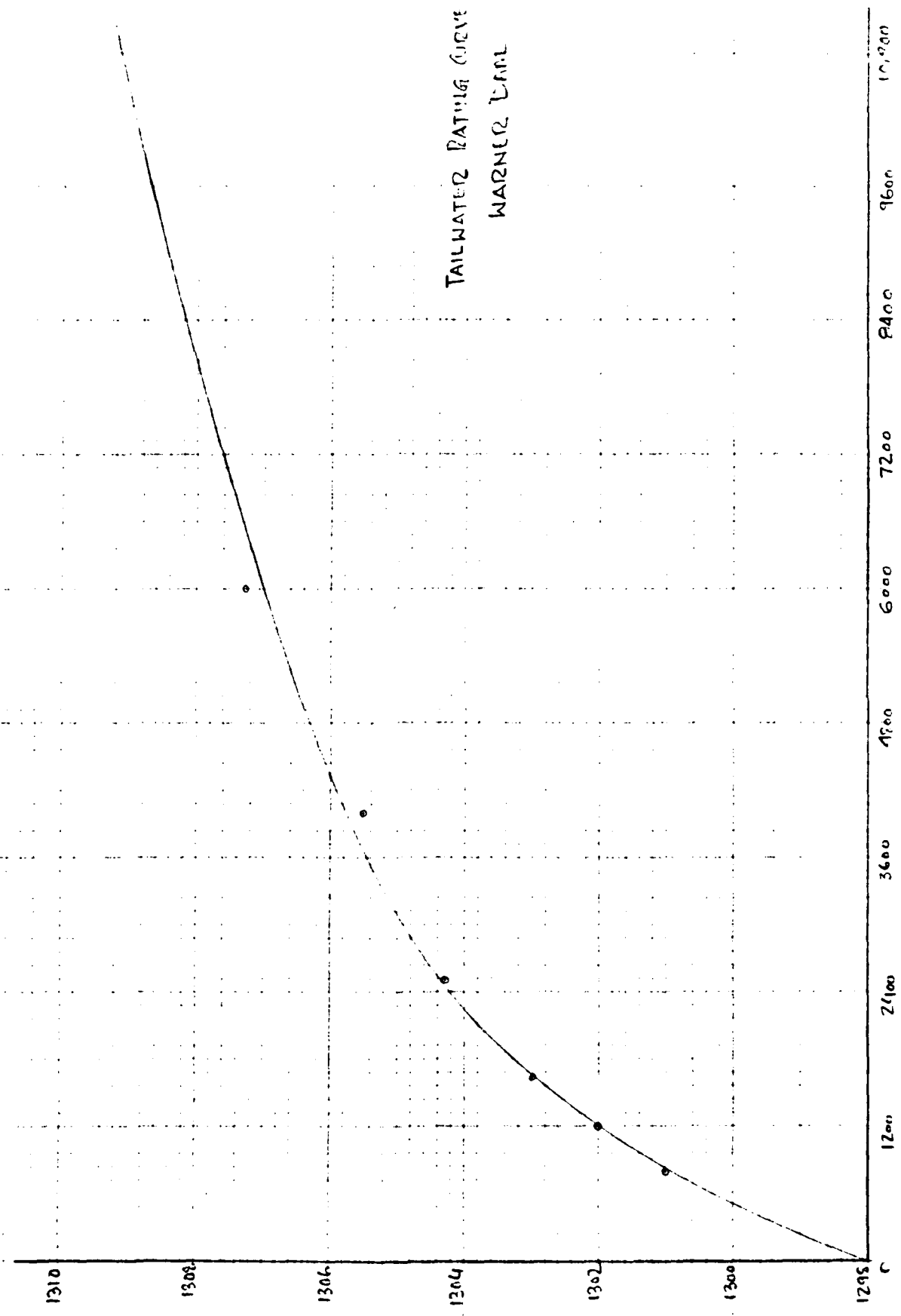

TAILWATER ELEV. IN FT.

DISCHARGE IN CFS.

STAGE-DISCHARGE CURVE

WARNER DAM

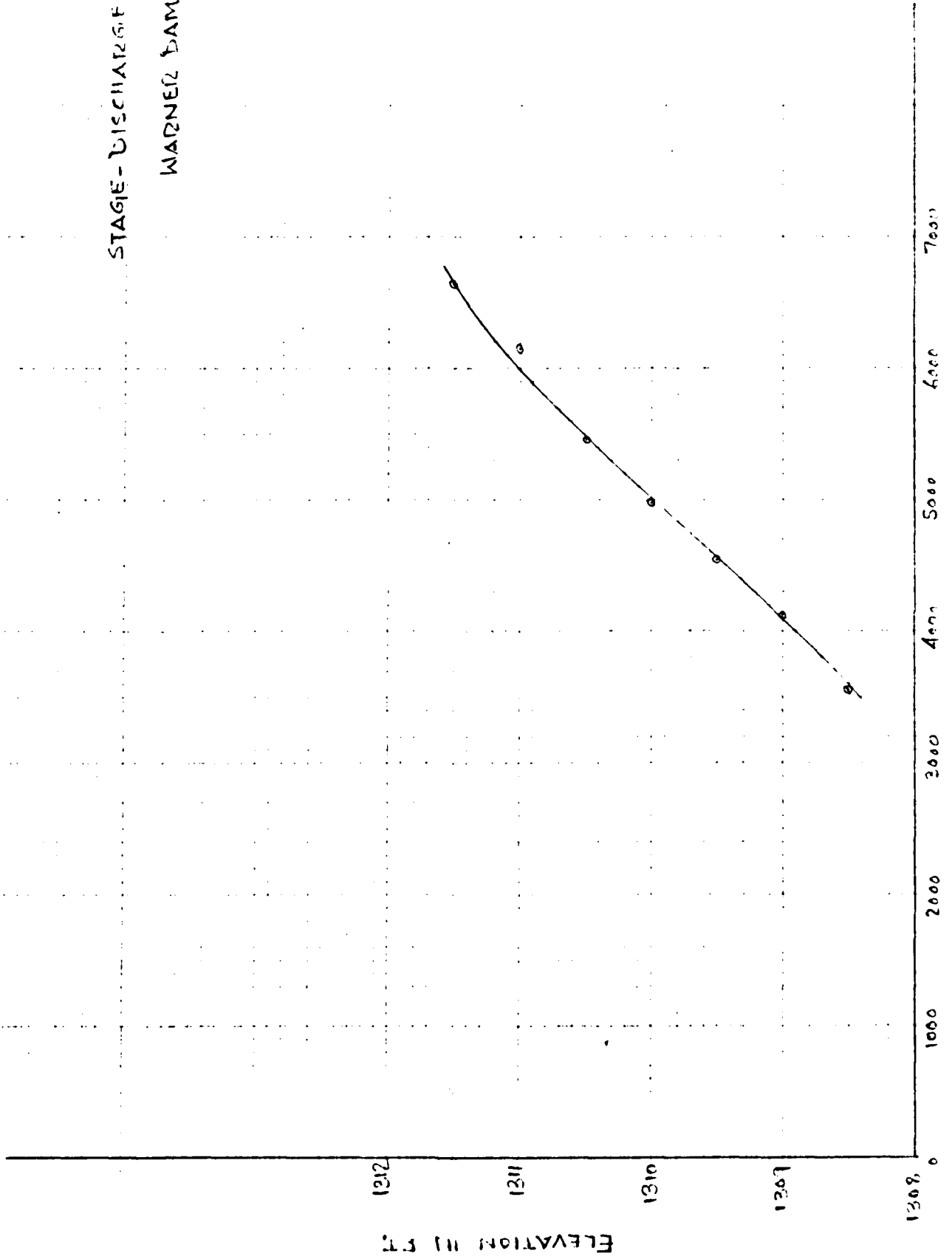

ELEVATION IN FT.

DISCHARGE IN CFS

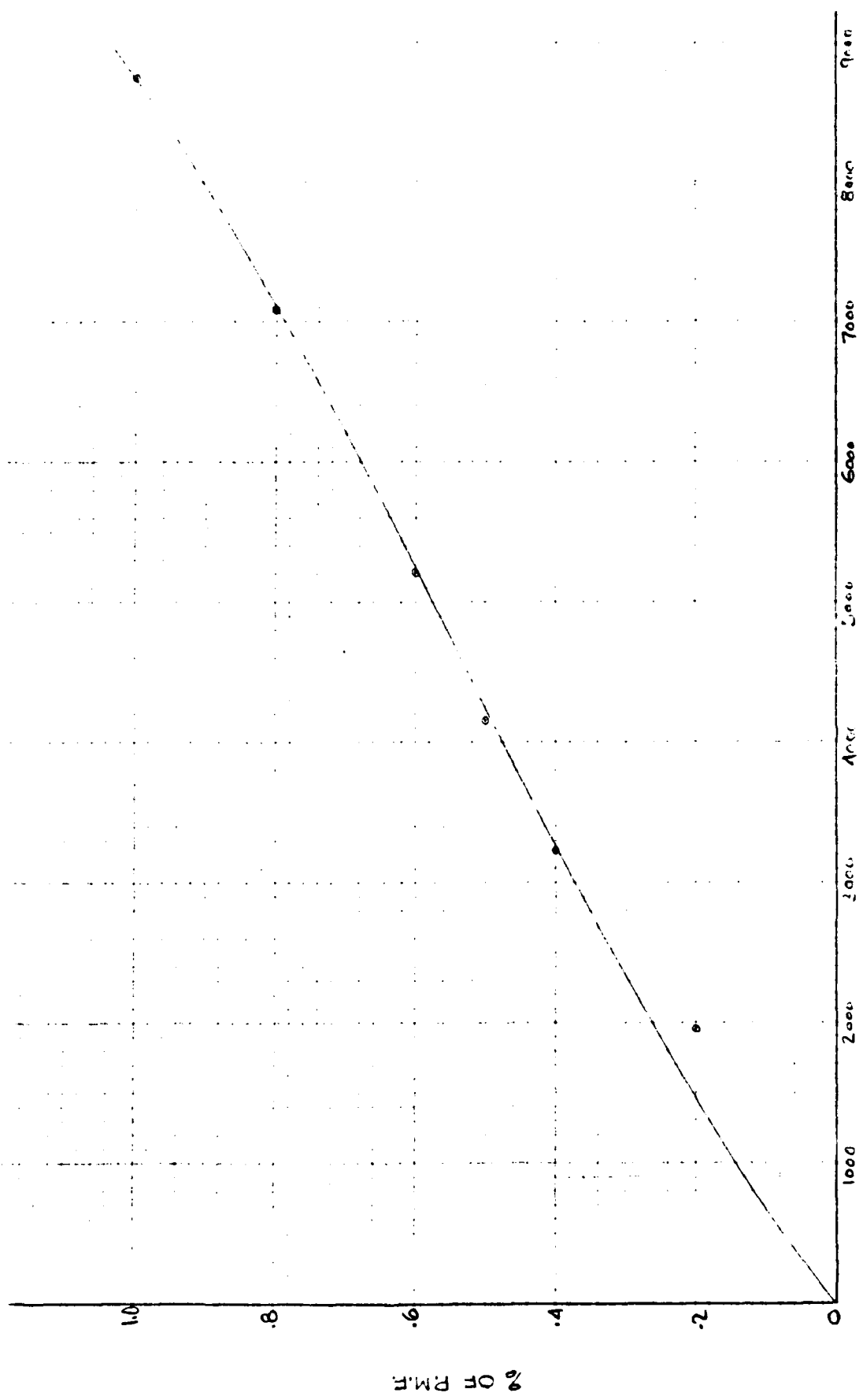

OUTLECH IN C.F.S.

% OF P.M.F.

16E 12 x 30 TO THE INCH 46 1975  
 7 1/2 x 10 INCHES  
 SCUFFEL & ESSER CO.

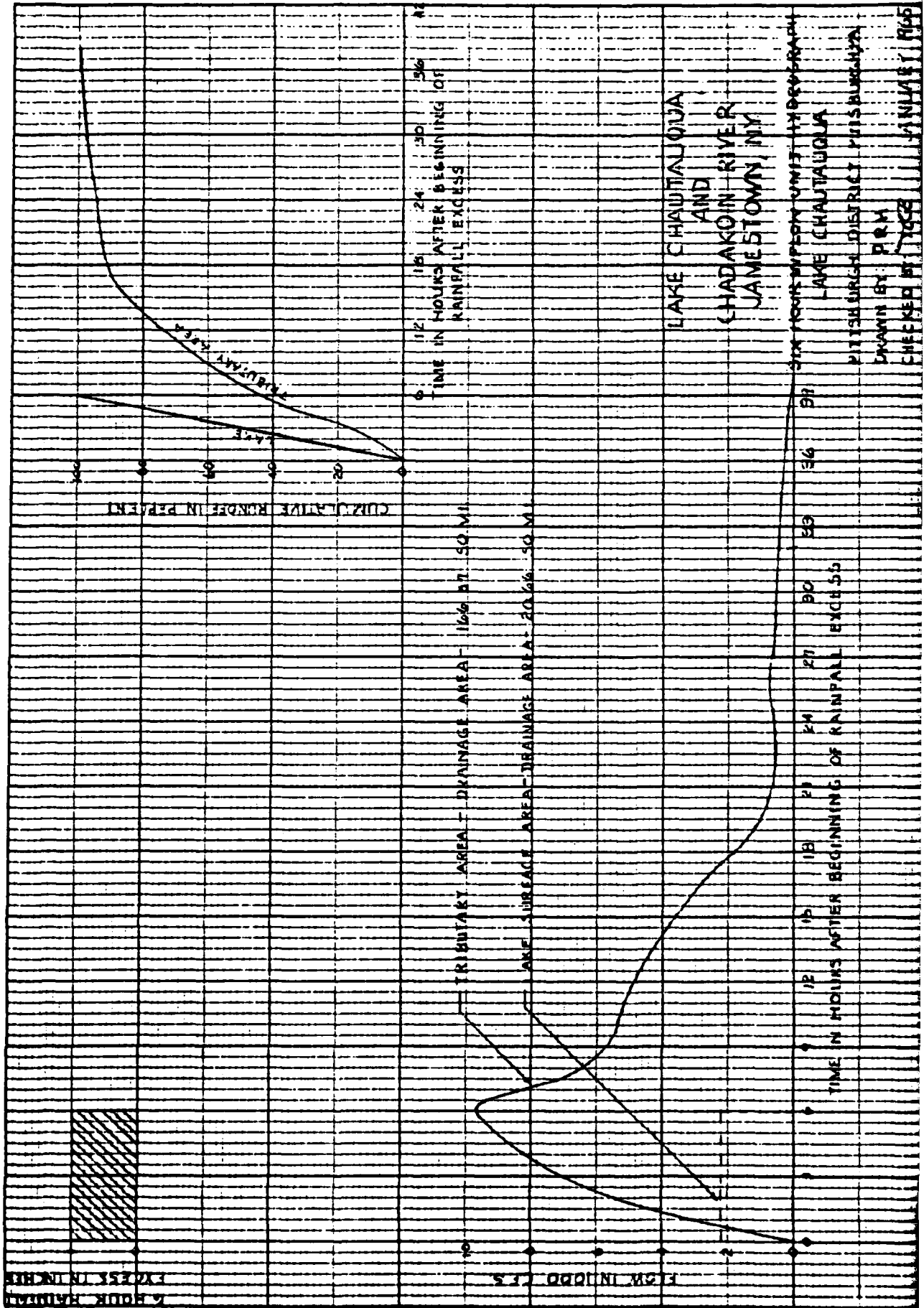

APPENDIX I PLATE 12

EXHIBIT B  
Enclosure 1

LAKE OUTFLOW OPERATIONAL SCHEDULE

Zone	Purpose	Release Rate in cfs	Operations
4	Flood Control	60 to 1270	(1) Releases up to 1270 cfs will be made as rapidly as possible. When lake stages exceed elevation 1310, releases in excess of 1270 cfs should be made. (2) When the lake level is in this zone, the release rate will be maintained at 60 cfs.
3	Conservation	60 (2)	When the lake level is in this zone, the release rate will be maintained at 60 cfs.
2	Conservation	40 (2)	When the lake level is in this zone, the release rate will be maintained at 40 cfs.
1	Conservation	20 (2)	When the lake level is in this zone, the release rate will be maintained at 20 cfs.

(1) Releases up to 1270 cfs are not possible until lake stage exceeds elevation 1309. Releases in this zone are affected by channel capacity of the outlet channel and will be made at the maximum capacity possible.

(2) Releases are both a minimum and maximum.

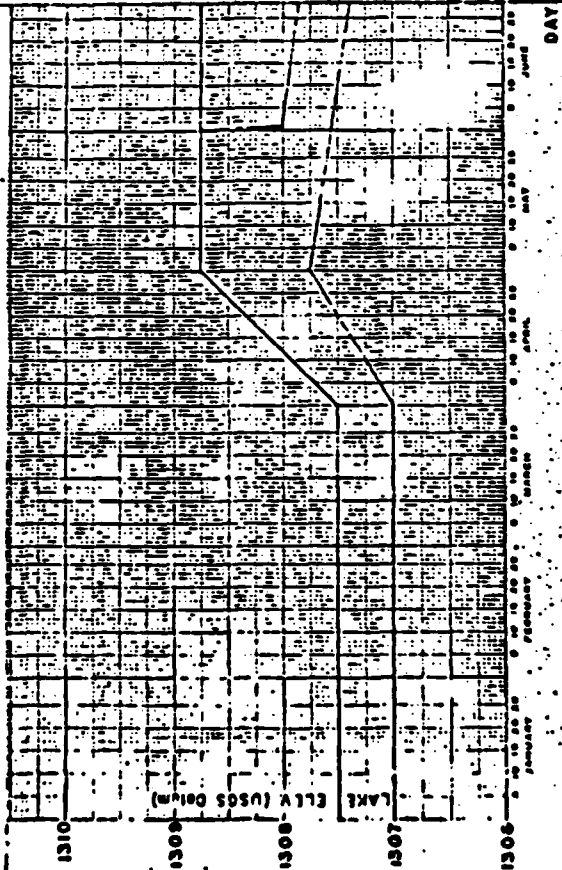

ALLEGHENY RIVER BASIN  
CHAUTAQUA LAKE 5311-6145M  
**LAKE LEVEL REGULATIONS PLAN**  
20-40-60-1270 W2 H1

to evacuate lake  
lake stages exceed  
1270 cfs should be  
the release rate will  
the release rate will  
the release rate will

ation 1309. Releases  
will be made at

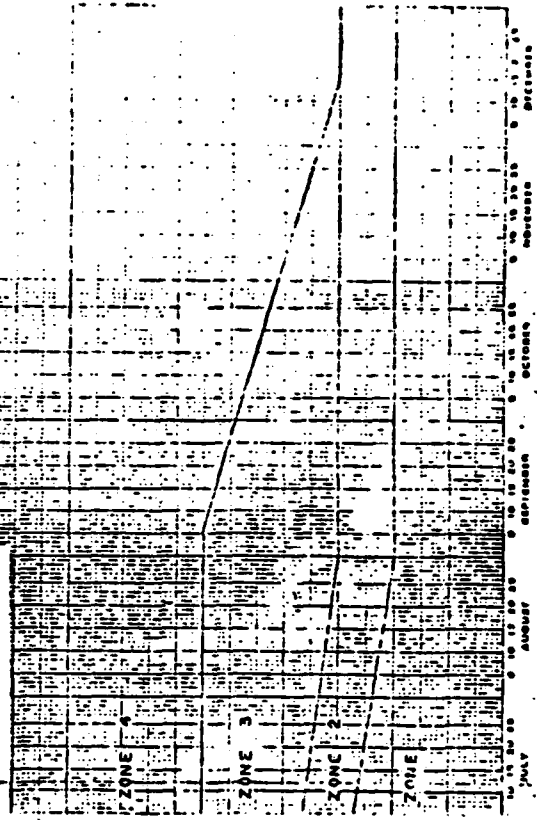

CHAUTAQUA LAKE ELEVATION in feet (USGS Datum)

New Dam

1310.0

Emergency Flood Control Level

1309.0

1308.0

1307.0

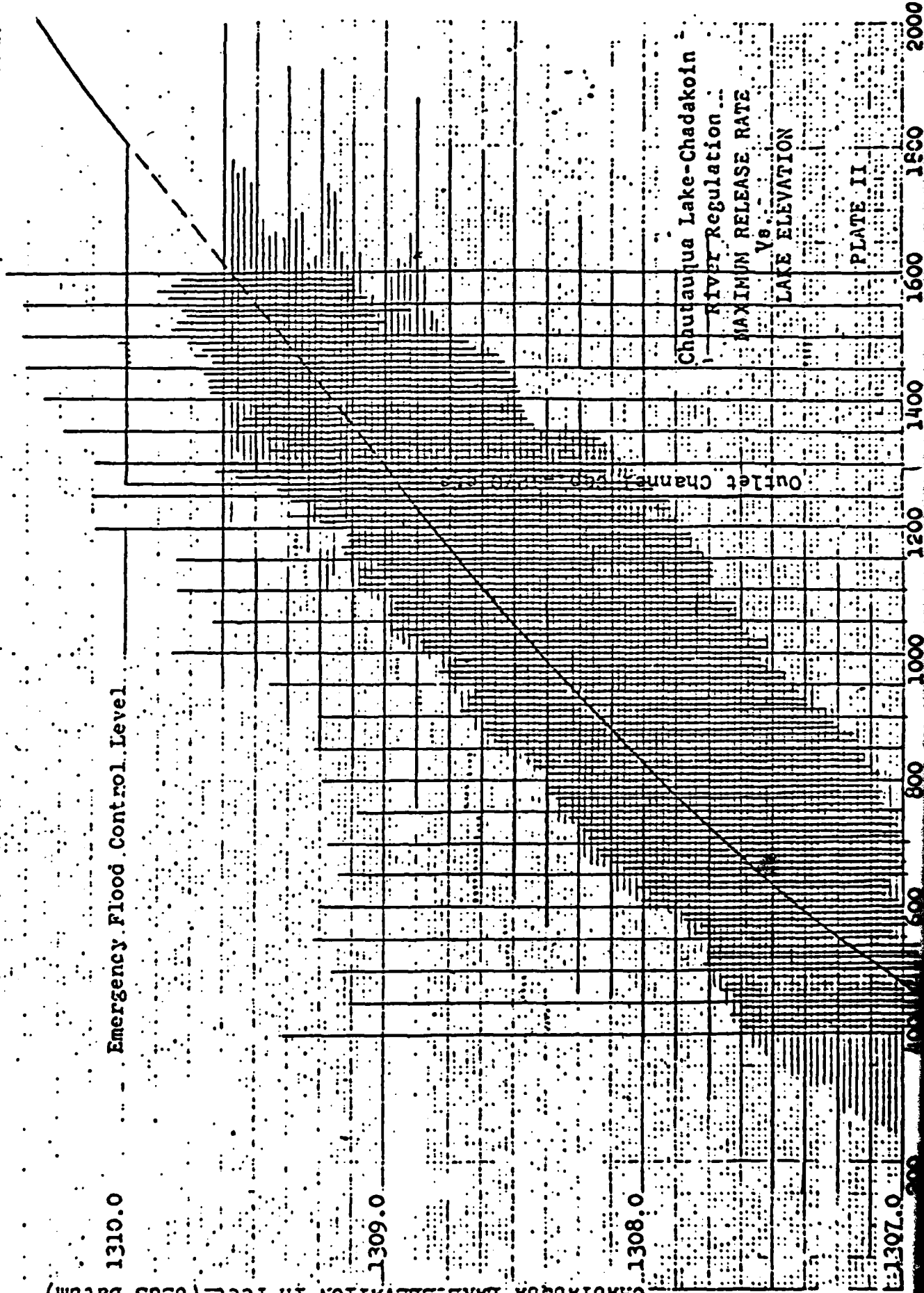

Chautauqua Lake-Chadako In

River Regulation

MAXIMUM RELEASE RATE

LAKE ELEVATION

PLATE II

2000

1500

1600

1400

1200

1000

800

600

400

200

HEADWATER E.G. ELEVATION  
100 FT. UPSTREAM OF ♯ SILL

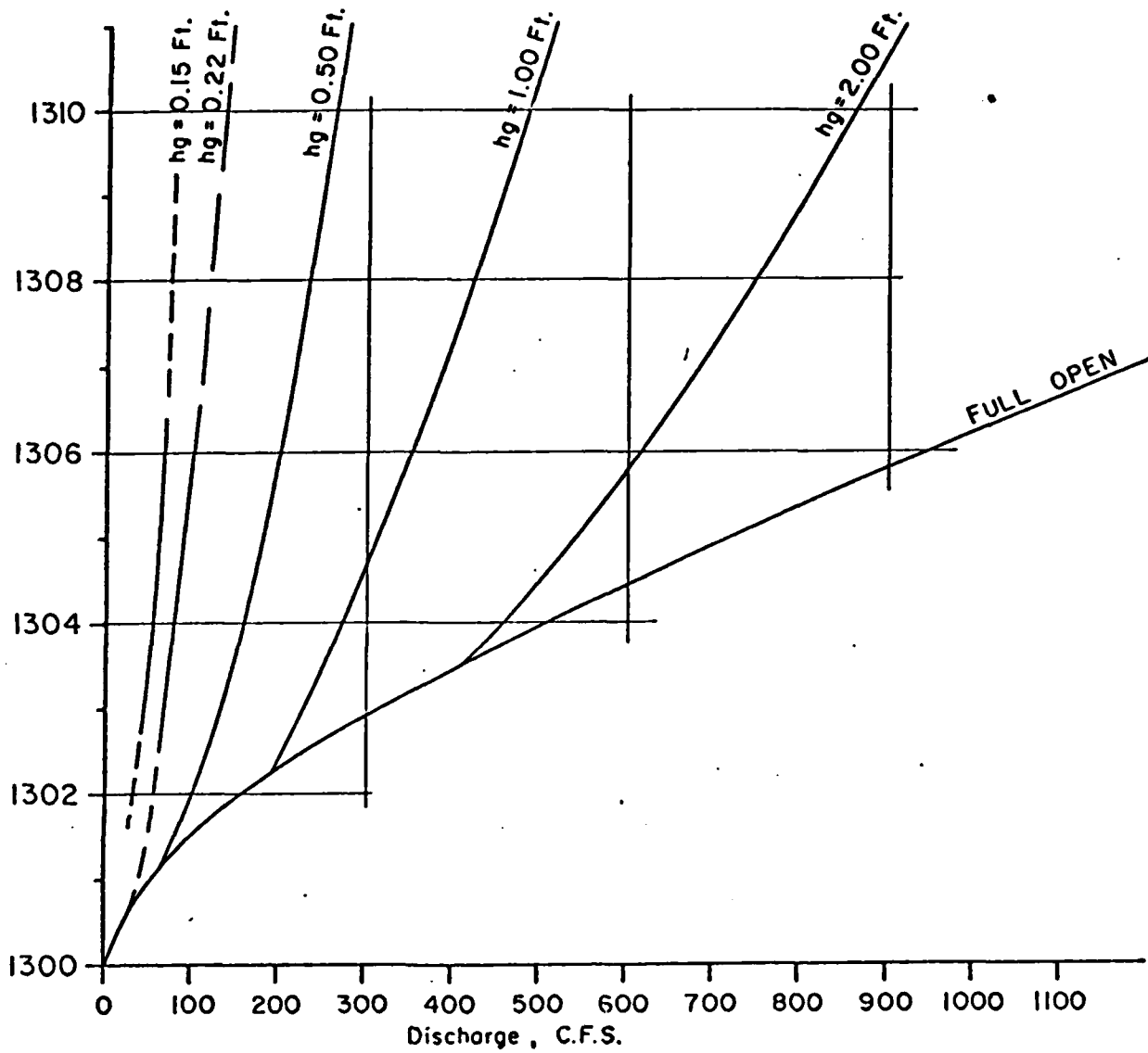

RATING CURVE  
FOR  
ONE GATE  
WARNER DAM



4/9/80 A J.D.

WIDTH OF GATE: 26' - 8"  
ELEVATION OF SILL: 1300.0  
E.G. = ENERGY GRADIENT  
hg = VERTICAL OPENING OF ONE GATE  
(OTHER GATES FULLY CLOSED)

EXHIBIT 5a



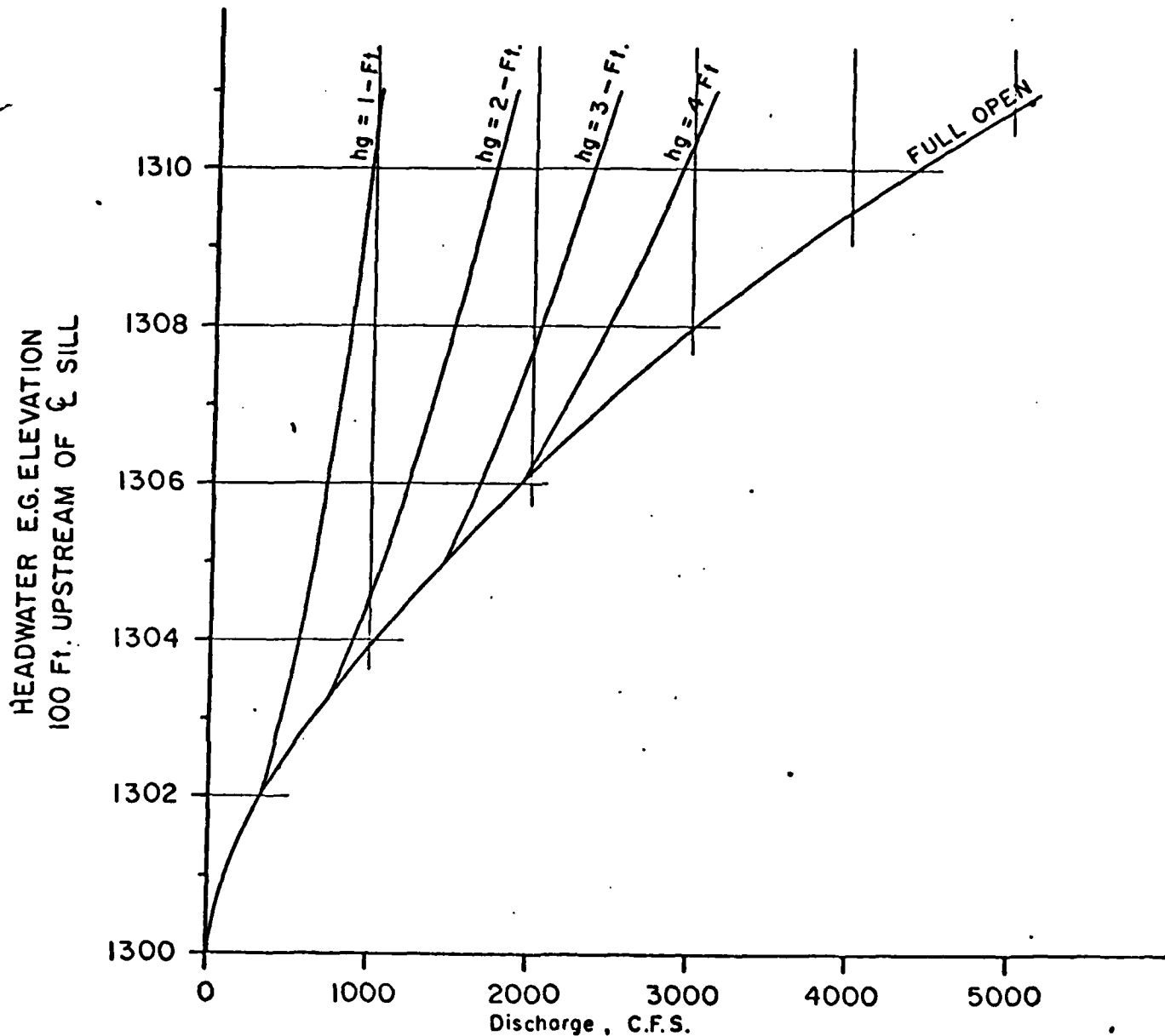

**RATING CURVE  
 FOR  
TWO GATES  
WARNER DAM**

WIDTH OF GATE: 26' - 8"  
 ELEVATION OF SILL: 1300.0  
 E.G. = ENERGY GRADIENT

hg = VERTICAL OPENING OF EACH GATE  
 (OTHER GATE FULLY CLOSED)

EXHIBIT 5b



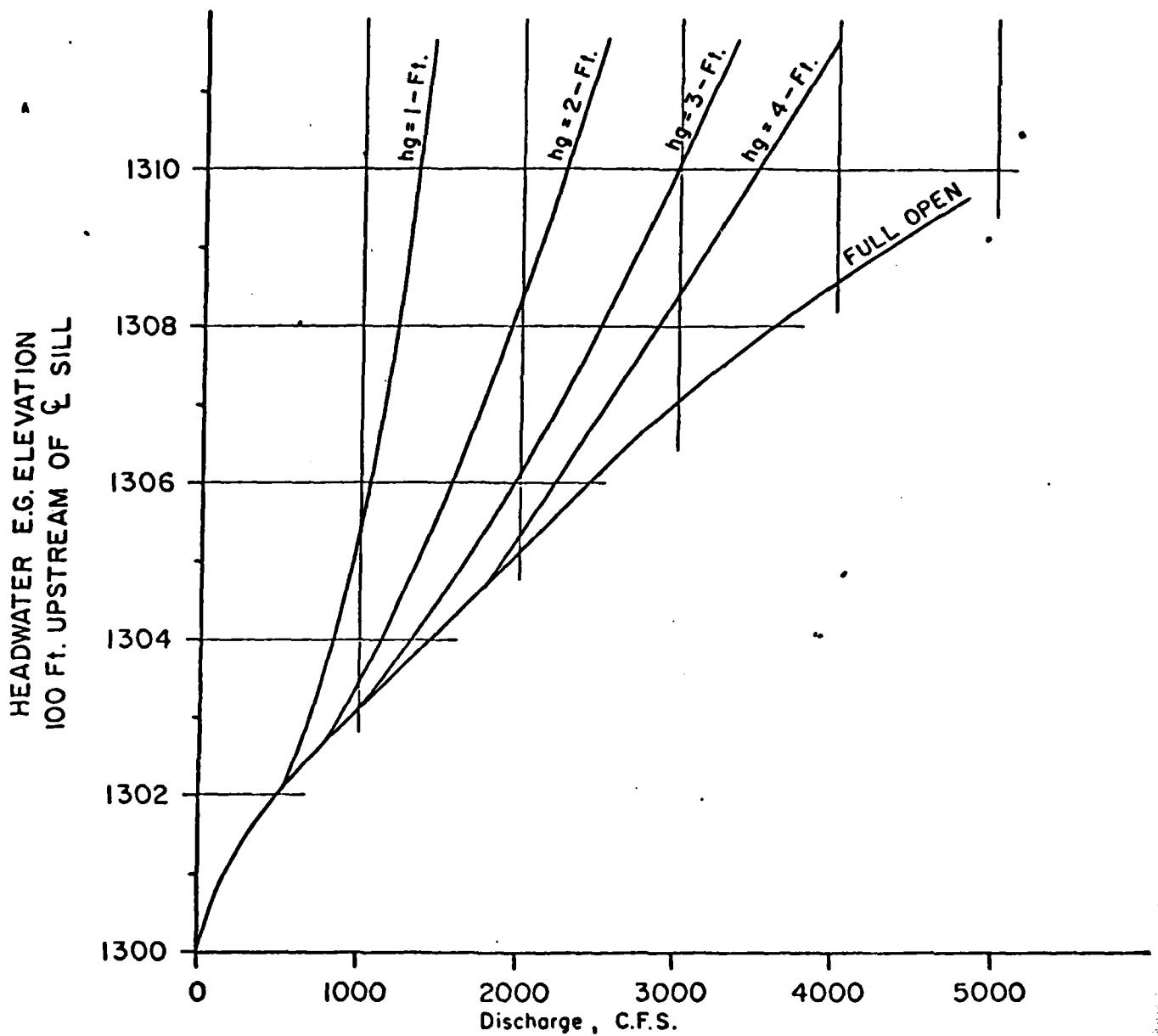

**RATING CURVE**  
**FOR**  
**THREE GATES**  
**WARNER DAM**

WIDTH OF GATE: 26' - 8"  
 ELEVATION OF SILL: 1300.0  
 E.G. = ENERGY GRADIENT

hg = VERTICAL OPENING OF EACH GATE

EXHIBIT 5c



\*\*\*\*\*  
 FLOOD HYDROGRAPH PACKAGE (REC-1)  
 DAM SAFETY VERSION JULY 1978  
 LAST MODIFICATION 20 FEB 79  
 \*\*\*\*\*

1	A1						ANALYSIS OF DAM OVERTOPPING
2	A2						HYDROLOGIC-HYDRAULIC ANALYSIS
3	A3						RATIOS OF PHE ROUTED THROUGH
4	B	40	0	0	0	0	
5	B1	5					
6	J	1	0	1			
7	J1	.2	.4	.5	.6	.8	
8	K	0	1	0	0	0	
9	K1						COMPUTATION OF INFLOW HYDROGRAPH
10	M	1	-1	187	0	187	
11	P	0	22.8	60	90	100	
12	I						
13	U	6					
14	U1	11800	4850	1800	600	420	
15	X	-2	-1	2			
16	K	1	2	0	0	0	
17	K1						ROUTING OF INFLOW HYDROGRAPH
18	Y	0	0	0	1	1	
19	Y1	1	0	0	0	0	
20	Y2	305000	390000	397000	405000	412000	
21	Z	950	3570	4112	4539	4986	
22	K	99					

ANALYSIS OF DAM OVERTOPPING USING RATIOS OF PMF  
 LOGIC-HYDRAULIC ANALYSIS OF SAFETY OF NY750 DAM  
 CASES OF PMF ROUTED THROUGH LAKE CHAUTAUKA

0	0	0	0	0	0	0	0
1							
5	.6	.8	1				
0	0	0	0	1	0	0	0
INFLOW HYDROGRAPH FROM GIVEN UNIT HYDROGRAPH							
7	0	187	0	0	0	1	0
0	90	100	110				
				1	.1		
0	600	420	20				
2							
0	0	0	0	1	0	0	0
LOW HYDROGRAPH							
0	1	1					
0	0	0	0	305000			
0	403000	412000	420000	430000	441000		
2	4539	4986	5459	6152	6629		

PREVIEW OF SEQUENCE OF STREAM NETWORK CALCULATIONS

RUNOFF HYDROGRAPH AT	1
ROUTE HYDROGRAPH TO	2
END OF NETWORK	

\*\*\*\*\*  
 FLOOD HYDROGRAPH PACKAGE (HEC-1)  
 DAM SAFETY VERSION JULY 1978  
 LAST MODIFICATION 26 FEB 79  
 \*\*\*\*\*

TIME OF EXECUTION 0-SEP-79 14:41:02

ANALYSIS OF DAM OVERTOPPING USING RATIOS  
 HYDROLOGIC-HYDRAULIC ANALYSIS OF SAFETY OF  
 RATIOS OF PMF ROUTED THROUGH LAKE CHAUTAUCU

JOB SPECIFICATION

NO	NR	NRN	LDAY	IHR	IMIN	MEIRC	IPL
40	6	0	0	0	0	0	0
			JUPER	WT	LROPT	TRACE	
			5	0	0	0	0

MULTI-PLAN ANALYSES TO BE PERFORMED  
 NPLAN= 1 NRTIU= 6 LRIO= 1  
 RIOS= 0.20 0.40 0.50 0.60 0.80 1.00

\*\*\*\*\*

SUB-AREA RUNOFF COMPUTATION

COMPUTATION OF INFLOW HYDROGRAPH FROM GIVEN UNIT HYDRO

ISIAQ	ICOMP	IECON	IIAPE	JPLI	JPRI
1	0	0	0	0	0

HYDROGRAPH DATA							
IHYG	IUNG	AREA	SNAP	TRSDA	TRSPC	RATIO	IS
1	-1	167.00	0.00	167.00	0.00	0.000	

PRECIP DATA						
SPFE	PMS	R6	R12	R24	R48	R
0.00	22.80	80.00	90.00	100.00	110.00	0.

TRSPC COMPUTED BY THE PROGRAM IS 0.881

LOSS DATA							
LROPT	STRKR	DLIKR	RTIOL	ERAIN	STRKS	RTIOK	SIRTL
0	0.00	0.00	1.00	0.00	0.00	1.00	1.00

GIVEN UNIT GRAPH, NUHQ= 6  
 11800. 4850. 1800. 600. 420. 20.  
 UNIT GRAPH TOTALS 19490. CFS OR 0.97 INCHES OVER

RECESSION DATA		
STRLE	GRCSN	RTIOK
-2.00	-0.10	

END-OF-PERIOD FLOW									
MO,DA	HR,MM	PERIOD	RAIN	EXCS	LOSS	COMP	MO,DA	HR,MM	
1.01	0.00	1	0.08	0.00	0.08	349.	1.00	6.00	
1.01	12.00	2	0.20	0.00	0.20	326.	1.00	1.00	
1.01	18.00	3	1.61	0.50					

McFARLAND-JOHNSON ENGINEERS, INC.

14:41:02

ANALYSIS OF DAM OVERTOPPING USING RATIOS OF PMF  
LOGIC-HYDRAULIC ANALYSIS OF SAFETY OF NY750 DAM  
OS OF PMF ROUTED THROUGH LAKE CHAUTAUGUA

JOB SPECIFICATION

IDAY	IHR	IMIN	METRC	IPLT	IPRI	NSTAN
0	0	0	0	0	0	0
JUPER	NWT	LROPI	TRACE			
5	0	0	0			

MULTI-PLAN ANALYSES TO BE PERFORMED

NPLAN= 1 NRTIO= 0 LRTIO= 1  
 .40 0.50 0.60 0.80 1.00

\*\*\* \*\*\*\*\* \*\*\*\*\* \*\*\*\*\*

SUB-AREA RUNOFF COMPUTATION

INFLOW HYDROGRAPH FROM GIVEN UNIT HYDROGRAPH

ICOMP	IECON	IIAPE	JPLI	JPRT	INAME	ISTAGE	IAUTO
0	0	0	0	0	1	0	0

HYDROGRAPH DATA

IA	SNAP	TRSDA	TRSPC	RATIO	ISNOW	ISAME	LUCAL
00	0.00	187.00	0.00	0.000	0	1	0

PRECIP DATA

R0	R12	R24	R48	R72	R96
80.00	90.00	100.00	110.00	0.00	0.00

LOSS DATA

RTIO	ERAIN	STRKS	RTIOK	SIRTL	CNSIL	ALSMX	RTIMP
1.00	0.00	0.00	1.00	1.00	0.10	0.00	0.00

GIVEN UNIT GRAPH, NUH30= 6

600. 420. 20.

TOTALS 19490. CFS OR 0.97 INCHES OVER THE AREA

RECESSION DATA

RE= -2.00 GRCSN= -0.10 RTIOK= 2.00

END-OF-PERIOD FLOW

LOSS	COMP U	NO. DA	HR. MN	PERIOD	RAIN	EXCS	LOSS	COMP U
0.08	349.	1.00	0.00	21	0.00	0.00	0.00	8547.
0.20	326.	1.00	1.00	22	0.00	0.00	0.00	8068.
			1.00	23	0.00	0.00	0.00	7528.

1.02	0.00	4	0.12	0.00	0.12	2982.	1.07	0.00
1.02	0.00	5	0.80	0.20	0.00	3000.	1.07	6.00
1.02	12.00	6	2.01	1.41	0.60	18188.	1.07	12.00
1.02	18.00	7	10.07	13.47	0.60	190189.	1.07	18.00
1.03	0.00	8	1.21	0.01	0.00	85040.	1.08	0.00
1.03	0.00	9	0.00	0.00	0.00	31909.	1.08	6.00
1.03	12.00	10	0.00	0.00	0.00	18530.	1.08	12.00
1.03	18.00	11	0.00	0.00	0.00	17295.	1.08	18.00
1.04	0.00	12	0.00	0.00	0.00	16137.	1.09	0.00
1.04	0.00	13	0.00	0.00	0.00	15050.	1.09	6.00
1.04	12.00	14	0.00	0.00	0.00	14048.	1.09	12.00
1.04	18.00	15	0.00	0.00	0.00	13107.	1.09	18.00
1.05	0.00	16	0.00	0.00	0.00	12229.	1.10	0.00
1.05	6.00	17	0.00	0.00	0.00	11410.	1.10	6.00
1.05	12.00	18	0.00	0.00	0.00	10646.	1.10	12.00
1.05	18.00	19	0.00	0.00	0.00	9933.	1.10	18.00
1.05	0.00	20	0.00	0.00	0.00	9268.	1.11	0.00

	PEAK	6-HOUR	24-HOUR	72-HOUR	TOTAL
CFS	190189.	137617.	81376.	30615.	
CMS	5380.	3897.	2304.	1037.	
INCHES		6.85	16.19	21.86	
MM		173.88	411.28	555.17	
AC-FT		68240.	161408.	217874.	
THOUS CU M		84175.	199094.	268744.	

HYDROGRAPH AT STA 1 FOR PLAN 1, RTIO 1

70.	65.	1374.	590.	733.	3030.	38038.
3459.	3227.	3011.	2810.	2021.	2440.	2282.
1729.	1014.	1500.	1405.	1311.	1223.	1141.
805.	607.	753.	702.	655.	611.	571.

	PEAK	6-HOUR	24-HOUR	72-HOUR	TOTAL
CFS	38030.	27523.	16275.	7323.	
CMS	1077.	779.	461.	207.	
INCHES		1.37	3.24	4.37	
MM		34.78	82.20	111.03	
AC-FT		13048.	32282.	43575.	
THOUS CU M		16835.	39819.	53749.	

HYDROGRAPH AT STA 1 FOR PLAN 1, RTIO 2

140.	130.	2748.	1193.	1467.	7275.	76076.
6918.	6455.	6022.	5619.	5243.	4892.	4564.
3459.	3227.	3011.	2810.	2021.	2440.	2282.
1729.	1014.	1500.	1405.	1311.	1223.	1141.

	PEAK	6-HOUR	24-HOUR	72-HOUR	TOTAL
CFS	16076.	55047.	32551.	14046.	
CMS	2154.	1559.	922.	415.	
INCHES		2.74	6.48	8.74	
MM		69.55	164.51	222.07	
AC-FT		27296.	64503.	67150.	
THOUS CU M		33609.	79037.	107	



0.12	2962.	1.07	0.00	24	0.00	0.00	0.00	7024.
0.00	3000.	1.07	6.00	25	0.00	0.00	0.00	6554.
0.00	16168.	1.07	12.00	26	0.00	0.00	0.00	6115.
0.00	190139.	1.07	18.00	27	0.00	0.00	0.00	5705.
0.00	85040.	1.08	0.00	28	0.00	0.00	0.00	5323.
0.00	31909.	1.08	6.00	29	0.00	0.00	0.00	4967.
0.00	18530.	1.08	12.00	30	0.00	0.00	0.00	4634.
0.00	17295.	1.08	18.00	31	0.00	0.00	0.00	4324.
0.00	16137.	1.09	0.00	32	0.00	0.00	0.00	4034.
0.00	15050.	1.09	6.00	33	0.00	0.00	0.00	3764.
0.00	14046.	1.09	12.00	34	0.00	0.00	0.00	3512.
0.00	13107.	1.09	18.00	35	0.00	0.00	0.00	3277.
0.00	12229.	1.10	0.00	36	0.00	0.00	0.00	3057.
0.00	11410.	1.10	6.00	37	0.00	0.00	0.00	2853.
0.00	10640.	1.10	12.00	38	0.00	0.00	0.00	2662.
0.00	9933.	1.10	18.00	39	0.00	0.00	0.00	2483.
0.00	9268.	1.11	0.00	40	0.00	0.00	0.00	2317.

SUM 22.09 18.24 3.85 584038.  
( 561. )( 463. )( 98. )( 16538.11 )

K	6-HOUR	24-HOUR	72-HOUR	TOTAL VOLUME
.	137617.	81376.	36615.	582706.
.	3897.	2304.	1037.	16500.
	6.85	16.19	21.86	28.99
	173.88	411.28	555.17	736.26
	68240.	161408.	217874.	288945.
	84173.	199094.	268744.	356408.

RAPH AT STA 1 FOR PLAN 1, RTIO 1

590.	733.	3038.	38038.	17009.	6382.	3707.
2810.	2021.	2440.	2282.	2129.	1987.	1854.
1405.	1311.	1223.	1141.	1065.	993.	927.
702.	655.	611.	571.	532.	497.	463.

6-HOUR	24-HOUR	72-HOUR	TOTAL VOLUME
27523.	16275.	7323.	116541.
779.	461.	207.	3300.
1.37	3.24	4.37	5.80
34.78	82.20	111.03	147.25
13646.	32282.	43575.	57789.
16835.	39819.	53749.	71282.

RAPH AT STA 1 FOR PLAN 1, RTIO 2

1193.	1467.	7275.	76076.	34018.	12764.	7414.
5619.	5243.	4892.	4564.	4259.	3973.	3707.
2810.	2021.	2440.	2282.	2129.	1987.	1854.
1405.	1311.	1223.	1141.	1065.	993.	927.

6-HOUR	24-HOUR	72-HOUR	TOTAL VOLUME
55047.	32551.	14646.	233082.
1559.	922.	415.	6600.
2.74	6.48	8.74	11.59
69.55	164.51	222.07	294.50
27296.	64503.	67150.	115578.
33609.	79037.	107	142503.

HYDROGRAPH AT STA				1 FOR PLAN 1, RTIO 3		
174.	103.	3430.	1491.	1833.	9094.	95094.
8647.	8066.	7520.	7024.	6554.	6115.	5705.
4324.	4034.	3704.	3512.	3277.	3057.	2853.
2102.	2017.	1862.	1750.	1638.	1529.	1426.

	PEAK	6-HOUR	24-HOUR	72-HOUR	TOTAL
CFS	95094.	68809.	40686.	18307.	
CMS	2693.	1948.	1152.	518.	
INCHES	.	3.42	8.10	10.93	
MM		86.94	205.64	277.58	
AC-FT		34120.	80704.	108937.	
THOUS CU M		42066.	99547.	134372.	

HYDROGRAPH AT STA				1 FOR PLAN 1, RTIO 4		
209.	195.	4122.	1789.	2200.	10913.	114113.
10377.	9602.	9034.	8429.	7864.	7338.	6846.
5188.	4841.	4517.	4214.	3932.	3669.	3423.
2594.	2421.	2256.	2107.	1966.	1834.	1712.

	PEAK	6-HOUR	24-HOUR	72-HOUR	TOTAL
CFS	114113.	82570.	48826.	21969.	
CMS	3231.	2338.	1383.	622.	
INCHES		4.11	9.72	13.11	
MM		104.33	240.77	333.10	
AC-FT		40944.	96845.	130724.	
THOUS CU M		50504.	119456.	161246.	

HYDROGRAPH AT STA				1 FOR PLAN 1, RTIO 5		
279.	260.	5496.	2386.	2933.	14550.	152151.
13830.	12909.	12045.	11238.	10486.	9783.	9128.
6918.	6455.	6022.	5619.	5243.	4892.	4504.
3459.	3227.	3011.	2810.	2621.	2440.	2282.

	PEAK	6-HOUR	24-HOUR	72-HOUR	TOTAL
CFS	152151.	110094.	65101.	29292.	
CMS	4308.	3116.	1843.	829.	
INCHES		5.48	12.95	17.49	
MM		139.11	329.03	444.13	
AC-FT		54592.	129126.	174299.	
THOUS CU M		67338.	159275.	214995.	

HYDROGRAPH AT STA				1 FOR PLAN 1, RTIO 6		
349.	326.	6870.	2982.	3666.	18186.	190189.
17295.	16137.	15050.	14048.	13107.	12229.	11410.
8647.	8066.	7520.	7024.	6554.	6115.	5705.
4324.	4034.	3704.	3512.	3277.	3057.	2853.

	PEAK	6-HOUR	24-HOUR	72-HOUR	TOTAL
CFS	190189.	137617.	81376.	36615.	
CMS	5380.	3697.	2304.	1037.	
INCHES		6.65	16.19	21.67	
MM					

HYDROGRAPH AT STA 1 FOR PLAN 1, RTIO 3

1.	1491.	1833.	9094.	95094.	42523.	15955.	9268.
2.	7024.	6554.	6115.	5705.	5323.	4967.	4634.
3.	3512.	3277.	3057.	2853.	2662.	2463.	2317.
4.	1750.	1638.	1529.	1426.	1331.	1242.	1159.

PEAK	6-HOUR	24-HOUR	72-HOUR	TOTAL VOLUME
95094.	68809.	40686.	18307.	291353.
2693.	1948.	1152.	518.	8250.
	3.42	8.10	10.93	14.49
	86.94	205.64	277.58	366.13
	34120.	80704.	108937.	144472.
	42066.	99547.	134372.	176204.

HYDROGRAPH AT STA 1 FOR PLAN 1, RTIO 4

1.	1789.	2200.	10913.	114113.	51027.	19145.	11122.
2.	8429.	7864.	7338.	6846.	6386.	5960.	5561.
3.	4214.	3932.	3669.	3423.	3194.	2980.	2780.
4.	2107.	1966.	1834.	1712.	1597.	1490.	1390.

PEAK	6-HOUR	24-HOUR	72-HOUR	TOTAL VOLUME
14113.	82570.	48826.	21969.	349623.
3231.	2338.	1383.	622.	9900.
	4.11	9.72	13.11	17.39
	104.33	246.77	333.10	441.76
	40944.	96845.	130724.	173367.
	50504.	119456.	161246.	213645.

HYDROGRAPH AT STA 1 FOR PLAN 1, RTIO 5

1.	2366.	2933.	14550.	152151.	68037.	25527.	14829.
2.	11236.	10486.	9783.	9128.	8517.	7947.	7414.
3.	5619.	5243.	4892.	4564.	4259.	3973.	3707.
4.	2610.	2621.	2446.	2282.	2129.	1987.	1854.

PEAK	6-HOUR	24-HOUR	72-HOUR	TOTAL VOLUME
52151.	110094.	65101.	29292.	466164.
4308.	3116.	1843.	629.	13200.
	5.48	12.95	17.49	23.19
	139.11	329.03	444.13	589.01
	54592.	129126.	174299.	231156.
	67338.	159275.	214995.	285126.

HYDROGRAPH AT STA 1 FOR PLAN 1, RTIO 6

1.	2982.	3666.	18168.	190169.	85046.	31909.	18536.
2.	14048.	13107.	12229.	11410.	10646.	9933.	9268.
3.	7024.	6554.	6115.	5705.	5323.	4967.	4634.
4.	3512.	3277.	3057.	2853.	2662.	2483.	2317.

PEAK	6-HOUR	24-HOUR	72-HOUR	TOTAL VOLUME
9169.	137617.	81376.	36615.	562700.
5386.	3897.	2304.	1037.	16500.
	6.65	16.19	2	28.99

AC-FT  
INJUS CU M

00240. 101400. 217874.  
04173. 199094. 200744.

\*\*\*\*\*

HIDROGRAPH ROUTING

ROUTING OF INFLOW HYDROGRAPH

	ISLAG	ICOMP	IECON	ITAPE	JPLT	JPRI
	2	.1	0	0	0	0
	ROUTING DATA					
GROSS	CROSS	AVG	IRES	ISAME	IUPI	IPMP
0.0	0.000	0.00	1	1	0	0
	INSTPS	INSTDL	LAG	AMSKK	X	ISK
	1	0	0	0.000	0.000	0.000
STORAGE	305000.00	390000.00	397000.00	405000.00	412000.00	420000.00
OUTFLOW	950.00	3570.00	4112.00	4539.00	4968.00	5459.00

STATION 2, PLAN 1, RTIO 1

	937.	923.	920.	921.	917.	937.	1239.
	1860.	1808.	1907.	1922.	1934.	1943.	1949.
	1952.	1940.	1942.	1934.	1920.	1910.	1905.
	1851.	1835.	1819.	1803.	1780.	1768.	1750.
	STOR						
	304507.	304139.	304039.	304071.	303944.	304508.	314362.
	334700.	335434.	335039.	335533.	336924.	337219.	337426.
	337500.	337308.	337177.	336938.	336654.	336330.	335969.
	334220.	333720.	333201.	332664.	332111.	331544.	330964.
	STAGE						
	0.0	0.0	0.0	0.0	0.0	0.0	0.0
	0.0	0.0	0.0	0.0	0.0	0.0	0.0
	0.0	0.0	0.0	0.0	0.0	0.0	0.0
	0.0	0.0	0.0	0.0	0.0	0.0	0.0

	PEAK	6-HOUR	24-HOUR	12-HOUR	TD
CFS	1955.	1955.	1953.	1942.	
CMS	55.	55.	55.	55.	
Inches		0.10	0.39	1.16	
MM		2.47	9.87	29.45	
AC-FT		969.	3874.	11559.	
INJUS CU M		1190.	4779.	14257.	

MAXIMUM STORAGE = 337004.

STATION 2, PLAN 1, RTIO 1  
McFARLAND-JOHNSON ENGINEERS, INC.



08240. 101400. 217874. 288945.  
 04173. 199091. 208744. 356408.

\*\*\*\* \*\*\*\*\* \*\*\*\*\* \*\*\*\*\*

HIDROGRAPH ROUTING

LOW HYDROGRAPH

ICOMP IECON IIAPE JPLT JPRI INAME ISTAGE IAUTO  
 .1 0 0 0 0 1 0 0

ROUTING DATA

AVG IRES ISAME IOPT IPMP LSTR  
 0.00 1 1 0 0 0

INSTOL LAG AMSKK X ISK STORA ISPRAT  
 0 0 0.000 0.000 0.000 305000. 0

0.00 405000.00 412000.00 420000.00 430000.00 441000.00  
 2.00 4539.00 4988.00 5459.00 6152.00 6629.00

STATION 2, PLAN 1, RTIO 1

OUTFLOW

921.	917.	937.	1239.	1637.	1790.	1839.
1922.	1934.	1943.	1949.	1953.	1955.	1954.
1934.	1926.	1916.	1905.	1892.	1879.	1865.
1803.	1786.	1768.	1750.	1732.	1714.	1695.

STOR

304071.	303944.	304568.	314362.	327297.	332247.	333848.
336533.	336924.	337219.	337426.	337552.	337604.	337586.
336938.	336654.	336330.	335969.	335574.	335149.	334697.
332664.	332111.	331544.	330964.	330374.	329775.	329168.

STAGE

0.0	0.0	0.0	0.0	0.0	0.0	0.0
0.0	0.0	0.0	0.0	0.0	0.0	0.0
0.0	0.0	0.0	0.0	0.0	0.0	0.0
0.0	0.0	0.0	0.0	0.0	0.0	0.0

AK	6-HOUR	24-HOUR	72-HOUR	TOTAL VOLUME
5.	1955.	1953.	1942.	66929.
5.	55.	55.	55.	1895.
	0.10	0.39	1.16	3.33
	2.47	9.87	29.45	84.57
	969.	3874.	11559.	33158.
	1196.	4779.	14257.	40936.

MAXIMUM STORAGE = 337604.

STATION 2, PLAN 1, RTIO 1

OUTFLOW						
938.	920.	933.	949.	955.	1007.	1024.
2920.	2955.	3035.	3077.	3113.	3142.	3100.
3215.	3217.	3215.	3211.	3203.	3193.	3100.
3110.	3000.	3000.	3040.	3015.	2980.	2961.

STOR						
304001.	304200.	304459.	304969.	305157.	300038.	326851.
309103.	371032.	372033.	374004.	375102.	370124.	376905.
370475.	370530.	370490.	370340.	370090.	377767.	377359.
375071.	374363.	373011.	372019.	371991.	371131.	370242.

STAGE						
0.0	0.0	0.0	0.0	0.0	0.0	0.0
0.0	0.0	0.0	0.0	0.0	0.0	0.0
0.0	0.0	0.0	0.0	0.0	0.0	0.0
0.0	0.0	0.0	0.0	0.0	0.0	0.0

	PEAK	6-HOUR	24-HOUR	72-HOUR	TOTAL
CFS	3217.	3216.	3214.	3196.	
CMS	91.	91.	91.	90.	
INCHES		0.10	0.64	1.91	
MM		4.00	16.24	48.46	
AC-FT		1595.	6375.	19017.	
THOUS CU M		1967.	7864.	23457.	

MAXIMUM STORAGE = 370530.

STATION 2, PLAN 1, R110 3

OUTFLOW						
938.	927.	940.	903.	974.	1042.	1816.
3460.	3534.	3641.	3770.	3891.	3984.	4056.
4164.	4104.	4150.	4144.	4124.	4094.	4051.
3820.	3702.	3694.	3623.	3502.	3532.	3501.

STOR						
304618.	304240.	304009.	305418.	305703.	307972.	333096.
380420.	380031.	390919.	392007.	394152.	395341.	396270.
397975.	397903.	397853.	397590.	397232.	396705.	396210.
393329.	392404.	391002.	390609.	389749.	388770.	387704.

STAGE						
0.0	0.0	0.0	0.0	0.0	0.0	0.0
0.0	0.0	0.0	0.0	0.0	0.0	0.0
0.0	0.0	0.0	0.0	0.0	0.0	0.0
0.0	0.0	0.0	0.0	0.0	0.0	0.0

	PEAK	6-HOUR	24-HOUR	72-HOUR	TOTAL
CFS	4164.	4164.	4159.	4113.	
CMS	110.	110.	110.	110.	
INCHES		0.21	0.83	2.46	
MM		5.20	21.02	62.30	
AC-FT		2005.	8249.	24472.	
THOUS CU M		2547.	10170.	30166.	

OUTFLOW

33.	949.	955.	1007.	1624.	2454.	2752.	2863.
35.	3077.	3113.	3142.	3166.	3165.	3199.	3209.
35.	3211.	3203.	3193.	3180.	3166.	3149.	3130.
35.	3040.	3015.	2986.	2961.	2933.	2904.	2874.

STOR

39.	304969.	305157.	306838.	326851.	353141.	363454.	367065.
33.	374004.	375162.	376124.	376905.	377517.	377975.	378291.
30.	378340.	378096.	377767.	377359.	376679.	376334.	375730.
1.	372819.	371991.	371131.	370242.	369327.	368390.	367434.

STAGE

0.	0.0	0.0	0.0	0.0	0.0	0.0	0.0
0.	0.0	0.0	0.0	0.0	0.0	0.0	0.0
0.	0.0	0.0	0.0	0.0	0.0	0.0	0.0
0.	0.0	0.0	0.0	0.0	0.0	0.0	0.0

PEAK	6-HOUR	24-HOUR	72-HOUR	TOTAL VOLUME
3217.	3216.	3214.	3196.	106370.
91.	91.	91.	90.	3012.
	0.16	0.64	1.91	5.29
	4.06	16.24	48.46	134.40
	1595.	6375.	19017.	52745.
	1967.	7864.	23457.	65061.

MAXIMUM STORAGE = 378538.

STATION 2, PLAN 1, RIID 3

OUTFLOW

0.	963.	974.	1042.	1816.	2832.	3233.	3375.
1.	3778.	3891.	3984.	4056.	4111.	4138.	4156.
3.	4144.	4124.	4094.	4051.	4002.	3948.	3890.
1.	3623.	3562.	3532.	3501.	3469.	3436.	3402.

STOR

0.	305418.	305763.	307972.	333096.	366063.	379058.	383673.
0.	392687.	394152.	395341.	396278.	396987.	397493.	397817.
0.	397598.	397232.	396765.	396210.	395581.	394685.	394132.
2.	390689.	389749.	388776.	387764.	386720.	385646.	384546.

STAGE

0	0.0	0.0	0.0	0.0	0.0	0.0	0.0
0	0.0	0.0	0.0	0.0	0.0	0.0	0.0
0	0.0	0.0	0.0	0.0	0.0	0.0	0.0
0	0.0	0.0	0.0	0.0	0.0	0.0	0.0

PEAK	6-HOUR	24-HOUR	72-HOUR	TOTAL VOLUME
4164.	4164.	4159.	4113.	130166.
116.	118.	118.	116.	3666.
	0.21	0.83	2.46	6.48
	5.26	21.02	62.36	164.47
	2065.	8249.	24472.	64545.
	2547.	10175.	30166.	79615.

MAXIMUM STORAGE = 397983.

STATION 2, PLAN 1, RTID 4

OUTFLOW						
939.	928.	946.	977.	992.	1077.	2008.
4445.	4602.	4751.	4875.	4978.	5054.	5113.
5207.	5201.	5180.	5163.	5131.	5093.	5048.
4600.	4734.	4659.	4582.	4508.	4440.	4371.
STOR						
304636.	304273.	304879.	305808.	306309.	309107.	339340.
403247.	405977.	408299.	410242.	411838.	413120.	414116.
415715.	415621.	415366.	414965.	414432.	413782.	413026.
409109.	408047.	408378.	405609.	404425.	403149.	401844.
STAGE						
0.0	0.0	0.0	0.0	0.0	0.0	0.0
0.0	0.0	0.0	0.0	0.0	0.0	0.0
0.0	0.0	0.0	0.0	0.0	0.0	0.0
0.0	0.0	0.0	0.0	0.0	0.0	0.0

	PEAK	6-HOUR	24-HOUR	72-HOUR	TOTAL
CFS	5207.	5204.	5199.	5143.	
CMS	147.	147.	147.	146.	
INCHES		0.26	1.03	3.07	
MM		6.58	26.28	77.97	
AC-FT		2581.	10312.	30600.	
THOUS CU M		3183.	12719.	37745.	

MAXIMUM STORAGE = 415715.

STATION 2, PLAN 1, RTID 5

OUTFLOW						
940.	930.	959.	1004.	1030.	1147.	2393.
6426.	6573.	6699.	6804.	6891.	6960.	7013.
7091.	7082.	7064.	7038.	7004.	6962.	6915.
6673.	6602.	6528.	6451.	6372.	6290.	6200.
STOR						
304670.	304340.	305299.	306766.	307581.	311376.	351829.
436311.	439719.	442615.	445040.	447031.	448622.	449847.
451648.	451450.	451030.	450426.	449638.	448688.	447592.
442014.	440381.	438672.	436697.	435064.	433182.	431255.
STAGE						
0.0	0.0	0.0	0.0	0.0	0.0	0.0
0.0	0.0	0.0	0.0	0.0	0.0	0.0
0.0	0.0	0.0	0.0	0.0	0.0	0.0
0.0	0.0	0.0	0.0	0.0	0.0	0.0

	PEAK	6-HOUR	24-HOUR	72-HOUR	TOTAL
CFS	7091.	7090.	7083.	7028.	
CMS	201.	201.	201.	199.	
INCHES		0.35	1.41		
MM					



MAXIMUM STORAGE = 397983.

STATION 2, PLAN 1, RTIO 4

OUTFLOW

977.	992.	1077.	2008.	3230.	3927.	4276.
4875.	4978.	5054.	5113.	5156.	5185.	5202.
5163.	5131.	5093.	5048.	4998.	4939.	4875.
4562.	4508.	4440.	4371.	4300.	4228.	4155.

STOR

305808.	306309.	309107.	339340.	378985.	394609.	400079.
410242.	411838.	413120.	414116.	414852.	415349.	415630.
414965.	414452.	413782.	413026.	412176.	411242.	410237.
405609.	404425.	403149.	401844.	400514.	399166.	397802.

STAGE

0.0	0.0	0.0	0.0	0.0	0.0	0.0
0.0	0.0	0.0	0.0	0.0	0.0	0.0
0.0	0.0	0.0	0.0	0.0	0.0	0.0
0.0	0.0	0.0	0.0	0.0	0.0	0.0

PEAK	6-HOUR	24-HOUR	72-HOUR	TOTAL VOLUME
5207.	5204.	5199.	5143.	161739.
147.	147.	147.	146.	4580.
	0.26	1.03	3.07	8.05
	6.56	26.28	77.97	204.36
	2581.	10312.	30600.	80201.
	3163.	12719.	37745.	98926.

MAXIMUM STORAGE = 415715.

STATION 2, PLAN 1, RTIO 5

OUTFLOW

1004.	1030.	1147.	2393.	4523.	5829.	6254.
6804.	6891.	6960.	7013.	7051.	7076.	7089.
7038.	7004.	6962.	6915.	6862.	6803.	6740.
6451.	6372.	6290.	6206.	6103.	5967.	5830.

STOR

306766.	307581.	311376.	351829.	404706.	425337.	432347.
445040.	447031.	448622.	449847.	450735.	451314.	451610.
450426.	449638.	448688.	447592.	446363.	445016.	443563.
436697.	435064.	433182.	431255.	429297.	427325.	425352.

STAGE

0.0	0.0	0.0	0.0	0.0	0.0	0.0
0.0	0.0	0.0	0.0	0.0	0.0	0.0
0.0	0.0	0.0	0.0	0.0	0.0	0.0
0.0	0.0	0.0	0.0	0.0	0.0	0.0

PEAK	6-HOUR	24-HOUR	72-HOUR	TOTAL VOLUME
7091.	7090.	7083.	7026.	222788.
201.	201.	201.	199.	6309.
	0.35	1.41		11.08
				281.50

AC-FT  
THOUS CU A

3516. 14049. 41616.  
4337. 17329. 51581.

MAXIMUM STORAGE = 451648.

STATION 2, PLAN 1, RTID 6

OUTFLOW						
941.	932.	972.	1032.	1067.	1216.	2776.
7679.	8067.	8226.	8362.	8473.	8562.	8632.
8740.	8732.	8712.	8682.	8642.	8592.	8535.
8242.	8150.	8065.	7971.	7873.	7773.	7671.

SIOR						
304704.	304407.	305719.	307665.	308793.	313645.	364316.
469637.	474172.	477366.	480968.	483527.	485585.	487183.
489690.	489502.	489044.	488339.	487411.	486279.	484963.
478196.	476203.	474115.	471943.	469698.	467389.	465025.

STAGE						
0.0	0.0	0.0	0.0	0.0	0.0	0.0
0.0	0.0	0.0	0.0	0.0	0.0	0.0
0.0	0.0	0.0	0.0	0.0	0.0	0.0
0.0	0.0	0.0	0.0	0.0	0.0	0.0

	PEAK	6-HOUR	24-HOUR	72-HOUR	TOTAL
CFS	8740.	8738.	8731.	8561.	
CMS	247.	247.	247.	245.	
INCHES		0.43	1.74	5.17	
MM		11.04	44.13	131.32	
AC-FT		4333.	17317.	51538.	
THOUS CU A		5345.	21360.	63571.	

MAXIMUM STORAGE = 489690.

\*\*\*\*\*

\*\*\*\*\*

\*\*\*\*\*

\*\*\*\*\*



3516.	14049.	41616.	110473.
4337.	17329.	51581.	136207.

MAXIMUM STORAGE = 451048.

STATION 2, PLAN 1, RTID 6

OUTFLOW

1032.	1067.	1216.	2776.	6167.	7280.	7661.
8302.	8473.	8502.	8632.	8683.	8717.	8736.
8682.	8642.	8592.	8535.	8471.	8400.	8324.
7971.	7873.	7773.	7671.	7566.	7400.	7352.

SIOR

307065.	308793.	313045.	364316.	430340.	456004.	464806.
480968.	483527.	485585.	487183.	488359.	489147.	489581.
488339.	487411.	486279.	484963.	483481.	481849.	480083.
471943.	469698.	467389.	465025.	462614.	460164.	457682.

STAGE

0.0	0.0	0.0	0.0	0.0	0.0	0.0
0.0	0.0	0.0	0.0	0.0	0.0	0.0
0.0	0.0	0.0	0.0	0.0	0.0	0.0
0.0	0.0	0.0	0.0	0.0	0.0	0.0

AK	5-HOUR	24-HOUR	72-HOUR	TOTAL VOLUME
0.	8738.	8731.	8501.	274200.
7.	247.	247.	245.	7764.
	0.43	1.74	5.17	13.64
	11.04	44.13	131.32	346.46
	4333.	17317.	51538.	135967.
	5345.	21300.	63571.	167713.

MAXIMUM STORAGE = 489090.

\*\*\*\*\*

\*\*\*\*\*

\*\*\*\*\*



PEAK FLOW AND STORAGE (END OF PERIOD) SUMMARY FOR MULTIPLE PLAN-RAT  
 FLOWS IN CUBIC FEET PER SECOND (CUBIC METERS PER SECOND)  
 AREA IN SQUARE MILES (SQUARE KILOMETERS)

OPERATION	STATION	AREA	PLAN	RATIOS APPLIED TO FLOWS			
				RATIO 1 0.20	RATIO 2 0.40	RATIO 3 0.50	RATIO 4 0.60
HYDROGRAPH AT	1	187.00	1	38038.	76076.	95094.	114113.
	( 484.33)			( 1077.11)	( 2154.22)	( 2692.77)	( 3231.33)
ROUTED TO	2	187.00	1	1955.	3217.	4164.	5207.
	( 484.33)			( 55.36)	( 91.09)	( 117.92)	( 147.44)



END OF PERIOD) SUMMARY FOR MULTIPLE PLAN-RATIO ECONOMIC COMPUTATIONS  
 IN CUBIC FEET PER SECOND (CUBIC METERS PER SECOND)  
 AREA IN SQUARE MILES (SQUARE KILOMETERS)

IN	RATIOS APPLIED TO FLOWS					
	RATIO 1 0.20	RATIO 2 0.40	RATIO 3 0.50	RATIO 4 0.60	RATIO 5 0.80	RATIO 6 1.00
1	38036.	76076.	95094.	114113.	152151.	190189.
(	1077.11)	2154.22)	2692.77)	3231.33)	4308.44)	5385.55)
1	1955.	3217.	4164.	5207.	7091.	8740.
(	55.36)	91.09)	117.92)	147.44)	200.79)	247.50)

APPENDIX D

STRUCTURAL STABILITY ANALYSIS

- A. Erdman, Anthony, Associates Analysis
- B. Review by Thomsen Associates
- C. Thomsen Associates Analysis

MEMORANDUM

From: K. Ketchek  
 To: E. C. Tonias  
 Date: 15 September 1980  
 Re: DESIGN WARNER DAM FOUNDATION

The foundation design against water percolation through the subsoil of the dam was performed on the basis of Art. 59 (pages 502-505, 1954) "Soil Mechanics in Engineering Practice" by K. Terzaghi and R. Peck. The weighted creep ratio  $C_w$  is expressed by the equation (59.2)

$$C_w = \frac{1/3 B + t}{h}$$

Four borings (B-1, B-2, No. 3, and No. 4) reveal, that below the elevation of the dam bottom (1291.5) the soil consists predominately of dense sand and gravel, with traces of clay and silt.

Table 27 of the above mentioned reference recommends a value of  $C_w$ , for coarse sand and fine gravel, between 4 and 5 (used vg 4.5). In our calculation  $1/3 B + t$  was estimated as 68.0' (page 3 of Structural Calculations). The maximum head  $h = 14'$ , which yields

$$\text{design } C_w = \frac{68}{14} = 4.85 \quad 4.50$$

The actual value of  $(1/3) B + t$ , after some modifications during the final design, equals  $49/3 + 58'-6" = 74.83'$  which gives

$$\text{actual } C_w = \frac{74.83}{14} = 5.35$$

Additionally, the old dam foundation was taken into consideration. The old dam, located just 60' upstream with the same head, had one timber sheet piling with unspecified length and composed of three 2" planks. Due to the denseness of the soils, length could not be more than 15'. Accordingly,

$B/3 + t$  of the old dam equals  $\frac{43}{3} + (2 \times 15 + 7.5 + 4 + 2) = 58'$ ;  $C_w = \frac{58}{14} = 4.14$ . This dam was built in 1913 and was in operation until 1978 (65 years).

On the basis of this comparison, using a more conservative approach, we increased our design of  $C_w$  to 4.85 which, with the further final design modification, became 5.35<sup>w</sup>. We consider this value safe against damage due to water percolation.

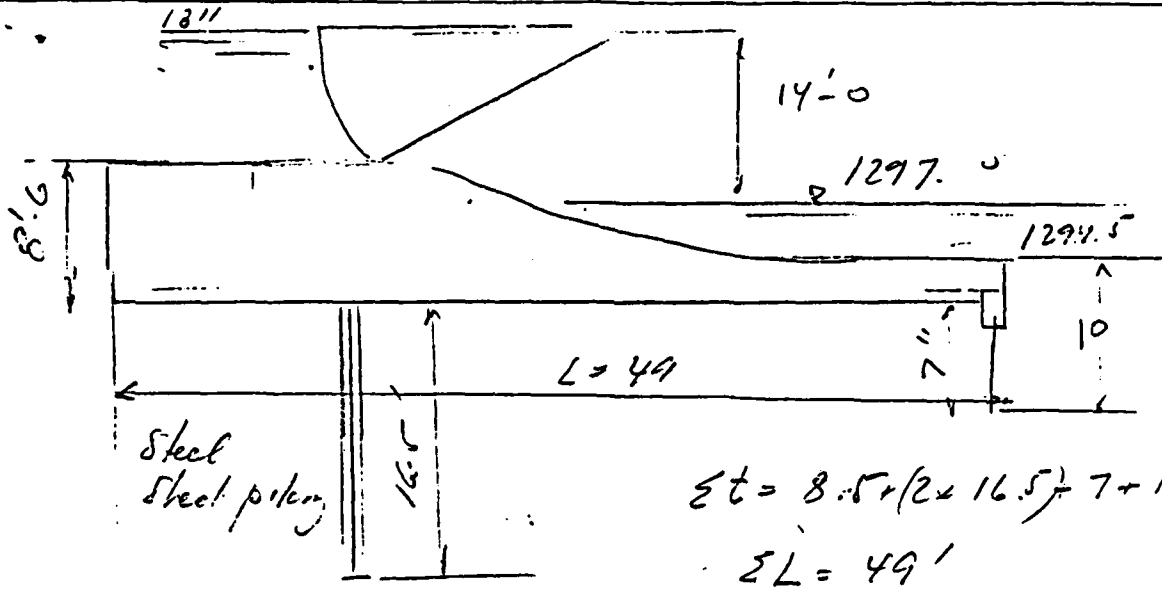

$$\sum t = 8.5 + (2 \times 16.5) + 7 + 10 = 63.5$$

$$\sum L = 49'$$

New dam

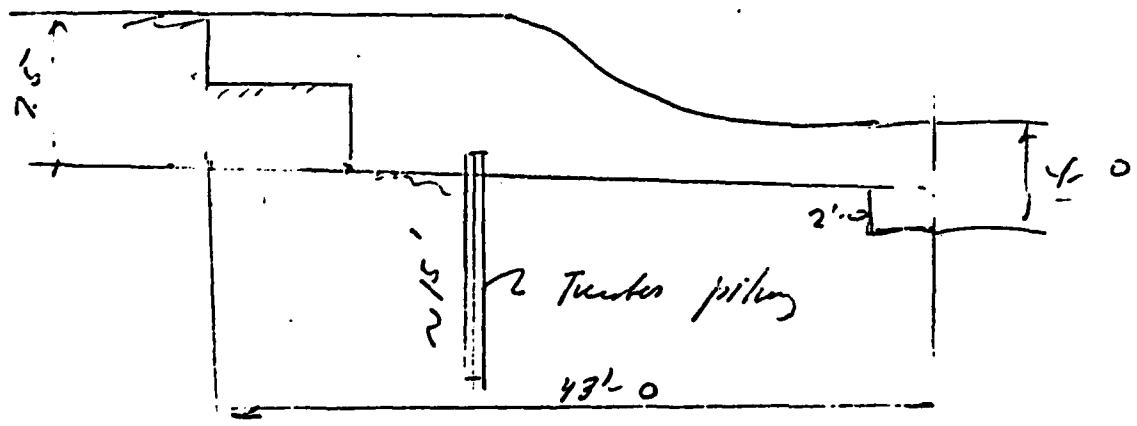

$$\sum t = 7.50 + (2 \times 15) + 3 + 4.0 = 43.50$$

$$\sum H = 43$$

Old dam



DATE

ERDMAN, ANTHONY, ASSOCIATES

SHEET

12

OF

DATE

SUBJECT

SUB-SHEET NO.

PROJECT NAME

WARNER DAM



Calculation of structure stability and foundation pressure

General concepts

The Warner Dam stability calculation are performed with the following criteria:

1. The dam is founded on sand gravel strates. \*)  
Weighted creep value (See Terzaghi & Peck "Soil Mechanics in Engineering Practice" Second. Edit. page 517) is selected as for mixture of sand in gravel (see table. 53.1) as average between 4 & 5.  $\frac{4+5}{2} = 4.50$  (min)
2. Safety sliding factor  $\geq 1.50$
- 3) Friction factor for sliding 0.40.
- 4) Safety factor for overturning  $\geq 2.0$
- 5) Max foundation pressure.

For all computations the portion of the dam with the attached pier, is considered as units. The abutments are not included in the computation. However in detailing on final plans, the abutment are designed integrated with the dam, which considerably increases dam stability.

The assumed dam dimensions - see sub-sheet 2

\*) See borings data in separate cover

Warner drain profile

Note: They are minor changes in the final plans

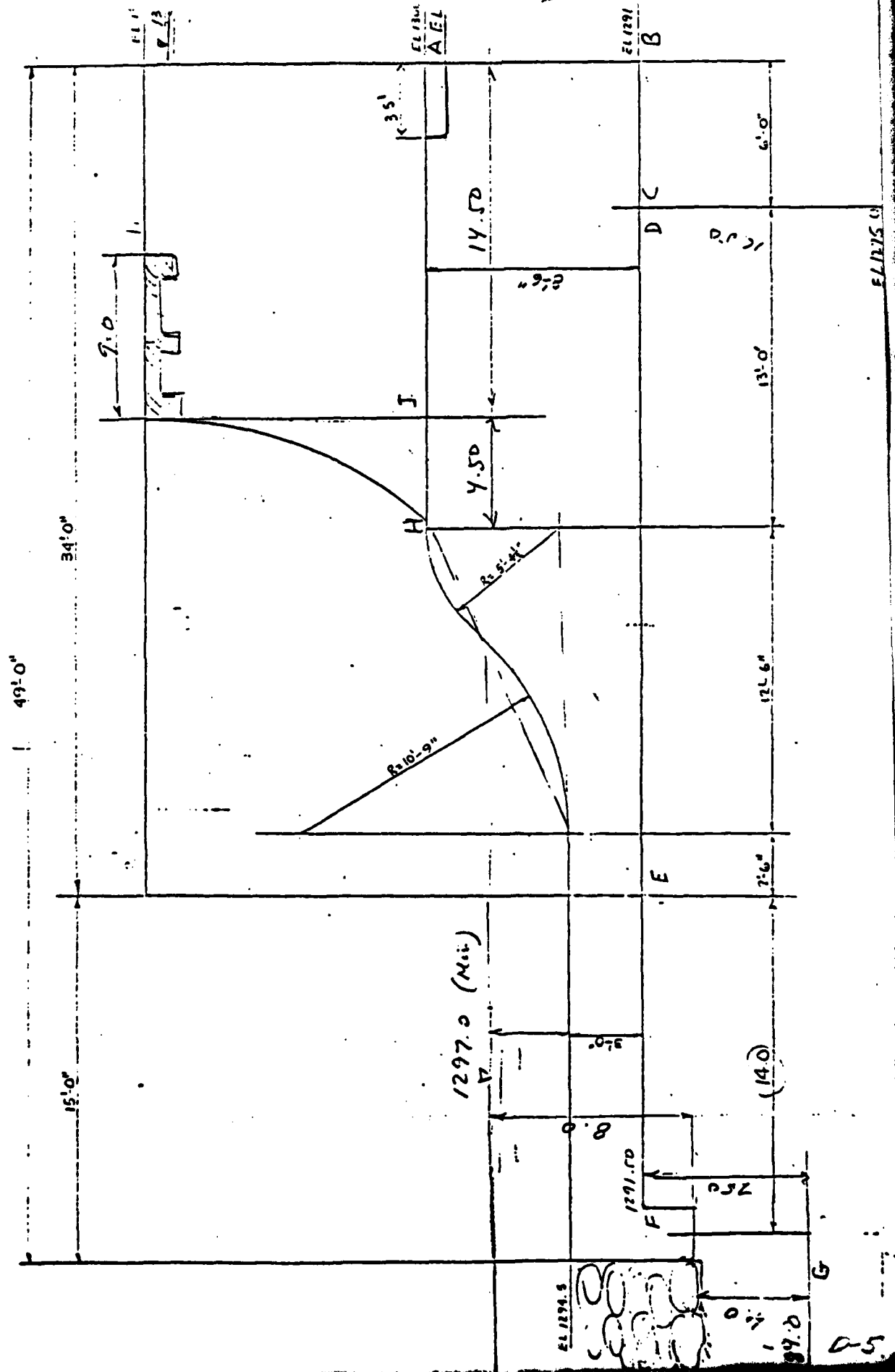

WEIGHTED LENGTH OF PATH

$7.5 + 6.0/3 + 16.5 + 16.5 + 42.0/3 + 7.5 + 40 = 68.0' \checkmark$

HEAD

$1311.0 - 1297.0 = 14.0' \checkmark$

GRADIENT

$14.0/68.0 = .206 \checkmark$

Creep factor  $68/14 = 4.85 > 4.5$  (select min)

PRESSURE

- @ A     $12.0(.0624) = .749$  KSF  $\checkmark$
- @ B     $(19.5 - 7.5(.206))(.0624) = 1.120$  KSF  $\checkmark$
- @ C     $(17.955 - 6.0/3(.206))(.0624) = 1.095$  KSF  $\checkmark$
- @ D     $(17.543 - 33.0(.206))(.0624) = .670$  KSF  $\checkmark$
- @ E     $(10.745 - 28.0/3(.206))(.0624) = .551$  KSF  $\checkmark$
- @ F     $(8.822 - 14.0/3(.206))(.0624) = .491$  KSF  $\checkmark$
- @ G     $(7.861 + 3.5 - 11.5(.206))(.0624) = .561$  KSF

VERTICAL

FORCE	CALCULATION	V	ARM <sup>ABOUT TOE OF DAM</sup>	M
<u>WATER</u>				
B-C	$(1.120 + 1.095)/2 (6.0) (31.667)$	- 210.40 $\checkmark$	31.0 $\checkmark$	- 6523.237
D-E	$(.670 + .551)/2 (28.0) (31.667)$	- 541.30 $\checkmark$	14.454 $\checkmark$	- 7827.181
H-I	$\sim (1/3)(11.0)(4.5)(.0624) (31.667)$	32.604 $\checkmark$	18.0 $\checkmark$	586.872 $\checkmark$
I-A	$\sim [(11.0)(14.5) + (3.5)(1.0)](.0624)(31.667)$	322.10 $\checkmark$	26.86 $\checkmark$	8651.602
<u>CONCRETE</u>				
PIER	$(20.0)(34.0)(5.0)(.15)$	510.0 $\checkmark$	17.0	+ 8670.00
DAM (1)	$[(19.0)(8.5) - (3.5)(1.0)](26.667)(.15)$	632.0 $\checkmark$	23.32	14725.80
DAM (2)	$(15.0)(3.0)(26.667)(.15)$	180.00 $\checkmark$	7.5 $\checkmark$	1350.00
DAM (3)	$(5.5)(12.5)(1/2)(26.667)(.15)$	137.50 $\checkmark$	10.833	1489.559
		1062.50	Total ..	+ 35474.0
			(Rounded)	- 14347.0
				21127.0

HORIZONTAL

<u>WATER</u>				
A-B	$(.749 + 1.120)/2 (7.5) (31.667)$	221.946 $\checkmark$	3.437	- 762.328
DOWNSTREAM	$(8.2)/2 (.0624) (31.667)$	- 63.233 $\checkmark$		disregarded for overturning
GATE+STEP	$(12.0)^2/2 (.0624) (31.667)$	142.273 $\checkmark$	11.5	- 1636.140
		300.985	D-6	- 2378.967

For stability on sliding entire structure including portion EF and weight of concrete bridge is considered. Additional forces which shall be accounted:

Vertical:

Water pressure on EF  $= \frac{0.551 + 0.491}{2} \times 14 \times 31.667 = -231 \text{ k}$

Weight of concrete  $15 \times 3.0 \times 0.15 \times 31.667 = +214$

Height of water above a)  $17.50 \times 2.50 \times 0.0624 \times 26.667 = 73 \text{ k}$

b)  $\frac{2}{3} \times 2.50 \times 6.0 \times 0.0624 \times 26.667 = 76 \text{ k}$

+ 72 k

Weight of concrete bridge over dam:

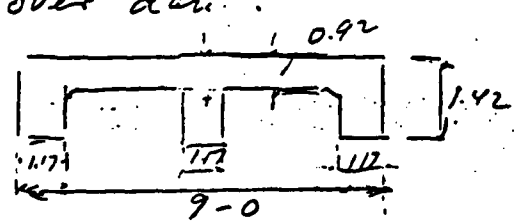

$A = (9.0 \times 0.92) + (1.50 \times 0.50) = 9.0 \text{ Ft}^2$

$W = 9.0 \times 0.15 \times 31.667 = 43.0 \text{ k}$

Addit. vert. forces  $V = 72 + 43 = \underline{\underline{115 \text{ k}}}$

Total vertical forces on one section (31.667') of dam are  $\Sigma V = 1062.50 + 115 = 1177.50 \text{ k}$

$\Sigma H = 301 \text{ k}$

For friction factor between concrete and footing use 0.40

Sliding S.F.  $= \frac{1177.50 \times 0.40}{301} = 1.56 > 1.50 \text{ OK}$

Actual sliding S.F. is higher, because of additional weight of abutments, gates and hoisting equipment.

Additional stability moment due to weight of concrete bridge

$$M_v = 43 \times 24 = 1032 \text{ IK}$$

Total: Overturning moment =  $14347 + 2400 = 16747 \text{ IK}$   
 Stabilizing moment =  $35474 + 1032 = 36506 \text{ IK}$

Overturning S.F. =  $\frac{36506}{16747} = 2.18 > 2.0 \text{ (OK)}$

Total  $\Sigma M$  on the portion of dam to the pt. E

$$\Sigma M = 21127 - 2400 = 18727 \text{ IK}$$

$$\Sigma P = 1062.50 + 43 = 1105.5 \text{ K}$$

Eccentricity

$$\eta = \frac{18727}{1105.5} = 16.94$$

$$e = 17 - 16.94 = 0.06$$

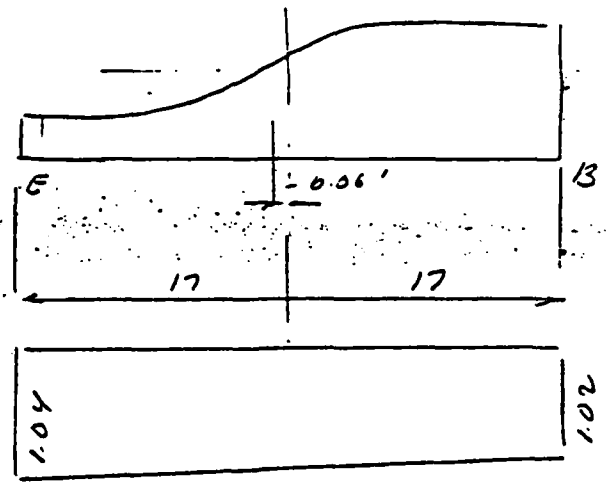

Foundation pressure:

$$\sigma = \frac{1105.50}{34 + 31667} \left( 1 \pm \frac{6 \times 0.06}{34} \right) = 1.027 (1 \pm 0.01)$$

$$P_{max} \approx 1.04 \text{ KSF}$$

$$P_{min} \approx 1.02 \text{ KSF}$$

Considering water pressure, total pressure on the concrete at different points is:

PT. B = 1.02 + 1.12 = 2.14 KSF

PT C = 1.025 + 1.095 = 2.12 KSF

PT D = 1.025 + 0.67 = 1.70 KSF

PT E = 1.04 + 0.551 = 1.59 KSF

Check for seismic stability

ADDITIONAL INERTIA FORCE DUE TO SEISMIC LOADING  $E_p = CD$

WEIGHT OF DAM (CONCRETE) = (510.0 + 632.0 + 180.0 + 137.5) = 1459.5  
 concrete bridge = 43.0  
 1502.5 K

C = .04 (FROM AASHTO)

$E_p = 1502.5 (.04) = 60.0 K$

$\Sigma F_H = 30.1 + 60 = 90.1 K$

SLIDING S.F. =  $\frac{1.177 \cdot 502.0 \cdot 0.40}{90.1} = 2.60 > 1.0$

addit. Horiz. force FOR OVERTURNING

		ARM	MOMENT	
PIER	510.0	10.0	5100.0	✓
DAM (1)	632.0	4.25	2686.0	✓
DAM (2)	180.002	1.5	270.0	✓
DAM (3)	137.502	4.933	664.5	
			8720.5	(.04) = 348.82

OVERTURNING S.F. =  $\frac{1.36506}{(16743 + 349)} = 2.13$

Stresses in the body of the dam

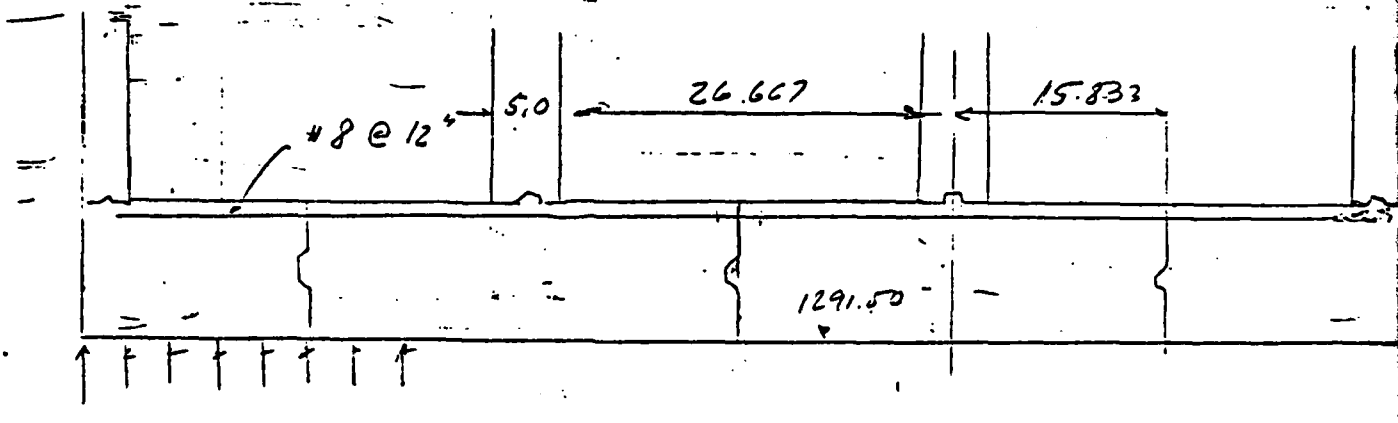

Upstream end

Max. footing pressure	1.1	-2.14	*) No water on the top
Weight of concrete	85 x 0.15	+1.27	
		<u>-0.87</u>	
Considering 11' of water		-0.87	Water at elev. 1311.0
	11 x 0.0624	+0.69	
		<u>-0.18</u>	k/sf.

Downstream end

Max footing pressure		-1.60	
Weight of concrete	3.0 x 0.15	+0.45	min. thickness at the end
3' of water	0.0624 x 3	+0.18	
		<u>-0.97</u>	k/sf.

\* This condition can exist by abrupt drop of upstream water level. (No water on the slab, pressure at bottom is not released)



Upstream section, thickness of concrete 8.5'  
Max possible moments: (per 1.4f)  
Over supports considering partial restriction  
 over piers - see  $M_{max} = wL^2/10$

$$M = \frac{0.87 \times 26.67^2}{10} = 62 \text{ k-ft}$$

Check stresses for plain concrete

Slab thickness = 8.5'

Stresses:  $f = \frac{M}{S}$ ;  $S = \frac{bh^2}{6} = \frac{10 \times 25^3}{6} = 12 \text{ ft}^3$

$$f = \frac{62}{12} = 5.2 \text{ k/ft}^2 < 6.95 = 36 \text{ psi (OK)}$$

Tensile stress is very low, no reinforcement required. !!

At mid-span joint

At the joint no tensile stresses can be taken by concrete. Calculate required reinforcement.

Using the same moment  $M = 62 \text{ k-ft}$

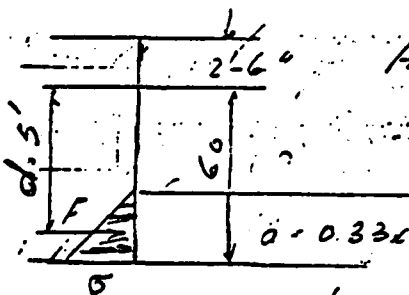

Assuming stress distribution as shown on the sketch

$$A_s = \frac{62}{5724} = 0.52 \text{ in}^2$$

Use # 8 @ 12"  $A_s = 0.78$

Concrete stress  $F = 62/5 = 12.4 \text{ k/ft}^2$   $\frac{6 \times 24 \times 12}{2} = 12400$

$$s = \frac{12400 \times 2}{2} = 86 \text{ psi}$$

Downstream end.

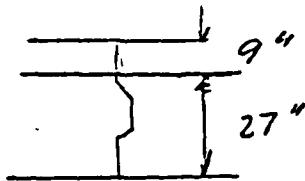
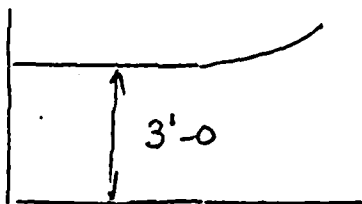

Max down pressure 0.97"/s.f

$$M_{max} = \frac{0.97 \times (26.67)^2}{12} = \text{(consider as slab restricted at both ends)}$$

$$= 57.50 \text{''k}$$

$$M_u = \frac{1.50}{0.90} \times 57.50 = 95.80 \text{''k}$$

Slab thickness = 36"  $d = 36'' - 9 = 27$

$$F = \frac{bd^2}{12000} = \frac{12 \times 27^2}{12000} = 0.729$$

$$K_u = \frac{M}{F} = \frac{95.80}{0.729} = 131.41$$

Use  $p = 0.0025$  (From table for  $f_c = 3000$ )

Use  $p = 0.0030$   $f_c = 60.44$   $K_u = 156$ )

$$A_s = 0.003 \times 27 \times 12 = 0.972$$

Use 4 # @ 12"  $A_s = 1.0 \text{''}^2$

AD-A090 937

NEW YORK STATE DEPT OF ENVIRONMENTAL CONSERVATION ALBANY F/6 13/13  
NATIONAL DAM SAFETY PROGRAM. WARNER DAM, CHAUTAUGUA LAKE OUTLET--ETC(U)  
SEP 80 B L THOMSEN, G L WOOD DACW51-79-C-0001

UNCLASSIFIED

NL

2 of 2  
MAR 2 1981



END
DATE
FILED
12-80
DTIC

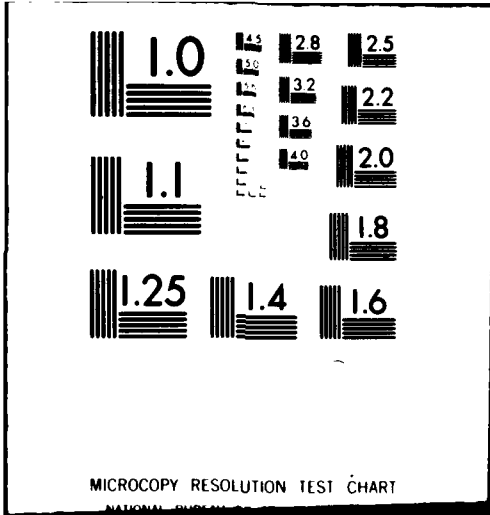

MICROCOPY RESOLUTION TEST CHART

NATIONAL BUREAU OF STANDARDS-1963-A

Reinforcement of bottom slab (Continued)

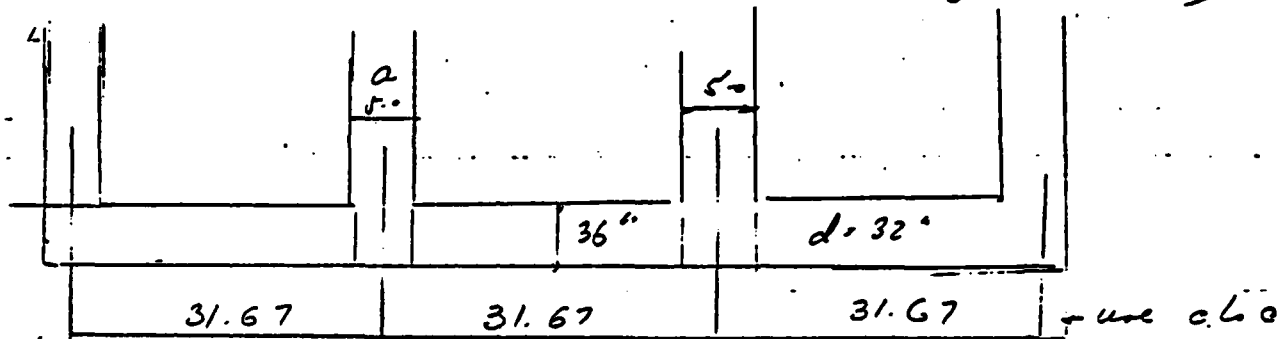

Max bottom pressure reduced to the weight of slab & 3'-0 of water ... (see page # of stability calculation) = 0.97  $\frac{1}{5.5}$

This pressure shall be considered as conservative, for the case of abrupt drop of water downstream usually level of water downstream is higher than 3'-0

The footing of dam is built integrated with the piers and abutments. The preliminary

computations (see dam's stability) were performed without consideration of moments

at the ends of footing due to horizontal forces. Using abutment design computer,

we apply moments of 172  $\frac{1}{2}$  at both ends,

and by ...

The scheme of forces & moments applied to the footing is shown below

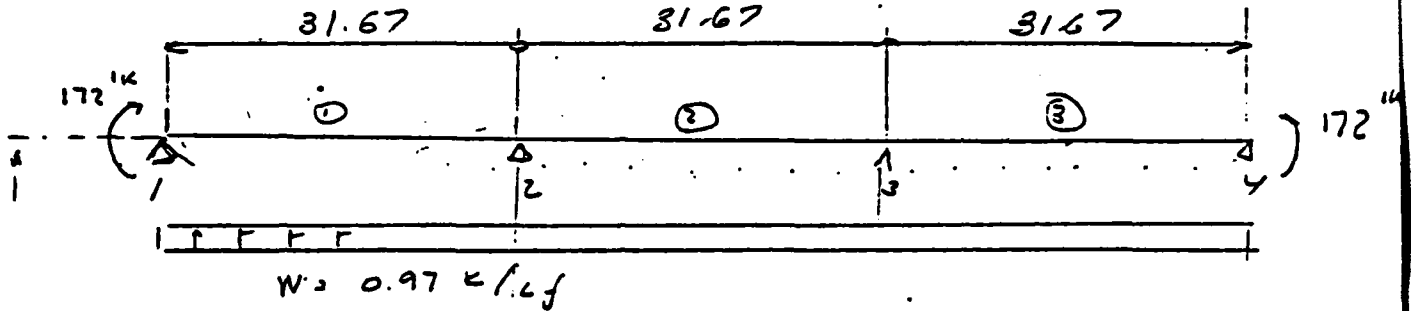

Distribution factors  $K_1 = K_3 = 3$        $K_2 = 4$

$DF \text{ pt } 1 = 0$        $DF(1-2) = \frac{3}{7} = 0.43$   
 $DF \text{ pt } 4 = 0$        $DF(2-1) = \frac{4}{7} = 0.57$

FEM due to  $W = 0.97 \text{ k/lf} = \frac{0.97 \times 31.67^2}{12} = 81 \text{ k}$

Moment distribution for applied moment = 172

172	1.0	0.43	0.57	0.57	0.43	172
+172	-	-	-	-	-	-172
	+86					
	-37	-49		+49	+37	
		+24.5		-24.5		
		-10.5		+14	+10.5	
		+7		-7		
		-3		+3		
		+2		-2		
		-1		+1		
+172	+35	-35		+35	-35	-172
						Total

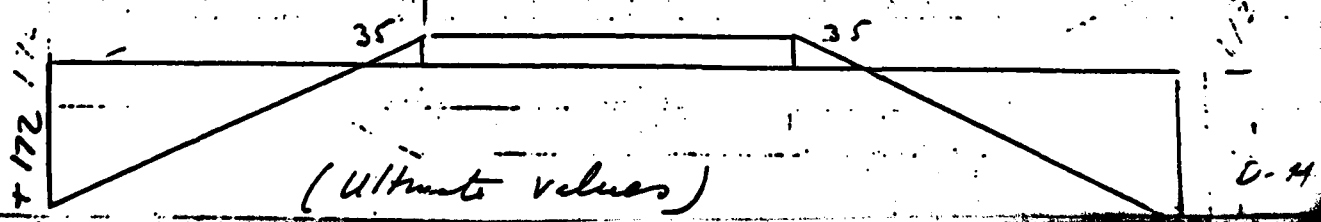

Moment distribution for uniform load 0.97 k/ft

	0.43	0.57	0.43	0.57		Dist. F.
+81	-81	+81	-81	+81	-81	FGM
-81	0	0	0	0	-81	Dist
	-40.5			+40.50		C.O
	+20.25	+20.25	-20.25	+20.25		Dist
		-10.0	+10			C.O
+5	+5		-5	-5.0		Dist
		-2.5	+2.5			C.O
	+1.0	+1.5	-1.5	-1.0		Dist
	-95	+95	+95	-95		Total

$$R_1 = 0.97 \times 31.67 / 2 - 95 / 31.67 = 15.36 - 3.0 = 12.36$$

$$M_1 = 12.36 \times 31.67 - 0.97 \times 31.67^2 / 2 = 39.14 - 9.86 = 34.28$$

$$M_2 = 2 \times 39.14 - 4.86 \times 4 = 78.28 - 19.44 = 58.84$$

$$M_3 = 3 \times 39.14 - 4.86 \times 9 = 117.42 - 43.74 = 73.68$$

$$M_4 = 4 \times 39.14 - 4.86 \times 16 = 156.56 - 77.76 = 78.8$$

$$M_5 = 5 \times 39.14 - 4.86 \times 25 = 195.7 - 121.50 = 74.2$$

$$M_{10} = 10 \times 39.14 - 4.86 \times 100 = 391.40 - 486 = -95.00$$

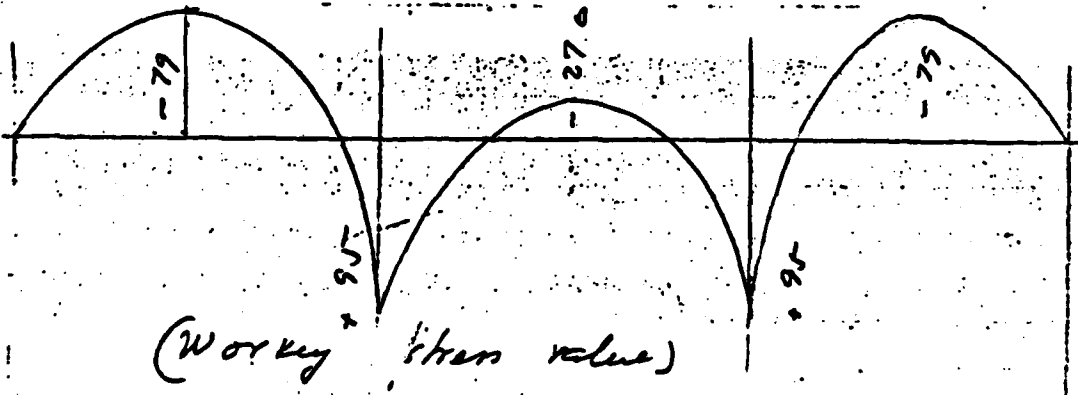

(Working stress values)

$$\text{Mid of center span } M = \frac{0.97 \times 31.67^2}{8} - 95 = 26.60$$

(These moments shall be multiplied on the factor 1.5, (for  $M_0$ )

From the vertical forces acting on the footing and from abutments design horizontal pressure produces at sect I-I, bending moment  $M_u = 172$  in-k

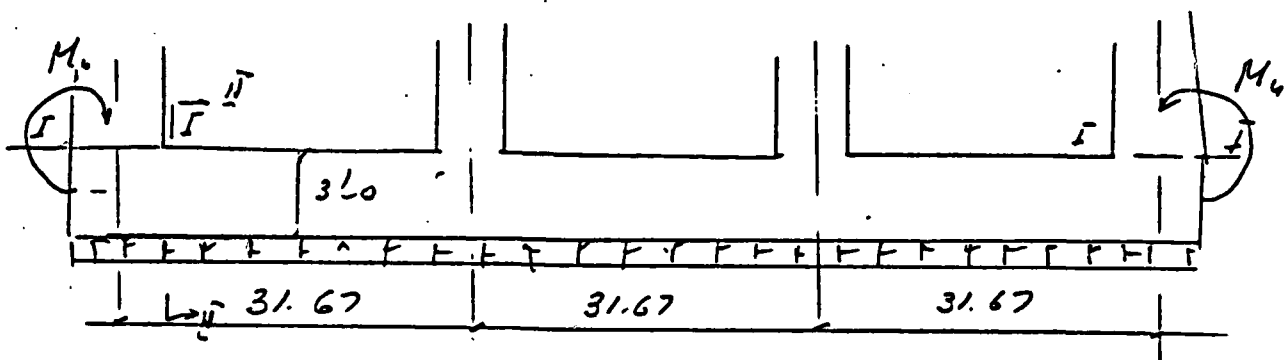

Consider the following Ult. Moments to be considered.

- 1) Max positive moments at sect. II-II -  $M_u = 172$  in-k
- 2) Max negative moment at span  $1.50 \times 79 = 119$  in-k
- 3) Max positive moment under piers  $-1.50 \times 95 = 143$  in-k
- 4) Max negative moment - central span  $35 + 1.50 \times 27 = 78.5$  in-k

Reinforcement: (Use ACI spec. Publ. #17 - Table 11.1.5)

Sect. II-II.  $d = 32$  in  $b = 12$  in  $F = \frac{bd^2}{12000} = 1.02$

$f_s = 60000$  psi  $f_c = 3000$  psi

$K_u = \frac{M_u}{F} = \frac{172}{1.02} = 169$   $p = 0.0030 + \frac{13}{25} \times 0.0005 = 0.00326$

$A_s = 0.00326 \times 12 \times 32 = 1.25$  in<sup>2</sup>

Used #7 & #8 @ 12" c/c

(Both)  $A_s = 0.79 + 0.60 = 1.39$  in<sup>2</sup>



Sec 2  $M = -119$ . (all other dimensions the same as above)

$$K_u = \frac{119}{1.02} = 117 \quad \text{use } p = 0.0023$$

$$A_s = 0.0023 \times 12 \times 32 = 0.88 \text{ in}^2$$

Use #8 @ 12  $A_s = 0.79$ .

Comparison with the computation on the page 9 it can be seen, that negative moment 119 in is too conservative, disregarding deduction due to the axis of support. Consider deduction recommended by Portl. Cont. Inst

$$M = 119 - \frac{V(L_c)}{2} \quad \text{where } V = 0.5 \times 0.97 \times 31.87 = 15.35$$

$$M = 119 - \frac{15.35 \times 5}{6} = 106 \text{ in} \quad K = \frac{106}{1.02} = 104 \text{ in}$$

$$A_s = 0.002 \times 12 \times 32 = 0.77 \quad (\text{use } 0.79) \text{ OK}$$

Sec 3  $M_u = 143$ .  $K = \frac{143}{1.02} = 140$

$$\text{use } 0.0030 \times 12 \times 32 = 1.15 \quad \text{use } 2\#8 \quad A_s = 1.58$$

Sec 4 Positive moment considering deduction

$$M_u = 75.5 - 15.35 \times \frac{5}{6} = 63 \text{ in}$$

$$K = \frac{63}{1.02} = 62 \quad \text{use } K = 80 \quad p = 0.0015$$

$$A_s = 0.0015 \times 12 \times 32 = 0.58$$

Use #8 @ 12 = 0.79 in<sup>2</sup>  
 10-12

**THOMSEN ASSOCIATES**  
CONSULTING GEOTECHNICAL ENGINEERS & GEOLOGISTS

**Review of Structural Stability Analysis  
Performed by Erdman, Anthony, Associates**

The case analyzed by the designer is a high water condition with the upstream pool at Elevation 1311.0 and the tailwater at Elevation 1297.0. The gates are assumed closed and the sheet piling is assumed to be 100 percent effective in preventing underseepage and reducing hydrostatic uplift pressure.

The method used in evaluating underseepage control is based on empirical rules discussed in Terzaghi & Peck, Soil Mechanics in Engineering Practice, Article 63, pp. 615-618, 2nd Edition.

The fundamental assumption that the sheet piles are 100 percent effective results in an increased cross-sectional length of the dam thereby decreasing the hydraulic gradient and uplift pressure along the base of the dam.

From a design standpoint the above fundamental assumption is a reasonable approach. The following errors were noted in the stability analysis:

A. Sheet 10, Subsheet 4.

The weight of the concrete (214 kips) used in the additional vertical force computed for sliding stability is already included in the calculations from Sheet 9, Subsheet 3. (See Weight of Dam (2) near bottom of Subsheet 3). The correct additional vertical forces should read -99 kips rather than +115 kips, therefore, the resulting sliding S.F. should be 1.28 not 1.56.

B. Sheet 11, Subsheet 5

The computation of the total sum of moments acting on the dam between pt. B and pt. E is incorrect. This moment included the weight of the concrete between pt. E and point G (See Weight of Dam (2) and resulting moment near bottom of Subsheet 3). The correct total sum of moments should be reduced by 1350.0 kip-ft. This correction effects the calculated eccentricity, foundation pressure and internal stress.

I  
I  
I  
I  
I  
I  
I  
I  
I  
I

We further note the Check for Seismic Stability on Sheet 12, Subsheet 6 used a seismic coefficient of 0.04. The Corps of Engineer Guidelines requires a seismic coefficient of 0.1 for structures in Seismic Zone 3. In addition, no hydrodynamic force and resulting moment were included in the computations for sliding and overturning safety factors, respectively. The difference in the seismic coefficient used and that recommended as well as the omission of the hydrodynamic force results in a significantly lower sliding safety factor.

The selected friction factor for sliding (0.40) is conservative and the analysis is based on the conventional 2 dimensional approach. The influence of additional sliding resistance between the abutments and soil was not considered as indicated on the bottom of subsheet 1.

Since the stability analysis was limited in scope, assumed completely effective sheet piling, and contained errors/omissions; a structural stability analysis was performed as part of the Phase I inspection. This following structural stability analysis is based on what we believe is the critical case-- that being maximum ice loading with and without seismic loads and includes the effects of sidewall shear friction (i.e. 3 dimensional analysis).

WARNER DAM

The following sections and dimensions shown are based on the as-built drawings prepared by the Designer (Erdman, Anthony, Associates)

A. Spillway & Abutment Section

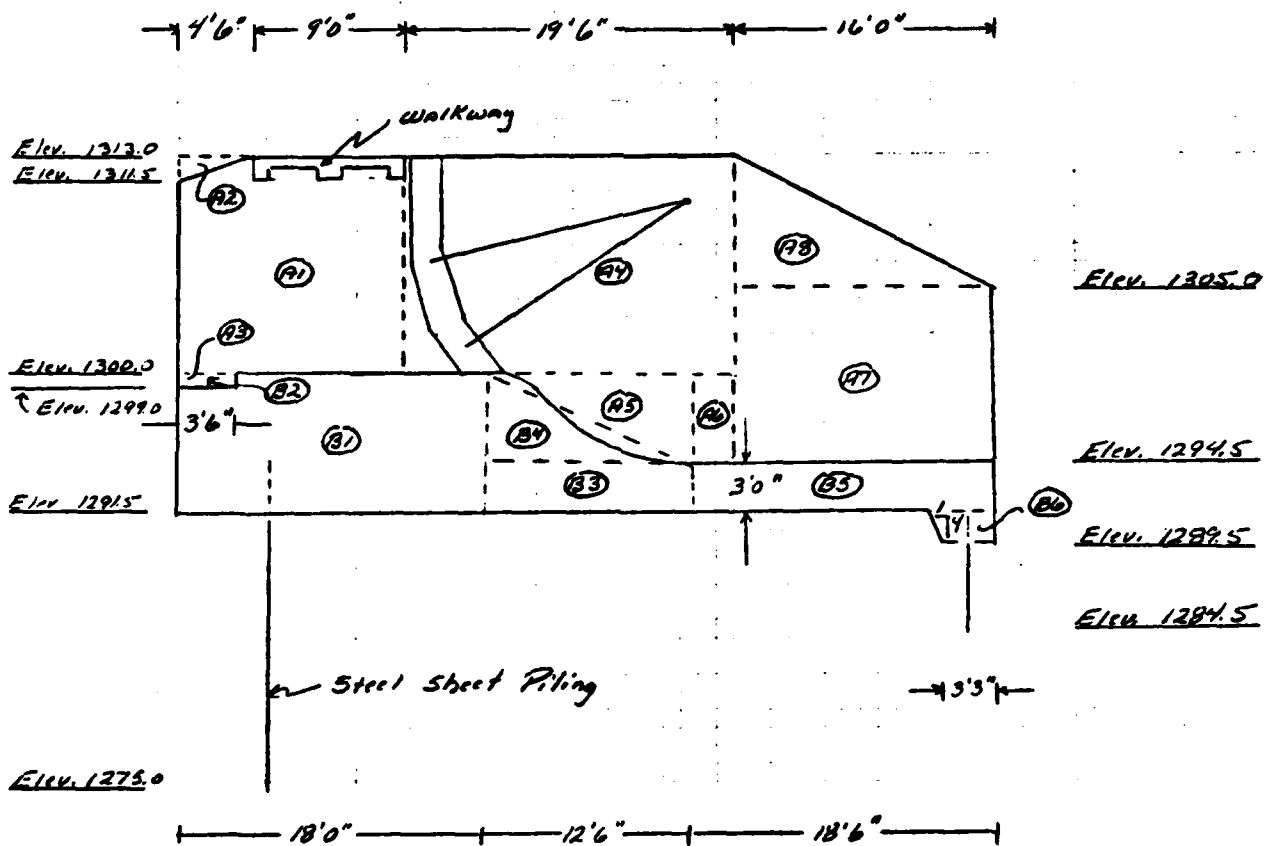

- (A1) - (A8) Abutment SubAreas
- (B1) - (B6) Base SubAreas

B. Spillway & Pier Section

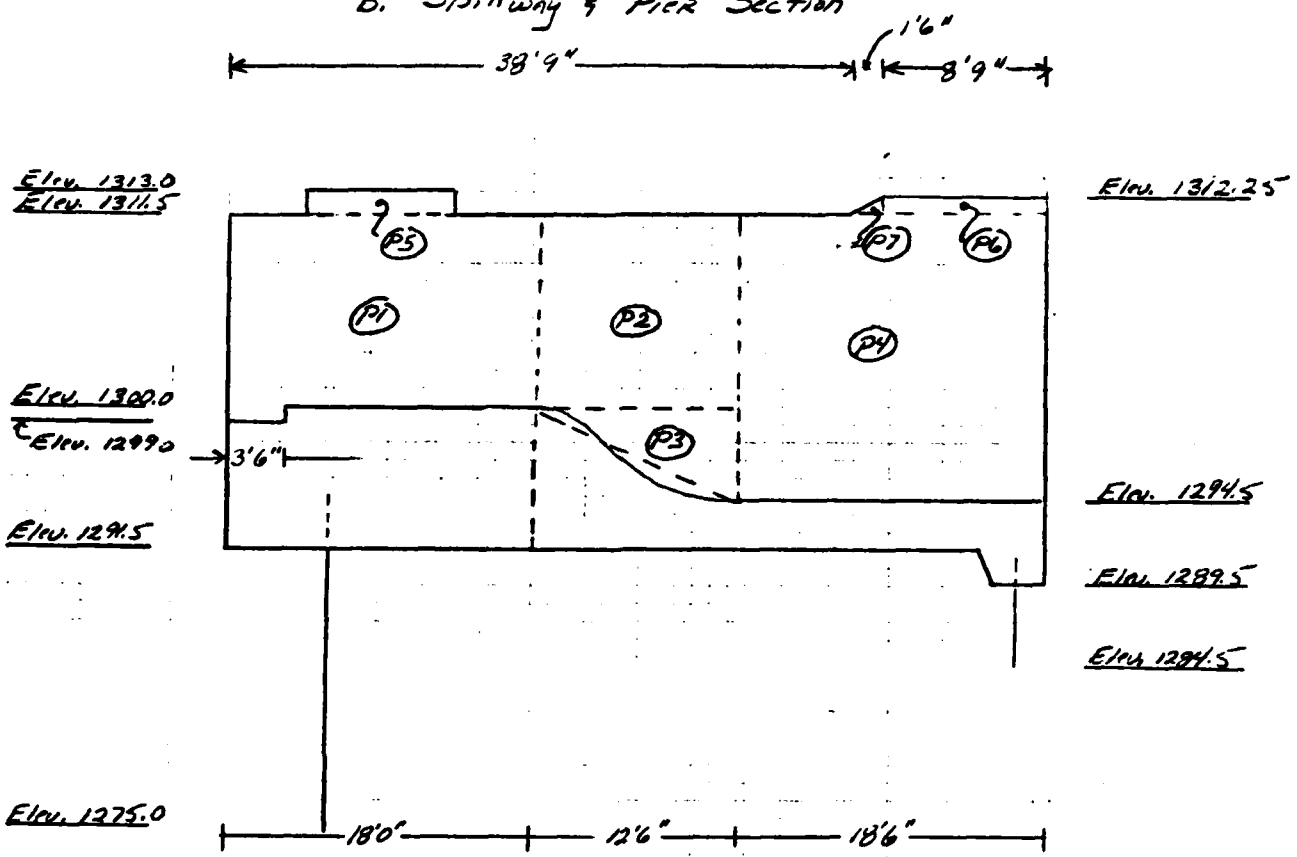

(P1) - (P7) Pier Sub Areas

C. Walkway Section

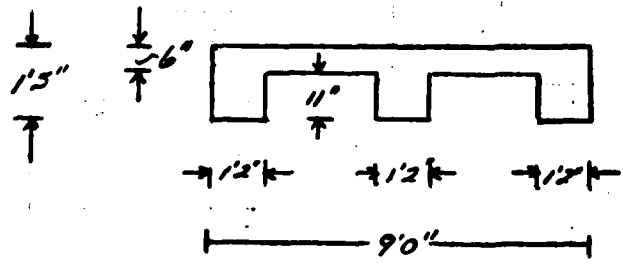

ASSUMPTIONS

- 1) Tainter Gates Closed
- 2) Tailwater at Elev. 1294.5 (i.e. no discharge)
- 3) Maximum Ice Load Applied During Winter Pool @ Elev. 1307.0
- 4) Steel Sheet Piling Ineffective to Full Hydrostatic Uplift  
Applied until proven otherwise by actual piezometric data.
- 5) "At Rest" Lateral Earth Pressures Applied on Upstream and  
Downstream Embedded Sections as well as Abutments
- 6) Upstream Streambed at Elev. 1300.0
- 7) Downstream Streambed @ Elev. 1294.5
- 8) Soil Behind Abutment @ Elev. equal to top of Adjacent  
Abutment
- 9) Backfill Against Abutments, Upstream & Downstream Embedded  
Sections and Foundation Soil as the following properties:
  - i)  $\phi = 35^\circ$
  - ii)  $c = 0$
  - iii)  $\gamma_{sat} = 135 \text{ pcf}$
  - iv)  $\gamma' = 73 \text{ pcf}$
- 10) No Silt Load
- 11) Seismic Loading for Zone 3 Seismicity
- 12) Sheet Piling Provides No Shear Resistance  
(Available resistance is not mobilized until the dam  
moves thus deforming sheet piling and beginning  
mobilization of soil resistance. However, if  
dam moves, this is considered to be failure.)

1) Determine Weight of Concrete ( $W_c$ )

## a) Base

$$\text{Area} = (18.0)(8.5) - (3.5)(1.0) + (12.5)(3.0) + \frac{1}{2}(12.5)(5.5) + (18.5)(3.0) + (3.25)(2.0) \\ = 283.38 \text{ ft}^2$$

$$\text{Weight} = (283.38 \text{ ft}^2)(.150 \text{ kcf}) = \underline{42.5 \text{ kips / Abutment foot}}$$

Resultant acts 29.4 ft. from toe

## b) Abutment

$$\text{Area} = (13.5)(13.0) - \frac{1}{2}(4.5)(1.5) + (3.5)(1.0) + (19.5)(13.0) + \frac{1}{2}(12.5)(5.5) \\ + (2.5)(5.5) + (16.0)(10.5) + \frac{1}{2}(16.0)(8.0) = 712.62 \text{ ft}^2$$

$$\text{Weight} = (709.25 \text{ ft}^2)(5.5 \text{ ft thick})(.150 \text{ kcf}) = \underline{585 \text{ kips / abutment}}$$

Resultant acts 24.2 ft. from toe

## c) Pier

$$\text{Area} = (18.0)(11.5) + (12.5)(11.5) + \frac{1}{2}(12.5)(5.5) + (18.5)(17.0) = 699.63 \text{ ft}^2$$

$$\text{Weight} = (699.63 \text{ ft}^2)(5.0 \text{ ft. thick})(.150 \text{ kcf}) = 525 \text{ kips / pier}$$

## i) Add Weight where pier is adjacent to Walkway @ Elevation 1313.0

$$\text{Volume} = (3.0)(1.5)(9.0) = 40.5 \text{ ft}^3$$

$$\text{Weight} = (40.5 \text{ ft}^3)(.150 \text{ kcf}) = 6 \text{ kips / pier}$$

## ii) Add Weight where top of pier rises to Elevation 1312.25

$$\text{Area} = (8.75)(0.75) + \frac{1}{2}(1.5)(0.75) = 7.1 \text{ ft}^2$$

$$\text{Weight} = (7.1 \text{ ft}^2)(5.0 \text{ ft thick})(.150 \text{ kcf}) = 5.3 \text{ kips / pier}$$

$$\text{Resultant acts } \underline{\underline{22.3 \text{ ft from toe}}}$$

TOTAL WEIGHT = 536.3 kips / pier

## d) Walkway

$$\text{Area} = (0.5)(9.0) + (3)(0.92)(1.17) = 7.71 \text{ ft}^2$$

$$\text{Weight} = (7.71 \text{ ft}^2)(3)(2867' \text{ long})(.150 \text{ kcf}) = \underline{99.45 \text{ kips total}}$$

Resultant acts 40.0 feet from toe

TOTAL WEIGHT OF CONCRETE

$$= (42.5 \text{ kips/ln ft.})(101 \text{ ft}) + 2(585 \text{ kips}) + 2(536.3 \text{ kips}) + 99.5 \text{ kips}$$

$$= \underline{6634.6 \text{ kips}}$$

Resultant Acts 27.5 ft. from toe  
Using Moment-Weight Method

2) Determine Weight of Water ( $W_w$ ) on Base Upstream of Gate

Water level @ Elevation 1307.0

$$\text{Area} = (1307 - 1299)(3.5) + (1307 - 1300)(10.0) = 98 \text{ ft}^2$$

$$\text{Weight} = (98 \text{ ft}^2)(26.67 \text{ ft})(3)(.0624) = \underline{489 \text{ kips}}$$

Resultant acts 42.4 feet from toe

3) Determine Water Force ( $P_w$ ) on Upstream Face

$$P_w = \frac{(1307 - 1291.5)^2 (.0624)}{2} = 7.5 \text{ kips/ln ft.}$$

$$\text{Total Force} = (7.5 \text{ kips/ln ft.})[(26.67)(3) + (50)(2)] = \underline{675 \text{ kips}}$$

Resultant Acts 5.17 feet above base

4) Determine Hydrostatic Uplift Force ( $P_u$ ) on the Base

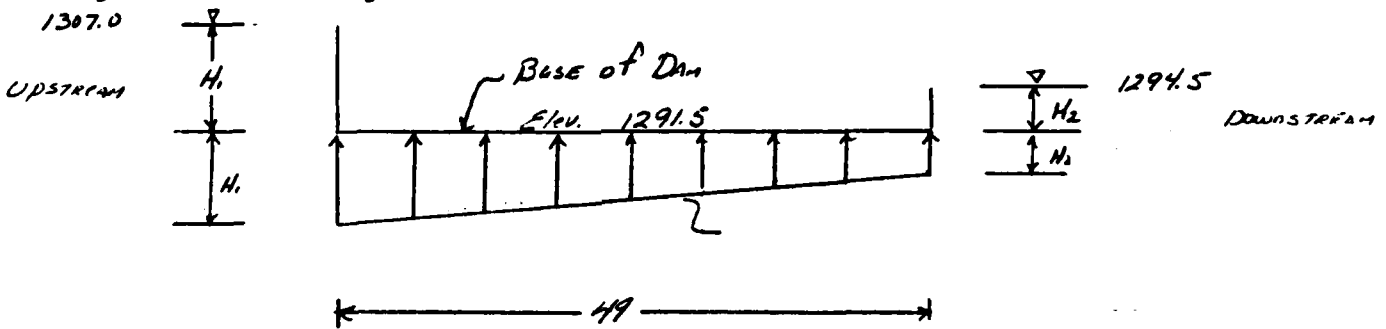

$$P_u = (H_2)(\gamma_w)(49) + (H_1 - H_2)(\gamma_w)(\frac{1}{2})(49)$$

$$= (3)(.0624)(49) + (15.5 - 3.0)(.0624)(\frac{1}{2})(49)$$

$$= 28.3 \text{ kips/ln ft.}$$

$$\text{TOTAL } P_u = (28.3 \text{ kips/ln ft.})(101 \text{ ft}) = 2857 \text{ kips}$$

Resultant acts 30 ft from toe



E) DETERMINE *AT REST* LATERAL EARTH FORCE ( $P_0$ )

a) UPSTREAM FACE

$$P_{0u} = \frac{(1300.0 - 1291.5)^2 (0.75) (0.073 \text{ kcf})}{2} = 2.0 \text{ k/lin ft.}$$

$$\text{TOTAL } P_{0u} = (2.0 \text{ k/lin ft.})(101') = \underline{202 \text{ kips}}$$

Resultant Acts 2.83 ft. Above base

b) DOWNSTREAM FACE

$$P_{0d} = \frac{(1294.5 - 1291.5)^2 (0.75) (0.073 \text{ kcf})}{2} = 0.25 \text{ k/lin ft.}$$

$$\text{TOTAL } P_{0d} = (0.25 \text{ k/lin ft.})(101') = \underline{25 \text{ kips}}$$

Resultant Acts 1.0 ft above base

c) ABUTMENT FACE

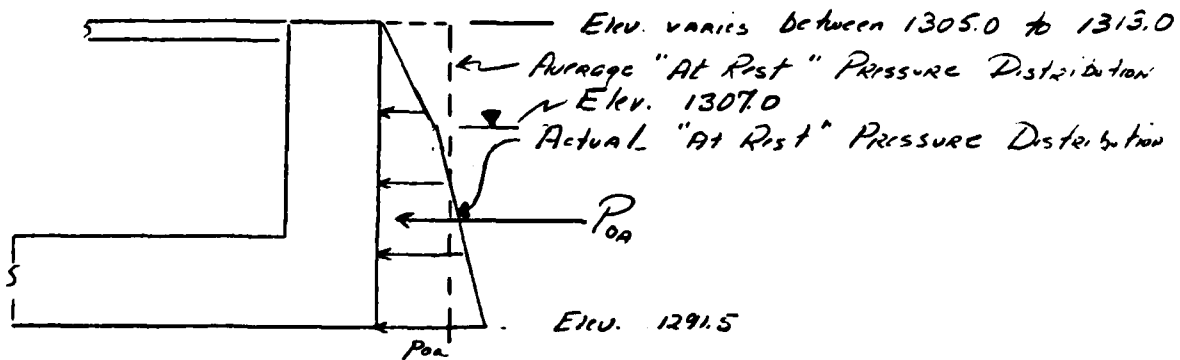

i) FOR MAXIMUM SECTION (i.e. top of abutment 1313.0)

$$\text{Max. Pressure } P_{0A} = (1313 - 1307) (0.75) (.135 \text{ kcf}) + (1307 - 1291.5) (0.75) (0.073) = 1.46 \text{ ksf}$$

$$\text{FORCE } P_{0A} = \left[ \frac{(1313 - 1307)^2 (0.75) (.135 \text{ kcf})}{2} + (1313 - 1307) (.75) (.135) (1307 - 1291.5) + \frac{(1307 - 1291.5)^2 (.75) (.073)}{2} \right] \times 33 \text{ ft.} = 587.4 \text{ kips}$$

Resultant acts 7.93 ft above base

22) For Section where top of Abutment varies between  
Elev 1305 and 1313.

$$\text{Average Elevation} = \left[ \frac{1313 - 1305}{2} \right] + 1305 = 1309$$

$$\text{MAX. PRESSURE } P_{0a} = (1309 - 1307)(0.75)(.135 \text{ k.c.f.}) + (1307 - 1291.5)(0.75)(.073) \\ = 1.05 \text{ ksf}$$

$$\text{FORCE } P_{0a} = \left[ \frac{(1309 - 1307)^2 (0.75)(.135)}{2} + (1309 - 1307)(0.75)(.135)(1307 - 1291.5) \right. \\ \left. + \frac{(1307 - 1291.5)^2 (0.75)(.073)}{2} \right] \times 16 \text{ ft} = 158.7 \text{ KIPS} \\ \text{PER} \\ \text{ABUTMENT}$$

Resultant Acts 7.72 feet above base

$$\text{TOTAL FORCE PER ABUTMENT} = 587.4 + 158.7 = 746 \text{ KIPS}$$

6) Determine ICE Load ( $P_E$ )

$$\text{Assume } P_{E_{max}} = 10 \text{ kips/ft.}$$

$$\text{Total } P_E = (10 \text{ k/ft}) (90 \text{ ft}) = 900 \text{ kips}$$

Resultant Acts 145 feet Above Base

7) Determine Hydrodynamic Force ( $Y_c$ ) and Moment ( $M_c$ )  
(Zangre Method)

a) Hydrodynamic pressure @ base

$$P_b = c \lambda \gamma_w h = 0.071 \text{ ksf/ft.}$$

$$\text{where } c = 0.73$$

$$\lambda = 0.1$$

$$\gamma_w = .0624 \text{ kcf}$$

$$h = 1307 - 1291.5 = 15.5'$$

$$b) Y_c = 0.726 P_b h = (0.726)(0.071)(15.5) = 0.80 \text{ k/ft}$$

$$\text{Total } Y_c = (0.80 \text{ k/ft}) (90 \text{ ft}) = 72 \text{ kips}$$

$$c) M_c = 0.299 P_b h^2 = (0.299)(0.071)(15.5)^2 = 5.10 \text{ k-ft/ft}$$

$$\text{Total } M_c = (5.10 \text{ k-ft/ft}) (90 \text{ ft}) = 459 \text{ k-ft}$$

Resultant Act 6.375 ft. above Base

8) Determine Inertial Force ( $P_i$ ) due to Seismic Loading

$$P_i = \lambda W_c$$

$$= (0.1)(6612 \text{ kip}) = 661.2 \text{ kips}$$

Resultant Acts 9.5' Above Base

Structural Stability

CASE 1) ICE LOADING

A. Overturning Stability

Overturning Force	Magnitude (Kips)	Moment Arm (ft)	Overturning Moment (Kip-ft)
$P_w$	675	5.17	3,490
$P_u$	2857	30.0	85,710
$P_{ou}$	202	2.83	572
$P_z$	900	14.5	13,050
			$\Sigma M_o = 102,822 \text{ Kip-ft.}$

Resisting Force	Magnitude (Kips)	Moment Arm (ft.)	Resisting Moment (Kip-ft)
$W_c$	6634.6	27.5	182,451
$W_w$	489	42.25	20,660
$P_o$	25	1.0	25
			$\Sigma M_r = 203,209 \text{ Kip-ft.}$

$$S.F. = \frac{\Sigma M_r}{\Sigma M_o} = \frac{203,209}{102,822} = 1.98$$

$$\bar{x} = \frac{\Sigma M_r - \Sigma M_o}{\Sigma F_v} = \frac{203,209 - 102,822}{6634.6 + 489 - 2857} = 23.5 \text{ ft.}$$

$$e = B/2 - \bar{x} = 49/2 - 23.5 = 1.0$$

$$B/6 = 49/6 = 8.17 > 1.0$$

OK, Resultant in Middle 1/3

B. Sliding Stability

$$S.F. = \frac{(W_c + W_n - P_u) \tan \phi + 2P_{oa} (\tan \phi)}{\sum \text{Driving Forces}}$$

$$S.F. = \frac{(6634.6 + 489 - 2857) (\tan 35^\circ) + (2)(746) (\tan 35^\circ)}{675 + 202 + 900 - 25} = 2.30$$

No Good  $2.30 < 3.0$  Recommended Min.

CASE 2) SEISMIC Loading

A. Overturning Stability

Overturning Force	Magnitude (kips)	Moment Arm (ft)	Moment k-in-ft
$P_w$	675	5.17	3,490
$P_u$	2857	30.0	85,710
$P_{oa}$	202	2.83	572
$V_e$	72	6.38	459
$P_e$	661	9.50	6,279

$$EM_0 = 96,507 \text{ k-in-ft}$$

$$S.F. = \frac{203,209}{96,507} = 2.11 \quad \text{OK} > \text{CASE I}$$

B. Sliding Stability

$$S.F. = \frac{4031.02}{675 + 202 + 72 + 661 - 25} = 2.54 \quad \text{OK} > 1.5$$

## CASE 3, ICE AND SEISMIC

## A. OVERTURNING

$$\Sigma M_o = 102,822 + 459 + 6,279 = 109,560$$

$$\Sigma M_r = 203,209 \text{ k-ft}$$

$$S.F. = \frac{203,209}{109,560} = 1.86$$

$$\bar{x} = \frac{214,573 - 109,560}{6640 + 489 - 2857} = 21.95 \text{ ft}$$

$$e = B/2 - \bar{x} = 49/2 - 21.95 = 2.55$$

OK RESULTANT IN MIDDLE 1/3

## B. Sliding

$$S.F. = \frac{403102}{675 + 202 + 900 + 72 + 661 - 25} = 1.62 \text{ OK } > 1.5$$

APPENDIX E

Operation Plans

Figure No. 1  
Initial Operation Plan

ALLEGHENY RIVER BASIN  
CHAUTAQUA LAKE SUB-BASIN  
LAKE LEVEL REGULATION PLAN  
80-40-50-1270 W3E

LAKE OUTFLOW OPERATIONAL SCHEDULE

Zone	Purpose	Release Rate in cfs	Operations
4	Flood Control	60 to 1270 (1)	Releases up to 1270 cfs will be made as rapidly as possible. When lake stages exceed elevation 1310, releases in excess of 1270 cfs should be made.
3	Conservation	60 (2)	When the lake level is in this zone be maintained at 60 cfs.
2	Conservation	40 (2)	When the lake level is in this zone be maintained at 40 cfs.
1	Conservation	20 (2)	When the lake level is in this zone be maintained at 20 cfs.

(1) Releases up to 1270 cfs are not possible until lake stage exceeds elevation 1309. Releases in this zone are affected by channel capacity of the outlet channel to the maximum capacity possible.

(2) Releases are both a minimum and maximum.

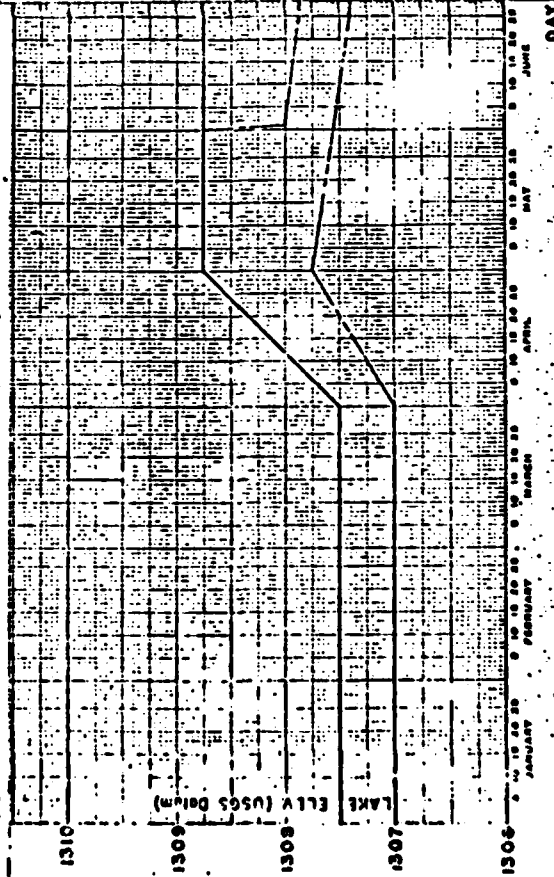

When the lake level is in this zone the release rate will be maintained at 60 cfs.

When the lake level is in this zone the release rate will be maintained at 40 cfs.

When the lake level is in this zone the release rate will be maintained at 20 cfs.

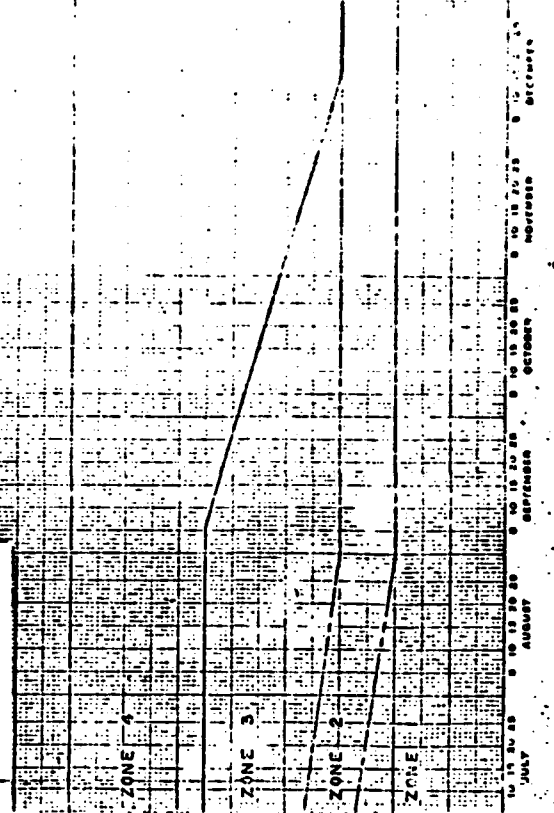

EXHIBIT D  
Enclosure 1



New Dam

Figure No. 2  
Initial Operation Plan

CHAUTAQUA LAKE ELEVATION in feet (USGS Datum)

1310.0

Emergency Flood Control Level

1309.0

1308.0

Chautauqua Lake-Chadakofoin

RIVER REGULATION

MAXIMUM RELEASE RATE

$V_8$

LAKE ELEVATION

PLATE II

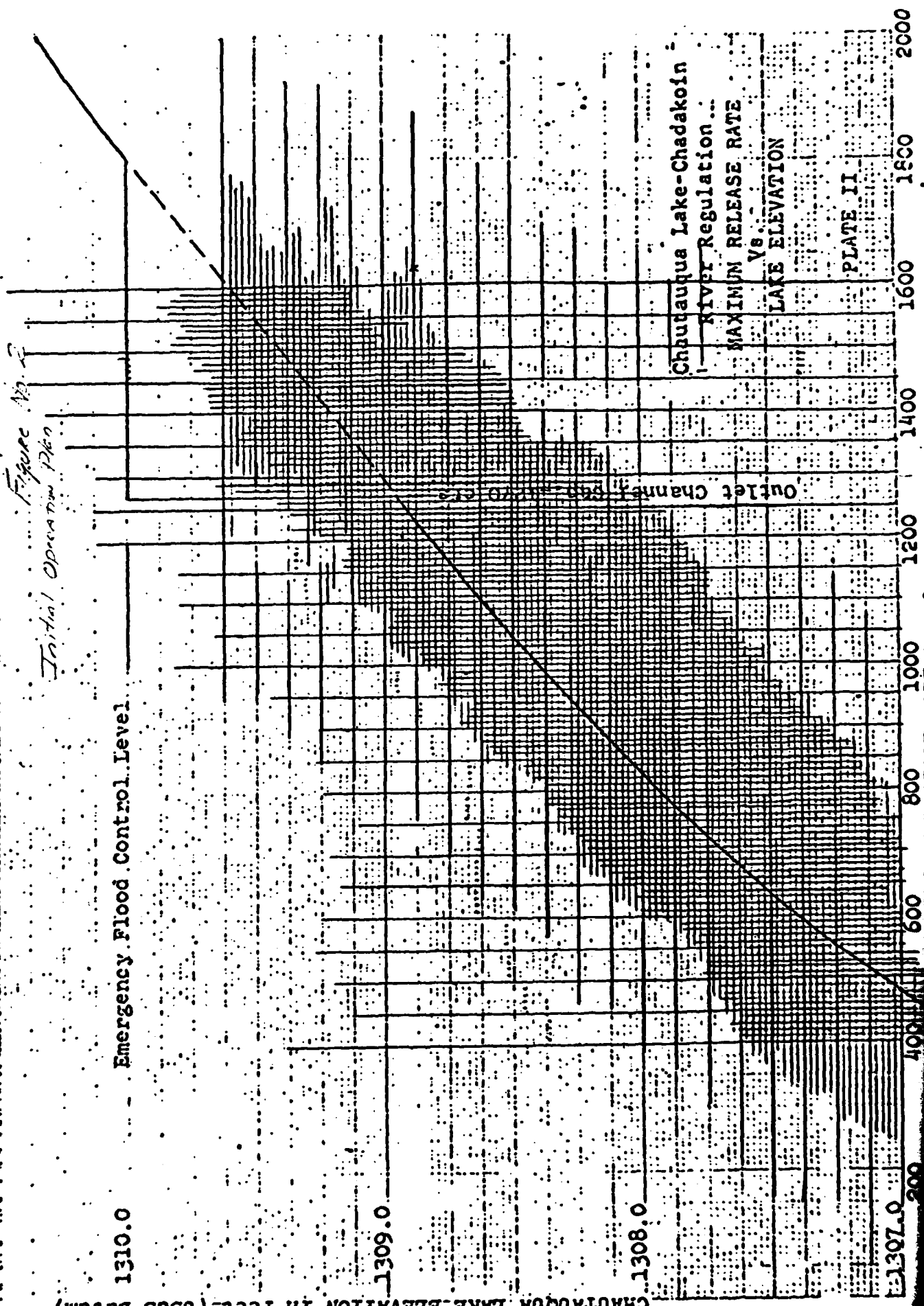



APPENDIX F

Available Documents

October 30, 1967

Dam No. 164 (Warner Dam)  
City of Jamestown  
County of Chautauqua

-----

Mr. Richard Burke  
Blauvelt Engineering Company  
79 Madison Avenue  
New York, New York 10016

Dear Sir:

As per your telephone request, a search was made of our records concerning the above referenced dam.

Please be advised that the data and information in our files pertaining to the structure are antiquated, dating back to the years 1912 through 1918. However, some of the information as listed below may be of help to you, to wit:

1. The original structure was built in or about the year 1840. It was extensively repaired or reconstructed during the subsequent years since then.
2. The ownership of the dam during the year 1912 was vested in an organization known as the "Warner Dam Association" which consisted of six or seven concerns that owned water rights in Chadakoin River.
3. During the year 1913, the Superintendent of Public Works was authorized by an act of the Legislature (under Chapter 758, of the Laws of 1913) to "...cause Chadakoin River, known also as Chautauqua Lake Outlet, to be dredged or otherwise improved between such points at or near the City of Jamestown as the Superintendent may determine in such manner as will relieve the high water conditions at and near such city, subject to the approval of the Canal Board. Such work shall be accomplished pursuant to plans and specifications to be furnished by the State Engineer and Surveyor;....."
4. A memorandum in the record states that "Warner Dam was replaced by the State with a new Tainter Gate Dam, under Chapter 758 of the Laws of 1913."

5. Subsequent correspondence concerning the Warner Dam from Frank H. Williams, State Engineer, to George E. Pratt, Commissioner, Conservation Commission, dated January 14, 1918, states that "...this dam is being reconstructed and other improvements made by the State of New York under Chapter 181 of the Laws of 1917, along Chadakoin River." Upon research of the said chapter, the only mention is in the Section for the General Fund, wherein it is stated that an appropriation was made to the Department of Public Works for the dredging of the Chadakoin River.

In view of the foregoing, it is evident that the State of New York was involved in the Warner Dam.

Since our records are incomplete concerning the structure, we suggest that you communicate with Mr. Norman W. Krapf, Regional Director of Transportation, New York State Department of Transportation, 13 Wayside Court, Buffalo, New York 14226, (Telephone 1-507-942-4432), who may be able to furnish you with additional and more recent data which we do not have.

Very truly yours,

1. The original structure was built in the year 1840. It was reconstructed during the reconstruction years of

**E. V. HOURIGAN**  
Acting Deputy Chief Engineer

2. The ownership of the vessel in an explosion. By which consisted of dam or other concrete work carried out right in Chadakoin River.

3. During the year 1917, work was authorized by an act Chapter 204, of the Laws of 1917, A. W. Moon, Asst. Deputy Chief Engineer

RCK/JEP/10

cc: B. Heller  
N. W. Krapf  
T. P. Curran

4. A provision in the act of 1917 was repealed by the act of 1921, Chapter 114 of the Laws of 1921.

(NOTICE: - After filling out one of these forms as completely as possible for each dam in your district, return it at once to the Conservation Commission, Albany.)

STATE OF NEW YORK  
CONSERVATION COMMISSION  
ALBANY

DAM REPORT

*Jamestown, N.Y.*, *Dec. 18*, 191*2*  
(Date)

CONSERVATION COMMISSION,  
DIVISION OF INLAND WATERS.

GENTLEMEN:

I have the honor to make the following report in relation to the structure known as the Warner Dam.

This dam is situated upon the Outlet of Chautaugus Lake  
(Give name of stream)  
in the City of City of Jamestown Chautaugus County,  
about \_\_\_\_\_ from the Village or City of \_\_\_\_\_  
(State distance)

The distance down stream from the dam, to the Main Street Bridge  
(Up or down) (Give name of nearest important stream or of a bridge)  
is about 630'  
(State distance)

The dam is now owned by the Warner Dam Association (consisting of several Firms and Corporations) that  
(Give name in full) 70 to 80 years ago, and was extensively repaired or reconstructed during the year 1907.

As it now stands, the spillway portion of this dam is built of Timber  
(State whether of masonry, concrete or timber)  
and the other portions are built of South Abutment is of Concrete  
(State whether of masonry, concrete, earth or timber with or without rock fill)

As nearly as I can learn, the character of the foundation bed under the spillway portion of the dam is of Piling and under the remaining portions such foundation bed is Gravel.

164  
O.C.

The total length of this dam is 78 feet. The spillway or waste-weir portion, is about 70 7/12 feet long, and the crest of the spillway is about 6 7/12 feet below the top of the dam.

The number, size and location of discharge pipes, waste pipes or gates which may be used for drawing off the water from behind the dam, are as follows:

State briefly, in the space below, whether, in your judgment, this dam is in good condition, or bad condition, describing particularly any leaks or cracks which you may have observed.)

The dam was recently repaired. The first plan was to rebuild, but lateness of season and high water determined the repairs. It is now proposed to rebuild the dam next season. The owners believe the dam is in safe and serviceable

Reported by Edw. E. Gyle Agent  
(Signature)  
for Warner and Marvin

201 Main street  
(Address—Street and number, P. O. Box or R. F. D. route)

James town, N.Y.  
(Name of place)

(SEE OTHER SIDE)

(In the space below, make one sketch showing the form and dimensions of a cross section through the spillway or waste-weir of this dam, and a second sketch showing the same information for a cross section through the other portion of the dam. Show particularly the greatest height of the dam above the stream bed, its thickness at the top, and thickness at the bottom, as nearly as you can learn.)

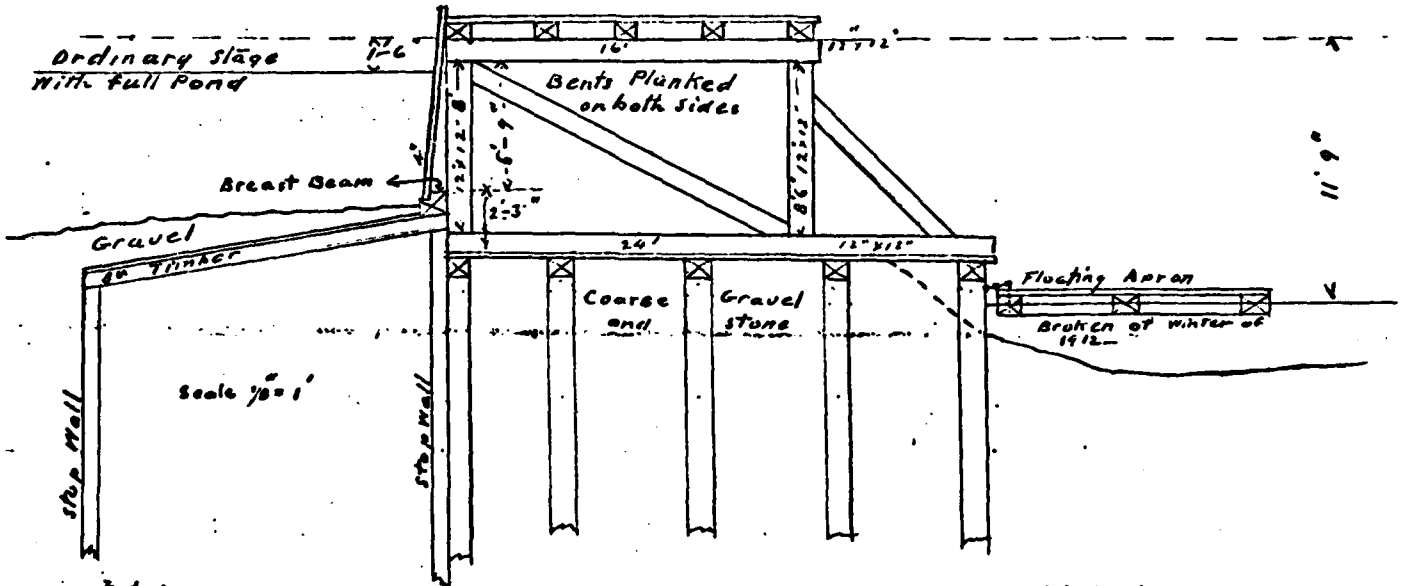

Note:  
 Bay 1 18' north  
 Bay 2 11.5'  
 Bay 3 13.8'  
 Bay 4 13.6'  
 Bay 5 13.9' south  
 70.5" = Total spillway

Bays 1 and 2 are closed by vertical stop Planks or Needles  
 Bays 3-4-5 Have Horizontal Flash Boards all are removed when necessary beginning with No 2.

(In the space below, make a third sketch showing the general plan of the dam, and its approximate position in relation to buildings or other conspicuous objects in the vicinity.)

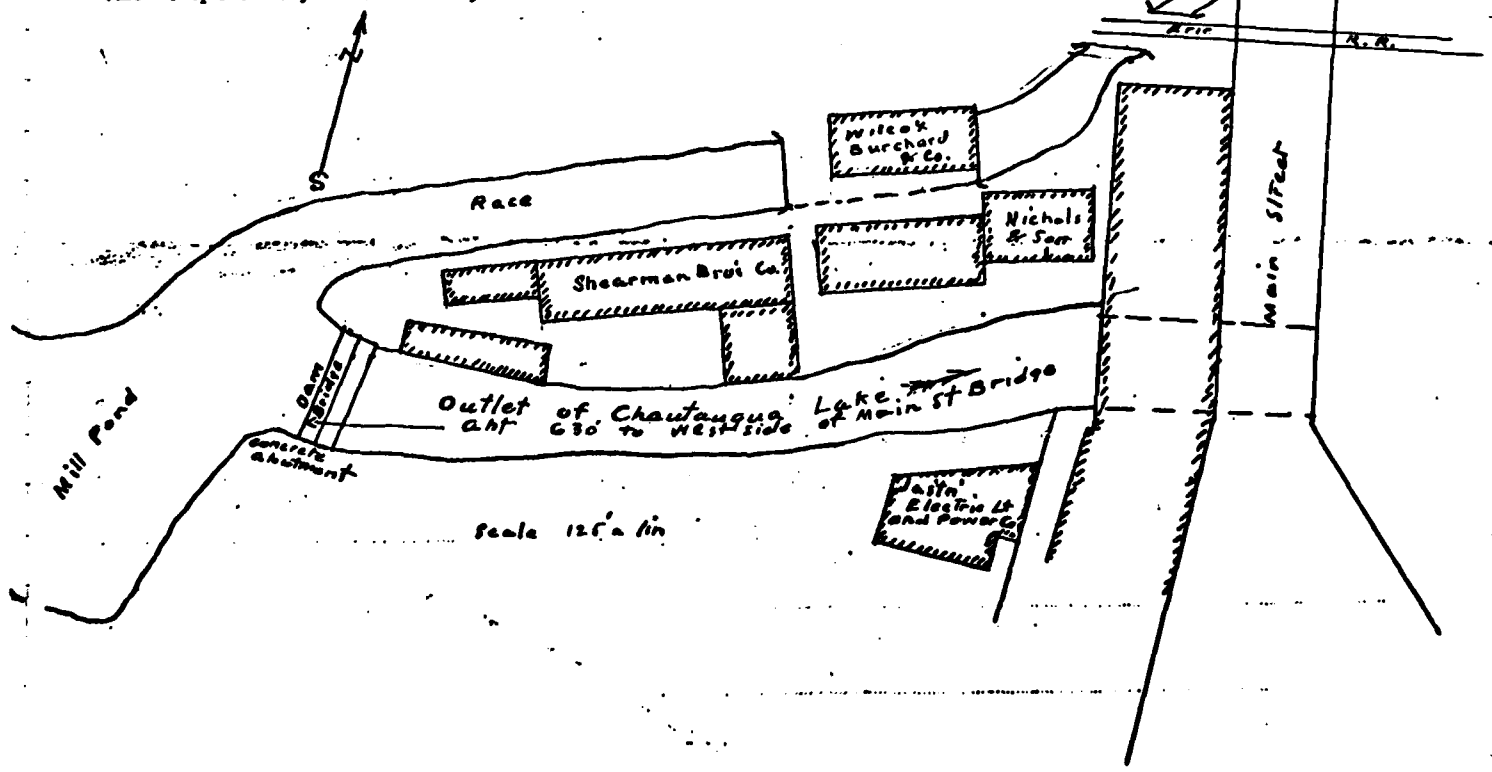



ENVIRONMENTAL ASSESSMENT

WARNER DAM REPLACEMENT

CITY OF JAMESTOWN, NEW YORK

ERDMAN, ANTHONY, ASSOCIATES

April 1978

I. PROJECT DESCRIPTION

I. Introduction

The purpose of an environmental assessment is to identify the effects of a proposed action on the physical, economic, social, and ecological elements of the study area. In this instance, the proposed action consists of constructing a replacement for the existing Warner Dam. Through the joint efforts of local, State, and Federal officials, the need for evaluation of the existing dam was established and a report entitled "Inspection and Analysis, Warner Dam, Jamestown, N.Y." was prepared by Konski Engineers, dated December 27, 1976. Based on the findings of that report, a decision was made that replacement of the existing dam would be in the best interests of the general public. The firm of Erdman, Anthony, Associates has been retained by the New York State Department of Environmental Conservation to furnish professional services for the detailed design and construction supervision of the project. This environmental assessment is part of the overall scope of services to be provided.

This assessment has been prepared concurrently with the preliminary design efforts for the project. The extent and nature of the proposed facilities has been essentially established. In recognition of this fact, the emphasis of the assessment is directed towards specific impacts, rather than generalities. In this manner, any mitigation measures to minimize adverse effects can be realistically evaluated.

The organization of this environmental assessment is that which would normally be followed for an Environmental Impact Statement. Section I provides the background information concerning the existing facilities and proposed action. In Section II, the general setting of the project is described as it exists today. Section III defines the impacts of the proposed action. Alternatives to the proposed action are enumerated in Section IV. Irreversible or irretrievable commitments of resources required by the proposed action are covered in Section V. Supporting materials are included in the Appendix.

2. Study Area

The site of the proposed action is located in Chautauqua County, within the City of Jamestown, New York. The existing dam is located on the Chadakoin River, approximately three miles downstream from Chautauqua Lake. A general location map and site map have been included in the Appendix of this assessment as Plates I and II respectively.

3. Existing Warner Dam Facilities

The existing structure is a concrete gravity dam which was constructed in 1919. The dam consists of four separate bays, each controlled by a 20 foot span counterweighted tainter gate. Each tainter gate is raised and lowered by manual cranking of a handwheel. An open steel decking walkway allows access to the gate operators.

Due to its age and physical deterioration, the existing facility is approaching the end of its useful lifespan. The construction of the Washington Street Bridge directly above the existing dam in the early 1960's has to some extent aided in the deterioration process. The drainage and roadway salts from the overhead bridge fall directly onto the dam. The corrosion of exposed steel members has progressed to such an extent that holes are present through the tainter gate skin and sections of structural members are entirely gone. Extensive deterioration has also occurred to the exposed concrete surfaces, resulting in areas of exposed reinforcement and deep failure cracking.

Downstream of the structure, the continuous flows over the dam have created scour holes which go as deep as 4 feet below the bottom of the existing dam apron. From information obtained by underwater inspection during the Konski study, there are no evidences of stone riprap downstream of the dam as originally specified on the construction plans of the existing dam. Uncontrolled scour of this magnitude is considered to be a potential threat to the safety of the dam.

Operation of the dam is currently under the direction of the City of Jamestown, Board of Public Utilities. The Attorney Generals Office has ruled that the State of New York must be considered as the current owner of the dam.

4. Functions of the Existing Dam

The primary function of the existing dam is to maintain the level of Chautauqua Lake for recreational and fishery resources during low flow periods of the year, while ensuring that minimum release objectives are met for the Chadakoin River.

The magnitude of minimum flows for the Chadakoin River to satisfy water quality management objectives, as determined by the Chautauqua County Comprehensive Sewerage Study and subsequent studies by the NYSDEC, is 60 CFS for the summer-fall period and 40 CFS for the winter-spring season. These flows were based on meeting State water quality standards in the Chadakoin River, considering the effects of treated waste water discharges from the South Chautauqua Lake Sewer District plant and the City of Jamestown plant.

Reference is made to Chapter V of the Comprehensive Water Resources Plan for the Allegheny River Basin, as prepared by the NYSDEC for the Allegheny River Basin Regional Water Resource Planning Board. This document contains details on the development of the Chautauqua Lake-Chadakoin River Regulation Plan, which is the current basis for operation of Warner Dam. The Plan bases the regulation of Chadakoin River flows on water quality management, recreation, power generation, and flood control considerations. It was determined in the regulation plan that the water needs for the Jamestown municipal power plant could be satisfied by maintenance of 60 CFS flow during the summer months.

According to the regulation plan, flood damage reduction benefits of the controls on Chautauqua Lake have been reduced in recent years due to shoreline encroachments.

5. The Proposed Action

The proposed action includes construction of a new dam approximately 95 feet downstream of the existing structure. The construction is intended to be a "replacement in kind" type of project. The new structure will be a concrete gravity dam having the same structural elevations and hydraulic

capacity as the existing dam. For economic reasons, the number of tainter gates have been reduced from four to three, but the total clear span of the gates remains at 80 feet (26'-8" per gate x 3 gates = 80'). The gates will be operated by a system of cable drum hoists and electric motors.

Control of seepage under the dam and scour downstream of the dam will be provided by steel sheet piling. In addition, steel sheeting will be used upstream of the dam to provide for maintenance working areas.

If additional details of the proposed action are desired, the reader is referenced to copies of the contract plans which are on file at the City of Jamestown, Department of Public Works; Chautauqua County Department of Public Works; and Chautauqua County Planning office.

The new dam has been located such that the Contractor may divert flows to the south of the cofferdam area during construction. It is anticipated that this will be the method of flow maintenance selected by the Contractor. The diversion would consist of an excavated channel which would carry all low flows plus storm discharges. A crossing of the diversion channel by means of pipes or temporary bridging may be necessary, depending on the contractors scheme for delivery of materials to the dam site.

After completion of the new dam, the existing dam will be removed as described under Section III-1A.

## II. ENVIRONMENTAL SETTING WITHOUT THE PROJECT

### I. Physical Elements

#### A. Geology and Soil

The Jamestown area lies in an uplands plateau region which is characterized by the presence of deep glacial deposits. Bedrock under the soils consists of nearly level-bedded shale, siltstone, and fine grained sandstone of the Devonian Age (about 280 million years old). Most of the soils on the plateau have developed from glacial till, defined as the remains of rocks ground up by action of the glaciers and deposited during the glacial retreat.

From a review of existing boring logs from projects immediately adjacent to the dam site, bedrock is approximately 140 feet below ground surface. Borings taken at the location of the proposed dam found the first 15 feet below ground to be composed of miscellaneous fill materials. Below the fill, a very dense strata of sands and gravels was encountered to a depth of 50 feet. Drilling logs from these test holes have been included in the Appendix. The extreme density of this lower strata is reflected by the blow count of the sampler required for penetration, and is indicative of the tremendous pressures exerted by the glaciers.

From field observations, the bed of the existing river channel consists of relatively clean sands and gravels, without evidence of fine grained river bottom sediments.

#### B. Topography

The uplands plateau area in the vicinity of Jamestown features rolling hills with rounded slopes. The river valley areas, such as that along the Chadakoin River, are relatively flat and sloping in the direction of the river flow.

C. Water Resources

(1) Groundwater Resources

Groundwater is used extensively in the upper plateau region of Chautauqua County as a source of water supply. There are three basic types of deposits which can be identified as follows:

- a. Stream deposited beds of sands and gravels, with well yields up to 700 GPM.
- b. Till and lake deposits, with yield of 1-10 GPM.
- c. Bedrock, with yields up to 100 GPM.

The density and relative imperviousness of the strata found in the 15-50 foot depth range would identify the local subsoils to be of the till and lake deposits nature.

The general quality of the groundwater is good, as attested by the extensive use of wells for water supply in the Jamestown area.

(2) Surface Waters

The current classifications which have been assigned to surface waters tributary to the project area are as follows.

Chautauqua Lake            Class "A"

Chadakoin River,  
from Chautauqua Lake  
to Eighteenth Street    Class "C"

Chadakoin River,  
Downstream of  
Eighteenth Street        Class "D"

The site of the proposed construction would be within the reach having a Class "D" rating. The best uses of class "A", "C", and "D" waters as defined in the New York State Codes, Rules, and Regulations, Part 6, are as follows:

Class "A" Waters

Source of water supply for drinking, culinary or food processing purposes and any other usages.

Class "C" Waters

Suitable for fishing and all other uses except as a source of water supply for drinking, culinary or food processing purposes and primary contact recreation.

Class "D" Waters

"These waters are suitable for secondary contact recreation, but due to such natural conditions as intermittency of flow, water conditions not conducive to propagation of game fishery or stream bed conditions, the waters will not support the propagation of fish."

The drainage area of the river at the site of the dam is approximately 190 square miles. From records of the USGS gauging station at Falconer, N.Y., from 1935 to 1976, the following data is available on the Chadakoin River flows:

Average Discharge (1935-1976)	=	343 CFS
Minimum Daily Recorded Flow,		
Flow, Nov. 20, 1960	=	3.0 CFS
Minimum Daily Flow 1973	=	30 CFS
Minimum Daily Flow 1974	=	30 CFS
Minimum Daily Flow 1975	=	40 CFS
Minimum Daily Flow 1976	=	47 CFS
Maximum Peak Discharge,		
March 5, 1976	=	2070 CFS



The above records indicate that the outflows for extreme flooding occurrences such as the March 1976 flood are quite low for a basin as large as the Chautauqua Lake Basin. This reflects the effect of Chautauqua Lake storage and the lack of adequate conveyance capacity in the Chadakoin River.

2. ECONOMIC ELEMENTS

A. Land Use

The extent of land adjacent to the proposed dam which should be viewed from a land use compatability standpoint would be bounded by the old Erie Railway on the north, Main Street on the east, Harrison Street on the south, and the Washington Street Bridge on the west. Within this area, the land use north of the river consists of a municipal parking lot and a formica countertop factory. Facilities south of the river include a restaurant, sporting goods store, and a lumber yard.

The localized area described above is situated in a general corridor of industrial, commercial, and municipal land uses which parallel the Chadakoin River between Main Street and Third Street. Major features in this larger corridor include the railway, the Board of Public Utilites power plant, and old commercial-industrial type buildings being removed by the City of Jamestown Urban Renewal agency.

B. Employment

The existing Warner Dam provides employment in the sense that personnel from the Municipal Power Plant are responsible for the control and maintenance of the facility.

3. SOCIAL ELEMENTS

A. Recreational

There are no recreational sites or activities currently in the vicinity

**APPENDIX G**

**DRAWINGS**

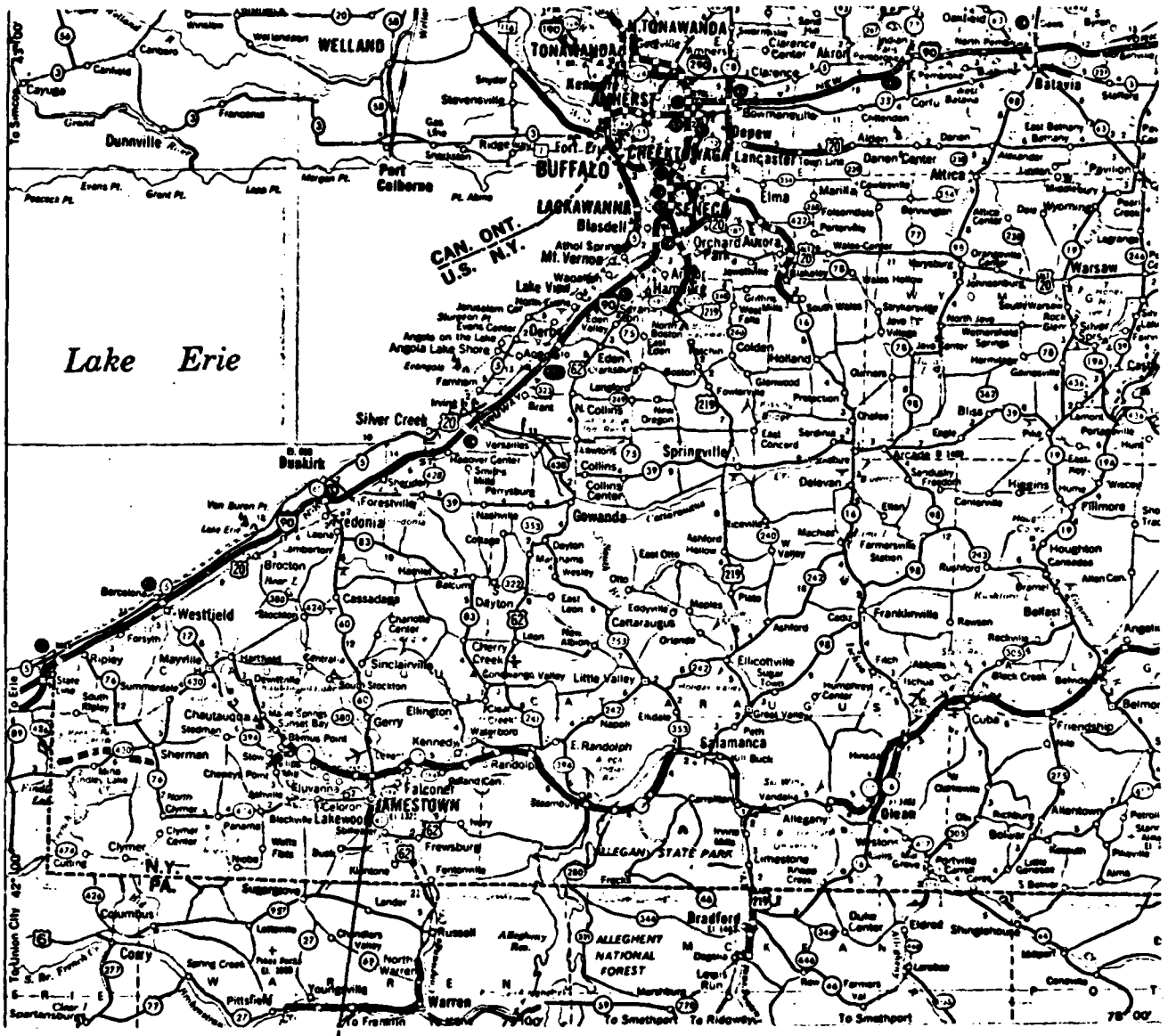

**DAM LOCATION**

**VICINITY MAP  
 WARNER DAM  
 CHAUTAUQUA LAKE OUTLET  
 ALLEGHENY RIVER BASIN  
 I.D. NO. N.Y. 750**

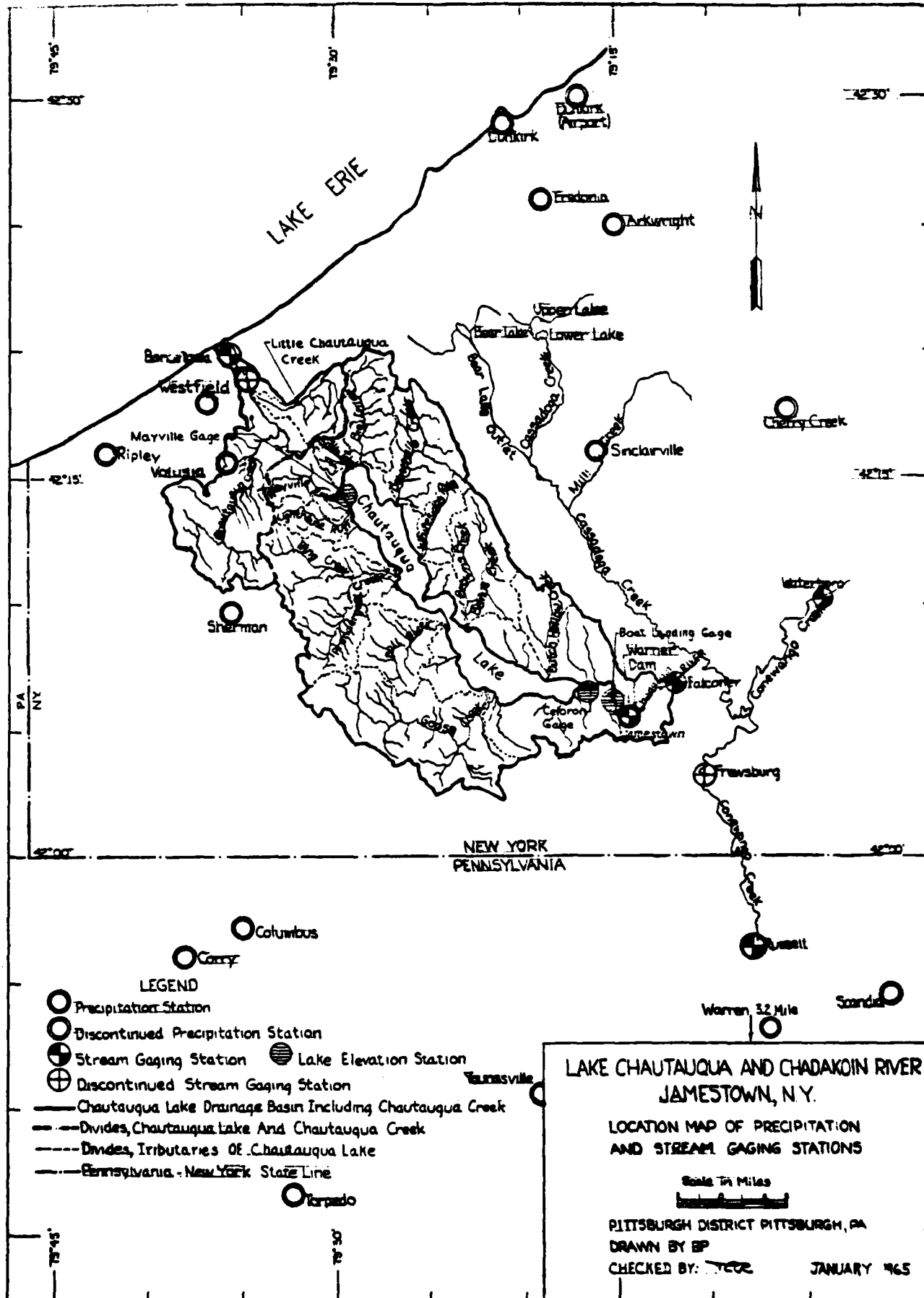

PA  
NY

NEW YORK  
PENNSYLVANIA

**LEGEND**

- Precipitation Station
- Discontinued Precipitation Station
- Stream Gaging Station
- Lake Elevation Station
- ⊕ Discontinued Stream Gaging Station
- Chauchaqua Lake Drainage Basin Including Chauchaqua Creek
- - - Divides, Chauchaqua Lake And Chauchaqua Creek
- - - Divides, Tributaries OF Chauchaqua Lake
- - - Pennsylvania - New York State Line





**TOPOGRAPHIC MAP  
WARNER DAM  
CHAUTAQUA LAKE OUTLET  
ALLEGHENY RIVER BASIN  
I.D. NO. N.Y. 750**

**DAM LOCATION**

# WARNER DAM RE

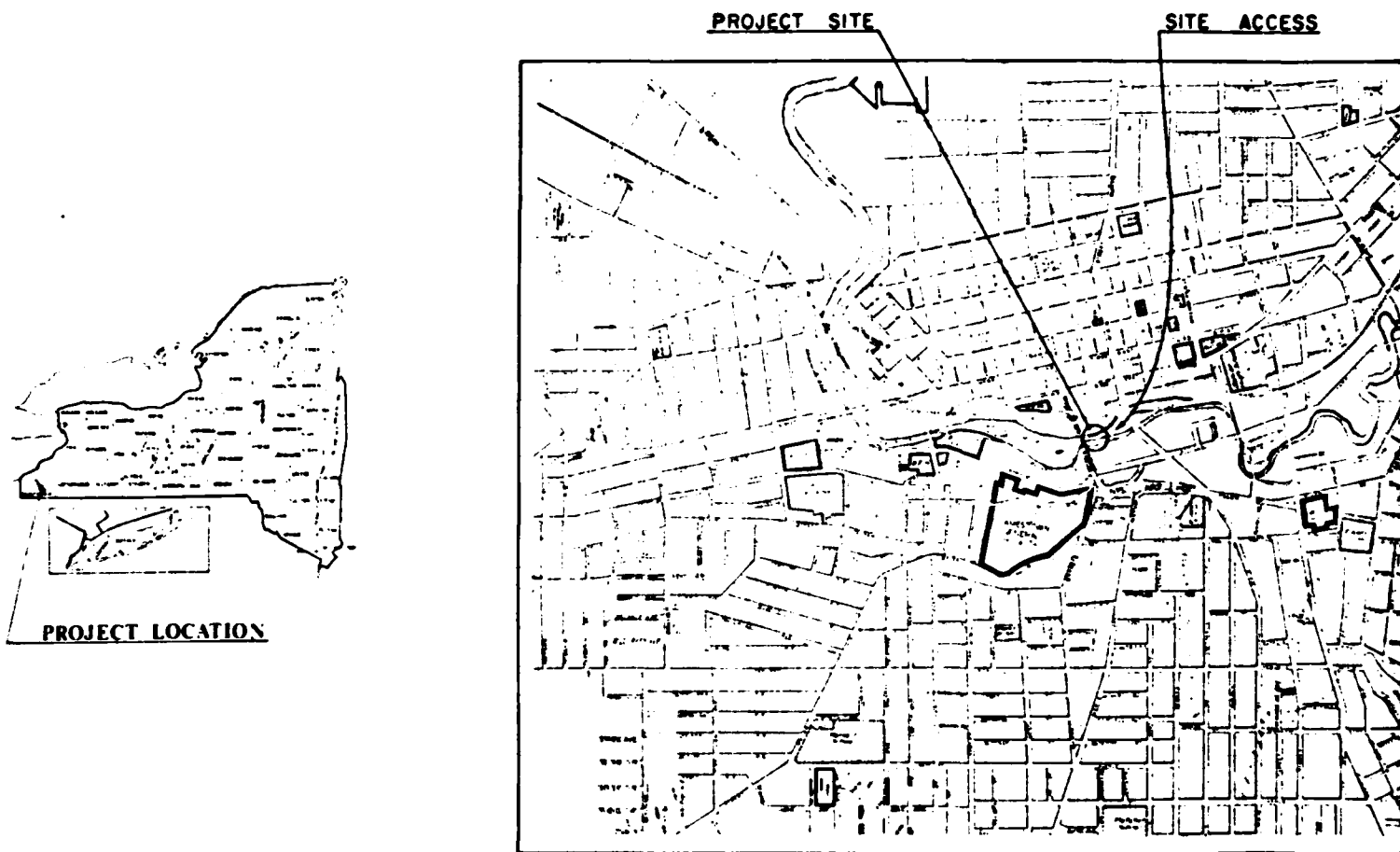

## JAMESTOWN, N

DATE .19

DATE .19

STATE OF NEW YORK  
DEPARTMENT OF ENVIRONMENTAL CON  
CONTRACT N2 D125679

# M REPLACEMENT

SITE ACCESS



RECORD PLANS

FEB 14, 1980

# N, NEW YORK

STATE OF NEW YORK  
DEPARTMENT OF ENVIRONMENTAL CONSERVATION  
CONTRACT NO D125679

ERDMAN, ANTHONY, ASSOCIATES  
CONSULTING ENGINEERS & PLANNERS  
842 ANDREWS ST.  
ROCHESTER, N.Y.

415 FALLOWFIELD RD  
CAMP HILL, PENNSA.

APPROVAL RECOMMENDED

*Elton J. ...*

DATE 2/14/80

19

2



**TABLE OF BENCHMARKS**

POINT	ELEVATION	DESCRIPTION
B.M. 100	1312.622	Chisled "X" in the vent cap bolt of a fire hydrant, located approximately 25 feet north of the north side of the existing Warner Dam and approximately 30 feet east of the east side of the Washington Street Bridge.

**LIST OF ABBREVIATIONS**

AL	Alignment
CL	Centerline
DL	Dredging
EL	Elevation
GR	Grade
IR	Intersection
MR	Manhole
PR	Proposed
SR	Standard
TR	Traverse
UR	Utility
VR	Vertical
WR	Water
XR	Existing
YR	Yield
ZR	Zoning
AR	Asymmetrical
BR	Bridge
CR	Curve
DR	Dredge
ER	Excavation
FR	Foundation
GR	Grade
HR	Horizontal
IR	Intersection
JR	Junction
KR	Key
LR	Level
MR	Manhole
NR	Not
OR	Original
PR	Proposed
QR	Quantity
RR	Right of Way
SR	Standard
TR	Traverse
UR	Utility
VR	Vertical
WR	Water
XR	Existing
YR	Yield
ZR	Zoning

**SURVEY CO**

**HORIZONTAL CONTROL**  
 The existing control in or near the project is considered as being established as part of a traverse established and Geodetic Survey. Station 20 Azimuth Mark were used for a station & G.S. as second order. The points are based on the 1927 North American Datum. All elevations are computed on the True Plane Coordinate System, West Zone.

**VERTICAL CONTROL**  
 The benchmark is a deep original & G.S. No. 1 (City of Jarestown) mark, 100 feet east of the station walk on the south side of Cherry of a water column, 70 feet south eastbound track, in the top of a and about 1 foot lower than the top of Jarestown bronze disk.

**SURVEY 8A**

NUMBER	STATION	POINT
P.I. 1	9+77.07	90
P.O.C. 1A	12+54.16	90
P. 8	15+78.74	90

**GENERAL**

**CENTERLINE GEOMETRY**

POINT	STATION	COORDINATES	CURVE DATA	AZIMUTH
PI	A 10+00.00	N 763426.54 E 321034.49		
PC	A 10+39.97	N 763410.41 E 321071.34	$\Delta = 53^{\circ} 17' 10''$ $D = 95.29' 35''$ $R = 60.00'$ $T = 30.10$ $L = 55.60$ $E = 7.13$	113° 29' 19"
PI	A 10+70.07	N 763398.62 E 321098.95		113° 29' 19"
PT	A 10+95.77	N 763413.57 E 321125.07		60° 12' 09"
PI	A 11+39.37	N 763435.20 E 321162.04		60° 12' 09"
PI	A 12+55.57	N 763465.62 E 321275.14		74° 51' 18"

POINT	STATION	COORDINATES	CURVE DATA	AZIMUTH
PI	W 10+00.00	N 763430.77 E 321114.59		170° 50' 40"
PI	W 11+37.70	N 763294.82 E 321130.50		241° 50' 40"
PC	W 12+42.94	N 763245.15 E 321043.70	$\Delta = 83^{\circ} 00' 00''$ $D = 114' 35' 30''$ $R = 90.00'$ $T = 44.24$ $L = 72.43$ $E = 16.76$	241° 50' 40"
PI	W 12+07.20	N 763103.03 E 321020.66		158° 50' 40"
PT	W 13+19.40	N 763103.03 E 321020.66		158° 50' 40"
PI	W 14+42.20	N 763018.14 E 321084.47		157° 50' 41"
PI	W 15+91.10	N 762926.54 E 321121.76		

**TABLE OF CO**

NO.	TITLE
1.	Cover
2.	Index and Legend
3.	Site Plan
4.	Site Plan
5.	Typical Sections, Earthwork and
6.	Water Main Relocation Details
7.	Standard Structure Sheet
8.	General Structural Plan
9.	General Structural Specifications
10.	Dam Face and Walkway Details
11.	Abutment Details
12.	Intermediate Pier Details
13.	Concrete Wall Repair Details
14.	Gate Schedule
15.	Steel Splice Detail
16.	Sealing and Walling Details
17.	Water Meter Detail
18.	Water Meter Detail
19.	Water Meter Detail
20.	Water Meter Detail
21.	Water Meter Detail
22.	Water Meter Detail
23.	Water Meter Detail
24.	Water Meter Detail
25.	Water Meter Detail
26.	Water Meter Detail
27.	Water Meter Detail
28.	Water Meter Detail
29.	Water Meter Detail
30.	Water Meter Detail

### SURVEY CONTROL

Survey control in or near the project area which was used for adjusting and closing the primary traverse of a traverse established by United States Coast and Geodetic Survey. Station "Jamestown 1935" and Jamestown Bench were used for a starting and closing adjustment. Any of these stations is published by the U.S.C.G. in second order. The position of these stations is on the 1927 North American Datum and plane coordinates computed on the Transverse Mercator Projection, Coordinate Center, West Zone.

Control is a loop originating and closing at U.S.C.G. Station 1 (City of Jamestown) located on the Erie Railroad 100 feet east of the station, in line with the pier on the south side of Cherry Street, 120 feet southeast of column 70 feet south of the south rail of the track, in the top of a concrete retaining wall 1 foot lower than the track. Station is a City Bench mark disk.

### SURVEY BASELINE

STATION	AZIMUTH	COORDINATES
9+77.87		N 763,432.81 E 370,986.48
12+54.16	90°-54'-47"	N 763,432.81 E 321,262.64
15+78.76	59°-19'-58"	N 763,593.97 E 321,541.84

### GENERAL NOTES

### TABLE OF CONTENTS

Page	Section
1-1	Legend
15-1	Rectangles, Earthwork and Restoration
15-2	Site Preparation Details
15-3	Structure Sheet
15-4	Structural Plan
15-5	Structural Elevation
15-6	and balcony Details
15-7	Gate Pier Details
15-8	Wall Repair Details
15-9	Gate
15-10	Gate Pier Details
15-11	and retaining Details
15-12	Gate
15-13	Gate
15-14	Gate
15-15	Gate
15-16	Gate
15-17	Gate
15-18	Gate
15-19	Gate
15-20	Gate
15-21	Gate
15-22	Gate
15-23	Gate
15-24	Gate
15-25	Gate
15-26	Gate
15-27	Gate
15-28	Gate
15-29	Gate
15-30	Gate
15-31	Gate
15-32	Gate
15-33	Gate
15-34	Gate
15-35	Gate
15-36	Gate
15-37	Gate
15-38	Gate
15-39	Gate
15-40	Gate
15-41	Gate
15-42	Gate
15-43	Gate
15-44	Gate
15-45	Gate
15-46	Gate
15-47	Gate
15-48	Gate
15-49	Gate
15-50	Gate

### LEGEND

#### PROPOSED

- FEE TAKING
- EASEMENTS, P.E. or T.E.
- SIDESLOPE IN CUT OR FILL
- DITCH or CHANNEL
- STONE FILL
- STRUCTURE
- CABLE GUIDE RAILING
- SPOT ELEVATIONS
- ROW MARKERS, CONCRETE TYPE L (100) 144 625 04
- BORING LOCATION
- SUBBASE COURSE
- ELECTRIC PULLBOX, TELEPHONE PULLBOX
- STREET LIGHT, STD LUMINAIRE
- ELECTRIC
- TELEPHONE

#### EXISTING

- BORING LOCATION
- TEST CORE
- BENCHMARK
- E.P.I., & P.I.
- GAS MAIN
- WATER MAIN
- SANITARY SEWER
- STORM SEWER
- MANHOLE
- ELECTRIC LINE, OVERHEAD
- TREE
- TREES or BRUSH
- STREAM
- UTILITY POLE
- FENCE
- PROPERTY LINE
- EXISTING EASEMENT
- SPOT ELEVATIONS
- HYDRANT
- ROW MARKER



ERDMAN  
ANTHONY  
ASSOCIATES

CONSULTING ENGINEERS & PLANNERS  
ROCHESTER, N.Y. CAMP HILL, PA.

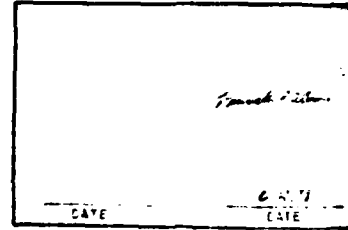

NOTE:  
UNAUTHORIZED ALTERATION OR ADDITION TO THIS DRAWING IS A VIOLATION OF THE NEW YORK STATE EDUCATION LAW ARTICLE 145, SECTION 7209.

NO.	DESCRIPTION	DATE

No As Built Revisions

PROJECT NAME:  
**WARNER DAM REPLACEMENT  
JAMESTOWN, NEW YORK**  
CONTRACT NO. D125679

CLIENT:  
STATE OF NEW YORK  
DEPARTMENT OF  
ENVIRONMENTAL CONSERVATION  
ALBANY, NEW YORK

DRAWING TITLE:  
**INDEX AND LEGEND**

NONE  
6/30/78  
K.P.A. DRAWING NO.  
SP  
E.C.I.  
2

CHADAKOIN  
FLOW

RIVER

PLEN-D-WOOD, INC

NELSON DR  
LUMBER AND MFG  
INC.

East S.C.P. Water  
Main to Remain

8" C.P. Waterline  
Out of Service

Existing Driveway  
Maintained for Plant

See Note 7 regarding location  
of S.C.P. 2" x 30" 20'

See Note 16 for grading

See Note 15

Stone Filling (Heavy)

Permanent Steel  
Sheet Piling

Existing guy wires  
Relocated

Relocated guy wires

Stone Filling (Heavy)  
ST. STA. 111-37.20

New Electric MH  
LUMBER YARD

225 LF Safety Wire  
Fencing (Temporary)

New Telephone Pullbox  
SMALL TREES  
AND BRUSH  
New Pad Mounted  
Transformer  
New Electric MH  
1912 5

See Note 8  
ST. STA. 111-37.20

Item 30405  
(Typ)

ST. STA. 111-30

FOR DETERMINATION  
STREET OR GUE

1/4" Maintenance Drive  
See Typ. C&I Sections

Siding removed by Urban Renewal Project  
Maintain a minimum of 90' between  
light structure and the closest  
roll of the siding

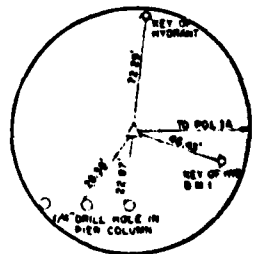

P.I.I.  
STA. 957' 07"  
5/8" DIA. B. CAP  
NOT TO SCALE

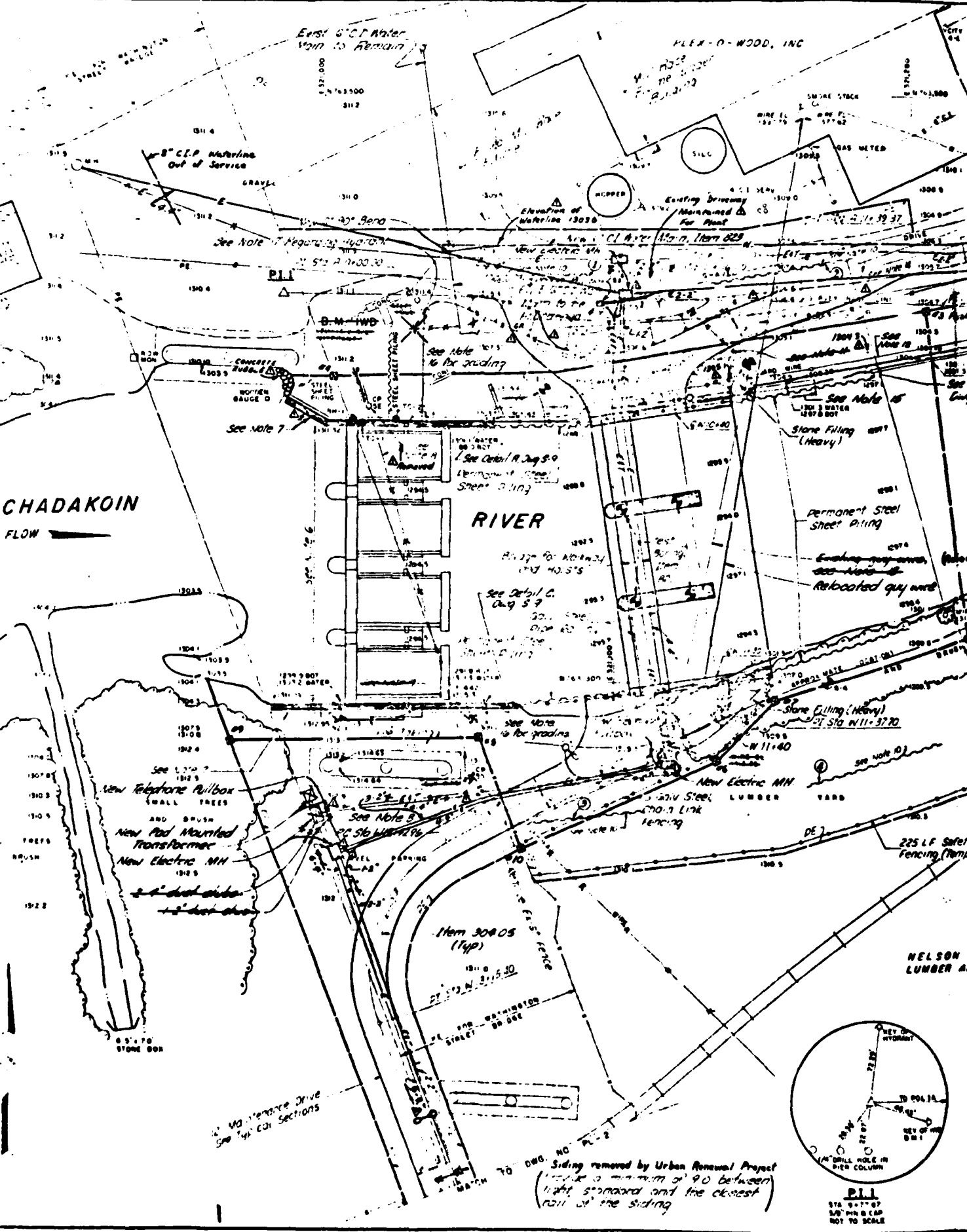

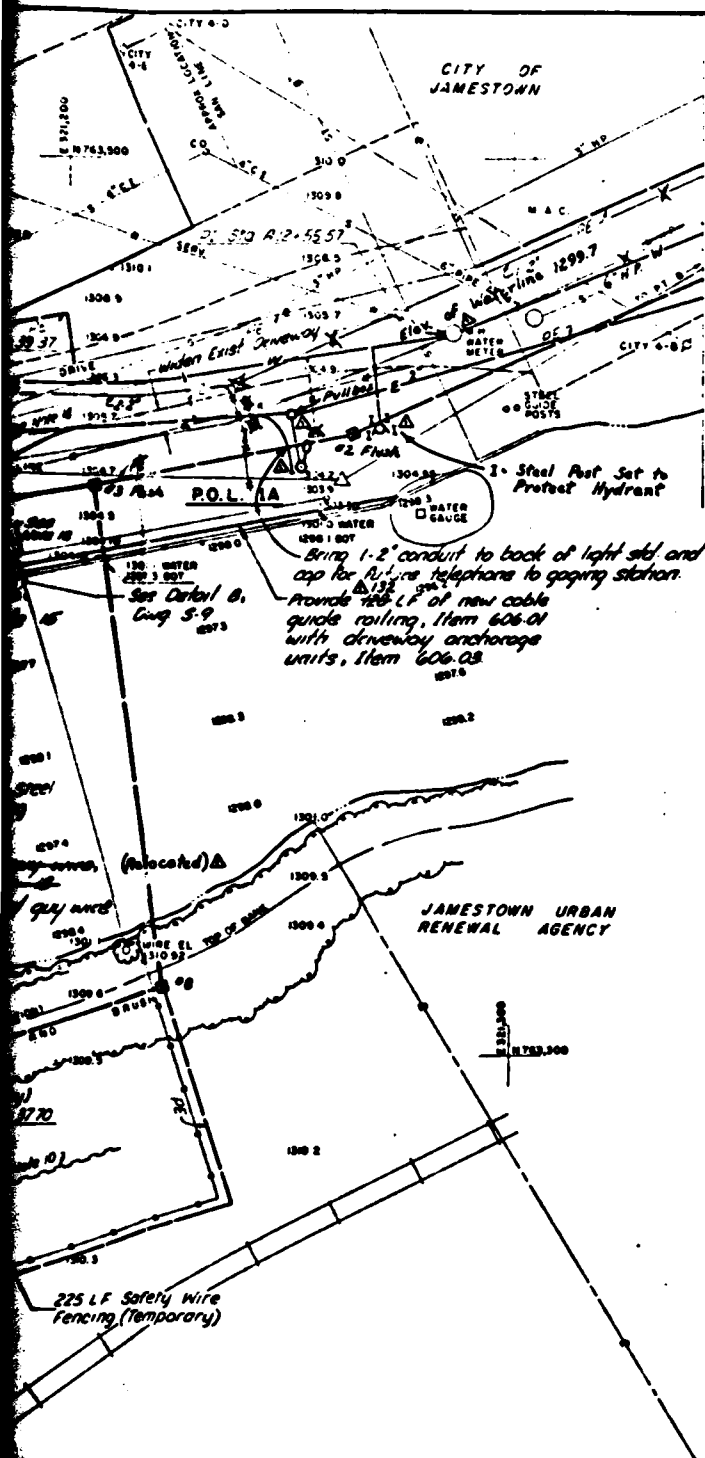

**NOTES**

1. Substructure of Washington Street not shown
2. Water surface elevations shown here at time of survey. Water levels vary. See spec. of specifications of Contract Documents for Hydrology Data.
3. Location of existing borings are approximate only.
4. Elevations shown in bottom of river are approximate only.
5. Details of new dam such as gate operators, etc. not shown on 1/20' scale plan. See structural plans for details.
6. All features of the existing dam between the abutment walls to be removed to elevation 1300.0 under Item 202.12. Item 202.2 also includes removal of fencing on abutment walls.
7. Existing abutment walls to be recessed. See Details, Div. 5-7.  
 a. NW Wingwall - 5' cap on side to elev. 1306.5
8. Existing light pole and luminaire to be removed and salvaged for Board of Public Utilities. Cost included in Item 201.00.01.
9. Existing ROW Marker to be reset after all work items in this area are completed. Cost to be included in Item 625.04.
10. Proposed steel sheeting deadman T-roads not shown. See structural plans. Numbers shown on sheeting deadman refer to Table "A" on Div. 5-9.
11. Provide 22 LF of 12" C.S.P. 4" pipe with end sections culvert to be located at E. Abutment. Set inverts to same elevation as 6" water main to be a minimum of 22" higher than south invert. Not Needed. Δ
12. Existing cable guide railing to be removed under Item 201.00.01.
13. Profile of "A" line shall be at 1311.5 from 7+10+00 to 7+10+91, 10% slope from 7+10+91 to 7+11+40.
14. Existing Gas Main and Service to be relocated if necessary by National Fuel Gas Co., cost to be paid by State of New York.
15. Row of existing timber piles observed during low water period extending approximately 85' to west from this point along base of existing wall.
16. Area to be filled and graded to drain west, refer to Div. 73-1.
17. Existing Hydrant to be relocated to a point on the new 6" water main near the meter pit. Exact location of hydrant to be set by Flex-O-Wood Inc. and fire insurance agent.
18. Contractor to provide adequate temporary support of existing guy wire until new anchor on abutment wall is completed.

**ERDMAN  
ANTHONY  
ASSOCIATES**  
 CONSULTING ENGINEERS & PLANNERS  
 ROCHESTER, N.Y.      CAMP HILL, PA.

6/30/78

DATE \_\_\_\_\_ DATE \_\_\_\_\_

**NOTE:**  
 UNAUTHORIZED ALTERATION OR ADDITION TO THIS DRAWING IS A VIOLATION OF THE NEW YORK STATE EDUCATION LAW ARTICLE 145, SECTION 2709.

REVISIONS		
NO.	DATE	DESCRIPTION
1	6/30/78	As Built JFM

**NELSON BROTHERS  
LUMBER AND MILLWORK,  
INC.**

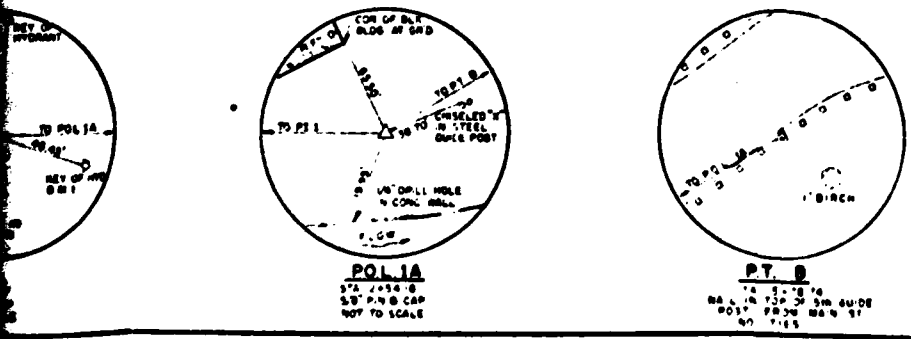

**PROJECT NAME**  
 WARNER DAM REPLACEMENT  
 JAMESTOWN, NEW YORK  
 CONTRACT NO. D125679

**CLIENT**  
 STATE OF NEW YORK  
 DEPARTMENT OF  
 ENVIRONMENTAL CONSERVATION  
 ALBANY, NEW YORK

**DRAWING TITLE**

**SITE PLAN**

1" = 20'  
 6/30/78

KPA  
 SP  
 PL  
 PROJECT  
 3

Typical for dam base section in fill      Typical for dam base section in cut

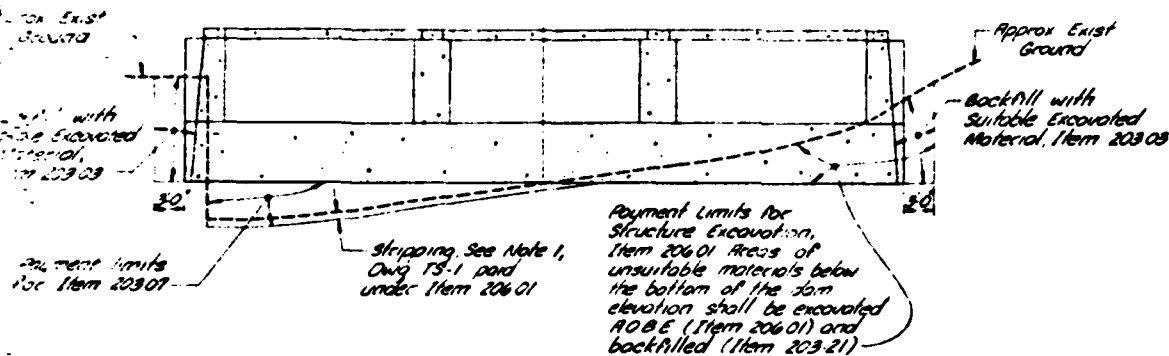

LONGITUDINAL SECTION THRU DAM

Typical for dam base section in fill      Typical for dam base section in cut

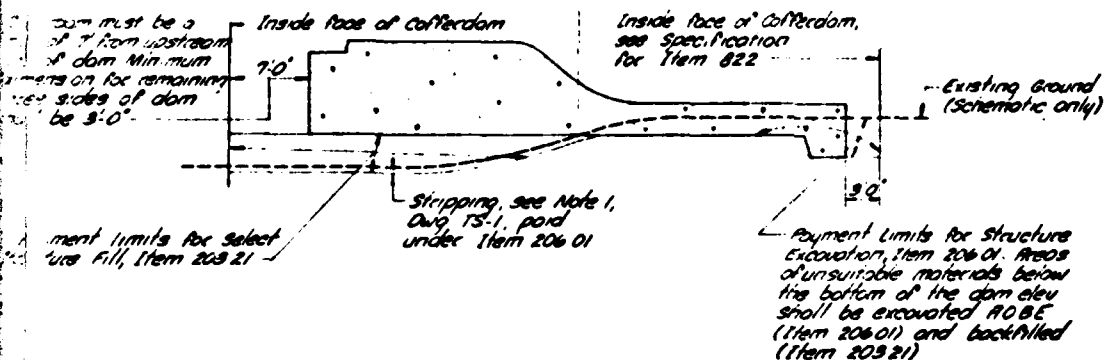

TRANSVERSE SECTION THRU DAM

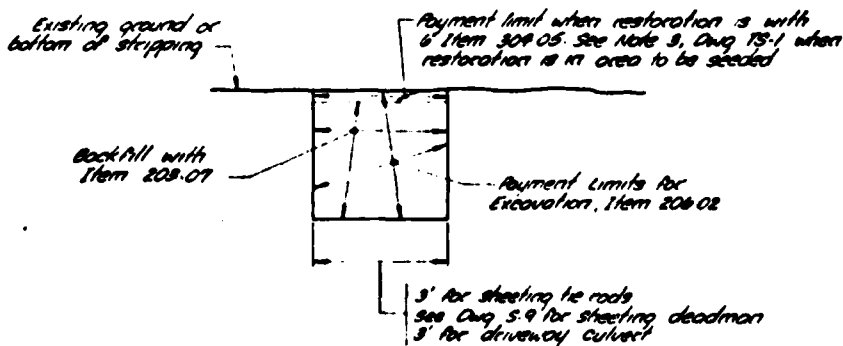

MINOR STRUCTURE EXCAVATION

EXCAVATION & BACKFILL DETAILS

NO SCALE

STANDARD STRUCTURE SHEET

1. Material and Construction Specifications and Sections of the New York State Department of Transportation dated January 3, 1978, with subsequent additions.
2. Concrete for Structures shall be Class "A", Item 556.01 or Class "B", Item 556.02 as noted on the Plans. Structures have been designed for 28 day concrete compressive strength of 3000 psi.
3. All bar reinforcement for concrete shall conform to Item 556.0201.
4. Details of reinforcement not specifically shown shall be in conformance with A.C.I. Standard 318-71.
5. All exposed edges of concrete shall be chattered 1".
6. The following minimum cover dimensions shall be required for all bar reinforcement in structural concrete:
 

Dam walkway and can of existing wall	2"
All other concrete pours	3"
7. The cost of all joint material will be included in the price bid for the various items of the Contract, except as otherwise specified.
8. Bituminous material, Item 558.01 shall be applied to the backs of all walls above top of footings where fill is in contact with the walls.
9. All embankments shall be compacted to not less than 95% of Standard Proctor Maximum Density.
10. For design purposes the foundation pressure does not exceed 1.5 tons per sq. foot.
11. All anchor bolts, nuts, and washers, except stainless steel hardware, shall conform to ASTM A 307, grade B, and shall be galvanized in accordance with ASTM A 153.



ERDMAN  
ANTHONY  
ASSOCIATES

CONSULTING ENGINEERS & PLANNERS  
ROCHESTER N.Y.      CAMP HILL PA.

*[Signature]*

6/27/78  
DATE

NOTE:  
UNAUTHORIZED ALTERATION OR ADDITION TO THIS DRAWING IS A VIOLATION OF THE NEW YORK STATE EDUCATION LAW ARTICLE 145, SECTION 7209.

REVISIONS			
NO.	DATE	DESCRIPTION	BY
1			
2			
3			
4			
5			
6			
7			
8			
9			
10			
11			

*No As Built Revisions*

PROJECT NAME  
WARNER DAM REPLACEMENT  
JAMESTOWN, NEW YORK  
CONTRACT NO D125679

CLIENT  
STATE OF NEW YORK  
DEPARTMENT OF  
ENVIRONMENTAL CONSERVATION  
ALBANY, NEW YORK

DRAWING TITLE  
STANDARD STRUCTURE SHEET

SCALE: 1" = 10' KPA  
NO SCALE R.J. S-1  
DATE ISSUED: 6/30/78 NO. BY ECT  
7 2

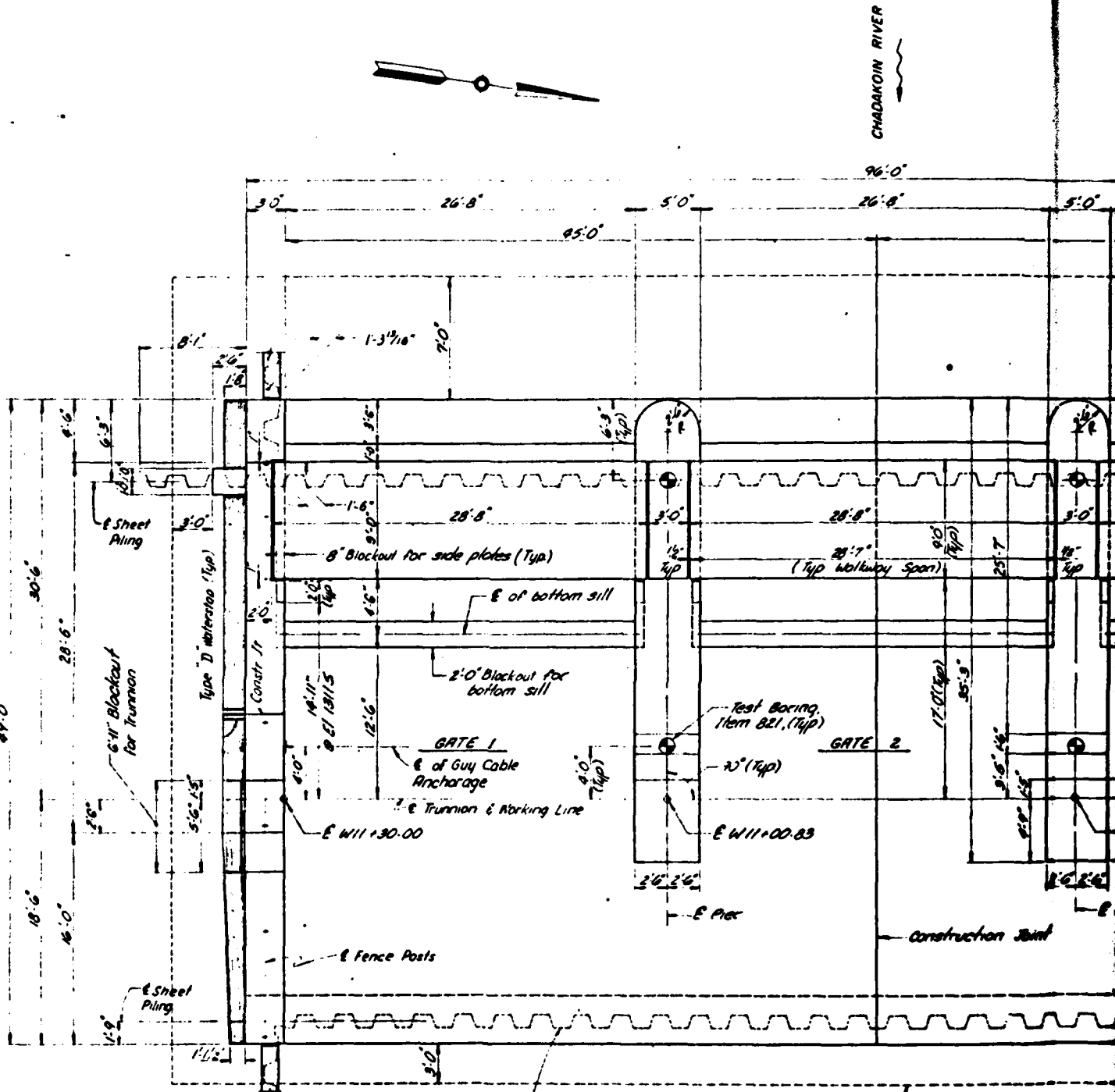

**NOTES:**

- 1 Gates and Operators not shown on this Dwg
- 2 For Fence Post Spacing See Dwg N° S-3

Maximum pay joints for structure Enclosure, Item 552.02

Permanent Steel Sheet Piling - Item 552.02 (Typ)

Stapling to wood form will only be permitted in this area on each side.

Note: Waterstops shall be of Section 255.24P or Hales must not be for any purpose except stapling to forms. Type 3 Waterstop in color. The cost of the waterstop shall be price bid for the

3/4" x 1/2" staples, place vertical @ 6" ctrs

Rear face of wall

Wood Form

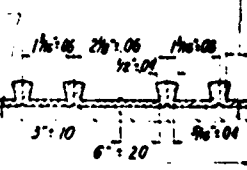

**TYPE D WATERSTOP**  
No scale

C	B	T/3
1/4"	1 1/2"	10 6"
1/8"	3 1/2"	6" to 10"
1/4"	5 1/2"	over 10"

Note: All Reus should begin and end 1.0" from the edge of pour as indicated above

**CONSTRUCTION JOINT DETAIL**

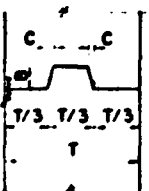

Type D Waterstop



ERDMAN  
ANTHONY  
ASSOCIATES

CONSULTING ENGINEERS & PLANNERS  
ROCHESTER, N.Y.      CAMP HILL, PA.



NOTE:  
UNAUTHORIZED ALTERATION OR ADDITION TO THE  
DRAWING IS A VIOLATION OF THE NEW YORK  
STATE EDUCATION LAW ARTICLE 140, SECTION  
7209.

REVISIONS			
NO.	DATE	DESCRIPTION	BY
1	2/1/80	As Built	JFM

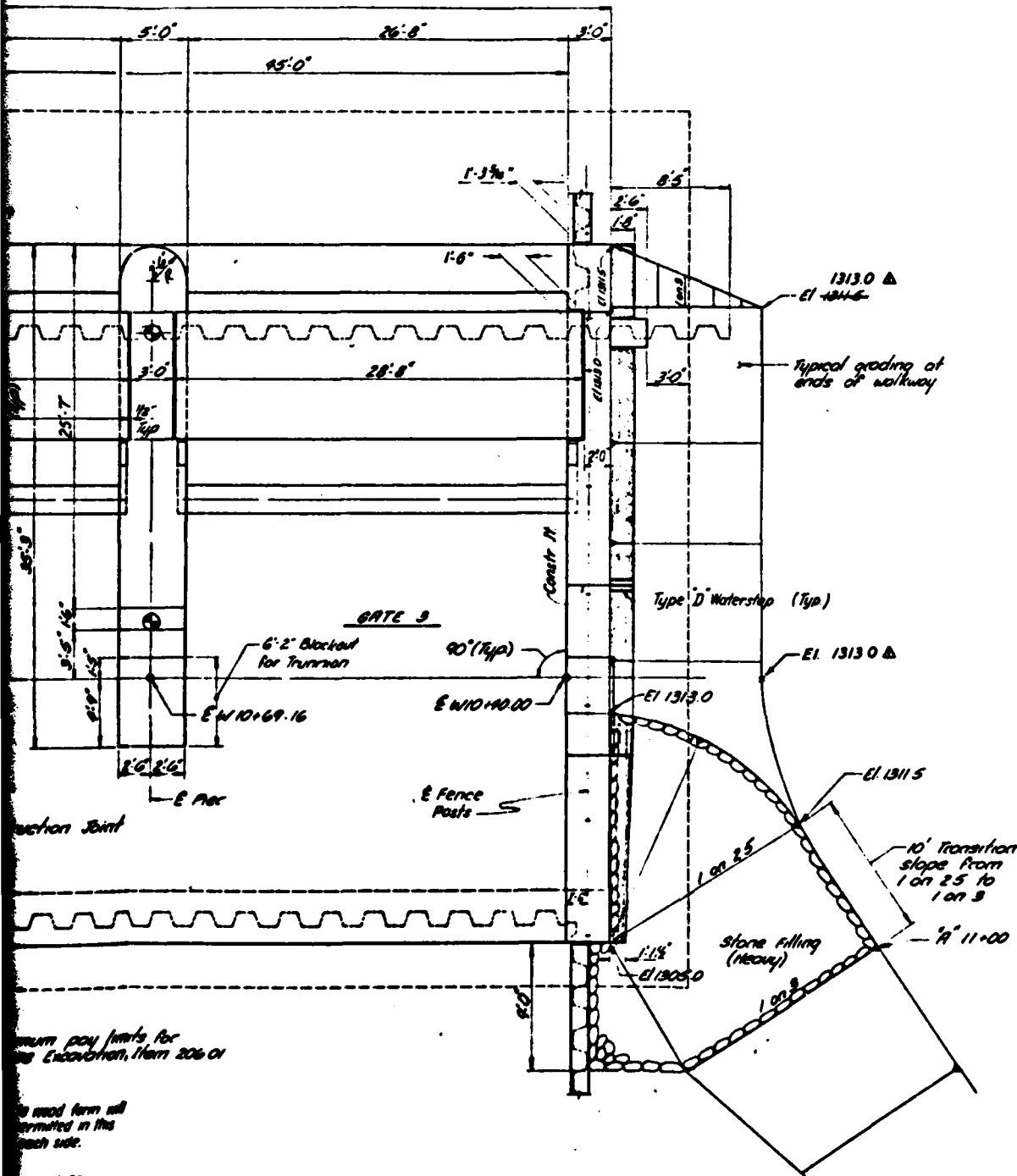

Note: Test borings shall be performed by the Contractor as located hereon or as ordered by the Engineer in accordance with Item 821 of the Specifications

Note: Waterstops shall conform to the requirements of Section 205.307 of the Specifications. Holes must not be made in waterstop for any purpose except as required for shaping to forms. Type B Waterstop shall be light gray in color. The cost of furnishing and placing waterstop shall be included in the unit price bid for the concrete items.

PROJECT NAME  
WARNER DAM REPLACEMENT  
JAMESTOWN, NEW YORK  
CONTRACT NO. D 125679

CLIENT  
STATE OF NEW YORK  
DEPARTMENT OF  
ENVIRONMENTAL CONSERVATION  
ALBANY, NEW YORK

DRAWING TITLE  
GENERAL STRUCTURAL PLAN

3/16" = 1'-0"      MD      S-2  
6/30/79      R.J.      S-2



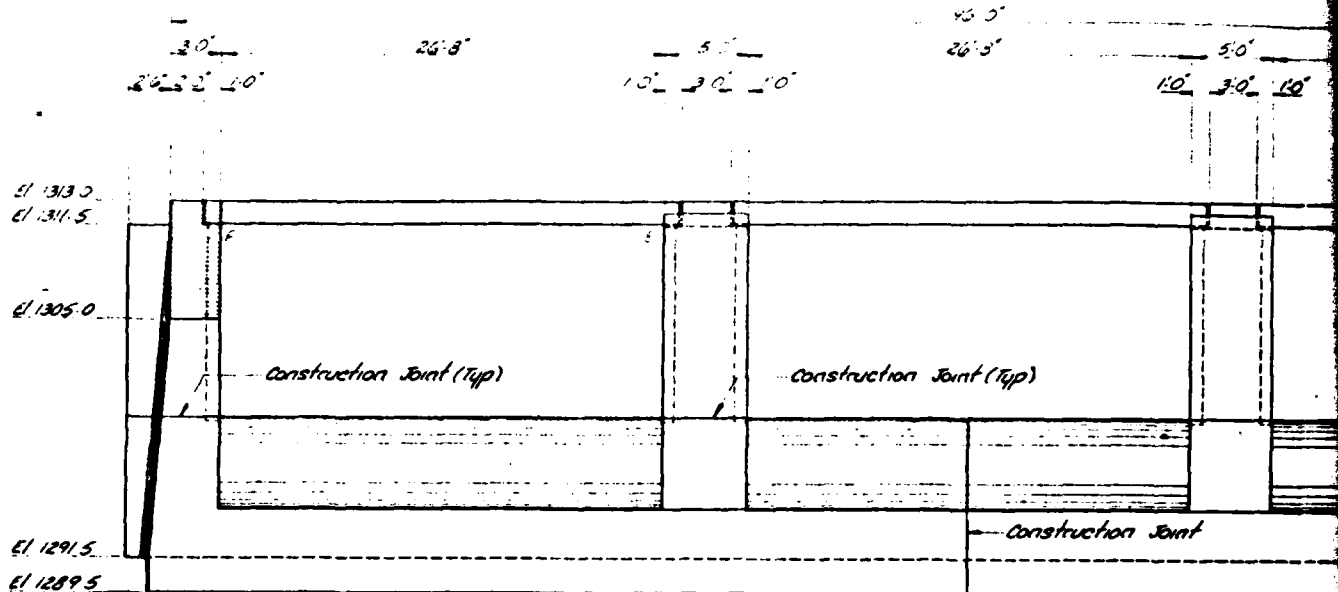

**END ELEVATION - FACING SPILLWAY**

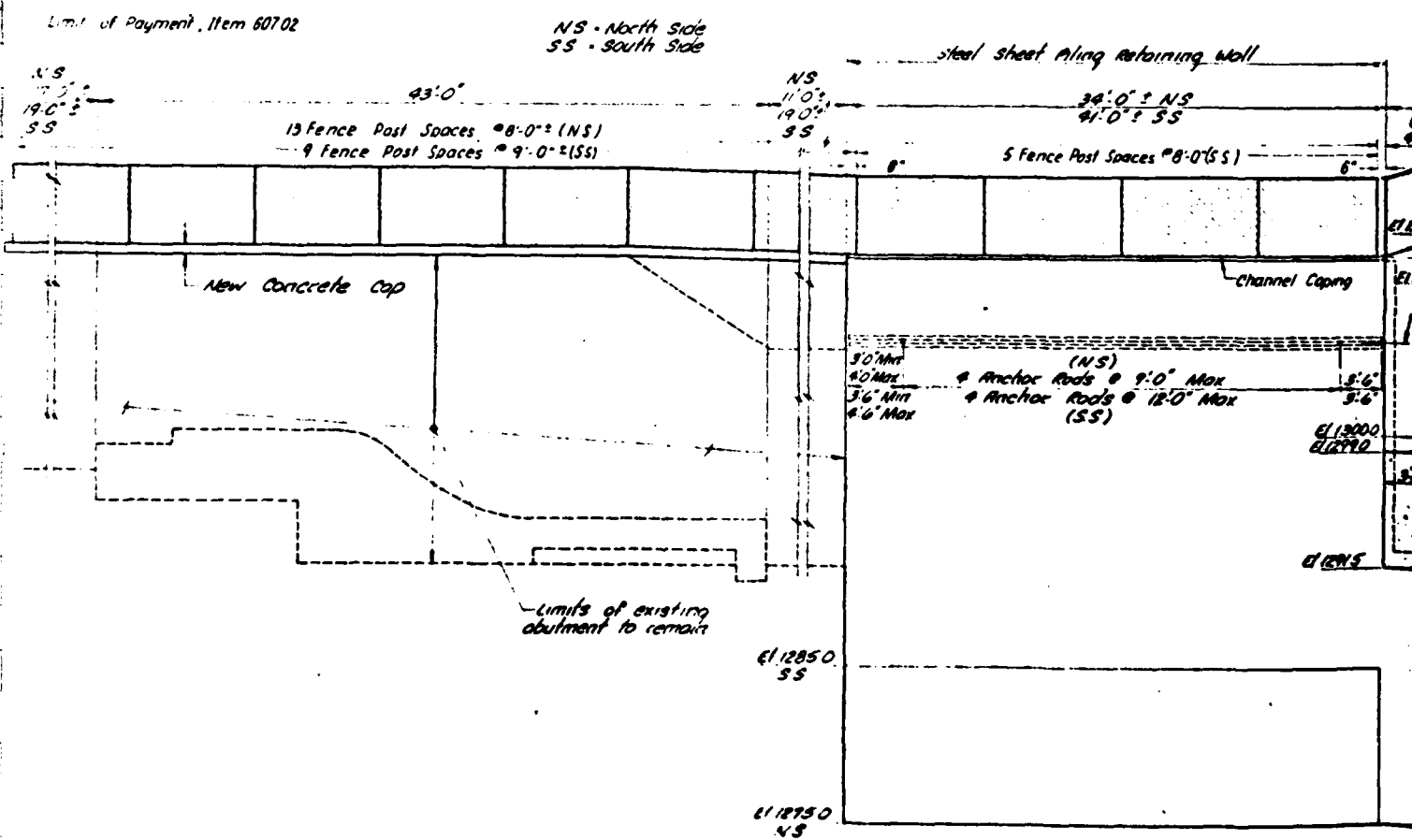

**INTERIOR ELEVATION**  
**NORTH SIDE SHOWN - SOUTH SIDE OPPOSITE HAND**

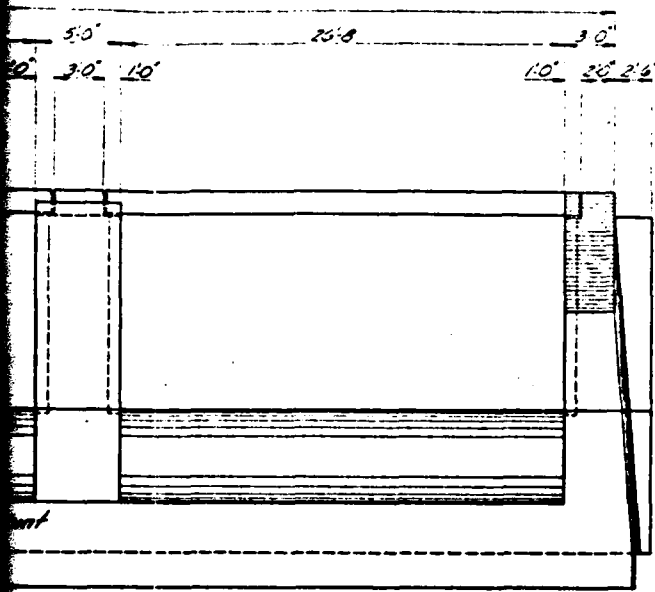

**Notes**

- 1) Gates and hoisting equipment not shown on End Elevation Hoisting equipment not shown on Interior Elevation
- 2) For Concrete Cap Details See Dwg. N° S-7
- 3) For Fence Post Detail See Dwg. N° S-10



ERDMAN  
ANTHONY  
ASSOCIATES

CONSULTING ENGINEERS & PLANNERS  
ROCHESTER, N.Y.      CAMP HILL, PA.

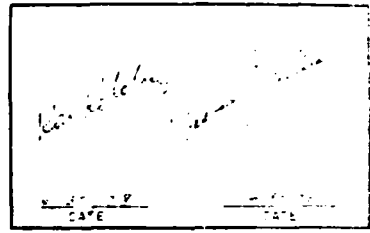

**NOTE**

UNAUTHORIZED ALTERATION OR ADDITION TO THIS DRAWING IS A VIOLATION OF THE NEW YORK STATE EDUCATION LAW ARTICLE 45 SECTION 7209.

REVISIONS	
NO.	DESCRIPTION

No As Built Revisions

MAY

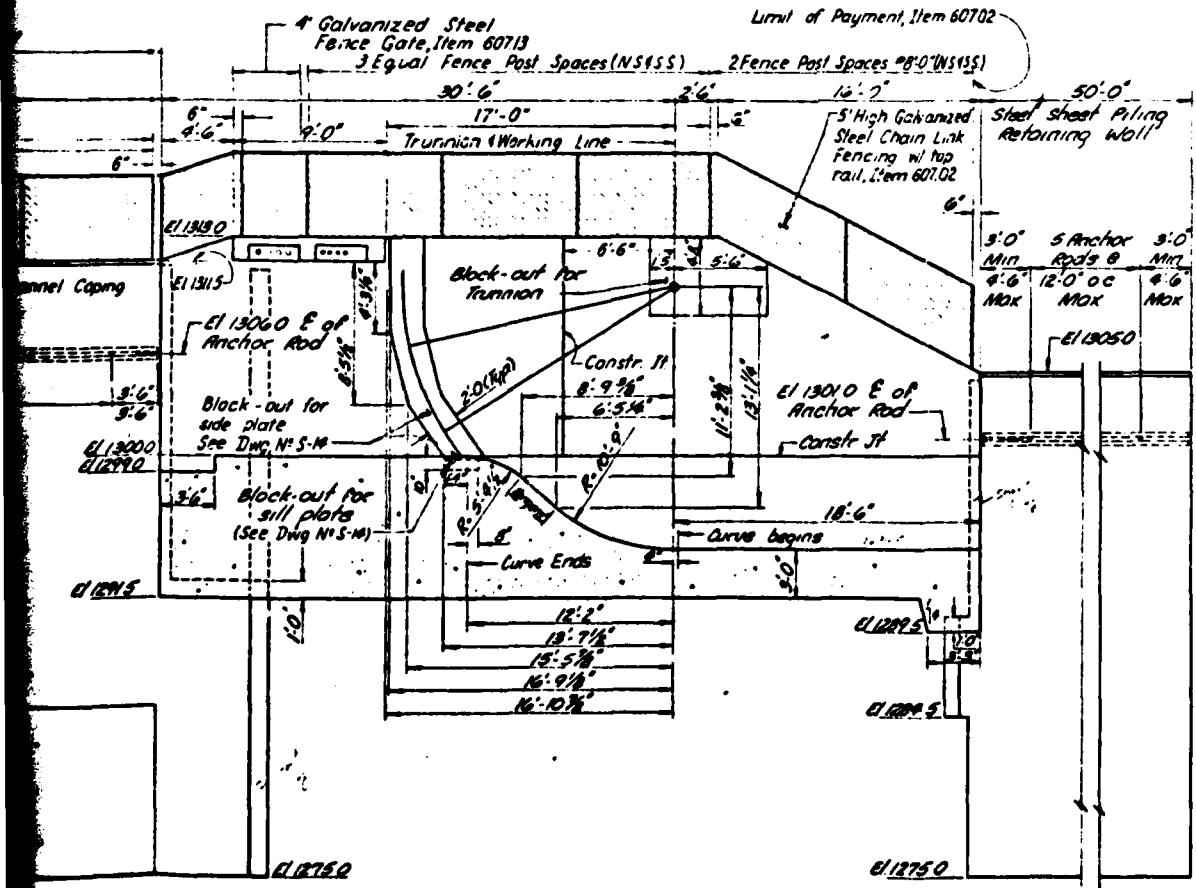

**PROJECT NAME**  
WARNER DAM REPLACEMENT  
JAMESTOWN, NEW YORK  
CONTRACT NO D 125679

**CLIENT**  
STATE OF NEW YORK  
DEPARTMENT OF  
ENVIRONMENTAL CONSERVATION  
ALBANY, NEW YORK

**DRAWING TITLE**  
GENERAL STRUCTURAL ELEVATION

FOR SITE HAND

DATE: 10/10/00      MD      S-3  
BY: R.J.      SHEET NO. 10

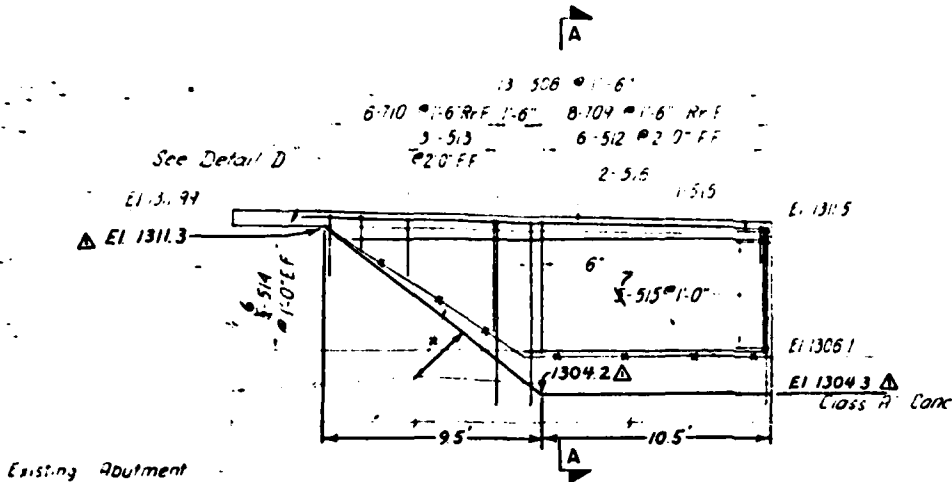

**NORTH SIDE INTERIOR ELEVATION**

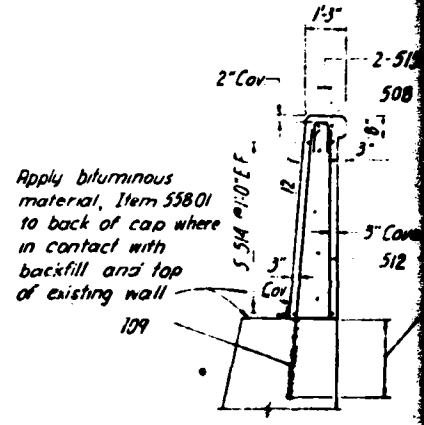

**SECTION A-A**

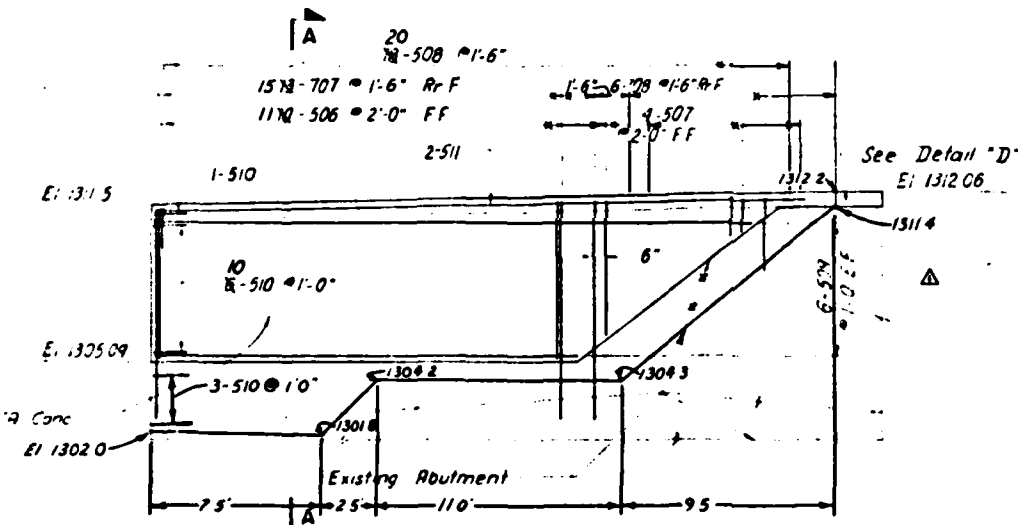

**SOUTH SIDE INTERIOR ELEVATION**

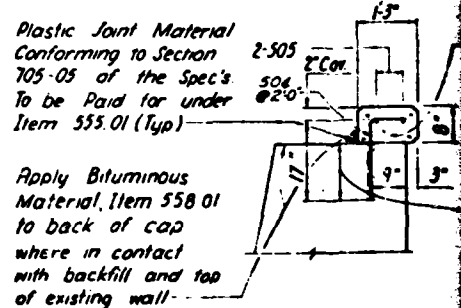

**DETAIL D CAP ON EXISTING WALL**

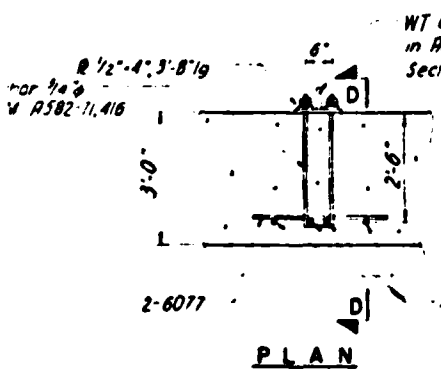

WT 6-665, 5-3' lg Galv in Accordance with Section 719

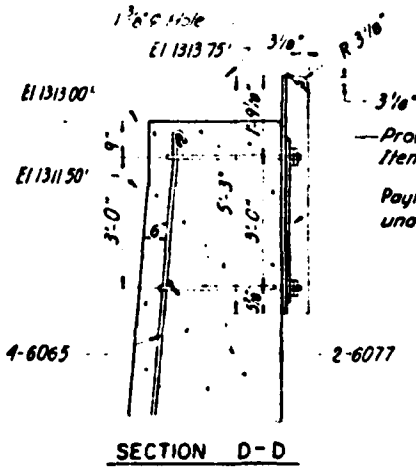

Provide 1/4" Pin of Chain Shackle, Item 656.01

Payment to be included under Item 656.01

**GUY CABLE ANCHORAGE DETAIL**

Scale 1/2" = 1'-0"



ERDMAN  
ANTHONY  
ASSOCIATES

CONSULTING ENGINEERS & PLANNERS  
ROCHESTER, N.Y.      CAMP HILL, PA

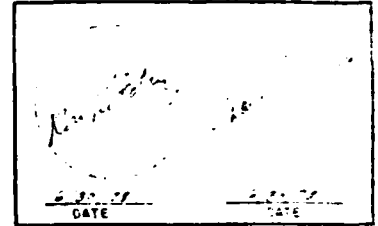

NOTE:  
UNAUTHORIZED ALTERATION OR ADDITION TO THIS  
DRAWING IS A VIOLATION OF THE NEW YORK  
STATE EDUCATION LAW ARTICLE 145, SECTION  
7209.

REVISIONS		
NO.	DATE	DESCRIPTION
1	2/14/00	As Built JFM

Notes

- Contractor shall remove unsound concrete from top of existing wall before adding cap
- Dimensions & elevations of existing structure shall be verified in the field by the contractor.

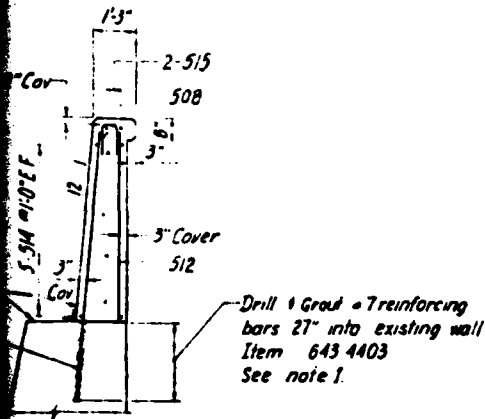

SECTION A-A

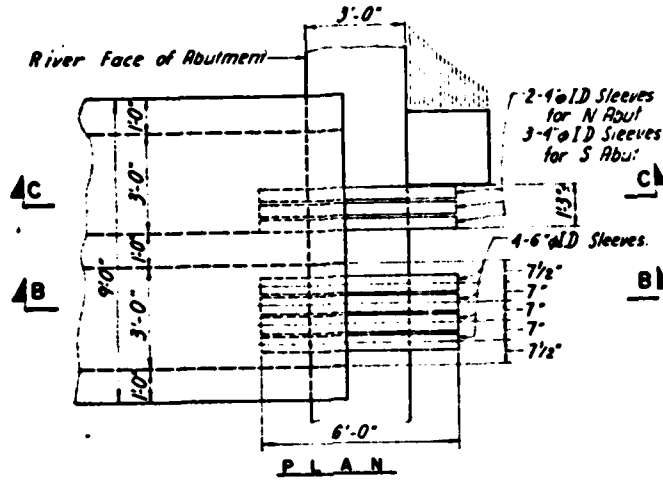

PLAN

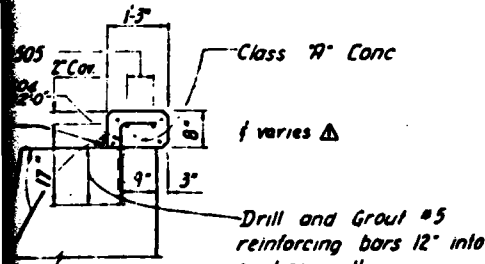

DETAIL D  
EXISTING WALL

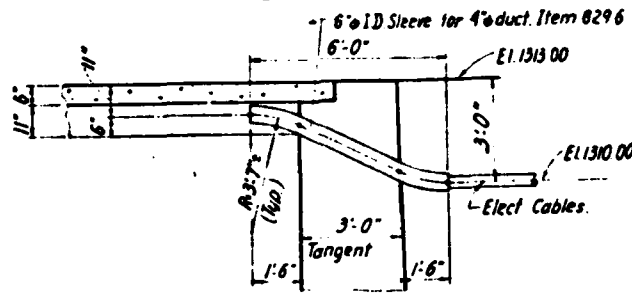

SECTION B-B

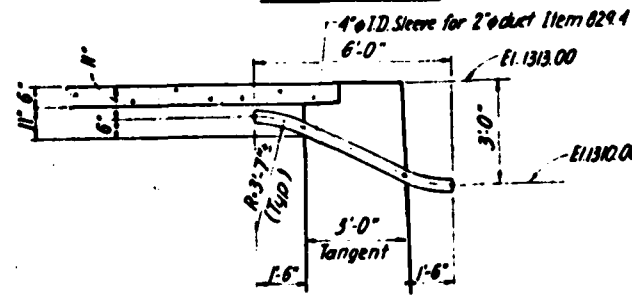

SECTION C-C

DETAILS OF SLEEVES  
THROUGH ABUTMENT WALLS:

*South Abutment Shown  
North Abutment Similar Except as Noted  
Scale 3/8"=1'-0"*

PROJECT NAME  
**WARNER DAM REPLACEMENT  
JAMESTOWN, NEW YORK  
CONTRACT NO D 125679**

CLIENT  
STATE OF NEW YORK  
DEPARTMENT OF  
ENVIRONMENTAL CONSERVATION  
ALBANY, NEW YORK

DRAWING TITLE  
**CONCRETE WALL  
REPAIR DETAILS**

SCALE	NO SCALE	MD	FZ	S-7
DATE	6/30/78	BY	MD	13

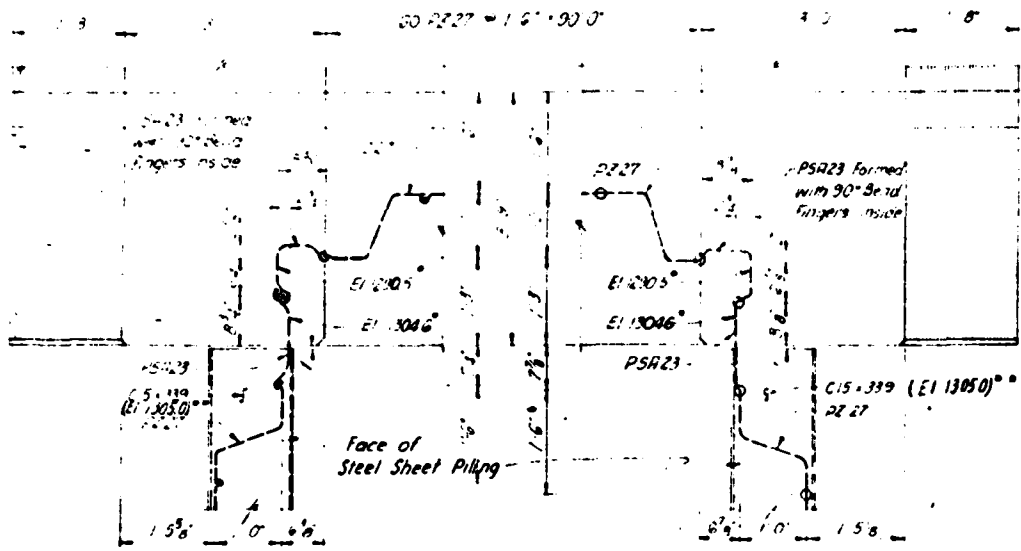

**SOUTHEAST CORNER**

**NORTHEAST CORNER**

**SHEET PILING PLAN**

Note:  
 • Top of Piling elevation  
 •• Top of Cap elevation

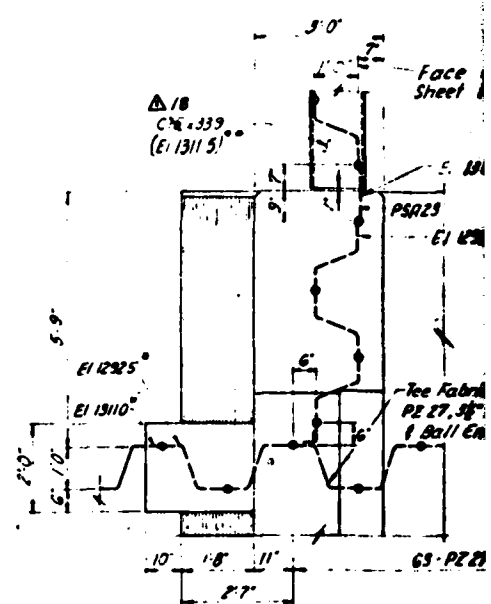

**SOUTHWEST CORNER**

**SHEET PILING PLAN**

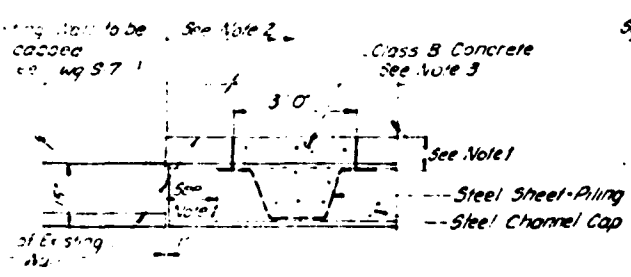

**DETAIL A**

**NORTH UPSTREAM TIE-IN**

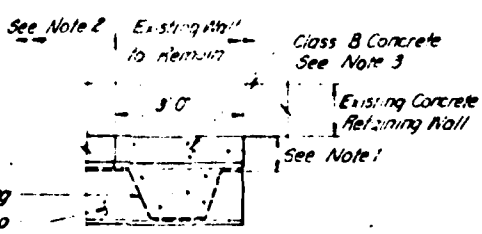

**DETAIL B**

**NORTH DOWNSTREAM TIE-IN**

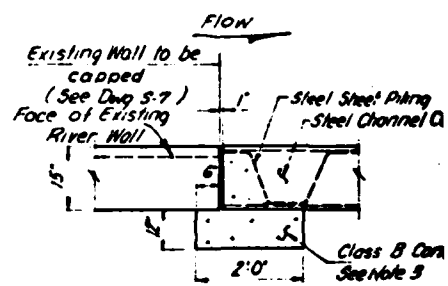

**DETAIL C**

**SOUTH UPSTREAM TIE-IN**

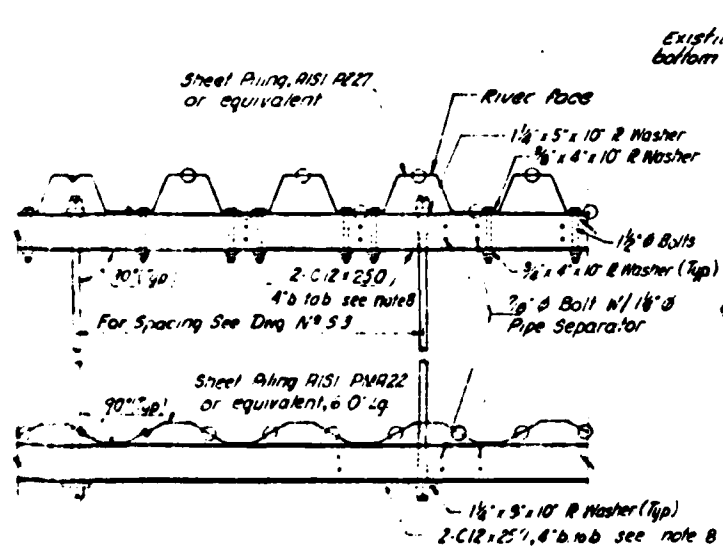

**PLAN**

T A B L E	LOCATION	A"	ELEV B"
1		52.3'	1301.0
2		41.0	1300.0
3		41.0'	1303.0
A"		41.0'	303.0

For Locations See Dwg N° 51-1

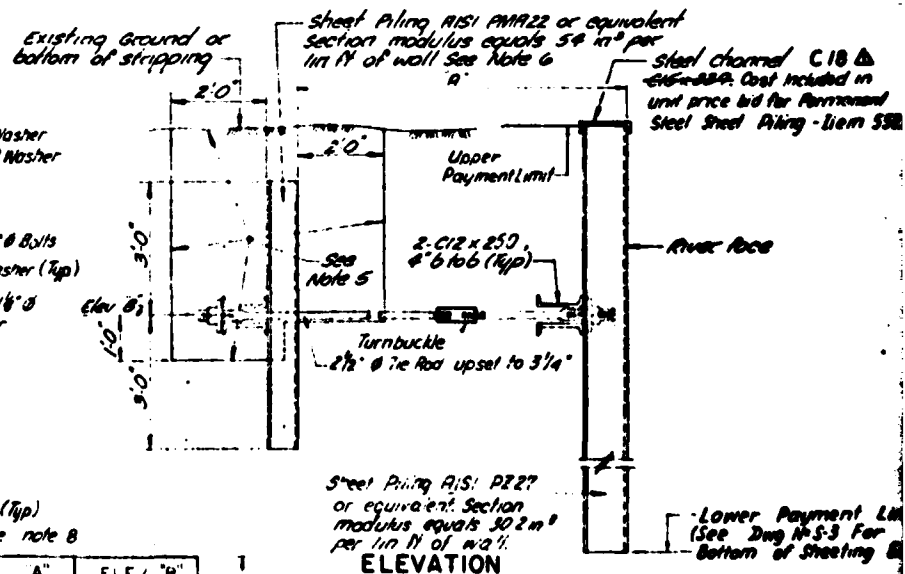

**ELEVATION**

SEE NOTE 4

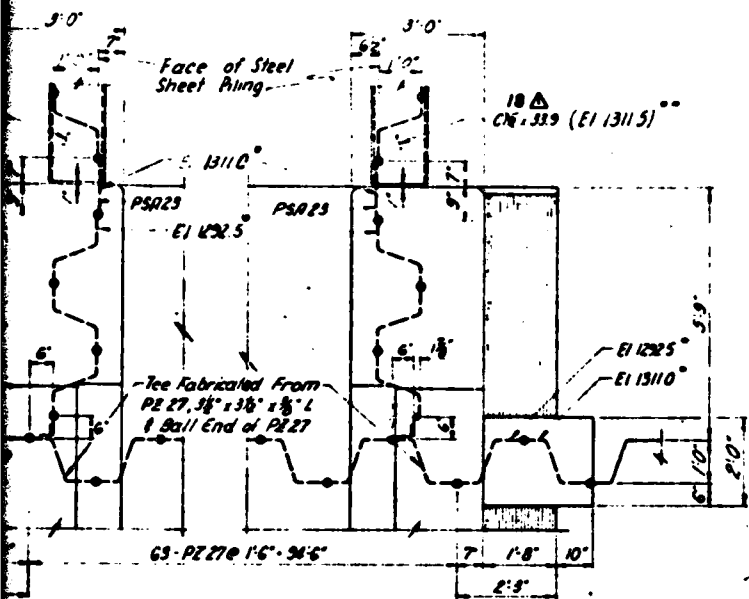

**CORNER NORTHWEST CORNER SHEET PILING PLAN**

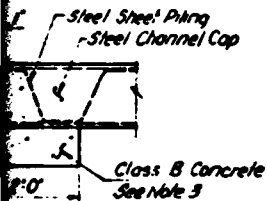

**REAM TIE-IN**

Channel C18 Δ  
 Δ Δ Δ Cost included in  
 price bid for Permanent  
 Steel Piling - Item 552.02

See Note

Lower Payment Limit  
 per Dwg No S-3 For  
 Bottom of Sheet Piling Elevation)

**NOTES:**

- 1 Dimensions to be determined in field. Steel sheet piling to be driven as close as practical to existing retaining walls, subject to approval of Engineer.
- 2 Existing wall to be lowered as necessary to a point 4' below finished grade. See Typical Section N° 8, Dwg TS-1.
- 3 Concrete to be poured under Item 555.02. Bottom of bulkhead pour to be at existing bottom of river. Top of pour to be level with adjacent existing concrete wall or concrete wall as lowered to clear grading.
- 4 Excavation for sheeting deadman shall be done in the presence of the engineer. If bearing capacity of soil is not sufficient sheeting deadman embedment shall be R.O.B.E.
- 5 Payment limits for sheeting deadman excavation, Item 206.02. Backfill with Item 203.07. Restore with 6" Item 304.05 or topsoil and seeding as appropriate.
- 6 Cost of sheeting deadmen, walers, tie rods, turnbuckles, and accessories to be included in unit price bid for Permanent Steel Sheet Piling, Item 552.02.
- 7 See Dwg. PL-1 for location of Details A thru D.
- 8 Any splices in walers shall develop full moment capacity of 2-C12-250.



**ERDMAN  
ANTHONY  
ASSOCIATES**

CONSULTING ENGINEERS & PLANNERS  
ROCHESTER, NY      CAMP HILL, PA



**NOTE:**  
 UNAUTHORIZED ALTERATION OR ADDITION TO THIS DRAWING IS A VIOLATION OF THE NEW YORK STATE EDUCATION LAW ARTICLE 45, SECTION 7209

REVISIONS		
NO.	DATE	DESCRIPTION
1	2/14/80	As Built

**PROJECT NAME**  
 WARNER DAM REPLACEMENT  
 JAMESTOWN, NEW YORK  
 CONTRACT NO D125679

**CLIENT**  
 STATE OF NEW YORK  
 DEPARTMENT OF  
 ENVIRONMENTAL CONSERVATION  
 ALBANY, NEW YORK

**DRAWING TITLE**

**STEEL SHEET PILING DETAILS**

NO SCALE      MD      S-9  
 GP      KK  
 6/30/78

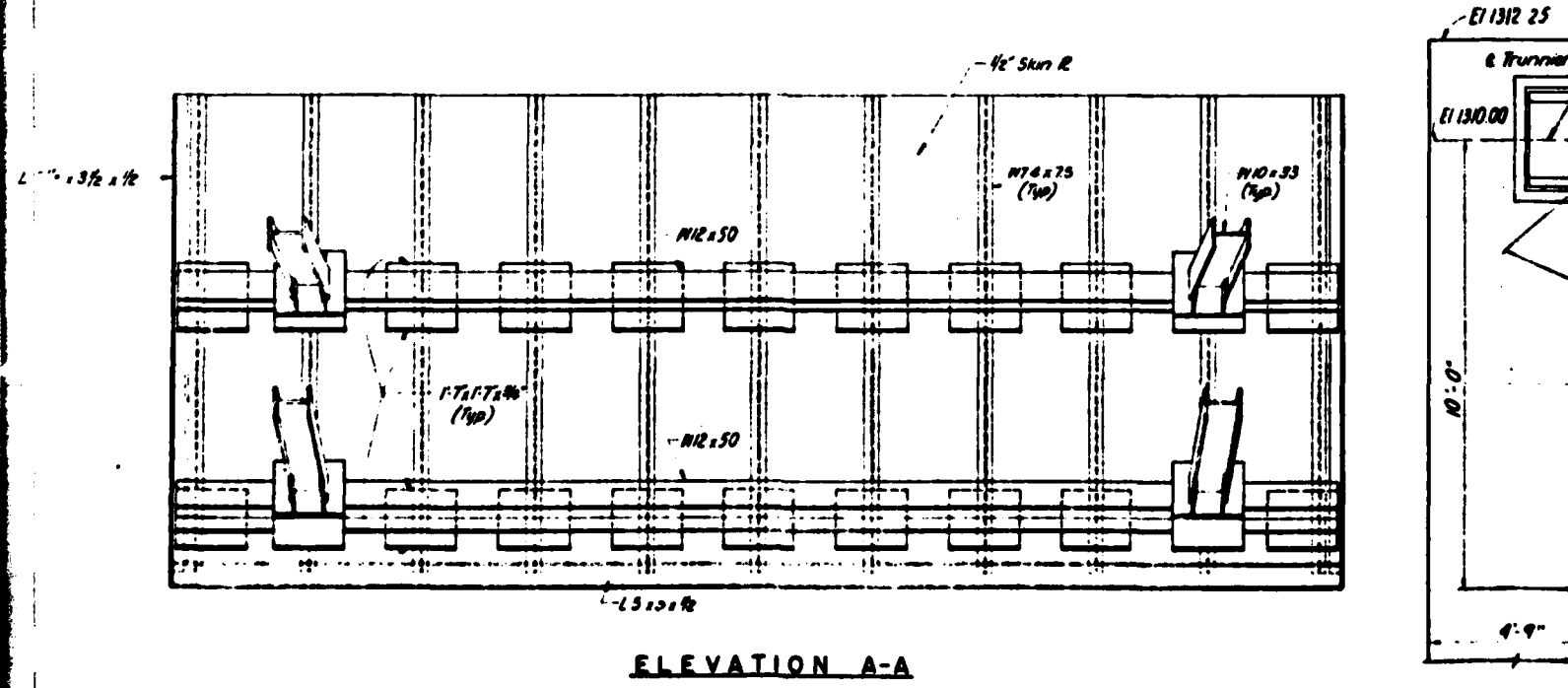
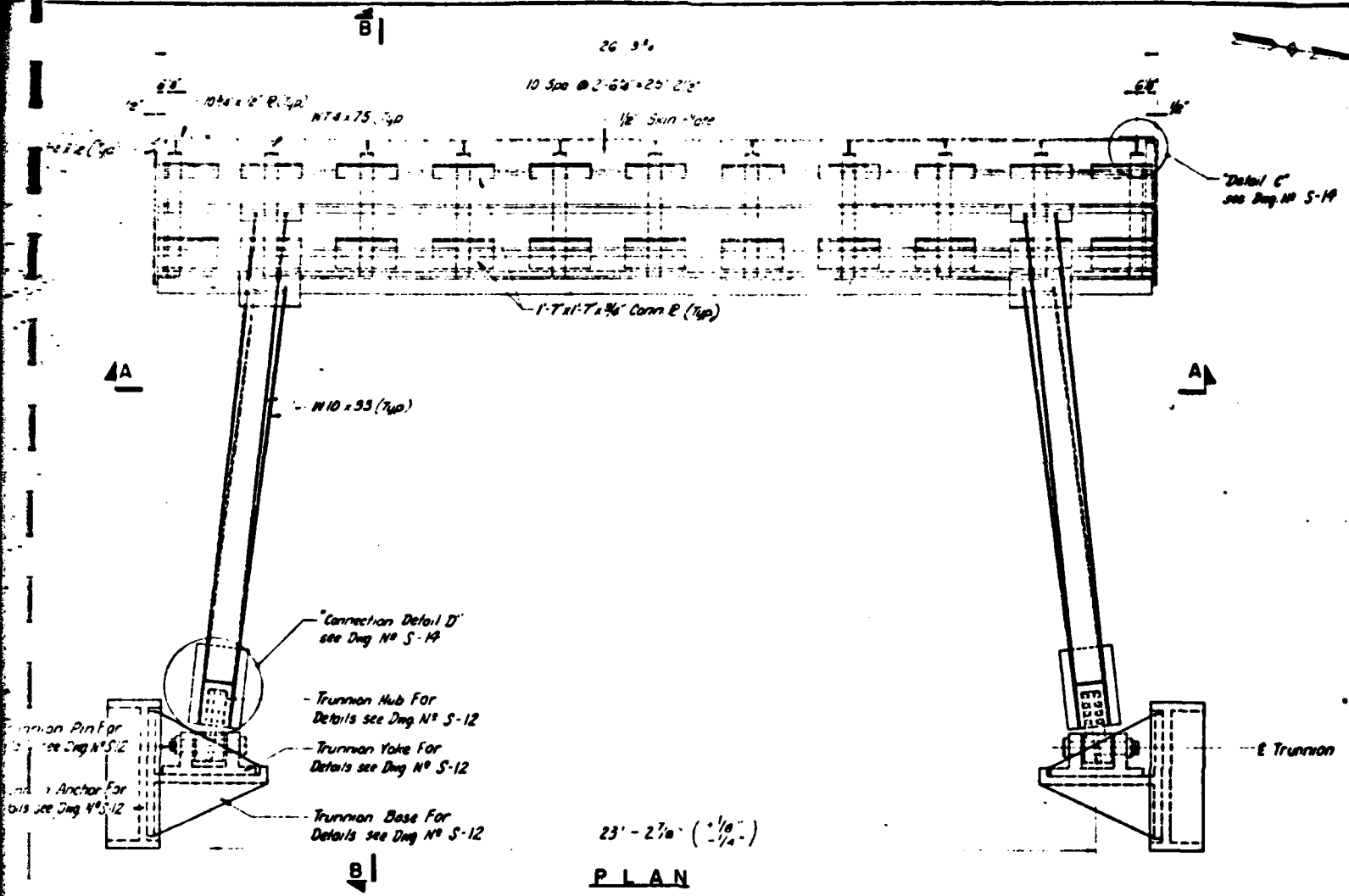

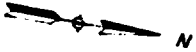

**NOTE:**

- 1) Payment for Tainter Gate included in Item B19
- 2) All Connections to be welded unless otherwise shown
- 3) Work this steel with Drawings S-12, S-13 & S-14
- 4) Dimensions suffixed by \* are given along outer surface of skin plate @ R: 16'-0"
- 5) Under no circumstances should bottom edge of gate be raised above El. 1311.4.

Detail C  
see Dwg. No S-19

8 Trunnion

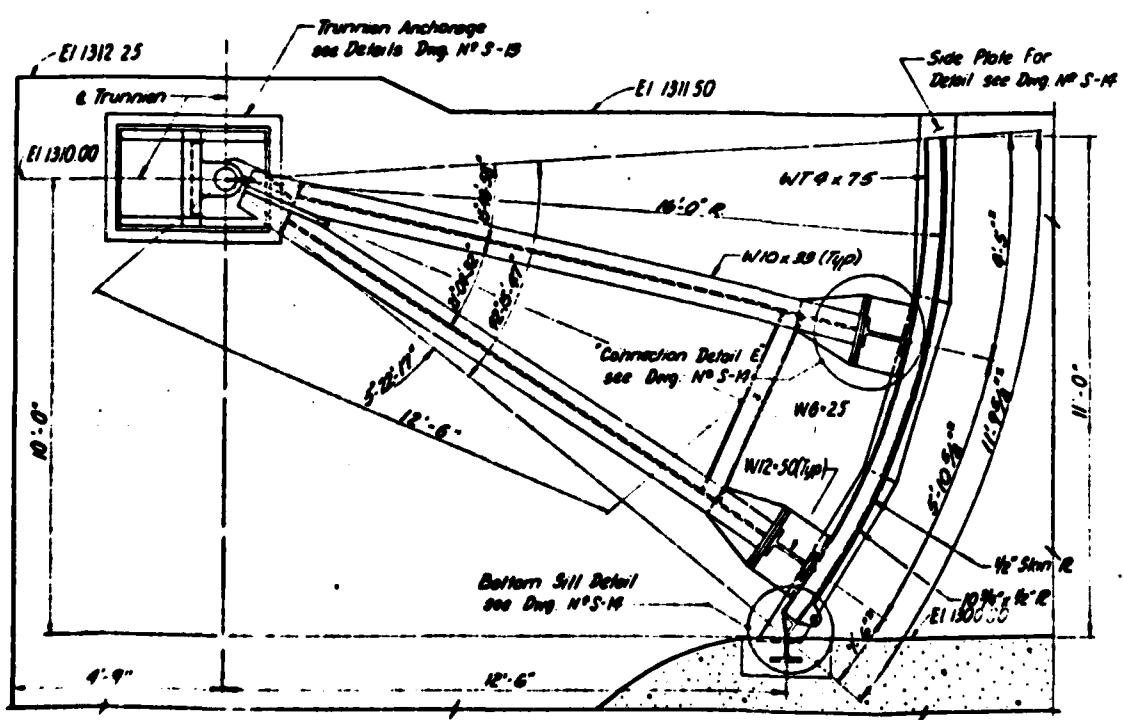

**SECTION B-B**



ERDMAN  
ANTHONY  
ASSOCIATES

CONSULTING ENGINEERS & PLANNERS  
ROCHESTER, N.Y.      CAMP HILL, PA.

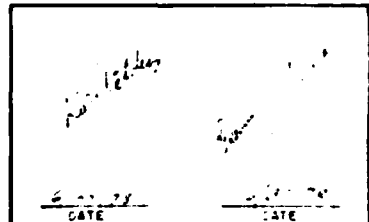

**NOTE:**  
UNAUTHORIZED ALTERATION OR ADDITION TO THIS  
DRAWING IS A VIOLATION OF THE NEW YORK  
STATE EDUCATION LAW ARTICLE 145, SECTION  
7209.

REVISIONS			
NO.	DATE	DESCRIPTION	BY

No As Built Revisions

**PROJECT NAME:**  
WARNER DAM REPLACEMENT  
JAMESTOWN, NEW YORK  
CONTRACT NO D125679

**CLIENT:**  
STATE OF NEW YORK  
DEPARTMENT OF  
ENVIRONMENTAL CONSERVATION  
ALBANY, NEW YORK

**DRAWING TITLE:**

**TAINTER GATE  
GATE DETAILS**

SCALE: 1/2" = 1'-0"	DESIGNED BY: AZ	CHECKED BY: R.J.	DATE ISSUED: 6/30/78
PROJECT NO: S-11	DRAWN BY: K.K.	DATE: 17	SHEET NO: 23



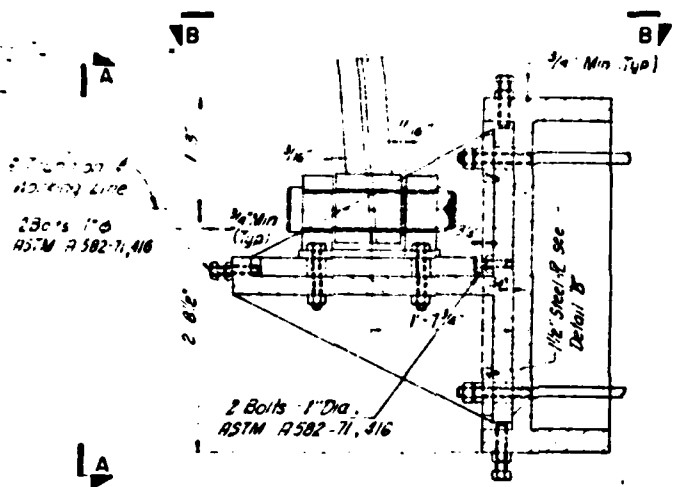

**PLAN SECTION K-K**

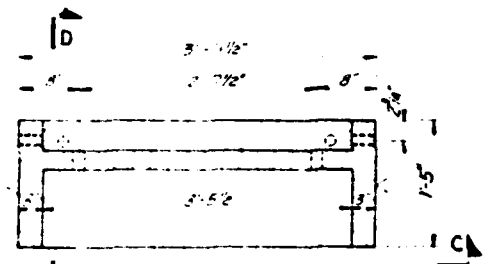

**PLAN SECTION L-L**

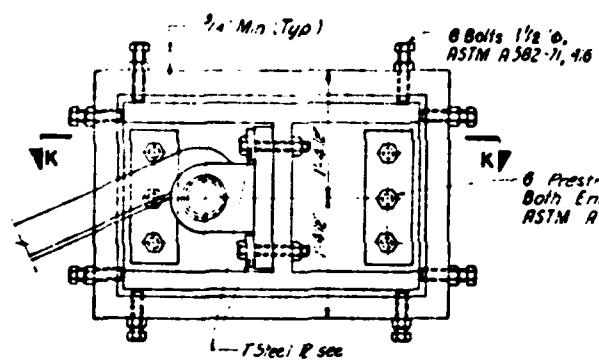

**ELEVATION A-A**

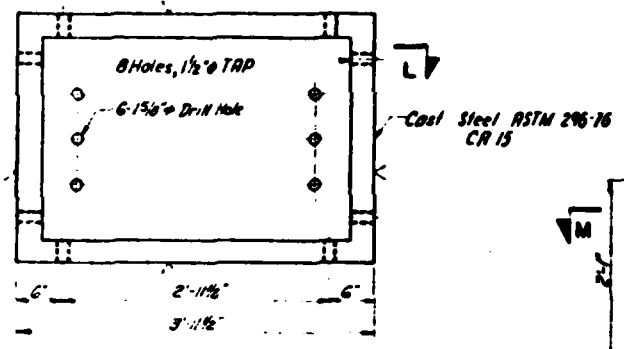

**ELEVATION C-C**

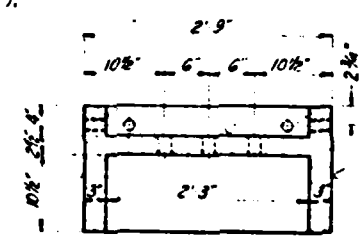

**SECTION D-D**

**TRUNNION ANCHOR DETAILS**

Scale 1" = 1-0"

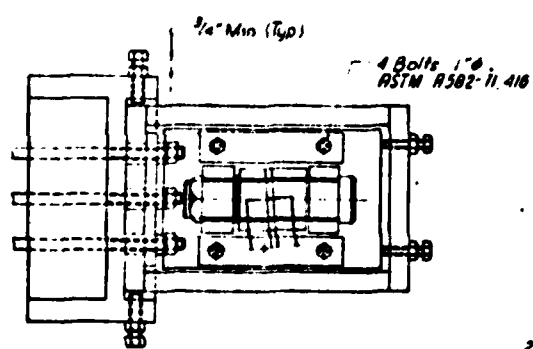

**ELEVATION B-B**

**TRUNNION ASSEMBLY DETAILS**

Scale 1" = 1-0"

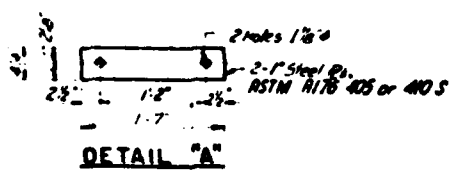

**DETAIL "A"**

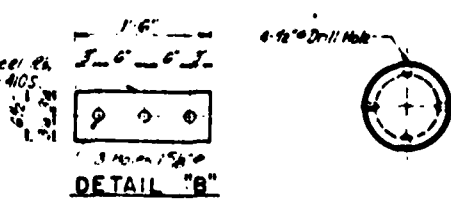

**DETAIL "B"**

**SHIM PLATES DETAILS**

Scale 1" = 1-0"

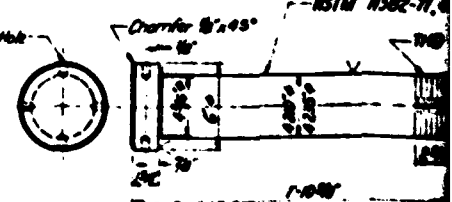

**TRUNNION PIN DETAIL**

Not to Scale

See Shop Drawings for check from cast steel to galvanized

Round Corners to 1" Radius

TRUNNION



**ERDMAN  
ANTHONY  
ASSOCIATES**

CONSULTING ENGINEERS & PLANNERS  
ROCHESTER, N.Y.      CAMP HILL, PA.

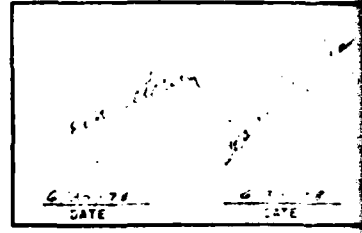

**NOTE:**  
UNAUTHORIZED ALTERATION OR ADDITION TO THIS DRAWING IS A VIOLATION OF THE NEW YORK STATE EDUCATION LAW ARTICLE 145, SECTION 7209.

REVISIONS			
NO.	DATE	DESCRIPTION	BY
1	2/14/80	As Built	JFM

**NOTE:**  
1. Payment for Trunnion Assembly included in Item 814.  
2. For Notes this Sheet see Dwg No S-14.

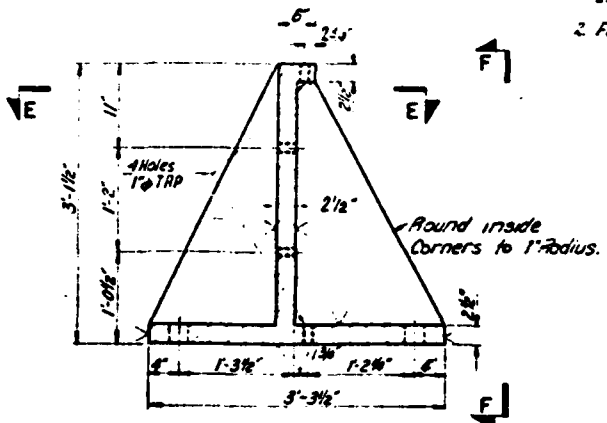

**PLAN SECTION M-M**

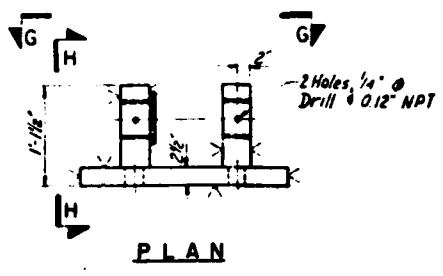

**PLAN**

ASTM 296-76  
# 15

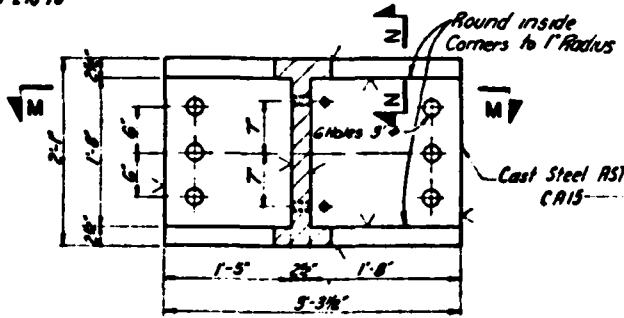

**ELEVATION E-E**

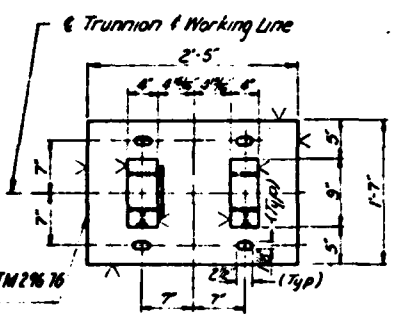

**ELEVATION G-G**

Shop Drawings for changes in trunnion assembly cast steel to galvanized steel

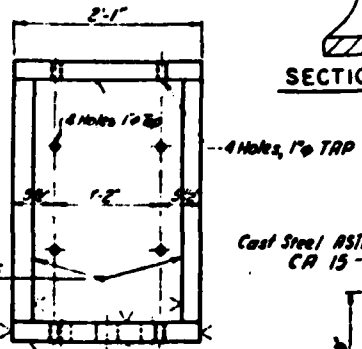

**ELEVATION F-F**

**TRUNNION BASE DETAILS**

Scale 1"=1'-0"

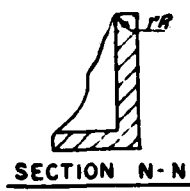

**SECTION N-N**

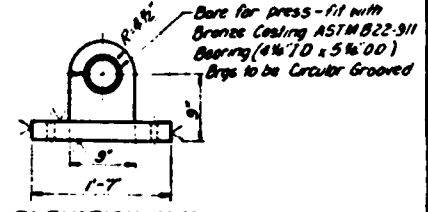

**ELEVATION H-H**

**TRUNNION YOKE DETAILS**

Scale: 1"=1'-0"

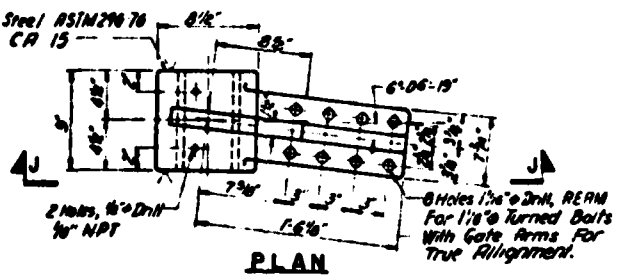

**PLAN**

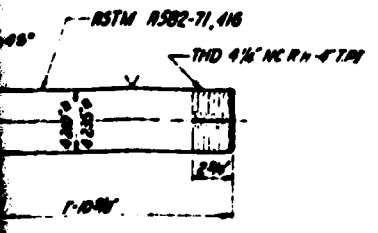

**PIN DETAIL**

Not to Scale

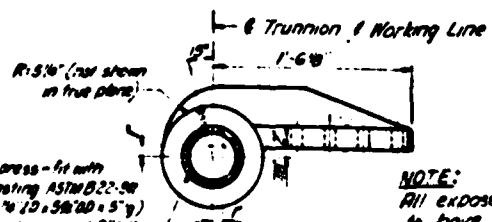

**ELEVATION J-J**

**TRUNNION HUB DETAILS**

Scale 1/2"=1'-0"

Bore for press-fit with Bronze Coating ASTM B22-30 Bearing (4 1/4" ID x 5 1/4" OD) 2 req'd to get the req'd 9" I.D. Brgs to be circular grooved

**NOTE:**  
All exposed edges are to have 1/8" Radius.

**PROJECT NAME**  
WARNER DAM REPLACEMENT  
JAMESTOWN, NEW YORK  
CONTRACT NO. D125679

**CLIENT:**  
STATE OF NEW YORK  
DEPARTMENT OF  
ENVIRONMENTAL CONSERVATION  
ALBANY, NEW YORK

**DRAWING TITLE**  
TANTIER GATE  
TRUNNION ASSEMBLY DETAIL

DATE	BY	CHECKED	SCALE
AS SHOWN	JFM	SK	S-12

6 Prestressing Rods, Threaded both ends  
(N 10") ASTM A582-71, 416

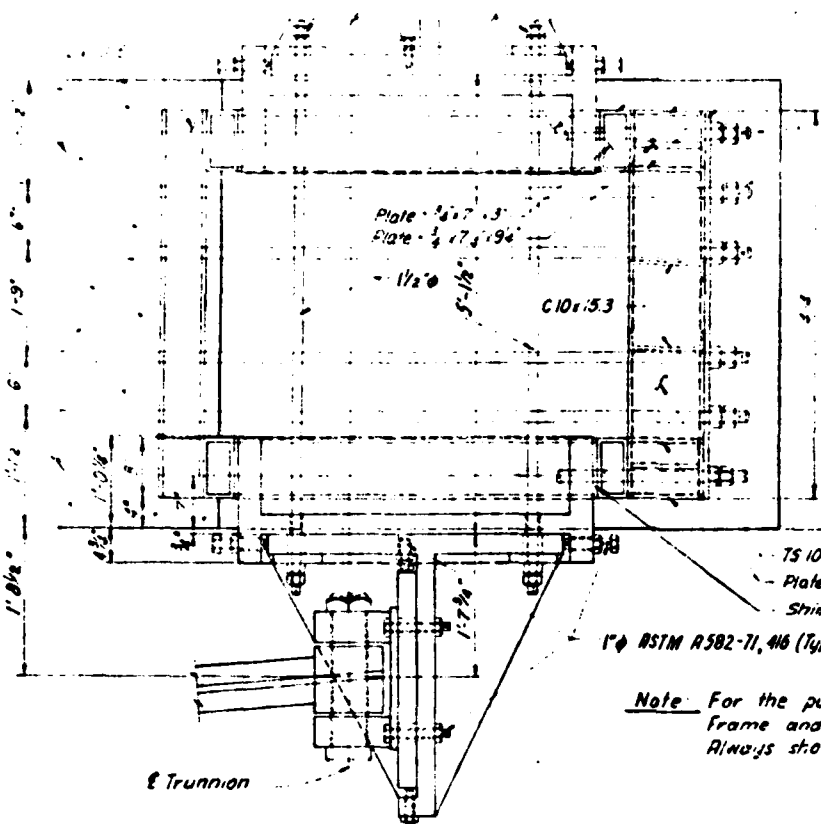

**SECTION A-A - PIER**  
Scale 1"=1'-0"

12 Prestressing Anchors (N 3/4")  
1 1/2" x 20" lg ASTM A307, F<sub>y</sub> 36 (Typ)  
Field Weld Shim  
Plates after  
Installation  
Typ 7/8"

Plate 1/2" x 3' x 1/4"  
(See Detail 'A')  
Plate  
Plate 1/2"  
TS 8 x 4 x 1/2"  
Shim Plate 8" x 8"

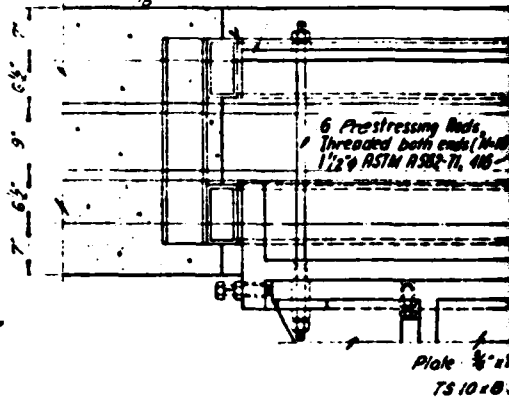

**SECTION C-C - ABUTMENT**  
Scale 1"=1'-0"

See Shop Drawings for change from cast steel to galvanized

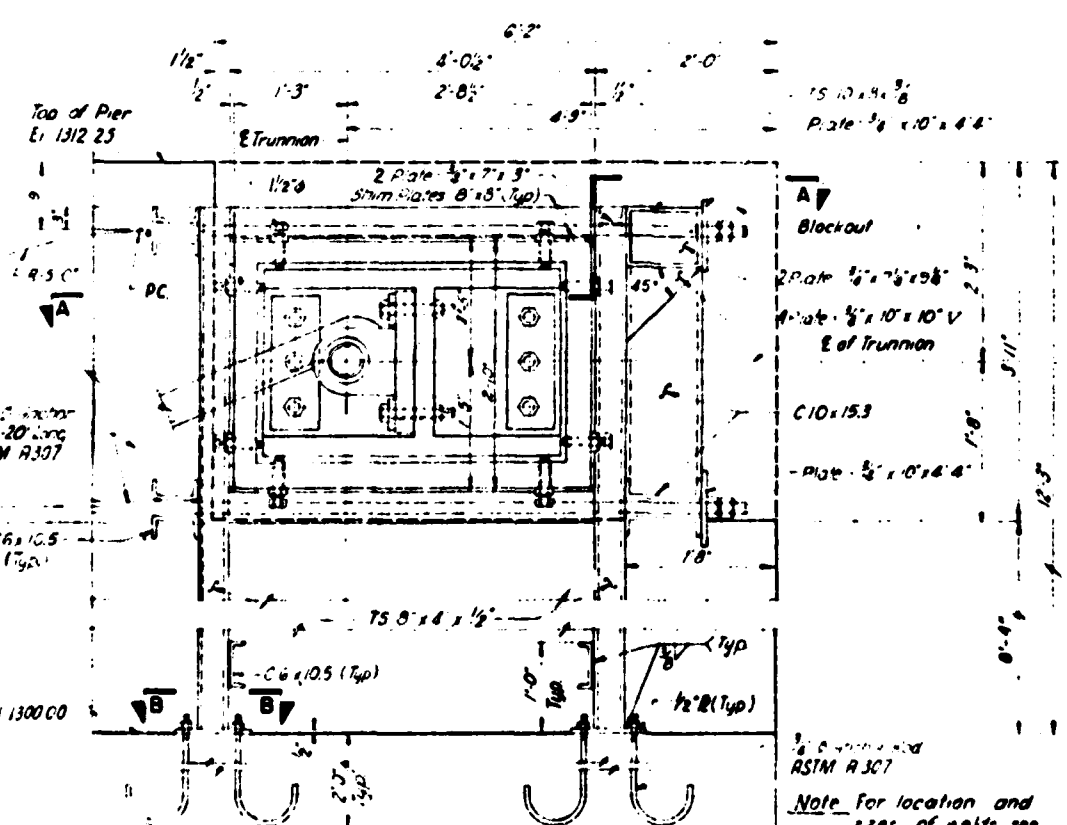

**ELEVATION - PIER**  
Scale 1"=1'-0"

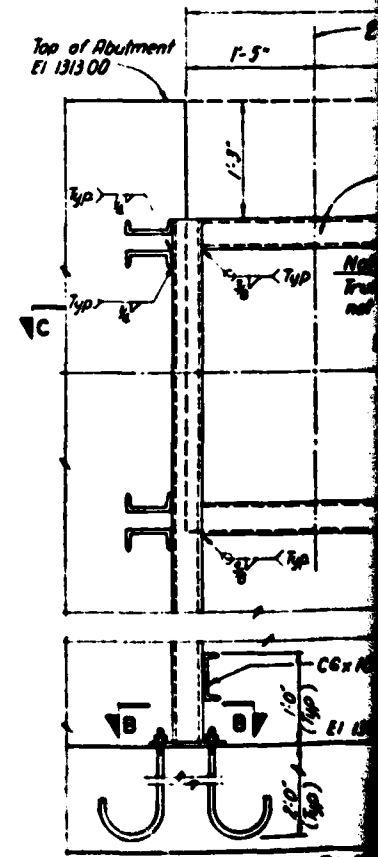

**ELEVATION - ABUTMENT**  
Scale 1"=1'-0"

Note for location and sizes of welds see Elevation - Abutment at right



ERDMAN  
ANTHONY  
ASSOCIATES

CONSULTING ENGINEERS & PLANNERS  
ROCHESTER, N.Y.      CAMP HILL, PA.

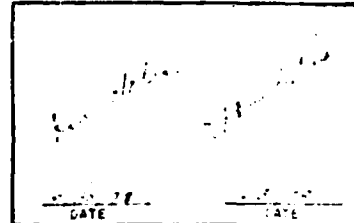

NOTE:  
UNAUTHORIZED ALTERATION OR ADDITION TO THIS DRAWING IS A VIOLATION OF THE NEW YORK STATE EDUCATION LAW ARTICLE 45, SECTION 7209.

REVISIONS		
NO.	DATE	DESCRIPTION
1	2/14/60	As Built

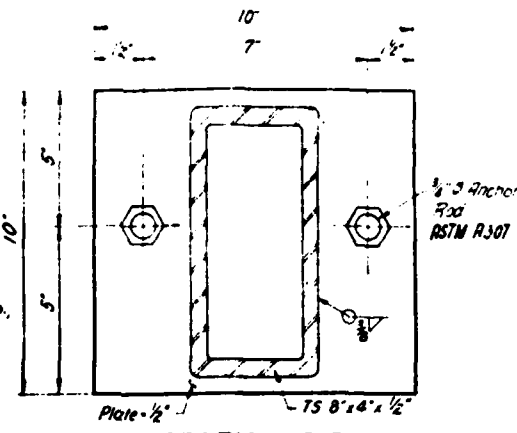

**SECTION B-B**

Scale 3/8" = 1"

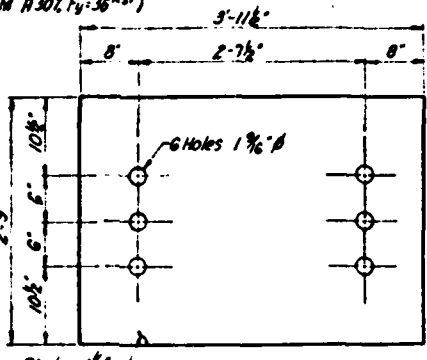

**DETAIL A**

Scale 1" = 1'0"

**NOTE:**

- 1) Payment for Trunnion Anchorage to be included under Item 656.01
- 2) All Structural Steel on this Sheet shall be ASTM A-36 and paid for under Item 656.01
- 3) All Stainless Steel, Cast Steel and Anchor Bolts to be ASTM A307 and paid for under Item 814
- 4) All Connections are to be welded, except those shown as bolted.
- 5) Frame to be prefabricated and completely assembled in shop before shipping to Construction Site for installation
- 6) During the installation of Trunnion System into the frame (Before the concrete backfilling of the Blockout) place accurately by dimensions shown. Clearance space between frame and Trunnion to be filled by means of shim plates and field welded all together. Install 6 prestressing rods and reinforcing bars as shown on Pier and Abutment Drawings. Place Nuts on Prestress Rods and Prestress Manually. After recesses have been backfilled with concrete & reached 50% of 1/2" prestress each rod of both ends to 10 kips
- 7) Dimensions suffixed by \* to be determined depending on prestressing jacks.

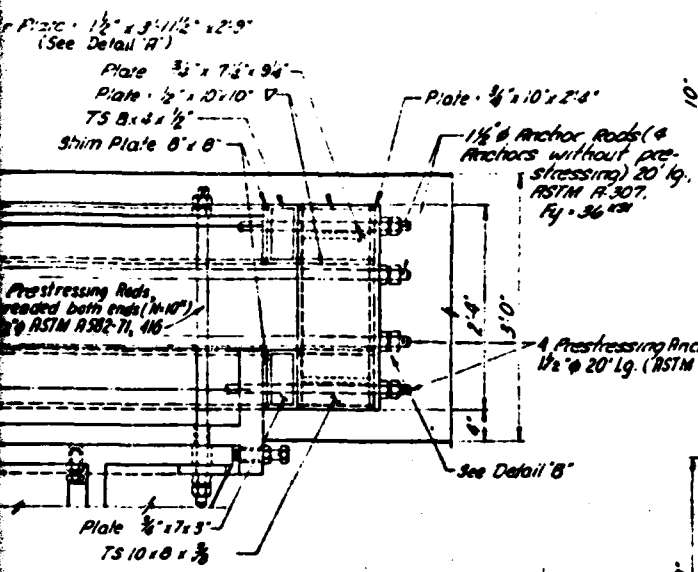

**SECTION C-C - ABUTMENT**

Scale 1" = 1'0"

Drawings for change in trunnion assembly steel to galvanized steel.

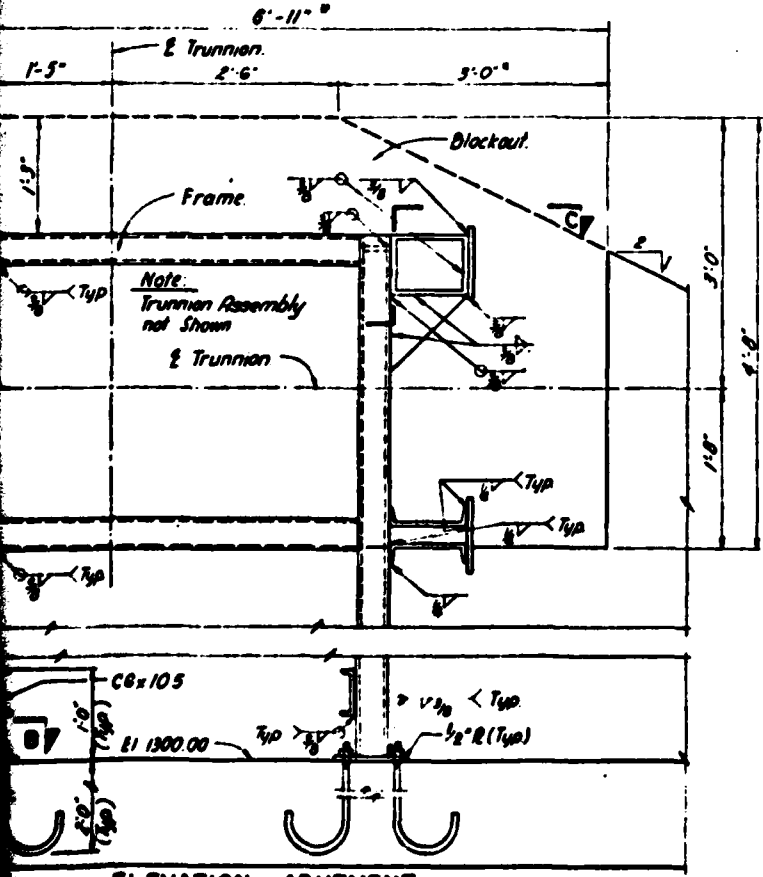

**ELEVATION - ABUTMENT**

Scale 1" = 1'0"

**PROJECT NAME**

WARNER DAM REPLACEMENT  
JAMESTOWN, NEW YORK  
CONTRACT NO. D125679

**CLIENT**

STATE OF NEW YORK  
DEPARTMENT OF  
ENVIRONMENTAL CONSERVATION  
ALBANY, NEW YORK

**DRAWING TITLE**

TAINTER GATE  
TRUNNION ANCHORAGE DETAIL

SCALE	AS NOTED	A.Z	S-13
DATE	2/14/60	END BY	K.R.

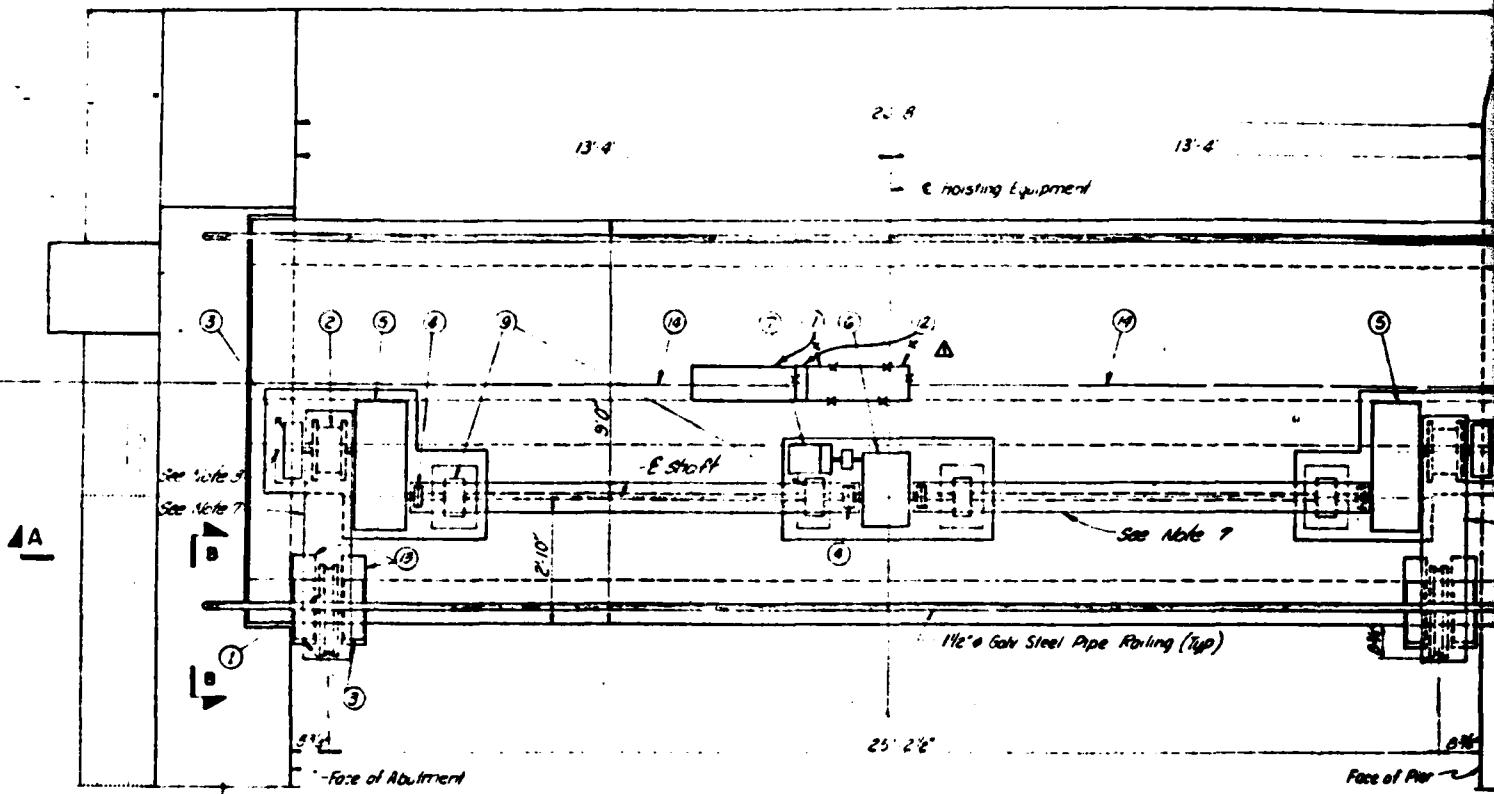

**PLAN-GATE NO. 1**

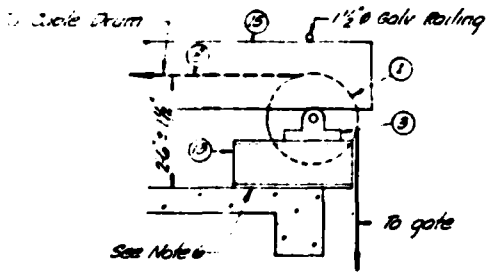

**SECTION B-B**  
No Scale

Note: Sheave and pulley shown on plan

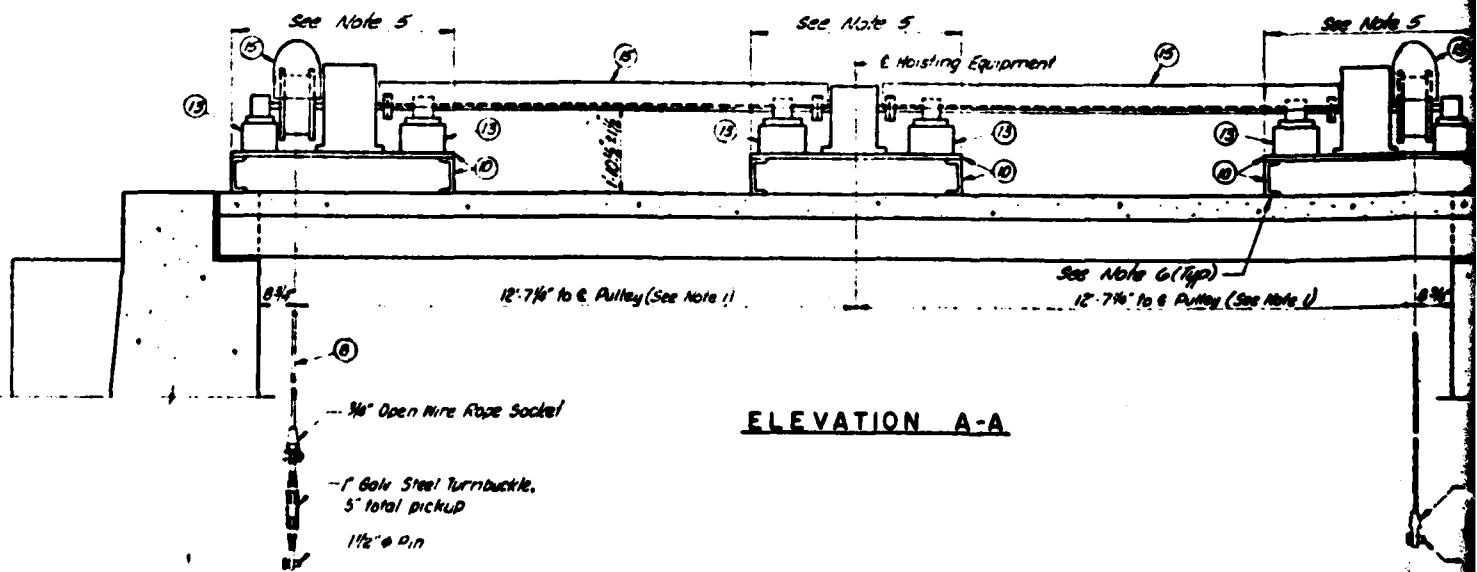

**ELEVATION A-A**

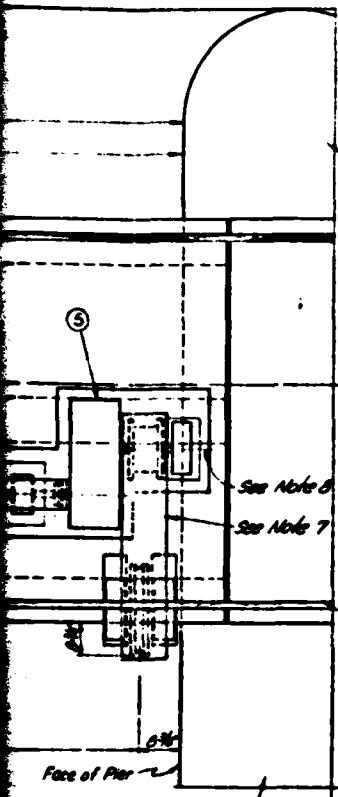

**NOTES:**

- 1) Geometry of pulley and drum shall be such that wire rope makes angle of 90° to axis of pulley with gate raised half of the total cable movement required to the fully open position
- 2) The details for Gates 2 and 3 are the same as Gate 1, except as noted otherwise.
- 3) Refer to special specification, Item 815, for description and payment for Hoisting Equipment.
- 4) Refer to special specification, Item 818, for description and payment for Electric Equipment
- 5) Pillow blocks and reducer to be shop mounted and aligned on common base plate
- 6) Provide connection to deck with heavy duty Deco Adjustable Anchors as manufactured by Decatur Engineering Co Inc, Decatur, Illinois, or equivalent
- 7) Area to be covered by ice shield
- 8) End of shaft to be drilled and tapped for standard 3/8" bolt to depth of 2"

△ See Shop Drawings for Revisions

**EQUIPMENT LIST**

- ① 24" Pitch dia Sheave - 4" dia shaft, 3/4" S.S. Cable. Sheaves to be provided with safety loop for cable.
- ② 15" Pitch dia Grooved Drum, 6 Arms, 6" width
- ③ Pillow Block, 4 Bolt, Spherical Double Roller Brg 15 3/8" x 5 3/8" W
- ④ Flexible Coupling 3" x 6" dia, 2 1/2" Shaft
- ⑤ Secondary Helical Gear Single Reduction Gear Reducer 7.56:1 Ratio, Parallel Shaft, Link Bell Series HS1200 67975 In Lb. Rated Output Capacity
- ⑥ Primary Gear Reducer, Double Worm Gear 2000:1 Ratio, Link Bell Model DNB 600, Rated 22975 In Lb Output
- ⑦ 3/4 HP, T.E.F.C., 1750 RPM, 230V, 3 PH Drive Motor w/ Electric DC Brake Mechanism, Foot MTD
- ⑧ 3/4" dia 6 x 37 Type 302 Stainless Steel Cable 44,000 Lb Rated Ultimate Strength
- ⑨ Pillow Block, Ball Brg, 2 1/2" Shaft
- ⑩ Base plates and base plate supports to be galvanized ASTM A36 steel or ASTM A296 cast steel, size and height dependent on equipment selected
- ⑪ Motor Control Panel (Gate 1)
- ⑫ Gate Control Panel (Gates 2 & 3)
- ⑬ Pillow Block Supports, gate ASTM A36 Steel or ASTM A296 Cast Steel
- ⑭ See Electrical Detail sheets for conduit and wiring on deck.
- ⑮ Ice shield, 1/2" galv steel with galv anchoring hardware. Shields to be mounted a minimum of 2" from any moving part

Note: Sheave and Raising not shown on this view

See Note 5

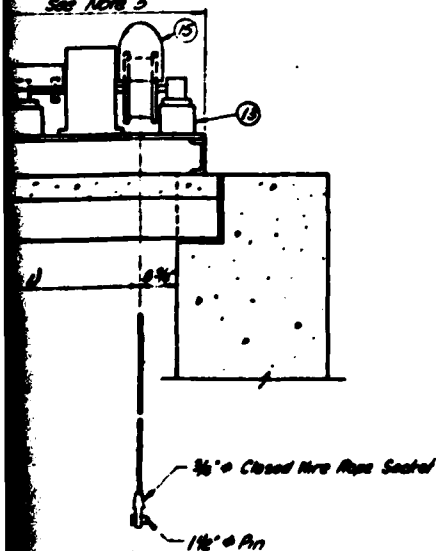

**ERDMAN  
ANTHONY  
ASSOCIATES**  
 CONSULTING ENGINEERS & PLANNERS  
 ROCHESTER, N.Y.      CAMP HILL, PA.

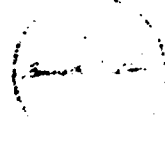
  
 JAMES H. ERDMAN  
 No. 12345  
 STATE OF NEW YORK  
 PROFESSIONAL ENGINEER

NOTE:  
UNAUTHORIZED ALTERATION OR ADDITION TO THIS DRAWING IS A VIOLATION OF THE NEW YORK STATE EDUCATION LAW ARTICLE 45, SECTION 7209.

REVISIONS			
NO.	DATE	DESCRIPTION	BY
1	2/14/80	As Built	JHE

**PROJECT NAME**  
 WARNER DAM REPLACEMENT  
 JAMESTOWN, NEW YORK  
 CONTRACT NO D125679

**CLIENT**  
 STATE OF NEW YORK  
 DEPARTMENT OF  
 ENVIRONMENTAL CONSERVATION  
 ALBANY, NEW YORK

**DRAWING TITLE**  
 HOISTING EQUIPMENT

1/2" = 1'-0"      KA      S-15  
 6/30/78      RJ      TR      2: