

AD-A090 275

ARMY ENGINEER WATERWAYS EXPERIMENT STATION VICKSBURG--ETC F/6 8/3  
TSUNAMI ELEVATION PREDICTIONS FOR AMERICAN SAMOA. (U)  
SEP 80 J R HOUSTON  
WES/TR/HL-80-16

UNCLASSIFIED

NL

1 of 2

AD-A  
090 275

090 275

090 275

090 275

090 275

090 275

090 275

090 275

090 275

090 275

090 275

090 275

090 275

090 275

090 275

090 275

090 275

090 275

090 275

090 275

090 275

090 275

090 275

090 275

090 275

090 275

090 275

090 275

090 275

090 275

090 275

090 275

090 275

090 275

090 275

090 275

090 275

090 275

090 275

090 275

090 275

090 275

090 275

090 275

090 275

090 275

090 275

090 275

090 275

090 275

090 275

090 275

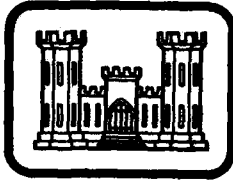

*C* LEVEL *(12)*



TECHNICAL REPORT HL-80-16

# TSUNAMI ELEVATION PREDICTIONS FOR AMERICAN SAMOA

by

James R. Houston

Hydraulics Laboratory

U. S. Army Engineer Waterways Experiment Station  
P. O. Box 631, Vicksburg, Miss. 39180

September 1980

Final Report

Approved For Public Release; Distribution Unlimited

DTIC  
ELECTE  
S OCT 15 1980 D

A

AD A090275



DDC FILE COPY

Prepared for U. S. Army Engineer Division, Pacific Ocean  
Fort Shafter, Hawaii 96858

80 10 14 195

Destroy this report when no longer needed. Do not return  
it to the originator.

The findings in this report are not to be construed as an official  
Department of the Army position unless so designated  
by other authorized documents.

(14) WEST/IR/H. - 20-16

Unclassified

SECURITY CLASSIFICATION OF THIS PAGE (When Data Entered)

REPORT DOCUMENTATION PAGE		READ INSTRUCTIONS BEFORE COMPLETING FORM
1. REPORT NUMBER Technical Report HL-80-16	2. GOVT ACCESSION NO. AD-A090275	3. RECIPIENT'S CATALOG NUMBER
4. TITLE (and Subtitle) TSUNAMI ELEVATION PREDICTIONS FOR AMERICAN SAMOA.	5. TYPE OF REPORT & PERIOD COVERED Final report Nov 79 - Jun 80	
7. AUTHOR(s) James R. Houston	6. PERFORMING ORG. REPORT NUMBER	
9. PERFORMING ORGANIZATION NAME AND ADDRESS U. S. Army Engineer Waterways Experiment Station Hydraulics Laboratory P. O. Box 631, Vicksburg, Miss. 39180	8. CONTRACT OR GRANT NUMBER(s)	
11. CONTROLLING OFFICE NAME AND ADDRESS U. S. Army Engineer Division, Pacific Ocean Building 230 Fort Shafter, Hawaii 96858	12. REPORT DATE September 1980	10. PROGRAM ELEMENT, PROJECT, TASK AREA & WORK UNIT NUMBERS
14. MONITORING AGENCY NAME & ADDRESS (if different from Controlling Office)	13. NUMBER OF PAGES 153	15. SECURITY CLASS. (of this report) Unclassified
16. DISTRIBUTION STATEMENT (of this Report)  Approved for public release; distribution unlimited.		15a. DECLASSIFICATION/DOWNGRADING SCHEDULE
17. DISTRIBUTION STATEMENT (of the abstract entered in Block 20, if different from Report)		
18. SUPPLEMENTARY NOTES		
19. KEY WORDS (Continue on reverse side if necessary and identify by block number) American Samoa Finite element method Mathematical models Tsunamis		
20. ABSTRACT (Continue on reverse side if necessary and identify by block number) Frequency-of-occurrence curves for tsunami elevations in American Samoa were determined. The islands of Tutuila, Aunuu, Ofu, Olosega, and Tau were considered in the analysis. A catalog of historical tsunamis in the Samoan Islands was compiled. Historical data were used to determine a frequency-of-occurrence curve for Pago Pago Harbor on Tutuila. A hybrid finite-element numerical model was then used to extend the historical data at Pago Pago to allow frequency-of-occurrence curves to be determined throughout American Samoa.		

DD FORM 1 JAN 73 1473 EDITION OF 1 NOV 65 IS OBSOLETE

Unclassified

SECURITY CLASSIFICATION OF THIS PAGE (When Data Entered)

411361 [Signature]

## PREFACE

Authority for the U. S. Army Engineer Waterways Experiment Station (WES) to conduct a tsunami study for American Samoa was granted by the U. S. Army Engineer Division, Pacific Ocean, in Intra-Army Order No. PODSP-CIV-80-7 dated 10 October 1979.

This study was conducted from November 1979 to June 1980 in the Hydraulics Laboratory, WES, under the direction of Mr. H. B. Simmons, Chief of the Hydraulics Laboratory, and Dr. R. W. Whalin, Chief of the Wave Dynamics Division. Dr. J. R. Houston conducted the study and prepared this report. Mrs. L. Chou made the computer plots and aided in the computer computations. Dr. Pararas-Carayannis, Director of the International Tsunami Information Center, performed the historical tsunami study presented in Appendix A of this report by purchase order from WES through the Research Corporation of the University of Hawaii.

Commander and Director of WES during the investigation and the preparation and publication of this report was COL Nelson P. Conover, CE. Technical Director was Mr. F. R. Brown.

CONTENTS

	<u>Page</u>
PREFACE . . . . .	1
CONVERSION FACTORS, U. S. CUSTOMARY TO METRIC (SI)	
UNITS OF MEASUREMENT . . . . .	3
PART I: INTRODUCTION . . . . .	4
Tsunamis . . . . .	4
Tsunamis in American Samoa . . . . .	5
Purpose of the Study . . . . .	7
PART II: NUMERICAL MODEL . . . . .	8
Background . . . . .	8
Description . . . . .	8
Verification . . . . .	12
Model Use . . . . .	16
PART III: METHODOLOGY FOR ELEVATION PREDICTIONS . . . . .	26
Use of Historical Data . . . . .	26
Influence of Reefs . . . . .	28
Effect of Tides on Tsunami Exceedance	
Frequency Distributions . . . . .	29
Calculation of Tsunami Exceedance	
Frequency Distributions . . . . .	31
PART IV: RESULTS . . . . .	36
Use of Tables and Plots . . . . .	36
Discussion . . . . .	37
Risk Calculation . . . . .	37
PART V: CONCLUSIONS . . . . .	40
REFERENCES . . . . .	42
TABLES 1-3	
PLATES 1-20	
APPENDIX A: CATALOG OF TSUNAMIS IN THE SAMOAN ISLANDS. . . . .	A1
APPENDIX B: EFFECT OF TIDES ON THE EXCEEDANCE FREQUENCY DISTRIBUTION OF THE MAXIMUM WAVE OF A TSUNAMI . . . . .	B1
APPENDIX C: NOTATION . . . . .	C1

CONVERSION FACTORS, U. S. CUSTOMARY TO METRIC (SI)  
UNITS OF MEASUREMENT

U. S. customary units of measurement used in this report can be converted to metric (SI) units as follows:

<u>Multiply</u>	<u>By</u>	<u>To Obtain</u>
feet	0.3048	metres
feet per second per second	0.3048	metres per second per second
miles (U. S. statute)	1.609344	kilometres
square feet	0.09290304	square metres
yards	0.9144	metres

## TSUNAMI ELEVATION PREDICTIONS FOR AMERICAN SAMOA

### PART I: INTRODUCTION

#### Tsunamis

1. Of all water waves that occur in nature, one of the most destructive is the tsunami. The term "tsunami," originating from the Japanese words "tsu" (harbor) and "nami" (wave), is used to describe sea waves of seismic origin. Tectonic earthquakes, i.e., earthquakes that cause a deformation of the seabed, appear to be the principal seismic mechanism responsible for the generation of tsunamis. Coastal and submarine landslides and volcanic eruptions also have triggered tsunamis.

2. Tsunamis are principally generated by undersea earthquakes of magnitudes greater than 6.5 on the Richter scale with focal depths less than 30 miles.\* They are very long-period waves (5 min to several hours) of low height (a few feet or less) when traversing water of oceanic depth. Consequently, they are not discernible in the deep ocean and go unnoticed by ships. Tsunamis travel at the shallow-water wave celerity equal to the square root of acceleration due to gravity times water depth even in the deepest oceans because of their very long wavelengths. This speed of propagation can be in excess of 500 mph in the deep ocean.

3. When tsunamis approach a coastal region where the water depth decreases rapidly, wave refraction, shoaling, and bay or harbor resonance may result in significantly increased wave heights. The great periods and wavelengths of tsunamis preclude their dissipating energy as a breaking surf; instead, they are apt to appear as rapidly rising water levels and only occasionally as bores.

4. Over 500 tsunamis have been reported within recorded history. Virtually all of these tsunamis have occurred in the Pacific Basin. This is because most tsunamis are associated with earthquakes, and most

---

\* A table of factors for converting U. S. customary units of measurements to metric (SI) units is presented on page 3.



seismic activity beneath the oceans is concentrated in the narrow fault zones adjacent to the great oceanic trench systems which are predominantly confined to the Pacific Ocean.

5. The loss of life and destruction of property due to tsunamis have been immense. The Great Hoei Tokaido-Nankaido tsunami of Japan killed 30,000 people in 1707. In 1868, the Great Peru tsunami caused 25,000 deaths and carried the frigate U.S.S. Waterlee 1,300 ft inland. The Great Meiji Sanriku tsunami of 1896 killed 27,122 persons in Japan and washed away over 10,000 houses (Iida et al. 1967).

6. In recent times, three tsunamis have caused major destruction in areas of the United States. The Great Aleutian tsunami of 1946 killed 173 persons in Hawaii, where heights as great as 55 ft were recorded. The 1960 Chilean tsunami killed 330 people in Chile, 61 in Hawaii, and 199 in distant Japan. The most recent major tsunami to affect the United States, the 1964 Alaskan tsunami, killed 107 people in Alaska, 4 in Oregon, and 11 in Crescent City, California, and caused over 100 million dollars in damage on the west coast of North America (Iida et al. 1967).

#### Tsunamis in American Samoa

7. Tsunamis recorded in American Samoa (American Samoa consists of the islands of Tutuila, Aunuu, Tau, Ofu, and Olosega, as shown in Figure 1) have not been as large as those recorded in many parts of the Hawaiian Islands. The abrupt rise of the islands of American Samoa from the ocean floor and the very limited extent of the shallow-water shelves surrounding the islands are apparently not conducive to the buildup of tsunamis through shoaling or shelf resonances. However, as is typical for triangular-shaped bays (e.g., Hilo Harbor, Hawaii), Pago Pago Harbor (Figure 1) does amplify tsunamis, with the largest elevations occurring at the back end of the bay. Several tsunamis (1917, 1919, 1922, 1952, and 1960) have caused damage in Pago Pago Harbor.

8. Many tsunamis that have been recorded in American Samoa are reported in the tsunami catalog of Iida et al. (1967). This catalog

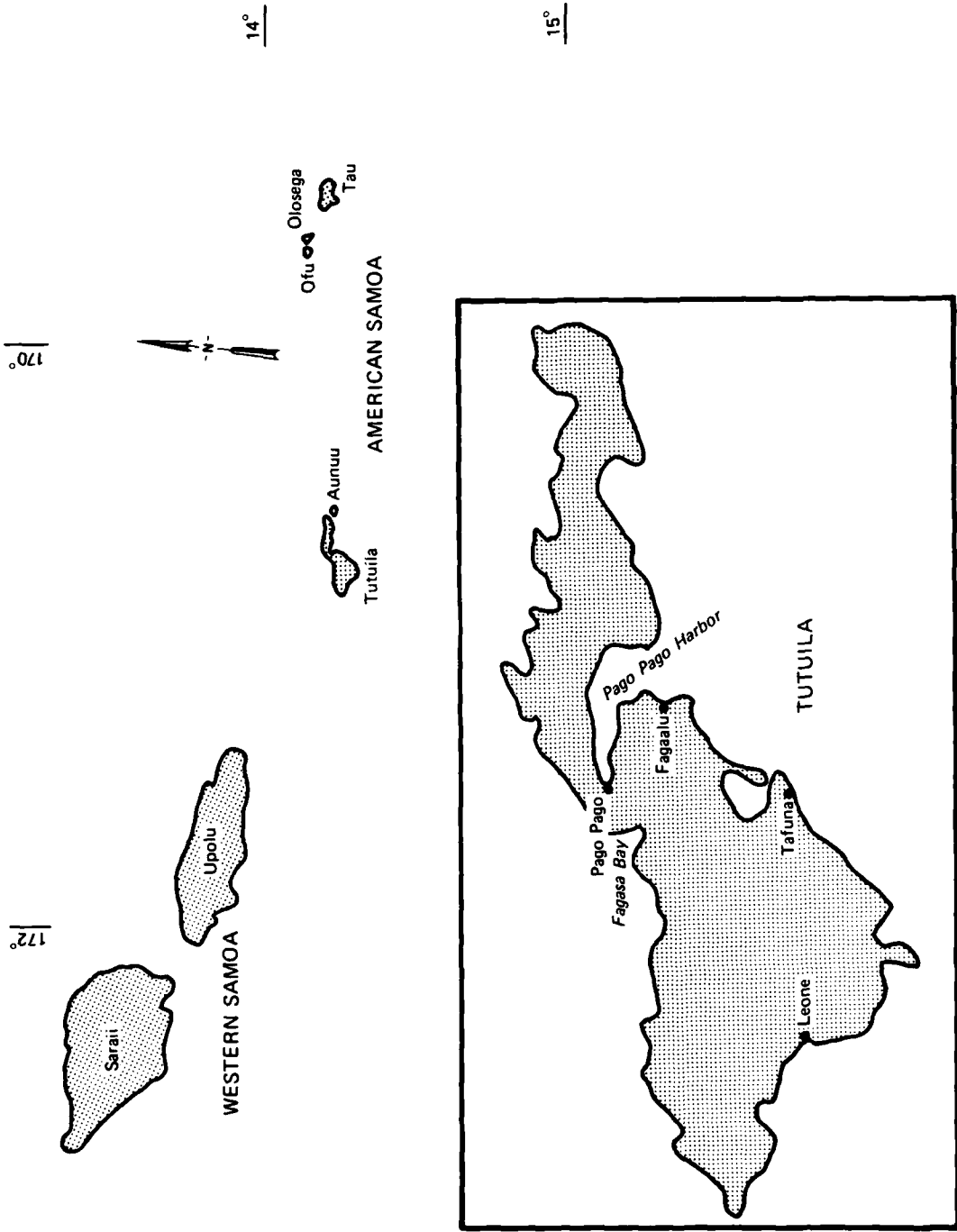

Figure 1. Location of American Samoa and enlargement of Tutuila

considers tsunamis throughout the Pacific Ocean and, therefore, does not report tsunamis in American Samoa in any detail. In addition, Heck (1947) reported a 40-ft tsunami in the Samoan Islands but was not specific concerning the basis for his report or the location of the 40-ft elevation. As a result of the lack of specific information, even for significant tsunamis, the U. S. Army Engineer Waterways Experiment Station (WES) entered into a contract with the Research Corporation of the University of Hawaii for a study of historical tsunamis in American Samoa. The study was performed under the supervision of Dr. George Pararas-Carayannis, Director, International Tsunami Information Center. Dr. Pararas-Carayannis is the coauthor of several tsunami catalogs (e.g., Iida et al. 1967, Cox and Pararas-Carayannis 1976, and Pararas-Carayannis 1977). Results of the historical tsunami study are presented in Appendix A and were used in this report to establish tsunami elevation frequency curves at Pago Pago.

#### Purpose of the Study

9. The purpose of this study was to establish frequency-of-occurrence curves for tsunami elevations in American Samoa. This information is required by the U. S. Army Engineer Division, Pacific Ocean, for use in tsunami flood hazard evaluations for floodplain management purposes. Results of this study should not be used to determine evacuation zones based upon 1-in-100-yr tsunami elevations without adding a safety factor through risk calculations (PART IV). The odds that an elevation greater than the 1-in-100-yr elevation will occur within a relatively short time span are not negligible. Any land development that would expose human life to possible danger should be initiated only after an evaluation of the possible risk.

## PART II: NUMERICAL MODEL

### Background

10. Historical data of tsunami activity in American Samoa are concentrated in Pago Pago Harbor (Appendix A). Only isolated reports describe tsunami activity on other parts of the Island of Tutuila (Figure 1), and there are no known reports of tsunami activity on the other islands of American Samoa. This lack of historical data of tsunami activity in American Samoa necessitates the use of a numerical model in addition to existing historical data to predict tsunami elevations along the entire coastline of American Samoa. A hybrid approach of combining existing historical data with numerical model calculations has been used in several previous studies (Houston and Garcia 1974, Garcia and Houston 1975, Houston et al. 1977, and Houston and Garcia 1978). In this study a finite-element numerical model was used as an interpolation tool (see PART III) to extend the data in Pago Pago Harbor to the remainder of the coast of American Samoa. The model calculated the interaction of tsunamis with the islands of American Samoa. A finite-element model was used since the telescoping feature of the computational grid allowed a fine resolution of tsunamis to be maintained as their wavelengths decreased in shallow water and also allowed an accurate representation of the shape of the islands and the surrounding bathymetry.

### Description

11. The interaction of tsunamis with the islands of American Samoa was determined by using a hybrid finite-numerical model originally developed for constant-depth harbor oscillation and wave scattering problems by Chen and Mei (1974). The model was modified for variable depth applications by Houston et al. (1977). The model solves the following generalized Helmholtz equation:

$$\nabla[h(x,y)\nabla\phi(x,y)] + \frac{\omega^2}{g} \phi(x,y) = 0 \quad (1)$$

where

$\nabla$  = gradient operator,  $\text{ft}^{-1}$

$h(x,y)$  = water depth at the location

$\phi(x,y)$  = total velocity potential at the location with  $U(x,y)$ ,  
a two-dimensional vector, equal to  $-\nabla\phi(x,y)$

$x,y$  = Cartesian coordinates, ft, of the location

$\omega$  = angular frequency, radians/sec

$g$  = acceleration due to gravity,  $\text{ft}/\text{sec}^2$

Equation 1 governs small amplitude undamped long waves in a region (Region D of Figure 2) with land masses of arbitrary shape and water of variable depth. It has further been assumed that the flow is irrotational.

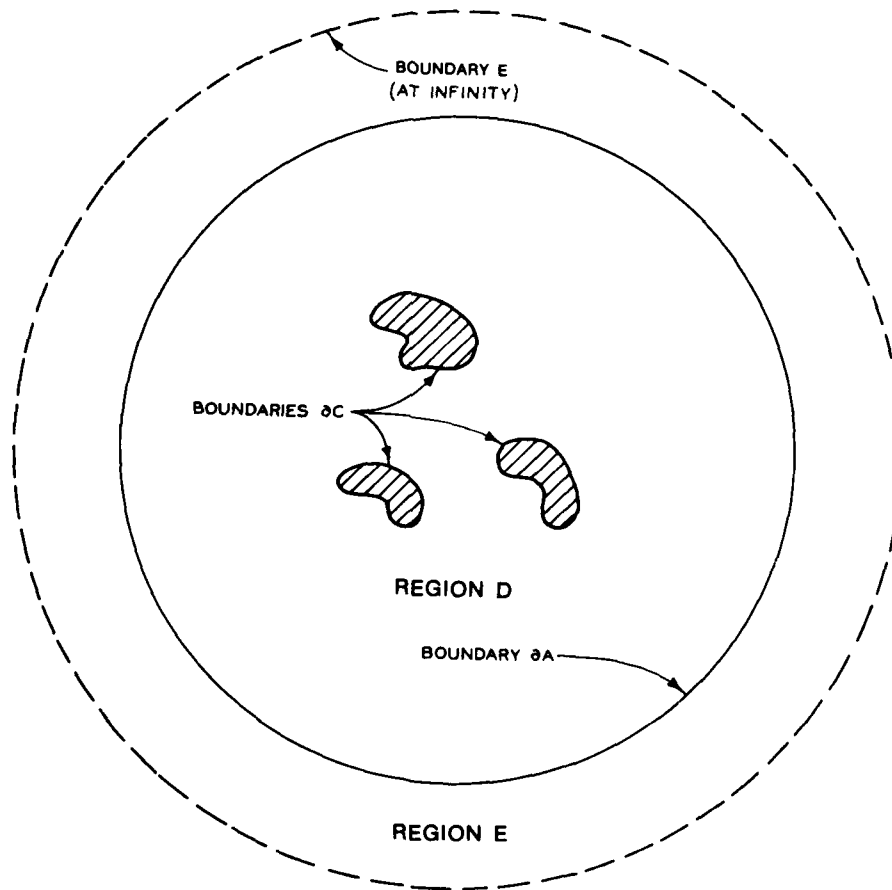

Figure 2. Computational regions

12. The Helmholtz equation expressed as

$$\nabla^2 \phi(x,y) + \frac{\omega^2}{gh} \phi(x,y) = 0 \quad (2)$$

is the governing equation for a constant-depth ocean region (Region E of Figure 2) outside the region containing the islands.

13. Waves incident upon islands in an infinite ocean produce a scattered wave in the constant-depth ocean region (Region E) having a velocity potential  $\phi_S$  given by

$$\phi_S = \sum_{n=0}^{\infty} H_n(kr) (\alpha_n \cos n \theta + \beta_n \sin n \theta) \quad (3)$$

where

$H_n$  = Hankel function of the first kind of order  $n$

$k$  = wave number

$r$  = spherical coordinate, ft

$\alpha_n$  = unknown coefficient

$\theta$  = spherical coordinate, radians

$\beta_n$  = unknown coefficient

14. The symbol  $\phi_S$  satisfies the Sommerfeld radiation condition that the scattered wave must behave as an outgoing wave at infinity. This condition may be expressed mathematically as

$$\lim_{r \rightarrow \infty} \sqrt{r} \left( \frac{\partial}{\partial r} - ik \right) \phi_S = 0 \quad (4)$$

where  $i$  equals  $\sqrt{-1}$ .

15. Chen and Mei (1974) used a calculus of variations approach and obtained a Euler-Lagrange formulation of the boundary value problem. The following functional with the property that it is stationary with respect to arbitrary first variations of  $\phi(x,y)$  was constructed by Chen and Mei:

$$\begin{aligned}
F(\phi) = & \iint \frac{1}{2} \left[ h(\nabla\phi)^2 - \frac{\omega^2}{g} \phi^2 \right] dD + \frac{1}{2} \oint \left[ h(\phi_E - \phi_I) \frac{\partial(\phi_E - \phi_I)}{\partial n_a} \right] \partial D \\
& - \oint \left[ h\phi_a \frac{\partial(\phi_E - \phi_I)}{\partial n_a} \right] \partial D - \oint \left( h\phi_a \frac{\partial\phi_I}{\partial n_a} \right) \partial D + \oint \left[ h\phi_I \frac{\partial(\phi_E - \phi_I)}{\partial n_a} \right] \partial D
\end{aligned} \tag{5}$$

where

D = variable depth region containing the islands

E = a constant depth region of infinite extent surrounding Region D

∫ = line integral along ∂D

φ<sub>E</sub> = velocity potential in Region E

φ<sub>I</sub> = velocity potential of incident wave

n<sub>a</sub> = unit normal vector outward from Region D

∂D = boundary of Region D

φ<sub>a</sub> = total velocity potential evaluated on boundary ∂D

16. Figure 2 shows the two regions of computation (D and E). Boundaries ∂C are land-water interfaces. The inner Region D is subdivided into a number of nonoverlapping subdomains which are called elements. Here the elements are triangular with linear shape functions. The infinite Region E is covered with a single superelement. The shape function for Region E is given by Equation 3.

17. Proof was given by Chen and Mei (1974) that the stationarity of the functional of Equation 5 is equivalent to the original boundary value problem. Since all integrals in Equation 5 are evaluated within Region D or along its boundary with Region E, the variational principle is a localized one.

18. If the shape functions are used to evaluate the integrals of Equation 5 and the functional is extremized with respect to the unknowns, a set of linear algebraic equations is obtained. Of course, the infinite series given by Equation 3 must be truncated at some finite extent. The number of terms that must be retained depends upon the incident wavelength and may be found by increasing the number of terms until the solution is insensitive to the addition of further terms. Solution of the

boundary value problem thus reduces to the solution of  $N$  linear algebraic equations for  $N$  unknowns (where  $N$  is the number of node points in the finite-element discretization plus the number of unknowns in the truncated series). That is,

$$\begin{array}{l} [K] \{\psi\} = \{Q\} \\ \text{NXN NX1 NX1} \end{array} \quad (6)$$

where

$[K]$  = coefficient matrix

$\{\psi\}$  = vector of unknowns

$\{Q\}$  = load vector

The symmetric complex coefficient matrix  $[K]$  is, in general, large, sparse, and banded. It can be stored and manipulated in the computer in a packed form. The packed form is chosen to be a rectangular array ( $N$  variables in length and the semibandwidth in width). Only elements of  $[K]$  on and above the diagonal and within the bandwidth need to be stored in the packed form.

19. Although the packed form of  $[K]$  greatly reduces the required computer memory, memory requirements of the packed form of  $[K]$  are large. However, since the symmetric coefficient matrix is positive definite, a solution is possible by elimination methods without pivoting. Without pivoting, elimination performed using one row affects only the triangle of elements within the band below that row. Thus, the packed form of  $[K]$  can be partitioned into several smaller blocks. Using Gaussian elimination, only two blocks at a time are involved in the reduction and back substitution with the remainder of the blocks kept in peripheral storage. This technique allows the solution of extremely large matrices.

#### Verification

20. To verify this numerical model, comparisons were made between the finite-element calculations and an analytical solution for the



interaction of waves with a circular island on a paraboloidal shoal. Figure 3 is a sketch of the problem. Homma (1950) presented the analytical solution of the long-wave equation for plane waves incident upon this island.

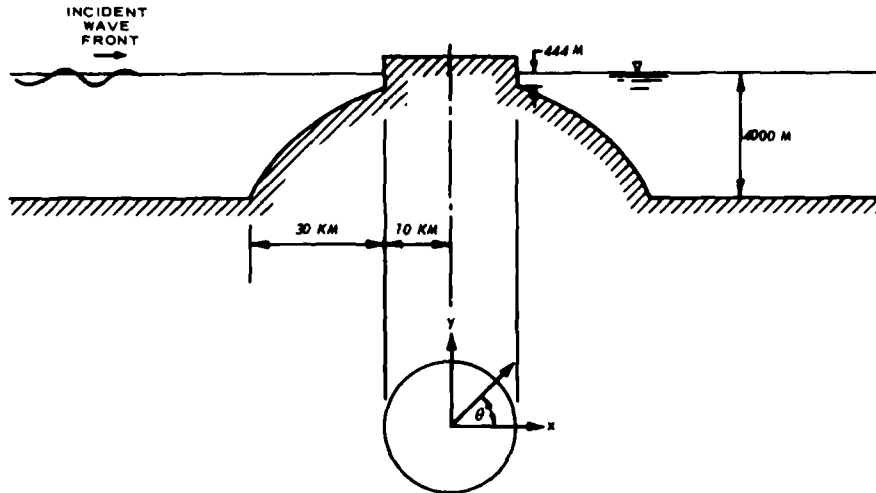

Figure 3. Circular island and paraboloidal shoal

21. Figure 4 shows a finite-element grid with 2640 elements used by the finite-element model to solve the problem of the interaction of long waves with a circular island on a paraboloidal shoal (by symmetry)

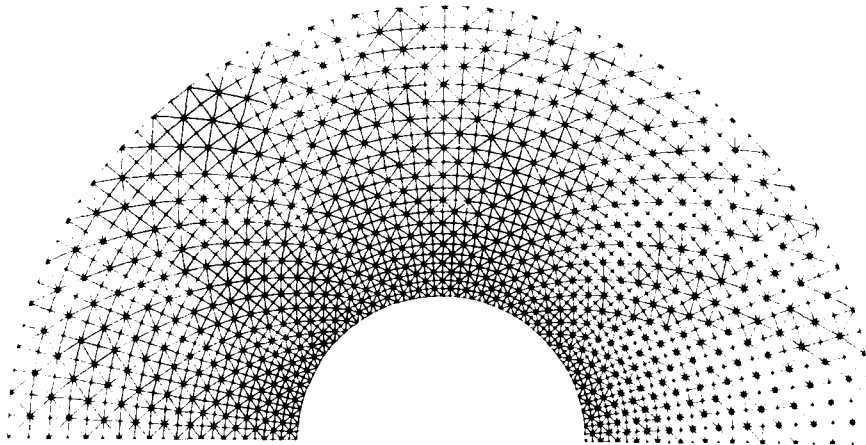

Figure 4. Finite-element grid for one-half of paraboloidal shoal

only half the shoal needs to be considered). Figure 5 shows comparisons between Hom-ma's analytical solution and the finite-element model solution for incident waves with five different periods. Agreement is excellent with only slight differences for the 240-sec wave (resulting from lower resolution of the incident wave for shorter period waves). By increasing the number of elements, the solution for the 240-sec wave can be made to be in arbitrarily close agreement with the analytic solution.

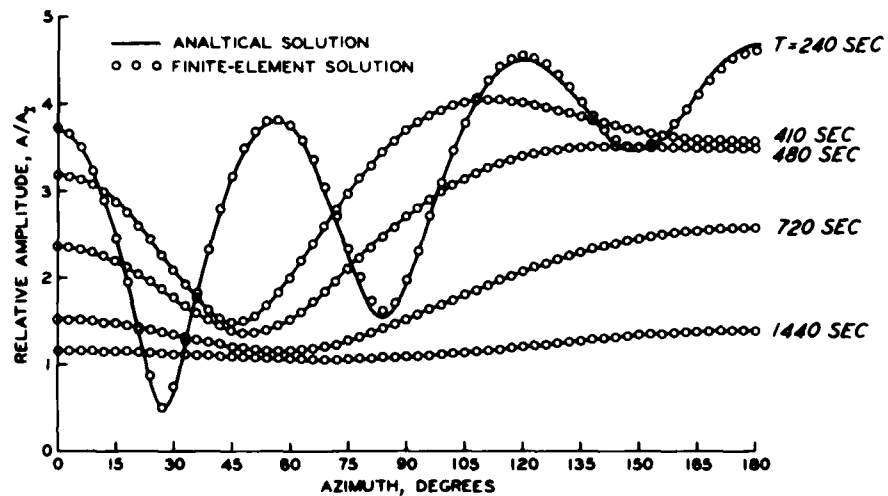

Figure 5. Comparison of finite-element solution with analytical solution

22. The finite-element model also was verified in an earlier study (Houston et al. 1977) by numerical simulations of two historical tsunamis in Hawaii (1960 and 1964 tsunamis). The 1960 Chilean and 1964 Alaskan tsunamis are the only major tsunamis for which some reliable information regarding source-generating characteristics exists, with far more information existing for the Alaskan source than for the Chilean source.

23. In order to obtain a wave form in the deep ocean for the 1960 and 1964 tsunamis, it was necessary to use finite-difference numerical models (Garcia 1976 and Houston et al. 1975) to generate these historical tsunamis and to propagate them to the vicinity of the Hawaiian

Islands. The initial condition used in the numerical model was that the uplift deformation of the ocean water surface was identical with the permanent vertical displacement of the ocean bottom during the generating earthquake. The permanent deformation of the ocean's bottom at the source as a function of spatial location was taken from Plafker (1969) for the Alaskan source and from Plafker and Savage (1970) and Hwang et al. (1970) for the Chilean source.

24. The wave forms calculated by the finite-difference model were used as input to the finite-element model which propagated the tsunamis from the deep ocean to the shoreline. Since the finite-element model is a time-harmonic solution to the boundary value problem, it was necessary to decompose the input wave forms (by Fourier analysis). The finite-element model was then used to determine the interaction of each Fourier component with the Hawaiian Islands. The transformed components were then summed to form time-histories all along the shoreline of each island. Figure 6 shows the finite-element grid used to perform the computations. Figures 7, 8, and 9 show comparisons between tide gage recordings of the 1964 tsunami at Kahului, Honolulu, and Hilo, Hawaii, and the numerical model calculations. Figure 10 shows a comparison between a tide gage recording of the 1960 tsunami at Honolulu (only tide gage in Hawaii not completely destroyed by the 1960 tsunami) and the numerical model calculations. For all cases, the largest waves recorded are shown. Agreement is quite good considering the fact that the ground displacements that generated the 1960 and 1964 tsunamis are not known precisely, and tide gages do not record tsunamis without some distortion.

25. The major point of the verification efforts illustrated is to demonstrate that the numerical model and the methodology used are indeed valid and can reproduce known historical tsunami occurrences. Thus for the case of islands that arise abruptly from deep water a linear theory, properly applied, can reproduce major historical tsunami occurrences. Nonlinear effects are not of major importance apparently because the islands have such short shallow-water shelves that there is not sufficient time for nonlinear effects to develop.

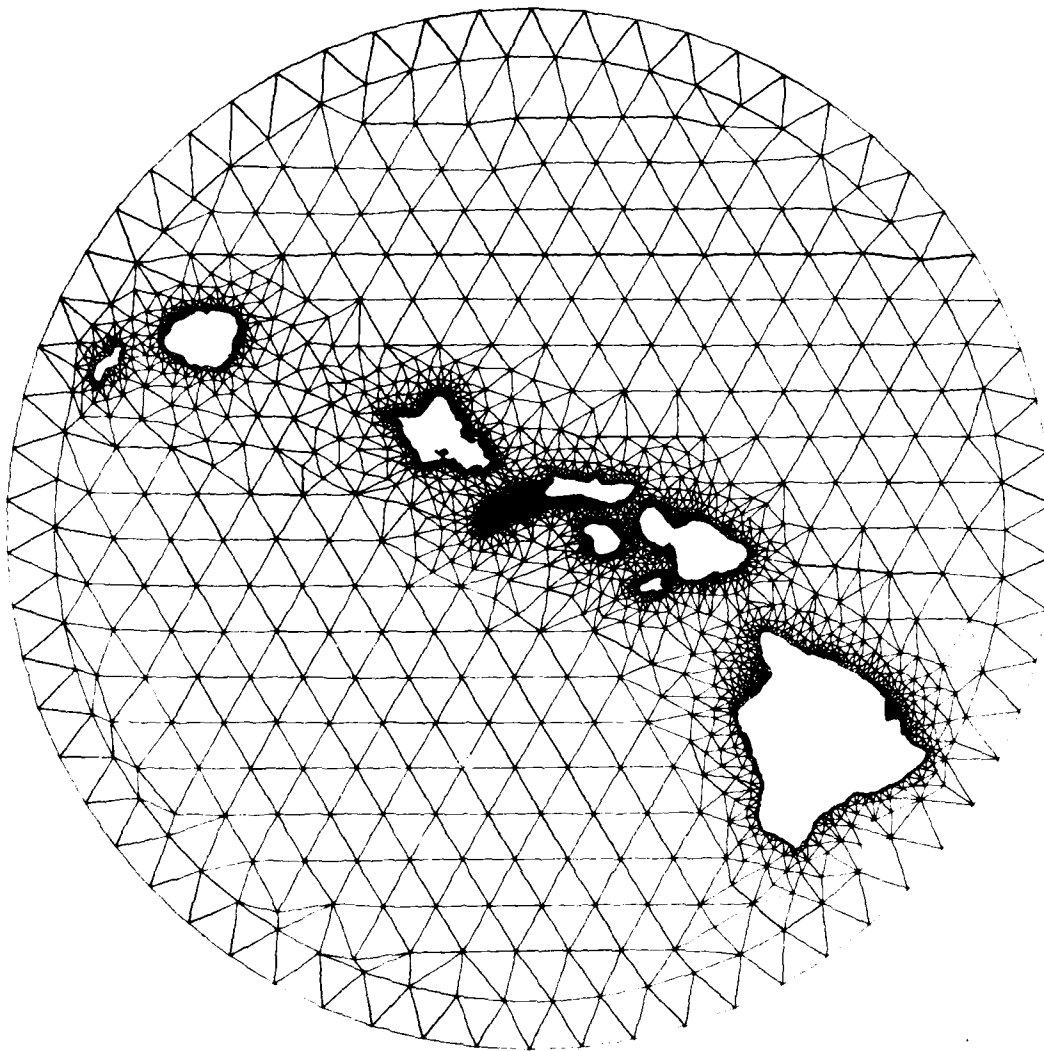

Figure 6. Finite-element grid for the Hawaiian Islands

Model Use

26. The numerical model was used to determine elevations of historical tsunamis along the entire coastline of the islands of American Samoa based upon historical data in Pago Pago Harbor. Figure 11 shows the finite-element grid for the Samoan Islands. Figures 12 and 13 show sections of the finite-element grid for Tutuila and for Olosega, Ofu, and

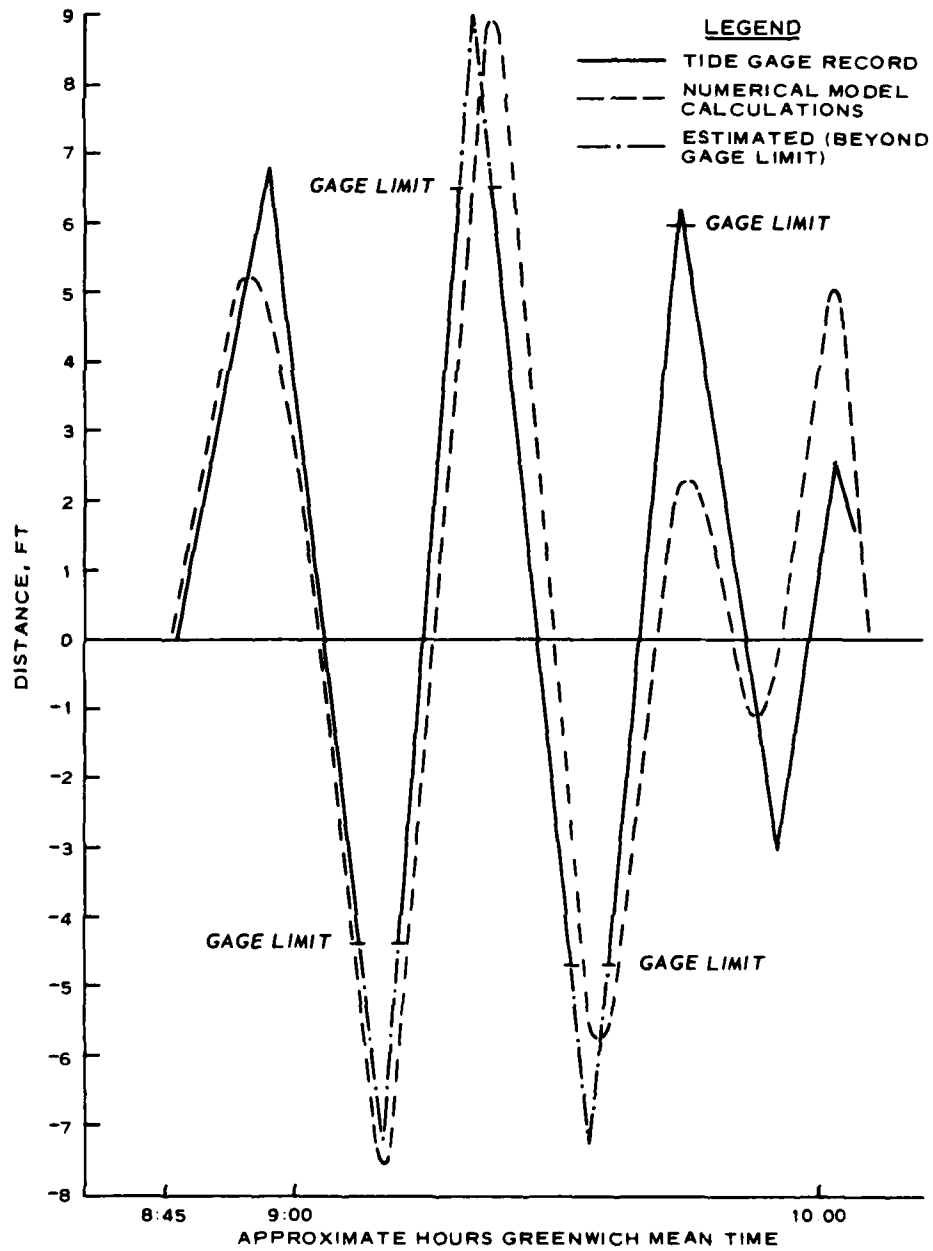

Figure 7. 1964 tsunami at Kahului, Maui

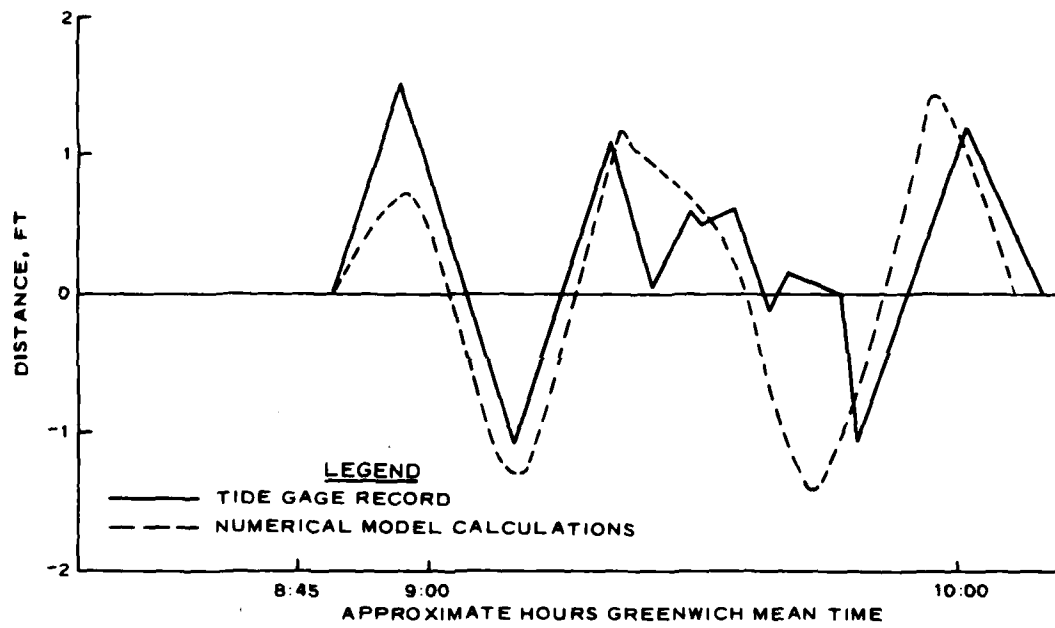

Figure 8. 1964 tsunami at Honolulu, Oahu

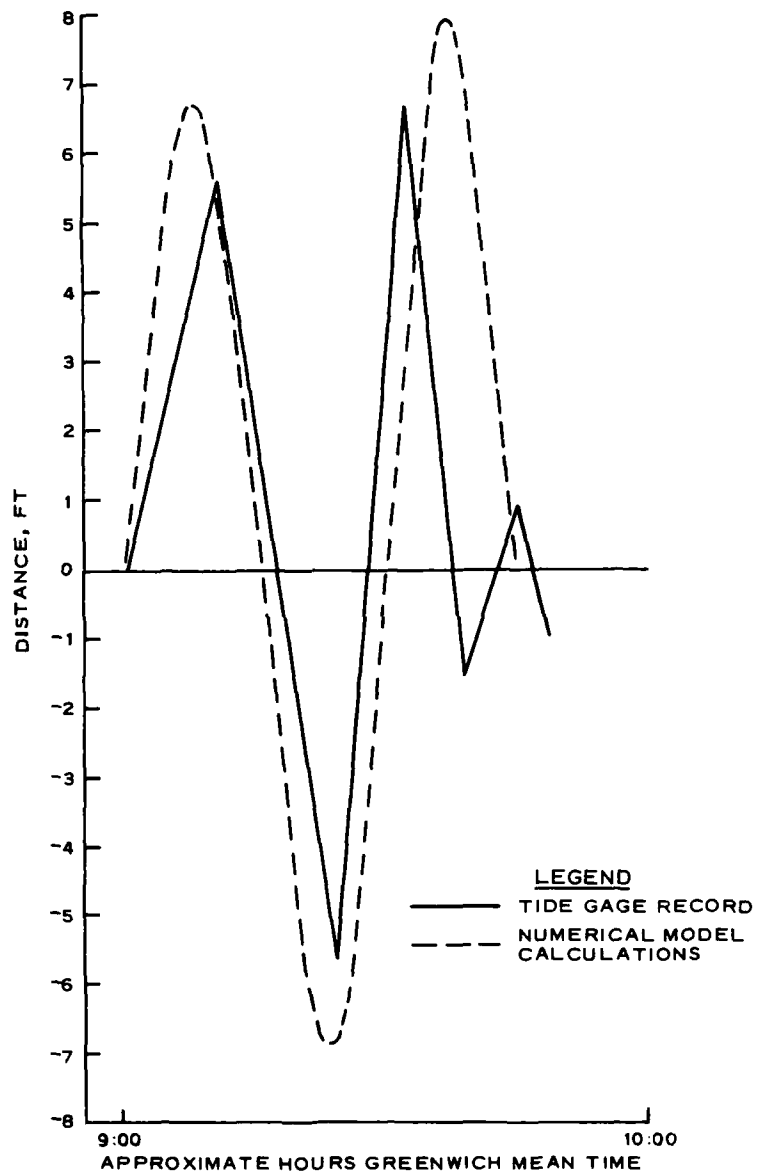

Figure 9. 1964 tsunami at Hilo, Hawaii

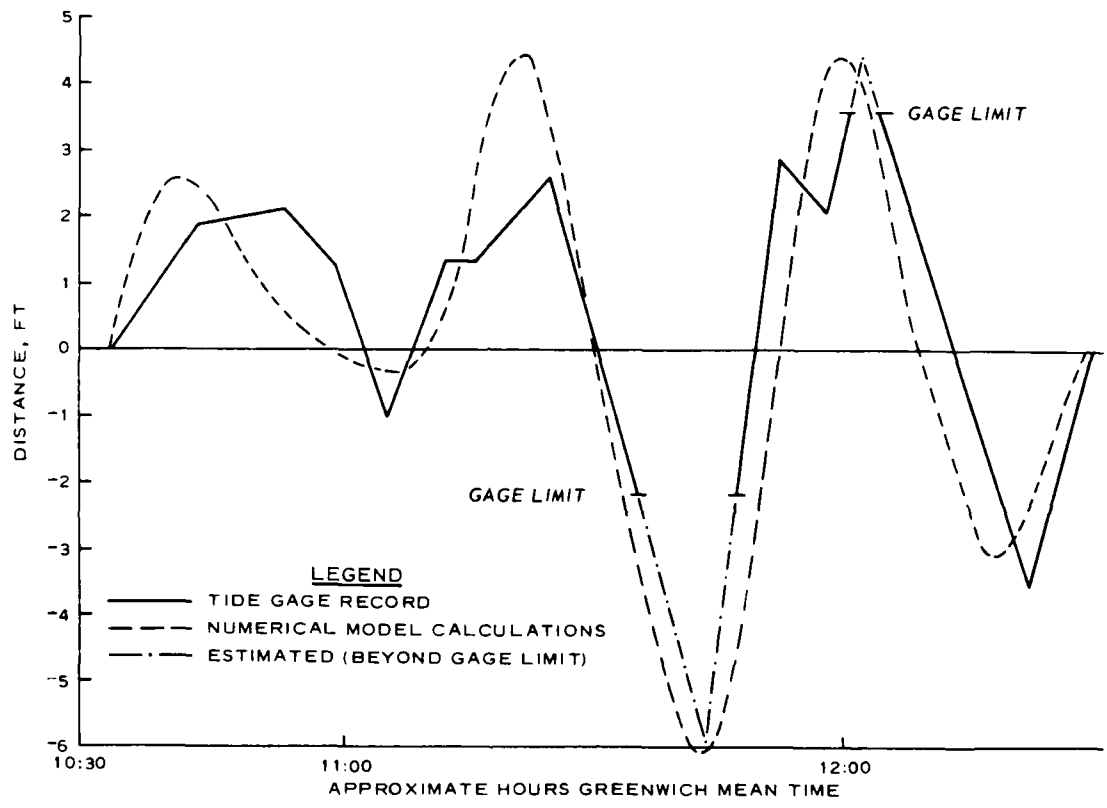

Figure 10. 1960 tsunami at Honolulu, Oahu



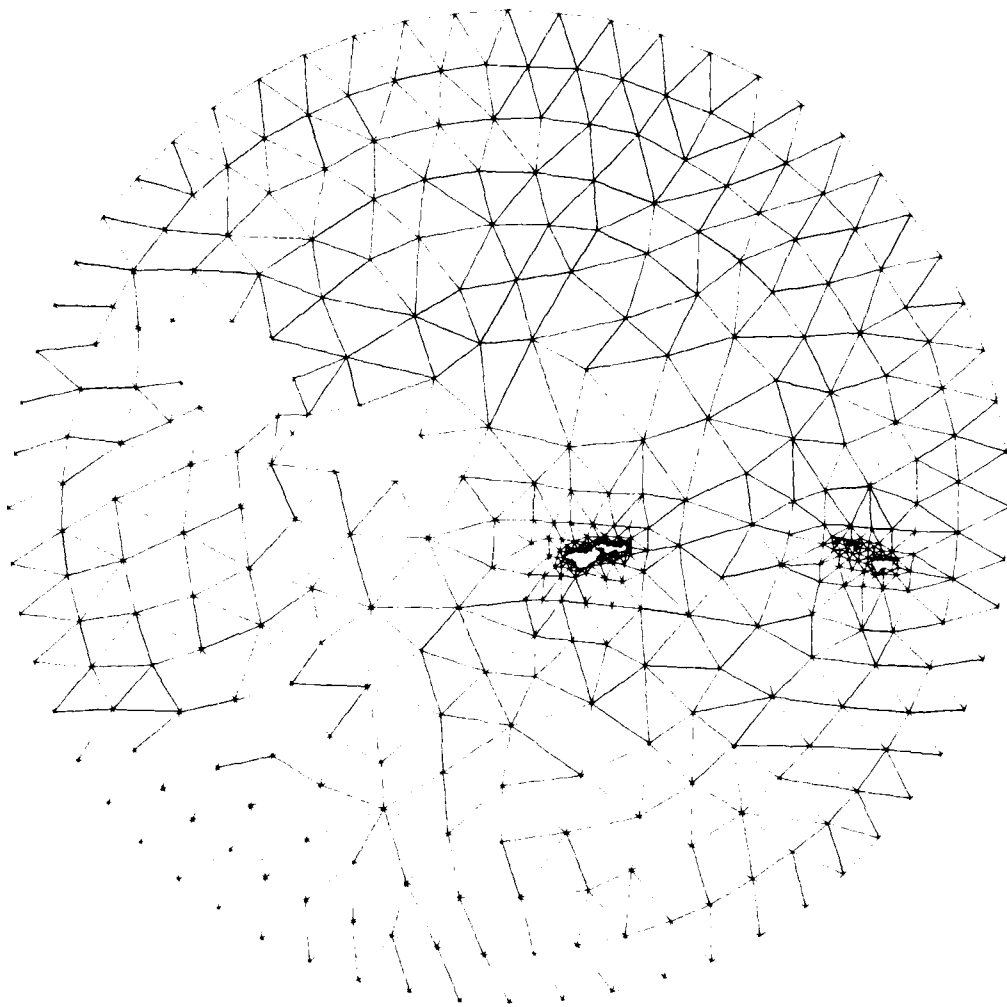

Figure 11. Finite-element grid for the Samoa Islands

Tau Islands. The model calculated the interaction of tsunamis with American Samoa and determined relative heights along the coastline. The tsunami elevation at an arbitrary location where historical data were not available was determined by multiplying the known historical elevation recorded at a location in Pago Pago Harbor by the ratio of the elevation calculated by the numerical model at the arbitrary location and the elevation calculated at the location in Pago Pago Harbor. The numerical model takes into account the major processes that would cause different

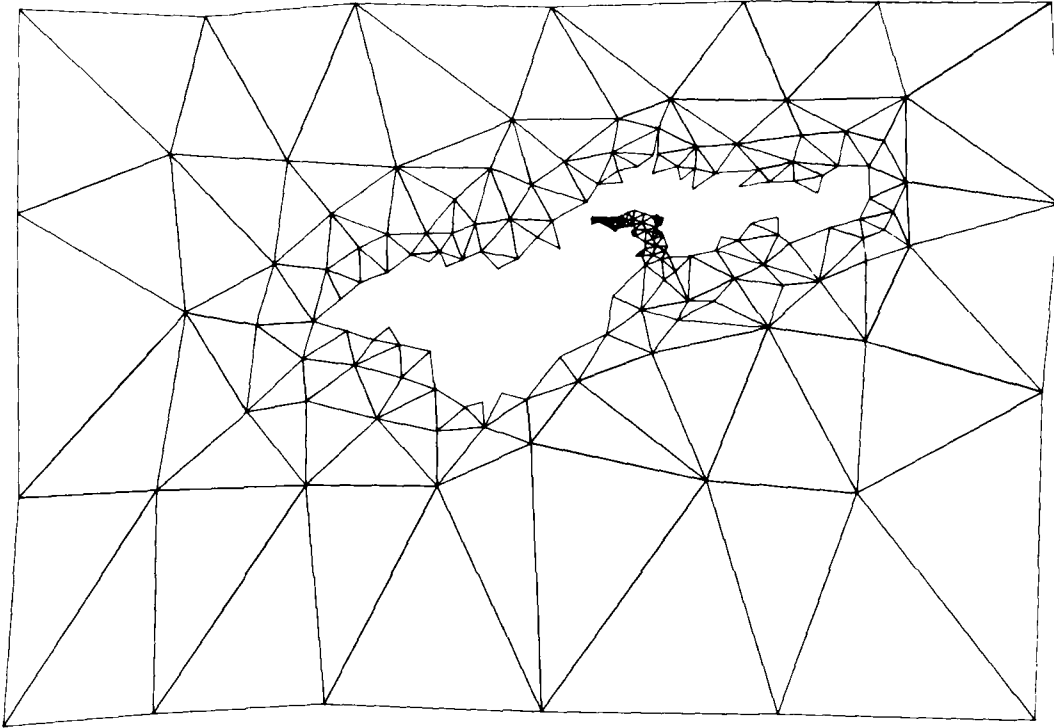

Figure 12. Section of finite-element grid for Tutuila Island

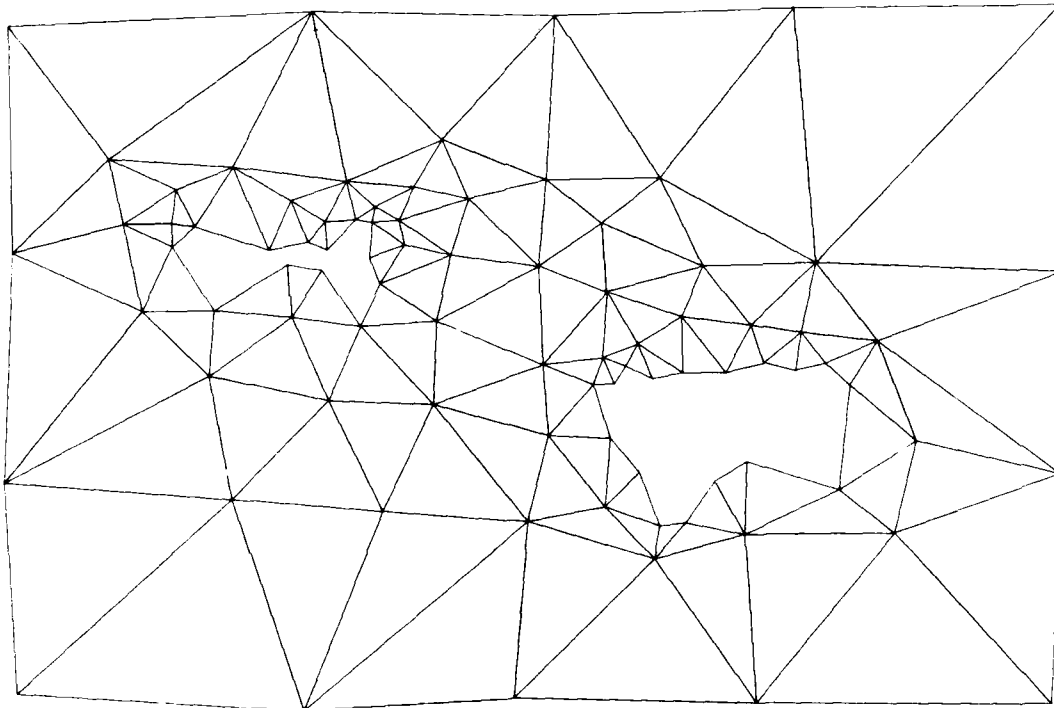

Figure 13. Section of finite-element grid for  
Ofu, Olosega, and Tau Islands

tsunami elevations at the arbitrary location and the location in Pago Pago Harbor where there is a historical record. That is, the model calculates shoaling, refraction, diffraction, reflection, resonance, shielding of the back side of an island by the front side, and reflections between islands.

27. Deepwater wave forms of historical tsunamis are not known. However, the directions of approach of historical tsunamis and the basic range of wave periods are known. By inputting sinusoidal waves of unit amplitude from the same direction as a historical tsunami into the numerical model over a band of wave periods, the interaction of the historical tsunami with American Samoa was determined. Waves with periods from 10 to 60 min in steps of 150 sec were used as input to the numerical model for each historical tsunami. At every shoreline location, the response to each of the incident wave periods was squared, the squared responses all summed, and a square root of the total sum was taken. Thus, at each shoreline location, a variance of the response wave form was calculated. By multiplying this variance by the ratio of a historical recording in Pago Pago Harbor and the variance of the response wave form calculated at the location in Pago Pago Harbor, elevations for the historical tsunami along all of the coastline of American Samoa were determined.

28. The method used to calculate tsunami elevations for historical events is approximate since the incident wave energy is spread uniformly over a range of wave periods. For an actual tsunami, there undoubtedly is a distribution of wave energy that is not perfectly uniform. Thus, the method used in this report provided the response for an average ensemble of tsunamis generated in a region. However, the average response may be very similar to the response for a particular tsunami, since it is well known that the tsunami response at a location is more dependent upon characteristics of the location than upon characteristics of the incident tsunami. Thus, two different tsunamis recorded at a single location are often very similar, whereas the same tsunami recorded at two different locations often appears remarkably different.

29. The 1960 tsunami from Chile is the only tsunami for which

there are recordings at several locations on the Island of Tutuila. Using the techniques described above, elevations were predicted and compared with actual historical measurements. The known elevation was taken to be the 9.5 crest elevation at the end of Pago Pago Harbor. The numerical model predicted a crest elevation of only 2.3 ft at Fagaalu (Figure 1) near the mouth of Pago Pago Harbor. Keys (1963) reported that "the sea rose no more than 2.5 ft" at Fagaalu. An elevation of 6.4 ft was predicted at the Administration boatshed in Pago Pago Harbor, and this compared favorably with the 6 to 7 ft reported at this location by Keys (1963). An elevation of 5.1 ft was predicted at the tide gage location. The maximum crest amplitude on the tide gage marigram (Symons and Zetler 1960) was approximately 4 ft. However, the tsunami had a sufficiently short wave period and great height at the tide gage location that maximum elevations may have been reduced somewhat by tide gage distortion. At Tafuna (Figure 1) near the airport, the numerical model predicted an elevation of only 0.6 ft. Keys (1963) reported that no disturbance was noticed at Tafuna. There was a reported (Keys 1963) maximum trough to crest range of 8 to 10 ft at a location 1/2 mile from the Administration boatshed in Pago Pago Harbor. Keys (1963) indicates that this reported range was 1/2 mile from the boatshed in a direction toward the end of the harbor. However, he also indicates that this location was in the vicinity of the Rainmaker Hotel, which is 1/2 mile away from the boatshed in a direction toward the harbor mouth. At this location, the numerical model predicts a range of 7.5 ft. Keys (1963) also indicates that there were no reports of tsunami activity outside Pago Pago Harbor. The average crest elevation predicted by the numerical model for all locations outside Pago Pago Harbor was only 1.5 ft. Since the maximum waves arrived at low tide, this crest elevation would have resulted in a combined tsunami and tide elevation just a fraction of a foot greater than mean sea level and about 1 ft less than high tide. Thus, the tsunami would not have produced any flooding at typical locations outside Pago Pago Harbor. The greatest elevation outside Pago Pago Harbor predicted by the numerical model was a 6-ft elevation in Leone Bay. This is an elevation of approximately 3.5 ft above mean high water. It is

interesting to note that the only report of tsunami damage outside Pago Pago Harbor for any historical tsunami was at Leone where the 1917 tsunami partly demolished the Catholic Church (Appendix A). Thus, Leone Bay apparently amplified tsunamis (note the peak displayed in Plate 17 in the Leone Bay region from Location 97 to 102).

### PART III: METHODOLOGY FOR ELEVATION PREDICTIONS

#### Use of Historical Data

30. Historical data of tsunami activity in American Samoa are presented in Appendix A. The data for American Samoa are concentrated almost exclusively within Pago Pago Harbor. Most of these data are for elevations at the end of Pago Pago Harbor or at the tide gage location near Goat Island Point (see Figure 15).

31. The historical data cover a time period from 1837 to the present. However, there are no quantitative reports on tsunami activity in American Samoa during the nineteenth century. Reliable reporting of events in American Samoa probably started around the turn of the century. The Samoa Times started publication in western Samoa in 1901, and a newspaper began publication in American Samoa in 1903. Newspapers in Honolulu are available from 1900 (Appendix A). Therefore, the period of time from 1900 to 1979 was used in the frequency analysis.

32. Since there may have been many small tsunamis in American Samoa from 1900 to 1979 that were not reported as a result of their negligible effects, only the more significant tsunamis are considered in this report. There have been seven significant tsunamis during this period of time. The 1917 tsunami was generated in the Kermadec Island area, the 1919 tsunami in the Tonga Island area, the 1922 tsunami off the coast of northern Chile, the 1946 tsunami in the central Aleutian Islands, the 1952 tsunami off the coast of Kamchatka, the 1957 tsunami in the western Aleutians, and the 1960 tsunami off the coast of southern Chile. The occurrence of tsunamis obviously has not been uniform. The concentration of tsunamis felt throughout the Pacific Ocean during the period from 1946 to 1960 is well known (Houston et al. 1977). The concentration from 1917 to 1922 is a consequence of increased local earthquake activity (1917 and 1919) and a probable coincidental occurrence of a South American tsunami (although increased tsunami activity such as the significant tsuanmis in 1918 in the Celebes Sea of the Philippine Islands, in 1918 in the south Kuril Islands, in 1918 in Chile, twice in

1923 in Kamchatka, and in 1923 in Japan may suggest a cluster of events with some casual connection). These seven events were used to establish a frequency of occurrence curve at the end of Pago Pago Harbor. Houston et al. (1977) used the 10 largest tsunamis at Hilo, Hawaii, to establish a frequency curve. However, Pago Pago Harbor does not have as large a data base as Hilo, and thus only seven tsunamis could be considered in the analysis.

33. As presented in Appendix A, the 5 June 1917 tsunami was reported to have reached a crest elevation of 6 to 8 ft above the existing tide level at the head of Pago Pago Harbor. Thus, a crest elevation of 7 ft at the end of Pago Pago Harbor was selected as being representative of this event. The 30 April 1919 tsunami was reported to have attained a height of 6 or 8 ft above high water somewhere on Tutuila. Since historical data and the numerical model calculations clearly show that the largest elevations on Tutuila occur at the end of Pago Pago Harbor, it was assumed that this recording was at the end of this harbor. An elevation of 7 ft above high water was selected as representative. Since there was no knowledge of the tide level during arrival of the largest wave, it was assumed that the tide level was mean sea level. Mean high tide is 1.3 ft above mean sea level in Pago Pago Harbor. Thus, the crest elevation was 8.3 ft above mean sea level (7 ft above mean high tide). The 11 November 1922 tsunami was reported by Iida et al. (1967) to have attained a height of 1.8 m, as measured by the tide gage in Pago Pago Harbor. No additional information was located in the historical study reported in Appendix A. The heights listed in the tsunami catalog of Iida et al. (1967) are supposedly crest amplitudes or runup. However, many of the tide gage reports in this catalog are trough to crest ranges. This also must be the case for the 1922 tsunami, since the tide gage in Pago Pago Harbor does not have the operating limits to record a 1.8-m crest and the lack of reports of damage is indicative of a smaller crest (a 1.8-m crest at the tide gage would be larger than that of any other historical tsunami). The assumption that the crest amplitude was one-half the total range resulted in a crest amplitude of 3 ft at the tide gage. The numerical model then predicted a crest

amplitude of 4.8 ft at the end of Pago Pago Harbor for a crest amplitude of 3 ft at the tide gage location. A rise and fall (therefore, a range) of 5 ft was reported for the 1 April 1946 tsunami. The location of this rise and fall is unknown, but it was reported by a ship in the harbor. Therefore, it was assumed in this report that the location was the main dock in Pago Pago Harbor. For a 2.5-ft elevation (one-half of range) at the main dock, the numerical model predicted a 3.9-ft elevation at the harbor end. A 3.2-ft crest was scaled off the marigram recorded by the tide gage for the 4 November 1952 tsunami. For a 3.2-ft crest elevation at the tide gage, the numerical model predicted a 6.8-ft elevation at the end of the harbor. The 9 March 1957 tsunami was reported to have flowed over a road (which was 4 ft above mean tide level) at the end of the harbor. The tide stage during this flow was high tide (1.3 ft above mean sea level). Thus, the tsunami reached an elevation of at least 2.7 ft above mean sea level at the end of the harbor. The 22 May 1960 tsunami was reported to have had a crest elevation of 9.5 ft above the tide at the end of the harbor. In summary, the elevations at the end of Pago Pago Harbor for the 1917, 1919, 1922, 1946, 1952, 1957, and 1960 tsunamis were 7 ft, 8.3 ft, 4.8 ft, 3.9 ft, 6.8 ft, 2.7 ft, and 9.5 ft, respectively.

#### Influence of Reefs

34. Reefs are known to sometimes affect tsunami elevations. For example, the extensive reefs of Kaneohe Bay, Oahu, in the Hawaiian Islands are known to reduce tsunami elevations substantially through reflection or dissipative processes. The effect of narrower reefs on tsunamis is not well understood. For example, the Island of Kauai in the Hawaiian Islands has reefs of similar width to those of American Samoa. However, it is difficult to distinguish any clear relationship between the width of the reef and the resultant tsunami elevations at the shoreline. For example, there is a stretch of coastline where the reef varies in width from 0 to 360 yd on the northeast shore of Kauai from Anapalau Point to a location north of Molaa Bay. The 1960 tsunami,



however, had the same height all along this coast. Along the other parts of the coast of Kauai, there also is no clear pattern of the effect of the reefs on tsunamis. The fringing reefs of American Samoa are similar in width to those of Kauai. Thus, in this study it was assumed that reefs of American Samoa did not significantly affect tsunamis. The tsunami elevations presented in PART IV are relatively small for most of the coast of American Samoa; and therefore, this assumption has little practical importance. At those locations where elevations are relatively large, the predictions made assuming that the reefs have no significant effects are consistent with historical observations. Therefore, the assumption that the reefs of American Samoa do not significantly affect tsunamis is reasonable.

#### Effect of Tides on Tsunami Exceedance Frequency Distributions

35. Tsunami heights are relatively small along the coasts of most of American Samoa. Thus, the state of the astronomical tide has an important effect on the total combined tsunami and tidal elevation. For example, the major waves of the 1960 tsunami arrived at Tutuila Island at low tide. Consequently, the combined tsunami and tide level along most of the coast of Tutuila was less than mean high water. Thus, the effect of the astronomical tides on tsunami exceedance frequency distributions must be considered.

36. Tsunamis consist of many waves; for example, the tide gage at Pago Pago typically has recorded tsunamis that consisted of several large waves that arrived during a 1- or 2-hr period and then were followed by smaller waves that persisted for days (see Figure 14). The smaller waves had maximum heights approximately one-half the height of the group of larger waves. Since the group of large waves arrives over a period of time which is sufficiently short that the tide remains at essentially the same level during their arrival, the largest wave in the group remains so after addition of the tide. However, this superposition of the largest tsunami wave and the tide may not result in an elevation that is greater than a superposition of smaller waves and the

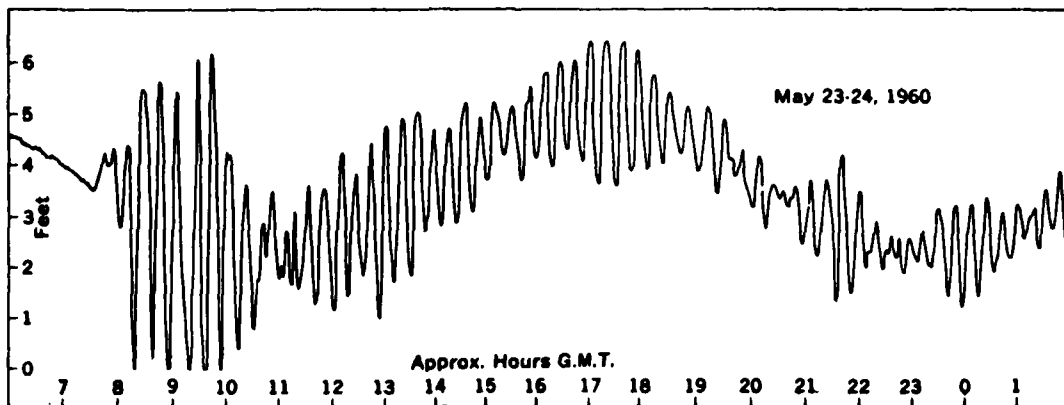

Figure 14. Tide gage recording of 1960 tsunami at Pago Pago (Symons and Zetler 1960)

tide, since these smaller waves persist for days and thus combine with a high tidal stage. For example, at the tide gage location during the 1960 tsunami, smaller waves arriving at high tide had a total combined elevation greater than the group of large waves that arrived at low tide (Figure 14).

37. To determine the effect of the tides on tsunami exceedance frequency distributions, first consider the effects of varying tidal stages just on the group of large waves. Again, suppose the largest of these waves reaches the largest combined elevation after addition of the tidal stage. Suppose further that the exceedance frequency distribution for this maximum tsunami elevation is known. Houston and Garcia (1974) show the effect that the tide has on such an exceedance frequency distribution. The derivation is repeated in Appendix B. The derivation shows that the net effect of the tide on the exceedance frequency distribution is to shift it by a constant elevation that is negligible for the case of American Samoa. Thus, the effect of the tide can be included merely by adding all the maximum waves to a mean sea level datum.

38. The effect of tides on the smaller waves that follow the maximum waves of the tsunami and persist for days cannot be included merely by adding these waves to mean sea level. These waves add to

a mean higher high-water level at some time since they persist for days. Therefore, in this study the maximum wave of a tsunami was added to a mean sea level datum and an elevation one-half of the maximum elevation (representing the height of the smaller waves that persist for days) was added to mean higher high water. The elevation of the maximum wave that was added to mean sea level was then compared with the elevation of the smaller waves added to mean higher high water, and the maximum of these two elevations was selected as the combined tsunami and tide elevation in the frequency analysis.

#### Calculation of Tsunami Exceedance Frequency Distributions

39. The historical data presented in Appendix A allowed elevations to be determined at the end of Pago Pago Harbor for seven historical tsunamis. The finite-element model was then used to simulate the interaction of these historical tsunamis with American Samoa. Using the techniques described in PART II, the numerical model calculations were used to determine elevations for these seven historical tsunamis at node points of the numerical grid all along the coasts of American Samoa. Figures 15-17 show 144 computational points along the coasts of Pago Pago Harbor, Tutuila Island, Aunuu Island, Ofu Island, Olosega Island, and Tau Island. Table 1 presents elevations for the seven historical tsunamis predicted at all 144 computational points. Table 2 presents elevations for these tsunamis including the effect of the astronomical tides. Table 3 presents the longitude and latitude of the 144 points.

40. Tsunami exceedance frequency distributions were determined by ordering the tsunami elevations (including effect of tides) at each location presented in Table 2 and relating elevation versus frequency of occurrence (using least-squares techniques)

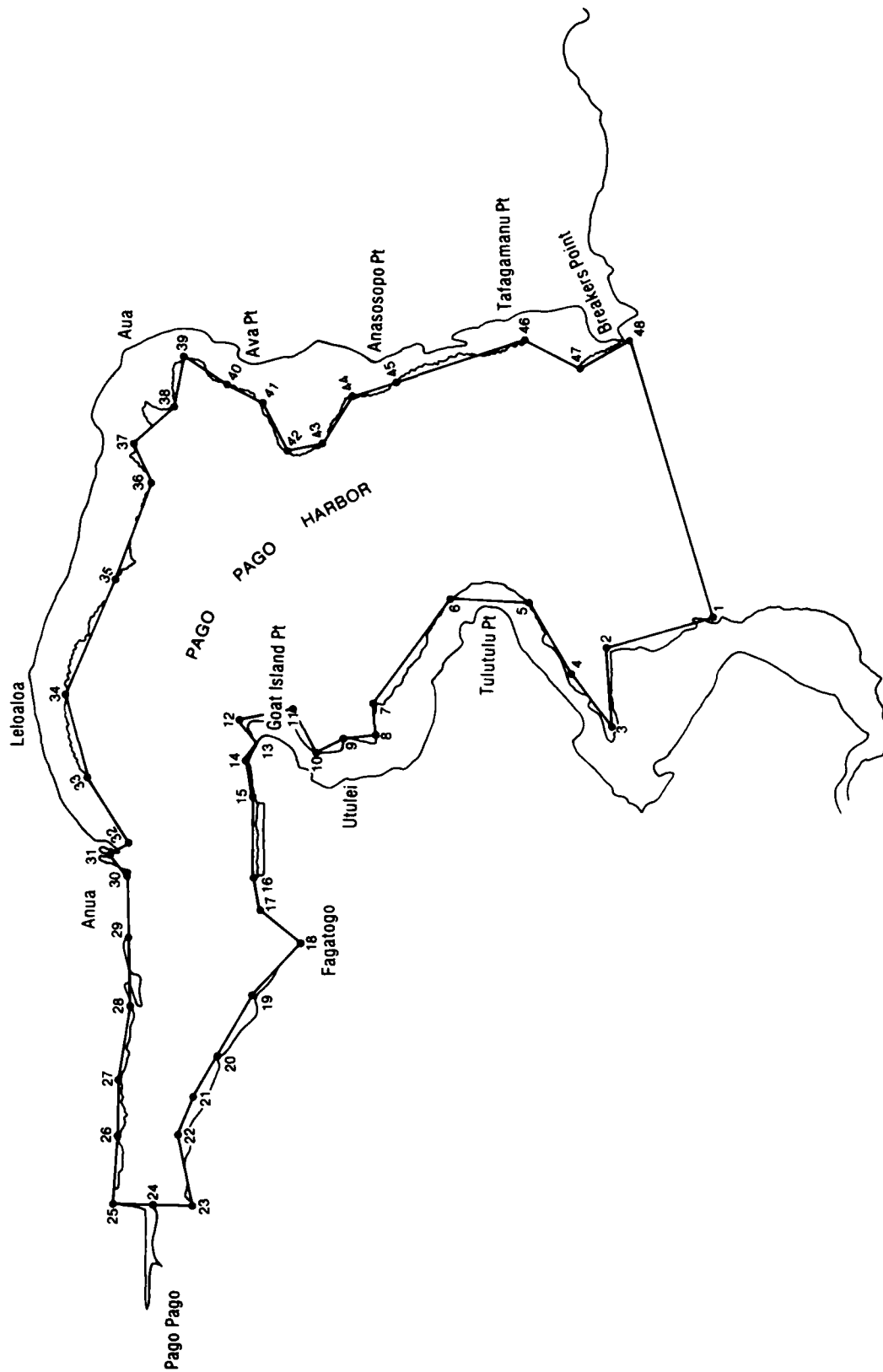

Figure 15. Computational points 1-48

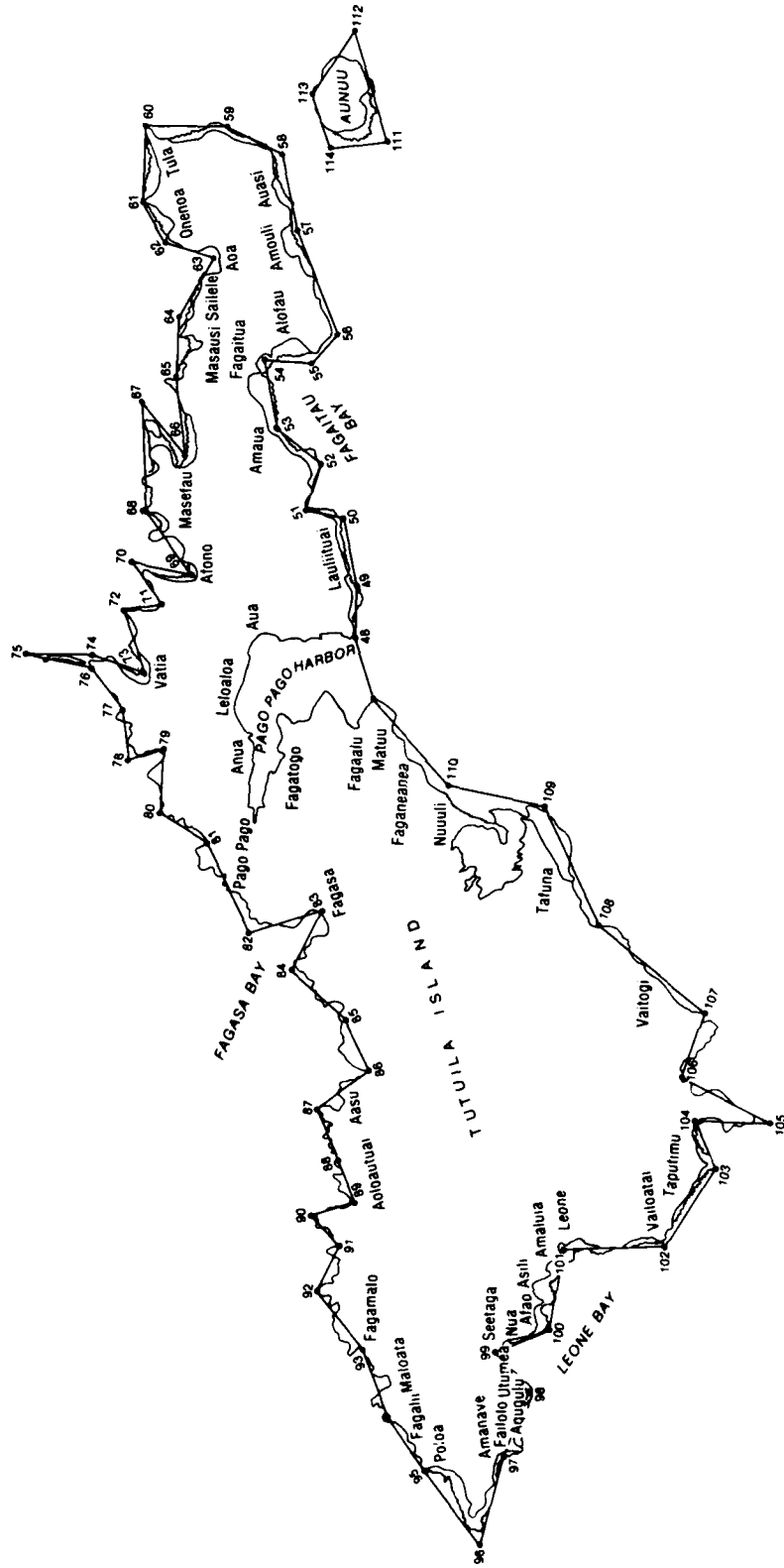

Figure 16. Computational points 48-114

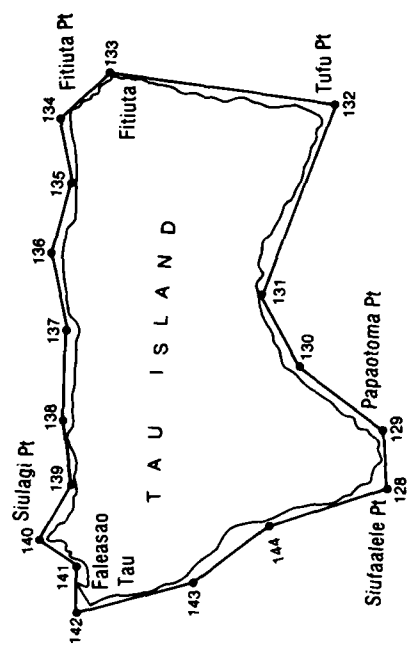
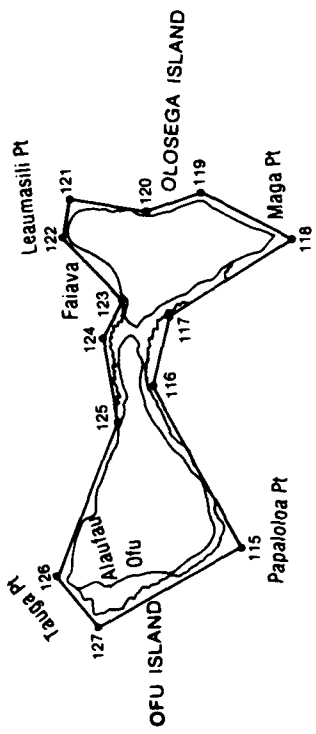

Figure 17. Computational points 115-144

by curves that can be represented by the equation

$$H = -B - A \log_{10} f \quad (7)$$

where

H = elevation of maximum combined tsunami and astronomical tide above mean sea level

f = frequency per year of tsunami occurrence

41. Cox (1964) found that the logarithm of the tsunami mean exceedance frequency was linearly related to tsunami elevations for the 10 largest tsunamis occurring from 1837 to 1964 in Hilo, Hawaii. Wiegel (1965) found the same relationship between tsunami frequency of occurrence and measured elevations for tsunamis at Hilo, Hawaii; San Francisco, California; and Crescent City, California; and Adams (1970), for tsunamis at Kahuku Point, Oahu. Rascon and Villarreal (1975) demonstrated that a linear relationship between the logarithm of the mean exceedance frequency and recorded elevations held for historical tsunamis on the west coast of Mexico (data from 1732) and on the Pacific west coast of America, excluding Mexico. Earthquake intensity and the mean exceedance frequency have been similarly related by Gutenberg and Richter (1965).

42. Table 2 presents the A and B coefficients for each of the 144 computational points determined by fitting the historical data with the distribution given by Equation 7. The 100-yr elevation at each of these points also is presented in Table 2.

## PART IV: RESULTS

### Use of Tables and Plots

43. Plates 1-10 present the A and B coefficients of Equation 7 plotted at all the computation points and connected by straight lines. Locations of these computational points are presented in Figures 15-17. Table 3 gives the longitude and latitude of each of the computational points. Some of the points are at the edge of the reef off the coastline. It can be assumed that the coefficients for these points also apply at the shoreline location closest to the point on the reef. These coefficients can be substituted in Equation 7 and tsunami elevations associated with various frequencies of occurrence can be calculated. For example, the 100-yr tsunami (a 100-yr elevation is one that is equaled or exceeded with an average frequency of once every 100 yr, i.e. a 100-yr return period) has an annual frequency of occurrence of  $1/100 = 0.01$ . Therefore,  $f = 0.01$  in Equation 7 and  $\log_{10} f = -2$ . Thus, the 100-yr elevation equals  $2A-B$ . Similarly,  $f = 0.005$  for a 200-yr tsunami,  $\log_{10} f = -2.3$ , and the 200-yr elevation equals  $2.3A-B$ . All elevations are relative to the mean sea level datum. Plates 11-20 present 100-yr elevations along the entire coastline of American Samoa.

44. Elevations calculated using Equation 7 are for combined tsunami and astronomical tide elevations given the occurrence of a significant tsunami in American Samoa. It is not true that in the limit of a tsunami with an amplitude of zero, the frequency analysis presented determines the maximum possible elevation over a 100-yr period for the astronomical tide alone. It is quite possible that the 100-yr combined tsunami and astronomical tide elevation is less than the maximum possible astronomical tide elevation over a 100-yr period. In fact, there are undoubtedly locations (wherever tsunami elevations are small) in American Samoa where the seven largest historical tsunamis combined with the tide and produced a combined elevation less than the maximum tide elevation that can be expected over a 100-yr period. Obviously, tsunamis are not a significant threat at such locations.



45. Tsunami elevations calculated using Equation 7 are elevations at the shoreline. Since these elevations are relatively small and the land topography is usually very steep (so that inland flooding distances are small), these elevations can be assumed to be runup elevations with little error.

#### Discussion

46. The 100-yr tsunami elevations presented in Plates 11-20 show that the largest elevations occur at the end of Pago Pago Harbor. This result is expected since a harbor whose cross-sectional area decreases from the harbor mouth to its end is known to amplify tsunamis. Of course, the largest elevations in American Samoa historically have occurred at the end of Pago Pago Harbor. There also are smaller peaks in the 100-yr elevations at Fagasa Bay (Location 83 in Plate 16) on the north coast of Tutuila and in the Leone Bay area (locations 97-102 in Plate 17) on the west coast of Tutuila. During the 1957 tsunami, Fagasa Bay apparently experienced a resonant oscillation that produced a significant tsunami elevation within the bay (Appendix A). Leone Bay appears to amplify most tsunamis incident on Tutuila (see locations 97-102 presented in Table 1). As mentioned earlier, the only tsunami destruction reported in American Samoa outside of Pago Pago Harbor was at Leone. Elevations at Fagaitua Bay (locations 52-56 in Plate 14) also are somewhat larger than surrounding areas.

47. The 100-yr tsunami elevations for much of Tutuila and for all of Aunuu, Ofu, Olosega, and Tau Islands are relatively small. It is quite likely that storm surges due to tropical storms and hurricanes are of more concern at these locations. Flooding from this source requires another set of computations and the combined probability distribution of flooding from tropical storms and tsunamis should be formed to evaluate to actual probability of flooding.

#### Risk Calculation

48. The average frequency of occurrence  $f$  is a mean exceedance frequency, i.e., an average frequency per year of tsunamis of equal

or greater elevation. It also is possible to calculate the chance of a given elevation being exceeded during a certain period of time. Such a calculation is a risk calculation.

49. Tsunamis are usually caused by earthquakes, and earthquakes are often idealized as a generalized Poisson process (Newmark and Rosenblueth 1971). Many investigators have assumed that tsunamis also follow such a stochastic process (Rascon and Villarreal 1975, and Wiegel 1965). The probability that a tsunami with an average frequency of occurrence of  $f$  is exceeded in  $d$  years, assuming that tsunamis follow a Poisson process, is given by the following equation:

$$P = 1 - e^{-fd} \quad (8)$$

50. For example, the probability that the 1-in-100-yr elevation will occur in a 50-yr period is

$$\begin{aligned} P &= 1 - e^{-(0.01)(50)} \\ &= 1 - e^{-0.05} \\ &= 1 - 0.61 \\ &= 0.39 \end{aligned}$$

and in a 10-yr period is

$$\begin{aligned} P &= 1 - e^{-(0.01)(10)} \\ &= 1 - e^{-0.1} \\ &= 1 - 0.9 \\ &= 0.1 \end{aligned}$$

51. As mentioned in the introductory section of PART I, an evaluation of risk is important whenever human life may be exposed to possible danger as a result of land development. For example, it would certainly be unwise to base tsunami evacuation zones simply on something like the 1-in-100-yr elevations given in this report. As shown in the previous paragraph, the odds that a 1-in-100-yr event will occur during

a 10-yr period are not insignificant.

52. Risk calculations can be used to add a safety factor when evaluating whether or not it is prudent to develop land at some elevation that might expose human life to possible danger. First, it is necessary to decide on some acceptable risk. For example, perhaps a one chance in 10,000 that an elevation be exceeded during a 10-yr period is an acceptable risk. (This risk is used only for illustration and not to suggest that such a risk is or is not acceptable.) Then  $d$  of Equation 5 equals 10 and  $P$  equals 0.0001. Substituting these values of  $d$  and  $P$  in Equation 8 yields an  $f$  equal to approximately 0.00001. Therefore, the elevation for which there is only one chance in 10,000 that the elevation will be exceeded during a 10-yr period is the 1-in-100,000-yr elevation. Of course, Equation 1 may not be valid for the 1-in-100,000-yr tsunami, since the linear relationship between  $h$  and the logarithm of  $f$  may not be valid for arbitrarily small values of  $f$ . However, there is not sufficient historical data at this time to determine any other relationship between  $h$  and  $f$ .

## PART V: CONCLUSIONS

53. This report presents tsunami elevation exceedance frequency distributions calculated for the entire coastline of American Samoa. From these distributions, it is easy to determine tsunami elevations for arbitrary return periods (e.g. 100-yr elevation as displayed in this report). The report also presents a detailed historical study of tsunami activity in American Samoa and a finite-element numerical model was used to predict tsunami elevations at locations not having actual historical data. The finite-element model is shown to provide accurate simulations of the interaction of tsunamis with islands.

54. The largest tsunami elevations in American Samoa occur in Pago Pago Harbor on Tutuila Island. These elevations increase from the mouth of the harbor and reach a maximum at the end of the harbor. Relatively large elevations also were found in the region of Leone Bay on the west coast and Fagasa Bay on the north coast of Tutuila Island. Tsunami elevations are relatively small on the remainder of the coast of Tutuila Island and on the islands of Aunuu, Ofu, Olosega, and Tau.

55. The tsunami elevations presented are at locations at or near the shoreline. Since these elevations are relatively small and the land topography is usually very steep (so that inland flooding distances are small), these elevations can be assumed to be runup elevations. Runup elevations and elevations at the shoreline are expected to be different only where inland flooding is extensive or the land topography is such that flow convergence (e.g. at V-shaped valleys) or divergence (e.g. at gaps through elevated areas such as beach dunes) is important. Such areas can be studied in detail using a two-dimensional flooding numerical model developed by Houston and Butler (1979) for the Pacific Ocean Division.

56. Predicted tsunami flooding for much of American Samoa is relatively small, especially on Aunuu Island and the Manua Islands of Ofu, Olosega, and Tau. It is quite probable that storm surges due to tropical storms or hurricanes will produce greater flooding than do tsunamis at these locations. Flooding in the Manua Islands during the

13 February 1915 hurricane is an example of the threat from storm surges. Numerical models (e.g. Wanstrath 1977) can be used to determine expected storm-surge levels in American Samoa.

## REFERENCES

- Adams, W. M. 1970. "Tsunami Effects and Risk at Kahuku Point, Oahu, Hawaii," Engineering Geology Case Histories, Geological Society of America, No. 8.
- Chandrasekhar, S. 1943. Reviews of Modern Physics, 15:1-89.
- Chen, H. S., and Mei, C. C. 1974. "Oscillations and Wave Forces in an Offshore Harbor (Applications of the Hybrid Finite Element Method to Water-Wave Scattering)," Report No. 190, Massachusetts Institute of Technology, Cambridge, Mass.
- Cox, D. C. 1964 (Nov). "Tsunami Height-Frequency Relationship of Hilo" (unpublished paper), Hawaii Institute of Geophysics, University of Hawaii, Honolulu, Hawaii.
- Cox, D. C., and Pararas-Carayannis, G. 1976. "Catalog of Tsunamis in Alaska, Revised 1976," World Data Center A, Report SE-1, for Solid Earth Geophysics, National Oceanic and Atmospheric Administration, Washington, D. C.
- Garcia, A. W. 1976 (Sep). "Effect of Source Orientation and Location in the Peru-Chile Trench on Tsunami Amplitude Along the Pacific Coast of the Continental United States," Research Report H-76-2, U. S. Army Engineer Waterways Experiment Station, CE, Vicksburg, Miss.
- Garcia, A. W., and Houston, J. R. 1975 (Nov). "Type 16 Flood Insurance Study: Tsunami Prediction for Monterey and San Francisco Bays and Puget Sound," Technical Report H-75-17, U. S. Army Engineer Waterways Experiment Station, CE, Vicksburg, Miss.
- Gutenberg, B., and Richter, C. F. 1965. Seismicity of the Earth and Associated Phenomena, 2d ed., Hafner Publishing Co., New York.
- Heck, N. H. 1947. "List of Seismic Sea Waves," Bulletin of the Seismological Society of America, Vol 37, No. 4, pp 269-286.
- Hom-ma, S. 1950. "On the Behavior of Seismic Sea Waves Around a Circular Island," Geophysical Magazine, Vol 21, pp 199-208.
- Houston, J. R., and Butler, H. L. 1979 (Feb). "A Numerical Model for Tsunami Inundation," Technical Report HL-79-2, U. S. Army Engineer Waterways Experiment Station, CE, Vicksburg, Miss.
- Houston, J. R., and Garcia, A. W. 1974 (May). "Type 16 Flood Insurance Study: Tsunami Predictions for Pacific Coastal Communities," Technical Report H-74-3, U. S. Army Engineer Waterways Experiment Station, CE, Vicksburg, Miss.
- Houston, J. R., and Garcia, A. W. 1978 (Dec). "Type 16 Flood Insurance Study: Tsunami Predictions for the West Coast of the Continental United States," Technical Report H-78-26, U. S. Army Engineer Waterways Experiment Station, CE, Vicksburg, Miss.

Houston, J. R., Carver, R. D., and Markle, D. G. 1977 (Aug). "Tsunami-Wave Elevation Frequency of Occurrence for the Hawaiian Islands," Technical Report H-77-16, U. S. Army Engineer Waterways Experiment Station, CE, Vicksburg, Miss.

Hwang, L.-S., Divoky, D., and Yuen, A. 1970 (Jun). "Amchitka Tsunami Study," Report TC-177, Tetra Tech, Inc., Pasadena, Calif.

Iida, K., Cox, D. C., and Pararas-Carayannis, G. 1967 (Dec). "Bibliography to the Tsunamis Occurring in the Pacific Ocean," HIG-67-25, Hawaii Institute of Geophysics, University of Hawaii, Honolulu, Hawaii.

Keys, J. G. 1963 (Dec). "The Tsunami of 22 May 1960, in the Samoa and Cook Islands," Bulletin of the Seismological Society of America, Vol 53, No. 6, pp 1211-1227.

Newmark, N. M., and Rosenblueth, E. 1971. Fundamentals of Earthquake Engineering, Prentice-Hall, Englewood Cliffs, N. J.

Pararas-Carayannis, G. 1977 (Mar). "Catalog of Tsunamis in the Hawaiian Islands," Report SE-4, National Oceanic and Atmospheric Administration, Boulder, Colo.

Plafker, G. 1969. "Tectonics of the March 27, 1964, Alaska Earthquake," U. S. Geological Survey Professional Paper 543-I, pp 11-174.

Plafker, G., and Savage, J. C. 1970. "Mechanism of the Chilean Earthquake of May 21 and 22, 1960," Bulletin, Geological Society of America, Vol 81, No. 4, pp 1001-1030.

Rascon, O. A., and Villarreal, A. G. 1975. "On a Stochastic Model to Estimate Tsunami Risk," Journal, Hydraulic Research, Vol 13, No. 4, pp 383-403.

Symons, J. M., and Zetler, B. D. 1960. "The Tsunami of May 22, 1960, as Recorded at Tide Stations," Preliminary Report, U. S. Department of Commerce, Coast and Geodetic Survey, Washington, D. C.

Wanstrath, J. J. 1977 (Sep). "Nearshore Numerical Storm Surge and Tidal Simulation," Technical Report H-77-17, U. S. Army Engineer Waterways Experiment Station, CE, Vicksburg, Miss.

Wiegel, R. L. 1965. "Protection of Crescent City, California, from Tsunami Waves," prepared for the Redevelopment Agency of the City of Crescent City, Berkeley, Calif.

Table 1  
Predicted Elevations (ft) of Seven Historical Tsunamis  
in American Samoa

LOCATION 1	1917 1919 1922 1946 1952 1957 1960	1.0 1.8 1.1 0.8 1.2 0.6 1.8	LOCATION 2	1917 1919 1922 1946 1952 1957 1960	0.8 2.2 1.4 0.9 1.2 0.9 2.2
LOCATION 3	1917 1919 1922 1946 1952 1957 1960	1.0 2.2 1.4 0.9 1.2 0.9 2.3	LOCATION 4	1917 1919 1922 1946 1952 1957 1960	0.8 2.2 1.4 0.9 1.2 0.9 2.2
LOCATION 5	1917 1919 1922 1946 1952 1957 1960	0.8 2.5 1.6 1.0 1.3 1.0 2.5	LOCATION 6	1917 1919 1922 1946 1952 1957 1960	1.0 2.9 1.9 1.2 1.6 1.2 2.9
LOCATION 7	1917 1919 1922 1946 1952 1957 1960	1.5 3.6 2.3 1.4 2.0 1.4 3.6	LOCATION 8	1917 1919 1922 1946 1952 1957 1960	1.6 3.6 2.3 1.4 2.0 1.4 3.7
LOCATION 9	1917 1919 1922 1946 1952 1957 1960	1.7 3.7 2.4 1.5 2.1 1.5 3.7	LOCATION 10	1917 1919 1922 1946 1952 1957 1960	1.7 3.7 2.4 1.5 2.1 1.5 3.8
LOCATION 11	1917 1919 1922 1946 1952 1957 1960	1.8 3.9 2.4 1.5 2.2 1.5 3.9	LOCATION 12	1917 1919 1922 1946 1952 1957 1960	2.1 4.2 2.6 1.7 2.4 1.6 4.3
LOCATION 13	1917 1919 1922 1946 1952 1957 1960	2.5 4.5 2.7 1.8 2.7 1.7 4.6	LOCATION 14	1917 1919 1922 1946 1952 1957 1960	2.6 4.6 2.8 1.9 2.9 1.7 4.7
LOCATION 15	1917 1919 1922 1946 1952 1957 1960	2.9 5.0 3.1 2.0 3.2 1.8 5.1	LOCATION 16	1917 1919 1922 1946 1952 1957 1960	3.8 5.9 3.4 2.4 3.9 2.0 6.1
LOCATION 17	1917 1919 1922 1946 1952 1957 1960	4.0 6.1 3.5 2.5 4.1 2.1 6.3	LOCATION 18	1917 1919 1922 1946 1952 1957 1960	4.3 6.2 3.6 2.7 4.4 2.1 6.6
LOCATION 19	1917 1919 1922 1946 1952 1957 1960	4.4 6.5 3.7 2.7 4.5 2.2 6.7	LOCATION 20	1917 1919 1922 1946 1952 1957 1960	5.2 7.2 4.0 3.1 5.2 2.3 7.6
LOCATION 21	1917 1919 1922 1946 1952 1957 1960	5.8 7.7 4.3 3.4 5.7 2.5 8.3	LOCATION 22	1917 1919 1922 1946 1952 1957 1960	6.4 8.4 4.6 3.7 6.3 2.6 8.9
LOCATION 23	1917 1919 1922 1946 1952 1957 1960	7.1 9.0 4.8 3.9 6.9 2.7 9.6	LOCATION 24	1917 1919 1922 1946 1952 1957 1960	7.0 8.9 4.8 3.9 6.8 2.7 9.5
LOCATION 25	1917 1919 1922 1946 1952 1957 1960	7.1 9.0 4.8 3.9 6.9 2.7 9.6	LOCATION 26	1917 1919 1922 1946 1952 1957 1960	6.6 8.5 4.6 3.7 6.4 2.6 9.0
LOCATION 27	1917 1919 1922 1946 1952 1957 1960	5.7 7.7 4.2 3.3 5.6 2.4 8.1	LOCATION 28	1917 1919 1922 1946 1952 1957 1960	4.8 6.8 3.8 2.9 4.8 2.2 7.1
LOCATION 29	1917 1919 1922 1946 1952 1957 1960	4.1 6.1 3.6 2.6 4.2 2.1 6.5	LOCATION 30	1917 1919 1922 1946 1952 1957 1960	3.6 5.7 3.3 2.3 3.8 2.0 5.9
LOCATION 31	1917 1919 1922 1946 1952 1957 1960	3.4 5.5 3.2 2.3 3.6 1.9 5.7	LOCATION 32	1917 1919 1922 1946 1952 1957 1960	3.3 5.3 3.2 2.2 3.5 1.9 5.5
LOCATION 33	1917 1919 1922 1946 1952 1957 1960	2.8 4.8 2.9 1.9 3.1 1.8 4.9	LOCATION 34	1917 1919 1922 1946 1952 1957 1960	2.4 4.4 2.7 1.8 2.7 1.7 4.5
LOCATION 35	1917 1919 1922 1946 1952 1957 1960	2.0 4.0 2.5 1.6 2.3 1.5 4.1	LOCATION 36	1917 1919 1922 1946 1952 1957 1960	1.7 3.8 2.4 1.5 2.2 1.5 3.8
LOCATION 37	1917 1919 1922 1946 1952 1957 1960	1.7 3.8 2.4 1.5 2.1 1.5 3.8	LOCATION 38	1917 1919 1922 1946 1952 1957 1960	1.7 3.7 2.4 1.5 2.1 1.5 3.8
LOCATION 39	1917 1919 1922 1946 1952 1957 1960	1.7 3.8 2.4 1.5 2.1 1.5 3.8	LOCATION 40	1917 1919 1922 1946 1952 1957 1960	1.6 3.7 2.4 1.5 2.0 1.5 3.7
LOCATION 41	1917 1919 1922 1946 1952 1957 1960	1.5 3.6 2.3 1.4 2.0 1.4 3.6	LOCATION 42	1917 1919 1922 1946 1952 1957 1960	1.4 3.5 2.2 1.3 1.8 1.3 3.4

(Continued)

(Sheet 1 of 4)



Table 1 (Continued)

LOCATION 43	1917 1.2	1919 3.2	1922 2.1	1946 1.2	1952 1.7	1957 1.3	1960 3.1	LOCATION 44	1917 1.0	1919 2.9	1922 1.9	1946 1.2	1952 1.6	1957 1.2	1960 2.9
LOCATION 45	1917 1.4	1919 2.8	1922 1.8	1946 1.1	1952 1.4	1957 1.1	1960 2.8	LOCATION 46	1917 0.8	1919 2.4	1922 1.6	1946 1.0	1952 1.3	1957 1.0	1960 2.4
LOCATION 47	1917 0.6	1919 2.2	1922 1.4	1946 0.9	1952 1.2	1957 0.9	1960 2.2	LOCATION 48	1917 1.2	1919 1.9	1922 1.2	1946 0.8	1952 1.3	1957 0.7	1960 2.0
LOCATION 49	1917 2.1	1919 2.7	1922 0.9	1946 1.1	1952 2.0	1957 1.4	1960 2.4	LOCATION 50	1917 2.5	1919 2.3	1922 1.0	1946 1.2	1952 2.2	1957 0.4	1960 2.7
LOCATION 51	1917 2.7	1919 2.6	1922 1.1	1946 1.3	1952 2.5	1957 1.4	1960 2.9	LOCATION 52	1917 2.8	1919 2.7	1922 1.1	1946 1.3	1952 2.6	1957 0.4	1960 3.0
LOCATION 53	1917 3.3	1919 3.1	1922 1.2	1946 1.6	1952 3.1	1957 1.5	1960 3.6	LOCATION 54	1917 3.4	1919 3.2	1922 1.3	1946 1.6	1952 3.1	1957 0.5	1960 3.7
LOCATION 55	1917 2.9	1919 2.8	1922 1.2	1946 1.4	1952 2.7	1957 1.4	1960 3.1	LOCATION 56	1917 2.7	1919 1.9	1922 0.8	1946 1.0	1952 1.8	1957 0.3	1960 2.2
LOCATION 57	1917 1.2	1919 1.2	1922 0.5	1946 0.6	1952 1.2	1957 0.2	1960 1.3	LOCATION 58	1917 0.8	1919 1.0	1922 0.4	1946 0.5	1952 1.0	1957 0.3	1960 1.0
LOCATION 59	1917 0.5	1919 0.9	1922 0.4	1946 0.6	1952 1.0	1957 1.3	1960 0.8	LOCATION 60	1917 0.3	1919 1.1	1922 0.4	1946 0.8	1952 1.0	1957 0.4	1960 1.7
LOCATION 61	1917 1.5	1919 1.3	1922 0.5	1946 1.1	1952 1.2	1957 0.5	1960 0.9	LOCATION 62	1917 0.6	1919 1.5	1922 0.5	1946 1.2	1952 1.3	1957 0.5	1960 0.9
LOCATION 63	1917 1.7	1919 1.5	1922 0.6	1946 1.3	1952 1.4	1957 0.6	1960 0.9	LOCATION 64	1917 0.7	1919 1.5	1922 0.6	1946 1.2	1952 1.3	1957 0.5	1960 0.9
LOCATION 65	1917 1.7	1919 1.5	1922 0.5	1946 1.2	1952 1.3	1957 0.5	1960 0.9	LOCATION 66	1917 0.8	1919 1.6	1922 0.6	1946 1.3	1952 1.4	1957 0.6	1960 0.9
LOCATION 67	1917 1.6	1919 1.5	1922 0.5	1946 1.2	1952 1.3	1957 0.5	1960 0.9	LOCATION 68	1917 0.7	1919 1.5	1922 0.5	1946 1.2	1952 1.3	1957 0.5	1960 1.9
LOCATION 69	1917 1.8	1919 1.6	1922 0.6	1946 1.4	1952 1.4	1957 0.6	1960 0.9	LOCATION 70	1917 0.7	1919 1.5	1922 0.6	1946 1.2	1952 1.3	1957 0.5	1960 1.9
LOCATION 71	1917 1.8	1919 1.6	1922 0.6	1946 1.3	1952 1.4	1957 0.6	1960 0.9	LOCATION 72	1917 0.7	1919 1.5	1922 0.6	1946 1.2	1952 1.3	1957 0.5	1960 1.9
LOCATION 73	1917 1.7	1919 1.5	1922 0.6	1946 1.3	1952 1.3	1957 0.6	1960 0.9	LOCATION 74	1917 0.6	1919 1.4	1922 0.5	1946 1.2	1952 1.2	1957 0.5	1960 1.9
LOCATION 75	1917 1.4	1919 1.2	1922 0.4	1946 0.9	1952 1.0	1957 0.4	1960 0.8	LOCATION 76	1917 0.3	1919 1.2	1922 0.5	1946 1.0	1952 1.0	1957 0.5	1960 1.8
LOCATION 77	1917 0.3	1919 1.2	1922 0.5	1946 1.0	1952 1.0	1957 0.5	1960 0.8	LOCATION 78	1917 0.3	1919 1.2	1922 0.5	1946 0.9	1952 1.0	1957 0.4	1960 1.8
LOCATION 79	1917 0.3	1919 1.2	1922 0.5	1946 0.9	1952 1.0	1957 0.5	1960 0.8	LOCATION 80	1917 0.3	1919 1.2	1922 0.5	1946 1.0	1952 1.0	1957 0.5	1960 1.8
LOCATION 81	1917 1.4	1919 1.2	1922 0.5	1946 1.1	1952 1.0	1957 0.5	1960 0.9	LOCATION 82	1917 0.5	1919 1.3	1922 0.6	1946 1.2	1952 1.1	1957 0.6	1960 1.9
LOCATION 83	1917 1.6	1919 1.5	1922 0.7	1946 1.4	1952 1.2	1957 1.0	1960 1.1	LOCATION 84	1917 0.6	1919 1.4	1922 0.7	1946 1.3	1952 1.2	1957 0.6	1960 1.0

(Continued)

(Sheet 2 of 4)

Table 1 (Continued)

LOCATION 85	1917	1919	1922	1946	1952	1957	1960	LOCATION 86	1917	1919	1922	1946	1952	1957	1960
	0.6	1.5	0.7	1.4	1.2	0.7	1.1		0.6	1.5	0.7	1.4	1.2	0.7	1.0
LOCATION 87	1917	1919	1922	1946	1952	1957	1960	LOCATION 88	1917	1919	1922	1946	1952	1957	1960
	0.4	1.3	0.6	1.3	1.1	0.6	0.9		0.3	1.2	0.6	1.2	1.0	0.6	1.9
LOCATION 89	1917	1919	1922	1946	1952	1957	1960	LOCATION 90	1917	1919	1922	1946	1952	1957	1960
	0.3	1.2	0.5	1.1	1.0	0.5	0.8		0.3	1.1	0.5	0.9	1.0	0.5	0.7
LOCATION 91	1917	1919	1922	1946	1952	1957	1960	LOCATION 92	1917	1919	1922	1946	1952	1957	1960
	0.3	1.0	0.4	0.9	0.9	0.4	0.7		0.3	0.9	0.4	0.7	0.8	0.4	0.7
LOCATION 93	1917	1919	1922	1946	1952	1957	1960	LOCATION 94	1917	1919	1922	1946	1952	1957	1960
	0.8	1.1	0.5	0.7	1.0	0.3	1.1		1.3	1.2	0.6	0.7	1.2	0.3	1.5
LOCATION 95	1917	1919	1922	1946	1952	1957	1960	LOCATION 96	1917	1919	1922	1946	1952	1957	1960
	1.7	1.6	0.7	0.7	1.6	0.2	2.1		2.5	2.3	1.0	1.0	2.3	0.2	2.9
LOCATION 97	1917	1919	1922	1946	1952	1957	1960	LOCATION 98	1917	1919	1922	1946	1952	1957	1960
	3.9	3.5	1.4	1.4	2.5	0.4	4.5		4.4	3.9	1.6	1.6	4.0	0.4	5.0
LOCATION 99	1917	1919	1922	1946	1952	1957	1960	LOCATION 100	1917	1919	1922	1946	1952	1957	1960
	5.2	4.6	1.9	1.9	4.8	0.5	6.0		4.5	4.0	1.6	1.6	4.1	0.4	5.1
LOCATION 101	1917	1919	1922	1946	1952	1957	1960	LOCATION 102	1917	1919	1922	1946	1952	1957	1960
	4.3	3.8	1.6	1.6	3.9	0.4	4.9		2.2	2.0	0.8	0.9	2.0	0.3	2.6
LOCATION 103	1917	1919	1922	1946	1952	1957	1960	LOCATION 104	1917	1919	1922	1946	1952	1957	1960
	0.7	0.6	0.3	0.4	0.7	0.2	0.9		0.6	0.5	0.3	0.4	0.7	0.2	0.8
LOCATION 105	1917	1919	1922	1946	1952	1957	1960	LOCATION 106	1917	1919	1922	1946	1952	1957	1960
	0.3	0.4	0.2	0.3	0.5	0.2	0.5		0.1	0.3	0.2	0.3	0.4	0.2	0.4
LOCATION 107	1917	1919	1922	1946	1952	1957	1960	LOCATION 108	1917	1919	1922	1946	1952	1957	1960
	0.1	0.3	0.2	0.3	0.4	0.2	0.4		0.3	0.4	0.2	0.3	0.5	0.2	0.5
LOCATION 109	1917	1919	1922	1946	1952	1957	1960	LOCATION 110	1917	1919	1922	1946	1952	1957	1960
	0.5	0.5	0.3	0.4	0.6	0.2	0.7		1.0	1.1	0.5	0.6	1.0	0.3	1.1
LOCATION 111	1917	1919	1922	1946	1952	1957	1960	LOCATION 112	1917	1919	1922	1946	1952	1957	1960
	0.5	0.5	0.3	0.4	0.7	0.2	0.7		0.4	0.5	0.3	0.4	0.6	0.2	0.6
LOCATION 113	1917	1919	1922	1946	1952	1957	1960	LOCATION 114	1917	1919	1922	1946	1952	1957	1960
	0.6	0.8	0.4	0.5	0.8	0.3	0.9		0.8	0.9	0.4	0.5	0.9	0.2	1.9
LOCATION 115	1917	1919	1922	1946	1952	1957	1960	LOCATION 116	1917	1919	1922	1946	1952	1957	1960
	0.2	0.3	0.1	0.2	0.3	0.1	0.2		0.2	0.2	0.1	0.3	0.3	0.1	0.2
LOCATION 117	1917	1919	1922	1946	1952	1957	1960	LOCATION 118	1917	1919	1922	1946	1952	1957	1960
	0.2	0.2	0.1	0.2	0.3	0.1	0.2		0.2	0.2	0.1	0.2	0.3	0.1	0.2
LOCATION 119	1917	1919	1922	1946	1952	1957	1960	LOCATION 120	1917	1919	1922	1946	1952	1957	1960
	0.1	0.3	0.1	0.2	0.3	0.1	0.2		0.1	0.3	0.1	0.2	0.3	0.1	0.2
LOCATION 121	1917	1919	1922	1946	1952	1957	1960	LOCATION 122	1917	1919	1922	1946	1952	1957	1960
	0.1	0.3	0.1	0.2	0.3	0.1	0.2		0.1	0.4	0.1	0.2	0.3	0.1	0.2
LOCATION 123	1917	1919	1922	1946	1952	1957	1960	LOCATION 124	1917	1919	1922	1946	1952	1957	1960
	0.2	0.4	0.1	0.2	0.4	0.1	0.3		0.2	0.4	0.1	0.2	0.3	0.1	0.3
LOCATION 125	1917	1919	1922	1946	1952	1957	1960	LOCATION 126	1917	1919	1922	1946	1952	1957	1960
	0.2	0.4	0.1	0.2	0.3	0.1	0.3		0.3	0.3	0.1	0.2	0.3	0.1	0.3

(Concluded)

(Sheet 3 of 4)

Table 1 (Concluded)

LOCATION 127	1917 .3	1919 .3	1922 7.1	1946 0.2	1952 0.3	1957 0.1	1960 0.2	LOCATION 128	1917 0.1	1919 0.1	1922 0.1	1946 0.2	1952 0.2	1957 0.1	1960 0.1
LOCATION 129	1917 .1	1919 0.1	1922 7.1	1946 0.2	1952 0.1	1957 0.1	1960 0.1	LOCATION 130	1917 0.1	1919 0.1	1922 0.1	1946 0.2	1952 0.1	1957 0.1	1960 0.1
LOCATION 131	1917 0.1	1919 0.1	1922 0.1	1946 0.2	1952 0.1	1957 0.1	1960 0.1	LOCATION 132	1917 0.1	1919 0.1	1922 0.0	1946 0.1	1952 0.1	1957 0.1	1960 0.2
LOCATION 133	1917 .1	1919 0.2	1922 0.1	1946 0.2	1952 0.2	1957 0.1	1960 0.2	LOCATION 134	1917 0.1	1919 0.3	1922 0.1	1946 0.2	1952 0.2	1957 0.1	1960 0.2
LOCATION 135	1917 .1	1919 .3	1922 0.1	1946 0.2	1952 0.2	1957 0.1	1960 0.2	LOCATION 136	1917 0.1	1919 0.3	1922 0.1	1946 0.2	1952 0.2	1957 0.1	1960 0.2
LOCATION 137	1917 0.1	1919 0.3	1922 0.1	1946 0.2	1952 0.2	1957 0.1	1960 0.2	LOCATION 138	1917 0.1	1919 0.3	1922 0.1	1946 0.2	1952 0.2	1957 0.1	1960 0.2
LOCATION 139	1917 .1	1919 .3	1922 0.1	1946 0.2	1952 0.2	1957 0.1	1960 0.2	LOCATION 140	1917 0.1	1919 0.3	1922 0.1	1946 0.2	1952 0.2	1957 0.1	1960 0.2
LOCATION 141	1917 .1	1919 0.2	1922 0.1	1946 0.2	1952 0.2	1957 0.1	1960 0.2	LOCATION 142	1917 0.1	1919 0.2	1922 0.1	1946 0.2	1952 0.2	1957 0.1	1960 0.2
LOCATION 143	1917 .1	1919 0.1	1922 0.1	1946 0.2	1952 0.2	1957 0.1	1960 0.1	LOCATION 144	1917 0.1	1919 0.1	1922 0.1	1946 0.2	1952 0.2	1957 0.1	1960 0.1

Table 2  
Historical and 100-yr Tsunami Elevations (ft) Including Astronomical Tide Effects

LOCATION 1	1917 2.8	1919 3.0	1922 2.6	1946 2.3	1952 2.5	1957 2.3	1960 3.0	1917 2.8	1919 3.0	1922 2.6	1946 2.3	1952 2.5	1957 2.3	1960 3.0	A	B
LOCATION 3	1917 2.3	1919 3.0	1922 2.6	1946 2.3	1952 2.5	1957 2.4	1960 3.0	1917 2.3	1919 3.0	1922 2.6	1946 2.3	1952 2.5	1957 2.4	1960 3.0	A	B
LOCATION 5	1917 2.7	1919 3.0	1922 2.6	1946 2.5	1952 2.5	1957 2.5	1960 3.4	1917 2.4	1919 3.0	1922 2.6	1946 2.5	1952 2.5	1957 2.5	1960 3.4	A	B
LOCATION 7	1917 2.7	1919 3.7	1922 3.1	1946 2.6	1952 2.9	1957 2.6	1960 3.8	1917 2.7	1919 3.7	1922 3.1	1946 2.6	1952 2.9	1957 2.6	1960 3.8	A	B
LOCATION 9	1917 2.9	1919 3.8	1922 3.1	1946 2.6	1952 3.0	1957 2.6	1960 3.8	1917 2.9	1919 3.8	1922 3.1	1946 2.6	1952 3.0	1957 2.6	1960 3.8	A	B
LOCATION 11	1917 2.9	1919 4.2	1922 3.2	1946 2.7	1952 3.1	1957 2.7	1960 4.3	1917 2.9	1919 4.2	1922 3.2	1946 2.7	1952 3.1	1957 2.7	1960 4.3	A	B
LOCATION 13	1917 3.1	1919 4.6	1922 3.2	1946 2.8	1952 3.3	1957 2.7	1960 4.7	1917 3.2	1919 4.6	1922 3.2	1946 2.8	1952 3.3	1957 2.7	1960 4.7	A	B
LOCATION 15	1917 3.4	1919 5.0	1922 3.6	1946 3.1	1952 3.9	1957 2.9	1960 6.1	1917 3.8	1919 5.0	1922 3.6	1946 3.1	1952 3.9	1957 2.9	1960 6.1	A	B
LOCATION 17	1917 4.1	1919 6.2	1922 3.7	1946 3.2	1952 4.4	1957 3.0	1960 6.6	1917 4.3	1919 6.2	1922 3.7	1946 3.2	1952 4.4	1957 3.0	1960 6.6	A	B
LOCATION 19	1917 4.4	1919 7.2	1922 4.0	1946 3.4	1952 5.0	1957 3.1	1960 7.6	1917 5.2	1919 7.2	1922 4.0	1946 3.4	1952 5.0	1957 3.1	1960 7.6	A	B
LOCATION 21	1917 5.1	1919 6.4	1922 4.6	1946 3.7	1952 6.3	1957 3.2	1960 8.9	1917 6.4	1919 6.4	1922 4.6	1946 3.7	1952 6.3	1957 3.2	1960 8.9	A	B

(Continued)

(Sheet 1 of 6)

Table 2 (Continued)

LOCATION 23	1917 1919 1922 1946 1952 1957 1960	A	F	1917 1919 1922 1946 1952 1957 1960	A	B
	7.0 4.8 4.8 4.8 4.8 4.8 4.8	7.0	4.8	4.8 4.8 4.8 4.8 4.8 4.8	7.0	4.8
LOCATION 25	1917 1919 1922 1946 1952 1957 1960	A	F	1917 1919 1922 1946 1952 1957 1960	A	B
	7.0 4.8 4.8 4.8 4.8 4.8 4.8	7.0	4.8	4.8 4.8 4.8 4.8 4.8 4.8	7.0	4.8
LOCATION 27	1917 1919 1922 1946 1952 1957 1960	A	F	1917 1919 1922 1946 1952 1957 1960	A	B
	5.0 4.8 4.8 4.8 4.8 4.8 4.8	5.0	4.8	4.8 4.8 4.8 4.8 4.8 4.8	5.0	4.8
LOCATION 29	1917 1919 1922 1946 1952 1957 1960	A	F	1917 1919 1922 1946 1952 1957 1960	A	B
	4.0 3.1 3.1 3.1 3.1 3.1 3.1	4.0	3.1	3.1 3.1 3.1 3.1 3.1 3.1	4.0	3.1
LOCATION 31	1917 1919 1922 1946 1952 1957 1960	A	F	1917 1919 1922 1946 1952 1957 1960	A	B
	3.0 3.0 3.0 3.0 3.0 3.0 3.0	3.0	3.0	3.0 3.0 3.0 3.0 3.0 3.0	3.0	3.0
LOCATION 33	1917 1919 1922 1946 1952 1957 1960	A	F	1917 1919 1922 1946 1952 1957 1960	A	B
	3.0 3.0 3.0 3.0 3.0 3.0 3.0	3.0	3.0	3.0 3.0 3.0 3.0 3.0 3.0	3.0	3.0
LOCATION 35	1917 1919 1922 1946 1952 1957 1960	A	F	1917 1919 1922 1946 1952 1957 1960	A	B
	2.0 2.0 2.0 2.0 2.0 2.0 2.0	2.0	2.0	2.0 2.0 2.0 2.0 2.0 2.0	2.0	2.0
LOCATION 37	1917 1919 1922 1946 1952 1957 1960	A	F	1917 1919 1922 1946 1952 1957 1960	A	B
	2.0 2.0 2.0 2.0 2.0 2.0 2.0	2.0	2.0	2.0 2.0 2.0 2.0 2.0 2.0	2.0	2.0
LOCATION 39	1917 1919 1922 1946 1952 1957 1960	A	F	1917 1919 1922 1946 1952 1957 1960	A	B
	2.0 2.0 2.0 2.0 2.0 2.0 2.0	2.0	2.0	2.0 2.0 2.0 2.0 2.0 2.0	2.0	2.0
LOCATION 41	1917 1919 1922 1946 1952 1957 1960	A	F	1917 1919 1922 1946 1952 1957 1960	A	B
	2.0 2.0 2.0 2.0 2.0 2.0 2.0	2.0	2.0	2.0 2.0 2.0 2.0 2.0 2.0	2.0	2.0
LOCATION 43	1917 1919 1922 1946 1952 1957 1960	A	F	1917 1919 1922 1946 1952 1957 1960	A	B
	2.0 2.0 2.0 2.0 2.0 2.0 2.0	2.0	2.0	2.0 2.0 2.0 2.0 2.0 2.0	2.0	2.0
LOCATION 45	1917 1919 1922 1946 1952 1957 1960	A	F	1917 1919 1922 1946 1952 1957 1960	A	B
	2.0 2.0 2.0 2.0 2.0 2.0 2.0	2.0	2.0	2.0 2.0 2.0 2.0 2.0 2.0	2.0	2.0

(Continued)

Table 2 (Continued)

LOCATION 47	1917 1.0 2.0	1922 1.0 1.0	1946 2.0 2.0	1952 2.5 2.5	1957 2.5 2.5	1960 3.0 3.0	LOCATION 48	1917 1919 1922 1946 1952 1957 1960 2.5 2.0 2.5 2.3 2.5 2.2 2.9	A B -1.3 3.2	0.8 -1.4 3.0
LOCATION 49	1917 1.0 2.0	1922 1.0 1.0	1946 2.0 2.0	1952 2.5 2.5	1957 2.5 2.5	1960 3.0 3.0	LOCATION 50	1917 1917 1922 1946 1952 1957 1960 3.1 3.1 2.0 2.5 3.0 2.1 3.2	A B 1.2 3.4	1.3 -1.0 3.6
LOCATION 51	1917 1.0 3.0	1922 1.0 1.0	1946 2.0 2.0	1952 2.5 2.5	1957 2.5 2.5	1960 3.0 3.0	LOCATION 52	1917 1919 1922 1946 1952 1957 1960 3.5 3.2 2.5 2.6 3.2 2.1 3.4	A B 1.3 3.8	1.5 -0.9 3.8
LOCATION 53	1917 1.0 3.0	1922 1.0 1.0	1946 2.0 2.0	1952 2.5 2.5	1957 2.5 2.5	1960 3.0 3.0	LOCATION 54	1917 1919 1922 1946 1952 1957 1960 3.6 3.5 2.5 2.7 3.5 2.1 3.8	A B 1.0 4.2	1.8 -0.6 4.2
LOCATION 55	1917 1.0 3.0	1922 1.0 1.0	1946 2.0 2.0	1952 2.5 2.5	1957 2.5 2.5	1960 3.0 3.0	LOCATION 56	1917 1919 1922 1946 1952 1957 1960 2.9 2.8 2.3 2.4 2.8 2.1 3.0	A B 1.0 3.3	1.0 -1.2 3.3
LOCATION 57	1917 1.0 2.0	1922 1.0 1.0	1946 2.0 2.0	1952 2.5 2.5	1957 2.5 2.5	1960 3.0 3.0	LOCATION 58	1917 1919 1922 1946 1952 1957 1960 2.3 2.4 2.1 2.2 2.4 2.0 2.4	A B 1.0 2.5	0.5 -1.6 2.5
LOCATION 59	1917 1.0 2.0	1922 1.0 1.0	1946 2.0 2.0	1952 2.5 2.5	1957 2.5 2.5	1960 3.0 3.0	LOCATION 60	1917 1919 1922 1946 1952 1957 1960 2.2 2.4 2.1 2.3 2.4 2.1 2.2	A B 1.0 2.5	0.5 -1.6 2.5
LOCATION 61	1917 1.0 2.0	1922 1.0 1.0	1946 2.0 2.0	1952 2.5 2.5	1957 2.5 2.5	1960 3.0 3.0	LOCATION 62	1917 1919 1922 1946 1952 1957 1960 2.2 2.7 2.2 2.5 2.5 2.2 2.3	A B 1.0 2.8	0.6 -1.5 2.8
LOCATION 63	1917 1.0 2.0	1922 1.0 1.0	1946 2.0 2.0	1952 2.5 2.5	1957 2.5 2.5	1960 3.0 3.0	LOCATION 64	1917 1919 1922 1946 1952 1957 1960 2.2 2.7 2.2 2.5 2.5 2.2 2.3	A B 1.0 2.8	0.6 -1.5 2.8
LOCATION 65	1917 1.0 2.0	1922 1.0 1.0	1946 2.0 2.0	1952 2.5 2.5	1957 2.5 2.5	1960 3.0 3.0	LOCATION 66	1917 1919 1922 1946 1952 1957 1960 2.3 2.7 2.2 2.6 2.6 2.2 2.4	A B 1.0 2.8	0.7 -1.5 2.8
LOCATION 67	1917 1.0 2.0	1922 1.0 1.0	1946 2.0 2.0	1952 2.5 2.5	1957 2.5 2.5	1960 3.0 3.0	LOCATION 68	1917 1919 1922 1946 1952 1957 1960 2.2 2.7 2.2 2.5 2.5 2.2 2.3	A B 1.0 2.8	0.6 -1.5 2.8
LOCATION 69	1917 1.0 2.0	1922 1.0 1.0	1946 2.0 2.0	1952 2.5 2.5	1957 2.5 2.5	1960 3.0 3.0	LOCATION 70	1917 1919 1922 1946 1952 1957 1960 2.2 2.7 2.2 2.5 2.5 2.2 2.4	A B 1.0 2.8	0.6 -1.5 2.8

(Continued)

Table 2 (Continued)

LOCATION 71	1917 1919 1922 1946 1952 1957 1960 2.7 2.7 2.2 2.6 2.6 2.2 2.4	A B 1.0 -1.5 2.8	LOCATION 72	1917 1919 1922 1946 1952 1957 1960 2.2 2.7 2.2 2.5 2.5 2.2 2.3	A B 1.0 0.6 -1.5 2.8
LOCATION 73	1917 1919 1922 1946 1952 1957 1960 2.0 2.7 2.6 2.6 2.5 2.2 2.4	A B 1.0 -1.5 2.6	LOCATION 74	1917 1919 1922 1946 1952 1957 1960 2.2 2.6 2.2 2.5 2.5 2.2 2.3	A B 1.0 0.6 -1.5 2.7
LOCATION 75	1917 1919 1922 1946 1952 1957 1960 2.1 2.6 2.1 2.4 2.4 2.1 2.3	A B 1.0 -1.5 2.6	LOCATION 76	1917 1919 1922 1946 1952 1957 1960 2.1 2.5 2.1 2.4 2.4 2.1 2.3	A B 1.0 0.5 -1.5 2.6
LOCATION 77	1917 1919 1922 1946 1952 1957 1960 2.1 2.6 2.1 2.4 2.4 2.1 2.3	A B 1.0 -1.5 2.6	LOCATION 78	1917 1919 1922 1946 1952 1957 1960 2.1 2.5 2.1 2.4 2.4 2.1 2.3	A B 1.0 0.5 -1.5 2.6
LOCATION 79	1917 1919 1922 1946 1952 1957 1960 2.1 2.6 2.1 2.4 2.4 2.1 2.3	A B 1.0 -1.5 2.6	LOCATION 80	1917 1919 1922 1946 1952 1957 1960 2.1 2.5 2.1 2.4 2.4 2.1 2.3	A B 1.0 0.5 -1.5 2.6
LOCATION 81	1917 1919 1922 1946 1952 1957 1960 2.1 2.6 2.1 2.4 2.4 2.1 2.3	A B 1.0 -1.5 2.6	LOCATION 82	1917 1919 1922 1946 1952 1957 1960 2.1 2.5 2.1 2.4 2.4 2.1 2.3	A B 1.0 0.5 -1.5 2.6
LOCATION 83	1917 1919 1922 1946 1952 1957 1960 2.1 2.6 2.1 2.4 2.4 2.1 2.3	A B 1.0 -1.5 2.6	LOCATION 84	1917 1919 1922 1946 1952 1957 1960 2.1 2.5 2.1 2.4 2.4 2.1 2.3	A B 1.0 0.5 -1.5 2.6
LOCATION 85	1917 1919 1922 1946 1952 1957 1960 2.1 2.6 2.1 2.4 2.4 2.1 2.3	A B 1.0 -1.5 2.6	LOCATION 86	1917 1919 1922 1946 1952 1957 1960 2.1 2.5 2.1 2.4 2.4 2.1 2.3	A B 1.0 0.5 -1.5 2.6
LOCATION 87	1917 1919 1922 1946 1952 1957 1960 2.1 2.6 2.1 2.4 2.4 2.1 2.3	A B 1.0 -1.5 2.6	LOCATION 88	1917 1919 1922 1946 1952 1957 1960 2.1 2.5 2.1 2.4 2.4 2.1 2.3	A B 1.0 0.5 -1.5 2.6
LOCATION 89	1917 1919 1922 1946 1952 1957 1960 2.1 2.6 2.1 2.4 2.4 2.1 2.3	A B 1.0 -1.5 2.6	LOCATION 90	1917 1919 1922 1946 1952 1957 1960 2.1 2.5 2.1 2.4 2.4 2.1 2.3	A B 1.0 0.5 -1.5 2.6
LOCATION 91	1917 1919 1922 1946 1952 1957 1960 2.1 2.6 2.1 2.4 2.4 2.1 2.3	A B 1.0 -1.5 2.6	LOCATION 92	1917 1919 1922 1946 1952 1957 1960 2.1 2.5 2.1 2.4 2.4 2.1 2.3	A B 1.0 0.5 -1.5 2.6
LOCATION 93	1917 1919 1922 1946 1952 1957 1960 2.1 2.6 2.1 2.4 2.4 2.1 2.3	A B 1.0 -1.5 2.6	LOCATION 94	1917 1919 1922 1946 1952 1957 1960 2.1 2.5 2.1 2.4 2.4 2.1 2.3	A B 1.0 0.5 -1.5 2.6

(Continued)

Table 2 (Continued)

LOCATION 95	1917 1919 1922 1946 1952 1957 1960	A	B	1917 1919 1922 1946 1952 1957 1960	A	B
	2.7 3.7 2.7 2.9 2.7 2.7 2.9	1.0	-1.1 1.2	3.2 3.1 2.4 2.4 2.4 3.1 2.0 3.4	1.5	-0.7 3.7
LOCATION 97	1917 1919 1922 1946 1952 1957 1960	A	B	1917 1919 1922 1946 1952 1957 1960	A	B
	4.1 4.5 3.2 2.8 3.7 2.1 4.5	2.7	4.4 5.0	4.4 3.9 2.7 2.7 4.5 2.1 5.0	3.4	1.1 5.7
LOCATION 99	1917 1919 1922 1946 1952 1957 1960	A	B	1917 1919 1922 1946 1952 1957 1960	A	B
	5.7 4.5 3.5 2.8 4.8 2.1 6.1	4.5	2.2 6.8	4.5 4.0 2.7 2.7 4.1 2.1 5.1	3.5	1.2 5.8
LOCATION 101	1917 1919 1922 1946 1952 1957 1960	A	F	1917 1919 1922 1946 1952 1957 1960	A	B
	4.3 3.6 2.7 2.5 3.6 2.1 4.9	3.2	1.0 5.6	3.5 2.9 2.3 2.3 2.9 2.0 3.2	1.3	-0.9 3.5
LOCATION 103	1917 1919 1922 1946 1952 1957 1960	A	B	1917 1919 1922 1946 1952 1957 1960	A	B
	2.2 2.7 2.1 2.1 2.1 2.1 2.3	1.4	-1.6 2.4	2.2 2.2 2.1 2.1 2.2 2.0 2.3	0.3	-1.7 2.3
LOCATION 105	1917 1919 1922 1946 1952 1957 1960	A	B	1917 1919 1922 1946 1952 1957 1960	A	B
	2.0 2.1 2.0 2.1 2.1 2.1 2.1	1.2	-1.5 2.2	2.3 2.2 2.1 2.1 2.1 2.0 2.1	0.2	-1.8 2.1
LOCATION 107	1917 1919 1922 1946 1952 1957 1960	A	B	1917 1919 1922 1946 1952 1957 1960	A	B
	2.0 2.0 2.0 2.1 2.1 2.1 2.1	1.3	-1.5 2.1	2.0 2.1 2.0 2.1 2.1 2.0 2.1	0.2	-1.8 2.2
LOCATION 109	1917 1919 1922 1946 1952 1957 1960	A	B	1917 1919 1922 1946 1952 1957 1960	A	B
	2.1 2.1 2.0 2.1 2.1 2.1 2.2	1.8	-1.8 2.3	2.4 2.4 2.2 2.2 2.4 2.0 2.5	0.5	-1.5 2.6
LOCATION 111	1917 1919 1922 1946 1952 1957 1960	A	B	1917 1919 1922 1946 1952 1957 1960	A	B
	2.1 2.0 2.1 2.1 2.1 2.1 2.2	1.2	-1.6 2.2	2.1 2.2 2.0 2.1 2.2 2.0 2.2	0.2	-1.8 2.3
LOCATION 113	1917 1919 1922 1946 1952 1957 1960	A	F	1917 1919 1922 1946 1952 1957 1960	A	B
	2.2 2.2 2.1 2.1 2.1 2.1 2.3	1.3	-1.7 2.4	2.3 2.3 2.1 2.2 2.3 2.0 2.4	0.4	-1.7 2.5
LOCATION 115	1917 1919 1922 1946 1952 1957 1960	A	B	1917 1919 1922 1946 1952 1957 1960	A	B
	3.0 3.1 2.8 3.0 2.9 3.0 3.2	2.8	-2.6 3.1	3.0 3.0 2.9 3.1 3.1 2.9 3.0	0.2	-2.7 3.1
LOCATION 117	1917 1919 1922 1946 1952 1957 1960	A	B	1917 1919 1922 1946 1952 1957 1960	A	B
	3.0 3.0 2.8 3.0 2.9 3.0 3.1	2.7	-2.7 3.1	3.0 3.0 2.9 3.0 3.1 2.9 3.0	0.2	-2.7 3.1

(Concluded)



Table 2 (Concluded)

LOCATION 119	1917 1919 1922 1946 1952 1957 1960 2.9 3.1 2.9 3.0 3.1 2.9 3.0	1917 1919 1922 1946 1952 1957 1960 2.9 3.1 2.9 3.0 3.1 2.9 3.0	A B 0.2 -2.7 3.1
LOCATION 121	1917 1919 1922 1946 1952 1957 1960 2.9 3.1 2.9 3.0 3.1 2.9 3.0	1917 1919 1922 1946 1952 1957 1960 2.9 3.1 2.9 3.0 3.1 2.9 3.0	A B 0.3 -2.6 3.2
LOCATION 123	1917 1919 1922 1946 1952 1957 1960 3.1 3.2 2.9 3.0 3.1 2.9 3.1	1917 1919 1922 1946 1952 1957 1960 3.1 3.2 2.9 3.0 3.1 2.9 3.1	A B 0.3 -2.6 3.2
LOCATION 125	1917 1919 1922 1946 1952 1957 1960 3.1 3.1 2.9 3.0 3.1 2.9 3.1	1917 1919 1922 1946 1952 1957 1960 3.1 3.1 2.9 3.0 3.1 2.9 3.1	A B 0.3 -2.7 3.2
LOCATION 127	1917 1919 1922 1946 1952 1957 1960 3.1 3.1 2.9 3.0 3.1 2.9 3.1	1917 1919 1922 1946 1952 1957 1960 3.1 3.1 2.9 3.0 3.1 2.9 3.1	A B 0.3 -2.7 3.2
LOCATION 129	1917 1919 1922 1946 1952 1957 1960 2.9 3.0 2.9 3.0 3.1 2.9 3.0	1917 1919 1922 1946 1952 1957 1960 2.9 3.0 2.9 3.0 3.1 2.9 3.0	A B 0.2 -2.7 3.0
LOCATION 131	1917 1919 1922 1946 1952 1957 1960 2.9 3.0 2.9 3.0 3.1 2.9 3.0	1917 1919 1922 1946 1952 1957 1960 2.9 3.0 2.9 3.0 3.1 2.9 3.0	A B 0.2 -2.7 3.0
LOCATION 133	1917 1919 1922 1946 1952 1957 1960 2.9 3.0 2.9 3.0 3.1 2.9 3.0	1917 1919 1922 1946 1952 1957 1960 2.9 3.0 2.9 3.0 3.1 2.9 3.0	A B 0.2 -2.7 3.0
LOCATION 135	1917 1919 1922 1946 1952 1957 1960 2.9 3.0 2.9 3.0 3.1 2.9 3.0	1917 1919 1922 1946 1952 1957 1960 2.9 3.0 2.9 3.0 3.1 2.9 3.0	A B 0.2 -2.7 3.0
LOCATION 137	1917 1919 1922 1946 1952 1957 1960 2.9 3.0 2.9 3.0 3.1 2.9 3.0	1917 1919 1922 1946 1952 1957 1960 2.9 3.0 2.9 3.0 3.1 2.9 3.0	A B 0.2 -2.7 3.0
LOCATION 139	1917 1919 1922 1946 1952 1957 1960 2.9 3.0 2.9 3.0 3.1 2.9 3.0	1917 1919 1922 1946 1952 1957 1960 2.9 3.0 2.9 3.0 3.1 2.9 3.0	A B 0.2 -2.7 3.0
LOCATION 141	1917 1919 1922 1946 1952 1957 1960 2.9 3.0 2.9 3.0 3.1 2.9 3.0	1917 1919 1922 1946 1952 1957 1960 2.9 3.0 2.9 3.0 3.1 2.9 3.0	A B 0.2 -2.7 3.0
LOCATION 143	1917 1919 1922 1946 1952 1957 1960 2.9 3.0 2.9 3.0 3.1 2.9 3.0	1917 1919 1922 1946 1952 1957 1960 2.9 3.0 2.9 3.0 3.1 2.9 3.0	A B 0.2 -2.7 3.0

Table 3

Gage Locations in Degrees, Minutes, Seconds  
(Sec with One Decimal Place)

GAGE NUMBER	LONGITUDE	LATITUDE	GAGE NUMBER	LONGITUDE	LATITUDE
1	170 40 28.0	14 17 51.1	58	170 35 54.7	14 16 35.4
2	170 40 32.6	14 17 35.8	59	170 33 36.3	14 15 54.6
3	170 40 43.6	14 17 36.0	60	170 33 37.9	14 14 54.9
4	170 40 36.8	14 17 30.1	61	170 34 35.5	14 14 53.9
5	170 40 25.9	14 17 24.4	62	170 35 3.1	14 15 12.3
6	170 40 25.9	14 17 12.7	63	170 35 15.3	14 15 45.4
7	170 40 40.8	14 17 1.7	64	170 35 56.1	14 15 22.5
8	170 40 45.3	14 17 2.2	65	170 36 42.6	14 15 23.5
9	170 40 46.0	14 16 57.8	66	170 37 39.2	14 15 30.6
10	170 40 48.0	14 16 53.6	67	170 37 2.5	14 15 0.0
11	170 40 41.5	14 16 50.3	68	170 38 23.1	14 15 5.6
12	170 40 43.6	14 16 42.5	69	170 39 6.5	14 15 36.8
13	170 40 46.9	14 16 45.2	70	170 39 1.9	14 14 57.5
14	170 40 49.4	14 16 44.1	71	170 39 28.9	14 15 17.9
15	170 40 54.2	14 16 44.6	72	170 39 34.5	14 14 52.9
16	170 41 6.7	14 16 44.9	73	170 40 21.0	14 15 6.1
17	170 41 11.2	14 16 45.6	74	170 40 10.8	14 14 29.4
18	170 41 15.7	14 16 51.2	75	170 40 9.7	14 13 40.9
19	170 41 23.5	14 16 43.7	76	170 40 18.9	14 14 29.9
20	170 41 32.5	14 16 38.8	77	170 40 49.5	14 14 52.9
21	170 41 38.3	14 16 35.8	78	170 41 25.8	14 15 0.0
22	170 41 43.8	14 16 33.6	79	170 41 17.1	14 15 22.0
23	170 41 54.3	14 16 36.2	80	170 42 2.0	14 15 25.5
24	170 41 54.1	14 16 30.3	81	170 42 25.0	14 15 58.2
25	170 41 54.0	14 16 24.7	82	170 43 28.2	14 16 33.4
26	170 41 44.0	14 16 25.8	83	170 43 13.4	14 17 24.9
27	170 41 35.8	14 16 25.7	84	170 43 55.8	14 17 4.5
28	170 41 25.1	14 16 27.7	85	170 44 32.5	14 17 43.8
29	170 41 15.4	14 16 27.1	86	170 45 8.2	14 18 2.2
30	170 41 6.2	14 16 26.9	87	170 45 39.4	14 17 29.8
31	170 41 3.2	14 16 24.2	88	170 46 14.6	14 17 43.8
32	170 41 2.0	14 16 27.0	89	170 46 45.2	14 17 56.4
33	170 40 52.0	14 16 21.1	90	170 46 56.9	14 17 29.0
34	170 40 40.1	14 16 17.8	91	170 47 17.9	14 17 47.4
35	170 40 23.4	14 16 24.7	92	170 47 50.5	14 17 34.1
36	170 40 9.3	14 16 29.9	93	170 48 35.4	14 18 7.3
37	170 40 3.6	14 16 27.4	94	170 49 24.9	14 18 25.7
38	170 39 58.5	14 16 33.1	95	170 50 2.7	14 18 57.3
39	170 39 51.4	14 16 34.0	96	170 50 54.2	14 19 38.6
40	170 39 55.4	14 16 40.2	97	170 49 51.4	14 19 56.5
41	170 39 57.6	14 16 45.2	98	170 49 1.4	14 20 13.3
42	170 40 5.0	14 16 48.7	99	170 48 33.4	14 19 49.3
43	170 40 3.6	14 16 54.7	100	170 48 13.0	14 20 22.0
44	170 39 57.1	14 16 58.6	101	170 47 16.8	14 20 34.2
45	170 39 58.7	14 17 4.9	102	170 47 7.1	14 21 45.7
46	170 39 48.5	14 17 23.5	103	170 46 11.0	14 22 19.9
47	170 39 52.5	14 17 30.7	104	170 45 38.4	14 22 10.2
48	170 39 47.0	14 17 41.0	105	170 45 35.8	14 22 57.6
49	170 39 17.0	14 17 40.3	106	170 45 3.7	14 21 55.4
50	170 38 22.6	14 17 29.5	107	170 44 16.7	14 22 7.1
51	170 38 12.9	14 17 5.0	108	170 43 15.5	14 21 48.0
52	170 37 4.7	14 17 11.2	109	170 41 47.7	14 20 5.7
53	170 37 17.8	14 16 39.5	110	170 41 35.5	14 18 54.7
54	170 36 27.3	14 16 28.8	111	170 33 43.5	14 17 51.5
55	170 36 26.2	14 17 2.0	112	170 32 22.3	14 17 23.9
56	170 36 5.3	14 17 18.8	113	170 33 9.8	14 16 54.3
57	170 34 5.8	14 16 49.2	114	170 33 48.1	14 17 9.6

GAGE NUMBER	LONGITUDE	LATITUDE	GAGE NUMBER	LONGITUDE	LATITUDE
115	169 40 17.0	14 11 34.2	130	169 28 12.3	14 15 42.7
116	169 38 30.3	14 10 29.2	131	169 27 25.7	14 15 14.4
117	169 37 4.2	14 10 37.2	132	169 25 12.3	14 15 55.6
118	169 36 44.6	14 11 58.1	133	169 24 56.8	14 13 24.2
119	169 36 15.7	14 10 56.7	134	169 25 32.3	14 12 52.7
120	169 36 37.8	14 10 18.7	135	169 26 15.1	14 13 3.1
121	169 36 27.0	14 9 27.4	136	169 27 1.1	14 12 52.4
122	169 36 51.0	14 9 23.7	137	169 27 56.2	14 13 5.8
123	169 37 32.6	14 10 7.6	138	169 28 58.4	14 13 4.3
124	169 38 7.1	14 9 55.8	139	169 29 42.7	14 13 14.7
125	169 38 56.6	14 10 7.9	140	169 30 21.4	14 12 56.3
126	169 40 44.0	14 9 33.0	141	169 30 37.2	14 13 22.6
127	169 41 16.9	14 10 1.7	142	169 31 8.8	14 13 23.2
128	169 29 31.8	14 16 47.1	143	169 30 43.3	14 14 48.6
129	169 28 54.2	14 16 42.9	144	169 30 1.3	14 15 29.7

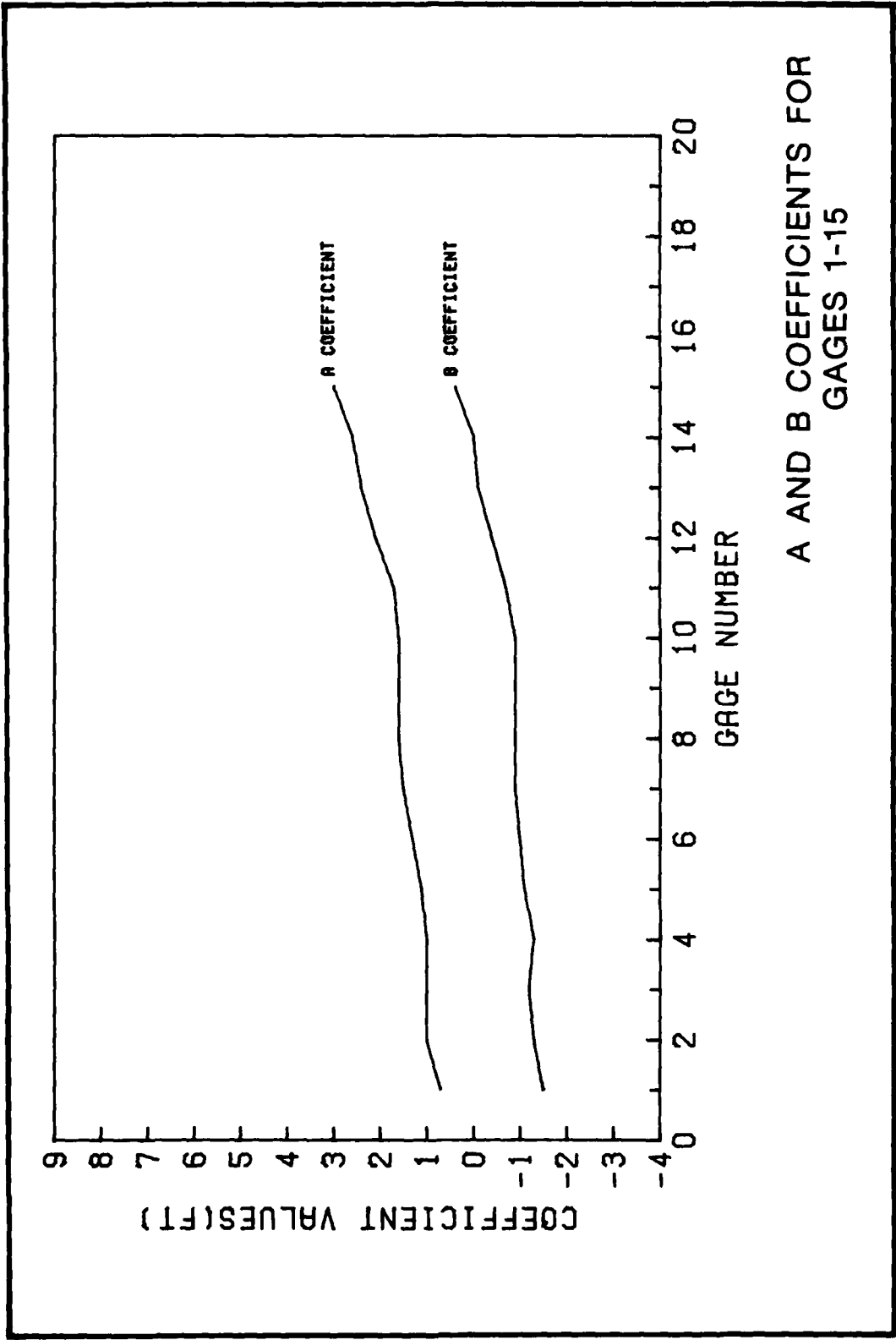

A AND B COEFFICIENTS FOR  
GAGES 1-15

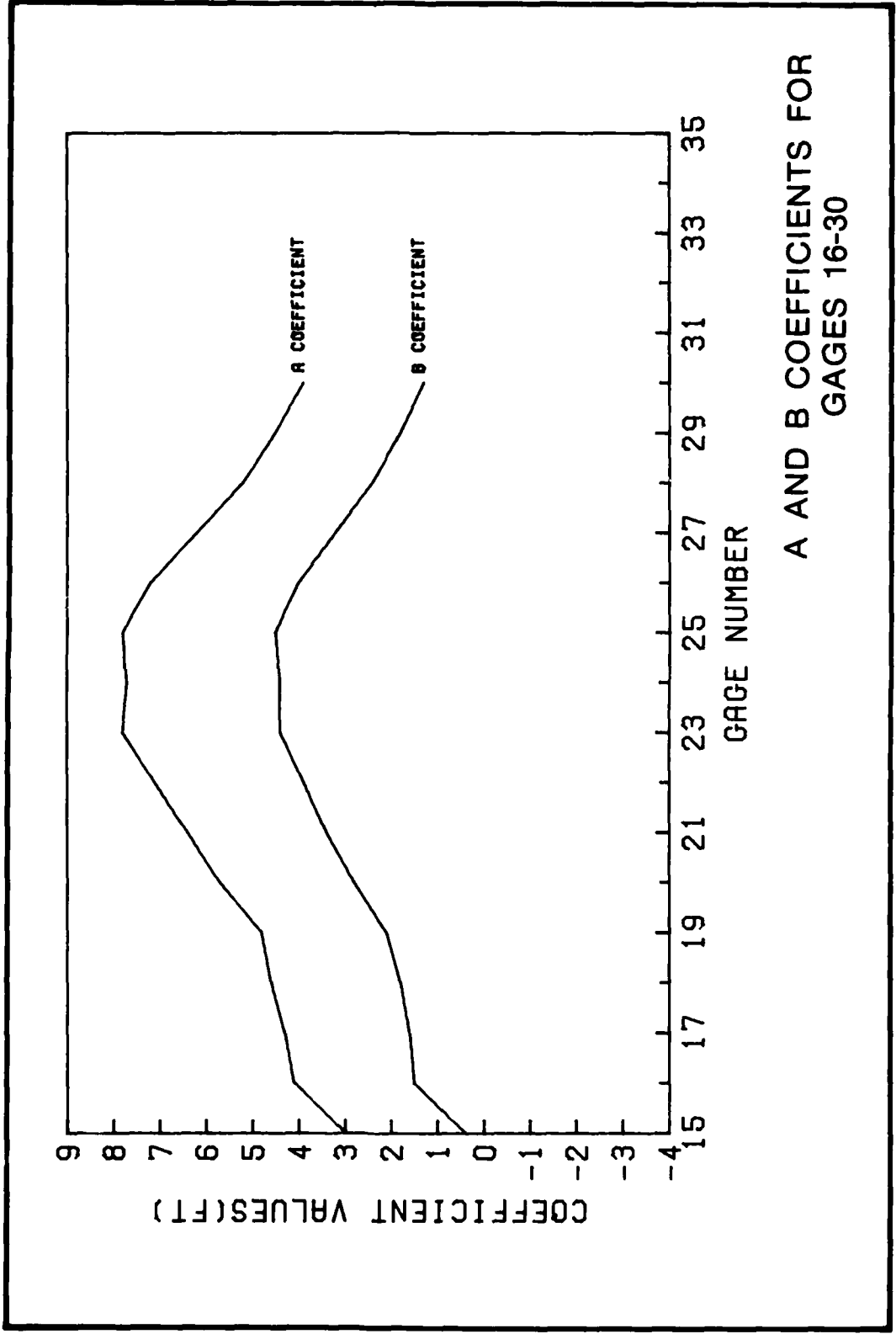

A AND B COEFFICIENTS FOR  
GAGES 16-30

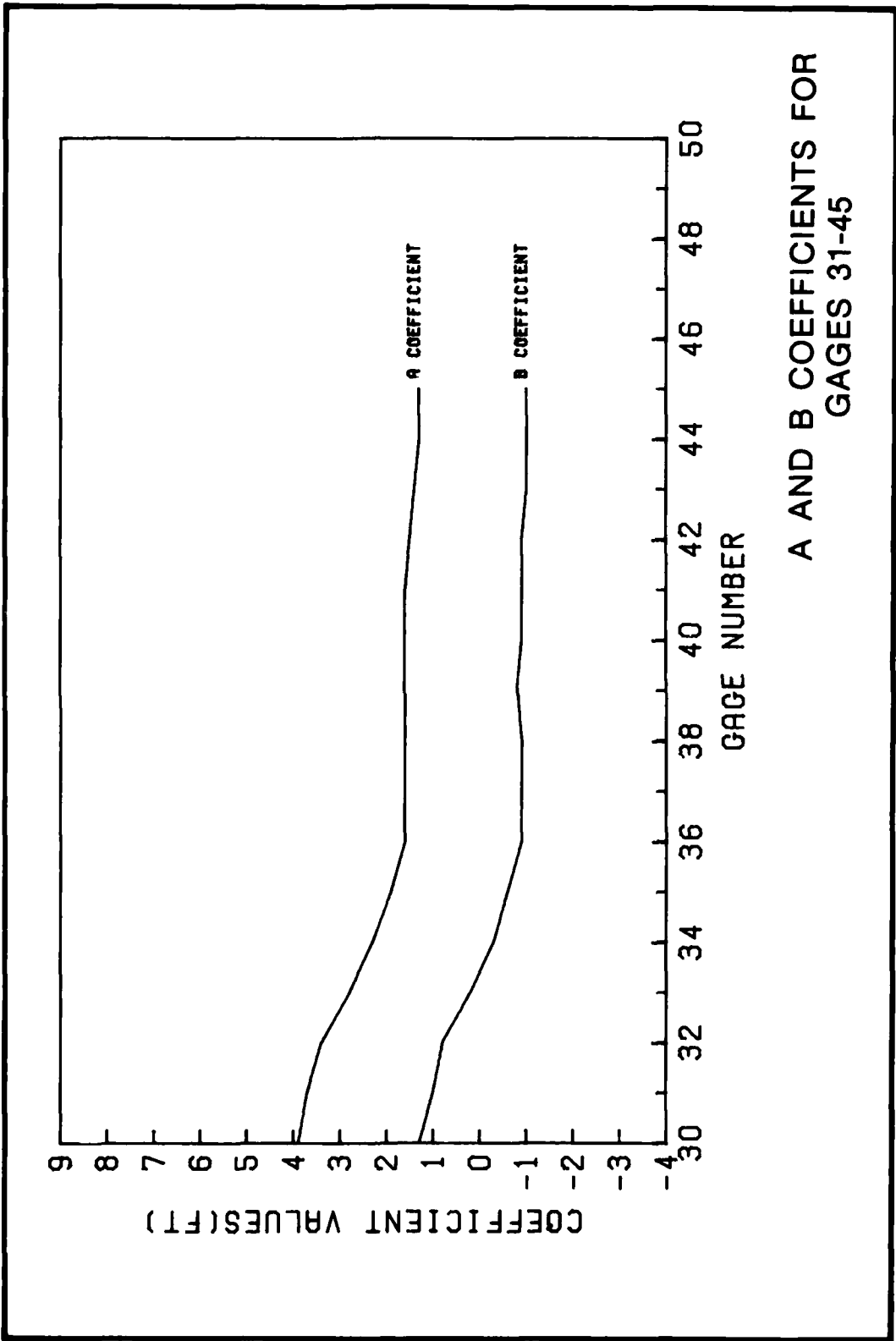

A AND B COEFFICIENTS FOR  
GAGES 31-45

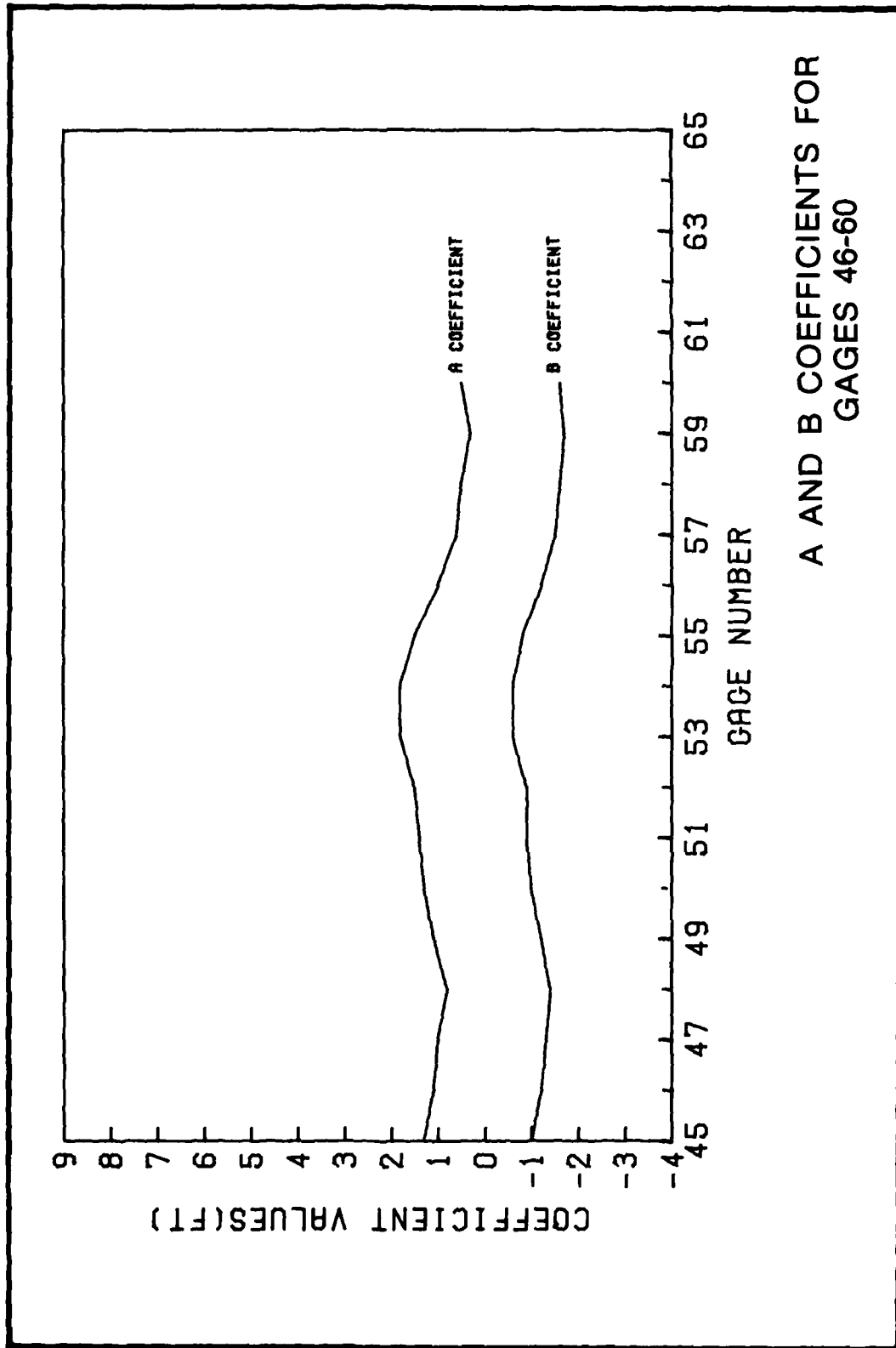
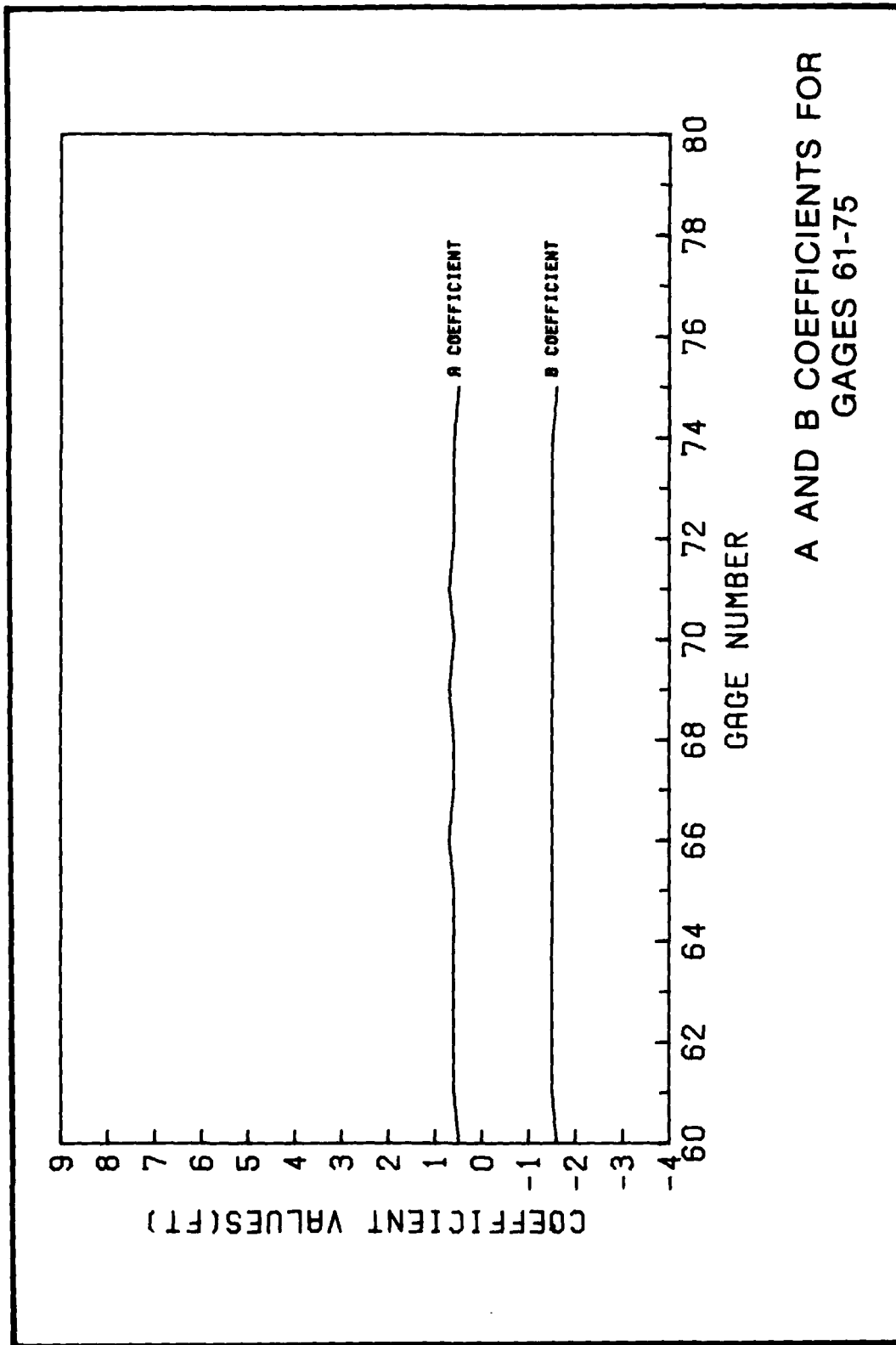
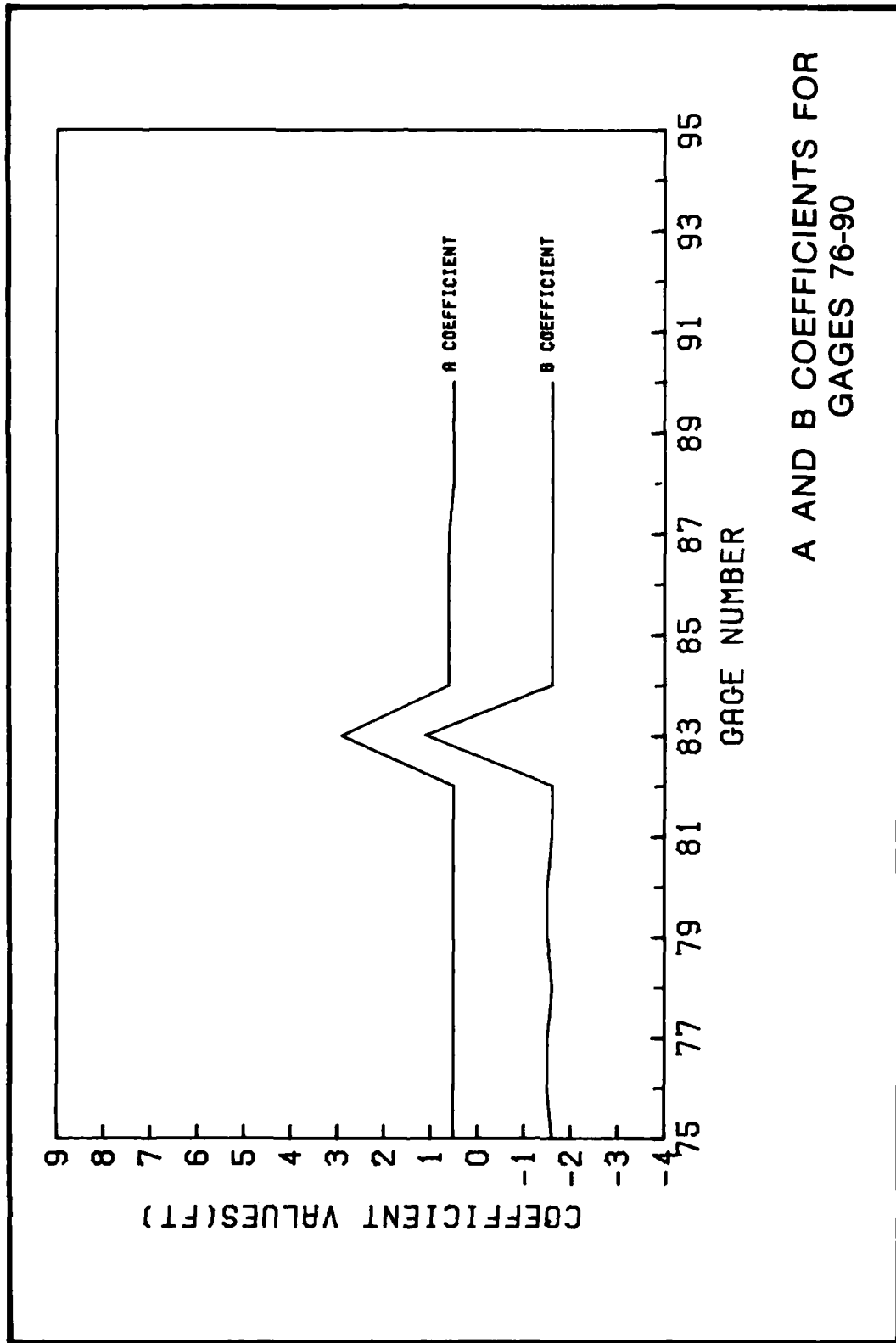

PLATE 4



A AND B COEFFICIENTS FOR  
GAGES 61-75



A AND B COEFFICIENTS FOR  
GAGES 76-90



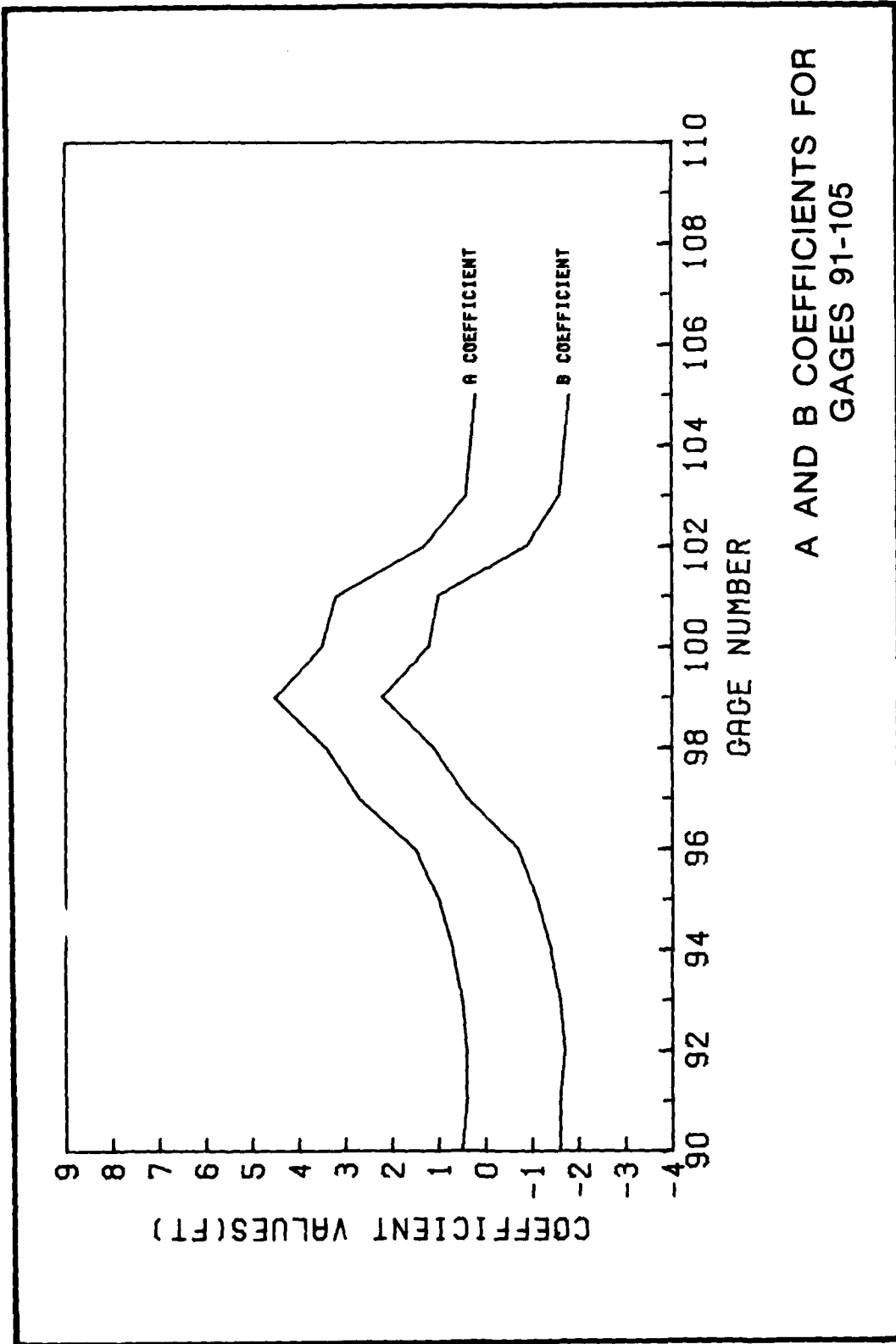

A AND B COEFFICIENTS FOR  
GAGES 91-105

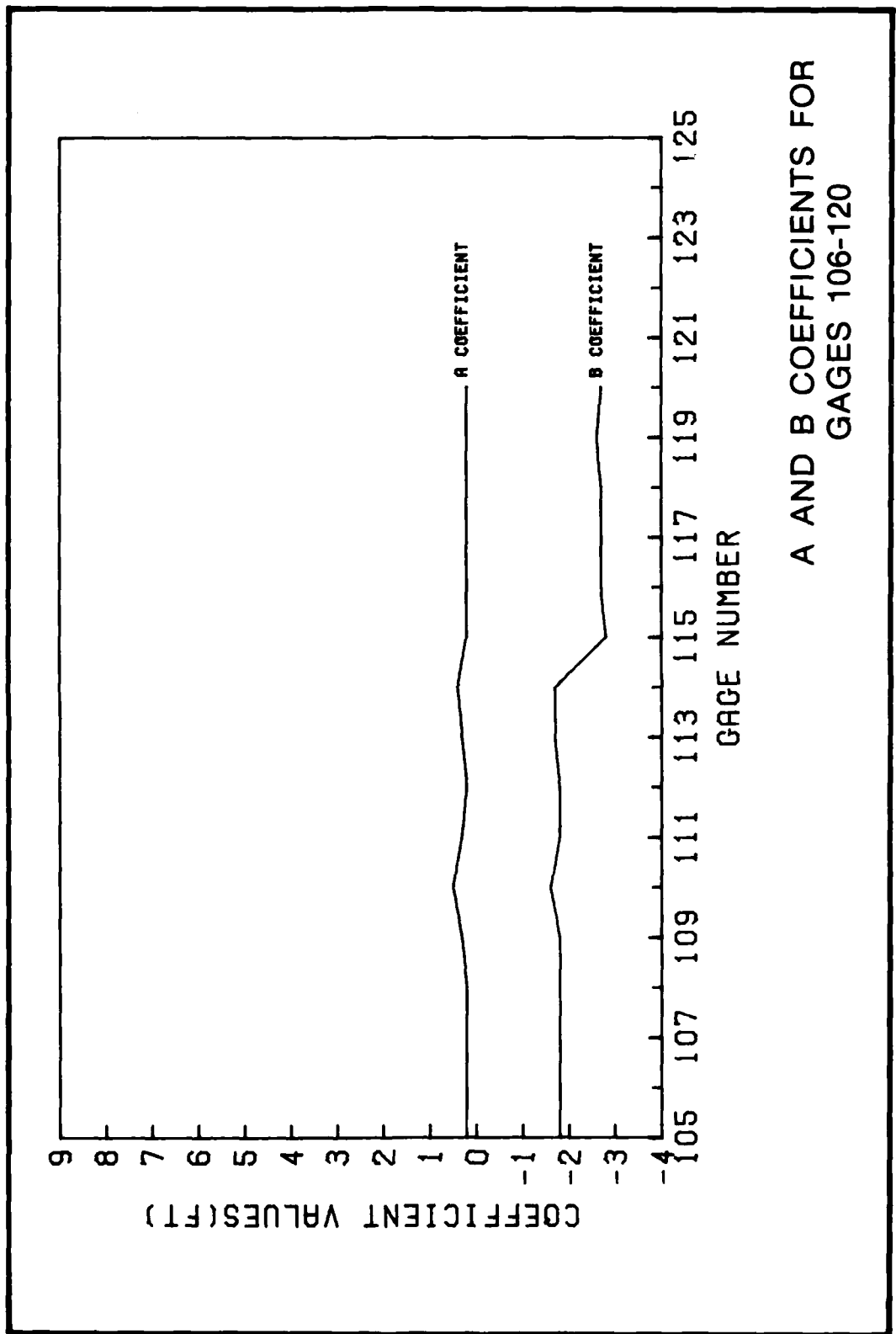

A AND B COEFFICIENTS FOR  
GAGES 106-120

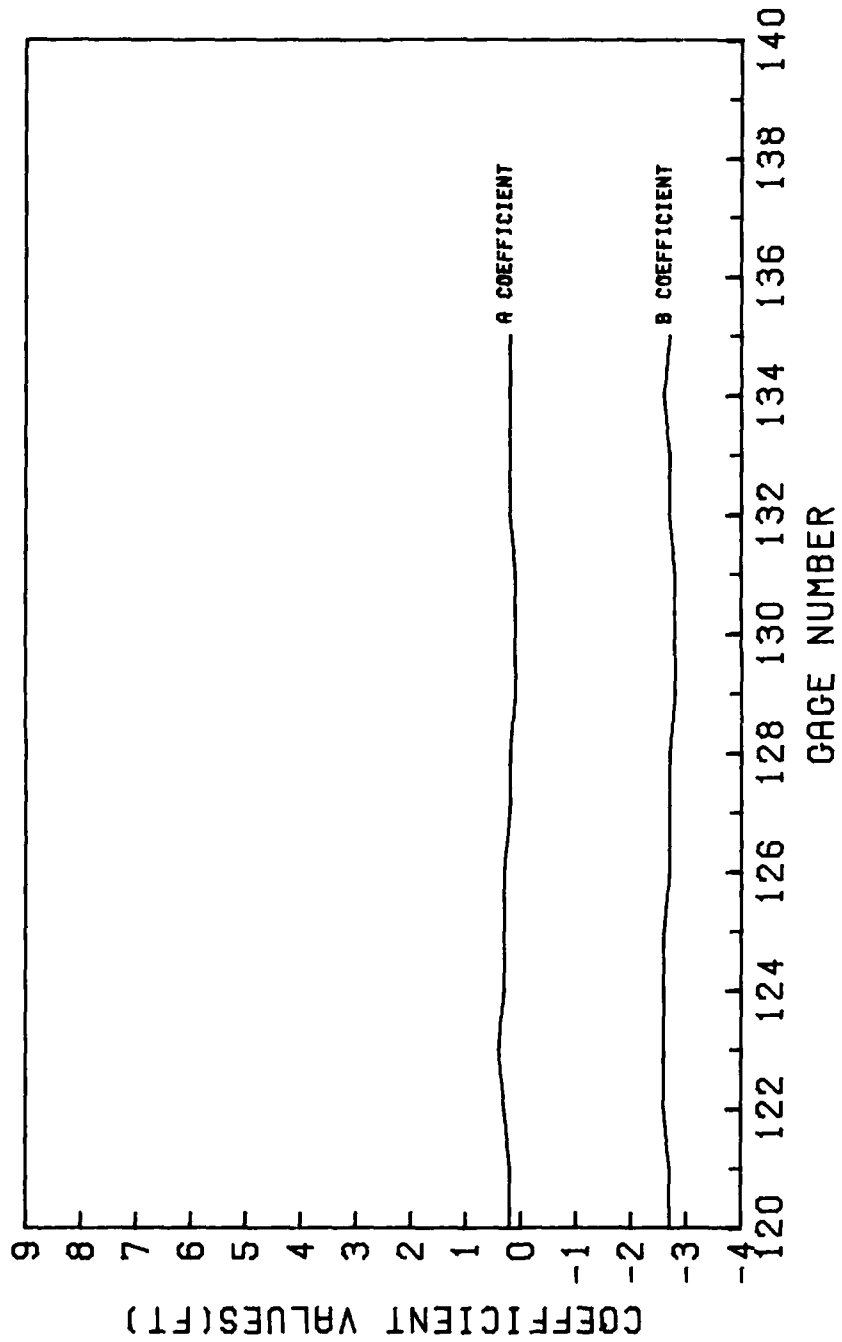

A AND B COEFFICIENTS FOR  
GAGES 121-135

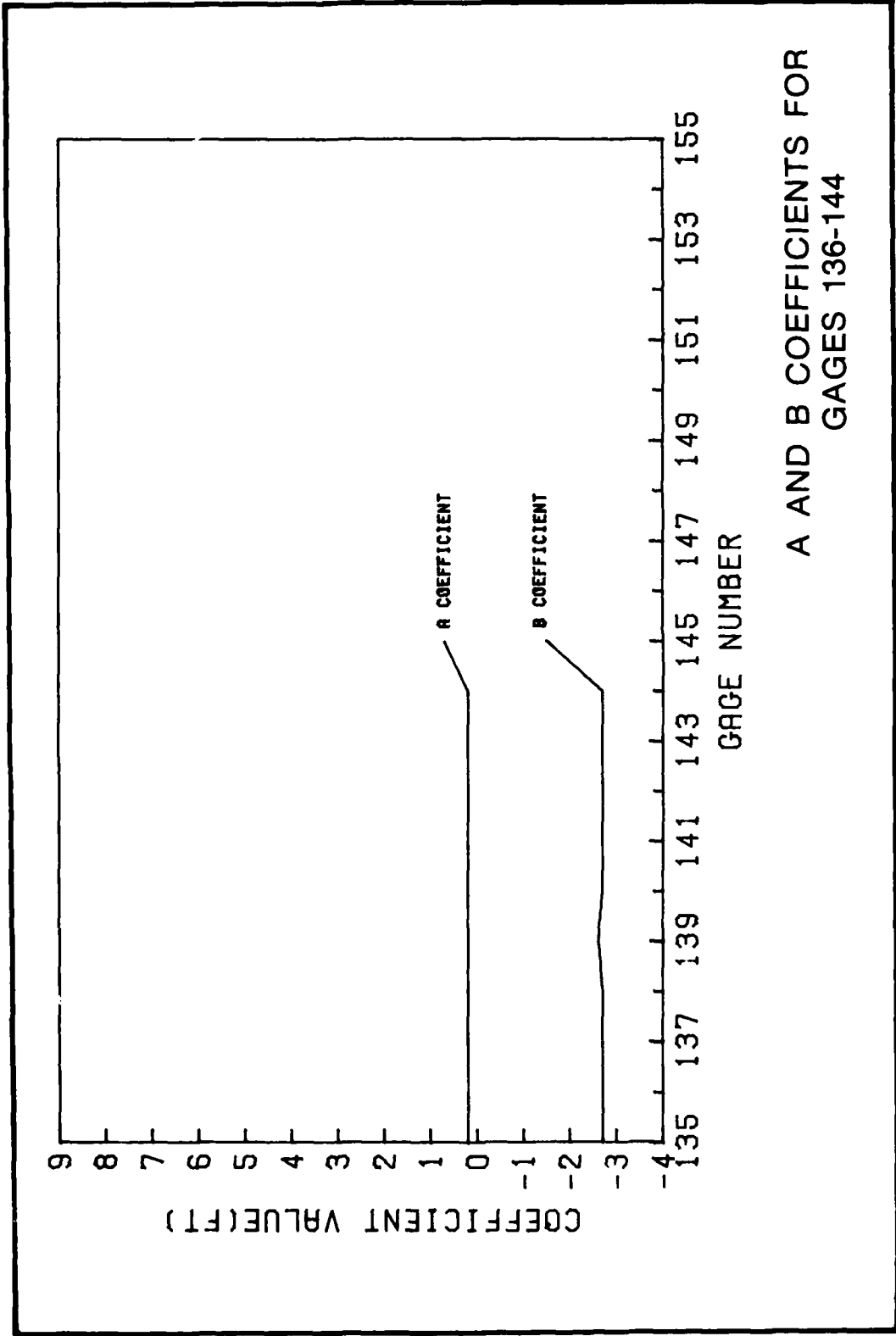

A AND B COEFFICIENTS FOR  
GAGES 136-144

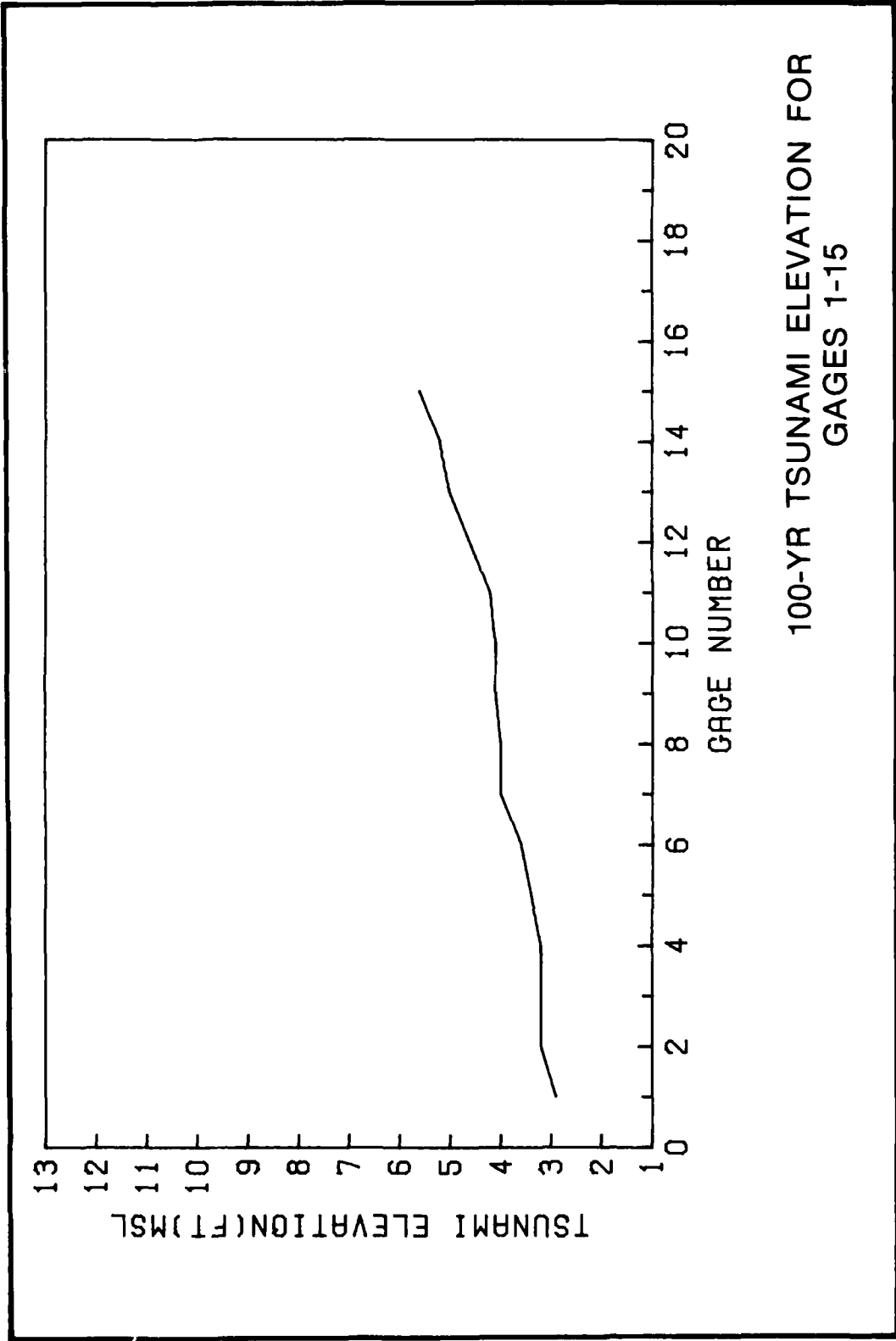

100-YR TSUNAMI ELEVATION FOR  
GAGES 1-15

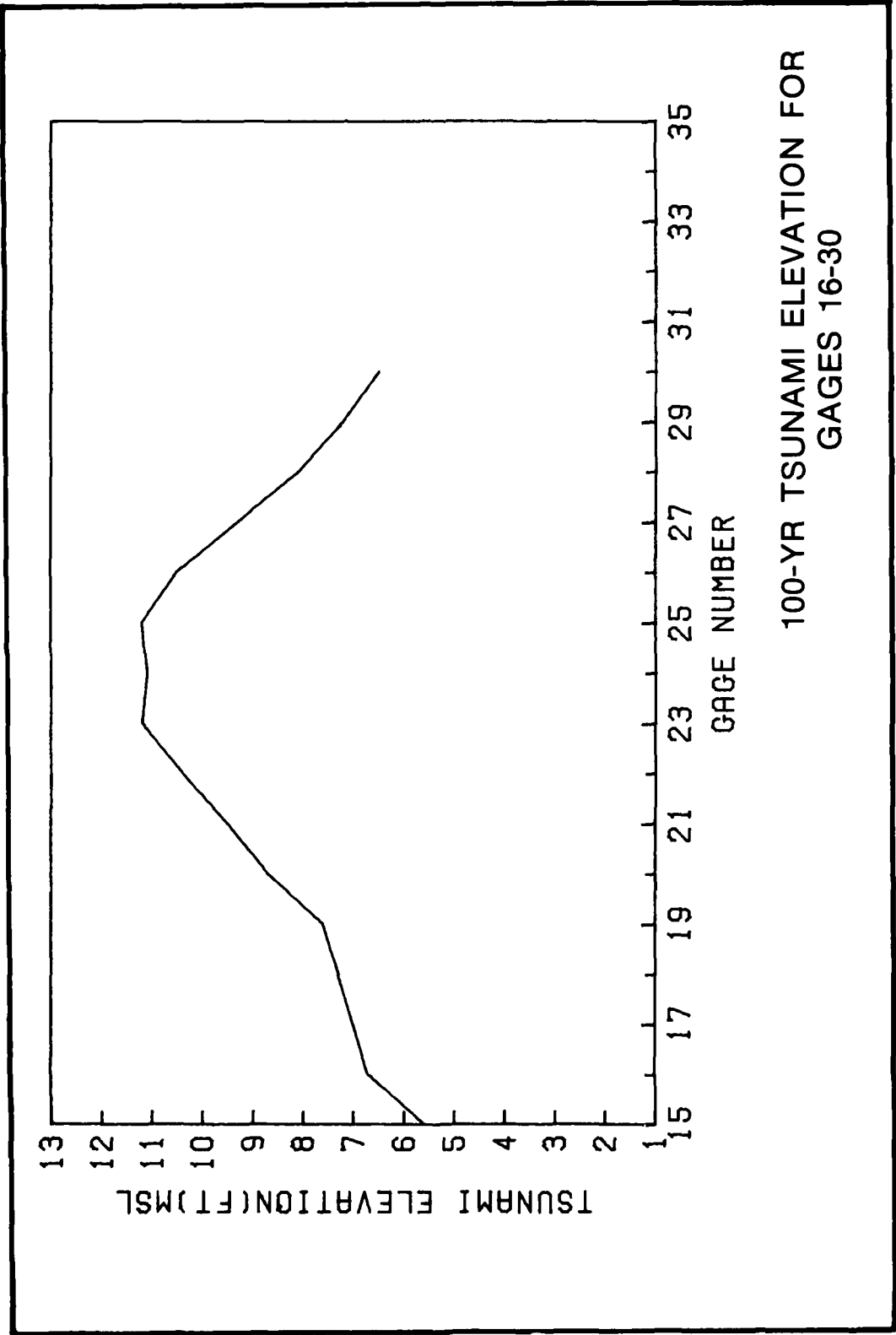
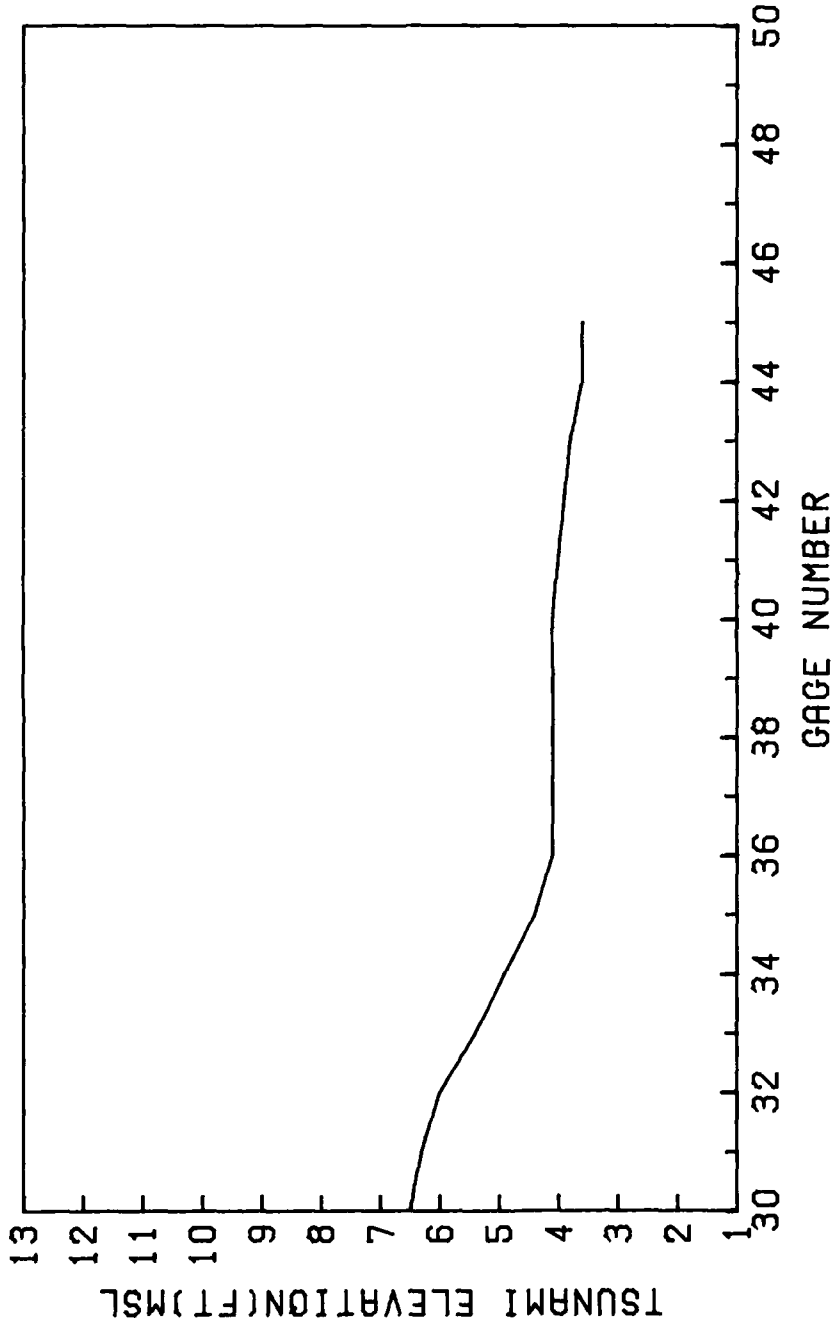

PLATE 12



100-YR TSUNAMI ELEVATION FOR  
GAGES 31-45

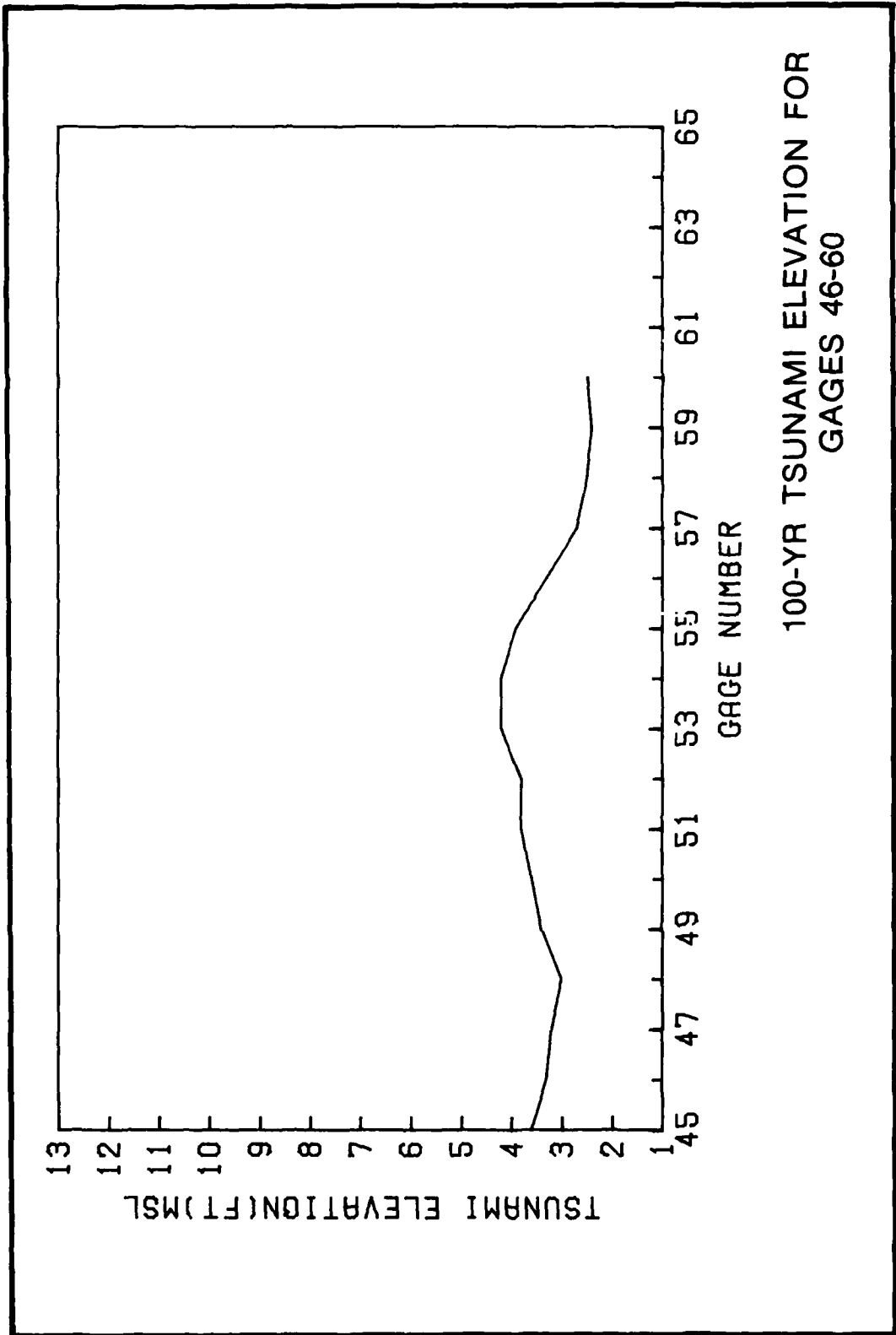
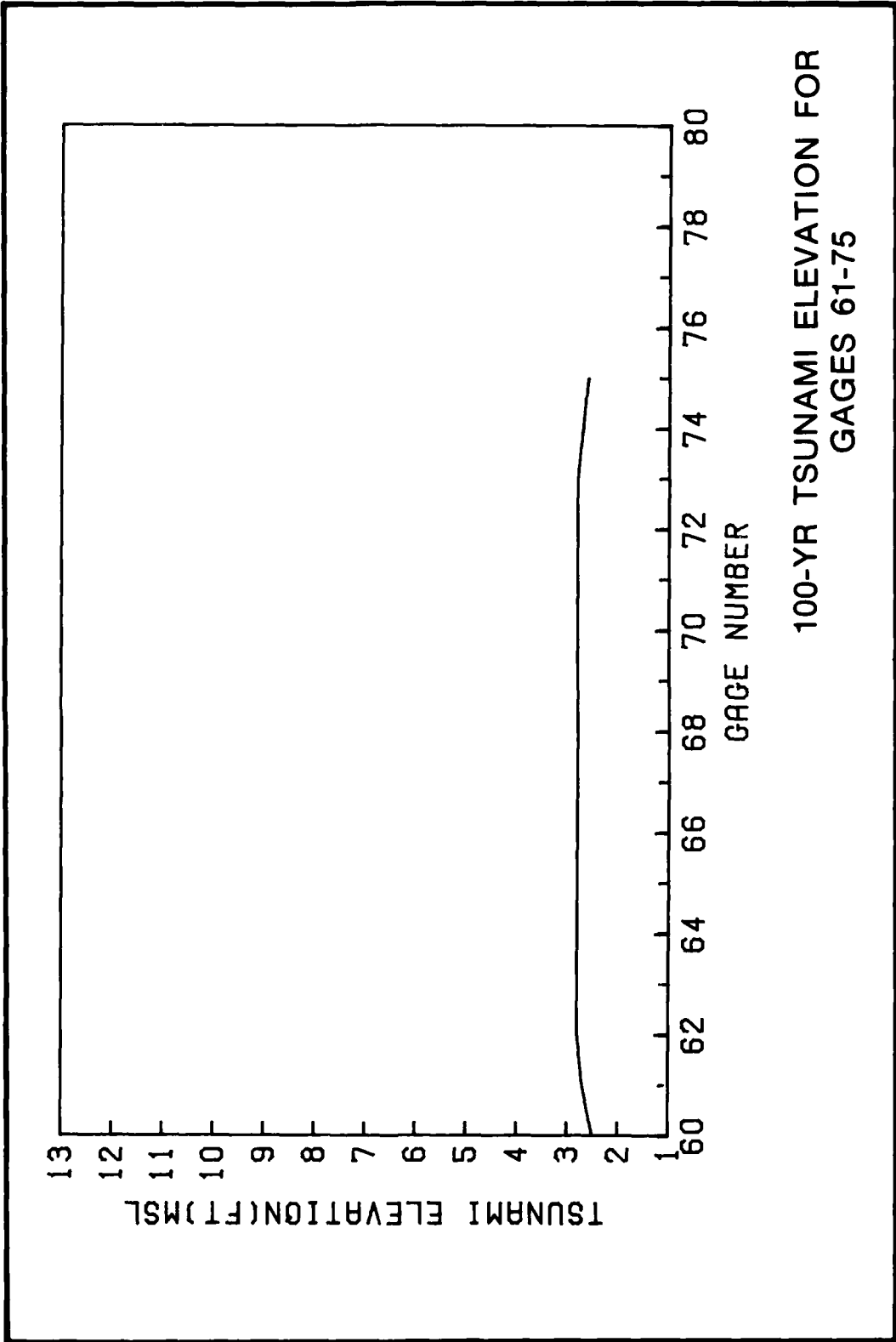
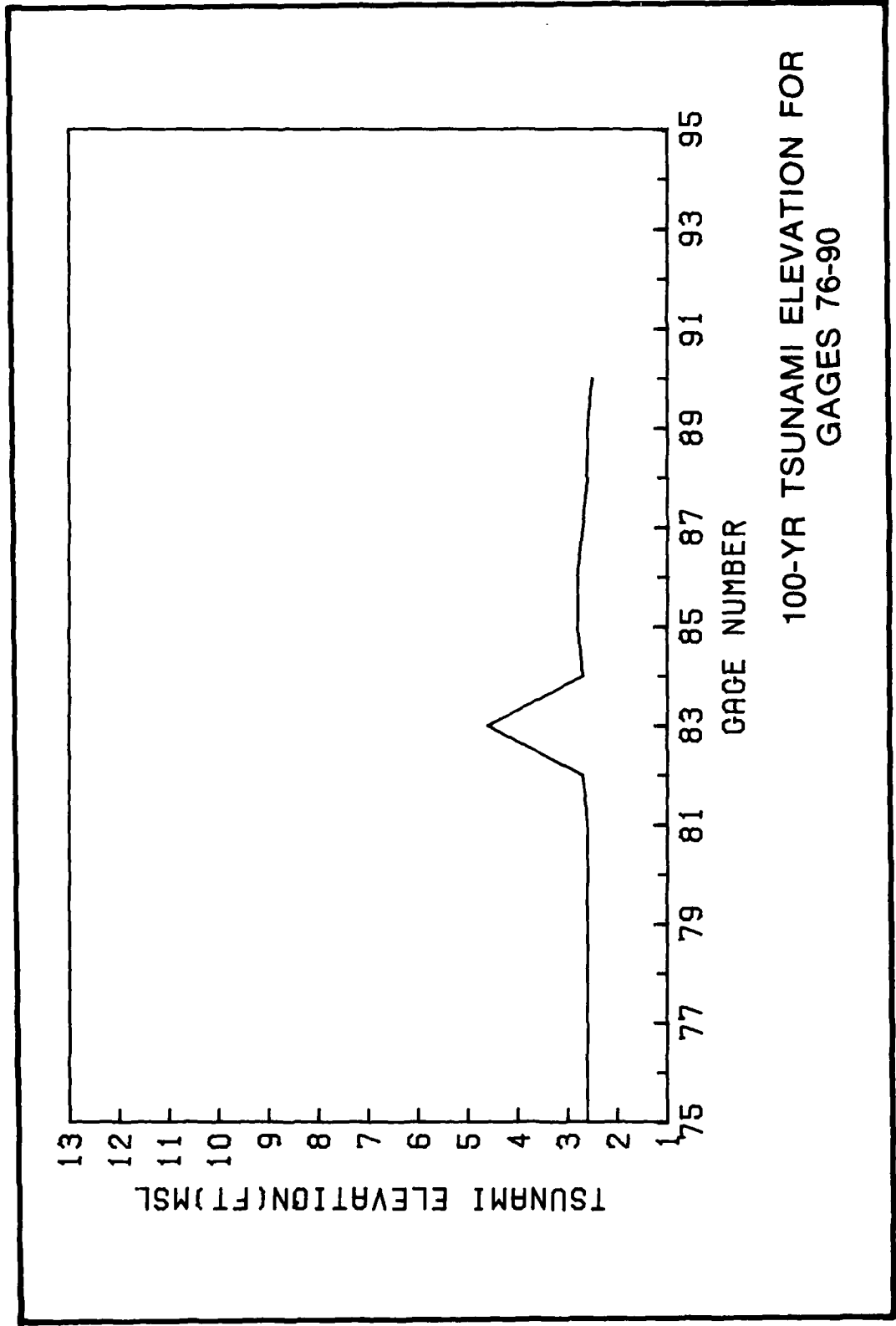

PLATE 14





100-YR TSUNAMI ELEVATION FOR  
GAGES 61-75



100-YR TSUNAMI ELEVATION FOR  
GAGES 76-90

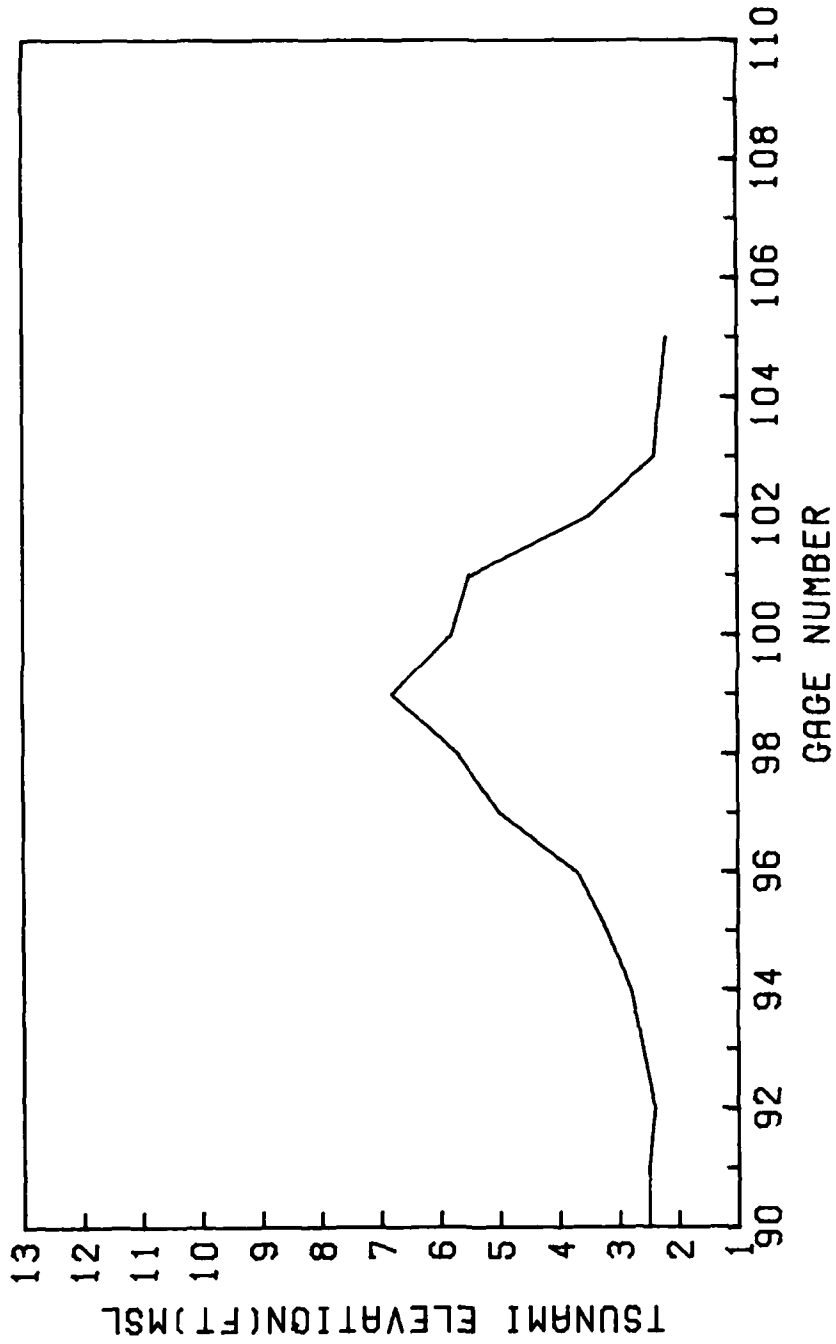

100-YR TSUNAMI ELEVATION FOR  
GAGES 91-105

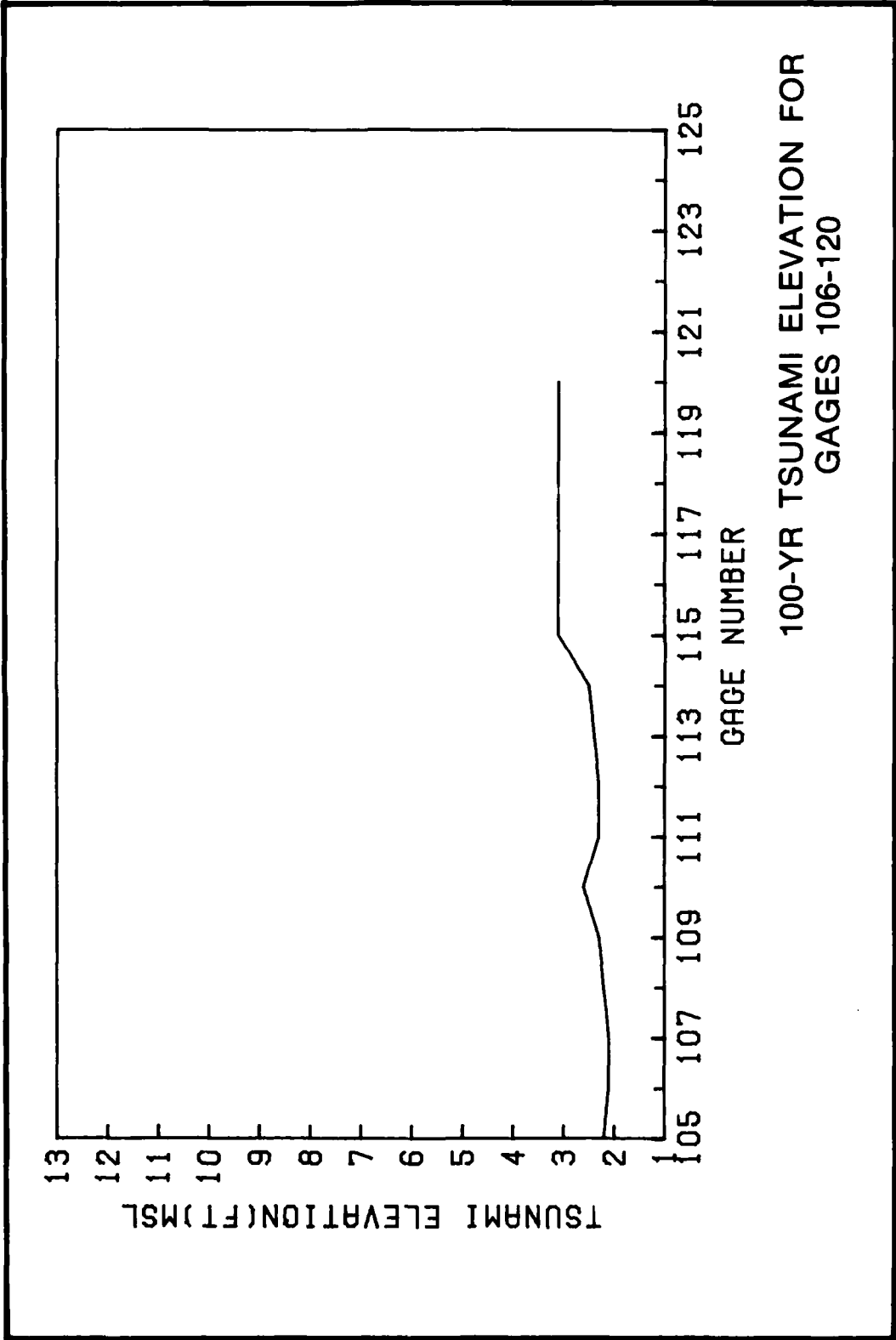
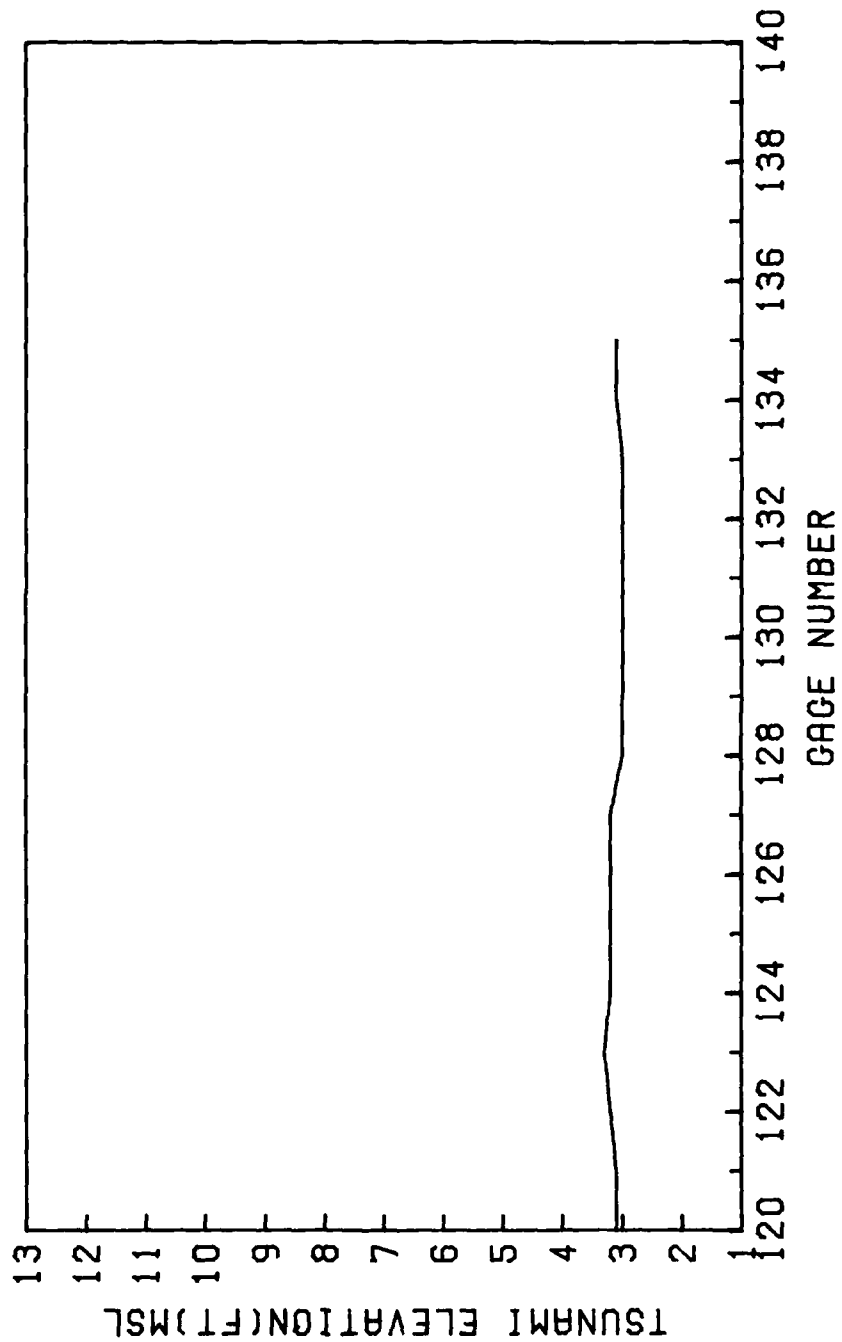
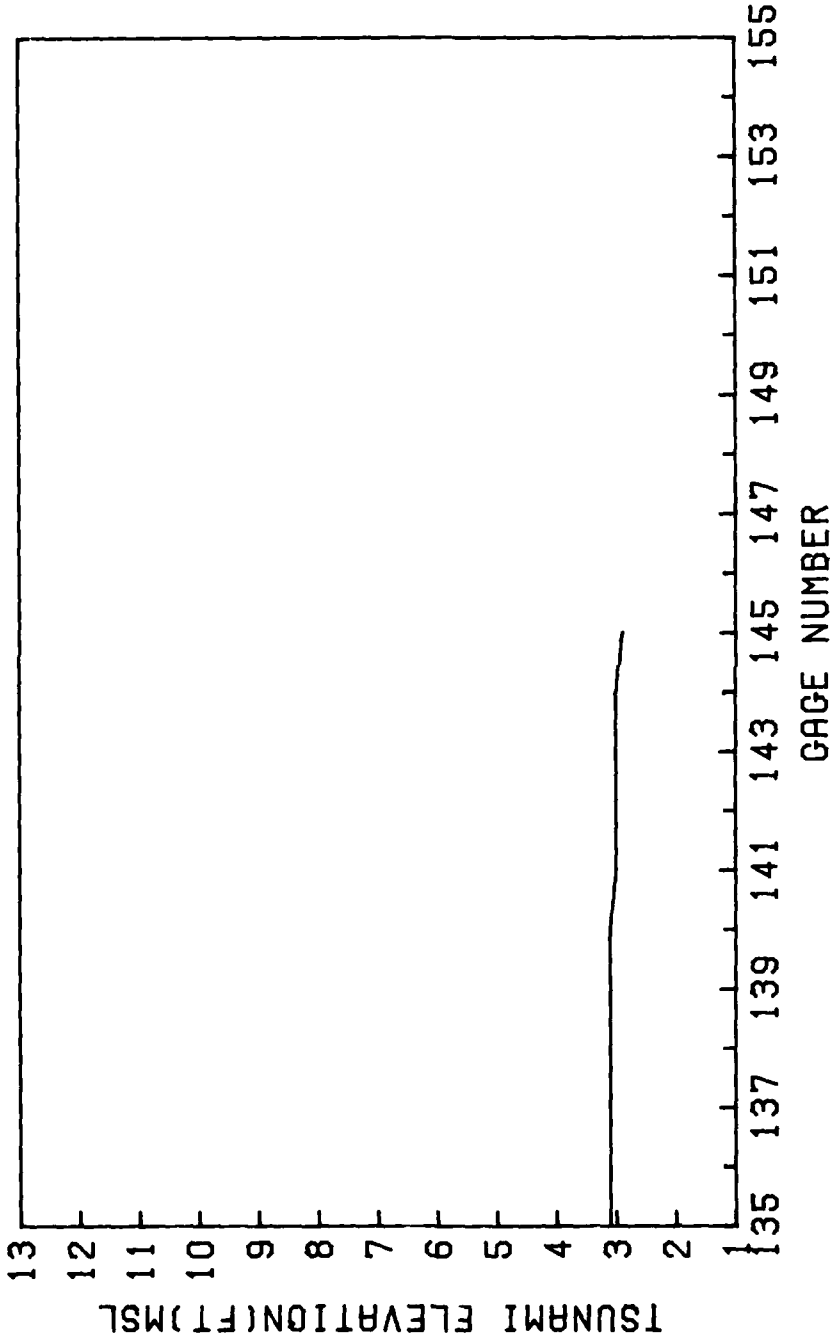

PLATE 18



100-YR TSUNAMI ELEVATION FOR  
GAGES 121-135



100-YR TSUNAMI ELEVATION FOR  
GAGES 136-144

APPENDIX A

CATALOG OF TSUNAMIS IN THE SAMOAN ISLANDS

by  
George Pararas-Carayannis  
and  
Bonnie Dong

June 1980  
International Tsunami Information Center

Geographical Setting

The Samoan Islands consist of three large islands, Savaii, Upolu, and Tutuila, with several neighboring smaller ones. (Fig. 1) The smaller islands are Anu'u, Ta'u, Ofu, Olosega, Rose and Swains. The latter two islands are coral atolls. The islands are of volcanic origin and form a chain from east to west from 169.5°W to 172.9°W at the approximate mean latitude of 14°S. The islands rise rapidly from the ocean floor from depths of over 4,000 meters.

American Samoa consists of several islands east of the 171st meridian of west longitude. It is separated from Western Samoa by a Strait which is 60 kilometers wide and over 2,000 meters deep. The main island is Tutuila with an area of 135 square kilometers. There are six smaller islands, Anu'u, Ta'u, Ofu, Olosega and a small isolated double island, Rose Island, which is uninhabited. The population of American Samoa, in 1977, was 30,600 with the bulk of the population (over 28,000) living in Tutuila and the remainder in Manua and Swain's Islands. More than a third

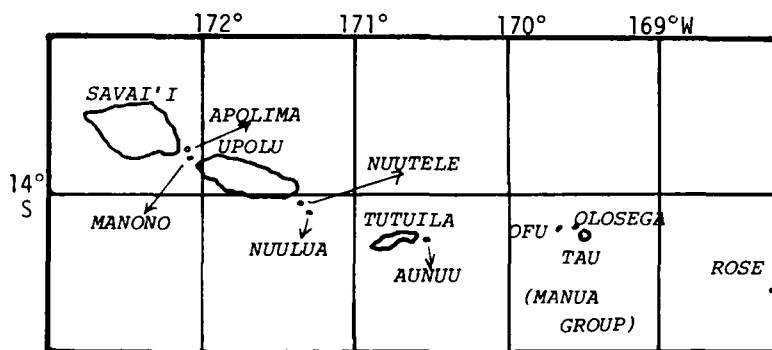

Fig. 1  
LOCATION OF THE SAMOAN ISLANDS

of the population (11,000) lives in Pago Pago which is the main town and administrative center of American Samoa. Approximately 2,000 people live in the other town of Leone, about 20 kilometers away. The rest of the population reside in rural communities.

The larger islands of Western Samoa are Upolu (70 kilometers by 20 kilometers), and Savai'i (70 kilometers by 50 kilometers). The smaller islands are Nuutele and Nuulua, on the eastern end of Upolu, and Manono and Apolima, between Upolu and Savai'i. The strait separating Upolu and Savai'i is 15 kilometers wide and about 100 meters deep. The islands are surrounded almost entirely by coral reef of several kilometers in width. The principal town of Western Samoa and the capital, Apia, is situated on the north coast of Upolu Island. The total area of Western Samoa exceeds 2,900 square kilometers. Western Samoa is an independent state and a member of the British Commonwealth. Its population as of 1977, was 152,000. Approximately 109,500 people inhabit Upolu and approximately 42,000 inhabit Savai'i.



## History

Archaeological excavations in Western Samoa revealed Lapita pottery dating back to about 800 B.C. Therefore, it can be assumed that all of the Samoan Islands have been inhabited by men over 2,500 years.

Contact with the western world was first made in 1722 when the Dutch navigator Jaco Roggereen of the Dutch West India Company sighted the Manua islands, Tau, Ofu and Olosega, and had brief contact with the Samoans. Forty-six years later, in 1768, the French explorer Louis Bougainville, touched at the Manua's in his voyage around the world and bartered trinkets for fresh food. He was struck by the manner in which the Samoans handled their boats that he named the islands "the Navigator Islands". In 1787, another French explorer, La Perouse, visited the islands. During the visit, his second in command, de Langle, and eleven of his men were massacred when they went ashore for water. Four years later, the Englishman Captain Edward Edwards of the British war vessel, Pandora, stopped on two occasions during his search for the mutineers of the "Bounty".

From about 1803 and thereafter, many sailors and escaping convicts from New South Wales began to reach the Samoan islands from Tonga and elsewhere. By 1830 many people of European origin had settled in the Samoan islands. In 1830, the first Christian missionaries, John Williams and Charles Barff, of the London Missionary Society arrived and left Tahitian teachers ashore. In 1836, the Rev. A.W. Murray settled on Tutuila, remaining there for many years. Pago Pago harbour had been discovered a few months earlier by Captain Cuthbert of the British whaler "Elizabeth". Pago Pago soon thereafter became a popular port of call for whaling vessels of many nations.

The United States Navy made the first scientific investigations in the islands in 1839. As early as 1850, England, Germany, and the United States were represented by commercial agents in Apia. During the next 20 years, Germans and Englishmen were more forward in developing and establishing close relations with the natives. Americans took very little interests at this time.

Recognizing the usefulness of Pago Pago as a port for the proposed trans-Pacific steamship service, American shipping interests took steps to obtain a foothold there. In 1872, Commander Richard W. Meade of the United States Navy signed a treaty with the Mauga (high chief) at Pago Pago area which gave the United States the exclusive right to build a naval station in return for U.S. Government protection. The treaty was made only on Meade's own responsibility. Later that year, President Grant communicated this agreement to the Senate which gave no action on the agreement. Finally, in 1878, a treaty which contained the formal definition of the relations of the United States and the Samoan group was ratified. The United States was granted the privilege of entering and using of Pago Pago, and establishing a coal station there. During the next 20 years, the Samoan islands were the subject of power struggles between the United States, Germany and Great Britain.

In 1899, treaties were drawn between the three powers to partition the islands. Western Samoa was placed under Germany; United States

accepted Tutuila and Manua; and Great Britain withdrew from the group in return for German concessions elsewhere.

The American territory was placed under the jurisdiction of the United States Department of the Navy from 1900 to 1951. The United States flag was formally raised on Tutuila on 17 April 1900 following the receipt of a deed of cession from the chiefs of that island. The Manua chiefs signed a deed of cession in 1904. In 1911, American Samoa was adopted as the name of the territory. In 1951, administration was transferred to the U.S. Department of the Interior.

## Tsunami History

Searching for historical tsunamis in the Samoan Islands turned out to be a difficult task. The Samoans had no written language. Their myths and history were preserved in memory only. The written record does not begin until 1830 when the first missionaries came to the Samoan Islands. Little is known of the Samoan Islands prior to that, although several Europeans touched on the islands briefly a few decades earlier. The tsunami history was researched by going back to all historical publications and to archival records. The following is an account of historical publications used in the search.

In 1830, the London Missionary Society established a mission in one of the Samoan Islands and followed that up by extensive operation in all the islands. From March 1845 to 1862, the London Missionary Society published twice a year the Samoa Reporter (Upolu, Western Samoa). Then in July, 1890, the missionary journal O le Sulu Samoa (in Samoan language) was started reporting monthly news and information. The Royal Gazette (Apia, 1892-1893) was the official gazette. Samoa Times (Apia) began its publication in April of 1901, in English and German until 1917, and stopped publication in February 1930. It was revived again in June of 1964 (English and Samoan) and later it absorbed the Samoa Bulletin (Nov. 1950 - May 1967) and is still currently being published in Western Samoa.

Western Samoa Gazette started in May of 1920 by the New Zealand Administration as the official gazette and is still continuing with the same title by the Western Samoan Government. Savali (Apia), is published by the Government of Western Samoa beginning September 1 of 1905 as a monthly publication and then later in 1970 as a biweekly publication.

In American Samoa, the oldest newspaper, titled O le Fa'atonu o le Kolone o Unaiete Setete Tutuila ma Manua, began in 1903. It was the official gazette in Samoan and English until 1955. Samoa News (Pago Pago) began publication in April of 1963 and lasted to 1966. The Office of Samoan Information of the Government of American Samoa published five times a week the News Bulletin starting July 12, 1965 and is still continuing up to the present time. Samoa News (Pago Pago), different from the original Samoa News (1963-1966), started publication on August 6 of 1969 and is still one of the current newspapers in American Samoa. The following is a list of periodicals that have been used for information in searching for historical tsunamis. Both national and local newspapers were used.

Honolulu Advertiser	1900 to present
Honolulu Star Bulletin	1900 to present
New York Times	1861 to present
News Bulletin for the People of American Samoa	1967 to present
O le Fa'atonu	1903 - 1955
O le Sulu Samoa	1890 - 1897
Pacific Islands Monthly	August 1930 to July 1945
Samoa Bulletin	1950 - 1967
Samoa News	1963 - 1966
Samoa News	1970 - 1979

Samoa Times	1901 - 1930
Samoa Reporter	1845 - 1860
Samoaana	May 1960 to March 1967

None of the Samoan newspapers provide indexes, therefore, to locate articles on any topic, manual search of each issue is required. In locating primary source of information for tsunami events, the dates of earthquake or known tsunami were first established, then a search of the newspapers available for these particular dates was initiated.

Search for the project initially began at the Hawaiian and Pacific Collection of the University of Hawaii Library. A handful of relevant journal articles and reports were located. Bibliographies from these articles were reviewed and provided further references. Several other bibliographies on the Pacific Islands and on Samoa were used to locate relevant publications. A list of these bibliographies can be found in Appendix I.

The Hawaii State Archives were reviewed but nothing was found pertaining to tsunamis in Samoa. The Bishop Museum archival and manuscript records were also thoroughly checked and some information on one historical tsunami was found. An annotated list of archival materials from approximately 1850 to 1925 found at the New Zealand National Archives indicates some reports on early exploration and on volcanic eruptions in Samoa. Mr. Norman Ridgway of the New Zealand Oceanographic Institute has helped in searching for material in the New Zealand National Archives for references to tsunamis in the Samoan Islands and found records of a few tsunami events (May 2, 1917, June 25, 1917, September 8, 1918, April 30, 1919, and February 4, 1923). Ms Lynette Hunter of the Office of Library Services of American Samoa Government has also helped in the search. However, no relevant materials has been located.

Scientific abstracts and indexes relevant to earthquakes, tsunamis, and geology were also reviewed. Since there are no cumulative indexes available in most cases, the search was done manually for each year. A computer search was thought to be an alternative which could have eliminated the manual task and could have provided more efficient searching of materials. However, it was found that most of the computer data base began only in the early 70's and therefore, was not useful in historical searching.

Several tsunami catalogs have been utilized to extract events of tsunamis in Samoa (Iida, et al, 1967; Pararas-Carayannis, 1977; Wigen, 1977; Heck, 1947; Keys, 1957). The U.S. Earthquakes published by the U.S. Geodetic Survey, and the Annual Summary of Information on Natural Disasters published by UNESCO are also used in locating events. Some of the most current events are found in the Tsunami Reports published by the International Tsunami Information Center. The most helpful source of primary information was provided by Mr. Seve Iosa of the Apia Observatory. Reports from the Apia Observatory provide detail accounts in Western Samoa for some of the events with high tsunami waves. In addition, the microfische collection of tsunami mareograms (March 1952 to December 1975) was also thoroughly searched and a number of events which occurred in Pago Pago were found.

Sixty tsunami events were located. The following are detailed narrative descriptions of the different events discussed given in chronological order and followed by a catalog listing.

November 7, 1837

Account of this event was found in Hitchcock's Hawaii and its Volcanoes where it records,

*On the 7th of November 1837, there was an earthquake in Chile, and a sea wave started by it was felt at the Hawaiian Islands; also at Tutuila in the Samoan Group. (Hitchcock, 1911)*

No other information concerning this tsunami and its other parameters in Samoa could be found.

August 14, 1868

The great "Peru" earthquake and tsunami on August 13, 1868 destroyed settlements in Apia according to the Preliminary Catalog of Pacific Tsunamis. (Iida, et al, 1967) No other detail could be found to verify this. No primary source of information is available for this year.

May 10, 1877

The May 10, 1877 great Chilean tsunami that caused devastating damages throughout the Pacific was also observed at Apia. According to the Preliminary Catalog of Pacific Tsunamis, the maximum height there was from 2 to 4 meters. (Iida, et al, 1967)

No primary source of local information could be located. The holdings of Samoa Times at the University of Hawaii Library began in 1901 and the Samoan Reporter is available from 1845 to 1860 only.

March 24, 1883

The New York Times reports,

*Captain Pearson, commanding the Wachusett, in a report from Apia, Samoan Islands, gives a description of a storm accompanied by shocks of earthquake which visited the Samoan group on the night of March 24... The east end of the Island of Savaii was visited by a tidal wave which swept away all houses within a quarter of a mile of the beach for a distance of 15 miles along the shore... (Anon., 1883)*

According to the Catalog of Tsunamis in the Pacific (Soloviev & Go, 1969) and Catalog of Tsunamis in Eastern Part of Pacific Ocean (Soloviev

& Go, 1975), there was an earthquake on March 24, 1883 in the Samoa Islands. However, no other detail on the exact location of the quake and damage was provided.

June 15, 1896

A letter from William Churchill, Consul General of the U.S. at Apia, Samoa to the Hydrographer of U.S.N. dated September 2, 1896 reads as follows:

*Sir: I have the honor to report for your information the fact of a tidal wave felt in this group at the latter part of June, information of which has just been brought to this office.*

*My reporters are Samoans and I have found it impossible to obtain from them an exact statement as to the day of the month on which this phenomenon was witnessed. Omitting, therefore, of necessity, this important detail their account is as follows. The tide was at the customary height of slack water flood in the morning of this particular day. After it has run ebb for a short time, apparently not much more than one hour, great waves were seen outside the reef and the water ceased to fall. There was a slow rise during all the period of ebb, the great waves continued at long intervals, the tide at the time which should have been slack water ebb was higher than it commonly is at high water springs by at least a foot. This would correspond to the height of five and one half feet above mean low water. It lasted during one whole period of ebb tide and is characteristically described by my Samoan reporters in the terms "low water was a foot higher than high water".*

*No damage was done by the strange tide except the carrying adrift of a few canoes beached not quite high enough. But considerable alarm was manifested over the unusual circumstance and I have been asked if it will not return with greater force and carry away the houses built on the beach just above high tide.*

*This had been reported in consistent terms from several places along the north coast of Savaii. At Iva, also on the north coast but rather more in toward the strait between Savaii and Upolu, the resident trader informs me that he noticed nothing of the sort. I have inquired generally as to the south coast and find that nothing was noticed of the sort since the earthquake shock of Christmas day last year.*

*No such phenomenon was noticed in Apia, on the north coast of Upolu, and as the German man of war "Folke" was lying in the harbor it is very likely that its trained officers would not have permitted such a thing to escape their notice if it has happened. (Churchill, 1896)*

No exact date in the month of June is specified in the letter. Several destructive tsunamis occurred on June 15, 1896 in Kamaishi, northeast Japan, according to Heck. (Heck, 1947) The only periodical source available in Hawaii covering this period is the "O le Sulu Samoa" published by the London Missionary Society. However, the publication is written in the Samoan language and it is not known whether any information about this event is reported.

#### 1905 - 1911

The Matavanu volcano eruption first began on August 4 of 1905. The flows occasionally generated small tsunamis by avalanching material into the sea according to Sapper. (Sapper, 1927; Richard, 1962) Several tsunami-like waves were observed when the crater was more than usually active.

*It is interesting to note that several so-called 'tidal' waves have occurred during the eruption. The following were noticed at Matautu by Amtmann Williams:--*

<i>November 28th, 1906</i>	<i>5:30 p.m.</i>
<i>June 8th, 1907</i>	<i>at noon</i>
<i>June 19th, 1907</i>	<i>3 a.m.</i>
<i>June 27th, 1907</i>	<i>between 6 &amp; 7 p.m.</i>
<i>July 9th, 1907</i>	<i>6:45 p.m.</i>
<i>July 25th, 1907</i>	<i>11 a.m.</i>

*The tide usually rises and falls about 4 feet at Matautu. Most of these waves did not exceed 6 to 8 feet in height, and as many of them occurred at low or half-tide, and there was no heavy sea on at the time, little damage was done, although in several cases the main road of the town was flooded. (Anderson, 1910)*

#### October 6, 1907

According to Anderson (1910), the largest and most important tsunami that was caused by the Matavanu volcano eruption occurred on October 6, 1907 at about 5:30 p.m. local time.

*The largest and most important of the series was that on Sunday, October 6th, 1907, about 5:30 p.m. It was just at the time of high water, but the sea was smooth. The wave was 10 or 12 feet high; it came from the north-east round the lave-point, as in fact the others had done, and at the Deutsche Handels & Plantagen Gesellschaft's place a boat-house was wrecked, a buggy in it smashed, and several boats were damaged; while, at a house a few score yards off, a 400-gallon tank of water was lifted bodily from its foundation and carried across the road. The wave appears to have spent itself here and, it was thought, probably rebounded out to sea.*

No damage was done at the Government Offices, 150 yards distant, nor in either direction along the coast.

The wave was noticed, but of smaller size, in some of the other islands. At Apia it had a height of only 1 or 2 feet. It was probably connected with the lava falling into the sea, but the exact cause was uncertain. Possibly it was due to a steam-explosion. (Anderson, 1910)

February 11, 1915

The New York Times (13 Feb. 1915) reported the following:

*Not only a hurricane, but with it an earthquake and a tidal wave, swept the Manua Islands of the Samoan group...*

*Fuller details received today show that three persons were killed. One of these was beheaded by flying wreckage. Entire villages disappeared. Those of which traces remain were ruined. All shipping was either destroyed or badly damaged. Three-fourths of the cocoa palms on which the islands depend for nourishment and their commerce on copra, were leveled, and all the remainder were injured. Some plantations were wiped out. It will be a year before any food plants can be brought into bearing again. Three thousands inhabitants are destitute. The American gunboat Princeton is conveying food, clothing and temporary assistance, but the need for further aid is urgent, as the food supply is so low that starvation will set in before three weeks are out.*

*The South seas have known hurricanes before, but the situation left in the wake of this storm is described as unprecedented. At the height of the storm the fury of the winds was unbelievable. Iron roofs were torn off and blow three miles. The very soil was torn from the coral rocks, and the coffins in new-made graves were left exposed. (Anon., 1915)*

No seismic activities were recorded for that period in that vicinity. No local newspaper articles reporting a hurricane or earthquake could be located. It is not known whether the "tidal wave" reported in the New York Times was indeed a tsunami generated by a local earthquake or high surge caused by the hurricane. The absence of any information on an earthquake or a tsunami elsewhere in the Samoan Islands suggests that the latter was the case.

May 1, 1917

Heck lists this event in his 'List of Seismic Sea Waves' as follows:



*Earthquake at 20.2°S, 177.0°W. Forty-foot wave at Samoa. Pronounced wave recorded at Honolulu and West Coast of United States. (Heck, 1947)*

The reference to the above statement came from International Seismological Summary, 1913-1934. (Anon., 1913) Copy of this Summary cannot be located in the University of Hawaii Library to verify the statement. Searches were carried out in the local newspapers "O le Fa'atonu" from Pago Pago; and "Samoa Times" from Western Samoa for that particular year (1917). No newspaper articles relating to a forty-foot wave or any indication of tsunami could be found for that month (May).

From the "Preliminary Catalog of Tsunamis Occurring in the Pacific Ocean", there is an earthquake recorded at 29°S and 177°W on May 1 with a magnitude of 8.0 at Kermadec Island. According to this catalog, a tsunami was observed in the Samoan Islands and is reported as follows:

*Recorded. 12 m. height reported by Heck is probably confused with height of June 25 tsunami. (Iida, et al, 1967)*

No record of this tsunami from Apia gauge was found. No other reference has been located thus far giving the actual height of the tsunami. The absence of any information in local papers is indeed strange, considering the magnitude and location of the earthquake.

#### June 26, 1917

Heck lists this June 25 event as follows:

*Samoa. Destructive earthquake and 40-foot tidal wave. Recorded at Honolulu and on West Coast of United States. (Heck, 1947)*

Reference to the above statement was found in "First Pan-Pacific Scientific Conference, 1921", which states the following:

*Important earthquakes occur in American Samoa, giving rise to tidal waves; a destructive one occurred in June 1917. There the earthquakes do not take place in the immediate neighborhood, but arise in Tongan Deep. The wave in 1917 was 40 feet high. (Anon., 1921)*

Mayor mentioned in his paper on "Causes which produce stable conditions in the Depth of the Floors of Pacific Fringing Reef-Flats" the following:

*The only unusual disturbance appears to have been due to the earthquake wave on the night of June 25, 1917, when the harbor-water suddenly sank about 3 feet above high tide, oscillating several times with decreasing amplitude. (Mayor, 1924)*

It is not known to which harbor he is referring to, but it is assumed to be Pago Pago. Report from records of Apia Observatory list the following:

1917 June 25: Earthquake about 150 miles S 20°W from Apia. Magnitude = 8.4. Destructive tsunami on south coast. At Apia Harbour, the wave arrived at about 0555 G.M.T. maximum range about 80 cm, period about 18 mins. (Apia, 1980)

A copy of the marigram from the Apia gauge is available.

The 'Samoa Times' of June 30, 1917 reports the following:

*As might have been expected... the earth tremors were accompanied or succeeded by a tidal wave which was observed all around the coast, but the full force of which was greatly minimized by the reef and also by the fact that the earthquake occurred coincident with low water. Nevertheless the accounts emanating from Lotofaga, if not exaggerated, are sensational to a degree... Dr. Angenheister in his report gives particulars of his observations at the Custom House Wharf, though the record here must have been considerably modified by the comparative shelter the spot enjoys...*

*On the Aleipata coast the tidal wave is described as sweeping in, a white wall of foam fully 10 ft. in height. Although dead low water at the time, the advancing wall of water swept over high water mark and across the beach into adjacent native houses, carrying everything before it. In some of the houses, mats, etc., stored several feet above ground, were washed away... At one point on the beach above high water mark a number of coconut tree logs, which had lain there unaffected by the highest and strongest tides, were lifted clear up and carried several yards from their original position...*

*In Lotofaga... the tidal wave swept right over the beach, flooding the houses and reaching out into the plantations at the rear. About two chains of solid cement wall, quite a foot thick and three feet high, was lifted up bodily and carried away, pieces weighing over half a ton being shifted back for fully 30 feet. Another account says that quite half the village was submerged and the houses destroyed.*

*... In Savai'i the tidal wave experienced was of an alarming character. At Palauli a bridge was washed away, and a number of native houses destroyed. At Satupaitea, a copra house was caught by the wave and carried down the coast for about a quarter of a mile, and here all native houses were demolished.*

*... In Tutuila a small tidal wave swept in through Pago Pago destroying many Samoan houses. Most of those living in Pago Pago took to the hills. (Anon., 1917a)*

The following is the account from the "O le Fa'atonu" of July 1917 from American Samoa:

Affected Areas by  
Tsunami of June 26, 1917  
In Western Samoa

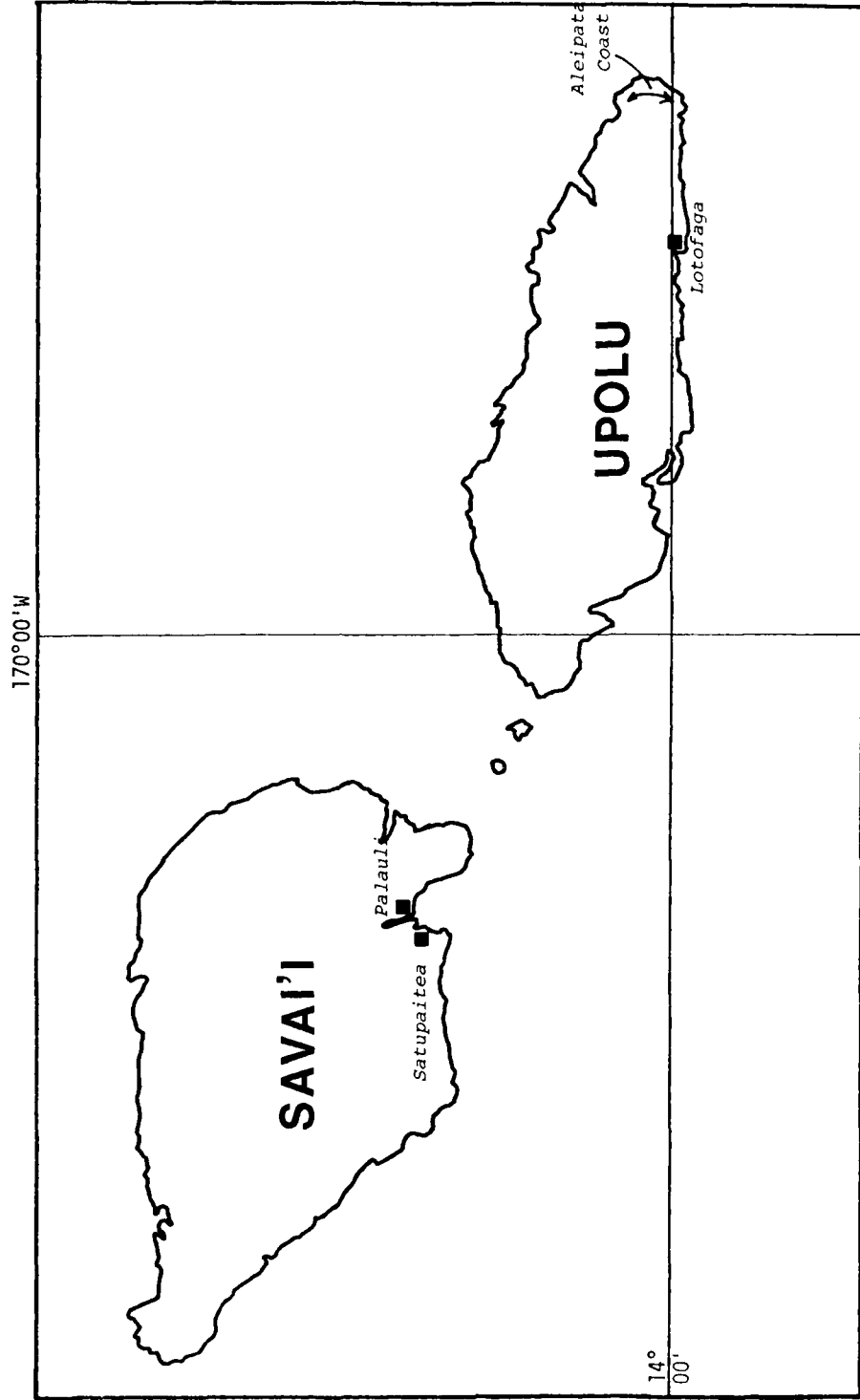

Affected Areas by  
Tsunami of June 26, 1917  
in American Samoa

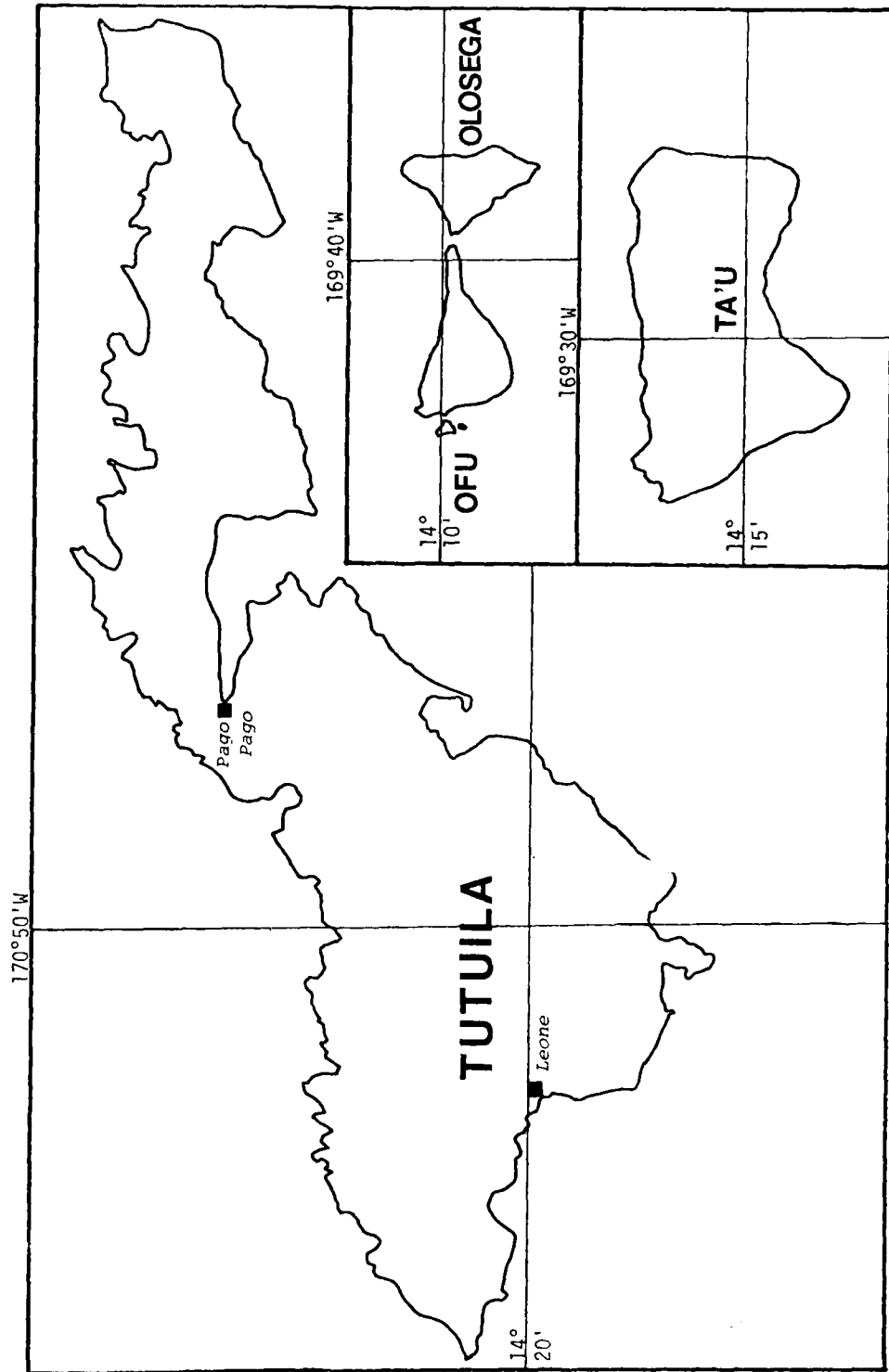

*The fear experienced from the violence of the tremors, is not to be compared with that experienced by the subsequent tidal wave. A few minutes after the quake ceased, the water began to leave Pago Pago Bay rapidly, falling about six feet. The return of the water resembled a small tidal wave at the head of the bay and there the water may have reached a height of six to eight feet above normal. No injuries occurred. There was much damage of minor importance, the most important being the damage to two large churches, which were partly demolished -- the Mormon Church in Pago Pago and the Catholic Church in Leone. Many of the natives around the bay sought refuge in the mountains where they remained until morning. (Anon., 1917b)*

#### September 7, 1918

Records of Apia Observatory in Western Samoa have the following information on this event.

*1918 September 7: Earthquake in the Kuril Is., about 7,500 km from Apia. Seismic register gives arrival time of Tsunami at Apia as September 8th at 0223 G.M.T., from which is calculated a velocity of 229 m/sec. Maximum range about 40 cm. Period about 20 mins. (Apia, 1980)*

The Samoa Times (Anon., 1918) reported that an earthquake was recorded at the Apia Observatory. Though it was generally not felt in Samoa, it was followed by a tidal wave observed at several points along the shores. The tide gauge record at Apia Harbour showed that the wave began a few minutes before 3 o'clock P.M. local time (Sept. 8). The maximum perturbation of the sea level was 18 inches, and the period 15 to 20 minutes. At Sogi, about 3 hours later, the water suddenly receded and later came rushing back at least a foot higher than before. At Safune of Savaii, it was reported that the same phenomenon occurred as in Sogi.

No reports from American Samoa newspaper can be found on this event.

#### April 30, 1919

Heck's list reports the following:

*1919 April 30. Tonga Islands. Recorded on Apia, Honolulu, and California tide gages. (Heck, 1947)*

Mayor's paper on "Causes which produce stable conditions in the Depth of the Floors of Pacific Fringing Reef-Flats" also reported this event as follows:

*... it may also be of interest to state that Tongan earthquake of April 30, 1919, produced quite similar oscillations of sea-level in Pago Pago Harbor. (Mayor, 1924)*

Reports from the Apia Observatory, Western Samoa, (Apia, 1980) showed that first wave arrived at Apia at 0812 G.M.T. Greatest height was 37 cm. The Samoa Times (Anon., 1919a) reported an earthquake occurrence but no details of the tsunami were given.

O le Fa'atonu (Anon., 1919b) reported that the quake was also followed by the tidal waves in Tutuila. The water receded about six feet below the low water mark, and when it returned it attained a height of six or eight feet above high water. No indication of where the tidal waves occurred on the island of Tutuila was provided.

#### August 1920

Heck's listed:

*1920 August. Samoa. Earthquake and tidal wave at Pago Pago.  
(Heck, 1947)*

Reference to the above comes from a report of the First Pan-Pacific Scientific Conference in 1920 where several scientists were having discussions. Mr. Mayor, one of the participants said,

*Recently at Pago Pago an earthquake was followed in half an hour by a wave. (Anon., 1921)*

According to the Preliminary Catalog of Pacific Tsunamis occurring in the Pacific Ocean,

*Heck's reference to an earthquake and tsunami are almost certainly mistaken. No quakes were recorded at Apia according to Keys (1957). The Apia record mentions no tsunami. Probably, a confused re-entry of the September 21 tsunami.  
(Iida, et al, 1967)*

No primary sources from local newspapers have recorded this event.

From the Apia Observatory (Apia, 1980), the seismic register did not mention any tsunami, nor were there any outstanding local earthquakes near the month of August. In conclusion, this was an erroneously reported event.

#### September 20, 1920

An earthquake occurred in the vicinity of New Hebrides on 20 September 1920. The first sea wave to reach Apia was at 1904 hours. Unfortunately, no tide gauge record at the Apia Observatory is available. (Apia, 1980) No other primary source of information could be located. No reports concerning this tsunami were found in the O le Fa'atonu from American Samoa or the Samoa Times from Western Samoa. (Heck, 1947) (Iida, et al, 1967)

November 11, 1922

According to the reports from Western Samoa, the first sea wave reached Apia at 1836 hours. (Apia, 1980) The Preliminary Catalog of Pacific Tsunamis (Iida, et al, 1967) indicates slight damage in Pago Pago. However, no other sources were found to verify this. No reports were found in the Samoa Times of Western Samoa nor from O le Fa'atolu of American Samoa.

February 3, 1923

The Apia Observatory records (Apia, 1980) show that the first wave reached Apia on February 4 at 0142 G.M.T. after the tsunami at Hawaiian Islands on February 3.

The Samoa Times (Anon., 1923) reported that a tidal wave was recorded by the tide gauge but the rise and fall of the water was small. No other information for Western Samoa or American Samoa could be found.

March 16, 1926

Heck indicated an earthquake at 16°S and 171°W (Samoa?) which caused tidal wave and swept over Palmerston Island (19°S, 162°W). (Heck, 1947) This was cited from a report of 30 June which recorded that the incident occurred about three months earlier. (Iida, et al, 1967)

The Apia tide records are available but no tsunami was recorded, and no notes appear in the seismic register. According to the Apia seismic records, this earthquake was 150 miles from Apia in direction S 14°W and was felt R.F. 4. Palmerston Island is about 750 miles from Apia in direction S 60°E. There was a cyclone 150 miles north of Apia on January 1. (Apia, 1980) The Preliminary Catalog of Pacific Tsunamis indicates that the storm was centered 15 miles north of Apia. The 15 miles distance is probably an error.

Doubtful tsunami.

June 17, 1928

The Apia tide gauge record (Apia, 1980) showed that first wave began at about 0450 local time in a period of about 20 mins. About three prominent cycles appeared on the mareogram.

No other sources of information could be located concerning detail of this event.

June 3, 1932

The Apia Observatory tide gauge recorded this event at about 1045 local time. The period was 20-25 mins. and the range was about 2 1/2 inches. (Apia, 1980)

No report was found in O le Fa'atunu of American Samoa. The Samoa Times of Western Samoa for 1932 was not available.

March 2, 1933

The event was recorded at Apia. No other detail could be found. O le Fa'atunu had no reports about this event and Samoa Times is not available for this year. (Apia, 1980)

December 7, 1944

Newspaper accounts cannot be found in O le Fa'atunu and Samoa Times is not available for this year. However, a small tsunami was recorded by the Apia tide gauge. Prominent weak waves, 2 inches in range began at 11 h 00 m with a period of 20 minutes. The waves may have lasted until 09 h but the trace is too weak. (Apia, 1980)

April 1, 1946

Records of Apia Observatory state the following:

*1946 April 1: Aleutian Is. First sea wave at Apia at 21h 43m G.M.T. was a recession. The period was 25 mins. There is also a reflection from the California Coast, arriving at Apia at April 2nd 02 08 G.M.T. causing an apparent period of 10-15 mins. Apia record available. (Apia, 1980)*

Local newspapers from American and Western Samoa for the year 1946 are not available from the University of Hawaii Library. Thus, no primary source of the account is located. However, an article from Honolulu Advertiser dated April 19, 1946 states:

*Several huts in the village of Pago Pago, Samoa, were washed away by the tidal wave which swept across the April 1 according to officers of the MV Honda Knot which arrived at Pearl Harbor Wednesday from Samoa... In that port, the officers said, the rise and fall of the harbor as the wave struck was about five feet. (Anon., 1946)*

From the Apia Observatory records, the following is an extract from a letter in the Observatory file about this event.

*Commencing at 10:30 a.m. local time on April 1st, the Apia Harbour was almost drained of water, leaving the inner reef quite dry. This was followed by an inrush completely filling the harbour as at high tide, the range being approximately 8 ft. This phenomenon occurred six times between 10:30 and 12:40 p.m., the time of low tide. When the tide was on the "make" the phenomenon was less noticeable except as a series of "swells" which were larger than usual. The level at high*



Affected Areas by  
Tsunami of April 1, 1946  
in American Samoa

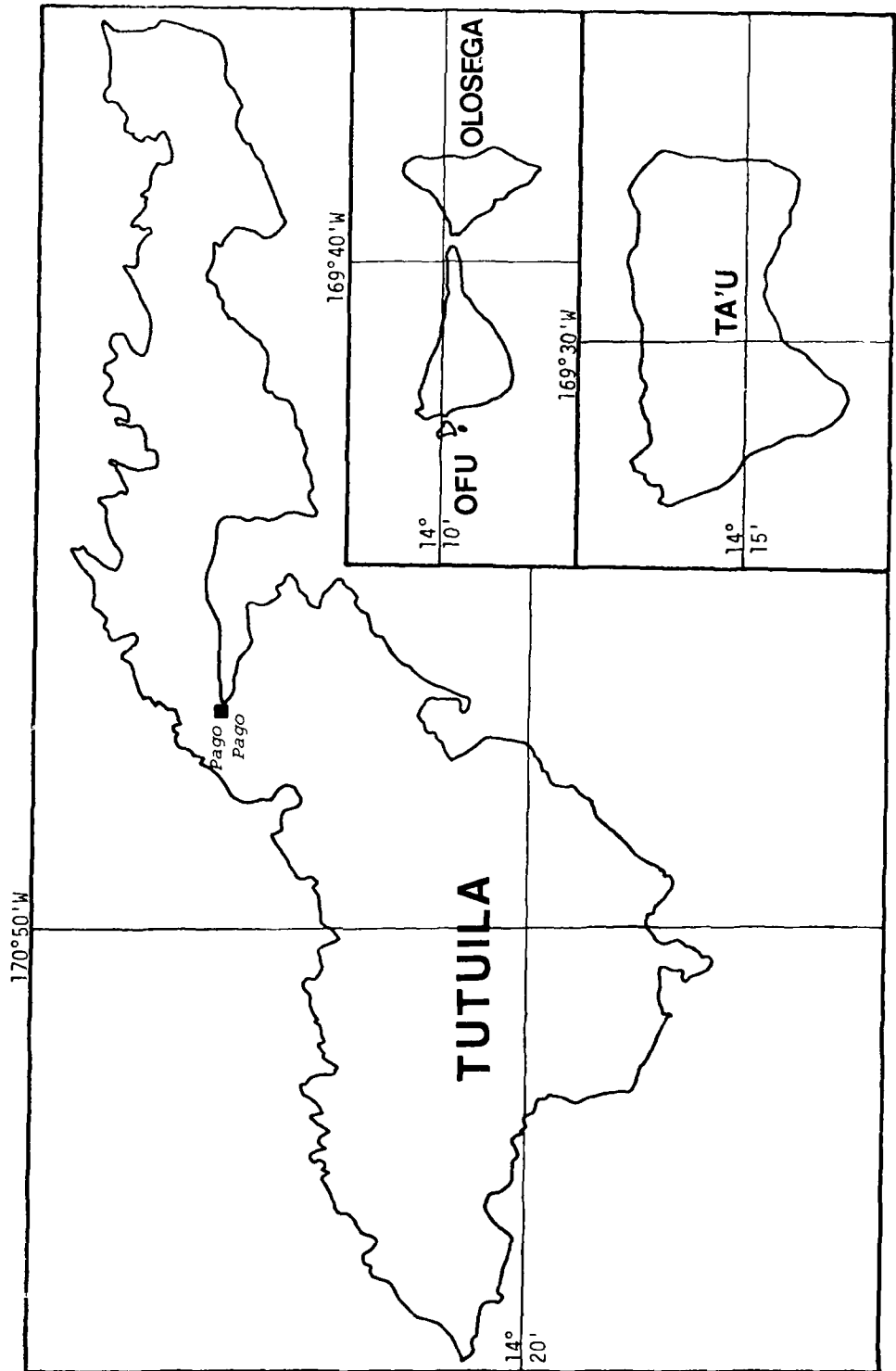

AD-A090 275

ARMY ENGINEER WATERWAYS EXPERIMENT STATION VICKSBURG--ETC F/6 8/3  
TSUNAMI ELEVATION PREDICTIONS FOR AMERICAN SAMOA.(U)

SEP 80 J R HOUSTON

WES/TR/HL-80-16

NL

UNCLASSIFIED

2 of 2

AD  
080275



END  
DATE  
FILMED  
11-80  
DTIC

Affected Areas by  
Tsunami of April 1, 1946  
in Western Samoa

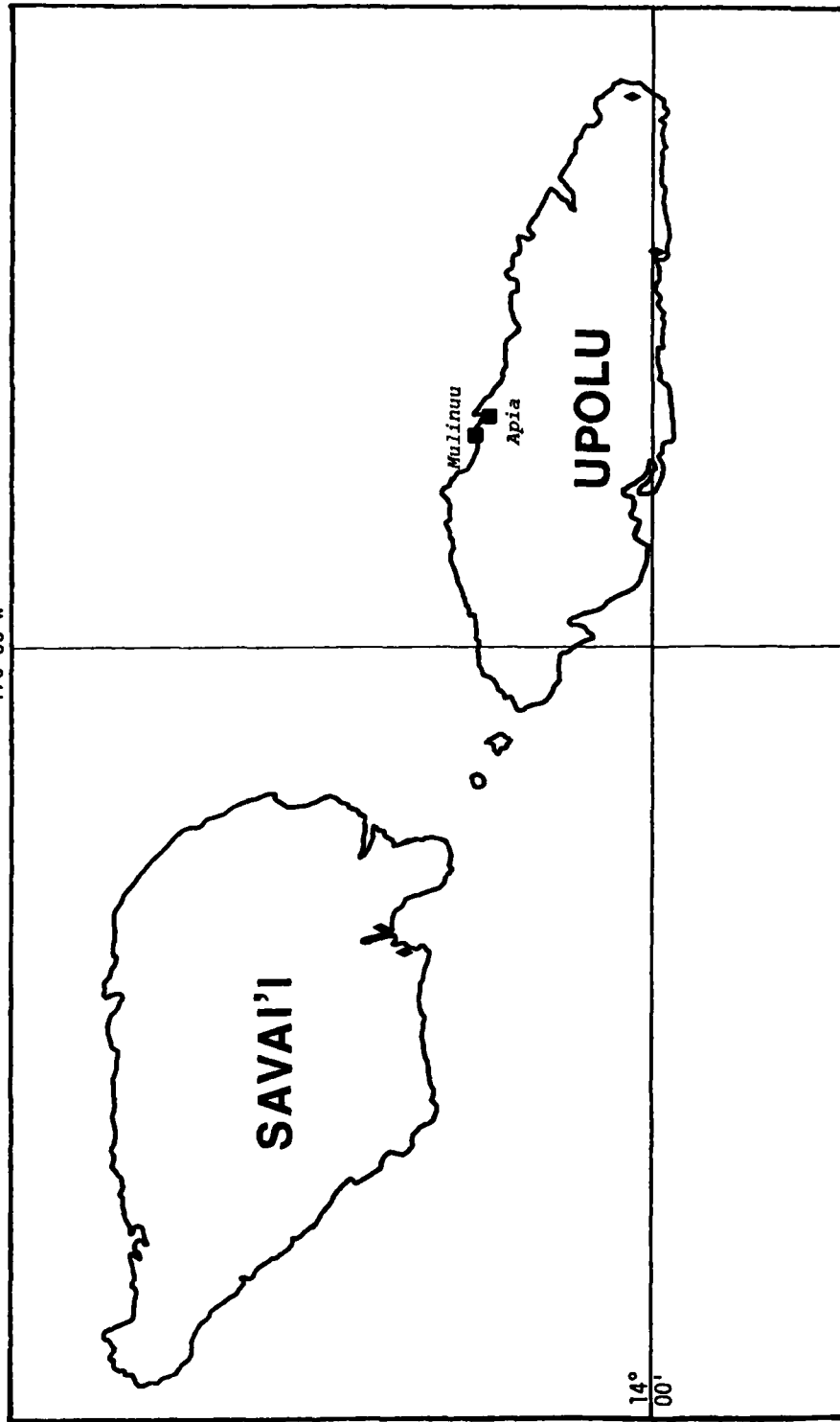

*tide was very high, and in some cases the sea encroached on the road, which is exceptional, even at spring tides.*

*At Mulinu'u by the Observatory, nothing unusual was noticed until the tide was on the turn. This was presumably due to our being protected by the reef which at low tide is entirely uncovered. The ingress of waves from the open sea was stopped by the reef, while tidal waves coming from the harbour did not have sufficient energy to traverse the lagoon as far as the Observatory. However, in the afternoon the series of "swells" were observed. These were recorded on our tide gauge, with amplitudes just under one foot. (Apia, 1980)*

No information from any other locality has been obtained concerning this tsunami.

#### September 8, 1948

The only reference relating to this event is found in the Preliminary Catalog of Tsunamis occurring in the Pacific Ocean. It is listed that the September 8, 1948 earthquake in Tonga (21°S 174°W) with a magnitude of 7.8 generated a tsunami of 0.1 m with a period of 17 minutes at Pago Pago. (Iida, et al, 1967) This is probably taken from a tide gauge record. No reports from O le Fa'atonu could be located. The Samoa Times for this year was not available at the University of Hawaii Library.

#### March 4, 1952

An earthquake occurred in Tokachi, Hokkaido of Japan generated local tsunamis and in Hawaii and elsewhere. A minor trace of tsunami was also recorded at the tide gauge of Pago Pago. (Microfische Collection of Tsunami Mareograms 1952-1975)

#### March 10, 1952

An earthquake with a magnitude of 7.1 in S.E. of Hokkaido, Japan caused a minor tsunami recorded at the tide gauge at Pago Pago. (Microfische Collection of Tsunami Mareograms 1952-1975)

#### March 17, 1952

A minor trace of tsunami was recorded at the tide gauge at Pago Pago due to the earthquake occurred off the shore of the Island of Hawaii. (Microfische Collection of Tsunami Mareograms 1952-1975)

#### March 19, 1952

An earthquake occurred in Mindanao of the Philippines with a magnitude

of 7.75 in the Richter scale caused a minor trace of tsunami recorded at the tide gauge of Pago Pago. (Microfische Collection of Tsunami Mareograms 1952-1975)

May 13, 1952

A minor trace of tsunami was recorded at the tide gauge of Pago Pago after the earthquake of May 13, 1953 in Costa Rica. (Microfische Collection of Tsunami Mareograms 1952-1975)

July 13, 1952

According to Iida, et al, 1976, no evidence to support tsunami generation by the earthquake that occurred in New Hebrides can be found. However, a minor trace of tsunami was recorded at the tide gauge of Pago Pago. (Microfische Collection of Tsunami Mareograms 1952-1975)

November 4, 1952

*The tidal wave which Western Samoa experienced last Tuesday afternoon could have caused serious damage along Apia's foreshore if it had happened four hours later. The incoming tide was well below its high water level at 3.42 when the first effects of the tidal wave were recorded on the tide gauge at the Apia Observatory at Mulinu'u. The third surge was the first of a series of spectacular movements of the sea. Shortly after 4 o'clock, the inner harbour became almost empty, then back came the sea swirling toward the shore in a rush which sprayed water over the sea wall, and inundated low-lying areas... The highest reading of the tide at the Observatory was recorded at 8:50 p.m. when the oscillations were still quite large and the tide was at its maximum height. (Anon., 1952)*

The above was recorded in the "Samoa Bulletin" from Western Samoa dated November 7, 1952. No newspapers for the year 1952 and 1953 from American Samoa is available in Hawaii.

From the special publication of the Coast and Geodetic Survey titled, "The Tsunami of November 4, 1952 as Recorded at Tide Stations," the following information is obtained.

*Apia, Western Samoa. The Observer-in-Charge, Apia Observatory reported: At 1 p.m. local time a further cable was received indicating that the wave had passed midway Island with an amplitude of approximately 5.8 feet. No further information was on hand when the first signs of a disturbance were noticed in Apia Harbour at about 3:45 p.m.*

*The harbour was alternately drained to below low tide level*

Affected Areas by  
Tsunami of November 4, 1952  
in Western Samoa

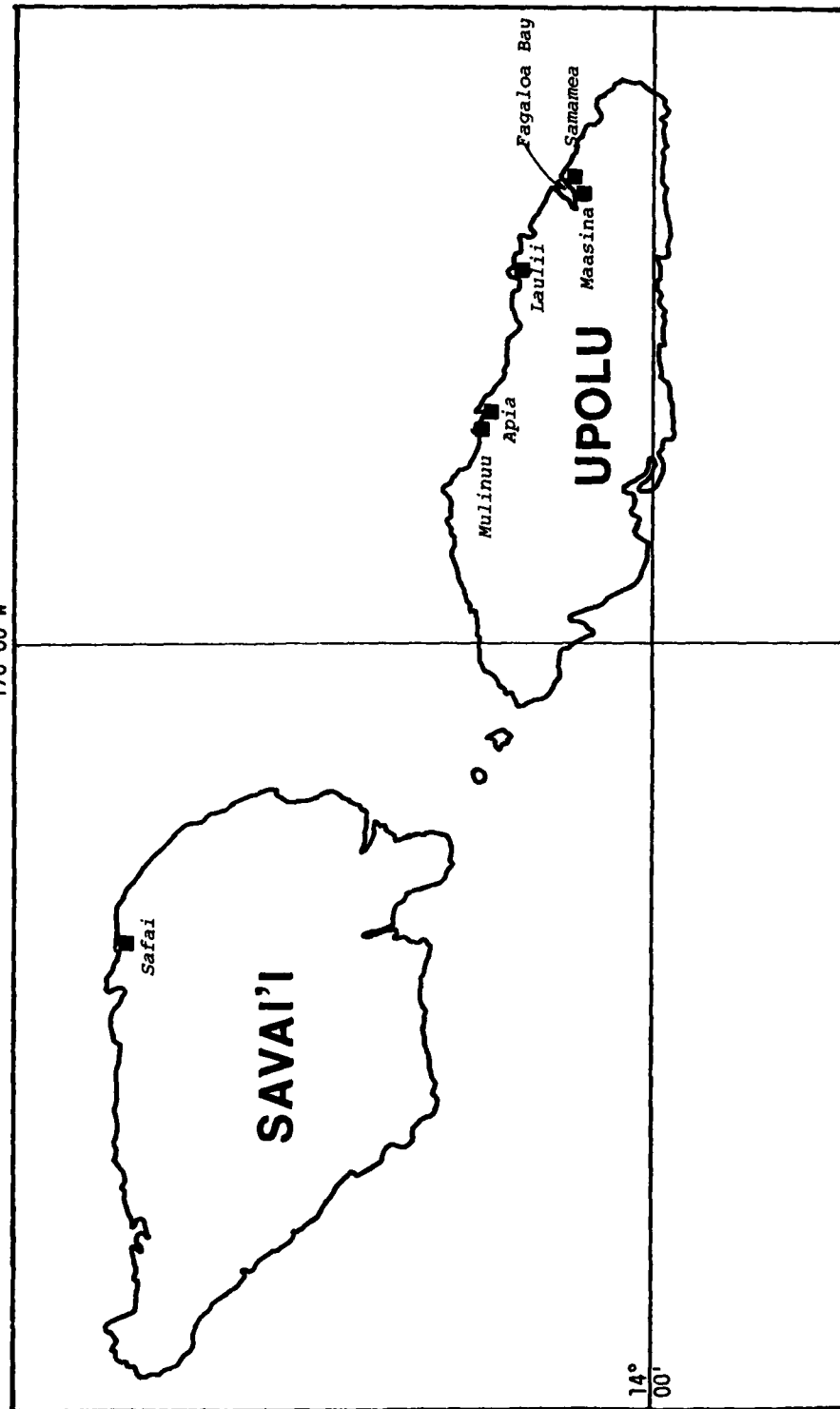

exposing all the inner reef, and filled to over highest tide level at intervals of approximately 15 minutes. The rise (and fall) of water was approximately 4.5 feet at Apia Wharf although at the Observatory's tide gage in the lagoon, this was reduced to only 1.1 feet. The first indications on the tide gage were recorded at 3:35 local time when the water level began to rise.

The oscillations of the lagoon were visible for several hours and disturbances on the tide gage record at 10:00 a.m. The following morning still maintained the same periodicity. The highest water level was at 8:50 p.m. when the oscillations were still quite large and the tide was at its maximum height.

Some property damage was reported from Fagaloa Bay near the eastern end of Upolu where the wave built up into a 5 foot wall of water. A school and some other Samoan buildings were completely lost. No other extensive damage was reported and there was no loss of life. (Zerbe, 1953)

A copy of the tide gauge record showing tsunami at Pago Pago on November 5, 1952 is available. The 1952 tsunami was believed to be larger than the 1957 event. However, descriptions about this tsunami is very meager. Report from Apia Observatory provides a brief account of tide activities of various places in Western Samoa.

At the Observatory in Mulinuu, the tide gauge record was suffering from a friction effect at low tide. The first deflection was a strong rise at 15:35 on 4/11/52. Maximum range appears to be 2.1 ft. at 4:20 or 5 p.m. with a period of 25-30 minutes.

In the Apia Harbour the effect was considerably greater than that of 1946. Land around the Custom House was flooded to in depth of a few inches.

At Lauli'i the water penetrated up to the road, which was about 3 ft. above low tide mark on that day (the Tsunami arrived in Samoa at low tide in 1952). Thus the water range may have been 6 ft. or more.

At Ma'asina in Fagaloa Bay the range was about 9 ft. The water was observed to pile up into sinusoidal waves which travelled up the bay. There was approximately 3 such crests, probably becoming larger towards the head of the bay, although this is uncertain. Taelefaga at the head, suffered considerably, but it was difficult to find out more than this. The range was of the same order, probably greater.

At Samamea in Fagaloa Bay, according to the resident Pastor the first motion was a recession, and the maximum range was 5-6 ft. There were three large

waves. This information had to be obtained by letter. To the question "How long did the sea keep coming in and going out (e.g. one day, etc.)?", his answer was  $\frac{1}{2}$  hour. He was probably referring to the period of maximum activity. In any case, estimates of time are likely to be unreliable, as they do not usually have clocks.

At Safa'i in Savai'i, the 1952 tidal wave was much higher than the 1957 March one. (Apia, 1980)

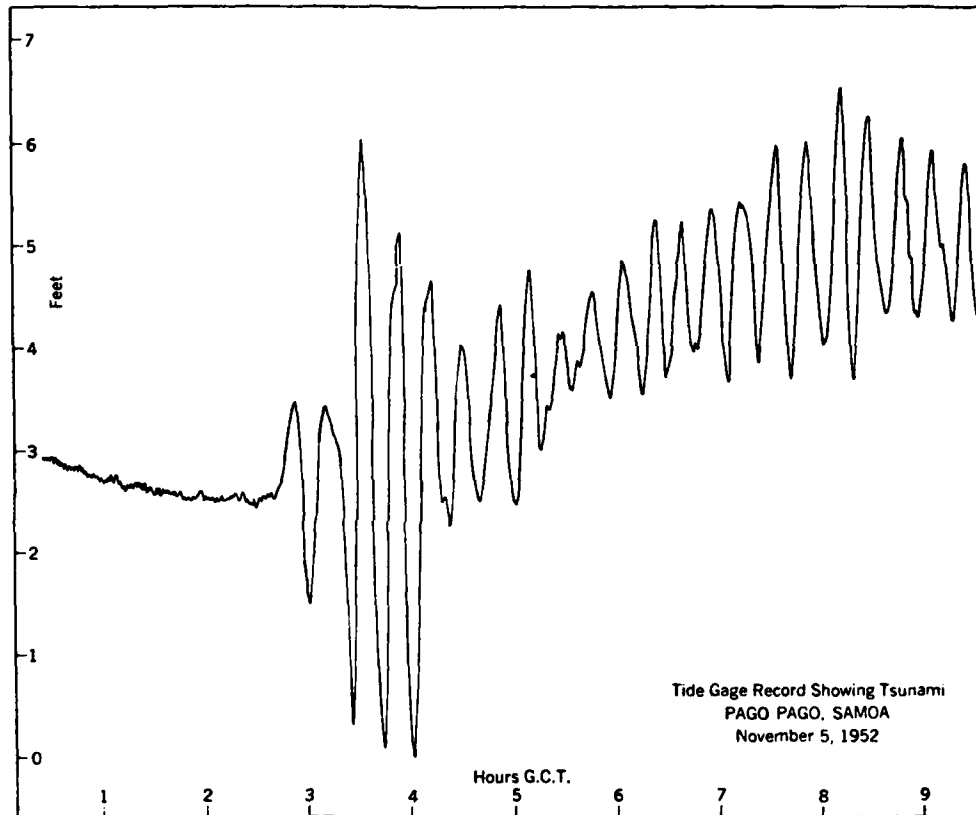

### September 13, 1953

The Preliminary Catalog of Tsunamis occurring in the Pacific Ocean lists that the earthquake of September 14, 1953 at Kandavu Passage of the Fiji Islands generated a small tsunami of 0.2 meter at Pago Pago. (Iida, et al, 1967)

No primary reports are located in the Samoa Bulletin or O le Fa'atonu. The 1953 issues of Samoa Times were not available for review.



March 9, 1957

A report from the Apia Observatory Western Samoa provides an account of this event in detail. Affecting areas are discussed individually. The report includes the following:

On the North coast of Upolu island, the following reports were obtained:

Faleolo Airport: The water level rose about one foot, once only. No other fluctuations were noticed.

Vaiusu Bay: The water current was apparently strong enough to damage a wire-netting fish-trap in the bay, but no inundation reports were received.

Mulinu'u Point: Noting the large earthquake on March 9th, although no warning has been received, a casual look out for a tsunami effect was kept, up till about 1:00 p.m. Nothing, apart from the general wave motion, was noticed, probably because of the non-continuity of the observations. The Observatory tide gauge, however, wrote a reasonable record of the disturbance; maximum height range one foot. From Mulinu'u point around the Apia Harbour coastline, fluctuations of the sea were noticed at about 2 p.m. by two or three citizens who were swimming. No heights were quoted, but the main effects seem to have been the change in currents caused within the confining reef.

Lauli'i: Most of the coastal strip of land at the head of this bay is very low-lying, flat land, just above high water level. Consequently, greatest inundation amounted to about 50 yds. inland from high water mark at roughly 2:30 p.m. The height range was about 3 ft. maximum. Following waves were smaller and did not penetrate inland. There was a slightly increased effect up a shallow stream on the eastern corner of the bay. The wave following the inundation, travelled a short distance up this stream.

Tidal fluctuations appeared to have ceased by (roughly) 4 p.m. on the same day.

Saluafata Harbour: At Vailoa College, situated upon a hill next to the coast, no tsunami was noticed, probably because of lack of observations. At Saluafata Village the effect was marked. The first motion noticed, was a small recession of the sea, when the reef was exposed (at 11 or 12 o'clock). This was followed by a small advance. The next advance washed over a gently sloping sandy bank, carrying some light vegetation debris, and flowed underneath some Samoan houses on the inland side. The water therefore rose about 3 ft. above tide level on that day. This was followed by two smaller waves which failed to wash over the top of the bank. Altogether there were 3 or 4 prominent waves.

Piula: First motion was a recession at about 2 or 3 p.m. Four or five prominent waves occurred, the largest height range being about 3 ft. (from low tide to about 1 ft. above high tide).

Small surges continued all afternoon, while one observer said they continued till about Monday. The coast here being steeper, there was no inundation. A mile or two towards the east the coast is flatter and there was slight penetration by the sea, the main observed feature being the long-shore currents within the reef.

Fagaloa Bay:

a) Taelefaga: About two large rises of the sea, the greatest height range being about 5 ft. The inundation over the lower lying part of the village was about 25 yds., the sea washing into huts and depositing a canoe, with boy, inside a Samoan house. Sea receded past reef leaving it dry so that fish were gathered before sea returned. The sea came level with the slightly higher portion of the village without inundation.

Sea invaded land about 40 yds. towards the head of the bay. People began shifting furniture to higher ground from memory of the 1952 Tsunami. No wave crests occurred (i.e. no piling-up of the water into sine waves).

b) Ma'asina: There was an initial recession of the water (the time given for this was 3:30 p.m. but is probably quite unreliable). The height range was given as about  $3\frac{1}{2}$  ft., having receded 50-100 yds from high tide mark, and advancing just a little above that mark. About two such high rises occurred. Smaller oscillations continued for nearly 3 days, the periods being about half an hour. There were no wave crests.

c) Samamea: The Pastor of this village was absent at the time but according to other villagers no disturbance was noticed at all.

On the South coast of Upolu, no one at all appeared to have noticed the Tsunami. Enquiries were made at the following places:

Falelatai,  
The eastern side of Lefaga Bay,  
Sa'anapu,  
Opposite to the Safata peninsula,  
Si'umu - Short period waves noticed here, but almost certainly not connected with Tsunami.  
Lotofaga - The people had heard the story of the Tsunami but had not noticed anything themselves.

Aufaga  
and Lalomanu

Reports from the island of Savai'i: The following report was obtained through the Resident Commissioner of Savai'i.

Safa'i: The abnormal tide was first observed at about 2:30 p.m., on a rising tide. The initial direction was not noticed, but it appeared that the water may have first advanced.

There were four or five large movements of the water, the greatest height range being six feet or more.

Oscillations of the water continued only during the one afternoon.

The water came right up the beach, over the beach, over the road, on to the malae. The land is very flat here, approximately six feet above high water mark.

Waves also rushed up the creek at the back of the village. This creek is tidal and drains a swamp. The waves had sufficient force to demolish a stone causeway used by the villages to cross the creek to their plantation area.

There was no effect either in Sato'alepai or Saleaula, the villages immediately to the west and east respectively of Safa'i. Enquiries were made by the Commissioner along the north coast of Savai'i, but as far as could be ascertained, the Tsunami was experienced in only the one village, i.e., Safa'i which is near Fagamalo.

There was no effect noticed at Tuasivi.

Letters of enquiry were sent to Falealupo at the western end, and to Gaga'emalae on the south of Savai'i. No replies were received, so it seems probable that nothing was noticed at these places either.

Report from American Samoa: The following information was obtained from the Director of Public Works, Pago Pago.

Pago Pago Harbour: The first motion was a recession of the water at 1248, although north shore people said it advanced.

At the Pago end of the harbour the sea went over the road which is 4 ft. above mean tide. Fagasa, the small bay on the north coast, had waves about 5 ft. higher than normal high tide. There were about 11 large size waves over a period of 1 hour and 50 minutes. The first three waves were approximately 14 minutes apart. About the 9th and 10th waves were coming in at about 8-9 minutes each -

smaller and faster. The harbour kept on oscillating for approximately 5 hrs. At 6 p.m. there was still a slight disturbance, but north shore Fagasa Port showed fairly rough waters. There is no record as to how long Fagasa oscillated.

The Pago Pago Administration Tide Gauge charts were sent to U.S.C. & G. Survey Honolulu, T.H. No measurements from these charts had been made. (Apia, 1980)

No reports were made anywhere else in Tutuila or in Manu'a.

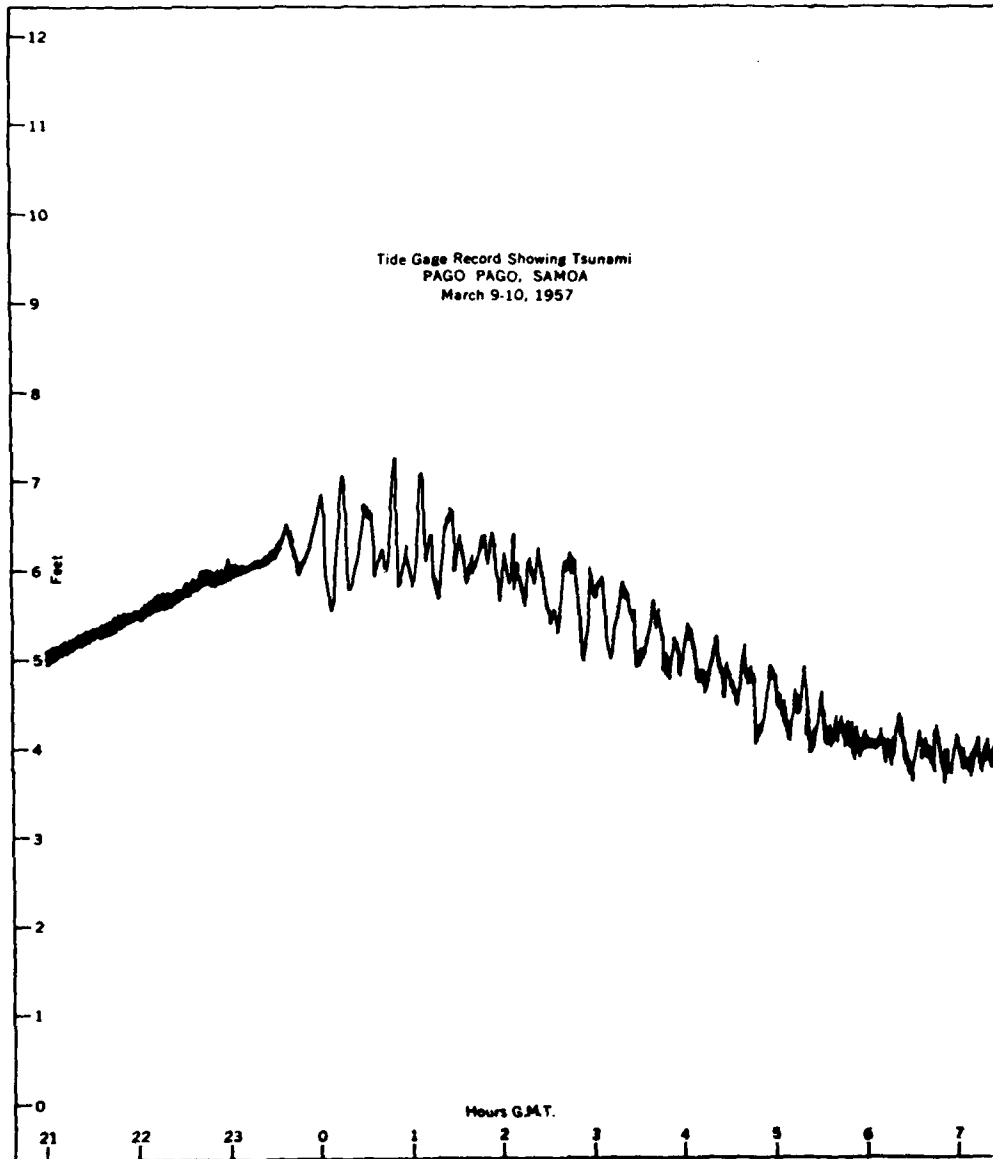

Affected Areas by  
Tsunami of March 9, 1957  
In Western Samoa

170°00'W

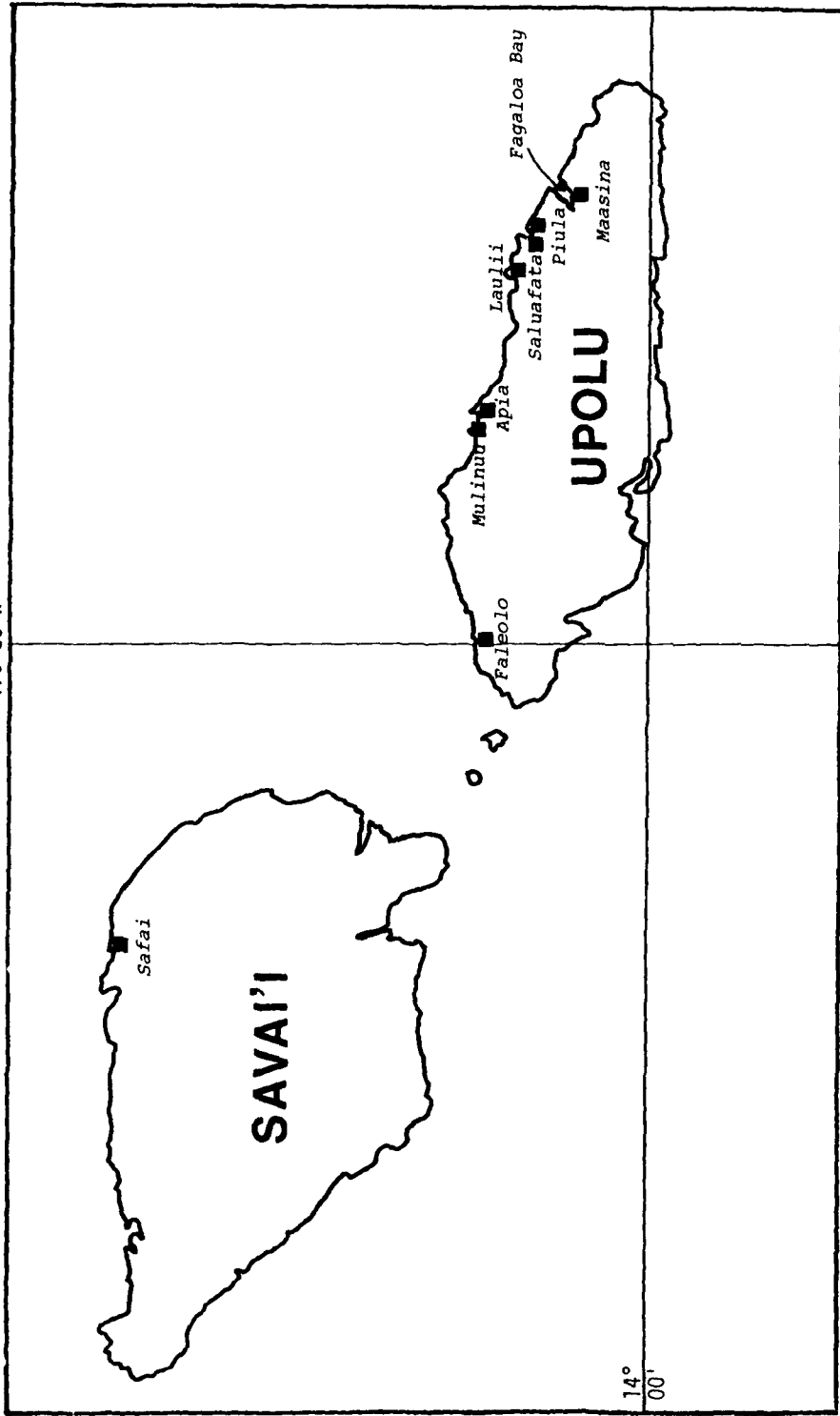

14°  
00'

Affected Areas by  
Tsunami of March 9, 1957  
in American Samoa

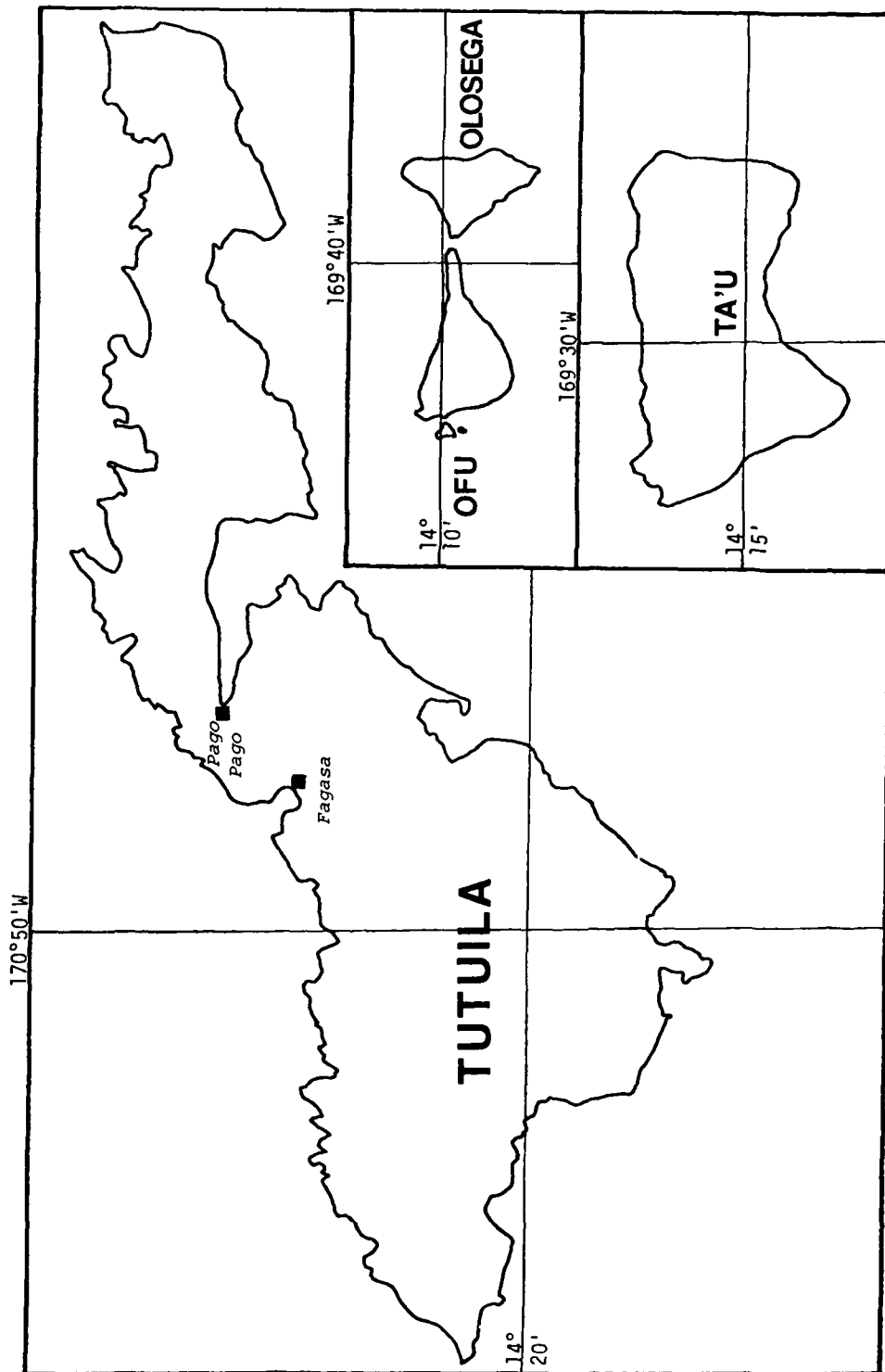

November 6, 1958

According to the Preliminary Catalog of Pacific Tsunamis, the November 6, 1958 earthquake at Iturup, South Kuril Islands generated a tsunami of 0.1 meter at Pago Pago. (Iida, et al, 1967) This is taken probably from a tide gauge record.

No other primary source information could be located.

May 22, 1960

The May 22, 1960 tsunami was undoubtedly one of the largest that has been recorded in the Samoa group. An extensive account of the event was written by Keys. The following are extracts from his report.

On the Island of Upolu

*The first wave struck Samoa at about 2050 hours. Since it was not a serious one, it did not seem to have been observed.*

*The second wave arrived at 2345 hours and caused considerable damage at Aleipata and Fagaloa Bay.*

*At Apia Harbor, a wave displayed period of about 8 minutes at a range of about 4 feet was observed about midnight.*

*At Lalomanu, the tide approached full and the 2345 hours wave had picked up two fisherman in canoes near the reef and washed them onto the beach by the road. The crest had an amplitude of about 6 feet.*

*At Malaela, the wave action was unusually short -- about 4 minutes ranging about 6 feet on May 23.*

*At Fagaloa Bay, residents has observed unusual tide activity since 2115 hours, with an estimated range of about 6 feet and a period of approximately 10 minutes. At about 2345 hours, a great recession caused the sea to retreat beyond the reef, and a few minutes later, a crest advanced 90 yards through the village, rising to a height of approximately 8 feet above the normal tide. The range between crest and trough maxima was estimated at 14-15 feet. This wave caused damage at Fagaloa Bay and the peak water level reached the roof of one of the native houses. Debris was scattered about the village. No lives were lost.*

Island of Savaii

*Information from Savaii is incomplete according to Keys, due in part of the time that elapsed between the tsunami and the collection of information, and in part to the necessary use of an interpreter.*

At Falelima, the tsunami seems to have been first observed on the northeast coast at 2100 hours. At 2345 hours, three large waves were observed with an estimated range of 8 or 9 feet and a period of about 30 minutes.

At Neiafu, one major crest was observed with a reported height of 7 to 8 feet. Times given were unreliable.

At Tufutafoe, two large crests were observed at approximately 2200 hours that attained a height of 6 to 7 feet, with a period of about 15 minutes.

At Sasina, the tsunami was not observed until approximately 0500 hours the next day because the bay entrance is enclosed by a reef. The peak range of the wave was about 5 feet with the period reported as about 30 minutes.

At Tuasivi, the shore is completely screened by a reef about 500 yards out. The tsunami have manifested itself as short-period surges, with peak ranges estimated at 4-5 feet.

#### The Island of Tutuila

The marigram at Pago Pago showed that the first wave arrived at approximately 2035 hours. Observers reported that there was approximately 10 wave crests and troughs with the third and fifth considered to be the largest and period estimated about 20 minutes.

800 yards farther up the bay, 6-7 feet peak amplitude was recorded above the normal tide at which time was on the ebb and approaching low water. The subsequent trough attained a maximum of approximately 4-5 feet, giving a range of approximately 10-12 feet.

Another half a mile up from the bay, five waves were observed of which the fourth was the largest. Maximum range here was estimated at 8-10 feet, crest to trough.

No tidal disturbance was noticed at Tafuna because it was screened by an offshore reef.

At Pago Pago village, which is located at the extreme west end of the harbor, the tsunami reached its greatest proportions in Samoa. The peak range here was 15.5 feet and damage estimated at \$50,000 resulted. According to the analysis of the damage, it is reported:

One house was lifted and moved about 10 feet inland and another was washed into the bay by the outgoing wave. A school, substantially constructed on concrete piers, was rotated about a foot with consequent springing of nearly all structural members.



At Fagaalua, the sea rose no more than 2.5 feet.

No reports of activity were obtained from other coastal villages. It seems evident that Pago Pago Harbor was the only location where the tsunami was observed. (Keys, 1963)

PAGO PAGO, AMERICAN SAMOA  
May 23-24, 1960

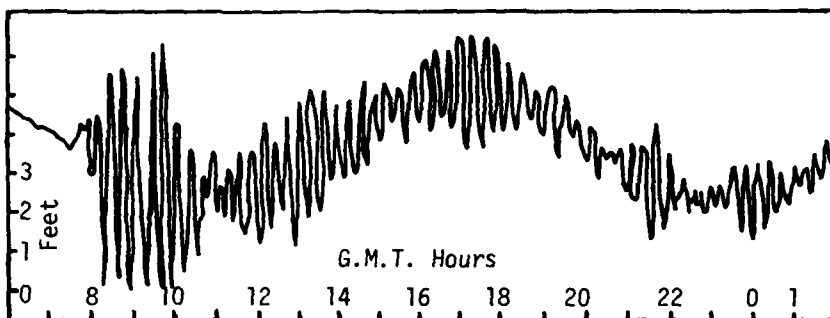

Marigram from Pago Pago Harbor, Tutuila, showing May 1960 Tsunami. (After Symons and Zetler, 1960)

APIA OBSERVATORY MARIGRAM  
May 22-23, 1960

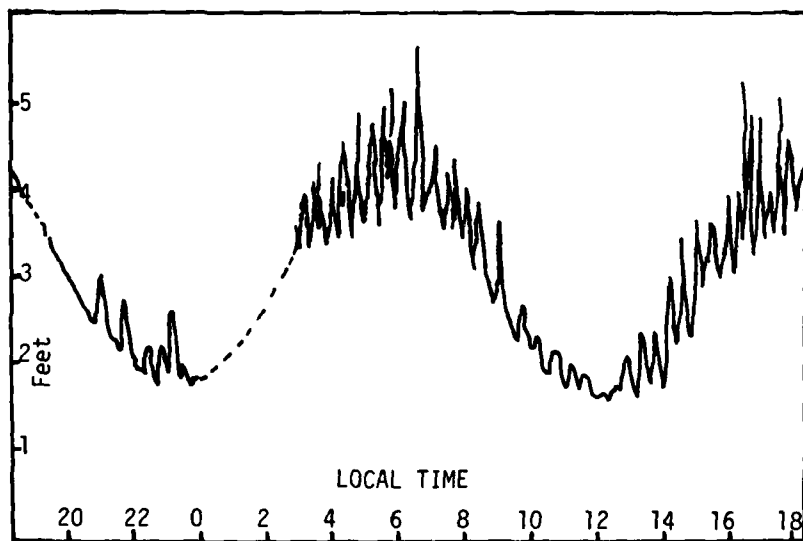

NOTE: 1) This is a reconstruction from the original. The dashed trace indicates that section of the original marigram missing as a result of faulty equipment.  
2) The short period activity at high tide is caused by surf crossing the reef.

Affected Areas by  
Tsunami of May 22, 1960  
in Western Samoa

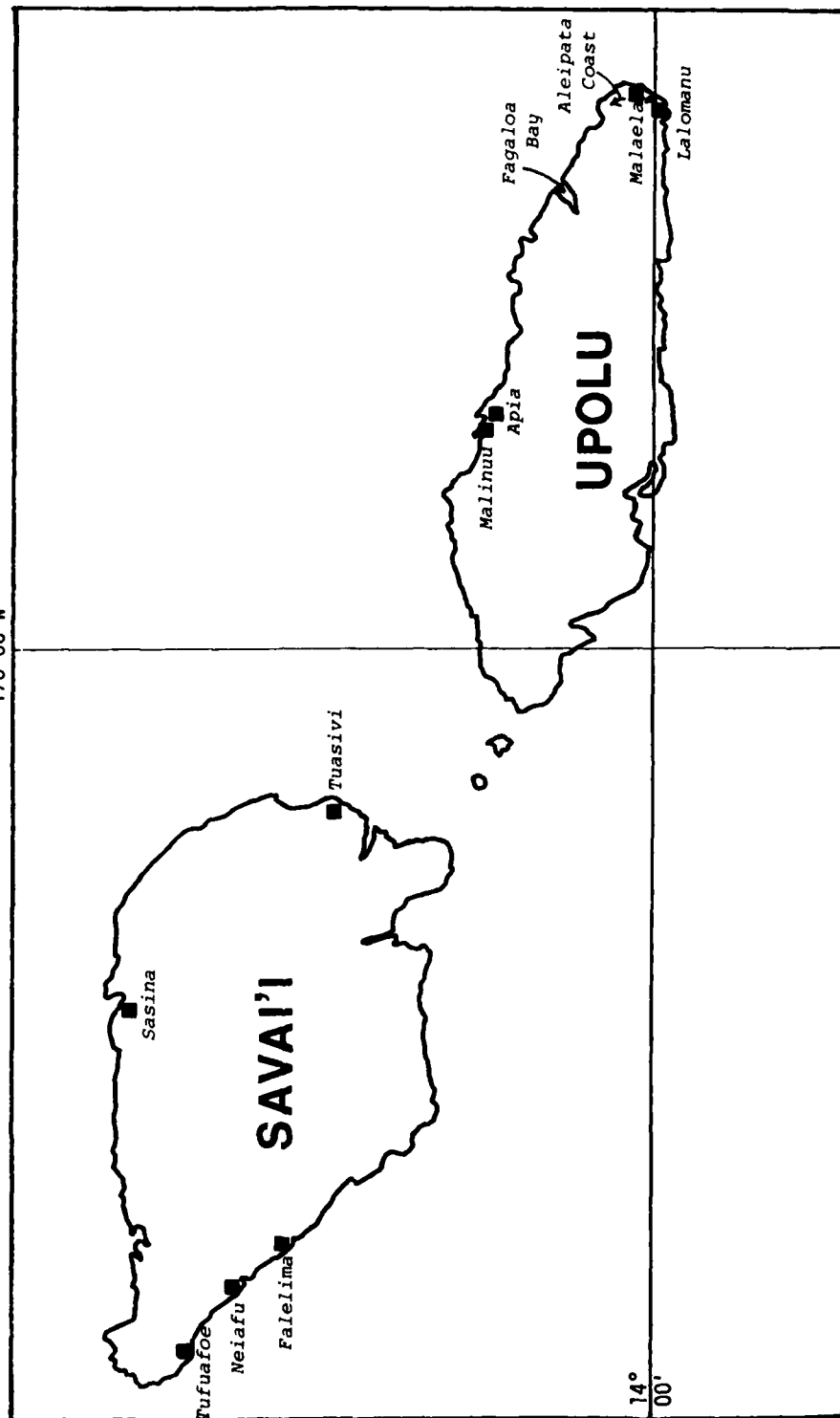

Affected Areas by  
Tsunami of May 22, 1960  
in American Samoa

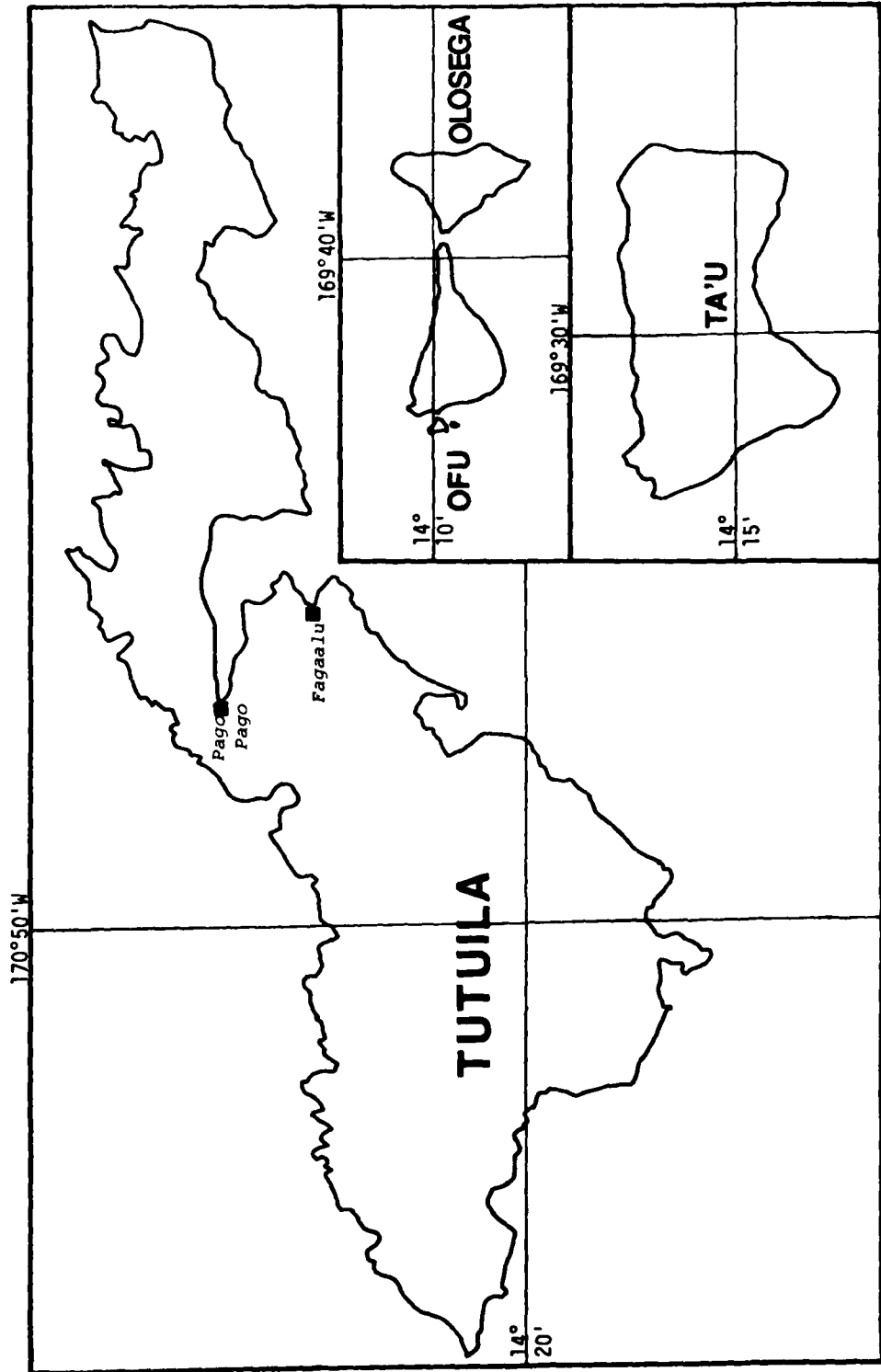

February 13, 1963

An earthquake occurred in the north of Taiwan on February 13, 1963 generated a minor trace of tsunami recorded at the tide gauge of Pago Pago.

March 30, 1963

No earthquake data is available for this day. However, a minor trace of tsunami was recorded at the tide gauge of Pago Pago.

October 12, 1963

A severe earthquake in the Kurile Islands on October 12, 1963 resulted in a Pacific-wide tsunami alert. (Anon., 1963a) (Anon., 1963b) No sign of a wave was observed in Western Samoa. (Anon., 1963c) A 0.2 meter was observed in Pago Pago. (Iida, et al, 1967)

October 19, 1963

A small tsunami of 0.1 meter was recorded at Pago Pago by the earthquake of October 20, 1963 in S. Kuril Islands according to the Preliminary Pacific Tsunami Catalog. (Iida, et al, 1967) This is probably a value taken from a tide gauge record.

The Samoa News from Pago Pago reported that a tidal wave alert was given early that night but no other detail was provided. (Anon., 1963d)

The Samoana from Apia reported as follows:

*A small amount of activity was recorded on the tide gauge at Apia Observatory and Observer-in-Charge, J. Milne said that he had received reports from several people of strong waves breaking at about 12:30 Saturday night. (Anon., 1963e)*

March 27, 1964

Western Samoa

*From the Samoa Bulletin: The wave was first recorded at Apia about 4:30 a.m. on Friday, and half-tide fluctuations in Apia Harbor continued for eight hours. No flooding has been reported. (Anon., 1964a)*

No other detail concerning the height of the wave can be located from any other sources.

American Samoa

From the U.S. Coast and Geodetic Survey reports (Spaeth & Berkman, 1965), a tide gage record was found showing the tsunami arriving at 1351 hours with a height of 1.3 feet.

No other sources concerning this event can be found.

The Samoa News of Pago Pago has no report indicating this tsunami.

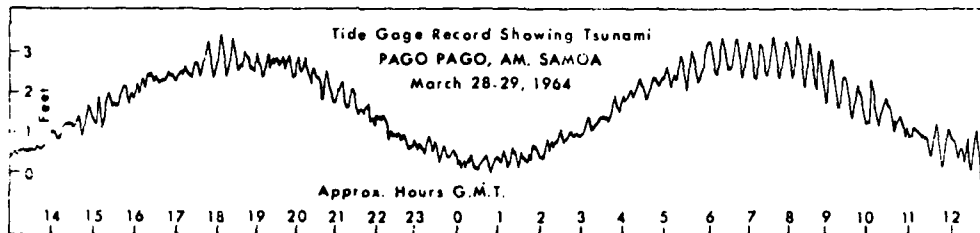

#### June 16, 1964

An earthquake, with a magnitude of 7.5, occurred in Niigata, Yamagata of Japan on June 16 of 1964, generated local tsunamis and in Korea. A minor trace of tsunami was also recorded at the tide gauge of Pago Pago.

#### January 24, 1965

An earthquake that occurred in Sanana Island of Indonesia on January 24, 1965 generated a destructive tsunami locally which destroyed 90% of the city with 71 people killed. A minor trace of tsunami was also recorded at the tide gauge of Pago Pago.

#### February 4, 1965

An earthquake in the Rat Island of the Aleutian Island on February 4, 1965 caused local tsunamis and in Japan and Hawaii. A Pacific-wide warning was issued by the Seismic Sea Wave Warning System. A minor trace of tsunami was also generated in Pago Pago according to the tide gauge records.

#### March 29, 1965

Another earthquake in the Aleutian Island on March 30 of 1965, also generated a minor trace of tsunami in Pago Pago according to the tide gauge records.

#### July 2, 1965

On July 2, 1965 an earthquake occurred near Unalaska Island of the Aleutian Island caused local tsunamis. A minor trace of tsunami was also recorded at the tide gauge of Pago Pago.

August 12, 1965

An earthquake occurred on August 12, 1965 in New Hebrides generated local tsunami and in Tonga. A minor trace of tsunami was also recorded at the tide gauge of Pago Pago.

October 17, 1966

A tidal wave warning was issued at Apia on October 16 evening and cleared early the following morning, according to the Samoa Bulletin from Apia. (Anon., 1966)

In Pago Pago, a 0.2 meter wave was recorded. (Anon., 1970)

December 28, 1966

An earthquake, with a magnitude of 7.5, near the coast of northern Chile generated local tsunami there and elsewhere across the Pacific. A 0.2 meter wave was observed at Pago Pago. (Anon., 1970)

No primary source of information is available from the University of Hawaii Library.

December 31, 1966

An earthquake of 7.5 magnitude in the Santa Cruz Islands on December 31, 1966 caused a small tsunami of 0.1 meter in Pago Pago. (Anon., 1970)

No primary source of information is available from the University of Hawaii Library.

March 31, 1968

A minor trace of tsunami was recorded at the tide gauge of Pago Pago on March 31, 1968. According to Wigen, 1977, an earthquake, with a magnitude of 6.2 occurred at 32.5°N, 132.2°E in the region of South Japan.

May 16, 1968

An earthquake off Honshu, Japan caused a small tsunami of 15 cm in Pago Pago. (Pararas-Carayannis, 1977)

No primary source of information can be located.

August 1, 1968

An earthquake occurred in Luzon of the Philippines on August 1, 1968 which generated a minor tsunami in Pago Pago according to the tide gauge record.

August 11, 1969

A tsunami watch was issued by Pacific Tsunami Warning Station as a result of an earthquake occurred in the Kuril Island on August 11, 1969. A minor trace of tsunami was recorded at the tide gauge of Pago Pago.

November 22, 1969

An earthquake occurred in the east coast of Kamchatka on November 22, 1969 resulted a minor trace of tsunami recorded at the tide gauge of Pago Pago.

July 14, 1971

An earthquake in New Ireland on July 14, 1971 generated a tsunami in the Pacific. A 6 cm wave was observed in Pago Pago. (Pararas-Carayannis, 1977)

No primary source of information can be found.

January 30, 1973

An earthquake on January 30, 1973 near the coast of Michoacan, Mexico, caused a minor tsunami of 21 cm at Pago Pago. (Coffman & Hake, 1975) (Anon., 1975a)

No primary source of information could be located regarding this event other than in the records of the International Tsunami Information Center and from tide gauge records at Pago Pago.

June 17, 1973

The Hokkaido, Japan earthquake of June 17, 1973 generated a small tsunami of 9 cm at Pago Pago. (Coffman & Hake, 1975) (Anon., 1975a)

No newspaper account could be located. The information above was obtained from the records of the International Tsunami Information Center and from tide gauge records at Pago Pago.

October 3, 1974

The earthquake of Lima, Peru occurred on October 3, 1974 generated a tsunami of 31 cm at Pago Pago. (Anon., 1976) (Coffman & Stover, 1976)

No other source of reference can be located from local newspapers. The information came from mareographic records of the tsunami at Pago Pago obtained by the International Tsunami Information Center.

November 29, 1975

The earthquake of November 29, 1975 at the Island of Hawaii generated minor tsunamis of 21 cm at Pago Pago and 34 cm at Apia. These heights were obtained from mareographic recordings. (Anon., 1979a)

December 26, 1975

On December 26, 1975, an earthquake, registering 7.6 on the Richter scale, approximately 200 miles south of Samoa at the northern end of the Tonga-Fiji arc (Anon., 1975b), generated a minor tsunami in the Samoan Islands which recorded 75 cm at Pago Pago and 15 cm at Apia. (Coffman & Stover, 1977) No damage resulted from the tsunami.

January 14, 1976

The Kermadec Islands earthquake on January 14, 1976 caused a minor tsunami in Apia with a height of 14 cm. (Coffman & Stover, 1978)

The Australian Domestic Service reported a 90 cm wave in the Southern Fiji islands, and a 15 cm wave at Suva.

April 2, 1977

The United States Earthquakes for 1977 lists an earthquake on April 2 in the Samoa Islands region which caused a minor tsunami that was recorded at Apia and Pago Pago. At Apia, the maximum amplitude was 4 cm and 15 cm at Pago Pago. (Coffman & Stover, 1979)

However, according to the Tsunami Reports published by ITIC, the maximum wave at Apia was 7 cm. Tsunami arrival at Pago Pago was at 0745 and the sea level disturbance lasted for about one hour. (ITIC, 1978a)

April 20, 1977

An earthquake in the Solomon Islands region (9.5 S, 160.4 E) on April 20, 1977 with a magnitude of 6.5 generated a tsunami of 4 cm maximum height at Apia. This value was taken from the tide gauge record. No tsunami was evident in the tide gauge record of Pago Pago. (ITIC, 1978b)

April 21, 1977

Another earthquake occurred in the same vicinity as the April 20 earthquake in the Solomon Islands (11.1°S, 160.7°E) with a magnitude of 7.5. This quake also generated a minor tsunami of 3 cm at Apia. No tsunami was evident in the tide gauge of Pago Pago. (ITIC, 1978c)



June 22, 1977

An earthquake in the Tonga Trench on June 22, 1977 generated a tsunami having a maximum height of 7 cm at Apia and of 13 cm at Pago Pago. (ITIC, 1978d)

October 10, 1977

The earthquake in the Tonga area with a magnitude of 6.9 caused a minor tsunami of 2 cm at Pago Pago. (ITIC, 1978e)

March 14, 1979

The Samoa News reported the following:

*A major earthquake centered near the Pacific coast of Mexico that killed several people and injured dozens, caused a four inch tsunami (tidal wave) to reach American Samoa Wednesday morning at 11:45. (Anon., 1979b)*

KEY TO CATALOG

<u>Column Heading</u>	<u>Notation</u>	<u>Explanation</u>
DATE	?	Questionable tsunami
	<u>1957 Mar 9</u>	Local date of the initial observation of a tsunami or possible tsunami in the Samoan Is. : year, month, day.
 <u>EARTHQUAKE DATA</u>		
Date	March 9	Universal date of earthquake (or eruption).
Time	14:22	Earthquake origin time given in universal time (UT): hours, minutes.
Epicenter	52.3 N 175.8 W	Latitude Longitude
Magnitude	8.3	Earthquake magnitude
	PAS	California Institute of Technology (Pasadena).
	G&R	Gutenberg and Richter, 1954
	CMO/JMA	Japan Central Meteorological Obsy./ Japanese Meteorological Agency
	TAO	Tokyo Astronomic Observatory
	CGS	U.S. - Coast and Geodetic Survey
Depth	60	Focal depth in kilometers.

<u>Column Heading</u>	<u>Notation</u>	<u>Explanation</u>
<u>TSUNAMI DATA</u>		
Area of Origin	Andreanof Is., Aleutian Is.	Name of general geographic area of tsunami origin.
M (Tsunami Magnitude)	3.5	Tsunami magnitude defined by $m = \log_2 H$ or $H = 2^m$ as revised by Iida, et al. (1967), where H is the maximum runup height or amplitude on a coastline near the generating area.
	?	Magnitude not assigned because of special generating conditions.
Place of Observation	Samoa Tutuila I. Pago Pago	Places of reported observations: name of major geographic unit is shown first, followed by more precise names.
H (Height)	1.2	Maximum runup height or amplitude, in meters.
At	9.1	Travel time from origin, in hours.
T	22	Average period of the initial wave, in minutes.
Observations and Remarks	No damage.	Summary of behavior and effects, discussion of data, comments on sources of information. All times are local and for the same date as listed under "DATE" column unless otherwise indicated.
REFERENCES	<u>Keys, 1957</u>	Author, year of publication. (Primary reference containing Samoan data)
	Keys, 1957	Author, year of publication. (Secondary reference)
		(If no references are shown, the data have been extracted from mareographic records or unpublished reports.)

DATE	EARTHQUAKE DATA	TSUNAMI DATA						REFERENCES	
		AREA OF ORIGIN	M	PLACE OF OBSERVATION	H	AT	T		OBSERVATIONS AND REMARKS
1837 Nov 7	Nov 7 12:51 36-38 S	Near Valdivia and Concepcion, South Chile	3?	Samoa Tutuila I.				Great earthquake in South Chile resulted in large tsunami in the Hawaiian Islands with great loss of life and property. No details are available on effects in American Samoa but it was probably recorded.	Hitchcock, 1911 Iida, et al, 1967 Pararas-Carayannis, 1977
1868 Aug 14	Aug 13 16:45 18.5 S 71.0 W	Near Iquique and Arica, North Chile	4?	Samoa Upolu I. Apia		16.0		Great "Peru" earthquake and tsunami destroyed settlements. This event has been extensively documented in the literature, however no details could be found on the Samoan Islands.	Iida, et al, 1967 Pararas-Carayannis, 1977
1877 May 10	May 10 00:59 21.5 S 71.0 W	Near Iquique, Chile	4?	Samoa Upolu I. Apia	2-4	15		Great Chilean earthquake and tsunami resulting in extensive loss of life and property in Chile, Japan and elsewhere. No details about effects in American Samoa.	Iida, et al, 1967 Pararas-Carayannis, 1977
1883 Mar 24	Samoa Is.?	Samoa Is.?	1	Samoa Savaii I.				According to New York Times, an earthquake was accompanied by strong storm and big waves. All ships suddenly broke loose from their anchors. Houses within a quarter of a mile of the beach on the east end of the Island of Savaii were swept away for a distance of 15 miles along the shore. The possibility of a local tsunami cannot be excluded.	Anon., 1883 Fuchs, 1885 Soloviev, Go, 1969, 1975

TSUNAMI DATA							REFERENCES		
DATE	EARTHQUAKE DATA	AREA OF ORIGIN	M	PLACE OF OBSERVATION	H	AT		T	OBSERVATIONS AND REMARKS
1896 Jun 15	Jun 15 10:33 39.6 N 144.2 E 7.6 TAO	Sanriku, Japan	4	Samoa Savaii I.				The great Meiji Sanriku tsunami caused great loss of life and property in Japan. No report of the tsunami in Samoa could be found other than in a letter of the U.S. Consul General to the Hydrographer U.S.N., stating the occurrence of a wave. No damage was reported.	Churchill, 1896 Tide, et al, 1967 Pararas-Carayannis, 1977
1905 - 1911		North coast of Savaii, Samoan Islands	0.5	Samoa Savaii I. N. Coast				Eruption of Matavanu volcano. Lava flows reached the coast. From time to time lava flows generated local waves of tsunami type. No details.	Anderson, 1910 Sapper, 1927 Richard, 1962
1906 Nov 28				Samoa Savaii I. Matautu				5:30 p.m. (local)	Anderson, 1910
1907 Jun 8				Matautu				12:00 noon (local)	
1907 Jun 19				Matautu				3:00 a.m. (local)	
1907 Jun 27				Matautu				Between 6 to 7:00 p.m. (local)	
1907 Jul 9				Matautu				6:45 p.m. (local)	
1907 Jul 25				Matautu				11:00 a.m. (local)	
								The above six tsunamis occurred during the eruption of Matavanu Volcano in Savaii. Average rises and falls of the waves did not exceed 6 to 8 feet. Little damage was done.	

DATE	EARTHQUAKE DATA	TSUNAMI DATA						REFERENCES
		AREA OF ORIGIN	M	PLACE OF OBSERVATION	H	AT	T	
1907 Oct 6				Samoa Savaif I. Matautu	3- 3.6			Anderson, 1910
1915 Feb 11	?	Samoa Is. ?	?	Upolu I. Apia	0.3- 0.6			Anon., 1915
1917 May 1	May 1 18:26 29.0 S 177.0 W 8.0 G&R Shallow	Kermadec Is.	1?	Samoa Upolu I. Apia				Anon., 1913 Heck, 1947 Iida, et al, 1967 Pararas-Carayannis, 1977 Apia, 1980

TSUNAMI DATA									
DATE	EARTHQUAKE DATA	AREA OF ORIGIN	M	PLACE OF OBSERVATION	H	AT	T	OBSERVATIONS AND REMARKS	REFERENCES
<u>1918 Sep 7</u> Sep 7 17:16 45.5 N 151.5 E 8.25 G&R Shallow	S. Kuril Is. 3.6	Samoa Upolu I. Apia Sogi Savaii I. Safune	1.8- 2.4 0.4 0.3 0.3?	9.7 12.7	Earthquake at S. Kuril Island generated tsunamis locally, and in Japan, and Hawaii resulting in loss of life and property. No damage was reported. Sudden recession occurred 3 hours later, followed by a wave of about 0.3 meter. Same phenomenon as at Sogi occurred at Safune	Anon., 1918 Lida, et al., 1967 Pararas-Carayannis, 1977 Apia, 1980			

TSUNAMI DATA							REFERENCES		
DATE	EARTHQUAKE DATA	AREA OF ORIGIN	M	PLACE OF OBSERVATION	H	AT		T	OBSERVATIONS AND REMARKS
1919 Apr 30	Apr 30 07.17 19.0 S 172.5 W 8.3 G&R Shallow	Tonga Is.	1	Samoa Upolu I. Apia Tutuila I.	0.37 1.8- 2.4	0.9		No details of tsunami. First motion was a recession of about 2 meters. No indication of where these observations were made of the tsunami occurred on the Island of Tutuila. A 2.5 meter wave was reported at Haapai, Tonga Island.	Anon., 1919b Mayor, 1924 Heck, 1947 Iida, et al, 1967 Pararas-Carayannis, 1977 Apia, 1980
1920 Aug --	?	Samoa Is.	?	Samoa Upolu I. Near Apia				No earthquakes were recorded at Apia during August. Reports of an earthquake and tsunami given in the literature are probably in error. Probably a confused re-entry of the September 21 tsunami.	Mayor, 1924 Heck, 1947 Iida, et al, 1967 Apia, 1980
1920 Sep 20	Sep 20 14.39 20.0 S 168.0 E 8.0 G&R Shallow	New Hebrides	1?	Samoa Upolu I. Apia		4.4?		No tide gauge record is available. First wave reached Apia at 1904 GMT.	Angenheister, 1923 Heck, 1947 Gutenberg & Richter, 1954 Keys, 1957 Iida, et al, 1967 Apia, 1980



TSUNAMI DATA							REFERENCES		
DATE	EARTHQUAKE DATA	AREA OF ORIGIN	M	PLACE OF OBSERVATION	H	AT		OBSERVATIONS AND REMARKS	
1922 Nov 11	Nov 11 04:33 28.5 S 70.0 W 8.3 G&R Shallow	North Chile	3?	Samoa Upolu I. Apia Tutuila I. Pago Pago	1.8	14.1	20	First wave reached Apia at 1836 GMT.  Slight damage. No details available.	Iida, et al, 1967 Pararas-Carayannis, 1977 Apia, 1980
1923 Feb 3	Feb 3 16:02 54.0 N 161.0 E 8.3 G&R Shallow	East Kamchatka	3?	Samoa  Upolu I. Apia			9.7	The earthquake of East Kamchatka generated local tsunamis and tsunamis in Japan, Hawaii and elsewhere causing considerable damage.  No details could be found for the Samoan Islands except that the wave was recorded and that the rise and fall of the water was small. No information could be found on American Samoa. First wave reached Apia at 0142 GMT.	Anon., 1923 Heck, 1947 Keys, 1957 Iida, et al, 1967 Pararas-Carayannis, 1977 Apia, 1980
1926 Mar 16 ?	Mar 16 17:32 16.5 S 171.0 W 6.0 G&R Shallow	Samoa ?		Samoa ?				A tsunami swept over Palmerston Island (Cook Island). No Samoan report of a tsunami nor seismic activity according to Apia seismogram and tide records. Doubtful tsunami.	Heck, 1947 Keys, 1957 Iida, et al, 1967 Apia, 1980

DATE	EARTHQUAKE DATA	TSUNAMI DATA						REFERENCES	
		AREA OF ORIGIN	M	PLACE OF OBSERVATION	H	AT	T		OBSERVATIONS AND REMARKS
1928 Jun 17	Jun 17 03:19 16.25 N 98.0 W 7.8 G&R Shallow	New Acapulco, Mexico	1?	Samoa Upolu I. Apia		14.7	20	About three prominent cycles appeared on the mareogram. First wave began at about 0450 local time. Period was approximately 20 minutes. No other details.	Keys, 1957 Iida, et al, 1967 Pararas-Carayannis, 1977 Apia, 1980
1932 Jun 3	Jun 3 10:37 19.5 N 104.3 W 8.1 G&R Shallow	Jalisco, Mexico	2?	Samoa Upolu I. Apia		0.7	20- 25	Recorded but no other details. First wave arrived at about 1045 local time. Wave had a period of 20-25 minutes and a range of 0.76 meters.	Keys, 1957 Iida, et al, 1967 Pararas-Carayannis, 1977 Apia, 1980
1933 Mar 2	Mar 2 17:31 39.1 N 144.7 E 8.3 CM0 0-20	Sanriku, Japan	4.8	Samoa Upolu I. Apia			30	The great Sanriku tsunami which caused great loss of life and property damage in Japan as also recorded at Apia. No other details could be found.	Keys, 1957 Iida, et al, 1967 Pararas-Carayannis, 1977 Apia, 1980

TSUNAMI DATA									
DATE	EARTHQUAKE DATA	AREA OF ORIGIN	M	PLACE OF OBSERVATION	H	AT	T	OBSERVATIONS AND REMARKS	REFERENCES
1946 Apr 1	Apr 1 12:29 53.5 N 163.0 W 7.4 G&R Shallow	E. Aleutian Is	5?	Samoa Upolu I. Apia	2.4?	9.4	25	Great (Eastern) Aleutian Tsunami First wave was a recession. Six oscillations were observed over a period of about 2 hours. No damage recorded.  Several huts in the village of Pago Pago were washed away; according to eyewitness accounts from officers of the MV Honda Knot.	Anon., 1946 Iida, et al, 1967 Pararas-Carayannis, 1977 Apia, 1980
1948 Sep 8	Sep 8 15:09 21.0 S 174.0 W 7.8 G&R Shallow	Tonga Is.	1?	Samoa Tutuila I. Pago Pago	0.1		17	Unofficial warning was issued by SSMS.	Iida, et al, 1967

TSUNAMI DATA							REFERENCES			
DATE	EARTHQUAKE DATA	AREA OF ORIGIN	M	PLACE OF OBSERVATION	H	AT		T	OBSERVATIONS AND REMARKS	
<u>1952 Mar 4</u>	Mar 4 01:23 42.2 N 143.8 E 8.1 CM0 45	Tokachi, Hokkaido, Japan	2.0	Samoa Tutuila I. Pago Pago					A minor trace of tsunami recorded at the tide gauge.	Iida, et al, 1967 Pararas-Carayannis, 1977 Wigen, 1977
<u>1952 Mar 10</u>	Mar 9 17:04 42.5 N 143.0 E 7.1 CM0 33	S. E. Hokkaido	2.5	Samoa Tutuila I. Pago Pago					A minor trace of tsunami recorded at the tide gauge.	Iida, et al, 1967 Wigen, 1977
<u>1952 Mar 17</u>	Mar 18 03:58 19.1 N 155.0 W	Off S. Shore Hawaii Is.	?	Samoa Tutuila I. Pago Pago					A minor trace of tsunami recorded at the tide gauge.	Iida, et al, 1967 Pararas-Carayannis, 1977 Wigen, 1977

DATE	EARTHQUAKE DATA	TSUNAMI DATA						REFERENCES	
		AREA OF ORIGIN	M	PLACE OF OBSERVATION	H	A	T		OBSERVATIONS AND REMARKS
1952 Mar 19	Mar 19 10:57 9.5 N 127.25 E 7.75 G&R Shallow	Mindanao, Philippines	?	Samoa Tutuila I. Pago Pago				A minor trace of tsunami recorded at the tide gauge.	Iida, et al, 1967 Wigen, 1977
1952 May 13	May 13 19:32 10.5 N 85.0 W 7.0 PAS 100 CGS	Costa Rica	-3	Samoa Tutuila I. Pago Pago				A minor trace of tsunami recorded at the tide gauge.	Iida, et al, 1967 Wigen, 1977
1952 Jul 13	Jul 13 11:59 18.5 S 167.5 E 7.0 PAS 260 CGS	New Hebrides		Samoa Tutuila I. Pago Pago				A minor trace of tsunami recorded at the tide gauge.	Iida, et al, 1967 Wigen, 1977

DATE	EARTHQUAKE DATA	TSUNAMI DATA						REFERENCES	
		AREA OF ORIGIN	M	PLACE OF OBSERVATION	H	AT	T		OBSERVATIONS AND REMARKS
1952 Nov 4	Nov 4 16:58 52.8 N 159.5 E 8.25 G&R 30-60	East Kamchatka	4	Samoa Tutuila I. Pago Pago Upolu I. Apia	1.8? 9.7 1.35 9.6		18	Great Kamchatka tsunami. Pacific-wide warning was issued by SSMWS. Some damage. No detail.	Anon., 1952 Zerbe, 1953 Iida, et al., 1967 Pararas-Carayannis, 1977 Aptis, 1980
				Fagaloa Bay	1.5		15	Third recession was followed by rushing wave which inundated low-lying areas. Land around the Custom House was flooded to a depth of a few inches. Oscillations lasted several hours. A school and some other Samoan buildings were completely lost. No other extensive damage was reported and there was no loss of life.	
				Mulinuu	0.63		25-30		
				Laulii'i	0.9				Water penetrated up the road.
				Ma'asina	2.7				Three prominent crests.
				Taelefaga	2.7				Suffered considerably. Probably greater tsunami than at Ma'asina.
				Samamea	1.5-1.8				First motion a recession.
				Savaii I. Safa'i					Wave higher than 1957 March one but no other detail.

DATE	EARTHQUAKE DATA	TSUNAMI DATA						REFERENCES	
		AREA OF ORIGIN	M	PLACE OF OBSERVATION	H	AT	T		OBSERVATIONS AND REMARKS
1953 Sep 13	Sep 14 00:27 18.5 S 178.5 E 6.75 PAS 60	Kandaru Passage, Fiji Is.	1?	Samoa Tutuila I. Pago Pago	0.2			No details for the Samoan Islands. Waves of 1.5 meter at Bega Island and 3 meters at Suva (Fiji Islands) were reported.	Iida, et al, 1967 Pararas-Carayannis, 1977
1957 Mar 9	Mar 9 14:22 51.3 N 175.8 W 8-8.5 PAS Shallow	Andreanof Is., Aleutian Is.	3.5 ?	Samoa Upolu I. Faleolo Mulindu'u Apia Lauli'i Saluafata Village Fagaloa Bay Taelefaga	0.3? 0.3? 0.3? 0.9 0.9 1.5	9.0	25	Pacific wide warning was issued by SSMWS. Water level rose once only.  3 or 4 prominent waves.  The inundation over the lower lying part of the village was about 25 yards, the sea washing into huts and depositing a canoe, with boy, inside a Samoan house.	Iida, et al, 1967 Pararas-Carayannis, 1977 <u>Apia, 1980</u>
				Ma'asina Savaii I. Safa'i	1.05 1.8			The waves had sufficient force to demolish a stone causeway used by the villages to cross creek to their plantation area.	

DATE	EARTHQUAKE DATA	TSUNAMI DATA						REFERENCES	
		AREA OF ORIGIN	M	PLACE OF OBSERVATION	H	AT	T		OBSERVATIONS AND REMARKS
1957 Mar 9 (cont.)				Tutuila I. Pago Pago Fagasa	1.27 1.5	9.1	22	Eleven large size waves over a period of one hour and fifty minutes.	
1958 Nov 7	Nov 6 22:58 44.5 N 148.5 E 8.25 SSI	Iturup, S. Kuril Is.	2?	Samoa Tutuila I. Pago Pago	0.1	9.9	22	Pacific-wide warning was issued by SSWS.	Iida, et al, 1967 Pararas-Carayannis, 1977
1960 May 22	May 22 19:11 39.5 S 74.5 W 8.5 PAS	S. Chile	0?	Samoa  Upolu I. Apia La'olomanu  Faga'olua Bay	1.5 1.8	12.3	8 10	Great Chile tsunami. Tremendous damage and many casualties in Chile, Hawaii and Japan. A Pacific-wide warning was issued by SSWS.  Two fisherman in canoes near the reef had been picked up by the wave and washed onto the beach by the road.  Caused damage. The peak water level reached the roof of one of the native houses. Debris was scattered about the village. No lives were lost.	Anon., 1960 Cox, 1961 Keys, 1963 Berkman & Symons, 1964 Iida, et al, 1967 Pararas-Carayannis, 1977



DATE	EARTHQUAKE DATA	TSUNAMI DATA							REFERENCES
		AREA OF ORIGIN	M	PLACE OF OBSERVATION	H	AT	T	OBSERVATIONS AND REMARKS	
1950 May 22 (cont.)				Savaii I. Falelima	2.4- 2.7		30	Three large waves.	
				Neiafu	2.1- 2.4				
				Tututafoe	1.8- 2.1		15		
				Tuasivi	1.2- 1.5			Screened by a reef about 500 yards out. Tsunami manifested as short-period surges.	
				Tutuila I. Pago Pago	3- 3.6	12.4	20	Damage at Pago Pago Village estimated \$50,000.	
May 23				Fagaalua	0.75				
				Upolu I. Matafa	1.8		4		
1963 Feb 13				Savaii I. Sasina	1.5		30		
	Feb 13 08:50 24.5 N 122.1 E 7.25 CGS 47	N. Taiwan	-2	Samoa Tutuila I. Pago Pago				A minor trace of tsunami recorded at the tide gauge.	Iida, et al, 1967

DATE	EARTHQUAKE DATA	TSUNAMI DATA					REFERENCES		
		AREA OF ORIGIN	M	PLACE OF OBSERVATION	H	AT		T	OBSERVATIONS AND REMARKS
1963 Mar 30		Dixon Entrance?		Samoa Tutuila I. Pago Pago				A minor trace of tsunami recorded at the tide gauge. However, no earthquake data can be found.	
1963 Oct 13	Oct 12 05:18 44.8 N 149.5 E 8:25 PAS 60	S. Kuril Is.	2?	Samoa Tutuila I. Pago Pago	0.1	9.6	14	A Pacific-wide warning was issued by SSMWS. Recorded.	Lida, et al, 1967 Pararas-Carayannis, 1977
1963 Oct 20	Oct 20 00:53 44.7 N 150.7 E 6:75-7 PAS 25	S. Kuril Is.	3.5 ?	Samoa Tutuila I. Pago Pago Upolu I. Apta	0.1	9.8	18	A Pacific-wide warning was issued by SSMWS. Strong waves breaking reported.	Anon., 1963a Anon., 1963b Lida, et al, 1967 Pararas-Carayannis, 1977
1964 Mar 27	Mar 28 03:36 61.1 N 147.7 W	Gulf of Alaska	4.5	Samoa Tutuila Pago Pago	0.39	10.3	20	Great Alaska (Prince William Sound) earth quake. Recorded	Anon., 1964a Anon., 1964b Spaeth & Berkman, 1965, 1967 Lida, et al, 1967 Pararas-Carayannis, 1977

TSUNAMI DATA							REFERENCES			
DATE	EARTHQUAKE DATA	AREA OF ORIGIN	M	PLACE OF OBSERVATION	H	AT		T	OBSERVATIONS AND REMARKS	
1964 Mar 27 (cont.)	8.4 CGS 33			Upolu I. Apia						
1964 Jun 16	Jun 16 04:02 38.3 N 139.2 E 7.5 JMA 40	Niigata - Yamagata	2.5	Samoa Tutuila I. Pago Pago					A minor trace of tsunami recorded at the tide gauge.	Iida, et al, 1967
1965 Jan 24	Jan 24 00:11 2.4 S 126.0 E 7.5-7.75 PAS 6	Indonesia Moluccas Sanana Is.	2?	Samoa Tutuila I. Pago Pago					A minor trace of tsunami recorded at the tide gauge.	Iida, et al, 1967
1965 Feb 4	Feb 4 05:01 51.3 S 178.6 E 7.75 PAS 40	Rat Is., Aleutian Is.	3	Samoa Tutuila I. Pago Pago					A Pacific-wide warning was issued by SSMSS. A minor trace of tsunami recorded at the tide gauge.	Iida, et al, 1967 Pararas-Carayannis, 1977

TSUNAMI DATA							REFERENCES		
DATE	EARTHQUAKE DATA	AREA OF ORIGIN	M	PLACE OF OBSERVATION	H	AT		T	OBSERVATIONS AND REMARKS
1965 Mar 29	Mar 30 02:27 50.6 N 177.9 E 7.3 PAS 51	Aleutian Is.	-1?	Samoa Tutuila I. Pago Pago				A minor trace of tsunami recorded at the tide gauge.	Pararas-Carayannis, 1977
1965 Jul 2	Jul 2 20:59 53.1 N 167.6 W 6.9 PAS 59	Near Unalaska I., Aleutian Is.	-1?	Samoa Tutuila I. Pago Pago				A Pacific-wide warning was issued by SSWMS. A minor trace of tsunami recorded at the tide gauge.	Pararas-Carayannis, 1977
1965 Aug 12	Aug 11 22:32 15.8 S 167.2 E 6.4 CGS	New Hebrides	1.5 ?	Samoa Tutuila I. Pago Pago				A minor trace of tsunami recorded at the tide gauge.	Iida, et al, 1967
1966 Oct 17	Oct 17 21:42 10.7 S 78.7 W	Near Coast of Peru		Samoa Tutuila I. Pago Pago			0.1	A Pacific-wide warning was issued by SSWMS. Recorded.	Anon., 1966 Iida, et al, 1967 Anon., 1970

DATE	EARTHQUAKE DATA	TSUNAMI DATA						REFERENCES
		AREA OF ORIGIN	M	PLACE OF OBSERVATION	H	AT	T	
1966 Oct 17 (cont.)	7.5 PAS 38							Pararas-Carayannis, 1977
1966 Dec 28	Dec 28 08:18 25.5 S 70.7 W 7.75 PAS 47	Near Coast of Northern Chile		Samoa Tutuila I. Pago Pago	0.2			Anon., 1970
1966 Dec 31	Dec 31 18:23 11.8 S 166.5 E 7.5 PAS 33	Santa Cruz Is.		Samoa Tutuila I. Pago Pago	0.1			Anon., 1970
1968 Mar 31	Apr 1 00:42 32.5 N 132.2 E 6.2? 33			Samoa Tutuila I. Pago Pago				Wigen, 1977

TSUNAMI DATA								REFERENCES	
DATE	EARTHQUAKE DATA	AREA OF ORIGIN	M	PLACE OF OBSERVATION	H	AT	T		OBSERVATIONS AND REMARKS
<u>1968 May 15</u>	May 16 00:49 40.8 N 143.2 E 7.9 CGS 7	Off Honshu, Japan		Samoa Tutuila I. Pago Pago	0.15			Arrival time indefinite.	Pararas-Carayannis, 1977
<u>1968 Aug 1</u>	Aug 1 20:19 16.5 N 122.2 E 7.0 PAS 36	Philippine Is. Luzon		Samoa Tutuila I. Pago Pago				A minor trace of tsunami recorded at the tide gauge.	Pararas-Carayannis, 1977
<u>1969 Aug 11</u>	Aug 11 21:27 43.5 N 147.4 E 7.8 PAS 28	Kuril Is.		Samoa Tutuila I. Pago Pago				A minor trace of tsunami recorded at the tide gauge.	Pararas-Carayannis, 1977

DATE	EARTHQUAKE DATA	TSUNAMI DATA						REFERENCES
		AREA OF ORIGIN	M	PLACE OF OBSERVATION	H	AT	T	
1969 Nov 22	Nov 22 23:09 57.8 N 163.5 E 7.1 PAS 33	East Coast of Kamchatka		Samoa Tutuila I. Pago Pago				Pararas-Carayannis, 1977
1971 Jul 14	Jul 14 06:11 5.5 S 153.9 E 7.7 PAS 47	New Ireland		Samoa Tutuila I. Pago Pago	0.06 ?			Pararas-Carayannis, 1977
1973 Jan 30	Jan 30 21:01 18.5 N 103.0 W 7.3 PAS 43	Near coast of Michoacan, Mexico		Samoa Tutuila I. Pago Pago Upolu I. Apia	0.22 0.09		0.21 at 08:18 (31st January)	Anon., 1975a Coffman & Hake, 1975 Pararas-Carayannis, 1977

TSUNAMI DATA								REFERENCES	
DATE	EARTHQUAKE DATA	AREA OF ORIGIN	M	PLACE OF OBSERVATION	H	AT	T		OBSERVATIONS AND REMARKS
<u>1973 Jun 17</u>	Jun 17 03:55 43.2 N 145.8 E 7.7 PAS 48	Hokkaido, Japan		Samoa Tutuila I. Pago Pago	0.09			Tsunami watch was issued by PTSM.	Anon., 1975a Coffman & Hake, 1975 Pararas-Carayannis, 1977
<u>1974 Oct 3</u>	Oct 3 14:21 12.3 S 77.8 W 7.5 PAS 13	Near coast of Peru		Samoa Tutuila I. Pago Pago	0.31				Anon., 1976 Coffman & Stover, 1976 Pararas-Carayannis, 1977
<u>1975 Nov 29</u>	Nov 29 14:47 19.33 N 155.01 W 7.2 PAS 47	Hawaii, near Kilauea Crater		Samoa Tutuila I. Pago Pago	0.21			No other details.	Pararas-Carayannis, 1977 Anon., 1979a



DATE	EARTHQUAKE DATA	TSUNAMI DATA						REFERENCES	
		AREA OF ORIGIN	M	PLACE OF OBSERVATION	H	AT	T		OBSERVATIONS AND REMARKS
<u>1975 Dec 26</u>	Dec 26 15:56 16.3 S 172.5 W 7.6 GRR	Tonga Trench		Samoa Tutuila I. Pago Pago Upolu I. Apia	0.75 0.15				Anon, 1975b Coffman & Stover, 1977
<u>1976 Jan 14</u>	Jan 14 28.4 S 177.7 W 8.0 MS	Kermadec Is.		Samoa Upolu I. Apia	0.14				Coffman & Stover, 1978
<u>1977 Apr 2</u>	Apr 2 07:15 16.2 S 171.6 W 7.2	Tonga Trench		Samoa Tutuila I. Pago Pago Upolu I. Apia	0.15 0.07	0.6 0.5	18 12	Small tsunami recorded.	Coffman & Stover, 1979 ITIC, 1978a
<u>1977 Apr 20</u>	Apr 20 23:13	Solomon Is.		Samoa Upolu I. Apia	0.04	6.5	13	Recorded. No details.	ITIC, 1978b

TSUNAMI DATA							REFERENCES		
DATE	EARTHQUAKE DATA	AREA OF ORIGIN	M	PLACE OF OBSERVATION	H	AT		T	OBSERVATIONS AND REMARKS
<u>1977 Apr 20</u> (cont.)	9.5 S 160.4 E 6.5 33+								
<u>1977 Apr 21</u>	Apr 21 04:24 11.1 S 160.7 E 7.5 33+	Solomon Is.		Samoa Upolu I. Apta	0.03	6.75	15	Recorded. No details.	<u>ITIC, 1978c</u>
<u>1977 Jun 22</u>	Jun 22 12:08 20.9 S 177.4 W 7.0 65	Tonga Trench		Samoa Tutuila I. Pago Pago	0.13	1.2	18	Recorded. No details.	<u>ITIC, 1978d</u>
<u>1977 Oct 10</u>	Oct 10 11:54	Tonga Trench		Samoa Tutuila I. Pago Pago	0.02	0.9		Recorded. No details.	<u>ITIC, 1978e</u>

DATE	EARTHQUAKE DATA	TSUNAMI DATA					REFERENCES	
		AREA OF ORIGIN	M	PLACE OF OBSERVATION	H	AT		T
1977 Oct 10 (cont.)	26.1 S 175.3 W 6.9 33+							
1979 Mar 14	Mar 14 11:07 17.82 N 101.26 W	Pacific Coast of Mexico		Samoa Tutuila I. Pago Pago	0.1			Minor tsunami. No damage reported.
								Anon., 1979b <u>ITIC, 1979</u>

## APPENDIX

List of Bibliographies used to locate relevant tsunami materials.

1. Dictionary Catalog of the Library Bernice P. Bishop Museum, Honolulu, Hawaii. 9 volumes and supplements. Boston: G.K. Hall, 1964, 1967.
2. Johnson, Edward W., Comp. Bibliographic List of Books, Magazine Articles, Notes and some Unpublished Materials on Samoa. Pago Pago, American Samoa, 1955.
3. Library of Congress. Division of Bibliography. Select List of References on Samoa. (Supplement to the Printed List 1901), 1911.
4. New York (City). Emergency Relief Bureau. Bibliographical Survey of Social, Economic, Governmental, Political, Racial and Education Factors in the American Possessions, Volume VI - Samoa. Ann Arbor; University Microfilms, 193\_?
5. Taylor, C.R.H. A Pacific Bibliography - Printed Matter Relating to the Native Peoples of Polynesia, Malanesia and Micronesia. Wellington, New Zealand: The Polynesian Society, 1951.
6. Titcomb, Margaret, comp. Pacific - A Cove Collection. Ann Arbor, Michigan: Xerox University Microfilms, 1973.
7. New York (City). U.S. Work Projects Administration. Classified Bibliography of American Samoa. New York: Federal Works Agency, Works Project Administration for the City of New York, 1942.

## BIBLIOGRAPHY

- AMERICAN SAMOA GOVERNOR, 1922.  
American Samoa, a General Report by the Governor, Government Printing Office, Washington D.C.
- AMERICAN SAMOA GOVERNOR, 1927.  
American Samoa, a General Report by the Governor, Government Printing Office, Washington, D.C.
- ANDERSON, T., 1910.  
The Volcano of Matavanu in Savaii, The Quarterly Journal of the Geological Society, 66:621-639.
- ANGENHEISTER, G., 1923.  
Five Earthquakes and Tidal Waves in the Pacific Ocean, Apia Obs. Rept. for 1921, Wellington, N.Z., p. 58-62.
- ANON., 1883.  
Earthquake and Tidal Wave: Destruction of Life and Property in the Samoan Islands, New York Times, August 15, 1883, p. 2.
- ANON., 1913.  
International Seismological Summary, Oxford University, England, 1913-1934.
- ANON., 1915a.  
Storm Sweeps Samoa: Hurricane Devastates Manua Islands and Famine Follows. New York Times, February 11, 1915, p.1.
- ANON., 1915b.  
Samoan Hurricane wiped out Villages: Earthquake and Tidal Wave added to terrors of Manua Island disaster, New York Times, February 13, 1915, p. 14.
- ANON., 1917a.  
Great Earthquake in Samoa, Samoa Times, June 30, 1917, p.4.
- ANON., 1917b.  
The Earthquake in the Samoan Islands, O le Fa'atonu, July 1917, No. 7, p. 5.
- ANON., 1918.  
An Earthquake, Samoa Times, September 14, 1918, p. 3.
- ANON., 1919a.  
Seismic Phenomena, Samoa Times, May 3, 1919, p. 5.
- ANON., 1919b.  
The Earthquake in the Samoa Islands, O le Fa'atonu, June 1919, No. 6, p. 3.

- ANON., 1921.  
First Pan-Pacific Scientific Conferences. Part II. Bernice P. Bishop Museum, Honolulu, Hawaii, Special Publication, 1921, p. 391.
- ANON., 1923.  
The Seismograph at Apia Observatory, Samoa Times, February 9, 1923, p. 5.
- ANON., 1946.  
MV Honda Knot gets Tidal Wave at Samoa, Honolulu Advertiser, April 19, 1946, p. 10.
- ANON., 1952.  
Serious Flooding in Apia if Tidal Wave had been Four Hours Later, Samoa Bulletin, November 7, 1952, p. 1.
- ANON., 1960.  
Wave Panic, Samoa Bulletin, May 26, 1960, p. 1.
- ANON., 1963a.  
Apia alert follows Kuriles Quake, Samoana, October 16, 1963, p. 1.
- ANON., 1963b.  
Police Force Handled Tidal Wave Alert in Good Order, Samoa News, October 18, 1963, p. 1.
- ANON., 1963c.  
Tidal Wave Emergency Last Saturday Night, Samoa Bulletin, October 18, 1963, Supplement.
- ANON., 1963d.  
Townfolks paid no heed to Tidal Wave Warning, Samoa News, October 25, 1963, p. 6.
- ANON., 1963e.  
Another Tidal Wave alert alarms Apia, Samoana, October 23, 1963, p. 1.
- ANON., 1964a.  
Tidal Wave Threat Follows Big Earthquake in Alaska, Samoa Bulletin, April 3, 1964, p. 1.
- ANON., 1964b.  
Samoa feels Alaskan Earthquake Effects, Samoana, April 1, 1964, p. 1.
- ANON., 1966.  
Tidal Wave Scare, Samoa Bulletin, October 21, 1966, p. 5.
- ANON., 1970.  
Annual Summary of Information on Natural Disasters 1966, Unesco, Paris, p. 58-62.

- ANON., 1975a.  
Annual Summary of Information on Natural Disasters 1973, Unesco,  
Paris, p. 63-66.
- ANON., 1975b.  
The Earthquake Story, News Bulletin, December 29, 1975, p. 1.
- ANON., 1976.  
Annual Summary of Information on Natural Disasters 1974, Unesco,  
Paris, p. 61-63.
- ANON., 1978.  
Pacific Islands Year Book, 13th ed., Pacific Publications, Sydney,  
Australia.
- ANON., 1979a.  
Annual Summary of Information on Natural Disasters 1975, Unesco,  
Paris, p. 71-75.
- ANON., 1979b.  
Mini Tidal-Wave, Samoa News, March 16, 1979, p. 1
- APIA OBSERVATORY, 1980.  
Reports from the Apia Observatory, Apia, Western Samoa, 9 p.
- BERKMAN, S.C. & J.M. SYMONS, 1964.  
The Tsunami of May 22, 1960 as Recorded at Tide Stations, U.S.  
Dept. of Comm., Coast and Geod. Survey, Washington D.C., 79 p.
- CHURCHILL, W., 1896.  
Letterbooks, June 10, 1896 to October 4, 1897, Vol. IV, p. 226-228.
- COFFMAN, J.L. & C.A. HAKE, 1975.  
U.S. Earthquakes 1973, Environmental Data Service, NOAA, Boulder,  
Colo., 112 p.
- COFFMAN, J.L. & C.W. STOVER, 1976.  
U.S. Earthquakes, 1974, Environmental Data Service, NOAA/U.S.  
Geological Survey, joint report, 126 p.
- COFFMAN, J.L. & C.W. STOVER, 1977.  
U.S. Earthquakes, 1975, Environmental Data Service, NOAA/U.S.  
Geological Survey, joint report, 136 p.
- COFFMAN, J.L. & C.W. STOVER, 1978.  
U.S. Earthquakes, 1976, Environmental Data Service, NOAA/U.S.  
Geological Survey, joint report, 94 p.
- COFFMAN, J.L. & C.W. STOVER, 1979.  
U.S. Earthquakes, 1977, Environmental Data Service, NOAA/U.S.  
Geological Survey, joint report, 81 p.
- COULTER, J.W., 1941.  
Land Utilization in American Samoa, Bernice P. Bishop Museum  
Bulletin 170, Honolulu, Hawaii.

- COX, D.C., 1963.  
Effects of the May 1960 Tsunami in Hawaii and other Polynesian Islands. I.U.G.G. Mono. No. 24, p. 87-95.
- DAVIDSON, J.W., 1967.  
Samoa mo Samoa: The Emergence of the Independent State of Western Samoa, Oxford University Press, Melbourne, Australia.
- FUCHS, C.W.C., 1885.  
Statistik der erdbeben von 1865-1885, Sitzungsberichte K. Akademie der Wissenschaften, Math. - Naturwisse, Kl. 92 Bd, I Abtheilung, Heft I-V, Wien, Jahrgang.
- GILSON, R.P., 1970.  
Samoa 1830 to 1900: The Politics of a Multi-Cultural Community, Oxford University Press, Melbourne, Australia.
- GRAY, J.A.C., 1960.  
Amerika Samoa: A History of American Samoa and its United States Naval Administration, United States Naval Institute, Annapolis, Maryland.
- GUTENBERG, B. & C.F. RICHTER, 1954.  
Seismicity of the Earth and Associated Phenomena, Princeton Univ. Press, Trenton, N.J., 303 p.
- HECK, N.H., 1947.  
List of Seismic Sea Waves, Bulletin of Seismological Society of America, Vol. 37, no. 4, p. 269-284.
- HITCHCOCK, C.H., 1911.  
Hawaii and Its Volcanoes, 2nd ed., The Hawaiian Gazette Co., Ltd., Honolulu, Hawaii, p. 291.
- IIDA, K., D.C. COX, & G. PARARAS-CARAYANNIS, 1967.  
Preliminary Catalog of Tsunami Occurring in the Pacific Ocean, Data Report no. 5, Hawaii Institute of Geophysics, Univ. of Hawaii, Honolulu, Hawaii.
- INTERNATIONAL TSUNAMI INFORMATION CENTER, 1978a.  
Tsunami Reports, Event No. 1977-5, International Tsunami Information Center, Honolulu, Hawaii.
- INTERNATIONAL TSUNAMI INFORMATION CENTER, 1978b.  
Tsunami Reports, Event No. 1977-6, International Tsunami Information Center, Honolulu, Hawaii.
- INTERNATIONAL TSUNAMI INFORMATION CENTER, 1978c.  
Tsunami Reports, Event No. 1977-8, International Tsunami Information Center, Honolulu, Hawaii.
- INTERNATIONAL TSUNAMI INFORMATION CENTER, 1978d.  
Tsunami Reports, Event No. 1977-9, International Tsunami Information Center, Honolulu, Hawaii.



- INTERNATIONAL TSUNAMI INFORMATION CENTER, 1978e.  
Tsunami Reports, Event No. 1977-16, International Tsunami Information Center, Honolulu, Hawaii.
- INTERNATIONAL TSUNAMI INFORMATION CENTER, 1979.  
Newsletter, International Tsunami Information Center, V. XII, no.2, Honolulu, Hawaii, 32+ p.
- KEYS, J.G., 1957.  
History of Tsunamis in Samoa, Apia Obs., Samoa, 6 p.
- KEYS, J.G., 1963.  
The Tsunami of 22 May 1960, in the Samoa and Cook Islands, Bulletin of the Seismological Society of America, V. 53, no. 6, p. 1211-1227.
- MAYOR, A.G., 1924.  
Causes which produce stable conditions in the Depth of the Floors of Pacific Fringing Reef-Flats, Papers from the Dept. of Marine Biology, Carnegie Institute of Washington, V. XIX, 1924, p. 29.
- PARARAS-CARAYANNIS, G., 1977.  
Catalog of Tsunamis in Hawaii, World Data Center A, Boulder, Colo., 78 p.
- RICHARD, J.J., 1962.  
Catalogue of the Active Volcanoes and Solfatara fields of Kermadec, Tonga and Samoa, International Volcanological Association, Napoli, 38 p.
- RICHSTAD, J. & M. MCMILLAN, 1978.  
Mass Communication and Journalism in the Pacific Islands: A Bibliography, The University Press of Hawaii, Honolulu, Hawaii.
- SAPPER, K.T., 1927.  
Volcanology [in German], J. Engelhorn, Stuttgart, Germany, 424 p.
- SOLOVIEV, S.L. & CH. N. GO, 1969.  
Catalog of Tsunamis in the Pacific, Main data, Rotaprint, Moscow.
- SOLOVIEV, S.L. & CH. N. GO, 1975.  
Catalog of Tsunamis in Eastern part of Pacific Ocean, [in Russian], Nauka, Moscow, 204 p.
- SPAETH, M.G. & S.C. BERKMAN, 1965.  
The Tsunami of March 28, 1964 as Recorded at Tide Stations, U.S. Dept. of Comm., Coast and Geod. Survey, Washington D.C., 59 p.
- SPAETH, M.G., S.C. BERKMAN, 1967.  
The Tsunami of March 28, 1964 as Recorded at Tide Stations, ESSA Technical Rept. C & GS 33, U.S. Dept. of Comm., Coast and Geod. Survey, Washington D.C., 86 p.
- WIGEN, S.O., 1977  
Historical Study of Tsunamis: Chronological and Area Lists, International Tsunami Information Center, Honolulu, Hawaii.

ZERBE, W.B., 1953.

The Tsunami of November 4, 1952 as Recorded at Tide Stations,  
Spec. Publ. 300, U.S. Dept. of Comm., Coast and Geod. Survey,  
Washington D.C., 62 p.

APPENDIX B: EFFECT OF TIDES ON THE EXCEEDANCE FREQUENCY  
DISTRIBUTION OF THE MAXIMUM WAVE OF A TSUNAMI

1. Let

$Z$  = the elevation at any time above local mean sea level

$P_T(Z)$  = the exceedance frequency distribution for elevations at a location being equal to or exceeding  $Z$  due only to the maximum wave of the tsunami

$P_S(Z)$  = the exceedance frequency distribution being equal to or exceeding  $Z$  due only to the astronomical tide

$P(Z)$  = the exceedance frequency distribution for elevations at a location being equal to or exceeding  $Z$  due to the maximum wave of the tsunami and the astronomical tide

According to Chandrasekhar (1943),  $P(Z)$  can be calculated from

$$P(Z) = \int_{-\infty}^{\infty} f_{\beta}(\lambda) P_S(Z - \lambda) d\lambda \quad (B1)$$

where

$$f_{\beta}(Z) = \frac{-dP_{\beta}(Z)}{dZ} \quad (B2)$$

and  $f_{\beta}(Z)$  is the probability density for the astronomical tide.

2.  $P_T(Z)$  can be represented by an exponential function (Cox 1964, Wiegel 1965, Adams 1970, and Rascon and Villarreal 1975). Thus,

$$P_T(Z) = Re^{-\alpha Z} \quad (B3)$$

If  $P_{\beta}(Z)$  is approximated by a Gaussian distribution, then

$$f_{\beta}(Z) = \frac{1}{2\pi\sigma} e^{-(Z^2/2\sigma^2)} \quad (B4)$$

where the variance,  $\sigma^2$ , equals

$$\sum_{m=1}^{\infty} C_m^2$$

and  $C_m$  is the  $m^{\text{th}}$  tidal constituent.

3. Substituting Equations B3 and B4 into Equation B1 and performing the integration yields

$$P(Z) = \text{Re} \left( Z - \frac{\alpha \sigma^2}{2} \right)^{-\alpha} \quad (\text{B5})$$

or

$$P(Z) = \text{Re}^{-\alpha Z^1} \quad (\text{B6})$$

where

$$Z^1 = Z - \frac{\alpha \sigma^2}{2} \quad (\text{B7})$$

4. Thus, the net effect of the astronomical tide is to produce a  $P(Z)$  identical with  $P_S(Z)$  except for a shift of  $Z$  by an amount  $\alpha \sigma^2 / 2$ . The variance,  $\sigma^2$ , is equal to approximately 2 sq ft for Tutuila. At the end of Pago Pago Harbor,  $\alpha = 0.06$ . Therefore, the shift is 0.06 ft. This shift in the frequency distribution is so minor that it can be neglected. Therefore, the astronomical tide has a negligible influence on the frequency distribution of the maximum wave of a tsunami and the maximum wave should be added to a mean sea level datum. This effect can be explained by noting that the maximum wave can arrive at any tidal stage. Since it arrives at a high level about as frequently as it arrives at a low level, the net effect is that on the average it arrives at a mean sea level datum.

APPENDIX C: NOTATION

A	Coefficient in wave-height equation
B	Coefficient in wave-height equation
$C_m$	$m^{\text{th}}$ tidal constituent
d	Number of years
D	Region of space
e	Transcendental number
E	Region of space
f	Frequency per year of tsunami occurrence
$f_{\beta}(Z)$	Probability density for the astronomical tide
F	Functional
g	Acceleration due to gravity, 32.2 ft/sec <sup>2</sup>
h	Water depth, ft
H	Elevation of the maximum combined tsunami and astronomical tide above mean sea level at the shoreline
$H_n$	Hankel function of the first kind of order n
i	$\sqrt{-1}$
k	Wave number
[K]	Coefficient matrix
m	Number of components
n	Integer
$n_a$	Unit normal vector outward from Region D
N	Number of node points
P	Probability
$P_T(Z)$	Exceedance frequency distribution due to maximum wave of tsunami
$P_{\beta}(Z)$	Exceedance frequency distribution due to astronomical tide
$P(Z)$	Exceedance frequency distribution due to maximum wave of tsunami and astronomical tide
{Q}	Load vector
r	Spherical coordinate, ft
R	Constant
t	Time, sec
U	Two-dimensional velocity vector, ft/sec

x,y	Cartesian coordinate, ft
Z	Elevation above local mean sea level
$\alpha$	Coefficient
$\alpha_n$	Unknown coefficient
$\beta_n$	Unknown coefficient
$\partial C$	Land-water interface
$\partial D$	Boundary of Region D
$\lambda$	Integration variable
$\theta$	Spherical coordinate, radians
$\phi$	Total velocity potential, ft <sup>2</sup> /sec
$\phi_a$	Total velocity potential evaluated on boundary $\partial D$ , ft <sup>2</sup> /sec
$\phi_E$	Velocity potential in Region E, ft <sup>2</sup> /sec
$\phi_I$	Velocity potential of incident wave, ft <sup>2</sup> /sec
$\phi_S$	Scattered wave velocity potential, ft <sup>2</sup> /sec
$\omega$	Angular frequency, radians/sec
$\sigma$	Variance, sq ft
$\nabla$	Gradient operator, ft <sup>-1</sup>
$\int$	Line integral
( $\psi$ )	Vector of unknowns

In accordance with letter from DAEN-RDC, DAEN-ASI dated 22 July 1977, Subject: Facsimile Catalog Cards for Laboratory Technical Publications, a facsimile catalog card in Library of Congress MARC format is reproduced below.

Houston, James R

Tsunami elevation predictions for American Samoa / by James R. Houston. Vicksburg, Miss. : U. S. Waterways Experiment Station ; Springfield, Va. : available from National Technical Information Service, 1980.

43, [90] p., [10] leaves of plates : ill. ; 27 cm.  
(Technical report - U. S. Army Engineer Waterways Experiment Station ; HL-80-16)

Prepared for U. S. Army Engineer Division, Pacific Ocean, Fort Shafter, Hawaii.

References: p. 42-43.

1. American Samoa. 2. Finite element method. 3. Mathematical models. 4. Tsunamis. I. United States. Army. Corps of Engineers. Pacific Ocean Division. II. Series: United States. Waterways Experiment Station, Vicksburg, Miss. Technical report ; HL-80-16.  
TA7.W34 no.HL-80-16