

ARCHIVE COPY
DO NOT LOAN

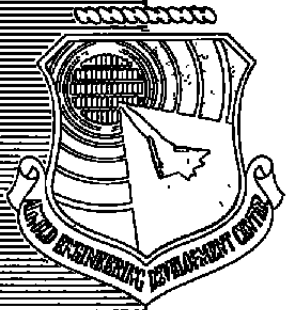

An Investigation of the Sound Generated by an Axisymmetric Jet Interacting with a Diffuser

J. R. Maus and C. V. Sundaram
The University of Tennessee Space Institute
Tullahoma, Tennessee

September 1980

Final Report for Period November 15, 1979 – January 15, 1980

Approved for public release; distribution unlimited.

AEDC TECHNICAL LIBRARY



UNCLASSIFIED REPORTS
1977-1980

Property of U. S. Air Force
AEDC LIBRARY
F40600-77-C-0003

ARNOLD ENGINEERING DEVELOPMENT CENTER
ARNOLD AIR FORCE STATION, TENNESSEE
AIR FORCE SYSTEMS COMMAND
UNITED STATES AIR FORCE

NOTICES

When U. S. Government drawings, specifications, or other data are used for any purpose other than a definitely related Government procurement operation, the Government thereby incurs no responsibility nor any obligation whatsoever, and the fact that the Government may have formulated, furnished, or in any way supplied the said drawings, specifications, or other data, is not to be regarded by implication or otherwise, or in any manner licensing the holder or any other person or corporation, or conveying any rights or permission to manufacture, use, or sell any patented invention that may in any way be related thereto.

Qualified users may obtain copies of this report from the Defense Technical Information Center.

References to named commercial products in this report are not to be considered in any sense as an indorsement of the product by the United States Air Force or the Government.

This report has been reviewed by the Office of Public Affairs (PA) and is releasable to the National Technical Information Service (NTIS). At NTIS, it will be available to the general public, including foreign nations.

APPROVAL STATEMENT

This report has been reviewed and approved.

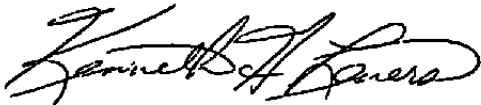

KENNETH H. LENERS, Captain, USAF
Project Manager, Research Division
Directorate of Technology

Approved for publication:

FOR THE COMMANDER

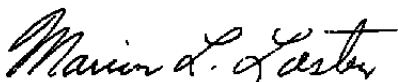

MARION L. LASTER
Director of Technology
Deputy for Operations

UNCLASSIFIED

20. ABSTRACT, Concluded.

intense discrete frequency tones occur that are, in many cases, 20 dB or more above the broad-band noise. The test results indicate that the smallest ratio of diffuser diameter to nozzle diameter tested ($D_d/D_n = 1.43$) with the diffuser entrance located less than 0.5 nozzle diameters from the nozzle produced the lowest sound power for all velocities tested. Tests with two different-sized nozzles (scale factor = 2) indicate that standard acoustic scaling laws are adequate to extrapolate the results to full-scale conditions.

UNCLASSIFIED

PREFACE

The work reported herein was conducted by the University of Tennessee Space Institute between November 1979 and January 1980. The investigation was sponsored by the Arnold Engineering Development Center (AEDC), Air Force Systems Command (AFSC), under Contract F40600-77-C-0009. The Air Force Program Manager for the contract was Mr. Eules L. Hively.

The authors express their appreciation to Dr. Grant T. Patterson, ARO, Inc., AEDC Group (a Sverdrup Corporation Company), who suggested the study and provided valuable assistance through numerous consultations. Mr. James R. Goodman supervised the construction of the apparatus and participated in all phases of the test program.

TABLE OF CONTENTS

| | PAGE |
|--|------|
| I. INTRODUCTION | 7 |
| II. EXPERIMENTAL FACILITIES AND TEST PROGRAM | |
| 2.1 Facilities | 8 |
| 2.2 Test Program | 8 |
| 2.3 Data Verification | 9 |
| III. DISCUSSION OF RESULTS | |
| 3.1 General Observations | 10 |
| 3.2 Discrete Tones | 10 |
| 3.3 Data Reduction Procedure | 12 |
| 3.4 General Trends of Sound Power | 13 |
| 3.5 Scale Relations | 15 |
| IV. SUMMARY AND CONCLUSIONS | 16 |
| REFERENCES | 17 |

ILLUSTRATIONS

FIGURE

| | |
|---|----|
| 1. Elevation View of Experimental Test Set-up Simulated Jet Exhaust Nozzle..... | 19 |
| 2. Plan View of Test Set-Up Showing Microphone Measurement Positions..... | 20 |
| 3. Microphone Support Device..... | 21 |
| 4. Modified Diffuser Section..... | 22 |
| 5. Exhaust Duct With Liner..... | 23 |
| 6. Sound Pressure Spectrum at $\phi = 60^\circ$ for 2.8/4.0 Combination With $M_e = 0.7$, $S/D_n = 1.5$, $T_o = 1210^\circ\text{R}$ | 24 |
| 7. Sound Pressure Spectrum at $\phi = 30^\circ$ for 2.8/4.0 Combination With $M_e = 0.7$, $S/D_n = 1.5$, $T_o = 530^\circ\text{R}$ | 25 |
| 8. Sound Pressure Spectrum at $\phi = 60^\circ$ for 2.8/4.0 Combination With $M_e = 0.7$, $S/D_n = 1.5$, $T_o = 530^\circ\text{R}$ | 26 |

| FIGURE | PAGE |
|--|------|
| 9. Sound Pressure Spectrum at $\phi = 90^\circ$ for 2.8/4.0 Combination With $M_e = 0.7$, $S/D_n = 1.5$, $T_o = 530^\circ\text{R}$ | 27 |
| 10. Sound Pressure Spectrum at $\phi = 30^\circ$ for 2.8/8.0 Combination With $M_e = 1.1$, $S/D_n = 0.0$, $T_o = 530^\circ\text{R}$ | 28 |
| 11. Sound Pressure Spectrum at $\phi = 60^\circ$ for 2.8/8.0 Combination With $M_e = 1.1$, $S/D_n = 0.0$, $T_o = 530^\circ\text{R}$ | 29 |
| 12. Sound Pressure Spectrum at $\phi = 90^\circ$ for 2.8/8.0 Combination With $M_e = 1.1$, $S/D_n = 0.0$, $T_o = 530^\circ\text{R}$ | 30 |
| 13. Variation Of Overall Sound Power For 2.8/4.0 Nozzle/Diffuser Combination. Cold Flow..... | 31 |
| 14. Variation Of Overall Sound Power For 2.8/4.0 Nozzle/Diffuser Combination. Heated Flow..... | 32 |
| 15. Variation Of Overall Sound Power For 2.8/6.0 Nozzle/Diffuser Combination. Cold Flow..... | 33 |
| 16. Variation Of Overall Sound Power For 2.8/6.0 Nozzle/Diffuser Combination. Heated Flow..... | 34 |
| 17. Variation Of Overall Sound Power For 2.8/8.0 Nozzle/Diffuser Combination. Cold Flow..... | 35 |
| 18. Variation Of Overall Sound Power For 2.8/8.0 Nozzle/Diffuser Combination. Heated Flow..... | 36 |
| 19. Variation Of Overall Sound Power For 5.6/8.0 Nozzle/Diffuser Combination. Cold Flow..... | 37 |
| 20. Sound Power Spectrum For 5.6/8.0 Nozzle/Diffuser Compared With Scaled Data For 2.8/4.0 Combination at $M_e = 0.9$, $S/D_n = .75$, $T_o = 530^\circ\text{R}$ | 38 |
| 21. Sound Power Spectrum For 5.6/8.0 Nozzle/Diffuser Compared With Scaled Data for 2.8/4.0 Combination at $M_e = 0.7$, $S/D_n = 1.5$, $T_o = 530^\circ\text{R}$ | 39 |
| 22. Sound Power Spectrum For 5.6/8.0 Nozzle/Diffuser Compared With Scaled Data For 2.8/4.0 Combination at $M_e = 0.7$, $S/D_n = 1.5$, $T_o = 1210^\circ\text{R}$ | 40 |
| 23. Sound Power Spectrum For 5.6/8.0 Nozzle/Diffuser Compared With Scaled Data For 2.8/4.0 Combination at $M_e = 1.1$, $S/D_n = 1.5$, $T_o = 530^\circ\text{R}$ | 41 |
| 24. Sound Power Spectrum For 5.6/12.0 Nozzle/Diffuser Compared With Scaled Data for 2.8/6.0 Combination at $M_e = 1.1$, $S/D_n = 0.0$, $T_o = 530^\circ\text{R}$ | 42 |

| FIGURE | PAGE |
|--|------|
| 25. Sound Pressure Spectrum For 5.6/12.0 Nozzle/Diffuser Compared With Scaled Data For 2.8/4.0 Combination at $M_e = 0.7$, $S/D_n = 0.0$, $T_o = 1210^{\circ}\text{R}$ | 43 |

TABLES

| | |
|---|-----|
| 1. Range of Geometrical Parameters in Experimental Test Program | 44 |
| 2. Range of Velocities for Each Test Configuration..... | 45 |
| 3. Sound Power Output for Free Jet | 46 |
| APPENDIX A | 47 |
| NOMENCLATURE | 185 |

I. INTRODUCTION

In order to predict the acoustic environment in an enclosure such as the engine test cells of the Engine Test Facility at AEDC, the acoustic sound power generated by the sound source must be known. The noise radiation characteristics of jet engine exhausts have been thoroughly studied over the past 30 years and can be satisfactorily predicted if the operating conditions are specified for a given engine. However, the situation in an engine test cell is quite different from that of a jet engine in a normal operating environment. In the test cells at AEDC the jet exhaust from the engine is captured by a diffuser or scavenging duct. The inlet of this diffuser is normally located a very short distance downstream of the engine exhaust nozzle. Thus, much of the sound generated by the exhaust jet may not be escaping into the test cell. On the other hand, if the nozzle exhaust impinges or scrubs the diffuser wall, additional noise sources will be present. Thus, there can be little doubt that the sound field produced by the jet-diffuser combination is quite different from that produced by the jet alone.

The purpose of the investigation reported here was to carry out a detailed study of the acoustic field produced by the interaction of the jet exhaust with the diffuser. Parameters varied during the study were the jet exit velocity and temperature, the ratio of the nozzle exit diameter to the diffuser diameter, and the distance between the nozzle exit and the diffuser entrance. Experiments were carried out for two different convergent nozzles, one with an exit diameter of 2.8 inches, and a larger nozzle with an exit diameter of 5.6 inches.

The acoustic prediction method developed for engine test cells at AEDC assumes a diffuse sound field and requires an input in terms of the sound power spectrum of the acoustic source. Therefore, the data obtained in this investigation were reduced primarily to sound power spectra.

11. EXPERIMENTAL FACILITIES AND TEST PROGRAM

2.1 FACILITIES

In order to achieve the high exit velocities typical of aircraft engine exhausts it was considered necessary to carry out the experiments in this program in a facility where the flow could be heated. For this reason, the acoustic measurements in the current study were taken in the UTSI Free Field Facility where a kerosene heater is available. For the experiments reported here the stilling chamber was lowered to the horizontal position with a diffuser consisting of a standard pipe section positioned just downstream of the nozzle exit. This arrangement is shown schematically in Fig. 1. To determine the sound field radiated from the nozzle-diffuser combination, microphone measurements were taken at 7 positions spaced 15 degree intervals between 30 degrees and 120 degrees. The microphone positions were initially set at a constant radius of 13 feet but were later moved in to 6 feet as shown in Fig. 2. It was necessary to measure the sound pressure in the acoustic far field in order to be able to easily evaluate the sound power. A single microphone, mounted on a rail, as shown in Fig. 3, was used to collect acoustic data during the tests and was moved between the measurement positions by hand.

2.2 TEST PROGRAM

Table 1 shows the geometrical parameters that were varied during the test program and the range of their variation. The two nozzles shown in this table were contoured converging nozzles that had been used in earlier studies - the smaller having been tested extensively in Phase I of this program (Ref. 1). The diffuser was simulated by standard pipe sections, 21 feet long, with inside diameters as given in Table 1. For each geometric configuration, as many as six different jet velocities were set as shown in Table 2. The velocities shown in this table, for the supersonic conditions, are computed assuming fully expanded flow and are therefore higher than the actual exit velocities. For the smaller diameter nozzle, the test matrix as defined by Tables 1 and 2 was closely followed.

An abbreviated test plan was used for the large nozzle, since the primary purpose of these tests was to verify the applicability of standard acoustic scaling techniques to this configuration.

2.3 DATA VERIFICATION

Initial data taken with the 2.8 inch nozzle without the diffuser in place were compared with the previous data taken in the usual test configuration (Ref. 1) and showed that the effects of ground reflection were small and could be minimized by an acoustic foam ground covering. This ground cover was used in all tests.

The noise generated by the diffuser exhaust flow proved to be a more difficult problem to overcome. Initial tests with the 2.8 inch diameter nozzle and a 4 inch diffuser of length 21 feet revealed a severe noise source from the diffuser exhaust that was contaminating the jet-diffuser interaction noise. A number of modifications to the test apparatus were required before this contamination was reduced to an acceptable level. The diffuser pipe diameter was increased in steps to 12 inches over the last 8 feet of the section and 18" x 24" rectangular duct with transition section was attached to the 12" exhaust. The final section of the duct was lined with 2" thick polyurethane foam to reduce the internal noise. A spray cooler was installed to prevent degradation of the foam liner during the heated flow tests. The modified diffuser section is shown in Fig. 4 and the final attached silencing duct is shown in Fig. 5. Finally, the microphone arc was moved from its initial radius of 13 feet to a radius of 6 feet to accentuate the jet-diffuser interaction noise. Previous tests (Ref. 1) had shown this distance to be in the far field for all frequencies above 200 Hz. With these modifications it was found that the sound generated by the jet diffuser interaction was sufficiently above the background to permit reliable data to be obtained.

III. DISCUSSION OF RESULTS

3.1 GENERAL OBSERVATIONS

A few general comments about the alteration of the acoustic field caused by the placement of the diffuser downstream of the nozzle exhaust will be made before undertaking a more detailed discussion of the results. The sound field generated by the interaction of an axisymmetric jet with a diffuser is usually quite different from that produced by the jet alone. These differences include the distribution of the radiated sound with direction and with frequency and the variation of the overall sound power output with jet velocity. The sound field radiated from the jet/diffuser combination tends to be much less directional than that radiated from a pure jet, although for certain geometries a pronounced directionality, associated with the discrete tones discussed below, was observed. The far field acoustic intensity for a circular jet almost always has its maximum between 30° and 60° to the jet axis. For the jet/diffuser combination this maximum frequently occurred at angles greater than 90° . This was usually the case when the larger diameter diffusers were placed very close to the nozzle exit plane.

The sound power spectra for the jet/diffuser combination varied in shape from a very flat distribution to a sharply peaked distribution depending on the test conditions. For certain geometries very strong discrete tones were observed in the sound pressure spectra. Only occasionally do these spectra display the broad "haystack" distribution typical of the noise from circular jets.

3.2 DISCRETE TONES

For certain test conditions, intense narrow-band acoustic oscillations occurred which completely dominated the broadband spectrum. These tones were, in many cases, 20 dB or more above the broadband noise level. For a very strong tone, a second harmonic was sometimes apparent in the frequency spectrum. Presumably, these higher harmonics are always present but are simply buried in the broadband noise, in most cases. Fig. 6 shows an example of the sound pressure spectrum for one such condition.

Since discrete tones have their origin in flow instabilities and rely upon an acoustic feedback mechanism to sustain and control the process (Ref. 2) they are, to a large degree, unpredictable. Small changes in flow conditions or geometry can often produce large changes in intensity, abrupt shifts in frequency, or cause the tone to completely disappear. Only when there is a reflecting object or a resonant cavity to accentuate and control the acoustic feedback does something approaching a stable equilibrium condition exist. This unstable behavior makes discrete tones difficult to accurately characterize and frequently difficult to reproduce in different test set ups. However, when they occur, the intensity of the associated pressure oscillation is of such magnitude that they might well be responsible for metal fatigue and engine failure in a confined test cell.

Generally speaking, there were two types of configurations where these intense discrete tones occurred. The first was for the smallest diffuser diameter, e.g. $D_n/D_d = 2.8/4.0$, with a large spacing ratio $S/D_n = 1.5$, and a relatively low subsonic Mach number (0.7). The sound pressure spectra in Figs. 7, 8, and 9 are examples of this type of tone. When the exit Mach number was increased to 0.9 or the diffuser entrance was brought closer to the nozzle exit plane, the tone disappeared. Although in these experiments this type of tone did not occur for choked flow, it should be noted that, in previous work for a similar geometry, a strong tone was observed at a pressure ratio of 2.5.

The second type of discrete tone encountered was for an underexpanded jet with a pressure ratio corresponding to a fully expanded Mach number of 1.1. This occurred only for the larger diffuser diameters and with the diffuser entrance very close to the nozzle exit plane. Figs. 10, 11 and 12 are examples of the sound pressure spectra produced by this condition.

It would appear that two different mechanisms are responsible for these tonal occurrences. The first is probably caused by the jet shear layer intersecting the diffuser wall at or near the entrance and is related to the edge tone (Ref. 3). The second is thought to be due to an amplification of the shock cell noise associated with an underexpanded jet (Ref. 4). In this case the diffuser may be acting as a sound reflector to accentuate the acoustic feedback mechanism. The question naturally arises as to why the second type of pure tone did not occur with the

smaller (4") diffuser. Although no firm explanation can be offered, it may be that the proximity of the diffuser wall acts to stabilize the shock cell structure in this situation.

3.3 DATA REDUCTION PROCEDURE

In these experiments, the acoustic data was taken as 1/3 octave sound pressure level spectra at each of the microphone positions indicated in Fig. 2. In order to present the results in a format that would permit maximum utility by the Air Force, a reduction to sound power spectra was carried out. This was accomplished by integrating the measured sound pressure level over the microphone arc. For spherical waves, the far field relation between the mean square acoustic pressure and sound intensity is

$$I = \frac{\overline{p^2}}{\rho_0 a_0} \quad \text{watts/m}^2$$

The total sound power in a given 1/3 octave frequency band can be obtained by integration, assuming an axisymmetric sound field.

$$P(f) = \int_0^{2\pi} \int_{\frac{\pi}{6}}^{\frac{2\pi}{3}} \frac{p^2(R, \phi, f)}{\rho_0 a_0} R^2 d\phi d\theta$$

This calculation gives the acoustic power in watts. The limits on the ϕ integration are, of course, determined by physical restrictions on the microphone arc. Since the maximum intensity for jet noise radiation almost always occurs between $\phi = 30^\circ$ and $\phi = 60^\circ$ it was initially thought that little error would be introduced by this restriction. However, since the sound field for the configuration tested is much less directional than for the jet alone, the computed sound power levels may be as much as 3 dB too low due to the limitation. The integration over ϕ was accomplished numerically using a Simpson's rule technique.

In Appendix A, complete results of all configurations tested are presented in tabular form. The data presented there are in terms of 1/3 octave intensity level at each microphone position

$$IL = 10 \log \frac{I}{I_0}$$

where $I_o = 10^{-12}$ watts/m². This value is almost identically equal to the sound pressure level actually measured.

$$SPL = 20 \log \frac{\sqrt{p^2}}{p_{ref}}$$

where $p_{ref} = 2.0 \times 10^{-5}$ N/m².

The sound power spectrum values, the result of the above integration are presented in terms of a decibel level

$$PWL(f) = 10 \log \frac{P(f)}{P_{ref}}$$

where $P_{ref} = 10^{-12}$ watts. The total sound power in watts can be obtained by summing the individual contributions in each frequency band

$$P = \sum_{f_1} P(f_1)$$

The total power is presented as a sound power level

$$PWL = 10 \log \frac{P}{P_{ref}}$$

3.4 GENERAL TRENDS OF SOUND POWER

Figs. 13 through 18 summarize the sound power results for the 2.8" diameter nozzle and the three diffusers tested with it. Separate graphs are given for each diffuser for both the cold flow test series and the heated flow tests. These plots are quite complex in that there are few general trends in the data which are consistent for the different diffusers. This, no doubt, reflects the fact that a number of competing factors are affecting the sound radiated by the nozzle/diffuser interaction.

Fig. 13 shows that, for the 2.8/4.0 combination, the sound power output increases as the nozzle/diffuser spacing ratio, S/D_n , increases. This trend was expected since, as the spacing ratio increases, more of the turbulent jet is exposed. Also, as the spacing ratio increases, the jet shear layer scrubs the diffuser wall nearer the entrance introducing an additional surface interaction that can easily radiate to the far field. The sound intensity spectra (see Appendix A) are very flat for the low spacing ratios but become more peaked as the distance between the nozzle and diffuser increases. For the largest ratio a discrete tone occurred at the lowest Mach number.

Fig. 13 also shows that the sound power increases with nozzle pressure ratio although this increase is not as large as would be expected from classical jet noise considerations. This trend is confused at the largest spacing by the occurrence of the tone for $M_e = 0.7$.

Fig. 14 shows a similar graph for the same test configurations as Fig. 13, but for heated flow. A similar trend with spacing ratio is observed as with the cold flow tests although the pure tone for $M_e = 0.7$ is now more intense and occurs at a smaller spacing ratio.

Fig. 15 shows the effect of spacing ratio and exit Mach number on the sound power generated by the 2.8/6.0 nozzle/diffuser combination for cold flow. Interestingly, in this series, there is very little variation with spacing ratio. The sound power generated is greater than that obtained for the 2.8/4.0 combination for small spacing ratios but less than that configuration for larger spacing ratios. This reversal is thought to indicate that the larger diameter diffuser does not shield the jet as well for small spacing ratios but that there is less scrubbing noise at the large spacing ratio.

For the 2.8/8.0 nozzle/diffuser combination Fig. 17 shows the same invariance of sound with spacing ratio for the subsonic exit Mach numbers. For $M_e = 1.1$, however, there is a decrease in sound power output as spacing ratio increases. This decrease is, at least in part, due to the discrete tone that occurs for this configuration at the lower spacing ratios.

Figs. 16 and 18 compared with Figs. 15 and 17 show that, as expected, an increase in stagnation temperature causes an increase in the generated sound power. However, at the higher temperatures, there is a smaller increase in sound power associated with an increase in exit Mach number than for cold flow. This behavior was not anticipated and the only

explanation for it that can be offered is that at the higher velocities the sound is being focused forward due to the convection effect. Thus, the diffuser is intercepting more of the generated sound under these conditions.

It is of interest to compare the sound power generated by the nozzle/diffuser combination with that which would be produced by the circular jet alone. The sound power output from a circular jet can be readily computed from Lighthill's equation (Ref. 5)

$$P = K \frac{\rho_o A_e U_e^8}{a_o^5} \quad \text{watts}$$

where the dimensionless constant K is approximately 5×10^{-5} . Table 3 shows the values of sound power level computed from this formula for the 2.8 inch nozzle and the jet exit velocities given in Table 2. In most cases, the sound power output of the nozzle/diffuser combination is well below these estimates. Only for those conditions where a strong discrete tone is generated is the sound power of a pure circular jet exceeded.

3.5 SCALE RELATIONS

As discussed earlier, an abbreviated test program was carried out with the larger 5.6" diameter nozzle to test the applicability of standard acoustic scaling relations to the nozzle/diffuser combination. Tests were carried out on a 5.6/8.0 combination and 5.6/12.0 combination. A fairly complete cold flow test program was carried out on the 5.6/8.0 configuration and the total acoustic power results are shown in Fig. 19. These values when compared with the results of the 2.8/4.0 nozzle/diffuser combination of Fig. 13 show that the sound power generated by the larger scale configuration is between 5 and 9 dB greater than the 2.8/4.0 results for the same spacing ratio and exit Mach number. Theoretically, doubling the length scale should quadruple the sound power output resulting in an increase of 6 dB in power level.

To examine the validity of scaling relations applied to sound power spectra, results for the 2.8 inch nozzle were scaled up for direct comparison with the measured spectra for the 5.6 inch nozzle. The scaling relations used are:

$$\frac{P_L}{P_S} = \left(\frac{D_L}{D_S} \right)^2$$

$$\frac{f_L}{f_S} = \frac{D_S}{D_L}$$

where P is the sound power in a one-third octave band and f is the geometric mean frequency of the band. The results of some of these comparisons is shown in Figs. 20 - 25. Although there are some serious discrepancies in the levels of discrete tones, as shown in Fig. 21, and at high frequencies, the agreement between the measured and scaled spectra is considered to be very acceptable. The general shape, location of peaks, and overall level of power are predicted quite well. These results tend to confirm our ability to extrapolate the data from the model tests obtained in this program to full-scale situations.

IV. SUMMARY AND CONCLUSIONS

An investigation of the sound field produced by the interaction of an axisymmetric exhaust jet with a constant area, circular diffuser has been carried out. The results of this investigation show that the sound field produced by the jet-diffuser interaction is quite different from that generated by the jet alone. Both the directivity of the radiated sound and its distribution with frequency are substantially altered by the placement of a diffuser just downstream of the jet exhaust. For certain test configurations, intense discrete frequency tones occur that are, in many cases, 20 dB or more above the broadhead noise level. It appears that the occurrence of these tones is associated with either impingement of the jet shear layer on the diffuser wall or with shock cell noise in an underexpanded jet.

The variation of the overall sound power with changes in the geometric and fluid dynamic parameter reveals the complexity of the acoustic phenomena. For different diffuser diameters, the change in sound power produced by changes in jet exit velocity or spacing between nozzle and diffuser can be quite different.

Standard acoustic scaling techniques appear to be applicable to predicting the full scale sound power spectrum for model data if the diameter ratio, spacing ratio, and jet exit conditions are the same.

To minimize the sound level in the test chamber, these test results indicate that a small diffuser to nozzle diameter ratio is preferred with the diffuser entrance located less than 1/2 nozzle diameter from nozzle exit plane.

REFERENCES

1. Maus, J. R. et al. "An Acoustic Source Modeling Technique to Predict the Near Field Sound of Axisymmetric Turbulent Jets." AEDC-TR-79-36, May 1979.
2. Chanaud, Robert C. "Aerodynamic Whistles." Scientific American, January 1970.
3. Powell, Alan. "On the Edgetone." Journal of the Acoustical Society of America, Vol. 33, No. 4, 1961, pp. 395-409.
4. Powell, Alan. "On the Mechanism of Choked Jet Noise." Proceedings Phys. Soc. B., Vol. 66, 1953, pp. 1039-1056.
5. Lighthill, M. J. "On Sound Generated Aerodynamically: I. General Theory." Proc. Roy. Soc., Vol. 222A, 1954, pp. 1-32.

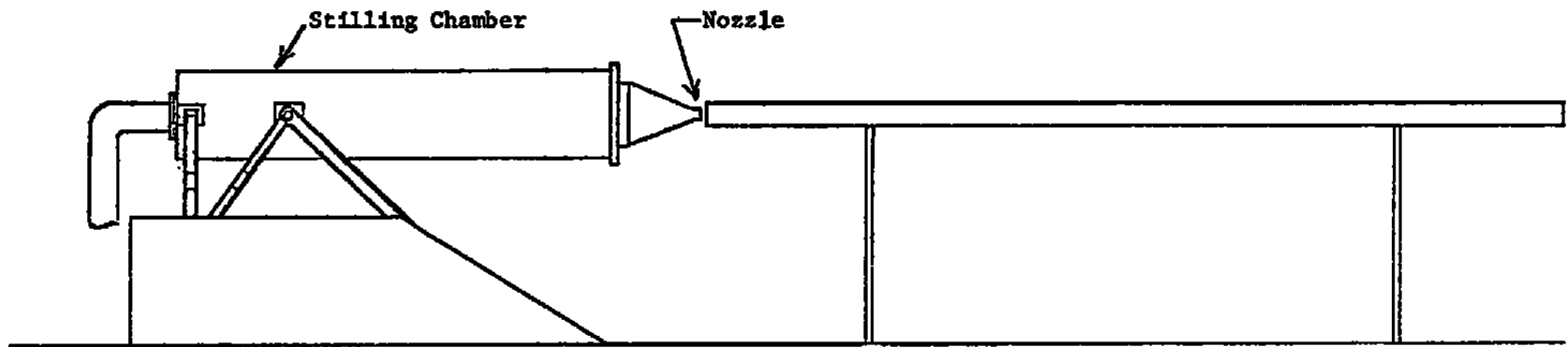

Fig. 1. Elevation View of Experimental Test Set-Up Showing Simulated Jet Exhaust Nozzle and Diffuser.

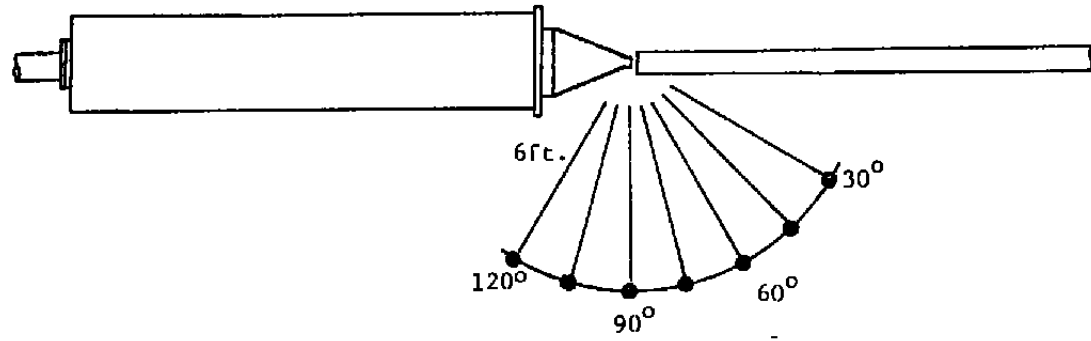

Fig. 2. Plan View of Test Set-Up Showing Microphone Measurement Positions.

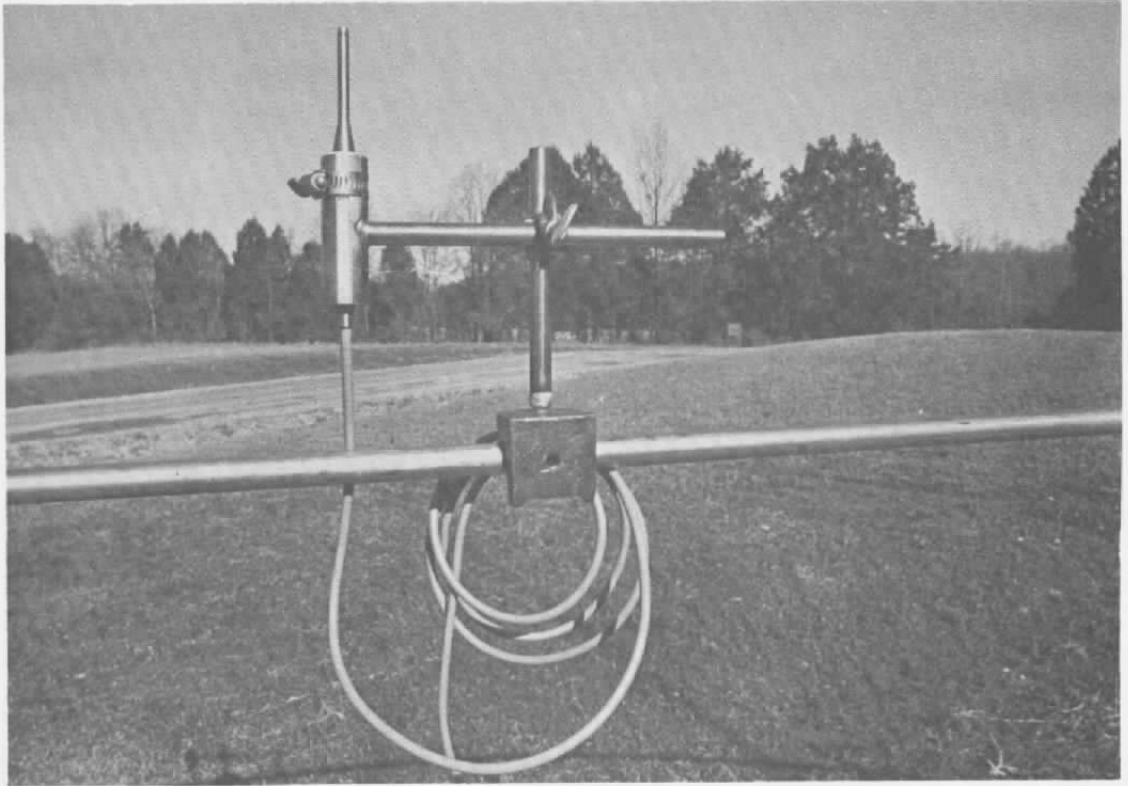

Fig. 3. Microphone Support Device.

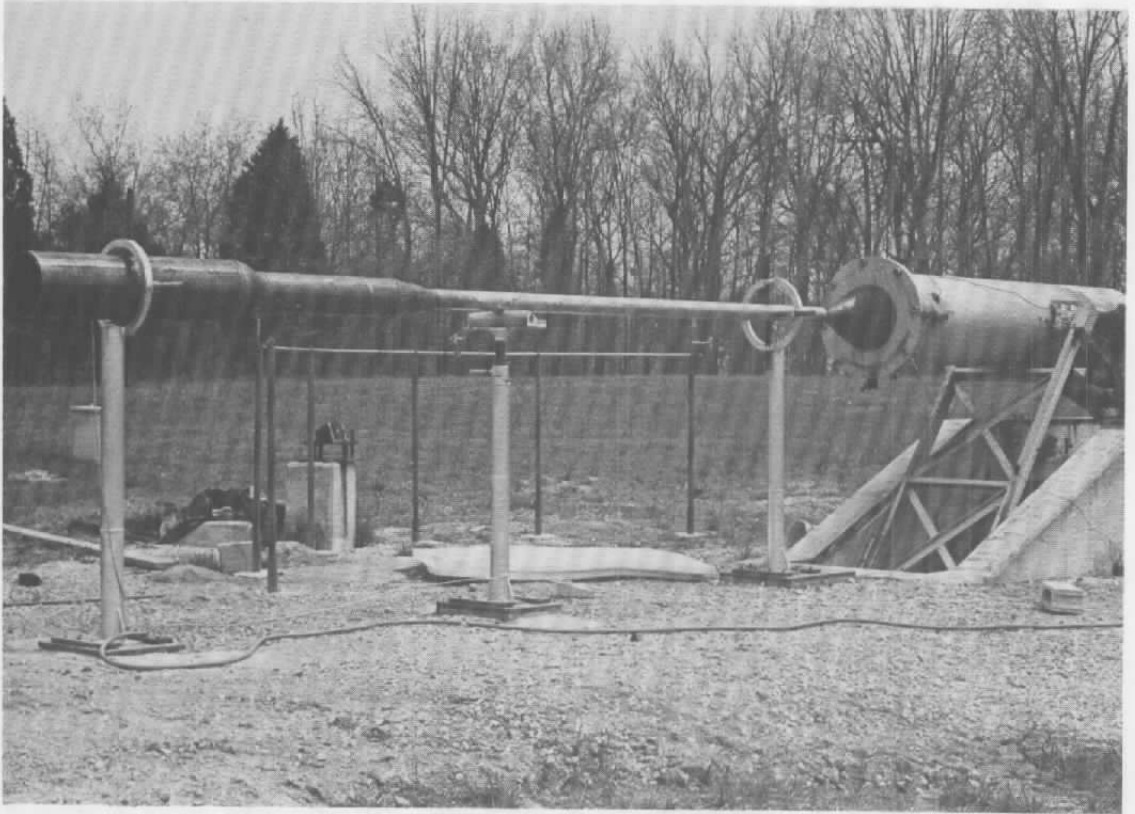

Fig. 4. Modified Diffuser Section.



Fig. 5. Exhaust Duct with Liner.

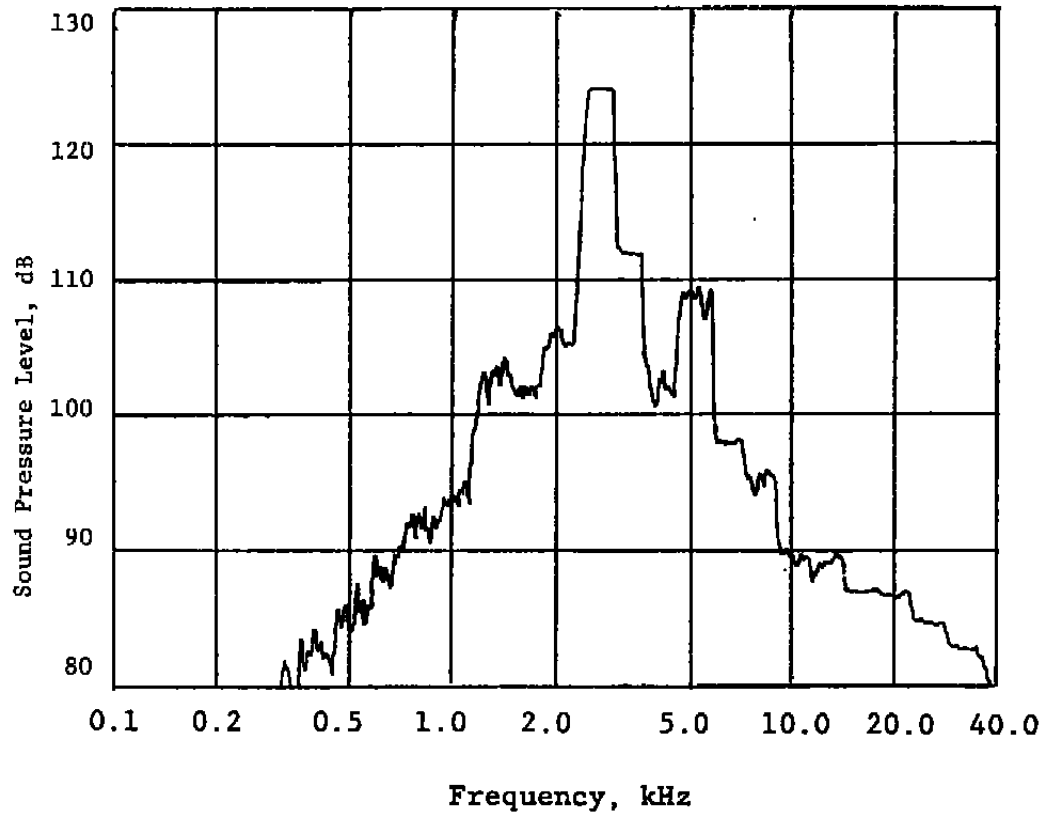

Fig. 6. Sound Pressure Spectrum at $\phi = 60^\circ$ for 2.8/4.0 Combination with $M_e = 0.7$, $S/D_n = 1.5$, $T_o = 1210^\circ R$

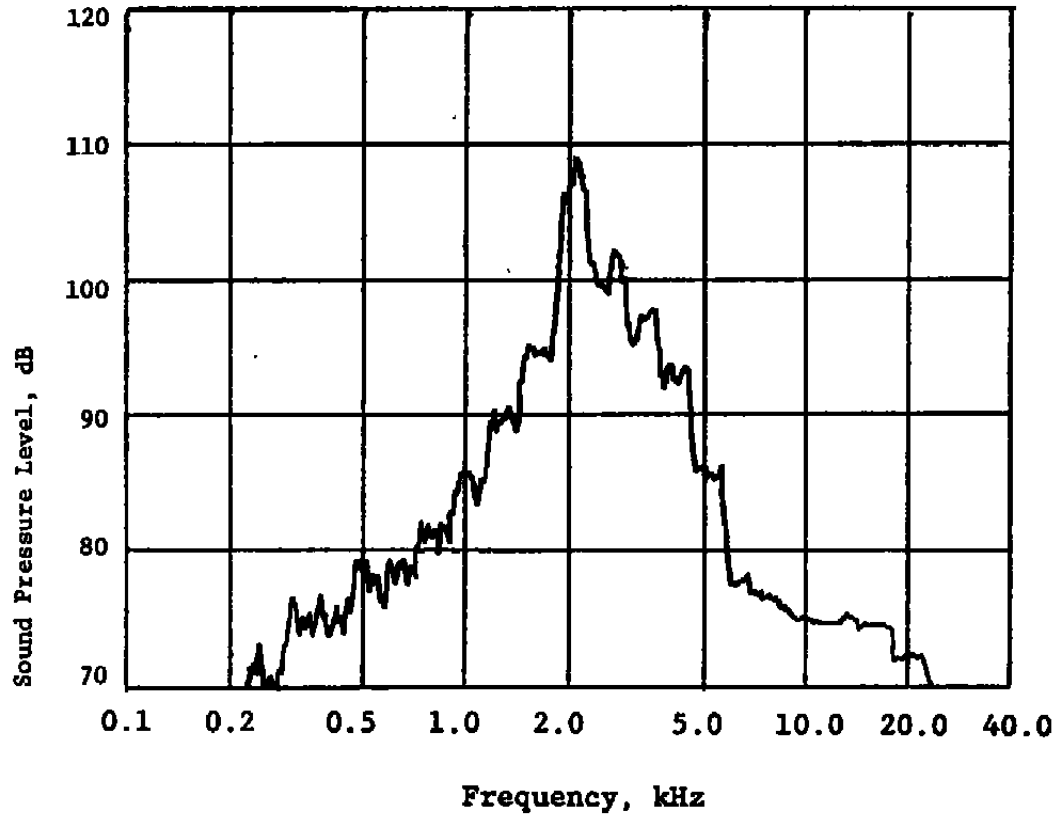

Fig. 7. Sound Pressure Spectrum at $\phi = 30^\circ$ for 2.8/4.0 Combination with $M_e = 0.7$, $S/D_n = 1.5$, $T_o = 530^\circ R$

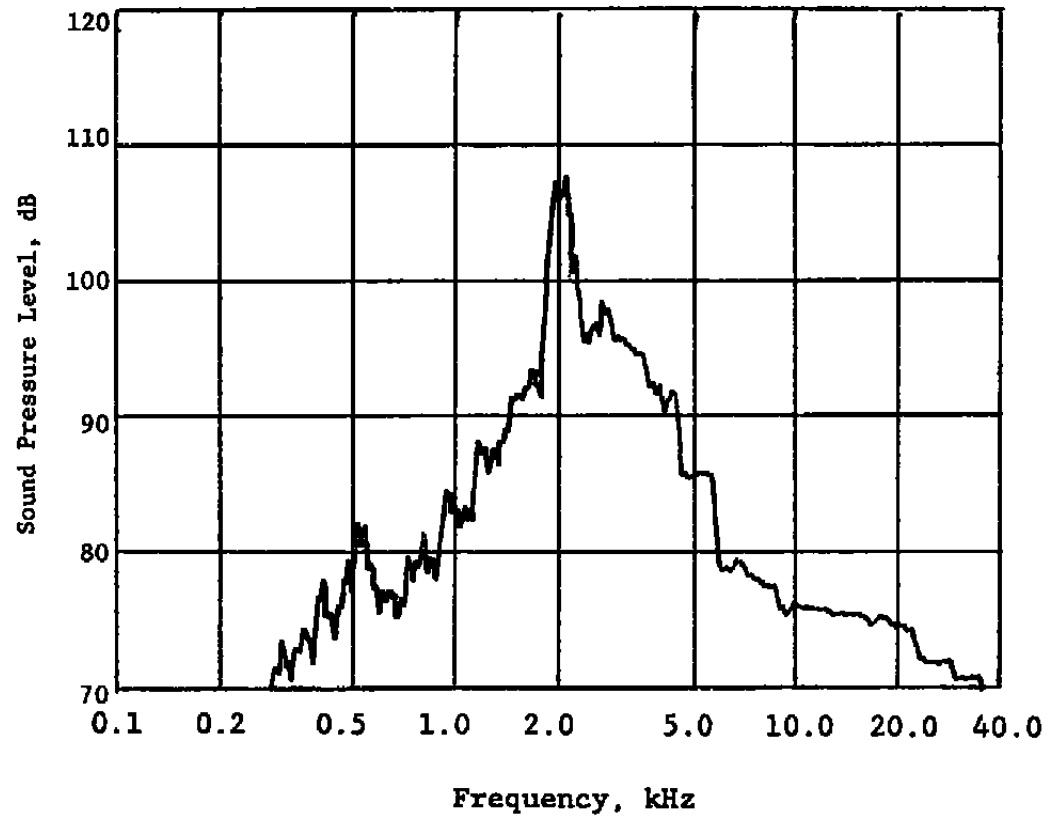

Fig. 8. Sound Pressure Spectrum at $\phi = 60^\circ$ for 2.8/4.0 Combination
with $M_e = 0.7$, $S/D_n = 1.5$, $T_o = 530^\circ R$

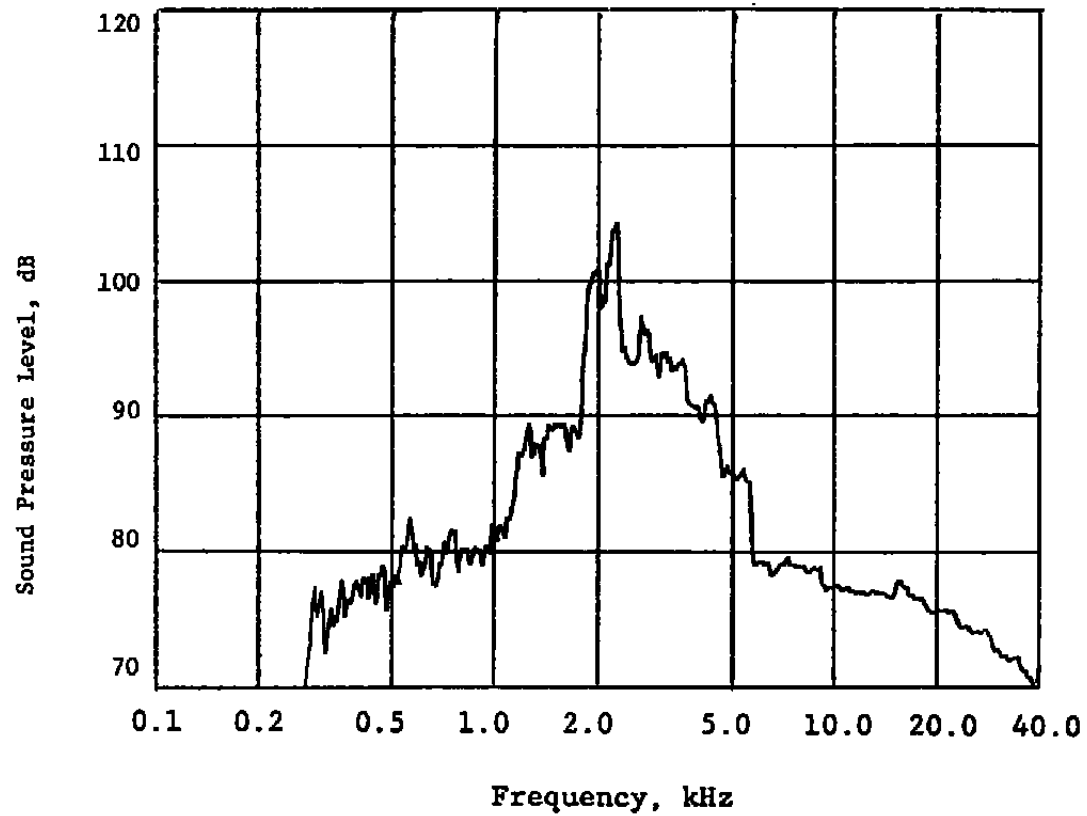

Fig. 9. Sound Pressure Spectrum at $\phi = 90^\circ$ for 2.8/4.0 Combination with $M_e = 0.7$, $S/D_n = 1.5$, $T_o = 530^\circ R$

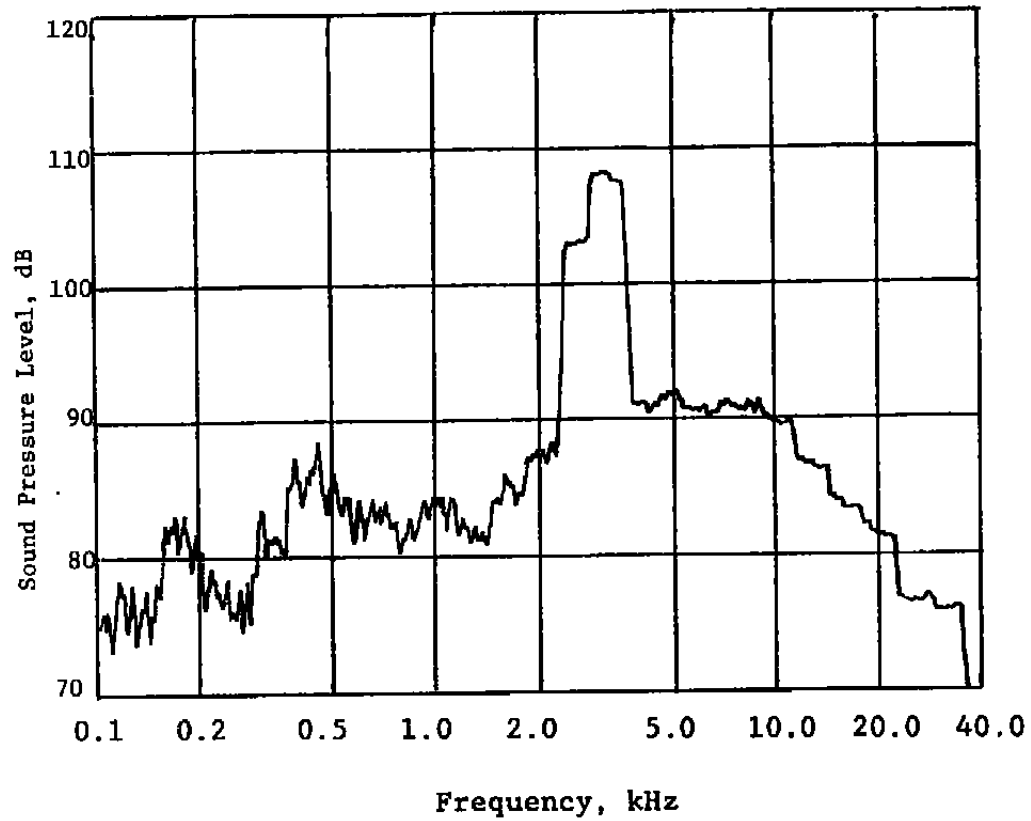

Fig. 10. Sound Pressure Spectrum at $\phi = 30^\circ$ for 2.8/8 combination with $M_e = 1.1$, $S/D_n = 0.0$, $T_o = 530^\circ R$

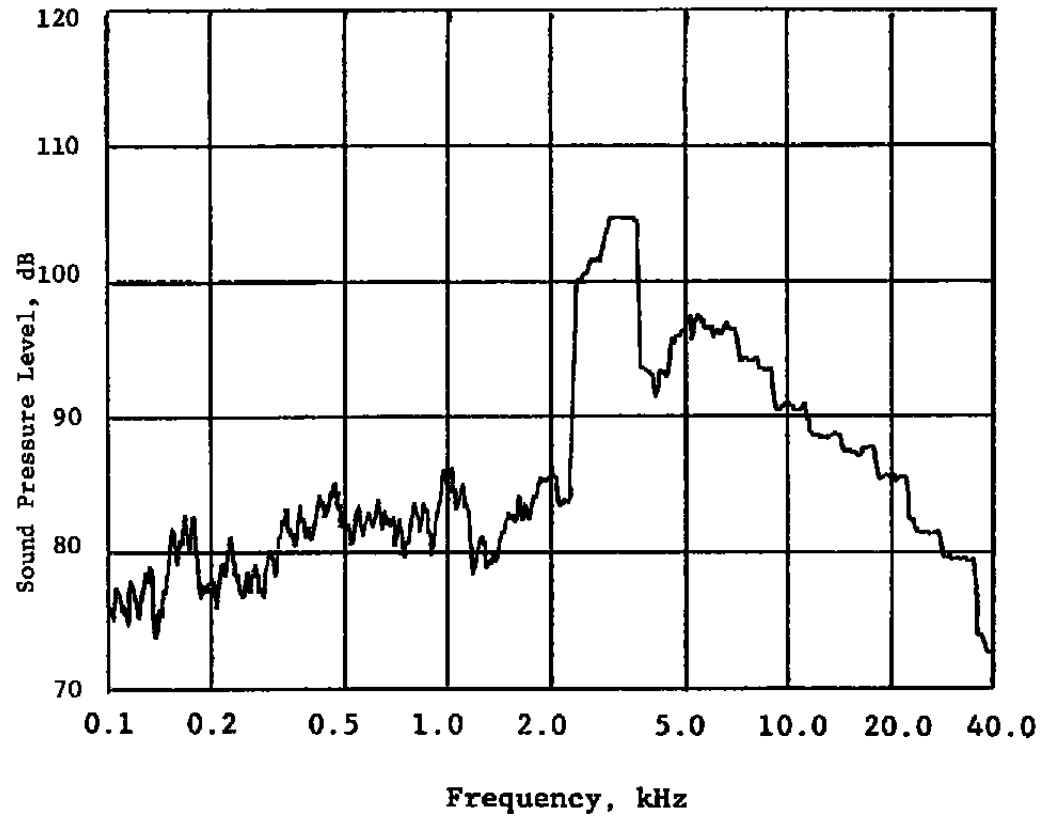

Fig. 11. Sound Pressure Spectrum at $\phi = 60^\circ$ for 2.8/8.0 combination with $M_e = 1.1$, $S/D_n = 0.0$, $T_o = 530^\circ R$

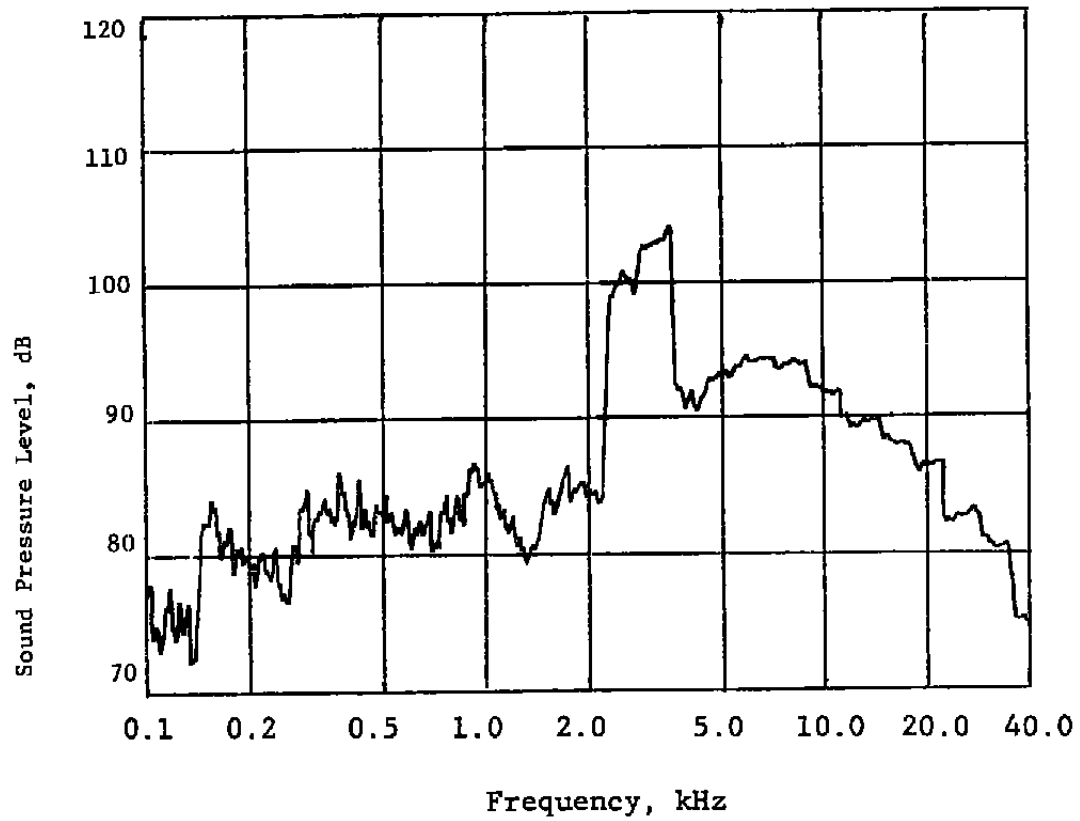

Fig. 12. Sound Pressure Spectrum at $\phi = 90^\circ$ for 2.8/8.0 combination
at $M_e = 1.1$, $S/D_n = 0.0$, $T_o = 530^\circ R$

NOZZLE DIA. (IN.) = 2.8
 DIFFUSOR DIA. (IN.) = 4.0
 FLOW TEMP. (TOTAL), DEG R = 530.0

MACH NOS.
 □ .7
 ○ .9
 ▲ 1.1

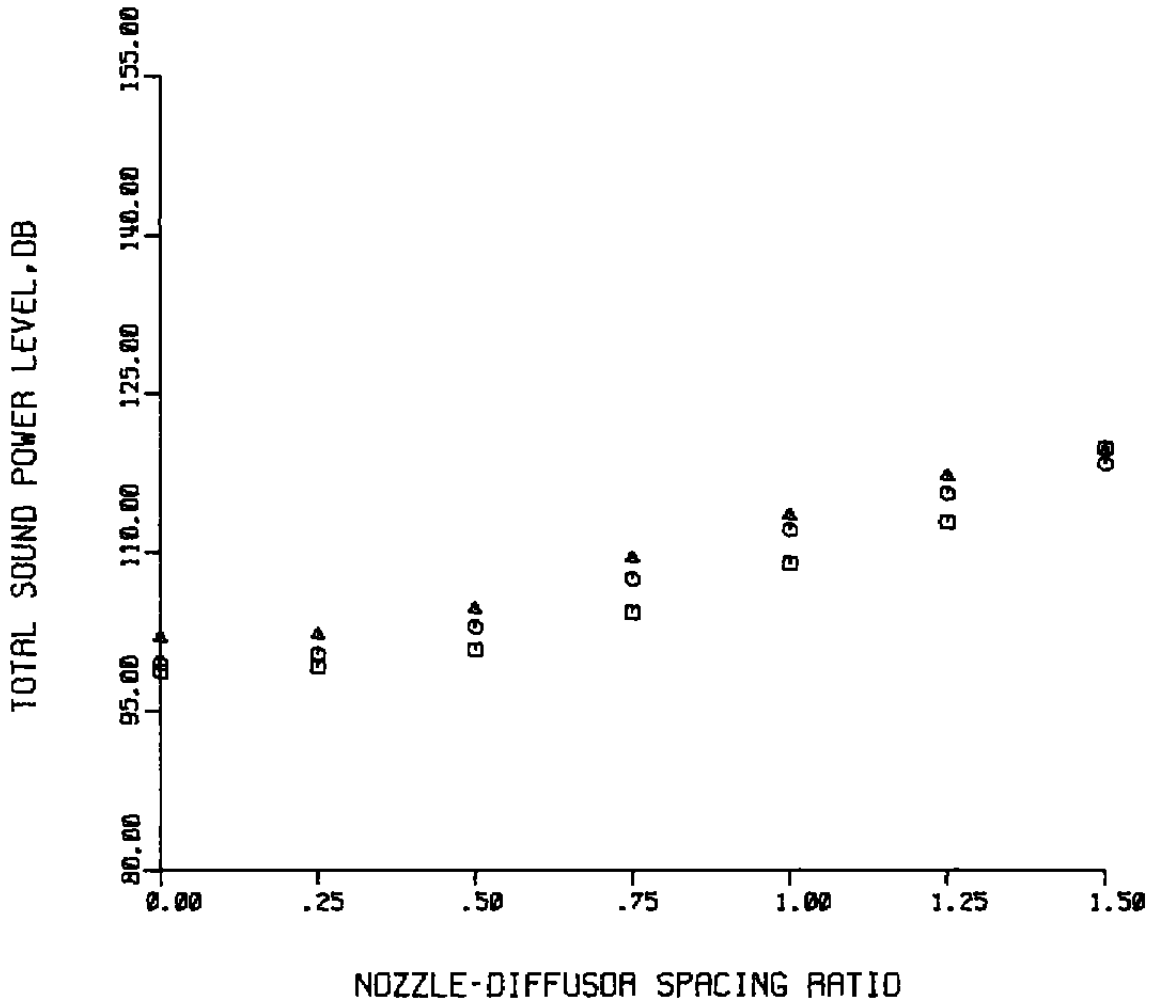

Fig. 13. Variation of Overall Sound Power for 2.8/4.0 Nozzle/Diffuser Combination. Cold Flow.

NOZZLE DIA.(IN.) = 2.8
 DIFFUSOR DIA.(IN.) = 4.0
 FLOW TEMP.(TOTAL),DEG R = 1210.0

MACH NOS.

- .7
- .9
- ▲ 1.1

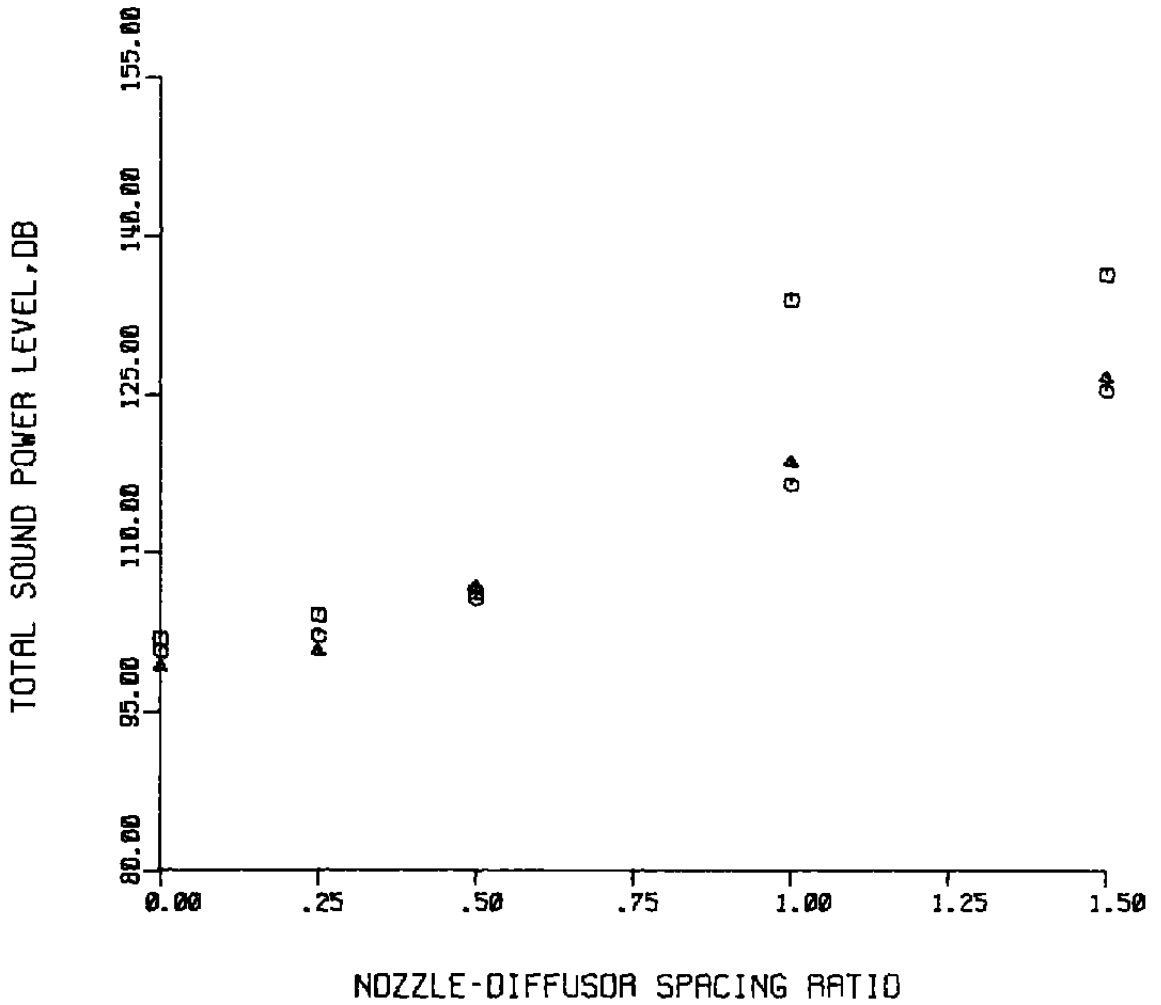

Fig. 14. Variation of Overall Sound Power for 2.8/4.0 Nozzle/Diffuser Combination. Heated Flow.

NOZZLE DIA.(IN.) = 2.8
 DIFFUSOR DIA.(IN.) = 6.0
 FLOW TEMP.(TOTAL).DEG R = 530.0

MACH NOS.
 □ .7
 ○ .9
 ▲ 1.1

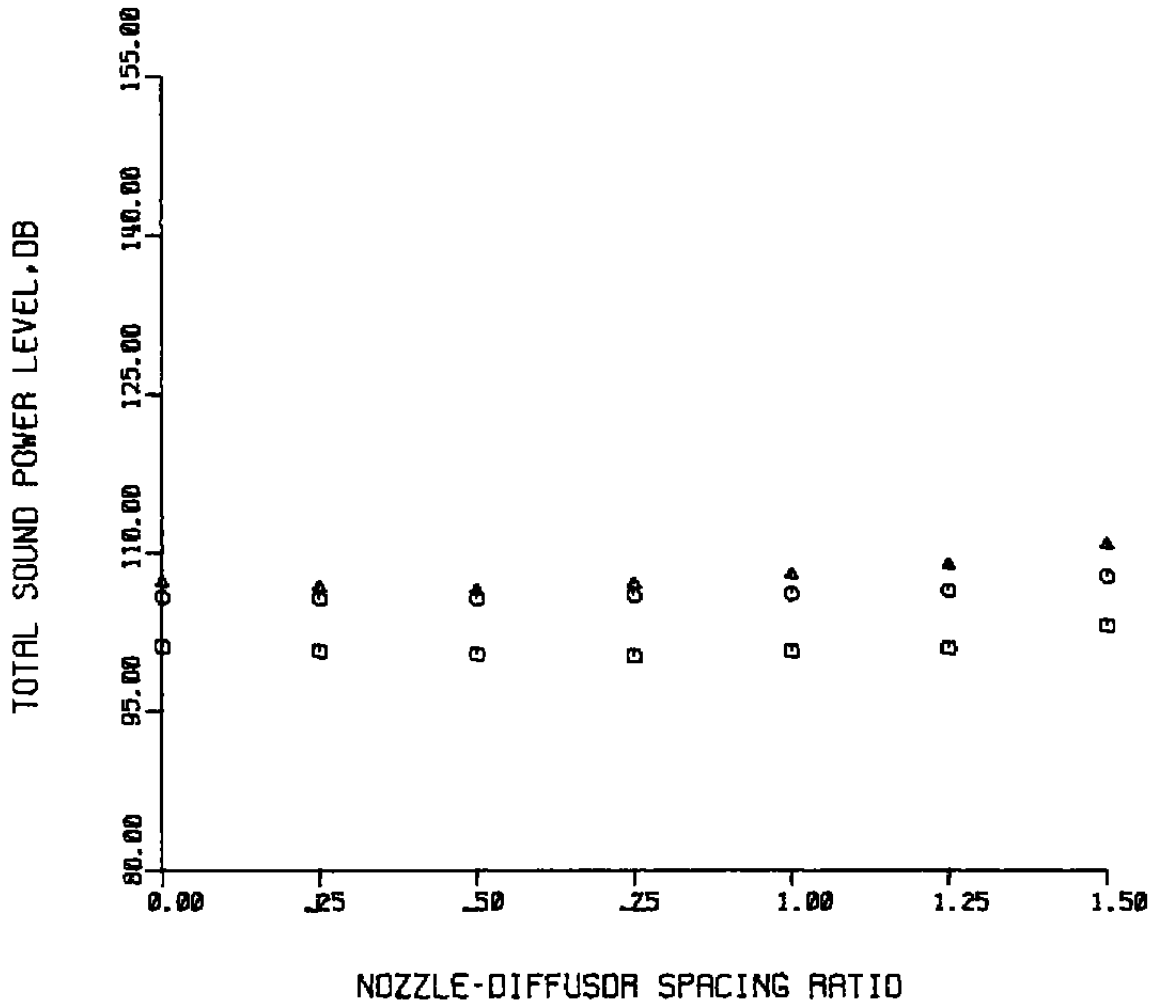

Fig. 15. Variation of Overall Sound Power for 2.8/6.0 Nozzle/Diffuser Combination. Cold Flow.

NOZZLE DIA. (IN.) = 2.8
 DIFFUSOR DIA. (IN.) = 6.0
 FLOW TEMP. (TOTAL), DEG F = 1210.0

MACH NOS.

- .7
- .9
- △ 1.1

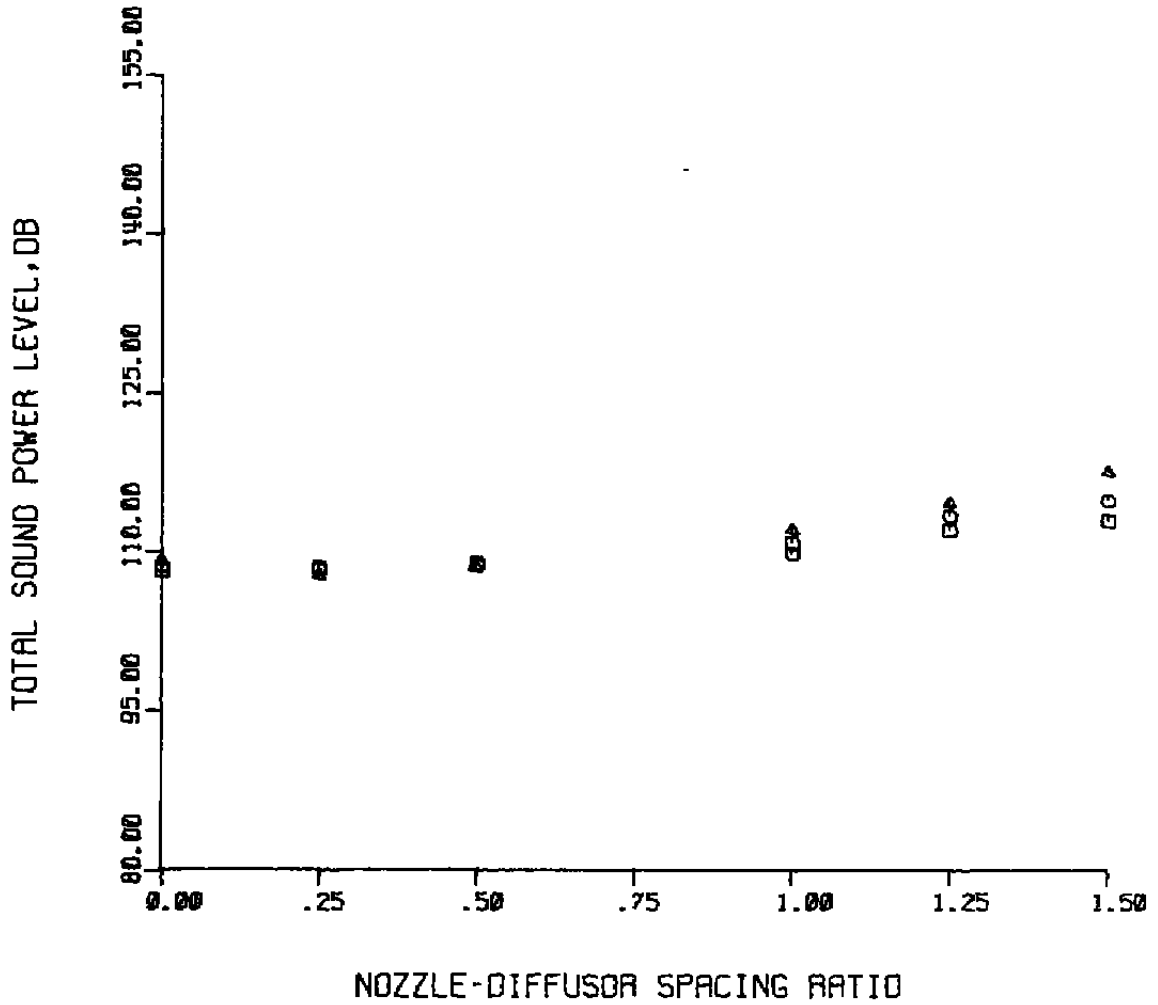

Fig. 16. Variation of Overall Sound Power for 2.8/6.0 Nozzle/Diffuser Combination. Heated Flow.

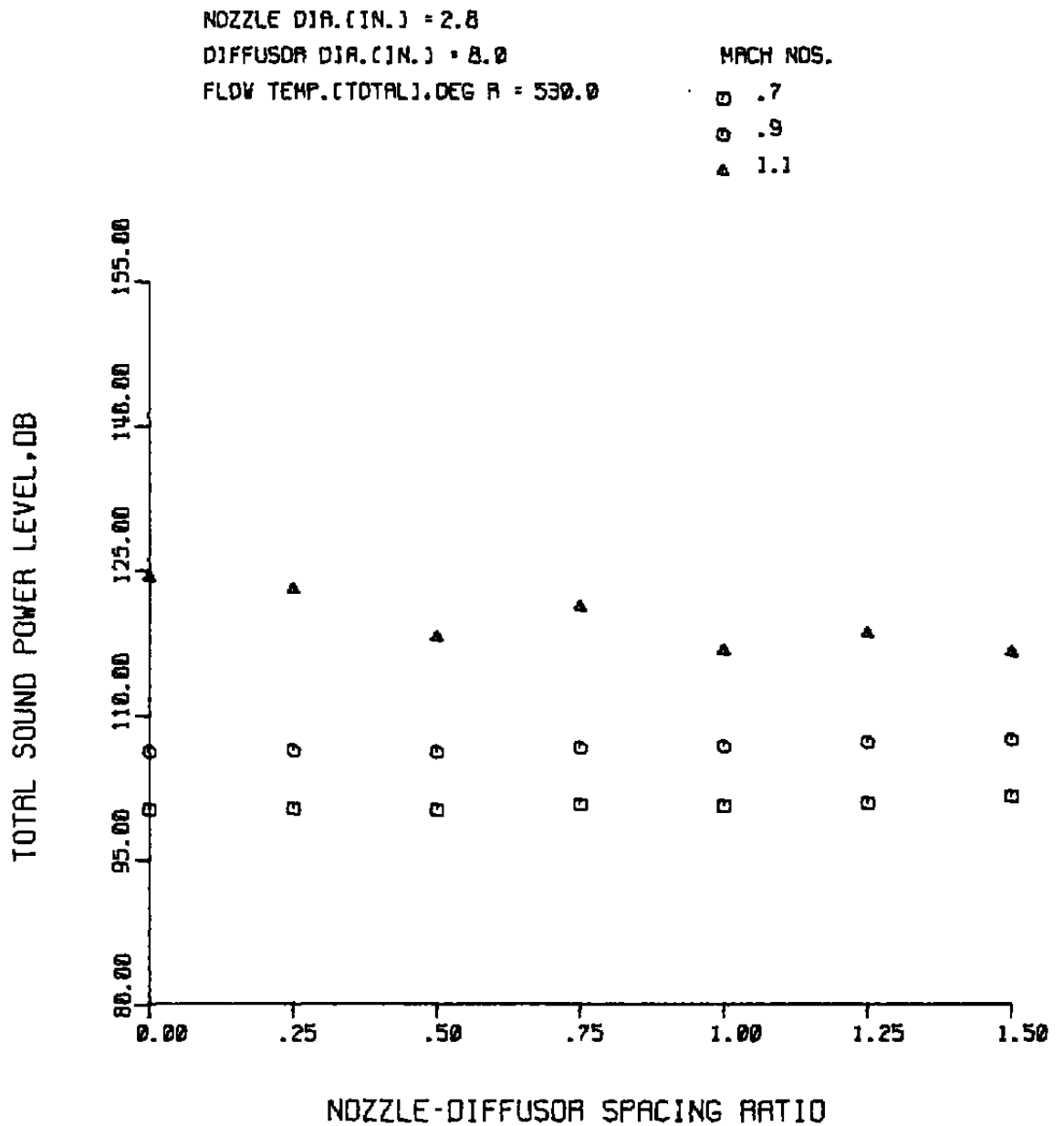

Fig. 17. Variation of Overall Sound Power for 2.8/8.0 Nozzle/Diffuser Combination. Cold Flow.

NOZZLE DIA.(IN.) = 2.8
 DIFFUSOR DIA.(IN.) = 8.0
 FLOW TEMP.(TOTAL),DEG R = 1210.0

MACH NOS.
 □ .7
 ○ .9
 ▲ 1.1

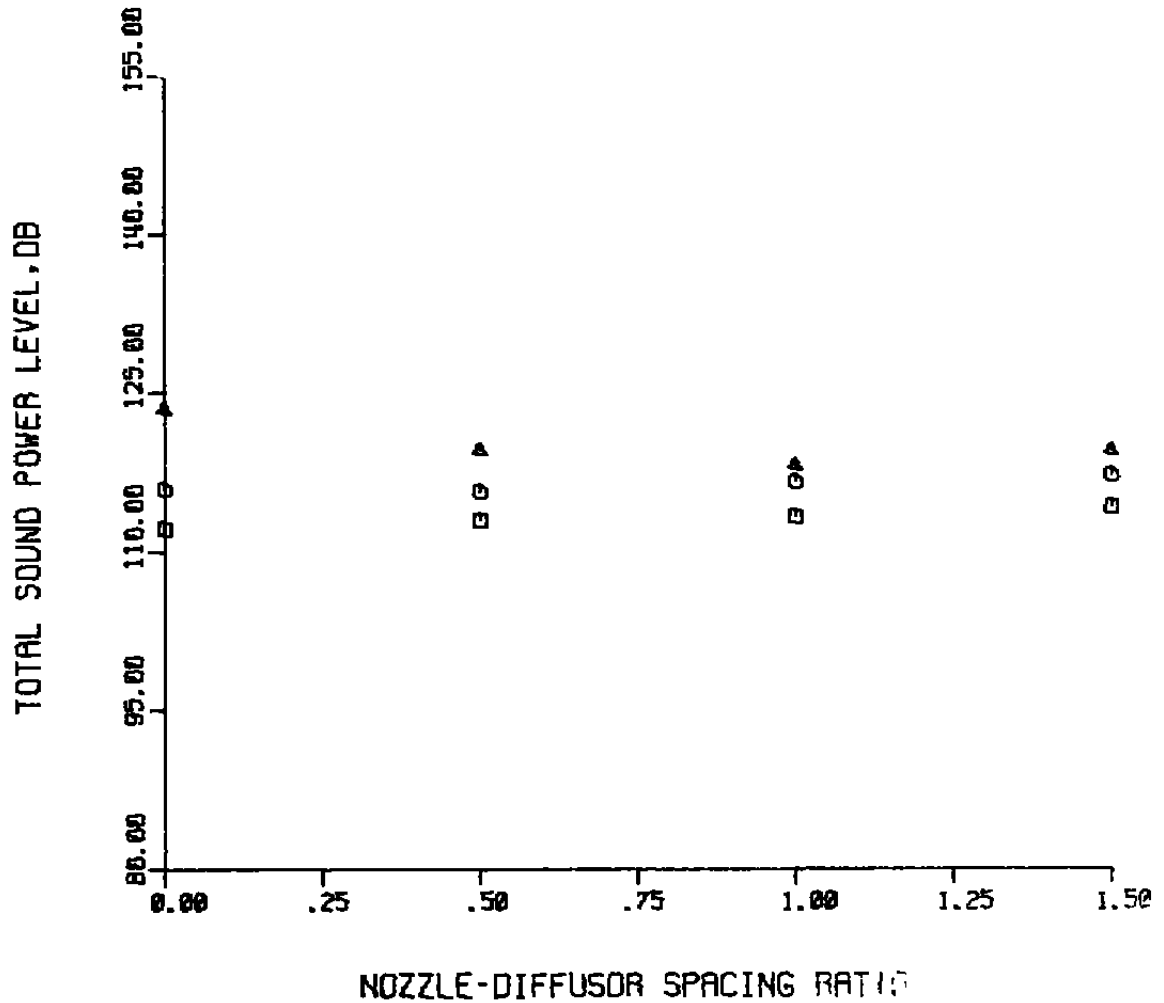

Fig. 18. Variation of Overall Sound Power for 2.8/8.0 Nozzle/Diffuser Combination. Heated Flow.

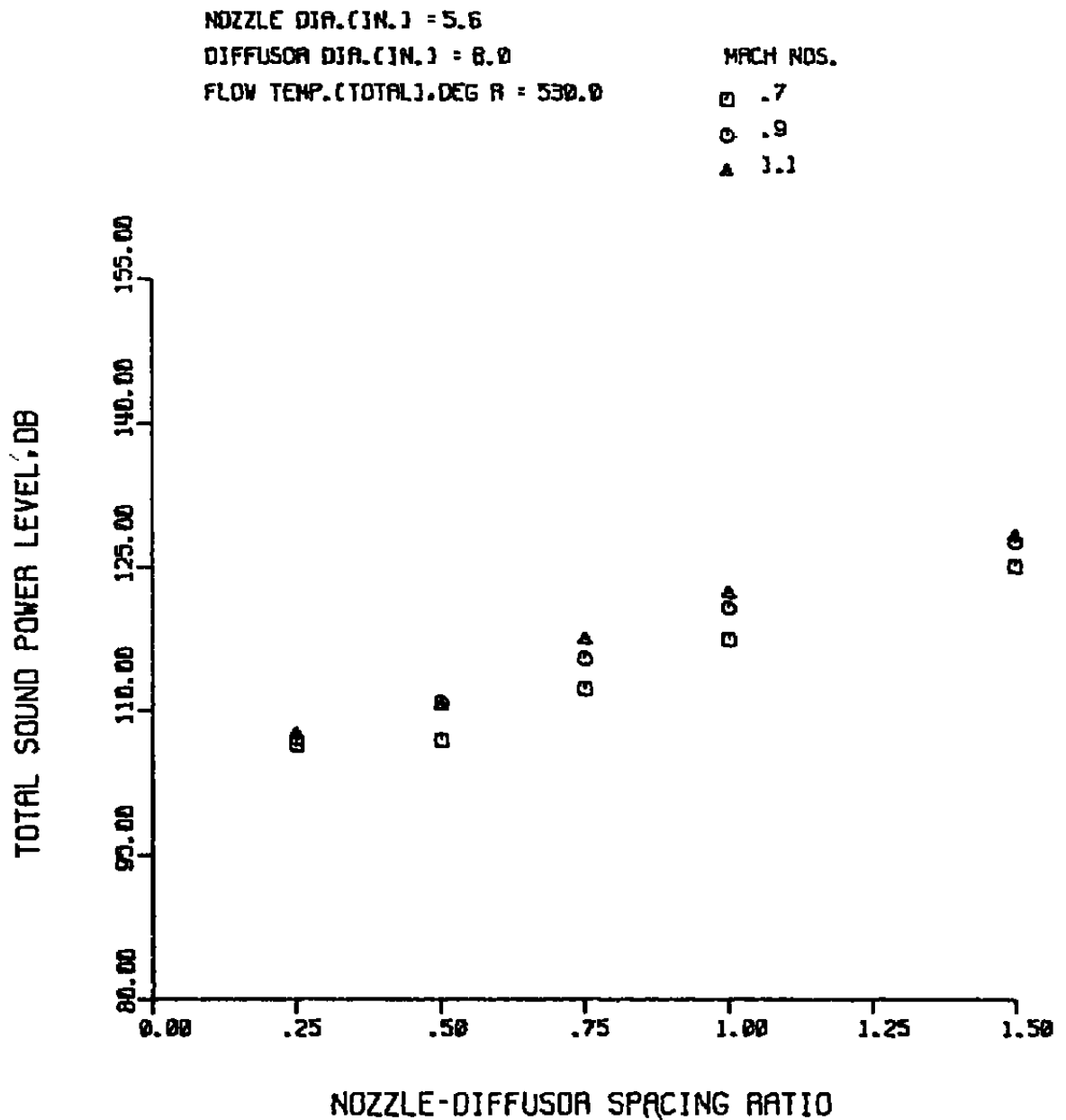

Fig. 19. Variation of Overall Sound Power for 5.6/8.0 Nozzle/Diffuser Combination. Cold Flow.

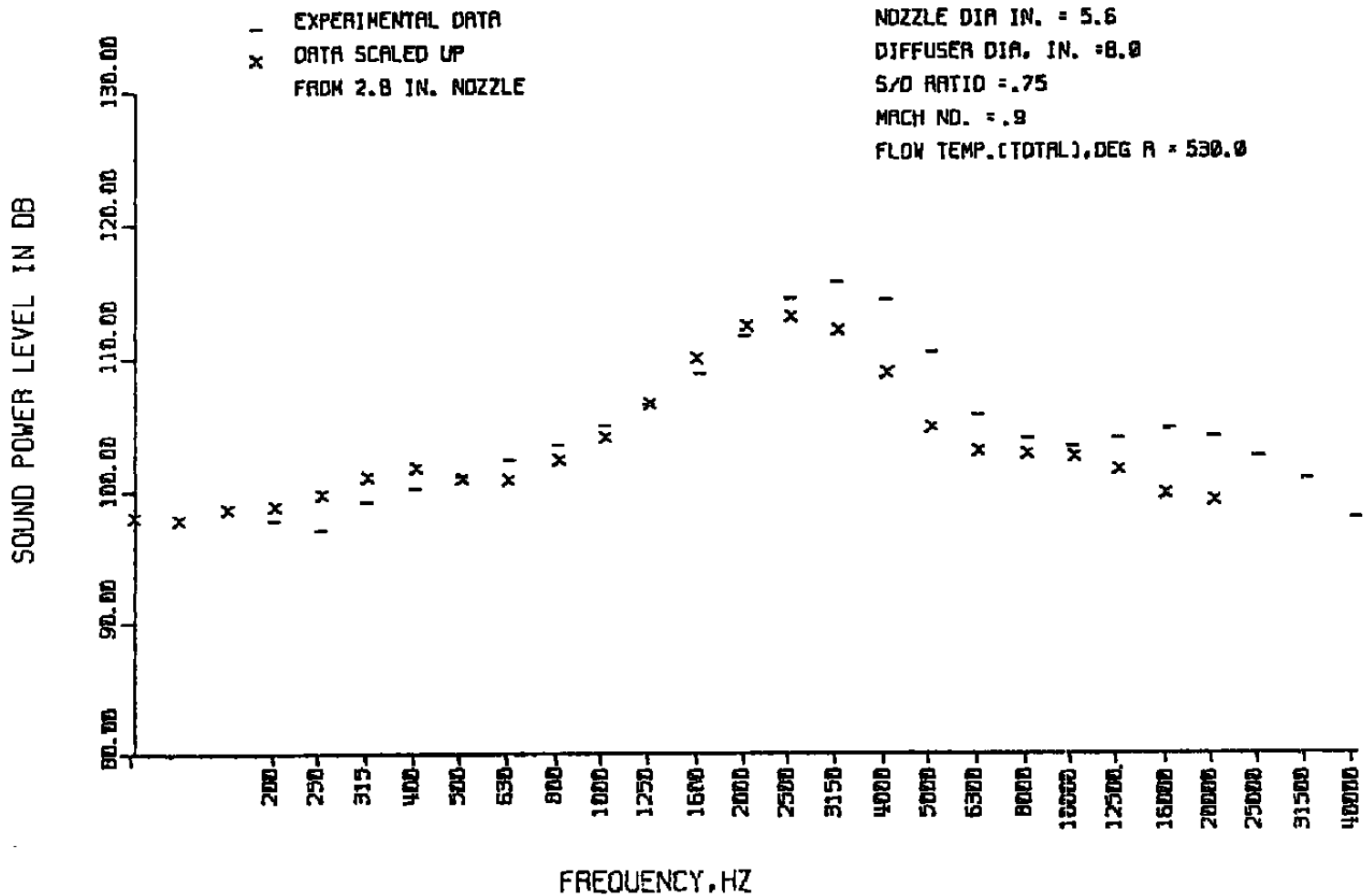

Fig. 20. Sound Power Spectrum for 5.6/8.0 Nozzle/Diffuser Compared with Scaled Data for 2.8/4.0 Combination at $M_e = 0.9$, $S/D_n = .75$, $T_o = 530^{\circ}R$

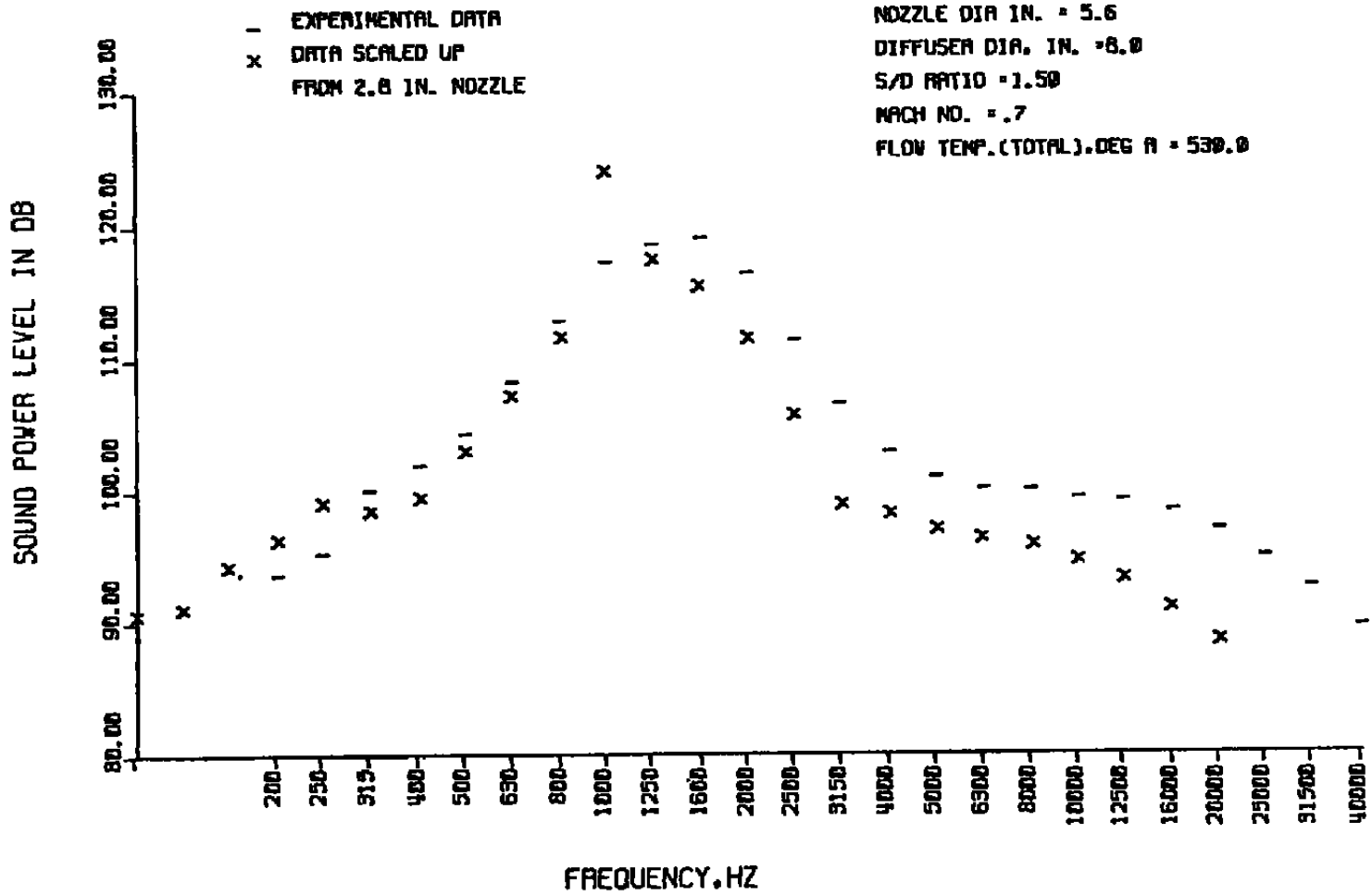

Fig. 21. Sound Power Spectrum for 5.6/8.0 Nozzle/Diffuser Compared with Scaled Data for 2.8/4.0 Combination at $M_e = 0.7$, $S/D_n = 1.5$, $T_0 = 530^{\circ}R$

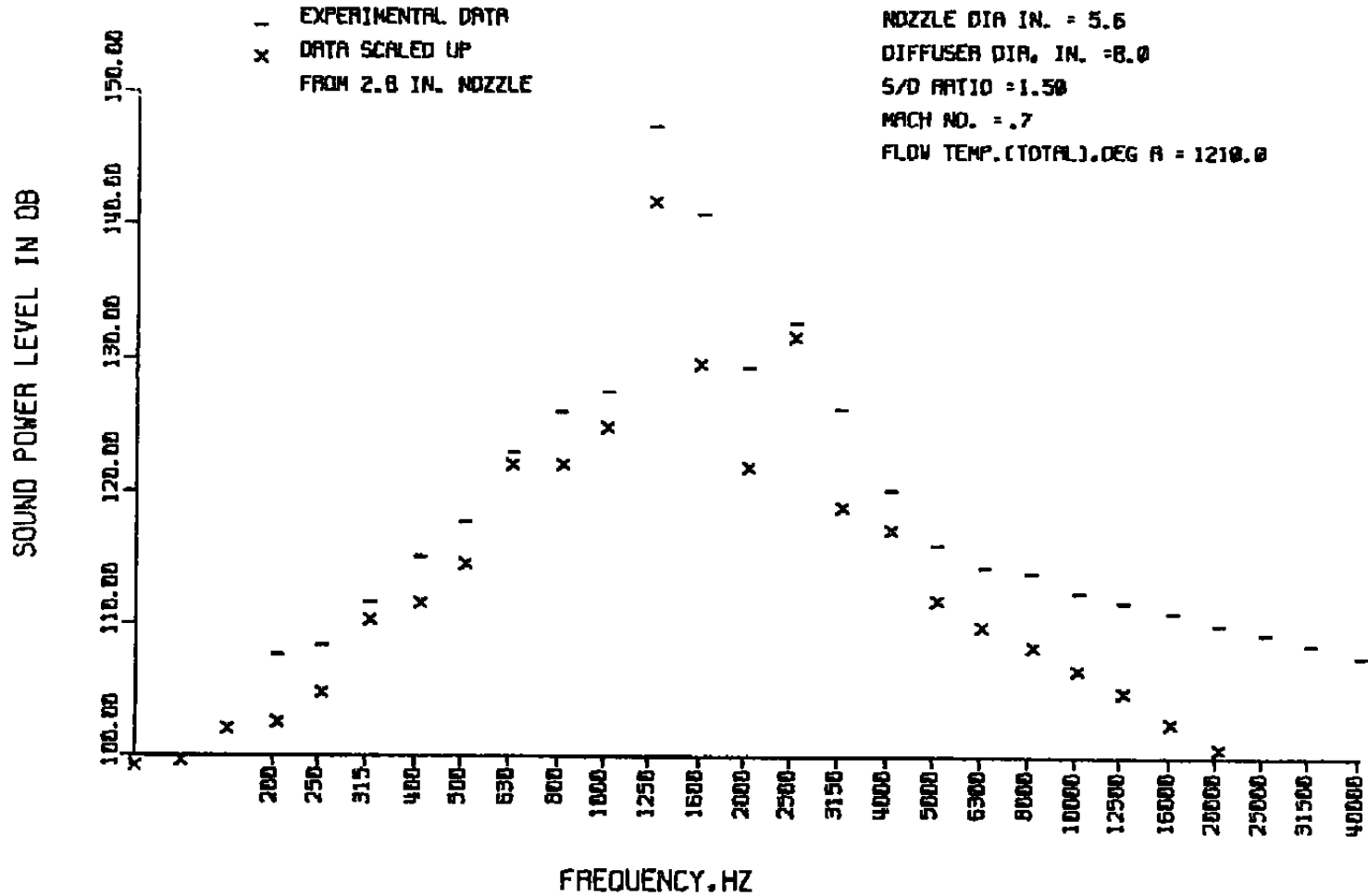

Fig. 22. Sound Power Spectrum 5.6/8.0 Nozzle/Diffuser Compared with Scaled Data for 2.8/4.0 Combination at $M_e = 0.7$, $S/D_n = 1.5$, $T_0 = 1210^{\circ}\text{R}$

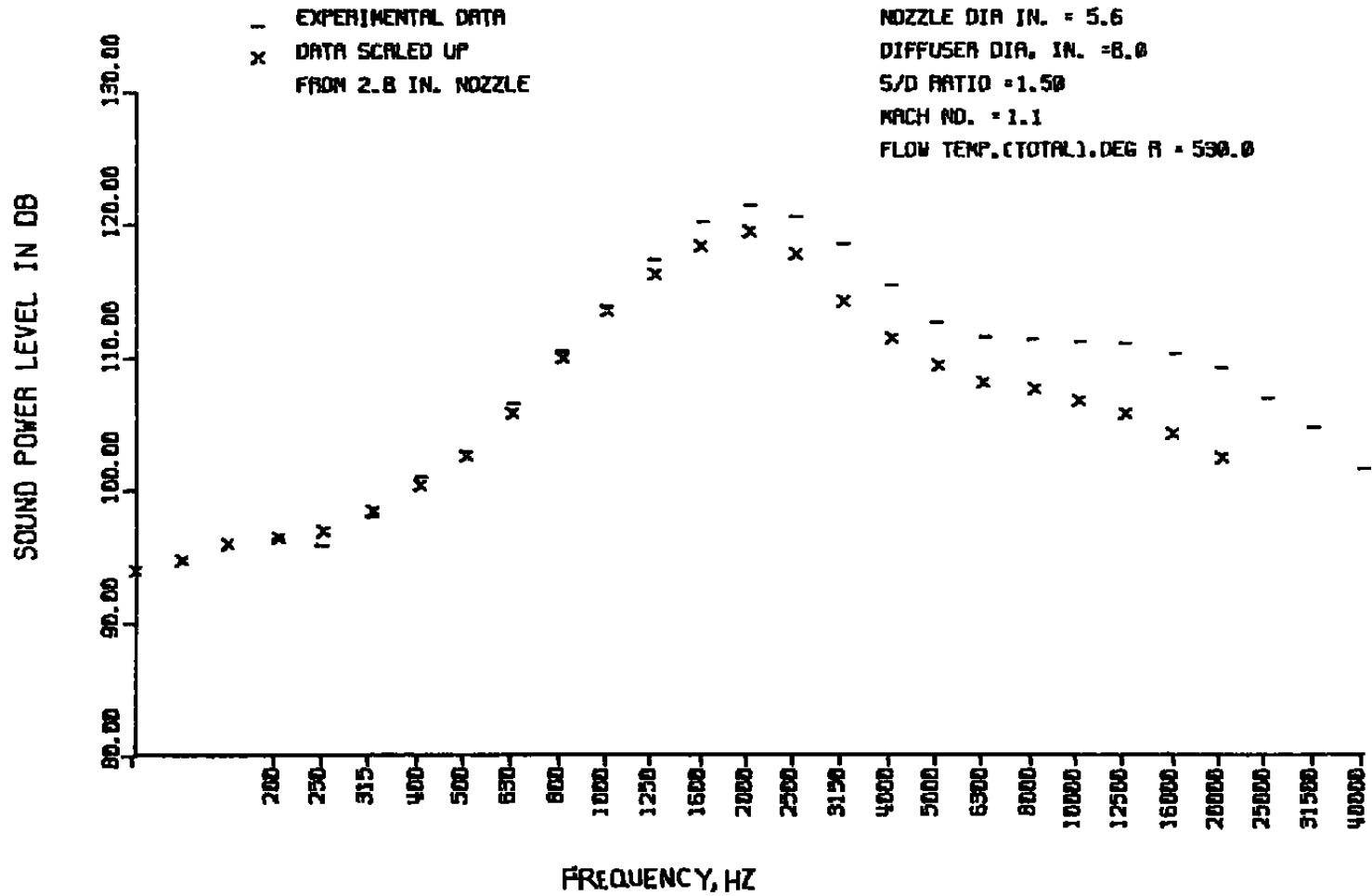

Fig. 23. Sound Power Spectrum 5.6/8.0 Nozzle/Diffuser Compared with Scaled Data for 2.8/4.0 Combination at $M_c = 1.1$, $S/D_n = 1.5$, $T_o = 530^{\circ}R$

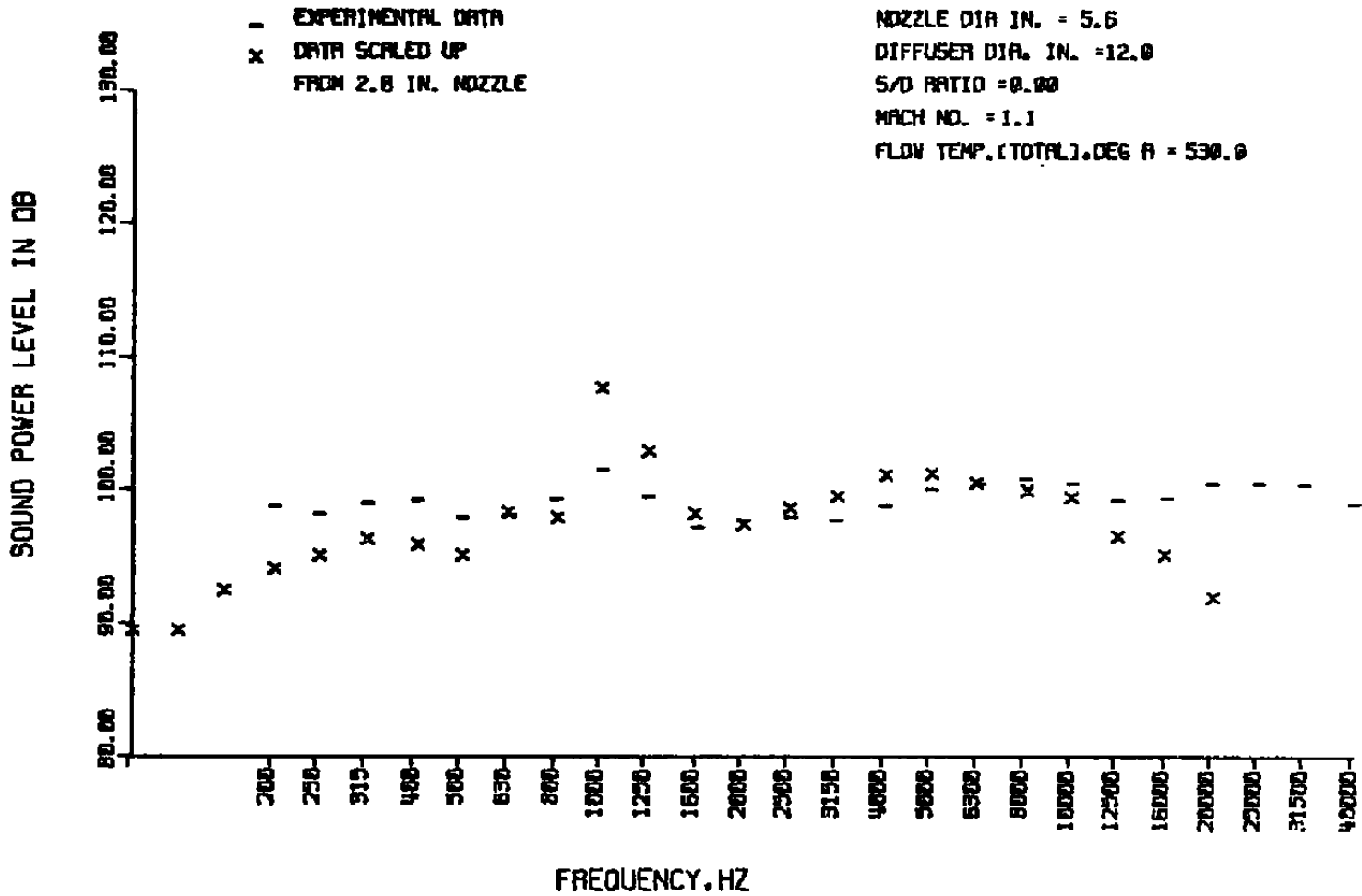

Fig. 24. Sound Power Spectrum for 5.6/12.0 Nozzle/Diffuser Compared with Scaled Data for 2.8/6.0 Combination at $M_e = 1.1$, $S/D_n = 0.0$, $T_o = 530^{\circ}R$

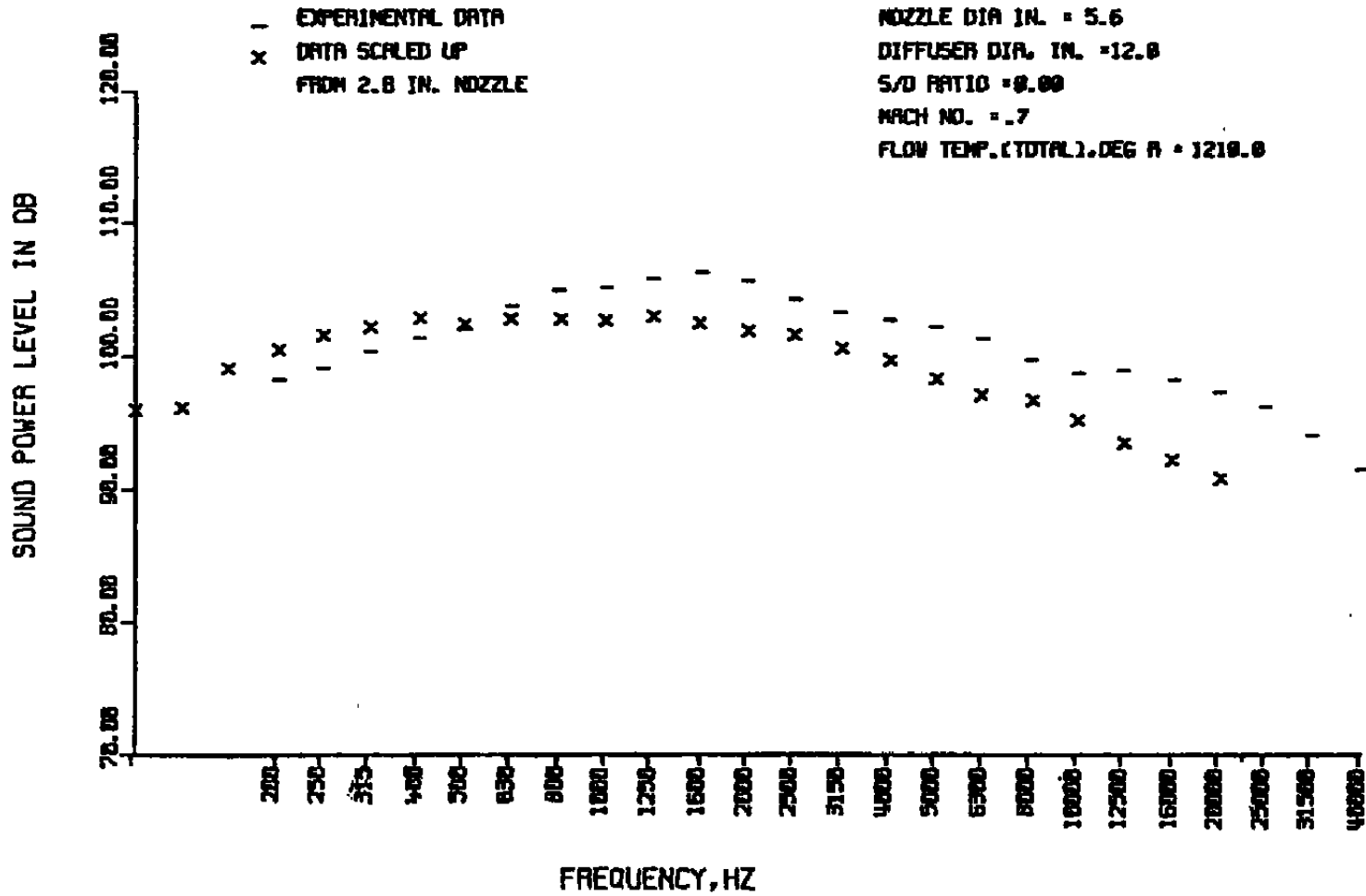

Fig. 25. Sound Power Spectrum for 5.6/12.0 Nozzle/Diffuser Compared with Scaled Data for 2.8/4.0 Combination at $M_e = 0.7$, $S/D_n = 0.0$, $T_o = 1210^\circ R$

TABLE 1.
RANGE OF GEOMETRICAL PARAMETERS IN EXPERIMENTAL TEST PROGRAM

| | | L_n/D_d | | | |
|-------|-------|-----------|------|------|------|
| D_n | D_d | 4" | 6" | 8" | 12" |
| 2.8" | | 1.43 | 2.14 | 2.86 | |
| 5.6" | | | | 1.43 | 2.14 |

| S/D_n |
|---------|
| 0 |
| .25 |
| .50 |
| .75 |
| 1.00 |
| 1.25 |
| 1.50 |

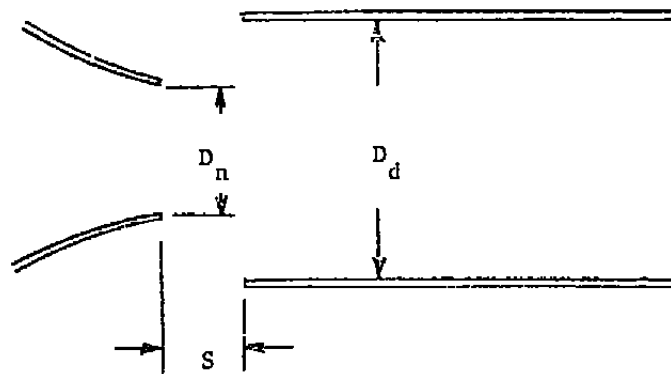

TABLE 2

RANGE OF VELOCITIES FOR EACH TEST CONFIGURATION

| | | Velocity Ft/Sec | | |
|--------|-------|-----------------|------|------|
| T_o | M_e | 0.7 | 0.9 | 1.1 |
| 530°R | | 750 | 940 | 1115 |
| 1210°R | | 1140 | 1425 | 1685 |

M_e : Fully expanded Mach number

T_o : Stagnation temperature

TABLE 3
SOUND POWER OUTPUT FOR FREE JET

| SOUND POWER LEVEL, dB | | | |
|--|-------|-------|-------|
| $D_n = 2.8''$ | | | |
| $\begin{matrix} M_e \\ T_o \end{matrix}$ | 0.7 | 0.9 | 1.1 |
| 530°R | 115.9 | 123.7 | 129.5 |
| 1210°R | 130.3 | 138.0 | 143.8 |

APPENDIX A

NOZZLE DIA = 2.8"
 DIFFUSOR DIA = 4.0"
 FLOW TEMPERATURE, TOTAL = 530.0 DEG R
 MICROPHONE RADIUS = 6 FT.

NOZZLE-DIFFUSOR SPACING RATIO = 0.00
 MACH NO. = 0.70

| FREQUENCY, HZ | MICROPHONE ANGLE, DEG | | | | | | | TOTAL POWER, DB (1/3 OCTAVE BAND) |
|-------------------|-----------------------|-------|-------|-------|-------|-------|-------|--------------------------------------|
| | 30. | 45. | 60. | 75. | 90. | 105. | 120. | |
| 200. | 67.15 | 68.09 | 73.84 | 67.97 | 68.34 | 67.33 | 68.32 | 84.41 |
| 250. | 67.47 | 67.97 | 71.32 | 68.17 | 67.92 | 68.07 | 68.43 | 83.74 |
| 315. | 70.58 | 70.44 | 69.69 | 70.65 | 71.27 | 71.55 | 69.38 | 85.93 |
| 400. | 73.88 | 73.15 | 72.45 | 72.05 | 73.33 | 73.44 | 71.02 | 88.08 |
| 500. | 73.89 | 74.92 | 73.99 | 73.77 | 74.26 | 74.57 | 74.00 | 89.51 |
| 630. | 72.62 | 72.68 | 72.11 | 74.03 | 73.46 | 72.91 | 73.67 | 88.34 |
| 800. | 69.26 | 69.43 | 69.46 | 71.24 | 70.76 | 69.15 | 69.98 | 85.21 |
| 1000. | 67.62 | 66.56 | 68.09 | 68.25 | 68.88 | 67.87 | 69.46 | 83.14 |
| 1250. | 67.81 | 65.47 | 66.58 | 67.55 | 68.02 | 68.62 | 68.67 | 82.70 |
| 1500. | 69.08 | 66.29 | 67.94 | 68.00 | 68.88 | 69.75 | 69.88 | 83.63 |
| 2000. | 69.28 | 68.05 | 68.47 | 68.20 | 69.23 | 69.86 | 70.45 | 84.13 |
| 2500. | 67.75 | 67.91 | 68.05 | 67.94 | 69.01 | 69.28 | 70.88 | 83.79 |
| 3150. | 67.31 | 68.85 | 68.32 | 68.33 | 68.85 | 69.14 | 71.19 | 84.04 |
| 4000. | 67.00 | 69.60 | 68.54 | 67.82 | 68.56 | 68.68 | 70.80 | 83.97 |
| 5000. | 66.37 | 70.03 | 68.82 | 66.68 | 68.21 | 68.16 | 70.34 | 83.73 |
| 6300. | 64.64 | 70.46 | 68.33 | 64.78 | 67.42 | 67.83 | 69.83 | 83.36 |
| 8000. | 65.68 | 70.96 | 67.08 | 63.57 | 66.49 | 67.69 | 69.88 | 83.24 |
| 10000. | 66.00 | 70.69 | 65.83 | 63.26 | 66.08 | 67.62 | 70.00 | 82.98 |
| 12500. | 65.75 | 70.10 | 65.41 | 63.64 | 66.24 | 67.79 | 70.18 | 82.80 |
| 16000. | 65.62 | 71.11 | 65.62 | 64.15 | 67.16 | 69.11 | 71.31 | 83.76 |
| 20000. | 67.40 | 72.62 | 67.04 | 66.70 | 70.44 | 72.53 | 74.68 | 86.26 |
| 25000. | 67.97 | 72.99 | 67.44 | 67.21 | 70.85 | 73.28 | 75.56 | 86.64 |
| 31500. | 63.41 | 68.78 | 64.23 | 63.15 | 66.11 | 69.97 | 71.03 | 82.91 |
| 40000. | 58.53 | 64.90 | 60.56 | 59.52 | 63.34 | 66.59 | 68.10 | 79.44 |
| TOTAL POWER, DB = | | | | | | | | 98.78 |

49

NOZZLE DIA = 2.8"
 DIFFUSOR DIA = 4.0"
 FLOW TEMPERATURE, TOTAL = 530.0 DEG R
 MICROPHONE RADIUS = 6 FT.

NOZZLE-DIFFUSOR SPACING RATIO = 0.00
 MACH NO. = 0.90

AEDC-TR-80-15

MICROPHONE ANGLE, DEG

| FREQUENCY, HZ | 30. | 45. | 60. | 75. | 90. | 105. | 120. | TOTAL POWER, DB (1/3 OCTAVE BAND) |
|---------------|---------------------------------|-------|-------|-------|-------|-------|-------|--------------------------------------|
| | SOUND POWER INTENSITY LEVEL, DB | | | | | | | |
| 200. | 70.74 | 70.31 | 70.80 | 69.32 | 69.26 | 69.34 | 69.47 | 85.02 |
| 250. | 74.37 | 70.34 | 68.86 | 69.05 | 68.70 | 67.90 | 69.34 | 84.84 |
| 315. | 74.83 | 70.95 | 70.42 | 70.19 | 71.18 | 69.20 | 69.28 | 85.90 |
| 400. | 72.31 | 70.98 | 71.44 | 70.13 | 70.94 | 69.80 | 69.92 | 85.84 |
| 500. | 72.58 | 70.82 | 72.09 | 71.85 | 69.75 | 71.54 | 71.19 | 86.60 |
| 630. | 73.42 | 71.60 | 72.98 | 72.98 | 72.03 | 72.90 | 73.09 | 87.85 |
| 800. | 73.31 | 72.03 | 72.41 | 73.17 | 72.24 | 71.59 | 73.79 | 87.66 |
| 1000. | 71.10 | 70.03 | 71.27 | 71.45 | 71.17 | 69.83 | 72.78 | 86.05 |
| 1250. | 70.42 | 68.85 | 69.74 | 70.50 | 69.91 | 69.92 | 71.14 | 85.12 |
| 1600. | 71.70 | 70.92 | 71.08 | 71.57 | 71.57 | 72.24 | 72.28 | 86.78 |
| 2000. | 72.17 | 72.03 | 71.47 | 71.44 | 71.58 | 72.58 | 73.49 | 87.22 |
| 2500. | 70.28 | 70.60 | 70.19 | 70.23 | 69.88 | 71.14 | 72.86 | 85.87 |
| 3150. | 70.93 | 71.71 | 71.09 | 70.35 | 70.83 | 71.42 | 73.11 | 86.45 |
| 4000. | 70.94 | 72.69 | 71.80 | 70.35 | 70.53 | 70.94 | 72.74 | 86.65 |
| 5000. | 68.80 | 71.65 | 70.97 | 68.00 | 68.89 | 69.63 | 71.16 | 85.23 |
| 6300. | 67.17 | 70.34 | 69.31 | 65.64 | 66.80 | 68.06 | 70.15 | 83.63 |
| 8000. | 66.67 | 70.06 | 67.53 | 64.06 | 65.29 | 67.90 | 69.77 | 82.96 |
| 10000. | 66.50 | 69.08 | 65.88 | 64.43 | 65.11 | 68.12 | 69.71 | 82.52 |
| 12500. | 65.63 | 68.22 | 64.99 | 65.00 | 65.88 | 68.59 | 70.03 | 82.45 |
| 16000. | 64.88 | 69.08 | 64.80 | 65.32 | 66.33 | 68.74 | 71.36 | 82.94 |
| 20000. | 65.73 | 70.95 | 65.44 | 66.77 | 67.80 | 70.48 | 73.02 | 84.58 |
| 25000. | 68.79 | 74.53 | 68.18 | 68.48 | 70.54 | 73.43 | 74.98 | 87.47 |
| 31500. | 67.98 | 74.75 | 68.56 | 68.29 | 70.36 | 73.65 | 74.92 | 87.58 |
| 40000. | 64.69 | 70.92 | 66.22 | 65.81 | 68.21 | 71.32 | 72.01 | 84.66 |

TOTAL POWER, DB = 99.59

50

NOZZLE DIA = 2.8"
 DIFFUSOR DIA = 4.0"
 FLOW TEMPERATURE, TOTAL = 530.0 DEG R
 MICROPHONE RADIUS = 6 FT.

NOZZLE-DIFFUSOR SPACING RATIO = 0.00
 MACH NO. = 1.10

| | | | | | | | | |
|--------|-------|-------|-------|-------|-------|-------|-------|-------|
| 200. | 73.61 | 74.64 | 81.99 | 74.09 | 72.57 | 72.36 | 73.04 | 90.98 |
| 250. | 74.56 | 74.40 | 78.40 | 72.96 | 72.91 | 72.69 | 72.16 | 89.50 |
| 315. | 76.34 | 75.62 | 77.03 | 74.62 | 74.52 | 73.28 | 71.16 | 90.12 |
| 400. | 76.15 | 75.76 | 75.03 | 75.13 | 73.65 | 72.34 | 70.72 | 89.73 |
| 500. | 73.75 | 73.49 | 73.72 | 73.43 | 71.96 | 73.11 | 72.19 | 88.41 |
| 630. | 73.63 | 72.35 | 72.35 | 74.01 | 71.79 | 73.32 | 73.02 | 86.23 |
| 800. | 73.50 | 72.05 | 73.01 | 73.38 | 72.45 | 71.04 | 72.84 | 87.67 |
| 1000. | 71.35 | 70.41 | 71.90 | 70.79 | 70.13 | 69.33 | 70.25 | 85.69 |
| 1250. | 70.28 | 69.34 | 70.85 | 70.17 | 70.15 | 69.09 | 69.25 | 85.00 |
| 1600. | 71.99 | 73.55 | 72.72 | 72.27 | 72.33 | 72.86 | 72.55 | 87.96 |
| 2000. | 73.78 | 73.75 | 73.32 | 73.68 | 74.06 | 74.59 | 74.91 | 89.19 |
| 2500. | 74.28 | 75.16 | 73.92 | 73.75 | 73.51 | 74.73 | 78.03 | 89.87 |
| 3150. | 76.24 | 77.72 | 75.15 | 73.89 | 74.67 | 77.09 | 78.55 | 91.54 |
| 4000. | 76.18 | 79.77 | 76.52 | 74.21 | 74.25 | 76.66 | 75.32 | 92.12 |
| 5000. | 73.78 | 77.49 | 75.15 | 71.30 | 71.42 | 73.49 | 71.66 | 89.62 |
| 6300. | 69.98 | 73.11 | 71.94 | 67.51 | 67.96 | 69.24 | 69.20 | 85.65 |
| 8000. | 66.09 | 70.97 | 68.73 | 65.36 | 65.26 | 67.67 | 68.07 | 83.49 |
| 10000. | 68.10 | 70.22 | 66.98 | 64.73 | 64.77 | 66.80 | 68.90 | 82.74 |
| 12500. | 68.98 | 70.93 | 66.88 | 65.31 | 65.56 | 67.12 | 69.01 | 83.34 |
| 16000. | 68.35 | 70.94 | 67.16 | 65.77 | 66.08 | 67.96 | 70.82 | 83.68 |
| 20000. | 65.89 | 70.50 | 66.49 | 64.89 | 66.42 | 68.80 | 71.21 | 83.51 |
| 25000. | 63.36 | 70.71 | 65.50 | 64.45 | 66.83 | 69.83 | 70.52 | 83.67 |
| 31500. | 62.23 | 70.40 | 65.34 | 64.21 | 67.36 | 70.80 | 70.78 | 83.90 |
| 40000. | 61.28 | 70.04 | 64.92 | 64.16 | 67.50 | 71.19 | 70.84 | 83.92 |

TOTAL POWER, DB = 101.85

NOZZLE DIA = 2.8"
 DIFFUSOR DIA = 4.0"
 FLUX TEMPERATURE, TOTAL = 530.0 DEG R
 MICROPHONE RADIUS = 6 FT.

NOZZLE-DIFFUSOR SPACING RATIO = 0.25
 MACH NO. = 0.70

AEDC-TR-80-15

52

| FREQUENCY, HZ | MICROPHONE ANGLE, DEG | | | | | | | TOTAL POWER, DB (1/3 OCTAVE BAND) |
|---------------|-----------------------|-------|-------|-------|-------|-------|-------|--------------------------------------|
| | 30. | 45. | 60. | 75. | 90. | 105. | 120. | |
| 200. | 69.39 | 68.99 | 68.74 | 70.60 | 68.70 | 68.25 | 68.77 | 84.41 |
| 250. | 70.57 | 68.27 | 68.75 | 70.80 | 69.58 | 68.80 | 67.45 | 84.56 |
| 315. | 72.14 | 71.05 | 71.76 | 72.02 | 71.47 | 71.19 | 68.67 | 86.60 |
| 400. | 74.02 | 73.63 | 74.95 | 73.36 | 74.13 | 73.14 | 71.91 | 88.63 |
| 500. | 74.83 | 75.39 | 75.47 | 74.44 | 75.96 | 75.66 | 74.84 | 90.47 |
| 630. | 73.73 | 72.83 | 73.83 | 74.26 | 74.11 | 74.29 | 73.97 | 89.06 |
| 800. | 70.78 | 70.21 | 70.23 | 70.76 | 71.05 | 70.50 | 71.95 | 85.63 |
| 1000. | 69.30 | 68.66 | 68.09 | 68.83 | 70.28 | 68.75 | 70.00 | 84.18 |
| 1250. | 69.08 | 67.24 | 68.10 | 68.39 | 68.75 | 69.17 | 68.75 | 83.62 |
| 1600. | 70.52 | 68.56 | 68.31 | 68.97 | 68.99 | 69.52 | 70.15 | 84.31 |
| 2000. | 70.25 | 69.75 | 68.83 | 68.66 | 69.65 | 69.94 | 71.49 | 84.75 |
| 2500. | 69.15 | 69.96 | 68.59 | 68.04 | 69.04 | 70.04 | 71.89 | 84.67 |
| 3150. | 68.68 | 70.28 | 68.86 | 68.56 | 68.78 | 69.88 | 71.58 | 84.74 |
| 4000. | 68.40 | 70.84 | 69.20 | 68.57 | 68.39 | 69.02 | 71.28 | 84.68 |
| 5000. | 67.67 | 71.45 | 69.72 | 67.62 | 67.87 | 69.06 | 70.65 | 84.69 |
| 6300. | 67.47 | 71.94 | 69.61 | 66.66 | 67.03 | 69.03 | 70.73 | 84.65 |
| 8000. | 67.38 | 71.98 | 68.61 | 66.25 | 66.90 | 68.75 | 70.81 | 84.45 |
| 10000. | 67.17 | 71.20 | 67.74 | 66.45 | 67.33 | 68.97 | 70.95 | 84.17 |
| 12500. | 66.83 | 70.74 | 67.05 | 67.03 | 67.70 | 69.45 | 71.15 | 84.18 |
| 16000. | 65.96 | 70.72 | 67.26 | 68.05 | 68.39 | 70.66 | 71.86 | 84.60 |
| 20000. | 65.45 | 70.70 | 67.09 | 68.44 | 68.70 | 70.16 | 72.63 | 84.76 |
| 25000. | 63.71 | 69.54 | 65.96 | 67.56 | 67.93 | 69.88 | 71.95 | 83.97 |
| 31500. | 60.64 | 66.72 | 63.36 | 65.10 | 65.70 | 67.17 | 69.49 | 81.35 |
| 40000. | 57.89 | 64.86 | 61.42 | 62.63 | 63.41 | 64.97 | 66.84 | 79.14 |

TOTAL POWER, DB = 99.28

NOZZLE DIA = 2.8"
 DIFFUSOR DIA = 4.0"
 FLOW TEMPERATURE, TOTAL = 530.0 DEG R
 MICROPHONE RADIUS = 6 FT.

NOZZLE-DIFFUSOR SPACING RATIO = 0.25
 MACH NO. = 0.90

| FREQUENCY, HZ | MICROPHONE ANGLE, DEG | | | | | | | TOTAL POWER, DB (1/3 OCTAVE BAND) |
|---------------|-----------------------|-------|-------|-------|-------|-------|-------|--------------------------------------|
| | 30. | 45. | 60. | 75. | 90. | 105. | 120. | |
| 200. | 70.69 | 70.81 | 72.78 | 68.36 | 72.53 | 70.95 | 66.94 | 86.04 |
| 250. | 70.65 | 71.10 | 72.38 | 67.88 | 70.95 | 72.52 | 70.52 | 86.25 |
| 315. | 72.39 | 71.46 | 72.05 | 70.65 | 70.60 | 72.13 | 70.72 | 86.65 |
| 400. | 72.35 | 71.18 | 72.11 | 71.06 | 70.75 | 71.22 | 70.64 | 86.47 |
| 500. | 72.06 | 71.92 | 72.35 | 71.21 | 71.29 | 71.91 | 72.18 | 86.97 |
| 630. | 73.35 | 72.72 | 73.08 | 72.51 | 72.71 | 72.60 | 74.60 | 88.12 |
| 800. | 73.25 | 72.31 | 73.74 | 72.35 | 73.06 | 72.33 | 74.28 | 87.96 |
| 1000. | 72.00 | 70.82 | 72.01 | 70.98 | 71.81 | 71.11 | 72.82 | 86.57 |
| 1250. | 71.70 | 70.41 | 70.85 | 70.95 | 70.88 | 71.61 | 72.88 | 86.34 |
| 1600. | 72.23 | 71.28 | 71.99 | 71.80 | 71.73 | 73.18 | 73.33 | 87.36 |
| 2000. | 72.96 | 71.51 | 71.85 | 71.07 | 71.19 | 73.36 | 73.71 | 87.33 |
| 2500. | 71.58 | 71.23 | 70.50 | 69.95 | 70.76 | 72.08 | 73.58 | 86.45 |
| 3150. | 71.03 | 71.78 | 71.45 | 70.30 | 70.72 | 71.81 | 72.82 | 86.56 |
| 4000. | 70.92 | 72.77 | 71.95 | 70.32 | 70.62 | 71.16 | 72.62 | 86.72 |
| 5000. | 69.93 | 72.87 | 71.75 | 69.53 | 69.50 | 70.32 | 71.61 | 86.22 |
| 6300. | 69.76 | 73.04 | 71.55 | 68.66 | 68.69 | 69.86 | 70.78 | 85.93 |
| 8000. | 70.55 | 73.40 | 71.22 | 68.63 | 68.53 | 69.66 | 70.47 | 86.00 |
| 10000. | 70.76 | 72.73 | 70.25 | 68.53 | 68.49 | 69.64 | 70.60 | 85.67 |
| 12500. | 69.89 | 72.26 | 69.67 | 68.81 | 69.28 | 70.52 | 71.67 | 85.70 |
| 16000. | 69.34 | 73.13 | 70.04 | 69.99 | 70.14 | 71.09 | 72.95 | 86.49 |
| 20000. | 68.91 | 73.80 | 70.73 | 70.91 | 70.35 | 71.77 | 73.52 | 87.12 |
| 25000. | 67.79 | 73.65 | 70.72 | 70.94 | 70.06 | 72.20 | 73.64 | 87.13 |
| 31500. | 65.52 | 72.09 | 69.69 | 69.95 | 69.25 | 71.68 | 72.88 | 86.09 |
| 40000. | 63.51 | 70.80 | 67.83 | 68.32 | 68.13 | 70.27 | 72.06 | 84.71 |

TOTAL POWER, DB = 100.40

NOZZLE DIA = 2.8"
 DIFFUSOR DIA = 4.0"
 FLOW TEMPERATURE, TOTAL = 530.0 DEG R
 MICROPHONE RADIUS = 6 FT.

NOZZLE-DIFFUSOR SPACING RATIO = 0.25
 MACH NO. = 1.10

MICROPHONE ANGLE, DEG

| FREQUENCY, HZ | MICROPHONE ANGLE, DEG | | | | | | | TOTAL POWER, DB (1/3 OCTAVE BAND) |
|---------------|-----------------------|-------|-------|-------|-------|-------|-------|--------------------------------------|
| | 30. | 45. | 60. | 75. | 90. | 105. | 120. | |
| 200. | 71.80 | 73.26 | 72.55 | 71.25 | 72.20 | 71.12 | 72.80 | 87.31 |
| 250. | 73.44 | 73.41 | 73.03 | 72.02 | 72.81 | 73.30 | 72.90 | 88.16 |
| 315. | 75.84 | 74.00 | 73.89 | 74.00 | 73.30 | 74.21 | 72.50 | 89.21 |
| 400. | 74.94 | 74.21 | 74.25 | 73.88 | 73.08 | 73.92 | 72.74 | 89.12 |
| 500. | 74.10 | 73.53 | 74.09 | 73.12 | 72.42 | 74.01 | 73.29 | 88.72 |
| 630. | 74.34 | 73.10 | 73.49 | 73.70 | 72.91 | 73.66 | 74.10 | 88.71 |
| 800. | 73.63 | 73.06 | 73.08 | 73.64 | 72.89 | 71.90 | 74.33 | 88.26 |
| 1000. | 71.14 | 71.17 | 72.10 | 71.74 | 70.57 | 69.96 | 71.59 | 86.33 |
| 1250. | 70.87 | 71.50 | 71.11 | 71.68 | 70.36 | 69.16 | 71.18 | 86.08 |
| 1600. | 72.39 | 74.20 | 73.06 | 73.03 | 73.40 | 73.57 | 73.51 | 88.68 |
| 2000. | 75.49 | 76.32 | 75.58 | 75.46 | 74.46 | 75.31 | 77.50 | 90.88 |
| 2500. | 74.97 | 75.95 | 75.10 | 75.59 | 72.91 | 75.71 | 76.18 | 90.78 |
| 3150. | 75.91 | 77.05 | 75.64 | 76.04 | 74.10 | 76.24 | 79.30 | 91.56 |
| 4000. | 75.07 | 77.07 | 75.36 | 74.90 | 74.78 | 74.81 | 78.39 | 90.95 |
| 5000. | 73.72 | 76.56 | 75.14 | 72.23 | 72.46 | 72.74 | 76.28 | 89.54 |
| 6300. | 71.10 | 74.82 | 72.82 | 69.74 | 69.18 | 70.16 | 72.96 | 87.23 |
| 8000. | 70.39 | 73.50 | 70.88 | 69.50 | 68.64 | 69.56 | 71.03 | 86.14 |
| 10000. | 71.08 | 72.63 | 70.41 | 69.57 | 68.75 | 69.33 | 71.01 | 85.78 |
| 12500. | 71.76 | 72.90 | 70.57 | 69.45 | 68.79 | 69.79 | 71.75 | 86.04 |
| 16000. | 71.05 | 73.05 | 70.35 | 69.71 | 69.28 | 70.46 | 72.25 | 86.27 |
| 20000. | 69.13 | 72.86 | 70.32 | 70.48 | 70.02 | 71.12 | 72.60 | 86.49 |
| 25000. | 67.34 | 72.51 | 70.29 | 70.61 | 70.06 | 71.59 | 72.64 | 86.46 |
| 31500. | 65.36 | 72.03 | 69.75 | 70.43 | 69.53 | 71.55 | 73.08 | 86.17 |
| 40000. | 63.76 | 71.73 | 69.28 | 69.92 | 69.12 | 70.75 | 72.80 | 85.67 |

TOTAL POWER, DB = 102.14

54

NOZZLE DIA = 2.8"
 DIFFUSOR DIA = 4.0"
 FLOW TEMPERATURE, TOTAL = 530.0 DEG R
 MICROPHONE RADIUS = 6 FT.

NOZZLE-DIFFUSOR SPACING RATIO = 0.50
 MACH NO. = 0.70

MICROPHONE ANGLE, DEG

| FREQUENCY, HZ | SOUND POWER INTENSITY LEVEL, DB | | | | | | | TOTAL POWER, DB (1/3 OCTAVE BAND) |
|---------------|---------------------------------|-------|-------|-------|-------|-------|-------|--------------------------------------|
| | 30. | 45. | 60. | 75. | 90. | 105. | 120. | |
| 200. | 67.89 | 68.65 | 68.78 | 69.14 | 69.21 | 69.11 | 68.66 | 84.10 |
| 250. | 68.43 | 69.31 | 67.62 | 69.33 | 69.13 | 69.98 | 69.08 | 84.43 |
| 315. | 71.36 | 71.68 | 70.65 | 71.93 | 71.14 | 72.03 | 71.41 | 86.97 |
| 400. | 73.92 | 74.06 | 73.74 | 73.19 | 73.66 | 73.76 | 72.97 | 88.85 |
| 500. | 75.14 | 74.14 | 76.14 | 74.52 | 74.78 | 76.60 | 75.87 | 90.51 |
| 630. | 74.16 | 72.39 | 73.06 | 74.02 | 74.70 | 74.48 | 75.08 | 89.07 |
| 800. | 71.14 | 71.40 | 69.92 | 70.98 | 72.14 | 70.08 | 73.13 | 86.29 |
| 1000. | 70.73 | 70.03 | 69.84 | 69.52 | 69.84 | 70.19 | 71.03 | 85.25 |
| 1250. | 70.63 | 69.99 | 69.81 | 69.90 | 68.74 | 71.19 | 70.39 | 85.36 |
| 1600. | 71.35 | 70.91 | 70.49 | 70.35 | 70.24 | 71.99 | 71.89 | 86.22 |
| 2000. | 72.57 | 72.52 | 71.43 | 70.73 | 70.67 | 71.91 | 72.87 | 86.94 |
| 2500. | 73.17 | 73.37 | 71.66 | 71.17 | 70.52 | 71.51 | 72.59 | 87.21 |
| 3150. | 74.02 | 75.11 | 73.29 | 71.87 | 71.26 | 71.74 | 72.62 | 88.24 |
| 4000. | 75.86 | 77.16 | 75.05 | 73.07 | 72.13 | 72.49 | 73.04 | 89.76 |
| 5000. | 75.59 | 77.38 | 75.28 | 73.57 | 72.88 | 74.42 | 73.77 | 90.15 |
| 6300. | 73.08 | 76.52 | 74.05 | 72.43 | 72.16 | 72.96 | 73.80 | 89.23 |
| 8000. | 71.21 | 75.27 | 71.67 | 70.35 | 70.36 | 72.24 | 73.39 | 87.83 |
| 10000. | 69.71 | 73.58 | 69.30 | 68.64 | 69.14 | 71.84 | 72.72 | 86.49 |
| 12500. | 68.41 | 72.91 | 68.51 | 67.88 | 69.12 | 71.44 | 72.24 | 85.91 |
| 16000. | 67.30 | 72.50 | 67.92 | 67.94 | 68.85 | 71.48 | 72.77 | 85.71 |
| 20000. | 65.99 | 71.44 | 67.83 | 67.94 | 68.83 | 71.34 | 72.18 | 85.26 |
| 25000. | 63.61 | 69.75 | 66.79 | 67.12 | 68.05 | 70.36 | 71.44 | 84.11 |
| 31500. | 60.98 | 67.81 | 64.99 | 65.35 | 66.32 | 67.87 | 69.50 | 82.05 |
| 40000. | 58.60 | 65.93 | 63.31 | 63.51 | 64.01 | 66.13 | 67.30 | 80.15 |

TOTAL POWER, DB = 100.95

55

NOZZLE DIA = 2.8"
 DIFFUSOR DIA = 4.0"
 FLOW TEMPERATURE, TOTAL = 530.0 DEG R
 MICROPHONE RADIUS = 6 FT.

NOZZLE-DIFFUSOR SPACING RATIO = 0.50
 MACH NU. = 0.90

| FREQUENCY, HZ | MICROPHONE ANGLE, DEG | | | | | | | TOTAL POWER, DB (1/3 OCTAVE BAND) |
|---------------|---------------------------------|-------|-------|-------|-------|-------|-------|--------------------------------------|
| | 30. | 45. | 60. | 75. | 90. | 105. | 120. | |
| | SOUND POWER INTENSITY LEVEL, DB | | | | | | | |
| 200. | 70.74 | 69.21 | 69.87 | 70.26 | 69.66 | 69.94 | 69.75 | 85.05 |
| 250. | 70.60 | 70.21 | 69.82 | 69.66 | 70.88 | 69.90 | 68.74 | 85.20 |
| 315. | 71.96 | 72.22 | 71.10 | 71.28 | 72.41 | 70.18 | 70.27 | 86.60 |
| 400. | 73.07 | 72.27 | 71.49 | 71.25 | 71.98 | 70.58 | 71.41 | 86.79 |
| 500. | 73.04 | 72.37 | 72.26 | 72.94 | 71.67 | 72.13 | 72.94 | 87.65 |
| 630. | 73.97 | 74.07 | 72.97 | 74.31 | 73.47 | 73.49 | 74.02 | 89.01 |
| 800. | 73.12 | 73.92 | 72.98 | 72.56 | 74.37 | 73.00 | 75.29 | 88.65 |
| 1000. | 72.27 | 72.25 | 72.80 | 72.35 | 73.05 | 71.88 | 73.90 | 87.65 |
| 1250. | 72.25 | 71.67 | 72.87 | 72.32 | 72.30 | 72.03 | 73.84 | 87.47 |
| 1600. | 73.36 | 72.85 | 73.51 | 73.69 | 73.52 | 73.83 | 75.18 | 88.78 |
| 2000. | 74.47 | 74.10 | 73.59 | 73.69 | 73.34 | 73.54 | 75.24 | 88.92 |
| 2500. | 74.01 | 74.14 | 73.02 | 71.98 | 72.40 | 72.54 | 74.17 | 88.26 |
| 3150. | 75.18 | 76.03 | 75.57 | 73.79 | 73.56 | 73.45 | 74.55 | 89.82 |
| 4000. | 77.11 | 79.18 | 77.87 | 76.05 | 74.97 | 74.24 | 74.74 | 92.00 |
| 5000. | 78.04 | 81.13 | 78.71 | 76.47 | 75.81 | 75.22 | 75.45 | 93.25 |
| 6300. | 77.57 | 80.73 | 78.21 | 76.24 | 76.14 | 75.94 | 76.15 | 93.69 |
| 8000. | 76.15 | 79.25 | 76.38 | 75.33 | 75.39 | 75.71 | 75.58 | 91.96 |
| 10000. | 73.66 | 76.76 | 74.03 | 72.82 | 72.80 | 74.14 | 74.38 | 89.71 |
| 12500. | 72.18 | 75.16 | 72.39 | 71.65 | 72.05 | 73.33 | 74.44 | 88.51 |
| 16000. | 71.34 | 74.69 | 72.15 | 71.49 | 72.63 | 73.36 | 74.89 | 88.37 |
| 20000. | 70.61 | 74.36 | 72.35 | 71.85 | 72.83 | 73.70 | 75.02 | 88.43 |
| 25000. | 69.71 | 73.70 | 71.96 | 71.69 | 72.28 | 73.53 | 74.64 | 86.04 |
| 31500. | 67.85 | 72.54 | 70.52 | 70.52 | 70.95 | 72.21 | 73.44 | 86.77 |
| 40000. | 65.80 | 71.19 | 69.14 | 69.16 | 69.57 | 70.90 | 72.37 | 85.43 |

TOTAL POWER, DB = 102.97

56

NOZZLE DIA = 2.8"
 DIFFUSOR DIA = 4.0"
 FLOW TEMPERATURE, TOTAL = 530.0 DEG R
 MICROPHONE RADIUS = 6 FT.

NOZZLE-DIFFUSOR SPACING RATIO = 0.50
 MACH NU. = 1.10

| FREQUENCY, HZ | MICROPHONE ANGLE, DEG | | | | | | | TOTAL POWER, DB (1/3 OCTAVE BAND) |
|---------------|-----------------------|-------|-------|-------|-------|-------|-------|--------------------------------------|
| | 30. | 45. | 60. | 75. | 90. | 105. | 120. | |
| 200. | 72.69 | 72.33 | 72.31 | 71.94 | 71.97 | 72.91 | 72.50 | 87.56 |
| 250. | 74.14 | 72.52 | 72.79 | 72.07 | 72.18 | 72.41 | 71.41 | 87.64 |
| 315. | 76.74 | 74.88 | 75.57 | 73.68 | 73.48 | 74.09 | 71.47 | 89.60 |
| 400. | 75.83 | 75.13 | 74.66 | 73.88 | 73.75 | 73.41 | 72.42 | 89.42 |
| 500. | 74.16 | 73.55 | 74.06 | 73.26 | 73.14 | 73.75 | 73.43 | 88.77 |
| 630. | 74.97 | 73.61 | 72.63 | 73.46 | 74.05 | 74.02 | 74.70 | 88.97 |
| 800. | 74.38 | 74.57 | 72.35 | 73.92 | 75.09 | 72.89 | 74.94 | 89.15 |
| 1000. | 72.90 | 73.18 | 71.69 | 73.36 | 73.40 | 70.94 | 72.77 | 87.84 |
| 1250. | 72.88 | 72.23 | 71.66 | 72.93 | 71.95 | 71.85 | 71.12 | 87.40 |
| 1600. | 73.95 | 75.09 | 74.82 | 74.02 | 73.57 | 74.41 | 73.97 | 89.59 |
| 2000. | 75.85 | 76.68 | 75.82 | 75.82 | 74.86 | 75.51 | 75.93 | 91.06 |
| 2500. | 76.28 | 77.00 | 75.34 | 74.94 | 73.80 | 74.77 | 75.30 | 90.68 |
| 3150. | 77.73 | 78.40 | 77.04 | 76.67 | 74.84 | 75.42 | 76.63 | 92.03 |
| 4000. | 79.56 | 80.95 | 79.31 | 77.76 | 76.14 | 76.40 | 76.81 | 93.78 |
| 5000. | 80.44 | 82.06 | 79.99 | 78.72 | 76.86 | 76.67 | 77.19 | 94.89 |
| 6300. | 79.90 | 82.92 | 80.21 | 77.46 | 76.18 | 76.43 | 76.67 | 94.73 |
| 8000. | 79.96 | 82.61 | 78.40 | 76.27 | 75.76 | 75.82 | 76.54 | 94.13 |
| 10000. | 78.03 | 79.37 | 75.70 | 74.76 | 74.57 | 74.76 | 75.70 | 91.76 |
| 12500. | 75.46 | 76.83 | 74.21 | 73.31 | 72.87 | 73.50 | 74.55 | 89.82 |
| 16000. | 74.04 | 76.58 | 74.09 | 73.25 | 72.90 | 73.90 | 74.29 | 89.75 |
| 20000. | 73.84 | 77.09 | 74.92 | 73.65 | 73.49 | 74.37 | 74.54 | 90.16 |
| 25000. | 73.06 | 77.10 | 74.26 | 73.41 | 73.58 | 74.07 | 74.47 | 89.98 |
| 31500. | 71.70 | 75.89 | 73.47 | 73.11 | 72.77 | 73.01 | 73.76 | 89.05 |
| 40000. | 69.96 | 74.94 | 72.68 | 72.23 | 72.03 | 72.08 | 72.93 | 88.13 |

TOTAL POWER, DB = 104.67

57

NOZZLE DIA = 2.8"
 DIFFUSOR DIA = 4.0"
 FLOW TEMPERATURE, TOTAL = 530.0 DEG R
 MICROPHONE RADIUS = 6 FT.

NOZZLE-DIFFUSOR SPACING RATIO = 0.75
 MACH NO. = 0.70

AEDC-TR-90-15

MICROPHONE ANGLE, DEG

| FREQUENCY, HZ | MICROPHONE ANGLE, DEG | | | | | | | TOTAL POWER, DB (1/3 OCTAVE BAND) |
|---------------|-----------------------|-------|-------|-------|-------|-------|-------|--------------------------------------|
| | 30. | 45. | 60. | 75. | 90. | 105. | 120. | |
| 200. | 68.05 | 67.83 | 67.66 | 69.21 | 67.93 | 68.31 | 68.05 | 83.48 |
| 250. | 68.11 | 67.77 | 67.67 | 68.55 | 68.30 | 68.89 | 68.93 | 83.54 |
| 315. | 71.40 | 70.69 | 69.78 | 70.95 | 70.29 | 70.82 | 69.44 | 85.81 |
| 400. | 73.36 | 72.85 | 72.22 | 73.35 | 71.51 | 72.23 | 71.27 | 87.78 |
| 500. | 74.75 | 75.58 | 75.79 | 75.63 | 73.55 | 75.88 | 75.09 | 90.62 |
| 630. | 76.02 | 74.50 | 75.36 | 75.99 | 74.64 | 75.12 | 75.97 | 90.47 |
| 800. | 73.42 | 71.71 | 71.88 | 72.42 | 71.77 | 71.51 | 73.49 | 87.27 |
| 1000. | 71.39 | 69.93 | 70.88 | 71.32 | 70.24 | 70.44 | 72.22 | 85.94 |
| 1250. | 72.08 | 70.44 | 71.21 | 71.43 | 69.99 | 70.77 | 71.51 | 86.14 |
| 1600. | 73.41 | 72.66 | 72.25 | 71.61 | 71.14 | 71.48 | 71.90 | 87.18 |
| 2000. | 75.88 | 75.65 | 74.55 | 73.25 | 72.49 | 72.20 | 72.97 | 89.16 |
| 2500. | 78.85 | 79.14 | 77.62 | 75.45 | 74.60 | 73.73 | 73.92 | 91.86 |
| 3150. | 81.45 | 82.44 | 81.12 | 78.48 | 77.54 | 76.55 | 76.27 | 94.99 |
| 4000. | 83.34 | 84.54 | 83.43 | 81.20 | 80.09 | 79.11 | 78.67 | 97.30 |
| 5000. | 82.46 | 83.84 | 82.94 | 81.00 | 79.71 | 79.25 | 79.44 | 96.87 |
| 6300. | 77.57 | 80.47 | 78.69 | 76.53 | 76.14 | 76.59 | 77.53 | 93.25 |
| 8000. | 72.44 | 76.28 | 72.93 | 71.69 | 72.50 | 73.67 | 74.99 | 89.13 |
| 10000. | 69.71 | 72.92 | 69.26 | 68.49 | 69.95 | 71.58 | 73.46 | 86.30 |
| 12500. | 68.18 | 71.77 | 68.32 | 67.84 | 69.31 | 71.08 | 72.50 | 85.44 |
| 16000. | 67.61 | 71.39 | 68.15 | 68.20 | 69.32 | 70.65 | 72.18 | 85.20 |
| 20000. | 66.78 | 70.43 | 67.91 | 67.67 | 69.25 | 70.15 | 71.41 | 84.62 |
| 25000. | 65.39 | 68.96 | 66.97 | 66.91 | 68.30 | 69.47 | 70.27 | 83.58 |
| 31500. | 63.17 | 67.44 | 65.72 | 65.61 | 67.03 | 67.69 | 68.48 | 82.03 |
| 40000. | 60.57 | 65.16 | 64.53 | 64.20 | 65.56 | 65.86 | 66.90 | 80.27 |

TOTAL POWER, DB = 104.17

NOZZLE DIA = 2.8"
 DIFFUSOR DIA = 4.0"
 FLOW TEMPERATURE, TOTAL = 530.0 DEG R
 MICROPHONE RADIUS = 6 FT.

NOZZLE-DIFFUSOR SPACING RATIO = 0.75
 MACH NO. = 0.90

MICROPHONE ANGLE, DEG

| FREQUENCY, HZ | MICROPHONE ANGLE, DEG | | | | | | | TOTAL POWER, DB (1/3 OCTAVE BAND) |
|---------------|-----------------------|-------|-------|-------|-------|-------|-------|--------------------------------------|
| | 30. | 45. | 60. | 75. | 90. | 105. | 120. | |
| 200. | 69.62 | 69.44 | 69.82 | 70.33 | 69.38 | 71.70 | 68.90 | 85.44 |
| 250. | 69.61 | 69.16 | 69.74 | 69.97 | 69.85 | 71.38 | 69.61 | 85.30 |
| 315. | 71.97 | 70.78 | 71.70 | 69.51 | 70.20 | 71.76 | 69.80 | 86.05 |
| 400. | 71.72 | 71.46 | 71.12 | 71.00 | 69.65 | 71.43 | 69.55 | 86.25 |
| 500. | 71.09 | 71.18 | 71.05 | 73.38 | 70.13 | 72.51 | 71.46 | 87.17 |
| 630. | 73.82 | 73.31 | 72.31 | 73.41 | 72.38 | 73.65 | 74.31 | 88.50 |
| 800. | 73.77 | 73.99 | 73.88 | 73.37 | 74.06 | 73.90 | 75.71 | 89.13 |
| 1000. | 73.77 | 73.07 | 72.73 | 72.89 | 72.50 | 73.45 | 74.89 | 88.38 |
| 1250. | 73.83 | 72.28 | 72.72 | 74.38 | 71.07 | 73.01 | 73.69 | 86.29 |
| 1600. | 75.24 | 74.35 | 74.62 | 75.67 | 72.67 | 73.96 | 74.58 | 89.75 |
| 2000. | 77.15 | 76.87 | 76.70 | 77.36 | 74.87 | 74.65 | 75.09 | 91.49 |
| 2500. | 79.88 | 79.96 | 78.85 | 80.63 | 75.73 | 75.16 | 75.22 | 93.93 |
| 3150. | 83.12 | 84.25 | 82.33 | 83.58 | 78.93 | 77.76 | 77.51 | 97.37 |
| 4000. | 86.11 | 86.90 | 85.49 | 84.63 | 81.69 | 81.00 | 80.18 | 99.74 |
| 5000. | 86.94 | 87.63 | 86.82 | 83.63 | 83.37 | 83.09 | 82.59 | 100.51 |
| 6300. | 85.54 | 86.91 | 86.04 | 79.97 | 82.64 | 82.64 | 82.85 | 99.46 |
| 8000. | 81.73 | 83.96 | 81.59 | 76.11 | 79.81 | 79.91 | 80.44 | 96.23 |
| 10000. | 77.68 | 79.11 | 76.63 | 73.90 | 76.15 | 76.73 | 77.27 | 92.17 |
| 12500. | 74.88 | 76.67 | 74.53 | 73.55 | 74.65 | 75.33 | 75.75 | 90.39 |
| 16000. | 73.93 | 76.45 | 74.46 | 73.95 | 74.37 | 75.07 | 75.12 | 90.21 |
| 20000. | 73.49 | 76.43 | 74.26 | 73.47 | 73.57 | 74.56 | 75.00 | 89.89 |
| 25000. | 72.22 | 75.64 | 73.04 | 71.97 | 73.03 | 73.73 | 74.75 | 88.98 |
| 31500. | 70.00 | 74.02 | 71.89 | 70.02 | 71.85 | 71.18 | 73.42 | 87.22 |
| 40000. | 67.72 | 72.54 | 70.87 | 70.84 | 70.61 | 72.04 | 71.96 | 86.67 |

TOTAL POWER, DB = 107.44

59

NOZZLE DIA = 2.8"
 DIFFUSOR DIA = 4.0"
 FLOW TEMPERATURE, TOTAL = 530.0 DEG R
 MICROPHONE RADIUS = 6 FT.

NOZZLE-DIFFUSOR SPACING RATIO = 0.75
 MACH NO. = 1.10

AEDC-TR-80-15

| FREQUENCY, HZ | MICROPHONE ANGLE, DEG | | | | | | | TOTAL POWER, DB (1/3 OCTAVE BAND) |
|---------------|-----------------------|-------|-------|-------|-------|-------|-------|--------------------------------------|
| | 30. | 45. | 60. | 75. | 90. | 105. | 120. | |
| 200. | 72.12 | 72.04 | 72.55 | 72.35 | 71.24 | 73.05 | 72.64 | 87.72 |
| 250. | 73.06 | 72.22 | 72.33 | 71.65 | 71.46 | 72.71 | 70.61 | 87.32 |
| 315. | 76.10 | 74.31 | 73.77 | 72.55 | 73.10 | 72.78 | 69.94 | 88.60 |
| 400. | 75.04 | 74.69 | 74.00 | 72.88 | 72.82 | 72.98 | 70.90 | 88.79 |
| 500. | 73.48 | 73.10 | 73.40 | 72.45 | 72.46 | 72.87 | 72.95 | 88.08 |
| 630. | 73.97 | 72.84 | 72.29 | 72.39 | 73.06 | 72.88 | 74.41 | 88.09 |
| 800. | 73.78 | 73.54 | 72.27 | 72.78 | 71.44 | 72.00 | 73.99 | 87.95 |
| 1000. | 73.45 | 72.33 | 72.88 | 72.41 | 71.78 | 70.81 | 71.59 | 87.29 |
| 1250. | 74.01 | 72.83 | 73.30 | 72.48 | 75.12 | 71.89 | 71.79 | 88.17 |
| 1600. | 75.05 | 70.00 | 75.69 | 75.73 | 75.98 | 75.26 | 74.02 | 90.84 |
| 2000. | 78.32 | 77.71 | 76.93 | 76.57 | 76.83 | 75.40 | 74.61 | 91.93 |
| 2500. | 80.40 | 80.49 | 79.13 | 77.97 | 79.06 | 70.10 | 75.63 | 93.96 |
| 3150. | 83.05 | 84.48 | 82.73 | 80.83 | 82.81 | 78.04 | 78.12 | 97.29 |
| 4000. | 80.10 | 87.40 | 86.07 | 83.76 | 85.32 | 81.57 | 80.55 | 100.25 |
| 5000. | 88.56 | 89.61 | 87.89 | 85.93 | 84.96 | 83.61 | 83.35 | 102.14 |
| 6300. | 88.11 | 89.48 | 87.07 | 85.87 | 82.89 | 84.50 | 83.61 | 102.01 |
| 8000. | 86.58 | 88.02 | 85.67 | 84.55 | 80.50 | 83.44 | 82.68 | 100.50 |
| 10000. | 83.20 | 84.59 | 82.41 | 81.07 | 78.18 | 80.85 | 80.79 | 97.35 |
| 12500. | 80.84 | 81.86 | 79.84 | 78.54 | 70.99 | 78.51 | 78.71 | 94.87 |
| 16000. | 79.05 | 80.53 | 78.06 | 77.35 | 76.77 | 77.13 | 77.00 | 93.62 |
| 20000. | 78.60 | 80.27 | 78.05 | 76.98 | 76.35 | 76.70 | 76.58 | 93.30 |
| 25000. | 77.76 | 80.08 | 78.30 | 76.73 | 75.36 | 76.32 | 75.89 | 92.93 |
| 31500. | 75.97 | 79.51 | 76.94 | 75.72 | 74.18 | 75.20 | 74.57 | 91.98 |
| 40000. | 73.49 | 78.62 | 75.97 | 74.72 | 74.84 | 74.20 | 73.38 | 91.09 |

TOTAL POWER, DB = 109.46

NOZZLE DIA = 2.8"
 DIFFUSOR DIA = 4.0"
 FLOW TEMPERATURE, TOTAL = 530.0 DEG R
 MICROPHONE RADIUS = 6 FT.

NOZZLE-DIFFUSOR SPACING RATIO = 1.00
 MACH NU. = 0.70

MICROPHONE ANGLE, DEG

| FREQUENCY, HZ | SOUND POWER INTENSITY LEVEL, DB | | | | | | | TOTAL POWER, DB (1/3 OCTAVE BAND) |
|---------------|---------------------------------|-------|-------|-------|-------|-------|-------|--------------------------------------|
| | 30. | 45. | 60. | 75. | 90. | 105. | 120. | |
| 200. | 68.34 | 67.76 | 68.71 | 68.81 | 69.20 | 70.13 | 68.32 | 84.12 |
| 250. | 69.23 | 68.17 | 68.76 | 68.50 | 69.24 | 70.32 | 69.21 | 84.28 |
| 315. | 71.60 | 71.07 | 71.93 | 71.00 | 71.95 | 71.93 | 70.43 | 86.65 |
| 400. | 73.83 | 74.86 | 75.22 | 73.75 | 73.51 | 73.28 | 73.12 | 69.25 |
| 500. | 75.62 | 75.91 | 76.10 | 75.30 | 75.08 | 76.04 | 76.05 | 90.93 |
| 630. | 75.74 | 74.55 | 74.50 | 74.62 | 74.10 | 75.21 | 75.17 | 89.97 |
| 800. | 74.29 | 72.93 | 72.77 | 72.92 | 73.44 | 72.15 | 73.46 | 88.12 |
| 1000. | 74.30 | 73.54 | 74.02 | 72.49 | 72.97 | 72.47 | 73.15 | 88.31 |
| 1250. | 77.07 | 75.80 | 76.55 | 73.91 | 74.02 | 73.82 | 73.35 | 90.19 |
| 1600. | 81.09 | 79.84 | 78.70 | 77.11 | 76.10 | 74.85 | 75.46 | 93.16 |
| 2000. | 85.39 | 84.20 | 82.18 | 81.07 | 81.10 | 78.89 | 78.85 | 97.24 |
| 2500. | 88.45 | 87.93 | 85.66 | 84.77 | 84.19 | 82.47 | 81.84 | 100.77 |
| 3150. | 90.36 | 90.82 | 88.00 | 80.82 | 85.81 | 85.03 | 83.76 | 103.19 |
| 4000. | 89.22 | 90.29 | 87.81 | 86.90 | 85.60 | 84.98 | 84.08 | 102.83 |
| 5000. | 84.01 | 86.31 | 84.48 | 82.73 | 82.20 | 81.79 | 81.68 | 99.03 |
| 6300. | 77.05 | 80.37 | 78.37 | 76.84 | 76.83 | 77.25 | 77.81 | 93.40 |
| 8000. | 73.02 | 76.72 | 73.59 | 72.54 | 73.12 | 74.38 | 75.46 | 89.72 |
| 10000. | 71.05 | 74.65 | 71.61 | 71.10 | 71.82 | 73.11 | 74.33 | 88.07 |
| 12500. | 70.61 | 73.73 | 70.64 | 70.67 | 71.60 | 72.54 | 73.70 | 87.40 |
| 16000. | 70.24 | 73.26 | 70.12 | 70.56 | 71.39 | 72.09 | 73.33 | 87.03 |
| 20000. | 68.85 | 72.34 | 69.35 | 70.07 | 70.85 | 71.40 | 72.70 | 86.29 |
| 25000. | 66.75 | 70.59 | 68.32 | 68.69 | 69.17 | 69.94 | 70.74 | 84.72 |
| 31500. | 63.56 | 67.95 | 66.34 | 66.62 | 67.11 | 67.83 | 68.52 | 82.45 |
| 40000. | 60.78 | 65.45 | 64.67 | 64.73 | 64.92 | 65.73 | 66.56 | 80.32 |

TOTAL POWER, DB = 109.01

NOZZLE DIA = 2.8"
 DIFFUSOR DIA = 4.0"
 FLOW TEMPERATURE, TOTAL = 530.0 DEG R
 MICROPHONE RADIUS = 6 FT.

NOZZLE-DIFFUSOR SPACING RATIO = 1.00
 MACH NO. = 0.90

AEDC-TR-80-15

MICROPHONE ANGLE, DEG

| FREQUENCY, HZ | 30. | 45. | 60. | 75. | 90. | 105. | 120. | TOTAL POWER, DB (1/3 OCTAVE BAND) |
|---------------|---------------------------------|-------|-------|-------|-------|-------|-------|--------------------------------------|
| | SOUND POWER INTENSITY LEVEL, DB | | | | | | | |
| 200. | 70.29 | 72.00 | 69.08 | 69.09 | 70.90 | 70.62 | 68.07 | 85.69 |
| 250. | 71.57 | 71.83 | 68.28 | 69.09 | 70.17 | 70.70 | 69.46 | 85.80 |
| 315. | 72.35 | 73.88 | 70.84 | 71.13 | 71.75 | 71.68 | 69.97 | 87.26 |
| 400. | 71.91 | 73.71 | 71.57 | 70.88 | 71.86 | 72.84 | 70.47 | 87.49 |
| 500. | 73.39 | 73.16 | 72.99 | 72.35 | 72.28 | 73.25 | 72.63 | 88.07 |
| 630. | 75.62 | 74.39 | 73.84 | 74.77 | 74.75 | 75.84 | 75.17 | 89.66 |
| 800. | 75.95 | 74.66 | 74.06 | 74.65 | 75.17 | 75.92 | 75.74 | 89.84 |
| 1000. | 76.34 | 75.51 | 75.04 | 74.59 | 74.77 | 74.90 | 75.79 | 90.31 |
| 1250. | 78.58 | 77.05 | 76.78 | 75.93 | 75.71 | 75.87 | 76.17 | 91.65 |
| 1600. | 81.19 | 80.51 | 80.17 | 78.35 | 77.28 | 76.59 | 77.57 | 94.12 |
| 2000. | 84.89 | 84.22 | 83.25 | 81.66 | 80.58 | 78.97 | 79.66 | 97.42 |
| 2500. | 88.13 | 87.86 | 86.19 | 84.65 | 83.04 | 81.34 | 81.37 | 100.54 |
| 3150. | 91.64 | 91.95 | 90.03 | 88.41 | 86.59 | 85.24 | 84.49 | 104.41 |
| 4000. | 93.17 | 93.88 | 91.39 | 89.62 | 87.78 | 86.73 | 86.71 | 106.02 |
| 5000. | 91.86 | 92.94 | 90.85 | 89.00 | 87.25 | 86.56 | 87.21 | 105.29 |
| 6300. | 87.17 | 88.89 | 86.86 | 85.50 | 84.75 | 83.83 | 85.49 | 101.63 |
| 8000. | 81.79 | 83.82 | 82.32 | 80.87 | 80.84 | 80.60 | 81.96 | 97.15 |
| 10000. | 77.93 | 80.72 | 78.66 | 77.58 | 78.02 | 78.33 | 79.62 | 94.10 |
| 12500. | 77.11 | 79.21 | 77.10 | 76.31 | 76.66 | 77.14 | 78.02 | 92.73 |
| 16000. | 77.07 | 79.04 | 77.06 | 76.00 | 76.26 | 76.65 | 77.50 | 92.45 |
| 20000. | 76.63 | 78.55 | 76.83 | 75.56 | 75.99 | 76.29 | 76.79 | 92.03 |
| 25000. | 75.00 | 77.36 | 76.03 | 74.68 | 74.95 | 75.48 | 75.70 | 91.01 |
| 31500. | 72.26 | 75.41 | 74.53 | 73.35 | 72.96 | 73.52 | 74.17 | 89.21 |
| 40000. | 70.14 | 73.46 | 72.97 | 71.77 | 70.26 | 71.76 | 72.76 | 87.39. |

TOTAL POWER, DB = 111.98

NOZZLE DIA = 2.8"
 DIFFUSOR DIA = 4.0"
 FLOW TEMPERATURE, TOTAL = 530.0 DEG R
 MICROPHONE RADIUS = 6 FT.

NOZZLE-DIFFUSOR SPACING RATIO = 1.00
 MACH NO. = 1.10

MICROPHONE ANGLE, DEG

| FREQUENCY, HZ | SOUND POWER INTENSITY LEVEL, DB | | | | | | | TOTAL POWER, DB (1/3 OCTAVE BAND) |
|---------------|---------------------------------|-------|-------|-------|-------|-------|-------|--------------------------------------|
| | 30. | 45. | 60. | 75. | 90. | 105. | 120. | |
| 200. | 72.12 | 72.65 | 72.25 | 72.65 | 72.54 | 71.28 | 71.22 | 87.41 |
| 250. | 73.25 | 72.64 | 72.68 | 71.94 | 72.68 | 72.67 | 71.86 | 87.69 |
| 315. | 75.65 | 75.06 | 74.06 | 73.58 | 74.48 | 74.25 | 73.09 | 89.54 |
| 400. | 75.77 | 74.93 | 74.93 | 73.57 | 74.82 | 74.81 | 73.66 | 89.81 |
| 500. | 75.05 | 74.30 | 74.84 | 73.81 | 74.27 | 75.00 | 74.83 | 89.69 |
| 630. | 75.86 | 74.67 | 74.70 | 74.24 | 74.98 | 74.93 | 75.99 | 90.07 |
| 800. | 76.74 | 74.74 | 75.12 | 74.48 | 75.58 | 73.97 | 76.00 | 90.08 |
| 1000. | 77.10 | 75.76 | 75.68 | 75.61 | 74.90 | 73.90 | 74.99 | 90.51 |
| 1250. | 78.04 | 77.09 | 76.48 | 76.62 | 75.43 | 75.54 | 74.18 | 91.56 |
| 1600. | 81.33 | 80.59 | 79.77 | 79.78 | 76.63 | 76.65 | 77.19 | 94.82 |
| 2000. | 84.88 | 84.29 | 82.80 | 82.06 | 81.14 | 79.73 | 79.62 | 97.59 |
| 2500. | 87.60 | 87.72 | 85.76 | 84.14 | 83.13 | 81.24 | 80.83 | 100.27 |
| 3150. | 90.76 | 91.85 | 89.37 | 87.43 | 86.20 | 84.60 | 83.14 | 103.92 |
| 4000. | 93.01 | 94.05 | 91.51 | 89.77 | 88.39 | 87.71 | 86.78 | 106.58 |
| 5000. | 94.04 | 94.59 | 92.76 | 90.14 | 88.85 | 88.02 | 87.94 | 106.89 |
| 6300. | 91.10 | 92.23 | 90.58 | 87.84 | 87.02 | 86.62 | 87.24 | 104.69 |
| 8000. | 87.77 | 89.50 | 85.99 | 84.90 | 84.88 | 84.52 | 85.29 | 101.84 |
| 10000. | 85.21 | 85.94 | 82.22 | 81.59 | 82.03 | 82.03 | 82.12 | 96.58 |
| 12500. | 83.01 | 83.32 | 80.74 | 79.98 | 80.33 | 80.18 | 79.84 | 96.53 |
| 16000. | 82.70 | 82.94 | 80.85 | 79.72 | 79.90 | 79.54 | 78.77 | 96.10 |
| 20000. | 81.47 | 82.95 | 81.27 | 79.58 | 79.66 | 78.77 | 78.28 | 95.89 |
| 25000. | 80.00 | 82.63 | 80.94 | 78.87 | 78.79 | 77.81 | 77.59 | 95.28 |
| 31500. | 78.01 | 81.03 | 79.52 | 77.58 | 77.41 | 76.15 | 76.58 | 93.77 |
| 40000. | 75.77 | 79.70 | 77.85 | 77.58 | 75.58 | 74.81 | 75.00 | 92.58 |

TOTAL POWER, DB = 113.40

63

NOZZLE DIA = 2.8"
 DIFFUSOR DIA = 4.0"
 FLOW TEMPERATURE, TOTAL =
 MICROPHONE RADIUS = 6 FT.

530.0 DEG R

NOZZLE-DIFFUSOR SPACING RATIO = 1.25
 MACH NO. = 0.70

AECC-TR-80-15

MICROPHONE ANGLE, DEG

| FREQUENCY, HZ | SOUND POWER INTENSITY LEVEL, DB | | | | | | | TOTAL POWER, DB (1/3 OCTAVE BAND) |
|---------------|---------------------------------|-------|-------|-------|-------|-------|-------|--------------------------------------|
| | 30. | 45. | 60. | 75. | 90. | 105. | 120. | |
| 200. | 68.48 | 68.75 | 68.56 | 69.07 | 69.64 | 68.92 | 68.79 | 84.12 |
| 250. | 69.84 | 68.69 | 68.96 | 69.73 | 69.53 | 69.58 | 69.62 | 84.57 |
| 315. | 73.05 | 70.80 | 71.46 | 71.84 | 70.95 | 71.32 | 70.40 | 86.58 |
| 400. | 73.46 | 72.77 | 73.19 | 73.45 | 72.38 | 73.19 | 72.76 | 88.26 |
| 500. | 76.35 | 75.82 | 76.19 | 76.00 | 74.88 | 75.63 | 76.52 | 91.03 |
| 630. | 78.29 | 77.23 | 76.55 | 77.23 | 76.30 | 75.08 | 77.29 | 91.92 |
| 800. | 76.72 | 76.72 | 75.60 | 75.86 | 75.75 | 72.95 | 75.34 | 90.77 |
| 1000. | 77.51 | 77.95 | 77.21 | 76.20 | 75.59 | 74.06 | 74.59 | 91.55 |
| 1250. | 81.29 | 80.99 | 80.08 | 76.95 | 77.33 | 76.19 | 76.51 | 94.32 |
| 1600. | 85.75 | 85.00 | 83.66 | 82.71 | 80.02 | 79.58 | 79.96 | 98.10 |
| 2000. | 90.20 | 89.65 | 88.51 | 87.04 | 84.67 | 85.60 | 83.65 | 102.60 |
| 2500. | 94.17 | 93.60 | 91.70 | 90.61 | 87.93 | 87.44 | 86.20 | 106.32 |
| 3150. | 94.83 | 95.44 | 92.67 | 91.01 | 88.85 | 89.37 | 87.30 | 107.62 |
| 4000. | 92.57 | 93.60 | 90.98 | 88.88 | 88.24 | 87.56 | 86.74 | 105.81 |
| 5000. | 86.35 | 88.01 | 86.36 | 84.53 | 84.33 | 83.21 | 83.77 | 100.82 |
| 6300. | 80.32 | 82.47 | 80.92 | 79.67 | 78.90 | 78.60 | 79.14 | 95.56 |
| 8000. | 75.19 | 77.90 | 76.04 | 75.32 | 75.05 | 75.53 | 76.55 | 91.40 |
| 10000. | 72.93 | 75.80 | 73.46 | 73.12 | 73.43 | 73.72 | 75.16 | 89.37 |
| 12500. | 72.50 | 74.85 | 72.78 | 72.45 | 72.63 | 72.98 | 74.54 | 88.58 |
| 16000. | 71.95 | 74.60 | 72.73 | 72.22 | 72.40 | 72.95 | 73.85 | 86.35 |
| 20000. | 70.64 | 73.52 | 71.86 | 71.73 | 71.73 | 72.60 | 73.04 | 87.61 |
| 25000. | 68.36 | 71.62 | 70.29 | 70.23 | 70.17 | 70.78 | 71.02 | 85.85 |
| 31500. | 65.53 | 68.88 | 68.34 | 68.42 | 68.10 | 68.59 | 68.56 | 83.60 |
| 40000. | 62.76 | 66.60 | 66.71 | 66.54 | 66.60 | 66.84 | 66.66 | 81.70 |

TOTAL POWER, DB = 112.87

NOZZLE DIA = 2.8"
 DIFFUSOR DIA = 4.0"
 FLOW TEMPERATURE, TOTAL = 530.0 DEG R
 MICROPHONE RADIUS = 6 FT.

NOZZLE-DIFFUSOR SPACING RATIO = 1.25
 MACH NU. = 0.90

| FREQUENCY, HZ | MICROPHONE ANGLE, DEG | | | | | | | TOTAL POWER, DB (1/3 OCTAVE BAND) |
|---------------|-----------------------|-------|-------|-------|-------|-------|-------|--------------------------------------|
| | 30. | 45. | 60. | 75. | 90. | 105. | 120. | |
| 200. | 70.04 | 70.71 | 70.71 | 69.30 | 70.34 | 69.60 | 70.38 | 65.28 |
| 250. | 70.11 | 69.92 | 70.43 | 68.67 | 70.15 | 69.28 | 71.28 | 64.92 |
| 315. | 72.67 | 71.41 | 71.04 | 70.33 | 70.59 | 70.68 | 70.84 | 66.14 |
| 400. | 72.88 | 71.77 | 72.15 | 70.59 | 70.27 | 71.50 | 71.10 | 66.59 |
| 500. | 73.47 | 72.44 | 72.26 | 72.19 | 71.47 | 72.83 | 72.76 | 67.63 |
| 630. | 76.09 | 75.20 | 73.63 | 74.93 | 74.07 | 74.35 | 74.87 | 69.91 |
| 800. | 77.44 | 76.69 | 75.89 | 76.34 | 75.46 | 74.54 | 76.27 | 91.20 |
| 1000. | 79.87 | 76.31 | 77.84 | 77.61 | 76.60 | 75.49 | 76.28 | 92.62 |
| 1250. | 83.12 | 81.52 | 80.60 | 79.08 | 78.00 | 77.26 | 77.24 | 94.98 |
| 1600. | 86.82 | 85.11 | 83.88 | 82.21 | 81.04 | 79.99 | 79.60 | 98.29 |
| 2000. | 90.34 | 89.27 | 87.10 | 86.28 | 84.91 | 83.55 | 83.36 | 102.14 |
| 2500. | 93.46 | 92.92 | 90.88 | 89.22 | 87.19 | 86.40 | 86.23 | 105.44 |
| 3150. | 96.02 | 96.83 | 94.10 | 92.09 | 89.79 | 89.19 | 89.29 | 108.76 |
| 4000. | 97.30 | 98.19 | 95.47 | 93.94 | 91.24 | 90.72 | 90.69 | 110.21 |
| 5000. | 95.10 | 95.42 | 93.35 | 91.91 | 89.91 | 89.51 | 89.75 | 108.14 |
| 6300. | 89.08 | 90.84 | 86.62 | 87.72 | 86.48 | 86.77 | 86.51 | 103.68 |
| 8000. | 84.45 | 86.88 | 84.60 | 83.52 | 83.11 | 83.21 | 83.65 | 99.78 |
| 10000. | 81.04 | 83.36 | 80.70 | 79.97 | 80.32 | 80.73 | 81.05 | 96.51 |
| 12500. | 80.23 | 81.68 | 79.52 | 78.77 | 78.54 | 79.46 | 79.59 | 95.09 |
| 16000. | 79.87 | 81.52 | 79.24 | 78.65 | 78.28 | 78.63 | 78.71 | 94.75 |
| 20000. | 79.12 | 81.24 | 79.16 | 78.27 | 77.96 | 77.99 | 77.89 | 94.35 |
| 25000. | 77.30 | 80.07 | 77.92 | 77.13 | 76.81 | 76.71 | 76.62 | 93.13 |
| 31500. | 74.32 | 77.82 | 76.25 | 75.55 | 74.84 | 74.74 | 74.28 | 91.11 |
| 40000. | 71.67 | 75.64 | 74.63 | 73.71 | 73.06 | 72.70 | 72.88 | 89.14 |

TOTAL POWER, DB = 115.60

NOZZLE DIA = 2.8"
 DIFFUSOR DIA = 4.0"
 FLOW TEMPERATURE, TOTAL = 530.0 DEG R
 MICROPHONE RADIUS = 6 FT.

NOZZLE-DIFFUSOR SPACING RATIO = 1.25
 MACH NO. = 1.10

AEDC-TR-80-15

MICROPHONE ANGLE, DEG

| FREQUENCY, HZ | 30. | 45. | 60. | 75. | 90. | 105. | 120. | TOTAL POWER, DB (1/3 OCTAVE BAND) |
|---------------|---------------------------------|-------|-------|-------|-------|-------|-------|--------------------------------------|
| | SOUND POWER INTENSITY LEVEL, DB | | | | | | | |
| 200. | 73.10 | 72.33 | 71.99 | 72.70 | 71.48 | 73.06 | 72.84 | 87.73 |
| 250. | 74.72 | 73.72 | 72.18 | 71.98 | 71.90 | 73.42 | 72.23 | 88.14 |
| 315. | 76.21 | 74.69 | 74.73 | 73.03 | 73.01 | 74.48 | 71.75 | 89.32 |
| 400. | 74.86 | 75.01 | 74.92 | 73.13 | 72.98 | 73.82 | 71.97 | 89.20 |
| 500. | 73.89 | 74.77 | 74.61 | 74.13 | 73.20 | 73.61 | 73.85 | 89.30 |
| 630. | 75.71 | 75.00 | 75.18 | 75.88 | 74.50 | 74.60 | 74.76 | 90.45 |
| 800. | 77.27 | 77.20 | 76.58 | 76.24 | 76.76 | 74.52 | 75.87 | 91.50 |
| 1000. | 79.05 | 79.05 | 76.49 | 77.42 | 76.86 | 75.19 | 75.33 | 92.80 |
| 1250. | 82.29 | 81.22 | 81.10 | 79.42 | 78.16 | 76.76 | 76.25 | 94.86 |
| 1600. | 86.50 | 84.97 | 84.79 | 83.15 | 81.76 | 80.61 | 80.92 | 98.67 |
| 2000. | 90.28 | 88.73 | 88.23 | 86.62 | 84.78 | 83.70 | 83.81 | 102.18 |
| 2500. | 93.29 | 92.92 | 91.08 | 89.45 | 87.16 | 86.67 | 85.75 | 105.50 |
| 3150. | 95.99 | 97.12 | 94.65 | 92.73 | 90.50 | 89.95 | 89.91 | 109.18 |
| 4000. | 97.02 | 95.65 | 96.05 | 94.29 | 92.44 | 91.51 | 91.09 | 110.72 |
| 5000. | 96.90 | 97.33 | 95.42 | 93.88 | 92.41 | 91.49 | 90.99 | 109.93 |
| 6300. | 93.52 | 95.49 | 92.94 | 91.63 | 88.28 | 90.32 | 89.81 | 107.79 |
| 8000. | 90.15 | 92.33 | 89.71 | 89.13 | 85.51 | 87.76 | 87.93 | 104.87 |
| 10000. | 87.34 | 89.49 | 87.23 | 86.63 | 83.31 | 85.20 | 85.80 | 102.24 |
| 12500. | 86.68 | 87.40 | 85.64 | 84.38 | 82.65 | 82.89 | 83.34 | 100.33 |
| 16000. | 86.85 | 87.22 | 85.14 | 83.65 | 82.04 | 82.36 | 82.16 | 99.92 |
| 20000. | 85.88 | 86.79 | 84.95 | 82.99 | 80.67 | 81.64 | 81.24 | 99.33 |
| 25000. | 83.90 | 85.76 | 83.75 | 81.89 | 78.74 | 79.77 | 79.55 | 98.04 |
| 31500. | 81.15 | 83.70 | 81.97 | 78.47 | 77.11 | 77.84 | 77.60 | 95.79 |
| 40000. | 78.73 | 81.42 | 80.39 | 79.34 | 78.04 | 76.49 | 76.17 | 94.51 |

TOTAL POWER, DB = 117.16

69

NOZZLE DIA = 2.8"
 DIFFUSOR DIA = 4.0"
 FLOW TEMPERATURE, TOTAL = 530.0 DEG R
 MICROPHONE RADIUS = 6 FT.

NOZZLE-DIFFUSOR SPACING RATIO = 1.50
 MACH NO. = 0.70

MICROPHONE ANGLE, DEG

| FREQUENCY, HZ | SOUND POWER INTENSITY LEVEL, DB | | | | | | | TOTAL POWER, DB (1/3 OCTAVE BAND) |
|---------------|---------------------------------|--------|--------|--------|-------|-------|-------|--------------------------------------|
| | 30. | 45. | 60. | 75. | 90. | 105. | 120. | |
| 200. | 68.38 | 68.65 | 69.43 | 70.24 | 69.78 | 68.35 | 71.74 | 84.60 |
| 250. | 70.27 | 70.15 | 68.78 | 67.59 | 67.13 | 69.38 | 75.99 | 85.06 |
| 315. | 74.26 | 72.86 | 71.23 | 72.35 | 72.79 | 74.31 | 72.85 | 88.25 |
| 400. | 75.00 | 74.94 | 74.44 | 75.00 | 75.19 | 76.04 | 74.16 | 90.35 |
| 500. | 77.72 | 77.39 | 79.92 | 77.84 | 75.93 | 77.71 | 78.20 | 93.04 |
| 630. | 78.40 | 78.89 | 76.86 | 76.34 | 77.44 | 75.87 | 76.60 | 92.45 |
| 800. | 80.93 | 79.44 | 79.06 | 78.67 | 77.66 | 75.05 | 76.38 | 93.50 |
| 1000. | 84.72 | 83.42 | 82.71 | 81.90 | 79.43 | 79.15 | 77.16 | 96.99 |
| 1250. | 89.16 | 87.41 | 87.06 | 85.70 | 85.66 | 82.73 | 82.32 | 101.20 |
| 1600. | 94.29 | 92.85 | 91.35 | 89.56 | 86.98 | 85.68 | 86.68 | 105.56 |
| 2000. | 107.87 | 103.32 | 106.22 | 102.49 | 97.18 | 97.25 | 97.47 | 117.94 |
| 2500. | 100.03 | 99.41 | 96.37 | 93.33 | 92.93 | 92.72 | 93.00 | 111.42 |
| 3150. | 96.65 | 96.59 | 95.02 | 92.98 | 91.82 | 91.65 | 90.69 | 109.38 |
| 4000. | 92.51 | 92.87 | 91.07 | 88.99 | 88.40 | 87.31 | 87.36 | 105.50 |
| 5000. | 85.25 | 86.74 | 85.15 | 83.33 | 83.38 | 81.96 | 82.12 | 99.59 |
| 6300. | 77.23 | 79.47 | 78.42 | 76.60 | 76.64 | 76.92 | 77.45 | 92.94 |
| 8000. | 75.68 | 78.87 | 77.00 | 75.61 | 76.10 | 76.36 | 77.05 | 92.17 |
| 10000. | 74.40 | 77.50 | 75.26 | 74.43 | 74.96 | 75.54 | 76.01 | 90.94 |
| 12500. | 74.19 | 76.59 | 74.86 | 74.01 | 74.32 | 74.85 | 75.29 | 90.27 |
| 16000. | 73.99 | 76.18 | 74.40 | 73.34 | 74.35 | 74.15 | 74.75 | 89.80 |
| 20000. | 71.56 | 74.38 | 73.49 | 72.61 | 73.17 | 73.46 | 73.84 | 88.61 |
| 25000. | 69.25 | 73.14 | 71.43 | 70.91 | 71.86 | 72.51 | 71.78 | 87.18 |
| 31500. | 66.89 | 70.57 | 69.96 | 69.03 | 69.54 | 70.22 | 70.17 | 85.01 |
| 40000. | 63.82 | 67.62 | 67.08 | 67.28 | 67.14 | 67.42 | 68.05 | 82.45 |

TOTAL POWER, DB = 119.84

NOZZLE DIA = 2.0"
 DIFFUSOR DIA = 4.0"
 FLOW TEMPERATURE, TOTAL = 530.0 DEG K
 MICROPHONE RADIUS = 6 FT.

NOZZLE-DIFFUSOR SPACING RATIO = 1.50
 MACH NO. = 0.90

AEDC-TR-80-15

MICROPHONE ANGLE, DEG

| FREQUENCY, HZ | 30. | 45. | 60. | 75. | 90. | 105. | 120. | TOTAL POWER, DB (1/3 OCTAVE BAND) |
|---------------|---------------------------------|--------|-------|-------|-------|-------|-------|--------------------------------------|
| | SOUND POWER INTENSITY LEVEL, DB | | | | | | | |
| 200. | 70.48 | 70.71 | 72.54 | 70.59 | 72.23 | 70.14 | 69.62 | 86.13 |
| 250. | 70.93 | 70.95 | 71.78 | 71.39 | 72.86 | 69.95 | 69.95 | 86.35 |
| 315. | 72.78 | 72.97 | 73.19 | 72.25 | 73.99 | 72.26 | 70.80 | 87.90 |
| 400. | 72.97 | 73.65 | 73.84 | 73.42 | 72.52 | 73.35 | 72.02 | 88.51 |
| 500. | 74.12 | 74.84 | 75.31 | 74.47 | 74.17 | 74.76 | 74.84 | 89.88 |
| 630. | 77.11 | 78.20 | 76.97 | 76.09 | 77.21 | 76.35 | 76.44 | 92.18 |
| 800. | 80.74 | 80.23 | 79.46 | 78.23 | 78.93 | 77.70 | 77.54 | 94.19 |
| 1000. | 83.80 | 83.14 | 82.02 | 80.93 | 80.06 | 79.30 | 78.64 | 96.60 |
| 1250. | 87.81 | 87.39 | 86.22 | 84.52 | 82.85 | 82.37 | 81.64 | 100.41 |
| 1600. | 91.56 | 91.52 | 90.11 | 88.12 | 86.99 | 85.69 | 84.91 | 104.26 |
| 2000. | 96.59 | 95.58 | 94.07 | 92.16 | 91.12 | 89.53 | 89.18 | 108.40 |
| 2500. | 99.46 | 98.37 | 96.88 | 94.09 | 93.46 | 91.95 | 91.61 | 110.99 |
| 3150. | 100.10 | 100.65 | 97.84 | 95.53 | 94.15 | 93.36 | 92.58 | 112.58 |
| 4000. | 98.64 | 99.93 | 96.45 | 94.73 | 93.83 | 92.92 | 91.96 | 111.75 |
| 5000. | 94.51 | 96.14 | 93.73 | 91.65 | 91.08 | 90.13 | 89.95 | 108.38 |
| 6300. | 88.91 | 90.70 | 88.77 | 87.10 | 87.12 | 86.24 | 86.90 | 103.51 |
| 8000. | 84.21 | 86.92 | 85.41 | 83.44 | 83.54 | 83.38 | 84.51 | 99.97 |
| 10000. | 81.67 | 85.25 | 83.00 | 81.57 | 81.75 | 82.04 | 82.42 | 98.17 |
| 12500. | 81.22 | 83.82 | 82.19 | 80.58 | 80.91 | 80.90 | 81.03 | 97.03 |
| 16000. | 81.10 | 83.36 | 82.26 | 80.42 | 80.46 | 80.27 | 80.16 | 96.66 |
| 20000. | 79.83 | 82.38 | 81.51 | 79.82 | 79.81 | 79.45 | 79.16 | 95.82 |
| 25000. | 77.54 | 80.96 | 80.12 | 78.38 | 78.34 | 78.18 | 77.91 | 94.39 |
| 31500. | 75.13 | 79.02 | 78.73 | 76.70 | 76.86 | 76.34 | 76.14 | 92.63 |
| 40000. | 71.95 | 76.90 | 76.83 | 75.08 | 75.70 | 74.87 | 74.76 | 90.86 |

TOTAL POWER, DB = 118.47

NOZZLE DIA = 2.6"
 DIFFUSOR DIA = 4.0"
 FLOW TEMPERATURE, TOTAL = 530.0 DEG R
 MICROPHONE RADIUS = 6 FT.

NOZZLE-DIFFUSOR SPACING RATIO = 1.50
 MACH NU. = 1.10

MICROPHONE ANGLE, DEG

| FREQUENCY, HZ | MICROPHONE ANGLE, DEG | | | | | | | TOTAL POWER, DB (1/3 OCTAVE BAND) |
|---------------|-----------------------|--------|-------|-------|-------|-------|-------|--------------------------------------|
| | 30. | 45. | 60. | 75. | 90. | 105. | 120. | |
| 200. | 73.40 | 74.08 | 72.91 | 72.89 | 71.77 | 71.30 | 71.52 | 87.94 |
| 250. | 74.99 | 75.01 | 72.90 | 72.80 | 73.29 | 72.03 | 71.60 | 88.60 |
| 315. | 76.28 | 75.30 | 75.64 | 74.29 | 74.67 | 73.89 | 72.90 | 89.93 |
| 400. | 76.73 | 75.40 | 75.95 | 75.47 | 75.17 | 73.85 | 73.17 | 90.34 |
| 500. | 76.74 | 76.13 | 76.26 | 75.70 | 75.22 | 75.08 | 75.94 | 90.95 |
| 630. | 76.21 | 77.95 | 77.27 | 77.00 | 76.92 | 76.12 | 77.68 | 92.39 |
| 800. | 80.70 | 79.71 | 79.44 | 79.13 | 78.18 | 77.67 | 77.44 | 94.21 |
| 1000. | 84.02 | 82.54 | 82.04 | 81.52 | 79.63 | 78.77 | 78.67 | 96.47 |
| 1250. | 87.79 | 86.33 | 85.98 | 84.10 | 81.98 | 81.09 | 80.54 | 99.70 |
| 1600. | 92.01 | 91.15 | 89.92 | 87.83 | 86.17 | 84.74 | 84.70 | 103.94 |
| 2000. | 95.98 | 95.00 | 92.91 | 90.85 | 89.53 | 88.00 | 88.17 | 107.46 |
| 2500. | 98.78 | 97.90 | 95.32 | 93.11 | 91.75 | 90.76 | 90.29 | 110.12 |
| 3150. | 100.45 | 100.49 | 97.48 | 95.06 | 93.77 | 92.44 | 92.28 | 112.34 |
| 4000. | 101.09 | 101.73 | 97.98 | 96.11 | 95.29 | 93.54 | 93.64 | 113.41 |
| 5000. | 98.42 | 99.86 | 96.51 | 94.48 | 93.74 | 92.80 | 93.34 | 111.69 |
| 6300. | 93.64 | 96.00 | 93.07 | 91.33 | 90.28 | 90.79 | 90.74 | 108.18 |
| 8000. | 90.59 | 93.24 | 90.26 | 87.92 | 87.27 | 88.46 | 88.09 | 105.35 |
| 10000. | 88.55 | 91.05 | 88.02 | 85.98 | 85.98 | 86.31 | 86.00 | 103.27 |
| 12500. | 87.92 | 89.74 | 86.87 | 85.18 | 84.62 | 84.36 | 83.85 | 101.98 |
| 16000. | 87.80 | 89.07 | 86.67 | 85.02 | 84.22 | 83.43 | 82.85 | 101.46 |
| 20000. | 86.21 | 88.09 | 86.16 | 84.74 | 83.57 | 82.37 | 81.72 | 100.63 |
| 25000. | 83.86 | 87.37 | 85.00 | 83.43 | 82.47 | 81.25 | 80.34 | 99.57 |
| 31500. | 82.01 | 85.94 | 82.96 | 82.00 | 80.92 | 79.68 | 78.38 | 98.01 |
| 40000. | 79.47 | 84.12 | 81.30 | 80.50 | 79.63 | 77.99 | 76.68 | 96.29 |

TOTAL POWER, DB = 119.67

69

NOZZLE DIA = 2.8"
 DIFFUSOR DIA = 4.0"
 FLOW TEMPERATURE, TOTAL = 1210.0 DEG R
 MICROPHONE RADIUS = 6 FT.

NOZZLE-DIFFUSOR SPACING RATIO = 0.00
 MACH NU. = 0.70

AEDC-TR-80-15

MICROPHONE ANGLE, DEG

| FREQUENCY, HZ | MICROPHONE ANGLE, DEG | | | | | | | TOTAL POWER, DB (1/3 OCTAVE BAND) |
|---------------|-----------------------|-------|-------|-------|-------|-------|-------|--------------------------------------|
| | 30. | 45. | 60. | 75. | 90. | 105. | 120. | |
| 200. | 68.94 | 70.58 | 71.57 | 71.24 | 71.63 | 71.56 | 69.89 | 66.28 |
| 250. | 69.30 | 70.40 | 71.53 | 71.12 | 71.00 | 71.94 | 70.37 | 66.27 |
| 315. | 72.45 | 71.88 | 72.38 | 72.79 | 73.16 | 73.10 | 71.74 | 67.79 |
| 400. | 73.13 | 74.11 | 73.17 | 73.18 | 75.14 | 74.69 | 73.11 | 69.16 |
| 500. | 72.42 | 74.70 | 75.10 | 75.10 | 76.04 | 76.55 | 75.37 | 70.59 |
| 630. | 74.05 | 74.34 | 76.40 | 77.97 | 77.06 | 77.70 | 76.80 | 71.97 |
| 800. | 74.48 | 74.10 | 75.54 | 77.13 | 77.25 | 76.19 | 76.97 | 71.45 |
| 1000. | 73.51 | 72.09 | 74.54 | 74.12 | 75.35 | 73.86 | 75.10 | 69.12 |
| 1250. | 72.36 | 71.47 | 72.53 | 71.97 | 72.76 | 73.30 | 73.94 | 67.69 |
| 1600. | 71.71 | 71.61 | 71.41 | 70.53 | 71.50 | 73.00 | 73.66 | 67.06 |
| 2000. | 72.45 | 72.64 | 72.33 | 70.33 | 71.63 | 73.07 | 75.60 | 67.03 |
| 2500. | 74.52 | 74.31 | 73.50 | 71.76 | 72.33 | 73.47 | 76.91 | 68.60 |
| 3150. | 74.38 | 74.57 | 73.93 | 70.94 | 71.39 | 73.10 | 76.63 | 68.58 |
| 4000. | 73.92 | 75.54 | 74.31 | 70.51 | 70.95 | 72.10 | 75.14 | 68.54 |
| 5000. | 72.70 | 76.70 | 74.47 | 70.08 | 70.71 | 72.24 | 75.43 | 68.95 |
| 6300. | 70.60 | 76.46 | 73.60 | 68.31 | 69.88 | 71.68 | 75.41 | 68.38 |
| 8000. | 69.63 | 75.53 | 73.43 | 67.57 | 69.45 | 71.57 | 75.57 | 67.62 |
| 10000. | 68.80 | 72.18 | 72.89 | 67.07 | 69.20 | 72.03 | 75.61 | 68.61 |
| 12500. | 67.01 | 69.47 | 73.42 | 66.51 | 69.14 | 72.29 | 74.89 | 68.01 |
| 16000. | 65.16 | 68.22 | 73.36 | 66.39 | 69.08 | 73.19 | 74.74 | 68.00 |
| 20000. | 62.74 | 66.84 | 71.44 | 66.03 | 69.09 | 73.58 | 74.58 | 65.67 |
| 25000. | 60.88 | 65.91 | 70.51 | 65.12 | 69.54 | 73.91 | 73.86 | 65.53 |
| 31500. | 59.60 | 65.99 | 69.43 | 65.35 | 69.61 | 73.99 | 74.22 | 65.49 |
| 40000. | 58.38 | 65.81 | 68.87 | 64.29 | 69.49 | 73.11 | 73.61 | 64.68 |

TOTAL POWER, DB = 101.99

NOZZLE DIA = 2.8"
 DIFFUSOR DIA = 4.0"
 FLOW TEMPERATURE, TOTAL = 1210.0 DEG R
 MICROPHONE RADIUS = 6 FT.

NOZZLE-DIFFUSOR SPACING RATIO = 0.00
 MACH NO. = 0.90

MICROPHONE ANGLE, DEG

| FREQUENCY, HZ | SOUND POWER INTENSITY LEVEL, DB | | | | | | | TOTAL POWER, DB (1/3 OCTAVE BAND) |
|---------------|---------------------------------|-------|-------|-------|-------|-------|-------|--------------------------------------|
| | 30. | 45. | 60. | 75. | 90. | 105. | 120. | |
| 200. | 70.70 | 70.63 | 71.75 | 69.73 | 69.36 | 70.81 | 68.01 | 85.59 |
| 250. | 70.65 | 70.22 | 71.01 | 70.01 | 69.23 | 69.92 | 67.26 | 85.21 |
| 315. | 72.53 | 71.13 | 71.86 | 71.88 | 70.24 | 70.17 | 68.54 | 86.29 |
| 400. | 73.33 | 72.18 | 72.52 | 72.10 | 71.07 | 71.25 | 70.20 | 87.07 |
| 500. | 71.58 | 70.31 | 70.84 | 70.92 | 69.99 | 71.75 | 70.46 | 86.10 |
| 630. | 71.23 | 69.52 | 70.86 | 71.08 | 69.99 | 72.44 | 71.42 | 86.23 |
| 800. | 71.58 | 70.88 | 71.39 | 71.80 | 72.72 | 72.36 | 73.21 | 87.09 |
| 1000. | 72.18 | 70.66 | 71.67 | 71.90 | 72.91 | 71.93 | 73.41 | 87.07 |
| 1250. | 71.58 | 69.93 | 70.50 | 71.10 | 71.13 | 71.67 | 71.84 | 86.21 |
| 1600. | 70.47 | 70.73 | 69.83 | 70.75 | 70.50 | 74.08 | 71.41 | 86.85 |
| 2000. | 72.53 | 72.40 | 72.70 | 71.92 | 72.47 | 75.03 | 74.52 | 88.41 |
| 2500. | 73.52 | 73.19 | 72.79 | 73.02 | 73.35 | 75.28 | 76.37 | 89.12 |
| 3150. | 72.47 | 73.29 | 72.18 | 72.67 | 72.78 | 75.28 | 76.57 | 88.95 |
| 4000. | 71.04 | 72.94 | 72.40 | 71.88 | 72.08 | 75.40 | 77.15 | 88.77 |
| 5000. | 70.44 | 73.10 | 72.61 | 71.97 | 72.34 | 75.78 | 76.60 | 88.90 |
| 6300. | 70.47 | 73.45 | 73.08 | 72.44 | 72.65 | 75.27 | 76.92 | 88.98 |
| 8000. | 69.81 | 72.91 | 72.66 | 71.59 | 72.34 | 74.44 | 76.56 | 88.35 |
| 10000. | 66.60 | 70.41 | 70.47 | 70.03 | 71.71 | 74.06 | 75.56 | 87.08 |
| 12500. | 63.64 | 67.84 | 69.17 | 69.17 | 70.69 | 73.61 | 74.50 | 86.05 |
| 16000. | 62.07 | 65.91 | 66.12 | 66.56 | 69.87 | 72.53 | 73.50 | 85.00 |
| 20000. | 61.18 | 64.87 | 67.19 | 67.32 | 69.49 | 72.08 | 72.88 | 84.32 |
| 25000. | 59.94 | 64.33 | 67.41 | 66.34 | 69.68 | 72.27 | 72.96 | 84.27 |
| 31500. | 58.57 | 62.21 | 67.69 | 65.61 | 69.55 | 72.07 | 72.66 | 83.92 |
| 40000. | 57.72 | 62.82 | 66.32 | 65.51 | 69.55 | 72.74 | 72.10 | 84.11 |

TOTAL POWER, DB = 100.77

NOZZLE DIA = 2.8"
 DIFFUSOR DIA = 4.0"
 FLOW TEMPERATURE, TOTAL = 1210.0 DEG K
 MICROPHONE RADIUS = 6 FT.

NOZZLE-DIFFUSOR SPACING RATIO = 0.00
 MACH NO. = 1.10

72

| FREQUENCY, HZ | MICROPHONE ANGLE, DEG | | | | | | | TOTAL POWER, DB (1/3 OCTAVE BAND) |
|-------------------|-----------------------|-------|-------|-------|-------|-------|-------|--------------------------------------|
| | 30. | 45. | 60. | 75. | 90. | 105. | 120. | |
| 200. | 70.43 | 71.07 | 70.22 | 70.03 | 69.84 | 70.11 | 71.49 | 85.60 |
| 250. | 71.54 | 72.89 | 70.67 | 70.33 | 68.97 | 71.35 | 71.05 | 86.47 |
| 315. | 73.91 | 73.82 | 73.41 | 72.54 | 71.60 | 71.44 | 69.71 | 87.63 |
| 400. | 75.72 | 73.67 | 74.30 | 73.41 | 73.33 | 71.59 | 69.27 | 88.45 |
| 500. | 72.20 | 70.98 | 71.64 | 70.40 | 70.31 | 70.16 | 68.76 | 85.86 |
| 630. | 69.88 | 68.30 | 68.77 | 69.30 | 67.99 | 68.86 | 68.44 | 83.99 |
| 800. | 69.47 | 68.84 | 68.02 | 69.03 | 68.20 | 67.60 | 68.76 | 83.74 |
| 1000. | 69.24 | 69.01 | 68.34 | 67.61 | 67.08 | 65.99 | 67.36 | 82.99 |
| 1250. | 72.38 | 70.64 | 70.00 | 68.10 | 67.48 | 67.10 | 66.79 | 84.28 |
| 1600. | 72.59 | 70.93 | 70.38 | 70.05 | 69.22 | 69.10 | 68.19 | 85.33 |
| 2000. | 73.32 | 72.12 | 72.23 | 72.01 | 69.94 | 69.38 | 69.65 | 86.57 |
| 2500. | 74.80 | 72.67 | 72.16 | 72.15 | 69.26 | 69.47 | 70.92 | 87.06 |
| 3150. | 73.69 | 72.20 | 70.89 | 71.20 | 69.16 | 71.15 | 71.88 | 86.63 |
| 4000. | 72.33 | 71.54 | 69.94 | 69.59 | 69.30 | 70.23 | 71.94 | 85.75 |
| 5000. | 72.48 | 72.09 | 70.52 | 69.45 | 68.82 | 69.56 | 71.62 | 85.78 |
| 6300. | 73.33 | 73.65 | 71.86 | 69.62 | 68.71 | 69.78 | 71.56 | 86.67 |
| 8000. | 73.30 | 74.02 | 72.56 | 69.86 | 69.25 | 70.38 | 71.68 | 86.99 |
| 10000. | 70.22 | 70.00 | 70.09 | 66.25 | 68.89 | 70.34 | 71.49 | 84.95 |
| 12500. | 68.03 | 67.88 | 67.99 | 67.02 | 68.40 | 70.37 | 70.54 | 83.85 |
| 16000. | 67.55 | 67.54 | 67.99 | 66.08 | 68.36 | 70.78 | 71.24 | 83.92 |
| 20000. | 64.80 | 65.99 | 67.87 | 65.39 | 68.19 | 70.94 | 72.13 | 83.57 |
| 25000. | 61.84 | 64.64 | 66.41 | 64.48 | 67.77 | 71.03 | 72.13 | 83.13 |
| 31500. | 58.83 | 63.79 | 64.13 | 63.25 | 67.29 | 70.36 | 71.68 | 82.31 |
| 40000. | 56.45 | 62.95 | 63.56 | 62.09 | 67.25 | 69.02 | 70.22 | 81.51 |
| TOTAL POWER, DB = | | | | | | | | 99.28 |

NOZZLE DIA = 2.8"
 DIFFUSOR DIA = 4.0"
 FLOW TEMPERATURE, TOTAL = 1210.0 DEG F
 MICROPHONE RADIUS = 6 FT.

NOZZLE-DIFFUSOR SPACING RATIO = 0.25
 MACH NU. = 0.70

| FREQUENCY, HZ | MICROPHONE ANGLE, DEG | | | | | | | TOTAL POWER, DB (1/3 OCTAVE BAND) |
|---------------|-----------------------|-------|-------|-------|-------|-------|-------|--------------------------------------|
| | 30. | 45. | 60. | 75. | 90. | 105. | 120. | |
| 200. | 70.20 | 69.66 | 70.98 | 70.38 | 69.57 | 69.91 | 69.32 | 85.24 |
| 250. | 70.71 | 71.23 | 70.76 | 70.45 | 69.93 | 70.37 | 69.30 | 85.75 |
| 315. | 72.08 | 73.82 | 71.50 | 72.12 | 71.50 | 71.77 | 69.98 | 87.51 |
| 400. | 73.19 | 74.51 | 73.37 | 71.67 | 71.43 | 73.24 | 72.12 | 88.28 |
| 500. | 73.89 | 74.17 | 74.23 | 73.35 | 72.68 | 74.64 | 74.96 | 89.25 |
| 630. | 75.01 | 74.16 | 74.64 | 75.59 | 74.69 | 75.08 | 76.15 | 90.36 |
| 800. | 75.36 | 74.40 | 73.85 | 75.21 | 74.87 | 74.99 | 76.07 | 90.07 |
| 1000. | 75.23 | 73.30 | 73.69 | 74.33 | 74.34 | 74.44 | 75.99 | 89.44 |
| 1250. | 75.05 | 72.90 | 73.91 | 73.77 | 73.25 | 75.08 | 75.53 | 89.27 |
| 1600. | 75.37 | 73.90 | 73.18 | 73.33 | 73.81 | 75.16 | 75.52 | 89.40 |
| 2000. | 76.64 | 76.68 | 75.19 | 75.06 | 75.19 | 76.31 | 76.30 | 91.28 |
| 2500. | 78.29 | 77.56 | 76.62 | 75.96 | 76.50 | 78.04 | 80.18 | 92.61 |
| 3150. | 78.10 | 77.10 | 76.84 | 76.10 | 76.61 | 77.92 | 80.16 | 92.51 |
| 4000. | 77.28 | 77.97 | 76.44 | 76.49 | 76.72 | 77.87 | 80.78 | 92.80 |
| 5000. | 76.33 | 78.40 | 77.61 | 76.69 | 77.34 | 76.77 | 81.28 | 93.30 |
| 6300. | 75.01 | 78.57 | 77.32 | 76.70 | 77.26 | 79.23 | 81.13 | 93.37 |
| 8000. | 73.99 | 77.99 | 76.71 | 76.27 | 76.93 | 79.56 | 81.18 | 93.17 |
| 10000. | 72.35 | 74.96 | 74.20 | 74.81 | 76.28 | 79.06 | 80.28 | 91.83 |
| 12500. | 69.81 | 72.30 | 72.70 | 73.61 | 75.37 | 77.81 | 78.86 | 90.36 |
| 16000. | 68.36 | 70.38 | 71.20 | 72.22 | 74.03 | 76.43 | 76.94 | 88.86 |
| 20000. | 67.15 | 69.09 | 70.22 | 71.27 | 72.81 | 75.23 | 75.34 | 87.66 |
| 25000. | 65.70 | 67.67 | 69.93 | 70.45 | 71.58 | 74.17 | 74.12 | 86.64 |
| 31500. | 63.35 | 67.28 | 69.45 | 69.00 | 70.49 | 72.15 | 72.01 | 85.11 |
| 40000. | 61.58 | 65.74 | 67.83 | 67.86 | 69.52 | 70.52 | 70.60 | 83.69 |

TOTAL POWER, DB = 104.10

NOZZLE DIA = 2.8"
 DIFFUSOR DIA = 4.0"
 FLOW TEMPERATURE, TOTAL = 1210.0 DEG R
 MICROPHONE RADIUS = 6 FT.

NOZZLE-DIFFUSOR SPACING RATIO = 0.25
 MACH NO. = 0.90

MICROPHONE ANGLE, DEG

| FREQUENCY, HZ | 30. | 45. | 60. | 75. | 90. | 105. | 120. | TOTAL POWER, DB (1/3 OCTAVE BAND) |
|---------------|---------------------------------|-------|-------|-------|-------|-------|-------|--------------------------------------|
| | SOUND POWER INTENSITY LEVEL, DB | | | | | | | |
| 200. | 70.36 | 69.31 | 71.27 | 69.70 | 70.70 | 70.70 | 68.72 | 85.35 |
| 250. | 71.55 | 68.08 | 70.11 | 68.77 | 69.37 | 70.47 | 68.19 | 84.65 |
| 315. | 74.08 | 71.30 | 72.51 | 70.84 | 70.51 | 70.50 | 69.31 | 86.44 |
| 400. | 73.67 | 73.31 | 72.17 | 71.76 | 71.03 | 70.65 | 70.12 | 87.19 |
| 500. | 71.63 | 72.20 | 71.58 | 71.02 | 70.71 | 70.62 | 70.98 | 86.48 |
| 630. | 72.12 | 70.97 | 71.43 | 72.00 | 70.65 | 71.78 | 71.91 | 86.73 |
| 800. | 72.49 | 72.91 | 72.68 | 73.24 | 73.26 | 72.31 | 73.92 | 88.11 |
| 1000. | 73.05 | 72.38 | 73.68 | 72.69 | 73.20 | 72.91 | 74.85 | 88.25 |
| 1250. | 72.40 | 71.46 | 72.26 | 71.58 | 71.30 | 73.00 | 73.69 | 87.33 |
| 1600. | 72.13 | 71.82 | 71.04 | 70.66 | 70.86 | 72.33 | 72.27 | 86.76 |
| 2000. | 74.52 | 74.60 | 72.99 | 73.29 | 74.10 | 74.70 | 75.93 | 89.44 |
| 2500. | 74.83 | 74.50 | 74.11 | 75.23 | 74.99 | 75.74 | 77.55 | 90.40 |
| 3150. | 73.16 | 73.84 | 73.27 | 74.94 | 74.80 | 75.64 | 77.85 | 90.06 |
| 4000. | 71.30 | 73.75 | 72.80 | 73.70 | 74.29 | 75.73 | 77.70 | 89.65 |
| 5000. | 71.48 | 74.11 | 73.29 | 73.34 | 73.86 | 76.01 | 77.04 | 89.67 |
| 6300. | 71.84 | 75.04 | 74.04 | 73.43 | 75.00 | 76.47 | 76.96 | 90.21 |
| 8000. | 72.05 | 74.82 | 74.02 | 73.85 | 75.32 | 77.13 | 77.06 | 90.51 |
| 10000. | 71.49 | 73.21 | 72.85 | 73.49 | 74.63 | 76.59 | 76.02 | 89.68 |
| 12500. | 70.40 | 72.23 | 72.52 | 72.82 | 73.93 | 75.79 | 75.68 | 88.95 |
| 16000. | 69.74 | 71.63 | 72.56 | 72.59 | 73.17 | 75.05 | 75.09 | 88.41 |
| 20000. | 68.58 | 70.71 | 72.03 | 72.18 | 72.99 | 74.51 | 74.24 | 87.84 |
| 25000. | 67.36 | 70.50 | 71.32 | 71.57 | 72.23 | 73.96 | 73.40 | 87.26 |
| 31500. | 65.69 | 70.15 | 71.68 | 70.77 | 71.15 | 73.48 | 73.06 | 86.75 |
| 40000. | 63.64 | 68.66 | 71.60 | 70.64 | 70.71 | 72.37 | 72.65 | 86.03 |

TOTAL POWER, DB = 102.12

NOZZLE DIA = 2.8"
 DIFFUSOR DIA = 4.0"
 FLOW TEMPERATURE, TOTAL = 1210.0 DEG R
 MICROPHONE RADIUS = 6 FT.

NOZZLE-DIFFUSOR SPACING RATIO = 0.25
 MACH NO. = 1.10

| FREQUENCY, HZ | MICROPHONE ANGLE, DEG | | | | | | | TOTAL POWER, DB (1/3 OCTAVE BAND) |
|---------------|-----------------------|-------|-------|-------|-------|-------|-------|--------------------------------------|
| | 30. | 45. | 60. | 75. | 90. | 105. | 120. | |
| 200. | 72.28 | 71.87 | 72.00 | 70.51 | 70.15 | 70.24 | 70.34 | 86.23 |
| 250. | 72.86 | 71.22 | 72.27 | 70.44 | 68.89 | 70.07 | 69.52 | 85.97 |
| 315. | 74.50 | 73.75 | 73.69 | 72.97 | 70.95 | 71.31 | 68.82 | 87.89 |
| 400. | 75.10 | 74.56 | 74.10 | 73.53 | 72.81 | 71.78 | 70.74 | 88.64 |
| 500. | 71.63 | 71.62 | 71.45 | 72.32 | 71.16 | 70.61 | 70.68 | 86.66 |
| 630. | 70.39 | 69.77 | 69.82 | 70.54 | 69.35 | 70.32 | 70.94 | 85.33 |
| 800. | 69.78 | 69.12 | 69.34 | 70.16 | 69.62 | 68.95 | 71.33 | 84.79 |
| 1000. | 69.30 | 69.68 | 69.93 | 68.89 | 69.19 | 67.84 | 68.79 | 84.24 |
| 1250. | 71.43 | 71.76 | 72.11 | 70.97 | 70.49 | 68.88 | 67.33 | 85.96 |
| 1600. | 73.74 | 72.64 | 72.90 | 72.99 | 71.15 | 71.19 | 69.95 | 87.47 |
| 2000. | 74.22 | 72.50 | 73.49 | 73.37 | 70.72 | 71.41 | 71.29 | 87.71 |
| 2500. | 74.88 | 73.25 | 73.26 | 73.55 | 70.10 | 70.87 | 72.32 | 87.88 |
| 3150. | 72.94 | 73.30 | 72.58 | 72.15 | 70.24 | 71.02 | 74.30 | 87.49 |
| 4000. | 71.32 | 71.64 | 71.59 | 70.24 | 69.76 | 69.91 | 72.08 | 86.00 |
| 5000. | 71.03 | 72.51 | 71.10 | 69.92 | 69.27 | 68.93 | 69.92 | 85.79 |
| 6300. | 72.39 | 74.15 | 72.52 | 70.86 | 69.60 | 69.14 | 69.73 | 86.89 |
| 8000. | 73.69 | 74.52 | 73.69 | 72.06 | 70.96 | 70.51 | 70.44 | 87.80 |
| 10000. | 72.51 | 72.54 | 72.95 | 71.68 | 71.36 | 70.98 | 71.08 | 87.08 |
| 12500. | 72.03 | 71.57 | 72.97 | 71.60 | 71.57 | 71.45 | 72.11 | 86.97 |
| 16000. | 72.38 | 72.20 | 73.66 | 72.17 | 72.29 | 71.79 | 73.77 | 87.64 |
| 20000. | 71.01 | 71.80 | 73.59 | 72.10 | 71.48 | 72.59 | 74.16 | 87.56 |
| 25000. | 69.51 | 71.03 | 72.97 | 71.91 | 71.18 | 73.12 | 74.04 | 87.33 |
| 31500. | 67.64 | 70.44 | 72.93 | 71.65 | 71.52 | 72.83 | 73.66 | 87.05 |
| 40000. | 65.76 | 69.80 | 72.32 | 71.20 | 71.03 | 72.35 | 73.35 | 86.53 |

TOTAL POWER, DB = 100.71

75

NOZZLE DIA = 2.8"
 DIFFUSOR DIA = 4.0"
 FLOW TEMPERATURE, TOTAL = 1210.0 DEG R
 MICROPHONE RADIUS = 6 FT.

NOZZLE-DIFFUSOR SPACING RATIO = 0.50
 MACH NO. = 1.10

AEDC-TR-80-15

76

| FREQUENCY, HZ | MICROPHONE ANGLE, DEG | | | | | | | TOTAL POWER, DB (1/3 OCTAVE BAND) |
|---------------|-----------------------|-------|-------|-------|-------|-------|-------|--------------------------------------|
| | 30. | 45. | 60. | 75. | 90. | 105. | 120. | |
| 200. | 72.57 | 71.97 | 71.75 | 71.47 | 72.96 | 71.24 | 72.07 | 87.04 |
| 250. | 73.70 | 72.30 | 71.86 | 70.31 | 70.49 | 70.81 | 71.39 | 86.60 |
| 315. | 76.30 | 75.37 | 73.75 | 72.03 | 71.58 | 71.79 | 71.59 | 88.60 |
| 400. | 76.74 | 76.08 | 74.24 | 73.23 | 73.12 | 72.06 | 70.90 | 89.30 |
| 500. | 74.24 | 72.58 | 72.63 | 71.49 | 70.90 | 71.57 | 70.60 | 87.19 |
| 630. | 71.74 | 71.00 | 70.32 | 70.72 | 69.76 | 70.76 | 71.69 | 85.97 |
| 800. | 70.77 | 70.95 | 70.68 | 70.58 | 70.53 | 69.95 | 71.58 | 85.80 |
| 1000. | 70.89 | 70.13 | 70.41 | 69.87 | 69.08 | 67.93 | 69.36 | 84.78 |
| 1250. | 74.06 | 71.22 | 71.98 | 70.75 | 69.08 | 68.33 | 69.00 | 85.63 |
| 1600. | 74.66 | 73.27 | 73.55 | 72.66 | 69.79 | 70.90 | 72.25 | 87.66 |
| 2000. | 75.31 | 74.93 | 74.11 | 73.55 | 71.97 | 72.00 | 73.72 | 88.86 |
| 2500. | 75.81 | 75.26 | 74.02 | 74.17 | 72.49 | 72.47 | 73.48 | 89.22 |
| 3150. | 75.92 | 75.72 | 74.58 | 73.97 | 72.43 | 72.81 | 73.81 | 89.46 |
| 4000. | 76.51 | 77.19 | 75.70 | 75.11 | 73.14 | 73.34 | 73.95 | 90.50 |
| 5000. | 78.76 | 80.70 | 78.74 | 77.78 | 74.30 | 75.65 | 74.60 | 93.30 |
| 6300. | 81.17 | 83.20 | 81.33 | 80.01 | 76.73 | 77.91 | 76.52 | 95.70 |
| 8000. | 84.66 | 85.25 | 83.09 | 80.96 | 78.40 | 80.35 | 79.64 | 97.69 |
| 10000. | 85.60 | 85.13 | 83.26 | 80.37 | 80.07 | 81.71 | 80.80 | 96.00 |
| 12500. | 84.76 | 83.55 | 82.92 | 76.96 | 79.95 | 80.77 | 79.61 | 96.91 |
| 16000. | 83.22 | 82.41 | 81.95 | 78.12 | 79.39 | 78.75 | 78.73 | 95.70 |
| 20000. | 80.85 | 81.78 | 80.79 | 78.17 | 78.50 | 78.19 | 78.81 | 94.96 |
| 25000. | 78.99 | 81.34 | 80.70 | 78.16 | 78.00 | 77.77 | 77.93 | 94.53 |
| 31500. | 78.02 | 80.65 | 80.94 | 78.22 | 77.95 | 77.02 | 77.37 | 94.17 |
| 40000. | 76.80 | 80.22 | 80.73 | 78.66 | 77.51 | 76.47 | 76.81 | 93.90 |

TOTAL POWER, DB = 106.67

NOZZLE DIA = 2.8"
 DIFFUSOR DIA = 4.0"
 FLOW TEMPERATURE, TOTAL = 1210.0 DEG R
 MICROPHONE RADIUS = 6 FT.

NOZZLE-DIFFUSOR SPACING RATIO = 0.50
 MACH NO. = 0.90

MICROPHONE ANGLE, DEG

| FREQUENCY, HZ | MICROPHONE ANGLE, DEG | | | | | | | TOTAL POWER, DB (1/3 OCTAVE BAND) |
|---------------|-----------------------|-------|-------|-------|-------|-------|-------|--------------------------------------|
| | 30. | 45. | 60. | 75. | 90. | 105. | 120. | |
| 200. | 69.08 | 70.84 | 70.38 | 70.60 | 68.73 | 70.55 | 69.38 | 65.50 |
| 250. | 71.11 | 70.22 | 70.89 | 69.34 | 68.65 | 71.02 | 69.28 | 65.37 |
| 315. | 72.52 | 71.05 | 72.04 | 70.87 | 71.43 | 71.24 | 70.77 | 66.48 |
| 400. | 73.03 | 73.09 | 73.25 | 72.47 | 72.11 | 72.79 | 71.25 | 67.90 |
| 500. | 72.27 | 72.33 | 71.85 | 72.10 | 71.39 | 72.69 | 71.21 | 67.35 |
| 630. | 72.59 | 72.40 | 71.66 | 72.74 | 72.07 | 72.97 | 73.02 | 67.74 |
| 800. | 73.67 | 73.36 | 73.50 | 73.70 | 74.02 | 73.57 | 75.21 | 68.90 |
| 1000. | 74.95 | 74.19 | 74.01 | 73.52 | 74.32 | 74.17 | 76.45 | 69.44 |
| 1250. | 74.44 | 73.75 | 72.87 | 72.83 | 73.15 | 75.15 | 75.78 | 69.15 |
| 1600. | 74.67 | 73.25 | 72.74 | 72.46 | 72.69 | 74.60 | 74.47 | 68.64 |
| 2000. | 77.06 | 75.67 | 75.03 | 74.50 | 74.83 | 76.03 | 76.86 | 90.73 |
| 2500. | 77.31 | 76.19 | 76.30 | 75.02 | 75.38 | 77.14 | 78.73 | 91.57 |
| 3150. | 76.62 | 76.77 | 76.62 | 75.66 | 75.36 | 77.29 | 79.14 | 91.88 |
| 4000. | 78.14 | 78.42 | 78.22 | 76.88 | 76.30 | 77.83 | 79.80 | 93.03 |
| 5000. | 80.76 | 81.61 | 81.21 | 79.17 | 77.74 | 78.75 | 80.28 | 95.23 |
| 6300. | 82.15 | 83.46 | 82.61 | 79.94 | 79.50 | 80.62 | 81.45 | 96.77 |
| 8000. | 82.47 | 83.65 | 81.91 | 79.32 | 79.29 | 80.78 | 81.35 | 96.68 |
| 10000. | 80.19 | 80.23 | 79.43 | 77.55 | 78.26 | 80.04 | 79.98 | 94.58 |
| 12500. | 77.08 | 77.38 | 77.56 | 76.16 | 77.22 | 78.59 | 78.35 | 92.69 |
| 16000. | 75.56 | 76.75 | 77.20 | 75.86 | 76.63 | 78.11 | 77.81 | 92.16 |
| 20000. | 75.12 | 77.20 | 77.32 | 75.99 | 76.55 | 77.69 | 77.52 | 92.13 |
| 25000. | 74.93 | 77.27 | 77.64 | 75.81 | 75.96 | 77.33 | 77.23 | 91.99 |
| 31500. | 73.96 | 77.08 | 77.13 | 75.76 | 75.17 | 76.21 | 76.56 | 91.45 |
| 40000. | 72.46 | 76.90 | 76.75 | 75.20 | 74.46 | 74.77 | 75.44 | 90.77 |

TOTAL POWER, DB = 105.71

77

NOZZLE DIA = 2.8"
 DIFFUSOR DIA = 4.0"
 FLOW TEMPERATURE, TOTAL = 1210.0 DEG R
 MICROPHONE RADIUS = 0 FT.

NOZZLE-DIFFUSOR SPACING RATIO = 0.50
 MACH NO. = 0.70

AEDC-TR-80-15

MICROPHONE ANGLE, DEG

| FREQUENCY, HZ | SOUND POWER INTENSITY LEVEL, DB | | | | | | | TOTAL POWER, DB (1/3 OCTAVE BAND) |
|---------------|---------------------------------|-------|-------|-------|-------|-------|-------|--------------------------------------|
| | 30. | 45. | 60. | 75. | 90. | 105. | 120. | |
| 200. | 70.32 | 72.31 | 71.03 | 70.87 | 71.17 | 70.59 | 70.31 | 86.36 |
| 250. | 71.92 | 71.22 | 70.70 | 70.97 | 71.05 | 70.84 | 70.22 | 86.19 |
| 315. | 73.71 | 72.67 | 71.21 | 72.35 | 73.33 | 71.92 | 71.35 | 87.57 |
| 400. | 73.85 | 75.32 | 72.47 | 73.66 | 72.89 | 73.44 | 72.22 | 89.00 |
| 500. | 74.37 | 70.01 | 75.71 | 74.46 | 73.84 | 75.85 | 75.13 | 90.47 |
| 630. | 75.34 | 76.25 | 76.72 | 75.57 | 75.42 | 76.61 | 77.21 | 91.37 |
| 800. | 75.22 | 76.11 | 75.95 | 75.80 | 75.74 | 76.16 | 77.51 | 91.23 |
| 1000. | 75.17 | 75.84 | 75.31 | 75.76 | 75.74 | 77.05 | 77.74 | 91.34 |
| 1250. | 75.63 | 76.08 | 74.92 | 75.31 | 75.23 | 77.43 | 77.66 | 91.34 |
| 1600. | 70.91 | 76.45 | 75.30 | 75.79 | 75.99 | 78.18 | 78.27 | 91.95 |
| 2000. | 78.70 | 79.11 | 77.77 | 77.29 | 77.07 | 78.88 | 80.87 | 93.66 |
| 2500. | 78.84 | 79.80 | 78.27 | 78.03 | 77.33 | 79.26 | 81.74 | 94.24 |
| 3150. | 78.34 | 80.54 | 78.78 | 78.25 | 77.83 | 80.21 | 81.84 | 94.77 |
| 4000. | 80.85 | 82.00 | 80.68 | 79.69 | 78.91 | 81.54 | 82.14 | 96.18 |
| 5000. | 81.54 | 82.87 | 81.69 | 80.36 | 79.93 | 81.85 | 83.20 | 96.89 |
| 6300. | 79.97 | 81.90 | 81.37 | 79.77 | 79.93 | 81.28 | 83.75 | 90.33 |
| 8000. | 70.74 | 79.96 | 79.01 | 78.28 | 79.23 | 80.32 | 83.03 | 94.87 |
| 10000. | 73.52 | 76.00 | 76.90 | 76.48 | 78.22 | 78.86 | 81.03 | 93.12 |
| 12500. | 71.95 | 75.83 | 75.16 | 75.05 | 76.82 | 77.39 | 78.90 | 91.42 |
| 16000. | 71.33 | 74.48 | 74.15 | 74.07 | 75.49 | 76.44 | 77.09 | 90.25 |
| 20000. | 70.39 | 74.15 | 74.02 | 73.54 | 74.15 | 74.72 | 76.56 | 89.37 |
| 25000. | 69.07 | 73.00 | 73.70 | 72.88 | 72.38 | 73.13 | 75.26 | 88.25 |
| 31500. | 67.37 | 71.78 | 72.80 | 72.22 | 71.43 | 71.47 | 73.39 | 87.06 |
| 40000. | 65.67 | 71.20 | 71.58 | 71.43 | 70.66 | 71.94 | 71.39 | 86.46 |

TOTAL POWER, DB = 106.20

NOZZLE DIA = 2.8"
 DIFFUSOR DIA = 4.0"
 FLOW TEMPERATURE, TOTAL = 1210.0 DEG R
 MICROPHONE RADIUS = 6 FT.

NOZZLE-DIFFUSOR SPACING RATIO = 1.00
 MACH NO. = 0.70

| FREQUENCY, HZ | MICROPHONE ANGLE, DEG | | | | | | | TOTAL POWER, DB (1/3 OCTAVE BAND) |
|---------------|-----------------------|--------|--------|--------|--------|--------|--------|--------------------------------------|
| | 30. | 45. | 60. | 75. | 90. | 105. | 120. | |
| 200. | 75.06 | 75.85 | 74.43 | 77.36 | 75.10 | 75.58 | 74.69 | 91.07 |
| 250. | 75.55 | 85.00 | 85.68 | 80.63 | 76.42 | 85.80 | 79.37 | 98.86 |
| 315. | 78.53 | 78.73 | 77.57 | 77.74 | 77.87 | 79.14 | 76.90 | 93.50 |
| 400. | 78.52 | 79.03 | 78.06 | 78.73 | 77.16 | 76.63 | 78.27 | 93.33 |
| 500. | 80.16 | 78.93 | 81.09 | 80.85 | 79.43 | 79.72 | 80.52 | 95.24 |
| 630. | 82.25 | 82.54 | 80.56 | 83.50 | 81.34 | 81.41 | 83.42 | 97.48 |
| 800. | 82.94 | 82.84 | 82.77 | 82.32 | 83.55 | 81.31 | 83.64 | 97.76 |
| 1000. | 85.09 | 85.61 | 83.70 | 86.30 | 84.11 | 84.46 | 85.13 | 100.35 |
| 1250. | 90.18 | 88.64 | 88.52 | 87.22 | 85.94 | 86.98 | 85.85 | 102.91 |
| 1600. | 91.50 | 91.55 | 91.17 | 90.49 | 89.56 | 89.81 | 89.13 | 105.79 |
| 2000. | 92.44 | 94.64 | 92.87 | 93.07 | 90.95 | 89.97 | 88.64 | 107.76 |
| 2500. | 97.78 | 97.87 | 96.48 | 95.08 | 91.36 | 91.41 | 92.11 | 110.57 |
| 3150. | 113.44 | 119.75 | 112.31 | 116.41 | 105.46 | 107.11 | 112.51 | 130.79 |
| 4000. | 108.14 | 120.23 | 108.98 | 116.39 | 106.46 | 107.46 | 112.66 | 130.88 |
| 5000. | 94.62 | 98.11 | 93.48 | 93.07 | 90.31 | 92.40 | 94.29 | 109.89 |
| 6300. | 95.75 | 99.36 | 90.28 | 94.95 | 92.72 | 91.66 | 90.61 | 110.67 |
| 8000. | 90.84 | 98.63 | 92.23 | 93.39 | 91.81 | 91.06 | 91.84 | 109.81 |
| 10000. | 82.23 | 87.71 | 86.91 | 84.64 | 85.29 | 86.63 | 86.82 | 101.48 |
| 12500. | 80.88 | 85.33 | 84.03 | 83.15 | 84.32 | 85.26 | 84.86 | 99.63 |
| 16000. | 80.42 | 84.10 | 82.54 | 82.48 | 82.90 | 84.08 | 82.39 | 98.42 |
| 20000. | 79.58 | 83.56 | 82.27 | 81.68 | 81.86 | 82.84 | 81.07 | 97.59 |
| 25000. | 78.61 | 82.07 | 80.46 | 80.38 | 79.43 | 80.45 | 78.86 | 95.80 |
| 31500. | 77.13 | 80.20 | 79.16 | 78.63 | 78.32 | 78.57 | 77.54 | 94.12 |
| 40000. | 76.55 | 78.71 | 76.78 | 78.66 | 75.30 | 75.55 | 75.39 | 92.54 |

TOTAL POWER, DB = 133.96

79

NOZZLE DIA = 2.6"
 DIFFUSOR DIA = 4.0"
 FLOW TEMPERATURE, TOTAL = 1210.0 DEG R
 MICROPHONE RADIUS = 6 FT.

NOZZLE-DIFFUSOR SPACING RATIO = 1.00
 MACH. NO. = 0.90

AEDC-TR-80-15

MICROPHONE ANGLE, DEG

| FREQUENCY, HZ | 30. | 45. | 60. | 75. | 90. | 105. | 120. | TOTAL POWER, DB (1/3 OCTAVE BAND) |
|---------------|---------------------------------|-------|-------|-------|-------|-------|-------|--------------------------------------|
| | SOUND POWER INTENSITY LEVEL, DB | | | | | | | |
| 200. | 73.53 | 70.76 | 71.18 | 71.11 | 69.77 | 69.84 | 71.44 | 86.05 |
| 250. | 76.71 | 71.34 | 70.57 | 70.14 | 69.72 | 70.77 | 70.56 | 86.96 |
| 315. | 74.92 | 71.99 | 72.36 | 72.41 | 72.47 | 72.00 | 70.77 | 88.15 |
| 400. | 75.35 | 72.19 | 74.28 | 72.97 | 73.13 | 72.54 | 71.73 | 88.21 |
| 500. | 72.81 | 72.14 | 73.09 | 72.13 | 71.87 | 72.75 | 73.02 | 87.64 |
| 630. | 74.30 | 73.42 | 72.73 | 73.51 | 73.17 | 74.25 | 74.62 | 88.67 |
| 800. | 75.97 | 75.34 | 75.03 | 75.15 | 76.17 | 75.29 | 76.68 | 90.67 |
| 1000. | 77.13 | 77.32 | 76.51 | 77.04 | 77.02 | 76.72 | 78.41 | 92.26 |
| 1250. | 79.76 | 79.18 | 78.81 | 78.10 | 78.37 | 76.53 | 79.38 | 93.92 |
| 1600. | 81.75 | 81.17 | 80.29 | 79.30 | 79.21 | 79.00 | 79.39 | 95.18 |
| 2000. | 84.83 | 84.81 | 83.99 | 82.78 | 82.09 | 81.58 | 81.44 | 98.45 |
| 2500. | 86.93 | 89.27 | 87.82 | 86.07 | 85.48 | 84.16 | 84.38 | 102.18 |
| 3150. | 92.77 | 93.17 | 91.58 | 89.81 | 88.29 | 87.56 | 86.69 | 105.86 |
| 4000. | 96.62 | 96.49 | 94.65 | 92.91 | 92.06 | 91.10 | 89.82 | 109.20 |
| 5000. | 97.52 | 96.95 | 95.61 | 93.66 | 93.10 | 92.40 | 92.83 | 110.04 |
| 6300. | 95.18 | 95.49 | 93.53 | 91.42 | 90.77 | 91.66 | 92.72 | 108.39 |
| 8000. | 91.87 | 92.63 | 89.74 | 88.28 | 88.43 | 88.88 | 90.05 | 105.41 |
| 10000. | 88.37 | 88.69 | 86.96 | 85.66 | 85.91 | 86.48 | 87.96 | 102.38 |
| 12500. | 86.79 | 86.60 | 86.28 | 84.75 | 84.98 | 84.46 | 84.79 | 100.69 |
| 16000. | 86.42 | 86.29 | 86.93 | 84.80 | 84.74 | 83.60 | 81.43 | 100.41 |
| 20000. | 85.92 | 86.43 | 87.01 | 84.97 | 84.25 | 82.92 | 81.57 | 100.32 |
| 25000. | 84.46 | 86.12 | 86.89 | 84.39 | 82.87 | 81.80 | 80.69 | 99.71 |
| 31500. | 82.75 | 85.43 | 86.02 | 82.59 | 81.11 | 80.10 | 78.28 | 98.48 |
| 40000. | 81.10 | 84.23 | 84.26 | 80.66 | 79.67 | 78.26 | 77.21 | 96.94 |

TOTAL POWER, DB = 116.38

88

NOZZLE DIA = 2.8"
 DIFFUSOR DIA = 4.0"
 FLOW TEMPERATURE, TOTAL = 1210.0 DEG R
 MICROPHONE RADIUS = 6 FT.

NOZZLE-DIFFUSOR SPACING RATIO = 1.00
 MACH NO. = 1.10

MICROPHONE ANGLE, DEG

| FREQUENCY, HZ | 30. | 45. | 60. | 75. | 90. | 105. | 120. | TOTAL POWER, DB (1/3 OCTAVE BAND) |
|---------------|---------------------------------|-------|-------|-------|-------|-------|-------|--------------------------------------|
| | SOUND POWER INTENSITY LEVEL, DB | | | | | | | |
| 200. | 71.93 | 72.04 | 71.60 | 71.68 | 70.70 | 70.64 | 71.55 | 86.64 |
| 250. | 71.30 | 73.30 | 72.14 | 71.34 | 70.27 | 70.76 | 71.29 | 86.93 |
| 315. | 75.15 | 75.06 | 74.28 | 73.17 | 73.27 | 71.66 | 71.80 | 88.80 |
| 400. | 78.99 | 75.63 | 74.95 | 74.10 | 74.05 | 73.38 | 72.31 | 90.00 |
| 500. | 71.28 | 73.71 | 72.89 | 72.68 | 72.48 | 73.18 | 72.63 | 88.17 |
| 630. | 73.65 | 73.01 | 71.98 | 72.67 | 72.31 | 72.29 | 73.26 | 87.84 |
| 800. | 74.56 | 73.69 | 74.05 | 73.98 | 73.53 | 72.99 | 74.41 | 88.92 |
| 1000. | 74.64 | 74.38 | 74.91 | 74.91 | 74.63 | 73.69 | 73.96 | 89.63 |
| 1250. | 78.42 | 77.35 | 76.98 | 76.42 | 75.66 | 74.90 | 74.66 | 91.60 |
| 1600. | 80.99 | 80.45 | 80.26 | 78.63 | 78.09 | 77.83 | 77.78 | 94.41 |
| 2000. | 84.57 | 83.81 | 83.10 | 82.10 | 81.42 | 79.94 | 79.61 | 97.51 |
| 2500. | 88.99 | 88.24 | 86.63 | 85.83 | 83.72 | 82.48 | 81.21 | 101.22 |
| 3150. | 92.58 | 93.12 | 91.62 | 89.56 | 87.05 | 86.88 | 84.32 | 105.59 |
| 4000. | 95.66 | 96.09 | 94.07 | 92.14 | 90.12 | 89.55 | 86.92 | 108.40 |
| 5000. | 98.42 | 97.92 | 96.34 | 93.84 | 92.49 | 91.53 | 91.31 | 110.46 |
| 6300. | 97.47 | 98.35 | 96.63 | 93.82 | 93.20 | 92.16 | 93.15 | 110.74 |
| 8000. | 96.78 | 97.77 | 94.89 | 92.47 | 91.44 | 91.66 | 92.51 | 109.82 |
| 10000. | 96.03 | 95.16 | 92.26 | 90.48 | 89.16 | 90.32 | 90.42 | 107.69 |
| 12500. | 95.60 | 93.06 | 91.66 | 89.32 | 88.10 | 89.17 | 88.51 | 106.32 |
| 16000. | 95.35 | 92.61 | 91.51 | 88.92 | 87.86 | 87.32 | 87.50 | 105.78 |
| 20000. | 94.35 | 92.66 | 91.54 | 89.03 | 87.62 | 86.43 | 86.67 | 105.54 |
| 25000. | 92.25 | 92.33 | 90.95 | 88.82 | 86.81 | 85.60 | 85.97 | 104.90 |
| 31500. | 90.16 | 91.37 | 90.03 | 87.65 | 85.04 | 83.69 | 85.21 | 103.70 |
| 40000. | 87.55 | 90.41 | 88.86 | 86.62 | 83.47 | 81.21 | 83.49 | 102.43 |

TOTAL POWER, DB = 118.49

NOZZLE DIA = 2.8"
 DIFFUSOR DIA = 4.0"
 FLOW TEMPERATURE, TOTAL = 1210.0 DEG R
 MICROPHONE RADIUS = 6 FT.

NOZZLE-DIFFUSOR SPACING RATIO = 1.50
 MACH NU. = 0.70

AEDC-TR-80-15

MICROPHONE ANGLE, DEG

| FREQUENCY, HZ | MICROPHONE ANGLE, DEG | | | | | | | TOTAL POWER, DB (1/3 OCTAVE BAND) |
|---------------|-----------------------|--------|--------|--------|--------|--------|--------|--------------------------------------|
| | 30. | 45. | 60. | 75. | 90. | 105. | 120. | |
| 200. | 83.54 | 73.91 | 83.53 | 74.89 | 74.57 | 75.58 | 74.28 | 93.15 |
| 250. | 83.49 | 75.75 | 83.53 | 76.41 | 75.89 | 74.84 | 76.18 | 93.57 |
| 315. | 85.10 | 80.07 | 83.57 | 79.13 | 80.58 | 79.55 | 78.20 | 95.99 |
| 400. | 83.58 | 81.14 | 83.62 | 80.58 | 80.12 | 80.52 | 78.83 | 96.43 |
| 500. | 85.44 | 83.11 | 84.44 | 82.73 | 83.28 | 83.96 | 82.70 | 96.74 |
| 630. | 91.45 | 90.35 | 89.09 | 87.55 | 89.06 | 86.17 | 88.61 | 104.28 |
| 800. | 92.80 | 90.41 | 90.66 | 90.15 | 90.88 | 89.19 | 90.19 | 105.55 |
| 1000. | 96.07 | 94.28 | 94.03 | 93.83 | 91.44 | 91.18 | 90.75 | 108.51 |
| 1250. | 105.07 | 101.33 | 102.25 | 99.80 | 100.84 | 98.12 | 97.36 | 115.94 |
| 1600. | 104.57 | 102.66 | 102.23 | 100.04 | 97.77 | 97.30 | 97.54 | 115.97 |
| 2000. | 106.88 | 105.58 | 105.02 | 103.52 | 101.76 | 98.39 | 99.76 | 118.80 |
| 2500. | 125.97 | 121.08 | 123.45 | 119.05 | 117.97 | 115.94 | 111.01 | 135.57 |
| 3150. | 113.73 | 109.32 | 110.81 | 106.68 | 105.80 | 104.65 | 102.54 | 123.48 |
| 4000. | 103.54 | 102.97 | 101.29 | 99.15 | 99.04 | 97.62 | 98.52 | 115.81 |
| 5000. | 112.42 | 114.40 | 107.34 | 108.62 | 101.95 | 104.23 | 108.62 | 125.39 |
| 6300. | 102.23 | 100.04 | 97.95 | 95.36 | 94.56 | 93.44 | 97.93 | 112.61 |
| 8000. | 97.08 | 99.27 | 96.72 | 93.24 | 93.78 | 91.73 | 94.86 | 111.12 |
| 10000. | 92.88 | 92.22 | 91.36 | 89.02 | 89.57 | 89.14 | 90.21 | 105.79 |
| 12500. | 89.89 | 89.61 | 89.43 | 87.73 | 88.08 | 87.25 | 86.55 | 103.73 |
| 16000. | 88.31 | 88.33 | 88.33 | 86.50 | 86.16 | 85.36 | 86.25 | 102.26 |
| 20000. | 86.28 | 85.85 | 87.43 | 85.21 | 84.56 | 83.71 | 84.64 | 100.56 |
| 25000. | 83.87 | 84.26 | 85.82 | 83.35 | 82.69 | 81.57 | 81.58 | 98.69 |
| 31500. | 83.76 | 81.97 | 83.70 | 80.85 | 80.20 | 79.55 | 79.09 | 96.57 |
| 40000. | 84.28 | 78.66 | 83.24 | 78.09 | 77.19 | 76.38 | 76.47 | 94.58 |

TOTAL POWER, DB = 136.46

NOZZLE DIA = 2.8"
 DIFFUSOR DIA = 4.0"
 FLOW TEMPERATURE, TOTAL = 1210.0 DEG R
 MICROPHONE RADIUS = 6 FT.

NOZZLE-DIFFUSOR SPACING RATIO = 1.50
 MACH NO. = 0.90

MICROPHONE ANGLE, DEG

| FREQUENCY, HZ | 30. | 45. | 60. | 75. | 90. | 105. | 120. | TOTAL POWER, DB (1/3 OCTAVE BAND) |
|---------------|---------------------------------|--------|--------|--------|--------|-------|--------|--------------------------------------|
| | SOUND POWER INTENSITY LEVEL, DB | | | | | | | |
| 200. | 71.15 | 72.56 | 72.27 | 72.14 | 72.10 | 71.83 | 71.15 | 87.27 |
| 250. | 72.75 | 73.14 | 72.95 | 72.07 | 72.93 | 71.97 | 71.29 | 87.70 |
| 315. | 74.42 | 73.67 | 75.29 | 73.08 | 73.08 | 72.88 | 73.21 | 88.75 |
| 400. | 74.57 | 74.12 | 75.66 | 73.52 | 73.41 | 74.05 | 72.91 | 89.27 |
| 500. | 74.97 | 74.97 | 75.53 | 74.66 | 74.89 | 76.80 | 73.82 | 90.58 |
| 630. | 77.97 | 77.20 | 78.12 | 76.81 | 77.83 | 77.90 | 77.01 | 92.69 |
| 800. | 81.93 | 80.32 | 81.60 | 79.99 | 80.13 | 79.26 | 79.70 | 95.45 |
| 1000. | 86.15 | 84.15 | 84.32 | 83.67 | 83.83 | 82.58 | 81.69 | 98.95 |
| 1250. | 90.87 | 87.66 | 88.89 | 86.84 | 87.78 | 85.53 | 83.81 | 102.56 |
| 1600. | 94.70 | 92.62 | 92.99 | 90.78 | 90.09 | 87.96 | 87.32 | 106.46 |
| 2000. | 98.92 | 97.60 | 97.30 | 95.35 | 93.09 | 91.17 | 91.09 | 110.82 |
| 2500. | 102.81 | 101.29 | 100.78 | 97.77 | 97.05 | 94.62 | 94.86 | 114.27 |
| 3150. | 105.94 | 105.24 | 104.45 | 100.88 | 100.24 | 97.81 | 98.50 | 117.82 |
| 4000. | 107.62 | 106.34 | 106.98 | 101.70 | 100.95 | 98.98 | 101.06 | 119.25 |
| 5000. | 106.93 | 105.52 | 108.24 | 100.48 | 100.97 | 99.64 | 101.78 | 119.14 |
| 6300. | 101.26 | 101.59 | 103.60 | 98.06 | 97.87 | 96.85 | 98.04 | 115.20 |
| 8000. | 96.53 | 97.29 | 96.04 | 94.49 | 93.82 | 93.06 | 94.05 | 110.46 |
| 10000. | 94.25 | 95.40 | 93.74 | 92.13 | 92.25 | 91.04 | 91.27 | 108.38 |
| 12500. | 94.08 | 94.71 | 93.67 | 91.60 | 92.52 | 89.15 | 89.37 | 107.80 |
| 16000. | 94.22 | 94.76 | 93.85 | 91.67 | 92.09 | 88.60 | 87.73 | 107.70 |
| 20000. | 93.66 | 94.41 | 93.84 | 91.28 | 90.96 | 87.98 | 86.80 | 107.27 |
| 25000. | 91.64 | 93.41 | 93.13 | 90.58 | 89.07 | 86.73 | 85.09 | 106.21 |
| 31500. | 89.56 | 91.71 | 91.79 | 88.73 | 86.29 | 84.14 | 82.50 | 104.37 |
| 40000. | 87.10 | 89.82 | 89.88 | 87.00 | 83.83 | 82.25 | 80.80 | 102.45 |

TOTAL POWER, DB = 125.44

83

NOZZLE DIA = 2.8"
 DIFFUSOR DIA = 4.0"
 FLOW TEMPERATURE, TOTAL = 1210.0 DEG R
 MICROPHONE RADIUS = 6 FT.

NOZZLE-DIFFUSOR SPACING RATIO = 1.50
 MACH NO. = 1.10

AEDC-TR-80-15

| FREQUENCY, HZ | MICROPHONE ANGLE, DEG | | | | | | | TOTAL POWER, DB (1/3 OCTAVE BAND) |
|---------------|-----------------------|--------|--------|--------|-------|-------|--------|--------------------------------------|
| | 30. | 45. | 60. | 75. | 90. | 105. | 120. | |
| 200. | 74.55 | 74.87 | 73.88 | 72.02 | 73.81 | 71.42 | 72.98 | 88.51 |
| 250. | 76.58 | 76.45 | 76.77 | 81.06 | 73.63 | 77.93 | 75.25 | 93.26 |
| 315. | 78.54 | 77.57 | 77.55 | 74.55 | 74.02 | 74.70 | 73.95 | 91.22 |
| 400. | 80.05 | 78.89 | 76.94 | 76.31 | 74.98 | 75.10 | 74.50 | 92.18 |
| 500. | 76.66 | 75.04 | 75.36 | 74.32 | 72.32 | 74.41 | 74.28 | 89.81 |
| 630. | 79.45 | 78.46 | 77.23 | 76.92 | 76.15 | 75.70 | 76.55 | 92.40 |
| 800. | 82.11 | 79.90 | 80.76 | 79.90 | 79.46 | 77.95 | 78.50 | 94.89 |
| 1000. | 85.85 | 84.15 | 83.45 | 85.36 | 81.44 | 81.53 | 81.15 | 98.89 |
| 1250. | 88.77 | 87.50 | 86.53 | 86.11 | 85.02 | 83.14 | 82.53 | 101.19 |
| 1600. | 93.40 | 92.44 | 90.70 | 89.47 | 87.32 | 86.40 | 85.24 | 105.25 |
| 2000. | 98.60 | 98.73 | 96.65 | 95.18 | 93.81 | 91.19 | 91.20 | 111.14 |
| 2500. | 101.90 | 100.24 | 98.01 | 96.12 | 94.40 | 93.38 | 92.96 | 112.76 |
| 3150. | 105.19 | 106.97 | 103.32 | 99.93 | 98.41 | 98.11 | 97.27 | 118.19 |
| 4000. | 106.64 | 107.26 | 102.64 | 101.19 | 99.19 | 99.01 | 98.20 | 118.69 |
| 5000. | 107.26 | 107.05 | 104.12 | 101.23 | 99.70 | 98.71 | 101.48 | 118.90 |
| 6300. | 104.84 | 104.42 | 101.98 | 99.38 | 99.14 | 97.39 | 99.49 | 116.69 |
| 8000. | 104.44 | 103.88 | 99.83 | 98.27 | 96.80 | 97.53 | 99.01 | 115.89 |
| 10000. | 103.73 | 101.06 | 97.17 | 96.09 | 94.77 | 95.13 | 97.14 | 113.62 |
| 12500. | 103.84 | 101.29 | 97.57 | 95.63 | 94.46 | 94.13 | 95.27 | 113.55 |
| 16000. | 103.96 | 101.33 | 97.65 | 95.62 | 93.84 | 92.61 | 93.65 | 113.42 |
| 20000. | 104.39 | 101.50 | 98.56 | 96.11 | 93.27 | 92.06 | 92.67 | 113.68 |
| 25000. | 101.01 | 100.27 | 97.63 | 95.33 | 92.14 | 90.35 | 90.48 | 112.14 |
| 31500. | 99.34 | 98.91 | 96.11 | 93.85 | 90.24 | 86.20 | 87.78 | 110.62 |
| 40000. | 95.00 | 95.76 | 93.65 | 90.84 | 87.39 | 85.10 | 84.06 | 107.46 |

TOTAL POWER, DB = 126.68

NOZZLE DIA = 2.8"
 DIFFUSOR DIA = 6.0"
 FLOW TEMPERATURE, TOTAL = 530.0 DEG R
 MICROPHONE RADIUS = 6 FT.

NOZZLE-DIFFUSOR SPACING RATIO = 0.00
 MACH NU. = 0.70

MICROPHONE ANGLE, DEG

| FREQUENCY, HZ | 30. | 45. | 60. | 75. | 90. | 105. | 120. | TOTAL POWER, DB (1/3 OCTAVE BAND) |
|---------------|---------------------------------|-------|-------|-------|-------|-------|-------|--------------------------------------|
| | SOUND POWER INTENSITY LEVEL, DB | | | | | | | |
| 200. | 70.72 | 69.79 | 71.82 | 71.64 | 71.49 | 70.00 | 69.70 | 85.98 |
| 250. | 68.12 | 68.70 | 69.93 | 70.83 | 71.56 | 70.36 | 69.26 | 85.30 |
| 315. | 70.75 | 69.95 | 70.51 | 71.02 | 71.75 | 71.29 | 69.63 | 86.01 |
| 400. | 71.09 | 70.44 | 70.01 | 70.08 | 71.00 | 71.59 | 69.82 | 85.86 |
| 500. | 69.97 | 69.67 | 70.22 | 69.45 | 69.04 | 70.05 | 69.69 | 84.92 |
| 630. | 70.36 | 69.02 | 69.40 | 70.21 | 69.49 | 70.35 | 70.26 | 85.04 |
| 800. | 69.50 | 68.81 | 68.84 | 69.40 | 70.12 | 70.40 | 71.39 | 84.90 |
| 1000. | 69.83 | 68.92 | 70.13 | 69.34 | 70.69 | 70.12 | 72.46 | 85.14 |
| 1250. | 70.80 | 70.30 | 70.84 | 70.91 | 71.33 | 73.33 | 74.10 | 86.91 |
| 1600. | 70.82 | 71.48 | 70.73 | 70.79 | 71.33 | 74.07 | 74.80 | 87.40 |
| 2000. | 71.29 | 71.40 | 70.29 | 69.16 | 70.39 | 73.04 | 74.73 | 86.70 |
| 2500. | 71.82 | 72.34 | 71.26 | 69.16 | 70.33 | 72.77 | 75.29 | 87.02 |
| 3150. | 71.07 | 72.95 | 71.40 | 69.46 | 70.27 | 72.56 | 75.10 | 87.11 |
| 4000. | 70.90 | 73.69 | 72.05 | 70.43 | 70.90 | 72.92 | 74.97 | 87.64 |
| 5000. | 69.65 | 74.44 | 72.76 | 70.55 | 71.79 | 74.04 | 76.17 | 88.39 |
| 6300. | 68.14 | 73.79 | 72.64 | 70.05 | 71.67 | 74.97 | 76.74 | 88.45 |
| 8000. | 67.91 | 73.14 | 70.94 | 69.62 | 71.73 | 74.89 | 77.24 | 88.15 |
| 10000. | 67.54 | 71.80 | 69.50 | 68.49 | 71.23 | 75.06 | 76.92 | 87.65 |
| 12500. | 67.43 | 71.91 | 68.93 | 67.92 | 71.23 | 75.35 | 76.85 | 87.69 |
| 16000. | 67.70 | 72.64 | 69.65 | 68.49 | 71.62 | 75.97 | 77.42 | 88.34 |
| 20000. | 68.81 | 73.84 | 70.42 | 68.87 | 72.88 | 76.64 | 78.17 | 89.13 |
| 25000. | 70.10 | 77.80 | 72.66 | 70.51 | 74.66 | 78.27 | 80.45 | 91.51 |
| 31500. | 67.51 | 75.70 | 70.13 | 67.93 | 72.07 | 76.60 | 78.48 | 89.49 |
| 40000. | 62.57 | 70.31 | 65.38 | 62.21 | 66.89 | 71.21 | 73.17 | 84.15 |

TOTAL POWER, DB = 101.20

85

NOZZLE DIA = 2.0"
 DIFFUSOR DIA = 6.0"
 FLOW TEMPERATURE, TOTAL = 530.0 DEG R
 MICROPHONE RADIUS = 0 FT.

NOZZLE-DIFFUSOR SPACING RATIO = 0.00
 MACH NO. = 0.90

98

| FREQUENCY, HZ | MICROPHONE ANGLE, DEG | | | | | | | TOTAL POWER, DB (1/3 OCTAVE BAND) |
|---------------|-----------------------|-------|-------|-------|-------|-------|-------|--------------------------------------|
| | 30. | 45. | 60. | 75. | 90. | 105. | 120. | |
| 200. | 72.46 | 70.32 | 73.47 | 72.70 | 73.20 | 71.10 | 71.12 | 87.21 |
| 250. | 72.05 | 70.74 | 73.47 | 72.44 | 73.63 | 72.65 | 73.39 | 87.76 |
| 315. | 75.43 | 72.99 | 74.10 | 74.15 | 74.95 | 75.62 | 73.90 | 89.65 |
| 400. | 75.92 | 75.31 | 74.22 | 73.34 | 74.62 | 75.79 | 73.83 | 90.02 |
| 500. | 74.25 | 74.07 | 74.41 | 73.47 | 73.16 | 75.07 | 74.71 | 89.38 |
| 630. | 74.42 | 75.35 | 73.64 | 74.80 | 73.47 | 75.17 | 75.40 | 89.57 |
| 800. | 74.40 | 73.32 | 73.07 | 74.29 | 74.66 | 74.31 | 77.04 | 89.43 |
| 1000. | 74.38 | 72.72 | 74.27 | 73.73 | 75.03 | 74.74 | 76.97 | 89.47 |
| 1250. | 73.66 | 73.77 | 74.39 | 74.74 | 74.32 | 76.17 | 77.63 | 90.14 |
| 1600. | 74.15 | 74.69 | 73.69 | 73.48 | 74.69 | 76.85 | 77.59 | 90.34 |
| 2000. | 74.63 | 74.80 | 73.44 | 72.85 | 74.18 | 76.38 | 77.58 | 90.10 |
| 2500. | 74.30 | 74.70 | 73.81 | 73.30 | 74.04 | 75.84 | 77.89 | 89.99 |
| 3150. | 73.71 | 74.42 | 73.87 | 73.30 | 74.10 | 75.94 | 76.14 | 89.96 |
| 4000. | 73.19 | 75.02 | 74.63 | 73.43 | 74.72 | 77.32 | 79.15 | 90.77 |
| 5000. | 72.28 | 76.07 | 76.02 | 74.63 | 76.29 | 79.33 | 80.98 | 92.31 |
| 6300. | 72.70 | 76.07 | 76.04 | 75.90 | 78.12 | 81.27 | 82.64 | 94.15 |
| 8000. | 75.48 | 80.58 | 78.93 | 76.98 | 80.26 | 83.03 | 84.39 | 95.94 |
| 10000. | 76.60 | 80.74 | 78.10 | 76.48 | 79.87 | 83.20 | 84.51 | 95.94 |
| 12500. | 75.63 | 80.20 | 76.32 | 75.41 | 78.34 | 82.00 | 84.06 | 95.21 |
| 16000. | 73.71 | 79.41 | 75.06 | 74.59 | 78.02 | 82.00 | 83.80 | 94.55 |
| 20000. | 72.16 | 77.67 | 73.98 | 73.39 | 77.12 | 80.32 | 82.65 | 93.07 |
| 25000. | 71.51 | 76.38 | 73.21 | 72.19 | 75.85 | 78.64 | 81.76 | 91.75 |
| 31500. | 71.55 | 78.06 | 73.27 | 72.13 | 76.22 | 78.61 | 81.63 | 92.17 |
| 40000. | 70.64 | 77.65 | 72.07 | 70.93 | 75.45 | 77.76 | 80.67 | 91.40 |

TOTAL POWER, DB = 105.77

NOZZLE DIA = 2.8"
 DIFFUSOR DIA = 6.0"
 FLOW TEMPERATURE, TOTAL = 530.0 DEG R
 MICROPHONE RADIUS = 6 FT.

NOZZLE-DIFFUSOR SPACING RATIO = 0.00
 MACH NO. = 1.10

| FREQUENCY, HZ | MICROPHONE ANGLE, DEG | | | | | | | TOTAL POWER, DB (1/3 OCTAVE BAND) |
|---------------|-----------------------|-------|-------|-------|-------|-------|-------|--------------------------------------|
| | 30. | 45. | 60. | 75. | 90. | 105. | 120. | |
| 200. | 68.18 | 68.09 | 69.31 | 66.99 | 67.74 | 69.27 | 68.66 | 83.51 |
| 250. | 67.52 | 67.38 | 68.35 | 68.27 | 68.07 | 68.77 | 69.70 | 83.44 |
| 315. | 71.89 | 70.36 | 71.10 | 71.25 | 71.82 | 72.14 | 71.11 | 86.56 |
| 400. | 73.58 | 73.92 | 72.32 | 71.51 | 70.88 | 73.73 | 71.58 | 88.02 |
| 500. | 71.91 | 73.72 | 74.49 | 72.15 | 72.86 | 75.32 | 75.09 | 89.06 |
| 630. | 77.15 | 72.82 | 75.51 | 75.46 | 74.26 | 75.71 | 77.02 | 90.36 |
| 800. | 74.85 | 74.27 | 74.62 | 75.14 | 74.08 | 73.94 | 76.78 | 89.83 |
| 1000. | 74.89 | 72.61 | 73.28 | 73.56 | 74.60 | 74.01 | 76.16 | 89.04 |
| 1250. | 75.12 | 76.80 | 74.88 | 77.05 | 76.01 | 78.60 | 78.28 | 92.30 |
| 1600. | 76.69 | 75.39 | 75.78 | 74.90 | 76.71 | 78.41 | 79.25 | 91.88 |
| 2000. | 92.66 | 81.43 | 83.24 | 83.35 | 89.35 | 85.65 | 90.58 | 101.68 |
| 2500. | 79.50 | 86.08 | 79.16 | 76.05 | 80.09 | 79.25 | 80.69 | 96.94 |
| 3150. | 72.62 | 79.83 | 74.77 | 74.65 | 75.92 | 76.33 | 77.78 | 92.13 |
| 4000. | 78.25 | 76.00 | 77.07 | 75.74 | 75.23 | 76.15 | 76.98 | 91.44 |
| 5000. | 78.10 | 78.48 | 77.45 | 76.12 | 76.13 | 77.10 | 78.39 | 92.54 |
| 6300. | 77.76 | 79.49 | 78.09 | 76.12 | 77.02 | 78.71 | 79.88 | 93.44 |
| 8000. | 77.74 | 80.18 | 78.80 | 77.84 | 79.06 | 81.75 | 82.18 | 95.18 |
| 10000. | 78.10 | 80.42 | 78.10 | 77.78 | 78.88 | 81.44 | 82.45 | 95.09 |
| 12500. | 75.02 | 80.03 | 76.70 | 76.13 | 78.39 | 81.26 | 82.28 | 94.49 |
| 16000. | 73.48 | 79.19 | 75.30 | 74.87 | 77.95 | 80.82 | 82.43 | 93.87 |
| 20000. | 72.50 | 78.03 | 75.05 | 74.49 | 77.52 | 80.32 | 83.27 | 93.44 |
| 25000. | 68.29 | 75.28 | 72.69 | 71.70 | 75.11 | 76.83 | 80.43 | 90.46 |
| 31500. | 67.56 | 74.38 | 71.29 | 69.48 | 72.78 | 75.44 | 79.44 | 89.10 |
| 40000. | 63.35 | 70.10 | 68.68 | 66.62 | 70.06 | 72.52 | 76.21 | 85.85 |

TOTAL POWER, DB = 107.11

87

NOZZLE DIA = 2.8"
 DIFFUSOR DIA = 6.0"
 FLOW TEMPERATURE, TOTAL = 530.0 DEG R
 MICROPHONE RADIUS = 6 FT.

NOZZLE-DIFFUSOR SPACING RATIO = 0.25
 MACH NO. = 0.70

88

| FREQUENCY, HZ | MICROPHONE ANGLE, DEG | | | | | | | TOTAL POWER, DB (1/3 OCTAVE BAND) |
|---------------|-----------------------|-------|-------|-------|-------|-------|-------|--------------------------------------|
| | 30. | 45. | 60. | 75. | 90. | 105. | 120. | |
| 200. | 69.13 | 69.33 | 71.45 | 70.48 | 69.74 | 71.16 | 71.09 | 85.62 |
| 250. | 68.45 | 69.52 | 70.02 | 69.70 | 70.04 | 71.52 | 70.12 | 85.36 |
| 315. | 70.61 | 71.10 | 70.99 | 69.62 | 71.11 | 71.57 | 69.46 | 86.01 |
| 400. | 70.82 | 72.30 | 70.82 | 68.71 | 70.34 | 71.56 | 69.12 | 86.06 |
| 500. | 69.51 | 70.16 | 69.39 | 68.44 | 69.70 | 70.47 | 70.36 | 84.94 |
| 630. | 69.40 | 69.02 | 69.85 | 69.75 | 70.00 | 70.33 | 71.15 | 85.04 |
| 800. | 69.41 | 69.27 | 69.75 | 69.29 | 70.38 | 69.18 | 71.83 | 84.82 |
| 1000. | 70.06 | 69.33 | 69.96 | 69.08 | 70.62 | 70.37 | 72.62 | 85.22 |
| 1250. | 71.03 | 70.28 | 71.00 | 70.20 | 71.12 | 73.53 | 73.93 | 86.84 |
| 1600. | 71.30 | 71.17 | 71.47 | 69.55 | 71.24 | 73.83 | 74.66 | 87.14 |
| 2000. | 71.69 | 71.54 | 70.73 | 68.89 | 70.22 | 72.49 | 74.83 | 86.59 |
| 2500. | 71.96 | 72.11 | 71.13 | 69.25 | 70.40 | 71.84 | 74.80 | 86.68 |
| 3150. | 71.16 | 72.74 | 72.04 | 69.49 | 70.76 | 72.14 | 74.78 | 87.03 |
| 4000. | 71.11 | 74.32 | 73.39 | 70.55 | 71.14 | 73.53 | 75.13 | 88.18 |
| 5000. | 69.73 | 74.70 | 73.65 | 70.59 | 72.15 | 74.66 | 76.37 | 88.81 |
| 6300. | 69.05 | 74.13 | 73.12 | 70.07 | 72.58 | 74.96 | 76.53 | 88.65 |
| 8000. | 68.94 | 73.63 | 71.68 | 69.29 | 72.44 | 75.20 | 76.51 | 88.38 |
| 10000. | 68.32 | 72.49 | 70.06 | 68.63 | 72.16 | 75.32 | 75.85 | 87.88 |
| 12500. | 68.62 | 72.24 | 69.70 | 68.36 | 72.48 | 75.17 | 76.08 | 87.76 |
| 16000. | 68.23 | 73.31 | 70.55 | 69.29 | 73.24 | 75.54 | 76.62 | 88.44 |
| 20000. | 68.05 | 73.94 | 70.00 | 69.59 | 73.86 | 75.00 | 76.54 | 88.69 |
| 25000. | 66.86 | 72.74 | 68.00 | 68.11 | 72.27 | 74.00 | 75.75 | 87.26 |
| 31500. | 62.57 | 69.71 | 64.29 | 65.24 | 68.82 | 71.32 | 72.86 | 84.30 |
| 40000. | 59.61 | 65.93 | 61.02 | 61.60 | 65.77 | 67.20 | 69.94 | 80.65 |

TOTAL POWER, DB = 100.65

NOZZLE DIA = 2.8"
 DIFFUSOR DIA = 6.0"
 FLOW TEMPERATURE, TOTAL = 530.0 DEG R
 MICROPHONE RADIUS = 6 FT.

NOZZLE-DIFFUSOR SPACING RATIO = 0.25
 MACH NO. = 0.90

| FREQUENCY, HZ | MICROPHONE ANGLE, DEG | | | | | | | TOTAL POWER, DB (1/3 OCTAVE BAND) |
|---------------|-----------------------|-------|-------|-------|-------|-------|-------|--------------------------------------|
| | 30. | 45. | 60. | 75. | 90. | 105. | 120. | |
| 200. | 71.88 | 71.20 | 72.63 | 72.86 | 71.82 | 72.77 | 71.50 | 87.45 |
| 250. | 71.90 | 70.70 | 73.47 | 73.68 | 72.55 | 72.90 | 74.08 | 87.95 |
| 315. | 73.95 | 73.07 | 74.89 | 74.69 | 74.92 | 75.11 | 74.38 | 89.66 |
| 400. | 73.85 | 74.62 | 74.21 | 73.23 | 74.00 | 75.30 | 74.24 | 89.53 |
| 500. | 72.42 | 74.00 | 73.92 | 72.85 | 73.02 | 75.86 | 74.48 | 89.32 |
| 630. | 73.90 | 73.38 | 74.01 | 74.87 | 73.11 | 75.54 | 75.79 | 89.68 |
| 800. | 73.55 | 74.04 | 73.46 | 74.99 | 74.47 | 74.08 | 76.98 | 89.65 |
| 1000. | 73.51 | 73.49 | 74.43 | 74.11 | 75.70 | 74.78 | 76.84 | 89.74 |
| 1250. | 73.72 | 73.70 | 73.57 | 74.48 | 74.27 | 76.23 | 76.89 | 90.00 |
| 1600. | 73.62 | 74.16 | 73.21 | 73.53 | 74.87 | 76.16 | 77.25 | 89.95 |
| 2000. | 74.09 | 73.99 | 73.61 | 73.02 | 74.14 | 75.34 | 77.05 | 89.55 |
| 2500. | 73.67 | 74.07 | 74.01 | 73.21 | 73.66 | 75.02 | 77.03 | 89.48 |
| 3150. | 72.56 | 74.28 | 74.10 | 73.08 | 73.75 | 75.71 | 77.27 | 89.69 |
| 4000. | 72.52 | 75.70 | 74.68 | 73.58 | 75.05 | 76.65 | 78.01 | 90.70 |
| 5000. | 72.17 | 76.99 | 76.49 | 74.84 | 76.85 | 78.68 | 80.15 | 92.29 |
| 6300. | 75.08 | 74.67 | 76.47 | 76.10 | 78.59 | 80.83 | 82.23 | 94.37 |
| 8000. | 75.95 | 81.60 | 79.32 | 77.68 | 80.39 | 83.36 | 84.05 | 96.37 |
| 10000. | 76.48 | 81.61 | 78.65 | 77.43 | 80.42 | 83.42 | 84.10 | 96.39 |
| 12500. | 75.56 | 81.58 | 76.90 | 76.03 | 79.56 | 81.63 | 83.76 | 95.42 |
| 16000. | 74.00 | 80.32 | 75.39 | 75.40 | 78.89 | 80.94 | 83.30 | 94.46 |
| 20000. | 72.70 | 78.18 | 74.91 | 74.70 | 78.48 | 80.62 | 82.59 | 93.59 |
| 25000. | 70.64 | 76.87 | 73.10 | 73.30 | 76.41 | 76.15 | 80.93 | 91.69 |
| 31500. | 67.62 | 74.66 | 70.96 | 70.90 | 74.04 | 76.63 | 78.76 | 89.68 |
| 40000. | 64.80 | 71.06 | 68.51 | 68.56 | 70.70 | 73.90 | 75.64 | 86.71 |

TOTAL POWER, DB = 105.69

68

NOZZLE DIA = 2.8"
 DIFFUSOR DIA = 6.0"
 FLOW TEMPERATURE, TOTAL = 530.0 DEG R
 MICROPHONE RADIUS = 6 FT.

NOZZLE-DIFFUSOR SPACING RATIO = 0.25
 MACH NU. = 1.10

| | | | | | | | | |
|--------|-------|-------|-------|-------|-------|-------|-------|-------|
| 200. | 69.94 | 69.58 | 69.25 | 71.26 | 68.91 | 68.23 | 69.40 | 84.87 |
| 250. | 68.72 | 67.98 | 68.45 | 69.18 | 70.47 | 69.70 | 72.12 | 84.55 |
| 315. | 72.88 | 71.98 | 72.15 | 72.81 | 75.07 | 72.30 | 71.72 | 87.93 |
| 400. | 72.74 | 72.61 | 72.12 | 73.58 | 71.85 | 73.07 | 71.84 | 87.98 |
| 500. | 70.69 | 73.11 | 74.10 | 74.02 | 74.04 | 75.87 | 75.44 | 89.50 |
| 630. | 75.68 | 73.94 | 75.15 | 75.31 | 74.19 | 76.45 | 77.21 | 90.55 |
| 800. | 74.07 | 73.61 | 73.08 | 74.23 | 75.11 | 72.88 | 76.05 | 89.14 |
| 1000. | 73.36 | 72.46 | 73.87 | 72.90 | 74.50 | 73.33 | 75.66 | 88.64 |
| 1250. | 75.30 | 75.12 | 75.22 | 76.47 | 75.48 | 77.97 | 78.25 | 91.64 |
| 1600. | 75.73 | 74.80 | 74.68 | 74.25 | 75.63 | 77.02 | 77.79 | 90.82 |
| 2000. | 88.57 | 82.99 | 82.49 | 81.12 | 83.47 | 86.12 | 88.39 | 99.76 |
| 2500. | 76.01 | 77.08 | 78.53 | 79.29 | 79.88 | 80.33 | 81.01 | 94.33 |
| 3150. | 73.64 | 75.35 | 77.10 | 77.96 | 77.30 | 78.04 | 79.16 | 92.45 |
| 4000. | 79.52 | 78.21 | 78.01 | 77.33 | 76.88 | 76.70 | 76.66 | 92.76 |
| 5000. | 78.23 | 78.52 | 78.98 | 77.06 | 78.05 | 77.53 | 78.43 | 93.19 |
| 6300. | 78.53 | 79.98 | 78.95 | 77.28 | 78.90 | 79.12 | 79.63 | 94.14 |
| 8000. | 78.95 | 80.35 | 80.68 | 78.75 | 80.07 | 82.50 | 82.66 | 95.95 |
| 10000. | 79.19 | 80.03 | 79.88 | 78.82 | 79.59 | 82.30 | 83.03 | 95.75 |
| 12500. | 76.51 | 79.58 | 77.94 | 77.17 | 78.98 | 81.73 | 83.02 | 94.93 |
| 16000. | 74.46 | 78.68 | 76.01 | 75.52 | 78.17 | 80.84 | 82.62 | 93.92 |
| 20000. | 73.18 | 77.66 | 76.10 | 74.51 | 78.20 | 80.14 | 82.29 | 93.29 |
| 25000. | 69.35 | 74.59 | 73.14 | 72.42 | 75.81 | 76.57 | 78.40 | 90.13 |
| 31500. | 67.81 | 74.91 | 71.58 | 70.07 | 72.91 | 75.05 | 76.99 | 88.83 |
| 40000. | 62.85 | 70.07 | 67.74 | 66.83 | 68.92 | 70.78 | 73.93 | 84.73 |

TOTAL POWER, DB = 106.63

NOZZLE DIA = 2.8"
 DIFFUSOR DIA = 6.0"
 FLOW TEMPERATURE, TOTAL = 530.0 DEG R
 MICROPHONE RADIUS = 6 FT.

NOZZLE-DIFFUSOR SPACING RATIO = 0.50
 MACH NO. = 0.70

| FREQUENCY, HZ | MICROPHONE ANGLE, DEG | | | | | | | TOTAL POWER, DB (1/3 OCTAVE BAND) |
|---------------|-----------------------|-------|-------|-------|-------|-------|-------|--------------------------------------|
| | 30. | 45. | 60. | 75. | 90. | 105. | 120. | |
| 200. | 70.05 | 71.61 | 70.85 | 71.32 | 71.86 | 71.54 | 70.66 | 86.57 |
| 250. | 69.83 | 70.11 | 70.18 | 70.95 | 71.19 | 71.03 | 71.30 | 85.89 |
| 315. | 70.85 | 70.33 | 70.65 | 71.67 | 71.30 | 71.36 | 70.80 | 86.29 |
| 400. | 70.79 | 70.00 | 70.36 | 70.49 | 70.70 | 70.53 | 70.24 | 85.79 |
| 500. | 69.53 | 69.01 | 69.39 | 69.56 | 69.53 | 70.53 | 70.44 | 85.02 |
| 630. | 70.42 | 69.00 | 68.98 | 70.21 | 69.70 | 70.85 | 71.27 | 85.22 |
| 800. | 69.01 | 69.15 | 69.14 | 70.35 | 70.12 | 69.83 | 72.43 | 85.15 |
| 1000. | 69.30 | 68.29 | 69.30 | 69.49 | 70.28 | 70.59 | 73.33 | 85.11 |
| 1250. | 70.63 | 69.26 | 70.60 | 70.65 | 70.51 | 72.88 | 73.27 | 86.37 |
| 1600. | 71.09 | 70.48 | 70.00 | 70.67 | 70.93 | 72.08 | 74.05 | 86.65 |
| 2000. | 71.54 | 70.95 | 69.01 | 69.48 | 70.21 | 71.80 | 74.31 | 86.15 |
| 2500. | 71.60 | 71.01 | 70.12 | 69.88 | 69.99 | 72.05 | 74.25 | 86.48 |
| 3150. | 71.36 | 71.81 | 70.85 | 70.28 | 70.65 | 72.94 | 74.20 | 86.96 |
| 4000. | 71.30 | 72.85 | 71.52 | 70.74 | 71.33 | 73.83 | 74.65 | 87.68 |
| 5000. | 70.04 | 73.70 | 72.44 | 70.83 | 71.82 | 74.72 | 75.87 | 88.38 |
| 6300. | 68.84 | 73.59 | 71.96 | 70.59 | 71.66 | 74.91 | 76.00 | 88.31 |
| 8000. | 68.53 | 73.30 | 70.53 | 70.01 | 71.64 | 75.16 | 75.95 | 88.21 |
| 10000. | 67.05 | 71.74 | 69.11 | 69.87 | 71.61 | 74.78 | 75.04 | 87.50 |
| 12500. | 67.34 | 71.57 | 69.26 | 69.57 | 71.78 | 75.04 | 75.59 | 87.55 |
| 16000. | 67.47 | 72.73 | 69.93 | 70.29 | 72.64 | 75.42 | 75.91 | 88.17 |
| 20000. | 66.46 | 72.57 | 69.64 | 70.62 | 72.68 | 74.84 | 75.48 | 87.89 |
| 25000. | 65.40 | 71.70 | 68.47 | 69.03 | 71.58 | 73.38 | 74.41 | 86.75 |
| 31500. | 62.61 | 69.44 | 60.21 | 67.05 | 69.39 | 70.40 | 71.95 | 84.17 |
| 40000. | 60.40 | 66.61 | 64.66 | 64.47 | 66.70 | 67.99 | 69.80 | 81.70 |

TOTAL POWER, DB = 100.45

NOZZLE DIA = 2.8"
 DIFFUSOR DIA = 6.0"
 FLOW TEMPERATURE, TOTAL = 530.0 DEG R
 MICROPHONE RADIUS = 6 FT.

NOZZLE-DIFFUSOR SPACING RATIO = 0.50
 MACH NO. = 0.90

AEDC-TR-80-15

| FREQUENCY, HZ | MICROPHONE ANGLE, DEG | | | | | | | TOTAL POWER, DB (1/3 OCTAVE BAND) |
|---------------|-----------------------|-------|-------|-------|-------|-------|-------|--------------------------------------|
| | 30. | 45. | 60. | 75. | 90. | 105. | 120. | |
| 200. | 72.69 | 71.82 | 74.03 | 72.94 | 72.15 | 73.44 | 72.57 | 88.05 |
| 250. | 72.40 | 72.33 | 74.31 | 72.77 | 73.21 | 74.78 | 74.11 | 88.69 |
| 315. | 74.15 | 75.17 | 75.11 | 73.86 | 75.02 | 75.82 | 74.39 | 90.14 |
| 400. | 75.89 | 75.17 | 75.33 | 74.82 | 73.99 | 75.84 | 74.36 | 90.35 |
| 500. | 74.72 | 73.77 | 74.99 | 74.08 | 72.88 | 75.28 | 73.94 | 89.53 |
| 630. | 74.44 | 73.20 | 74.45 | 74.40 | 73.62 | 74.98 | 75.42 | 89.47 |
| 800. | 73.32 | 73.20 | 73.79 | 73.91 | 74.49 | 74.87 | 76.84 | 89.43 |
| 1000. | 73.16 | 73.51 | 73.57 | 73.60 | 74.98 | 75.39 | 77.18 | 89.67 |
| 1250. | 73.32 | 73.63 | 73.23 | 74.32 | 74.26 | 76.04 | 76.95 | 89.86 |
| 1600. | 73.66 | 73.69 | 73.14 | 73.89 | 74.30 | 76.31 | 76.72 | 89.87 |
| 2000. | 74.02 | 73.75 | 73.17 | 72.82 | 73.77 | 75.57 | 76.88 | 89.44 |
| 2500. | 73.04 | 73.24 | 73.27 | 72.14 | 73.68 | 74.82 | 76.40 | 88.91 |
| 3150. | 72.37 | 73.43 | 73.68 | 72.97 | 73.91 | 75.47 | 76.48 | 89.32 |
| 4000. | 72.21 | 74.50 | 74.35 | 74.06 | 74.78 | 76.50 | 77.14 | 90.24 |
| 5000. | 72.16 | 76.27 | 75.84 | 75.15 | 76.66 | 79.06 | 79.32 | 92.15 |
| 6300. | 73.42 | 78.80 | 77.71 | 76.43 | 78.29 | 81.36 | 81.87 | 94.20 |
| 8000. | 75.01 | 80.82 | 76.83 | 78.16 | 80.36 | 83.73 | 84.12 | 96.34 |
| 10000. | 76.52 | 80.76 | 77.97 | 78.30 | 80.53 | 83.94 | 84.33 | 96.45 |
| 12500. | 75.73 | 80.12 | 76.81 | 77.48 | 78.86 | 83.00 | 83.85 | 95.55 |
| 16000. | 74.16 | 79.55 | 75.19 | 76.80 | 78.39 | 82.13 | 83.43 | 94.83 |
| 20000. | 72.02 | 78.22 | 74.72 | 76.05 | 77.35 | 80.74 | 81.88 | 93.57 |
| 25000. | 70.88 | 76.25 | 73.49 | 74.10 | 76.00 | 78.73 | 79.88 | 91.69 |
| 31500. | 66.76 | 74.86 | 72.39 | 71.64 | 74.13 | 76.46 | 77.69 | 89.72 |
| 40000. | 66.57 | 72.76 | 70.40 | 70.07 | 72.27 | 74.31 | 75.62 | 87.70 |

TOTAL POWER, DB = 105.74

NOZZLE DIA = 2.8"
 DIFFUSOR DIA = 6.0"
 FLOW TEMPERATURE, TOTAL = 530.0 DEG R
 MICROPHONE RADIUS = 6 FT.

NOZZLE-DIFFUSOR SPACING RATIO = 0.50
 MACH NO. = 1.10

| FREQUENCY, HZ | MICROPHONE ANGLE, DEG | | | | | | | TOTAL POWER, DB (1/3 OCTAVE BAND) |
|---------------|---------------------------------|-------|-------|-------|-------|-------|-------|--------------------------------------|
| | 30. | 45. | 60. | 75. | 90. | 105. | 120. | |
| | SOUND POWER INTENSITY LEVEL, DB | | | | | | | |
| 200. | 70.65 | 70.33 | 69.38 | 69.98 | 69.95 | 69.08 | 69.52 | 85.02 |
| 250. | 70.90 | 69.65 | 69.36 | 70.20 | 71.33 | 70.91 | 70.49 | 85.59 |
| 315. | 73.12 | 71.46 | 71.25 | 72.51 | 74.03 | 72.81 | 72.23 | 87.66 |
| 400. | 74.70 | 72.95 | 73.71 | 72.99 | 73.83 | 73.37 | 73.33 | 88.57 |
| 500. | 75.08 | 74.16 | 74.26 | 73.71 | 73.56 | 75.26 | 74.81 | 89.57 |
| 630. | 76.34 | 73.91 | 74.06 | 75.26 | 74.36 | 76.08 | 76.86 | 90.36 |
| 800. | 75.20 | 73.98 | 73.72 | 75.42 | 74.98 | 74.99 | 77.07 | 90.11 |
| 1000. | 73.99 | 73.48 | 73.96 | 74.81 | 74.33 | 74.98 | 76.02 | 89.67 |
| 1250. | 75.00 | 73.86 | 74.96 | 75.35 | 74.70 | 77.75 | 77.18 | 90.95 |
| 1600. | 76.71 | 75.52 | 75.90 | 76.33 | 76.01 | 80.19 | 78.78 | 92.95 |
| 2000. | 79.37 | 76.45 | 78.23 | 78.57 | 79.48 | 80.78 | 82.04 | 94.68 |
| 2500. | 76.54 | 78.19 | 78.85 | 79.87 | 79.84 | 76.17 | 81.49 | 94.32 |
| 3150. | 76.70 | 77.37 | 77.37 | 78.31 | 77.80 | 76.76 | 78.79 | 92.77 |
| 4000. | 78.60 | 78.52 | 78.31 | 77.33 | 76.77 | 76.88 | 77.29 | 92.86 |
| 5000. | 80.31 | 79.48 | 79.63 | 77.23 | 77.01 | 78.71 | 77.38 | 93.81 |
| 6300. | 80.30 | 80.06 | 79.80 | 77.76 | 78.19 | 81.94 | 79.61 | 95.17 |
| 8000. | 80.36 | 81.01 | 79.97 | 79.19 | 80.01 | 83.07 | 82.93 | 96.35 |
| 10000. | 80.11 | 81.91 | 79.17 | 79.28 | 80.82 | 82.17 | 83.64 | 96.43 |
| 12500. | 78.33 | 81.35 | 78.46 | 77.72 | 80.17 | 81.59 | 83.10 | 95.60 |
| 16000. | 75.73 | 80.02 | 76.75 | 76.48 | 79.71 | 81.07 | 82.68 | 94.66 |
| 20000. | 73.95 | 78.76 | 76.17 | 76.07 | 79.25 | 79.16 | 82.13 | 93.54 |
| 25000. | 72.36 | 76.86 | 75.07 | 74.45 | 77.53 | 76.74 | 80.45 | 91.67 |
| 31500. | 70.46 | 75.73 | 74.04 | 72.64 | 74.98 | 74.76 | 78.50 | 89.95 |
| 40000. | 68.30 | 74.59 | 72.95 | 71.53 | 73.45 | 75.64 | 77.26 | 89.28 |

TOTAL POWER, DB = 106.54

NOZZLE DIA = 2.8"
 DIFFUSOR DIA = 6.0"
 FLOW TEMPERATURE, TOTAL = 530.0 DEG R
 MICROPHONE RADIUS = 6 FT.

NOZZLE-DIFFUSOR SPACING RATIO = 0.75
 MACH NO. = 0.70

| FREQUENCY, HZ | MICROPHONE ANGLE, DEG | | | | | | | TOTAL POWER, DB (1/3 OCTAVE BAND) |
|---------------|-----------------------|-------|-------|-------|-------|-------|-------|--------------------------------------|
| | 30. | 45. | 60. | 75. | 90. | 105. | 120. | |
| 200. | 66.74 | 70.05 | 70.93 | 70.65 | 70.18 | 71.07 | 70.07 | 85.67 |
| 250. | 66.20 | 69.73 | 70.73 | 69.96 | 70.56 | 71.42 | 71.64 | 85.67 |
| 315. | 71.20 | 71.31 | 70.90 | 71.11 | 72.07 | 71.14 | 71.01 | 86.45 |
| 400. | 70.70 | 71.76 | 70.68 | 70.55 | 70.77 | 70.85 | 69.93 | 86.14 |
| 500. | 69.38 | 69.91 | 70.43 | 70.23 | 69.40 | 71.07 | 70.24 | 85.45 |
| 630. | 70.03 | 66.13 | 69.96 | 70.56 | 69.87 | 71.10 | 71.18 | 85.32 |
| 800. | 69.66 | 66.45 | 70.14 | 70.25 | 70.22 | 70.63 | 72.06 | 85.27 |
| 1000. | 69.60 | 65.82 | 69.62 | 69.61 | 70.31 | 70.79 | 72.56 | 85.29 |
| 1250. | 71.14 | 69.77 | 70.36 | 70.01 | 70.66 | 72.66 | 73.95 | 86.34 |
| 1600. | 71.79 | 71.17 | 70.41 | 70.71 | 71.45 | 72.50 | 73.86 | 86.79 |
| 2000. | 72.12 | 71.42 | 69.44 | 69.76 | 70.78 | 71.14 | 73.74 | 86.19 |
| 2500. | 72.26 | 72.24 | 70.19 | 69.96 | 70.30 | 70.98 | 73.74 | 86.43 |
| 3150. | 71.76 | 72.62 | 70.67 | 70.09 | 70.77 | 71.83 | 74.05 | 86.84 |
| 4000. | 71.14 | 73.37 | 71.42 | 70.66 | 71.43 | 73.26 | 74.86 | 87.68 |
| 5000. | 70.15 | 73.50 | 71.91 | 71.19 | 72.23 | 74.25 | 75.87 | 88.22 |
| 6300. | 68.95 | 73.05 | 71.39 | 70.75 | 72.00 | 74.40 | 75.99 | 88.02 |
| 8000. | 66.59 | 72.60 | 70.49 | 70.50 | 72.41 | 74.50 | 75.66 | 87.66 |
| 10000. | 67.97 | 71.20 | 69.40 | 69.87 | 72.19 | 74.28 | 75.41 | 87.20 |
| 12500. | 67.00 | 71.14 | 66.67 | 69.94 | 72.15 | 74.25 | 75.21 | 87.18 |
| 16000. | 67.61 | 71.90 | 69.62 | 70.14 | 72.31 | 74.47 | 75.21 | 87.51 |
| 20000. | 66.04 | 71.64 | 69.41 | 69.90 | 72.02 | 74.06 | 74.63 | 87.14 |
| 25000. | 65.10 | 70.87 | 68.19 | 66.63 | 71.28 | 72.82 | 73.87 | 86.10 |
| 31500. | 62.64 | 68.52 | 66.02 | 66.98 | 69.15 | 70.38 | 71.77 | 83.89 |
| 40000. | 59.61 | 65.96 | 64.10 | 65.34 | 66.77 | 67.67 | 69.30 | 81.56 |

TOTAL POWER, DB = 100.27

NOZZLE DIA = 2.8"
 DIFFUSOR DIA = 6.0"
 FLOW TEMPERATURE, TOTAL = 530.0 DEG R
 MICROPHONE RADIUS = 6 FT.

NOZZLE-DIFFUSOR SPACING RATIO = 0.75
 MACH NO. = 0.90

MICROPHONE ANGLE, DEG

| FREQUENCY, HZ | SOUND POWER INTENSITY LEVEL, DB | | | | | | | TOTAL POWER, DB (1/3 OCTAVE BAND) |
|---------------|---------------------------------|-------|-------|-------|-------|-------|-------|--------------------------------------|
| | 30. | 45. | 60. | 75. | 90. | 105. | 120. | |
| 200. | 71.33 | 72.19 | 73.08 | 73.60 | 73.43 | 72.42 | 72.71 | 88.02 |
| 250. | 71.90 | 72.27 | 73.58 | 73.97 | 74.40 | 73.88 | 73.46 | 88.69 |
| 315. | 74.12 | 73.24 | 73.90 | 74.16 | 76.26 | 75.09 | 74.78 | 89.69 |
| 400. | 75.26 | 74.33 | 74.35 | 73.27 | 75.07 | 76.05 | 74.32 | 89.91 |
| 500. | 73.42 | 74.22 | 73.77 | 74.35 | 73.18 | 76.44 | 75.32 | 89.93 |
| 630. | 73.42 | 73.47 | 73.20 | 73.96 | 73.97 | 76.19 | 75.94 | 89.69 |
| 800. | 73.17 | 73.43 | 73.84 | 74.28 | 74.75 | 74.87 | 76.30 | 89.53 |
| 1000. | 73.42 | 74.08 | 74.35 | 74.02 | 74.70 | 75.00 | 76.48 | 89.71 |
| 1250. | 73.67 | 73.71 | 74.03 | 74.46 | 74.34 | 75.96 | 76.33 | 89.92 |
| 1600. | 73.61 | 73.67 | 73.39 | 73.62 | 74.68 | 75.84 | 76.32 | 89.72 |
| 2000. | 73.93 | 74.00 | 72.89 | 73.32 | 74.31 | 75.08 | 76.43 | 89.42 |
| 2500. | 74.05 | 74.08 | 73.39 | 73.18 | 73.51 | 75.15 | 76.35 | 89.39 |
| 3150. | 73.29 | 74.03 | 73.46 | 73.30 | 74.10 | 75.92 | 76.02 | 89.63 |
| 4000. | 73.17 | 74.80 | 73.84 | 74.06 | 75.26 | 76.94 | 76.95 | 90.46 |
| 5000. | 72.72 | 76.22 | 75.04 | 75.46 | 76.55 | 79.10 | 79.92 | 92.20 |
| 6300. | 73.67 | 77.81 | 76.44 | 77.16 | 78.10 | 81.45 | 81.69 | 94.09 |
| 8000. | 75.58 | 79.98 | 77.96 | 79.00 | 80.72 | 83.61 | 83.26 | 96.14 |
| 10000. | 75.77 | 80.44 | 77.39 | 78.81 | 81.06 | 83.75 | 84.20 | 96.37 |
| 12500. | 75.07 | 79.76 | 76.19 | 77.28 | 80.44 | 82.99 | 84.05 | 95.60 |
| 16000. | 74.18 | 79.02 | 75.42 | 76.58 | 79.76 | 83.13 | 83.27 | 95.24 |
| 20000. | 72.91 | 77.70 | 75.04 | 76.20 | 78.95 | 81.55 | 81.92 | 94.00 |
| 25000. | 70.63 | 76.01 | 73.90 | 74.55 | 77.13 | 78.89 | 79.88 | 91.90 |
| 31500. | 68.29 | 73.94 | 72.44 | 73.21 | 75.37 | 76.93 | 77.83 | 90.05 |
| 40000. | 66.20 | 72.12 | 70.79 | 72.00 | 73.29 | 74.76 | 76.03 | 88.19 |

TOTAL POWER, DB = 105.81

95

NOZZLE DIA = 2.8"
 DIFFUSOR DIA = 6.0"
 FLUX TEMPERATURE, TOTAL = 530.0 DEG R
 MICROPHONE RADIUS = 6 FT.

NOZZLE-DIFFUSOR SPACING RATIO = 0.75
 MACH NO. = 1.10

AEDC-TR-80-15

MICROPHONE ANGLE, DEG

| FREQUENCY, HZ | 30. | 45. | 60. | 75. | 90. | 105. | 120. | TOTAL POWER, DB (1/3 OCTAVE BAND) |
|---------------|---------------------------------|-------|-------|-------|-------|-------|-------|--------------------------------------|
| | SOUND POWER INTENSITY LEVEL, DB | | | | | | | |
| 200. | 72.01 | 70.69 | 71.23 | 71.74 | 70.78 | 70.60 | 70.00 | 86.23 |
| 250. | 73.29 | 70.64 | 70.30 | 71.70 | 71.26 | 71.12 | 71.50 | 86.45 |
| 315. | 74.96 | 73.50 | 73.49 | 74.38 | 74.34 | 73.29 | 72.80 | 89.01 |
| 400. | 75.10 | 75.46 | 75.53 | 75.61 | 73.94 | 75.59 | 73.97 | 90.49 |
| 500. | 74.23 | 75.19 | 75.87 | 75.00 | 74.10 | 75.86 | 75.53 | 90.44 |
| 630. | 75.26 | 74.00 | 75.64 | 75.72 | 75.26 | 75.94 | 77.53 | 90.68 |
| 800. | 74.20 | 74.02 | 74.46 | 74.80 | 75.83 | 73.79 | 77.31 | 89.88 |
| 1000. | 73.39 | 73.10 | 73.41 | 74.45 | 74.47 | 75.99 | 76.46 | 89.26 |
| 1250. | 74.99 | 73.37 | 73.49 | 75.42 | 74.76 | 76.04 | 77.00 | 90.22 |
| 1600. | 76.09 | 75.35 | 75.04 | 76.33 | 75.82 | 76.88 | 78.05 | 91.38 |
| 2000. | 79.85 | 78.78 | 77.40 | 79.26 | 79.85 | 80.20 | 81.57 | 94.68 |
| 2500. | 74.99 | 79.87 | 79.00 | 81.24 | 81.09 | 81.67 | 81.99 | 96.02 |
| 3150. | 76.35 | 78.81 | 78.39 | 79.06 | 79.35 | 79.65 | 80.05 | 94.32 |
| 4000. | 79.96 | 79.21 | 79.55 | 78.20 | 77.81 | 77.50 | 78.06 | 93.73 |
| 5000. | 81.30 | 80.63 | 80.08 | 76.54 | 77.72 | 77.64 | 77.53 | 94.36 |
| 6300. | 81.51 | 81.27 | 80.03 | 79.01 | 78.90 | 78.98 | 78.70 | 95.05 |
| 8000. | 81.72 | 82.12 | 80.44 | 80.11 | 80.71 | 81.67 | 81.27 | 96.42 |
| 10000. | 81.10 | 82.26 | 80.46 | 80.01 | 81.13 | 82.19 | 82.32 | 96.64 |
| 12500. | 79.08 | 81.14 | 78.96 | 76.63 | 80.66 | 81.69 | 82.29 | 95.77 |
| 16000. | 76.69 | 79.65 | 77.22 | 77.76 | 79.69 | 80.94 | 82.07 | 94.69 |
| 20000. | 75.43 | 78.91 | 76.66 | 77.05 | 78.96 | 79.87 | 81.79 | 93.91 |
| 25000. | 73.36 | 77.54 | 75.94 | 76.32 | 77.60 | 78.05 | 80.18 | 92.52 |
| 31500. | 71.34 | 76.79 | 74.63 | 75.27 | 75.93 | 76.47 | 78.69 | 91.25 |
| 40000. | 69.90 | 75.61 | 73.77 | 74.16 | 74.32 | 75.34 | 77.40 | 90.06 |

TOTAL POWER, DB = 106.95

NOZZLE DIA = 2.8"
 DIFFUSOR DIA = 6.0"
 FLOW TEMPERATURE, TOTAL = 530.0 DEG R
 MICROPHONE RADIUS = 6 FT.

NOZZLE-DIFFUSOR SPACING RATIO = 1.00
 MACH NO. = 0.70

MICROPHONE ANGLE, DEG

| FREQUENCY, HZ | 30. | 45. | 60. | 75. | 90. | 105. | 120. | TOTAL POWER, DB (1/3 OCTAVE BAND) |
|---------------|---------------------------------|-------|-------|-------|-------|-------|-------|--------------------------------------|
| | SOUND POWER INTENSITY LEVEL, DB | | | | | | | |
| 200. | 70.10 | 69.59 | 69.28 | 71.68 | 71.29 | 71.28 | 70.96 | 85.97 |
| 250. | 70.04 | 69.29 | 69.31 | 71.29 | 70.98 | 70.76 | 70.77 | 85.64 |
| 315. | 72.72 | 70.83 | 70.49 | 71.47 | 71.56 | 71.31 | 70.57 | 86.43 |
| 400. | 71.89 | 72.30 | 70.27 | 71.08 | 70.62 | 71.11 | 70.12 | 86.45 |
| 500. | 68.78 | 69.71 | 69.35 | 69.99 | 69.94 | 71.15 | 71.25 | 85.36 |
| 630. | 69.74 | 69.34 | 69.19 | 70.24 | 70.13 | 71.08 | 71.56 | 85.40 |
| 800. | 70.25 | 69.35 | 69.17 | 70.74 | 70.40 | 69.92 | 72.45 | 85.37 |
| 1000. | 70.13 | 69.05 | 69.46 | 70.22 | 70.34 | 69.90 | 72.86 | 85.24 |
| 1250. | 71.40 | 70.20 | 70.82 | 70.46 | 70.99 | 72.04 | 73.39 | 86.35 |
| 1600. | 72.48 | 71.30 | 71.49 | 70.71 | 71.75 | 72.41 | 73.38 | 86.92 |
| 2000. | 72.99 | 72.52 | 71.21 | 70.83 | 71.39 | 71.69 | 73.31 | 87.02 |
| 2500. | 72.93 | 72.76 | 71.50 | 70.94 | 71.02 | 72.00 | 72.86 | 87.13 |
| 3150. | 72.43 | 72.73 | 71.79 | 71.19 | 71.02 | 72.08 | 73.74 | 87.38 |
| 4000. | 71.61 | 73.25 | 71.88 | 71.62 | 71.66 | 73.30 | 75.00 | 87.69 |
| 5000. | 70.85 | 73.40 | 72.11 | 71.80 | 72.56 | 74.04 | 75.95 | 88.33 |
| 6300. | 69.52 | 72.96 | 71.45 | 71.09 | 72.57 | 74.72 | 75.82 | 88.20 |
| 8000. | 68.63 | 72.59 | 70.66 | 71.02 | 72.58 | 74.96 | 75.75 | 88.11 |
| 10000. | 68.44 | 71.65 | 69.61 | 70.76 | 72.40 | 74.88 | 75.66 | 87.77 |
| 12500. | 68.51 | 71.54 | 69.71 | 70.75 | 72.41 | 74.93 | 75.42 | 87.75 |
| 16000. | 68.26 | 72.19 | 69.87 | 71.25 | 72.74 | 74.98 | 75.66 | 88.03 |
| 20000. | 67.05 | 72.39 | 69.53 | 71.05 | 72.37 | 74.52 | 75.15 | 87.74 |
| 25000. | 65.47 | 71.58 | 68.42 | 69.90 | 71.11 | 73.04 | 73.94 | 86.53 |
| 31500. | 63.63 | 69.56 | 66.74 | 68.30 | 69.16 | 71.12 | 72.09 | 84.66 |
| 40000. | 61.66 | 67.22 | 65.07 | 66.58 | 67.65 | 68.95 | 70.44 | 82.69 |

TOTAL POWER, DB = 100.59

NOZZLE DIA = 2.8"
 DIFFUSOR DIA = 6.0"
 FLOW TEMPERATURE, TOTAL = 530.0 DEG R
 MICROPHONE RADIUS = 6 FT.

NOZZLE-DIFFUSOR SPACING RATIO = 1.00
 MACH NO. = 0.90

AEDC-TR-80-15

MICROPHONE ANGLE, DEG

| FREQUENCY, HZ | 30. | 45. | 60. | 75. | 90. | 105. | 120. | TOTAL POWER, DB (1/3 OCTAVE BAND) |
|---------------|---------------------------------|-------|-------|-------|-------|-------|-------|--------------------------------------|
| | SOUND POWER INTENSITY LEVEL, DB | | | | | | | |
| 200. | 72.33 | 72.22 | 73.31 | 71.79 | 74.12 | 73.00 | 71.95 | 87.87 |
| 250. | 72.40 | 72.21 | 73.37 | 73.00 | 74.92 | 73.54 | 73.32 | 88.45 |
| 315. | 74.96 | 74.31 | 74.31 | 75.42 | 75.40 | 75.55 | 74.69 | 90.23 |
| 400. | 75.29 | 76.41 | 74.75 | 74.28 | 75.05 | 75.40 | 74.85 | 90.48 |
| 500. | 74.23 | 74.19 | 74.30 | 74.10 | 74.39 | 75.24 | 75.33 | 89.72 |
| 630. | 74.37 | 73.10 | 73.72 | 74.23 | 74.93 | 75.35 | 76.00 | 89.63 |
| 800. | 73.58 | 73.80 | 74.03 | 74.05 | 75.60 | 75.07 | 76.23 | 89.76 |
| 1000. | 73.96 | 73.87 | 73.77 | 73.93 | 75.32 | 75.10 | 77.35 | 89.80 |
| 1250. | 74.60 | 73.99 | 74.34 | 73.55 | 74.59 | 76.16 | 77.20 | 90.04 |
| 1600. | 75.32 | 74.37 | 74.46 | 73.44 | 74.31 | 75.69 | 76.85 | 89.94 |
| 2000. | 75.78 | 75.01 | 74.20 | 73.62 | 74.28 | 75.22 | 76.39 | 89.99 |
| 2500. | 75.61 | 75.58 | 74.57 | 74.27 | 74.51 | 75.26 | 76.36 | 90.26 |
| 3150. | 75.03 | 75.90 | 75.07 | 74.34 | 75.11 | 76.18 | 76.90 | 90.70 |
| 4000. | 74.69 | 76.28 | 75.83 | 74.86 | 76.16 | 77.36 | 77.96 | 91.45 |
| 5000. | 73.86 | 76.73 | 76.58 | 75.82 | 77.72 | 79.37 | 80.21 | 92.75 |
| 6300. | 73.63 | 77.93 | 77.21 | 76.64 | 79.21 | 81.18 | 81.83 | 94.14 |
| 8000. | 75.12 | 79.84 | 76.35 | 78.24 | 81.34 | 83.44 | 83.27 | 96.04 |
| 10000. | 75.96 | 80.22 | 78.09 | 78.44 | 82.07 | 84.18 | 84.13 | 96.61 |
| 12500. | 75.84 | 79.52 | 77.32 | 77.49 | 81.26 | 83.71 | 84.17 | 96.06 |
| 16000. | 74.85 | 78.94 | 76.87 | 77.18 | 80.36 | 82.79 | 84.52 | 95.45 |
| 20000. | 73.59 | 77.80 | 76.29 | 76.74 | 79.20 | 81.31 | 83.23 | 94.26 |
| 25000. | 71.77 | 76.41 | 75.14 | 75.61 | 77.77 | 79.13 | 80.67 | 92.48 |
| 31500. | 70.32 | 75.58 | 73.99 | 74.53 | 76.35 | 77.26 | 78.74 | 91.04 |
| 40000. | 68.68 | 73.60 | 73.04 | 73.01 | 74.80 | 75.90 | 76.75 | 89.51 |

TOTAL POWER, DB = 106.14

NOZZLE DIA = 2.8"
 DIFFUSOR DIA = 6.0"
 FLOW TEMPERATURE, TOTAL = 530.0 DEG R
 MICROPHONE RADIUS = 6 FT.

NOZZLE-DIFFUSOR SPACING RATIO = 1.00
 MACH NU. = 1.10

MICROPHONE ANGLE, DEG

| FREQUENCY, HZ | MICROPHONE ANGLE, DEG | | | | | | | TOTAL POWER, DB (1/3 OCTAVE BAND) |
|---------------|-----------------------|-------|-------|-------|-------|-------|-------|--------------------------------------|
| | 30. | 45. | 60. | 75. | 90. | 105. | 120. | |
| 200. | 71.50 | 70.75 | 71.04 | 72.02 | 70.96 | 70.48 | 71.14 | 86.32 |
| 250. | 72.57 | 70.96 | 71.21 | 72.20 | 71.85 | 71.20 | 72.61 | 86.82 |
| 315. | 75.05 | 73.89 | 74.16 | 74.03 | 73.64 | 74.02 | 73.96 | 89.22 |
| 400. | 75.49 | 75.50 | 75.09 | 74.58 | 74.41 | 75.13 | 75.04 | 90.23 |
| 500. | 74.54 | 74.63 | 75.07 | 74.32 | 74.49 | 76.29 | 75.94 | 90.29 |
| 630. | 75.29 | 74.71 | 74.86 | 75.45 | 75.45 | 77.59 | 77.16 | 91.12 |
| 800. | 74.98 | 74.41 | 74.20 | 75.44 | 75.97 | 75.71 | 76.92 | 90.50 |
| 1000. | 74.34 | 74.18 | 74.37 | 74.34 | 74.52 | 74.97 | 76.67 | 89.83 |
| 1250. | 75.41 | 74.51 | 74.35 | 75.03 | 74.41 | 76.14 | 77.13 | 90.42 |
| 1600. | 76.24 | 75.48 | 75.72 | 75.65 | 76.19 | 76.80 | 78.09 | 91.35 |
| 2000. | 80.42 | 78.74 | 78.80 | 79.07 | 80.19 | 80.70 | 82.54 | 95.05 |
| 2500. | 80.35 | 80.02 | 80.05 | 80.83 | 81.54 | 81.80 | 83.06 | 96.23 |
| 3150. | 79.65 | 80.04 | 79.58 | 79.99 | 80.79 | 80.75 | 80.79 | 95.45 |
| 4000. | 80.85 | 81.01 | 80.70 | 79.65 | 79.92 | 79.76 | 79.84 | 95.47 |
| 5000. | 82.50 | 80.90 | 80.49 | 79.58 | 79.42 | 79.41 | 79.60 | 95.36 |
| 6300. | 82.05 | 81.05 | 80.28 | 79.70 | 80.26 | 80.06 | 80.94 | 95.64 |
| 8000. | 81.67 | 81.69 | 81.14 | 80.45 | 81.92 | 82.50 | 83.17 | 96.95 |
| 10000. | 81.35 | 81.98 | 81.18 | 80.50 | 82.37 | 83.22 | 84.07 | 97.29 |
| 12500. | 80.33 | 81.36 | 80.21 | 79.79 | 82.13 | 82.99 | 84.15 | 96.83 |
| 16000. | 78.30 | 80.55 | 79.49 | 79.14 | 81.64 | 82.32 | 84.09 | 96.17 |
| 20000. | 77.40 | 80.00 | 79.02 | 79.00 | 80.95 | 81.40 | 83.78 | 95.58 |
| 25000. | 76.00 | 79.58 | 78.43 | 78.35 | 79.38 | 80.28 | 82.14 | 94.62 |
| 31500. | 74.23 | 78.58 | 77.71 | 77.14 | 77.75 | 78.59 | 80.44 | 93.28 |
| 40000. | 72.96 | 77.59 | 76.55 | 76.23 | 76.81 | 77.41 | 79.36 | 92.23 |

TOTAL POWER, DB = 107.84

NOZZLE DIA = 2.8"
 DIFFUSOR DIA = 6.0"
 FLOW TEMPERATURE, TOTAL = 530.0 DEG R
 MICROPHONE RADIUS = 6 FT.

NOZZLE-DIFFUSOR SPACING RATIO = 1.25
 MACH NO. = 0.70

AEEDC-TR-80-15

MICROPHONE ANGLE, DEG

| FREQUENCY, HZ | 30. | 45. | 60. | 75. | 90. | 105. | 120. | TOTAL POWER, DB (1/3 OCTAVE BAND) |
|---------------|---------------------------------|-------|-------|-------|-------|-------|-------|--------------------------------------|
| | SOUND POWER INTENSITY LEVEL, DB | | | | | | | |
| 200. | 70.55 | 70.70 | 71.31 | 70.46 | 70.32 | 70.48 | 70.75 | 85.81 |
| 250. | 70.56 | 69.47 | 70.11 | 70.13 | 70.94 | 69.76 | 70.38 | 85.24 |
| 315. | 72.60 | 70.60 | 69.88 | 70.38 | 72.13 | 70.06 | 70.21 | 85.89 |
| 400. | 71.86 | 71.09 | 69.58 | 69.86 | 71.03 | 70.61 | 70.92 | 85.80 |
| 500. | 70.27 | 70.31 | 69.59 | 69.60 | 69.42 | 71.04 | 71.13 | 85.45 |
| 630. | 70.42 | 70.41 | 69.37 | 70.64 | 69.97 | 71.08 | 71.91 | 85.63 |
| 800. | 70.37 | 70.52 | 69.46 | 70.23 | 70.59 | 69.86 | 72.43 | 85.53 |
| 1000. | 71.59 | 71.01 | 70.57 | 70.60 | 70.95 | 71.04 | 72.63 | 86.21 |
| 1250. | 73.70 | 71.82 | 72.25 | 71.30 | 71.63 | 72.29 | 72.90 | 87.23 |
| 1600. | 76.19 | 73.90 | 73.54 | 72.18 | 72.38 | 72.40 | 73.55 | 88.41 |
| 2000. | 76.33 | 75.60 | 73.76 | 73.06 | 73.06 | 72.57 | 75.05 | 89.29 |
| 2500. | 75.83 | 76.34 | 74.22 | 73.50 | 73.36 | 73.12 | 75.70 | 89.76 |
| 3150. | 74.89 | 76.00 | 73.92 | 72.73 | 73.08 | 73.55 | 75.97 | 89.49 |
| 4000. | 73.25 | 75.03 | 72.67 | 71.65 | 72.62 | 73.91 | 76.11 | 88.86 |
| 5000. | 71.23 | 73.55 | 71.59 | 70.62 | 72.60 | 74.65 | 76.06 | 88.38 |
| 6300. | 69.72 | 73.08 | 71.50 | 70.36 | 72.71 | 74.76 | 76.01 | 88.19 |
| 8000. | 69.54 | 73.13 | 70.89 | 70.42 | 73.26 | 75.12 | 75.71 | 88.31 |
| 10000. | 69.30 | 72.41 | 70.28 | 70.41 | 73.05 | 75.10 | 75.60 | 88.07 |
| 12500. | 69.12 | 72.20 | 70.11 | 70.47 | 72.97 | 74.39 | 75.17 | 87.71 |
| 16000. | 68.95 | 72.56 | 70.19 | 70.91 | 72.95 | 74.18 | 74.24 | 87.70 |
| 20000. | 67.69 | 71.97 | 69.83 | 70.58 | 72.36 | 73.59 | 72.86 | 87.09 |
| 25000. | 65.67 | 70.81 | 68.64 | 69.50 | 71.07 | 72.24 | 70.78 | 85.80 |
| 31500. | 62.63 | 68.50 | 66.57 | 67.39 | 68.88 | 69.87 | 69.02 | 83.55 |
| 40000. | 60.29 | 65.81 | 65.19 | 65.41 | 66.70 | 67.57 | 69.64 | 81.57 |

TOTAL POWER, DB = 101.06

100

NOZZLE DIA = 2.8"
 DIFFUSOR DIA = 6.0"
 FLOW TEMPERATURE, TOTAL = 530.0 DEG R
 MICROPHONE RADIUS = 6 FT.

NOZZLE-DIFFUSOR SPACING RATIO = 1.25
 MACH NO. = 0.90

MICROPHONE ANGLE, DEG

| FREQUENCY, HZ | MICROPHONE ANGLE, DEG | | | | | | | TOTAL POWER, DB (1/3 OCTAVE BAND) |
|---------------|-----------------------|-------|-------|-------|-------|-------|-------|--------------------------------------|
| | 30. | 45. | 60. | 75. | 90. | 105. | 120. | |
| 200. | 71.85 | 72.14 | 73.03 | 73.56 | 73.18 | 74.05 | 72.02 | 88.33 |
| 250. | 72.33 | 72.34 | 72.61 | 72.62 | 73.48 | 74.78 | 72.31 | 88.40 |
| 315. | 73.97 | 73.67 | 75.11 | 72.87 | 75.69 | 75.90 | 74.12 | 89.80 |
| 400. | 74.77 | 74.38 | 75.65 | 73.25 | 75.15 | 75.75 | 75.18 | 90.01 |
| 500. | 73.36 | 73.51 | 74.40 | 73.44 | 73.35 | 74.90 | 75.60 | 89.24 |
| 630. | 73.84 | 73.57 | 73.09 | 74.51 | 74.02 | 74.49 | 76.27 | 89.39 |
| 800. | 74.34 | 73.26 | 73.37 | 74.90 | 75.28 | 73.90 | 77.20 | 89.60 |
| 1000. | 74.32 | 74.29 | 73.91 | 74.38 | 74.66 | 74.69 | 76.92 | 89.63 |
| 1250. | 75.19 | 75.05 | 75.33 | 74.13 | 74.91 | 76.01 | 76.32 | 90.40 |
| 1600. | 76.76 | 76.14 | 76.12 | 74.57 | 75.34 | 75.73 | 76.43 | 90.90 |
| 2000. | 76.14 | 77.74 | 76.78 | 75.71 | 76.40 | 76.15 | 77.26 | 91.94 |
| 2500. | 76.86 | 79.27 | 77.12 | 76.66 | 76.63 | 76.44 | 78.06 | 92.79 |
| 3150. | 78.80 | 80.04 | 77.53 | 76.59 | 76.86 | 77.17 | 79.18 | 93.29 |
| 4000. | 77.70 | 79.35 | 77.68 | 77.10 | 77.29 | 78.29 | 80.37 | 93.47 |
| 5000. | 75.96 | 76.21 | 77.33 | 77.16 | 78.03 | 79.86 | 81.67 | 93.70 |
| 6300. | 74.42 | 78.15 | 77.29 | 77.03 | 79.41 | 81.48 | 83.36 | 94.54 |
| 8000. | 74.59 | 78.98 | 77.82 | 78.24 | 80.73 | 83.30 | 84.29 | 95.84 |
| 10000. | 75.66 | 79.56 | 77.59 | 78.75 | 80.96 | 84.35 | 84.20 | 96.45 |
| 12500. | 75.00 | 79.38 | 77.24 | 78.17 | 80.49 | 84.14 | 83.29 | 96.10 |
| 16000. | 74.00 | 79.13 | 77.01 | 77.78 | 80.09 | 83.03 | 81.80 | 95.32 |
| 20000. | 73.69 | 78.57 | 76.84 | 77.27 | 78.98 | 81.10 | 79.61 | 94.05 |
| 25000. | 71.83 | 77.04 | 75.85 | 75.86 | 77.17 | 78.34 | 77.17 | 92.07 |
| 31500. | 69.05 | 75.21 | 74.22 | 74.46 | 75.36 | 76.16 | 75.63 | 90.25 |
| 40000. | 67.40 | 73.69 | 72.09 | 72.29 | 73.62 | 74.74 | 75.94 | 88.69 |

TOTAL POWER, DB = 106.43

101

NOZZLE DIA = 2.8"
 DIFFUSOR DIA = 8.0"
 FLOW TEMPERATURE, TOTAL = 530.0 DEG R
 MICROPHONE RADIUS = 6 FT.

NOZZLE-DIFFUSOR SPACING RATIO = 1.25
 MACH NO. = 1.10

AEDC-TR-80-15

MICROPHONE ANGLE, DEG

| FREQUENCY, HZ | MICROPHONE ANGLE, DEG | | | | | | | TOTAL POWER, DB (1/3 OCTAVE BAND) |
|---------------|-----------------------|-------|-------|-------|-------|-------|-------|--------------------------------------|
| | 30. | 45. | 60. | 75. | 90. | 105. | 120. | |
| 200. | 71.59 | 71.59 | 71.92 | 71.77 | 71.42 | 72.51 | 71.10 | 67.03 |
| 250. | 71.88 | 71.25 | 71.36 | 71.63 | 71.02 | 73.08 | 72.80 | 67.15 |
| 315. | 75.03 | 73.32 | 73.85 | 74.17 | 74.11 | 75.29 | 73.23 | 69.43 |
| 400. | 76.21 | 74.81 | 75.52 | 74.74 | 74.41 | 75.67 | 74.29 | 70.24 |
| 500. | 74.72 | 74.65 | 75.22 | 74.67 | 74.20 | 75.00 | 75.49 | 70.17 |
| 630. | 75.07 | 75.58 | 74.72 | 75.37 | 75.50 | 76.22 | 76.74 | 70.83 |
| 800. | 74.98 | 75.17 | 74.24 | 74.60 | 75.07 | 75.13 | 77.17 | 70.33 |
| 1000. | 74.13 | 74.06 | 73.49 | 73.90 | 74.89 | 75.50 | 76.53 | 69.66 |
| 1250. | 75.81 | 74.73 | 75.22 | 74.65 | 74.93 | 76.36 | 76.32 | 70.59 |
| 1600. | 77.88 | 76.80 | 76.83 | 75.73 | 76.05 | 77.07 | 77.20 | 71.65 |
| 2000. | 81.35 | 79.95 | 79.64 | 79.73 | 80.80 | 80.82 | 81.18 | 75.54 |
| 2500. | 82.08 | 82.21 | 81.30 | 81.38 | 81.65 | 82.90 | 82.81 | 77.29 |
| 3150. | 81.79 | 83.13 | 82.52 | 80.60 | 81.38 | 82.90 | 82.42 | 77.46 |
| 4000. | 82.72 | 84.05 | 82.79 | 81.72 | 81.11 | 82.44 | 81.90 | 77.71 |
| 5000. | 82.50 | 83.77 | 81.35 | 80.67 | 80.51 | 81.73 | 80.94 | 77.13 |
| 6300. | 81.84 | 83.11 | 81.04 | 80.35 | 80.62 | 81.47 | 81.11 | 76.75 |
| 8000. | 82.00 | 83.08 | 82.02 | 80.92 | 81.87 | 82.86 | 82.05 | 77.44 |
| 10000. | 82.03 | 83.50 | 82.10 | 81.98 | 82.07 | 83.99 | 83.18 | 76.10 |
| 12500. | 80.67 | 83.02 | 81.09 | 81.10 | 82.65 | 83.79 | 83.42 | 77.73 |
| 16000. | 79.18 | 82.49 | 80.86 | 80.65 | 82.05 | 83.15 | 83.22 | 77.14 |
| 20000. | 78.26 | 82.08 | 80.81 | 80.14 | 81.27 | 81.99 | 82.70 | 76.53 |
| 25000. | 76.58 | 81.54 | 80.51 | 79.66 | 79.60 | 80.20 | 80.91 | 75.39 |
| 31500. | 74.65 | 79.98 | 79.31 | 77.60 | 77.73 | 78.22 | 78.74 | 73.73 |
| 40000. | 72.52 | 78.18 | 77.61 | 76.67 | 76.44 | 76.68 | 77.15 | 72.10 |

TOTAL POWER, DB = 106.77

NOZZLE DIA = 2.8"
 DIFFUSOR DIA = 6.0"
 FLOW TEMPERATURE, TOTAL = 530.0 DEG R
 MICROPHONE RADIUS = 6 FT.

NOZZLE-DIFFUSOR SPACING RATIO = 1.50
 MACH NO. = 0.70

| FREQUENCY, HZ | MICROPHONE ANGLE, DEG | | | | | | | TOTAL POWER, DB (1/3 OCTAVE BAND) |
|---------------|-----------------------|-------|-------|-------|-------|-------|-------|--------------------------------------|
| | 30. | 45. | 60. | 75. | 90. | 105. | 120. | |
| 200. | 70.26 | 71.34 | 71.18 | 71.72 | 70.97 | 71.97 | 68.04 | 86.53 |
| 250. | 70.24 | 71.30 | 69.19 | 70.88 | 71.44 | 72.64 | 68.76 | 86.42 |
| 315. | 71.87 | 71.90 | 69.83 | 71.06 | 72.10 | 72.30 | 69.36 | 86.73 |
| 400. | 71.72 | 71.73 | 70.71 | 70.16 | 71.12 | 71.20 | 69.89 | 86.21 |
| 500. | 70.37 | 70.81 | 70.77 | 70.28 | 69.81 | 70.22 | 71.00 | 85.63 |
| 630. | 71.62 | 71.34 | 71.21 | 70.21 | 70.86 | 70.71 | 72.17 | 86.16 |
| 800. | 73.19 | 71.93 | 71.90 | 71.34 | 71.71 | 71.13 | 72.90 | 86.94 |
| 1000. | 75.06 | 73.74 | 73.24 | 72.73 | 71.68 | 71.55 | 73.50 | 88.11 |
| 1250. | 77.41 | 76.04 | 75.97 | 74.12 | 73.10 | 73.44 | 73.78 | 90.05 |
| 1600. | 80.25 | 76.73 | 77.94 | 76.08 | 74.65 | 74.88 | 75.01 | 92.20 |
| 2000. | 81.50 | 80.97 | 79.02 | 77.15 | 76.08 | 76.26 | 76.57 | 93.79 |
| 2500. | 80.91 | 80.93 | 78.81 | 77.33 | 76.17 | 77.00 | 76.59 | 93.83 |
| 3150. | 78.29 | 79.63 | 76.90 | 75.60 | 74.80 | 76.40 | 76.68 | 92.46 |
| 4000. | 74.52 | 76.99 | 74.79 | 73.75 | 73.88 | 75.36 | 76.64 | 90.53 |
| 5000. | 71.90 | 75.12 | 73.51 | 72.47 | 73.91 | 75.28 | 76.48 | 89.53 |
| 6300. | 70.67 | 74.44 | 72.80 | 72.08 | 73.81 | 75.45 | 76.44 | 89.24 |
| 8000. | 70.40 | 74.66 | 72.86 | 72.33 | 73.96 | 75.74 | 76.40 | 89.43 |
| 10000. | 70.44 | 73.86 | 72.60 | 72.83 | 73.93 | 75.78 | 75.92 | 89.28 |
| 12500. | 70.49 | 73.95 | 72.84 | 72.94 | 73.89 | 75.57 | 75.37 | 89.22 |
| 16000. | 70.53 | 74.55 | 73.03 | 73.25 | 73.92 | 75.48 | 75.14 | 89.39 |
| 20000. | 69.05 | 73.94 | 72.20 | 72.80 | 73.13 | 74.63 | 74.34 | 88.67 |
| 25000. | 67.51 | 72.12 | 70.79 | 71.52 | 71.95 | 72.90 | 73.21 | 87.13 |
| 31500. | 65.26 | 70.19 | 68.87 | 69.16 | 70.20 | 71.03 | 71.46 | 85.17 |
| 40000. | 62.39 | 67.99 | 67.33 | 67.16 | 68.20 | 69.35 | 69.25 | 83.23 |

TOTAL POWER, DB = 103.23

103

NOZZLE DIA = 2.8"
 DIFFUSOR DIA = 6.0"
 FLOW TEMPERATURE, TOTAL = 530.0 DEG K
 MICROPHONE RADIUS = 6 FT.

NOZZLE-DIFFUSOR SPACING RATIO = 1.50
 MACH NU. = 0.90

AEDC-TR-80-15

MICROPHONE ANGLE, DEG

| FREQUENCY, HZ | 30. | 45. | 60. | 75. | 90. | 105. | 120. | TOTAL POWER, DB (1/3 OCTAVE BAND) |
|---------------|---------------------------------|-------|-------|-------|-------|-------|-------|--------------------------------------|
| | SOUND POWER INTENSITY LEVEL, DB | | | | | | | |
| 200. | 71.81 | 72.93 | 73.45 | 72.95 | 74.44 | 72.94 | 71.17 | 88.25 |
| 250. | 72.74 | 72.11 | 72.42 | 72.98 | 74.78 | 73.70 | 73.39 | 88.36 |
| 315. | 73.07 | 74.08 | 72.47 | 74.79 | 75.50 | 76.05 | 74.86 | 90.66 |
| 400. | 73.37 | 75.54 | 74.88 | 74.70 | 74.76 | 76.24 | 74.41 | 90.51 |
| 500. | 73.83 | 74.97 | 75.24 | 74.03 | 73.64 | 75.79 | 74.79 | 90.01 |
| 630. | 74.84 | 74.59 | 74.60 | 74.31 | 74.61 | 75.04 | 75.94 | 89.94 |
| 800. | 75.63 | 75.42 | 74.84 | 74.92 | 75.34 | 74.13 | 77.08 | 90.30 |
| 1000. | 76.75 | 77.27 | 75.97 | 76.16 | 74.85 | 75.40 | 77.27 | 91.43 |
| 1250. | 78.04 | 79.87 | 77.46 | 76.76 | 75.44 | 76.67 | 77.21 | 92.93 |
| 1600. | 80.40 | 82.41 | 79.25 | 77.43 | 76.93 | 76.85 | 77.21 | 94.51 |
| 2000. | 82.60 | 83.94 | 80.76 | 78.86 | 78.53 | 77.74 | 78.23 | 95.99 |
| 2500. | 83.59 | 84.51 | 81.83 | 79.84 | 78.75 | 79.13 | 78.99 | 96.79 |
| 3150. | 83.07 | 82.74 | 82.00 | 79.08 | 79.21 | 79.77 | 80.07 | 96.14 |
| 4000. | 80.95 | 80.33 | 80.26 | 78.48 | 79.49 | 80.08 | 80.96 | 95.09 |
| 5000. | 77.83 | 79.07 | 78.61 | 78.25 | 79.51 | 80.46 | 81.16 | 94.54 |
| 6300. | 75.97 | 79.84 | 78.03 | 78.96 | 80.29 | 81.66 | 81.92 | 95.24 |
| 8000. | 76.27 | 80.26 | 78.65 | 79.59 | 81.27 | 82.49 | 82.87 | 96.13 |
| 10000. | 76.62 | 80.15 | 78.83 | 79.36 | 81.73 | 83.75 | 83.70 | 96.51 |
| 12500. | 76.73 | 80.35 | 78.62 | 79.54 | 81.82 | 83.81 | 83.70 | 96.60 |
| 16000. | 76.72 | 79.72 | 78.87 | 79.05 | 81.40 | 83.62 | 83.51 | 96.29 |
| 20000. | 76.00 | 78.77 | 78.53 | 77.87 | 80.28 | 81.65 | 79.75 | 94.73 |
| 25000. | 74.46 | 77.75 | 77.38 | 76.12 | 78.27 | 79.36 | 77.59 | 92.85 |
| 31500. | 72.98 | 75.74 | 75.97 | 74.38 | 76.58 | 77.19 | 76.06 | 91.69 |
| 40000. | 70.42 | 76.34 | 74.69 | 74.84 | 75.33 | 75.35 | 76.54 | 90.52 |

TOTAL POWER, DB = 107.76

NOZZLE DIA = 2.8"
 DIFFUSOR DIA = 6.0"
 FLOW TEMPERATURE, TOTAL = 530.0 DEG R
 MICROPHONE RADIUS = 6 FT.

NOZZLE-DIFFUSOR SPACING RATIO = 1.50
 MACH NO. = 1.10

105

| | | | | | | | | |
|--------|-------|-------|-------|-------|-------|-------|-------|--------|
| 200. | 72.16 | 70.50 | 71.28 | 72.11 | 72.53 | 71.28 | 71.81 | 86.75 |
| 250. | 72.93 | 71.24 | 71.39 | 74.05 | 72.32 | 73.85 | 72.65 | 88.10 |
| 315. | 76.18 | 74.52 | 74.29 | 75.10 | 75.48 | 75.85 | 72.92 | 90.28 |
| 400. | 76.20 | 74.89 | 75.74 | 74.12 | 76.35 | 76.13 | 74.65 | 90.58 |
| 500. | 75.77 | 74.18 | 75.85 | 74.86 | 75.50 | 76.22 | 75.88 | 90.55 |
| 640. | 76.99 | 75.81 | 75.58 | 75.53 | 76.50 | 76.50 | 77.42 | 91.33 |
| 800. | 76.68 | 75.92 | 75.57 | 76.08 | 77.06 | 75.84 | 78.07 | 91.44 |
| 1000. | 76.70 | 76.60 | 75.68 | 75.93 | 76.15 | 75.74 | 77.13 | 91.35 |
| 1250. | 78.88 | 77.98 | 77.44 | 76.67 | 76.64 | 77.04 | 76.83 | 92.49 |
| 1600. | 81.55 | 80.76 | 79.71 | 78.93 | 78.65 | 78.08 | 77.99 | 94.64 |
| 2000. | 84.04 | 83.60 | 82.43 | 82.02 | 81.88 | 81.42 | 81.88 | 97.67 |
| 2500. | 86.15 | 85.61 | 84.63 | 84.21 | 84.08 | 83.73 | 83.99 | 99.80 |
| 3150. | 86.29 | 86.48 | 85.19 | 84.82 | 85.47 | 84.77 | 84.45 | 100.60 |
| 4000. | 86.18 | 86.47 | 85.05 | 84.86 | 85.83 | 84.87 | 83.90 | 100.62 |
| 5000. | 84.67 | 84.93 | 84.08 | 83.69 | 84.92 | 84.39 | 83.35 | 99.56 |
| 6300. | 82.98 | 83.83 | 83.49 | 83.41 | 83.82 | 83.52 | 83.29 | 96.75 |
| 8000. | 82.93 | 84.14 | 83.67 | 83.56 | 83.93 | 84.51 | 83.95 | 99.15 |
| 10000. | 83.07 | 84.38 | 83.90 | 83.68 | 84.16 | 84.66 | 84.15 | 99.38 |
| 12500. | 82.77 | 84.23 | 83.32 | 83.53 | 83.82 | 84.75 | 84.55 | 99.21 |
| 16000. | 82.09 | 84.41 | 83.24 | 83.18 | 83.74 | 84.47 | 84.44 | 99.06 |
| 20000. | 80.97 | 84.39 | 83.16 | 82.59 | 82.96 | 83.29 | 83.56 | 98.48 |
| 25000. | 79.46 | 83.55 | 82.13 | 80.97 | 81.54 | 81.60 | 81.49 | 97.15 |
| 31500. | 77.20 | 82.14 | 80.58 | 79.55 | 80.06 | 79.22 | 79.72 | 95.48 |
| 40000. | 75.37 | 81.11 | 79.11 | 78.25 | 78.07 | 77.53 | 78.28 | 94.11 |

TOTAL POWER, DB = 110.79

NOZZLE DIA = 2.8"
 DIFFUSOR DIA = 6.0"
 FLOW TEMPERATURE, TOTAL = 1210.0 DEG R
 MICROPHONE RADIUS = 6 FT.

NOZZLE-DIFFUSOR SPACING RATIO = 0.00
 MACH NO. = 0.70

AEDC-TR-80-15

MICROPHONE ANGLE, DEG

| FREQUENCY, HZ | 30. | 45. | 60. | 75. | 90. | 105. | 120. | TOTAL POWER, DB (1/3 OCTAVE BAND) |
|---------------|---------------------------------|-------|-------|-------|-------|-------|-------|--------------------------------------|
| | SOUND POWER INTENSITY LEVEL, DB | | | | | | | |
| 200. | 73.83 | 74.70 | 73.69 | 73.19 | 76.36 | 75.66 | 75.56 | 89.98 |
| 250. | 75.20 | 74.69 | 73.35 | 73.91 | 75.83 | 75.84 | 75.96 | 90.13 |
| 315. | 78.73 | 77.27 | 77.20 | 77.68 | 78.72 | 77.81 | 79.29 | 93.06 |
| 400. | 78.59 | 80.11 | 79.02 | 78.34 | 79.02 | 79.77 | 80.00 | 94.55 |
| 500. | 78.76 | 80.92 | 80.26 | 78.87 | 79.31 | 81.29 | 81.61 | 95.52 |
| 630. | 80.51 | 80.97 | 81.25 | 81.18 | 79.66 | 81.04 | 82.65 | 96.22 |
| 800. | 81.31 | 80.52 | 81.48 | 82.22 | 80.91 | 81.42 | 84.70 | 96.84 |
| 1000. | 80.15 | 80.12 | 81.58 | 80.22 | 81.27 | 81.42 | 85.29 | 96.41 |
| 1250. | 80.71 | 79.73 | 80.86 | 81.07 | 80.54 | 82.49 | 85.88 | 96.74 |
| 1600. | 81.07 | 80.42 | 80.52 | 80.59 | 80.45 | 83.07 | 85.70 | 96.68 |
| 2000. | 81.05 | 80.85 | 79.92 | 79.53 | 80.55 | 82.75 | 85.46 | 96.62 |
| 2500. | 81.22 | 80.83 | 80.40 | 80.38 | 81.48 | 82.68 | 86.25 | 96.98 |
| 3150. | 80.25 | 80.63 | 80.06 | 80.03 | 80.95 | 82.18 | 85.69 | 96.53 |
| 4000. | 79.16 | 80.36 | 79.59 | 79.16 | 79.59 | 81.67 | 84.81 | 95.86 |
| 5000. | 77.11 | 80.29 | 79.50 | 78.05 | 78.86 | 81.68 | 84.63 | 95.56 |
| 6300. | 74.75 | 79.32 | 79.16 | 76.48 | 77.95 | 80.85 | 84.08 | 94.63 |
| 8000. | 73.02 | 77.86 | 77.61 | 74.99 | 76.78 | 80.34 | 83.46 | 93.62 |
| 10000. | 71.61 | 75.82 | 75.36 | 73.05 | 75.42 | 79.78 | 82.01 | 92.30 |
| 12500. | 69.95 | 73.46 | 74.19 | 71.55 | 74.19 | 79.01 | 80.62 | 91.05 |
| 16000. | 68.28 | 73.19 | 73.59 | 70.88 | 74.10 | 78.64 | 80.39 | 90.68 |
| 20000. | 65.73 | 72.35 | 71.28 | 69.00 | 73.31 | 77.05 | 78.75 | 89.18 |
| 25000. | 62.93 | 71.71 | 69.03 | 66.87 | 72.14 | 75.03 | 76.72 | 87.46 |
| 31500. | 60.57 | 70.16 | 67.23 | 65.81 | 71.35 | 73.83 | 75.27 | 86.16 |
| 40000. | 58.21 | 67.44 | 65.29 | 63.36 | 70.06 | 73.07 | 74.14 | 84.83 |

TOTAL POWER, DB = 108.22

108

NOZZLE DIA = 2.8"
 DIFFUSOR DIA = 6.0"
 FLOW TEMPERATURE, TOTAL = 1210.0 DEG R
 MICROPHONE RADIUS = 6 FT.

NOZZLE-DIFFUSOR SPACING RATIO = 0.00
 MACH NO. = 0.90

| FREQUENCY, HZ | MICROPHONE ANGLE, DEG | | | | | | | TOTAL POWER, DB (1/3 OCTAVE BAND) |
|---------------|-----------------------|-------|-------|-------|-------|-------|-------|--------------------------------------|
| | 30. | 45. | 60. | 75. | 90. | 105. | 120. | |
| 200. | 76.48 | 76.37 | 73.06 | 74.42 | 74.35 | 74.29 | 73.94 | 90.08 |
| 250. | 75.52 | 75.53 | 73.14 | 75.96 | 76.15 | 75.19 | 75.02 | 90.59 |
| 315. | 78.70 | 76.60 | 76.39 | 76.58 | 78.77 | 79.02 | 77.07 | 93.25 |
| 400. | 81.04 | 78.69 | 79.58 | 79.80 | 79.19 | 80.19 | 79.17 | 94.82 |
| 500. | 80.27 | 79.70 | 80.36 | 80.01 | 79.47 | 80.97 | 80.58 | 95.40 |
| 630. | 81.22 | 79.94 | 81.07 | 81.23 | 80.32 | 82.07 | 82.04 | 96.31 |
| 800. | 81.08 | 80.12 | 80.33 | 81.63 | 81.17 | 81.33 | 82.75 | 96.31 |
| 1000. | 80.44 | 79.92 | 80.41 | 81.14 | 81.39 | 81.11 | 83.59 | 96.18 |
| 1250. | 80.25 | 80.49 | 80.61 | 81.02 | 80.78 | 82.71 | 83.78 | 96.64 |
| 1600. | 79.99 | 80.22 | 79.80 | 79.64 | 81.00 | 82.99 | 83.22 | 96.32 |
| 2000. | 80.17 | 79.90 | 79.31 | 79.28 | 80.78 | 82.82 | 83.80 | 96.16 |
| 2500. | 79.34 | 80.33 | 79.71 | 79.36 | 80.11 | 82.59 | 84.31 | 96.16 |
| 3150. | 79.39 | 80.70 | 79.79 | 79.69 | 80.20 | 82.74 | 83.87 | 96.30 |
| 4000. | 79.58 | 80.44 | 79.48 | 79.90 | 80.42 | 82.63 | 84.39 | 96.31 |
| 5000. | 78.66 | 80.30 | 79.56 | 79.59 | 80.45 | 82.91 | 84.77 | 96.35 |
| 6300. | 75.88 | 80.16 | 79.45 | 78.65 | 80.92 | 83.38 | 85.09 | 96.37 |
| 8000. | 74.48 | 80.26 | 79.15 | 78.55 | 80.95 | 83.46 | 84.72 | 96.32 |
| 10000. | 73.96 | 78.69 | 77.96 | 77.10 | 80.09 | 82.28 | 83.20 | 95.04 |
| 12500. | 71.61 | 76.32 | 76.77 | 75.02 | 78.66 | 81.79 | 82.06 | 93.84 |
| 16000. | 69.62 | 75.55 | 76.66 | 73.83 | 78.37 | 80.86 | 81.75 | 93.12 |
| 20000. | 66.29 | 75.03 | 75.03 | 72.51 | 77.01 | 78.73 | 81.50 | 91.72 |
| 25000. | 65.61 | 73.37 | 72.83 | 70.49 | 74.82 | 76.53 | 79.47 | 89.65 |
| 31500. | 63.26 | 72.54 | 71.25 | 67.71 | 72.94 | 73.70 | 77.82 | 87.66 |
| 40000. | 61.22 | 68.91 | 69.24 | 65.76 | 70.76 | 71.56 | 75.86 | 85.28 |

TOTAL POWER, DB = 108.64

107

NOZZLE DIA = 2.8"
 DIFFUSOR DIA = 6.0"
 FLOW TEMPERATURE, TOTAL = 1210.0 DEG R
 MICROPHONE RADIUS = 6 FT.

NOZZLE-DIFFUSOR SPACING RATIO = 0.00
 MACH NO. = 1.10

AEDC-TR-80-15

MICROPHONE ANGLE, DEG

| FREQUENCY, HZ | 30. | 45. | 60. | 75. | 90. | 105. | 120. | TOTAL POWER, DB (1/3 OCTAVE BAND) |
|---------------|---------------------------------|-------|-------|-------|-------|-------|-------|--------------------------------------|
| | SOUND POWER INTENSITY LEVEL, DB | | | | | | | |
| 200. | 72.99 | 73.95 | 73.66 | 72.18 | 73.93 | 74.61 | 73.26 | 88.85 |
| 250. | 72.38 | 71.26 | 72.05 | 72.21 | 74.39 | 74.46 | 72.53 | 88.12 |
| 315. | 78.90 | 75.32 | 74.06 | 78.54 | 76.06 | 75.52 | 75.05 | 91.70 |
| 400. | 80.27 | 79.75 | 76.53 | 79.14 | 76.14 | 78.93 | 76.29 | 93.90 |
| 500. | 78.39 | 77.19 | 77.01 | 77.45 | 76.22 | 79.09 | 78.35 | 92.96 |
| 630. | 78.48 | 76.28 | 77.12 | 77.11 | 76.69 | 79.39 | 80.36 | 93.04 |
| 800. | 77.36 | 77.79 | 75.44 | 78.60 | 77.15 | 77.58 | 79.94 | 92.99 |
| 1000. | 74.97 | 73.12 | 74.14 | 74.69 | 75.95 | 74.82 | 76.91 | 89.90 |
| 1250. | 77.36 | 76.73 | 76.35 | 78.79 | 76.80 | 79.12 | 79.04 | 93.18 |
| 1600. | 77.13 | 77.54 | 76.01 | 76.02 | 78.09 | 79.60 | 79.46 | 93.05 |
| 2000. | 81.11 | 83.89 | 84.97 | 81.59 | 88.56 | 86.70 | 90.64 | 100.95 |
| 2500. | 79.55 | 84.32 | 83.29 | 84.74 | 87.24 | 85.59 | 91.82 | 100.97 |
| 3150. | 78.68 | 81.30 | 79.00 | 79.69 | 78.71 | 80.16 | 80.50 | 95.24 |
| 4000. | 81.20 | 80.77 | 80.06 | 79.53 | 78.09 | 78.35 | 78.42 | 94.79 |
| 5000. | 82.94 | 81.01 | 81.12 | 79.87 | 78.87 | 79.79 | 80.11 | 95.62 |
| 6300. | 81.06 | 81.12 | 81.36 | 79.91 | 79.27 | 80.72 | 81.29 | 95.83 |
| 8000. | 81.79 | 82.18 | 82.04 | 81.15 | 81.96 | 83.66 | 83.42 | 97.58 |
| 10000. | 83.48 | 83.50 | 82.59 | 81.63 | 82.11 | 83.92 | 83.90 | 96.22 |
| 12500. | 79.81 | 80.68 | 80.59 | 79.56 | 79.89 | 82.68 | 83.54 | 96.28 |
| 16000. | 76.34 | 77.15 | 78.59 | 77.49 | 79.21 | 82.15 | 83.51 | 94.85 |
| 20000. | 72.99 | 76.24 | 77.30 | 76.63 | 78.78 | 81.29 | 82.77 | 93.96 |
| 25000. | 68.75 | 74.95 | 74.98 | 73.99 | 75.60 | 78.09 | 79.80 | 91.22 |
| 31500. | 67.38 | 72.45 | 73.18 | 70.78 | 73.13 | 75.52 | 78.88 | 88.93 |
| 40000. | 61.42 | 67.53 | 68.69 | 66.42 | 68.11 | 71.99 | 74.44 | 84.69 |

TOTAL POWER, DB = 109.02

108

NOZZLE DIA = 2.8"
 DIFFUSOR DIA = 6.0"
 FLOW TEMPERATURE, TOTAL = 1210.0 DEG R
 MICROPHONE RADIUS = 6 FT.

NOZZLE-DIFFUSOR SPACING RATIO = 0.25
 MACH NO. = 0.70

MICROPHONE ANGLE, DEG

| FREQUENCY, HZ | 30. | 45. | 60. | 75. | 90. | 105. | 120. | TOTAL POWER, DB (1/3 OCTAVE BAND) |
|---------------|---------------------------------|-------|-------|-------|-------|-------|-------|--------------------------------------|
| | SOUND POWER INTENSITY LEVEL, DB | | | | | | | |
| 200. | 74.18 | 75.26 | 75.33 | 75.00 | 75.14 | 74.03 | 74.31 | 90.03 |
| 250. | 75.42 | 75.00 | 75.11 | 75.36 | 75.20 | 74.75 | 74.15 | 90.25 |
| 315. | 78.06 | 78.30 | 77.26 | 79.31 | 79.77 | 78.69 | 77.74 | 93.86 |
| 400. | 80.06 | 81.22 | 79.34 | 79.49 | 79.96 | 79.41 | 79.94 | 95.20 |
| 500. | 79.22 | 80.90 | 80.66 | 79.62 | 79.39 | 82.03 | 81.56 | 95.92 |
| 630. | 80.78 | 80.20 | 80.45 | 81.45 | 81.03 | 82.87 | 82.30 | 96.64 |
| 800. | 81.39 | 81.08 | 81.13 | 82.15 | 82.24 | 81.31 | 83.42 | 96.89 |
| 1000. | 81.30 | 79.74 | 81.49 | 82.41 | 81.67 | 81.90 | 83.71 | 96.87 |
| 1250. | 80.57 | 80.19 | 81.34 | 81.58 | 81.54 | 83.31 | 83.68 | 97.04 |
| 1600. | 81.31 | 81.56 | 80.69 | 80.11 | 80.97 | 83.39 | 84.10 | 97.01 |
| 2000. | 81.96 | 81.07 | 80.03 | 78.65 | 80.47 | 82.72 | 84.65 | 96.49 |
| 2500. | 81.90 | 81.13 | 80.71 | 80.04 | 80.66 | 82.92 | 85.25 | 96.89 |
| 3150. | 80.80 | 81.82 | 80.88 | 79.65 | 80.59 | 82.62 | 84.91 | 96.80 |
| 4000. | 79.43 | 81.38 | 80.68 | 79.08 | 80.21 | 82.07 | 83.87 | 96.24 |
| 5000. | 77.50 | 80.93 | 79.64 | 78.63 | 79.13 | 81.78 | 83.72 | 95.71 |
| 6300. | 75.13 | 80.10 | 78.54 | 76.78 | 78.24 | 80.84 | 83.44 | 94.73 |
| 8000. | 74.09 | 79.21 | 78.07 | 75.32 | 77.01 | 80.68 | 82.59 | 94.06 |
| 10000. | 72.07 | 76.92 | 76.21 | 73.60 | 76.28 | 80.25 | 81.04 | 92.75 |
| 12500. | 70.07 | 75.01 | 74.60 | 72.39 | 75.32 | 79.63 | 80.51 | 91.74 |
| 16000. | 68.43 | 74.88 | 73.50 | 71.56 | 74.95 | 78.83 | 79.53 | 91.03 |
| 20000. | 65.93 | 72.90 | 71.70 | 70.23 | 74.12 | 77.14 | 77.73 | 89.37 |
| 25000. | 63.56 | 70.87 | 69.33 | 68.89 | 72.73 | 75.00 | 75.80 | 87.42 |
| 31500. | 60.61 | 68.77 | 66.83 | 67.55 | 70.76 | 73.75 | 74.44 | 85.86 |
| 40000. | 57.79 | 66.35 | 64.07 | 65.90 | 68.16 | 71.74 | 72.58 | 83.76 |

TOTAL POWER, DB = 108.48

109

NOZZLE DIA = 2.8"
 DIFFUSOR DIA = 6.0"
 FLOW TEMPERATURE, TOTAL = 1210.0 DEG R
 MICROPHONE RADIUS = 6 FT.

NOZZLE-DIFFUSOR SPACING RATIO = 0.25
 MACH NO. = 0.90

AEDC-TR-80-15

MICROPHONE ANGLE, DEG

| FREQUENCY, HZ | MICROPHONE ANGLE, DEG | | | | | | | TOTAL POWER, DB (1/3 OCTAVE BAND) |
|---------------|-----------------------|-------|-------|-------|-------|-------|-------|--------------------------------------|
| | 30. | 45. | 60. | 75. | 90. | 105. | 120. | |
| 200. | 75.33 | 75.76 | 74.37 | 73.31 | 74.54 | 75.50 | 73.62 | 90.02 |
| 250. | 75.13 | 75.57 | 74.07 | 74.67 | 76.15 | 76.19 | 76.04 | 90.60 |
| 315. | 80.50 | 78.15 | 78.22 | 76.38 | 79.09 | 79.42 | 78.67 | 94.00 |
| 400. | 82.33 | 78.83 | 80.46 | 78.22 | 80.25 | 80.23 | 79.37 | 94.90 |
| 500. | 81.62 | 79.45 | 81.17 | 78.32 | 80.47 | 81.94 | 81.41 | 95.68 |
| 630. | 81.04 | 79.66 | 80.24 | 80.18 | 80.80 | 82.00 | 82.05 | 95.98 |
| 800. | 80.26 | 79.56 | 80.19 | 80.85 | 81.27 | 80.60 | 83.01 | 95.89 |
| 1000. | 80.06 | 78.31 | 80.91 | 80.06 | 81.17 | 80.28 | 83.59 | 95.52 |
| 1250. | 80.94 | 79.12 | 80.42 | 80.47 | 80.55 | 82.04 | 83.02 | 96.03 |
| 1600. | 80.80 | 80.50 | 78.98 | 79.87 | 80.96 | 82.23 | 83.09 | 96.13 |
| 2000. | 80.66 | 80.35 | 79.07 | 79.77 | 80.47 | 81.59 | 83.79 | 95.92 |
| 2500. | 79.88 | 80.01 | 79.40 | 79.42 | 79.99 | 81.33 | 83.79 | 95.65 |
| 3150. | 79.05 | 79.61 | 79.36 | 79.08 | 80.13 | 81.51 | 83.48 | 95.51 |
| 4000. | 79.10 | 79.65 | 79.25 | 79.49 | 80.73 | 81.63 | 83.41 | 95.71 |
| 5000. | 78.01 | 80.02 | 79.06 | 79.46 | 80.82 | 82.52 | 83.61 | 95.99 |
| 6300. | 75.76 | 79.81 | 79.35 | 79.36 | 81.03 | 82.89 | 83.99 | 96.10 |
| 8000. | 75.19 | 78.84 | 79.24 | 79.46 | 81.37 | 83.45 | 84.32 | 96.23 |
| 10000. | 74.67 | 75.97 | 77.74 | 78.35 | 80.69 | 82.56 | 83.17 | 95.05 |
| 12500. | 72.51 | 74.30 | 76.17 | 76.35 | 79.51 | 81.60 | 81.96 | 93.76 |
| 16000. | 70.72 | 74.15 | 74.86 | 75.50 | 76.83 | 80.96 | 81.39 | 93.08 |
| 20000. | 68.62 | 73.37 | 73.99 | 73.94 | 77.71 | 76.60 | 79.93 | 91.38 |
| 25000. | 65.81 | 72.91 | 71.60 | 71.69 | 75.26 | 76.12 | 77.32 | 89.21 |
| 31500. | 63.39 | 72.13 | 69.52 | 70.08 | 73.12 | 75.30 | 76.49 | 86.04 |
| 40000. | 61.29 | 70.84 | 67.89 | 68.97 | 71.05 | 73.70 | 74.71 | 86.48 |

TOTAL POWER, DB = 108.39

NOZZLE DIA = 2.8"
 DIFFUSOR DIA = 6.0"
 FLOW TEMPERATURE, TOTAL = 1210.0 DEG R
 MICROPHONE RADIUS = 6 FT.

NOZZLE-DIFFUSOR SPACING RATIO = 0.25
 MACH NO. = 1.10

| FREQUENCY, HZ | MICROPHONE ANGLE, DEG | | | | | | | TOTAL POWER, DB (1/3 OCTAVE BAND) |
|---------------|-----------------------|-------|-------|-------|-------|-------|-------|--------------------------------------|
| | 30. | 45. | 60. | 75. | 90. | 105. | 120. | |
| 200. | 73.85 | 74.37 | 72.44 | 71.94 | 72.18 | 74.19 | 72.73 | 88.52 |
| 250. | 74.24 | 74.34 | 72.62 | 72.66 | 72.87 | 73.93 | 71.71 | 86.63 |
| 315. | 77.23 | 76.15 | 73.43 | 76.67 | 75.17 | 77.31 | 72.93 | 91.38 |
| 400. | 78.83 | 79.23 | 77.42 | 77.46 | 76.38 | 78.77 | 75.99 | 93.33 |
| 500. | 78.06 | 77.60 | 78.55 | 76.53 | 76.45 | 79.28 | 78.35 | 93.14 |
| 630. | 77.97 | 76.31 | 77.26 | 77.00 | 76.64 | 78.77 | 79.05 | 92.70 |
| 800. | 76.71 | 76.09 | 75.02 | 77.28 | 76.07 | 76.18 | 78.61 | 91.70 |
| 1000. | 75.33 | 74.15 | 74.24 | 75.41 | 75.06 | 75.86 | 76.84 | 90.39 |
| 1250. | 76.04 | 75.71 | 76.45 | 76.69 | 76.52 | 77.71 | 78.94 | 92.02 |
| 1600. | 77.07 | 76.56 | 77.39 | 77.92 | 78.06 | 79.23 | 80.09 | 93.26 |
| 2000. | 79.68 | 80.09 | 80.68 | 80.17 | 81.05 | 82.48 | 83.73 | 96.35 |
| 2500. | 76.99 | 80.00 | 80.60 | 80.32 | 80.60 | 82.54 | 83.48 | 96.27 |
| 3150. | 78.37 | 78.88 | 79.37 | 78.57 | 78.57 | 79.81 | 80.56 | 94.33 |
| 4000. | 79.97 | 80.25 | 79.93 | 78.79 | 78.13 | 76.17 | 76.72 | 94.37 |
| 5000. | 81.07 | 81.23 | 80.74 | 78.81 | 78.90 | 78.74 | 78.79 | 95.02 |
| 6300. | 81.14 | 81.52 | 80.65 | 79.22 | 79.60 | 80.33 | 81.15 | 95.69 |
| 8000. | 81.60 | 82.63 | 81.66 | 80.95 | 81.57 | 83.07 | 83.95 | 97.43 |
| 10000. | 82.62 | 83.42 | 82.26 | 81.74 | 81.64 | 83.83 | 84.41 | 98.12 |
| 12500. | 80.67 | 81.74 | 80.74 | 80.43 | 80.56 | 83.07 | 83.78 | 96.90 |
| 16000. | 76.75 | 78.66 | 78.18 | 77.99 | 79.55 | 82.06 | 83.15 | 95.08 |
| 20000. | 72.95 | 75.32 | 76.26 | 75.93 | 77.77 | 80.60 | 81.69 | 93.14 |
| 25000. | 69.60 | 73.77 | 74.33 | 73.36 | 75.23 | 77.81 | 78.64 | 90.61 |
| 31500. | 66.13 | 71.07 | 71.71 | 70.60 | 72.81 | 75.21 | 76.74 | 88.06 |
| 40000. | 63.48 | 68.30 | 69.66 | 68.22 | 70.33 | 72.60 | 74.65 | 85.60 |

TOTAL POWER, DB = 107.81

NOZZLE DIA = 2.8"
 DIFFUSOR DIA = 6.0"
 FLOW TEMPERATURE, TOTAL = 1210.0 DEG R
 MICROPHONE RADIUS = 6 FT.

NOZZLE-DIFFUSOR SPACING RATIO = 0.50
 MACH NO. = 0.70

AEDC-TR-80-15

MICROPHONE ANGLE, DEG

| FREQUENCY, HZ | SOUND POWER INTENSITY LEVEL, DB | | | | | | | TOTAL POWER, DB (1/3 OCTAVE BAND) |
|---------------|---------------------------------|-------|-------|-------|-------|-------|-------|--------------------------------------|
| | 30. | 45. | 60. | 75. | 90. | 105. | 120. | |
| 200. | 74.77 | 74.71 | 73.81 | 74.23 | 74.80 | 74.83 | 74.72 | 89.74 |
| 250. | 75.36 | 74.16 | 77.21 | 74.99 | 75.21 | 75.40 | 74.22 | 90.43 |
| 315. | 78.63 | 77.16 | 79.40 | 77.41 | 78.17 | 78.01 | 77.16 | 93.09 |
| 400. | 80.69 | 80.99 | 80.64 | 79.19 | 79.54 | 79.35 | 78.82 | 95.15 |
| 500. | 80.14 | 81.01 | 80.54 | 80.35 | 79.70 | 81.20 | 81.13 | 95.88 |
| 630. | 81.16 | 80.39 | 81.14 | 82.19 | 80.43 | 81.58 | 83.30 | 96.62 |
| 800. | 81.45 | 80.79 | 81.66 | 81.88 | 82.44 | 81.39 | 84.52 | 96.97 |
| 1000. | 80.97 | 80.24 | 81.45 | 81.26 | 82.03 | 81.58 | 84.47 | 96.68 |
| 1250. | 80.48 | 80.58 | 80.72 | 80.57 | 80.95 | 84.13 | 85.25 | 97.23 |
| 1600. | 81.08 | 81.61 | 79.73 | 80.14 | 81.08 | 84.32 | 84.95 | 97.35 |
| 2000. | 81.73 | 82.14 | 80.52 | 79.45 | 80.73 | 83.24 | 84.32 | 97.00 |
| 2500. | 81.88 | 82.67 | 80.58 | 80.47 | 81.15 | 83.81 | 85.03 | 97.56 |
| 3150. | 80.82 | 82.50 | 81.25 | 80.86 | 82.14 | 83.36 | 84.98 | 97.56 |
| 4000. | 79.51 | 82.39 | 81.47 | 80.56 | 81.85 | 82.65 | 84.29 | 97.20 |
| 5000. | 77.75 | 82.09 | 81.18 | 79.49 | 81.20 | 82.53 | 84.50 | 96.77 |
| 6300. | 76.12 | 81.66 | 80.00 | 78.23 | 80.46 | 82.15 | 84.57 | 96.18 |
| 8000. | 75.06 | 80.60 | 78.31 | 77.04 | 79.48 | 82.21 | 83.82 | 95.45 |
| 10000. | 73.68 | 78.21 | 76.05 | 75.27 | 78.31 | 81.26 | 82.25 | 93.91 |
| 12500. | 71.79 | 76.96 | 74.80 | 74.39 | 77.52 | 80.62 | 80.92 | 92.96 |
| 16000. | 70.67 | 76.66 | 74.07 | 74.09 | 76.85 | 79.98 | 80.17 | 92.41 |
| 20000. | 68.47 | 74.06 | 72.95 | 72.89 | 75.56 | 78.33 | 78.59 | 90.72 |
| 25000. | 66.01 | 70.80 | 72.03 | 71.57 | 73.75 | 76.23 | 76.89 | 88.72 |
| 31500. | 62.85 | 68.54 | 69.96 | 70.88 | 72.26 | 74.00 | 74.61 | 86.82 |
| 40000. | 59.56 | 66.40 | 67.95 | 68.99 | 70.58 | 71.64 | 71.76 | 84.64 |

TOTAL POWER, DB = 108.98

NOZZLE DIA = 2.8"
 DIFFUSOR DIA = 6.0"
 FLOW TEMPERATURE, TOTAL = 1210.0 DEG R
 MICROPHONE RADIUS = 6 FT.

NOZZLE-DIFFUSOR SPACING RATIO = 0.50
 MACH NO. = 0.90

MICROPHONE ANGLE, DEG

| FREQUENCY, HZ | MICROPHONE ANGLE, DEG | | | | | | | TOTAL POWER, DB (1/3 OCTAVE BAND) |
|---------------|-----------------------|-------|-------|-------|-------|-------|-------|--------------------------------------|
| | 30. | 45. | 60. | 75. | 90. | 105. | 120. | |
| 200. | 75.85 | 76.89 | 74.96 | 74.42 | 75.45 | 74.04 | 75.40 | 90.51 |
| 250. | 77.07 | 76.61 | 74.63 | 75.75 | 75.92 | 75.10 | 76.77 | 91.14 |
| 315. | 80.38 | 78.72 | 77.14 | 78.36 | 78.49 | 79.10 | 78.73 | 93.86 |
| 400. | 81.47 | 79.60 | 80.08 | 78.93 | 79.66 | 80.93 | 80.61 | 95.23 |
| 500. | 80.41 | 80.42 | 81.17 | 79.19 | 80.26 | 82.20 | 82.25 | 96.04 |
| 630. | 81.50 | 80.22 | 80.60 | 80.33 | 80.41 | 82.69 | 83.74 | 96.48 |
| 800. | 80.69 | 80.28 | 80.17 | 80.34 | 81.96 | 80.85 | 84.37 | 96.17 |
| 1000. | 80.13 | 76.69 | 79.86 | 80.21 | 81.87 | 80.34 | 84.28 | 95.69 |
| 1250. | 80.27 | 76.61 | 80.31 | 80.15 | 81.26 | 81.73 | 83.62 | 95.90 |
| 1600. | 80.28 | 79.50 | 79.50 | 79.39 | 81.46 | 81.65 | 82.96 | 95.82 |
| 2000. | 80.67 | 80.20 | 78.74 | 79.27 | 81.32 | 81.78 | 83.33 | 95.89 |
| 2500. | 79.93 | 79.10 | 78.75 | 79.21 | 80.77 | 81.65 | 83.68 | 95.57 |
| 3150. | 79.11 | 79.16 | 79.59 | 79.08 | 80.99 | 82.21 | 83.14 | 95.73 |
| 4000. | 79.25 | 79.96 | 80.04 | 79.47 | 80.89 | 82.71 | 83.25 | 96.14 |
| 5000. | 79.20 | 80.61 | 80.50 | 79.73 | 81.11 | 83.28 | 84.31 | 96.65 |
| 6300. | 77.50 | 81.24 | 80.38 | 79.41 | 81.33 | 83.64 | 84.86 | 96.88 |
| 8000. | 75.92 | 81.04 | 80.33 | 79.86 | 81.81 | 84.41 | 85.16 | 97.24 |
| 10000. | 74.79 | 79.00 | 78.94 | 78.60 | 80.82 | 83.64 | 84.12 | 96.10 |
| 12500. | 72.83 | 76.51 | 76.97 | 76.95 | 79.51 | 82.11 | 82.76 | 94.44 |
| 16000. | 71.45 | 76.70 | 76.15 | 76.44 | 79.04 | 81.53 | 82.10 | 93.94 |
| 20000. | 70.00 | 77.33 | 75.33 | 75.87 | 78.30 | 80.00 | 80.93 | 93.06 |
| 25000. | 67.85 | 75.46 | 74.07 | 74.55 | 76.55 | 77.33 | 76.81 | 91.06 |
| 31500. | 65.58 | 73.88 | 72.93 | 72.90 | 74.68 | 75.55 | 76.81 | 89.35 |
| 40000. | 63.56 | 72.79 | 71.47 | 71.19 | 72.55 | 73.70 | 74.63 | 87.66 |

TOTAL POWER, DB = 108.83

NOZZLE DIA = 2.8"
 DIFFUSOR DIA = 0.0"
 FLOW TEMPERATURE, TOTAL = 1210.0 DEG R
 MICROPHONE RADIUS = 6 FT.

NOZZLE-DIFFUSOR SPACING RATIO = 0.50
 MACH NU. = 1.10

AEDC-TR-80-15

MICROPHONE ANGLE, DEG

| FREQUENCY, Hz | 40. | 45. | 60. | 75. | 90. | 105. | 120. | TOTAL POWER, DB (1/3 OCTAVE BAND) |
|---------------|---------------------------------|-------|-------|-------|-------|-------|-------|--------------------------------------|
| | SOUND POWER INTENSITY LEVEL, DB | | | | | | | |
| 200. | 74.54 | 73.95 | 72.91 | 71.85 | 73.13 | 74.06 | 73.16 | 88.57 |
| 250. | 74.92 | 74.14 | 73.52 | 72.71 | 72.94 | 74.42 | 72.04 | 88.87 |
| 315. | 77.59 | 76.69 | 73.82 | 76.68 | 74.29 | 76.77 | 72.96 | 91.34 |
| 400. | 79.01 | 78.54 | 76.14 | 78.43 | 75.88 | 78.41 | 75.22 | 93.11 |
| 500. | 77.03 | 77.34 | 77.05 | 77.26 | 76.47 | 79.10 | 77.42 | 92.94 |
| 630. | 78.91 | 76.71 | 77.18 | 77.74 | 77.37 | 78.77 | 79.60 | 93.08 |
| 800. | 77.41 | 76.65 | 76.21 | 77.45 | 78.01 | 77.62 | 79.76 | 92.63 |
| 1000. | 75.47 | 74.88 | 75.29 | 75.40 | 76.56 | 76.26 | 77.14 | 90.94 |
| 1250. | 76.36 | 75.01 | 75.91 | 76.06 | 76.51 | 77.72 | 77.99 | 91.66 |
| 1600. | 76.04 | 76.29 | 77.16 | 77.31 | 76.87 | 79.49 | 80.70 | 93.36 |
| 2000. | 79.96 | 76.90 | 79.17 | 79.31 | 80.91 | 81.08 | 83.65 | 95.44 |
| 2500. | 79.90 | 79.48 | 79.46 | 80.29 | 81.24 | 81.76 | 83.49 | 95.95 |
| 3150. | 79.60 | 78.34 | 78.87 | 79.25 | 79.28 | 80.23 | 81.31 | 94.62 |
| 4000. | 80.44 | 79.74 | 79.80 | 79.03 | 78.14 | 79.01 | 79.06 | 94.47 |
| 5000. | 81.72 | 81.02 | 80.79 | 79.19 | 78.85 | 79.57 | 79.47 | 95.26 |
| 6300. | 81.79 | 81.15 | 81.72 | 80.05 | 79.68 | 81.91 | 82.48 | 96.38 |
| 8000. | 82.76 | 82.36 | 83.29 | 81.86 | 83.32 | 84.89 | 85.69 | 98.60 |
| 10000. | 83.07 | 83.56 | 84.03 | 82.22 | 84.47 | 85.76 | 86.42 | 99.47 |
| 12500. | 81.53 | 82.25 | 82.67 | 80.85 | 82.89 | 85.06 | 85.76 | 98.34 |
| 16000. | 77.75 | 79.53 | 80.24 | 79.56 | 82.01 | 83.65 | 85.03 | 96.71 |
| 20000. | 73.96 | 77.31 | 78.18 | 78.64 | 80.94 | 81.80 | 83.81 | 95.09 |
| 25000. | 71.01 | 74.65 | 76.51 | 76.52 | 78.16 | 79.76 | 81.50 | 92.84 |
| 31500. | 66.24 | 72.69 | 75.21 | 74.84 | 75.37 | 76.70 | 76.74 | 90.42 |
| 40000. | 65.66 | 71.65 | 73.29 | 72.72 | 73.09 | 74.73 | 76.12 | 88.35 |

TOTAL POWER, DB = 108.51

NOZZLE DIA = 2.0"
 DIFFUSOR DIA = 6.0"
 FLOW TEMPERATURE, TOTAL = 1210.0 DEG R
 MICROPHONE RADIUS = 0 FT.

NOZZLE-DIFFUSOR SPACING RATIO = 1.00
 MACH NO. = 0.70

MICROPHONE ANGLE, DEG

| FREQUENCY, HZ | SOUND POWER INTENSITY LEVEL, DB | | | | | | | TOTAL POWER, DB (1/3 OCTAVE BAND) |
|---------------|---------------------------------|-------|-------|-------|-------|-------|-------|--------------------------------------|
| | 30. | 45. | 60. | 75. | 90. | 105. | 120. | |
| 200. | 74.95 | 76.62 | 75.72 | 74.27 | 75.07 | 76.89 | 75.68 | 91.04 |
| 250. | 75.78 | 75.35 | 75.44 | 76.33 | 76.50 | 75.83 | 75.54 | 91.05 |
| 315. | 80.09 | 78.62 | 78.07 | 79.15 | 79.77 | 78.51 | 78.58 | 94.08 |
| 400. | 81.05 | 81.08 | 79.44 | 80.07 | 80.95 | 80.88 | 79.08 | 95.74 |
| 500. | 81.05 | 82.33 | 81.00 | 81.88 | 81.37 | 83.05 | 81.68 | 97.28 |
| 630. | 82.12 | 82.04 | 81.67 | 82.48 | 82.29 | 82.81 | 84.72 | 97.82 |
| 800. | 82.06 | 82.82 | 81.70 | 82.51 | 83.47 | 81.50 | 85.41 | 97.81 |
| 1000. | 82.44 | 83.44 | 81.93 | 83.17 | 83.13 | 81.52 | 85.59 | 98.13 |
| 1250. | 83.59 | 84.12 | 83.04 | 83.26 | 82.47 | 82.81 | 85.32 | 98.61 |
| 1600. | 84.35 | 84.81 | 83.27 | 83.16 | 83.22 | 84.22 | 86.33 | 99.30 |
| 2000. | 85.04 | 85.24 | 83.30 | 83.07 | 83.70 | 83.67 | 85.74 | 99.33 |
| 2500. | 85.74 | 85.67 | 84.04 | 83.98 | 84.81 | 84.70 | 86.24 | 100.09 |
| 3150. | 84.65 | 85.47 | 83.09 | 83.76 | 84.60 | 85.67 | 86.67 | 100.16 |
| 4000. | 87.62 | 84.58 | 83.22 | 82.70 | 83.81 | 84.74 | 86.98 | 99.33 |
| 5000. | 81.65 | 83.62 | 82.94 | 81.53 | 83.02 | 84.44 | 86.78 | 98.65 |
| 6300. | 78.95 | 83.05 | 82.14 | 80.54 | 82.48 | 83.83 | 85.61 | 97.89 |
| 8000. | 78.13 | 82.41 | 81.23 | 80.12 | 81.95 | 83.47 | 84.84 | 97.33 |
| 10000. | 77.24 | 81.07 | 80.00 | 79.58 | 80.85 | 82.60 | 83.93 | 96.34 |
| 12500. | 77.05 | 80.56 | 79.39 | 79.86 | 80.76 | 82.36 | 82.96 | 96.04 |
| 16000. | 76.86 | 80.55 | 79.94 | 80.14 | 80.86 | 82.00 | 82.25 | 95.98 |
| 20000. | 74.95 | 79.40 | 79.47 | 79.66 | 79.69 | 80.63 | 80.83 | 94.98 |
| 25000. | 72.67 | 76.00 | 78.67 | 78.42 | 77.71 | 78.62 | 76.91 | 93.39 |
| 31500. | 69.68 | 76.35 | 77.63 | 76.42 | 75.76 | 76.36 | 76.67 | 91.49 |
| 40000. | 66.96 | 74.64 | 75.83 | 74.16 | 73.40 | 73.97 | 73.54 | 89.34 |

TOTAL POWER, DB = 110.97

NOZZLE DIA = 2.8"
 DIFFUSOR DIA = 6.0"
 FLOW TEMPERATURE, TOTAL = 1210.0 DEG R
 MICROPHONE RADIUS = 0 FT.

NOZZLE-DIFFUSOR SPACING RATIO = 1.00
 MACH NO. = 0.90

| FREQUENCY, HZ | MICROPHONE ANGLE, DEG | | | | | | | TOTAL POWER, DB (1/3 OCTAVE BAND) |
|---------------|-----------------------|-------|-------|-------|-------|-------|-------|--------------------------------------|
| | 30. | 45. | 60. | 75. | 90. | 105. | 120. | |
| 200. | 75.07 | 74.97 | 73.25 | 75.17 | 75.07 | 25.12 | 74.39 | 88.90 |
| 250. | 76.77 | 76.06 | 72.69 | 77.29 | 76.73 | 24.98 | 75.60 | 90.35 |
| 315. | 82.21 | 80.20 | 78.59 | 79.17 | 81.12 | 28.70 | 78.34 | 94.06 |
| 400. | 83.59 | 80.47 | 80.69 | 80.79 | 80.87 | 31.28 | 80.13 | 95.03 |
| 500. | 81.16 | 82.01 | 82.10 | 81.09 | 80.95 | 33.04 | 82.68 | 95.73 |
| 630. | 81.97 | 81.96 | 81.10 | 81.95 | 81.72 | 34.48 | 84.08 | 96.10 |
| 800. | 81.45 | 80.45 | 80.04 | 81.23 | 82.61 | 32.95 | 84.10 | 95.51 |
| 1000. | 81.05 | 80.47 | 80.31 | 80.76 | 82.18 | 32.18 | 83.92 | 95.29 |
| 1250. | 81.16 | 81.25 | 81.15 | 80.54 | 81.43 | 32.29 | 83.17 | 95.34 |
| 1600. | 81.46 | 81.07 | 80.91 | 80.45 | 81.57 | 32.28 | 83.25 | 95.28 |
| 2000. | 82.84 | 82.68 | 81.24 | 82.33 | 82.91 | 32.84 | 84.09 | 96.67 |
| 2500. | 82.89 | 83.58 | 82.02 | 82.43 | 82.73 | 33.52 | 84.29 | 97.06 |
| 3150. | 83.38 | 84.10 | 82.22 | 82.47 | 82.99 | 33.95 | 84.75 | 97.36 |
| 4000. | 83.61 | 84.50 | 82.68 | 83.14 | 83.51 | 34.70 | 85.77 | 97.94 |
| 5000. | 83.73 | 84.32 | 83.02 | 83.05 | 83.64 | 35.51 | 86.55 | 98.00 |
| 6300. | 81.88 | 83.83 | 82.71 | 82.58 | 83.90 | 36.00 | 86.67 | 97.68 |
| 8000. | 80.66 | 82.77 | 81.97 | 82.75 | 84.23 | 36.43 | 87.40 | 97.44 |
| 10000. | 79.75 | 81.63 | 81.48 | 82.53 | 83.67 | 35.54 | 86.40 | 96.79 |
| 12500. | 78.98 | 81.91 | 81.43 | 82.51 | 83.43 | 34.64 | 85.14 | 96.54 |
| 16000. | 78.83 | 82.94 | 82.27 | 82.99 | 83.44 | 34.12 | 84.58 | 96.99 |
| 20000. | 78.75 | 83.47 | 82.80 | 82.90 | 83.00 | 33.15 | 83.96 | 97.07 |
| 25000. | 77.02 | 82.59 | 82.62 | 81.99 | 81.43 | 30.80 | 81.69 | 96.06 |
| 31500. | 75.99 | 81.85 | 82.20 | 81.07 | 79.59 | 28.45 | 79.81 | 95.13 |
| 40000. | 73.12 | 80.15 | 80.50 | 79.34 | 77.51 | 25.84 | 77.79 | 93.34 |

TOTAL POWER, DB = 109.87

NOZZLE DIA = 2.8"
 DIFFUSOR DIA = 6.0"
 FLOW TEMPERATURE, TOTAL = 1210.0 DEG R
 MICROPHONE RADIUS = 6 FT.

NOZZLE-DIFFUSOR SPACING RATIO = 1.00
 MACH NU. = 1.10

| FREQUENCY, HZ | MICROPHONE ANGLE, DEG | | | | | | | TOTAL POWER, DB (1/3 OCTAVE BAND) |
|---------------|-----------------------|-------|-------|-------|-------|-------|-------|--------------------------------------|
| | 30. | 45. | 60. | 75. | 90. | 105. | 120. | |
| 200. | 73.22 | 73.79 | 73.15 | 70.91 | 72.94 | 74.39 | 73.06 | 88.40 |
| 250. | 73.04 | 75.27 | 73.23 | 71.93 | 73.13 | 74.94 | 73.26 | 89.13 |
| 315. | 78.49 | 77.13 | 76.11 | 76.84 | 77.02 | 77.59 | 73.92 | 92.21 |
| 400. | 80.22 | 79.06 | 76.16 | 78.88 | 78.43 | 80.17 | 76.03 | 94.29 |
| 500. | 77.86 | 79.65 | 79.52 | 80.04 | 77.93 | 80.21 | 79.46 | 94.80 |
| 630. | 78.59 | 78.76 | 78.71 | 78.72 | 79.27 | 80.45 | 80.43 | 94.52 |
| 800. | 77.52 | 78.30 | 77.34 | 77.92 | 79.03 | 78.84 | 79.75 | 93.58 |
| 1000. | 76.13 | 76.04 | 77.17 | 76.03 | 76.67 | 76.60 | 78.95 | 91.78 |
| 1250. | 77.09 | 76.44 | 77.89 | 76.87 | 76.68 | 78.04 | 78.91 | 92.51 |
| 1600. | 76.24 | 76.62 | 77.85 | 78.47 | 78.79 | 79.67 | 80.00 | 94.04 |
| 2000. | 81.04 | 80.99 | 79.90 | 80.59 | 80.39 | 81.11 | 82.11 | 96.02 |
| 2500. | 83.05 | 83.10 | 82.27 | 82.37 | 82.43 | 83.44 | 84.41 | 98.18 |
| 3150. | 83.22 | 83.57 | 82.99 | 82.64 | 82.82 | 84.18 | 84.05 | 98.59 |
| 4000. | 84.11 | 84.35 | 84.28 | 82.92 | 82.70 | 83.66 | 84.13 | 98.89 |
| 5000. | 85.39 | 85.52 | 85.45 | 83.95 | 83.41 | 83.89 | 84.53 | 99.77 |
| 6300. | 85.21 | 85.80 | 85.47 | 84.09 | 84.94 | 85.65 | 86.32 | 100.49 |
| 8000. | 85.34 | 86.13 | 85.75 | 84.99 | 86.03 | 86.90 | 88.24 | 101.34 |
| 10000. | 85.61 | 86.22 | 85.83 | 85.58 | 86.61 | 87.83 | 88.89 | 101.86 |
| 12500. | 84.03 | 85.16 | 85.35 | 85.21 | 86.10 | 87.75 | 88.59 | 101.38 |
| 16000. | 83.16 | 84.68 | 85.62 | 85.61 | 86.11 | 87.48 | 88.17 | 101.26 |
| 20000. | 82.59 | 85.34 | 86.28 | 85.88 | 85.73 | 86.51 | 87.62 | 101.13 |
| 25000. | 80.96 | 85.55 | 86.11 | 84.50 | 84.15 | 84.78 | 85.67 | 100.11 |
| 31500. | 79.89 | 85.13 | 85.63 | 84.01 | 82.75 | 82.34 | 83.67 | 99.10 |
| 40000. | 78.00 | 84.07 | 84.25 | 82.57 | 80.79 | 80.36 | 81.03 | 97.60 |

TOTAL POWER, DB = 112.02

NOZZLE DIA = 2.8"
 DIFFUSOR DIA = 6.0"
 FLOW TEMPERATURE, TOTAL = 1210.0 DEG R
 MICROPHONE RADIUS = 6 FT.

NOZZLE-DIFFUSOR SPACING RATIO = 1.25
 MACH NO. = 0.70

118

| | | | | | | | | |
|--------|-------|-------|-------|-------|-------|-------|-------|--------|
| 200. | 75.31 | 74.62 | 75.09 | 74.94 | 75.91 | 76.25 | 74.15 | 90.50 |
| 250. | 76.73 | 76.18 | 74.39 | 75.12 | 76.94 | 76.73 | 75.39 | 91.21 |
| 315. | 81.70 | 79.52 | 79.73 | 77.39 | 80.13 | 79.87 | 78.22 | 94.60 |
| 400. | 83.57 | 81.27 | 81.70 | 79.03 | 80.09 | 80.79 | 79.53 | 95.96 |
| 500. | 83.29 | 80.61 | 81.95 | 80.80 | 80.12 | 82.72 | 82.10 | 96.76 |
| 630. | 84.20 | 82.42 | 81.94 | 81.55 | 82.99 | 82.76 | 84.61 | 97.80 |
| 800. | 84.43 | 82.91 | 82.96 | 82.74 | 84.15 | 82.66 | 85.53 | 98.46 |
| 1000. | 84.71 | 82.82 | 82.19 | 83.17 | 82.72 | 83.77 | 85.32 | 98.53 |
| 1250. | 85.25 | 83.49 | 82.95 | 83.67 | 83.12 | 85.77 | 85.17 | 99.45 |
| 1600. | 86.61 | 85.09 | 84.54 | 83.66 | 83.78 | 85.67 | 85.21 | 100.21 |
| 2000. | 88.35 | 87.09 | 85.75 | 84.53 | 84.88 | 85.39 | 86.07 | 101.28 |
| 2500. | 88.51 | 88.17 | 86.32 | 85.28 | 85.21 | 86.18 | 86.93 | 101.86 |
| 3150. | 87.34 | 87.83 | 85.55 | 84.32 | 84.60 | 86.21 | 86.46 | 101.30 |
| 4000. | 85.09 | 86.73 | 84.91 | 83.16 | 83.68 | 85.55 | 86.56 | 100.42 |
| 5000. | 82.72 | 85.18 | 83.82 | 81.61 | 83.13 | 85.01 | 86.54 | 99.38 |
| 6300. | 80.60 | 84.52 | 82.68 | 80.97 | 82.58 | 84.53 | 85.75 | 98.65 |
| 8000. | 80.06 | 83.92 | 82.04 | 81.28 | 82.60 | 84.44 | 85.28 | 98.38 |
| 10000. | 79.78 | 82.76 | 82.10 | 81.52 | 82.37 | 83.90 | 84.24 | 97.87 |
| 12500. | 79.67 | 82.66 | 82.86 | 81.64 | 82.26 | 83.61 | 83.52 | 97.85 |
| 16000. | 80.16 | 83.47 | 83.62 | 81.62 | 82.03 | 83.07 | 82.80 | 97.89 |
| 20000. | 78.29 | 82.55 | 83.11 | 80.97 | 80.91 | 81.64 | 81.31 | 96.89 |
| 25000. | 75.92 | 80.86 | 81.96 | 79.56 | 78.91 | 79.33 | 79.32 | 95.16 |
| 31500. | 72.84 | 79.20 | 80.30 | 77.52 | 76.33 | 76.70 | 76.51 | 93.09 |
| 40000. | 69.90 | 76.96 | 76.07 | 75.28 | 74.20 | 73.68 | 73.57 | 90.70 |

TOTAL POWER, DB = 112.03

NOZZLE DIA = 2.8"
 DIFFUSOR DIA = 0.0"
 FLOW TEMPERATURE, TOTAL = 1210.0 DEG R
 MICROPHONE RADIUS = 0 FT.

NOZZLE-DIFFUSOR SPACING RATIO = 1.25
 MACH NO. = 0.90

MICROPHONE ANGLE, DEG

| FREQUENCY, HZ | MICROPHONE ANGLE, DEG | | | | | | | TOTAL POWER, DB (1/3 OCTAVE BAND) |
|---------------|-----------------------|-------|-------|-------|-------|-------|-------|--------------------------------------|
| | 30. | 45. | 60. | 75. | 90. | 105. | 120. | |
| 200. | 76.39 | 74.94 | 74.10 | 74.01 | 75.20 | 74.73 | 75.10 | 89.94 |
| 250. | 78.70 | 76.23 | 75.08 | 75.18 | 76.13 | 77.09 | 76.98 | 91.53 |
| 315. | 82.22 | 79.23 | 79.11 | 80.17 | 79.42 | 80.74 | 79.30 | 95.22 |
| 400. | 81.32 | 80.07 | 82.00 | 81.34 | 79.85 | 81.97 | 80.41 | 96.37 |
| 500. | 80.62 | 80.67 | 82.03 | 81.19 | 80.34 | 82.43 | 82.86 | 96.88 |
| 630. | 81.97 | 81.13 | 80.53 | 82.30 | 81.72 | 82.76 | 84.73 | 97.30 |
| 800. | 82.32 | 80.90 | 80.76 | 82.02 | 82.40 | 82.72 | 84.52 | 97.29 |
| 1000. | 82.03 | 81.36 | 80.72 | 82.00 | 81.81 | 83.11 | 84.49 | 97.39 |
| 1250. | 82.88 | 82.14 | 82.03 | 82.22 | 82.23 | 83.90 | 84.98 | 98.05 |
| 1600. | 83.54 | 83.17 | 82.06 | 82.76 | 82.98 | 84.67 | 84.57 | 98.64 |
| 2000. | 85.41 | 85.00 | 83.93 | 84.38 | 84.17 | 85.26 | 85.50 | 100.13 |
| 2500. | 86.57 | 87.06 | 85.48 | 84.93 | 84.60 | 86.17 | 85.85 | 101.13 |
| 3150. | 86.90 | 88.49 | 86.47 | 85.21 | 85.21 | 86.31 | 86.40 | 101.85 |
| 4000. | 87.13 | 88.52 | 86.50 | 85.50 | 85.51 | 86.77 | 87.19 | 102.08 |
| 5000. | 85.95 | 86.95 | 85.71 | 84.90 | 85.30 | 86.98 | 87.61 | 101.45 |
| 6300. | 83.82 | 86.01 | 85.17 | 84.37 | 85.15 | 87.31 | 87.97 | 101.10 |
| 8000. | 83.21 | 85.91 | 85.13 | 84.53 | 85.64 | 87.08 | 87.88 | 101.05 |
| 10000. | 83.17 | 85.80 | 85.10 | 84.88 | 85.82 | 86.20 | 87.29 | 100.83 |
| 12500. | 83.19 | 86.20 | 85.83 | 85.87 | 85.92 | 86.09 | 86.18 | 101.11 |
| 16000. | 83.66 | 87.36 | 87.51 | 86.60 | 86.10 | 85.59 | 85.71 | 101.07 |
| 20000. | 83.44 | 87.70 | 87.93 | 86.00 | 85.31 | 84.68 | 84.93 | 101.36 |
| 25000. | 81.68 | 86.90 | 87.51 | 85.02 | 83.51 | 81.93 | 83.25 | 100.28 |
| 31500. | 79.29 | 85.90 | 85.58 | 83.26 | 81.84 | 79.97 | 80.44 | 98.71 |
| 40000. | 76.65 | 84.58 | 83.71 | 81.16 | 80.04 | 78.84 | 76.87 | 97.02 |

TOTAL POWER, DB = 113.33

NOZZLE DIA = 2.8"
 DIFFUSOR DIA = 6.0"
 FLOW TEMPERATURE, TOTAL = 1210.0 DEG R
 MICROPHONE RADIOS = 6 FT.

NOZZLE-DIFFUSOR SPACING RATIO = 1.25
 MACH NO. = 1.10

120

| FREQUENCY, HZ | MICROPHONE ANGLE, DEG | | | | | | | TOTAL POWER, DB (1/3 OCTAVE BAND) |
|---------------|-----------------------|-------|-------|-------|-------|-------|-------|--------------------------------------|
| | 30. | 45. | 60. | 75. | 90. | 105. | 120. | |
| 200. | 74.51 | 74.58 | 76.85 | 72.47 | 75.36 | 74.86 | 72.07 | 89.78 |
| 250. | 75.86 | 74.35 | 77.67 | 73.38 | 75.46 | 74.71 | 72.85 | 90.11 |
| 315. | 78.99 | 75.84 | 79.38 | 77.04 | 77.59 | 77.30 | 74.78 | 92.49 |
| 400. | 80.28 | 76.40 | 80.64 | 78.02 | 78.01 | 77.98 | 77.72 | 93.79 |
| 500. | 79.02 | 78.30 | 80.25 | 78.63 | 77.67 | 79.16 | 79.58 | 94.07 |
| 630. | 78.21 | 76.64 | 78.90 | 78.28 | 78.53 | 80.10 | 80.17 | 94.22 |
| 800. | 77.97 | 78.04 | 78.00 | 77.10 | 78.37 | 78.36 | 79.69 | 93.25 |
| 1000. | 76.05 | 76.96 | 77.29 | 77.14 | 77.33 | 78.09 | 78.76 | 92.71 |
| 1250. | 79.40 | 78.34 | 78.87 | 78.12 | 78.45 | 80.29 | 80.11 | 94.23 |
| 1600. | 81.14 | 80.39 | 80.52 | 79.61 | 79.69 | 80.85 | 81.72 | 95.60 |
| 2000. | 83.83 | 84.46 | 83.82 | 82.76 | 82.52 | 83.18 | 84.03 | 96.70 |
| 2500. | 86.13 | 87.17 | 86.35 | 85.01 | 85.03 | 85.38 | 86.14 | 101.12 |
| 3150. | 87.48 | 88.47 | 87.55 | 85.80 | 85.64 | 86.32 | 86.80 | 102.16 |
| 4000. | 88.90 | 89.19 | 88.62 | 86.66 | 85.93 | 86.66 | 86.95 | 102.87 |
| 5000. | 89.74 | 89.79 | 88.87 | 86.70 | 85.90 | 86.60 | 87.23 | 103.17 |
| 6300. | 89.44 | 89.75 | 88.41 | 86.47 | 85.94 | 86.89 | 87.81 | 103.11 |
| 8000. | 89.39 | 89.71 | 88.66 | 86.82 | 86.99 | 88.34 | 88.54 | 103.59 |
| 10000. | 89.15 | 89.04 | 88.84 | 87.49 | 87.86 | 88.89 | 88.88 | 103.74 |
| 12500. | 88.66 | 88.62 | 89.34 | 87.90 | 88.08 | 88.74 | 88.58 | 103.72 |
| 16000. | 88.80 | 89.47 | 90.54 | 88.70 | 88.18 | 88.15 | 88.29 | 104.14 |
| 20000. | 88.75 | 90.13 | 91.55 | 88.98 | 87.84 | 87.31 | 87.80 | 104.36 |
| 25000. | 87.63 | 90.34 | 90.77 | 87.87 | 86.74 | 85.64 | 85.86 | 103.62 |
| 31500. | 86.56 | 90.24 | 89.55 | 86.50 | 84.88 | 83.33 | 84.04 | 102.63 |
| 40000. | 83.77 | 89.06 | 87.89 | 84.69 | 83.01 | 81.09 | 81.97 | 101.05 |

TOTAL POWER, DB = 114.72

NOZZLE DIA = 2.8"
 DIFFUSOR DIA = 6.0"
 FLOW TEMPERATURE, TOTAL = 1210.0 DEG R
 MICROPHONE RADIUS = 6 FT.

NOZZLE-DIFFUSOR SPACING RATIO = 1.50
 MACH NO. = 0.70

MICROPHONE ANGLE, DEG

| FREQUENCY, HZ | MICROPHONE ANGLE, DEG | | | | | | | TOTAL POWER, DB (1/3 OCTAVE BAND) |
|---------------|-----------------------|-------|-------|-------|-------|-------|-------|--------------------------------------|
| | 30. | 45. | 60. | 75. | 90. | 105. | 120. | |
| 200. | 75.04 | 74.82 | 74.03 | 74.17 | 75.16 | 74.91 | 75.42 | 89.90 |
| 250. | 76.54 | 74.54 | 74.01 | 75.24 | 75.59 | 75.62 | 76.06 | 90.43 |
| 315. | 80.03 | 78.16 | 76.01 | 77.20 | 78.75 | 79.05 | 77.51 | 93.53 |
| 400. | 80.80 | 79.86 | 80.32 | 78.66 | 79.12 | 80.39 | 76.87 | 94.93 |
| 500. | 81.44 | 80.90 | 81.19 | 80.62 | 80.44 | 81.41 | 82.52 | 96.27 |
| 630. | 82.65 | 82.39 | 80.79 | 81.94 | 82.20 | 82.62 | 85.21 | 97.60 |
| 800. | 83.11 | 83.12 | 82.34 | 82.96 | 83.27 | 82.83 | 85.94 | 98.37 |
| 1000. | 83.69 | 83.85 | 82.95 | 83.28 | 82.94 | 83.26 | 85.60 | 98.72 |
| 1250. | 85.97 | 85.03 | 84.19 | 84.10 | 83.63 | 85.13 | 85.57 | 99.92 |
| 1600. | 89.08 | 86.22 | 86.68 | 85.56 | 85.14 | 85.39 | 86.36 | 101.85 |
| 2000. | 90.64 | 90.41 | 88.50 | 87.70 | 86.96 | 86.29 | 87.86 | 103.65 |
| 2500. | 90.81 | 90.95 | 89.17 | 87.70 | 87.14 | 87.50 | 88.78 | 104.17 |
| 3150. | 87.92 | 89.59 | 87.58 | 85.37 | 86.06 | 87.01 | 88.49 | 102.77 |
| 4000. | 84.78 | 87.54 | 85.23 | 84.05 | 84.65 | 85.70 | 87.77 | 101.05 |
| 5000. | 82.20 | 85.80 | 84.02 | 82.92 | 83.95 | 85.27 | 87.18 | 99.91 |
| 6300. | 80.76 | 84.51 | 83.75 | 82.99 | 83.56 | 84.96 | 86.32 | 99.31 |
| 8000. | 80.65 | 84.10 | 84.30 | 83.63 | 83.49 | 84.98 | 85.86 | 99.35 |
| 10000. | 80.29 | 84.14 | 84.72 | 83.82 | 83.10 | 84.61 | 85.32 | 99.27 |
| 12500. | 80.61 | 84.36 | 85.01 | 83.94 | 83.66 | 83.74 | 84.71 | 99.17 |
| 16000. | 80.43 | 84.33 | 85.50 | 84.01 | 83.14 | 83.56 | 83.29 | 99.11 |
| 20000. | 76.43 | 83.86 | 85.04 | 83.32 | 81.99 | 82.31 | 81.75 | 98.30 |
| 25000. | 75.54 | 82.07 | 83.32 | 81.81 | 80.34 | 80.43 | 79.57 | 96.55 |
| 31500. | 71.95 | 80.52 | 81.60 | 79.48 | 77.36 | 77.12 | 77.13 | 94.42 |
| 40000. | 68.56 | 77.71 | 79.26 | 77.41 | 75.13 | 75.27 | 74.90 | 91.99 |

TOTAL POWER, DB = 113.12

NOZZLE DIA = 2.8"
 DIFFUSOR DIA = 6.0"
 FLOW TEMPERATURE, TOTAL = 1210.0 DEG R
 MICROPHONE RADIUS = 0. FT.

NOZZLE-DIFFUSOR SPACING RATIO = 1.50
 MACH NU. = 0.90

AEDC-TR-80-15

MICROPHONE ANGLE, DEG

| FREQUENCY, HZ | 30. | 45. | 60. | 75. | 90. | 105. | 120. | TOTAL POWER, DB (1/3 OCTAVE BAND) |
|---------------|---------------------------------|-------|-------|-------|-------|-------|-------|--------------------------------------|
| | SOUND POWER INTENSITY LEVEL, DB | | | | | | | |
| 200. | 75.99 | 75.23 | 74.45 | 76.12 | 75.72 | 75.37 | 75.35 | 90.69 |
| 250. | 77.73 | 75.45 | 75.10 | 76.03 | 75.91 | 76.21 | 76.37 | 91.17 |
| 315. | 81.44 | 78.44 | 78.54 | 78.78 | 78.24 | 79.26 | 78.27 | 94.10 |
| 400. | 81.66 | 78.78 | 80.46 | 79.07 | 79.19 | 80.93 | 80.24 | 95.09 |
| 500. | 80.94 | 79.76 | 81.62 | 80.87 | 79.94 | 82.65 | 82.34 | 96.48 |
| 630. | 81.29 | 80.91 | 81.19 | 81.09 | 81.20 | 83.18 | 84.62 | 97.09 |
| 800. | 81.83 | 81.13 | 81.27 | 82.52 | 82.09 | 82.00 | 85.38 | 97.34 |
| 1000. | 81.86 | 82.30 | 81.86 | 82.81 | 81.89 | 82.40 | 84.83 | 97.73 |
| 1250. | 83.35 | 83.14 | 82.64 | 83.47 | 82.33 | 83.55 | 84.52 | 98.46 |
| 1600. | 85.49 | 85.19 | 84.62 | 84.52 | 83.65 | 84.14 | 84.91 | 99.89 |
| 2000. | 89.56 | 88.43 | 87.24 | 87.21 | 86.25 | 86.12 | 86.44 | 102.54 |
| 2500. | 90.55 | 90.91 | 88.65 | 88.76 | 87.00 | 86.71 | 86.64 | 104.06 |
| 3150. | 91.15 | 92.20 | 88.92 | 88.22 | 87.06 | 87.42 | 88.47 | 104.70 |
| 4000. | 90.74 | 91.35 | 87.99 | 87.94 | 87.06 | 87.63 | 89.11 | 104.26 |
| 5000. | 88.37 | 86.80 | 86.87 | 86.46 | 86.61 | 87.15 | 88.12 | 102.70 |
| 6300. | 86.07 | 87.63 | 86.63 | 86.24 | 86.80 | 86.97 | 87.81 | 102.12 |
| 8000. | 85.66 | 87.60 | 87.10 | 86.66 | 87.18 | 87.68 | 87.95 | 102.50 |
| 10000. | 86.01 | 87.18 | 87.56 | 87.77 | 87.11 | 87.52 | 87.26 | 102.57 |
| 12500. | 86.06 | 86.09 | 88.33 | 86.49 | 87.17 | 86.91 | 86.83 | 102.94 |
| 16000. | 87.16 | 89.00 | 89.62 | 89.66 | 86.98 | 86.61 | 86.39 | 103.62 |
| 20000. | 86.62 | 89.47 | 90.09 | 89.00 | 86.59 | 85.62 | 86.15 | 103.43 |
| 25000. | 85.01 | 87.99 | 86.71 | 87.40 | 85.14 | 83.68 | 84.27 | 101.86 |
| 31500. | 82.20 | 86.13 | 86.90 | 86.04 | 83.05 | 81.86 | 81.62 | 100.08 |
| 40000. | 80.02 | 83.89 | 85.14 | 83.37 | 80.71 | 78.98 | 78.42 | 97.72 |

TOTAL POWER, DB = 114.95

NOZZLE DIA = 2.8"
 DIFFUSOR DIA = 6.0"
 FLOW TEMPERATURE, TOTAL = 1210.0 DEG K
 MICROPHONE RADIUS = 0 FT.

NOZZLE-DIFFUSOR SPACING RATIO = 1.50
 MACH NU. = 1.10

MICROPHONE ANGLE, DEG

| FREQUENCY, HZ | MICROPHONE ANGLE, DEG | | | | | | | TOTAL POWER, DB (1/3 OCTAVE BAND) |
|---------------|-----------------------|-------|-------|-------|-------|-------|-------|--------------------------------------|
| | 30. | 45. | 60. | 75. | 90. | 105. | 120. | |
| 200. | 74.10 | 74.51 | 72.57 | 71.67 | 75.07 | 74.64 | 72.38 | 89.02 |
| 250. | 74.58 | 74.28 | 74.88 | 73.13 | 74.89 | 74.90 | 73.11 | 89.50 |
| 315. | 79.39 | 75.82 | 77.01 | 76.04 | 76.62 | 77.38 | 74.80 | 91.89 |
| 400. | 80.26 | 77.73 | 78.50 | 77.37 | 77.96 | 79.53 | 76.80 | 93.55 |
| 500. | 77.83 | 78.20 | 76.17 | 76.32 | 77.79 | 80.17 | 79.69 | 93.96 |
| 630. | 79.14 | 79.73 | 76.88 | 78.83 | 78.12 | 80.05 | 80.43 | 94.41 |
| 800. | 79.82 | 78.93 | 77.24 | 78.07 | 78.71 | 79.11 | 80.40 | 93.95 |
| 1000. | 80.36 | 78.45 | 77.72 | 78.45 | 78.03 | 78.42 | 79.61 | 93.73 |
| 1250. | 81.82 | 80.23 | 80.29 | 79.40 | 79.31 | 80.13 | 79.97 | 95.23 |
| 1600. | 84.72 | 83.80 | 83.24 | 81.93 | 81.74 | 81.46 | 81.78 | 97.83 |
| 2000. | 87.94 | 87.94 | 87.14 | 85.60 | 84.86 | 84.06 | 85.24 | 101.42 |
| 2500. | 90.40 | 90.99 | 89.90 | 88.32 | 87.22 | 87.80 | 87.44 | 104.35 |
| 3150. | 92.10 | 93.04 | 91.20 | 86.76 | 88.31 | 89.07 | 89.12 | 105.81 |
| 4000. | 93.73 | 94.07 | 91.05 | 89.02 | 88.52 | 89.33 | 88.65 | 106.42 |
| 5000. | 92.89 | 92.31 | 90.21 | 88.38 | 88.41 | 89.02 | 88.06 | 105.38 |
| 6300. | 92.04 | 91.70 | 89.55 | 88.19 | 88.23 | 89.09 | 88.47 | 105.00 |
| 8000. | 92.47 | 91.97 | 90.17 | 89.33 | 89.52 | 90.11 | 89.65 | 105.73 |
| 10000. | 93.06 | 91.93 | 91.60 | 90.41 | 89.91 | 90.81 | 89.69 | 106.30 |
| 12500. | 93.45 | 92.52 | 92.78 | 91.74 | 90.18 | 90.50 | 89.48 | 106.88 |
| 16000. | 93.68 | 94.50 | 94.06 | 92.37 | 90.50 | 90.38 | 89.89 | 107.87 |
| 20000. | 92.90 | 95.53 | 94.75 | 91.93 | 90.40 | 90.00 | 90.31 | 108.17 |
| 25000. | 91.04 | 94.98 | 94.23 | 90.79 | 88.84 | 88.18 | 88.70 | 107.24 |
| 31500. | 89.56 | 93.04 | 92.62 | 89.02 | 86.44 | 86.22 | 86.27 | 105.37 |
| 40000. | 87.44 | 91.16 | 90.90 | 86.61 | 84.05 | 83.51 | 83.52 | 103.32 |

TOTAL POWER, DB = 117.62

NOZZLE DIA = 2.8"
 DIFFUSOR DIA = 8.0"
 FLOW TEMPERATURE, TOTAL =
 MICROPHONE RADIUS = 6 FT.

530.0 DEG R

NOZZLE-DIFFUSOR SPACING RATIO = 0.00
 MACH NO. = 0.70

| FREQUENCY, HZ | MICROPHONE ANGLE, DEG | | | | | | | TOTAL POWER, DB (1/3 OCTAVE BAND) |
|---------------|-----------------------|-------|-------|-------|-------|-------|-------|--------------------------------------|
| | 30. | 45. | 60. | 75. | 90. | 105. | 120. | |
| 200. | 70.46 | 72.90 | 72.59 | 73.63 | 73.30 | 71.15 | 72.69 | 87.84 |
| 250. | 70.17 | 71.58 | 70.99 | 71.89 | 72.24 | 72.35 | 72.49 | 87.03 |
| 315. | 71.47 | 71.72 | 72.12 | 72.05 | 72.59 | 73.11 | 72.81 | 87.51 |
| 400. | 73.34 | 72.70 | 71.60 | 71.00 | 71.72 | 72.86 | 72.29 | 87.40 |
| 500. | 71.06 | 71.38 | 70.76 | 69.52 | 70.61 | 72.10 | 72.29 | 86.35 |
| 630. | 71.38 | 69.68 | 70.56 | 70.88 | 69.94 | 72.35 | 74.05 | 86.37 |
| 800. | 71.54 | 69.89 | 69.22 | 71.05 | 70.79 | 72.10 | 74.30 | 86.38 |
| 1000. | 71.63 | 70.29 | 70.92 | 71.27 | 72.21 | 73.24 | 75.75 | 87.27 |
| 1250. | 70.96 | 70.69 | 70.33 | 70.92 | 71.41 | 73.49 | 75.49 | 87.15 |
| 1600. | 71.38 | 70.90 | 70.20 | 69.38 | 70.67 | 73.43 | 74.60 | 86.77 |
| 2000. | 72.61 | 72.07 | 70.37 | 69.03 | 69.94 | 72.54 | 74.28 | 86.70 |
| 2500. | 72.07 | 71.77 | 70.68 | 69.63 | 69.71 | 71.34 | 73.89 | 86.33 |
| 3150. | 70.05 | 71.28 | 70.16 | 69.16 | 69.99 | 71.85 | 74.07 | 86.17 |
| 4000. | 69.29 | 71.61 | 70.02 | 68.50 | 69.32 | 71.78 | 74.32 | 86.04 |
| 5000. | 68.31 | 71.45 | 70.57 | 67.52 | 68.77 | 71.97 | 74.95 | 86.01 |
| 6300. | 67.64 | 71.14 | 70.05 | 66.98 | 68.80 | 72.10 | 75.13 | 85.67 |
| 8000. | 67.42 | 71.04 | 68.97 | 66.32 | 68.44 | 72.04 | 74.93 | 85.61 |
| 10000. | 67.01 | 70.16 | 67.94 | 65.97 | 68.15 | 72.16 | 74.61 | 85.25 |
| 12500. | 68.37 | 72.03 | 68.94 | 66.83 | 69.00 | 73.30 | 75.43 | 86.47 |
| 16000. | 69.92 | 73.32 | 70.89 | 67.62 | 70.48 | 74.26 | 76.82 | 87.71 |
| 20000. | 69.76 | 74.42 | 71.38 | 67.41 | 71.08 | 74.83 | 77.25 | 88.32 |
| 25000. | 67.70 | 74.00 | 69.98 | 65.23 | 69.90 | 73.81 | 75.92 | 87.34 |
| 31500. | 63.02 | 68.86 | 65.00 | 60.57 | 65.68 | 70.07 | 72.24 | 83.04 |
| 40000. | 59.40 | 64.55 | 60.84 | 56.85 | 61.20 | 60.32 | 68.17 | 78.97 |

TOTAL POWER, DB = 100.33

NOZZLE DIA = 2.8"
 DIFFUSOR DIA = 8.0"
 FLOW TEMPERATURE, TOTAL = 530.0 DEG R
 MICROPHONE RADIUS = 6 FT.

NOZZLE-DIFFUSOR SPACING RATIO = 0.00
 MACH NO. = 0.90

MICROPHONE ANGLE, DEG

| FREQUENCY, HZ | 30. | 45. | 60. | 75. | 90. | 105. | 120. | TOTAL POWER, DB (1/3 OCTAVE BAND) |
|---------------|---------------------------------|-------|-------|-------|-------|-------|-------|--------------------------------------|
| | SOUND POWER INTENSITY LEVEL, DB | | | | | | | |
| 200. | 74.24 | 75.47 | 75.76 | 76.18 | 75.73 | 75.57 | 76.68 | 90.92 |
| 250. | 73.73 | 75.36 | 75.39 | 76.34 | 76.35 | 76.87 | 76.76 | 91.26 |
| 315. | 75.90 | 77.03 | 76.73 | 76.64 | 78.63 | 79.88 | 77.86 | 93.11 |
| 400. | 78.20 | 78.19 | 77.50 | 76.36 | 78.55 | 79.22 | 78.57 | 93.30 |
| 500. | 77.63 | 77.20 | 76.99 | 76.34 | 76.50 | 79.26 | 78.27 | 92.78 |
| 630. | 77.19 | 75.96 | 76.30 | 76.76 | 75.79 | 79.10 | 78.79 | 92.47 |
| 800. | 77.52 | 76.11 | 76.86 | 77.00 | 77.05 | 77.93 | 80.21 | 92.51 |
| 1000. | 76.62 | 76.00 | 77.01 | 77.48 | 78.76 | 78.98 | 81.24 | 93.17 |
| 1250. | 75.88 | 76.62 | 76.07 | 77.33 | 77.72 | 79.27 | 80.24 | 92.88 |
| 1600. | 76.84 | 76.24 | 75.18 | 76.48 | 76.70 | 79.50 | 80.19 | 92.70 |
| 2000. | 76.62 | 77.65 | 76.02 | 76.14 | 76.62 | 79.21 | 81.09 | 93.06 |
| 2500. | 78.25 | 76.12 | 77.23 | 76.18 | 76.46 | 78.23 | 80.86 | 92.95 |
| 3150. | 76.66 | 78.01 | 77.55 | 76.03 | 76.08 | 76.84 | 81.00 | 93.00 |
| 4000. | 75.91 | 76.73 | 77.81 | 75.89 | 76.13 | 79.00 | 81.71 | 93.29 |
| 5000. | 74.90 | 79.39 | 78.71 | 75.48 | 76.25 | 79.86 | 82.87 | 93.69 |
| 6300. | 74.78 | 79.03 | 76.21 | 74.57 | 76.55 | 80.78 | 83.65 | 94.09 |
| 8000. | 74.53 | 78.36 | 77.13 | 74.10 | 76.67 | 81.20 | 83.22 | 93.90 |
| 10000. | 72.82 | 76.99 | 75.30 | 73.00 | 75.83 | 80.28 | 82.03 | 92.76 |
| 12500. | 71.94 | 76.31 | 74.61 | 71.19 | 74.93 | 79.55 | 81.22 | 91.94 |
| 16000. | 72.45 | 76.46 | 74.99 | 71.08 | 75.17 | 78.96 | 81.11 | 91.81 |
| 20000. | 72.52 | 76.54 | 74.87 | 71.21 | 74.20 | 78.17 | 81.00 | 91.40 |
| 25000. | 71.77 | 76.00 | 74.05 | 69.73 | 73.43 | 77.32 | 80.63 | 90.68 |
| 31500. | 69.60 | 74.50 | 72.54 | 66.84 | 71.19 | 75.39 | 78.81 | 88.65 |
| 40000. | 67.27 | 71.92 | 66.86 | 64.34 | 69.20 | 72.06 | 76.48 | 86.04 |

TOTAL POWER, DB = 106.27

NOZZLE DIA = 2.8"
 DIFFUSOR DIA = 8.0"
 FLOW TEMPERATURE, TOTAL = 530.0 DEG R
 MICROPHONE RADIUS = 6 FT.

NOZZLE-DIFFUSOR SPACING RATIO = 0.00
 MACH NO. = 1.10

AEDC-TR-80-15

MICROPHONE ANGLE, DEG

| FREQUENCY, HZ | SOUND POWER INTENSITY LEVEL, DB | | | | | | | TOTAL POWER, DB (1/3 OCTAVE BAND) |
|---------------|---------------------------------|--------|--------|-------|--------|--------|--------|--------------------------------------|
| | 30. | 45. | 60. | 75. | 90. | 105. | 120. | |
| 200. | 78.39 | 78.25 | 77.07 | 78.63 | 78.95 | 77.49 | 78.49 | 93.36 |
| 250. | 76.60 | 76.90 | 77.89 | 77.61 | 78.53 | 79.69 | 78.94 | 93.39 |
| 315. | 80.72 | 81.08 | 81.32 | 82.73 | 82.38 | 83.22 | 81.17 | 97.36 |
| 400. | 85.29 | 83.99 | 82.00 | 82.60 | 83.24 | 84.53 | 82.62 | 98.60 |
| 500. | 83.94 | 82.83 | 82.49 | 81.26 | 82.94 | 84.17 | 83.39 | 98.15 |
| 630. | 82.71 | 77.92 | 82.23 | 83.38 | 81.70 | 82.49 | 83.19 | 97.19 |
| 800. | 81.99 | 81.65 | 82.46 | 82.68 | 82.93 | 82.45 | 85.48 | 97.80 |
| 1000. | 82.74 | 80.69 | 84.43 | 82.04 | 85.06 | 83.44 | 86.86 | 98.50 |
| 1250. | 81.77 | 80.92 | 80.01 | 82.43 | 81.01 | 84.75 | 85.28 | 97.86 |
| 1600. | 83.73 | 84.28 | 82.48 | 81.73 | 83.90 | 85.29 | 87.25 | 99.29 |
| 2000. | 87.09 | 86.55 | 84.82 | 83.14 | 84.31 | 86.53 | 89.80 | 101.11 |
| 2500. | 102.43 | 104.23 | 100.75 | 97.33 | 99.83 | 102.94 | 103.91 | 117.28 |
| 3150. | 107.76 | 108.22 | 104.76 | 98.68 | 103.11 | 108.06 | 106.58 | 121.42 |
| 4000. | 91.00 | 94.52 | 93.39 | 91.39 | 91.59 | 95.29 | 99.04 | 109.34 |
| 5000. | 90.98 | 97.11 | 96.56 | 91.21 | 92.77 | 97.49 | 101.01 | 111.39 |
| 6300. | 90.26 | 96.60 | 96.10 | 90.57 | 93.75 | 99.37 | 100.82 | 111.85 |
| 8000. | 90.18 | 96.38 | 93.98 | 89.87 | 93.58 | 97.74 | 99.41 | 110.72 |
| 10000. | 89.21 | 94.08 | 90.58 | 87.95 | 91.63 | 95.16 | 96.91 | 106.29 |
| 12500. | 86.14 | 92.09 | 88.34 | 85.91 | 89.24 | 93.80 | 95.50 | 106.55 |
| 16000. | 83.07 | 90.17 | 87.05 | 83.74 | 87.73 | 92.43 | 93.90 | 104.93 |
| 20000. | 80.69 | 87.54 | 85.18 | 82.02 | 86.10 | 89.85 | 92.17 | 102.64 |
| 25000. | 76.54 | 83.39 | 81.34 | 78.44 | 82.17 | 86.12 | 88.59 | 98.82 |
| 31500. | 74.93 | 81.85 | 78.96 | 75.31 | 79.77 | 82.84 | 86.10 | 96.26 |
| 40000. | 68.99 | 74.64 | 72.69 | 69.50 | 74.18 | 77.46 | 80.02 | 90.22 |

TOTAL POWER, DB = 124.25

NOZZLE DIA = 2.8"
 DIFFUSOR DIA = 8.0"
 FLOW TEMPERATURE, TOTAL = 530.0 DEG K
 MICROPHONE RADIUS = 6 FT.

NOZZLE-DIFFUSOR SPACING RATIO = 0.25
 MACH NO. = 0.70

| FREQUENCY, HZ | MICROPHONE ANGLE, DEG | | | | | | | TOTAL POWER, DB (1/3 OCTAVE BAND) |
|---------------|-----------------------|-------|-------|-------|-------|-------|-------|--------------------------------------|
| | 30. | 45. | 60. | 75. | 90. | 105. | 120. | |
| 200. | 71.13 | 72.28 | 71.08 | 73.54 | 72.95 | 72.64 | 70.88 | 87.71 |
| 250. | 70.27 | 69.98 | 70.55 | 71.29 | 71.84 | 72.01 | 73.02 | 86.48 |
| 315. | 71.01 | 71.45 | 71.47 | 71.46 | 73.14 | 72.71 | 72.43 | 87.20 |
| 400. | 72.57 | 72.41 | 71.51 | 70.67 | 71.71 | 72.90 | 72.98 | 87.26 |
| 500. | 71.98 | 71.07 | 71.54 | 69.82 | 70.22 | 73.16 | 72.58 | 86.71 |
| 630. | 71.57 | 69.35 | 70.30 | 70.55 | 70.69 | 72.59 | 74.01 | 86.38 |
| 800. | 71.80 | 70.62 | 69.90 | 71.04 | 71.81 | 71.77 | 74.82 | 86.66 |
| 1000. | 71.52 | 71.07 | 70.95 | 71.84 | 72.66 | 73.36 | 76.01 | 87.62 |
| 1250. | 71.49 | 71.00 | 71.05 | 72.07 | 71.68 | 74.19 | 75.73 | 87.77 |
| 1600. | 71.60 | 71.07 | 70.32 | 71.26 | 71.20 | 73.30 | 75.33 | 87.21 |
| 2000. | 72.05 | 71.64 | 70.54 | 70.11 | 70.79 | 71.97 | 74.79 | 86.79 |
| 2500. | 72.14 | 71.90 | 70.96 | 69.77 | 70.12 | 71.98 | 74.33 | 86.60 |
| 3150. | 71.01 | 71.70 | 70.61 | 69.49 | 70.09 | 72.30 | 74.11 | 86.52 |
| 4000. | 69.65 | 72.22 | 70.46 | 69.08 | 69.74 | 72.17 | 74.47 | 86.50 |
| 5000. | 68.67 | 72.09 | 70.81 | 68.29 | 69.52 | 72.43 | 74.83 | 86.46 |
| 6300. | 67.95 | 71.76 | 70.14 | 67.63 | 69.68 | 72.62 | 74.68 | 86.27 |
| 8000. | 67.42 | 71.39 | 69.17 | 67.35 | 69.84 | 72.18 | 74.66 | 85.93 |
| 10000. | 67.33 | 70.94 | 68.25 | 67.14 | 69.61 | 72.19 | 74.89 | 85.76 |
| 12500. | 68.13 | 72.02 | 69.55 | 67.81 | 70.34 | 73.27 | 75.70 | 86.72 |
| 16000. | 69.12 | 73.29 | 70.98 | 68.55 | 71.58 | 74.10 | 76.63 | 87.75 |
| 20000. | 68.65 | 73.36 | 70.90 | 68.14 | 71.87 | 74.23 | 76.73 | 87.80 |
| 25000. | 68.65 | 72.09 | 69.47 | 66.15 | 70.31 | 72.96 | 75.57 | 86.44 |
| 31500. | 62.37 | 68.52 | 65.82 | 62.18 | 66.34 | 69.21 | 71.92 | 82.72 |
| 40000. | 58.47 | 63.93 | 61.60 | 58.66 | 63.20 | 66.17 | 68.59 | 79.11 |

TOTAL POWER, DB = 100.42

NOZZLE DIA = 2.8"
 DIFFUSOR DIA = 8.0"
 FLOW TEMPERATURE, TOTAL = 530.0 DEG R
 MICROPHONE RADIUS = 6 FT.

NOZZLE-DIFFUSOR SPACING RATIO = 0.25
 MACH NO. = 0.90

AEDC-TR-80-15

MICROPHONE ANGLE, DEG

| FREQUENCY, HZ | MICHROPHONE ANGLE, DEG | | | | | | | TOTAL POWER, DB (1/3 OCTAVE BAND) |
|---------------|------------------------|-------|-------|-------|-------|-------|-------|--------------------------------------|
| | 30. | 45. | 60. | 75. | 90. | 105. | 120. | |
| 200. | 74.04 | 75.92 | 76.37 | 76.37 | 76.81 | 76.14 | 76.91 | 91.39 |
| 250. | 72.91 | 75.84 | 75.73 | 76.01 | 77.29 | 77.00 | 77.02 | 91.47 |
| 315. | 77.83 | 77.79 | 76.92 | 77.81 | 78.22 | 79.86 | 77.31 | 93.49 |
| 400. | 80.08 | 78.65 | 77.99 | 76.83 | 77.62 | 79.79 | 77.86 | 93.68 |
| 500. | 77.63 | 77.42 | 77.47 | 75.71 | 77.09 | 78.81 | 78.54 | 92.71 |
| 630. | 77.08 | 75.43 | 76.44 | 77.00 | 76.93 | 76.78 | 79.40 | 92.49 |
| 800. | 77.24 | 76.23 | 76.55 | 77.79 | 78.31 | 77.74 | 81.23 | 92.88 |
| 1000. | 77.39 | 76.91 | 77.68 | 77.31 | 76.85 | 78.92 | 81.90 | 93.44 |
| 1250. | 76.46 | 76.25 | 76.59 | 76.83 | 77.56 | 79.40 | 80.93 | 92.98 |
| 1600. | 77.06 | 76.74 | 76.07 | 75.71 | 76.83 | 79.12 | 80.33 | 92.64 |
| 2000. | 78.48 | 77.86 | 76.31 | 75.55 | 76.87 | 78.39 | 81.01 | 92.82 |
| 2500. | 78.00 | 78.22 | 76.36 | 75.76 | 76.66 | 77.98 | 80.67 | 92.75 |
| 3150. | 76.88 | 78.20 | 76.86 | 75.34 | 76.36 | 78.84 | 80.52 | 92.86 |
| 4000. | 76.21 | 79.13 | 77.54 | 75.50 | 76.29 | 79.25 | 81.32 | 93.36 |
| 5000. | 75.79 | 79.55 | 78.10 | 75.52 | 76.26 | 79.86 | 82.64 | 93.86 |
| 6300. | 75.43 | 79.66 | 78.15 | 74.85 | 76.93 | 80.02 | 82.93 | 93.95 |
| 8000. | 74.95 | 79.51 | 77.19 | 74.56 | 76.91 | 80.25 | 83.10 | 93.89 |
| 10000. | 73.51 | 78.09 | 75.27 | 73.77 | 76.12 | 79.39 | 82.44 | 92.84 |
| 12500. | 72.90 | 77.11 | 74.18 | 72.65 | 75.59 | 76.60 | 81.91 | 92.02 |
| 16000. | 72.93 | 77.53 | 75.24 | 72.93 | 75.82 | 78.83 | 82.65 | 92.45 |
| 20000. | 72.44 | 78.02 | 75.36 | 72.19 | 75.47 | 78.10 | 82.56 | 92.25 |
| 25000. | 71.64 | 77.36 | 75.28 | 70.77 | 74.43 | 76.81 | 81.72 | 91.35 |
| 31500. | 69.57 | 75.81 | 72.67 | 68.38 | 72.44 | 75.26 | 79.47 | 89.48 |
| 40000. | 66.61 | 72.99 | 70.12 | 66.07 | 69.87 | 71.87 | 76.78 | 86.61 |

TOTAL POWER, DB = 106.42

NOZZLE DIA = 2.8"
 DIFFUSOR DIA = 8.0"
 FLOW TEMPERATURE, TOTAL = 530.0 DEG R
 MICROPHONE RADIUS = 6 FT.

NOZZLE-DIFFUSOR SPACING RATIO = 0.25
 MACH NO. = 1.10

| FREQUENCY, HZ | MICROPHONE ANGLE, DEG | | | | | | TOTAL POWER, DB (1/3 OCTAVE BAND) | |
|---------------|-----------------------|--------|--------|--------|--------|--------|--------------------------------------|--------|
| | 30. | 45. | 60. | 75. | 90. | 105. | | 120. |
| 200. | 76.04 | 78.29 | 79.15 | 79.63 | 79.87 | 76.99 | 79.05 | 93.63 |
| 250. | 74.95 | 77.78 | 78.07 | 80.43 | 79.28 | 79.24 | 80.66 | 94.29 |
| 315. | 82.40 | 80.14 | 80.41 | 82.37 | 82.53 | 83.19 | 81.17 | 97.14 |
| 400. | 84.81 | 84.08 | 82.37 | 82.27 | 82.77 | 84.08 | 82.78 | 98.59 |
| 500. | 81.93 | 83.89 | 83.06 | 81.22 | 82.12 | 84.00 | 83.48 | 98.40 |
| 630. | 84.16 | 80.27 | 82.35 | 81.89 | 82.04 | 83.47 | 84.45 | 97.60 |
| 800. | 81.61 | 82.56 | 81.64 | 83.00 | 83.56 | 82.52 | 85.99 | 98.10 |
| 1000. | 82.94 | 81.03 | 82.32 | 82.66 | 83.16 | 83.23 | 86.95 | 98.12 |
| 1250. | 81.47 | 81.41 | 81.55 | 82.31 | 82.51 | 84.20 | 86.46 | 98.09 |
| 1600. | 83.43 | 83.26 | 82.17 | 82.34 | 83.39 | 85.03 | 86.97 | 98.96 |
| 2000. | 86.74 | 86.69 | 84.90 | 83.07 | 84.91 | 85.87 | 89.33 | 100.95 |
| 2500. | 99.09 | 101.80 | 98.41 | 98.05 | 97.99 | 100.90 | 103.30 | 115.46 |
| 3150. | 102.02 | 105.24 | 101.08 | 104.89 | 100.09 | 106.88 | 106.94 | 120.14 |
| 4000. | 92.58 | 94.79 | 91.95 | 91.82 | 92.35 | 95.39 | 97.27 | 109.23 |
| 5000. | 92.20 | 95.24 | 95.44 | 91.34 | 93.04 | 96.85 | 101.73 | 110.81 |
| 6300. | 92.26 | 96.07 | 94.28 | 90.67 | 93.66 | 97.89 | 99.52 | 110.64 |
| 8000. | 90.85 | 95.17 | 91.91 | 89.94 | 93.71 | 97.00 | 99.02 | 109.97 |
| 10000. | 88.54 | 92.88 | 89.09 | 87.94 | 91.98 | 95.16 | 96.99 | 107.93 |
| 12500. | 86.12 | 90.97 | 87.17 | 85.36 | 89.92 | 93.40 | 95.15 | 106.02 |
| 16000. | 83.63 | 89.06 | 85.62 | 83.29 | 88.31 | 91.25 | 93.70 | 104.12 |
| 20000. | 81.20 | 86.13 | 83.06 | 81.48 | 85.93 | 88.33 | 91.35 | 101.45 |
| 25000. | 76.99 | 83.20 | 79.85 | 77.12 | 82.86 | 84.71 | 87.85 | 98.03 |
| 31500. | 76.09 | 82.31 | 79.84 | 75.50 | 79.52 | 82.11 | 86.40 | 96.29 |
| 40000. | 69.02 | 75.93 | 72.62 | 70.25 | 75.30 | 76.57 | 80.73 | 90.50 |

TOTAL POWER, DB = 123.08

NOZZLE DIA = 2.8"
 DIFFUSOR DIA = 8.0"
 FLOW TEMPERATURE, TOTAL = 530.0 DEG R
 MICROPHONE RADIUS = 6 FT.

NOZZLE-DIFFUSOR SPACING RATIO = 0.50
 MACH NO. = 0.70

AEDC-TR-80-15

MICROPHONE ANGLE, DEG

| FREQUENCY, HZ | 30. | 45. | 60. | 75. | 90. | 105. | 120. | TOTAL POWER, DB (1/3 OCTAVE BAND) |
|---------------|---------------------------------|-------|-------|-------|-------|-------|-------|--------------------------------------|
| | SOUND POWER INTENSITY LEVEL, DB | | | | | | | |
| 200. | 71.56 | 71.11 | 72.06 | 72.37 | 74.29 | 70.67 | 71.36 | 67.12 |
| 250. | 71.13 | 70.16 | 71.02 | 71.50 | 73.30 | 72.68 | 72.36 | 67.01 |
| 315. | 72.56 | 71.29 | 71.31 | 72.04 | 74.17 | 74.29 | 73.43 | 68.01 |
| 400. | 72.01 | 72.60 | 72.30 | 70.60 | 71.98 | 72.68 | 72.53 | 67.34 |
| 500. | 70.13 | 70.33 | 72.52 | 70.45 | 70.17 | 72.39 | 72.97 | 66.50 |
| 630. | 70.92 | 68.56 | 70.59 | 70.29 | 70.05 | 72.36 | 73.46 | 66.06 |
| 800. | 70.50 | 69.95 | 69.66 | 69.94 | 71.95 | 71.38 | 74.09 | 66.09 |
| 1000. | 71.04 | 70.68 | 71.46 | 71.18 | 71.99 | 73.01 | 75.48 | 67.21 |
| 1250. | 70.87 | 70.45 | 71.26 | 70.89 | 70.86 | 73.74 | 75.08 | 67.10 |
| 1600. | 71.79 | 71.05 | 70.98 | 70.09 | 70.53 | 72.63 | 74.13 | 66.68 |
| 2000. | 72.89 | 71.84 | 71.40 | 69.68 | 71.14 | 72.35 | 73.80 | 66.86 |
| 2500. | 72.26 | 72.00 | 71.18 | 69.33 | 70.92 | 72.07 | 73.92 | 66.69 |
| 3150. | 70.59 | 71.83 | 70.77 | 69.17 | 70.45 | 71.72 | 73.91 | 66.36 |
| 4000. | 69.35 | 71.93 | 70.67 | 69.07 | 69.91 | 72.01 | 74.03 | 66.37 |
| 5000. | 68.07 | 71.51 | 70.64 | 68.34 | 69.88 | 72.49 | 74.40 | 66.33 |
| 6400. | 68.12 | 71.22 | 70.62 | 67.35 | 69.06 | 72.52 | 74.13 | 66.00 |
| 8000. | 67.56 | 70.67 | 69.19 | 66.81 | 69.64 | 72.50 | 73.75 | 65.74 |
| 10000. | 67.35 | 70.90 | 68.15 | 68.84 | 69.80 | 72.66 | 73.87 | 65.74 |
| 12500. | 68.96 | 71.75 | 69.39 | 68.15 | 70.53 | 73.52 | 75.57 | 66.76 |
| 16000. | 70.14 | 72.73 | 70.25 | 68.88 | 71.27 | 74.31 | 76.70 | 67.66 |
| 20000. | 69.84 | 73.27 | 69.97 | 68.85 | 71.17 | 73.84 | 76.09 | 67.62 |
| 25000. | 67.45 | 71.05 | 68.03 | 66.71 | 69.24 | 71.91 | 74.77 | 65.74 |
| 31500. | 63.73 | 67.86 | 64.00 | 63.01 | 66.16 | 69.21 | 70.63 | 62.37 |
| 40000. | 59.75 | 64.07 | 60.73 | 60.83 | 63.46 | 65.50 | 67.07 | 78.90 |

TOTAL POWER, DB = 100.26

130

NOZZLE DIA = 2.8"
 DIFFUSOR DIA = 8.0"
 FLOW TEMPERATURE, TOTAL = 530.0 DEG R
 MICROPHONE RADIUS = 6 FT.

NOZZLE-DIFFUSOR SPACING RATIO = 0.50
 MACN NU. = 0.90

| FREQUENCY, HZ | MICROPHONE ANGLE, DEG | | | | | | | TOTAL POWER, DB (1/3 OCTAVE BAND) |
|---------------|-----------------------|-------|-------|-------|-------|-------|-------|--------------------------------------|
| | 30. | 45. | 60. | 75. | 90. | 105. | 120. | |
| 200. | 74.86 | 75.73 | 76.02 | 76.29 | 76.28 | 76.38 | 75.54 | 91.24 |
| 250. | 75.06 | 75.95 | 74.91 | 76.52 | 76.51 | 76.92 | 76.48 | 91.45 |
| 315. | 77.73 | 77.39 | 76.06 | 77.83 | 77.75 | 77.64 | 78.05 | 92.81 |
| 400. | 76.46 | 78.05 | 77.27 | 77.17 | 76.96 | 78.12 | 79.12 | 92.97 |
| 500. | 77.11 | 76.75 | 76.49 | 76.20 | 76.23 | 78.79 | 79.49 | 92.51 |
| 630. | 76.94 | 74.87 | 74.56 | 76.62 | 76.01 | 79.01 | 79.98 | 92.23 |
| 800. | 77.31 | 76.43 | 75.36 | 76.34 | 77.51 | 78.41 | 80.74 | 92.54 |
| 1000. | 77.41 | 77.16 | 76.79 | 77.21 | 77.93 | 78.70 | 81.74 | 93.20 |
| 1250. | 76.49 | 75.99 | 75.75 | 76.55 | 76.75 | 78.47 | 80.53 | 92.40 |
| 1600. | 76.60 | 76.59 | 75.79 | 76.02 | 76.34 | 78.00 | 79.88 | 92.18 |
| 2000. | 78.03 | 77.26 | 76.27 | 75.68 | 76.19 | 78.03 | 79.43 | 92.37 |
| 2500. | 77.18 | 77.74 | 76.44 | 75.65 | 76.35 | 78.00 | 79.74 | 92.48 |
| 3150. | 76.14 | 78.40 | 76.79 | 75.45 | 75.81 | 78.28 | 80.24 | 92.66 |
| 4000. | 75.60 | 78.88 | 77.53 | 75.74 | 75.53 | 76.82 | 81.18 | 93.11 |
| 5000. | 75.20 | 79.36 | 78.58 | 75.41 | 76.14 | 79.49 | 82.12 | 93.65 |
| 6300. | 74.91 | 79.45 | 78.62 | 75.00 | 76.74 | 80.22 | 82.61 | 93.95 |
| 8000. | 75.08 | 79.01 | 77.45 | 74.60 | 76.84 | 80.51 | 82.54 | 93.94 |
| 10000. | 73.72 | 76.50 | 75.33 | 73.50 | 76.12 | 79.71 | 81.83 | 92.94 |
| 12500. | 73.12 | 76.08 | 74.86 | 72.64 | 75.64 | 79.11 | 81.00 | 92.37 |
| 16000. | 74.05 | 78.56 | 75.85 | 73.52 | 75.80 | 79.08 | 81.37 | 92.70 |
| 20000. | 74.02 | 78.85 | 76.14 | 73.50 | 75.07 | 78.28 | 81.68 | 92.57 |
| 25000. | 73.37 | 78.37 | 76.06 | 72.27 | 74.03 | 76.98 | 80.66 | 91.73 |
| 31500. | 71.24 | 75.54 | 73.43 | 70.03 | 72.15 | 75.30 | 78.56 | 89.46 |
| 40000. | 67.78 | 71.56 | 69.98 | 67.41 | 69.90 | 72.22 | 75.89 | 86.26 |

TOTAL POWER, DB = 106.25

NOZZLE DIA = 2.8"
 DIFFUSOR DIA = 8.0"
 FLOW TEMPERATURE, TOTAL = 530.0 DEG R
 MICROPHONE RADIUS = 6 FT.

NOZZLE-DIFFUSOR SPACING RATIO = 0.50
 MACH NO. = 1.10

AEDC-TR-80-15

MICROPHONE ANGLE, DEG

| FREQUENCY, HZ | MICROPHONE ANGLE, DEG | | | | | | | TOTAL POWER, DB (1/3 OCTAVE BAND) |
|---------------|-----------------------|-------|-------|-------|-------|-------|--------|--------------------------------------|
| | 30. | 45. | 60. | 75. | 90. | 105. | 120. | |
| 200. | 77.08 | 78.63 | 77.41 | 76.83 | 77.85 | 79.18 | 77.30 | 93.25 |
| 250. | 78.00 | 78.45 | 78.25 | 77.73 | 79.19 | 80.50 | 78.02 | 94.67 |
| 315. | 81.22 | 80.82 | 79.47 | 81.18 | 82.13 | 81.90 | 81.53 | 96.46 |
| 400. | 81.95 | 83.25 | 81.07 | 81.27 | 82.39 | 82.39 | 82.63 | 97.43 |
| 500. | 80.78 | 81.49 | 80.52 | 80.59 | 80.31 | 82.26 | 82.47 | 96.49 |
| 630. | 80.56 | 80.11 | 79.77 | 80.30 | 80.32 | 82.12 | 83.06 | 96.08 |
| 800. | 80.34 | 80.77 | 80.11 | 80.32 | 82.37 | 81.55 | 83.66 | 96.38 |
| 1000. | 80.19 | 80.03 | 80.88 | 80.53 | 81.94 | 81.80 | 84.12 | 96.40 |
| 1250. | 79.71 | 79.03 | 80.13 | 79.92 | 79.85 | 82.30 | 83.57 | 95.88 |
| 1600. | 80.76 | 80.70 | 80.09 | 79.88 | 80.82 | 82.42 | 83.72 | 96.36 |
| 2000. | 83.02 | 83.13 | 82.13 | 80.85 | 82.16 | 82.80 | 85.21 | 97.77 |
| 2500. | 88.20 | 88.35 | 87.47 | 84.08 | 85.98 | 86.66 | 89.48 | 102.28 |
| 3150. | 92.30 | 93.20 | 91.67 | 90.48 | 90.09 | 93.12 | 95.35 | 107.63 |
| 4000. | 93.67 | 90.20 | 94.79 | 92.28 | 93.31 | 96.55 | 98.81 | 110.56 |
| 5000. | 92.44 | 90.60 | 94.94 | 91.98 | 94.02 | 97.62 | 100.03 | 111.15 |
| 6300. | 90.56 | 95.79 | 93.68 | 90.54 | 93.39 | 96.79 | 99.16 | 110.21 |
| 8000. | 89.08 | 94.10 | 90.72 | 88.86 | 92.52 | 95.96 | 97.47 | 108.83 |
| 10000. | 87.02 | 91.89 | 87.57 | 87.04 | 91.01 | 94.05 | 95.46 | 106.79 |
| 12500. | 84.13 | 89.37 | 85.24 | 84.33 | 88.42 | 91.63 | 93.01 | 104.30 |
| 16000. | 81.43 | 87.23 | 82.85 | 81.75 | 85.69 | 89.40 | 90.87 | 102.06 |
| 20000. | 78.80 | 84.06 | 80.83 | 79.68 | 83.75 | 86.54 | 88.41 | 99.34 |
| 25000. | 76.04 | 80.86 | 78.63 | 76.72 | 80.27 | 83.17 | 85.32 | 96.15 |
| 31500. | 74.42 | 79.17 | 77.19 | 73.89 | 77.10 | 79.61 | 82.80 | 93.50 |
| 40000. | 71.47 | 70.71 | 74.61 | 71.69 | 74.40 | 76.62 | 79.97 | 90.81 |

TOTAL POWER, DB = 118.15

NOZZLE DIA = 2.8"
 DIFFUSOR DIA = 6.0"
 FLOW TEMPERATURE, TOTAL = 530.0 DEG R
 MICROPHONE RADIUS = 6 FT.

NOZZLE-DIFFUSOR SPACING RATIO = 0.75
 MACH NO. = 0.70

| FREQUENCY, HZ | MICROPHONE ANGLE, DEG | | | | | | | TOTAL POWER, DB (1/3 OCTAVE BAND) |
|---------------|-----------------------|-------|-------|-------|-------|-------|-------|--------------------------------------|
| | 30. | 45. | 60. | 75. | 90. | 105. | 120. | |
| 200. | 71.88 | 69.36 | 71.39 | 72.08 | 72.40 | 71.86 | 72.10 | 86.69 |
| 250. | 71.65 | 69.15 | 70.36 | 71.04 | 72.64 | 72.70 | 71.12 | 86.51 |
| 315. | 72.45 | 71.84 | 71.76 | 73.83 | 73.96 | 73.42 | 72.38 | 88.20 |
| 400. | 72.48 | 71.93 | 72.46 | 72.11 | 72.24 | 72.68 | 71.80 | 87.45 |
| 500. | 71.24 | 71.26 | 72.21 | 71.53 | 71.79 | 72.90 | 72.67 | 87.16 |
| 630. | 71.65 | 70.46 | 70.99 | 71.70 | 72.73 | 73.68 | 73.86 | 87.36 |
| 800. | 71.05 | 70.29 | 70.60 | 70.93 | 72.47 | 73.32 | 74.99 | 87.12 |
| 1000. | 71.64 | 71.27 | 71.88 | 72.00 | 72.77 | 74.37 | 76.05 | 88.06 |
| 1250. | 72.70 | 71.68 | 71.49 | 71.23 | 71.88 | 74.58 | 75.46 | 87.94 |
| 1600. | 72.29 | 72.27 | 70.66 | 70.91 | 71.74 | 73.84 | 74.69 | 87.59 |
| 2000. | 73.09 | 72.37 | 70.98 | 70.90 | 71.92 | 73.29 | 73.91 | 87.47 |
| 2500. | 72.29 | 72.20 | 71.61 | 70.70 | 71.72 | 73.24 | 74.27 | 87.41 |
| 3150. | 70.92 | 72.03 | 71.67 | 70.24 | 71.01 | 73.52 | 75.65 | 87.40 |
| 4000. | 70.06 | 72.37 | 71.46 | 69.72 | 70.75 | 73.35 | 75.39 | 87.25 |
| 5000. | 69.77 | 72.53 | 71.03 | 69.08 | 71.06 | 73.37 | 75.25 | 87.18 |
| 6300. | 68.85 | 71.92 | 70.32 | 68.75 | 70.92 | 73.59 | 75.41 | 86.99 |
| 8000. | 68.31 | 71.37 | 68.79 | 68.74 | 71.04 | 73.74 | 75.06 | 86.77 |
| 10000. | 68.08 | 71.08 | 68.41 | 68.86 | 70.84 | 74.02 | 75.07 | 86.78 |
| 12500. | 69.01 | 72.50 | 69.60 | 69.80 | 71.65 | 74.35 | 75.62 | 87.56 |
| 16000. | 69.61 | 73.67 | 70.31 | 70.30 | 72.09 | 74.50 | 75.99 | 88.09 |
| 20000. | 69.20 | 73.82 | 69.92 | 70.22 | 71.83 | 73.83 | 75.53 | 87.81 |
| 25000. | 66.75 | 71.63 | 68.08 | 68.44 | 69.98 | 72.00 | 73.10 | 85.80 |
| 31500. | 63.27 | 68.48 | 65.21 | 64.48 | 66.48 | 69.73 | 70.09 | 82.84 |
| 40000. | 59.04 | 64.13 | 61.07 | 61.48 | 63.18 | 66.77 | 66.97 | 79.40 |

TOTAL POWER, DB = 100.86

NOZZLE DIA = 2.8"
 DIFFUSOR DIA = 8.0"
 FLOW TEMPERATURE, TOTAL = 530.0 DEG R
 MICROPHONE RADIUS = 6 FT.

NOZZLE-DIFFUSOR SPACING RATIO = 0.75
 MACH NU. = 0.90

AEDC-TR-80-15

MICROPHONE ANGLE, DEG

| FREQUENCY, HZ | 30. | 45. | 60. | 75. | 90. | 105. | 120. | TOTAL POWER, DB (1/3 OCTAVE BAND) |
|---------------|---------------------------------|-------|-------|-------|-------|-------|-------|--------------------------------------|
| | SOUND POWER INTENSITY LEVEL, DB | | | | | | | |
| 200. | 74.84 | 75.10 | 75.57 | 75.52 | 76.28 | 75.91 | 76.55 | 90.83 |
| 250. | 75.32 | 75.47 | 74.20 | 76.57 | 75.89 | 75.97 | 76.28 | 91.01 |
| 315. | 79.55 | 79.75 | 77.49 | 78.01 | 77.91 | 79.35 | 77.72 | 93.96 |
| 400. | 79.40 | 79.21 | 77.28 | 77.54 | 77.97 | 78.79 | 78.03 | 93.59 |
| 500. | 77.96 | 77.07 | 77.71 | 76.62 | 77.90 | 78.98 | 76.46 | 93.11 |
| 630. | 77.95 | 76.58 | 77.11 | 77.94 | 77.95 | 79.37 | 79.71 | 93.28 |
| 800. | 77.48 | 76.57 | 77.02 | 78.05 | 78.89 | 78.67 | 81.28 | 93.39 |
| 1000. | 77.52 | 77.26 | 77.45 | 77.71 | 78.44 | 79.51 | 82.28 | 93.72 |
| 1250. | 77.17 | 76.99 | 76.41 | 76.54 | 77.03 | 79.20 | 80.30 | 92.69 |
| 1600. | 77.00 | 77.43 | 75.94 | 76.06 | 76.96 | 78.44 | 79.90 | 92.62 |
| 2000. | 76.05 | 77.08 | 76.62 | 76.37 | 76.95 | 77.94 | 79.82 | 92.71 |
| 2500. | 76.24 | 77.67 | 76.65 | 76.22 | 77.19 | 78.84 | 80.06 | 92.96 |
| 3150. | 77.33 | 78.61 | 76.95 | 75.82 | 77.44 | 79.41 | 80.93 | 93.35 |
| 4000. | 76.00 | 79.30 | 77.12 | 75.86 | 77.05 | 79.48 | 81.62 | 93.00 |
| 5000. | 76.39 | 79.67 | 77.99 | 75.84 | 77.86 | 80.51 | 82.49 | 94.26 |
| 6300. | 76.42 | 79.67 | 78.29 | 75.94 | 78.30 | 81.21 | 82.54 | 94.54 |
| 8000. | 75.83 | 79.40 | 77.25 | 75.79 | 78.61 | 81.79 | 82.97 | 94.65 |
| 10000. | 74.47 | 78.25 | 75.50 | 74.95 | 77.58 | 81.04 | 82.12 | 93.70 |
| 12500. | 73.93 | 78.11 | 74.91 | 74.42 | 77.32 | 80.28 | 81.60 | 93.19 |
| 16000. | 74.35 | 78.29 | 75.33 | 74.77 | 77.56 | 79.97 | 81.58 | 93.21 |
| 20000. | 73.44 | 78.03 | 75.31 | 74.24 | 76.85 | 78.76 | 80.81 | 92.49 |
| 25000. | 72.78 | 77.51 | 74.84 | 72.95 | 75.44 | 77.18 | 79.65 | 91.42 |
| 31500. | 70.02 | 74.50 | 72.59 | 71.09 | 73.52 | 74.90 | 76.96 | 88.97 |
| 40000. | 66.88 | 71.69 | 70.02 | 67.50 | 70.72 | 72.36 | 74.28 | 86.17 |

TOTAL POWER, DB = 106.75

134

NOZZLE DIA = 2.8"
 DIFFUSOR DIA = 8.0"
 FLOW TEMPERATURE, TOTAL = 530.0 DEG R
 MICROPHONE RADIUS = 6 FT.

NOZZLE-DIFFUSOR SPACING RATIO = 0.75
 MACH NU. = 1.10

| | | | | | | | | |
|--------|--------|--------|--------|-------|-------|--------|--------|--------|
| 200. | 76.69 | 76.87 | 77.08 | 78.91 | 77.06 | 76.89 | 79.07 | 92.77 |
| 250. | 76.26 | 74.94 | 75.70 | 75.48 | 77.22 | 77.56 | 77.97 | 91.55 |
| 315. | 81.24 | 80.41 | 79.80 | 83.14 | 85.60 | 81.93 | 78.71 | 97.42 |
| 400. | 82.72 | 82.49 | 80.90 | 79.41 | 80.47 | 82.36 | 81.18 | 96.67 |
| 500. | 78.41 | 81.64 | 81.75 | 80.64 | 80.95 | 83.67 | 82.04 | 97.04 |
| 630. | 81.86 | 80.49 | 78.64 | 80.72 | 81.30 | 83.26 | 83.36 | 96.71 |
| 800. | 78.25 | 81.04 | 81.09 | 80.04 | 82.22 | 81.90 | 84.17 | 96.53 |
| 1000. | 81.63 | 79.69 | 81.04 | 81.33 | 81.24 | 83.02 | 84.21 | 96.86 |
| 1250. | 80.25 | 80.37 | 80.11 | 78.67 | 78.91 | 83.00 | 83.04 | 96.05 |
| 1600. | 81.35 | 81.95 | 80.76 | 81.18 | 81.55 | 82.27 | 84.03 | 97.01 |
| 2000. | 85.37 | 85.69 | 82.95 | 81.52 | 82.99 | 83.64 | 85.92 | 99.17 |
| 2500. | 97.92 | 96.38 | 96.74 | 90.07 | 92.01 | 95.74 | 101.44 | 111.04 |
| 3150. | 100.35 | 101.14 | 101.10 | 99.38 | 97.92 | 102.28 | 107.92 | 116.87 |
| 4000. | 94.26 | 97.87 | 95.95 | 93.35 | 95.90 | 96.11 | 101.06 | 112.19 |
| 5000. | 92.69 | 96.20 | 96.10 | 93.12 | 95.62 | 99.04 | 101.12 | 112.04 |
| 6300. | 91.62 | 94.92 | 94.21 | 91.29 | 94.06 | 98.51 | 99.45 | 110.86 |
| 8000. | 89.79 | 93.37 | 91.29 | 90.23 | 92.81 | 97.02 | 97.77 | 109.31 |
| 10000. | 87.14 | 91.06 | 88.19 | 87.95 | 90.93 | 94.95 | 95.39 | 107.09 |
| 12500. | 84.23 | 88.69 | 85.91 | 84.85 | 88.67 | 91.74 | 93.33 | 104.34 |
| 16000. | 81.76 | 86.38 | 83.44 | 82.45 | 86.85 | 89.61 | 91.64 | 102.27 |
| 20000. | 79.74 | 83.82 | 81.29 | 80.81 | 84.71 | 87.10 | 89.08 | 99.85 |
| 25000. | 76.45 | 81.12 | 78.25 | 76.69 | 80.92 | 83.05 | 85.30 | 96.21 |
| 31500. | 77.55 | 79.77 | 77.76 | 75.44 | 77.83 | 80.28 | 83.49 | 94.30 |
| 40000. | 69.29 | 74.27 | 72.17 | 70.11 | 73.01 | 75.22 | 77.55 | 88.86 |

TOTAL POWER, DB = 121.17

NOZZLE DIA = 2.8"
 DIFFUSOR DIA = 8.0"
 FLOW TEMPERATURE, TOTAL = 530.0 DEG R
 MICROPHONE RADIUS = 6 FT.

NOZZLE-DIFFUSOR SPACING RATIO = 1.00
 MACH NO. = 0.70

AEDC-TR-80-15

| FREQUENCY, HZ | MICROPHONE ANGLE, DEG | | | | | | | TOTAL POWER, DB (1/3 OCTAVE BAND) |
|---------------|-----------------------|-------|-------|-------|-------|-------|-------|--------------------------------------|
| | 30. | 45. | 60. | 75. | 90. | 105. | 120. | |
| 200. | 69.12 | 71.31 | 71.82 | 70.26 | 71.58 | 72.84 | 71.74 | 86.71 |
| 250. | 68.81 | 70.52 | 71.45 | 70.63 | 71.20 | 73.31 | 72.56 | 86.73 |
| 315. | 72.45 | 71.45 | 71.39 | 71.19 | 73.23 | 72.77 | 72.48 | 87.24 |
| 400. | 73.80 | 72.50 | 71.52 | 70.48 | 72.72 | 73.17 | 72.34 | 87.51 |
| 500. | 71.39 | 71.35 | 71.46 | 70.96 | 70.82 | 73.64 | 72.84 | 87.21 |
| 630. | 71.15 | 70.43 | 70.57 | 70.91 | 70.70 | 72.90 | 73.84 | 86.73 |
| 800. | 71.29 | 71.05 | 70.32 | 70.13 | 71.33 | 72.18 | 74.47 | 86.59 |
| 1000. | 72.07 | 72.23 | 70.69 | 71.27 | 72.34 | 73.35 | 75.54 | 87.65 |
| 1250. | 72.40 | 72.28 | 71.47 | 71.26 | 71.77 | 74.21 | 75.14 | 87.86 |
| 1600. | 72.03 | 72.32 | 71.26 | 70.93 | 71.20 | 73.22 | 73.98 | 87.35 |
| 2000. | 72.93 | 73.12 | 70.90 | 70.99 | 71.77 | 72.81 | 74.04 | 87.53 |
| 2500. | 71.99 | 72.97 | 71.10 | 70.53 | 71.77 | 72.96 | 74.40 | 87.45 |
| 3150. | 71.05 | 72.51 | 70.59 | 69.82 | 71.33 | 72.80 | 74.90 | 87.10 |
| 4000. | 70.30 | 72.87 | 70.46 | 69.75 | 71.08 | 72.70 | 74.95 | 87.10 |
| 5000. | 69.30 | 73.10 | 70.65 | 69.42 | 71.01 | 73.11 | 74.75 | 87.21 |
| 6300. | 68.48 | 72.76 | 70.06 | 68.71 | 71.01 | 73.20 | 74.54 | 87.01 |
| 8000. | 68.11 | 72.80 | 69.84 | 68.90 | 70.95 | 72.91 | 74.60 | 86.87 |
| 10000. | 68.12 | 72.14 | 69.27 | 69.08 | 71.01 | 72.88 | 74.58 | 86.66 |
| 12500. | 68.77 | 72.82 | 70.35 | 69.89 | 71.46 | 73.29 | 75.08 | 87.26 |
| 16000. | 69.30 | 73.88 | 71.18 | 70.33 | 72.72 | 73.31 | 75.70 | 87.90 |
| 20000. | 68.67 | 74.24 | 71.00 | 69.94 | 72.72 | 72.90 | 75.50 | 87.81 |
| 25000. | 66.71 | 72.12 | 69.22 | 68.47 | 70.76 | 71.53 | 73.77 | 86.04 |
| 31500. | 62.27 | 69.04 | 65.72 | 65.91 | 67.72 | 68.84 | 70.31 | 83.05 |
| 40000. | 58.47 | 64.94 | 62.73 | 63.05 | 65.88 | 66.40 | 67.63 | 80.12 |

TOTAL POWER, DB = 100.72

NOZZLE DIA = 2.8"
 DIFFUSOR DIA = 8.0"
 FLOW TEMPERATURE, TOTAL = 530.0 DEG R
 MICROPHONE RADIUS = 6 FT.

NOZZLE-DIFFUSOR SPACING RATIO = 1.00
 MACH NO. = 0.90

| FREQUENCY, HZ | MICROPHONE ANGLE, DEG | | | | | | | TOTAL POWER, DB (1/3 OCTAVE BAND) |
|---------------|-----------------------|-------|-------|-------|-------|-------|-------|--------------------------------------|
| | 30. | 45. | 60. | 75. | 90. | 105. | 120. | |
| 200. | 75.05 | 74.59 | 74.79 | 76.65 | 75.11 | 77.31 | 77.02 | 91.22 |
| 250. | 75.46 | 75.23 | 75.92 | 76.27 | 75.61 | 77.79 | 77.12 | 91.56 |
| 315. | 78.03 | 77.73 | 77.25 | 76.73 | 77.90 | 79.86 | 76.67 | 93.26 |
| 400. | 78.52 | 78.19 | 78.19 | 76.48 | 77.45 | 79.84 | 77.49 | 93.41 |
| 500. | 76.63 | 76.04 | 77.17 | 76.88 | 76.88 | 78.60 | 77.99 | 92.44 |
| 630. | 76.53 | 74.84 | 76.14 | 76.82 | 77.31 | 78.44 | 79.62 | 92.27 |
| 800. | 77.45 | 76.00 | 75.31 | 76.45 | 78.40 | 79.11 | 80.57 | 92.80 |
| 1000. | 78.05 | 77.10 | 76.82 | 77.16 | 78.65 | 80.99 | 81.07 | 93.94 |
| 1250. | 77.12 | 76.66 | 76.62 | 76.41 | 76.99 | 81.15 | 80.23 | 93.54 |
| 1600. | 77.22 | 76.86 | 76.23 | 76.03 | 77.05 | 79.47 | 79.53 | 92.79 |
| 2000. | 78.46 | 77.77 | 76.67 | 75.79 | 77.88 | 79.76 | 79.58 | 93.23 |
| 2500. | 78.23 | 78.42 | 76.66 | 75.29 | 77.43 | 79.29 | 80.65 | 93.20 |
| 3150. | 77.24 | 77.98 | 76.26 | 75.17 | 77.10 | 80.02 | 81.08 | 93.25 |
| 4000. | 76.82 | 78.70 | 76.83 | 75.31 | 77.29 | 80.25 | 81.58 | 93.61 |
| 5000. | 76.92 | 79.79 | 77.83 | 75.83 | 78.05 | 80.98 | 82.46 | 94.42 |
| 6300. | 76.69 | 79.99 | 78.02 | 75.70 | 78.56 | 81.66 | 82.70 | 94.78 |
| 8000. | 76.15 | 79.75 | 77.05 | 75.91 | 78.81 | 82.07 | 82.31 | 94.79 |
| 10000. | 74.90 | 78.37 | 75.58 | 75.66 | 78.43 | 81.72 | 81.35 | 94.08 |
| 12500. | 74.87 | 77.74 | 75.19 | 75.61 | 77.65 | 80.81 | 81.09 | 93.45 |
| 16000. | 75.28 | 77.94 | 76.20 | 75.87 | 77.59 | 80.65 | 81.58 | 93.58 |
| 20000. | 73.72 | 77.77 | 75.93 | 75.37 | 76.89 | 79.16 | 80.69 | 92.74 |
| 25000. | 72.73 | 77.21 | 75.23 | 73.73 | 75.55 | 77.73 | 79.16 | 91.56 |
| 31500. | 70.21 | 74.68 | 73.18 | 71.57 | 73.82 | 76.05 | 76.23 | 89.43 |
| 40000. | 67.44 | 71.63 | 70.57 | 69.87 | 72.10 | 72.97 | 74.26 | 86.85 |

TOTAL POWER, DB = 106.83

NOZZLE DIA = 2.6"
 DIFFUSOR DIA = 8.0"
 FLOW TEMPERATURE, TOTAL = 530.0 DEG R
 MICROPHONE RADIUS = 6 FT.

NOZZLE-DIFFUSOR SPACING RATIO = 1.00
 MACH NU. = 1.10

AEDC-TR-80-15

| FREQUENCY, HZ | MICROPHONE ANGLE, DEG | | | | | | | TOTAL POWER, DB (1/3 OCTAVE BAND) |
|---------------|-----------------------|-------|-------|-------|-------|-------|-------|--------------------------------------|
| | 30. | 45. | 60. | 75. | 90. | 105. | 120. | |
| 200. | 75.37 | 75.70 | 76.54 | 78.34 | 78.49 | 77.41 | 77.31 | 92.46 |
| 250. | 76.09 | 76.29 | 76.09 | 78.19 | 79.11 | 77.98 | 78.70 | 92.82 |
| 315. | 79.73 | 80.01 | 78.05 | 80.83 | 81.31 | 79.96 | 80.29 | 95.36 |
| 400. | 81.40 | 81.62 | 80.38 | 81.19 | 81.61 | 81.81 | 81.66 | 96.64 |
| 500. | 79.44 | 78.71 | 79.55 | 80.41 | 80.39 | 82.20 | 82.71 | 95.60 |
| 630. | 80.03 | 77.40 | 79.10 | 79.75 | 80.00 | 82.20 | 82.97 | 95.49 |
| 800. | 80.81 | 78.57 | 80.17 | 79.73 | 81.38 | 81.19 | 83.48 | 95.68 |
| 1000. | 80.51 | 78.40 | 80.10 | 79.90 | 81.11 | 81.13 | 83.42 | 95.61 |
| 1250. | 79.64 | 78.17 | 79.32 | 78.73 | 79.57 | 81.71 | 82.72 | 95.15 |
| 1600. | 80.29 | 79.72 | 79.44 | 79.41 | 80.63 | 81.40 | 82.35 | 95.50 |
| 2000. | 82.28 | 81.46 | 81.14 | 80.34 | 81.51 | 82.24 | 83.31 | 96.77 |
| 2500. | 86.37 | 80.13 | 85.96 | 83.17 | 85.30 | 85.80 | 80.74 | 100.69 |
| 3150. | 90.40 | 91.12 | 90.70 | 88.54 | 90.04 | 91.40 | 93.35 | 105.89 |
| 4000. | 92.07 | 94.27 | 93.23 | 91.32 | 93.00 | 95.15 | 97.67 | 109.15 |
| 5000. | 91.20 | 94.61 | 93.80 | 91.74 | 94.07 | 96.94 | 99.45 | 110.22 |
| 6300. | 89.05 | 92.40 | 91.95 | 90.13 | 93.29 | 96.24 | 98.69 | 109.03 |
| 8000. | 87.09 | 90.83 | 88.51 | 87.95 | 91.94 | 94.98 | 96.54 | 107.33 |
| 10000. | 84.37 | 88.16 | 85.71 | 85.58 | 89.90 | 92.57 | 93.30 | 104.79 |
| 12500. | 82.03 | 85.52 | 83.67 | 83.02 | 87.66 | 90.16 | 90.76 | 102.35 |
| 16000. | 80.13 | 84.21 | 81.56 | 81.60 | 86.25 | 87.88 | 88.54 | 100.44 |
| 20000. | 78.24 | 82.83 | 79.97 | 79.93 | 84.07 | 85.09 | 86.19 | 98.25 |
| 25000. | 76.28 | 80.68 | 78.75 | 77.94 | 81.33 | 81.22 | 83.34 | 95.46 |
| 31500. | 75.08 | 78.99 | 78.05 | 75.82 | 78.78 | 78.86 | 81.62 | 93.55 |
| 40000. | 73.38 | 76.78 | 76.07 | 73.90 | 75.97 | 76.85 | 78.77 | 91.32 |

TOTAL POWER, DB = 116.83

NOZZLE DIA = 2.8"
 DIFFUSOR DIA = 8.0"
 FLOW TEMPERATURE, TOTAL = 530.0 DEG R
 MICROPHONE RADIUS = 6 FT.

NOZZLE-DIFFUSOR SPACING RATIO = 1.25
 MACH NU. = 0.70

| FREQUENCY, HZ | MICROPHONE ANGLE, DEG | | | | | | | TOTAL POWER, DB (1/3 OCTAVE BAND) |
|---------------|-----------------------|-------|-------|-------|-------|-------|-------|--------------------------------------|
| | 30. | 45. | 60. | 75. | 90. | 105. | 120. | |
| 200. | 71.11 | 70.05 | 72.00 | 72.92 | 72.35 | 71.45 | 71.98 | 86.94 |
| 250. | 70.29 | 69.35 | 71.13 | 72.36 | 71.66 | 71.45 | 72.45 | 86.49 |
| 315. | 72.13 | 71.57 | 71.79 | 72.26 | 72.75 | 73.22 | 72.22 | 87.54 |
| 400. | 72.58 | 71.64 | 72.38 | 71.46 | 72.38 | 72.97 | 72.88 | 87.41 |
| 500. | 70.79 | 70.63 | 71.20 | 71.04 | 71.25 | 72.40 | 73.48 | 86.69 |
| 630. | 71.68 | 70.24 | 70.71 | 70.36 | 71.14 | 72.33 | 74.40 | 86.54 |
| 800. | 71.18 | 70.88 | 70.10 | 69.75 | 71.78 | 72.26 | 75.06 | 86.62 |
| 1000. | 72.51 | 71.96 | 71.07 | 71.04 | 71.99 | 73.54 | 75.85 | 87.05 |
| 1250. | 72.77 | 72.15 | 71.67 | 71.25 | 71.62 | 73.98 | 74.60 | 87.76 |
| 1600. | 73.02 | 72.85 | 71.24 | 71.15 | 71.00 | 73.23 | 74.05 | 87.56 |
| 2000. | 73.53 | 73.42 | 71.27 | 71.49 | 71.21 | 73.54 | 74.85 | 87.96 |
| 2500. | 72.64 | 72.66 | 71.10 | 71.26 | 71.09 | 73.00 | 75.12 | 87.71 |
| 3150. | 71.37 | 72.09 | 70.07 | 70.83 | 71.10 | 73.29 | 74.83 | 87.28 |
| 4000. | 71.11 | 72.05 | 71.01 | 70.92 | 71.12 | 73.42 | 74.73 | 87.47 |
| 5000. | 70.48 | 72.91 | 71.17 | 70.88 | 71.38 | 73.54 | 75.01 | 87.60 |
| 6300. | 69.39 | 72.40 | 70.55 | 70.14 | 71.58 | 73.85 | 74.91 | 87.39 |
| 8000. | 68.89 | 72.47 | 70.19 | 69.97 | 71.79 | 74.24 | 74.93 | 87.50 |
| 10000. | 68.95 | 72.21 | 69.84 | 70.12 | 71.86 | 74.30 | 75.28 | 87.50 |
| 12500. | 70.03 | 72.72 | 70.81 | 71.03 | 72.45 | 74.08 | 75.75 | 88.07 |
| 16000. | 70.35 | 73.61 | 71.66 | 71.31 | 73.09 | 74.61 | 75.96 | 88.52 |
| 20000. | 69.90 | 73.48 | 70.73 | 70.88 | 72.47 | 74.11 | 75.67 | 88.04 |
| 25000. | 67.55 | 71.70 | 69.03 | 69.64 | 70.84 | 72.34 | 73.85 | 86.34 |
| 31500. | 64.50 | 68.65 | 67.09 | 67.57 | 68.44 | 70.31 | 71.39 | 83.97 |
| 40000. | 60.61 | 65.42 | 64.95 | 64.92 | 65.85 | 67.33 | 67.72 | 81.03 |

TOTAL POWER, DB = 100.98

NOZZLE DIA = 2.8"
 DIFFUSOR DIA = 8.0"
 FLOW TEMPERATURE, TOTAL =
 MICROPHONE RADIUS = 6 FT.

530.0 DEG R

NOZZLE-DIFFUSOR SPACING RATIO = 1.25
 MACH NO. = 0.90

MICROPHONE ANGLE, DEG

| FREQUENCY, Hz | SOUND POWER INTENSITY LEVEL, DB | | | | | | | TOTAL POWER, DB (1/3 OCTAVE BAND) |
|---------------|---------------------------------|-------|-------|-------|-------|-------|-------|--------------------------------------|
| | 30. | 45. | 60. | 75. | 90. | 105. | 120. | |
| 200. | 75.24 | 75.17 | 76.37 | 75.15 | 76.37 | 77.03 | 77.63 | 91.26 |
| 250. | 75.67 | 75.41 | 76.42 | 75.77 | 75.64 | 77.10 | 76.87 | 91.35 |
| 315. | 77.64 | 77.87 | 77.43 | 78.62 | 79.12 | 78.44 | 77.01 | 93.42 |
| 400. | 76.53 | 76.11 | 79.14 | 78.10 | 78.21 | 78.69 | 78.22 | 93.59 |
| 500. | 76.42 | 76.20 | 77.74 | 77.14 | 76.28 | 78.63 | 78.67 | 92.58 |
| 630. | 76.60 | 76.25 | 76.59 | 76.24 | 76.76 | 76.44 | 79.82 | 92.39 |
| 800. | 77.66 | 76.62 | 76.90 | 76.80 | 77.19 | 78.12 | 80.84 | 92.71 |
| 1000. | 78.88 | 77.43 | 76.89 | 77.75 | 77.80 | 79.20 | 81.29 | 93.51 |
| 1250. | 76.50 | 76.84 | 76.44 | 76.97 | 77.08 | 79.01 | 80.09 | 92.94 |
| 1600. | 78.05 | 77.53 | 76.88 | 76.90 | 76.67 | 78.12 | 79.66 | 92.76 |
| 2000. | 78.67 | 78.72 | 77.32 | 77.46 | 78.24 | 78.95 | 79.65 | 93.60 |
| 2500. | 78.66 | 78.71 | 77.56 | 76.82 | 77.90 | 79.01 | 80.94 | 93.59 |
| 3150. | 78.09 | 78.70 | 76.92 | 76.37 | 77.31 | 79.39 | 81.70 | 93.55 |
| 4000. | 77.64 | 79.83 | 77.74 | 76.46 | 77.54 | 80.41 | 82.22 | 94.28 |
| 5000. | 77.63 | 80.07 | 78.56 | 76.54 | 78.34 | 81.75 | 83.06 | 95.00 |
| 6300. | 77.05 | 80.31 | 78.30 | 76.59 | 79.02 | 82.45 | 83.24 | 95.36 |
| 8000. | 76.60 | 80.80 | 77.66 | 76.71 | 79.70 | 82.65 | 83.25 | 95.57 |
| 10000. | 75.58 | 79.76 | 76.32 | 76.38 | 79.04 | 82.07 | 82.63 | 94.85 |
| 12500. | 75.06 | 79.00 | 76.36 | 76.18 | 78.76 | 81.63 | 82.50 | 94.45 |
| 16000. | 74.86 | 79.50 | 77.01 | 76.74 | 79.12 | 81.12 | 81.94 | 94.45 |
| 20000. | 73.90 | 78.85 | 76.94 | 76.29 | 78.46 | 79.71 | 81.44 | 93.62 |
| 25000. | 73.01 | 78.07 | 76.30 | 75.39 | 76.98 | 78.12 | 79.80 | 92.44 |
| 31500. | 71.28 | 75.97 | 74.20 | 73.67 | 75.18 | 75.76 | 77.64 | 90.36 |
| 40000. | 67.90 | 73.61 | 72.10 | 70.93 | 72.74 | 73.21 | 75.17 | 87.88 |

TOTAL POWER, DB = 107.23

140

NOZZLE DIA = 2.8"
 DIFFUSOR DIA = 8.0"
 FLOW TEMPERATURE, TOTAL = 530.0 DEG R
 MICROPHONE RADIUS = 6 FT.

NOZZLE-DIFFUSOR SPACING RATIO = 1.25
 MACH NU. = 1.10

MICROPHONE ANGLE, DEG

| FREQUENCY, HZ | 30. | 45. | 60. | 75. | 90. | 105. | 120. | TOTAL POWER, DB (1/3 OCTAVE BAND) |
|---------------|---------------------------------|-------|-------|-------|-------|-------|--------|--------------------------------------|
| | SOUND POWER INTENSITY LEVEL, DB | | | | | | | |
| 200. | 77.10 | 76.23 | 77.07 | 76.97 | 76.95 | 76.32 | 75.93 | 91.82 |
| 250. | 77.59 | 76.47 | 76.45 | 77.41 | 77.11 | 77.17 | 77.10 | 92.21 |
| 315. | 79.87 | 79.06 | 78.11 | 79.26 | 80.42 | 79.42 | 79.35 | 94.52 |
| 400. | 81.64 | 80.96 | 80.10 | 79.45 | 80.58 | 80.72 | 80.39 | 95.46 |
| 500. | 79.86 | 78.90 | 79.79 | 79.13 | 79.47 | 81.57 | 81.50 | 95.23 |
| 630. | 79.65 | 78.82 | 76.91 | 79.96 | 79.02 | 81.01 | 82.10 | 95.19 |
| 800. | 79.96 | 78.93 | 80.26 | 79.83 | 80.66 | 80.53 | 83.21 | 95.43 |
| 1000. | 80.02 | 76.41 | 80.34 | 79.45 | 80.25 | 80.81 | 83.11 | 95.29 |
| 1250. | 79.82 | 78.52 | 79.34 | 78.49 | 79.90 | 81.02 | 82.12 | 94.94 |
| 1600. | 80.70 | 79.77 | 80.11 | 79.77 | 80.69 | 80.98 | 82.15 | 95.60 |
| 2000. | 83.43 | 81.79 | 81.33 | 81.17 | 82.23 | 83.11 | 83.77 | 97.42 |
| 2500. | 87.99 | 86.73 | 86.56 | 85.30 | 85.61 | 87.65 | 87.79 | 101.89 |
| 3150. | 93.20 | 93.39 | 92.62 | 90.39 | 91.96 | 93.79 | 96.01 | 106.14 |
| 4000. | 94.97 | 96.36 | 95.37 | 93.51 | 95.78 | 97.89 | 99.46 | 111.52 |
| 5000. | 93.76 | 96.15 | 95.70 | 94.02 | 95.81 | 98.93 | 100.51 | 112.01 |
| 6300. | 90.94 | 93.78 | 93.04 | 91.85 | 94.07 | 96.24 | 99.52 | 110.54 |
| 8000. | 88.84 | 92.31 | 90.70 | 90.39 | 92.84 | 96.80 | 98.03 | 109.03 |
| 10000. | 85.90 | 89.94 | 87.72 | 87.71 | 90.84 | 94.54 | 95.64 | 106.67 |
| 12500. | 83.41 | 87.36 | 84.93 | 85.24 | 88.53 | 92.00 | 92.88 | 104.12 |
| 16000. | 81.49 | 86.03 | 83.36 | 83.58 | 86.79 | 90.37 | 90.69 | 102.45 |
| 20000. | 79.89 | 84.24 | 81.78 | 82.37 | 85.17 | 86.95 | 88.43 | 100.03 |
| 25000. | 77.53 | 81.30 | 80.65 | 79.57 | 81.47 | 83.60 | 85.48 | 97.01 |
| 31500. | 76.44 | 80.14 | 80.34 | 77.73 | 79.03 | 81.14 | 82.59 | 95.12 |
| 40000. | 73.31 | 77.84 | 77.75 | 75.57 | 77.36 | 78.61 | 80.01 | 92.75 |

TOTAL POWER, DB = 118.57

NOZZLE DIA = 2.8"
 DIFFUSOR DIA = 8.0"
 FLOW TEMPERATURE, TOTAL = 530.0 DEG R
 MICROPHONE RADIUS = 6 FT.

NOZZLE-DIFFUSOR SPACING RATIO = 1.50
 MACH NO. = 0.70

AEDC-TR-80-15

142

| FREQUENCY, HZ | MICROPHONE ANGLE, DEG | | | | | | | TOTAL POWER, DB (1/3 OCTAVE BAND) |
|---------------|-----------------------|-------|-------|-------|-------|-------|-------|--------------------------------------|
| | 30. | 45. | 60. | 75. | 90. | 105. | 120. | |
| 200. | 70.36 | 71.25 | 71.32 | 72.20 | 72.18 | 71.74 | 71.23 | 66.84 |
| 250. | 70.81 | 70.35 | 70.99 | 71.96 | 72.53 | 72.78 | 71.87 | 66.95 |
| 315. | 72.54 | 72.02 | 71.81 | 72.30 | 73.45 | 72.80 | 72.83 | 67.68 |
| 400. | 72.49 | 72.61 | 72.11 | 71.61 | 72.53 | 71.81 | 73.54 | 67.41 |
| 500. | 70.91 | 71.74 | 71.84 | 70.80 | 70.92 | 71.96 | 73.56 | 66.80 |
| 630. | 71.95 | 71.83 | 71.39 | 71.20 | 71.83 | 72.55 | 74.96 | 67.27 |
| 800. | 72.97 | 72.48 | 71.37 | 71.60 | 72.43 | 71.81 | 74.85 | 67.44 |
| 1000. | 73.43 | 74.47 | 72.36 | 73.21 | 72.97 | 73.36 | 75.55 | 68.61 |
| 1250. | 73.83 | 75.25 | 73.00 | 73.66 | 72.69 | 74.53 | 74.48 | 69.35 |
| 1600. | 74.66 | 75.01 | 72.73 | 73.11 | 72.34 | 74.04 | 74.88 | 69.09 |
| 2000. | 74.99 | 75.16 | 72.28 | 72.67 | 72.31 | 74.00 | 75.90 | 69.14 |
| 2500. | 73.61 | 74.67 | 71.88 | 72.44 | 72.15 | 73.89 | 76.16 | 68.80 |
| 3150. | 72.29 | 73.67 | 71.49 | 72.14 | 72.12 | 73.92 | 75.73 | 68.34 |
| 4000. | 71.54 | 73.95 | 71.75 | 71.90 | 72.34 | 74.32 | 75.74 | 68.49 |
| 5000. | 71.04 | 73.84 | 71.76 | 71.60 | 72.50 | 74.41 | 75.88 | 68.46 |
| 6300. | 70.23 | 73.75 | 71.45 | 71.42 | 72.85 | 74.49 | 75.95 | 68.42 |
| 8000. | 69.54 | 73.62 | 71.12 | 71.63 | 72.94 | 74.64 | 76.02 | 68.44 |
| 10000. | 69.36 | 73.45 | 70.98 | 72.03 | 73.48 | 74.85 | 75.97 | 68.57 |
| 12500. | 69.69 | 73.91 | 71.54 | 72.30 | 73.70 | 75.19 | 75.85 | 68.89 |
| 16000. | 70.41 | 73.81 | 72.03 | 72.38 | 73.73 | 75.22 | 75.67 | 68.92 |
| 20000. | 69.78 | 72.81 | 71.51 | 71.94 | 73.00 | 74.54 | 75.11 | 68.23 |
| 25000. | 67.45 | 71.12 | 69.85 | 70.63 | 71.07 | 72.59 | 72.95 | 66.45 |
| 31500. | 63.84 | 68.98 | 67.62 | 68.67 | 68.95 | 69.76 | 70.01 | 64.10 |
| 40000. | 60.48 | 66.46 | 65.26 | 65.76 | 66.51 | 67.17 | 67.76 | 61.46 |

TOTAL POWER, DB = 101.75

NOZZLE DIA = 2.8"
 DIFFUSOR DIA = 8.0"
 FLOW TEMPERATURE, TOTAL = 530.0 DEG R
 MICROPHONE RADIUS = 6 FT.

NOZZLE-DIFFUSOR SPACING RATIO = 1.50
 MACH NO. = 0.90

| FREQUENCY, HZ | MICROPHONE ANGLE, DEG | | | | | | | TOTAL POWER, DB (1/3 OCTAVE BAND) |
|---------------|-----------------------|-------|-------|-------|-------|-------|-------|--------------------------------------|
| | 30. | 45. | 60. | 75. | 90. | 105. | 120. | |
| 200. | 74.24 | 74.94 | 75.33 | 75.88 | 76.12 | 77.33 | 75.29 | 91.13 |
| 250. | 74.55 | 75.28 | 75.28 | 76.02 | 77.07 | 77.99 | 75.10 | 91.54 |
| 315. | 78.10 | 77.97 | 76.70 | 78.32 | 78.71 | 78.52 | 77.21 | 93.31 |
| 400. | 79.42 | 78.25 | 78.49 | 78.72 | 78.01 | 78.79 | 79.32 | 93.80 |
| 500. | 77.19 | 76.43 | 77.68 | 76.45 | 76.99 | 79.13 | 79.14 | 92.77 |
| 630. | 77.31 | 75.70 | 75.66 | 76.40 | 76.80 | 79.09 | 80.03 | 92.52 |
| 800. | 77.69 | 75.92 | 76.64 | 76.99 | 78.00 | 78.73 | 80.55 | 92.83 |
| 1000. | 79.65 | 76.22 | 76.25 | 78.09 | 78.51 | 79.52 | 81.45 | 94.06 |
| 1250. | 79.01 | 78.37 | 77.32 | 77.21 | 77.93 | 79.10 | 80.32 | 93.55 |
| 1600. | 78.94 | 78.72 | 77.53 | 77.29 | 77.74 | 78.80 | 79.70 | 93.50 |
| 2000. | 79.88 | 79.76 | 76.05 | 77.75 | 78.12 | 79.58 | 80.15 | 94.21 |
| 2500. | 79.81 | 79.21 | 78.20 | 77.51 | 77.73 | 79.35 | 81.11 | 94.04 |
| 3150. | 78.48 | 79.17 | 77.77 | 77.15 | 77.48 | 79.57 | 81.75 | 93.94 |
| 4000. | 77.83 | 79.04 | 77.98 | 77.10 | 77.98 | 80.40 | 82.27 | 94.40 |
| 5000. | 77.57 | 80.05 | 78.36 | 77.31 | 78.68 | 81.64 | 83.30 | 95.09 |
| 6300. | 77.25 | 80.20 | 78.76 | 77.26 | 79.62 | 82.17 | 83.63 | 95.46 |
| 8000. | 77.24 | 80.07 | 78.86 | 77.79 | 80.32 | 82.36 | 83.51 | 95.74 |
| 10000. | 78.22 | 79.81 | 78.12 | 77.74 | 80.06 | 82.02 | 82.82 | 95.24 |
| 12500. | 75.71 | 79.64 | 77.82 | 77.88 | 79.87 | 81.79 | 82.13 | 95.02 |
| 16000. | 76.08 | 80.49 | 76.03 | 78.15 | 80.06 | 81.56 | 82.01 | 95.21 |
| 20000. | 75.57 | 79.37 | 77.54 | 77.34 | 79.61 | 80.38 | 81.26 | 94.29 |
| 25000. | 74.17 | 78.13 | 76.36 | 75.96 | 77.89 | 78.31 | 79.93 | 92.73 |
| 31500. | 71.43 | 78.57 | 75.30 | 74.64 | 76.05 | 78.42 | 77.59 | 91.04 |
| 40000. | 68.38 | 73.43 | 72.65 | 72.94 | 73.25 | 73.65 | 75.12 | 88.41 |

TOTAL POWER, DB = 107.57

143

AEPC-TR-80-16

NOZZLE DIA = 2.8"
 DIFFUSOR DIA = 8.0"
 FLOW TEMPERATURE, TOTAL = 530.0 DEG R
 MICROPHONE RADIUS = 6 FT

NOZZLE-DIFFUSOR SPACING RATIO = 1.50
 MACH NO. = 1.10

AEDC-TR-80-15

MICROPHONE ANGLE, DEG

| FREQUENCY, HZ | MICROPHONE ANGLE, DEG | | | | | | | TOTAL POWER, DB (1/3 OCTAVE BAND) |
|---------------|-----------------------|-------|-------|-------|-------|-------|-------|--------------------------------------|
| | 30. | 45. | 60. | 75. | 90. | 105. | 120. | |
| 200. | 76.42 | 74.85 | 76.54 | 76.52 | 77.93 | 78.14 | 77.07 | 92.53 |
| 250. | 77.08 | 76.35 | 77.22 | 77.26 | 78.82 | 79.02 | 77.95 | 93.35 |
| 315. | 81.42 | 79.76 | 79.55 | 79.84 | 81.43 | 80.78 | 80.05 | 95.51 |
| 400. | 81.76 | 81.39 | 81.44 | 80.28 | 81.20 | 81.38 | 82.14 | 96.41 |
| 500. | 79.43 | 79.47 | 80.26 | 80.27 | 79.68 | 81.00 | 83.28 | 95.77 |
| 630. | 80.72 | 78.51 | 79.30 | 79.63 | 79.86 | 81.11 | 83.72 | 95.39 |
| 800. | 81.82 | 79.06 | 80.01 | 80.20 | 81.28 | 80.57 | 84.28 | 95.92 |
| 1000. | 81.08 | 80.00 | 80.43 | 80.57 | 81.17 | 81.04 | 84.34 | 96.15 |
| 1250. | 80.03 | 79.79 | 79.69 | 79.93 | 80.22 | 81.44 | 82.69 | 95.68 |
| 1600. | 81.51 | 80.41 | 80.03 | 80.24 | 80.74 | 81.00 | 82.75 | 96.15 |
| 2000. | 82.74 | 81.98 | 81.43 | 81.50 | 81.20 | 83.52 | 83.83 | 97.50 |
| 2500. | 86.00 | 85.95 | 84.79 | 84.36 | 83.55 | 85.95 | 87.31 | 100.58 |
| 3150. | 89.71 | 90.31 | 88.84 | 88.80 | 89.21 | 91.04 | 93.86 | 105.39 |
| 4000. | 91.64 | 93.27 | 91.82 | 91.71 | 92.90 | 95.05 | 96.83 | 108.69 |
| 5000. | 91.28 | 93.95 | 91.79 | 91.83 | 93.80 | 96.80 | 98.92 | 109.75 |
| 6300. | 88.70 | 91.34 | 89.92 | 90.18 | 93.17 | 95.93 | 98.02 | 108.49 |
| 8000. | 86.75 | 89.68 | 88.19 | 88.52 | 91.72 | 94.50 | 96.58 | 106.97 |
| 10000. | 84.16 | 87.63 | 85.50 | 85.85 | 89.20 | 92.25 | 93.20 | 104.48 |
| 12500. | 81.58 | 85.46 | 83.32 | 84.63 | 87.17 | 89.99 | 90.40 | 102.31 |
| 16000. | 80.78 | 84.75 | 82.85 | 83.80 | 86.04 | 87.80 | 88.88 | 100.87 |
| 20000. | 80.16 | 84.29 | 82.45 | 82.96 | 84.59 | 85.48 | 87.10 | 99.47 |
| 25000. | 78.54 | 82.56 | 81.54 | 81.85 | 82.31 | 82.98 | 84.24 | 97.39 |
| 31500. | 77.29 | 81.41 | 80.44 | 79.33 | 80.04 | 81.10 | 82.14 | 95.78 |
| 40000. | 74.96 | 79.62 | 78.70 | 77.23 | 77.83 | 78.72 | 80.11 | 93.70 |

TOTAL POWER, DB = 116.56

NOZZLE DIA = 2.8"
 DIFFUSOR DIA = 8.0"
 FLOW TEMPERATURE, TOTAL = 1210.0 DEG R
 MICROPHONE RADIUS = 6 FT.

NOZZLE-DIFFUSOR SPACING RATIO = 0.00
 MACH NO. = 0.70

MICROPHONE ANGLE, DEG

| FREQUENCY, HZ | MICROPHONE ANGLE, DEG | | | | | | | TOTAL POWER, DB (1/3 OCTAVE BAND) |
|---------------|-----------------------|-------|-------|-------|-------|-------|-------|--------------------------------------|
| | 30. | 45. | 60. | 75. | 90. | 105. | 120. | |
| 200. | 77.18 | 76.23 | 76.55 | 77.59 | 78.63 | 78.90 | 76.27 | 92.29 |
| 250. | 77.70 | 77.67 | 77.57 | 78.54 | 79.70 | 79.80 | 79.14 | 93.92 |
| 315. | 81.91 | 80.65 | 81.19 | 83.31 | 83.12 | 84.18 | 81.32 | 97.86 |
| 400. | 84.28 | 82.67 | 83.28 | 83.62 | 84.64 | 84.88 | 83.18 | 99.04 |
| 500. | 85.05 | 85.01 | 84.81 | 84.18 | 84.76 | 86.50 | 85.35 | 100.39 |
| 630. | 85.63 | 83.85 | 85.76 | 86.28 | 85.64 | 87.06 | 87.59 | 101.16 |
| 800. | 86.21 | 85.88 | 86.40 | 86.72 | 87.16 | 86.60 | 90.09 | 101.98 |
| 1000. | 86.79 | 86.12 | 86.40 | 86.39 | 87.22 | 86.96 | 91.18 | 102.22 |
| 1250. | 86.03 | 85.10 | 85.26 | 85.94 | 86.78 | 88.34 | 90.18 | 102.01 |
| 1600. | 87.06 | 84.20 | 85.52 | 85.11 | 86.33 | 88.48 | 89.25 | 101.71 |
| 2000. | 86.37 | 84.63 | 84.70 | 83.95 | 85.44 | 87.11 | 88.75 | 100.89 |
| 2500. | 84.71 | 84.31 | 84.00 | 83.63 | 84.87 | 86.20 | 88.32 | 100.24 |
| 3150. | 81.79 | 83.15 | 82.87 | 82.22 | 83.85 | 86.24 | 87.70 | 99.44 |
| 4000. | 80.01 | 82.95 | 82.81 | 81.07 | 83.15 | 86.36 | 88.29 | 99.26 |
| 5000. | 79.06 | 82.50 | 82.81 | 80.43 | 82.45 | 86.02 | 88.82 | 99.00 |
| 6300. | 77.02 | 81.10 | 81.95 | 78.32 | 80.99 | 85.43 | 87.44 | 97.90 |
| 8000. | 75.56 | 79.56 | 79.71 | 76.35 | 79.97 | 84.27 | 86.12 | 96.50 |
| 10000. | 73.86 | 77.65 | 77.69 | 74.11 | 78.07 | 82.60 | 84.99 | 94.80 |
| 12500. | 71.81 | 76.62 | 76.55 | 73.03 | 76.73 | 81.38 | 83.99 | 93.65 |
| 16000. | 69.78 | 75.92 | 75.09 | 71.49 | 75.65 | 79.64 | 82.99 | 92.31 |
| 20000. | 67.43 | 75.02 | 73.01 | 68.94 | 73.30 | 77.98 | 81.29 | 90.65 |
| 25000. | 64.50 | 71.96 | 70.73 | 66.20 | 70.96 | 76.43 | 78.76 | 88.45 |
| 31500. | 61.44 | 68.59 | 66.93 | 62.50 | 69.43 | 73.94 | 75.92 | 85.71 |
| 40000. | 58.67 | 64.08 | 62.69 | 58.24 | 66.39 | 69.34 | 71.74 | 81.39 |

TOTAL POWER, DB = 112.39

NOZZLE DIA = 2.6"
 DIFFUSOR DIA = 8.0"
 FLOW TEMPERATURE, TOTAL = 1210.0 DEG R
 MICROPHONE RADIUS = 6 FT.

NOZZLE-DIFFUSOR SPACING RATIO = 0.00
 MACH NO. = 0.90

MICROPHONE ANGLE, DEG

| FREQUENCY, HZ | SOUND POWER INTENSITY LEVEL, DB | | | | | | | TOTAL POWER, DB (1/3 OCTAVE BAND) |
|---------------|---------------------------------|-------|-------|-------|-------|-------|-------|--------------------------------------|
| | 30. | 45. | 60. | 75. | 90. | 105. | 120. | |
| 200. | 77.38 | 78.76 | 78.03 | 78.68 | 79.31 | 77.64 | 78.00 | 93.58 |
| 250. | 80.15 | 79.72 | 78.37 | 79.75 | 81.25 | 80.30 | 81.62 | 95.28 |
| 315. | 84.34 | 81.94 | 82.39 | 85.07 | 85.68 | 84.94 | 84.43 | 99.44 |
| 400. | 87.66 | 87.05 | 85.77 | 86.53 | 86.93 | 87.93 | 86.54 | 102.30 |
| 500. | 88.45 | 88.10 | 86.80 | 86.58 | 88.06 | 89.65 | 89.28 | 103.38 |
| 630. | 86.86 | 88.37 | 87.39 | 89.24 | 89.69 | 90.00 | 91.13 | 104.62 |
| 800. | 89.58 | 89.83 | 88.54 | 89.43 | 91.32 | 91.10 | 93.30 | 105.58 |
| 1000. | 89.80 | 89.40 | 86.68 | 89.36 | 92.07 | 90.97 | 94.21 | 105.69 |
| 1250. | 88.49 | 88.14 | 87.30 | 89.10 | 90.27 | 91.54 | 93.53 | 105.12 |
| 1600. | 88.90 | 88.40 | 86.01 | 88.40 | 89.23 | 92.11 | 92.98 | 105.05 |
| 2000. | 89.37 | 88.54 | 86.94 | 87.24 | 88.26 | 90.90 | 92.81 | 104.42 |
| 2500. | 88.88 | 88.42 | 87.40 | 87.43 | 87.99 | 90.45 | 92.26 | 104.17 |
| 3150. | 87.13 | 87.99 | 86.76 | 86.91 | 87.40 | 90.00 | 91.90 | 103.64 |
| 4000. | 85.44 | 87.81 | 85.84 | 85.83 | 86.55 | 90.25 | 91.98 | 103.55 |
| 5000. | 83.82 | 87.75 | 85.78 | 84.81 | 86.15 | 90.57 | 92.44 | 103.33 |
| 6300. | 82.13 | 87.64 | 85.29 | 83.34 | 85.75 | 90.00 | 91.89 | 102.60 |
| 8000. | 80.95 | 86.82 | 84.35 | 81.75 | 84.84 | 89.29 | 90.83 | 101.88 |
| 10000. | 78.25 | 84.05 | 82.01 | 79.08 | 82.92 | 87.31 | 89.21 | 99.71 |
| 12500. | 75.67 | 82.92 | 80.05 | 77.10 | 81.56 | 85.78 | 87.71 | 98.22 |
| 16000. | 74.11 | 81.98 | 79.23 | 76.59 | 80.15 | 84.51 | 86.46 | 97.08 |
| 20000. | 71.41 | 79.40 | 76.04 | 73.86 | 78.29 | 82.41 | 84.52 | 94.87 |
| 25000. | 68.51 | 77.31 | 75.25 | 71.06 | 76.49 | 79.80 | 82.07 | 92.54 |
| 31500. | 64.86 | 73.84 | 71.76 | 68.07 | 73.61 | 77.00 | 79.49 | 89.57 |
| 40000. | 60.89 | 69.74 | 67.32 | 65.02 | 70.92 | 74.38 | 75.97 | 86.37 |

TOTAL POWER, DB = 116.04

NOZZLE DIA = 2.8"
 DIFFUSOR DIA = 8.0"
 FLOW TEMPERATURE, TOTAL = 1210.0 DEG R
 MICROPHONE RADIUS = 6 FT.

NOZZLE-DIFFUSOR SPACING RATIO = 0.00
 MACH NO. = 1.10

MICROPHONE ANGLE, DEG

| FREQUENCY, HZ | 30. | 45. | 60. | 75. | 90. | 105. | 120. | TOTAL POWER, DB (1/3 OCTAVE BAND) |
|---------------|---------------------------------|--------|--------|--------|--------|--------|--------|--------------------------------------|
| | SOUND POWER INTENSITY LEVEL, DB | | | | | | | |
| 200. | 81.72 | 80.74 | 78.03 | 81.30 | 84.25 | 82.45 | 79.60 | 96.81 |
| 250. | 80.83 | 79.20 | 80.70 | 83.60 | 80.46 | 83.09 | 83.20 | 97.18 |
| 315. | 85.86 | 82.50 | 85.60 | 86.72 | 86.73 | 86.77 | 85.38 | 101.02 |
| 400. | 90.76 | 90.97 | 88.65 | 90.55 | 88.67 | 90.15 | 89.56 | 105.36 |
| 500. | 87.26 | 91.34 | 90.05 | 88.38 | 88.83 | 91.61 | 93.15 | 105.66 |
| 630. | 91.02 | 87.44 | 91.14 | 92.59 | 91.34 | 91.16 | 92.85 | 100.29 |
| 800. | 89.87 | 90.68 | 90.57 | 91.31 | 92.13 | 90.39 | 94.79 | 106.44 |
| 1000. | 90.95 | 88.12 | 92.03 | 89.53 | 92.86 | 92.18 | 94.68 | 106.44 |
| 1250. | 86.69 | 86.45 | 87.46 | 88.06 | 87.98 | 91.41 | 92.85 | 104.29 |
| 1600. | 91.85 | 91.53 | 90.51 | 90.61 | 92.98 | 94.84 | 94.97 | 107.87 |
| 2000. | 91.40 | 90.88 | 91.15 | 89.85 | 90.59 | 92.67 | 95.75 | 106.82 |
| 2500. | 95.67 | 95.27 | 94.27 | 92.98 | 94.31 | 95.16 | 96.78 | 110.16 |
| 3150. | 100.70 | 102.85 | 101.45 | 100.18 | 105.10 | 107.70 | 109.85 | 120.08 |
| 4000. | 95.03 | 98.82 | 96.37 | 93.68 | 97.55 | 100.68 | 105.90 | 114.42 |
| 5000. | 91.21 | 97.02 | 95.68 | 92.27 | 94.33 | 97.76 | 100.94 | 111.52 |
| 6300. | 88.60 | 96.05 | 94.47 | 90.17 | 93.34 | 97.06 | 99.56 | 110.44 |
| 8000. | 89.94 | 95.08 | 92.63 | 89.02 | 92.86 | 96.07 | 98.17 | 109.60 |
| 10000. | 85.41 | 92.32 | 88.70 | 86.22 | 90.22 | 93.80 | 94.94 | 106.64 |
| 12500. | 82.80 | 90.14 | 86.41 | 83.54 | 88.21 | 92.46 | 93.94 | 104.93 |
| 16000. | 79.23 | 87.20 | 84.70 | 81.43 | 86.90 | 90.23 | 92.55 | 102.77 |
| 20000. | 77.32 | 84.25 | 83.12 | 79.59 | 84.63 | 87.68 | 89.82 | 100.25 |
| 25000. | 72.87 | 80.54 | 79.18 | 75.19 | 80.59 | 83.79 | 85.82 | 96.32 |
| 31500. | 71.34 | 82.18 | 78.10 | 74.17 | 78.64 | 82.13 | 83.73 | 95.52 |
| 40000. | 65.35 | 74.33 | 71.18 | 68.04 | 72.81 | 75.82 | 77.69 | 88.60 |

TOTAL POWER, DB = 123.46

NOZZLE DIA = 2.8"
 DIFFUSOR DIA = 8.0"
 FLOW TEMPERATURE, TOTAL = 1210.0 DEG R
 MICROPHONE RADIUS = 0 FT.

NOZZLE-DIFFUSOR SPACING RATIO = 0.50
 MACH NU. = 0.70

| FREQUENCY, HZ | MICROPHONE ANGLE, DEG | | | | | | | TOTAL POWER, DB (1/3 OCTAVE BAND) |
|---------------|-----------------------|-------|-------|-------|-------|-------|-------|--------------------------------------|
| | 30. | 45. | 60. | 75. | 90. | 105. | 120. | |
| 200. | 76.34 | 76.54 | 77.00 | 76.29 | 78.26 | 78.43 | 76.92 | 92.44 |
| 250. | 78.00 | 77.49 | 78.39 | 78.66 | 79.08 | 80.88 | 78.66 | 94.26 |
| 315. | 82.12 | 83.14 | 80.09 | 81.86 | 82.51 | 83.91 | 81.04 | 97.78 |
| 400. | 83.07 | 84.54 | 82.62 | 82.97 | 83.08 | 84.39 | 83.48 | 98.94 |
| 500. | 84.54 | 84.47 | 84.33 | 83.77 | 82.95 | 87.29 | 85.86 | 100.29 |
| 630. | 85.71 | 84.47 | 85.78 | 86.20 | 85.17 | 87.97 | 88.49 | 101.55 |
| 800. | 85.81 | 85.61 | 86.34 | 86.17 | 87.39 | 88.08 | 89.85 | 102.17 |
| 1000. | 85.52 | 85.42 | 86.33 | 86.08 | 86.82 | 88.19 | 90.20 | 102.10 |
| 1250. | 84.98 | 84.09 | 85.61 | 85.29 | 85.34 | 88.49 | 89.34 | 101.55 |
| 1600. | 85.65 | 85.25 | 85.73 | 85.26 | 86.61 | 88.61 | 89.25 | 101.91 |
| 2000. | 85.94 | 85.49 | 85.08 | 84.46 | 85.90 | 87.89 | 88.90 | 101.43 |
| 2500. | 84.76 | 84.85 | 84.75 | 84.11 | 85.70 | 87.62 | 89.25 | 101.11 |
| 3150. | 83.46 | 84.35 | 83.91 | 82.44 | 84.23 | 87.35 | 88.20 | 100.32 |
| 4000. | 82.34 | 85.04 | 84.21 | 82.09 | 83.72 | 87.09 | 87.85 | 100.23 |
| 5000. | 81.23 | 85.04 | 84.71 | 81.68 | 83.65 | 87.61 | 88.52 | 100.25 |
| 6300. | 80.12 | 84.35 | 83.49 | 80.06 | 82.43 | 88.29 | 87.72 | 99.34 |
| 8000. | 78.02 | 83.46 | 81.63 | 78.63 | 81.60 | 85.05 | 86.49 | 98.38 |
| 10000. | 75.99 | 81.74 | 79.58 | 77.53 | 80.19 | 84.93 | 85.57 | 97.20 |
| 12500. | 74.02 | 80.80 | 78.30 | 75.72 | 79.29 | 83.84 | 84.53 | 96.05 |
| 16000. | 72.88 | 79.14 | 77.27 | 74.74 | 78.78 | 82.31 | 83.48 | 94.75 |
| 20000. | 70.24 | 76.98 | 75.35 | 72.93 | 76.09 | 80.71 | 81.23 | 92.81 |
| 25000. | 67.67 | 74.20 | 72.60 | 70.94 | 74.56 | 78.48 | 78.16 | 90.44 |
| 31500. | 64.08 | 71.65 | 68.70 | 69.64 | 72.77 | 75.99 | 76.29 | 88.10 |
| 40000. | 59.15 | 67.78 | 65.26 | 67.32 | 69.96 | 72.82 | 74.17 | 85.08 |

TOTAL POWER, DB = 112.93

NOZZLE DIA = 2.8"
 DIFFUSOR DIA = 8.0"
 FLOW TEMPERATURE, TOTAL = 1210.0 DEG R
 MICROPHONE RADIUS = 6 FT.

NOZZLE-DIFFUSOR SPACING RATIO = 0.50
 MACH NO. = 0.90

MICROPHONE ANGLE, DEG

| FREQUENCY, HZ | MICROPHONE ANGLE, DEG | | | | | | | TOTAL POWER, DB (1/3 OCTAVE BAND) |
|---------------|-----------------------|-------|-------|-------|-------|-------|-------|--------------------------------------|
| | 30. | 45. | 60. | 75. | 90. | 105. | 120. | |
| 200. | 76.43 | 78.71 | 79.07 | 79.20 | 78.21 | 77.92 | 77.60 | 93.68 |
| 250. | 79.65 | 79.03 | 79.22 | 80.83 | 80.71 | 81.08 | 80.88 | 95.78 |
| 315. | 85.18 | 82.14 | 83.05 | 83.55 | 85.49 | 85.88 | 83.85 | 99.44 |
| 400. | 86.89 | 86.30 | 86.87 | 85.94 | 86.47 | 87.47 | 86.63 | 101.84 |
| 500. | 86.33 | 87.47 | 88.03 | 86.69 | 86.88 | 86.68 | 88.71 | 102.83 |
| 630. | 89.18 | 86.67 | 88.62 | 88.77 | 88.49 | 89.45 | 91.48 | 103.57 |
| 800. | 89.12 | 88.18 | 89.53 | 89.26 | 90.42 | 89.46 | 93.43 | 104.82 |
| 1000. | 88.55 | 88.34 | 89.66 | 89.06 | 90.33 | 90.23 | 93.80 | 105.01 |
| 1250. | 87.67 | 87.87 | 88.81 | 88.79 | 87.88 | 91.00 | 92.77 | 104.60 |
| 1600. | 88.18 | 86.03 | 87.88 | 88.02 | 88.17 | 91.00 | 91.48 | 104.31 |
| 2000. | 88.82 | 88.36 | 87.89 | 87.50 | 88.13 | 90.44 | 91.06 | 104.15 |
| 2500. | 86.44 | 86.67 | 87.66 | 87.17 | 88.10 | 90.57 | 91.70 | 104.17 |
| 3150. | 87.62 | 88.20 | 87.55 | 85.95 | 87.49 | 90.07 | 91.62 | 103.04 |
| 4000. | 86.86 | 88.01 | 87.63 | 84.61 | 86.63 | 89.38 | 91.73 | 103.27 |
| 5000. | 85.03 | 86.84 | 87.53 | 83.84 | 86.53 | 89.76 | 92.16 | 103.36 |
| 6300. | 83.00 | 88.36 | 86.34 | 82.87 | 85.99 | 89.52 | 91.19 | 102.75 |
| 8000. | 81.93 | 88.02 | 84.90 | 82.23 | 85.51 | 89.08 | 90.23 | 102.17 |
| 10000. | 79.40 | 85.71 | 82.32 | 80.38 | 84.06 | 87.94 | 88.75 | 100.54 |
| 12500. | 77.37 | 83.08 | 80.86 | 78.78 | 82.91 | 87.06 | 87.26 | 99.04 |
| 16000. | 75.98 | 82.48 | 80.07 | 77.82 | 81.92 | 85.60 | 86.63 | 97.97 |
| 20000. | 73.77 | 80.92 | 78.00 | 76.28 | 79.92 | 83.20 | 84.96 | 95.98 |
| 25000. | 71.93 | 78.30 | 75.00 | 74.81 | 78.12 | 81.04 | 83.04 | 93.84 |
| 31500. | 68.13 | 75.67 | 72.65 | 73.03 | 76.12 | 78.13 | 80.62 | 91.25 |
| 40000. | 63.51 | 73.61 | 68.92 | 70.10 | 72.15 | 75.02 | 76.22 | 86.10 |

TOTAL POWER, DB = 115.79

NOZZLE DIA = 2.8"
 DIFFUSOR DIA = 8.0"
 FLOW TEMPERATURE, TOTAL = 1210.0 DEG R
 MICROPHONE RADIUS = 6 FT.

NOZZLE-DIFFUSOR SPACING RATIO = 0.50
 MACH NO. = 1.10

AEDC-TR-80-15

150

| FREQUENCY, HZ | MICROPHONE ANGLE, DEG | | | | | | | TOTAL POWER, DB (1/3 OCTAVE BAND) |
|---------------|-----------------------|-------|-------|-------|-------|-------|--------|--------------------------------------|
| | 30. | 45. | 60. | 75. | 90. | 105. | 120. | |
| 200. | 80.12 | 79.95 | 78.76 | 79.87 | 81.34 | 79.85 | 78.16 | 95.09 |
| 250. | 78.95 | 77.35 | 81.95 | 80.96 | 79.67 | 80.93 | 82.27 | 95.55 |
| 315. | 83.51 | 84.18 | 84.50 | 84.97 | 86.04 | 85.96 | 84.65 | 100.24 |
| 400. | 89.34 | 89.99 | 87.24 | 87.91 | 87.50 | 88.76 | 89.52 | 103.91 |
| 500. | 85.49 | 90.39 | 89.21 | 88.99 | 89.28 | 91.30 | 92.29 | 105.27 |
| 630. | 89.80 | 87.08 | 89.53 | 90.21 | 90.81 | 93.02 | 93.01 | 105.94 |
| 800. | 89.20 | 90.47 | 90.54 | 90.79 | 91.38 | 89.27 | 93.86 | 105.84 |
| 1000. | 90.20 | 89.08 | 89.52 | 90.54 | 90.67 | 91.62 | 95.09 | 106.05 |
| 1250. | 85.52 | 86.28 | 87.16 | 87.94 | 86.83 | 90.79 | 91.33 | 103.67 |
| 1600. | 90.66 | 88.52 | 89.13 | 90.55 | 90.91 | 93.59 | 93.52 | 106.44 |
| 2000. | 90.18 | 89.36 | 89.70 | 89.16 | 90.20 | 90.67 | 93.09 | 105.30 |
| 2500. | 93.92 | 92.16 | 91.99 | 91.33 | 91.73 | 92.96 | 95.02 | 107.65 |
| 3150. | 96.19 | 95.95 | 97.16 | 96.81 | 97.52 | 99.89 | 107.32 | 114.50 |
| 4000. | 92.53 | 92.45 | 92.56 | 91.02 | 91.78 | 94.87 | 97.74 | 108.51 |
| 5000. | 88.43 | 90.99 | 90.65 | 88.93 | 91.01 | 94.23 | 97.31 | 107.36 |
| 6300. | 86.37 | 91.70 | 90.13 | 88.17 | 91.19 | 93.40 | 95.98 | 106.65 |
| 8000. | 85.83 | 90.69 | 89.17 | 87.93 | 90.74 | 93.28 | 95.10 | 106.31 |
| 10000. | 83.89 | 87.39 | 85.41 | 84.69 | 88.69 | 91.18 | 93.27 | 103.83 |
| 12500. | 80.11 | 85.74 | 82.92 | 82.72 | 86.64 | 89.59 | 91.36 | 102.02 |
| 16000. | 77.41 | 84.98 | 80.87 | 82.35 | 86.38 | 87.67 | 90.16 | 100.63 |
| 20000. | 76.62 | 84.10 | 80.87 | 80.32 | 84.02 | 86.28 | 88.65 | 99.34 |
| 25000. | 72.07 | 81.17 | 77.55 | 77.65 | 80.37 | 82.84 | 85.15 | 96.06 |
| 31500. | 72.75 | 81.18 | 78.57 | 76.77 | 79.28 | 81.70 | 85.10 | 95.56 |
| 40000. | 66.73 | 73.48 | 73.08 | 72.51 | 73.15 | 76.61 | 78.65 | 89.66 |

TOTAL POWER, DB = 119.64

NOZZLE DIA = 2.8"
 DIFFUSOR DIA = 8.0"
 FLOW TEMPERATURE, TOTAL = 1210.0 DEG R
 MICROPHONE RADIUS = 6 FT.

NOZZLE-DIFFUSOR SPACING RATIO = 1.00
 MACn NO. = 1.10

| FREQUENCY, HZ | MICROPHONE ANGLE, DEG | | | | | | | TOTAL POWER, DB (1/3 OCTAVE BAND) |
|---------------|-----------------------|-------|-------|-------|-------|-------|-------|--------------------------------------|
| | 30. | 45. | 60. | 75. | 90. | 105. | 120. | |
| 200. | 78.80 | 79.59 | 78.65 | 78.64 | 80.77 | 80.15 | 79.38 | 94.73 |
| 250. | 81.27 | 78.80 | 80.11 | 81.83 | 81.51 | 81.44 | 80.56 | 96.07 |
| 315. | 84.76 | 83.04 | 85.05 | 84.05 | 85.29 | 86.40 | 84.08 | 100.11 |
| 400. | 85.45 | 88.30 | 87.39 | 87.14 | 87.74 | 89.09 | 87.54 | 103.15 |
| 500. | 86.14 | 89.67 | 88.46 | 88.50 | 87.85 | 91.01 | 90.74 | 104.02 |
| 630. | 88.01 | 88.95 | 86.27 | 89.60 | 89.15 | 90.84 | 93.06 | 105.03 |
| 800. | 88.29 | 89.13 | 88.77 | 89.37 | 91.35 | 90.04 | 93.47 | 105.16 |
| 1000. | 88.10 | 87.39 | 88.25 | 88.57 | 89.68 | 89.62 | 93.18 | 104.30 |
| 1250. | 80.81 | 86.30 | 87.42 | 87.45 | 87.57 | 90.02 | 91.37 | 103.45 |
| 1600. | 87.76 | 87.42 | 88.24 | 88.23 | 88.49 | 90.61 | 91.27 | 104.14 |
| 2000. | 89.15 | 87.97 | 88.49 | 88.82 | 89.23 | 90.64 | 92.18 | 104.61 |
| 2500. | 89.27 | 89.67 | 88.80 | 89.35 | 89.84 | 91.80 | 93.29 | 105.56 |
| 3150. | 89.71 | 91.36 | 91.01 | 89.88 | 91.28 | 93.34 | 95.23 | 107.02 |
| 4000. | 89.96 | 92.01 | 91.77 | 90.60 | 92.27 | 94.57 | 96.91 | 108.15 |
| 5000. | 88.17 | 92.15 | 90.87 | 90.37 | 92.69 | 95.60 | 97.38 | 108.40 |
| 6300. | 85.69 | 90.73 | 89.34 | 89.00 | 91.97 | 95.06 | 96.05 | 107.49 |
| 8000. | 84.00 | 89.13 | 87.37 | 87.94 | 91.13 | 93.88 | 94.77 | 106.16 |
| 10000. | 82.25 | 87.01 | 85.21 | 86.44 | 89.33 | 91.87 | 92.64 | 104.19 |
| 12500. | 80.21 | 85.34 | 83.55 | 85.00 | 87.72 | 90.05 | 90.70 | 102.46 |
| 16000. | 79.88 | 83.92 | 83.74 | 85.28 | 87.13 | 88.62 | 89.33 | 101.50 |
| 20000. | 78.01 | 83.20 | 84.11 | 84.98 | 86.10 | 86.68 | 88.15 | 100.43 |
| 25000. | 76.82 | 83.00 | 83.72 | 83.80 | 83.92 | 84.54 | 85.70 | 98.95 |
| 31500. | 75.86 | 82.02 | 83.65 | 82.30 | 82.19 | 82.60 | 84.21 | 97.62 |
| 40000. | 72.87 | 79.53 | 80.92 | 80.48 | 78.68 | 79.45 | 80.74 | 94.92 |

TOTAL POWER, DB = 118.06

151

NOZZLE DIA = 2.8"
 DIFFUSOR DIA = 8.0"
 FLOW TEMPERATURE, TOTAL = 1210.0 DEG R
 MICROPHONE RADIUS = 6 FT.

NOZZLE-DIFFUSOR SPACING RATIO = 1.00
 MACH NO. = 0.90

152

| FREQUENCY, HZ | MICROPHONE ANGLE, DEG | | | | | | | TOTAL POWER, DB (1/3 OCTAVE BAND) |
|---------------|-----------------------|-------|-------|-------|-------|-------|-------|--------------------------------------|
| | 30. | 45. | 60. | 75. | 90. | 105. | 120. | |
| 200. | 77.10 | 78.14 | 80.00 | 79.93 | 79.58 | 79.10 | 79.38 | 94.41 |
| 250. | 80.11 | 80.25 | 79.44 | 81.31 | 81.91 | 82.43 | 81.51 | 96.43 |
| 315. | 84.33 | 83.50 | 82.93 | 83.65 | 86.08 | 86.40 | 84.72 | 99.93 |
| 400. | 86.27 | 86.47 | 86.36 | 86.19 | 87.20 | 88.21 | 87.66 | 102.66 |
| 500. | 85.60 | 88.92 | 86.94 | 87.83 | 87.94 | 89.64 | 90.07 | 103.73 |
| 630. | 88.10 | 88.93 | 87.97 | 89.21 | 89.12 | 90.70 | 91.94 | 104.77 |
| 800. | 87.84 | 89.76 | 89.56 | 89.39 | 91.07 | 90.48 | 94.20 | 105.50 |
| 1000. | 86.66 | 89.32 | 89.19 | 89.38 | 90.54 | 90.90 | 94.62 | 105.45 |
| 1250. | 87.03 | 88.50 | 88.06 | 88.03 | 89.57 | 91.12 | 93.45 | 104.77 |
| 1600. | 87.04 | 88.95 | 88.32 | 87.07 | 89.35 | 90.53 | 92.35 | 104.42 |
| 2000. | 88.50 | 88.89 | 88.14 | 87.05 | 89.52 | 90.30 | 92.26 | 104.39 |
| 2500. | 88.60 | 88.90 | 86.15 | 87.36 | 89.25 | 90.42 | 92.81 | 104.50 |
| 3150. | 87.18 | 88.84 | 87.40 | 86.71 | 88.65 | 90.13 | 93.29 | 104.19 |
| 4000. | 85.57 | 86.34 | 87.41 | 86.38 | 88.25 | 90.24 | 92.44 | 103.86 |
| 5000. | 84.03 | 87.90 | 87.35 | 86.05 | 88.67 | 91.04 | 92.60 | 104.03 |
| 6300. | 82.86 | 87.05 | 87.30 | 85.40 | 88.40 | 90.82 | 92.13 | 103.72 |
| 8000. | 81.20 | 87.15 | 86.23 | 83.92 | 87.67 | 90.23 | 91.22 | 102.95 |
| 10000. | 79.59 | 85.76 | 83.71 | 82.57 | 86.83 | 89.12 | 89.07 | 101.64 |
| 12500. | 77.66 | 85.06 | 82.38 | 81.99 | 86.04 | 88.14 | 88.31 | 100.70 |
| 16000. | 76.81 | 84.18 | 82.08 | 82.10 | 85.32 | 87.11 | 87.05 | 99.95 |
| 20000. | 75.21 | 81.07 | 81.26 | 81.77 | 83.77 | 85.18 | 85.91 | 98.20 |
| 25000. | 73.35 | 79.60 | 80.45 | 80.68 | 82.22 | 82.87 | 83.80 | 96.49 |
| 31500. | 70.35 | 77.96 | 79.57 | 78.69 | 80.30 | 80.44 | 81.04 | 94.46 |
| 40000. | 67.60 | 75.43 | 77.74 | 77.15 | 77.80 | 78.13 | 77.91 | 92.24 |

TOTAL POWER, DB = 116.47

NOZZLE DIA = 2.8"
 DIFFUSOR DIA = 8.0"
 FLOW TEMPERATURE, TOTAL = 1210.0 DEG R
 MICROPHONE RADIUS = 6 FT.

NOZZLE-DIFFUSOR SPACING RATIO = 1.00
 MACH NO. = 0.70

| | | | | | | | | |
|--------|-------|-------|-------|-------|-------|-------|-------|--------|
| 200. | 76.71 | 76.60 | 77.72 | 77.68 | 78.10 | 77.23 | 76.14 | 92.60 |
| 250. | 78.20 | 77.27 | 76.73 | 78.63 | 80.56 | 78.33 | 79.50 | 93.61 |
| 315. | 82.51 | 82.08 | 81.08 | 81.56 | 83.59 | 83.56 | 83.50 | 97.74 |
| 400. | 83.39 | 85.36 | 83.99 | 82.89 | 83.90 | 84.03 | 85.41 | 99.38 |
| 500. | 83.83 | 85.27 | 84.43 | 84.48 | 84.27 | 86.02 | 87.51 | 100.39 |
| 630. | 87.25 | 85.95 | 85.19 | 86.01 | 87.05 | 87.63 | 90.37 | 102.07 |
| 800. | 86.74 | 86.50 | 86.65 | 86.64 | 88.31 | 87.33 | 91.20 | 102.61 |
| 1000. | 85.91 | 86.99 | 86.27 | 86.64 | 87.10 | 88.05 | 91.20 | 102.60 |
| 1250. | 85.90 | 86.14 | 85.45 | 85.94 | 85.88 | 88.26 | 90.70 | 102.07 |
| 1600. | 86.34 | 86.11 | 86.40 | 85.25 | 86.38 | 88.09 | 89.62 | 102.01 |
| 2000. | 87.03 | 85.52 | 85.70 | 85.18 | 86.81 | 87.34 | 89.62 | 101.68 |
| 2500. | 86.39 | 85.56 | 85.19 | 84.61 | 85.79 | 86.98 | 89.62 | 101.30 |
| 3150. | 84.41 | 85.03 | 84.43 | 83.78 | 84.90 | 86.49 | 89.12 | 100.62 |
| 4000. | 83.58 | 85.14 | 84.50 | 83.59 | 84.86 | 86.36 | 88.93 | 100.52 |
| 5000. | 83.00 | 85.43 | 84.18 | 83.28 | 85.13 | 87.04 | 88.43 | 100.66 |
| 6300. | 81.54 | 84.56 | 82.98 | 82.07 | 84.04 | 86.55 | 87.54 | 99.61 |
| 8000. | 80.00 | 83.42 | 81.08 | 80.35 | 83.33 | 85.93 | 86.96 | 98.83 |
| 10000. | 78.35 | 82.12 | 79.17 | 79.14 | 82.50 | 85.12 | 86.66 | 97.86 |
| 12500. | 77.64 | 80.90 | 78.67 | 78.95 | 82.11 | 84.38 | 85.46 | 97.09 |
| 16000. | 76.49 | 80.24 | 78.54 | 78.69 | 81.34 | 83.51 | 83.81 | 96.28 |
| 20000. | 75.09 | 77.80 | 77.91 | 78.00 | 79.43 | 81.75 | 82.17 | 94.65 |
| 25000. | 71.90 | 75.30 | 76.07 | 76.91 | 77.33 | 78.90 | 79.50 | 92.35 |
| 31500. | 68.28 | 73.05 | 73.98 | 75.20 | 75.23 | 75.67 | 76.14 | 89.91 |
| 40000. | 63.82 | 70.11 | 72.27 | 72.91 | 73.06 | 74.04 | 73.74 | 87.70 |

TOTAL POWER, DB = 113.35

NOZZLE DIA = 2.8"
 DIFFUSOR DIA = 8.0"
 FLOW TEMPERATURE, TOTAL = 1210.0 DEG R
 MICROPHONE RADIUS = 6 FT.

NOZZLE-DIFFUSOR SPACING RATIO = 1.50
 MACH NO. = 0.70

AEDG-TR-80-15

154

| FREQUENCY, HZ | MICROPHONE ANGLE, DEG | | | | | | | TOTAL POWER, DB (1/3 OCTAVE BAND) |
|---------------|-----------------------|-------|-------|-------|-------|-------|-------|--------------------------------------|
| | 30. | 45. | 60. | 75. | 90. | 105. | 120. | |
| 200. | 77.62 | 77.33 | 77.67 | 77.64 | 77.71 | 78.94 | 76.24 | 93.04 |
| 250. | 78.94 | 78.60 | 78.91 | 78.77 | 80.15 | 80.04 | 78.65 | 94.42 |
| 315. | 82.30 | 82.55 | 80.60 | 81.56 | 82.91 | 83.76 | 81.65 | 97.66 |
| 400. | 82.99 | 84.21 | 82.73 | 83.71 | 83.96 | 85.00 | 83.94 | 99.24 |
| 500. | 83.02 | 83.90 | 84.66 | 84.27 | 84.18 | 86.75 | 86.23 | 100.22 |
| 630. | 86.16 | 85.48 | 85.94 | 85.78 | 85.93 | 87.60 | 89.22 | 101.69 |
| 800. | 87.04 | 86.13 | 86.33 | 86.78 | 87.74 | 88.07 | 90.56 | 102.55 |
| 1000. | 87.22 | 86.13 | 86.63 | 87.03 | 86.56 | 89.06 | 91.20 | 102.87 |
| 1250. | 87.46 | 86.00 | 86.85 | 86.70 | 86.34 | 88.51 | 89.28 | 102.43 |
| 1600. | 86.47 | 87.09 | 87.02 | 86.81 | 87.39 | 86.74 | 89.03 | 102.87 |
| 2000. | 88.21 | 87.41 | 86.55 | 86.93 | 87.30 | 88.76 | 88.97 | 102.90 |
| 2500. | 86.80 | 87.03 | 86.08 | 85.45 | 86.18 | 88.15 | 88.91 | 102.14 |
| 3150. | 84.88 | 86.27 | 84.66 | 84.35 | 85.07 | 87.42 | 88.78 | 101.26 |
| 4000. | 83.50 | 85.89 | 84.76 | 83.71 | 85.04 | 87.77 | 88.58 | 101.13 |
| 5000. | 82.76 | 86.28 | 85.44 | 83.82 | 85.90 | 88.11 | 88.59 | 101.47 |
| 6300. | 81.54 | 86.08 | 84.96 | 83.67 | 85.55 | 87.88 | 88.20 | 101.21 |
| 8000. | 81.09 | 85.27 | 83.99 | 83.73 | 85.20 | 87.47 | 87.37 | 100.67 |
| 10000. | 80.70 | 84.25 | 83.39 | 83.65 | 84.79 | 86.99 | 86.55 | 100.15 |
| 12500. | 79.86 | 83.64 | 83.30 | 84.34 | 84.50 | 86.06 | 85.78 | 99.72 |
| 16000. | 78.26 | 82.79 | 83.59 | 84.46 | 84.02 | 84.62 | 84.95 | 99.10 |
| 20000. | 75.77 | 81.78 | 82.87 | 83.17 | 82.65 | 83.07 | 82.91 | 97.75 |
| 25000. | 72.83 | 80.19 | 81.51 | 81.25 | 80.79 | 81.06 | 80.63 | 95.90 |
| 31500. | 69.77 | 77.14 | 79.96 | 79.20 | 78.54 | 77.84 | 78.01 | 93.41 |
| 40000. | 66.90 | 75.11 | 77.34 | 77.22 | 75.97 | 75.77 | 75.59 | 91.21 |

TOTAL POWER, DB = 114.16

NOZZLE DIA = 2.8"
 DIFFUSOR DIA = 8.0"
 FLOW TEMPERATURE, TOTAL = 1210.0 DEG R
 MICROPHONE RADIUS = 6 FT.

NOZZLE-DIFFUSOR SPACING RATIO = 1.50
 MACH NO. = 0.90

| FREQUENCY, HZ | MICROPHONE ANGLE, DEG | | | | | | | TOTAL POWER, DB (1/3 OCTAVE BAND) |
|-------------------|-----------------------|-------|-------|-------|-------|-------|-------|--------------------------------------|
| | 30. | 45. | 60. | 75. | 90. | 105. | 120. | |
| 200. | 78.52 | 78.91 | 79.49 | 80.88 | 80.26 | 79.71 | 79.20 | 94.99 |
| 250. | 82.19 | 79.88 | 80.42 | 81.48 | 81.43 | 82.06 | 81.70 | 96.45 |
| 315. | 85.75 | 84.40 | 83.56 | 84.18 | 86.09 | 86.06 | 84.84 | 100.20 |
| 400. | 85.92 | 87.27 | 87.22 | 85.61 | 87.27 | 88.15 | 87.35 | 102.30 |
| 500. | 85.59 | 86.97 | 88.09 | 87.61 | 88.45 | 89.10 | 90.36 | 103.31 |
| 630. | 89.01 | 88.06 | 88.00 | 90.05 | 90.13 | 89.61 | 92.92 | 104.77 |
| 800. | 89.50 | 88.34 | 89.00 | 90.53 | 91.05 | 90.25 | 94.29 | 105.47 |
| 1000. | 89.30 | 88.93 | 88.28 | 89.86 | 89.50 | 91.01 | 94.76 | 105.43 |
| 1250. | 86.96 | 86.50 | 86.45 | 88.43 | 88.65 | 90.94 | 93.08 | 104.75 |
| 1600. | 88.86 | 88.40 | 88.49 | 87.96 | 90.14 | 90.44 | 92.54 | 104.62 |
| 2000. | 90.01 | 88.93 | 88.59 | 88.50 | 90.56 | 90.94 | 92.83 | 105.08 |
| 2500. | 89.87 | 89.00 | 89.20 | 88.97 | 90.34 | 91.26 | 93.24 | 105.33 |
| 3150. | 88.77 | 88.83 | 88.55 | 88.31 | 89.55 | 90.37 | 92.89 | 104.69 |
| 4000. | 88.05 | 88.92 | 88.33 | 87.58 | 89.33 | 90.37 | 93.30 | 104.57 |
| 5000. | 87.21 | 88.87 | 86.31 | 87.80 | 89.62 | 91.32 | 93.65 | 104.93 |
| 6300. | 86.05 | 88.57 | 88.10 | 87.07 | 89.34 | 91.45 | 92.61 | 104.60 |
| 8000. | 85.20 | 88.40 | 88.01 | 87.67 | 89.25 | 91.07 | 91.63 | 104.38 |
| 10000. | 84.23 | 87.54 | 87.55 | 87.64 | 89.22 | 90.44 | 90.58 | 103.85 |
| 12500. | 83.83 | 87.43 | 87.78 | 87.67 | 88.93 | 89.55 | 89.66 | 103.46 |
| 16000. | 84.26 | 87.57 | 88.39 | 88.06 | 88.46 | 88.91 | 89.44 | 103.39 |
| 20000. | 82.85 | 80.96 | 88.30 | 87.42 | 87.23 | 87.39 | 87.76 | 102.45 |
| 25000. | 80.79 | 86.22 | 87.65 | 86.37 | 85.68 | 85.11 | 85.83 | 101.16 |
| 31500. | 77.66 | 84.27 | 86.04 | 84.50 | 83.50 | 82.06 | 83.26 | 99.03 |
| 40000. | 74.84 | 82.39 | 83.23 | 82.12 | 81.12 | 79.71 | 80.00 | 96.66 |
| TOTAL POWER, DB = | | | | | | | | 117.31 |

NOZZLE DIA = 2.6"
 DIFFUSOR DIA = 6.0"
 FLOW TEMPERATURE, TOTAL = 1210.0 DEG R
 MICROPHONE RADIUS = 6 FT.

NOZZLE-DIFFUSOR SPACING RATIO = 1.50
 MACH NO. = 1.10

AEDC-TR-80-15

MICROPHONE ANGLE, DEG

| FREQUENCY, HZ | MICROPHONE ANGLE, DEG | | | | | | | TOTAL POWER, DB (1/3 OCTAVE BAND) |
|---------------|-----------------------|-------|-------|-------|-------|-------|-------|--------------------------------------|
| | 30. | 45. | 60. | 75. | 90. | 105. | 120. | |
| 200. | 78.58 | 78.07 | 79.20 | 80.37 | 79.94 | 80.94 | 79.73 | 94.99 |
| 250. | 79.37 | 78.37 | 80.92 | 81.39 | 80.44 | 82.39 | 81.09 | 96.12 |
| 315. | 84.31 | 85.66 | 84.87 | 83.73 | 86.87 | 86.43 | 85.71 | 100.70 |
| 400. | 86.16 | 88.85 | 87.36 | 88.04 | 87.63 | 88.70 | 87.94 | 103.38 |
| 500. | 87.23 | 88.77 | 88.38 | 89.44 | 88.32 | 90.22 | 90.55 | 104.43 |
| 630. | 89.02 | 89.33 | 88.14 | 89.89 | 90.35 | 91.26 | 93.03 | 105.44 |
| 800. | 89.67 | 89.38 | 88.91 | 90.47 | 91.69 | 91.78 | 94.50 | 106.08 |
| 1000. | 88.88 | 88.79 | 88.22 | 89.78 | 90.28 | 91.26 | 94.27 | 105.41 |
| 1250. | 87.86 | 87.66 | 86.77 | 87.13 | 88.37 | 90.24 | 91.94 | 103.84 |
| 1600. | 89.86 | 89.33 | 88.81 | 88.78 | 89.07 | 91.25 | 92.02 | 105.06 |
| 2000. | 90.33 | 90.71 | 89.90 | 90.37 | 90.15 | 92.06 | 92.99 | 106.17 |
| 2500. | 90.81 | 91.84 | 90.93 | 91.13 | 91.23 | 92.87 | 94.77 | 107.16 |
| 3150. | 91.69 | 92.15 | 91.89 | 91.26 | 92.24 | 94.13 | 96.37 | 107.99 |
| 4000. | 91.44 | 92.06 | 92.09 | 91.65 | 92.94 | 95.07 | 97.46 | 108.57 |
| 5000. | 90.19 | 91.35 | 92.04 | 91.02 | 93.12 | 95.63 | 97.42 | 108.55 |
| 6300. | 88.85 | 91.01 | 91.79 | 90.65 | 92.61 | 95.12 | 96.67 | 108.03 |
| 8000. | 87.83 | 90.68 | 91.10 | 90.40 | 92.04 | 94.22 | 95.36 | 107.33 |
| 10000. | 86.84 | 89.58 | 89.90 | 90.09 | 91.21 | 92.56 | 93.54 | 106.11 |
| 12500. | 85.97 | 89.44 | 90.36 | 90.48 | 90.63 | 91.86 | 92.23 | 105.76 |
| 16000. | 86.13 | 90.76 | 91.64 | 90.99 | 90.56 | 91.09 | 91.55 | 106.05 |
| 20000. | 85.52 | 90.93 | 91.90 | 90.56 | 89.80 | 89.56 | 90.36 | 105.55 |
| 25000. | 83.89 | 90.41 | 91.59 | 89.80 | 88.33 | 87.77 | 86.67 | 104.63 |
| 31500. | 81.25 | 89.88 | 90.33 | 88.48 | 86.17 | 85.93 | 86.40 | 103.37 |
| 40000. | 79.43 | 88.40 | 88.56 | 86.14 | 83.81 | 83.19 | 83.57 | 101.37 |

TOTAL POWER, DB = 119.40

NOZZLE DIA = 5.6"
 DIFFUSOR DIA = 8.0"
 FLOW TEMPERATURE, TOTAL = 530.0 DEG R
 MICROPHONE RADIUS = 6 FT.

NOZZLE-DIFFUSOR SPACING RATIO = 0.25
 MACH NO. = 0.70

| FREQUENCY, HZ | MICROPHONE ANGLE, DEG | | | | | | | TOTAL POWER, DB (1/3 OCTAVE BAND) |
|---------------|-----------------------|-------|-------|-------|-------|-------|-------|--------------------------------------|
| | 30. | 45. | 60. | 75. | 90. | 105. | 120. | |
| 200. | 77.91 | 76.59 | 77.06 | 75.39 | 77.22 | 77.47 | 77.84 | 92.05 |
| 250. | 76.01 | 76.21 | 76.10 | 75.65 | 77.46 | 77.73 | 77.61 | 91.92 |
| 315. | 78.54 | 78.37 | 77.46 | 79.24 | 79.68 | 80.90 | 79.21 | 94.55 |
| 400. | 82.15 | 81.30 | 79.75 | 79.63 | 81.07 | 81.15 | 79.99 | 95.93 |
| 500. | 82.28 | 81.60 | 81.19 | 80.41 | 80.99 | 82.22 | 82.03 | 96.71 |
| 630. | 81.90 | 78.92 | 81.05 | 81.89 | 81.42 | 81.33 | 82.88 | 96.29 |
| 800. | 80.63 | 78.46 | 80.46 | 80.63 | 83.13 | 79.54 | 82.52 | 95.71 |
| 1000. | 80.36 | 78.42 | 81.85 | 81.72 | 84.01 | 79.53 | 82.66 | 96.32 |
| 1250. | 78.48 | 78.54 | 80.49 | 80.21 | 80.30 | 80.35 | 82.05 | 95.21 |
| 1600. | 77.91 | 78.09 | 77.94 | 77.67 | 77.68 | 79.52 | 80.93 | 93.70 |
| 2000. | 77.40 | 77.70 | 76.71 | 76.28 | 76.52 | 77.65 | 80.25 | 92.61 |
| 2500. | 76.64 | 77.64 | 75.69 | 75.28 | 75.04 | 76.20 | 78.67 | 91.65 |
| 3150. | 76.07 | 75.81 | 74.91 | 74.27 | 74.14 | 75.18 | 77.50 | 90.70 |
| 4000. | 74.68 | 75.42 | 74.89 | 73.58 | 73.55 | 74.66 | 76.69 | 90.17 |
| 5000. | 73.15 | 75.10 | 75.13 | 73.15 | 73.41 | 75.03 | 76.39 | 90.01 |
| 6300. | 71.70 | 75.34 | 74.48 | 72.46 | 73.46 | 75.09 | 76.16 | 89.56 |
| 8000. | 70.94 | 74.95 | 73.19 | 72.03 | 73.13 | 75.15 | 76.18 | 89.23 |
| 10000. | 70.05 | 74.05 | 71.97 | 71.66 | 73.05 | 75.08 | 75.82 | 88.75 |
| 12500. | 69.61 | 74.31 | 72.27 | 71.99 | 73.42 | 75.58 | 76.66 | 89.16 |
| 16000. | 69.54 | 75.00 | 73.00 | 72.70 | 74.05 | 76.28 | 77.63 | 89.87 |
| 20000. | 69.10 | 74.62 | 73.66 | 72.65 | 73.78 | 75.70 | 77.52 | 89.55 |
| 25000. | 68.78 | 73.72 | 72.16 | 70.95 | 72.62 | 74.93 | 76.59 | 88.56 |
| 31500. | 66.25 | 72.51 | 69.54 | 68.35 | 70.12 | 72.19 | 74.26 | 86.33 |
| 40000. | 62.82 | 69.52 | 66.92 | 65.94 | 67.37 | 69.38 | 71.56 | 83.54 |

TOTAL POWER, DB = 106.59

NOZZLE DIA = 5.6"
 DIFFUSOR DIA = 8.0"
 FLOW TEMPERATURE, TOTAL = 530.0 DEG R
 MICROPHONE RADIUS = 6 FT.

NOZZLE-DIFFUSOR SPACING RATIO = 0.25
 MACH NO. = 0.90

MICROPHONE ANGLE, DEG

| FREQUENCY, HZ | 30. | 45. | 60. | 75. | 90. | 105. | 120. | TOTAL POWER, DB (1/3 OCTAVE BAND) |
|---------------|---------------------------------|-------|-------|-------|-------|-------|-------|--------------------------------------|
| | SOUND POWER INTENSITY LEVEL, DB | | | | | | | |
| 200. | 77.27 | 77.97 | 76.12 | 76.50 | 76.78 | 76.04 | 75.88 | 91.98 |
| 250. | 77.87 | 78.28 | 76.71 | 76.02 | 75.73 | 75.73 | 75.61 | 91.90 |
| 315. | 79.36 | 77.76 | 77.87 | 77.95 | 77.71 | 77.39 | 76.28 | 92.96 |
| 400. | 81.04 | 78.32 | 78.84 | 79.31 | 78.55 | 77.91 | 77.21 | 93.89 |
| 500. | 83.36 | 78.63 | 80.76 | 80.41 | 78.75 | 78.36 | 77.82 | 94.86 |
| 630. | 83.65 | 79.45 | 81.73 | 81.33 | 79.35 | 78.82 | 78.31 | 95.04 |
| 800. | 87.24 | 80.33 | 82.32 | 81.99 | 79.68 | 79.27 | 78.53 | 96.67 |
| 1000. | 87.84 | 81.21 | 82.90 | 82.27 | 79.70 | 79.34 | 78.57 | 97.11 |
| 1250. | 87.10 | 82.16 | 83.30 | 82.49 | 79.33 | 79.23 | 78.36 | 97.23 |
| 1600. | 86.24 | 82.47 | 83.38 | 81.95 | 78.77 | 78.86 | 77.76 | 96.96 |
| 2000. | 84.47 | 82.40 | 82.95 | 80.78 | 77.83 | 77.91 | 77.09 | 96.21 |
| 2500. | 82.65 | 82.26 | 82.01 | 79.35 | 76.52 | 76.78 | 75.86 | 95.28 |
| 3150. | 80.46 | 81.74 | 79.94 | 76.84 | 75.07 | 75.77 | 75.01 | 93.97 |
| 4000. | 79.45 | 80.20 | 76.42 | 75.48 | 74.19 | 74.09 | 73.71 | 92.48 |
| 5000. | 78.07 | 77.97 | 76.98 | 74.93 | 73.70 | 73.95 | 73.30 | 91.13 |
| 6300. | 77.21 | 76.94 | 76.17 | 74.46 | 73.79 | 74.15 | 73.02 | 90.54 |
| 8000. | 75.63 | 76.17 | 75.30 | 74.36 | 73.73 | 73.84 | 72.99 | 90.00 |
| 10000. | 73.75 | 75.27 | 74.23 | 73.75 | 73.24 | 73.60 | 72.65 | 89.25 |
| 12500. | 72.37 | 74.62 | 73.99 | 73.97 | 73.90 | 74.18 | 73.90 | 89.28 |
| 16000. | 71.31 | 74.93 | 74.33 | 74.44 | 74.42 | 75.33 | 75.27 | 89.87 |
| 20000. | 69.17 | 73.90 | 73.52 | 73.33 | 73.07 | 74.58 | 74.81 | 88.96 |
| 25000. | 66.65 | 70.84 | 70.42 | 70.51 | 70.64 | 72.17 | 72.80 | 86.22 |
| 31500. | 63.23 | 68.47 | 67.83 | 66.48 | 67.16 | 68.24 | 69.72 | 82.91 |
| 40000. | 60.13 | 66.43 | 63.91 | 63.09 | 63.67 | 64.82 | 66.26 | 79.85 |

TOTAL POWER, DB = 107.26

NOZZLE DIA = 5.6"
 DIFFUSOR DIA = 8.0"
 FLOW TEMPERATURE, TOTAL = 530.0 DEG R
 MICROPHONE RADIUS = 6 FT.

NOZZLE-DIFFUSOR SPACING RATIO = 0.25
 MACH NU. = 1.10

MICROPHONE ANGLE, DEG

| FREQUENCY, HZ | SOUND POWER INTENSITY LEVEL, DB | | | | | | | TOTAL POWER, DB (1/3 OCTAVE BAND) |
|---------------|---------------------------------|-------|-------|-------|-------|-------|-------|--------------------------------------|
| | 30. | 45. | 60. | 75. | 90. | 105. | 120. | |
| 200. | 82.12 | 81.55 | 79.82 | 79.42 | 79.30 | 79.09 | 79.19 | 95.32 |
| 250. | 81.53 | 81.50 | 79.60 | 78.39 | 75.75 | 77.49 | 77.49 | 94.46 |
| 315. | 82.22 | 81.13 | 80.32 | 78.81 | 76.85 | 75.69 | 75.27 | 94.35 |
| 400. | 81.00 | 80.63 | 80.03 | 78.23 | 78.02 | 76.44 | 74.84 | 94.07 |
| 500. | 78.70 | 77.33 | 76.18 | 76.24 | 75.68 | 74.96 | 74.86 | 91.51 |
| 630. | 78.50 | 75.75 | 76.08 | 76.55 | 74.74 | 75.77 | 76.53 | 91.32 |
| 800. | 78.99 | 76.97 | 76.04 | 77.03 | 74.89 | 75.25 | 76.61 | 91.68 |
| 1000. | 79.62 | 77.61 | 76.82 | 78.29 | 74.91 | 75.93 | 75.80 | 92.44 |
| 1250. | 79.10 | 77.50 | 77.49 | 77.83 | 74.10 | 75.72 | 75.18 | 92.15 |
| 1600. | 79.15 | 78.78 | 78.02 | 77.31 | 75.01 | 75.71 | 74.87 | 92.50 |
| 2000. | 79.96 | 80.00 | 79.44 | 77.86 | 75.86 | 75.69 | 75.21 | 93.35 |
| 2500. | 83.25 | 82.30 | 83.47 | 80.01 | 77.34 | 75.87 | 75.54 | 95.72 |
| 3150. | 84.32 | 83.39 | 83.62 | 80.44 | 78.32 | 76.61 | 75.24 | 96.43 |
| 4000. | 84.49 | 83.14 | 83.06 | 80.55 | 78.46 | 76.60 | 74.62 | 96.29 |
| 5000. | 84.86 | 83.22 | 82.47 | 81.29 | 77.97 | 76.07 | 75.02 | 96.36 |
| 6300. | 84.98 | 83.54 | 82.88 | 81.28 | 77.99 | 76.25 | 75.10 | 96.56 |
| 8000. | 83.00 | 82.15 | 81.69 | 80.05 | 76.80 | 75.79 | 74.73 | 95.27 |
| 10000. | 79.87 | 79.30 | 78.54 | 77.37 | 75.48 | 74.82 | 74.30 | 92.71 |
| 12500. | 77.13 | 77.59 | 76.85 | 76.21 | 74.80 | 74.67 | 75.08 | 91.41 |
| 16000. | 75.27 | 77.48 | 76.37 | 76.00 | 75.46 | 75.93 | 77.33 | 91.58 |
| 20000. | 73.73 | 77.68 | 76.46 | 76.12 | 76.05 | 76.61 | 78.11 | 91.87 |
| 25000. | 72.77 | 78.32 | 75.97 | 75.15 | 75.24 | 76.34 | 78.00 | 91.68 |
| 31500. | 71.36 | 76.90 | 76.19 | 74.31 | 74.37 | 75.69 | 77.95 | 91.56 |
| 40000. | 69.95 | 76.81 | 75.64 | 73.40 | 73.24 | 74.28 | 76.18 | 90.07 |

TOTAL POWER, DB = 107.62

159

NOZZLE DIA = 5.0"
 DIFFUSOR DIA = 8.0"
 FLOW TEMPERATURE, TOTAL = 530.0 DEG R
 MICROPHONE RADIUS = 6 FT.

NOZZLE-DIFFUSOR SPACING RATIO = 0.50
 MACH NO. = 0.70

AEDC-TR-80-15

MICROPHONE ANGLE, DEG

| FREQUENCY, HZ | 30. | 45. | 60. | 75. | 90. | 105. | 120. | TOTAL POWER, DB (1/3 OCTAVE BAND) |
|---------------|---------------------------------|-------|-------|-------|-------|-------|-------|--------------------------------------|
| | SOUND POWER INTENSITY LEVEL, DB | | | | | | | |
| 200. | 75.64 | 76.54 | 75.84 | 76.14 | 76.71 | 77.77 | 77.44 | 91.91 |
| 250. | 77.09 | 76.00 | 76.92 | 76.38 | 77.16 | 77.45 | 76.93 | 91.98 |
| 315. | 79.63 | 79.07 | 78.58 | 78.97 | 79.44 | 79.67 | 79.28 | 94.41 |
| 400. | 81.35 | 81.57 | 80.30 | 80.42 | 80.21 | 80.87 | 81.26 | 96.05 |
| 500. | 81.09 | 80.82 | 81.00 | 80.98 | 79.89 | 82.01 | 82.72 | 96.41 |
| 630. | 81.34 | 79.64 | 80.74 | 81.08 | 79.90 | 80.99 | 82.28 | 95.90 |
| 800. | 81.34 | 79.54 | 79.97 | 80.17 | 80.98 | 79.91 | 82.54 | 95.50 |
| 1000. | 80.44 | 78.79 | 79.52 | 79.07 | 80.35 | 80.60 | 82.73 | 95.14 |
| 1250. | 79.55 | 78.56 | 78.50 | 78.54 | 77.94 | 80.28 | 81.34 | 94.37 |
| 1600. | 79.36 | 79.54 | 78.24 | 77.69 | 77.94 | 79.26 | 80.90 | 94.09 |
| 2000. | 80.12 | 79.94 | 78.36 | 77.36 | 77.95 | 77.86 | 79.75 | 93.83 |
| 2500. | 79.92 | 79.71 | 78.30 | 77.02 | 77.51 | 77.23 | 79.00 | 93.47 |
| 3150. | 79.79 | 79.86 | 78.80 | 77.57 | 77.57 | 77.79 | 78.74 | 93.75 |
| 4000. | 79.72 | 80.45 | 79.05 | 77.61 | 77.58 | 77.66 | 78.56 | 93.93 |
| 5000. | 78.00 | 78.82 | 77.97 | 76.39 | 76.63 | 77.22 | 78.43 | 92.61 |
| 6300. | 74.30 | 76.05 | 75.22 | 74.71 | 75.55 | 76.64 | 77.23 | 90.97 |
| 8000. | 72.01 | 74.55 | 73.43 | 73.99 | 75.43 | 76.58 | 76.53 | 90.20 |
| 10000. | 71.62 | 74.25 | 72.98 | 73.84 | 75.24 | 76.26 | 76.35 | 89.93 |
| 12500. | 71.67 | 75.04 | 74.00 | 74.46 | 75.69 | 76.95 | 77.24 | 90.63 |
| 16000. | 72.06 | 76.27 | 74.76 | 74.95 | 76.13 | 77.26 | 77.81 | 91.24 |
| 20000. | 71.49 | 76.10 | 74.19 | 74.42 | 75.25 | 76.82 | 77.37 | 90.79 |
| 25000. | 70.27 | 75.55 | 73.29 | 73.25 | 74.17 | 76.12 | 77.25 | 90.04 |
| 31500. | 68.17 | 73.98 | 71.70 | 71.19 | 72.46 | 74.46 | 75.60 | 88.35 |
| 40000. | -65.93 | 72.10 | 69.39 | 68.62 | 69.87 | 71.41 | 73.13 | 85.87 |

TOTAL POWER, DB = 107.05

160

NOZZLE DIA = 5.6"
 DIFFUSOR DIA = 8.0"
 FLOW TEMPERATURE, TOTAL = 530.0 DEG R
 MICROPHONE RADIUS = 6 FT.

NOZZLE-DIFFUSOR SPACING RATIO = 0.50
 MACH NO. = 0.90

| FREQUENCY, HZ | MICROPHONE ANGLE, DEG | | | | | | | TOTAL POWER, DB (1/3 OCTAVE BAND) |
|---------------|-----------------------|-------|-------|-------|-------|-------|-------|--------------------------------------|
| | 30. | 45. | 60. | 75. | 90. | 105. | 120. | |
| 200. | 77.04 | 77.70 | 77.28 | 76.72 | 76.62 | 77.16 | 76.53 | 92.30 |
| 250. | 78.14 | 77.58 | 76.98 | 75.66 | 75.44 | 75.86 | 75.57 | 91.67 |
| 315. | 80.45 | 76.72 | 76.52 | 76.38 | 78.72 | 77.88 | 76.71 | 93.30 |
| 400. | 81.61 | 77.96 | 76.09 | 76.01 | 80.27 | 78.68 | 77.52 | 93.60 |
| 500. | 83.02 | 76.76 | 76.90 | 76.29 | 83.55 | 80.44 | 78.53 | 94.74 |
| 630. | 84.63 | 77.27 | 80.22 | 79.10 | 84.47 | 81.25 | 80.05 | 96.12 |
| 800. | 87.00 | 77.76 | 79.41 | 77.98 | 85.52 | 81.99 | 81.00 | 96.65 |
| 1000. | 89.62 | 77.15 | 77.65 | 76.60 | 86.37 | 82.86 | 82.38 | 97.73 |
| 1250. | 91.99 | 77.96 | 76.37 | 77.89 | 86.78 | 83.60 | 83.33 | 98.97 |
| 1600. | 94.16 | 80.27 | 79.59 | 78.23 | 86.75 | 84.47 | 83.76 | 100.26 |
| 2000. | 96.28 | 81.26 | 80.11 | 78.62 | 86.52 | 85.09 | 84.14 | 101.52 |
| 2500. | 94.21 | 82.43 | 81.08 | 79.77 | 86.11 | 85.51 | 84.00 | 100.73 |
| 3150. | 92.65 | 84.46 | 82.56 | 81.34 | 85.37 | 85.36 | 84.12 | 100.55 |
| 4000. | 91.53 | 85.74 | 83.97 | 82.44 | 84.76 | 84.19 | 83.98 | 100.43 |
| 5000. | 88.95 | 85.86 | 84.11 | 82.46 | 83.07 | 83.02 | 82.69 | 99.58 |
| 6300. | 84.41 | 82.95 | 81.02 | 80.51 | 80.36 | 80.20 | 79.89 | 96.62 |
| 8000. | 80.82 | 78.69 | 77.73 | 77.22 | 77.91 | 77.18 | 77.53 | 93.24 |
| 10000. | 78.24 | 77.12 | 76.47 | 76.98 | 77.42 | 76.40 | 75.99 | 92.11 |
| 12500. | 76.30 | 77.63 | 77.19 | 77.89 | 76.28 | 76.88 | 76.62 | 92.64 |
| 16000. | 75.75 | 79.47 | 78.16 | 78.07 | 78.57 | 77.75 | 78.07 | 93.65 |
| 20000. | 75.46 | 79.60 | 78.50 | 78.18 | 78.59 | 77.67 | 78.44 | 93.70 |
| 25000. | 74.66 | 79.10 | 78.00 | 77.38 | 77.79 | 77.13 | 77.80 | 93.00 |
| 31500. | 72.97 | 78.53 | 76.62 | 76.00 | 76.42 | 75.97 | 76.77 | 91.93 |
| 40000. | 70.90 | 76.38 | 75.55 | 73.72 | 73.39 | 73.59 | 74.79 | 89.77 |

TOTAL POWER, DB = 110.62

NOZZLE DIA = 5.6"
 DIFFUSOR DIA = 8.0"
 FLOW TEMPERATURE, TOTAL = 530.0 DEG R
 MICROPHONE RADIUS = 6 FT.

NOZZLE-DIFFUSOR SPACING RATIO = 0.50
 MACH NO. = 1.10

MICROPHONE ANGLE, DEG

| FREQUENCY, HZ | 30. | 45. | 60. | 75. | 90. | 105. | 120. | TOTAL POWER, DB (1/3 OCTAVE BAND) |
|---------------|---------------------------------|-------|-------|-------|-------|-------|-------|--------------------------------------|
| | SOUND POWER INTENSITY LEVEL, DB | | | | | | | |
| 200. | 82.02 | 81.20 | 80.15 | 79.83 | 80.13 | 79.51 | 78.84 | 95.52 |
| 250. | 82.13 | 81.38 | 79.24 | 78.40 | 77.07 | 76.20 | 76.08 | 94.32 |
| 315. | 82.85 | 82.38 | 80.36 | 80.06 | 77.19 | 76.31 | 75.80 | 95.24 |
| 400. | 82.23 | 81.20 | 80.21 | 79.64 | 78.57 | 77.12 | 76.16 | 94.67 |
| 500. | 78.83 | 78.53 | 78.79 | 77.69 | 76.21 | 76.00 | 75.62 | 92.80 |
| 630. | 79.10 | 77.43 | 76.58 | 77.39 | 76.33 | 76.34 | 76.36 | 92.49 |
| 800. | 79.18 | 78.62 | 79.13 | 77.16 | 76.51 | 76.58 | 76.02 | 92.88 |
| 1000. | 82.10 | 81.41 | 80.70 | 78.26 | 76.95 | 77.05 | 76.25 | 94.60 |
| 1250. | 82.20 | 81.08 | 80.42 | 78.21 | 76.50 | 76.44 | 76.09 | 94.32 |
| 1600. | 82.96 | 81.64 | 80.33 | 78.99 | 77.12 | 76.79 | 76.70 | 94.82 |
| 2000. | 82.87 | 83.40 | 81.77 | 80.60 | 78.63 | 77.35 | 77.25 | 96.17 |
| 2500. | 84.60 | 85.67 | 84.04 | 81.95 | 79.70 | 78.29 | 77.42 | 98.07 |
| 3150. | 87.10 | 87.39 | 85.79 | 83.30 | 81.16 | 80.50 | 79.36 | 99.72 |
| 4000. | 88.45 | 88.51 | 87.04 | 84.71 | 82.74 | 82.08 | 81.09 | 101.02 |
| 5000. | 89.42 | 89.20 | 87.08 | 85.05 | 83.68 | 83.21 | 83.19 | 101.67 |
| 6300. | 87.85 | 87.21 | 85.73 | 82.79 | 81.70 | 81.80 | 81.12 | 99.84 |
| 8000. | 83.94 | 84.01 | 83.10 | 81.09 | 80.42 | 79.88 | 78.37 | 97.19 |
| 10000. | 80.41 | 81.44 | 80.98 | 80.22 | 79.78 | 78.85 | 77.52 | 95.40 |
| 12500. | 79.03 | 81.18 | 81.21 | 80.94 | 80.34 | 79.16 | 78.25 | 95.60 |
| 16000. | 78.80 | 82.24 | 82.33 | 81.85 | 81.03 | 79.84 | 79.94 | 96.51 |
| 20000. | 78.43 | 82.80 | 82.50 | 81.60 | 80.89 | 79.64 | 80.24 | 96.64 |
| 25000. | 78.20 | 82.97 | 82.29 | 81.12 | 80.18 | 78.93 | 79.70 | 96.31 |
| 31500. | 77.45 | 82.77 | 81.82 | 80.36 | 78.77 | 78.15 | 78.00 | 95.73 |
| 40000. | 75.95 | 82.05 | 79.89 | 78.43 | 77.05 | 76.30 | 76.28 | 94.30 |

TOTAL POWER, DB = 110.65

NOZZLE DIA = 5.6"
 DIFFUSOR DIA = 2.0"
 FLOW TEMPERATURE, TOTAL = 530.0 DEG R
 MICROPHONE RADIUS = 6 FT.

NOZZLE-DIFFUSOR SPACING RATIO = 0.75
 MACH NO. = 0.70

| FREQUENCY, HZ | MICROPHONE ANGLE, DEG | | | | | | | TOTAL POWER, DB (1/3 OCTAVE BAND) |
|---------------|-----------------------|-------|-------|-------|-------|-------|-------|--------------------------------------|
| | 30. | 45. | 60. | 75. | 90. | 105. | 120. | |
| 200. | 76.75 | 75.91 | 75.46 | 75.91 | 77.10 | 76.65 | 76.10 | 91.43 |
| 250. | 77.39 | 75.60 | 75.60 | 76.84 | 77.09 | 77.17 | 77.19 | 91.86 |
| 315. | 81.27 | 79.32 | 78.55 | 79.69 | 80.33 | 79.73 | 80.13 | 94.90 |
| 400. | 82.04 | 81.95 | 80.99 | 80.57 | 80.84 | 80.95 | 81.41 | 96.39 |
| 500. | 81.27 | 81.71 | 82.67 | 81.51 | 80.96 | 83.19 | 83.07 | 97.33 |
| 630. | 83.06 | 80.85 | 81.79 | 81.94 | 81.06 | 82.06 | 84.17 | 97.13 |
| 800. | 82.67 | 82.01 | 81.10 | 81.54 | 81.72 | 80.60 | 83.35 | 96.82 |
| 1000. | 83.44 | 83.11 | 82.20 | 81.40 | 81.65 | 81.37 | 82.99 | 97.35 |
| 1250. | 86.62 | 86.12 | 84.64 | 83.36 | 81.96 | 82.15 | 83.25 | 99.38 |
| 1600. | 88.92 | 88.62 | 86.13 | 85.89 | 83.74 | 83.43 | 84.03 | 101.46 |
| 2000. | 91.02 | 92.20 | 89.01 | 88.23 | 86.41 | 85.29 | 85.95 | 104.33 |
| 2500. | 92.16 | 93.50 | 90.30 | 88.79 | 87.36 | 86.90 | 86.53 | 105.48 |
| 3150. | 91.34 | 92.31 | 88.73 | 87.43 | 86.40 | 86.59 | 86.48 | 104.40 |
| 4000. | 86.50 | 87.57 | 85.24 | 84.29 | 83.28 | 83.60 | 84.02 | 100.48 |
| 5000. | 80.89 | 82.13 | 80.53 | 79.44 | 79.79 | 80.80 | 81.04 | 95.96 |
| 6300. | 76.50 | 78.97 | 76.98 | 76.94 | 77.94 | 79.15 | 79.09 | 93.40 |
| 8000. | 75.35 | 77.98 | 76.35 | 76.80 | 77.61 | 78.78 | 78.84 | 92.90 |
| 10000. | 74.59 | 77.56 | 75.99 | 77.10 | 77.87 | 78.26 | 78.41 | 92.65 |
| 12500. | 74.39 | 77.90 | 76.58 | 77.34 | 77.87 | 78.42 | 78.55 | 92.88 |
| 16000. | 74.01 | 76.74 | 76.91 | 77.26 | 77.93 | 78.49 | 78.09 | 93.11 |
| 20000. | 72.60 | 78.13 | 76.16 | 76.48 | 76.78 | 77.86 | 78.07 | 92.38 |
| 25000. | 71.59 | 76.88 | 75.16 | 74.81 | 75.51 | 76.72 | 77.07 | 91.12 |
| 31500. | 69.55 | 74.74 | 73.01 | 73.07 | 73.53 | 74.50 | 74.98 | 89.05 |
| 40000. | 66.81 | 72.10 | 70.79 | 70.76 | 70.93 | 71.96 | 72.26 | 86.54 |

TOTAL POWER, DB = 112.39

163

NOZZLE DIA = 5.6"
 DIFFUSOR DIA = 8.0"
 FLOW TEMPERATURE, TOTAL = 530.0 DEG R
 MICROPHONE RADIUS = 6 FT.

NOZZLE-DIFFUSOR SPACING RATIO = 0.75
 MACH NO. = 0.90

| FREQUENCY, HZ | MICROPHONE ANGLE, DEG | | | | | | | TOTAL POWER, DB (1/3 OCTAVE BAND) |
|---------------|-----------------------|-------|-------|-------|-------|-------|-------|--------------------------------------|
| | 30. | 45. | 60. | 75. | 90. | 105. | 120. | |
| 200. | 79.06 | 76.09 | 76.05 | 76.22 | 76.24 | 75.81 | 75.48 | 91.46 |
| 250. | 78.24 | 76.31 | 74.86 | 74.65 | 75.64 | 75.15 | 73.96 | 90.73 |
| 315. | 79.64 | 79.44 | 77.30 | 76.64 | 77.70 | 75.63 | 74.80 | 92.78 |
| 400. | 81.63 | 81.31 | 77.62 | 76.85 | 76.60 | 75.98 | 75.38 | 93.73 |
| 500. | 83.04 | 82.47 | 78.66 | 77.32 | 76.70 | 76.18 | 76.59 | 94.68 |
| 630. | 84.32 | 83.70 | 79.95 | 78.23 | 77.43 | 76.54 | 78.57 | 95.94 |
| 800. | 85.65 | 85.05 | 81.37 | 79.33 | 78.35 | 78.83 | 79.15 | 97.12 |
| 1000. | 87.26 | 86.60 | 82.91 | 81.06 | 79.46 | 78.23 | 78.20 | 98.40 |
| 1250. | 88.92 | 88.33 | 85.15 | 83.05 | 80.70 | 79.09 | 78.33 | 100.11 |
| 1600. | 90.65 | 90.77 | 87.90 | 85.30 | 82.69 | 80.85 | 80.44 | 102.41 |
| 2000. | 92.50 | 93.76 | 90.65 | 87.55 | 85.69 | 84.50 | 84.71 | 105.22 |
| 2500. | 95.19 | 95.96 | 94.04 | 91.06 | 89.03 | 88.03 | 87.64 | 107.95 |
| 3150. | 95.96 | 96.74 | 95.39 | 92.99 | 90.96 | 90.10 | 90.00 | 109.20 |
| 4000. | 94.57 | 95.05 | 93.69 | 91.99 | 90.24 | 89.86 | 89.09 | 107.88 |
| 5000. | 90.62 | 90.55 | 89.19 | 87.81 | 87.67 | 87.25 | 87.15 | 103.98 |
| 6300. | 85.53 | 85.80 | 84.37 | 82.81 | 83.41 | 83.11 | 82.90 | 99.32 |
| 8000. | 82.80 | 83.65 | 83.05 | 81.62 | 81.67 | 81.11 | 80.48 | 97.44 |
| 10000. | 81.72 | 82.72 | 82.94 | 81.70 | 81.46 | 80.20 | 79.60 | 96.90 |
| 12500. | 81.41 | 83.25 | 83.66 | 82.29 | 82.12 | 80.93 | 79.80 | 97.47 |
| 16000. | 81.29 | 84.15 | 84.31 | 82.82 | 82.41 | 81.66 | 80.88 | 98.15 |
| 20000. | 80.27 | 83.79 | 83.94 | 82.14 | 81.81 | 81.01 | 80.57 | 97.60 |
| 25000. | 78.05 | 83.05 | 81.99 | 80.31 | 79.95 | 79.27 | 79.24 | 96.13 |
| 31500. | 76.15 | 81.80 | 79.71 | 78.36 | 77.96 | 77.03 | 77.09 | 94.35 |
| 40000. | 72.71 | 78.89 | 77.18 | 75.39 | 75.14 | 74.27 | 73.85 | 91.49 |

TOTAL POWER, DB = 115.61

NOZZLE DIA = 5.6"
 DIFFUSOR DIA = 6.0"
 FLOW TEMPERATURE, TOTAL = 530.0 DEG R
 MICROPHONE RADIUS = 6 FT.

NOZZLE-DIFFUSOR SPACING RATIO = 0.75
 MACH NU. = 1.10

MICROPHONE ANGLE, DEG

| FREQUENCY, HZ | 30. | 45. | 60. | 75. | 90. | 105. | 120. | TOTAL POWER, DB (1/3 OCTAVE BAND) |
|---------------|---------------------------------|-------|-------|-------|-------|-------|-------|--------------------------------------|
| | SOUND POWER INTENSITY LEVEL, DB | | | | | | | |
| 200. | 81.50 | 82.39 | 79.53 | 78.96 | 81.22 | 81.57 | 79.47 | 96.17 |
| 250. | 81.26 | 81.77 | 78.19 | 76.82 | 78.53 | 78.08 | 76.94 | 94.42 |
| 315. | 82.85 | 81.78 | 79.14 | 78.67 | 78.75 | 78.02 | 75.31 | 94.95 |
| 400. | 82.00 | 81.99 | 80.80 | 80.09 | 79.23 | 78.08 | 75.90 | 95.43 |
| 500. | 80.12 | 79.71 | 79.96 | 79.53 | 78.82 | 77.26 | 76.36 | 94.23 |
| 630. | 82.20 | 80.30 | 80.98 | 80.50 | 79.18 | 78.27 | 77.27 | 95.14 |
| 800. | 83.38 | 82.09 | 81.30 | 80.77 | 80.48 | 78.40 | 77.04 | 95.99 |
| 1000. | 84.82 | 85.59 | 83.72 | 82.25 | 82.16 | 79.92 | 78.20 | 98.30 |
| 1250. | 86.45 | 87.00 | 85.37 | 83.85 | 82.83 | 80.62 | 79.17 | 99.65 |
| 1600. | 89.48 | 89.80 | 87.79 | 85.71 | 84.33 | 81.57 | 80.78 | 102.00 |
| 2000. | 91.93 | 92.73 | 90.66 | 88.97 | 86.46 | 84.74 | 84.62 | 104.92 |
| 2500. | 94.63 | 95.86 | 93.91 | 92.23 | 89.66 | 87.84 | 87.44 | 108.06 |
| 3150. | 97.10 | 97.52 | 95.56 | 93.96 | 91.86 | 90.63 | 90.51 | 109.93 |
| 4000. | 97.90 | 97.41 | 96.07 | 94.35 | 92.59 | 91.08 | 91.23 | 110.21 |
| 5000. | 96.60 | 95.83 | 94.66 | 92.65 | 91.80 | 90.19 | 90.29 | 108.80 |
| 6300. | 92.89 | 92.42 | 90.45 | 88.99 | 87.40 | 87.21 | 87.32 | 105.20 |
| 8000. | 90.00 | 89.26 | 87.20 | 86.40 | 85.33 | 84.36 | 84.29 | 102.28 |
| 10000. | 87.30 | 87.56 | 86.30 | 86.03 | 84.67 | 82.58 | 82.40 | 100.93 |
| 12500. | 86.39 | 87.82 | 86.74 | 86.30 | 84.77 | 82.46 | 82.36 | 101.08 |
| 16000. | 86.42 | 88.79 | 87.89 | 86.19 | 84.74 | 82.58 | 83.07 | 101.60 |
| 20000. | 85.76 | 89.06 | 87.95 | 85.57 | 84.02 | 82.01 | 82.46 | 101.45 |
| 25000. | 84.59 | 88.24 | 87.05 | 84.44 | 83.03 | 81.00 | 81.27 | 100.50 |
| 31500. | 82.97 | 86.86 | 85.90 | 83.51 | 81.17 | 79.48 | 79.63 | 99.19 |
| 40000. | 80.41 | 85.22 | 84.56 | 81.87 | 78.98 | 77.13 | 77.43 | 97.47 |

TOTAL POWER, DB = 117.47

NOZZLE DIA = 5.0"
 DIFFUSOR DIA = 8.0"
 FLOW TEMPERATURE, TOTAL = 530.0 DEG R
 MICROPHONE RADIUS = 6 FT.

NOZZLE-DIFFUSOR SPACING RATIO = 1.00
 MACH NO. = 0.70

MICROPHONE ANGLE, DEG

| FREQUENCY, Hz | MICROPHONE ANGLE, DEG | | | | | | | TOTAL POWER, DB (1/3 OCTAVE BAND) |
|---------------|-----------------------|-------|-------|-------|-------|-------|-------|--------------------------------------|
| | 30. | 45. | 60. | 75. | 90. | 105. | 120. | |
| 200. | 77.27 | 77.50 | 75.96 | 77.09 | 75.67 | 77.14 | 76.51 | 92.12 |
| 250. | 77.80 | 77.95 | 76.49 | 76.14 | 76.99 | 77.50 | 77.56 | 92.81 |
| 315. | 81.94 | 82.73 | 79.74 | 80.62 | 81.61 | 81.02 | 80.13 | 96.57 |
| 400. | 83.29 | 83.37 | 83.05 | 82.16 | 82.93 | 82.76 | 81.81 | 96.01 |
| 500. | 84.14 | 83.18 | 84.26 | 82.91 | 83.48 | 84.27 | 84.32 | 98.66 |
| 630. | 86.63 | 84.65 | 84.52 | 84.34 | 83.40 | 83.30 | 85.43 | 99.56 |
| 800. | 85.74 | 87.20 | 86.37 | 86.01 | 84.27 | 82.76 | 85.39 | 101.07 |
| 1000. | 92.63 | 91.52 | 90.13 | 88.83 | 86.86 | 85.08 | 86.31 | 104.48 |
| 1250. | 90.06 | 94.07 | 93.18 | 91.71 | 89.64 | 88.10 | 88.76 | 107.34 |
| 1600. | 99.08 | 98.65 | 95.71 | 94.27 | 92.99 | 91.00 | 91.27 | 110.83 |
| 2000. | 99.67 | 99.10 | 97.20 | 95.63 | 94.31 | 92.88 | 93.07 | 111.78 |
| 2500. | 96.14 | 97.27 | 95.74 | 94.27 | 92.13 | 91.01 | 91.83 | 109.92 |
| 3150. | 90.45 | 92.70 | 91.30 | 89.49 | 88.10 | 87.24 | 88.29 | 105.40 |
| 4000. | 85.52 | 86.61 | 86.03 | 84.40 | 83.69 | 83.41 | 84.68 | 100.22 |
| 5000. | 81.00 | 82.74 | 82.42 | 81.64 | 81.57 | 81.67 | 82.60 | 97.24 |
| 6300. | 79.40 | 81.00 | 80.65 | 80.48 | 80.67 | 80.95 | 81.23 | 96.08 |
| 8000. | 78.91 | 81.42 | 80.59 | 80.70 | 80.90 | 80.99 | 80.94 | 96.07 |
| 10000. | 78.74 | 81.36 | 80.79 | 81.04 | 81.01 | 80.77 | 80.20 | 96.07 |
| 12500. | 78.31 | 81.24 | 81.05 | 81.20 | 80.80 | 80.74 | 80.18 | 96.07 |
| 16000. | 77.38 | 80.80 | 80.80 | 80.65 | 80.84 | 80.26 | 80.31 | 95.73 |
| 20000. | 75.18 | 79.35 | 79.60 | 79.37 | 79.30 | 78.60 | 79.00 | 94.30 |
| 25000. | 72.91 | 77.51 | 77.51 | 77.31 | 77.05 | 76.99 | 76.86 | 92.29 |
| 31500. | 69.51 | 75.29 | 74.72 | 74.94 | 74.11 | 73.98 | 74.46 | 89.69 |
| 40000. | 65.46 | 71.42 | 71.49 | 71.42 | 70.91 | 70.85 | 70.54 | 86.20 |

166

TOTAL POWER, DB = 117.57

NOZZLE DIA = 5.6"
 DIFFUSOR DIA = 8.0"
 FLOW TEMPERATURE, TOTAL = 530.0 DEG R
 MICROPHONE RADIUS = 6 FT.

NOZZLE-DIFFUSOR SPACING RATIO = 1.00
 MACH NO. = 0.90

MICROPHONE ANGLE, DEG

| FREQUENCY, Hz | SOUND POWER INTENSITY LEVEL, DB | | | | | | | TOTAL POWER, DB (1/3 OCTAVE BAND) |
|---------------|---------------------------------|--------|--------|-------|-------|-------|-------|--------------------------------------|
| | 30. | 45. | 60. | 75. | 90. | 105. | 120. | |
| 200. | 81.21 | 78.34 | 77.08 | 76.35 | 76.60 | 75.54 | 75.31 | 92.40 |
| 250. | 79.48 | 77.22 | 76.52 | 75.33 | 75.89 | 75.02 | 74.88 | 91.45 |
| 315. | 79.91 | 79.71 | 79.96 | 77.04 | 77.02 | 76.53 | 76.10 | 93.40 |
| 400. | 82.00 | 81.70 | 82.00 | 79.76 | 78.16 | 78.23 | 78.15 | 95.44 |
| 500. | 84.00 | 83.75 | 84.42 | 80.65 | 79.48 | 79.81 | 78.86 | 97.25 |
| 630. | 87.00 | 86.25 | 87.09 | 82.80 | 82.77 | 81.38 | 80.27 | 99.63 |
| 800. | 89.60 | 88.55 | 90.02 | 86.10 | 85.18 | 82.83 | 81.56 | 102.17 |
| 1000. | 92.00 | 91.43 | 92.51 | 88.82 | 86.36 | 84.03 | 83.73 | 104.64 |
| 1250. | 95.42 | 95.01 | 94.93 | 90.79 | 89.42 | 86.62 | 87.82 | 107.60 |
| 1600. | 98.85 | 98.46 | 96.71 | 94.34 | 93.60 | 90.60 | 91.14 | 110.87 |
| 2000. | 101.70 | 101.53 | 99.83 | 96.75 | 96.20 | 94.53 | 94.46 | 113.85 |
| 2500. | 102.06 | 102.57 | 100.86 | 98.08 | 96.19 | 95.47 | 95.17 | 114.79 |
| 3150. | 99.83 | 100.74 | 98.77 | 96.11 | 94.78 | 94.13 | 93.98 | 112.94 |
| 4000. | 96.44 | 96.17 | 95.04 | 92.61 | 91.21 | 90.87 | 91.06 | 109.01 |
| 5000. | 91.53 | 91.48 | 90.35 | 88.93 | 87.90 | 87.08 | 87.90 | 104.82 |
| 6300. | 88.02 | 88.19 | 87.57 | 86.26 | 85.92 | 85.58 | 84.92 | 102.00 |
| 8000. | 87.37 | 87.95 | 87.45 | 86.26 | 85.46 | 84.67 | 84.04 | 101.65 |
| 10000. | 86.91 | 88.22 | 88.03 | 86.32 | 85.58 | 84.41 | 83.73 | 101.77 |
| 12500. | 86.33 | 88.68 | 88.01 | 86.70 | 85.83 | 84.39 | 83.56 | 102.08 |
| 16000. | 86.06 | 88.76 | 88.75 | 86.95 | 85.94 | 84.13 | 83.76 | 102.15 |
| 20000. | 84.33 | 87.44 | 87.74 | 85.86 | 84.85 | 83.35 | 82.95 | 101.02 |
| 25000. | 81.71 | 85.80 | 85.66 | 83.83 | 83.00 | 81.24 | 81.18 | 99.10 |
| 31500. | 78.07 | 83.15 | 83.38 | 81.61 | 80.83 | 78.75 | 78.58 | 96.65 |
| 40000. | 74.11 | 80.43 | 80.73 | 78.62 | 77.58 | 76.01 | 75.61 | 93.79 |

TOTAL POWER, DB = 120.81

NOZZLE DIA = 5.6"
 DIFFUSOR DIA = 8.0"
 FLOW TEMPERATURE, TOTAL = 530.0 DEG R
 MICROPHONE RADIUS = 6 FT.

NOZZLE-DIFFUSOR SPACING RATIO = 1.00
 MACH NU. = 1.10

MICROPHONE ANGLE, DEG

| FREQUENCY, HZ | MICROPHONE ANGLE, DEG | | | | | | | TOTAL POWER, DB (1/3 OCTAVE BAND) |
|---------------|-----------------------|--------|--------|-------|-------|-------|-------|--------------------------------------|
| | 30. | 45. | 60. | 75. | 90. | 105. | 120. | |
| 200. | 81.42 | 81.14 | 80.97 | 79.47 | 80.85 | 79.51 | 79.74 | 95.55 |
| 250. | 82.51 | 80.55 | 79.23 | 79.05 | 79.01 | 77.44 | 77.22 | 94.55 |
| 315. | 83.35 | 81.80 | 81.46 | 80.28 | 79.64 | 77.96 | 76.60 | 95.67 |
| 400. | 83.24 | 82.40 | 83.22 | 81.31 | 80.79 | 78.74 | 78.14 | 96.59 |
| 500. | 84.01 | 82.20 | 83.00 | 81.78 | 79.96 | 79.01 | 78.98 | 96.64 |
| 630. | 85.94 | 83.78 | 84.80 | 83.58 | 81.10 | 80.04 | 79.63 | 96.22 |
| 800. | 86.18 | 86.88 | 86.55 | 85.50 | 83.07 | 81.01 | 80.35 | 100.38 |
| 1000. | 91.18 | 90.42 | 90.06 | 86.32 | 85.62 | 83.43 | 82.21 | 103.51 |
| 1250. | 94.63 | 94.16 | 92.95 | 90.56 | 88.86 | 86.81 | 84.90 | 106.72 |
| 1600. | 96.58 | 97.69 | 95.89 | 93.12 | 92.54 | 88.73 | 86.98 | 110.05 |
| 2000. | 101.97 | 101.67 | 99.79 | 96.82 | 94.76 | 92.81 | 94.02 | 113.83 |
| 2500. | 102.81 | 103.77 | 101.35 | 98.81 | 96.61 | 95.04 | 95.82 | 115.60 |
| 3150. | 102.69 | 103.37 | 100.74 | 98.14 | 96.42 | 94.93 | 95.71 | 115.19 |
| 4000. | 101.05 | 100.93 | 98.75 | 96.13 | 94.38 | 93.36 | 93.88 | 113.06 |
| 5000. | 97.95 | 96.84 | 95.16 | 92.85 | 91.46 | 90.84 | 90.78 | 109.51 |
| 6300. | 94.06 | 93.13 | 91.52 | 89.89 | 89.05 | 88.38 | 88.38 | 106.17 |
| 8000. | 92.82 | 92.09 | 91.11 | 89.53 | 88.60 | 87.32 | 87.57 | 105.36 |
| 10000. | 92.07 | 92.20 | 91.35 | 89.61 | 88.60 | 86.95 | 87.33 | 105.37 |
| 12500. | 91.45 | 92.76 | 92.25 | 90.21 | 88.86 | 86.78 | 87.28 | 105.75 |
| 16000. | 91.20 | 93.57 | 92.66 | 90.49 | 88.86 | 86.86 | 87.17 | 106.17 |
| 20000. | 90.20 | 93.16 | 92.25 | 90.00 | 88.41 | 85.92 | 86.30 | 105.66 |
| 25000. | 87.98 | 92.19 | 91.65 | 88.82 | 87.27 | 84.61 | 84.85 | 104.61 |
| 31500. | 85.71 | 90.64 | 90.35 | 87.45 | 85.62 | 83.04 | 83.21 | 103.10 |
| 40000. | 83.05 | 88.64 | 88.48 | 86.01 | 83.71 | 81.47 | 81.38 | 101.35 |

TOTAL POWER, DB = 122.36

168

NOZZLE DIA = 5.6"
 DIFFUSOR DIA = 8.0"
 FLOW TEMPERATURE, TOTAL = 530.0 DEG R
 MICROPHONE RADIUS = 6 FT.

NOZZLE-DIFFUSOR SPACING RATIO = 1.50
 MACH NO. = 0.70

| FREQUENCY, Hz | MICROPHONE ANGLE, DEG | | | | | | | TOTAL POWER, DB (1/3 OCTAVE BAND) |
|---------------|-----------------------|--------|--------|--------|--------|-------|-------|--------------------------------------|
| | 30. | 45. | 60. | 75. | 90. | 105. | 120. | |
| 200. | 78.99 | 78.99 | 78.30 | 78.44 | 78.97 | 78.43 | 78.03 | 93.81 |
| 250. | 81.36 | 81.59 | 79.50 | 79.29 | 78.98 | 80.14 | 79.48 | 95.41 |
| 315. | 86.15 | 86.42 | 86.01 | 84.66 | 83.56 | 84.25 | 82.45 | 100.29 |
| 400. | 88.14 | 88.32 | 88.03 | 86.90 | 85.67 | 84.83 | 84.15 | 102.09 |
| 500. | 92.22 | 90.48 | 89.61 | 89.79 | 87.58 | 87.17 | 86.48 | 104.52 |
| 630. | 96.31 | 96.19 | 93.33 | 92.10 | 90.01 | 88.76 | 89.52 | 108.39 |
| 800. | 102.12 | 100.38 | 98.14 | 97.15 | 94.27 | 92.37 | 92.55 | 112.90 |
| 1000. | 107.10 | 104.45 | 102.56 | 101.50 | 100.06 | 97.94 | 94.57 | 117.45 |
| 1250. | 108.51 | 105.46 | 104.71 | 102.41 | 100.65 | 99.21 | 97.48 | 118.68 |
| 1600. | 109.16 | 105.96 | 104.32 | 103.20 | 101.23 | 99.85 | 98.60 | 119.17 |
| 2000. | 105.49 | 103.74 | 101.66 | 100.23 | 98.50 | 97.19 | 98.77 | 116.51 |
| 2500. | 99.14 | 98.59 | 96.78 | 95.04 | 94.07 | 93.71 | 94.24 | 111.48 |
| 3150. | 92.54 | 94.01 | 92.15 | 90.86 | 89.31 | 89.29 | 89.32 | 106.78 |
| 4000. | 88.04 | 89.62 | 88.28 | 87.26 | 86.08 | 86.31 | 86.69 | 102.95 |
| 5000. | 85.32 | 87.21 | 86.31 | 85.56 | 84.69 | 85.12 | 85.40 | 101.07 |
| 6300. | 83.31 | 86.31 | 85.49 | 84.95 | 83.75 | 84.30 | 83.99 | 100.18 |
| 8000. | 83.13 | 86.18 | 85.67 | 84.84 | 83.89 | 84.17 | 83.45 | 100.10 |
| 10000. | 82.70 | 85.54 | 85.22 | 84.36 | 83.77 | 83.01 | 82.80 | 99.59 |
| 12500. | 81.83 | 85.03 | 84.90 | 84.25 | 83.59 | 83.17 | 82.08 | 99.23 |
| 16000. | 80.00 | 84.01 | 84.45 | 83.70 | 82.90 | 82.54 | 81.56 | 98.49 |
| 20000. | 77.85 | 82.01 | 82.99 | 82.58 | 81.32 | 81.08 | 80.52 | 97.12 |
| 25000. | 75.77 | 80.64 | 80.69 | 80.44 | 79.17 | 78.81 | 78.21 | 95.00 |
| 31500. | 74.07 | 78.22 | 78.48 | 78.04 | 76.38 | 76.72 | 76.60 | 92.67 |
| 40000. | 73.26 | 74.09 | 75.81 | 75.01 | 74.04 | 74.32 | 74.23 | 89.73 |

TOTAL POWER, DB = 125.02

NOZZLE DIA = 5.6"
 DIFFUSOR DIA = 6.0"
 FLOW TEMPERATURE, TOTAL = 530.0 DEG K
 MICROPHONE RADIUS = 6 FT.

NOZZLE-DIFFUSOR SPACING RATIO = 1.50
 MACH NO. = 0.90

AEDC-TR-80-15

MICROPHONE ANGLE, DEG

| FREQUENCY, HZ | 30. | 45. | 60. | 75. | 90. | 105. | 120. | TOTAL POWER, DB (1/3 OCTAVE BAND) |
|---------------|---------------------------------|--------|--------|--------|--------|--------|--------|--------------------------------------|
| | SOUND POWER INTENSITY LEVEL, DB | | | | | | | |
| 200. | 79.71 | 78.74 | 78.21 | 79.01 | 78.20 | 78.53 | 79.06 | 93.91 |
| 250. | 80.80 | 79.88 | 79.22 | 80.50 | 79.94 | 79.59 | 78.80 | 95.10 |
| 315. | 84.18 | 85.06 | 83.54 | 82.11 | 82.25 | 82.35 | 80.45 | 98.41 |
| 400. | 87.94 | 87.59 | 86.60 | 85.19 | 84.55 | 83.78 | 82.16 | 101.00 |
| 500. | 93.74 | 92.96 | 93.26 | 91.44 | 88.89 | 89.71 | 86.09 | 106.75 |
| 630. | 102.56 | 100.86 | 99.87 | 97.32 | 94.82 | 93.88 | 90.35 | 113.60 |
| 800. | 102.85 | 101.62 | 100.95 | 98.10 | 94.96 | 94.29 | 91.23 | 114.29 |
| 1000. | 104.00 | 102.81 | 102.22 | 99.21 | 96.57 | 95.84 | 93.26 | 115.53 |
| 1250. | 109.35 | 106.61 | 105.46 | 103.11 | 101.23 | 99.56 | 97.58 | 119.54 |
| 1600. | 111.02 | 108.82 | 106.54 | 105.36 | 101.69 | 102.83 | 99.55 | 121.45 |
| 2000. | 110.84 | 108.24 | 105.14 | 103.54 | 101.71 | 101.34 | 100.05 | 120.68 |
| 2500. | 107.74 | 106.21 | 103.05 | 100.76 | 99.89 | 99.22 | 98.02 | 118.36 |
| 3150. | 101.97 | 102.09 | 99.49 | 97.41 | 96.92 | 96.40 | 95.47 | 114.43 |
| 4000. | 97.03 | 97.33 | 95.30 | 93.94 | 93.51 | 92.69 | 92.99 | 110.21 |
| 5000. | 93.29 | 93.76 | 92.69 | 91.48 | 91.05 | 90.95 | 90.83 | 107.37 |
| 6300. | 91.21 | 92.51 | 91.49 | 90.10 | 90.05 | 89.85 | 88.66 | 106.06 |
| 8000. | 91.22 | 92.50 | 91.49 | 90.19 | 89.75 | 89.44 | 87.64 | 105.94 |
| 10000. | 90.85 | 92.31 | 91.74 | 90.02 | 89.33 | 88.96 | 86.82 | 105.73 |
| 12500. | 90.04 | 92.55 | 91.55 | 90.17 | 89.29 | 88.30 | 86.69 | 105.66 |
| 16000. | 88.85 | 91.92 | 91.04 | 90.13 | 88.73 | 87.45 | 85.98 | 105.12 |
| 20000. | 86.06 | 90.39 | 89.90 | 88.69 | 87.35 | 86.15 | 84.65 | 103.68 |
| 25000. | 82.58 | 87.92 | 87.61 | 86.67 | 85.15 | 83.96 | 82.42 | 101.38 |
| 31500. | 79.16 | 85.12 | 84.62 | 83.45 | 82.18 | 81.59 | 79.68 | 98.49 |
| 40000. | 75.30 | 81.76 | 81.38 | 80.86 | 79.41 | 77.62 | 76.19 | 95.29 |

TOTAL POWER, DB = 127.59

170

NOZZLE DIA = 5.6"
 DIFFUSOR DIA = 6.0"
 FLOW TEMPERATURE, TOTAL = 530.0 DEG R
 MICROPHONE RADIUS = 0 FT.

NOZZLE-DIFFUSOR SPACING RATIO = 1.50
 MACH NO. = 1.10

| FREQUENCY, HZ | MICROPHONE ANGLE, DEG | | | | | | | TOTAL POWER, DB (1/3 OCTAVE BAND) |
|---------------|-----------------------|--------|--------|--------|--------|--------|--------|--------------------------------------|
| | 30. | 45. | 60. | 75. | 90. | 105. | 120. | |
| 200. | 82.51 | 81.85 | 80.90 | 81.51 | 80.95 | 80.46 | 80.35 | 96.45 |
| 250. | 83.58 | 81.50 | 81.41 | 80.89 | 79.30 | 79.76 | 79.08 | 96.04 |
| 315. | 85.48 | 83.58 | 84.52 | 83.11 | 81.52 | 80.83 | 79.14 | 96.08 |
| 400. | 87.44 | 87.81 | 86.93 | 85.97 | 83.92 | 82.47 | 80.09 | 100.99 |
| 500. | 90.42 | 90.13 | 88.27 | 87.75 | 85.06 | 83.86 | 82.88 | 102.95 |
| 630. | 94.30 | 93.92 | 92.07 | 90.67 | 88.29 | 86.58 | 85.35 | 106.44 |
| 800. | 99.18 | 97.39 | 96.45 | 95.43 | 92.21 | 89.55 | 88.89 | 110.47 |
| 1000. | 102.80 | 101.23 | 100.63 | 97.72 | 95.25 | 93.22 | 92.18 | 113.97 |
| 1250. | 106.90 | 104.89 | 103.68 | 100.13 | 99.31 | 96.38 | 95.60 | 117.39 |
| 1600. | 109.90 | 107.79 | 105.26 | 103.43 | 100.69 | 99.99 | 99.08 | 120.15 |
| 2000. | 110.91 | 109.10 | 106.47 | 104.39 | 102.59 | 101.63 | 102.62 | 121.44 |
| 2500. | 109.18 | 108.31 | 105.52 | 103.70 | 101.57 | 101.75 | 101.80 | 120.58 |
| 3150. | 106.00 | 106.45 | 103.50 | 101.74 | 100.12 | 100.22 | 99.59 | 118.57 |
| 4000. | 102.62 | 103.38 | 100.59 | 98.07 | 97.32 | 97.43 | 97.56 | 115.50 |
| 5000. | 100.27 | 100.00 | 98.18 | 95.35 | 95.10 | 95.45 | 95.41 | 112.73 |
| 6300. | 98.99 | 99.21 | 96.79 | 94.47 | 93.83 | 93.61 | 93.32 | 111.57 |
| 8000. | 96.54 | 99.07 | 96.80 | 94.61 | 93.70 | 93.29 | 92.31 | 111.41 |
| 10000. | 97.77 | 99.04 | 96.80 | 94.61 | 93.63 | 92.96 | 91.74 | 111.26 |
| 12500. | 96.69 | 98.83 | 96.87 | 94.62 | 93.50 | 92.32 | 91.42 | 111.04 |
| 16000. | 95.54 | 97.80 | 96.49 | 94.31 | 93.12 | 91.87 | 90.85 | 110.36 |
| 20000. | 93.05 | 96.57 | 95.67 | 93.24 | 92.10 | 90.73 | 89.59 | 109.15 |
| 25000. | 89.62 | 94.07 | 93.77 | 91.60 | 90.13 | 88.31 | 87.56 | 106.95 |
| 31500. | 85.93 | 91.70 | 91.68 | 89.13 | 88.23 | 85.77 | 84.90 | 104.61 |
| 40000. | 83.31 | 88.44 | 88.58 | 86.41 | 86.01 | 82.79 | 81.99 | 101.62 |

TOTAL POWER, DB = 128.24

171

NOZZLE DIA = 5.6"
 DIFFUSOR DIA = 8.0"
 FLOW TEMPERATURE, TOTAL = 1210.0 DEG R
 MICROPHONE RADIUS = 6 FT.

NOZZLE-DIFFUSOR SPACING RATIO = 0.50
 MACH NU. = 0.70

| | | | | | | | | |
|--------|-------|-------|-------|-------|-------|-------|-------|--------|
| 200. | 77.30 | 77.25 | 78.49 | 78.83 | 78.99 | 77.53 | 77.24 | 93.24 |
| 250. | 77.74 | 77.87 | 77.86 | 78.03 | 79.31 | 78.34 | 78.94 | 93.44 |
| 315. | 80.48 | 80.28 | 79.23 | 79.00 | 80.52 | 80.42 | 80.25 | 95.18 |
| 400. | 82.25 | 82.25 | 81.72 | 80.74 | 81.41 | 81.61 | 81.81 | 96.82 |
| 500. | 82.68 | 82.04 | 84.22 | 83.49 | 82.16 | 83.50 | 83.76 | 98.33 |
| 630. | 85.04 | 82.41 | 84.17 | 84.79 | 83.44 | 84.70 | 85.20 | 99.35 |
| 800. | 84.77 | 83.68 | 83.87 | 84.05 | 84.20 | 84.42 | 86.19 | 99.43 |
| 1000. | 84.43 | 84.17 | 84.46 | 84.45 | 84.71 | 84.66 | 87.63 | 99.91 |
| 1250. | 85.12 | 84.10 | 84.73 | 84.47 | 84.14 | 85.47 | 87.85 | 100.12 |
| 1600. | 85.81 | 84.98 | 85.25 | 84.18 | 84.45 | 85.89 | 87.76 | 100.46 |
| 2000. | 86.94 | 86.81 | 85.71 | 85.02 | 85.40 | 85.81 | 88.43 | 101.29 |
| 2500. | 87.64 | 86.20 | 86.36 | 85.94 | 85.86 | 86.30 | 88.92 | 102.14 |
| 3150. | 88.45 | 85.59 | 86.44 | 86.09 | 86.62 | 87.49 | 89.59 | 103.02 |
| 4000. | 89.01 | 89.84 | 86.52 | 86.17 | 86.93 | 87.60 | 89.69 | 103.21 |
| 5000. | 86.69 | 88.04 | 85.90 | 84.86 | 86.17 | 87.33 | 89.28 | 102.11 |
| 6300. | 82.39 | 85.03 | 83.63 | 83.10 | 84.46 | 86.36 | 87.40 | 100.09 |
| 8000. | 79.42 | 82.02 | 82.06 | 81.73 | 83.24 | 85.19 | 85.27 | 96.34 |
| 10000. | 77.87 | 80.28 | 80.42 | 80.86 | 82.23 | 84.09 | 83.83 | 97.10 |
| 12500. | 77.41 | 80.78 | 80.88 | 81.33 | 82.36 | 83.43 | 83.23 | 97.04 |
| 16000. | 77.46 | 81.92 | 81.59 | 82.05 | 82.42 | 82.78 | 83.52 | 97.32 |
| 20000. | 76.42 | 81.97 | 82.00 | 81.94 | 81.34 | 81.67 | 82.92 | 96.91 |
| 25000. | 75.89 | 81.25 | 82.33 | 80.89 | 80.01 | 80.83 | 81.10 | 96.10 |
| 31500. | 73.70 | 80.09 | 81.20 | 79.51 | 78.86 | 79.53 | 78.97 | 94.79 |
| 40000. | 72.08 | 78.87 | 78.92 | 77.88 | 77.66 | 77.16 | 77.86 | 93.09 |

TOTAL POWER, DB = 113.04

NOZZLE DIA = 5.6"
 DIFFUSOR DIA = 8.0"
 FLOW TEMPERATURE, TOTAL = 1210.0 DEG R
 MICROPHONE RADIUS = 6 FT.

NOZZLE-DIFFUSOR SPACING RATIO = 1.00
 MACH NO. = 0.70

| | | | | | | | | |
|--------|--------|--------|--------|--------|--------|--------|--------|--------|
| 200. | 85.50 | 85.19 | 85.58 | 85.42 | 81.98 | 80.40 | 85.32 | 100.58 |
| 250. | 86.00 | 86.57 | 86.50 | 86.76 | 82.32 | 87.98 | 86.38 | 101.86 |
| 315. | 88.11 | 89.53 | 88.57 | 89.73 | 83.61 | 88.80 | 86.41 | 103.89 |
| 400. | 88.72 | 91.86 | 90.63 | 90.80 | 84.27 | 89.87 | 89.11 | 105.48 |
| 500. | 92.70 | 94.95 | 93.46 | 94.36 | 87.79 | 92.34 | 92.39 | 108.60 |
| 630. | 98.85 | 101.02 | 97.19 | 99.12 | 92.14 | 96.79 | 97.33 | 113.99 |
| 800. | 101.94 | 105.48 | 102.31 | 103.69 | 95.98 | 100.21 | 100.16 | 118.01 |
| 1000. | 103.95 | 107.49 | 104.31 | 105.08 | 98.74 | 101.47 | 99.88 | 119.73 |
| 1250. | 109.79 | 111.35 | 109.18 | 107.93 | 102.45 | 105.09 | 101.88 | 123.55 |
| 1600. | 119.57 | 122.47 | 118.62 | 117.85 | 104.00 | 114.57 | 102.87 | 133.60 |
| 2000. | 123.04 | 125.82 | 122.03 | 119.62 | 107.84 | 118.19 | 104.37 | 136.94 |
| 2500. | 113.01 | 115.59 | 111.25 | 112.17 | 111.86 | 110.15 | 104.34 | 127.85 |
| 3150. | 103.43 | 110.39 | 106.00 | 107.45 | 106.29 | 104.60 | 104.05 | 122.58 |
| 4000. | 103.53 | 108.38 | 103.23 | 106.55 | 97.90 | 101.91 | 105.80 | 120.65 |
| 5000. | 99.55 | 102.42 | 99.06 | 100.56 | 94.99 | 97.69 | 101.76 | 115.31 |
| 6300. | 94.50 | 97.09 | 94.14 | 95.53 | 93.68 | 93.23 | 96.76 | 110.46 |
| 8000. | 92.55 | 95.47 | 93.40 | 94.50 | 94.56 | 91.81 | 93.22 | 109.21 |
| 10000. | 91.69 | 94.41 | 93.18 | 93.85 | 93.52 | 90.84 | 91.85 | 108.35 |
| 12500. | 91.99 | 93.81 | 93.53 | 93.40 | 92.01 | 90.51 | 91.06 | 107.87 |
| 16000. | 90.75 | 93.27 | 92.86 | 93.14 | 91.20 | 89.67 | 89.82 | 107.27 |
| 20000. | 88.04 | 92.41 | 91.88 | 92.24 | 89.63 | 88.38 | 89.27 | 106.22 |
| 25000. | 85.98 | 90.84 | 90.63 | 91.02 | 88.06 | 86.58 | 88.54 | 104.79 |
| 31500. | 85.50 | 89.15 | 89.40 | 88.85 | 85.84 | 84.79 | 87.17 | 103.03 |
| 40000. | 84.13 | 87.46 | 87.33 | 85.85 | 83.82 | 83.18 | 85.17 | 100.93 |

TOTAL POWER, DB = 139.42

NOZZLE DIA = 5.6"
 DIFFUSOR DIA = 8.0"
 FLOW TEMPERATURE, TOTAL = 1210.0 DEG R
 MICROPHONE RADIUS = 6 FT.

NOZZLE-DIFFUSOR SPACING RATIO = 1.50
 MACH NO. = 0.70

MICROPHONE ANGLE, DEG

| FREQUENCY, HZ | MICROPHONE ANGLE, DEG | | | | | | | TOTAL POWER, DB (1/3 OCTAVE BAND) |
|---------------|-----------------------|--------|--------|--------|--------|--------|--------|--------------------------------------|
| | 30. | 45. | 60. | 75. | 90. | 105. | 120. | |
| 200. | 85.02 | 93.58 | 93.69 | 93.65 | 93.62 | 88.18 | 88.68 | 107.60 |
| 250. | 90.54 | 95.22 | 94.80 | 94.29 | 94.30 | 90.11 | 89.82 | 108.83 |
| 315. | 96.66 | 98.32 | 98.39 | 96.27 | 97.58 | 93.94 | 91.26 | 111.94 |
| 400. | 101.76 | 101.66 | 100.77 | 99.85 | 98.83 | 96.63 | 95.25 | 115.03 |
| 500. | 104.31 | 105.09 | 103.21 | 102.91 | 100.71 | 99.56 | 99.69 | 118.02 |
| 630. | 107.44 | 109.03 | 107.18 | 107.44 | 105.78 | 104.24 | 105.08 | 122.25 |
| 800. | 113.43 | 112.26 | 111.27 | 109.80 | 108.68 | 106.87 | 105.32 | 125.47 |
| 1000. | 117.03 | 117.46 | 117.02 | 112.68 | 112.15 | 111.78 | 108.17 | 130.10 |
| 1250. | 120.96 | 127.16 | 127.78 | 119.18 | 122.24 | 121.59 | 113.87 | 139.34 |
| 1600. | 126.13 | 126.08 | 127.30 | 116.38 | 121.13 | 121.67 | 113.41 | 136.81 |
| 2000. | 121.74 | 119.63 | 118.75 | 112.82 | 115.57 | 112.16 | 110.54 | 132.14 |
| 2500. | 114.36 | 115.92 | 114.40 | 113.98 | 112.62 | 108.63 | 108.56 | 126.78 |
| 3150. | 109.71 | 112.91 | 111.00 | 111.24 | 110.56 | 105.54 | 106.51 | 125.60 |
| 4000. | 106.60 | 107.67 | 104.74 | 104.86 | 105.00 | 101.75 | 103.70 | 120.48 |
| 5000. | 102.34 | 102.94 | 101.59 | 100.56 | 100.59 | 99.36 | 100.96 | 116.44 |
| 6300. | 98.59 | 100.75 | 100.67 | 99.16 | 98.59 | 97.28 | 97.90 | 114.48 |
| 8000. | 96.75 | 99.52 | 100.25 | 99.17 | 97.67 | 96.04 | 95.92 | 113.65 |
| 10000. | 95.29 | 98.16 | 99.20 | 98.41 | 96.75 | 94.91 | 94.38 | 112.57 |
| 12500. | 93.04 | 97.89 | 98.02 | 97.20 | 95.97 | 93.79 | 92.65 | 111.66 |
| 16000. | 91.54 | 97.11 | 97.41 | 96.19 | 95.63 | 92.86 | 91.49 | 110.84 |
| 20000. | 89.26 | 95.32 | 96.42 | 95.31 | 95.03 | 91.74 | 89.89 | 109.93 |
| 25000. | 86.65 | 95.35 | 95.44 | 94.68 | 94.30 | 90.68 | 89.05 | 109.05 |
| 31500. | 84.87 | 94.63 | 95.02 | 94.05 | 93.83 | 89.44 | 88.41 | 108.37 |
| 40000. | 84.24 | 94.29 | 94.35 | 93.16 | 93.42 | 88.44 | 87.19 | 107.75 |

TOTAL POWER, DB = 143.21

NOZZLE DIA = 5.6"
 DIFFUSOR DIA = 8.0"
 FLOW TEMPERATURE, TOTAL = 1210.0 DEG R
 MICROPHONE RADIUS = 6 FT.

NOZZLE-DIFFUSOR SPACING RATIO = 1.50
 MACH NO. = 0.70

| FREQUENCY, HZ | MICROPHONE ANGLE, DEG | | | | | | | TOTAL POWER, DB. (1/3 OCTAVE BAND) |
|-------------------|-----------------------|--------|--------|--------|--------|--------|--------|---------------------------------------|
| | 30. | 45. | 60. | 75. | 90. | 105. | 120. | |
| 200. | 85.77 | 93.71 | 93.69 | 93.98 | 93.94 | 88.31 | 88.68 | 107.80 |
| 250. | 92.16 | 94.88 | 94.55 | 94.23 | 93.80 | 89.05 | 89.43 | 108.56 |
| 315. | 96.94 | 97.90 | 98.21 | 95.61 | 97.86 | 94.69 | 92.02 | 111.83 |
| 400. | 102.49 | 102.01 | 101.23 | 99.79 | 98.61 | 96.07 | 96.34 | 115.21 |
| 500. | 104.28 | 104.33 | 102.78 | 103.65 | 100.00 | 99.07 | 99.25 | 117.84 |
| 630. | 106.20 | 109.65 | 107.84 | 108.47 | 106.23 | 104.74 | 106.89 | 122.91 |
| 800. | 115.77 | 112.48 | 111.63 | 110.04 | 110.04 | 107.52 | 106.23 | 126.14 |
| 1000. | 117.43 | 114.30 | 114.71 | 110.92 | 108.24 | 107.94 | 103.41 | 127.58 |
| 1250. | 121.20 | 135.18 | 137.17 | 123.68 | 129.91 | 130.50 | 119.97 | 147.58 |
| 1600. | 129.49 | 127.29 | 129.62 | 116.55 | 122.82 | 123.99 | 113.13 | 140.73 |
| 2000. | 124.52 | 113.29 | 111.49 | 109.67 | 108.58 | 108.00 | 108.39 | 129.45 |
| 2500. | 111.26 | 120.33 | 118.34 | 118.24 | 116.85 | 110.84 | 110.92 | 132.60 |
| 3150. | 111.00 | 113.40 | 111.80 | 111.68 | 110.97 | 105.22 | 105.42 | 126.27 |
| 4000. | 107.18 | 106.67 | 104.06 | 105.13 | 105.41 | 101.51 | 104.82 | 120.24 |
| 5000. | 101.70 | 102.10 | 101.99 | 100.79 | 100.16 | 99.00 | 100.02 | 116.10 |
| 6300. | 97.88 | 100.22 | 100.94 | 99.58 | 98.30 | 97.20 | 97.13 | 114.37 |
| 8000. | 97.11 | 99.98 | 100.77 | 99.56 | 97.70 | 96.22 | 95.58 | 114.01 |
| 10000. | 95.14 | 97.71 | 99.21 | 98.72 | 96.67 | 94.80 | 94.16 | 112.52 |
| 12500. | 93.87 | 97.81 | 98.22 | 97.89 | 96.02 | 93.83 | 92.29 | 111.87 |
| 16000. | 92.02 | 97.00 | 97.48 | 96.60 | 95.56 | 93.04 | 91.25 | 110.94 |
| 20000. | 89.60 | 96.13 | 96.75 | 95.82 | 95.16 | 91.87 | 89.96 | 110.10 |
| 25000. | 86.80 | 96.10 | 95.57 | 94.80 | 94.37 | 90.83 | 89.17 | 109.37 |
| 31500. | 84.70 | 94.65 | 95.15 | 94.72 | 93.91 | 89.67 | 88.52 | 108.62 |
| 40000. | 84.70 | 94.04 | 93.78 | 93.82 | 93.51 | 88.18 | 86.97 | 107.75 |
| TOTAL POWER, DB = | | | | | | | | 148.68 |

177

NOZZLE DIA = 5.6"
 DIFFUSOR DIA = 12.0"
 FLOW TEMPERATURE, TOTAL = 530.0 DEG R
 MICROPHONE RADIUS = 6 FT.

NOZZLE-DIFFUSOR SPACING RATIO = 0.00
 MACH NO. = 1.10

AEDC-TR-80-15

MICROPHONE ANGLE, DEG

| FREQUENCY, HZ | 30. | 45. | 60. | 75. | 90. | 105. | 120. | TOTAL POWER, DB (1/3 OCTAVE BAND) |
|---------------|---------------------------------|-------|-------|-------|-------|-------|-------|--------------------------------------|
| | SOUND POWER INTENSITY LEVEL, DB | | | | | | | |
| 200. | 85.44 | 84.25 | 83.15 | 84.52 | 82.99 | 82.27 | 83.98 | 98.95 |
| 250. | 85.71 | 83.14 | 83.25 | 83.09 | 82.23 | 82.93 | 81.86 | 98.33 |
| 315. | 85.46 | 84.19 | 83.40 | 84.34 | 83.43 | 83.85 | 82.02 | 99.16 |
| 400. | 85.54 | 85.31 | 82.35 | 83.99 | 83.37 | 83.49 | 82.18 | 99.22 |
| 500. | 84.79 | 83.23 | 82.38 | 82.62 | 82.04 | 82.69 | 83.11 | 98.06 |
| 630. | 82.58 | 81.66 | 82.85 | 83.68 | 82.16 | 83.42 | 84.05 | 98.13 |
| 800. | 84.24 | 82.91 | 83.84 | 84.16 | 83.75 | 85.36 | 85.67 | 99.44 |
| 1000. | 86.16 | 85.63 | 86.60 | 86.24 | 86.67 | 87.17 | 86.73 | 101.64 |
| 1250. | 85.41 | 83.62 | 83.32 | 83.59 | 84.13 | 85.60 | 85.62 | 99.58 |
| 1600. | 83.21 | 82.18 | 80.68 | 81.01 | 81.78 | 82.82 | 83.30 | 97.24 |
| 2000. | 84.61 | 84.00 | 82.93 | 80.91 | 81.85 | 82.14 | 82.71 | 97.86 |
| 2500. | 84.88 | 84.03 | 82.90 | 81.02 | 82.04 | 82.42 | 82.68 | 97.97 |
| 3150. | 84.77 | 83.11 | 82.23 | 80.61 | 81.72 | 83.09 | 83.93 | 97.78 |
| 4000. | 85.35 | 84.10 | 82.89 | 81.22 | 82.73 | 84.71 | 85.88 | 98.90 |
| 5000. | 84.98 | 85.09 | 83.94 | 81.82 | 83.75 | 86.58 | 87.76 | 100.12 |
| 6300. | 83.34 | 84.93 | 83.78 | 82.05 | 84.32 | 87.63 | 88.43 | 100.51 |
| 8000. | 83.04 | 85.02 | 84.19 | 82.22 | 84.32 | 88.29 | 88.98 | 100.69 |
| 10000. | 83.31 | 85.57 | 83.39 | 81.23 | 84.07 | 87.61 | 88.32 | 100.50 |
| 12500. | 81.92 | 84.83 | 82.59 | 79.54 | 82.99 | 86.17 | 87.28 | 99.34 |
| 16000. | 81.81 | 84.74 | 83.19 | 79.19 | 82.42 | 86.20 | 87.44 | 99.32 |
| 20000. | 82.39 | 86.16 | 84.94 | 80.00 | 82.29 | 87.37 | 88.75 | 100.51 |
| 25000. | 82.98 | 85.63 | 85.41 | 79.77 | 81.78 | 87.84 | 88.73 | 100.57 |
| 31500. | 82.48 | 83.87 | 85.06 | 79.49 | 81.85 | 86.38 | 86.32 | 100.34 |
| 40000. | 78.94 | 81.10 | 83.05 | 77.67 | 81.08 | 87.45 | 87.85 | 98.99 |

TOTAL POWER, DB = 113.26

178

NOZZLE DIA = 5.6"
 DIFFUSOR DIA = 12.0"
 FLOW TEMPERATURE, TOTAL = 530.0 DEG R
 MICROPHONE RADIUS = 6 FT.

NOZZLE-DIFFUSOR SPACING RATIO = 0.50
 MACH NU. = 1.10

| | | | | | | | | |
|--------|-------|-------|-------|-------|-------|-------|-------|--------|
| 200. | 84.02 | 84.81 | 82.02 | 83.61 | 84.85 | 83.90 | 83.73 | 99.19 |
| 250. | 84.17 | 84.43 | 81.70 | 81.85 | 82.44 | 82.07 | 81.35 | 97.96 |
| 315. | 85.59 | 84.54 | 82.84 | 83.60 | 82.78 | 82.79 | 81.84 | 96.76 |
| 400. | 85.56 | 84.21 | 83.92 | 82.80 | 82.22 | 83.13 | 82.90 | 98.68 |
| 500. | 82.98 | 83.18 | 82.57 | 81.36 | 80.56 | 82.84 | 82.81 | 97.59 |
| 630. | 81.16 | 80.51 | 80.02 | 81.90 | 80.98 | 82.61 | 83.43 | 96.79 |
| 800. | 81.38 | 80.43 | 79.38 | 81.29 | 81.19 | 82.44 | 84.87 | 96.72 |
| 1000. | 84.26 | 81.69 | 82.30 | 82.34 | 82.92 | 83.35 | 86.57 | 98.19 |
| 1250. | 83.21 | 81.11 | 82.11 | 82.11 | 81.79 | 82.93 | 85.08 | 97.56 |
| 1600. | 81.83 | 80.72 | 80.57 | 80.16 | 80.09 | 81.99 | 82.26 | 96.20 |
| 2000. | 81.60 | 81.73 | 80.75 | 79.81 | 80.43 | 81.31 | 81.53 | 96.18 |
| 2500. | 82.07 | 81.91 | 80.88 | 80.60 | 80.76 | 81.40 | 82.15 | 96.51 |
| 3150. | 82.29 | 81.71 | 80.68 | 80.57 | 81.15 | 82.13 | 83.34 | 96.75 |
| 4000. | 82.82 | 83.16 | 81.44 | 80.79 | 82.38 | 84.19 | 85.03 | 98.07 |
| 5000. | 83.74 | 84.49 | 82.77 | 81.52 | 83.48 | 85.93 | 86.86 | 99.45 |
| 6300. | 82.81 | 84.36 | 83.28 | 81.81 | 83.88 | 87.10 | 88.30 | 100.06 |
| 8000. | 82.27 | 84.54 | 84.16 | 82.28 | 84.08 | 87.44 | 88.60 | 100.39 |
| 10000. | 82.16 | 84.46 | 83.58 | 81.42 | 83.40 | 86.64 | 88.00 | 99.80 |
| 12500. | 81.43 | 83.95 | 82.05 | 80.30 | 82.27 | 85.70 | 87.22 | 98.90 |
| 16000. | 81.64 | 84.45 | 82.68 | 79.75 | 82.34 | 84.77 | 87.07 | 96.72 |
| 20000. | 82.75 | 86.34 | 84.01 | 79.78 | 82.62 | 84.28 | 87.75 | 99.47 |
| 25000. | 83.09 | 86.72 | 85.47 | 79.81 | 81.42 | 83.67 | 87.85 | 99.61 |
| 31500. | 83.24 | 86.71 | 85.59 | 79.58 | 80.80 | 83.43 | 88.15 | 99.58 |
| 40000. | 81.11 | 84.53 | 83.22 | 77.94 | 78.91 | 81.10 | 87.17 | 97.58 |

TOTAL POWER, Db = 112.26

NOZZLE DIA = 5.6"
 DIFFUSOR DIA = 12.0"
 FLOW TEMPERATURE, TOTAL = 530.0 DEG R
 MICROPHONE RADIUS = 6 FT.

NOZZLE-DIFFUSOR SPACING RATIO = 1.50
 MACH NO. = 1.10

180

| | | | | | | | | |
|--------|-------|-------|-------|-------|-------|-------|-------|--------|
| 200. | 85.92 | 85.43 | 84.69 | 85.35 | 84.18 | 84.00 | 84.77 | 100.10 |
| 250. | 85.39 | 85.22 | 82.45 | 83.87 | 81.40 | 82.22 | 83.69 | 98.85 |
| 315. | 86.69 | 85.51 | 83.53 | 84.17 | 82.95 | 84.05 | 83.49 | 99.64 |
| 400. | 86.28 | 85.74 | 84.61 | 84.47 | 83.23 | 83.15 | 83.23 | 99.69 |
| 500. | 85.29 | 84.76 | 83.96 | 83.69 | 82.67 | 82.95 | 83.34 | 99.01 |
| 630. | 86.54 | 86.01 | 84.92 | 84.49 | 83.85 | 83.21 | 83.98 | 99.93 |
| 800. | 89.25 | 88.02 | 87.84 | 86.96 | 85.71 | 85.30 | 85.88 | 102.21 |
| 1000. | 91.63 | 90.55 | 91.67 | 90.25 | 88.41 | 88.67 | 87.97 | 105.22 |
| 1250. | 93.52 | 92.76 | 92.43 | 90.55 | 88.94 | 89.43 | 88.55 | 106.37 |
| 1600. | 94.12 | 93.37 | 91.59 | 90.59 | 89.54 | 89.17 | 88.41 | 106.53 |
| 2000. | 93.58 | 93.21 | 90.89 | 89.43 | 89.56 | 88.84 | 88.53 | 106.10 |
| 2500. | 92.03 | 91.53 | 89.22 | 88.45 | 88.82 | 88.84 | 88.34 | 104.95 |
| 3150. | 90.73 | 89.85 | 88.89 | 89.07 | 86.97 | 89.03 | 88.78 | 104.50 |
| 4000. | 91.15 | 90.27 | 89.59 | 89.43 | 89.44 | 89.78 | 89.28 | 105.01 |
| 5000. | 91.62 | 91.20 | 90.54 | 89.93 | 90.54 | 90.73 | 89.97 | 105.84 |
| 6300. | 91.47 | 91.62 | 90.92 | 90.54 | 91.71 | 91.11 | 90.49 | 106.34 |
| 8000. | 91.12 | 92.23 | 91.87 | 91.22 | 91.86 | 90.85 | 90.92 | 106.70 |
| 10000. | 90.20 | 92.59 | 92.06 | 91.21 | 91.25 | 90.07 | 90.34 | 106.55 |
| 12500. | 89.41 | 92.69 | 91.99 | 91.06 | 91.02 | 89.43 | 90.02 | 106.37 |
| 16000. | 89.83 | 93.18 | 92.24 | 90.85 | 90.59 | 89.49 | 90.40 | 106.52 |
| 20000. | 89.99 | 93.60 | 92.42 | 90.51 | 89.79 | 88.85 | 90.33 | 106.47 |
| 25000. | 89.70 | 93.13 | 91.91 | 89.73 | 88.47 | 87.38 | 89.17 | 105.74 |
| 31500. | 87.59 | 91.70 | 90.43 | 87.86 | 86.58 | 85.40 | 87.45 | 104.09 |
| 40000. | 85.27 | 89.76 | 87.81 | 85.55 | 84.69 | 82.90 | 85.07 | 101.91 |

TOTAL POWER, D6 = 118.51

NOZZLE DIA = 5.6"
 DIFFUSOR DIA = 12.0"
 FLOW TEMPERATURE, TOTAL = 1210.0 DEG R
 MICROPHONE RADIUS = 6 FT.

NOZZLE-DIFFUSOR SPACING RATIO = 0.00
 MACH NO. = 0.70

| | | | | | | | | |
|--------|-------|-------|-------|-------|-------|-------|-------|--------|
| 200. | 84.74 | 82.52 | 82.63 | 82.40 | 85.80 | 83.23 | 81.92 | 98.47 |
| 250. | 83.45 | 83.27 | 83.81 | 81.99 | 86.46 | 85.23 | 84.54 | 99.34 |
| 315. | 86.39 | 84.01 | 86.07 | 82.60 | 87.74 | 85.87 | 86.24 | 100.51 |
| 400. | 88.93 | 85.70 | 87.32 | 83.27 | 85.77 | 87.48 | 86.10 | 101.44 |
| 500. | 88.73 | 86.70 | 87.47 | 84.52 | 85.53 | 88.63 | 87.11 | 102.18 |
| 630. | 90.39 | 86.61 | 88.20 | 89.11 | 88.98 | 89.29 | 90.55 | 103.98 |
| 800. | 92.10 | 87.74 | 88.16 | 89.72 | 90.64 | 89.94 | 93.15 | 105.04 |
| 1000. | 91.71 | 88.10 | 89.08 | 89.43 | 91.16 | 90.46 | 93.91 | 105.36 |
| 1250. | 91.82 | 89.22 | 89.36 | 88.96 | 90.72 | 92.19 | 94.53 | 105.97 |
| 1600. | 91.82 | 90.73 | 90.28 | 88.55 | 90.48 | 92.72 | 94.76 | 106.43 |
| 2000. | 90.65 | 90.45 | 89.73 | 88.32 | 90.17 | 91.84 | 93.49 | 105.78 |
| 2500. | 88.93 | 89.41 | 87.84 | 87.02 | 89.23 | 90.07 | 92.26 | 104.37 |
| 3150. | 86.81 | 88.24 | 86.53 | 85.13 | 87.14 | 89.95 | 92.12 | 103.42 |
| 4000. | 85.13 | 87.84 | 86.23 | 83.37 | 85.55 | 89.90 | 91.47 | 102.85 |
| 5000. | 83.72 | 86.86 | 85.94 | 82.45 | 85.11 | 89.47 | 90.68 | 102.21 |
| 6300. | 82.37 | 85.44 | 85.64 | 80.95 | 84.87 | 86.85 | 90.17 | 101.40 |
| 8000. | 80.56 | 84.27 | 84.32 | 79.83 | 83.41 | 86.95 | 88.68 | 99.88 |
| 10000. | 79.53 | 83.29 | 83.01 | 78.78 | 82.27 | 85.94 | 87.46 | 98.77 |
| 12500. | 80.23 | 83.84 | 83.16 | 78.69 | 82.10 | 86.15 | 87.19 | 98.95 |
| 16000. | 79.77 | 83.89 | 82.29 | 77.51 | 81.22 | 85.26 | 86.92 | 98.36 |
| 20000. | 78.61 | 82.33 | 81.68 | 76.00 | 80.46 | 84.58 | 86.02 | 97.38 |
| 25000. | 77.45 | 80.53 | 79.79 | 74.50 | 79.96 | 84.14 | 84.79 | 96.34 |
| 31500. | 73.99 | 77.45 | 76.36 | 71.08 | 78.51 | 82.44 | 82.87 | 94.16 |
| 40000. | 71.42 | 75.32 | 74.85 | 69.20 | 75.90 | 79.58 | 80.30 | 91.62 |

TOTAL POWER, DB = 116.18

NOZZLE DIA = 5.6"
 DIFFUSOR DIA = 12.0"
 FLOW TEMPERATURE, TOTAL = 1210.0 DEG R
 MICROPHONE RADIUS = 6 FT.

NOZZLE-DIFFUSOR SPACING RATIO = 0.50
 MACH NO. = 0.70

| | | | | | | | | |
|--------|-------|-------|-------|-------|-------|-------|-------|--------|
| 200. | 82.95 | 83.32 | 81.75 | 83.81 | 84.58 | 83.89 | 81.12 | 98.66 |
| 250. | 81.95 | 82.03 | 82.56 | 81.31 | 84.17 | 83.89 | 82.78 | 97.93 |
| 315. | 84.21 | 82.72 | 85.96 | 82.82 | 86.06 | 84.84 | 85.01 | 99.55 |
| 400. | 86.08 | 83.79 | 87.72 | 83.75 | 85.27 | 87.21 | 86.29 | 100.89 |
| 500. | 86.61 | 86.77 | 87.82 | 85.33 | 85.81 | 88.86 | 88.32 | 102.39 |
| 630. | 89.00 | 89.00 | 88.44 | 88.31 | 89.48 | 90.46 | 91.71 | 104.82 |
| 800. | 89.72 | 90.19 | 88.60 | 88.92 | 90.73 | 90.26 | 93.94 | 105.37 |
| 1000. | 89.49 | 89.35 | 87.76 | 89.54 | 89.30 | 90.64 | 94.13 | 105.20 |
| 1250. | 89.65 | 90.17 | 88.12 | 90.04 | 89.03 | 91.86 | 93.93 | 105.78 |
| 1600. | 89.16 | 90.67 | 88.79 | 90.01 | 90.27 | 92.94 | 93.54 | 106.30 |
| 2000. | 89.00 | 89.82 | 88.70 | 89.29 | 89.86 | 92.23 | 93.48 | 105.72 |
| 2500. | 87.81 | 88.60 | 87.54 | 87.81 | 88.57 | 90.70 | 92.78 | 104.42 |
| 3150. | 85.99 | 87.52 | 86.76 | 86.14 | 86.95 | 89.86 | 92.52 | 103.45 |
| 4000. | 84.11 | 87.49 | 86.48 | 85.03 | 86.80 | 89.79 | 92.26 | 103.09 |
| 5000. | 82.16 | 86.58 | 86.20 | 84.50 | 86.77 | 90.11 | 91.42 | 102.80 |
| 6300. | 80.78 | 84.58 | 85.36 | 83.66 | 86.11 | 89.53 | 90.15 | 101.90 |
| 8000. | 79.28 | 82.67 | 83.30 | 81.72 | 84.17 | 88.25 | 88.74 | 100.26 |
| 10000. | 77.52 | 81.64 | 81.94 | 80.30 | 83.51 | 86.97 | 87.65 | 99.07 |
| 12500. | 77.36 | 82.20 | 81.73 | 80.47 | 83.42 | 85.94 | 87.52 | 98.70 |
| 16000. | 77.32 | 82.57 | 82.09 | 80.52 | 82.89 | 84.66 | 86.31 | 98.12 |
| 20000. | 76.90 | 82.88 | 81.37 | 80.56 | 81.97 | 83.95 | 85.53 | 97.71 |
| 25000. | 73.87 | 81.14 | 79.50 | 79.91 | 80.73 | 82.29 | 83.42 | 96.15 |
| 31500. | 69.37 | 76.60 | 77.00 | 78.36 | 79.37 | 79.73 | 80.74 | 93.55 |
| 40000. | 67.16 | 74.54 | 75.58 | 76.93 | 77.30 | 78.13 | 78.82 | 91.84 |

TOTAL POWER, Db = 116.21

NOZZLE DIA = 5.6"
 DIFFUSOR DIA = 12.0"
 FLOW TEMPERATURE, TOTAL = 1210.0 DEG R
 MICROPHONE RADIUS = 6 FT.

NOZZLE-DIFFUSOR SPACING RATIO = 1.50
 MACH NO. = 0.70

| FREQUENCY, HZ | MICROPHONE ANGLE, DEG | | | | | | | TOTAL POWER, DB (1/3 OCTAVE BAND) |
|---------------|-----------------------|-------|-------|-------|-------|-------|-------|--------------------------------------|
| | 30. | 45. | 60. | 75. | 90. | 105. | 120. | |
| 200. | 83.26 | 83.01 | 81.40 | 84.80 | 85.40 | 83.10 | 82.54 | 98.85 |
| 250. | 85.48 | 85.84 | 81.83 | 84.39 | 85.11 | 84.30 | 85.68 | 99.95 |
| 315. | 87.44 | 88.92 | 84.62 | 85.50 | 86.48 | 87.47 | 87.56 | 102.35 |
| 400. | 88.12 | 89.51 | 88.30 | 88.73 | 86.82 | 88.67 | 87.71 | 103.79 |
| 500. | 91.29 | 90.87 | 90.70 | 90.55 | 88.39 | 89.61 | 90.98 | 105.52 |
| 630. | 94.97 | 94.21 | 94.00 | 93.77 | 92.06 | 91.19 | 94.12 | 108.58 |
| 800. | 99.42 | 97.35 | 97.67 | 96.23 | 94.32 | 93.16 | 95.67 | 111.46 |
| 1000. | 101.18 | 99.22 | 99.25 | 96.52 | 95.50 | 94.74 | 95.70 | 112.81 |
| 1250. | 100.46 | 99.24 | 98.79 | 96.87 | 95.59 | 95.94 | 96.42 | 112.91 |
| 1600. | 97.94 | 97.60 | 95.47 | 94.41 | 94.02 | 95.35 | 95.75 | 111.08 |
| 2000. | 95.05 | 94.81 | 93.23 | 92.02 | 93.22 | 94.52 | 95.14 | 109.14 |
| 2500. | 92.86 | 92.79 | 91.82 | 91.29 | 92.36 | 93.62 | 94.72 | 107.89 |
| 3150. | 91.05 | 92.17 | 91.68 | 91.83 | 92.64 | 93.80 | 94.11 | 107.79 |
| 4000. | 91.09 | 92.32 | 93.01 | 92.95 | 93.25 | 93.73 | 93.94 | 108.22 |
| 5000. | 91.96 | 93.42 | 94.52 | 93.68 | 93.98 | 93.97 | 93.78 | 108.94 |
| 6300. | 92.13 | 93.95 | 95.40 | 94.54 | 93.75 | 93.32 | 92.85 | 109.18 |
| 8000. | 91.41 | 94.04 | 95.77 | 95.02 | 93.33 | 92.62 | 91.92 | 109.16 |
| 10000. | 90.17 | 93.99 | 95.63 | 94.61 | 92.98 | 91.59 | 91.12 | 108.76 |
| 12500. | 89.00 | 94.33 | 95.61 | 94.13 | 92.37 | 91.07 | 90.70 | 108.55 |
| 16000. | 87.19 | 93.71 | 94.96 | 93.33 | 91.31 | 89.91 | 89.70 | 107.73 |
| 20000. | 85.51 | 92.58 | 94.19 | 92.21 | 90.06 | 86.82 | 88.20 | 106.66 |
| 25000. | 82.80 | 90.56 | 91.82 | 90.20 | 88.05 | 86.52 | 86.26 | 104.53 |
| 31500. | 79.40 | 87.33 | 89.52 | 87.93 | 85.46 | 83.91 | 82.79 | 101.88 |
| 40000. | 76.44 | 84.35 | 87.03 | 85.60 | 83.32 | 81.93 | 81.21 | 99.43 |

TOTAL POWER, DB = 122.15

NOMENCLATURE

| | |
|------------|--|
| A_e : | Nozzle Exit Area. |
| a_o : | Sonic Velocity at Ambient Conditions. |
| D_d : | Diffuser Diameter. |
| D_n : | Nozzle Diameter. |
| f : | Frequency. |
| I : | Sound Intensity. |
| I_o : | Reference Sound Intensity. |
| M_e : | Fully Expanded Mach Number. |
| P : | Sound Power. |
| p : | Sound Pressure. |
| PWL: | Sound Power Level. |
| R : | Microphone Arc Radius. |
| S : | Distance From Nozzle Exit Plane to Diffuser Inlet Plane. |
| T_o : | Stagnation Temperature. |
| U_e : | Jet Exit Velocity. |
| ρ_o : | Ambient Air Density. |
| ϕ : | Microphone Angle. |
| θ : | Azimuthal Angle. |
| Subscripts | |
| L: | Larger Nozzle. |
| S: | Smaller Nozzle. |