

AD-A089 024

AERONAUTICAL RESEARCH LABS MELBOURNE (AUSTRALIA)

F/6 11/1

A DESIGN STUDY IN CRACK PATCHING, (U)

JUL 79 R JONES, R J CALLINAN

ARL/STRUC-376

UNCLASSIFIED

NL

1 of 1  
7/79/02



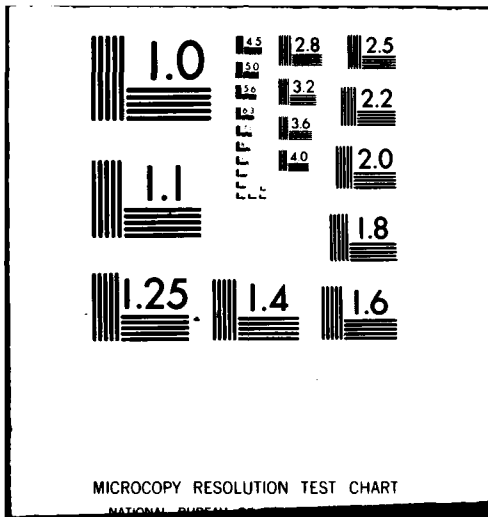

MICROCOPY RESOLUTION TEST CHART

NATIONAL BUREAU OF STANDARDS-1963-A

**LEVEL II**

12



AD A089024

**DEPARTMENT OF DEFENCE  
DEFENCE SCIENCE AND TECHNOLOGY ORGANISATION  
AERONAUTICAL RESEARCH LABORATORIES  
MELBOURNE, VICTORIA**

STRUCTURES REPORT 376

**A DESIGN STUDY IN CRACK PATCHING**

by

R. JONES and R. J. CALLINAN

**SDTIC  
ELECTE  
SEP 12 1980**

THE UNITED STATES NATIONAL  
TECHNICAL INFORMATION SERVICE  
IS AUTHORISED TO  
REPRODUCE AND SELL THIS REPORT

Approved for Public Release



© COMMONWEALTH OF AUSTRALIA 1979

COPY No 15

JULY 1979

DDC FILE COPY

80 9 11 044

DEPARTMENT OF DEFENCE  
DEFENCE SCIENCE AND TECHNOLOGY ORGANISATION  
AERONAUTICAL RESEARCH LABORATORIES

12

12) 25 L

STRUCTURES REPORT 376

6

A DESIGN STUDY IN CRACK PATCHING

by

10

R. JONES ~~AND~~ R. J. CALLINAN

REC'D  
10

14

ARL/STRUCT-376

11

JUL 79

SUMMARY

*A numerical investigation into the behaviour of cracked sheets which are patched with an overlay of composite material, is presented. This study gives guidelines as to the optimum location, size, and shape of patches. The main considerations are: reduction in the stress intensity factors at the crack tip, the maximum fibre stress in the patch and the maximum shear stress in the adhesive bond between patch and sheet.*

POSTAL ADDRESS: Chief Superintendent, Aeronautical Research Laboratories,  
Box 4331, P.O., Melbourne, Victoria, 3001, Australia.

008650 xcl

**DOCUMENT CONTROL DATA SHEET**

Security classification of this page: Unclassified

**1. Document Numbers**

- (a) AR Number:  
AR-001-750
- (b) Document Series and Number:  
Structures Report 376
- (c) Report Number:  
ARL-Struc-Report-376

**2. Security Classification**

- (a) Complete document:  
Unclassified
- (b) Title in isolation:  
Unclassified
- (c) Summary in isolation:  
Unclassified

**3. Title: A DESIGN STUDY IN CRACK PATCHING**

**4. Personal Author(s):**

Jones, R.  
Callinan, R. J.

**5. Document Date:**

July, 1979

**6. Type of Report and Period Covered:**

**7. Corporate Author(s):**

Aeronautical Research Laboratories

**8. Reference Numbers**

- (a) Task:  
AIR 72/20
- (b) Sponsoring Agency:  
Dept. of Defence (Air Office)

**9. Cost Code:**

21 4670

**10. Imprint:**

Aeronautical Research Laboratories,  
Melbourne

**11. Computer Program(s)**

(Title(s) and language(s)):

**12. Release Limitations (of the document)**

Approved for public release

12-0. Overseas:	N.O.	P.R.	I	A	B	C	D	E
-----------------	------	------	---	---	---	---	---	---

**13. Announcement Limitations (of the information on this page):**

No Limitations

**14. Descriptors:**

Cracks  
Stress analysis  
Shear stress  
Stress concentration

Adhesive bonding  
Composite materials  
Patch tests

**15. Cosati Codes:**

1113

**16. ABSTRACT**

*A numerical investigation into the behaviour of cracked sheets which are patched with an overlay of composite material, is presented. This study gives guidelines as to the optimum location, size, and shape of patches. The main considerations are: reduction in the stress intensity factors at the crack tip, the maximum fibre stress in the patch and the maximum shear stress in the adhesive bond between patch and sheet.*

Accession For	
NTIS GRA&I	<input checked="" type="checkbox"/>
DDC TAB	<input type="checkbox"/>
Unannounced	<input type="checkbox"/>
Justification	
Dist. and/or special	

## CONTENTS

	Page No.
<b>NOTATION</b>	
<b>1. INTRODUCTION</b>	1
<b>2. NUMERICAL INVESTIGATION</b>	1
<b>2.1 General</b>	1
<b>2.2 Strip Patches</b>	5
<b>2.3 Crack Covering Patches</b>	5
<b>3. PATCH DESIGN STUDY</b>	5
<b>3.1 Guide Lines for Patch Design</b>	5
<b>3.2 Step Thickness Patches</b>	6
<b>3.3 Effect of Adhesive Thickness</b>	6
<b>3.4 Effect of Sheet Thickness</b>	11
<b>3.5 Effect of Single Side Reinforcement</b>	11
<b>4. EFFECTS OF PATCH DEBONDING</b>	11
<b>5. CONCLUSION</b>	15
<b>DISTRIBUTION</b>	

## NOTATION

$\sigma$	Applied tensile stress.
$\sigma_f$	Tensile stress in the fibres.
$\tau_a$	Shear stress in the adhesive.
$K_{1p}$	Stress intensity factor for the patched crack.
$K_{1u}$	Stress intensity factor for the unpatched crack.
$t_a$	Thickness of the adhesive layers.
$t_s$	Thickness of the sheet.
$t_p$	Thickness of the patch.
$G_{12}, G_{13}, G_{23}$	Shear moduli of the patch.
$E_1, E_2$	Young's moduli of the patch.
$\nu_{12}$	Poisson's ratio of the patch.

## 1. INTRODUCTION

This report forms part of a general research programme into the repair of aircraft structures, using high strength composite material, currently underway at the Aeronautical Research Laboratories, Australia [1-5]. In a previous report [4] the authors developed the analytical and numerical tools required for the analysis of cracked metal sheets reinforced by a bonded overlay of composite material. These tools are now used to determine the effectiveness of various patch configurations. Here the "effectiveness" of the patch is measured in terms of the reduction of the stress intensity factor  $K_1$  at the crack tip. However the shear stresses developed in the adhesive bond between patch and sheet and the stresses in the fibres of the patch are also major considerations since a patch must be designed such that it will not fail in service.

## 2. NUMERICAL INVESTIGATION

### 2.1 General

In a previous report [4] the authors developed a "bonded" element which models the behaviour of an element of adhesive plus an element of patch. This "bonded" element will now be used in a numerical investigation into crack patching based on the finite element method. Here we will confine our attention to the repair of a centrally located crack in a thin sheet of aluminium which is subjected to a uniform tensile stress denoted by  $\sigma$ . The crack has a total length of 38.1 mm while the sheet has dimensions 508 mm  $\times$  635 mm; see Figure 1 where the finite element grid in the vicinity of the crack is also shown. This grid incorporates the advanced crack tip element described in Reference 3. In this investigation the thickness of the sheet will be treated as a variable. Throughout the analysis the composite overlay will be taken as a unidirectional boron epoxy laminate with the fibre direction being perpendicular to the crack. The laminate moduli are as follows:

$$\begin{aligned} E_1 &= 208.1 \text{ GPa} & G_{12} &= G_{13} = 7.24 \text{ GPa} \\ E_1/E_2 &= 8.18 & G_{23} &= 4.94 \text{ GPa} \\ \nu_{12} &= 0.1677 \end{aligned}$$

where the 1-axis is in the fibre direction  
the 2-axis is parallel to the crack  
the 3-axis is in the thickness direction.

The overlay is considered as being bonded to the sheet by an adhesive which has a shear modulus  $G_a$  of  $9.65 \times 10^2$  MPa.

1. A. A. Baker and M. M. Hutchinson. Fibre Composite Reinforcement of Cracked Aircraft Structures, A.R.L. Materials Division Tech. Memo. 366, (1976).
2. A. A. Baker. A Summary of Work on Applications of Advanced Fibre Composites at the Aeronautical Research Laboratories, Australia, Composites, Vol. 9, pp. 11-16, (1978).
3. R. Jones and R. J. Callinan. On the use of Special Crack Tip Elements in Cracked Elastic Sheets, Int. J. Fracture, Vol. 13, 1, pp. 51-64, (1977).
4. R. Jones and R. J. Callinan. Finite Element Analysis of Patched Cracks, J. Structural Mechanics, Vol. 7, 2, 1979 (in press); also published as A.R.L. Structures Report 367, 1978.
5. M. J. Davis. Stress Intensity Reduction by Strategic Reinforcement, Proc. 1977 Conference Australian Fracture Group, pp. 90-101, (1977).



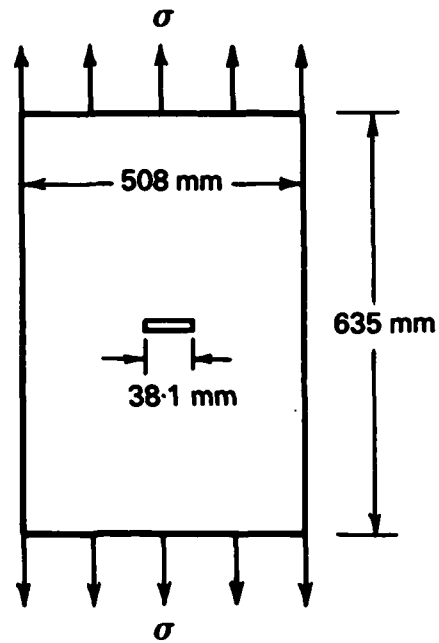

(a) Centrally cracked sheet

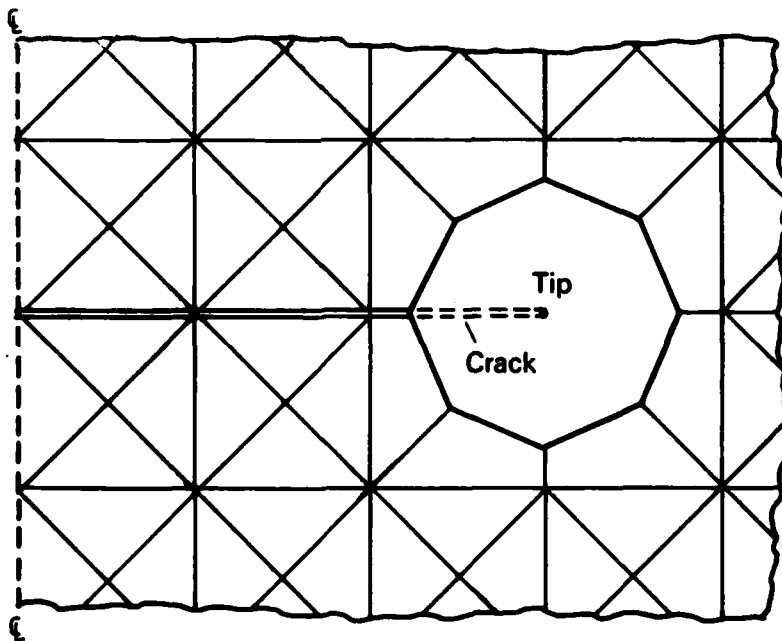

(b) Finite element grid in sheet in vicinity of crack

FIG. 1: CRACKED SHEET FOR FINITE ELEMENT ANALYSIS  
STUDY OF PATCH DESIGN

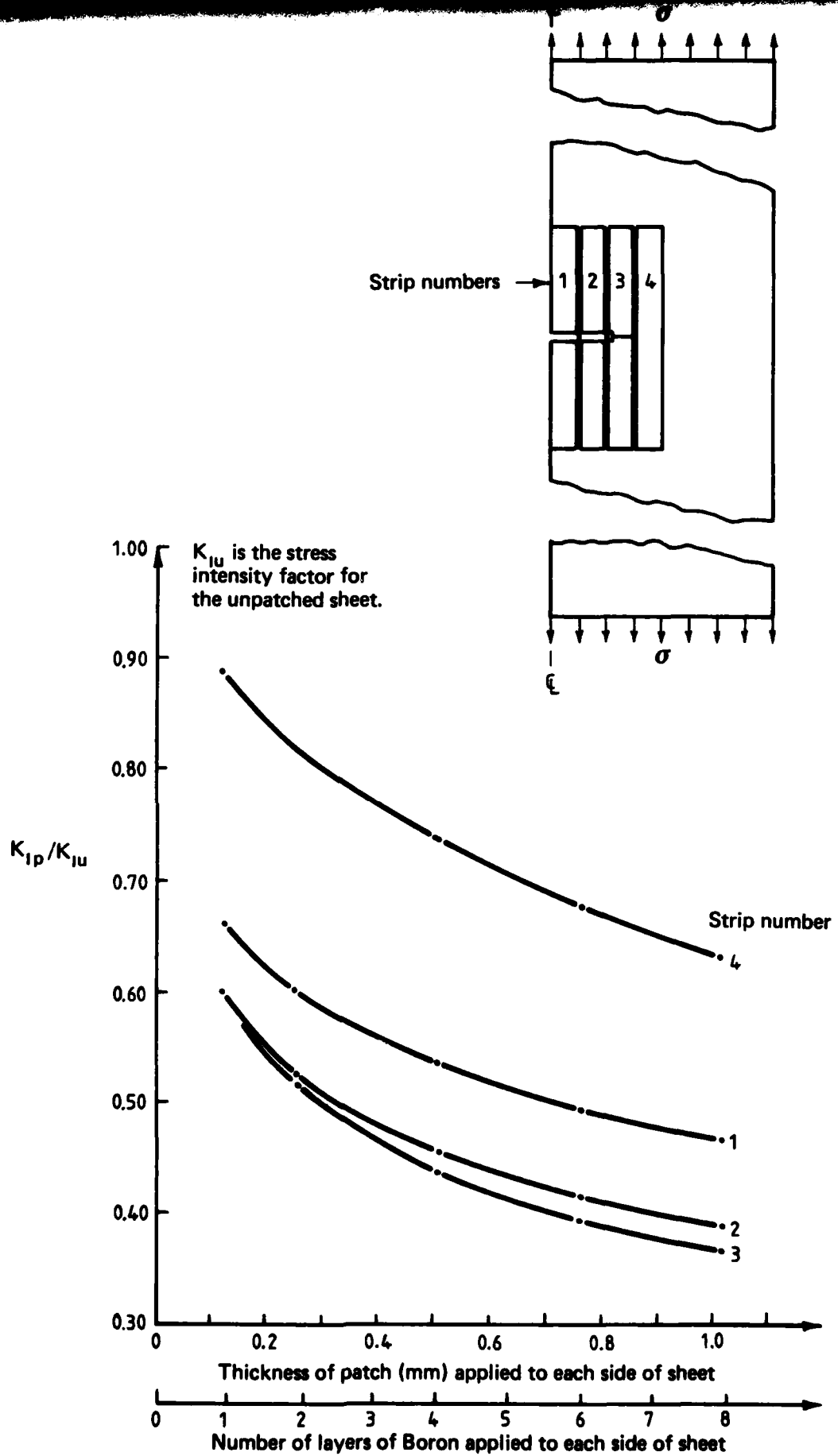

FIG. 2. EFFECT OF PATCH LOCATION ON THE STRESS INTENSITY FACTOR.  
 (Patch on each side of sheet)

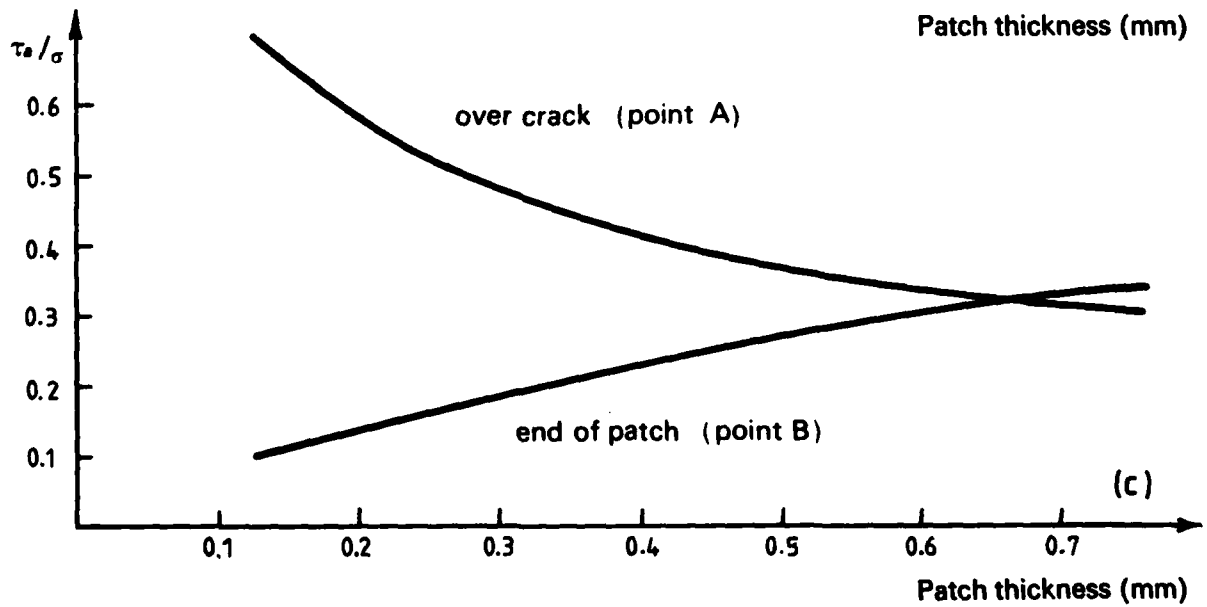
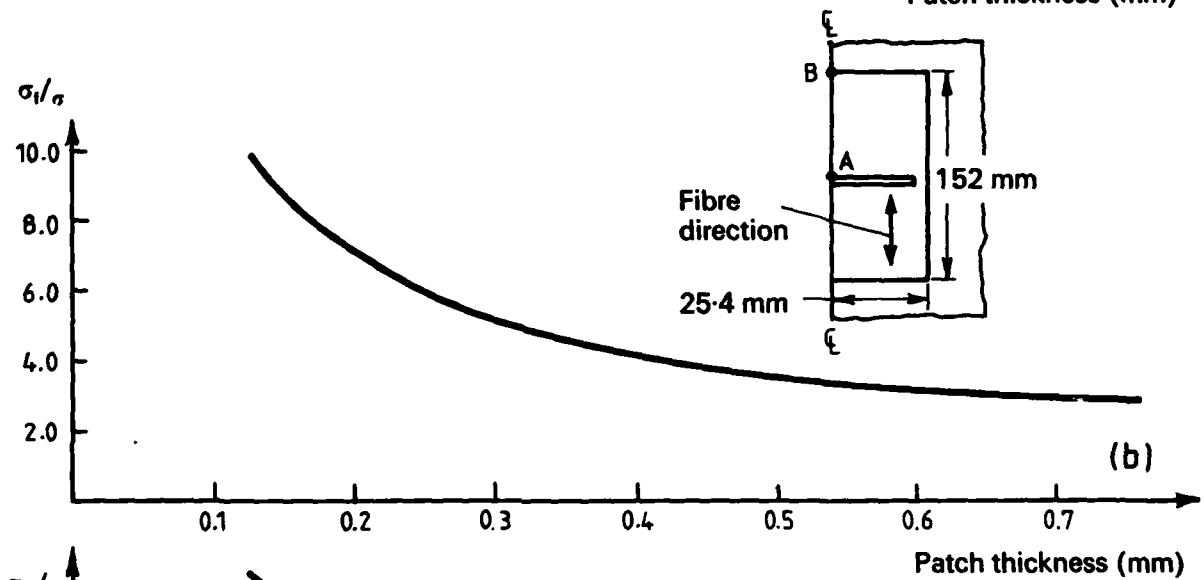
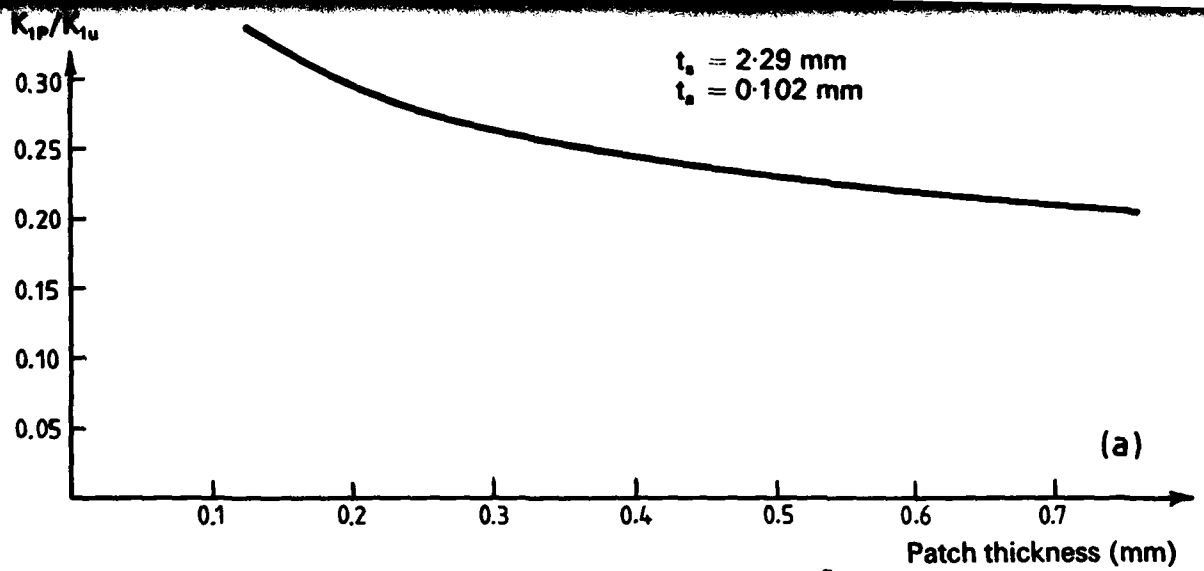

FIG. 3 : EFFECT ON PATCH THICKNESS ON DESIGN VARIABLES :  
DOUBLE REINFORCEMENT

## 2.2 Strip Patches

We will begin our investigation into patch design by considering the optimum location of thin strip patches. Patches of this type have been considered in detail in [4] and, whilst they significantly reduce the stress intensity factor, they can lead to severe stresses in both the fibres and the adhesive. As a result such patches are generally not practical repair schemes. Never the less, a study of strip patches throws light on the question of where along a crack a patch has its most marked influence.

Figure 2 shows the ratio of the stress intensity factor,  $K_{1p}$ , obtained for a crack patched with boron-epoxy laminates of dimensions  $t_p$  by 100.8 mm by 6.35 mm to the stress intensity factor,  $K_{1u}$ , for the unpatched crack, plotted against the patch thickness  $t_p$  for four different patch locations. The sheet thickness is here taken as 2.29 mm and a patch is applied to each side of the sheet.

Although with only four different locations it is not possible to predict accurately the optimum location of a thin strip patch, it is clear that strip 4 has little effect on the crack. As a result we see that patch material beyond the crack tip will not greatly contribute to the effectiveness of the patch. On the other hand patch 3, which is immediately inboard of the crack tip, is the most effective in reducing the stress intensity factor although only marginally more so than patch 2.

At this stage it should be mentioned that although the results presented in Figure 2, and subsequent figures, are shown as continuous curves the computations were in fact made for discrete values of patch thickness  $t_p$ . These values of  $t_p$  are multiples of 0.127 mm which is the thickness of a single layer of unidirectional boron epoxy laminate which is commercially available.

## 2.3 Crack Covering Patches

Let us now turn our attention to the analysis and design of patches which cover the entire length of the crack. In particular we will consider patches whose width does not extend beyond the extreme right hand edge of strip 4, as shown in Figure 2. Figures 3(a), (b), (c) show respectively the ratio of the stress intensity factors  $K_{1p}/K_{1u}$ , the maximum fibre stress in the patch,  $\sigma_f$ , and the shear stresses in the adhesive,  $\tau_a$ , plotted against the patch thickness,  $t_p$ , for uniaxial boron-epoxy laminate patches of dimensions 152 mm  $\times$  50.8 mm placed on each side of the sheet so as to cover the crack completely. The shear stresses shown in these figures are the values occurring at point A, over the centre of the crack, and at point B, at the end of the patch, as shown in Figure 3.

From Figure 3 we see that even the 0.127 mm (one layer) patch reduces the stress intensity factor to 33.5% of its value for the unpatched crack. The stress intensity factor  $K_{1p}$  decreases monotonically as the patch thickness increases, but its rate of decrease is relatively low. For example with a 0.762 mm (six layer) patch the stress intensity factor is 19.5% of the unpatched value so that a six fold increase in patch thickness has only led to a 14% reduction in the stress intensity factor.

The effect of patch thickness on the stresses in the adhesive and the patch is much more dramatic. We see that thin patches have severe stress concentrations in the fibres over the crack, together with a high stress concentration in the adhesive over the crack. These stress concentrations decrease significantly as the thickness of the patch is increased. However as the thickness of the patch increases the shear stress in the adhesive at the ends of the patch also increases until it is greater than the corresponding value at the crack.

## 3. PATCH DESIGN STUDY

### 3.1 Guideline for Patch Design

We are now in a position to begin our study in patch design. From Figure 3(a) we see that any design requirement based upon a necessary reduction in the stress intensity factor can readily be achieved by a large number of patch configurations. However there are two other design requirements which are based upon maintaining the structural integrity of the patch. These requirements are as follows:

- (1) The maximum strain in the fibres must be kept below the breaking strain of the fibres. For a boron laminate the limiting strain is taken as 0.005 so that we require that the patch stress satisfy

$$\sigma_f (\approx \epsilon_f E_b) \leq 0.005 E_1 \quad (1)$$

where  $E_1$  is the Young's modulus of the composite in the direction of the fibres, which in the present patch is equal to 208.1 GPa. If we denote the stress concentration in the fibres as  $C$  this then tells us that the patch thickness must be such that

$$\sigma_f = C \sigma \leq 1.04 \text{ GPa} \quad (2)$$

Hence knowing the applied stress determines the maximum permissible value of  $C$  which in turn determines the minimum permissible patch thickness.

- (2) In addition, the shear stress in the adhesive must not exceed a threshold value typically 45 MPa, see [6]; otherwise fatigue damage to the adhesive will occur. Denoting the shear stress concentrations in the adhesive at the ends of the patch and at the crack as  $C_e$  and  $C_c$  respectively this means that the patch thickness must be such that

$$(\tau_a)_c = C_c \sigma \leq 45 \text{ MPa} \quad (3)$$

$$(\tau_a)_e = C_e \sigma \leq 45 \text{ MPa} \quad (4)$$

In general for full thickness patches, it will be very difficult to satisfy all of these requirements. It is usually fairly simple to satisfy the stress requirements in the adhesive and the patch at the crack. Indeed this is done by taking the maximum of the thicknesses obtained from equations (2) and (3). However this patch thickness is often too large for equation (4) to be satisfied which means that the adhesive at the ends of the patch would be stress critical.

### 3.2 Step Thickness Patches

In order to overcome the difficulty mentioned above it is necessary to use step thickness patches. For example, the stress distribution in both the patch and the adhesive in a typical step thickness patch is shown in Figures 4(a), (b) while the corresponding stress distribution for two full thickness patches of thicknesses 0.762 mm and 0.127 mm respectively are shown in Figures 5 and 6. Perhaps the most important features of these Figures are that the shear stress in the ends of the step thickness patch, which is only 0.127 mm thick (i.e. one layer) is virtually the same value as for the 0.127 mm full thickness patch. Similarly the shear stress and the fibre stress at the centre of the stepped patch, which is 0.762 mm thick (i.e. 6 layers) at this point, is virtually the same as for the 0.762 mm full thickness patch. Furthermore, it transpires that the stepped patch and the 0.762 mm full thickness patch give very similar values for the ratio of the stress intensity factors  $K_{1p}/K_{1u}$ ; namely 0.18 and 0.20 respectively. Thus the design rules enunciated above in equations (2) and (4) may be used for determining the maximum patch thickness, and provided that the patch is stepped sufficiently it seems reasonable to assume that the shear stress in the adhesive at the ends of the patch will be of the same order as for a full thickness patch of the thickness of the final step in the stepped patch. In practice it is wise to have the final step only 0.127 mm thick, i.e. one layer, as this leads to the lowest value of the shear stress.

From Figure 4a we also see that stepped patches are a much better way of distributing the load carried by the patch. Indeed whereas in full thickness patches the fibre stress has a large peak near the crack, step patches distribute the fibre stresses more uniformly over the entire patch length.

### 3.3 Effect of Adhesive Thickness

In the above analysis we have been primarily concerned with an adhesive thickness of 0.1016 mm, which is commercially available. Another commercially available thickness is

6. A. A. Baker. Evaluation of adhesives for fibre composite reinforcement of fatigue cracked aluminium. Proc. 10th Nat. SAMPE Technical Conference pp. 397-415, (1978).

Schematic layout of stepping of patch from 6 to 1 layers of boron				
0.762 mm	0.635 mm	0.508 mm	0.381 mm	0.254 mm
0.127 mm				

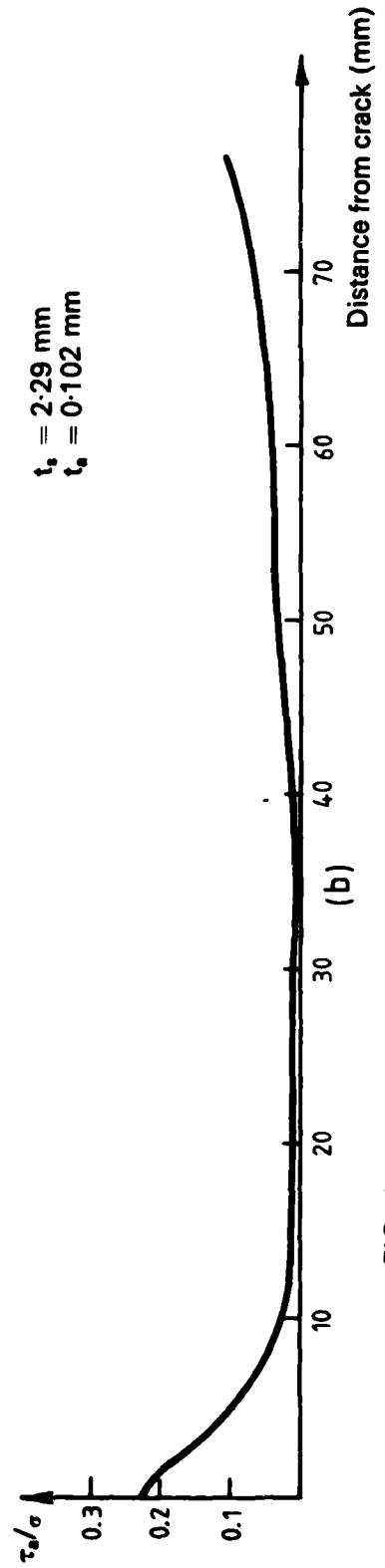
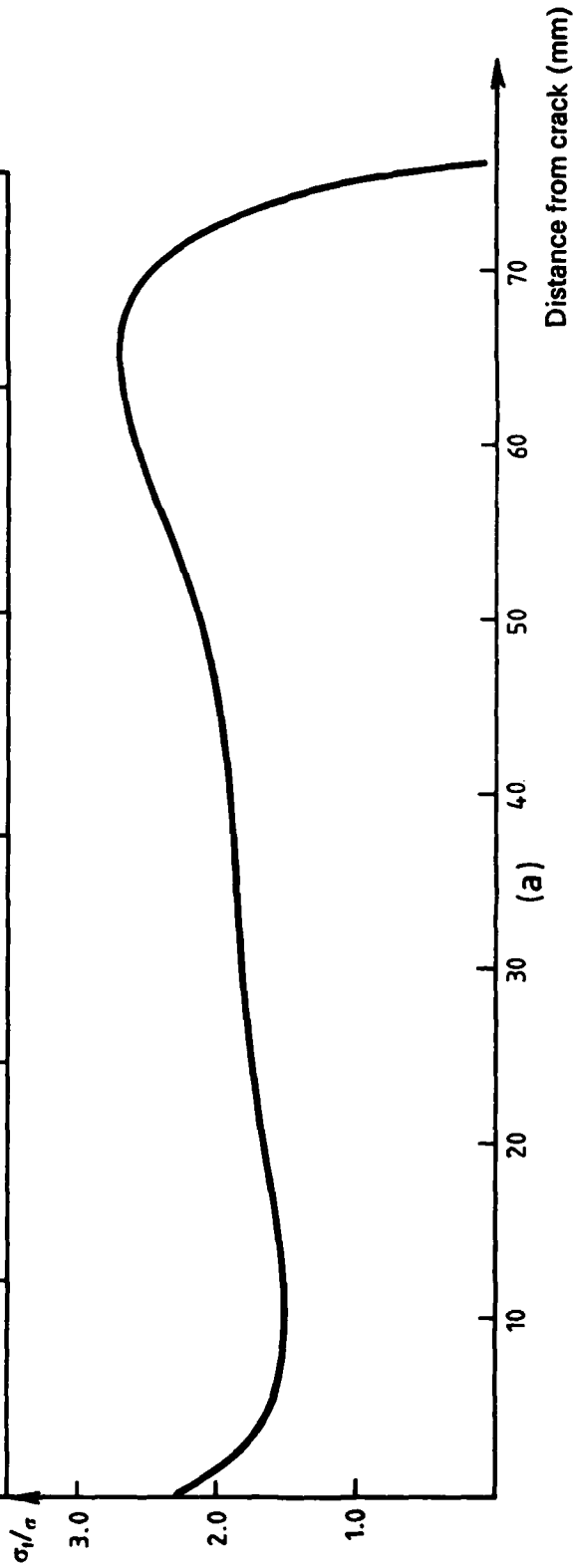

FIG. 4: VARIATION OF FIBRE AND ADHESIVE STRESSES ALONG CENTRE LINE OF PATCH: DOUBLE REINFORCEMENT

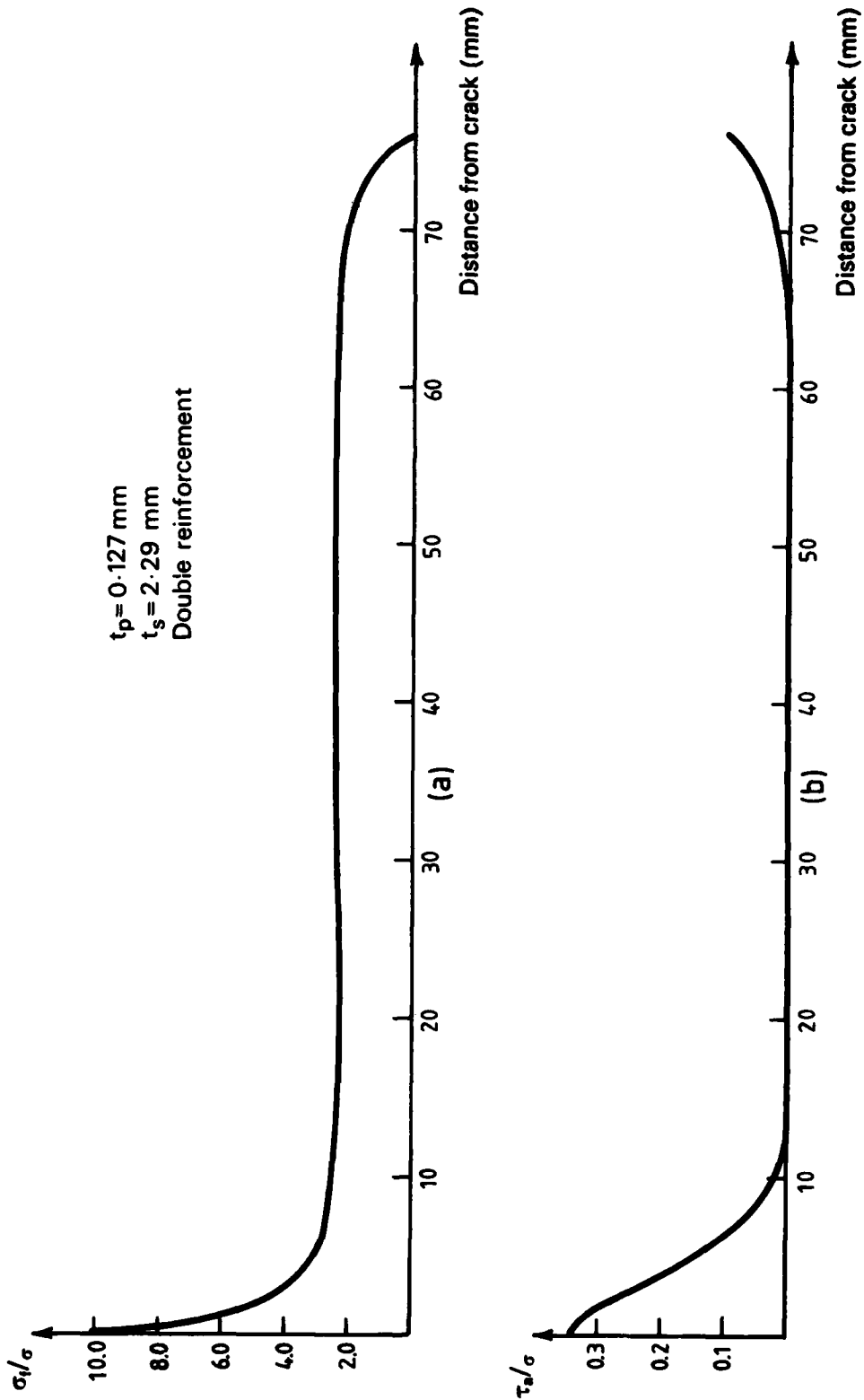

FIG. 5 : DISTRIBUTION OF FIBRE AND ADHESIVE STRESSES  
ALONG CENTRE LINE

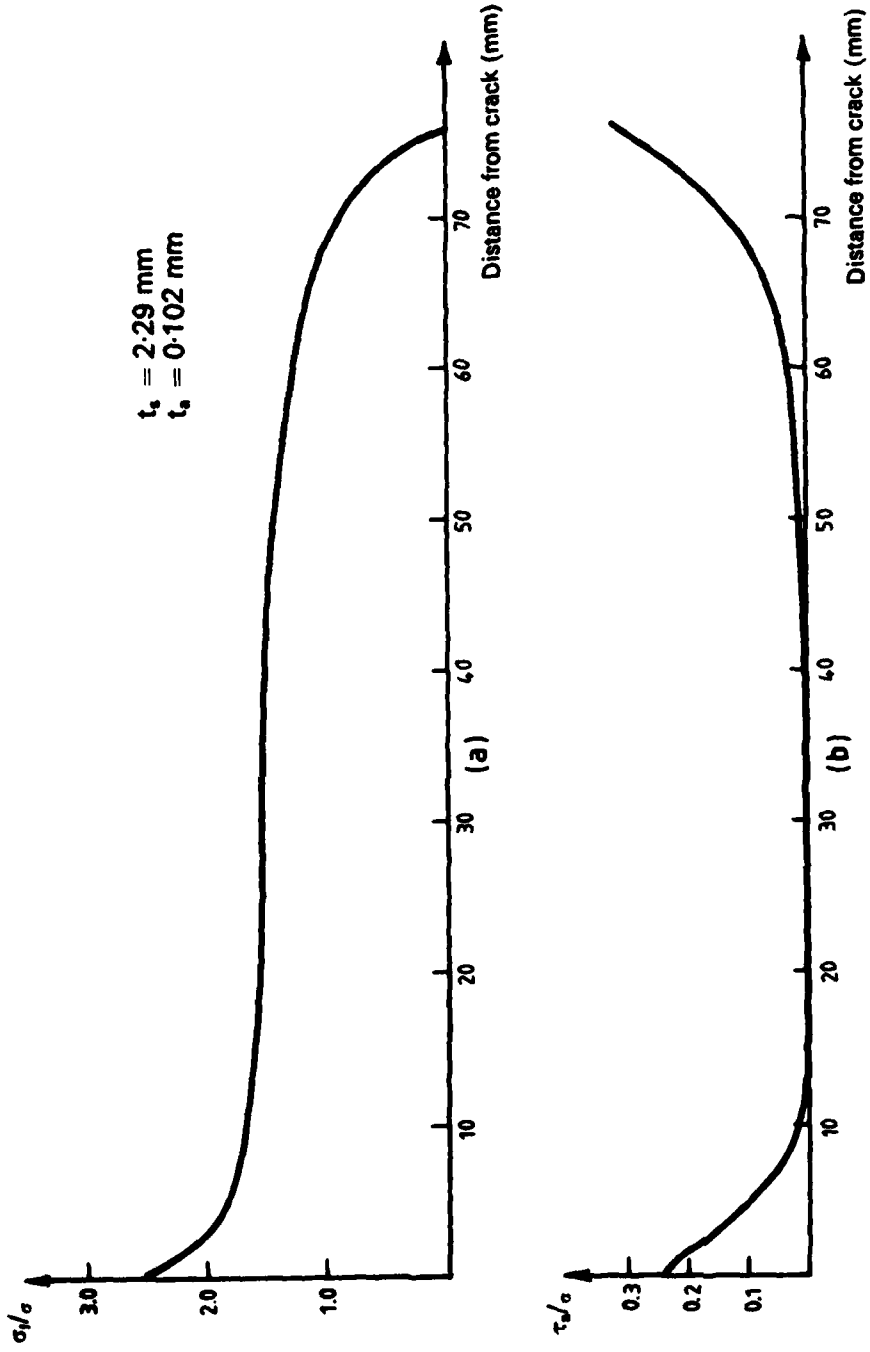

FIG. 6 : DISTRIBUTION OF FIBRE AND ADHESIVE STRESSES ALONG CENTRE LINE:  $t_s = 0.762 \text{ mm}$



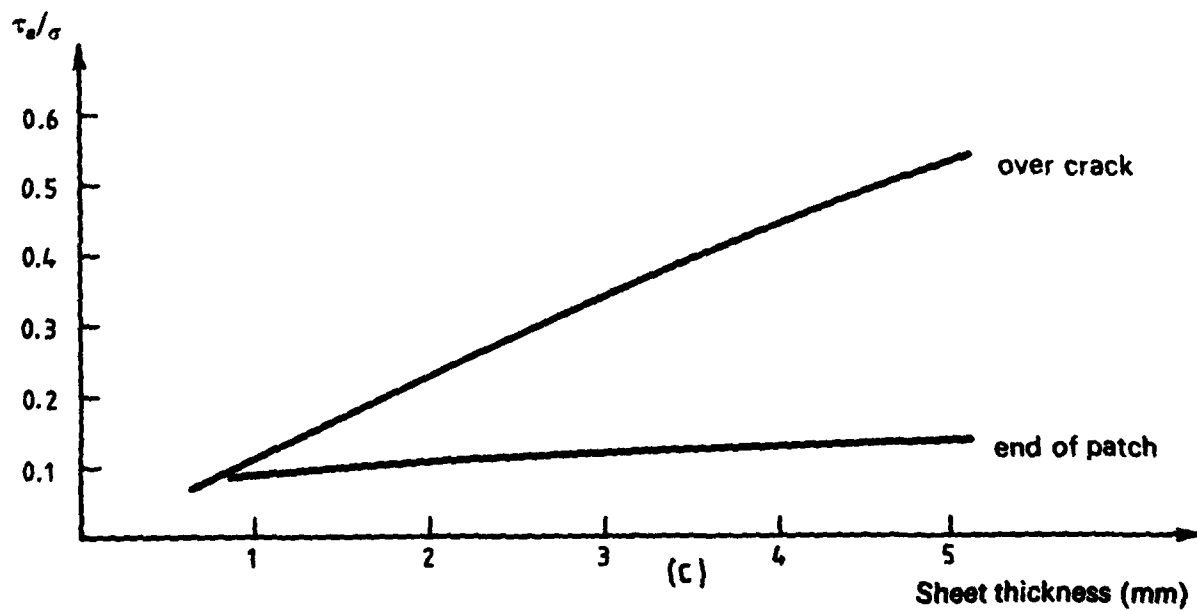
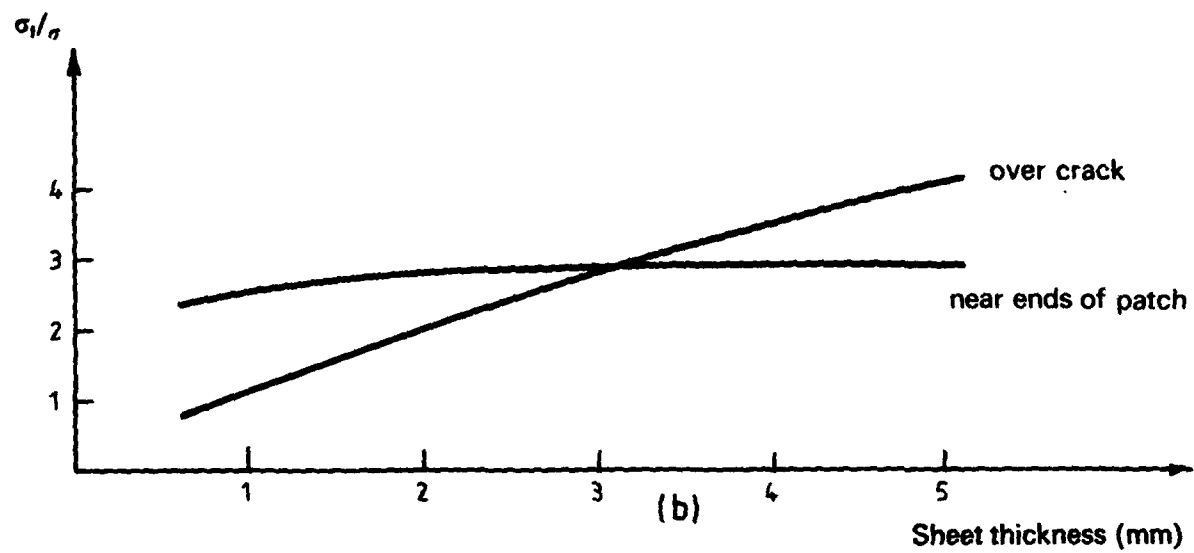
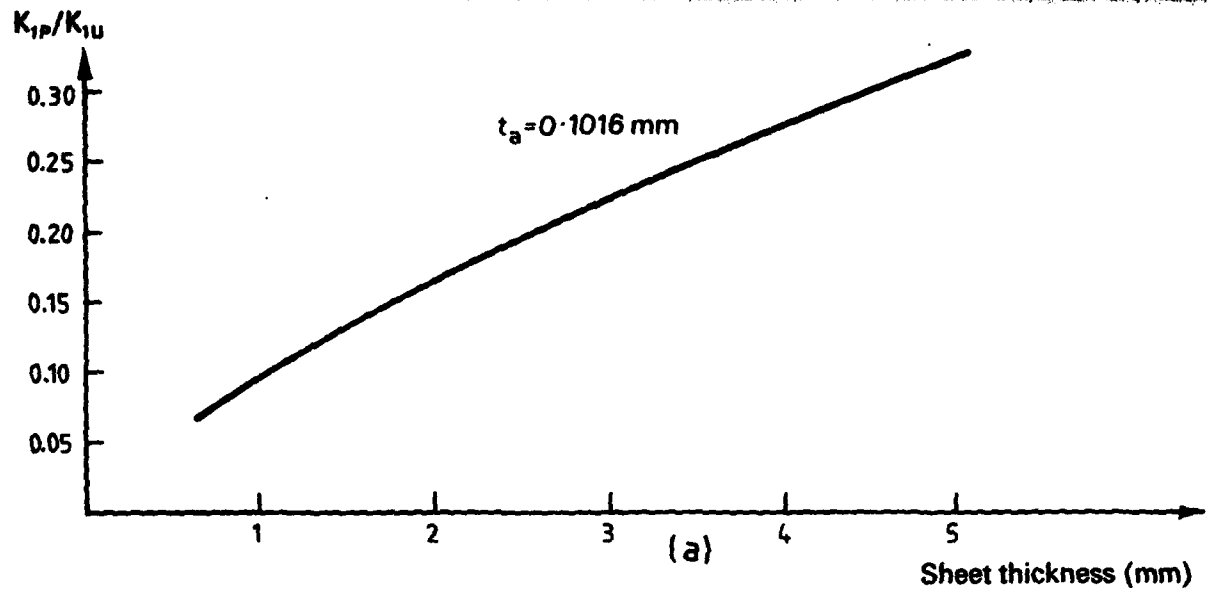

FIG. 7: EFFECT OF SHEET THICKNESS ON DESIGN VARIABLES:  
DOUBLE REINFORCEMENT

0.2032 mm. The effect of this increase in the adhesive thickness is shown in Table 1 for the step thickness patch previously considered.

TABLE 1

Adhesive Thickness mm	$K_{1p}/K_{1u}$	$(\tau_a)_e/\sigma$	$(\tau_{ac})_e/\sigma$	$\sigma_f/\sigma$
0.1016	0.180	0.257	0.103	2.7
0.2032	0.193	0.177	0.088	2.69

We thus see that doubling the adhesive thickness has very little effect on the reduction in the stress intensity factor  $K_{1p}$  or on the maximum fibre stress. However it significantly reduces the peaks in the shear stress in the adhesive. Hence since the benefits of decreased adhesive shear stresses outweigh the slight rise of 1.3% in the stress intensity factor the use of an increased adhesive thickness is recommended.

### 3.4 Effect of Sheet Thickness

We have thus seen that in the design of patches significant use can be made of the results for full thickness patches. However the previous results have been for a sheet thickness of 2.29 mm. Increasing the sheet thickness causes a significant increase in the stress intensity factor, and in both the fibre stresses and the adhesive stresses at the crack, but has less effect on the adhesive stress at the ends of the patch; see Figure 7, where the patch considered is the step thickness patch previously described.

### 3.5 Single Side Reinforcement

Let us now turn our attention to the case of a single sided reinforcement, i.e. patching of the crack on one side of the sheet only. We will further confine our attention to the cases for which bending, due to the shifting of the neutral axis of the patch-sheet pair, is negligible because of other constraints on the sheet. For this analysis we will also revert to the constant thickness patches considered in Section 2.3 and to the previous values of sheet and adhesive thicknesses viz. 2.29 mm and 0.1016 mm respectively.

Figure 8 shows the effect that increasing the patch thickness has upon the stress intensity factor, and the stresses in both the patch and the adhesive. Comparing these Figures with Figure 3, for the case of double sided reinforcement, i.e. patching on each side of the crack, we see the following.

1. For any given patch thickness the shear stress at the ends of the patch is slightly higher than for the case of a double sided reinforced crack, the total volume of composite being the same in each case.
2. The reduction in the stress intensity factor is less than that achieved by reinforcing on each side, the total volume of composite being the same in either case.
3. The shear stress in the adhesive at the crack is greater than for the case of reinforcing on each side, the total volume of composite being the same in either case.

## 4. EFFECTS OF PATCH DEBONDING

Let us finally turn our attention to the problem of debonding. Previously we have been considering patches in which the adhesive has not failed. However, in poorly designed patches under high loads it is possible for the maximum permissible value of the shear stress in the adhesive to be exceeded. If these loads are repeated fatigue damage to the adhesive will occur and it is possible that the adhesive will debond in the regions of maximum shear stress. An extreme case of a debond extending 12.7 mm on either side of the crack and over the full width of the patch was considered. The stress distribution for the stepped patch, previously considered,

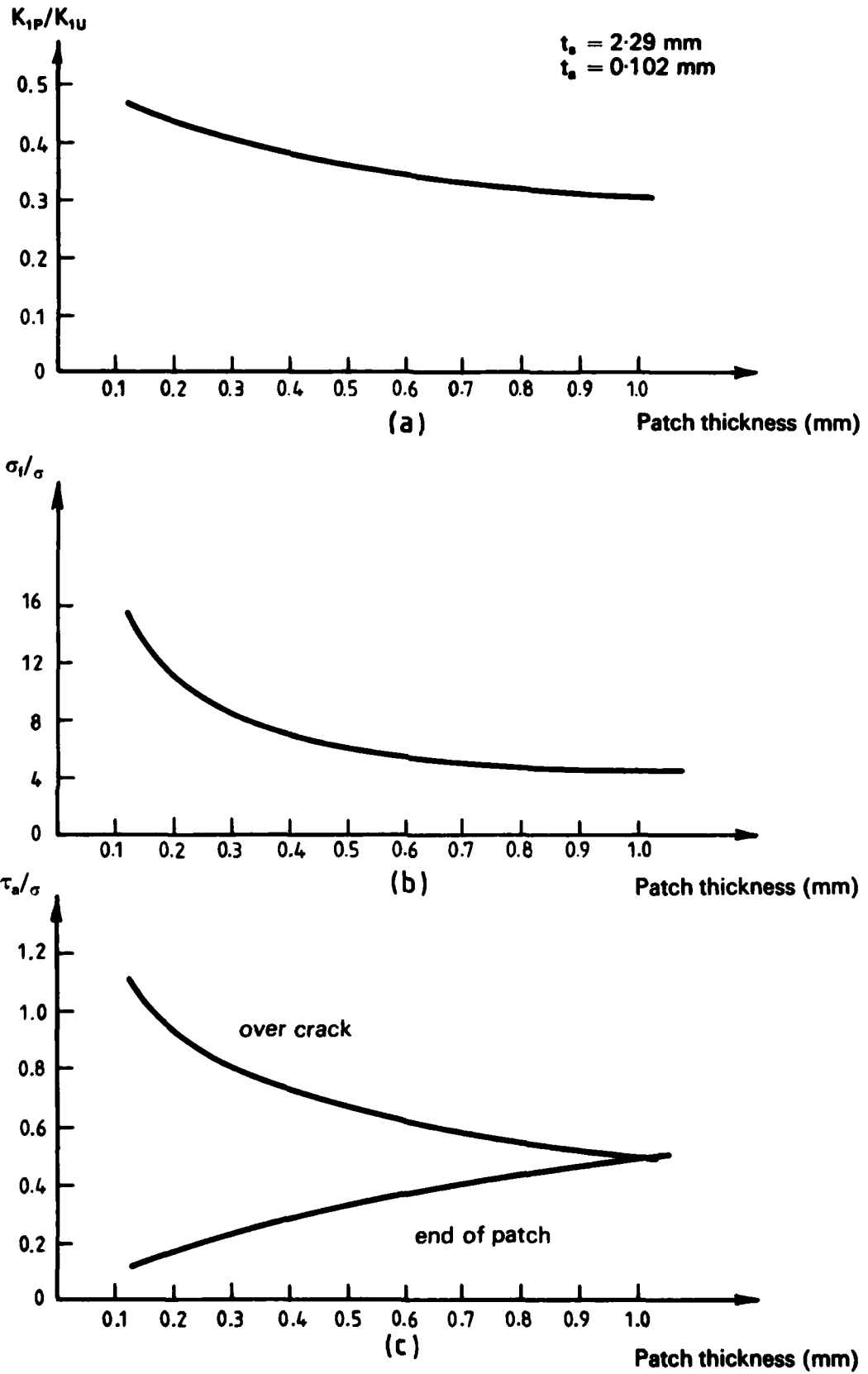

FIG. 8: EFFECT OF PATCH THICKNESS ON DESIGN VARIABLES: SINGLE REINFORCEMENT

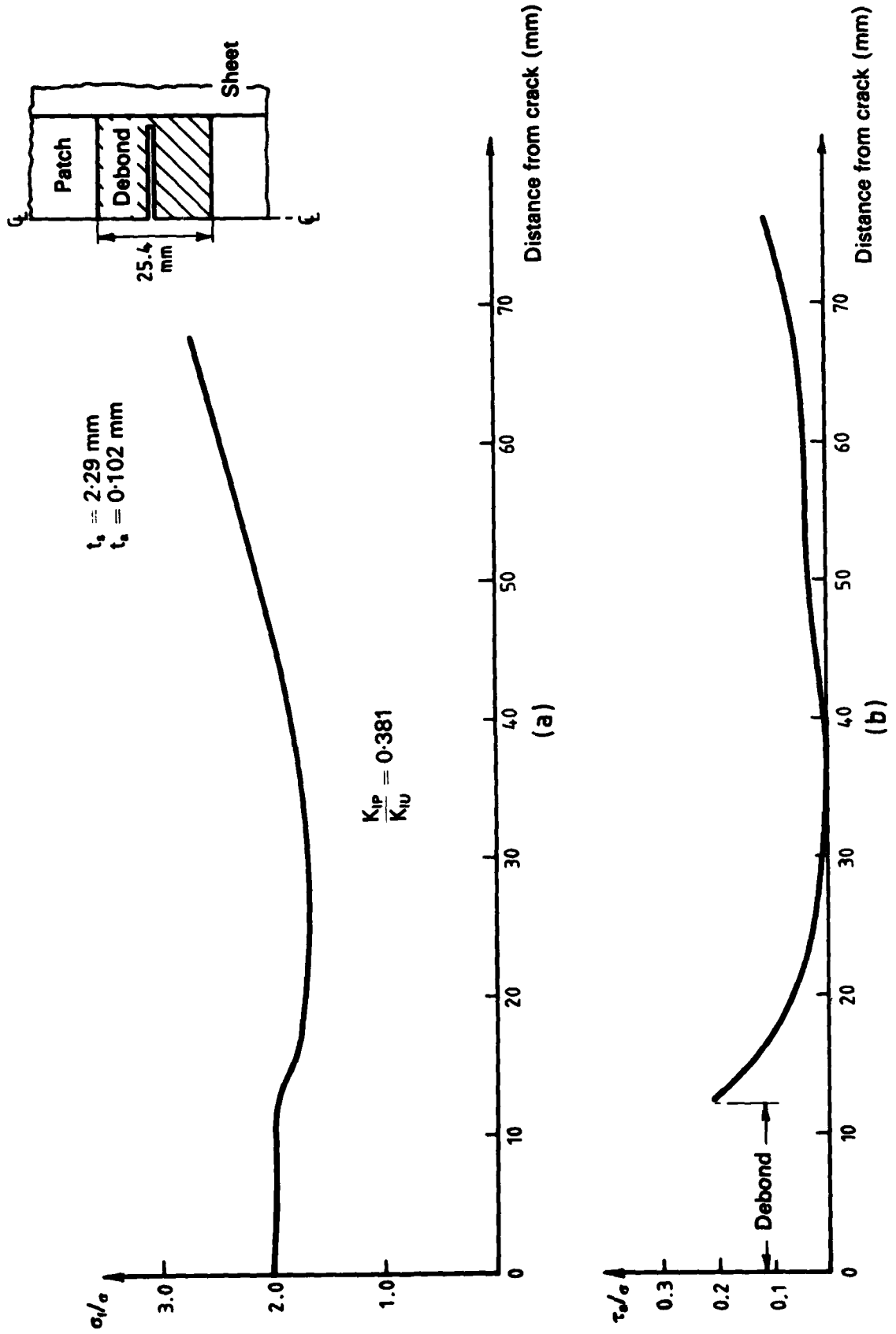

FIG. 9: VARIATION OF FIBRE AND ADHESIVE STRESSES—  
DOUBLE REINFORCEMENT AND DEBOND

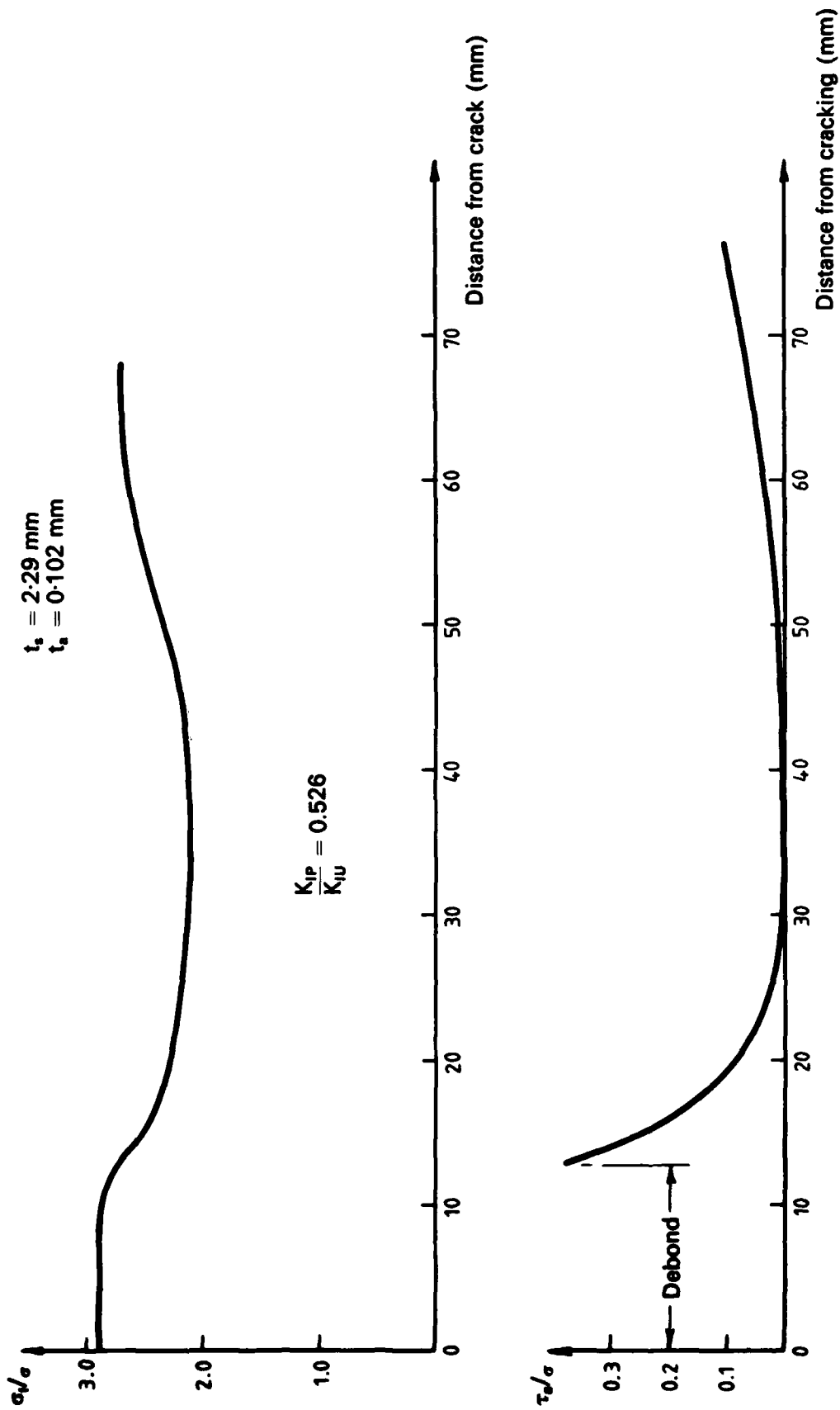

FIG. 10: VARIATION OF FIBRE AND ADHESIVE STRESSES—  
SINGLE REINFORCEMENT AND DEBOND

with the debond as described above is shown in Figure 9 where the patch is considered to be on each side of the sheet.

From this Figure and by comparison with Figure 4 we see that even an extreme debond of 12.7 mm has relatively little effect on the peak stresses in either the patch or the adhesive. However it significantly raises the stress intensity factor. For example the ratio of the stress intensity factors  $K_{1p}/K_{1u}$  was found to be 0.381 whereas, without debonding, the corresponding value was 0.180. This is a increase of 20% in the ratio of the stress intensity factors. Whilst debonding is clearly detrimental, it still appears that even with a relatively large debond a patch can retain some effectiveness for reducing further crack growth in the sheet.

## 5. CONCLUSION

We have seen that the patching of cracks with a bonded overlay of composite material is an effective method for reducing the stress intensity factors at the crack tip. A detailed study of the stress distributions in the adhesive and the composite overlay, for several typical repairs, have been presented. This study has shown that the shear stress-concentrations at the edges of the patch can be reduced to tolerable levels by stepping the thickness of the patch and that the main design variables are the stresses in the fibres and the shear stresses in the adhesive at the crack.

## DISTRIBUTION

Copy No.

### AUSTRALIA

#### Department of Defence

##### Central Office

Chief Defence Scientist	1
Deputy Chief Defence Scientist	2
Superintendent, Science and Technology Programs	3
Australian Defence Scientific and Technical Representative (U.K.)	4
Counsellor, Defence Science (U.S.A.)	5
Joint Intelligence Organization	6
Defence Library	7
Assistant Secretary, D.I.S.B.	8-23

##### Aeronautical Research Laboratories

Chief Superintendent	24
Library	25
Superintendent Division — Structures	26
Divisional File — Structures	27
Authors: R. Jones	28
R. J. Callinan	29
B. C. Hoskin	30

##### Materials Research Laboratories

Library	31
---------	----

##### Defence Research Centre, Salisbury

Library	32
---------	----

##### Central Studies Establishment

Information Centre	33
--------------------	----

##### Engineering Development Establishment

Library	34
---------	----

##### RAN Research Laboratory

Library	35
---------	----

##### Defence Regional Office

Library	36
---------	----

##### Navy Office

Naval Scientific Adviser	37
--------------------------	----

##### Army Office

Army Scientific Adviser	38
Royal Military College Library	39
US Army Standardisation Group	40

##### Air Force Office

Aircraft Research & Development Unit, Scientific Flight Group	41
Air Force Scientific Adviser	42
Technical Division Library	43
D. Air Eng.	44
HQ Support Command (SENGSO)	45
RAAF Academy, Point Cook	46

<b>Department of Productivity</b>		
<b>Government Aircraft Factories</b>		
Manager/Library		47
<b>Department of National Resources</b>		
Secretary		48
<b>Department of Transport</b>		
Secretary/Library		49
Airworthiness Group, Mr K. O'Brien		50
<b>Statutory, State Authorities and Industry</b>		
CSIRO Mechanical Engineering Division, Chief		51
CSIRO Materials Science Division, Director		52
Qantas, Library		53
Trans Australia Airlines, Library		54
Ansett Airlines of Australia, Library		55
BHP Central Research Laboratories, NSW		56
BHP Melbourne Research Laboratories		57
Commonwealth Aircraft Corporation, Manager		58
Commonwealth Aircraft Corporation, Manager of Engineering		59
Hawker de Havilland Pty. Ltd., Librarian, Bankstown		60
Hawker de Havilland Pty. Ltd., Manager, Lidcombe		61
<b>Universities and Colleges</b>		
Adelaide	Barr Smith Library	63
Flinders	Library	64
James Cook	Library	65
Latrobe	Library	66
Melbourne	Engineering Library	67
Monash	Library	68
	Professor I. J. Polmear	69
Newcastle	Library	70
New England	Library	71
Sydney	Engineering Library	72
	Professor G. A. Bird	73
N.S.W.	Physical Sciences Library	74
Queensland	Library	75
Tasmania	Engineering Library	76
West Australian	Library	77
R.M.I.T.	Library	78
<b>CANADA</b>		
Aluminium Laboratories Ltd., Library		79
CAARC Co-ordinator Structures		80
International Civil Aviation Organization, Library		81
NRC, National Aeronautical Establishment, Library		82
NRC, Division of Mechanical Engineering, Director		83
<b>Universities and Colleges</b>		
McGill	Library	84
Toronto	Institute for Aerospace Studies	85



<b>FRANCE</b>		
AGARD, Library		86
ONERA, Library		87
Service de Documentation, Technique de l'Aeronautique		88
<b>GERMANY</b>		
ZLDI		89
<b>INDIA</b>		
CAARC Co-ordinator Materials		90
CAARC Co-ordinator Structures		91
Civil Aviation Department, Director		92
Defence Ministry, Aero Development Establishment, Library		93
Hindustan Aeronautics Ltd., Library		94
Indian Institute of Science, Library		95
Indian Institute of Technology, Library		96
National Aeronautical Laboratory, Director		97
<b>ISRAEL</b>		
Technion—Israel Institute of Technology, Professor J. Singer		98
<b>ITALY</b>		
Associazione Italiana di Aeronautica e Astronautica		99
<b>JAPAN</b>		
National Aerospace Laboratory, Library		100
<b>Universities</b>		
Tohoku (Sendai)	Library	101
Tokyo	Inst. of Space and Aeroscience	102
<b>NETHERLANDS</b>		
Central Org. for Applied Science Research TNO, Library		103
National Aerospace Laboratory (NLR), Library		104
<b>NEW ZEALAND</b>		
The Librarian, Defence Scientific Establishment		105
Transport Ministry, Civil Aviation Division, Library		106
<b>Universities</b>		
Canterbury	Library	107
<b>SWEDEN</b>		
Aeronautical Research Institute		108
SAAB-Scania, Library		109
Research Institute of the Swedish National Defence		110
<b>UNITED KINGDOM</b>		
Mr A. R. G. Brown, ADR/MAT (MEA)		111
Aeronautical Research Council, Secretary		112
CAARC, Secretary		113
Royal Aircraft Establishment Library, Farnborough		114
Royal Aircraft Establishment Library, Bedford		115
Royal Armament Research and Development Establishment		116
Commonwealth Air Transport Council Secretariat		117
Admiralty Materials Laboratories, Dr R. G. Watson		118
Military Vehicles Engineering Establishment		119
National Engineering Laboratories, Superintendent		120

National Physical Laboratory, Library	121
British Library, Science Reference Library	122
British Library, Lending Division	123
Naval Construction Research Establishment, Superintendent	124
CAARC Co-ordinator, Structures	125
Aircraft Research Association, Library	126
British Non-Ferrous Metals Res. Assoc.	127
Rolls-Royce Ltd., Aeronautics Division, Chief Librarian	128
Rolls-Royce Ltd., Bristol Siddeley Division T.R. & I. Library Services	129
Science Museum Library	130
Welding Institute, Library	131
Hawker Siddeley Aviation Ltd. Library, Brough	132
Hawker Siddeley Aviation Ltd. Library, Greensgate	133
Hawker Siddeley Aviation Ltd. Library, Kingston-upon-Thames	134
Hawker Siddeley Dynamics Ltd., Hatfield	135
British Aircraft Corporation (Holdings) Ltd., Commercial Aircraft Div.	136
British Aircraft Corporation (Holdings) Ltd., Military Aircraft Div.	137
British Hovercraft Corporation Ltd., Library	138
Fairey Engineering Ltd., Hydraulic Division	139
Short Brothers Harland	140
Westland Helicopters Ltd.	141

**Universities and Colleges**

Bristol	Library, Engineering Department	142
Cambridge	Library, Engineering Department	143
Belfast	Dr A. Q. Chapleo, Dept. of Aeron. Engineering	144
Manchester	Professor, Applied Mathematics	145
Nottingham	Library	146
Southampton	Library	147
Strathclyde	Library	148
Cranfield Inst. of Technology	Library	149
Imperial College	The Head Professor of Mechanical Engineering	150 151

**UNITED STATES OF AMERICA**

NASA Scientific and Technical Information Facility	152
American Institute of Aeronautics and Astronautics	153
Applied Mechanics Review	154
The John Crerar Library	155
The Chemical Abstracts Service	156
Bell Helicopter Textron	157
Boeing Co., Head Office, Mr R. Watson	158
Cessna Aircraft Co., Executive Engineer	159
Lockheed Missiles and Space Company	160
Lockheed California Company	161
Lockheed Georgia Company	162
McDonnell Douglas Corporation, Director	163
Westinghouse Laboratories, Director	164
Calspan Corporation	165
United Technologies Corporation, Pratt and Whitney Aircraft Group	166
Batelle Memorial Institute, Library	167

**Universities and Colleges**

Florida	Aero Engineering Dept.	168
Stanford	Department of Aeronautics Library	169

Brooklyn Inst. of Polytechnique	Polytech. Aeronautical Labs. Library	170
California Institute of Technology	Guggenheim Aeronautical Labs. Library	171
Massachusetts Inst. of Technology	Library	172
Spares		173-182