

AD-A083 335

BDM CORP MCLEAN VA F/G 15/7
REPRESENTATIVE COMMAND POST CONFIGURATIONS, C3 STRUCTURES, AND --ETC(U)
JUL 78 H E REYNOLDS, W E SWEENEY DNA001-78-C-0077
BDM/W-78-C-0077-VOL-1 DNA-4352T-3A-VOL-1 NL

UNCLASSIFIED

1 of 3
AL
WWW

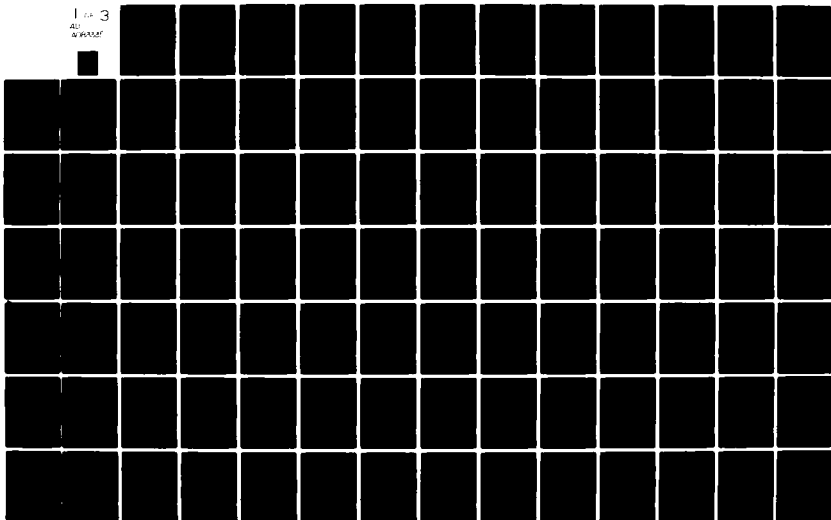

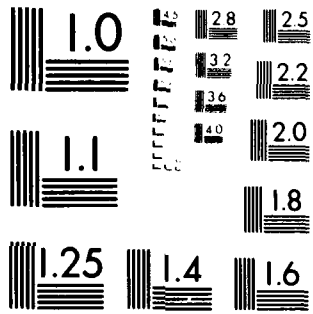

MICROCOPY RESOLUTION TEST CHART
NATIONAL BUREAU OF STANDARDS-1963-A

12 LEVEL III
nu

AD-E 300 733

DNA 4352T-3A

ADA 083335

REPRESENTATIVE COMMAND POST CONFIGURATIONS, C³ STRUCTURES, AND REFERENCE DATA

Volume I

The BDM Corporation
7915 Jones Branch Drive
McLean, Virginia 22102

31 July 1978

Topical Report for Period September 1977—July 1978

CONTRACT No. DNA 001-78-C-0077

APPROVED FOR PUBLIC RELEASE;
DISTRIBUTION UNLIMITED.

THIS WORK SPONSORED BY THE DEFENSE NUCLEAR AGENCY
UNDER RDT&E RMSS CODE B363078464 O99QAXCA10711 H2590D.

Prepared for
Director
DEFENSE NUCLEAR AGENCY
Washington, D. C. 20305

DTIC
ELECTE
S D
APR 23 1980
B

FILE COPY

80 3 21 005

Destroy this report when it is no longer needed. Do not return to sender.

PLEASE NOTIFY THE DEFENSE NUCLEAR AGENCY,
ATTN: STTI, WASHINGTON, D.C. 20305, IF
YOUR ADDRESS IS INCORRECT, IF YOU WISH TO
BE DELETED FROM THE DISTRIBUTION LIST, OR
IF THE ADDRESSEE IS NO LONGER EMPLOYED BY
YOUR ORGANIZATION.



UNCLASSIFIED

SECURITY CLASSIFICATION OF THIS PAGE (When Data Entered)

REPORT DOCUMENTATION PAGE		READ INSTRUCTIONS BEFORE COMPLETING FORM
1. REPORT NUMBER DNA 4352T-3A	2. GOVT ACCESSION NO. AD-A083338	3. RECIPIENT'S CATALOG NUMBER
4. TITLE (and Subtitle) REPRESENTATIVE COMMAND POST CONFIGURATIONS, C ³ STRUCTURES, AND REFERENCE DATA Volume I	5. TYPE OF REPORT & PERIOD COVERED Topical Report for Period Sep 77-Jul 78	6. PERFORMING ORG. REPORT NUMBER BDM/W-78-C-0077
7. AUTHOR(s) Homer E. Reynolds William E. Sweeney	8. CONTRACT OR GRANT NUMBER(s) DNA 001-78-C-0077	
9. PERFORMING ORGANIZATION NAME AND ADDRESS The BDM Corporation 7915 Jones Branch Drive McLean, Virginia 22102	10. PROGRAM ELEMENT, PROJECT, TASK AREA & WORK UNIT NUMBERS Subtask 099QAXCA107-11	
11. CONTROLLING OFFICE NAME AND ADDRESS Director Defense Nuclear Agency Washington, D.C. 20305	12. REPORT DATE 31 July 1978	13. NUMBER OF PAGES 236
14. MONITORING AGENCY NAME & ADDRESS (if different from Controlling Office)	15. SECURITY CLASS (of this report) UNCLASSIFIED	15a. DECLASSIFICATION/DOWNGRADING SCHEDULE
16. DISTRIBUTION STATEMENT (of this Report) Approved for public release; distribution unlimited.		
17. DISTRIBUTION STATEMENT (of the abstract entered in Block 20, if different from Report)		
18. SUPPLEMENTARY NOTES This work sponsored by the Defense Nuclear Agency under RDT&E RMSS Code B363078464 099QAXCA10711 H2590D.		
19. KEY WORDS (Continue on reverse side if necessary and identify by block number) Command, Control and Communications Structures Nuclear Survivability Electromagnetic Pulses Tactical Nuclear Targets		
20. ABSTRACT (Continue on reverse side if necessary and identify by block number) This study has been conducted as a part of DNA's Integrated Nuclear Communi- cations Assessment (NCA) Program. It is a consolidation of information to be used as a working document for nuclear survivability analysis of eight (8) U.S. Army tactical command posts. Each command post (CP) is geographically displayed as representative of actual field deployment. The study describes each mission and deployment concept and provides representative quantities, types, and functions of personnel, equipment and communications systems based		

DD FORM 1473 1 JAN 73 EDITION OF 1 NOV 65 IS OBSOLETE

SECURITY CLASSIFICATION OF THIS PAGE (When Data Entered)

UNCLASSIFIED

SECURITY CLASSIFICATION OF THIS PAGE(When Data Entered)

20. ABSTRACT (Continued)

on a postulation of command, staff and communications elements which would be expected to be present at a "snapshot" in time.

The study also describes the CP interrelationships with higher, lower and adjacent units as well as the fire support requirements for Air Force and Army units. Command structures, communications structures, and technical data have been selected relative to these specific command posts and where appropriate, information was reproduced from existing publications.

The results are given in the form of figures and tables and can be used in the following areas of analysis:

- (1) determining minimum safe offset distances between Command Posts and other potential tactical nuclear targets,
- (2) identifying the sensitivity of tactical unit mission effectiveness to the EMP hardness of electronic systems,
- (3) providing data for use in large scale war gaming simulations which consider nuclear weapons,
- (4) providing data for use in EW analysis, and
- (5) providing data for use in tactical communications engineering and systems architecture.

An important contribution of this study is the specification of personnel, equipment, and circuits, the routing and control of these circuits within Tactical CP, and has consolidation of C³ structures and reference data into one document.

ACCESSION for	
NTIS	White Section <input checked="" type="checkbox"/>
DDC	Buff Section <input type="checkbox"/>
UNANNOUNCED	<input type="checkbox"/>
JUSTIFICATION _____	
BY _____	
DISTRIBUTION/AVAILABILITY CODES	
Dist.	AVAIL. and/or SPECIAL
A	

UNCLASSIFIED

SECURITY CLASSIFICATION OF THIS PAGE(When Data Entered)

TABLE OF CONTENTS

<u>Section</u>	<u>Page</u>
FORM 1473	
TABLE OF CONTENTS	1
LIST OF FIGURES	5
LIST OF TABLES	9
1. EXECUTIVE SUMMARY	13 to 19
1.1 Background	13
1.2 Objective	14
1.3 Approach	15
1.4 Scope	16
1.5 Methodology	17
1.5.1 Recognition of the Overall Threat	17
1.5.2 Assumptions	18
1.5.3 System Parameters	18
1.5.4 Communications Design Techniques	19
2. DESIGN APPROACH	20 to 23
2.1 Personnel and Equipment	20
2.2 Dispersion	20
2.3 Remote Facilities	20
2.4 Geographical Layout	20
2.5 Communications System Design Techniques	21
2.5.1 Command and Control Requirements	21
2.5.2 Sole User Telephones	21
2.5.3 Common User Telephones	21
2.5.4 Manual/Automatic Telephone Integration	21
2.5.5 Sole User Telephone Network	22
2.5.6 Communications Loading Factors	22
2.6 C ³ Structures	22
2.7 Reference Data	23
2.8 Study Structure	23

TABLE OF CONTENTS (CONTINUED)

<u>Section</u>	<u>Page</u>
3. 155mm FIELD ARTILLERY BATTERY CP CONFIGURATION AND C ³ STRUCTURES	24 to 31
3.1 Mission and Deployment Concept	24
3.2 CP Configuration	24
3.2.1 Radio Enhancements	24
3.2.2 Wire Enhancements	24
3.2.3 Technical Control	24
3.3 C ³ Structures	27
4. 155mm FIELD ARTILLERY BATTALION CP CONFIGURATION AND C ³ STRUCTURES	32 to 41
4.1 Mission and Deployment Concept	32
4.2 CP Configuration	32
4.2.1 Radio Enhancements	32
4.2.2 Wire Enhancements	32
4.2.3 Technical Control	35
4.3 C ³ Structures	35
5. 8" FIELD ARTILLERY BATTERY CP CONGIFURATION AND C ³ STRUCTURES	42 to 48
5.1 Mission and Deployment Concept	42
5.2 CP Configuration	42
5.3 C ³ Structures	42
6. 8" FIELD ARTILLERY BATTALION CP CONFIGURATION AND C ³ STRUCTURES	49 to 56
6.1 Mission and Deployment Concept	49
6.2 CP Configuration	49
6.3 C ³ Structures	49
7. DIVISION ARTILLERY CP CONFIGURATION AND C ³ STRUCTURES	57 to 77
7.1 Mission and Deployment Concept	57
7.2 CP Configuration	57

TABLE OF CONTENTS (CONTINUED)

<u>Section</u>	<u>Page</u>
7.2.1 Radio Enhancements	57
7.2.2 Wiring Enhancements	60
7.2.3 Technical Control	61
7.3 C ³ Structures	62
8. DIVISION TAC CP CONFIGURATION AND C ³ STRUCTURES	78 to 89
8.1 Mission and Deployment Concept	78
8.2 CP Configuration	78
8.2.1 Radio Enhancements	78
8.2.2 Wiring Enhancements	81
8.2.3 Technical Control Facilities	81
8.3 C ³ Structures	81
9. MECHANIZED INFANTRY BRIGADE CP CONFIGURATION AND C ³ STRUCTURES	90 to 104
9.1 Mission and Deployment Concept	90
9.2 CP Configuration	90
9.2.1 Radio Enhancements	90
9.2.2 Wiring Enhancements	93
9.2.3 Technical Control Facilities	93
9.2.4 Teletypewriter Enhancements	93
9.3 C ³ Structures	93
10. MECHANIZED INFANTRY BATTALION CP CONFIGURATION AND C ³ STRUCTURES	105 to 116
10.1 Mission and Deployment Concept	105
10.2 CP Configuration	105
10.2.1 Radio Enhancements	105
10.2.2 Technical Control Facility	105
10.3 C ³ Structures	108
<u>Appendix</u>	<u>Page</u>
A. DIVISION COMMAND AND CONTROL STRUCTURES	117 to 120
B. COMMUNICATIONS STRUCTURES	121 to 136

TABLE OF CONTENTS (CONTINUED)

<u>Appendix</u>		<u>Page</u>
C.	MULTICHANNEL RADIO REFERENCE DATE	137 to 154
D.	SINGLE CHANNEL RADIO REFERENCE DATA	155 to 162
E.	RADIO WIRE INTEGRATION REFERENCE DATA	163 to 166
F.	RADIO REMOTE SET REFERENCE DATA	167 to 172
G.	FIELD EXPEDIENT ANTENNA REFERENCE DATA	173 to 178
H.	TELEPHONE REFERENCE DATA	179 to 182
I.	SWITCHBOARD REFERENCE DATA	183 to 188
J.	TECHNICAL CONTROL REFERENCE DATA	189 to 192
K.	TELETYPEWRITER REFERENCE DATA	193 to 200
L.	WIRE AND CABLE REFERENCE DATA	201 to 212
M.	VEHICLE REFERENCE DATA	213 to 214
N.	POWER UNIT REFERENCE DATA	215 to 216
O.	RADIO FREQUENCY REFERENCE DATA	217 to 218
P.	EMMISSION CODES REFERENCE DATA	219 to 220
Q.	JOINT ELECTRONICS TYPE DESIGNATION SYSTEM	221 to 222
R.	LIST OF REFERENCES	223 to 226
S.	COMMUNICATION EQUIPMENT INDEX	227 to 230

LIST OF FIGURES

<u>Figure</u>		<u>Page</u>
3-1	Field artillery battery (155mm) CP configuration	25
3-2	FA battery (155mm) CP radio structure	29
3-3	FA battery (155mm) wiring structure	30
4-1	Field artillery battalion (155mm) CP configuration	33
4-2	FA battalion (155mm) CP radio structure	37
4-3	FA battalion (155mm) internal radio nets	38
4-4	FA battalion (155mm) wiring structure	39
5-1	Field artillery battery (8") CP configuration	43
5-2	FA battery (8") CP radio structure	46
5-3	FA battery (8") wiring structure	47
6-1	Field artillery battalion (8") CP configuration	50
6-2	FA battalion (8") CP radio structure	53
6-3	FA battalion (8") internal radio nets	54
6-4	FA battalion (8") wiring structure	55
7-1	Division artillery command post configuration	58
7-2	Divarty radio net structure	69
7-3	Divarty CMD/Fire direction radio net	70
7-4	Divarty miscellaneous internal radio nets	71
7-5	Divarty wiring structure	72
8-1	Division TAC CP configuration	79
8-2	Division TAC CP wiring structure	88
9-1	Mechanized infantry brigade CP configuration	91

LIST OF FIGURES (CONTINUED)

<u>Figure</u>		<u>Page</u>
9-2	Brigade CP radio structure	96
9-3	Division, Air Force, and field artillery radios supporting a brigade	97
9-4	Brigade INTEL and COMD/OPNS	98
9-5	Brigade ADMIN/LOG, RATT and AVN section radio nets	99
9-6	Brigade CP wiring structure	100
10-1	Mechanized infantry battalion CP configuration	106
10-2	Maneuver battalion CP radio net structure	110
10-3	Air Force and field artillery radios supporting a maneuver battalion	111
10-4	Maneuver battalion radio nets - COMD/OPNS and ADMIN/LOG	112
10-5	Maneuver battalion fire direction and miscellaneous internal radio nets	113
10-6	Maneuver battalion wiring structure	114
A-1	Division organizational structure	118
A-2	Division fire planning structure	119
A-3	Categories of tactical air missions and air request structure	120
B-1	Types of communications equipment at division, brigade, and battalion	122
B-2	Types of communications equipment at battalion and below	123
B-3	Radio features	125
B-4	Field expedient antenna employment concepts	127
B-5	Division multichannel radio system structure	128

LIST OF FIGURES (CONTINUED)

<u>Figure</u>		<u>Page</u>
B-6	Multichannel radio features	129
B-7	Radio-wire integration features	131
B-8	Division tape relay traffic diagram	132
B-9	Teletypewriter features	133
B-10	Division line route map	134
B-11	Wire and cable features	135
C-1	Radio set AN/GRC-103 technical characteristics	140
C-2	AN/TRC-145 subassemblage connectivities	144
C-3	Antenna AS-1852	145
C-4	AN/GRC-163 technical characteristics	153
D-1	Major components of the AN/VRC-12 family of radio sets	156
D-2	Antenna RC-292	158
D-3	Major components of the AN/GRC-142 and AN/GRC-122 radio sets	159
D-4	Radio AN/GRC-106	160
E-1	Radio set control AN/GSA-7	164
E-2	RWI operations using the AN/GSA-7	165
E-3	RWI operations using the AN/GRA-39	166
F-1	Radio set control group AN/GRA-39B	168
F-2	AN/GRA-39 remote operation	169
F-3	Radio set control group AN/GRA-6	170
F-4	AN/GRA-6 remote operation	171

LIST OF FIGURES (CONTINUED)

<u>Figure</u>		<u>Page</u>
G-1	Field expedient antenna design formulas	174
G-2	Field expedient uni-directional antennas	175
G-3	Field expedient bi-directional antennas	176
G-4	Field expedient long wire antennas	177
K-1	Telegraph-telephone AN/TCC-29	200
L-1	WD-1 splicing techniques	203
L-2	Use of repeater coils C-161	204
L-3	Field cable WF-16	205
L-4	Distribution cable CX-4566 (26 pair)	206
L-5	Distribution cable stub CX-4760	207
L-6	Carrier cable CX-11230	208
L-7	Power cable assembly	211
M-1	Vehicle reference data	213

LIST OF FIGURES (CONTINUED)

<u>Figure</u>		<u>Page</u>
G-1	Field expedient antenna design formulas	174
G-2	Field expedient uni-directional antennas	175
G-3	Field expedient bi-directional antennas	176
G-4	Field expedient long wire antennas	177
K-1	Telegraph-telephone AN/TCC-29	200
L-1	WD-1 splicing techniques	203
L-2	Use of repeater coils C-161	204
L-3	Field cable WF-16	205
L-4	Distribution cable CX-4566 (26 pair)	206
L-5	Distribution cable stub CX-4760	207
L-6	Carrier cable CX-11230	208
L-7	Power cable assembly	211
M-1	Vehicle reference data	213

LIST OF TABLES

<u>Table</u>		<u>Page</u>
3-1	Glossary of terms for Figure 3-1	26
3-2	Field artillery battery (155mm) personnel and equipment list	28
3-3	Field artillery battery (155mm) wire distribution	31
4-1	Glossary of terms for Figure 4-1	34
4-2	Field artillery battalion (155mm) personnel and equipment list	36
4-3	Field artillery battalion (155mm) wire and cable distribution	40
5-1	Glossary of terms for Figure 5-1	44
5-2	Field artillery battery (8") personnel and equipment list	45
5-3	Field artillery battery (8") wire distribution	48
6-1	Glossary of terms for Figure 6-1	51
6-2	Field artillery battalion (8") personnel and equipment list	52
6-3	Field artillery battalion (8") wire and cable distribution	56
7-1	Glossary of terms for Figure 7-1	59
7-2	Division artillery TOC personnel and equipment list	63
7-3	Division artillery main CP personnel and equipment list	64
7-4	Division artillery SIGNAL center personnel and equipment list	66
7-5	Divarty radio nets for division and above	68

LIST OF TABLES (CONTINUED)

<u>Table</u>		<u>Page</u>
7-6	DIV ARTY COMD and TOC switchboard trunking allocation	73
7-7	Division artillery CP multichannel circuit allocation	74
7-8	Division artillery TOC wire and cable distribution	75
7-9	Division artillery main CP wire and cable distribution	76
7-10	Division artillery signal center wire and cable distribution	77
8-1	Glossary of terms for Figure 8-1	80
8-2	Division TAC CP personnel and equipment list	82
8-3	Division TAC CP radio nets for division and above	84
8-4	TAC CP COMD and TOC switchboard trunking allocation	85
8-5	Division TAC CP multichannel circuit allocation	86
8-6	Division TAC CP wire and cable distribution	88
9-1	Glossary of terms for Figure 9-1	92
9-2	Brigade CP personnel and equipment list	94
9-3	Brigade COMD and TOC switchboard trunking allocation	101
9-4	Brigade CP multichannel circuit allocation	102
9-5	Brigade CP wire and cable distribution	103
10-1	Glossary of terms for Figure 10-1	107
10-2	Mechanized infantry battalion CP personnel and equipment list	109
10-3	Mechanized infantry battalion wire distribution	115

LIST OF TABLES (CONTINUED)

<u>Table</u>		<u>Page</u>
B-1	Division single channel radio net structure	124
B-2	Single channel radio employment concepts	126
B-3	Multichannel radio employment concepts	130
C-1	Multichannel radio terminal set AN/TRC-145	138
C-2	Radio set AN/GRC-103 general information	139
C-3	Signal converter CV-1548	141
C-4	Multiplexer TD-660	142
C-5	PCM cable transmission interface unit TD-754	143
C-6	AS-1852 technical characteristics	146
C-7	AS-1852 deployment and cable assemblies	147
C-8	Radio repeater set AN/TRC-113 description	148
C-9	AN/TRC-113 characteristics	149
C-10	Telephone terminal AN/TCC-65 description	150
C-11	AN/TCC-65 characteristics	151
C-12	Radio terminal set AN/GRC-163 general information	152
C-13	Multiplexer TCC-70 description	154
D-1	Technical characteristics of the AN/VRC-12 family of radio sets	157
D-2	Air Force TACP communications central AN/MRC-108 technical data	161
D-3	AN/MRC-108 major components	162
H-1	Telephone set TA-312	180
H-2	Telephone set TA-838	181

LIST OF TABLES (CONTINUED)

<u>Table</u>		<u>Page</u>
I-1	Switchboard SB-993	184
I-2	Switchboard SB-22	185
I-3	Switchboard SB-3614	186
I-4	Switchboard SB-3082	187
J-1	Terminal box TA-125	190
J-2	Distribution box J-1077	191
J-3	Patching central AN/TSC-76	192
K-1	Teletypewriter set AN/PGC-1 (TT-4, TT-335, and TT-537)	194
K-2	Teletypewriter set AN/GGC-3 and TT-76	195
K-3	Teletypewriter central office AN/TGC-30	196
K-4	Telegraph terminal AN/TSC-58	197
K-5	Telegraph-telephone signal converter CV-425	198
K-6	Telegraph terminal TH-22	199
L-1	General characteristics of field wire WD-1	202
L-2	Unattended repeaters TD-206 for PCM cable CX-11230	209
L-3	Summary of wire and cable characteristics	210
M-1	Metric conversion formulas	214
N-1	Power unit reference data	215
O-1	Radio frequency reference data	217
P-1	Emission codes reference data	219
Q-1	Joint electronics type designation system	221

1. EXECUTIVE SUMMARY

1.1 Background

Command Post layouts have never been provided in sufficient detail to model adequately either the physical or operational relationships necessary to determine survivability, communications effectiveness, and mission effectiveness of the Command Post (CP). In particular, the elements on information not readily available include a lack of identification of specific CP elements, the geographical relationships of these elements at the Command Post location, and the operational relationship of the CP to the overall command and control structure involving higher to lower, left to right, and supporting to supported units. For those few cases where CP configurations are identified, geographical relationships are not defined and organic assets have not been integrated with assets provided by higher, adjacent, and supporting units. Other CP configuration details which have never been fully integrated include:

- (1) A detailed layout of the unit level switch and associated four wire system when integrated with the existing two-wire system.
- (2) Integration of the sole user voice network, the common user voice network, and the teletypewriter network for local (CP) and long haul circuit distribution.
- (3) Detailed identification of wire and cable connectivity within the CP and between CPs to include numbers of end instruments, types of wires and cables, and switching and technical control devices.
- (4) Identification of equipment and subassemblages where wire and cable connections are required as well as signal forms (VF or DC) and signal converter settings (2 wire or 4 wire).
- (5) Employment of detached antennas for range extension and employment of field expedient antennas to reduce the EW threat.
- (6) Employment of remote radio control sets when the staff is away from their vehicle radios and are consolidated in a facility such as a tent.
- (7) Identification of mobile power units and their geographical relationships to the supporting elements.

- (8) Identification of man-machine interfaces and their skill levels to be used in communication effectiveness analysis.

1.2 Objective

The objective of this study is to produce representative layouts both necessary and sufficient to model CP survivability, communications effectiveness, and mission effectiveness subsequent to exposure to nuclear weapons effects. The representative layouts directly support the models and sensitivity analyses developed in Reference 1. Additional benefits which can be derived from these layouts are:

- (1) The detailed descriptions will allow for prioritization of survivability assessments by identifying equipments and configurations that appear repeatedly in tactical C³ units.
- (2) The detailed wire and cable connectivity showing the numbers, types, lengths and distribution techniques places in perspective the amount and nature of coupling calculations required for electromagnetic pulse (EMP) vulnerability assessments.
- (3) EMP hardness improvements can be postulated and evaluated through modeling techniques described in Reference 1. For example, wire and cable lines could be made "hard" by replacing them with optical fibers and the reduction of the impact of EMP effects can be quantified using the models of Reference 1. Priorities can then be assessed as to which wires or cables should be replaced first by optical fibers when technology will allow for tactical implementation when it becomes cost effective.
- (4) The configurations and employment concepts can be used for electronic warfare (EW) studies. The detailed layouts provide sufficient details (equipments, antenna types, usage) for jamming calculations to be performed. Elements can be modified, deleted, or displaced and the impact on survivability, communication effectiveness, and mission effectiveness in an EW environment can be determined.
- (5) The representative configurations in this study and the associated modeling techniques in Reference 1 are flexible such that new equipment can be introduced and evaluated prior to actual fielding.

Examples are satellite communications terminals (UHF and SHF), facsimile, data keyboard terminals, acoustical couplers for dial-up data transfers, and computer processing units.

- (6) Finally, new circuit distribution techniques can be introduced such as the use of the data multiplexer (TD-1069) and the high-speed serial data buffer (TD-1065). Numbers of physical wire lines can be reduced through remoting of the TD-1069 up to 3 KM for locations where there is a concentration of data terminals. This reduction in numbers of wire lines along with the wider dispersion of data facilities can then be evaluated.

1.3 Approach

Reference material (Appendix R) was used to assist in defining the mission and deployment concepts, the structures and distribution of personnel and equipment, and the other CP configuration details listed under paragraph 1.1 above. However, due to the lack of specific detailed information, representative configurations were constructed based on the unit mission and the functional requirements of the commander and his staff. Since there are three types of divisions (Armored, Infantry, and Mechanized Infantry), the Mechanized Infantry Division was chosen as the representative unit because it has features common to the other two types of divisions. This does not preclude changing of vehicles and structures in the future to accommodate any force mix, and the configurations can be changed as desired.

Specific geographical relationships of CP elements were defined as representative and, as mentioned earlier, can be changed to reflect a more accurate representation, to reflect a change in concept of doctrine, and to support sensitivity analysis.

Specific numbers of circuits were defined as representative of those needed to support the functional requirements of the command and staff personnel. This was necessary in order to determine the numbers and types of end instruments, switching centers, technical control facilities and multichannel radio facilities.

Specific numbers of remote radio sets, detached antennas, and field expedient antennas were defined as representative of those needed to

support the functional requirements of the command and staff, the radio propagation requirements of the radio terminals, and the counter EW measures required when dealing with a sophisticated adversary.

A high level of detail has been provided for each CP in tables and figures to identify personnel, equipment, radio structures, wiring structures, switchboard trunking allocations, multichannel circuit allocations, wire distribution, and cable distribution. The information is heavily oriented towards hardware nomenclature so analysis can have a basis for further research as required.

In addition to the layouts presented in the main body of the report, additional data is provided in appendices as follows:

- (1) Division organization, fire planning, and air request structures (Appendix A)
- (2) Types of communications equipment, features, employment concepts, and network structures (Appendix B)
- (3) Communications technical data for all systems and subassemblages (Appendices C through L)
- (4) Miscellaneous information about vehicles, mobile power units, the radio frequency spectrum, emission codes, the joint electronic type designation system, a list of references and an index to the communications technical data (Appendices M through S).

These additional appendices provide a consolidated set of information for each analyst that should be sufficient to support most of the analytic efforts discussed above. This consolidation eliminates the necessity of each analyst having a complete set of documentation and serves as a quick reference to the base set of documentation since each figure/table is keyed to the basic reference.

1.4 Scope

The design approach is discussed in the following chapter and subsequent chapters discuss each of eight CP configurations with a table and figure to indicate the vehicles and equipment. Personnel, equipment, the radio structure and radio nets, the wiring structure, the wiring and cable distribution, and the circuit allocation for the multi-

channel system (when applicable) are also provided in each CP configuration chapter. Since this study is primarily concerned with the CP configurations, the figure describing each representative configuration is discussed in detail. All other tables and figures in each chapter, as well as in the appendices, are provided only as background data items of operational and technical value to analysts and are not discussed as a part of the text. However, a list of references is provided where further discussions of these C³ structures and communications data can be found. Administrative and logistics functions are not accommodated in detail in this study so as to bound the scope of the study to critical C³ I functions. The CP configurations in this study are:

- (a) 155mm Battery
- (b) 155mm Battalion
- (c) 8" Battery
- (d) 8" Battalion
- (e) Division Artillery
- (f) Division TAC CP
- (g) Mechanized Infantry Brigade
- (h) Mechanized Infantry Battalion

1.5 Methodology

1.5.1 Recognition of the Overall Threat

Conventional warfare, nuclear warfare, and electronic warfare are threats which were considered when designing the baseline configurations. Dispersion, cover and concealment, rapid response time of communications support systems, low communications electronic "signature", COMSEC and OPSEC (electronic and physical protection), and high CP mobility requirements (set up and tear down times) are factors which required trade-offs to determine the size and grouping of the staff and communications elements. However, the driving factor influencing CP configuration designs in this study is the mobility requirement (set-up and teardown times) for CP displacement.

1.5.2 Assumptions

1.5.2.1 CP Configurations

An assumption is made that the personnel and equipment can support the C³I requirements of the CP, realizing that any element can be changed for any reason and that each representative configuration is only a baseline for analysis.

1.5.2.2 CP Displacement Times

An assumption is made that units will be moving back and forth on the modern battlefield, CPs will be constantly displacing, and future CP displacement objectives for set up and tear down times will be:

- (a) Battalion - 5 minutes
- (b) Brigade - 15 minutes
- (c) Division - 30 minutes

The definition for "set-up" is when a commander or staff member can send the first teletype message and can make the first telephone call outside the CP. This means that communications facilities must be able to set up, tear down, and reestablish communications much faster than in the past.

1.5.2.3 Employment of the Automatic Switchboard

An assumption is made that the concept of employment of the interim automatic switchboard (SB-3614) for the transition period 1976 through 1986 will be as described in reference 3. As stated in the reference, the use of dedicated circuits is to continue to satisfy critical command and control requirements at Division Main TOC, Div Arty TOC, the Tactical CP, and at Brigade CP's.

1.5.2.4 Determination of Dedicated Circuit Requirements

An assumption is made that the number of dedicated circuits is, as a minimum, those described in FM 11-50 (reference 2).

1.5.3 System Parameters

The basic system parameter in this study is that which identifies the command and staff elements required for command and control of maneuver units, command and control of fire support units (Army and Air Force), and coordination between maneuver and fire support units. Other system parameters include:

- (a) Operational facilities for command and staff personnel.
- (b) Communications personnel and equipment to support the command and staff operational facilities.
- (c) Vehicle dispersion and modified radio and teletype facilities to enhance CP survivability without degrading operational capabilities in conventional, nuclear, and electronic warfare environments.

1.5.4 Communications Design Techniques

Communications design techniques are flexible and the representative designs in this study are not designed to reflect doctrine. Representative designs are necessary because of the lack of exact guidelines for CP configurations, distribution and control of field cable (WF-16), use of multichannel radio relay systems when deployed as a radio terminal (TRC-113), use of multichannel multiplex terminals (TCC-65) when deployed in support of the TRC-113, use of the multichannel radio terminal set (GRC-163), and lack of details on the total number of end instruments and long haul links required to support the combination of sole user (ring down) and common user (dial-up) customers when the SB-3614 is introduced to the field. The numbers and types of circuits, equipment, and C³ structures can be changed and can be accommodated in the analytical models discussed in reference 1. In fact, the geographical layouts are to be changed for sensitivity analysis to determine if there is an "optimum" dispersion pattern which is more survivable in a nuclear environment.

2. DESIGN APPROACH

2.1 Personnel and Equipment

Personnel are defined and equipment is designed based on a "snapshot" of command and staff elements which could be present in the command post as well as communications personnel and equipment to support the command and staff elements. A detailed discussion is provided for each command post configuration.

2.2 Dispersion

Dispersion of personnel and equipment depends upon the set-up and tear-down time requirements, the facilities used for staff personnel, the LOS requirements of FM voice radio terminals and multichannel radio terminals, the cover and concealment requirements (natural and man-made), and the warfare threats (conventional, nuclear, and EW). Therefore, for representative configurations, the communications facilities are dispersed with 35-50 meters between each facility and the staff facilities are located adjacent to each other or adjacent to a covered area used for staff planning.

2.3 Remote Facilities

When facilities are located outside the CP area, consideration is given to technical capabilities of communications systems and tactical objectives for CP displacement times.

2.4 Geographical Layout

The baseline configurations have been geographically portrayed in a two dimensional layout with symbols to identify each element. Ground distances can be measured from the centroid of a symbol on a scale of one inch equals 27 meters. Vehicles and trailers are twice their size in relation to the ground scale and can be measured on a scale of 1 inch equals 13.5 meters and are oriented as a "top view". Vertical elements such as radio antennas, RADAR reflectors, and artillery aiming circles are not to scale. They are oriented as a "side view". Field expedient antennas are to ground scale (one inch equals 27 meters) and are also oriented as a "side view".

Wire and cable lines are layed separately in some cases and are consolidated in other cases due to the nature of the display. However, ground distances can be measured from symbol centroids using the ground scale

and adding 20 percent for slack in WD-1 wire and WF-16 cable. This slack is due to indirect routing to any location and overhead routing in the CP area. A slack of 10 percent can be used for 26-pair cable, carrier cable, and power cable for initial estimates. However, these cables are only available in fixed lengths of 75 meters (250 feet) and 4.7 meters (15 feet) for 26-pair cable, 400 meters (1/4 mile) and 30 meters (100 feet) for carrier cable, and 30 meters (100 feet) for power cable. Multiples of these fixed lengths must be judged when determining total communications cable lengths. However, only one cable length (30 meters) should be used for power cables connecting transportable generators and communications terminals.

2.5 Communications System Design Techniques

2.5.1 Command and Control Requirements

The mission and deployment concepts are described and radios, telephones, teletypewriters, and facsimile terminals are provided to support the command and staff elements.

2.5.2 Sole User Telephones

Sole user telephones are terminated in manual switchboards to provide for switching and manual interrupt by an operator, realizing that separate telephones could be used for each line in an "end-to-end" configuration in lieu of a switchboard.

2.5.3 Common User Telephones

Common user telephones are terminated in automatic switchboards.

2.5.4 Manual/Automatic Telephone Integration

The only integration of manual (2-wire) and automatic (4-wire) telephone capability is from Battalion to its parent (or similar) headquarters since the decision was made not to employ the SB-3614 below Brigade. This is accomplished with a TA-955 DTMF Pad which permits the operator at a manual switchboard to digit, on an unassisted basis, over a ringdown trunk through an SB-3614 switchboard for automatic dialing/digitng service. Therefore, although the SB-3614 can accommodate 18 four-wire applications (either terminations or trunks) and 12 two-wire applications (lines or trunks),

the only two-wire terminations in this study will be for trunks from Brigade, Div Arty, and the Division TAC CP to battalions which require common user service. This simplification assists in the management and identification of wire and cable lines and signal converter settings for 2-wire and 4-wire operations.

2.5.5 Sole User Telephone Network

The sole user telephone network is a "closed" two-wire network which always uses WD-1 at the telephone and manual switchboard locations. This "closed" system is not available to common user (dial-up) customers. However, dial-up telephones are provided to selected staff members for direct connectivity to their local automatic switchboard using WF-16 cable. This is a supplement (not an integration) of the sole user telephone network.

2.5.6 Communications Loading Factors

The total number of sole user circuits, teletype circuits, and communications systems control circuits specified in the references have been accommodated before considering common user dial-up circuits, and they are provided the most direct route over multichannel systems. As a result of these loading factors, the total number of common user telephone trunks differ from those recommended by the COMSR data base (reference 3) particularly when they would cause an additional 12-channel microwave system to be installed. Some common user trunks were accommodated by indirect routing over multichannel systems. Other circuits were added where literature indicated a need for additional common user trunks. This being a representative system, adjustments can be made when a total system requirement for dedicated and common user circuits as well as data requirements are available.

2.6 C³ Structures

All relevant operational and technical data which could be directly reproduced from the list of references were reproduced and enclosed in the configuration chapters and appendices. Where this was not possible, tables were developed to consolidate data as appropriate. Radio structures and nets, wire and cable systems, and multichannel radio systems are provided to

support the command and staff voice and record requirements for command and control. Also, switchboards, radio wire integration stations, remote radio facilities, detached antenna systems, teletypewriter centrals, message centers, and technical control facilities are structured to enhance the speed of service, grade of service, and reliability of the communications terminals being used by the command and staff elements.

2.7 Reference Data

Technical data such as types and lengths of wire and cable systems, signal forms at teletypewriter terminals, and signal converter settings at multichannel radio/multiplex terminals are found in each chapter associated with each configuration. Additional data is provided in the appendices to describe C^2 structures, communications structures, and technical characteristics of radios, wires, cables, antennas, signal converters, etc., to preclude the need for each analyst to have a large inventory of publications. However, this does not include data systems or tactical satellite systems due to the lack of information. Also, information on COMSEC devices is not available due to classification constraints.

2.8 Study Structure

There is a separate chapter for each of the 8 configurations. The CP configuration is discussed in detail as are the major elements in each configuration. However, to prevent redundancy, a discussion of a similar element is not repeated in subsequent CP configuration chapters. Therefore, each subsequent CP configuration contains new information unique to that configuration and, possibly, subsequent CP configurations. All other tables and figures at the end of the configuration chapters are provided as C^3 structures for analysts and contain no text. Additionally, tables and figures in the appendices describing Division C^2 structures, communications structures, and selected reference data, are provided for analyst use.

3. 155mm FIELD ARTILLERY BATTERY CP CONFIGURATION AND C³ STRUCTURES

3.1 Mission and Deployment Concept

The battery is an element of the 155mm Battalion, has the mission to provide direct support (DS) to a maneuver battalion, and is usually deployed near the maneuver battalion CP. The 155mm battery CP is a facility for the commander and his staff to command and control the firing sections and support platoons of the battery. However, the primary function within the CP configuration is to provide a fire direction center (FDC) for control of the six artillery launchers.

3.2 CP Configuration

Figure 3-1 is a geographical layout of the CP and Table 3-1 is a glossary of abbreviations associated with the configuration. As can be observed, there is the possibility that other units such as a countermortar RADAR terminal, an element of the air defense team, and a section of the artillery battalion survey platoon could be co-located with the battery.

3.2.1 Radio Enhancements

A field expedient uni-directional antenna (half rhombic) has been used for communications to the parent artillery battalion CP/FDC to improve the quality of transmission and to protect against the EW threat.

3.2.2 Wire Enhancements

A "hot line" has been established between the artillery launchers, the battery operations center (BOC), and the FDC as a backup to the wire lines and as an intercom system. It is indicated by an "H" symbol. Additionally, a wire head is established using repeater coils (C-161) to reduce the number of physical pairs of wires which must be layed from the battalion CP/FDC, three circuits being accommodated over two physical pairs for each repeater coil set.

3.2.3 Technical Control

Patching, testing, and re-routing of circuits are performed near the dismount point (entrance to the CP/FDC) through terminal boxes (TA-125). Wires can be layed to this box and tagged as soon as an element is in place, and the connection to other elements is completed as they become operational.

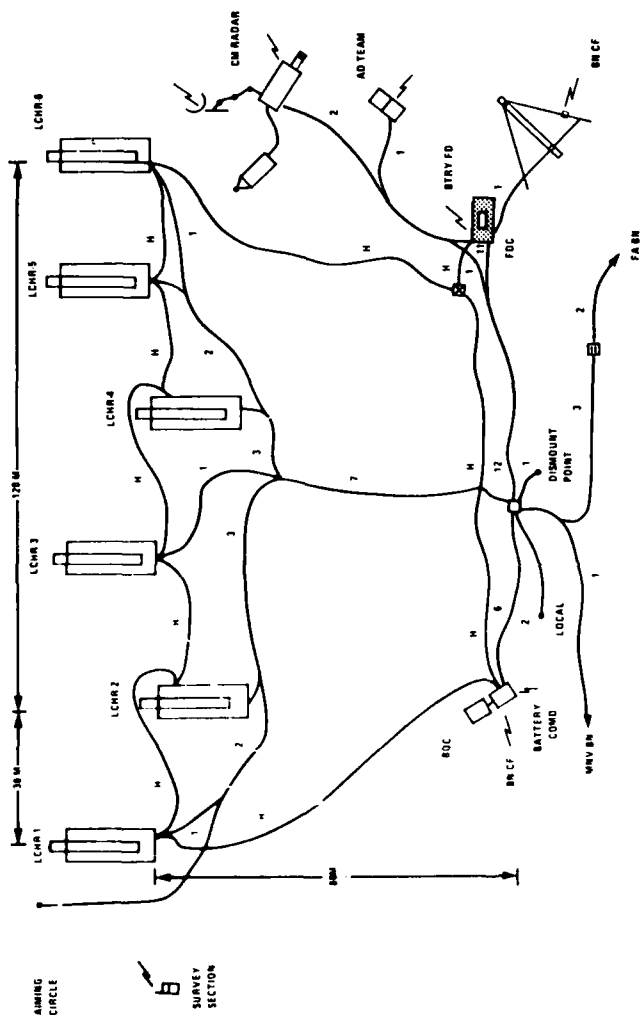

LEGEND

	155mm LAUNCHER		AIMING CIRCLE		RADAR REFLECTOR
	2 1/2 TON TRUCK		PORTABLE RADIO		FIELD WIRE
	5 1/4 TON TRAILER		TERMINAL BOX		"HOTLINE" OVER FIELD WIRE
	GOAT VEHICLE		INTERCOM BOX		NUMBER OF WIRES
	CP CARRIER		REPEATER COIL SET (IC-161)		RF CABLE TO REFLECTOR
	REP		FIELD TELEPHONE		UN-DIRECTIONAL ANTENNA (FIELD EXPEDIENT HALF WINDMILL)
			POWER CABLE		RADIO/RADAR EMISSION

Figure 3-1 Field artillery battery (155mm) CP configurations.

2359-18W

Table 3-1. Glossary of terms for Figure 3-1.

AD	Air Defense
BN	Battalion
BOC	Battery Operations Center
BTRY	Battery
CF	Command/Fire Direction
CM	Counter Mortar
COMD	Command
FA	Field Artillery
FD	Fire Direction
FDC	Fire Direction Center
LCHR	Launcher
M	Meters
MNV	Maneuver

Note: Shaded area is center of activity for command and control.

2359/78W

3.3

C³ Structures

The following C³ structures are provided in tables and figures to assist in analysis:

- (a) CP Personnel and Equipment List
- (b) CP Radio Structure
- (c) Wiring Structure
- (d) Wire Distribution

Table 3-2. Field artillery battery (155mm) personnel and equipment list.

DESCRIPTION ELEMENT	FACILITY	EQUIPMENT	PERSONNEL	FUNCTION
LCHR-1, 2, 3, 4, 5, 6	WEAPONS CARRIER (M 109)	(1) 155mm HOWITZER (1) TELEPHONE (TA-312) (1) HANDSET (H-182/VIC-1)	2 - SKILL (ARTY OP)	ARTY FIRE IN DIRECT SUPPORT
AIMING CIRCLE	OPEN	(1) AIMING CIRCLE (1) TELEPHONE (TA-312)	1 - SKILL (ARTY OP)	WPN ALIGNMENT
BOC VEHICLE	GOAT (M 561)	(1) VRC-47 RADIO SET (FM) (1) KY-38 COMSEC FOR RADIO (FM) (1) SMD (SB-993) (3) TELEPHONES (TA-312)	COMDR, ADMIN, COMM	BN CF/BTRY COMB NETS
FDC VEHICLE	CP CARRIER (M 577)	(2) VRC-46 RADIOS (FM) (2) KY-38 (2) SMD (SB-22) (1) FADAC COMPUTER WITH TT-537 (1) REMOTE SET (GRA-39) (1) FIELD EXPEDIENT UNI-DIRECTIONAL ANT.	XO, AD SEC LDR, COMMO, ADMIN	BN CF/BTRY FDC NETS
AD TEAM	1/4 TON JEEP (M 151)	(1) GRC-160 RADIO (FM) (1) KY-8 COMSEC FOR FM RADIO (1) LOCAL SET (GRA-39)		AD NET (FM) REMOVED TO FDC
CM RADAR	2 1/2 TON TRUCK (M 35) 1-1/2 TON TRAILER	(1) VRC-46 RADIO (FM) (1) KY-38 COMSEC (1) TELEPHONE (TA-312) (1) MPQ-4A RADAR	1 - SKILLED (RADAR OP) PLUS 1 - COMM	BN CF NET CM RADAR
SURVEY SECTION	OPEN	(1) PRC-77 RADIO (FM) MANPACK (1) KY-8 COMSEC	2 - ARTY SURV	BN SURV NET (FM)
TB	OPEN	(2) TA-125 TERMINAL BOARDS	COMM AS REQ	TECH CONTROL
INTERCOMM BOX	OPEN	(1) MK-155/GT	COMM AS REQ	HOT LINE CONTROL

2359/78W

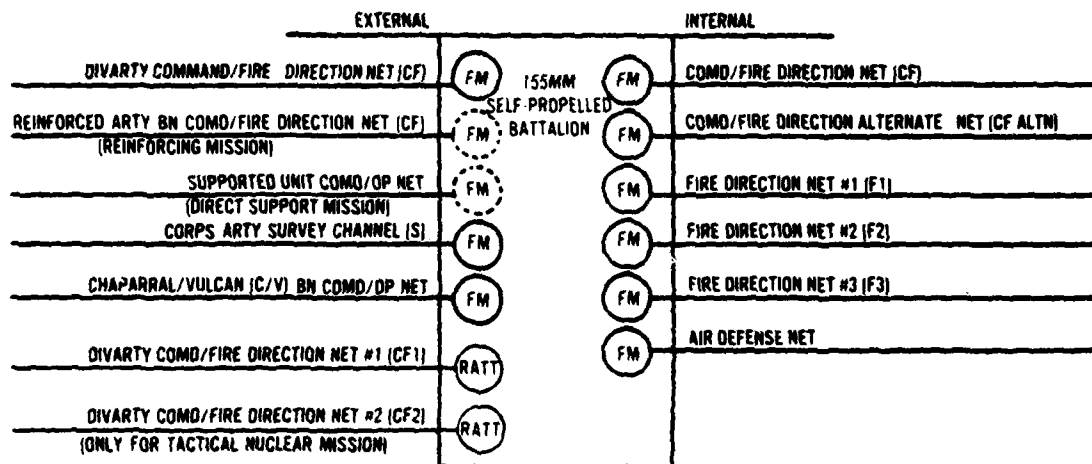

155mm SELF-PROPELLED BATTALION RADIO NET STRUCTURE

THE FA BATTERY (155mm) IS REQUIRED TO PROVIDE RADIO TERMINALS FOR ENTERING THE BATTALION CF, F1, AND AD NETS (DESCRIBED ABOVE AS INTERNAL NETS FOR BN). THE BATTERY ALSO HAS ITS OWN CF (FM) NET FOR COMMAND OF ITS COMPONENTS. A COUNTER MORTAR RADAR SYSTEM FROM BATTALION COULD BE LOCATED IN THE VICINITY OF THE BATTERY AND HAS BEEN ADDED TO THE CONFIGURATION.

2359/78W

R.2 (5-12)

Figure 3-2. FA battery (155mm) CP radio structure.

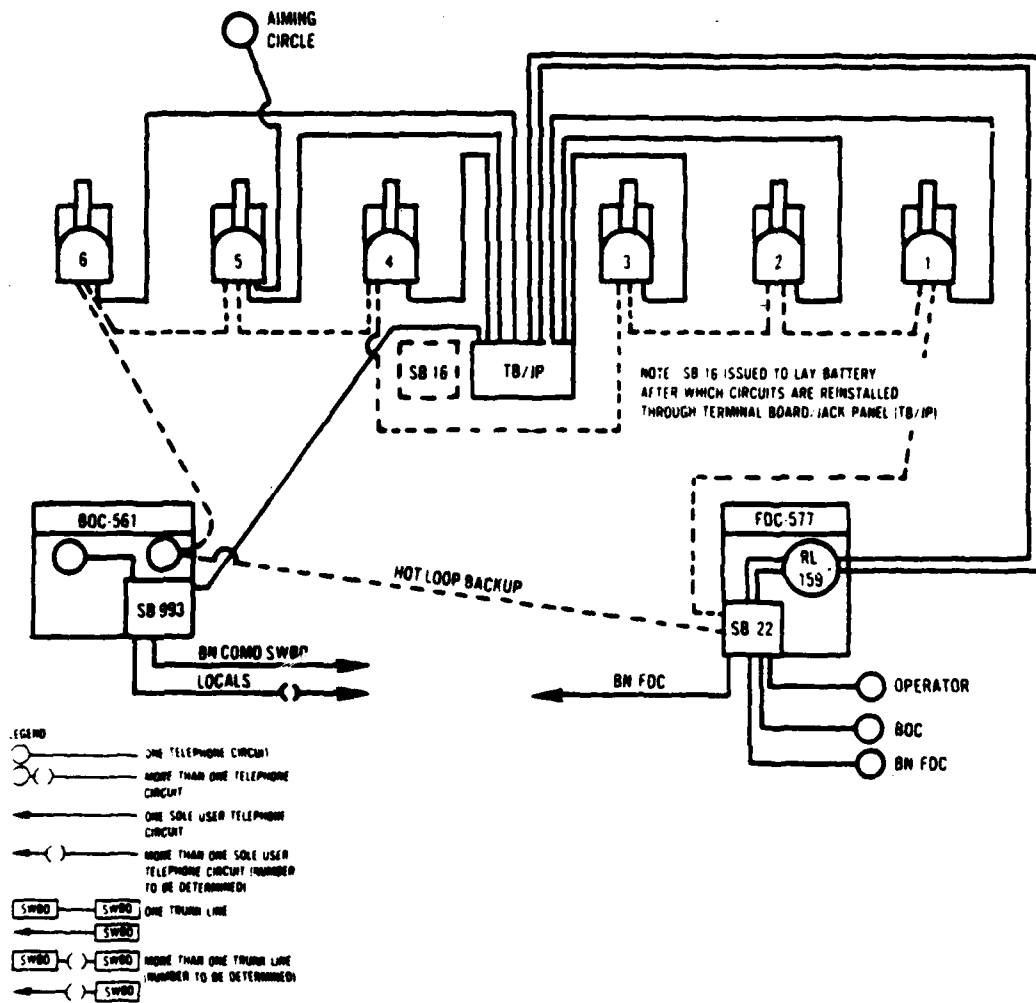

INTRABATTERY WIRE COMMUNICATIONS SYSTEM

ADD: A LONG DISTANT TRUNK FROM THE FDC TO THE MANEUVER BATTALION AND A LONG DISTANT TRUNK FROM THE CM RADAR TO THE FA BN FDC.

2359/78W

R.2 (5-17)

Figure 3-3. FA battery (155mm) wiring structure

Table 3-3. Field artillery battery (155mm) wire distribution.

FROM	TO	WIRE	LENGTH (METERS)	DESTINATION
LCMR-1	LCMR-2	(1) MD-1 HOT LINE	45	INTERCOM BOX
	BOC	(1) MD-1 HOT LINE	100	INTERCOM BOX
	TB	(1) MD-1	130	FDC SMD
LCMR-2	LCMR-3	(1) MD-1 HOT LINE	45	INTERCOM BOX
	TB	(1) MD-1	90	FDC SMD
LCMR-3	LCMR-4	(1) MD-1 HOT LINE	45	INTERCOM BOX
	TB	(1) MD-1	110	FDC SMD
LCMR-4	LCMR-5	(1) MD-1 HOT LINE	45	INTERCOM BOX
	TB	(1) MD-1	90	FDC SMD
LCMR-5	LCMR-6	(1) MD-1 HOT LINE	35	INTERCOM BOX
	TU	(1) MD-1	110	FDC SMD
LCMR-6	INTERCOM BOX	(1) MD-1 HOT LINE	130	HOT LINE NET
	TB	(1) MD-1	80	FDC SMD
AIMING CIRCLE	TB	(1) MD-1	150	FDC SMD
BOC VEHICLE HANDSET SMD	INTERCOM BOX	(1) MD-1 HOT LINE	100	HOT LINE NET
	TB	(6) MD-1	50	(2) FDC SMD (1) DISMOUNT POINT (1) FA BN SMD (2) LOCAL ADMIN/LOC (3) TELE
	INTERNAL	(3) MD-1	5	
FDC VEHICLE HANDSET	INTERCOM BOX	(1) MD-1 HOT LINE	20	HOT LINE NET
	TB	(11) MD-1	60	(2) BOC SMD (6) LCHRS (1-EACH) (1) AIMING CIRCLE (1) FA BN FDC (1) MVV BN GP (1) TELE (4) TELE LOCAL SET (GRA-39)
REMOTE SET (GRA-39)	CM RADAR	(1) MD-1	60	
	INTERNAL	(4) MD-1	5	
	AD TEAM	(1) MD-1	40	
CM RADAR VEHICLE	TB	(1) MD-1	110	DS BN FDC
TB	DISMOUNT POINT	(1) MD-1	15	TELE
	MVV BN	(1) MD-1	500	BN SMD
	REPEATER COIL SET	(3) MD-1	50	BN SMD
REPEATER COIL SET	FA BN	(2) MD-1	5000	FA BN RPTR COIL SET

2359/78W

4. 155mm FIELD ARTILLERY BATTALION CP CONFIGURATION AND C³ STRUCTURES

4.1 Mission and Deployment Concept

The battalion is an element of the Division Artillery, has the mission to provide direct support to a maneuver brigade, and its CP is usually deployed near the maneuver brigade CP. The 155mm battalion CP is a facility for the commander and his staff to command and control three field artillery (FA) batteries and one service battery. However, the primary function within the CP configuration is to provide a fire direction center (FDC) for directing the fires of its FA batteries.

4.2 CP Configuration

Figure 4-1 is a geographical layout of the CP and Table 4-1 is a glossary of abbreviations associated with the configuration. As can be observed, a tent has been used for sheltering of staff personnel. This can later be changed to a bunker, a building, a vehicle, or completely eliminated as the analyst so perceives. Of particular note, the command group is generally not in the CP area since they have scout vehicles and are usually looking for new firing locations, directly supervising battery operations, or coordinating with supporting, adjacent, and higher headquarters command and staff.

4.2.1 Radio Enhancements

All voice radios are remoted to the staff facilities (tent), range extension is provided by a standard RC-292 antenna, and a field expedient uni-directional antenna is used for both range extension and to reduce the electronic signature. A dismount point is used for traffic control. Administrative/logistics units are provided local telephone service to those areas which are adjacent to (but not a part of) the CP/FDC area.

4.2.2 Wire Enhancements

Field wire (WD-1) is used for most local and for all long haul circuits (other than single channel radio). However, 26 pair cable

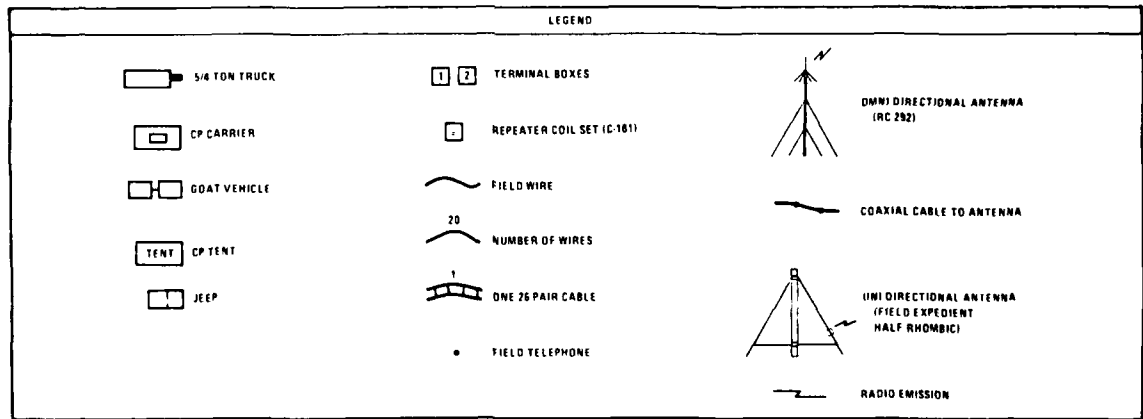
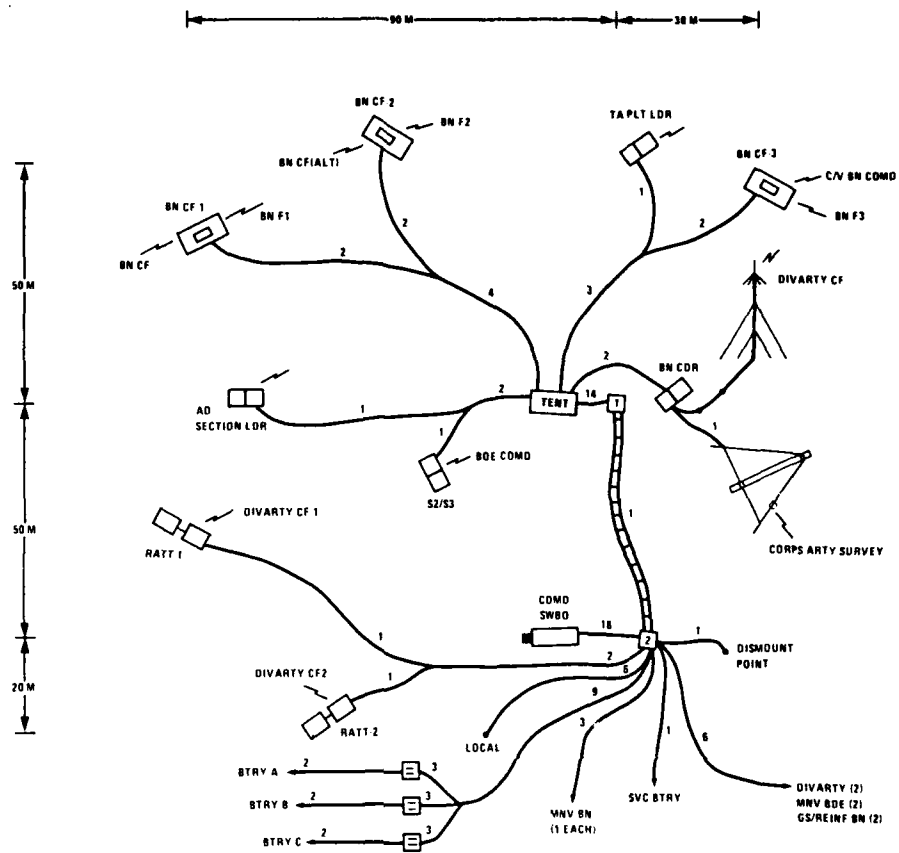

2359 78W

Figure 4-1. Field artillery battalion (155mm) CP configuration.

Table 4-1. Glossary of terms for Figure 4-1.

AD	Air Defense
ALT	Alternate
ARTY	Artillery
BDE	Brigade
BN	Battalion
BTRY	Battery
CDR	Commander
CF	Command/Fire Direction
COMD	Command
C/V	Chaparral/Vulcan
DIVARTY	Division Artillery
GS	General Support
LDR	Leader
M	Meters
MNV	Maneuver
PLT	Platoon
RATT	Radio Teletype
REINF	Reinforcing
S2	Staff (Intelligence)
S3	Staff (Operations)
SVC	Service
SWBD	Switchboard
TA	Target Acquisition

Note: Shaded area is center of activity for command and control.

2359/78W

(CX-4566) is used to consolidate the local distribution of circuits. The cable length is fixed at 75 meters per section and only one section has been used in this configuration.

6
4.2.3 Technical Control

A terminal box (J-1077) has been used to patch, switch, and test the combination of WD-1 wire and 26-pair cable circuits.

4.3 C³ Structures

The following C³ structures are provided in tables and figures to assist in analysis:

- (a) CP Personnel and Equipment List
- (b) CP Radio Structure
- (c) Internal Radio Nets
- (d) Wiring Structure
- (e) Wire and Cable Distribution

Table 4-2. Field artillery battalion (155mm) personnel and equipment list.

DESCRIPTION ELEMENT	FACILITY	EQUIPMENT	PERSONNEL	FUNCTION
BN CF-1, 2, 3 VEHICLES	CP CARRIER (M 577)	(2) VRC-46 RADIOS (FM) (2) LOCAL SETS (GRA-39) (2) KY-38 CONSEC FOR FM RADIOS		REMOTE RADIOS FOR BN F-1, 2, 3 (EACH BTRY), BN CF, BN CF (ALT), C/V BN COMM NETS (FM)
TA PLT LDR VEHICLE	JEEP	(1) VRC-46 (1) LOCAL SET (GRA-39) (1) KY-38 CONSEC		REMOTE RADIO FOR BN AD SECTION NET
S2/S3 VEHICLE	JEEP	(1) VRC-47 RADIO SET (1) LOCAL SET (GRA-39) (1) KY-38 CONSEC		REMOTE RADIO FOR BDE COMO NET (FM)
BN CDR VEHICLE	JEEP	(2) VRC-46 RADIOS (2) LOCAL SET (GRA-39) (2) KY-38 CONSEC (1) RC-292 (FM) ANTENNA (1) FIELD EXPEDIENT UNI-DIRECTIONAL ANTENNA		REMOTE RADIOS FOR DIVERSITY CF NET (FM) AND CORPS ARTILLERY SURVEY NET (FM)
TENT	CP TENT	(2) SB-22 SBRD (SOLE USER) (1) REMOTE SETS (GRA-39) (6) TA-312 TELEPHONES	BN CDR, S2, S3, FD ELEMENT FOR EACH BATTERY, TA PLT LDR, AD SECTION LDR, ADMIN, COMM	COMMAND FIRE DIRECTION CENTER (FDC)
COMO SBRD	5/4 TON TRUCK (M 715)	(2) SB-222 SBRD (COMMON USER) (1) TA-955 DTMF PAD FOR INTERFACE WITH AUTOMATIC SBRDS VIA OPERATOR ASSISTANCE USING DUAL TONE MULTIFREQUENCY (DTMF) DIALING	1 - UNSKILLED (SBRD OP)	COMMON USER SERVICE AND SUPPLEMENT FOR SOLE USER "CLOSED" NETWORK
RATT-1, 2 VEHICLES	GOAT VEHICLE (M 561)	(1) GRC-142 SSB/RATT SYSTEM (1) RM-7 CONSEC FOR TTY (1) TA-312 TELEPHONE	1 - SKILLED (RATT OP)	DIVERSITY CF1 AND CF2 RATT NETS FOR RECORD TRAFFIC
TB-1	OPEN	(1) J-1077 TERMINAL BOX		TECHNICAL CONTROL OF 26-PAIR CABLE AND WD-1 FIELD WIRE
TB-2	OPEN	(1) J-1077 TERMINAL BOX (2A) (2) TA-125 TERMINAL BOXES (2B, 2C)		TECHNICAL CONTROL OF 26-PAIR CABLE AND WD-1 FIELD WIRE TECHNICAL CONTROL OF WD-1 FIELD WIRE
REPEATER COIL SET	OPEN	(5) C-161 REPEATER COILS		REDUCES THE NUMBER OF PHYSICAL PAIRS FROM 3 TO 2 FOR CONSERVATION OF WIRE OVER LONG DISTANCES

2359/78W

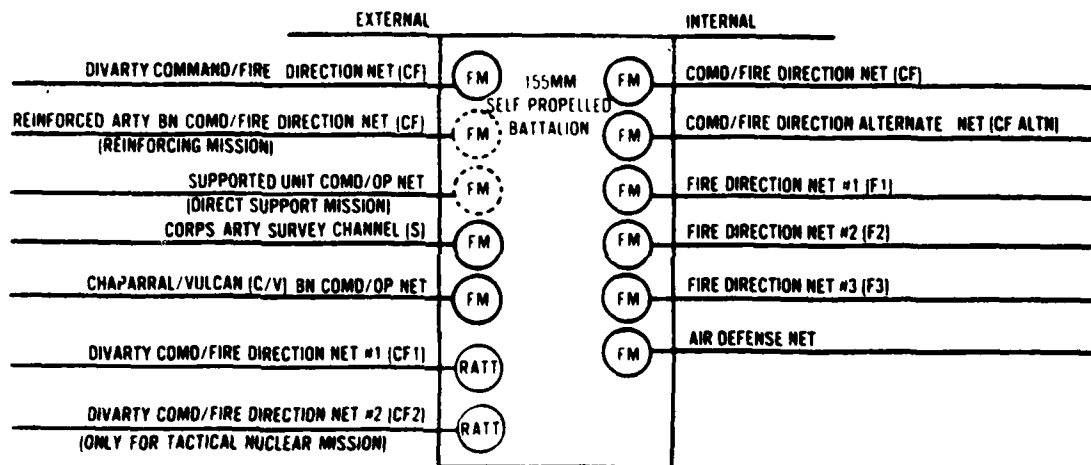

155mm SELF-PROPELLED BATTALION RADIO NET STRUCTURE

2359/78w

R.2 (5-12)

Figure 4-2. FA battalion (155mm) CP radio structure.

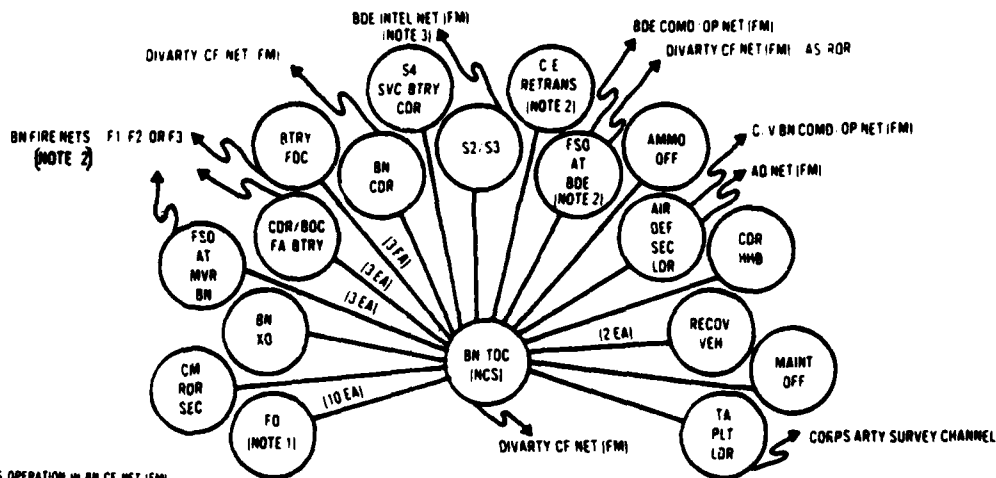

- NOTES
- 1 FO COMMENCES OPERATION IN BN CF NET (FM)
FO MAY SWITCH TO BN CF ALTN NET (FM) AS TRAFFIC INCREASES
ASSIGNED FIRE DIRECTION NETS ARE EXPOSED UNDER THE TRAFFIC DEMANDS OF FIRE REQUESTS
 - 2 USED FOR RETRANSMISSION AS REQUIRED
 - 3 MONITORS AS REQUIRED

DS BN COMMAND/FIRE DIRECTION NET (FM) AND CF ALTN (FM)

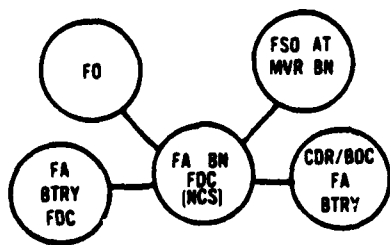

155mm-Self-Propelled Fire Direction Nets (FM) F1, F2, F3

2359/78W

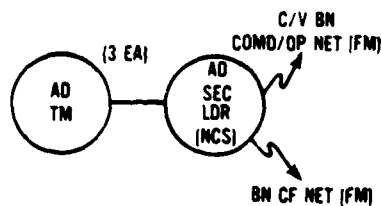

AIR DEFENSE SECTION NET (FM)

R.2 (5-13,14)

Figure 4-3. FA battalion (155mm) internal radio nets

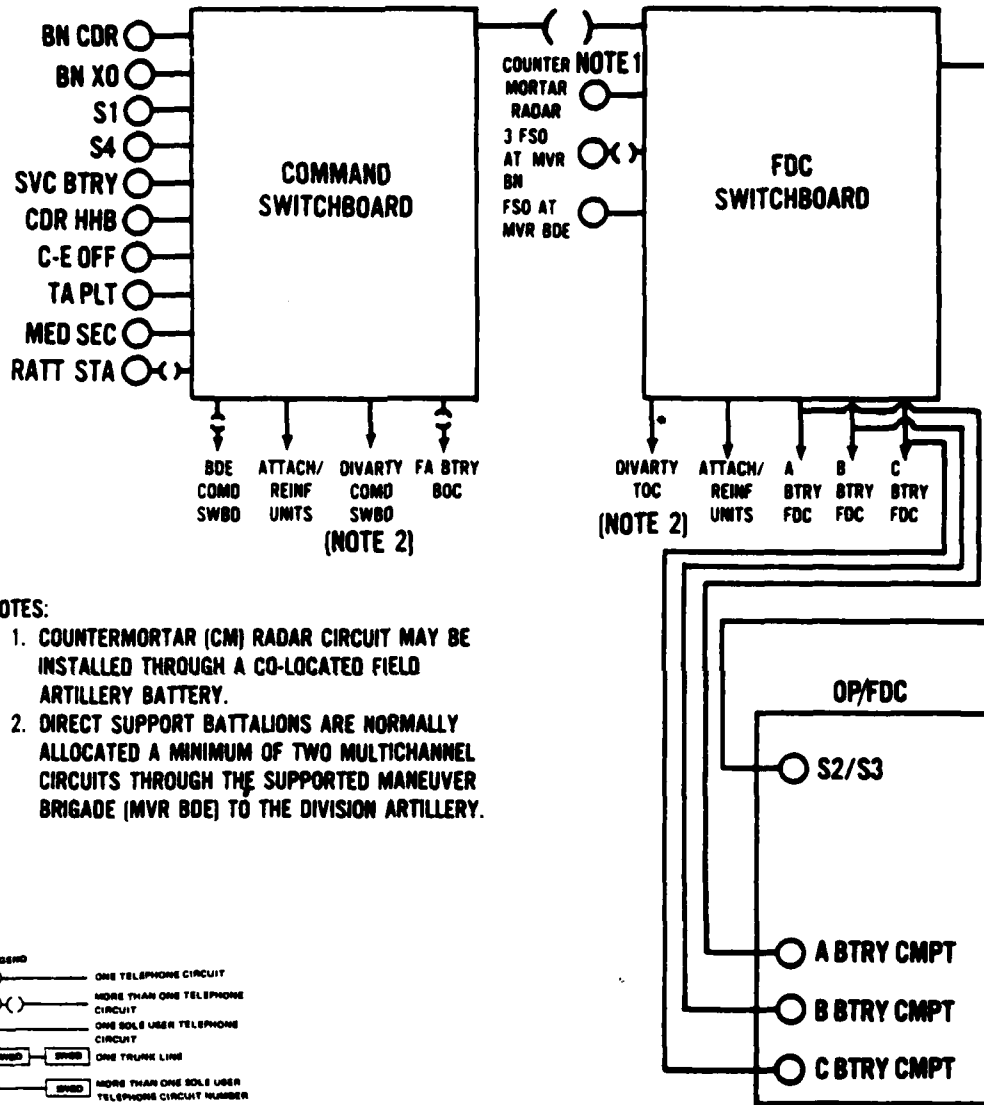

- NOTES:**
1. COUNTERMORTAR (CM) RADAR CIRCUIT MAY BE INSTALLED THROUGH A CO-LOCATED FIELD ARTILLERY BATTERY.
 2. DIRECT SUPPORT BATTALIONS ARE NORMALLY ALLOCATED A MINIMUM OF TWO MULTICHANNEL CIRCUITS THROUGH THE SUPPORTED MANEUVER BRIGADE (MVR BDE) TO THE DIVISION ARTILLERY.

TELEPHONE AND CIRCUIT DISTRIBUTION DIAGRAM DIRECT SUPPORT BATTALION

2359/78W

R.2 (5-16)

Figure 4-4. FA battalion (155mm) wiring structure.

Table 4-3. Field artillery battalion (155mm) wire and cable distribution.

FROM	TO	WIRE	CABLE	LENGTH (METERS)	DESTINATION
BN CF-1 VEHICLE					
LOCAL SETS (GRA-39)	TENT	(2) WD-1		80	REMOTE SETS (GRA-39)
BN CF-2 VEHICLE					
LOCAL SETS (GRA-39)	TENT	(2) WD-1		70	REMOTE SETS (GRA-39)
BN CF-3 VEHICLE					
LOCAL SETS (GRA-39)	TENT	(2) WD-1		65	REMOTE SETS (GRA-39)
TA PLT LDR VEHICLE					
LOCAL SETS (GRA-39)	TENT	(1) WD-1		60	REMOTE SET (GRA-39)
AD SECTION LDR VEHICLE					
LOCAL SET (GRA-39)	TENT	(1) WD-1		70	REMOTE SET (GRA-39)
S2/53 VEHICLE					
LOCAL SET (GRA-39)	TENT	(1) WD-1		35	REMOTE SET (GRA-39)
BN CDR VEHICLE					
LOCAL SETS (GRA-39)	TENT	(2) WD-1		30	REMOTE SETS (GRA-39)
TENT (SOLE USER SHBD)	TB-1	(14) WD-1		10	(1) DIVARTY TOC (1) MVV BDE TOC (1) GS/REINF BN FDC (3) MVV BN (1-EACH) CP (6) BTRY (FDC SHBD/RADAR) (2) COMD SHBD (LOCAL) (6) SOLE USER TELEPHONES
TB-1	INTERNAL	(6) WD-1		5	
TB-1	TB-2A		(1) CX-4566	75	

2359/78W

Table 4-3. Field artillery battalion (155mm) wire and cable distribution (continued).

LOMB SHBU								
TB-2A	DISMOUNT POINT	(2) WD-1	20	(2) SOLE USER SMBD (TENT)				
		(9) WD-1	20	(1) DISMOUNT POINT				
				(1) RATT-1				
TB-2B	RATT-1			(1) RATT-2				
				(6) LOCAL ADMIN/LOG				
TB-2C	RATT-2	(7) WD-1	20	(1) DIVARTY				
				(1) MNV BDE				
				(1) GS/REINF BN				
				(1) SVC BATTERY				
LOMB SHBU	LOCAL			(3) BTRY BOC (1-EACH)				
				TELEPHONE				
				TELEPHONE				
				TELEPHONE				
				TELEPHONE				
				COMD SMBD				
				COMD SMBD				
				COMD SMBD				
				BTRY A BOC SMBD				
				BTRY B BOC SMBD				
		BTRY C BOC SMBD						
REPEATER COIL (A)	BTRY A RPTR COIL	(2) WD-1	3000	BTRY A BOC/FDC				
REPEATER COIL (B)	BTRY B RPTR COIL	(2) WD-1	3000	BTRY B BOC/FDC				
REPEATER COIL (C)	BTRY C RPTR COIL	(2) WD-1	3000	BTRY C BOC/FDC				
TB-2A	DIVARTY	(1) WD-1	5000	TOC SMBD				
		(1) WD-1	1000	TOC SMBD				
		(1) WD-1	4000	FDC SMBD				
		(3) WD-1	3500	CP SMBD				
		(2) WD-1	3000	BTRY FDC/RADAR				
		(2) WD-1	3000	BTRY FDC/RADAR				
		(2) WD-1	3000	BTRY FDC/RADAR				

5. 8" FIELD ARTILLERY BATTERY CP CONFIGURATION AND C³ STRUCTURES

5.1 Mission and Deployment Concept

The battery is an element of the 8" battalion, has the mission to provide general support (GS) to the division area of operations, and its CP can be deployed anywhere in the division area. The 8" battery CP is a facility for the commander and his staff to command and control the firing sections and support platoon of the battery. However, the primary function within the CP configuration is to provide a fire direction center (FDC) for control of the four artillery launchers.

5.2 CP Configuration

Figure 5-1 is a geographical layout of the CP and Table 5-1 is a glossary of abbreviations associated with the configuration. All discussions about the 155mm battery apply to the 8" battery and all supporting data is provided in C³ structures at the end of this chapter.

5.3 C³ Structures

The following C³ structures are provided in tables and figures to assist in analysis:

- (a) CP Personnel and Equipment List
- (b) CP Radio Structure
- (c) Wiring Structure
- (d) Wire Distribution

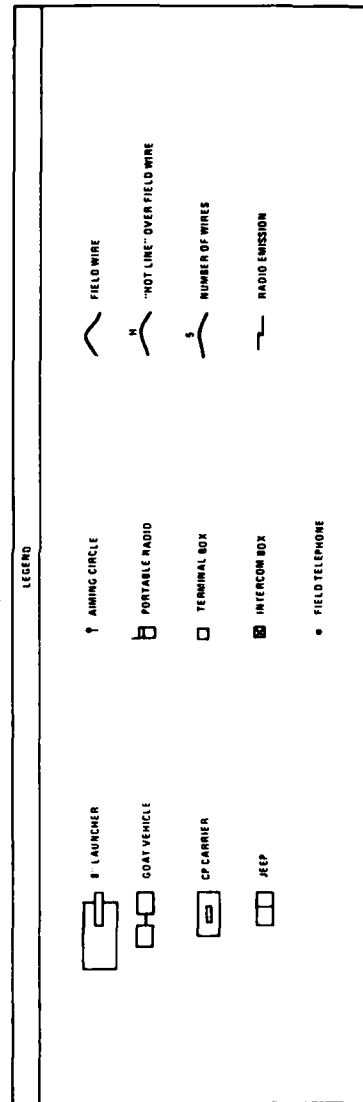
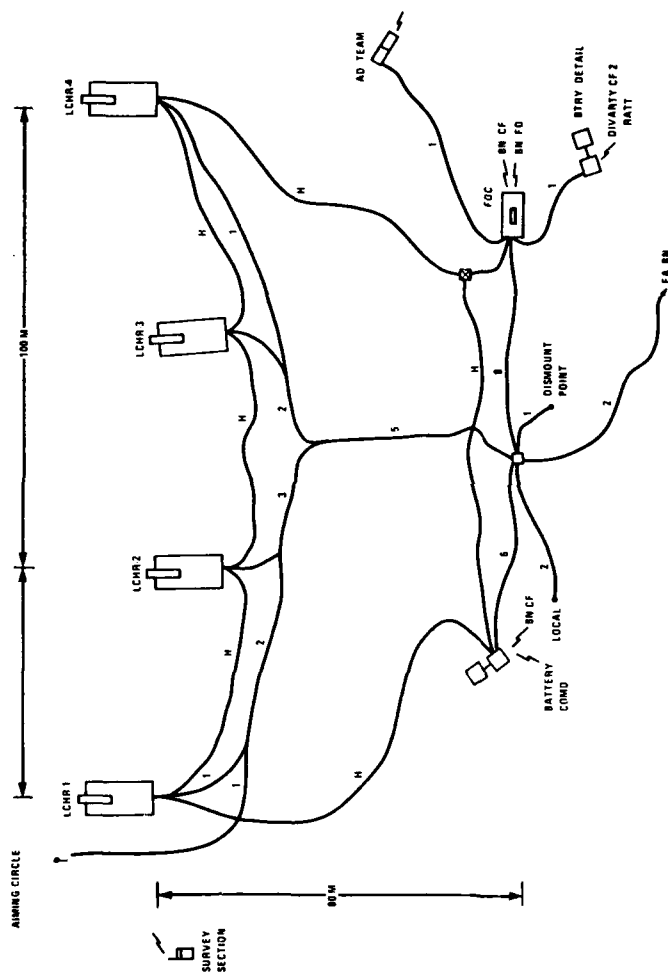

2359/78W

Figure 5-1. Field artillery battery (8") CP configuration.

Table 5-1. Glossary of terms for Figure 5-1.

AD	Air Defense
BN	Battalion
BOC	Battery Operations Center
BTRY	Battery
CF	Command/Fire Direction
COMD	Command
DIVARTY	Division Artillery
FA	Field Artillery
FD	Fire Direction
FDC	Fire Direction Center
LCHR	Launcher
M	Meters
RATT	Radio Teletype

Note: Shaded area is center of activity for command and control.

2359/78W

Table 5-2. Field artillery battery (8") personnel and equipment list.

DESCRIPTION ELEMENT	FACILITY	EQUIPMENT	PERSONNEL	FUNCTION
LCHR-1, 2, 3, 4	WEAPONS CARRIER (M 55)	(1) 8 INCH HOWITZER (1) TELEPHONE (TA-312) (1) HANDSET (H-182/VIC-1)	2 - SKILL (ARTY OP)	ARTY FIRE IN GENERAL SPT OR RETINF SPT
AIMING CIRCLE	OPEN	(1) AIMING CIRCLE (1) TELEPHONE (TA-312)	1 - SKILL (ARTY OP)	MPN ALIGNMENT
FDC VEHICLE	CP CARRIER (M 577)	(2) VRC-46 RADIOS (FM) (2) KY-38 (1) SMRD (SB-22) (1) FADAC COMPUTER WITH TTY-537 (3) TELEPHONES (TA-312) (1) REMOTE SET (GRA-39)	XO, AD SEC LDR, COMM'D, ADMIN	BN CF/BTRY FDC NETS (FM) AD NET (REMOVED)
AD TEAM	1/4 TON JEEP (M 151)	(1) GRC-160 RADIO (FM) (1) KY-8 CONSEC FOR FM RADIO (1) LOCAL SET (GRA-39)		AD NET (FM) REMOVED TO FDC
BTRY DETAIL	GOAT (M561)	(1) GRC-142 SSB VOICE/RATT SET (1) KM-7 CONSEC FOR TTY (1) TELEPHONE (TA-312)	1 - SKILLED (RATT OP)	BN RATT NET FOR RECORD TRAFFIC OVER HF RADIO
SURVEY SECTION	OPEN	(1) PRC-77 RADIO (FM) MANPACK (1) KY-8 CONSEC	2 - ARTY SURV	ON SURV NET (FM)
TB	OPEN	(1) TA-125 TERMINAL BOARD	COMM AS REQ	TECH CONTROL
INTERCOMM BOX	OPEN	(1) MX-155/GT	COMM AS REQ	HOT LINE CONTROL

2359/78W

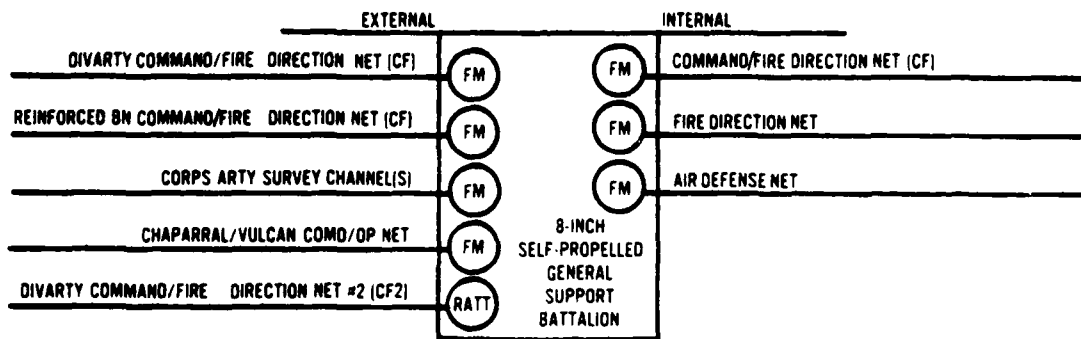

8-INCH SELF-PROPELLED GENERAL SUPPORT BATTALION RADIO NET STRUCTURE

THE FA BATTERY (8") IS REQUIRED TO PROVIDE TERMINALS FOR ENTERING THE BATTALION (FM), CF, FD, AND AD NETS (DESCRIBED ABOVE AS INTERNAL NETS TO BN). THE BATTERY ALSO HAS ITS OWN CF FM NET FOR COMMAND OF ITS COMPONENTS AND ITS OWN RATT TERMINAL TO ENTER DIVARTY CF 2 NET.

2359/78W

R.2 (5-13)

Figure 5-2. FA battery (8") CP radio structure.

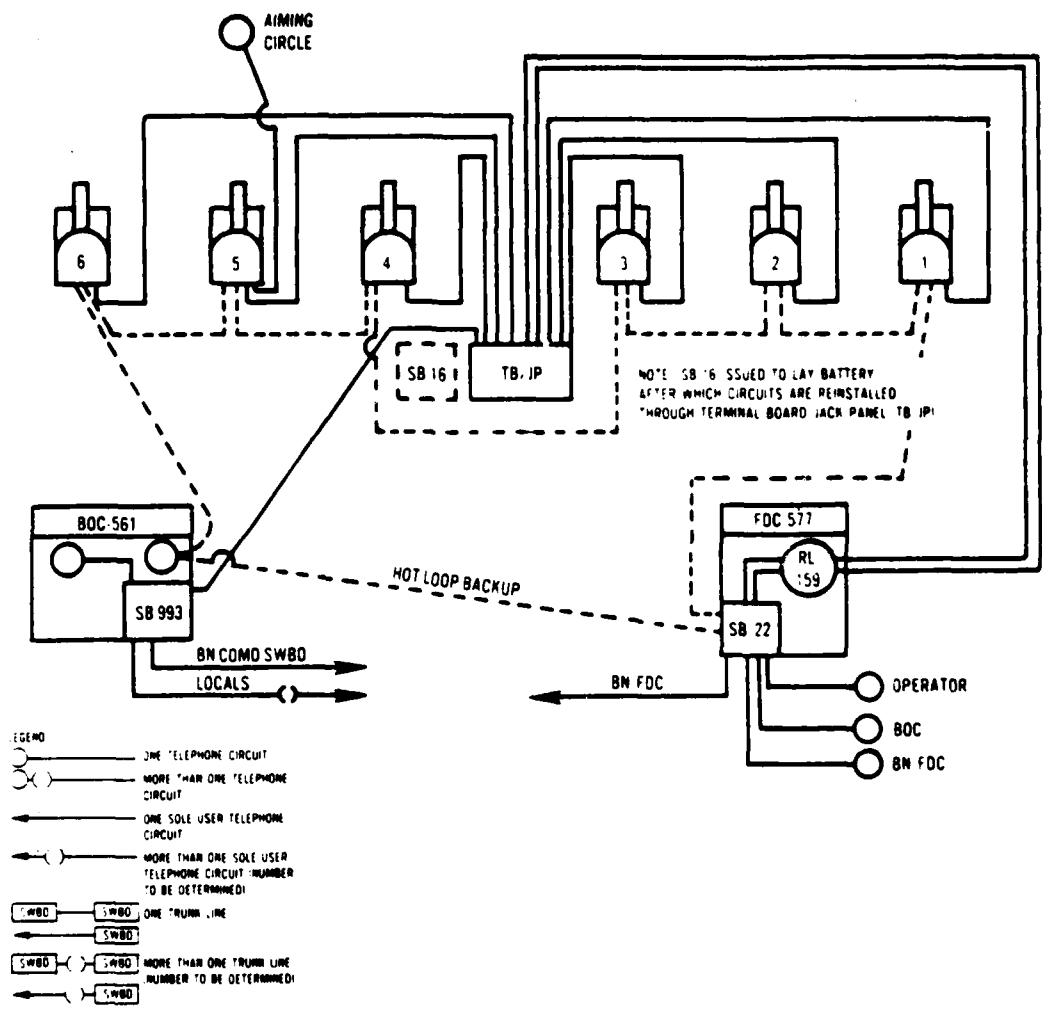

INTRABATTERY WIRE COMMUNICATIONS SYSTEM

COMMENT: USE ONLY 4 GUN POSITIONS FOR AN 8" BATTERY.

2359/78W

R.2 (5-17)

Figure 5-3. FA battery (8") wiring structure.

Table 5-3. Field artillery battery (8") wire distribution.

FROM	TO	WIRE	LENGTH (METERS)	DESTINATION
LCHR-1	LCHR-2	(1) WD-1 HOT LINE	60	INTERCOM BOX
	BOC	(1) WD-1 HOT LINE	90	INTERCOM BOX
	TB	(1) WD-1	150	FDC SHBD
LCHR-2	LCHR-3	(1) WD-1 HOT LINE	60	INTERCOM BOX
	TB	(1) WD-1	90	FDC SHBD
LCHR-3	LCHR-4	(1) WD-1 HOT LINE	60	INTERCOM BOX
	TB	(1) WD-1	90	FDC SHBD
LCHR-4	INTERCOM BOX	(1) WD-1 HOT LINE	90	HOT LINE NET
	TB	(1) WD-1	150	FDC SHBD
BOV VEHICLE HANDSET SHBD	INTERCOM BOX	(1) WD-1 HOT LINE	100	HOT LINE NET
	TU	(6) WD-1	50	(2) FDC SHBD (1) DISMOUNT POINT (1) FA BN SHBD (2) LOCAL ADMIN/LOG
FDC VEHICLE HANDSET SHBD	INTERCOM BOX	(8) WD-1	20	HOT LINE SET
	TB		50	(2) BOC SHBD (4) LCHRS (1-EACH) (1) AIMING CIRCLE (1) FA BN FDC (3) TELE AD TEAM REMOTE (FM)
REMOTE (GRA-39)	INTERNAL	(3) WD-1	5	
	AD TEAM	(1) WD-1		
AIMING CIRCLE	TB	(1) WD-1	150	FDC SHBD
	FDC	(1) WD-1	50	FDC REMOTE (FM)
AD TEAM LOCAL SET (GRA-39)	FDC	(1) WD-1	25	FDC SHBD
	FDC	(1) WD-1		
BTRY DETAIL TELE	LOCAL	(2) WD-1	60	(2) ADMIN/LOG TELE
	DISMOUNT POINT	(1) WD-1	15	TELE
TB	FA BN	(2) WD-1	5000	FA BN SHBD

2359/7BW

6. 8" FIELD ARTILLERY BATTALION CP CONFIGURATION AND C³ STRUCTURES

6.1 Mission and Deployment Concept

The battalion is an element of the Division Artillery, has the mission to provide general support (GS) to the division area of operations, and its CP is usually deployed near the Division Artillery CP or the Division TAC CP. The 8" battalion CP is a facility for the commander and his staff to command and control three firing batteries and one service battery. However, the primary function within the CP configuration is to provide a fire direction center (FDC) for directing the fire of its FA batteries.

6.2 CP Configuration

Figure 6-1 is a geographical layout of the CP and Table 6-1 is a glossary of abbreviations associated with the configuration. All discussions about the 155mm battalion apply to the 8" battalion and all supporting data is provided in C³ structures at the end of this chapter.

6.3 C³ Structures

The following C³ structures are provided in tables and figures to assist in analysis:

- (a) CP Personnel and Equipment List
- (b) CP Radio Structure
- (c) Internal Radio Nets
- (d) Wiring Structure
- (e) Wire and Cable Distribution

6. 8" FIELD ARTILLERY BATTALION CP CONFIGURATION AND C³ STRUCTURES

6.1 Mission and Deployment Concept

The battalion is an element of the Division Artillery, has the mission to provide general support (GS) to the division area of operations, and its CP is usually deployed near the Division Artillery CP or the Division TAC CP. The 8" battalion CP is a facility for the commander and his staff to command and control three firing batteries and one service battery. However, the primary function within the CP configuration is to provide a fire direction center (FDC) for directing the fire of its FA batteries.

6.2 CP Configuration

Figure 6-1 is a geographical layout of the CP and Table 6-1 is a glossary of abbreviations associated with the configuration. All discussions about the 155mm battalion apply to the 8" battalion and all supporting data is provided in C³ structures at the end of this chapter.

6.3 C³ Structures

The following C³ structures are provided in tables and figures to assist in analysis:

- (a) CP Personnel and Equipment List
- (b) CP Radio Structure
- (c) Internal Radio Nets
- (d) Wiring Structure
- (e) Wire and Cable Distribution

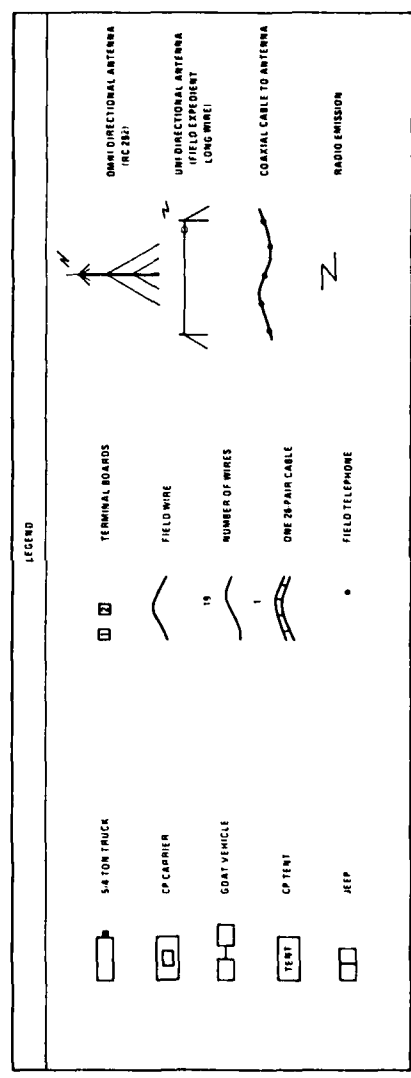
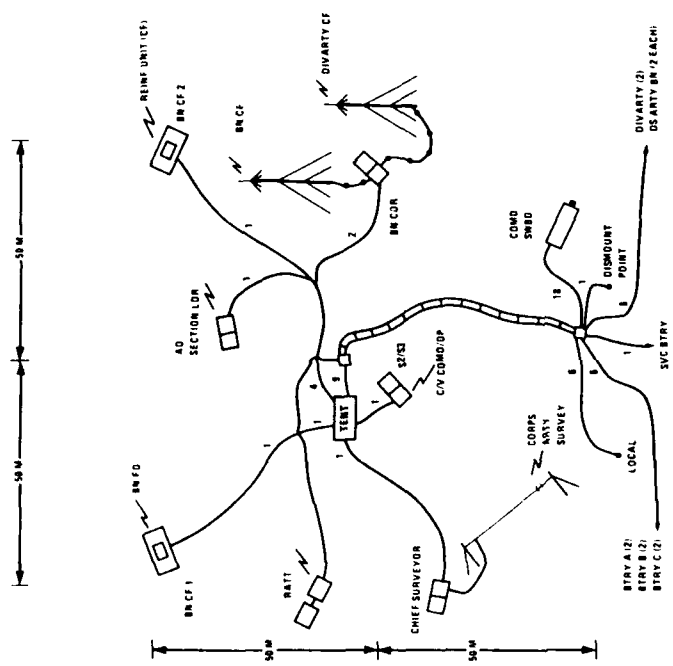

Figure 6-1. Field artillery battalion (8") CP configuration.

2359, 78M

Table 6-1. Glossary of terms for Figure 6-1.

AD	Air Defense
ARTY	Artillery
BN	Battalion
BTRY	Battery
CDR	Commander
CF	Command/Fire Direction
COMD	Command
C/V	Chaparral/Vulcan
DIVARTY	Division Artillery
DS	Direct Support
FD	Fire Direction
LDR	Leader
M	Meters
OP	Operations
RATT	Radio Teletype
REINF	Reinforcing
S2	Staff (Intelligence)
S3	Staff (Operations)
SVC	Service
SWBD	Switchboard

Note: Shaded area is center of activity for command and control.

2359/78W

Table 6-2. Field artillery battalion (8") personnel and equipment list.

DESCRIPTION ELEMENT	FACILITY	EQUIPMENT	PERSONNEL	FUNCTION
BN CF-1, 2 VEHICLES	CP CARRIER (M 577)	(2) VRC-46 RADIOS (FM) (2) KY-38 COMSEC FOR RADIOS (1) LOCAL SET (GRA-39)		REMOTE RADIOS FOR BN FD AND REINF UNIT NETS (FM)
AD SECTION LEADER VEHICLE	JEEP (M 151)	(1) VRC-47 RADIO SET (FM) (1) KY-38 COMSEC (1) LOCAL SET (GRA-39)		REMOTE RADIO FOR BN AD SEC NET (FM)
BN CDR VEHICLE	JEEP	(2) VRC-46 RADIOS (2) KY-38 COMSEC (2) LOCAL SETS (GRA-39) (2) RC-292 ANTENNAS (FM)		REMOTE RADIOS FOR BN CF AND DIVARTY CF NETS (FM)
S2/S3 VEHICLE	JEEP	(1) VRC-47 RADIO SET (1) KY-38 COMSEC (1) LOCAL SET (GRA-39)		REMOTE RADIO FOR C/V COMD OP NET (FM)
CHIEF SURV VEHICLE	JEEP	(1) VRC-46 RADIO (1) KY-38 COMSEC (1) LOCAL SET (GRA-39) (1) FIELD EXPEDIENT UNI-DIRECTIONAL ANTENNA (LONG WIRE)		REMOTE RADIO FOR CORPS ARTY SURV NET (FM)
RATT VEHICLE	GOAT (M 561)	(1) GRC-142 SSB/RATT SYSTEM (1) KM-7 COMSEC FOR TTY (1) TA-312 TELEPHONE		DIVARTY CF2 RATT NET FOR RECORD TRAFFIC
TENT	CP TENT	(1) SB-22 SMOB (SOLE USER) (7) REMOTE SETS (GRA-39) (3) TA-312 TELEPHONES	BN CDR, S2, S3, FSE, AD SEC LDR, CHIEF SURV, ADMIN, COMM	COMMAND FIRE DIRECTION CENTER (FDC)
COMD SMOB	5/4 TON TRUCK (M 715)	(2) SB-22A SMOB (COMMON USER) (1) TA-955 DTMF PAD FOR DUAL TONE MULTIFREQUENCY (DTMF) DIALING BY OPERATOR WHEN INTERACTING WITH AUTOMATIC SMOBS (SB-361A).	1 - SKILLED (SMOB OP)	COMMON USER SERVICE AND SUPPLEMENT FOR SOLE USER "CLOSED" NETWORK
TB-1	OPEN	(1) J-1077 TERMINAL BOX		TECHNICAL CONTROL OF 26-PAIR CABLE AND MO-1 FIELD WIRE
TB-2	OPEN	(1) J-1077 TERMINAL BOX (A) (2) TA-125 TERMINAL BOXES (B, C)		SAME AS TB-1 TECHNICAL CONTROL OF MO-1 FIELD CABLE.

2359/78W

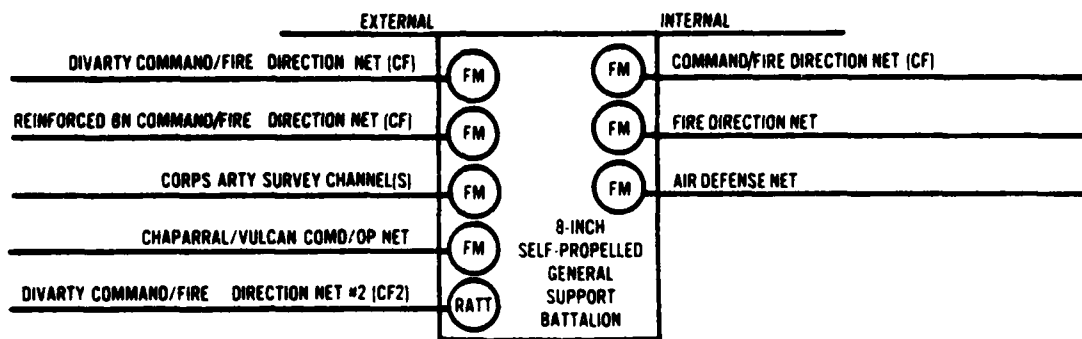

8-INCH SELF-PROPELLED GENERAL SUPPORT BATTALION RADIO NET STRUCTURE

2359/78W

R.2 (5-13)

Figure 6-2. FA battalion (8") CP radio structure.

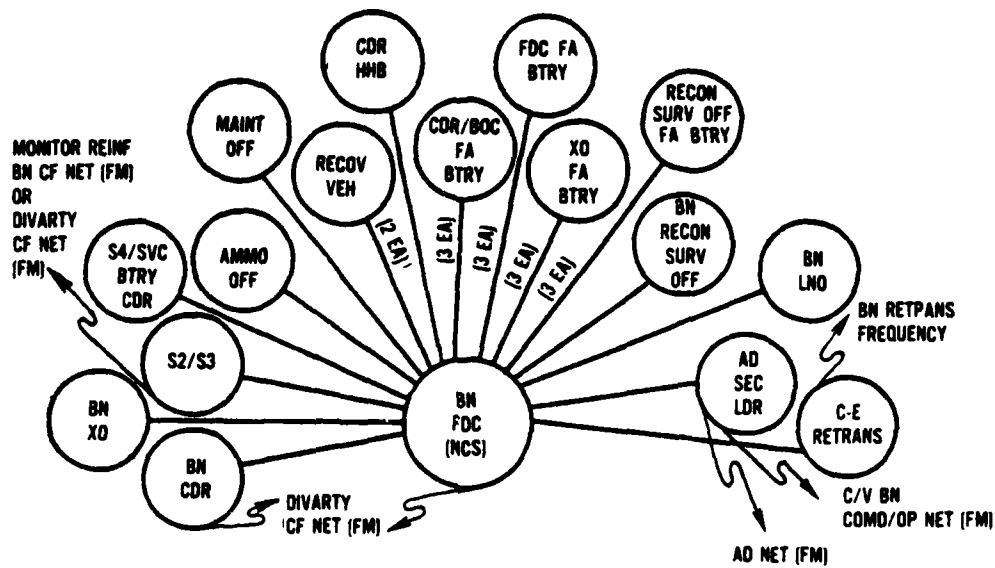

8-INCH SELF-PROPELLED GENERAL SUPPORT BN COMD/FIRE DIRECTION NET (FM)

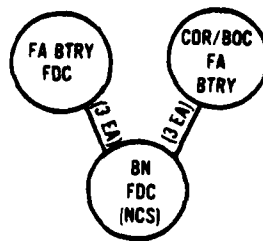

FIRE DIRECTION NET (FM)
8-INCH SELF-PROPELLED GS BN

2359/78W

R.2 (5-14)

Figure 6-3. FA battation (8") internal radio nets.

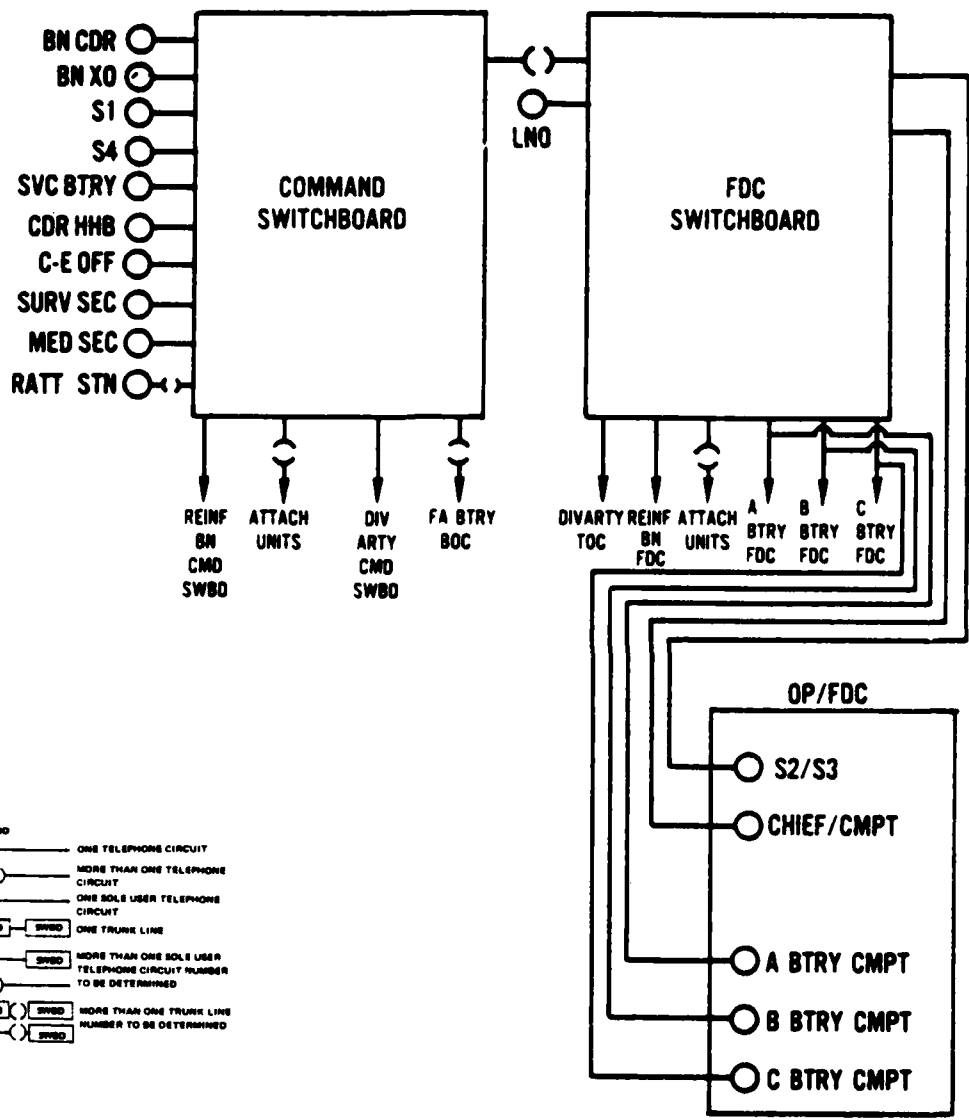

TELEPHONE AND CIRCUIT DISTRIBUTION DIAGRAM
GENERAL SUPPORT BATTALION

2359/78W

Figure 6-4. FA battalion (8") wiring structure.

R.2 (5-15)

Table 6-3. Field artillery battalion (8") wire and cable distribution (continued).

TB-1	TB-2A	(1) CX-4566	75	
COMD SWBD	TB-2A	(2) WD-1	25	(2) TENT (S/U SWBD) RATT VEHICLE TELEPHONE
	TB-2B	(1) WD-1 (7) WD-1	25	(1) DISMOUNT POINT (6) LOCAL ADMIN/LOG
	TB-2C	(8) WD-1	25	(1) DIVARTY COMD SWBD (3) DS ARTY BNS (1-EACH) (1) SVC BTRY SWBD (3) BTRY-A,B,C, BOC SWBD
	TB-2B	DISMOUNT POINT LOCAL	15 60	TELEPHONE TELEPHONES
TB-2C	DIVARTY	(1) WD-1	1000	COMD SWBD
	DS ARTY BNS	(3) WD-1	4000	COMD SWBDS (1-EACH)
	SVC BTRY	(1) WD-1	500	CP SWBD
	BTRYS	(3) WD-1	2000	BOC SWBDS (1-EACH)
TB-2A	DIVARTY TOC	(1) WD-1	1000	TOC SWBD
	DS ARTY BNS	(3) WD-1	4000	FDC SWBDS (1-EACH)
	BTRYS	(3) WD-1	2000	FDC SWBDS (1-EACH)

2359/78W

7. DIVISION ARTILLERY CP CONFIGURATION AND C³ STRUCTURES

7.1 Mission and Deployment Concept

The Division Artillery is an element of the Division and its Headquarters and Headquarters Battery has the mission to direct and coordinate operations of the Division Artillery and attached units and to primarily provide facilities for control of three 155mm FA battalions and one 8" FA battalion. The CP consists of a tactical operations center (TOC), additional staff and weather support facilities at a nearby main CP, and a remote command signal center. The main CP is located in the center of the division area between the division main command post and its maneuver brigade command posts. The center of activity is at the TOC where the division counterfire function and field artillery support for the combined arms team is managed.

7.2 CP Configuration

Figure 7-1 shows a geographical layout of all three CP elements and Table 7-1 is a glossary of abbreviations associated with the CP configuration. There is a separation of 100 meters between the TOC and the main CP to isolate C³ activities and a separation of 4 kilometers between the main CP and the remote signal center to reduce congestion and provide an improved EW environment for C³ elements. This distance of 4 KM is probably the maximum separation allowable due to CP displacement objectives (30 Minutes).

7.2.1 Radio Enhancements

A radio wire integration (RWI) station is used at the main CP location, a radio retransmission station is used at the signal center location, multichannel radio terminals are used at the signal center, and multichannel multiplex terminals are used at both the signal center and main CP. Of special note is use of the multichannel radio relay terminal (TRC-113) as a radio terminal when the multichannel multiplex terminal (TCC-65) is employed.

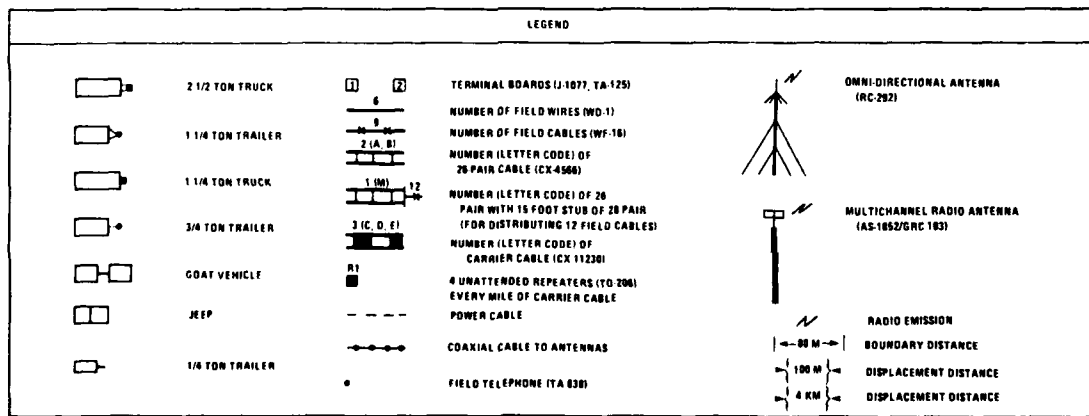
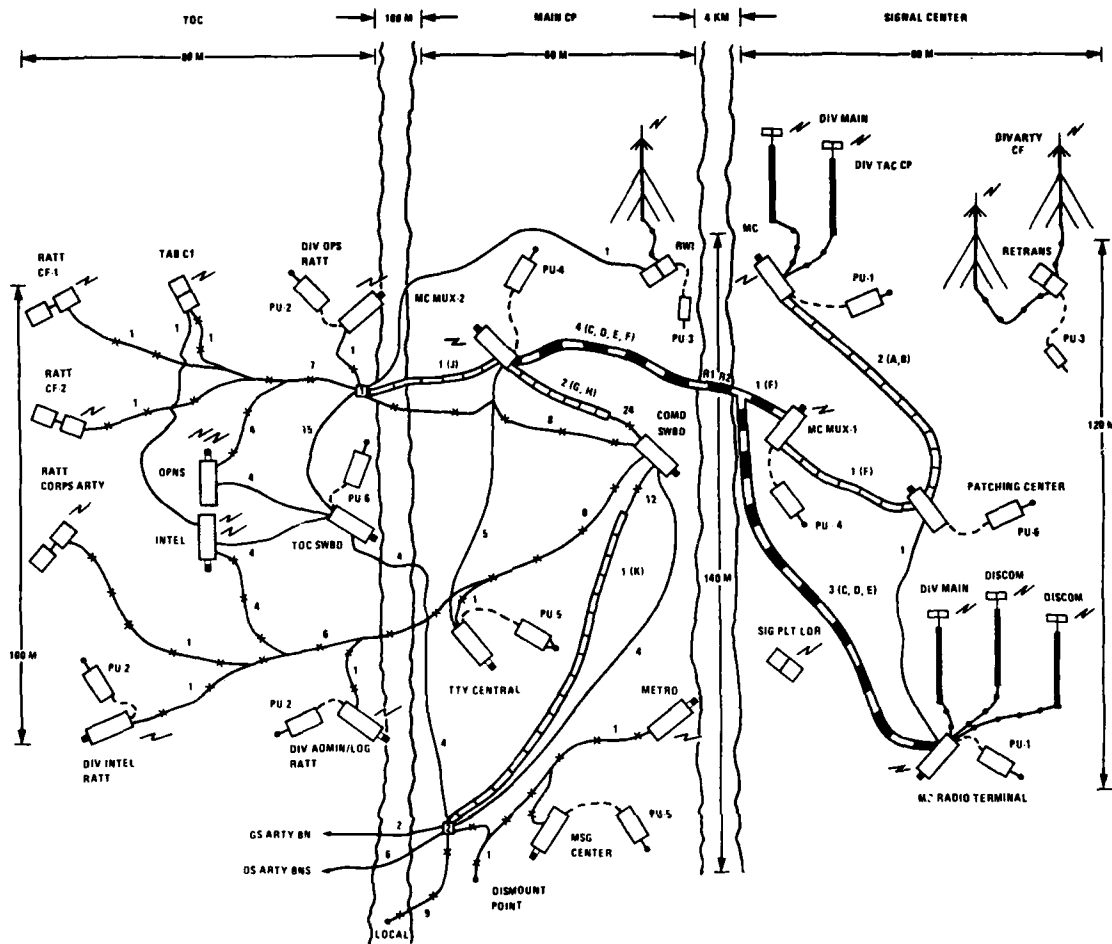

2359/78W

Figure 7-1. Division artillery command post configuration.

Table 7-1. Glossary of terms for Figure 7-1.

ADMIN	Administrative
ARTY	Artillery
BN	Battalion
C1	Command #1
CF	Command/Fire Direction
COMD	Command
CP	Command Post
DIVARTY	Division Artillery
DISCOM	Division Support Command
DIV	Division
DS	Direct Support
GS	General Support
INTEL	Intelligence
KM	Kilometers
LDR	Leader
LOG	Logistics
M	Meters
MC	Multichannel
METRO	Meteorological
MSG	Message
MUX	Multiplex
OPS	Operations
PLT	Platoon
PU	Power Units
RATT	Radio Teletype
RETRANS	Re-transmission
RWI	Radio-Wire Integration
SIG	Signal
SWBD	Switchboard
TAC	Tactical
TOC	Tactical Operations Center
TTY	Teletype

Note: Shaded area is center of activity for command and control.

7.2.2 Wiring Enhancements

Integration of wire and radio provides flexibility for telephone users at the TOC to contact mobile radio subscribers through the RWI station. Also, an improved manual switchboard (SB-3082) was used at the TOC to provide faster service than is normally available (if an SB-22 were used).

The use of a multiplex terminal at the Main CP reduces the radio requirements in that area since it is remotely connected to the systems at the signal center using carrier cable (CX-11230) and unattended repeaters (TD-206). The cable combiners (TD-754 or TD-204) in the TRC-145 and TRC-113 provide the power for up to 39 of these repeaters (40 miles). Then, an attended repeater is required.

A patching central is provided in a shelter (TSC-76) at the signal center and all circuits from the multichannel radio terminal (TRC-145) are terminated over 26-pair cable and controlled at the patching facility. Some of these circuits are routed from the patching central to a multichannel multiplex terminal (TCC-65) over 26 pair cable then changed to a 12 channel cable carrier system and routed to another multichannel multiplex terminal (TCC-65) at the main CP. Three other 12 channel carrier systems are routed directly from the multichannel multiplex terminal (TCC-65) at the signal center to the multichannel multiplex terminal at the main CP, bypassing the patching central at the signal center. This technique provides for much faster set up time and saves three sets of multiplex equipment at the signal center TCC-65. Any circuits requiring patch through from the TRC-145 system to the TRC-113 system can be performed at the loop side of the CV-1548 (signal converter) at the TCC-65 (multichannel multiplex terminal) in the main CP. In effect, the TCC-65 at the main CP is used as a "long local" extension of the command centers at distant ends of the TRC-113 systems (Division Main and Division Support Command). An order wire is provided over WD-1 wire between the patching central and the TRC-113 whereas an order wire (channel 12 for communications system control) is provided from the patching central to Division Main and Division TAC CP over the TRC-145 multichannel system.

Lastly, the order wires to the Division Support Command (DISCOM) and the Corps Area Signal Center (CASC) are over channel 12 of the multichannel systems from the TCC-65 at the main CP through the TRC-113 at the signal center.

There are WD-1 wires going directly from the teletype central of the main CP to the local TCC-65, terminating in the appropriate CV-1548. Also, there are WD-1 wires terminating in the SB-3614 for trunks from battalions who require common user service from their SB-22 manual switchboards. This is where the manual and automatic voice switching system is integrated, using a TA-955 DTMF pad at the SB-22s for the switchboard operator assistance required in dialing for a 2-wire user at battalion and below.

The 26 pair cable is used to carry 2-wire and 4-wire circuits, being controlled and patched at a J-1077 terminal box. However, some assemblages do not have 26-pair connectors as an integral part of their shelter. Therefore, a 15 foot stub of 26 pair cable is required to break out the physical pairs to connect into CP carriers and command switchboards.

As a convention in all CP configurations, a 26 pair cable stub carries either WD-1 (2-wire) or WF-16 (4-wire) lines and does not carry both WD-1 and WF-16 lines so as to aid in determining the types of lines for analysts to trace when conducting distribution studies. This may also become a practice in field applications particularly for connectivity at the SB-3614 since lines 1 to 18 are for 4-wire, 19 to 30 are for 2-wire, and there is no similar coding for 26 pair cable.

7.2.3 Technical Control

Technical control is provided at a sheltered configuration (TSC-76), terminal boards (TA-125 for WD-1 only and J-1077 for WD-1, WF-16, and 26 pair cable), and the loop side of CV-1548 signal converters at the TCC-65 at the main CP (for local teletype and long haul circuits patched from the TRC-145 to the TRC-113). The teletype signals are available on 2-wire circuits and are at voice frequency, having been converted from DC by a frequency shift keying device (TH-22) at the teletype central (TSC-58).

7.3

C³ Structures

The following C³ structures are provided in tables and figures to assist in analysis:

- (a) TOC Personnel and Equipment List
- (b) Main CP Personnel and Equipment List
- (c) Signal Center Personnel and Equipment List
- (d) Radio Nets for Division and Above
- (e) DIVARTY Radio Net Structure
- (f) CMD/FIRE Direction Radio Net
- (g) Miscellaneous Internal Radio Nets
- (h) Wiring Structure
- (i) Command and TOC Switchboard Trunking Allocation
- (j) Multichannel Circuit Allocation
- (k) TOC Wire and Cable Distribution
- (l) Main CP Wire and Cable Distribution
- (m) Signal Center Wire and Cable Distribution

Table 7-2. Division artillery TOC personnel and equipment list.

DESCRIPTION ELEMENT	FACILITY	EQUIPMENT	PERSONNEL	FUNCTION
RATT CF-1 RATT CF-2 RATT CORPS ARTY	5/4 TON GOAT (M 561)	(1) GRC-142 HF-SSB/RATT (1) FM-7 COMSEC (1) TA-838 TELEPHONE	1-SKILLED (RATT OPERATOR)	ORGANIC SYSTEMS FOR TTY WHILE MOVING AND FOR TTY AS BACKUP TO MULTICHANNEL/TTY CENTRAL SYSTEM WHILE STATIC SELF- CONTAINED GENERATOR ORGANIC TO CAB.
DIV INTEL RATT DIV OPS RATT DIV ADMIN/LOG RATT	5/4 TON TRUCK (M 715)	SAME AS FOR RATT CF-1	1-SKILLED (RATT OPERATOR)	SAME AS ABOVE
PU-2	3/4 TON TRLR (M 101)	(2) 5 kW GENERATORS (PU-620)		
TAB C1	1/4 TON JEEP (M 151)	(1) VRC-46 RADIO (1) KY-38 COMSEC (1) GRC-39 LOCAL SET (1) TA-838 TO COMD SHBD		MONITORED BY TAB PROCESSING SECTION IN INTEL VEHICLE USING REMOTE SET
TOC SHBD	5/4 TON TRUCK (M 715)	(1) TTC-35 (V) SEMIAUTOMATIC 50 LINE SWITCHBOARD	1-SKILLED (SHBD OPERATOR)	TERMINATE SOLE USER TELEPHONES FROM OPS/INTEL, LINE FROM RMT STATION, AND TERMINATE SOLE USERS FROM HIGHER, LOWER, AND ADJACENT UNITS. SERVES AS A MONITOR FOR OPS/ INTEL STAFF AND A MANUAL INTERUPT CAPABILITY IN LIEU OF PRECEDENCE LEVEL. ALL 2- WIRE OPERATIONS IN A CLOSED SOLE USER NETWORK.
PU-6	3/4 TON TRAILER (M 101)	(2) 3 kW GENERATORS (PU-617)		
OPNS	2-1/2 TON TRUCK (M 35)	(1) VRC-46 RADIO (1) KY-38 COMSEC (1) VRC-46 RADIO		DIV CMD/OPS NET VOICE SECURITY AS REQUIRED DIV ARTY CF NET
INTEL		(1) VRC-46 RADIO (1) KY-38 COMSEC (1) VRC-46 RADIO (1) KY-38 COMSEC (1) GRC-106 RADIO (1) GRC-39 REMOTE (1) TA-125 EACH		DIV INTEL NET VOICE SECURITY AS REQUIRED AS REQUIRED DIV TOC NET TAB C1 RADIO CONTROL TECH CONTROL FOR 6 WF-16 CABLES OR 12 WD-1 WIRES
TB-1A, 1B, 1C	OPLN			
TB-1J	OPEH	(1) J-1077		TECH CONTROL FOR 26 WD-1 WIRES OR 13 WF-16 CABLES OR A 26 PAIR CABLE

2358/78W

Table 7-3. Division artillery main CP personnel and equipment list.

TTY CENTRAL	2-1/2 TON TRUCK (M 35)	(1) TSC-58 TELEGRAPH TERMINAL (6) TT-76B REPERF-TRANSMITTERS (6) TT-98B TELETYPEWRITERS (8) TH-22 FREQ SHIFT CONVERTERS (1) SB-22 MANUAL SWBD (1) TA-312 TELEPHONE (1) J-1077 TERMINAL BOX (6) KW-7 COMSEC FOR TTY (NOT A BASIC ISSUE ITEM) (2) 10 KW GENERATORS (PU-619)	2-SKILLED (TTY OP)	(3) HDX TTY TO DIV MAIN, DIV TAC CP, AND DISCOM COMMON USER CENTRALS. CAN ACCOMMODATE THREE MORE HDX CIRCUITS OR ONE FDX AND ONE HDX ADDITIONAL CIRCUIT. TTY SIGNALS CONVERTED TO VF USING (TH-22) FSK DEVICE
PU-5	1-1/2 TON TRAILER	(1) GSO-80 MESSAGE CENTER (1) TELEPHONE (TA-838)	1-UNSKILLED	RECEIVING, SORTING, DISTRIBUTING, AND TEMPORARY STORAGE OF MESSAGES, DISPATCHES, AND PACKAGES.
M56 CENTER	2-1/2 TON TRUCK	(1) GSO-80 MESSAGE CENTER (1) TELEPHONE (TA-838)	1-UNSKILLED	RECEIVING, SORTING, DISTRIBUTING, AND TEMPORARY STORAGE OF MESSAGES, DISPATCHES, AND PACKAGES.
PU-5	1-1/2 TON TRAILER	(2) 10 KW GENERATORS (PU-619)		
METRO VEHICLE	2-1/2 TON TRUCK	(1) VRC-46 RADIO (FM) (1) KY-38 COMEC FOR RADIO (1) TELEPHONE (TA-838) (1) RADIOSONDE GMM-TA (1) RAWIN SET GMD-1 (1) WEATHER RECORD SET THQ-5	1-SKILLED (WEATHER OP)	DIVARTY CF NET (FM) WEATHER SUPPORT
TB-2K	OPEN	(1) J-1077		TECHNICAL CONTROL FOR 26-PAIR CABLE (K), AND WF-16 FIELD CABLES.
TB-2A	OPEN	(1) TA-125 TERMINAL BOX		TECH CONTROL FOR WD-1 FIELD WIRES
DISMOUNT POINT	OPEN	(1) TELEPHONE (TA-838)		MONITOR TRAFFIC IN CP AND TOC AREAS.

2359/78W

Table 7-4. Division artillery SIGNAL center personnel and equipment list.

DESCRIPTION ELEMENT	FACILITY	EQUIPMENT	PERSONNEL	FUNCTION
MC MUX-1	5/4 TON TRUCK (M 715)	(1) TCC-65 MULTICHANNEL MULTIPLY TERMINAL (4) CV-1548 SIGNAL CONVERTERS (4) TD-660A VOICE FREQUENCY CHANNEL CONVERTER TO TOM-PCM (4) TD-754 CABLE TRANSMISSION INTERFACE UNIT (MULTIPLYER) (2) TD-206 UNATTENDED REPEATERS (1) KG-27 COMSEC FOR LINKS (2) 3 KW GENERATORS (PU-628)	2-SKILLED (COMM OP)	PROVIDE MULTIPLY EQUIPMENT FOR CARRIER CABLE TRANSMISSION TO CP AREA. TD-754 PROVIDES POWER FOR UNATTENDED REPEATERS WHICH ARE SPACED EVERY 1600 METERS OF CABLE LENGTH.
PU-4	3/4 TON TRAILER (M 101)			
MC	5/4 TON TRUCK	(1) TRC-145 MULTICHANNEL MULTIPLY SYSTEM (2) CV-1548 (2) TD-660A (2) TD-754 (2) GRC-103 RADIOS (MC) (2) KG-27 COMSEC FOR LINKS (2) AS-1852/GRC-103 (V) ANTENNAS (2) 3 KW GENERATORS (PU-625)	2-SKILLED (COMM OP)	PROVIDES TWO MULTIPLY AND RADIO TERMINALS FOR ONE 12-CHANNEL SYSTEM TO DIV MAIN AND DIV TAC CP. CIRCUITS CAN TERMINATE AT DIVARTY OR CAN BE PATCHED OVER NEARBY MC SYSTEMS.
PU-1	3/4 TON TRAILER			
PATCHING CENTER	5/4 TON TRUCK	(1) TSC-76 COMM PATCHING CENTER (1) PATCH PANELS FOR 572 TWO- WIRE CIRCUITS OR 286 FOUR- WIRE CIRCUITS OR COMBINATION (22) 26-PAIR CONNECTORS	2-SKILLED (COMM OP)	PATCHING, TESTING, AND MONITOR- ING TELEPHONE CIRCUITS AND VOICE- FREQUENCY TTY CIRCUITS

2359/7BW

Table 7-4. Division artillery SIGNAL center personnel and equipment list (continued).

PU-6	3/4 TON TRAILER	(1) SB-22 SMBD (MANUAL) (1) TA-312 TELEPHONE (1) TT-98 TTY SET (1) TH-22 TG SET (2) 3 KW GENERATORS (PU-617)	
MC RADIO TERMINAL	5/4 TON TRUCK	(1) TRC-113 RADIO TERMINAL OR RADIO REPEATER SET (3) TD-204 CABLE/RADIO INTERFACE MULTIPLEXERS (3) GRC-103 RADIOS (MC) (3) AS-1852/GRC-103 (V) ANTENNAS (6) TD-206 UNATTENDED REPEATERS (3) KG-27 COMSEC FOR LINKS (1) TA-312 TO PATCH PANEL (2) 3 KW GENERATORS (PU-625)	PROVIDES RADIO TERMINAL FOR TWO 12-CHANNEL SYSTEMS TO DISCOM AND ONE 12-CHANNEL SYSTEM TO DIV MAIN. CIRCUITS CAN TERMINATE AT DIVARTY OR BE PATCHED OVER OTHER NEARBY MC SYSTEMS. REQUIRES MULTICHANNEL MULTIPLEX TERMINAL (TCC-65) WHEN EMPLOYED AS A RADIO REPEATER ALSO BE USED AS A RADIO REPEATER FOR ONE 12-CHANNEL SYSTEM OR A COMBINATION OF REPEATERS/RADIO TERMINAL. TD-204 PROVIDES POWER FOR TD-206 UNATTENDED REPEATERS
SIG PLT LDR	1/4 TON JEEP (M 151)	(1) VRC-47 RADIO SET (FM) (1) KY-38 COMSEC FOR RADIOS	ACTIVE - SIG BN COMMO NET MONITOR - DIVARTY CF NET
RETRANS VEHICLE	1/4 TON JEEP	(1) VRC-49 RADIO SET (FM) (2) KY-38 COMSEC FOR RADIOS (1) RETRANS MODEM (2) RC-292 ANTENNAS	PROVIDE RANGE EXTENSION THROUGH RETRANSMISSION AND RC-292 ANTENNAS FOR DIVARTY CF NET (FM) IN SUPPORT OF OPNS RADIO IN DIVARTY TOC AREA. COMMON USER TELEPHONE CONNECTED TO DIVARTY COMMO SMBD.
PU-3	1/4 TON TRAILER (M 416)	(2) 1.5 KW GENERATORS (PU-630)	

2359/78W

Table 7-5. Divarty radio nets for division and above.

NET STATIONS	DIV COMD. OP NET (FMI)	DIV INTEL NET (FMI)	DIV WEA NET (FMI)	DIV TOC NET (SSBI)	DIV OP NET (RATT)	DIV INTEL NET (RATT)	DIV ADMIN. LOG NET (RATT)	CORPS COMD. OP NET (RATT)	CORPS INTEL NET (RATT)	CORPS INTEL NET (SSBI)	CORPS WEA NET (RATT)	USAF AIR REQ NET (SSBI)	USAF AIR DIR NET (UMF)	CORPS RECON SURVL NET (RATT)
DIV CDR	*													
G3 OP (MAIN)	*			*	*A			*B				*C	*C	
G2 CM&D (MAIN)		*D	*D SWO			*A			*	*D SWO				
G1 G4 (MAIN)							*A							
DIV TAC OP	*A	*A		*A	*A	*A				*D		*C	*C	
DIVARTY	*	*		*	*	*	*							
BDE (EAI)	*	*	* WEA 'M	*	*A	*A	SEE FASC					*ACP C	*ACP C	
MNV BN												*ACP C	*ACP C	
CAV SQDN	*	*		*	*	*	*					*ACP C	*ACP C	
AVN UNIT	*	*	* WEA 'M		*	*								*D
SIG BN	*													
ENGR BN	*	*			*	*	*							
FASC							*A							
DISCOM	*	*			*A		*A							
40A BN	*	*			*	*	*							
EW CO OP GEN		*												
MP CO	*													
DIV REAP							*A							
CBT CO	*	*												

LEGEND:
A-PROVIDED BY DIV SIG BN
B-PROVIDED BY CORPS SIG BDE.
C-PROVIDED BY USAF
D-PROVIDED BY CBTI CO.

NOTE: TWO IDENTICAL SETS OF C-E EQUIPMENT ARE PROVIDED FOR THE DIVISION TACTICAL COMMAND POST BY THE DIVISION SIGNAL BATTALION.

DIVISION RADIO NET STRUCTURE

2059, 78W

3.2 (7-18)

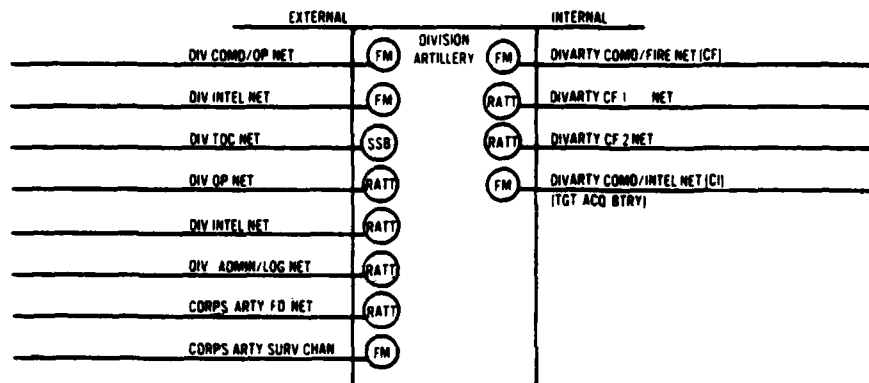

DIVISION ARTILLERY RADIO NET STRUCTURE

2359/78W

R.2 (7-7)

Figure 7-2. Divarty radio net structure.

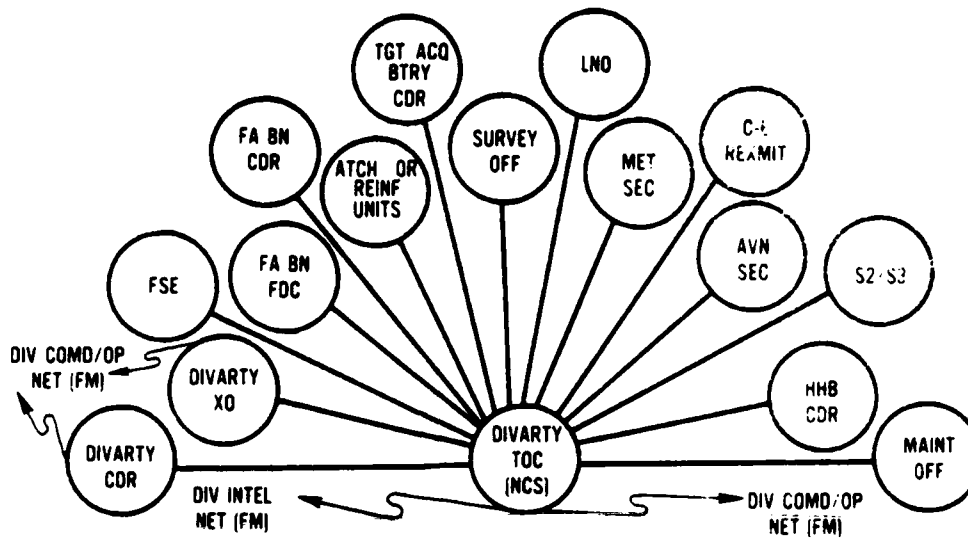

DIVISION ARTILLERY COMMAND/FIRE DIRECTION NET (FM)

DIVARTY SINGLE CHANNEL RADIO

Single channel radio usually satisfies initial needs for basic communications. The division artillery operates in the single channel nets shown in the illustration.

Radio sets must never be arranged so that split operations, dispersion of assets, and other electronic signature-reducing techniques are hindered. Radio set installation and physical TOC organization must provide for an adequate degree of flexibility. Specific stations in internal divarty radio nets are shown on this page and the next page.

2359/78W

R.2 (7-8)

Figure 7-3. Divarty CMD/Fire direction radio net.

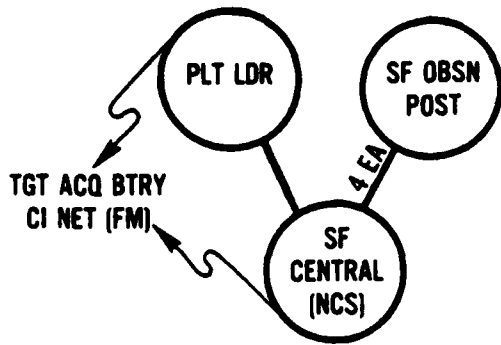

SOUND/FLASH RANGING PLATOON
(TGT ACQ BTRY)
SOUND/FLASH NET (FM)

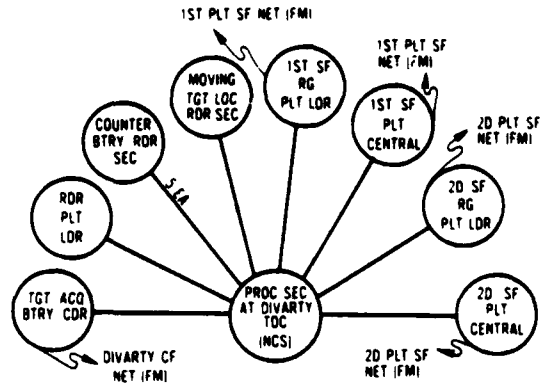

DIVISION ARTILLERY TARGET
ACQUISITION BATTERY
COMMAND/INTELLIGENCE NET (FM)

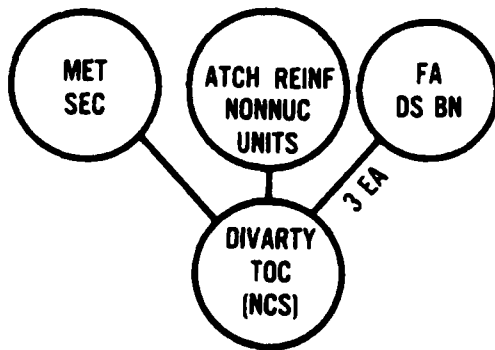

NOTE: METEOROLOGICAL SECTION ALTERNATES
BETWEEN COMMAND/FIRE DIRECTION
NET #1 AND #2.

DIVISION ARTILLERY COMMAND/
FIRE DIRECTION NET #1 (RATT)

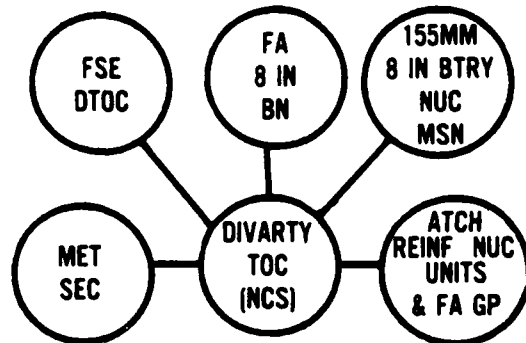

NOTE: METEOROLOGICAL SECTION ALTERNATES
BETWEEN COMMAND/FIRE DIRECTION
NET #1 AND #2.

DIVISION ARTILLERY COMMAND
FIRE DIRECTION NET #2 (RATT)

2389/78W

R.2 (7-9)

Figure 7-4. Divarty miscellaneous internal radio nets.

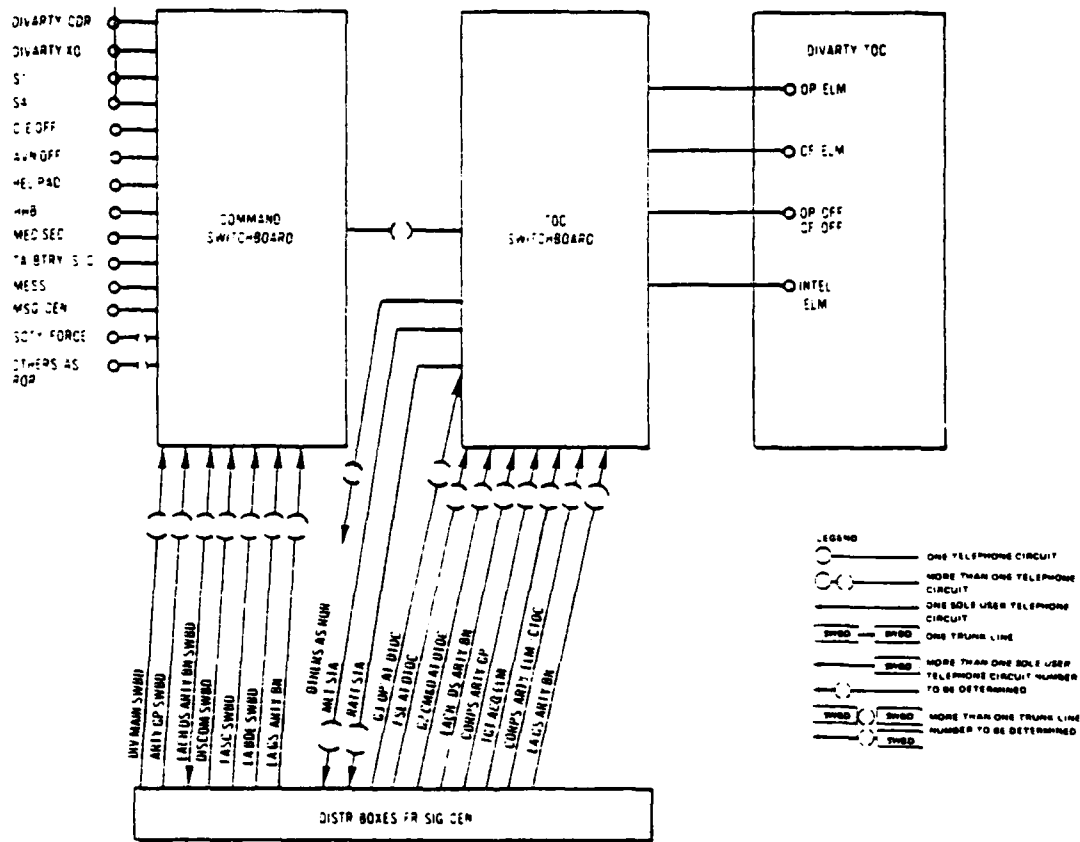

SWITCHBOARD AND WIRE CONFIGURATION OF DIVISION ARTILLERY HEADQUARTERS

2359.78W

R.2 (7-10)

Figure 7-5. Divarty wiring structure.

Table 7-6. DIV ARTY COMD and TOC switchboard trunking allocation.

<u>COMD (4W COMMON USER)</u>	<u>TOC (2W) SOLE USER</u>
DIV MAIN (3)	LANCE BN (2)
DISCOM (4)	LANCE BN FDC (1)
DIV REAR (1)	DIV TOC (3)
BDE #1 (2)	CORPS TOC (3)
BDE #2 (2)	CORPS MOBILE (2)
BDE #3 (2)	BDE #1 (1)
FASC #1 (1)	BDE #2 (1)
FASC #2 (1)	BDE #3 (1)
FASC #3 (1)	
TAC CP (2)	
ADA BN (1)	
CORPS MAIN (3)	
CORPS MOBILE (1)	
FA GP (1)	

Table 7-7. Division artillery CP multichannel circuit allocation.

SYSTEM	CHANNEL	TO	(NO) TYPE	PATCH-THROUGH SYSTEM	
DIVARTY (A)/DIV MAIN	1 THRU 3	DIV TOC	(3) SOLE USER		
	4 THRU 6	DIV MAIN	(3) COMMON USER		
	7	DIV MAIN	(1) HDX TTY		
	8 THRU 11 12	PATCH FOR TAC CP DIV MAIN TCF	(4) COMMON USER (1) SOLE USER	TAC CP (B)/DIVARTY(B)/DIVARTY(A)/DIV MAIN	
DIVARTY(B)/TAC CP (B)	1 THRU 2	TAC CP TOC	(2) SOLE USER		
	3 THRU 4	TAC CP MAIN	(2) COMMON USER		
	5	PATCH FOR TAC CP	(1) SOLE USER	TAC CP(B)/DIVARTY(B)/DISCOM(D)/CASC/WIRE	
	6 THRU 9 10 THRU 11 12	PATCH FOR TAC CP SPARE TAC CP TRC-145 (B)	(4) COMMON USER (1) SOLE USER	TAC CP(B)/DIVARTY(B)/DIVARTY(A)/DIV MAIN	
DIVARTY(C)/DIV MAIN	1 THRU 2	CORPS TOC	(2) SOLE USER		
	3 THRU 5	CORPS MAIN	(3) COMMON USER		
	6 THRU 7	CORPS MOBILE TOC	(2) SOLE USER		
	8	CORPS MOBILE	(1) COMMON USER		
	9	ADA BN	(1) SOLE USER		
	10 THRU 11	SPARE	(1) SOLE USER		
	12	CORPS MAIN TCF	(1) SOLE USER		
DIVARTY(D)/DISCOM	1 THRU 4	DISCOM	(4) COMMON USER		
	5	DISCOM	(1) HDX TTY		
	6	DIV REAR	(1) COMMON USER		
	7	FA GP	(1) COMMON USER		
	8 THRU 9	LANCE BN	(2) SOLE USER		
	10	LANCE BN FDC	(1) SOLE USER		
	11	PATCH FOR TAC CP (B)	(1) SOLE USER		
	12	CASC TCF	(1) SOLE USER		
	DIVARTY(E)/DISCOM	1 THRU 2	BDE-1	(2) COMMON USER	
		3	FASC-1	(1) COMMON USER	
		4	FASC-1	(1) HDX TTY	
		5 THRU 6	BDE-2	(2) COMMON USER	
7		FASC-2	(1) COMMON USER		
8		FASC-2	(1) HDX TTY		
9		FASC-3	(1) COMMON USER		
10		BDE-3	(1) COMMON USER		
11		FASC-3	(1) HDX TTY		
12		DISCOM TCF	(1) SOLE USER		

NOTES:

1. PATCH AT DIVARTY FOR TAC CP SOLE USER
CIRCUIT TO LANCE BN IS AT MC MUX-2 (TCC-65)
IN THE CP AREA INSTEAD OF THE
TECH CONTROL FACILITY (TCF) AT THE SIG CENTER AREA
2. CHANNEL 12 CIRCUITS FOR TCF ON SYSTEMS
(C), (D), AND (E) TERMINATE AT MC MUX-2 (TCC-65)
IN THE CP AREA AS IT IS TREATED AS
A TERMINAL "SPOKE" FROM DIV MAIN AND DISCOM.
THIS PRECLUDES UNNECESSARY USE OF THE TCC-65 AND
TCF (TSC-76) AT THE DIVARTY SIGNAL CENTER AREA.

2359/78W

Table 7-8. Division artillery TOC wire and cable distribution.

FROM	TO	WIRE	CABLE	LENGTH (METERS)	DESTINATION
RATT CF-1 VEHICLE TELEPHONE	TB-1J (J-1077)		(1) WF-16	70	COMD SMBD (SB-3614)
RATT CF-2 VEHICLE TELEPHONE	TB-1J (J-1077)		(1) WF-16	70	COMD SMBD
TAB C1 VEHICLE TELEPHONE	TB-1J (J-1077)		(1) WF-16	50	COMD SMBD
LOCAL SET (GRA-39)	INTEL VEHICLE	(1) WD-1		60	REMOTE SET (GRA-39)
DIV OPS RATT VEHICLE TELEPHONE	TB-1J (J-1077)		(1) WF-16	20	COMD SMBD
OPNS VEHICLE	TB-1J (J-1077)		(4) WF-16	40	COMD SMBD
(4) TELEPHONES	TOC SMBD (SOLE USER)	(4) WD-1		30	SB-3082 (TOC SMBD)
(4) TELEPHONES					
INTEL VEHICLE	COMD SMBD		(4) WF-16	180	SB-3614
(4) TELEPHONES	TOC SMBD (SOLE USER)	(4) WD-1		30	TOC SMBD
(4) TELEPHONES					
RATT CORPS ARTY VEHICLE TELEPHONE	COMD SMBD		(1) WF-16	230	SB-3614
DIV INTEL RATT VEHICLE	COMD SMBD		(1) WF-16	180	SB-3614
DIV ADMIN/LOG RATT TELEPHONE	COMD SMBD		(1) WF-16	120	SB-3614
TOC SMBD (TTC-35 V1)	TB-1B (TA-125)	(12) WD-1		30	MC MUX-2
	TB-1C (TA-125)	(3) WD-1		30	(2) MC MUX-1
				75	(1) RMJ VEHICLE (GSA-7)
	TB-2A	(4) WD-1		160	GS/DS ARTY BNS

Table 7-9. Division artillery main CP wire and cable distribution.

FROM	TO	WIRE	CABLE	LENGTH (METERS)	DESTINATION
MC MUX-2 VEHICLE	COMD SWBD		(2) CX-4566/STUB (G,H)	75	SB-3614 (60 LINE)
	TTY CENTRAL	(5) WD-1		65	HDX TTY MACHINES
	MC MUX-1 VEHICLE		(4) CX-11230 (C,D,E,F)	4400	SIG CENTER/MC SYSTEM
	TB-1		(1) CX-4566 (J)	150	TOC SWBD
	TB-2K (J-1077)		(1) CX-4566/STUB (K)	75	LOCAL DISTRIBUTION
	TTY CENTRAL		(1) WF-16	60	TELEPHONE
	DIV ADMIN/LOG RATT		(1) WF-16	120	TELEPHONE
	DIV INTEL RATT		(1) WF-16	180	TELEPHONE
	RATT CORPS ARTY		(1) WF-16	230	TELEPHONE
	INTEL VEHICLE		(4) WF-16	180	TELEPHONES
COMD SWBD	TB-2A (TA-125)	(4) WD-1		70	(1) GS BN COMD SWBD
	TB-1J (TOC J-1077)		(8) WF-16	160	(3) DS BN COMD SWBDS
					(4) OPNS VEHICLES
					(1) DIV OPS RATT
					(1) TAB C1
					(1) RATT CF-1
					(1) RATT CF-2
					TELEPHONE
					TELEPHONE
					TELEPHONE
TB-2K (J-1077)	DISMOUNT POINT		(1) WF-16	10	TELEPHONE
	MSG CENTER		(1) WF-16	30	TELEPHONE
	METRO		(1) WF-16	70	TELEPHONE
	LOCAL		(9) WF-16	60	TELEPHONE
					SB-3068
					(1) COMD SWBD
					(1) FDC SWBD
					(2) EACH COMD SWBD
					(2) EACH FDC SWBD
	TB-2A (TA-125)	TOC SWBD	(4) WD-1		160
GS ARTY BN		(2) WD-1		1000	
DS ARTY BNS		(6) WD-1		5000	

NOTE: BATTALION SWITCHBOARDS HAVE A TA-955 DTMF PAD TO INTERFACE WITH THE AUTOMATIC VOICE SWITCHING (DIAL-UP) NETWORK AND THE SB-3614 (COMD SWBD) CAN ACCOMMODATE THESE 2-WIRE CIRCUITS.

Table 7-10. Division artillery signal center wire and cable distribution.

FROM	TO	WIRE	CABLE	LENGTH (METERS)	CIRCUIT DESTINATIONS
MC	PATCHING CENTER		(2) CX-4566 (A,B)	75	DIVARTY CP, TOC, OTHER MCs
MC RADIO TERMINAL	MC MUX-2 (AT CP)		(3) CX-11230 (C,D,E)	4400	SAME AS ABOVE
PATCHING CENTER	MC MUX-1 (AT SIG CENTER)		(1) CX-4566 (F)	75	SAME AS ABOVE
PATCHING CENTER	MC RADIO TERMINAL	(1) WD-1			ORDER WIRE BETWEEN VANS

NOTE: THE CABLE BETWEEN UNATTENDED REPEATERS IS CX-11230, REPEATERS BEING PLACED EVERY MILE OF CABLE FOR PULSE RESTORAL. THE TD-204 OR TD-754 CABLE COMBINER PROVIDES POWER FOR THE TD-206 REPEATERS UP TO 39 REPEATERS.

2359/78W

8. DIVISION TAC CP CONFIGURATION AND C³ STRUCTURES

8.1 Mission and Deployment Concept

The Division TAC CP is an element of the Division and is a facility for the commander and staff to command and control elements of the division. Primary functions are:

- (a) Obtaining and acting on combat information and intelligence of interest to the commander fighting the present battle
- (b) Control of maneuver forces
- (c) Control and coordination of all immediately or near-immediately available fire support means
- (d) Coordination of immediate use of airspace and air defense operations in the forward area
- (e) Continually assessing the priorities of the immediate battle and providing direction as appropriate.

The CP is located well forward in the main battle area in close proximity to the brigade CP whose operation is most critical to accomplish the immediate division mission.

8.2 CP Configuration

Figure 8-1 shows a geographical layout of the CP and Table 8-1 describes the CP elements. The tactical operations center contains the commander and staff as well as terminal, switching, and tech control facilities for communications. In order to reduce the size of the operations center, reduce the electronic signature, provide for improved cover and concealment of C³ elements, and enhance line-of-sight radio requirements, a "radio park" has been displaced one kilometer from the main CP. This one KM distance is limited due to CP displacement objectives (15 minutes).

8.2.1 Radio Enhancements

One radio system which has not been previously discussed is the use of a GRC-163 assemblage for multichannel communications to the alternate TAC CP over FM/VHF radio (VRC-47). Using a multiplexer (TCC-70), the system can accommodate up to four voice channels and two HDX teletype channels. Since there is no link encryption, the voice channels are

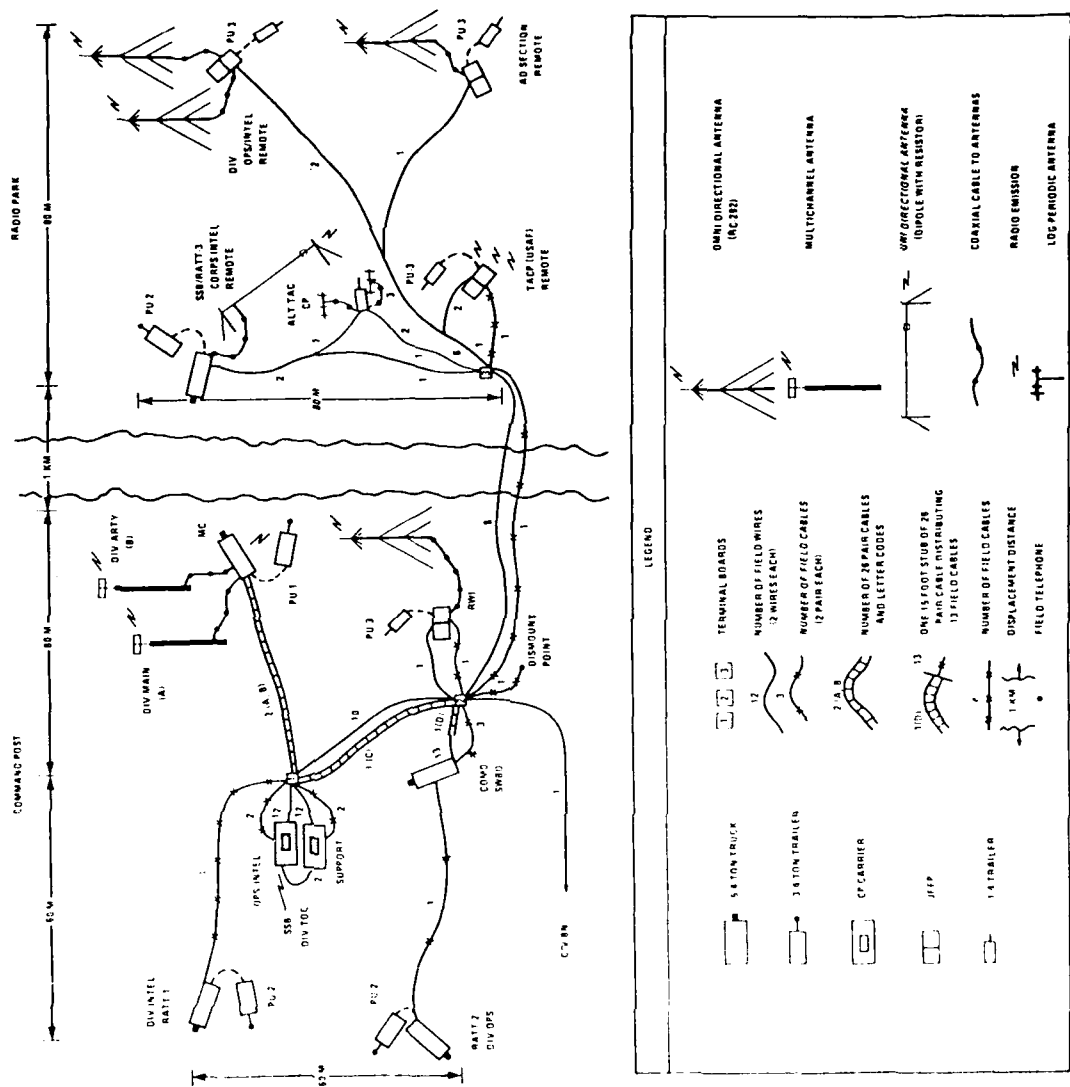

23587 14W

Figure 8-1. Division TAC CP configuration.

Table 8-1. Glossary of terms for Figure 8-1.

AD	Air Defense
ALT	Alternate
BN	Battalion
COMD	Command
CP	Command Post
C/V	Chaparral/Vulcan
DIV	Division
INTEL	Intelligence
KM	Kilometers
M	Meters
MC	Multichannel
OPS	Operations
PU	Power Units
RATT	Radio Teletype
RWI	Radio-Wire Integration
SSB	Single Sideband
SWBD	Switchboard
TAC	Tactical
TACP	Tactical Air Control Party
TOC	Tactical Operations Center
USAF	United States Air Force

Note: Shaded area is center of activity for command and control.

2359/78W

Table 8-1. Glossary of terms for Figure 8-1.

AD	Air Defense
ALT	Alternate
BN	Battalion
COMD	Command
CP	Command Post
C/V	Chaparral/Vulcan
DIV	Division
INTEL	Intelligence
KM	Kilometers
M	Meters
MC	Multichannel
OPS	Operations
PU	Power Units
RATT	Radio Teletype
RWI	Radio-Wire Integration
SSB	Single Sideband
SWBD	Switchboard
TAC	Tactical
TACP	Tactical Air Control Party
TOC	Tactical Operations Center
USAF	United States Air Force

Note: Shaded area is center of activity for command and control.

2359/78W

unsecure unless the telephone instrument has a security device (such as a PARKHILL with wire line adapter). Also, the telephone instrument must use 2-wire operation (TA-312) to meet the electrical requirements of the built-in telephone ringers in the TCC-70.

8.2.2 Wiring Enhancements

The teletypewriter sets in the GRC-122 RATT vehicle supporting the Corps Intelligence Net are not used. Therefore, a field expedient splice is made before the teletype signal enters the radio modem and the TTY is connected from the frequency shift keying device (TH-22) to the TCC-70 for transmission over the VRC-47. The same assemblage modification is made on the GRC-122 at the TAC CP alternate, providing record traffic capability between the two sites by optimizing the voice and TTY capabilities of the GRC-122.

8.2.3 Tech Control Facilities

Terminal boxes (TA-125 and J-1077) are used for patching, testing, and re-routing of circuits.

8.3 C³ Structures

The following C³ structures are provided in tables and figures to assist in analysis:

- (a) CP Personnel and Equipment List
- (b) Radio Nets for Division and Above
- (c) Command and TOC Switchboard Trunking Allocation
- (d) Multichannel Circuit Allocation
- (e) CP Wiring Structure
- (f) Wire and Cable Distribution

Table 8-2. Division TAC CP personnel and equipment list.

DESCRIPTION ELEMENT	FACILITY	EQUIPMENT	PERSONNEL	FUNCTION
RATT-1 RATT-2 PU-2	5/4 TON TRUCK (M 715) 3/4 TON TRL (M 101)	(1) GRC-142 AM VOICE/TTY RADIO SYSTEM (1) KH-7 COMSEC DEVICE FOR TTY (1) TA-838 DIAL-UP TELEPHONE (COMMON USER) (2) 5 KW-GENERATORS (PU-62D) FOR ELECTRONICS	1-SKILLED (COMMUNICATIONS) RATT OPERATOR	OPERATES IN THE DIVISION INTEL (RATT) AND DIVISION OPERATIONS (RATT) NETS. CAN OPERATE FROM VEHICLE POWER
SSB/RATT-3 PU-2	SAME AS RATT-1	SAME AS RATT-1 PLUS: (1) GRA-6 LOCAL UNIT FOR VOICE REMOTE (1) GRA-50 DOUBLET ANTENNA FOR RANGE EXTENSION	1-SKILLED (COMMUNICATIONS) RATT OPERATOR	OPERATES IN THE CORPS INTEL (SSB) NET WITH VOICE REMOTE TO STAFF ELEMENT
OPS/INTEL	CP CARRIER (M 577)	(2) SB-22 MANUAL SWITCHBOARDS FOR SOLE USER SERVICE AND RMT (2-WIRE) (4) TA-312 RING-DOWN (2-WIRE) SOLE USER TELEPHONES (4) TA-838 DIAL-UP TELEPHONES (4-WIRE) (1) VRC-47 FM RADIO SYSTEM FOR VEHICULAR USE (2) KY-38 FM RADIO COMSEC DEVICES (1) GRC-106 AM RADIO FOR VEHICULAR USE (1) VEHICLE POWER SYSTEM FOR ELECTRONICS	4-STAFF CDR, G3, ASST G-2, FSO	COMMAND AND STAFF WITH TELEPHONES (SOLE USER AND COMMON USER). ONE RADIO (AM) USED IN THE DIVISION TOC (SSB) VOICE NET FROM VEHICLE ONE RADIO (FM) FOR ADMIN TO COURIER AT RADIO PARK.
SUPPORT	SAME AS COMD/OPS	(1) SB-22 (4) TA-312 (4) TA-838 (2) GRA-6 REMOTE UNITS TO TACP ELEMENT SSB AND UHF RADIOS (2) VRC-46 FM RADIO SYSTEMS (2) KY-38 (1) VEHICLE POWER SYSTEM	4-STAFF ASST G1, ASST G4, ASST FSO, ALO	COMBAT SUPPORT, FIRE SUPPORT, TACTICAL AIR CONTROL WITH SIMILAR COMMUNICATIONS AS IN COMD/OPS.
COVERED AREA	TENT	(2) SB-22 MANUAL SWITCHBOARD FOR SOLE USER SERVICE (FROM GP CARRIERS) (1) GRA-6 REMOTE UNIT TO SSB/RATT-3 ELEMENT (2) GRA-6 REMOTE UNITS TO TACP ELEMENT SSB AND UHF (2) GRA-39 REMOTE UNITS TO REMOTE (FM) ELEMENT (1) TA-312 (1) TA-838	4-UNSKILLED (COMM/ADMIN) 1-SHBD OPERATOR, 2-RADIO/TELEPHONE OPERATORS 1-ADMIN	PROVIDES MONITORING OF REMOTE RADIOS, MANAGEMENT OF SOLE USER CIRCUITS, AND ADMINISTRATIVE ASSISTANCE. CAN BE USED BY STAFF WHEN NOT IN VEHICLES.
MC	5/4 TON TRUCK (M 715)	(1) TRC-145 MULTICHANNEL SYSTEM (1) VRC-46 RADIO FOR ADMIN (2) KG-27 COMSEC DEVICES (LINK ENCRYPTION) (1) TA-838 (2) AS-1852/GRC-103 ANTENNAS (2) 3KM-GENERATORS (PU-625) FOR ELECTRONICS	2-SKILLED (COMMUNICATIONS) MC OPERATORS	12 CHANNELS TO DIVISION MAIN AND 12 CHANNELS TO DIVISION ARTILLERY. REQUIRES EXTERNAL POWER. CAN OPERATE OVER CARRIER CABLE AS WELL AS RADIO.
PU-1	3/4 TON TRL (M 101)			

Table 8-2. Division TAC CP personnel and equipment list (continued).

SMBD	5/4 TON TRUCK (M 715)	(1) SB-3614 AUTOMATIC SWITCHBOARD (UNIT LEVEL SWITCH) (1) LOCAL BATTERY FOR ELECTRONICS (PORTABLE) (1) WIRE, CABLE, TERMINAL BOARD, AND TELEPHONE KIT	1-SKILLED (COMMUNICATIONS) SMD OPERATOR	30 LINE SWITCHBOARD TO PROVIDE COMMON USER DIAL-UP (4-WIRE) SERVICE BOTH LOCALLY AND TO OTHER SWITCHBOARDS. ALSO HAS 2-WIRE CAPABILITY AND CAN BE INCREASED IN CAPACITY UP TO A MULTIPLE OF 4 (120 LINES AND TRUNKS).
TB	NOT REQUIRED	(4) J-1077 TERMINAL BOXES FOR PATCHING WIRE/CABLE (1) TA-125 TERMINAL BOX FOR PATCHING WIRE	NONE REQUIRED (AT THE LOCATION AFTER INSTALLATION)	BINDING POSTS ARE FOR WIRE (WD-1) AND CABLE (WF-16) AND CONNECTORS ARE FOR 26 PAIR CABLE. THIS IS ALSO THE TECHNICAL CONTROL FACILITY WHERE RE-ROUTING AND CIRCUIT TESTING IS PERFORMED.
TACP	1/4 TON JEEP (M 151)	(1) MRC-1088 AIR FORCE RADIO CENTRAL (1) KY-38	NOT REQUIRED (AFTER INSTALLATION)	TACTICAL AIR CONTROL PARTY COMMUNICATIONS WITH REMOTES (SSB AND UHF) TO THE SUPPORT ELEMENT. CAN OPERATE FROM VEHICLE POWER.
PU-3	1/4 TON TRL (M 416)	(2) GRA-6 AND 39 LOCAL UNITS FOR VOICE REMOTE (2) 1.5 KW-GENERATORS (PU-630) FOR ELECTRONICS		
REMOTE (FM)	1/4 TON JEEP (M 151)	(1) VRC-49 FM RADIO SYSTEM (2) KY-38 (2) GRA-39 LOCAL UNITS FOR VOICE REMOTE (1) TA-312	NOT REQUIRED (AFTER INSTALLATION)	OPERATES IN THE DIVISION INTEL (FM) AND DIVISION OPERATIONS (FM) NETS. REMOTE TO COMD/OPS ELEMENT. CAN BE USED FOR FM RADIO RETRANSMISSION
RMT	1/4 TON JEEP (M 151)	(2) RC-292 FM RADIO ANTENNAS FOR RANGE EXTENSION (1) VEHICLE POWER SYSTEM (1) VRC-46 (1) KY-38 (1) GSA-7 RADIO WIRE INTEGRATION TERMINAL FOR RMT (1) TA-838 (1) TA-312 (1) RC-292 (1) VEHICLE POWER SYSTEM	1-UNSKILLED (COMMUNICATIONS) RMT OPERATOR	PERMITS FM RADIO USERS TO ACCESS THE STAFF TELEPHONES THROUGH A MANUAL SWITCHBOARD AND VICE VERSA
ALT TAC CP	1/4 TON TRAILER	(1) GRC-163 (VRC-47 RADIO) (1) TCC-70 MULTIPLEXER (2) 1.5 LEW GENERATORS (PU 630) (2) LOG PERIODIC ANTENNAS	1-SKILLED	MULTICHANNEL LINK TO ALT TAC CP USING FM RADIO. HAS TWO VOICE CKTS TO TOC AND ONE TTY FROM RATT-3
COURTIER	1/4 TON JEEP	(1) VRC-46	1-UNSKILLED	ADMIN NET TO MAIN CP. ALSO COURTIERS TTY MESSAGES

Table 8-3. Division TAC CP radio nets for division and above.

NET STATIONS	DIV COMD OP NET (FMI)	DIV INTEL NET (FMI)	DIV WEA NET (FMI)	DIV TOC NET (SSB)	DIV OP NET (RATT)	DIV INTEL NET (RATT)	DIV ADMIN LOG NET (RATT)	CORPS COMD OP NET (RATT)	CORPS INTEL NET (RATT)	CORPS INTEL NET (SSB)	CORPS WEA NET (RATT)	USAF AIR REQ NET (SSB)	USAF AIR DIR NET (UHF)	CORPS RECON SURVL NET (RATT)
DIV CDR	*													
G3 OP (MAIN)	*			*	*A			*B				*C	*C	
G2 CM&D (MAIN)		*D	*D SWD			*A			*	*D	*D SWD			
G1 G4 (MAIN)							*A							
DIV TAC CP	*A	*A		*A	*A	*A				*D		*C	*C	
DIVARTY	*	*		*	*	*	*							
BDE (3 EAI)	*	*	*D NET IM	*	*A	*A	SEE FASC					*ACP C	*ACP C	
MNV BN												*ACP C	*ACP C	
CAV SQDN	*	*		*	*	*	*					*ACP C	*ACP C	
AVN UNIT	*	*	*D NET IM		*	*								*D
SIG BN	*													
ENGR BN	*	*			*	*	*							
FASC							*A							
DISCOM	*	*			*A		*A							
ADA BN	*	*			*	*	*							
EW CO OP CEN		*												
MP CO	*													
DIV REAR							*A							
CBTI CO	*	*												

LEGEND:
A-PROVIDED BY DIV SIG BN.
B-PROVIDED BY CORPS SIG BDE.
C-PROVIDED BY USAF.
D-PROVIDED BY CBTI CO.

NOTE: TWO IDENTICAL SETS OF C-E EQUIPMENT ARE PROVIDED FOR THE DIVISION TACTICAL COMMAND POST BY THE DIVISION SIGNAL BATTALION.

R.2 (7-18)

Table 8-4. TAC CP COMD and TOC switchboard trunking allocation.

<u>COMD (4W COMMON USER)</u>	<u>TOC (2W SOLE USER)</u>
DIV MAIN (4)	DIV TOC (5)
DIV ARTY (2)	DIVARTY TOC (2)
CORPS MAIN (2)	CORPS TOC (1)
	LANCE BN (1)
	BDE #1 (1)
	BDE #2 (1)
	BDE #3 (1)
	C/V BN (1)
	ALT TAC CP (2)

2359/78W

Table 8-5. Division TAC CP multichannel circuit allocation.

SYSTEM	CHANNEL	TO	(NO) TYPE	PATCH-THROUGH SYSTEM	
TAC CP(A)/DIV MAIN	1 THROUGH 5	DIV TOC	(5) SOLE USER	TAC CP(A)/DIV MAIN/DIV MAIN/BDE-1	
	6	BDE-1 TOC	(1) SOLE USER	TAC CP(A)/DIV MAIN/DIV MAIN/BDE-2	
	7	BDE-2 TOC	(1) SOLE USER	TAC CP(A)/DIV MAIN/DIV MAIN/BDE-3	
	8	BDE-3 TOC	(1) SOLE USER	TAC CP(A)/DIV MAIN/DIV MAIN/CORPS MAIN	
	9	CORPS TOC	(1) SOLE USER	TAC CP(A)/DIV MAIN/DIV MAIN/CORPS MAIN	
	10 THROUGH 11	CORPS MAIN	(2) COMMON USER		
	12	DIV MAIN (TCF)	(1) SOLE USER		
	TAC CP(B)/DIVARTY(B)	1 THROUGH 2	DIVARTY TOC	(2) SOLE USER	TAC CP(B)/DIVARTY(B)/DISCOM(D)/CASC/WIRE
		3 THROUGH 4	DIVARTY MAIN	(2) COMMON USER	TAC CP(B)/DIVARTY(B)/DIVARTY(B)/DIV MAIN
		5	LANCE BN FDC	(1) SOLE USER	
		6 THROUGH 9	DIV MAIN	(4) COMMON USER	
		10 THROUGH 11	SPARE		
12		DIVARTY SIG GEN (TCF)	(1) SOLE USER		

NOTES:

- SOLE USER CIRCUITS ARE 2 WIRE WITH CONVERSION TO 4 WIRE (FOR TRANSMISSION) BEING AT THE CV-1548 OF EACH TRC-1455. ALSO, CONVERSION TAKES PLACE AT EACH TCC-65.
- COMMON USER CIRCUITS ARE 4 WIRE WITH STRAIGHT PATCH-THROUGH AT THE CV-1548s.
- SYSTEM PATCH THROUGHS ARE NORMALLY ACCOMMODATED AT TECH CONTROL FACILITIES (TCF).
- THE TCF AT DIV MAIN AND DIVARTY USES THE AN/TSC-76 WHILE THE CORPS MAIN AND CORPS AREA SIGNAL CENTER (CASC) WILL USE THE AN/TSQ-84.
- THE LANCE BN CAN TIE INTO A CASC WITH WIRE LINES. HOWEVER, FUTURE PLANS CALL FOR A MULTICHANNEL SYSTEM FROM THE BN TO A MISSILE HQ (FA GROUP) AND A PATCH-THROUGH SYSTEM FOR THE TAC CP MAY BE VIA DIVARTY/DIV MAIN/CORPS MAIN/MISSILE HQ/LANCE BN.

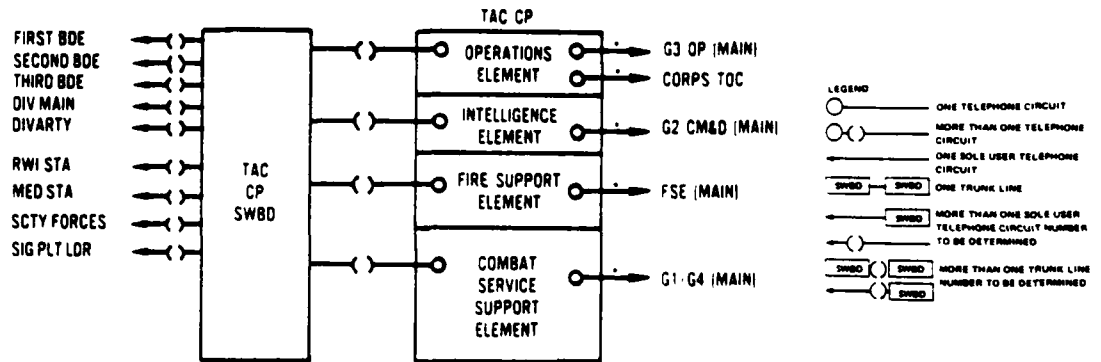

DIVISION TACTICAL COMMAND POST SWITCHBOARD
& TACTICAL COMMAND POST SOLE-USER CIRCUITS

2359/78W

R.2 (7-16)

Figure 8-2. Division TAC CP wiring structure.

Table 8-6. Division TAC CP wire and cable distribution.

FROM	TO	WIRE	CABLE	LENGTH (METERS)	CIRCUIT DESTINATION
RATT-1 TELE (C/U)	TB-1D		(1) WF-16	70	COMD SMBD
RATT-2 TELE (C/U)	COMD SMBD		(1) WF-16	70	SB-3614
MULTICHANNEL TERMINAL					
SYSTEM A (DIV MAIN)	TB-1A		(1) CX-4566	75	OPS/INTEL, SUPPORT, COMD SMBD
SYSTEM B (DIVARTY)	TB-1B		(1) CX-4566	75	OPS/INTEL, SUPPORT, COMD SMBD
OPS/INTEL VEHICLE					
TELE (C/U)	TB-1C		(2) WF-16	15	COMD SMBD
SMBD	TB-1A	(6) WD-1		15	MULTICHANNEL (A)
	TB-1B	(1) WD-1		15	MULTICHANNEL (B)
	TB-1D	(2) WD-1		15	RWI, C/V BN
	SUPPORT SMBD	(2) WD-1		15	ALT TAC CP
	INTERNAL TELE	(2) WD-1		10	SB-22
	TB-1D	(4) WD-1		5	TA-312
REMOTE SET (FM)	TB-1D	(1) WD-1		15	DIV OPS REMOTE
SUPPORT VEHICLE					
TELE (C/U)	TB-1D		(2) WF-16	15	COMB SMBD
SMBD	TB-1A	(3) WD-1		15	MULTICHANNEL (A)
	TB-1B	(2) WD-1		15	MULTICHANNEL (B)
	TB-1D	(1) WD-1		15	C/V BN
	OPS/INTEL SMBD	(2) WD-1		10	SB-22
	INTERNAL TELE	(4) WD-1		5	TA-312
REMOTE SETS (FM/UHF)	TB-1D	(4) WD-1		15	DIV INTEL, AD, TACP (2)
REMOTE SET (SSB)	TB-1D	(2) WD-1		15	CORPS INTEL, TACP

Table 8-6. Division TAC CP wire and cable distribution (continued).

RADIO WIRE INTEGRATION (PWT)						
TELEPHONE	TB-2D	(1) WD-1	(1) WF-16	20	OPS/INTEL VEHICLE	
TELE (C/U)	CORD SMD			40	CORD SMD	
CORD SMD	TB-2C	(11) WF-16		5	(2) MC-A, (6) MC-B (1) RATT-1 TELE (4) OPS/INTEL TELE (4) SUPPORT TELE TELE (TA-838) TELE AT TACP IN RADIO PARK	
	DISMOUNT POINT			30		
	TB-2D	(1) WF-16 (1) WF-16		5		
	TB-1C	(1) CX-4566		75	CORD SMD	
	TB-1D	(10) WD-1		45		
	TB-2D	(8) WD-1 (1) WD-1	(1) WF-16	1100	RADIO PARK	
	TB-3 (RADIO PARK) C/V BN			2000	C/V BN FDC	
	TACP	(2) WD-1	(1) WF-16	20	(2) REMOTE, (1) TELE (C/U)	
	AU SECTION	(1) WD-1		60	(1) REMOTE (FM)	
	DIV OP/INTEL	(2) WD-1		90	(2) REMOTE (FM), TELE (S/U)	
	SSB/RATT-3	(1) WD-1		90	(1) REMOTE (VOICE)	
	ALT TAC CP	(2) WD-1		50	(2) ALT TAC CP (S/U)	
	ALT TAC CP	(1) WD-1		45	(1) HDX TTY TO ALT TAC CP	

AD-A083 335

BOM CORP MCLEAN VA F/B 15/7
REPRESENTATIVE COMMAND POST CONFIGURATIONS, C3 STRUCTURES, AND --ETC(U)
JUL 78 H E REYNOLDS, W E SWEENEY DNA001-78-C-0077
BDM/W-78-C-0077-VOL-1 DNA-4352T-3A-VOL-1 NL

UNCLASSIFIED

2 of 3
AD
000000

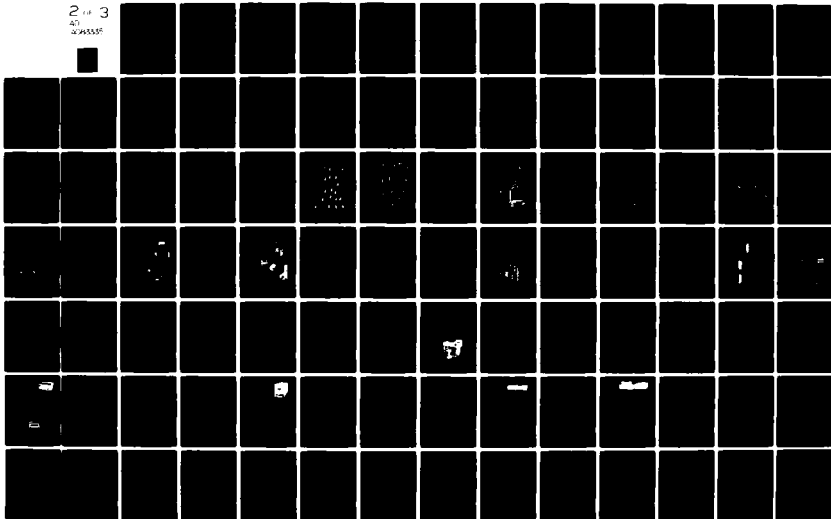

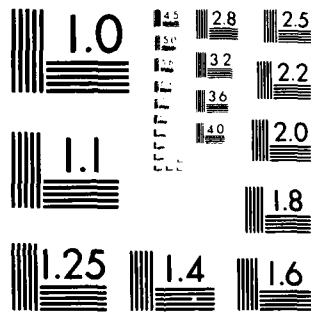

MICROCOPY RESOLUTION TEST CHART
NATIONAL BUREAU OF STANDARDS 1963-A

9. MECHANIZED INFANTRY BRIGADE CP CONFIGURATION AND C³ STRUCTURES

9.1 Mission and Deployment Concept

The brigade is an element of the division and the CP is a facility for the commander and staff to command and control three or four mechanized infantry battalions and one or two armored battalions. As such, it is a tactical command post similar to the Division TAC CP in that it is not organized for additional admin/ logistics capabilities other than staff monitoring of these functions as they relate to the subordinate battalions. Other missions in the CP are:

- (1) Coordination of preplanned Air Force and Filed Artillery missions through the fire support element (FSE)
- (2) Interface through the FSE to the close air support and tactical air reconnaissance element of the USAF tactical air control party (TACP) which monitors and acknowledges receipt of immediate requests as well as transmits disapprovals of immediate requests when necessary.

The CP is located well forward in the battle area, usually within line-of-site of the CPs of maneuver battalions, the DS FA battalion, and possibly the Division TAC CP.

9.2 CP Configuration

Figure 9-1 is a geographical layout of the CP and Table 9-1 describes the elements of the CP. Rationale for a radio park is the same as for the TAC CP.

9.2.1 Radio Enhancements

Uni-directional antennas have been installed for FM radios in Division nets using WD-1 wire and a resistor. The same type of antenna has been installed for the RATT radios, modifying the bi-directional antenna organic to the RATT set (GRA-50) and adding a resistor for directivity. Lastly, a bi-directional antenna has been installed for an FM radio to net with adjacent brigades (using WD-1 wire). The absence of a resistor in this field expedient antenna system will cause the bi-directional effect desired.

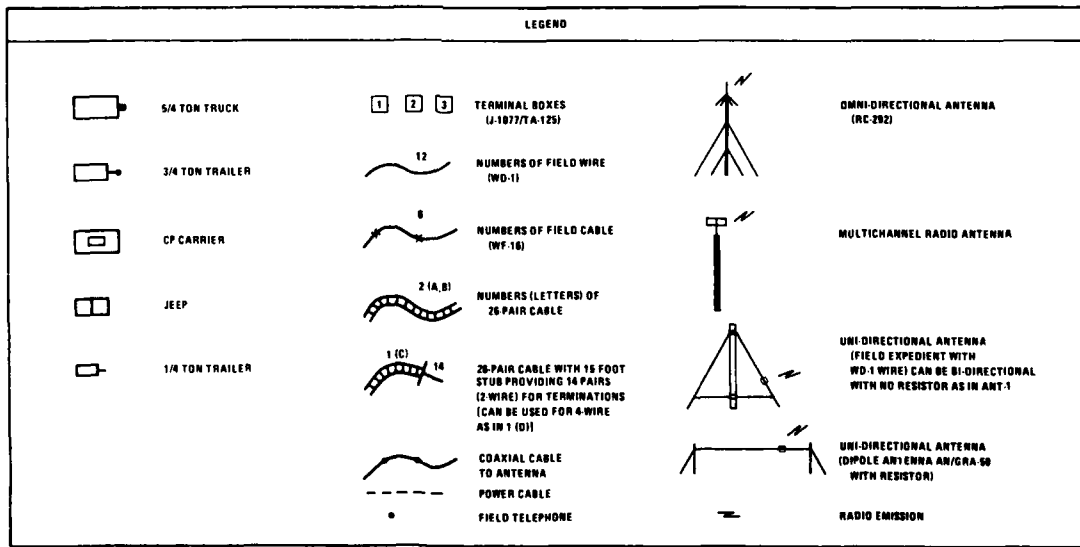
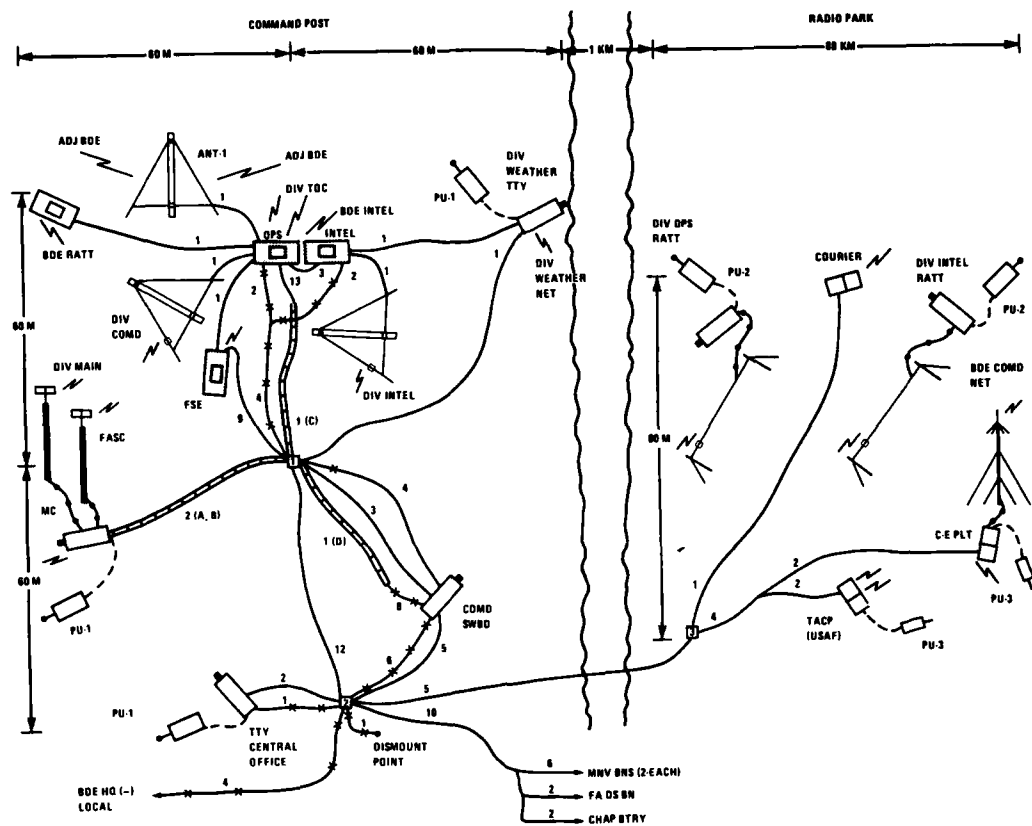

2359/7RW

Figure 9-1. Mechanized infantry brigade CP configuration.

Table 9-1. Glossary of terms for Figure 9-1.

ADJ BDE	Adjacent Brigade
ANT-1	Antenna called out as field expedient bi-directional
BDE	Brigade
BN	Battalion
BTRY	Battery
C - E	Communications - Electronics
CHAP	Chaparral
COMD	Command
DIV	Division
DS	Direct Support
FA	Field Artillery
FASC	Forward Area Signal Center
FSE	Fire Support Element
HQ(-)	Headquarters less TOC and Signal Support Elements
INTEL	Intelligence
KM	Kilometers
M	Meters
MC	Multichannel System
MNV	Maneuver
OPS	Operations
PU	Power Units
PLT	Platoon
RATT	Radio Teletype
SWBD	Switchboard
TACP	Tactical Air Control Party
TTY	Teletype
TOC	Tactical Operations Center
USAF	United States Air Force

Note: Shaded area is center of activity for command and control.

9.2.2 Wiring Enhancements

The SB-3614 has both 4-wire (WF-16) and 2-wire (WD-1) trunks, the 2-wire trunks being to battalions which have a manual switchboard (SB-22) and a TA-955 DTMF Pad for operator assistance in dial-up for 2-wire (ring down) users at battalion and below. This is the integration capability for the manual and automatic voice switching networks.

9.2.3 Technical Control Facilities

Terminal boards (TA-125 and J-1077) are used for patching, testing, and re-routing of circuits over WD-1, WF-16, and 26 pair cable.

9.2.4 Teletypewriter Enhancements

The frequency shift keying devices (TH-22) and telegraph-telephone signal converters (CV-425) of the teletypewriter central (TGC-30) provides the required signalling (voice frequency) over the field wire. Therefore, only 2-wire to 4-wire settings are required at the signal converter (CV-1548) of the multichannel terminal (TRC-145).

9.3 C³ Structures

The following C³ structures are provided in tables and figures to assist in analysis:

- (a) CP Personnel and Equipment List
- (b) CP Radio Structure
- (c) Division, Air Force, and Field Artillery Radios Supporting a Brigade
- (d) INTEL and COMD/OPNS Radio Nets
- (e) ADMIN/LOG, RATT, and Section Radio Nets
- (f) Wiring Structure
- (g) Command and TOC Switchboard Trunking Allocation
- (h) Multichannel Circuit Allocation
- (i) Wire and Cable Distribution

Table 9-2. Brigade CP personnel and equipment list.

DESCRIPTION ELEMENT	FACILITY	EQUIPMENT	PERSONNEL	FUNCTION
BDE RATT	CP CARRIER (M 577)	(1) GRC-142 SSB VOICE/TTY RADIO SYSTEM (1) KM-7 COMSEC DEVICE FOR TTY (1) TA-312 RING-DOWN TELEPHONE	1 - SKILLED (RATT OPERATOR)	INTERNAL RECORD TRAFFIC (VEHICLE POWER) USING HF RADIO
DIV WEATHER TTY	5/4 TON TRUCK (M 715)	(1) FGC-25 TELETYPE TERMINAL (1) KM-7 COMSEC (1) TCC-29 TELEGRAPH-TELEPHONE TERMINAL (1) VRC-46 RADIO	1 - SKILLED (TTY OPERATOR)	WEATHER TRAFFIC TTY (SPECIAL SYMBOLS) DIV FM RADIO NET
PU-1	3/4 TON TRAILER (M 101)	(2) 3-KW GENERATORS (PU-625)		POWER (TTY CAN OPERATE FROM VEHICLE FOR SHORT PERIODS)
OPS VEHICLE	CP CARRIER	(2) SMD (SB-22) MANUAL TO ASSIST S/U (4) TELEPHONES (TA-312) TO SB-22 (2) TELEPHONES (TA-838) TO COMD SMD (1) REMOTE SET (GRA-39) (1) GRC-106 RADIO (SSB) (1) VRC-46 RADIO (FM) (1) VRC-46 RADIO (FM) (2) KY-38 COMSEC DEVICES FOR FM RADIOS (VRC-46)	CDR, S-3, FSO, ADMIN, COMM	COMD/OPS CENTER SMD BDE COMD NET (FM) DIV TOC SSB NET DIV COMD/ADJ BDE NET (CHANGE ANT AS REQ) ADMIN (RADIO PARK) FM
INTEL VEHICLE	CP CARRIER	(1) SMD (SB-22) (4) TELEPHONES (TA-312) TO SB-22 (2) TELEPHONES (TA-838) TO COMD SMD (2) VRC-46 RADIOS (FM) (2) KY-38	S-2, MK OFF, AVN OFF, ADMIN, COMM	DIV/BDE INTEL NETS
FSE VEHICLE	CP CARRIER	(1) SMD (SB-22) (3) TELEPHONES (TA-312) TO SB-22 (1) VRC-47 RADIO (FM) (2) KY-38 (2) REMOTE SETS (SSB, UHF) TO USAF (TACP)	FSO, AF L.O, ASST S-3, ADMIN, COMM	ARTY AND USAF FIRE SUPPORT DS FA CF NET TACP RADIOS

Table 9-2. Brigade CP personnel and equipment list (continued).

MC VEHICLE PU-1	5/4 TON TRUCK 3/4 TON TRAILER	(2) 12-CHANNEL SYSTEMS (AN/TRC-145) (1) VRC-46 RADIO FOR ADMIN	2 - SKILLED (MC OP)	DIV MAAH (A), FASC (B)
COMD SMD	5/4 TON TRUCK	(1) SB-3614 (30-LINE) AUTOMATIC FOR C/U	1 - SKILLED (SMD OP)	DIAL-UP SERVICE (INTERNAL/EXTERNAL)
TTY CENTRAL	5/4 TON TRUCK	(1) AN/TGC-30 SYSTEM (2) TT-76/66C REPEATER-TRANSMITTERS (2) TT-98/FG TELETYPEWRITERS (2) KH-7 COMSEC FOR TTY (2) 3-KH GENERATORS (PU-625)	1 - SKILLED (TTY OP)	EXTERNAL RECORD TRAFFIC USING MC SYSTEM
PU-1	3/4 TON TRAILER			
TB-1A, 1B, 1C	OPEN	(3) TERMINAL BOXES (J-1077)	COMM AS REQ	TECH CONTROL 26-PAJR, 2-WIRE, 4-WIRE
TB-2A, 2B, 3	OPEN	(3) TERMINAL BOXES (TA-125)	COMM AS REQ	TECH CONTROL 2-WIRE, 4-WIRE
DIV OPS RATT AND DIV INTEL RATT	5/4 TON TRUCK	(1) GRC-142 SSB VOICE/TTY RADIO SYSTEM (1) KH-7 (1) GRA-50 DOUBLET ANTENNA WITH RESISTOR ADDED FOR UNI-DIRECTIONAL REQ.	1 - SKILLED (COMM OP)	EXTERNAL RECORD TRAFFIC USING HF RADIO
PU-2	3/4 TON TRAILER	(2) 5-KH GENERATORS (PU-620)		
COURIER	1/4 TON JEEP (M 151)	(1) VRC-46(FM) RADIO - ADMIN (1) TELEPHONE (TA-312) TO OPS VEHICLE	1 - UNSKILLED (COMM OP)	COURIER OF RATT TRAFFIC
TACP (USAF) PU-3	1/4 TON JEEP 1/4 TON TRAILER (M 416)	(1) AN/MC-108B COMMUNICATIONS CENTRAL (1) HF RT GROUP 718F-2 AND REMOTE SET (GRA-6) (1) VHF/UHF RT GROUP 718M-2 AND REMOTE (GRA-39) (2) 1.5 KW GENERATORS (PU-630)		USAF AIR REQUEST (SSB) USAF AIR DIRECTION (UHF)

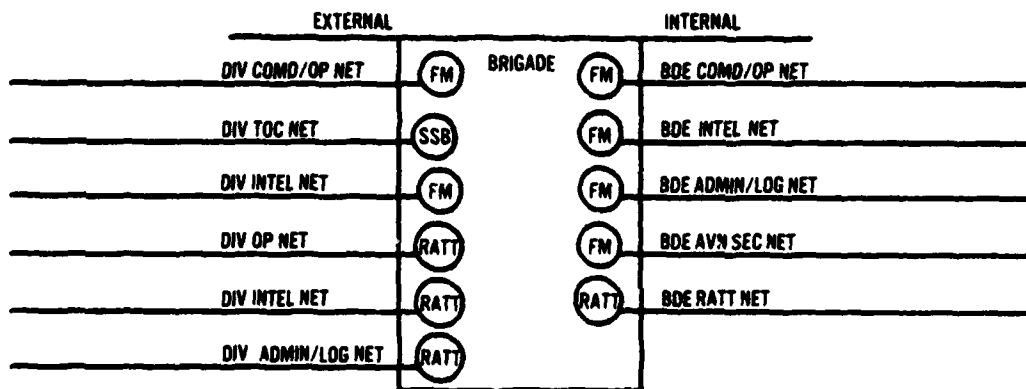

BRIGADE RADIO NET STRUCTURE

ADDITIONS: TACP - SSB/UHF (AIR FORCE NETS)
 FA DS BN FSO - FM (FA CF NETS)
 DIV WEATHER - FM (FROM CBTI CO)

DELETIONS: DIV ADMIN/LOG NET - RATT AND FM (LOCATED AT BDE TRAINS)

2359/78W

R.2 (7-3)

Figure 9-2. Brigade CP radio structure.

NET STATIONS	DIV COMD OP NET (FM)	DIV INTEL NET (FM)	DIV WEA NET (FM)	DIV TOC NET (SSB)	DIV OP NET (RATT)	DIV INTEL NET (RATT)	DIV ADMIN LOG NET (RATT)	CORPS COMD OP NET (RATT)	CORPS INTEL NET (RATT)	CORPS INTEL NET (SSB)	CORPS WEA NET (RATT)	USAF AIR REQ NET (SSB)	USAF AIR DIR NET (UMF)	CORPS RECON SURVL NET (RATT)
DIV CDR	*													
G3 OP (MAIN)	*			*	*A			*B				*C	*C	
G2 CM&D (MAIN)		*D	*D SWO			*A			*	*D	*D SWO			
G1 G4 (MAIN)							*A							
DIV TAC CP	*A	*A		*A	*A	*A				*D		*C	*C	
DIVARTY	*	*		*	*	*	*							
BDE (EAI)	*	*	* WEA FM	*	*A	*A	SFE FASC					*ACP C	*ACP C	

LEGEND:
A-PROVIDED BY DIV SIG BN.
B-PROVIDED BY CORPS SIG BDE.
C-PROVIDED BY USAF.
D-PROVIDED BY CBTI CO.
E-PROVIDED BY DS FA BN

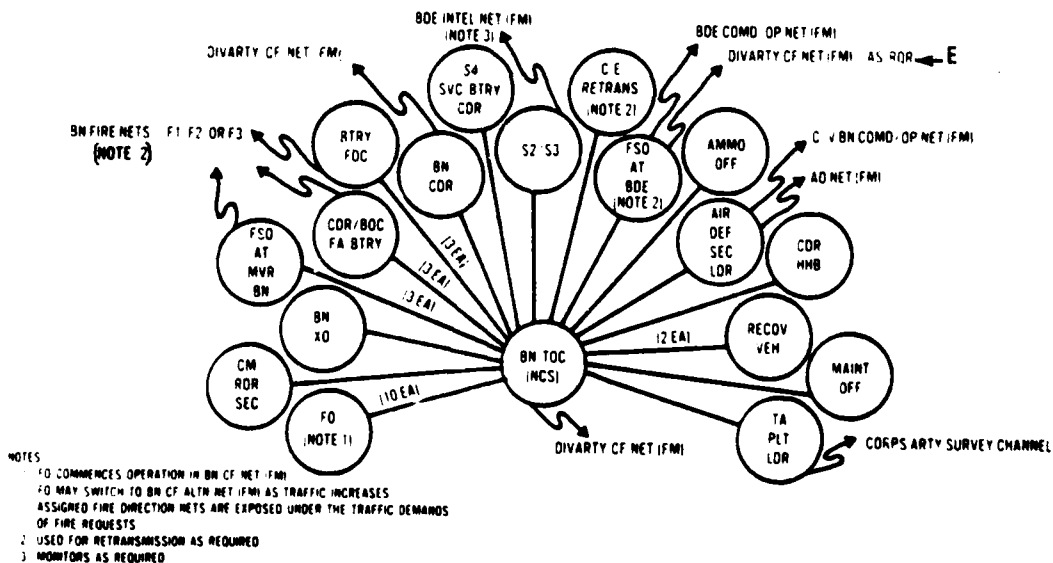

DS/BN COMMAND/FIRE DIRECTION NET (FM) AND CF ALTN (FM)

2359/78W

R.2 (7-18,5-13)

Figure 9-3. Division, Air Force, and field artillery radios supporting a brigade.

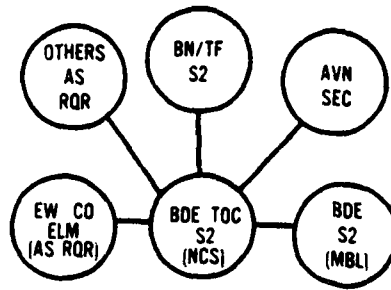

BRIGADE INTELLIGENCE NET (FM)

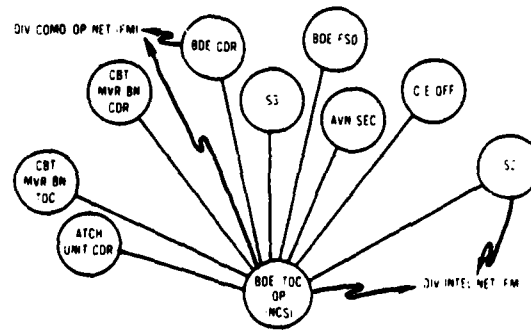

BRIGADE COMMAND/OPERATIONS NET (FM)

2359/78W

R.2 (7-3)

Figure 9-4. Brigade INTEL and COMD/OPNS radio nets.

The brigade also operates in external radio nets, and its single channel voice stations are provided from organic assets. Radio teletypewriter stations in external nets are provided by the division signal battalion. The diagrams on this page and the previous page illustrate the details of the standard brigade radio nets.

4

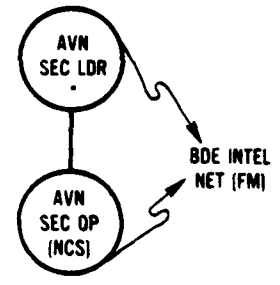

*FM, AM, UHF, VHF
CAPABILITY IN ACFT

AVIATION SECTION OPERATIONS NET

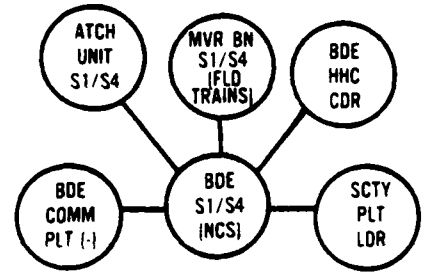

BRIGADE ADMINISTRATIVE/
LOGISTIC NET (FM)

- The brigade has no organic means to enter the division's multichannel communications system. The forward communications company of the division signal battalion provides multichannel terminal teams to each brigade. The terminal teams establish a site in the vicinity of each brigade headquarters to terminate multichannel systems. Other teams set up as a part of the forward area signal center (FASC) in the vicinity of the brigade trains.

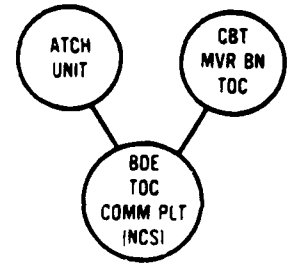

BRIGADE RADIO TELETYPEWRITER NET

- Internal CP wire lines are installed by the brigade communications platoon. The distribution cable between the multichannel terminals and the brigade CP is the responsibility of the division signal battalion. However, normal conditions often demand that the brigade communications platoon assists signal battalion personnel installing the distribution cable from the multichannel site. This cable must be installed as the first priority wire link so that sole-user circuits between the brigade TOC and the division TOC can be activated.

2359/78W

R.2 (7-4)

Figure 9-5. Brigade ADMIN/LOG, RATT, and AVN section radio nets.

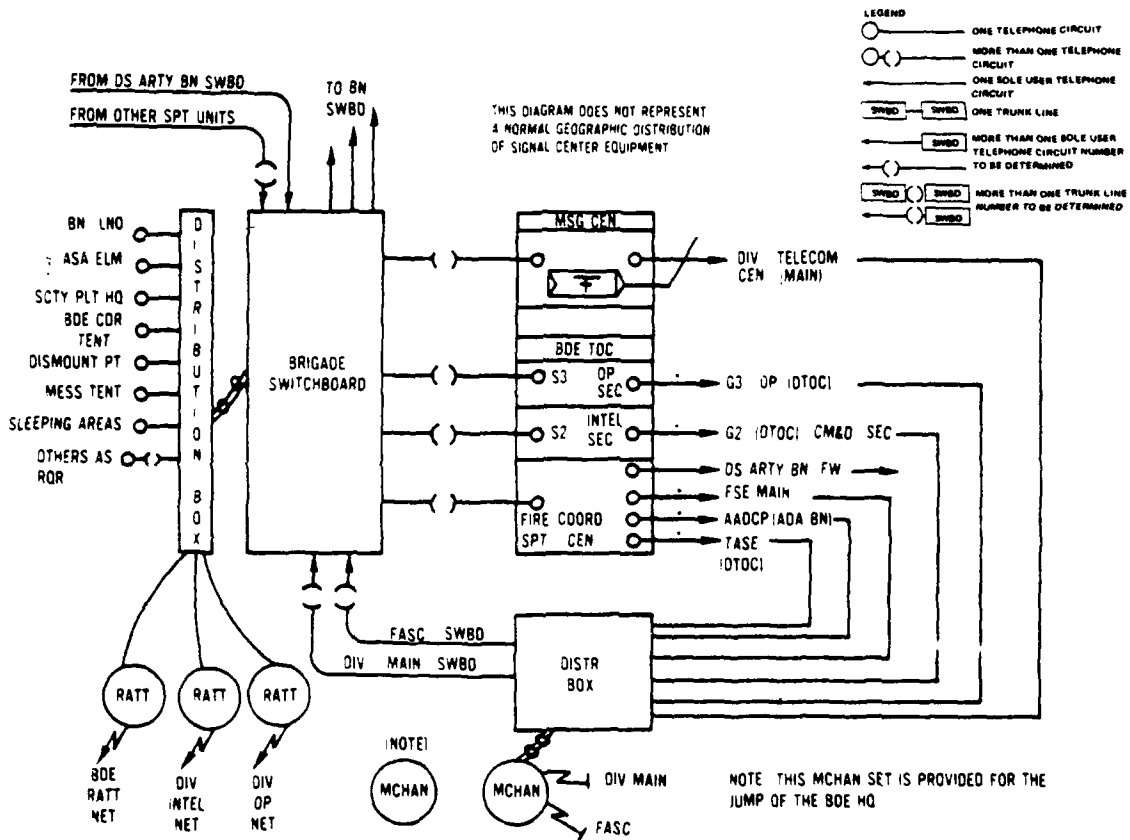

BRIGADE HEADQUARTERS SIGNAL CENTER AND WIRING CONFIGURATION

2359/78W

R.2 (7-6)

Figure 9-6. Brigade CP wiring structure.

Table 9-3. Brigade COMD and TOC switchboard trunking allocation.

<u>COMD(4W)</u>	<u>COMD(2W COMMON USER)</u>	<u>TOC (2W SOLE USER)</u>
DIV MAIN (2)	INF BN (1) (WIRE) INF BN (1) (WIRE) TNK BN (1) (WIRE) FA BN (1) (WIRE)	INF BN (1) (WIRE) INF BN (1) (WIRE) TNK BN (1) (WIRE) FA BN (1) (WIRE)
DIV ARTY (2)	CHAF BTRY (1) (WIRE) ENGR BN (1)	CHAP BTRY (1) (WIRE) DIV TOC (4)
FASC (3)	DISCOM (1) REAR (1)	TAC CP (1) DIV ARTY TOC (1) ADA BN (1)
*ADJACENT BDE (1)		
*ADJACENT BDE (1)		

*Optional or can be long locals

NOTE: ALL CIRCUITS ARE OVER THE MULTICHANNEL SYSTEM UNLESS WIRE IS INDICATED.

Table 9-4. Brigade CP multichannel circuit allocation.

SYSTEM	CHANNEL	TO	(NO)	TYPE	PATCH-THROUGH SYSTEM	
BDE/DIV MAIN (A)	1 THRU 4	DIV TOC	(4)	S/U VOICE		
	5 AND 6	DIV MAIN	(2)	C/U VOICE		
	7	DIV MAIN	(1)	HDX C/U TTY		
	8	DIV MAIN	(1)	HDX WX TTY		
	9	ADA BN	(1)	S/U VOICE	BDE/DIV MAIN/ADA BN	
	10	TAC CP	(1)	S/U VOICE	BDE/DIV MAIN/TAC CP	
	11	ADJ BDE (B)	(1)	C/U VOICE	BDE/DIV MAIN/BDE (B)	
	12	ADJ BDE (C)	(1)	C/U VOICE	BDE/DIV MAIN/BDE (C)	
	BDE/FASC (B)	1 THRU 3	FASC SWBD	(3)	C/U VOICE	
		4	FASC TTY	(1)	HDX C/U TTY	
		5	ENGR BN	(1)	C/U (2-W) VOICE	BDE/FASC/ENGR BN (WIRE)
		6	DS ARTY BN	(1)	C/U (2-W) VOICE	BDE/FASC/DS ARTY BN (WIRE)
7		DS ARTY BN	(1)	S/U VOICE	BDE/FASC/DS ARTY BN (WIRE)	
8		DISCOM SWBD	(1)	C/U VOICE	BDE/FASC/DISCOM	
9		REAR SWBD	(1)	C/U VOICE	BDE/FASC/DISCOM/REAR	
10		DIVARTY SWBD	(1)	C/U VOICE	BDE/FASC/DISCOM/DIVARTY	
11		DIVARTY FSE	(1)	S/U VOICE	BDE/FASC/DISCOM/DIVARTY	
12		FASC PATCH PANEL	(1)	S/U VOICE	BDE/FASC	

NOTES:

1. ALL SOLE USER (S/U), TTY, AND COMMON USER (2-WIRE) CIRCUITS REQUIRE 2-WIRE TO 4-WIRE SETTINGS ON THE SIGNAL CONVERTER (CV-1548) AT THE MULTICHANNEL (MC) RADIO TERMINAL.
2. CONVERSION OF TTY SIGNALS (DC) TO VOICE FREQUENCY WILL BE PERFORMED AT THE TTY CENTRAL AND THEREFORE IS NOT REQUIRED AT THE MC TERMINAL.

Table 9-5. Brigade CP wire and cable distribution.

FROM	TO	WIRE	CABLE	LENGTH (METERS)	CIRCUIT DESTINATION
BDE RATT	OPS VEHICLE	(1) WD-1		50	OPS SMBD
DIV WEATHER TTY	TB-1A	(1) WD-1		50	MULTICHANNEL (A)
TELETYPEWRITER	INTEL VEHICLE	(1) WD-1		50	INTEL SMBD
TELEPHONE (S/U)					
OPS VEHICLE	TB-1A, TB-1C		(1) CX-4760/4566	5/75	(4) MC-A, (2) MC-5, (3) RADIO PARK, (4) MNV/DS BNS
SMBD					
BDE RATT		(1) WD-1		50	TELE (S/U)
FSE VEHICLE		(1) WD-1		35	FSE SMBD
INTEL VEHICLE		(3) WD-1		15	(2) INTEL SMBD
INTERNAL TELE (S/U)	OPS VEHICLE	(4) WD-1		10	(1) CX-4760/4566/MC (A)
INTERNAL TELE (C/U)	NEAR TB-1 AREA			5	OPS SMBD
REMOTE SET (FM)	CX-4760/4506	(1) WD-1	(2) WF-16	90	COMD SMBD
				5	BDE COMD (REMOTE)
INTEL VEHICLE					
SMBD	OPS VEHICLE	(2) WD-1		15	OPS SMBD
SMBD	OPS VEHICLE	(1) WD-1		15	MULTICHANNEL (A)
SMBD	DIV WEATHER	(1) WD-1		50	TELE (S/U)
INTERNAL TELE (S/U)	INTEL VEHICLE	(4) WD-1		5	INTEL SMBD
INTERNAL TELE (C/U)	NEAR TB-1 AREA		(2) WF-16	110	COMD SMBD
FSE VEHICLE					
SMBD	OPS VEHICLE	(1) WD-1		35	OPS SMBD
	TB-1A	(2) WD-1		35	MC (A)
	TB-1B	(2) WD-1		35	MC (B)
	TB-1C	(4) WD-1		35	(3) MNV BN, (1) DS FA BN
REMOTE SET (UHF)	TB-1C	(1) WD-1		5	TACP (REMOTE)
REMOTE SET (SSD)	TB-1C	(1) WD-1		5	TACP (REMOTE)
INTERNAL TELE (S/U)	FSE VEHICLE	(3) WD-1		5	FSE SMBD

Table 9-5. Brigade CP wire and cable distribution (continued).

MULTICHANNEL VEHICLE	SYSTEM (A) - DIV MATR	TB-1A	(1) CX-4566	75	(3) OPS, (1) INTEL, (2) FSE, (4) COMD SMBD, (1) DIV WEATHER, (1) TTY CENTRAL (2) FSE, (2) OPS, (6) COMD SMBD, (1) TTY CENTRAL, (1) INTERNAL SYSCOM
	SYSTEM (B) - FASC	TB-1B	(1) CX-4566	75	
COMD SMBD	NEAR TB-1 AREA TB-1C		(4) WF-16 (1) CX-4760/4566	90,100 5/75	OPS, INTEL (4) MC-A (6) MC-B
TB-1C	TB-2A, 2B		(15) WD-1	60	(2) TTY CENTRAL, (5) RADIO PARK, (8) MNV/DS BNS
TTY CENTRAL TERMINALS	TB-2A		(2) WD-1	35	HDX-MC (A) HDX-MC (B) COMD SMBD
TELE (C/U)	NEAR TB-2 AREA		(1) WF-16	70	
DISMOUNT POINT TELE (C/U)	NEAR TB-2 AREA		(1) WF-16	50	COMD SMBD
TB-2A	TB-3		(3) WD-1	1100	OPS VEHICLES
	TTY CENTRAL		(2) WD-1	35	MC-A, B
	FSE VEHICLE		(6) WD-1	35	
TB-2B	MNV BNS DS BN		(6) WD-1 (2) WD-1	5000 1000	BN SMBDS BN SMBD/FDC
TB-3 (RADIO PARK)	TACP		(2) WD-1	50	REMOTE SETS
	C-E PLT		(2) WD-1	70	REMOTE/TELE (S/U)
	COUNTER		(1) WD-1	90	TELE (S/U)
BUK HQ(-) LOCAL	NEAR TB-2		(4) WF-16	100	COMD SMBD

2359/78W

10. MECHANIZED INFANTRY BATTALION CP CONFIGURATION AND C³ STRUCTURES

10.1 Mission and Deployment Concept

The battalion is an element of a brigade and the CP is a facility for the commander and staff to command and control three mechanized infantry companies and one support company. Other missions in the CP area include:

- (a) Coordination of preplanned Air Force and Field Artillery missions through the fire support element (FSE)
- (b) Interface through the FSE to the USAF Tactical Air Control Party (TACP) for initiation of immediate close air support and tactical air reconnaissance missions.

The CP is located within radio line-of-sight of its maneuver companies, the DS FA battery, and its parent brigade CP.

10.2 CP Configuration

Figure 10-1 shows a geographical layout of the CP and Table 10-1 describes the elements. Non-organic radios are supplied by the DS FA Battery for the artillery fire support officer (FSO). Also, a radio central is provided by the USAF for its TACP element. The radios used in the brigade and battalion admin/logistics net are usually located at the battalion trains and are not shown in the CP configuration. Also, the REDEYE section comd/op net is not shown as it is not directly monitored at the battalion CP.

10.2.1 Radio Enhancements

All voice radios are remoted to the command operations center (tent or covered area), omni-directional antennas (RC-292) are used for internal radio nets, and field expedient (half rhombic) antennas are used for external radio nets to brigade.

10.2.2 Technical Control Facility

A terminal board (TA-125) is used for patching and re-routing of circuits.

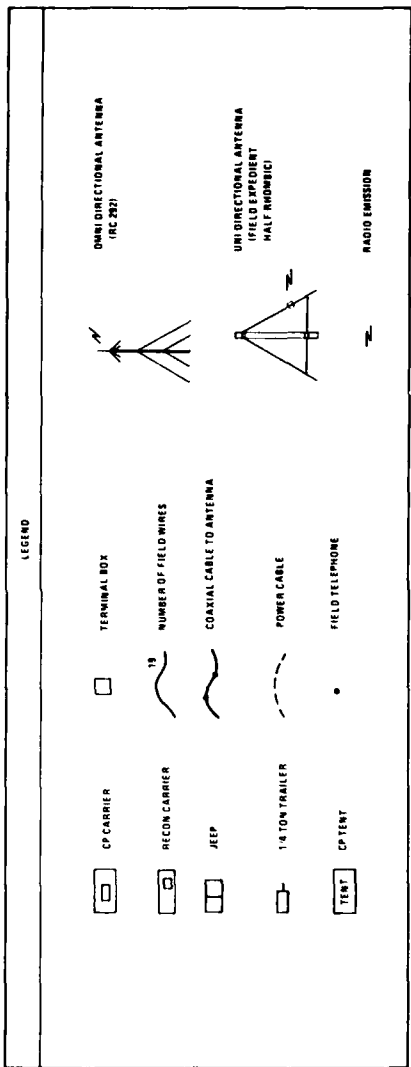
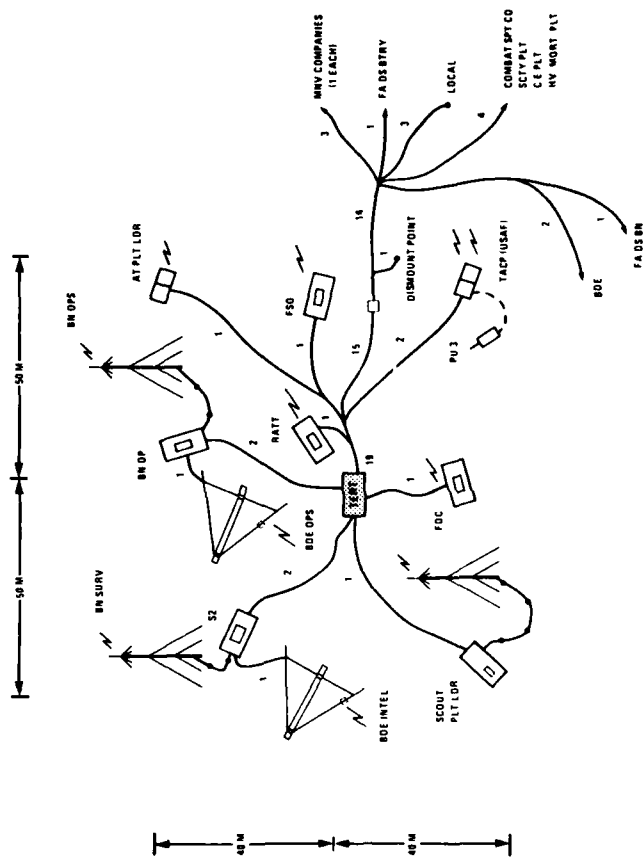

2359/78W

Figure 10-1. Mechanized infantry battalion CP configuration.

Table 10-1. Glossary of terms for Figure 10-1.

AT	Anti-Tank
BDE	Brigade
BN	Battalion
BTRY	Battery
C - E	Communications - Electronics
CO	Company
DS	Direct Support
FA	Field Artillery
FDC	Fire Direction Center
FSO	Fire Support Officer
HV	Heavy
INTEL	Intelligence
LDR	Leader
M	Meters
MNV	Maneuver
MORT	Mortar
OP	Operations
OPS	Operations
PLT	Platoon
PU	Power Units
RATT	Radio Teletype
SCTY	Security
SPT	Support
S2	Staff (Intelligence)
SURV	Survey
TACP	Tactical Air Control Party
USAF	United States Air Force

Note: Shaded area is center of activity for command and control.

2359/78W

10.3

C³ Structures

The following C³ structures are provided in tables and figures to assist in analysis:

- (a) CP Personnel and Equipment List
- (b) CP Radio Structure
- (c) Air Force and Field Artillery Radios Supporting a Maneuver Battalion
- (d) COMD/OPNS and ADMIN/LOG Radio Nets
- (e) Fire Direction and Miscellaneous Radio Nets
- (f) Wiring Structure
- (g) Wire Distribution

Table 10-2. Mechanized infantry battalion CP personnel and equipment list.

DESCRIPTION ELEMENT	FACILITY	EQUIPMENT	PERSONNEL	FUNCTION
S-2 VEHICLE AND BN OP VEHICLE	CP CARRIER (M 577)	(2) VRC-47 RADIO SET (S-2)/(2) VRC-46 (BN OP) (1) KY-38 COMSEC FOR FM RADIOS (EACH) (2) LOCAL SETS (GRA-39) FOR REMOTE OPN (EACH) (1) RC-292 ANTENNA (FM) FOR RANGE EXT. (EACH) (1) FIELD EXPEDIENT UNI-DIRECTIONAL ANTENNA FOR EW ENHANCEMENTS (EACH)		BDE/BN SURV NETS AND BDE/BN OPS NETS
F50 VEHICLE AND FDC VEHICLE	CP CARRIER	(1) VRC-49 RADIO SET (FM) (2) KY-38 (1) LOCAL SET (GRA-39)		DS ARTY BN CF NET AND BN HVY MORT PLT NET
AT PLT LDR	1/4 TON JEEP (M 151)	(1) VRC-47 RADIO SET (FM) (1) FY-38 (1) LOCAL SET (GRA-39)		AT PLT COMD NET
TACP (USAF)	1/4 TON JEEP	(1) AN/MRC-108B COMMUNICATIONS CENTRAL (1) HF RT GROUP 718F-2, REMOTE (GRA-6) (1) VHF/UHF RT GROUP 718M-2, REMOTE (GRA-39)		USAF AIR REQ (SSB) NET USAF AIR DIR (UHF) NET
PU-3	1/4 TON TRAILER (M 416)	(2) 1.5 KW GENERATORS (PU-630)		
RATT VEHICLE	CP CARRIER	(1) GRC-142 SSB VOICE/TTY RADIO SYSTEM (1) KH-7 COMSEC DEVICE FOR TTY	1 - SKILLED (RATT OP)	RECORD TRAFFIC - BDE NET
TENT	CP TENT	(2) SB-22 SMD (8) TELEPHONES (TA-312) TO SMD SET (8) REMOTE SETS (1) TA-955 DTMF PAD FOR OPERATOR ASSISTANCE (INTERFACE WITH DIAL-UP SYSTEM)	COMDR, S-2, S-3, F50, HVY MORT PLT LDR, SCOUT PLT LDR, AF LO, ADMIN, COMM	BN TOC
TB	OPEN	(2) TA-125 TERMINAL BOARDS EACH HANDLING 12 CIRCUITS	COMM AS REQ	TECH CONTROL

NOTE: THE COMMAND SECTION (COMDR AND S-3) HAS A SET OF RECON CARRIER VEHICLES FOR COMMAND AND CONTROL OUTSIDE THE CP AREA AND THE COMMANDER/S-3 ARE ONLY IN THE TENT AREA FOR COMBAT PLANNING AND STAFF MEETINGS.

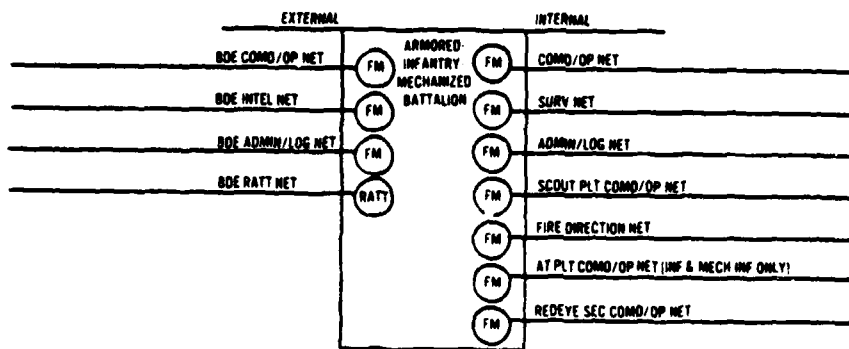

AIM BATTALION RADIO NET STRUCTURE

ADDITIONS: TACP-SSB/FM/UHF (AIR FORCE NETS)
 FA DS BN FSO - FM (FA NETS)

DELETIONS: BDE ADMIN/LOG (FM),
 REDEYE SEC-FM

2359/78W

R.2 (5-8)

Figure 10-2. Maneuver battalion CP radio net structure.

NET STATIONS	DIV COMDO/OP NET (FM)	DIV INTEL NET (FM)	DIV WEA NET (FM)	DIV TOC NET (SSB)	DIV OP NET (RATT)	DIV INTEL NET (RATT)	DIV ADMIN/LOG NET (RATT)	CORPS COMDO/OP NET (RATT)	CORPS INTEL NET (RATT)	CORPS INTEL NET (SSB)	CORPS WEA NET (RATT)	USAF AIR REQ NET (SSB)	USAF AIR DIR NET (UHF)	CORPS RECON/SURVL NET (RATT)
DIV CDR	*													
G3 OP (MAIN)	*			*	*A			*B				*C	*C	
G2 CM&D (MAIN)		*D	*D SWO			*A			*	*D	*D SWO			
G1/G4 (MAIN)							*A							
DIV TAC CP	*A	*A		*A	*A	*A					*D		*C	*C
DIVARTY	*	*		*	*	*	*							
BDE (3 EA)	*	*	*D WEA FM	*	*A	*A	SEE FASC					TACP C	TACP C	
MNV BN												TACP C	TACP C	

LEGEND:
A-PROVIDED BY DIV SIG BN.
B-PROVIDED BY CORPS SIG BDE.
C-PROVIDED BY USAF.
D-PROVIDED BY CBTI CO.
E-PROVIDED BY DS FA BN

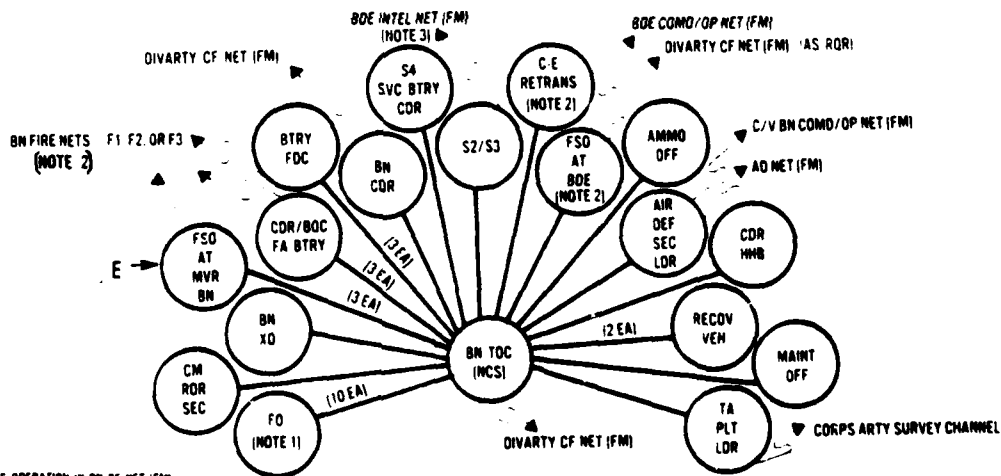

NOTES
1. FO COMMENCES OPERATION IN BN CF NET (FM)
FO MAY SWITCH TO BN CF ALTN NET (FM) AS TRAFFIC INCREASES
ASSIGNED FIRE DIRECTION NETS ARE EXPOSED UNDER THE TRAFFIC DEMANDS
OF FIRE REQUESTS
2. USED FOR RETRANSMISSION AS REQUIRED
3. MONITORS AS REQUIRED

DS/BN COMMAND/FIRE DIRECTION NET (FM) AND CF ALTN (FM)

2359/78W

R.2 (7-18,5-13)

Figure 10-3. Air Force and field artillery radios supporting a maneuver battalion.

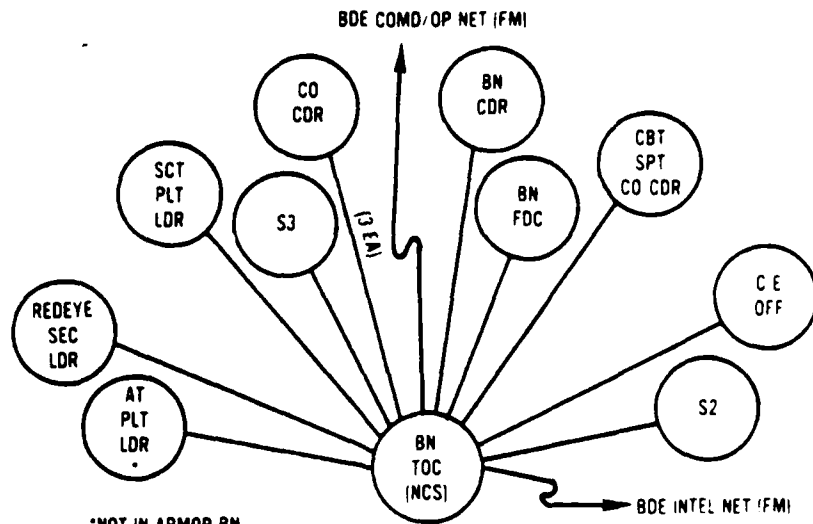

AIM BATTALION COMMAND/OPERATIONS NET (FM)

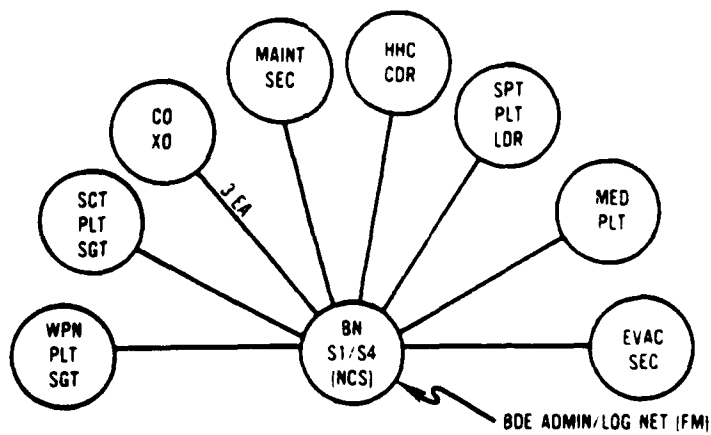

AIM BATTALION ADMINISTRATIVE/LOGISTICS NET (FM)

2359/78W

R.2 (5-9)

Figure 10-4. Maneuver battalion radio nets - COMD/OPNS and ADMIN/LOG.

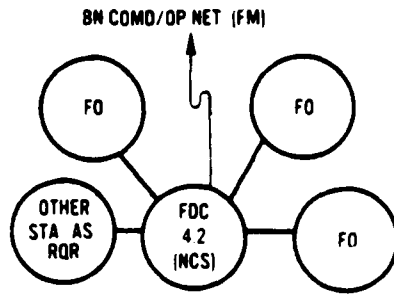

AIM BATTALION FIRE DIRECTION NET (FM)

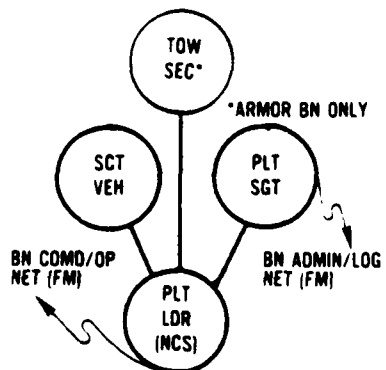

AIM BATTALION SCOUT PLATOON COMMAND/OPERATIONS NET (FM)

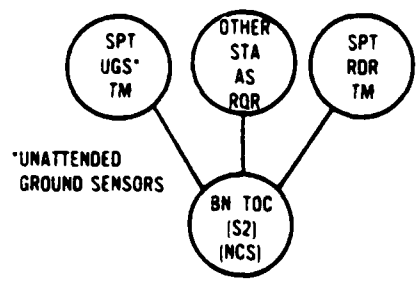

AIM BATTALION SURVEILLANCE NET (FM)

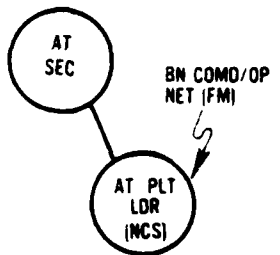

ANTITANK PLATOON COMMAND/OPERATIONS NET (FM)

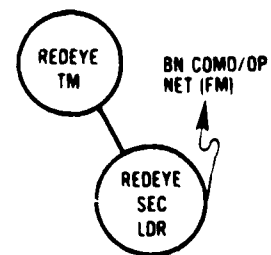

AIM BATTALION REDEYE SECTION COMMAND/OPERATIONS NET (FM)

2359/78W

R.2 (5-10)

Figure 10-5. Maneuver battalion fire direction and miscellaneous internal radio nets.

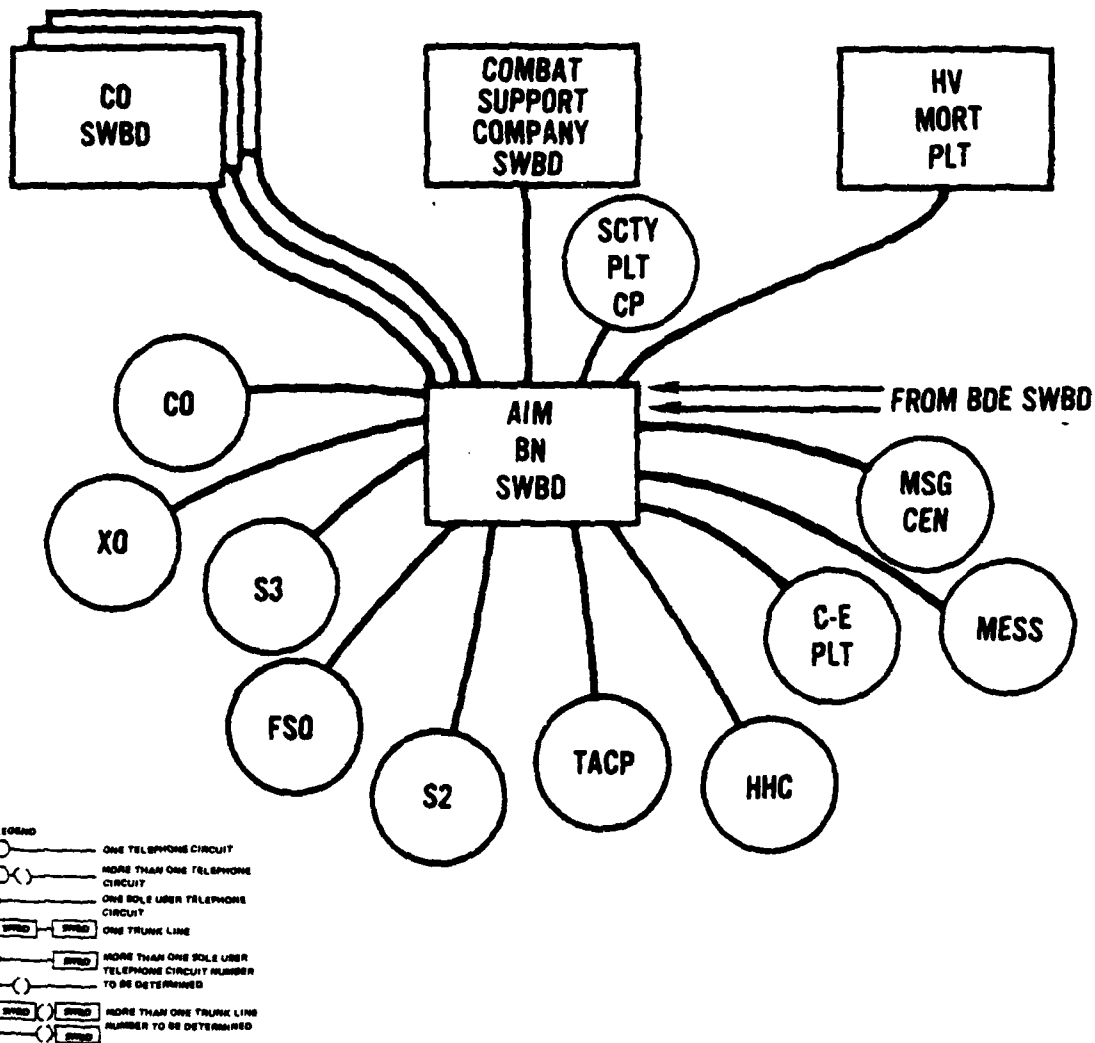

AIM BATTALION WIRE SYSTEM

ADDITIONS: FA DS BATTERY FDC
 REMOTE LINES TO 10 RADIOS

2359/78W

R.2 (5-11)

Figure 10-6. Maneuver battalion wiring structure.

Table 10-3. Mechanized infantry battalion wire distribution.

FROM	TO	WIRE	LENGTH (METERS)	DESTINATION
S-2 VEHICLE				
LOCAL SETS (FM)	TENT	(2) WD-1	50	(2) REMOTE SETS (FM)
BN OP VEHICLE				
LOCAL SETS (FM)	TENT	(2) WD-1	50	(2) REMOTE SETS (FM)
AT PLT LDR				
LOCAL SET (FM)	TENT	(1) WD-1	75	(1) REMOTE SET (FM)
FSO VEHICLE				
LOCAL SET (FM)	TENT	(1) WD-1	30	(1) REMOTE SET (FM)
SCOUT PLT LDR				
LOCAL SET (FM)	TENT	(1) WD-1	50	(1) REMOTE SET (FM)
FDC VEHICLE				
LOCAL SET (FM)	TENT	(1) WD-1	35	(1) REMOTE SET (FM)
TACP (USAF) VEHICLE				
LOCAL SET (SSB)	TENT	(2) WD-1	65	(2) REMOTE SETS (SSB/UHF)
LOCAL SET (UHF)				
RATT VEHICLE				
TELE (2-WIRE)	TENT	(1) WD-1	25	SMBD
TENT LOCATION				
SMBD	TB	(15) WD-1	50	DISMOUNT POINT/EXTERNAL (14)
SMBD	INTERNAL	(8) WD-1	5	STAFF TELEPHONES (TENT)
TB	MNV CO	(3) WD-1	2000	CO TELE/SMBD
	FA DS BTRY	(1) WD-1	500	BTRY FDC SMBD
	LOCAL	(3) WD-1	60	ADMIN/LOG TELE
	OTHER	(4) WD-1	200	TELE/SMBD
	BDE	(2) WD-1	5000	TOC/COMD SMBD
	FA DS BN	(1) WD-1	3500	BN FDC SMBD

APPENDIX A

A. DIVISION COMMAND AND CONTROL STRUCTURES

The following division command and control structures are provided to assist in analysis:

- (a) Organizational Structure
- (b) Fire Planning Structure
- (c) Categories of Tactical Air Missions and Air Request Structure

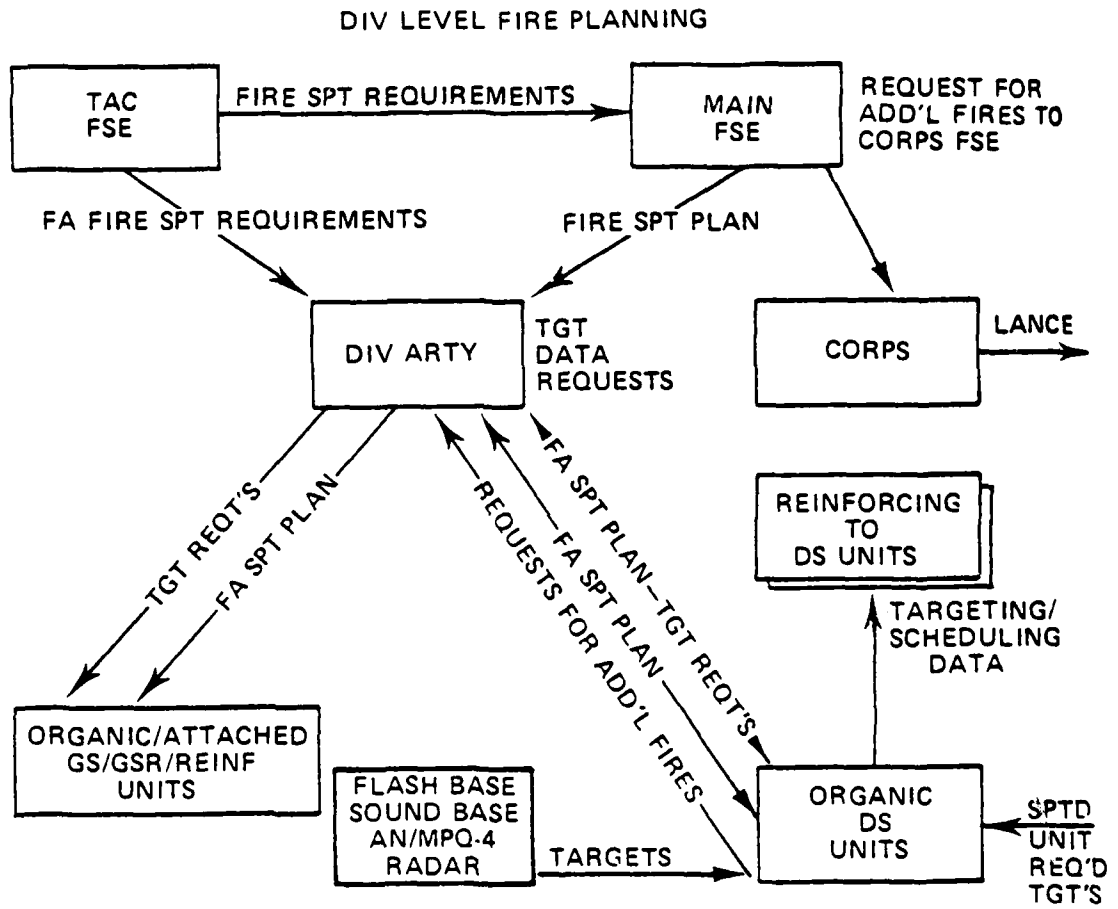

2359/78W

R.13 (2-56)

Figure A-2. Division fire planning structure.

CATEGORIES OF TACTICAL AIR MISSIONS

Tactical air missions are categorized as preplanned and immediate.

PREPLANNED

Preplanned missions are those for which a requirement can be foreseen. They permit detailed planning, integration, and coordination with the ground tactical plan. Typical preplanned missions are preassault bombardment and air interdiction of railways or roads. Preplanned missions are most desirable from the standpoint of efficient utilization because aircraft and munitions can be precisely matched to the target and complete mission planning can be accomplished.

IMMEDIATE

Immediate missions are those for which specific target makeup and location cannot be determined in advance. Air defense and close air support normally generate the greatest demands for immediate missions. Immediate missions involve launching ground alert aircraft, using air alert sorties, and/or diverting aircraft from other missions. Immediate strikes are typically employed to meet unexpected enemy air attacks, to interdict fleeting surface targets, or to provide additional fire support to friendly ground forces.

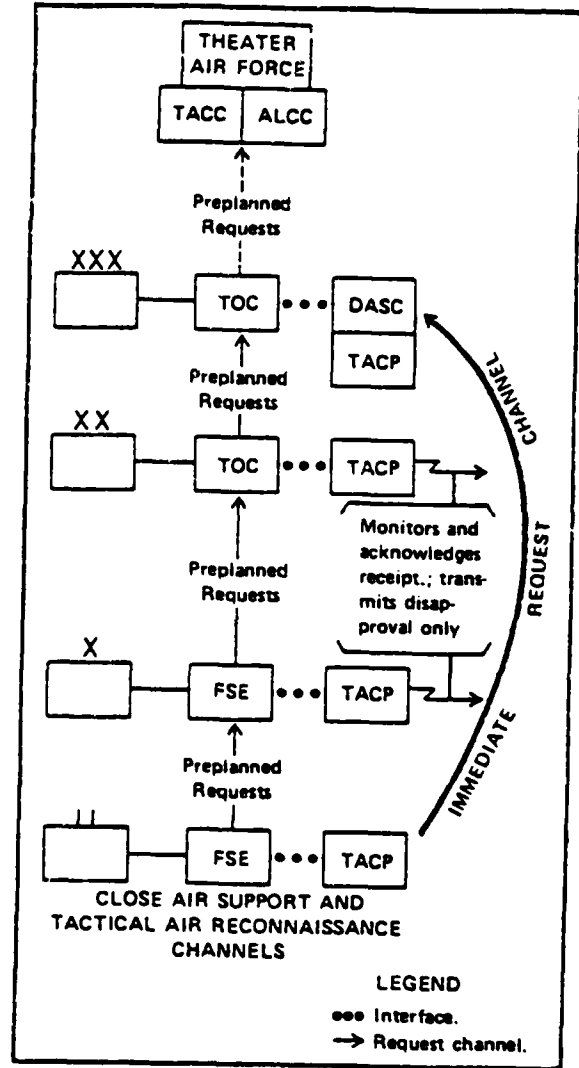

2359/78W

R.13 (2-62)

Figure A-3. Categories of tactical air missions and air request structure.

APPENDIX B

B. COMMUNICATIONS STRUCTURES

The following communications structures are provided in tables and figures to assist in analysis:

- (a) Types of Communications Equipment at Division, Brigade and Battalion
- (b) Types of Communications Equipment at Battalion and Below
- (c) Radio Features and Employment Concepts
- (d) Division Multichannel System Structure and Features
- (e) Division Radio Structure and Features
- (f) Radio Wire Integration Features
- (g) Division Teletype Structure and Features
- (h) Division Wire and Cable Structure, Features, and Employment Concepts

U. S. ARMY ELECTRONICS COMMAND
 TYPES OF
 COMMUNICATIONS EQUIPMENT
 EMPLOYED WITHIN
 DIVISION - BRIGADE & BATTALION

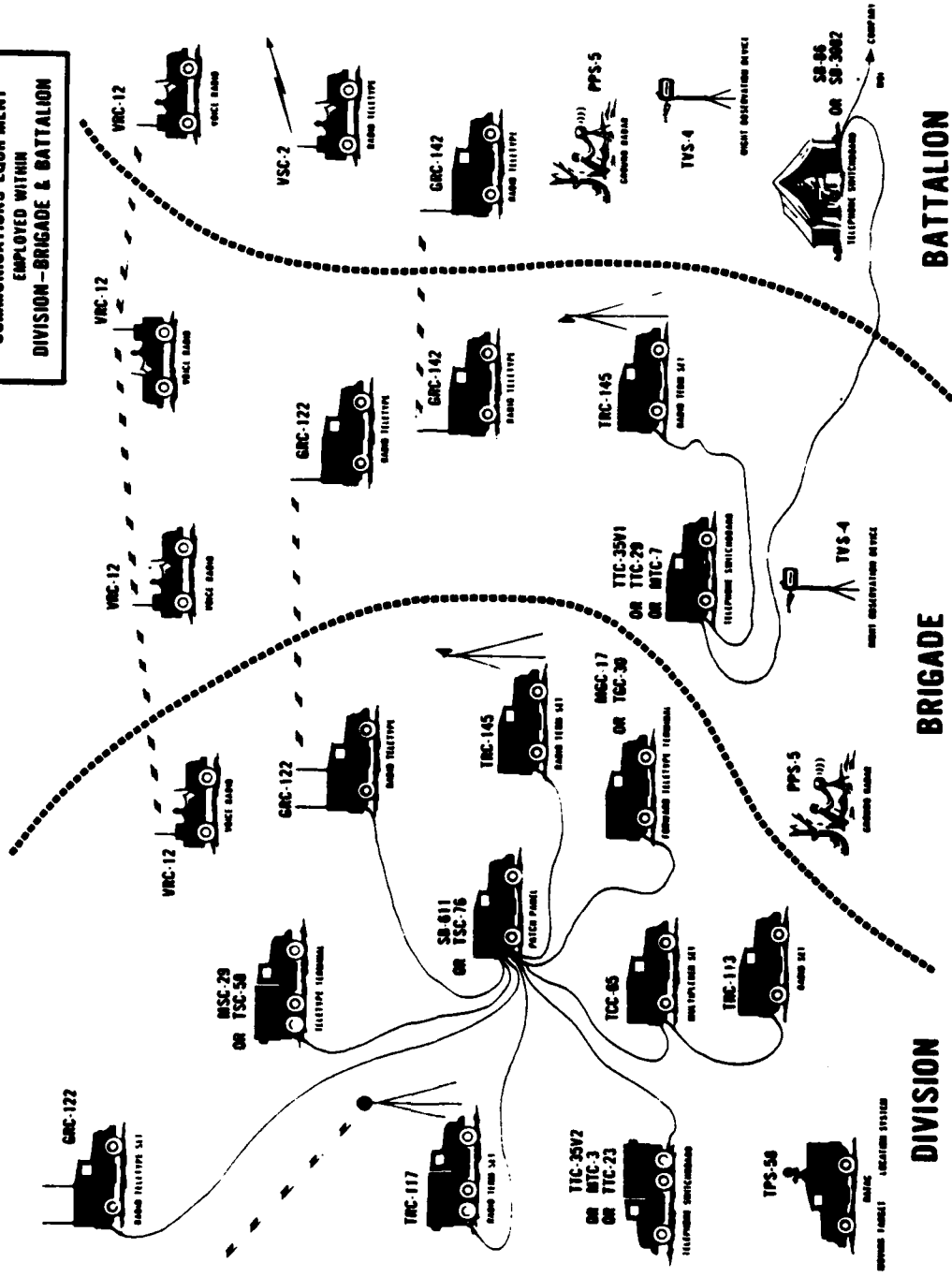

BATTALION

BRIGADE

DIVISION

2359/78W
 Figure B-1. Types of communications equipment at division, brigade, and battalion. R.5 (1-15)

Table B-1. Division single channel radio net structure.

NET STATIONS	DIV COMD OP NET (FM)	DIV INTEL NET (FM)	DIV WEA NET (FM)	DIV TOC NET (SSB)	DIV OP NET (RATT)	DIV INTEL NET (RATT)	DIV ADMIN LOG NET (RATT)	CORPS COMD OP NET (RATT)	CORPS INTEL NET (RATT)	CORPS INTEL NET (SSB)	CORPS WEA NET (RATT)	USAF AIR REQ NET (SSB)	USAF AIR DIR NET (UMF)	CORPS RECON SURVL NET (RATT)
DIV CDR	*													
G3 OP (MAIN)	*			*	*A			*B				*C	*C	
G2 CM&D (MAIN)		*D	*D SWO			*A		*	*D	*D SWO				
G1 G4 (MAIN)							*A							
DIV TAC CP	*A	*A		*A	*A	*A				*D		*C	*C	
DIVARTY	*	*		*	*	*	*							
BDE (3 EAI)	*	*	*D WE 2 FM	*	*A	*A	SEE FASC					TACP C	TACP C	
MMV BN												TACP C	TACP C	
CAV SQDN	*	*		*	*	*	*					TACP C	TACP C	
AVN UNIT	*	*	*D WE 3 W	*	*	*								*D
SIG BN	*													
ENGR BN	*	*			*	*	*							
FASC							*A	<p>LEGEND: A-PROVIDED BY DIV SIG BN. B-PROVIDED BY CORPS SIG BDE. C-PROVIDED BY USAF. D-PROVIDED BY CBTI CO.</p> <p>NOTE: TWO IDENTICAL SETS OF C-E EQUIPMENT ARE PROVIDED FOR THE DIVISION TACTICAL COMMAND POST BY THE DIVISION SIGNAL BATTALION.</p>						
DISCOM	*	*			*A		*A							
ADA BN	*	*			*	*	*							
EW CO OP GEN		*												
MP CO	*													
DIV REAR							*A							
CBTI CO	*	*												

RADIO

Main Features:

- Wireless -- can operate while mobile.
- Fast and can handle a large number of messages.
- Operates from ground to ground -- ground to air -- air to air -- ground to ship.
- Uses include --
 - Voice
 - Radiotelegraph (CW)
 - Radio Teletypewriter (RATT)
 - Multichannel
- Types of modulation it uses are --
 - Amplitude Modulated (AM)
 - Frequency Modulated (FM)
 - Single Side Band AM (SSB)
- Primary frequencies used are --
 - High Frequency (HF)
 - Very High Frequency (VHF)
 - Ultrahigh Frequency (UHF)
 - Super High Frequency (SHF)
 - Extremely High Frequency (EHF)
- Transmission paths include --
 - Ground Wave
 - Skywave
 - Line of Sight
 - Tropospheric Scatter



2359/78W

Figure B-3. Radio features.

R.26 (3-8)

Table B-2. Single channel radio employment concepts.

SUMMARY OF BASIC SINGLE CHANNEL TECHNIQUES

- Assign frequencies as high as possible to VHF nets of forward units.
- Allocate alternate (spare) frequencies to encrypted nets of critical importance and have all stations in the net use the alternate frequency when jammed. If possible, use another transmitter to continue operations on the jammed frequency.
- Select a frequency as close as possible to an enemy frequency. This is called "frequency hugging," and is used when the enemy is jamming you. This will cause him some intercept difficulty but primarily will cause him to hesitate to jam since he may interfere with his own transmissions.
- Use clear text brevity-list operations only if alternate frequencies are not available and you have to communicate, and then only with an approved code. This technique narrows your bandwidth and slightly increases your power output which may give you some advantage over the jamming signal.
- Train operators thoroughly in the recognition of common jamming signals and imitative deception. Specific threat modulations to FM and SSB voice nets are audio noise, wideband noise, and RF noise. Asynchronous frequency shift keying, keyed CW, and RF noise are used to jam radioteletypewriter links.
- Change mode of operation to overcome interference. IMC can be heard much easier than voice when signal-to-noise ratio is poor.
- Detune (a small shift in operating frequency) to decrease effectiveness of spot jamming.
- Turn radios to high power when contact with the enemy is imminent so that friendly transmissions are not overcome by the enemy's transmissions.
- Operate all transmitters at lowest power until jamming is experienced. Then increase power to give better signal-to-noise ratio.
- Use abbreviated call signs, message abbreviations, brevity lists, and nonaddressed messages to cut down on transmission time.
- Operate a free net as opposed to a directed net.
- Take advantage of terrain masking and shielding by natural or man-made objects.
- Remote your transmitter whenever possible and insure that you are in a protected position.
- Use directional antennas to increase signal strength in the desired direction and cut down on signal strength toward the enemy.

This appendix discusses the basic types of tactical antennas, and gives some field expedient solutions to their being broken or damaged. These solutions are only temporary, but they will help you get the message through.

Field expedient antennas sometimes provide a way to beat the enemy's Electronic Warfare efforts. A field expedient bi- or uni-directional antenna can be used to prevent the enemy from intercepting transmissions. If you use a whip antenna, you can expect the enemy to intercept and locate your transmitter 73% of the time. If you use a horizontal/ directional antenna, you can eliminate his ability to locate you and reduce his probability of intercept to only 3% of the time. (These figures apply to the PRC-77 radio, however, the same basic facts apply to all radios.)

When you fabricate an antenna, there is one important fact that you have to keep in mind—the location of the station(s) you need to communicate with. Why? Because the direction and distance are critical factors and the selection of the right type of antenna is important. Basically, there are three types of antennas according to their directional characteristics. They are—

- OMNI-Directional All directions
- BI-Directional Any two opposite directions
- UNI-Directional Any one direction

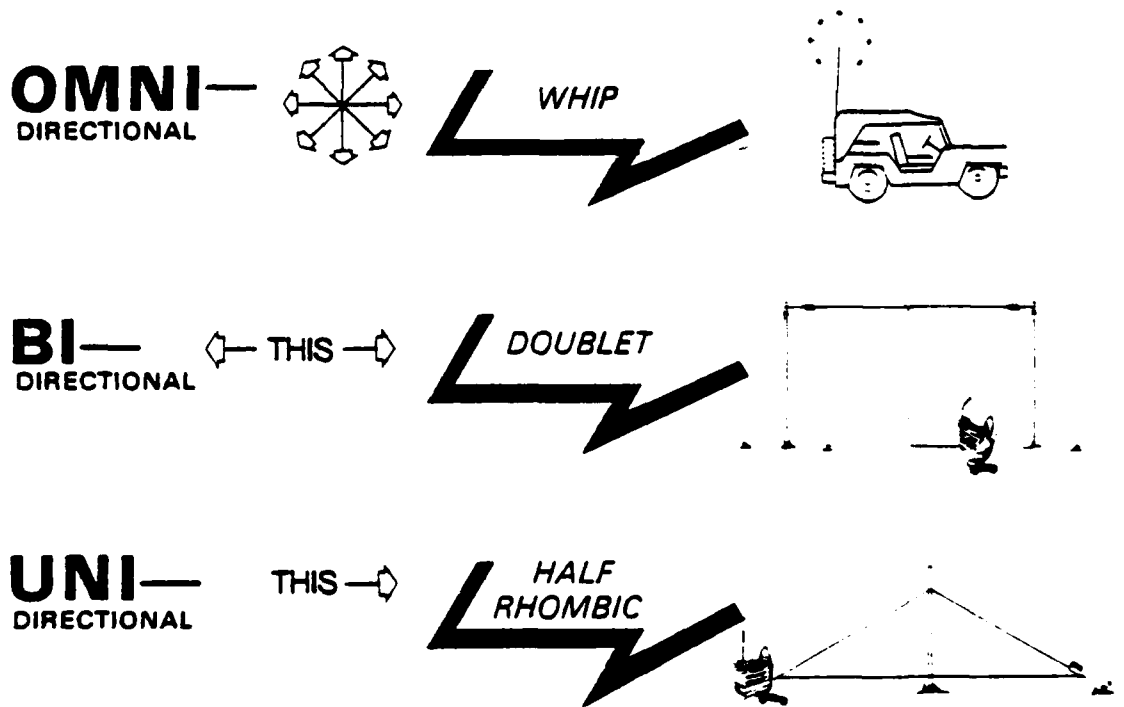

2359/78W

R.26 (M-1)

Figure B-4. Field expedient antenna employment concepts.

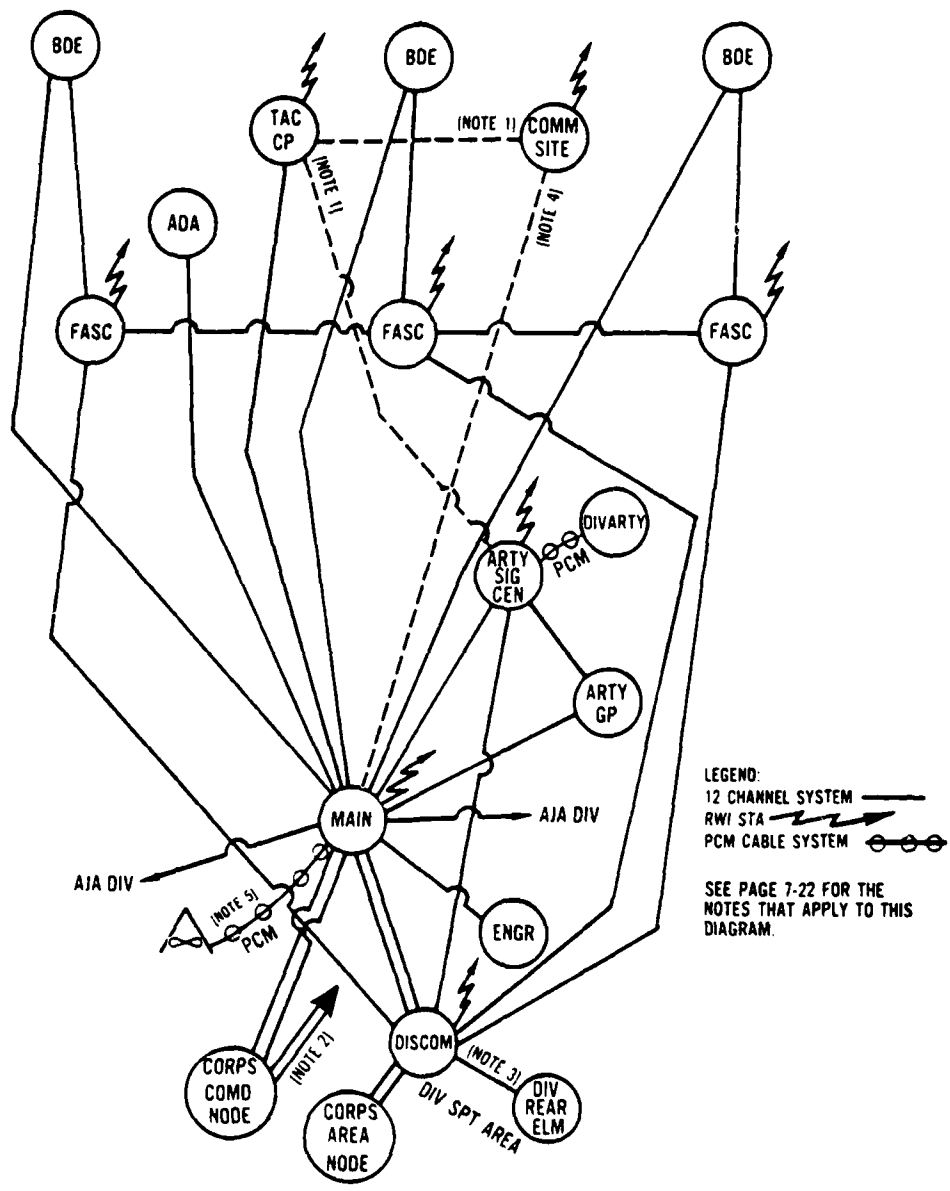

LEGEND:
 12 CHANNEL SYSTEM ———
 RWI STA ~~~~~
 PCM CABLE SYSTEM —●—●—●—
 SEE PAGE 7-22 FOR THE
 NOTES THAT APPLY TO THIS
 DIAGRAM.

2359/78W

R.2 (7-23)

Figure B-5. Division multichannel radio system structure.

MULTICHANNEL

Multichannel systems (or links) are used to provide communications for combat operations and tie units into the area communications system. Multichannel links make use of multiplexing--a system of transmitting several messages over one transmission path at the same time. The transmission path can be either radio or wire.

Main Features:

- Meets increased demand for circuit expansion.
- Cuts cable cost and maintenance.
- Can be extended over great distance.

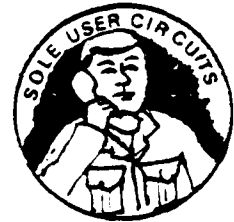
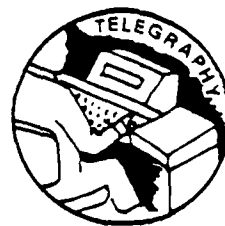

Weak Points:

- Loss of cable or radio path drops all circuits.
- Large equipment reduces mobility
- Large power requirements.

Strong Points:

- Increased circuits over single path.
- Increased range.
- Builds up weak signals.
- Add and drop circuits along system.
- Can be secured.

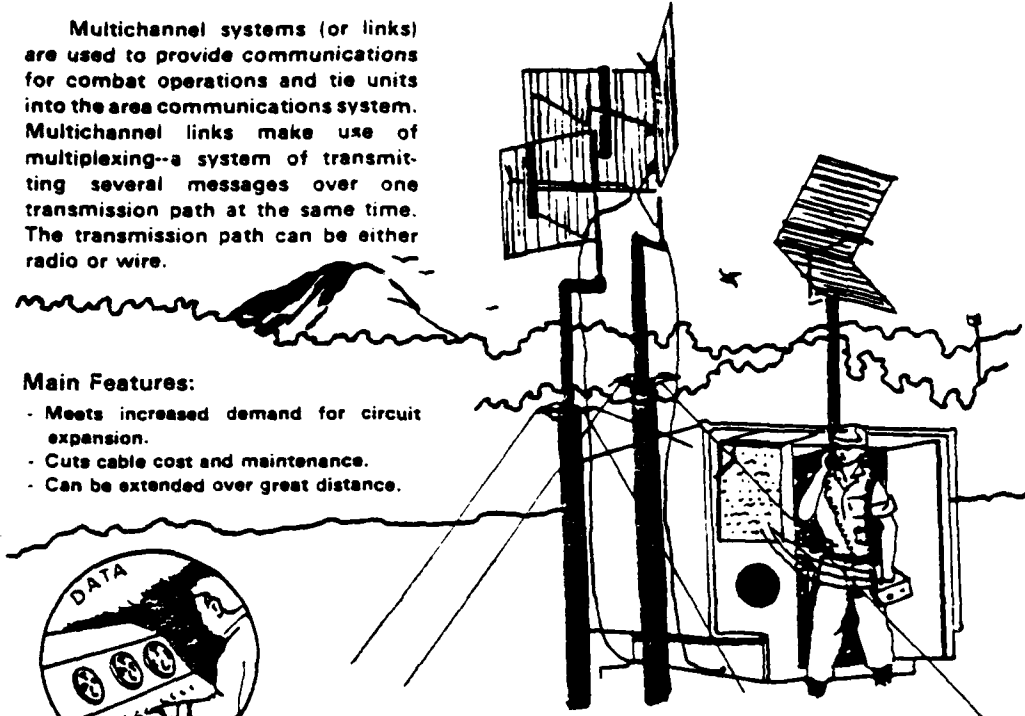

2359/78W

R.26 (3-11)

Figure B-6. Multichannel radio features.

Table B-3. Multichannel radio employment concepts.

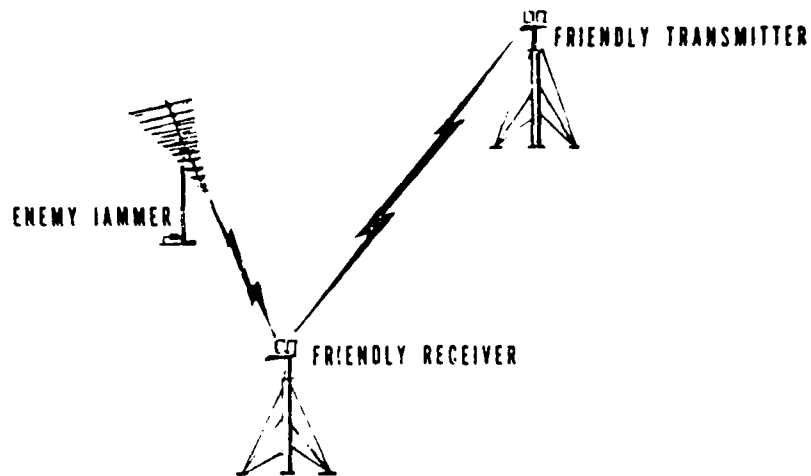

SUMMARY OF BASIC MULTICHANNEL TECHNIQUES

- Site equipment to make optimum use of terrain to boost signals in the desired direction while masking them from the enemy.
- Remote traffic over as many links as possible. This causes the enemy to overextend his jamming capabilities.
- Use the least transmitter power possible when establishing links and use increased power only to overcome interference.
- Use the frequency hugging technique. Plan to operate the equipment at a channel adjacent to the enemy. This makes intercept difficult and hinders the enemy's capability to jam since he may interfere with his own transmissions.
- Avoid direct multichannel shots toward the FEBA.
- Limit orderwire conversations to necessary technical conversations
- Assign dual frequencies to both multichannel terminals.
- Provide secure voice capability, if possible, to the operators while they are establishing the initial multichannel communications.
- Use good single channel voice procedures while establishing multichannel communications.

2359/78W

R.27 (3-7)

Radio-wire integration stations interconnect mobile radios to a switchboard. From there the routing goes to telephone subscribers.

Main Features:

- Flexibility.
- Speed.

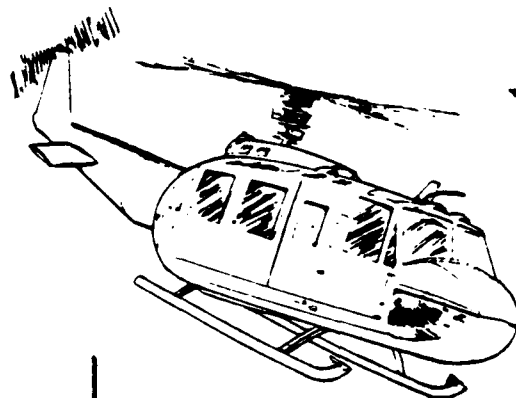

Strong Points:

- Emergency communications.
- Can connect widely separated facilities
- Alternate routes.
- Initial communications.
- Effective during river crossing operations.

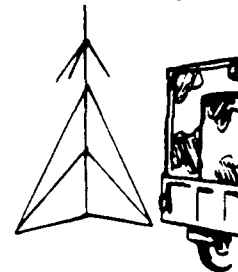

Weak Points:

- Can't be totally secured without loop security equipment.
- More vulnerable to jamming, interception, and deception.
- Located on high ground.
- Uses high power.
- Combines conversations on radio and landlines.

2359/78W

R.26 (3-18)

Figure B-7. Radio-wire integration features.

TAPE RELAY TRAFFIC DIAGRAM

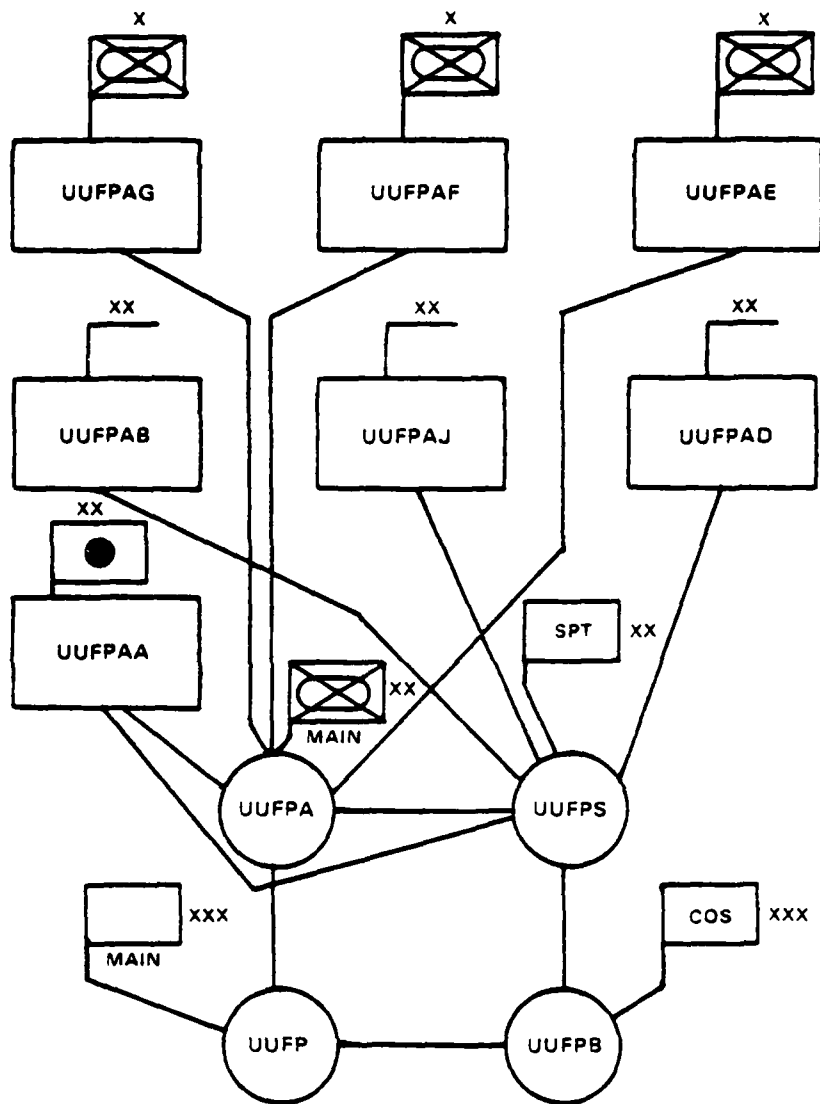

COPY NO. OF COPIES
 152d SIG BN
 LOCATION
 DATE TIME
 APPENDIX 8
 TO ANNEX E
 TO OPOD 12 (year)

ACKNOWLEDGE
 POSITIVE
 LTC
 OFFICIAL
 /s/ Action
 ACTION
 DISTRIBUTION A

2359/78W

R.26 (E-6)

Figure B-8. Division tape relay traffic diagram.

TELETYPEWRITER AND RADIO TELETYPEWRITER (RATT)

Teletypewriter provides a rapid method of transmitting messages over wire or multichannel circuits or by radio (RATT). Messages are received in the form of page copy or paper tape.

Main Features:

- Variable speeds.
- Accuracy.
- Page copy of message.

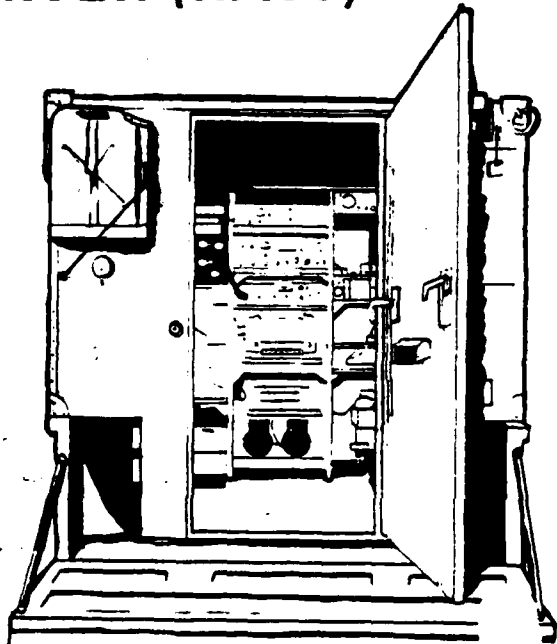

Strong Points:

- Easy to secure.
- Easily retransmitted.
- Point to point.
- Links to higher, lower, and adjacent headquarters.
- RATT is backup to multichannel radio, tropo, satellite, and cable links.
- Alert warning.
- Rear area security control.

Weak Points:

- Needs higher quality circuits than voice.
- Increased equipment requires more power and maintenance than a simpler message.

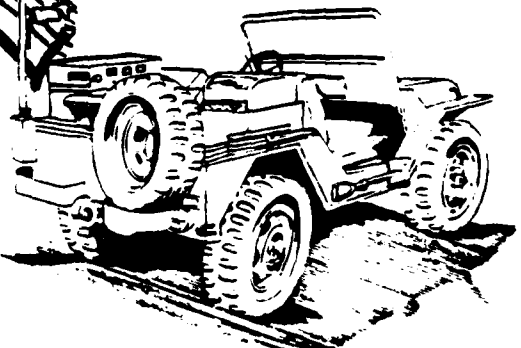

2359/78W

Figure B-9. Teletypewriter features.

R.26 (3-12)

Wire and cable are some of the most dependable means of communications.

Main Features:

- Interconnects closely located activities.
- Uses field wire and cable, telephones, and switchboards to provide person-to-person conversations.
- Joins teletypewriter terminals.
- Extends subscriber equipments from multichannel terminals, and provides transmission path for multichannel.
- Integrates with radio systems.

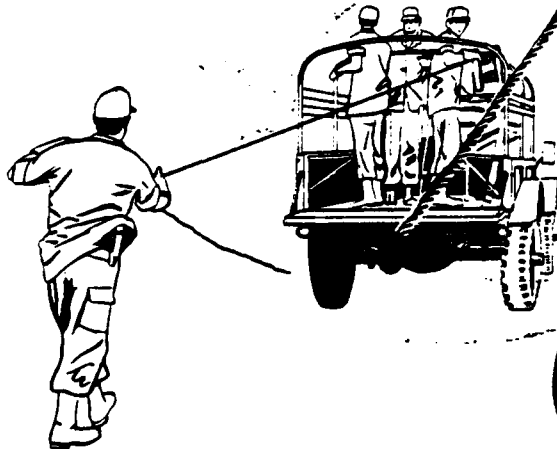
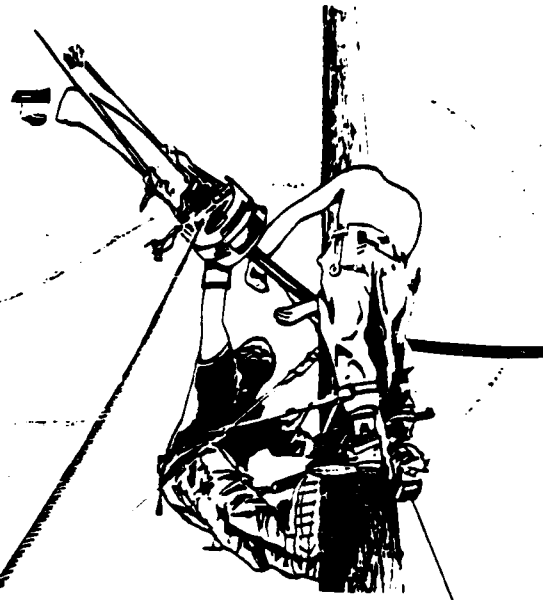

Strong Points:

- More secure than radio.
- Reduces the probability of interception.
- Key in river crossings.
- Commercial circuits can be exploited.
- Desirable in defensive operations.
- Backup for radio.
- Used during surprise attack.

Weak Points:

- Compared to radio, wire requires more time, men, and equipment to install and maintain.
- Loss of signal over long distances.
- Subject to damage from tracked and wheeled vehicles.
- Subject to wiretap.
- Not a workable means when the force or station is mobile.



2359/78W

R.26 (3-10)

Figure B-11. Wire and cable features.

APPENDIX C

C. MULTICHANNEL RADIO REFERENCE DATA

The following multichannel radio reference data are provided to assist in analysis:

- (a) The AN/TRC-145 System and Major Components
- (b) The AN/TRC-113 System
- (c) The AN/GRC-163 System and Major Components

Table C-1. Multichannel radio terminal set AN/TRC-145.

STATUS: STD-A; NSN: 5820-00-791-3365

REF: TM 11-5895-453-15

General Information

The AN/TRC-145 is an air- or vehicular-transportable radio terminal set. It provides either two 6- or 12-channel cable terminals, or two 6- or 12-channel line of sight PCM radio terminals for use in forward areas.

MAJOR COMPONENTS - - - - - 1 Shelter S-390/TRC-145 (modified S-250/G)
2 Radio Set AN/GRC-103
2 Converter CV-1548/G
2 Multiplexer TD-660A/G
2 Multiplexer TD-204/U or Multiplexer TD-754/G
2 Security Equipment TSEC/KG-27 (a basic issue item)

Technical Characteristics

POWER REQUIREMENT - - - - - 115V, 50 to 60 Hz, 3,200W (approx)
WEIGHT - - - - - 670 kg (1,475 lb)
VEHICULAR REQUIREMENT - - - - - One 1-1/4-ton truck

2359/78W

R.9 (4-104)

Table C-2. Radio set AN/GRC-103 general information.

STATUS: STD-A; NSN: 5820-00-935-4931

REF: TM 11-5820-540-12

General Information

The AN/GRC-103 is a compact, transportable UHF-FM radio set which provides facilities for multichannel transmission and reception of PCM signals. It will accommodate up to 24 telephone channels when used with appropriate PCM multiplex equipment. The multichannel radio system can be secured by using Electronic Key Generator, TSEC/KG-27. In various configurations, the AN/GRC-103 can be employed as radio terminals or repeater stations.

DEPLOYMENT - - - - - Division
 MAJOR COMPONENTS - - - - - Transmitter, T-983
 Receiver, R-1329
 Amplifier-Frequency Multiplier,
 AM-4320
 Amplifier Converter, AM-4316
 Receiver-Transmitter Order Wire,
 RT-773

ORGANIZATIONAL MAINTENANCE
 TEST EQUIPMENT - - - - - Multimeter, AN/URM-105
 Frequency Converter, CV-2500/GRC

REMOTE OPERATION - - - - - None

RETRANSMISSION - - - - - Radio Repeater Set, AN/TRC-113

WEIGHT - - - - - 212.5 kg (468 lb)

LIMITATIONS - - - - - None

SECURITY DEVICE - - - - - TSEC/KG-27

EQUIPMENT CONFIGURATIONS--

NOMEN	AN/GRC-103	TD-660	TD-754/204	CV-1548	POWER UNIT	WEIGHT
AN/MRC-115	2	2	0	2	SF-1.5 MD	862.6 kg (1900 lb)
AN/MRC-126	1	1	Optional (2)	1	SF-1.5 MD	703.7 kg (1550 lb)
AN/TRC-127	2	2	Optional (2)	2	SF-1.5 MD	930.7 kg (2050 lb)
AN/TRC-113	3	0	Optional (3)	0	PU-625/G	883.0 kg (1945 lb)
AN/TRC-145	2	2	Optional (2)	2	PU-625/G	976.1 kg (2150 lb)

2359/78W

R.7 (4-8)

Technical Characteristics

TYPE OF SERVICE	-----	500F9 (designed for use with multi-channel PCM equipment only)
FREQUENCY RANGE	-----	Band I, 220 to 404.5 MHz Band II, 394.5 to 705 MHz Band III, 695 to 1000 MHz Band IV, 1350 to 1850 MHz
FREQUENCY SEPARATION TRANSMIT TO	-----	
RECEIVE	-----	16.5 MHz
PLANNING RANGE	-----	80 km (50 mi)
NUMBER OF CHANNELS	-----	Band I, 369 Band II, 621 Band III, 610 Band IV, 1000
POWER INPUT	-----	115V ac, 47 to 420 Hz
POWER OUTPUT	-----	15 to 25W
ANTENNA	-----	Combination of Mast AB-952/GRC-103 and: AS-1852/GRC-103 - Band I AS-1853/GRC-103 - Band II AS-1854/GRC-103 - Band III AS-3047()/GRC-103 - Band IV
TUNING	-----	Continuous
SQUELCH	-----	None

Note: Band IV is developmental; it should be fielded in 1979.
The AN/GRC-103 with Band IV will replace Radio Set, AN/GRC-50.

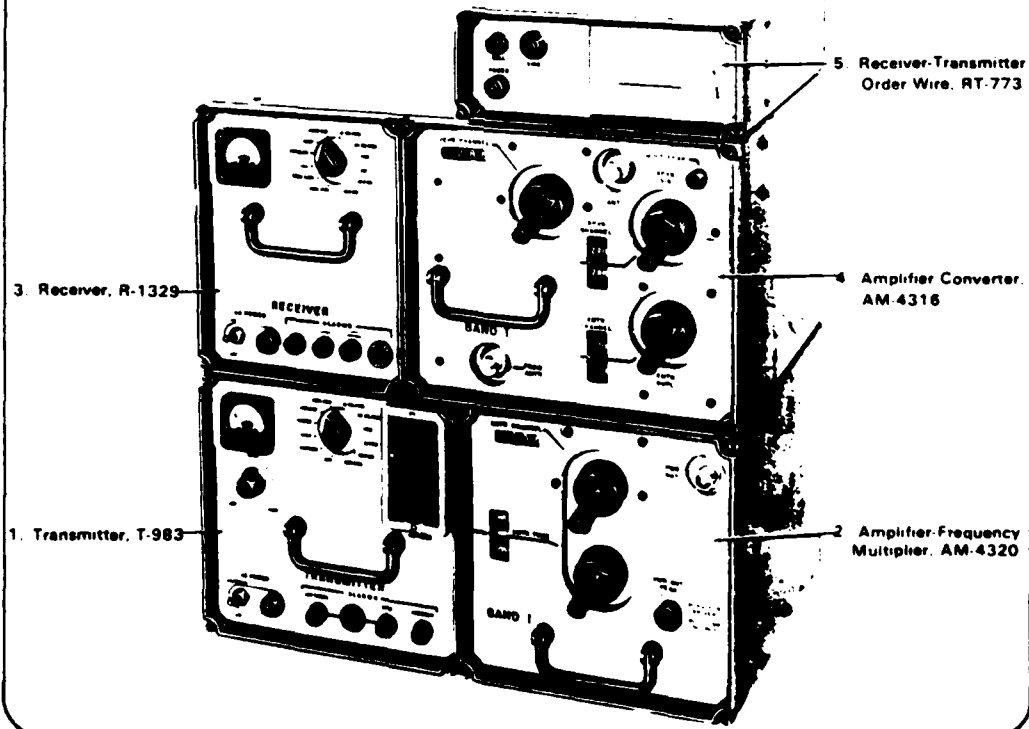

Figure C-1. Radio set AN/GRC-103 technical characteristics.

2359/78W

R.7 (4-9)

Table C-3. Signal converter CV-1548.

STATUS: STD-A: NSN: 5805-00-069-8795

REF: TM 11-5805-367-12

General Information

The CV-1548/G converts 2-wire telephone circuits to 4-wire circuits for transmission over multiplex systems. A straight-through patch is provided in the 4-wire mode. It also provides three signaling options. It converts a 20 Hz ringing signal to 1600 Hz, and 1600 Hz to 20 Hz for two-way ringing. It converts a dc closure to 1600 Hz, and 1600 Hz to a dc closure for originate and terminate plug supervision on one-way ringdown trunks. It also provides the option of no ringing signal conversion. The CV-1548/G is used with the TD-352/U, TD-353/U, and TD-660/U multiplexers.

Technical Characteristics

NUMBER OF CHANNELS	-----	12; each channel operates independently
LOOP IMPEDANCE	-----	600 ohms
LINE IMPEDANCE	-----	600 ohms
POWER REQUIREMENT	-----	109 to 121V, 47 to 420 Hz, 60W
WEIGHT	-----	24.5 kg (54 lb)

2359/78W

R.9 (3-28)

Table C-4. Multiplexer TD-660.

STATUS: STD-A; NSN: 5820-00-930-8079 (TD-660G)
STD-A; NSN: 5820-00-928-3382 (TD-660A/G)

REF: TM 11-5805-382-12

General Information

The TD-660/G converts six or twelve 4-wire voice-frequency channels to a TDM-PCM signal, and vice versa. The TD-660/G is used in nonsecure communications systems, and the TD-660A/G is used in secure communications systems.

Technical Characteristics

NUMBER OF CHANNELS	-----	6 or 12
TYPE OF OPERATION	-----	4-wire, full duplex
TYPE OF MULTIPLEXING	-----	Time division
TYPE OF MODULATION	-----	Pulse code
CHANNEL BANDWIDTH	-----	300 to 3500 Hz
PULSE RATE:		
6-channel	-----	288 kHz
12-channel	-----	576 kHz
LOOP IMPEDANCE	-----	600 ohms, send and receive
LINE IMPEDANCE	-----	900 ohms, send and receive
POWER REQUIREMENT	-----	109 to 121V, 50 to 400 Hz, 45W
WEIGHT	-----	22.2 kg (49 lb)

2359/78W

R.9 (3-10)

Table C-5. PCM cable transmission interface unit TD-754.

STATUS: STD-A; NSN: 5820-00-930-8078

REF: TM 11-5805-383-12

General Information

The TD-754/G is a 6-, 12-, 24-, or 48-channel PCM cable transmission interface unit. Its transmit section accepts TDM-PCM output signals from a TD-202/U, TD-660/G, TD-206/G, or from another TD-754/G, and processes the signals for cable transmission. The receive section accepts a PCM signal from a transmission cable, processes and retimes it. The TD-754/G provides power for up to 39 TD-206/G's in the transmission cable.

Technical Characteristics

NUMBER OF CHANNELS	- - - - -	6, 12, 24, or 48
TYPE OF OPERATION	- - - - -	Full duplex
TYPE OF MULTIPLEXING	- - - - -	Time division
TYPE OF MODULATION	- - - - -	Pulse code
PULSE RATE:		
6-channel	- - - - -	288 kHz
12-channel	- - - - -	576 kHz
24-channel	- - - - -	1152 kHz
48-channel	- - - - -	2304 kHz
LOOP IMPEDANCE	- - - - -	91 ohms
LINE IMPEDANCE	- - - - -	62 ohms
POWER REQUIREMENT	- - - - -	109 to 121V, 47 to 420 Hz, 35W
WEIGHT	- - - - -	20.38 kg (45 lb)

2359/78W

R.9 (3-18)

TYPICAL PCM MULTICHANNEL
LOW TRAFFIC TERMINAL

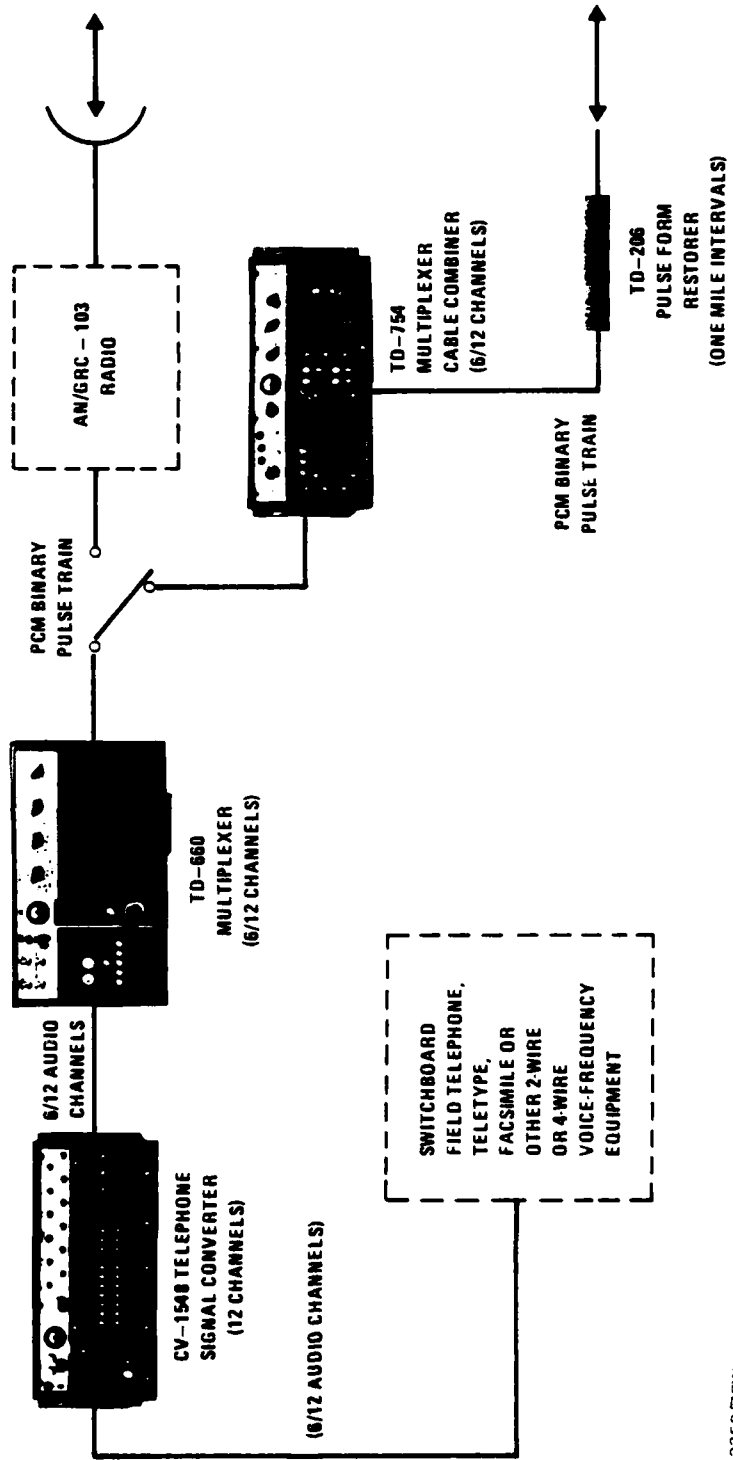

2359/78W

R.5 (2-23)

Figure C-2. AN/TRC-145 subassemblage connectivities.

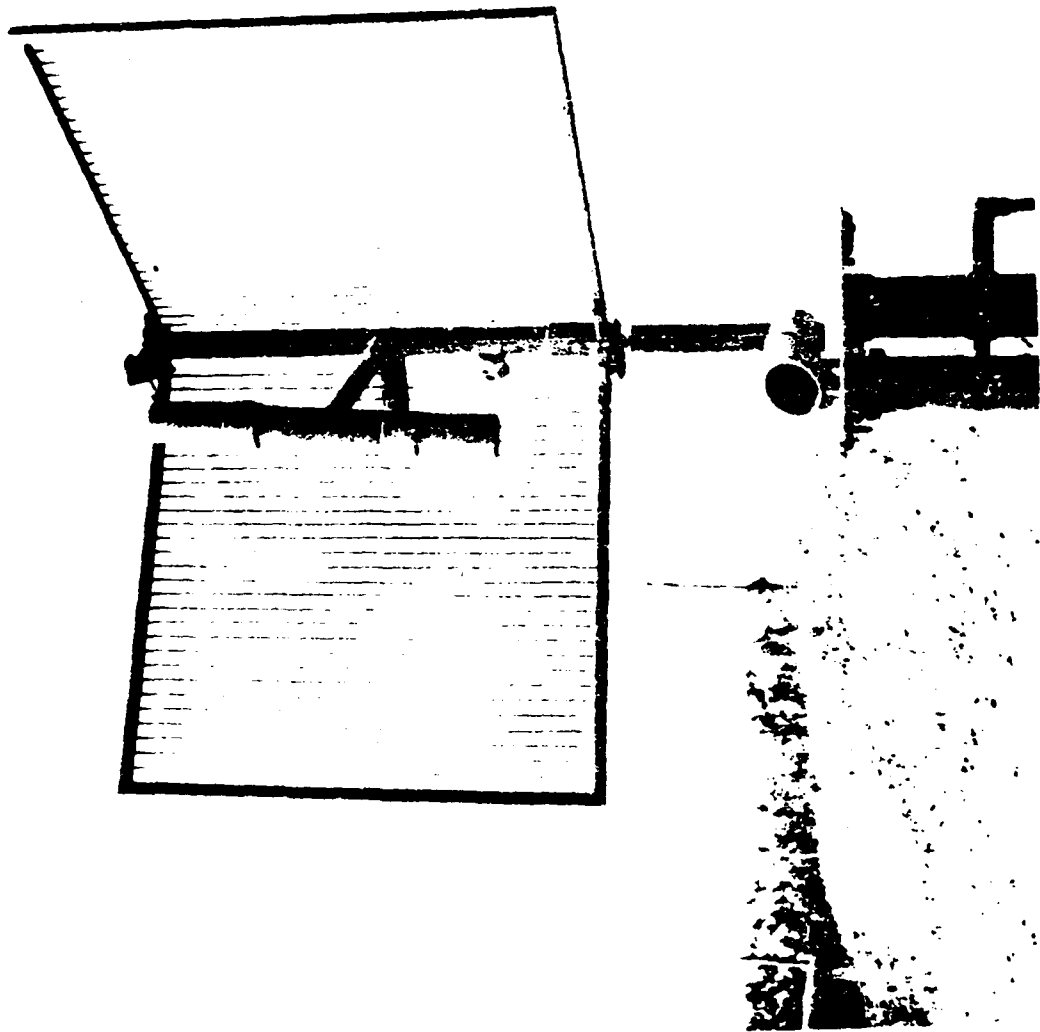

Figure C-3. Antenna AS-1852.

R.5 (2-9)

2359/78W

Table C-6. AS-1852 technical characteristics.

Antenna for Radio Set AN/GRC-103:

1. Description of Antenna:

Bands I, II and III antennas have a common, variable-corner reflector with a plug-in dipole element. The antenna AS-1852/GRC-103(V)(Band I) is mounted on Mast AB-952/GRC-103(V) and extension Kit MK-1009/GRC-103(V).

2. Antenna Characteristics:

Antenna Type	AS-1852/GRC-103(V) for Band I, AS-1853/GRC-103(V) for Band II and AS-1854/GRC-103(V) for Band III Band IV Antenna is currently under development
	AS-1852/GRC-103(V) (Band I) consists of: Reflector AS-2150/GRC-103(V) Element AS-2151/GRC-103(V)
	AS-1853/GRC-103(V) (Band II) consists of: Reflector AS-2150/GRC-103(V) Element AS-2194/GRC-103(V)
	AS-1854/GRC-103(V) (Band III) consists of: Reflector AS-2150/GRC-103(V) Element AS-2195/GRC-103(V)
Corner Reflector Weight	24-3/4 pounds
Antenna Gain	7db at 220 MHz 14 db at 1350 MHz 10db at 400 MHz 18 db at 1850 MHz 12.4db at 1000 MHz
Mast Type	AB-952/GRC-103(V) consists of Elevator Assembly AB-1072/GRC-103(V) and seven 5 feet 3 inches Mast Sections AB-1071/GRC-103(V)
Weight	98 pounds
Height	36-3/4 feet
FSN	5985-089-8993
Elevator Assembly	AB-1072/GRC-103(V) part of AB-952/GRC-103(V)
Weight	48 pounds
Height	5 feet 3 inches
FSN	5985-089-8992

Table C-7. AS-1852 deployment and cable assemblies.

Extension Kit	MK-1009/GRC-103(V) used to extend the height of the mast assembly from 36-3/4 feet to 52 feet
Weight	74 pounds
Height	15½ feet
FSN	5985-179-7767

Maximum safe antenna height with Extension Kit 52 feet

Coaxial RF Cables:	CG-3443/U (80 ft)
	CG-3444/U (1 ft 6 in)
	CG-3444/U (3 ft 6 in)
	CG-1040B/U (4 ft)

Cable Assembly	CX-10762/U (5 ft)
	CX-10763/GRC-103(V)

2359/78W

R.5 (2-11)

Table C-8. Radio repeater set AN/TRC-113 description.

1. Description:

A radio relay repeater to extend the range of a radio circuit employing two Radio Sets AN/GRC-103. It also contains one extra or spare Radio Set AN/GRC-103. It may be used as a radio terminal to terminate three multichannel radio circuits. It has been designed to be linked with Telephone Terminal AN/TCC-65 by coaxial cable CX-11230.

2. Federal Stock Number:

5820-868-8211.

3. Major Components:

<u>QTY</u>	<u>NOMENCLATURE</u>	<u>TYPE NO.</u>
1	Shelter, Electrical Equipment (Modified S-250/G)	S-335/TRC-113
3	Radio Set	AN/GRC-103(V)1
3	Multiplexer (Cable Combiner)	TD-204/TD-754/G
1	Telephone Set	TA-312/PT
1	Intercommunication Station	LS-147/F1

4. Ancillary Equipment:

a. Power Unit (USATROSCOM)

1 ea Generator Set, Gasoline Engine, Trailer
Mounted (2 ea 3KW units mounted on 3/4-Ton
Trailer) PU-625/G

b. Transporter (USATACOM)

1 ea Truck, Cargo, 1 $\frac{1}{4}$ Ton M-715

c. Air Conditioner (USATROSCOM)

(Currently authorized by DA for use in tropical areas.)

1 ea 18,000 BTU Unit, Trailer Mounted FSN 4120-930-5700

2359/78W

R.5 (2-29)

Table C-9. AN/TRC-113 characteristics.

6. Characteristics:

a. Physical

Dimensions - Refer to S-250/G Shelter on page 8-4.

Weight - 1,945 lbs (Including Shelter)

All operating components are housed in 1½ Ton (S-250/G) Shelter. The shelter is fully insulated and weatherproofed and contains ports for use of an air-conditioner (when authorized). Equipment racks housing electronic components are secured to the walls and floor. Storage areas and mounting fixtures are provided for spares and accessory items. Power and signal wiring is housed in ducts. The assemblage can be transported by air or ground vehicle. Normally, the assemblage is intended for operation while mounted on the transporter truck. The transporter truck also tows the power unit trailer on which are mounted power supplies, cable on reels, fuel cans and additional accessory items for use with assemblage.

b. Technical

Input Voltage	115 Volts, 50-60 Hz, Single Phase
Power Consumption	2,975 Watts
Local Communications Facility	TA-312/PT and LS-147/F1
Multiplexing	Time Division (TDM)
Modulation:	
Multiplexer	Pulse Code (PCM)
Radio	Frequency (FM)
Radio:	
Frequency Range	220-404.5 MHz (Band D)
Range (Distance)	20 Miles
Power Output	25 Watts

7. Concept of Employment:

Provides complete radio repeater facilities with spare radio for backup. The spare radio when connected to its antenna may be used for swing shots or as a third radio terminal when connected by coaxial cable to PCM multiplexing equipment located in Telephone Terminal AN/TCC-65. Patch panels are provided with the AN/TRC-113 for switching to either repeater or terminal mode and to utilize the spare radio and cable combiner equipment. As a split terminal, it will be used with the AN/TCC-65 at the Command Post of Infantry, Armored, and Mechanized Divisions.

Table C-10. Telephone terminal AN/TCC-65 description.

1. Description:

A quad 12-channel multiplex telephone terminal used to provide secure or nonsecure multiplex terminal or repeater facilities.

2. Federal Stock Number:

5805-156-436^R

3. Major Components:

QTY

1	Shelter, Electrical Equipment (Modified S-250/G)	S-333/TCC-65
4	Multiplexer	TD-660A/G
4	Multiplexer (Cable Combiner)	TD-204/TD-754/G
4	Converter, Telephone Signal	CV-1548/G
*4	Electronic Key Generator	TSEC/KG-27
1	Intercommunication Station	LS-147/F1

4. Ancillary Equipment:

a. Power Unit (USATROSCOM)

1 ea Generator Set, Gasoline Engine, Trailer
Mounted (2 ea 3 KW units on 3/4-Ton Trailer) PU-623()/G

b. Transporter (USATACOM)

1 ea Truck, Cargo, 1½ Ton M-715

c. Air Conditioner (USATROSCOM)

(Currently authorized by DA for use in tropical areas.)

1 ea 18,000 BTU Unit, Trailer Mounted FSN 4120-930-5700

*Has provision for mounting optional security equipment.

Table C-11. AN/TCC-65 characteristics.

5. Appropriate Literature:

TM 11-5805-371-14
TM 11-5895-458-14 (Systems)

6. Characteristics:

a. Physical

Dimensions - Refer to S-250/G Shelter on page 8-4
Weight - 2,465 lbs (including Shelter)

All operating components are housed in a 1½ Ton (S-250/G) Shelter. The shelter is fully insulated and weatherproofed and contains ports for use of an air conditioner (when authorized). Equipment racks housing electronics components are secured to the walls and floor. Storage areas and mounting fixtures are provided for spares and accessory items. Power and signal wiring is housed in ducts. The assemblage can be transported by air or ground vehicle. Normally, the assemblage is intended for operation while mounted on the transporter truck. The transporter truck also tows the power unit trailer on which are mounted generators, cable on reels, fuel cans and additional accessory items for use with the assemblage.

b. Technical

Input Voltage	115 Volts, 50-60 Hz, Single Phase
Power Consumption	2944 Watts
Local Communication Facility	TA-312/PT and LS-147/F1
Multiplexing	Time Division (TDM)
Modulation:	
Multiplexer	Pulse Code (PCM)

7. Concept of Employment:

Used in Division to extend circuits from a Command Post to a remote Radio Terminal AN/TRC-113. Assemblage may be used with Coaxial Cable CX-11230 to link up with Radio Terminal equipped with Radio Sets AN/GRC-103.

8. Improved Operation Capabilities Over Previous Types:

This telephone terminal when used with Radio Repeater Set AN/TRC-113 partially replaces the AN/MRC-69. It is capable of handling a larger volume of traffic and by using the new Time Division Multiplexing-Pulse Code Modulation equipment improves the quality of the transmissions. Also, the terminal has the optional capability of making the system secure.

Table C-12. Radio terminal set AN/GRC-163
general information.

STATUS: STD-B; NSN: 5820-00-054-3324

REF: TM 11-5820-713-15

General Information

The AN/GRC-163 is a compact, transportable, multichannel VHF-FM radio terminal set used in point-to-point radio circuits. It can provide four voice and two teletypewriter channels plus an orderwire circuit. Four telephone ringers are built into the AN/TCC-70. Although the RT-524 can provide a secure single voice channel, current tactical bulk encryption devices are not compatible with the AN/TCC-70; therefore, this system cannot be operated in a secure mode.

DEPLOYMENT - - - - -	Infantry division
MAJOR COMPONENTS - - - - -	Receiver-Transmitter, RT-524 (modified) Receiver, R-442 (modified) Telephone Carrier, AN/TCC-70 Power Supply, PP-2953B/U

ORGANIZATIONAL MAINTENANCE

TEST EQUIPMENT - - - - -	Multimeter, AN/URM-105
REMOTE OPERATION - - - - -	None
RETRANSMISSION - - - - -	None
WEIGHT - - - - -	105.1 kg (231.5 lb)
LIMITATIONS - - - - -	Nonsecure voice operation
SECURITY DEVICE - - - - -	None
EQUIPMENT CONFIGURATIONS - - - - -	None

Technical Characteristics

TYPE OF SERVICE	-----	40F9 (multichannel system)
FREQUENCY RANGE	-----	30.00 to 75.95 MHz
FREQUENCY SEPARATION TRANSMIT TO RECEIVE	-----	Vehicular whips, 10 MHz Fixed, with antennas 30.50 m (100 ft) apart, 3 MHz
PLANNING RANGE	-----	8 to 41 km (5 to 25.5 mi)
NUMBER OF CHANNELS	-----	920
POWER INPUT	-----	115V ac, 50, 60, or 400 Hz or 230V ac, 50 to 60 Hz
POWER SOURCE	-----	1.5 kW Generator Set, SF-1.5 MD
POWER OUTPUT	-----	Low, 3W High, 35W
ANTENNA	-----	Two log periodic, AS-2169/G or Two 3.05 m (10 ft) Whip, AS-1729
TUNING	-----	Detent
SQUELCH	-----	150 Hz tone and noise

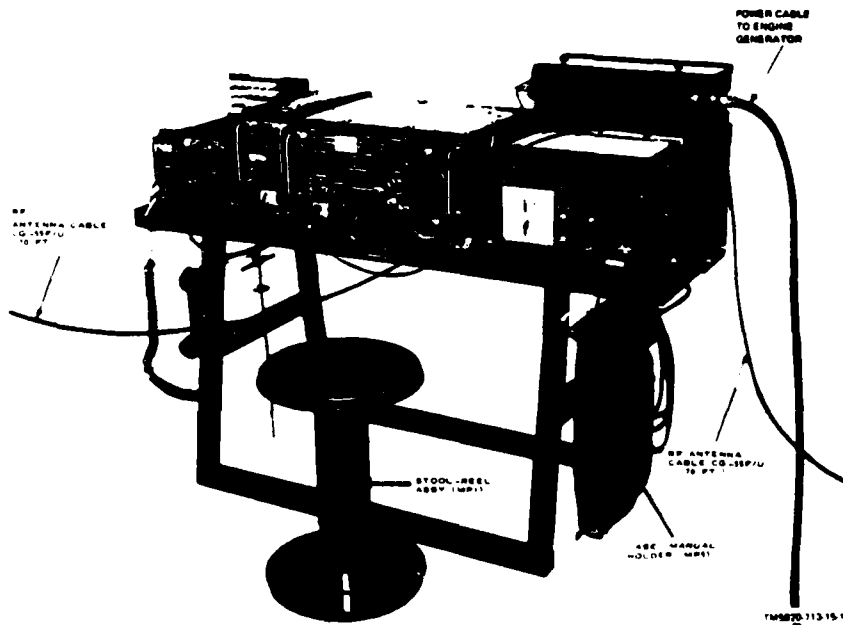

2359/78W

Figure C-4. AN/GRC-163 technical characteristics. R.7 (4-11)

Table C-13. Multiplexer TCC-70 description.

STATUS: STD-B; NSN: 5805-00-933-6653

REF: TM 11-5805-413-12

General Information

The AN/TCC-70 is a lightweight, tactical, frequency division multiplex equipment. It is used in conjunction with the AN/VRC-12 series of radios. External voice-frequency telegraph terminals such as the TH-5/TG or the TH-22/TG must be used for teletypewriter circuits.

Technical Characteristics

NUMBER OF CHANNELS	4-voice frequency, 1 orderwire and 2 teletypewriter
TOTAL TRANSMISSION BANDWIDTH	0.3 to 20 kHz
LINE SIDE OPERATION	4-wire full duplex
LOOP SIDE OPERATION	2- or 4-wire voice circuits, duplex or half-duplex teletypewriter
MAXIMUM MODULATION RATE	100 wpm (75 baud)
FREQUENCY SHIFT	100 Hz
LINE IMPEDANCE	600 ohms, send and receive
LOOP IMPEDANCE	600 ohms, send and receive
POWER REQUIREMENT	22 to 35V dc
WEIGHT	11.8 kg (30 lb)

2359/78W

R.9 (2-16)

APPENDIX D

D. SINGLE CHANNEL RADIO REFERENCE DATA

The following single channel radio reference data are provided to assist in analysis:

- (a) The AN/VRC-12 family of radios
- (b) The AN/GRC-142 and AN/GRC-122 Radio Systems and Major Components

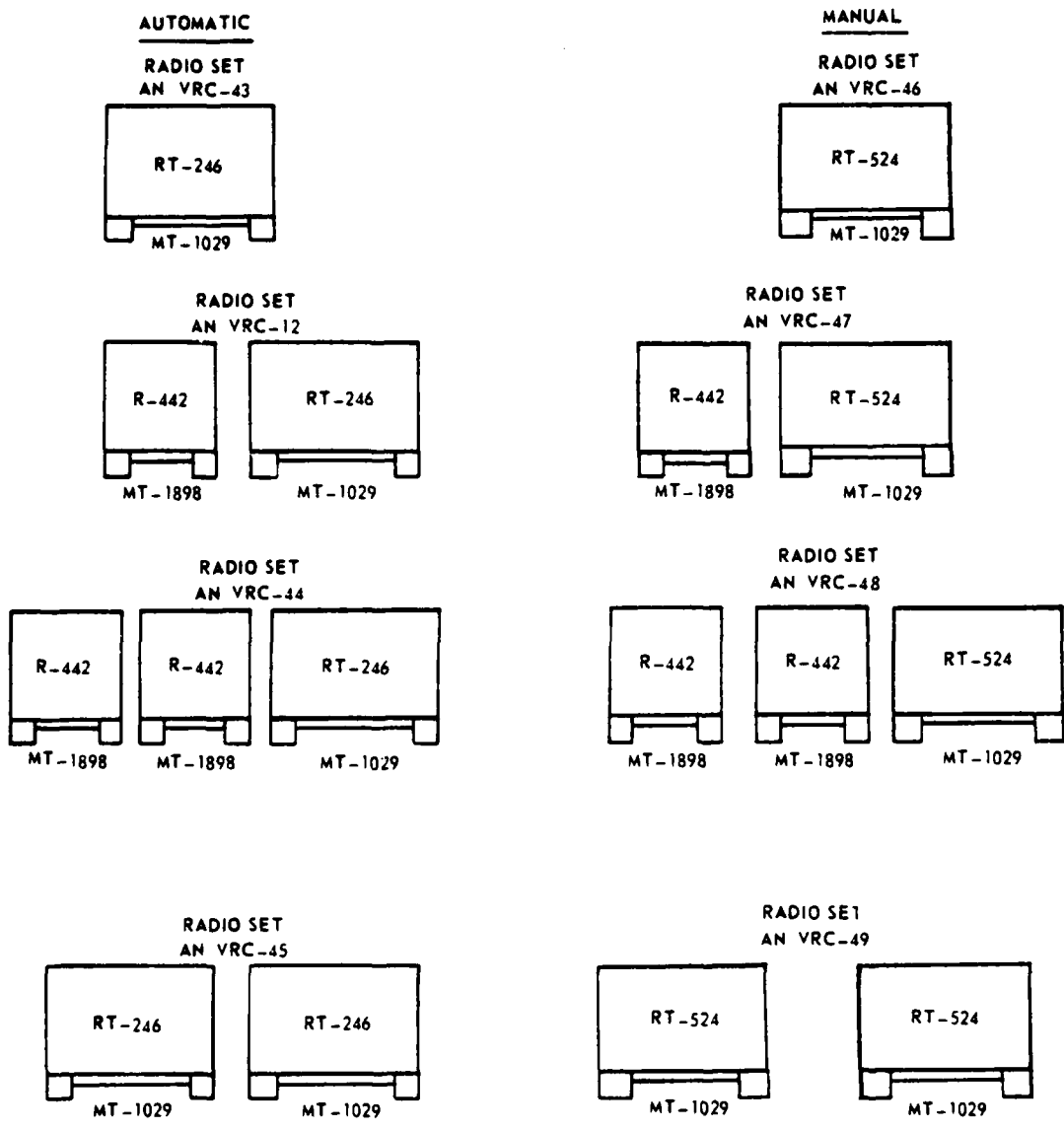

LEGEND:

- RT-246 - MEDIUM POWER RECEIVER-TRANSMITTER, 10 PRE, SET AUTOMATICALLY TUNED CHANNELS.
- RT-524 - MEDIUM POWER RECEIVER-TRANSMITTER, MANUALLY TUNED
- R-442 - AUXILIARY RECEIVER

2359/78W

R.21 (3-6)

Figure D-1. Major components of the AN/VRC-12 family of radio sets.

Table D-1. Technical characteristics of the AN/VRC-12 family of radio sets.

WEIGHT - - - - - 25.5 kg (56 lb), RT-246
 23 kg (51 lb), RT-524

LIMITATIONS - - - - - An internal leak between the transmit and receive circuits of the RT unit prohibits the use of frequencies 33.40, 45.20, 56.50, and 67.80 MHz. Furthermore, frequencies separated by exactly 5.75 or 23.00 MHz will cause mutual interference between RT units located close together.

SECURITY DEVICE - - - - - TSEC/KY-8 or TSEC/KY-38

RWI OPERATIONS - - - - - Using AN/GSA-7

EQUIPMENT CONFIGURATIONS--

NOMEN	RT-246	R-442	RT-524	C-2299	AT-912 or AS-1729		AB-15 or AB-558 w/ANTENNA ELEMENTS
AN/VRC-12	1	1	0	0	1	0	0
AN/VRC-43	1	0	0	0	1	0	0
AN/VRC-44	1	2	0	0	1	1	1
AN/VRC-45	2	0	0	1	2	0	0
AN/VRC-46	0	0	1	0	1	0	0
AN/VRC-47	0	1	1	0	1	0	0
AN/VRC-48	0	2	1	0	1	1	1
AN/VRC-49	0	0	2	1	2	0	0

AN INCOMING CARRIER WITH 150 HZ TONE IS REQUIRED BY RECEIVER SECTION TO DEACTIVATE SQUELCH CIRCUITRY. TRANSMITTER 150 HZ OSCILLATOR OPERATES WHEN RT UNIT IS KEYED

NO SQUELCH OPERATION IN RECEIVER SECTION. TRANSMITTER 150 HZ OSCILLATOR OPERATES WHEN RT UNIT IS KEYED

AN INCOMING CARRIER IS REQUIRED BY RECEIVER SECTION TO DEACTIVATE SQUELCH CIRCUITRY. TRANSMITTER 150 HZ DOES NOT OPERATE WHEN RT UNIT IS KEYED

NO SQUELCH OPERATION IN RECEIVER SECTION. TRANSMITTER 150 HZ OSCILLATOR OPERATES WHEN RT UNIT IS KEYED

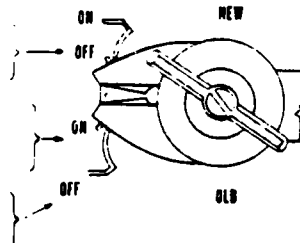

General information on RT-246/VRC and RT-524/VRC

The RT-246 is the receiver-transmitter of Radio Sets, AN/VRC-12 and AN/VRC-43 through -45. The RT-524 is the receiver-transmitter of Radio Sets, AN/VRC-46 through -49. Both models may be used in vehicular or fixed station installation. The differences in the models are:

The RT-246 has 10 automatic presets and remote select/power capability.

The RT-524 is equipped with a built-in loudspeaker.

STATUS: STD-A; NSN: 5820-00-497-8554

REF: TM 11-5820-348-15

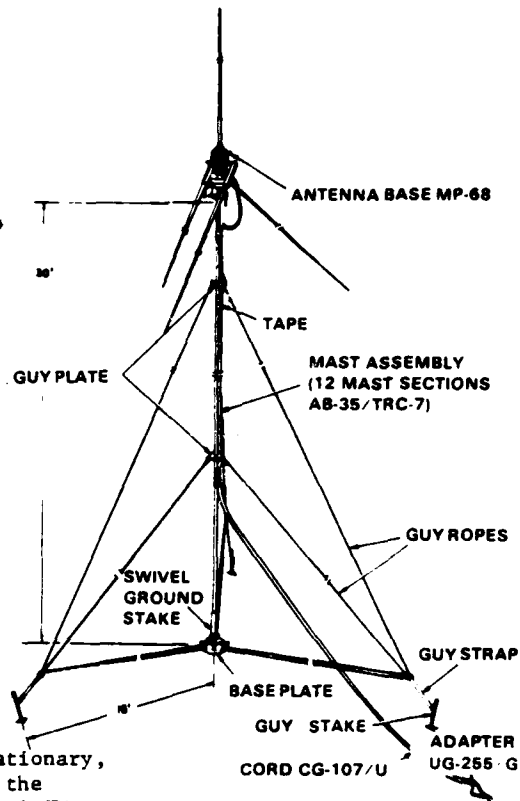

General Information

The RC-292 is a general purpose, stationary, ground plane antenna used to increase the transmission/reception range of tactical FM radio sets. The radiating and ground plane elements must be of the proper length for a particular operating frequency.

FREQUENCY RANGE - - - - - 20 to 76 MHz
 PLANNING RANGE - - - - - Approximately twice the planning range of a radio set using a quarter-wave whip antenna
 HEIGHT ERECTED - - - - - 11.28 to 12.56 m (37 to 41.2 ft)
 WEIGHT - - - - - Approximately 15.9 kg (35 lb)

RC-292 ANTENNA SELECTION REQUIREMENTS

OPERATING FREQUENCY (MHz)	ANTENNA SECTIONS REQUIRED	TYPE OF ANTENNA SECTIONS USED				GROUND PLANE SECTIONS REQUIRED	TYPE OF GROUND PLANE SECTIONS			
		AB-	AB-	AB-	AB-		AB-	AB-	AB-	AB-
		21/ GR	22/ GR	23/ GR	24/ GR		21/ GR	22/ GR	23/ GR	24/ GR
20-27.9	6	3	1	1	1	18	3	1	1	1
27.9-38.9	4	1	1	1	1	15	2	1	1	1
38.9-54.4	3	0	1	1	1	12	1	1	1	1
54.4-75.95	2	0	1	0	1	9	0	1	1	1

2359/78W

Figure D-2. Antenna RC-292.

R.7 (1-22)

NOMEN	RT-662	AM-3349	MD-522	TT-98	TT-76	TT-4	AN/GRA-6	WEIGHT
AN/GRC-122	2*	1	1	2	1	0	1	831.7 kg (1832 lb)
AN/GRC-142	1	1	1	1	1	0	1	769.1 kg (1694 lb)
AN/VSC-2	1	1	1	0	0	1	0	681.9 kg (1502 lb)
AN/VSC-3	1	1	1	1	1	0	0	661.0 kg (1456 lb)

*One RT-662 is used as a receiver only.

2359/78W

R.7 (3-8)

Figure D-3. Major components of the AN/GRC-142 and AN/GRC-122 radio sets.

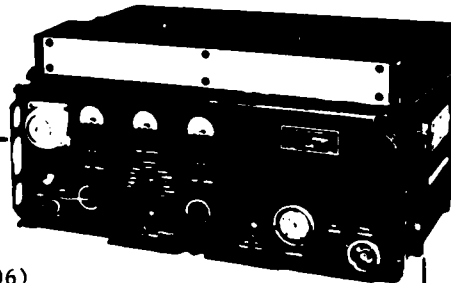

STATUS: STD-B; NSN: 5820-00-402-2263 (AN/GRC-106)
 STD-A; NSN: 5820-00-223-7548 (AN/GRC-106A)

AM-3349/GRC-106

REF: TM 11-5820-520-12

General Information

The AN/GRC-106 is an HF, SSB radio set used primarily as a mobile link in a communications network. It may also be used in fixed and semifixed applications, and it has an AM mode to make it compatible with standard AM radio sets. The AN/GRC-106 is now being used as the basic radio set with all of the newer SSB radioteletypewriter configurations. The AN/GRC-106 and -106A are identical except that the AN/GRC-106 uses a RT-662/GRC and the AN/GRC-106A uses a RT-834/GRC. Current tactical speech security equipment is not compatible with the AN/GRC-106; therefore, secure voice is not a mode of operation. The AN/GRC-106 is replacing Radio Set, AN/GRC-19.

DEPLOYMENT	-----	Division through COMMZ
MAJOR COMPONENTS	-----	RT-662/GRC or RT-834/GRC Radio Frequency Amplifier, AM-3349 Antenna; Vehicular Whip or AN/GRA-50
ORGANIZATIONAL MAINTENANCE		
TEST EQUIPMENT	-----	Multimeter, AN/URM-105 Electron Tube Test Set, TV-7D/U
REMOTE OPERATION	-----	Using AN/GRA-6
RETRANSMISSION	-----	None
WEIGHT	-----	58.1 kg (128 lb)
LIMITATIONS	-----	Nonsecure voice operation
SECURITY DEVICE	-----	None
EQUIPMENT CONFIGURATIONS	-----	None

ISOLATOR, SHOCK
 MX P/N 438904-1(2)

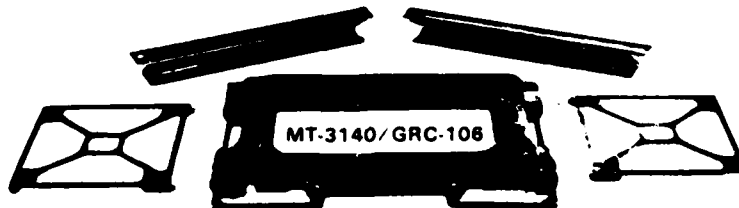

CROSSBAR, LONG
 SM-C-508645(2)

Table D-2. Air Force TACP communications central AN/MRC-108 technical data. AFCSP-100-98

COMMUNICATIONS CENTRAL

1. **Functional Description.** The AN/MRC-108 communications central is a completely mobile communications facility including antenna and a power generator system mounted on an M-151 4x4 utility truck. It provides ground-to-ground and ground-to-air communications utilizing half-duplex voice operation with all four receiver-transmitters, as well as upper and lower sideband and full break-in keying on CW with the 618T-3 HF receiver-transmitter. The equipment is capable of operating on any one of 33,780 channels; 28,000 on HF, 1360 on VHF-AM, 920 on VHF-FM and 3500 on UHF.

2. **Technical Data:**

a. **Characteristics:**

Frequency Range

Transmit & HF 2.000 - 29.999 MHz
VHF 116.000 - 149.975 MHz

Receive UHF 225.000 - 399.950 MHz
VHF-FM 30.000 - 75.950 MHz

Type of Antenna HF - 16' whip for mobile operation. Dipole, long-wire, or 16 to 32' whip for stationary operation.
VHF - 437Z-1 antenna, vertical sleeve dipole type with rigid construction.
UHF - AS-1404/PRC, vertical sleeve dipole type with rigid construction.

Modes HF - USB, LSB, AM (half duplex voice CW)
VHF - AM (half duplex voice)
UHF - AM (half duplex voice)
VHF FM - FM (half duplex voice)

Tuning Method HF - Automatic
VHF - Automatic
UHF - Automatic
VHF - FM - semiautomatic

Receiver Tuning HF - 4 sec average, 8 sec max

Time, After VHF - 4 sec max

Frequency Selection UHF - 3 sec average, 6 sec max
VHF - FM - N/A

Transmitter Tuning HF - 15 sec average, 28 sec max

Time, After VHF - 4 sec max

Frequency Selection UHF - 3 sec average, 6 sec max
VHF - FM - N/A

2359/78W

R.6 (3-28)

Table D-3. AN/MRC-108 major components.

AFCSP 100-98

3-29

Output Power	HF - 400 watts PP (SB or LSB). 125 watts aver (AM or CW) VHF - 30 watts (618M-1C) UHF - 16 watts VHF - FM 1.5 to 2.0 watts
--------------	--

Transmitter Duty

Cycle	HF - continuous VHF - continuous UHF - 5 minute transmit, 10 minute receive VHF - FM - continuous
-------	--

Power Input	+28 vDC, 100 amperes for complete system
-------------	--

b. Principal Components:

HF Receiver - Transmitter Group 718F-2
Control, Radio Set 313V-1
Coupler, Automatic Antenna 490B-1
Coil, Antenna Loading 960D-1
Antenna, Whip 16 to 32'
Speaker/Amplifier 76F - 3
Hand Set H-33/PT

VHF/UHF Receiver - Transmitter Group 718M-2
Control, Radio Set VIII 313V-3
Antenna, VHF 437Z-1
Control, Radio Set UHF 313V-4
Antenna, UHF AS-1404/PRC
Speaker/Amplifiers 76F-3, 2 ea
Hand Set H-33/PT, 2 ea
VHF-FM Radio Set AN/GRC-125
FM Antenna Mount MT-912/VRC
Hand Set H-138/U
Control Group AN/GRA-6, which permits remote control HF, VHF, UHF receiver-transmitter groups up to 300'
Power Generating System MK-486/MRC

3. Operational Data:

a. Configuration. The AN/MRC-108 is a self-contained mobile unit which has its own power source. It may be operated in a mobile or stationary configuration. The trailer-mounted gasoline engine generator set, PU-630/M, should be used whenever possible so as to relieve the strain on the M-151 vehicle engine. The communications components may be operated from the M-151 batteries for a short period of time if all other power sources become disabled. Separate control and simultaneous operation of the four communications groups is possible, limited only by certain frequency combinations prone to interference.

b. Interface Capability, N/A.

APPENDIX E

E. RADIO WIRE INTEGRATION REFERENCE DATA

The following radio-wire integration reference data are provided to assist in analysis:

- (a) The GSA-7
- (b) Connectivity Requirements

2

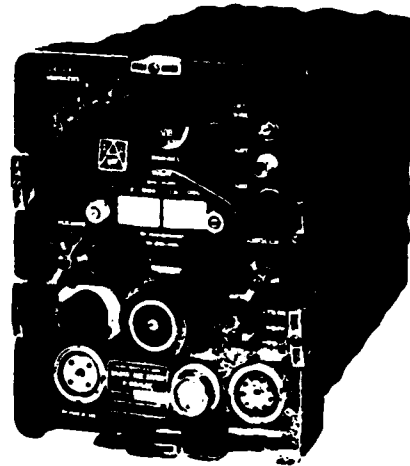

STATUS: STD-A; NSN: 5820-00-543-1397

REF: TM 11-5135-15

General Information

The AN/GSA-7 is a small, lightweight electronic switching device used to integrate FM radio equipment with local, push-to-talk telephone circuits (RWI). It permits the AN/GSA-7 operator to key the transmitter, and it automatically converts a 20 Hz telephone ringing signal to a 1600 Hz radio ringing signal and vice versa. Operation with the AN/VRC-12 family of radio sets requires the use of Cable Assembly, CX-7474/U.

DEPLOYMENT - - - - -	Division through COMMZ
MAJOR COMPONENTS - - - - -	Radio Set Control, AN/GSA-7 Cable Assembly, CX-7474/U
ORGANIZATIONAL MAINTENANCE	
TEST EQUIPMENT - - - - -	Multimeter, AN/URM-105 Electron Tube Test Set, TV-7D/U
REMOTE OPERATION - - - - -	None
RETRANSMISSION - - - - -	None
WEIGHT - - - - -	12.5 kg (27.5 lb)
LIMITATIONS - - - - -	Depends on radio set used
SECURITY DEVICE - - - - -	None
EQUIPMENT CONFIGURATIONS - - - - -	None

Technical Characteristics

TYPE OF SERVICE - - - - -	Voice
FREQUENCY RANGE - - - - -	300 to 3500 Hz
PLANNING RANGE - - - - -	16 km (10 mi), using Field Wire, WD-1/TT
NUMBER OF CHANNELS - - - - -	NA
POWER INPUT - - - - -	22 to 30V dc or 115/230V ac, 50 to 400 Hz
POWER SOURCE - - - - -	Vehicle power system or any appro- priate ac power source
POWER OUTPUT - - - - -	NA
ANTENNA - - - - -	None
TUNING - - - - -	None
SQUELCH - - - - -	None

RWI

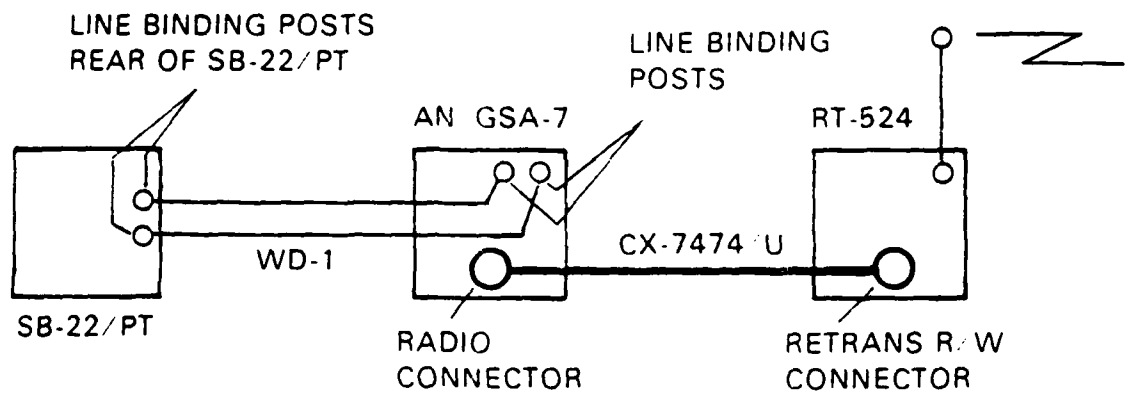

R.7 (1-21)

Figure E-2. RWI operations using the AN/GSA-7.

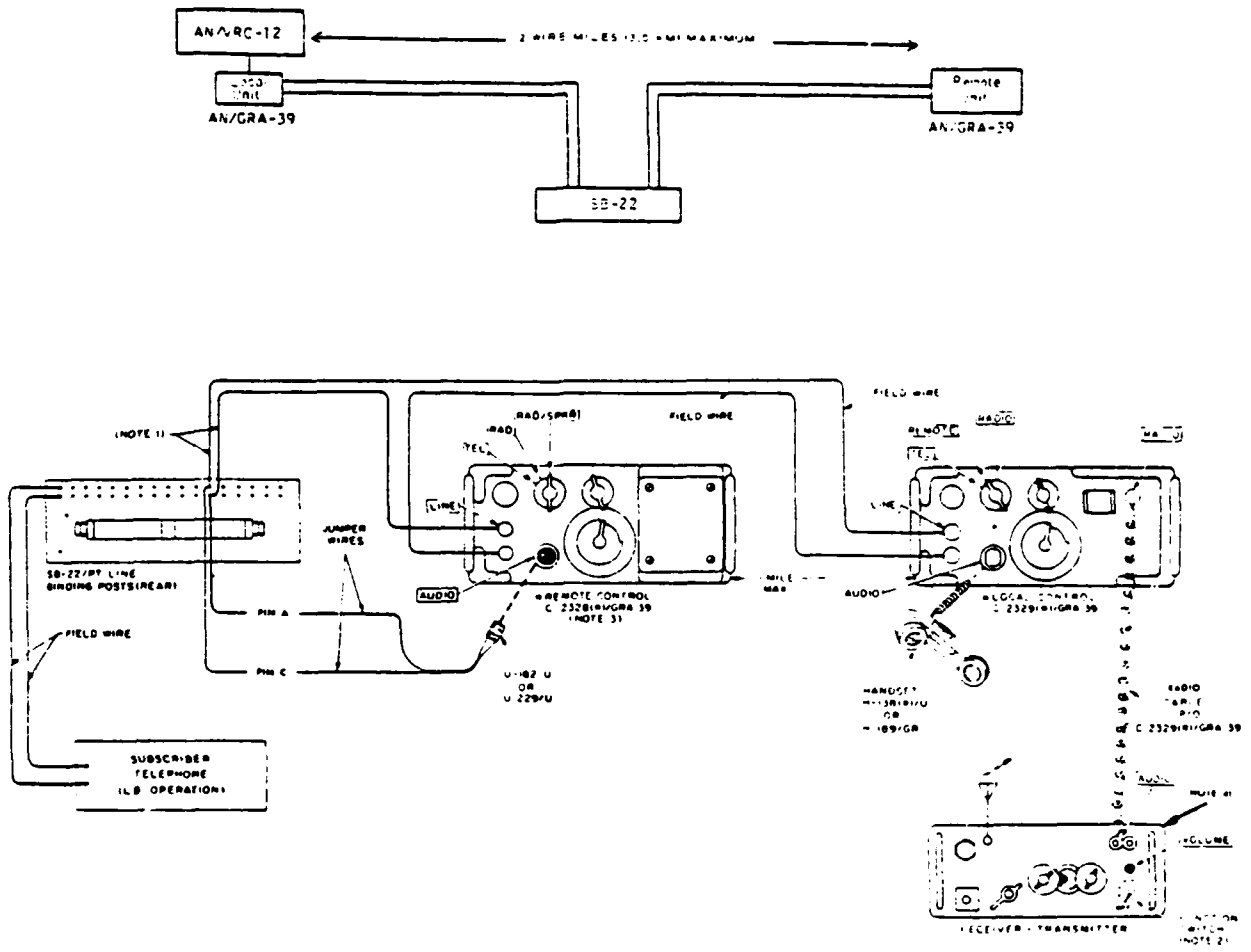

A INTERCONNECTIONS AND SWITCH POSITIONS

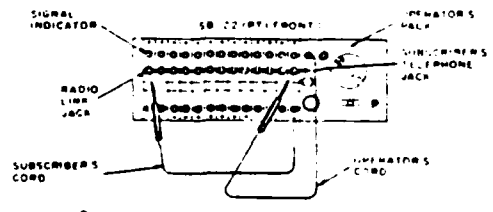

B SWITCHBOARD CONNECTIONS FOR SUBSCRIBER-RADIO LINE

- NOTES
1. PART OF AN/GRA 39 IS A RECEIVED TRANSMITTER. A SERIES TRANSFORMER CONNECTION OF THIS TYPE IS NOT USED BY SB-22.
 2. SWITCH POSITIONING MAY BE BY U.S. ARMY OR U.S. NAVY. THE C 23291/GR 39 HAS A SWITCH POSITIONING JACK. THE C 23291/GR 39 HAS A SWITCH POSITIONING JACK.
 3. THE REMOTE CONTROL IS LOCATED NEXT TO THE RADIO LINE JACK. THE REMOTE CONTROL IS USED TO MUTE THE RADIO LINE JACK.
 4. RADIO LINE JACK IS SHOWN IN POSITION TO RECEIVE RADIO LINE. THE RADIO LINE JACK IS SHOWN IN POSITION TO RECEIVE RADIO LINE. THE RADIO LINE JACK IS SHOWN IN POSITION TO RECEIVE RADIO LINE.

2359 78W

R.21 (5-20)

Figure E-3. RWI operations using the AN/GRA-39.

APPENDIX F

F. RADIO REMOTE SET REFERENCE DATA

The following radio remote set reference data are provided to assist in analysis:

- (a) The AN/GRA-39 System
- (b) The AN/GRA-6 System

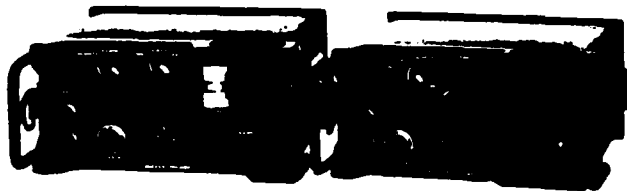

STATUS: STD-A; NSN: 5820-00-949-9909

REF: TM 11-5820-477-12

General Information

The AN/GRA-39B is a transistorized, battery-operated remote control system.

It provides:

- Local and remote control facilities for various radio sets.
- Telephone service between local and remote sites.
- 3900 Hz ringing signal between local and remote sites.
- Radio set transmission and reception from the local or remote control unit.

DEPLOYMENT - - - - - Division through COMMZ
MAJOR COMPONENTS - - - - - Radio Set Local Control, C-2329/GR
Radio Set Remote Control, C-2328/GR

ORGANIZATIONAL MAINTENANCE

TEST EQUIPMENT - - - - - Multimeter, AN/URM-105
REMOTE OPERATION - - - - - Using C-2328/GR
RETRANSMISSION - - - - - None
WEIGHT - - - - - 9.6 kg (21.25 lb)
LIMITATIONS - - - - - Depends on radio set used
SECURITY DEVICE - - - - - None
EQUIPMENT CONFIGURATION - - - - - None

Technical Characteristics

TYPE OF SERVICE - - - - - Voice
FREQUENCY RANGE - - - - - 300 to 3500 Hz
PLANNING RANGE - - - - - 3.2 km (2 mi), using Field Wire,
WD-1/TT
NUMBER OF CHANNELS - - - - - NA
POWER INPUT - - - - - 9V dc
POWER SOURCE - - - - - Battery, BA-30, 6 each
POWER OUTPUT - - - - - NA
ANTENNA - - - - - None
TUNING - - - - - None
SQUELCH - - - - - None

2359/78W

Figure F-1. Radio set control group AN/GRA-39B. R.7 (1-18)

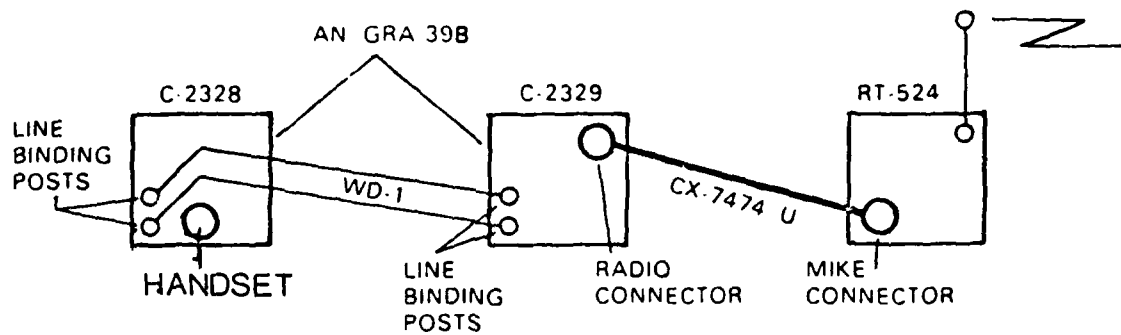

2359/78W

R.7 (1-19)

Figure F-2. AN/GRA-39 remote operation.

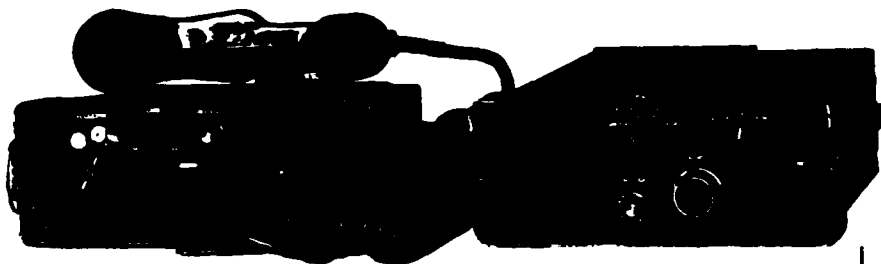

STATUS: STD-A; NSN: 5820-00-644-4554

REF: TM 11-5038

General Information

The AN/GRA-6 provides local and remote control facilities for various push-to-talk radio sets. It can provide remote control for one or two radio sets.

Remote control of one radio set provides:

Two-way telephone communications between control units, including 20 Hz ringing signal.

Transmitting and monitoring of the receiver.

Control of input power to the radio set from the remote location.

Remote control of two radio sets provides:

Two-way telephone communications between control units, including 20 Hz ringing signal.

Transmitting from either transmitter and monitoring of both receivers.

No control of the input power to the radio sets from the remote location.

DEPLOYMENT	-----	Division, airborne/air assault and airborne corps
MAJOR COMPONENTS	-----	Local Control Unit, C-434/GRC Remote Control Unit, C-433/GRC
ORGANIZATIONAL MAINTENANCE		
TEST EQUIPMENT	-----	Multimeter, TS-505/U
REMOTE OPERATION	-----	Using Remote Control Unit, C-433/GRC
RETRANSMISSION	-----	None
WEIGHT	-----	7.9 kg (17.5 lb)
LIMITATIONS	-----	Depends on radio set used
SECURITY DEVICE	-----	None
EQUIPMENT CONFIGURATION	-----	None

2359/78W

Figure F-3. Radio set control group AN/GRA-6. R.7 (1-16)

Technical Characteristics

TYPE OF SERVICE	- - - - -	Voice
FREQUENCY RANGE	- - - - -	300 to 3500 Hz
PLANNING RANGE	- - - - -	3.2 km (2 mi), using Field Wire, WD-1/TT
NUMBER OF CHANNELS	- - - - -	NA
POWER INPUT	- - - - -	6V dc and 45V dc
POWER SOURCE	- - - - -	4 BA-30s and 1 BA-414/U
POWER OUTPUT	- - - - -	NA
ANTENNA	- - - - -	None
TUNING	- - - - -	None
SQUELCH	- - - - -	None

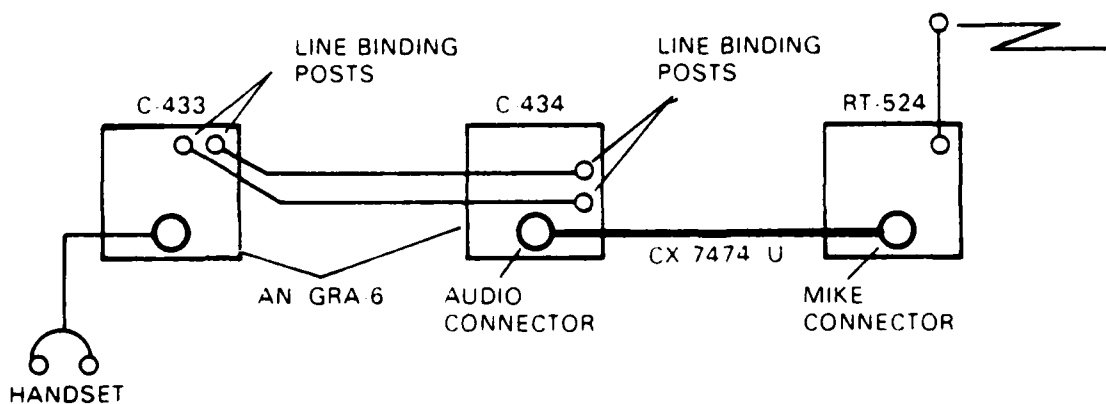

REMOTE OPERATION

2359/78W

R.7 (1-17)

Figure F-4. AN/GRA-6 remote operation.

APPENDIX G

G. FIELD EXPEDIENT ANTENNA REFERENCE DATA

The following field expedient antenna reference data are provided to assist in analysis:

- (a) Design Formulas
- (b) Long Wire Antenna
- (c) Half Rhombic Antenna

HOW TO DO IT WITH FORMULAS

■ To figure a quarter wave length in feet: Divide 234 (constant) by your operating frequency in MHz. Example: $234 \div 44.8 = 5.22'$ or $5'3''$.

■ To figure a half wave length in feet: Divide 468 (constant) by your operating frequency in MHz. Example: $468 \div 56 = 8.36'$ or $8'5''$.

■ To figure a full wave length in feet: Divide 936 (constant) by your operating frequency in MHz. Example: $936 \div 45 = 20.8'$ or $20'10''$.

■ To convert feet to meters, multiply by .3048 (constant). Example: $110' \times .3048 = 33.5$ meters.

■ To convert meters to feet multiply by 3.28 (constant). Example: 100 (meters) $\times 3.28 = 328$ feet.

QUICK REFERENCE CHART

High Frequency (HF) Antenna Length in Feet & Inches				Very High Frequency (VHF) Antenna Length in Feet & Inches			
Op Freq in MHZ	1/4 Wave	1/2 Wave	1 Wave	Op Freq in MHZ	1/4 Wave	1/2 Wave	1 Wave
2	117'	234'	468'	30	7'10"	15'7"	31'2"
3	78'	156'	312'	33	7'1"	14'2"	28'4"
4	58'6"	117'	234'	35	6'9"	13'5"	26'10"
5	46'9"	93'7"	187'4"	37	6'4"	12'7"	25'2"
6	39'	78'	156'	40	5'10"	11'8"	23'4"
7	33'5"	66'10"	133'8"	43	5'5"	10'10"	21'8"
8	29'3"	58'6"	117'	45	5'3"	10'5"	20'10"
9	26'	52'	104'	48	4'10"	9'8"	19'4"
10	23'5"	46'10"	93'8"	50	4'9"	9'5"	18'10"
11	21'3"	42'6"	85'	55	4'3"	8'6"	17'
12	19'6"	39'	78'	57	4'1"	8'2"	16'4"
13	18'	36'	72'	60	3'11"	7'10"	15'8"
14	16'9"	33'5"	66'10"	65	3'7"	7'2"	14'4"
15	15'7"	31'2"	62'4"	68	3'5"	6'10"	13'8"
16	14'7"	29'2"	58'4"	70	3'4"	6'7"	13'2"
17	13'9"	27'6"	55'	75	3'1"	6'2"	12'4"
18	13'	26'	52'	80	3'	5'11"	11'10"

REFERENCE LIST

There are many other antennas that can be constructed. If you'd care to become an expert, we recommend the following reading material.

- TM 11-366 Antennas and Radio Propagation
- FM 24-18 Field Radio Techniques
- FM 24-21 Tactical Multichannel Radio Communications Techniques
- FM 31-20 Special Forces Operational Techniques
- FM 31-73 Advisor Handbook for Stability Operations
- TM 11-486-6 Electrical Communications Systems Engineering-Radio

2359/78W

Figure G-1. Field expedient antenna design formulas.

R.26 (M-11)

Vertical Half Rhombic

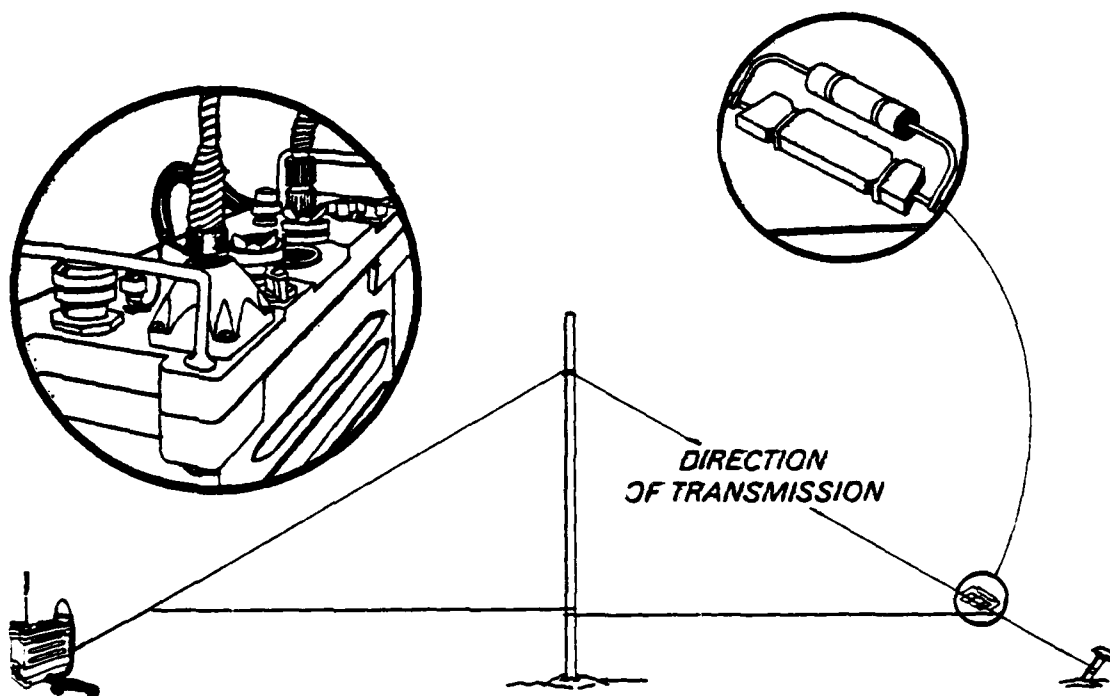

You say this antenna looks like the end of a big pup tent? Good! That means it's put up correctly. Use it to work out of a bad spot when your manpack's whip won't do the job. Tie insulators on both ends of 100 feet of any kind of wire. Run one end in the direction of the people you have to talk to, tie some wire to the other side of that insulator and stake it down with a metal stake. You need to support the center of the wire with a mast tree, pole or whatever's handy that is 20-30 feet high. Keeping the direction line straight, extend the near end till it's tight, attach more wire to the other side of the insulator and stake it down, again using a metal stake. Attach WD-1 lead-in wire as shown, and you're on the air. Here are a couple of tricks if you have the material and time.....Run a length of WD-1 from the ground side of both insulators, stretched so it's right under the antenna and about a foot high, then attach another piece from the near end ground stake to a screw on your radio set case. Why? Because it'll improve your signal. It's called a counterpoise. When you wire a 600-ohm, 1- or 2-watt carbon resistor across the insulator at the far end, you really improve your radio's punch in that direction. It's BI-Directional without the resistor and UNI-Directional with it.

2359/78W

R.26 (M-8)

Figure G-2. Field expedient uni-directional antennas.

BI-DIRECTIONAL ANTENNAS

The typical military half-wave antenna is a highly effective bi-directional antenna. It is normally used in the high frequency range.

HF Doublet

When a doublet isn't available, you can easily fabricate a replacement which will do a very good job. The antenna we'll show can replace your doublet when necessary. You'll need these items:

- Two supports, 19-to 30-feet high.
- Wire, any type that's long enough.
- Rope or wire for halyards.
- Three insulators.
- A water can or similar heavy object.

Now build it!

Step 1. Cut the wire to your operating frequency using the chart or formula to compute the length needed for a half-wave antenna.

Step 2. Determine your direction of transmission, because the doublet antenna is Bi-Directional and shoots straight out from both sides of the wire.

Step 3. Cut the wire in half and put an insulator on each wire end.

Step 4. Locate and erect the two supports. Be certain they are 3 or 4 feet further apart than the antenna's actual length, and broadside to the direction of communication.

Step 5. Separate the two wires of the WD-1 far enough to attach one wire to each end of the center insulator. Be sure it is long enough to drop nearly to the ground and then to your radio's position.

Step 6. Tie rope or wire to the two end insulators, then using whatever method is easiest, hang the antenna up between the supports, keeping it as level as possible.

Step 7. Connect one wire of the WD-1 to the antenna connector of the radio set and the other wire of the WD-1 to a ground point on the radio. The ground point should be as close as possible to the antenna connector.

In this example, we've used a can tied to one end to demonstrate counterweight. This is tied to the tree end halyard, and prevents the antenna from breaking in case of high winds blowing the support tree around.

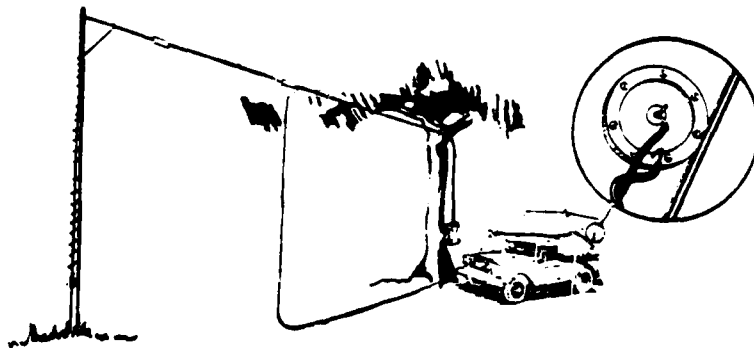

R.26 (M-6)

2359/78W

Figure G-3. Field expedient bi-directional antennas.

Here's another way of erecting a long wire antenna. Its overall length must be 3-7 wavelengths. Use the chart or formula to get the correct wire length. It's UNI-Directional with the 600 ohm resistor and BI-Directional without the resistor. The wattage rating of the resistor must be at least half the power output of the transmitter. You'll need to put some side guys on the 9-10' lance poles to hold them up. The antenna is erected as shown, use insulators wire, stakes etc, same as the others. You'll be able to communicate with increased range.

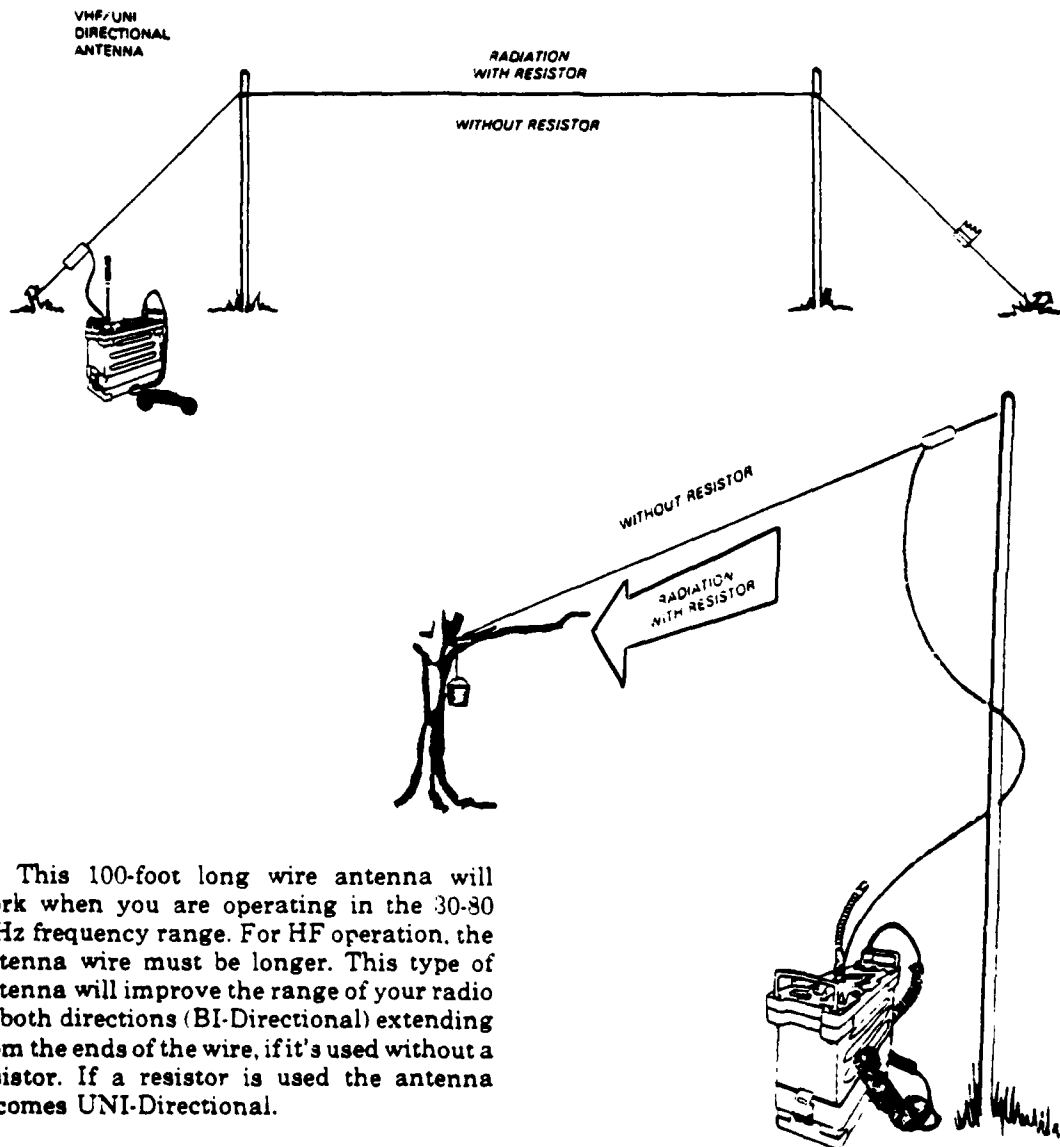

This 100-foot long wire antenna will work when you are operating in the 30-80 MHz frequency range. For HF operation, the antenna wire must be longer. This type of antenna will improve the range of your radio in both directions (BI-Directional) extending from the ends of the wire, if it's used without a resistor. If a resistor is used the antenna becomes UNI-Directional.

APPENDIX H

H. TELEPHONE REFERENCE DATA

The following telephone reference data are provided to assist in analysis:

- (a) The TA-312
- (b) The TA-838

PRECEDING PAGE BLANK-NOT FILMED

Table H-1. Telephone set TA-312.

STATUS: STD-A; NSN: 5805-00-543-0012

REF: TM 11-5805-201-12

GENERAL INFORMATION

The TA-312/PT is a 2-wire, battery operated field telephone. It may be used in a simple point-to-point voice-frequency wire communications link or in any 2-wire ringdown subscriber position of a telephone communications system.

TECHNICAL CHARACTERISTICS

RANGE:
Wet - - - - - Approx 22 km (13.7 mi) on WD-1/TT
Dry - - - - - Approx 35 km (21.8 mi) on WD-1/TT

TYPE OF OPERATION:
Common Battery (CB) - - - - - Power supplied by switchboard
Local Battery (LB) - - - - - Power supplied from TA-312/PT
Common Battery Signaling (CBS) - Signaling power supplied by switchboard,
talk power supplied from TA-312/PT

SIGNALING VOLTAGE - - - - - 90V, 20 Hz
TYPE OF SIGNAL - - - - - Audible (adjustable loud to low, but
not off)

POWER REQUIREMENT - - - - - 3V dc (2 ea BA-30 or an external source)
WEIGHT - - - - - 4.3 kg (9.5 lb)

2359/78W

R.9 (1-4)

Table H-2. Telephone set TA-838.

STATUS: Under development; NSN: To be assigned.

REF: To be published.

GENERAL INFORMATION

The TA-838/TT is a ruggedized, solid state field telephone designed for use with the SB-3614/TT switchboard or with the AN/TTC-25 or AN/TTC-38 tactical automatic switches. It is a 2- or 4-wire, local or common battery set using dual-tone, multifrequency (DTMF) tones for signaling. Up to four sets can be bridged across a single 4-wire line for extension service.

TECHNICAL CHARACTERISTICS

RANGE	- - - - -	3.2 km (2 mi) from SB-3614/TT under worst conditions
TYPE OF OPERATION	- - - - -	Local or common battery
SIGNALING VOLTAGE	- - - - -	-4 dBm (+ 2dB)
TYPE OF SIGNAL	- - - - -	Audible tone
POWER REQUIREMENT	- - - - -	6V dc (4 ea BA-42 or BA-2042)
WEIGHT	- - - - -	3.6 kg (8 lb)

2359/78W

R.9 (1-12)

APPENDIX I

I. SWITCHBOARD REFERENCE DATA

The following switchboard reference data are provided to assist in analysis:

- (a) The SB-993
- (b) The SB-22
- (c) The SB-3614
- (d) The SB-3082

Table I-1. Switchboard SB-993.

STATUS: STD-A; NSN: 5805-00-708-2202

REF: TM 11-5805-294-15

General Information

The SB-993/GT is a lightweight, portable switchboard capable of handling six local battery telephone lines. It is designed for use in forward combat areas. It requires the use of either a local battery telephone or a sound powered telephone (not a component) for the operator.

Technical Characteristics

TYPE OF OPERATION	- - - - -	Manual, local battery
LINE CAPACITY	- - - - -	6
SIGNALING VOLTAGE	- - - - -	None
TYPE OF SIGNAL	- - - - -	Neon glow lamp
POWER REQUIREMENT	- - - - -	None
WEIGHT	- - - - -	2.04 kg (4.5 lb)

2359/78W

R.9 (1-18)

Table I-2. Switchboard SB-22.

STATUS: STD-A; NSN: 5805-00-257-3602 (SB-22/PT)
STD-A; NSN: 5805-00 715-6171 (SB-22A/PT)

REF: TM 11-5805-262-12 and TM 11-5805-262-ESC

General Information

The SB-22/PT and SB-22A/PT are lightweight, manual switchboards that can be rapidly installed to provide field facilities for interconnecting 12 local battery telephone circuits, remote controlled radio circuits, or voice-frequency teletypewriter circuits. Replacing a line pack with a trunk pack permits one-way ringdown, one-way automatic trunk circuits between the SB-22A/PT and any other switchboard with common battery signaling.

Technical Characteristics

TYPE OF OPERATION	-----	Manual, local battery
LINE CAPACITY	-----	12
SIGNALING VOLTAGE	-----	90V, 20 Hz (hand crank or external source)
TYPE OF SIGNAL	-----	Buzzer or lamp
POWER REQUIREMENT:		
Operator's Talking Circuit	---	3V dc (2 ea BA-30)
Night Alarm and Panel Light	---	3V dc (2 ea BA-30)
WEIGHT	-----	15.4 kg (34 lb)

2359/78W

R.9 (1-20)

Table I-3. Switchboard SB-3614.

STATUS: STD A; NSN: 5805-01-032-1694.

REF: To be published.

General Information

PRICE \$18,700

The SB-3614/TT is a modular, ruggedized switchboard which provides switching of both analog and digital signals from voice, teletypewriter, and data terminal subscribers. The SB-3614/TT is capable of operation as a 30-terminal switchboard or it may be combined to operate as a 60- or a 90-terminal switchboard. It will replace the SB-86/P. The SB-3614/TT is compatible with both the older manual switchboards and the newer automatic switches (such as the AN/TTC-38).

Technical Characteristics

TYPE OF OPERATION	-----	Manual or automatic
LINE CAPACITY	-----	30
SIGNALING VOLTAGE	-----	120V, 20 Hz; or DTMF
TYPE OF SIGNAL	-----	Audible tone and lamp
POWER REQUIREMENT	-----	To be published
WEIGHT	-----	65 lbs

2359/78W

R.9 (1-28)

Table I-4. Switchboard SB-3082.

STATUS: STD-B; NSN: 5805-00-235-5035

REF: TM 11-5805-471-12

General Information

The SB-3082(V)1/G1 is a 50-termination telephone switchboard that can be mounted in a 1/4-ton truck or in a shelter. The switchboard has no cords: connections are made by push-button switches. The operator can connect any two terminations, perform preemption of any termination in use, and establish a conference for up to six subscribers. The switchboard includes a battery charger to keep the two 12V emergency batteries charged.

Technical Characteristics

TYPE OF OPERATION	- - - - -	Manual; with local or common battery signaling
LINE CAPACITY:	- - - - -	50
CBS/CB/20 Hz Ringdown Line/Trunk	- - - - -	32
1600 Hz Ringdown Trunk	- - - - -	11
TAS Trunk	- - - - -	3
dc Closure Civilian Lines	- - - - -	4
SIGNALING VOLTAGE	- - - - -	120V, 20 Hz
TYPE OF SIGNAL	- - - - -	Audible tone and lamp
POWER REQUIREMENT	- - - - -	105 to 125V, 50, 60, or 400 Hz; or +12V dc and -12V dc (24V dc center tapped) emergency use only
WEIGHT	- - - - -	127 kg (280 lb)

2359/78W

R.9 (1-26)

APPENDIX J

J. TECHNICAL CONTROL REFERENCE DATA

The following technical control reference data are provided to assist in analysis:

- (a) The TA-125 Terminal Box
- (b) The J-1077 Distribution Box
- (c) The AN/TSC-76 Patching Central

Table J-1. Terminal box TA-125.

STATUS: STD-B; NSN: 5805-00-538-0777

REF: TM 11-2138

General Information

The TA-125/GT is a small, lightweight, weatherproof terminal box capable of terminating 12 lines. It is used at terminal and test points and can be used as a main frame for small tactical switchboards.

2359/78W

R.9 (1-30)

Table J-2. Distribution box J-1077.

Distribution Box J-1077A/U. The J-1077A/U is a drop line box which is used to connect field wire pairs into a 26-pair cable. It contains 26 pairs of binding posts and two 26-pair cable receptacles. The binding posts are under the hinged front cover. The two 26-pair receptacles are mounted at the sides. A wire-entry slot on each side permits the cover to be closed after the field wire is connected to the binding posts. Pairs 1 through 26 of one 26-pair receptacle are wired to the corresponding binding posts and to pairs 1 through 26 of the other 26-pair receptacle. The J-1077A/U is used primarily to distribute local telephone circuits within a signal center, and to consolidate circuits into a 26-pair cable when binding posts are not available on a shelter.

2359/78W

R.10 (4-12)

AD-A083 335

BOM CORP MCLEAN VA
REPRESENTATIVE COMMAND POST CONFIGURATIONS, C3 STRUCTURES, AND --ETC(U)
JUL 78 H E REYNOLDS, W E SWEENEY DNAS001-78-C-0077
UNCLASSIFIED BDM/W-78-C-0077-VOL-1 DNA-4352T-3A-VOL-1 NL

3 of 3
AL
KASMP

END
DATE
FILMED
5 80
DTIC

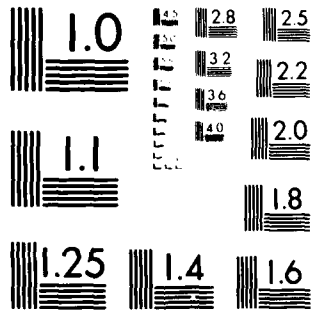

MICROCOPY RESOLUTION TEST CHART
 NATIONAL BUREAU OF STANDARDS-1963-A

Table J-3. Patching central AN/TSC-76.

STATUS: STD-A; NSN: 5895-00-168-1574

REF: TM 11-5805-583-15

General Information

The AN/TSC-76 is an air- or vehicular-transportable communications patching center used to provide an audio technical control facility for use in a division communications system. The AN/TSC-76 provides facilities for patching, testing, and monitoring telephone circuits and voice-frequency teletypewriter circuits. It can handle 572 two-wire circuits. It is used at division level in an area communications system.

MAJOR COMPONENTS - - - - - 1 Electrical Equipment Shelter
S-403/TSC-76 (modified S-250/G)
1 Manual Telephone Switchboard SB-22A/PT
1 Telephone Set TA-312/PT
1 Teletypewriter Set TT-98/FG
1 Telegraph Terminal TH-22/TC

Technical Characteristics

POWER REQUIREMENT - - - - - 115V, 50 to 60 Hz, 3,500W
WEIGHT - - - - - 997 kg (2,200 lb)
VEHICULAR REQUIREMENT - - - - - One 1-1/4 ton truck

2359/78W

R.9 (4-34)

APPENDIX K

K. TELETYPEWRITER REFERENCE DATA

The following teletypewriter reference data are provided to assist in analysis:

- (a) Teletype Sets
- (b) Teletype Centrals

Table K-1. Teletypewriter set AN/PGC-1
(TT-4, TT-335, and TT-537).

STATUS: STD-B; NSN: 5815-00-198-5963 (AN/PGC-1)
 STD-B; NSN: 5815-00-198-4438 (TT-4/TG)
 STD-B; NSN: 5815-00-198-4438 (TT-4A,B,C)
 STD-U; NSN: 5815-00-878-8449 (TT-335/TG)
 STD-A; NSN: 5815-00-926-7378 (TT-537/G)

REF: TM 11-5815-206-12 and TM 11-5815-206-ESC

General Information

The AN/PGC-1 is a lightweight, transportable teletypewriter set which may be used in either a fixed plant or in a tactical teletypewriter station. The TT-4(A,B, or C)/TG is the basic teletypewriter of the AN/PGC-1.

The TT-335/TG is a TT-4()/TG modified to operate on 400 Hz power, and incorporates a heater to maintain the equipment at operating temperatures.

The TT-537/G is a TT-335/TG modified to receive low level (+6V) signals in addition to standard 120- to 130-volt dc signals.

These components cannot supply line current.

Technical Characteristics

METHOD OF TRANSMITTING	- - - - -	Standard keyboard
METHOD OF RECEIVING	- - - - -	Page copy (up to 3-ply paper)
TYPE OF SIGNAL	- - - - -	20 to 60 mA dc neutral; 5-unit code plus start-stop impulses, stop impulse equals start impulse times 1.42.
OPERATION MODES	- - - - -	Duplex or half duplex
SPEED OPTIONS	- - - - -	60, 66, 75, and 100 wpm
POWER REQUIREMENT:		
TT-4()/TG	- - - - -	105 to 125V dc or ac; 50 to 60 Hz ac
TT-335/TG and TT-537/G	- - - - -	108 to 132V, 396 to 404 Hz
WEIGHT	- - - - -	44 kg (97 lb)

2389/78W

R.9 (1-38)

Table K-2. Teletypewriter set AN/GGC-3 and TT-76.

STATUS: STD-B; NSN: 5815-00-503-3309

REF: TM 11-5815-238-12 and TM 11-5815-238-ESC

General Information

The AN/GGC-3 is a lightweight, transportable teletypewriter set that is used in both fixed and tactical teletypewriter stations. It cannot supply line current. The TT-76(A,B, or C)/GGC is the basic teletypewriter of the AN/GGC-3.

Technical Characteristics

METHOD OF TRANSMITTING	Standard keyboard or transmitter-distributor for transmitting a prepunched tape
METHOD OF RECEIVING	Message printed and perforated on 2.22 cm (7/8-in) paper tape
TYPE OF SIGNAL	20 or 60 mA dc neutral or polar receiving, neutral sending; 7.42 start-stop 5-unit code
OPERATION MODES	Duplex or half duplex
SPEED OPTIONS	60, 66, 75, and 100 wpm
POWER REQUIREMENT	115V, 50 to 60 Hz
WEIGHT	44 kg (97 lb)

2359/78W

R.9 (1-40)

Table K-3. Teletypewriter central office AN/TGC-30.

STATUS: STD-A; NSN: 5815-00-156-4365

REF: To be published.

General Information

The AN/TGC-30 teletypewriter central office terminates one duplex or two half-duplex, secure teletypewriter circuits. It also provides for switching 15 voice-frequency teletypewriter lines by means of an SB-22/PT switchboard. Security is provided by TSEC/KW-7's. The AN/TGC-30 is used at division and corps levels.

MAJOR COMPONENTS - - - - -

- 2 Reperforator-Transmitter TT-76/GGC
- 2 Teletypewriter TT-98/FG
- 1 Telephone Switchboard SB-22/PT
- 3 Telegraph Terminal TH-22/TG
- 6 Telegraph-Telephone Signal Converter CV-425/U
- 1 Telephone Set TA-312/PT
- 2 Communications Security Equipment TSEC/KW-7 (not a basic issue item)
- 1 Air Conditioner, 6,000 BTU
- 1 Shelter S-391/TGC-30 (modified S-250/G)

Technical Characteristics

POWER REQUIREMENT - - - - - 115V, 50 to 60 Hz, 2,500W
WEIGHT - - - - - Not available
VEHICULAR REQUIREMENT - - - - - One 1-1/4-ton truck

2359/78W

R.9 (4-20)

Table K-4. Telegraph terminal AN/TSC-58.

STATUS: STD-A; NSN: 5805-00-010-5287

REF: TM 11-5805-574-15

General Information

The AN/TSC-58 is an air- or vehicular-transportable assemblage that serves as a voice-frequency teletypewriter terminal. It contains facilities for three voice-frequency full-duplex, or six voice-frequency half-duplex circuits in either the secure or nonsecure modes. Circuits are secured with the TSEC/KW-7. The AN/TSC-58 has an SB-22/PT which provides 12 lines for switching teletypewriter transmissions from other components in an area communications system or from local subscribers. It is used at division and corps levels.

MAJOR COMPONENTS - - - - - 6 Communications Security Equipment
TSEC/KW-7 (not a basic issue item)
1 Distribution Box J-1077A/U
1 Telephone Set TA-312/PT
6 Reperforator-Transmitter TT-76B/GGC
6 Teletypewriter TT-98B/FG
8 Telegraph Terminal TH-22/TG
1 Manual Switchboard SB-22/PT
2 Air Conditioner, 9,000 BTU
1 Shelter S-348/TSC-58 (modified S-280/G)

Technical Characteristics

POWER REQUIREMENT - - - - - 115V, 50 to 60 Hz, 7,176W
WEIGHT - - - - - 2,423 kg (5,350 lb)
VEHICULAR REQUIREMENT - - - - - One 2-1/2-ton truck

2359/78W

R.9 (4-22)

Table K-5. Telegraph-telephone signal converter CV-425.

STATUS: STD-A; NSN: 5805-00-985-9088

REF: TM 11-5805-356-12

General Information

The CV-425/U converts 20 Hz ringing signals to a higher audio frequency for transmission over circuits that will not pass 20 Hz. It also converts higher audio frequencies back to 20 Hz ringing signals at the receiving CV-425/U.

Technical Characteristics

TYPE OF OPERATION	4-wire duplex or 2-wire half duplex
LINE SIGNALING FREQUENCY:	
Telegraph	1232.5 Hz
Telephone	1600 Hz
LOOP IMPEDANCE	600 ohms
LINE IMPEDANCE	600 ohms
LOOP OUTPUT	90V, 20 Hz
POWER REQUIREMENT	115 or 230V, 50 to 60 Hz, 25W
WEIGHT	4.5 kg (10 lb)

2359/78W

R.9 (2-24)

Table K-6. Telegraph terminal TH-22.

STATUS: STD-A; NSN: 5805-00-907-8300

REF: TM 11-5805-356-12

General Information

The TH-22/TG is a lightweight, frequency-shift keying device. It changes the dc marks and spaces of a teletypewriter to audio mark and space frequencies. The receiving end can break in on the transmitting end during 2-wire operation. This item is replacing the TH-5/TG.

Technical Characteristics

TYPE OF OPERATION	- - - - -	4-wire duplex or 2-wire half duplex
LINE FREQUENCIES:		
Mark	- - - - -	1317.5 Hz
Space	- - - - -	1232.5 Hz
LOOP CURRENT	- - - - -	20 mA
TELETYPEWRITER SPEED	- - - - -	200 wpm (151 baud)
LOOP IMPEDANCE	- - - - -	600 ohms
LINE IMPEDANCE	- - - - -	600 ohms
POWER REQUIREMENT	- - - - -	115 or 230V, 50 to 60 Hz, 20W; or 22 to 30V dc, 24W
WEIGHT	- - - - -	4.5 kg (10 lb)

2359/78W

R.9 (2-26)

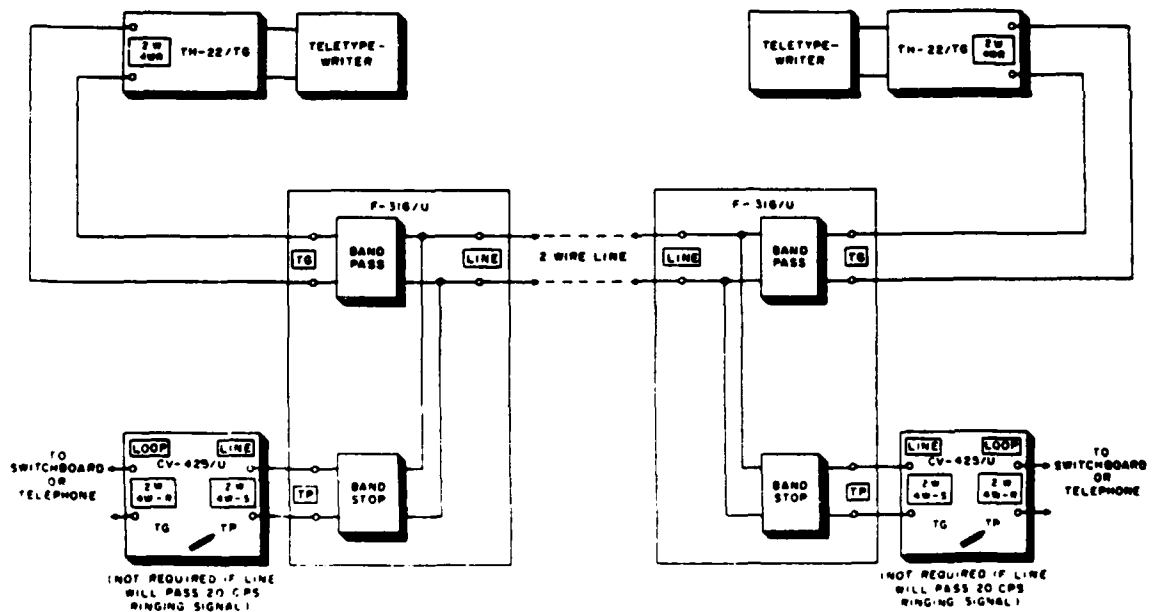
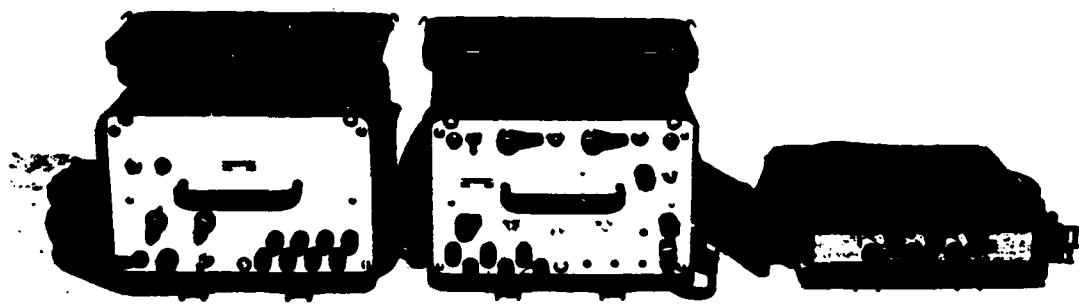

2359/78W

R.21 (9-42)

Figure K-1. Telegraph-telephone AN/TCC-29.

APPENDIX L

L. WIRE AND CABLE REFERENCE DATA

The following wire and cable reference data are provided to assist in analysis:

- (a) Field Wire
- (b) Repeater Coils
- (c) Field Cable
- (d) Distribution Cable
- (e) Carrier Cable
- (f) Unattended Repeaters
- (g) Summary of Wire and Cable Characteristics

Table L-1. General characteristics of field wire WD-1.

9-1. **GENERAL:** Wire is one of the most dependable means of communication. Wire Communications includes the use of field wire, wire laying and recovery equipment, battery-operated and sound-powered telephones, switchboards, teletypewriters, multiplexers and other associated or terminating equipment. The decision to establish wire communications depends on the need for it, the time available to install, use, and the capability to maintain it. The supply of wire on hand, the expected re-supply, and future needs must also be considered. Wire is particularly adaptable to static situations, but can be used in any tactical operation if its use is properly planned.

a. Advantages of Wire Communications.

(1) Wire communications affords person-to-person conversation with break-in operation. Break-in operation refers to the capability of the persons conversing to interrupt one another without waiting until a transmission is completed.

(2) Wire is a more secure means of communication than radio. However, it does not ensure complete security of information transmitted in the clear because it is susceptible to enemy monitoring devices.

b. Disadvantages of Wire Communications.

(1) Installing a wire system is time-consuming.

(2) Wire lines are susceptible to breakage by vehicular traffic and artillery fire.

9-2. **WIRE.** Field wire is used for telephone communication and is characterized by flexible conductors, high tensile strength, good conductivity, and weatherproof insulation. Wire WD-1/TT is the type presently used by infantry units. It weighs 48 pounds per mile and has a tensile strength of 200 pounds maximum (both conductors). Each conductor has 3 steel and 4 copper strands. The insulation is an inner polyethylene cover with an outer nylon jacket. The communication range varies with the terminal equipment used and other factors such as weather, method of installation, condition of wire, and number of splices.

a. Field Wire Splices. Splicing is a method of joining the conductors of field wire lines to maintain electrical continuity. There are two methods of splicing field wire: the standard field wire splice and the field wire splice. A good splice restores broken wire lines and prevents shorts, open circuits, and grounded conductors.

b. Construction of an Expedient Field Wire Splice.

(1) The conductors are first prepared as illustrated in figure 9-1. This preparation results in the splices of the two conductors being staggered to prevent excessive bulk and eliminate the possibility of electrical contact between them. The insulation is left on the ends of the conductors to bind the strands of wire together until after the square knots have been tied. When tying the square knots, as indicated in figure 9-2, the first knot is tied and then the twist is restored in the wire line by wrapping the 2 remaining untied conductors around the 2 conductors already tied. After the twist is restored, the second square knot is tied. Both knots should be tied one after the other so that communication is possible even though the splices have not been completed.

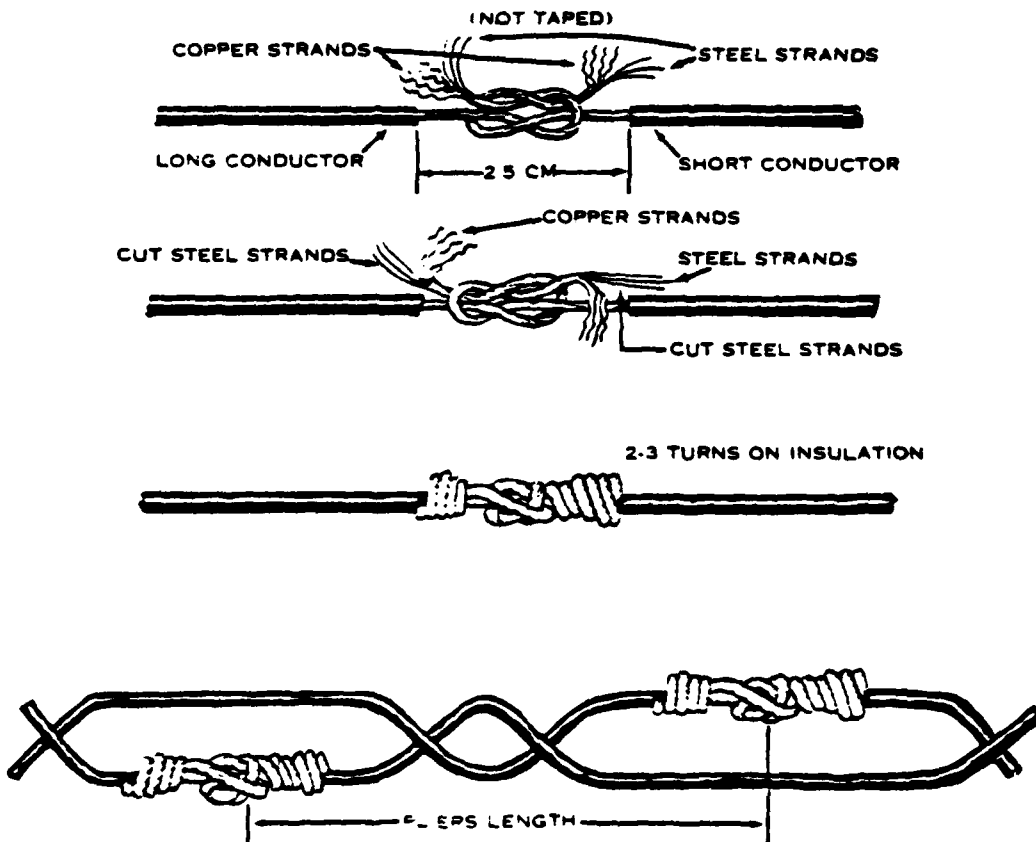

2359/78W

R.21 (9-2)

Figure L-1. WD-1 splicing techniques.

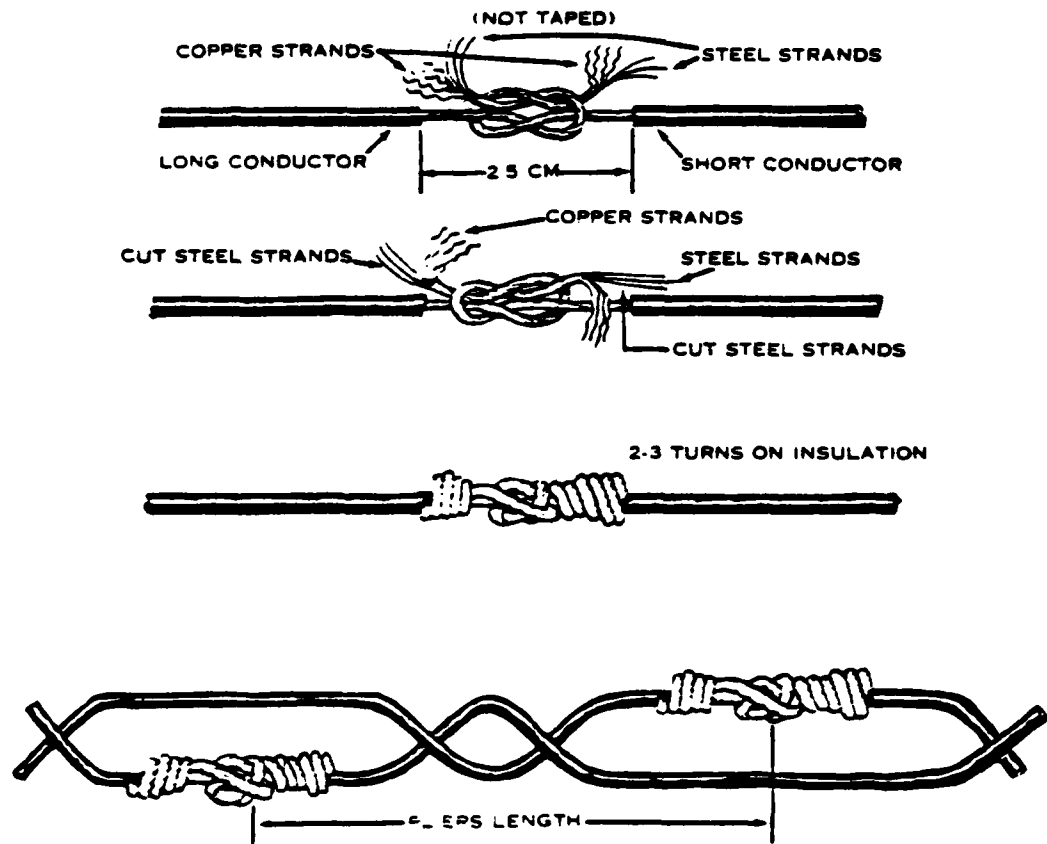

2359/78W

R.21 (9-2)

Figure L-1. WD-1 splicing techniques.

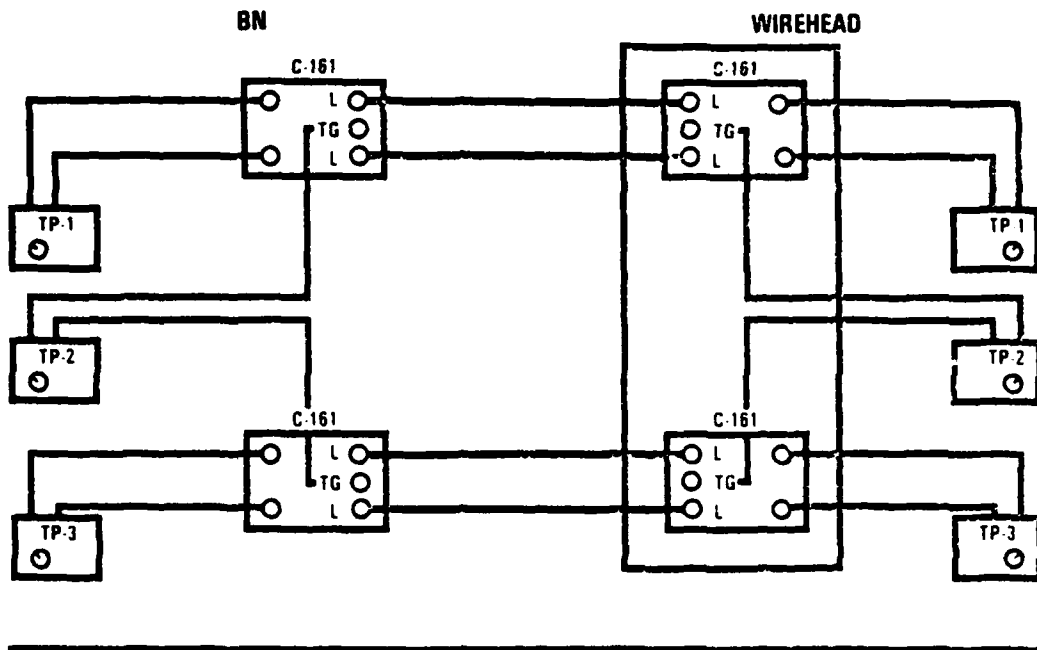

BATTALION WIREHEAD

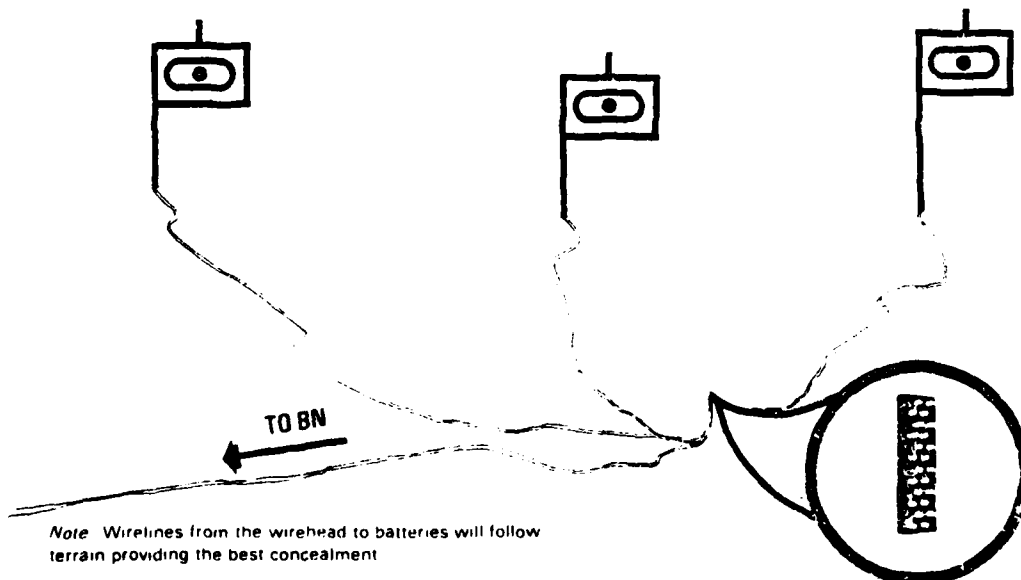

Note Wirelines from the wirehead to batteries will follow terrain providing the best concealment

2359/78W

Figure L-2. Use of repeater coils C-161.

R.23 (22)

1. Type Cable:

WF-16/U Telephone Cable.

2. Federal Stock Number:

6145-910-8847.

3. Pictorial View:



4. Description:

The WF-16/U is a four conductor field wire for interconnecting the Tactical Automatic Switches and its subscribers. It is available in 1 mile lengths and weighs 62 lbs. The conductors are made of copper-cadmium alloy, stranded. There are two pairs of conductors, one pair is color coded and one pair is ridged for touch identification.

2359/78W

R.5 (7-9)

Figure L-3. Field cable WF-16.

1. Type Cable:

CX-4566A/U Telephone Cable Assembly.

2. Federal Stock Number:

5995-985-7569

3. Pictorial View:

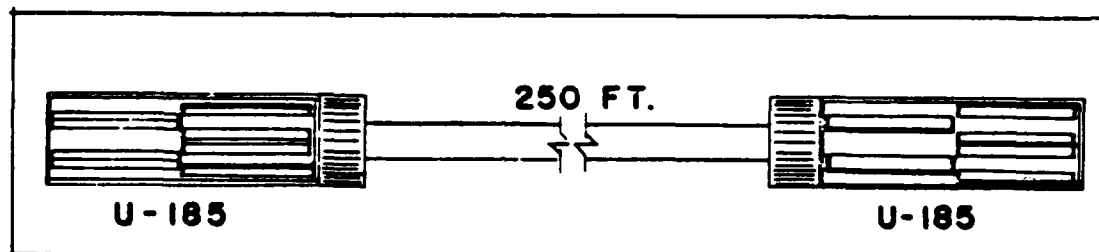

4. Description:

CX-4566A/U (250 ft) is a 26-pair cable used to interconnect the components in an area-type communication system. It uses standard conductors, 6 copper and 1 steel #24 AWG. Each end of the 26 pair cable is terminated in a waterproof 26-pair U-185 connector with a waterproof cover. The CX-4566A/U is also available in 25 foot lengths. It is identical with the CX-4566A/U (250 ft) except for its length. It is used where a shorter span of 26-pair cable is required. The CX-4566A/U (250 ft) on Cable Reel RC-435/U weighs 68 pounds.

2359/78W

R.5 (7-8)

Figure L-4. Distribution cable CX-4566 (26 pair).

1. Type Cable:
CX-4760 A/U Telephone Cable Stub .
2. Federal Stock Number:
5995-889-0803.
3. Pictorial View:

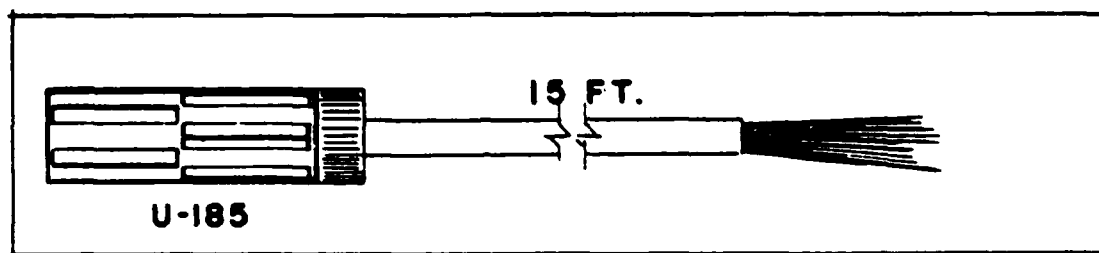

4. Description:

The CX-4760A/U is a 15 foot stub (4.5 meters) of 26-pair cable with universal U-185 connector on one end for mating with CX-4566A/U, and with exposed conductors available at the other end for connection to equipment not provided with cable connectors. The stub weighs 5 pounds.

2359/78W

R.5 (7-12)

Figure L-5. Distribution cable stub CX-4760.

1. Type Cable:

CX-11230/G Coaxial Cable Assembly

2. Federal Stock Number:

5995-133-9126 (1/4 mile)

5995-133-9127 (100 feet)

3. Pictorial View:

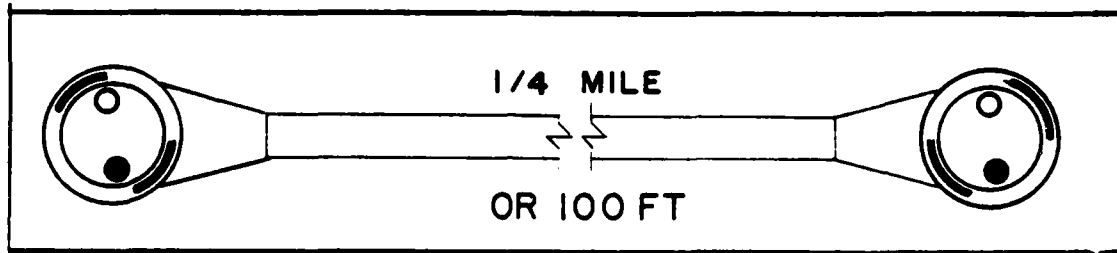

4. Description:

The CX-11230/G is used for transmission of wideband PCM 12, 24 and 48 Channel TDM carrier systems. It is available in 1/4 mile and 100 foot lengths. The CX-11230/G consists of two twisted coaxial tubes jacketed in low-density polyethylene. The tubes are protected by mylar tape and a medium density polyethylene jacket. The two tubes terminate in a universal connector at each end. A copper-clad steel braid strength member is part of the cable assembly. The cable is very rugged for both ground and aerial installations. Cable Assembly CX-11230/G replaces Cable Assembly CX-4245/G.

2359/78W

R.5 (7-17)

Figure L-6. Carrier cable CX-11230.

Table L-2. Unattended repeater TD-206
for PCM cable CX-11230.

STATUS: STD-A; NSN: 5895-00-868-8078

REF: TM 11-5805-367-12

General Information

The TD-206/G is a two-way unattended repeater for PCM cable systems. It is installed at 1.6 km (1 mi) intervals in the PCM transmission cable to restore PCM pulse form and timing.

Technical Characteristics

LINE IMPEDANCE	-----	62 ohms
PULSE RATE	-----	2304 kHz
POWER REQUIREMENT	-----	38 mA dc supplied by TD-204/U or TD-754/G through the cable
WEIGHT	-----	2.04 kg (4.5 lb)

2359/78W

R.9 (3-24)

Table L-3. Summary of wire and cable characteristics.

ITEM	PAIRS	BANDWIDTH	OTHER CHARACTERISTICS
WD-1 FIELD WIRE	1 PHYSICAL	4 KC PER PAIR	VOICE OR DATA UP TO 16 MILES WET AND 22 MILES DRY. RWI REMOTE UP TO 3.2 KM. VARIABLE LENGTH.
WF-16 FIELD CABLE	2 PHYSICAL	50 Kbps PER PAIR	FULL DUPLEX CAPABILITY UP TO 3.2 KILOMETERS. VARIABLE LENGTH.
CX-4566 DISTRIBUTION CABLE	26 PHYSICAL	4 KC PER PAIR	VOICE OR DATA FROM EITHER WD-1 OR WF-16 UP TO 300 METERS (1000 FEET) WHEN CONNECTED TO A MULTICHANNEL SYSTEM AND UP TO 600 METERS WHEN ONLY USED LOCALLY. 250 FEET FIXED LENGTHS.
CX-4760 DISTRIBUTION CABLE	26 PHYSICAL	4 KC PER PAIR	USED AS AN EXTENSION OF CX-4566 WHERE PHYSICAL PAIRS ARE REQUIRED DUE TO THE LACK OF A 26-PAIR CONNECTOR (AS WITH THE CARRIER VEHICLE OR SB-3614 ASSEMBLAGE). 15 FEET FIXED LENGTH
CX-11230 CARRIER CABLE	2 COAXIAL TUBES	576 Kbps 1152 Kbps 2304 Kbps	USED FOR TRANSMISSION OF WIDEBAND PCM 12, 24 and 48 CHANNEL TDM CARRIER SYSTEMS. 1/4 MILE AND 100 FEET FIXED LENGTHS.

2359/78W

1. Type Cable:
CX-4694A/U Power Cable Assembly.
2. Federal/Stock Number:
5995-889-1228.
3. Pictorial View:

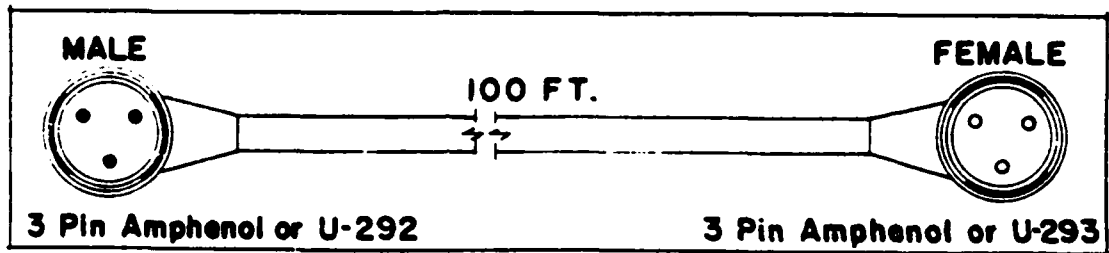

4. Description:











The CX-4694A/U is a flat, three-conductor power cable used to connect the output of power generating equipment to a shelter. It has a waterproof, three-terminal male connector with cover at one end and a waterproof, female connector with cover at the other end. Two CX-4694A/U's cannot be interconnected, except through Connector Adapter UG-1312/U. Conductors in the CX-4694A/U are two 6-gauge (power) and one 12-gauge (ground). The CX-4694 is the same as the CX-4694A/U except that the conductors are two 8-gauge (power) and one 12-gauge (ground).

2389/78W

R.5 (7-11)

Figure L-7. Power cable assembly.

APPENDIX M

ITEM	SILHOUETTE	TYPE	DIMENSIONS			GROSS WEIGHT
			L"	W"	H"	
155mm LAUNCHER		M109	261	124	120	52,461
8" LAUNCHER		M65	311	141	137	90,000
TRUCK VAN SHOP 2-1/2 TON		M35	276	88	109	18,350
TRUCK CARGO 1-1/4 TON		M715	210	85	95	11,000*
TRUCK CARGO 1-1/4 TON ROUGH TERRAIN (GOAT)		M561	227	84	91	10,200*
TRUCK UTILITY 1/4 TON		M151	133	64	85	3,600
TRAILER 1/4 TON		M416	108	46	42	1,070*
TRAILER 3/4 TON		M101	147	74	83	3,200*
TRAILER 1-1/2 TON		M104	164	83	98	4,300*
CARRIER COMMAND AND RECONNAISSANCE ARMORED		M114	196	92	81	14,740
CARRIER COMMAND POST		M577	191	106	101	24,260

* BASED ON NET WEIGHT PLUS SHELTER
OR GENERATOR WEIGHTS

2359/78W

Figure M-1. Vehicle reference data.

Table M-1. Metric conversion formulas.

METRIC CONVERSION FORMULAS

1. Abbreviations:

gram - g	gallon - gal
ounce - oz	centimeter - cm
kilogram - kg	inch - in
pound - lb	meter - m
metric ton - MT	feet - ft
ton - t	yard - yd
liter - l	kilometer - km
	mile - mi
	nautical mile - naut mi

2 Conversion formulas:

g to oz	$g \times .0353 = oz$
oz to g	$oz \times 28.349 = g$
kg to lb	$kg \times 2.2 = lb$
lb to kg	$lb \times .454 = kg$
MT to t	$MT \times 1.1023 = t$
t to MT	$t \times .907 = MT$
l to gal	$l \times .2642 = gal$
gal to l	$gal \times 3.785 = l$
cm to in	$cm \times .3939 = in$
in to cm	$in \times 2.54 = cm$
m to ft	$m \times 3.281 = ft$
ft to m	$ft \times .3048 = m$
m to yd	$m \times .9144 = yd$
yd to m	$yd \times 1.0936 = m$
km to mi	$km \times .6214 = mi$
mi to km	$mi \times 1.6093 = km$
km to naut mi	$km \times .540 = naut\ mi$
naut mi to km	$naut\ mi \times 1.852 = km$
mi to naut mi	$mi \times .8689 = naut\ mi$
naut mi to mi	$naut\ mi \times 1.1508 = mi$

Note: k = 1000, therefore, 1 km = 1000 m
1 kg = 1000 g
1 kl = 1000 l

R.7 (App C)

APPENDIX N

Table N-1. Power unit reference data.

Item	TrL	Type	Rating	Diminsions			Weight Lbs.	No. Gen.
				L"	W"	H"		
PU-1	3/4 T	PU-625	3 KW	35	24	25	285	2
PU-2	3/4 T	PU-620	5 KW	40	30	25	488	2
PU-3	1/4 T	PU-630	1.5 KW	28	21	19	125	2
PU-4	3/4 T	PU-628	3 KW	35	24	25	285	2
PU-5	1 1/2 T	PU-619	10 KW	57	30	28	850	2
PU-6	3/4 T	PU-617	3 KW	35	24	25	285	2

APPENDIX 0

Table 0-1. Radio frequency reference data.

Frequency	3 kHz	30 kHz	300 kHz	3 MHz	30 MHz	300 MHz	3 GHz	30 GHz	300 GHz
Wavelength		30km	3km	300m	30m	3m	30cm	3cm	.3cm
Band Designation	VLF	LF	MF	HF	VHF	UHF	SHF	EHF	
Band Number	4	5	6	7	8	9	10	11	

Legend: kHz - Kilohertz
 MHz - Megahertz
 GHz - Gigahertz
 km - Kilometers
 m - Meters
 cm - Centimeters

VLF - Very low frequency
 LF - Low frequency
 MF - Medium frequency
 HF - High frequency
 VHF - Very high frequency
 UHF - Ultra high frequency
 SHF - Super high frequency
 EHF - Extremely high frequency

2359/78W

R.7 (A-2)

APPENDIX Q

Table Q-1. Joint electronics type designation system.

- | | |
|--|------------------------------|
| 1. A COMPLETE SET | AN/GRC-106 A (X, Y OR Z) (V) |
| Indicates "JETDS" system | |
| Installation | |
| Type of Equipment | |
| Purpose | |
| Model Number | |
| Modification Letter | |
| Changes in Voltage, Phase of Frequency | |
| Variable Grouping | |
| 2. SAMPLE OF A COMPONENT USED WITH A PARTICULAR SET: | RT-662/GRC-106A |
| 3. SAMPLE OF A COMPONENT NOT USED WITH A PARTICULAR SET: | S-69/GRC |
| 4. TABLE OF SET OR EQUIPMENT INDICATOR LETTERS: | |

INSTALLATION	TYPE	PURPOSE
A - Piloted aircraft	A - Invisible light, heat radiation	B - Bombing
B - Underwater mobile, submarine	C - Carrier	C - Communications
D - Pilotless carrier	D - Radiac	D - Direction finder reconnaissance and/or surveillance
F - Fixed ground	G - Telegraph or teletype	E - Ejection and/or release
G - General ground use	I - Interphone and public address	G - Fire control or searchlight directing
K - Amphibious	J - Electromechanical or inertial wire covered	H - Recording and/or reproducing
M - Mobile (ground)	K - Telemetering	K - Computing
P - Portable	L - Countermeasures	M - Maintenance and/or test assemblies
S - Water	M - Meteorological	N - Navigational aids
T - Transportable (ground)	N - Sound in air	Q - Special or combination of purposes
U - General utility	P - Radar	R - Receiving, passive detecting
V - Vehicular (ground)	Q - Sonar and underwater sound	S - Detecting and/or range and bearing, search
W - Water surface and underwater comb.	R - Radio	T - Transmitting
Z - Piloted-pilotless airborne vehicle combination	S - Special or combinations of types	W - Automatic flight or remote control
	T - Telephone (wire)	X - Identification and recognition
	V - Visual and visible light	
	W - Armament	
	X - Facsimile or television	
	Y - Data Processing	

2359/78W

R.26 (P-1)

APPENDIX R

R. LIST OF REFERENCES

- R.1 "Assessment and Models of Mobile Command Post Survivability in a Tactical Nuclear Environment," The BDM Corporation. (Unpublished)
- R.2 "Combat Communications within the Division," FM 11-50, Headquarters Department of the Army, Washington, D.C., 31 March 1977.
- R.3 "Employment Concept for the SB-3614/TT Unit Level Switchboard (Transition Period 1976-1986)," United States Army Signal School, Fort Gordon, Georgia, November 1976.
- R.4 "Communications in Approved Infantry and Infantry (Mechanized) Divisions," Fm 11-50, Headquarters Department of the Army, Washington, D.C., 16 October 1972.
- R.5 "The Army Tactical Communications System - Description of Army Tactical Communications Assemblages and Equipment," Project Manager, ATACS, Fort Monmouth, New Jersey, 1 January 1974.
- R.6 "AFCS Mobile/Transportable Communications and Support Equipment Directory," AFCSP 100-98, Department of the Air Force, Headquarters Air Force Communications Service, Richards-Gebar AFB, Missouri 64030, 15 October 1972 with changes 1 and 2 dated 23 August 1974.
- R.7 "Radio and RADAR Reference Data," FM 24-24, Headquarters Department of the Army, Washington, D.C., 20 May 1977.
- R.8 "Radio and RADAR Communications Equipment," ST-11-154-2, U.S. Army Southeastern Signal School, Fort Gordon, Georgia, 1 February 1974.
- R.9 "Wire and Multichannel Reference Data," FM 24-25, Headquarters Department of the Army, Washington, D.C., 30 June 1977.
- R.10 "Wire and Multichannel Communications Equipment," ST-11-154-3, U.S. Army Southeastern Signal School, Fort Gordon, Georgia, 1 October 1973.
- R.11 "Modification Table of Organization and Equipment (MTOE) Signal Battalion, Aim Division," MTOE 11035HE101 Category Code 2, Headquarters Department of the Army, Washington, D.C., 21 December 1977.
- R.12 "Communications - Electronics Management System," FM 24-22, Headquarters Department of the Army, Washington, D.C., 30 June 1977.

- R.13 "Brigade and Division Operations," FM 71-100, Headquarters Department of the Army, Combined Arms Center and Fort Leavenworth, Fort Leavenworth, Kansas 66027, 29 April 1977.
- R.14 "Command and Control of Combat Operations," FM 101-5, Headquarters Department of the Army, Combined Arms Center and Fort Leavenworth, Fort Leavenworth, Kansas 66027, 1 July 1977.
- R.15 "Control and Coordination of Division Operations," TC 101-5, Headquarters Department of the Army, Washington, D.C., April 1976.
- R.16 "Field Artillery Tactics and Operations," FM 6-20, Headquarters Department of the Army, Washington, D.C., 30 August 1973.
- R.17 "Field Artillery Communications," FM 6-10, Headquarters Department of the Army, Washington, D.C., March 1975.
- R.18 "Field Artillery Communications," TC 6-10-1, U.S. Army Field Artillery School, Fort Sill, Oklahoma 73503, February 1977.
- R.19 "Field Artillery Reference Data," ST 6-1-1, U.S. Army Field Artillery School, Fort Sill, Oklahoma, December 1976.
- R.20 "Tactical Operations Handbook," ST 7-153 FY74, U.S. Army Infantry School, Fort Benning, Georgia, 27 February 1975.
- R.21 "Infantry Communications Data," ST 7-180 FY73, U.S. Army Infantry School, Fort Benning, Georgia, 13 October 1972.
- R.22 "Artillery Handbook," ST 7-163 FY 72, U.S. Army Infantry School, Fort Benning, Georgia, 23 August 1971.
- R.23 "The Field Artillery Cannon Battery," FM 6-50, Headquarters Department of the Army, Washington, D.C., 1 July 1976.
- R.24 "ADA Signal Operations Battalions," FM 11-44 (Test), Headquarters Department of the Army, Washington, D.C., 11 March 1977.
- R.25 "Tactical Multichannel Digital Communications," Information Sheet, U.S. Army Signal School, Fort Gordon, Georgia, 6 October 1976.
- R.26 "Combat Communications," FM 24-1, Headquarters Department of the Army, Washington, D.C., 30 September 1976.
- R.27 "Electronic Warfare Tactics of Defense," FM 32-30, U.S. Army Signal School, Fort Gordon, Georgia 30905, 31 August 1976.

- R.28 "Reference Book the Division," RB 61-1, U.S. Army Command and General Staff College, Fort Leavenworth, Kansas, 1 April 1971.
- R.29 "Combat Communications Within the Corps," FM 11-92, Headquarters Department of the Army, Washington, D.C., Advance Copy.
- R.30 "DOD Family Mobile Electric Power Generating Sources," Brochure, Project Manager of Mobile Electric Power, 1 March 1978.
- R.31 "Handbook of Army Materiel," ST 9-159, U.S. Army Ordnance Center and School, Aberdeen Proving Ground, Maryland, May 1972.

APPENDIX S
COMMUNICATION EQUIPMENT INDEX

<u>Item</u>	<u>Page</u>
Air-to-ground radio	161, 162
AN/GGC-3	195
AN/GRA-6	159, 160, 170, 171
AN/GRA-39	166, 168, 169
AN/GRC-103	139, 140, 144
AN/GRC-106	159, 160
AN/GRC-122	159
AN/GRC-142	159
AN/GRC-163	152, 153, 154
AN/GSA-7	157, 164, 165
AN/MRC-108	161, 162
AN/PGC-1	194
AN/TCC-29	200
AN/TCC-65	150, 151
AN/TCC-70	152, 153, 154
AN/TGC-30	196
AN/TRC-113	139, 148, 149
AN/TRC-145	138, 139, 149
AN/TSC-58	197
AN/TSC-76	192
AN/TTC-35	187
AN/VRC-12	156, 157
AN/VRC-46	156, 157, 165, 169, 171
AN/VRC-47	156, 157
AN/VRC-49	156, 157
AS-1852/GRC-103	145, 146, 147
BI- directional antenna	164, 174, 176, 177
C-161	204

<u>Item</u>	<u>Page</u>
C-433 Remote set	170, 171
C-434 Local set	170, 171
C-2328 Remote set	165, 168, 169
C-2329 Local Set	165, 168, 169
CV-425	196, 198, 200
CV-1548	138, 140, 144, 150
CX-4566	144, 150, 191, 192, 206, 210
CX-4760	207
CX-11230	143, 150, 208, 209, 210
J-1077	191, 197
Long Wire Antennas	174, 175, 176, 177
Multichannel Radio Systems	138, 148, 150, 152
Patching Central	192
Radio Wire Integration	164, 165, 166
Radio Teletype	159, 160
RC-292 Antenna	158
Repeater Coil C-161	204
RT-524	156, 157, 165, 169, 171
SB-22	165, 166, 185, 192, 196, 197
SB-993	184
SB-3082	187
SB-3614	181, 186

<u>Item</u>	<u>Page</u>
TA-125	190
TA-312	175
TA-838	181
TD-206	143, 208, 209
TD-660	138, 142, 144, 150
TD-754	139, 143, 144, 148
Terminal Box TA-125	190
TH-22	154, 192, 196, 197, 199, 200
TT-4	159, 194
TT-76	159, 195, 196, 197
TT-98	159, 192, 196, 197
Unattended Repeater TD-206	143, 208, 209
Uni-directional Antennas	174, 175, 177
WD-1 Field Wire	154, 164, 165, 166
	168, 169, 170, 171, 175, 176
	177, 180, 190, 191, 199
	200, 202, 203, 204, 210
WF-16 Field Cable	181, 186, 205
26 Pair Cable	144, 150, 191, 192, 206, 210
26 Pair Cable Stub	207

DISTRIBUTION LIST

DEPARTMENT OF DEFENSE

AFSOUTH

ATTN: U.S. Documents Officer

Armed Forces Staff College

ATTN: Reference & Technical Services Branch
ATTN: Dept. of Command Control & Comm.

Assistant Secretary of Defense

Comm., Cmd., Cont. & Intell
ATTN: Strat. & Theater C&C System
ATTN: Assistant for NATO C3
ATTN: Surveillance & Warning Systems

Assistant Secretary of Defense

Program Analysis & Evaluation
ATTN: General Purpose Programs

Assistant to the Secretary of Defense

Atomic Energy

ATTN: Executive Assistant
ATTN: B. Adams

Command & Control Technical Center

ATTN: C-610
ATTN: C-300
ATTN: C-650
ATTN: C-330

Commander-in-Chief

U.S. European Command

ATTN: J-5NPG
ATTN: J-LW
ATTN: J-6
ATTN: ECJ6-OP
ATTN: J-2
ATTN: ECJ-6-OJ
ATTN: J-3

Commander-in-Chief, Pacific

ATTN: J-6
ATTN: J-2
ATTN: J-54
ATTN: J-3

Defense Advanced Rsch. Proj. Agency

ATTN: T10

Defense Communications Agency

ATTN: Code 510
ATTN: Code 205
ATTN: Code 530
ATTN: Code 410
ATTN: Code 1018
ATTN: Code 520

Defense Communications Engineer Center

ATTN: Code R720
ATTN: Code R123
ATTN: Code R400

Defense Technical Information Center

12 cy ATTN: DD

DEPARTMENT OF DEFENSE (Continued)

Defense Intelligence Agency

ATTN: DT-4B
ATTN: RDS-3A
6 cy ATTN: DT-1B

Defense Nuclear Agency

ATTN: DDST
ATTN: STSP
ATTN: OASO
ATTN: STNA
ATTN: STRA
ATTN: STVL
ATTN: VLIS
ATTN: STSS
4 cy ATTN: TITL

Field Command

Defense Nuclear Agency

ATTN: FCP-FCPRK
ATTN: FCPR

Field Command

Defense Nuclear Agency

Livermore Division
ATTN: FCPRL

Interservice Nuclear Weapons School

ATTN: TTV

Joint Chiefs of Staff

ATTN: J-3
ATTN: J-3, WWMCCS Evaluation Office
ATTN: J-3, Nuclear Contingency Branch
ATTN: J-5, Nuclear Division
ATTN: J-3, WWMCCS Council Support Office
ATTN: J-3, NMCC
ATTN: SAGA

Joint Strat. Tgt. Planning Staff

ATTN: JPST
ATTN: JLTW-2
ATTN: NRI-STINFO Library
ATTN: JSAS
2 cy ATTN: JL

Joint Tactical Communications Ofc.

ATTN: TT-E-SS

National Communications System

ATTN: NCS-TS

National Security Agency

ATTN: TDL
ATTN: R-52, O. Van Gunten

Director

Net Assessment

ATTN: Military Assistants

U.S. Forces, Korea

ATTN: CJ-P-G
ATTN: DJ-AM-SM

DEPARTMENT OF DEFENSE (Continued)

U.S. National Military Representative
SHAPE

ATTN: U.S. Documents Officer

Undersecretary of Defense for Rsch. & Engrg.

ATTN: Tactical Warfare Programs
ATTN: Strategic & Space Systems (OS)
ATTN: Research & Adv. Tech.

WWMCCS System Engineering Org.

ATTN: WWMCCS/SEE

DEPARTMENT OF THE ARMY

Asst. Chief of Staff for Intelligence

Department of the Army
ATTN: DAMI-FI

Deputy Chief of Staff for Ops. & Plans

Department of the Army

ATTN: DAMO-ZD
ATTN: DAMO-ODW
ATTN: DAMO-SSP
ATTN: DAMO-RQC

Deputy Chief of Staff for Rsch., Dev. & Acq.

Department of the Army

ATTN: DAMA-CSS-N
ATTN: Advisor for RDA Analysis (M. Gale)

Harry Diamond Laboratories

Department of the Army

ATTN: DELHD-N-CO
ATTN: DELHD-N-P
ATTN: DELHD-N-RBA
ATTN: DELHD-N-RBH
ATTN: DELHD-I-TL

2 cy ATTN: DELHD-N-EM

Multi Service Communications Systems

Department of the Army

ATTN: DRCPM-MSCS-APB, M. Francis

U.S. Army Ballistic Research Labs.

ATTN: DRDAR-VL
ATTN: TBL
ATTN: CAL

U.S. Army Comb. Arms Combat Dev. Acty.

ATTN: ATCA-CA
ATTN: ATCA-CO
ATTN: ATCA-CFT

U.S. Army Comd. & General Staff College

ATTN: ATSW-TA-D

U.S. Army Communications Sys. Agency

ATTN: CCM-AD-LB

U.S. Army Concepts Analysis Agency

ATTN: Code 605/606

U.S. Army Electronics Rsch. & Dev. Command

ATTN: DRCPM-TDS-SD
ATTN: DRCPM-ATC

U.S. Army Materiel Sys. Analysis Activity

ATTN: DRXSY-DS
ATTN: DRXS'-S

DEPARTMENT OF THE ARMY (Continued)

Commander-in-Chief

U.S. Army Europe and Seventh Army

ATTN: DCSOPS-AEAGC-DSW
ATTN: DCSOPS-AEAGB
ATTN: DCSOPS-AEAGD-MM
ATTN: DCSOPS-AEAGC-O
ATTN: ODCSE-E AEAGE

U.S. Army Missile R&D Command

ATTN: DRSMI-YDR

U.S. Army Nuclear & Chemical Agency

ATTN: Library for MONA-WED
ATTN: Library for MONA-SAL
ATTN: Library

U.S. Army Satellite Comm. Agency

ATTN: TACSAT Office
ATTN: DRCPM-SC-11

U.S. Army TRADOC Systems Analysis Activity

ATTN: ATAA-TAC

U.S. Army Training and Doctrine Command

ATTN: ATORI-OP-SD
ATTN: Technical Library

U.S. Army War College

ATTN: Library

V Corps

Department of the Army

ATTN: AETVGC
ATTN: AETVGB
ATTN: AETVCE

VII Corps

Department of the Army

ATTN: AETSGB-C
ATTN: AETSCE
ATTN: AETSGC

DEPARTMENT OF THE NAVY

Command & Control Programs

Department of the Navy

ATTN: OP 941

Naval Ocean Systems Center

ATTN: Research Library

Naval Surface Weapons Center

ATTN: Code F31

Office of the Chief of Naval Operations

ATTN: OP 604 E/F
ATTN: OP 96
ATTN: OP 94

Commander-in-Chief

U.S. Atlantic Fleet

Department of the Navy

ATTN: Code J54
ATTN: Code J-611A

Commander-in-Chief

U.S. Naval Forces, Europe

ATTN: N3262, Nuclear Surety Officer

DEPARTMENT OF THE AIR FORCE

Air Force Weapons Laboratory, AFSC

ATTN: SUL
ATTN: DYC

Assistant Chief of Staff
Intelligence
Department of the Air Force
ATTN: INAK

Assistant Chief of Staff
Studies & Analyses
Department of the Air Force
ATTN: AF/SASC
ATTN: AF/SAGF

Deputy Chief of Staff
Operations Plans and Readiness
Department of the Air Force
ATTN: AFXOXM
ATTN: AFXOK

Deputy Chief of Staff
Research, Development, & Acq.
Department of the Air Force
ATTN: AFRDQSM

Electronic Systems Division
Department of the Air Force
ATTN: XRC

Foreign Technology Division
Air Force Systems Command
ATTN: NIIS Library

Headquarters Space Division
Air Force Systems Command
ATTN: SKA

Headquarters Space Division
Air Force Systems Command
ATTN: YCPC

Strategic Air Command
Department of the Air Force
ATTN: NRT
ATTN: XPFS
ATTN: DCXT

Tactical Air Command
Department of the Air Force
ATTN: DRA

Commander-in-Chief
U.S. Air Forces in Europe
ATTN: XPXX
ATTN: DOC

OTHER GOVERNMENT AGENCY

Central Intelligence Agency
ATTN: OSR/SEC
ATTN: OSI/LSD, R. Hart

DEPARTMENT OF DEFENSE CONTRACTORS

BDM Corp.
ATTN: W. Sweeney
ATTN: H. Reynolds
ATTN: Corporate Library

66th MI Group
ATTN: RDA

Computer Sciences Corp.
ATTN: H. Blank
ATTN: Library

ESL, Inc.
ATTN: Library
ATTN: J. Marshall

General Electric Company-TEMPO
ATTN: DASIAIC

General Electric Company-TEMPO
ATTN: DASIAIC

GTE Sylvania, Inc.
ATTN: M. Cross

Institute for Defense Analyses
ATTN: Classified Library
ATTN: D. Signori

Kaman Sciences Corp.
ATTN: W. Long

R&D Associates
ATTN: R. Latter
ATTN: R. Po11
ATTN: R. Schaefer
ATTN: Technical Information Center
ATTN: C. MacDonald

R&D Associates
ATTN: A. Cicolani
ATTN: L. Delaney

RCA Corp.
ATTN: E. Van Keuren

SRI International
ATTN: C. Shoens
ATTN: W. Jaye

TRW Defense & Space Sys. Group
ATTN: R. Webb

TRW Defense & Space Sys. Group
ATTN: J. Dyche