

NOSC

12
P.S.

LEVEL

NOSC TR 483

NOSC TR 483

Technical Report 483

HYDRAULIC COMPONENT ACOUSTIC COMPATIBILITY STUDY

MS Shimamoto

October 1979

Final Report: 1972 — 1975

DDC
REFINANCE
FEB 20 1980
REGISTRY
E

AD A 080 859

DDC FILE COPY

Approved for public release; distribution unlimited

NAVAL OCEAN SYSTEMS CENTER
SAN DIEGO, CALIFORNIA 92152

80 2 19 081

**Best
Available
Copy**



NAVAL OCEAN SYSTEMS CENTER, SAN DIEGO, CA 92152

AN ACTIVITY OF THE NAVAL MATERIAL COMMAND

SL GUILLE, CAPT, USN

Commander

HL BLOOD

Technical Director

ADMINISTRATIVE INFORMATION

The work reported here was conducted under the NAVORD 6.2 Deep Recovery System (DRS) program, task number 00000-3-65025. Testing was performed during the period 1972-1975.

Released by
JK Katayama, Head
Ocean Systems Division

Under Authority of
JD Hightower, Head
Environmental Sciences Department

UNCLASSIFIED

SECURITY CLASSIFICATION OF THIS PAGE (When Data Entered)

REPORT DOCUMENTATION PAGE		READ INSTRUCTIONS BEFORE COMPLETING FORM
1. REPORT NUMBER NOSC Technical Report 483 (TR 483)	2. GOVT ACCESSION NO.	3. RECIPIENT'S CATALOG NUMBER
6. TITLE (and Subtitle) HYDRAULIC COMPONENT ACOUSTIC COMPATIBILITY STUDY.	5. TYPE OF REPORT & PERIOD COVERED Final 1972-1975	
	6. PERFORMING ORG. REPORT NUMBER	
7. AUTHOR(s) MS SHIMAMOTO	8. CONTRACT OR GRANT NUMBER(s) NOSC/TR-483	
9. PERFORMING ORGANIZATION NAME AND ADDRESS Naval Ocean Systems Center, Hawaii Laboratory PO Box 997 Kailua, Hawaii 96734	10. PROGRAM ELEMENT, PROJECT, TASK AREA & WORK UNIT NUMBERS NAVORD 6.2 DRS Task Number 00000-3-65025	
11. CONTROLLING OFFICE NAME AND ADDRESS 12101	12. REPORT DATE Oct 1979	
	13. NUMBER OF PAGES 99	
14. MONITORING AGENCY NAME & ADDRESS (if different from Controlling Office)	15. SECURITY CLASS. (of this report) Unclassified	
	15a. DECLASSIFICATION/DOWNGRADING SCHEDULE	
16. DISTRIBUTION STATEMENT (of this Report) Approved for public release; distribution unlimited. Final rept, 1972-1975		
17. DISTRIBUTION STATEMENT (of the abstract entered in Block 20, if different from Report)		
18. SUPPLEMENTARY NOTES		
19. KEY WORDS (Continue on reverse side if necessary and identify by block number) Acoustic Pumps Compatibility Relief valves Hydraulic Servo valves Motors Noise		
20. ABSTRACT (Continue on reverse side if necessary and identify by block number) The Remote Unmanned Work System (RUWS) is a cable-tethered, unmanned work vehicle capable of performing deep ocean search, inspection and work tasks to depths of 20,000 feet. The vehicle and primary cable termination are open frame structures, thus, hydraulic components are located directly in seawater. Since the submersibles generally require simultaneous use of their propulsive capability and acoustic sensors such as sonar, the acoustic noise of the equipment must be low so that performance of the acoustic sensors is not degraded. This document reports the investigation of acoustic noise outputs of off-the-shelf hydraulic components for use aboard RUWS.		

DD FORM 1 JAN 73 1473

EDITION OF 1 NOV 65 IS OBSOLETE
S/N 0102-LF-014-6601

UNCLASSIFIED

SECURITY CLASSIFICATION OF THIS PAGE (When Data Entered)

393159

MIT

CONTENTS

INTRODUCTION . . .	page 3
BACKGROUND . . .	3
SYSTEM OPERATING REQUIREMENTS . . .	5
ACOUSTIC COMPATIBILITY CRITERIA . . .	7
COMPONENT SELECTION . . .	8
COMPONENT EVALUATION . . .	9
Test Facilities . . .	9
Sound Measurement Equipment . . .	11
COMPONENT TESTS AND RESULTS . . .	15
Relief Valves . . .	15
Motors . . .	19
Pumps . . .	21
Servo Valves . . .	23
COMPONENTS SELECTED FOR USE ON RUWS . . .	24
CONCLUSIONS . . .	27
REFERENCES . . .	28
APPENDIX A: TEST DATA OF FIRST TEST SERIES . . .	29
APPENDIX B: TEST DATA OF SECOND TEST SERIES . . .	75
APPENDIX C: TEST DATA OF THIRD TEST SERIES . . .	89
APPENDIX D: NOSC ROLAMITE VALVE DESIGN . . .	97

Accession For	
NTIS	GRA&I
DDC TAB	<input checked="" type="checkbox"/>
Unannounced	
Justification	
By _____	
Distribution/	
Availability Codes	
Dist	Avail and/or special
Pi	

ILLUSTRATIONS

1. The Remote Unmanned Work System (RUWS) . . . page 4
2. The RUWS vehicle . . . 6
3. RUWS acoustic frequency spectrum . . . 7
4. RUWS simplified hydraulic schematic . . . 8
5. Ku Tree Reservoir test layout . . . 10
6. Doughboy swimming pool test layout . . . 10
7. Acoustic tests on Moog 74 servo valve comparing swimming pool result with Ku Tree Reservoir result . . . 11
8. NOSC saltwater test pool layout . . . 14
9. Hydrophone-analyzer simplified schematic . . . 14
10. Test schematic: relief valves . . . 16
11. Rolamite valve test arrangement . . . 18
12. Test schematic: motors . . . 19
13. Disk data (rpm vs torque) . . . 20
14. Disk data (rpm vs hp) . . . 20
15. Test schematic: pumps . . . 22
16. Test schematic: servo valves (initial configuration) . . . 23
17. Test schematic: servo valve/motor (final configuration) . . . 24
18. Electrohydraulic acoustic spectrum for RUWS . . . 26
- D-1. NOSC Rolamite valve . . . 97
- D-2. NOSC Rolamite valve parts . . . 98

TABLE

1. Index of components and test sites . . . 12

INTRODUCTION

Deep ocean submersibles often employ an open frame construction which necessitates locating hydraulic components directly in seawater. The noise produced by the hydraulic components is therefore directly transmitted to the water. The submersibles generally require simultaneous use of their propulsive capability and acoustic sensing in carrying out their missions. Remote Unmanned Work System (RUWS) operations, for example, require that a variety of variable-speed mechanical functions be performed during the mission, thrusters will be in continuous operation on both the vehicle and primary cable termination (PCT). Since all of the sonar systems will be operating during the same period, the acoustic noise of the RUWS equipment must be sufficiently low that the performance of the acoustic sensors is not degraded.

An investigation was performed under the Deep Recovery Systems Program during 1972-1975 to evaluate the acoustic noise outputs of off-the-shelf hydraulic components. For the purposes of this test series the acoustic compatibility requirements used were those for the RUWS. The objective was to test available components and select those with acceptable acoustic outputs for use in the RUWS hydraulic system. The components were evaluated under conditions that would be seen in the RUWS system, i.e., a 1000-psig system with a pressure compensated reservoir. Four types of components were acoustically tested and compared: motors, pumps, relief valves, and servo valves.

Tests were run with atmospheric return line pressure and elevated return line pressure to simulate the effect of increased ambient pressure on the noise output of the components when they are compensated to the higher ambient pressures at depth. This was done by increasing the return line pressure while maintaining a 1000-psi differential pressure. Hydraulic noise output may be significantly reduced by back-pressuring the components above 450 psi. This high pressure eliminates cavitation and its attendant noise in the components, indicating that a hydraulic system, pressure compensated to ambient pressure, will be much quieter at depths below 1000 feet, where the pressure is approximately 450 psi.

Graphs of the recorded acoustic signatures are shown in the appendices.

BACKGROUND

The RUWS, illustrated conceptually in figure 1, is designed to perform a variety of engineering and scientific tasks at ocean depths of 6,100 metres (20,000 feet). It is a major element of the Navy's Deep Ocean Technology (DOT) project. RUWS provides coverage of more than 98 percent of the ocean floor.

To accomplish a wide variety of missions (such as recovery, repair, emplacement, survey, documentation, and gathering of oceanographic data), a modular design approach has been taken. The RUWS work suit consists of a manipulator pair with interchangeable tools (e.g., drilling and cable cutting). The work suit simulates man's presence in the remote vehicle to achieve maximum versatility in its operation.

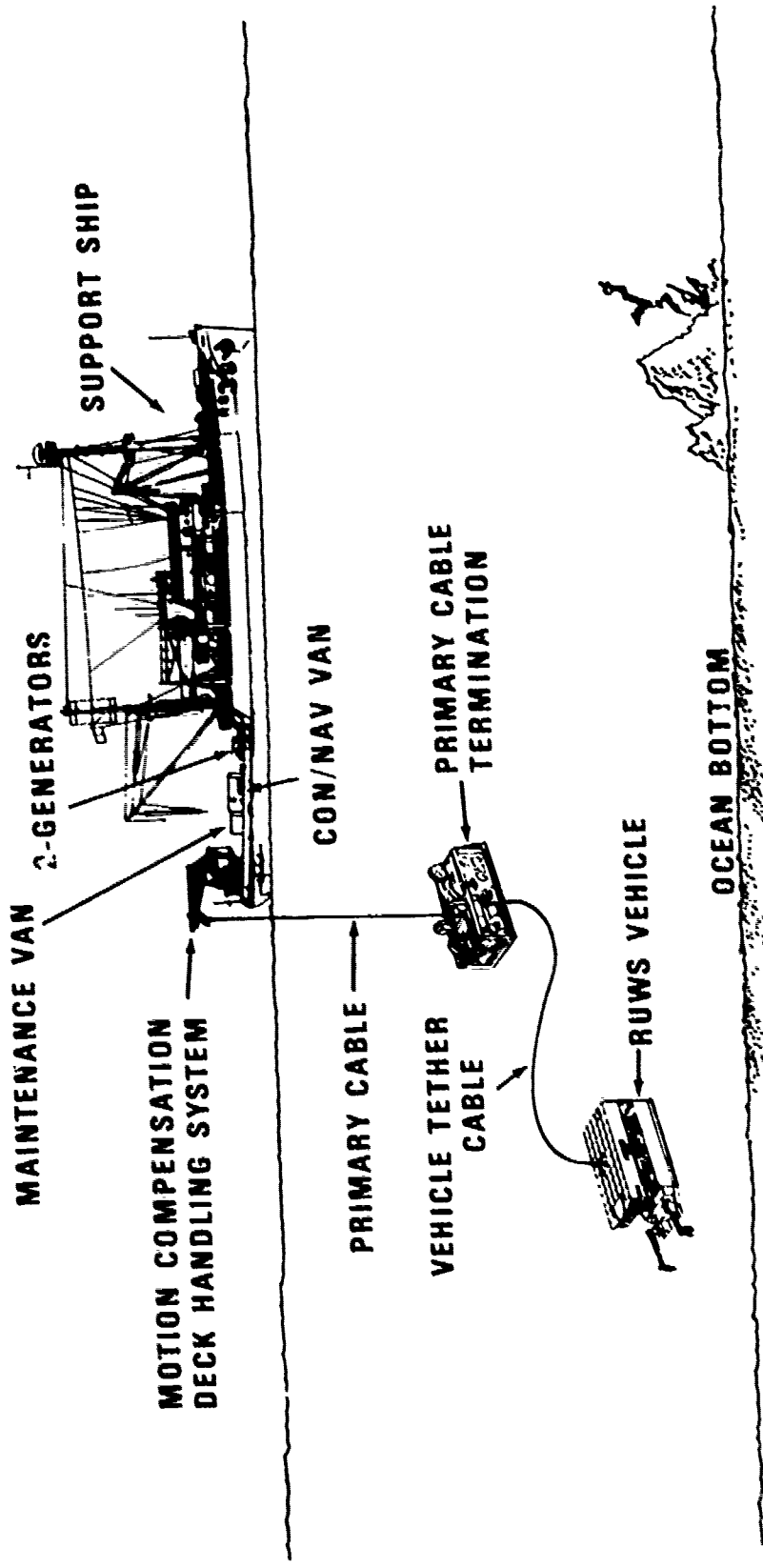

Figure 1. The Remote Unmanned Work System (RUWS).

The electromechanical tether cable for RUWS employs a Kevlar strength member and single coaxial electrical member. Power and command/control signals to the vehicle and the wide bandwidth video and sensor data from the vehicle are simultaneously transmitted on the tether cable through use of time and frequency multiplexing techniques.

Hydraulically-powered systems were selected to perform the RUWS mechanical functions because of their tolerance to high ambient pressures and their inherent versatility through simple variable-speed controls. Hydraulic systems are compact and offer a low weight-to-power ratio. Weight is significant because of the high cost of syntactic foam that is needed to provide vehicle buoyancy at depths to 6,100 metres (9,000 psi).

Another major factor for selecting electrohydraulic propulsion systems over electric propulsion systems was that controllable electric drive motors would cause a varying electrical load which would produce large line voltage variations at the vehicle due to the IR (current X cable resistance) loss in the cable. The RUWS system uses a 8,315-metre (24,000-foot) coaxial electromechanical cable that transmits up to 45 kVA of 60-Hz, 3000-volt power to the PCT and vehicle. The electrical control and information signals are time-division multiplexed onto the coaxial power cable. The sensitivity of the multiplexing circuitry requires a fairly constant voltage level. Large voltage regulators with their attendant high heat load would be required for large line voltage variations. By operating a fixed-displacement hydraulic pump at a constant speed and throttling excess oil flow through a relief valve the electric pump-drive motor is under constant load, thereby minimizing the electrical current variation.

Hydraulic propulsion systems, however, tend to produce more noise than electric propulsion systems. Components in a hydraulic system considered to be major noise producers are pumps, motors and valves.

The objective of this program was to select several commercially available hydraulic pumps, motors and valves as candidate components for the RUWS electrohydraulic propulsion system, perform acoustic tests on the components, and select the quietest components that would fit the requirements for the RUWS hydraulic system.

SYSTEM OPERATING REQUIREMENTS

The components in RUWS submersibles requiring electrohydraulic power consist of the thruster drives, vehicle tether winch and traction drives, and the vehicle's work suit (manipulators, camera gimbal, and special tool drives). Figure 2 depicts the RUWS vehicle, its thrusters and work suit. The thruster arrangement provides four degrees of propulsive control: vertical, transverse, fore and aft, and yaw.

The vehicle work suit (reference 1) consists of a seven-function manipulator, a four-function grabber, a TV-camera pan and tilt gimbal, and various work tools. The work suit is electronically controlled and hydraulically powered. To meet the design performance goals for the work suit, 1000 psi was needed for the hydraulic supply pressure, and therefore 1000 psi was selected for the RUWS vehicle system pressure. Candidate hydraulic components selected for use on the vehicle were tested at 1000-psi differential pressure for the acoustic compatibility evaluation.

1. Marrone, R. A., J. Held, and R. W. Uhrich, "Manipulator, Grabber and Tools for the RUWS Work Subsystem", NUC TN 818, Volume 2, November 1972.

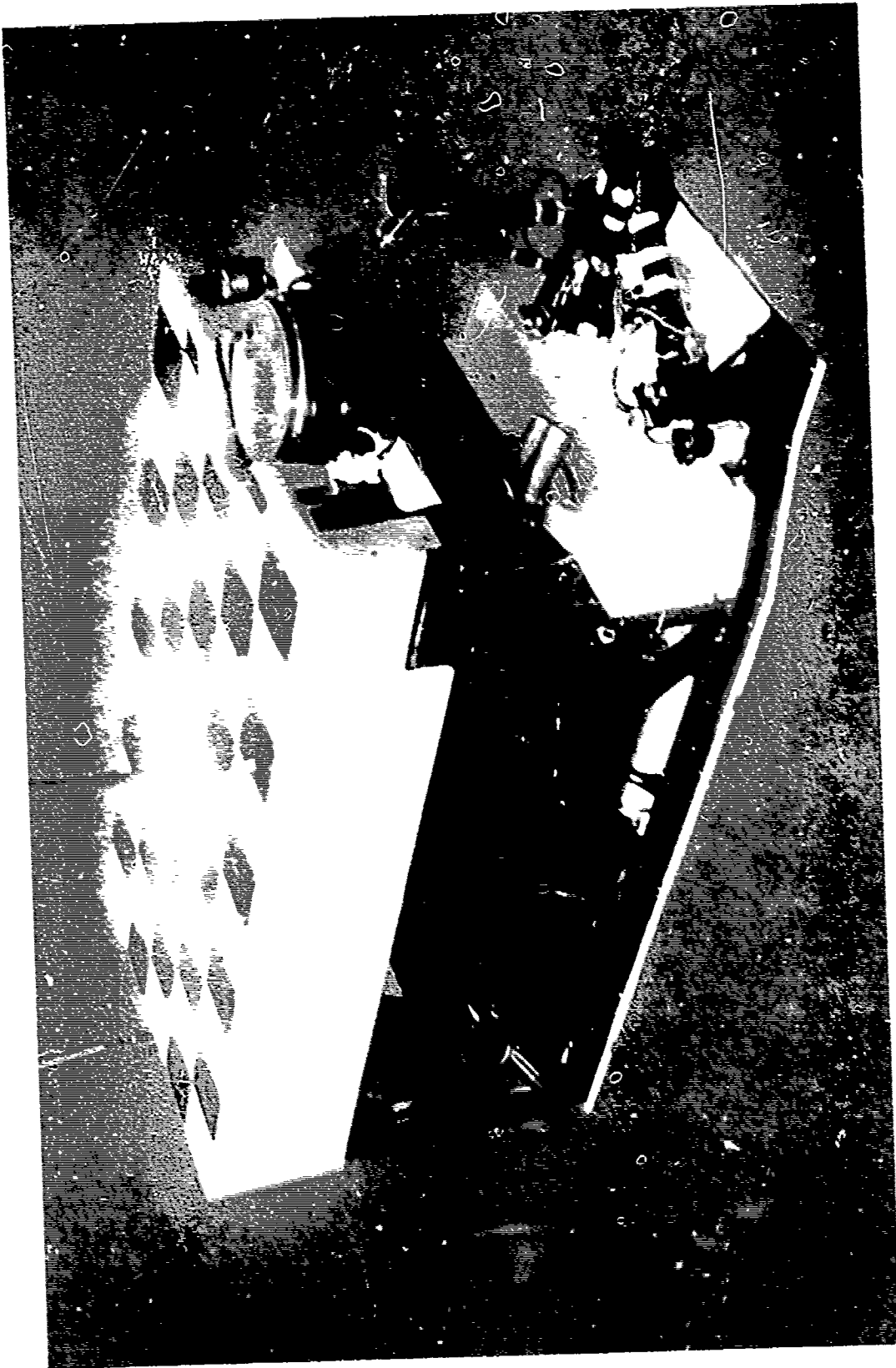

Fig. 1. - Propeller

ACOUSTIC COMPATIBILITY CRITERIA

Prior to selecting components for the power system it is necessary to establish the operating ranges for the submersible system's acoustic sensors. The acoustic frequency bands for the RUWS search and navigation systems are shown in figure 3 (references 2 and 3). To achieve acoustic compatibility, the acoustic output of the hydraulic components must be minimized in the operating bands of the various RUWS acoustic sensors.

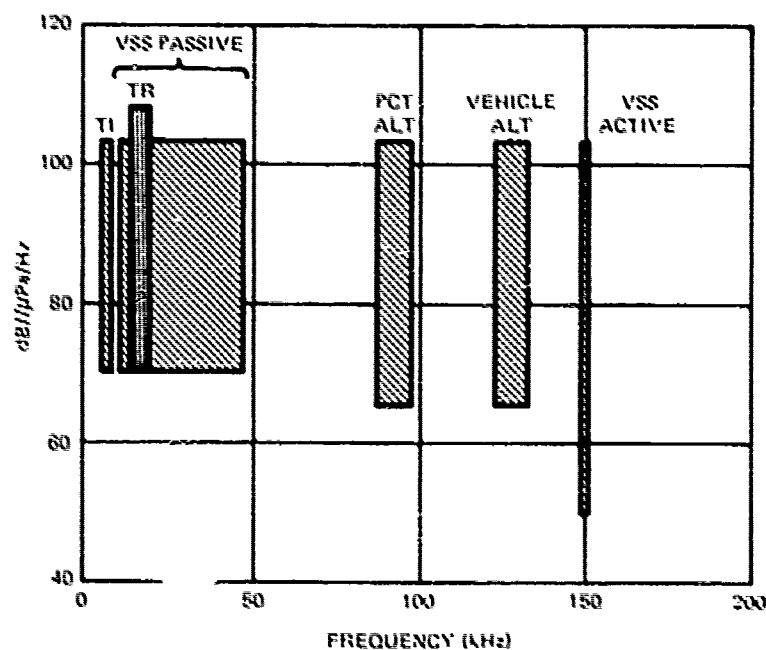

Figure 3. RUWS acoustic frequency spectrum.

2. Volberg, H. W., "Specifications for Vehicle Search Sonar (VSS) Equipment", NUC Hawaii Laboratory, Code 6531, December 1971.
3. Volberg, H. W., "Specification for Long Range Tracking Sonar (LRTS) and Altimeter Equipment for the Remote Unmanned Work System", NUC Hawaii Laboratory, Code 6531, February 1972.

COMPONENT SELECTION

The hydraulic power and propulsion system used on RUWS is shown schematically in figure 4; the schematic is simplified to show only one propulsion motor and one typical actuator. The system is typical of most hydraulic systems consisting of a prime mover, pump, relief valve, proportional control valves, motors, hydraulic cylinders and a heat exchanger

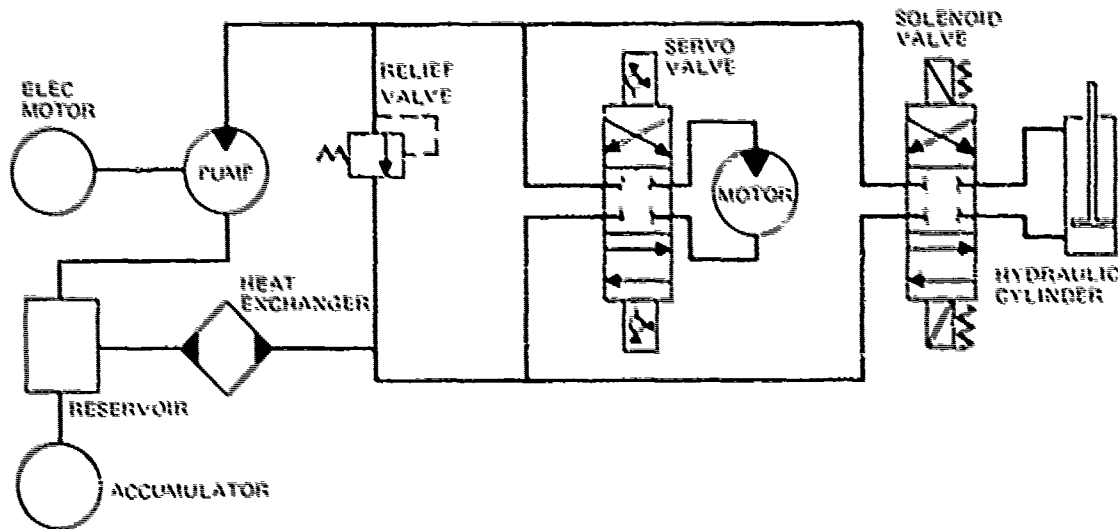

Figure 4. RUWS simplified hydraulic schematic.

The RUWS hydraulic system reservoir has a spring-loaded accumulator that maintains reservoir pressure at 5 to 10 psi above ambient while compensating for the reduction in oil volume due to the high ambient pressure and low ambient temperature at depth. Therefore, the pump output is always 1000 psi above ambient pressure.

A variety of commercial hydraulic components were selected as being operationally suitable for use in the RUWS hydraulic system. These components were tested underwater with acoustic instrumentation to determine their waterborne acoustic profile under simulated RUWS operating conditions. The following components have been tested

Electric Motors	General Electric, Model 4K254A K205 Louis Allis Pacemaker Motor
Pumps	Borg Warner, Model P4-2B DeLaval, Model IMO A12-DB-137 Vickers, Model V30-1F15F-1CL Racine Supervane Hydrastar, Model 5-HI-20G
Motors	WSI, Model 35 Mark VI* Nutron, Model MF AV-2.5 Char-Lynn, Orbit Model AAS* Lamina, Model A-62F* Planet, Model MV-93-A1A2B1A1*
Servo Valves	Olsen, Model S-5C Moog, Model 74-104 Moog, Model 35-A-76-15-E-05-6-A 4 Sanders, Model SV-438-10P
Relief Valves	Republic, Model RG70-2-3/4 S2-1/4 Vickers, Model CT-10-C-20 Fluid Controls, Model 1AR41-F10-30S Fluid Controls, Model 1A32-R6-30S Circle Seal, Model P10-776 Rolamite, designed and fabricated at NOSC

*Tested at Ku Tree Reservoir

The electric motors were necessary for test purposes to drive the pumps. Their noise outputs were very low and did not significantly contribute to the results of the pump tests (graphs A-101 and A-102 in appendix A).

COMPONENT EVALUATION

The facilities and procedures used in evaluating the candidate components are described in the following paragraphs.

TEST FACILITIES

The initial tests were conducted at Ku Tree Reservoir (figure 5) in central Oahu. This site was desirable because of its large water volume and its bottom profile, which minimized reverberation at the hydrophone. Because of logistics problems encountered at that remote test site, however, the tests were continued in a Doughboy swimming pool, 28 feet in diameter by 4 feet deep (figure 6). The reverberation off the walls and bottom of the pool produced an

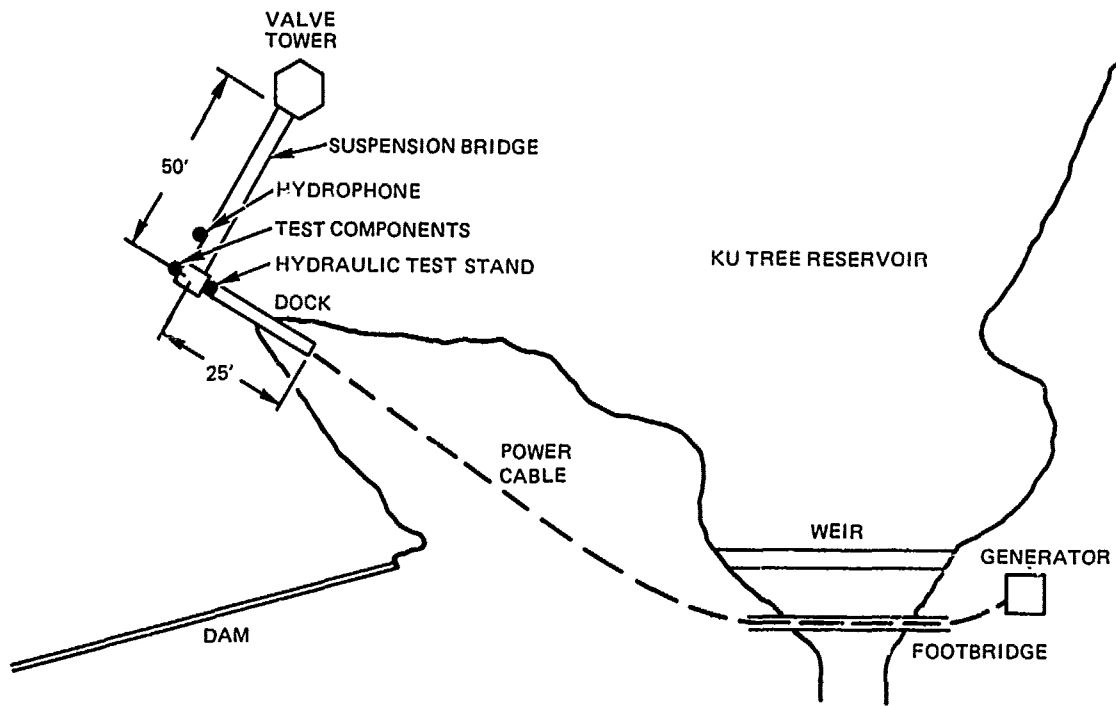

Figure 5. Ku Tree Reservoir test layout.

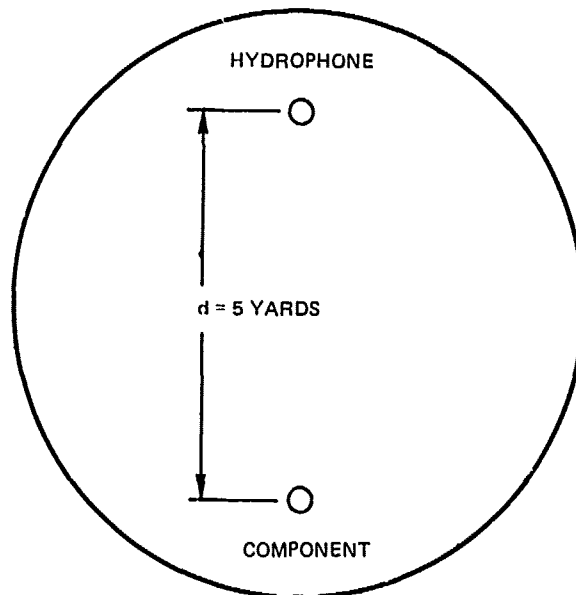

Figure 6. Doughboy swimming pool test layout.

increase in the measured sound pressure levels, but the shapes of the noise spectrum approximated those recorded for the same component tests at the reservoir (figure 7). It was observed that the sound pressure curve shift was in proportion to the absolute noise level; i.e., the increase in sound pressure level was largest for the noisiest components and less for the quieter ones. In all cases, pool readings were higher than open water readings, so the use of pool noise readings for component selection is felt to be on the conservative side.

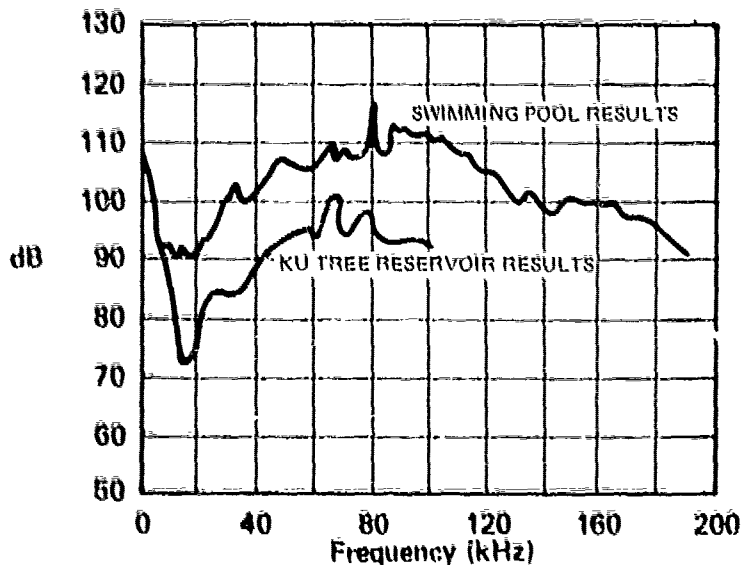

Figure 7. Acoustic tests on Moog 74 servo valve comparing swimming pool result with Ku Tree Reservoir result.

In 1973 a saltwater test pool was built at the NOSC Hawaii Laboratory and was then used for further acoustic testing. Figure 8 illustrates the layout of the saltwater test pool. Table 1 shows which components were tested at which facility. Only those components tested in the same facility should be compared.

The components and hydrophone were suspended from cantilevered beams and submerged half-way to the bottom of the pool. No hoses or brackets touched the sides or bottom of the pool.

A hydraulic test stand was used to supply pressure and flow to the motors and valves for testing. The test stand was equipped with pressure gages to monitor output and return pressures, a flowmeter to monitor flow to the components, and valves to control output and return pressures and flows. Hydraulic oil, MIL-H-5606, was used in the tests.

SOUND MEASUREMENT EQUIPMENT

Acoustic measurements were made using a Clevite Hydrophone, Model CS-331AAG (KMY), which consists of a CH-3A sensor and a CA-31AG preamplifier assembly. This system was calibrated by Clevite and had a flat response of -66 ± 2 dB reference 1 volt/microbar. The hydrophone system is powered by a 12-volt battery.

Table 1 Index of components and test sites.

Device and Manufacturer	Ku Tree Reservoir	Test Facility Doughboy Swimming Pool	Saltwater Test Pool
A. Electric motors			
G.E.		X	
Pacemaker		X	
B. Relief valves			
Fluid controls 1A-32		X	
Fluid controls 1AR-41		X	
Vickers		X	
Republic RG 70		X	X
Circle Seal P10 776		X	
Rolanite			X
C. Hydraulic motors			
Cha-Lynn	X		
Laminata	X		
Planet	X		
WSI	X	X	
Nutten		X	
D. Pump			
Vickers V30-15		X	X
Borg Warner PM-2B		X	
Delaval IMO		X	
Racine supervane		X	X
Hydrastar			X
E. Servovalve			
Moog 74		X	
Moog 35		X	
Olsen		X	
Sanders SV-438-10P			X
F. Servovalve/Motor combinations			
Olsen/Nutten		X	
Moog 74/WSI		X	
Moog 35/WSI		X	
Olsen/WSI		X	
G. Comparative data			
Vickers vs. Sanders valves			X
Rolanite vs. Vickers relief valves			X
Rolanite vs. Sanders relief valves			X
Hydrastar vs. Vickers pumps			X
Hydrastar vs. Supervane pumps			X

To convert from the scope reading to the standard units of dB//microPascal/Hz/yd, the following relationship was used: dB//1 μ Pa/1Hz/1 yd = scope reading + 148.2. This relationship is derived as follows: the scope reading is in dB milliwatt (dBm), which is defined as $10 \log 1000 \frac{V^2}{R}$. The following equation is used to convert scope reading to dB volts (dBv):

$$\begin{aligned} \text{dBm} &= 10 \log 1000 \frac{V^2}{50} && \text{where } R = 50 \text{ ohms} \\ &= 10 \log 20 V^2 \\ &= 10 (\log 20 + 2 \log V) \\ &= 13 + 20 \log V \\ &= 13 + \text{dBv} && \text{where dBv} = 20 \log V \end{aligned}$$

therefore: $\text{dBv} = \text{dBm} - 13$

$$= \text{scope reading} - 13$$

A scan bandwidth (BW) of 300 Hz was used. To convert to a 1-Hz BW, $10 \log \text{BW}$ must be subtracted from the scope readings. Therefore:

$$\begin{aligned} \text{dBv//1 Hz} &= \text{dBm} - 13 - 10 \log \text{BW} \\ &= \text{dBm} - 13 - 10 \log 300 \\ &= \text{dBm} - 13 - 24.8 \\ &= \text{dBm} - 37.8 \end{aligned}$$

The spectrum analyzer has a 50-ohm shunt resistor, and when the hydrophone amplifier is plugged into the analyzer the voltage that the scope receives is one-half the open-circuit voltage.

Since voltage into the scope is one-half the hydrophone output, a correction factor, $20 \log 2$, is added to the scope readings. Therefore:

$$\begin{aligned} \text{dBv//1 Hz} &= \text{dBm} - 37.8 + 20 \log 2 \\ &= \text{dBm} - 37.8 + 6 \\ &= \text{dBm} - 31.8 \end{aligned}$$

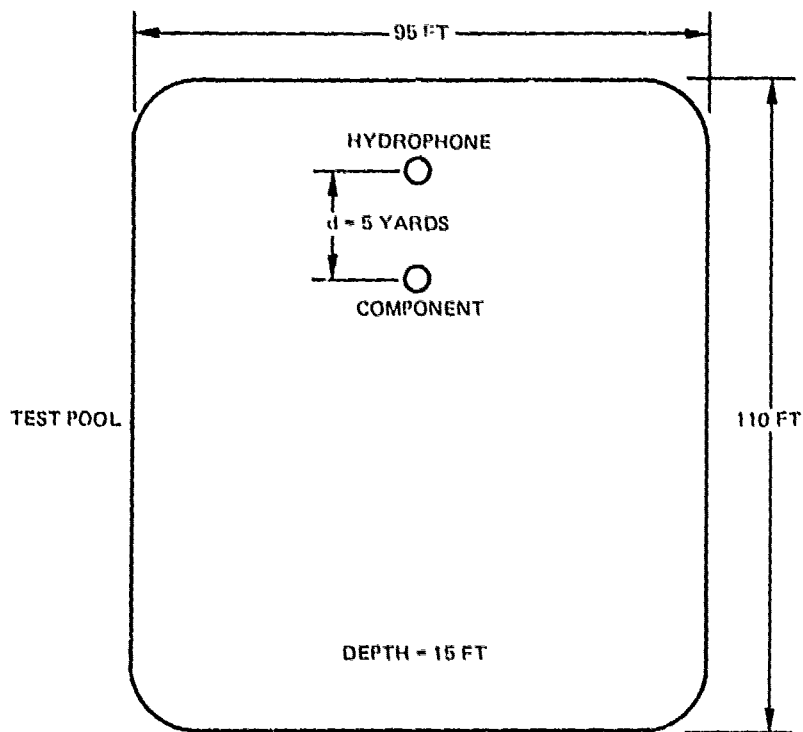

Figure 8. NOSC saltwater test pool layout.

The hydrophone output is fed into a Hewlett-Packard 141T Spectrum Analyzer. A simplified schematic is shown in figure 9.

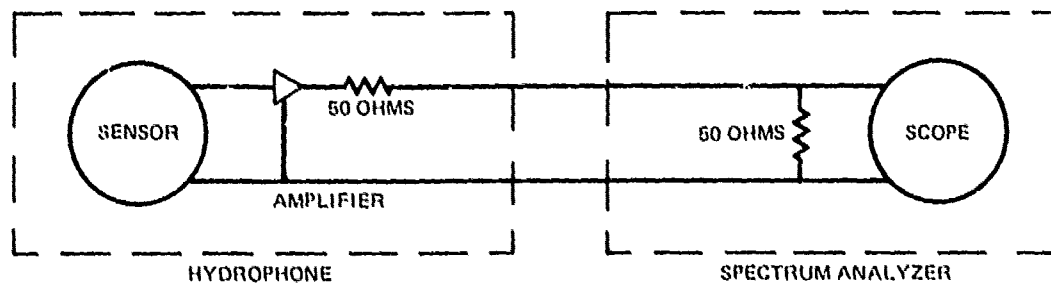

Figure 9. Hydrophone-analyzer simplified schematic.

Hydrophone sensitivity must be subtracted to get the actual sound pressure levels at the hydrophone. Therefore:

$$\begin{aligned} \text{dB//1 microbar/1 Hz} &= \text{dBm} - 31.8 - (-66) \\ &= \text{dBm} + 34.2 \end{aligned}$$

To determine the sound pressure levels at one yard spacing, a correction factor, $20 \log D$, must be added to account for the spreading loss. The absorption loss for five yards spacing is negligible and was not considered. Therefore, where hydrophone spacing $D = 5$ yards,

$$\begin{aligned} \text{dB//1 microbar/1 Hz/1 yd} &= \text{dBm} + 34.2 + 20 \log 5 \\ &= \text{dBm} + 34.2 + 14 \\ &= \text{dBm} + 48.2 \end{aligned}$$

A microPascal is equivalent to 10^{-5} microbar, so, in dB, the zero reference on the microbar scale is equivalent to 100 dB on the microPascal scale. Therefore:

$$\begin{aligned} \text{dB//1 microPascal/1 Hz/1 yard} &= \text{dBm} + 48.2 + 100 \\ &= \text{dBm} + 148.2 \end{aligned}$$

When transposing the acoustic curves from the polaroid pictures to the graphs, 148.2 was added to the dB scale.

COMPONENT TESTS AND RESULTS

The methods that were employed in acoustic testing of the different components are described in the following paragraphs.

RELIEF VALVES

The relief valves tested were set to open at 1000-psi differential pressure. The valves were installed as shown in figure 10 and tested at various flow rates. To determine the effects of higher ambient pressures on the noise output of hydraulic components, simulated high ambient pressure tests were run by increasing return line pressures while maintaining a 1000-psi differential pressure across the valves. Three pressure relief valves were tested at various return line pressures to determine the effects of the higher pressures on noise output.

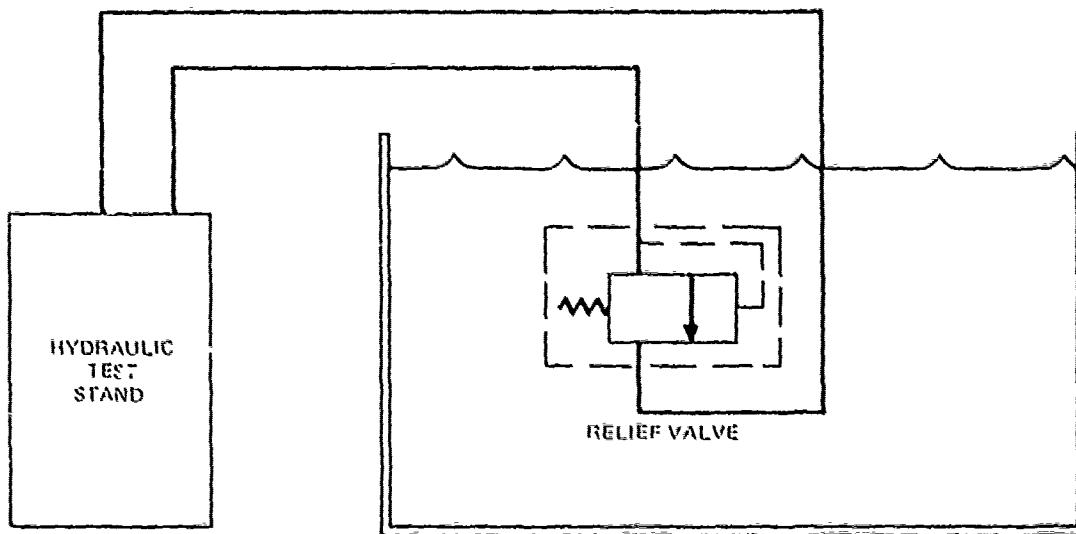

Figure 10. Test schematic: relief valves.

Relief valve test results are shown in graphs B-101 through B-510, B-601 through B-604, G-201 through G-208, and G-301 through G-304 in the appendices.

The Vickers relief valve was tested at return line pressures of 0, 250, 300, 400, 450, and 500 psi. Acoustic data (graphs B-301 through B-315 of appendix A) show that by increasing the return line pressure from 0 to 250 psi, the low frequency (0-40 kHz) noise output was reduced considerably but there was little effect on the higher frequencies. There was no further reduction in low frequency noise output with increasing pressures; however, the mid-range (40-kHz) noise output decreased with increasing pressure up to 400 psi. The high frequency (140-200 kHz) noise output decreased when the pressure was increased from 350 to 450 psi. There was no change in noise output with an increase in pressure from 450 to 500 psi.

The Republic relief valve was tested with return line pressures of 0, 250, 500, and 750 psi, as seen in graphs B-401 through B-408 of appendix A. The low frequency noise output decreased with increasing pressure up to 500 psi; however, there was little or no significant change in noise output with an increase in return line pressure from 500 to 750 psi.

The acoustic data indicate that cavitation noise was probably reduced or eliminated at pressures above 450 psi. It would also appear that operations at depths below 1000 feet, where ambient pressures are greater than 450 psi, will have much lower noise levels than operations nearer the surface. All relief valves were tested at both 0- and 500-psi return pressures to determine their noise output at the surface and at depth.

The results show inconsistencies in some of the curves from tests run under apparently similar operating conditions (graphs B-301 vs B-311 in appendix A). This may have been due to dissolved gases in the hydraulic oil coming out of solution during testing. With less dissolved gases there would be less gaseous cavitation. Foam was observed in the oil reservoir during testing even though the reservoir oil level was sufficiently high and the reservoir was mounted above the pump.

The amount of air dissolved in the oil was not measured during the tests. Components tested with saturated oil may appear noisier than those tested with low gas content. Therefore, the best comparisons are made between components that were tested with 500-psi return line pressure.

A Sanders frictional-throttling servo valve, model number SV-438-10P, was acoustically tested in a relief valve mode; i.e., it was used to regulate pressure by throttling the hydraulic oil flow with no extreme load. It was compared with the Vickers relief valve, model number CT-10-C-20 (turbulent-throttling). A comparative evaluation was conducted using degassed oil and oil from an open reservoir.

The Sanders servo valve and the Vickers relief valve test results are shown in graphs B-316 through B-339 and E-401 through F-410 in appendix B. The test results show that the Sanders frictional-throttling valve is much quieter than the Vickers turbulent-throttling valve. The results also suggest that degassed oil makes little, if any, difference in the noise output of the Vickers valve at the lower flow rates, but reduces the noise output by approximately 10 dB at 20 gpm.

The Sanders servo valve and the Vickers relief valve were tested at return line pressures of 0 and 500 psi. Acoustic data (graphs G-101 through G-108 of appendix B) show that there is a large decrease in noise output for the Vickers valve when back-pressured to 500 psi. The data also show that there is no decrease in noise output of the Sanders valve when back-pressured. The Vickers valve, when back-pressured to 500 psi, is as quiet as the Sanders valve at 5 gpm; however, the Sanders valve is approximately 10 dB quieter at the higher flow rates.

With design assistance from Richard A. Milroy of the NSRDC Annapolis Laboratory, a Rolamite pressure relief valve was designed, fabricated, and acoustically tested. In earlier NSRDC tests, Rolamite valves had proved to be comparatively quiet; this experience led to NOSC's interest in the valve for potential use in submersibles. According to Milroy (reference 4), the Rolamite valve achieves quiet frictional throttling with none of the problems of conventional designs, such as close machining, leakage, extreme filtering, etc.

4. Milroy, R. A., "ROLAMITE Rolling-Gate Valves", Naval Ship Research and Development Center Report Number 4407, September 1974.

The frictional-throttling Rolamite valve, NOSC drawing number DRS-1000 (appendix D), uses Collimated Hole Structure (CHS), manufactured by Brunswick Corporation, as the throttling element.

The Rolamite valve was designed as a pilot-operated relief valve. The pilot stage was designed into the Rolamite valve, however, the pilot stage designed into the Rolamite housing was not used in the acoustic tests because of its poor performance. The pressure would oscillate approximately 200 psi between 900 psi and 1100 psi, causing an audible squeal on the upward slope of the pressure cycle. The pilot stage was made nonfunctional by adjusting the loading screw to place a large load on the pilot stage spring. A remote relief valve was connected to the control port and used as a remote pilot stage (figure 11), the Rolamite valve then operated steadily. The remote relief valve was not submerged during the acoustic tests and it did not contribute to the acoustic output of the Rolamite valve.

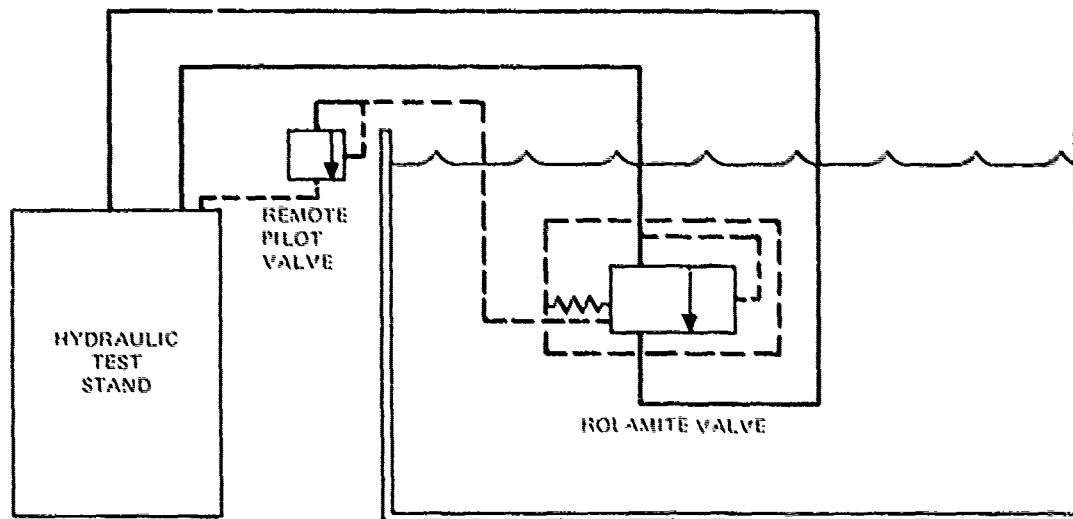

Figure 11. Rolamite valve test arrangement.

Graphs B-601 through B-604 in appendix B show that the Rolamite valve had its highest acoustic output at 10 gpm and was quieter at the higher flow rates. This characteristic may be due to the arrangement of the CHS throttling elements (appendix D). As shown in appendix D, the two throttling elements are separated by a plenum ring forming a plenum chamber. Flow through the elements is regulated by the amount the band is uncovered on the first element. For all flow rates, the flow area of the second element remains the same. Therefore, the pressure drop across the second element varies proportionally with the flow, the higher the flow, the greater the pressure drop. The second element is effective at the higher flow rates and not at the low rates. However, at 10 gpm, the second element may not have enough effect over the increased turbulence to keep the noise level as low as it is at 5 gpm.

Graphs G-201 through G-204 (appendix C) clearly show that the Rolamite valve is much quieter near the surface than the Vickers relief valve at normal operating conditions.

Graphs G-205 through G-208 show that at higher ambient pressures, where cavitation is reduced in the Vickers valve, the difference is much less, however, the Rolamite valve still is quieter.

Graphs G-301 through G-304 (appendix C) show that the Rolamite is generally quieter than the Sanders servo valve except at frequencies above 30 kHz for the 10-gpm flow rates, and above 130 kHz at the 20-gpm flow rates.

MOTORS

The hydraulic motors were tested at various power levels to simulate the loading characteristics of the submersible propulsion units. To simulate propeller loading without creating the usual propeller turbulence, 1 1/2-inch thick aluminum disks were attached to the motor shafts (figure 12). A tachometer sending unit was also attached to the shaft to monitor shaft rpm. Several disks having different diameters were available. Each disk was experimentally calibrated to determine the torque required to rotate it at a given rpm while submerged in water. The torque vs rpm curves of the various disks were used to select a propeller simulator that would present the proper amount of loading for a given motor.

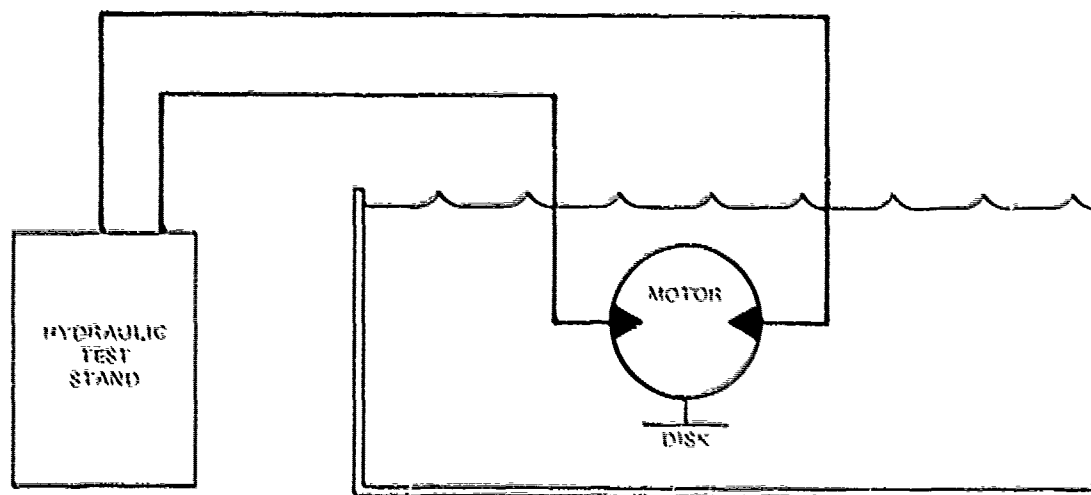

Figure 12. Test schematic - motors.

Several motors were tested which would have required speed reducers to match the propeller drive requirements, hence the need for disks giving several speed torque curves. The horsepower required to drive the disks at various rpms was calculated from the torque and rpm data, and curves of horsepower vs rpm were plotted. These data are presented in figures 13 and 14.

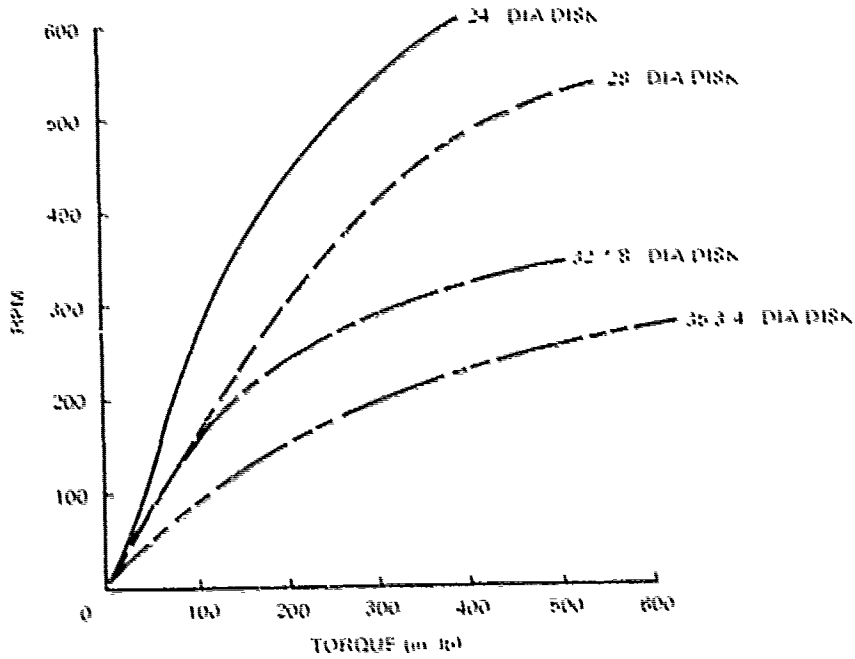

Figure 13. Disk data (rpm vs torque)

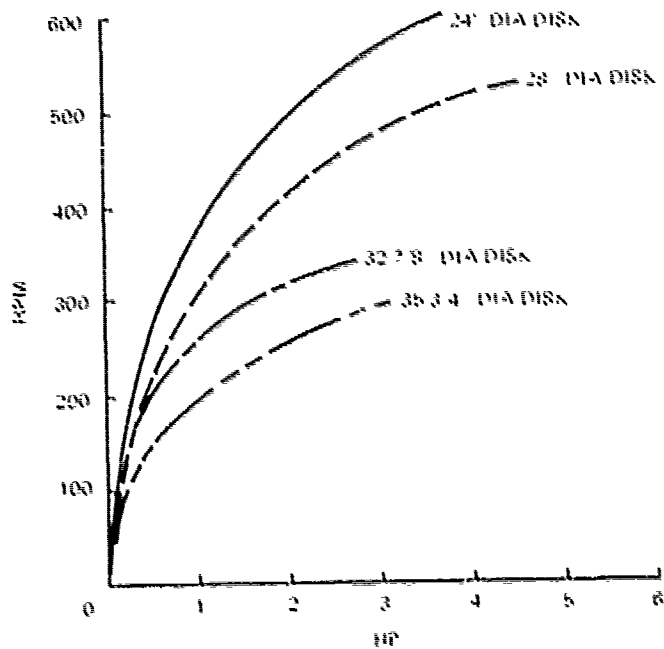

Figure 14. Disk data (rpm vs hp)

The types of motors tested included the following

MOTOR	TYPE	DISC m ² x A	WEIGHT (lb)
Washington Scientific Industries	Axial Rolling Vane	3.42	20
Nutron	Axial Ball Piston	2.8	30
Chas-Lynn	Gerotor	3.0	11
Lamuna	Gerotor	3.5	33.4
Planet	Radial Ball Piston	0.93	101.4

Initial testing of the motors was conducted at Ku Tree Reservoir and the results are shown in graphs C-101 through C-104 of appendix A. The results showed the Washington Scientific Industries (WSI) motor was, by far, the quietest of all the motors tested.

Due to the time scheduling it was felt that no further effort should be spent on the noisier motors and that they could be eliminated as candidate components. Therefore, when testing was resumed in the swimming pool and when the Nutron motor was acquired, only the WSI motor was retested for comparison with the Nutron motor. The WSI motor was quieter than the Nutron motor and was selected for use on RWSS. Swimming pool test results are shown in graphs C-105 through C-117 of appendix A.

PUMPS

The pumps selected for the evaluation were tested at 1750 rpm and 1000 psi output pressure. The test pumps were mounted and direct-coupled to a 1750-rpm electric motor in a cylindrical housing. This arrangement simulates the actual RWSS motor-pump configuration. Hydraulic lines were routed to a pressure gage and flowmeter to monitor the pressure and flow output, and relief valve was used to control the pressure. The meters and valve were mounted on a fixture not directly connected to the pool so the noise they produced was not transmitted to the water.

The test units were connected as shown in figure 15.

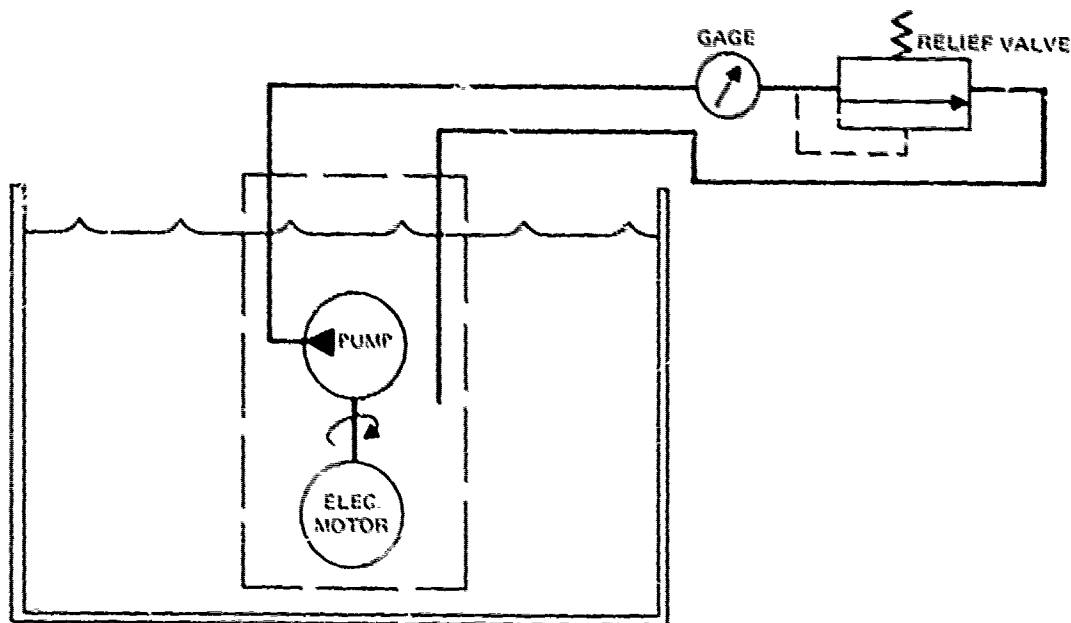

Figure 15. Test schematic: pumps.

SERVO VALVES

The servo valves were initially tested by connecting their control ports together, as shown in figure 16, and connecting the 1000-psi pressure across the valve. Hydraulic flow through the valve was adjusted by varying the electrical supply voltage. This method of testing did not simulate the actual use conditions. The full 1000-psi pressure was being dropped across ports C1 and C2, 500 psi at each port. In the actual system, the 1000-psi pressure drop would be divided between the hydraulic motor and the servo valve; the pressure drops across each would depend on the amount of flow through the valve to the motor. In the "final system" test (figure 17), the control ports were connected to a hydraulic motor. Part of the 1000-psi pressure drop then occurred across the hydraulic motor, and part occurred across the valve. The measured noise output was taken as the combined noise output of the motor and the servo valve. The aluminum disk propeller simulator was mounted on the motor shaft to load the motor without creating the turbulence and thrust inherent in a rotating propeller.

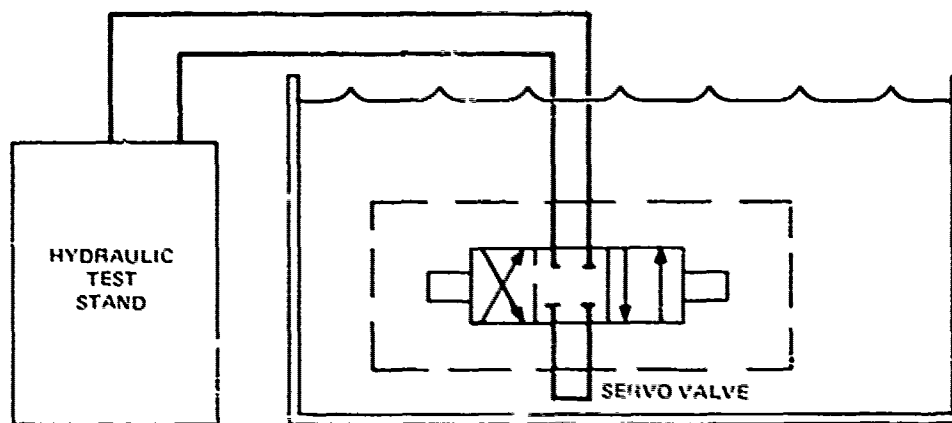

Figure 16. Test schematic: servo valves (initial configuration).

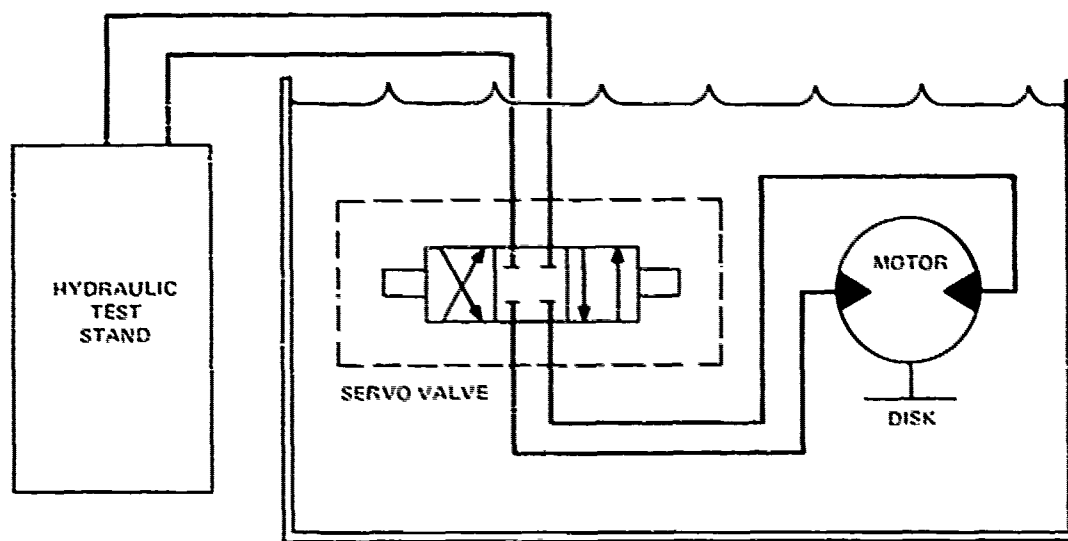

Figure 17. Test schematic: servo valve/motor (final configuration).

Results of the servo valve tests are shown in graphs E-101 through E-310 of appendix A. Test results of servo valves and motors in the final test configuration are shown in graphs F-101 through F-413 of appendix A. In this configuration, the highest noise levels were produced at low motor rpm where the largest pressure drop occurred across the servo valve. When the motors were run at the higher speeds, more pressure was dropped across the motors, resulting in lower noise outputs. The Olsen-WSI combination exhibited the lowest noise output and was selected for use on RUWS.

COMPONENTS SELECTED FOR USE ON RUWS

The components selected for the initial construction of the vehicle in 1973, after the first component acoustic test series in the doughboy swimming pool were done, were:

1. Vickers pump
2. Vickers relief valve
3. Olsen servo valves
4. Washington Scientific Industries motors

The types of pumps tested included the following:

PUMP	TYPE	DISPLACEMENT	WEIGHT
Vickers	Vane, fixed-displacement	20 gpm	34
Borg-Warner	Gear, fixed-displacement	24 gpm	27
DeLaval	Screw	10 gpm @ 1000 psi	121
Racine	Vane, pressure-compensated	13 gpm @ 0 psi	62
Hydrastar	Gear, fixed-displacement	20 gpm	60

Test results are shown in graphs D-101 through D-404 of appendix A. The DeLaval pump was the quietest pump tested. However, it had high internal leakage and it was also the heaviest pump tested.

The Vickers pump was originally selected for RUWS. This pump was also tested with 500-psi inlet pressure, which resulted in a significantly lower acoustic output, however, the acoustic output for that test was recorded only up to 100 kHz. The reduction in acoustic output is probably due to a reduction in internal and inlet cavitation noise.

The Racine pump was originally tested only to evaluate that type of pump, a pressure-compensated, variable-displacement design. It has a lower acoustic output than any fixed-displacement vane pump tested.

Laboratory operation of the RUWS system has since shown that changes in electrical load at the vehicles are tolerable. A pressure-compensated, variable-displacement pump would therefore offer a significant noise reduction. In addition, its use would eliminate the flow through the relief valve and the inherent noise caused by the throttling of the flow.

A Hydrastar pump, model 5-HI-20G, manufactured by Hartum Corporation, also was acoustically tested. This pump was direct-coupled to a 1750-rpm GE electric motor and run in the oil-filled motor pump container. The tests were conducted in June 1975 at the NOSC saltwater test pool. Graphs D-501 through D-503 show that the Hydrastar pump is quietest at a 500-psi load, and noisiest at no load (0 psi).

Graph G-401 shows that the Vickers pump is quieter than the Hydrastar pump up to 20 kHz, above 20 kHz, the Hydrastar pump is quieter.

Graph G-501 shows that the Racine super-vane pump is quieter than the Hydrastar pump.

After installation and checkout, the vehicle was acoustically tested with the hydrophone mounted on the front of the foam pack where the vehicle search sonar (VSS) ultimately would be mounted. Testing was done in Kaneohe Bay, and sea level measurements were recorded. To simulate 1000-foot depth operations, the hydraulic system was pressurized to 500 psi. The results are shown in figure 18.

Since 1973, when the hydraulic components were selected, component acoustic tests have continued. Because of the new OSHA regulations on noise in the working environment, hydraulic component manufacturers have been expending greater efforts in designing quieter hydraulic components. Quiet hydraulics development has also been continuing at Navy laboratories.

Component acoustic tests have continued on pumps and valves which were the major noise producers. Commercial pumps advertised by the manufacturers to be quiet were tested, as were valves incorporating quiet throttling techniques. As a result of these continuing tests a new Silentyne model Racine pump has been selected to replace the Vickers vane pump.

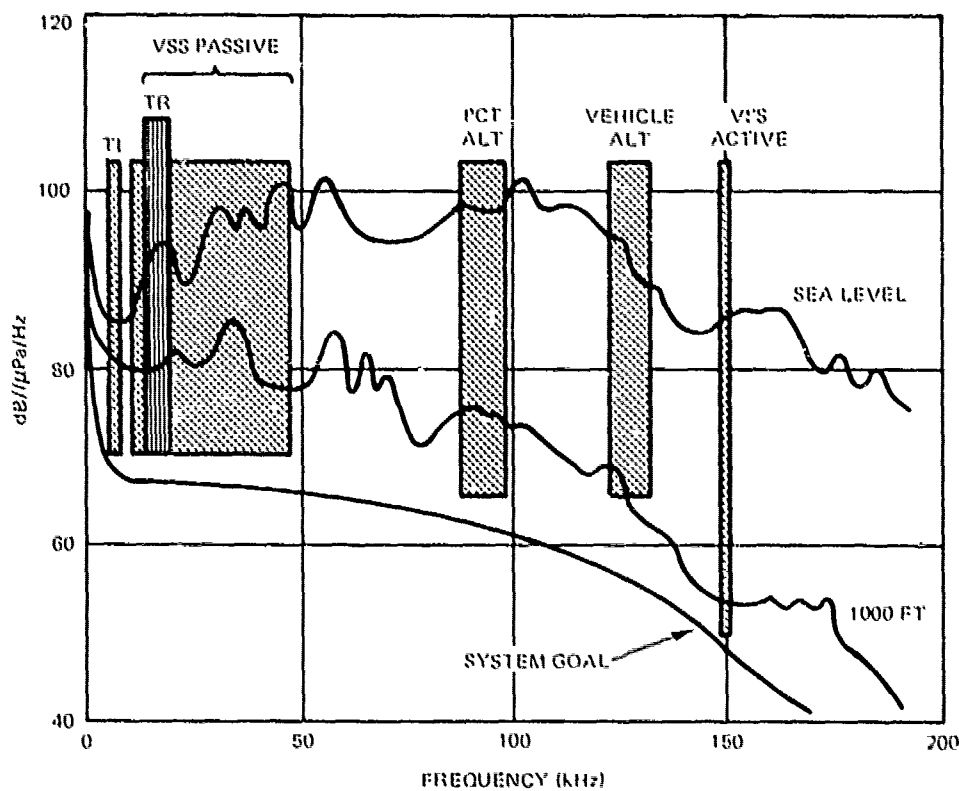

Figure 18. Electrohydraulic acoustic spectrum for RUWS.

CONCLUSIONS

There are several mechanisms of noise generation in hydraulic systems. The major mechanisms are cavitation, machinery and fluid flow.

In hydraulic components and systems of which noise was not a design consideration, cavitation could be the most serious noise source. Cavitation occurs when, at some point in the system, the local pressure is less than the vapor pressure of the hydraulic fluid and bubbles are formed. This can occur in areas of high velocity flow and intense turbulence. Then, at a point downstream, the pressure rises above the vapor pressure and the bubble collapses (implodes) producing broad band noise extending from the audible into the inaudible frequency ranges.

By maintaining the pressure throughout the system at a level high enough that even in areas of intense turbulence the local pressure does not drop below the vapor pressure of the fluid, cavitation would be eliminated. The components tested showed a reduction in noise output when return line pressures were maintained above 450 psi. This is the condition of submersible hydraulic systems that have reservoirs compensated to ambient pressure in the deep ocean. It may also be accomplished with a closed system with a sealed reservoir pressurized to 450 psi.

Hydraulic components are being designed and produced without a tendency for cavitation. Sharp-edged orifice valves are highly susceptible to cavitation because of the high fluid velocities and turbulence on the exit side of the orifice. Several throttling techniques using small-cross-section multiple paths are presently employed by manufacturers making quiet throttling valves. These techniques keep flow velocities and turbulence at levels which do not produce cavitation.

REFERENCES

1. Marrone, R. A., J. Held, and R. W. Uhrich, "Manipulator, Grabber and Tools for the RUWS Work Subsystem", NUC TN 818, Volume 2, November 1972.*
2. Volberg, H. W., "Specifications for Vehicle Search Sonar (VSS) Equipment", NUC Hawaii Laboratory, Code 6531, December 1971.
3. Volberg, H. W., "Specification for Long Range Tracking Sonar (LRTS) and Altimeter Equipment for the Remote Unmanned Work System", NUC Hawaii Laboratory, Code 6531, February 1972.
4. Milroy, R.A., "ROLAMITE Rolling-Gate Valves", Naval Ship Research and Development Center Report Number 4407, September 1974.

*TNs are informal documents intended chiefly for internal use.

APPENDIX A

TEST DATA OF FIRST TEST SERIES

GRAPHS

This appendix presents the results of the first series of acoustic tests, depicted by noise profile graphs for each of the components and specified test conditions. The decibel scales for all graphs have a reference of 1 microPascal per hertz per yard (dB// μ Pa/Hz/yd).

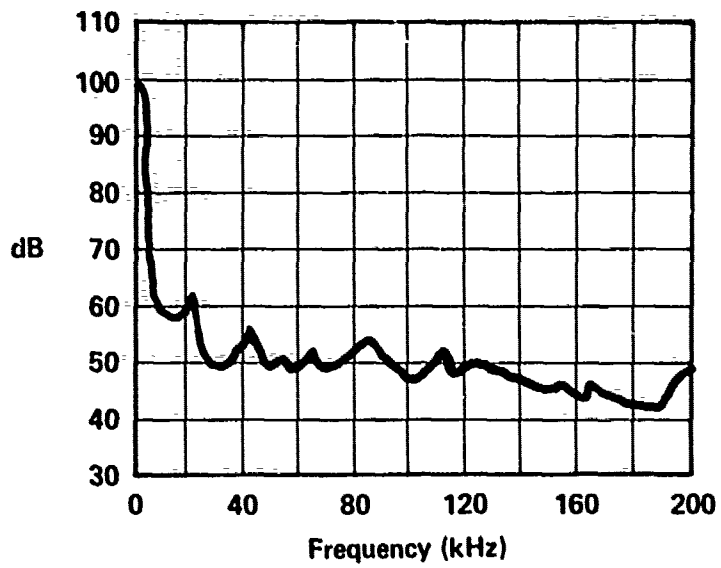

ELECTRIC MOTOR - GENERAL ELECTRIC
 MOTOR SPEED - 1750 RPM
 A-101

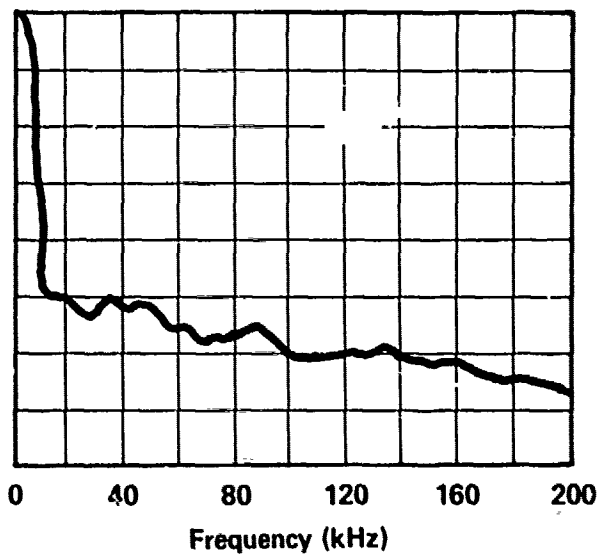

ELECTRIC MOTOR - PACEMAKER
 MOTOR SPEED - 3450 RPM
 A-102

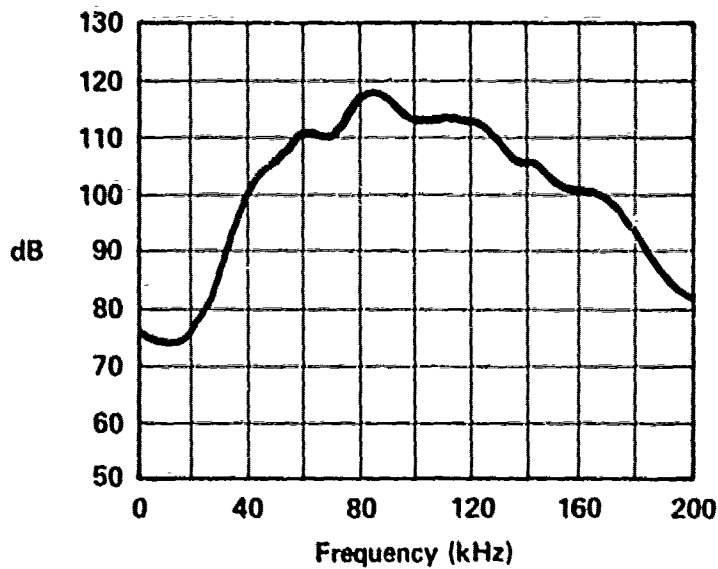

RELIEF VALVE - FLUID CONTROLS 1A-32
 INLET PRESSURE - 1000 PSI
 RETURN PRESSURE - 0 PSI
 FLOW TO VALVE - 5 GPM
 B-101

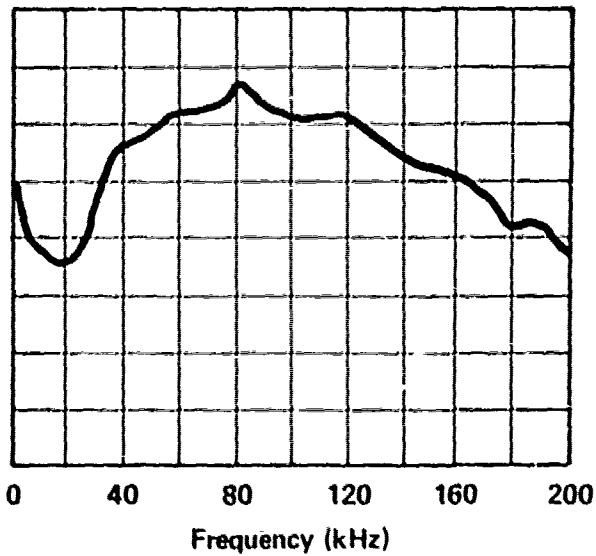

RELIEF VALVE - FLUID CONTROLS 1A-32
 INLET PRESSURE - 1000 PSI
 RETURN PRESSURE - 0 PSI
 FLOW TO VALVE - 10 GPM
 B-102

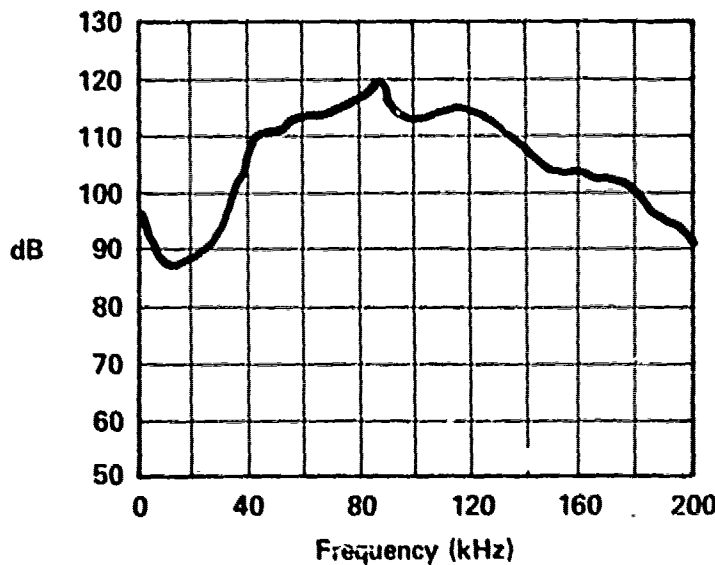

RELIEF VALVE - FLUID CONTROLS 1A-32
 INLET PRESSURE - 1000 PSI
 RETURN PRESSURE - 0 PSI
 FLOW TO VALVE - 15 GPM
 B-103

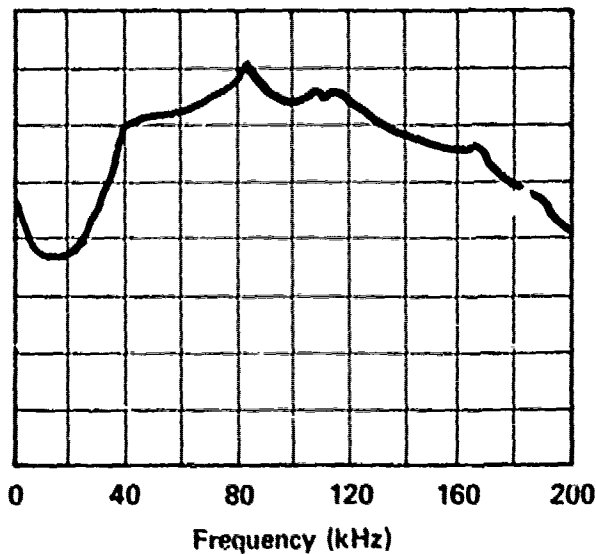

RELIEF VALVE - FLUID CONTROLS 1A-32
 INLET PRESSURE - 1000 PSI
 RETURN PRESSURE - 0 PSI
 FLOW TO VALVE - 20 GPM
 B-104

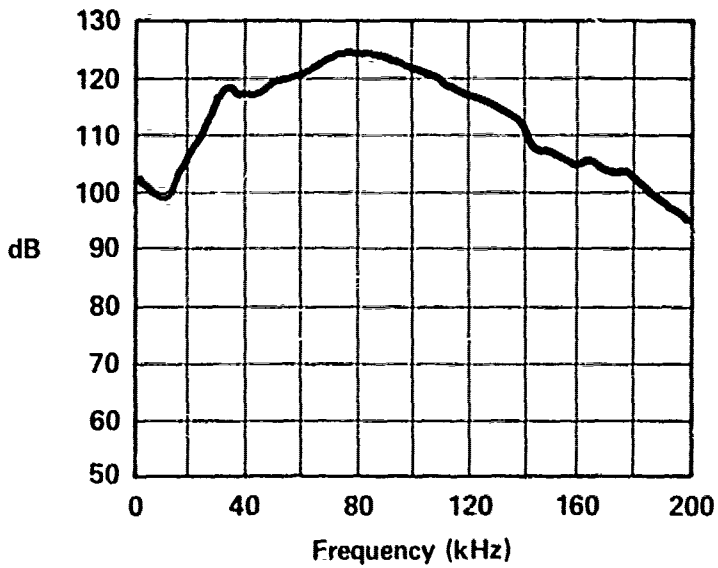

RELIEF VALVE - FLUID CONTROLS 1AR-41
 INLET PRESSURE - 1000 PSI
 RETURN PRESSURE - 0 PSI
 FLOW TO VALVE - 5 GPM
 B-201

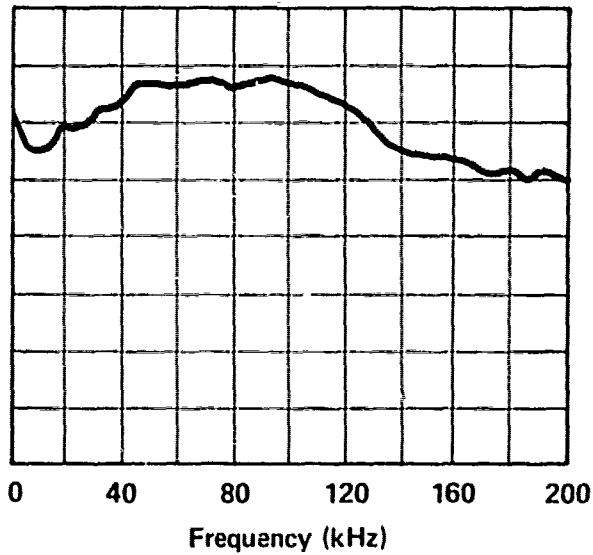

RELIEF VALVE - FLUID CONTROLS 1AR-41
 INLET PRESSURE - 1000 PSI
 RETURN PRESSURE - 0 PSI
 FLOW TO VALVE - 10 GPM
 B-202

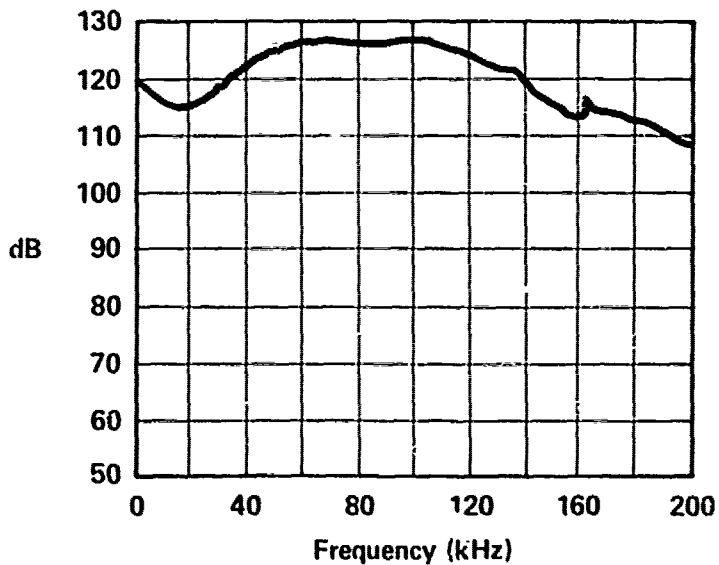

RELIEF VALVE - FLUID CONTROLS 1AR-41
 INLET PRESSURE - 1000 PSI
 RETURN PRESSURE - 0 PSI
 FLOW TO VALVE - 15 GPM
 B-203

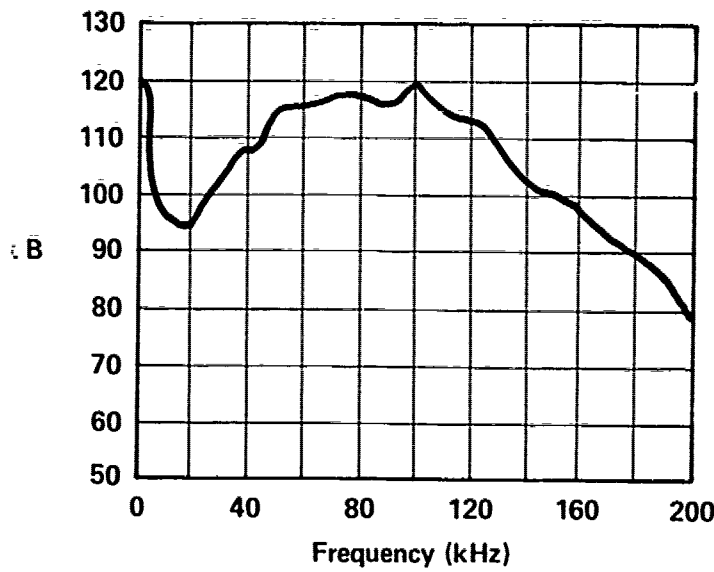

RELIEF VALVE - FLUID CONTROLS 1AR-41
 INLET PRESSURE - 1500 PSI
 RETURN PRESSURE - 500 PSI
 FLOW TO VALVE - 5 GPM
 B-204

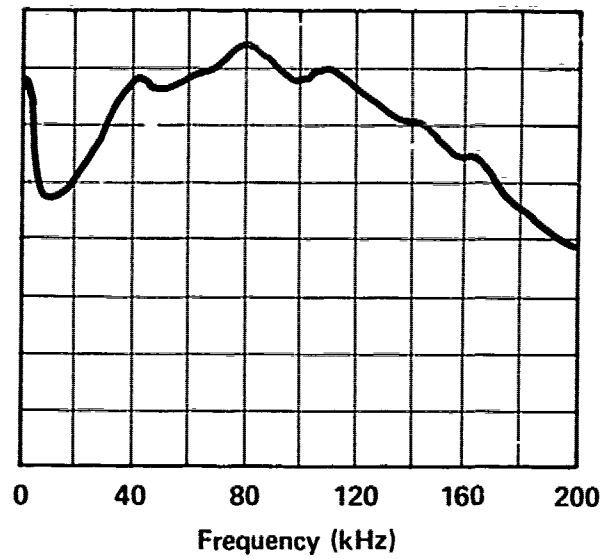

RELIEF VALVE - FLUID CONTROLS 1AR-41
 INLET PRESSURE - 1500 PSI
 RETURN PRESSURE - 500 PSI
 FLOW TO VALVE - 10 GPM
 B-205

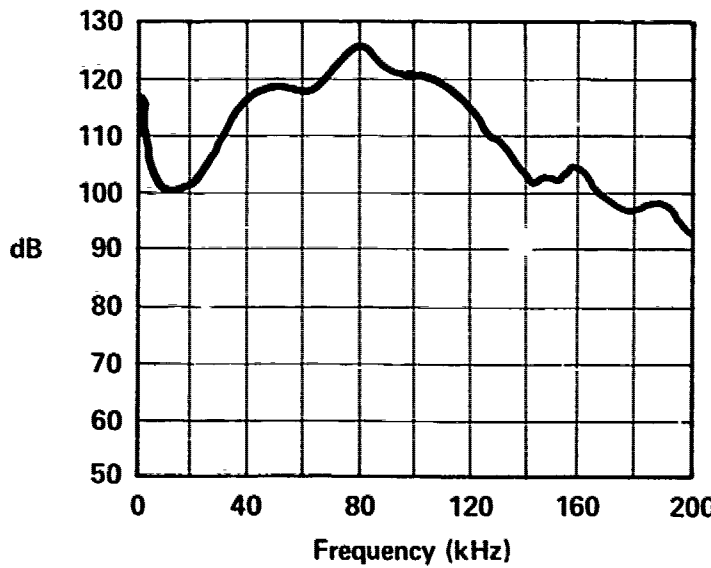

RELIEF VALVE - FLUID CONTROLS 1AR-41
 INLET PRESSURE - 1500 PSI
 RETURN PRESSURE - 500 PSI
 FLOW TO VALVE - 15 GPM
 B-206

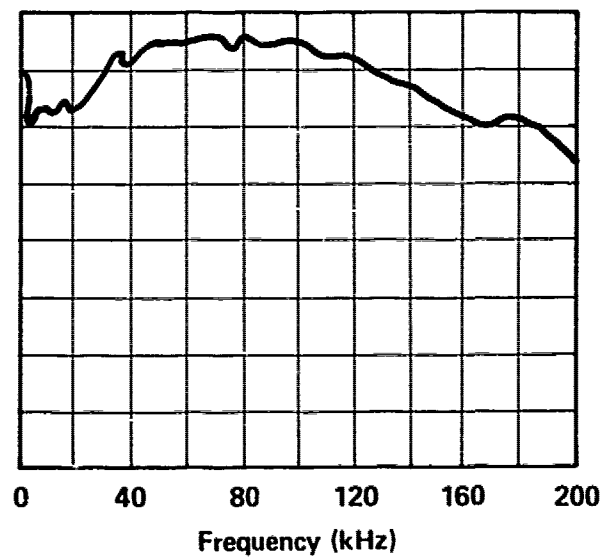

RELIEF VALVE - FLUID CONTROLS 1AR-41
 INLET PRESSURE - 1500 PSI
 RETURN PRESSURE - 500 PSI
 FLOW TO VALVE - 20 GPM
 B-207

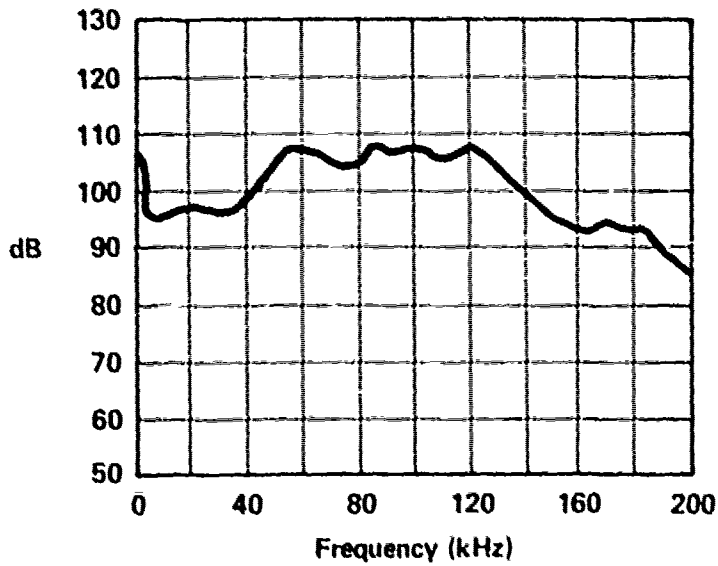

RELIEF VALVE - VICKERS
 INLET PRESSURE - 1000 PSI
 RETURN PRESSURE - 0 PSI
 FLOW TO VALVE - 20 GPM
 B-301

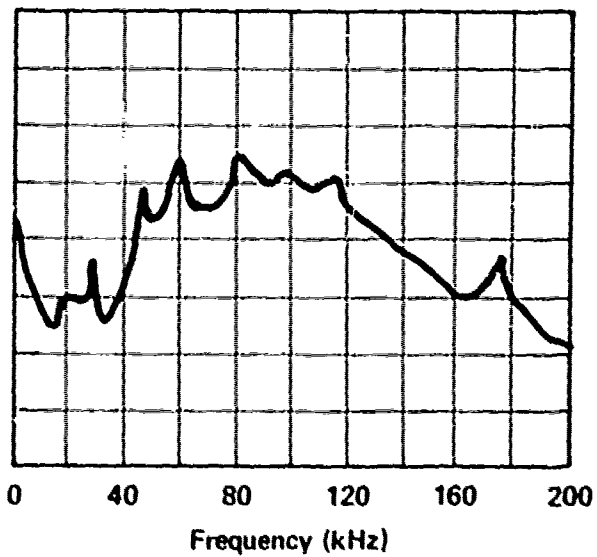

RELIEF VALVE - VICKERS
 INLET PRESSURE - 1250 PSI
 RETURN PRESSURE - 250 PSI
 FLOW TO VALVE - 20 GPM
 B-302

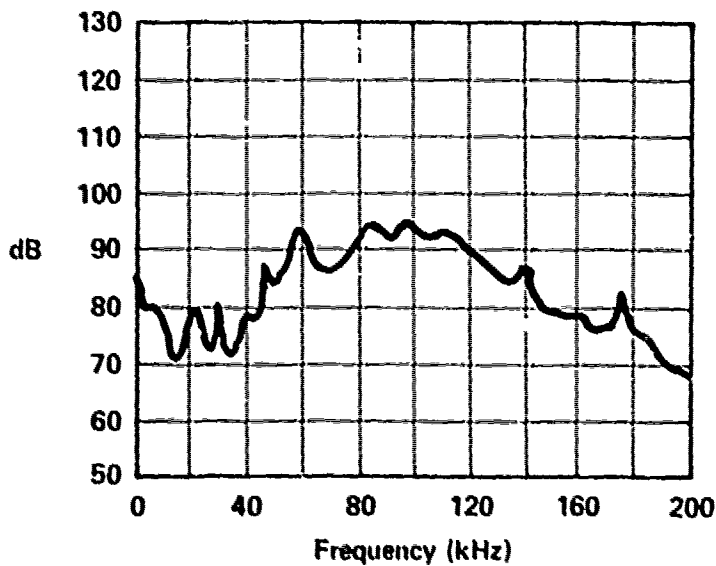

RELIEF VALVE - VICKERS
 INLET PRESSURE - 1300 PSI
 RETURN PRESSURE - 300 PSI
 FLOW TO VALVE - 20 GPM
 B-303

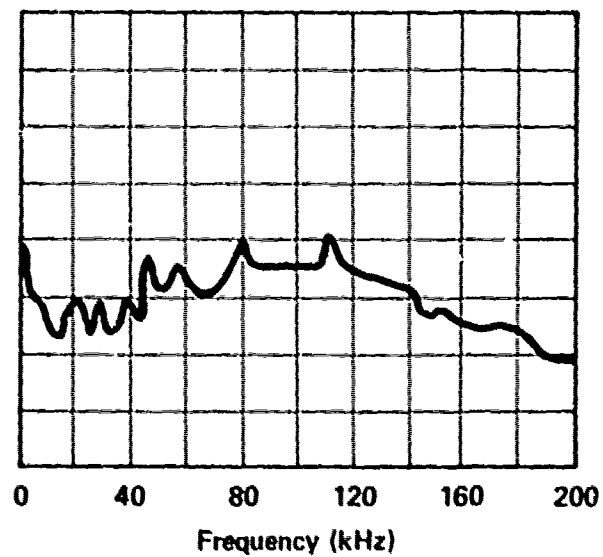

RELIEF VALVE - VICKERS
 INLET PRESSURE - 1350 PSI
 RETURN PRESSURE - 350 PSI
 FLOW TO VALVE - 20 GPM
 B-304

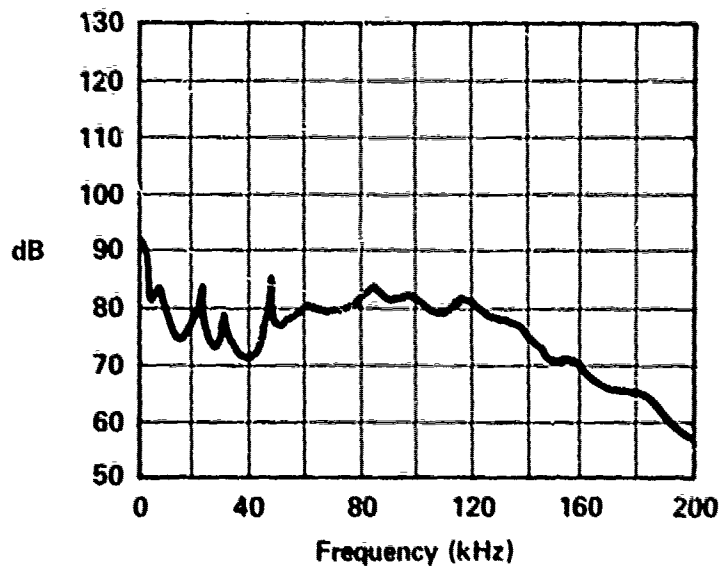

RELIEF VALVE - VICKERS
 INLET PRESSURE - 1400 PSI
 RETURN PRESSURE - 400 PSI
 FLOW TO VALVE - 20 GPM
 B-305

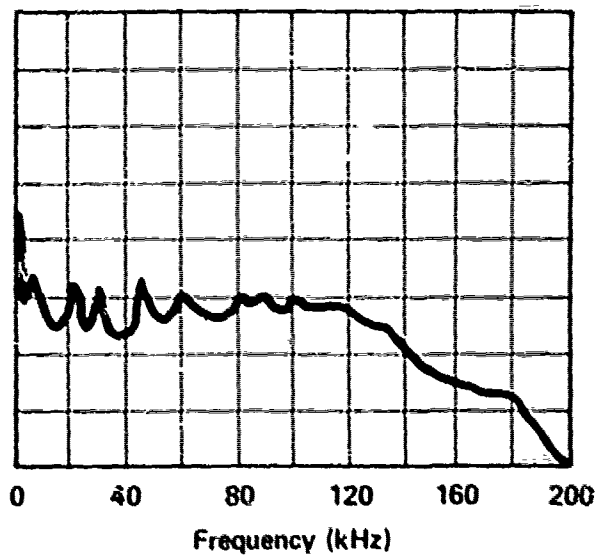

RELIEF VALVE - VICKERS
 INLET PRESSURE - 1450 PSI
 RETURN PRESSURE - 450 PSI
 FLOW TO VALVE - 20 GPM
 B-306

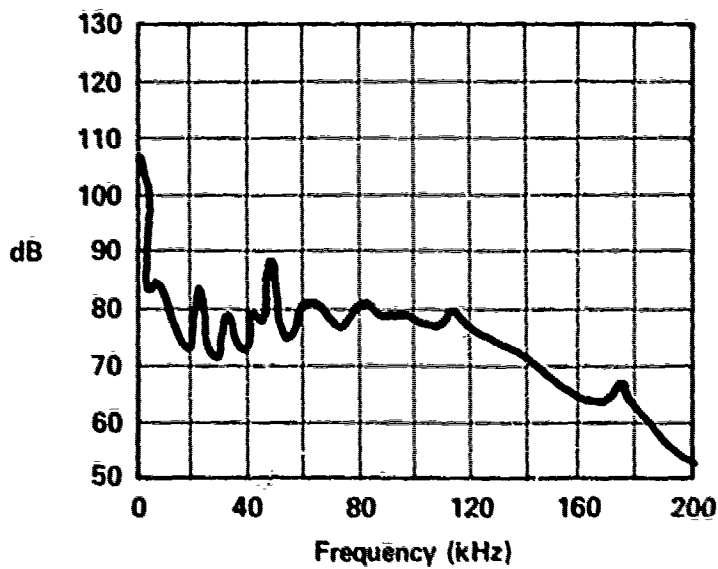

RELIEF VALVE - VICKERS
 INLET PRESSURE - 1500 PSI
 RETURN PRESSURE - 500 PSI
 FLOW TO VALVE - 20 GPM
 B-307

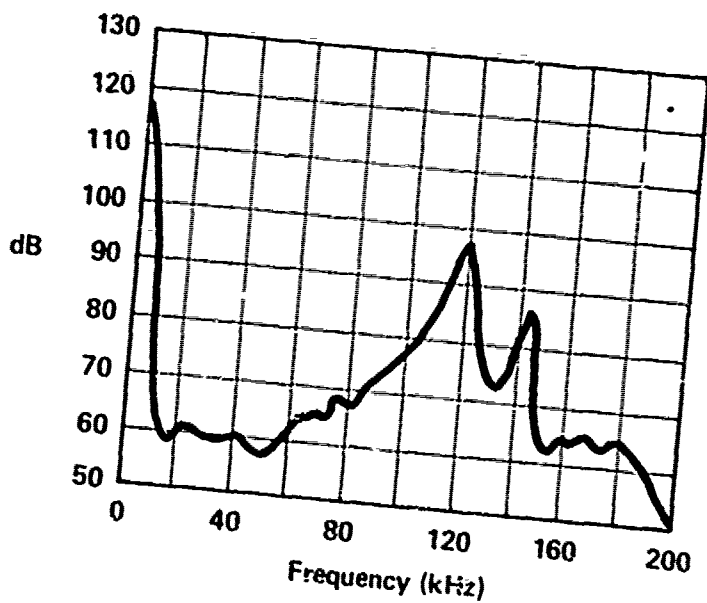

RELIEF VALVE - VICKERS
 INLET PRESSURE - 1000 PSI
 RETURN PRESSURE - 0 PSI
 FLOW TO VALVE - 5 GPM
 B-308

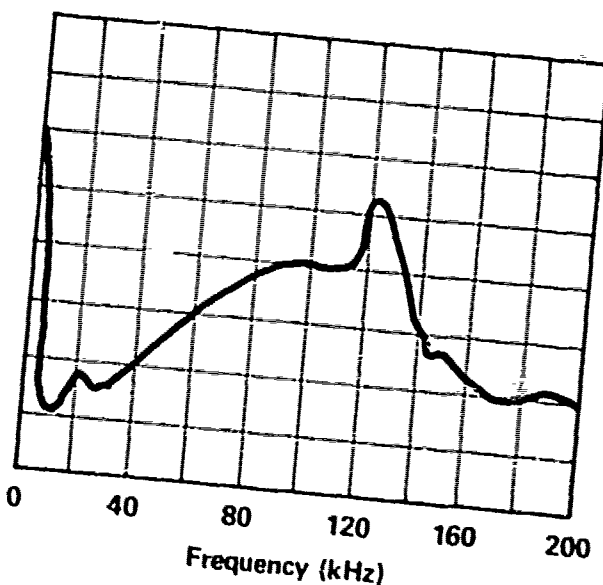

RELIEF VALVE - VICKERS
 INLET PRESSURE - 1000 PSI
 RETURN PRESSURE - 0 PSI
 FLOW TO VALVE - 10 GPM
 B-309

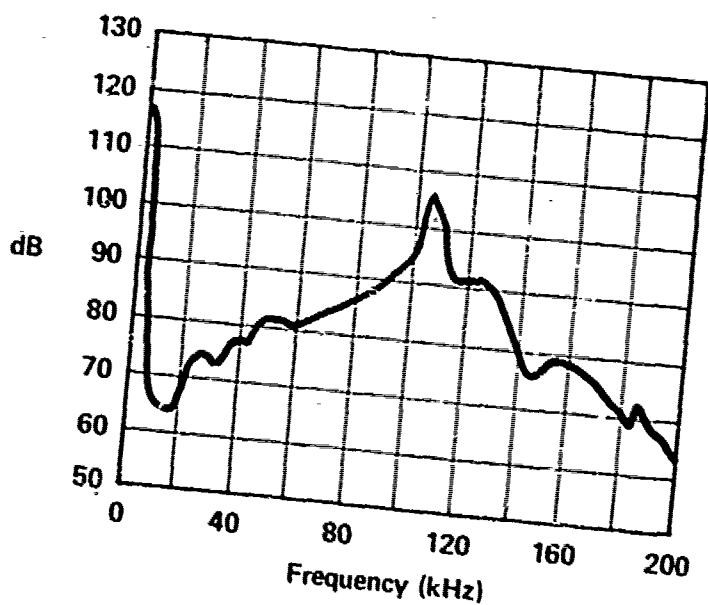

RELIEF VALVE - VICKERS
 INLET PRESSURE - 1000 PSI
 RETURN PRESSURE - 0 PSI
 FLOW TO VALVE - 15 GPM
 B-310

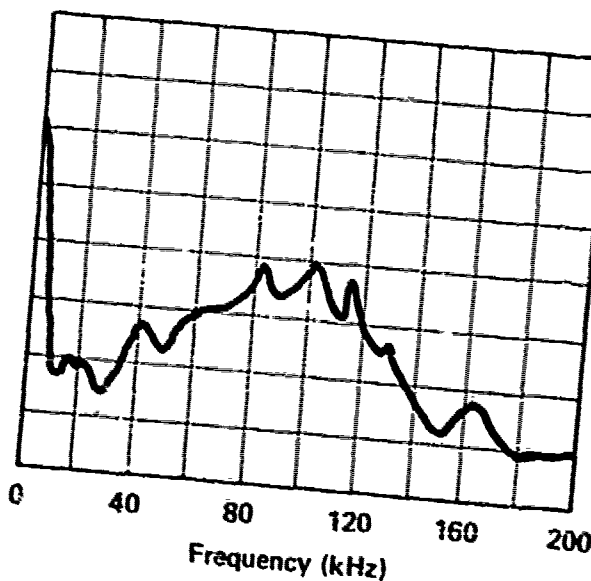

RELIEF VALVE - VICKERS
 INLET PRESSURE - 1000 PSI
 RETURN PRESSURE - 0 PSI
 FLOW TO VALVE - 20 GPM
 B-311

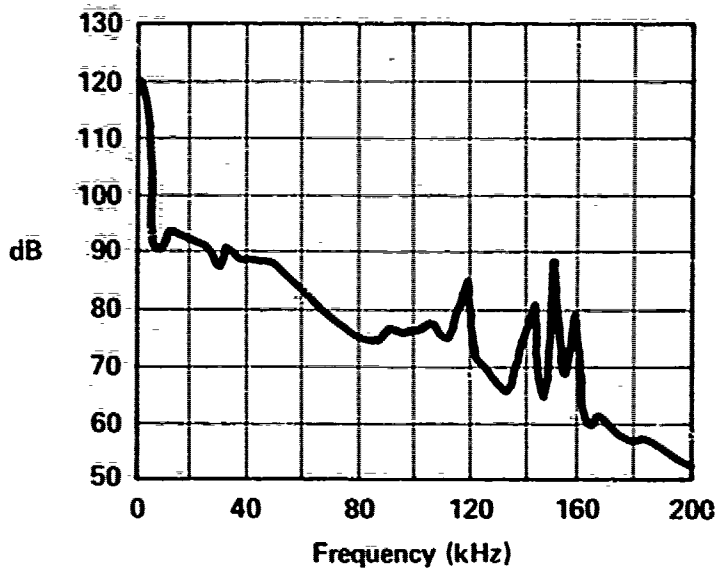

RELIEF VALVE - VICKERS
 INLET PRESSURE - 1500 PSI
 RETURN PRESSURE - 500 PSI
 FLOW TO VALVE - 5 GPM
 B-312

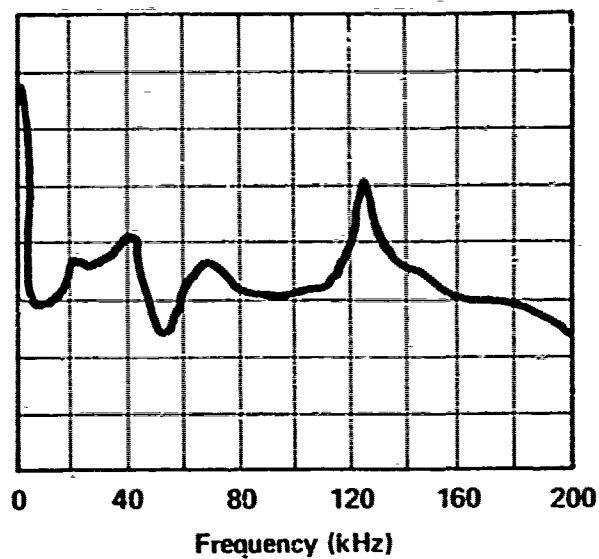

RELIEF VALVE - VICKERS
 INLET PRESSURE - 1500 PSI
 RETURN PRESSURE - 500 PSI
 FLOW TO VALVE - 10 GPM
 B-313

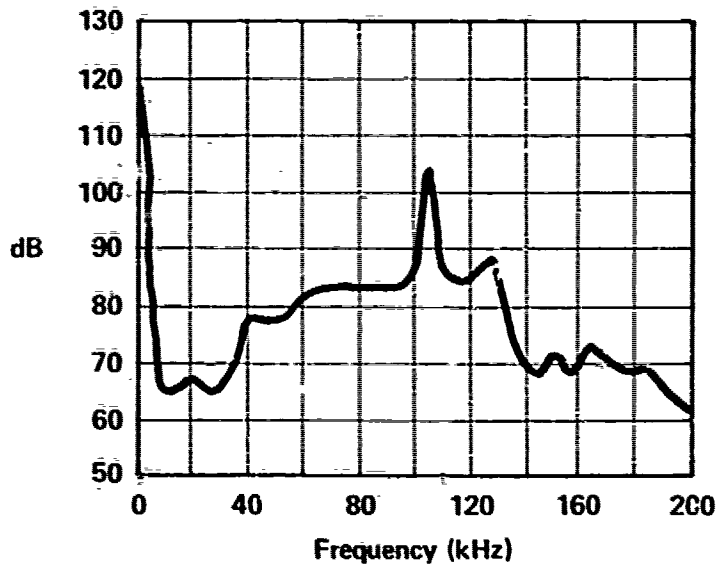

RELIEF VALVE - VICKERS
 INLET PRESSURE - 1500 PSI
 RETURN PRESSURE - 500 PSI
 FLOW TO VALVE - 15 GPM
 B-314

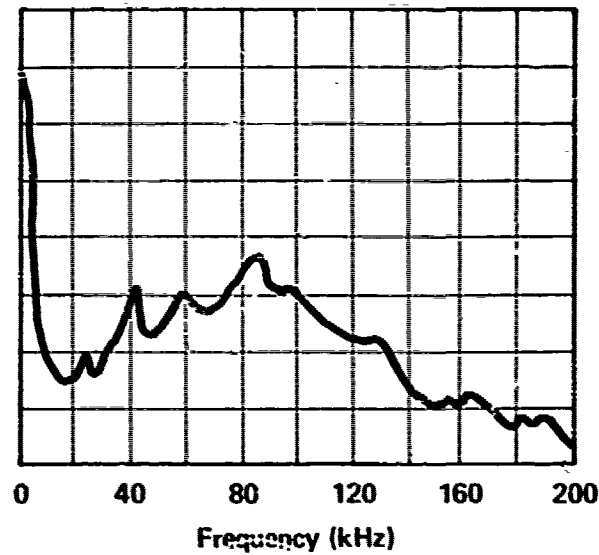

RELIEF VALVE - VICKERS
 INLET PRESSURE - 1500 PSI
 RETURN PRESSURE - 500 PSI
 FLOW TO VALVE - 20 GPM
 B-315

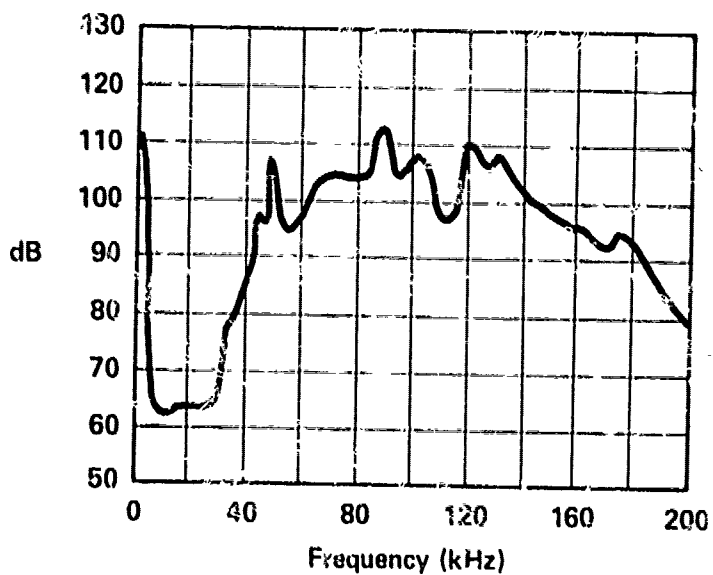

RELIEF VALVE - REPUBLIC RG70
 INLET PRESSURE - 1000 PSI
 RETURN PRESSURE - 0 PSI
 FLOW TO VALVE - 5 GPM
 B-401

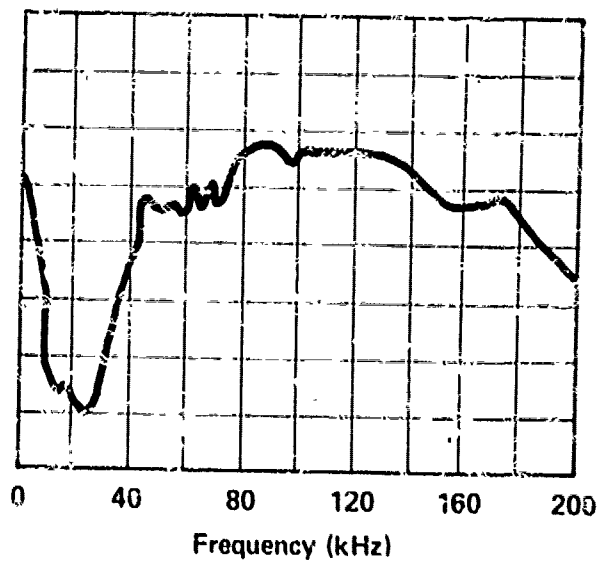

RELIEF VALVE - REPUBLIC RG70
 INLET PRESSURE - 1000 PSI
 RETURN PRESSURE - 0 PSI
 FLOW TO VALVE - 10 GPM
 B-402

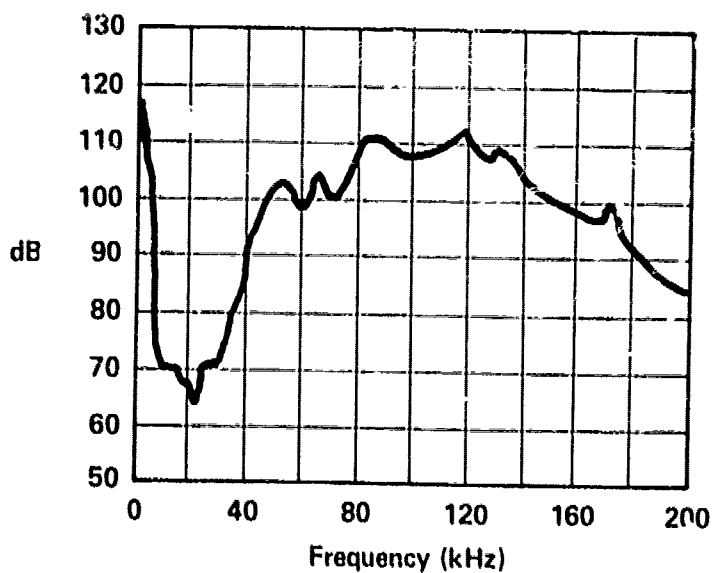

RELIEF VALVE - REPUBLIC RG70
 INLET PRESSURE - 1000 PSI
 RETURN PRESS. RE - 0 PSI
 FLOW TO VALVE - 15 GPM
 B-403

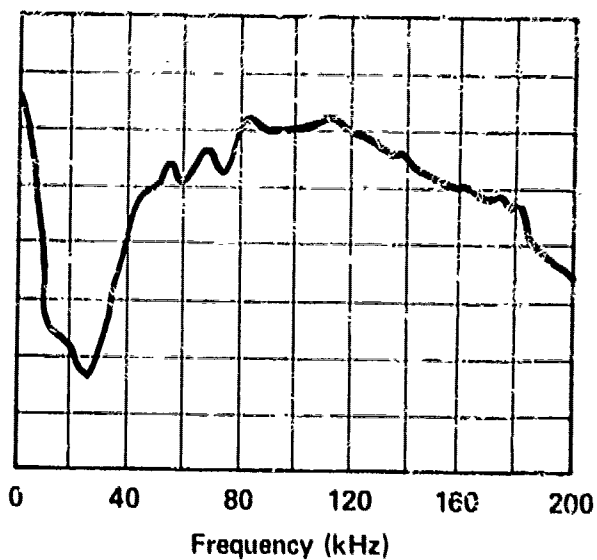

RELIEF VALVE - REPUBLIC RG70
 INLET PRESSURE - 1000 PSI
 RETURN PRESSURE - 0 PSI
 FLOW TO VALVE - 20 GPM
 B-404

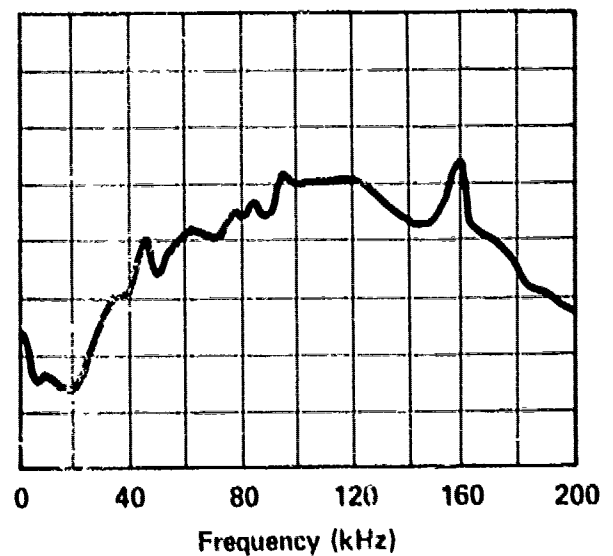
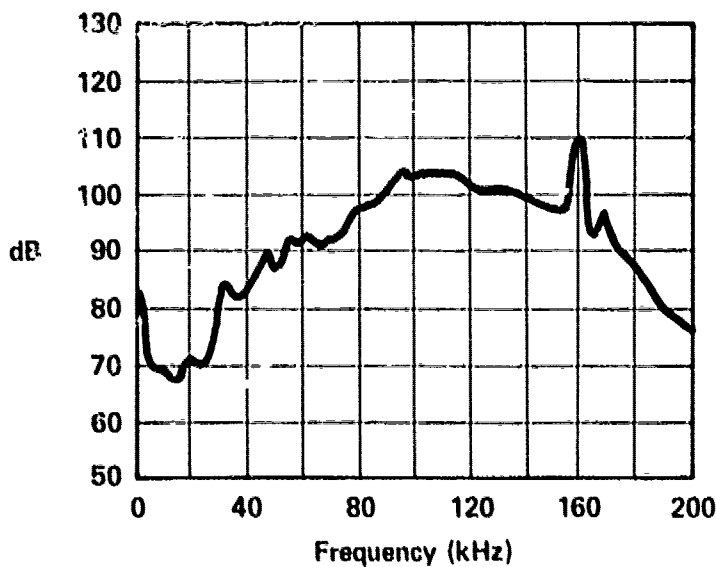
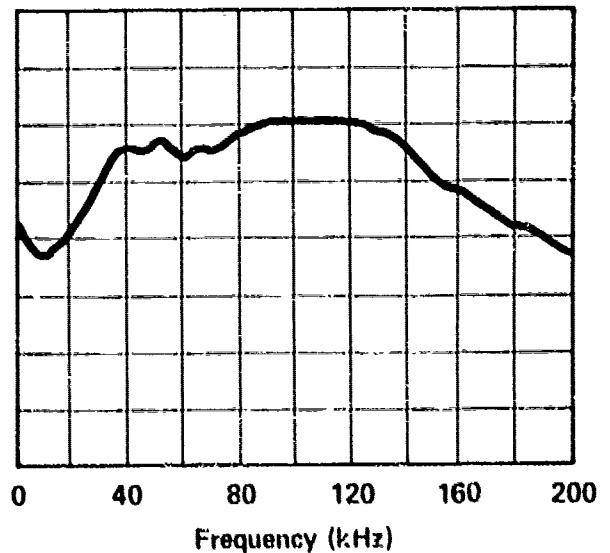
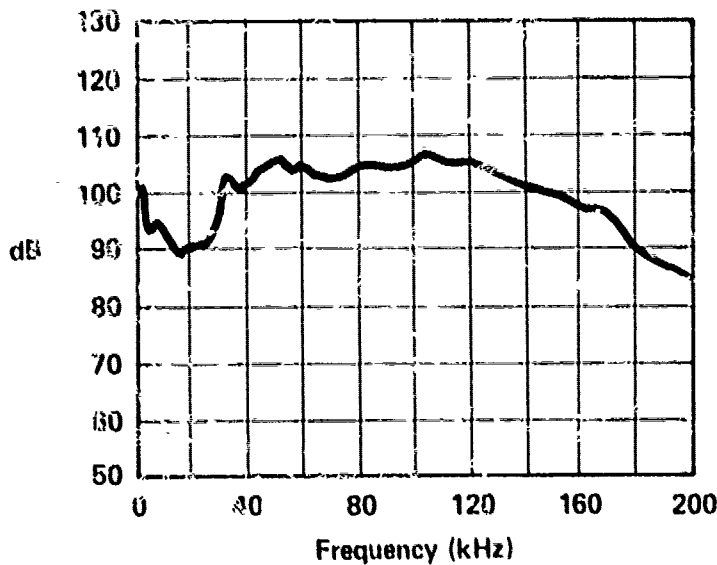

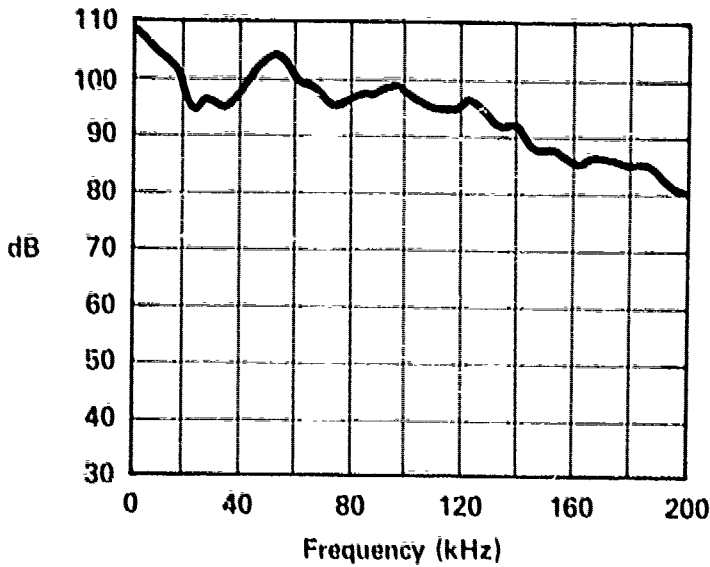

RELIEF VALVE - CIRCLE SEAL P10-776
 INLET PRESSURE - 1000 PSI
 RETURN PRESSURE - 0 PSI
 FLOW TO VALVE - 9 GPM
 B-501

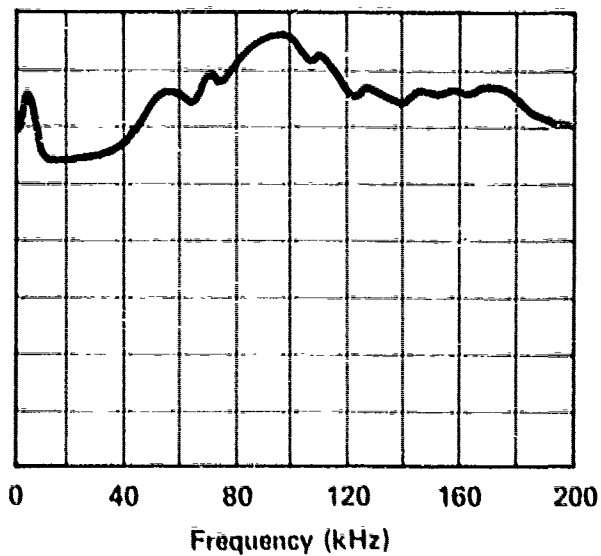

RELIEF VALVE - CIRCLE SEAL P10-776
 INLET PRESSURE - 1500 PSI
 RETURN PRESSURE - 500 PSI
 FLOW TO VALVE - 9 GPM
 B-502

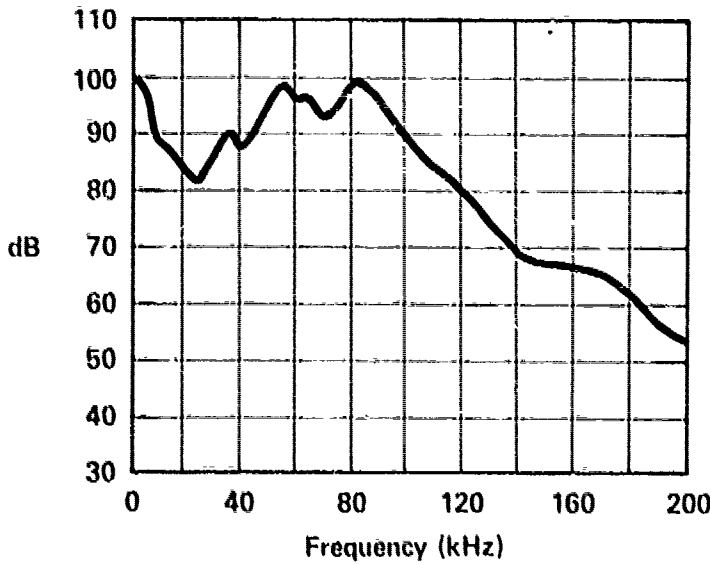

RELIEF VALVE - CIRCLE SEAL P10-776
 INLET PRESSURE - 1000 PSI
 RETURN PRESSURE - 500 PSI
 FLOW TO VALVE - 9 GPM
 B-503

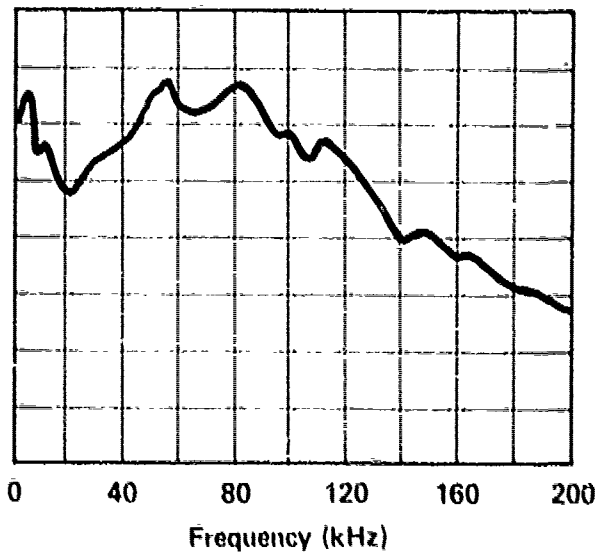

RELIEF VALVE - CIRCLE SEAL P10-776
 INLET PRESSURE - 1500 PSI
 RETURN PRESSURE - 1000 PSI
 FLOW TO VALVE - 9 GPM
 B-504

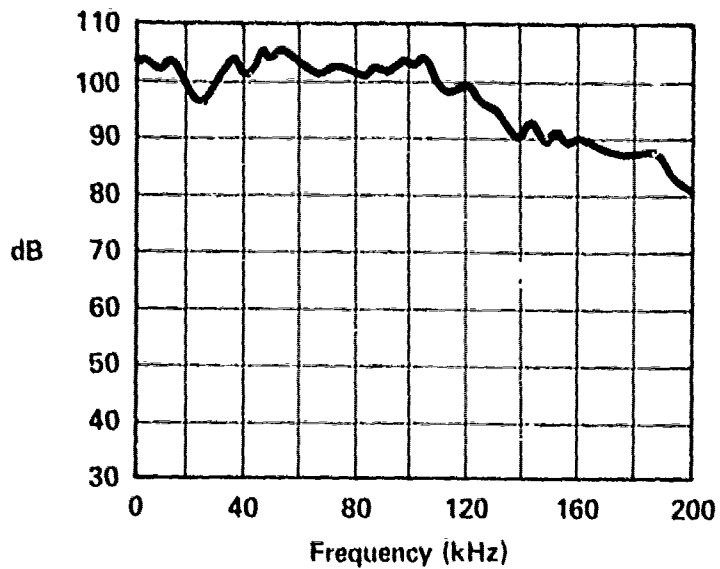

RELIEF VALVE - CIRCLE SEAL P10-776
 INLET PRESSURE - 500 PSI
 RETURN PRESSURE - 0 PSI
 FLOW TO VALVE - 9 GPM
 B-505

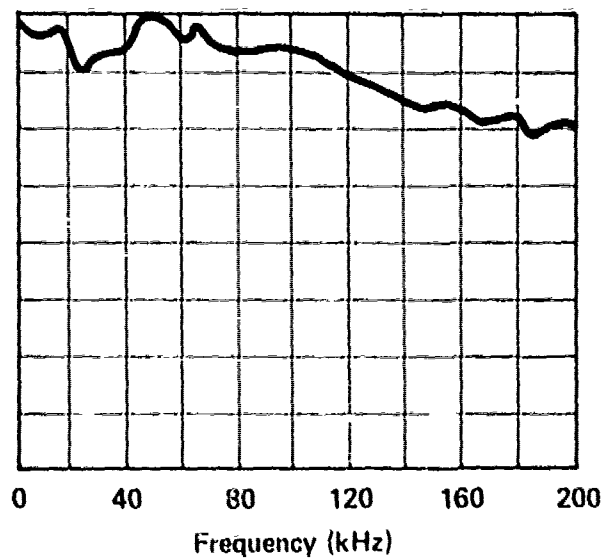

RELIEF VALVE - CIRCLE SEAL P10-776
 INLET PRESSURE - 500 PSI
 RETURN PRESSURE - 0 PSI
 FLOW TO VALVE - 18 GPM
 B-506

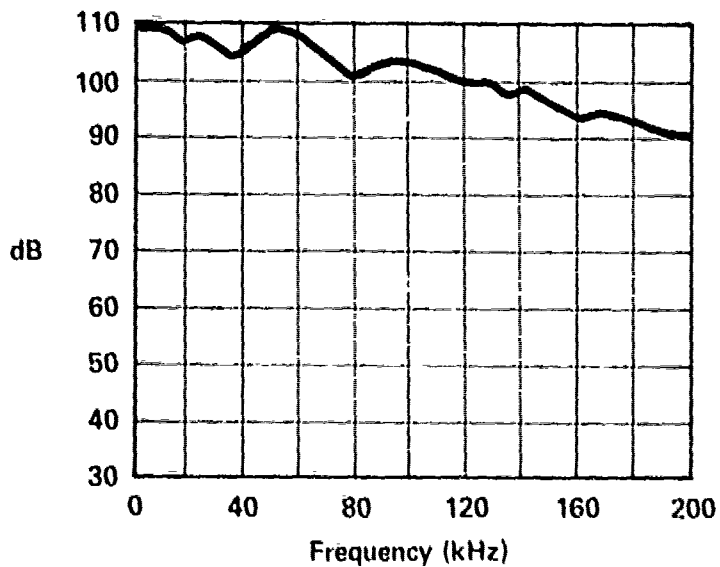

RELIEF VALVE - CIRCLE SEAL P10-776
 INLET PRESSURE - 1000 PSI
 RETURN PRESSURE - 0 PSI
 FLOW TO VALVE - 18 GPM
 B-507

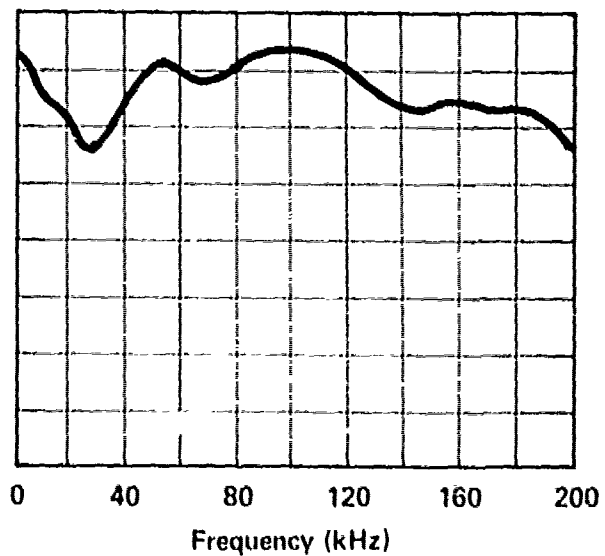

RELIEF VALVE - CIRCLE SEAL P10-776
 INLET PRESSURE - 1500 PSI
 RETURN PRESSURE - 500 PSI
 FLOW TO VALVE - 18 GPM
 B-508

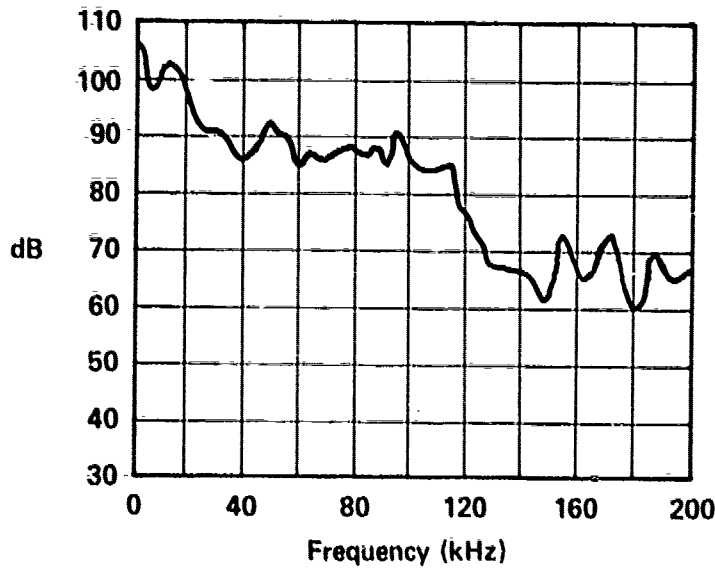

RELIEF VALVE - CIRCLE SEAL P10-776
 INLET PRESSURE - 1000 PSI
 RETURN PRESSURE - 500 PSI
 FLOW TO VALVE - 18 GPM
 B-509

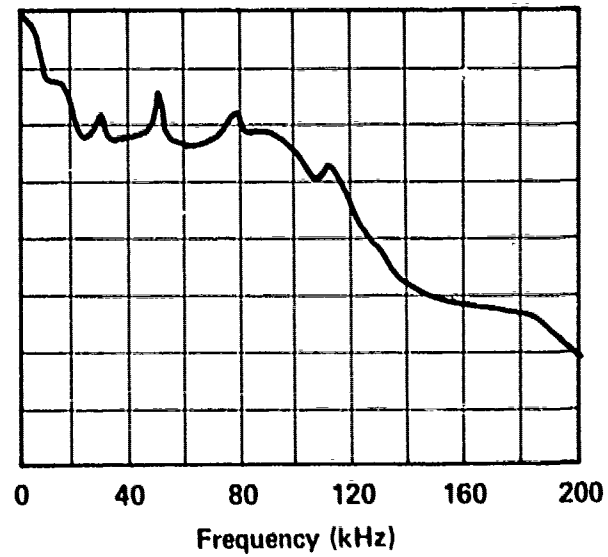

RELIEF VALVE - CIRCLE SEAL P10-776
 INLET PRESSURE - 1500 PSI
 RETURN PRESSURE - 1000 PSI
 FLOW TO VALVE - 18 GPM
 B-510

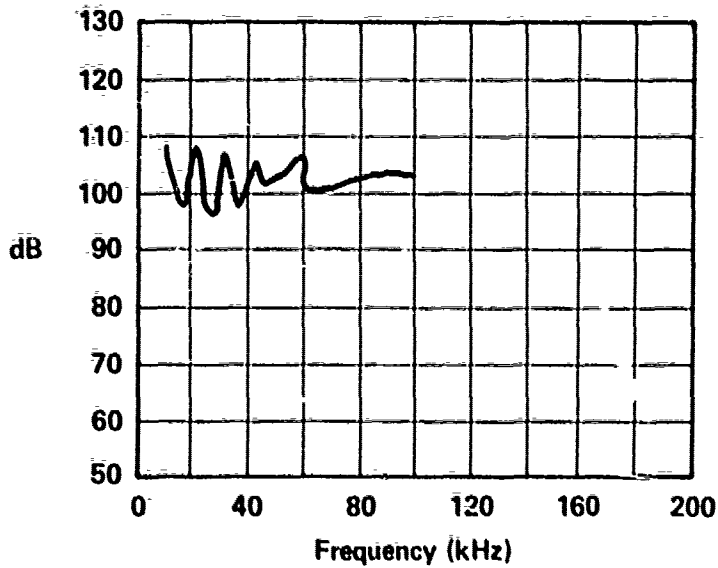

MOTOR - CHAR-LYNN
 MOTOR RPM - 300 RPM
 DISK DIAMETER - 22.625 IN
 TESTED AT KU TREE RESERVOIR
 C-101

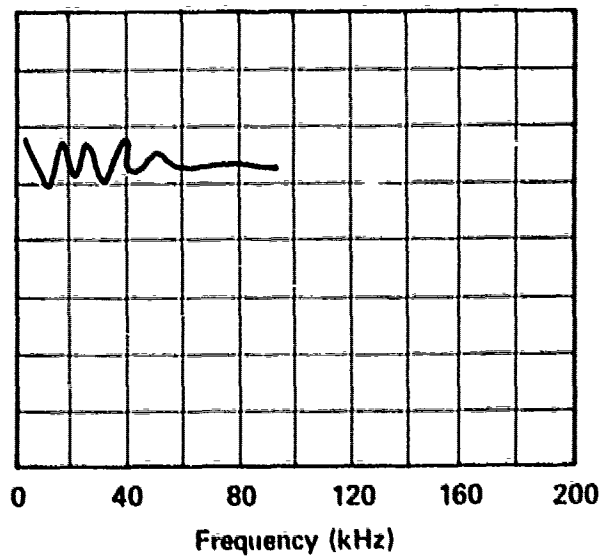

MOTOR - CHAR-LYNN
 MOTOR RPM - 600 RPM
 DISK DIAMETER - 22.625 IN
 TESTED AT KU TREE RESERVOIR
 C-102

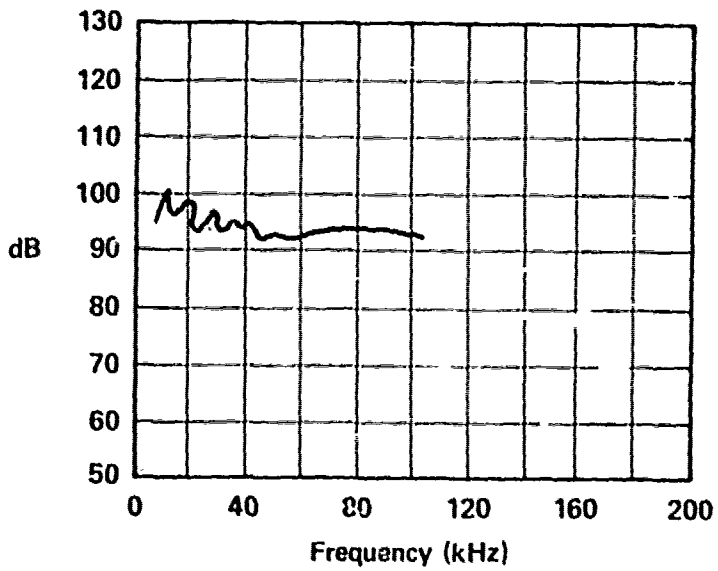

MOTOR - LAMINA
 MOTOR RPM - 300 RPM
 DISK DIAMETER - 22.625 IN
 TESTED AT KU TREE RESERVOIR
 C-201

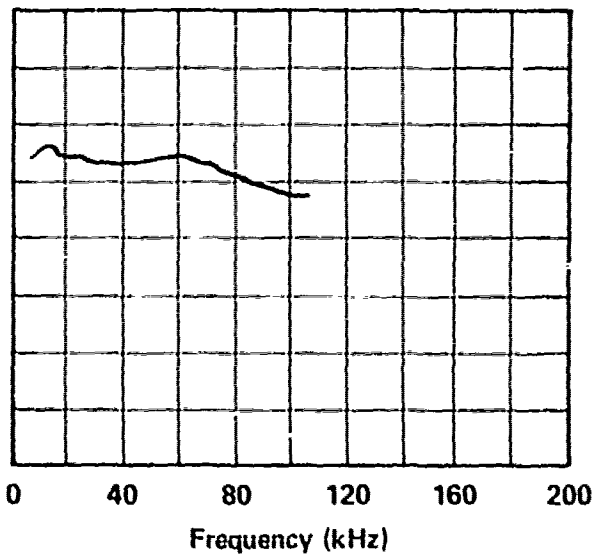

MOTOR - LAMINA
 MOTOR RPM - 450 RPM
 DISK DIAMETER - 22.625 IN
 TESTED AT KU TREE RESERVOIR
 C-202

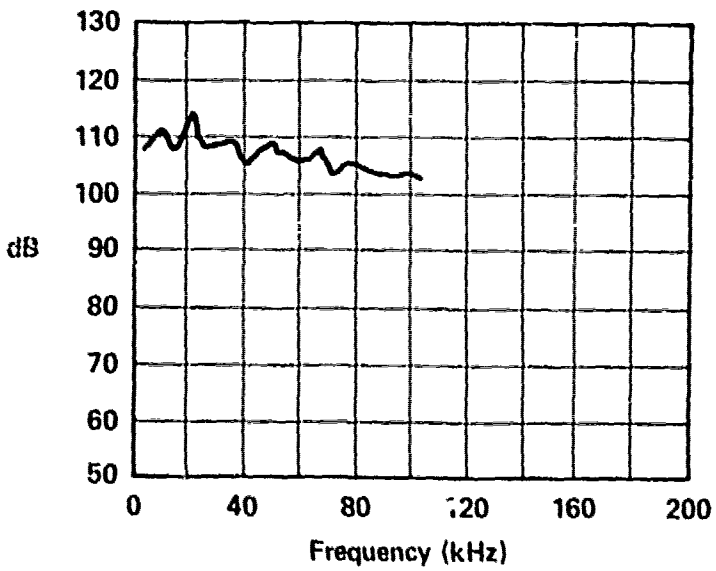

MOTOR - LAMINA
 MOTOR RPM - 600 RPM
 DISK DIAMETER - 22.625 IN
 TESTED AT KU TREE RESERVOIR
 C-203

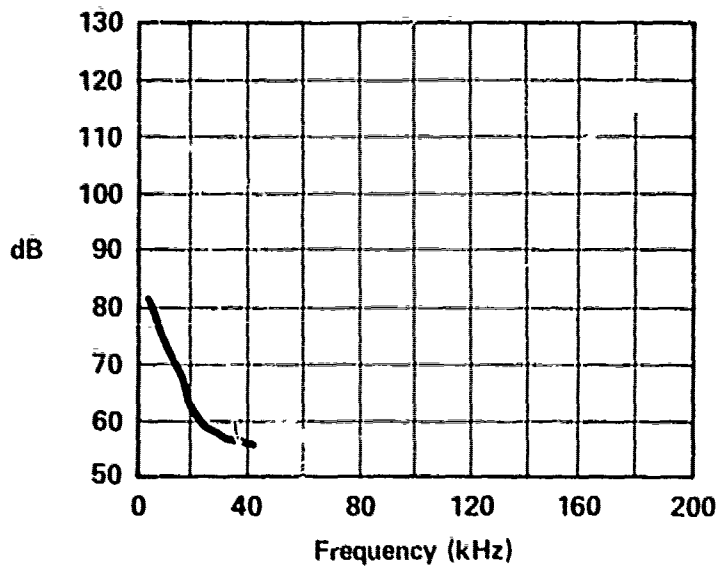

MOTOR - PLANET
 MOTOR RPM - 300 RPM
 DISK DIAMETER - 22.625 IN
 TESTED AT LI TREE RESERVOIR
 C-301

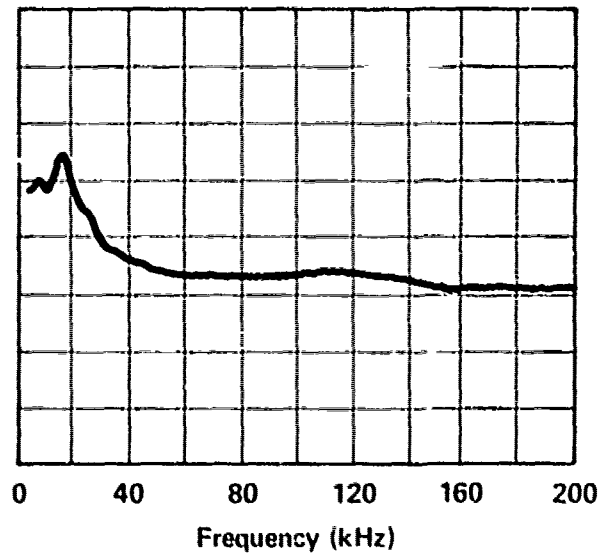

MOTOR - PLANET
 MOTOR RPM - 450 RPM
 DISK DIAMETER - 22.625 IN
 TESTED AT KU TREE RESERVOIR
 C-302

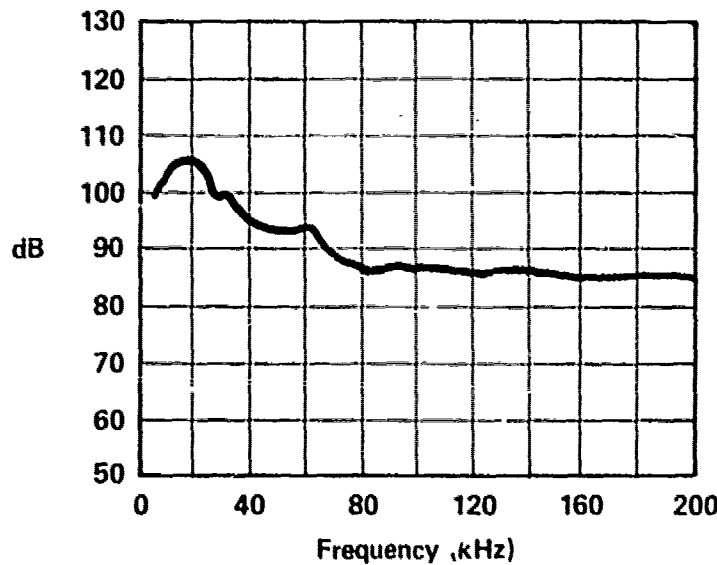

MOTOR - PLANET
 MOTOR RPM - 600 RPM
 DISK DIAMETER - 22.625 IN
 TESTED AT KU TREE RESERVOIR
 C-303

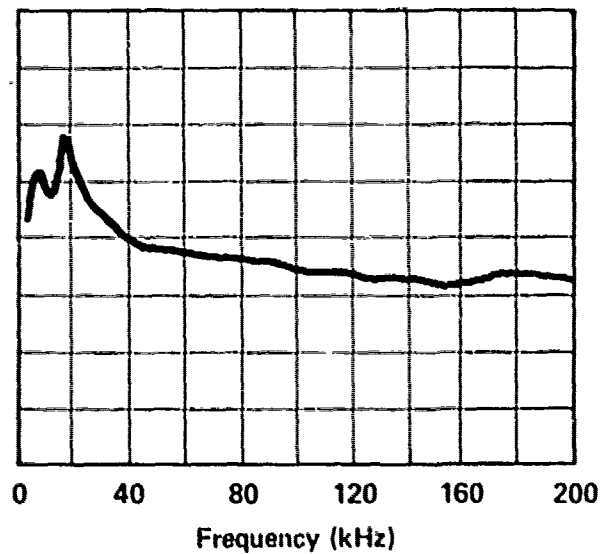

MOTOR - PLANET
 MOTOR RPM - 900 RPM
 DISK DIAMETER - 22.625 IN
 TESTED AT KU TREE RESERVOIR
 C-304

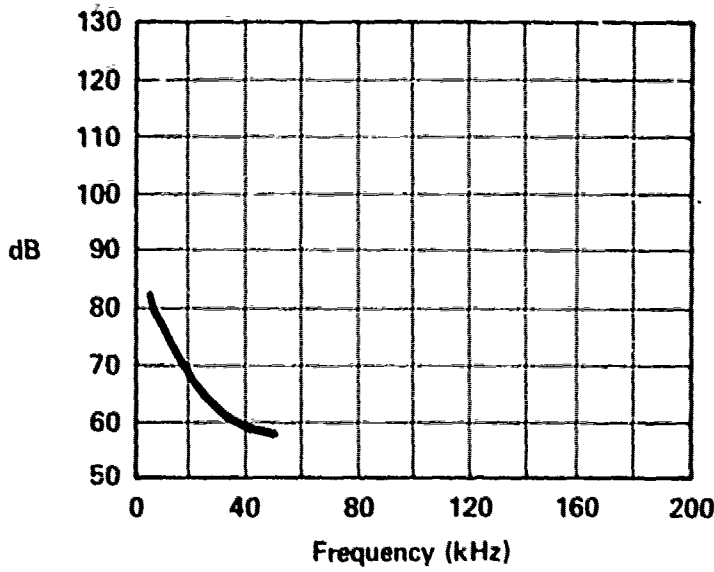

MOTOR - WSI
 MOTOR RPM - 300 RPM
 DISK DIAMETER - 22.625 IN
 TESTED AT KU TREE RESERVOIR
 C-401

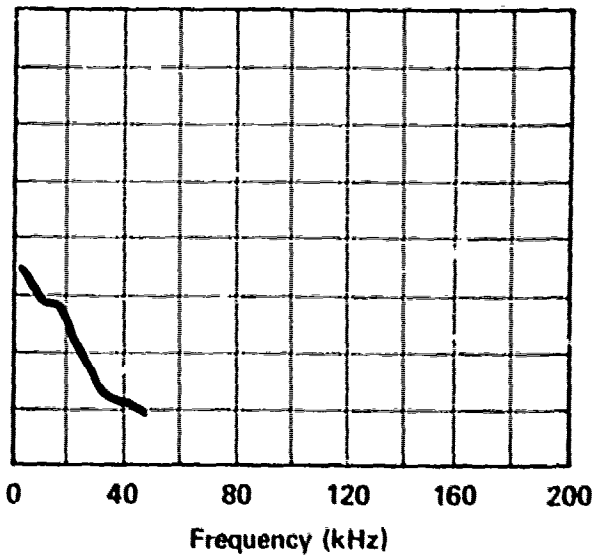

MOTOR - WSI
 MOTOR - 450 RPM
 DISK DIAMETER - 22.625 IN
 TESTED AT KU TREE RESERVOIR
 C-402

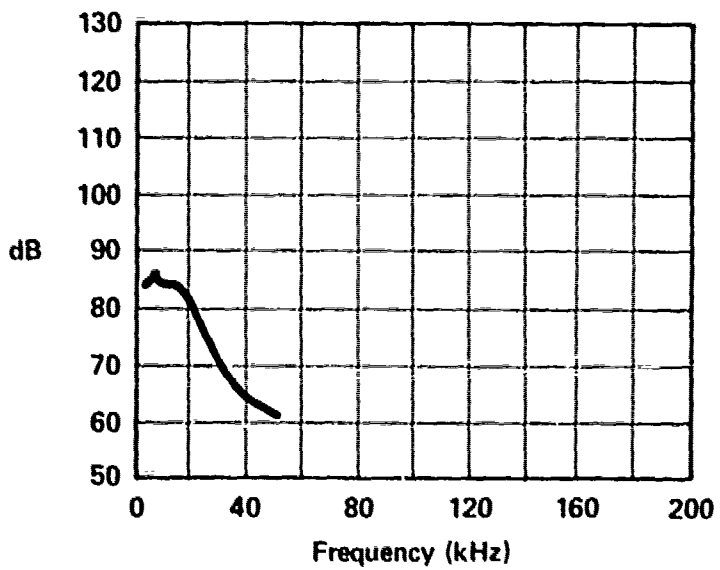

MOTOR - WSI
 MOTOR RPM - 600 RPM
 DISK DIAMETER - 22.625 IN
 TESTED AT KU TREE RESERVOIR
 C-403

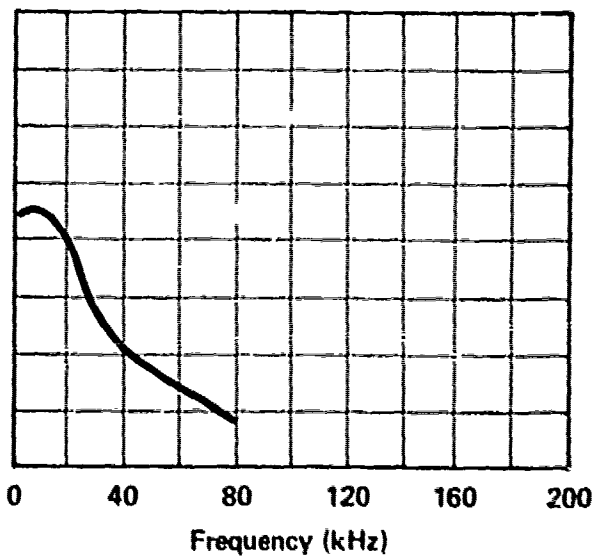

MOTOR - WSI
 MOTOR RPM - 900 RPM
 DISK DIAMETER - 22.625 IN
 TESTED AT KU TREE RESERVOIR
 C-404

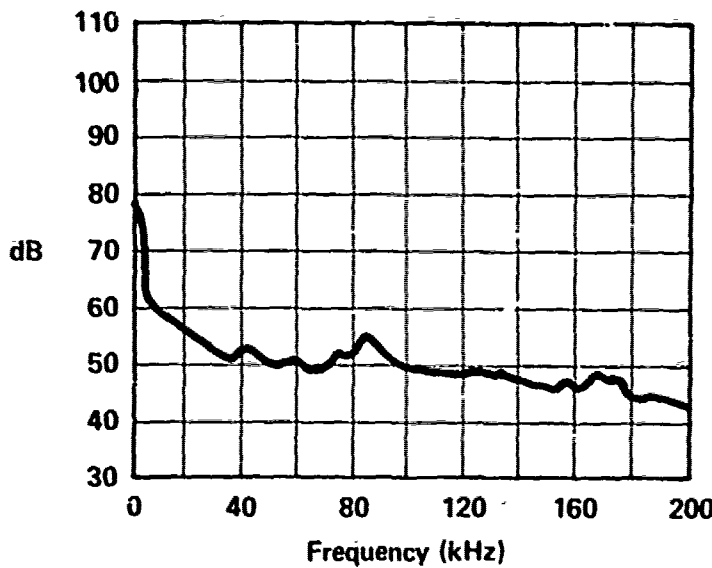

MOTOR - WSI
 INLET PRESSURE - 100 PSI
 RETURN PRESSURE - 0 PSI
 FLOW TO MOTOR - 1 GPM
 SHAFT RPM - 200 RPM
 TORQUE PRODUCED - 80 IN-LB
 DISK DIAMETER - 24 IN
 C-405

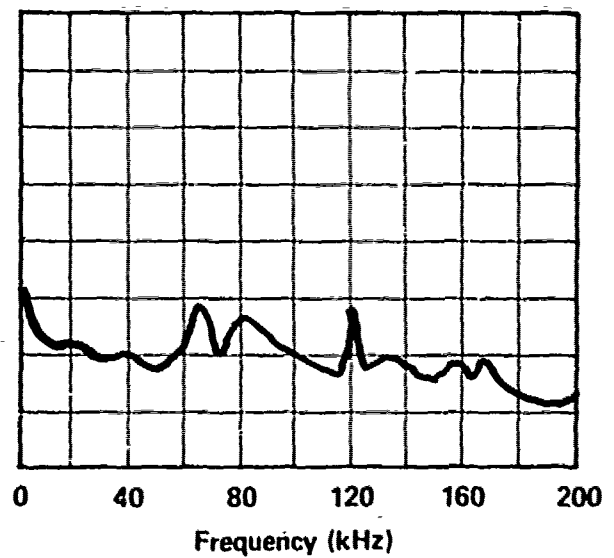

MOTOR - WSI
 INLET PRESSURE - 300 PSI
 RETURN PRESSURE - 100 PSI
 FLOW TO MOTOR - 5 GPM
 SHAFT RPM - 300 RPM
 TORQUE PRODUCED - 120 IN-LB
 DISK DIAMETER - 24 IN
 C-406

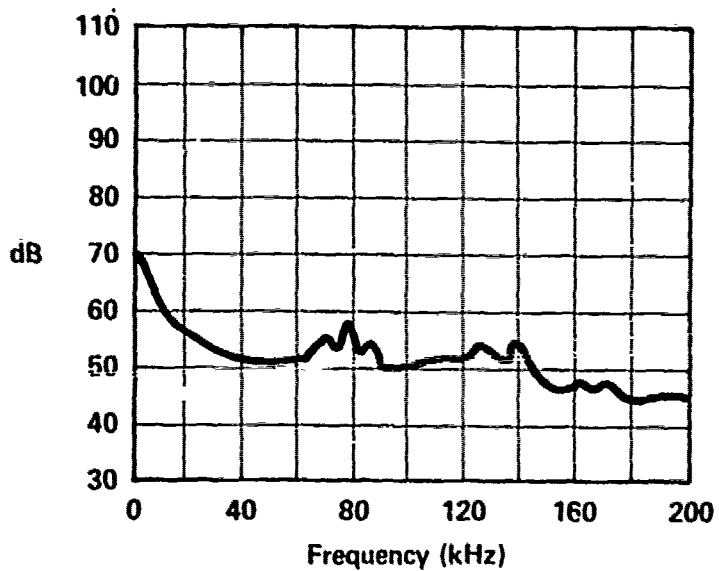

MOTOR - WSI
 INLET PRESSURE - 500 PSI
 RETURN PRESSURE - 150 PSI
 FLOW TO MOTOR - 7.1 GPM
 SHAFT RPM - 450 RPM
 TORQUE PRODUCED - 220 IN-LB
 DISK DIAMETER - 24 IN
 C-407

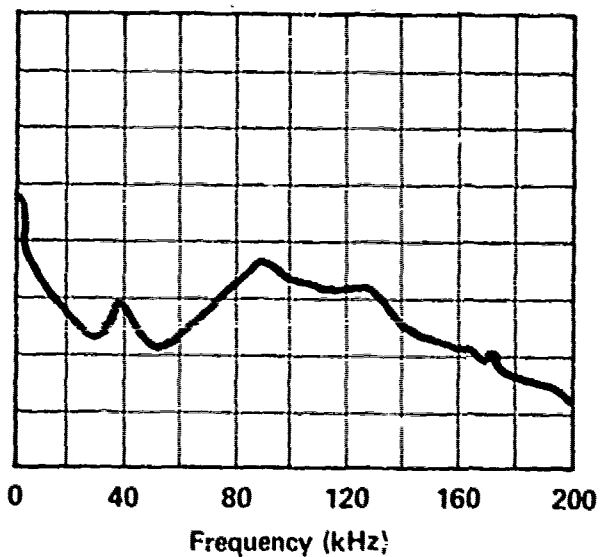

MOTOR - WSI
 INLET PRESSURE - 800 PSI
 RETURN PRESSURE - 150 PSI
 FLOW TO MOTOR - 10 GPM
 SHAFT RPM - 600 RPM
 TORQUE PRODUCED - 400 IN-LB
 DISK DIAMETER - 24 IN
 C-408

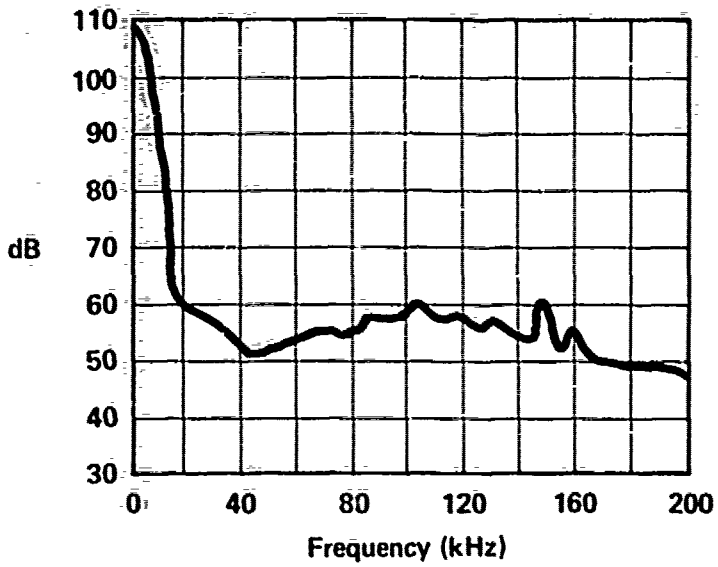

MOTOR - WSI
 INLET PRESSURE - 500 PSI
 RETURN PRESSURE - 150 PSI
 FLOW TO MOTOR - 5 GPM
 SHAFT RPM - 300 RPM
 TORQUE PRODUCED - 200 IN-LB
 DISK DIAMETER - 28 IN
 C-409

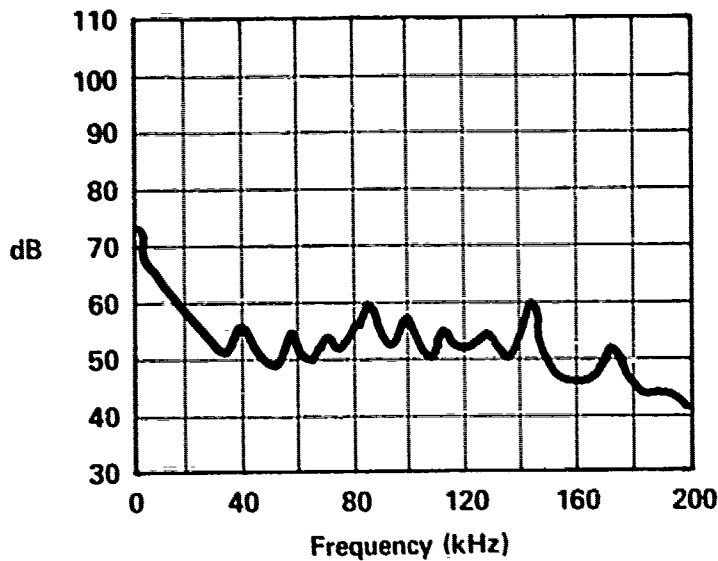

MOTOR - WSI
 INLET PRESSURE - 250 PSI
 RETURN PRESSURE - 125 PSI
 FLOW TO MOTOR - 2.5 GPM
 SHAFT RPM - 150 RPM
 TORQUE PRODUCED - 100 IN-LB
 DISK DIAMETER - 32.875 IN
 C-410

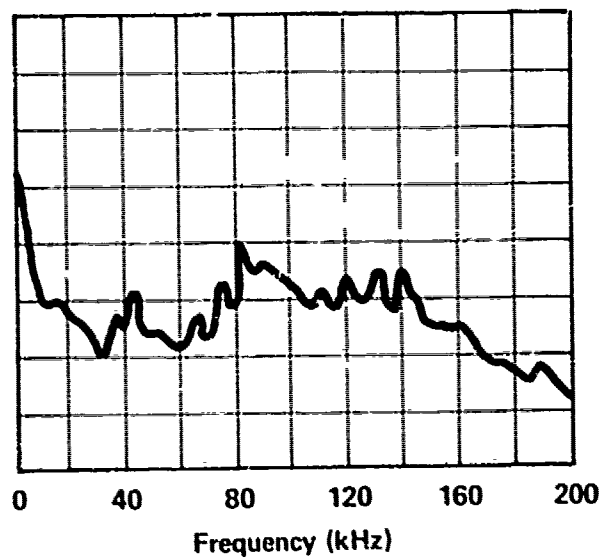

MOTOR - WSI
 INLET PRESSURE - 750 PSI
 RETURN PRESSURE - 125 PSI
 FLOW TO MOTOR - 5 GPM
 SHAFT RPM - 300 RPM
 TORQUE PRODUCED - 340 IN-LB
 DISK DIAMETER - 32.875 IN
 C-411

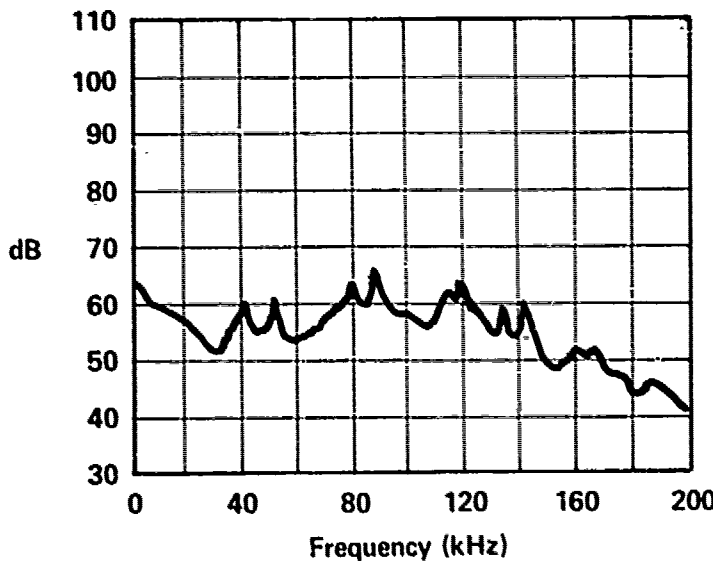

MOTOR - WSI
 INLET PRESSURE - 800 PSI
 RETURN PRESSURE - 125 PSI
 FLOW TO MOTOR - 5.6 GPM
 SHAFT RPM - 324 RPM
 TORQUE PRODUCED - 420 IN-LB
 DISK DIAMETER - 32.875 IN
 C-412

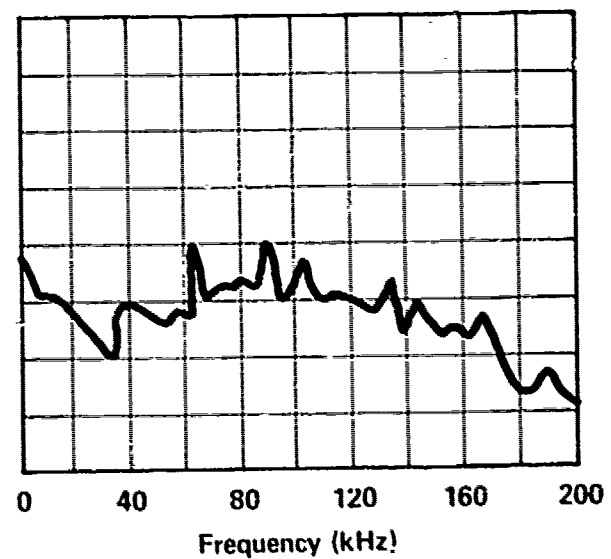

MOTOR - WSI
 INLET PRESSURE - 1000 PSI
 RETURN PRESSURE - 125 PSI
 FLOW TO MOTOR - 6.5 GPM
 SHAFT RPM - 342 RPM
 TORQUE PRODUCED - 510 IN-LB
 DISK DIAMETER - 32.875 IN
 C-413

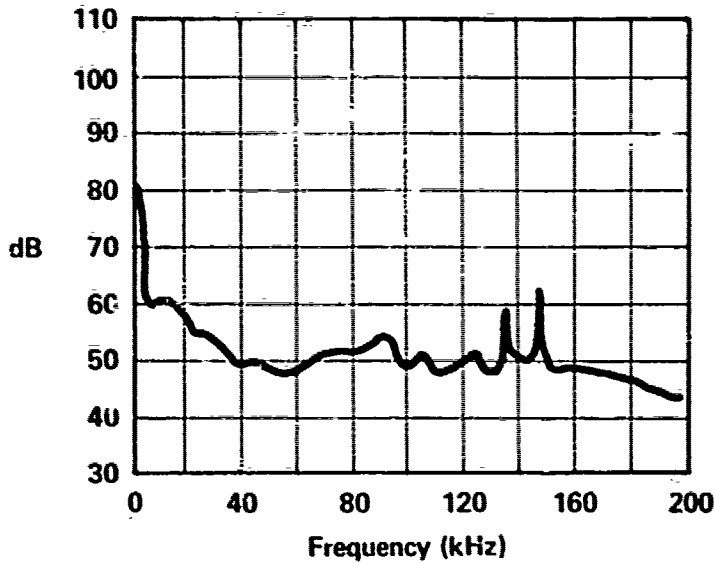

MOTOR - WSI
 INLET PRESSURE - 400 PSI
 RETURN PRESSURE - 125 PSI
 FLOW TO MOTOR - 2.5 GPM
 SHAFT RPM - 150 RPM
 TORQUE PRODUCED - 220 IN-LB
 DISK DIAMETER - 35.75 IN
 C-114

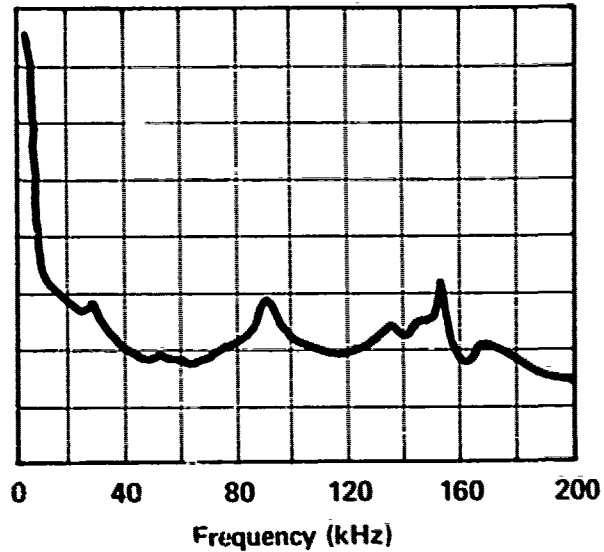

MOTOR - WSI
 INLET PRESSURE - 600 PSI
 RETURN PRESSURE - 125 PSI
 FLOW TO MOTOR - 3.8 GPM
 SHAFT RPM - 210 RPM
 TORQUE PRODUCED - 320 IN-LB
 DISK DIAMETER - 35.75 IN
 C-115

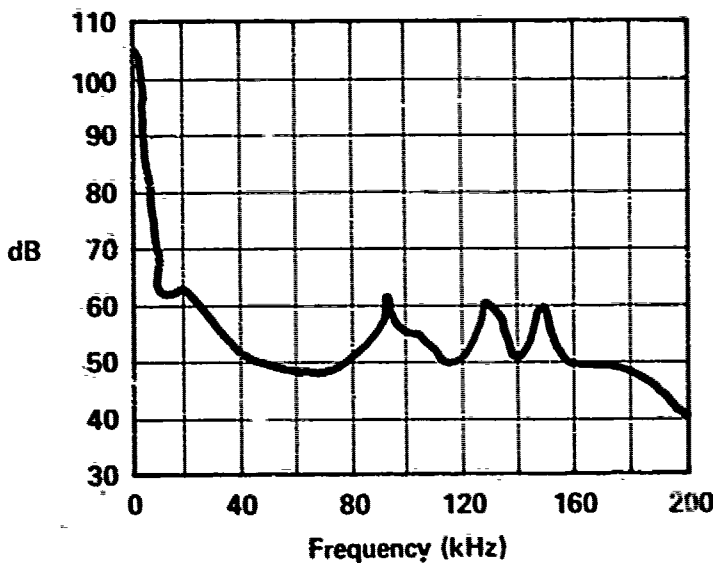

MOTOR - WSI
 INLET PRESSURE - 850 PSI
 RETURN PRESSURE - 125 PSI
 FLOW TO MOTOR - 4.8 GPM
 SHAFT RPM - 260 RPM
 TORQUE PRODUCED - 510 IN-LB
 DISK DIAMETER - 35.75 IN
 C-116

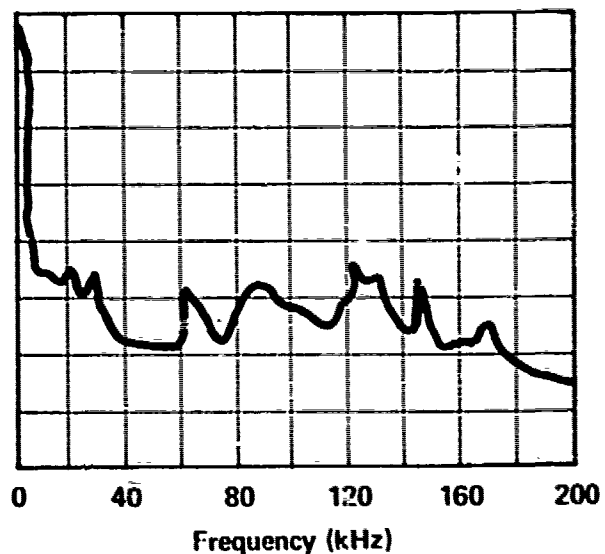

MOTOR - WSI
 INLET PRESSURE - 1100 PSI
 RETURN PRESSURE - 125 PSI
 FLOW TO MOTOR - 5 GPM
 SHAFT RPM - 300 RPM
 TORQUE PRODUCED - 600 IN-LB
 DISK DIAMETER - 35.75 IN
 C-117

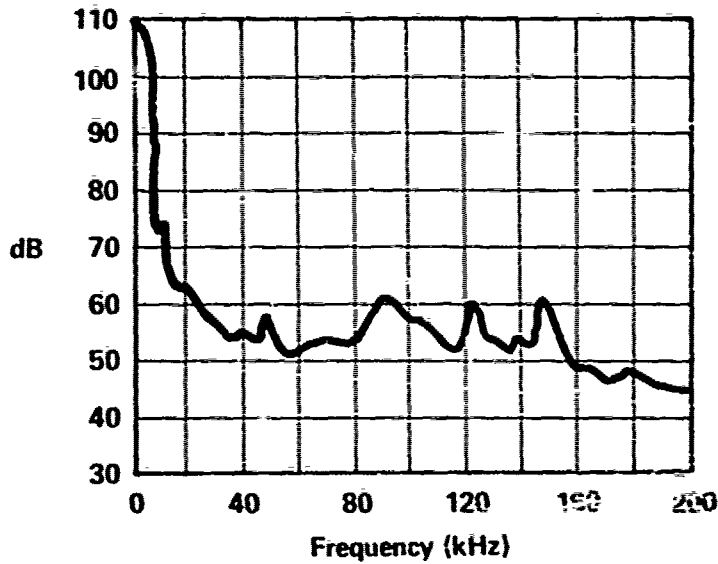

MOTOR - NUTRON
 INLET PRESSURE - 250 PSI
 RETURN PRESSURE - 150 PSI
 FLOW TO MOTOR - 2 GPM
 SHAFT RPM - 192 RPM
 TORQUE PRODUCED - 40 IN-LB
 DISK DIAMETER - 24 IN
 C-501

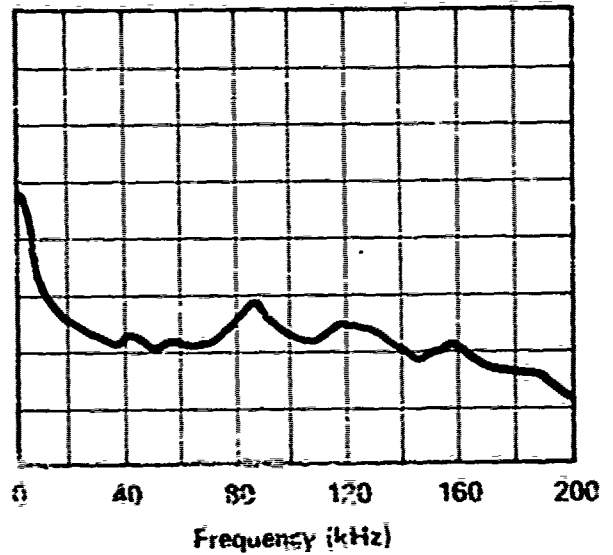

MOTOR - NUTRON
 INLET PRESSURE - 500 PSI
 RETURN PRESSURE - 150 PSI
 FLOW TO MOTOR - 3 GPM
 SHAFT RPM - 288 RPM
 TORQUE PRODUCED - 100 IN-LB
 DISK DIAMETER - 24 IN
 C-502

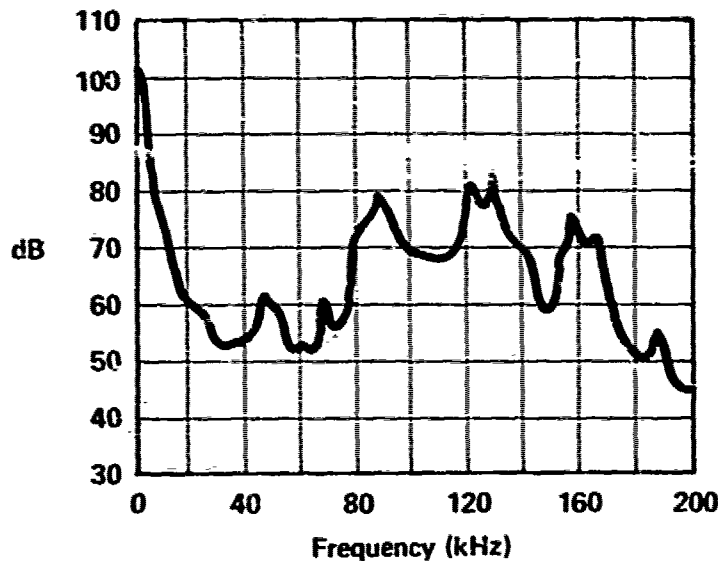

MOTOR - NUTRON
 INLET PRESSURE - 850 PSI
 RETURN PRESSURE - 150 PSI
 FLOW TO MOTOR - 4.5 GPM
 SHAFT RPM - 432 RPM
 TORQUE PRODUCED - 200 IN-LB
 DISK DIAMETER - 24 IN
 C-503

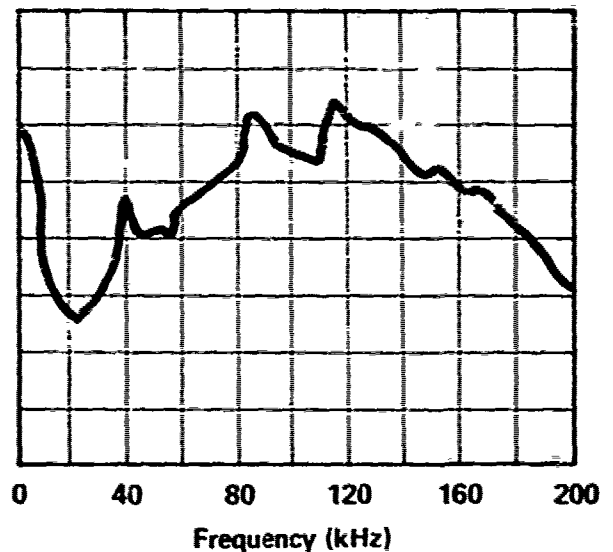

MOTOR - NUTRON
 INLET PRESSURE - 1150 PSI
 RETURN PRESSURE - 150 PSI
 FLOW TO MOTOR - 6 GPM
 SHAFT RPM - 552 RPM
 TORQUE PRODUCED - 390 IN-LB
 DISK DIAMETER - 24 IN
 C-504

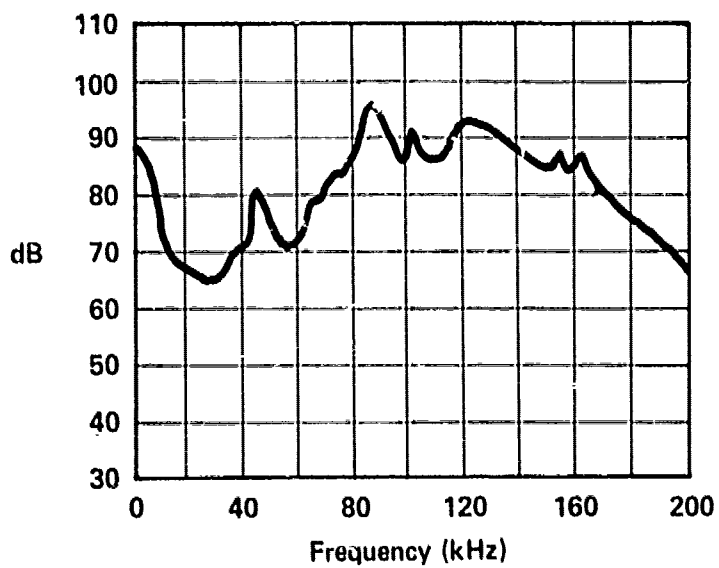

MOTOR - NUTRON
 INLET PRESSURE - 1300 PSI
 RETURN PRESSURE - 150 PSI
 FLOW TO MOTOR - 6.6 GPM
 SHAFT RPM - 600 RPM
 TORQUE PRODUCED - 400 IN-LB
 DISK DIAMETER - 24 IN
 C-505

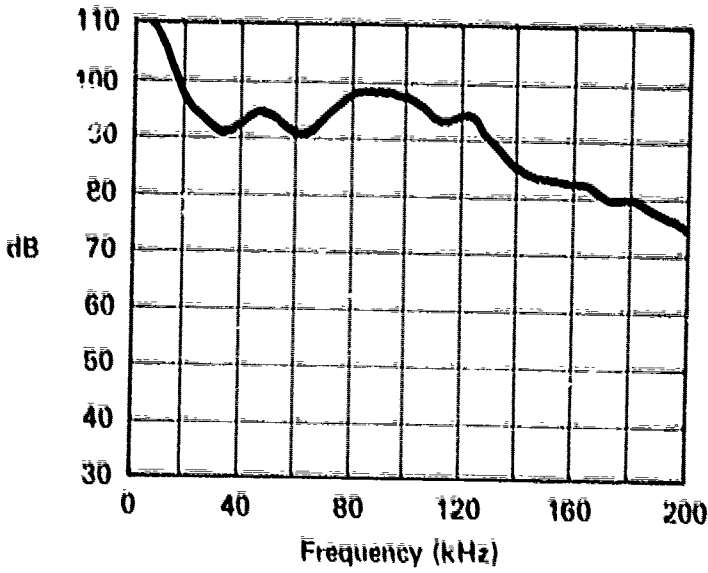

PUMP - VICKERS V30-15
 OUTPUT PRESSURE - 1000 PSI
 OUTPUT FLOW - 20 GPM
 DRIVE MOTOR - GE MOTOR @ 1750 RPM
 DRIVE COUPLING - DELRIN DIRECT DRIVE
 D-101

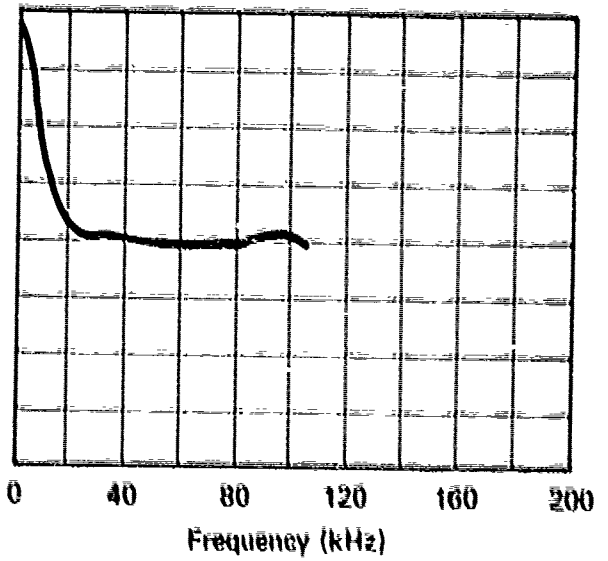

PUMP - VICKERS V30-15
 OUTPUT PRESSURE - 1500 PSI
 INLET PRESSURE - 500 PSI
 OUTPUT FLOW - 20 GPM
 DRIVE MOTOR - GE MOTOR @ 1750 RPM
 DRIVE COUPLING - DELRIN DIRECT DRIVE
 D-102

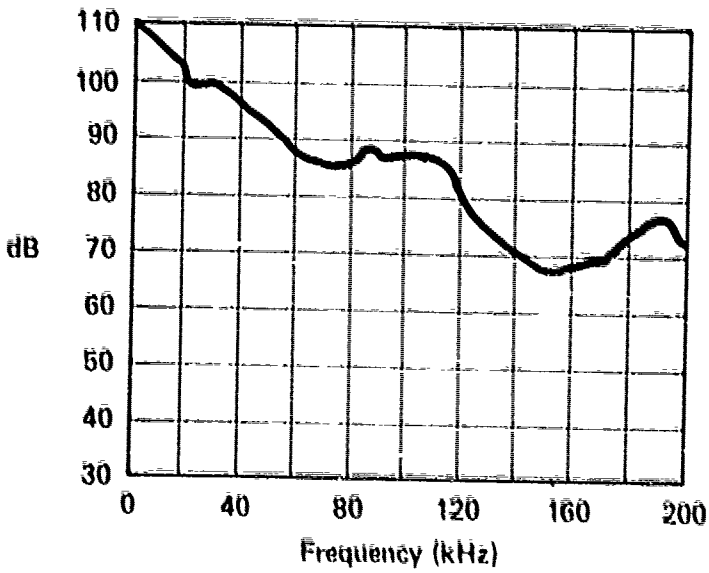

PUMP - BORG WARNER P4-2B
 OUTPUT PRESSURE - 1000 PSI
 OUTPUT FLOW - 24 GPM
 DRIVE MOTOR - GE MOTOR @ 1750 RPM
 DRIVE COUPLING - DELRIN DIRECT DRIVE
 D-201

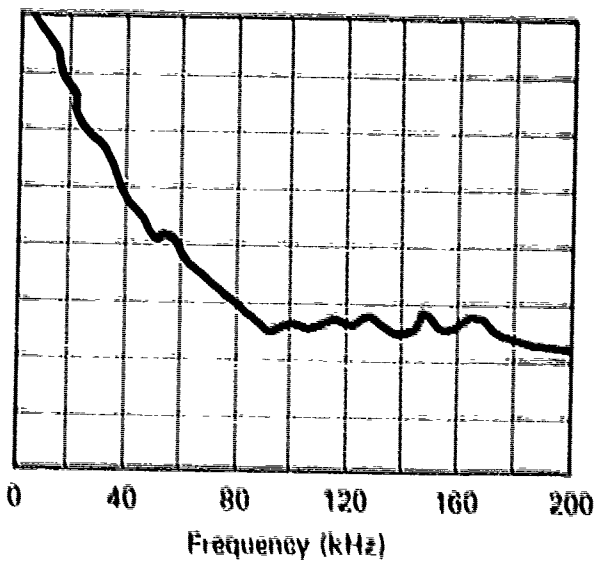

PUMP - DELAVAL IAO
 OUTPUT PRESSURE - 1000 PSI
 OUTPUT FLOW - 10 GPM
 DRIVE MOTOR - GE MOTOR @ 1750 RPM
 DRIVE COUPLING - DELRIN DIRECT DRIVE
 D-301

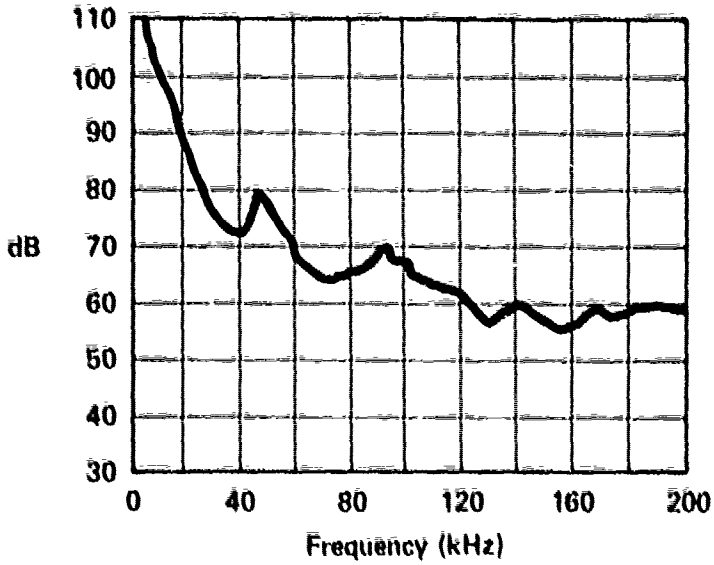

PUMP - RACINE SUPERVANE
 OUTPUT PRESSURE - 1000 PSI
 OUTPUT FLOW - 0 GPM
 DRIVE MOTOR - GE MOTOR @ 1750 RPM
 DRIVE COUPLING - DELRIN DIRECT DRIVE
 D-401

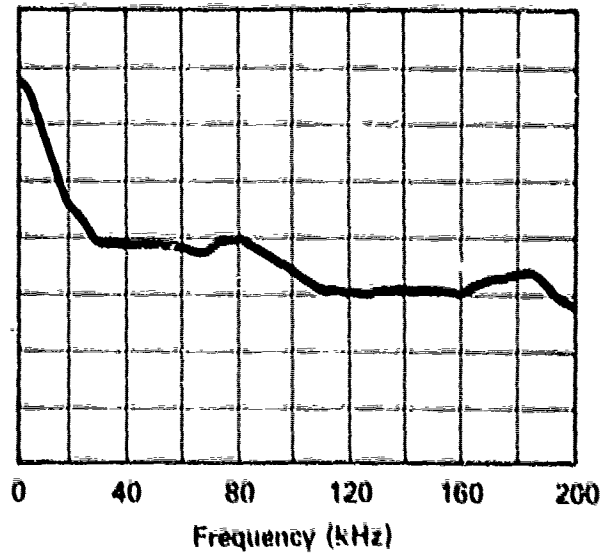

PUMP - RACINE SUPERVANE
 OUTPUT PRESSURE - 1000 PSI
 OUTPUT FLOW - 5 GPM
 DRIVE MOTOR - GE MOTOR @ 1750 RPM
 DRIVE COUPLING - DELRIN DIRECT DRIVE
 D-402

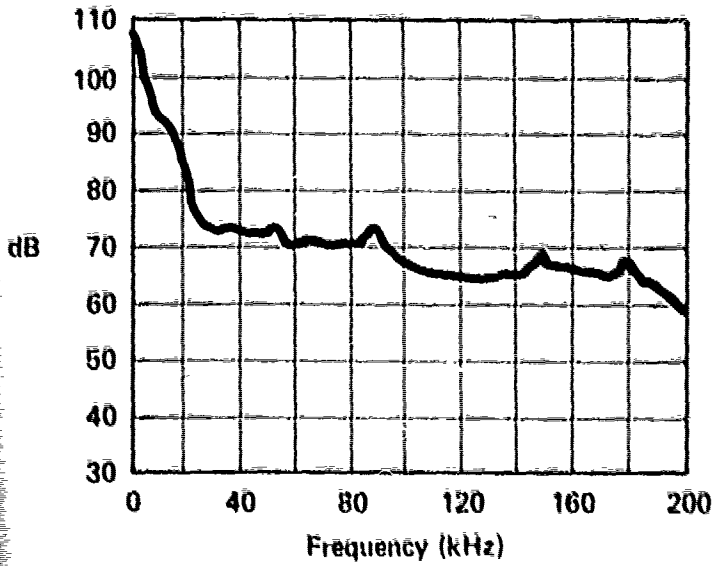

PUMP - RACINE SUPERVANE
 OUTPUT PRESSURE - 1000 PSI
 OUTPUT FLOW - 10 GPM
 DRIVE MOTOR - GE MOTOR @ 1750 RPM
 DRIVE COUPLING - DELRIN DIRECT DRIVE
 D-403

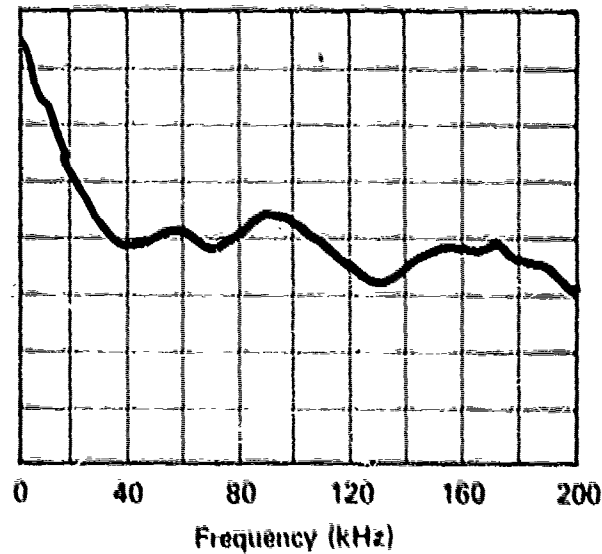

PUMP - RACINE SUPERVANE
 OUTPUT PRESSURE - 1000 PSI
 OUTPUT FLOW - 13 GPM
 DRIVE MOTOR - GE MOTOR @ 1750 RPM
 DRIVE COUPLING - DELRIN DIRECT DRIVE
 D-404

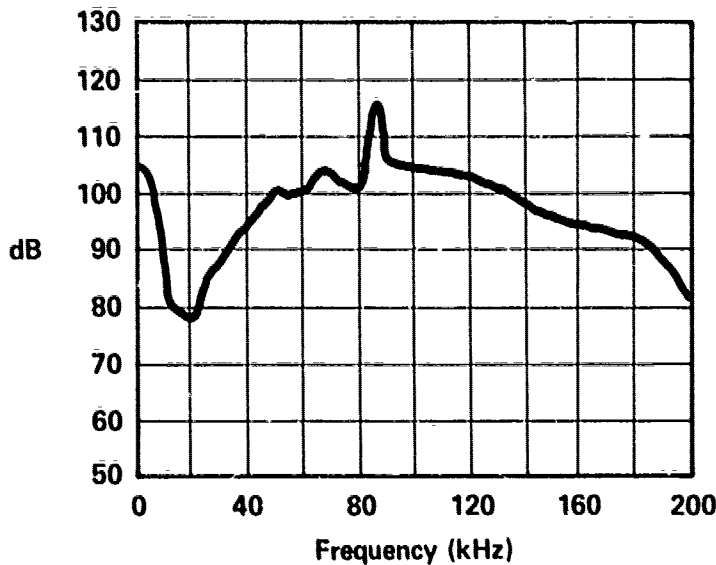

SERVO VALVE - MOOG 74
 INLET PRESSURE - 1000 PSI
 C₁/C₂ PRESSURE - 500 PSI
 RETURN PRESSURE - 0 PSI
 FLOW TO VALVE - 1.8 GPM
 E-101

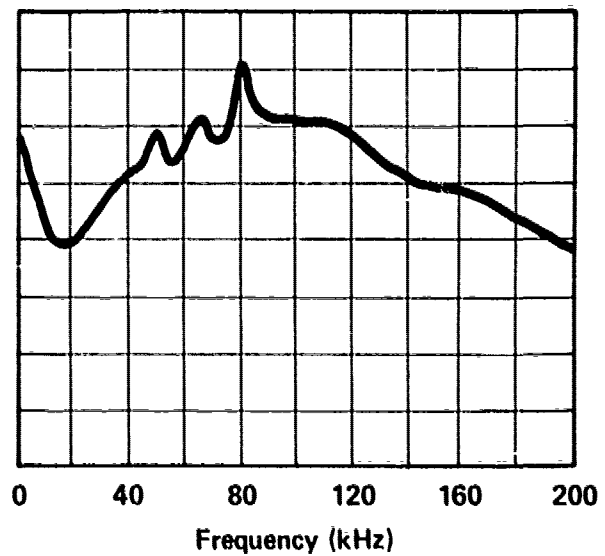

SERVO VALVE - MOOG 74
 INLET PRESSURE - 1000 PSI
 C₁/C₂ PRESSURE - 500 PSI
 RETURN PRESSURE - 0 PSI
 FLOW TO VALVE - 4.7 GPM
 E-102

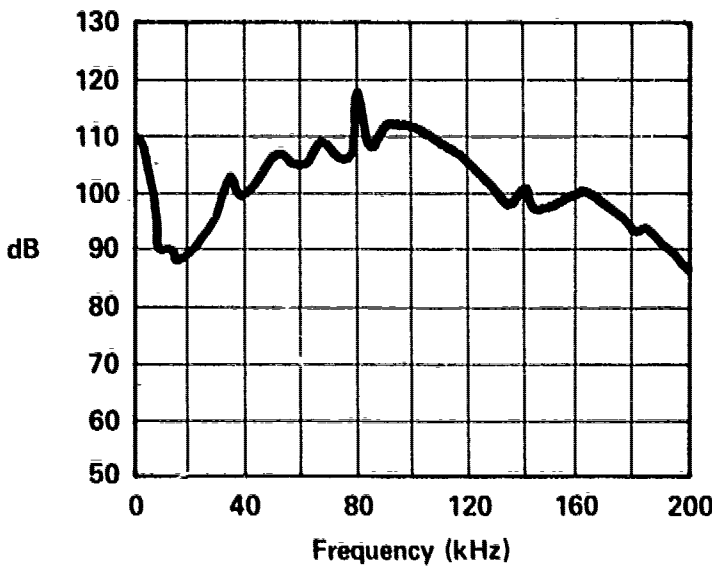

SERVO VALVE - MOOG 74
 INLET PRESSURE - 1000 PSI
 C₁/C₂ PRESSURE - 500 PSI
 RETURN PRESSURE - 0 PSI
 FLOW TO VALVE - 7.2 GPM
 E-103

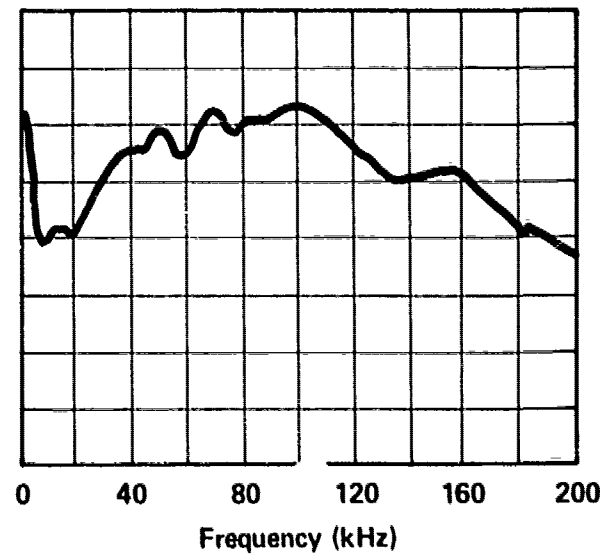

SERVO VALVE - MOOG 74
 INLET PRESSURE - 1000 PSI
 C₁/C₂ PRESSURE - 500 PSI
 RETURN PRESSURE - 0 PSI
 FLOW TO VALVE - 7.4 GPM
 E-104

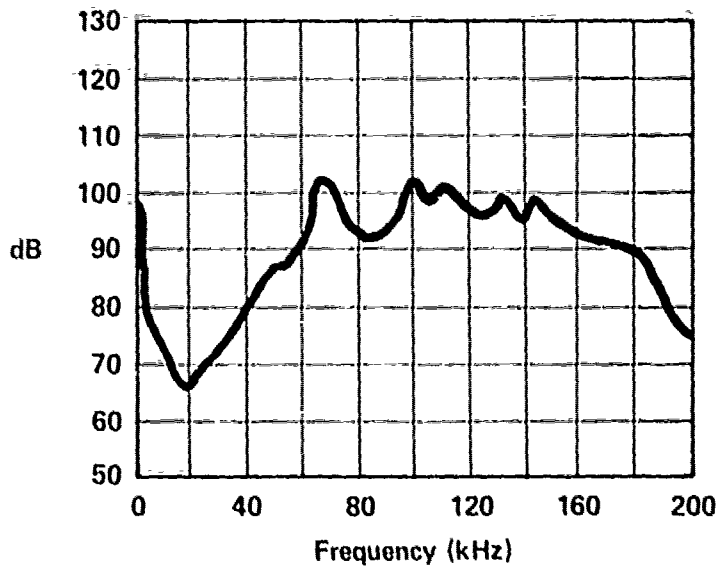

SERVO VALVE - MOOG 74
 INLET PRESSURE - 1250 PSI
 C₁/C₂ PRESSURE - 750 PSI
 RETURN PRESSURE - 250 PSI
 FLOW TO VALVE - 4 GPM
 E-105

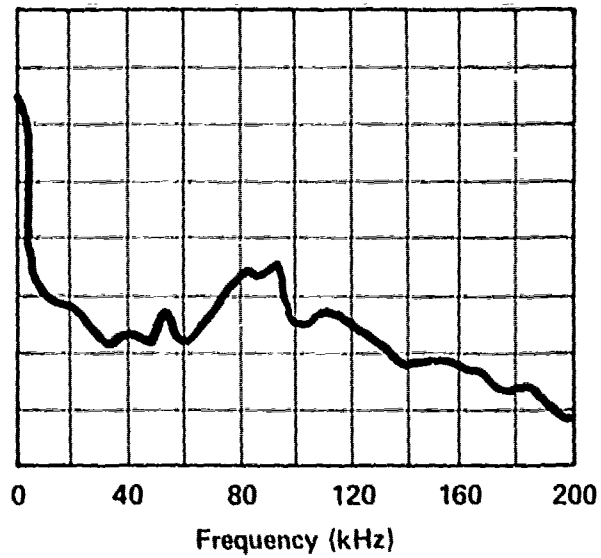

SERVO VALVE - MOOG 74
 INLET PRESSURE - 1500 PSI
 C₁/C₂ PRESSURE - 1000 PSI
 RETURN PRESSURE - 500 PSI
 FLOW TO VALVE - 0 GPM
 E-106

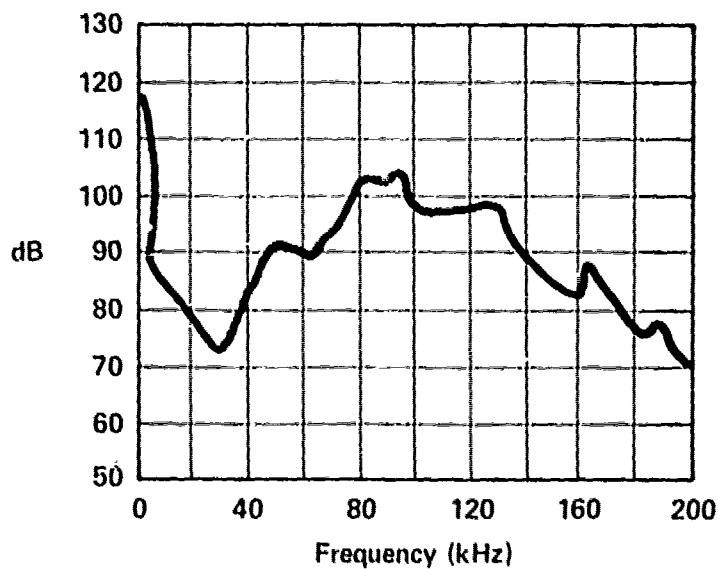

SERVO VALVE - MOOG 74
 INLET PRESSURE - 1500 PSI
 C₁/C₂ PRESSURE - 1000 PSI
 RETURN PRESSURE - 500 PSI
 FLOW TO VALVE - 3.2 GPM
 E-107

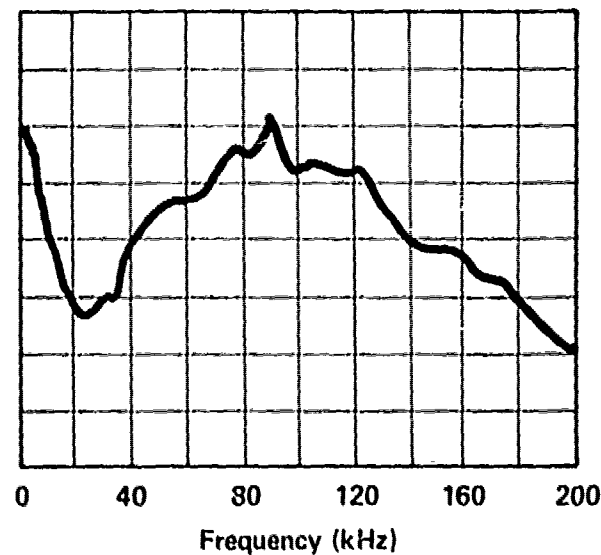

SERVO VALVE - MOOG 74
 INLET PRESSURE - 1500 PSI
 C₁/C₂ PRESSURE - 1000 PSI
 RETURN PRESSURE - 500 PSI
 FLOW TO VALVE - 5.7 GPM
 E-108

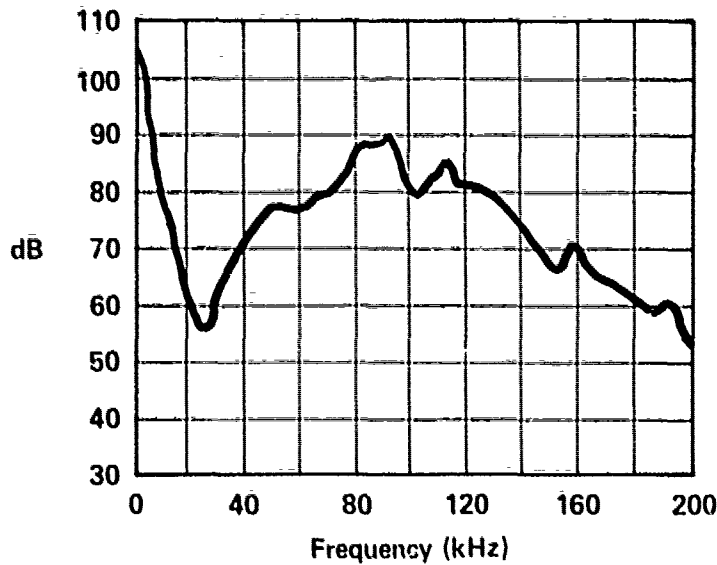

SERVO VALVE - MOOG 74
 INLET PRESSURE - 1500 PSI
 C₁/C₂ PRESSURE - 1000 PSI
 RETURN PRESSURE - 500 PSI
 FLOW TO VALVE - 7.5 GPM
 E-109

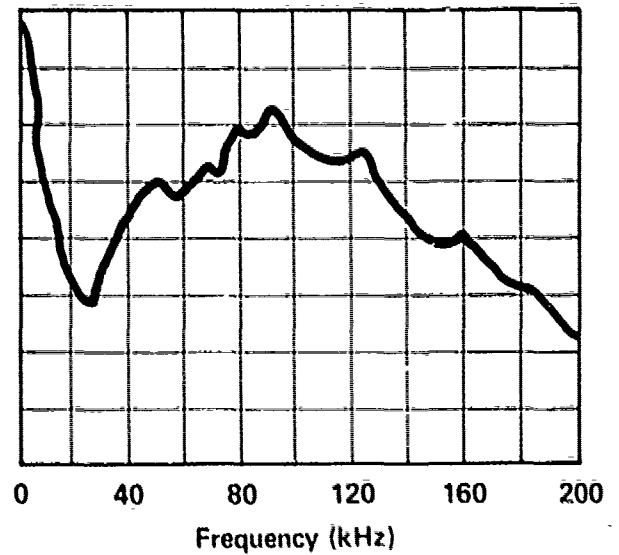

SERVO VALVE - MOOG 74
 INLET PRESSURE - 1500 PSI
 C₁/C₂ PRESSURE - 1000 PSI
 RETURN PRESSURE - 500 PSI
 FLOW TO VALVE - 7.6 GPM
 E-110

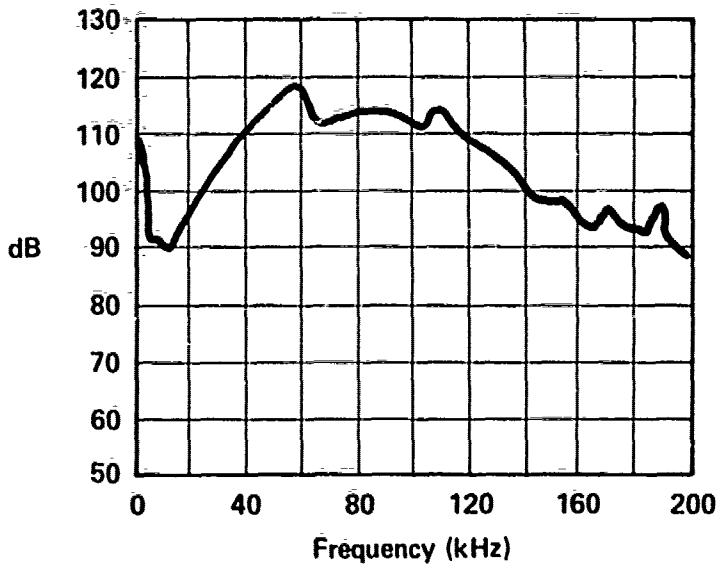

SERVO VALVE - MOOG 35
 INLET PRESSURE - 1000 PSI
 C₁/C₂ PRESSURE - 500 PSI
 RETURN PRESSURE - 0 PSI
 FLOW TO VALVE - 4 GPM
 E-201

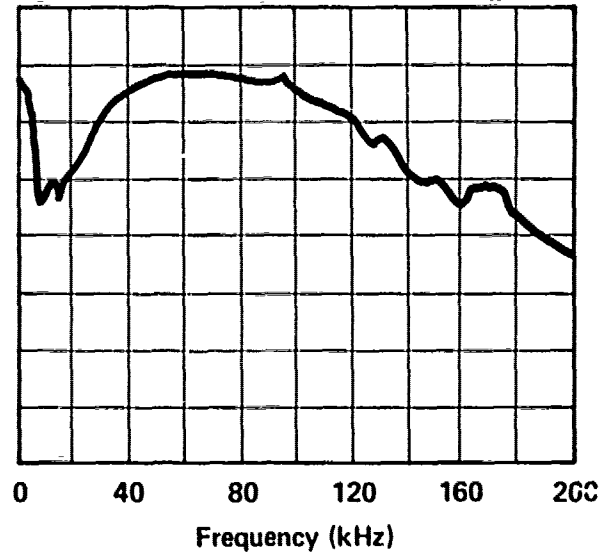

SERVO VALVE - MOOG 35
 INLET PRESSURE - 1000 PSI
 C₁/C₂ PRESSURE - 500 PSI
 RETURN PRESSURE - 0 PSI
 FLOW TO VALVE - 6 GPM
 E-202

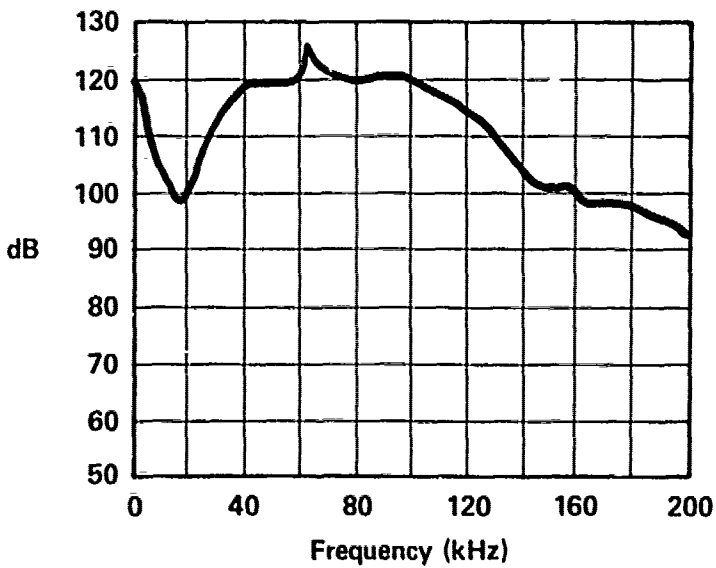

SERVO VALVE - MOOG 35
 INLET PRESSURE - 1000 PSI
 C₁/C₂ PRESSURE - 500 PSI
 RETURN PRESSURE - 0 PSI
 FLOW TO VALVE - 8 GPM
 E-203

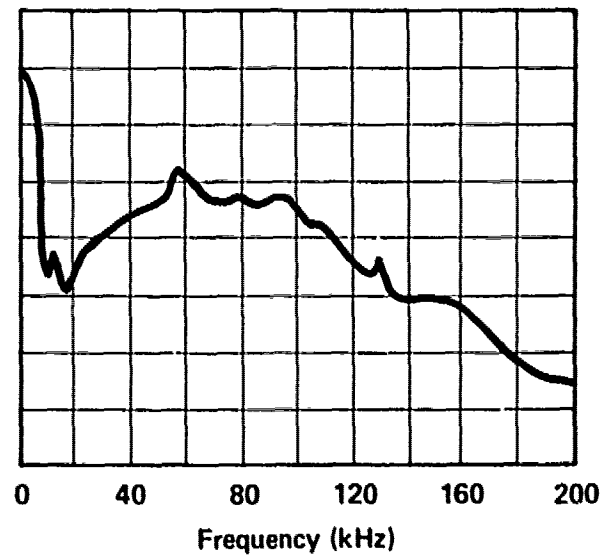

SERVO VALVE - MOOG 35
 INLET PRESSURE - 1500 PSI
 C₁/C₂ PRESSURE - 1000 PSI
 RETURN PRESSURE - 500 PSI
 FLOW TO VALVE - 4 GPM
 E-204

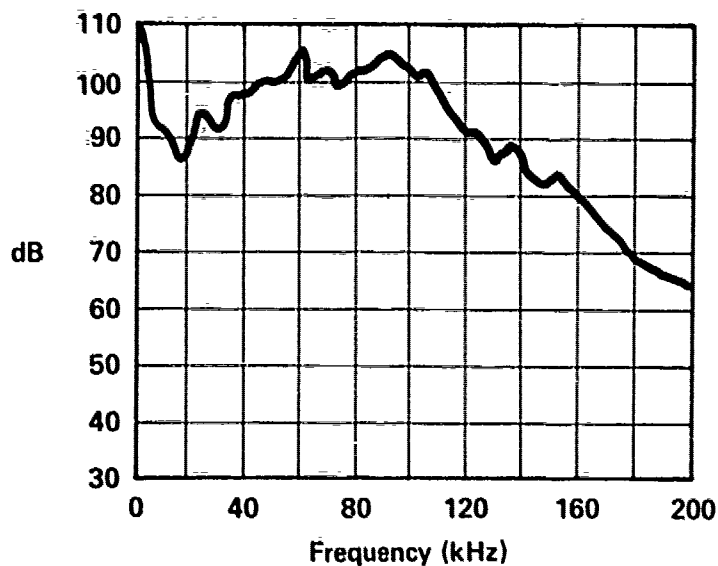

SERVO VALVE - MOOG 35
 INLET PRESSURE - 1500 PSI
 C₁/C₂ PRESSURE - 1000 PSI
 RETURN PRESSURE - 500 PSI
 FLOW TO VALVE - 6 GPM
 E-205

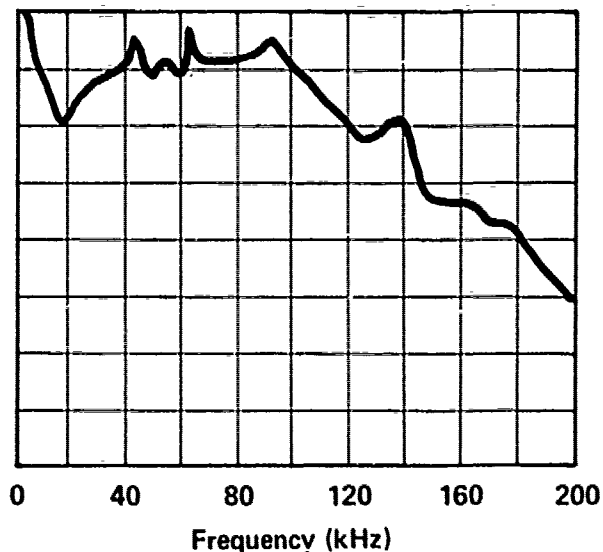

SERVO VALVE - MOOG 35
 INLET PRESSURE - 1500 PSI
 C₁/C₂ PRESSURE - 1000 PSI
 RETURN PRESSURE - 500 PSI
 FLOW TO VALVE - 8 GPM
 E-206

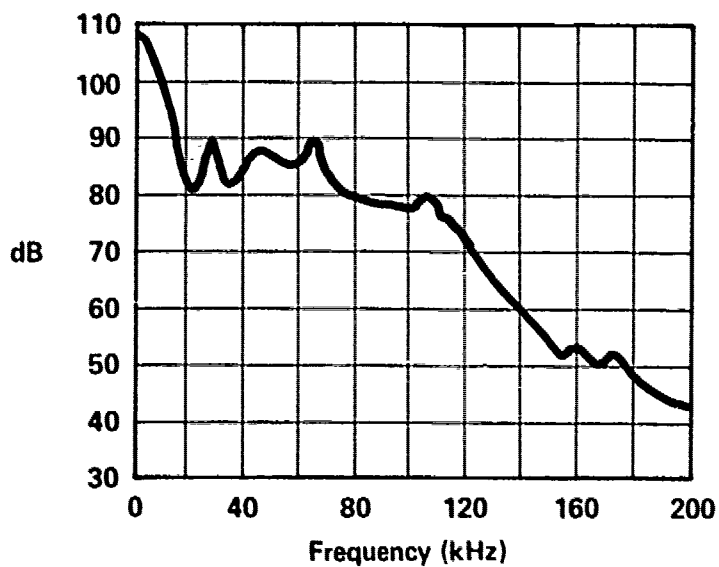

SERVO VALVE - MOOG 35
 INLET PRESSURE - 1500 PSI
 C₁/C₂ PRESSURE - 1000 PSI
 RETURN PRESSURE - 500 PSI
 FLOW TO VALVE - 10 GPM
 E-207

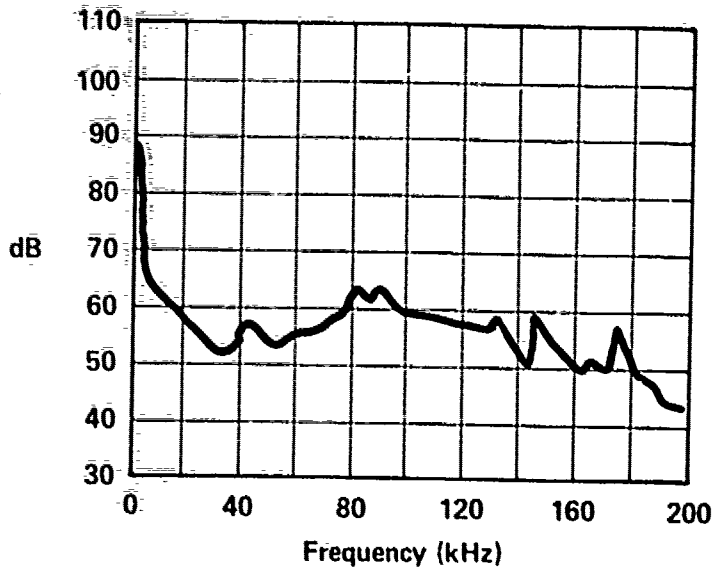

SERVO VALVE - OLSEN
 INLET PRESSURE - 1000 PSI
 C₁/C₂ PRESSURE - 500 PSI
 RETURN PRESSURE - 0 PSI
 FLOW TO VALVE - 0 GPM
 E-301

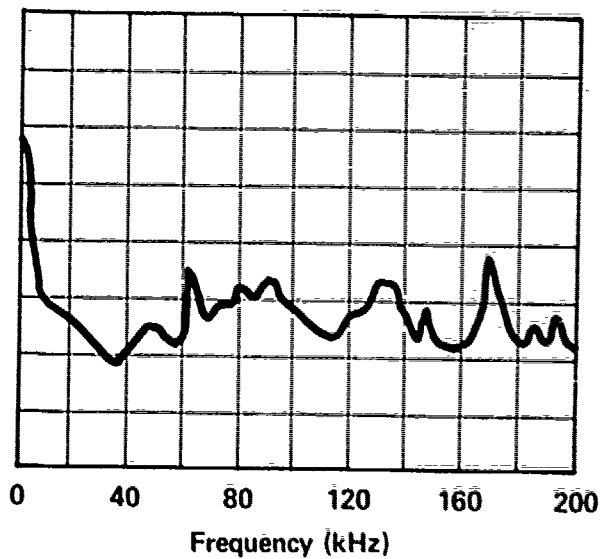

SERVO VALVE - OLSEN
 INLET PRESSURE - 1000 PSI
 C₁/C₂ PRESSURE - 500 PSI
 RETURN PRESSURE - 0 PSI
 FLOW TO VALVE - 0.4 GPM
 E-302

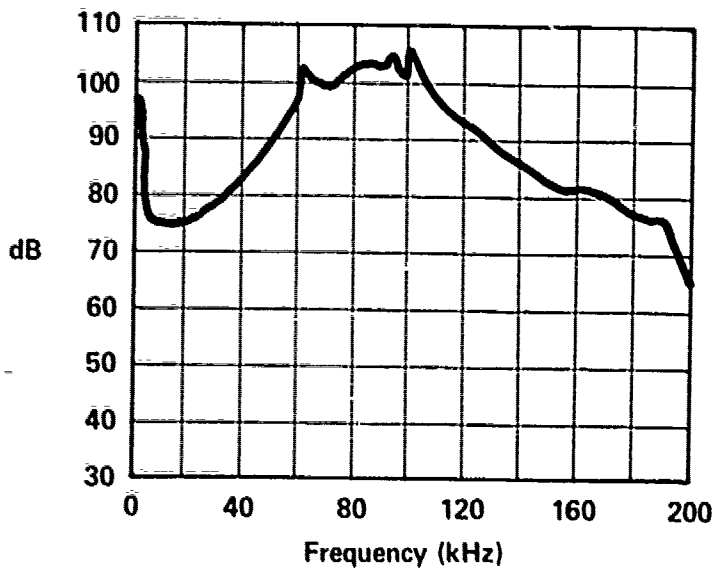

SERVO VALVE - OLSEN
 INLET PRESSURE - 1000 PSI
 C₁/C₂ PRESSURE - 500 PSI
 RETURN PRESSURE - 0 PSI
 FLOW TO VALVE - 1 GPM
 E-303

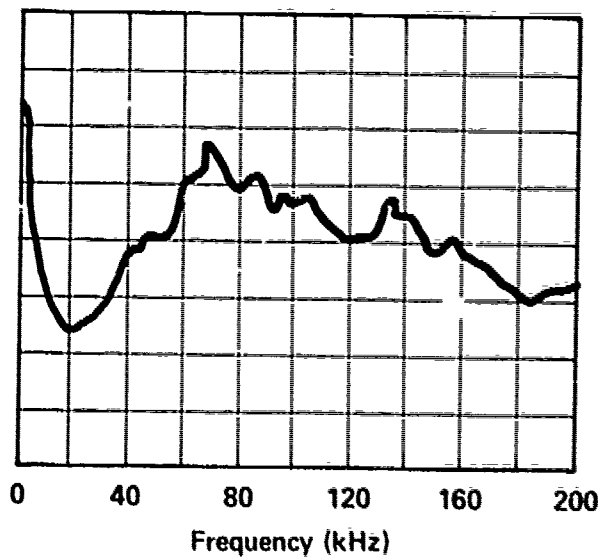

SERVO VALVE - OLSEN
 INLET PRESSURE - 1000 PSI
 C₁/C₂ PRESSURE - 500 PSI
 RETURN PRESSURE - 0 PSI
 FLOW TO VALVE - 4 GPM
 E-304

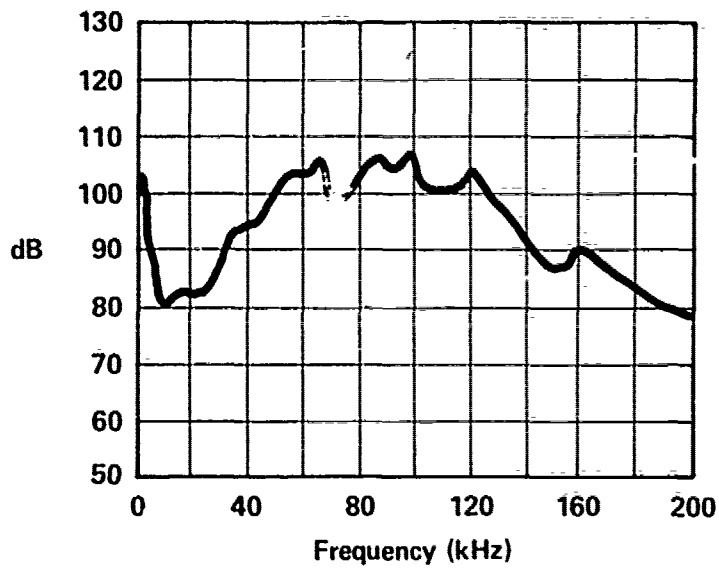

SERVO VALVE - OLSEN
 INLET PRESSURE - 1000 PSI
 C₁/C₂ PRESSURE - 500 PSI
 RETURN PRESSURE - 0 PSI
 FLOW TO VALVE - 6 GPM
 E-305

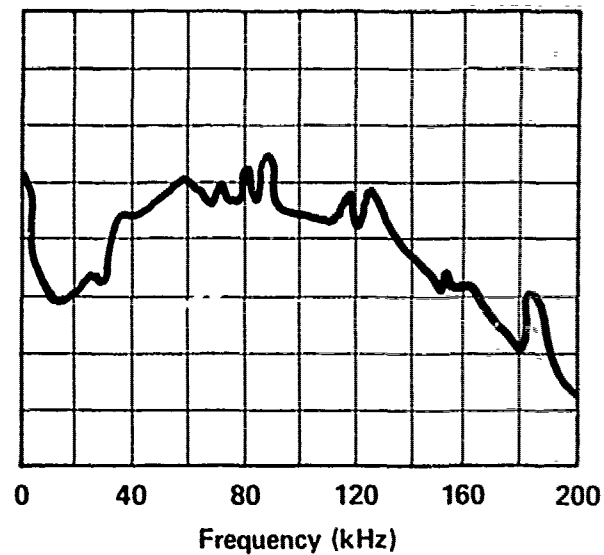

SERVO VALVE - OLSEN
 INLET PRESSURE - 1000 PSI
 C₁/C₂ PRESSURE - 500 PSI
 RETURN PRESSURE - 0 PSI
 FLOW TO VALVE - 7 GPM
 E-306

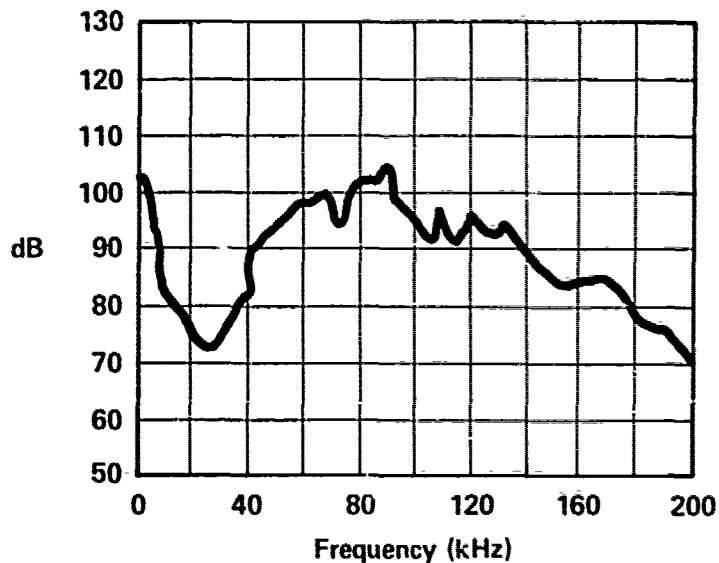

SERVO VALVE - OLSEN
 INLET PRESSURE - 1500 PSI
 C₁/C₂ PRESSURE - 1000 PSI
 RETURN PRESSURE - 500 PSI
 FLOW TO VALVE - 1.5 GPM
 E-307

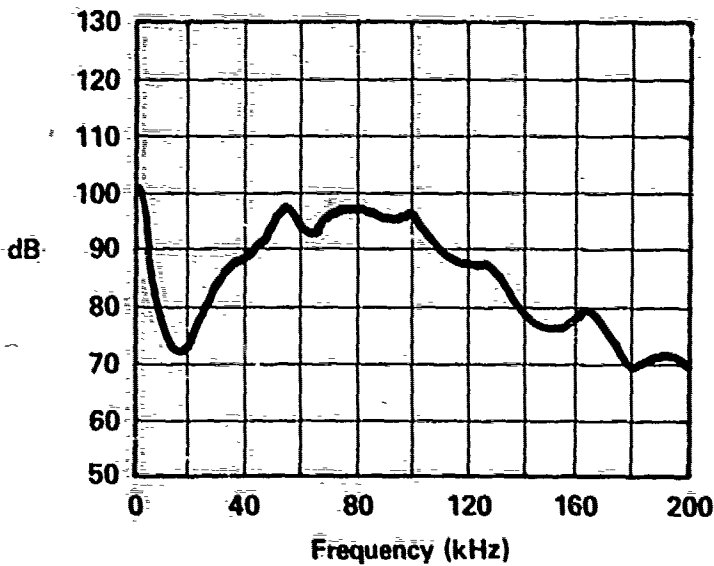

SERVO VALVE - OLSEN
 INLET PRESSURE - 1500 PSI
 C₁/C₂ PRESSURE - 1000 PSI
 RETURN PRESSURE - 500 PSI
 FLOW TO VALVE - 4 GPM
 E-308

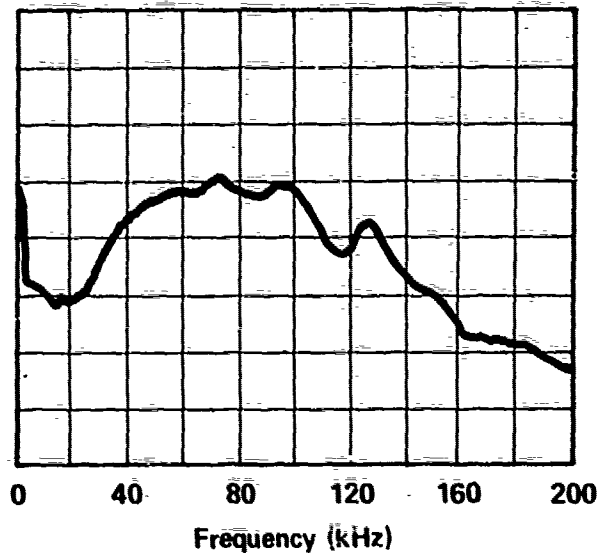

SERVO VALVE - OLSEN
 INLET PRESSURE - 1500 PSI
 C₁/C₂ PRESSURE - 1000 PSI
 RETURN PRESSURE - 500 PSI
 FLOW TO VALVE - 6 GPM
 E-309

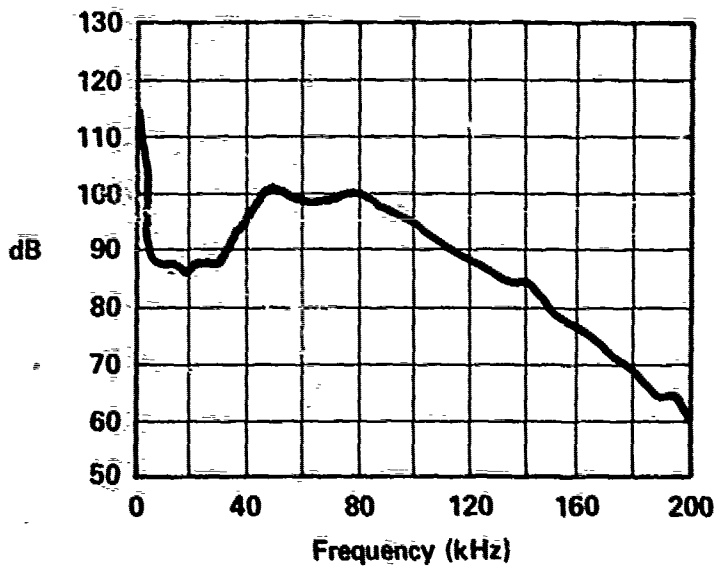

SERVO VALVE - OLSEN
 INLET PRESSURE - 1500 PSI
 C₁/C₂ PRESSURE - 1000 PSI
 RETURN PRESSURE - 500 PSI
 FLOW TO VALVE - 9 GPM
 E-310

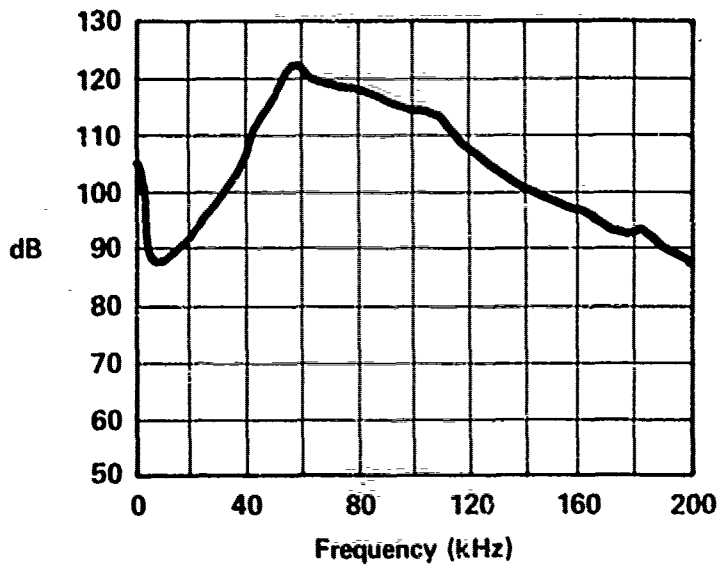

SERVO VALVE & MOTOR - OLSEN & NUTRON
 INLET PRESSURE - 1000 PSI
 C₁ PRESSURE -
 C₂ PRESSURE -
 RETURN PRESSURE - 0 PSI
 FLOW TO VALVE/MOTOR - 1.8 GPM
 MOTOR RPM - 150 RPM
 DISK DIAMETER - 24 IN
 F-101

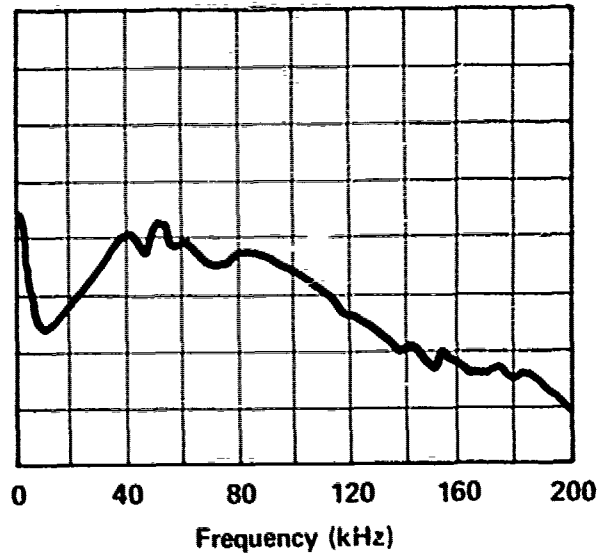

SERVO VALVE & MOTOR - OLSEN & NUTRON
 INLET PRESSURE - 1000 PSI
 C₁ PRESSURE - 700 PSI
 C₂ PRESSURE - 300 PSI
 RETURN PRESSURE - 0 PSI
 FLOW TO VALVE/MOTOR - 3.8 GPM
 MOTOR RPM - 300 RPM
 DISK DIAMETER - 24 IN
 F-102

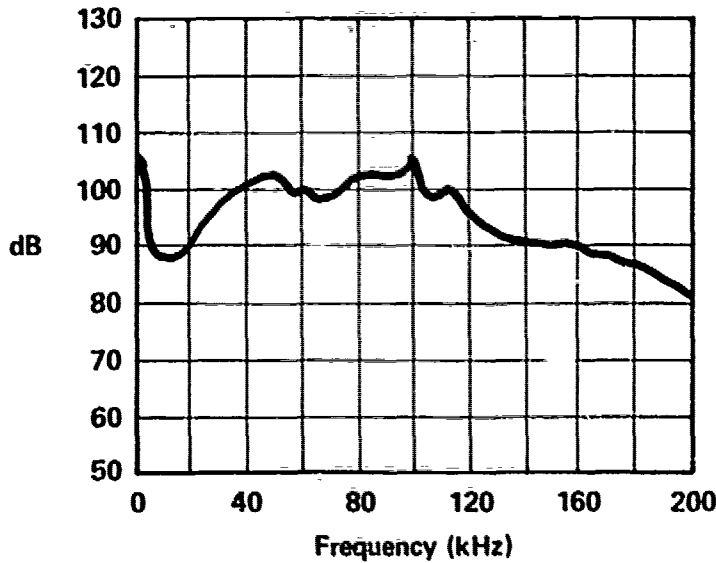

SERVO VALVE & MOTOR - OLSEN & NUTRON
 INLET PRESSURE - 1000 PSI
 C₁ PRESSURE - 900 PSI
 C₂ PRESSURE - 100 PSI
 RETURN PRESSURE - 0 PSI
 FLOW TO VALVE/MOTOR - 5.2 GPM
 MOTOR RPM - 450 RPM
 DISK DIAMETER - 24 IN
 F-103

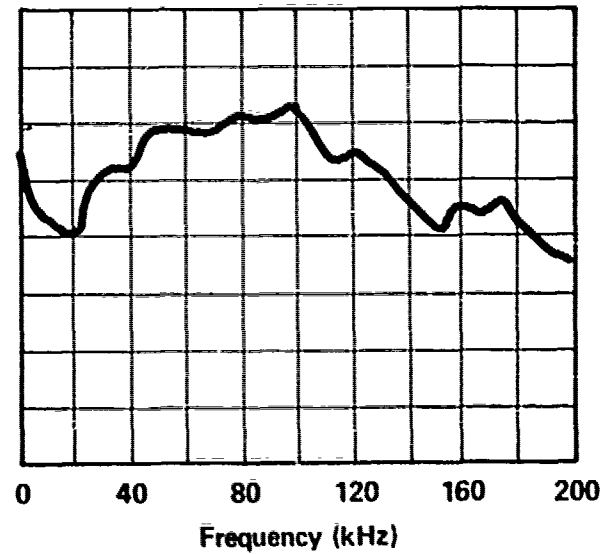

SERVO VALVE & MOTOR - OLSEN & NUTRON
 INLET PRESSURE - 1450 PSI
 C₁ PRESSURE - 1350 PSI
 C₂ PRESSURE - 100 PSI
 RETURN PRESSURE - 0 PSI
 FLOW TO VALVE/MOTOR - 7.4 GPM
 MOTOR RPM - 600 RPM
 DISK DIAMETER - 24 IN
 F-104

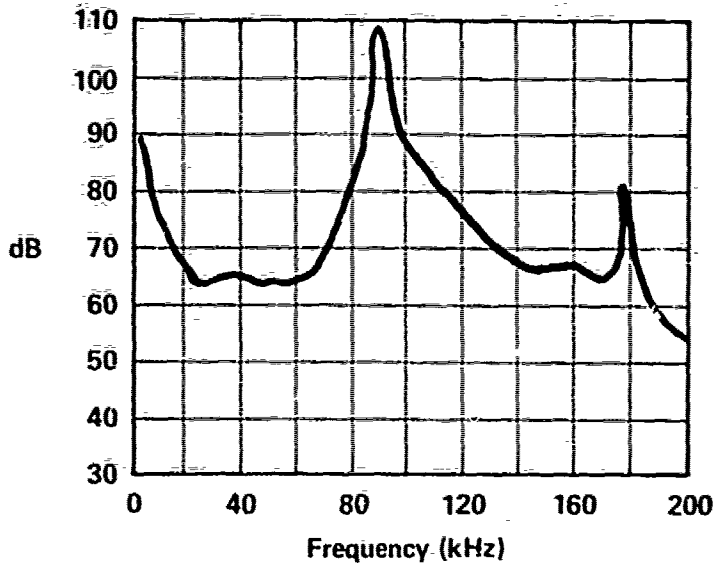

SERVO VALVE & MOTOR - MOOG 74 & WSI
 INLET PRESSURE - 1500 PSI
 C₁ PRESSURE - 500 PSI
 C₂ PRESSURE - 500 PSI
 RETURN PRESSURE - 300 PSI
 FLOW TO VALVE/MOTOR - 0 GPM
 MOTOR RPM - 0 RPM
 DISK DIAMETER - 35.75 IN
 F-201

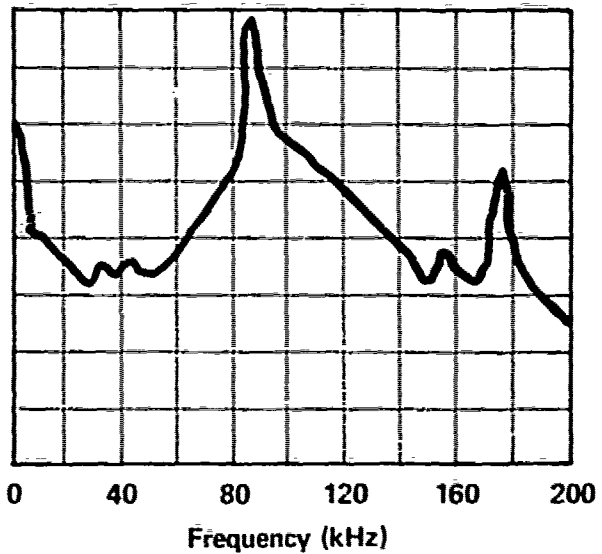

SERVO VALVE & MOTOR - MOOG 74 & WSI
 INLET PRESSURE - 1500 PSI
 C₁ PRESSURE - 1000 PSI
 C₂ PRESSURE - 900 PSI
 RETURN PRESSURE - 500 PSI
 FLOW TO VALVE/MOTOR - 0.5 GPM
 MOTOR RPM - 60 RPM
 DISK DIAMETER - 35.75 IN
 F-202

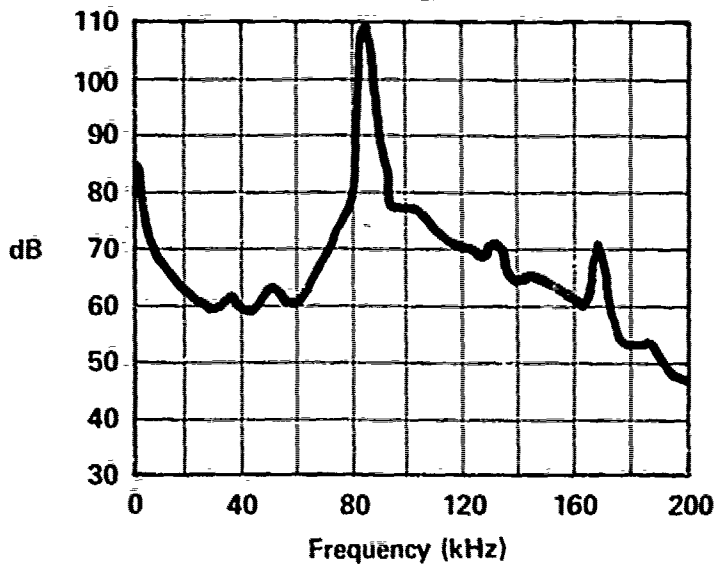

SERVO VALVE & MOTOR - MOOG 74 & WSI
 INLET PRESSURE - 1500 PSI
 C₁ PRESSURE - 1100 PSI
 C₂ PRESSURE - 900 PSI
 RETURN PRESSURE - 500 PSI
 FLOW TO VALVE/MOTOR - 2 GPM
 MOTOR RPM - 120 RPM
 DISK DIAMETER - 35.75 IN
 F-203

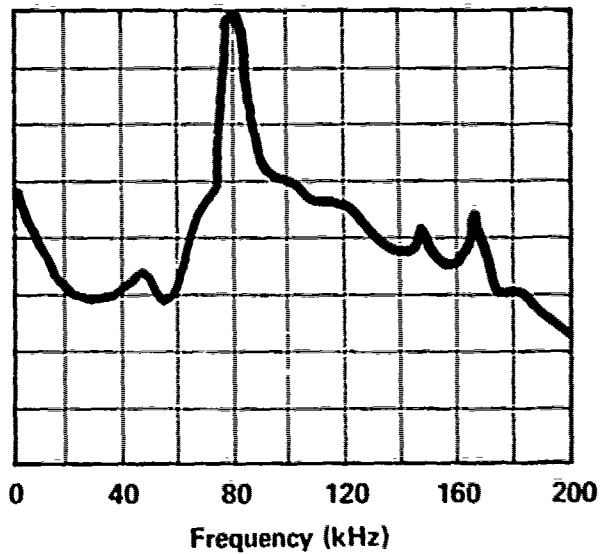

SERVO VALVE & MOTOR - MOOG 74 & WSI
 INLET PRESSURE - 1500 PSI
 C₁ PRESSURE - 1100 PSI
 C₂ PRESSURE - 850 PSI
 RETURN PRESSURE - 500 PSI
 FLOW TO VALVE/MOTOR - 2.6 GPM
 MOTOR RPM - 150 RPM
 DISK DIAMETER - 35.75 IN
 F-204

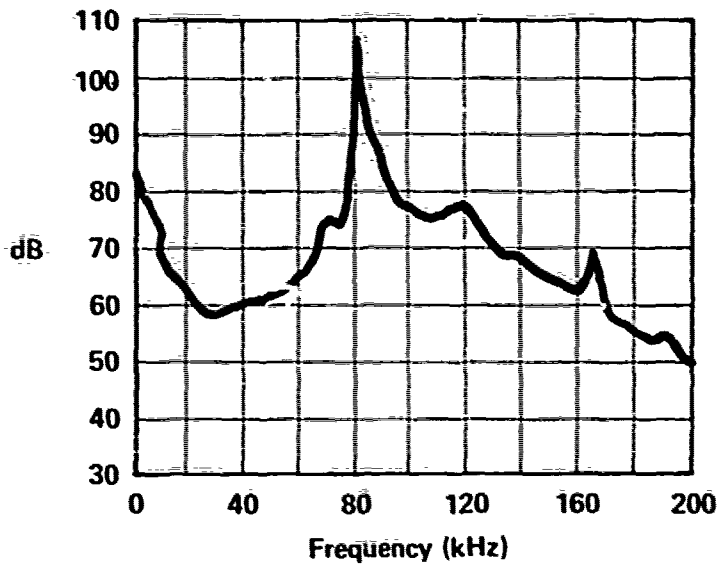

SERVO VALVE & MOTOR - MOOG 74 & WSI
 INLET PRESSURE - 1500 PSI
 C₁ PRESSURE - 1150 PSI
 C₂ PRESSURE - 800 PSI
 RETURN PRESSURE - 500 PSI
 FLOW TO VALVE/MOTOR - 3.2 GPM
 MOTOR RPM - 180 RPM
 DISK DIAMETER - 35.75 IN
 F-205

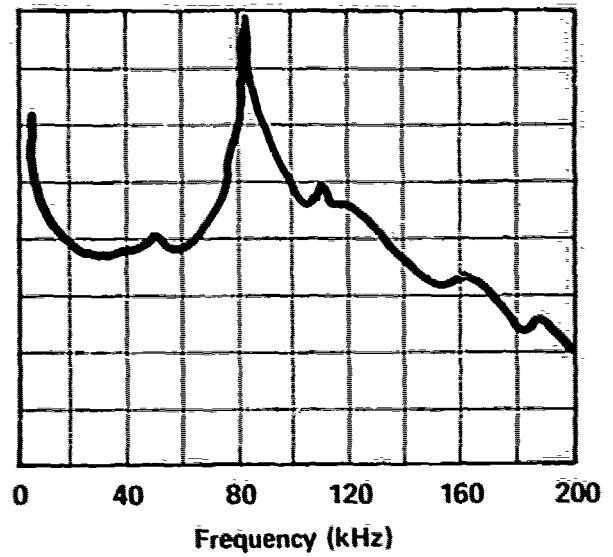

SERVO VALVE & MOTOR - MOOG 74 & WSI
 INLET PRESSURE - 1500 PSI
 C₁ PRESSURE - 1200 PSI
 C₂ PRESSURE - 750 PSI
 RETURN PRESSURE - 500 PSI
 FLOW TO VALVE/MOTOR - 3.6 GPM
 MOTOR RPM - 210 RPM
 DISK DIAMETER - 35.75 IN
 F-206

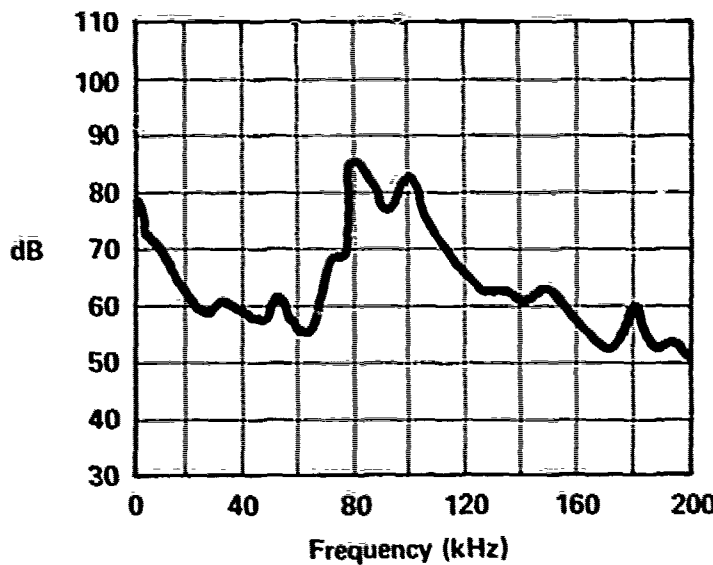

SERVO VALVE & MOTOR - MOOG 74 & WSI
 INLET PRESSURE - 1500 PSI
 C₁ PRESSURE - 1350 PSI
 C₂ PRESSURE - 700 PSI
 RETURN PRESSURE - 500 PSI
 FLOW TO VALVE/MOTOR - 4.6 GPM
 MOTOR RPM - 246 RPM
 DISK DIAMETER - 35.75 IN
 F-207

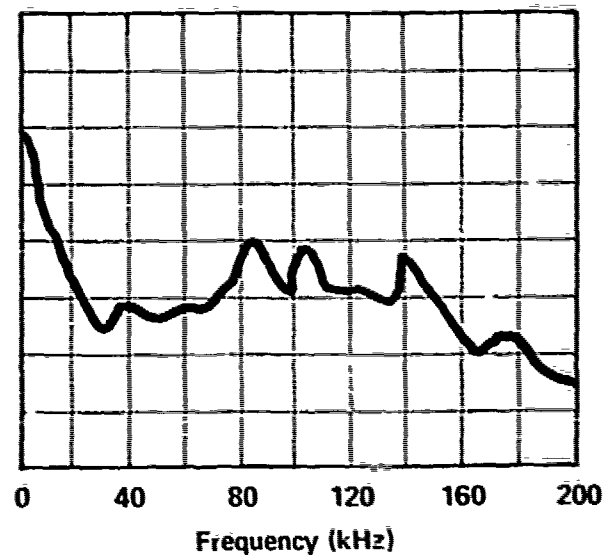

SERVO VALVE & MOTOR - MOOG 74 & WSI
 INLET PRESSURE - 1500 PSI
 C₁ PRESSURE - 1450 PSI
 C₂ PRESSURE - 700 PSI
 RETURN PRESSURE - 500 PSI
 FLOW TO VALVE/MOTOR - 5.1 GPM
 MOTOR RPM - 270 RPM
 DISK DIAMETER - 35.75 IN
 F-208

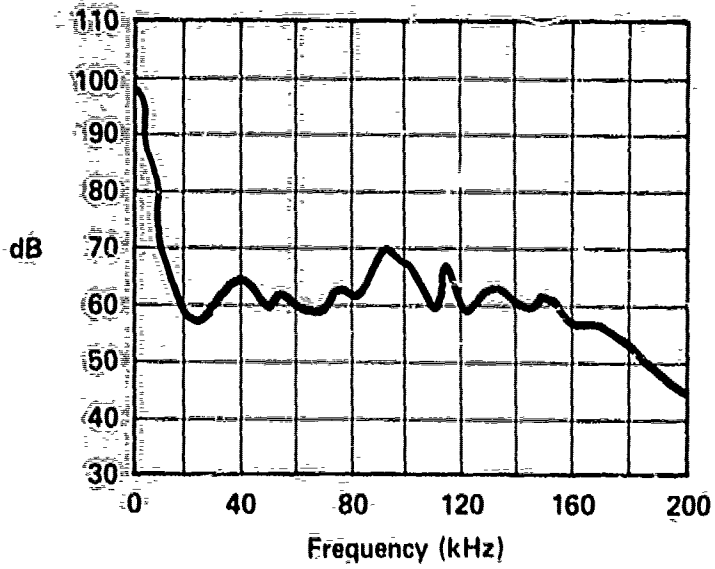

SERVO VALVE & MOTOR - MOOG 74 & WSI
 INLET PRESSURE - 1500 PSI
 C₁ PRESSURE - 1500 PSI
 C₂ PRESSURE - 500 PSI
 RETURN PRESSURE - 500 PSI
 FLOW TO VALVE/MOTOR - 5 GPM
 MOTOR RPM - 282 RPM
 DISK DIAMETER - 35.75 IN
 F-209

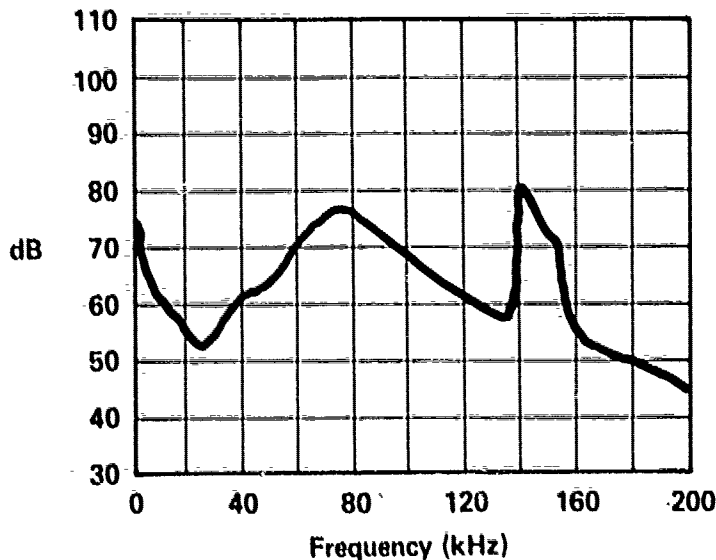

SERVO VALVE & MOTOR - MOOG 35 & WSI
 INLET PRESSURE - 1500 PSI
 C₁ PRESSURE - 1150 PSI
 C₂ PRESSURE - 900 PSI
 RETURN PRESSURE - 500 PSI
 FLOW TO VALVE/MOTOR - 0.5 GPM
 MOTOR RPM - 30 RPM
 DISK DIAMETER - 35.75 IN
 F-301

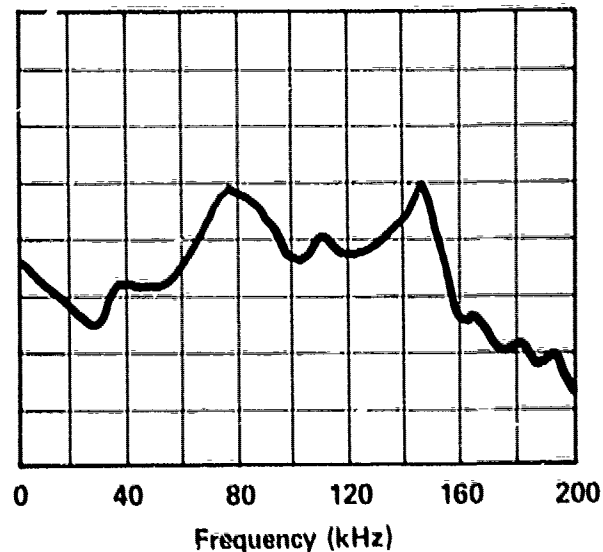

SERVO VALVE & MOTOR - MOOG 35 & WSI
 INLET PRESSURE - 1500 PSI
 C₁ PRESSURE - 1100 PSI
 C₂ PRESSURE - 950 PSI
 RETURN PRESSURE - 500 PSI
 FLOW TO VALVE/MOTOR - 1 GPM
 MOTOR RPM - 60 RPM
 DISK DIAMETER - 35.75 IN
 F-302

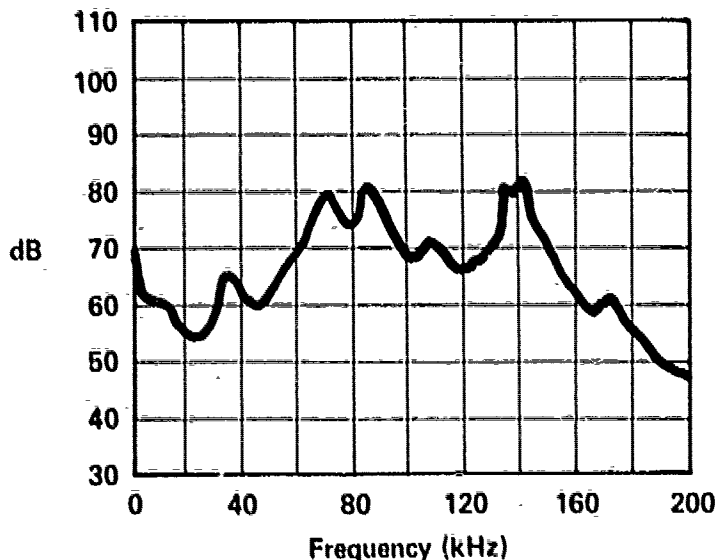

SERVO VALVE & MOTOR - MOOG 35 & WSI
 INLET PRESSURE - 1500 PSI
 C₁ PRESSURE - 1150 PSI
 C₂ PRESSURE - 800 PSI
 RETURN PRESSURE - 500 PSI
 FLOW TO VALVE/MOTOR - 1.5 GPM
 MOTOR RPM - 90 RPM
 DISK DIAMETER - 35.75 IN
 F-303

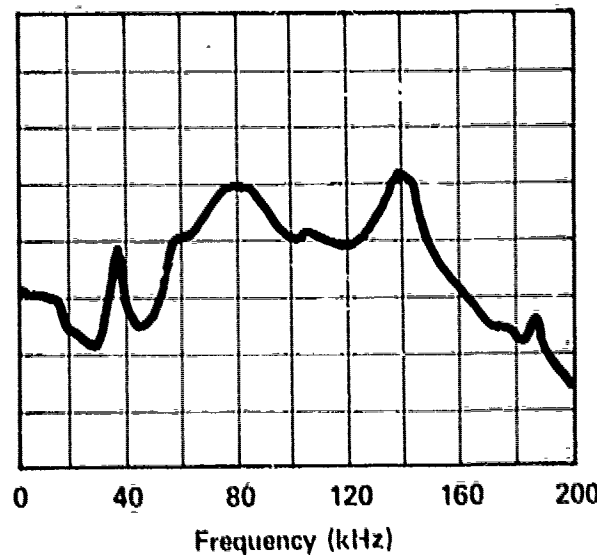

SERVO VALVE & MOTOR - MOOG 35 & WSI
 INLET PRESSURE - 1500 PSI
 C₁ PRESSURE - 1200 PSI
 C₂ PRESSURE - 800 PSI
 RETURN PRESSURE - 500 PSI
 FLOW TO VALVE/MOTOR - 1.8 GPM
 MOTOR RPM - 120 RPM
 DISK DIAMETER - 35.75 IN
 F-304

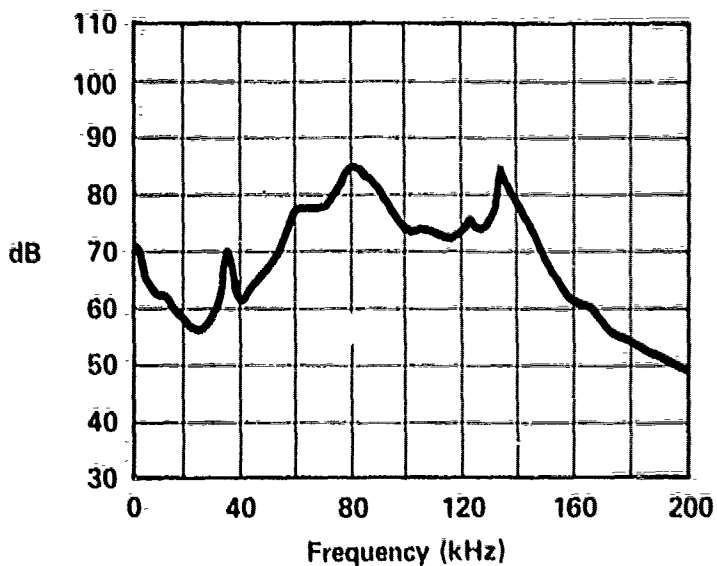

SERVO VALVE & MOTOR - MOOG 35 & WSI
 INLET PRESSURE - 1500 PSI
 C₁ PRESSURE - 1225 PSI
 C₂ PRESSURE - 775 PSI
 RETURN PRESSURE - 500 PSI
 FLOW TO VALVE/MOTOR - 2.0 GPM
 MOTOR RPM - 150 RPM
 DISK DIAMETER - 35.75 IN
 F-305

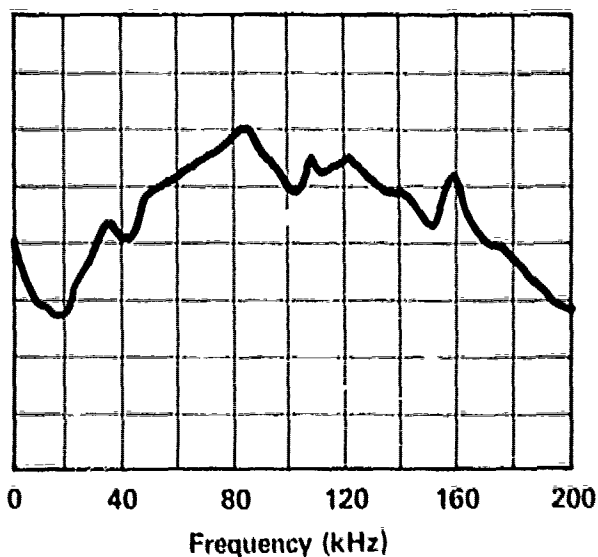

SERVO VALVE & MOTOR - MOOG 35 & WSI
 INLET PRESSURE - 1500 PSI
 C₁ PRESSURE - 1250 PSI
 C₂ PRESSURE - 700 PSI
 RETURN PRESSURE - 500 PSI
 FLOW TO VALVE/MOTOR - 3.2 GPM
 MOTOR RPM - 180 RPM
 DISK DIAMETER - 35.75 IN
 F-306

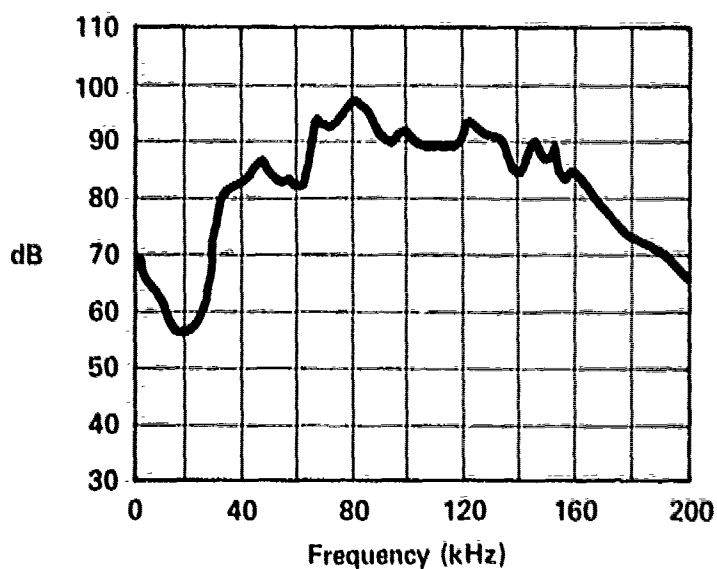

SERVO VALVE & MOTOR - MOOG 35 & WSI
 INLET PRESSURE - 1500 PSI
 C₁ PRESSURE - 1200 PSI
 C₂ PRESSURE - 500 PSI
 RETURN PRESSURE - 500 PSI
 FLOW TO VALVE/MOTOR - 3.8 GPM
 MOTOR RPM - 210 RPM
 DISK DIAMETER - 35.75 IN
 F-307

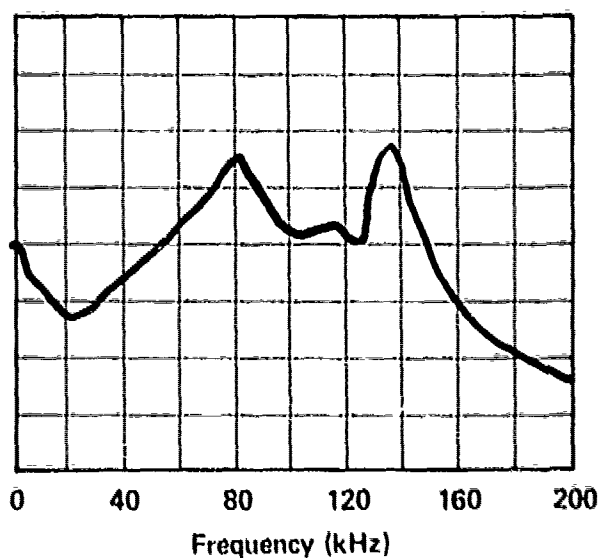

SERVO VALVE & MOTOR - MOOG 35 & WSI
 INLET PRESSURE - 1500 PSI
 C₁ PRESSURE - 1350 PSI
 C₂ PRESSURE - 600 PSI
 RETURN PRESSURE - 500 PSI
 FLOW TO VALVE/MOTOR - 4.1 GPM
 MOTOR RPM - 240 RPM
 DISK DIAMETER - 35.75 IN
 F-308

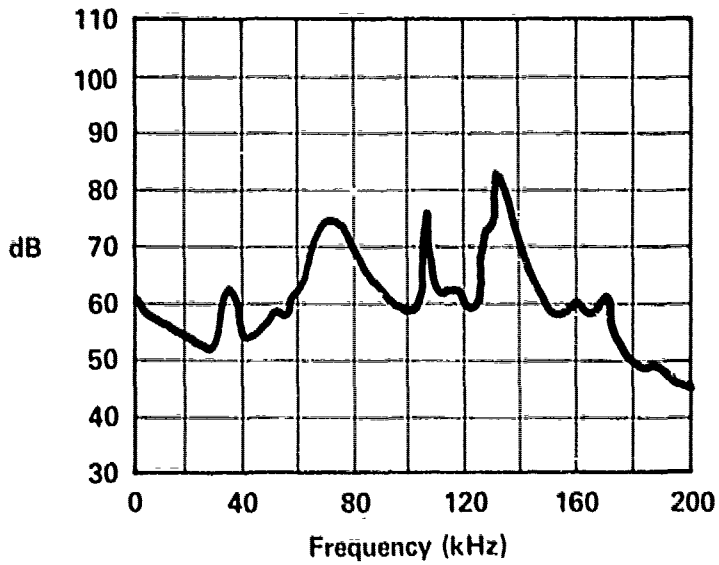

SERVO VALVE & MOTOR - MOOG 35 & WSI
 INLET PRESSURE - 1500 PSI
 C₁ PRESSURE - 1450 PSI
 C₂ PRESSURE - 500 PSI
 RETURN PRESSURE - 500 PSI
 FLOW TO VALVE/MOTOR - 5 GPM
 MOTOR RPM - 270 RPM
 DISK DIAMETER - 35.75 IN
 F-309

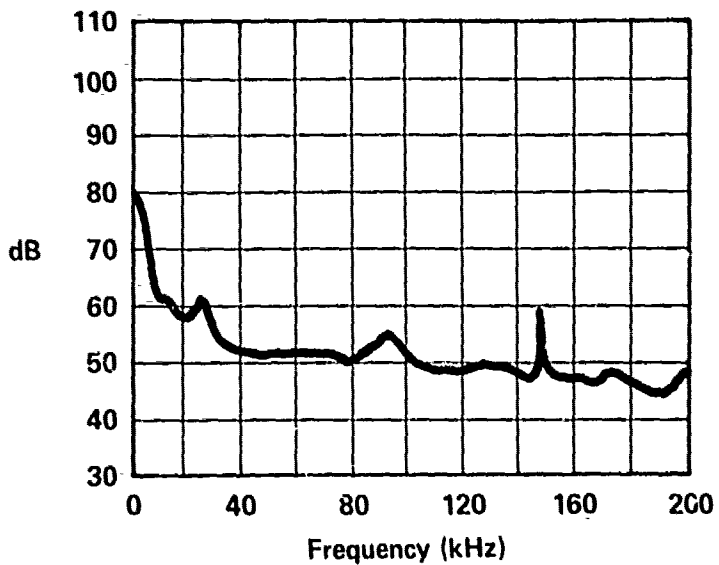

SERVO VALVE & MOTOR - OLSEN & WSI
 INLET PRESSURE - 1000 PSI
 C₁ PRESSURE - 580 PSI
 C₂ PRESSURE - 450 PSI
 RETURN PRESSURE - 100 PSI
 FLOW TO VALVE/MOTOR - 0 GPM
 MOTOR RPM - 0 RPM
 DISK DIAMETER - 35.75 IN
 F-401

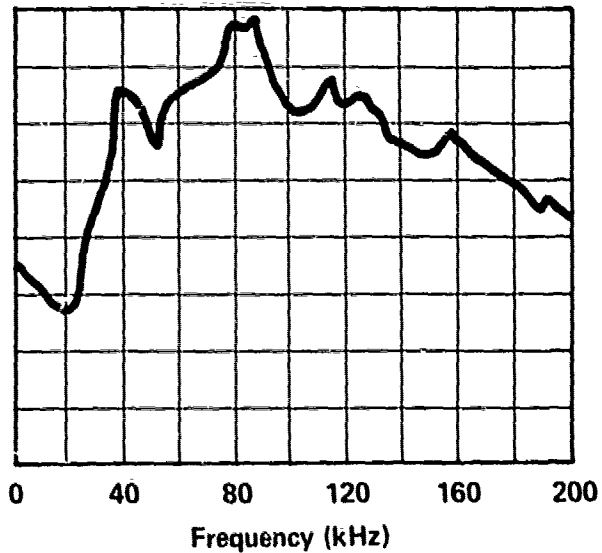

SERVO VALVE & MOTOR - OLSEN & WSI
 INLET PRESSURE - 1000 PSI
 C₁ PRESSURE - 700 PSI
 C₂ PRESSURE - 500 PSI
 RETURN PRESSURE - 125 PSI
 FLOW TO VALVE/MOTOR - 2 GPM
 MOTOR RPM - 144 RPM
 DISK DIAMETER - 35.75 IN
 F-402

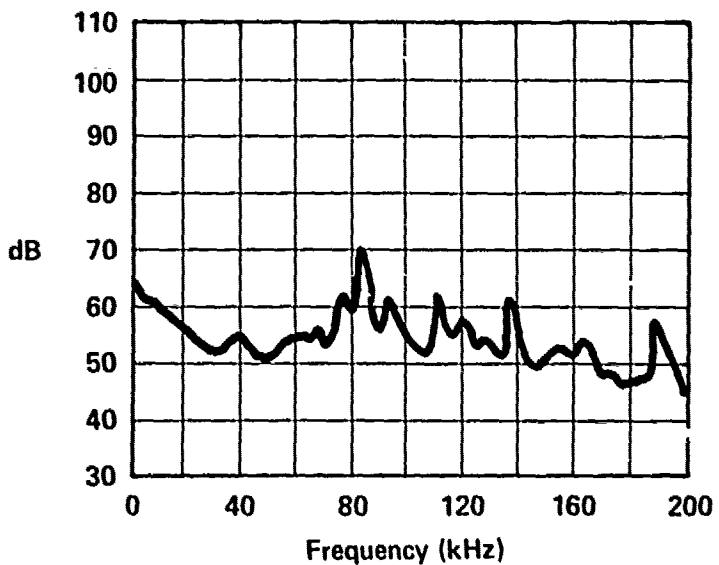

SERVO VALVE & MOTOR - OLSEN & WSI
 INLET PRESSURE - 1000 PSI
 C₁ PRESSURE - 950 PSI
 C₂ PRESSURE - 150 PSI
 RETURN PRESSURE - 125 PSI
 FLOW TO VALVE/MOTOR - 4.8 GPM
 MOTOR RPM - 252 RPM
 DISK DIAMETER - 35.75 IN
 F-403

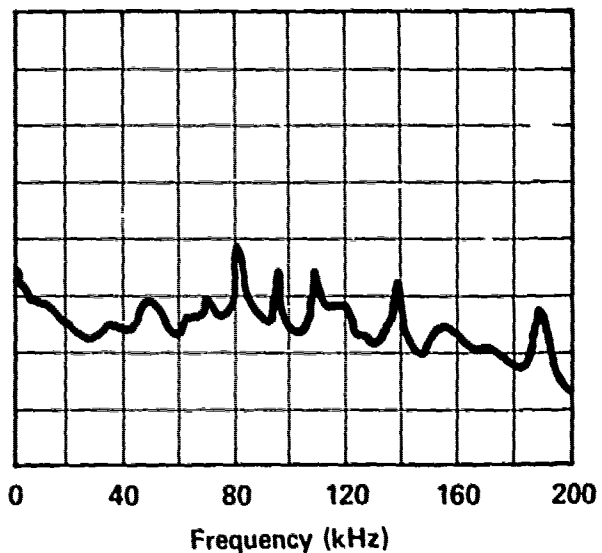

SERVO VALVE & MOTOR - OLSEN & WSI
 INLET PRESSURE - 1125 PSI
 C₁ PRESSURE - 1000 PSI
 C₂ PRESSURE - 125 PSI
 RETURN PRESSURE - 125 PSI
 FLOW TO VALVE/MOTOR - 4.9 GPM
 MOTOR RPM - 276 RPM
 DISK DIAMETER - 35.75 IN
 F-404

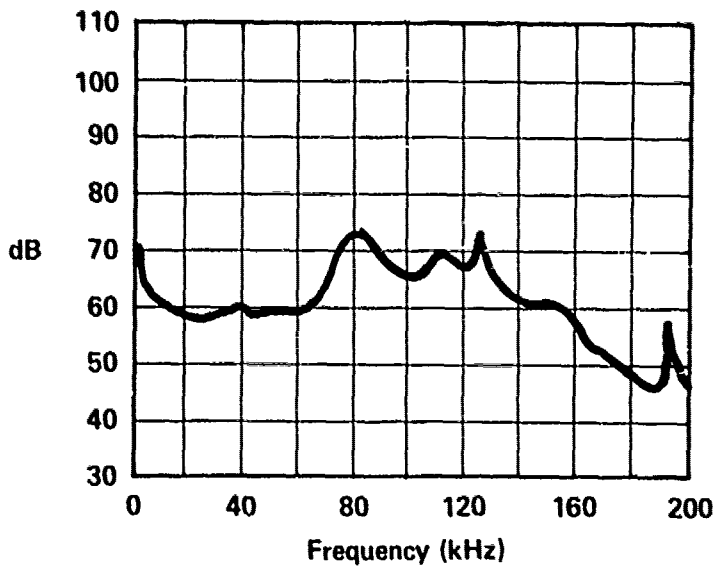

SERVO VALVE & MOTOR - OLSEN & WSI
 INLET PRESSURE - 1250 PSI
 C₁ PRESSURE - 1150 PSI
 C₂ PRESSURE - 150 PSI
 RETURN PRESSURE - 100 PSI
 FLOW TO VALVE/MOTOR - 5 GPM
 MOTOR RPM - 300 RPM
 DISK DIAMETER - 35.75 IN
 F-405

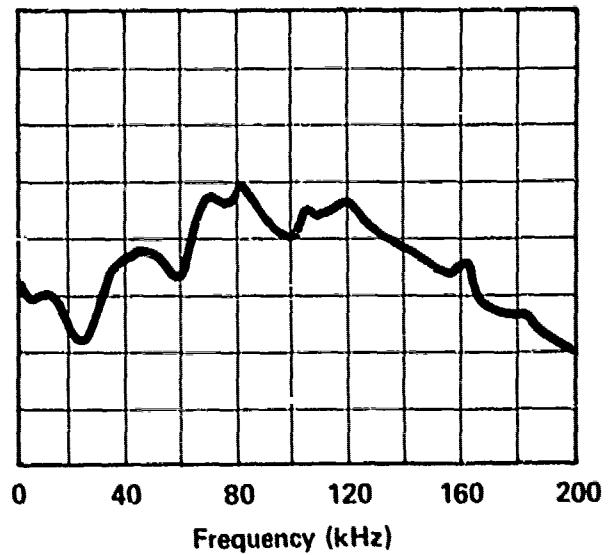

SERVO VALVE & MOTOR - OLSEN & WSI
 INLET PRESSURE - 1500 PSI
 C₁ PRESSURE - 1200 PSI
 C₂ PRESSURE - 850 PSI
 RETURN PRESSURE - 500 PSI
 FLOW TO VALVE/MOTOR - 2 GPM
 MOTOR RPM - 108 RPM
 DISK DIAMETER - 35.75 IN
 F-406

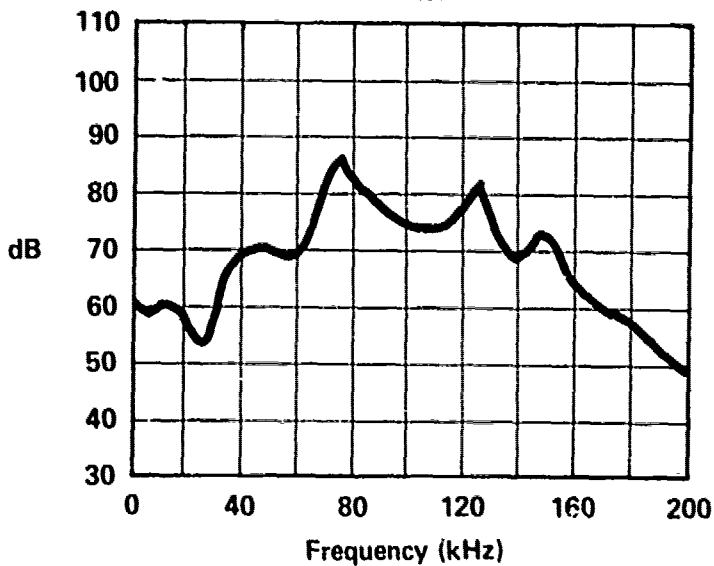

SERVO VALVE & MOTOR - OLSEN & WSI
 INLET PRESSURE - 1500 PSI
 C₁ PRESSURE - 1200 PSI
 C₂ PRESSURE - 800 PSI
 RETURN PRESSURE - 500 PSI
 FLOW TO VALVE/MOTOR - 2.5 GPM
 MOTOR RPM - 150 RPM
 DISK DIAMETER - 35.75 IN
 F-407

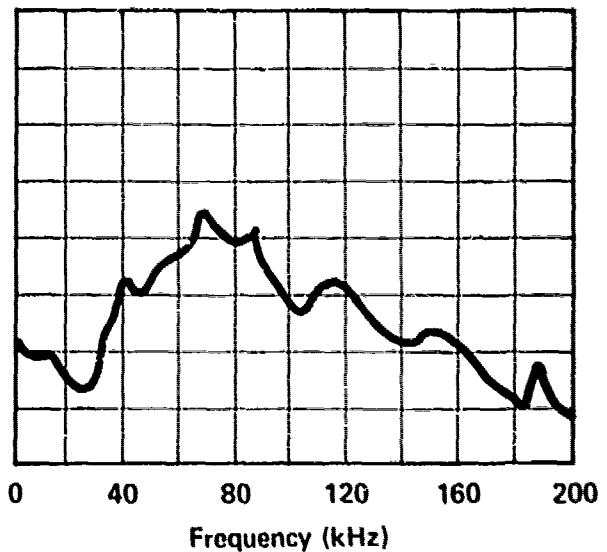

SERVO VALVE & MOTOR - OLSEN & WSI
 INLET PRESSURE - 1500 PSI
 C₁ PRESSURE - 1100 PSI
 C₂ PRESSURE - 900 PSI
 RETURN PRESSURE - 500 PSI
 FLOW TO VALVE/MOTOR - 2.6 GPM
 MOTOR RPM - 156 RPM
 DISK DIAMETER - 35.75 IN
 F-408

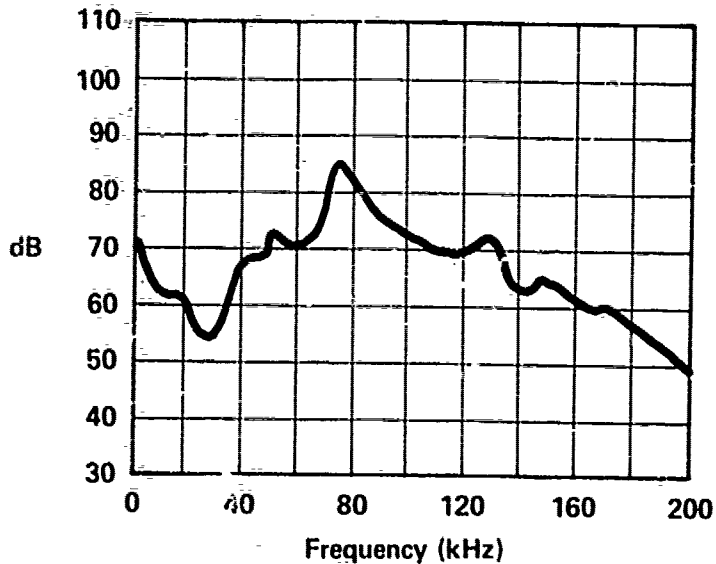

SERVO VALVE & MOTOR - OLSEN & WSI
 INLET PRESSURE - 1500 PSI
 C₁ PRESSURE - 1150 PSI
 C₂ PRESSURE - 800 PSI
 RETURN PRESSURE - 500 PSI
 FLOW TO VALVE/MOTOR - 3 GPM
 MOTOR RPM - 180 RPM
 DISK DIAMETER - 35.75 IN
 F-409

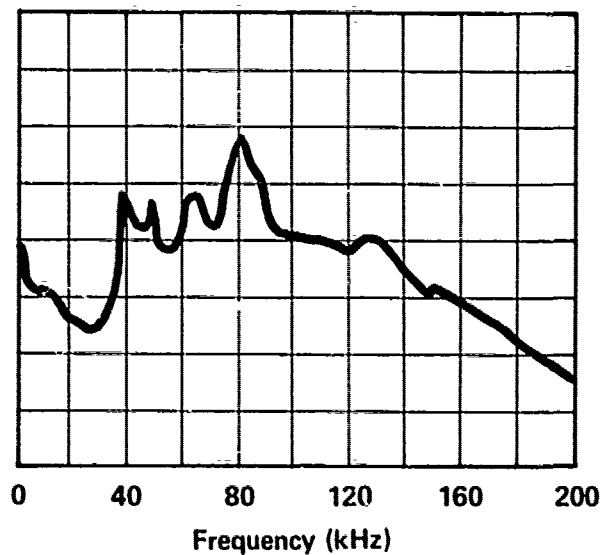

SERVO VALVE & MOTOR - OLSEN & WSI
 INLET PRESSURE - 1500 PSI
 C₁ PRESSURE - 1200 PSI
 C₂ PRESSURE - 800 PSI
 RETURN PRESSURE - 500 PSI
 FLOW TO VALVE/MOTOR - 4 GPM
 MOTOR RPM - 216 RPM
 DISK DIAMETER - 35.75 IN
 F-410

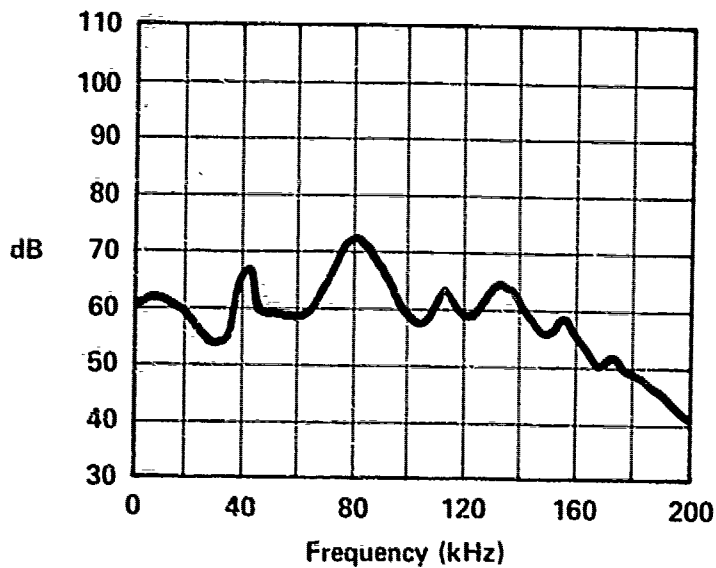

SERVO VALVE & MOTOR - OLSEN & WSI
 INLET PRESSURE - 1500 PSI
 C₁ PRESSURE - 1250 PSI
 C₂ PRESSURE - 750 PSI
 RETURN PRESSURE - 500 PSI
 FLOW TO VALVE/MOTOR - 4.5 GPM
 MOTOR RPM - 252 RPM
 DISK DIAMETER - 35.75 IN
 F-411

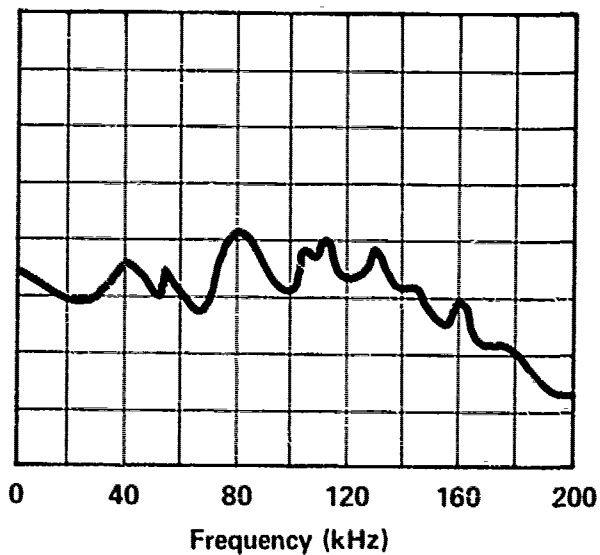

SERVO VALVE & MOTOR - OLSEN & WSI
 INLET PRESSURE - 1500 PSI
 C₁ PRESSURE - 1350 PSI
 C₂ PRESSURE - 550 PSI
 RETURN PRESSURE - 500 PSI
 FLOW TO VALVE/MOTOR - 5 GPM
 MOTOR RPM - 264 RPM
 DISK DIAMETER - 35.75 IN
 F-412

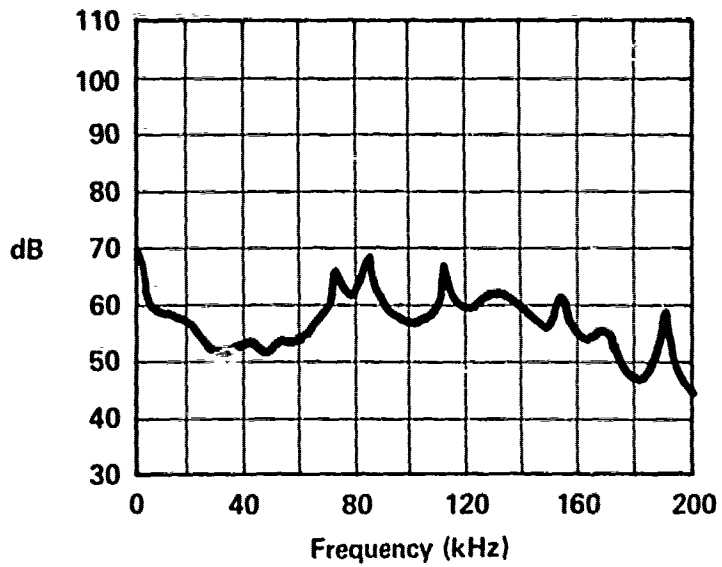

SERVO VALVE & MOTOR - OLSEN & WSI
 INLET PRESSURE - 1500 PSI
 C₁ PRESSURE - 1400 PSI
 C₂ PRESSURE - 750 PSI
 RETURN PRESSURE - 500 PSI
 FLOW TO VALVE/MOTOR - 5 GPM
 MOTOR RPM - 276 RPM
 DISK DIAMETER - 35.75 IN
 F-413

APPENDIX B

TEST DATA OF SECOND TEST SERIES

GRAPHS

This appendix presents the results of the second series of acoustic tests, depicted by noise profile graphs for each of the components and specified test conditions. The decibel scales for all graphs have a reference of 1 microPascal per hertz per yard (dB// μ Pa/Hz/yd).

PRECEDING PAGE BLANK - NOT FILLED

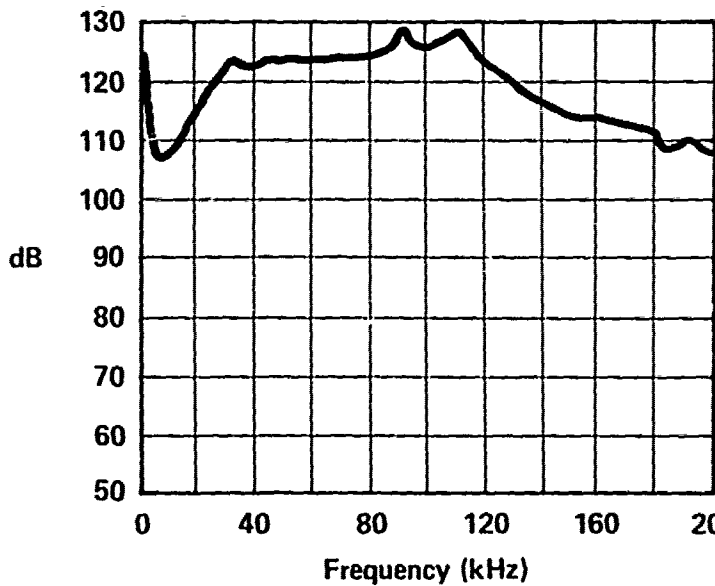

FLOW - 5 GPM
B-316

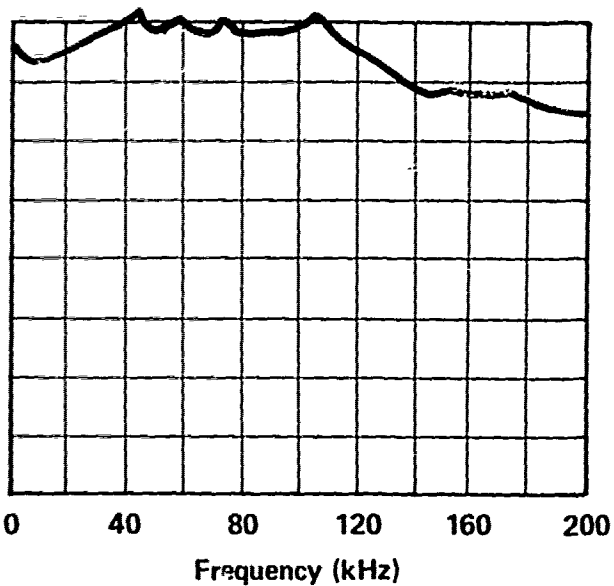

FLOW - 10 GPM
B-317

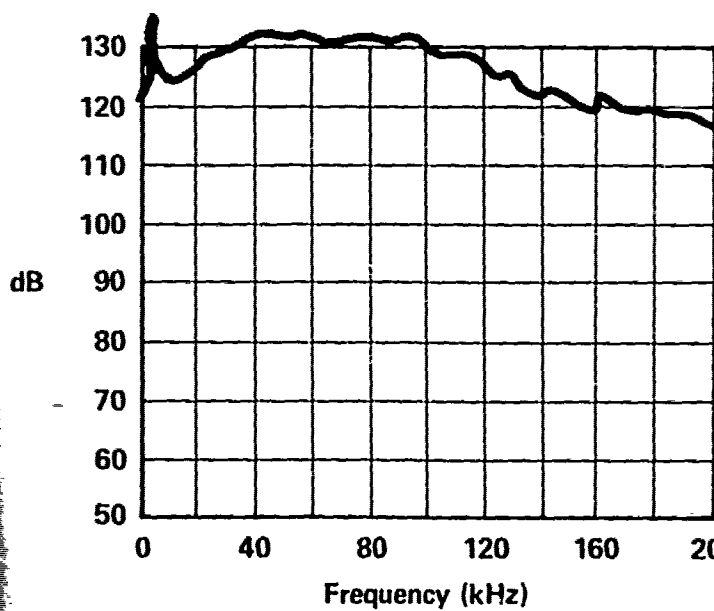

FLOW - 15 GPM
B-318

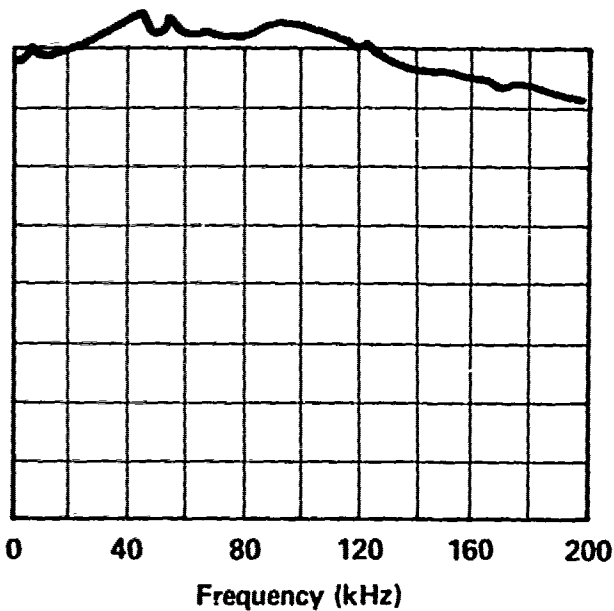

FLOW - 20 GPM
B-319

VICKERS RELIEF VALVE =CT-10-C-20
INLET - 1000 PSI
RETURN - 0 PSI
LOCATION - 5°C SALTWATER TEST POOL

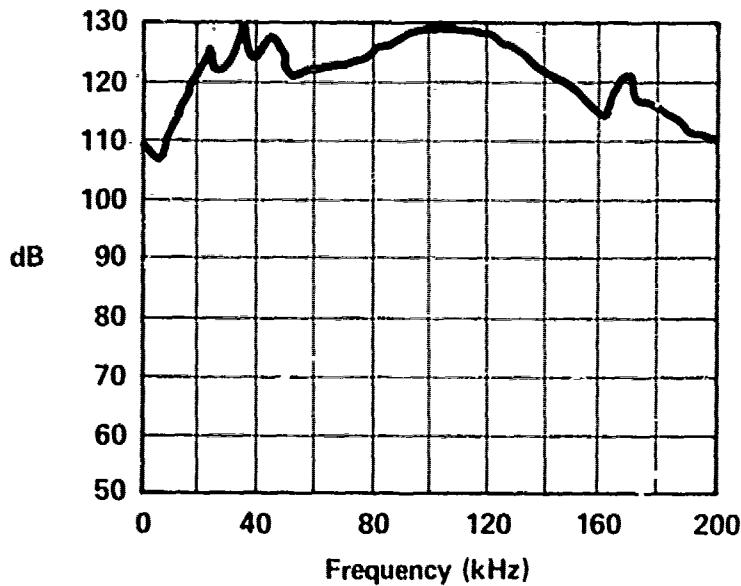

FLOW - 5 GPM
B-320

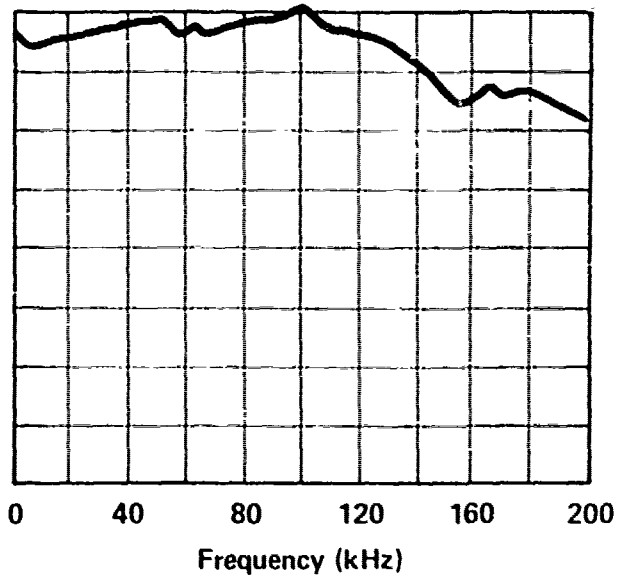

FLOW - 10 GPM
B-321

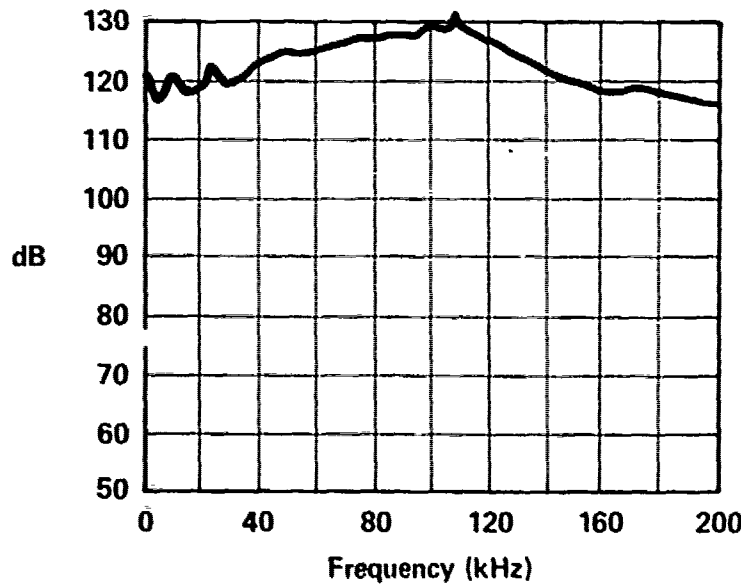

FLOW - 15 GPM
B-322

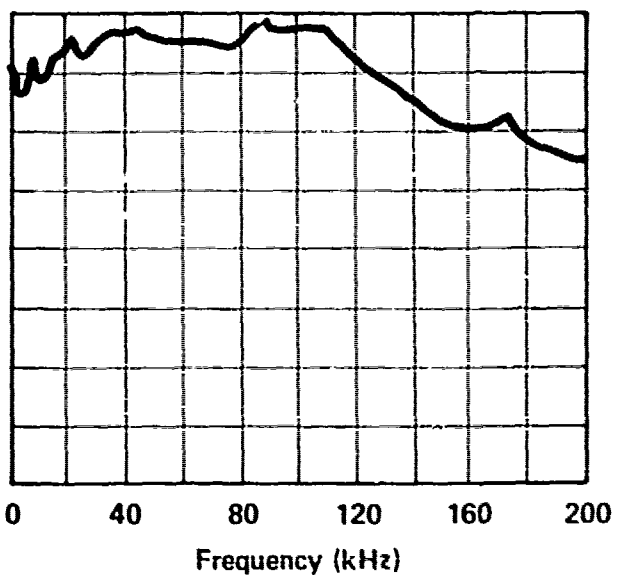

FLOW - 20 GPM
B-323

VICKERS RELIEF VALVE =CT-10 C 20
DEGASSED OIL
INLET - 1000 PSI
RETURN - 0 PSI
LOCATION - NUC SALTWATER TEST POOL

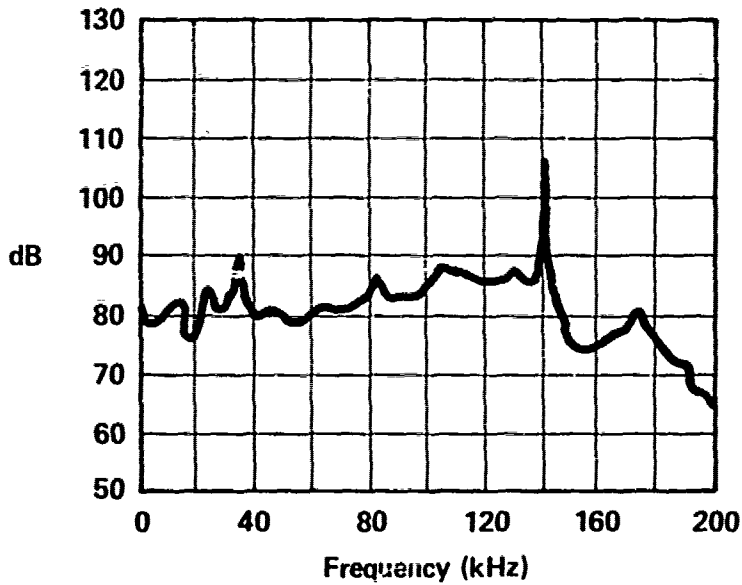

FLOW - 5 GPM
B-324

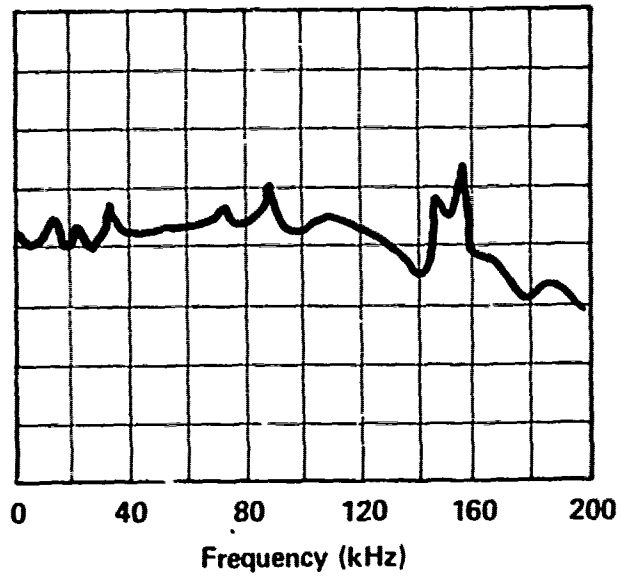

FLOW - 10 GPM
B-325

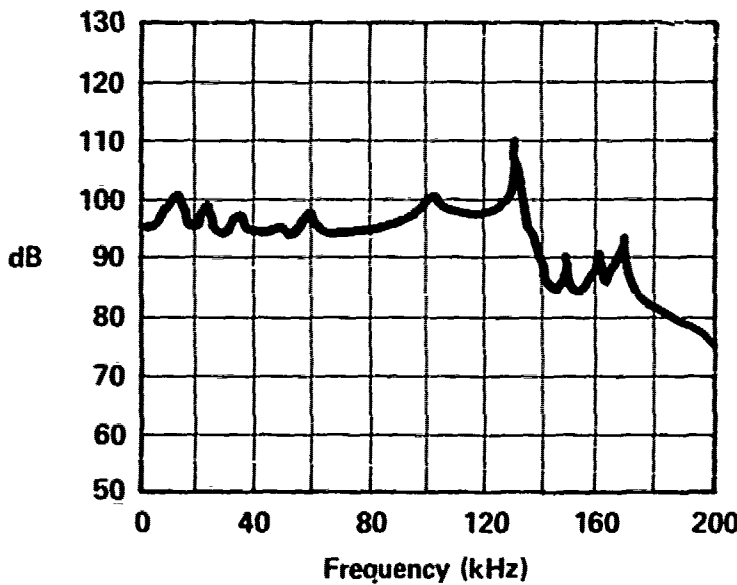

FLOW - 15 GPM
B-326

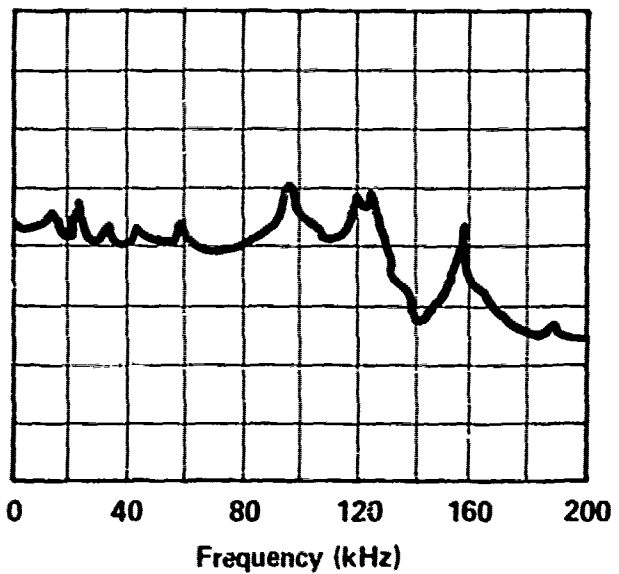

FLOW - 20 GPM
B-327

VICKERS RELIEF VALVE NO. CT-10-C-20
INLET - 1500 PSI
RETURN - 500 PSI
LOCATION - NUC SALTWATER TEST POOL

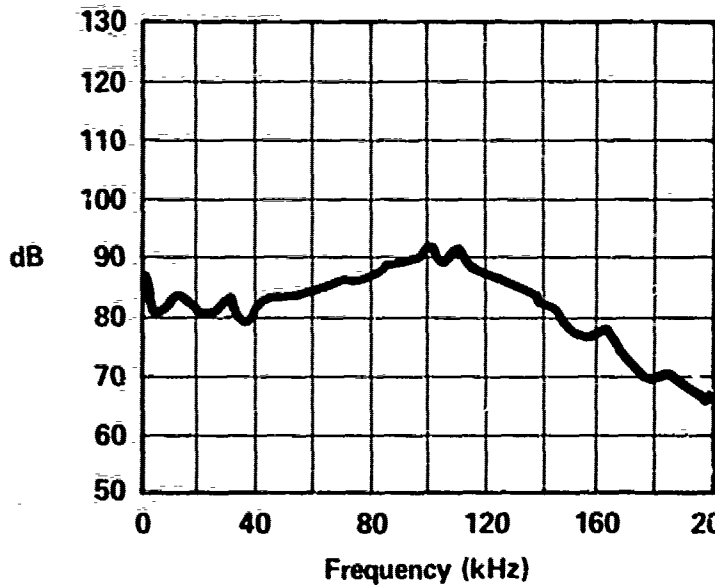

FLOW - 5 GPM
E-401

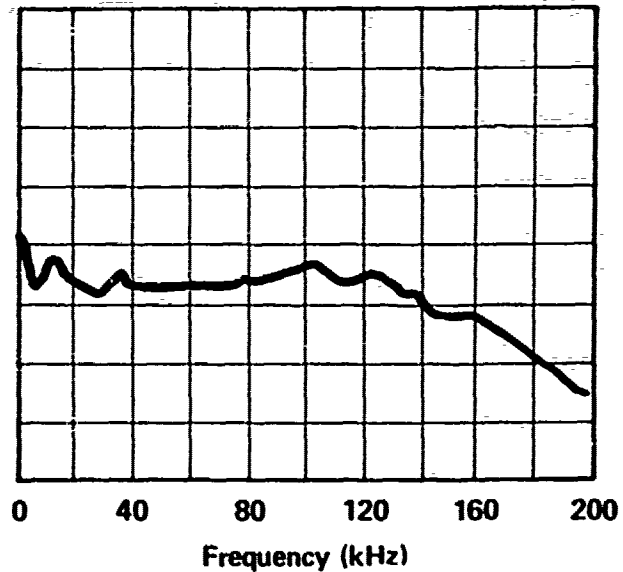

FLOW - 10 GPM
E-402

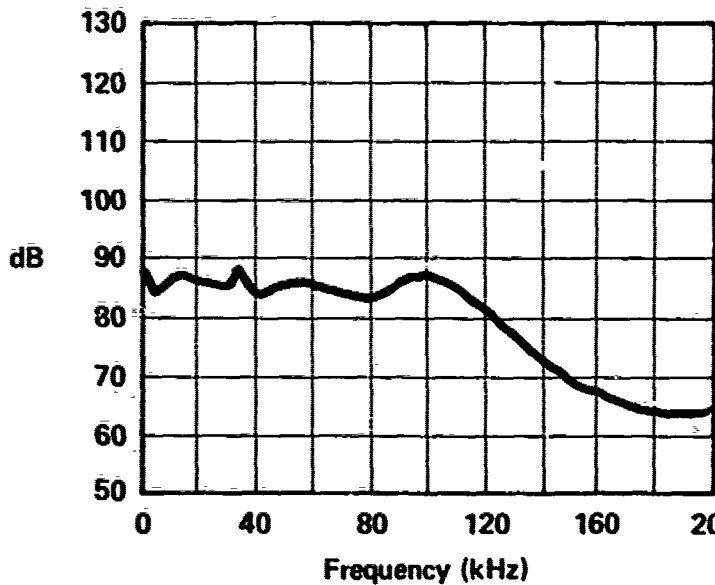

FLOW - 15 GPM
E-403

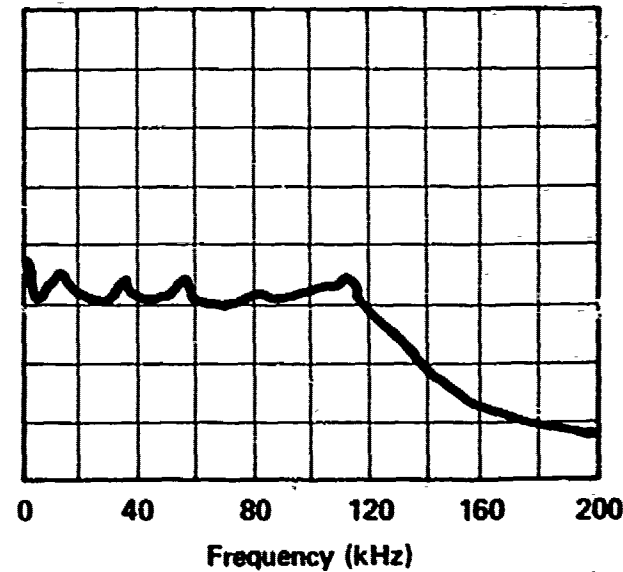

FLOW - 20 GPM
E-404

SANDERS SERVO VALVE NO. SV-432-10P
INLET - 1000 PSI
RETURN - 0 PSI
LOCATION - NUC SALTWATER TEST POOL

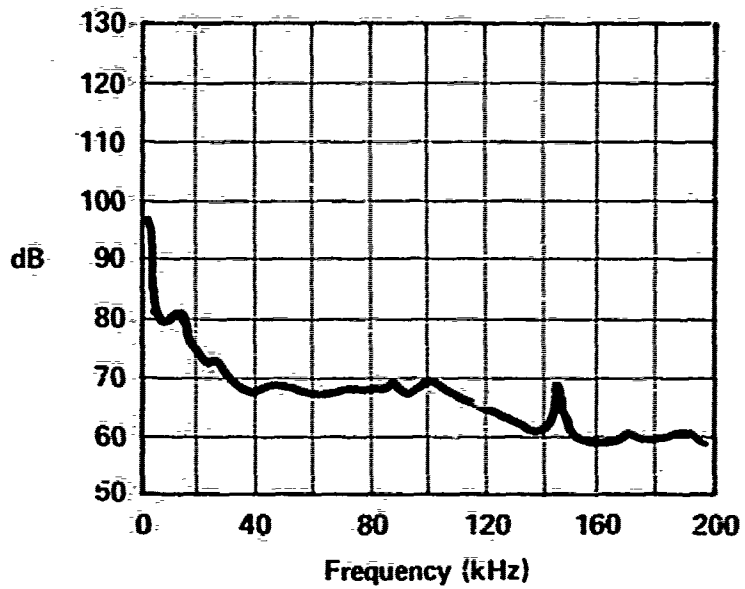

FLOW - 22 GPM
E-405

SANDERS SERVO VALVE NO. SV-438-10P
INLET - 500 PSI
RETURN - 0 PSI
LOCATION - NUC SALTWATER TEST POOL

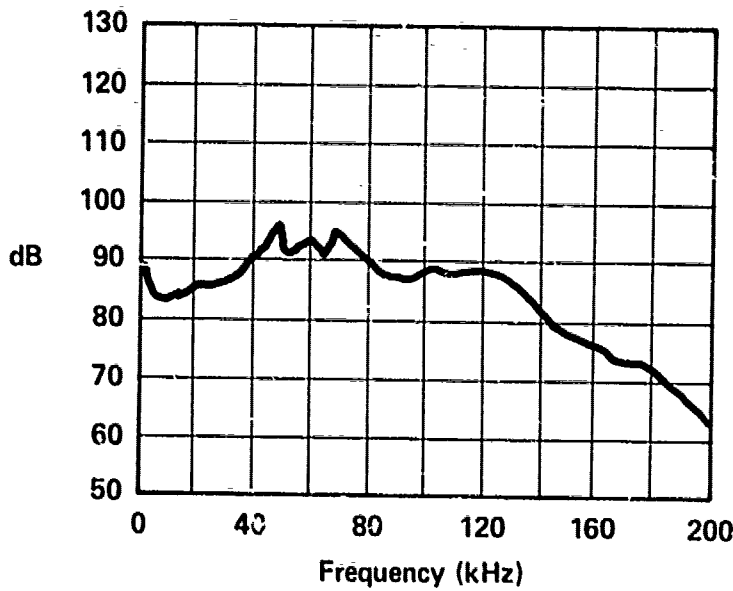

FLOW - 5 GPM
E-406

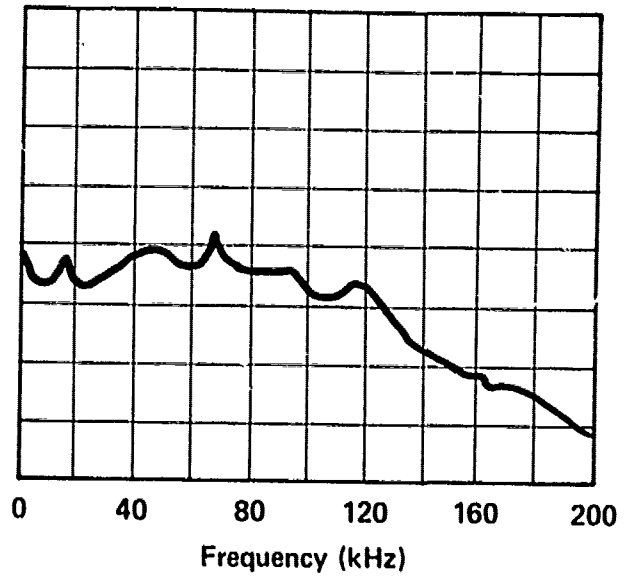

FLOW - 10 GPM
E-407

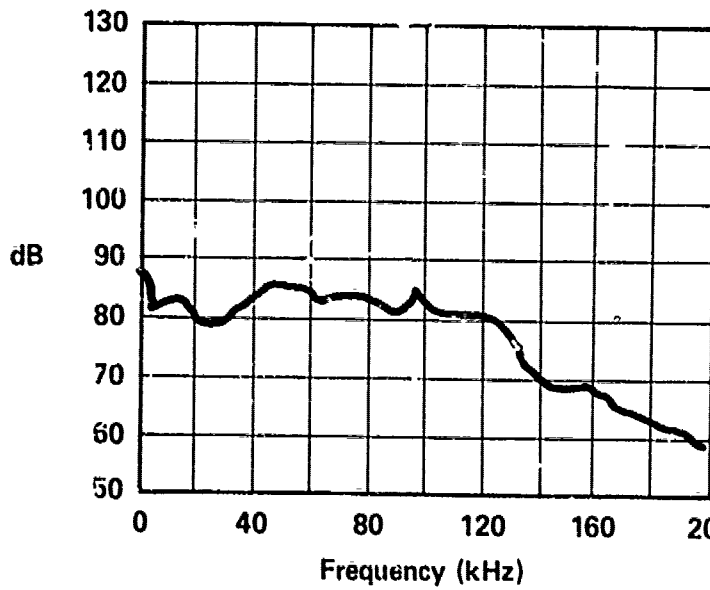

FLOW - 15 GPM
E-408

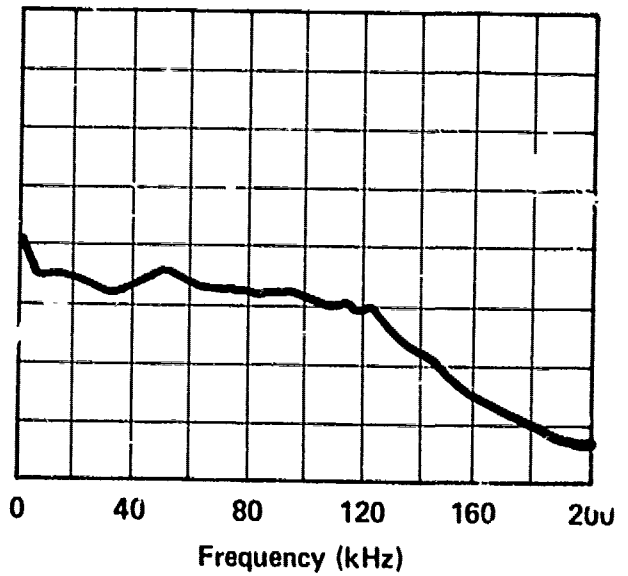

FLOW - 20 GPM
E-409

SANDERS SERVO VALVE NO. SV-438-10P
INLET - 1500 PSI
RETURN - 500 PSI
LOCATION - NUC SALTWATER TEST POOL

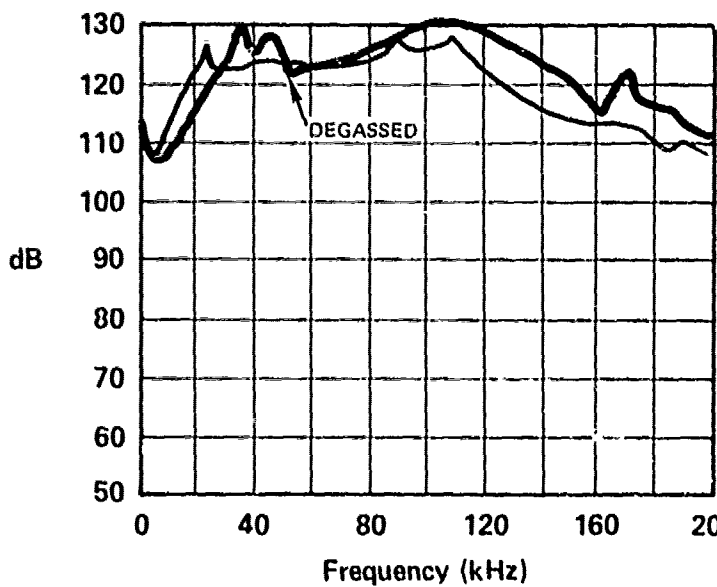

FLOW - 5 GPM
B-328

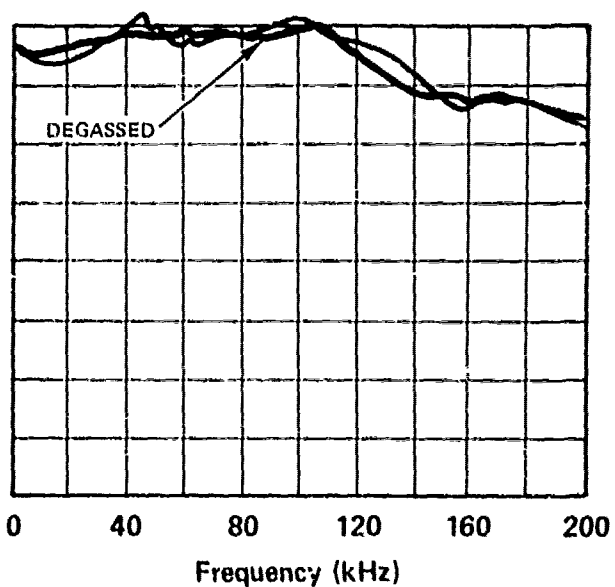

FLOW - 10 GPM
B-329

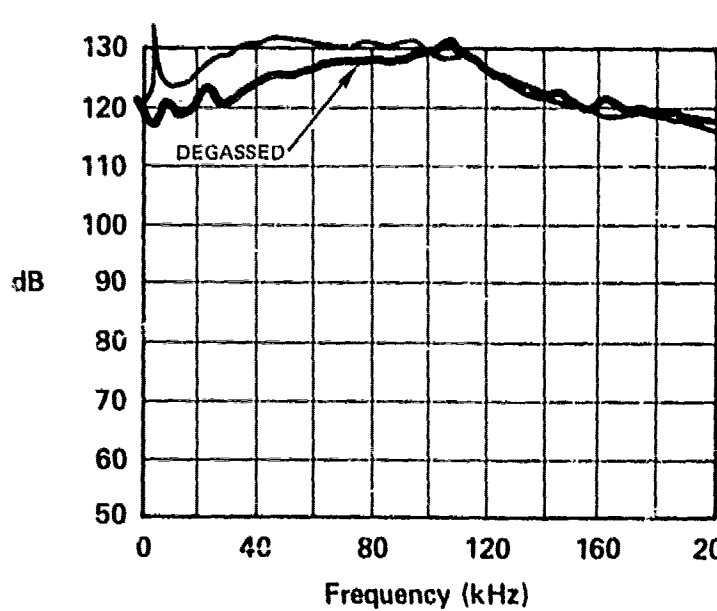

FLOW - 15 GPM
B-330

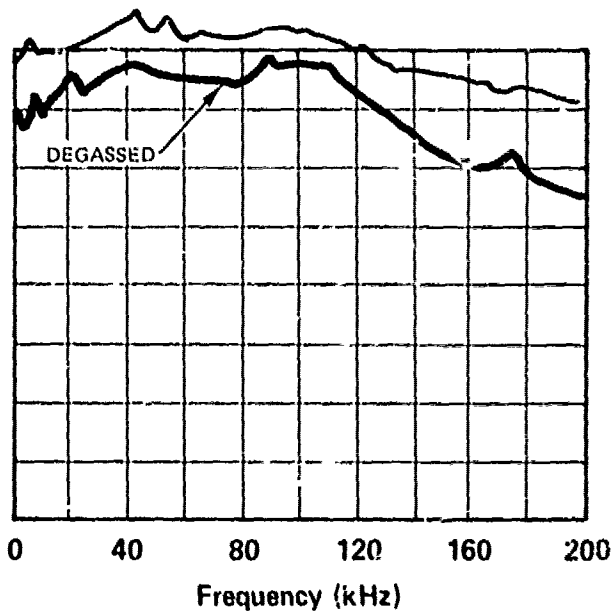

FLOW - 20 GPM
B-331

COMPARATIVE DATA (DEGASSING)

VICKERS RELIEF VALVE

DEGASSED OIL vs INLET - 1000 PSI
 INLET - 1000 PSI RETURN - 0 PSI
 RETURN - 0 PSI
 LOCATION - SALTWATER TEST POOL

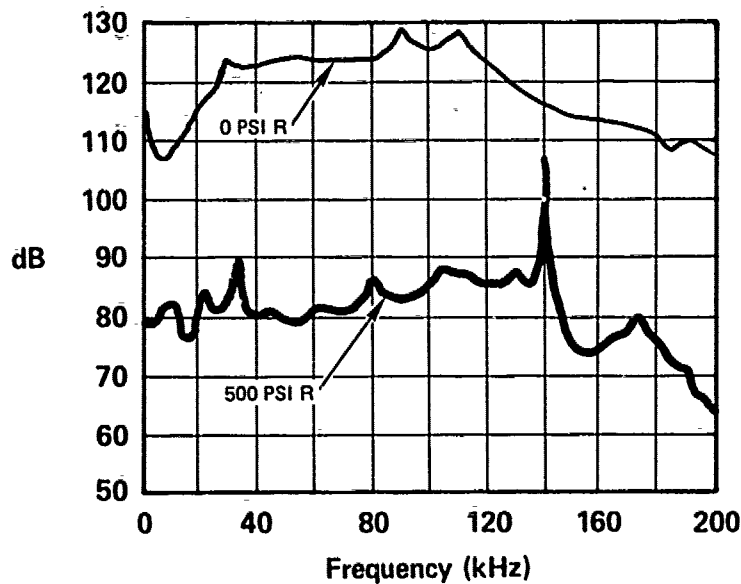

FLOW - 5 GPM
332

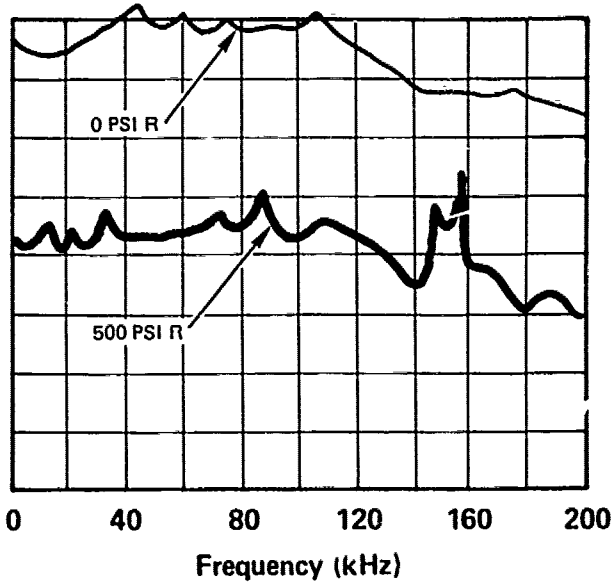

FLOW - 10 GPM
B-333

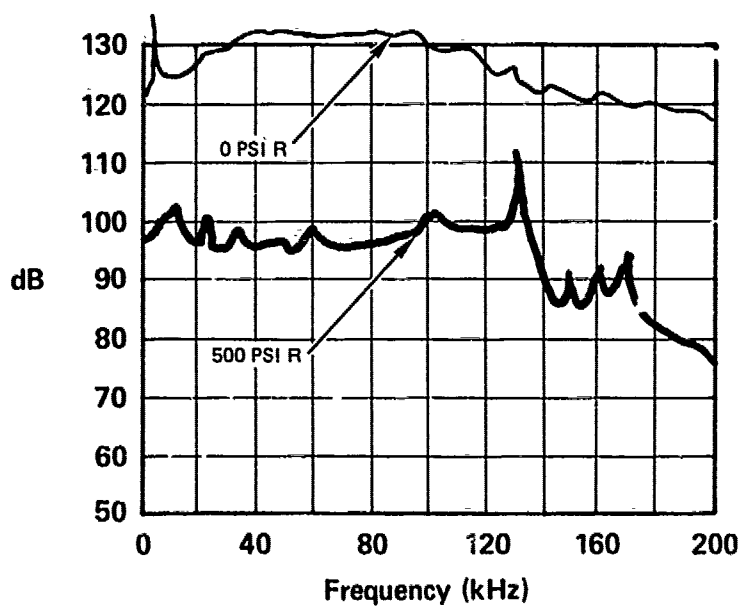

FLOW - 15 GPM
B-334

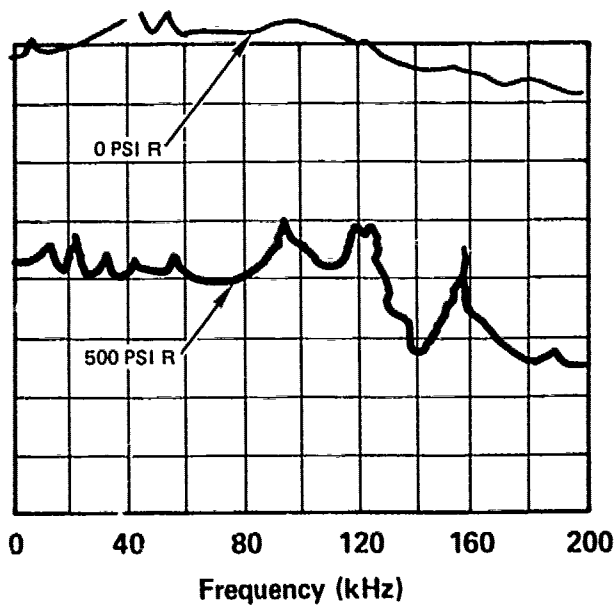

FLOW - 20 GPM
B-335

COMPARATIVE DATA (BACK-PRESSURING)

VICKERS RELIEF VALVE

INLET - 1000 PSI vs INLET - 1500 PSI
RETURN - 1 PSI RETURN - 500 PSI

LOCATION - NUC SALTWATER TEST POOL

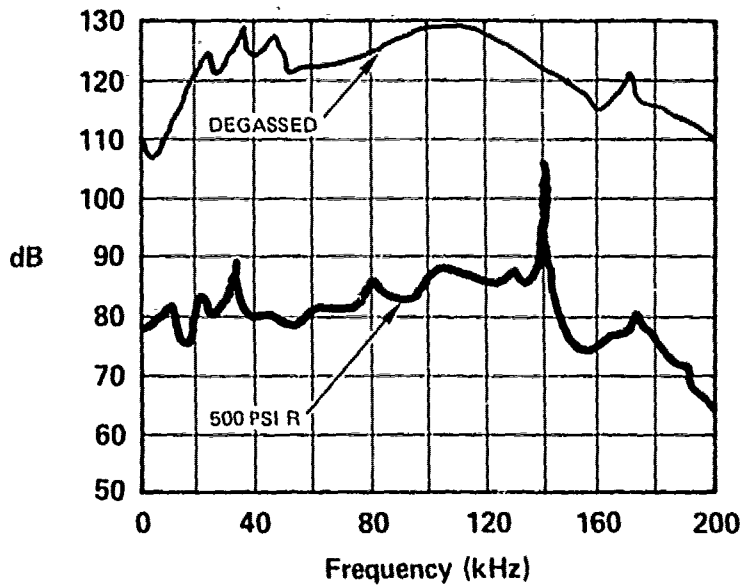

FLOW - 5 GPM
B-336

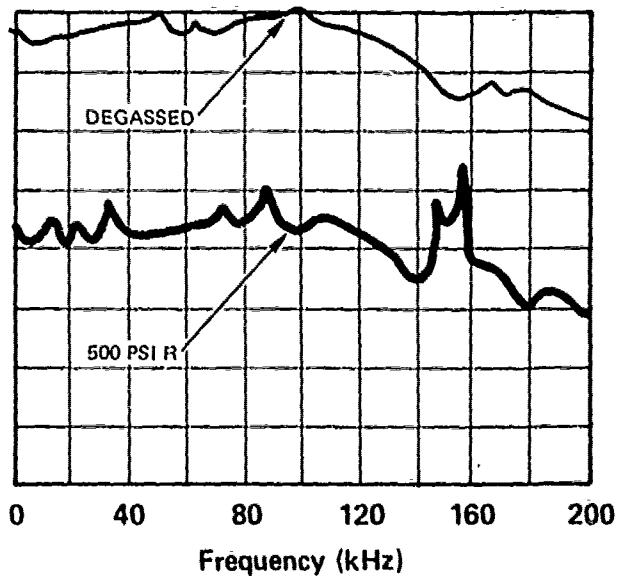

FLOW - 10 GPM
B-337

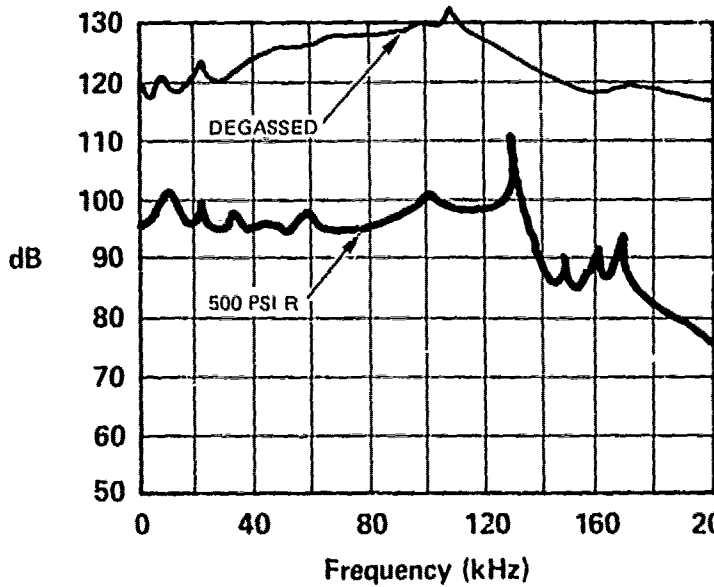

FLOW - 15 GPM
B-338

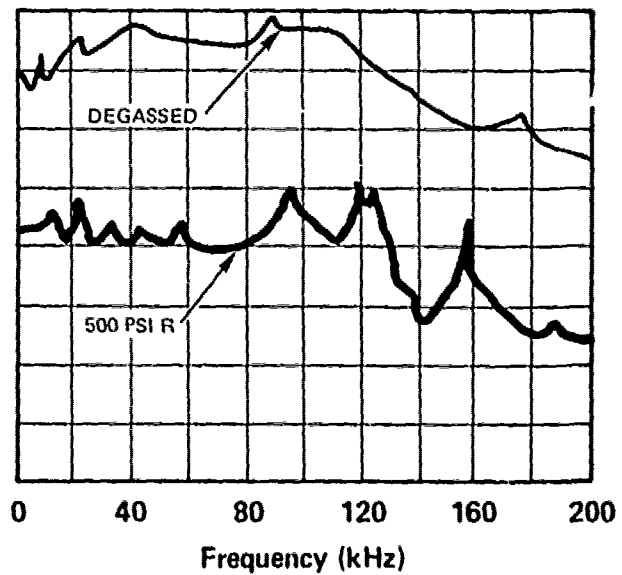

FLOW - 20 GPM
B-339

VICKERS RELIEF VALVE (DEGASSING vs BACK-PRESSURING)

DEGASSED OIL
INLET - 1000 PSI
RETURN - 0 PSI

vs

BACK-PRESSURED
INLET - 1500 PSI
RETURN - 500 PSI

LOCATION - NUC SALTWATER TEST POOL

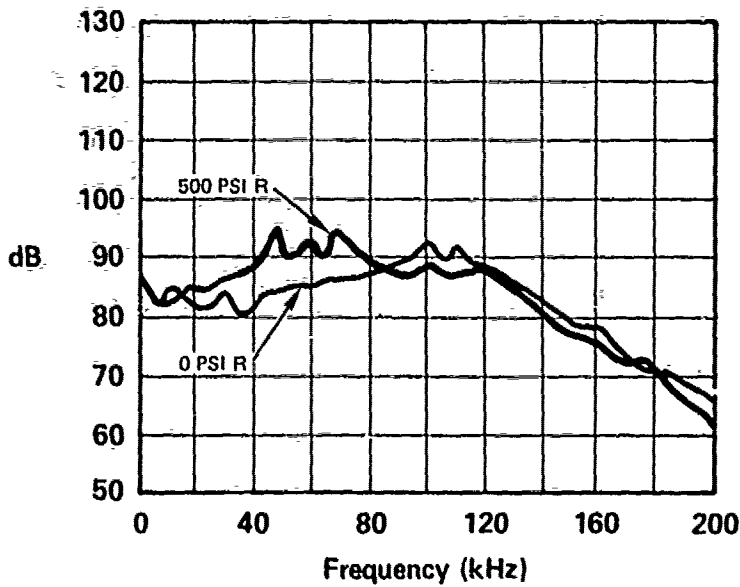

FLOW - 5 GPM
E-410

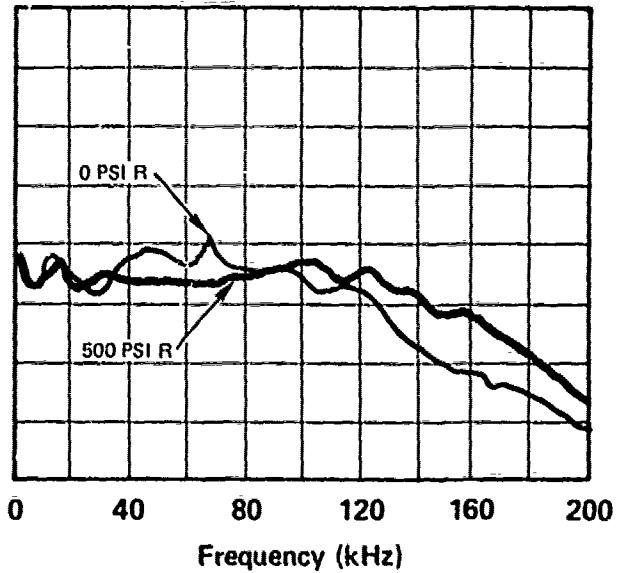

FLOW - 10 GPM
E-411

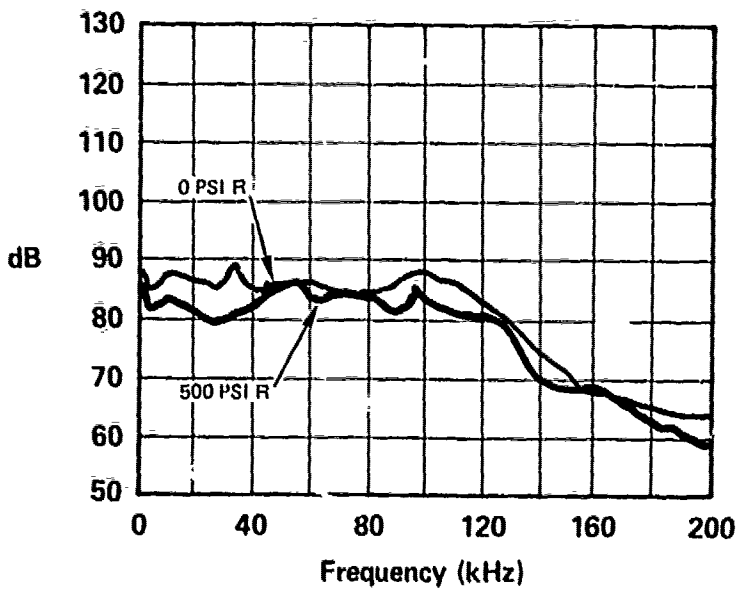

FLOW - 15 GPM
E-412

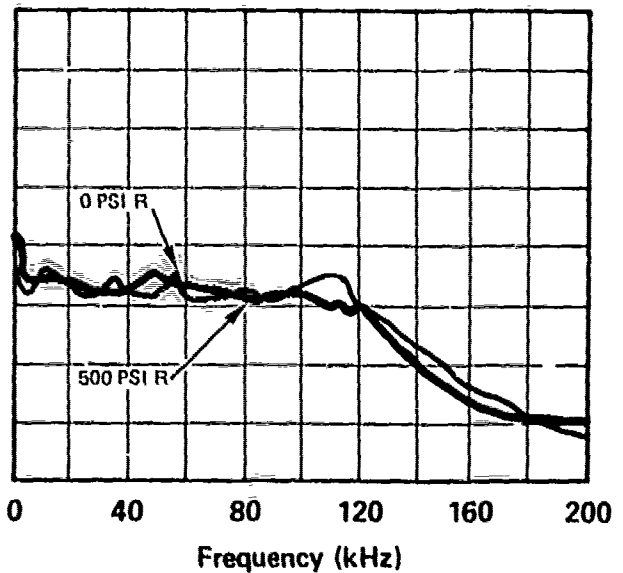

FLOW - 20 GPM
E-413

SANDERS SERVO VALVE NO. SV-438-10P (BACK-PRESSURING)

INLET - 1000 PSI
RETURN - 0 PSI

vs

INLET - 1500 PSI
RETURN - 500 PSI

LOCATION - NUC SALTWATER TEST POOL

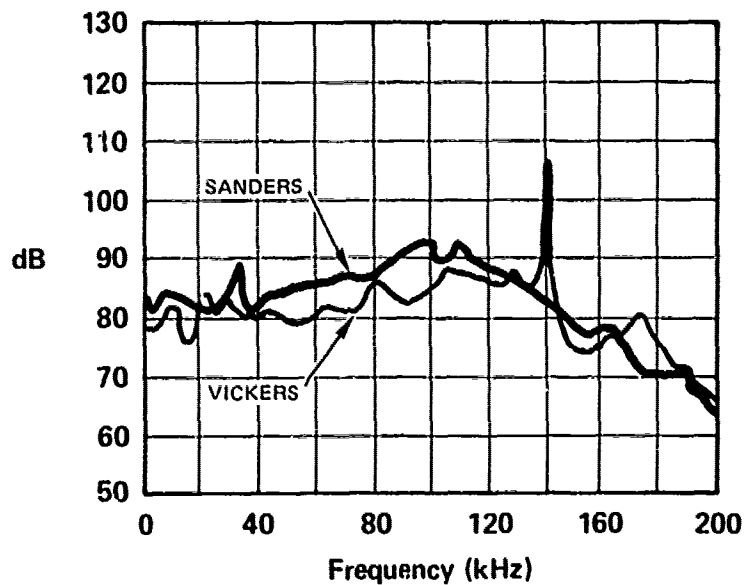

FLOW - 5 GPM
G-101

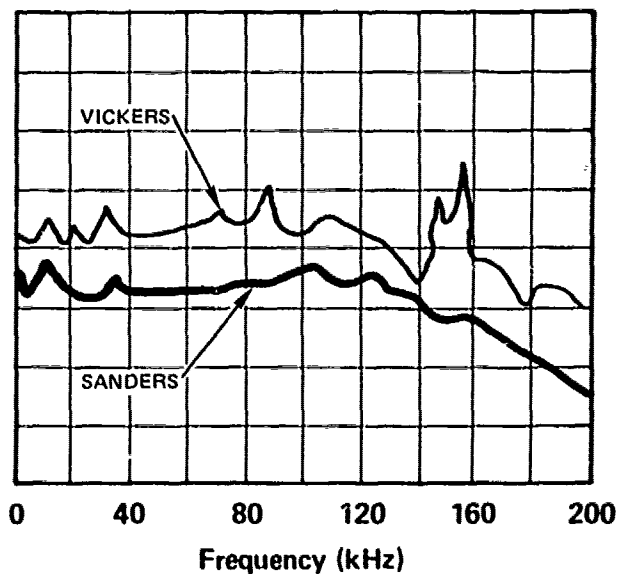

FLOW - 10 GPM
G-102

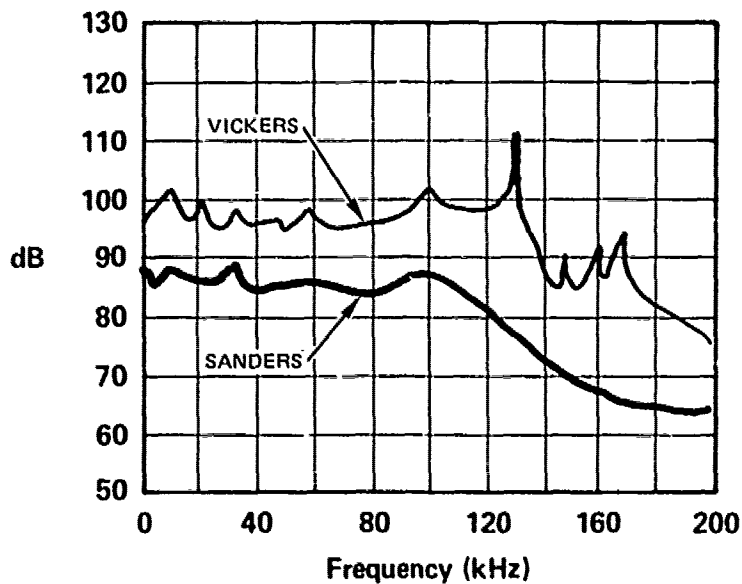

FLOW - 15 GPM
G-103

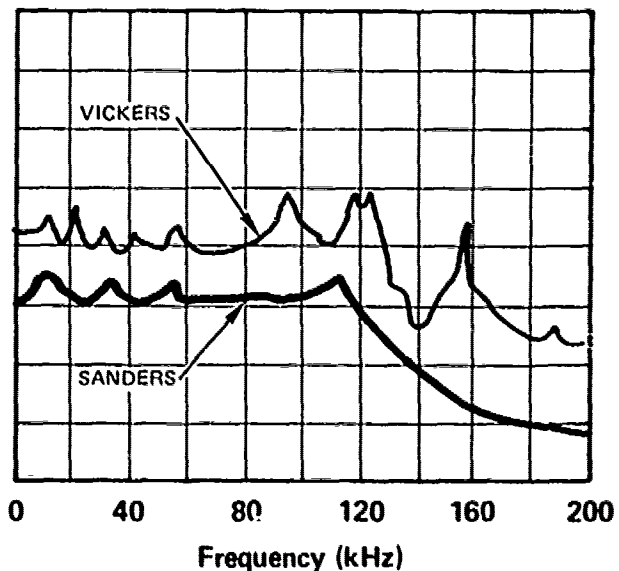

FLOW - 20 GPM
G-104

COMPARATIVE DATA (VICKERS vs SANDERS VALVES)

VICKERS	vs	SANDERS
INLET - 1500 PSI		INLET - 1000 PSI
RETURN - 500 PSI		RETURN - 0 PSI

LOCATION - NUC SALTWATER TEST POOL

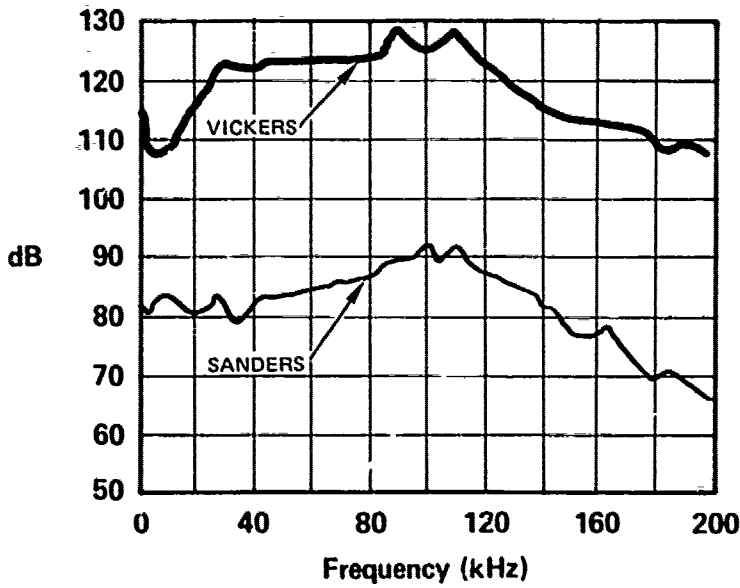

FLOW - 5 GPM
G-105

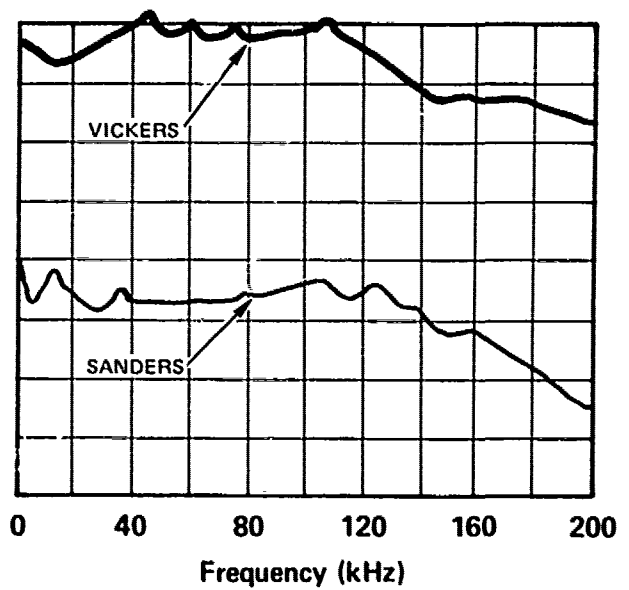

FLOW - 10 GPM
G-106

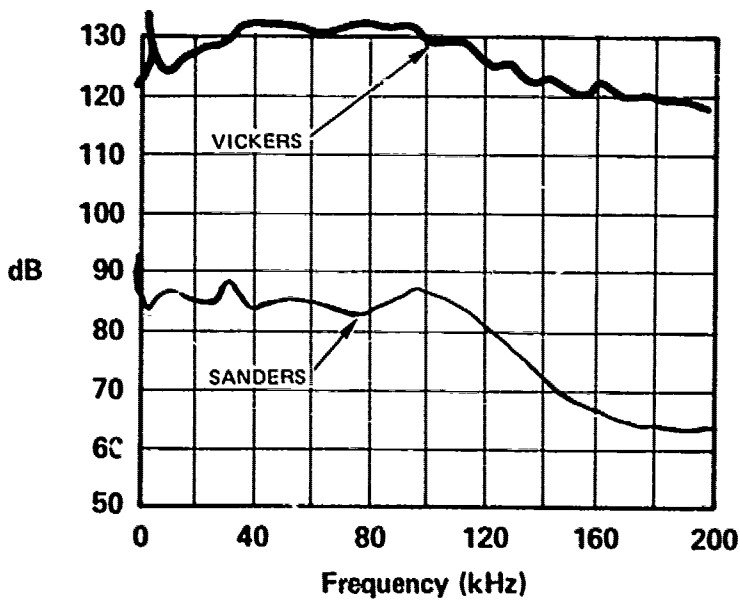

FLOW - 15 GPM
G-107

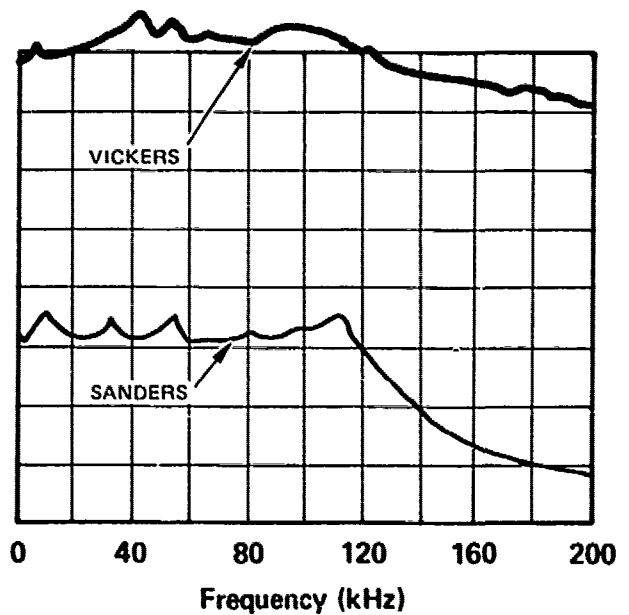

FLOW - 20 GPM
G-108

COMPARATIVE DATA (VICKERS vs SANDERS VALVES)

INLET - 1000 PSI
RETURN - 0 PSI

LOCATION - NUC SALTWATER TEST POOL

APPENDIX C

TEST DATA OF THIRD TEST SERIES

GRAPHS

This appendix presents the results of the third series of acoustic tests, depicted by noise profile graphs for each of the components and specified test conditions. The decibel scales for all graphs have a reference of 1 microPascal per hertz per yard (dB// μ Pa/Hz/yd).

PRECEDING PAGE BLANK - NOT FILMED

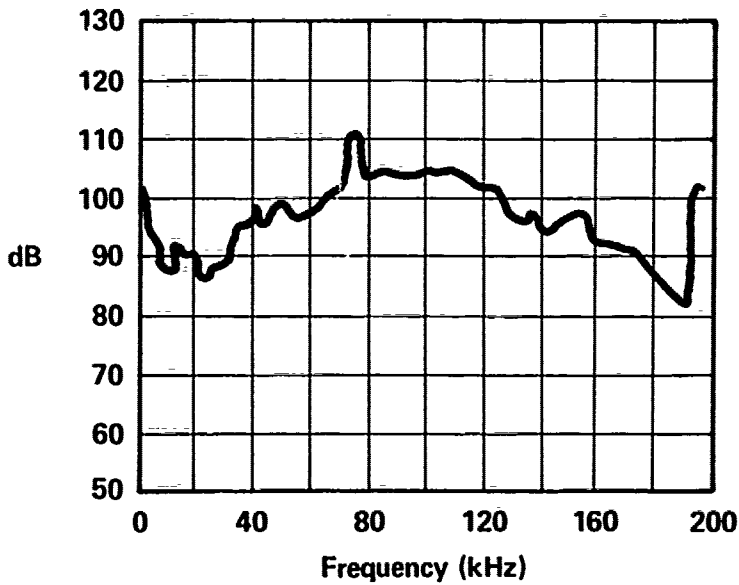

FLOW - 5 GPM
B-601

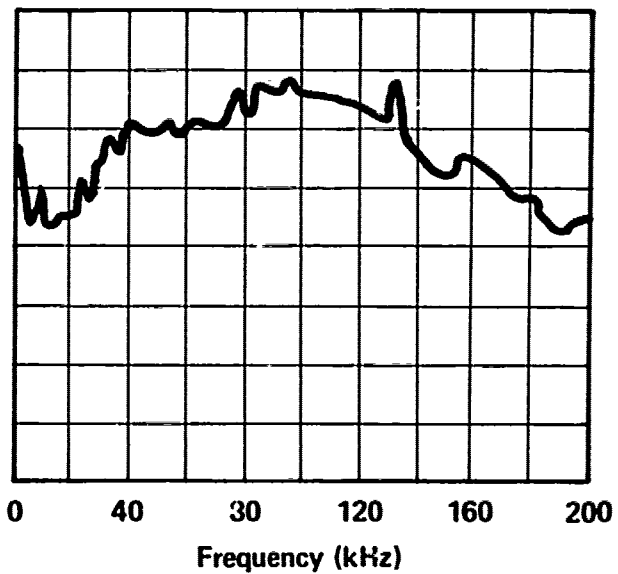

FLOW - 10 GPM
B-602

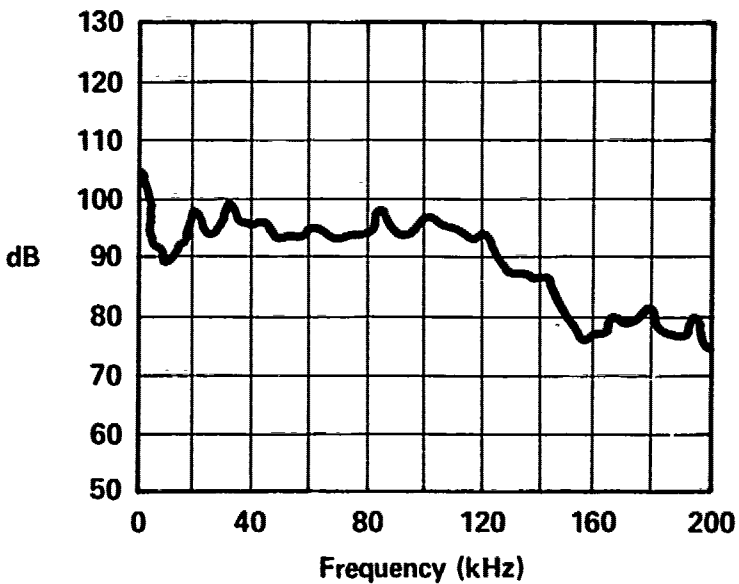

FLOW - 15 GPM
B-603

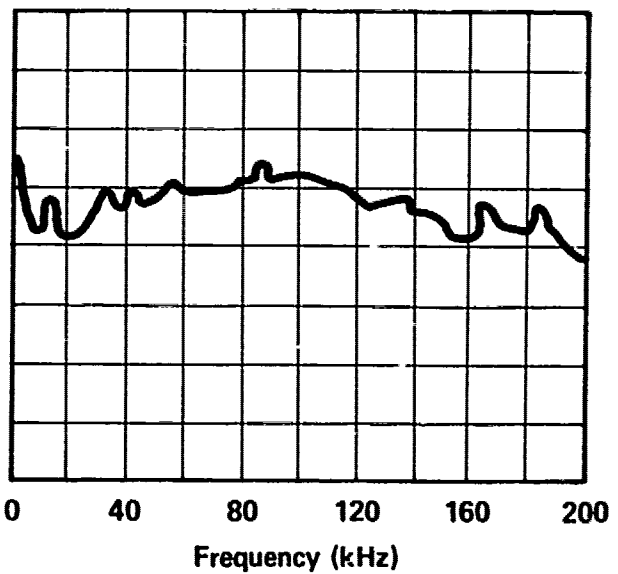

FLOW - 20 GPM
B-604

ROLAMITE PRESSURE RELIEF VALVE (EXTERNAL PILOT VALVE)

INLET - 1000 PSI
RETURN - 0 PSI

LOCATION - NUC SALTWATER TEST POOL

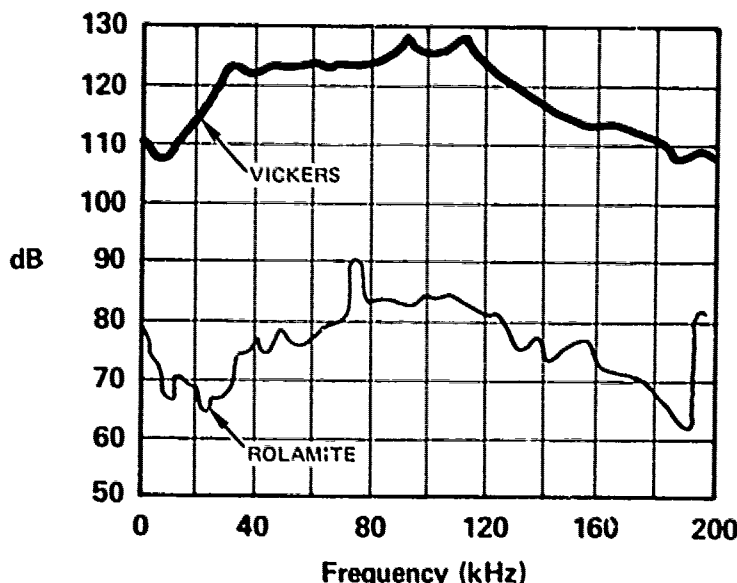

FLOW - 5 GPM
G-201

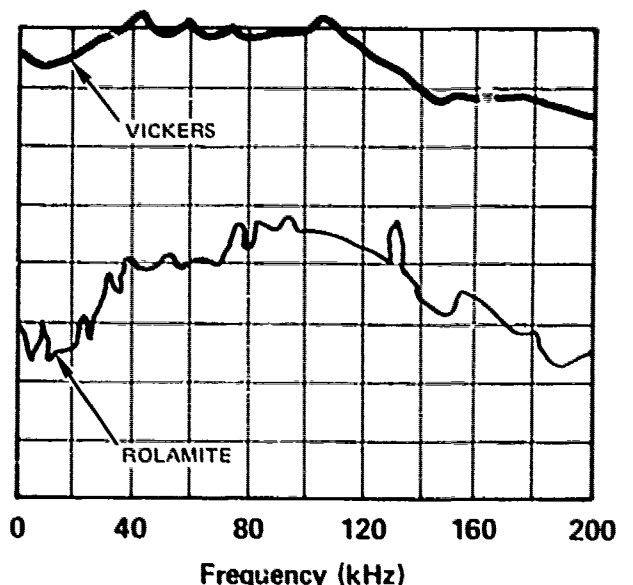

FLOW - 10 GPM
G-202

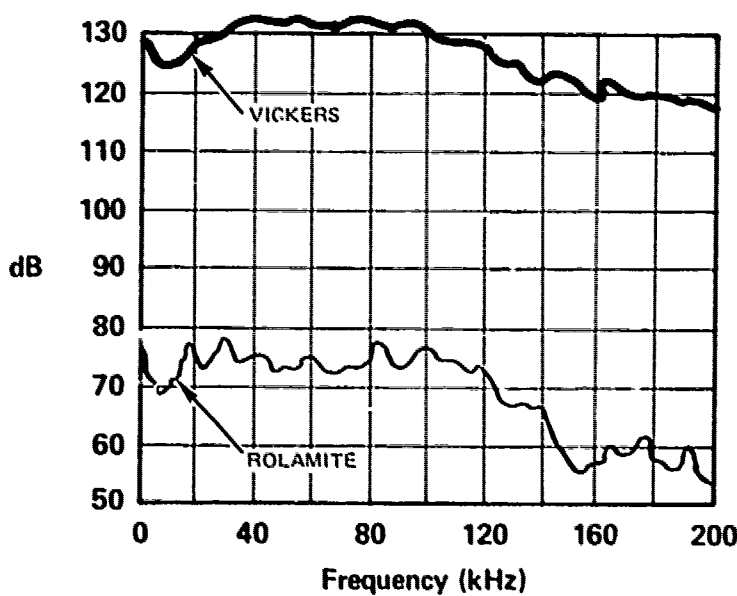

FLOW - 15 GPM
G-203

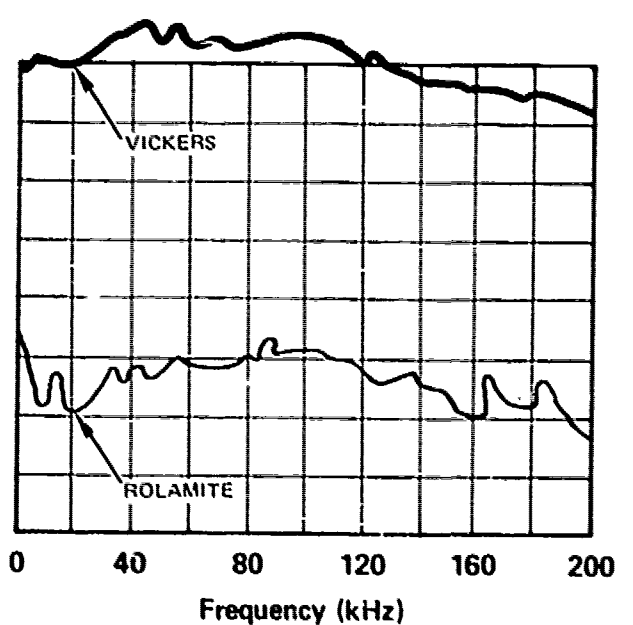

FLOW - 20 GPM
G-204

COMPARATIVE DATA (ROLAMITE vs. VICKERS)

INLET - 1000 PSI
RETURN - 0 PSI

LOCATION - NUC SALTWATER TEST POOL

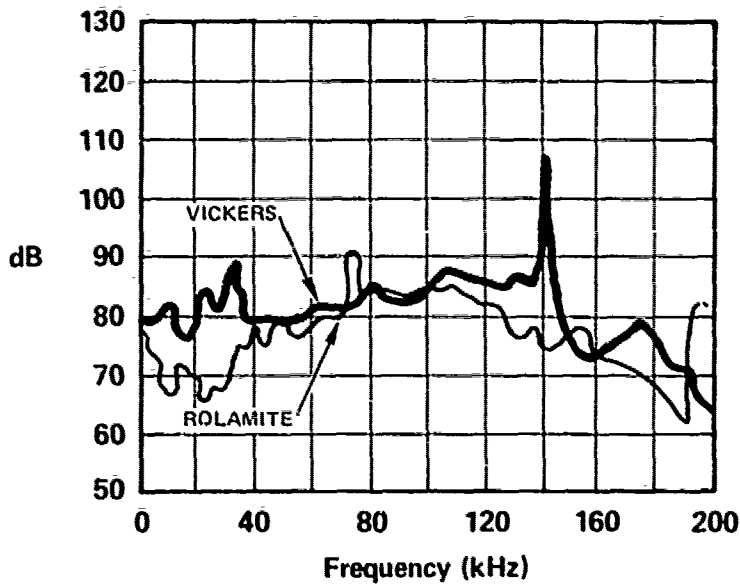

FLOW - 5 GPM
G-205

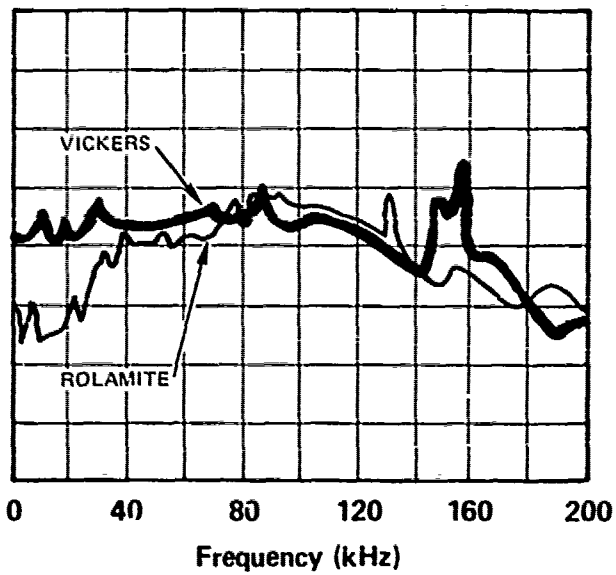

FLOW - 10 GPM
G-206

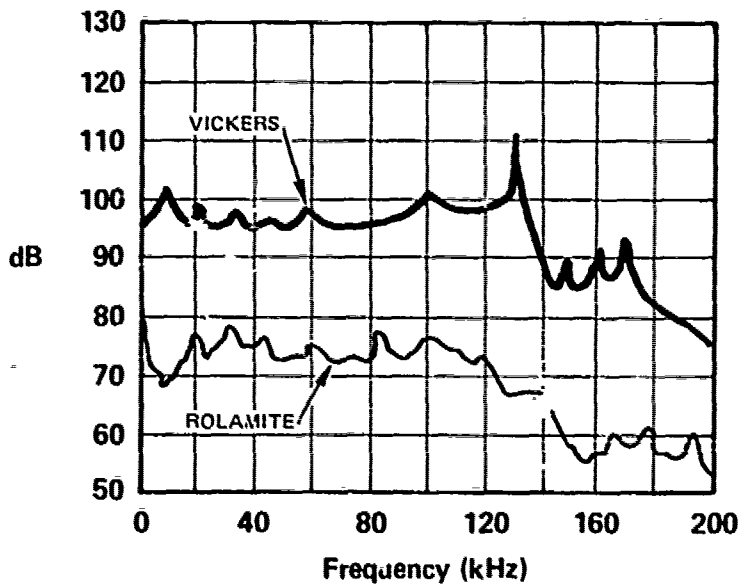

FLOW - 15 GPM
G-207

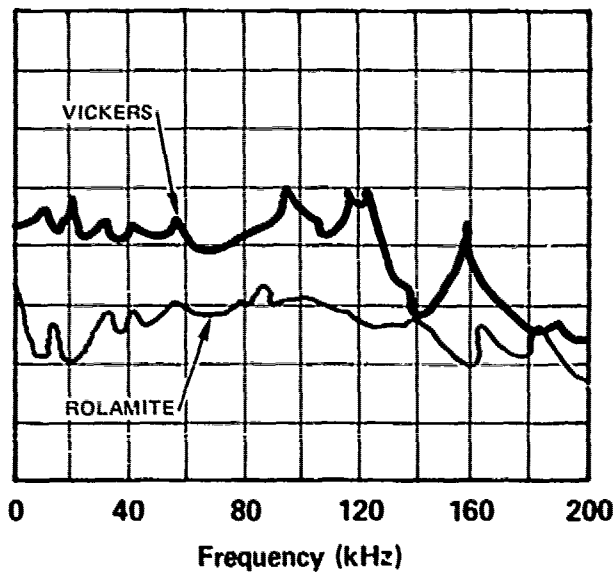

FLOW - 20 GPM
G-208

COMPARATIVE DATA (ROLAMITE vs VICKERS)

ROLAMITE	VICKERS
INLET - 1000 PSI	1500 PSI
RETURN - 0 PSI	500 PSI
LOCATION - NUC SALTWATER TEST POOL	

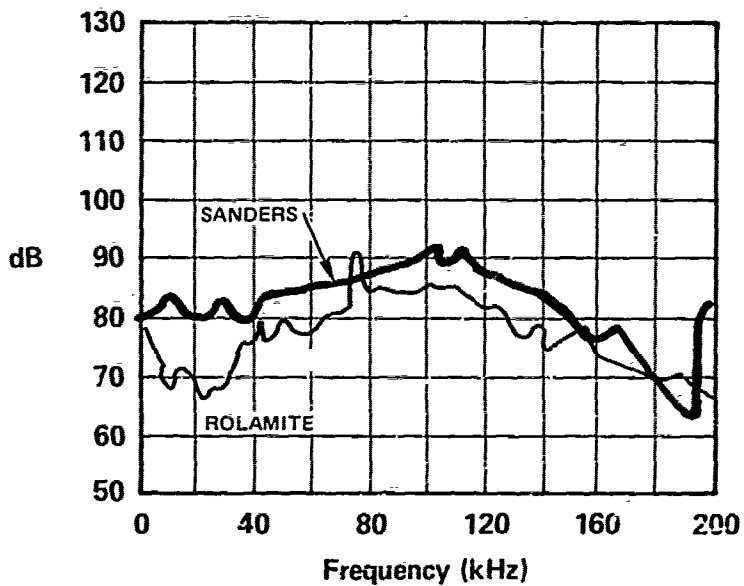

FLOW - 5 GPM
G-301

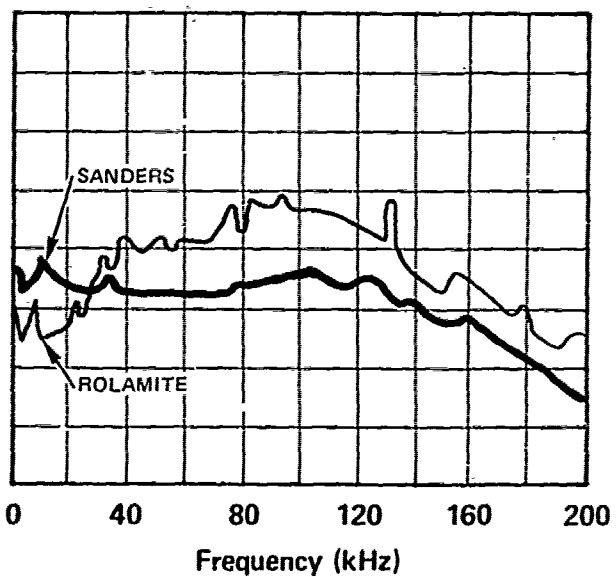

FLOW - 10 GPM
G-302

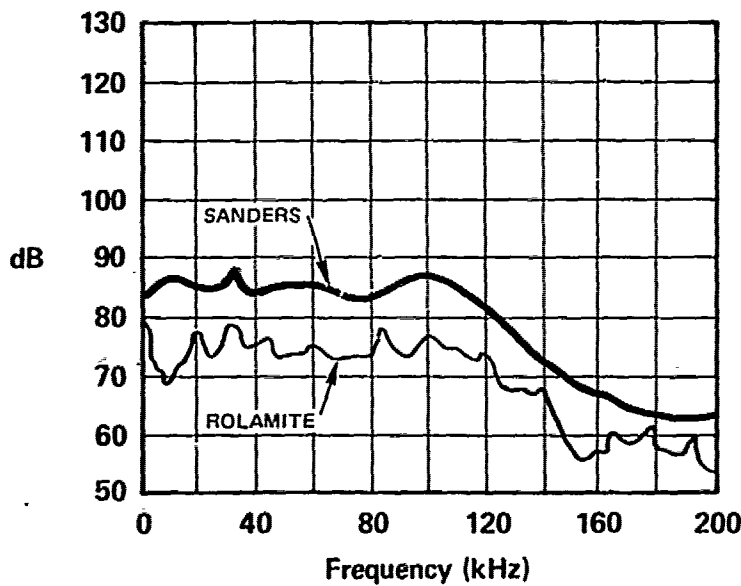

FLOW - 15 GPM
G-303

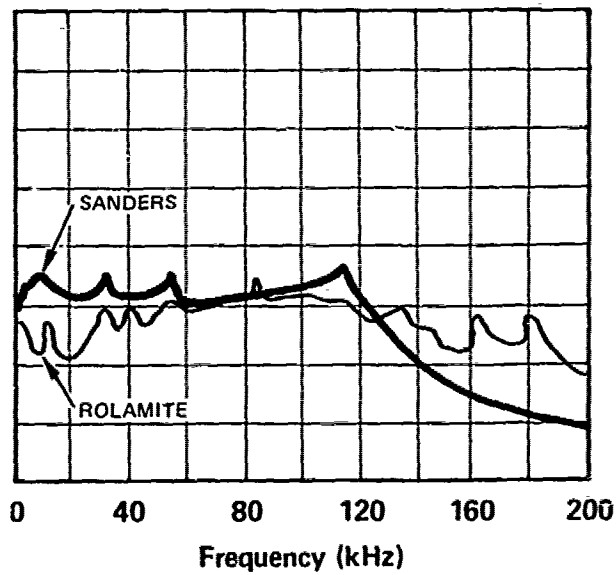

FLOW - 20 GPM
G-304

COMPARATIVE DATA (ROLAMITE vs SANDERS)

INLET - 1000 PSI
RETURN - 0 PSI

LOCATION - NUC SALTWATER TEST POOL

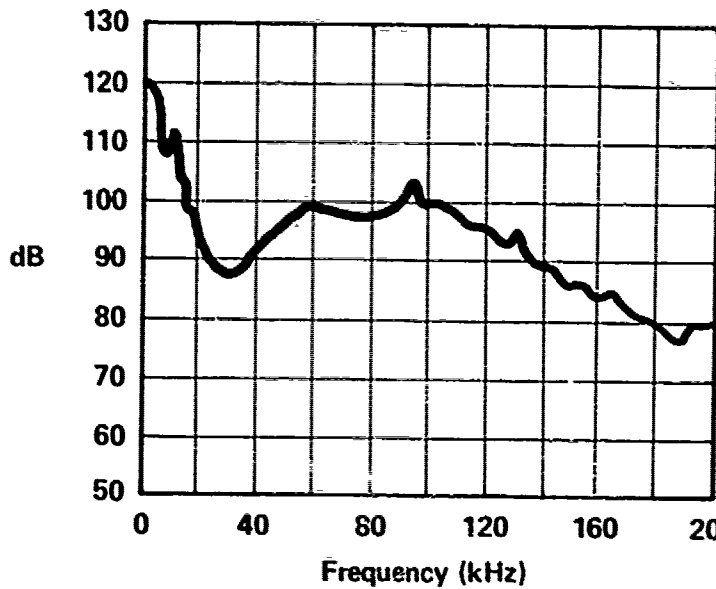

OUTPUT
PRESSURE - 0 PSI
D-501

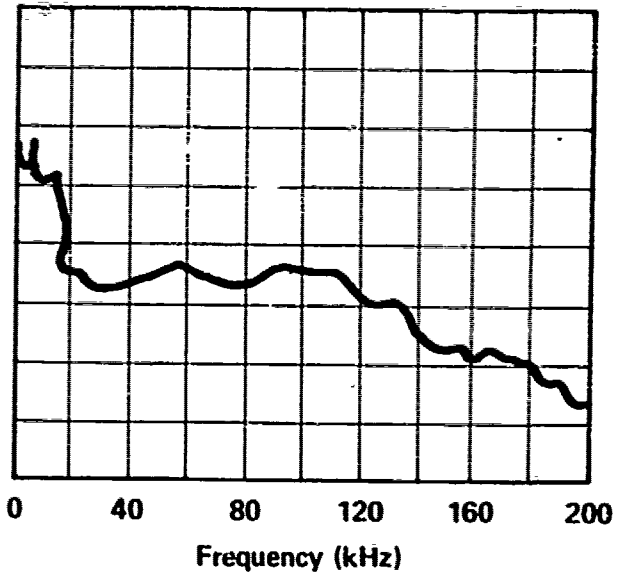

OUTPUT
PRESSURE - 500 PSI
D-502

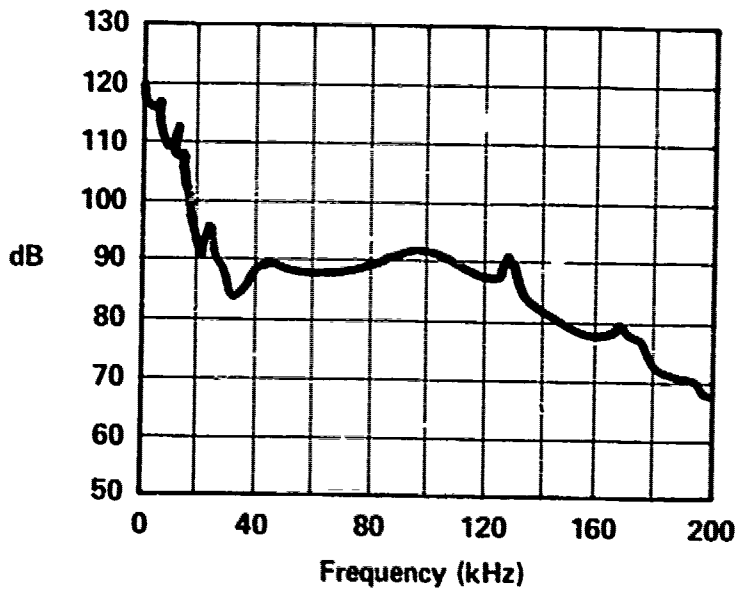

OUTPUT
PRESSURE - 1000 PSI
D-503

HYDRASTAR PUMP

RPM - 1750
FLOW - 20 GPM

LOCATION - NUC SALTWATER TEST POOL

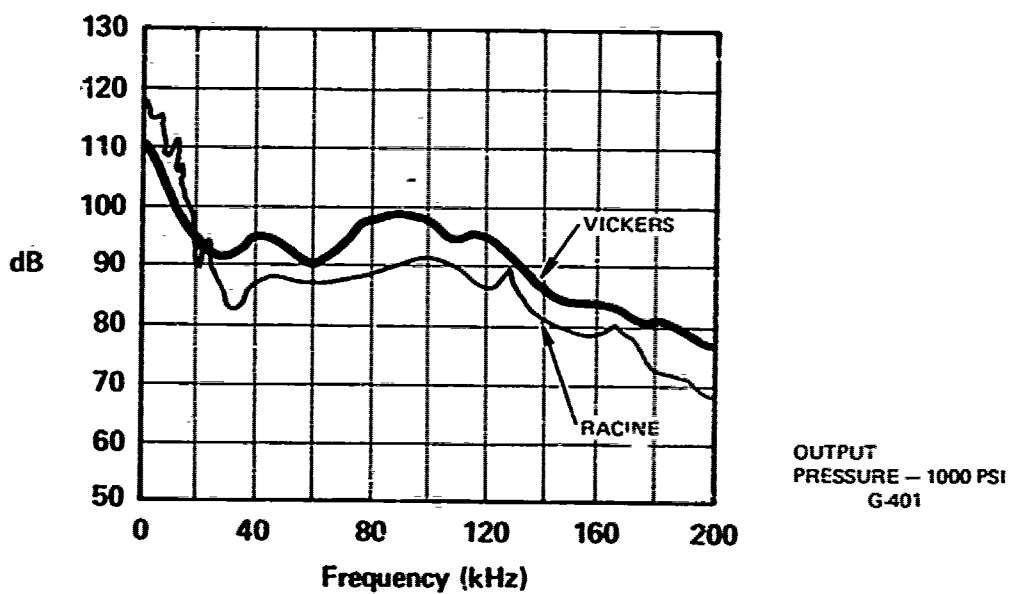

COMPARATIVE DATA (HYDRASTAR vs VICKERS PUMPS)
 PUMP PRESS - 1000 PSI
 HYDRASTAR VICKERS
 RPM - 1750 RPM - 1750
 FLOW - 20 GPM FLOW - 20 GPM

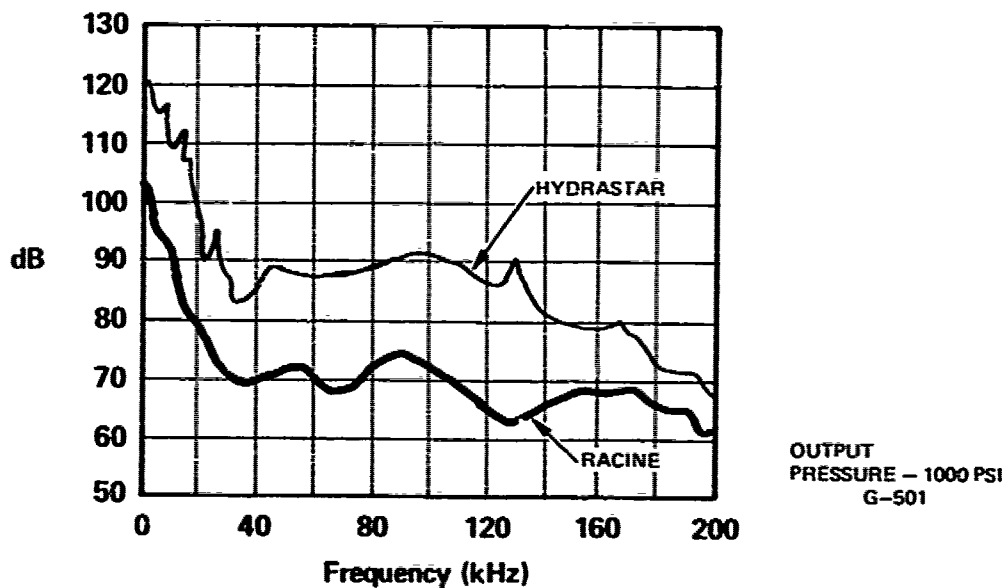

COMPARATIVE DATA (HYDRASTAR vs RACINE SUPERVANE PUMPS)
 PUMP PRESS - 1000 PSI
 HYDRASTAR RACINE
 RPM - 1750 RPM - 1750
 FLOW - 20 GPM FLOW - 13 GPM

APPENDIX D

NOSC ROLAMITE VALVE DESIGN

A Rolamite valve was designed and tested by the Naval Ocean Systems Center, Hawaii Laboratory. The valve is shown in figures D-1 and D-2; design details are contained in the NOSC drawing DRS-1000 (3 sheets).

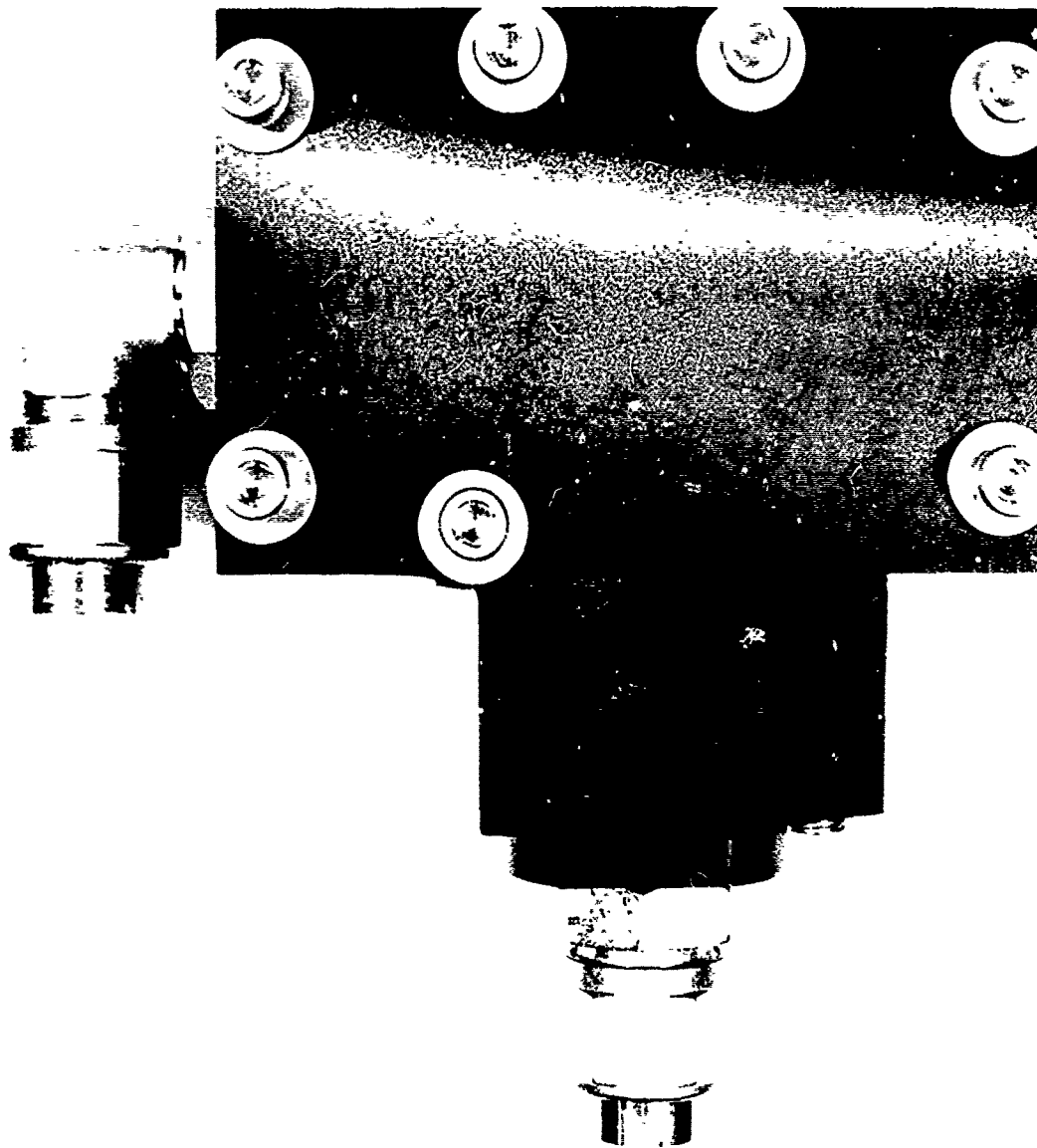

Figure D-1. NOSC Rolamite valve

"Quiet throttle" is achieved through use of a porous port made of Brunswick Number 5 Co-located Hole Structure (CHS) material. The Number 5 CHS is a 50 percent open area structure containing about 11,500 holes having an equivalent hole diameter based on area measurement of about .009 inch. The material is type 304 stainless steel.

Two CHS disks are used in series separated by a plenum chamber. The first disk (part number 10) is 0.000 inches thick. The second disk (part number 11) is 0.000 inches thick.

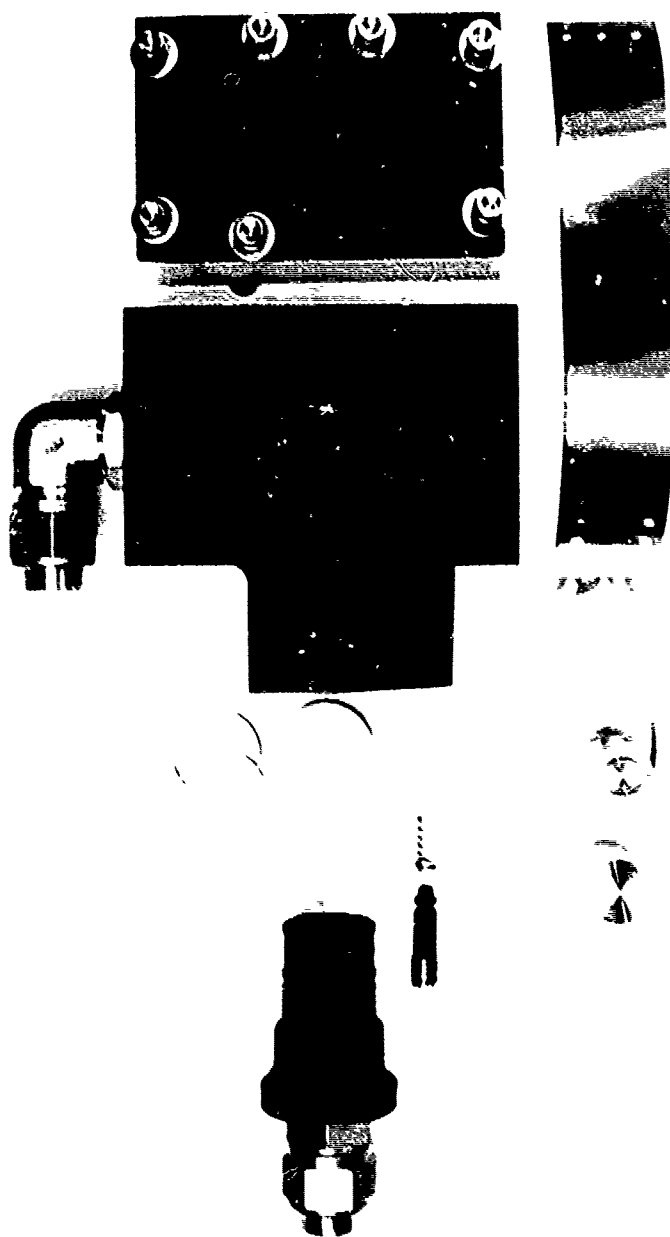
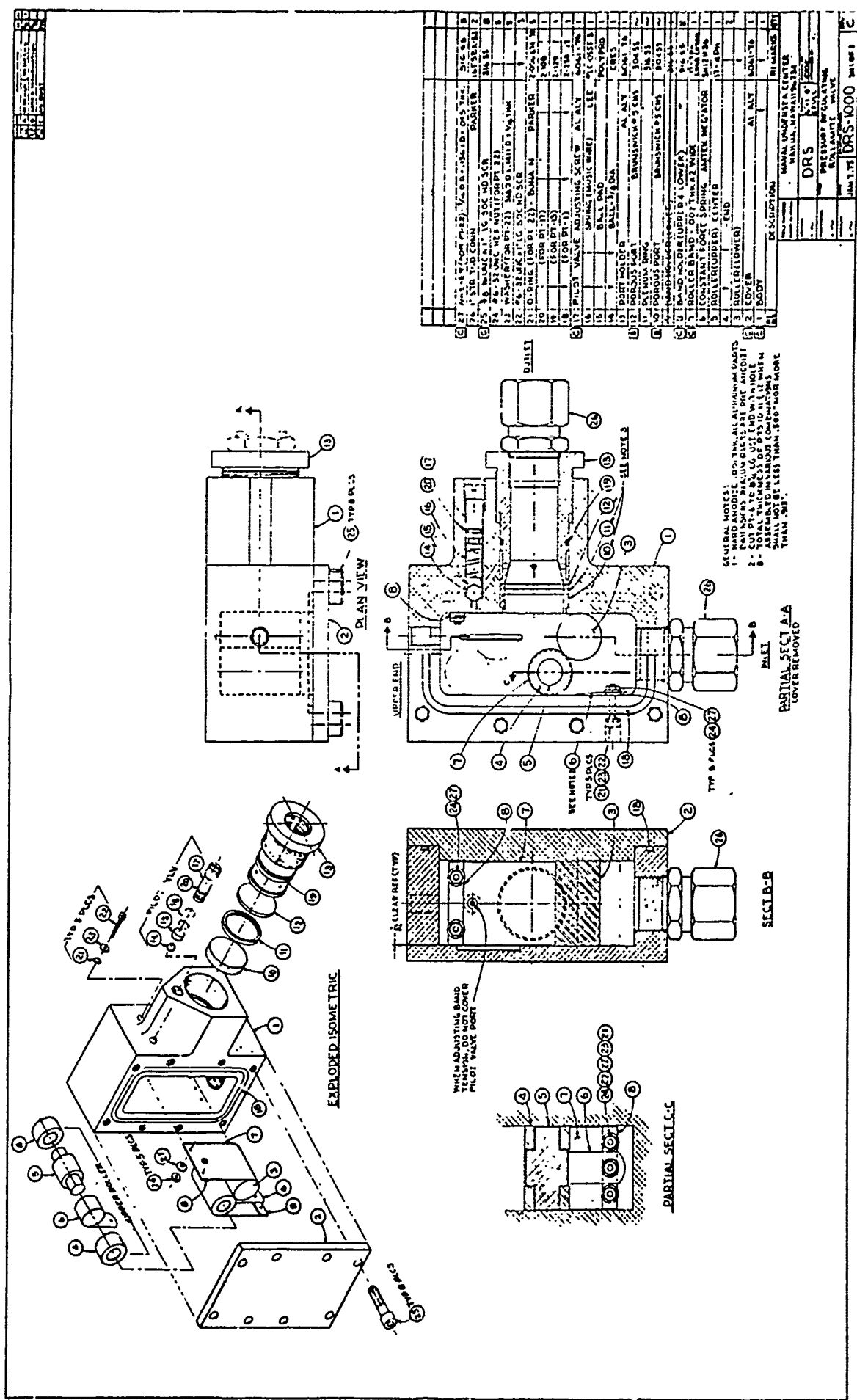

Figure D - NOSC Rolamite valve parts



1	VALVE BODY	AL ALY	1
2	COVER	AL ALY	1
3	VALVE LEVER	AL ALY	1
4	VALVE LEVER PIN	17-7000	1
5	VALVE LEVER SPRING	17-7000	1
6	VALVE LEVER PIN	17-7000	1
7	VALVE LEVER SPRING	17-7000	1
8	VALVE LEVER PIN	17-7000	1
9	VALVE LEVER SPRING	17-7000	1
10	VALVE LEVER PIN	17-7000	1
11	VALVE LEVER SPRING	17-7000	1
12	VALVE LEVER PIN	17-7000	1
13	VALVE LEVER SPRING	17-7000	1
14	VALVE LEVER PIN	17-7000	1
15	VALVE LEVER SPRING	17-7000	1
16	VALVE LEVER PIN	17-7000	1
17	VALVE LEVER SPRING	17-7000	1
18	VALVE LEVER PIN	17-7000	1
19	VALVE LEVER SPRING	17-7000	1
20	VALVE LEVER PIN	17-7000	1
21	VALVE LEVER SPRING	17-7000	1
22	VALVE LEVER PIN	17-7000	1
23	VALVE LEVER SPRING	17-7000	1
24	VALVE LEVER PIN	17-7000	1
25	VALVE LEVER SPRING	17-7000	1
26	VALVE LEVER PIN	17-7000	1
27	VALVE LEVER SPRING	17-7000	1
28	VALVE LEVER PIN	17-7000	1
29	VALVE LEVER SPRING	17-7000	1
30	VALVE LEVER PIN	17-7000	1
31	VALVE LEVER SPRING	17-7000	1
32	VALVE LEVER PIN	17-7000	1
33	VALVE LEVER SPRING	17-7000	1
34	VALVE LEVER PIN	17-7000	1
35	VALVE LEVER SPRING	17-7000	1
36	VALVE LEVER PIN	17-7000	1
37	VALVE LEVER SPRING	17-7000	1
38	VALVE LEVER PIN	17-7000	1
39	VALVE LEVER SPRING	17-7000	1
40	VALVE LEVER PIN	17-7000	1
41	VALVE LEVER SPRING	17-7000	1
42	VALVE LEVER PIN	17-7000	1
43	VALVE LEVER SPRING	17-7000	1
44	VALVE LEVER PIN	17-7000	1
45	VALVE LEVER SPRING	17-7000	1
46	VALVE LEVER PIN	17-7000	1
47	VALVE LEVER SPRING	17-7000	1
48	VALVE LEVER PIN	17-7000	1
49	VALVE LEVER SPRING	17-7000	1
50	VALVE LEVER PIN	17-7000	1
51	VALVE LEVER SPRING	17-7000	1
52	VALVE LEVER PIN	17-7000	1
53	VALVE LEVER SPRING	17-7000	1
54	VALVE LEVER PIN	17-7000	1
55	VALVE LEVER SPRING	17-7000	1
56	VALVE LEVER PIN	17-7000	1
57	VALVE LEVER SPRING	17-7000	1
58	VALVE LEVER PIN	17-7000	1
59	VALVE LEVER SPRING	17-7000	1
60	VALVE LEVER PIN	17-7000	1
61	VALVE LEVER SPRING	17-7000	1
62	VALVE LEVER PIN	17-7000	1
63	VALVE LEVER SPRING	17-7000	1
64	VALVE LEVER PIN	17-7000	1
65	VALVE LEVER SPRING	17-7000	1
66	VALVE LEVER PIN	17-7000	1
67	VALVE LEVER SPRING	17-7000	1
68	VALVE LEVER PIN	17-7000	1
69	VALVE LEVER SPRING	17-7000	1
70	VALVE LEVER PIN	17-7000	1
71	VALVE LEVER SPRING	17-7000	1
72	VALVE LEVER PIN	17-7000	1
73	VALVE LEVER SPRING	17-7000	1
74	VALVE LEVER PIN	17-7000	1
75	VALVE LEVER SPRING	17-7000	1
76	VALVE LEVER PIN	17-7000	1
77	VALVE LEVER SPRING	17-7000	1
78	VALVE LEVER PIN	17-7000	1
79	VALVE LEVER SPRING	17-7000	1
80	VALVE LEVER PIN	17-7000	1
81	VALVE LEVER SPRING	17-7000	1
82	VALVE LEVER PIN	17-7000	1
83	VALVE LEVER SPRING	17-7000	1
84	VALVE LEVER PIN	17-7000	1
85	VALVE LEVER SPRING	17-7000	1
86	VALVE LEVER PIN	17-7000	1
87	VALVE LEVER SPRING	17-7000	1
88	VALVE LEVER PIN	17-7000	1
89	VALVE LEVER SPRING	17-7000	1
90	VALVE LEVER PIN	17-7000	1
91	VALVE LEVER SPRING	17-7000	1
92	VALVE LEVER PIN	17-7000	1
93	VALVE LEVER SPRING	17-7000	1
94	VALVE LEVER PIN	17-7000	1
95	VALVE LEVER SPRING	17-7000	1
96	VALVE LEVER PIN	17-7000	1
97	VALVE LEVER SPRING	17-7000	1
98	VALVE LEVER PIN	17-7000	1
99	VALVE LEVER SPRING	17-7000	1
100	VALVE LEVER PIN	17-7000	1

THIS PAGE IS BEST QUALITY PRACTICE
 FROM COPY FURNISHED TO DDO

100

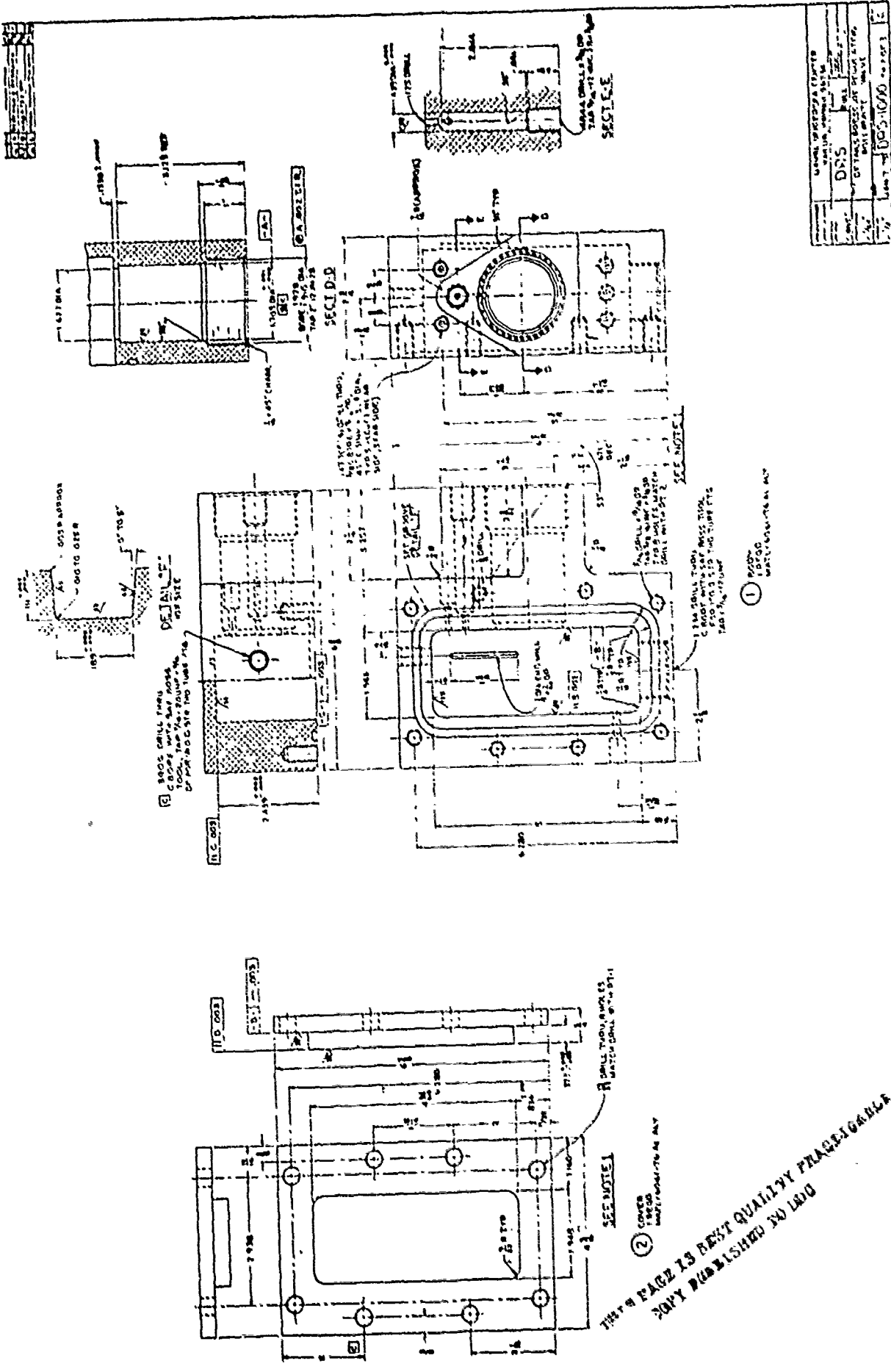

NO.	REV.	DATE	BY	CHKD.
1				
2				
3				
4				
5				
6				
7				
8				
9				
10				
11				
12				
13				
14				
15				
16				
17				
18				
19				
20				
21				
22				
23				
24				
25				
26				
27				
28				
29				
30				
31				
32				
33				
34				
35				
36				
37				
38				
39				
40				
41				
42				
43				
44				
45				
46				
47				
48				
49				
50				
51				
52				
53				
54				
55				
56				
57				
58				
59				
60				
61				
62				
63				
64				
65				
66				
67				
68				
69				
70				
71				
72				
73				
74				
75				
76				
77				
78				
79				
80				
81				
82				
83				
84				
85				
86				
87				
88				
89				
90				
91				
92				
93				
94				
95				
96				
97				
98				
99				
100				

THIS PAGE IS BEST QUALITY PRINTING
 COPY PUBLISHED TO LOG

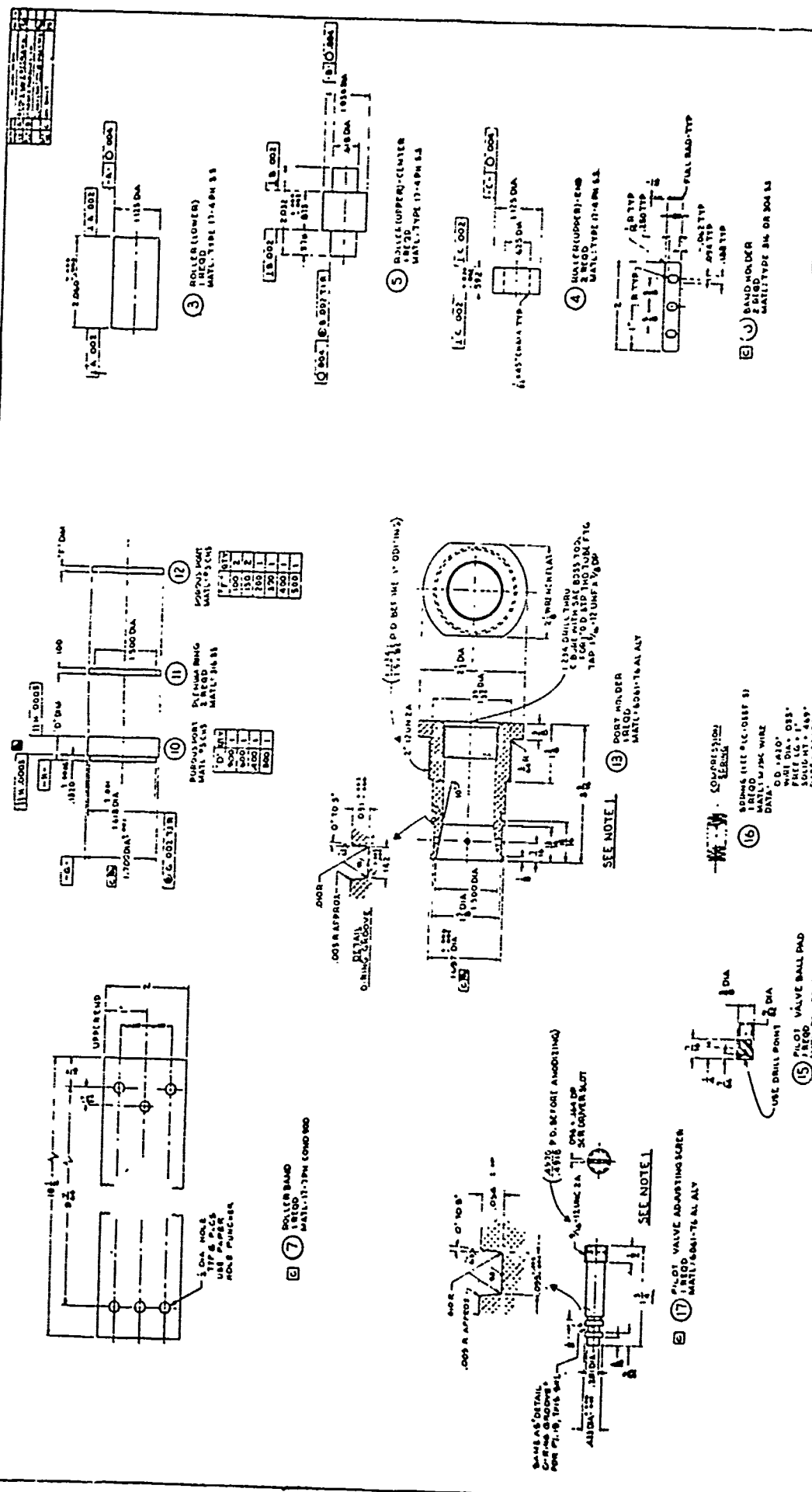

MATERIAL CENTER	
DRS	DRS
DETAILS PRESSURE REGULATING	DRS
CONJUGATE VALVE	DRS
JAN 23 1968	DRS-1000 2nd OF 3

THIS PAGE IS BEST QUALITY PRINTING
FROM COPY FORWARDED TO DND