

AD-A071 961

UNITED TECHNOLOGIES CORP SUNNYVALE CALIF CHEMICAL SY--ETC F/G 21/9.2  
84-INCH PROPELLANT GRAINS.(U)

APR 79 T V O'HARA, A J MARTEL

F04611-78-C-0010

UNCLASSIFIED

CSD-2660-FR(D)

AFRPL-TR-79-25

NL

1 OF 1  
AD  
A071961

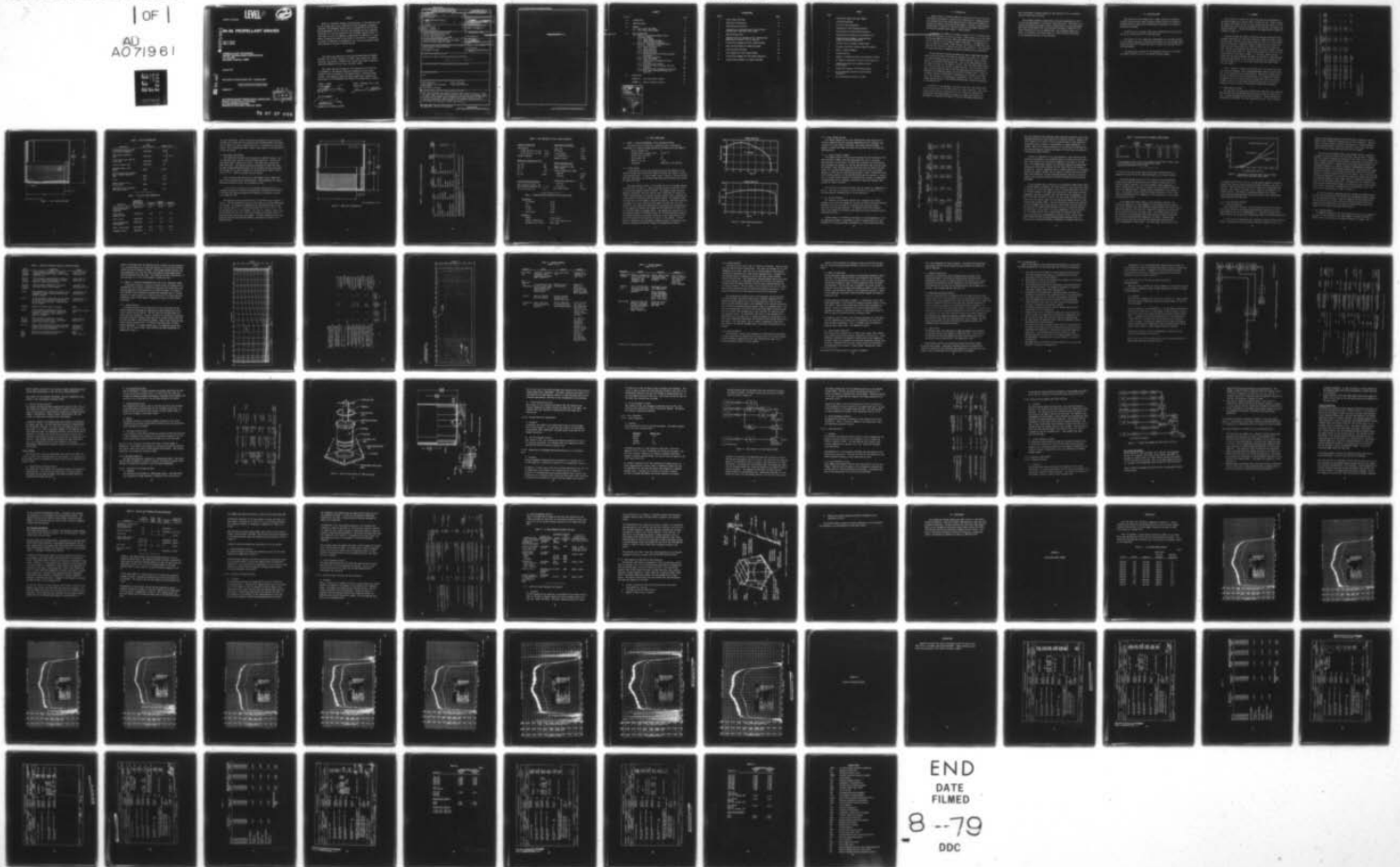

END  
DATE  
FILMED  
8--79  
DDC

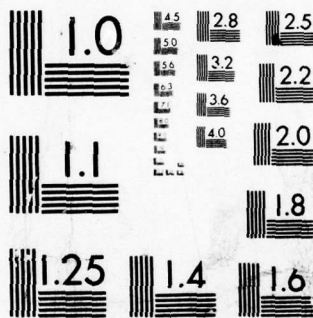

MICROCOPY RESOLUTION TEST CHART  
NATIONAL BUREAU OF STANDARDS-1963-A

**LEVEL II**

**2**

AFRPL-TR-79-25

CSD 2660-FR

**AD A 071 961**

**84-IN. PROPELLANT GRAINS**

Terry V. O'Hara  
Albert J. Martel

**CHEMICAL SYSTEMS DIVISION  
UNITED TECHNOLOGIES CORPORATION  
P.O. Box 358  
Sunnyvale, California 94086**

28 April 1979

Final Report for Period January 1978 — February 1979

Approved for Public Release: Distribution Unlimited

Prepared for

**AIR FORCE ROCKET PROPULSION LABORATORY  
Director of Science and Technology  
Air Force Systems Command  
Edwards Air Force Base, California 93523**

**DDC  
RECEIVED  
JUL 30 1979  
RECEIVED  
D**

**DDC FILE COPY**

**79 07 27 066**

## NOTICES

When U.S. Government drawings, specifications, or other data are used for any purpose other than a definitely related Government procurement operation, the Government thereby incurs no responsibility nor any obligation whatsoever, and the fact that the Government may have formulated, furnished, or in any way supplied the said drawings, specifications, or other data, is not to be regarded by implication or otherwise, or in any manner licensing the holder or any person or corporation, or conveying any rights or permission to manufacture, use, or sell any patented inventions that may in any way be related thereto.

## FOREWORD

This report was submitted by United Technologies/Chemical Systems Division, P.O. Box 358, Sunnyvale, CA 94086, under contract No. F04611-78-C-0010, job order No. 305909 LR with the Air Force Rocket Propulsion Laboratory, Edwards Air Force Base, California 93523.

This report has been reviewed by the Information Office /XOJ and is releasable to the National Technical Information Service (NTIS). At NTIS it will be available to the general public, including foreign nations. This technical report has been reviewed and is approved for publication; it is unclassified and suitable for general public release.

THOMAS L. KINSEL  
Project Manager

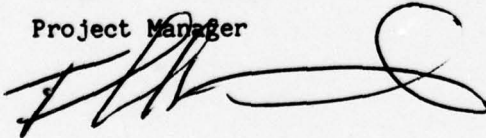

JAMES D. AHLSTROM, Major, USAF  
Branch Chief

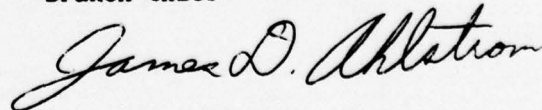

FOR THE COMMANDER

CHARLES R. COOKE

Director, Solid Rocket Division

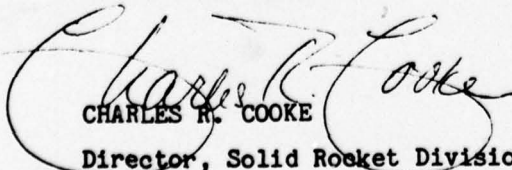

UNCLASSIFIED

SECURITY CLASSIFICATION OF THIS PAGE (When Data Entered)

19 REPORT DOCUMENTATION PAGE		READ INSTRUCTIONS BEFORE COMPLETING FORM
1. REPORT NUMBER 18 AFRPL-TR-79-25	2. GOVT ACCESSION NO.	3. RECIPIENT'S CATALOG NUMBER
4. TITLE (and Subtitle) 6 84- <del>1</del> Propellant Grains, Inert		5. TYPE OF REPORT & PERIOD COVERED 9 Final rept. Jan <del>1978</del> 78 - Feb <del>1979</del> 79
7. AUTHOR(s) 10 Terry V. O'Hara Albert J. Martel		6. PERFORMING ORG. REPORT NUMBER 14 CSD-2660-FR (D) 8. CONTRACT OR GRANT NUMBER(s) 15 F04611-78-C-0010
9. PERFORMING ORGANIZATION NAME AND ADDRESS United Technologies Corporation Chemical Systems Division P.O. Box 358, Sunnyvale, Ca 94086		10. PROGRAM ELEMENT, PROJECT, TASK AREA & WORK UNIT NUMBERS JON 305909 LR
11. CONTROLLING OFFICE NAME AND ADDRESS Air Force Rocket Propulsion Laboratory/MKBS Edwards Air Force Base, CA 93523	11	12. REPORT DATE 28 Apr 1979
14. MONITORING AGENCY NAME & ADDRESS (if different from Controlling Office) AFPRO, Chemical Systems Division P.O. Box 358 Sunnyvale, CA 94086		13. NUMBER OF PAGES 107 12 89p
		15. SECURITY CLASS. (of this report) Unclassified
16. DISTRIBUTION STATEMENT (of this Report) Approved for public release; distribution unlimited 16 3059 17 09		
17. DISTRIBUTION STATEMENT (of the abstract entered in Block 20, if different from Report) 62302F		
18. SUPPLEMENTARY NOTES None		
19. KEY WORDS (Continue on reverse side if necessary and identify by block number) HTPB propellant 84-in. cartridge High solids loaded propellant Propellant production UTP-18,803A SLSH loaded cartridges		
20. ABSTRACT (Continue on reverse side if necessary and identify by block number) This report documents the results obtained during casting a total of 7 84-in. SLSH cartridges with UTP-18,803A propellant (90% solids, 21% aluminum, HTPB) for AFRPL. This program is an extension of the work discussed in AFRPL-TR-77-92 and brings the total amount of UTP-18,803A produced under full-scale production conditions to over 880,000 lb. In addition one ELSH grain was cast with 22,000 lb of UTI-610B, an inert propellant. ←		

UNCLASSIFIED

SECURITY CLASSIFICATION OF THIS PAGE (When Data Entered)

391 927

JOB

REPORT NUMBER 1562-18-72-22	REPORT DOCUMENTATION PAGE
RECIPIENT'S CATALOG NUMBER	
PERFORMING ORGANIZATION NAME AND ADDRESS	801 East Duane Street, Detroit, Michigan 48207
PERFORMING ORGANIZATION REPORT NUMBER	1562-18-72-22
AUTHORITY STATEMENT	
DISTRIBUTION STATEMENTS (See Instructions for Page 2)	1. Unclassified 2. Restricted 3. Confirmed
DISTRIBUTION STATEMENTS (See Instructions for Page 2)	1. Unclassified 2. Restricted 3. Confirmed
DISTRIBUTION STATEMENTS (See Instructions for Page 2)	1. Unclassified 2. Restricted 3. Confirmed
DISTRIBUTION STATEMENTS (See Instructions for Page 2)	1. Unclassified 2. Restricted 3. Confirmed
DISTRIBUTION STATEMENTS (See Instructions for Page 2)	1. Unclassified 2. Restricted 3. Confirmed
DISTRIBUTION STATEMENTS (See Instructions for Page 2)	1. Unclassified 2. Restricted 3. Confirmed
DISTRIBUTION STATEMENTS (See Instructions for Page 2)	1. Unclassified 2. Restricted 3. Confirmed
DISTRIBUTION STATEMENTS (See Instructions for Page 2)	1. Unclassified 2. Restricted 3. Confirmed
DISTRIBUTION STATEMENTS (See Instructions for Page 2)	1. Unclassified 2. Restricted 3. Confirmed
DISTRIBUTION STATEMENTS (See Instructions for Page 2)	1. Unclassified 2. Restricted 3. Confirmed
DISTRIBUTION STATEMENTS (See Instructions for Page 2)	1. Unclassified 2. Restricted 3. Confirmed
DISTRIBUTION STATEMENTS (See Instructions for Page 2)	1. Unclassified 2. Restricted 3. Confirmed
DISTRIBUTION STATEMENTS (See Instructions for Page 2)	1. Unclassified 2. Restricted 3. Confirmed
DISTRIBUTION STATEMENTS (See Instructions for Page 2)	1. Unclassified 2. Restricted 3. Confirmed
DISTRIBUTION STATEMENTS (See Instructions for Page 2)	1. Unclassified 2. Restricted 3. Confirmed
DISTRIBUTION STATEMENTS (See Instructions for Page 2)	1. Unclassified 2. Restricted 3. Confirmed
DISTRIBUTION STATEMENTS (See Instructions for Page 2)	1. Unclassified 2. Restricted 3. Confirmed
DISTRIBUTION STATEMENTS (See Instructions for Page 2)	1. Unclassified 2. Restricted 3. Confirmed
DISTRIBUTION STATEMENTS (See Instructions for Page 2)	1. Unclassified 2. Restricted 3. Confirmed
DISTRIBUTION STATEMENTS (See Instructions for Page 2)	1. Unclassified 2. Restricted 3. Confirmed
DISTRIBUTION STATEMENTS (See Instructions for Page 2)	1. Unclassified 2. Restricted 3. Confirmed

## CONTENTS

Section		Page
1.0	INTRODUCTION	5
2.0	OBJECTIVE/SCOPE	7
3.0	SUMMARY	9
3.1	Inert Grain (UTI-610B)	9
3.2	Live Grains (UTP-18,803A)	13
4.0	WORK ACCOMPLISHED	17
4.1	Phase I - Design Requirements, 84-in. Propellant Grains	17
4.1.1	Grain Design	17
4.1.2	Grain Thermal Analysis	19
4.1.3	Grain Structural Analysis	23
4.2	Phase II - Propellant Processing and QA for 84-in. Propellant Grains	26
4.2.1	Process Controls	26
4.2.2	Mixer Selection	35
4.2.3	Quality Controls	35
4.2.4	Processing Logic	38
4.2.5	Materials Control and Process Tooling Description	39
4.2.6	Cartridge Insulation	44
4.2.7	Liner (UTL-0040A)	50
4.2.8	Casting Tooling Assembly and Liner Precuring	55
4.2.9	Propellant (UTP-18,803A)	55
4.2.10	Casting Tooling, Stripping, and Grain Trimming	62
4.2.11	Loaded Cartridge Packaging and Shipping	65
4.2.12	SLSH Loaded Cartridge NDT and Data Reporting	66
5.0	CONCLUSIONS	69
	APPENDIX A: 15-lb Bates Motor Firings	71
	APPENDIX B: Product Acceptance Records	93

Accession For	
NTIS GRA&I	<input checked="" type="checkbox"/>
DDC TAB	<input type="checkbox"/>
Unannounced	<input type="checkbox"/>
Justification	<input type="checkbox"/>
By _____	
Distribution/	
Availability Codes	
Dist.	Avail and/or special
<b>A</b>	

## ILLUSTRATIONS

Figure		Page
1	Inert Loaded Cartridge	11
2	SLSH Grain Configuration	14
3	SLSH Predicted Ballistics	18
4	Correlation of Convective Heat Flux with Rubber Ablation Data from Titan 120-in. SRMs	23
5	SLSH Cartridge Grain	27
6	Deformed Grain for Cooldown to 60 F (Deformations Magnified by a Factor of 5 for Clarity)	31
7	Process Flow Diagram for 84-in. SLSH Cartridge	40
8	Basic Tooling Concept for SLSH Cartridges	47
9	SLSH Insulated Cartridge	48
10	Flow Diagram for Liner Mixing Process	52
11	Process Flow Diagram for UTP-18,803A Propellant	51
12	Shipping Base Assembly for Loaded Cartridge	56

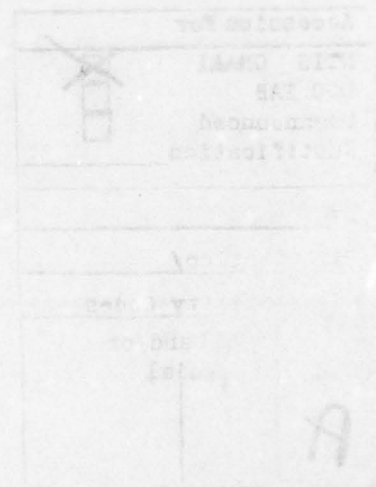



TABLES

Table		Page
1	Deliverable Loaded Cartridge Summary	10
2	UTI-610B Formulation	12
3	Al-122-2C Liner Formulation	12
4	Formulation of UTP-18,803A Propellant	15
5	Key Properties of UTP-18,803A Propellant	16
6	Formulation and Properties of UTL-0040A Liner	16
7	Thermal Analysis Summary - SLSH Cartridge Insulation and Grain Restrictors	20
8	Ablation Data for Forward Closure Rubber	22
9	Principal Structural Analysis Computer Programs	25
10	Margin of Safety Summary	29
11	Process Controls	33
12	Summary of Inspections/Tests and Acceptance Criteria	41
13	QC Inspection/Acceptance Criteria for Raw Materials	45
14	Inspections, Tests, and Acceptance Criteria for UTL-0040A	53
15	400-gal Mix Procedure for HTPB Propellants	60
16	QC and Acceptance Criteria for UTP-18,803A Propellant	63
17	QC and Acceptance Criteria for SLSH	65

## 1.0 INTRODUCTION

Design studies of advanced ICBMs have indicated the need for increased performance requirements in advanced solid rocket motors. Advanced propellant systems involve high flame temperatures and high solids loading which increase the severity of the nozzle environment. Testing of these advanced nozzles must be conducted at sufficient scale and environment severity to realistically simulate their usage in actual systems.

To meet this end, AFRPL will conduct a series of 7-in. C/C nozzle tests as part of the overall Air Force C/C effort. These nozzles, to be fabricated by CSD under AFRPL contract No. F04611-78-C-0022 using GFE supplied C/C billets for the ITE, will be tested on AFRPL's SLSH motor. The SLSH motor is one in a family of cartridge loaded ballistic test motors at AFRPL which provides the Air Force with a unique and varied test capability. The propellant for these test motors is generally provided by AFRPL selected contractors.

CSD was selected to provide the AFRPL with seven loaded SLSH cartridges under contract No. F04611-78-C-0010 for testing of the seven 7-in. nozzles. All seven cartridges were cast with UTP-18,803A propellant which is a 90% solids, 21% aluminized HTPB formulation. This is the same propellant which was previously cast into 20 ELSH and 10 84-in. Char cartridges under contract No. F04611-76-C-0010 and reported in AFRPL-TR-77-92. As in the earlier program, the UTP-18,803A was cast in GFE cartridges which were insulated with ORCO-9250 silica-asbestos rubber and lined with UTL-0040A liner. A total of 32 400-gal batches of UTP-18,803A, representing over 150,000 lb of propellant, were produced in fulfilling the requirements of this contract. This brings the total amount of UTP-18,803A produced under production conditions to over 880,000 lb.

In addition to the casting of the seven grains with UTP-18,803A, CSD also cast one grain with UTI-610B, which is an inert propellant. This grain, using the same casting tooling and cast to the same basic configuration as the seven UTP-18,803A grains, is used as a volume restrictor for the ELSH motor by replacing a live grain in the four cartridge loaded motor.

This allows AFRPL to further extend its test flexibility for its existing family of ballistic test motors.

This document presents a description of the work accomplished in fulfilling the requirements of contract No. FO4611-78-C-0010. Since many of the detailed discussions relating to specific characteristics of the UTP-18,803A propellant and UTL-0040A liner were previously discussed in AFRPL-TR-77-92, these discussions will not be repeated here. The interested reader will, however, be directed to the above report for further detailed discussions at the appropriate sections of this document.

## 2.0 OBJECTIVE/SCOPE

The objective of this program was to design, fabricate, and deliver to AFRPL seven cartridge loaded propellant grains suitable for testing of advanced ballistic missile nozzle components and materials in a realistic propellant environment.

In addition, one cartridge loaded inert propellant grain was provided for use as a volume restrictor in the ELSH motor.

The objective of this program was accomplished as a two-phase program. The first phase consisted of the design and analysis of the cartridge loaded propellant grains for the SLSH test motor to ensure that they met the program requirements.

The second phase consisted of the casting and delivery of the loaded cartridges to AFRPL for use in the hardware testing program.

### 3.0 SUMMARY

The objective of contract No. F04611-78-C-0010 was accomplished as a two-phase program from 3 January 1978 to 28 February 1979. Phase I covered the design and analysis of the cartridge loaded propellant grains for both the single inert grain (UTI-610B propellant) and the seven live grains (UTP-18,803A propellant). Casting and delivery of the eight grains to AFRPL was completed in phase II.

The grain designs were based on using the casting tooling previously designed, fabricated, and used under contract No. F04611-76-C-0010. Therefore the phase I effort, as described further in section 4.0, was primarily based on conducting a comparative analysis between the earlier grain configuration used under contract No. F04611-76-C-0010 and that being cast here. Having once demonstrated the adequacy of the grain designs, castings were initiated under phase II. Phase II provided delivery of the following loaded propellant cartridges to AFRPL: (1) one 84-in. ELSH cartridge loaded with the inert propellant UTI-610B, (2) seven 84-in. SLSH cartridges loaded with UTP-18,803A, (3) 32 15-lb Bates nozzles and cartridges loaded with UTP-18,803A, and (4) 14 70-lb Bates nozzles and cartridges loaded with UTP-18,803A.

Table 1 presents a summary by production run of the loaded cartridges cast under this program. The following paragraphs present a brief description of the propellant/liner characteristics. Section 4.0 presents a more complete discussion of the work accomplished in the program's two phases. The appendices to this report present the Bates motor test data obtained by AFRPL as part of its cartridge acceptance evaluations and the product acceptance records for each of the delivered loaded SLSH cartridges.

#### 3.1 INERT GRAIN (UTI-610B)

The inert grain was cast with UTI-610B inert propellant in an insulated GFE cartridge using the GFE casting tooling from contract No. F04611-76-C-0010. The grain configuration is shown in figure 1. Table 2 provides the formulation for UTI-610B. The liner used was A1-122-2C. Table 3 provides

TABLE 1. DELIVERABLE LOADED CARTRIDGE SUMMARY

Production Run No.	Cast Date	Batch Identification	Cartridges*	Propellant Weight (lb)	Burning Rate at 85 F, 1000 psia (IPS)	Burning Rate	
						Burning Rate Exponent	70-lb Bates
1	29 Aug 1978	400-1652 through 1656	S/N 2660-01	20,698	0.4111	0.4326	9
		400-1656 through 1660	S/N 2660-02	20,687	0.4139	0.4096	4
2	27 Sep 1978	400-1665 through 1669	S/N 2660-03	20,982	0.4074	0.4182	9
		400-1661 through 1665	S/N 2660-04	20,773	0.4065	0.4096	4
3	9 Nov 1978	400-1670 through 1674	S/N 2660-05	20,645	0.4120	0.4076	5
4	7 Dec 1978	400-1675 through 1679	S/N 2660-06	20,818	0.4150	0.4082	9
		400-1679 through 1683	S/N 2660-07	20,821	0.4190	0.4125	4
†	1 Jun 1978	750-6310 through 6312	P/N C12629-02-01		N/A	N/A	N/A

\*P/N C13199-01-01

† Inert grain cast with UTI-610B

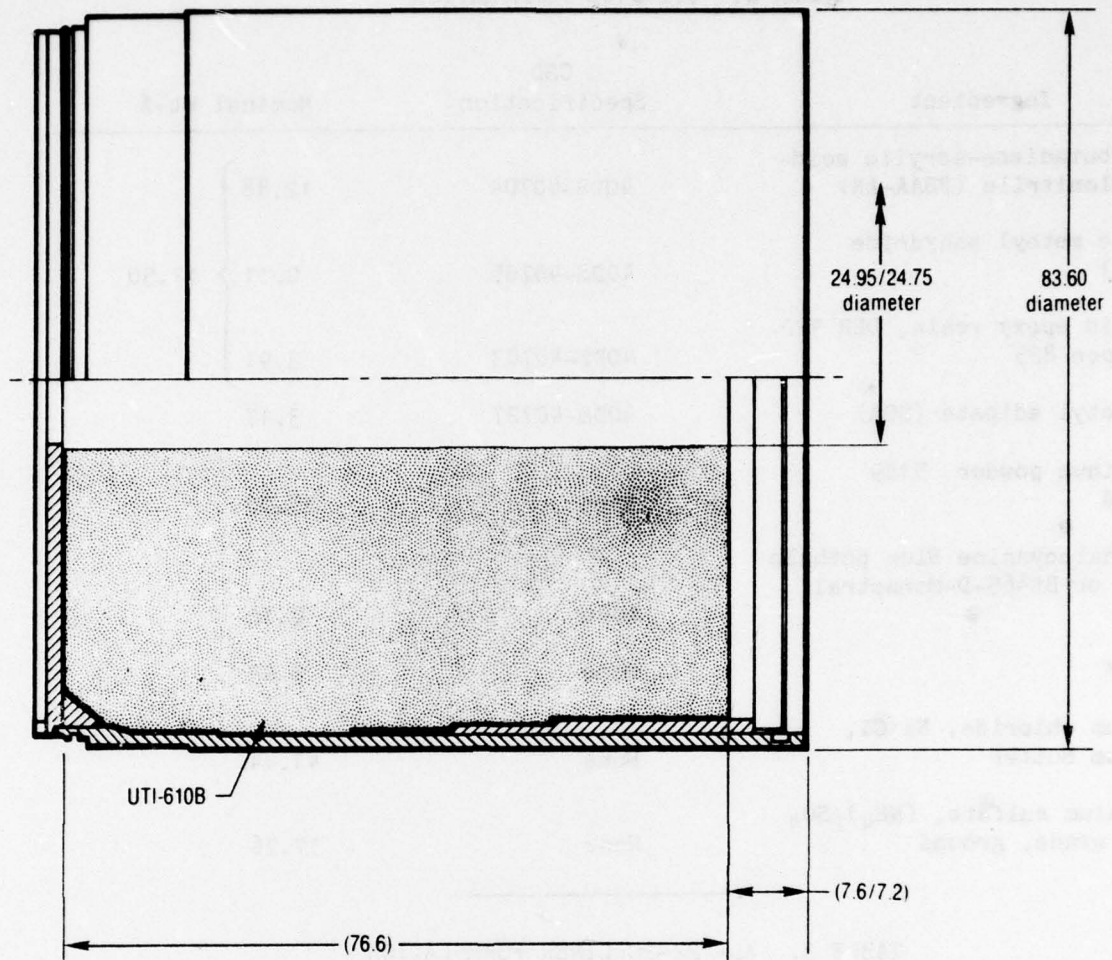

Note: All dimensions are in inches

Figure 1. Inert Loaded Cartridge

TABLE 2. UTI-610B FORMULATION

Ingredient	CSD Specification	Nominal Wt-%
Polybutadiene-acrylic acid-acrylonitrile (PBAA-AN)	40DS-40704	12.88
Nadic methyl anhydride (NMA)	40DS-40705	0.71
Liquid epoxy resin, DER 322 or Epon 825	40DS-40703	3.91
Di-octyl adipate (DOA)	40DS-40727	3.17
Aluminum powder, 5159 ALCOA	None	20.00
Phthalocyanine Blue phthalo Blue or Bt465-D-Monastral Blue	None	0.10
Fe AA	None	0.03
Sodium chloride, Na Cl, Vacuum Butter	None	41.44
Ammonium sulfate, (NH <sub>4</sub> ) <sub>2</sub> SO <sub>4</sub> food grade, ground	None	17.76

TABLE 3. AL-122-2C LINER FORMULATION

Ingredient	Applicable CSD Material Specification	Wt-%		
		Minimum	Nominal	Maximum
Polybutadiene-acrylic acid-acrylonitrile (PBAA-AN)	40DS-40704	20.0	26.69	30.0
Nadic methyl anhydride (NMA)	40DS-40705	15.0	16.1	19.0
Ferric oxide	40DS-40706	1.0	2.9	5.0
Polytetramethylene ether glycol	40DS-40707	4.5	7.5	8.5
Resin, liquid epoxy	40DS-40708	35.0	44.3	46.3
Pyrogenic silica	40DS-40719	2.0	2.5	3.0



the liner formulation. Since the fabrication approach for the inert grain followed very closely that for the grains cast with UTP-18,803A, the discussion in section 4.0 will be limited strictly to a description of the latter grains. The procedures discussed, however, apply equally to the fabrication of the inert grain.

### 3.2 LIVE GRAINS (UTP-18,803A)

Seven GFE SLSH cartridges were insulated with ORCO-9250 rubber, lined with UTL-0040A liner and cast with UTP-18,803A propellant. This was the same system used in casting the 30 84-in. cartridges under contract No. F04611-76-C-0010. The casting tooling from contract No. F04611-76-C-0010 was used in manufacturing the grains for this program with the only difference between the two grain configurations being the grain length (76.83 in. versus 70 in.). Figure 2 presents the grain design.

Table 4 presents the formulation of UTP-18,803A; table 5 summarizes some of the key properties of the propellant. This propellant is virtually Newtonian and exhibits a pot life in excess of 12-hr.

A more detailed discussion of the propellant characteristics (i.e., rheological properties, ballistic characteristics, AP particle size effects on burning rate, physical properties and hazards) is presented in section 3.0 of AFRPL-TR-77-92.

The formulation and key properties for the UTL-0040A liner are given in table 6. CSD has standardized the use of this liner with current HTPB propellant systems. As discussed in AFRPL-TR-77-92, UTL-0040A provides the best bond characteristics if it is partially precured for 16 hr at 140 F. This was the approach used in this program. The liner can, however, be held up to and additional 72 hr at 120 F without exhibiting any detrimental effect on propellant/liner/insulation bond strength. A further discussion of the liner physical properties and migration effects is presented in section 3.0 of AFRPL-TR-77-92.

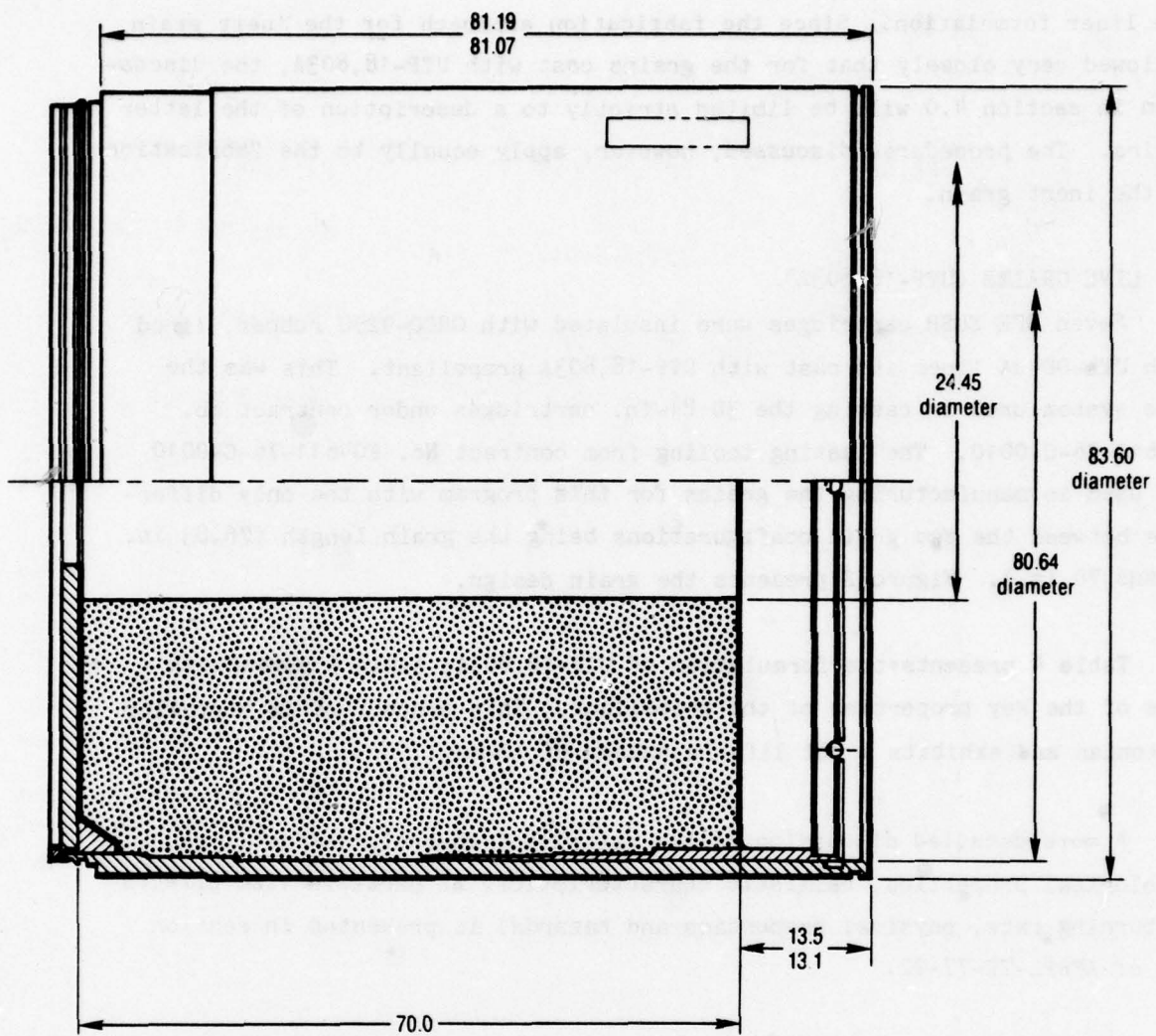

Note: All dimensions are in inches

Figure 2. SLSH Grain Configuration

TABLE 4. FORMULATION OF UTP-18,803A PROPELLANT

Ingredient	Function	CSD Specification/ Manufacturer	Manufacturer Designation	Nominal Formulation by Wt-%	Weight Tolerance Limits, %
HTPB	Binder	ARCO	BDR-45M	6.67 <sup>*</sup>	-
Isophorone diisocyanate	Curative	Thorson Chemical	IPDI	0.48 <sup>*</sup>	-
Iso-decyl pelargonate	Plasticizer	Emery Industries	Emolein 2911 (IDP)	2.60	0.2
PRO-TECH <sup>®</sup>	Antioxidant	CSD	2705	0.10	0.05
HX-752	Bonding agent	3M Company	HX-752	0.15	0.07
Aluminum	Fuel	40DS-40702	MD101	21.0	0.4
Ammonium perchlorate	Oxidizer	40DS-40701	200 $\mu$ <sup>†</sup>	44.85	1.0
Ammonium perchlorate	Oxidizer	40DS-40701	9.5 $\mu$ <sup>‡</sup>	24.15	

\* For information only; may be adjusted to optimize mechanical properties.

† The unground ammonium perchlorate shall conform to 40DS-40701, type II except the material shall be manufactured by a rotary rounded process.

‡ Particle size of ground ammonium perchlorate shall be controlled by CSD Quality Control Laboratory Methods and Procedures No. QC-J-703.

TABLE 5. KEY PROPERTIES OF UTP-18,803A PROPELLANT

<u>Ballistic Properties</u>		<u>Theoretical Properties</u>	
Burning Rate		$I_{sps}^0$ , sec	264.3
(1,000 psi/70 F), in./sec	0.42	c*, ft/sec	5,172
(1,400 psi/70 F), in./sec	0.492	$\gamma$ (efficiency)	1.11
Pressure exponent	0.37	$T_c$ (1,000 psi), F	6,250
		Density, lb/in. <sup>3</sup>	0.0666
<u>Mechanical Properties at 70 F</u>		<u>Hazard Characteristics</u>	
$\sigma_m$ , psi	144	Impact sensitivity (50% fire), kg-cm	35
$\sigma_m^c$ , psi	180	Friction sensitivity (ESSO)	
$\epsilon_m^c$ , %	27.5	Negative	No grit
$\epsilon_R$ , %	28	Positive	Pyrex grit
$E_o$ , psi	1,458	Autoignition temperature, F	
		at 10 sec	670
		at 30 sec	580
		DOT classification	Class B
<u>Processing Characteristics</u>			
Mix viscosity at 160 F 1 hr after curative addition, kps	2 to 4		
Pot life at 160 F, hr	12		

TABLE 6. FORMULATION AND PROPERTIES OF UTL-0040A LINER

<u>Formulation</u>	
R-45M HTPB	41.8%
DDI	12.2%
HX-868	6.0%
AO 2246	0.5%
Carbon black	39.5%
<u>Properties</u>	
Density	0.425 lb/in. <sup>3</sup>
Thermal conductivity	$2.27 \times 10^{-6}$ Btu/in. sec F
Ultimate strain (70 F)	160 to 340%

## 4.0 WORK ACCOMPLISHED

### 4.1 PHASE I - DESIGN REQUIREMENTS, 84-IN. PROPELLANT GRAINS

The design criteria called for a propellant grain configuration consisting of a loaded cartridge meeting the following basic requirements.

Throat diameter, in.	7
Average chamber pressure, psi	1,250 $\pm$ 60
Erosion rate, mils/sec	10
Action time, sec	60
MEOP at 70 F, psi	1,700
Propellant	90% solids, 21% aluminum

#### 4.1.1 Grain Design

A firm data base was already available from the CSD ELSH/84-in. Char designs produced under contract No. F04611-76-C-0010 with respect to propellant characteristics. The grain design, shown in figure 2, used the casting mandrels, base plates, and rounding rings which were available from contract No. F04611-76-C-0010.

This grain design resulted in the nominal web burn and chamber pressure histories shown in figure 3. These curves were acquired using CSD's internal ballistics computer program (LF12ZZZ). The program accepts the grain geometry, propellant, and motor data as input, calculates the surface area history, then switches to an internal ballistic mode so that a complete end-to-end analysis is obtained with one computer access. The program divides the motor into a finite number of sections or modules. Each module performs according to its local conditions (Mach number, burning rate, and static pressure). Mach number and pressure-field calculations were determined from 1D flow equations; however, the program has a 2D capability for model slot flow and flow behind a submerged nozzle. The program also accounts for erosive burning effects by a modified version of the Lenior-Robillard equation. The program simulates actual motor conditions in that nonequilibrium conditions are assumed for the mass flow in and out of the chamber. In this manner, a continuous rate of change in chamber pressure is obtained so that ignition transients and tailoff blowdown are automatically obtained.

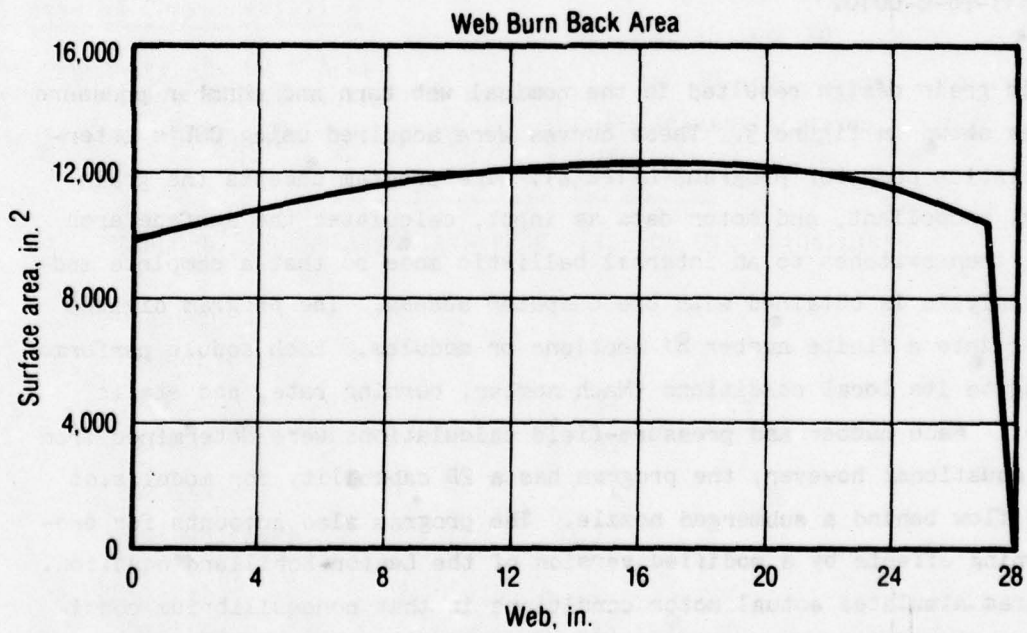
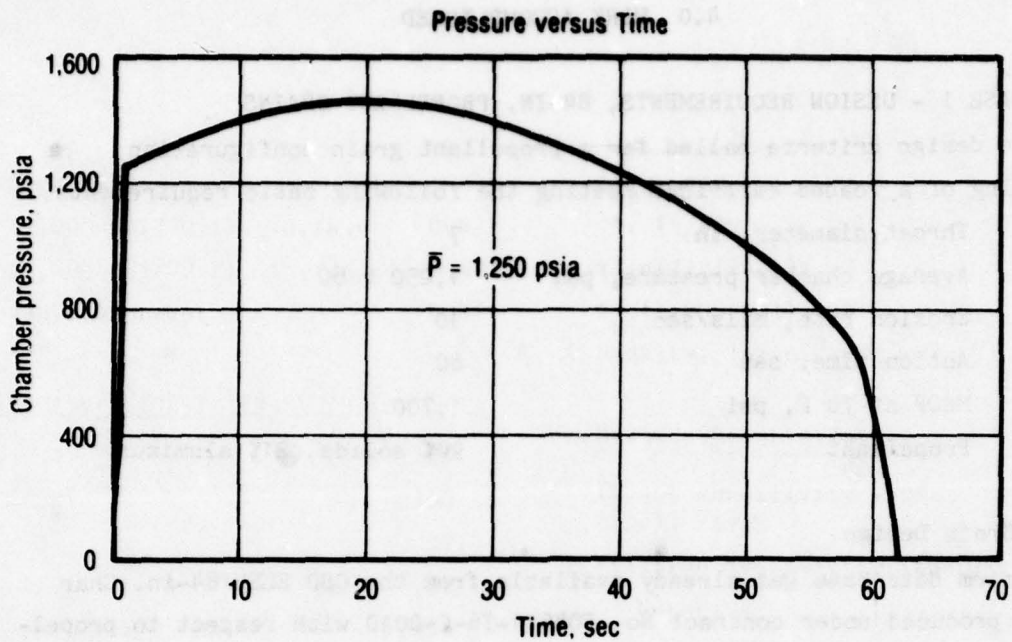

**Figure 3. SLSH Predicted Ballistics**

#### 4.1.2 Grain Thermal Analysis

The thermal adequacy of the basic ELSH/SLSH cartridge insulation and internal components has been thoroughly demonstrated by the successful test firing of four Super HIPPO, eleven ELSH, and several SLSH cartridges. A majority of these cartridges was tested with the 90% solids, 21% aluminized HTPB propellant.

##### 4.1.2.1 Analysis Results Summary

The thermal analysis of the insulation design had been completed by CSD under contract to AFRPL during the design phase for each of the motors mentioned above. In particular, the ELSH motor insulation had been analyzed for an average test pressure of 1,400 psi and web action time of 59 sec using UTP-18,803A. Since the SLSH operating conditions were the same as for ELSH except that the SLSH operating pressure was lower by 150 psi, the thermal analysis for ELSH could be applied conservatively to SLSH. Therefore no additional thermal analysis for the SLSH/UTP-18,803A use was required. A discussion of the ELSH thermal analysis is presented below, however, to demonstrate the methodology used in originally verifying the insulation adequacy under contract No. F04611-76-C-0010.

The results of the analysis (ablation and char depths) are summarized in table 7. The results show that all safety factors are in excess of 2.0 on the cartridge wall insulation and 1.4 on the restrictor.

##### 4.1.2.2 Analysis Approach

The objective of the thermal analysis was to determine the thermal adequacy of the insulation design for the motor ballistic conditions specified. Components which were included in the analysis were the grain forward restrictor and cartridge insulator. All analysis results were computed using 1D gas dynamics and ablation predictions were derived scaling available correlated test data.

Thermal analysis of sacrificial insulators in a high temperature, corrosive heating environment is performed by either scaling previous test data parameters or by basing predicted performance on a proven theoretical model.

TABLE 7. THERMAL ANALYSIS SUMMARY - SLSH CARTRIDGE INSULATION AND GRAIN RESTRICTORS

Location	Diameter, in.	Material# Thickness, in.	Exposure † Duration, sec	Total Ablated Depth, in.	Char Penetration at EOF	Safety ‡ Factor
Aft restrictor	54.2	1.0	1.5	0.05	0.01	16.7
Aft restrictor	61.0	1.0	17.5	0.30	0.01	3.2
Aft restrictor	66.7	1.0	31.5	0.41	0.01	2.4
Cartridge insulation	80	0.45	22.6	0.17	0.02	2.4
		1.10	43.1	0.45	0.02	2.3
		1.25	59.0	0.60	0.02	7.02
Forward restrictor	35	1.0	10.8	0.62	0.02	1.56
Forward restrictor	52.5	1.0	29.7	0.69	0.02	1.41
Forward restrictor	78	1.0	57.2	0.55	0.02	1.75

\* Silica-asbestos rubber

† Exposure times and ablation depths indicated for restrictors correspond to time from ignition until the time the grain surface has recessed below the station

‡ Safety factor = (nominal thickness)/(ablation + char)



With few exceptions, the theoretical model has given acceptable results when analyzing ablation and char penetration of phenolic ablators. Whenever possible, however, it is safer to rely on available data to scale theoretical calculations and as a guide for expectations of thermal degradation. At present, there is no reliable alternative to the scaling of correlated test data when analyzing the ablative performance of silica-filled and asbestos-silica-filled rubber materials.

Analysis of components in the high temperature, high aluminum content combustion environments in the SLSH/ELSH motors is complex due to the dominance of gas radiation as the principal component (up to 90%) of the heat flux. In low Mach number regions, the convection heating and erosion mechanism may be effectively decoupled from the actual ablative performance of the material. Material degradation due to thermal penetration in a radiation dominant environment, however, may be limited to surface char and swelling. Under these conditions, the most promising analysis technique is one where radiation and convection heating are treated as separate ablation-causing mechanisms.

Of the available data on erosion of silica-asbestos-loaded Buna-N rubber in low Mach number environments, the data available at the time of this analysis having the closest environment to that of the ELSH/SLSH motors were from the forward closures of the large scale test motors fired during the C4 EDP. (Subsequent test data from ELSH, Char, and SLSH verify the adequacy of this data.) The rubber ablation in the LS-1 and LS-2 forward closures was nearly uniform over the entire closure and the heating environment was one of high radiation and low Mach number. The data from these two motors are tabulated in table 8 together with typical data for silica rubber from the Titan forward closure; the scaled average ablation rate, due to radiation heating in the ELSH motor, is also shown. The basic assumptions of this calculation are (1) average ablation rate is proportional to radiation heat flux; (2) below a heat flux of approximately  $4.28 \text{ Btu/in.}^2/\text{sec}$ , silica-filled Buna-N rubber exhibits the same heating/ablating characteristics; (3) ablation due to radiation heating is independent of pressure level; and

TABLE 8. ABLATION DATA FOR FORWARD CLOSURE RUBBER

Motor	Chamber Pressure, psi	Aluminum, Wt-%	$T_o$ , R	$Q_{rad}$	$a$ ,* mil/sec
Titan	574	16	5,999	4.28	1.5 to 2.0
LS1†	778	18	6,309	5.23	2.31
LS2†	950	18	6,339	5.33	3.30
ELSH/Super HIPPO	1,500	21	6,775	6.98	5.70

\* Average ablation rates are for silica-asbestos loaded Buna-N rubber except for Titan data which is silica-filled Buna-N rubber.

† Large-scale test motors from C-4 EDP.

(4) emissivity of high alumina content gases under consideration may be assumed to be unity due to the large beam lengths in the forward closure.

The scaled average ablation rate of 6 mils/sec for silica-asbestos-loaded Buna-N rubber was prescribed as the radiation induced part of the ablation boundary condition to all silica-asbestos rubber components. A similar average ablation rate of 7.5 mils/sec for silica-asbestos rubber components was computed based on average relative performance of the two materials. The average ablation rates thus computed were applied to all silica-asbestos-loaded Buna-N rubber components as the average erosion rates caused by radiation heat flux.

In the higher Mach number regions of the cartridge insulation, the erosion was computed as a linear summation of the average radiation erosion rates and a convective heat flux dependent average ablation rate scaled from the correlative portion of the heat flux. Figure 4 illustrates the correlations for the convective portion of the heat flux. The convective heat flux was calculated with a time-dependent Bartz convective heat transfer coefficient and a constant ablating surface temperature of 2,000 F. The Bartz heat transfer coefficients were calculated from chamber gas properties and a local time-dependent 1D Mach number. This Mach number varied linearly from

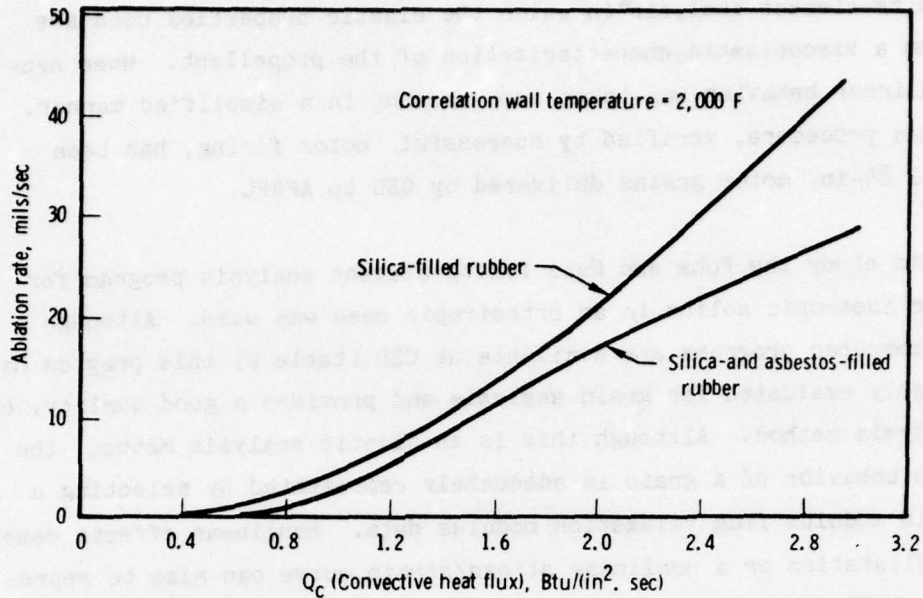

Figure 4. Correlation of Convective Heat Flux with Rubber Ablation Data from Titan 120-in. SRMs

an assumed initial value of 0.01 to a 1D Mach number computed at the grain diameter when the flow from the burned back grain attaches at the point of interest. From this time until the end of firing, the 1D Mach number was assumed to vary linearly with time to the 1D value of the diameter of the analysis station. This method of computing convective heat transfer coefficients and predicting ablation has been shown to give results which compare favorably with test data.

#### 4.1.3 Grain Structural Analysis

##### 4.1.3.1 Analysis Approach

From a structural viewpoint, the SLSH propellant grains were conservatively characterized as cartridge-loaded cylindrical grains with a b/a of approximately 3 and an L/D of approximately 1. They have free ends with a rubber inhibitor on one end and no stress-relief boots at the bond terminations.

As such, they were analyzed with a conventional quasiviscoelastic analysis method. Conventional 2D quasiviscoelastic analysis includes the use of an

elastic finite-element analysis in which the elastic properties used are derived from a viscoelastic characterization of the propellant. When necessary, nonlinear behavior was taken into account in a simplified manner. This analysis procedure, verified by successful motor firing, has been used for all 84-in. motor grains delivered by CSD to AFRPL.

For this study the Rohm and Haas finite-element analysis program for axisymmetric isotropic solids in an orthotropic case was used. Although a variety of computer programs are available at CSD (table 9) this program has been thoroughly evaluated for grain analysis and provides a good quality, economical analysis method. Although this is an elastic analysis method, the viscoelastic behavior of a grain is adequately represented by selecting a uniform grain modulus from relaxation modulus data. Nonlinear effects demonstrated by dilatation or a nonlinear stress/strain curve can also be represented in a simplified manner for use in this program. This is done by using the Von Mises expression for the effective stress in an element and selecting an appropriate modulus for each element based on a uniaxial stress/strain curve for the applicable loading rate. By making one or two iterative solutions with the finite-element program, the stress and strain in each element can be made to form a pair consistent with the stress/strain curve. The model used for this analysis is shown in figure 5.

The stress and strain components used for cooldown and storage analysis are the bore hoop strain for bore cracking and the maximum principle stress for bond termination failures. These are compared with the measured endurance failure strain in a biaxial stress field and the measured endurance uniaxial stress, respectively. The values are obtained from tests at the temperatures which give the minimum safety margins.

#### 4.1.3.2 Analysis Results

The margins of safety for all the principal failure modes are summarized in table 10. The locations of the lowest margins of safety are shown in figure 6 which is the profile of the grain deformed by a thermal load. It

TABLE 9. PRINCIPAL STRUCTURAL ANALYSIS COMPUTER PROGRAMS

Label	Capability	Source
AMG 032 (CSD No. LI65ZZZ)	Finite element; Axisymmetric isotropic continuum; orthotropic shell; linear strain elements; CSD.	Rohm & Haas Co. Huntsville, AL
AMG 033 (CSD No. LI82ZZZ)	Finite element; plane isotropic continuum; orthotropic shell perpendicular to plane of analysis; linear strain elements.	Rohm & Haas Co. Huntsville, AL
SAAS III (CSD No. LI77ZZZ)	Finite element; axisymmetric orthotropic continuum; linear strain elements.	Aerospace Corp. San Bernardino, CA
BOSOR	Finite difference; orthotropic layered shell; nonsymmetric loads; stress, stability, and dynamic response.	Lockheed MSC, Inc. Palo Alto, CA
STAGS	Finite difference; orthotropic layered shells of general shape; nonuniform loads; stress and stability calculations. Nonlinear geometric response.	Lockheed MSC, Inc. Palo Alto, CA
NASTRAN	General structural analysis program.	NASA
TEXGAP	Finite element; axisymmetric orthotropic continuum; orthotropic shell; higher order elements; nonsymmetric loads; fracture mechanics elements.	University of Texas/ CSD
AMG 038 (CSD No. LI94ZZZ)	Finite element; axisymmetric isotropic continuum; orthotropic shell; nonsymmetric loads; linear strain elements.	Rohm & Haas Co. Huntsville, AL
SAP III	General structural analysis program; includes a higher order three-dimensional element and various plate and beam elements.	University of California, Berkeley, CA
SA034 SA035 SA036 SA037	Nonlinear, two-dimensional viscoelastic solid propellant grain analysis	AFRPL Edwards AFB, CA

should be noted here that the required factors of safety for the propellant (1.5) and the bondlines (2.0) have been applied to the calculated stresses before deriving the margins of safety. Three-sigma maximum propellant and bond responses to the loads have been calculated and three-sigma minimum failure properties have been used. This combination shows a probability of grain failure of 1 in  $10^9$  if the margins of safety are zero.

#### 4.2 PHASE II - PROPELLANT PROCESSING AND QA FOR 84-IN. PROPELLANT GRAINS

It was CSD's objective to provide a quality product at minimum cost by implementing a well planned, effectively controlled, and operationally disciplined approach to the production of the SLSH cartridges. The significant elements in CSD's approach in meeting this objective were (1) process controls, (2) mixer selection, (3) quality controls, (4) process logic and processing. Each of these items is discussed in detail in the following subsections.

##### 4.2.1 Process Controls

During the course of HTPB propellant and liner processing, CSD has obtained extensive knowledge and experience of those factors which affect overall quality and performance. CSD has found that the HTPB family produces excellent propellants. However, production of reproducible propellant batches has been found somewhat more sensitive to certain process variables than have the PBAN or CTPB propellant systems. Some of these variables that require special attention are: (1) effect of mix shear rate, (2) mixer process conditions, (3) elapsed process time, (4) propellant burning rate control, and (5) liner curing. These variables and their importance are summarized in table 11.

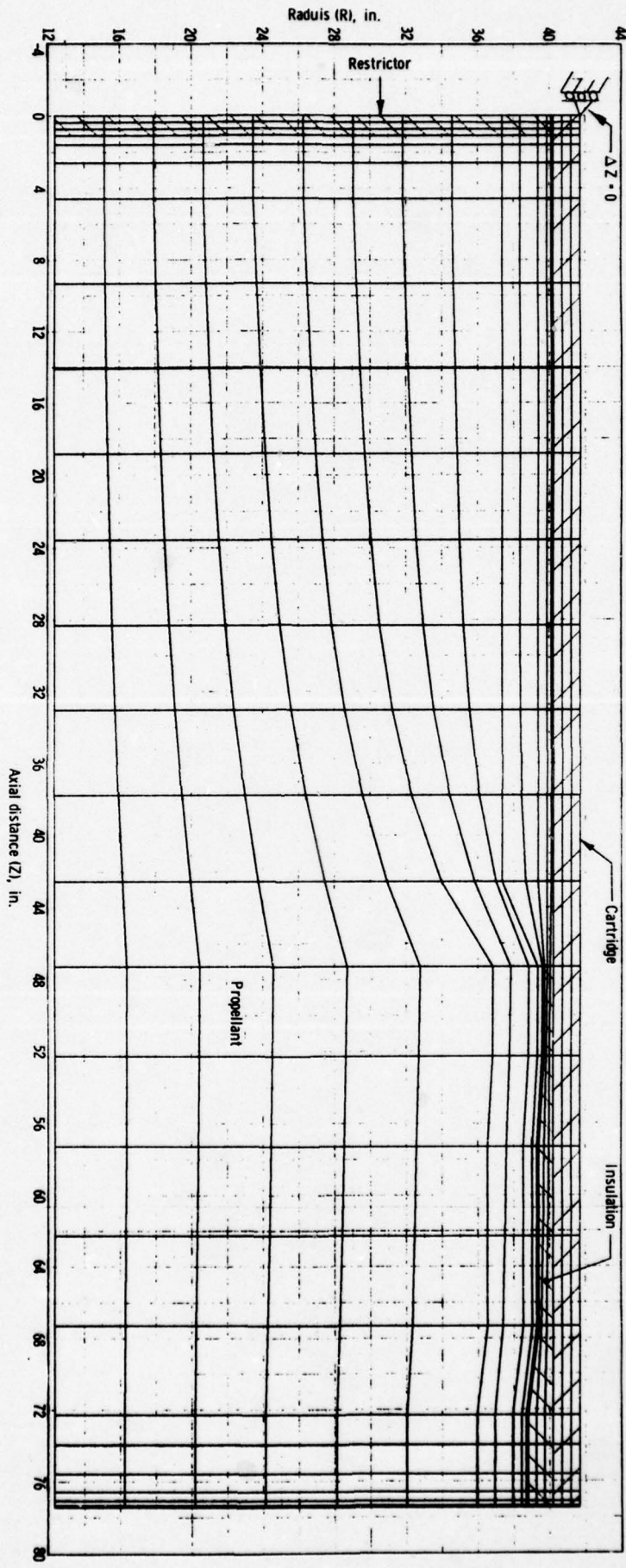

Figure 5. SISR Cartridge Grain

TABLE 10. MARGIN OF SAFETY SUMMARY

1	2	3	4	5	6
Failure Mode	Calculated Stress/Strain, psi, %	Minimum Specified Allowable Stress/Strain, psi, %	Reduced Allowability for Aging Effects, psi, %	Margin of Safety, $\frac{4}{2}-1$	
Failure modes due to storage for 2 yr between 60 and 80 F					
Unbond at grain termination due to combined shear and tension forces	16.7	20 ] C	16.7	0.14	A
Hoop strain failure in bore	4.1	8 ] D	6.7	0.63	B
Failure modes during transportation					
Unbond at grain termination from combined shear and tension forces due to cooldown to -20 F	29.4	60 ] E	50	0.70	C
Unbond at grain termination due to 2.8 shock load	7.2	100 ] F	83	>10	D
Hoop strain failure in bore due to cooldown to -20 F	8.2	13 ] E	10.8	0.32	E
Unbond at grain termination due to cumulative damage effects of transportation				0.70 ] G	F
Failure modes due to pressurization H					
Unbond at grain termination due to deviatoric normal tension forces	40	200 ] I	167	3.18	G
Hoop strain failure in bore	6.7	20 ] I	16.7	1.49	H

- Notes
- A Include the required safety factors of 2 on bondlines and 1.5 on the propellant.
  - B Allowables have been reduced by a factor of 1.2 to account for the effects of chemical aging. A batch-to-batch reduction factor of 1 is used, as the allowables are the specified minimums.
  - C Uniaxial endurance stress at 2 yr at 60 F is estimated to be the same as the uniaxial endurance stress at 1 yr at 70 F.
  - D Biaxial endurance strain at 2 yr at 60 F is estimated from the specified uniaxial endurance strain at 1 yr at 70 F.
  - E Appropriate endurance stress and strain values at -20 F at 1 day are estimated from the specified minimum properties.
  - F Standard rate JANNAF stress has been increased by a factor of 2 to account for the improvement due to high rate shock loadings.
  - G Cumulative damage margins of safety for combined loading conditions are computed as follows:  

$$MS = FS_c^{-1} \text{ where } \frac{1}{(FS_c)^a} = \frac{1}{(FS_1)^b} + \frac{1}{(FS_2)^c} + \dots$$
and a,b,c, etc. are the relevant endurance curve slopes.
  - H The pressurization analysis is inherently conservative as it assumes pressure does not occur between the case and cartridge. The cartridge thus deflects radially outward until it contacts the steel motor case.
  - I The standard rate JANNAF stress at 70 F has been increased by a factor of 4 to account for the effects of high strain rate improvement and pressure field enhancement. The JANNAF strain has not been increased for these effects.



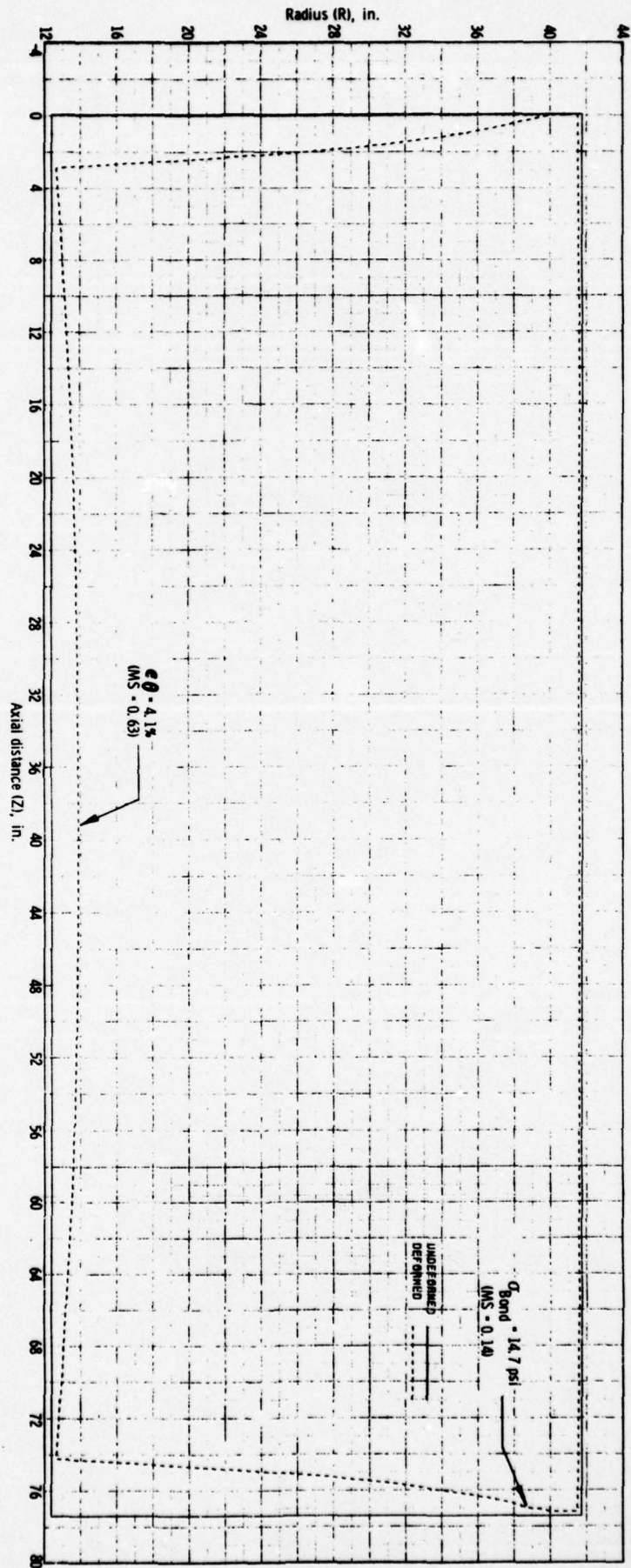

Figure 6. Deformed Grain for Cooledown to 60 F (Deformations Magnified by a Factor of 5 for Clarity)

TABLE 11. PROCESS CONTROLS  
(Sheet 1 of 2)

Parameter	Effect	Control	Comments
Mixer shear rate	Significant isocyanate consumption due to temperature and mixer shear conditions	Limit mixer shear rate	NCO/OH ratio sampled at the end of mix
Mixer variables*			
Mix temperature	Low temperatures could produce a thick layer adding thermal resistance resulting in unmixed areas	Maintain $145 \pm 5$ F during mixing	Temperature control is maintained by controlled mixer speed and jacket water temperature
Vacuum	Needed to produce void-free mixture	Maintain pressure of less than 10-mmHg during mixing	
Elapsed mix time	Impact final propellant mechanical properties	Careful observance of time of mix and time between batches	Short mix-time can result in poor ingredient mixing and result in unsatisfactory propellant characteristics  Too long of a mix time for multibatch casting may result in gelling of the initial batches prior to completion of casting resulting in poor mechanical (knitting) characteristics

TABLE 11. PROCESS CONTROLS  
(Sheet 2 of 2)

Parameter	Effect	Control	Comments
Temperature history	Excessive temperature could reduce the liner propellant bond strength of last propellant cast	Monitor time to keep conditions below allowable of 24 hr. at 130 F	This criteria is based on laboratory tests and verified by full-scale 84-in. castings
Burning rate	Out of specification conditions can result in undesirable motor operation	Established in-process LSBR-controls  Verify cured propellant performance in subscale motors (e.g., 4-lb, 15-lb Bates, 70-lb Bates)	
Liner curing	Adequate curing time needed for strength to resist propellant flow but not over-cured such as to impair bondability	Limits set on cure temperature and cure time	

\* Section 4.2.2 discusses mixer selection

#### 4.2.2 Mixer Selection

CSD uses two basic mixer types in production processing: vertical planetary and vertical helical blade mixers. Both types are designed for use with changeable mixer bowls. Each bowl has an undercarriage for over-the-road towing and is equipped with a flush bottom discharge valve. A pressure lid and follower plate is installed on the mix bowl which permits casting directly from the bowl. This change-bowl technique permits short cycle times at the mix station as it eliminates the need for both fuel and propellant transfer carts and removes the mixer bowl and valve cleaning function from the mixing operation. The two largest vertical mixers at CSD are the 750-gal Mixco helical blade mixer and the 400-gal Day planetary blade mixer. Both mixers have been used in large quantity production of propellants.

The characteristic mixing actions of the planetary and helical mixers are very different; the helical mixer uses a (vertical) pumping action to achieve mixing and depends on the flow characteristics of the mix being made, while the planetary mixer is less dependent on the fluidity characteristic of the mix to achieve mixing but mixes by more of a kneading action. For more fluid propellants, such as the 84% solids loaded PBAN, the helical mixer with its current blade configuration is more efficient for production than the planetary mixers. For propellants that exhibit a high Bingham plastic characteristic or are shear rate or temperature sensitive such as many of the high solids-loaded HTPB propellants, the planetary mixer provides better process control. For this reason, and as a result of experience to date with UTP-18,803A in the 400-gal planetary mixer, this mixer was selected for this program.

#### 4.2.3 Quality Controls

QC requirements, methods, and procedures for HTPB propellant processing have been established and demonstrated on previous IR&D and contract programs and all propellant inspection and test data collected have been used to optimize acceptance methods for this program.

Specific controls employed to adequately control the quality and document the critical processing areas described in section 4.2.1 are provided below:

#### A. Effect of Shear Rate

CSD has developed inspection methods for determining ingredient concentrations. The key technique is GPC, which separates the propellant binder into its constituents (plasticizer, curative, HTPB, and polymer) and provides fingerprint scans of these ingredients within the premix and propellant. GPC was also used to determine the percent HX-752 in premix A\*, the percent oxidizer and aluminum in premix C before curative addition, and the percent curative in the completed propellant. Shifts in the fingerprint scan after curative addition indicate the degree of propellant cure.

Infrared scans are also made of premix C. A calibration curve is prepared using premix C plus artificially adding the proper percent of curative (IPDI). This is then scanned and curative versus absorbants is plotted. A scan is then prepared for the final mixed propellant to determine the amount of IPDI within the mix. A quantitative value for IPDI can then be calculated from the calibration curve.

A fingerprint scan is taken of the finished propellant for verification that all ingredients are present and for comparison with scans from other batches of propellant. Thus, a redundant check is provided on weighing, mixer speed, power, and temperature control.

#### B. Mixer Process Conditions

Controllable mixer variables such as speed, mixer jacket water temperature, vacuum, and mix time have been identified in section 4.2.1. These parameters, together with dependent variables such as mix temperature and power input, were included in the detailed processing procedure (see appendix C, AFRPL-TR-77-92) and they required buyoff and verification by processing and QC personnel. Actual speeds, temperatures, times,

---

\* See table 16 for identification of content of premixes.

etc., were documented for record purposes. Variations from established requirements required written disposition and direction by process and quality engineers.

#### C. Elapsed Process Time

Controllable variables and time requirements were included in the detailed procedure. QC laboratory inspection/test activities were accomplished very quickly to provide authority to continue; i.e., mixed propellant was analyzed by the QC laboratory in the time required for the propellant pot to arrive at the casting station and be hooked up for casting. Total elapsed time was less than 1 hr.

#### D. Propellant Burning Rate Control

LSBRs were conducted by the QC laboratory both for premix C before adding curative and for the final propellant prior to go-ahead approval for casting. Process control and acceptance limits have been established for the LSBRs (see appendix B, AFRPL-TR-77-92) and the results were reported immediately to process and quality engineers for evaluation and batch acceptance. QC process control charts were maintained current to track LSBR. To control the variations of ratios of ground-to-unground AP or any other variations required to compensate for single batch variation, process and quality engineering must authorize the change by preparing a planning change order defining the detailed changes plus the justification for such a change. This provides assurance that all such activities were planned, approved, and documented before initiating the action.

#### E. Liner Curing

Controllable liner cure operations of time and temperature are defined by detailed procedure (see appendix J, AFRPL-TR-77-92). The cure cycle was monitored by recording temperature versus time continuously and providing QC surveillance/review of the temperature cycle.

These specific controls and inspections assured that batch-to-batch variations were minimal. Additional acceptance testing was conducted and reported in the PAR for each cartridge (see appendix B) to provide final verification that the propellant met all specification requirements.

#### 4.2.4 Processing Logic

Based on CSD experience with processing UTP-18,803A and the previously discussed considerations, the following logic was followed for processing:

- A. All materials were purchased to existing detailed specifications and after acceptance were stored in environmentally controlled facilities suitable for each chemical.
- B. Each propellant chemical was purchased as a single lot to eliminate any effects of lot-to-lot variation.
- C. All processing was performed in conformance with controlled procedures and specification. Any changes to procedures or specifications went through formal review and approval.
- D. All materials requiring special preparation before use (such as grinding of the oxidizer) were processed within a specified maximum time after preparation to eliminate time-dependent variations.
- E. The time-temperature history for precured liner was maintained within specified limits over the entire cycle from applications of liner to completion of propellant casting.
- F. The 400-gal planetary mixer was used for maximum batch-to-batch reproducibility of the propellant.
- G. During the mix cycle, the specified limits for process conditions (such as jacket wall temperature, propellant mix temperature, vacuum mix time for each step, and mixer rpm) were rigorously met.
- H. For each defined QC inspection point, specific acceptance criteria were defined and rigidly enforced.
- I. Corrective actions and alternate courses of action were defined for all potential problems during the processing cycle so that no event interfered with completion of the mix/cast cycle within specified time limits. Any situations which were not covered by these advanced preparations were handled by the MRB (personnel from program management, engineering, QC, and the customer) for critical discrepancies.
- J. Cartridges were put through the entire process cycle in pairs, when possible, to minimize the program cost.

Implementation of the processing logic discussed above through the various mechanical steps of the process flow shown in figure 7 is described in the following sections. A summary of all the QC inspections/tests associated with the specific cartridge processing steps with related acceptance criteria is shown in table 12.

#### 4.2.5 Materials Control and Process Tooling Description

##### Materials Control

Materials control included the timely purchase of all materials required for the program, acceptance, proper storage, handling, and control of usage of those materials.

##### A. Procedure

Each propellant ingredient was procured as a single lot. These ingredients were stored in specially controlled areas and bonded for use only on this program.

AP was purchased in one crossblended lot. The purchased AP oxidizer was stored at the vendor site. It was shipped to CSD in 5,000-lb flo-bins. The flo-bins were stored inside the oxidizer storage building (station 0300). A comparison of the CSD AP specification to the specification in AFRPL-TR-73-111 indicates that the CSD specification is tighter in most respects. Of particular interest are the tighter CSD requirements on sulfonated ash (0.50% versus 0.9%); perchlorate assay (98.5% versus 98.3%); moisture (0.065% maximum versus 0.09 maximum).

Aluminum was received in truck load shipments of 40,000 lb and was stored at CSD building 0331 until use.

BDR-45, IDP, and IPDI were shipped and stored in 55-gal sealed drums in CSD building 0460 until required for use.



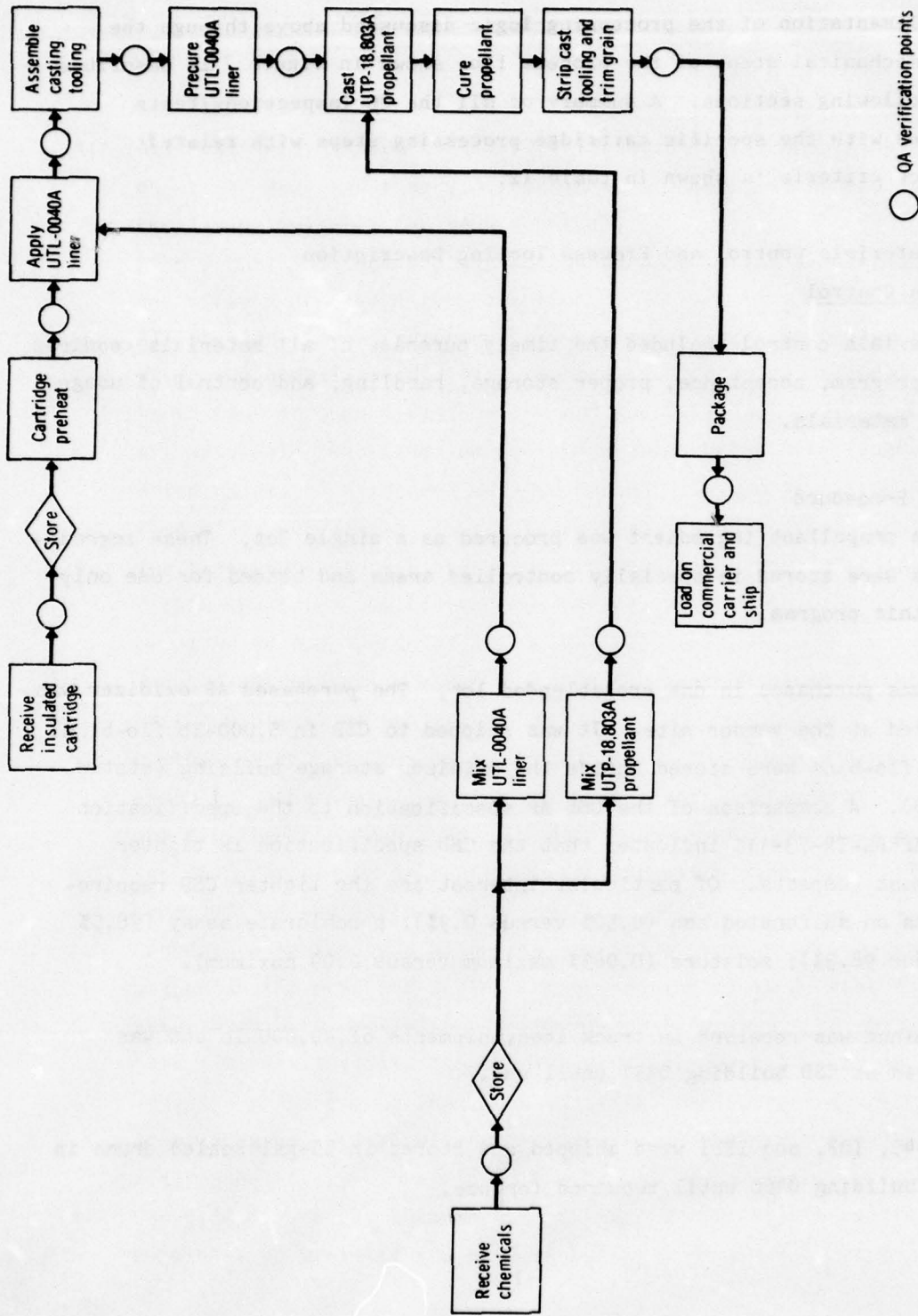

Figure 7. Process Flow Diagram for 8 1/4-in. SLSH Cartridge

TABLE 12. SUMMARY OF INSPECTIONS/TESTS AND ACCEPTANCE CRITERIA

Level of Inspection	Inspection/Test	Reason for Inspection/Test	Acceptance Criteria		Action to be Taken if Not per Specification
			Limits	QC Procedure	
Materials and Ingredients	See table 13	See table 13	See table 13	See table 13	See table 13
Process cooling	Functional assembly	Verify functionality of process cooling	N/A	QA-COI or O&QR	Rework as required to assure fit and function
	Mandrel bore dimensional verification	Assure B/P requirements are maintained for ballistic correlations and predictions	Per B/P	QA-COI or O&QR	Rework to B/P or submit to MRB
	Visual for coating adequacy	Assure that RTV/teflon-coated areas are uniform and fully covered	100%	QA-COI or O&QR	Rework to B/P
Insulated cartridge preheat	Monitor and review preheat cycles	Verify that preheat temperature and time meet established procedures	120 hr minimum at 215 F to 225 F	O&QR	Low or high temperature - submit to MRB Too short preheat time - submit to MRB
Liner preparation	See table 14	See table 14	See table 14	See table 14	See table 14
Apply UTL-0040A liner	Weight	Verify that the proper amount of liner was applied	25 lb minimum	O&QR	Add additional liner until 25 lb minimum is achieved
	Visual check of liner coverage	Verify that all surfaces of insulation are covered with liner	100% coverage	O&QR	Add additional liner to achieve 100% coverage
Assemble casting tooling	Monitor and review preheat cycles	Verify preheat (and liner cure) temperature and time meet established procedures	8 hr at 160 ±10 F and 4 hr at 130 ±10 F	O&QR	Low or high temperature - submit to MRB
	Mandrel location	Verify proper mandrel location before casting	Per B/P	O&QR	Rework to B/P
	Weight	Verify assembled casting assembly weight as base for establishing net propellant weight	N/A	O&QR	N/A
Cure UTL-0040A liner	See table 14	See table 14	See table 14	See table 14	See table 14
Propellant mixing	See table 16	See table 16	See table 16	See table 16	See table 16
Casting and cure UTP-18,803A propellant	Monitor and review cure cycle	Verify propellant cure temperature and time to meet specification requirements	10 days at 140 ±10 F 24 hr at 70 ±10 F	O&QR	Low or high temperature - submit to MRB
Package and ship	Surveillance inspection	Verify packaging and shipping requirements per specified	-	O&QR	N/A

HX-752, HX-868, and DDI-1410 were received in small containers and were stored under refrigeration in the cold box at CSD building 0210.

Upon receipt of the insulated cartridges, they were inspected for compliance to the requirements of drawing C13200.

#### B. QC and Acceptance Criteria

All chemical raw materials were inspected upon receipt at CSD. The routine inspection is defined in QC laboratory procedure QC-201 and consists of verification of identification, checking for shipment/handling damage or contamination, review of vendor certifications, and test results for compliance of purchase order requirements.

In addition, specific verification tests were conducted to corroborate the vendor test data. All such tests were conducted to sampling plans per MIL-STD-424, table A-2, C-1, and C-3 at an inspection level of IV and an AQL of 1.0. Table 13 provides a summary of raw chemicals for the SLSH loaded cartridge, the parameters which were verified by the CSD QC laboratory, the reasons for verification, acceptance criteria, and a reference to existing QC laboratory procedures used to conduct the verification. Since extended storage was required for some of the materials, the reinspection period is also reflected in the table. Reinspection requirements are defined in detail in QC laboratory procedure QC-J702.

#### Process Tooling

The tooling used to cast the ELSH grains under contract No. F04611-76-C-0010 was used to cast the SLSH grains for this program. The tooling, which was provided as GFE, is illustrated in figure 8 and its major components are described below.

#### A. Transportation and Process Pallet

This pallet was used to support the cartridge throughout the propellant loading process. Since the process takes place in several stations, this pallet was also used to support the loaded cartridge during its transportation through the plant.

#### B. Baseplate/Rounding Ring

Earlier experience in loading fiberglass cartridges showed that they did not stay round during thermal cycles. To ensure that the loaded cartridges met drawing roundness requirements, a machined steel rounding ring was used at the forward end of the cartridge throughout the process.

#### C. Holddown/Rounding Ring

This machined steel ring was used to round the aft end of the cartridge in the same manner described above for the cartridge forward end. In addition, this ring also provided a means to attach tiedown cables to secure the cartridge to the support pallet.

#### D. Mandrel

The mandrel consisted of aluminum weldments, machined to the correct configuration, and Teflon coated which provided accurate and reproducible grains throughout the program.

#### E. Cartridge Lifting Fixture

A lift fixture for the SLSH cartridges was provided as GFE which consisted of steel weldments which attached to the vertical cartridges at the lift holes located equally spaced around the upper end of each cartridge.

When not in use, tooling was protected and stored to prevent damage or degradation. Upon removal from storage, all tooling was checked for functionality and to assure that special coated surfaces were adequate. Upon program completion, the tooling was returned to AFRPL.

### 4.2.6 Cartridge Insulation

The SLSH cartridges were insulated by a CSD-selected vendor. The insulated cartridge configuration is shown in figure 9 with specific details of the insulation configuration presented in the following subparagraphs.

#### 4.2.6.1 Insulation of Cartridge Side Wall

##### A. Procedure

This function was performed by a CSD-selected vendor. (The same vendor also installed the items described in sections 4.2.6.2 and 4.2.6.3).

TABLE 13. QC INSPECTION/ACCEPTANCE CRITERIA FOR RAW MATERIALS

Propellant/Liner	Raw Material Ingredient	Inspection	Reason for Inspection/Test	Acceptance Criteria	Action to be Taken if out of Specification
		Inspection/Test		QC Procedure	
Propellant (UTP-18,803A)	HK-752 (bonding agent)	In-line equivalent weight	Acceptance testing	125 minimum QC-J703 (6 months)*	Returned to vendor for replacement or submit to MSB
	IDP (plasticizer)	Hydroxyl value	Acceptance testing	0.0050 maximum QC-L583 (2 yr)*	
	BDK-65H (binder)	Hydroxyl value Water	Required for formulation Water interferes with cure mechanism Maximum allowable acceptance testing	0.075 to 0.008 QC-L585 (2 yr)*	
	PRO-TECH @ 3705 (anti-oxidant)	Color Melting point	Acceptance testing	GRAY 205 to 235 C (2yr)*	
	Aluminum MD 101 (fuel)	Purity Volatiles Particle size	Required for formulation Acceptance testing Acceptance testing	97.5 minimum QC-L508 0.1 maximum % (2 yr)* 80% - 40/60 micron 50% - 20/40 micron 10% - 6/20 micron	
	Ammonium perchlorate (oxidizer)	Assay Water pH Sulfated ash TCP Particle size	Required for formulation Water interferes with cure Acceptance testing Acceptance testing Acceptance testing Required for formulation	98.5% minimum QC-L504 and 0.085 maximum % QC-K534 5.5 to 6.5 0.50 % maximum 0.10 to 0.30 Specification table	
	IDPI (curative)	NCO content (Assay) In-line equivalent weight	Required for formulation	109/113 QC-J703 (6 months)*	
	HX-868 (bonding agent)	In-line equivalent weight	Required for formulation	125 to 150 QC-J703 (6 months)*	
	BDK-65H (binder)	Hydroxyl value Water	Required for formulation Water interferes with cure	0.075 to 0.085 QC-L586 (2 yr)* 0.05 maximum %	
	Thermax (carbon black filler)	N/A	N/A	N/A	
DOI (curative)	NCO content (assay) GNC/IR	Required for formulation Identify impurities	96.7 % minimum QC-L586 (6 months)*		

\*Reinspection period

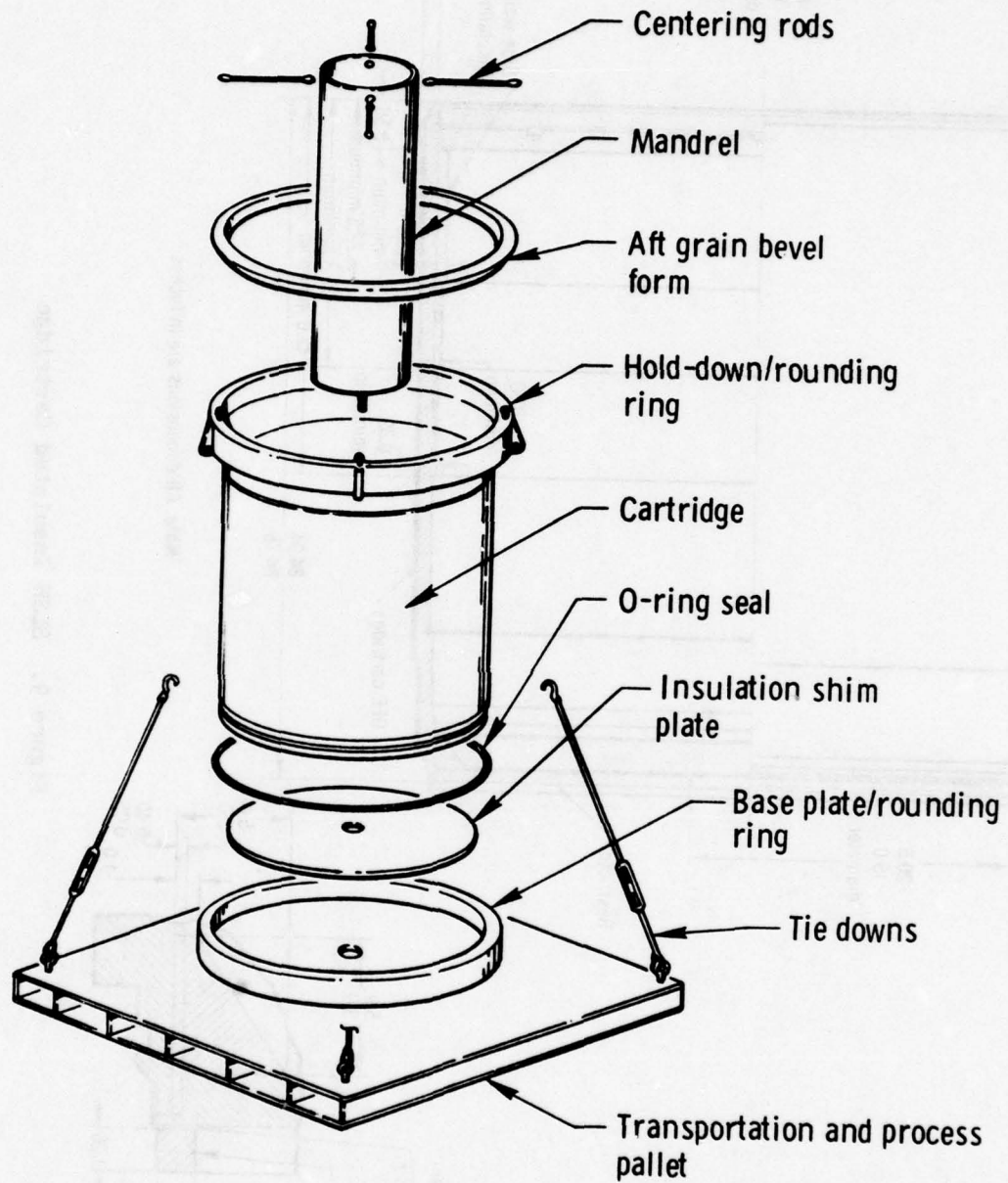
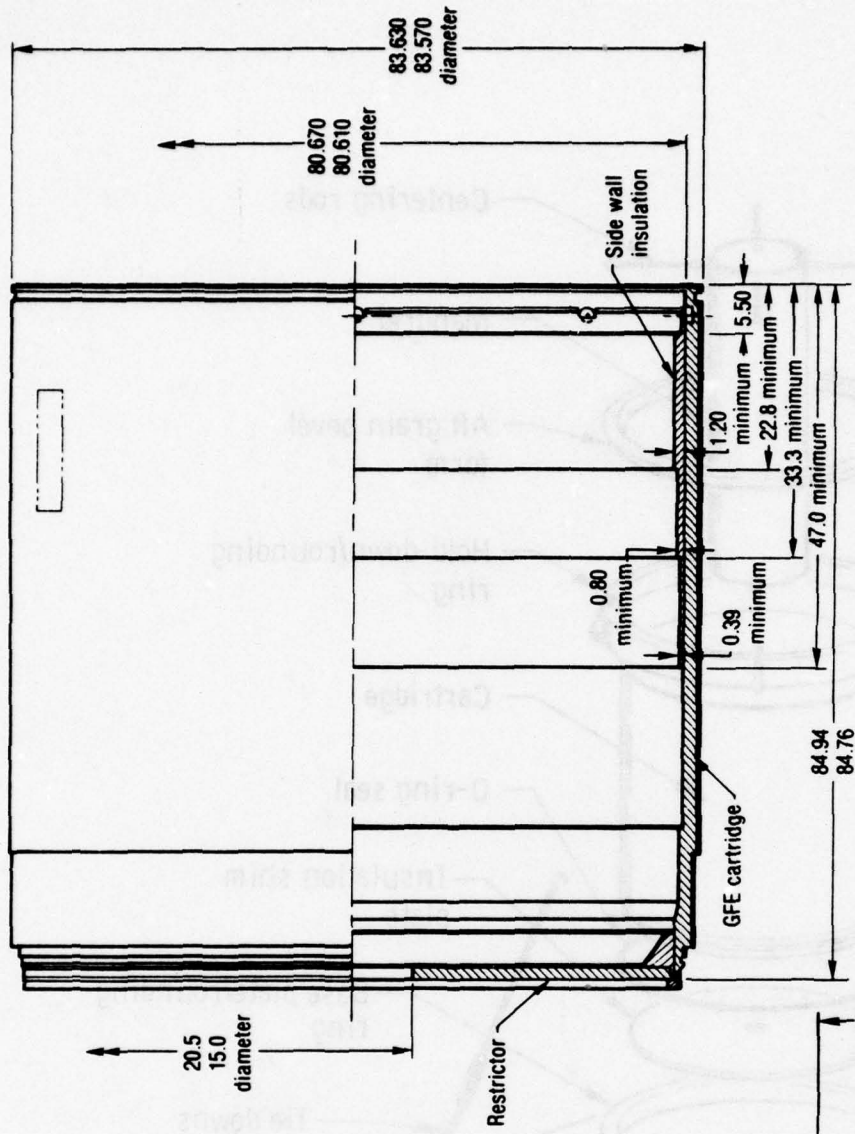

Figure 8. Basic Tooling Concept for SLSH Cartridges



Note: All dimensions are in inches

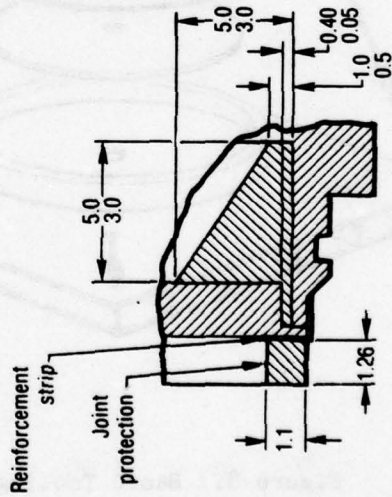

Figure 9. SLSH Insulated Cartridge

The aft side wall of the SLSH cartridges was insulated with silica-asbestos loaded Buna-N rubber (ORCO-9250). The rubber insulation was bonded to the cartridge with an epoxy adhesive (EA-921) in three sections; each section insulated approximately one-third of the circumference of the cartridge.

B. QC and Acceptance Criteria

Upon receipt of the insulated cartridge at CSD, the insulation was visually inspected for proper location and 100% bond at the edges. Any unbonded areas were repaired by injecting EA-921 into them with a caulking gun.

4.2.6.2 Forward Restrictor Installation

A. Procedure

A restrictor was bonded to the forward end of each of the cartridges with an epoxy adhesive. The restrictor was a disc of silica-asbestos-filled Buna-N rubber (ORCO-9250), the same rubber as was used for the sidewall insulation.

B. QC and Acceptance Criteria

Upon receipt at CSD, the insulated cartridge was inspected for restrictor location and unbonds. All unbonded areas were repaired by injecting them with EA-913 followed by adhesive cure.

4.2.6.3 Installation of Fiberglass Reinforcing Strip and Joint Protection Strip

A. Procedure

A woven fiberglass reinforcing strip was bonded to the forward end of the cartridge OD to reinforce the restrictor to cartridge bond (figure 9).

In addition, a large fillet of Al 227-70 potting compound was cast into the cartridge where it was bonded to the forward restrictor (figure 9).

Al 227-70 is a polyimide-epoxy resin potting compound that is used by CSD primarily to pot propellant stress relief boots and repair minor insulation-to-propellant bond separations on the Titan IIID segments and closures.



It bonds well to both the Buna-N rubber insulation and propellant. This fillet is used to ensure that the propellant surface in this area is not inadvertently ignited by hot gas flow through an undetected gas path in the cartridge-to-restrictor bond line. This fillet was cast in place by the vendor who insulated the cartridge.

B. QC and Acceptance Criteria

Upon receipt at CSD, the fiberglass reinforcing strip and the joint protector were inspected for proper location and unbonds. Any unbonds were repaired using EA-913 adhesive.

4.2.7 Liner (UTL-0040A)

4.2.7.1 Liner Preparation

A. Procedure

Liner UTL-0040A was used for the SL5H cartridges. The nominal composition of the liner is given below:

<u>Materials</u>	<u>Nominal Wt-%</u>
BDR-45M	41.8
HX-868	6
Thermax	40
DDI-1410	12.2

UTL-0040A was mixed in a 5-gal planetary blade mixer, which has a capacity of 80 lb of liner, sufficient for lining two cartridges. The mixer has a special capability for adding dry powdered ingredients through a vibratory screener-feeder into the mix bowl with agitation and under vacuum conditions.

All chemical ingredients used were analyzed and accepted before use. A double weighing/double operator check of ingredient weights was used. All ingredients for the 5-gal mix station were weighed in a separate weighout room. A separate set of scales in the mixer building was used to reweigh ingredients just before addition to the mixer.

Mixing operations and all materials used were controlled by process procedures and O&QRs. The basic process steps for mixing UTL-0040A liner are shown in figure 10.

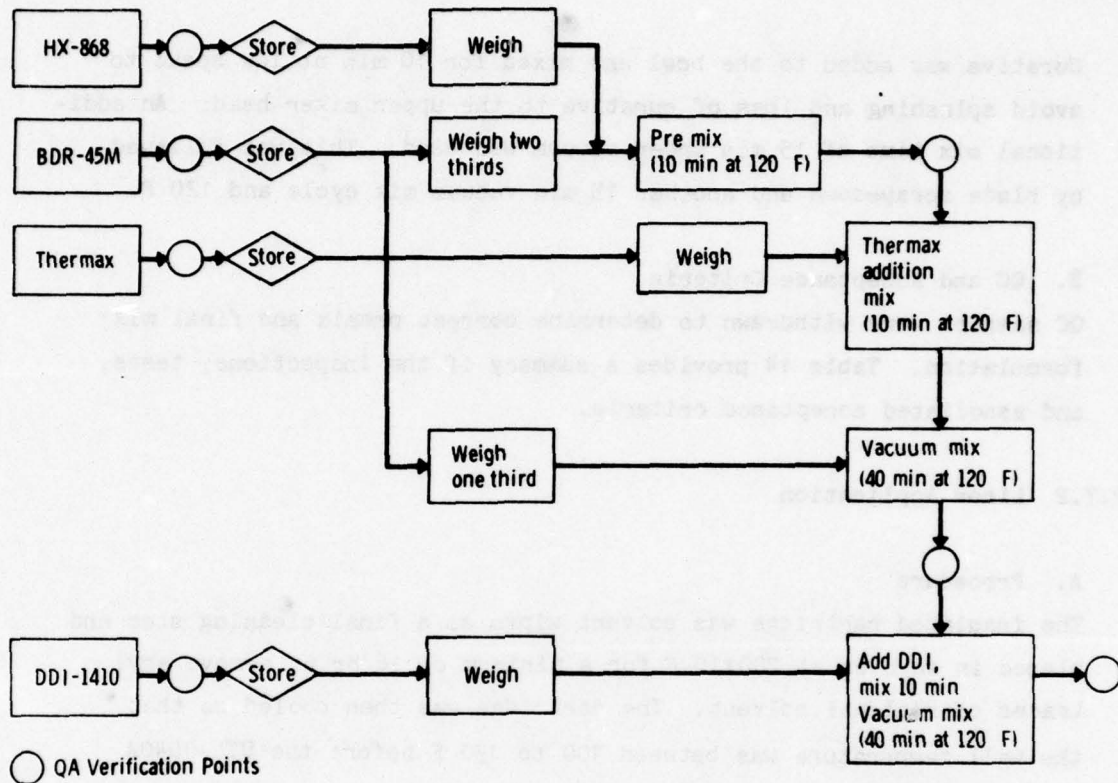

Figure 10. Flow Diagram for Liner Mixing Process

A premix of two-thirds of the BDR-45M polymer and two-thirds of the HX-868 was made by mixing at 120 F for 10 min. Less than the fully required amount of the BDR-45M was used to achieve a high viscosity mix of polymer and Thermax. Following this initial premix step, the Thermax was loaded into the screener-feeder, and vacuum was applied to the system (10-mm Hg absolute pressure). The Thermax was then added and mixed into the polymer premix at a predetermined rate. Mixing was continued for 10 min beyond the time of the last Thermax addition. The mix bowl was lowered,

the blades scraped down, and the remaining one-third of the BDR-45M polymer added. The bowl was raised, and mixing continued for 10 min at low speed to incorporate the liquid polymer. Vacuum was applied to the bowl (10-mm Hg absolute pressure) and mixing continued for an additional 30 min.

Curative was added to the bowl and mixed for 10 min at low speed to avoid splashing and loss of curative to the upper mixer head. An additional mix time of 15 min under vacuum was used. This was followed by blade scrapedown and another 15 min vacuum mix cycle and 120 F.

#### B. QC and Acceptance Criteria

QC samples were withdrawn to determine correct premix and final mix formulation. Table 14 provides a summary of the inspections, tests, and associated acceptance criteria.

### 4.2.7.2 Liner Application

#### A. Procedure

The insulated cartridge was solvent wiped as a final cleaning step and placed in an oven at  $200 \pm 10$  F for a minimum of 16 hr to remove any traces of residual solvent. The cartridge was then cooled so that the wall temperature was between 100 to 130 F before the UTL-0040A liner application.

Approximately 25 lb of QC-accepted UTL-0040A liner was applied to the side wall and restrictor. The liner was cured in the casting oven just before propellant casting to avoid overcuring the liner.

#### B. QC and Acceptance Criteria

Liner samples were prepared from the liner batch used to line the cartridge. These included one sample tray for mechanical properties and one peel tray for liner-to-propellant bond testing. The samples were sent to the casting oven to be cast with the cartridge.

TABLE 14. INSPECTIONS, TESTS, AND ACCEPTANCE CRITERIA FOR UTL-0040A

Inspection		Acceptance Criteria				
Level of Inspection	Inspection/Test	Reason for Inspection/Test	Limits	QC Procedure	Action to be Taken if Not Per Specification	
Ingredient	BDR-45-M	H <sub>2</sub> O content GPC/IR	To detect any deleterious storage and aging effects (material always analyzed immediately before use).	0.05% maximum	QC-K522	Degas to achieve in specification condition
	DDI	Assay Dimer GPC/IR	Formulation purposes To detect storage of environmental effects	56.7% minimum	QC-L585	Dimer above specification - scrap Assay out of specification - scrap
Premix A:	(HX-868 + two-thirds BDR-45M)	H <sub>2</sub> O content HX-868 content	Moisture can degrade cure Essential to liner physical properties	0.03% maximum 6.26 to 7.40%	QC-K522	Degas to achieve in specification condition Re-sample and if still out scrap
	Premix B: (Premix A + Thermax	None	N/A	-	N/A	N/A
Premix C:	(Premix B + one-third BDR-45M)	Solids GPC-IR	Verification of formulation	43.26 to 47.81%	QC-N512	Low - Add solids High - Add BDR-45M to bring into specification
	(Premix C + DDI)	DDI GPC/IR	Verification and acceptance	3.70% minimum	IQCL-4011	High - Re-sample and if still out, scrap Low - Add DDI to bring into specification
Cured liner	Peels	Post process assurance that material did cure and give the desired bond strength (liner to insulation)	4 lb/in. width minimum	QC-N618 QC-M605	Submit to MRB	

QC verification steps included verification of liner weight and verification that all surfaces of the insulation were covered with liner.

#### 4.2.8 Casting Tooling Assembly and Liner Precuring

##### A. Procedure

The Teflon-coated mandrel was installed in the lined cartridge and secured to the forward face of the lined restrictor through the casting baseplate. Aft centering rods were installed between the mandrel and the ID of the cartridge to ensure core centering. The completed casting assembly was then weighed. After weighing, the cartridge was transported to the vacuum casting and curing oven. Once removed from the transporter, it was placed in the oven and leveled as required. The oven lid was installed and vacuum checked to ensure that there were no unbonds between the uncured liner and the cartridge. After the vacuum check, the cartridge was heated in the oven for  $16 \pm 1$  hr at  $140 \pm 10$  F to partially cure the UTL-0040A liner. Liner samples were cured with the cartridge.

##### B. QC and Acceptance Criteria

QC inspection points during this operation included in-process checks to verify that preheat cure cycles followed established procedures. Inspection also included verification of the mandrel configuration and location for grain configuration as well as verification of casting assembly weight.

#### 4.2.9 Propellant (UTP-18,803A)

##### 4.2.9.1 Propellant Mixing

##### A. Procedure

UTP-18,803A propellant mixing operations included (1) fuel premix preparation; (2) oxidizer preparation; and (3) mixing the oxidizer, fuel, and curative together to make propellant. The process flow diagram for UTP-18,803A is given in figure 11 and discussed below.

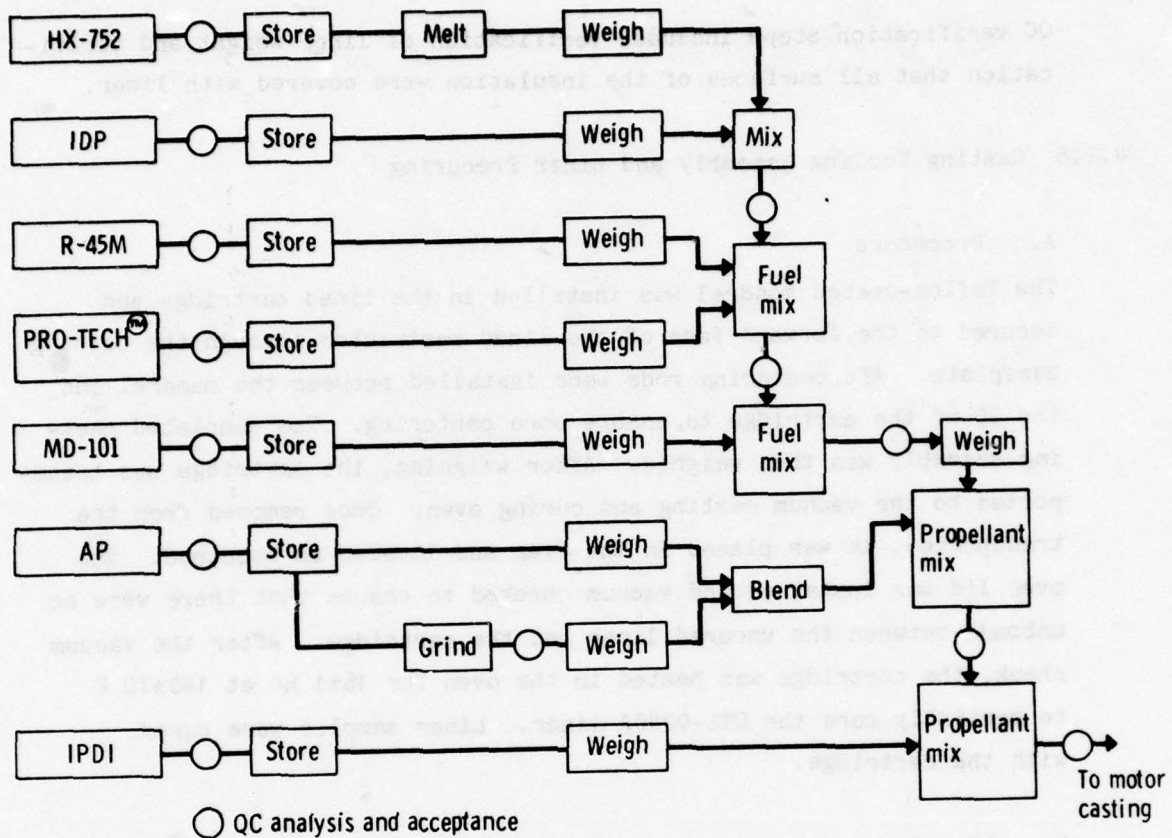

Figure 11. Process Flow Diagram for UTP-18,803A Propellant

#### Fuel Premix Preparation

Before loading the SLSH cartridges, which required nine propellant batches for two grains, fuel premix (R-45M, HX-752, PRO-TECH®, Al) was made in a master batch in a premix facility separate and removed from the propellant mix station. This is the same technique used for all castings of UTP-18,803A made under contract No. F04611-76-C-0010.

Several distinct advantages arise from the use of large master batches of fuel premix:

1. Improved batch-to-batch uniformity and reproducibility. For example, a typical 5,000-lb propellant batch will contain 1,525 lb of fuel and be weighed to an accuracy of 0.5 lb. This is a potential variation of 0.03% and, since the BDR-45M is one-fifth of the fuel, the variation in NCO/OH is 0.0002.
2. Less time to charge the propellant mixer. This results in significantly reduced turnaround times between batches (3 versus 9 hr) and a shorter time for loading the cartridge (15 versus 45 hr).
3. Overall improvement of efficiency from a reduced number of individual weighings, QC analyses, and manually-controlled mixing operations.

Fuel premix was prepared in batches of 30,000 lb at the fuel premix station. This quantity of fuel premix converts to approximately 98,000 lb of propellant, or enough propellant for loading four SLSH cartridges.

Fuel premix preparation consisted of the following operations:

1. IDP plasticizer was weighed into a jacketed, heating mixing vessel equipped with an agitator and heated to approximately 160 F.
2. HX-752 was taken from the cold box storage (0 F) and warmed to 80 to 120 F to facilitate handling. The HX-752 was weighed and added to the IDP. The two ingredients were mixed under moderately high shear conditions by using a Cowles-type agitator to obtain proper dispersion. A QC sample was taken to assure correct composition.
3. R-45M and PRO-TECH 2705 were weighed and added to the primary fuel premix vessel followed by the IDP and HX-752 mixture. This vessel was equipped with an agitator to provide adequate dispersion of liquid fuels and aluminum powder. A QC sample was analyzed to verify composition.
4. Aluminum powder was weighed, added, and mixed by means of agitation into the liquid fuels. After adequate mixing of aluminum and liquid fuels, a sample was analyzed to assure conformance to

acceptable standards. In order to maintain a uniform composition, the completed premix was stirred continuously to prevent settling of the aluminum.

5. Aliquot portions of the fuel premix master batch were weighed and added to the mix bowl at the fuel mixing station and transported to the mixer station.

#### Oxidizer Preparation

UTP-18,803A is a bimodal AP blend propellant containing both ground (9.5 micron) and unground (200 micron) oxidizer fractions. The CSD oxidizer facilities are designed to weigh out, grind, and load these fractions into an oxidizer transfer cart. Oxidizer was received at the oxidizer preparation station in 5,000-lb flo-bins. The required unground oxidizer fraction for a batch of propellant was discharged directly through a magnetic grate and scalper screen into the flo-bin, which is on a redundant electrical/mechanical scale. (The double weighing concept has proven itself in controlling weight variations.) The oxidizer from a second transfer cart was discharged through the magnetic grate and scalper screen into the grinder feed bin. The feed bin was then transported to the oxidizer grinding station and positioned over a screw feeder which fed the grinder at a controlled rate. The grinder, a Raymond hammer mill, which has a grinding capacity of 2,000 lb/hr, yielded reproducible particles to the desired size of 9.5 microns. This was achieved by using a predetermined hammer configuration, controlled hammer speed, and feed rate.

QC acceptance samples of ground and unground oxidizer were taken to ensure conformance to particle size and moisture standards.

The ground oxidizer was discharged directly from the mill into a flo-bin which contained the preweighed unground oxidizer and which was resting on an electronic weighing scale. The increase in flo-bin weight was continuously monitored as ground oxidizer was added to the flo-bin until the correct weight of the ground oxidizer had been obtained. The correct weight was verified under static conditions by redundant weighings



on the electronic and mechanical scales. The weights were recorded and verified by QC in accordance with established procedures. This assured that the correct weight of each oxidizer function had been added to the flo-bin and that the correct ratio of ground to unground oxidizer had been prepared.

#### Mix Procedure Description

The 400-gal mixer capacity is variable, and propellant batches ranging from 1,200 to 5,600 lb may be prepared. For the SLSH grains, a nominal 5,000-lb batch size was used.

The motor drive for the 400-gal mixer is equipped with a variable speed control which allows selection of any desired speed between 0 and 24 rpm. During startup, the blades were slowly accelerated to the desired speed. During mixer shutdown, the blades were slowed to 0 rpm by manual control. A wattmeter recorded power density.

In mixing, the blade action causes the entire volume of the mixer bowl to be swept by the blades during a half revolution of the planetary action. This assures that all parts of the batch are subjected to blade action. Blade-to-blade and blade-to-wall clearance in the 400-gal mixer is 0.250 to 0.400 in., respectively. Heat transfer and temperature are controlled in the mixer. During operation a water jacket temperature about 5 F lower than batch temperature is needed to maintain a constant batch temperature. The small blade clearance and small temperature differential greatly reduce the possibility of unmixed propellant adhering to the mixer bowl wall. A summary of the 400-gal mix procedure is shown in table 15 and discussed below.

The bowl was raised to the mix position, water jacket circulation lines attached, and oxidizer cart positioned over the screener-feeder. Oxidizer was added to the fuel at a controlled rate over a nominal period of 30 min. The oxidizer was fed to the mixer via a vibratory screener-feeder which can be operated continuously or intermittently, as

TABLE 15. 400-GAL MIX PROCEDURE FOR HTPB PROPELLANTS

Operation	Jacket Temperature, F	Blade Speed, RPM	Mix Time, min	Pressure, mm Hg	Propellant Temperature, F
Add premix C to mix bowl (R45M, IDP, HX752, PRO-TECH® and Al)	145	-	-	Atmosphere	-
Add AP to mix bowl	145	12	30	Atmosphere	90 to 140
Vacuum mix	145	12	30	10	140±10
Scrape down; take QA sample; add IPDI	120 to 150	-	-	Atmosphere	140±10
	120 to 150	-	-	Atmosphere	140±10
Vacuum mix	120 to 150	12	30	10	140±10
Shut down; take QA sample	120 to 150	-	-	Atmosphere	140±10

required. The feeder permits controlled oxidizer addition on a unit weight per minute basis. The operator monitored the mixer instantaneous power level and controlled oxidizer addition so that the power level was maintained at about 15 kw. All of the oxidizer added to the mixer passed through a 1/4-in. mesh screen with an effective opening of 3/16 in.

A mixer blade speed of 12 rpm was used, and 135 F water was circulated through the jacket. Mixing was continued for 10 min after addition of the oxidizer. The oxidizer cart was then removed, and the addition port closed.

Incorporation of the oxidizer into the mix was completed by vacuum mixing at an absolute pressure of less than 20-mm Hg, with a blade speed of 12 rpm, and at a temperature of 140±5 F. After vacuum mixing, the bowl was lowered, and the blades and upper part of the bowl were scraped down.

A QC sample was taken at this point to verify solids content and LSBR.

Following QC acceptance of the above sample, curative was added, the bowl raised, the blades set in motion to 12 rpm, and mixing continued at an absolute pressure of 10-mm Hg at a temperature of  $140 \pm 5$  F for 30 min.

Then the bowl was lowered and QC samples were taken to verify curative content, solids content, and LSBR. The bowl was covered and transported to the casting station, where the follower plate and pressure lid were installed.

Propellant casting proceeded upon verification of QC test results.

#### B. QC and Acceptance Criteria

QC inspections/tests and associated acceptance criteria for the mixer operation are summarized in table 16.

Detailed process sampling procedures are defined by existing QC laboratory procedure QC-K400 to assure that samples taken from materials, premixes, or final mixes are truly representative of the material being tested and to assure that this material is being handled properly to provide meaningful test results.

### 4.2.9.2 Propellant Casting and Curing

#### A. Procedure

Following mix operations, the propellant mix bowl was received at the casting station. Propellant for sample casting (e.g., 4-lb motors, 15- and 70-lb Bates, as well as mechanical property samples) were taken from the mix, and a follower plate and pressure dome installed on the bowl. The bowl was then moved to the casting oven where it was connected to the casting line and casting manifold in the oven. After the QC laboratory notified casting personnel that the batch

was acceptable, the casting valve was opened and the batch cast into the preheated cartridge. A vacuum of approximately 35-mm Hg was maintained in the chamber during casting to minimize entrapment of gases in the propellant.

At completion of the vacuum casting operation, the propellant was trowelled to height as specified on the fabrication drawing (C13199-01-01, figure 2), with a minor quantity of propellant removed or added as required to meet drawing requirements. The loaded cartridges were cured for 10 days  $\pm$  12 hr at 140  $\pm$  10 F. At completion of the cure cycle, the cartridges were cooled for a minimum of 24 hr before stripping operations.

The following propellant samples were made for this program: 70-lb Bates motor (two per SLSH cartridge), 15-lb Bates motor (one per propellant batch), 4-lb ballistic motors (four per propellant batch), 0.5 gal mechanical properties cartons (two per propellant batch), peel trays (one per cartridge).

#### B. QC and Acceptance Criteria

Following casting operations, the propellant sample cartons and peel trays were sent to the QC laboratory for testing. The cure cycle records were monitored to assure that procedure/specification requirements were satisfied.

### 4.2.10 Casting Tooling, Stripping, and Grain Trimming

#### A. Procedure

After a 10 day cure at a nominal 140 F and a 1-day cooldown, the loaded assembly was weighed to the nearest 0.1% to determine net propellant weight. The mandrel was removed using a hydroset fixture. The cartridge was removed from the casting base, lifted, and placed on supports, while the forward restrictor was inspected visually for separation and by audio testing for unbonds. The cartridge was then placed on the shipping pallet.

TABLE 16. QC AND ACCEPTANCE CRITERIA FOR UTP-18, 803A PROPELLANT

Ingredient	Inspection		Reason for Inspection/Test	Acceptance Criteria		Action to be Taken if Not Per Specification
	Level of Inspection	Inspection/Test		Limits	QC Procedure	
BDR-4SM	GPC/IR H <sub>2</sub> O		Analysis performed before use to detect any storage or aging phenomena	0.05 maximum	QC-L585	Degas to bring within limits
AP	H <sub>2</sub> O Particle size		Routine surveillance and assurance that material is still processable	0.065 maximum (Specification table)	QC-K522 QC-L504	Reject if caking problems could exist Determine suitable AP balance for batch
IPDI	NCO Dimer GPC/IR		Analysis before use to detect formation of dimer and obtain formulation information	109/113	QC-J703	NCO out of specification - Scrap Dimer out of specification - Scrap
Fuel Premix A: (HX-752 + IDP BDR-45 + PRO-TECH®)	HX-752		Process control point; imine content is essential in obtaining desired physical properties	9.34 to 11.34%	IQCI-4016	HX-752 out specification - Scrap
	H <sub>2</sub> O GPC/IR BRP IPD		Water interferes with the curing reaction Comparison analysis (an in-process control)	0.030 maximum	QC-K522 IQCL-4016	Degas to bring within limits
	% AI			N/A	N/A	
Premix C: (Premix A + AP+AI)	% AP % AI GPC/IR LSBR		Verification Verification Comparison analysis	68.5/69.8 20.6/21.6	IQCL-4016	% AP, % AI - Add curative and continue resample after curative
Propellant mix: (Premix D + IPDI)	LSBR		For ballistic evaluation optional	TBS	IQCL-4016	LSBR - In-process check (outside single batch limits - Scrap) Check % AP and AI - If still out (see premix D) High AP - Scrap; low AP - check LSBR; Add AP if possible
	% IPDI GPC/IR		Verification (acceptance) Verification (acceptance) Verification of correct IPDI addition Comparison analysis	68.3/69.5 20.3/21.5 0.45 to 0.55		% IPDI low - calculate and add; high - Scrap
Cured propellant	Tensile True strain Density (29 batches) 1 set peel/cartridge 1 set bite/cartridge		Specification requirements (acceptance) Specification requirements (acceptance) Specification requirements (acceptance) Specification requirements (acceptance) Specification requirements (acceptance)	80 psi 20% minimum 6 lb/in. width 50 psi minimum minimum	QC-N603 QC-N602 QC-N602 QC-N605 QC-N608 QC-N606	MRB action

**B. QC and Acceptance Criteria**

Table 17 provides the QC inspection/test which was conducted on the loaded cartridge and identifies the associated acceptance criteria (see section 4.2.12 for further detailed discussion of the loaded cartridge NDT).

**TABLE 17. QC AND ACCEPTANCE CRITERIA FOR SLSH**

Inspection/Test	Reason for Inspection/Test	Acceptance Criteria		Corrective Action If Out of Specification
		Limits	CSD Procedure	
Inspect all visible surfaces for separations/unbonds	Acceptance per B/P	None allowed	O&QR	Fill with A1-227-70
Inspect all propellant surfaces for cracks and voids	Acceptance per B/P	None allowed	O&QR	Submit to MRB or repair per note 15 of drawing C13199
Dimensionally inspect grain:	Acceptance per B/P			Submit to MRB
length		Per B/P	O&QR	
bore		Per B/P	O&QR	
roundness		Per B/P	O&QR	
Workmanship:	Acceptance per B/P	None allowed	O&QR	Submit to MRB
Free of defects which could affect function				
Weight to 0.1%	Determine net propellant weight	Per B/P	O&QR	Submit to MRB
Visually inspect forward restrictors for unbonds and separations at edges	Acceptance per B/P	Per B/P	O&QR	Submit to MRB

**4.2.11 Loaded Cartridge Packaging and Shipping**

**A. Procedure**

The GFE shipping pallet design was in accordance with the basic requirements of the code of federal regulations (DOT) and made by CSD on contract No. F04611-73-C-0023. The pallet design and method of tiedown

has been approved by the Bureau of Explosives and has been assigned a permanent approval number (BA-1845) which is marked on the shipping pallet.

The shipping pallet was constructed as shown in figure 12 to accept the cartridge grain in the vertical attitude and is secured to the pallet by four tie-down assemblies. Dessicant bags were inserted into the grain perforation to maintain the relative humidity at less than 50%. The open end of the cartridge was closed by using a one-piece cover of electrostatic free (electroconductive) barrier material, 4-mil thick, which was taped to the OD of the cartridge to form a waterproof closure. A plywood shipping closure was placed onto the top of the cartridge and secured in place by using tension steel strapping attached to the pallet.

The palletized cartridge grains were loaded directly onto the carriers' equipment by using an overhead crane and the GFE lifting fixture.

#### 4.2.12 SLSH Loaded Cartridge NDT and Data Reporting

CSD produced a NDT baseline offering zero risk of catastrophic failure based on the small risk of out-of specification performance as demonstrated with UTP-18,803A under contract No. F04611-76-C-0010. The baseline NDT approach used on SLSH loaded cartridges included restrictor audio testing, propellant surface examination, visual inspection of bondline edges, weight control, propellant mechanical property, and bond system control (peel tests). The quality certification that was provided with each deliverable cartridge (see appendix B) included:

- A. General certification that B/P and specification and control requirements had been met
- B. Cartridge P/N and S/N identification
- C. Summary of MRB actions or waivers

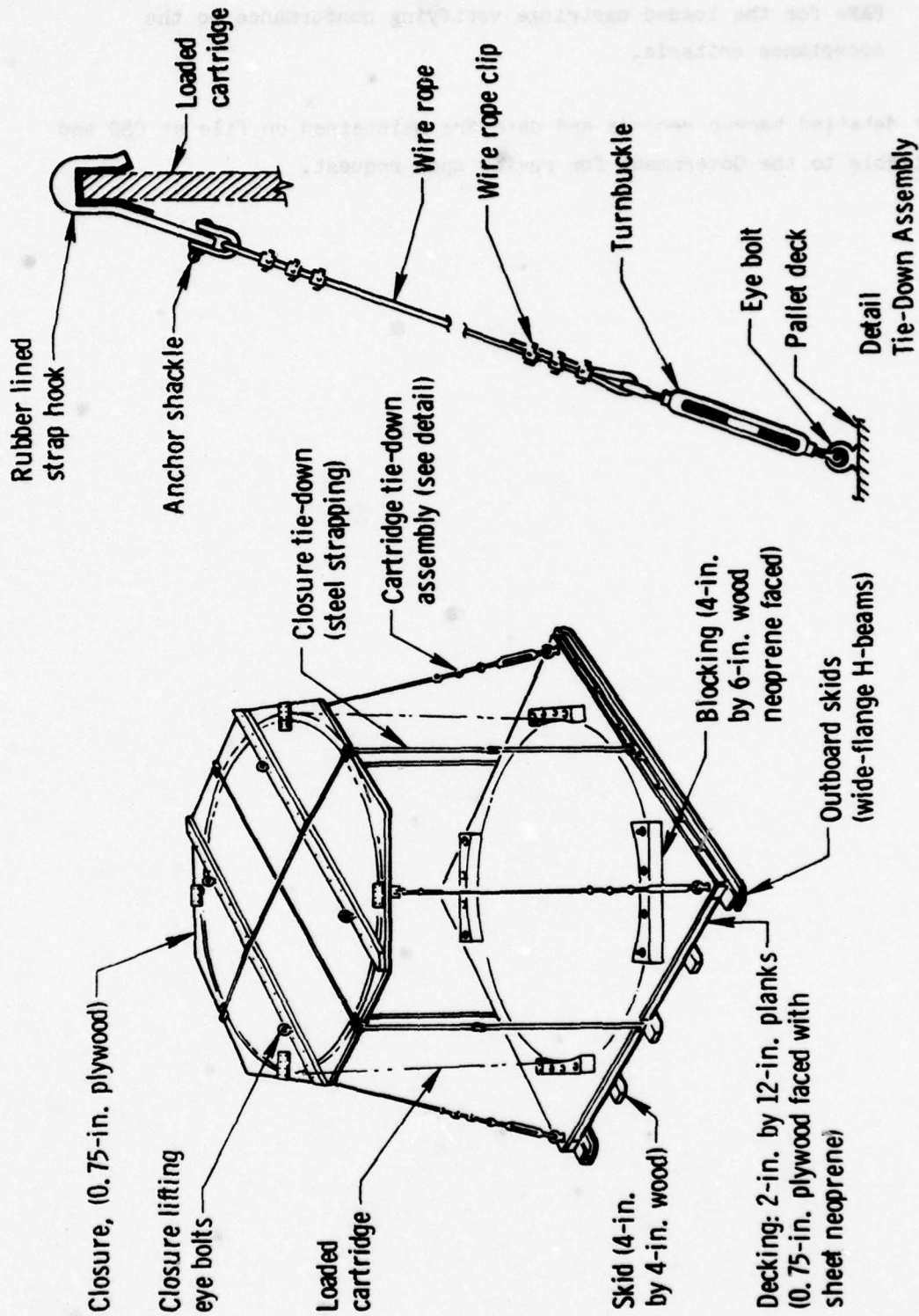
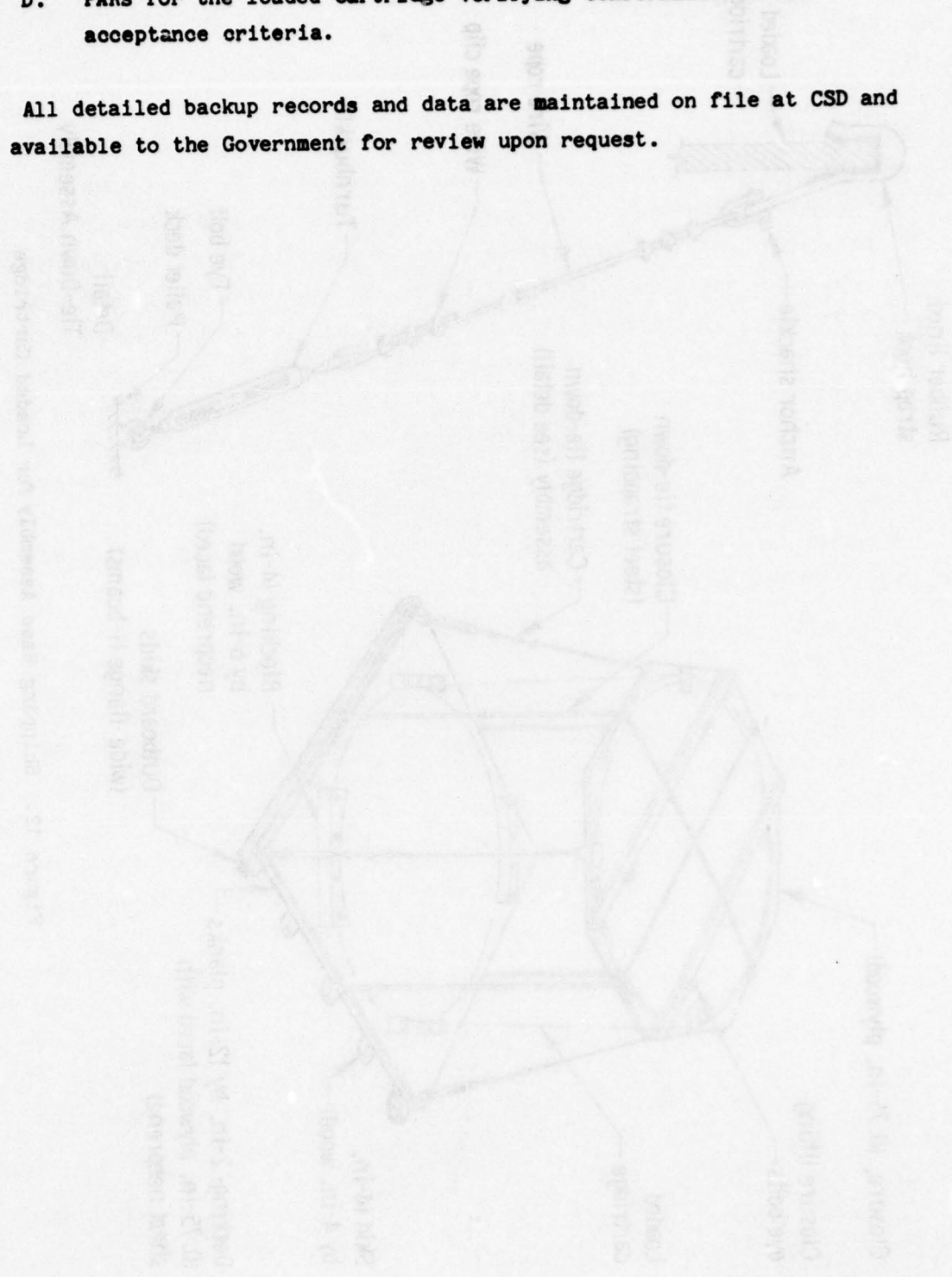

Figure 12. Shipping Base Assembly for Loaded Cartridge



D. PARs for the loaded cartridge verifying conformance to the acceptance criteria.

All detailed backup records and data are maintained on file at CSD and are available to the Government for review upon request.



## 5.0 CONCLUSIONS

This program has further demonstrated CSD's ability to efficiently process reproducible, high solids loaded, HTPB propellant under full-scale production conditions. The data obtained from this effort adds significantly to the information previously obtained under contract No. FO4611-76-C-0010 and verifies the conclusions reached from that effort in the areas of propellant processing, propellant burning rate, burning rate control, and mechanical properties as stated in AFRPL-TR-77-92.

INTRODUCTION

The 15-lb Bates test firings are summarized in Appendix A. Various procedures are listed for each firing along with a list of target classes, pressure, and the ratio of thrust chamber pressure as provided in Table A-1. Table A-1 provides a cross-reference between the firing test run number, firing tube identification number, and the test target's batch number. The listed test parameters which contain each of these specific parameters is also included.

TABLE A-1. 15-LB BATES MOTOR FIRINGS

1982

APPENDIX A

15-LB BATES MOTOR FIRINGS

Run No.	Test No.	Pressure (psi)	Ratio	Batch No.
1458-027	100-1002	1000	1.00	100-01
1458-028	100-1003	1100	1.10	100-02
1458-029	100-1004	1200	1.20	100-03
1458-030	100-1005	1300	1.30	100-04
1458-031	100-1006	1400	1.40	100-05
1458-032	100-1007	1500	1.50	100-06
1458-033	100-1008	1600	1.60	100-07
1458-034	100-1009	1700	1.70	100-08
1458-035	100-1010	1800	1.80	100-09
1458-036	100-1011	1900	1.90	100-10
1458-037	100-1012	2000	2.00	100-11
1458-038	100-1013	2100	2.10	100-12
1458-039	100-1014	2200	2.20	100-13
1458-040	100-1015	2300	2.30	100-14
1458-041	100-1016	2400	2.40	100-15
1458-042	100-1017	2500	2.50	100-16
1458-043	100-1018	2600	2.60	100-17
1458-044	100-1019	2700	2.70	100-18
1458-045	100-1020	2800	2.80	100-19
1458-046	100-1021	2900	2.90	100-20
1458-047	100-1022	3000	3.00	100-21
1458-048	100-1023	3100	3.10	100-22
1458-049	100-1024	3200	3.20	100-23
1458-050	100-1025	3300	3.30	100-24
1458-051	100-1026	3400	3.40	100-25
1458-052	100-1027	3500	3.50	100-26
1458-053	100-1028	3600	3.60	100-27
1458-054	100-1029	3700	3.70	100-28
1458-055	100-1030	3800	3.80	100-29
1458-056	100-1031	3900	3.90	100-30
1458-057	100-1032	4000	4.00	100-31
1458-058	100-1033	4100	4.10	100-32
1458-059	100-1034	4200	4.20	100-33
1458-060	100-1035	4300	4.30	100-34
1458-061	100-1036	4400	4.40	100-35
1458-062	100-1037	4500	4.50	100-36
1458-063	100-1038	4600	4.60	100-37
1458-064	100-1039	4700	4.70	100-38
1458-065	100-1040	4800	4.80	100-39
1458-066	100-1041	4900	4.90	100-40
1458-067	100-1042	5000	5.00	100-41
1458-068	100-1043	5100	5.10	100-42
1458-069	100-1044	5200	5.20	100-43
1458-070	100-1045	5300	5.30	100-44
1458-071	100-1046	5400	5.40	100-45
1458-072	100-1047	5500	5.50	100-46
1458-073	100-1048	5600	5.60	100-47
1458-074	100-1049	5700	5.70	100-48
1458-075	100-1050	5800	5.80	100-49
1458-076	100-1051	5900	5.90	100-50
1458-077	100-1052	6000	6.00	100-51
1458-078	100-1053	6100	6.10	100-52
1458-079	100-1054	6200	6.20	100-53
1458-080	100-1055	6300	6.30	100-54
1458-081	100-1056	6400	6.40	100-55
1458-082	100-1057	6500	6.50	100-56
1458-083	100-1058	6600	6.60	100-57
1458-084	100-1059	6700	6.70	100-58
1458-085	100-1060	6800	6.80	100-59
1458-086	100-1061	6900	6.90	100-60
1458-087	100-1062	7000	7.00	100-61
1458-088	100-1063	7100	7.10	100-62
1458-089	100-1064	7200	7.20	100-63
1458-090	100-1065	7300	7.30	100-64
1458-091	100-1066	7400	7.40	100-65
1458-092	100-1067	7500	7.50	100-66
1458-093	100-1068	7600	7.60	100-67
1458-094	100-1069	7700	7.70	100-68
1458-095	100-1070	7800	7.80	100-69
1458-096	100-1071	7900	7.90	100-70
1458-097	100-1072	8000	8.00	100-71
1458-098	100-1073	8100	8.10	100-72
1458-099	100-1074	8200	8.20	100-73
1458-100	100-1075	8300	8.30	100-74
1458-101	100-1076	8400	8.40	100-75
1458-102	100-1077	8500	8.50	100-76
1458-103	100-1078	8600	8.60	100-77
1458-104	100-1079	8700	8.70	100-78
1458-105	100-1080	8800	8.80	100-79
1458-106	100-1081	8900	8.90	100-80
1458-107	100-1082	9000	9.00	100-81
1458-108	100-1083	9100	9.10	100-82
1458-109	100-1084	9200	9.20	100-83
1458-110	100-1085	9300	9.30	100-84
1458-111	100-1086	9400	9.40	100-85
1458-112	100-1087	9500	9.50	100-86
1458-113	100-1088	9600	9.60	100-87
1458-114	100-1089	9700	9.70	100-88
1458-115	100-1090	9800	9.80	100-89
1458-116	100-1091	9900	9.90	100-90
1458-117	100-1092	10000	10.00	100-91
1458-118	100-1093	10100	10.10	100-92
1458-119	100-1094	10200	10.20	100-93
1458-120	100-1095	10300	10.30	100-94
1458-121	100-1096	10400	10.40	100-95
1458-122	100-1097	10500	10.50	100-96
1458-123	100-1098	10600	10.60	100-97
1458-124	100-1099	10700	10.70	100-98
1458-125	100-1100	10800	10.80	100-99
1458-126	100-1101	10900	10.90	100-100

## INTRODUCTION

The 15-lb Bates test firings are summarized in appendix A. Various parameters are listed for each firing along with a plot of thrust, chamber pressure, and the ratio of thrust/chamber pressure as provided by AFRPL (see figures A-1 through A-10).

Table A-1 provides a cross-reference between the AFRPL test run number, Bates tube identification number, and the CSD propellant batch number. The loaded SLSH cartridge which contains each of these specific propellant batches is also identified.

TABLE A-1. 15-LB BATES MOTOR FIRINGS

T4955

Run No.	Tube No.	Batch No.	Batch Used in 84-in. SLSH No.	Reference Figure No.
148B-087	1080	400-1652	2660-01	A-1
148B-088	1100	400-1654	2660-01	A-2
148B-091	1084	400-1662	2660-04	A-3
148B-092	1092	400-1666	2660-03	A-4
148B-093	1096	400-1668	2660-03	A-5
148B-094	1097	400-1670	2660-05	A-6
148B-095	1111	400-1674	2660-05	A-7
148B-097	1104	400-1673	2660-05	A-8
148B-098	1094	400-1679	2660-07	A-9
148B-099	1114	400-1683	2660-07	A-10

BATES 15LB RUN 148B-087

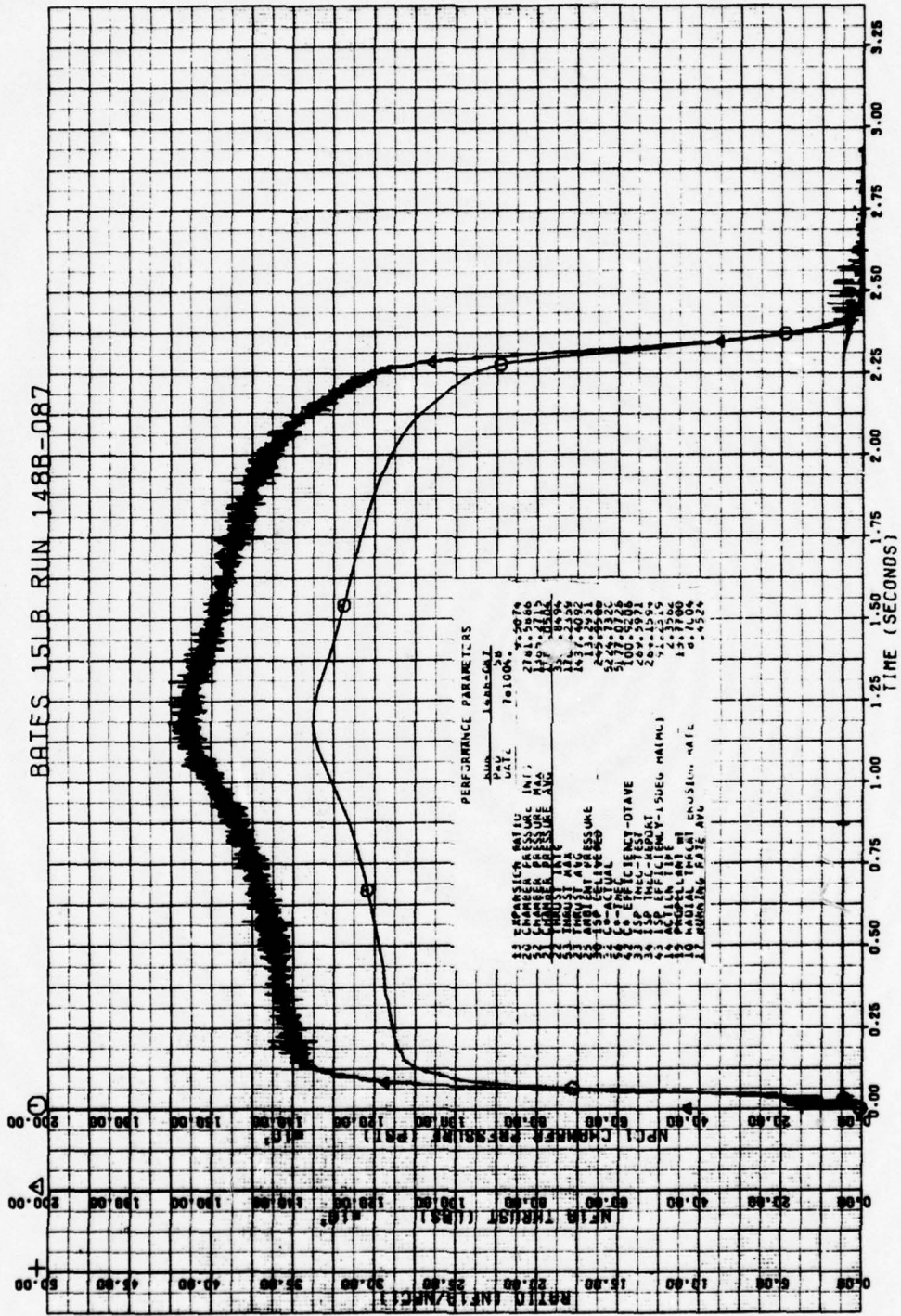

Figure A-1. Run No. 148B-087

RATES 15LB RUN 148B-088

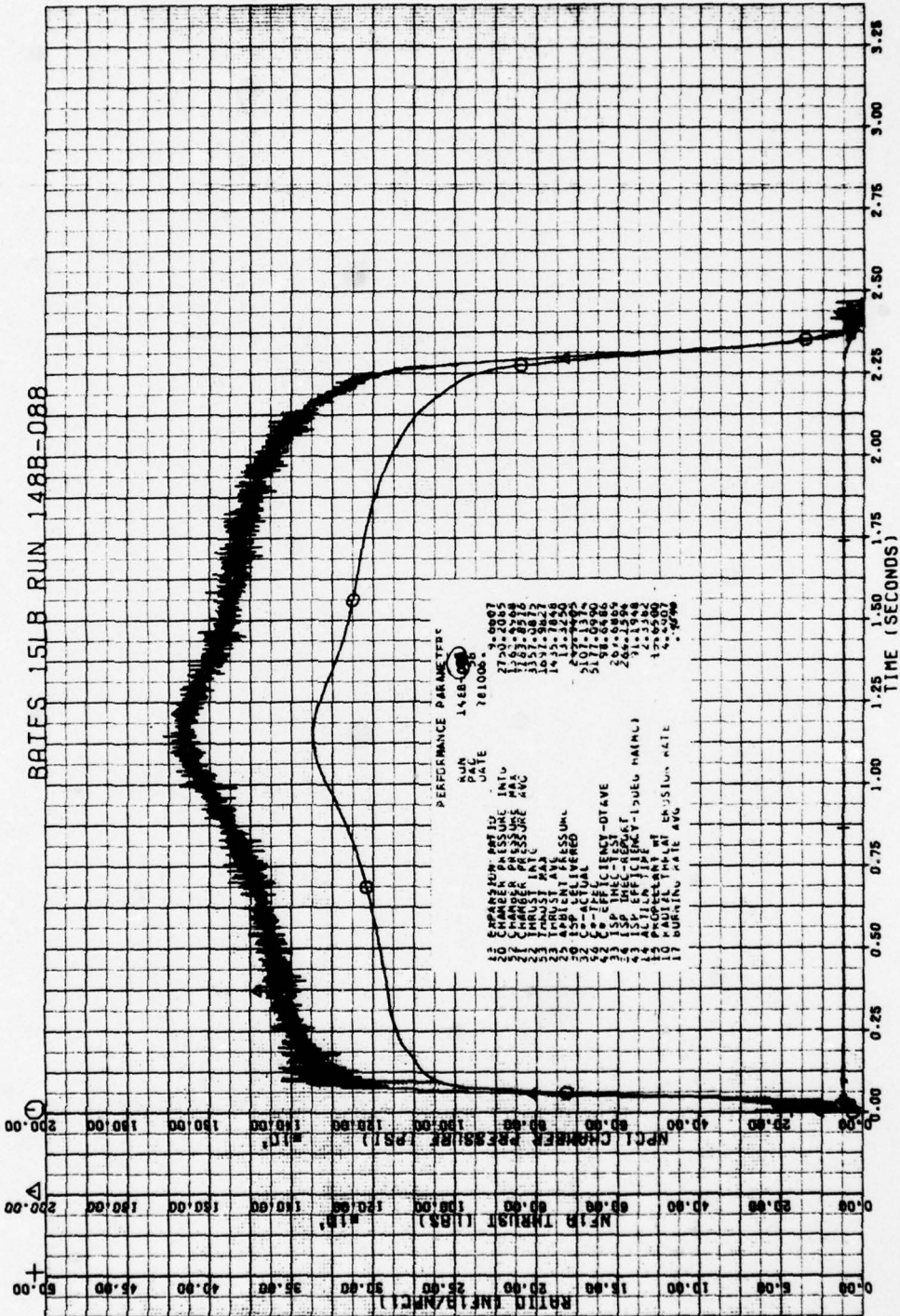

Figure A-2. Run No. 148B-088

BRIEF 15LB RUN 148B-091

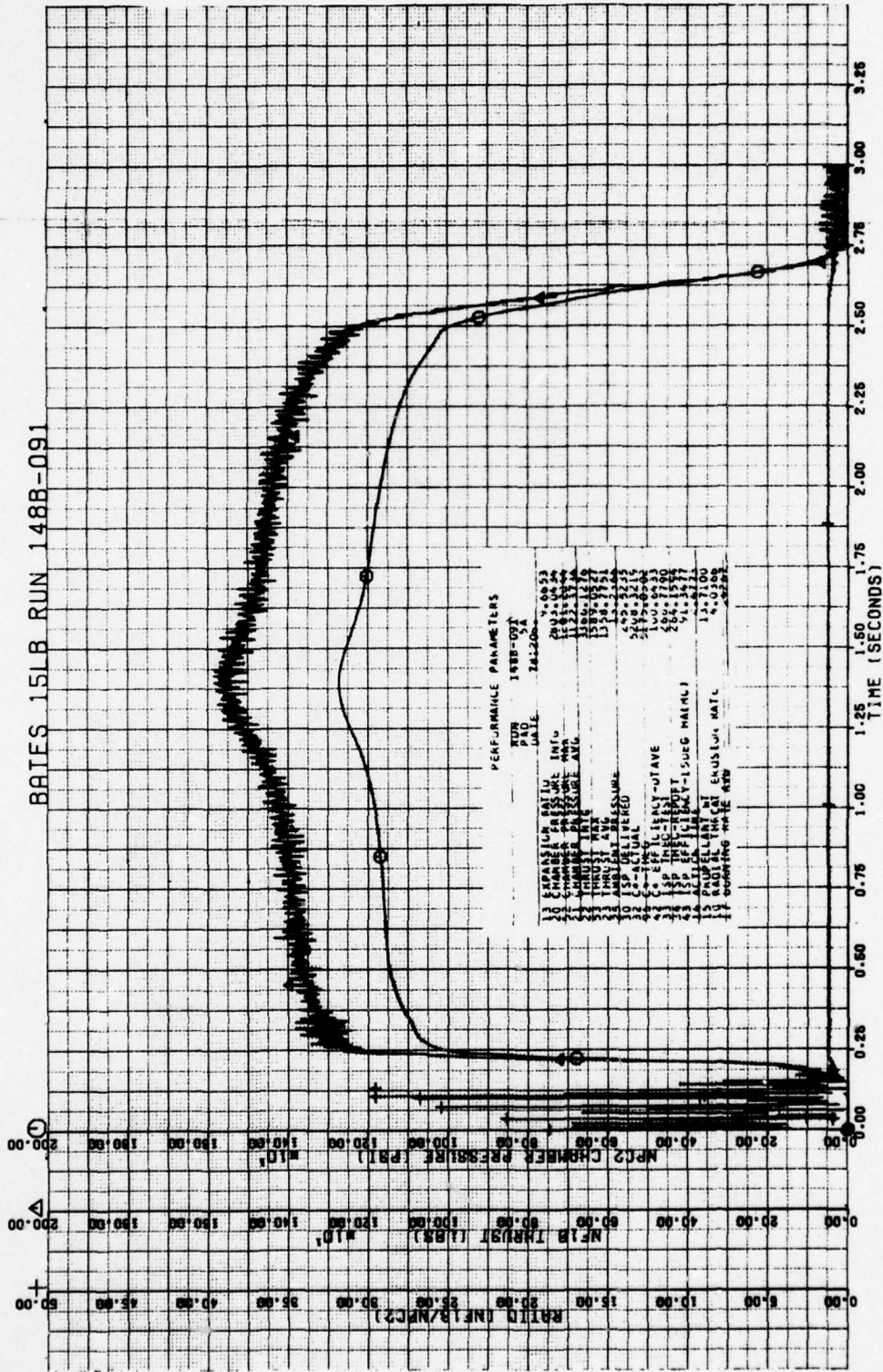

Figure A-3. Run No. 148B-091

BATES 15LB RUN 148B-092

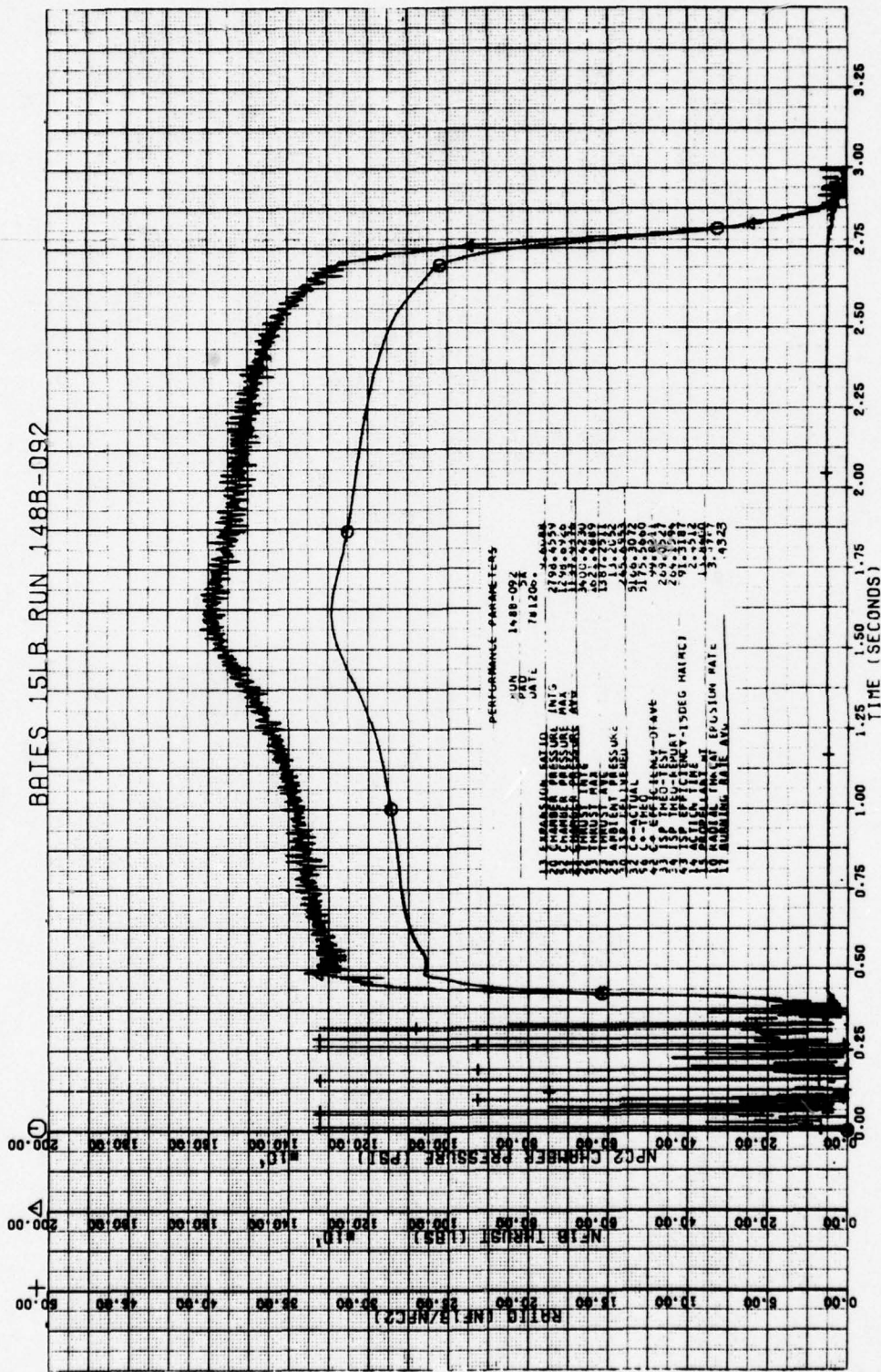
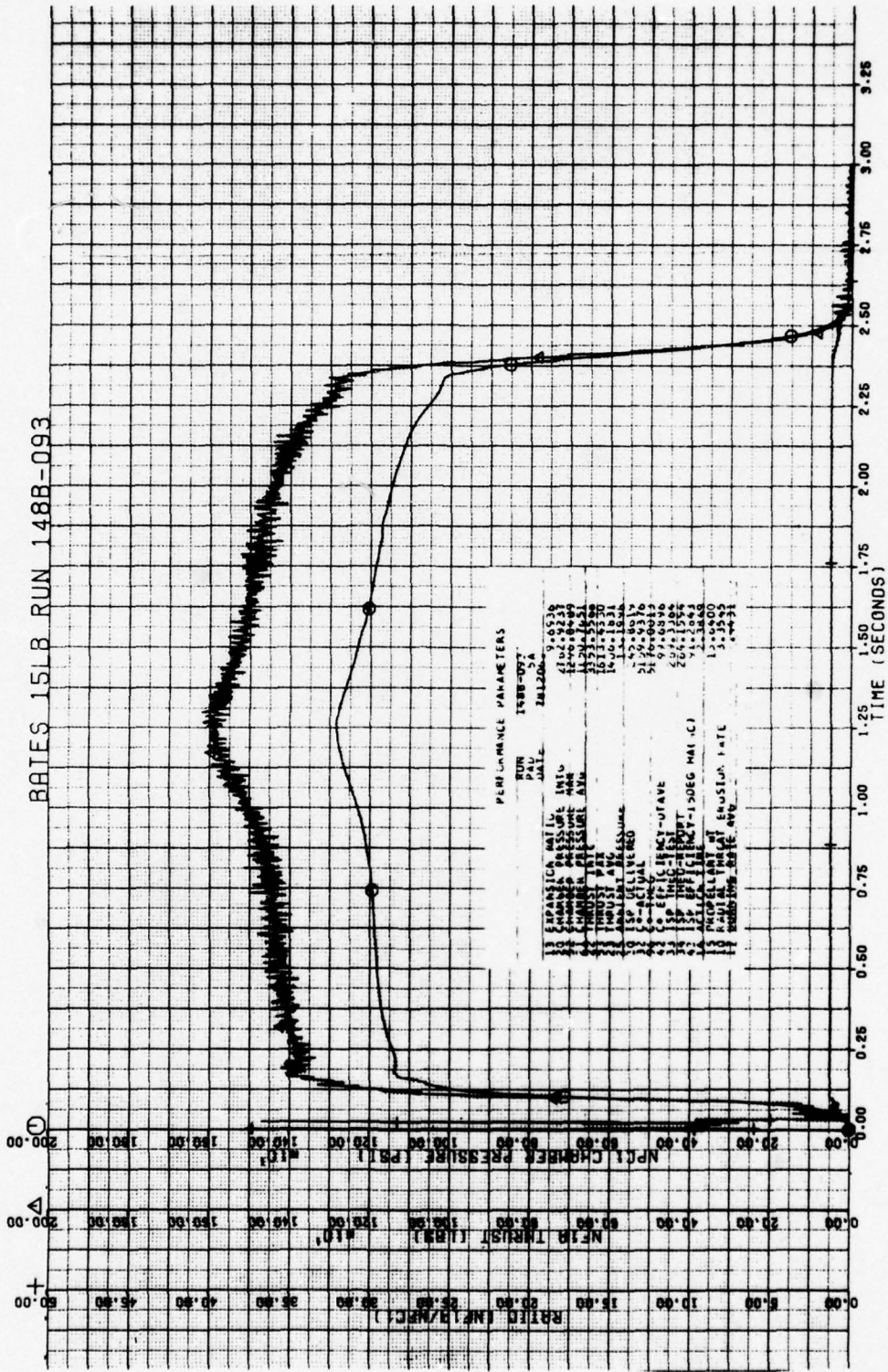

Figure A-1. Run No. 148B-092



BATES 15LB RUN 148B-093



PERFORMANCE PARAMETERS

13	ERASICA MAT L	241200	0.4539
14	ERASICA MAT L	241200	0.4539
15	CHAMBER PRESSURE INT	4100	0.9339
16	CHAMBER PRESSURE NET	4100	0.9339
17	THRUST INT	1574	0.5221
18	THRUST NET	1574	0.5221
19	THRUST PRT	1574	0.5221
20	THRUST PRT	1574	0.5221
21	THRUST PRT	1574	0.5221
22	THRUST PRT	1574	0.5221
23	THRUST PRT	1574	0.5221
24	THRUST PRT	1574	0.5221
25	THRUST PRT	1574	0.5221
26	THRUST PRT	1574	0.5221
27	THRUST PRT	1574	0.5221
28	THRUST PRT	1574	0.5221
29	THRUST PRT	1574	0.5221
30	THRUST PRT	1574	0.5221
31	THRUST PRT	1574	0.5221
32	THRUST PRT	1574	0.5221
33	THRUST PRT	1574	0.5221
34	THRUST PRT	1574	0.5221
35	THRUST PRT	1574	0.5221
36	THRUST PRT	1574	0.5221
37	THRUST PRT	1574	0.5221
38	THRUST PRT	1574	0.5221
39	THRUST PRT	1574	0.5221
40	THRUST PRT	1574	0.5221
41	THRUST PRT	1574	0.5221
42	THRUST PRT	1574	0.5221
43	THRUST PRT	1574	0.5221
44	THRUST PRT	1574	0.5221
45	THRUST PRT	1574	0.5221
46	THRUST PRT	1574	0.5221
47	THRUST PRT	1574	0.5221
48	THRUST PRT	1574	0.5221
49	THRUST PRT	1574	0.5221
50	THRUST PRT	1574	0.5221
51	THRUST PRT	1574	0.5221
52	THRUST PRT	1574	0.5221
53	THRUST PRT	1574	0.5221
54	THRUST PRT	1574	0.5221
55	THRUST PRT	1574	0.5221
56	THRUST PRT	1574	0.5221
57	THRUST PRT	1574	0.5221
58	THRUST PRT	1574	0.5221
59	THRUST PRT	1574	0.5221
60	THRUST PRT	1574	0.5221
61	THRUST PRT	1574	0.5221
62	THRUST PRT	1574	0.5221
63	THRUST PRT	1574	0.5221
64	THRUST PRT	1574	0.5221
65	THRUST PRT	1574	0.5221
66	THRUST PRT	1574	0.5221
67	THRUST PRT	1574	0.5221
68	THRUST PRT	1574	0.5221
69	THRUST PRT	1574	0.5221
70	THRUST PRT	1574	0.5221
71	THRUST PRT	1574	0.5221
72	THRUST PRT	1574	0.5221
73	THRUST PRT	1574	0.5221
74	THRUST PRT	1574	0.5221
75	THRUST PRT	1574	0.5221
76	THRUST PRT	1574	0.5221
77	THRUST PRT	1574	0.5221
78	THRUST PRT	1574	0.5221
79	THRUST PRT	1574	0.5221
80	THRUST PRT	1574	0.5221
81	THRUST PRT	1574	0.5221
82	THRUST PRT	1574	0.5221
83	THRUST PRT	1574	0.5221
84	THRUST PRT	1574	0.5221
85	THRUST PRT	1574	0.5221
86	THRUST PRT	1574	0.5221
87	THRUST PRT	1574	0.5221
88	THRUST PRT	1574	0.5221
89	THRUST PRT	1574	0.5221
90	THRUST PRT	1574	0.5221
91	THRUST PRT	1574	0.5221
92	THRUST PRT	1574	0.5221
93	THRUST PRT	1574	0.5221
94	THRUST PRT	1574	0.5221
95	THRUST PRT	1574	0.5221
96	THRUST PRT	1574	0.5221
97	THRUST PRT	1574	0.5221
98	THRUST PRT	1574	0.5221
99	THRUST PRT	1574	0.5221
100	THRUST PRT	1574	0.5221

Figure A-5. Run No. 148B-093

BATES 15LB RUN 1488-094

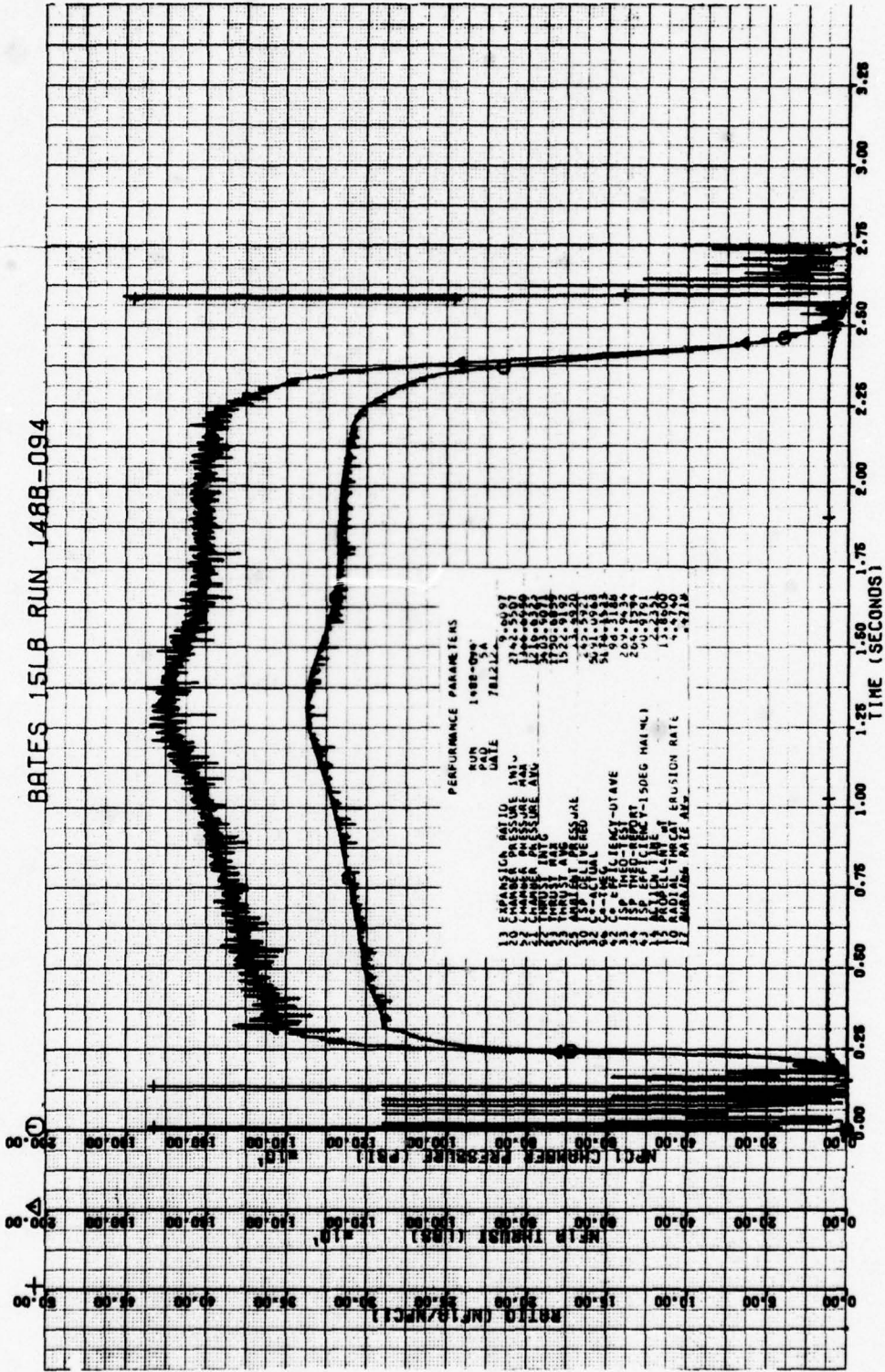

Figure A-6. Run No. 1488-094

# BATES ISLB RUN 148B-095

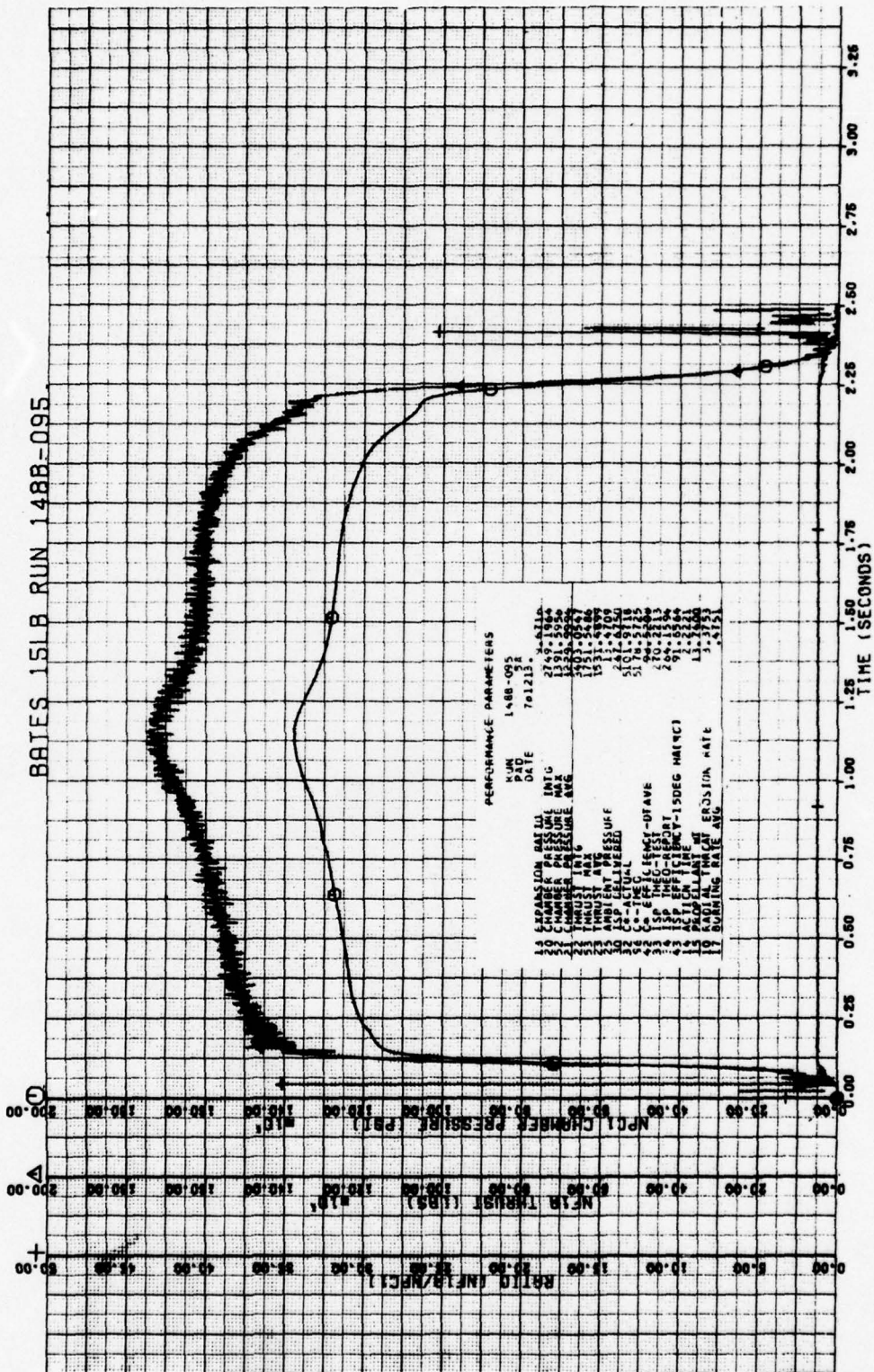

Figure A-7. Run No. 148B-095

BATES 15LB RUN 148B-097

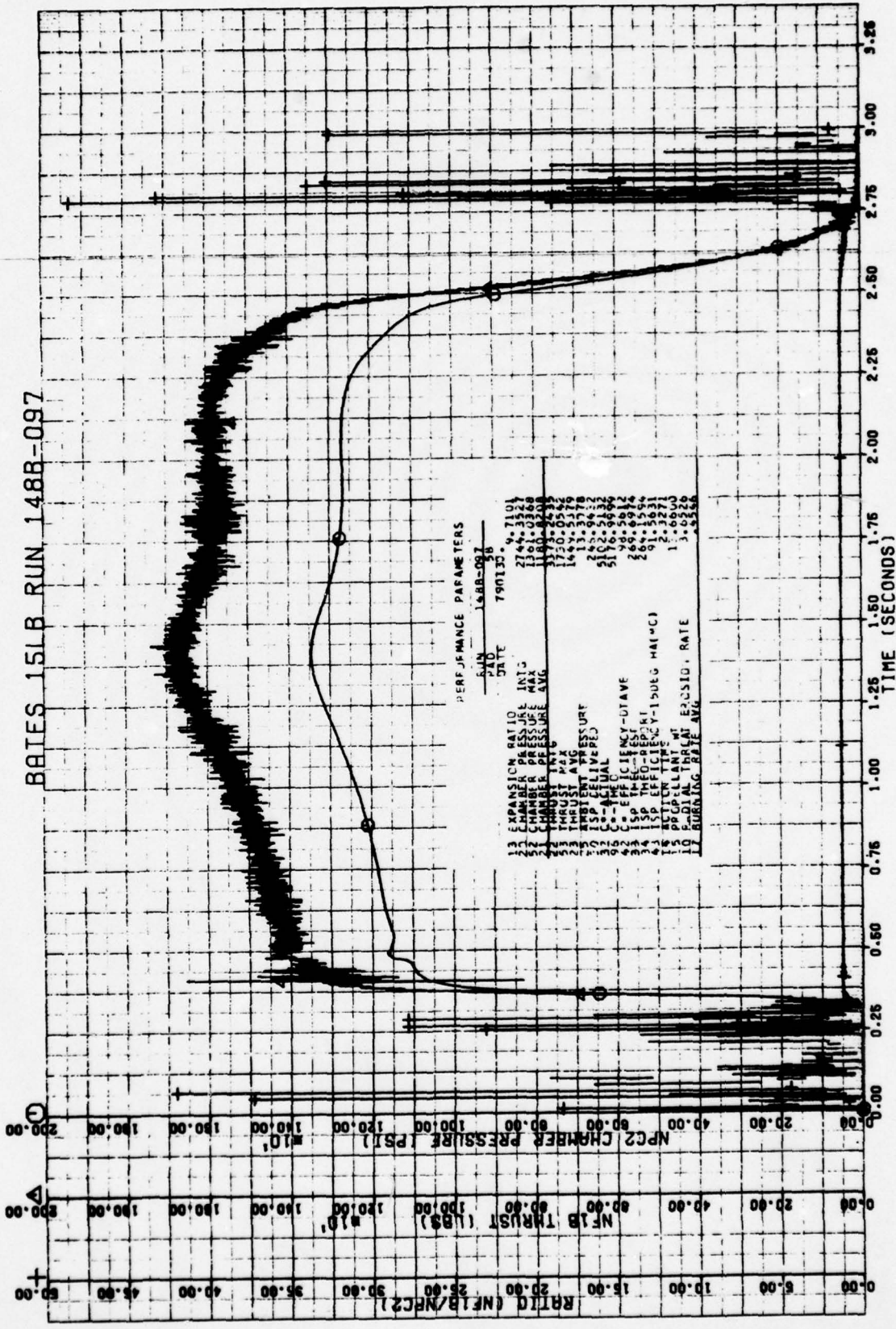

Figure A-8. Run No. 148B-097

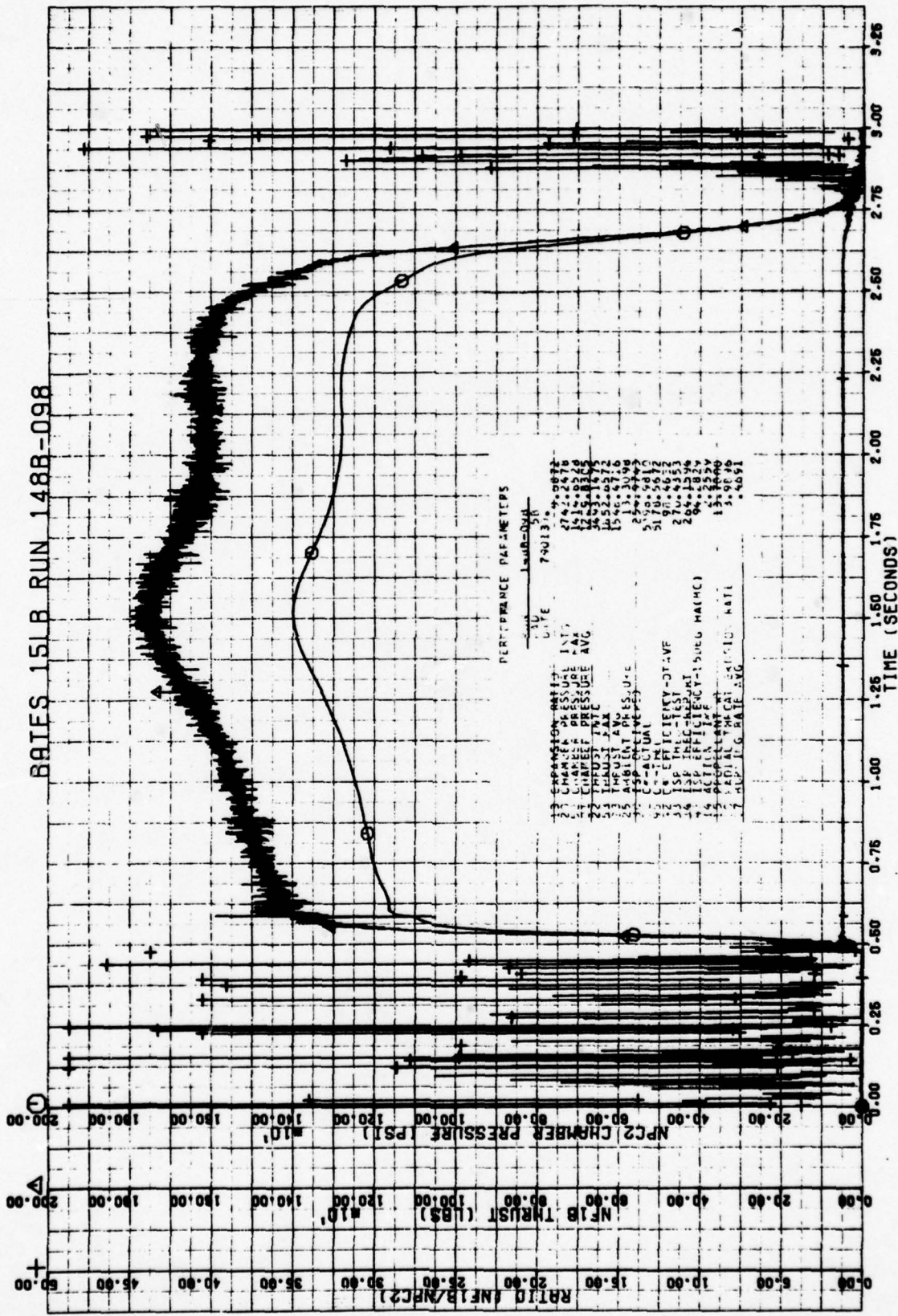

Figure A-9. Run No. 148B-098

THIS PAGE IS BEST QUALITY PRACTICE FROM COPY FURNISHED TO DDC

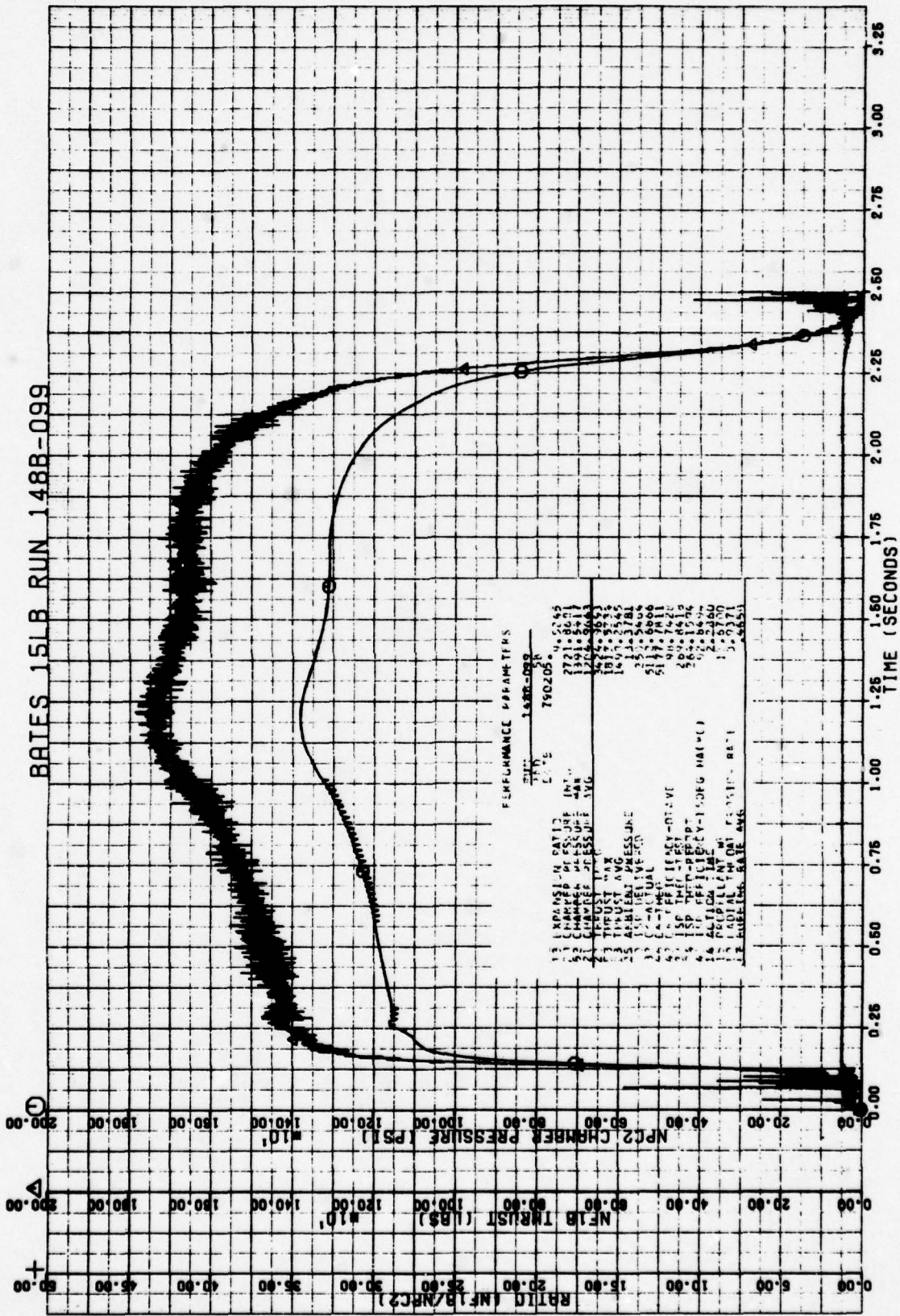

Figure A-10. Run No. 148B-099

THIS PAGE IS BEST QUALITY PRACTICABLE  
FROM COPY FURNISHED TO DDC

INTRODUCTION

Appendix B contains the product acceptance records for each of the seven 22-lb. cartridges containing M79-15, 802A. These records were provided with each grain at the time of delivery to AFMFL.

APPENDIX B

PRODUCT ACCEPTANCE RECORDS

## INTRODUCTION

Appendix B contains the product acceptance records for each of the seven 84-in. cartridges containing UTP-18,803A. These records were provided with each grain at the time of delivery to AFRPL.



PRODUCT ACCEPTANCE RECORD															
1 PART NUMBER C13199-01-01	2 PART NAME LOADED CARTRIDGE SLSH	3 SERIAL NUMBER/ LOT NUMBER 2660-01	4 CONFIGURATION C13199 and ECO 21323	5. PAR REVISION NUMBER BASIC DATE 8-4-78	6. OPERATIONS PLANNING REFERENCE 56762	12. VERIFICATION STAMP									
7 PVP HEF	8 QUALITY REQUIREMENT DESCRIPTION (FEATURE)	9 FEATURE TOLERANCE	10 ATT/ VAR	11 MEASURED RESULTS											
1	Verify propellant weight.	Engineering Information VAR		20,697.54 lbs.											
2	After cure, visually inspect propellant for cracks and voids.	No cracks allowed. No voids > 0.5"	VAR	O.K.											
3	Verify bore diameter at 0° and 90° at forward center and aft end.	Engineering Information VAR	VAR	<table border="1"> <tr><td>24.76</td><td>90°</td><td>ATT</td></tr> <tr><td>24.582</td><td>24.582</td><td>ATT</td></tr> <tr><td>24.500</td><td>24.492</td><td>ATT</td></tr> </table>	24.76	90°	ATT	24.582	24.582	ATT	24.500	24.492	ATT		
24.76	90°	ATT													
24.582	24.582	ATT													
24.500	24.492	ATT													
4	Verify grain length at four locations - 0°, 90°, 180°, 270°	Engineering Information VAR	VAR	0° 90° 180° 270° 70.0 70.0 69.8 70.0											
5	Verify identification per (ECO 21323).	Clear and complete	ATT												
6	Propellant Physical Properties per SE0719A and 720A. (BIT data not required per ECO 21487) Viscosity, 1 hour after IPDI addition @ 140°F 40 Kpoise max. Modulus (Engineering Information) Tensile Strength at max. load $\epsilon_m$ True Elongation at max. load $\epsilon_m$	Propellant Physical Properties per SE0719A and 720A. (BIT data not required per ECO 21487) Viscosity, 1 hour after IPDI addition @ 140°F 40 Kpoise max. Modulus (Engineering Information) Tensile Strength at max. load $\epsilon_m$ True Elongation at max. load $\epsilon_m$	VAR	Batch Summary attached											
7	Propellant Ballistic batch check	Per Figure 1, SE0719A	VAR	Batch Summary attached											
14 QA ACCEPTANCE M.E. Heblum 8-4-78		15 CUSTOMER ACCEPTANCE M.E. Heblum 9/22/78													

THIS PAGE IS BEST QUALITY PRACTICES  
FROM COPY FURNISHED TO DDC

PRODUCT ACCEPTANCE RECORD





1 PART NUMBER C13199-01-01	2 PART NAME LOADED CARTRIDGE SLSH	3 SERIAL NUMBER/ LOT NUMBER 2660-02	4 CONFIGURATION C13199 and ECO 21323	5 PAR REVISION NUMBER BASIC DATE 8-4-78	6 OPERATIONS PLANNING REFERENCE 56763
7 PVP REF	8 QUALITY REQUIREMENT DESCRIPTION (FEATURE)	9 FEATURE TOLERANCE	10 ATT/ VAR	11 MEASURED RESULTS	12 VERIFICATION STAMP
1	Verify propellant weight.	Engineering Information VAR	VAR	29,696.85 lbs.	
2	After cure, visually inspect propellant for cracks and voids.	No cracks allowed. No voids > 0.5"	VAR	O.K.	
3	Verify bore diameter at 0° and 90° at forward center and aft end.	Engineering Information VAR	VAR	0° 24.371 90° 24.533 24.567 24.368 24.551 AFT.	
4	Verify grain length at four locations - 0°, 90°, 180°, 270°	Engineering Information VAR	VAR	0° 90° 180° 270° 70.0 70.0 70.0 70.0	
5	Verify identification per (ECO 21323).	Clear and complete	ATT		
6	Propellant Physical Properties per SE0719A and 720A. (BIT data not required per ECO 21487) Viscosity, 1 hour after IPDI addition @ 140°F 40 Kpoise max. Modulus (Engineering Information) Tensile Strength at max. load $\frac{d_c}{m}$ True Elongation at max. load $\frac{d_c}{m}$	Propellant Physical Properties per SE0719A and 720A. (BIT data not required per ECO 21487) Viscosity, 1 hour after IPDI addition @ 140°F 40 Kpoise max. Modulus (Engineering Information) Tensile Strength at max. load $\frac{d_c}{m}$ True Elongation at max. load $\frac{d_c}{m}$	VAR	Batch Summary attached	
7	Propellant Ballistic batch check	Per Figure 1, SE0719A	VAR	Batch Summary attached	
13. JR. SIGNATOR M.C. Nicholson 8-4-78		14. QA ACCEPTANCE M.C. Nicholson 9/22/78		15. CUSTOMER ACCEPTANCE	

THIS PAGE IS BEST QUALITY PRACTICES  
FROM COPY FURNISHED TO DDC

TABLE B-1.

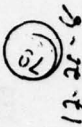

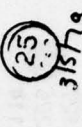

Batch No.	Burning Rate	Burning Rate Exponent	Burning Rate At 85 F ( K = 0.104#/F)		
	At 1,000 psi At 70 F (IPS)		800 psia (IPS)	1,000 psia (IPS)	1,700 psia (IPS)
400-1652	0.4016	0.4095	0.3699	0.4053	0.5036
400-1653	0.4067	0.4675	0.3694	0.4101	0.5255
400-1654	0.4059	0.4227	0.3726	0.4095	0.5124
400-1655	0.4136	0.4366	0.3784	0.4172	0.5259
400-1656	0.4090	0.4096	0.3766	0.4127	0.5129
400-1657	0.4190	0.4508	0.3821	0.4226	0.5368
400-1658	0.4074	0.3738	0.3784	0.4114	0.5016
400-1659	0.4078	0.4058	0.3756	0.4116	0.5105
400-1660	0.4053	0.3850	0.3755	0.4096	0.5019
<u>Motor S/N 2660-01</u>					
400-1652 through 1656	0.4075	0.4326	0.3732	0.4111	0.5171
<u>Motor S/N 2660-02</u>					
400-1656 through 1660	0.4101	0.4096	0.3777	0.4139	0.5144
<u>Total nine batches</u>					
400-1652 through 1660	0.4088	0.4227	0.3753	0.4125	0.5162
<u>Specification Limits</u>					
		Upper	0.403	0.442	0.553
		Lower	0.360	0.397	0.501

THIS PAGE IS BEST QUALITY PRACTICE  
FROM COPY FURNISHED TO DDG

PRODUCT ACCEPTANCE RECORD							57295
1 PART NUMBER	2 PART NAME	3 SERIAL NUMBER/ LOT NUMBER	4 CONFIGURATION	5. PAR REVISION NUMBER	6 OPERATIONS PLANNING REFERENCE	12 VERIFICATION STAMP	
C13199-01-01	LOADED CARTRIDGE SLSH	2660-03	C13199 and ECO 21323	BASIC DATE 8-4-78			
7 PVP REF	8 QUALITY REQUIREMENT DESCRIPTION (FEATURE)	9 FEATURE TOLERANCE	10 ATT/ VAR	11. MEASURED RESULTS			
1	Verify propellant weight.	Engineering Information VAR		Ref. to PCN 57295-A I.D.R. # 045053			
2	After cure, visually inspect propellant for cracks and voids.	No cracks allowed. No voids > 0.5"					
3	Verify bore diameter at 0° and 90° at forward center and aft end.	Engineering Information VAR					
4	Verify grain length at four locations - 0°, 90°, 180°, 270°	Engineering Information VAR					
5	Verify identification per (ECO 21323).	Clear and complete	ATT				
6	Propellant Physical Properties per SE0719A and 720A. (BIT data not required per ECO 21323) Viscosity, 1 hour after IPDI addition @ 140°F 40 Kpoise max. Modulus (Engineering Information) Tensile Strength at max. load $\epsilon_m^c$ True Elongation at max. load $\epsilon_m^c$	Propellant Physical Properties per SE0719A and 720A. (BIT data not required per ECO 21323) Viscosity, 1 hour after IPDI addition @ 140°F 40 Kpoise max. Modulus (Engineering Information) Tensile Strength at max. load $\epsilon_m^c$ True Elongation at max. load $\epsilon_m^c$	VAR	Batch Summary attached			
7	Propellant Ballistic batch check	Per Figure 1, SE0719A	VAR	Batch Summary attached			
13 ORIGINATOR W.C. Nicholas 8-4-78		14 QA ACCEPTANCE <i>E. Reed</i>		15 CUSTOMER ACCEPTANCE 76/79			

PRODUCT ACCEPTANCE RECORD

\* For IIRK #045053.

1. PART NUMBER	2. PART NAME	3. SERIAL NUMBER/ LOT NUMBER	4. CONFIGURATION	5. PVP PART NUMBER	6. OPERATIONS PLANNING REFERENCE
C13199-01-01	LOADED CARTRIDGE SLSH - REPAIR	003	C13199 and ECO 21323	PVP BASIC DATE 2/2/79	
7. PVP REF	8. QUALITY REQUIREMENT DESCRIPTION (FEATURE)	9. FEATURE TOLERANCE	10. ATT/ VAR	11. MEASURED RESULTS	12. VERIFICATION STAMP
1	Verify propellant weight.	Engineering Information	VAR	20,982.2	 3-1-9
2	After cure, visually inspect propellant for	No cracks allowed. No voids 0.5"	VAR	O.K.	 3-1-9
3	Verify bore diameter at 0° and 90° at forward center and aft end.	Engineering Information	VAR	fwd 24.77 aft 24.60 aft 24.43	 3-1-9
4	Verify grain length at four locations - 0°, 90°, 180°, 270°	Engineering Information	VAR	0°: 70 1/2 90°: 70 1/4 180°: 70 3/4 270°: 70 1/2	 3-1-9
13 ORIGINATOR	14. QA ACCEPTANCE		15. CUSTOMER ACCEPTANCE		
			3/6/79		

THIS PAGE IS BEST QUALITY PRACTICABLE  
FROM COPY FURNISHED TO DDC

**THIS PAGE IS BEING QUALITY PRACTICES FROM COPY FURNISHED TO DDG**

PRODUCT ACCEPTANCE RECORD				5700	
7 PART NO.	8 PART NAME	9 SERIAL NUMBER	10 CONFIGURATION	11 PART REVISION NUMBER	12 OPERATIONS PLANNING REFERENCE
CL1119-01-01	LOADED CARTRIDGE	7660-Y	CL1199 and ECO 21323	BASIC	
	QUALITY REQUIREMENT DESCRIPTION, FEATURE	SLSH		DATE	
				8-4-78	
				MEASURED RESULTS	12 VERIFICATION STAMP
1	Verify propellant weight.		Engineering Information VAR	25772.97	
2	After cure, visually inspect propellant for cracks and voids.		No cracks allowed. No voids > 0.5" VAR	<del>25772.97</del>	
3	Verify bore diameter at 0° and 90° at forward center and aft end.		Engineering Information VAR	9.6 FW - 24.35 CA - 24.55 ART - 24.52	
4	Verify grain length at four locations - 0°, 90°, 180°, 270°		Engineering Information VAR	27.54 27.25 27.25 27.25	
5	Verify identification per (ECO 21323).		Clear and complete ATT		
6	Propellant Physical Properties per SE0719A and 720A. (BIT data not required per ECO 21487) Viscosity, 1 hour after IPDI addition @ 140°F 40 Kpoise max. Modulus (Engineering Information) Tensile Strength at max. load $\sigma_c$ True Elongation at max. load $\epsilon_c$		VAR Batch Summary attached		
7	Propellant Ballistic batch check		Per Figure: VAR Batch Summary attached 1, SE0719A		
				14 QA ACCEPTANCE	
				15 CUSTOMER ACCEPTANCE	
				11-18-78	

TABLE B-2.

Batch No.	Burning Rate At 1,000 psi at 70 F (IPS)	Burning Rate Exponent	Burning Rate At 85 F ( K = 0.104%/F)	
			800 psia (IPS)	1,000 psia (IPS)
400-1661	0.3992	0.4099	0.3677	0.4029
400-1662	0.4042	0.3688	0.3759	0.4082
400-1663	0.4039	0.4173	0.3714	0.4076
400-1664	0.3996	0.3884	0.3699	0.4034
400-1665	0.4009	0.4199	0.3683	0.4045
400-1666	0.4029	0.4353	0.3688	0.4065
400-1667	0.4037	0.4223	0.3708	0.4074
400-1668	0.4063	0.4363	0.3719	0.4099
400-1669	0.4041	0.3855	0.3744	0.4080
<u>Motor S/N 2660-04</u>				
400-1661 through 1665	0.4015	0.3994	0.3707	0.4053
<u>Motor S/N 2660-03</u>				
400-1665 through 1669	0.4037	0.4182	0.3711	0.4074
<u>Total nine batches</u>				
400-1661 through 1669	0.4028	0.4096	0.3709	0.4065
<u>Specification Limits</u>				
		Upper	0.403	0.442
		Lower	0.360	0.397
				0.5086
				0.5052
				0.553
				0.501

THIS PAGE IS BEST QUALITY PRACTICABLE  
FROM COPY FURNISHED TO DDG

PRODUCT ACCEPTANCE RECORD						
1 PART NUMBER C13199-01-01	2 PART NAME LOADED CARTRIDGE SLSH	3 SERIAL NUMBER 266-05	4 CONFIGURATION C13199 and EOD 21323	5 PART NUMBER OF MODEL BASIC	6 DATE 8-4-78	7 REVISION 57906
7 PVP REF	8 QUALITY REQUIREMENT DESCRIPTION (FEATURE)	9 FEATURE TOLERANCE	10 ATT VAR	11 MEASURED RESULTS	12 SIGNATURE	13 DATE
1	Verify propellant weight.	Engineering Information VAR		29,515.0 ACS *		11/15/78
2	After cure, visually inspect propellant for cracks and voids.	No cracks allowed. No voids > 0.5"	VAR	O.K.		11/15/78
3	Verify bore diameter at 0° and 90° at forward center and aft end.	Engineering Information VAR	VAR	0° 24.390 90° 24.971 180° 24.630		11/29/78
4	Verify grain length at four locations - 0°, 90°, 180°, 270°	Engineering Information VAR	VAR	0°-69.70 90°-69.70 180°-69.70		11/29/78
5	Verify identification per (EOD 21323).	Clear and complete	ATT			12/4/78
6	Propellant Physical Properties per SE0719A and 720A. (BIT data not required per ECU 21167) Viscosity, 1 hour after IPDI addition @ 140°F 40 Kpoise max. Modulus (Engineering Information) Tensile Strength at max. load d <sub>c</sub> True Elongation at max. load ε <sub>m</sub>	Per Figure 1, SE0719A	VAR	Batch Summary attached		12/11/78
7	Propellant Ballistic batch check *Correct weight is 20,645 lb	Per Figure 1, SE0719A	VAR	Batch Summary attached		12/11/78
13 ORIGINATOR	14 QA ACCEPTANCE		15 CUSTOMER ACCEPTANCE			
ME Nicholson 8-4-78	ME Nicholson 12/15/78					



TABLE B-3







T4958

Batch No.	Burning Rate at 85 F	
	800 psia (IPS)	1,000 psia (IPS)
400-1670	0.378	0.409
400-1671	0.380	0.412
400-1672	0.380	0.404
400-1673	0.374	0.409
400-1674	0.385	0.420
Total of five batches		
400-1670 through 400-1674	0.379	0.412
<u>Specification Limits</u>		
Upper	0.403	0.442
Lower	0.360	0.397
<u>Burning Rate Exponent</u>		
0.3665 below 1100 psia		
0.6680 above 1100 psia		

THIS PAGE IS BEST QUALITY PRACTICE  
FROM OUR UNFINISHED TO DOG

PRODUCT ACCEPTANCE RECORD						
1 PART NUMBER	2 CARTRIDGE	3 SERIAL NUMBER LOT NUMBER	4 CONFIGURATION	5 MANUFACTURE DATE	6 OPERATING PLANS REFERENCE	7 VERIFICATION STAMP
C13199-01-01	LOADED CARTRIDGE SLSH	2660-06	C13199 and ECO 21323	8-6-75		
8 PWP REF	9 FEATURE TOLERANCE	10 ATT' VAR	11	12 ACQUIRED RESULTS	13	14
	QUALITY REQUIREMENT DESCRIPTION (IF FEATURE)		Engineering Information VAR			
1	Verify propellant weight.		Engineering Information VAR	20818.1 LBS		
2	After cure, visually inspect propellant for cracks and voids.		No cracks allowed. No voids > 0.5" VAR	OK		
3	Verify bore diameter at 0° and 90° at forward center and aft end.		Engineering Information VAR	0° 90° 24.465 24.431 FWD 24.943 24.947 CEAR 24.570 24.518 AFT		
4	Verify grain length at four locations - 0°, 90°, 180°, 270°		Engineering Information VAR	0° 90° 180° 270° 0° 70.0 90° 69.87 180° 69.87 270° 69.37		
5	Verify identification per (ECO 21323).		Clear and complete ATT			
6	Propellant Physical Properties per SE0719A and 720A. (SIT data not required per ECO 21323) Viscosity, 1 hour after IPDI addition @ 140°F ± 0.1 kpoise max. Modulus (Engineering Information) Tensile Strength at max. load σ <sub>m</sub> True Elongation at max. load ε <sub>m</sub>		VAR	Batch Summary attached		
7	Propellant Ballistic batch check		VAR	Batch Summary attached		
11	ORIGINATOR	12	13	14	15	16
MIC Techn. Co. 5-4-76						

**PRODUCT ACCEPTANCE RECORD**

<b>1 PART NUMBER</b> C13199-01-01	<b>2 PART NAME</b> LOADED CARTRIDGE SLSH	<b>3 SERIAL NUMBER/ LOT NUMBER</b> 2660-07	<b>4 CONFIGURATION</b> C13199 and ECO 21323	<b>5 PART REVISION NUMBER</b> BASIC DATE 8-4-78	<b>6 VERIFICATION REFERENCE</b> 14
<b>7 PVP REF</b>	<b>8 QUALITY REQUIREMENT DESCRIPTION (FEATURE)</b>	<b>9 FEATURE TOLERANCE</b>	<b>10 ATT. VAR</b>	<b>11 MEASURED RESULTS</b>	<b>12 VERIFICATION STAMP</b>
1	Verify propellant weight.	Engineering Information VAR			
2	After cure, visually inspect propellant for cracks and voids.	No cracks allowed. No voids > 0.5"	VAR	O.K.	
3	Verify bore diameter at 0° and 90° at forward center and aft end.	Engineering Information VAR		0°-69.25 90°-69.25 180°-69.25 270°-69.25	
4	Verify grain length at four locations - 0°, 90°, 180°, 270°	Engineering Information VAR		0° 79.9 24.320 24.362 24.975 24.983 24.522 24.504	
5	Verify identification per (ECO 21323).	Clear and complete	ATT		
6	Propellant Physical Properties per SE0719A and 720A. (BIT data not required per ECO 21487) Viscosity, 1 hour after IPDI addition @ 140°F 40 Kpoise max. Modulus (Engineering Information) Tensile Strength at max. load $\epsilon_m$ True Elongation at max. load $\epsilon_m$	Batch Summary attached	VAR		
7	Propellant Ballistic batch check	Per Figure 1, SE0719A	VAR	Batch Summary attached	
<b>13 ORIGINATOR</b> Mc Donnell Douglas 8-4-78		<b>14 QA ACCEPTANCE</b> <i>E. Blinn</i>		<b>15 DATE OF ACCEPTANCE</b>	

**THIS PAGE IS BEST QUALITY PRACTICE  
FROM COPY FURNISHED TO DDC**

TABLE B-4

Batch No.	Burning Rate at 85 F	
	800 psia (IPS)	1,000 psia (IPS)
400-1675	0.384	0.422
400-1676	0.387	0.422
400-1677	0.379	0.412
400-1678	0.376	0.409
400-1679	0.394	0.415
400-1680	0.384	0.422
400-1681	0.385	0.420
400-1682	0.385	0.419
400-1683	0.386	0.420
Total of nine batches		
400-1675 through 1683	0.382	0.417
S/N 2560-06 Batches	0.381	0.415
400-1675 through 1679		
S/N 2560-07 Batches	0.385	0.419
400-1679 through 1683		
<u>Specification Limits</u>		
Upper	0.403	0.442
Lower	0.360	0.397

#### ABBREVIATIONS

AFRPL	Air Force Rocket Propulsion Laboratory
AP	ammonium perchlorate
AQL	acceptable quality level
BATES	ballistic and test evaluation system
C/C	carbon/carbon
CSD	Chemical Systems Division
DOT	Department of Transportation
EDP	engineering development program
ELSH	extended length super HIPPO
EOF	end of firing
GFE	Government-furnished equipment
GPC	gel permeation chromatography
HIPPO	high internal pressure producing orifice
HTPB	hydroxyl-terminated polybutadiene
ICBM	intercontinental ballistic missile
ID	inner diameter
IDP	isodecyl pelargonate
IPDI	isophorone diisocyanate
IR&D	independent research and development
ITE	integral throat and entrance
LSBR	liquid strand burning rate
MEOP	maximum expected operating pressure
MRB	Material Review Board
NDT	nondestructive testing
OD	outside diameter
O&QR	operation and quality record
PAR	product acceptance record
PBAN	poly(butadiene-acrylic acid-acrylonitrile)
PCO	Procuring Contracting Officer
QC	quality control
SLSH	short length super HIPPO
SRM	solid rocket motor
UTI	Chemical Systems Division inert propellant prefix
UTL	Chemical Systems Division liner prefix
UTP	Chemical Systems Division propellant prefix