

LEVEL

AD

TECHNICAL REPORT
WATICK/TR-79/918

**EXPERIMENTAL MEASUREMENT OF
STRAIN AND DEFLECTION IN A UNIFORMLY LOADED
SIMPLY SUPPORTED COMPOSITE PANEL**

ADA070917

D D C
PROFILE
JUL 8 1978
RECEIVED
D

by

Franklin D. Barca

Approved for public release;
Distribution unlimited.

November 1978



UNITED STATES ARMY
RESEARCH AND DEVELOPMENT COMMAND
WATICK, MASSACHUSETTS 01760

Aero-Mechanical Engineering Laboratory

Approved for public release; distribution unlimited.

Citation of trade names in this report does not constitute an official indorsement or approval of the use of such items.

Destroy this report when no longer needed. Do not return it to the originator.

REPORT DOCUMENTATION PAGE		READ INSTRUCTIONS BEFORE COMPLETING FORM												
1. REPORT NUMBER 14 NATICK/TR-79/018	2. GOVT ACCESSION NO.	3. RECIPIENT'S CATALOG NUMBER 9												
4. TITLE (and Subtitle) 6 EXPERIMENTAL MEASUREMENT OF STRAIN AND DEFLECTION IN A UNIFORMLY LOADED SIMPLY SUPPORTED COMPOSITE PANEL		5. TYPE OF REPORT & PERIOD COVERED Final Report January 1976 - September 1977												
7. AUTHOR(s) 10 Franklin D. Barca		6. PERFORMING ORG. REPORT NUMBER												
9. PERFORMING ORGANIZATION NAME AND ADDRESS US Army Natick Research & Development Command Aero-Mechanical Engineering Laboratory Natick, MA 01760		10. PROGRAM ELEMENT, PROJECT, TASK AREA & WORK UNIT NUMBERS 10 1L762723AH98AE 030 BG 1L762723A427 007 BG												
11. CONTROLLING OFFICE NAME AND ADDRESS US Army Natick Research & Development Command Aero-Mechanical Engineering Laboratory Natick, MA 01760		12. REPORT DATE 11 November 1978												
14. MONITORING AGENCY NAME & ADDRESS (if different from Controlling Office) 12 81 P.		13. NUMBER OF PAGES												
		15. SECURITY CLASS. (of this report) UNCLASSIFIED												
		15a. DECLASSIFICATION/DOWNGRADING SCHEDULE												
16. DISTRIBUTION STATEMENT (of this Report) Approved for public release; distribution unlimited.														
17. DISTRIBUTION STATEMENT (of the abstract entered in Block 20, if different from Report)														
18. SUPPLEMENTARY NOTES														
19. KEY WORDS (Continue on reverse side if necessary and identify by block number) <table border="0"> <tr> <td>PANELS</td> <td>LOAD (FORCES)</td> <td>PORTABLE SHELTERS</td> </tr> <tr> <td>STRESSES</td> <td>MEASUREMENT</td> <td>SANDWICH PANELS</td> </tr> <tr> <td>STRAINS</td> <td>CONTAINERS</td> <td>SANDWICH CONSTRUCTION</td> </tr> <tr> <td>DEFLECTION</td> <td>SHELTERS</td> <td>HONEYCOMB STRUCTURES</td> </tr> </table>			PANELS	LOAD (FORCES)	PORTABLE SHELTERS	STRESSES	MEASUREMENT	SANDWICH PANELS	STRAINS	CONTAINERS	SANDWICH CONSTRUCTION	DEFLECTION	SHELTERS	HONEYCOMB STRUCTURES
PANELS	LOAD (FORCES)	PORTABLE SHELTERS												
STRESSES	MEASUREMENT	SANDWICH PANELS												
STRAINS	CONTAINERS	SANDWICH CONSTRUCTION												
DEFLECTION	SHELTERS	HONEYCOMB STRUCTURES												
20. ABSTRACT (Continue on reverse side if necessary and identify by block number) <p>The details of a study to experimentally determine the strain and deflection profile induced in a uniformly loaded, simply supported 1.1-m X 2.3-m aluminum-skin Kraft-paper-honeycomb-core sandwich panel are documented. Twelve panels typical of the type used in military rigid wall tactical shelters were tested at loadings up to 70 kPa. The experimental procedure and apparatus, including a special vacuum chamber constructed to stress the large panels, are described as well as details of the various panels tested. The</p>														

392674

JP

UNCLASSIFIED

SECURITY CLASSIFICATION OF THIS PAGE(When Data Entered)

20. Abstract (cont'd)

effects of loading arrangement, strain gage transverse sensitivity and adhesive joint location are addressed. Panel strain and deflection data and core shear data are presented.

The details of a study to experimentally determine the strain and deflection profiles induced in a uniformly loaded, simply supported 1.1m x 2.3m aluminum-skin stiff-panel sandwich-type sandwich panel are documented. Twelve panels typical of the type used in testing this well-patched behavior were tested at loading up to 2.5 kPa. The experimental procedure and apparatus, including a special vacuum chamber constructed to test the large panels, are described as well as details of the various panels tested. The

UNCLASSIFIED

SECURITY CLASSIFICATION OF THIS PAGE(When Data Entered)

PREFACE

The author expresses his appreciation to Henry E. Antkowiak, Gregory Chiriaco, John J. Durkin, John F. Lanza, Josef P. Maroney, Edward M. Rolles and Michael Stephen, all of the US Army Natick Research and Development Command, for the design of the instrumentation systems, acquisition of the experimental data, and execution of the test program.

Accession For	
NTIS GRA&I	<input checked="" type="checkbox"/>
DDC TAB	<input type="checkbox"/>
Unannounced	<input type="checkbox"/>
Justification	<input type="checkbox"/>
By _____	
Distribution/ _____	
Availability Codes	
Dist.	Avail and/or special
A	

DDC
RECEIVED
JUL 9 1979
D

TABLE OF CONTENTS

	Page
LIST OF FIGURES	4
LIST OF TABLES	6
INTRODUCTION	7
OBJECTIVE	7
EXPERIMENTAL SETUP	10
Load Application	10
Strain Measurement	12
Deflection Measurement	12
EXPERIMENTAL TECHNIQUE	19
TEST SAMPLES	19
RESULTS	20
Experimental Strain and Deflection Data	20
Experimental Core Shear Property Data	25
DISCUSSION	25
Effect of Loading Method	25
Effect of Strain Gage Transverse Sensitivity	31
Effect of an Adhesive Joint Located between a Strain Gage Pair	36
Strain Distribution Profile	42
Deflection Profile	46
CONCLUDING REMARKS	46
REFERENCES	50
APPENDIX A - Raw Microstrain Data	51
APPENDIX B - Deflection Data	63
APPENDIX C - Microstrain Data Adjusted for Transverse Sensitivity	67
LIST OF SYMBOLS	79

LIST OF FIGURES

	Page
Figure 1. Rigid Wall Tactical Shelter	8
Figure 2. Sandwich Panel	9
Figure 3. Vacuum Load Chamber	11
Figure 4. Strain and Displacement Gage Location	13
Figure 5. Instrumented Panel	14
Figure 6. Temperature Compensation Strain Gage	15
Figure 7. Strain Gage Instrumentation	16
Figure 8. Dial Indicator Placement	17
Figure 9. Electronic Micrometer Sensor	18
Figure 10. Panels #1 and #2	22
Figure 11. Panel #5	22
Figure 12. Panel #6	23
Figure 13. Panel #9	23
Figure 14. Panel #10	24
Figure 15. Panels #3, 4, 7, 8, 11 and 12	24
Figure 16. Core Shear Sample	26
Figure 17. Shear Sample Located in Tester	27
Figure 18. Core Shear Property Instrumentation	28
Figure 19. Panel Load Application	30
Figure 20. Displacement Sensor Schematic	32

LIST OF TABLES
LIST OF FIGURES (Continued)

	Page
Figure 21. Verification of Loading Arrangement, Mid Center Deflection	33
Figure 22. Forty-Five Degree Rectangular Rosette	35
Figure 23. Adhesive Joint Located between Strain Gage Pair	37
Figure 24. Major Principal Strain Directions for Panels 2 thru 4 at 50 kPa	43
Figure 25. Major Principal Strain Directions for Panels 5 thru 8 at 70 kPa	44
Figure 26. Major Principal Strain Directions for Panels 9 thru 12 at 70 kPa	45
Figure 27. General Strain Distribution Pattern	47
Figure 28. Intrapanel Deflection	48
Figure 29. Interpanel Deflection	48
Figure 30. Deflection Profile	49

LIST OF TABLES

	Page
Table 1. Test Specimens	21
Table 2. Core Shear Properties	29
Table 3. Gage 43 and 44 Raw Strain Data	39
Table 4. Rosette 4/5/6 and 13/14/15 Computed Principle Strain Information	41
Table A1. Panel 2 Raw Microstrain Data	52
Table A2. Panel 2 Raw Microstrain Data	53
Table A3. Panel 4 Raw Microstrain Data	54
Table A4. Panel 5 Raw Microstrain Data	55
Table A5. Panel 6 Raw Microstrain Data	56
Table A6. Panel 7 Raw Microstrain Data	57
Table A7. Panel 8 Raw Microstrain Data	58
Table A8. Panel 9 Raw Microstrain Data	59
Table A9. Panel 10 Raw Microstrain Data	60
Table A10. Panel 11 Raw Microstrain Data	61
Table A11. Panel 12 Raw Microstrain Data	62
Table B1. Deflection Data	64
Table B2. Deflection Data	65
Table B3. Deflection Data	66
Table C1. Panel 2 Microstrain Data Adjusted for Transverse Sensitivity	68
Table C2. Panel 3 Microstrain Data Adjusted for Transverse Sensitivity	69
Table C3. Panel 4 Microstrain Data Adjusted for Transverse Sensitivity	70
Table C4. Panel 5 Microstrain Data Adjusted for Transverse Sensitivity	71
Table C5. Panel 6 Microstrain Data Adjusted for Transverse Sensitivity	72
Table C6. Panel 7 Microstrain Data Adjusted for Transverse Sensitivity	73
Table C7. Panel 8 Microstrain Data Adjusted for Transverse Sensitivity	74
Table C8. Panel 9 Microstrain Data Adjusted for Transverse Sensitivity	75
Table C9. Panel 10 Microstrain Data Adjusted for Transverse Sensitivity	76
Table C10. Panel 11 Microstrain Data Adjusted for Transverse Sensitivity	77
Table C11. Panel 12 Microstrain Data Adjusted for Transverse Sensitivity	78

EXPERIMENTAL MEASUREMENT OF STRAIN AND DEFLECTION IN A UNIFORMLY LOADED SIMPLY SUPPORTED COMPOSITE PANEL

INTRODUCTION

The Army designs and fields a large number of various types of rigid-wall tactical shelters. Figure 1 is a representative unit. The primary construction material for walls, floor, and roof is a lightweight composite panel composed of a paper-honeycomb core hot-bonded to aluminum face sheets. The Army's ability to produce and field these tactical shelters has progressed more rapidly than its ability to accurately predict critical stress distributions induced in the shelters by applied environmental and transportation-related forces. Knowledge of the stress distribution is required for both a fundamental understanding of the shelter's load-carrying capability and as a basis for the most efficient structural design. Lack of this knowledge presents a technical barrier hindering advancement of the state of the art of tactical shelter design.

A combination analytical and experimental research program has been initiated at the Natick Research and Development Command (NARADCOM) in order to surmount the technical barrier. The analytical phase of the program is concerned with investigations of the effects of environmental loads on shelters through the use of theories of solid mechanics, elasticity and computer modeling. The experimental phase of the program is concerned with the measurement of the stresses and deflections in composite panels and shelters under simulated and actual loads. Results of the experimental program will be used both to verify the analytical theory and to provide factual data on the mechanical properties of existing shelter systems.

This report details the results of an initial experimental study to determine the strain distribution profile in the basic composite panel. Results of a complementary analytical study¹ and a study of a full-size shelter² will be reported on separately.

OBJECTIVE

The objective of the study was to experimentally determine the strain and deflection induced in a 1.1-metre x 2.3-metre, aluminum-skin, Kraft-paper-honeycomb-core sandwich panel, Figure 2, simply supported along the four edges when a uniform load was applied perpendicular to one face. The effects of various skin thickness, core thickness, and ribbon direction were considered.

¹A. Johnson, A Study of Stresses in Transversely Loaded Panels Used in Tactical Shelters, NARADCOM Technical Report, under preparation.

²F. Barca, Experimental Measurement of Strain and Acceleration Levels in a Rigid Wall Shelter Subjected to Environmental Loadings, NARADCOM Technical Report, Under Preparation.



Figure 1. Rigid Wall Tactical Shelter. Prototype expandable unit shown with only the right side completely expanded and left side partially expanded.

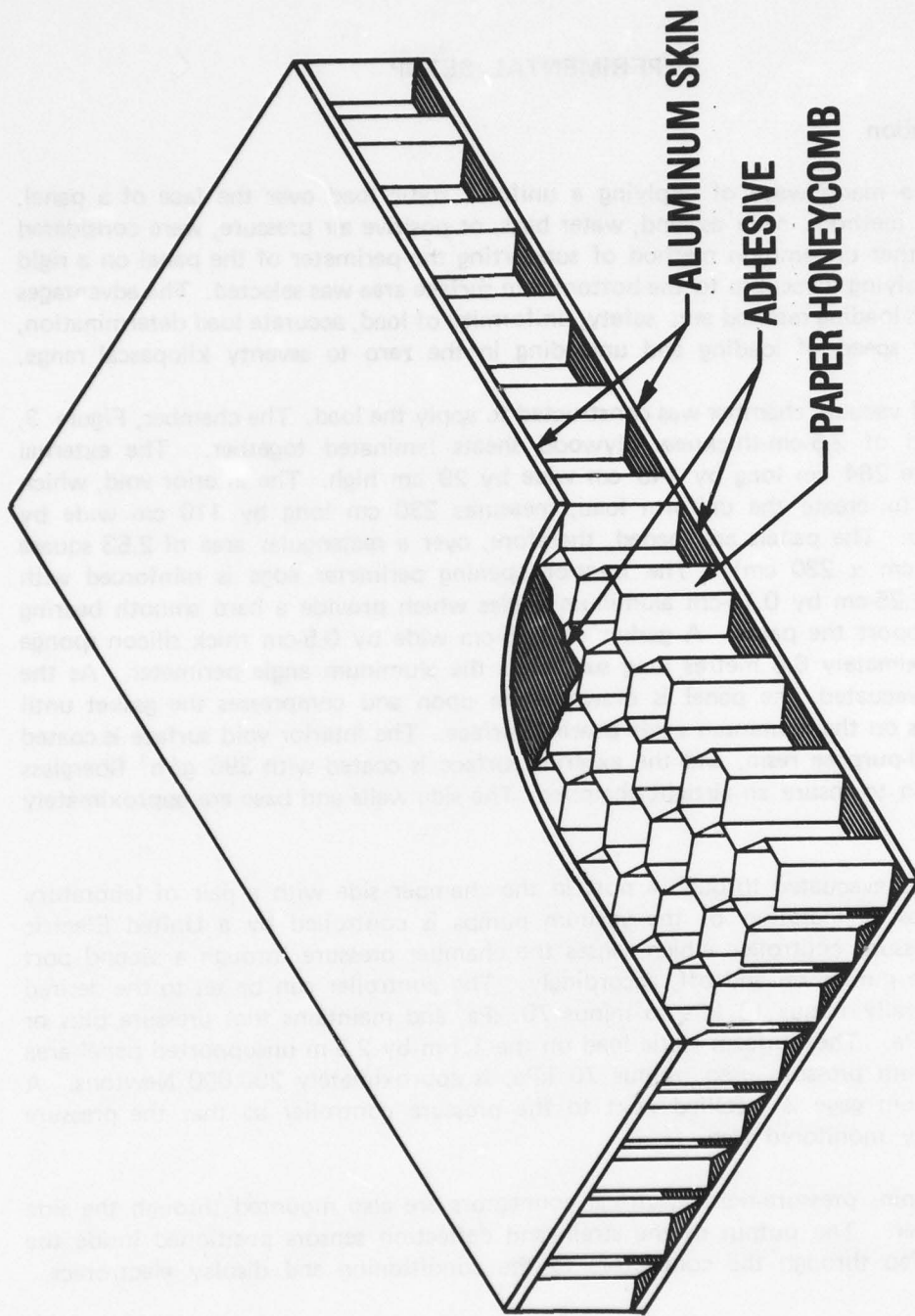

Figure 2. Sandwich Panel. Aluminum-skin, hexagonal paper-honeycomb-core composite panel typical of type used in rigid-wall tactical shelters.

EXPERIMENTAL SETUP

Load Application

There are many ways of applying a uniform static load over the face of a panel. The common methods, such as sand, water bags, or positive air pressure, were considered before the rather uncommon method of supporting the perimeter of the panel on a rigid frame and applying a vacuum to the bottom skin surface area was selected. The advantages of the vacuum loading method are: safety, uniformity of load, accurate load determination, and ease and speed of loading and unloading in the zero to seventy kilopascal range.

A special vacuum chamber was constructed to apply the load. The chamber, Figure 3, is constructed of 2.5-cm-thickness plywood sheets laminated together. The external dimensions are 264 cm long by 145 cm wide by 29 cm high. The interior void, which is evacuated to create the uniform load, measures 230 cm long by 110 cm wide by 11.5 cm deep. The panels are loaded, therefore, over a rectangular area of 2.53 square metres (110 cm x 230 cm). The interior opening perimeter edge is reinforced with 1.25-cm by 1.25-cm by 0.16-cm aluminum angles which provide a hard smooth bearing surface to support the panel. A gasket of 1.25-cm wide by 0.5-cm thick silicon sponge rubber approximately 6.8 metres long surrounds the aluminum angle perimeter. As the chamber is evacuated, the panel is drawn down upon and compresses the gasket until the panel rests on the aluminum angle bearing surface. The interior void surface is coated with a general-purpose resin, and the exterior surface is coated with 390 g/m² fiberglass cloth and resin to insure an airtight chamber. The side walls and base are approximately 17 cm thick.

The air is evacuated through a port in the chamber side with a pair of laboratory vacuum pumps. Operation of the vacuum pumps is controlled by a United Electric automatic pressure controller which senses the chamber pressure through a second port and cycles the pumps on and off, accordingly. The controller can be set to the desired pressure, generally minus 10 kPa to minus 70 kPa, and maintains that pressure plus or minus 0.15 kPa. The uniform static load on the 1.1-m by 2.3-m unsupported panel area at the maximum pressure used, minus 70 kPa, is approximately 200,000 Newtons. A mirrored vacuum gage is installed next to the pressure controller so that the pressure can be visually monitored also.

Four 32-pin, pressure-tight electrical connectors are also mounted through the side of the chamber. The output of the strain and deflection sensors positioned inside the chamber are fed through the connectors to the conditioning and display electronics.

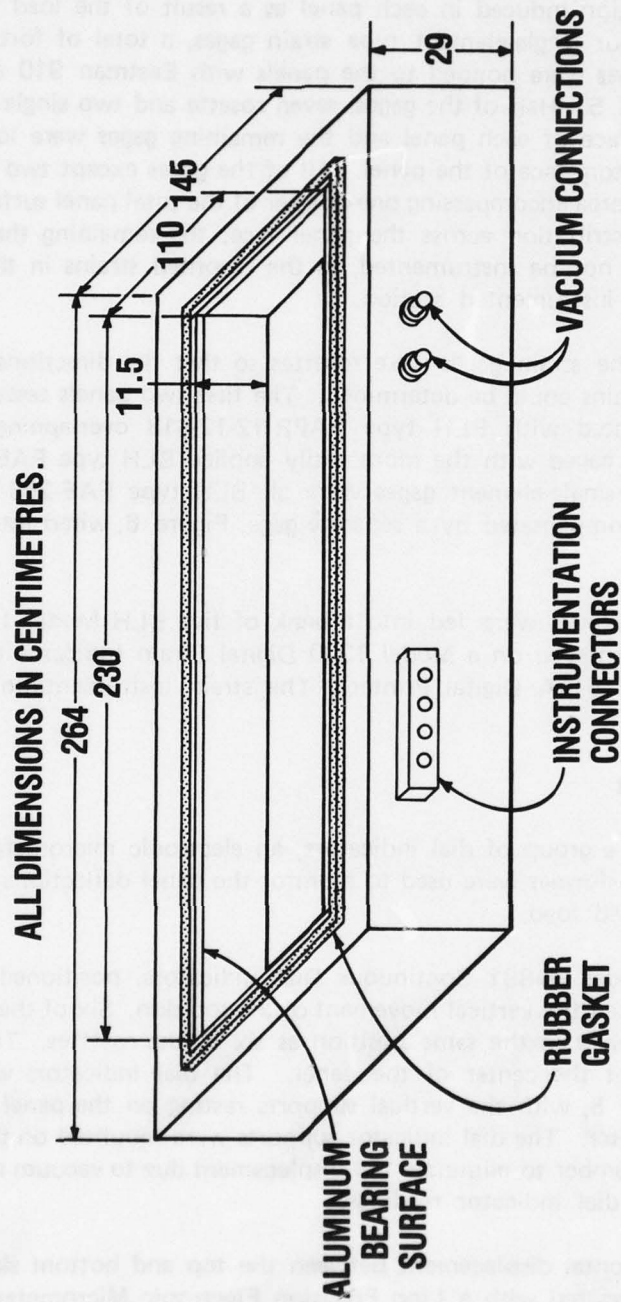

Figure 3. Vacuum Load Chamber.

Strain Measurement

The strain distribution induced in each panel as a result of the load was sensed by fourteen rosette and four single-element type strain gages, a total of forty-six channels of strain data. The gages were bonded to the panels with Eastman 910 and located as shown in Figures 4 and 5. Half of the gages, seven rosette and two single-element, were positioned on the top face of each panel and the remaining gages were located directly below them on the bottom face of the panel. All of the gages except two single-element gages were located in an area encompassing one-quarter of the total panel surface. Assuming a symmetrical strain distribution across the panel face, the remaining three-quarters of the panel surface need not be instrumented, as the recorded strains in this area would be the same as in the instrumented section.

The majority of the strain gages were rosettes so that the directions of the major and minor principal strains could be determined. The first two panels tested (numbers 1 and 5) were instrumented with BLH type FAPR-12-12-S13 overlapping rosettes but subsequent panels were gaged with the more easily applied BLH type FAER-25B-35-S13 coplanar rosette. The single-element gages were all BLH type FAE-25S-35-S13. Each gage was temperature compensated by a separate gage, Figure 6, wired into a half-bridge configuration.

The strain gage outputs were fed into a bank of five BLH Model 1225 Switching and Balancing Units, displayed on a Model 1200 Digital Strain Indicator and printed on paper tape by a Model 511A Digital Printer. The strain instrumentation is shown in Figure 7.

Deflection Measurement

A combination of a group of dial indicators, an electronic micrometer and a linear variable differential transformer were used to monitor the panel deflections resulting from the incrementally applied load.

Seven Starrett Model 25-881 Continuous Dial Indicators, positioned as previously shown in Figure 2, sensed the vertical movement of the top skin. Six of the dial indicators were located symmetrically in the same position as six of the rosettes. The seventh dial indicator was located at the center of the panel. The dial indicators were suspended from cross rods, Figure 8, with the vertical supports resting on the panel directly above the interior void perimeter. The dial indicator supports were mounted on the panel rather than on the vacuum chamber to eliminate the displacement due to vacuum chamber gasket compression from the dial indicator readings.

The relative horizontal displacement between the top and bottom skins as a result of shear stress was measured with a Lion Precision Electronic Micrometer. The sensor, Figure 9, was located on the edge of the panel at the midpoint of the panel width. The

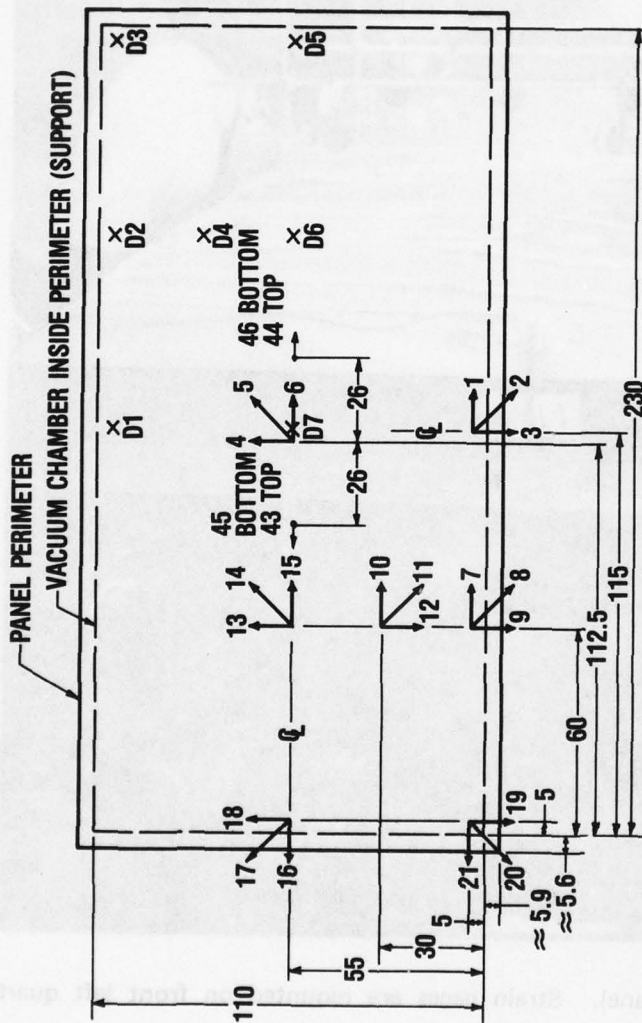

1. ALL DIMENSIONS IN CENTIMETRES.
2. GAGES 1 THRU 21 & 45 & 46 ON BOTTOM FACE. GAGES 22 THRU 44 ON TOP FACE. GAGE 22 LOCATED ABOVE 1, 23 ABOVE 2, 24 ABOVE 3, . . . 42 ABOVE 21.
3. SIX DISPLACEMENTS ARE TAKEN SYMMETRICALLY IN THE SAME POSITION AS THE STRAIN GAGES. THE SEVENTH DISPLACEMENT (D7) IS TAKEN AT THE CENTER OF THE PANEL.

Figure 4. Location of Strain and Displacement Gages.

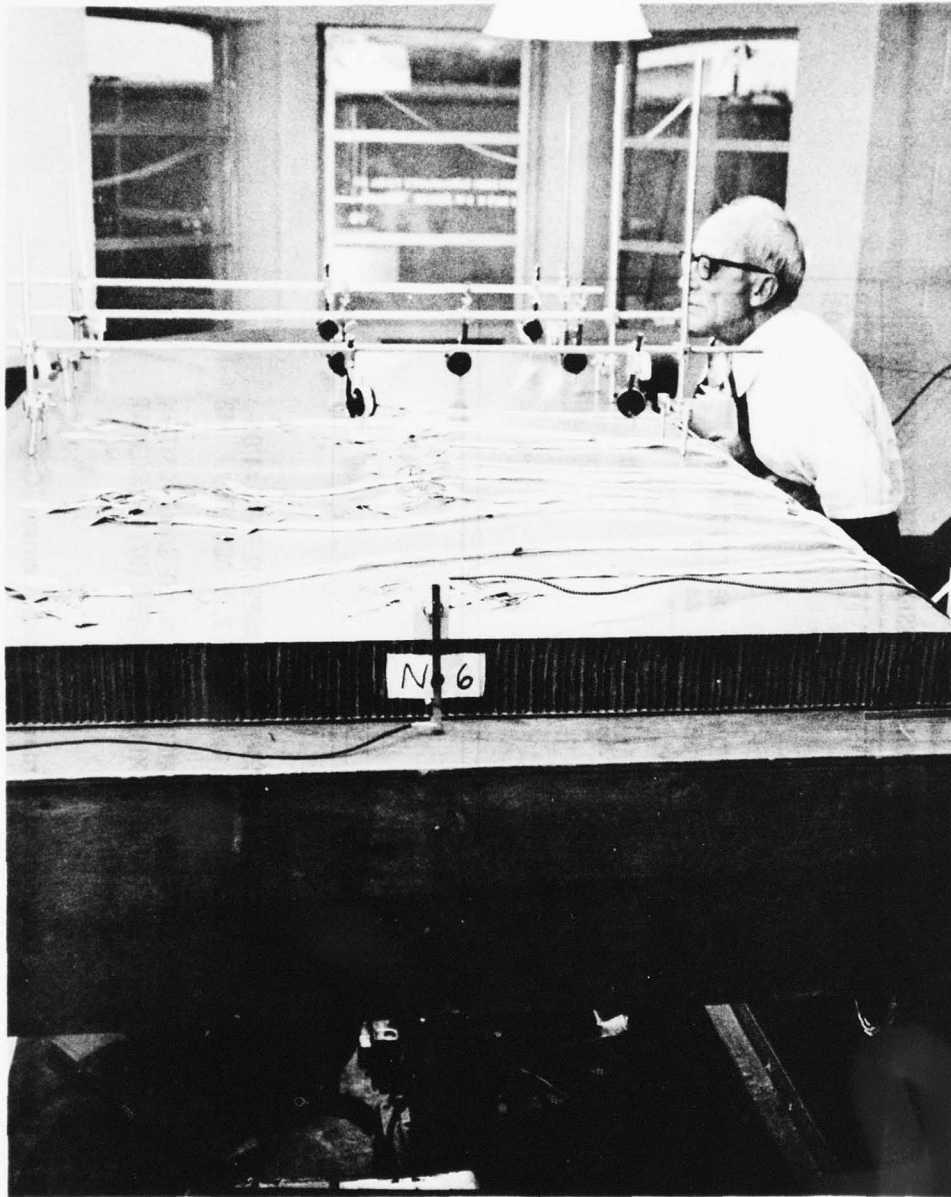

Figure 5. Instrumented Panel. Strain gages are mounted on front left quarter of panel.

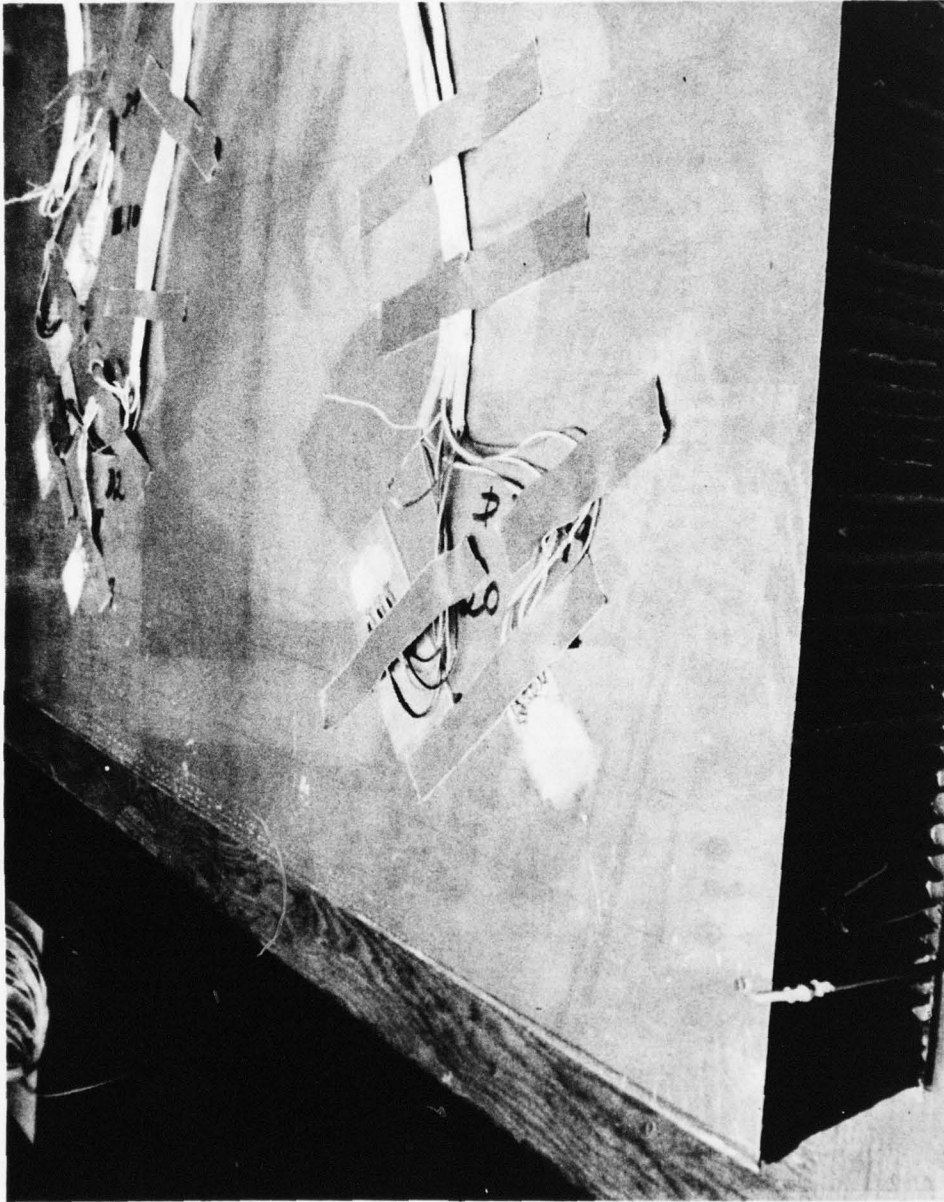

Figure 6. Temperature Compensation Strain Gage. Temperature compensating rosette mounted on separate aluminum plate shown slightly above and to the right of active rosette.

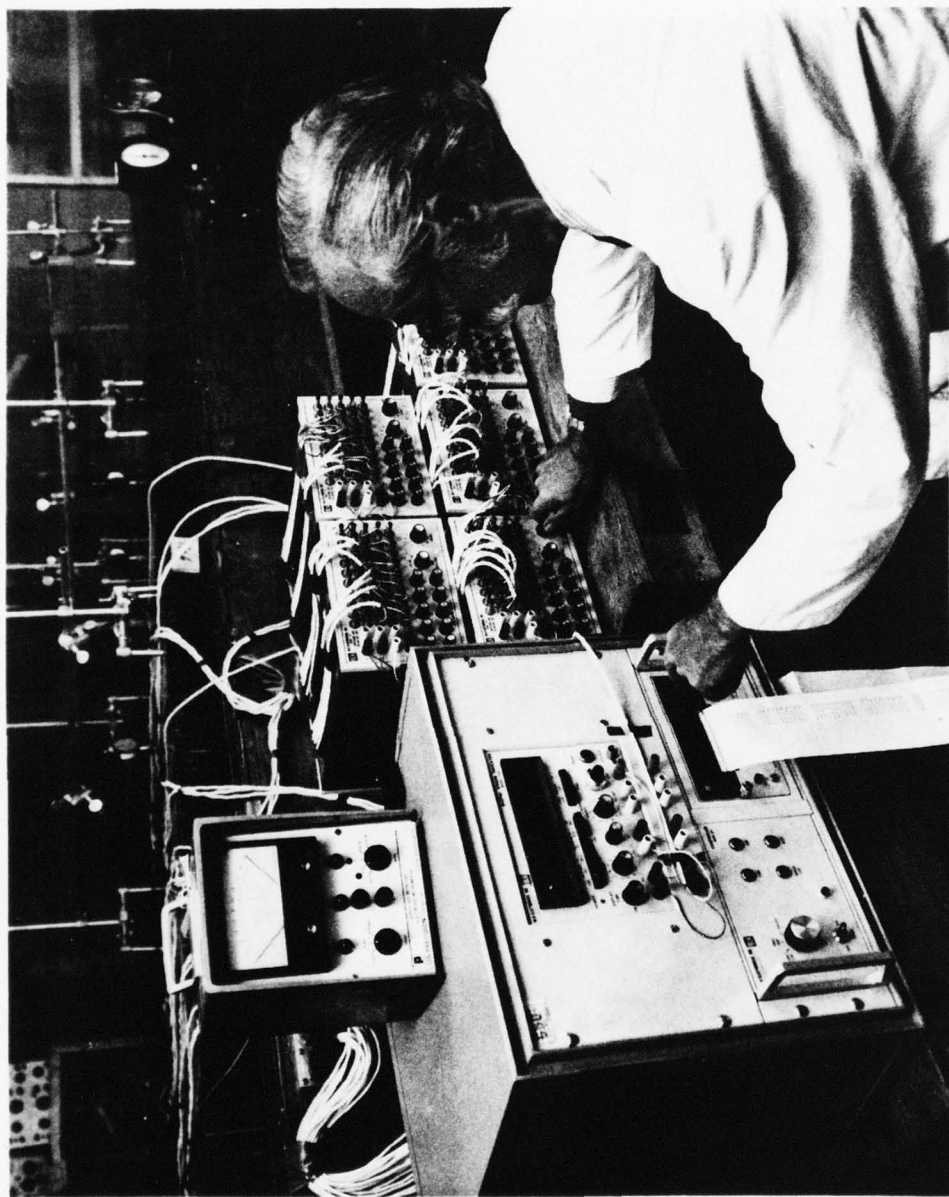

Figure 7. Strain Gage Instrumentation. From left to right: rack containing digital strain indicator and paper tape printer; analog shear displacement indicator, five switching and balancing units, and vacuum gage.

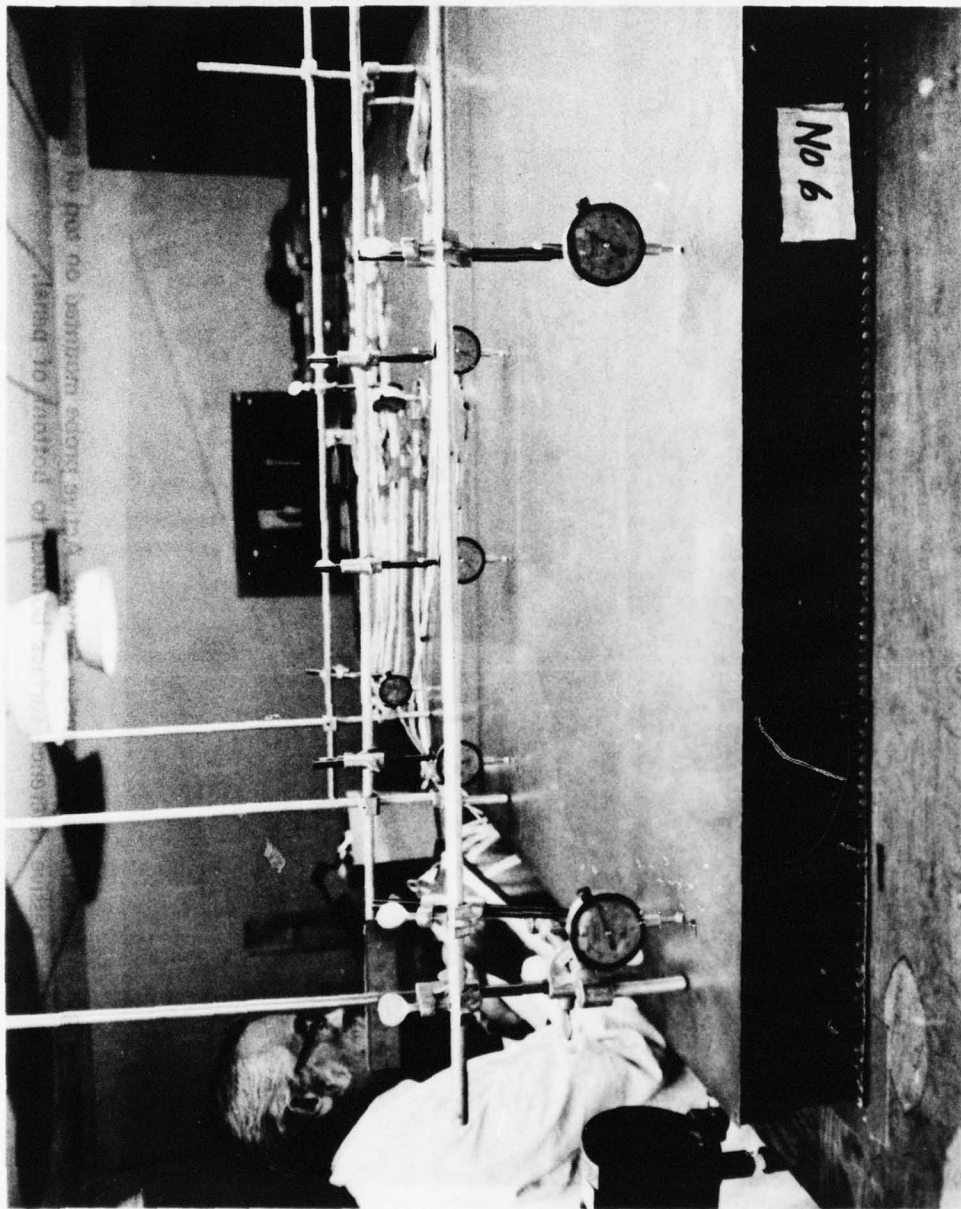

Figure 8. Dial Indicator Placement. Seven dial indicators suspended from rods, positioned in one quarter of panel diagonally opposite from strain gaged quarter.

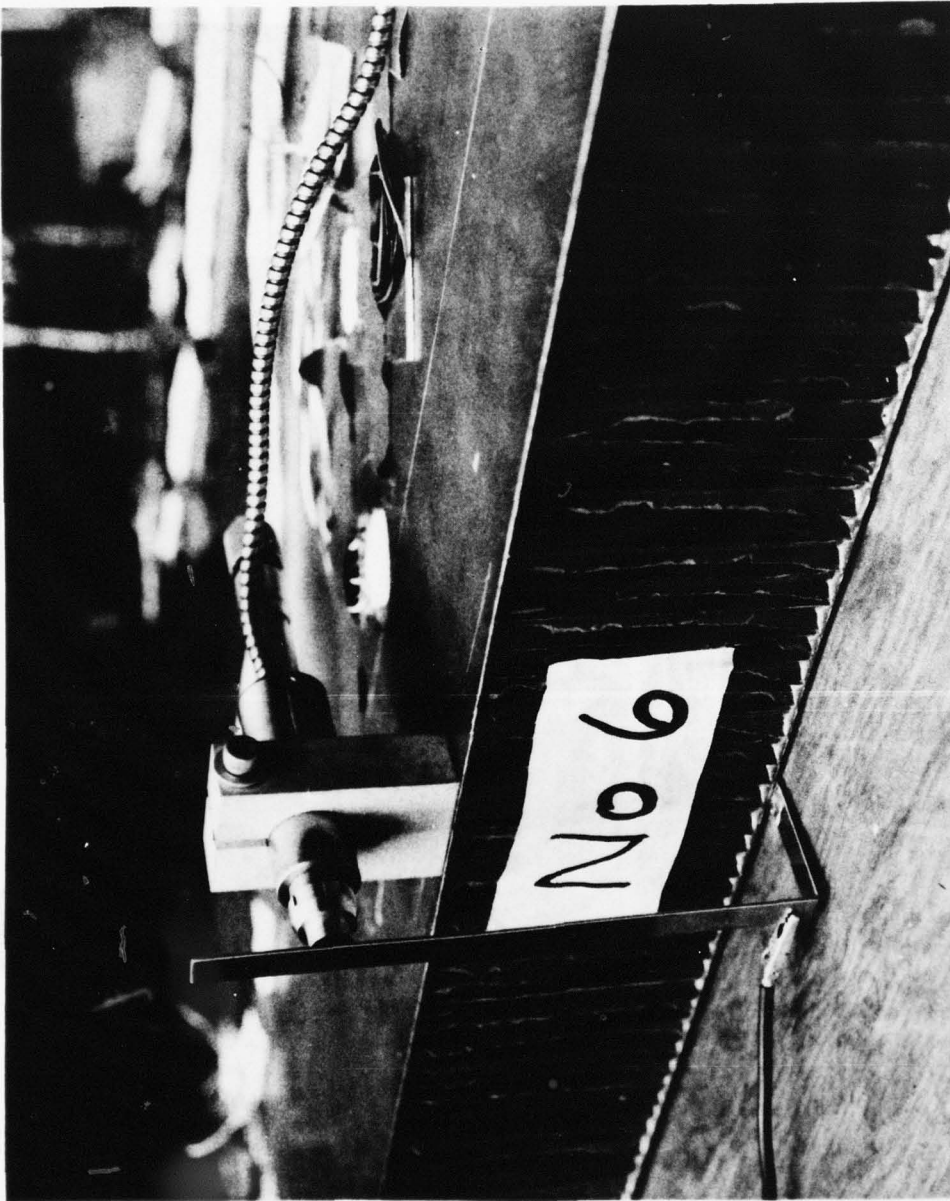

Figure 9. Electronic Micrometer Sensor. Active probe mounted on top of panel and passive reference surface bonded to bottom of panel.

active capacitance probe was bonded to the top skin and the passive reference surface, in this case an "L" - shaped piece of aluminum, was bonded to the bottom skin. The probe sensed the change in distance between the probe head and the reference surface, which is the same as the associated skin shear displacement, and the value was displayed on an analog meter.

The vertical displacements of the top and bottom skins of the panel were also simultaneously monitored occasionally to confirm that they were identical and therefore no panel delamination or bond failure was occurring as a result of the loading arrangement. The bottom skin displacement relative to the vacuum chamber was sensed with a Schaevitz Engineering linear variable differential transformer (LVDT) positioned inside the vacuum chamber at the center of the panel. The LVDT output was displayed on a Metroc Digital Readout external to the vacuum chamber. The top skin dead center vertical displacement relative to the vacuum chamber was measured with an independent dial indicator. The two displacement values were compared as a check on the effect of the loading arrangement on the panel.

EXPERIMENTAL TECHNIQUE

Each panel for which data were to be generated was laid out top and bottom to indicate the intended positions of the strain gages, dial indicators, and vacuum chamber opening (load application area). The strain gages and electronic micrometer sensor were then mounted and connected to the appropriate electronics. The panel was carefully positioned on the vacuum chamber gasket, the dial indicators placed on the panel, and all zero readings recorded.

The vacuum pumps were energized, the panel loaded, normally to a stabilized pressure of minus 10 kPa, and strain/displacement data recorded. The vacuum was then increased in 10-kPa increments and the procedure repeated until the data at maximum desired pressure, depending on panel thickness, were recorded. The load was then removed, the panel allowed to return to the unstressed state, and zero readings again recorded as a check for instrumentation drift or permanent panel deformation. The loading and recording procedure was then repeated an additional four times for each panel to obtain a statistical average based on five readings at each pressure for each location.

TEST SAMPLES

Twelve commercially available panels, typical of the type extensively used in military tactical shelters, were procured from the Brunswick Corporation Marion Facility for use as test specimens. All of the panels had 5052-H34/36 aluminum skins and 60.9-kgs/cu metre (3.8 PCF), MIL-H-21040³, 11.1-mm (7/16") cell, Kraft paper honeycomb cores.

³Military Specification, MIL-H-21040C, Honeycomb Materials, Water Migration Resistant Type, Structural, Paper Base, 16 July 1974

All of the panels measured 121.8 cm x 241.2 cm. (When placed on the open face of the vacuum load chamber the panels overhung the void, 110 cm x 230 cm, by approximately 6 cm on each edge.) Four of the panels had 9-cm-thick cores and 1.27-mm-thick skins. Four of the panels had 5-cm-thick cores and 1.02-mm-thick skins. The remaining four panels had 9-cm thick cores and a 1.27-mm skin on one side and a 1.02-mm skin on the other side. Reliabond 7114 adhesive was used to bond the paper core to the metal skins on all the panels.

It was intended that each of the four panels in a particular group be identical in order that four replicates of each panel type may be tested. It was found, however, that half of the panels, two in each group, were of single-piece honeycomb core construction, and the other half of the panels had multipiece honeycomb cores bonded together. In addition, the ribbon direction (TL) in the multipiece panels was parallel to the panel length while the ribbon direction in the one-piece core panels was perpendicular to the panel length. In actuality, therefore, two replicates of six panel types were available and tested. Complete descriptions of the test specimens are presented in Table 1 and Figures 10 through 15.

RESULTS

Experimental Strain and Deflection Data

The experimental strain and deflection data generated for eleven of the twelve panels are presented in Appendices A and B, respectively. No data are presented for panel number one. It was the first panel tested and the gage layout and load application dimensions were not the same as the remaining panels, and, therefore, the data cannot be compared. Compressive strains are indicated as negative values. Tensile strains are indicated as positive values. Generally, each strain and deflection reading is the mean of five separate readings. In some cases an observation was rejected; in which case the reported datum is the mean of four readings. The mere fact that an observation differed considerably from the others was not sufficient cause for rejection because the normal frequency distribution indicates the possibility of deviations between $+\infty$ and $-\infty$. However, the normal frequency curve is derived on the assumption of an infinitely large number of observations; and for a small number of observations, as in this case, the inclusion of a questionable value could erroneously distort the result. The basis for rejection of observed data was Chauvenet's Criterion which, in brief, states that if in a series of "n" measurements the probability of occurrence of a deviation of "x" magnitude is less than one-half, then the observation exhibiting such deviation should be rejected.

The range of the standard deviations of the data is also included in the appendices. Generally, the strain data exhibited standard deviations less than ten microstrain. The deflection data deviations were normally below 0.075 millimetres. The shear displacement data obtained with the electronic micrometer were very inconsistent and unreliable, possibly as a result of improper mounting or use of the instrumentation, and this portion of the data gathering effort was discontinued.

Table 1. Test Specimens

Panel Number	Skin Thickness (mm)	Core Thickness (mm)	Ribbon Direction	Core Construction
1	1.02 Both Sides	50	TL Parallel TO Length	Multipiece Figure 10
2	"	"	"	"
3	"	"	TL Parallel TO Width	One Piece Figure 15
4	"	"	"	"
5	1.27 Both Sides	90	TL Parallel TO Length	Multipiece Figure 11
6	"	"	"	Multipiece Figure 12
7	"	"	TL Parallel TO Width	One Piece Figure 15
8	"	"	"	"
9	1.02 One Side 1.27 Other Side	"	TL Parallel TO Length	Multipiece Figure 13
10	"	"	"	Multipiece Figure 14
11	"	"	TL Parallel TO Width	One Piece Figure 15
12	"	"	"	"

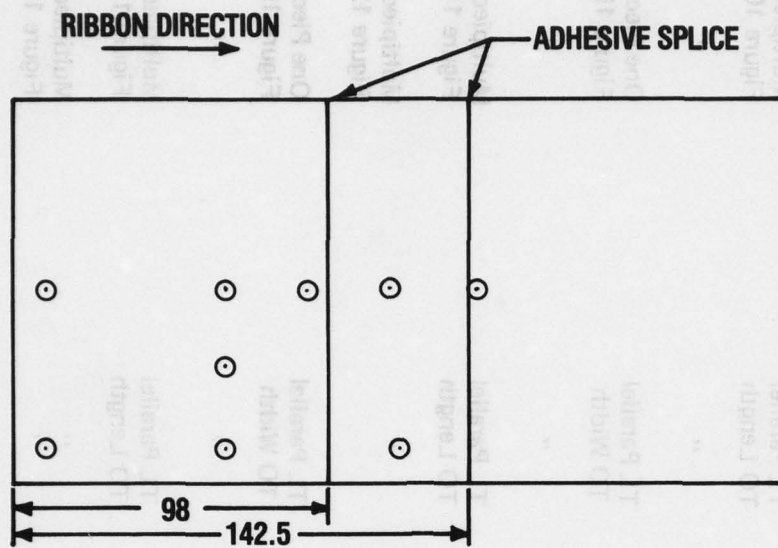

Figure 10. Panels 1 and 2. Location of splices in relation to strain gages (⊙).

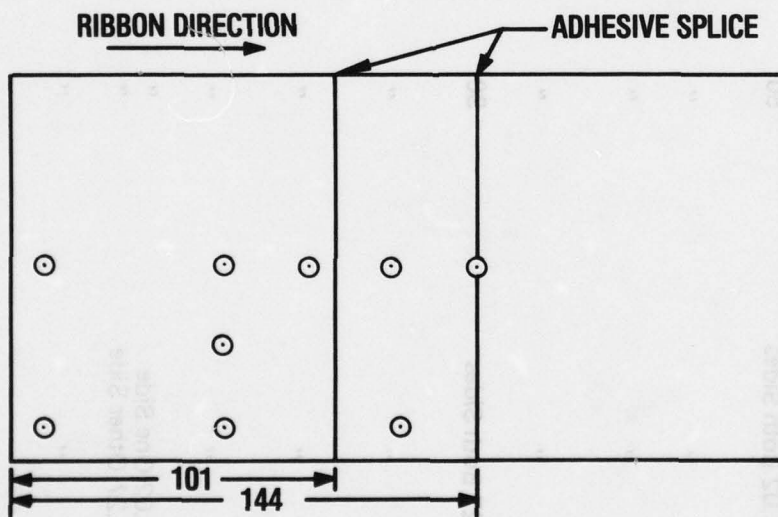

Figure 11. Panel 5. Location of splices in relation to strain gages (⊙).

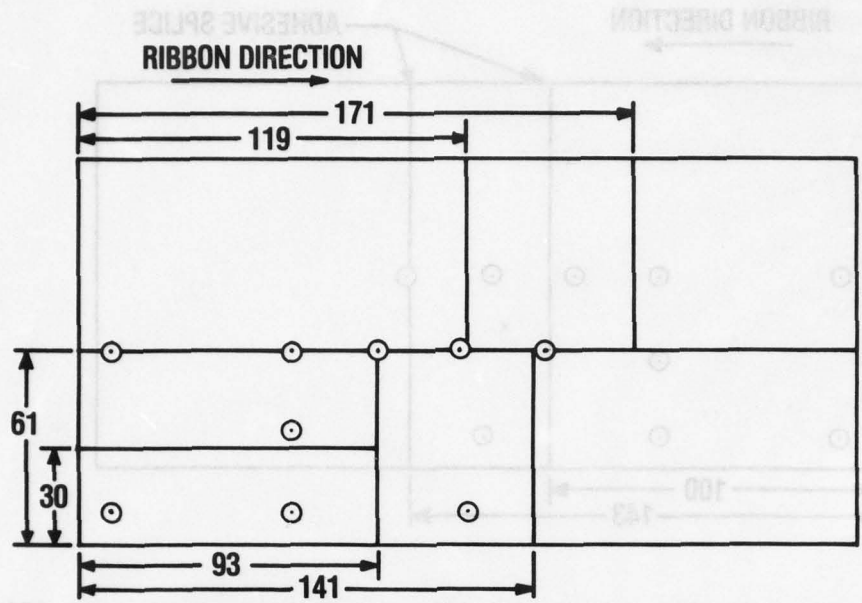

Figure 12. Panel 6. Location of splices in relation to strain gages (⊙).

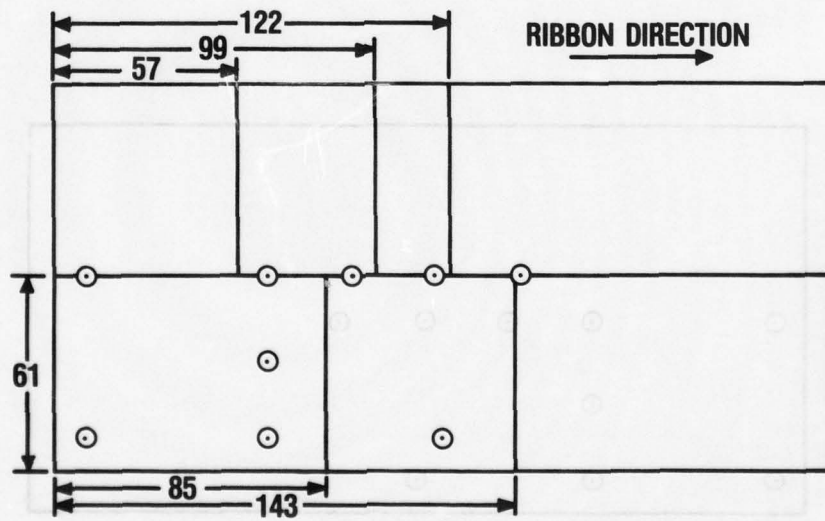

Figure 13. Panel 9. Location of splices in relation to strain gages (⊙).

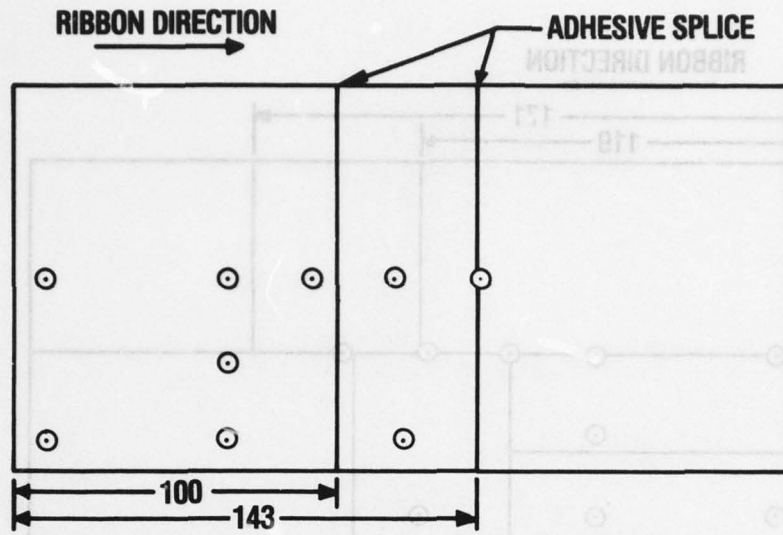

Figure 14. Panel 10. Location of splices in relation to strain gages (⊙).

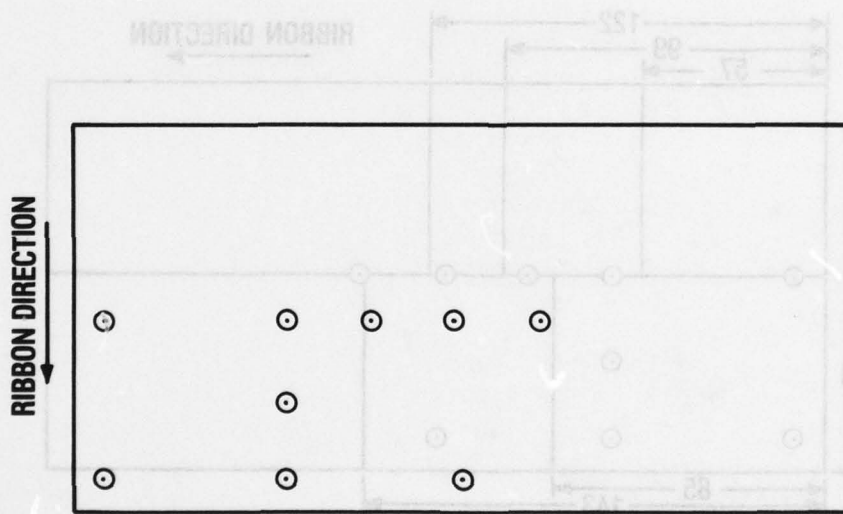

Figure 15. Panels 3, 4, 7, 8, 11 and 12. One piece cores. No adhesive splices.

Experimental Core Shear Property Data

After completion of the uniform load tests, samples were cut from each panel and core shear properties were determined in accordance with MIL-STD-401B⁴, "Sandwich Constructions and Core Materials; General Test Methods."

The core samples measured nominally 51 mm x 153 mm x 13 mm thick and were bonded to two steel plates with an epoxy resin as shown in Figure 16. Shear displacement was measured with a dial indicator attached to the steel plates. The compressive load was applied at a rate of 0.5 mm/min with an Instron Model 1125 Universal Tester, Figures 17 and 18, and the load/time history was generated on a strip chart recorder. Core conditioning and shear testing was accomplished at approximately 22° Celsius, 40% relative humidity. The data generated are presented in Table 2. Values for core shear modulus in the table were determined from the initial linear portion of the stress/strain curve.

DISCUSSION

Effect of Loading Method

As previously mentioned, the uniform load was applied to each panel by placing the panel on the open face of a five-sided vacuum chamber and exhausting air from the chamber. The bottom face of the panel was free, subject to simple support boundary conditions, to deflect into the chamber void as the air pressure differential between the top of the bottom face and the bottom of the bottom face increased. As the bottom face was forced down by atmospheric pressure, the honeycomb core was placed in a state of tension, and it, in turn, pulled the top face of the panel down, as shown in Figure 19a.

This loading condition differed from a more common loading condition where the uniform load is applied to the top face of the panel, the core is placed in a state of compression, Figure 19b, and it in turn pushes the bottom face of the panel down.

The question arose, therefore, as to whether the vacuum loading arrangement, which places the panel core in tension, would also cause the panel thickness to increase as a result of core elongation or core-to-skin adhesive delamination. Either condition would cause misleading strain and deflection data. Theoretically, the answer is no; core elongation is not significant and skin-to-core adhesive failure will not occur because the tensile stress induced in the core during vacuum loading is well below allowable values.

In the cases of panels with one-piece cores and symmetrical skins, the strain measured at a top skin location should be the same as the strain measured at the bottom skin

⁴Military Standard, MIL-STD-401B, Sandwich Constructions and Core Materials; General Test Methods, 26 September 1967

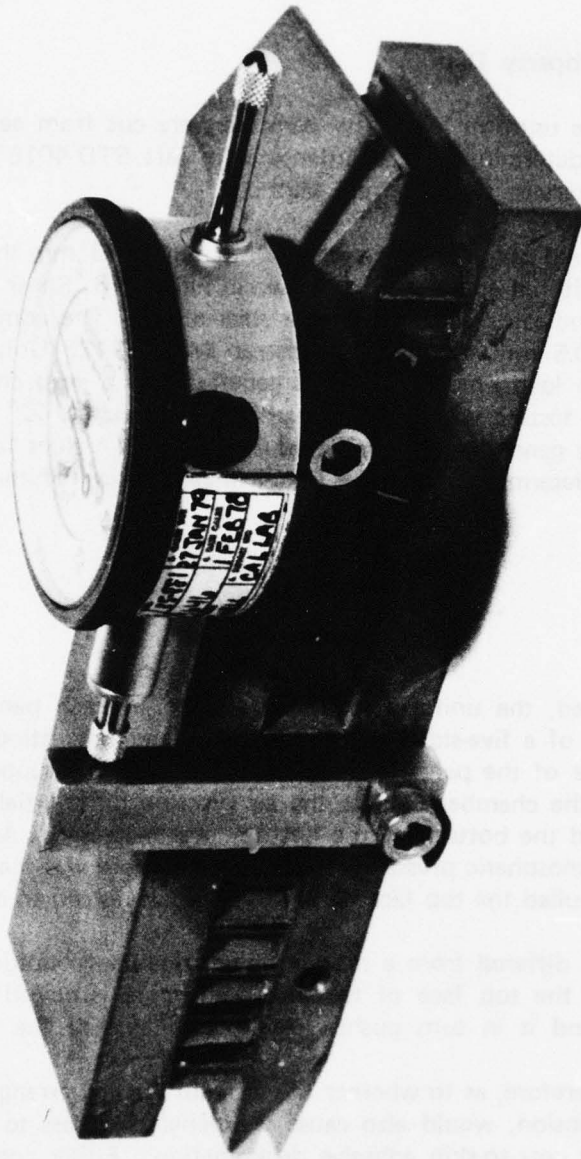

Figure 16. Core Shear Sample. Honeycomb core sample bonded to two steel plates with attached dial indicator for displacement measurement.

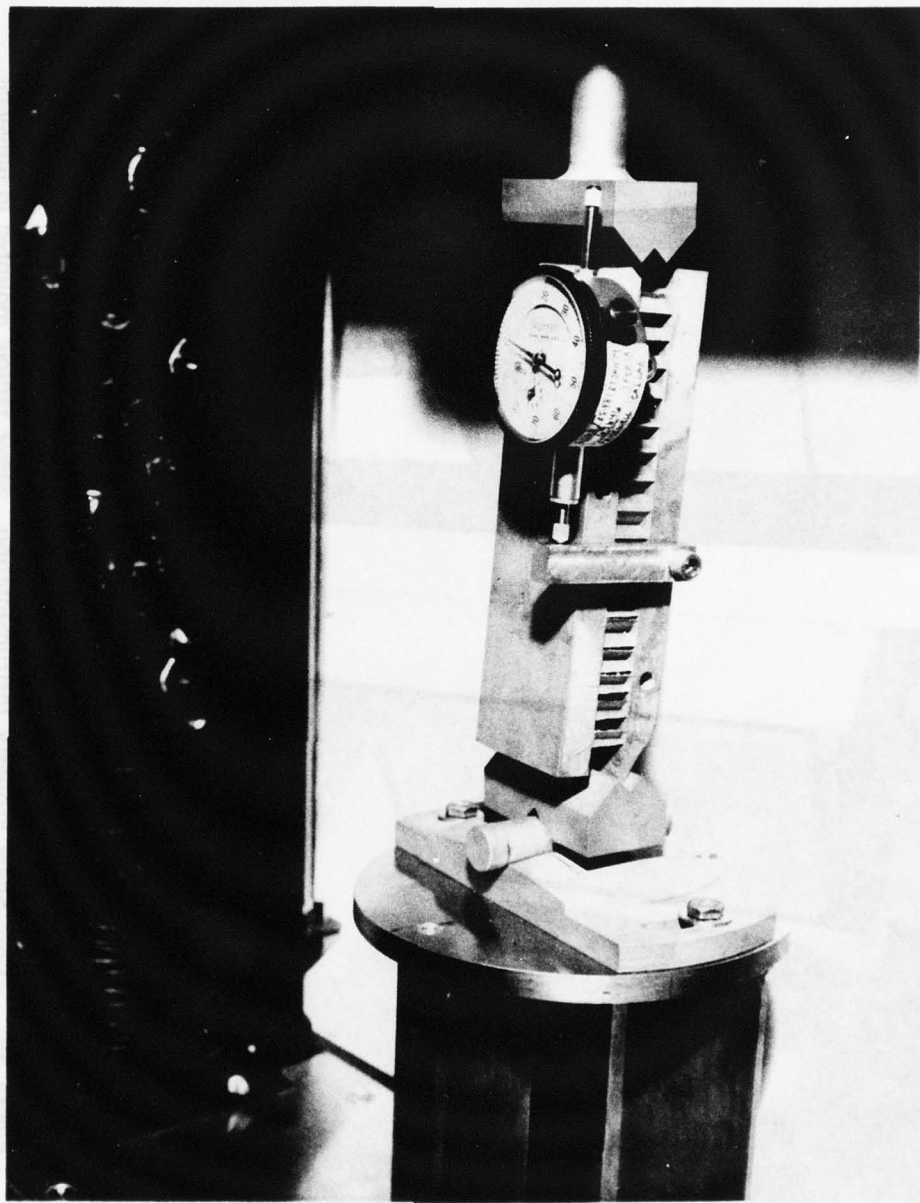

Figure 17. Shear Sample Located in Tester.

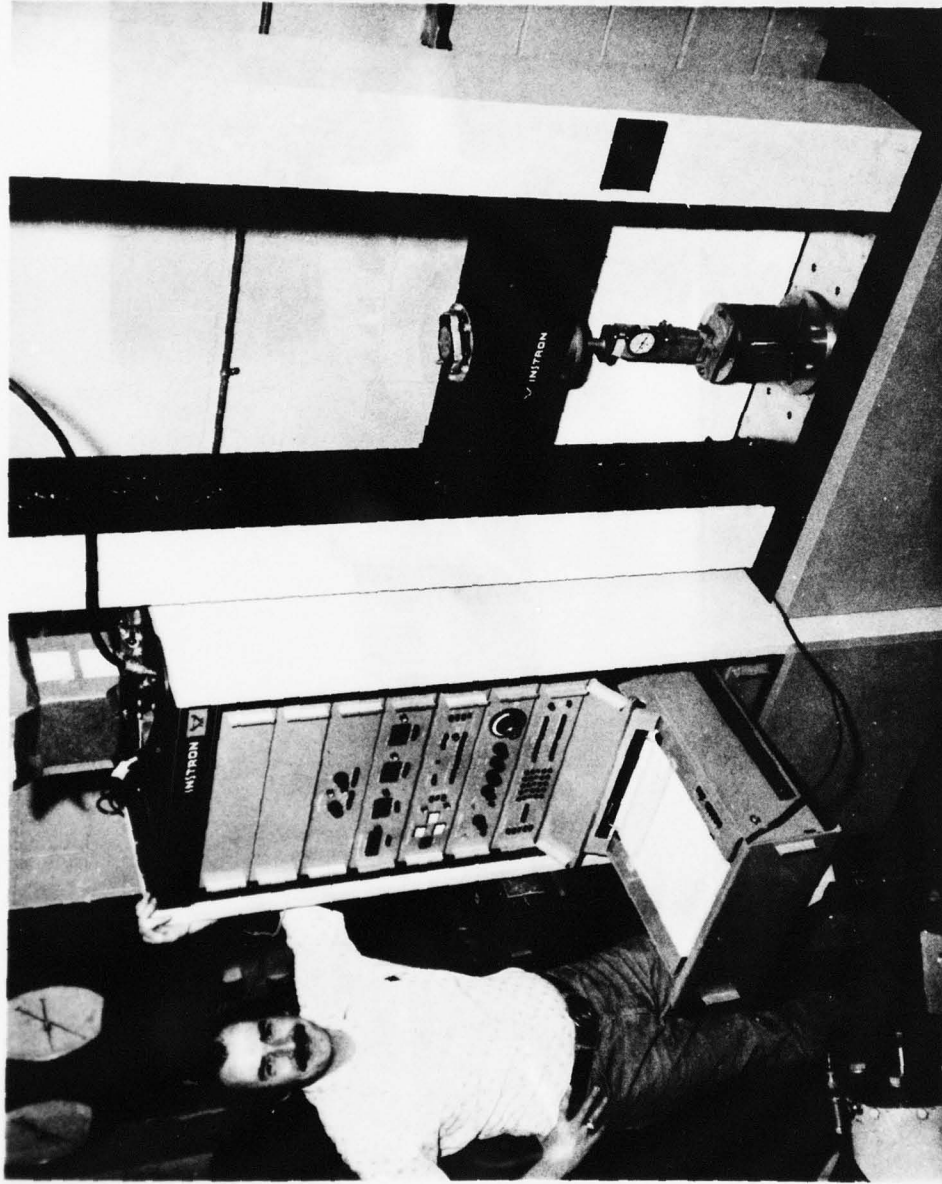
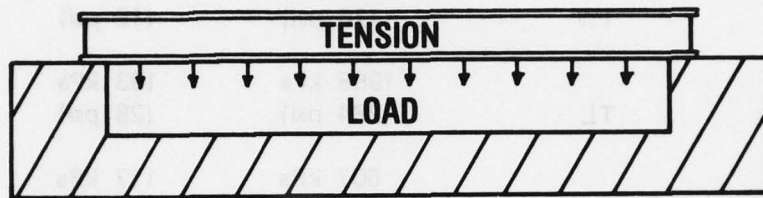

Figure 18. Core Shear Property Instrumentation. Shear sample mounted in universal tester with control panel and integral strip chart recorder located to the left.

Table 2. Core Shear Properties

Property	Direction	Mean	Standard Deviation	Number of Samples
Ultimate Strength	TW	1213 kPa (176 psi)	83 kPa (12 psi)	34
	TL	1958 kPa (284 psi)	193 kPa (28 psi)	32
Proportional Limit Stress	TW	607 kPa (88 psi)	117 kPa (17 psi)	33
	TL	1034 kPa (150 psi)	228 kPa (33 psi)	30
Modulus of Rigidity	TW	70,782 kPa (10,266 psi)	9370 kPa (1359 psi)	34
	TL	148,313 kPa (21,511 psi)	26,269 kPa (3810 psi)	32

- NOTES:
1. MIL-H-21040C, Honeycomb
 2. 60.9 kgs/m³ (3.8 PCF) Density
 3. Test conditions approximately 22°C, 40% RH
 4. TL direction parallel to honeycomb ribbons
 5. TW direction perpendicular to honeycomb ribbons



(a)

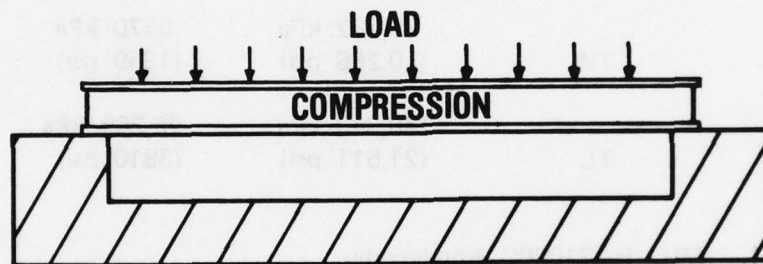

(b)

Figure 19. Panel Load Application.

location, directly below, if the panel thickness remains constant. The experimental strain data between top and bottom skins generally agreed but not to a degree to confirm the theoretical prediction of constant thickness.

Additional experimental deflection measurements were required, therefore, and were accomplished with the simple setup illustrated in Figure 20. A linear variable differential transformer was placed inside the vacuum chamber and positioned to measure the panel bottom skin dead center, total travel distance. This distance is equal to the sum of the displacement due to gasket compression and the displacement due to panel deformation. A dial indicator was also mounted above the panel top dead center and supported on the vacuum chamber independent of the panel. The dial indicator measured the total deflection of the top skin due to vacuum chamber gasket compression and due to panel deflection.

If, as predicted by theory, no appreciable core elongation or adhesive failure occurred, the displacements measured by the two devices should be equal. And, in fact, they were. As evidenced by Figure 21, the top and bottom skin deflections were the same and the vacuum loading arrangement was therefore judged suitable for the test program.

Effect of Strain Gage Transverse Sensitivity

Strain gages are normally calibrated by the manufacturer on a material with a Poisson's ratio of 0.285 which is subjected to a uniaxial stress and in which the principal axis of the gage is aligned with the principal strain direction. If the gage is used in any other application, the indicated strain must be adjusted to correct for errors resulting from the strain gage transverse sensitivity; or, it must be shown that the transverse sensitivity error is negligible and can be ignored.

Two errors resulting from strain gage transverse sensitivity were possible in the experimental stress analysis setup: One, arising from use of the gage on aluminum with a Poisson ratio of 0.334, and the second, from application of the gage in a biaxial stress field.

The error due to mismatched Poisson's ratios can be calculated according to equation (1) from Baumberger and Hines.⁵

$$e = \frac{k}{1-\mu_0 k} \left(\mu_0 + \frac{\epsilon_n}{\epsilon} \right) \quad (1)$$

⁵R. Baumberger, and F. Hines, "Practical Reduction Formulas for Use on Bonded Wire Strain Gages in Two-Dimensional Stress Fields", *Proceedings, SESA*, Volume II, No. 1, pp 113-147, 1944

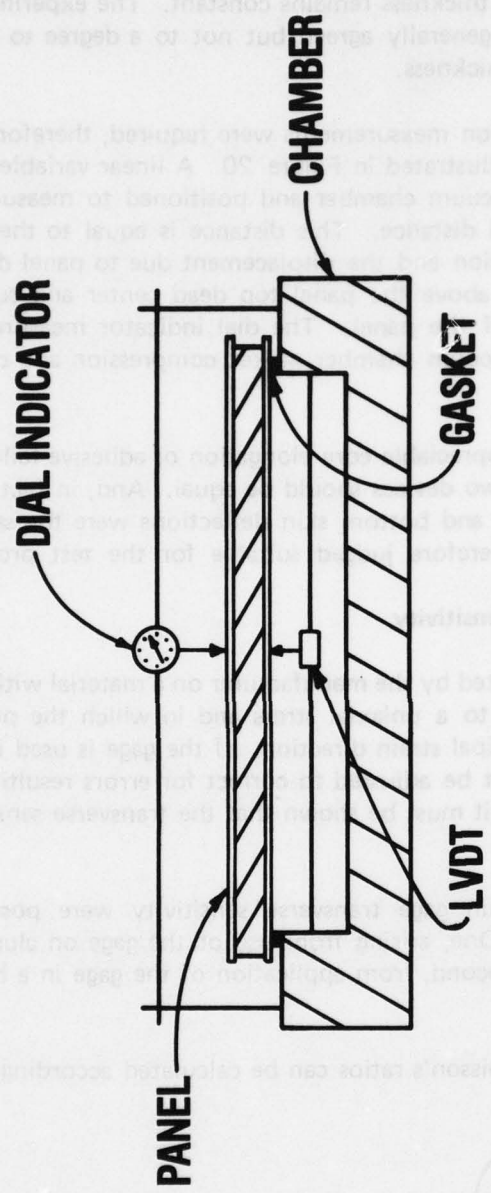

Figure 20. Displacement Sensor Schematic.

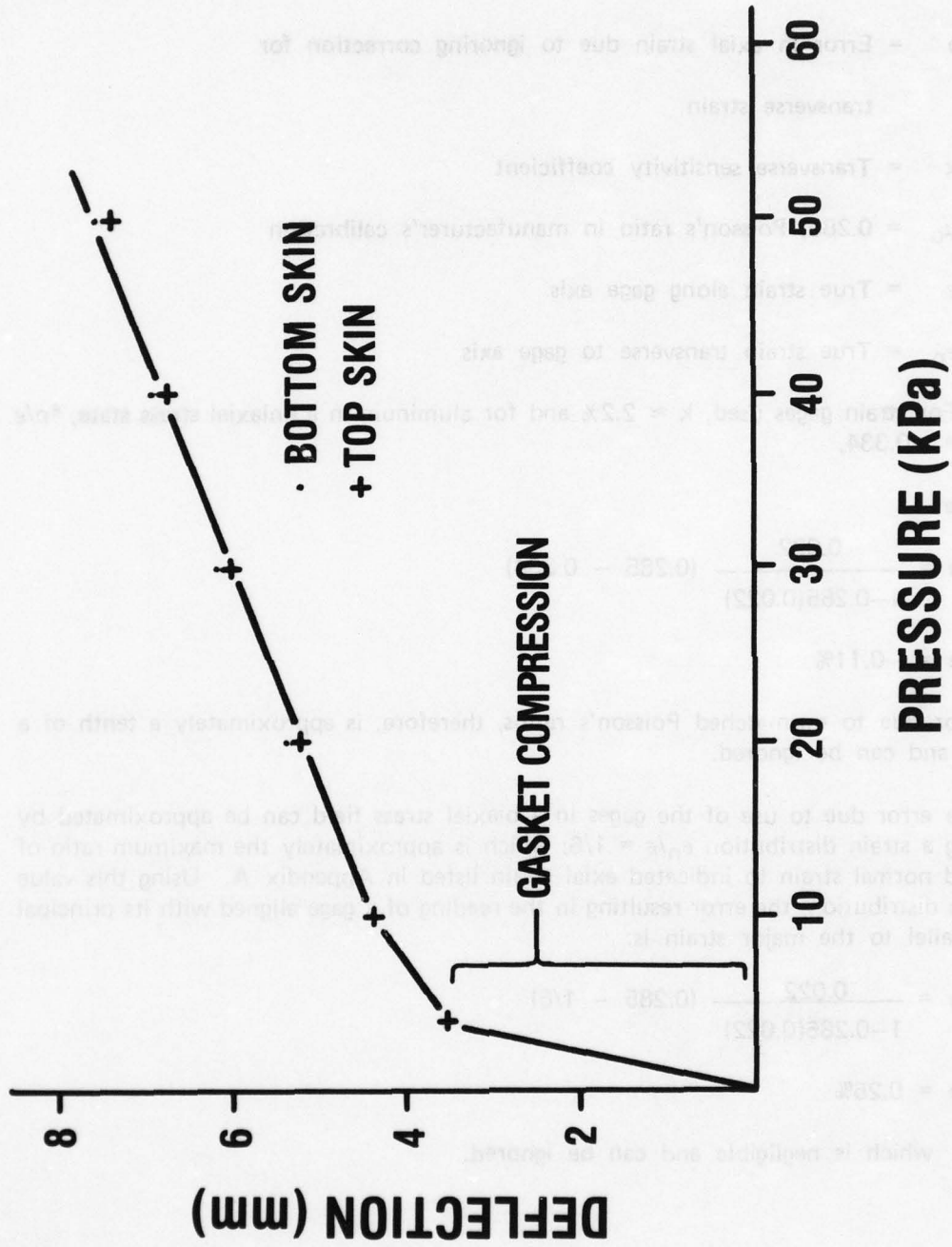

Figure 21. Verification of Loading Arrangement, Mid Center Deflection.

where

e = Error in axial strain due to ignoring correction for transverse strain

k = Transverse sensitivity coefficient

μ_0 = 0.285, Poisson's ratio in manufacturer's calibration

ϵ = True strain along gage axis

ϵ_n = True strain transverse to gage axis

For strain gages used, $k \approx 2.2\%$ and for aluminum in a uniaxial stress state, $\epsilon_n/\epsilon = -0.334$,

therefore

$$e = \frac{0.022}{1 - 0.285(0.022)} (0.285 - 0.334)$$

$$e = -0.11\%$$

The error due to mismatched Poisson's ratios, therefore, is approximately a tenth of a percent and can be ignored.

The error due to use of the gages in a biaxial stress field can be approximated by assuming a strain distribution $\epsilon_n/\epsilon = 1/6$; which is approximately the maximum ratio of indicated normal strain to indicated axial strain listed in Appendix A. Using this value of strain distribution, the error resulting in the reading of a gage aligned with its principal axis parallel to the major strain is:

$$e = \frac{0.022}{1 - 0.285(0.022)} (0.285 - 1/6)$$

$$e = 0.25\%$$

which is negligible and can be ignored.

However, when one gage of a 45° rosette is aligned with its principal axis parallel to the major strain, another gage in the rosette must necessarily be aligned with its principal axis perpendicular to the major strain, and the error resulting in that gage is:

$$e = \frac{0.022}{1 - 0.285(0.022)} (0.285 - 6)$$

$$e = 12.65\%$$

which is significant and must be accounted for.

The following formulas, from Reference 5, can be used to compute the true strains along the gage axis for a 45° rosette with axes as designated in Figure 22.

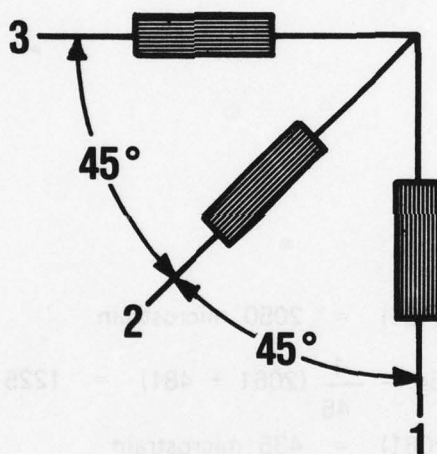

Figure 22. Forty-Five Degree Rectangular Rosette.

$$\epsilon_1 = R_1 - \frac{1}{b} R_3$$

$$\epsilon_2 = \left(1 + \frac{1}{b}\right) R_2 - \frac{1}{b} (R_1 + R_3)$$

$$\epsilon_3 = R_3 - \frac{1}{b} R_1$$

where:

$\epsilon_1, \epsilon_2, \epsilon_3$ are the true strains along the gage axes,

R_1, R_2, R_3 are the apparent strains along the gage axes based on the manufacturer's gage factor,

and

b is the auxiliary factor, +45, supplied with the strain gages used.

As an example; from Appendix A, Panel Number 2, the indicated strains at 70 kPa for channels 4, 5, and 6 were 2061, 1254, and 481 microstrain, respectively.

Therefore,

$$R_1 = 2061$$

$$R_2 = 1254$$

$$R_3 = 481$$

and the actual strains were,

$$\epsilon_1 = 2061 - \frac{1}{45} (481) = 2050 \text{ microstrain}$$

$$\epsilon_2 = \left(1 + \frac{1}{45}\right) 1254 - \frac{1}{45} (2061 + 481) = 1225 \text{ microstrain}$$

$$\epsilon_3 = 481 - \frac{1}{45} (2061) = 435 \text{ microstrain}$$

Following this method, the raw strain data of Appendix A were corrected for strain gage transverse sensitivity and the adjusted data are presented in Appendix C.

Effect of an Adhesive Joint Located between a Strain Gage Pair

Test panels numbered one through six had multipiece cores joined by adhesive splices approximately one centimetre thick running perpendicular to the aluminum face sheets. In each of these panels, purely by chance, the strain gage layout resulted in at least one pair of strain gages being mounted in the vertical plane of the splice directly above and below the adhesive, as depicted in Figure 23.

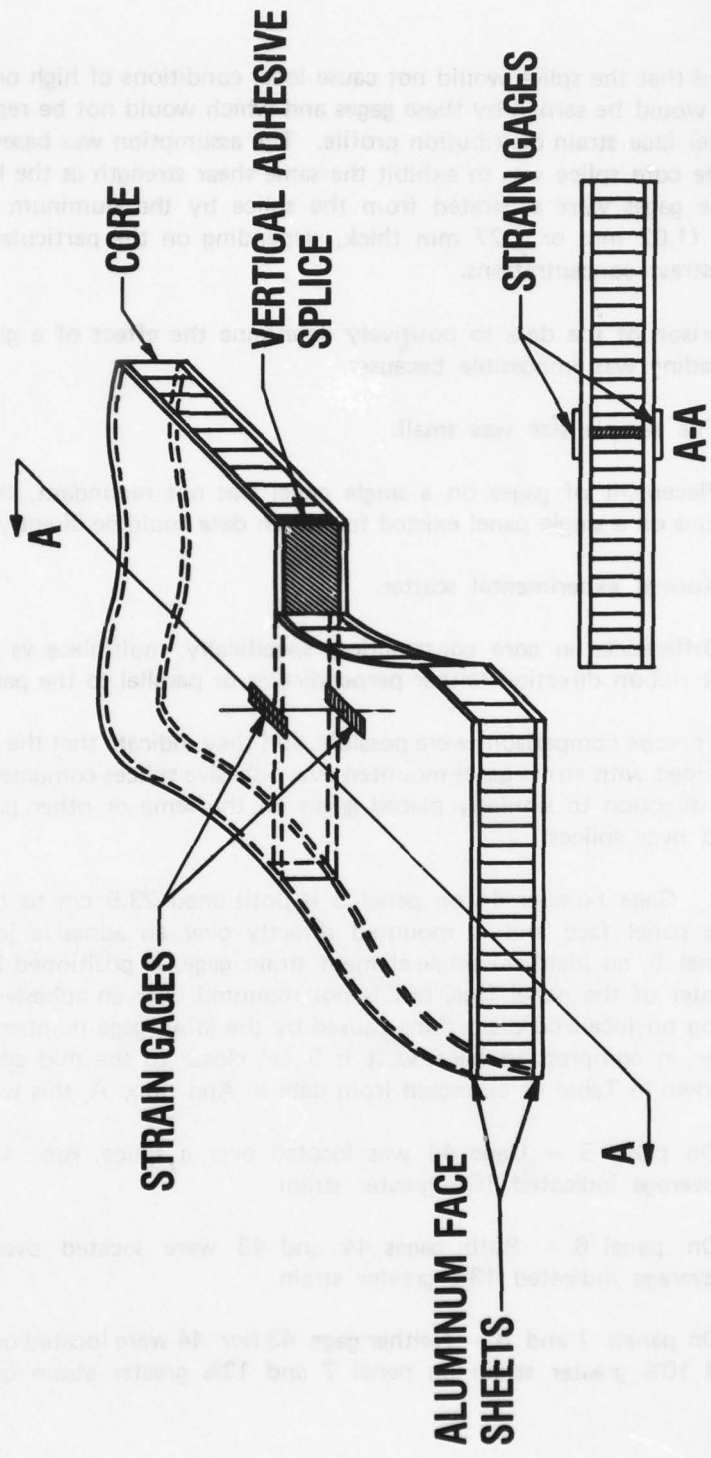

Figure 23. Adhesive Joint Located Between Strain Gage Pair.

It was assumed that the splice would not cause local conditions of high or low strain in the skin which would be sensed by these gages and which would not be representative of the general panel face strain distribution profile. The assumption was based on: one, by specification the core splice was to exhibit the same shear strength as the honeycomb core; and two, the gages were separated from the splice by the aluminum skin which was thick enough (1.02 mm or 1.27 mm thick, depending on the particular panel) to redistribute local stress concentrations.

Direct comparison of the data to positively determine the effect of a glue joint on the strain gage reading was impossible because:

- (1) The sample size was small.
- (2) Placement of gages on a single panel was not redundant, therefore no symmetrical positions on a single panel existed for which data could be directly compared.
- (3) Normal experimental scatter.
- (4) Differences in core construction; specifically, multipiece vs single-piece cores and different ribbon direction (either perpendicular or parallel to the panel length).

However, less precise comparisons were possible, and they indicate that the assumption is valid. Data obtained with strain gages mounted over adhesive splices compared favorably in magnitude and direction to similarly placed gages on the same or other panels which were not mounted over splices.

For example: Gage number 44 on panel 5 is positioned 23.5 cm to the right of the center of the panel face and is mounted directly over an adhesive joint. Gage number 43 on panel 5, an identical single-element strain gage, is positioned 28.5 cm to the left of the center of the panel face, but is not mounted over an adhesive joint. By symmetry, assuming no localized distortions caused by the joint, gage number 44 should read slightly higher in compression because it is 5 cm closer to the mid center of the panel face. As shown in Table 3, extracted from data in Appendix A, this was the case.

- (1) On panel 5 — Gage 44 was located over a splice, gage 43 was not. Gage 44 on the average indicated 16% greater strain.
- (2) On panel 6 — Both gages 44 and 43 were located over a splice. Gage 44 on the average indicated 13% greater strain.
- (3) On panels 7 and 8 — Neither gage 43 nor 44 were located over a splice. Gage 44 indicated 10% greater strain on panel 7 and 13% greater strain on panel 8.

Table 3. Gage 43 and 44 Raw Strain Data. Comparison of Raw Strain Data ($\times 10^{-6}$) from Gages 43 and 44 on Panels 5, 6, 7 and 8

	Vacuum (kPa)						
	10	20	30	40	50	60	70
Panel 5 Gage 43	-54	-86	-118	-147	-182	-214	-248
Panel 5 Gage 44	-69	-108	-142	-180	-210	-246	-283
Δ	15	22	24	33	28	32	35
% Δ	22	20	17	18	13	13	12
Ave % Δ	16						
Panel 6 Gage 43	-64	-100	-138	-173	-208	-242	-276
Panel 6 Gage 44	-78	-122	-163	-199	-234	-267	-300
Δ	14	22	25	26	26	25	24
% Δ	18	18	15	13	11	9	8
Ave % Δ	13						
Panel 7 Gage 43	-125	-153	-177	-202	-226	-248	-269
Panel 7 Gage 44	-147	-172	-198	-223	-248	-270	-292
Δ	22	19	21	21	22	22	23
% Δ	15	11	11	9	9	8	8
Ave % Δ	10						
Panel 8 Gage 43	-127	-157	-183	-206	-228	-248	-267
Panel 8 Gage 44	-143	-178	-207	-237	-264	-287	-309
Δ	16	21	24	31	36	39	42
% Δ	11	12	12	13	14	14	14
Ave % Δ	13						

As a second example: Panels 9, 10, 11 and 12 all have 90-mm thick cores and a 1.02-mm-thick skin on the top face and a 1.27-mm-thick skin on the bottom face. On panel number 9 several gages were located over adhesive seams but two (rosettes 4/5/6 and 13/14/15 on bottom skin) in particular are suitable for comparison with other panels because they were not located near the perimeter (subject to boundary effects) and because they indicated appreciable strains.

Table 4 is a listing of the major strain (ϵ max), minor strain (ϵ min), and angle (α) between the major strain direction and strain gage axis 4 or 13 (as applicable); for rosette positions 4/5/6 and 13/14/15 at loadings from 10 kPa to 70 kPa for panels 9 through 12. The principal strains and angle in the table have been calculated from Appendix A data according to the following equations from Hetenyi,⁶ with a slight change in nomenclature. They are not corrected for strain gage transverse sensitivity error.

$$\epsilon \text{ max} = A + B$$

$$\epsilon \text{ min} = A - B$$

$$\tan 2\alpha = \frac{R_2 - A}{R_1 - A}$$

where

$$A = \frac{R_1 + R_3}{2}$$

and

$$B = \sqrt{(R_1 - A)^2 + (R_2 - A)^2}$$

When reviewing the table it must be remembered that:

- (1) The rosettes on panel 9 are located over an adhesive splice. Those on panels 10, 11, and 12 are not.
- (2) Panels 9 and 10 have multipiece cores. Panels 11 and 12 have single-piece cores.
- (3) The core ribbon direction is parallel to the length in panels 9 and 10, and perpendicular to the length in panels 11 and 12.

⁶M. Hetenyi, Handbook of Experimental Stress Analysis, John Wiley & Sons, 1950

**Table 4. Rosette 4/5/6 and 13/14/15 Computed Principal Strain.
Comparison of Computed Principal Strain ($\times 10^6$) and Angle (Degrees)
from Rosettes 4/5/6 and 13/14/15 on Panels 9 through 12**

Panel	ϵ or α	Vacuum Load (kPa)						
		10	20	30	40	50	60	70
Rosette 4/5/6								
*9	ϵ max	144	286	430	567	702	830	960
	ϵ min	53	94	129	160	193	221	252
	α	-16	-6	-4	-2	-1	-1	-1
10	ϵ max	144	271	411	551	687	817	949
	ϵ min	94	152	189	221	253	286	319
	α	-43	12	5	3	2	2	1
11	ϵ max	172	335	497	659	817	966	1116
	ϵ min	22	49	74	101	127	151	174
	α	-7	-3	-2	-2	-1	-1	-1
12	ϵ max	173	334	494	654	811	960	1109
	ϵ min	13	35	58	80	102	123	144
	α	-4	-1	-1	0	0	0	0
Rosette 13/14/15								
*9	ϵ max	134	268	382	496	606	173	818
	ϵ min	54	89	129	171	213	253	293
	α	-10	-6	-3	-2	-2	-2	-2
10	ϵ max	119	245	358	470	581	686	792
	ϵ min	92	132	168	206	245	284	323
	α	17	-1	-3	-4	-4	-5	-5
11	ϵ max	161	306	440	577	708	834	958
	ϵ min	19	43	75	108	139	169	200
	α	-1	1	1	0	0	0	0
12	ϵ max	159	305	444	580	714	840	965
	ϵ min	12	34	61	90	119	147	175
	α	-2	-2	-2	-2	-2	-2	-2

*Gage located over adhesive splice.

With these points in mind, the following observations are noted:

(1) Simple percentage calculations show that the major principal strain (ϵ max) for a gage located over an adhesive joint (4/5/6 or 13/14/15 on panel 9) differs on the average by no more than 5% from a similarly located gage on a similar panel without a nearby adhesive joint (4/5/6 or 13/14/15 on panel 10).

(2) The minor principal strain (ϵ min) for a gage located over an adhesive joint (4/5/6 or 13/14/15 on panel 9) differs on the average by 26% from a similarly located gage on a similar panel but without a nearby adhesive joint (4/5/6 or 13/14/15 on panel 10). Although 26% is significant it cannot be attributed to the joint because two gages on similar panels without adhesive joints (4/5/6 and 13/14/15 on panels 11 and 12) exhibit an average 22% difference in the minor principal strain.

(3) The principal strains from the two gages over the adhesive joint (3/4/5 and 13/14/15 on panel 9) were always bracketed by the principal strains of the same gages, but without nearby adhesive joints on similar panels (panels 10, 11 and 12).

(4) The angle (α) between the major principal strain direction and strain gage axis 4 or 13 (as applicable) did not differ significantly between gages over splices and gages not over splices.

Therefore it is concluded that the adhesive splices did not cause local stress concentrations which would be sensed by the strain gages and which would not be representative of the general strain distribution profile of the panel face.

Strain Distribution Profile

The general strain distribution profile in the face of the panels, as presented in the Appendix C data, may be more easily visualized by calculating the principal strains and plotting the angle of the major principal strain. Figure 24 is a plot of the orientation of the major principal strain at each rosette location for panels 2, 3 and 4 at a loading of 50 kPa. (Sufficient data are not available to plot this information at 70 kPa.) Top skin locations are denoted by solid arrows and bottom skin locations are indicated by dashed arrows. Figures 25 and 26 are similar plots for panels 5 through 12 at 70 kPa. From the calculations and the figures it can be summarized that:

(1) The angle of the principal strain tends to rotate quickly into the final position as the load increases.

(2) The principal strain direction for complementary rosettes (same location, top and bottom skins) on the same panel agree, except as noted in (4).

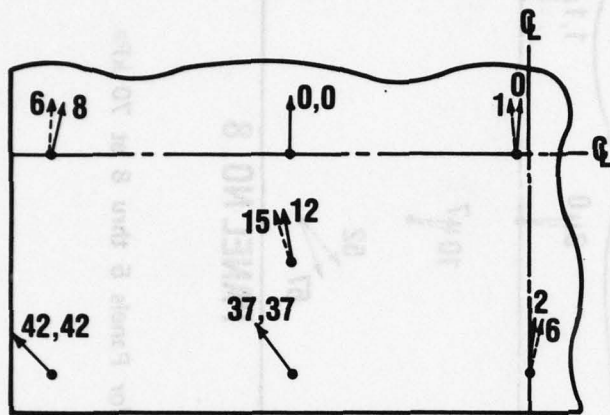

PANEL NO. 2

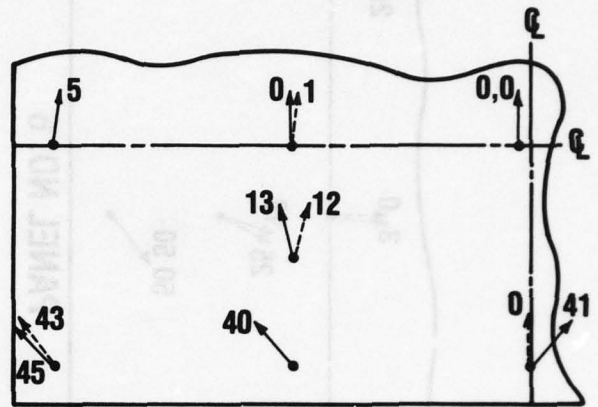

PANEL NO. 3

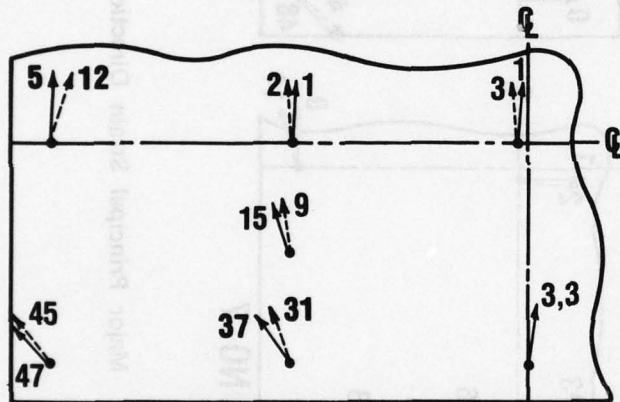

PANEL NO. 4

Figure 24. Major Principal Strain Directions for Panels 2 thru 4 at 50 kPa.

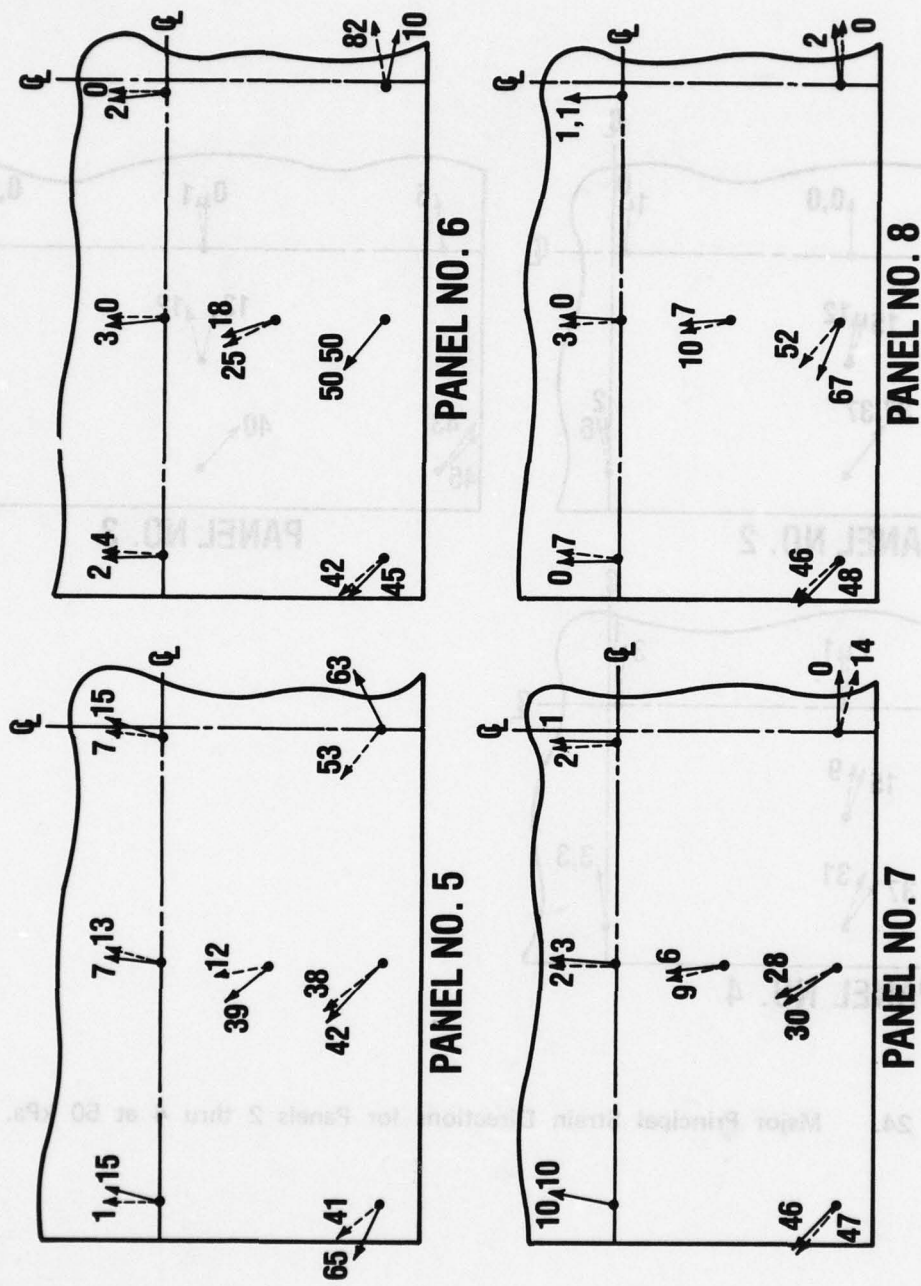

Figure 25. Major Principal Strain Directions for Panels 5 thru 8 at 70 kPa.

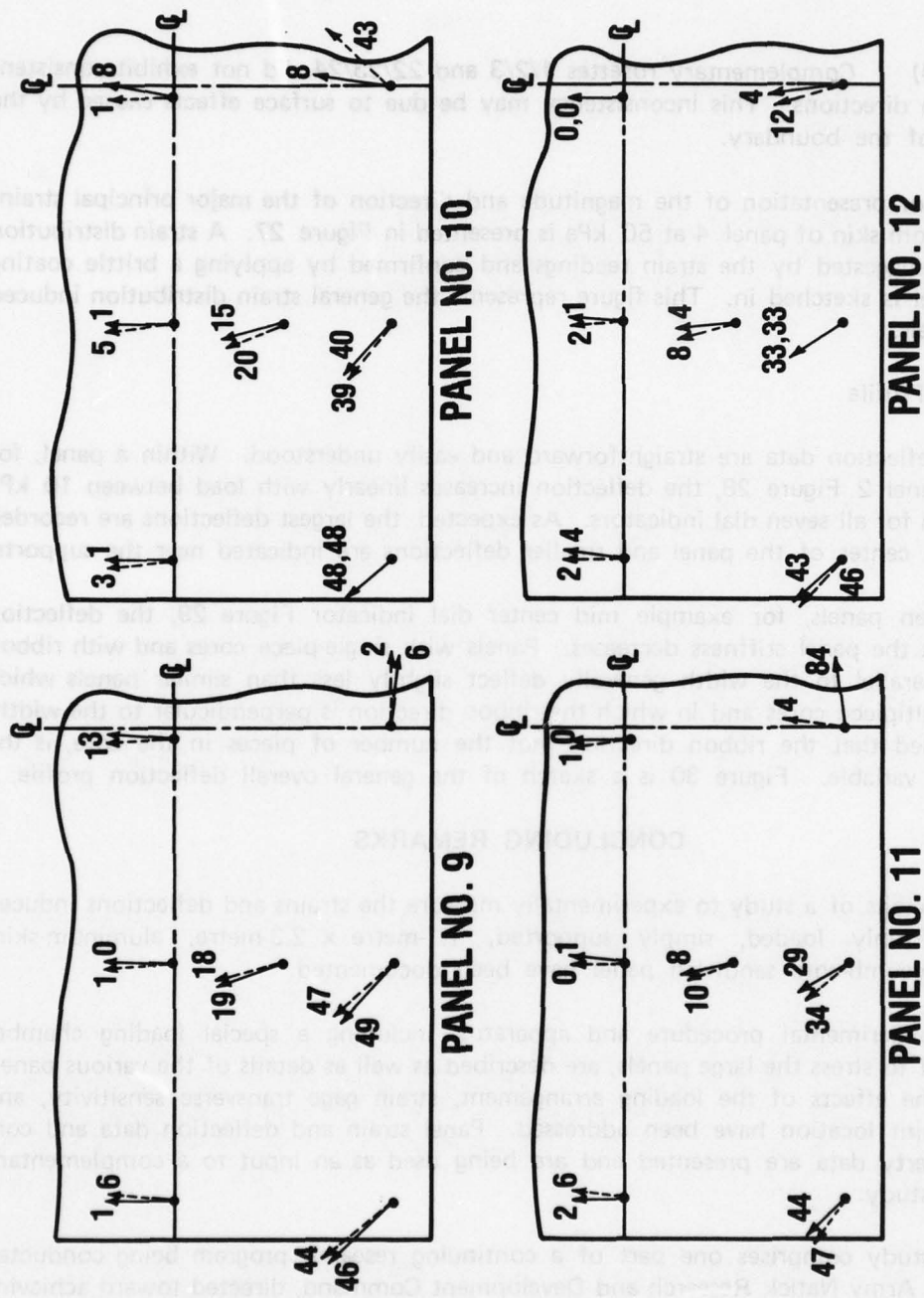

Figure 26. Major Principal Strain Directions for Panels 9 thru 12 at 70 kPa.

(3) The principal strain directions from panel to panel agree, except as noted in (4).

(4) Complementary rosettes 1/2/3 and 22/23/24 did not exhibit consistent major strain directions. This inconsistency may be due to surface effects caused by the proximity of the boundary.

A vector presentation of the magnitude and direction of the major principal strains on the bottom skin of panel 4 at 50 kPa is presented in Figure 27. A strain distribution pattern as suggested by the strain readings and confirmed by applying a brittle coating to the panel is sketched in. This figure represents the general strain distribution induced in the panels.

Deflection Profile

The deflection data are straightforward and easily understood. Within a panel, for example panel 2 Figure 28, the deflection increases linearly with load between 10 kPa and 70 kPa for all seven dial indicators. As expected, the largest deflections are recorded toward the center of the panel and smaller deflections are indicated near the supports.

Between panels, for example mid center dial indicator Figure 29, the deflection increases as the panel stiffness decreases. Panels with single-piece cores and with ribbon direction parallel to the width generally deflect slightly less than similar panels which contain multipiece cores and in which the ribbon direction is perpendicular to the width. It is assumed that the ribbon direction, not the number of pieces in the core, is the controlling variable. Figure 30 is a sketch of the general overall deflection profile.

CONCLUDING REMARKS

The details of a study to experimentally measure the strains and deflections induced in a uniformly loaded, simply supported, 1.1-metre x 2.3-metre, aluminum-skin, paper-honeycomb-core sandwich panel have been documented.

The experimental procedure and apparatus, including a special loading chamber constructed to stress the large panels, are described as well as details of the various panels tested. The effects of the loading arrangement, strain gage transverse sensitivity, and adhesive joint location have been addressed. Panel strain and deflection data and core shear property data are presented and are being used as an input to a complementary analytical study.

This study comprises one part of a continuing research program being conducted by the US Army Natick Research and Development Command, directed toward achieving the most efficient structural design for military rigid wall tactical shelters.

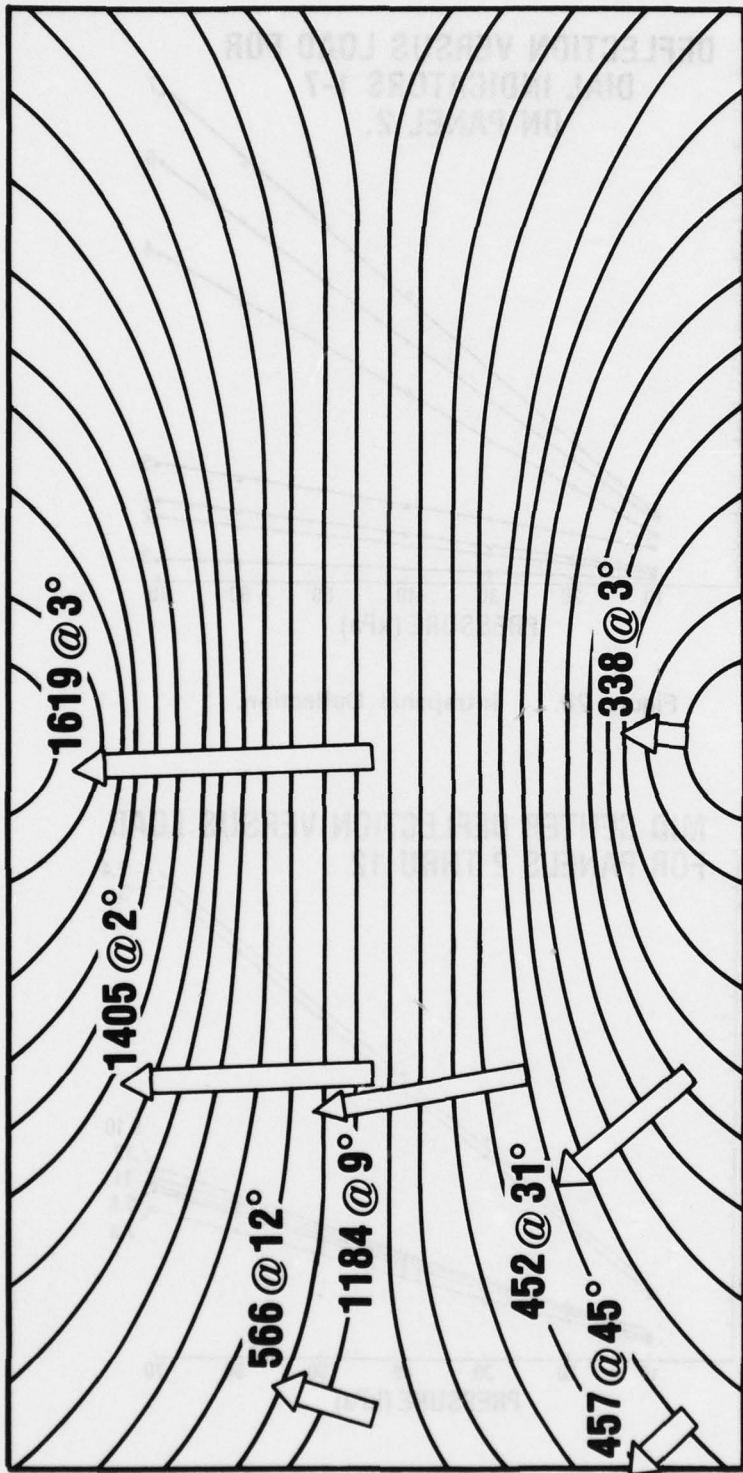

Figure 77. General Strain Distribution Pattern.

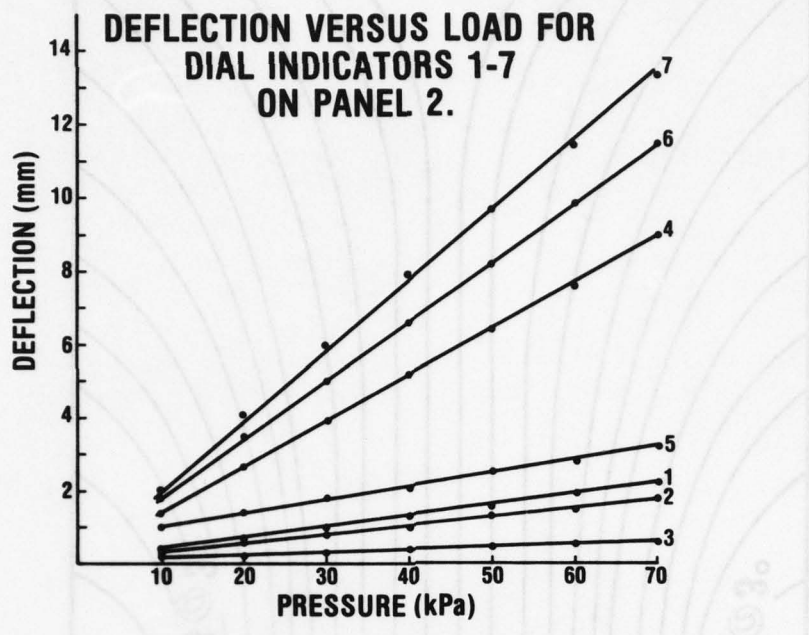

Figure 28. Intrapanel Deflection.

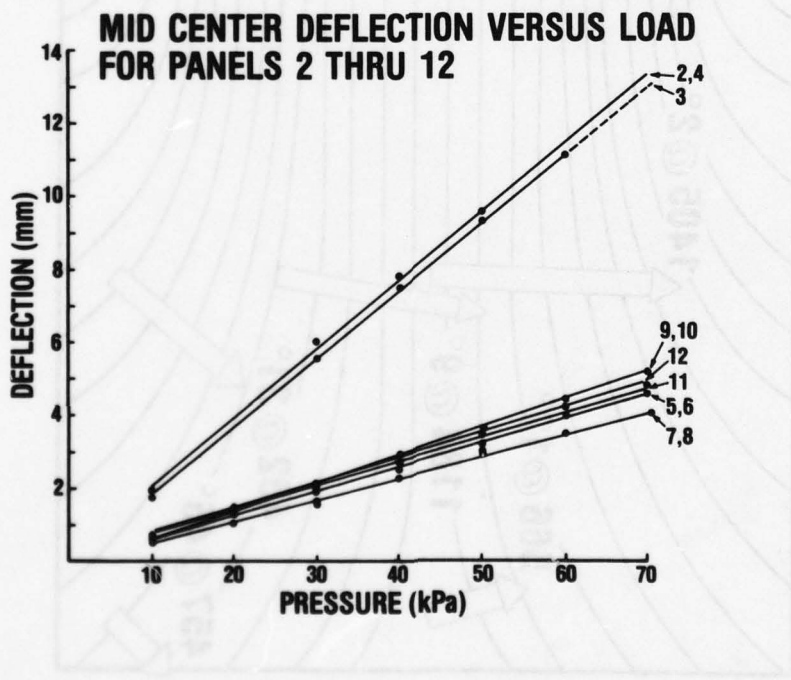

Figure 29. Interpanel Deflection.

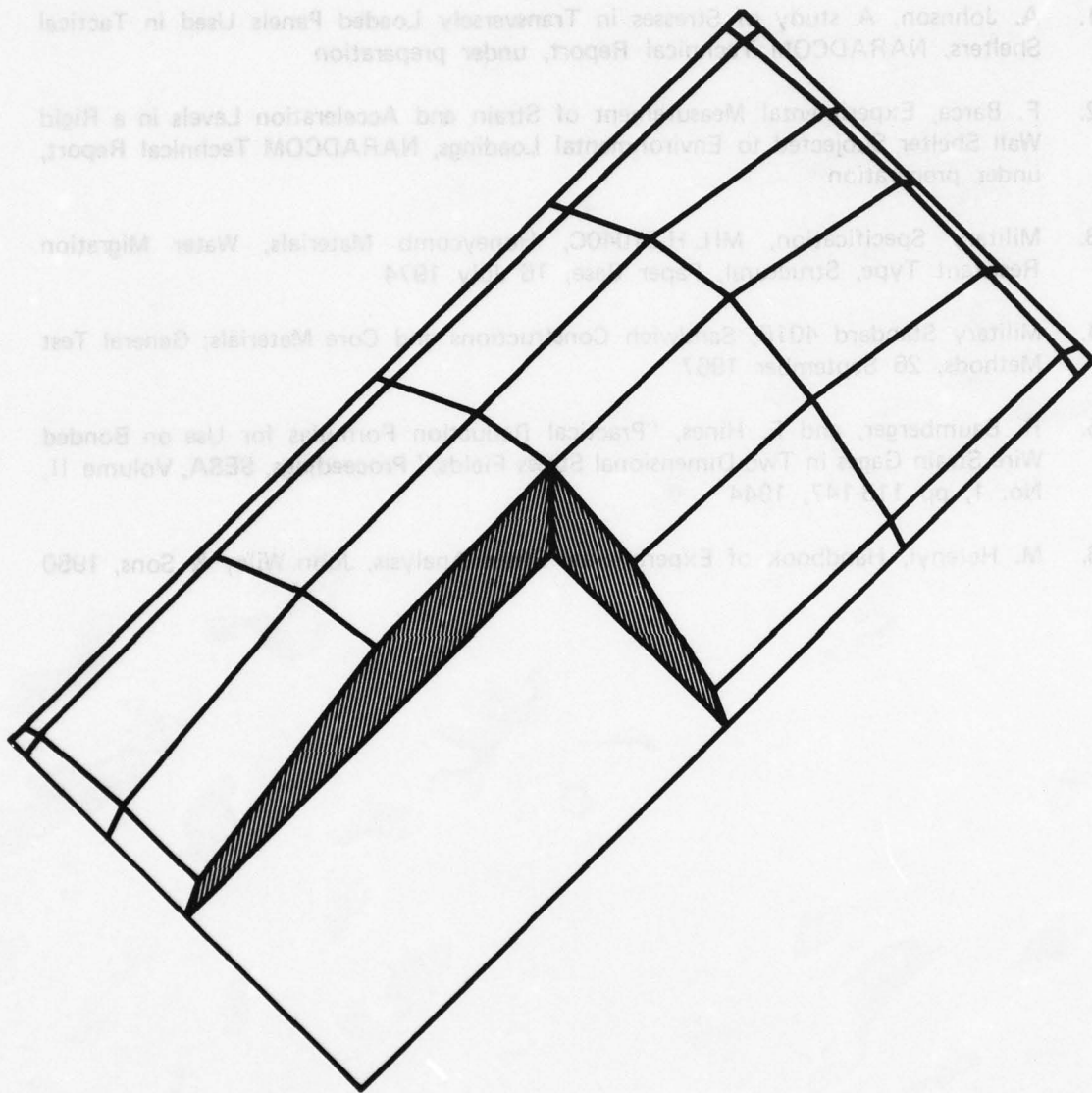

Figure 30. Deflection Profile. Panel number 2 deflection profile at 70 kPa loading. Deflection exaggerated and shown in opposite direction for ease of visualization.

REFERENCES

1. A. Johnson, A study of Stresses in Transversely Loaded Panels Used in Tactical Shelters, NARADCOM Technical Report, under preparation
2. F. Barca, Experimental Measurement of Strain and Acceleration Levels in a Rigid Wall Shelter Subjected to Environmental Loadings, NARADCOM Technical Report, under preparation
3. Military Specification, MIL-H-21040C, Honeycomb Materials, Water Migration Resistant Type, Structural, Paper Base, 16 July 1974
4. Military Standard 401B, Sandwich Constructions and Core Materials; General Test Methods, 26 September 1967
5. R. Baumberger, and F. Hines, "Practical Reduction Formulas for Use on Bonded Wire Strain Gages in Two-Dimensional Stress Fields," *Proceedings, SESA*, Volume II, No. 1, pp 113-147, 1944
6. M. Hetenyi, *Handbook of Experimental Stress Analysis*, John Wiley & Sons, 1950

[REVERSED]							[REVERSED]
01	02	03	04	05	06	07	
01	000	00	00	00	00	00	1
011	011	011	011	011	011	011	2
015	015	015	015	015	015	015	3
019	019	019	019	019	019	019	4
023	023	023	023	023	023	023	5
027	027	027	027	027	027	027	6
031	031	031	031	031	031	031	7
035	035	035	035	035	035	035	8
039	039	039	039	039	039	039	9
043	043	043	043	043	043	043	10
047	047	047	047	047	047	047	11
051	051	051	051	051	051	051	12
055	055	055	055	055	055	055	13
059	059	059	059	059	059	059	14
063	063	063	063	063	063	063	15
067	067	067	067	067	067	067	16
071	071	071	071	071	071	071	17
075	075	075	075	075	075	075	18
079	079	079	079	079	079	079	19
083	083	083	083	083	083	083	20
087	087	087	087	087	087	087	21
091	091	091	091	091	091	091	22
095	095	095	095	095	095	095	23
099	099	099	099	099	099	099	24
103	103	103	103	103	103	103	25
107	107	107	107	107	107	107	26
111	111	111	111	111	111	111	27
115	115	115	115	115	115	115	28
119	119	119	119	119	119	119	29
123	123	123	123	123	123	123	30
127	127	127	127	127	127	127	31
131	131	131	131	131	131	131	32
135	135	135	135	135	135	135	33
139	139	139	139	139	139	139	34
143	143	143	143	143	143	143	35
147	147	147	147	147	147	147	36
151	151	151	151	151	151	151	37
155	155	155	155	155	155	155	38
159	159	159	159	159	159	159	39
163	163	163	163	163	163	163	40
167	167	167	167	167	167	167	41
171	171	171	171	171	171	171	42
175	175	175	175	175	175	175	43
179	179	179	179	179	179	179	44
183	183	183	183	183	183	183	45
187	187	187	187	187	187	187	46
191	191	191	191	191	191	191	47
195	195	195	195	195	195	195	48
199	199	199	199	199	199	199	49
203	203	203	203	203	203	203	50
207	207	207	207	207	207	207	51
211	211	211	211	211	211	211	52
215	215	215	215	215	215	215	53
219	219	219	219	219	219	219	54
223	223	223	223	223	223	223	55
227	227	227	227	227	227	227	56
231	231	231	231	231	231	231	57
235	235	235	235	235	235	235	58
239	239	239	239	239	239	239	59
243	243	243	243	243	243	243	60
247	247	247	247	247	247	247	61
251	251	251	251	251	251	251	62
255	255	255	255	255	255	255	63
259	259	259	259	259	259	259	64
263	263	263	263	263	263	263	65
267	267	267	267	267	267	267	66
271	271	271	271	271	271	271	67
275	275	275	275	275	275	275	68
279	279	279	279	279	279	279	69
283	283	283	283	283	283	283	70
287	287	287	287	287	287	287	71
291	291	291	291	291	291	291	72
295	295	295	295	295	295	295	73
299	299	299	299	299	299	299	74
303	303	303	303	303	303	303	75
307	307	307	307	307	307	307	76
311	311	311	311	311	311	311	77
315	315	315	315	315	315	315	78
319	319	319	319	319	319	319	79
323	323	323	323	323	323	323	80
327	327	327	327	327	327	327	81
331	331	331	331	331	331	331	82
335	335	335	335	335	335	335	83
339	339	339	339	339	339	339	84
343	343	343	343	343	343	343	85
347	347	347	347	347	347	347	86
351	351	351	351	351	351	351	87
355	355	355	355	355	355	355	88
359	359	359	359	359	359	359	89
363	363	363	363	363	363	363	90
367	367	367	367	367	367	367	91
371	371	371	371	371	371	371	92
375	375	375	375	375	375	375	93
379	379	379	379	379	379	379	94
383	383	383	383	383	383	383	95
387	387	387	387	387	387	387	96
391	391	391	391	391	391	391	97
395	395	395	395	395	395	395	98
399	399	399	399	399	399	399	99
403	403	403	403	403	403	403	100

APPENDIX A

RAW MICROSTRAIN DATA

Small number 114, approximately 75 km. All recorded until not necessary.

TABLE A1. PANEL 2 RAW MICROSTRAIN DATA

Channel	Pressure (kPa)						
	10	20	30	40	50	60	70
1	73	91	85	72	56	38*	19
2	65	103	115	118	119	118	117
3	49	111	152	185	219	251	283
4	325	643*	920*	1208	1499	1786	2061
5	195	387	554	727	906	1082	1254
6	83	151	211	275	342	411	481
7	26	12	23	35	45	55	65
8	88	174	254	331	412	486	558
9	71	129	159	185	213	240	265
10	66	120	179	241	306	370	433
11	175	350	513	677	846	1011	1174
12	234	442	624	804	992	1172	1355
13	294	556	790	1020	1262	1491	1729
14	186	356	513	668	832	988	1150
15	77	155	235	316	404	489	579
16	2*	49*	81*	101*	118*	132*	144*
17	78	136*	184*	224*	265*	301	335*
18	189*	275*	355*	424*	494*	555*	615*
19	34	68	97	126	157	185	215
20	-21	-64	-106	-148	-193	-235	-278
21	27	45	62	77	94	109	124
22	-71	-102	-112	-121	-130	-139	-150
23	-69	-108	-127	-147	-167	-187	-209
24	-42	-93	-135	-172	-210	-244	-280
25	-339	-665*	-979*	-1298	-1616*	-1906*	-2247*
26	-201	-396	-578	-762	-940	-1110	-1295
27	-77	-138	-187	-234	-277	-315	-356
28	-28	-34	-57	-85	-117	-151	-188
29	-91	-177	-268	-372	-475	-574	-680
30	-72	-133	-181	-228	-272	-313	-354
31	-60	-102	-167	-229	-291	-346	-405
32	-176	-353	-531	-718	-906	-1076	-1263
33	-240	-465	-671	-878	-1085	-1272	-1478
34	-302	-578	-838	-1096	-1355*	-1591	-1852
35	-187	-361	-528	-691	-854	-1002	-1167
36	-69	-136	-207	-278	-349	-412	-480
37	10	-31	-60	-81	-98	-114	-128
38	-64	-119	-169	-215	-262	-305	-353
39	-190*	-282*	-373*	-461	-553	-638	-734*
40	-33	-67	-100	-131	-164	-194	-227
41	18	58	99	140	181	218	257
42	-27	-46	-64	-82	-100	-116	-133
43	-74	-131	-183	-237	-289	-332	-379
44	-80	-150	-207	-260	-311	-356	-403
45	79	147	213	283	356	426	507
46	77	147	211	279	349	416	494

*Standard deviation between 10 and 25 microstrain, all others less.

TABLE A2. PANEL 3 RAW MICROSTRAIN DATA

Channel	Pressure (kPa)						
	10	20	30	40	50	60 ¹	70
1	145	150*	168	166	156	161	↑ N O D A T A ↓
2	92	141	183	212	234	249	
3	40	125	202	265	314	345	
4	307	642*	970	1290	1602	1901	
5	220	417	613	801	986	1163	
6	139	189	248	306	364	423	
7	83	91	100	108	117	123	
8 ²	36	29	16	-8	-34*	-51	
9	61	133	193	240	277	308	
10	109	155	206	256	309	359	
11	149	251	350	439*	531	618	
12	227	458*	686*	909	1127	1335	
13	286*	564	834	1094	1349	1588	
14	207	385	559	732	902	1060	
15	115	185	261	334	408	475	
16	4	44	86	117	142	150	
17	45*	112	175	227*	272*	322	
18	--	--	--	--	--	--	
19	26	55	88	125	159	194	
20	-10*	-43	-80	-115	-146	-185	
21	43	66	85	103	117	132	
22	-146	-177	-210	-246	-283	-318	
23	-81	-134	-177	-218	-257	-293	
24	-31	-106	-177	-237	-292	-335	
25	-307	-644	-967*	-1311	-1642	-2007	
26	-215	-407	-595	-779	-963	-1159	
27	-132	-179	-223	-263	-298	-325	
28	-82	-99	-127	-160	-193	-227	
29	-94	-176	-265	-354	-439	-524	
30	-46	-112	-168	-216	-261	-302	
31	-98	-140	-184	-230	-276	-315	
32	-190	-377	-560	-747	-939	-1113	
33	-235	-473	-708	-934	-1155	-1366	
34	-281	-566	-837	-1107	-1378	-1654	
35	-200	-375	-535	-699	-860	-1022	
36	-106	-169	-233	-294	-353	-401	
37	7	-29	-66	-98	-124	-145	
38	-50	-112	-176	-236	-296	-348	
39	-184	-288	-379	-466	-549	-630	
40	-17	-42	-68	-99	-128	-157	
41	17	55	96	136	177	213	
42	-36	-63	-86	-109	-130	-146	
43	-118	-166	-213	-254	-295	-329	
44	-132	-176	-221	-261	-298	--	
45	129	186	249	310	373	440	
46	140	198	254	312	372	435	

*Standard deviation between 10 and 25 microstrain, all others less

¹One run only

²Gage 8 defective

TABLE A3. PANEL 4 RAW MICROSTRAIN DATA

Channel	Pressure (kPa)						70
	10	20	30	40	50	60 ¹	
1	78	94	108	116	120	121	↑ N O D A T A ↓
2	80	132	173	197	220	239	
3	76	164	239	292	341	389*	
4	348	689	1014	1310*	1625*	1929	
5	200	398	592	778	965	1145	
6	109	193*	277*	357*	436	519 ²	
7	41	67	90	111	128	144	
8	68	167	262*	342	427	492	
9	103	188	251	296	333	367	
10	60	110	162	212	265	311	
11	168	353	529	699	864	1024	
12	268	512	739	953	1166	1368	
13	330	611	887	1153	1411	1657	
14	195	363	528	689	845	997	
15	65	139	212	288	364	434	
16	-23	19	71	111	145	172	
17	61	115	173	220	260	294	
18	241	345	422	491	550	609	
19	36	61	87	112	141	165	
20	4	-39	-81	-123	-167	-208	
21	38	69	97	124	145	166	
22	-73	-103	-135	-173	-209	-243	
23	-75	-127	-172	-208	-245	-277	
24	-63	-143	-202	-248	-291	-334	
25	-345	-685	-1024	-1358	-1693	-2044 ²	
26	-193	-392	-581	-764	-950	-1145*	
27	-54	-90	-125	-153	-178	-204	
28	-38	-76	-114	-158	-202	-241	
29	-65	-170	-264	-363	-462	-553	
30	-91	-167	-224	-269	-314	-358	
31	-52	-108	-159	-210	-263	-308	
32	-179	-379	-574	-762	-963*	-1144*	
33	-263	-500	-728	-946	-1161	-1376	
34	-317	-603	-875	-1143	-1412	-1683*	
35	-203	-383	-550	-719	-883	-1044*	
36	-58	-125	-188	-248	-306	-357	
37	34	-3	-46	-82	-116	-144	
38	-60	-124	-193	-256	-313	-371	
39	-240	-348	-436	-516	-600*	-668	
40	-28	-53	-76	-94	-114	-131	
41	6	45	87	131	170	210	
42	-33	-64	-97	-129	-161	-191	
43	-58	-108	-152	-192	-227	-260	
44	-71	-117	-162	-199	-234	-267	
45	65	119	176	234	293	355	
46	76	128	186	242	300	359	

*Standard deviation between 10 and 35 microstrain, all others less except as noted in ².

¹Three runs only.

²Standard deviation between 50 and 60 microstrain.

TABLE A4. PANEL 5 RAW MICROSTRAIN DATA

Channel	Pressure (kPa)						
	10	20	30	40	50	60	70
1	69	74	59	50	33	16	5
2	57	78	92	109	123	133	142
3	-28	-33	-44	-61	-78	-94	-115
4	134	262	377	501*	615	723	838
5	92	185	264	355	436	515	592
6	60	82	101	123	145	163	183
7	33	33	41	63	75	89	101
8	35	68	103	146	187	226	260
9	39	70	87	115	132	153	167
10	46	71	101	134	166	191	219
11	76	137	207	287	363	433	502
12	104	202	285	376*	456	532	614
13	130	254	360	467*	566	654	745
14	104	190	276*	355	434	504	576
15	26	29	42	53	74	98	111
16	-40	-60	-73	-76	-75	-78	-67
17	32	53	69	89	119	145	168
18	95	169	228	277	326	380	426
19	7	13	20	21	26	31	35
20	8	1	-15	-28	-41	-57	-80
21	20	32	39	54	56	62	69
22	-89	-119	-137	-139*	-149*	-160*	-173
23	-50	-72	-91	-106	-126	-144	-161
24	-5	-30	-59	-84	-110	-137	-163
25	-92	-198	-302	-391	-494	-596	-696
26	-83	-168	-253	-323	-402	-482	-560
27	-37	-43	-55*	-57*	-59*	-64*	-67
28	-11	-10	-21	-21	-30	-40	-49
29	-13	-33	-64	-94	-122	-153	-184
30	-14	-34	-46	-56	-65	-70	-77
31	-20	-29	-46	-49*	-77	-85*	-107*
32	-85	-155	-236	-312	-397	-476	-561
33	-49	-99	-135	-156*	-195	-230	-270
34	-132	-253	-357	-460	-572	-667	-768
35	-93	-182	-261	-342	-424	-500	-574
36	-39	-63	-96	-136	-170	-205	-242
37	-21	-35	-40	-38	-33	-28	-28
38	-29	-48	-58	-70	-85	-102	-118
39	-108	-194	-255	-312	-358	-404	-448
40	9	8	1	24*	-10	24*	21*
41	-3	5	17	30	45	59	70
42	-10	-20	-21	-27	-37	-38	-41
43	-54	-86	-118	-147	-182	-214	-248
44	-69	-108	-142	-180	-210	-246	-283
45	--	--	--	--	--	--	--
46	--	--	--	--	--	--	--

*Standard deviation between 10 and 25 microstrain, all others less.

TABLE A5. PANEL 6 RAW MICROSTRAIN DATA

Channel	Pressure (kPa)						
	10	20	30	40	50	60	70
1	93	117	135	151	161	168	175
2	56	72	88	102	115	124	135
3	1	23	47	66	83	98	112
4	121	256	388	512	638	755	876
5	78	168	254	337	419	497	577
6	82	119	154	190	223	252	284
7	65	77	84	96	108	120	133
8	51	82	116	148	182	214	245
9	10	36	54	63	70	75	80
10	66	93	122	152	182	210	238
11	100	189	283	370	462	547	637
12	91	188	279	358	443	519	600
13	131	256	376	480	590	689	795
14	86	171	253	327	404	473	547
15	54	90	133	173	218	257	299
16	-16	-16	-11	-3	2	3	3
17	39	74	109	136	163	187	212
18	124	209	282	341	397	448	499
19	12	22	33	42	52	60	70
20	9	-1	-14	-27	-43	-59	-76
21	28	45	59	71	81	91	99
22	-84	-114	-142	-169	-194	-217	-239
23	-58	-83	-107	-130	-155	-177	-201
24	2	-22	-45	-65	-84	-103	-123
25	-130	-277	-415	-556	-703	-837	-975
26	-77	-168	-260	-345	-435	-516	-601
27	-70	-106	-143	-175	-208	-237	-267
28	-56	-68	-80	-98	-116	-134	-157
29	-44	-76	-112	-152	-194	-235	-277
30	-7	-27	-44	-59	-73	-85	-98
31	-61	-92	-125	-160	-196	-229	-264
32	-92	-163	-266	-355	-448	-535	-621
33	-95	-202	-303	-398	-497	-587	-68
34	-133	-265	-390	-507	-628	-740	-85
35	-87	-170	-250	-326	-402	-473	-54
36	-53	-90	-131	-172	-215	-256	-29
37	24	28	24	18	12	7	
38	-36	-72	-108	-138	-171	-202	-23
39	-122	-208	-279	-339	-396	-450	-50
40	-7	-19	-31	-42	-54	-66	-7
41	-5	5	16	29	41	56	7
42	-21	-35	-47	-56	-65	-74	-8
43	-64	-100	-138	-173	-208	-242	-27
44	-78	-122	-163	-199	-234	-267	-30
45	67	102	138	173	208	241	27
46	83	124	164	199	235	268	30

All standard deviations less than or equal to 10 microstrain.

TABLE A6. PANEL 7 RAW MICROSTRAIN DATA

Channel	Pressure (kPa)						
	10	20	30	40	50	60	70
1	185	214	236	256	274	288	301
2	93	128	157	185	215	236	259
3	-25	10	44	81	115	146	176
4	105	270	433	599	767	925	1081
5	110	204	298	392	488	578	666
6	151	184	208	234	259	281	302
7	73	81	98	115	129	143	157
8	22	52	87	126	162	194	226
9	31	77	112	146	172	193	212
10	89	115	143	172	198	224	249
11	85	169	259	347	438	521	601
12	106	228	343	459	575	682	785
13	132	275	412	553	692	824	954
14	123	215	303	392	479	563	643
15	88	119	153	187	225	260	293
16	-4	7	20	34	48	62	73
17	27	52	82	114	145	172	198
18	119	186	249	306	362	412	459
19	18	28	39	49	60	70	80
20	13	8	4	-12	-26	-39	-51*
21	26	41	55	64	79	92	100
22	-184	-218	-244	-268	-294	-318	-342
23	-83	-118	-150	-181	-210	-238	-264
24	35*	8	-45*	-84	-115*	-148*	-188*
25	-99	-262	-427	-592	-758	-918	-1071*
26	-103	-197	-289	-384	-479	-568	-666
27	-147	-173	-200	-221	-246	-267	-287
28	-65	-77	-95	-114	-134	-153	-172
29	-16	-48	-87	-126	-166	-202	-238
30	-32	-76	-111	-143	-173	-198	-221
31	-85	-110	-137	-165	-193	-217	-244
32	-76	-157	-240	-328	-414	-497	-582
33	-101	-223	-341	-457	-575	-687	-794
34	-122	-264	-399	-535	-671	-805	-932
35	-114	-205	-295	-385	-474	-559	-640
36	-86*	-117	-150	-184	-219	-248	-279
37	11	3	-14	-28	-41	-54	-68
38	19	-44	-72	-104	-136	-166	-194
39	-111	-183	-246	-307	-367	-422	-476
40	-10	-21	-33	-44	-55	-67	-77
41	-6	-3	10	22	34	44	60
42	-22	-36	-47	-60	-69	-81	-90
43	-125	-153	-177	-202	-226	-248	-269
44	-147	-172	-198	-223	-248	-270	-292
45	134	160	185	210	236	259	281
46	161	184	215	241	268	287	314

*Standard deviation between 10 and 25 microstrain, all others less.

TABLE A7. PANEL 8 RAW MICROSTRAIN DATA

Channel	Pressure (kPa)						
	10	20	30	40	50	60	70
1	173	205	224	238	249	256	265
2	81	111	136	161	183	202	218
3	-23	7	43	79	111	143	170
4	102	255	412	569	724	876	1025
5	111	210	304	395	486	573	659
6	150	184	212	238	262	285	307
7	103	117	130	143	158	171	185
8	52	82	116	150	184	213	244
9	7	43	70	91	111	128	142
10	103	123	145	167	189	211	232
11	97	179	261	344	425	525	582
12	93	212	326	435	542	647	748
13	114	254	389	523	656	783	908
14	104	185	264	341	416	491	563
15	105	137	167	198	228	259	286
16	-4	5	18	28	39	50	58
17	39	72	105	137	163	191	218
18	112	185	250	313	372	428	480
19	19	29	39	49	58	67	77
20	13	12	-5	-15	-27	-39	-51
21	21	34	45	55	64	73	82
22	-165	-202	-227	-252	-274	-297	-318
23	-81	-111	-138	-161	-185	-207	-229
24	28	-3	-32	-64	-93	-127	-150
25	-97	-253	-408	-565	-720	-879	-1032
26	-102	-198	-292	-387	-478	-568	-654
27	-148	-177	-204	-228	-251	-271	-291
28	-100	-119	-140	-165	-190	-217	-242
29	-44	-74	-105	-139	-173	-208	-242
30	3	-25	-59	-84	-105	-129	-150
31	-97	-115	-134	-155	-176	-197	-217
32	-88	-163	-238	-315	-392	-475	-548
33	-82	-198	-312	-425	-534	-642	-748
34	-109	-244	-381	-515	-652	-781	-908
35	-102	-186	-267	-349	-430	-508	-584
36	-98	-130	-158	-187	-216	-244	-271
37	16	16	13	10	7	4	5
38	-34	-67	-100	-132	-162	-193	-223
39	-105	-174	-236	-295	-352	-405	-458
40	-7	-17	-26	-35	-42	-49	-59
41	-2	8	18	30	42	56	68
42	-21	-33	-45	-57	-68	-78	-89
43	-127	-157	-183	-206	-228	-248	-267
44	-143	-178	-207	-237	-264	-287	-309
45	138	168	194	217	241	263	284
46	143	178	208	235	262	287	309

All standard deviations less than or equal to 10 microstrain.

TABLE A8. PANEL 9 RAW MICROSTRAIN DATA

Channel	Pressure (kPa)						
	10	20	30	40	50	60	70
1	87	130	156	177	198	216	234
2	68	97	118	135	149	161	172
3	6	26	47	65	77	89	100
4	137	284	429	566	702	830	960
5	75	170	261	348	435	516	599
6	60	96	130	161	193	221	252*
7	60	69	77	90	104	117*	132*
8	58	100	145	186	226	266	304
9	16	46	65	76	85	93	102
10	63	95*	125*	159*	193*	226*	258*
11	101	185	267	351	434	513	590
12	98	207	299	389	478	563	645
13	132	266	381	495	606	713	818
14	80	160*	243	320	396	468	540
15	56	91	130	172	213	253	293*
16	-16	-13	-1	10	19	28	36*
17	42	75	105	134	162	188	214
18	115	199	261	321	377	427	478
19	7	17	25	35	45	55	65
20	0	-14	-26	-40	-54	-69	-84
21	22	35	46	56	65	72	79
22	-105	-170	-223	-270	-315	-355	-397
23	-83	-119	-144	-168	-191	-213	-236
24	-5	-27	-49	-70	-92	-114	-135
25	-173	-360	-533	-713	-892	-1071	-1248
26	-90	-205	-312	-417	-520	-626	-728
27	-79	-128	-171	-210	-248	-284	-320
28	-74	-94	-116	-144	-173	-200	-230*
29	-75	-130	-190	-252	-314	-375	-437
30	-16	-48	-75	-98	-120	-141	-162
31	-75	-114	-153	-196*	-240	-280	-322
32	-125	-236	-345	-458	-576	-683	-795
33	-122	-260	-381	-501	-625	-739	-858
34	-162	-331	-481	-629	-783	-922	-1070
35	-102	-215	-315	-414	-519	-612	-713
36	-65	-112	-158	-205	-257	-301	-350
37	26	32	31	28	27	25	24
38	-49	-86	-121	-155	-188	-218	-250
39	-137	-231	-301	-366	-430	-486	-546
40	-8	-22	-35	-49	-65	-79	-93
41	2	15	30	46	62	78	95
42	-23	-36	-48	-58	-69	-77	-85
43	-74	-118	-158	-197	-237	-273	-310
44	-59	-104	-147	-187	-225	-258	-295
45	63	102	138	174	211	244	280
46	54	92	128	161	195	226	259

*Standard deviation between 10 and 25 microstrain, all others less.

TABLE A9. PANEL 10 RAW MICROSTRAIN DATA

Channel	Pressure (kPa)						
	10	20	30	40	50	60	70
1	105	127	153	179	203	224	244
2	42	70	96	124	149	171	190
3	16	62	105	146	185	219	251
4	117	266	409	550	686	817	949
5	144	235	321	406	488	567	648
6	121	157	191	222	254	286	319
7	91*	124	153	174	192	210	226
8	41	94	144	192	237	281	323
9	20	53	83	109	131	151	171
10	85*	122	151	185	217	251	284
11	84	179	269	360	450	537	626
12	97	205	302	396	486	572	661
13	117	245	358	469	579	683	788
14	113	186	254	320	387	450	516
15	94	132	168	207	247	287	327
16	-1	3	8	12	15	17	19
17	59	107	146	182	213	240	264
18	104	186	252	312	365	414	461
19	23	40	55	68	81	93	105
20	-7	-21	-36	-54	-72	-89	-108
21	10	17	25	36	43	51	59
22	-117*	-132	-154	-175	-196	-219	-239
23	-52	-91	-126	-162	-197	-232	-267
24	-19	-77	-128	-180	-228	-272	-317
25	-142	-320	-494	-671	-851	-1019	-1192
26	-183	-292	-403	-511	-622	-723	-831
27	-98	-121	-143	-160	-175	-187	-199
28	-113*	-156	-202	-236	-270	-303	-338
29	-56	-128	-204	-278	-351	-418	-489
30	-20	-63	-106	-150	-192	-232	-273
31	-100	-145	-186	-222	-260	-300	-342
32	-99	-215	-332	-446	-560	-671	-784
33	-118	-258	-394	-526	-656	-781	-906
34	-144	-305	-459	-610	-759	-902	-1044
35	-142	-243	-339	-437	-536	-633	-729
36	-111	-157	-202	-248	-297	-348	-396
37	9	4	-9	-21	-33	-47	-60
38	-68	-120	-170	-216	-257	-294	-331
39	-128	-227	-308	-383	-453	-517	-583
40	29	-50	-68	-84	-100	-116	-131
41	11	25	40	57	76	94	112
42	-8	-19	-32	-45	-57	-68	-79
43	-135	-178	-217	-256	-298	-337	-377
44	-136	-189	-243	-291	-338	-381	-425
45	113	148	180	212	247	280	313
46	122	163	199	232	264	295	327

*Standard deviation between 10 and 20 microstrain, all others less.

TABLE A10. PANEL 11 RAW MICROSTRAIN DATA

Channel	Pressure (kPa)						
	10	20	30	40	50	60	70
1	43	66	83	100	114	126	138
2	47	73	95	118	138	156	173
3	31	66	102	136	164	192	219
4	170	334	496	658	817	966	1116
5	78	175	269	363	455	541	628
6	24	50	75	102	127	151	174
7	20	27	34	42	49*	65	75
8	38	65	100	132	165	196	226
9	37	70	96	116	135	149	163
10	19	36	55	78	101	121	144
11	84	165	248	331	414	492	569
12	130	248	358	470	573	673	772
13	161	306	440	577	708	834	958
14	88	177	261	346	427	506	581
15	19	43	75	108	139	169	200
16	-22	-19	-9	5	16	26	35
17	34	60	88	116	141	163	183
18	124	188	240	288	335	376	418
19	17	29	42	55	68	80	92
20	9	1	-9	-22	-35	-48	-62
21	18	31	41	51	59	68	74
22	-33	-74	-115	-155	-193	-230	-266
23	-50	-84	-114	-148	-177	-222*	-239
24	-45	-76	-104	-133	-162	-191	-219
25	-200	-400	-593	-795	-989	-1177	-1370
26	-88	-204	-319	-437	-549	-657	-766
27	-18	-47	-73	-102	-128	-154	-177
28	-13	-22	-35	-51	-71	-89	-110
29	-37	-73	-111	-156	-201	-247	-291
30	-42	-85	-123	-159	-192	-223	-252
31	-15	-34	-56	-81	-107	-132	-158
32	-94	-188	-283	-385	-485	-581	-680
33	-151	-298	-434	-575	-711	-840	-968
34	-190	-363	-531	-690	-864	-1024	-1180
35	-102	-211	-316	-421	-525	-620	-716
36	-16	-45	-79	-115	-151	-185	-219
37	38	36	26	10	-4	-18	-31
38	-45	-85	-128	-171	-211	-249	-285
39	-155	-247	-321	-393	-459	-521	-580
40	-14	-28	-42	-57	-72	-86	-99
41	-5	5	18	33	45	65	81
42	-14	-29	-42	-55	-65	-75	-86
43	-18	-42	-68	-98	-124	-149	-175
44	-15	-45	-75	-102	-129	-153	-177
45	20	43	67	92	117	138	164
46	24	52	78	105	128	152	174

*Standard deviation between 10 and 20 microstrain, all others less.

TABLE A11. PANEL 12 RAW MICROSTRAIN DATA

Channel	Pressure (kPa)						
	10	20	30	40	50	60	70
1	28	49	67	79	92	105	116
2	38	67	93	119	142	164	183
3	32	65	100	128	159	185	209
4	172	334	494	654	811	960	1109
5	83	178	271	365	454	542	628
6	14	35	58	80	102	123	144
7	5	12	22	35	49	63	78
8	33	64	96	132	165	198	230
9	41	74	103	124	143	159	172
10	7	20	38	58	77	98	121
11	78	153	232	313	394	469	545
12	131	252	364	474	579	682	782
13	159	305	444	580	713	839	964
14	80	161	241	320	399	471	544
15	12	34	61	90	120	148	176
16	-19	-15	-1	16	32	44	59
17	44	76	113	150	187	217	249
18	129	207	268	323	376	423	469
19	18	29	41	53	64	75	85
20	10	5	-8	-21	-35	-50	-65
21	15	27	38	48	59	65	72
22	-31	-63	-93	-122	-151	-176	-203
23	-42	-78	-112	-144	-174	-205	-235
24	-35	-75	-115	-153	-190	-227	-260
25	-205	-406	-603	-803	-1002	-1192	-1387
26	-92	-208	-320	-436	-546	-654	-762
27	-10	-34	-61	-86	-110	-132	-154
28	-2	-15	-38	-59	-84	-108	-132
29	-38	-76	-117	-162	-209	-251	-300
30	-44	-85	-120	-152	-182	-210	-237
31	-3	-21	-43	-69	-94	-118	-144
32	-86	-173	-264	-358	-450	-542	-635
33	-161	-311	-451	-594	-733	-865	-996
34	-193	-373	-546	-716	-887	-1048	-1211
35	-96	-200	-301	-400	-499	-594	-689
36	-7	-33	-64	-96	-129	-159	-192
37	35	37	27	15	2	-11	-22
38	-41	-76	-117	-157	-196	-234	-271
39	-159	-255	-333	-403	-470	-532	-593
40	-16	-31	-46	-62	-77	-88	-104
41	-7	4	17	32	50	66	84
42	-14	-27	-39	-50	-62	-69	-77
43	-11	-37	-66	-95	-121	-149	-175
44	-11	-42	-74	-104	-131	-157	-183
45	11	32	56	79	103	125	149
46	13	39	64	89	113	135	160

All standard deviations less than or equal to 10 microstrain.

STATION	DEFLECTION (mm)						REMARKS
	10	20	30	40	50	60	
1	1.000	1.000	1.000	1.000	1.000	1.000	1
2	1.000	1.000	1.000	1.000	1.000	1.000	2
3	1.000	1.000	1.000	1.000	1.000	1.000	3
4	1.000	1.000	1.000	1.000	1.000	1.000	4
5	1.000	1.000	1.000	1.000	1.000	1.000	5
6	1.000	1.000	1.000	1.000	1.000	1.000	6
7	1.000	1.000	1.000	1.000	1.000	1.000	7
8	1.000	1.000	1.000	1.000	1.000	1.000	8
9	1.000	1.000	1.000	1.000	1.000	1.000	9
10	1.000	1.000	1.000	1.000	1.000	1.000	10
11	1.000	1.000	1.000	1.000	1.000	1.000	11
12	1.000	1.000	1.000	1.000	1.000	1.000	12
13	1.000	1.000	1.000	1.000	1.000	1.000	13
14	1.000	1.000	1.000	1.000	1.000	1.000	14
15	1.000	1.000	1.000	1.000	1.000	1.000	15
16	1.000	1.000	1.000	1.000	1.000	1.000	16
17	1.000	1.000	1.000	1.000	1.000	1.000	17
18	1.000	1.000	1.000	1.000	1.000	1.000	18
19	1.000	1.000	1.000	1.000	1.000	1.000	19
20	1.000	1.000	1.000	1.000	1.000	1.000	20

**APPENDIX B
DEFLECTION DATA**

TABLE B1. DEFLECTION DATA (mm)

Dial Indicator	Pressure (kPa)						
	10	20	30	40	50	60	70
	PANEL 2						
1	.350	.680	.986	1.293	1.609	1.896	2.203
2	.281	.539	.774	1.013	1.290	1.515	1.756
3 ¹	.155	.248	.325	.398	.477	.546	.577
4	1.396	2.698	3.941	5.160	6.432	7.635	8.893
5	.993	1.448	1.793	2.139	2.495	2.836	3.188
6	1.804	3.469*	4.999	6.604	8.234*	9.787	11.452*
7	2.049	4.097	6.010	7.868	9.721*	11.412	13.308*
	PANEL 3						
1	.276	.576	.880	1.172	1.460	1.730 ²	
2	.250	.502	.750	.974	1.210	1.450	
3	.122	.196	.262	.330	.396	.420	
4	1.214	2.508	3.756	4.956*	6.148*	7.300	
5	.770	1.016*	1.436*	1.784*	2.062*	2.020	
6	1.574	3.234	4.844	6.382*	7.914*	9.410	
7	1.776	3.680	5.600	7.450	9.308	11.100	
	PANEL 4						
1	.318	.636	.940	1.218	1.512	1.733 ³	
2	.286	.560	.824	1.066	1.306	1.527	
3	.146	.234	.312	.390	.456	.517	
4	1.338	2.664	3.934	5.160	6.354	7.413	
5	.946	1.460	1.898	2.272	2.628	2.923	
6	1.734	3.443	5.072	6.632	8.176	9.540	
7	2.000	4.020	5.966	7.772*	9.630*	11.400*	

S
O
D
A
T
A

*Standard deviation between 0.1 and 0.2 mm, all others less.

¹Data for this indicator from one run only.

²Data at 60 kPa from one run only.

³Data at 60 kPa from three runs only.

TABLE B2. DEFLECTION DATA (mm)

Dial Indicator	Pressure (kPa)						
	10	20	30	40	50	60	70
PANEL 5							
1	.119	.218	.333	.437	.533	.643	.744
2	.091	.196	.292	.378	.475	.549	.635
3	.076	.119	.150	.178	.208	.236	.259
4	.457	.960	1.448	1.882	2.322	2.769	3.180
5	.483	.818	1.013	1.168	1.361	1.501	1.638
6	.597	1.247	1.824	2.408	2.972	3.531	4.089
7	.622	1.318	1.976	2.647	3.294	3.952	4.605
PANEL 6							
1	.102	.222	.333	.447	.561	.669	.779
2	.087	.194	.296	.400	.504	.601	.704
3	-.001	-.002	.113	.144	.176	.206	.239
4	.412	.886	1.341	1.805	2.272	2.721	3.178
5	.393	.696	.921	1.091	1.259	1.407	1.560
6	.511	1.111	1.688	2.267	2.857	3.416	3.999
7	.608	1.342	2.028	2.728	3.446	4.112	4.818
PANEL 7							
1	.072	.170	.260	.360	.450	.540	.630
2	.090	.140	.240	.330	.420	.500	.590
3	.030	.070	.100	.130	.160	.180	.210
4	.280	.730	1.170	1.620	2.040	2.470	2.880
5	.130	.370	.550	.710	.880	1.000	1.080
6	.380	.950	1.520	2.080	2.640	3.190	3.710
7	.410	1.050	1.670	2.280	2.920	3.490	4.060*
PANEL 8							
1	.072	.166	.257	.355	.449	.545	.640
2	.069	.160	.248	.329	.413	.488	.564
3	.047	.080	.110	.140	.163	.190	.212
4	.337	.757	1.169	1.586	2.002	2.394	2.791
5	.278	.490	.698	.851	.981	1.061	1.159
6	.427	.979	1.510	2.046	2.581	3.095	3.600
7	.400	1.010	1.620	2.240	2.860	3.460	4.030

*Standard deviation 0.11 mm, all others less.

TABLE B3. DEFLECTION DATA (mm)

Dial Indicator	Pressure (kPa)						
	10	20	30	40	50	60	70
PANEL 9							
1	.109	.247	.369	.484	.598	.712	.822
2	.106	.221	.327	.432	.536	.633	.734
3	.004	.018	.043	.072	.106	.135	.168
4	.537	1.064	1.543	2.026	2.516	2.978	3.447
5	.422	.671	.838	1.006	1.162	1.304	1.455
6	.700	1.388	2.008	2.642	3.274	3.865	4.479
7	.698	1.470	2.192	2.932	3.685	4.361	5.074
PANEL 10							
1	.058	.175	.290	.398	.511	.615	.721
2	.076	.178	.273	.371	.470	.566	.661
3	.027	.051	.076	.101	.124	.148	.176
4	.419	.925	1.423	1.916	2.424	2.894	3.361
5	--	--	--	--	--	--	--
6	.553	1.205	1.842	2.475	3.124	3.728	4.332
7	.560	1.339	2.105	2.879	3.642	4.374	5.131
PANEL 11							
1	.100	.208	.315	.425	.523	.620	.710
2	.100	.205	.285	.373	.465	.543	.625
3	.060	.106	.134	.160	.190	.224	.248
4 ¹	.517	1.000	1.467	1.920	2.373	2.810	3.227
5	.408	.675	.858	.935	1.045	1.333	1.478
6 ¹	.677	1.297	1.893	2.483	3.060	3.617	4.160
7	.717	1.410	2.068	2.763	3.368	3.983	4.573
PANEL 12							
1	.126	.242	.348	.458	.560	.666	.756
2	.110	.224	.324	.422	.514	.612	.704
3	.052	.094	.128	.160	.186	.210	.234
4	.512	1.002	1.476	1.938	2.402	2.834	3.250
5	.413	.636	.814	.978	1.118	1.200	1.314
6	.684	1.308	1.902*	2.500*	3.090*	3.644*	4.182
7	.745	1.486*	2.180	2.884	3.568	4.216*	4.810*

*Standard deviation 0.11 mm, all others less.

¹Data for this indicator from these runs only.

Data							Location
01	02	03	04	05	06	07	
24	492	47	87	58	49	27	1
144	411	311	176	111	101	24	2
220	503	312	282	277	212	14	3
3200	514	184	251	212	212	21	4
2301	3102	288	277	144	212	21	5
114	171	282	277	144	212	21	6
11	24	24	17	11	11	24	7
230	282	212	177	250	212	24	8
202	271	177	111	254	212	11	9
204	277	282	177	251	212	11	10
2011	277	282	282	252	242	211	11
201	211	282	282	252	242	211	12
201	2821	177	177	282	252	242	13
201	282	282	177	282	242	242	14
201	282	282	177	282	242	242	15
201	282	282	177	282	242	242	16
201	282	282	177	282	242	242	17
201	282	282	177	282	242	242	18
201	282	282	177	282	242	242	19
201	282	282	177	282	242	242	20
201	282	282	177	282	242	242	21
201	282	282	177	282	242	242	22
201	282	282	177	282	242	242	23
201	282	282	177	282	242	242	24
201	282	282	177	282	242	242	25
201	282	282	177	282	242	242	26
201	282	282	177	282	242	242	27
201	282	282	177	282	242	242	28
201	282	282	177	282	242	242	29
201	282	282	177	282	242	242	30
201	282	282	177	282	242	242	31
201	282	282	177	282	242	242	32
201	282	282	177	282	242	242	33
201	282	282	177	282	242	242	34
201	282	282	177	282	242	242	35
201	282	282	177	282	242	242	36
201	282	282	177	282	242	242	37
201	282	282	177	282	242	242	38
201	282	282	177	282	242	242	39
201	282	282	177	282	242	242	40
201	282	282	177	282	242	242	41
201	282	282	177	282	242	242	42
201	282	282	177	282	242	242	43
201	282	282	177	282	242	242	44
201	282	282	177	282	242	242	45
201	282	282	177	282	242	242	46
201	282	282	177	282	242	242	47
201	282	282	177	282	242	242	48
201	282	282	177	282	242	242	49
201	282	282	177	282	242	242	50
201	282	282	177	282	242	242	51
201	282	282	177	282	242	242	52
201	282	282	177	282	242	242	53
201	282	282	177	282	242	242	54
201	282	282	177	282	242	242	55
201	282	282	177	282	242	242	56
201	282	282	177	282	242	242	57
201	282	282	177	282	242	242	58
201	282	282	177	282	242	242	59
201	282	282	177	282	242	242	60
201	282	282	177	282	242	242	61
201	282	282	177	282	242	242	62
201	282	282	177	282	242	242	63
201	282	282	177	282	242	242	64
201	282	282	177	282	242	242	65
201	282	282	177	282	242	242	66
201	282	282	177	282	242	242	67
201	282	282	177	282	242	242	68
201	282	282	177	282	242	242	69
201	282	282	177	282	242	242	70
201	282	282	177	282	242	242	71
201	282	282	177	282	242	242	72
201	282	282	177	282	242	242	73
201	282	282	177	282	242	242	74
201	282	282	177	282	242	242	75
201	282	282	177	282	242	242	76
201	282	282	177	282	242	242	77
201	282	282	177	282	242	242	78
201	282	282	177	282	242	242	79
201	282	282	177	282	242	242	80
201	282	282	177	282	242	242	81
201	282	282	177	282	242	242	82
201	282	282	177	282	242	242	83
201	282	282	177	282	242	242	84
201	282	282	177	282	242	242	85
201	282	282	177	282	242	242	86
201	282	282	177	282	242	242	87
201	282	282	177	282	242	242	88
201	282	282	177	282	242	242	89
201	282	282	177	282	242	242	90
201	282	282	177	282	242	242	91
201	282	282	177	282	242	242	92
201	282	282	177	282	242	242	93
201	282	282	177	282	242	242	94
201	282	282	177	282	242	242	95
201	282	282	177	282	242	242	96
201	282	282	177	282	242	242	97
201	282	282	177	282	242	242	98
201	282	282	177	282	242	242	99
201	282	282	177	282	242	242	100

APPENDIX C
MICROSTRAIN DATA ADJUSTED FOR
TRANSVERSE SENSITIVITY

TABLE C1. PANEL 2 MICROSTRAIN DATA ADJUSTED FOR TRANSVERSE SENSITIVITY

Channel	Pressure (kPa)						
	10	20	30	40	50	60	70
1	72	89	82	68	51	32*	13
2	64	101	112	115	116	114	113
3	47	109	150	183	218	250	283
4	323	640*	915*	1202	1491	1777	2050
5	190	378	541	710	885	1057	1225
6	76	137	191	248	309	371	435
7	24	9	19	31	40	50	59
8	88	175	256	333	415	490	563
9	70	129	158	184	212	239	264
10	61	110	165	223	284	344	403
11	172	345	506	669	836	999	1160
12	233	439	620	799	985	1164	1345
13	292	553	785	1013	1253	1480	1716
14	182	348	502	653	813	966	1124
15	70	143	217	293	376	456	541
16 ¹	-2*	43*	73*	92*	107*	120*	130*
17	75	132*	178*	217*	257*	292	326*
18	189*	274*	353*	422*	491*	552*	612*
19	33	67	96	124	155	183	212
20	-23	-68	-112	-156	-203	-247	-292
21	26	43	60	74	91	105	119
22	-70	-100	-109	-117	-125	-134	-144
23	-68	-106	-124	-144	-163	-183	-204
24	-40	-91	-133	-169	-207	-241	-277
25	-337	-662*	-975*	-1293	-1610*	-1899*	-2239*
26	-196	-387	-565	-745	-919	-1085	-1266
27	-69	-123	-165	-205	-241	-273	-306
28	-26	-31	-53	-80	-111	-144	-180
29	-91	-177	-269	-373	-477	-576	-683
30	-71	-132	-180	-226	-269	-310	-350
31	-55	-92	-152	-209	-267	-318	-372
32	-173	-348	-524	-709	-895	-1064	-1249
33	-239	-463	-667	-873	-1079	-1264	-1469
34	-300	-575	-833	-1090	-1347*	-1582	-1841
35	-183	-353	-516	-676	-835	-980	-1141
36	-62	-123	-188	-254	-319	-377	-439
37	14	-25	-52	-71	-86	-100	-112
38	-61	-115	-163	-208	-253	-295	-342
39	-190*	-281*	-372*	-459	-551	-635	-731*
40	-32	-66	-99	-129	-162	-191	-224
41	20	62	105	148	191	230	271
42	-26	-45	-62	-79	-96	-112	-128
43	-74	-131	-183	-237	-289	-332	-379
44	-80	-150	-207	-260	-311	-356	-403
45	79	147	213	283	356	426	507
46	77	147	211	279	349	416	494

*Standard deviation between 10 and 25 microstrain, all others less.

¹Rosette 16/17/18 possibly defective.

TABLE C2. PANEL 3 MICROSTRAIN DATA ADJUSTED FOR TRANSVERSE SENSITIVITY

Channel	Pressure (kPa)						
	10	20	30	40	50	60 ¹	70
1	144	147*	164	160	149	153	
2	90	138	179	207	229	243	
3	37	122	198	261	311	341	
4	304	638*	964	1283	1594	1892	
5	215	408	599	783	964	1137	
6	132	175	266	277	328	381	
7			No Data				
8			No Data				
9			No Data				
10	104	145	191	236	284	329	
11	145	243	338	423*	511	594	
12	225	455*	681*	903	1120	1327	
13	283*	560	828	1047	1340	1577	
14	203	377	547	717	883	1037	
15	109	172	242	311	378	440	
16			No Data				
17			No Data				
18			No Data				
19	25	54	86	123	156	191	
20	-12*	-47	-86	-123	-155	-196	
21	42	65	83	100	113	128	
22	-145	-175	-206	-241	-277	-311	N
23	-79	-131	-172	-212	-250	-285	O
24	-28	-102	-172	-232	-286	-328	
25	-304	-640	-962*	-1305	-1635	-2000	D
26	-210	-398	-582	-761	-941	-1133	A
27	-125	-165	-202	-234	-262	-280	T
28	-81	-97	-123	-155	-187	-220	A
29	-93	-175	-264	-353	-439	-524	
30	-44	-110	-165	-212	-257	-297	
31	-103	-129	-168	-209	-250	-285	
32	-197	-372	-552	-738	-928	-1100	
33	-237	-470	-704	-929	-1149	-1359	
34	-279	-562	-832	-1100	-1370	-1645	
35	-196	-367	-523	-683	-840	-999	
36	-100	-156	-214	-269	-322	-364	
37	11	-23	-58	-88	-112	-131	
38	-47	-107	-170	-229	-288	-338	
39	-184	-287	-378	-464	-546	-627	
40	-16	-41	-66	-97	-125	-154	
41	19	59	102	144	187	224	
42	-36	-62	-84	-107	-127	-143	
43	-118	-166	-213	-254	-295	-329	
44	-132	-176	-221	-261	-298	--	
45	129	186	249	310	373	440	
46	140	198	254	312	372	435	

*Standard deviation between 10 and 25 microstrain, all others less.
¹One run only.

TABLE C3. PANEL 4 MICROSTRAIN DATA ADJUSTED FOR TRANSVERSE SENSITIVITY

Channel	Pressure (kPa)						70
	10	20	30	40	50	60 ¹	
1	76	90	103	110	112	112	
2	78	129	169	192	215	233	
3	74	162	237	289	338	386*	
4	346	685	1008	1302*	1615*	1917	
5	194	387	576	758	940	1116	
6	101	178*	254*	328*	400	476 ²	
7	39	63	84	104	121	136	
8	66	165	260*	340	426	491	
9	102	187	249	294	330	364	
10	54	99	146	191	239	281	
11	164	347	521	688	851	1009	
12	267	510	735	948	1160	1361	
13	329	608	882	1147	1403	1647	
14	191	354	515	672	824	972	
15	58	125	192	262	333	397	
16	-28	11	62	100	133	158	
17	57	109	166	211	250	283	
18	242	345	420	489	547	605	
19	35	59	85	109	138	161	
20	2	-43	-87	-131	-177	-220	
21	37	68	95	122	142	162	N
22	-72	-100	-131	-167	-203	-236	O
23	-74	-124	-168	-203	-237	-270	
24	-61	-141	-199	-244	-284	-329	D
25	-344	-683	-1021	-1350	-1689	-2039 ²	A
26	-188	-383	-568	-747	-929	-1120*	T
27	-46	-75	-102	-123	-140	-159	A
28	-36	-72	-109	-152	-195	-233	
29	-64	-168	-262	-361	-461	-552	
30	-90	-165	-221	-265	-310	-353	
31	-46	-97	-143	-189	-237	-277	
32	-176	-374	-567	-753	-953*	-1132*	
33	-262	-498	-724	-941	-1155	-1369	
34	-316	-630	-871	-1137	-1405	-1675*	
35	-199	-375	-538	-704	-864	-1022*	
36	-51	-112	-169	-223	-275	-320	
37	39	5	-36	-71	-103	-129	
38	-57	-119	-187	-248	-304	-361	
39	-241	-348	-435	-514	-597*	-665	
40	-27	-52	-74	-91	-110	-127	
41	7	49	93	139	180	222	
42	-32	-63	-95	-127	-158	-188	
43	-58	-108	-152	-192	-227	-260	
44	-71	-117	-162	-199	-234	-267	
45	65	119	176	234	293	355	
46	76	128	186	242	300	359	

*Standard deviation between 10 and 35 microstrain. All others less except as noted in ².

¹Three runs only.

²Standard deviation between 50 and 60 microstrain.

TABLE C4. PANEL 5 MICROSTRAIN DATA ADJUSTED FOR TRANSVERSE SENSITIVITY

Channel	Pressure (kPa)						
	10	20	30	40	50	60	70
1	70	75	60	51	35	18	8
2	57	79	94	112	127	138	148
3	-30	-35	-45	-62	-79	-94	-115
4	133	260	375	498*	612	719	834
5	90	181	259	349	429	507	582
6	57	76	93	112	131	147	164
7	32	31	39	60	72	86	97
8	34	67	102	145	187	226	260
9	38	69	86	114	130	151	165
10	44	67	95	126	156	179	205
11	74	134	203	282	357	426	495
12	103	200	283	373*	452	528	609
13	129	253	359	466*	564	652	743
14	103	188	273*	351	429	498	570
15	23	23	34	43	61	83	94
16	-42	-64	-78	-82	-82	-86	-76
17	31	52	67	86	116	141	164
18	96	170	230	279	328	382	427
19	7	12	19	20	25	30	33
20	8	0	-17	-30	-44	-60	-84
21	20	32	39	54	55	61	68
22	-89	-118	-136	-137*	-147*	-157*	-169
23	-49	-70	-89	-103	-123	-141	-157
24	-3	-27	-56	-81	-107	-133	-159
25	-91	-197	-301	-390	-493	-595	-695
26	-82	-166	-251	-320	-399	-478	-555
27	-35	-39	-48*	-48*	-48*	-51*	-52
28	-11	-9	-20	-20	-29	-38	-47
29	-13	-33	-64	-94	-123	-154	-185
30	-14	-34	-46	-56	-64	-69	-76
31	-19	-27	-43	-46	-73	-80	-101
32	-85	-156	-237	-314	-400	-479	-565
33	-49	-98	-134	-155*	-193	-228	-268
34	-131	-252	-355	-457	-568	-662	-763
35	-91	-179	-257	-336	-417	-492	-564
36	-36	-57	-88	-126	-157	-190	-225
37	-19	-31	-34	-31	-25	-19	-18
38	-27	-44	-53	-64	-78	-95	-110
39	-108	-193	-254	-311	-357	-403	-447
40	9	8	1	25*	-9	25*	22*
41	-3	5	18	31	47	61	72
42	-10	-20	-21	-28	-37	-39	-41
43	-54	-86	-118	-147	-182	-214	-248
44	-69	-108	-142	-180	-210	-246	-283
45	--	--	--	--	--	--	--
46	--	--	--	--	--	--	--

*Standard deviation between 10 and 25 microstrain, all others less.

TABLE C5. PANEL 6 MICROSTRAIN DATA ADJUSTED FOR TRANSVERSE SENSITIVITY

Channel	Pressure (kPa)						
	10	20	30	40	50	60	70
1	93	116	134	150	159	166	173
2	55	70	86	99	112	121	132
3	-1	20	44	63	79	94	108
4	119	253	385	508	633	749	870
5	75	163	248	329	409	486	564
6	79	113	145	179	209	235	265
7	65	76	83	95	106	118	131
8	50	81	115	148	182	214	246
9	9	34	52	61	68	72	77
10	64	89	116	144	172	198	225
11	99	187	280	367	458	543	632
12	90	186	276	355	439	514	595
13	130	254	373	476	585	683	788
14	84	167	247	320	395	462	535
15	51	84	125	162	205	242	281
16	-19	-21	-17	-11	-7	-7	-8
17	37	71	105	131	158	181	206
18	124	209	282	341	397	448	499
19	11	21	32	40	50	58	68
20	8	-3	-16	-30	-47	-64	-81
21	28	45	58	70	80	90	97
22	-84	-114	-141	-168	-192	-215	-236
23	-57	-82	-105	-128	-152	-174	-197
24	4	-19	-42	-61	-80	-98	-118
25	-128	-275	-412	-552	-698	-832	-973
26	-74	-163	-253	-336	-424	-503	-587
27	-67	-100	-134	-163	-192	-218	-245
28	-56	-67	-79	-97	-114	-132	-151
29	-44	-76	-112	-152	-194	-235	-278
30	-6	-25	-42	-57	-70	-82	-95
31	-59	-88	-118	-151	-185	-216	-249
32	-91	-160	-262	-350	-442	-529	-619
33	-94	-200	-300	-394	-493	-582	-675
34	-132	-263	-387	-503	-623	-734	-849
35	-85	-166	-244	-318	-392	-461	-535
36	-50	-84	-122	-161	-201	-240	-280
37	27	33	30	26	21	17	11
38	-35	-70	-105	-134	-166	-197	-229
39	-123	-209	-280	-339	-396	-450	-502
40	-7	-20	-30	-41	-53	-64	-76
41	-4	5	18	32	45	60	75
42	-21	-35	-46	-55	-64	-73	-80
43	-64	-100	-138	-173	-208	-242	-276
44	-78	-122	-163	-199	-234	-267	-300
45	67	102	138	173	208	241	275
46	83	124	164	199	235	268	303

All standard deviations less than or equal to 10 microstrain.

TABLE C6. PANEL 7 MICROSTRAIN DATA ADJUSTED FOR TRANSVERSE SENSITIVITY

Channel	Pressure (kPa)						
	10	20	30	40	50	60	70
1	186	214	235	254	271	285	297
2	91	126	154	182	211	232	254
3	-29	5	39	75	109	140	169
4	102	266	428	594	761	919	1074
5	107	198	290	382	476	564	650
6	149	178	198	221	242	260	278
7	72	79	96	112	125	139	152
8	20	50	84	123	159	191	223
9	29	75	110	143	169	190	209
10	87	110	135	162	185	209	232
11	83	165	254	341	430	512	591
12	104	225	340	455	571	677	779
13	130	272	409	549	687	818	947
14	121	211	297	384	469	551	629
15	85	113	144	175	210	247	272
16	-7	3	14	27	40	53	63
17	25	49	78	109	139	165	191
18	119	186	249	305	361	411	457
19	17	27	38	48	58	68	78
20	12	7	2	-15	-30	-43	-56*
21	26	40	54	63	78	90	98
22	-185	-218	-243	-266	-291	-315	-338
23	-82	-116	-147	-177	-206	-233	-258
24	39*	13	-40*	-78	-108*	-141*	-180*
25	-96	-258	-423	-587	-753	-912	-1065*
26	-100	-192	-281	-374	-467	-554	-650
27	-145	-167	-191	-208	-229	-247	-263
28	-64	-75	-93	-111	-130	-149	-167
29	-14	-46	-84	-123	-163	-199	-235
30	-31	-74	-109	-140	-170	-195	-217
31	-83	-105	-129	-155	-180	-202	-226
32	-74	-153	-235	-321	-406	-488	-572
33	-99	-221	-338	-453	-571	-682	-789
34	-120	-261	-396	-531	-666	-799	-926
35	-112	-201	-289	-377	-465	-548	-627
36	-83*	-111	-141	-172	-204	-230	-258
37	13	7	-9	-21	-33	-45	-57
38	22	-41	-68	-99	-130	-159	-186
39	-111	-183	-246	-306	-366	-421	-474
40	-10	-20	-32	-43	-53	-65	-75
41	-5	-2	12	25	38	48	65
42	-22	-36	-46	-59	-68	-80	-88
43	-125	-153	-177	-202	-226	-248	-269
44	-147	-172	-198	-223	-248	-270	-292
45	134	160	185	210	236	259	281
46	161	184	215	241	268	287	314

*Standard deviation between 10 and 25 microstrain, all others less.

TABLE C7. PANEL 8 MICROSTRAIN DATA ADJUSTED FOR TRANSVERSE SENSITIVITY

Channel	Pressure (kPa)						
	10	20	30	40	50	60	70
1	174	205	223	236	247	253	261
2	79	109	133	157	179	198	213
3	-27	2	38	74	105	137	164
4	99	251	407	564	718	870	1018
5	108	205	297	386	475	560	644
6	148	178	203	225	246	266	284
7	103	116	128	141	156	168	182
8	51	80	114	148	182	211	242
9	5	40	67	88	107	124	138
10	101	118	138	157	177	197	215
11	95	175	256	338	418	517	573
12	91	209	323	431	538	642	743
13	112	251	385	519	651	777	902
14	101	180	257	332	406	479	549
15	102	131	158	186	213	242	266
16	-6	1	12	21	31	40	47
17	37	69	101	132	157	185	211
18	112	185	250	312	371	427	479
19	19	28	38	48	57	65	75
20	12	11	-7	-18	-30	-43	-56
21	21	33	44	54	63	72	80
22	-166	-202	-226	-251	-272	-294	-315
23	-80	-109	-135	-158	-181	-202	-224
24	32	1	-27	-58	-87	-120	-143
25	-94	-249	-403	-560	-714	-873	-1026
26	-99	-193	-285	-378	-467	-555	-639
27	-146	-171	-195	-215	-235	-251	-268
28	-100	-118	-139	-163	-188	-214	-239
29	-43	-73	-103	-137	-170	-205	-239
30	5	-22	-56	-80	-101	-124	-145
31	-95	-111	-127	-146	-164	-183	-200
32	-86	-160	-233	-309	-385	-467	-539
33	-80	-195	-309	-422	-530	-638	-743
34	-107	-241	-377	-511	-647	-776	-902
35	-100	-182	-261	-341	-420	-496	-571
36	-96	-125	-150	-176	-202	-227	-251
37	18	20	18	17	15	13	15
38	-33	-65	-97	-129	-158	-188	-218
39	-105	-174	-236	-295	-352	-405	-458
40	-7	-16	-25	-34	-40	-47	-57
41	-1	9	20	33	45	60	73
42	-21	-33	-44	-56	-67	-77	-88
43	-127	-157	-183	-206	-228	-248	-267
44	-143	-178	-207	-237	-264	-287	-309
45	138	168	194	217	241	263	284
46	143	178	208	235	262	287	309

All standard deviations less than or equal to 10 microstrain.

TABLE C8. PANEL 9 MICROSTRAIN DATA ADJUSTED FOR TRANSVERSE SENSITIVITY

Channel	Pressure (kPa)						
	10	20	30	40	50	60	70
1	87	129	155	176	196	214	232
2	67	96	116	133	146	158	168
3	4	23	44	61	73	84	95
4	136	282	426	562	698	825	954
5	72	165	254	340	425	504	585
6	57	90	120	148	177	203	231
7	60	68	76	88	102	115*	130*
8	58	100	145	186	227	267	305
9	15	44	63	74	83	90	99
10	61	90*	118*	150*	182*	213*	244*
11	100	182	263	347	429	507	583
12	97	205	296	385	474	558	639
13	131	264	378	491	601	707	811
14	78	156*	237	312	387	457	527
15	53	85	122	161	200	237	275*
16	-19	-17	-7	3	11	19	25*
17	41	73	102	130	157	182	207
18	115	199	261	321	377	426	477
19	7	16	24	34	44	53	63
20	-1	-15	-28	-43	-58	-73	-89
21	22	35	45	55	64	71	78
22	-105	-169	-222	-268	-313	-352	-394
23	-82	-117	-141	-164	-186	-207	-229
24	-3	-23	-44	-64	-85	-106	-126
25	-171	-357	-529	-708	-886	-1065	-1241
26	-86	-199	-303	-406	-506	-610	-709
27	-75	-120	-159	-194	-228	-260	-292
28	-74	-93	-114	-142	-170	-197	-226*
29	-75	-130	-190	-252	-314	-376	-438
30	-14	-46	-72	-95	-116	-137	-197
31	-72	-108	-145	-185*	-226	-264	-303
32	-123	-233	-341	-453	-569	-675	-786
33	-120	-257	-378	-497	-620	-733	-851
34	-161	-329	-477	-624	-777	-915	-1062
35	-99	-210	-308	-405	-507	-598	-697
36	-61	-105	-147	-191	-240	-281	-326
37	29	37	38	36	37	36	36
38	-48	-83	-118	-151	-183	-213	-244
39	-138	-232	-302	-367	-431	-487	-547
40	-7	-21	-34	-48	-63	-77	-91
41	3	17	33	49	66	83	101
42	-23	-36	-47	-57	-68	-75	-83
43	-74	-118	-158	-197	-237	-273	-310
44	-59	-104	-147	-187	-225	-258	-295
45	63	102	138	174	211	244	280
46	54	92	128	161	195	226	259

*Standard deviation between 10 and 25 microstrain, all others less.

TABLE C9. PANEL 10 MICROSTRAIN DATA ADJUSTED FOR TRANSVERSE SENSITIVITY

Channel	Pressure (kPa)						
	10	20	30	40	50	60	70
1	105	126	151	176	199	219	238
2	40	67	92	120	144	165	183
3	14	59	102	142	180	214	246
4	114	263	405	545	680	811	942
5	142	231	315	398	478	555	634
6	118	151	182	210	239	268	298
7	91*	123	151	172	189	207	222
8	39	92	142	190	235	289	321
9	18	50	80	105	127	146	166
10	83*	117	144	176	206	238	269
11	82	176	265	355	444	531	619
12	95	202	299	392	481	566	655
13	115	242	354	464	574	677	781
14	111	182	248	312	377	438	503
15	91	133	160	197	234	272	309
16	-3	-1	2	5	7	8	9
17	58	105	143	179	209	236	259
18	104	186	252	312	365	414	461
19	23	40	54	67	80	92	104
20	-8	-23	-39	-57	-76	-94	-114
21	9	16	24	34	41	49	57
22	-117*	-130	-151	-171	-191	-213	-232
23	-50	-88	-123	-158	-192	-226	-261
24	-16	-74	-125	-176	-224	-267	-312
25	-140	-317	-491	-667	-847	-1015	-1188
26	-182	-289	-398	-504	-613	-712	-818
27	-95	-114	-132	-145	-156	-164	-173
28	-113*	-155	-200	-233	-266	-298	-332
29	-54	-126	-202	-276	-348	-415	-486
30	-17	-60	-102	-145	-186	-225	-265
31	-97	-139	-177	-210	-245	-283	-322
32	-96	-211	-326	-439	-552	-662	-774
33	-116	-255	-390	-521	-650	-774	-898
34	-142	-302	-455	-604	-752	-894	-1035
35	-139	-238	-332	-428	-524	-619	-713
36	-108	-150	-192	-234	-280	-328	-373
37	12	9	-2	-12	-23	-36	-47
38	-67	-118	-167	-212	-252	-288	-324
39	-128	-227	-308	-383	-452	-516	-582
40	-29	-50	-67	-83	-99	-114	-129
41	12	27	43	61	81	100	119
42	-7	-18	-30	-43	-55	-65	-76
43	-135	-178	-217	-256	-298	-337	-377
44	-136	-189	-243	-291	-338	-381	-425
45	113	148	180	212	247	280	313
46	122	163	199	232	264	295	327

*Standard deviation between 10 and 20 microstrain, all others less.

TABLE C10. PANEL 11 MICROSTRAIN DATA ADJUSTED FOR TRANSVERSE SENSITIVITY

Channel	Pressure (kPa)						
	10	20	30	40	50	60	70
1	42	65	81	97	110	122	133
2	46	72	93	115	135	152	169
3	30	65	100	134	161	189	216
4	169	333	494	656	814	963	1112
5	75	170	262	354	444	528	613
6	20	43	64	87	109	130	149
7	19	25	32	39	46*	62	71
8	38	64	99	131	165	196	226
9	37	69	95	115	134	148	161
10	16	30	47	68	88	106	127
11	83	162	244	326	408	485	561
12	130	247	357	468	571	670	769
13	161	305	438	575	705	830	954
14	86	173	255	338	418	495	568
15	15	36	65	95	123	150	179
16	-25	-23	-14	-1	9	18	26
17	32	58	85	112	136	158	177
18	124	188	240	288	335	375	417
19	17	28	41	54	67	78	90
20	8	0	-11	-25	-39	-52	-67
21	18	30	40	50	57	66	72
22	-32	-72	-113	-152	-189	-226	-261
23	-49	-83	-112	-145	-173	-218*	-233
24	-44	-74	-101	-130	-158	-186	-213
25	-200	-399	-591	-793	-986	-1174	-1366
26	-85	-199	-311	-427	-536	-642	-748
27	-14	-38	-60	-84	-106	-128	-147
28	-12	-20	-32	-47	-67	-84	-104
29	-37	-72	-110	-155	-200	-246	-289
30	-42	-85	-122	-158	-190	-221	-250
31	-12	-27	-46	-68	-91	-113	-136
32	-92	-185	-278	-379	-477	-572	-670
33	-151	-297	-433	-573	-709	-837	-964
34	-190	-362	-529	-695	-861	-1020	-1175
35	-100	-207	-309	-412	-514	-607	-701
36	-12	-37	-67	-99	-132	-162	-193
37	41	41	33	19	6	-6	-18
38	-43	-82	-124	-166	-205	-243	-278
39	-156	-248	-322	-393	-459	-521	-579
40	-14	-27	-41	-56	-71	-84	-97
41	-4	6	20	36	49	70	87
42	-14	-28	-41	-54	-63	-73	-84
43	-18	-42	-68	-98	-124	-149	-175
44	-15	-45	-75	-102	-129	-153	-177
45	20	43	67	92	117	138	164
46	24	52	78	105	128	152	174

*Standard deviation between 10 and 20 microstrain, all others less.

TABLE C11. PANEL 12 MICROSTRAIN DATA ADJUSTED FOR TRANSVERSE SENSITIVITY

Channel	Pressure (kPa)						
	10	20	30	40	50	60	70
1	27	48	65	76	88	101	111
2	38	66	91	117	140	161	180
3	31	64	99	126	157	183	206
4	172	333	493	652	809	957	1106
5	81	174	265	357	444	530	614
6	10	28	47	65	84	102	119
7	4	10	30	32	46	59	74
8	33	63	95	131	164	197	230
9	41	74	103	123	142	158	170
10	4	14	30	47	64	83	104
11	77	150	228	308	388	462	537
12	131	252	363	473	577	680	779
13	159	304	443	578	710	836	960
14	78	157	235	312	389	459	531
15	8	27	51	77	104	129	155
16	-20	-20	-7	9	24	35	49
17	42	73	110	146	182	211	243
18	129	207	268	323	375	422	468
19	18	28	40	52	63	74	83
20	9	4	-10	-24	-39	-54	-70
21	15	26	37	47	58	63	70
22	-30	-61	-90	-119	-147	-171	-197
23	-41	-77	-110	-141	-170	-201	-230
24	-34	-74	-113	-150	-187	-223	-255
25	-205	-405	-602	-801	-1000	-1189	-1384
26	-89	-203	-312	-426	-533	-639	-745
27	-5	-25	-48	-68	-88	-106	-123
28	-1	-13	-35	-56	-80	-103	-127
29	-38	-75	-116	-161	-208	-249	-298
30	-44	-85	-119	-151	-180	-208	-234
31	1	-14	-33	-56	-78	-99	-122
32	-84	-169	-259	-351	-442	-532	-624
33	-161	-311	-450	-592	-731	-836	-993
34	-193	-372	-545	-714	-884	-1044	-1207
35	-94	-195	-294	-391	-487	-580	-673
36	-3	-25	-52	-80	-109	-136	-165
37	39	43	34	24	12	-1	-9
38	-39	-73	-113	-152	-190	-227	-263
39	-160	-256	-334	-403	-470	-532	-593
40	-16	-30	-45	-61	-76	-86	-102
41	-6	5	19	35	54	71	90
42	-14	-26	-38	-49	-60	-67	-75
43	-11	-37	-66	-95	-121	-149	-175
44	-11	-42	-74	-104	-131	-157	-183
45	11	32	56	79	103	125	149
46	13	39	64	89	113	135	160

All standard deviations less than or equal to 10 microstrain.

LIST OF SYMBOLS

b	Auxiliary factor, supplied with strain gage
e	Error in axial strain due to ignoring correction for transverse strain
k	Transverse sensitivity coefficient
R	Apparent strain along the gage axis based on the manufacturer's gage factor
α	Angle between major strain direction and axis
ϵ	True strain along gage axis
ϵ_{\max}	Major principal strain
ϵ_{\min}	Minor principal strain
ϵ_n	True strain transverse to gage axis
μ_0	Poisson's ratio in manufacturer's calibration (normally 0.285)