

AD-A070 913

AD

EN-78-03

TECHNICAL
LIBRARY

MACHINING POWDER METALLURGY MATERIALS

BY

C. H. KAHNG

SEPTEMBER 1978

TECHNICAL REPORT



PREPARED BY:

**DEPARTMENT OF MECHANICAL ENGINEERING
MICHIGAN TECHNOLOGICAL UNIVERSITY**

Approved for public release; distribution unlimited

**ENGINEERING DIRECTORATE
ROCK ISLAND ARSENAL
ROCK ISLAND, ILLINOIS 61299**

UNCLASSIFIED

SECURITY CLASSIFICATION OF THIS PAGE (When Data Entered)

REPORT DOCUMENTATION PAGE		READ INSTRUCTIONS BEFORE COMPLETING FORM
1. REPORT NUMBER EN-78-03	2. GOVT ACCESSION NO.	3. RECIPIENT'S CATALOG NUMBER
4. TITLE (and Subtitle) MACHINING POWDER METALLURGY MATERIALS		5. TYPE OF REPORT & PERIOD COVERED Technical Report - Final
		6. PERFORMING ORG. REPORT NUMBER
7. AUTHOR(s) C. H. Kahng		8. CONTRACT OR GRANT NUMBER(s) DAAA09-74-C-2062
9. PERFORMING ORGANIZATION NAME AND ADDRESS Dept. of Mechanical Engineering Michigan Technological University Houghton, Michigan 49931		10. PROGRAM ELEMENT, PROJECT, TASK AREA & WORK UNIT NUMBERS AMS Code 3297.06.7461
11. CONTROLLING OFFICE NAME AND ADDRESS CDR, Rock Island Arsenal Engineering Directorate Rock Island, IL 61299		12. REPORT DATE September 1978
		13. NUMBER OF PAGES 63
14. MONITORING AGENCY NAME & ADDRESS (if different from Controlling Office)		15. SECURITY CLASS. (of this report) Unclassified
		15a. DECLASSIFICATION/DOWNGRADING SCHEDULE
16. DISTRIBUTION STATEMENT (of this Report) Approved for public release; distribution unlimited.		
17. DISTRIBUTION STATEMENT (of the abstract entered in Block 20, if different from Report)		
18. SUPPLEMENTARY NOTES		
19. KEY WORDS (Continue on reverse side if necessary and identify by block number)		
1. Machining	5. Reaming	
2. Machinability	6. Forces and accuracy	
3. Turning	7. Powder Metallurgy	
4. Drilling	8. Low alloy steel	
20. ABSTRACT (Continue on reverse side if necessary and identify by block number) Powder metallurgy (P/M) products offer many economic advantages in manufacturing and, as such, have become important industrial materials. P/M parts eliminate the need for most machining; however, many P/M components do require some machining and little is known about the machinability of these materials. Toward providing guidelines for machining P/M materials, machining tests were conducted on low and high density P/M steel (AISI 4640) specimens. Results of these tests are presented along with data on conventionally wrought		

20. AISI 4140 steel. The preference for low alloy steels in the manufacture of weapon components led to the choice of these materials for the investigation.

Significant differences in cutting forces were experienced in the cutting of high and low density P/M materials. The maximum practical cutting speed in drilling was higher for low density P/M material than that for high density material. Tool wear in the reaming of P/M materials was negligible. In drilling, improvement of hole geometry by sequential machining operations varied greatly; for example, center drilling prior to through drilling provided the greatest improvement of hole geometry. Boring with a rigid bar gave the best geometry. Hardness of the material had decisive effect on machinability. Relatively burr-free holes could be drilled in P/M materials. Overall machinability of the investigated materials did not show significant differences since each material had its own advantages in specific machining processes.

FOREWORD

This report was prepared by Dr. C. H. Kahng, Michigan Technological University, Houghton, Michigan, in compliance with contract DAAA09-74-C-2062, under the direction of the Engineering Directorate, Rock Island Arsenal, Rock Island, Illinois, with Mr. R. A. Kirschbaum as Project Engineer.

The author would like to thank Dr. G. L. Scofield, Professor and Head of the Department of Mechanical Engineering and Engineering Mechanics, Michigan Technological University, for his kind encouragement and support which made the completion of this project possible.

This project was carried out solely by the faculty and students of Michigan Technological University. Machine operation and data evaluation was conducted by Mr. David A. Bauchat and evaluation of data and drawing for the final report was made by Mr. Arthur L. Campbell. The author would like to thank these students for their assistance.

This work was authorized as part of the Manufacturing Methods and Technology Program of the US Army Materiel Development and Readiness Command and was administered by the US Army Industrial Base Engineering Activity.

LIST OF FIGURES, Cont'd.

<u>Fig. No.</u>	<u>Title</u>	<u>Page</u>
48	Tooth Path Generated when Slotting	50
49	Cutting Force Components when Profiling	51
50	Force Comparison of Up and Down Milling	52
51	Instrumentation for Cutting Force Measurement	52
52	Cutting Force Characteristics of a 2-flute End Mill when Profiling	53
53	Cutting Force Characteristics of a 4-flute End Mill when Profiling	54
54	Cutting Forces when Slotting with a 2-Flute End Mill	55
55a	Effect of Feed Rate on Cutting Forces when a 2-Flute End Mill is Used for Profiling Workmaterial - AISI 4140	56
55b	Effect of Feed Rate on Cutting Forces when a 2-Flute End Mill is Used for Profiling Workmaterial - Low Density P/M	56
55c	Effect of Feed Rate on Cutting Forces when a 2-Flute End Mill is Used for Profiling Workmaterial - High Density P/M	57
56a	Effect of Feed Rate on Cutting Forces when a 2-Flute End Mill is Used for Slotting Workmaterial - AISI 4140	58
56b	Effect of Feed Rate on Cutting Forces when a 2-Flute End Mill is Used for Slotting Workmaterial - Low Density P/M	58
56c	Effect of Feed Rate on Cutting Forces when a 2-Flute End Mill is Used for Slotting Workmaterial - High Density P/M	59
57a	Effect of Feed Rate on Cutting Forces when a 4-Flute End Mill is Used for Profiling Workmaterial - AISI 4140	59

LIST OF FIGURES, Cont'd.

<u>Fig. No.</u>	<u>Title</u>	<u>Page</u>
57b	Effect of Feed Rate on Cutting Forces when a 4-Flute End Mill is Used for Profiling; Workmaterial - Low Density P/M	60
57c	Effect of Feed Rate on Cutting Forces when a 4-Flute End Mill is Used for Profiling Workmaterial - High Density P/M	60
58a	Effect of Feed Rate on Cutting Forces when a 4-Flute End Mill is Used for Slotting Workmaterial - AISI 4140	61
58b	Effect of Feed Rate on Cutting Forces when a 4-Flute End Mill is Used for Slotting Workmaterial - Low Density P/M	61
58c	Effect of Feed Rate on Cutting Forces when a 4-Flute End Mill is Used for Slotting Workmaterial - High Density P/M	62

INTRODUCTION

The powder metallurgy (P/M) process is an economical method for the production of a variety of parts subjected to light and medium loads. Recently, powder metallurgy parts and products have been continuing to make inroads in traditional markets and production fields, such as gears, hydraulic equipment, farm machinery, appliances, and even weapons. Iron-powder shipments in North America in 1973 reached 194,000 tons, scoring a 26% gain over 1972. Powder metallurgy parts accounted for almost 78% of this total, with their parts shipments gaining 28% over the 1972 level. These P/M parts can be produced by a number of metal powder process combinations. In many cases, a change in the required mechanical properties can be produced by a simple material change.

Numerous powder blends and prealloyed powders are available that develop better mechanical properties in sintered and heat-treated P/M parts than those obtainable with ordinary iron-base powder blends. Other advantages stressed include elimination of scrap, low labor input, high volume, precision, and improved strength.

Since P/M materials, forged or sintered, sometimes show superiority when compared with wrought alloy steel, and offer many advantages, they can replace the conventional alloy steel in machinery parts. Even though the goal of forged or sintered P/M parts is to eliminate sequential machining, machining is required in some cases. Since there is not a great deal of information concerning the machinability of P/M materials, it would be significant to establish a relationship between wrought iron, another important material, and P/M materials, from a machinability point of view.

Since properties of P/M materials are largely dependent upon the density of the materials, which are determined in the sintering and forging process, the effect of P/M density on material properties is essential. Effective and reliable information on the machinability can be gained only through the investigation of several processes, rather than a single process.

In this project, two processes, turning and drilling, were compared for their machinability, especially with cutting force measurement, in wrought alloy and two different density P/M materials.

The most frequently applied machining process in P/M materials is the hole making process. After the drilling process, reaming and boring processes were conducted in the two different P/M density materials. The improvement in terms of accuracy in hole geometry, especially displacement and parallelism, were extensively studied.

Burr free tapping is most desirable. The optimum tapping conditions and the results of tapping in the two materials was also investigated.

Very often, P/M materials require an end milling operation. Therefore, it was interesting to investigate profiling and slotting, using 2-flute and 4-flute helical end milling cutters, in comparing the machinability of the three different materials under light machining conditions.

PREPARATION OF INVESTIGATION

Specimens

For this investigation, the specimens for two different density P/M materials were purchased from Powder-Tech Associates, Burlington, Massachusetts. The material was 4600 series A. O. Smith prealloyed steel powder with sufficient graphite added to yield $0.40 \pm 0.05\%$ when sintered. Maximum O_2 was 300 PPM. The low diameter x 1-3/4" long, at 6.6 ± 0.1 g/cc, pressed and sintered in a dry $H_2 - N_2$ mix. Sintering was conducted for 1/2 hour at 2050°F. The hardness of the low density P/M materials was measured as BHN 114. The high density (99%) P/M materials were forged in a size of 3" diameter x 2" long and obtained 7.85 g/cm or 7/78 g/cc. The hardness test for this high density material was measured as BHN 179.

For the wrought materials, AISI 4140 was supplied by the Rock Island Arsenal. The hardness of this material was BHN 212.

Machine Tools

For the turning test, the Monarch Series 50 Lathe, 10 HP, variable speed drive was utilized. For the hole-making processes such as, drilling, reaming, boring, and tapping, the Bridgeport Series II, 4 HP was mainly used.

Instrumentations

The cutting force measurements for the turning operation were conducted using the Kistler's Piezo-Electric Force Transducer, Type 9257A, an amplifier, and compensation device.

The drilling force measurements were conducted using a four-spoke type dynamometer, which was designed at Michigan Technological University, and is described in Part 1 of the report in this project.

The roundness measurements for the holes were conducted using the Talyrond 100.

For surface roughness measurements, the Bendix profilometer was used and surface roughness profiles were recorded using a Surfcom Type-2 having a stylus tip of 120 μ in. radius.

TURNING PROCESS

Recently, many researchers have been interested in observing the details of chip formation in order to give a more precise analysis of the chip formation phenomenon.

As shown in Fig. 1, the formation of a segmented chip produces a variation in its cutting force measurement (bottom figure), while a uniformly deformed chip draws a smooth diagram (top figure).

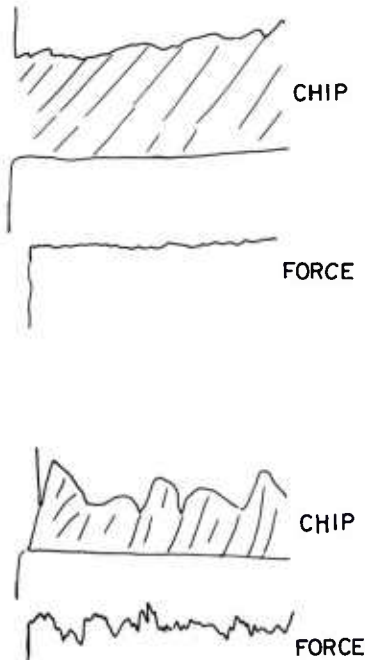

Fig. 1

*Schematic Illustration
Describing the Relationship
between Chip Formation
and Cutting Forces*

Chip formation in metal cutting is conducted at very high strain and strain rates. Continuous, discontinuous, or segmented chips may occur depending on the workpiece properties, and the magnitude of the shear strain which occurs at the shear zone.

Three different types of workpieces (AISI 4140, low density P/M, and high density P/M) were turned and their respective cutting force diagrams were compared. The Kistler Type 9257A piezo-electric dynamometer utilizing an amplifier was used to carry out this test. Due to this instrument being very sensitive, accurate details of the changes of cutting force during turning were obtained.

As shown in Fig. 2, the AISI 4140 material demonstrated entirely different cutting force characteristics when two different cutting speeds were used. At a cutting speed of $V = 80$ fpm, the variation of cutting force obtained is one-third that of the

WORK AISI 4140



Fig. 2

*Cutting Force
Characteristics when
Turning AISI 4140*



maximum cutting force. However, at a cutting speed of $V = 500$ fpm, the variation is reduced to one-fifth of the maximum cutting force. This can be explained by the fact that at higher cutting speeds, the chip formation is very steady and uniform chip thickness and continuous chip formation are obtained.

Low density P/M material showed similar results to that of AISI 4140 (Fig. 3). However, for the high density P/M material, we

WORK PM 6.6 gm/cc

Fig. 3

*Cutting Force
Characteristics when
Turning Low Density
P/M Material*

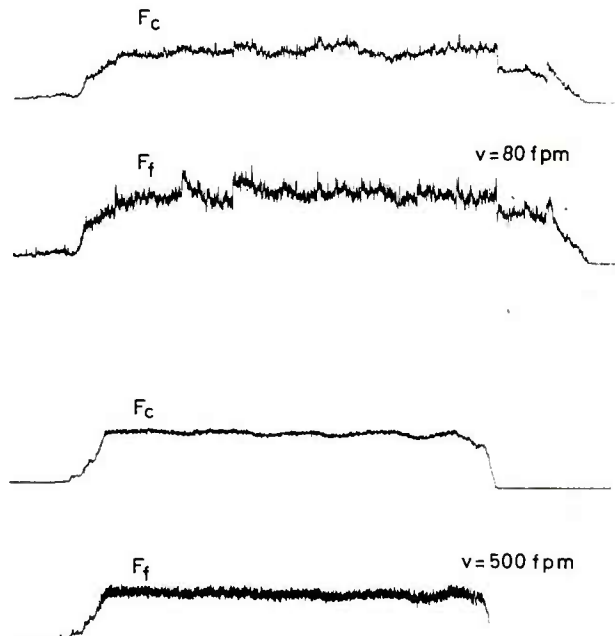

can see significant characteristics in the cutting force diagram (Fig. 4). Even though a high cutting speed of $V = 500$ fpm was used, the existence of a variation in cutting force was still recognized.

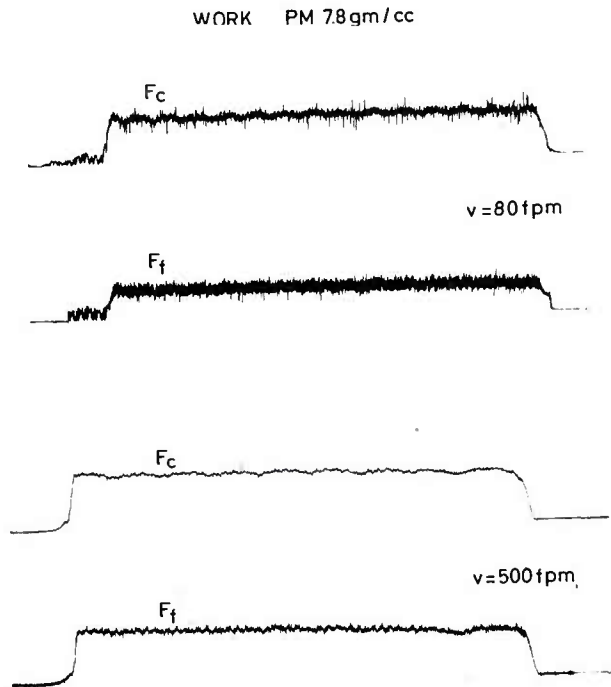

Fig. 4

*Cutting Force
Characteristics when
Turning High Density
P/M Material*

The reason for this is that low density P/M materials are brittle and produce discontinuous chips resulting in cutting force variation. Therefore, the chip formation or type of chip should be directly related to the nature of the cutting force. The continuous chip produces a smooth cutting force diagram while a discontinuous chip results in cutting force variation.

In order to compare the types of chips produced in the three different materials, the chips were collected and photographed. As shown in Fig. 5, the types of chips have very good correlation with the cutting force diagram, i.e. low density P/M material exhibited the most uneven chips, while AISI 4140 showed longer continuous chips.

Most alloy steels are subject to built-up edge at relatively low cutting speeds. The surface roughness also correlates with the built-up edge occurrence. The photographs of the machined surface at three different cutting speeds, $V = 40$ fpm, $V = 160$ fpm, and $V = 640$ fpm, are presented in Fig. 6. The surface profile recordings obtained by the respective cutting speeds are shown in Figs. 7, 8, and 9, for comparison.

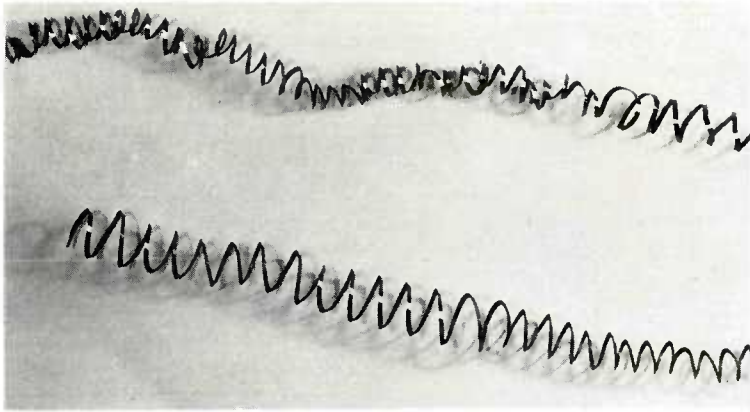

a) AISI 4140
 $f = 0.003$ ipr
 $f = 0.008$ ipr

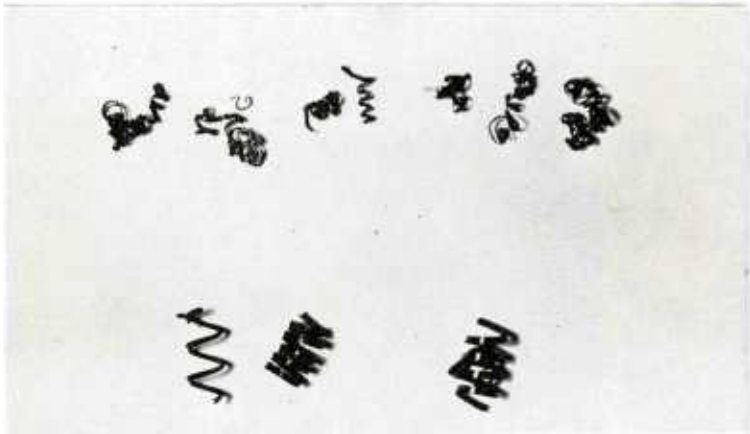

b) Low Density P/M
 $f = 0.003$ ipr
 $f = 0.008$ ipr

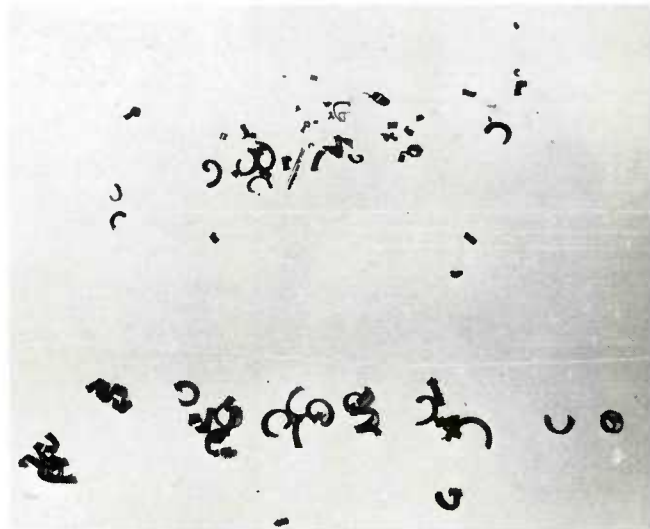

c) High Density P/M
 $f = 0.003$ ipr
 $f = 0.008$ ipr

Fig. 5: Chip Types Produced by Different Work Materials

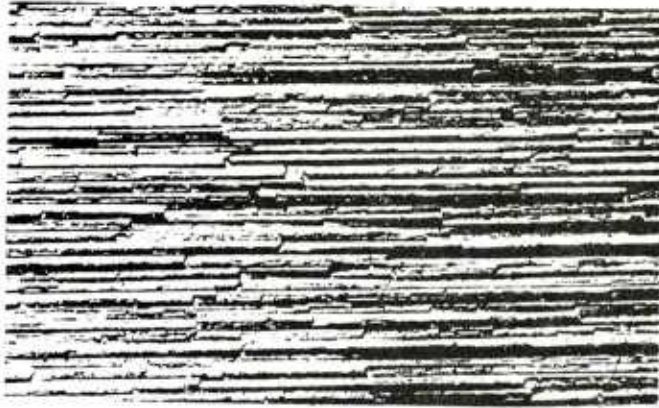

V = 40 fpm

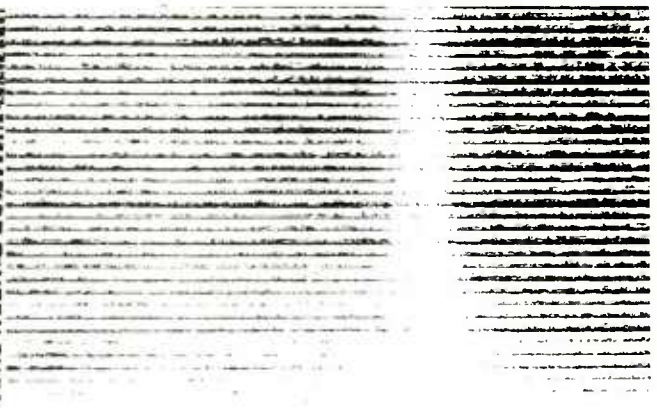

V = 640 fpm

AISI 4140

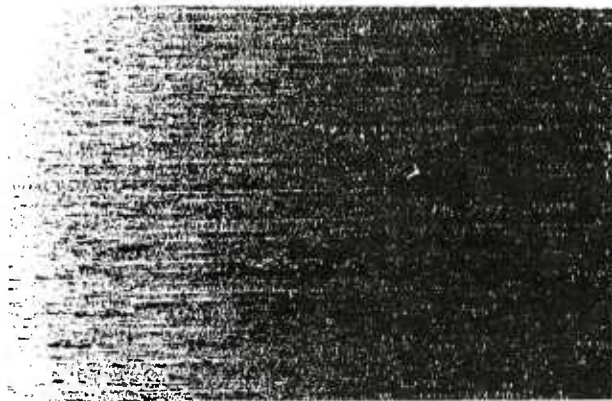

V = 40 fpm

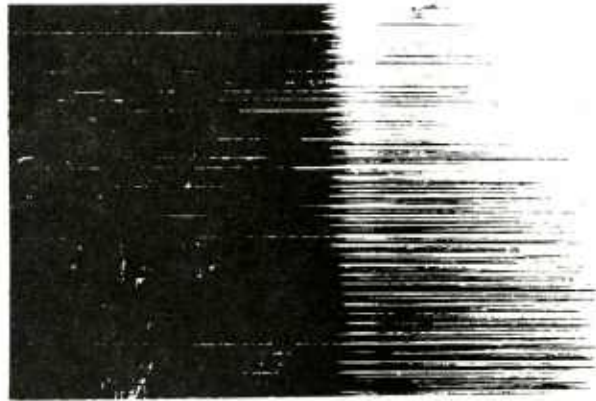

V = 640 fpm

Low Density P/M



V = 40 fpm

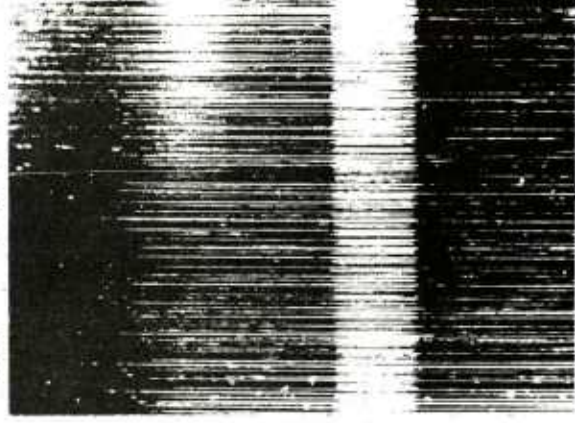

V = 640 fpm

High Density P/M

*Fig. 6: Surface Roughness Photography
Produced by Different Materials*

WORK : AISI 4140
TOOL : WC, NR=0.031in
DEPTH OF CUT : 0.030in
FEED RATE : 0.008 ipr

Fig. 7

Surface Profile Produced
by AISI 4140 at Three
Different Speeds

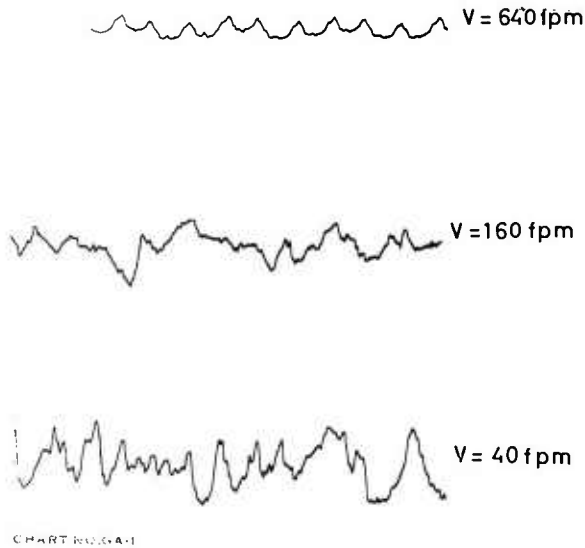

WORK : LOW P/M
TOOL WC, NR=0.031in
DEPTH OF CUT : 0.030in
FEED RATE : 0.008 ipr

Fig. 8

Surface Profiles Produced
by Low Density P/M
Material at Three
Different Speeds

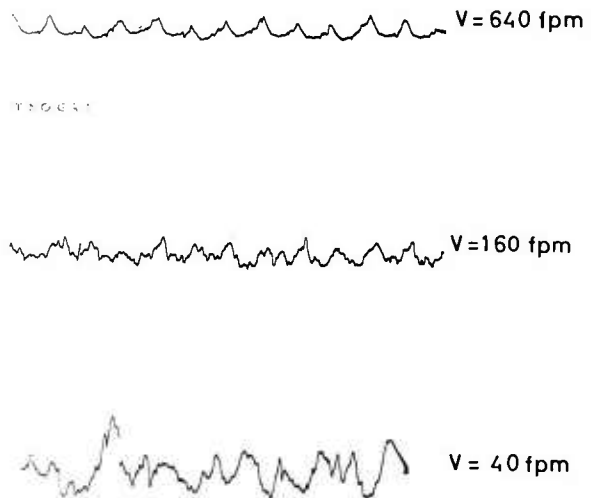

WORK : HI P/M
NR . 0031in
DEPTH OF CUT : 0030in
FEED RATE : 0008ipr

Fig. 9

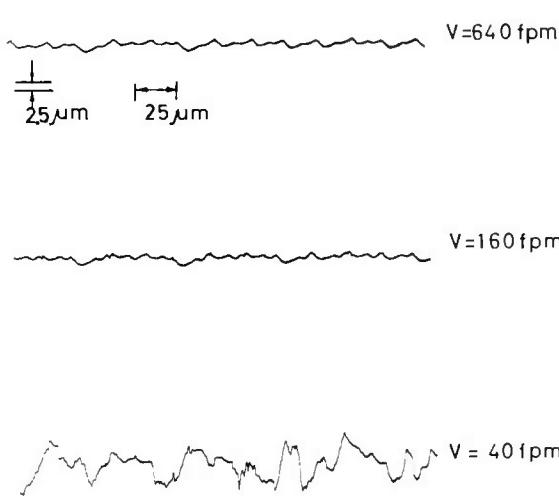

Surface Profiles Produced
by High Density P/M
Materials at Three
Different Speeds

Clearly, when turning AISI 4140 alloy steel at low cutting speeds, built-up edge occurrence was evident. The high density P/M materials conveyed no built-up edge occurrence when a cutting speed of $V = 160$ fpm is exceeded.

The low density P/M materials, however, produced built-up edge for a wide range of cutting speeds, from low to $V = 640$ fpm. A comprehensive comparison of surface roughness and built-up edge occurrence was made and is shown in Fig. 10. From this figure, the affinity toward built-up edge for the three materials can be characterized. AISI 4140 was most affected by built-up edge production in the low speed range.

Even though built-up edge is visual, in the range of cutting speeds used, the cutting force showed very small changes. Because of the small depth of cut and feed rate, the cutting force measurements were not affected by built-up edge occurrence, even though characteristics of cutting force are different, as previously explained. Fig. 11 presents the cutting force comparison (tangential force F_c and feed force F_f) of the three materials in the range of cutting speeds from 40 fpm to 640 fpm. High density P/M material required the highest cutting force, while low density P/M material required the least.

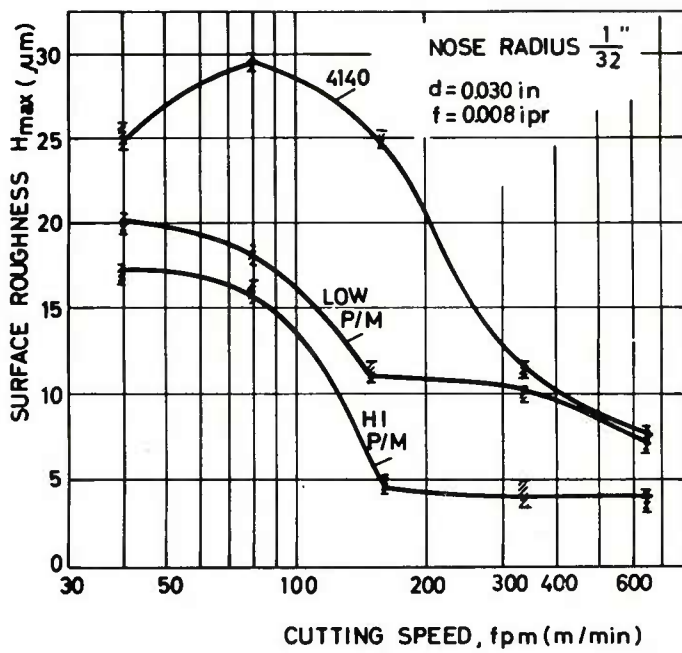
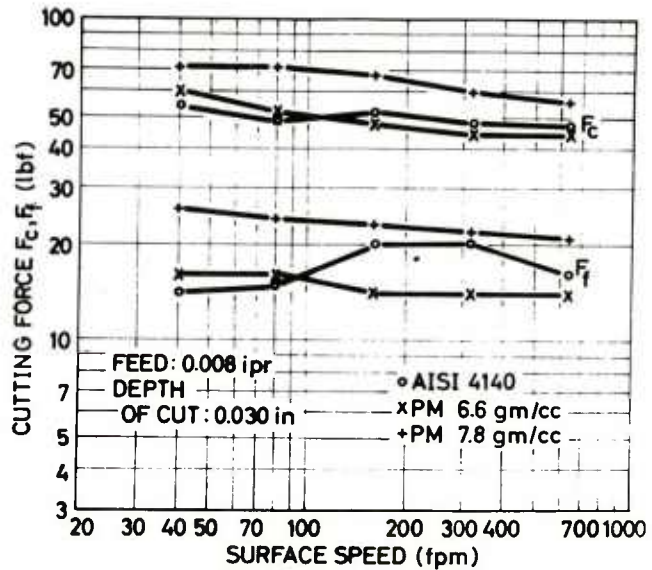

Fig. 10
 Surface Roughness as a
 Function of Cutting Speed
 for Three Different
 Materials

Fig. 11
 Cutting Forces as a
 Function of
 Surface Speed



The effect of feed rate on the cutting force of the three materials showed similar order in the cutting force measurements, which is shown in Fig. 12. This result is acceptable because the hardness measurement on the three materials demonstrated a similar order as well.

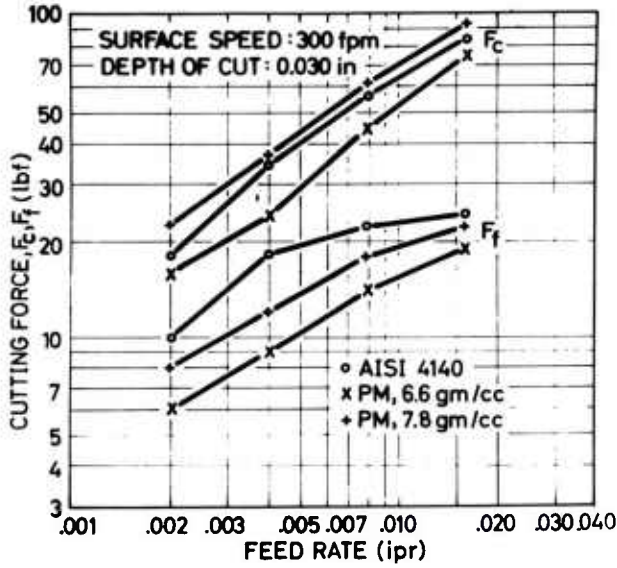

Fig. 12
Cutting Forces as a
Function of Feed Rate

DRILLING PROCESS

In order to compare three materials from the drilling performance point of view, drill forces, both thrust and torque, were compared with their respective cutting force diagrams.

As shown in Fig. 13, both the P/M materials, high density and low density, generated relatively steady cutting force diagrams. The P/M material supplied by the U.S. Armament Command (hardness was read as BHN 555) showed much more steady drilling force diagrams in both torque and thrust. Even though the magnitude of the forces is very high, no variation was recorded in the cutting force diagrams. It seems to be that this particular material is perfectly compacted and the chip is formed almost perfectly in the continuous form.

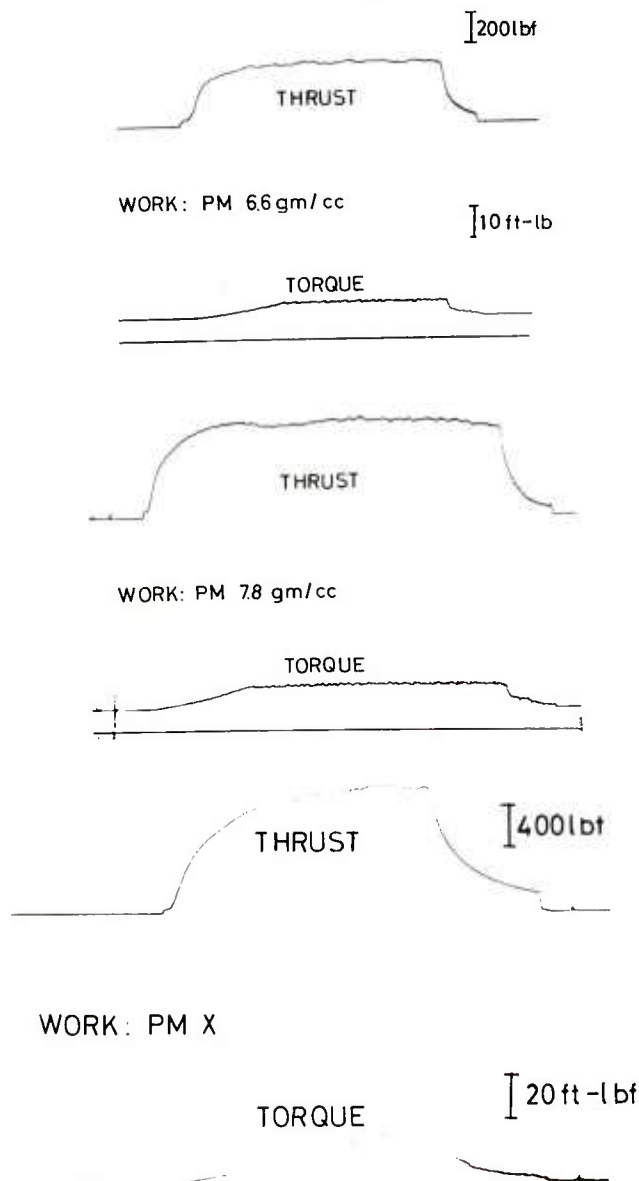

Fig. 13

*Drilling Force
Characteristics for
Three Different
Materials*

The drilling force measurement under varied feed rates exhibited the differences of the material properties as shown in Fig. 14. The highest drilling force was shown when drilling the

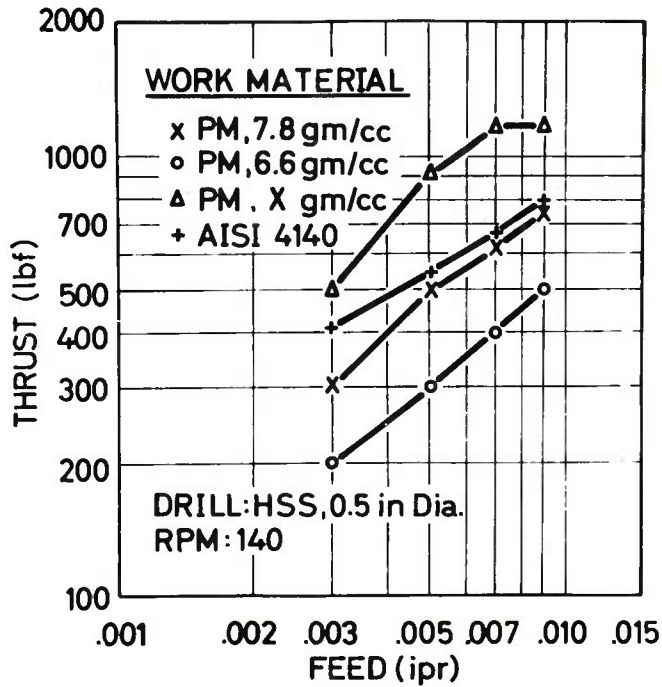
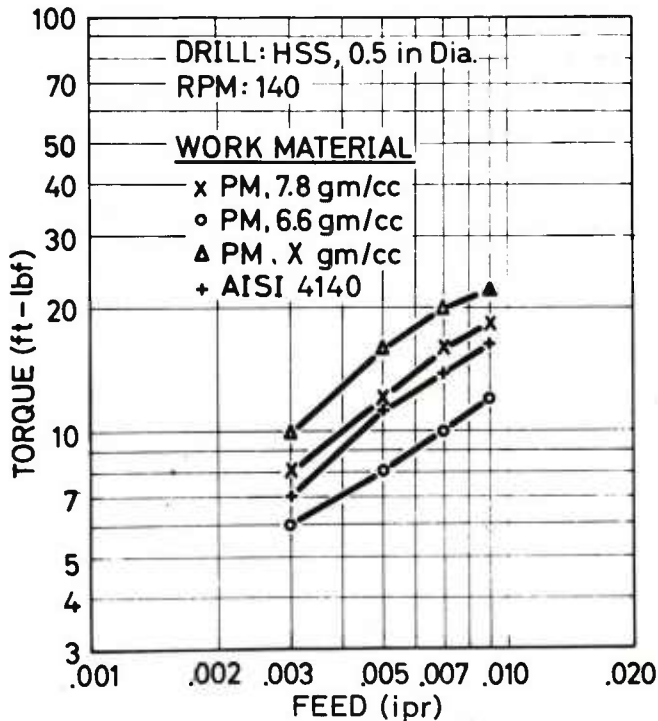

Fig. 14

Drilling Forces as a Function of Feed Rate



P/M specimen supplied by the Rock Island Arsenal, while the lowest force was produced by the low density P/M material. The AISI 4140 and high density P/M materials showed reverse order in the torque and thrust measurements. The drilling force measurement and investigation also satisfactorily agreed with the results from the turning process test.

The chip formation after drilling in the low and high density P/M materials were compared in Fig. 15 and Fig. 16. At both feed rates of 0.003 ipr and 0.005 ipr, the low density P/M material produced very well-broken chips, having a fan type. However, the high density P/M material showed similar chip formation to that of AISI 4140 annealed steel, in which the length of the chip is reduced as the feed rate is increased. From this observation, it could be conveyed that high density P/M materials are related very closely to the material properties of AISI 4140.

Drill wear patterns have a unique feature, as shown in Fig. 17. Three main areas of wear on a drill could be classified as follows:

- a) Chisel edge - With an increasing number of holes, the chisel edge developed wear in the form of two fans.
- b) Lip - A wearland on the lip developed in triangular form along the edge of the whole lip extending from chisel to margin, but seldom did both lips have similar progress of wear. The lip curvature, web centrality, and relative lip height are the most prominent reasons for the difference of wear on both lips.
- c) Margin - At the point of junction between the lip and margin, wear took place in the form of a narrow triangle which developed upward. It was observed that as the error of drill axis centrality increased, the difference in wear on the two margins became noticeable.

An extensive drill life test was conducted in the two P/M materials in order to compare it with that for AISI 4140 annealed alloy steel.

Only taper-shank, standard HSS drills having a 0.5 in. diameter were used for this investigation. At the beginning of this investigation, a preliminary test was conducted to observe built-up edge occurrence without a cutting fluid. However, fumes with an odor were observed on the one hand, and the drill edge changed its color and looked as if the drill would break. It was also very difficult to establish the drill wear progress as a function of cutting time.

In order to carry out a realistic investigation, a cutting fluid consisting of a 20:1 water soluble oil, Vantrol 450, produced by the Van Straaten Chemical Company, was used. The cutting fluid

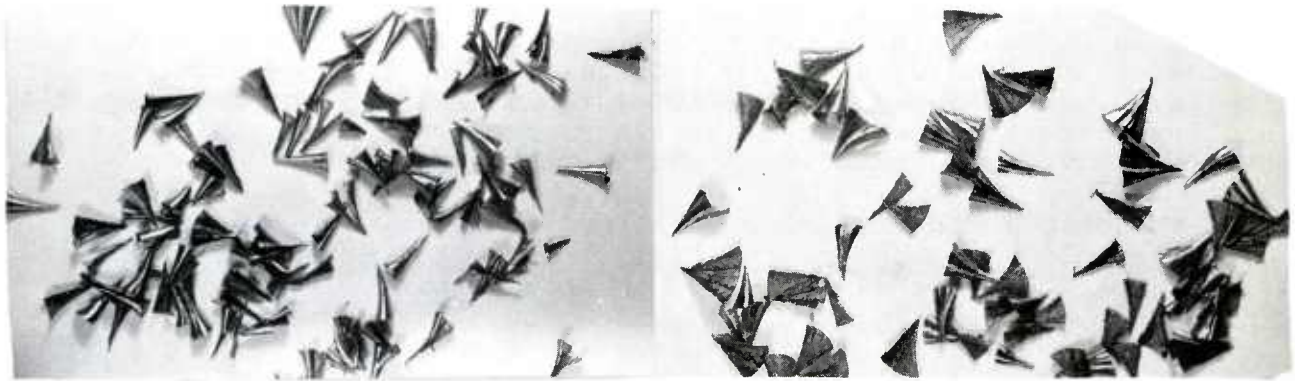

a)

b)

Fig. 15: Chips Produced in Low Density P/M Materials
 a) $f = 0.003$ ipr; b) $f = 0.005$ ipr

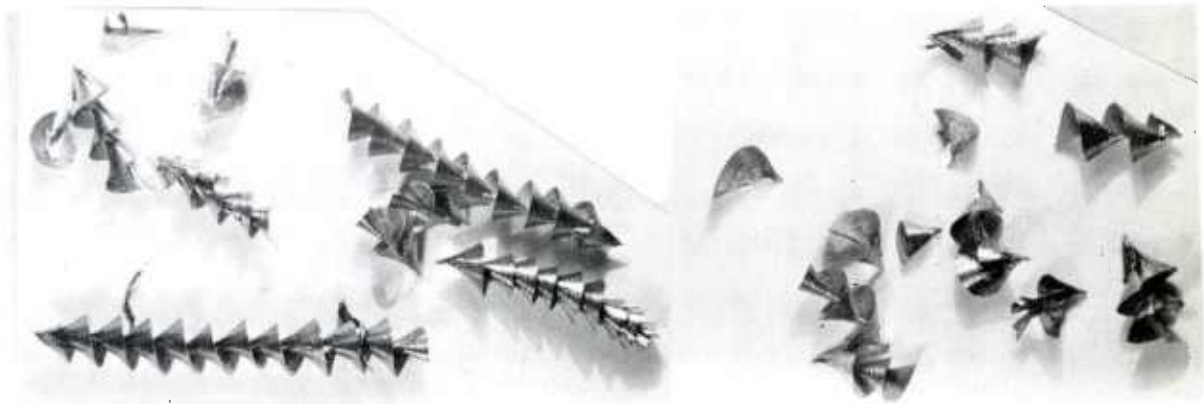

a)

b)



Fig. 16: Chips Produced in High Density P/M Materials
 a) $f = 0.003$ ipr; b) $f = 0.005$ ipr; c) $f = 0.009$ ipr

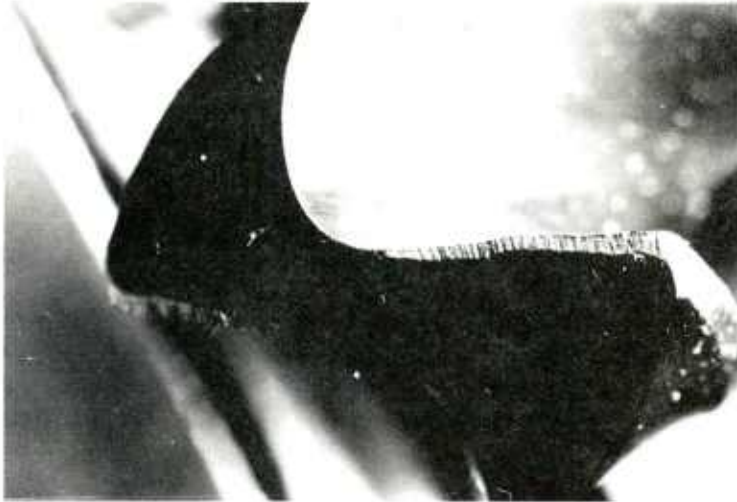

Fig. 17
Typical Wear Pattern
in a Twist Drill

was supplied from two tubes which were spaced at 180° and the cutting fluid flow was controlled at constant pressure of approximately 20 psi and in such a manner so that the cooling action on the workpiece and drill was sufficient.

After a certain cutting time, the drill wear was carefully observed by a microscope and it was found that the progress wear of both lips and chisel were entirely different from the case of drilling in AISI 4140 annealed alloy steel.

Wear on the chisel edge was nearly invisible, while the wear on the lip edge increasingly appeared with increasing cutting time. There was much greater chipping occurrence on the lip than in the case of drilling AISI 4140 steel. The wearland increase showed a large variation in its value as drilling condition was varied.

After extensive tests, the wearland on the lip edge when low density P/M material was drilled was determined and is exhibited in Fig. 18. The feed rate was held constant at 0.008 ipr and the depth of the holes was $3/4$ inches throughout the investigation.

The wearland vs. cutting time (or number of holes) demonstrated very different results compared with the previous investigation in AISI 4140. As drilling speeds were increased, wearland increased distinctly, while in the case of drilling in AISI 4140, reverse trends were obtained. The reason for this was that at increased cutting speeds, the drill wear was protected by the built-up edge occurrence, which is more active at higher cutting speeds.

In high density P/M material, the wearland progressed as a function of the number of holes drilled, and this is indicated in Fig. 19. As expected, the wearland progress was slightly larger than in the case of low density P/M materials.

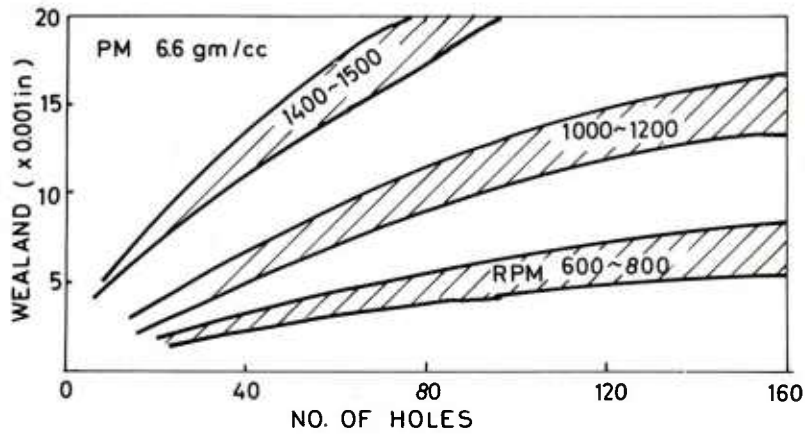

Fig. 18
Wearland Progress in
Low Density P/M
Material

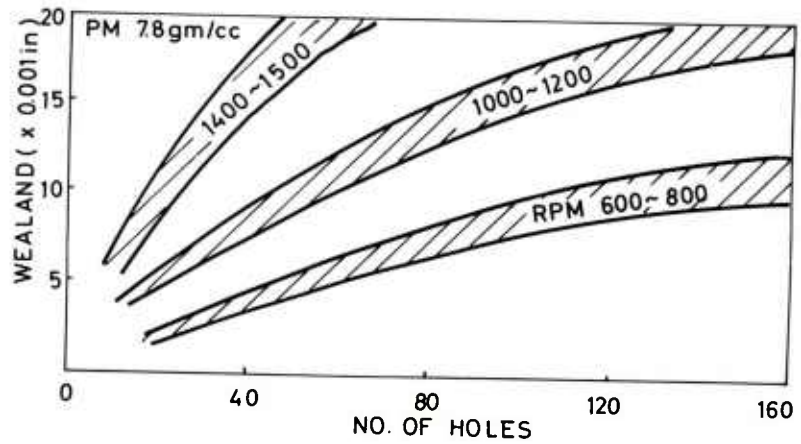

Fig. 19
Wearland Progress in
High Density P/M
Material

As previously mentioned, the results of the investigation of drill wear have less reliability because of the intense variation in the wearland measured. The results in Figs. 18 and 19 were based on the conducted investigation only.

The most significant and important test was to find the drilling condition at which total failure of the drill frequently took place. Fig. 20 indicates how and where a total failure of a drill is initiated. When the drilling speed was too high, a severe wear was initiated at the margin (Fig. 20a). Without changing the drilling conditions, the initiated wear spread quickly (Fig. 20b and Fig. 20c) and finally, the drill demolished completely (Fig. 20d). When the drill initiated an unusual wear on the margin, a high "octave" noise could be heard.

The holes produced by the drill which had severe wear could be easily distinguished as shown in Fig. 21. In most cases, the drilled holes had a triangular shape. The reason for this can be explained by the fact that the drill having a severe wear cannot control an accurate rotation and, therefore, conducts very heavy "walking" when the penetration begins.

In order to establish a maximum drilling speed, the investigation was repeated. As shown in Fig. 22, at a spindle RPM of 1200, a drill failed after drilling more than 120 holes. However, when the RPM was increased to 1500, the drills failed after drilling 40 holes, 30 holes, and 13 holes, and at RPM's of 1800, the drills failed after drilling less than 5 holes. Even though, in this investigation, drill life varied for low density P/M material, the maximum RPM of the spindle would be 1500 or less.

A similar investigation was undertaken in the high density P/M material. As shown in Fig. 23, at an RPM of 1200, two drills failed after drilling 84 holes and 72 holes. At higher than 1200 RPM's most drills failed after very short cutting. From this investigation, the maximum spindle RPM for high density P/M material would be 1200 or less.

The effect of feed rate on drill failure was not clearly obtained through this investigation because only a very limited range of feed rates were applied. An extensive investigation would have been necessary to determine the effects of various feeds on drill life.

The performance of the drill is largely dependent on the drill manufacturer. Material, heat treatment, and process of manufacturing are dissimilar and dependent on the drill manufacturers. Three drills obtained from different manufacturers were tested. The results show a remarkable difference among the three drill manufacturers. Even though these results may be considered as a feasible range of variation for drills produced by a single drill manufacturer, it is significant to note that no two drills performed with any close similarity.

Drill Failure

a)



b)



c)



d)

Fig. 20: Progress of Failure in a Twist Drill

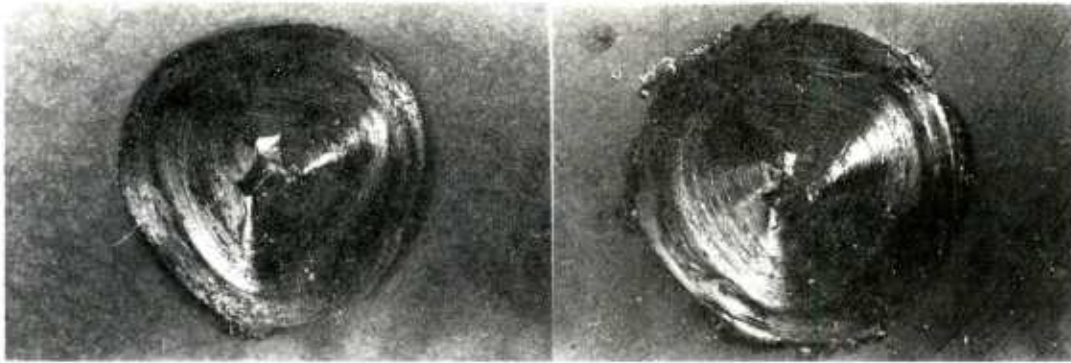

Fig. 21: Typical Hole Shape Produced by a Drill Prior to Failure

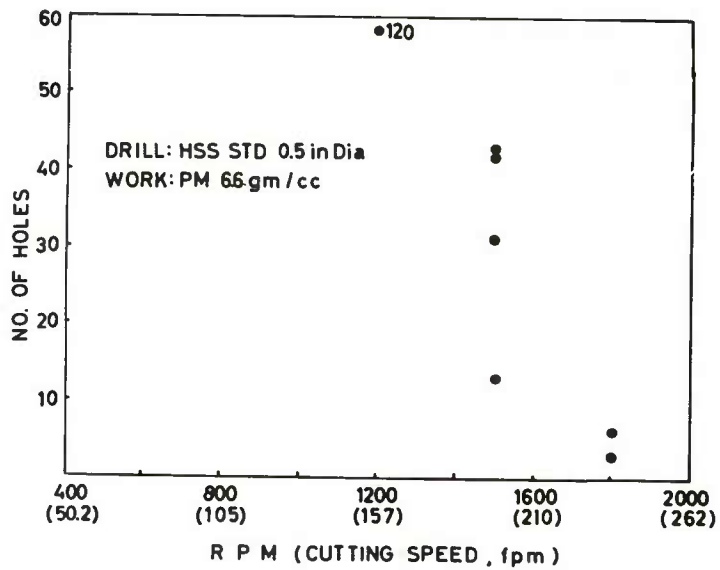

Fig. 22: Relationship between Drill Failure and Drilling Speed in Low Density P/M

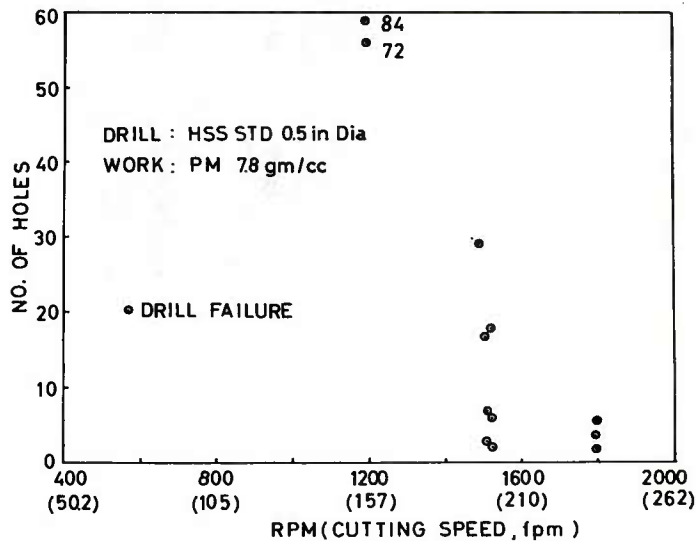

Fig. 23

Relationship between Drill Failure and Drilling Speed in High Density P/M

It was also expected that tungsten-carbide tipped drills would be able to run at very high speeds, therefore, a series of tests were carried out. After preliminary tests of drill wear, it was confirmed that drill wear was negligibly small under low drill speeds. It was also interesting to note how the tungsten carbide tipped drill performed in terms of drill wear, under high speed operations. The RPM was selected at 1500 and the test was repeated three times. The RPM was then reduced to 1000 and the test was repeated three more times under a feed rate of 0.005 ipr. During all six tests, the drill failed, as shown in Fig. 24.

From this investigation, it was felt that tungsten carbide tipped drills should not be recommended for drilling P/M materials. Considering the higher price (4-5 times that of high speed drills), the tungsten carbide tipped drills showed no advantage in terms of performance. The reason for the sudden failure may be caused by the dynamic behavior of the drill under high spindle RPM. This kind of a drill may display its performance when drilling non-ferrous materials having low hardness. A typical failure of a tungsten carbide tipped drill is shown in Fig. 25.

In order to compare two P/M materials in terms of surface roughness, a series of investigations were conducted. As shown in Fig. 26, the spindle RPM was varied from 207 to 1500 under a constant feed rate of 0.005 ipr. As shown in the figure, the surface roughness demonstrated a large variation. At 574 RPM, surface roughness, in terms of arithmetic average, AA, ranges from

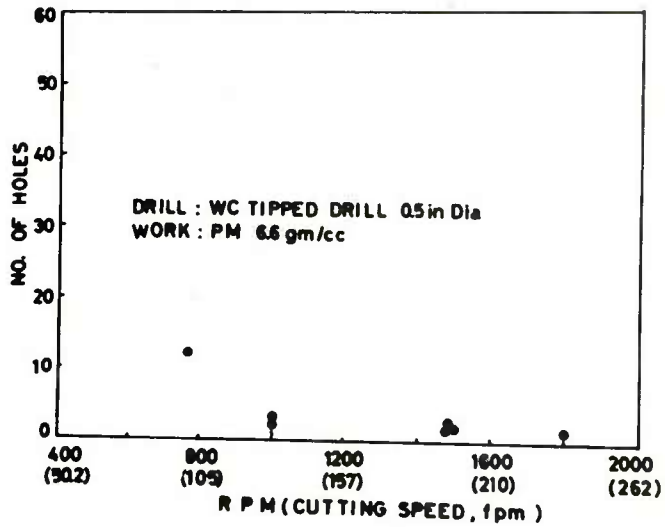

Fig. 24
Relationship between
Drill Failure and
Drilling Speed when
Using a WC-Tipped Drill

Fig. 25
Typical Failure of
WC-Tipped Drill



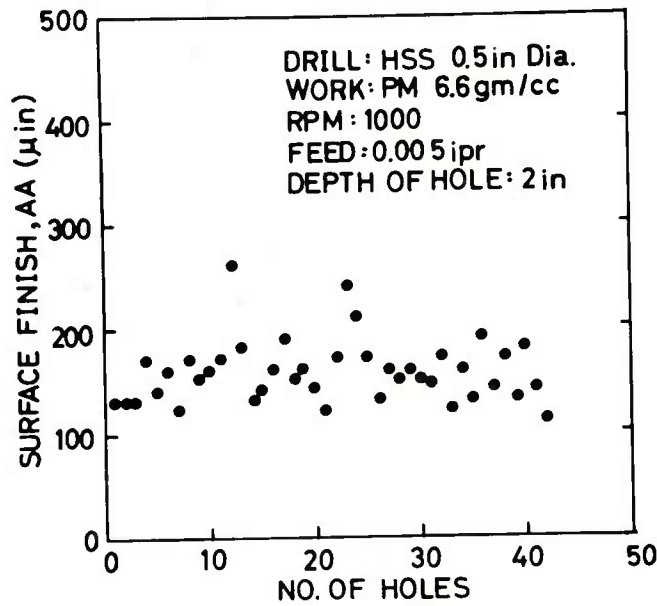
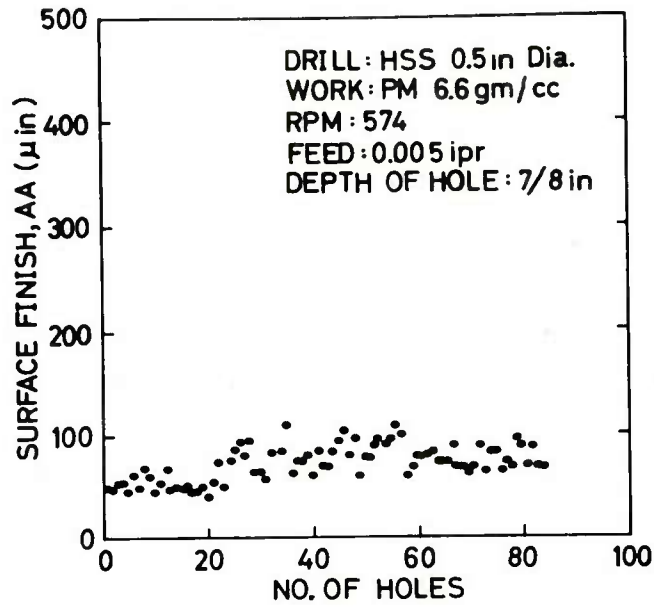
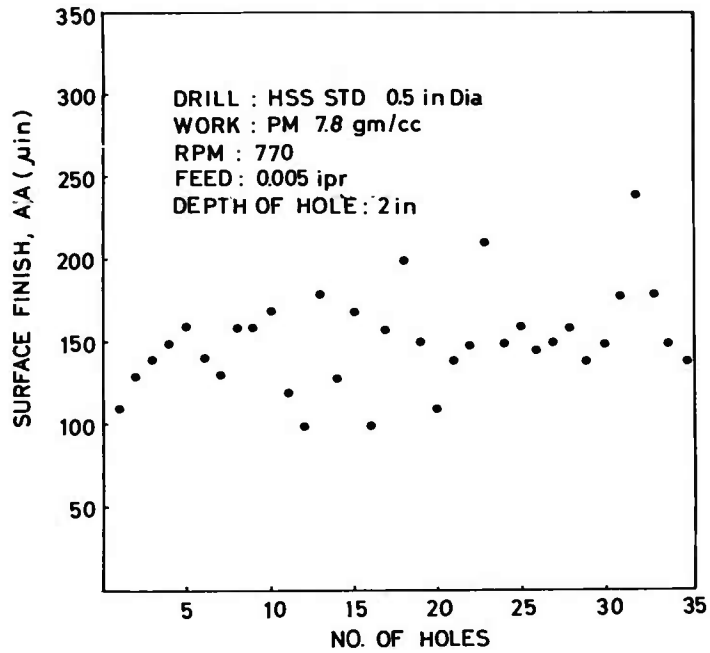

Fig. 26: Surface Finish Obtained in Drilled Holes in Low Density P/M Material

50 μ in. to 105 μ in. when a total of 83 holes were drilled. At increased RPM, the value of surface finish increased and at 1000 RPM, surface finish varied between 100 μ in. to 250 μ in.

Surface finish generated by twist drills is influenced by many factors, such as drill grinding conditions, drill geometry, spindle-adapter-drill system, coolant, etc. It is almost impossible to establish the effect of one single factor. However, in this investigation, the dynamic behavior of spindle-drill system would be the most effective factor since the surface finish increased as the spindle RPM increased.

High density P/M materials showed similar results when compared with low density P/M materials. As shown in Fig. 27a, at 770 RPM the surface finish in terms of AA, ranged between 100 μ in. and 200 μ in. A much higher variation in the surface finish was obtained as the spindle RPM was increased to 1000 as shown in Fig. 27b. Even 250 μ in. was measured at this drilling condition.



a)

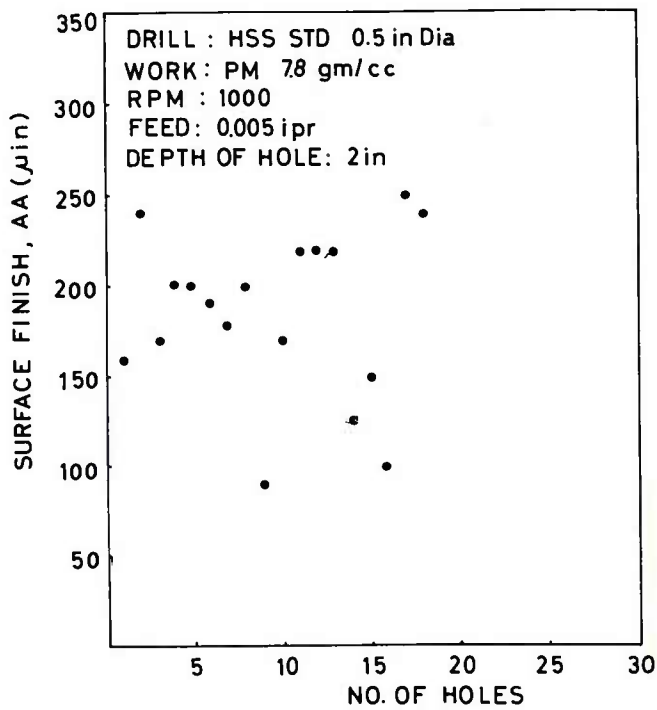

b)

Fig. 27: Surface Finish Obtained in Drilled Holes in High Density P/M Material

REAMING PROCESS

A reamer is a rotary cutting tool, generally of cylindrical or conical shape, intended for enlarging and finishing holes to accurate dimensions. It is usually equipped with two or more peripheral grooves or flutes, either parallel to its axis or in a right- or left-hand helix as required. Those with helical flutes provide smooth shear cutting and produce a better finish. The flutes form cutting teeth and provide grooves for removing the chips.

Fig. 28 describes the terms applied to reamers for a machine reamer point. The most critical points where cutting action takes place and wear occurs are the chamfer relief and the margin. Relief is the result of the removal of tool material behind or adjacent to the cutting edge to provide clearance and prevent rubbing. Margin is the unrelieved part of the periphery of the land adjacent to the cutting edge.

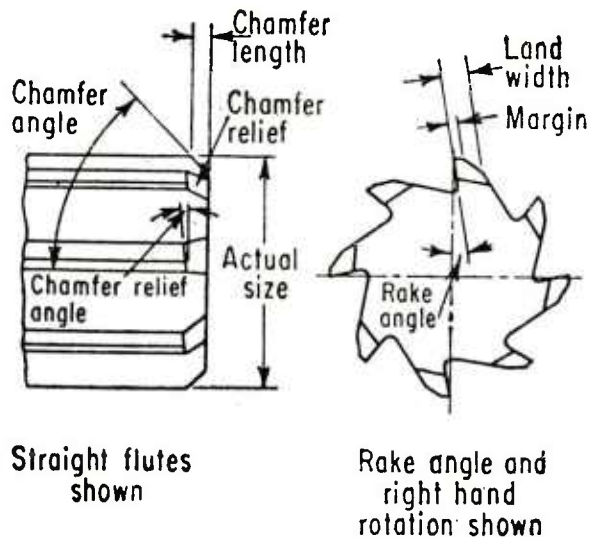

Fig. 28: Terms Applying to Machine Reamer Point

In this investigation, two different types of reamers were used - a high speed steel reamer and a tungsten carbide tipped reamer, both having a diameter of 17/32 inch and shown in Fig. 29.



a)



b)

Fig. 29: Two Kinds of Reamers
a) *Tungsten Carbide*
b) *HSS*

The machine tool used for this investigation was the same as that for the drilling investigation. Two different kinds of reamer holders, Jacob chuck and floating reamer chuck, were used. Stock removal, after the drilling operation, was measured as 0.015 inch on one side for both types of reamers.

The wear on the reamers was measured by microscope and it was found that the tungsten carbide tipped reamer had almost negligible wear on the margin and chamfer. However, the high speed reamer showed an increasing wearland as a function of cutting time and this is shown in Fig. 30. B_1 is defined as wearland on the chamfer and B_2 as that on the margin. It was also noted that the progress of B_1 is larger than B_2 . Compared to the drill wear, the wear on the reamer is very small. The reason for this is that the reamer removes only small stock while the drill removes the material in large stock or the total material in the total hole. The ratio of stock removals for these processes would be approximately 85:1.

As shown in Fig. 30, the wearland is so small that no effect of reamer wear on the dimensional accuracy can be counted. The most important purpose of reaming is to improve the accuracy in the location, roundness, and parallelism of a hole after a drilling operation. As illustrated in Fig. 31, a lack of rigidity of the

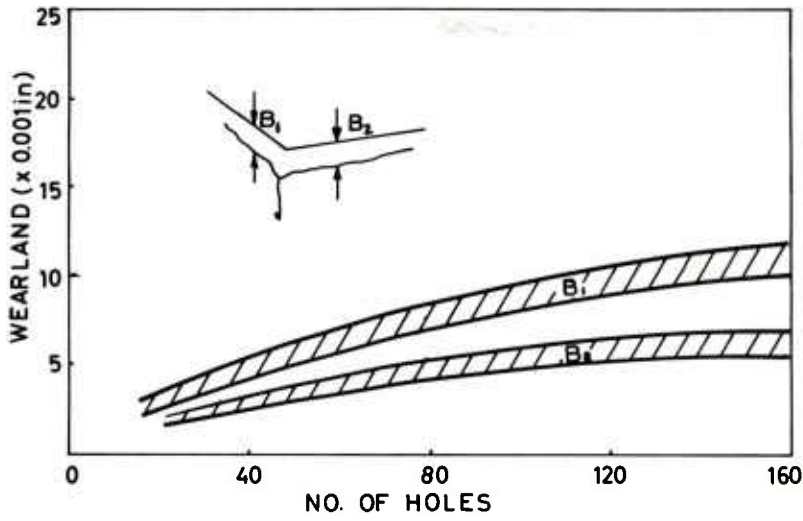
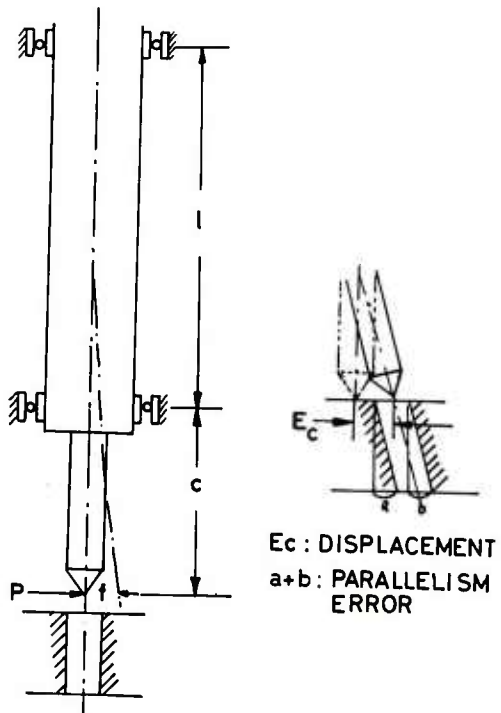

Fig. 30
Progress of Wear as a
Function of Reaming Time

Fig. 31
Schematic Illustration
Indicating Cause of
Displacement and
Parallelism Error



spindle-adapter-drill system, the play of the bearing on the spindle, and the location of the bearings, the hole center location after drilling is not identical with the spindle-center, i.e. a displacement will take place.

The deflection, f , of the end of a rotating tool is expressed as

$$f = \frac{P}{EI} \frac{(\ell+c)c^2}{3}$$

- where
- P = Difference in radial forces produced by both lips
 - E = Young's Modulus of the system
 - I = Moment of inertia of the system
 - ℓ = Distance of the two bearings
 - c = Distance from the lower bearing to the end of the drill

When the drill (or other hole making tool) is deflected at the beginning of the operation, the hole cannot be parallel to the spindle axis, i.e. error in parallelism will take place. In this investigation, a "Federal's Center Find Attachment" was utilized for the measurement of displacement and parallelism. The attachment provided a very precise and convenient method for the centering of cylindrical work for critical machining. As shown in Fig. 32, it allows the gage head to rotate with the machine spindle while the amplifier cord, which is attached to the friction-free collar, remains stationary. This permits the spindle to be rotated by power

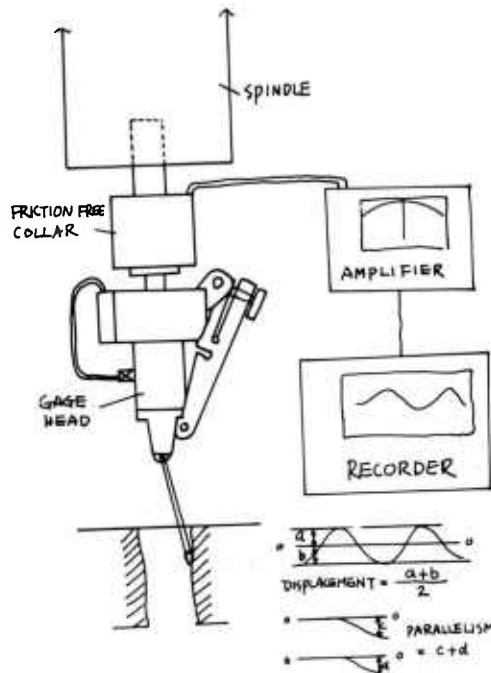

Fig. 32

Schematic Illustration
Indicating Displacement
and Parallelism Error
Measurement

at slow speeds, eliminating the inevitable deflection which results when the spindle is rotated by hand. Removal of this prime cause of inaccuracy makes the "Center Find" well suited to precisely check roundness, displacement, parallelism, squareness, and other geometrical conditions of the work.

After drilling or reaming, the tool is removed from the spindle and the measuring device is inserted in the spindle. The workpiece is kept clamped and the border of the hole is tested by the stylus so that records will indicate the displacement of the hole.

The parallelism error can be evaluated by moving the spindle axis in four appointed directions: 12 o'clock, 6 o'clock, 3 o'clock, and 9 o'clock from the position of the machine operator. The combined measurements of two directions, 12 o'clock and 6 o'clock or 3 o'clock and 9 o'clock, can be used to illustrate the error of parallelism.

Fig. 33a presents how the drilled holes are located, off from the center of the spindle axis, and how the sequential reaming process can improve the mislocations. Drilling was conducted without centering. After 11 tests on low density P/M material, it was found that the displacement after drilling ranged from 25 μm to 170 μm ; and after reaming, the displacement was improved to the range 10 μm to 60 μm . The error is reduced approximately by half.

The parallelism error demonstrated a much higher variation in the error measurements. After drilling, parallelism was obtained in the range of 60 μm to 230 μm as shown in Fig. 33b. However, after reaming, the error was approximately reduced to a range of 20 μm to 70 μm . By the reaming process, it is possible to reduce the error due to parallelism by almost two-thirds.

As indicated in Fig. 34, high density P/M material obtained a displacement error in the range of 25 μm to 120 μm , and after reaming, the error was reduced to the range of 10 μm to 70 μm . The improvement ratio was almost similar to that in the case of low density P/M material. Regarding the parallelism error, which ranged from 80 μm to 230 μm after drilling, it was improved to 20 μm to 90 μm by the sequential reaming process.

The question concerning why the reaming process does not reduce the error to zero can be explained by the fact that the spindle-adapter-reamer system is not rigid enough; and, when previous error must be corrected by the reamer, the stock removal becomes very high, so that the spindle-adapter-reamer system deflects where stock removal is exceedingly large compared to the normal operation.

It was expected that the use of centering prior to drilling would greatly help to reduce the displacement and parallelism error.

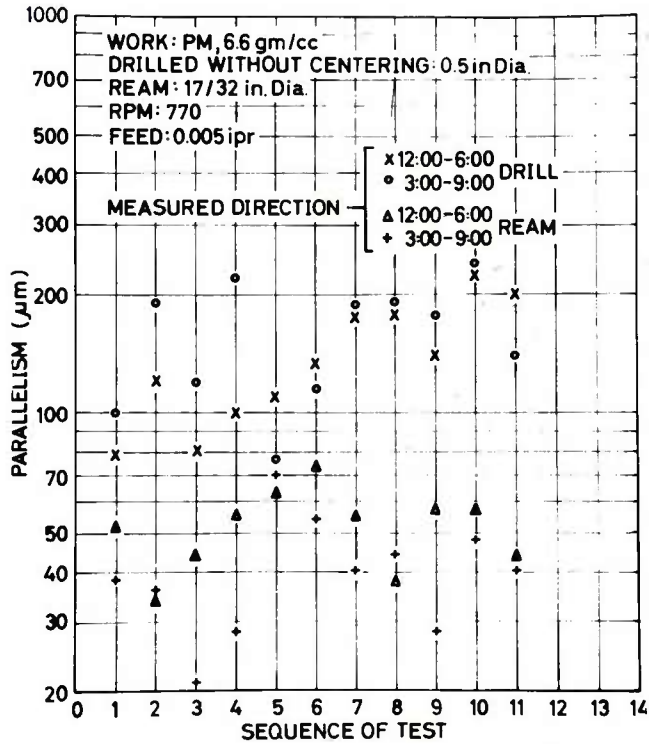
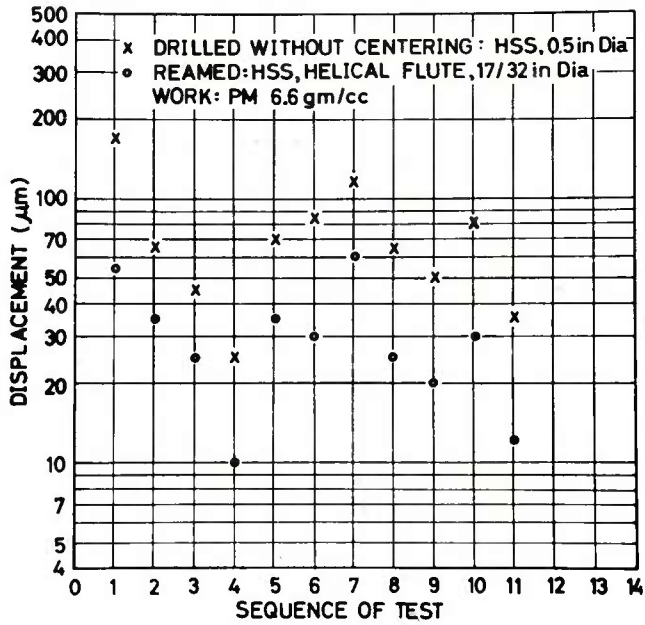

Fig. 33: Improvement of Hole Geometries After Reaming Low Density P/M Material

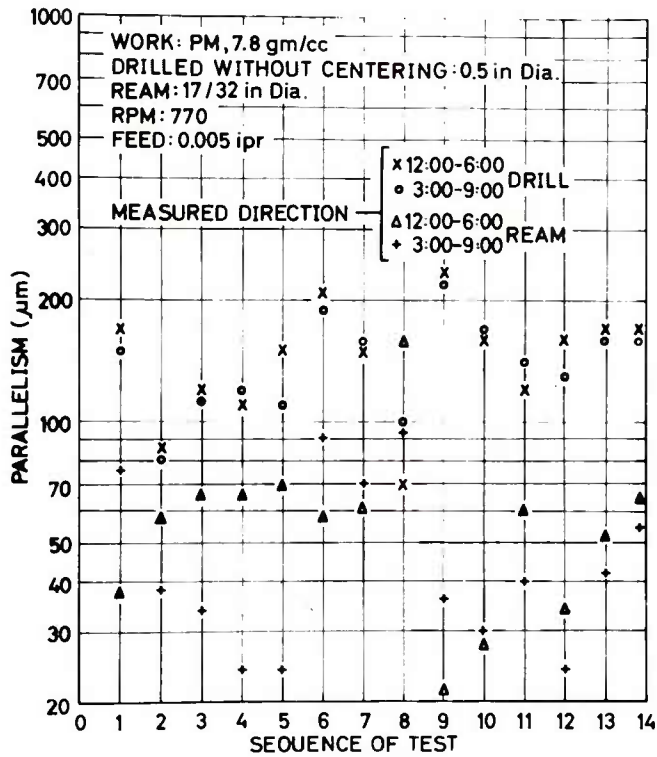
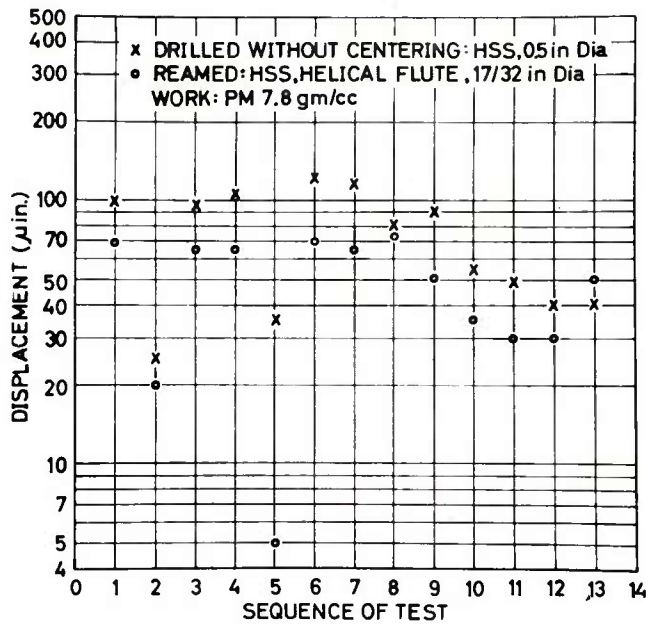

Fig. 34: Improvement of Hole Geometries After Reaming High Density P/M Materials

As expected, Fig. 35a shows that the displacement error after drilling ranged from 20 μm to 60 μm and can be reduced to a range of 8 μm to 25 μm .

However, regarding the parallelism error, the use of centering prior to drilling had no significant effect, either on the initial error or the improvement by the sequential reaming process and this is shown in Fig. 35b. After 13 tests in high density P/M materials, the displacement and parallelism errors showed similar results to that obtained in low density P/M materials. In this case, the displacement error ranged from 9 μm to 40 μm after drilling and was reduced to 5 μm to 40 μm , although in 4 cases, the displacement error became worse after reaming (Fig. 36a). The parallelism errors obtained after reaming, showed a remarkable improvement compared with the case of reaming in low density P/M materials. The majority of the tests show an improvement to under 40 μm .

The effect of the floating chuck, for the reamer, on the geometrical error was also investigated. After the pre-reaming was conducted by a Jacob's chuck, holes were then reamed by other floating chucks and the results were measured. The stock removal of 0.015 inch on one side was the same as previous tests.

The investigation in low density P/M material is plotted and is shown in Fig. 37, but it presents a very disappointing result. The displacement error was not reduced greatly after the second reaming operation, and shows a very close measurement to the first one. In some cases, the second reaming adapted by the floating chuck had a greater displacement error.

Parallelism error improvements due to the use of a floating chuck showed no significant changes. The measured results of the second reaming operation are very close to the first reaming (Fig. 37b).

For the high density P/M material, the results of the displacement test were very disordered. As shown in Fig. 38a, the pre-reaming error range was extremely large, which was also true for the floating chuck but the error due to the latter was close to the previous error.

Fig. 38b shows that pre-reaming high density P/M material produced an error of parallelism in the range of approximately 150 μm to 350 μm and that the second reaming operation using a floating chuck had reduced the error to a range of approximately 40 μm to 80 μm .

Surface roughness indicated a variation between the range of 60 $\mu\text{in.}$ to 110 $\mu\text{in.}$ but most surface roughness obtained by the reaming process was 100 $\mu\text{in.}$, which is accepted and is rougher than some drilling (Fig. 39a). Surface finish for the high density P/M material after reaming, showed similar results to that for low

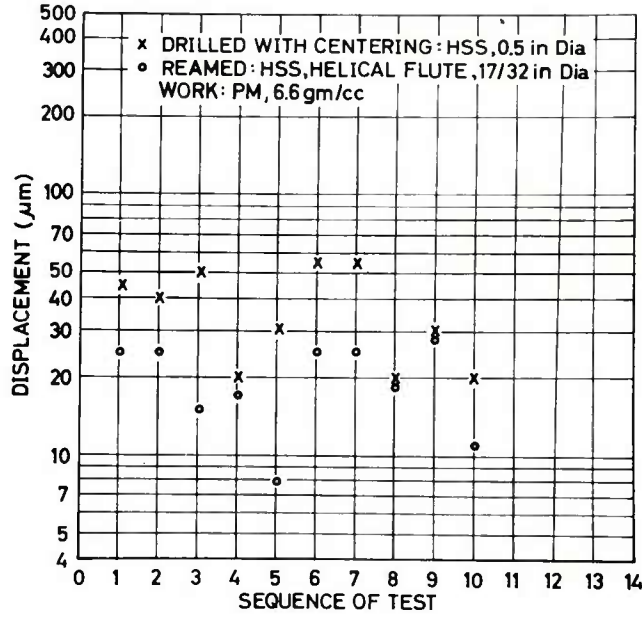

a)

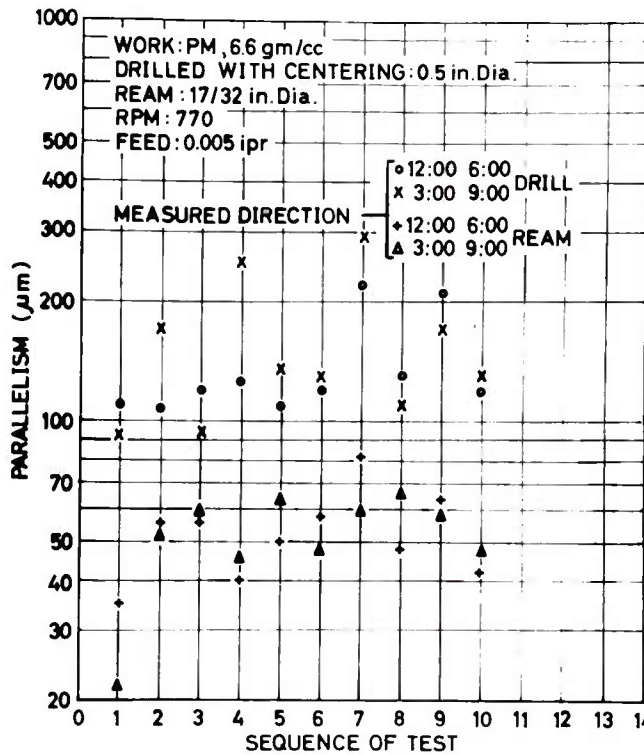

b)

Fig. 35: Effect of Centering on the Hole Geometry Improvement When Reaming Low P/M Material

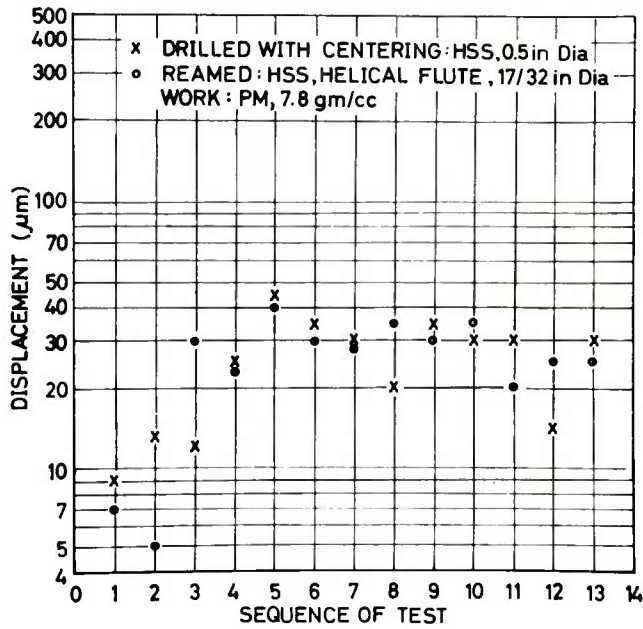

a)

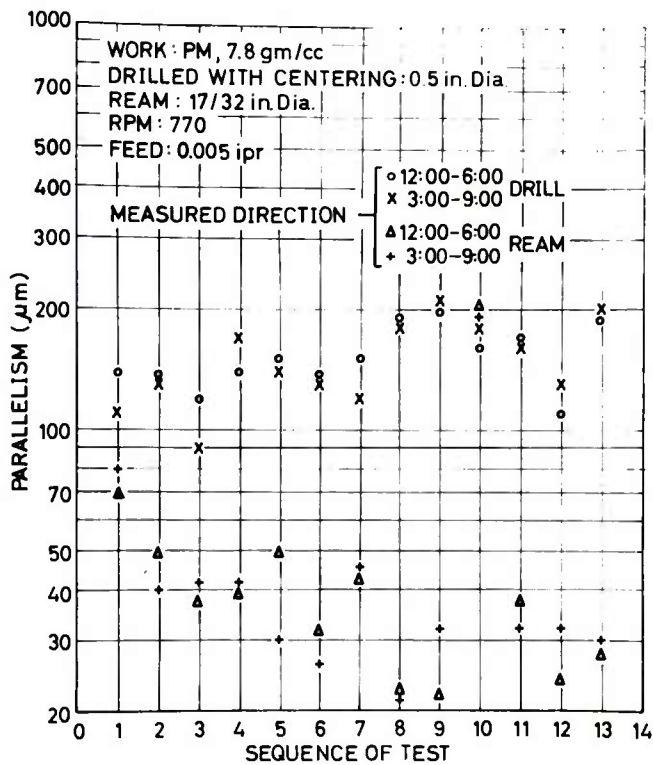

b)

Fig. 36: Effect of Centering on the Hole Geometry Improvement When Reaming High P/M Material

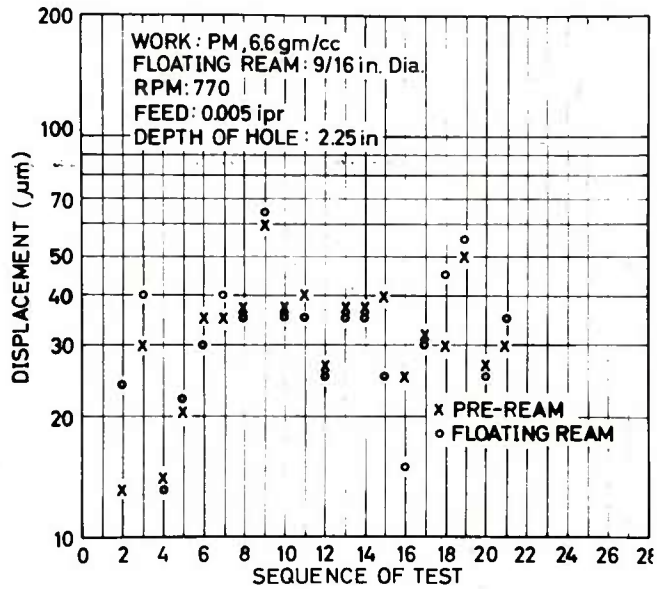

a)

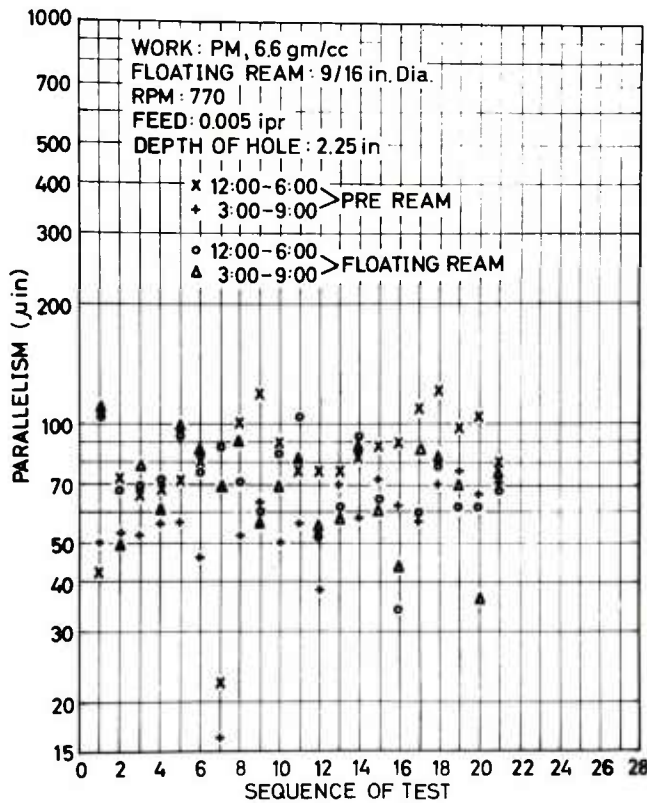

b)

Fig. 37: Effect of a Floating Reamer Chuck on the Hole Geometry when Reaming Low Density P/M Material

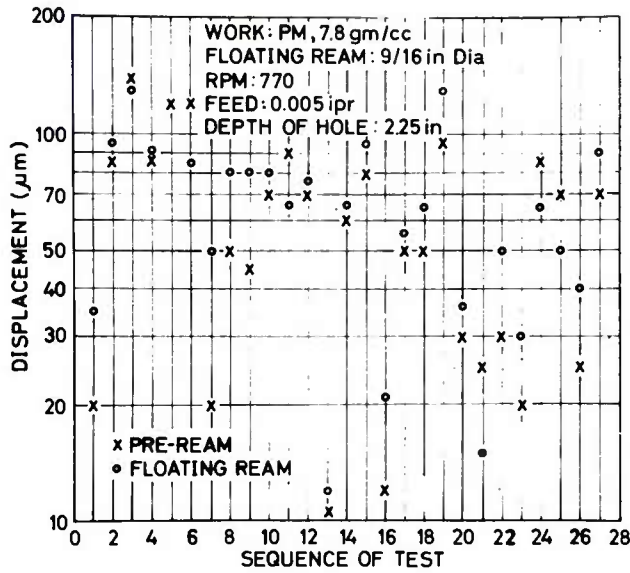

a)

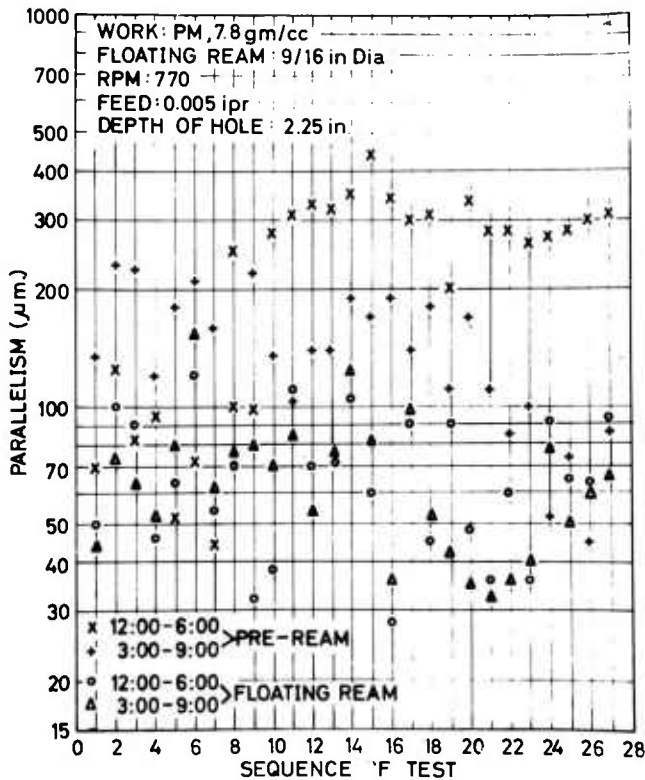

b)

Fig. 38: Effect of a Floating Reamer Chuck on the Hole Geometry when Reaming High Density P/M Material

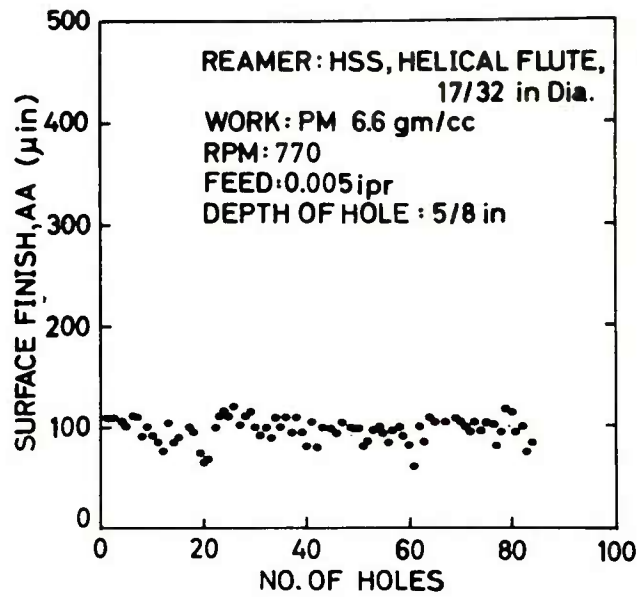

a)

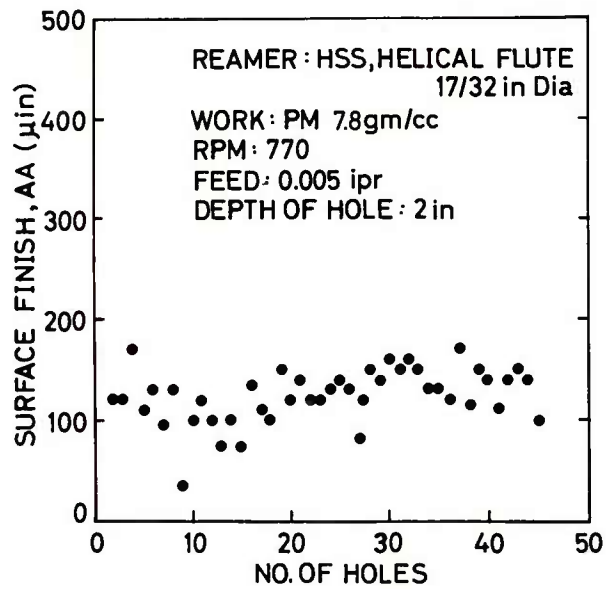

b)

Fig. 39: Surface Finish After Reaming in Low (a) and high (b) density P/M Materials

density P/M materials, however, there was a large variation, which ranged from approximately 70 μ in. to 150 μ in. After reaming 45 holes, the average would be approximately 120 μ in. (Fig. 39b).

Results of the roundness error in the drilling and reaming process are presented in Fig. 40a, b, and c. The drilling process

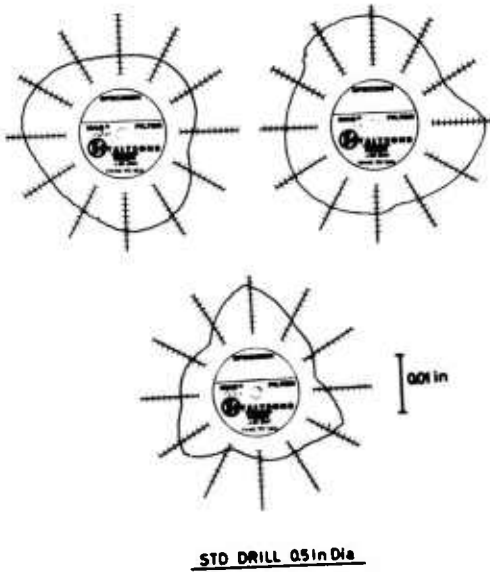

Fig. 40a

Roundness Diagrams
Produced by Drilling

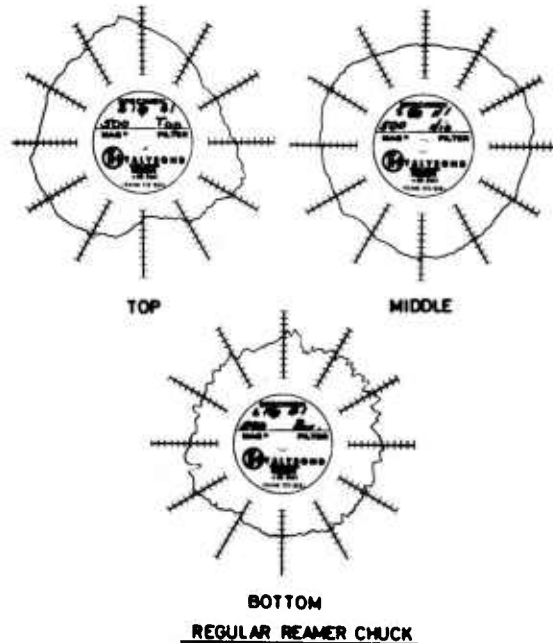

Fig. 40b

Roundness Diagrams
Produced by Regular
Reamer Chuck

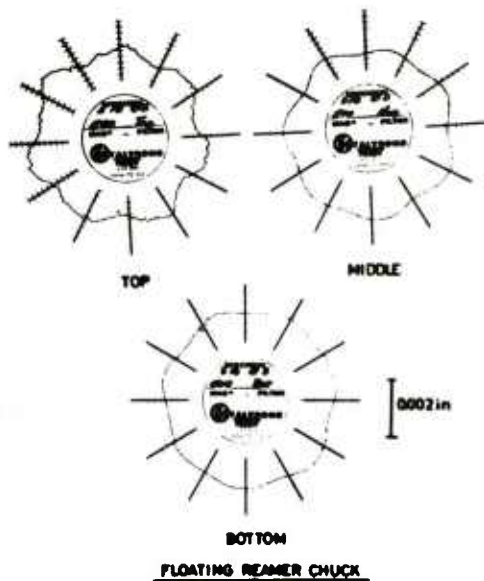

Fig. 40c

*Roundness Diagrams
Produced by a Floating
Reamer Chuck*

produced a very large number of different roundness profiles. The roundness profile is largely dependent upon the condition of drill grinding, concentricity of spindle-drill axis, etc. Fig. 40a presents three typical roundness profiles produced by improper drilling conditions.

Commonly out-of-roundness (or roundness error) is defined as the regularly or randomly spaced deviations from the ideal roundness of the actual profile, which may result from numerous parameters in the workpiece-tool-machine system in the machining field. Because the out-of-roundness value is defined as the difference between the largest and smallest radius which will just contain the measured profile, these radii must be measured from a specified center.

In most cases the evaluation of roundness error is made in terms of minimum circumscribed circle (MCC), which can be obtained by using a templet on a roundness polar chart.

The magnitude of the error reached more than 0.0014 in. However, after reaming, the roundness error was remarkably improved. Fig. 40b shows a typical roundness error after reaming, which was produced by the Jacob chuck. The top, middle, and bottom indicate slightly different figures. The reason for this can be explained by the fact that the reamer was not on similar positions against the workpiece during the reaming process. The deflection and vibration of the reamer were different throughout the penetration. This was especially true when a floating reamer holder was used (Fig. 40c), which produced seven cornered profiles. The maximum error in roundness was measured as 0.002 in. Therefore, it can be concluded that a floating reamer holder does not always have advantages.

BORING PROCESS

Boring is the enlarging of a hole for the purpose of improving the hole geometry, dimensional accuracy, and surface finish. High cutting speeds, light depth of cuts, and small feed rates are commonly applied.

In this investigation, two different assemblies of boring bars and heads were used. Each assembly had special features, and, therefore, performed differently. The first boring bar, A (insert-type, 1/2 in. dia. x 3 in. long), was used in an Erickson "tenthset" boring head which permits adjustable depth of cuts (in increments of 0.0001 in.) at variable axial lengths. The second boring bar, B (solid-type, 3/4 in. dia. x 3 in. long), was set in a cartridge which permits only depth of cuts adjustment, in increments of 0.001 in. Cutting conditions for hole roundness were $V = 250$ fpm (770 RPM), feed = 0.005 ipr, and depth of cut = 0.005 in. Feeds for axial surface profiles were 0.0003 in. and 0.0008 in.

The boring operation was expected to improve errors in both displacement and parallelism, which occur after drilling or reaming. The main interest was to establish the magnitude of the improvement in both errors after boring. As shown in Fig. 41, the displacement was obtained by measurement after boring for both boring heads when boring low density P/M materials. From this figure, it was noted that boring bar B showed a much greater improvement, in both errors, because of higher rigidity. The cutting conditions were selected as $V = 250$ fpm (RPM - 770), feed rate = 0.005 ipr, and depth of cut = 0.005 inch.

Figure 42 presents the obtained displacement and parallelism errors by the boring process after drilling in high density P/M material. Similar to the case shown in Fig. 41, the two different boring bars accomplished their performance slightly differently. The more rigid boring bar assumed a much higher grade in parallelism correction.

The surface profile generation is dependent upon the nose radius of tool, feed rate, and dynamic behavior of the machine and cutting tool system. A slight difference in the surface roughness profile records obtained by use of the two different boring bars is shown in Fig. 43.

The boring bar A has less rigidity; and, a dynamic behavior of the boring bar during the boring process was reflected in the roughness profile record. An example of the roundness records measured in bored holes which were obtained by use of two different boring bars, is shown in Fig. 44a and 44b. Boring bar A, which had less rigidity when compared with bar B, showed a large number of irregularities on the circumference. However, boring bar B, demonstrated a sufficient improvement in the roundness on the top, middle and

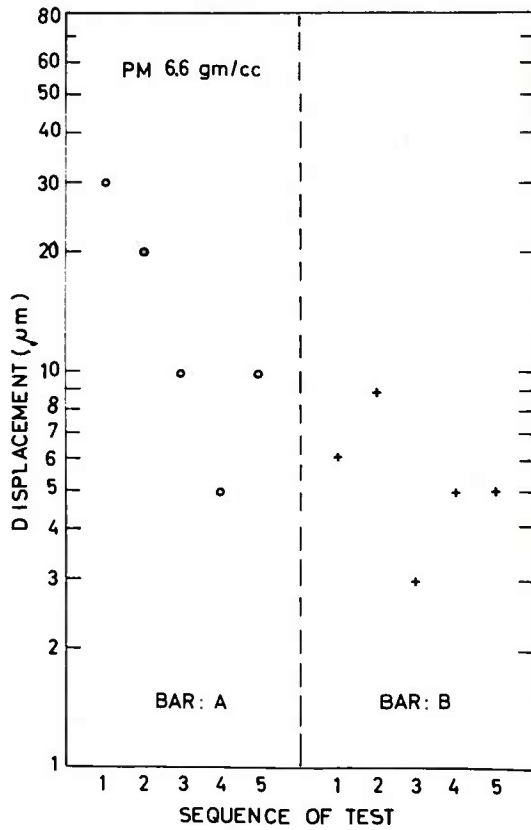
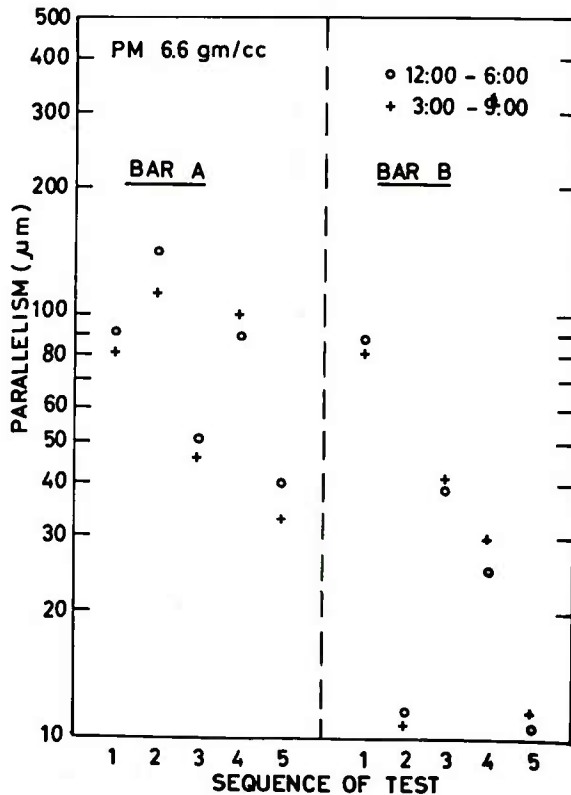

Fig. 41a
 Displacements Produced by
 the Boring Process in
 Low Density P/M Material

Fig. 41b
 Parallelism Produced by
 the Boring Process in
 Low Density P/M Material



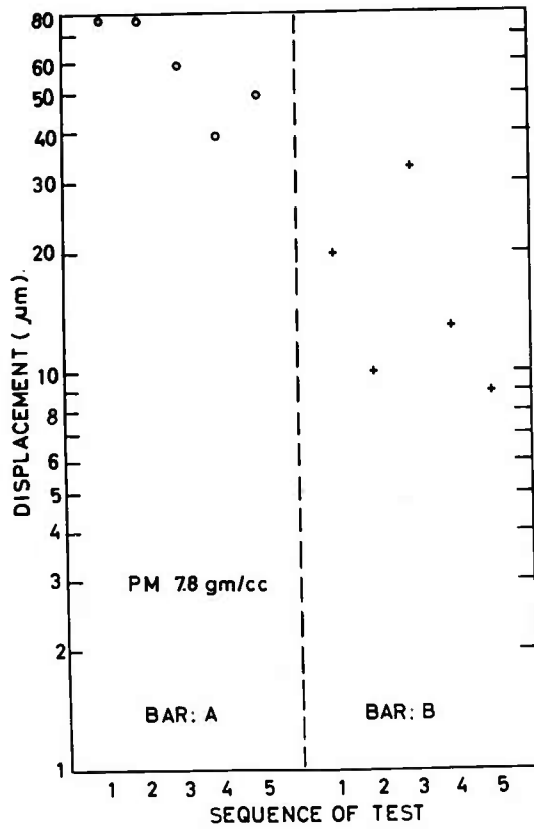
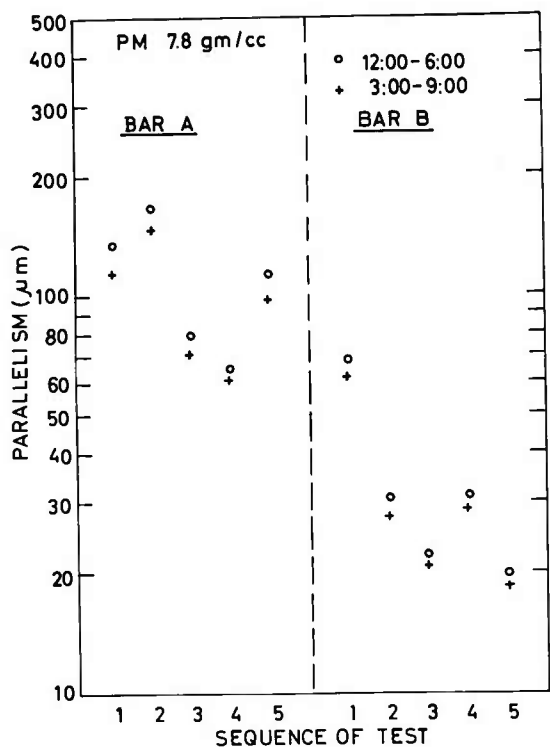

Fig. 42a

Displacements Produced by the Boring Process in High Density P/M Material

Fig. 42b
Parallelism Produced by the Boring Process in High Density P/M Material



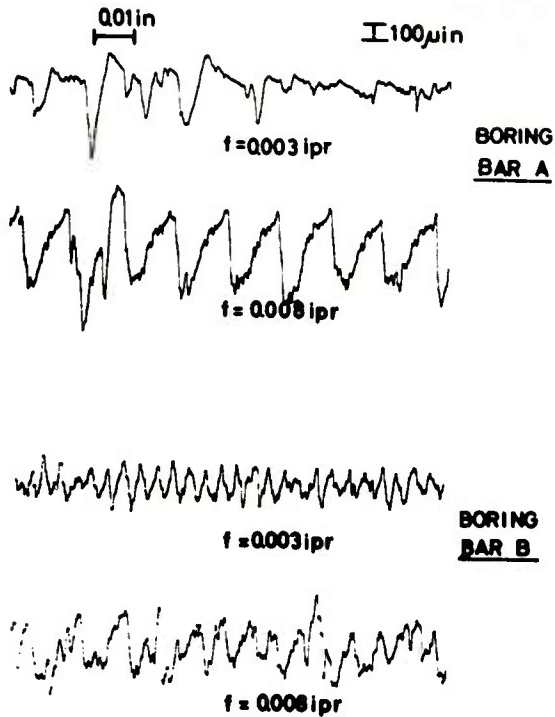

Fig. 43

Surface Profile Diagrams
Produced by Two Different
Types of Boring Bars

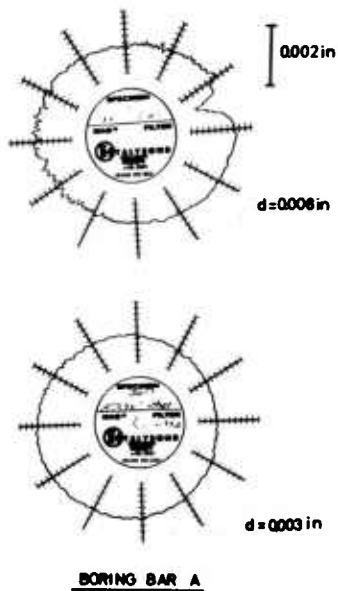

Fig. 44a: Roundness Diagrams
Produced by Boring
Bar A

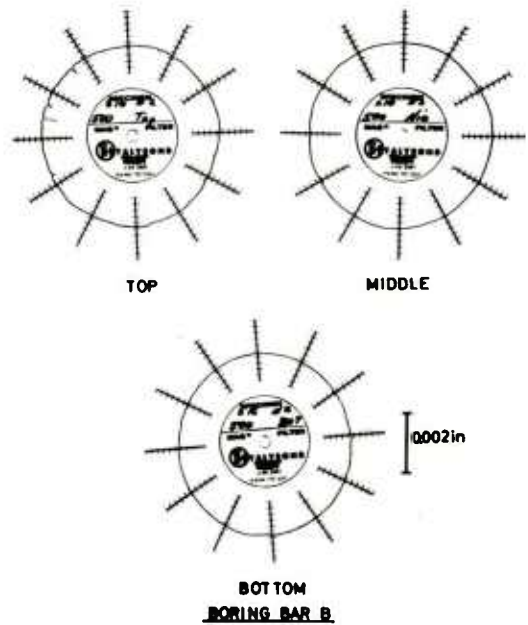

Fig. 44b: Roundness Diagrams
Produced by Boring
Bar B

bottom of the hole. A maximum average error in roundness by the boring process was calculated to be .001 μ in.

TAPPING PROCESS

A tap is used to cut internal threads. A tap is a screw on which longitudinal straight or helical flutes have been formed as cutting edges. It operates with two simultaneous motions: rotation of the work or tap, and tap advancement along the thread axis. The principal parts and constructional elements of a tap are shown in Fig. 45.

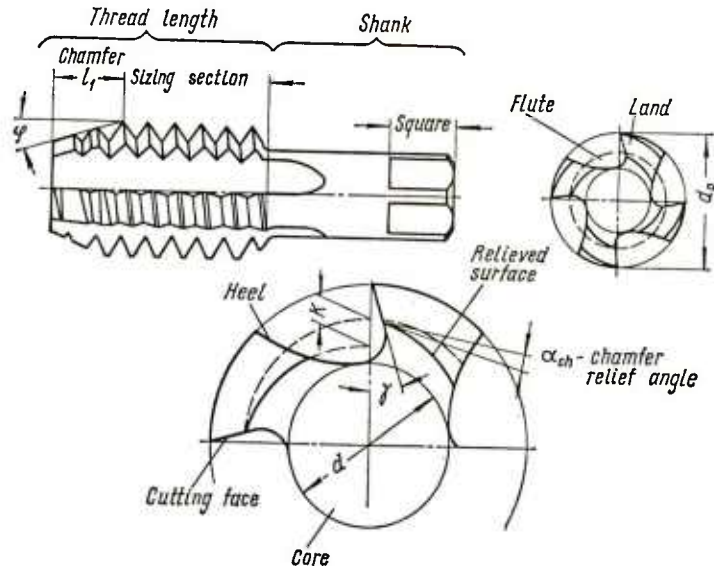

Fig. 45: Principal Parts and Constructional Elements of a Tap

The thread length refers to the part of the tap on which the thread is cut. It is made up of the chamfer and sizing section. The chamfer (or cutting section) is the front tapered end of the tap and serves for the rough cutting of the thread. The sizing section cleans up the threads cut by the chamfer.

The chamfer length differs on the three taps. It is longest on the roughing tap ($4S$, S is the pitch of the thread to be cut) and shortest on the finishing tap ($1.5S$ to $2S$). The most commonly applied stock removal distribution has 50 to 60 percent removed by the roughing tap, 28 to 30 percent by the middle tap, and 16 to 10 percent by the finishing tap.

The thickness, a_z , of the uncut chip accounted for by each cutting element (thread) on each land is determined on the basis of the height of thread, t , and number, K , of cutting elements (thread) on the tap chamfer.

The cross-hatched area in Fig. 46 represents the part of the thread groove removed in one (the first) revolution of the tap. The uncut chip thickness removed from each land is

$$a_z = \frac{t}{zK},$$

but $K = \frac{L}{S},$

then $a_z = \frac{tS}{zL} = \frac{S}{z} \tan\phi$

where $L =$ chamfer length
 $z =$ number of lands (flutes)
 $t =$ depth of thread with clearance

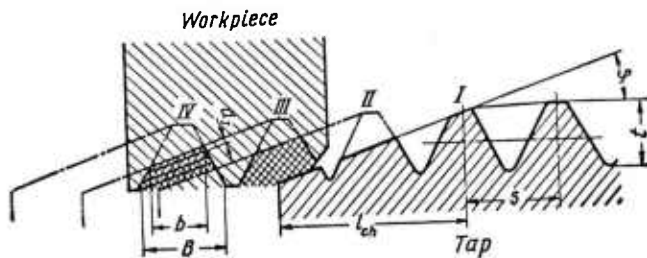

Fig. 46; Material Removal in Tapping Threads

When a hole is tapped, there is always a certain amount of expansion caused by the cutting action and heat created by friction. When a tap begins, there is a slight hole expansion; as it goes further into the hole, there is an increase in heat and the tapped hole is further expanded by a slight amount. When the tap reaches the end and is ready for reversal, the pressure of the cutting action of the tap is removed and a slight shrinkage takes place at this point.

In this investigation, the drilled holes were made by a drill having a diameter of 0.5 inch. On the drilled hole, three taps were used - first roughing, semifinishing and finishing. The tapping operation was conducted by a machine (powered tapping) and a tapping lubricant was used. The size of the tap was 5/8-11 in NC - UNC series.

After completing the finishing tapping, the accuracy of the threads were inspected by means of gages. Both P/M materials (high density and low density) showed significant results and all 10 holes for both materials had passed their inspection. As shown in Fig. 47, no burr is visual after tapping.

A tap will work at the same surface feet per minute as any other metal cutting tool if the proper style is used and held rigidly and accurately as in the other metal cutting tools. Although this critical speed varies with the material, depth of hole, and pitch, a little care used in the study of each particular job will soon establish the maximum speed of each size of tap, for each grade of material.

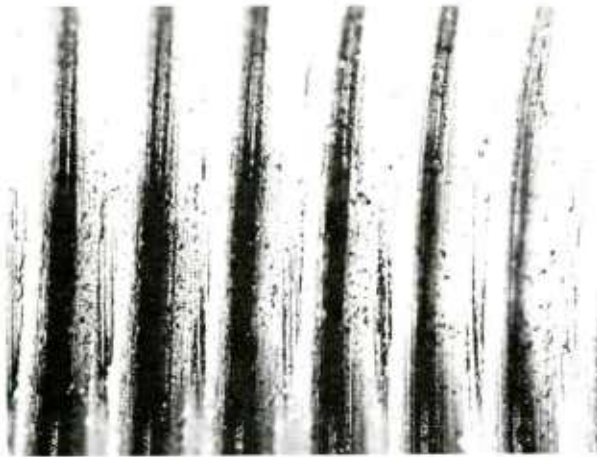

a) *Low Density P/M*



b) *High Density P/M*

Fig. 47: *Tapped Surfaces*

END MILLING

End milling is one of the most popular processes in machining. As tools, many different types of end mills are used.

In the past, many research reports on peripheral milling and face milling have been presented. In most cases, those operations were heavy metal cutting operations and research information is limited to practical use. Even though many of the basic principles solved by the above operations can be applied to end milling, it would be desirable to conduct an investigation on the end milling as end milling is essentially a light machining operation and because of differences in tool geometry and operational limitations. Precise measurements of the variables involved are essential for the study of end milling, as end milling is one of precision machining.

For a basic study of end milling, two different typical types of end mills - 2-flute, and 4-flute - were used. All end mills for this investigation were of HSS, right hand helix, right hand cut and $\frac{1}{2}$ inch diameter having a single end.

More than 30 years ago, several basic classical analyses of the milling processes were made. According to the other literature, end milling could be considered a combination of face milling and peripheral milling.

As shown in Fig. 48, the cutting edge of an end mill tooth generates a curved path when the end mill is operated as a slotting tool. The chip thickness is minimum at the points where the tooth enters and leaves the work, and maximum at the transition point between up-milling and down-milling. This results from the combination of the translatory motion of the work and the rotary motion of the cutter. Hence, the direction of motion of a tool point is continuously changing depending on the direction of motion of the work-piece, and therefore, results in a trochoid path for the tooth rather than a circular path.

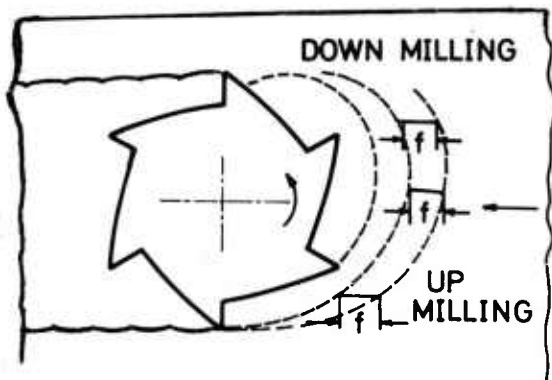

Fig. 48:
Tooth Path Generated
when Slotting

A point on the peripheral cutting edge of an end mill generates three-dimensional cutting forces when an end mill is used as a profiling tool - two normal forces in the horizontal plane, P_x parallel to the feed direction and P_y perpendicular to the feed direction and a vertical force P_z (Fig. 49). The resultant force R can be expressed as

$$R = \sqrt{P_x^2 + P_y^2 + P_z^2}$$

The resultant force also could be resolved into a radial force, P_r , a tangential force, P_t , and a vertical force, P_z .

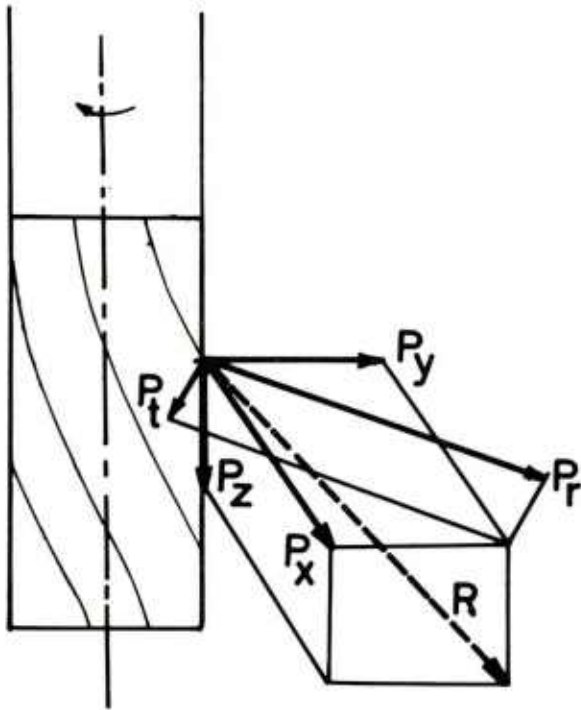

Fig. 49:
Cutting Force Components
When Profiling

When the helix angle is zero, there is no vertical force, P_z , and the directions of the forces at any instant are as shown in Fig. 50 for both up and down milling processes. From this figure, it is clear that most of the force vectors are symmetric but opposite in direction.

Whatever the operation may be, profiling or slotting, the periodic chip discontinuity inherent in milling chip formation, and associated changing geometry of the cutter, lead to cyclic conditions of cutting forces in all directions.

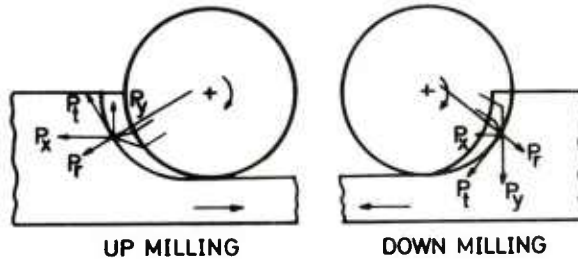

Fig. 50: Force Comparison of Up and Down Milling

In order to measure the cutting forces, a piezoelectric three component dynamometer was employed, which is capable of measuring very small changes in cutting force. The instrumentation is shown schematically in Fig. 51. An I-shape workpiece was prepared and

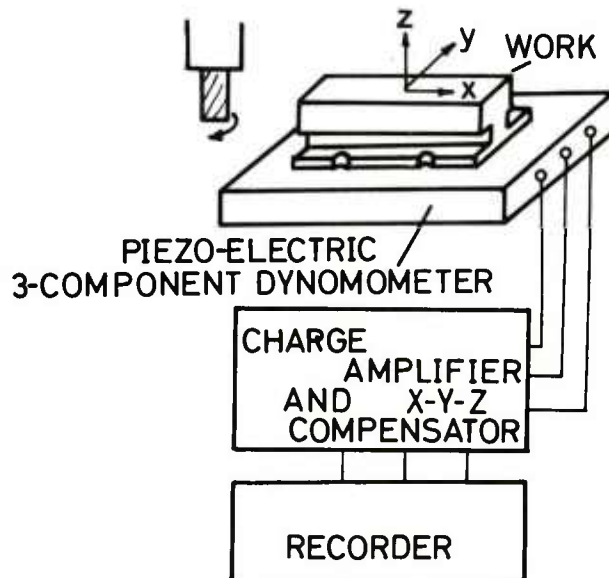

Fig. 51: Instrumentation for Cutting Force Measurement

fixed on the dynamometer (Kistler Type 9257A). Calibration and compensation in X-Y-Z directions were carefully conducted. A 3-channel amplifier with compensator (Kistler Type 9801) and recorder (Gould Brush) were installed for the study of the cutting forces in end milling.

Fig. 52 shows the characteristics of cutting forces in three directions during profiling with a two flute end mill. As expected, the periodic variation of the three forces are evident. It is known that the periodicity of the multiple toothed end milling cutter can be obtained by appropriate superposition of the individual pulses of every tooth. From the cutting force record, it is interesting to note that the peak force in P_y in down milling and P_x in up milling are uneven. It appears that the slight difference in chip thickness produced by the two flutes affected only P_y in down and P_x in up milling, respectively.

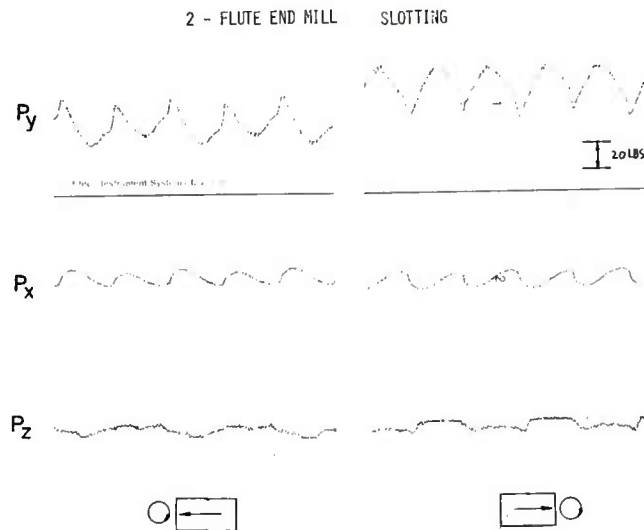

Fig. 52: Cutting Force Characteristics of a 2-flute End Mill When Profiling

A standard four-flute end mill was employed under the same conditions as in the previous case. As shown in Fig. 53, forces, especially P_x , are observed to be uneven. Compared with Fig. 52, it seems each of the four-flutes generated highly dissimilar chips. The magnitude of the force is relatively smaller than in the case of the two-flute end mill. The generated thrust forces, P_z , in both cases, two-flute and four-flute end mill, were recorded as

4 - FLUTE END MILL, PROFILING

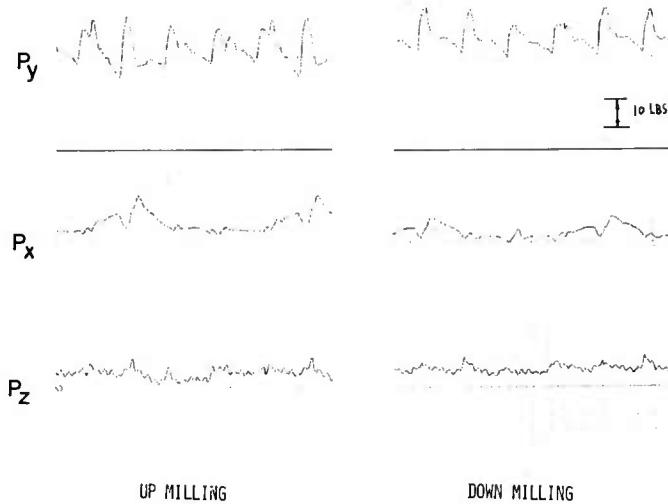

Fig. 53: *Cutting Force Characteristics of a 4-Flute End Mill When Profiling*

negligibly small. Although there was a slight difference in the helix angles in the two types of end mills, two-flute and four-flute, one would expect the same pattern and magnitude of cutting forces if the feed per tooth is the same in both cases. However, from this study, the characteristics of cutting forces have confirmed an entirely different picture. The smaller the number of flutes, the greater is the possibility of maintaining an accurate and similar grinding of each of the flutes.

A two-flute end mill (having flat ends) was used as a slotting cutter under a constant depth of cut of 0.005 inch. As previously explained, the slotting cutter tooth generates a "trochoid" curve and chip thickness varies with respect to the curve generation. The cutting forces should vary harmonically with the changes in chip thickness. Fig. 54 shows the periodic variation of cutting forces P_x and P_y . The progressive increase and decrease in cutting forces of one edge producing a curved chip were not harmonic, but the peak was shifted in the direction of rotation of the cutter. The reason can be traced back to the dissimilarity of chip formation. This conclusion also explains the opposite "jagged" relationships that were observed when the direction of the workpiece movement against the cutter was changed as shown in the two cutting force diagrams.

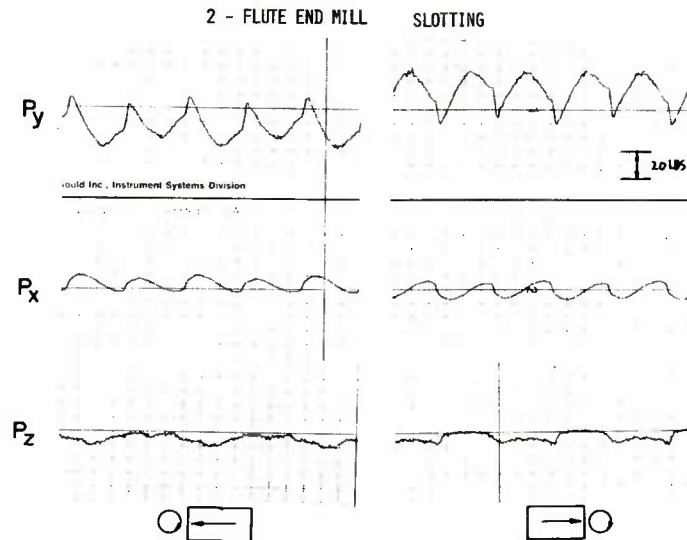

Fig. 54: Cutting Forces When Slotting with a 2-Flute End Mill

End milling belongs in the realm of light cutting operations, since small depth of cuts and relatively small feed rates are used. Due to the small cross section of chips produced, cutting forces are expected to be small. However, to establish the effect of the cutting conditions on the cutting forces, a more complete study of end milling is necessary.

Figures 55 a, b, and c show cutting forces in two directions, x and y, at increasing feed rates, in three workmaterials, AISI 4140, low density P/M materials, and high density P/M materials, when a 2-flute end mill is used. Cutting forces in two directions, with two different relationships between table movement direction and spindle rotating direction in respect to the cutting force, increased as the feed rate increased. All three materials demonstrated very similar results. A RPM of 770 and depth of cut of 0.005 in. were held constant and only the table feed was varied from 1.2 in/min to 10 in/min.

There are no significant differences which reflect the material properties. As previously mentioned, due to small depth of cuts and small feed rates, the chip cross section is very small and, therefore, the specific energy is small and can not be used to reflect the difference in measured cutting forces. However, we can assume that the cutting forces will be distinguished when large chip cross sections are produced.

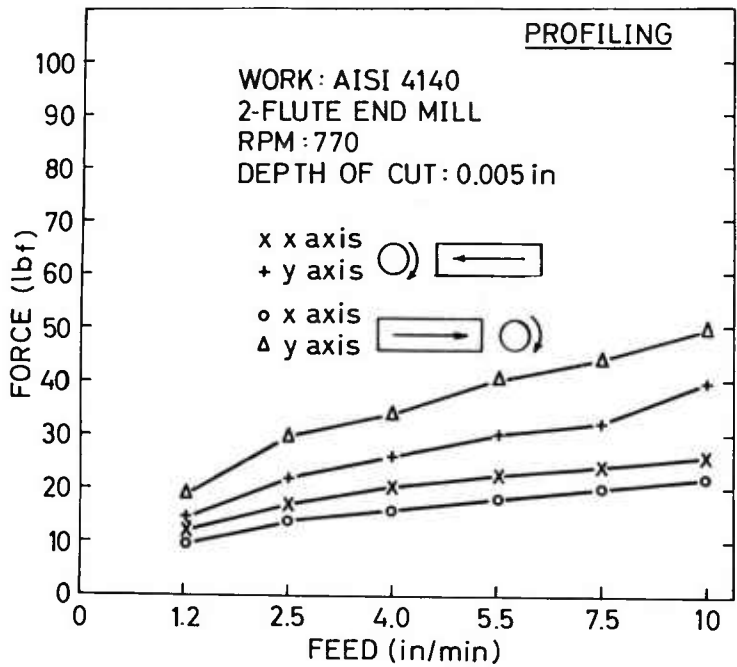

Fig. 55a: Effect of Feed Rate on Cutting Forces When a 2-Flute End Mill is Used for Profiling Workmaterial - AISI 4140

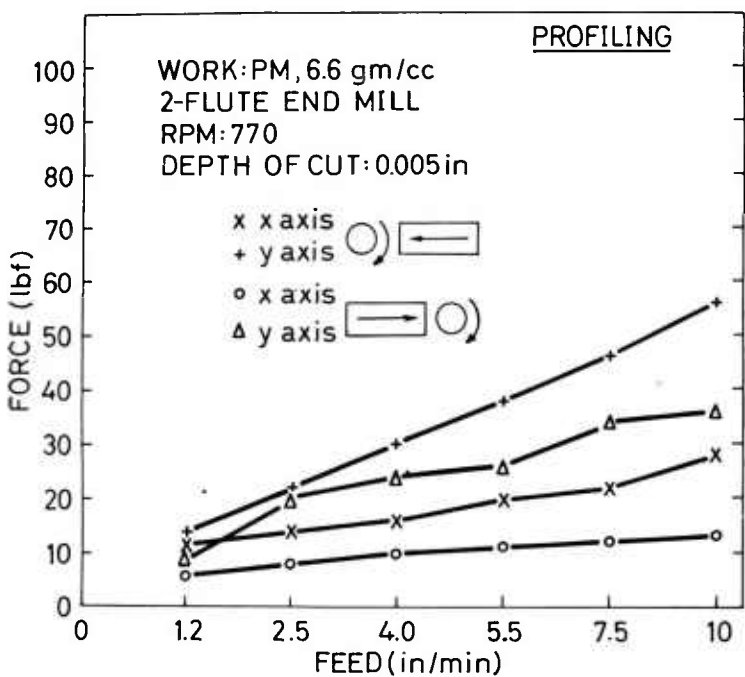

Fig. 55b: Effect of Feed Rate on Cutting Forces When a 2-Flute End Mill is Used for Profiling Workmaterial - Low Density P/M

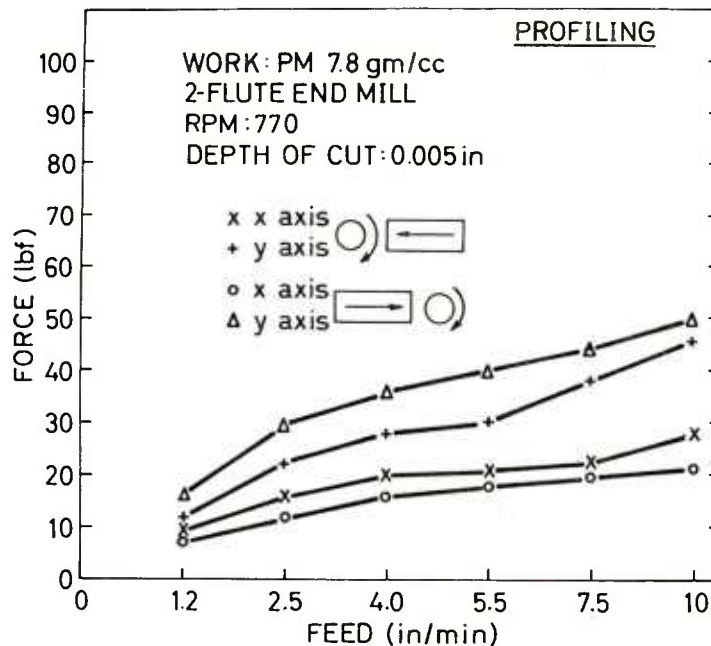

Fig. 55c: Effect of Feed Rate on Cutting Forces When a 2-Flute End Mill is Used for Profiling Workmaterial - High Density P/M

Slotting, using a 2-flute end mill, indicated a good correlation between cutting force and material hardness. The magnitude of cutting forces in different measured directions showed this order - low density, AISI 4140, and high density - which is coincident with hardness measurements (Figs. 56a, 56b, and 56c).

Profiling, using a 4-flute end mill, showed very similar results when compared to the case of the 2-flute end mill (Fig. 57). However, generally the cutting force magnitudes are slightly higher than those in the case of the 2-flute end mill.

In the slotting process, using a 4-flute end mill (Fig. 58), the cutting force magnitudes increased in the order of 4140, low-density P/M, and high-density P/M. This order differs from the order found with a 2-flute end mill.

End milling force measurements, alone, do not enable an explanation of the machinability differences among the three work materials. However, this end milling investigation may offer a contribution for end milling cutter design.

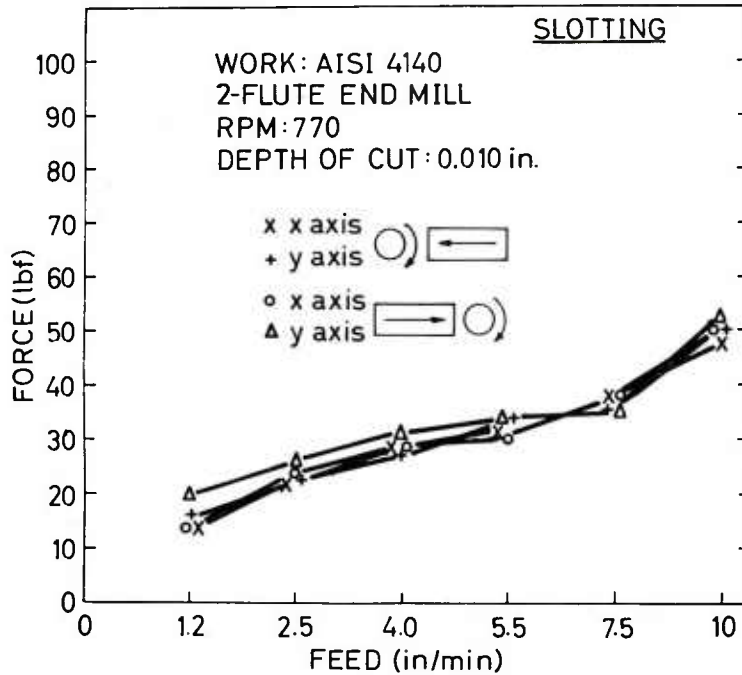

Fig. 56a: Effect of Feed Rate on Cutting Forces When a 2-Flute End Mill is Used for Slotting Workmaterial - AISI 4140

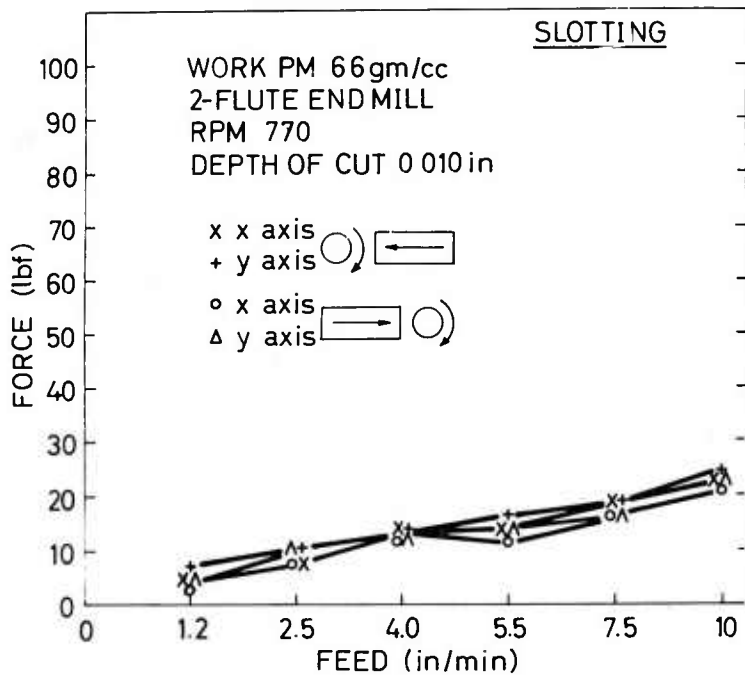

Fig. 56b: Effect of Feed Rate on Cutting Forces When a 2-Flute End Mill is Used for Slotting Workmaterial - Low Density P/M

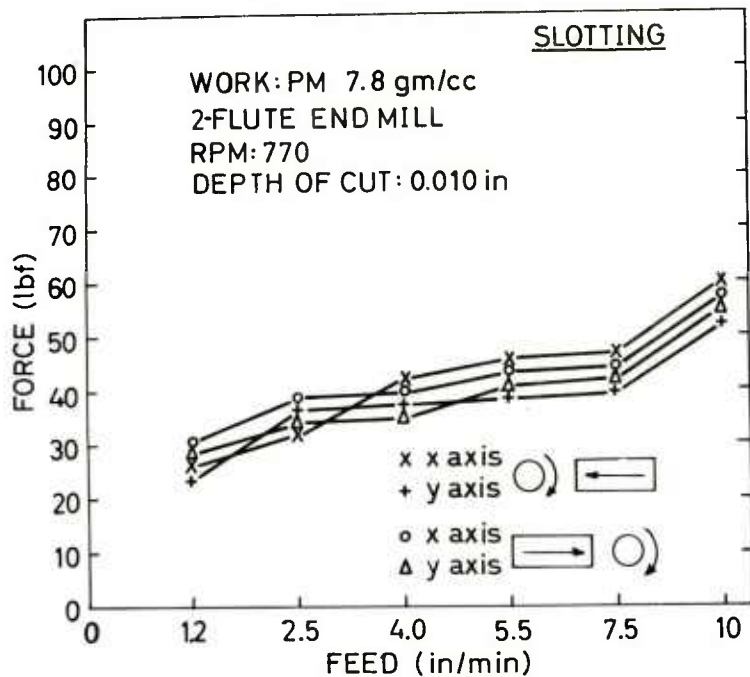

Fig. 56c: Effect of Feed Rate on Cutting Forces When a 2-Flute End Mill is Used for Slotting Workmaterial - High Density P/M

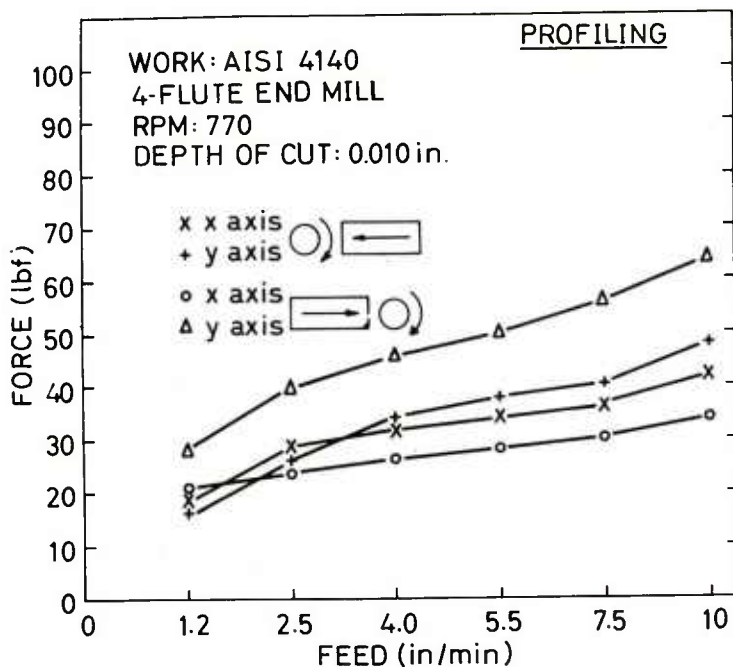

Fig. 57a: Effect of Feed Rate on Cutting Forces When a 4-Flute End Mill is Used for Profiling Workmaterial - AISI 4140

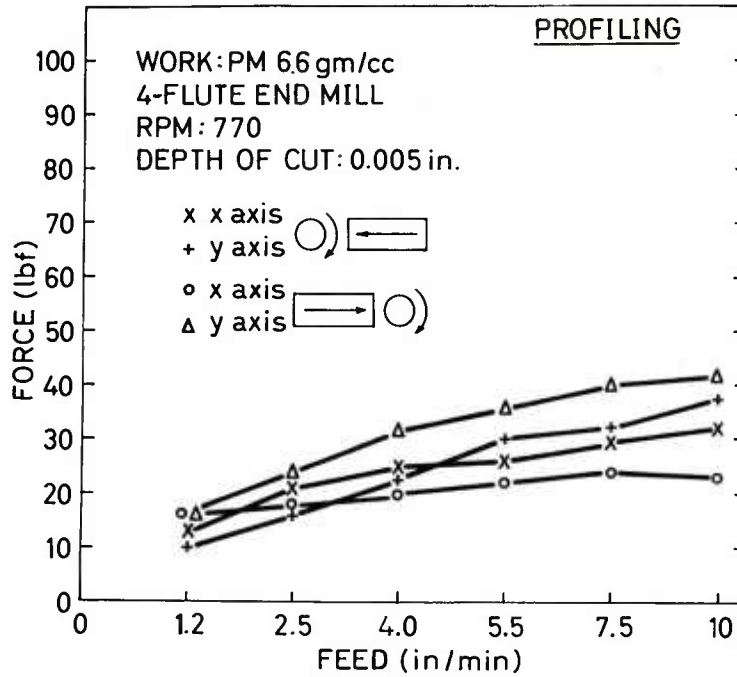

Fig. 57b: Effect of Feed Rate on Cutting Forces When a 4-Flute End Mill is Used for Profiling Workmaterial-Low Density P/M

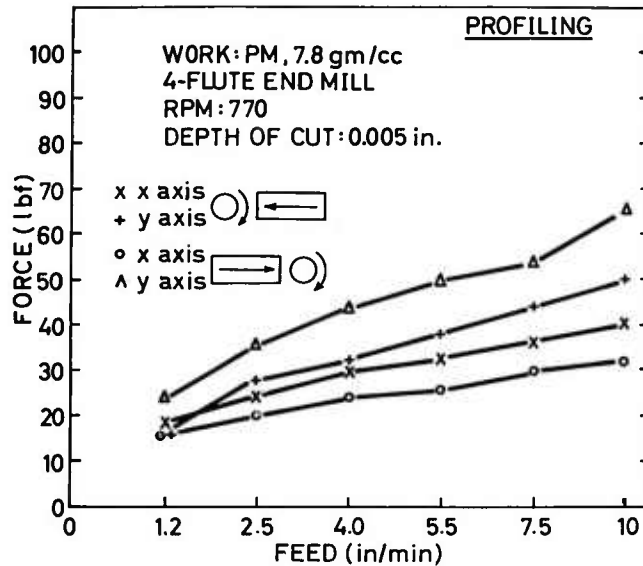

Fig. 57c: Effect of Feed Rate on Cutting Forces When a 4-Flute End Mill is Used for Profiling Workmaterial - High Density P/M

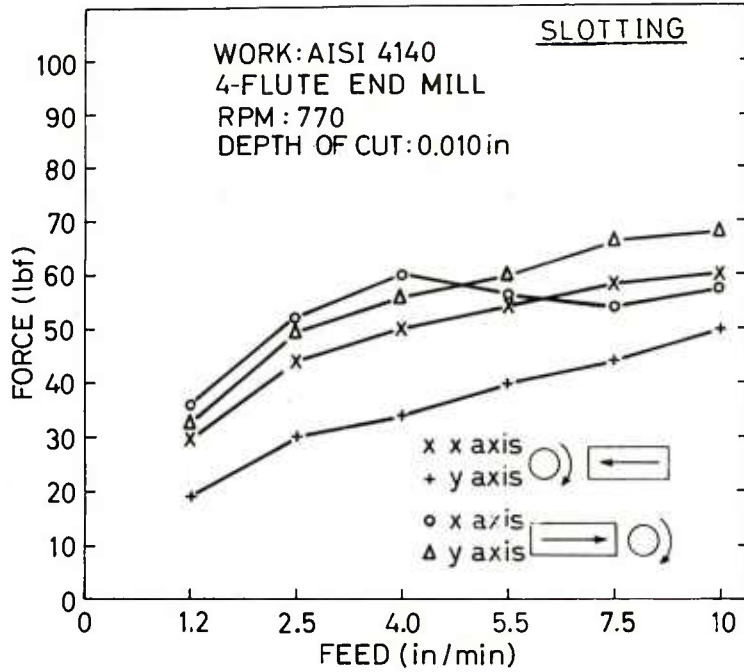

Fig. 58a: Effect of Feed Rate on Cutting Forces When a 4-Flute End Mill is Used for Slotting Workmaterial - AISI 4140

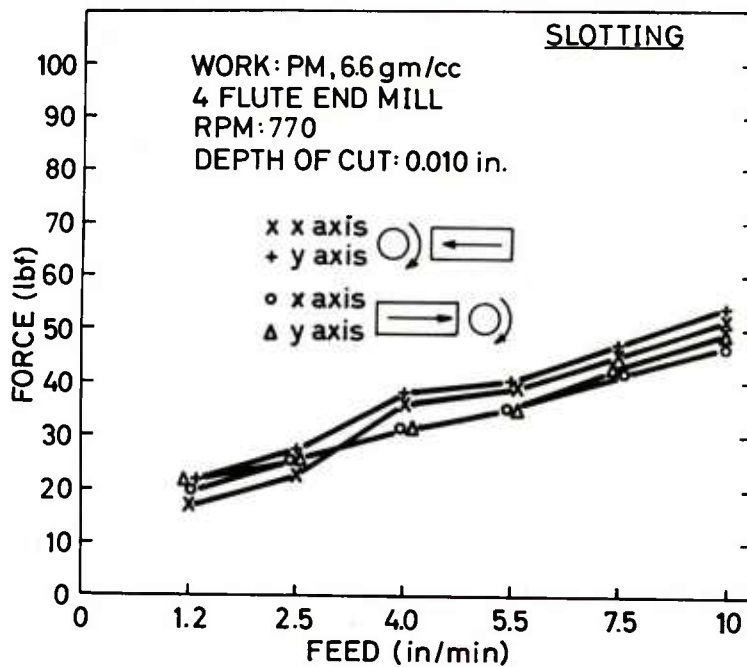

Fig. 58b: Effect of Feed Rate on Cutting Forces When a 4-Flute End Mill is Used for Slotting Workmaterial - Low Density P/M

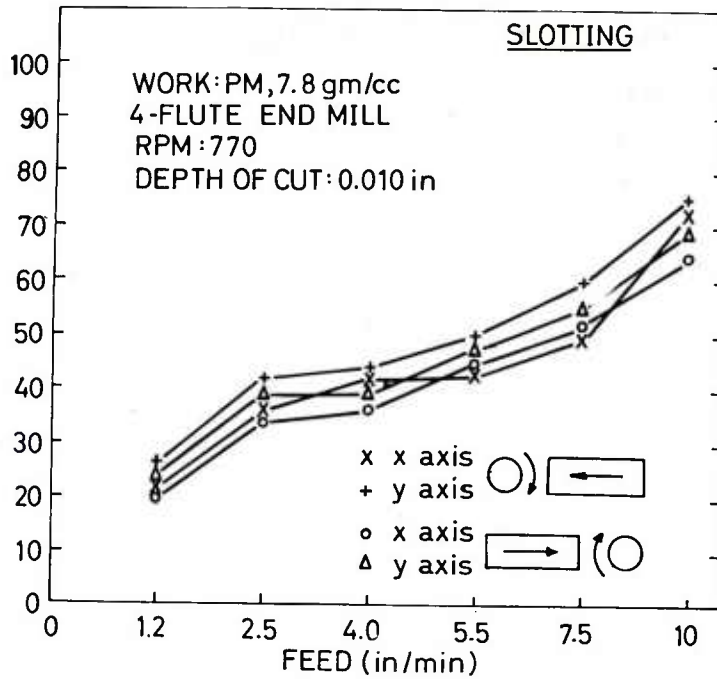

Fig. 58c: Effect of Feed Rate on Cutting Forces When a 4-Flute End Mill is Used for Slotting Workmaterial - High Density P/M

CONCLUSIONS

1. The correlation between chip formation, cutting force characteristics, and surface roughness, were demonstrated in three different materials.
2. The magnitude of the cutting forces in turning represent the material properties to a great extent.
3. In the drilling process, drilling forces gave an excellent indication of the differences in the material properties.
4. Maximum spindle RPM for drilling low density P/M material with a 0.5-inch diameter drill.
5. The tool wear in reaming is negligibly small.
6. Reaming and boring processes cannot improve, ideally, the hole geometry whose errors are displacement and parallelism.
7. In the boring process, the rigidity of the boring bar plays a significant role in respect to hole geometry improvement.
8. No burrs were observed in either low or high density P/M materials when tapping was conducted.
9. Profiling and slotting by 2-flute and 4-flute end milling indicated no definite machinability characteristics.
10. Overall machinability of the investigated materials showed no significant trends since each material had its own advantages in specific machining processes.

DISTRIBUTION

Copies

A. Department of Defense

Defense Documentation Center
ATTN: TIPDR
Cameron Station
Alexandria, VA 22314

12

B. Department of the Army

Commander
U. S. Army Materiel Development and Readiness Command
ATTN: DRCRD-E
 DRCRP-1
 DRCQA-E
5001 Eisenhower Avenue
Alexandria, VA 22333

1
1
1

Commander
U. S. Army Materiel Development and Readiness Command
Scientific and Technical Information Team - Europe
ATTN: DRXST-STL Dr. Richard B. Griffin
APO New York 09710

1

Commander
U. S. Army Armament Materiel Readiness Command
ATTN: DRSAR-PPI-K
 DRSAR-PPI-WW
 DRSAR-RDP
 DRSAR-SC
 DRSAR-QAE
Rock Island, IL 61299

1
1
1
1
1

Director
U. S. Army Materials and Mechanics Research Center
ATTN: DRXMR-M
Watertown, MA 02172

1

Director
U. S. Army Maintenance Management Center
ATTN: DRXMD-A
Lexington, KY 40507

1

DISTRIBUTION

Copies

Commander
U. S. Army Electronics Command
ATTN: DRSEL-PP/I/IM
Fort Monmouth, NJ 07703 1

Commander
U. S. Army Missile Command
ATTN: DRSMI-IIE 1
DRSMI-PRT 1
Redstone Arsenal, AL 35809

Commander
U. S. Army Tank-Automotive Command
ATTN: DRSTA-RK 1
DRSTA-RCM.1 1
Warren, MI 48090

Commander
U. S. Army Aviation Systems Command
ATTN: DRS AV-ERE
P. O. Box 209
St. Louis, MO 63166 1

Commander
U. S. Army Troop Support Command
ATTN: DRSTS-PLC
4300 Goodfellow Blvd.
St. Louis, MO 63120 1

Commander
Ballistic Missile Defense Systems
ATTN: BNDSC-TS
P. O. Box 1500
Huntsville, AL 35804 1

Project Manager
Munition Production Base Mod
Picatinny Arsenal
Dover, NJ 07801 1

Commander
Harry Diamond Laboratories
ATTN: DRXDO-RCD
2800 Powder Mill Road
Adelphi, MD 20783 1

DISTRIBUTION

	<u>Copies</u>
Director U. S. Army Industrial Base Engineering Activity ATTN: DRXIB-MT Rock Island Arsenal Rock Island, IL 61299	2
Director USDARCOM Intern Training Center ATTN: DRXMC-ITC-PPE Red River Army Depot Texarkana, TX 75501	1
Commander U. S. Army Tropic Test Center ATTN: STETC-MO-A (Technical Library) APO New York 09827	1
Commander Anniston Army Depot ATTN: DRXAN-DM Anniston, AL 36201	1
Commander Corpus Christi Army Depot ATTN: DRXAD-EFT Corpus Christi, TX 78419	1
Commander Fort Wingate Depot Activity ATTN: DRXFW-M Gallup, NM 87301	1
Commander Letterkenny Army Depot ATTN: DRXLE-M DRXLE-MM Chambersburg, PA 17201	1 1
Commander Lexington-Blue Grass Army Depot ATTN: DRXLX-SE-1 Lexington, KY 40507	1

DISTRIBUTION

Copies

Commander U. S. Army Natick Research and Development Command ATTN: DRXN1-EM Kansas Street Natick, MA 01760	1
Commander U. S. Army Air Mobility R&D Labs ATTN: SAVDL-ST Fort Eustis, VA 23604	1
Commander Rock Island Arsenal ATTN: SARRI-AOE SARRI-APP Rock Island, IL 61299	1 1
Commander Watervliet Arsenal ATTN: SARW-PPP-WP SARW-PPI-LAJ SARW-QA Watervliet, NY 12189	1 1 1
Commander Picatinny Arsenal ATTN: SARPA-MT-C SARPA-QA-T-T SARPA-C-C Dover, NJ 07801	1 1 1
Commander Frankford Arsenal ATTN: SARFA-T1000 SARFA-QA SARFA-N5400 Bridge & Tacony Streets Philadelphia, PA 19137	1 1 2
Commander Edgewood Arsenal ATTN: SAREA-QA Aberdeen Proving Ground, MD 21010	1

DISTRIBUTION

Copies

Commander
New Cumberland Army Depot
ATTN: DR SAR-ISS-A
New Cumberland, PA 17070

1

Commander
Pueblo Army Depot
ATTN: DRXPU-ME
DRXPU-SE
Pueblo, CO 81001

1

1

Commander
Red River Army Depot
ATTN: DRXRR-MM
Texarkana, TX 75501

1

Commander
Sacramento Army Depot
ATTN: DRXSA-MME-LB
Sacramento, CA 95813

1

Commander
Seneca Army Depot
ATTN: DRXSE-SE
Romulus, NY 14541

1

Commander
Sharpe Army Depot
ATTN: DRXSH-SO
DRXSH-M
Lathrop, CA 95330

1

1

Commander
Sierra Army Depot
ATTN: DRXSI-DQ
Herlong, CA 96113

1

Commander
Tobyhanna Army Depot
ATTN: DRXTO-ME-B
Tobyhanna, PA 18466

1

DISTRIBUTION

Copies

Commander
Radford Army Ammunition Plant
Radford, VI 24141 1

Commander
Ravenna Army Ammunition Plant
Ravenna, OH 44266 1

Commander
Riverbank Army Ammunition Plant
Riverbank, CA 95367 1

Commander
Scranton Army Ammunition Plant
Scranton, PA 18501 1

Commander
Sunflower Army Ammunition Plant
Lawrence, KS 66044 1

Commander
Twin Cities Army Ammunition Plant
New Brighton, MN 55112 1

Commander
Volunteer Army Ammunition Plant
ATTN: SARVO-T
P. O. Box 6008
Chattanooga, TN 37401 1

C. Department of the Navy

Officer in Charge
U. S. Navy Materiel Industrial Resources Office
ATTN: Code 227
Philadelphia, PA 19112 1

D. Department of the Air Force

Commander
Air Force Materials Laboratory
ATTN: LTE 1
LTM 1
LTN 1
Dayton, OH 45433 69

DISTRIBUTION

	<u>Copies</u>
Commander Tooele Army Depot ATTN: DRXTE-SEN DRXTE-EMD Tooele, UT 84074	1 1
Commander Badger Army Ammunition Plant Baraboo, WI 53913	1
Commander Holston Army Ammunition Plant Kingsport, TN 37660	1
Commander Indiana Army Ammunition Plant Charleston, IN 47111	1
Commander Iowa Army Ammunition Plant Middletown, IA 52601	1
Commander Joliet Army Ammunition Plant Joliet, IL 60434	1
Commander Lone Star Army Ammunition Plant Texarkana, TX 75501	1
Commander Louisiana Army Ammunition Plant P. O. Box 30058 Shreveport, LA 71161	1
Commander Milan Army Ammunition Plant Milan, TN 38358	1
Commander Newport Army Ammunition Plant Newport, IN 47966	1

AO _____ Accession _____ UNCLASSIFIED

CDR, Rock Island Arsenal
Engineering Directorate
Rock Island, IL 61299

MACHINING POWDER METALLURGY MATERIALS, by C.H. Kahng

Report EN-78-03, Sep 78, 63 p. incl. illus. tables,
(AMS Code 3297.06.7461)
Unclassified report.

Powder metallurgy (P/M) products offer many economic advantages in manufacturing and, as such, have become important industrial materials. P/M part eliminate the need for most machining; however, many P/M components do require some machining and little is known about the machinability of these materials. Toward providing guidelines for machining P/M materials, machining tests were conducted on low and high density P/M steel (AISI 4640) specimens. Results of these tests are presented

(Cont.) over

1. Machining
2. Machinability
3. Turning
4. Drilling
5. Reaming
6. Forces and accuracy
7. Powder Metallurgy
8. Low alloy steel

DISTRIBUTION
Copies available
from DDC

AD _____ Accession _____ UNCLASSIFIED

CDR, Rock Island Arsenal
Engineering Directorate
Rock Island, IL 61299

MACHINING POWDER METALLURGY MATERIALS, by C.H. Kahng

Report EN-78-03, Sep 78, 63 p. incl. illus. tables,
(AMS Code 3297.06.7461)
Unclassified report.

Powder metallurgy (P/M) products offer many economic advantages in manufacturing and, as such, have become important industrial materials. P/M part eliminate the need for most machining; however, many P/M components do require some machining and little is known about the machinability of these materials. Toward providing guidelines for machining P/M materials, machining tests were conducted on low and high density P/M steel (AISI 4640) specimens. Results of these tests are presented

(Cont.) over

1. Machining
2. Machinability
3. Turning
4. Drilling
5. Reaming
6. Forces and accuracy
7. Powder Metallurgy
8. Low alloy steel

DISTRIBUTION
Copies available
from DDC

AO _____ Accession _____ UNCLASSIFIED

CDR, Rock Island Arsenal
Engineering Directorate
Rock Island, IL 61299

MACHINING POWDER METALLURGY MATERIALS, by C.H. Kahng

Report EN-78-03, Sep 78, 63 p. incl. illus. tables,
(AMS Code 3297.06.7461)
Unclassified report.

Powder metallurgy (P/M) products offer many economic advantages in manufacturing and, as such, have become important industrial materials. P/M part eliminate the need for most machining; however, many P/M components do require some machining and little is known about the machinability of these materials. Toward providing guidelines for machining P/M materials, machining tests were conducted on low and high density P/M steel (AISI 4640) specimens. Results of these tests are presented

(Cont.) over

1. Machining
2. Machinability
3. Turning
4. Drilling
5. Reaming
6. Forces and accuracy
7. Powder Metallurgy
8. Low alloy steel

DISTRIBUTION
Copies available
from DDC

AD _____ Accession _____ UNCLASSIFIED

CDR, Rock Island Arsenal
Engineering Directorate
Rock Island, IL 61299

MACHINING POWDER METALLURGY MATERIALS, by C.H. Kahng

Report EN-78-03, Sep 78, 63 p. incl. illus. tables,
(AMS Code 3297.06.7461)
Unclassified report.

Powder metallurgy (P/M) products offer many economic advantages in manufacturing and, as such, have become important industrial materials. P/M part eliminate the need for most machining; however, many P/M components do require some machining and little is known about the machinability of these materials. Toward providing guidelines for machining P/M materials, machining tests were conducted on low and high density P/M steel (AISI 4640) specimens. Results of these tests are presented

(Cont.) over

1. Machining
2. Machinability
3. Turning
4. Drilling
5. Reaming
6. Forces and accuracy
7. Powder Metallurgy
8. Low alloy steel

DISTRIBUTION
Copies available
from DDC

along with data on conventionally wrought AISI 4140 steel. The preference for low alloy steels in the manufacture of weapon components led to the choice of these materials for the investigation.

Significant differences in cutting forces were experienced in the cutting of high and low density P/M materials. The maximum practical cutting speed in drilling was higher for low density P/M material than that for high density material. Tool wear in the reaming of P/M materials was negligible. In drilling, improvement of hole geometry by sequential machining operations varied greatly; for example, center drilling prior to through drilling provided the greatest improvement of hole geometry. Boring with a rigid bar gave the best geometry. Hardness of the material had decisive effect on machinability. Relatively burr-free holes could be drilled in P/M materials. Overall machinability of the investigated materials did not show significant differences since each material had its own advantages in specific machining processes.

along with data on conventionally wrought AISI 4140 steel. The preference for low alloy steels in the manufacture of weapon components led to the choice of these materials for the investigation.

Significant differences in cutting forces were experienced in the cutting of high and low density P/M materials. The maximum practical cutting speed in drilling was higher for low density P/M material than that for high density material. Tool wear in the reaming of P/M materials was negligible. In drilling, improvement of hole geometry by sequential machining operations varied greatly; for example, center drilling prior to through drilling provided the greatest improvement of hole geometry. Boring with a rigid bar gave the best geometry. Hardness of the material had decisive effect on machinability. Relatively burr-free holes could be drilled in P/M materials. Overall machinability of the investigated materials did not show significant differences since each material had its own advantages in specific machining processes.

along with data on conventionally wrought AISI 4140 steel. The preference for low alloy steels in the manufacture of weapon components led to the choice of these materials for the investigation.

Significant differences in cutting forces were experienced in the cutting of high and low density P/M materials. The maximum practical cutting speed in drilling was higher for low density P/M material than that for high density material. Tool wear in the reaming of P/M materials was negligible. In drilling, improvement of hole geometry by sequential machining operations varied greatly; for example, center drilling prior to through drilling provided the greatest improvement of hole geometry. Boring with a rigid bar gave the best geometry. Hardness of the material had decisive effect on machinability. Relatively burr-free holes could be drilled in P/M materials. Overall machinability of the investigated materials did not show significant differences since each material had its own advantages in specific machining processes.

along with data on conventionally wrought AISI 4140 steel. The preference for low alloy steels in the manufacture of weapon components led to the choice of these materials for the investigation.

Significant differences in cutting forces were experienced in the cutting of high and low density P/M materials. The maximum practical cutting speed in drilling was higher for low density P/M material than that for high density material. Tool wear in the reaming of P/M materials was negligible. In drilling, improvement of hole geometry by sequential machining operations varied greatly; for example, center drilling prior to through drilling provided the greatest improvement of hole geometry. Boring with a rigid bar gave the best geometry. Hardness of the material had decisive effect on machinability. Relatively burr-free holes could be drilled in P/M materials. Overall machinability of the investigated materials did not show significant differences since each material had its own advantages in specific machining processes.

AD	Accession	UNCLASSIFIED	AD	Accession	UNCLASSIFIED
CDR, Rock Island Arsenal Engineering Directorate Rock Island, IL 61299		1. Machining 2. Machinability	CDR, Rock Island Arsenal Engineering Directorate Rock Island, IL 61299		1. Machining 2. Machinability
MACHINING POWDER METALLURGY MATERIALS, by C.H. Kahng		3. Turning	MACHINING POWDER METALLURGY MATERIALS, by C.H. Kahng		3. Turning
Report EN-78-03, Sep 78, 63 p. incl. illus. tables, (AMS Code 3297.06.7461) Unclassified report.		4. Drilling	Report EN-78-03, Sep 78, 63 p. incl. illus. tables, (AMS Code 3297.06.7461) Unclassified report.		4. Drilling
		5. Reaming			5. Reaming
Powder metallurgy (P/M) products offer many economic advantages in manufacturing and, as such, have become important industrial materials. P/M part eliminate the need for most machining; however, many P/M components do require some machining and little is known about the machinability of these materials. Toward providing guidelines for machining P/M materials, machining tests were conducted on low and high density P/M steel (AISI 4640) specimens. Results of these tests are presented		6. Forces and accuracy	Powder metallurgy (P/M) products offer many economic advantages in manufacturing and, as such, have become important industrial materials. P/M part eliminate the need for most machining; however, many P/M components do require some machining and little is known about the machinability of these materials. Toward providing guidelines for machining P/M materials, machining tests were conducted on low and high density P/M steel (AISI 4640) specimens. Results of these tests are presented		6. Forces and accuracy
		7. Powder Metallurgy			7. Powder Metallurgy
		8. Low alloy steel			8. Low alloy steel
		DISTRIBUTION Copies available from DDC			DISTRIBUTION Copies available from DDC
		(Cont.) over			(Cont.) over
AD	Accession	UNCLASSIFIED	AD	Accession	UNCLASSIFIED
CDR, Rock Island Arsenal Engineering Directorate Rock Island, IL 61299		1. Machining 2. Machinability	CDR, Rock Island Arsenal Engineering Directorate Rock Island, IL 61299		1. Machining 2. Machinability
MACHINING POWDER METALLURGY MATERIALS, by C.H. Kahng		3. Turning	MACHINING POWDER METALLURGY MATERIALS, by C.H. Kahng		3. Turning
Report EN-78-03, Sep 78, 63 p. incl. illus. tables, (AMS Code 3297.06.7461) Unclassified report.		4. Drilling	Report EN-78-03, Sep 78, 63 p. incl. illus. tables, (AMS Code 3297.06.7461) Unclassified report.		4. Drilling
		5. Reaming			5. Reaming
Powder metallurgy (P/M) products offer many economic advantages in manufacturing and, as such, have become important industrial materials. P/M part eliminate the need for most machining; however, many P/M components do require some machining and little is known about the machinability of these materials. Toward providing guidelines for machining P/M materials, machining tests were conducted on low and high density P/M steel (AISI 4640) specimens. Results of these tests are presented		6. Forces and accuracy	Powder metallurgy (P/M) products offer many economic advantages in manufacturing and, as such, have become important industrial materials. P/M part eliminate the need for most machining; however, many P/M components do require some machining and little is known about the machinability of these materials. Toward providing guidelines for machining P/M materials, machining tests were conducted on low and high density P/M steel (AISI 4640) specimens. Results of these tests are presented		6. Forces and accuracy
		7. Powder Metallurgy			7. Powder Metallurgy
		8. Low alloy steel			8. Low alloy steel
		DISTRIBUTION Copies available from DDC			DISTRIBUTION Copies available from DDC
		(Cont.) over			(Cont.) over

along with data on conventionally wrought AISI 4140 steel. The preference for low alloy steels in the manufacture of weapon components led to the choice of these materials for the investigation.

Significant differences in cutting forces were experienced in the cutting of high and low density P/M materials. The maximum practical cutting speed in drilling was higher for low density P/M material than that for high density material. Tool wear in the reaming of P/M materials was negligible. In drilling, improvement of hole geometry by sequential machining operations varied greatly; for example, center drilling prior to through drilling provided the greatest improvement of hole geometry. Boring with a rigid bar gave the best geometry. Hardness of the material had decisive effect on machinability. Relatively burr-free holes could be drilled in P/M materials. Overall machinability of the investigated materials did not show significant differences since each material had its own advantages in specific machining processes.

along with data on conventionally wrought AISI 4140 steel. The preference for low alloy steels in the manufacture of weapon components led to the choice of these materials for the investigation.

Significant differences in cutting forces were experienced in the cutting of high and low density P/M materials. The maximum practical cutting speed in drilling was higher for low density P/M material than that for high density material. Tool wear in the reaming of P/M materials was negligible. In drilling, improvement of hole geometry by sequential machining operations varied greatly; for example, center drilling prior to through drilling provided the greatest improvement of hole geometry. Boring with a rigid bar gave the best geometry. Hardness of the material had decisive effect on machinability. Relatively burr-free holes could be drilled in P/M materials. Overall machinability of the investigated materials did not show significant differences since each material had its own advantages in specific machining processes.

along with data on conventionally wrought AISI 4140 steel. The preference for low alloy steels in the manufacture of weapon components led to the choice of these materials for the investigation.

Significant differences in cutting forces were experienced in the cutting of high and low density P/M materials. The maximum practical cutting speed in drilling was higher for low density P/M material than that for high density material. Tool wear in the reaming of P/M materials was negligible. In drilling, improvement of hole geometry by sequential machining operations varied greatly; for example, center drilling prior to through drilling provided the greatest improvement of hole geometry. Boring with a rigid bar gave the best geometry. Hardness of the material had decisive effect on machinability. Relatively burr-free holes could be drilled in P/M materials. Overall machinability of the investigated materials did not show significant differences since each material had its own advantages in specific machining processes.

along with data on conventionally wrought AISI 4140 steel. The preference for low alloy steels in the manufacture of weapon components led to the choice of these materials for the investigation.

Significant differences in cutting forces were experienced in the cutting of high and low density P/M materials. The maximum practical cutting speed in drilling was higher for low density P/M material than that for high density material. Tool wear in the reaming of P/M materials was negligible. In drilling, improvement of hole geometry by sequential machining operations varied greatly; for example, center drilling prior to through drilling provided the greatest improvement of hole geometry. Boring with a rigid bar gave the best geometry. Hardness of the material had decisive effect on machinability. Relatively burr-free holes could be drilled in P/M materials. Overall machinability of the investigated materials did not show significant differences since each material had its own advantages in specific machining processes.