

1

6 LOW VOLTAGE ELECTROSTRICTION AND PIEZOELECTRIC CERAMIC TRANSDUCERS

9 Final rept. 1 Jun 77 - 31 Oct 78

Final Report

LEVEL 77

10 L.E. / CROSS

Period June 1, 1977 to October 31, 1978

Contract No. N00014-77-C-0445 ✓ ARPA Order-34

15 Project No. 3416

12 SA P

Sponsored by

Advanced Research Projects Agency (DOD)

11 1978

ARPA Order No. 3416

Office of Naval Research

DDC RECEIVED MAR 16 1979 A

Monitored by ONR

APPROVED FOR PUBLIC RELEASE: DISTRIBUTION UNLIMITED

Reproduction in whole or in part is permitted for any purpose of the United States Government

L.E. Cross

DDC FILE COPY AD A0 65840

Per... 220 750
79 08 15 002
220 750

- 2 -

Abstract

The objective of this program was to demonstrate the feasibility of using established multilayer ceramic technology from the capacitor industry to develop internally electroded electrostrictive displacement transducers which could be operated at low terminal voltages. It has been shown that for units fabricated from a BaTiO_3 based proprietary dielectric formulation (Erie K 5,500) the conventional tape casting methods can be extended to produce units with up to 100 internally electroded dielectric layers, provided suitable care is taken with the thermal processing. Electrostriction measurements on units with 10, 50, and 100 layers have shown no detectable degradation of the electrostrictive effect with increasing numbers of electrode layers, and this is also supported by evidence from single and multilayers in cylindrical configuration. Thus it is established that the internal electrode arrangement can be used to enhance the electric field at lower voltages without deleterious consequence.

A new family of relaxor ferroelectrics based on $\text{Pb}(\text{Mg}_{1/3}\text{Nb}_{2/3})\text{O}_3$ has been explored and dielectrics in the $\text{Pb}(\text{Mg}_{1/3}\text{Nb}_{2/3})\text{O}_3:\text{PbTiO}_3$ system shown to have low frequency electrostriction properties superior to those of the BaTiO_3 based capacitor compositions. Advantages of the relaxors include lower hysteresis, higher stability, improved sensitivity and exceedingly low thermal expansion. ←

Multilayer stacks have also been fabricated from a hard PZT8 formulation and shown to have similar piezoelectric properties to the bulk material, so that again the internal electrodes can be used to greatly enhance the strain developed at low terminal voltages.

TABLE OF CONTENTS

	<u>Page</u>
1. INTRODUCTION-----	2
2. PREPARATION AND FABRICATION-----	4
2.1 Fabrication of Larger K 5,500 Multilayers-----	4
(a) Selection of the Electrostriction Dielectric-----	4
(b) Design and Fabrication of the 50 and 100 layer Structures-----	5
(c) Tubular Extruded Monolayer and Sprayed Coaxial Multilayer Elements-----	6
2.2 Fabrication of Lead Magnesium Niobate Based Relaxor Compositions-----	8
2.3 PZT8 Multilayers-----	10
3. DIELECTRIC AND ELECTROSTRICTIVE RESPONSE-----	11
3.1 K 5,500 Composition Materials-----	11
(a) Dielectric Measurements-----	11
(b) Dilatometric Measurements-----	11
3.2 Lead Magnesium Niobate-----	14
(a) Strain Measurements-----	14
3.3 PZT8 Multilayers-----	16
(a) Poling-----	16
(b) Strain Measurement-----	17
4. THERMAL MEASUREMENTS-----	18
5. DISCUSSION-----	20

ACCESSION for	
NTIS	White Section <input checked="" type="checkbox"/>
ODD	Buff Section <input type="checkbox"/>
UNANNOUNCED	<input type="checkbox"/>
JUSTIFICATION	
BY	
DISTRIBUTION/AVAILABILITY CODES	
Dist.	AVAIL. and/or SPECIAL
A	

1. INTRODUCTION

This report documents work performed during the period June 1, 1977 to October 31, 1978 under joint ONR-DARPA sponsorship. The effort was focused on tasks associated with the development of multilayer monolithic samples of piezoelectric and electrostrictive ceramic materials in configurations which would permit exploring some of the potential of the multilayer technology for changing the impedance levels, voltage requirements, power and strain levels possible in electrostrictive and piezoelectric electroceramics.

Fabrication of the larger multilayer elements was carried out by Erie Technological Products under the supervision of the chief engineer, N. Coda. Evaluation of the electrical and elastic performance of the fabricated multilayers was carried out in the Materials Research Laboratory of The Pennsylvania State University under the direction of Dr. L.E. Cross, who was principal investigator for the whole program.

Specific tasks which were attempted included the development of techniques to fabricate large 1 cm square multilayers with up to 100 dielectric layers, using the proprietary Erie K 5,550 composition; the detailed evaluation of the dielectric and electromechanical response in these structures for both DC and low frequency AC voltages, and the intercomparison with single layer dielectrics of the same composition; the fabrication by extrusion and by a spraying technique of tubular and coaxial cylindrical multilayers and their evaluation; fabrication of multilayer PZT piezoelectric monolithic structures using a PZT8 formulation to provide preliminary evaluation for very low voltage "hard" piezoelectric positioners.

Tape casting and fabrication techniques have also been developed for $\text{Pb}_3\text{MgNb}_2\text{O}_9$ ferroelectric relaxor based compositions, and a detailed study of the reproducibility of the low frequency strain in $\text{Pb}_3\text{MgNb}_2\text{O}_9:\text{PbTiO}_3$ solid solutions

show this material to be clearly superior to the K 5,500. Unfortunately the fabrication of larger multilayer test structures in this ceramic was delayed by difficulties encountered in handling large batches during calcining.

2. PREPARATION AND FABRICATION

2.1 Fabrication of Larger K 5,500 Multilayers

(a) Selection of the Electrostriction Dielectric

Erie K 5,500 is a proprietary BaTiO_3 based dielectric formulation designed to have a maximum permittivity $K \approx 6,000$ centered at or just above room temperature. Control of batch-to-batch dielectric properties is by the use of an additive which acts as a grain growth inhibitor serving both to reduce the Curie temperature and to slightly flatten the peak response in the original mix.

Before fabricating the larger more expensive multilayers it was decided to ascertain for the composition batch being used the influence of the additive upon the electrostrictive part of the dielectric response. Small ten-layer multilayers were fabricated by Erie using the standard tape casting method and platinum based electrode inks. Three lots were fabricated:

- Lot (a) containing no additives
- Lot (b) containing 0.2 wt% peak shifter additive
- Lot (c) containing 0.4 wt% peak shifter additive

Representative samples from each lot were selected, the sides perpendicular to the electrode terminations were polished flat and plane parallel, and the transverse contraction measured as a function of DC applied field using a Scheavitz model LVDT. Typical data are reproduced in Figs. 1, a,b,c.

Clearly the peak shifting additive has a significant effect on the strain response, both reducing the maximum and increasing the hysteresis. For this batch it was therefore decided to fabricate the larger samples without added peak shifter.

(b) Design and Fabrication of the 50 and 100 layer Structures

To provide adequate response at low voltage without pushing the fabrication to extremes, it was decided to fabricate the test pieces from 50 micron cast tape, giving a dielectric layer of about 40 microns in the finished part. Electrode screens were made up so that electrode cutback at the termination ends, and along the sides was kept to the minimum required for insulation and sealing so as to minimize clamping effects from the electrically unstressed dielectric. Similarly, the pieces were fabricated without passivating surface layers, so that the same sample could be used for both longitudinal and transverse electrostriction measurements.

Casting, drying, screen printing and make-up of the parts followed the typical manufacturing process for the conventional multilayer capacitor. Because of the very much larger size of the electrostriction units, however, bake-out and firing cycles required considerable care.

For the 50 layer units initial experiments using normal bake-out procedure showed serious bloating and delamination. After several attempts, a final bake-out procedure involved linear ramp heating to 270°C over a one-week period, followed by a one-week linear cooling.

In the 100 layer units, the final bake-out cycle was similar.

Firing was accomplished in a standard kiln, but again the heat-up cycle had to be considerably lengthened to avoid problems with delamination and uneven shrinkage in the larger units.

The fired in platinum electrodes were contacted using a conventional solder dip coating. Typical finished units are shown in Fig. 2 to examine the integrity of electrode and ceramic, and to determine the electrode spacing in the final fired body, several of both the 50 and 100 layer monoblocks were sectioned and polished for optical and Scanning Electron Microscope (SEM)

evaluation. SEM pictures of typical sections taken at 100X and 500X magnification are shown in Figs. 3 and 4. It is evident from these sections that there is a significant closed porosity, and that this problem increases on going from 50 to 100 layer devices. Simple 10 layer monoblock of the same composition shows much reduced closed porosity, suggesting that the difficulty is associated with processing of the larger units. Several attempts were made to modify the processing parameters to reduce the closed porosity without significant improvement. Two of the units were also subjected to a cycle of hot isostatic pressing at a pressure of 3,000 psi and a temperature of 1350°C for 2 hours, but again the pore structure was not significantly modified.

Fortunately, since the pore structure is largely closed, it does not significantly degrade either the dielectric permittivity or the electrostrictive response (see following sections). It does, however, have a seriously deleterious effect on the dielectric strength, which is lower in the 100 layer units than in 50 layer units, and significantly lower than in the normal 10 layer multilayers.

The electrode separation is quite remarkably uniform, both along a single layer, and from layer to layer.

For the 50 layer unit, a typical single layer gives $\ell_e = 40.8 \pm 2.0$ microns and the average between 20 layers $\ell_T = 40.0 \pm 2.5 \mu$. In the 100 layer units sectioned, the equivalent dimensions were $\ell_e = 40.6 \pm 2.5 \mu$, and $\ell_T = 40.0 \pm 1.9 \mu$.

(c) Tubular Extruded Monolayer and Sprayed Coaxial Multilayer Elements

To make an intercomparison of the behavior of elements with cylindrical geometry of the type which might be used in the transverse mode for micro-positioner applications, two types of element were fabricated from the same batch of the K 5,500 dielectric:

- (i) Single dielectric layers were extruded in the form of tubes.
- (ii) Multilayer monolithic elements with integrated platinum electrodes were built up using a proprietary spraying process onto a rotating cylindrical mandril.

The single dielectric layer tubes used a standard extrusion press and die-set of the type normally used for extruding tubular capacitors. The only difference from the regular processing was to interrupt the cutting operation so that longer tubular units were extruded. The greenware was placed upon grooved zirconia setters using a small amount of uncompact powder as a parting medium and fired in the regular batch kiln.

Silver electrodes of the fritted type were applied to the bore and to the outer surface by dip coating and a separate low temperature firing operation. Care was taken to adjust the silver frit to obtain a very thin conductive coating so as to provide the minimum constraint against longitudinal contraction. Termination wires were attached by air drying silver paint, and the normal organic protective coating was omitted.

The multi-element monolithic tubular units were made up by alternately spraying a ceramic slip of the K 5,500 composition and a platinum ink composition onto a rotating mandril chosen to have the diameter of the bore of the extruded tubular unit. Details of the slip preparation, the ink composition, the regulation of the coating thickness and the drying and firing schedules are retained as proprietary information.

For the electrostriction measurements units were built up with a dielectric thickness of about 42 μ meters and the normal passive inner and outer protective dielectric layers were omitted to avoid mechanical constraint. A typical tubular unit is also shown in Fig. 2.

2.2 Fabrication of Lead Magnesium Niobate Based Relaxor Compositions

Parallel work in the Materials Research Laboratory under our Navy contract suggests that lead magnesium niobate ($\text{Pb}_3\text{MgNb}_2\text{O}_9$) and compositions in the lead magnesium niobate:lead titanate solid solution system have electrostriction properties which may be superior to those of the BaTiO_3 based K 5,500 composition both with regard to the level of electrostrictive response and the absence of dielectric hysteresis from the lower PbTiO_3 compositions.

In both the PMN and the PMN:PT compositions, the electric field levels required to produce large strain response are such that for many types of devices, integrated electrodes would be required to lower the terminal voltages. It was therefore decided to attempt the fabrication of both tape cast and spray coated planar and cylindrical structures in these PMN based compositions.

Preliminary experiments using the solid state reaction

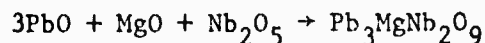

had shown that the preparation of the required perovskite phase of PMN needed considerable care. In PMN as in several lead containing perovskites^(1,2) there is an alternative stable phase with a defect pyrochlore structure. Unfortunately, once the pyrochlore modification is formed it cannot be eliminated by further heat treatments.

Using small (50 to 100 gm) batches the following points have been identified as important:

- (a) The MgO powder (Baker reagent grade) must be carefully dehydrated at a temperature of about 400°C before batch weighing.
- (b) The yellow (massicot) phase of PbO must be used.

(c) First calcining must be carried out at a temperature greater than 850°C.

(d) Milling must be carried out with care to avoid conversion of massicot to litharge which can occur on grinding.

(e) Initial lead oxide stoichiometry must be preserved by firing in a closed alumina crucible.

(f) At least one grinding and re-firing at 900°C is required to produce a homogeneous final powder.

After carefully defining conditions which resulted in the production of no pyrochlore phase using small batches, the process was scaled up to generate the 10 lb lots required for spray coating. Unfortunately, parts generated from these calcines showed major contamination from the pyrochlore phase, and were useless for electrostrictive evaluation.

We believe that the problem may be associated with the heat-up cycle in the calcining operation, which is known to be critical in lead:niobia compositions⁽³⁾. However, after several attempts to modify the processing were unsuccessful, it was decided to fabricate the smaller quantities of powder required for tape casting using the small batch processing and to omit the spray coating studies on this material. Powder was generated in both the pure PMN and the PMN:0.1 PT compositions.

Tape casting of both these compositions was accomplished using a proprietary Cladan binder composition B-62. For initial screening tapes of 0.012" were cast so as to achieve a final fired thickness of 0.010". After drying the green tapes were screen printed with a platinum electrode ink (Englehard composition R305-14) and cut to size.

For initial evaluation 10 layer structures with dimensions 2 cm x 1 cm were made up. Final firing was accomplished after a conventional binder burn-out cycle, using parameters established earlier for disks of the same formula-

tions. With the larger surface area in the tape system, firing was performed in a closed system to avoid surface depletion of PbO.

2.3 PZT8 Multilayers

To provide comparative data and explore the possible application of the tape cast multilayers for reducing the voltage levels in a multielement IR deformable mirror system, a number of monolithic samples with 10 internal platinum electrodes separated by 10 mil layers of a PZT8 formulation were fabricated.

The tape was prepared from a commercial Ultrasonics PZT 401-888 formulation, using again the commercial Cladan binder. Electrodes were screen-printed using the Englehard pure platinum ink No. R305-14. The tapes were cut so as to minimize the dielectric which was not subjected to field. In stacking, the arrangement was such that alternate electrodes could be picked up at alternate ends of the stacked monoblock, as in the conventional multilayer capacitor.

For binder burn-out and final firing, the parts were stacked on zirconia setters in a closed alumina crucible, with one layer of PbZrO_3 powder to act as lead source. Final firing followed closely the schedule recommended by Ultrasonic for the 401-888 composition.

3. DIELECTRIC AND ELECTROSTRICTIVE RESPONSE

3.1 K 5,500 Composition Materials

(a) Dielectric Measurements

To compare the response of the larger 50 and 100 layer monoblock units with that of the disk, tubular and smaller monoblocks measured earlier, it is necessary to have an accurate measure of the total dielectric polarization as a function of applied field under cyclic field conditions. Since the measured capacitance of the 50 layer elements is about 5 μF and of the 100 layer units about 10 μF it is obvious that the normal Sawyer and Tower bridge circuit cannot be used since the condition

$$C_S \ll C_I$$

where C_S is the sample capacitance and C_I of the integrating capacitor, is violated.

For these measurements a new low impedance bridge was designed with C_I provided by electrolytic capacitors chosen for low leakage raising $C_I \approx 100 \mu\text{F}$, and a special low impedance 60 Hz driving transformer and variac capable of 0:500 V RMS.

Hysteresis curves for the 50 layer and 100 layer units are shown in Fig.5 and Fig. 6. Scaling these figures according to the ratio of the weak field capacitances, it is evident that the nonlinear dielectric response is not significantly modified by the layer structure.

(b) Dilatometric Measurements

Transverse and longitudinal strain was measured using a Schaevitz Engineering HR-050 AC-LVDT. This instrument has a linear range of ± 50 mils. A Schaevitz CAS-025 signal conditioner supplied a stable 2.5 kHz driving signal and phase locked detection system. For strain measurement the LVDT was mounted on a micrometer drive head and enclosed within a thermally regulated insulated chamber. Heating coils were attached directly to the head unit, as was the

thermistor regulating element. Temperature control at 23°C was better than $\pm 0.1^\circ\text{C}$ over periods of several days.

Initial problems with mechanical noise were eliminated by a low pass filter with 70 db attenuation for frequencies above 100 Hz on the DC output of the lock-in detector, and by mounting the complete dilatometer and support structure upon a pneumatically isolated optical bench. Gain of the CAS amplifier system was set to 2.485 volts/mil from the micrometer read adjustment. DC bias for the electrostrictor was provided from a regulated 2 KV double ended supply whose output could be continuously adjusted between ± 1 KV by a 10 turn precision potentiometer.

Zero stability of the LVDT dilatometer was checked over a 16-hour period using a ceramic post of the K 5,500 composition; maximum displacement recorded was 1.9 μ inches. Since the electrostrictive deformations measured under DC field were about 150 μ inches, the data are probably reliable to $\pm 2\%$.

Ceramic samples for dilatometric measurement were mounted below the LVDT head with a short fused silica push rod in contact with the surface to be measured. Bias voltage was increased continuously in discrete steps up to just below breakdown; at each step the induced strain was recorded. The voltage was then reduced stepwise to zero and the measurement of strain again repeated at each step. The reverse cycle was then accomplished in the same manner.

Typical values for the transverse strain as a function of DC bias are shown for the 50 layer structure in Fig. 7. and for the 100 layer structure in Fig. 8. Longitudinal strain data for the same units are summarized in Fig. 9 and Fig. 10, respectively.

In the samples with cylindrical symmetry the configuration is such that only the transverse effect can be measured. For this purpose, the ends of the extruded or sprayed multilayer tube were polished flat and plane parallel, and the tubes were mounted vertically under the fused silica push rod of the LVDT.

Typical data for a tubular extruded structure are shown in Fig. 11, and for the corresponding multilayer in Fig. 12.

To establish the DC stability of the electrostrictive deformation, the strain induced at high DC field was measured over an 80-hour period. A typical response curve is shown in Fig. 13, which was taken on the transverse strain in a 50 element monoblock. Single and multilayer elements did not differ significantly in DC stability.

That the longitudinal and transverse strains are essentially electrostrictive in character may be seen from Fig. 14 and Fig. 15 which compare the measured strain in the 50 layer units to the square of the electric polarization deduced from the corresponding dielectric hysteresis plots.

From the relations

$$s_{11} = Q_{11}P_1^2 \quad \text{and} \quad s_{22} = Q_{12}P_1^2$$

the polarization dependent electrostriction constants have values

$$Q_{11} = 4.8 \times 10^{-2} \text{ M}^4/\text{C}^2$$

$$Q_{12} = -1.8 \times 10^{-2} \text{ M}^4/\text{C}^2$$

Similar curves for the 100 layer units give Q values

$$Q_{11} = 5.5 \times 10^{-2} \text{ M}^4/\text{C}^2$$

$$Q_{12} = -1.7 \times 10^{-2} \text{ M}^4/\text{C}^2$$

From earlier studies on small 10 layer units the mean Q values are

$$Q_{11} = 5.71 \times 10^{-2} \text{ M}^4/\text{C}^2$$

$$Q_{12} = -1.71 \times 10^{-2} \text{ M}^4/\text{C}^2$$

While for monolithic ceramic BaTiO_3 the values are

$$\bar{Q}_{11} = 6.32 \times 10^{-2} \text{ M}^4/\text{C}^2$$

$$\bar{Q}_{12} = -1.8 \times 10^{-2} \text{ M}^4/\text{C}^2$$

Thus there is good evidence that the internal electrode structure does not modify the bulk electrostriction behavior and can therefore be used to change the input impedance level without modifying other characteristics of the system.

3.2 Lead Magnesium Niobate

Because of the difficulty in preparation of the lead magnesium niobate based powders, the samples fabricated were in the form of bars and of small 10 layer multilayers. Material could not be prepared for the larger multilayers or for the spray coated tubular parts in the time available.

Measurements carried out on earlier contract support have suggested the potential importance of the PMN based compositions for static or low frequency positioning devices. It was evident from this work that at low frequency PMN has anhysteretic dielectric properties up to very high field levels and gives a pure electrostrictive response at room temperature.

The objectives of the present studies were to extend the strain measurements to a range of temperatures about room temperature and to explore in more detail the DC stability of the strain, and the response for a range of low cycling frequencies. Earlier studies had suggested that the properties of pure PMN could be improved by limited solid solution with lead titanate (PT), improving the strain sensitivity without seriously degrading the anhysteretic character so these measurements were also carried through on a PMN:0.1 PT composition.

(a) Strain Measurements

To permit low level strain measurements as a function of temperature, a resistive strain gauge measuring technique was used. The mode of gauge attachment to the samples for linear and transverse electrostriction measurement is shown in Fig. 16. The transverse measurement positions the gauge in an equipotential plane and gives measured values of the strain at room temperature which are identical to those obtained by the LVDT direct method.

For longitudinal strain, the gauge was tried in two configurations (b,c) but in both cases the measured values were lower than those obtained by the LVDT, probably due to the perturbation of the field distribution by the gauge, and from the problems of attachment.

In each case, however, the scaling factor did not change significantly with strain level, and thus the longitudinal strain curves certainly reflect the major features of the temperature dependence.

For measurements down to liquid nitrogen and up to 250°C, the simple cryostat shown in Fig. 17. was used. To compensate for temperature change in the gauges used, a balanced measuring circuit was developed (Fig. 18). In this system the strain can be directly related to the bridge unbalance signal which is amplified and displayed on the y axis, while the cycling voltage drives the x axis of an x-y recorder.

For the very low frequencies cycling voltage was derived from a motor control variac driving a DC power supply. At higher frequency an Interstate model FT4 ramp function generator was used in conjunction with a Kepco model BOP 1,000 M bipolar voltage control power supply.

The transverse electrostrictive response was measured at a series of fixed temperature in the range +150°C to -150°C both for pure PMN and for PMN:0.1 PT. Figure 19 and Fig. 20 give representative data for the two systems. From these data the temperature dependence of the response at a fixed field can be deduced (Fig. 21).

Frequency dependence of the response at 27°C was measured from 0.001 Hz to 0.1 Hz, and the data are summarized in Fig. 22. For pure PMN the response is similar in character with only a very minor change exhibited over the two decade frequency range.

A feature of importance for several possible applications is the true stability of the field induced DC strain. Using the rather simple cryostat of Fig. 17, reference stability was limited by the need to keep the liquid level in the cryostat under continuous control. This limited stability runs to 8 hours at most.

For the pure PMN, under a bias of KV/cm corresponding to an induced strain of 1.0×10^{-5} at room temperature, the drift over a 10-hour period was below the resolution of the bridge. The strain is constant to better than $\pm 2\%$ over a 10-hour period, which is considerably better than the K 5,500 material.

For the PMN:0.1 PT, there is an initial rapid exponential rise of the strain which then stabilizes and remains constant over a 5-hour period, the full time for which measurements were made.

3.3 PZT8 Multilayers

It was not possible to make a detailed evaluation of the PZT8 multilayers as the units we were fabricating were being supplied directly to ITEK Optical Systems Division for more detailed evaluation.

Our electrical studies were concerned with

- (a) Developing an adequate poling procedure for the multilayers.
- (b) Building up a jig system to assemble 10 layer stacked units.
- (c) Preliminary evaluation of the longitudinal strain to enable a comparison of the d_{33} for the multilayer with that of the disk unit of the same composition.

(a) Poling

- Since the stacked units were only to be used in a thickness extension mode (using d_{33}), poling was carried out using parallel connection to produce alternate positive and negative directions in adjacent lamellar strips. With this poled configuration application of a DC field to the same terminal produces thickness expansion in all layers, even though again the fields are oppositely directed in adjacent layers.

Poling was accomplished at 80°C using a field of 20 KV/cm applied for 20 minutes. After cooling measurement of the units on the Berlincourt d_{33} meter $d_{33} = 220 \times 10^{-12}$ C/N which is close to the specified value for this composition.

(b) Strain Measurement

Only the thickness mode expansion was measured to determine the total throw of the 10 unit stacks made up from 10 layer units (Fig. 23).

The LVDT system was used at 25°C for a sample which was only aged for 10 days after poling. Curves for the thickness extension under rising and falling field are given in Fig. 24.

4. THERMAL MEASUREMENTS

A feature of any material which is to be of practical interest for precise position control applications that is most important is the dimensional stability under thermal change, i.e. the thermal expansion characteristics. In the PZT family piezoelectrics which are presently used for experimental purposes, the coefficients of thermal expansions are usually in the range $5-10 \times 10^{-5} \text{ }^\circ\text{C}$.

Thermal dilatation has been measured for both the modified BaTiO_3 Erie K 5,500 material, and for the PMN and PMN:PT solid solutions. For the higher temperature region above 25°C , a modified Harrop direct reading dilatometric analyzer was used. Since the Harrop system is designed primarily to measure ceramics at temperatures above 500°C , modification was required for the furnace system to reduce the thermal time constants and thermal lag and to the standard support tube which was replaced with a low expansion silica glass tube.

In the lower temperature region, the precise LVDT used for striction measurements was employed with a simple dewar cooling system. Dilatations measured in this manner were also compared with the dilatation measured by the bonded strain gauge technique and the environment control system discussed in Fig. 17.

For the Erie K 5,500 material, the thermal dilatation is linear over the range from -100°C to $+75^\circ\text{C}$ with no obvious anomaly near the dielectric maximum at 20°C . The slope of the curve gives a constant thermal expansion $\alpha = 5.7 \times 10^{-6} \text{ }^\circ\text{C}$ which is normal for ferroelectric perovskites. Lead magnesium niobate (PMN) and the PMN:PT solid solutions give a more interesting result summarized in Fig. 25.

In the pure PMN, there is a region about the diffuse phase change, in which the thermal expansion is much reduced giving a range from -80 to $+80^\circ\text{C}$ over which $\alpha < 1 \times 10^{-6} \text{ }^\circ\text{C}$. With increasing PT content, the expansion in this relaxation range is further reduced and for 20 mole% PT in fact becomes negative.

For the most practical 10 mole% composition thermal expansion is below the limit of resolution for our equipment over the range from -80°C to $+100^{\circ}\text{C}$.

5. DISCUSSION

The data obtained for the K 5,500 in larger multilayer form confirm:

(a) Using present technology it is possible to produce larger units with up to 100 active layers/unit.

(b) That at low frequency, the behavior of the larger units scales very closely from the behavior of single layer units, i.e. the fired in noble metal electrode does not seriously degrade either the longitudinal or the transverse electrostriction.

Thus these results do demonstrate that as was proposed initially, multilayer technology could be used to reduce the voltage drive requirements for DC and for low frequency micropositioning devices based on electrostriction.

Reproducibility of the induced strain using the K 5,500 composition is, however, disappointing, particularly in the multilayer tubular units. We believe that the variability of the strain hysteresis in this material may be associated with the characteristics of the dielectric body which is obviously very sensitive to low levels of additives which modify the grain size, and thus is probably sensitive to the changes in processing procedures between tape casting, extrusion, and spray coating. It is probable that some of this variability could be removed by tailoring the additive concentration to suit each fabrication procedure.

DC drift of the induced strain was approaching the limits of discrimination of our simple LVDT dilatometers, but would probably be tolerable for many applications.

It is immediately evident, however, that the PMN based compositions offer several significant advantages for low frequency devices.

(a) The induced strain levels are larger.

(b) The compositions up to PMN:0.1 PT are almost completely anhysteretic at room temperature.

(c) By changing the solid solution composition strain level, hysteresis, working temperature can be modified to suit particular applications.

(d) The diffuse phase change in these materials gives rise to a temperature region over which the thermal expansion is exceedingly low.

(e) The material can be tape cast using conventional methods.

(f) The DC drift is below our detection limit in PMN.

We believe that in all respects the PMN:PT solid solutions are to be preferred over the BaTiO_3 based high K dielectrics. Problems with the phase purity of PMN produced by solid state reactions do, however, require further study so that fabricators will be able to be provided with formulations which can be fired to produce the electrostrictive perovskite structure form.

From the limited study of hard PZT8 materials with implanted noble metal electrodes, it again appears highly probable that the voltage sensitivity for longitudinal strain can be much improved without any significant change in the bulk piezoelectric properties. As with the high voltage single electrode samples, however, the multilayers will of course still suffer from the aging and dimensional instabilities associated with the poled ferroelectric domain structure, a feature which is absent from the nonferroelectric relaxor compositions.

One unexpected aspect of the behavior of both the Erie K 5,500 BaTiO_3 base compositions, and of the PMN based solid solution is the long-time DC stability of the electrostrictive deformation. Normally it is to be expected that in homogeneous imperfect insulators the field becomes inhomogeneously distributed due to space charge accumulation near the surfaces, so that in a quadratic device the dilatation would change markedly with time. This phenomenon is very well known in quadratic electro-optic modulators and limits their DC

performance. It appears probable that the fact that such field redistribution does not appear to occur in the ceramics may be associated with the dominant grain:grain boundary heterogeneity which serves to even out longer range space charge accumulation through the higher conductivity of the more defective grain boundary phase.

References

1. Longo, J.M., Raccah, P.M. and Goodenough, J.B. Mat. Res. Bull. 4, 191 (1970).
2. Sleight, A.W. Mat. Res. Res. Bull. 4, 377 (1969).
3. Nikiforov, L.G., Ivanova, V.V., Venetsev, Y.N. and Ivanova, V.V., Neorg. Mat. 4, 381 (1968).

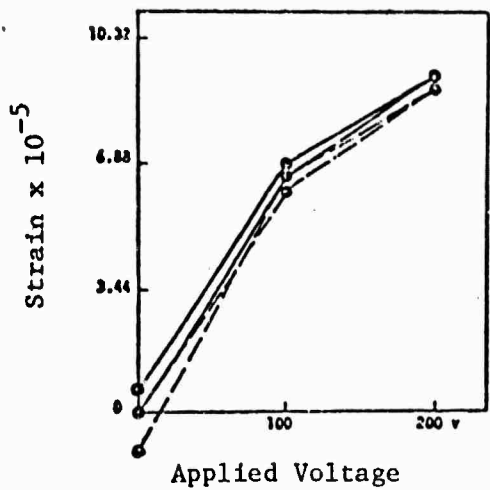

(a)
No Additive

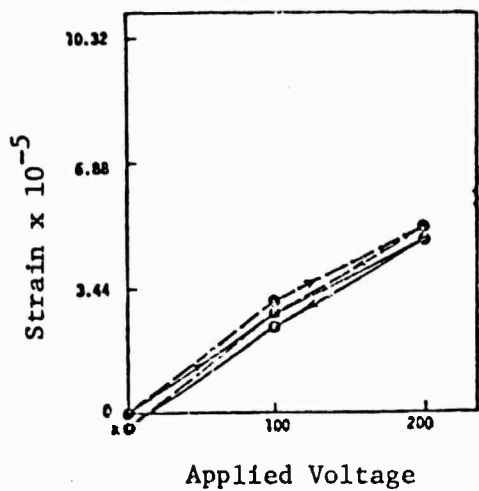
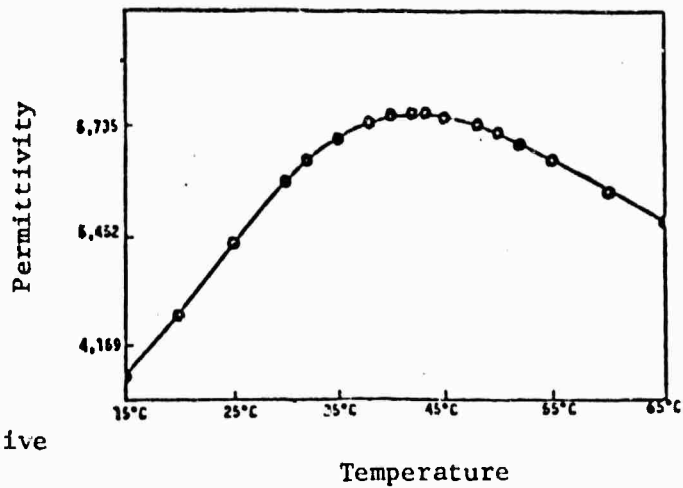

(b)
0.2 Weight %

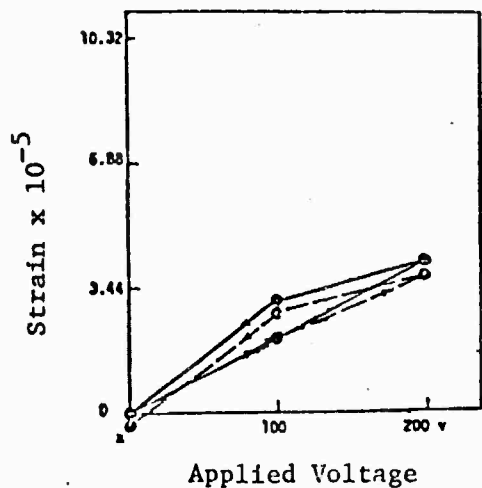
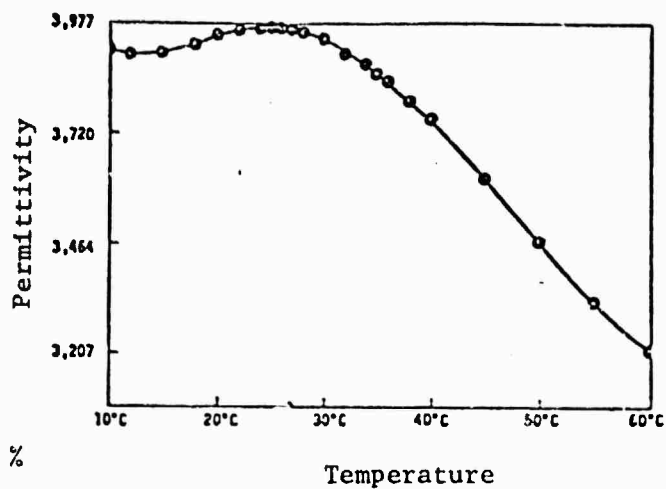

(c)
0.4 Weight %

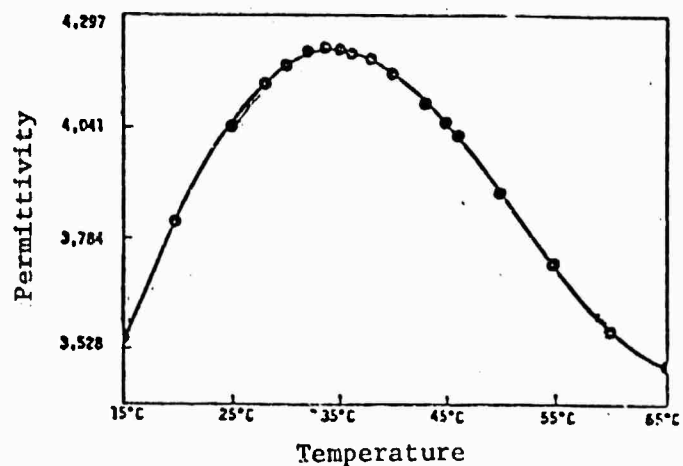

Figure 1. Transverse electrostrictive strain and dielectric permittivity for 3 different levels of peak shifting additive in Erie K 5,500 dielectric bodies.

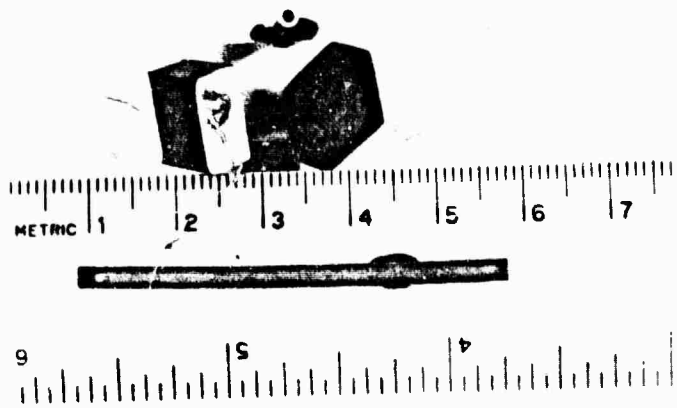
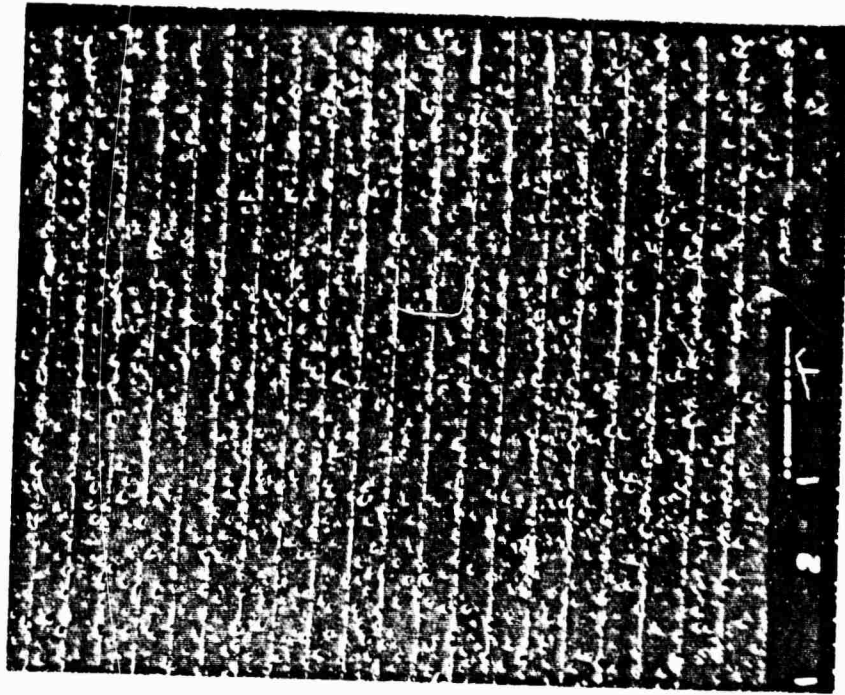

Figure 2. Typical finished multilayer planar and tubular units.



Magnification 100X



Magnification 500X

Figure 3. Scanning electron microscope image of cross section of a 50 layer unit showing regular electrode spacing.

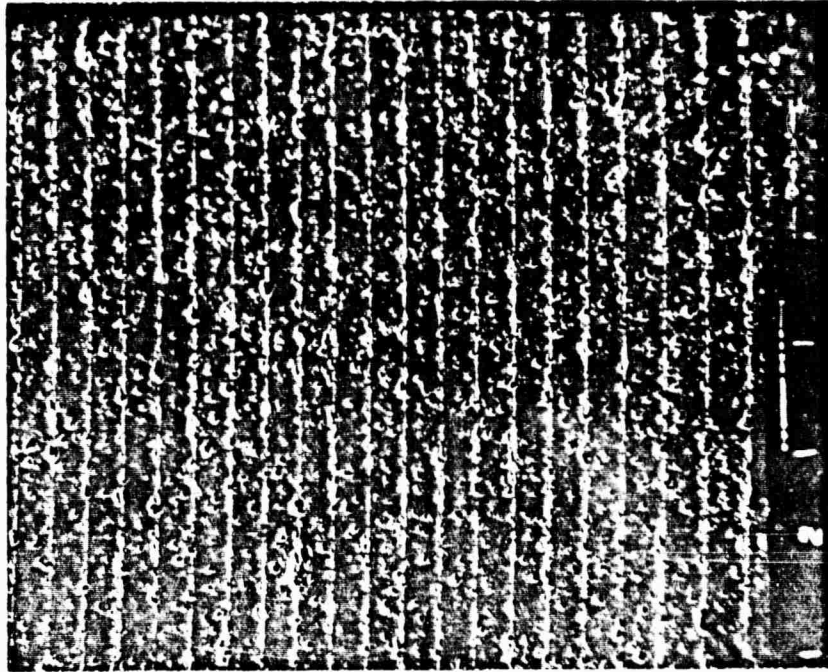

Magnification 100X

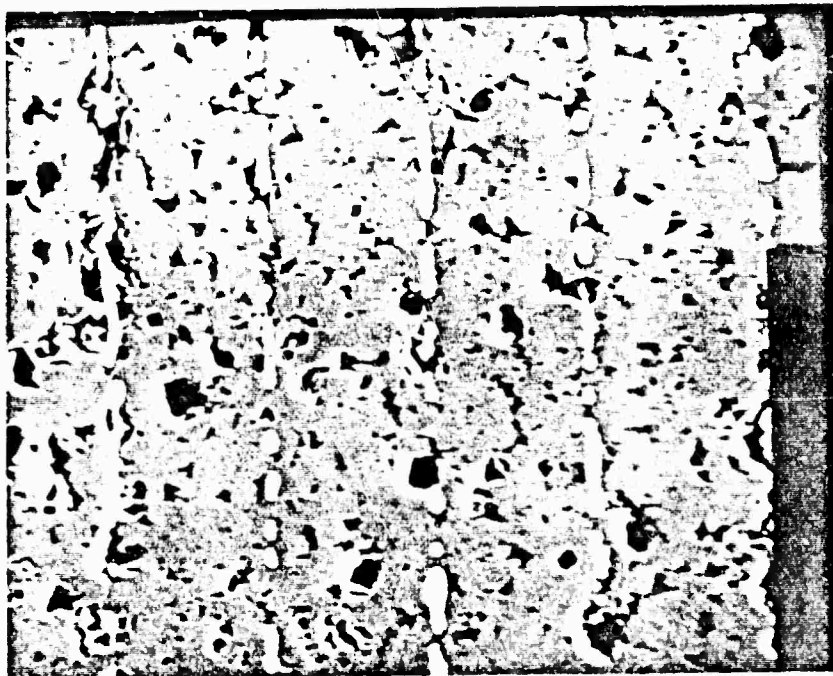

Magnification 500X

Figure 4. Scanning microscope image of cross section of a 100 layer unit showing regular electrode spacing.

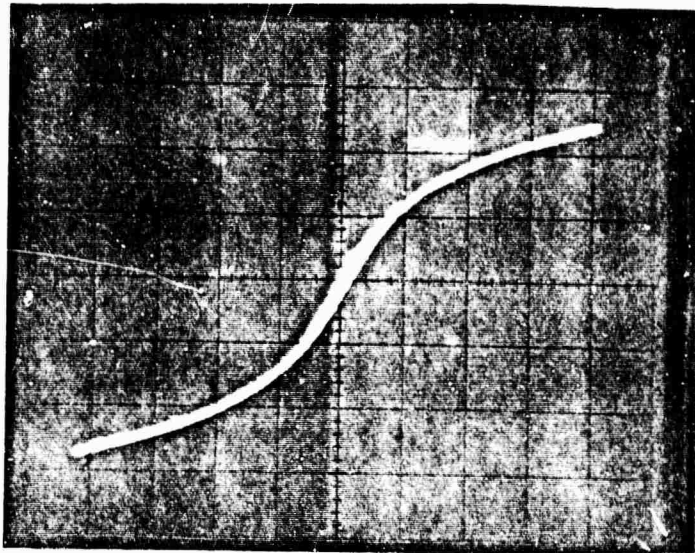

Figure 5. Dielectric hysteresis in a 50 layer K 5,500 multilayer.

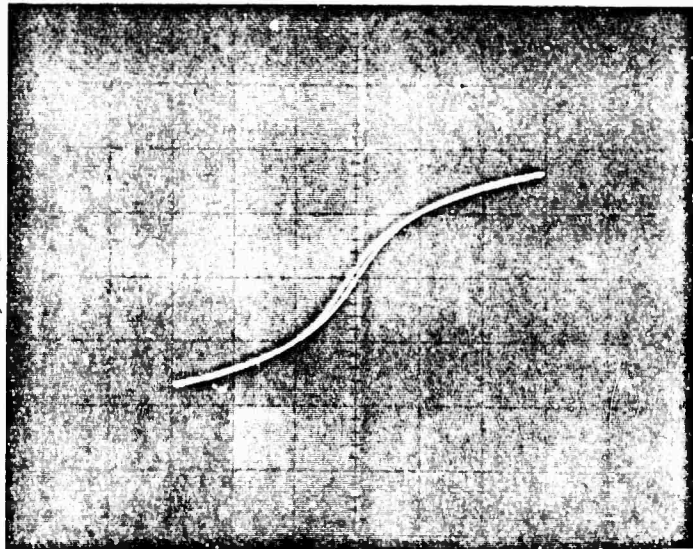

Figure 6. Dielectric hysteresis in a 100 layer K 5,500 multilayer.

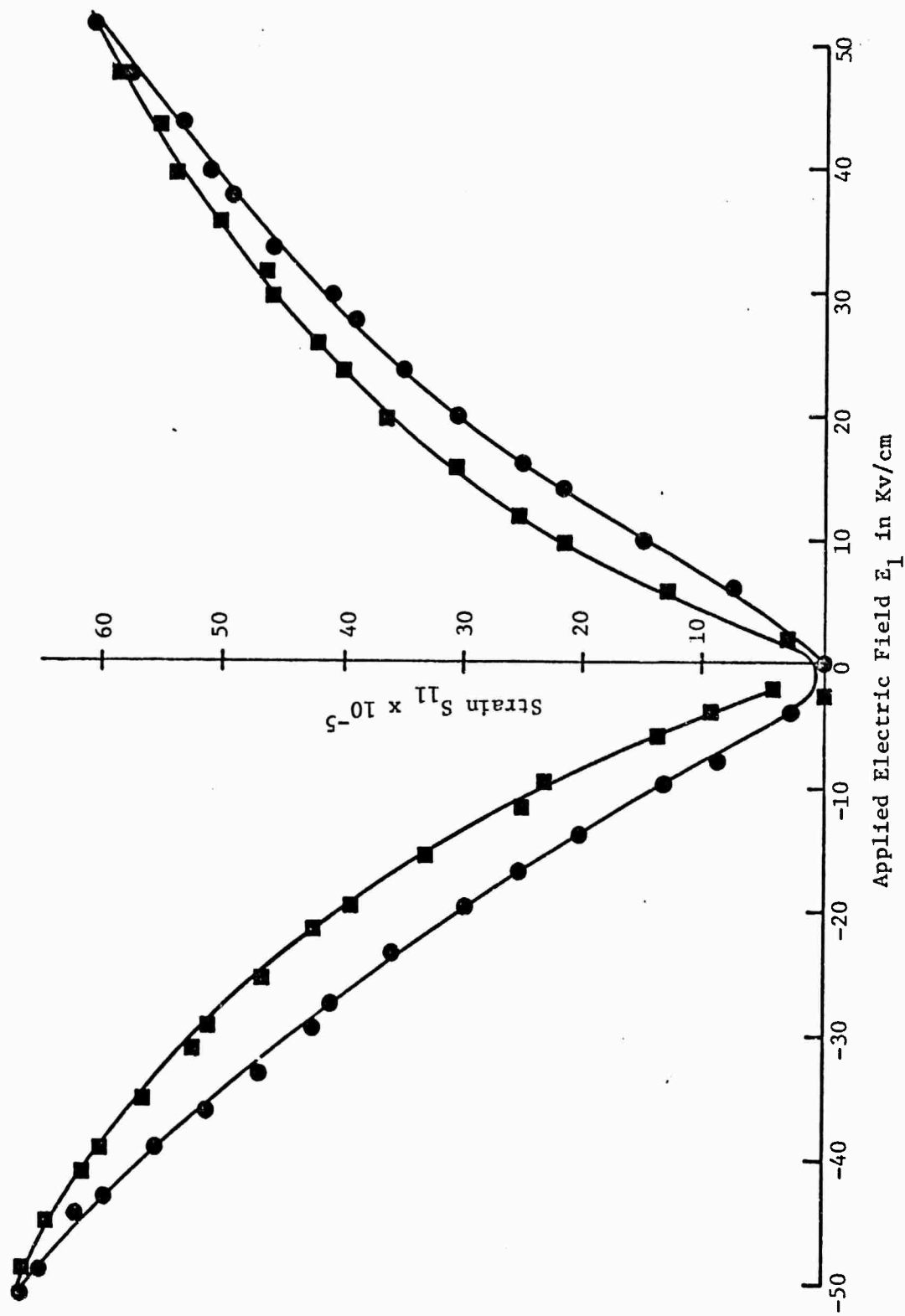

Figure 7. Longitudinal electrostrictive strain S_{11} as a function of applied field E_1 in a 50 layer multilayer structure with Eric K 5,500 dielectric.

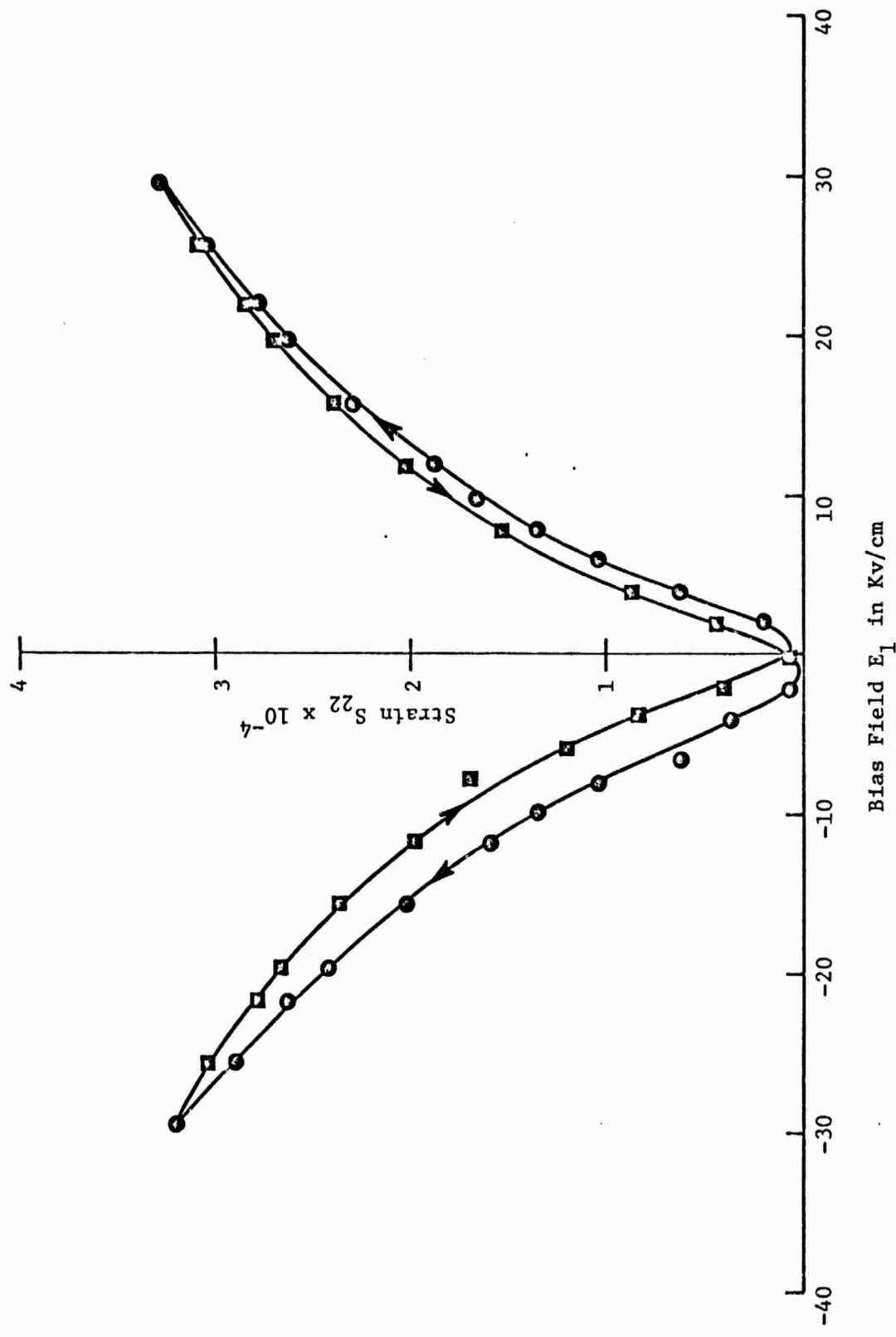

Figure 8. Electrostrictive transverse strain in 100 layer Erie K 5,500 multilayer unit.

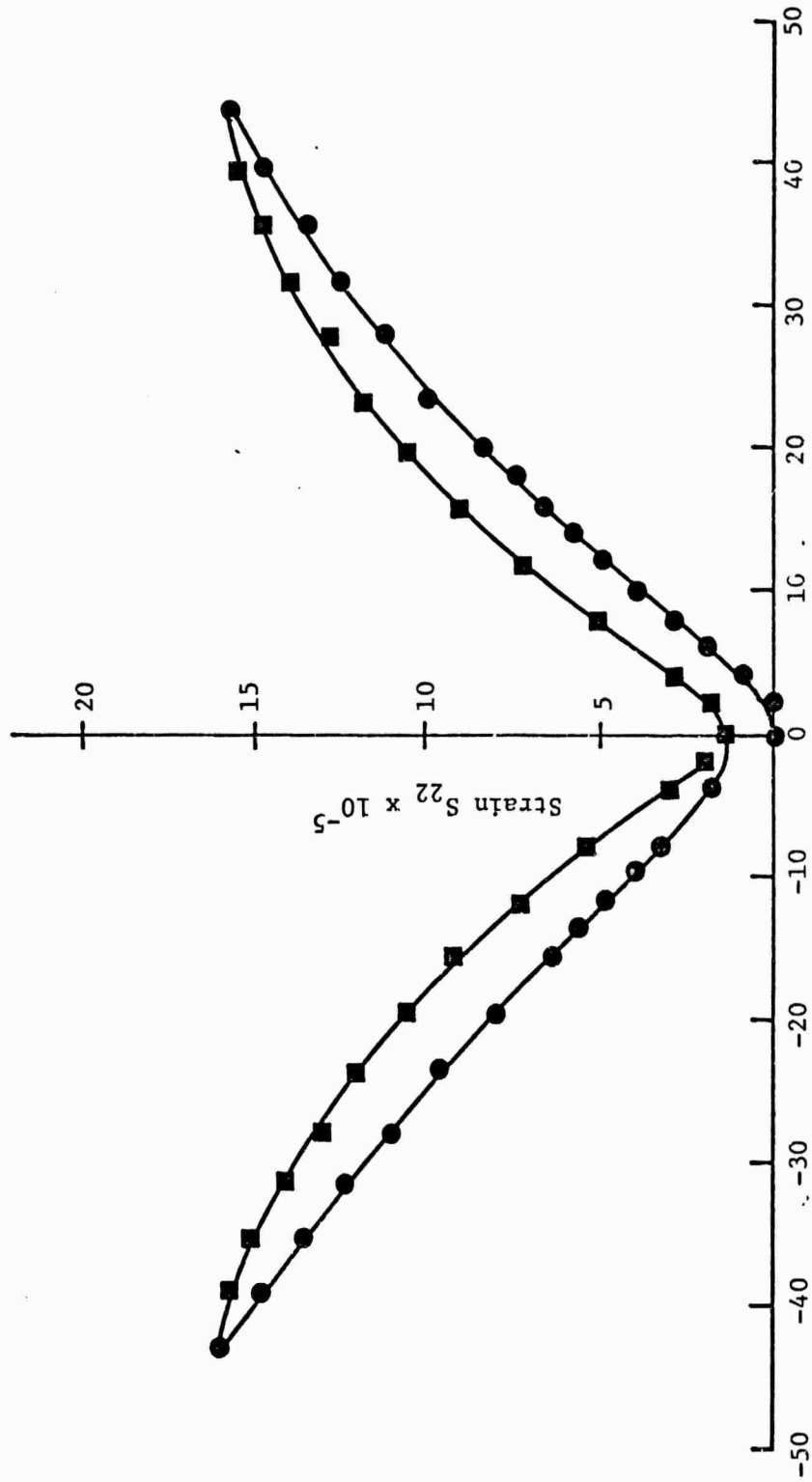

Figure 9. Transverse electrostrictive strain S_{22} as a function of applied field E_1 in a 50 layer multilayer of Erie K 5,500 dielectric.

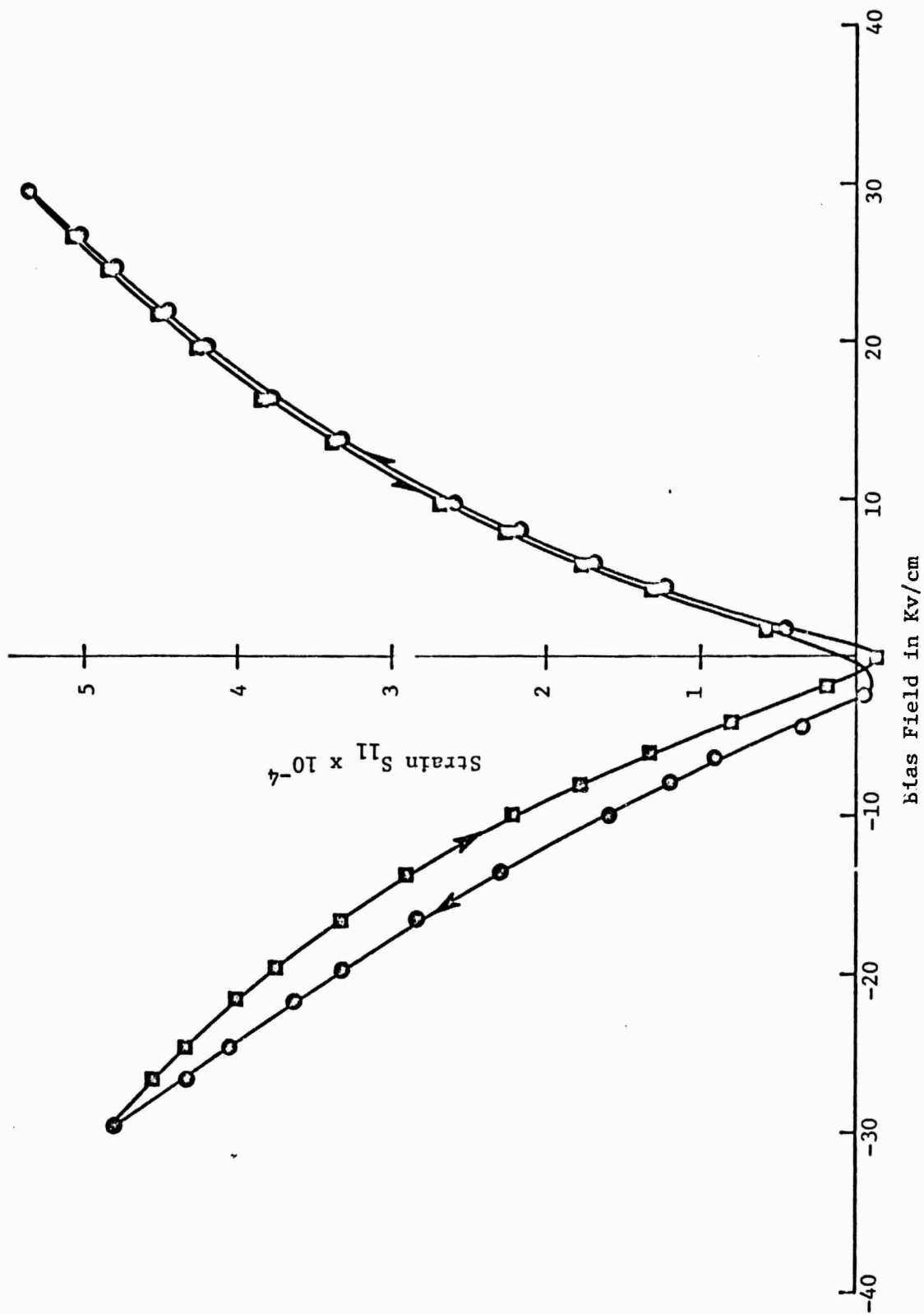

Figure 10. Longitudinal electrostrictive strain in 100 layer Erie K 5,500 multilayer unit.

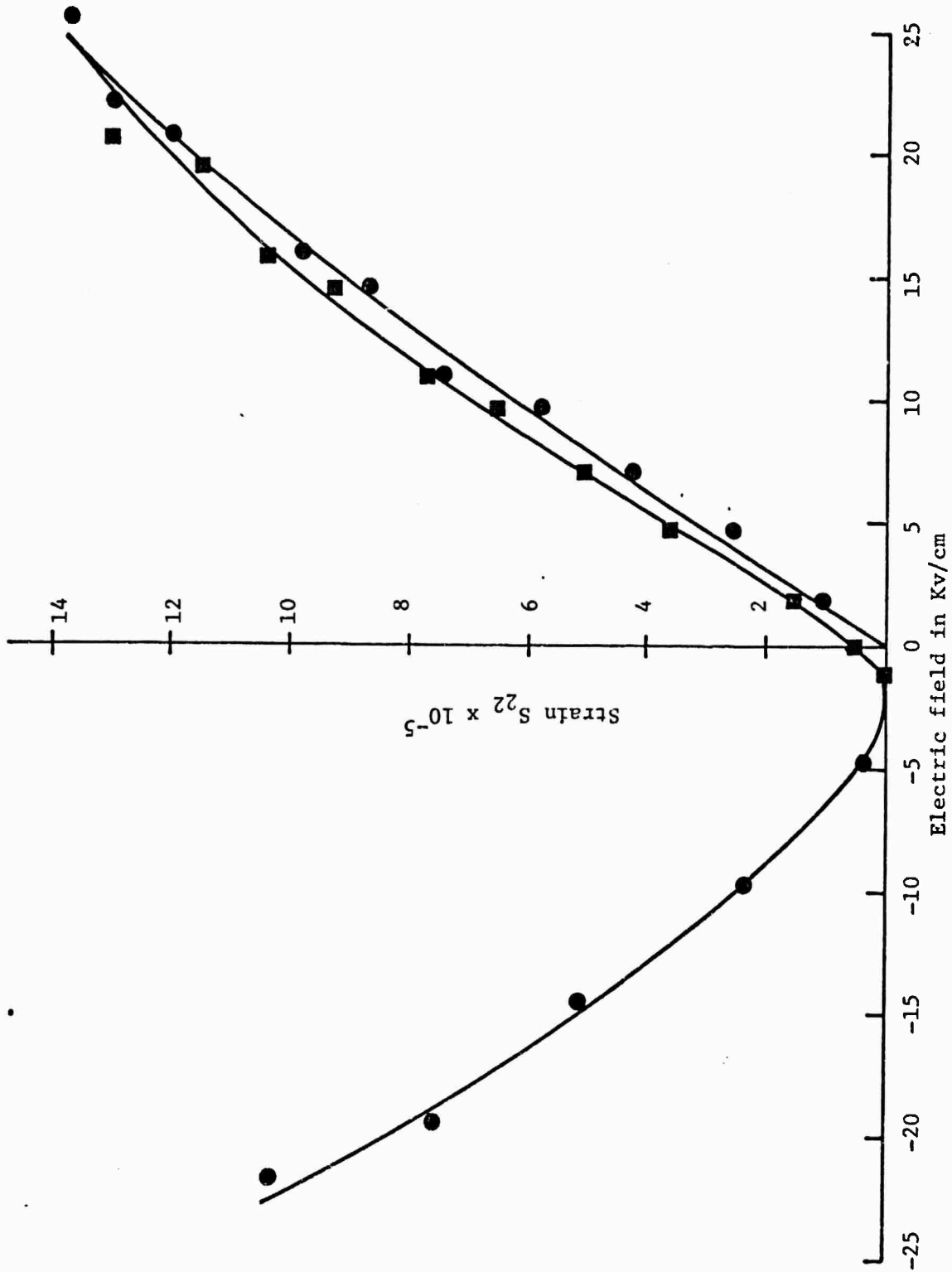

Figure 11. Transverse electrostrictive strain S_{22} as a function of applied field E_1 in an extruded cylindrical Erie K 5,500 dielectric.

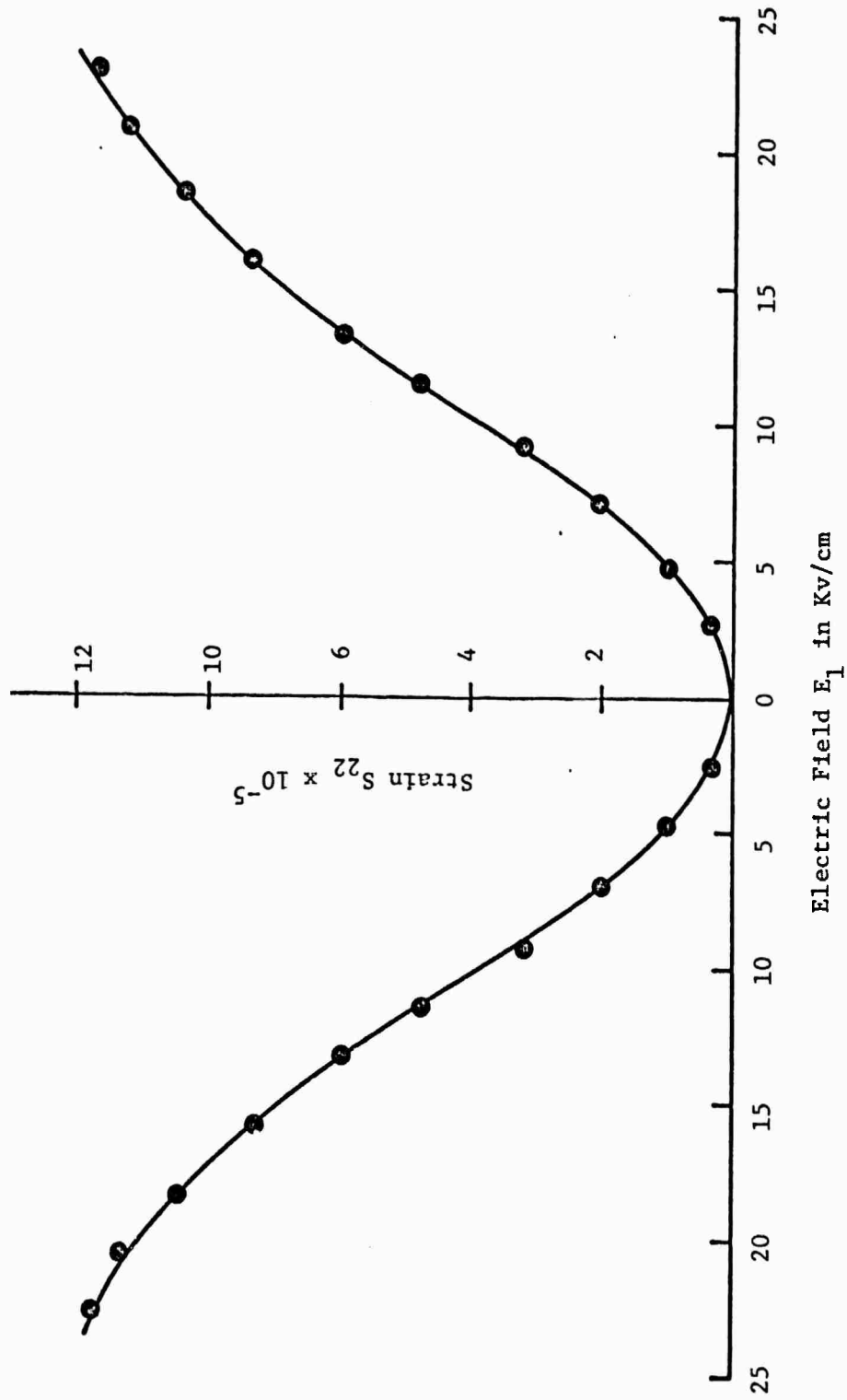

Figure 12. Transverse electrostrictive strain S_{22} as a function of applied field E_1 , in a spray coated cylindrical body with 10 dielectric layers of Erie K 5,500 dielectric.

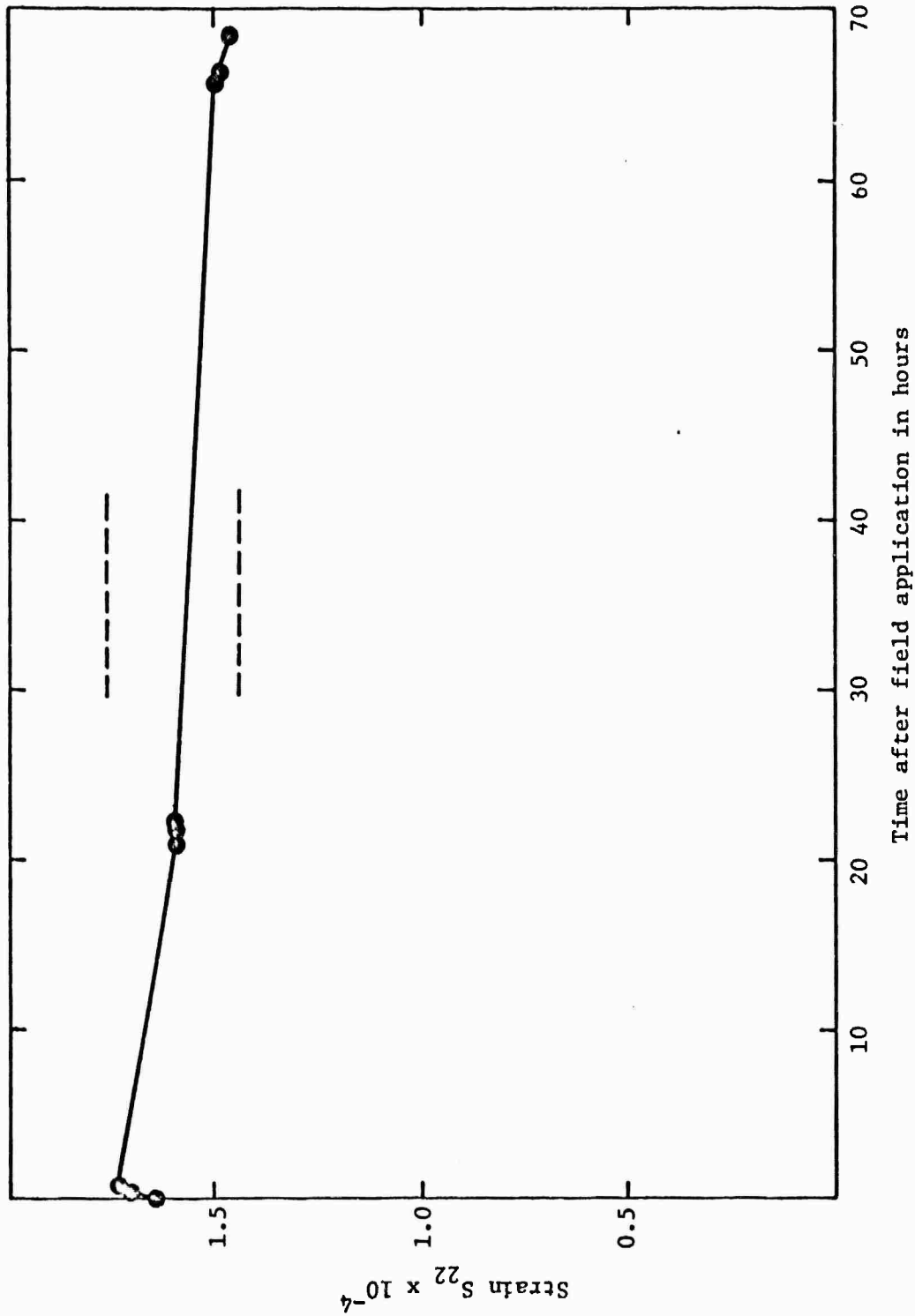

Figure 13. Stability of DC transverse electrostrictive strain in Erie K 5,500 fifty layer monoblock under 29.5 Kv/cm DC bias field.

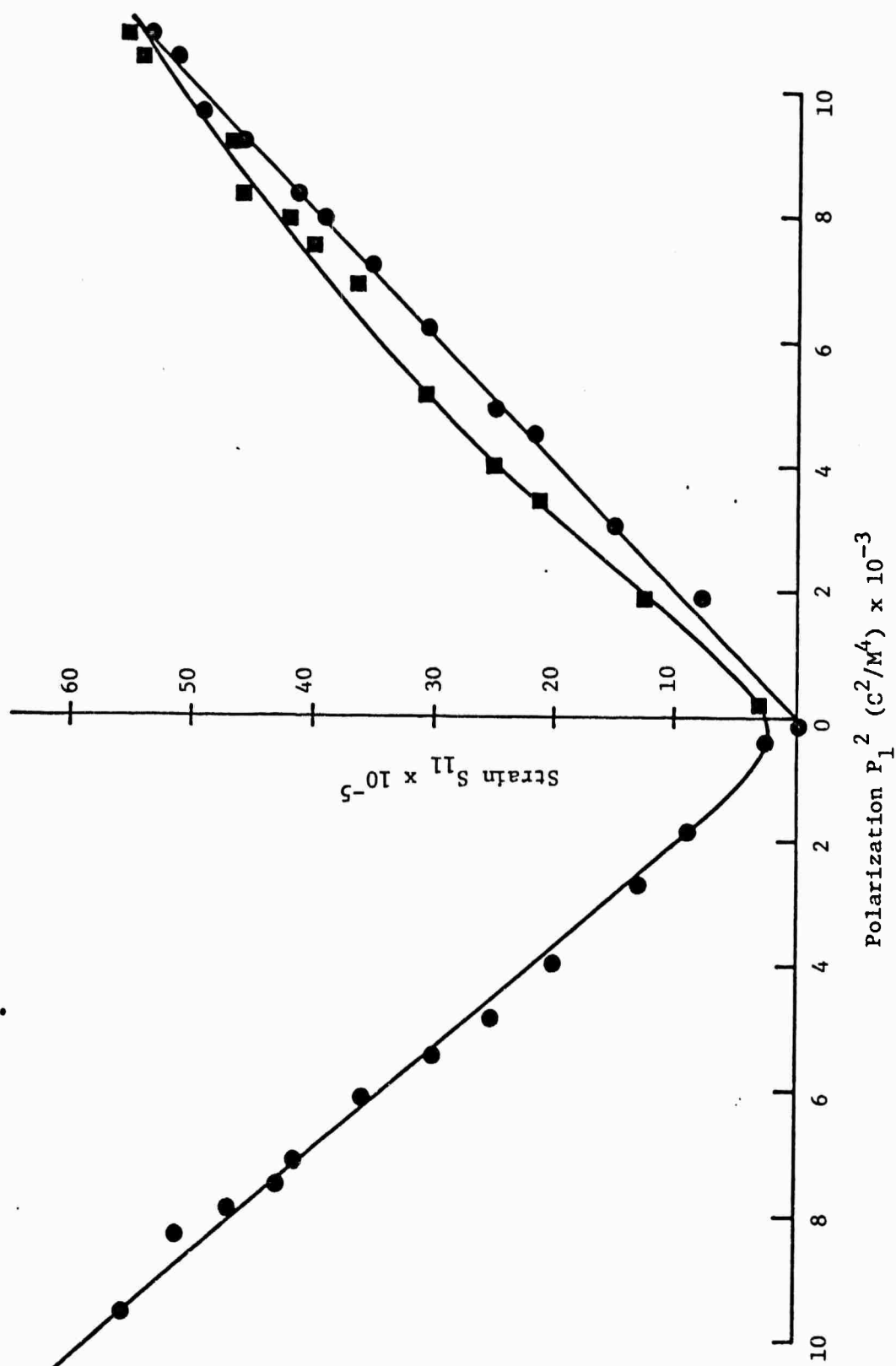

Figure 14. Longitudinal electrostrictive strain S_{11} as function of the square of the induced polarization P_1 in a 50 layer multilayer of Erie K 5,500 dielectric.

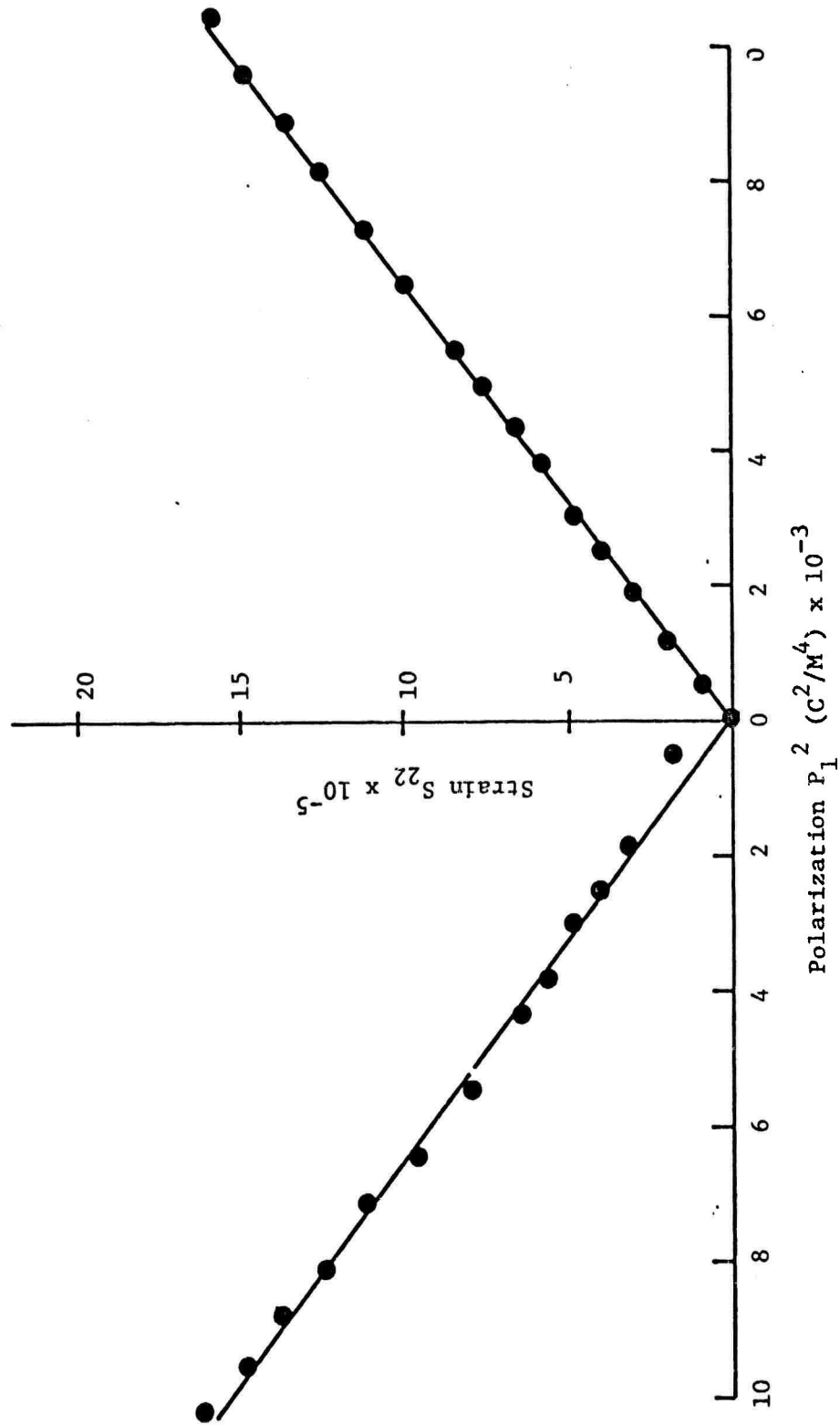

Figure 15. Electrostrictive strain S_{22} as a function of the square of the induced electric polarization P_1 in a 50 layer multilayer of ERIE K 5,500 dielectric.

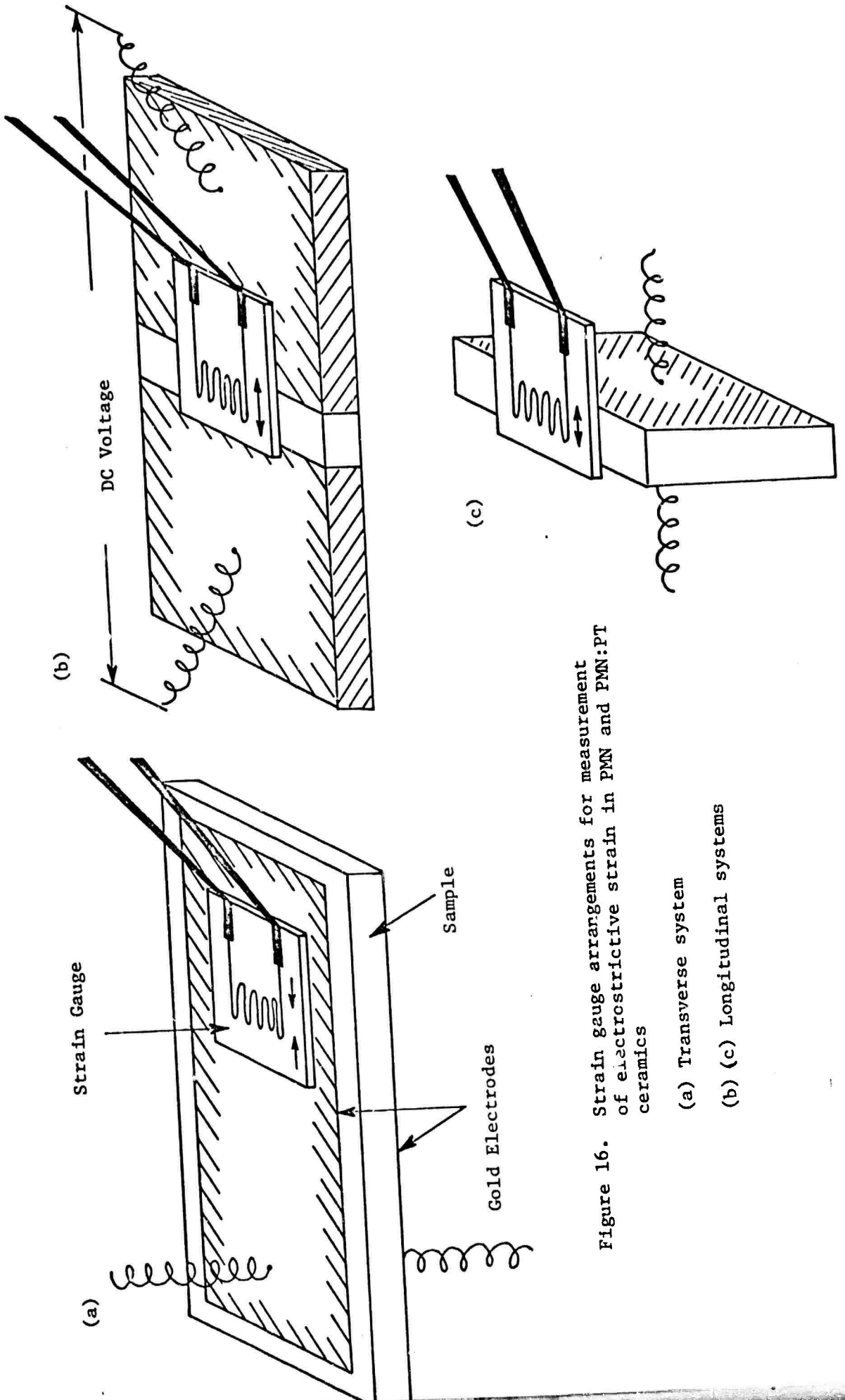

Figure 16. Strain gauge arrangements for measurement of electrostrictive strain in PMN and PMN:PT ceramics

(a) Transverse system

(b) (c) Longitudinal systems

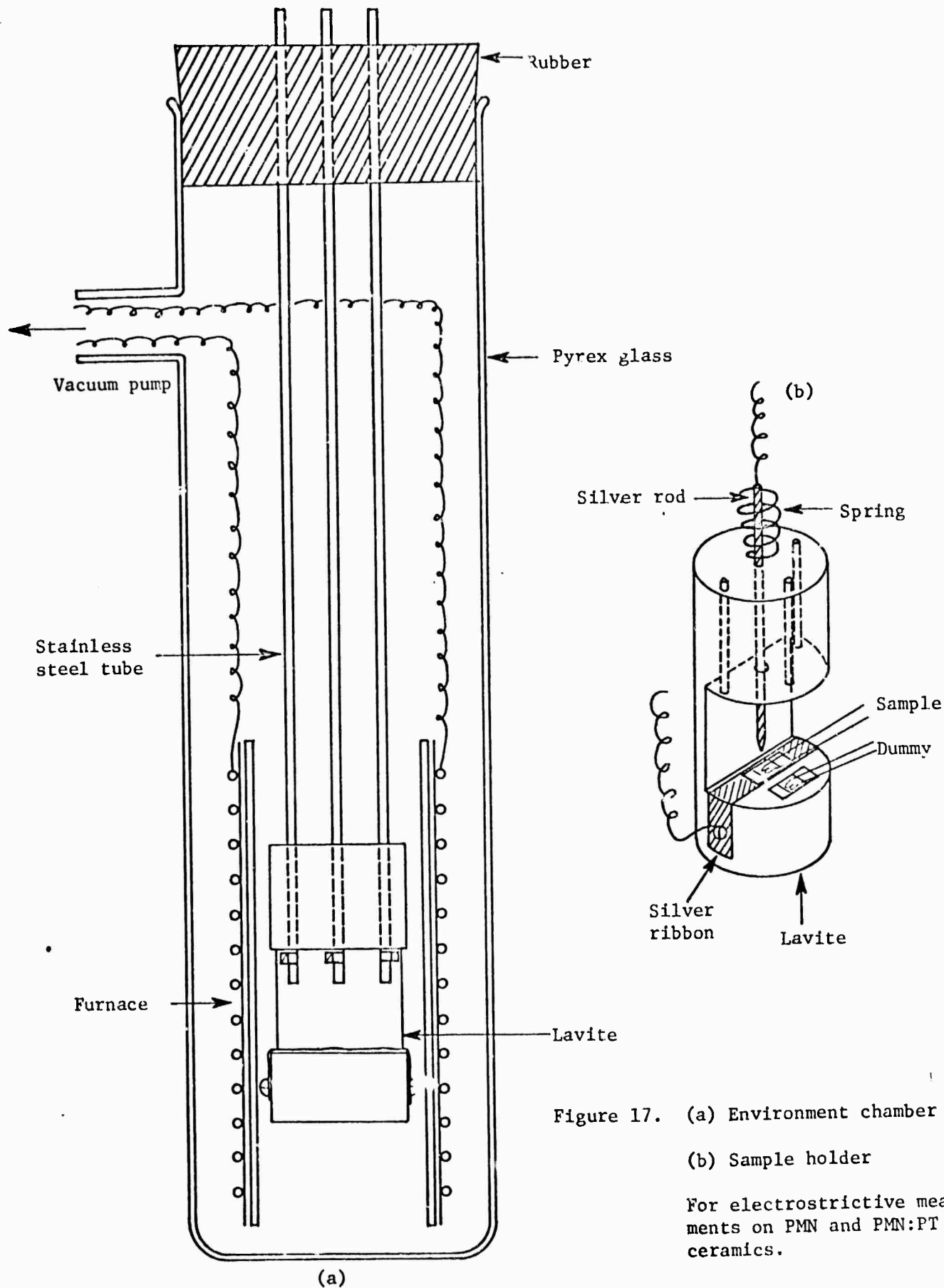

Figure 17. (a) Environment chamber

(b) Sample holder

For electrostrictive measurements on PMN and PMN:PT ceramics.

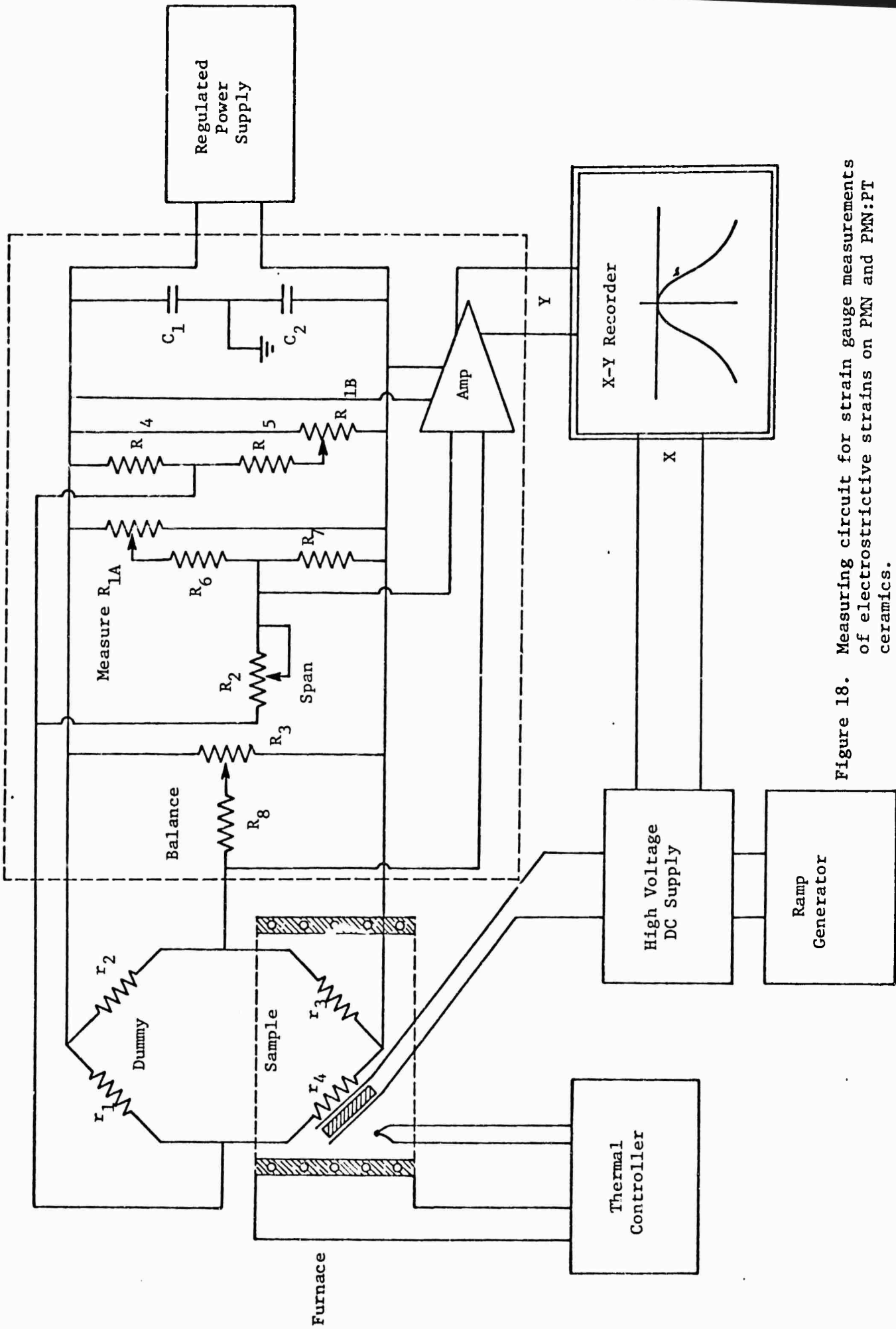

Figure 18. Measuring circuit for strain gauge measurements of electrostrictive strains on PMN and PMN:PT ceramics.

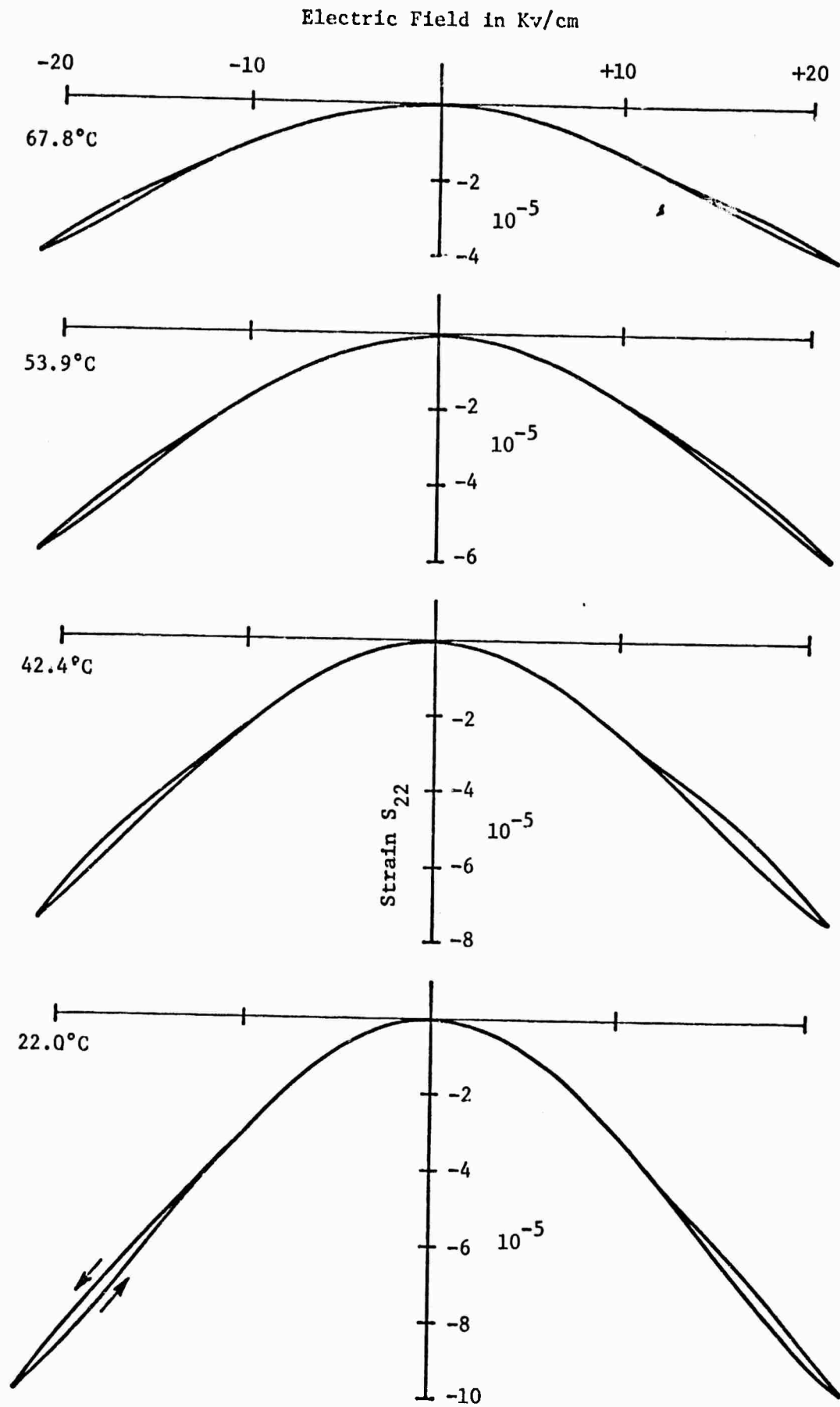

Figure 19(a) Electrostrictive transverse strain in pure PMN ceramic at various temperatures.

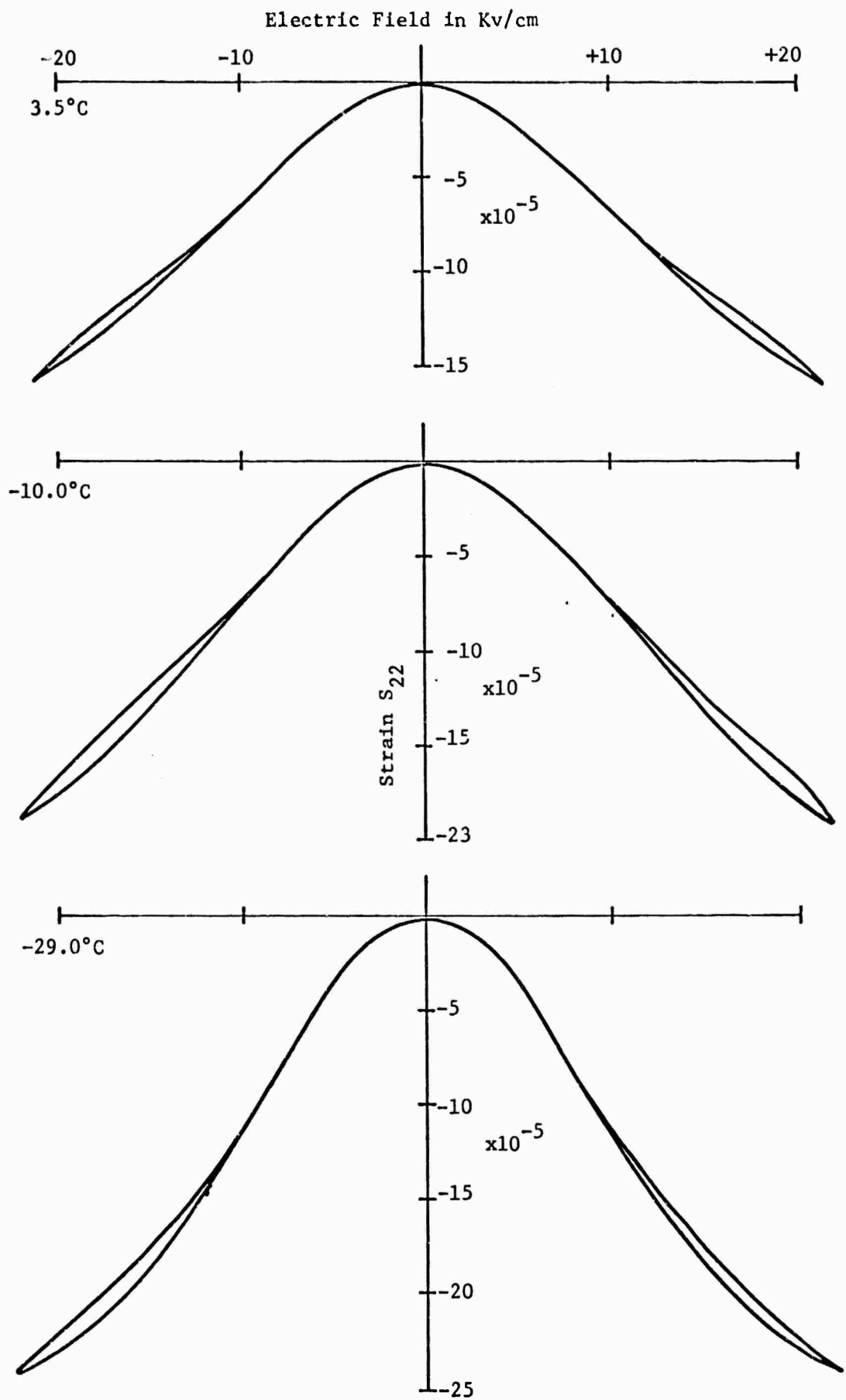

Figure 19(b) Electrostrictive transverse strain in pure PMN ceramic at various temperatures.

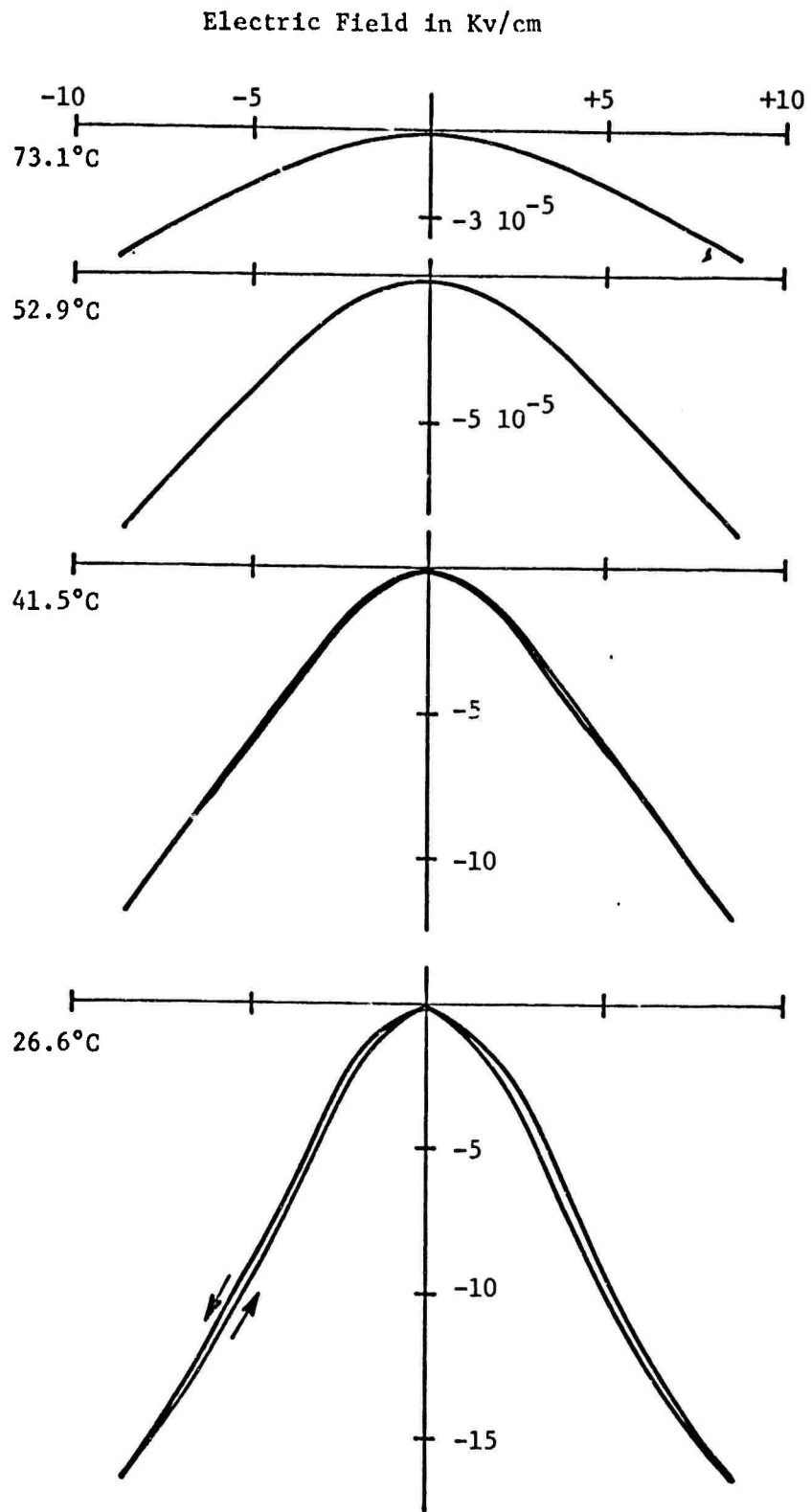

Figure 20(a) Transverse electrostrictive strain in 0.90 PMN:0.10 PT solid solution at various temperatures.

Electric Field in Kv/cm

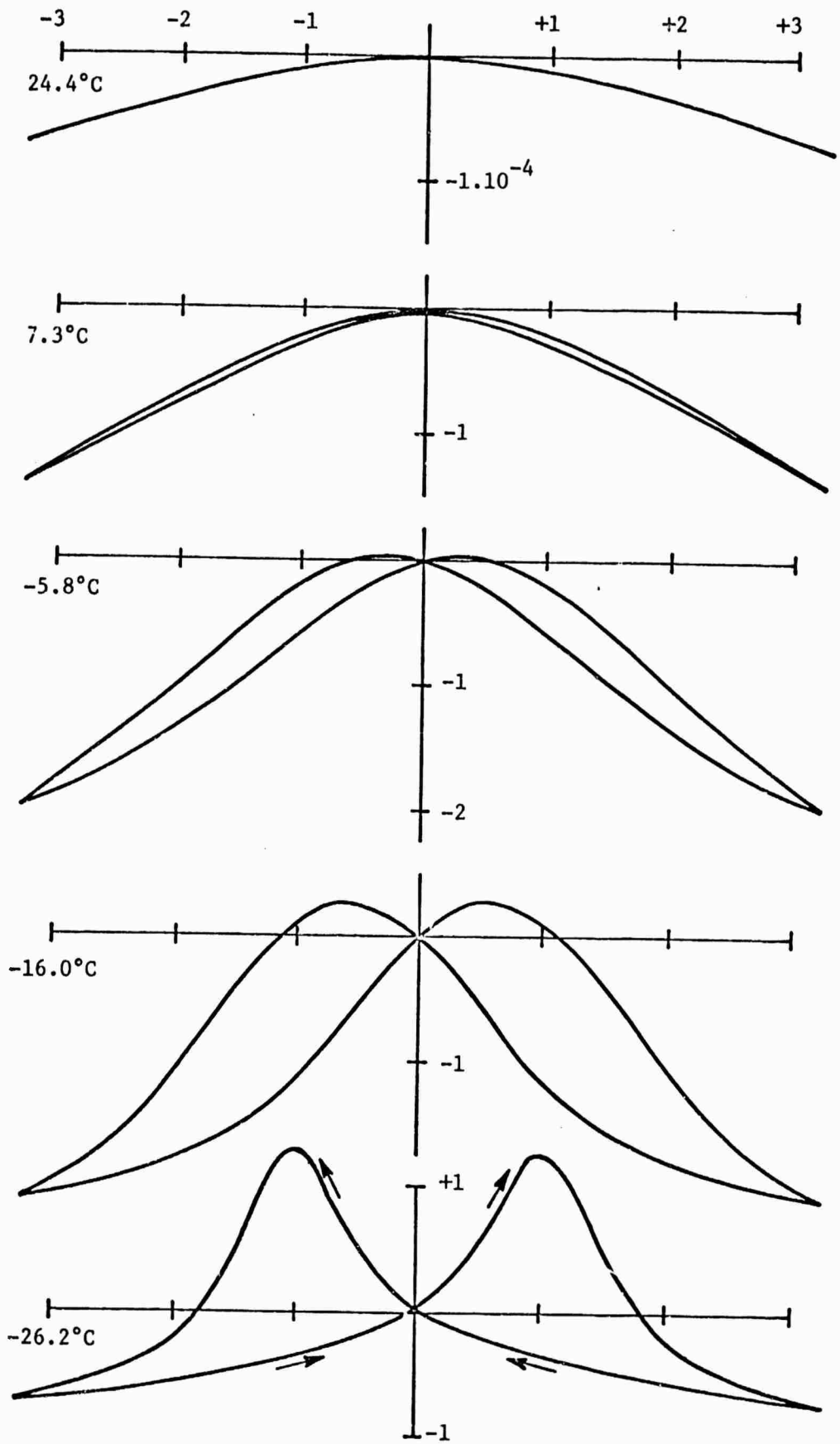

Figure 20(b) Transverse electrostrictive strain in 0.90 PMN:0.10 PT solid solutions at various temperatures.

Composition 0.9 Pb(Mg_{1/3}Nb_{2/3})O₃:0.1 PbTiO₃

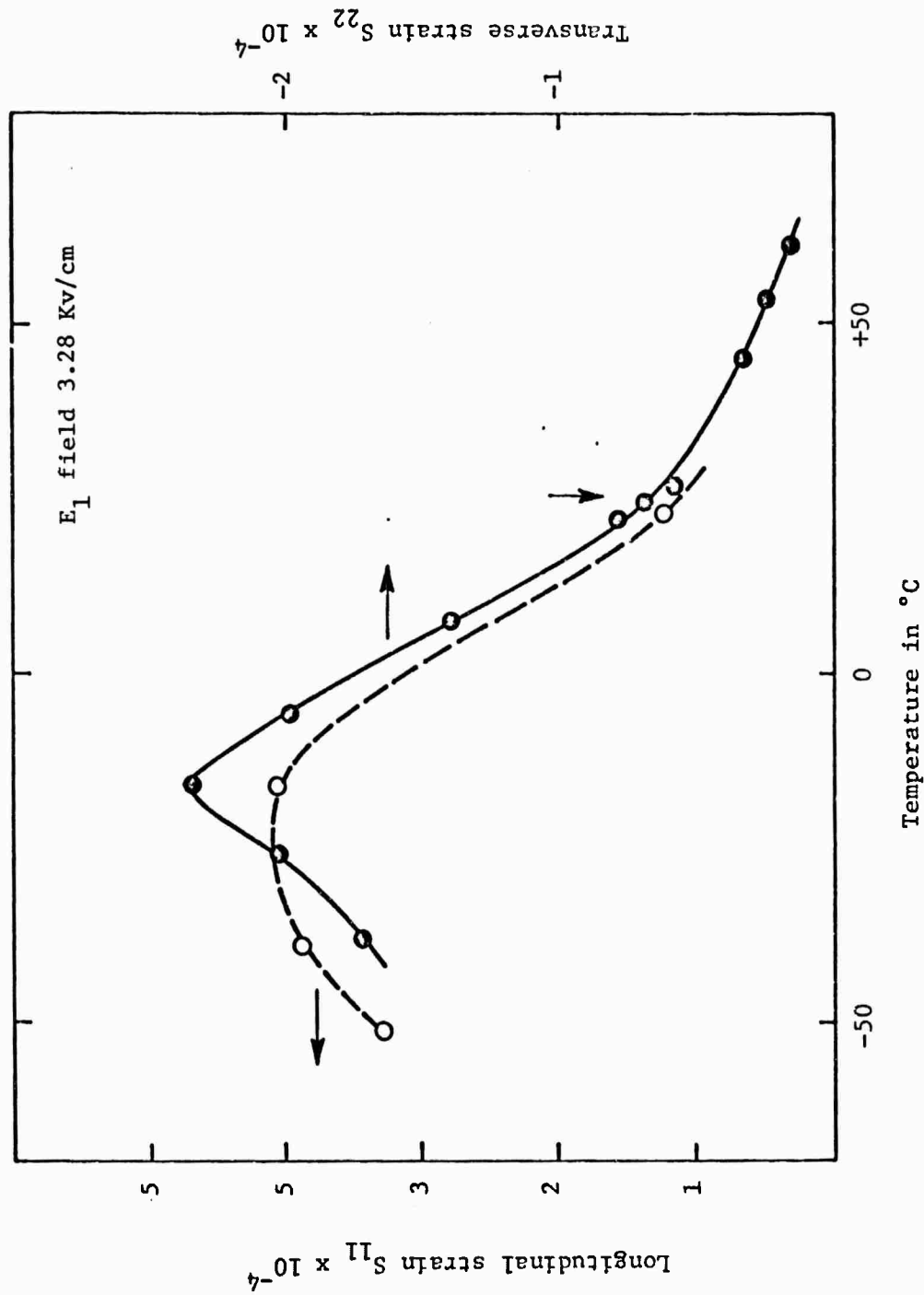

Figure 21. Transverse and longitudinal electrostrictive strains under fixed electric field as a function of temperature in 0.9 PMN:0.1 PT solid solution.

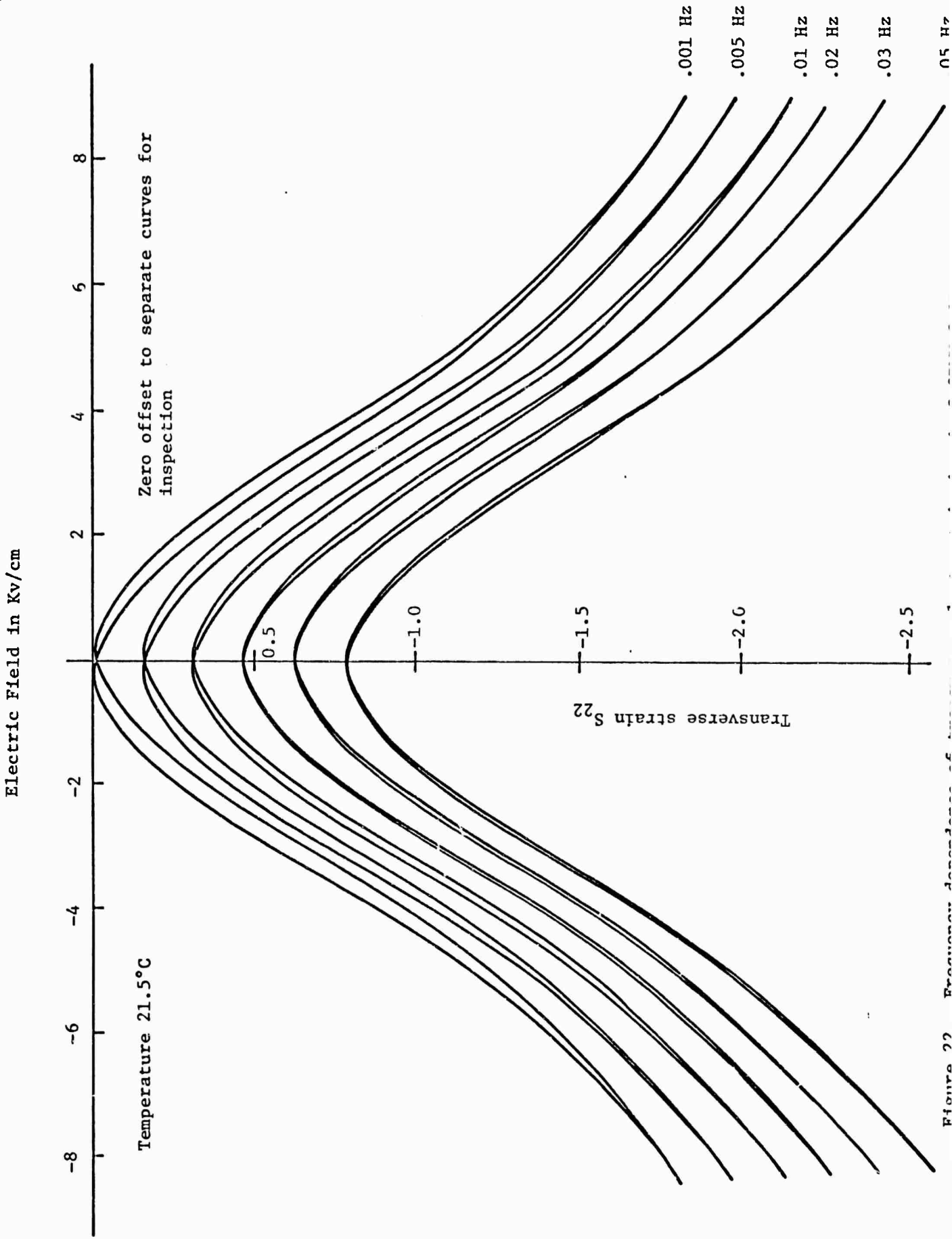

Figure 27 Frequency dependence of S_{22}

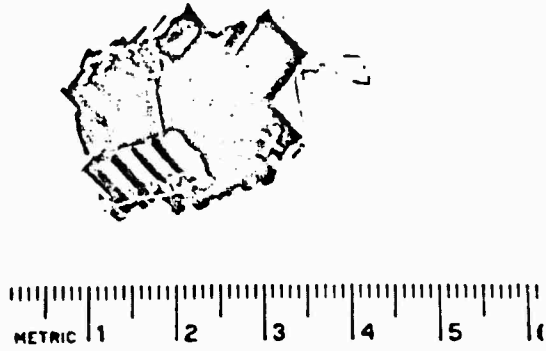

Figure 23. PZT8 Stack of 10 x 10 layer units.

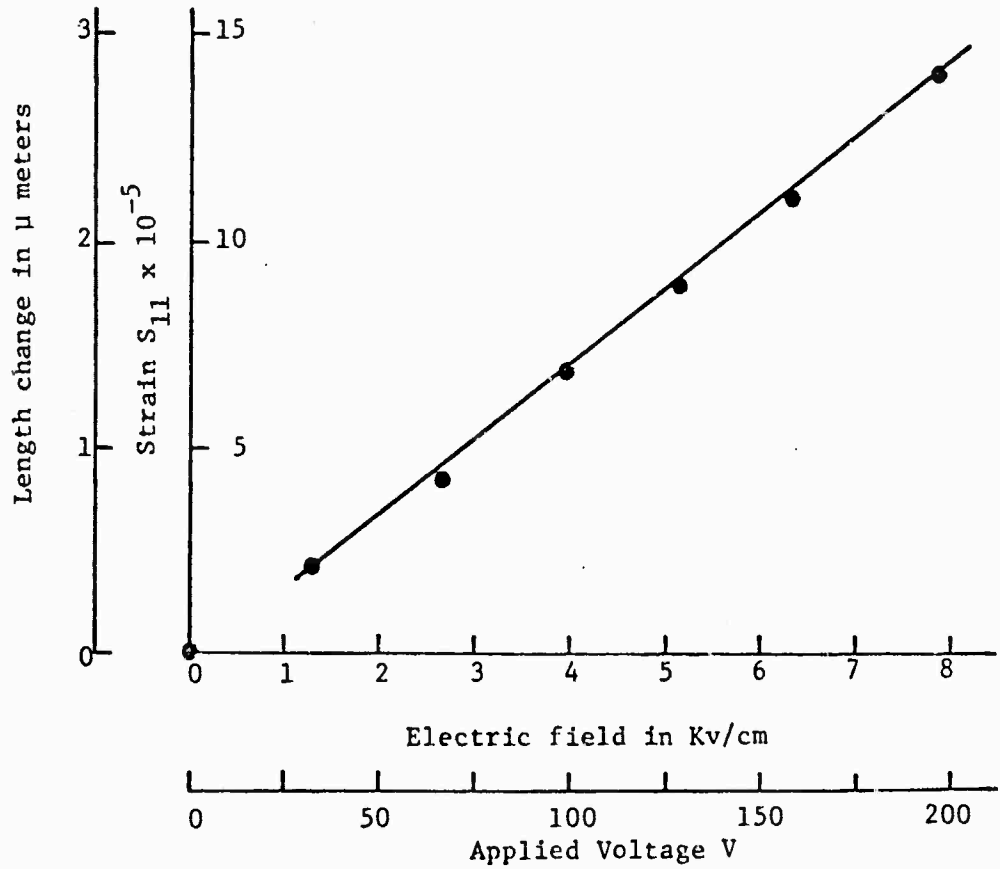

Figure 24. Thickness extension dilation in a deaged 10 x 10 layer PZT8 stack.

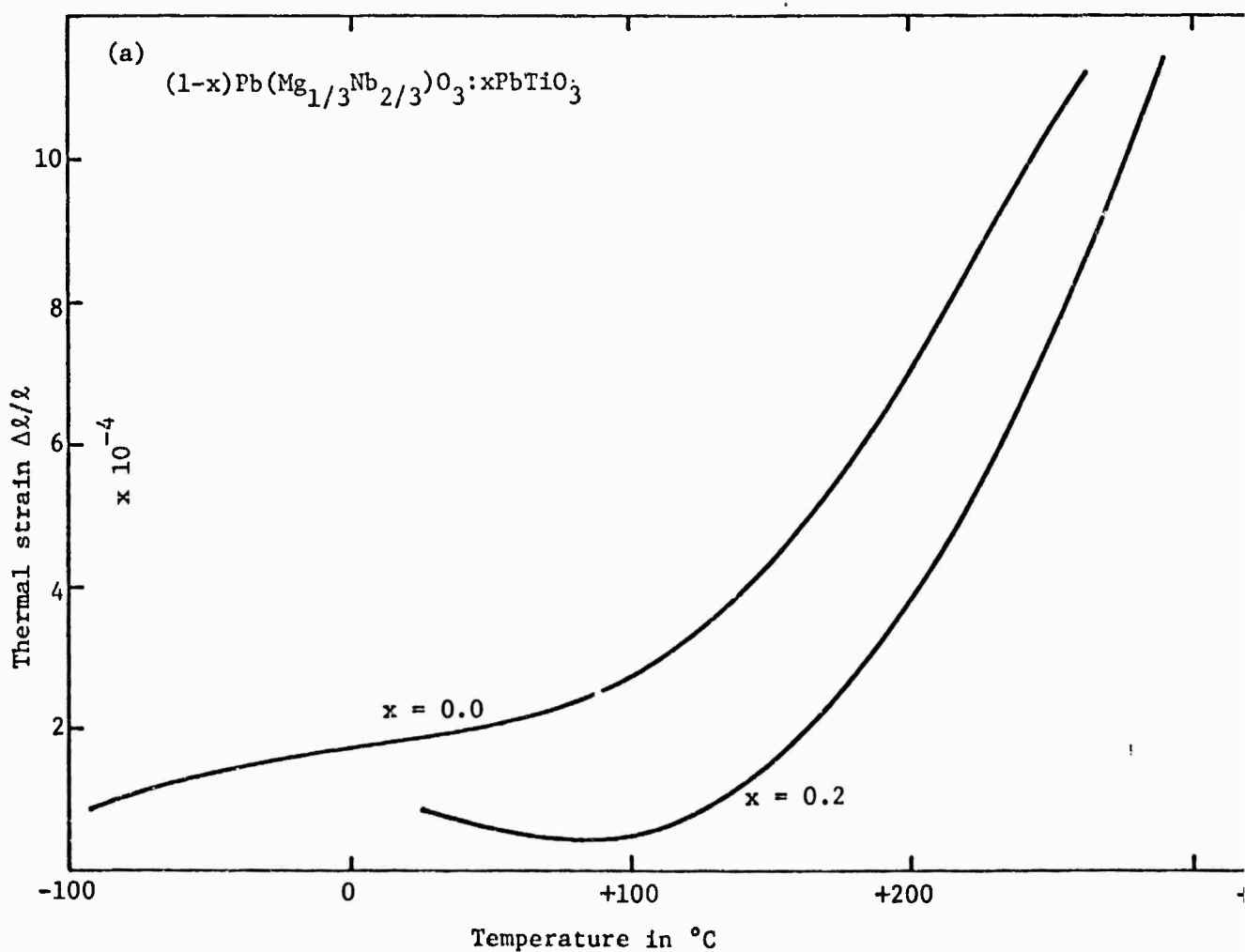
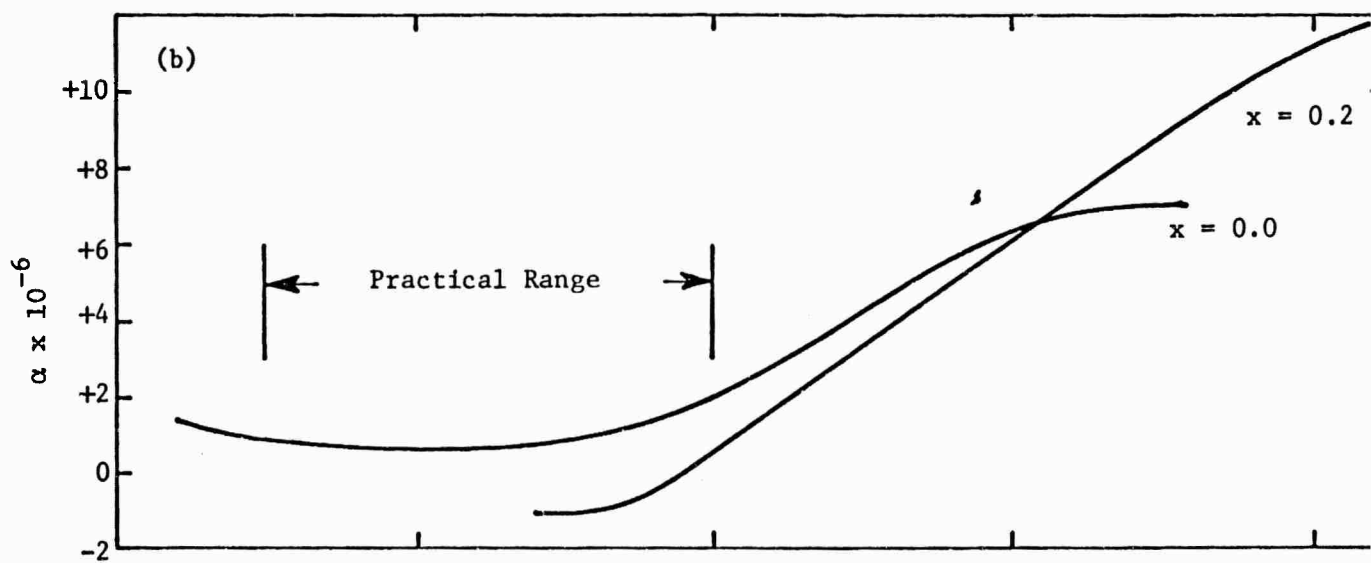

Figure 25. Thermal strain and thermal expansion coefficient α in PMN:PT solid solutions.