

**LEVEL II**

**12**  
B.S.

USAAEFA PROJECT NO. 77-36



ADA 064359

**ENGINEER DESIGN TEST I  
HUGHES YAH-64  
ADVANCED ATTACK HELICOPTER**

FINAL REPORT

RICHARD C. TARR  
MAJ, FA  
US ARMY  
PROJECT OFFICER/PILOT

VERNON L. DIEKMANN  
SENIOR PROJECT ENGINEER

ROBERT L. STEWART  
MAJ, AD  
US ARMY  
PROJECT PILOT

RALPH WORATSCHEK  
PROJECT ENGINEER

SEPTEMBER 1978

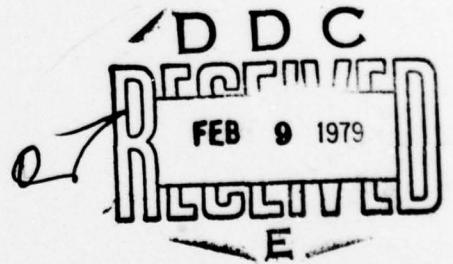

Approved for public release; distribution unlimited.

UNITED STATES ARMY AVIATION ENGINEERING FLIGHT ACTIVITY  
EDWARDS AIR FORCE BASE, CALIFORNIA 93523

DDC FILE COPY

79 02 05 137

#### **DISCLAIMER NOTICE**

**The findings of this report are not to be construed as an official Department of the Army position unless so designated by other authorized documents.**

#### **DISPOSITION INSTRUCTIONS**

**Destroy this report when it is no longer needed. Do not return it to the originator.**

#### **TRADE NAMES**

**The use of trade names in this report does not constitute an official endorsement or approval of the use of the commercial hardware and software.**

REPORT DOCUMENTATION PAGE		READ INSTRUCTIONS BEFORE COMPLETING FORM
1. REPORT NUMBER USAAEFA PROJECT NO. 77-36	2. GOVT ACCESSION NO.	3. RECIPIENT'S CATALOG NUMBER
6. TITLE (and Subtitle) ENGINEER DESIGN TEST 1, HUGHES YAH-64, ADVANCED ATTACK HELICOPTER.	9. AUTHOR(S) RICHARD C/TARR, RALPH/WORATSCHK ROBERT L/STEWART, VERNON L/DIEKMANN	5. TYPE OF REPORT & PERIOD COVERED FINAL REPORT
		6. PERFORMING ORG. REPORT NUMBER USAAEFA PROJECT NO. 77-36
9. PERFORMING ORGANIZATION NAME AND ADDRESS US ARMY AVIATION ENGINEERING FLIGHT ACTIVITY EDWARDS AIR FORCE BASE, CALIFORNIA 93523	10. PROGRAM ELEMENT, PROJECT, TASK AREA & WORK UNIT NUMBERS 46-8-P2088-01-46-EC	8. CONTRACT OR GRANT NUMBER(s)
11. CONTROLLING OFFICE NAME AND ADDRESS US ARMY AVIATION ENGINEERING FLIGHT ACTIVITY EDWARDS AIR FORCE BASE, CALIFORNIA 93523	11. REPORT DATE SEPTEMBER 1978	13. NUMBER OF PAGES 154
14. MONITORING AGENCY NAME & ADDRESS (if different from Controlling Office) USAAEFA-77-36	15. SECURITY CLASS. (of this report) UNCLASSIFIED	15a. DECLASSIFICATION/DOWNGRADING SCHEDULE
16. DISTRIBUTION STATEMENT (of this Report) Approved for public release; distribution unlimited.		
17. DISTRIBUTION STATEMENT (of the abstract entered in Block 20, if different from Report)		
18. SUPPLEMENTARY NOTES		
19. KEY WORDS (Continue on reverse side if necessary and identify by block number) Handling qualities evaluation      Handling qualities design Engineer Design Test 1              change effects Hughes YAH-64 advanced              Stability augmentation system attack helicopter Yaw divergence                      was conducted		
20. ABSTRACT (Continue on reverse side if necessary and identify by block number) The United States Army Aviation Engineering Flight Activity conducted a Handling Qualities Evaluation, Engineer Design Test 1, of the Hughes Helicopter Company YAH-64 advanced attack helicopter from 22 April 1978 through 1 May 1978 at the Hughes Helicopter Company Flight Test Facility, Palomar Airport, Carlsbad, California (elevation 320 feet). A total of 15 flights were conducted during 21.8 hours (17.4 hours productive). The objectives of the test were to reevaluate certain flight characteristics which were undesirable during Phase 1 testing, and		

409 025

JOB

**UNCLASSIFIED**

SECURITY CLASSIFICATION OF THIS PAGE(When Data Entered)

(cont.) 20. Abstract

to assess the effect of design changes on aircraft handling qualities. This phase of the aircraft development was not intended to address all of the undesirable flight characteristics uncovered during the Phase 1 testing. Many enhancing characteristics, deficiencies, and shortcomings, reported during the government competitive test (GCT) remain valid. Handling qualities in left sideward flight, stability augmentation system (SAS) both ON and OFF, are improved compared to the GCT. The yaw divergence seen during the GCT in left sideward flight, SAS ON or OFF, has been eliminated. Two deficiencies and five shortcomings were corrected between the CGT and this evaluation. Four new deficiencies, identified during this evaluation, require correction: excessive vibration levels and canopy drumming in decelerations through translational lift and in forward flight at airspeeds greater than 120 knots calibrated airspeed (KCAS); tail rotor teeter stop pounding and resulting high tail rotor and tail boom loads with relatively small pedal inputs at airspeeds greater than 115 KCAS; a main rotor/canopy clearance of less than 9 inches and droop stop contact following a rapid 1.4-inch forward longitudinal control input with the incorporation of the quickening feature of the SAS; and inability to control heading in left sideward flight with SAS OFF at 20 to 35 knots true airspeed (KTAS) at the critical azimuth (handling qualities rating scale (HQRS)9), and at the 270-degree azimuth at 25 to 30 KTAS (HQRS 7). Ten new shortcomings were identified: poor heading control in right and left sideward flight, SAS OFF, and left sideward flight and flight at the critical azimuth, SAS ON; the divergent pitch coupled dutch roll short term dynamic characteristics, SAS OFF, above 117 KCAS; the requirement to continually retrim the aircraft to minimize longitudinal cyclic trim changes; the requirement to manually disengage the SAS for all ground taxi operations; the illumination of the ENGINE OIL BYPASS caution light during engine start; the accessory gearbox oil pressure low light illumination in sideward flight above 10 knots true airspeed and during low g maneuvers; the slow rotor speed trim rate; poor trimmability between 75 and 105 KCAS; the inaccurate vertical velocity indications during an instrument takeoff; and the high directional control sensitivity in a hover (SAS ON). The YAH-64 continues to have the potential to be developed into an excellent attack helicopter.

ACCESSION for	
NTIS	White Section <input checked="" type="checkbox"/>
DDC	Buff Section <input type="checkbox"/>
UNANNOUNCED	<input type="checkbox"/>
JUSTIFICATION	
BY	
DISTRIBUTION/AVAILABILITY CODES	
Dist.	AVAIL. SPECIAL
A	

**UNCLASSIFIED**

SECURITY CLASSIFICATION OF THIS PAGE(When Data Entered)



**DEPARTMENT OF THE ARMY**  
HQ, US ARMY AVIATION RESEARCH AND DEVELOPMENT COMMAND  
P O BOX 209, ST. LOUIS, MO 63166

DRDAV-EQ

DEC 22 1978

**SUBJECT:** Directorate for Development and Engineering Position on the Final Report of USAAEFA Project No. 77-36, Engineering Design Test 1, Hughes YAH-64, Advanced Attack Helicopter (AAH)

SEE DISTRIBUTION

1. The subject report represents the first Government flight evaluation of the YAH-64 after its entrance into full scale engineering development. The overall configuration remains in an early stage of development, resulting in flight envelope limitations that are only slightly different from those imposed during the Government Competitive Test (GCT). That test program resulted in the US Army Aviation Engineering Flight Activity (USAAEFA) assessing 16 enhancing characteristics, 7 deficiencies, and 64 shortcomings. This recent flight test effort documents significant improvements in many areas; however, four additional deficiencies and ten additional shortcomings were identified. This partly results from increased flight envelope made possible by the incorporation of the swept tip main rotor blade. Two deficiencies and five shortcomings from the original AEFA assessment were determined during these tests to have been corrected with the Mod 1 configuration.
2. The YAH-64 was selected as the AAH design to enter full scale engineering development based on the proceedings of a Source Selection Evaluation Board (SSEB). The AAH SSEB negotiated corrections which were incorporated in the Phase 2 design for all significant problems encountered during the GCT but were not necessarily in agreement with all the deficiencies and shortcomings proposed by AEFA. Therefore, this report or any future reports should not be used as a check list for development status based solely on the correction of deficiencies and shortcomings as defined by any test agency. The incorporation of Mod 1 changes was not intended to incorporate corrections to all airframe problems. For example, increased blade to canopy clearance will be achieved by increasing the rotor height an additional six inches. This could not be achieved in the Mod 1 work effort but was first flown as part of Mod 2 on 28 November 1978.

DRDAV-EQ

SUBJECT: Directorate for Development and Engineering Position on the  
Final Report of USAAEFA Project No. 77-36, Engineering Design  
Test 1, Hughes YAH-64, Advanced Attack Helicopter (AAH)

DEC 22 1978

3. Specific comments on the conclusions and recommendations are contained herein:

a. Paragraphs 74 b and c: The report clearly substantiates the improvement and handling qualities during left sideward flight with stability augmentation system (SAS) operative. It should also be noted that the prohibition against accelerating to the left (as opposed to steady state sideward flight) has been lifted. This prohibition was imposed for GCT to avoid potential loss of control due to excessive pilot workload in maintaining heading during rapid acceleration to the left. While some improvement also has been made on left sideward flight with SAS inoperable, additional improvement is needed.

b. Paragraph 74 e: The vibration environment and significance of canopy drumming have degraded from the GCT configuration as illustrated in the report; however, until comparable data for the final rotor hub and rotor support structure with the increased rotor height are available, specific actions as a result of these high vibrations need not be taken. Increasing rotor height has been shown on other articulated rotor systems to improve vibration.

c. Paragraph 74 g: The ease of control of the YAH-64 as a result of single axis hardover failures of the SAS should be considered an enhancing characteristic in that pilot compensations are significantly less than any of our current US Army operational aircraft. This represents a step forward in safety.

d. Paragraph 74 h: The concept of reduced speed with inoperative SAS is common to most helicopters; however, the magnitude of the required slow down on AAH remains open in that the divergent oscillations grow quite rapidly at speeds above 120 knots, and the impact of the acceptable reduced speed on overall range must be deferred until performance testing with Target Acquisition Designation System/Pilot Night Vision System (TADS/PNVS) and HELLFIRE penalties is accomplished.

e. Paragraph 74 k: The peak tail rotor power discussed in this report will not be a problem when the Mod 2 tail rotor/drive system is incorporated. This drive system will accept transient inputs up to 875 shaft horsepower without adverse effects. The tail rotor drive system has been successfully tested on the bench to the transient horsepower mentioned.

DRDAV-EQ

DEC 22 1978

SUBJECT: Directorate for Development and Engineering Position on the Final Report of USAAEFA Project No. 77-36, Engineering Design Test 1, Hughes YAH-64, Advanced Attack Helicopter (AAH)

f. Paragraph 75: As previously pointed out the increased rotor height and the final rotor support structure together with canopy glass design changes should alleviate the excessive vibration problems and rotor canopy clearance problems. Mod 2 design changes eliminate tail rotor teeter stop pounding and in turn excessive loads. The poor left sideward flight characteristic with SAS inoperative remains an unsolved problem; however, it must be emphasized that the aircraft incorporates a three-axis SAS with the longitudinal and lateral axis being essentially redundant. Redundancy in the directional axis would further reduce the probability of a total SAS failure and therefore should be considered.

g. Paragraph 76 a: It must be understood that while heading control and left and right sideward flight SAS OFF and left and right sideward SAS ON remain a problem, significant improvements have been made from the GCT configuration in that this was originally considered a deficiency during the GCT.

h. Paragraph 76 b: The divergent pitch coupled dutch-roll oscillation at high airspeeds and with total SAS inoperative was not uncovered during GCT because the aircraft was not cleared to the speeds evaluated in this test at the altitude and gross weight in question. Developmental progress allowing the aircraft to be evaluated at higher speeds uncovered this shortcoming. The impact of this shortcoming on IMC flight remains open as previously discussed.

i. Paragraph 76 d: Design changes are being incorporated to make SAS disengagement for ground operations automatic.

j. Paragraphs 76 e and f: Design changes are being incorporated to correct these drive system problems.

4. This Directorate concurs with Recommendations 79 - 83 and is working with the AAH Program Manager for their implementation. Changes in the YAW CAS gain in high speed flight will significantly improve the flight characteristics of the aircraft. IMC flight limitations under SAS failure modes must remain open until further testing has been accomplished. Such testing will logically require input from user pilots as well.

5. Although not a new shortcoming, a significant concern remains regarding the high nose up attitude during climbing flight of this high performance helicopter and for some nap-of-the-earth operations. Studies are being conducted to improve this situation as well as those discussed by the AEFA recommendations.

DRDAV-EQ

DEC 22 1978

SUBJECT: Directorate for Development and Engineering Position on the  
Final Report of USAAEFA Project No. 77-36, Engineering Design  
Test 1, Hughes YAH-64, Advanced Attack Helicopter (AAH)

6. As discussed in paragraph 1, this AEFA evaluation was conducted within a restricted flight envelope on a prototype aircraft that is not representative of the final Phase 2 design, and therefore, must be considered an interim progress report. Improvements made by the contractor through the optimization of the flight control system have been substantial. EDT 2 to be conducted in March 1979 will allow evaluation of remaining significant Phase 2 air vehicle design changes. Until this is accomplished, the ability of the YAH-64 to meet airworthiness flying quality requirements must remain open, although the potential exists for excellent flight characteristics of this aerial vehicle as a weapons platform.

FOR THE COMMANDER:

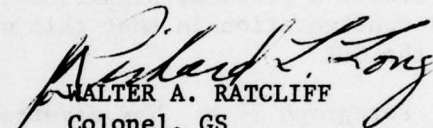
  
WALTER A. RATCLIFF  
Colonel, GS  
Director of Development  
and Engineering



# TABLE OF CONTENTS

	<u>Page</u>
<b>INTRODUCTION</b>	
Background . . . . .	1
Test Objectives . . . . .	1
Description . . . . .	1
Test Scope . . . . .	3
Test Methodology . . . . .	3
 <b>RESULTS AND DISCUSSION</b>	
Handling Qualities . . . . .	5
General . . . . .	5
Control System Mechanical Characteristics . . . . .	5
Control Positions in Trimmed Forward Flight . . . . .	7
Static Longitudinal Stability . . . . .	8
Static Lateral-Directional Stability . . . . .	8
Maneuvering Stability . . . . .	9
Dynamic Stability . . . . .	9
Ground Handling Characteristics . . . . .	11
Takeoff and Landing Characteristics . . . . .	11
Low-Speed Flight Characteristics . . . . .	11
Sideward Flight . . . . .	12
Forward and Rearward Flight . . . . .	15
Power Management . . . . .	15
Mission Maneuvering Characteristics . . . . .	16
Simulated Instrument Meteorological Conditions (IMC) . . . . .	16
Simulated Stability Augmentation System Failures During Simulated IMC Flight . . . . .	16
Structural Dynamics . . . . .	17
Vibration Characteristics . . . . .	17
Structural Loads . . . . .	18
 <b>CONCLUSIONS</b>	
General . . . . .	19
Deficiencies . . . . .	20
Shortcomings . . . . .	20

79 02 05 137

	<u>Page</u>
RECOMMENDATIONS . . . . .	21

APPENDIXES

A. References . . . . .	22
B. Aircraft Description . . . . .	23
C. Flight Control Description . . . . .	29
D. Engine Description . . . . .	49
E. Instrumentation . . . . .	52
F. Data Analysis Methods . . . . .	55
G. Test Data . . . . .	59

DISTRIBUTION

1	General
2	Control System Description
3	Control System in Forward Flight
4	State-Variable Stability
5	State-Variable Stability
6	Steady-State Stability
7	Dynamic Stability
8	Control System Characteristics
9	Control System Characteristics
10	Control System Characteristics
11	Control System Characteristics
12	Control System Characteristics
13	Control System Characteristics
14	Control System Characteristics
15	Control System Characteristics
16	Control System Characteristics
17	Control System Characteristics
18	Control System Characteristics
19	Control System Characteristics
20	Control System Characteristics
21	Control System Characteristics
22	Control System Characteristics
23	Control System Characteristics
24	Control System Characteristics
25	Control System Characteristics
26	Control System Characteristics
27	Control System Characteristics
28	Control System Characteristics
29	Control System Characteristics
30	Control System Characteristics
31	Control System Characteristics
32	Control System Characteristics
33	Control System Characteristics
34	Control System Characteristics
35	Control System Characteristics
36	Control System Characteristics
37	Control System Characteristics
38	Control System Characteristics
39	Control System Characteristics
40	Control System Characteristics
41	Control System Characteristics
42	Control System Characteristics
43	Control System Characteristics
44	Control System Characteristics
45	Control System Characteristics
46	Control System Characteristics
47	Control System Characteristics
48	Control System Characteristics
49	Control System Characteristics
50	Control System Characteristics
51	Control System Characteristics
52	Control System Characteristics
53	Control System Characteristics
54	Control System Characteristics
55	Control System Characteristics
56	Control System Characteristics
57	Control System Characteristics
58	Control System Characteristics
59	Control System Characteristics
60	Control System Characteristics
61	Control System Characteristics
62	Control System Characteristics
63	Control System Characteristics
64	Control System Characteristics
65	Control System Characteristics
66	Control System Characteristics
67	Control System Characteristics
68	Control System Characteristics
69	Control System Characteristics
70	Control System Characteristics
71	Control System Characteristics
72	Control System Characteristics
73	Control System Characteristics
74	Control System Characteristics
75	Control System Characteristics
76	Control System Characteristics
77	Control System Characteristics
78	Control System Characteristics
79	Control System Characteristics
80	Control System Characteristics
81	Control System Characteristics
82	Control System Characteristics
83	Control System Characteristics
84	Control System Characteristics
85	Control System Characteristics
86	Control System Characteristics
87	Control System Characteristics
88	Control System Characteristics
89	Control System Characteristics
90	Control System Characteristics
91	Control System Characteristics
92	Control System Characteristics
93	Control System Characteristics
94	Control System Characteristics
95	Control System Characteristics
96	Control System Characteristics
97	Control System Characteristics
98	Control System Characteristics
99	Control System Characteristics
100	Control System Characteristics

# INTRODUCTION

## BACKGROUND

1. In June 1973, the United States Army Aviation Systems Command (AVSCOM) awarded a Phase 1 advanced development contract to Hughes Helicopter Company (HHC). The contract required HHC to design, develop, fabricate, and initiate development/qualification of two advanced attack helicopter (AAH) prototypes and a ground test vehicle as part of a Government Competitive Test (GCT). As part of the GCT, the United States Army Aviation Engineering Flight Activity (USAAEFA) conducted Development Test I (DT I) using two of these aircraft. The terms Phase 1, GCT, and DT I are synonymous and are used interchangeably throughout this report. Several deficiencies and shortcomings of the aircraft were found during DT I (ref 1, app A). In December 1976, the United States Army Aviation Research and Development Command (AVRADCOM) (formerly AVSCOM) awarded a Phase 2 engineering development contract to HHC for further development and qualification of the YAH-64 to include the qualification of full systems, subsystems, and mission essential equipment. In April 1978 AVRADCOM requested that USAAEFA conduct Engineer Design Test 1 (EDT-1) on the YAH-64 at the Hughes flight test facility, Palomar Airport, Carlsbad, California, during April and May 1978 (ref 2). A test plan (ref 3) was submitted in April 1978, and the airworthiness release (ref 4) was issued 20 April 1978 and revised on 22 April 1978 to reflect flight time limitations above 140 knots calibrated airspeed (KCAS) (ref 5).

## TEST OBJECTIVES

2. The test objectives of EDT-1 were as follows:
  - a. Reevaluate flight characteristics of the aircraft which were undesirable during Phase 1 testing.
  - b. Assess the effect of design changes on aircraft handling qualities.

NOTE: The DT I (GCT) list of enhancing characteristics, deficiencies, and shortcomings will not be readdressed in this report except for those specific items observed during this evaluation.

## DESCRIPTION

3. The YAH-64 is a two-place, tandem-seat (pilot-in-the-rear), twin-engine helicopter with four-bladed main and antitorque rotors and conventional wheel landing gear. The helicopter is powered by two General Electric T700-GE-700 turboshaft engines. The YAH-64 incorporates a T-tail empennage with the fixed horizontal stabilizer mounted above the tail rotor. Two T-tail configurations were evaluated during this test. The Phase 1 horizontal stabilizer features swept leading

(25-degree) and trailing (6.62-degree) edges. The Mod 1 horizontal stabilizer features a straight leading edge and a swept forward (-19.31-degree) trailing edge. Both horizontal stabilizers are of approximately equal area (33 ft<sup>2</sup>). A 30mm gun can be mounted on a turret assembly on the underside of the fuselage below the forward cockpit. A wooden mockup of the 30mm cannon was used to aerodynamically simulate the gun in the stowed position. Wing pylons can carry HELLFIRE missiles or 2.75-inch folding fin aircraft rockets (FFAR). The test aircraft was Army serial number 74-22248. The mission gross weight was assumed to be 14,392 pounds, and the structural design gross weight was 14,660 pounds. The aircraft did not include operable armament subsystems or typical mission equipment except for communications radios. A more detailed description of the aircraft and flight controls is contained in appendixes B and C. Appendix D contains an abbreviated description of the YT700-GE-700 engines used during this test.

4. Major changes to the helicopter since DT I included the following:

- a. Nacelle and adjacent fuselage structure redesigned to accommodate the "black hole" infrared (BHOIR) suppression system.
- b. Horizontal and upper vertical stabilizer replaced with a T-tail configuration as described above (Mod 1 tail).
- c. Deck area catwalk extended forward to cover tail rotor drive shaft area exposed by cooling fan removal.
- d. Modified trailing edge for the lower vertical stabilizer.
- e. Airspeed static port relocated due to BHOIR installation.
- f. Rotor support truss members strengthened.
- g. Main transmission heat exchangers replaced.
- h. Antiflail strap added to auxiliary power unit (APU) drive shaft.
- i. Main rotor blades incorporating swept tips.
- j. Automatic stabilization equipment (ASE) computer modified to incorporate design refinements.
- k. Environmental control system (ECS) cooling air duct relocated to accommodate the BHOIR suppression system.
- l. APU exhaust relocated to accommodate the BHOIR.
- m. Fire bottle charge capacity increased to 1.5 pounds.
- n. Hydraulic subsystem oil cooling hardware modified to accommodate removal of engine cooling fan.
- o. Tail rotor blades incorporating an effective reduction in camber.

### TEST SCOPE

5. Flight testing for EDT-1 was conducted at Palomar Airport, Carlsbad, California (320-foot elevation) from 22 April 1978 through 1 May 1978. A total of 15 flights were conducted during which 21.8 hours (17.4 hours productive) were flown. Each Army test pilot (two) flew with an HHC test pilot acting as the aircraft commander/data recorder. HHC installed, calibrated, and maintained the test instrumentation and performed all aircraft maintenance during the test. Flight restrictions and operating limitations contained in the airworthiness release issued by AVRADCOM were observed during the evaluation. Handling qualities data were compared to results obtained during the GCT, when possible.

6. The scope of test is shown in table 1. The aircraft with the Mod 1 tail installed was the primary test configuration; however, low-speed left sideward flight and high-speed dutch roll characteristics were also evaluated with the Phase 1 tail installed on the aircraft.

### TEST METHODOLOGY

7. Established flight test techniques and data reduction procedures were used (ref 6, app A). Test methods are briefly discussed in the Results and Discussion section of this report. A handling qualities rating scale (HQRS) (fig. 1, app F) was used to correlate with pilot comments on the handling qualities of the test aircraft. A vibration rating scale (VRS) (fig. 2) was used to augment crew comments relative to aircraft vibration levels. Flight test data were obtained from calibrated test instrumentation and were recorded on magnetic tape. Real time telemetry was used to monitor selected critical parameters throughout the flight test. A detailed listing of the test instrumentation is contained in appendix E. Data analysis methods are described in appendix F.

Table 1. Test Conditions<sup>1</sup>

Type of Test	Average Gross Weight (lb)	Longitudinal Center-of-Gravity Location <sup>2</sup> (ft)	Average Density Altitude (ft)	Trim Calibrated Airspeed (kt)	Tail Configuration	Stability Augmentation System Condition
Control positions in trimmed forward flight	13,860 to 14,640	206.8 (aft) to 207.2 (aft)	4860 to 5680	37 to 146	Mod 1	ON
	14,740	206.7 (aft)	4740	50 to 133	Phase 1	ON
Static longitudinal stability	14,700 and 14,900	206.9 (aft) and 207.0 (aft)	5020 and 5400	60 to 138	Mod 1	ON
Static lateral-directional stability	14,560 and 14,780	206.7 (aft) and 206.8 (aft)	4840 and 5240	94 and 145	Mod 1	ON
Maneuvering stability	14,300 to 14,680	206.9 (aft) to 207.1 (aft)	4340 to 5340	94	Mod 1	ON
Dynamic stability	13,900 to 14,960	206.6 (aft) to 207.1 (aft)	4880 to 5280	86 to 128	Mod 1	ON and OFF
	14,560 to 14,880	206.8 (aft) to 206.9 (aft)	4900 to 5120	98 to 132	Mod 1	ON and OFF
Sideward flight	14,340 to 14,860	200.4 (fwd) to 200.8 (fwd)	100 to 400	47 left to 47 right <sup>3</sup>	Mod 1	ON and OFF
	13,960 to 14,240	201.1 (fwd)	340 to 460	Zero to 45 left <sup>3</sup>	Phase 1	ON and OFF
Sideward flight-critical azimuth <sup>4</sup>	14,240 to 14,520	200.1 (fwd) to 200.2 (fwd)	360 to 400	Zero to 43 left <sup>3</sup>	Mod 1	ON and OFF
	14,600 to 14,880	201.1 (fwd)	440 to 600	Zero to 43 left <sup>3</sup>	Phase 1	ON and OFF
Low-speed forward and rearward flight	13,920 to 14,800	200.2 (fwd) to 200.4 (fwd)	200 to 480	45 rear to 60 (fwd) <sup>3</sup>	Mod 1	ON and OFF
Simulated SAS failures	13,460 to 14,900	206.7 (aft) to 207.0 (aft)	4180 to 5560	124 to 143	Mod 1	ON then OFF

<sup>1</sup>Rotor speed 288 rpm, clean configuration, attitude hold OFF.

<sup>2</sup>Lateral center of gravity location: Buttline station 0.4 left for all tests.

<sup>3</sup>Knots true airspeed (KTAS).

<sup>4</sup>Critical azimuth: Relative wind from 110° left of nose (250° azimuth).

## RESULTS AND DISCUSSION

### HANDLING QUALITIES

#### General

8. Handling qualities characteristics were evaluated at the test conditions listed in table 1. The handling qualities evaluation included both engineering flight maneuvers and operational-type flying. An HQRS was used to quantify the degree of difficulty or pilot effort required to accomplish specific tasks. Numerous enhancing characteristics, deficiencies, and shortcomings, reported during the GCT and not readdressed in this report, remain valid.

9. Four new deficiencies, identified during this evaluation, require correction: excessive vibration levels and canopy drumming in decelerations through translational lift and in forward flight at airspeeds greater than 120 KCAS; tail rotor teeter stop pounding and resulting high tail rotor and tail boom loads with relatively small pedal inputs at airspeeds greater than 115 KCAS; a main rotor/canopy clearance of less than 9 inches and droop stop contact following a rapid 1.4-inch forward longitudinal control input with the incorporation of the quickening feature of the SAS; and inability to control heading in left sideward flight with the SAS OFF at 20 to 35 KTAS at the critical azimuth (HQRS 9), and at the 270-degree azimuth at 25 to 30 KTAS (HQRS 7).

10. Ten new shortcomings were identified as a result of the handling qualities testing: poor heading control in right and left sideward flight, SAS OFF, and left sideward flight and flight at the critical azimuth, SAS ON; the divergent pitch coupled dutch-roll, short-term dynamic characteristics, SAS OFF, above 117 KCAS; the requirement to continually retrim the aircraft to minimize longitudinal cyclic trim changes; the requirement to manually disengage the SAS for all ground taxi operations; the illumination of the ENGINE OIL BYPASS caution light during engine start; the accessory gearbox oil pressure low light illumination in sideward flight above 10 KTAS and during low g maneuvers; the slow rotor speed trim rate; the poor trimmability between 75 and 105 KCAS; the inaccurate vertical velocity indications during an instrument takeoff (ITO); and the high directional control sensitivity in a hover (SAS ON).

#### Control System Mechanical Characteristics

11. The control system mechanical characteristics of the YAH-64 were measured on the ground with hydraulic and electrical power provided by ground power units, force trim system (FTS) ON and force feel system (FFS) ON and OFF, and were evaluated in flight throughout the flight test program. Results are presented in figures 1 through 5, appendix G. Table 2 is a summary of control system mechanical characteristics.

12. Longitudinal, lateral, and directional control centering was positive but not absolute. Control jump was significant in the directional control axis with activation or deactivation of the FTS. The directional control jump was particularly annoying during hover and ground taxi operations and when retrimming, a shortcoming previously reported during the GCT.

Table 2. Control System Mechanical Characteristics

Test Parameter	Control System		
	Longitudinal	Lateral <sup>2</sup>	Directional <sup>2</sup>
Breakout force (plus friction) (lb)	1.0 fwd, 1.6 aft <sup>1</sup>	1.4 left, 0.9 right	7.0 left, 13.5 right
	0.7 fwd, 0.9 aft <sup>2</sup>		
Full control travel (in.)	9.82	8.65	5.52
Control oscillation	None	None	None
Free play (in.)	Negligible	Negligible	Negligible
Mechanical coupling	None	None	None
Force to move stick 0.5 inch from trim (lb)	2.5 fwd, 2.9 aft <sup>1</sup>	1.5 left, 1.1 right	NA
	1.2 fwd, 1.25 aft <sup>2</sup>		
Limit control force (lb)	14.0 fwd, 13.6 aft <sup>1</sup>	3.0 left, 2.5 right	24 left, 22 right
	6.0 fwd, 4.9 aft <sup>2</sup>		
Control centering	Positive	Positive	Positive
Control jump	Negligible	Negligible	Significant
Control forces trimmable to zero	Yes	Yes	Yes
Force gradient (lb/in.)	2.6 fwd, 2.3 aft <sup>1</sup>	0.19 left, 0.18 right	5.4 left, 2.05 right
	0.86 fwd, 0.61 aft <sup>2</sup>		

<sup>1</sup>FFS ON.

<sup>2</sup>FFS OFF



13. Control forces could be readily and easily trimmed to zero in all three axes. Control force gradients presented in figures 2 through 5, appendix G, were measured with the FTS ON. All gradients were within those limits specified in reference 7, appendix A. There was no mechanical coupling in any of the controls. Breakout forces (plus friction) were not objectionable.

#### Control Positions In Trimmed Forward Flight

14. The control positions in trimmed forward flight were evaluated with both the Mod 1 and Phase 1 tail configurations. Typical level flight control position plots for each configuration are shown in figures 6 and 7, appendix G, and they were essentially identical. The variation of longitudinal control position with forward airspeed was conventional (increasing forward stick with increasing airspeed); however, a definite flattening of the control position versus airspeed gradient occurred between 75 and 105 KCAS. Minor variations shown between the two tail configurations in the longitudinal control position plots were not noticeable in flight. Adequate longitudinal control margins existed at the maximum airspeed tested. The trimmability at airspeeds in the 75 and 105 KCAS range was more difficult (HQRS 5) than at higher airspeeds (HQRS 3). Poor trimmability between 75 and 105 KCAS is a shortcoming.

15. The variations of lateral and directional control positions with forward airspeed were minimal and control margins were adequate. The instantaneous trim release button allowed all control forces to be easily trimmed to zero. The variation of lateral and directional control positions with forward airspeed and the mechanical characteristics of the trim release system were satisfactory.

16. The pitch attitude with the Mod 1 tail was nearly constant between 37 and 60 KCAS (8 degrees nose up) and decreased linearly with increasing forward airspeed to the maximum airspeed tested (0 degrees at 143 KCAS). The pitch attitude variation with the Phase 1 tail differed only at the lower airspeeds, in that the pitch attitude change from 50 to 61 KCAS was 1.5 degrees nose up.

17. Figure 8, appendix G, shows the effect of climb and descent on the trimmed control positions. For normal instrument meteorological condition (IMC) climbs and descents near approach or cruise altitude ( $\pm 500$  ft/min), very little retrimming was required. Maximum variation of power (intermediate rated power (IRP) climb to autorotation) at 80 KCAS required a 2.6-inch aft displacement of longitudinal control with no lateral trim change. This characteristic was also observed during the Phase 1 testing and remains a shortcoming, although the requirements of the Army systems specification (ref 7, app A) were met. Airspeed was difficult to establish during IRP climb due to the longitudinal trim shift caused by increased power, the lack of pitch attitude cues, and the nose-high attitude. Once airspeed was established in the climb, it could be maintained (HQRS 3) except around 60 KCAS, where small longitudinal control movements caused large changes in airspeed (HQRS 4). Pitch attitude in the IRP climbs ranged from 12 degrees nose up at 61 KCAS to 9 degrees nose up at 81 KCAS. The excessive nose-high pitch attitude in climbs and in forward flight seriously degraded forward field of view, a shortcoming previously reported during the GCT.

### Static Longitudinal Stability

18. Static longitudinal stability characteristics were evaluated at the conditions listed in table 1. The aircraft was trimmed in zero sideslip flight at the desired airspeed. With the collective control fixed, airspeed was stabilized both faster and slower than the trim airspeed without retrimming. Tests were flown with SAS ON and FFS OFF. Data recorded at each stabilized airspeed are presented in figures 9 and 10, appendix G.

19. At all conditions tested, the SAS did not significantly affect the static longitudinal stability. Longitudinal cyclic control position and control force did not provide adequate cues to the pilot of small deviations ( $\pm 10$  knots) from both trim airspeeds tested.

20. The static longitudinal stability of the YAH-64 about a trim airspeed of 60 KCAS was stable at airspeeds slower than trim, and essentially neutral at airspeeds near and faster than the trim airspeed. As airspeed was increased between 45 and 60 KCAS, the pitch attitude became increasingly nose-up, a shortcoming previously reported during the GCT. The essentially neutral longitudinal static stability characteristics (SAS ON or OFF) degraded aircraft trimmability at airspeeds greater than 60 KCAS when small airspeed changes (2 to 4 knots) were attempted (HQRS 4) and are a shortcoming previously reported during the GCT.

21. At a trim airspeed of 138 KCAS, the aircraft displayed weak static stability. The variation of pitch attitude with airspeed was conventional (increased nose-down pitch attitude for increased airspeed). Although the pitch attitude changes with airspeed variations were small, they were observable. With SAS ON, pilot workload in maintaining a desired airspeed was decreased when compared to SAS OFF. While small airspeed changes were difficult to precisely trim, large airspeed changes did not present a problem. The static longitudinal stability of the YAH-64 at a trim airspeed of 138 KCAS is acceptable.

### Static Lateral-Directional Stability

22. The static lateral directional stability characteristics were evaluated at the conditions listed in table 1. Tests were conducted by trimming the aircraft in steady-heading zero sideslip. Then, with the collective control fixed, the aircraft was stabilized at incremental sideslip angles, left and right, at a constant airspeed. Test results are presented in figures 11 and 12, appendix G.

23. At all conditions tested the aircraft exhibited positive directional stability (as indicated by the variation of directional control position with sideslip); positive dihedral effect (as indicated by the lateral control displacement with sideslip); and a positive side-force characteristic (as indicated by the variation of roll attitude with sideslip). The variation of longitudinal control position with sideslip indicates that some degree of coupling was still present with SAS ON, but not to the extent observed during the GCT and it is now acceptable. The 94 KCAS data (fig. 11, app G) showed essentially constant longitudinal control required in right sideslip while left sideslip required increasing aft control. The static lateral-directional stability characteristics were satisfactory.

### Maneuvering Stability

24. Maneuvering stability was evaluated during pushovers and pull-ups and constant collective, constant airspeed left- and right-hand turns at the flight conditions listed in table 1. The variation of longitudinal control position and pitch rates with cg normal acceleration was determined using symmetrical pushovers and pull-ups. The variation of longitudinal control position and force with cg normal acceleration was determined by stabilizing the aircraft at increasing bank angles, holding airspeed and collective position constant with zero sideslip during the maneuver. Maneuvering stability characteristics are presented in figures 14 and 15, appendix G.

25. All maneuvering stability tests were conducted with FFS OFF. With FFS ON, the longitudinal control centering device (longitudinal force trim) was by design electrically deactivated. A trim airspeed of 102 KCAS could not be maintained with hands off the controls. Figure 13, appendix G, shows the aircraft response with FFS ON, hands off the controls.

26. Figure 14, appendix G, shows the stick-fixed (control position) and the stick-free (control force) maneuvering stability of the YAH-64 during fixed collective, zero sideslip turning flight at 94 KCAS. The stick-fixed maneuvering stability was positive and essentially linear with a gradient of approximately 0.8 in./g. The stick-free maneuvering stability was weakly positive at approximately 1.5 lb/g. Control forces were qualitatively judged to be light at the airspeed tested. However, the pilot does not generally use control force or control position cues when maneuvering at g levels between 1.0 and 2.0g. Roll attitude control was adequate up to the maximum roll attitude tested (50 degrees) (HQRS 3). Precise airspeed control became increasingly more difficult as roll attitude increased (HQRS 5 at 45 degrees bank angle, HQRS 6 at 50 degrees bank angle).

27. Vibration increases with increasing normal acceleration were mild but noticeable as an increase in the 4-per-rotor-revolution (4/rev) airframe vibration levels. No perceptible instrument blurring or control vibrations were noted.

28. Stick-fixed maneuvering stability during symmetrical pull-ups and pushovers was evaluated using standard test techniques. Data are presented in figure 15, appendix G. Stick-fixed maneuvering stability was stable at the airspeed tested. The gradient was approximately 0.7 in./g. No divergent pitch tendencies were noted. The aircraft was fully controllable at the lowest g level tested (0.48g). At low g levels, the accessory gearbox low oil pressure caution light often illuminated, but extinguished very soon after reestablishing a 1.0g flight condition. The problems with the oil pressure sensor are further discussed in paragraph 53. The maneuvering stability characteristics of the YAH-64 remain unchanged from those observed during the GCT, and are satisfactory.

### Dynamic Stability

29. The short-term dynamic stability characteristics (gust response) of the YAH-64 were evaluated at the conditions listed in table 1. Longitudinal and lateral dynamic stability characteristics were excited by 1-inch, 1/2-second single-axis pulses, SAS ON and OFF, attitude hold OFF. A limited evaluation of directional dynamic stability characteristics was accomplished using 1/2-inch pulses, SAS ON, and 1-inch

pulses SAS OFF; SAS ON 1/2-inch pedal doublets; and releases from steady heading sideslips. Directional dynamic stability tests were discontinued due to tail rotor teeter stop pounding and resulting high structural loads (para 72). Typical time histories are presented in figures 16 through 24, appendix G, and damping summaries with the Mod 1 and Phase 1 tails are presented in figures 25 and 26.

30. The SAS ON longitudinal response characteristics were essentially deadbeat, as shown in figure 16, appendix G. The roll response to pitch input was not objectionable. Pitch rate was damped rapidly, and the aircraft returned toward the trim attitude with a slight overshoot. The SAS ON longitudinal dynamic stability characteristics were satisfactory. By contrast the SAS OFF forward pulse (fig. 17) excited a three axis-coupled oscillation, which was characteristic of SAS OFF pulse control inputs in all axes. This pitch coupled dutch-roll oscillation is discussed in paragraphs 32, 33, 35, and 36.

31. Figure 18, appendix G, is a time history of a SAS ON left lateral pulse. The response was deadbeat and the aircraft tended to return to the trim roll attitude. Virtually no tendency toward pitch coupling was seen with SAS ON. The SAS ON roll dynamic stability characteristics are satisfactory.

32. The response of the YAH-64 to SAS OFF lateral pulses was a coupled pitch and dutch-roll oscillation. This mode couples all three axes and was characteristic of the aircraft's response to SAS OFF inputs in any axis. The lateral control was chosen as a convenient method of exciting this dynamic response. SAS OFF 1-inch left lateral inputs were made at 5-knot increments between 86 and 128 KCAS. Figures 19, 20, and 21, appendix G, are typical examples of this oscillatory response as a function of airspeed with the Mod 1 tail installed. The damping of the oscillation decreased with increasing airspeed. At 86 KCAS the oscillation was noticeable but well damped. At slower airspeeds the oscillation was not readily discernable. As airspeed was increased from 86 KCAS, damping decreased until the oscillation became neutrally damped at approximately 117 KCAS. As airspeed increased above 117 KCAS, damping became increasingly negative. The oscillatory mode was generally superimposed on a spiral mode or a longitudinal mode. The period of the oscillation varied slightly but was always near 4 seconds. In all cases, this oscillation was easily controlled when the pilot entered the control loop under either visual flight conditions or simulated instrument flight conditions.

33. Left lateral pulses were also used to excite this oscillation with the Phase 1 tail installed. Figures 22, 23, 24, appendix G, are time histories of the oscillation with the Phase 1 tail. There was no difference in the oscillatory characteristics of the aircraft with either tail installed.

34. Figures 25 and 26, appendix G, summarize the damping ratios as a function of airspeed. A comparison of these two figures shows that, with either the Mod 1 or Phase 1 tails installed, damping is essentially the same.

35. The response of the aircraft to 1-inch pedal pulses at 93 KCAS is shown in figures 27 and 28, appendix G. The SAS ON response (fig. 27) was essentially deadbeat. The roll response to pedal input shows an initial tendency to roll left with a right pedal pulse input, followed immediately by a right roll as the aircraft began to sideslip. The yaw SAS time history shows that the yaw control

augmentation system (CAS) made a full 20 percent authority input in either direction in response to the pedal movement during the pulse. Structural loads were not excessive during this input because of the low airspeed. A similar input at higher airspeed which caused excessive structural loads due to tail rotor teeter stop pounding is discussed in paragraph 72. The response of the YAH-64 to a release from steady-heading sideslip, SAS ON, at 142 KCAS also resulted in high structural loads due to teeter stop contact and tail boom bending, and is also discussed in paragraph 72. The divergent pitch coupled dutch-roll short-term dynamic response characteristics are a shortcoming at airspeeds above 117 KCAS.

36. The YAH-64 response to a SAS OFF directional pulse is shown in figure 33, appendix G. The response was the typical coupled pitch and dutch roll oscillation. The oscillation was damped in all axes, and the aircraft was easily recovered once the pilot reentered the control loop. The SAS OFF pitch coupled dutch-roll short-term dynamic characteristics are acceptable at airspeeds below 117 KCAS.

#### Ground Handling Characteristics

37. Ground handling characteristics were evaluated on a daily basis on concrete and macadam ramps and taxiways with a portion of the taxiway inclined approximately 3 degrees. Wind conditions were generally calm except for occasional conditions with gusts to 10 knots.

38. Ground handling characteristics remained essentially unchanged from those noted during the GCT, with one addition: it was necessary to disengage the SAS for all ground taxi operations. This action was necessary to prevent the SAS from imposing small control inputs, particularly in the directional axis, while attempting precise taxiing maneuvers. The directional SAS authority increase from 10 to 20 percent and the yaw CAS apparently caused this problem. The requirement to manually disengage the SAS for all ground taxi operations is a shortcoming.

#### Takeoff and Landing Characteristics

39. Takeoff and landing characteristics were evaluated throughout the test at a gross weight of 15,100 pounds, forward and aft cg, and SAS ON and OFF. Wind conditions ranged from generally calm to occasionally gusting to 10 knots.

40. Takeoff and landing characteristics remain essentially unchanged from those noted during the GCT, with one exception. Hover stability during the GCT was satisfactory. Hover stability during the EDT-1, SAS OFF, was acceptable. However, the directional control characteristics, SAS ON, were degraded and are further discussed in paragraph 52.

41. Vibration levels during the approach to hover were significantly increased over those observed during the GCT. These increased vibration levels are further discussed in paragraph 70.

#### Low-Speed Flight Characteristics

42. The low-speed flight characteristics of the YAH-64 with the Mod 1 horizontal stabilizer were evaluated at the conditions listed in table 1. These tests were accomplished to assess low-speed handling qualities and to simulate hovering with

a head wind, tail wind, right and left crosswind, and at the critical azimuth (wind from 110 degrees left of the nose). Handling qualities were evaluated with SAS ON and OFF. A limited evaluation of left sideward flight characteristics was conducted using a Phase 1 horizontal stabilizer at the test conditions listed in table 1. A ground pace vehicle was used as a speed reference during all low-speed flight evaluations. Data from the pace vehicle were corrected for winds to obtain true airspeed. Winds for tests of the Mod 1 configuration were less than 3 knots, while less favorable conditions (winds variable 3 to 7 knots) were encountered during tests of the Phase 1 configuration. Tests were conducted at a main wheel height of approximately 10 feet in ground effect (IGE). Data are presented in figures 29 through 40, appendix G.

#### **Sideward Flight:**

43. Two techniques were used to evaluate sideward flight. Figure 29, appendix G, depicts the results when the aircraft was trimmed at each stabilized point (*ie*, the SAS was recentered, thus allowing full authority). Figure 30 depicts sideward flight characteristics when the aircraft was trimmed only at the zero airspeed hover. In this case a portion of the SAS authority was lost to the limited authority pitch and roll attitude retention feature of the SAS. Lateral and directional control characteristics were similar in both cases.

44. In figure 29, appendix G, the gradient of longitudinal control position with respect to airspeed shows a distinct change when compared to the similar curve of figure 30; however, this change was not objectionable to the pilot. At approximately 20 KTAS in right sideward flight, a local maximum of left pedal and tail rotor power occurred. Flight at this airspeed required that the pilot divide his attention between aircraft attitude control and monitoring the tail rotor horsepower, because of the temporary tail rotor horsepower limitation imposed on the developmental hardware. As airspeed was increased, the tail rotor power became less critical and less left directional control was required up to an airspeed of approximately 30 KTAS. At airspeeds greater than 30 KTAS, increased left directional control and increasing tail rotor horsepower was required. When operating the aircraft in a right crosswind of 15 to 20 knots or in excess of 35 knots, the tail rotor horsepower required is in a 2-minute time limited area. Gusty wind conditions may demand peak tail rotor power in excess of the present temporary limit.

45. The variations of lateral control position with sideward flight airspeed using both trim techniques were essentially identical, with more lateral control displacement required for increased sideward airspeed in either direction. This variation was greater in right sideward flight than in left sideward flight. This asymmetry was barely noticeable to the pilot, and was not objectionable.

46. Control activity at the higher sideward airspeeds, both left and right, was greater when the aircraft was not trimmed at each point. This is attributed to decreased SAS authority due to a SAS bias caused by the attitude retention feature. When the aircraft was trimmed at a hover, telemetry data showed that the SAS actuators were positioned to full extension during the high workload points. The effect of trim technique was most noticeable in the longitudinal control position characteristics. When the aircraft was trimmed at each point there was less variation

in longitudinal control position with sideward airspeed. When the aircraft was trimmed at a hover, the effects of the attitude retention feature of the SAS were evident in the increased pilot workload. The requirement to continually retrim the aircraft to minimize longitudinal cyclic trim changes is a shortcoming. Consideration should be given to providing the pilot with a capability of selecting or rejecting SAS attitude hold while retaining full SAS authority.

47. Figure 31, appendix G, presents the trim curves of the YAH-64 with Mod 1 horizontal stabilizer in SAS OFF left and right sideward flight. Control position data are in close agreement with figure 30 (SAS ON, trimmed at a hover); however, there is a marked increase in longitudinal and directional control activity (as indicated by the size of the extreme travel points) in left sideward flight at airspeeds in excess of 20 KTAS. Adequate heading control could not be maintained at this condition with maximum tolerable pilot workload (HQRS 7). The inability to control heading, SAS OFF, in left sideward flight at 25 to 30 KTAS is a deficiency.

48. Though still a deficiency, the YAH-64 handling qualities in SAS OFF left sideward flight are improved over the GCT configuration (reported in ref 1, app A). In the GCT configuration aircraft control was lost in left sideward flight, SAS ON and OFF, through a yaw divergence (tail into the wind) and accompanying nose-down pitch. The sideward flight task was rated HQRS 10. The problem with the EDT-1 configurations was reduced to one of an inability to control heading within tolerable pilot workload, SAS OFF only (HQRS 7). Aircraft control in the EDT-1 configurations was not in question. With SAS ON in left sideward flight, the pilot was able to control heading with moderate compensation (HQRS 4).

49. Contractor data indicated that the critical condition for the Mod 1 tail configuration was a wind from 110 degrees left of the nose (250-degree azimuth). The data are presented in figures 32 and 33, appendix G. The aircraft could be flown at this azimuth, SAS ON; however, considerable pilot compensation was required at the critical airspeeds from 25 to 35 KTAS (HQRS 5). At airspeeds faster and slower than this airspeed range, control was easier (HQRS 4). With SAS OFF the aircraft could not be stabilized at the critical azimuth (HQRS 9). In an attempt to stabilize, the pilot characteristically drove the aircraft in an oscillatory fashion about the desired trim azimuth. Figure 4 is a time history of an attempt to maintain heading control at 30 KTAS in 110 degrees left sideward flight. At this condition, control of the aircraft was not in doubt, but the desired stabilized flight condition could not be attained.

50. Table 3 is a summary of sideward flight handling qualities ratings as a function of evaluator, airspeed, SAS condition, and relative wind azimuth. In general, the YAH-64 handling qualities in right and left sideward flight, SAS OFF, and in left sideward flight and flight at the critical azimuth, SAS ON, are a shortcoming. The inability to control heading, SAS OFF, in flight at the critical azimuth from 20 to 35 KTAS is a deficiency.

51. To compare the effects of the Mod 1 horizontal stabilizer to the Phase 1 horizontal stabilizer, both pilots flew the Phase 1 stabilizer in left sideward flight and at the critical azimuth. Wind conditions for this test were 3 to 7 knots. Data from the Phase 1 tail flights are presented in figures 35 through 38, appendix G. Both pilots rated this configuration as slightly more difficult to fly than the Mod 1

Table 3. Sideward Flight Qualitative Evaluation.

Sideward True Airspeed Velocity (kt)	Right Sideward <sup>1</sup> (90°)		Left Sideward <sup>1</sup> (90°)		Left Sideward <sup>1</sup> (110°)					
	Pilot 1	Pilot 2	Pilot 1	Pilot 2	Pilot 1	Pilot 2				
	SAS ON	SAS OFF	SAS ON	SAS OFF	SAS ON	SAS OFF				
5	2	4	3	4	2	3	3	4	3	4
10	3	4	3	4	3	4	3	4	4	5
15	4	5	4	5	4	5	4	5	4	6
20	3	4	3	4	4	6	4	5	5	7
25	3	4	3	4	4	7	4	6	5	9
30	3	4	3	4	4	7	3	6	5	9
35	3	4	3	4	4	6	3	5	4	7
40	3	4	3	4	4	5	3	4	4	5
45	3	4	3	4	4	5	3	4	4	5

<sup>1</sup>Numbers represent handling qualities ratings (see fig. 1, app F).



tail. Slightly more pilot effort was required to stabilize the aircraft, possibly due to the less favorable wind conditions. However, there was no significant difference in the two tail configurations regarding sideward flight handling qualities.

52. In establishing the hover trim points for sideward flight, yaw attitude control was very sensitive. This was probably due to the changed gain and authority of the yaw SAS and incorporation of the yaw CAS. This degraded the stable hover characteristics the aircraft exhibited in the GCT. The high directional control sensitivity in a hover is a shortcoming. Since the yaw SAS/CAS was required in left sideward flight, consideration should be given to programming the yaw CAS gain as a function of lateral airspeed below some selected forward airspeed.

53. During sideward flight at airspeeds above 10 KTAS the unwarranted illumination of the ACCESSORY GEARBOX OIL PRESSURE LOW caution light is a shortcoming.

#### **Forward and Rearward Flight:**

54. Figures 39 and 40, appendix G, depict the control positions and pitch attitude of the YAH-64 in SAS ON and SAS OFF low-speed forward and rearward flight. With SAS ON, a control reversal was noted between zero and 15 KTAS forward airspeed and at airspeeds greater than 20 KTAS rearward, in that an aft control trim position was required to maintain a higher forward airspeed in forward flight, and a forward control position was required to maintain a higher rearward airspeed in rearward flight. Neither of these control reversals were objectionable and were not noted during the course of normal takeoffs and low-speed maneuvering. The low-speed forward and rearward flight handling qualities of the YAH-64 remain satisfactory.

#### **Power Management**

55. Power management characteristics of the YAH-64 were evaluated throughout the test program. No handling qualities problems were attributable to power management. The torque matching and turbine gas temperature (TGT) limiting features of the T700 engines were excellent. Rotor speeds were maintained within limits during all flight conditions tested. The widest fluctuation of rotor speeds was encountered during large rapid pedal inputs during sideward flight which were enough to illuminate the ROTOR SPEED HIGH warning light. While this momentary rotor speed increase was not a significant handling qualities problem due to the speed range of the rotor system, superior rotor speed control systems have been demonstrated on T700 engine installations in other aircraft, and a study should be undertaken to determine the feasibility of adopting similar characteristics in the YAH-64.

56. The rotor speed trim system was extremely slow. An rpm change from 100 to 102 percent rotor speed for the overspeed governor check required 10 to 45 seconds. The slow rotor speed trim rate is a shortcoming.

57. After engine start while moving the power lever to the FLY position, engine oil pressure exceeded 100 psi (100 psi was the limit of the instrument range) and the ENGINE OIL BYPASS caution light illuminated. This occurred during every engine start. Since the pilot becomes conditioned to seeing the master caution

light illuminate on every start, an urgent warning may be ignored. The illumination of the ENGINE OIL BYPASS caution light during engine start is a shortcoming.

### Mission Maneuvering Characteristics

#### **Simulated Instrument Meteorological Conditions:**

58. Instrument flight characteristics were evaluated throughout the test. However, two specific flights were conducted to simulate IMC. During both of these flights, the pilot wore a removable "hood" to restrict his vision to the instrument panel. All flights were conducted in smooth air or light turbulence. Zero sideslip was used as a trim reference. Installed navigational equipment limited the evaluation to basic instrument pilot tasks, *ie*, climbs and descents, standard rate turns, level flight, airspeed changes, ITO's, and simulated ground controlled approaches (GCA's).

59. Comments regarding the size of the present vertical situation display (VSD) were made in the GCT report and are still valid.

60. The ITO procedure was to apply climb power from a stabilized 5-foot main wheel height hover (IGE), then rotate to a 4-degree nose-up pitch attitude and accelerate to the best rate of climb airspeed (75 knots indicated airspeed (KIAS)). Between hover and 65 KIAS, aircraft pitch attitude changed 8 degrees nose-up, and an undesirable large forward cyclic input (3 inches) was required to continue the climb and acceleration, a shortcoming previously discussed in the GCT report. During the ITO, a rate of descent of up to 400 ft/min was indicated until 60 KIAS was achieved. This inaccurate vertical velocity indication during the ITO is a shortcoming. Except for the ITO, basic instrument pilot tasks were accomplished with minimum pilot effort (HQRS 3) with SAS ON. Airspeed and altitude could easily be maintained within  $\pm 5$  knots and  $\pm 50$  feet, respectively. Throughout the airspeed range selected (zero to 143 KCAS) SAS OFF flight resulted in increased pilot workloads to hold within airspeed and attitude constraints. Flight path stability was evaluated by flying simulated GCA's both SAS ON and OFF, using the front seat pilot as a simulated ground controller. Rate of descent and airspeed were easily controlled and small heading corrections were accomplished with minimum pilot effort.

#### **Simulated SAS Failures During Simulated IMC Flight:**

61. Aircraft response to SAS hardover failures was evaluated during the simulated IMC tests. SAS hardovers were electrically introduced through a test hardover box. A part of the ASE was the SAS channel hardover monitor (para 12, app C), which functioned to disable individual SAS channels within 0.2 second following a hardover. Pilot warning of a hardover was illumination of a master caution light and a momentary angular acceleration. Little or no pilot response was required (HQRS 2). The SAS hardover characteristics exhibited by the aircraft are satisfactory. The SAS monitor system continues to be an enhancing feature reported during the GCT.

62. Simulated total SAS failures (disengagements) were qualitatively evaluated during the simulated IMC evaluations. Representative time histories of these SAS failures are presented in figures 41 through 44, appendix G. Figure 41 represents

a self-excited dutch roll at 129 KCAS caused by a total SAS disengagement, with the pilot initiating no corrective action to stop the oscillation for at least 13 seconds. No difficulty was encountered during recovery from this maneuver (HQRS 3).

63. Figure 42, appendix G, presents a time history of a total SAS failure at 124 KCAS in level flight, with the pilot immediately taking corrective action to stop or damp all undesirable aircraft motions (pilot in the loop). Very little pilot effort was required to maintain aircraft control (HQRS 2).

64. Figures 43 and 44, appendix G, present time histories of total SAS disengagements at 143 and 142 KCAS, respectively. Figure 43 presents the results of the pilot remaining fixed on the aircraft controls (pilot out of the loop) for approximately 9 seconds after the SAS disengagement. The lateral-directional oscillation was allowed to increase during this time. When the pilot initiated recovery techniques, approximately 5 seconds was required to recover from the pitch, roll, and yaw rates generated after the SAS release (HQRS 4). Figure 44 presents the results of the pilot continuing to fly the aircraft (pilot in the loop) through the total SAS release. Minimal pilot effort was required to maintain aircraft control (HQRS 3).

65. Figure 45, appendix G, represents a roll SAS failure at 132 KCAS while in a standard rate (3 deg/sec) right turn. The pilot remained in the loop, and approximately 6 seconds after the roll SAS failure, both pitch and roll rates were essentially eliminated (HQRS 4). Yaw rate remained essentially unchanged throughout the maneuver.

66. Initial pilot control requirements resulting from simulated SAS failures were minimal, as the aircraft flight path stability remained essentially unchanged. Basic maneuvers were performed SAS OFF with minimal pilot effort (HQRS 3). Although the handling qualities of the aircraft are degraded with SAS OFF as compared to SAS ON, the SAS OFF handling qualities of the YAH-64 under approximately 120 KCAS during IMC are satisfactory. Simulated IMC flight and simulated total SAS failures (disengagements) in moderate or greater turbulence should be evaluated prior to a final judgment of SAS OFF IMC flight characteristics.

## STRUCTURAL DYNAMICS

### Vibration Characteristics

67. Vibration characteristics of the YAH-64 were qualitatively evaluated throughout the test program. Figures 46 through 48, appendix G, show that the pilot seat vibration levels were significantly higher than those recorded during the GCT (ref 1, app A). The 4/rev vertical vibration levels increased as airspeed increased (0.33g at 146 KCAS), and were objectionable to the pilot. Lateral 4/rev vibration levels increased when airspeed increased or decreased from 60 KCAS, and were also objectionable to the pilot.

68. Figures 49 through 51, appendix G, depict the copilot/gunner seat vibration levels, which were significantly higher than those recorded during the GCT. The 1/rev vertical vibration levels increased as airspeed increased (0.08g at 146 KCAS), and were objectionable to the copilot.

69. Figures 52 through 54, appendix G, present vibration data from sensors located near the center of gravity. Cg vibrations were primarily at a 4/rev frequency. The cg vibration levels were significantly higher than those recorded during the GCT.

70. Vibration levels and canopy drumming were qualitatively assessed, based on the VRS (fig. 2, app F), as severe at operational airspeeds higher than 120 KCAS (VRS 7) and were objectionable to the crew. Vibration levels and canopy drumming decreased as airspeed was reduced to approximately 60 KCAS, but increased as airspeed was further reduced in an approach to a landing. The vibrations were qualitatively assessed as severe (VRS 9) and were very objectionable. Noticeable blurring of instruments was reported by the crewmembers during this maneuver. The high vibration level at the crew stations above 120 KCAS and decelerating through translational lift is nearly intolerable, and is a deficiency.

71. Figures 55 through 63, appendix G, depict the vibrations with the old Phase 1 tail installed. The vibration levels were generally lower than those observed with the new Mod 1 tail installed, including the vertical 4/rev vibration at the pilot station. This 4/rev vibration decreased with airspeed, and was significantly lower than the 4/rev vibration recorded with the new Mod 1 tail.

#### Structural Loads

72. During a left pedal pulse, a release from left sideslip, and a forward longitudinal pulse, high structural loads were observed. Figure 64, appendix G, shows a 1.2-inch left pedal input, which resulted in tail rotor teeter stop pounding and high tail rotor and tail boom loads. Figure 65 shows a release from left sideslip which also resulted in tail rotor teeter stop pounding and high tail rotor and tail boom loads. The relatively small directional control input required to cause pounding of the tail rotor teeter stops, with resultant high tail rotor and tail boom loads in forward flight at airspeeds greater than 115 KCAS, is a deficiency. Consideration should be given to reducing the yaw CAS quickening as a function of forward airspeed to alleviate this problem.

73. Figure 66, appendix G, shows a rapid 1.4-inch forward longitudinal control input which resulted in droop stop pounding, main rotor/canopy clearance less than 9 inches, and high main rotor and control system loads. The relatively small forward longitudinal control input required to cause contact of the main rotor droop stops in forward flight with resultant high rotor and control system loads and minimal rotor blade/canopy clearance is a deficiency.

## CONCLUSIONS

### GENERAL

74. Based on the EDT-1 flight tests of the YAH-64 helicopter, the following conclusions were reached:

- a. The YAH-64 continues to have the potential to be developed into an excellent attack helicopter.
- b. Handling qualities in left sideward flight, SAS ON, are significantly improved compared to the GCT (HQRS 10 to HQRS 4) (para 48).
- c. Handling qualities in left sideward flight, SAS OFF, are improved compared to the GCT (HQRS 10 to HQRS 7) (para 48).
- d. The yaw divergence seen during the GCT in left sideward flight, SAS ON or OFF, has been eliminated (para 48).
- e. Vibration levels and canopy drumming have significantly increased (paras 67 through 70).
- f. Vibration levels are generally higher with the new (Mod 1) tail compared to the old (Phase 1) tail (para 71).
- g. Aircraft responses to SAS disengagements and single-axis hardover failures (VMC or IMC) were easily controlled (paras 61 through 66).
- h. IMC flight with SAS OFF is satisfactory below approximately 120 KCAS in smooth air or light turbulence (para 66).
- i. The SAS ON gust response characteristics were essentially deadbeat and the SAS OFF response was a pitch coupled dutch roll (para 30).
- j. There were no significant differences observed between the new (Mod 1) and old (Phase 1) tails in sideward flight or SAS OFF dynamic stability characteristics evaluations (paras 51 and 33).
- k. During low-speed flight, gusty wind conditions may demand peak tail rotor power in excess of the temporary limit (para 44).
- l. Numerous enhancing characteristics, deficiencies, and shortcomings, reported during the GCT, remain valid.
- m. Four new deficiencies and 10 new shortcomings were identified.
- n. Two deficiencies and five shortcomings were corrected between the GCT and this evaluation.

## DEFICIENCIES

75. The following new deficiencies (in order of their importance) were identified:

- a. Excessive vibration levels and canopy drumming above 120 KCAS and when decelerating through translational lift (para 70).
- b. Tail rotor teeter stop pounding and resulting high tail rotor and tail boom loads with relatively small pedal inputs at airspeeds greater than 115 KCAS (para 72).
- c. Main rotor/canopy clearance less than 9 inches and droop stop contact following a rapid 1-inch forward longitudinal control input with the incorporation of the quickening feature of the CAS (paras 73 and 72).
- d. Inability to control heading in left sideward flight at 20 to 35 KTAS, SAS OFF, at the critical azimuth (HQRS 9) and at 25 to 30 KTAS, SAS OFF, at the 270 degree azimuth (HQRS 7) (paras 50 and 47).

## SHORTCOMINGS

76. The following new shortcomings (in order of their importance) were identified:

- a. Poor heading control in right and left sideward flight SAS OFF, and left sideward flight and flight at the critical azimuth, SAS ON (para 50).
- b. The divergent pitch coupled dutch-roll short-term dynamic response characteristics, SAS OFF, above 117 KCAS (para 35).
- c. Requirement to continually retrim the aircraft to minimize longitudinal cyclic trim changes (para 46).
- d. Requirement to manually disengage the SAS for all ground taxi operations (para 38).
- e. Illumination of the ENGINE OIL BYPASS caution light during engine start (para 57).
- f. Accessory gearbox oil pressure low light illumination in sideward flight above 10 KTAS and during low g maneuvers (paras 53 and 28).
- g. The slow rotor speed trim rate (para 56).
- h. Poor trimmability between 75 and 105 KCAS (para 14).
- i. Inaccurate vertical velocity indications during an ITO (para 60).
- j. The high directional control sensitivity in a hover (SAS ON) (paras 40 and 52).

## **RECOMMENDATIONS**

77. Correct the deficiencies identified during this evaluation prior to Engineer Design Test 2 (EDT-2) (para 75).
78. The shortcomings identified during this evaluation should be corrected (para 76).
79. Consideration should be given to providing the pilot with a capability of selecting or rejecting SAS attitude hold while retaining full SAS authority (para 46).
80. Consideration should be given to programming YAW CAS gain as a function of lateral airspeed below some selected forward airspeed (para 52).
81. Consideration should be given to reducing the YAW CAS quickening as a function of forward airspeed (para 72).
82. A study should be undertaken to determine the feasibility of adapting the superior rotor speed control characteristics to the YAH-64 which have been demonstrated on T700 installations in other aircraft (para 55).
83. Simulated IMC flight and simulated total SAS failures (disengagements) in moderate or greater turbulence should be evaluated prior to a final judgment of SAS OFF IMC flight characteristics (para 66).

## APPENDIX A. REFERENCES

1. Final Report, USAAEFA, Project No. 74-07-2, *Development Test 1, Advanced Attack Helicopter Competitive Evaluation, Hughes YAH-64 Helicopter*, December 1976.
2. Letter, AVRADCOM, DRDAV-EQI, 16 November 1977, subject: Engineer Design Test 1 (EDT-1) of YAH-64 Advanced Attack Helicopter (AAH), with Revision 1, 4 April 1978.
3. Test Plan, USAAEFA, Project No. 77-36, *Engineer Design Test 1, YAH-64 Advanced Attack Helicopter*, April 1978.
4. Letter, AVRADCOM, DRDAV-EQ, 20 April 1978, subject: Airworthiness Release for the Engineer Design Test (EDT-1) of the YAH-64.
5. Message, AVRADCOM, DRDAV-EQ, 221925Z April 1978, subject: Engineer Design Test 1, YAH-64 Advanced Attack Helicopter.
6. Flight Test Manual, Naval Air Test Center, FTM No. 101, *Stability and Control*, 10 June 1968.
7. Systems Specification, United States Army Materiel Command, AMC-85-AAH-10000A, "Systems Specification for Advanced Attack Helicopter," 1 July 1976.
8. Training Manual, Hughes Helicopter Company, *Hughes YAH-64 Advanced Attack Helicopter*, 1 April 1976.
9. Flight Manual, Hughes Helicopter Company, Report No. 77-TM-8001-2, *YAH-64 Advanced Attack Helicopter*, 19 May 1976, reissued 28 February 1978.
10. EDT-1 Familiarization Manual, Hughes Helicopter Company, Report No. 77-TD-8001, *YAH-64 Helicopter*, January 1978.



## APPENDIX B. AIRCRAFT DESCRIPTION

The YAH-64 advanced attack helicopter is a tandem, two-place twin turbine-engine, single-main-rotor aircraft manufactured by Hughes Helicopter Company, a division of Summa Corporation. The aircraft is designed to deliver various combinations of ordnance stored both internally and externally on the four wing store/positions during day and night combat conditions. Photos 1 through 4 are views of the prototype YAH-64. A three-view drawing of the YAH-64 is shown in figure 1. Basic design information is listed below. A complete description of the aircraft is contained in references 8, 9, and 10, appendix A, copies of which are on file in the USAAEFA Technical Library.

### Dimensions and General Data

#### Main Rotor:

Diameter (ft)	48 ft
Blade chord (in.)	21.0*
Main rotor blade area (ft <sup>2</sup> )	150.88
Main rotor disc area (ft <sup>2</sup> )	1809.56
Main rotor solidity (thrust weighted, no tip loss)	0.092
Airfoil	HH-02**
Twist	9 deg washout
Number of blades	4
Rotor speed at 100 percent Np (rpm)	289.3
Normal tip speed ( $\Omega R$ ) (ft/sec)	727.09

#### Tail Rotor:

Diameter (ft)	8.33
Chord constant (in.)	10
Tail rotor blade area (ft <sup>2</sup> )	10
Tail rotor disc area (ft <sup>2</sup> )	54.54
Tail rotor solidity	0.2475
Airfoil	NACA 632-414 modified
Twist	8 deg washout
Number of blades	4
Rotor speed at 100 percent Np (rpm)	1411
Distance from main rotor (ft)	28.49
Normal tip speed ( $\Omega R$ ) (ft/sec)	615.44
$\delta 3$ (teetering angle) (deg)	35

\*Includes tips

\*\*Outer 20 inches swept back 20 degrees and transitioned to an NACA 64A 006 airfoil



**Photo 1. Front View.**

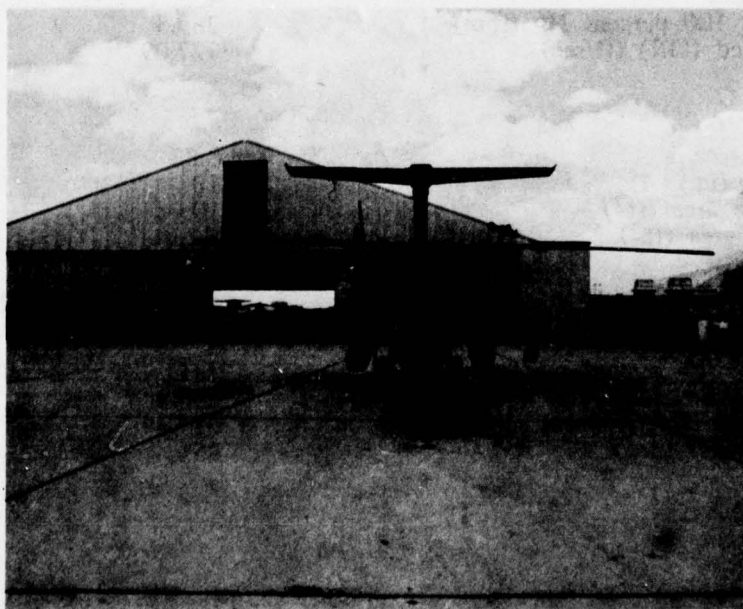

**Photo 2. Rear View.**



**Photo 3. Left Side View.**



**Photo 4. Left Front Quarter View.**

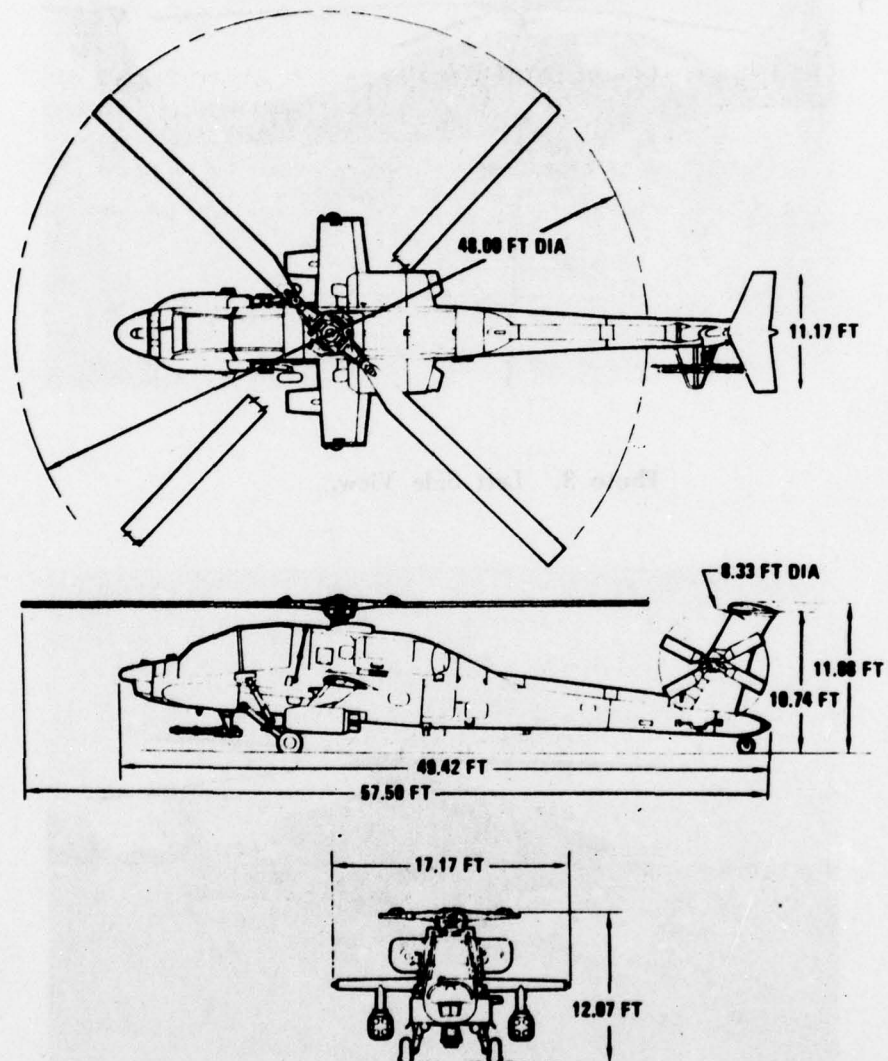

Figure 1. Dimensions.

Horizontal Stabilizer:	Phase 1	Mod 1
Weight (lb)	106	37.1
Area (ft <sup>2</sup> )	32.95	32.99
Span (ft)	11.03	11.46
Tip chord (ft)	1.97	1.94
Root chord (ft)	3.90	3.81***
Airfoil	NACA 0015	NACA 0015
Aspect ratio	3.69	3.98
Incidence of chord line (deg)	Zero	-1
Sweepback of leading edge (deg)	25	Zero
Sweepback of trailing edge (deg)	6.62°	(-19.13)
Dihedral (deg)	0	0
<b>Vertical Stabilizer:</b>		
Area (from boom CL) (ft <sup>2</sup> )		31.97
Span (from boom CL) (in.)		113.0
Tip chord (constant from span 66 to 113 in.)		37.76
Root chord (at boom CL) (in.)		47.84
Geometric aspect ratio (b <sup>2</sup> /S)		2.77
Airfoil		NACA 4415 modified at root (CL boom) tapering to NACA 4416 at 66 in. span
Leading edge sweep (deg) To 66 in. span from 66 to 113 in. span)		32.28
Rudder (%)		30
Rudder deflection (above fold joint) (deg): Note: Below fold joint deflection should fair from 12 deg at top to half ellipse at bottom		12
<b>Wing:</b>		
Span (ft)		16.33
Chord (mean aerodynamic) (in.)		45.9
Total area (ft <sup>2</sup> )		61.56
Flap area (ft <sup>2</sup> )		8.71
Airfoil at root		NACA 4418
Airfoil at tip		NACA 4415.5
Thickness (avg) (% chord)		16.9
Incidence (deg)		6
Aspect ratio		4.26

\*\*\*Reference is 3.2 inches from center line (CL)

**Weights (lb):**

<b>Empty weight (includes instrumentation)</b>	<b>11,623</b>
<b>Mission gross weight</b>	<b>14,392</b>
<b>Basic structural design gross weight</b>	<b>14,660 (calculated)</b>
<b>Maximum gross weight</b>	<b>17,650</b>
<b>Ferry alternate mission takeoff weight</b>	<b>18,500 (calculated)</b>

## **APPENDIX C. FLIGHT CONTROL DESCRIPTION**

### **GENERAL**

1. The YAH-64 helicopter employs a single hydromechanical irreversible flight control system with an electrohydraulic backup system. The hydromechanical system is mechanically activated with conventional pilot cyclic, collective and pedal controls through a series of push-pull tubes going to four airframe-mounted hydraulic servo actuators. The four hydraulic servo actuators control longitudinal cyclic, lateral cyclic, collective, and tail rotor collective pitch, and are powered by two independent 3000-psi hydraulic systems which are powered by hydraulic pumps mounted on the accessory gearbox to allow full operation under a dual-engine failure condition. An automatic stabilization equipment (ASE) system is installed to provide closed-loop rate stability augmentation control (SAS) of limited 10 percent authority in pitch and roll and 20 percent authority in yaw. Included with the ASE are a force feel system (FFS), a wing flap control system, and a fly-by-wire emergency backup control system (BUCS) which was not connected during this evaluation. A force trim system (FTS) is incorporated in cyclic and pedal controls to provide a control force gradient with control displacement from a selected trim position. A force trim interrupter button, located on the cyclic grip, provides a momentary interruption of the force trim in all axes simultaneously to allow the cyclic or pedal control to be placed in a new trim position. Lateral-cyclic and directional 1g springs are incorporated to reduce control imbalance characteristics with the FTS OFF. The collective lever has a mechanical friction device and a 1g balance spring to balance the collective control forces. Full control travel is 9.5 inches in the cyclic longitudinal control, 9 inches in the lateral control, 11.8 inches in the collective control, and 6.5 inches in the rudder pedals.

### **CONTROL SYSTEMS**

#### **Cyclic Control System**

2. The cyclic control system consists of dual-tandem cyclic control sticks attached to individual support assemblies at the cyclic stick (fig. 1). The support assembly houses the primary longitudinal and lateral control stops, a lateral 1g spring to reduce stick imbalance characteristics, and two linear variable displacement transducers (LVDT) designed to measure electrically the longitudinal and lateral motions of the cyclic for ASE computer inputs. A series of push-pull tubes and bell cranks (fig. 2) transmits the motion of the cyclic stick to servo actuators and the mixer assembly. Motion of the mixer assembly (fig. 3) positions the nonrotating swashplate, which is linked to the rotating swashplate to control the main rotor blades in cyclic and collective pitch. The cyclic stick uses the standard Army handgrip.

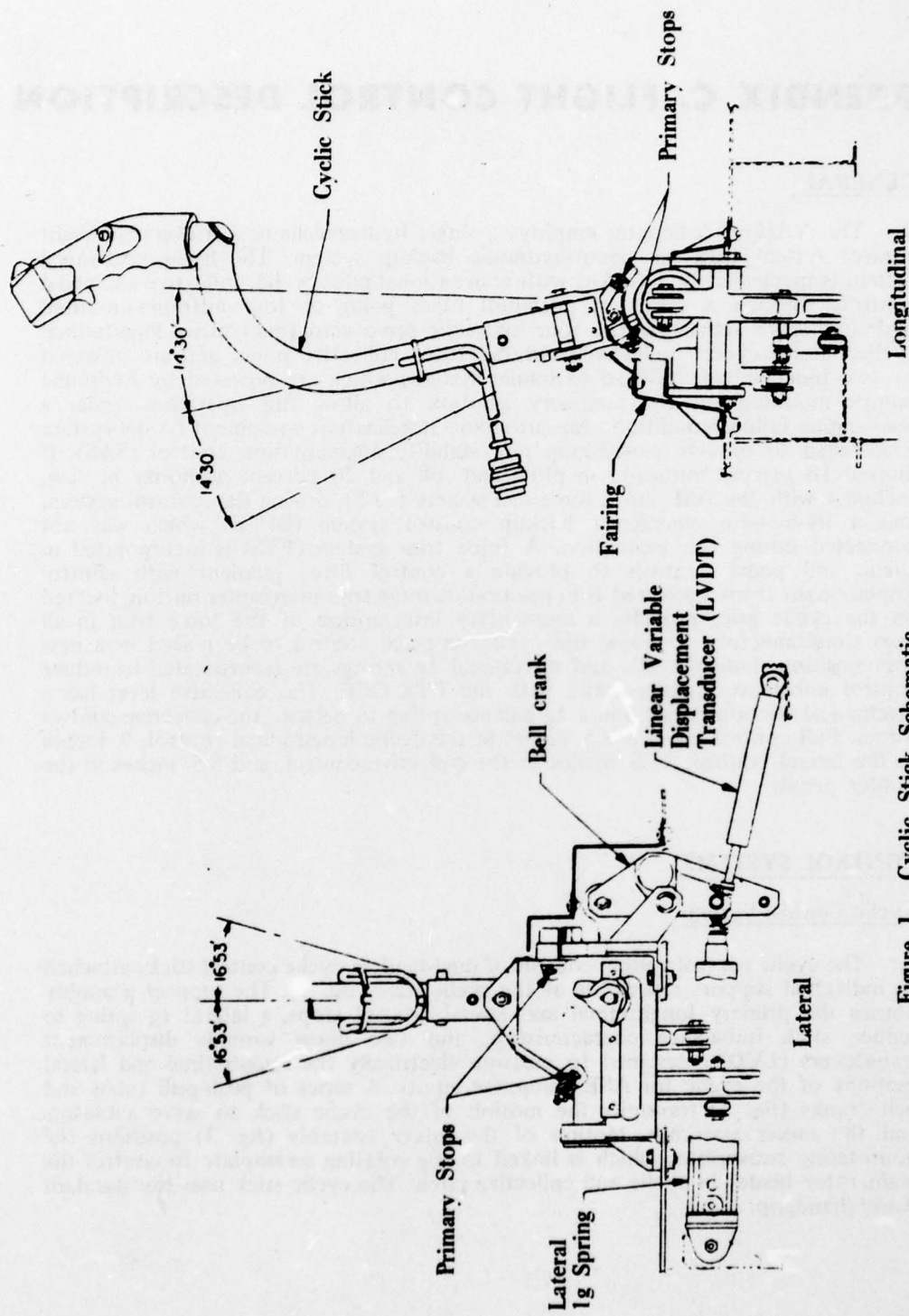

Figure 1. Cyclic Stick Schematic.



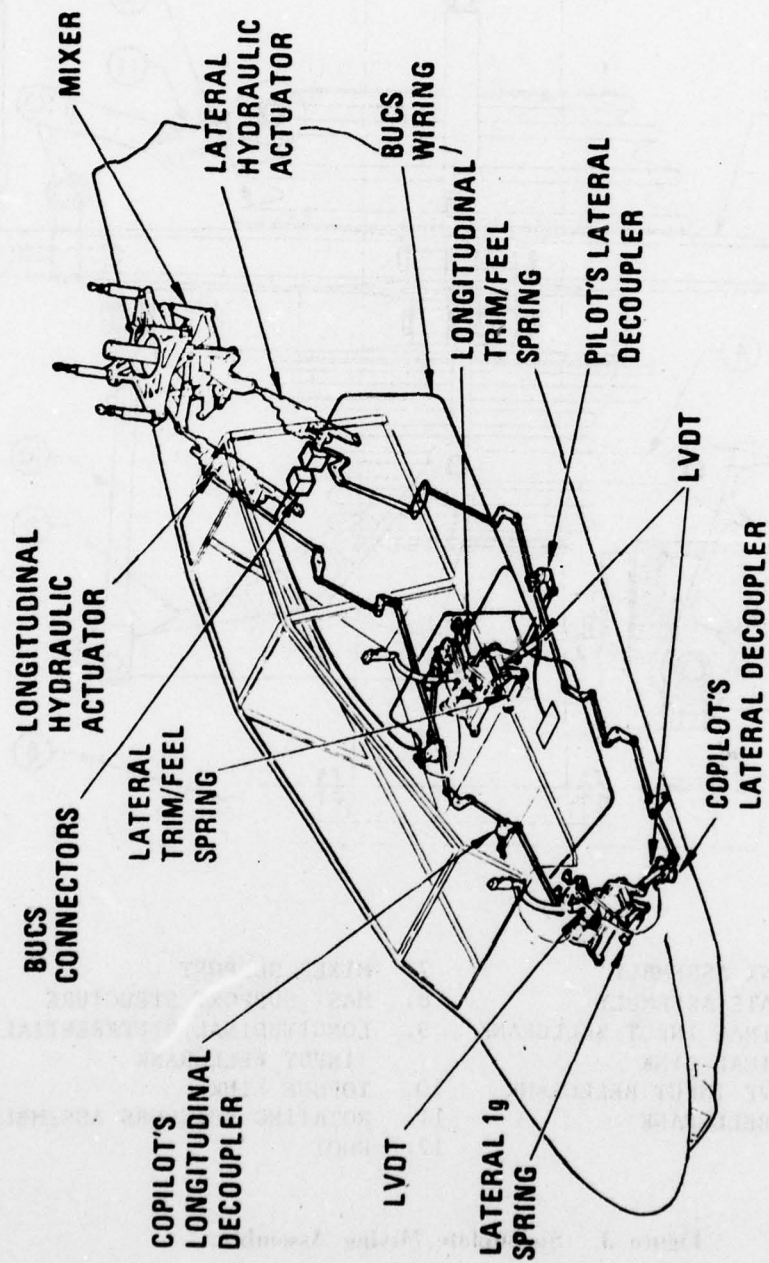
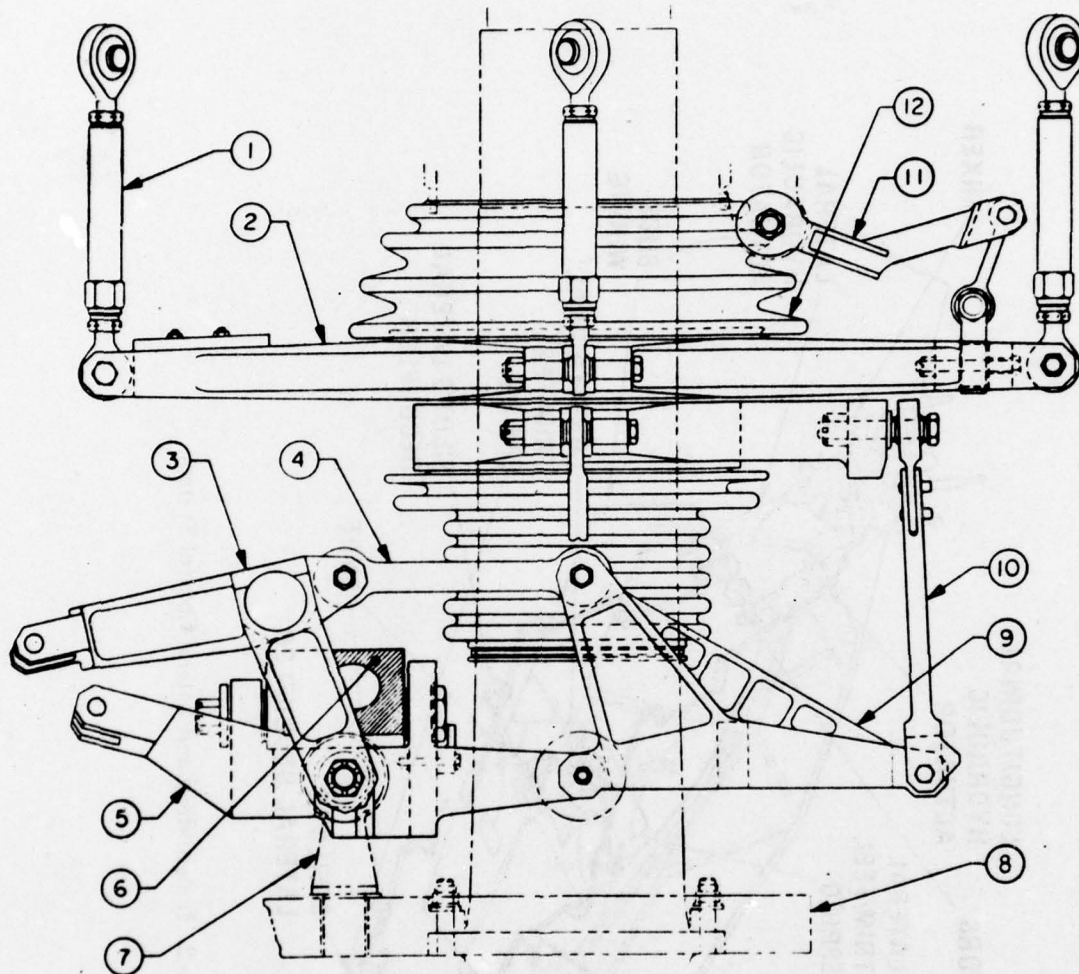

Figure 2. Longitudinal and Lateral Control System.



- |                                 |   |
|---------------------------------|---|
| 1. PITCH LINK ASSEMBLY          | 7. MIXER SUPPORT                                |
| 2. SWASK PLATE ASSEMBLY         | 8. MAST SUPPORT STRUCTURE                       |
| 3. LONGITUDINAL INPUT BELLCRANK | 9. LONGITUDINAL DIFFERENTIAL<br>INPUT BELLCRANK |
| 4. LONGITUDINAL LINK            | 10. TORQUE LINK                                 |
| 5. COLLECTIVE INPUT BELLCRANK   | 11. ROTATING SCISSORS ASSEMBLY                  |
| 6. LATERAL BELLCRANK            | 12. ROOT  |

Figure 3. Swashplate Mixing Assembly.

### Force Trim System

3. The cyclic control FTS provides cyclic control stick feel and allows close repositioning with the use of the cyclic trim button. Individual longitudinal and lateral electromagnetic brake clutches incorporating trim feel springs are provided for stick centering and a stick force gradient. Additionally, a toggle switch is provided on the pilot left console to activate or disable the trim system. The electromagnetic brake clutch is powered by 28 VDC and is protected by a trim circuit breaker panel. In the event of complete DC failure, both the FTS and FFS are disabled, and cyclic stick movement will not be resisted fore and aft but will be held laterally by the 1g spring.

### Collective Control System

4. The collective pitch control system consists of dual-tandem control sticks connected by push-pull tubes and bell cranks (fig. 4). Located at each collective stick base assembly unit are the primary control stops, a 1g balance spring to counteract the collective control forces of the stick and linkages, and an LVDT (fig. 5). The LVDT supplies electrical inputs to the ASE and to the load-demand spindle of the engine hydromechanical unit (HMU), which is a section of the fuel control unit for the YT700-GE-700 engines. The input to the HMU provides collective pitch compensation which acts as a main rotor droop compensator. Additionally, the collective LVDT provides inputs to the wing flap control system. A series of push-pull tubes and bell cranks transmits collective movements to the collective servo actuator, the main rotor mixer unit, and the main rotor.

5. A switch box assembly at the top of each collective pitch stick contains numerous switches, among which is one nonstandard switch. The engine-cut button provides for rapid deceleration of the engines to ground-idle in event of an emergency where the pilot cannot release the collective control to retard the speed selectors. Both collective sticks incorporate adjustable friction devices.

### Directional Control System

6. The directional control system (fig. 6) consists of the following components: two sets of adjustable directional control pedals with a total adjustment of 6 inches, accomplished through the use of pedal adjust knobs located between the pilot/copilot's feet (fig. 7); two sets of wheel brake cylinders; and a series of push-pull tubes and bell cranks which extend the length of the airframe via the tail rotor servo actuator and terminate at the tail rotor gearbox. Attached to each directional pedal assembly are the primary tail rotor control stops and one LVDT.

### Pedal Trim System

7. The pedal trim gradient system incorporates the same magnetic clutch and spring assembly as previously described for the cyclic stick (para 3). The trim gradient is high to help reduce control sensitivity. A directional control 1g spring is installed to balance the pedal forces in 1g flight with FTS OFF.

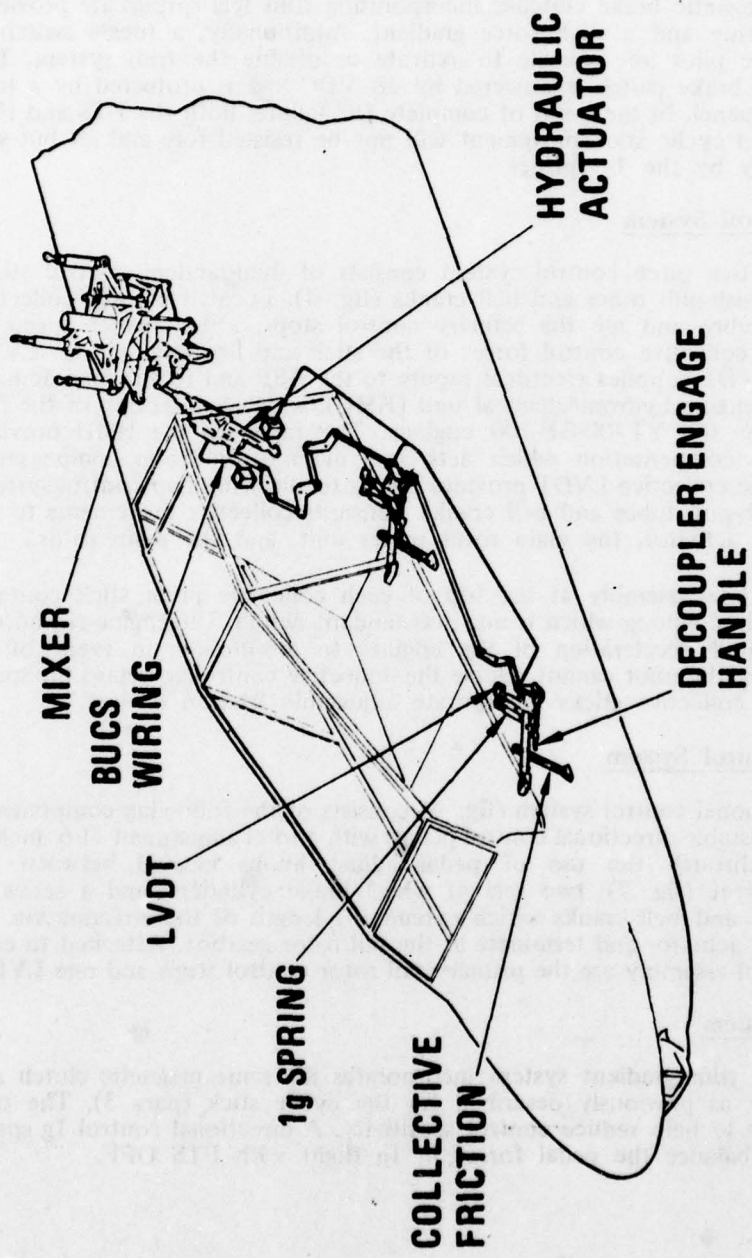
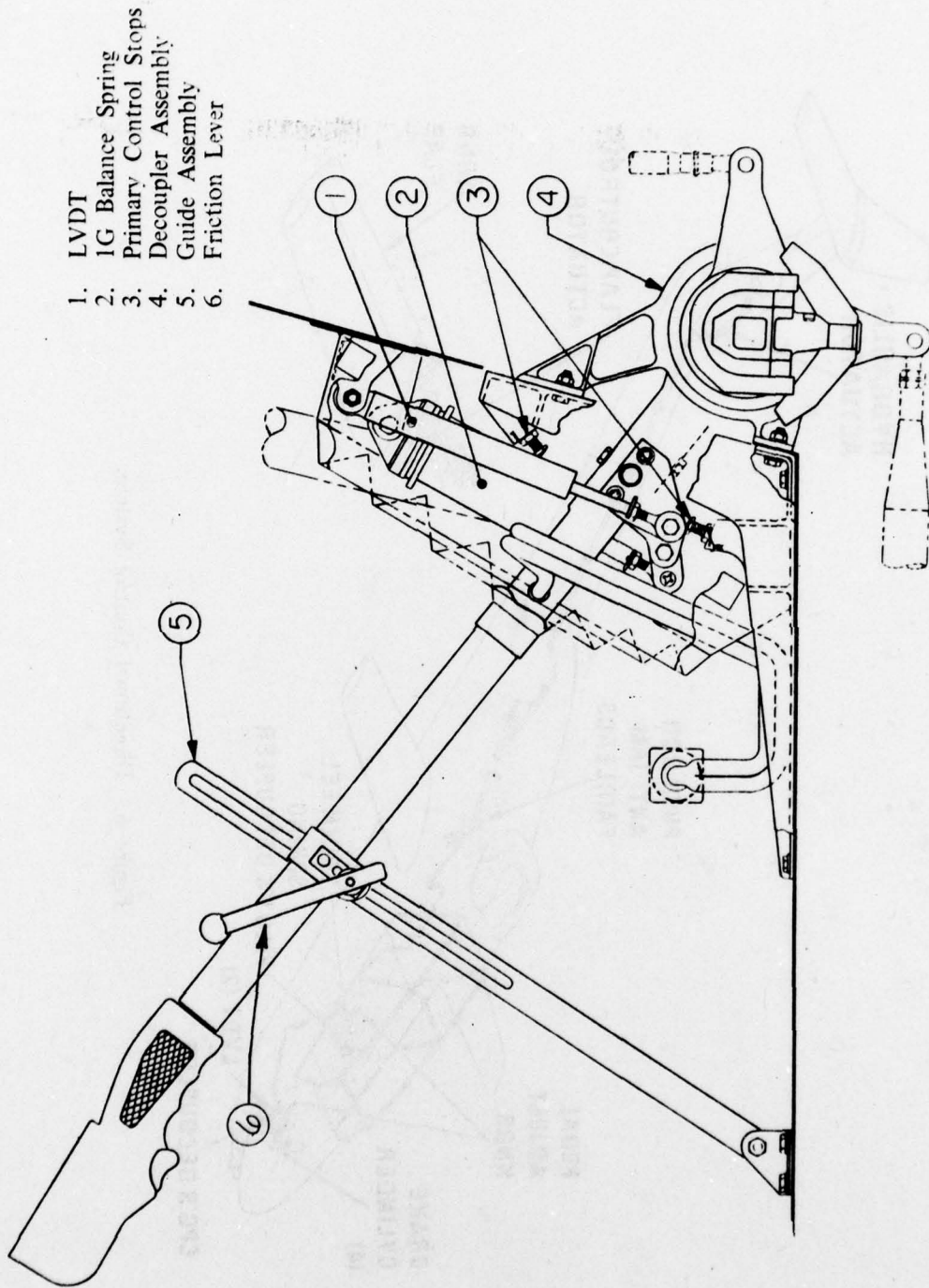

Figure 4. Collective Control System.



- 1. LVDT
- 2. 1G Balance Spring
- 3. Primary Control Stops
- 4. Decoupler Assembly
- 5. Guide Assembly
- 6. Friction Lever

Figure 5. Collective Stick Schematic.

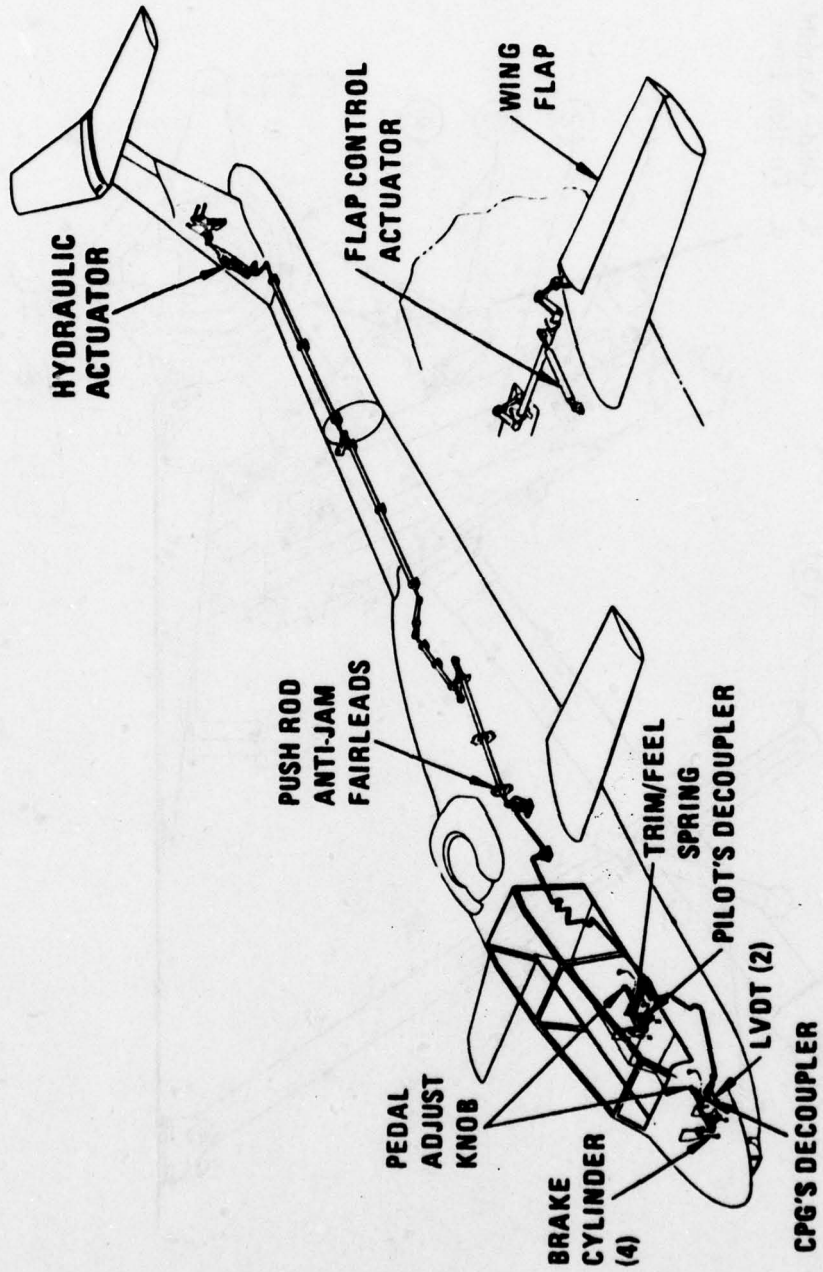

Figure 6. Directional Control System.

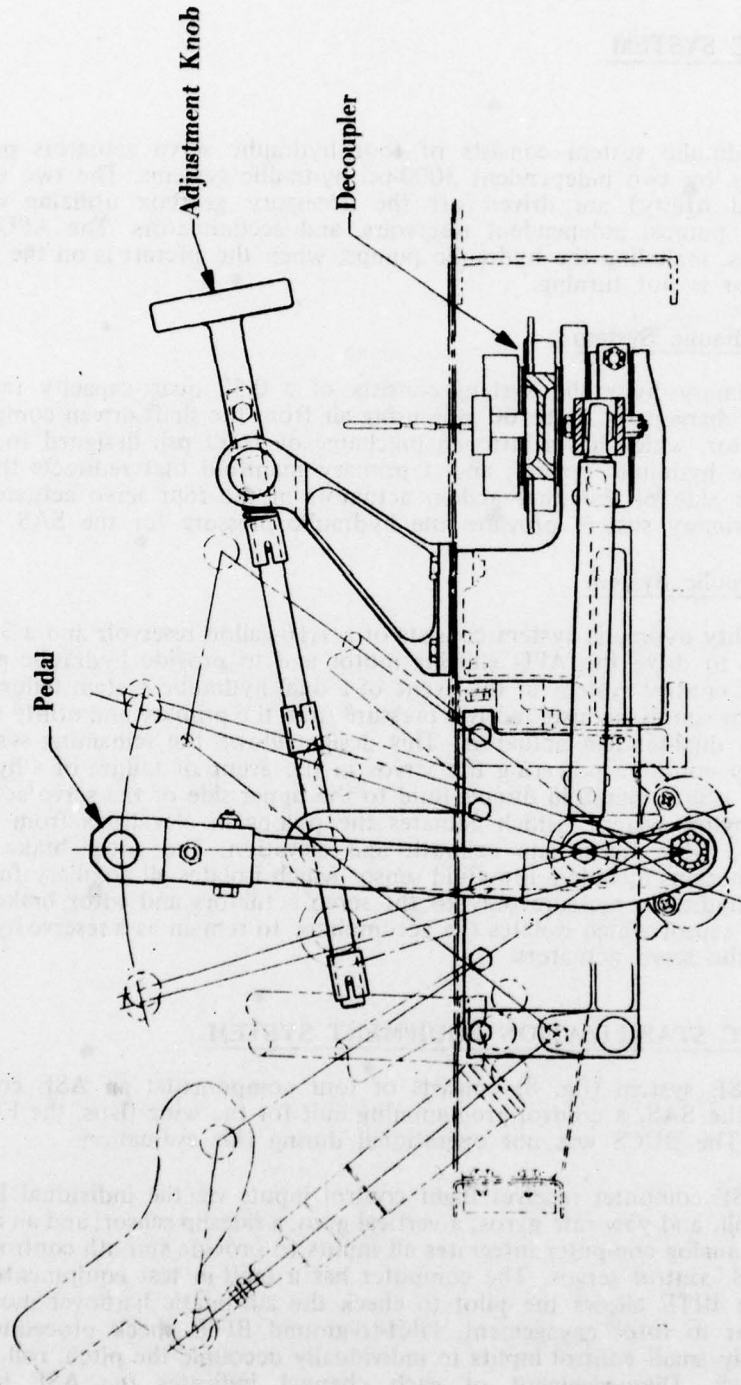

Figure 7. Directional Pedal Assembly.

## HYDRAULIC SYSTEM

### General

8. The hydraulic system consists of four hydraulic servo actuators powered simultaneously by two independent 3000-psi hydraulic systems. The two systems (primary and utility) are driven off the accessory gearbox utilizing variable displacement pumps, independent reservoirs, and accumulators. The APU drives all accessories, including the hydraulic pumps, when the aircraft is on the ground and the rotor is not turning.

### Primary Hydraulic System

9. The primary hydraulic system consists of a 0.52 quart-capacity reservoir, which is air charged to 20 to 60 psig using air from the shaft-driven compressor; an accumulator, which has a nitrogen precharge of 1600 psi, designed to reduce surges in the hydraulic system; and a primary manifold that redirects the fluid to the lower side of the dual-tandem actuators of the four servo actuators and SAS. The primary system provides the hydraulic pressure for the SAS.

### Utility Hydraulic System

10. The utility hydraulic system consists of a 1.16-gallon reservoir and a 3000-psi accumulator to drive the APU starting motor and to provide hydraulic pressure to the flight control system in the event of a dual hydraulic system failure. Each servo actuator simultaneously receives pressure from the primary and utility systems to drive the dual-tandem actuators. This design allows the remaining system to automatically continue powering the servos in the event of failure of a hydraulic system. The utility manifold directs fluid to the upper side of the servo actuators, the stores pylon system (which actuates the pylons in elevations from +10 to -28 degrees), wing flaps, gun azimuth and elevation, and rotor brake. Other manifold functions include a low fluid sensor which isolates all auxiliary functions to provide hydraulic pressure only to the servo actuators and rotor brake and a low-pressure sensor which isolates the accumulator to remain as a reserve hydraulic source for the servo actuators.

## AUTOMATIC STABILIZATION EQUIPMENT SYSTEM

11. The ASE system (fig. 8) consists of four components: an ASE computer controlling the SAS, a control programming unit for the wing flaps, the FFS, and the BUCS. The BUCS was not operational during this evaluation.

12. The ASE computer receives flight control inputs via the individual LVDT's; the pitch, roll, and yaw rate gyros; a vertical gyro; a sideslip sensor; and an airspeed sensor. The analog computer integrates all inputs to provide smooth control signals for the SAS control servos. The computer has a built-in test equipment (BITE) system. The BITE allows the pilot to check the automatic hardover monitoring circuits prior to rotor engagement. Pilot-to-ground BITE check procedure is to quickly apply small control inputs to individually decouple the pitch, roll, or yaw SAS channels. Disengagement of each channel indicates the ASE hardover



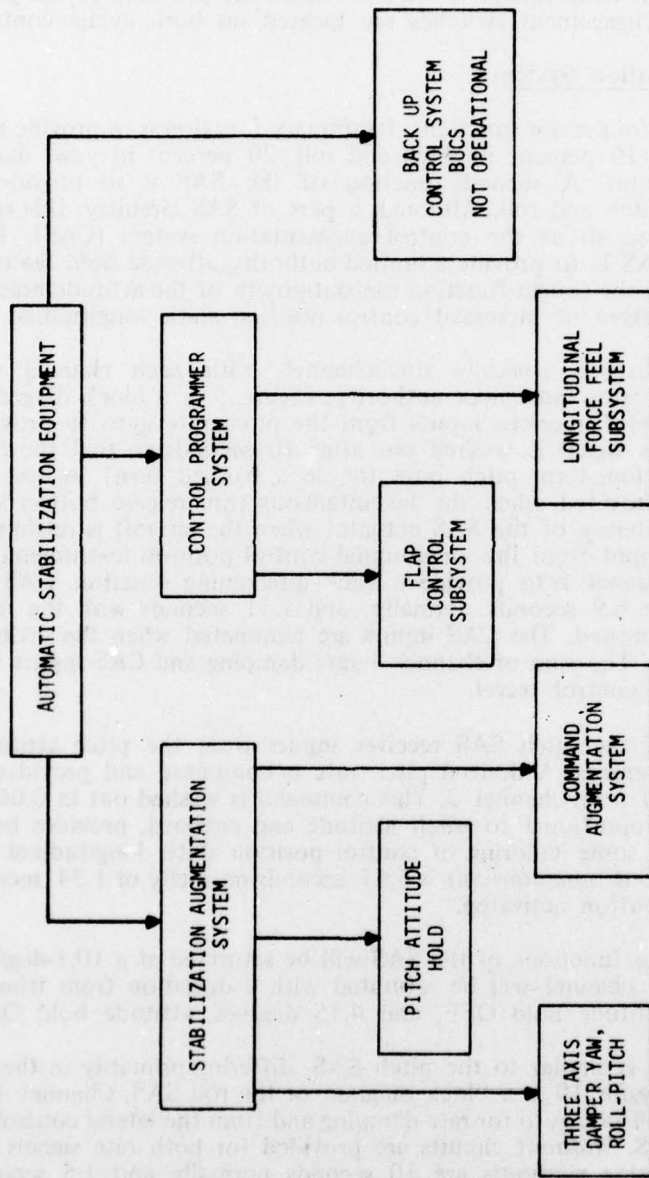

Figure 8. Automatic Stabilization Block Schematic.

protection system is operable. Additionally, in flight the automatic servo monitor system is designed to compare control rate to control displacement, disabling a particular SAS channel if the two are not compatible (hardover protection). The FFS ground check is to verify that there is a fore and aft control force with cyclic displacement. ASE cockpit control switches are provided to the pilot only; however, SAS disengagement switches are located on both cyclic control grips.

### Stability Augmentation System

13. The SAS has four major functions. Its primary function is to provide three-axis limited authority (10 percent in pitch and roll, 20 percent in yaw) damping of aircraft angular rates. A second function of the SAS is to provide control augmentation in pitch and roll. Although a part of SAS circuitry, this subsystem is generally referred to as the control augmentation system (CAS). The third function of the SAS is to provide a limited authority attitude hold feature (pitch and roll only), and the fourth function (an outgrowth of the attitude hold feature) is to provide a degree of increased control position static longitudinal stability.

14. The pitch SAS is basically dual-channel, with each channel providing  $\pm 5$  percent of actuator movement authority. Figure 9 is a block diagram of the pitch SAS. Channel 1 receives inputs from the pitch rate gyro to provide pitch rate damping. This signal is washed out after 10 seconds so that the SAS does not try to damp long-term pitch rates (*ie*, in a banked turn). A fast washout (1.5 seconds) is provided when the instantaneous trim release button is pressed to allow rapid centering of the SAS actuator when the aircraft is retrimmed. The CAS receives an input from the longitudinal control position instrumentation and works through channel 1 to provide a stick quickening function. CAS washout time constants are 6.9 seconds normally, and 1.11 seconds with the force trim release button depressed. The CAS inputs are eliminated when the attitude hold feature is selected. The sum of channel 1 rate damping and CAS inputs is limited to  $\pm 5$  percent of control travel.

15. Channel 2 of the pitch SAS receives inputs from the pitch attitude gyros and the airspeed sensors. A derived pitch rate is computed and provides the rate damping command from channel 2. This command is washed out in 0.06 second. Another signal, proportional to pitch attitude and airspeed, provides both pitch attitude hold and some tailoring of control position static longitudinal stability. The attitude washout time constant is 6.65 seconds normally or 1.34 seconds with the trim release button activated.

16. The pitch rate functions of the SAS will be saturated at a 10.1-deg/sec pitch rate. The attitude channel will be saturated with a deviation from trim attitude of 8.3 degrees, attitude hold OFF, and 4.15 degrees, attitude hold ON.

17. The roll SAS is similar to the pitch SAS, differing primarily in the gain and time constants. Figure 10 is a block diagram of the roll SAS. Channel 1 receives inputs from the roll rate gyro for rate damping and from the lateral control position sensor for the CAS. Washout circuits are provided for both rate signals and CAS signals. Rate damping washouts are 10 seconds normally and 1.5 seconds with force trim release. The CAS washouts are 5 seconds normally and 1.25 seconds with force trim release, and 0.02 second with attitude hold engaged. The operation

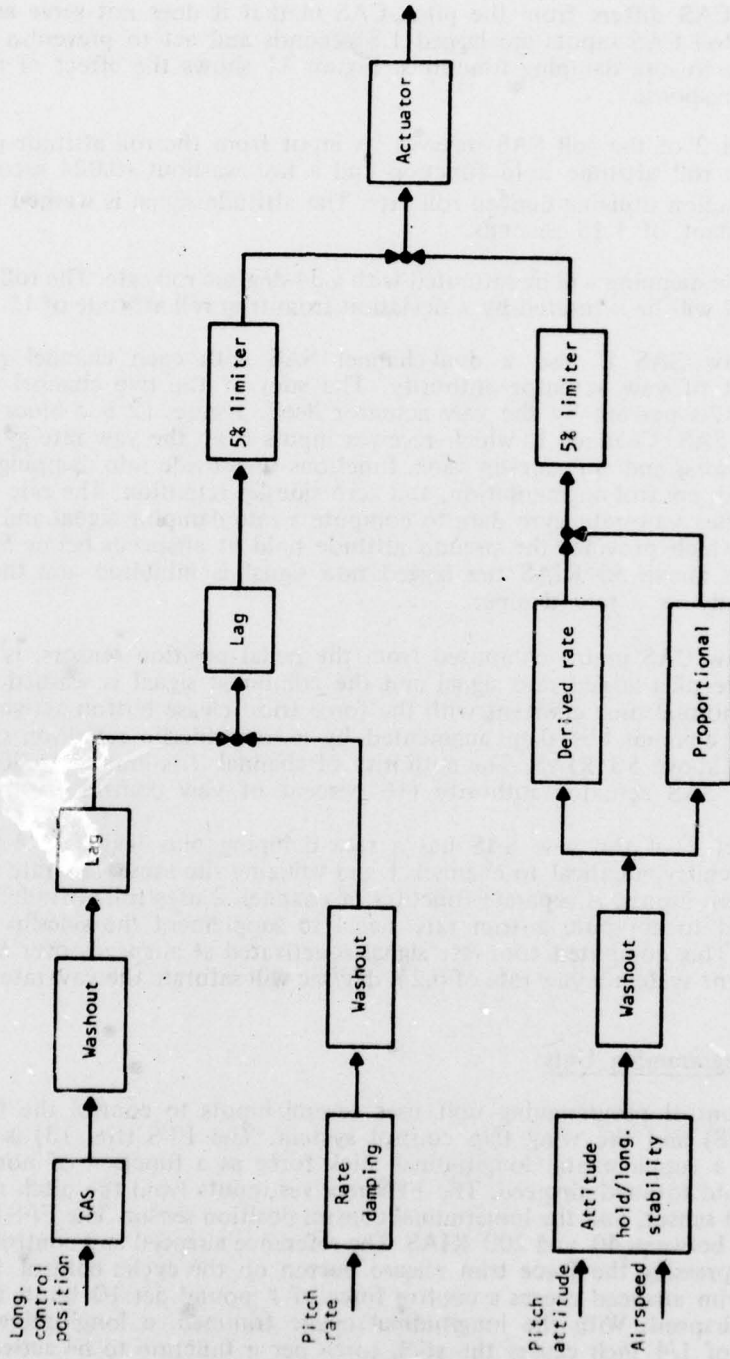

Figure 9. Pitch SAS.

of the roll CAS differs from the pitch CAS in that it does not serve as a stick quickener. Roll CAS inputs are lagged 1.3 seconds and act to prevent a roll rate decrease due to rate damping functions. Figure 11 shows the effect of roll CAS on aircraft response.

18. Channel 2 of the roll SAS receives its input from the roll attitude gyro and provides the roll attitude hold function and a fast washout (0.024 second) rate damping function utilizing derived roll rate. The attitude signal is washed out with a time constant of 1.15 seconds.

19. Roll rate damping will be saturated with a 34-deg/sec roll rate. The roll attitude hold channel will be saturated by a deviation from trim roll attitude of 15 degrees.

20. The yaw SAS is also a dual-channel SAS with each channel providing  $\pm 16$  percent of yaw actuator authority. The sum of the two channel inputs is limited to  $\pm 20$  percent by the yaw actuator itself. Figure 12 is a block diagram of the yaw SAS. Channel 1, which receives inputs from the yaw rate gyro, pedal position sensors, and the sideslip vane, functions to provide rate damping, pseudo attitude hold, control augmentation, and zero sideslip retention. The rate damping subsystem uses yaw rate gyro data to compute a rate damping signal and a lagged rate signal which provides the pseudo attitude hold at airspeeds below 50 KIAS. At airspeeds above 50 KIAS the lagged rate signal is inhibited and the system functions only as a rate damper.

21. The yaw CAS input, computed from the pedal position sensors, is summed with the rate plus lagged rate signal and the combined signal is washed out with a 5-second normal time constant with the force trim release button activated. This washed out command is then augmented by a zero sideslip retention command at airspeeds above 50 KIAS. The authority of channel 1 is limited to 80 percent of the yaw SAS actuator authority (16 percent of yaw control authority).

22. Channel 2 of the yaw SAS has a rate damping plus lagged rate CAS and washout circuitry identical to channel 1 and utilizing the same yaw rate gyro and pedal position inputs. A separate function of channel 2 uses roll attitude, roll rate, and airspeed to compute a trim rate signal to supplement the sideslip signal of channel 1. This computed trim rate signal is activated at airspeeds over 50 KIAS. In the present system a yaw rate of 6.25 deg/sec will saturate the yaw rate damping circuitry.

#### Control Programming Unit

23. The control programming unit uses several inputs to control the force feel system (FFS) and the wing flap control system. The FFS (fig. 13) is designed to provide a supplemental longitudinal stick force as a function of normal load factor (g) and forward airspeed. The FFS receives inputs from the pitch rate gyro, the airspeed sensor, and the longitudinal control position sensor. The FFS functions at airspeeds between 40 and 200 KIAS. The reference airspeed and control position are set by pressing the force trim release button on the cyclic control. Deviation from the trim airspeed causes a control force of 1 pound per 10 knots to restore the trim airspeed. With the longitudinal cyclic trimmed, a longitudinal control movement of 1/4 inch causes the stick force per g function to be activated. The

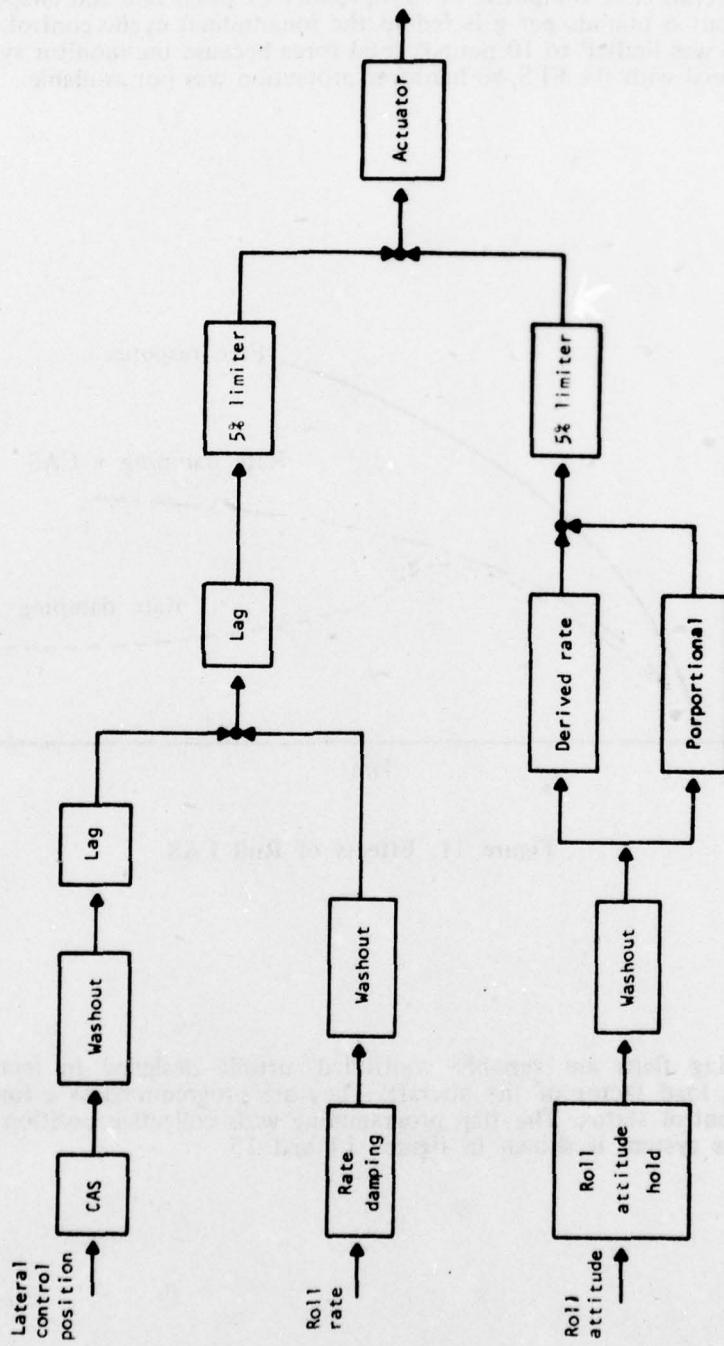

Figure 10. Roll SAS

normal acceleration is computed by the product of pitch rate and airspeed and a force of about 6 pounds per g is fed to the longitudinal cyclic control. The test aircraft FFS was limited to 10 pounds total force because the monitor system was not operational with the FFS, so hardover protection was not available.

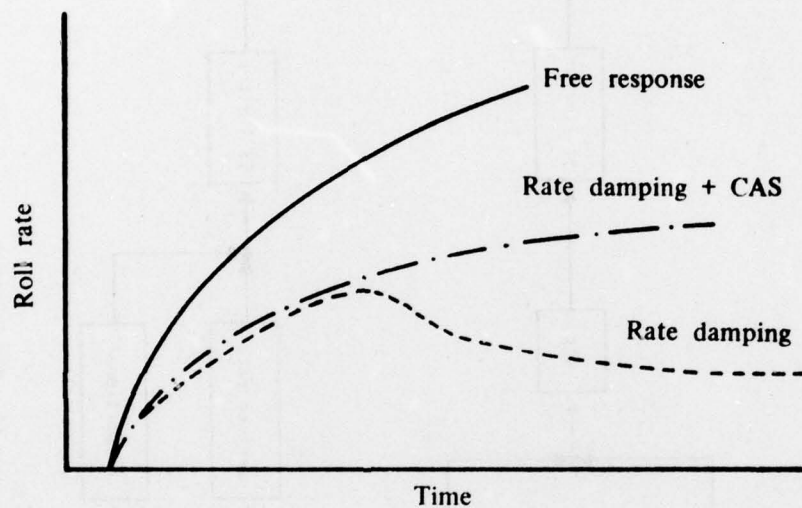

Figure 11. Effects of Roll CAS.

24. The wing flaps are variably controlled airfoils designed to increase the maneuvering load factor of the aircraft. They are programmed as a function of collective control status. The flap programming with collective position airspeed and weapons system is shown in figures 14 and 15.

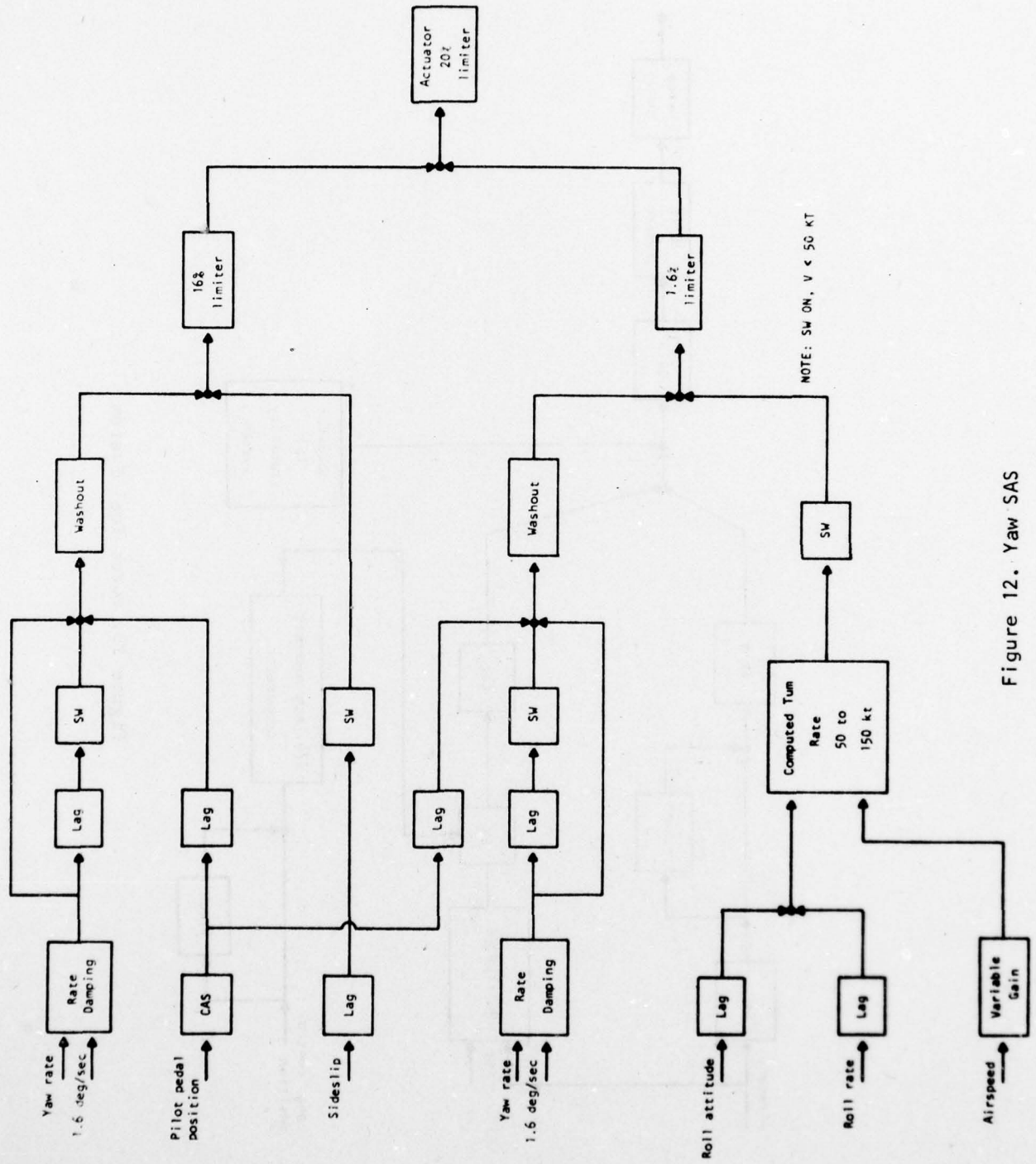

Figure 12. Yaw SAS

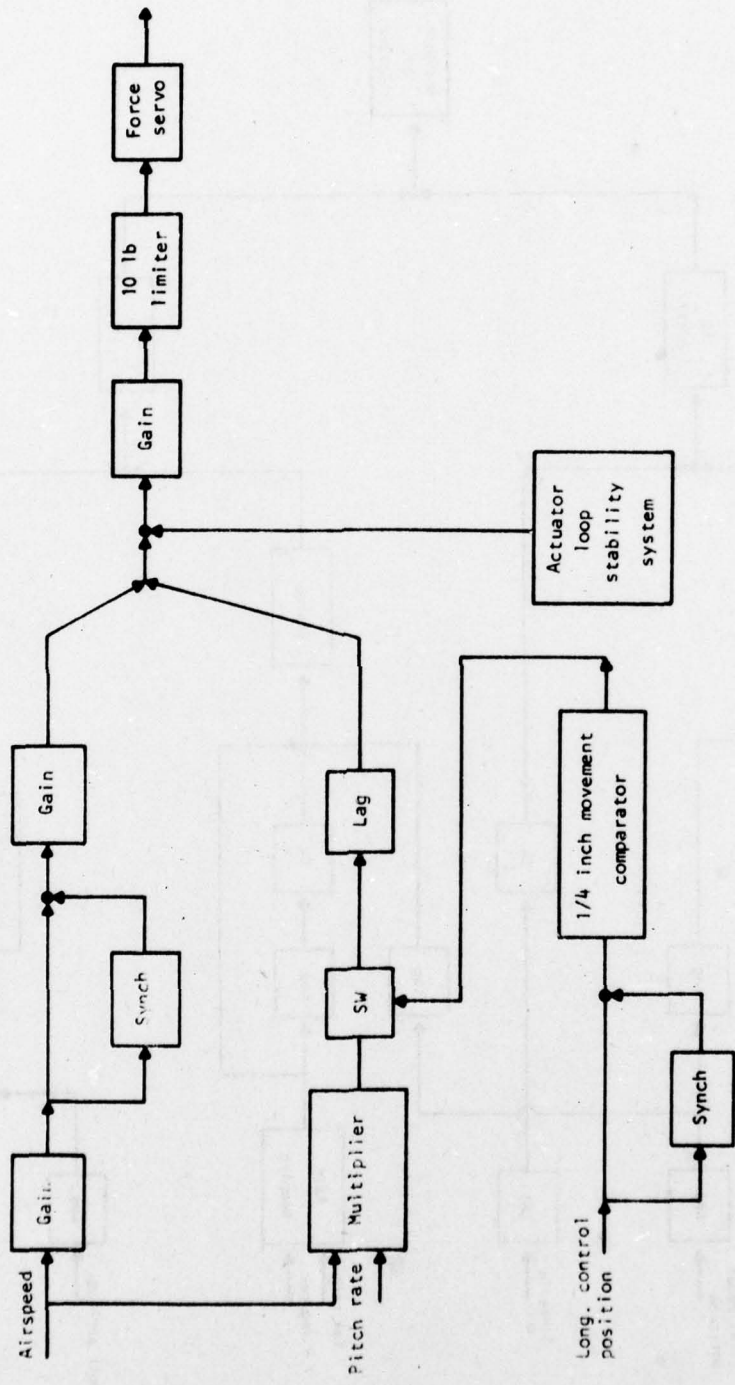

Figure 13. Force Feel System



Case	Crew Station Controls	Other Conditions	Flap Position
1.	Collective stick: Full Down (autorotation)	---	-45° up (full up)
2.	Collective stick: Greater than 5.2 inches	Airspeed less than 110 knots	20° down (full down)
3.	Collective stick: Greater than 4.0 inches longitudinal cyclic stick inputs	Airspeed greater than 110 knots	5° down plus inputs to assist pitch control with slow washout to 5° down
4.	Action switch: Rocket position	Airspeed less than 50 knots, pods 10° nose down	-25° up
5.	Action switch: Rocket	Airspeed greater than 50 knots, pods 10° nose down	5° down

Notes: Case 1 overrides cases 4 & 5  
Case 4 overrides case 2  
Case 5 overrides cases 2 & 3

Figure 14. Wing Flap Position Chart.

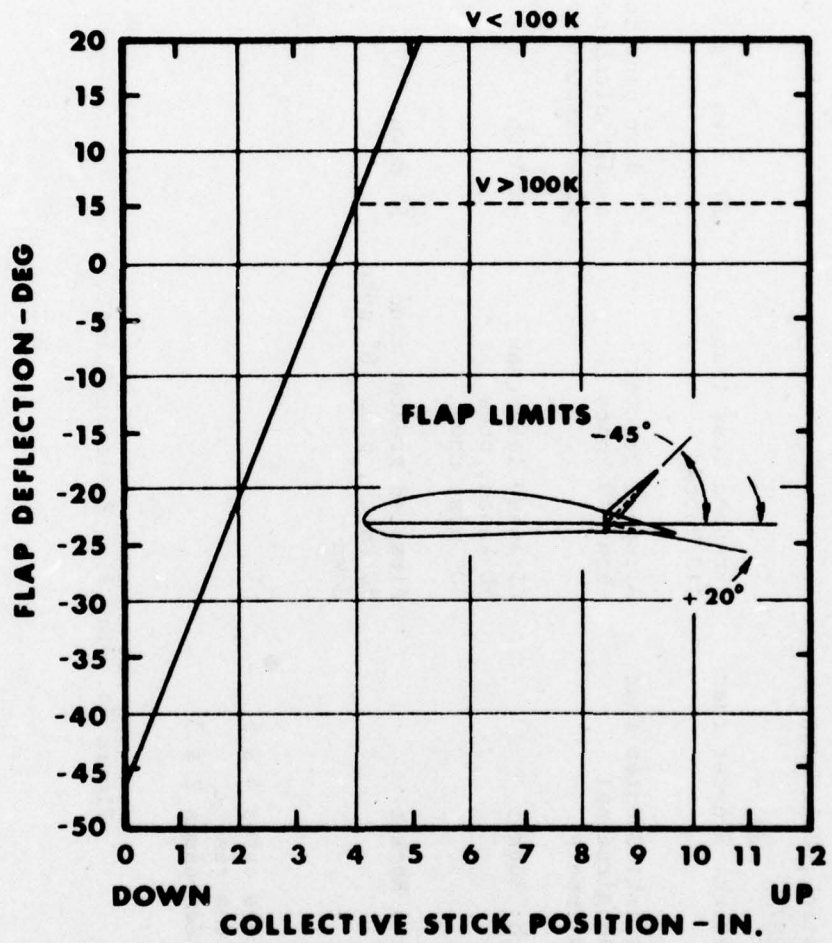

Figure 15. Flap Programming.

## APPENDIX D. ENGINE DESCRIPTION

### GENERAL

1. The primary power plant for the YAH-64 helicopter is the General Electric YT700-GE-700 front drive turboshaft engine, rated at 1543 shp (sea level, standard day, uninstalled). The engines are mounted in nacelles on either side of the main transmission. The basic engine consists of four modules: a cold section, a hot section, a power turbine, and an accessory section. Design features of each engine include an axial-centrifugal flow compressor, a through-flow combustor, a two-stage air-cooled high-pressure gas generator turbine, a two-stage uncooled power turbine, and self-contained lubrication and electrical systems. In order to reduce sand and dust erosion and foreign object damage (FOD), an integral particle separator operates when the engine is running. The YT700-GE-700 engine also incorporates a history recorder which records total engine events. Pertinent engine data are shown below. A more complete engine description is contained in reference 1, appendix A, a copy of which is on file in the USAAEFA Technical Library.

Model	YT700-GE-700
Type	Turboshaft
Rated power (intermediate)	1543 shp, sea-level, standard-day, uninstalled
Output speed (Np 100%)	20,000 rpm
Compressor	5 axial stages, 1 centrifugal stage
Variable geometry	Inlet guide vanes, stages 1 and 2 stator vanes
Combustion chamber	Single annular chamber with axial flow
Gas generator turbine stages	2
Power turbine stages	2
Direction of rotation (aft looking fwd)	Clockwise
Weight (dry)	415 lb (max)
Length	47 in.
Maximum diameter	25 in.
Fuel	MIL-T-5624 (JP-4 or JP-5)
Lubricating oil	MIL-L-7808 or MIL-L-23699
Electrical power requirements for history recorder and Np overspeed protection	40W, 115VAC, 400 Hz
Electrical power requirements for anti-ice valve, filter bypass indication, oil filter bypass indication, and magnetic chip detector	1 amp, 28VDC

## **BLACK HOLE INFRARED SUPPRESSOR ENGINE COOLER**

2. The black hole infrared suppressor (BHOIR) was designed to replace the engine cooling fan used in the Phase 1 aircraft. The BHOIR consists of finned exhaust pipes attached to the engine outlet and bent 35 degrees outboard to mask hot engine parts. The finned pipes radiate heat which is cooled by rotor downwash in hover and turbulent air flow in forward flight. The engine exhaust plume is cooled by mixing it with engine cooling air and bay cooling air, as shown in figure 1. The exhaust acts as an eductor, creating air flow over the combustion section of the engine providing engine cooling. Fixed louvers on the top and bottom of the aft cowl and a door on the bottom forward cowling provide convective cooling to the engine during shut down. The movable bottom door is closed by engine bleed air during engine operation.

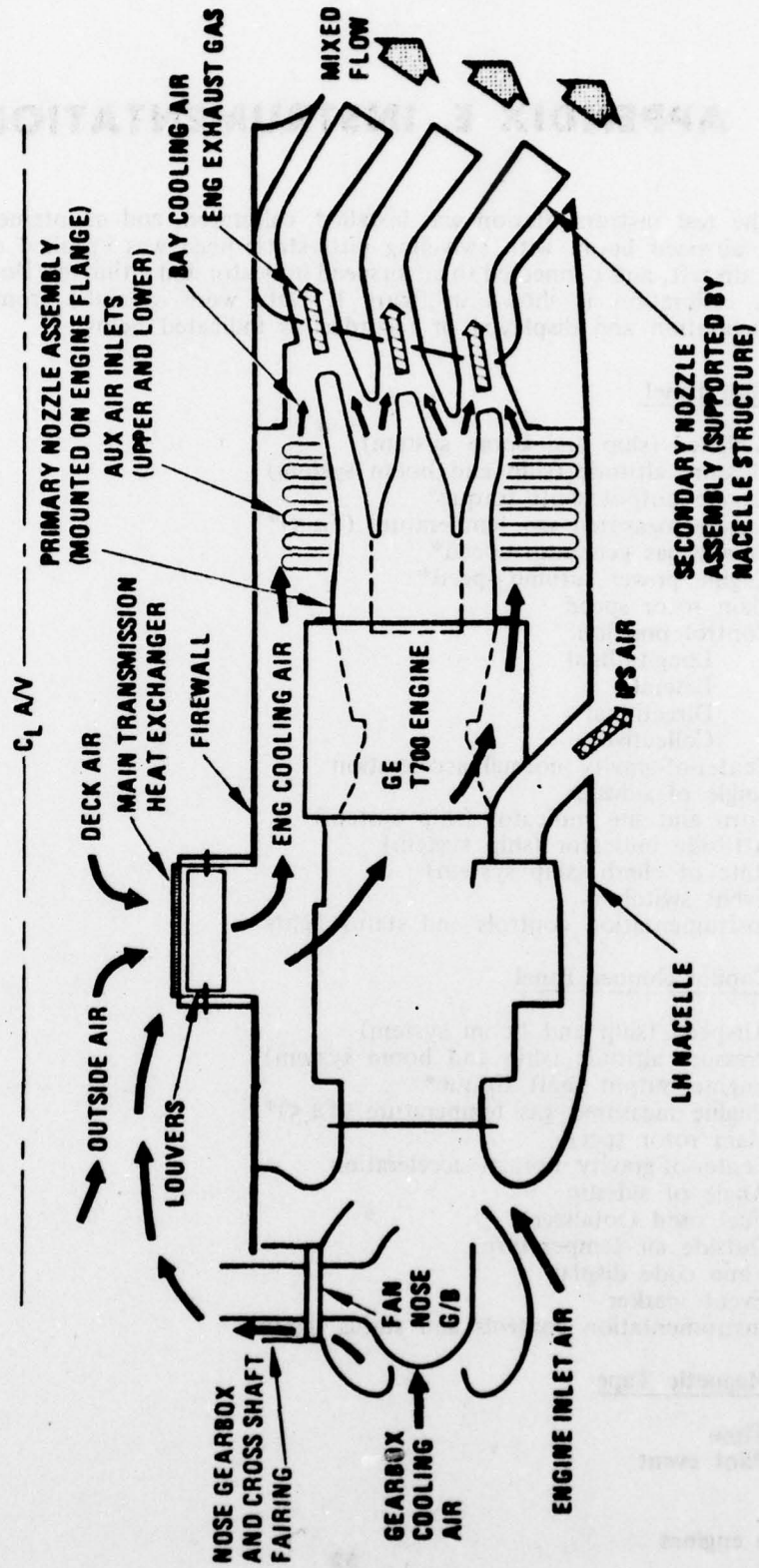

Figure 1. BHOIR Suppressor Engine Cooling.

## **APPENDIX E. INSTRUMENTATION**

1. The test instrumentation was installed, calibrated, and maintained by HHC. A test airspeed boom with swiveling pitot-static head was installed on the nose of the aircraft, and connected to an airspeed indicator and altimeter. Boom airspeed system calibration is shown in figure 1. Data were obtained from calibrated instrumentation and displayed or recorded as indicated below.

### **Pilot Panel**

Airspeed (ship and boom system)  
Pressure altitude (ship and boom system)  
Engine output shaft torque\*  
Engine measured gas temperature (T4.5)\*  
Engine gas generator speed\*  
Engine power turbine speed\*  
Main rotor speed  
Control position:  
    Longitudinal  
    Lateral  
    Directional  
    Collective  
Center-of-gravity normal acceleration  
Angle of sideslip  
Turn and slip indicator (ship system)  
Attitude indicator (ship system)  
Rate of climb (ship system)  
Event switch  
Instrumentation controls and status lights

### **Copilot/Gunner Panel**

Airspeed (ship and boom system)  
Pressure altitude (ship and boom system)  
Engine output shaft torque\*  
Engine measured gas temperature (T4.5)\*  
Main rotor speed  
Center-of-gravity normal acceleration  
Angle of sideslip  
Fuel used (totalizer)  
Outside air temperature  
Time code display  
Event marker  
Instrumentation controls and status lights

### **Magnetic Tape**

Time  
Pilot event

\*Both engines

**FIGURE 1  
BOOM AIRSPEED CALIBRATION  
TAB-68/ USA 8/S 74-22248**

Avg GROSS WEIGHT (LB)	Avg CG LOCATION		Avg DENSITY ALTITUDE (FT)	Avg OAT (°C)	Avg MPOB SPEED (KPH)	TRIM FLIGHT CONDITION
	LONG (°S)	LAT (°N)				
14640	206.8(AFT)	0.4 LT	5000	13.0	288	LVL FLT

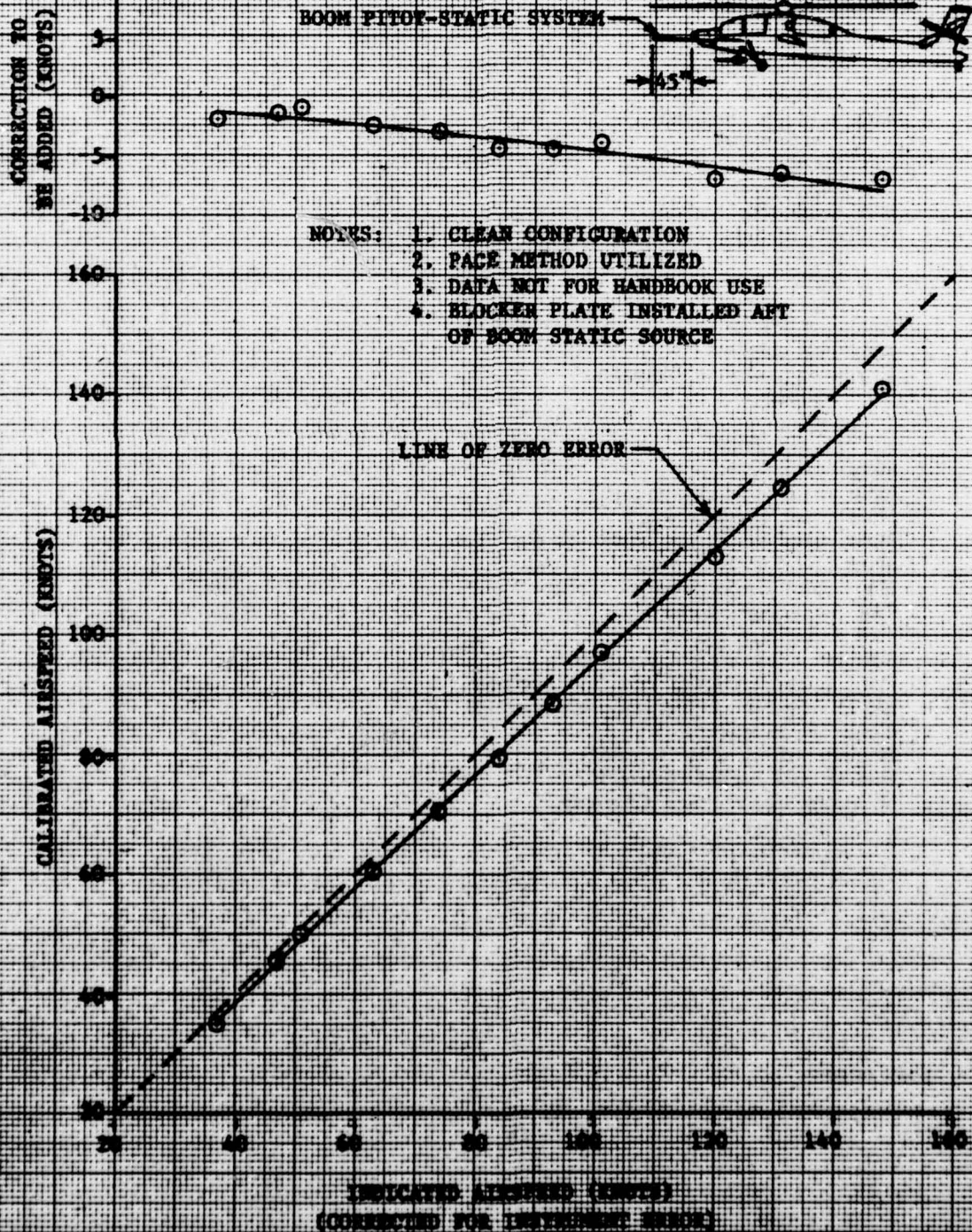

Engineer event  
Control position:  
    Longitudinal  
    Lateral  
    Directional  
    Collective  
Control force:  
    Longitudinal  
    Lateral  
    Directional  
    Collective  
SAS actuator position:  
    Longitudinal  
    Lateral  
    Directional  
ASE wing flap position  
Aircraft attitude, rate, and angular acceleration:  
    Pitch  
    Roll  
    Yaw  
Angle of attack  
Angle of sideslip  
Center-of-gravity acceleration:  
    Vertical  
    Lateral  
    Longitudinal  
Main rotor speed  
Main rotor drive shaft torque  
Main rotor flapping angle  
Main rotor feathering angle  
Main rotor lead-lag angle  
Main rotor azimuth index  
Tail rotor shaft torque  
Tail rotor teeter angle  
Tail rotor swashplate position  
Pitot pressure (boom and ship system)  
Static pressure (boom and ship system)  
Total air temperature  
Engine output shaft torque\*  
Engine fuel used (totalizer)\*  
Vibration acceleration (3 axes):  
    Pilot seat  
    Copilot/gunner seat  
    Aircraft cg

\*Both engines



## APPENDIX F. DATA ANALYSIS METHODS

### GENERAL

1. Handling qualities data were collected and evaluated using standard test methods as described in reference 6, appendix A. The Handling Qualities Rating Scale presented in figure 1 was used to augment pilot comments relative to handling qualities and workload. Definitions of deficiencies and shortcomings are as stipulated in Army Regulation 310-25.

### Dynamic Response

2. The dynamic response characteristics of the aircraft were evaluated to determine the rate damping ratios (E). These ratios were derived for all conditions tested by the logarithmic decrement method. The logarithmic decrement is defined as the natural logarithm of the ratio of any two successive peaks. For lightly damped responses, E is approximately proportional to the decrement, as shown below.

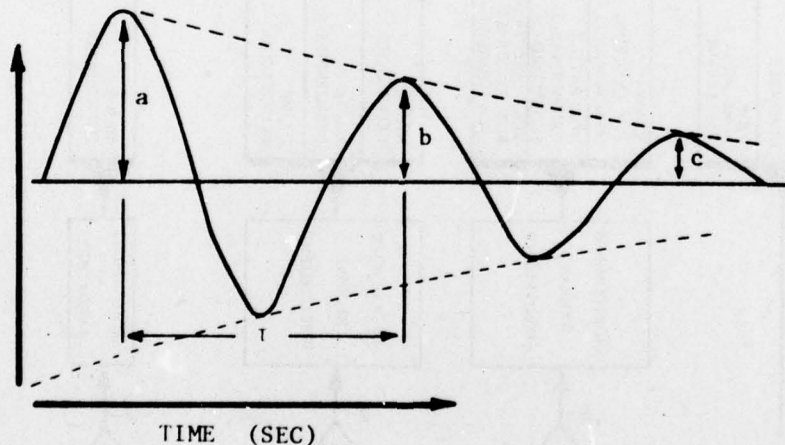

$$\text{DAMPING RATIO } \zeta = \frac{1}{2\pi} \ln (a/d) = \frac{1}{2\pi} \ln (b/c)$$

$$\text{FREQUENCY } \omega = 2\pi/\tau \text{ rad/sec}$$

$$\text{NATURAL FREQUENCY } \omega_n = \frac{2\pi}{\tau \sqrt{1 - \zeta^2}} \text{ rad/sec}$$

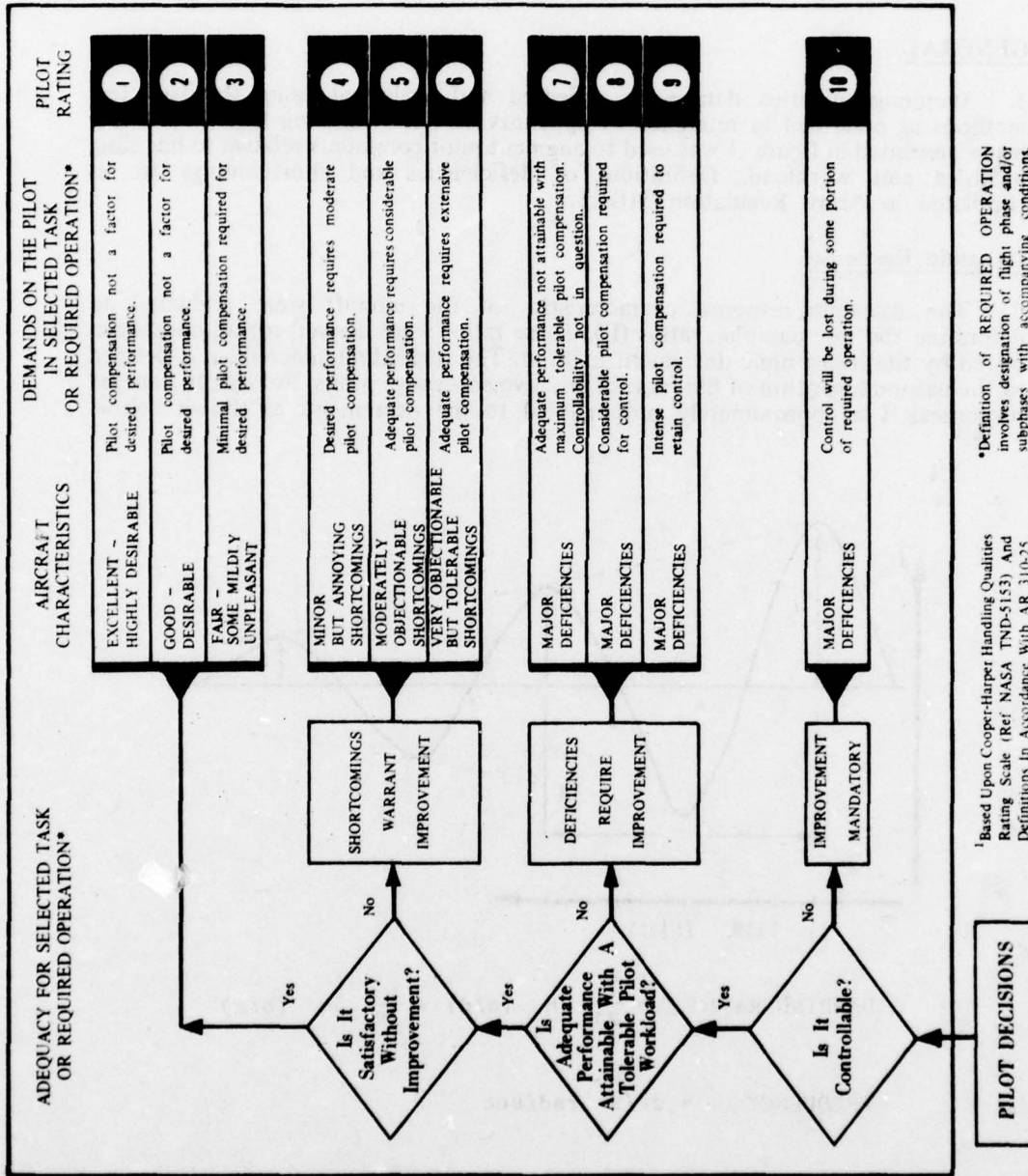

\*Based Upon Cooper-Harper Handling Qualities Rating Scale (Ref NASA TND-5153) And Definitions In Accordance With AR 310-25.

\*Definition of REQUIRED OPERATION involves designation of flight phase and/or subphases with accompanying conditions.

Figure 1. Handling Qualities Rating Scale.

### Vibrations

3. The PCM vibration data were reduced by means of fast Fourier transform from the analog flight tape. Vibration levels, representing peak amplitudes, were extracted from this analysis at selected harmonics of the main rotor frequency. The Vibration Rating Scale, presented in figure 2, was used to augment crew comments on aircraft vibration levels.

### AIRSPPEED CALIBRATION

4. The boom and ship's standard pitot-static system were calibrated by using the pace aircraft method to determine airspeed position error. Calibrated airspeed ( $V_{cal}$ ) was obtained by correcting indicated airspeed ( $V_i$ ) for instrument error ( $\Delta V_{ic}$ ) and position error ( $\Delta V_{pc}$ ).

$$V_{cal} = V_i + \Delta V_{ic} + \Delta V_{pc}$$

True airspeed ( $V_T$ ) was calculated from the calibrated airspeed and density ratio.

$$V_T = V_{cal} / \sqrt{\sigma}$$

Where:

$$\sigma = \text{density ratio} = \rho / \rho_0$$

Where  $\rho$  is the test ambient density

### Weight and Balance

5. Prior to testing, the aircraft gross weight and longitudinal and lateral cg were determined using calibrated scales. The longitudinal cg was calculated by a summation of moments about a reference datum line (FS 0.0). Two weighings were accomplished: the first with all fuel drained, and the second with a full fuel load. Both weighings included instrumentation and neither included external stores.

6. All engine starts were initiated with a full fuel load. Aircraft gross weight and cg were controlled by installing ballast at various locations in the aircraft.

Degree of Vibration	Description <sup>1</sup>	Pilot Rating
No vibration		<b>0</b>
Slight	Not apparent to experienced aircrew fully occupied by their tasks, but noticeable if their attention is directed to it or if not otherwise occupied.	<b>1</b>
		<b>2</b>
		<b>3</b>
Moderate	Experienced aircrew are aware of the vibration but it does not affect their work, at least over a short period.	<b>4</b>
		<b>5</b>
		<b>6</b>
Severe	Vibration is immediately apparent to experienced aircrew even when fully occupied. Performance of primary task is affected or tasks can only be done with difficulty.	<b>7</b>
		<b>8</b>
		<b>9</b>
Intolerable	Sole preoccupation of aircrew is to reduce vibration level.	<b>10</b>

<sup>1</sup>Based upon the Subjective Vibration Assessment Scale developed by the Aeroplane and Armament Experimental Establishment, Boscombe Down, England.

Figure 2. Vibration Rating Scale.

## APPENDIX G. TEST DATA

### INDEX

<u>Figure</u>	<u>Figure Number</u>
Control System Mechanical Characteristics	1 through 5
Control Positions in Trimmed Forward Flight	6 through 8
Collective-Fixed Static Longitudinal Stability	9 and 10
Static Lateral-Directional Stability	11 and 12
Maneuvering Stability	13 through 15
Dynamic Stability	16 through 28
Low-Speed Flight Characteristics	29 through 40
Simulated SAS Failures	41 through 45
Vibration Characteristics	46 through 63
Structural Loads	64 through 66

FIGURE 1  
LIMITS OF CYCLIC CONTROL TRAVEL  
YAH-64 USA S/N 74-22248

- NOTES:
1. MOTORS STATIC
  2. HYDRAULIC AND ELECTRICAL POWER PROVIDED BY GROUND POWER UNITS
  3. CONTROL POSITION MEASURED AT CENTER OF GRIP
  4. COLLECTIVE CONTROL FULL DOWN
  5. NO CYCLIC CONTROL PATTERN CHANGE WITH CHANGE OF COLLECTIVE CONTROL POSITION

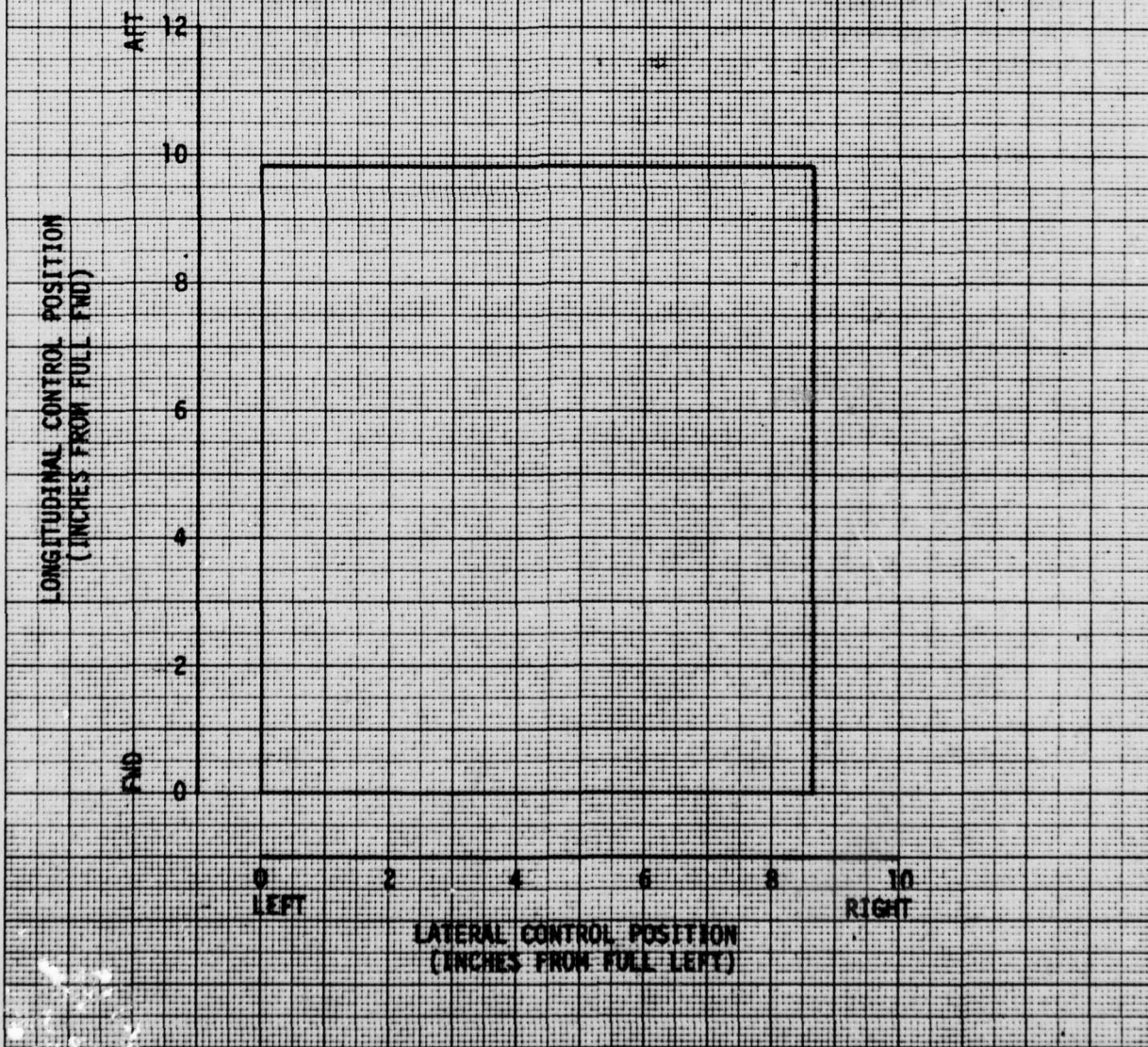

**FIGURE 2**  
**LONGITUDINAL CONTROL SYSTEM CHARACTERISTICS**  
 YAN-64 USA S/N 74-22248

- NOTES:**
1. ROTORS STATIC
  2. FORCES AND POSITIONS MEASURED AT CENTER OF GRIP
  3. HYDRAULIC AND ELECTRICAL POWER PROVIDED BY GROUND POWER UNITS
  4. FORCE FEEL OFF
  5. FORCE TRIM ON
  6. HYDRAULIC FLIGHT CONTROL SYSTEM PRESSURIZED
  7. AIRSPEED (Q) SENSOR NONPRESSURIZED
  8. TOTAL LONGITUDINAL CONTROL TRAVEL = 9.82 INCHES
  9. LATERAL CONTROL POSITION = 4.3 INCHES FROM FULL LEFT

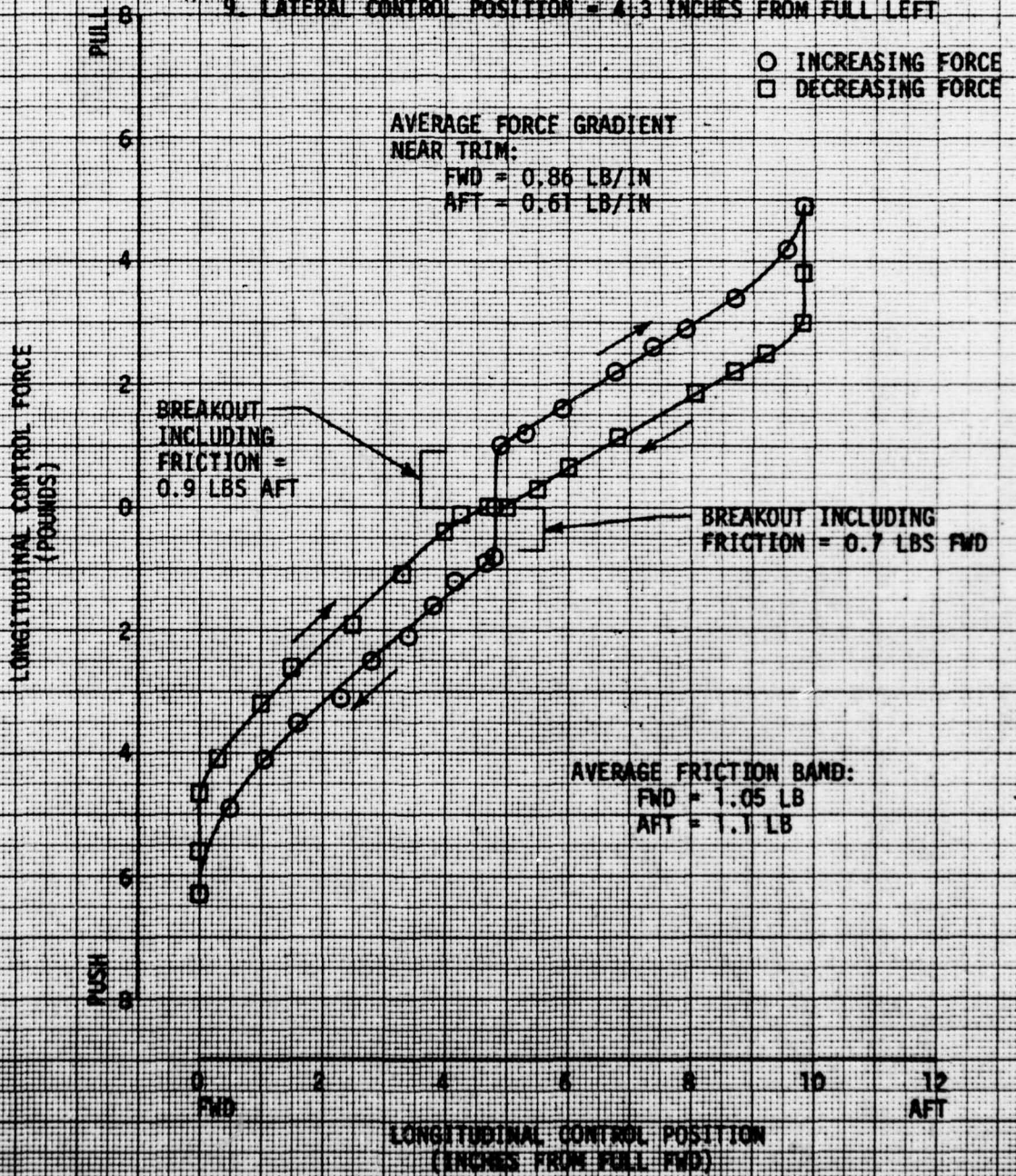

**FIGURE 3**  
**LONGITUDINAL CONTROL SYSTEM CHARACTERISTICS**

YAN-64 USA S/N 74-22248

- NOTES:-
1. ROTORS STATIC
  2. FORCES AND POSITIONS MEASURED AT CENTER OF GRIP
  3. HYDRAULIC AND ELECTRICAL POWER PROVIDED BY GROUND POWER UNITS
  4. FORCE FEEL ON
  5. FORCE TRIM ON
  6. HYDRAULIC FLIGHT CONTROL SYSTEM PRESSURIZED
  7. AIRSPEED (0) SENSOR NONPRESSURIZED
  8. TOTAL LONGITUDINAL CONTROL TRAVEL = 9.82 INCHES
  9. LATERAL CONTROL POSITION = 4.3 INCHES FROM FULL LEFT

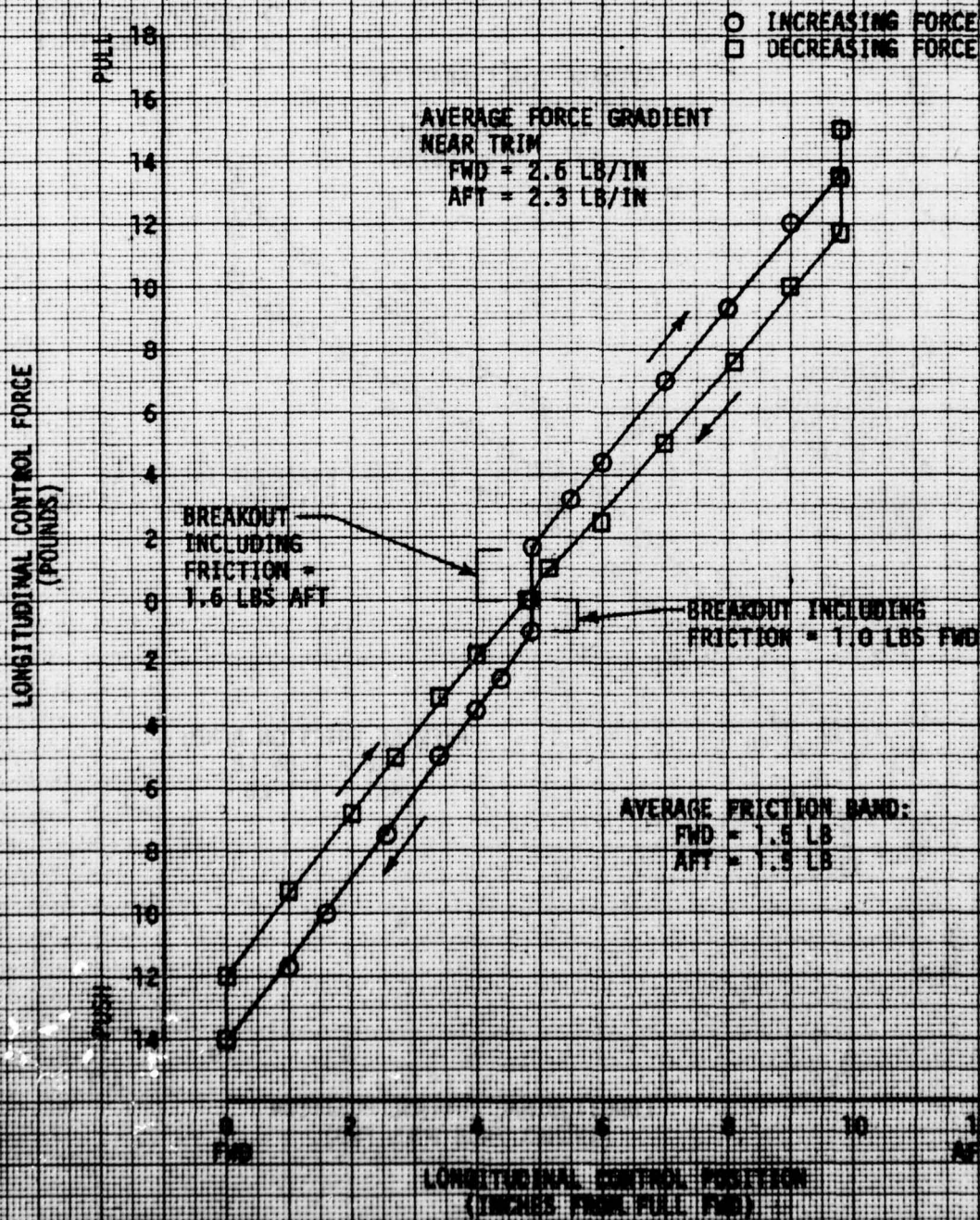



**FIGURE 4**  
**LATERAL CONTROL SYSTEM CHARACTERISTICS**  
 130-64 USA 5/8 74-22240

- NOTES:**
1. MOTORS STATIC
  2. FORCES AND POSITIONS MEASURED AT CENTER OF GRIP
  3. HYDRAULIC AND ELECTRICAL POWER PROVIDED BY GROUND POWER UNITS
  4. FORCE TRIM ON
  5. HYDRAULIC FLIGHT CONTROL SYSTEM PRESSURIZED
  6. AIRSPEED (0) SENSOR NONPRESSURIZED
  7. TOTAL LATERAL CONTROL TRAVEL = 8.63 INCHES
  8. LONGITUDINAL CONTROL POSITION = 4.9 INCHES FROM FULL FORWARD

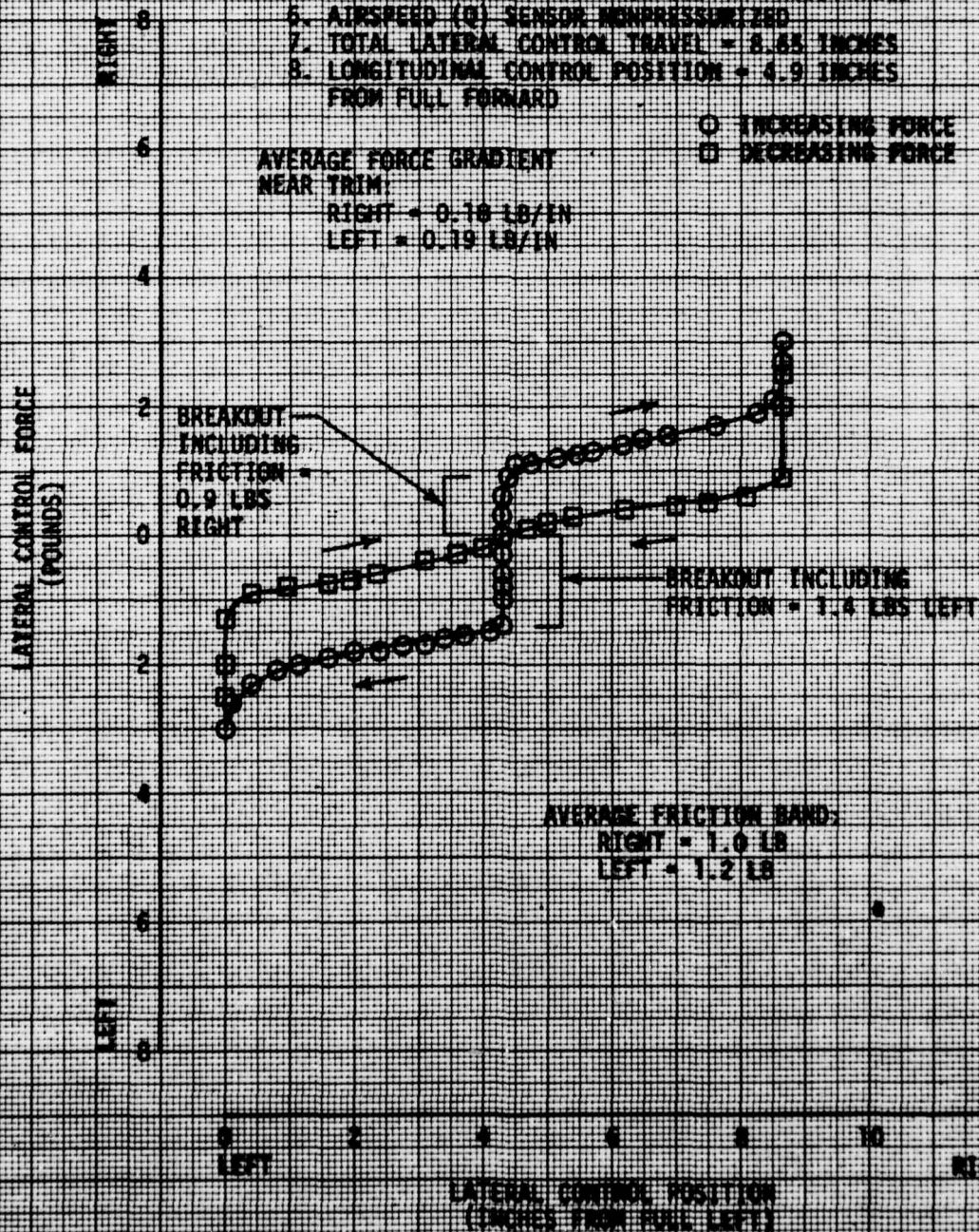

**FIGURE 5**  
**DIRECTIONAL CONTROL SYSTEM CHARACTERISTICS**  
 YAP-86 USA S/N 74-22246

- NOTES:**
1. ROTORS STATIC
  2. FORCES MEASURED AT THE DIRECTIONAL CONTROL
  3. HYDRAULIC AND ELECTRICAL POWER PROVIDED
  4. FORCE TRIM ON
  5. HYDRAULIC FLIGHT CONTROL SYSTEM PRESSURIZED
  6. AIRSPEED (0) SENSOR NONPRESSURIZED
  7. TOTAL DIRECTIONAL CONTROL TRAVEL = 5.52 INCHES

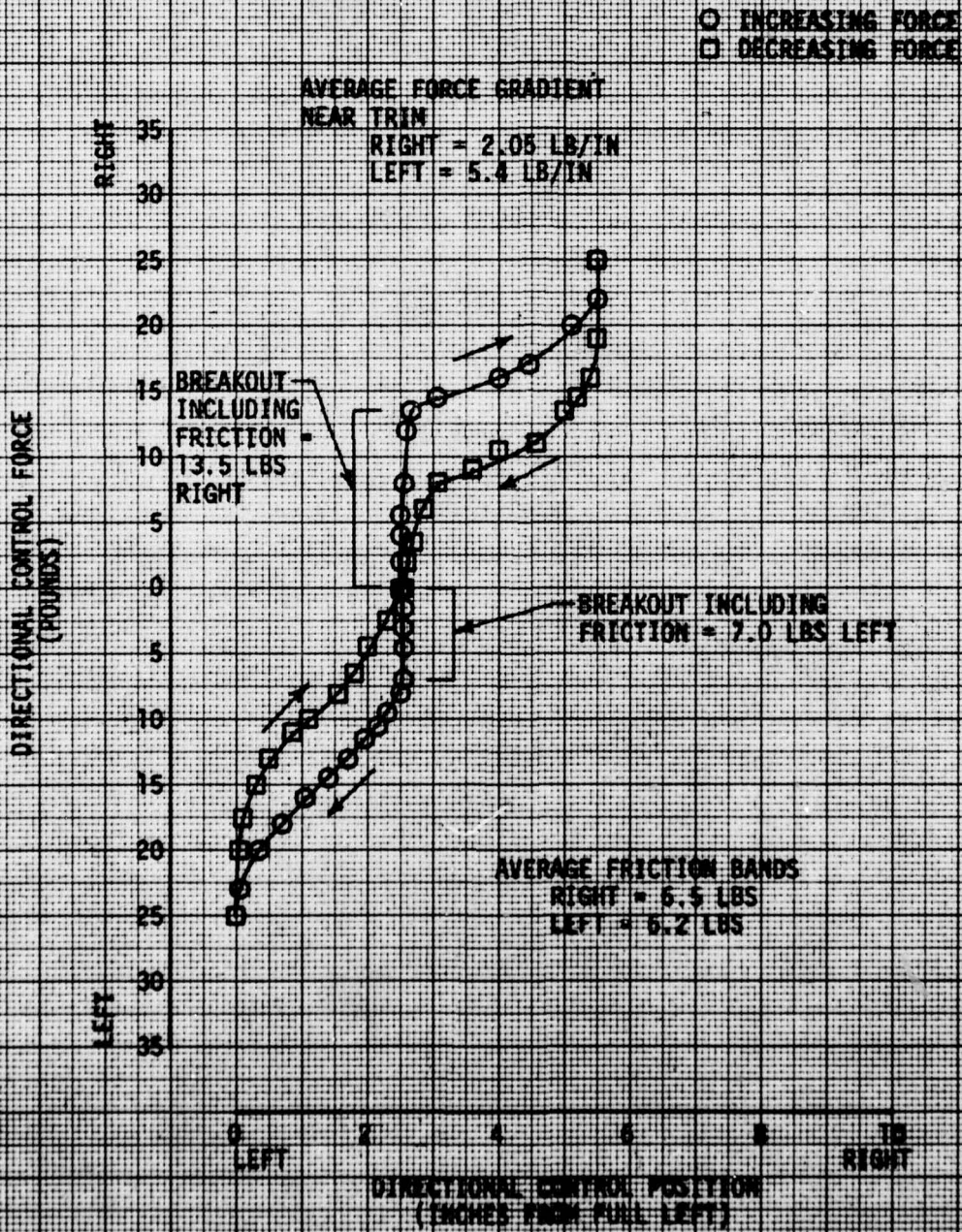
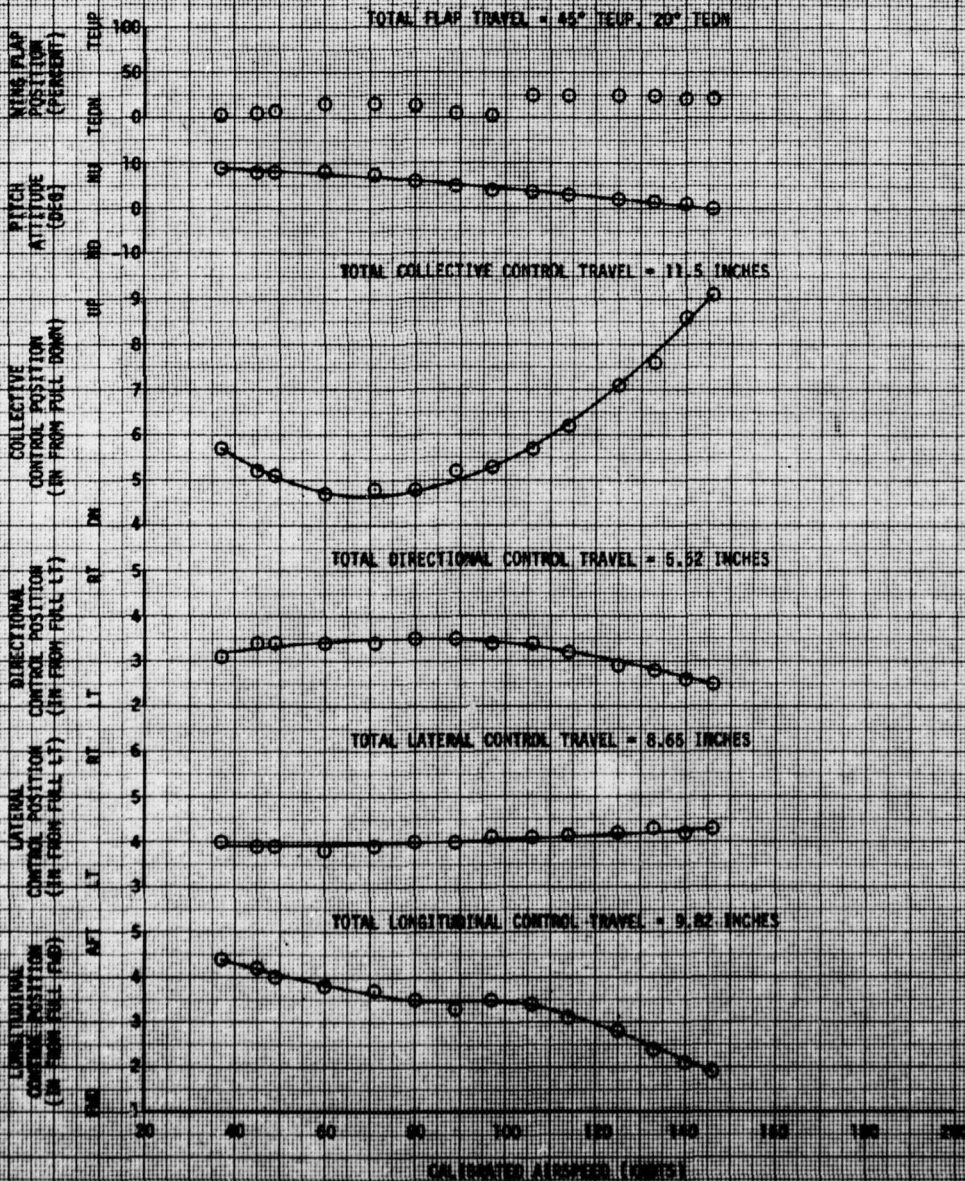

FIGURE 5  
CONTROL POSITIONS IN TRIMMED FORWARD FLIGHT  
YAK-04 USA S/N 74-22506

AVG GROSS WEIGHT (LB)	AVG CR LOCATION LONG (FS) LAT (DL)	AVG DENSITY ALTITUDE (FT)	AVG QAT (FC)	AVG ROTOR SPEED (RPM)	TRIM FLIGHT CONDITION	SAS CONDITION
14440	206.8(AFT) -0.4(FT)	5000	13.0	298	LM FLT	ON

NOTE: HDG 1 TAIL



**FIGURE 7**  
**CONTROL POSITIONS IN TURNED FORWARD FLIGHT**  
 YAN-04 BSR 57874-22248

Avg Gross Weight (LB)	Avg CG Location (Long (IN), Lat (IN))	Avg Density Altitude (FT)	Avg DAT (°C)	Avg Rotor Speed (RPM)	Test Flight Condition	SAS Condition
18740	206.7 (RFT)-0.4 (LF)	4740	6.0	288	LVL FLT	ON

NOTE: PHASE 1 TAIL

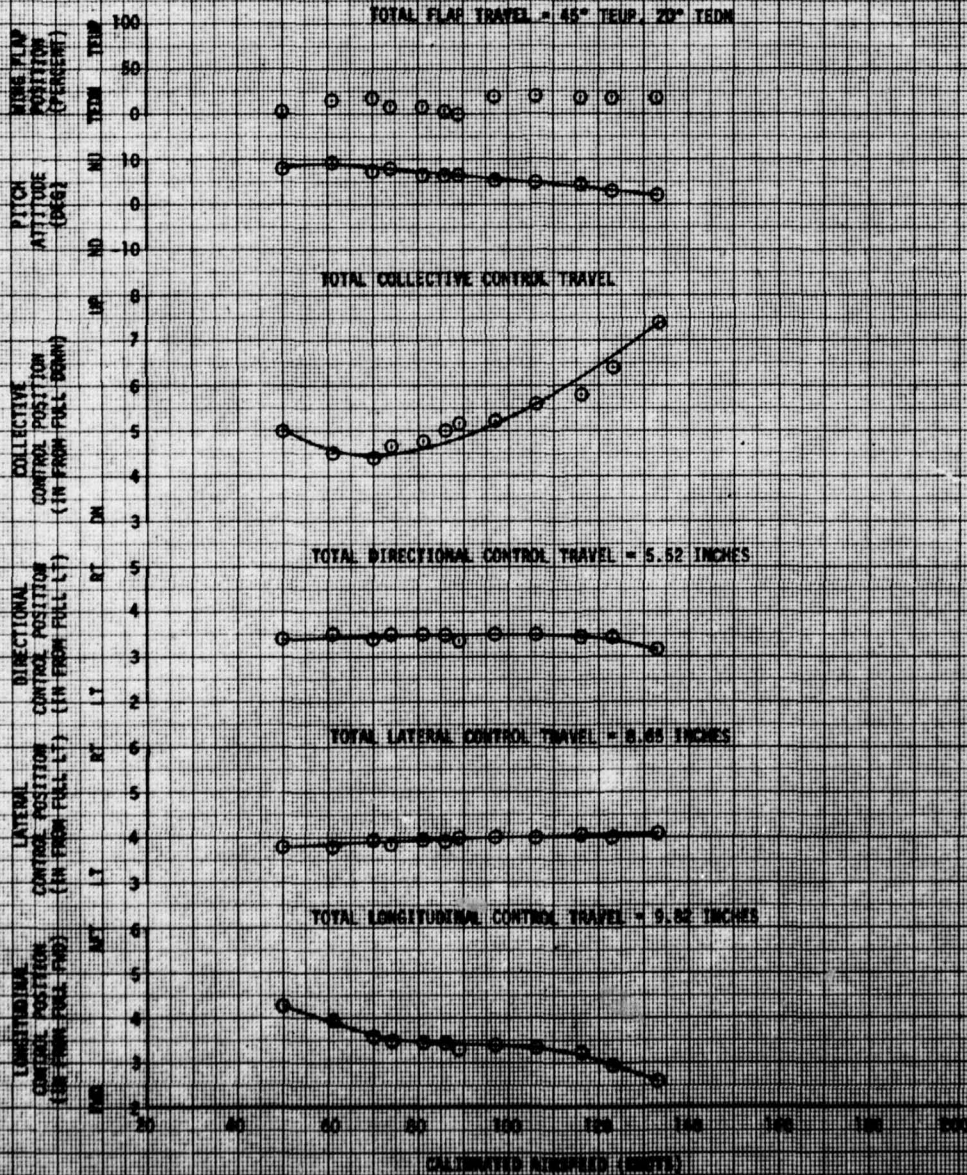

**FIGURE 3  
CONTROL POSITIONS IN THE STABLE FLIGHT**

SYM	AVG GROSS WEIGHT (LB)	AVG CG LOCATION (IN)		AVG DENSITY ALTIMETER (FT)	AVG DAY TEMP (°C)	AVG WIND SPEED (KPH)	FRM FLIGHT CONDITION	SEA CONDITION
		(FS)	(SC)					
14240	207.0	11.4	11.4	4800	13.0	268	CLIMBING (PM)	SM
14280	207.0	11.4	11.4	4800	12.0	268	DESCENDING (PM)	SM
13900	207.0	11.4	11.4	4800	12.5	268	1st CLIMB	SM
13660	207.0	11.4	11.4	4800	10.5	268	AUTO	SM

NOTE: WIND 1 TAIL

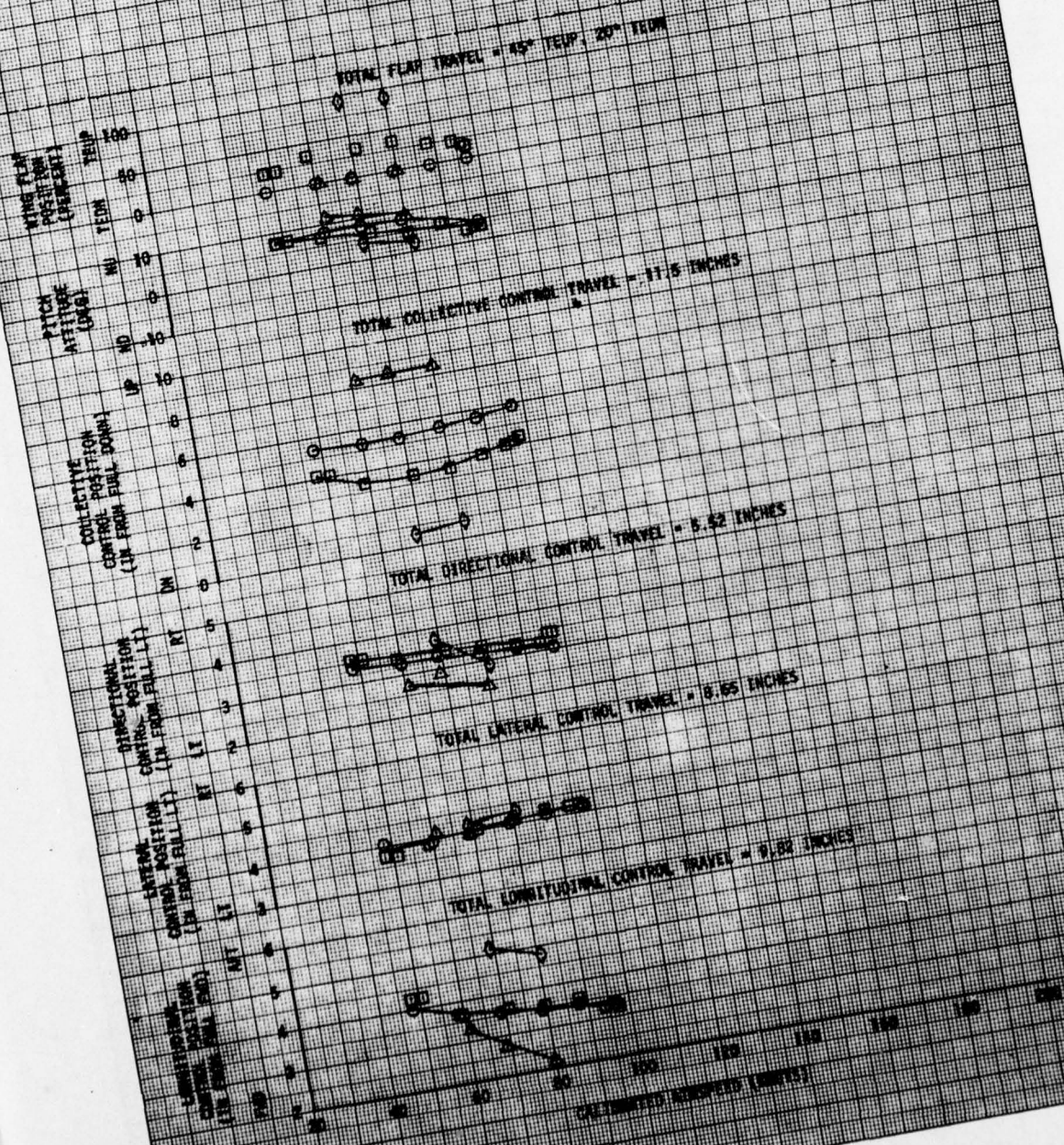

**FIGURE 9**  
**COLLECTIVE-FIXED STATIC LONGITUDINAL STABILITY**

YAH-64 USA S/N 74-22248

AVG GROSS WEIGHT (LB)	AVG CG LOCATION		AVG DENSITY ALTITUDE (FT)	AVG OAT (°C)	AVG ROTOR SPEED (RPM)	TRIM FLIGHT CONDITION	SAS CONDITION
14900	206.9(AFT)	-0.4(LT)	5020	14.0	288	LVL FLT	ON

- NOTES: 1. SHADED SYMBOL DENOTES TRIM  
 2. CLEAN CONFIGURATION  
 3. FORCE TRIM ON  
 4. FORCE FEEL OFF  
 5. MOD 1 TAIL

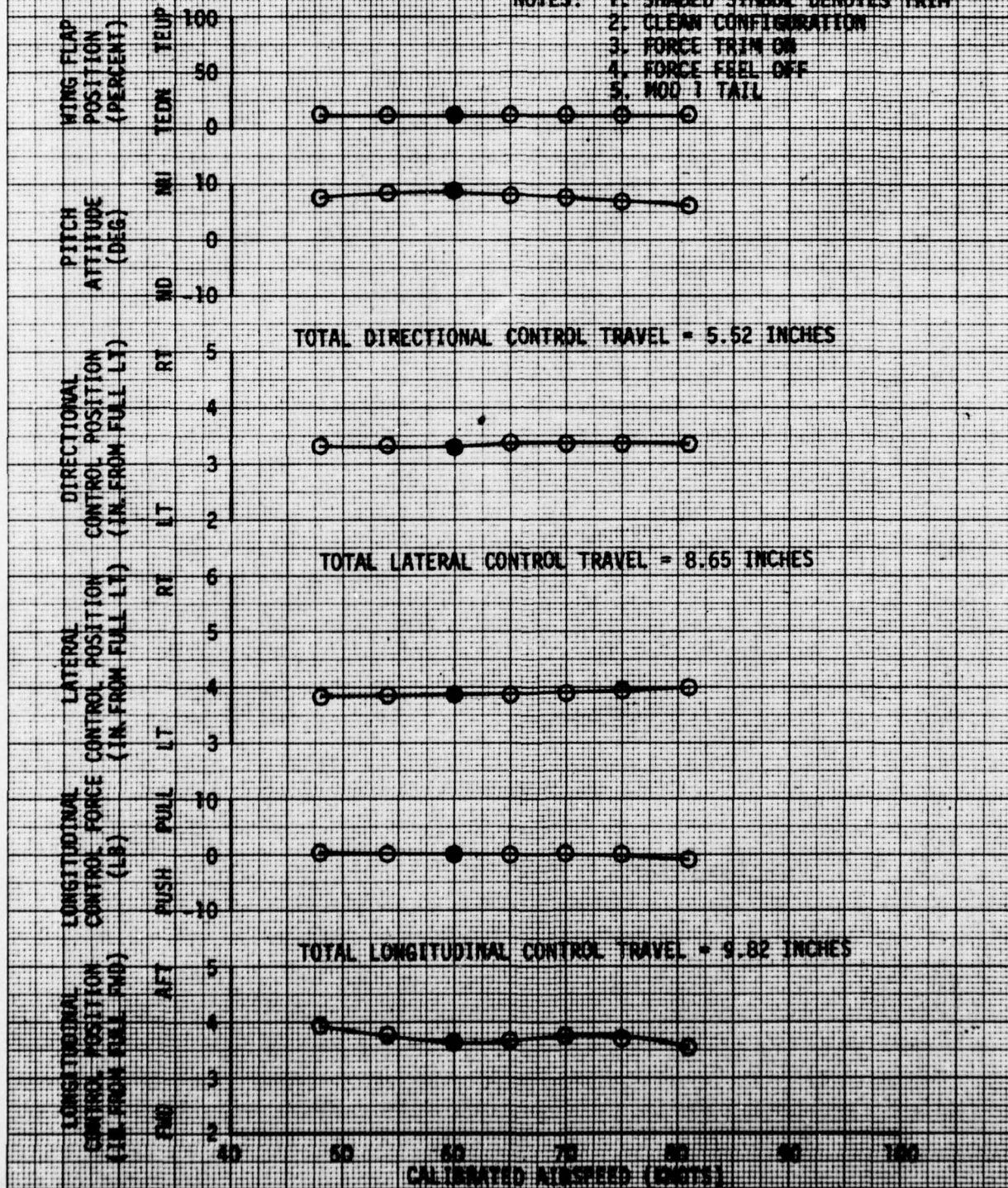

FIGURE 10  
COLLECTIVE-FIXED STATIC LONGITUDINAL STABILITY

YAH-64 USA S/N 74-22248

Avg Gross Weight (LB)	Avg CG Location		Avg Density Altitude (FT)	Avg OAT (°C)	Avg Rotor Speed (RPM)	Trim Flight Condition	SAS Condition
	LONG (FS)	LAT (BL)					
14700	207.0(AFT)	-0.4(LT)	5400	15.5	288	LVL FLT	ON

- NOTES: 1. SHADED SYMBOL DENOTES TRIM  
2. CLEAN CONFIGURATION  
3. FORCE TRIM ON  
4. FORCE FEEL OFF  
5. MOD 1 TAIL

WING FLAP POSITION (PERCENT)

TEON TEUP

100  
50  
0

PITCH ATTITUDE (DEG)

NU ND

10  
0  
-10

DIRECTIONAL CONTROL POSITION (IN FROM FULL LT)

RT LT

4  
3  
2  
1

TOTAL DIRECTIONAL CONTROL TRAVEL = 5.52 INCHES

LATERAL CONTROL POSITION (IN FROM FULL LT)

RT LT

6  
5  
4  
3

TOTAL LATERAL CONTROL TRAVEL = 8.65 INCHES

LONGITUDINAL CONTROL FORCE (LB)

PULL PUSH

10  
0  
-10

TOTAL LONGITUDINAL CONTROL TRAVEL = 9.82 INCHES

LONGITUDINAL CONTROL POSITION (IN FROM FULL FWD)

AFT FWD

4  
3  
2  
1

CALIBRATED AIRSPEED (KNOTS)

110 120 130 140 150 160 170

FIGURE 11  
 STATIC LATERAL-DIRECTIONAL STABILITY  
 REP-OR USA 578 74-22293

AVG GROSS WEIGHT (LB)	AVG CG LOCATION (LONG (FS) LAT (BL))	AVG DENSITY ALTITUDE (FT)	AVG WAT (%)	AVG MOTOR SPEED (RPM)	TRIM CALIBRATED AIRSPEED	SAS CONDITION
11780	206.7(AFT)-0.4(LT)	4840	16.0	288	94	ON

NOTES: 1. SHADED SYMBOLS DENOTE TRIM  
 2. MOD 1 TAIL  
 3. FORCE FEEL DEF

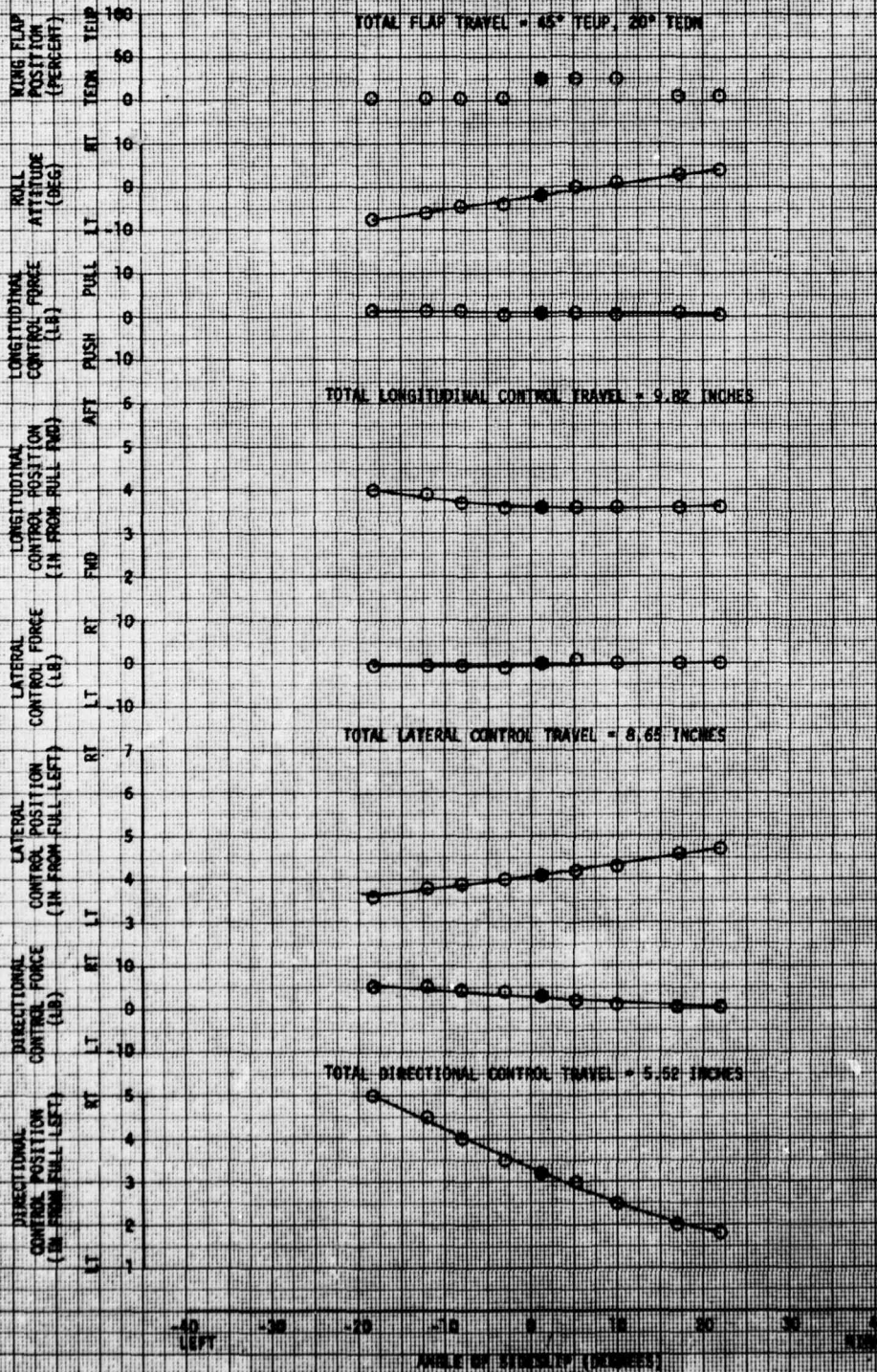
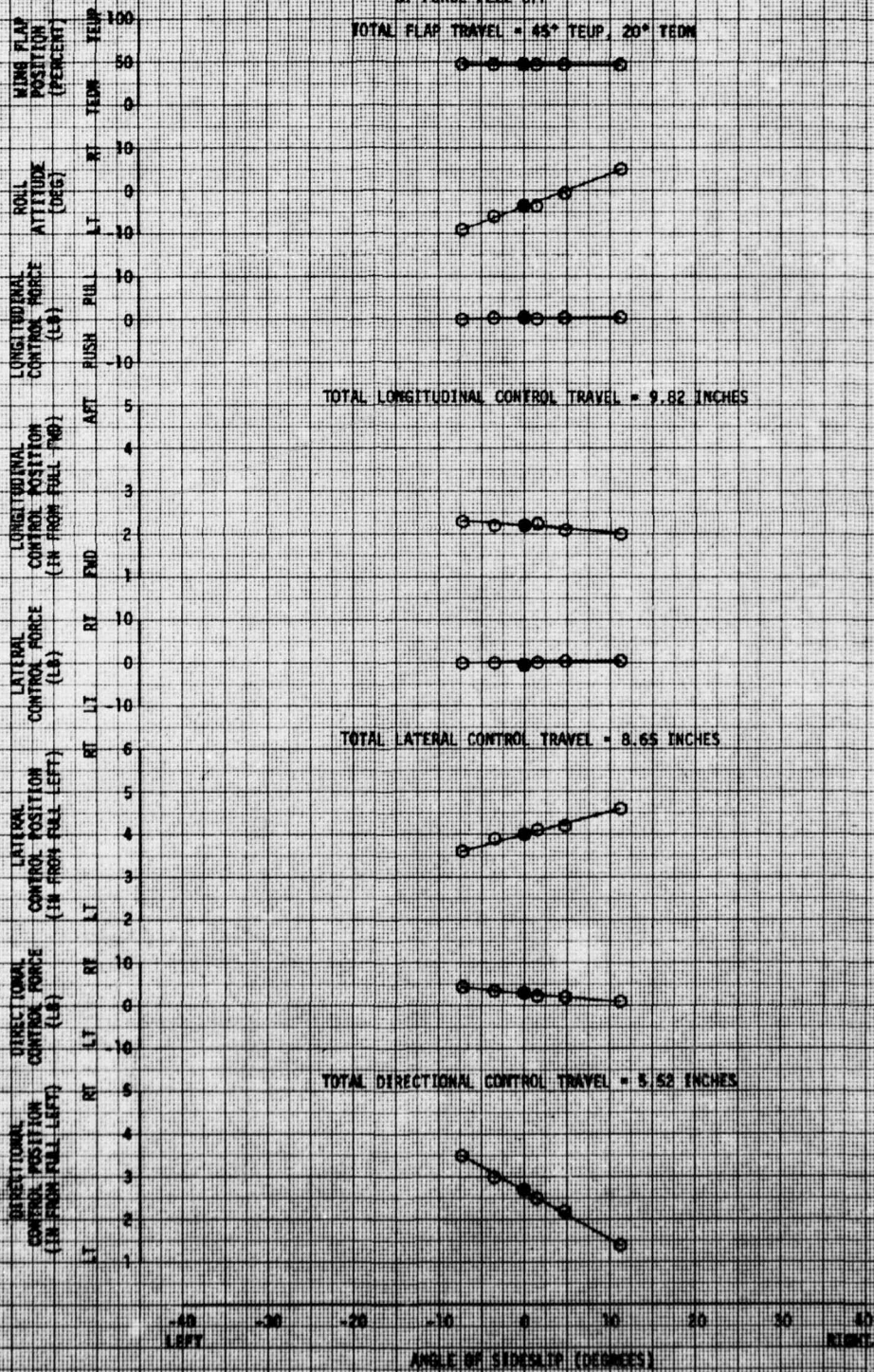



FIGURE 12  
 STATIC LATERAL-DIRECTIONAL STABILITY  
 YAF-64 USA S/N 74-2224B

AVG GROSS WEIGHT (LB)	AVG CG LOCATION (LONG (FS), LAT (BL))	AVG DENSITY ALTITUDE (FT)	AVG OAT (°C)	AVG ROTOR SPEED (RPM)	TRIM CALIBRATED AIRSPEED	SAS CONDITION
14560	206.8(AFT)-0.4(LT)	5290	15.0	208	145	ON

NOTES: 1. SHADED SYMBOLS DENOTE TRIM  
 2. MID 1 TAIL  
 3. FORCE FEEL OFF



TRIMMABILITY - FORCE FEEL ON  
YAH-64 USA S/N 74-22248

AVG GROSS WEIGHT (LB)	14840	AVG CG LONG (FS)	206.9(AFT)	AVG CG LAT (BL)	-0.4	AVG DENSITY ALTITUDE (FT)	4940	AVG OAT (°C)	6.0	TRIM ROTOR SPEED (RPM)	288	TRIM CALIBRATED AIRSPEED (KTS)	102	SAS CONDITION	ON
-----------------------	-------	------------------	------------	-----------------	------	---------------------------	------	--------------	-----	------------------------	-----	--------------------------------	-----	---------------	----

NOTES: 1. MOD 1 TAIL  
2. LONGITUDINAL FORCE TRIM DEACTIVATED

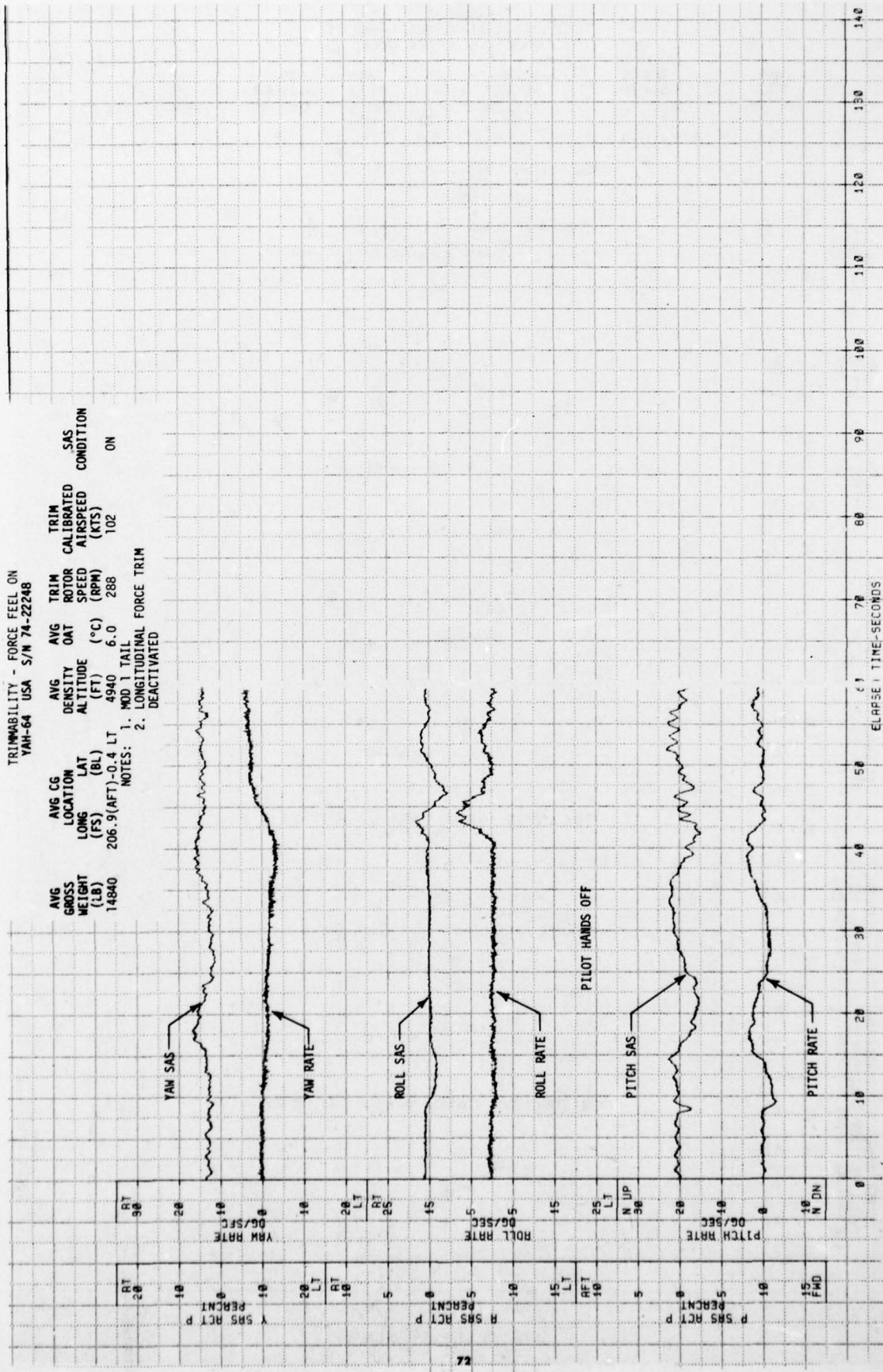

FIGURE 13 CONTINUED

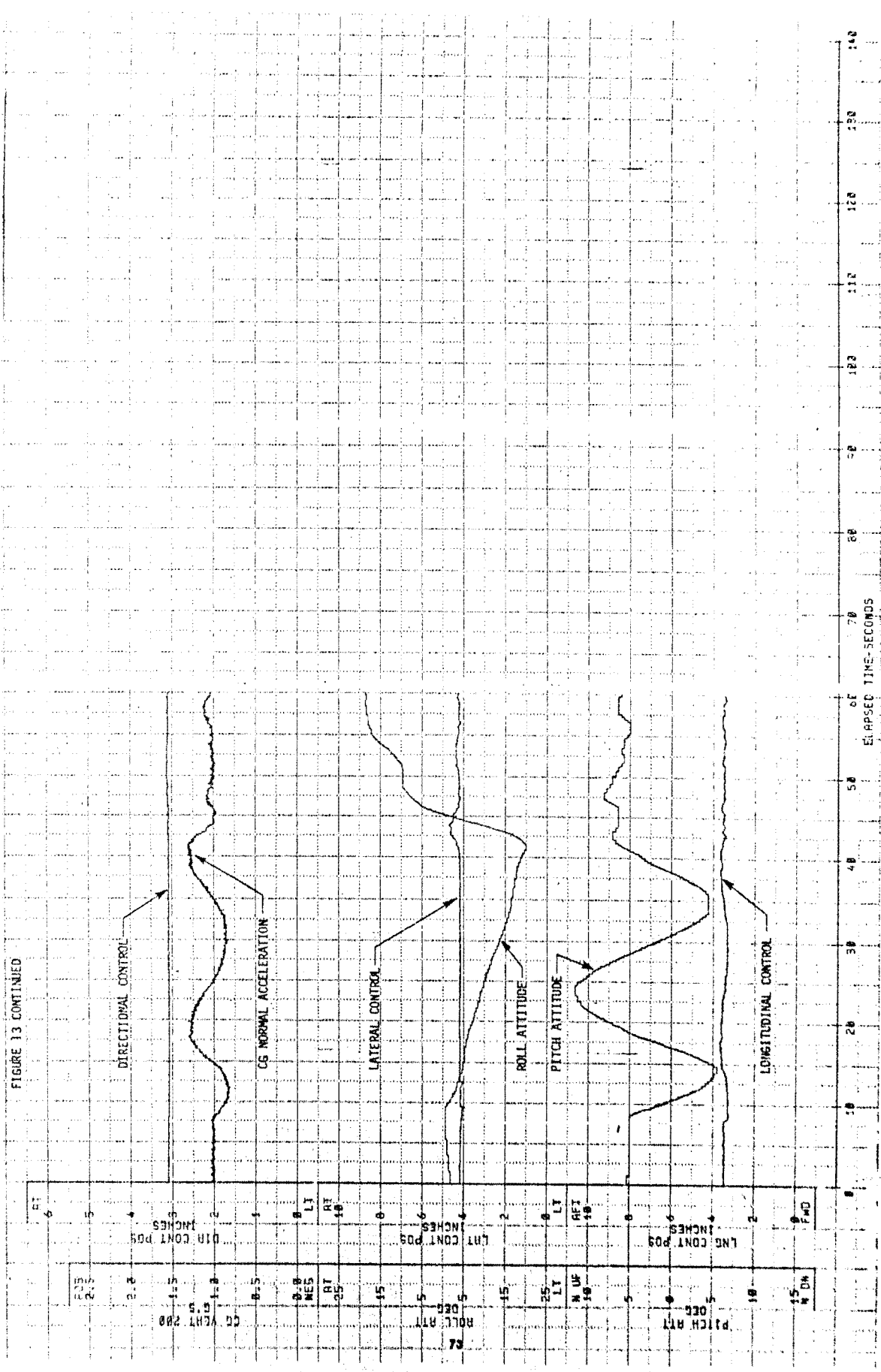

FIGURE 14  
MANEUVERING STABILITY

YAN-04 USA S/N 74-22208

SYM	AVG GROSS WEIGHT (LB)	AVG CG LOCATION		AVG DENSITY ALTITUDE (FT)	AVG OAT (°C)	AVG MOTOR SPEED (RPM)	FLIGHT CONDITION	SAS CONDITION
		LONG (FS)	LAT (BL)					
○	14680	206.9(AFT)	-0.4 LT	4340	4.0	288	RT TURN	ON
□	14500	207.0(AFT)	-0.4 LT	5340	4.0	288	LT TURN	ON

- NOTES:
1. CLEAN CONFIGURATION
  2. FORCE FEEL OFF
  3. 94 KCAS
  4. MOD 1 TAIL

TOTAL FLAP TRAVEL = 45° TEUP, 20° TEDN

WING FLAP POSITION (PERCENT)

LATERAL CONTROL POSITION (IN FROM FULL LEFT)

LONGITUDINAL CONTROL FORCE (LB)

LONGITUDINAL CONTROL POSITION (IN FROM FULL FWG)

TEUP  
TEDN  
RT  
LT  
PULL  
PUSH  
AFT  
FWD

TOTAL LATERAL CONTROL TRAVEL = 8.65 INCHES

TOTAL LONGITUDINAL CONTROL TRAVEL = 9.82 INCHES

CG NORMAL ACCELERATION (G)

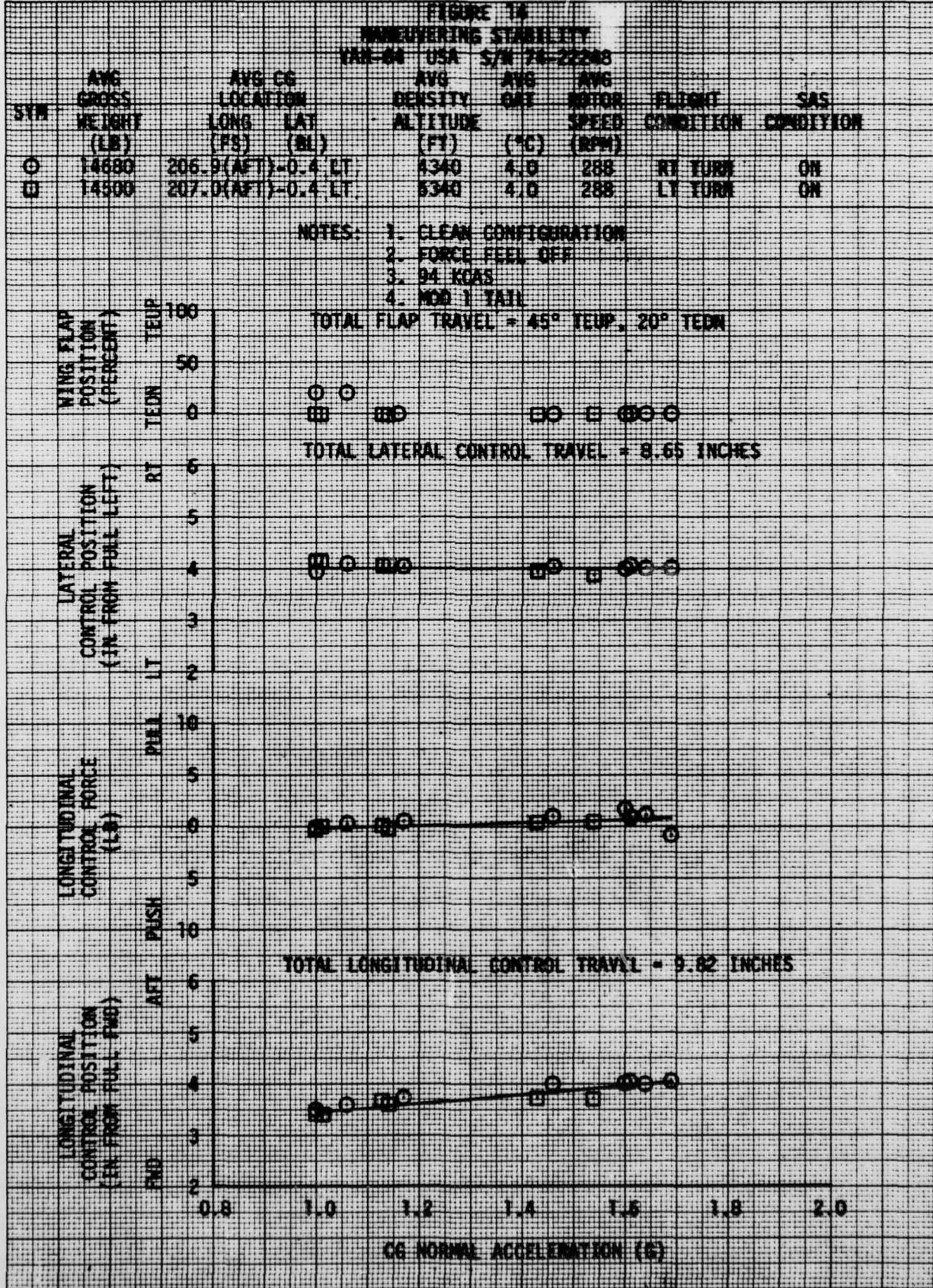

**FIGURE 15**  
**MANEUVERING STABILITY**  
**SYMMETRICAL PUSHOVERS AND PULLUPS**  
**YAH-64 USA S/N 74-22248**

Avg GROSS WEIGHT (LB)	Avg CG LOCATION LONG (FS) LAT (BL)	Avg DENSITY ALTITUDE (FT)	Avg OAT (°C)	Avg ROTOR SPEED (RPM)	SAS CONDITION
14300	207.1(AFT)-0.4(LT)	5320	4.5	288	ON

- NOTES: 1. CLEAN CONFIGURATION  
 2. FORCE FEEL OFF  
 3. STICK MOVEMENT AT 94 KCAS  
 4. MOD 1 TAIL

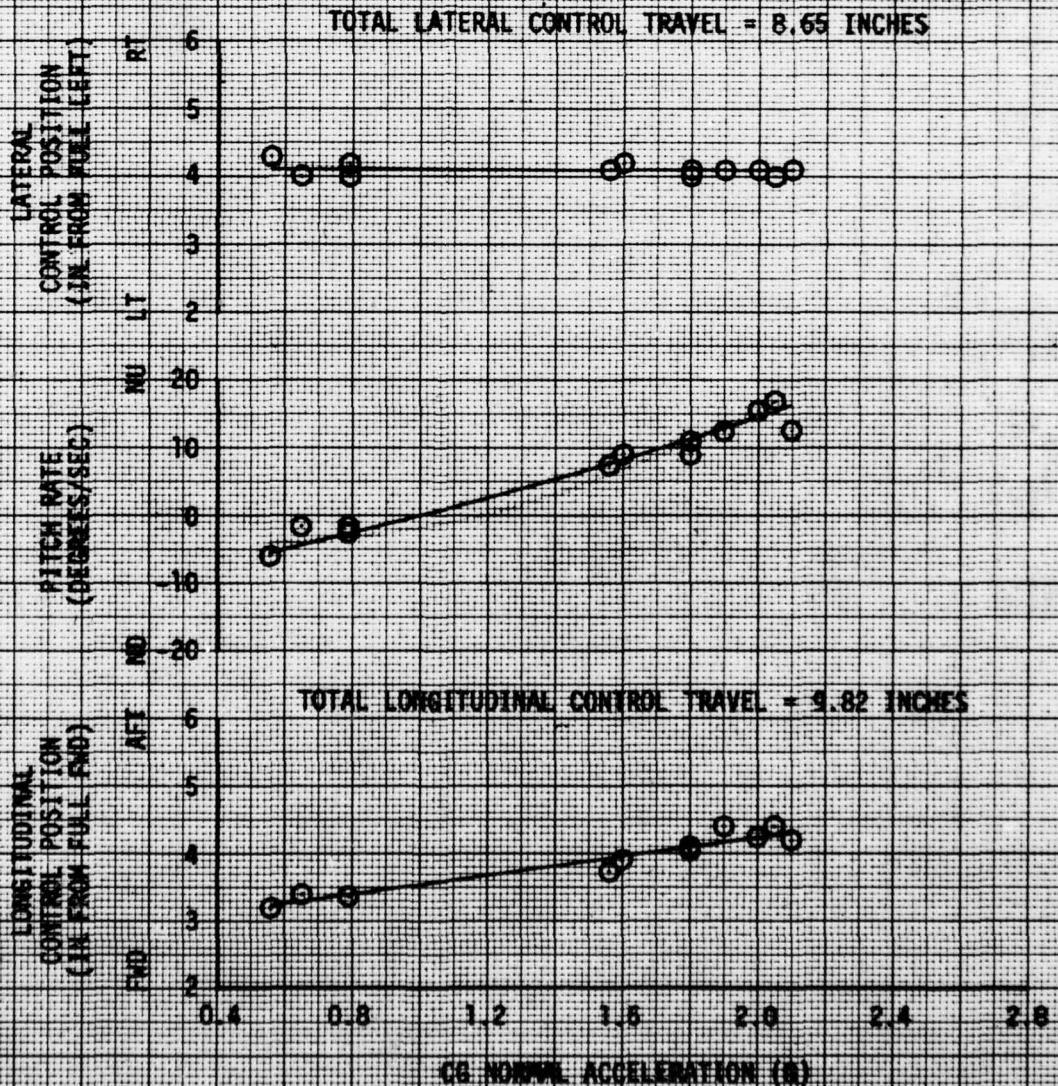

FORWARD PULSE  
YAH-64 USA S/N 74-22248

AVG GROSS WEIGHT (LB) 14400  
 AVG CG LOCATION LONG (FS) 207.0(AFT)-0.4 LT  
 LAT (BL)  
 AVG DENSITY ALTITUDE (FT) 5280  
 OAT (°C) 18.0  
 TRIM ROTOR SPEED (RPM) 288  
 CALIBRATED AIRSPEED (KTS) 121  
 SAS CONDITION ON  
 NOTE: MOD 1 TAIL

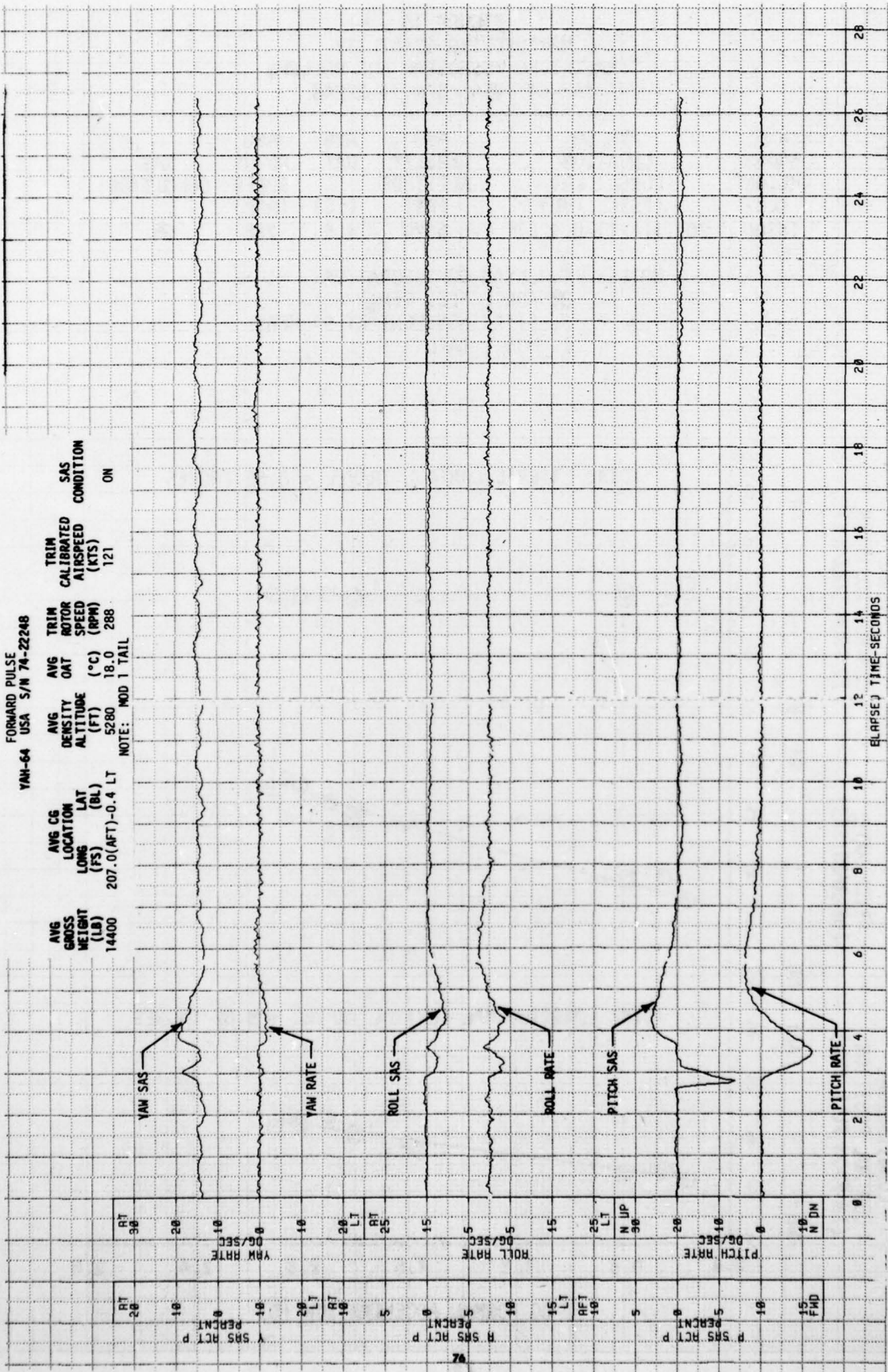

RT 30  
LT 20

YAW RATE  
DG/SEC

RT 20  
LT 10

YAW SAS  
PERCENT

RT 25  
LT 15

ROLL RATE  
DG/SEC

RT 15  
LT 5

ROLL SAS  
PERCENT

RT 25  
LT 15

PITCH RATE  
DG/SEC

RT 20  
LT 10

PITCH SAS  
PERCENT

RT 15  
LT 5

PITCH RATE  
IN/DN

RT 10  
LT 5

PITCH SAS  
IN/DN

RT 10  
LT 5

PITCH RATE  
IN/DN

RT 10  
LT 5

PITCH SAS  
IN/DN

RT 10  
LT 5

PITCH RATE  
IN/DN

RT 10  
LT 5

PITCH SAS  
IN/DN

RT 10  
LT 5

PITCH RATE  
IN/DN

RT 10  
LT 5

PITCH SAS  
IN/DN

RT 10  
LT 5

PITCH RATE  
IN/DN

RT 10  
LT 5

PITCH SAS  
IN/DN

RT 10  
LT 5

PITCH RATE  
IN/DN

RT 10  
LT 5

PITCH SAS  
IN/DN

RT 10  
LT 5

PITCH RATE  
IN/DN

RT 10  
LT 5

PITCH SAS  
IN/DN

ELAPSED TIME-SECONDS

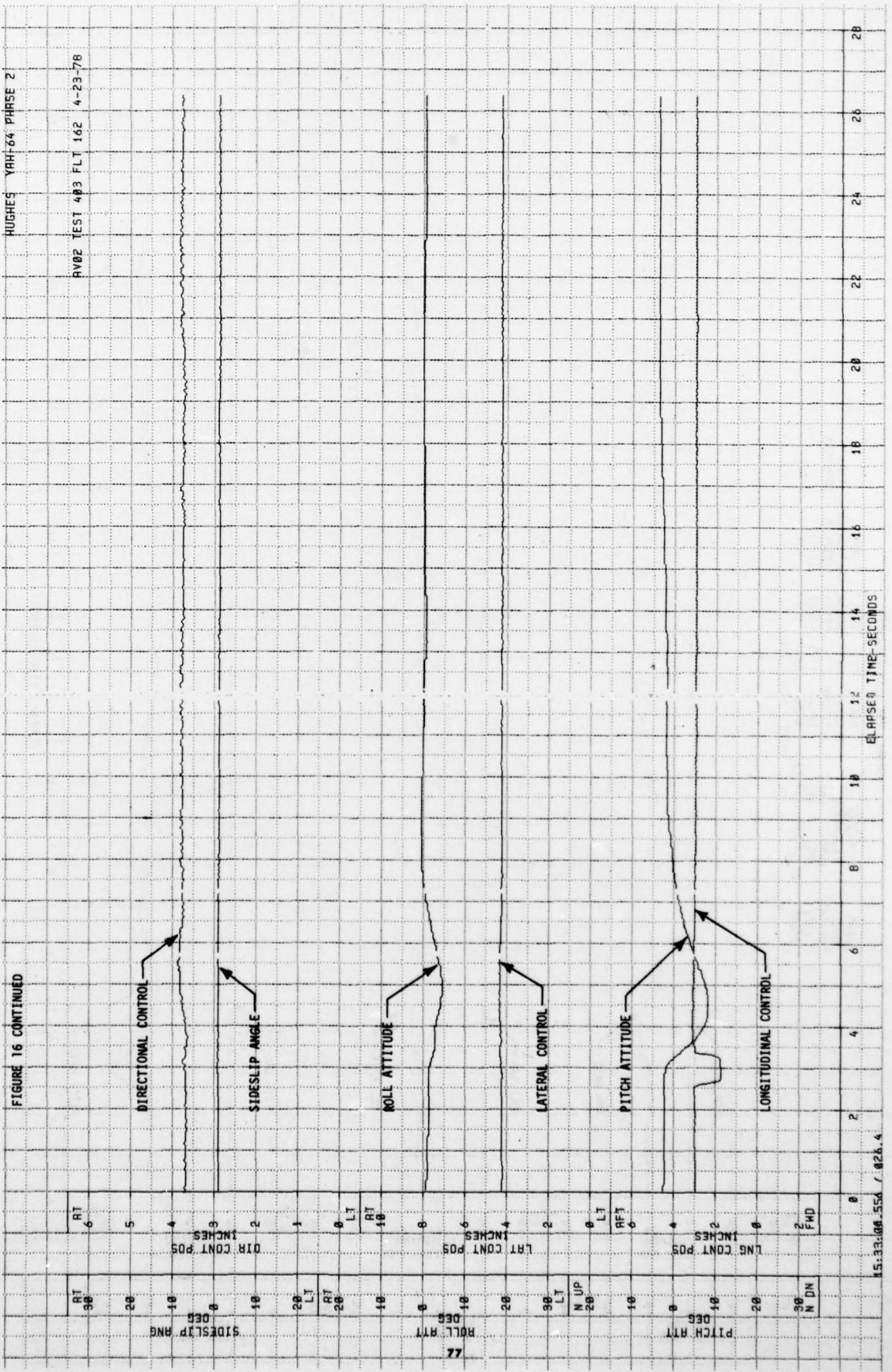

FORWARD PULSE  
YAH-64 USA S/N 74-22248

AVG GROSS WEIGHT (LB) 14200  
AVG CG LOCATION LONG (FS) 207.0(AFT)-0.4 LT LAT (BL)  
AVG DENSITY ALTITUDE (FT) 5240 OAT (°C) 18.0 RPM 288  
TRIM CALIBRATED AIRSPEED (KTS) 120  
SAS CONDITION OFF

NOTE: MOD 1 TAIL

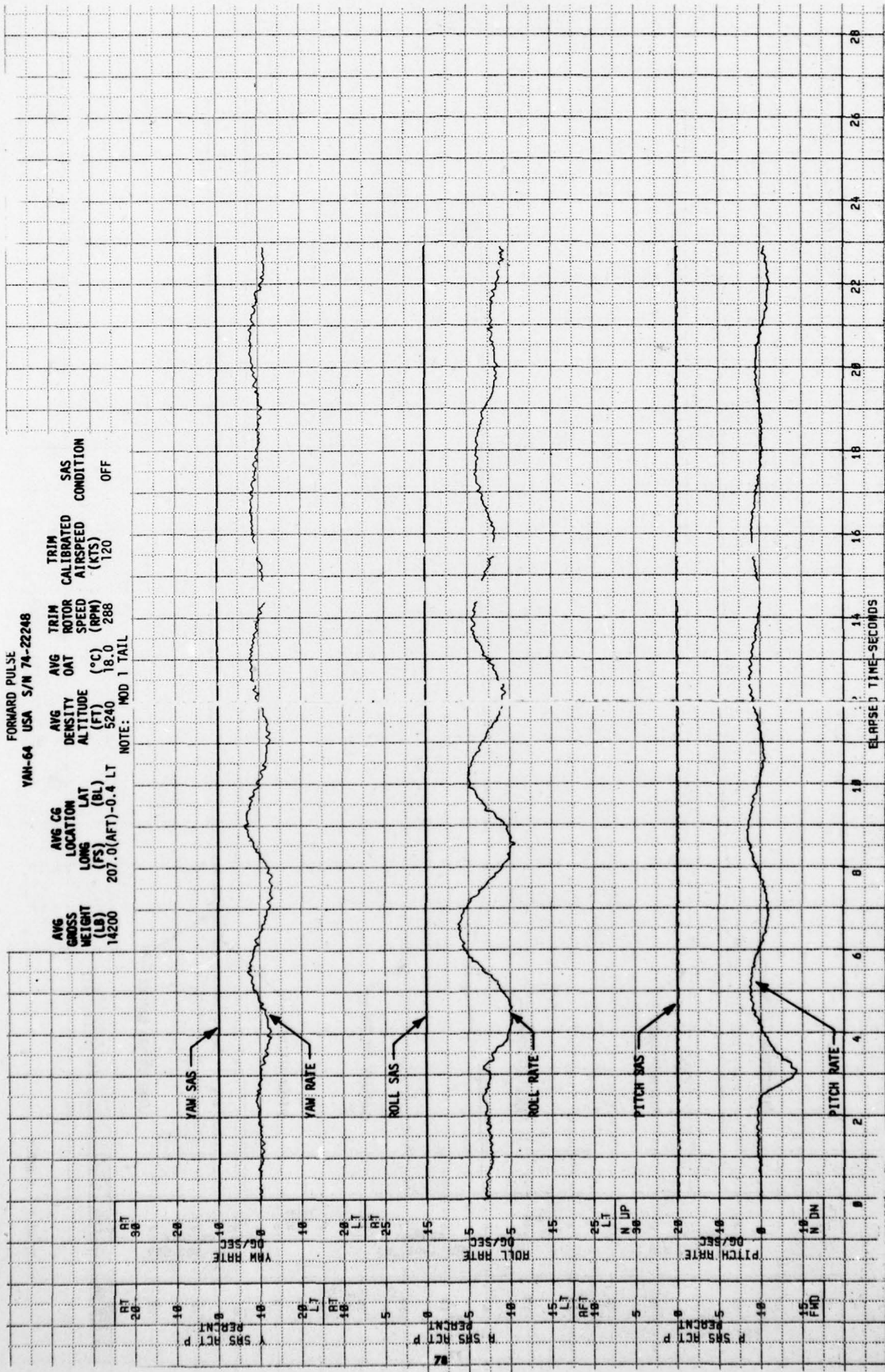



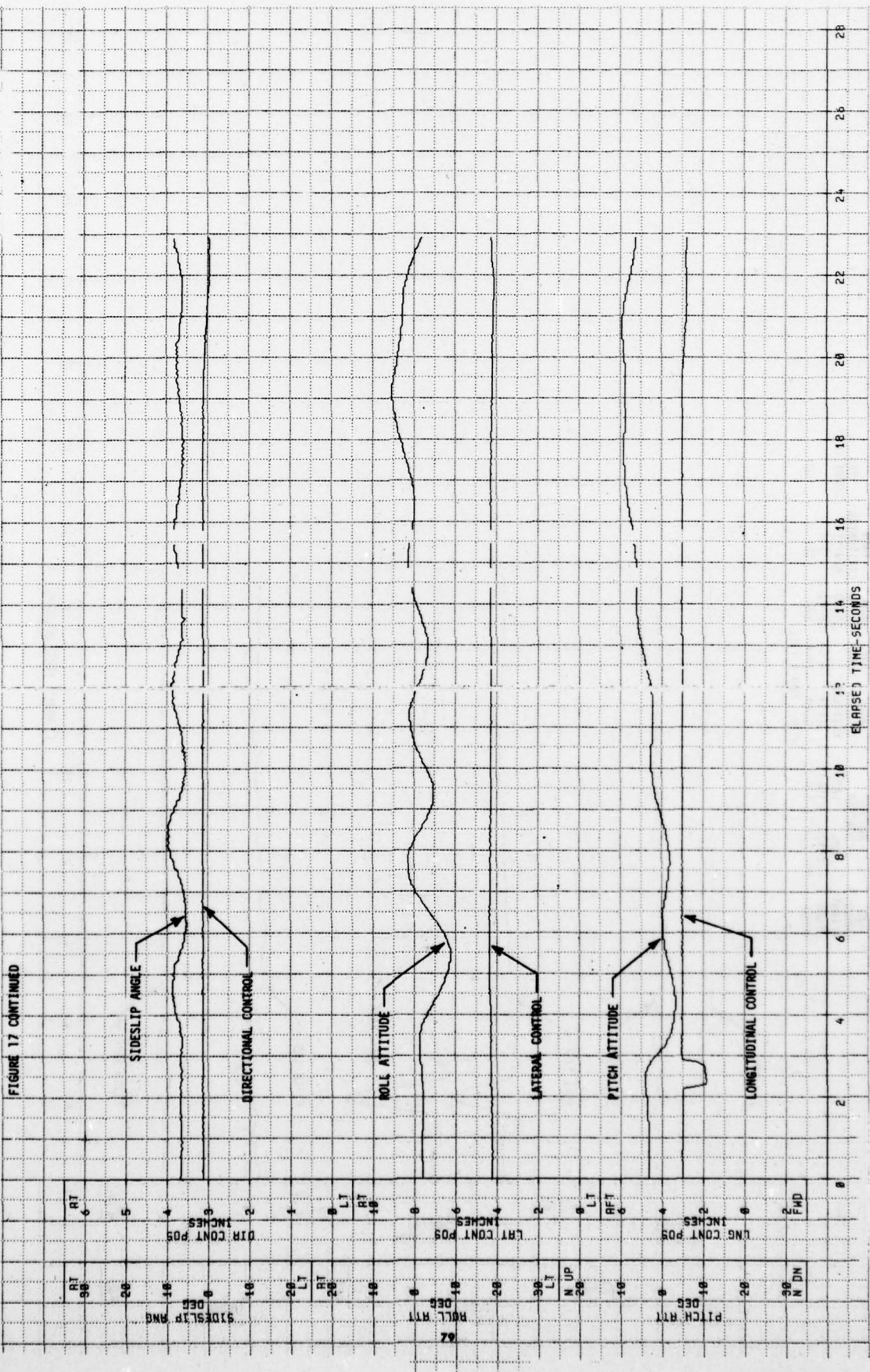

LEFT LAIR-KOL MULDE  
YAN-64 USA S/N 74-22248

AVG GROSS WEIGHT (LB) 14260  
AVG CG LOCATION LONG (FS) 207.2(AFT)-0.4 LT  
AVG DENSITY ALTITUDE (FT) 5140  
AVG OAT (°C) 18.0  
TRIM ROTOR SPEED (RPM) 288  
TRIM CALIBRATED AIRSPEED (KTS) 121  
SAS CONDITION ON

NOTE: MOD 1 TAIL

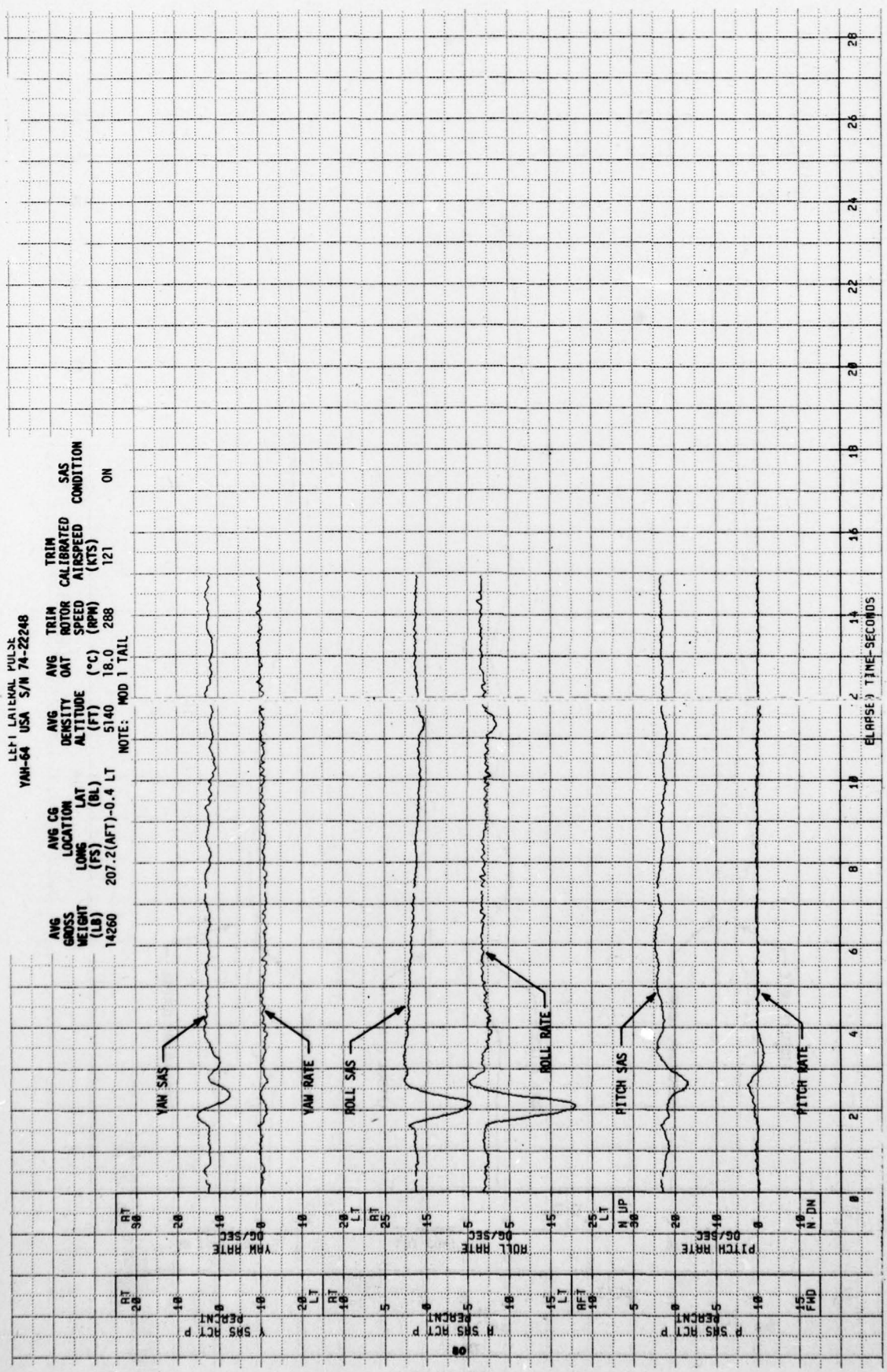

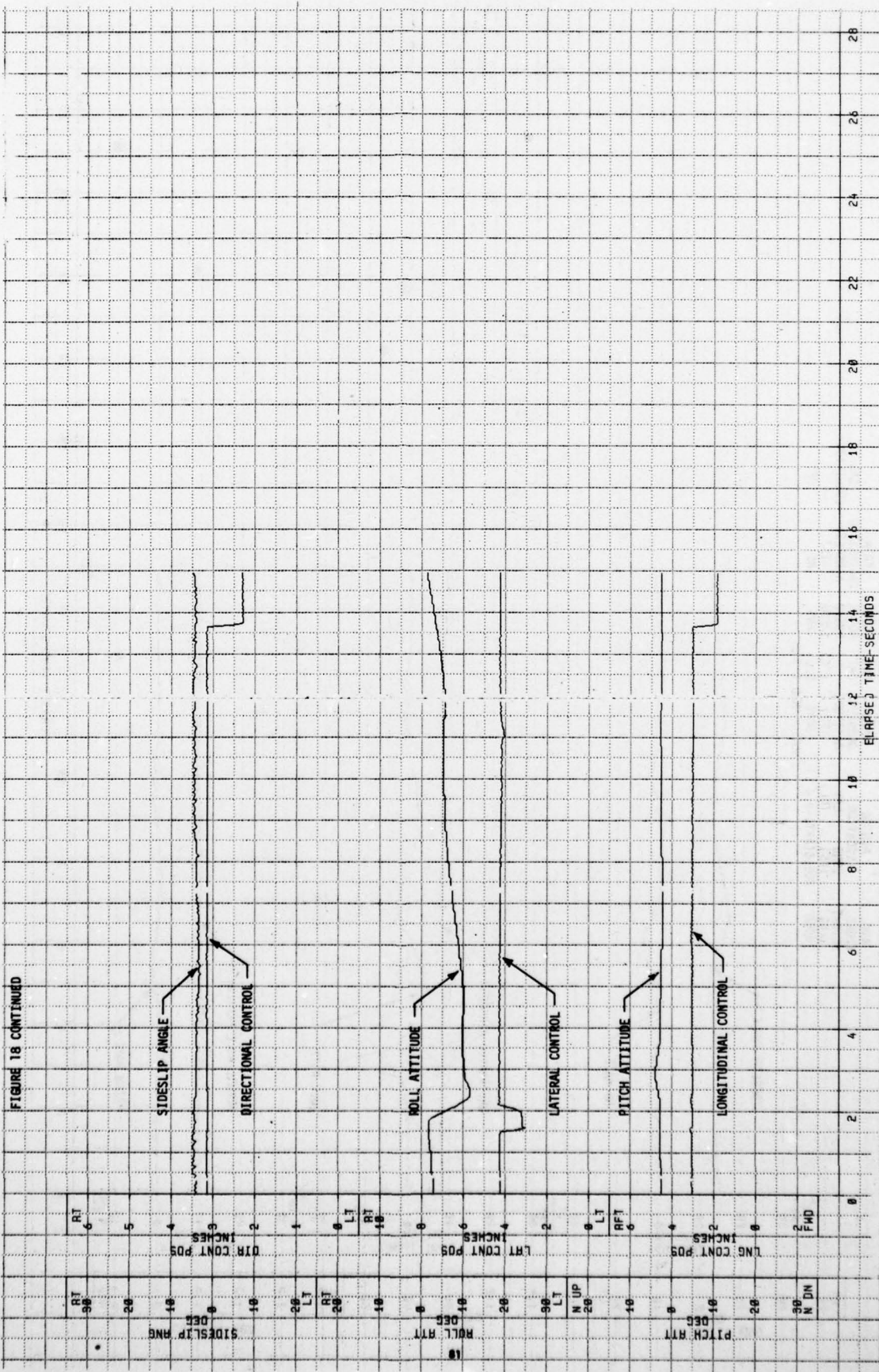
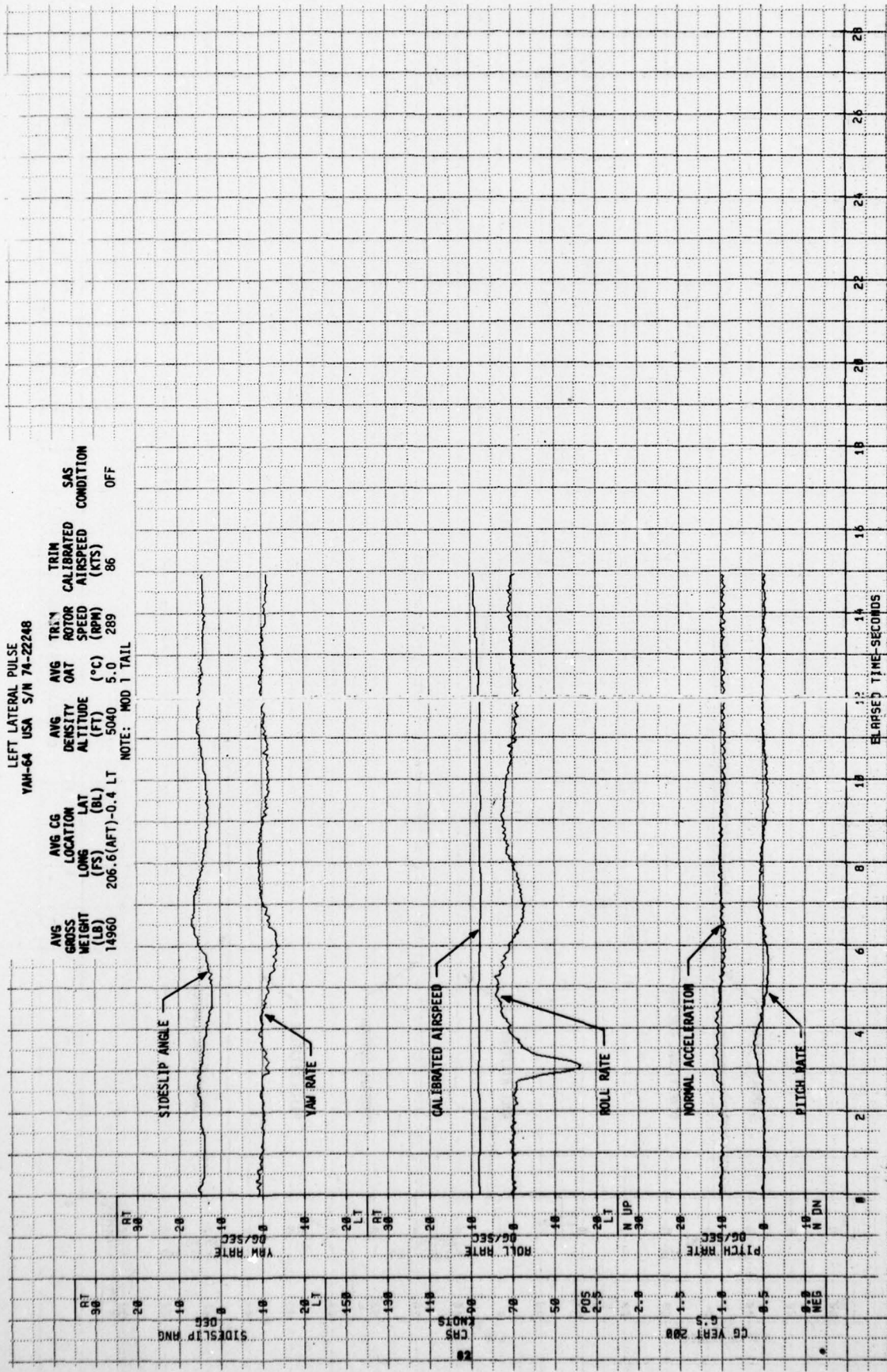

FIGURE 18 CONTINUED

ELAPSED TIME-SECONDS

LEFT LATERAL PULSE  
YAH-64 USA S/N 74-22248

AVG GROSS WEIGHT (LB) 14960  
 AVG CG LONG (FS) 206.6(AFT)-0.4 LT  
 AVG DENSITY ALTITUDE (FT) 5040  
 TRIM ROTOR SPEED (RPM) 289  
 CALIBRATED AIRSPEED (KTS) 86  
 SAS CONDITION OFF  
 NOTE: MOD 1 TAIL



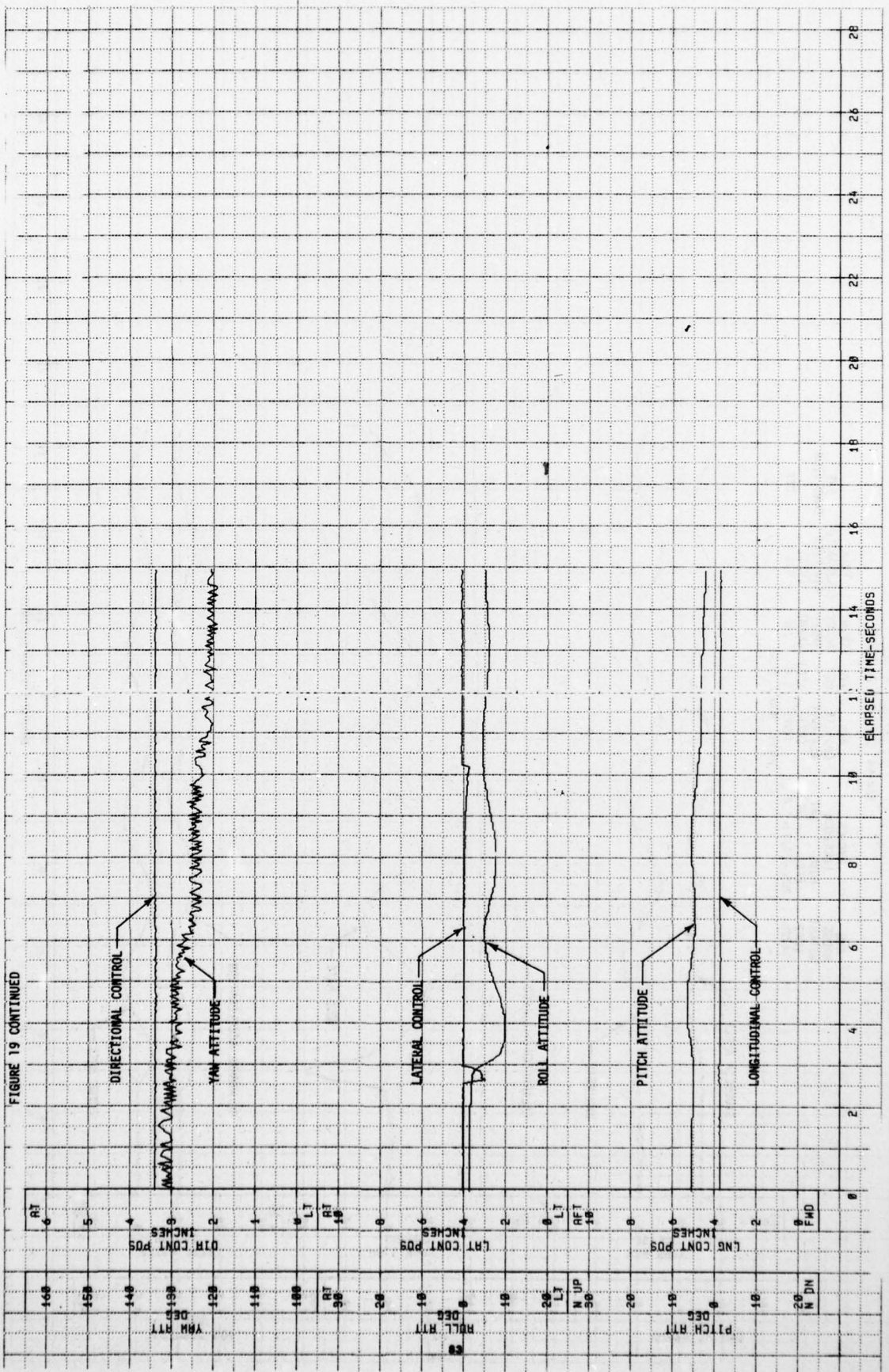

LEFT LATERAL PULSE  
YAH-64 USA S/N 74-22248

AVG GROSS WEIGHT (LB) 14760  
 AVG CG LOCATION LONG (FS) 206.6(AFT)-0.4 LT  
 AVG DENSITY ALT (FT) 5000  
 AVG OAT (°C) 6.0  
 TRIM ROTOR SPEED (RPM) 288  
 TRIM CALIBRATED AIRSPEED (KTS) 115  
 SAS CONDITION OFF

NOTE: MOD 1 TAIL

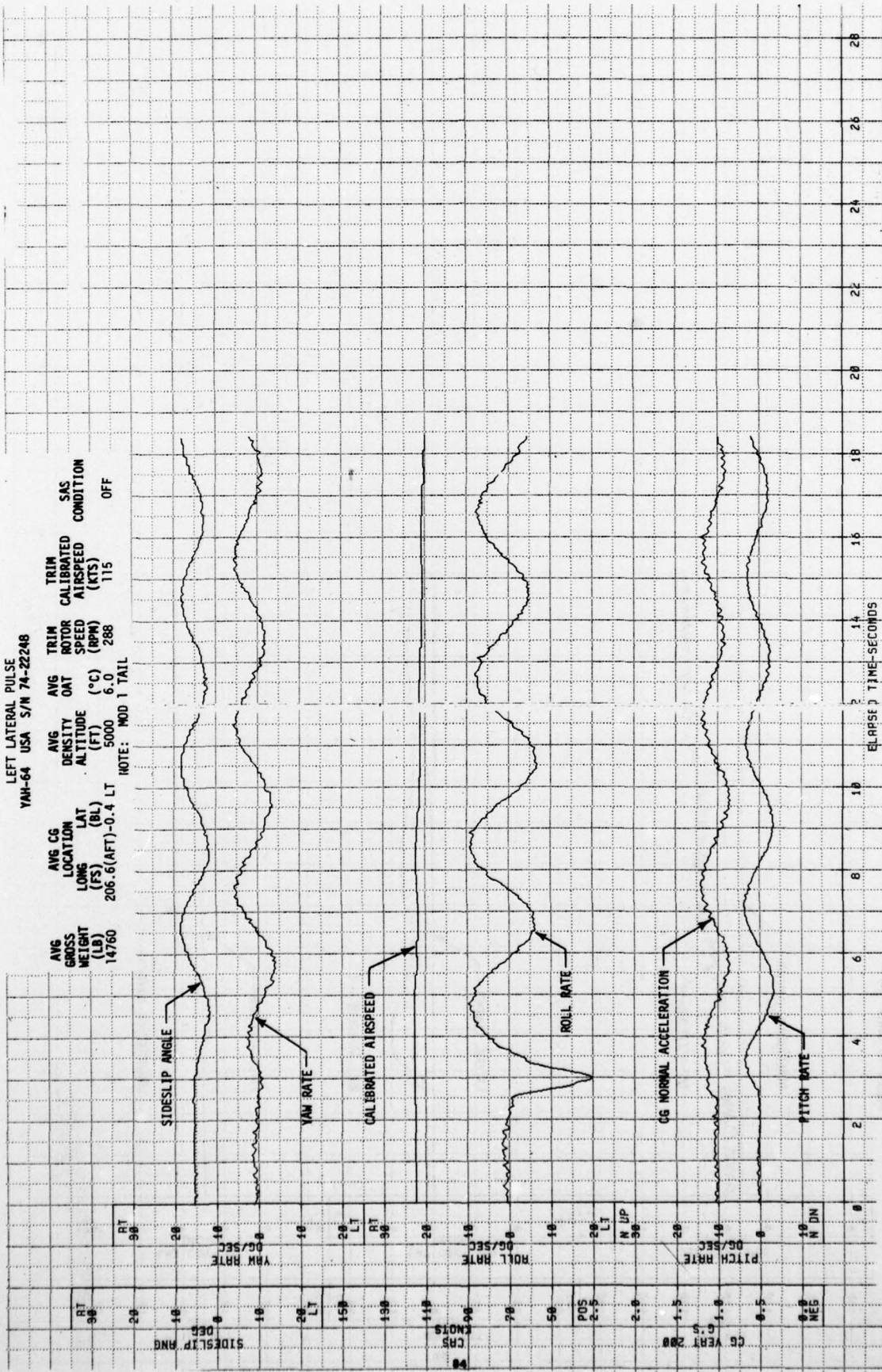

ELAPSED TIME-SECONDS

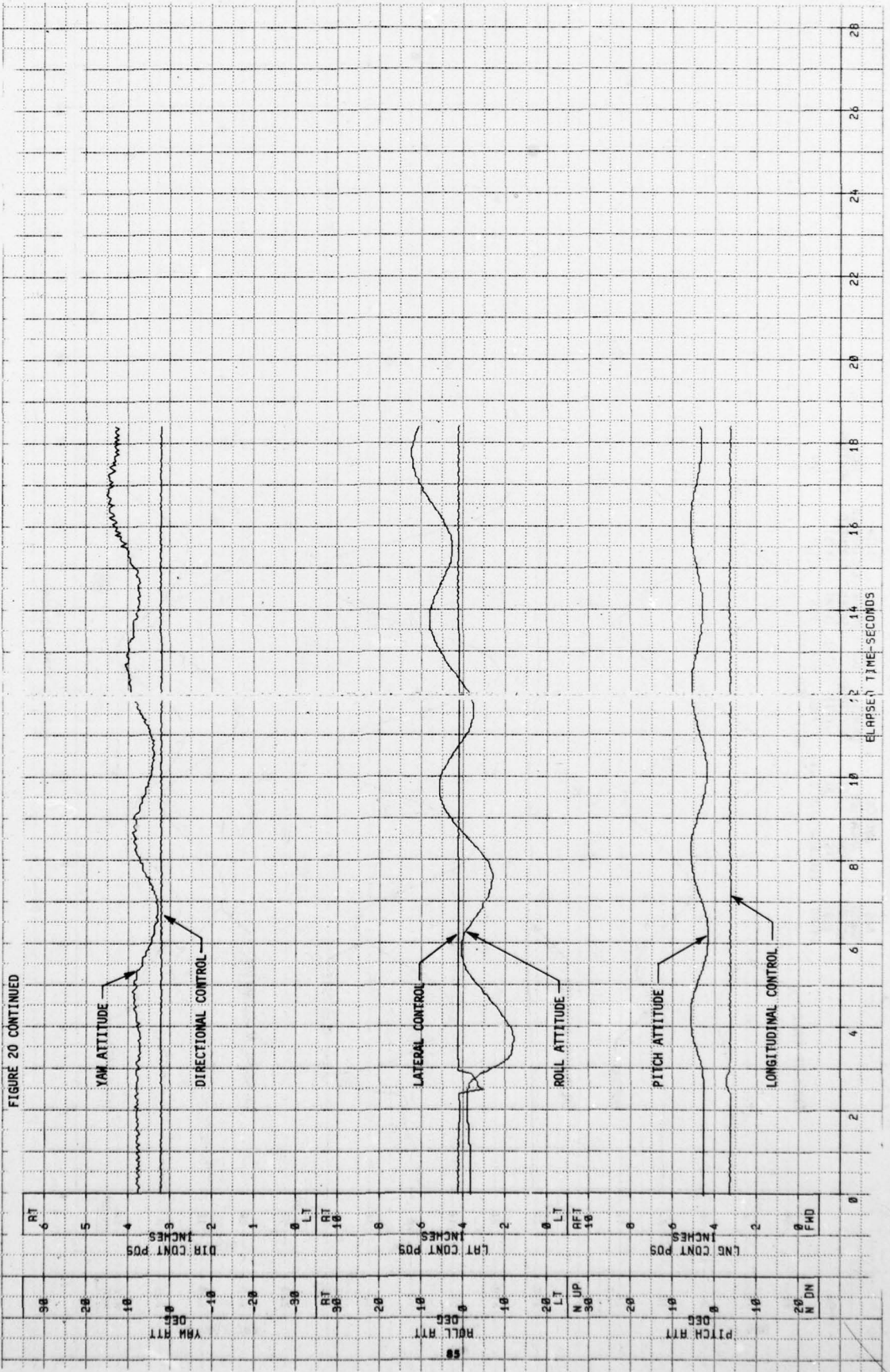

LEFT LAIENAL PULSE  
YAH-64 USA S/M 74-22248

AVG GROSS WEIGHT (LB) 14560  
 AVG CG LOCATION LONG (FS) 206.6(AFT)-0.4 LT  
 AVG DENSITY ALTITUDE (FT) 4880  
 AVG OAT (°C) 6.5  
 TRIM ROTOR SPEED (RPM) 288  
 CALIBRATED AIRSPEED (KTS) 128  
 SAS CONDITION OFF  
 NOTE: MOD 1 TAIL

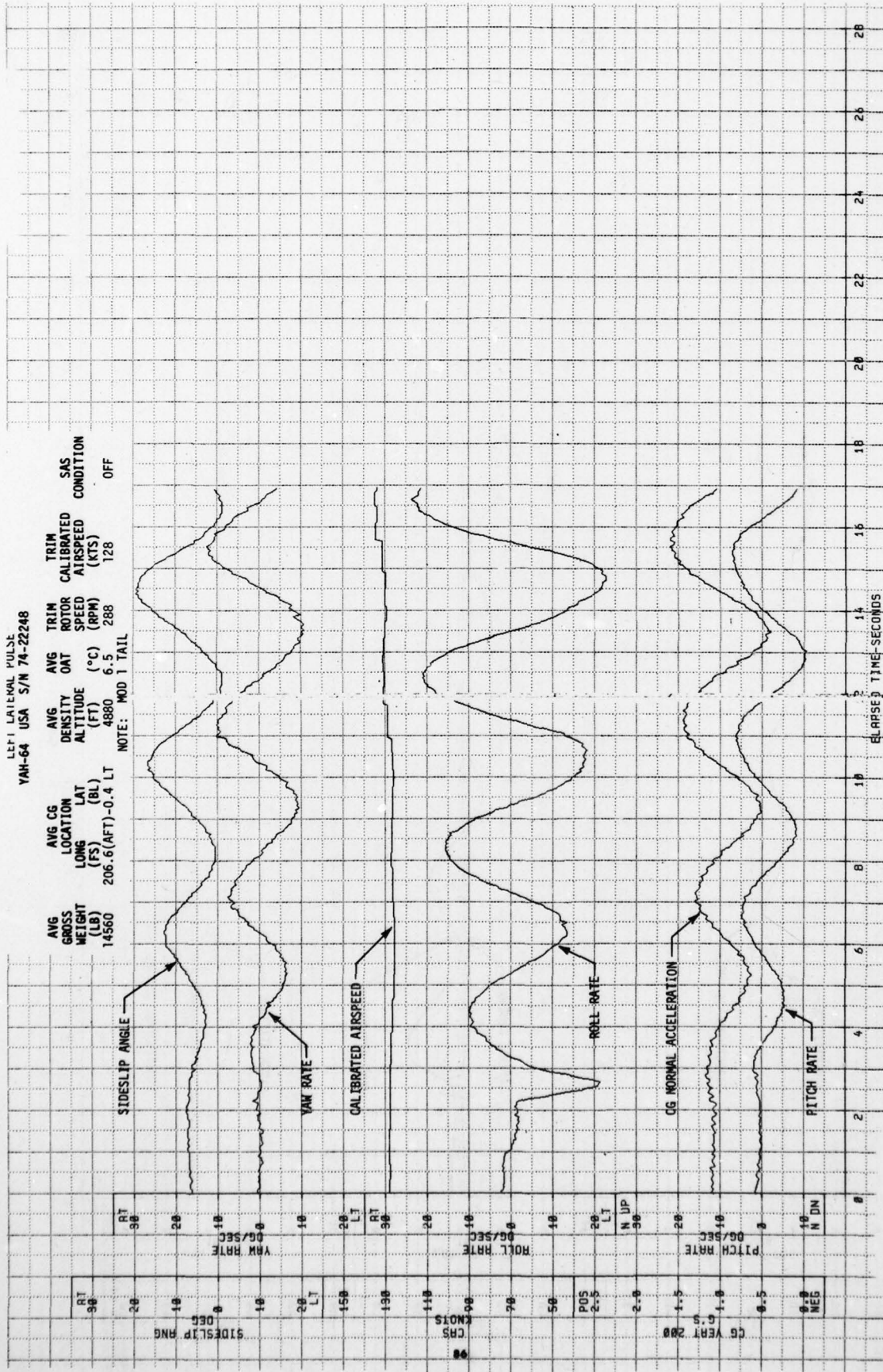
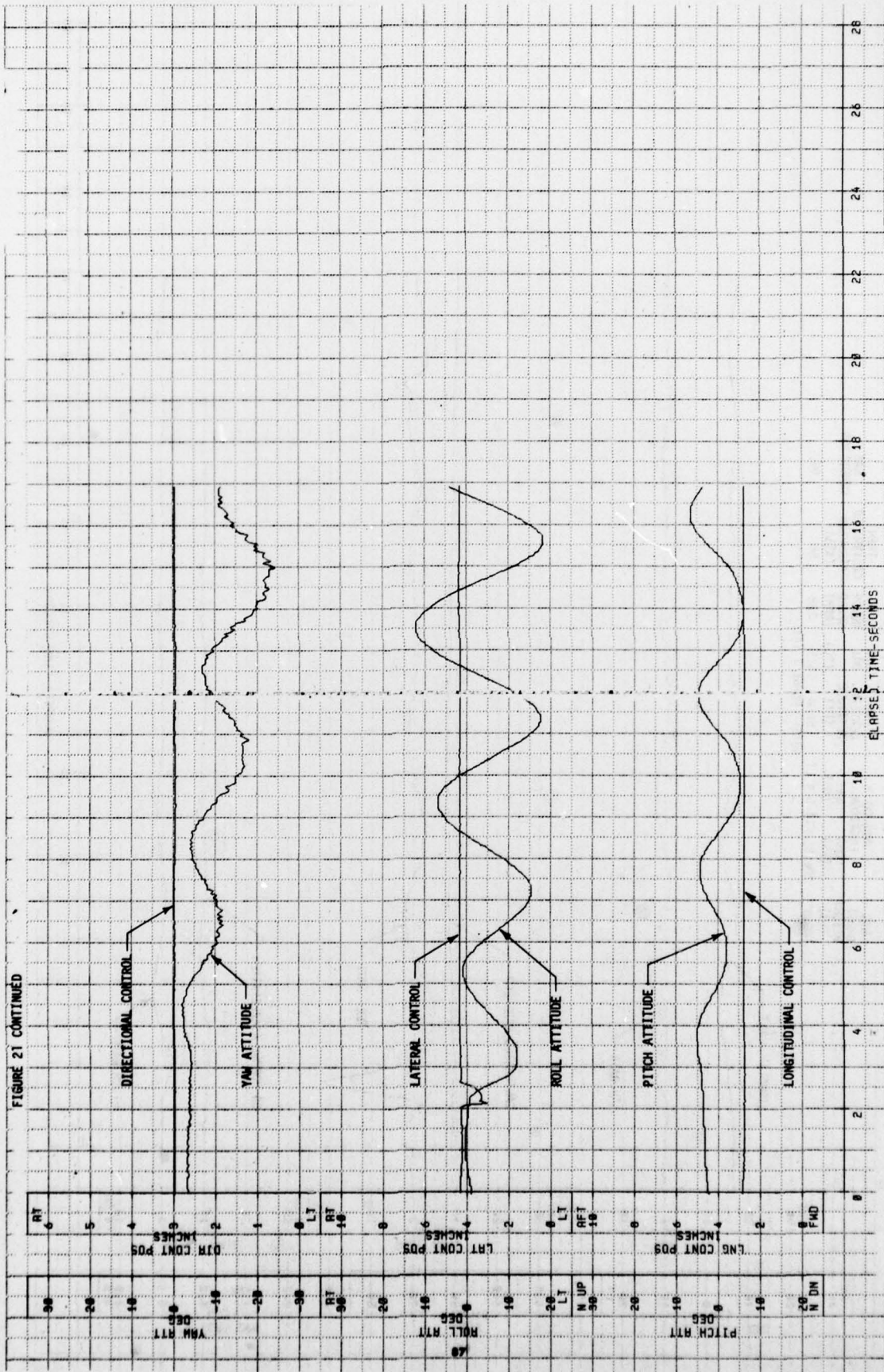



FIGURE 21 CONTINUED



LEFT LATERAL PULSE  
YAH-64 USA S/N 74-22248

AVG GROSS WEIGHT (LB) 14880  
 AVG CG LONG (FS) 206.8(AFT)-0.4 LT  
 AVG CG LAT (BL) 5120  
 AVG DENSITY ALTITUDE (FT) 5120  
 AVG OAT (°C) 6.5  
 TRIM MOTOR SPEED (RPM) 288  
 TRIM CALIBRATED AIRSPEED (KTS) 88  
 SAS CONDITION OFF

NOTE: PHASE 1 TAIL



ELAPSE TIME-SECONDS

14-00000-1

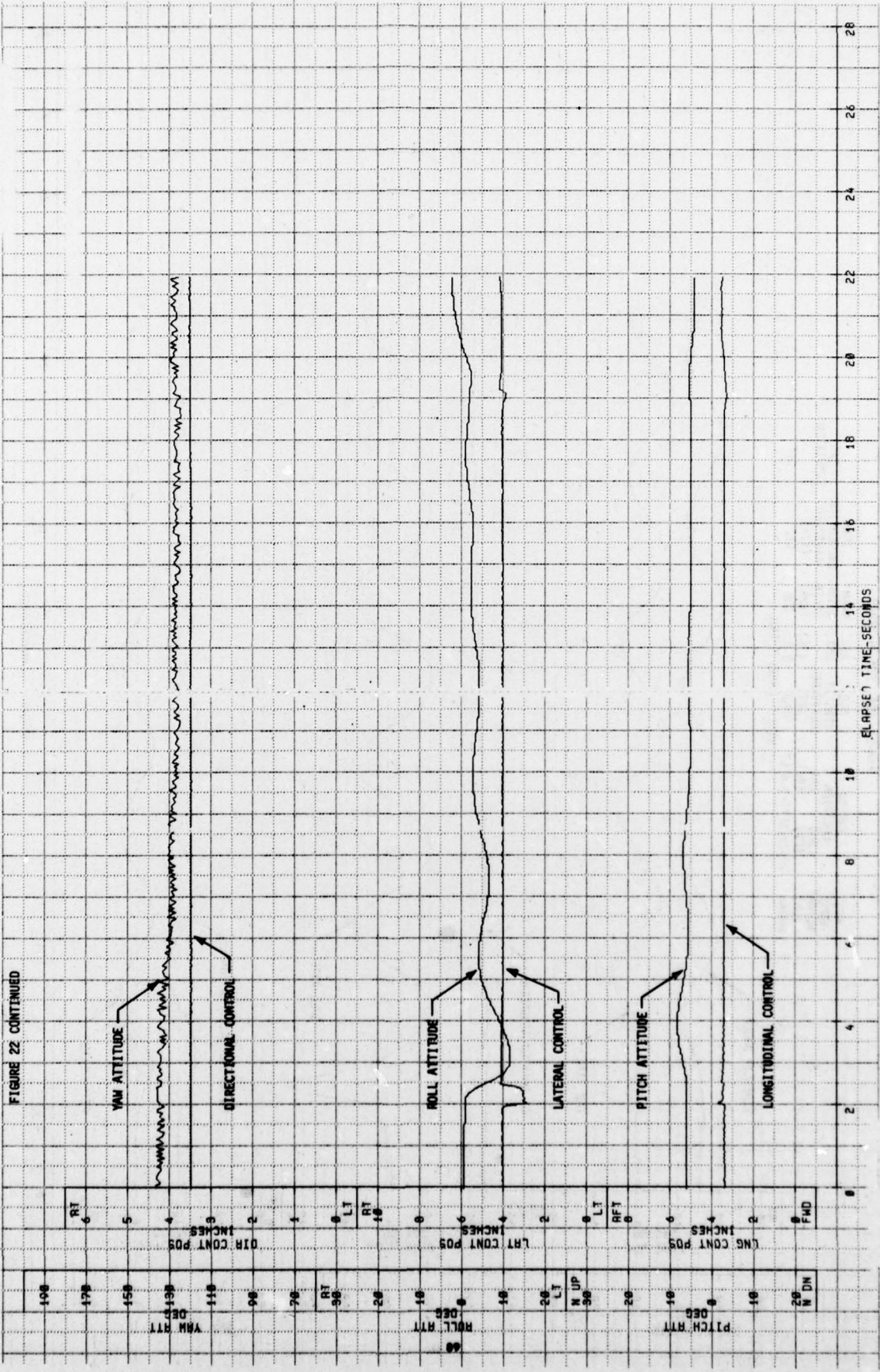

FIGURE 22 CONTINUED

ELAPSED TIME-SECONDS

190  
175  
150  
140  
130  
120  
110  
100  
90  
80  
70  
60  
50  
40  
30  
20  
10  
0  
RT  
LT  
RT  
LT  
N UP  
N DN  
6  
5  
4  
3  
2  
1  
0  
6  
5  
4  
3  
2  
1  
0  
6  
5  
4  
3  
2  
1  
0  
6  
5  
4  
3  
2  
1  
0  
6  
5  
4  
3  
2  
1  
0  
RT  
LT  
RT  
LT  
N UP  
N DN

YAW ATTITUDE

DIRECTIONAL CONTROL

ROLL ATTITUDE

LATERAL CONTROL

PITCH ATTITUDE

LONGITUDINAL CONTROL

DIR CONT POS INCHES

L,R CONT POS INCHES

LNG CONT POS INCHES

YAW ATTITUDE

ROLL ATTITUDE

PITCH ATTITUDE

LONGITUDINAL CONTROL

FIGURE 23  
LEFT LATERAL PULSE  
YAH-64 USA S/N 74-22248

AVG GROSS WEIGHT (LB) 14680  
 AVG CG LOCATION LONG (FS) 206.9(AFT)-0.4 LT  
 AVG DENSITY ALTITUDE (FT) 4900  
 AVG OAT (°C) 8.0  
 TRIM MOTOR SPEED (RPM) 288  
 TRIM CALIBRATED AIRSPEED (KTS) 117  
 SAS CONDITION OFF

NOTE: PHASE 1 TAIL

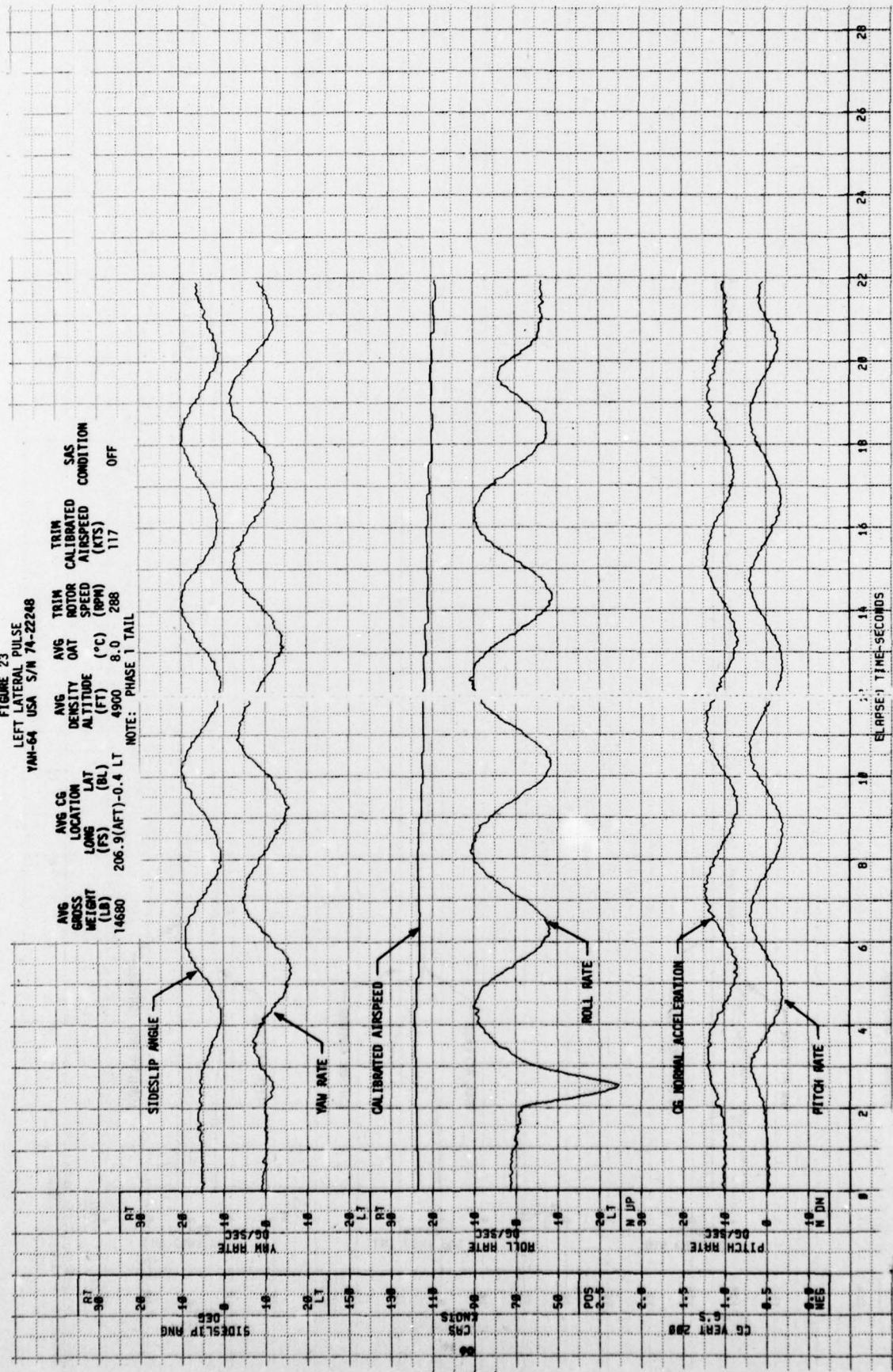

ELAPSED TIME-SECONDS

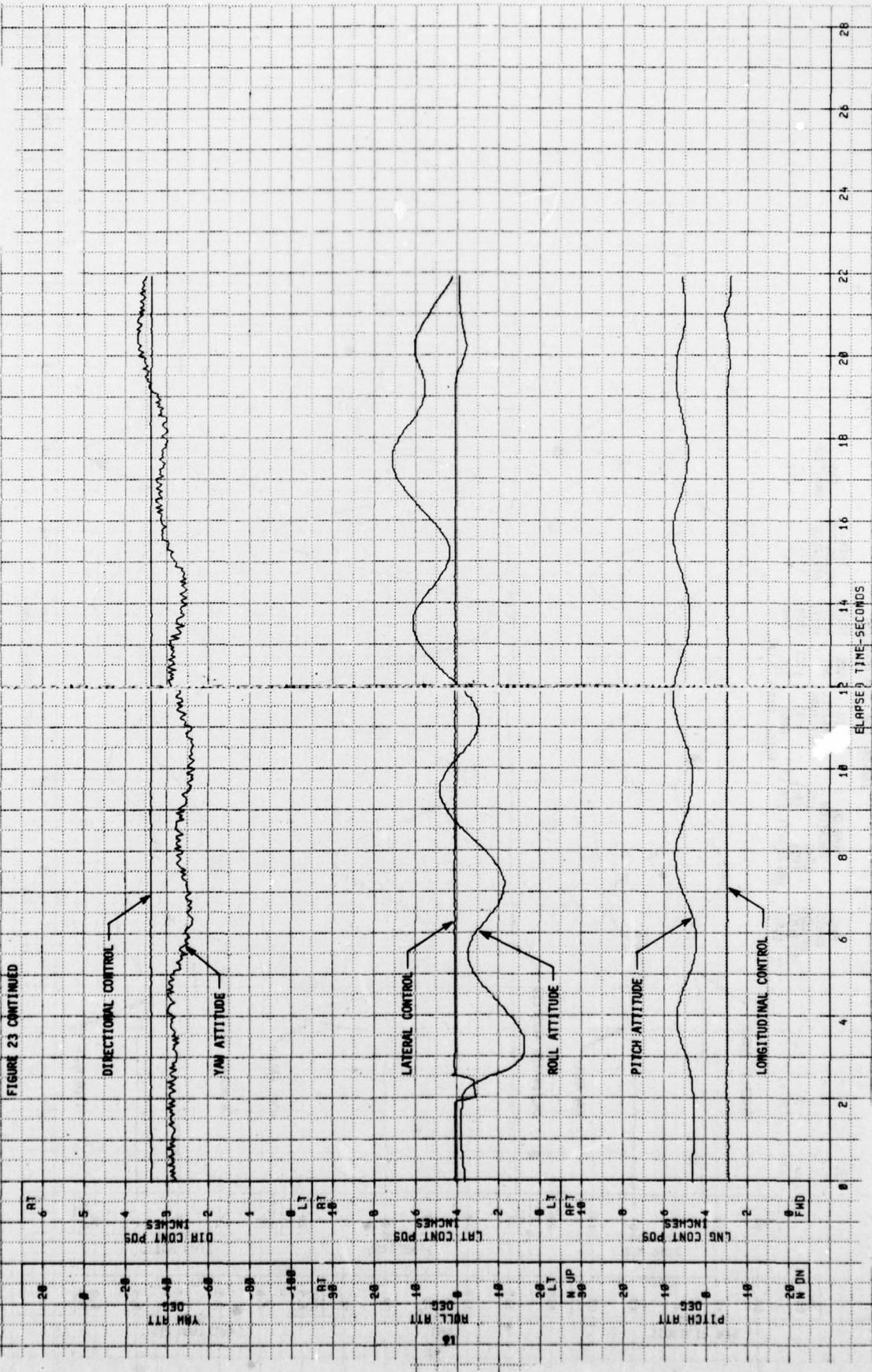
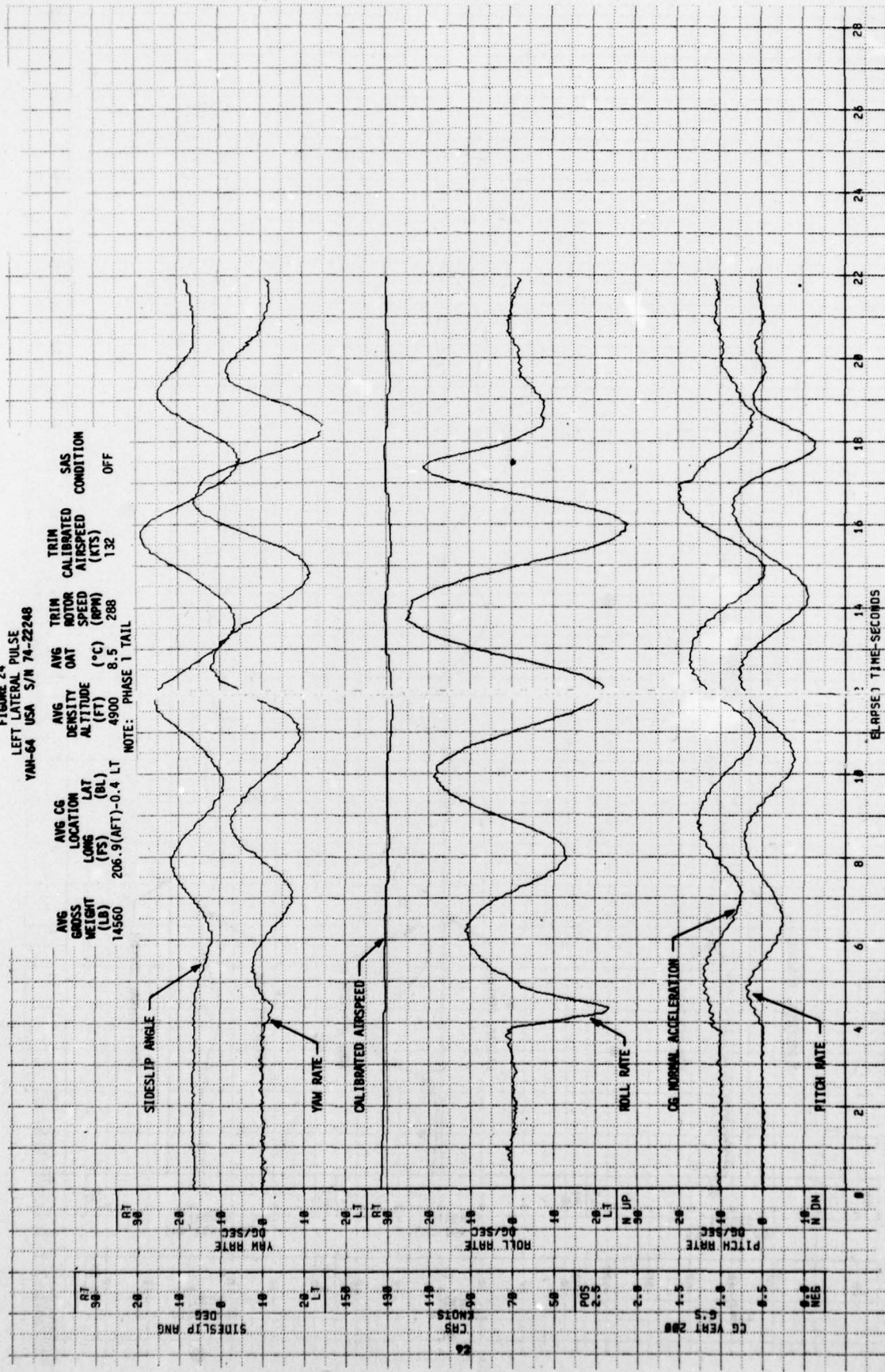
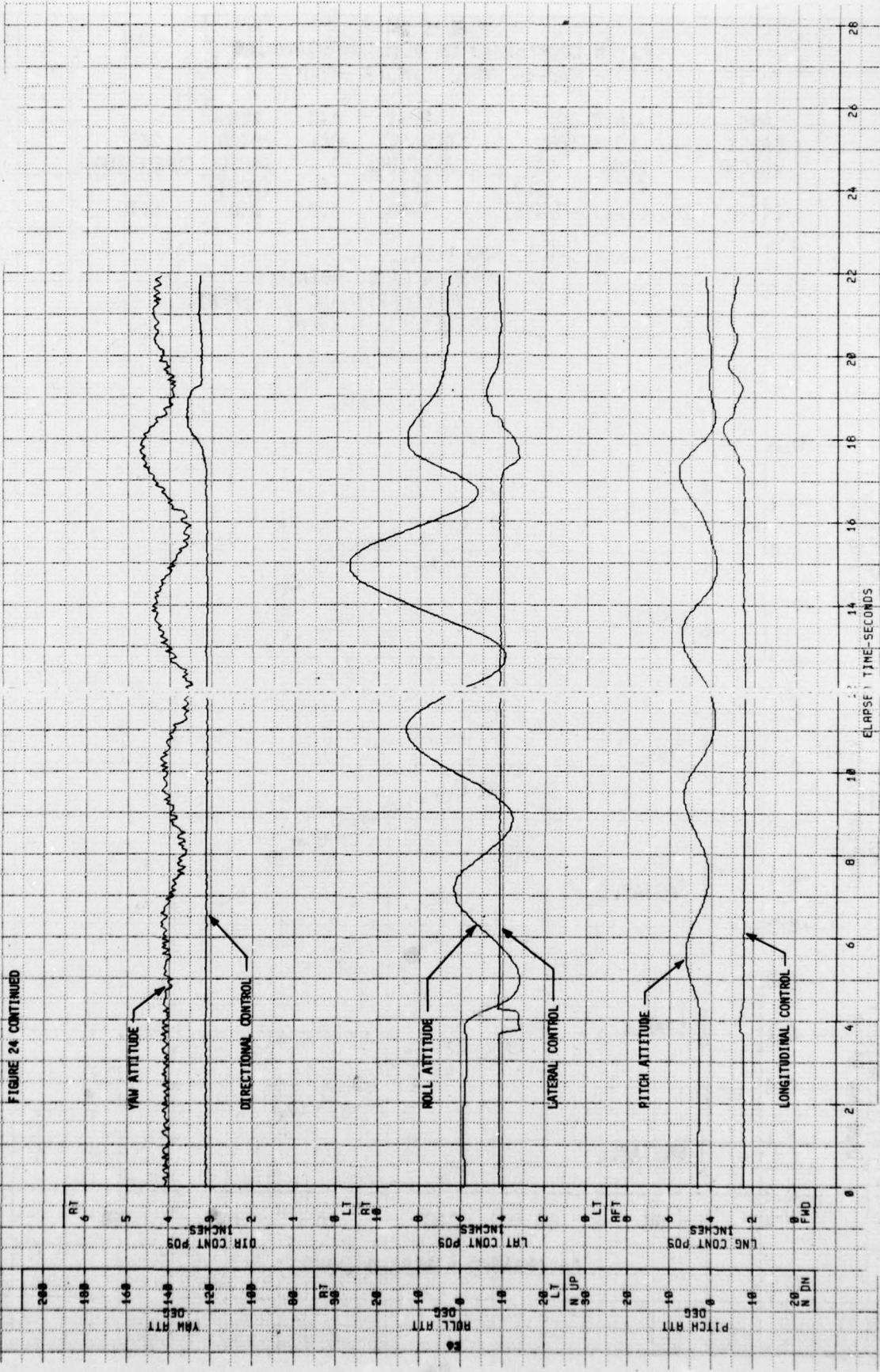

FIGURE 24  
LEFT LATERAL PULSE  
YAM-64 USA S/W 74-22248

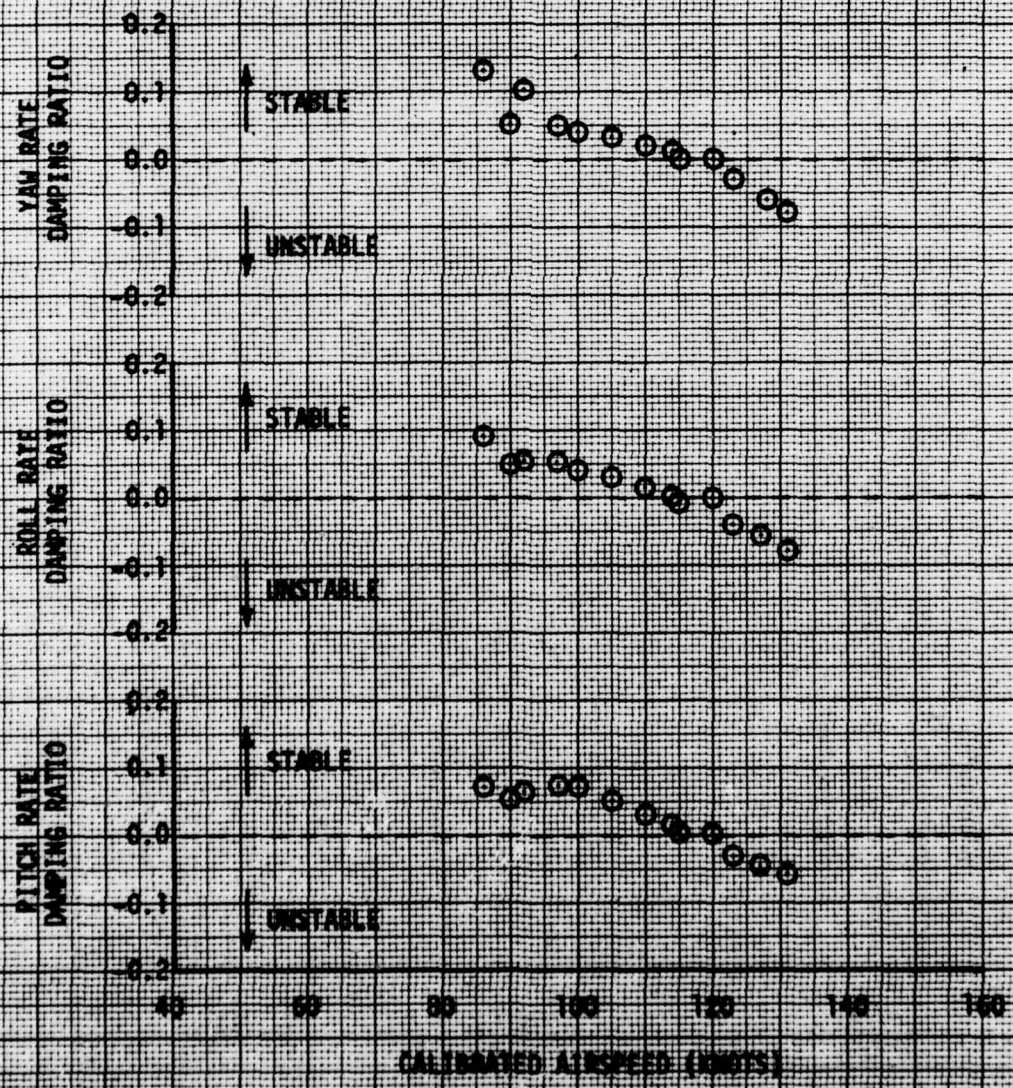



**FIGURE 25**  
**PITCH COUPLED DUTCH ROLL RATE DAMPING**  
 YAN-64 USA S/N 74-22248

Avg GROSS WEIGHT (LB)	Avg CG LOCATION LONG (FS) LAT (BL)	Avg DENSITY ALTITUDE (FT)	Avg OAT (°C)	Avg ROTOR SPEED (RPM)	SAS CONDITION
14740	206.6(AFT)-0.4 LT	4940	5.0	288	OFF

- NOTES: 1. MOD 1 TAIL.  
 2. DAMPING RATIO OBTAINED USING LOGARITHMIC DECREMENT.  
 3. FREQUENCY = 0.25 HZ





**FIGURE 26**  
**PITCH COUPLED ROLL RATE DAMPING**  
**YAH-64 USA S/N 74-22248**

AVG GROSS WEIGHT (LB)	AVG CG LOCATION		AVG DENSITY ALTITUDE (FT)	AVG OAT (°C)	AVG ROTOR SPEED (RPM)	SAS CONDITION
	LONG (FS)	LAT (DE)				
14740	206.9(AFT)	0.4(LE)	5000	7.0	288	OFF

- NOTES: 1. PHASE 1 TAIL.  
 2. DAMPING RATIO OBTAINED USING LOGARITHMIC DECREMENT.  
 3. FREQUENCY = 0.25 HZ

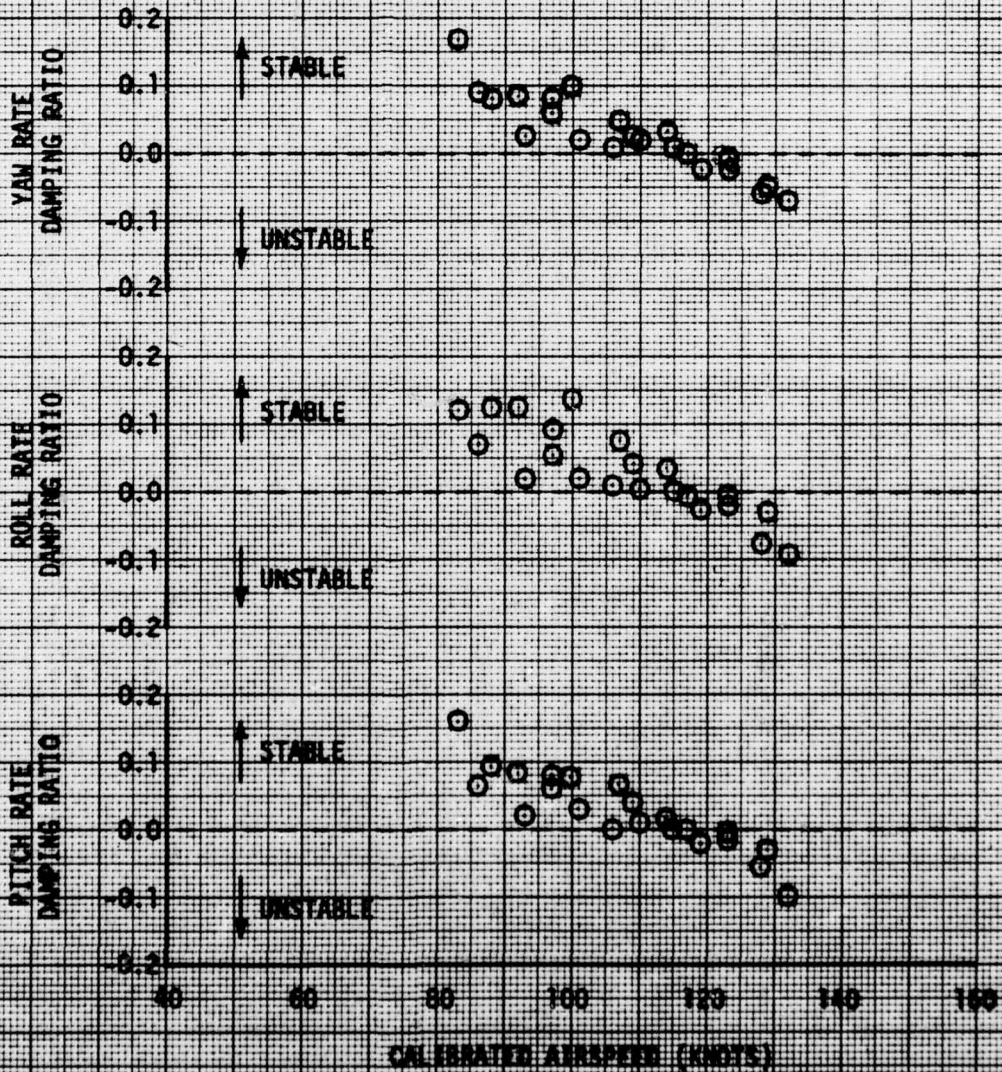
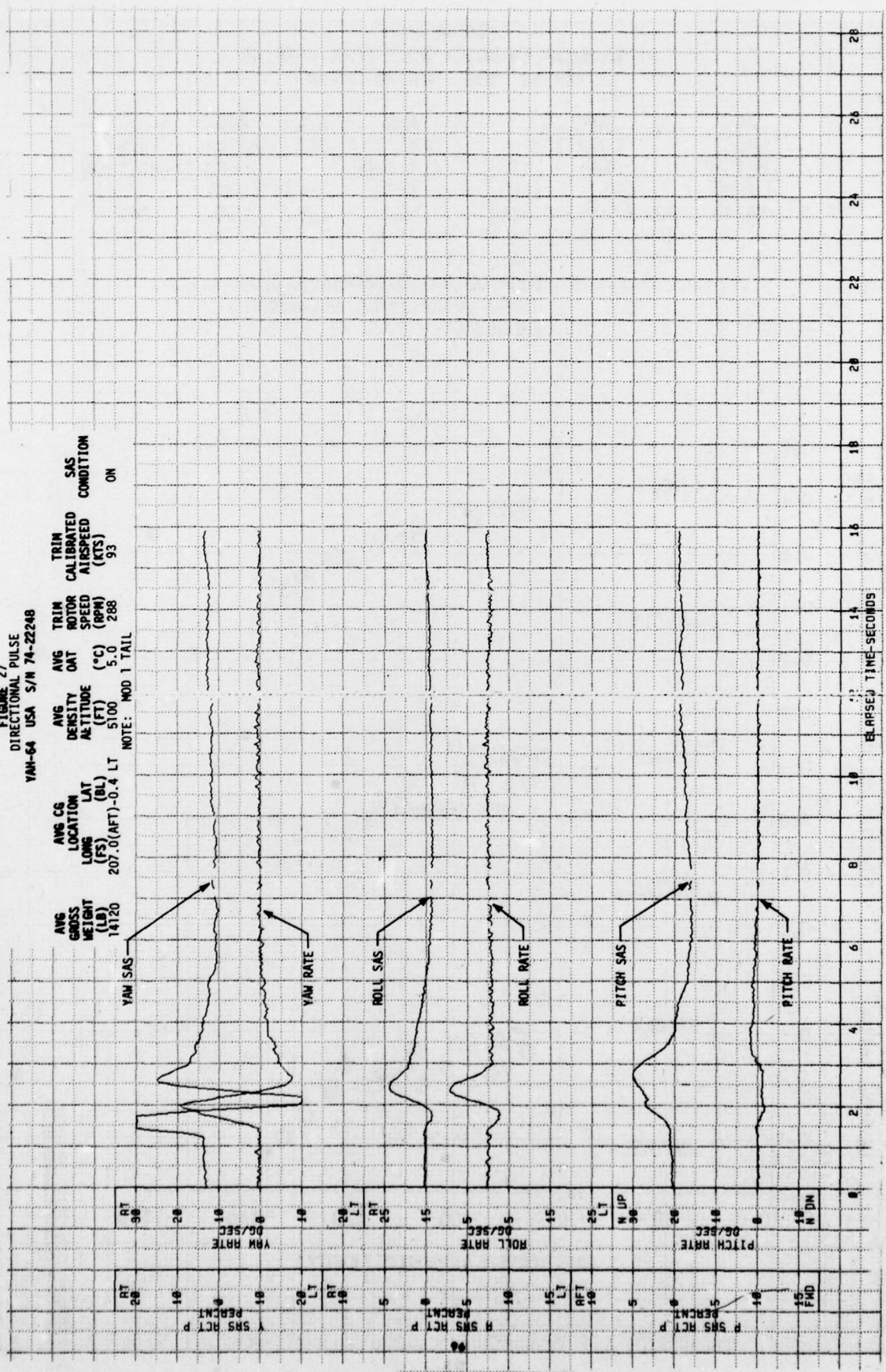

FIGURE 27  
DIRECTIONAL PULSE  
YAH-64 USA S/N 74-22248

AVG GROSS WEIGHT (LB) 14120  
 AVG CG LOCATION LONG (FS) 207.0(AFT)-0.4 LT  
 AVG DENSITY ALTITUDE (FT) 5100  
 AVG ROTOR SPEED (RPM) 5.0  
 TRIM CALIBRATED AIRSPEED (KTS) 93  
 SAS CONDITION ON

NOTE: MOD 1 TAIL



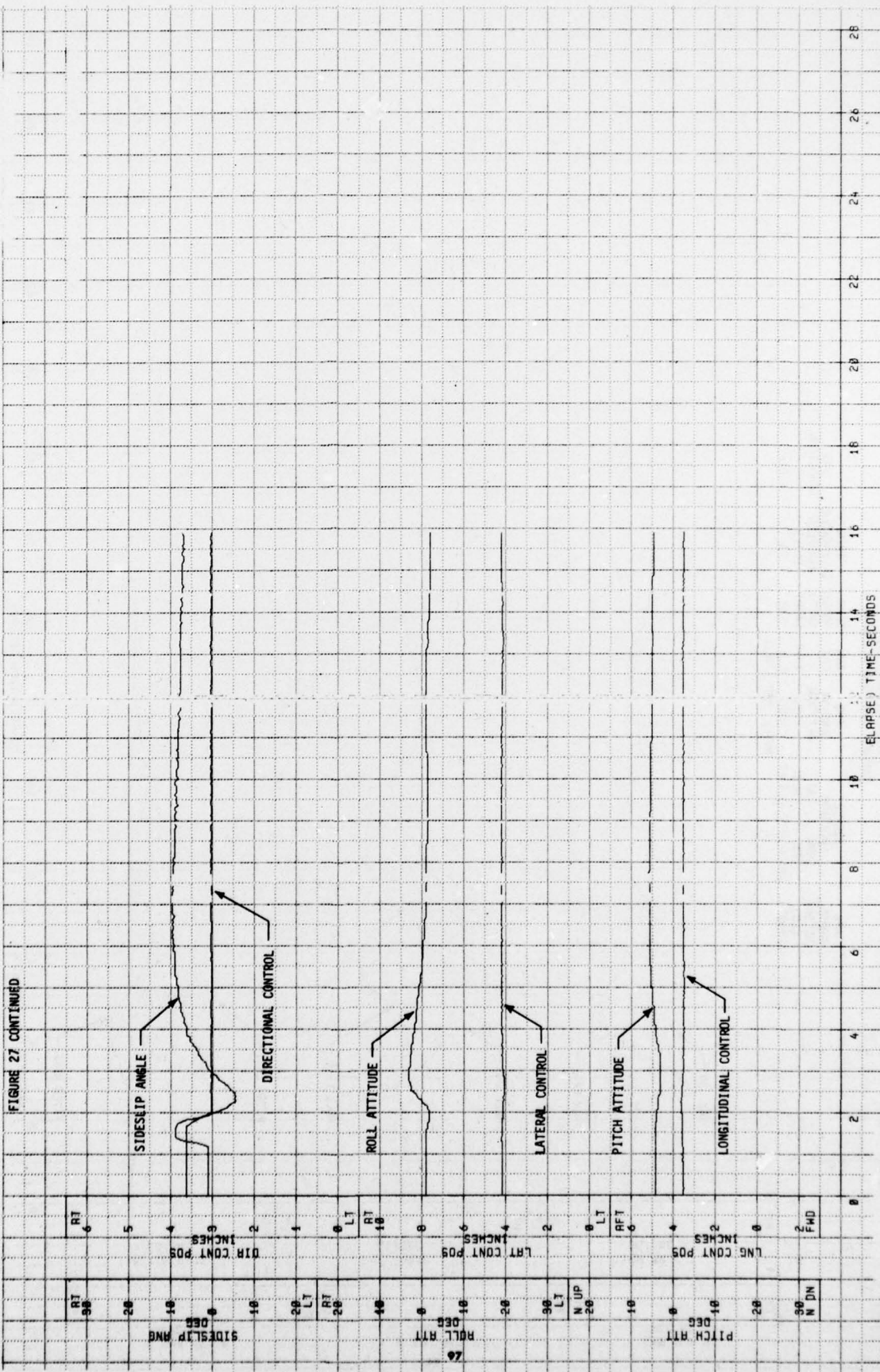

FIGURE 28  
 DIRECTIONAL PULSE  
 YAH-64 USA S/N 74-22248

AVG GROSS WEIGHT (LB)	13900	AVG CG LONG (FS)	207.0(AFT)-0.4 LT	AVG DENSITY ALTITUDE (FT)	5080	AVG OAT (°C)	5.0	AVG ROTOR SPEED (RPM)	288	TRIM CALIBRATED AIRSPEED (KTS)	93	SAS CONDITION	OFF
-----------------------	-------	------------------	-------------------	---------------------------	------	--------------	-----	-----------------------	-----	--------------------------------	----	---------------	-----

NOTE: MOD 1 TAIL

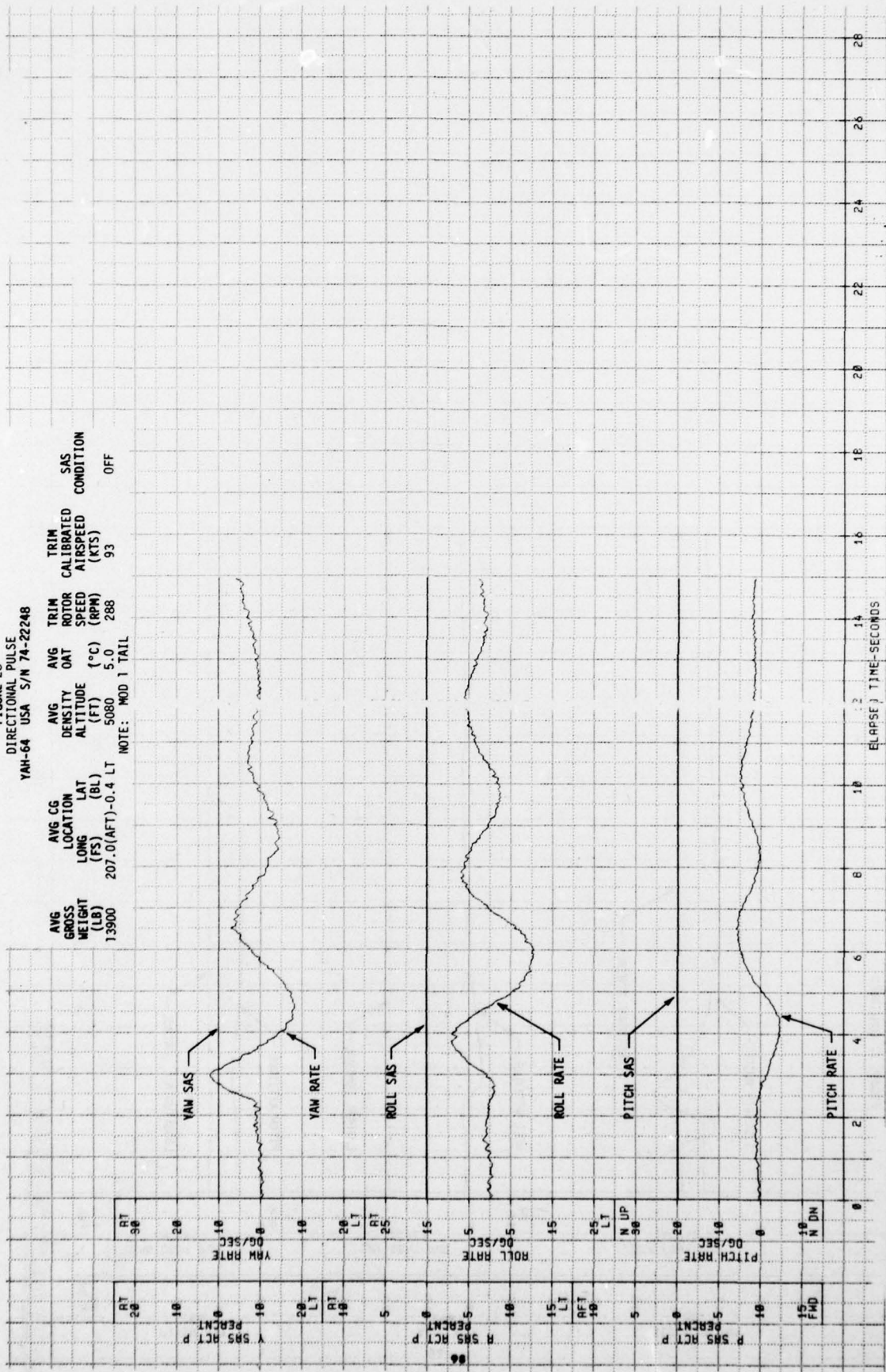
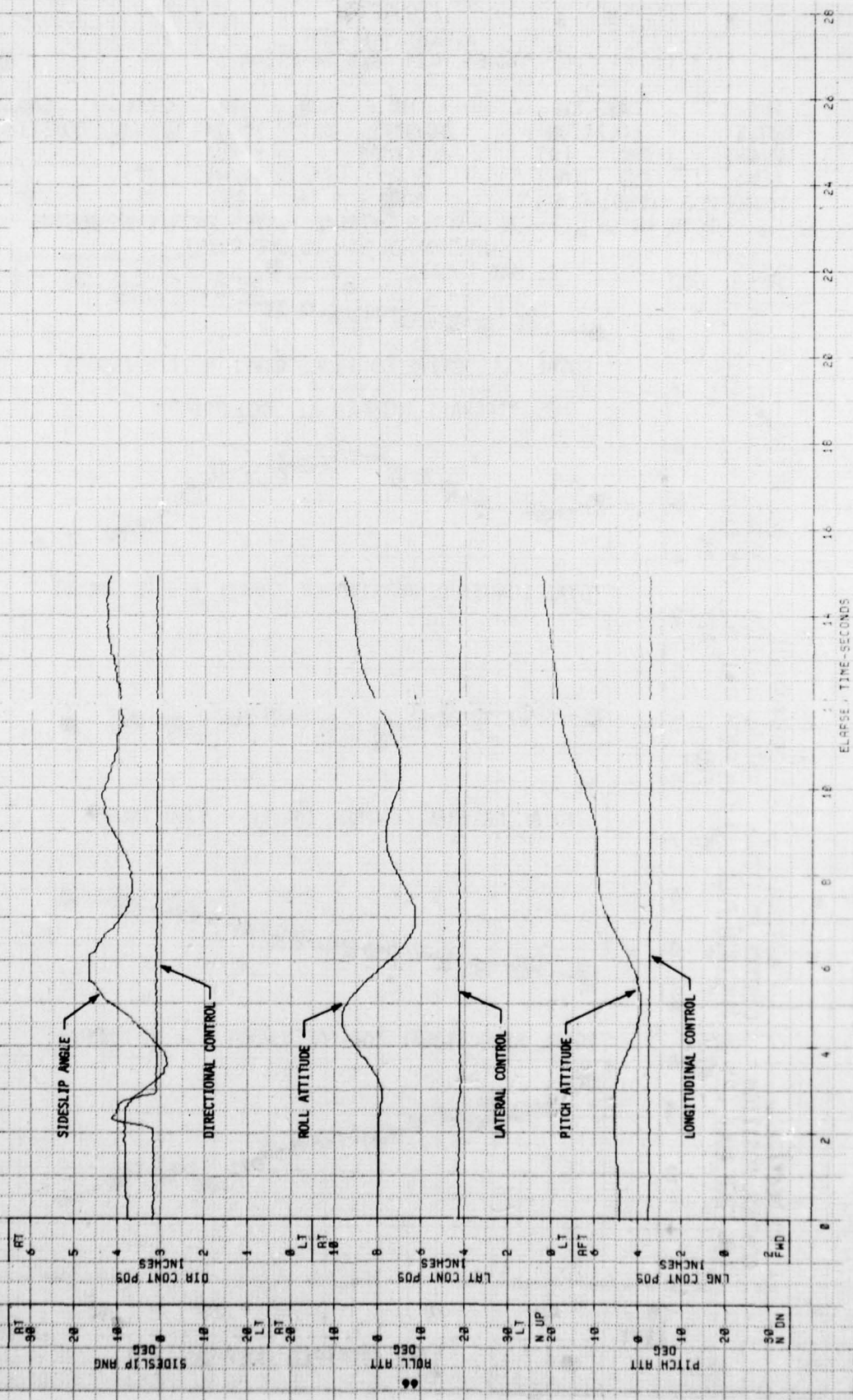

FIGURE 28 CONTINUED



**FIGURE 10  
STRESS POINT  
LOCATIONS**

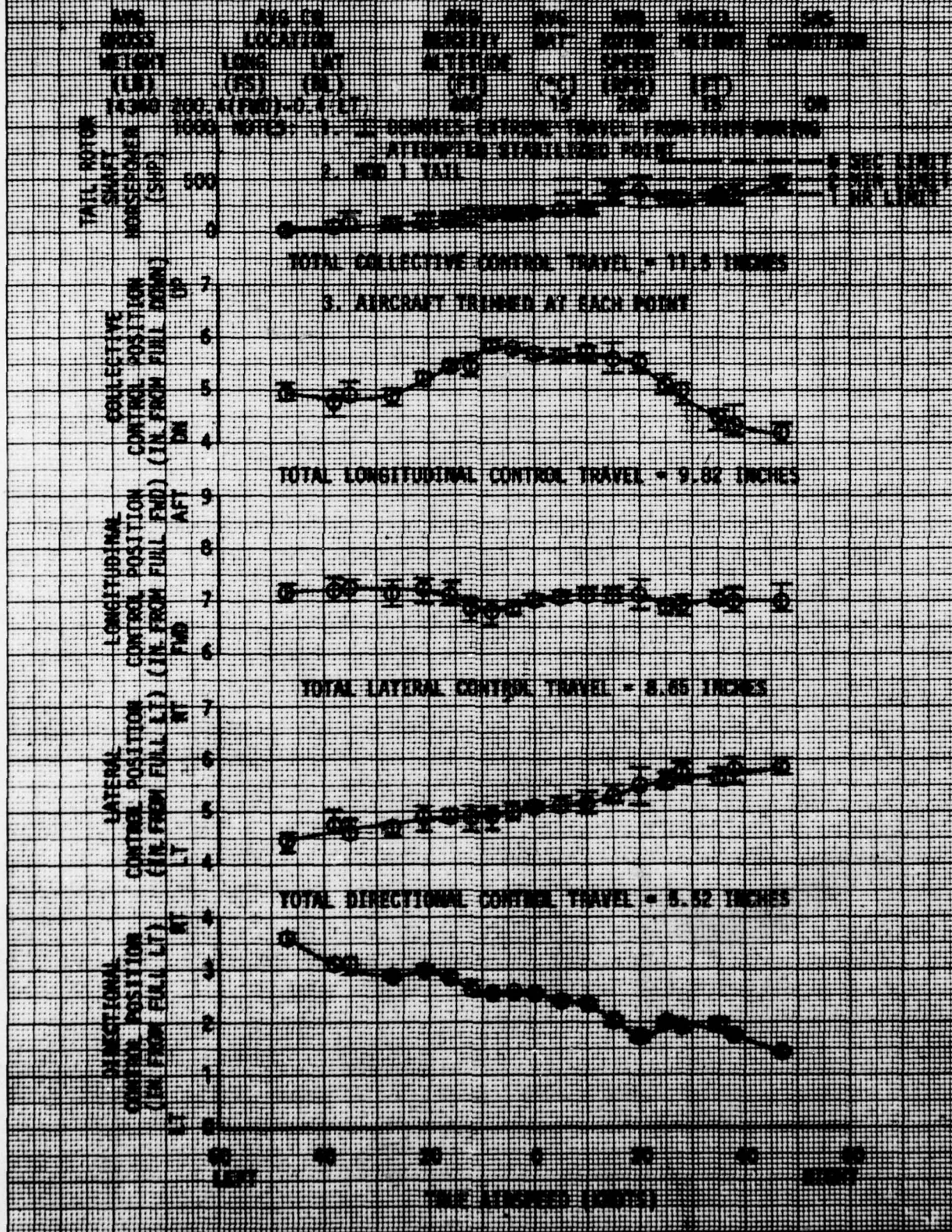

FIGURE 30  
 STANDARD FLIGHT  
 YAH-64 USA S/N 74-22248

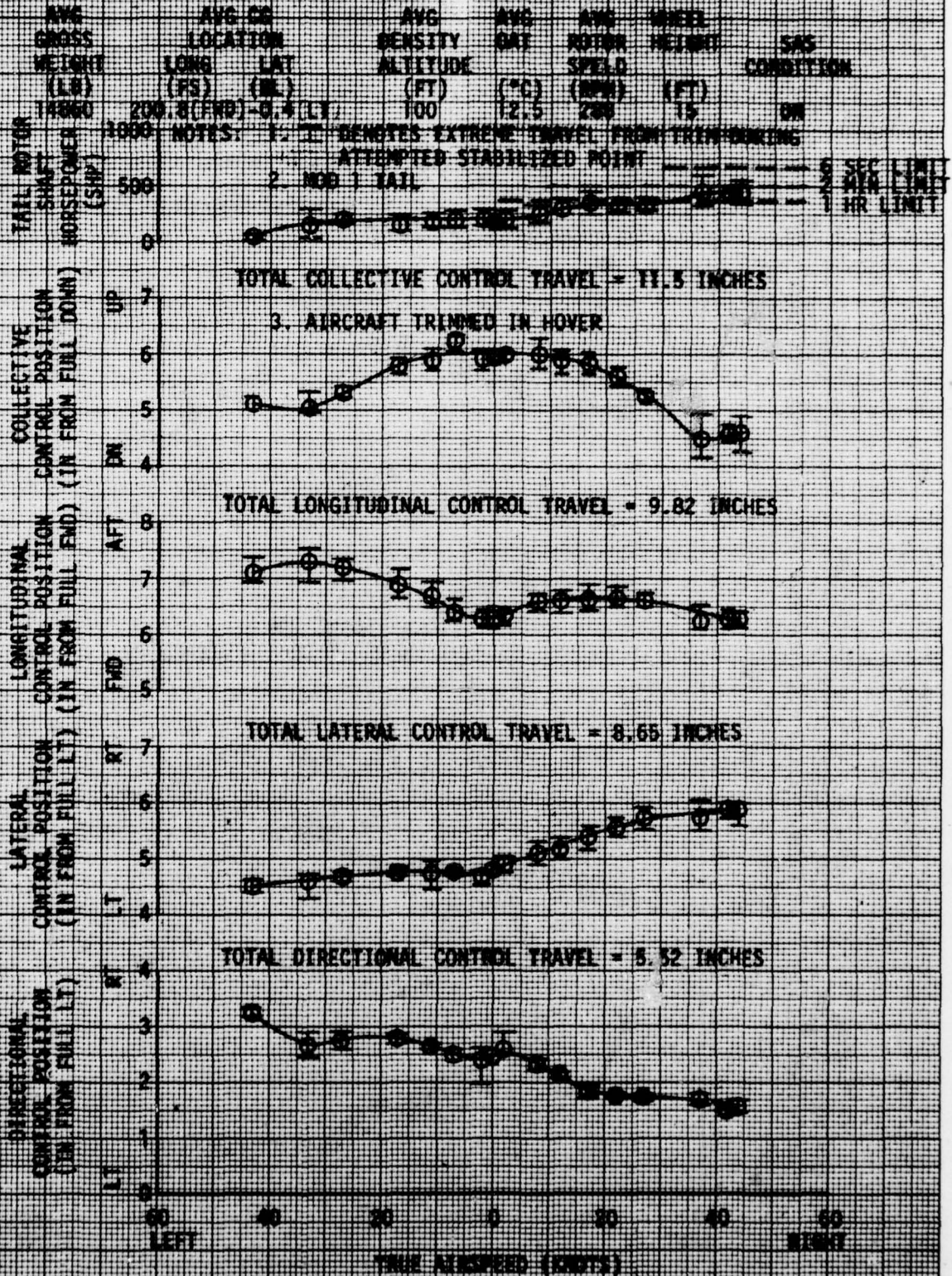

FIGURE 31  
 SIDEWARD FLIGHT  
 YAN-84 USA S/N 74-22246

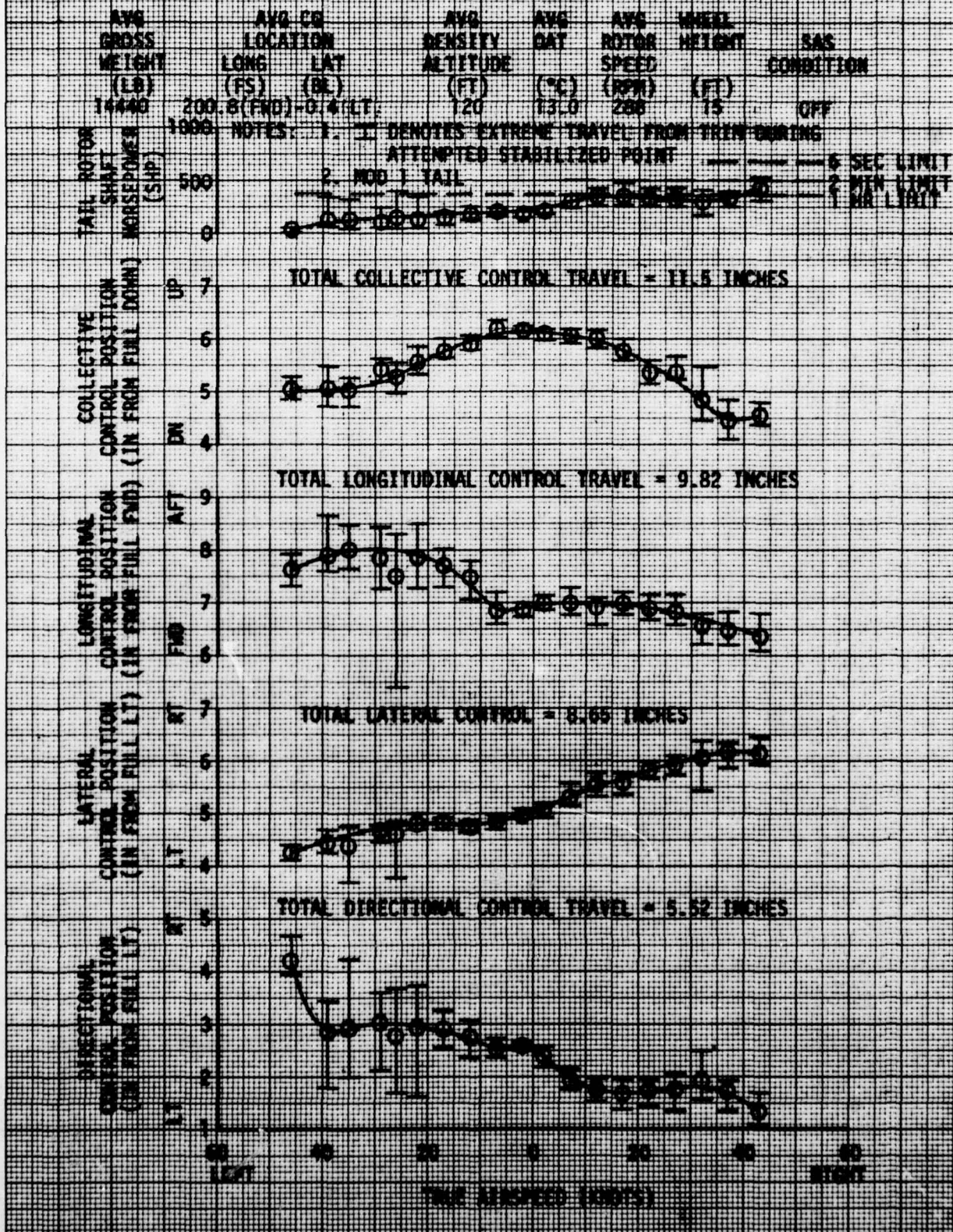



FIGURE 32  
 SIDEWARD FLIGHT  
 YAG-84 USA 57N 74-22248

WING WEIGHT (LB)	AVG CG LOCATION		AVG DENSITY ALTITUDE (FT)	AVG DAY TEMP (°C)	AVG ROTOR SPEED (RPM)	WHEEL HEIGHT (FT)	SAS CONDITION
	LONG (ES)	LAT (RL)					
14520	200.1 (FR3)-0.4 (LT)		400	12.5	288	15	ON

NOTES: 1. 'E' DENOTES EXTREME TRAVEL FROM TRIM DURING ATTEMPTED STABILIZED POINT

2. MOD 1 TAIL

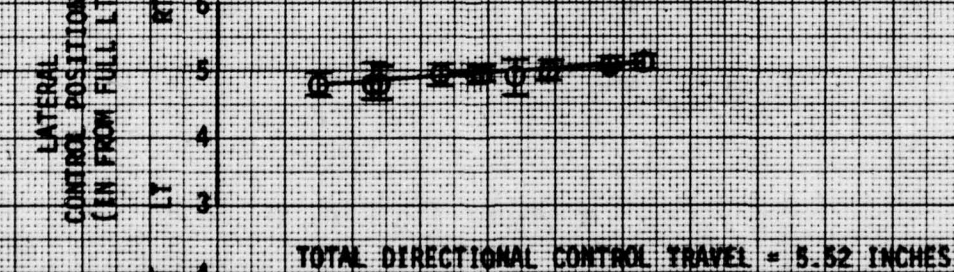
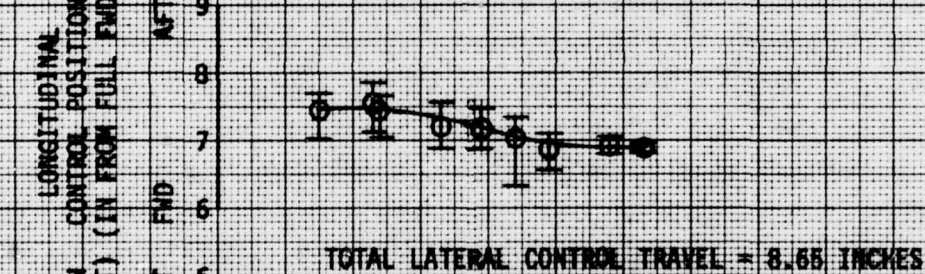
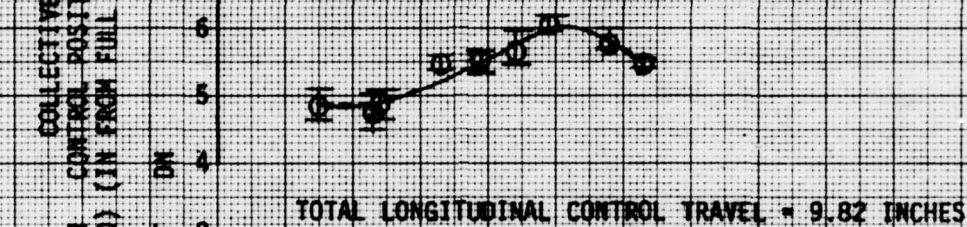
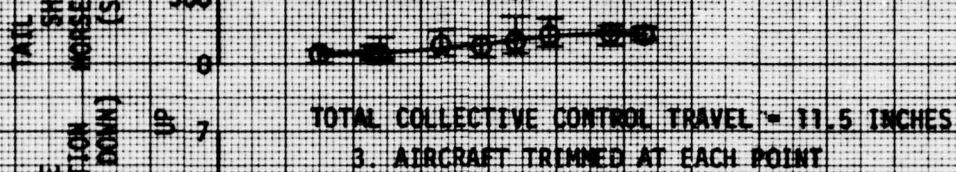

FIGURE 13  
STORAGE FLIGHT

YAN-94 USA 578 14-22248  
CRITICAL AZIMUTH - 280 DEGREES

AVG CO LOCATION	AVG DENSITY	AVG SAT	AVG WIND SPEED	AVG WIND DIRECTION	SEA CONDITION
LONG (FS) LAT (DL)	ALTITUDE (FT)	(°C)	(KPH)	(°)	
2 (FWD) - 0.4 (LT)	360	14.5	200	15	04F

NOTES: 1.  $\square$  DENOTES EXTREME TRAVEL FROM TRIM DURING ATTEMPTED STABILIZED POINT  
2. MOB 1 FAIL

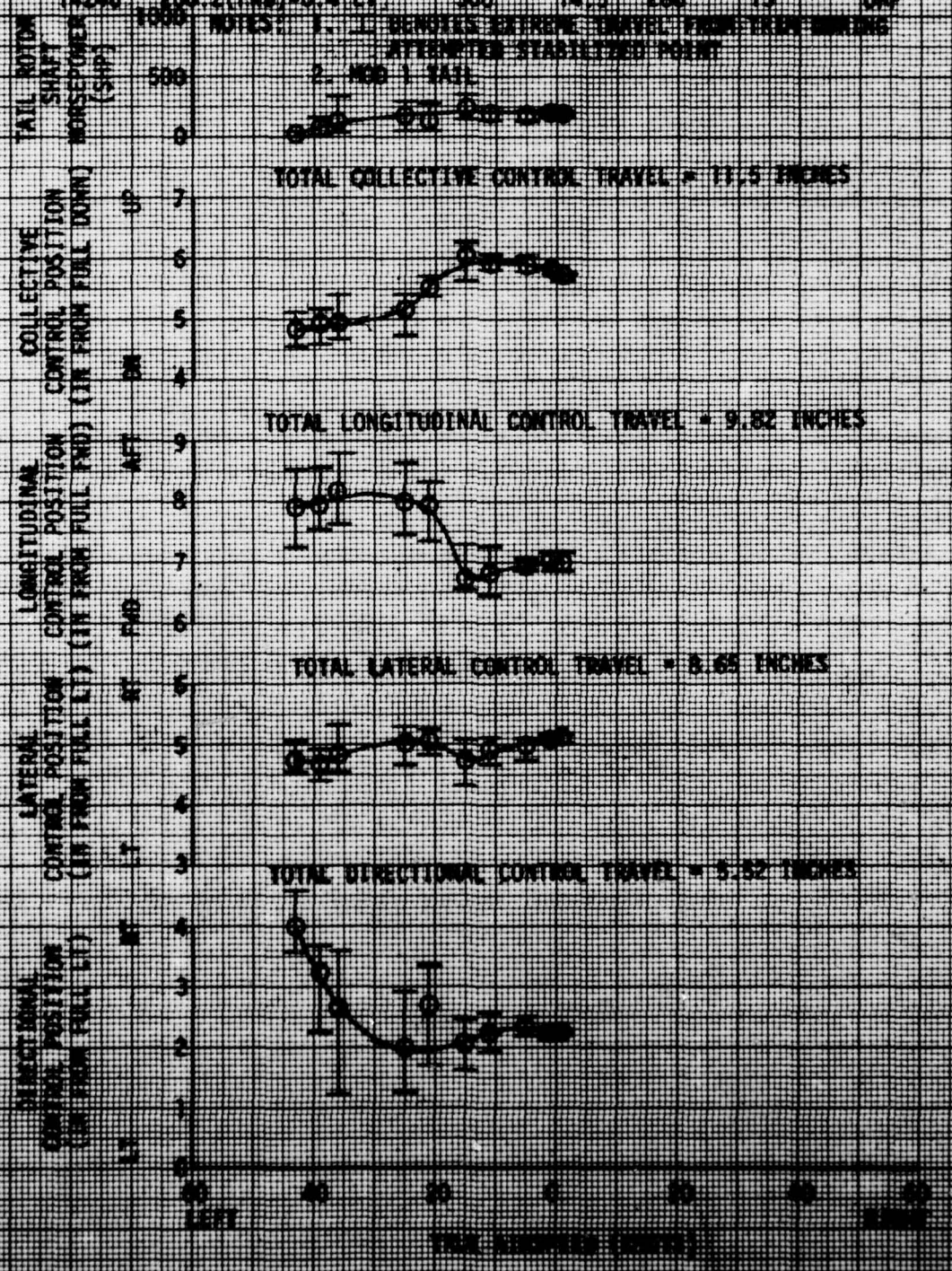
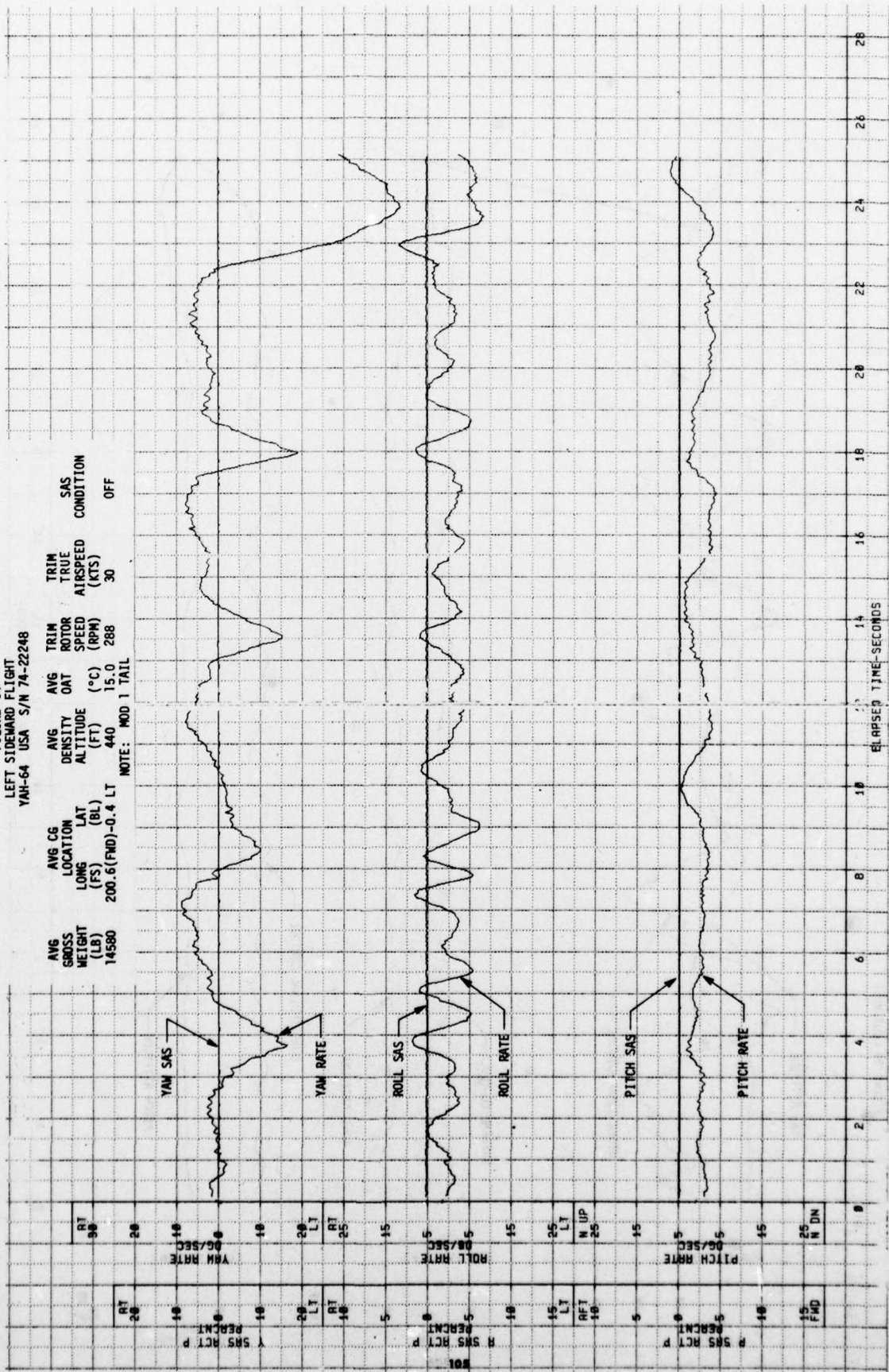

FIGURE 34  
LEFT SIDEMARD FLIGHT  
YAH-64 USA S/N 74-22248



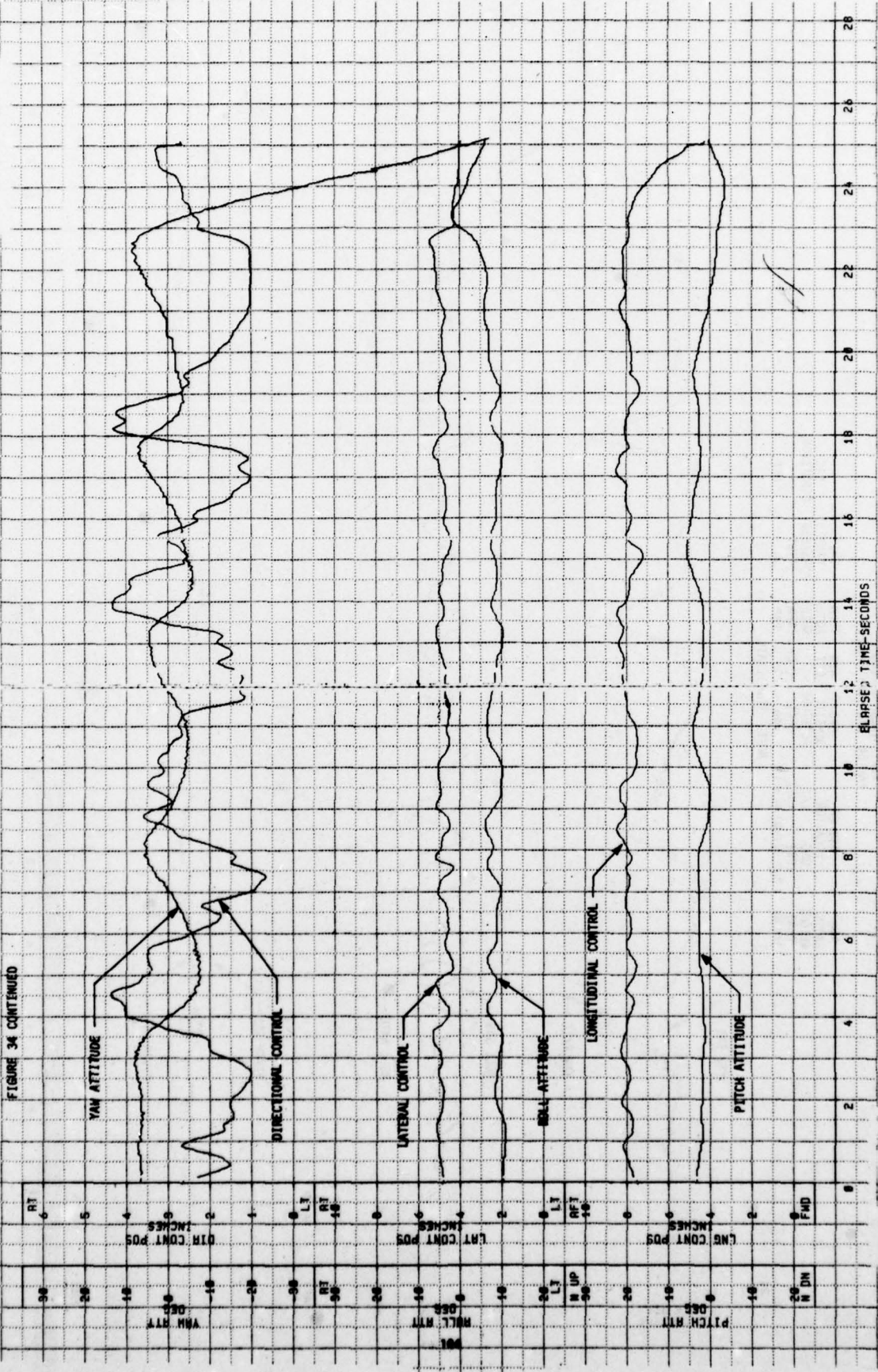
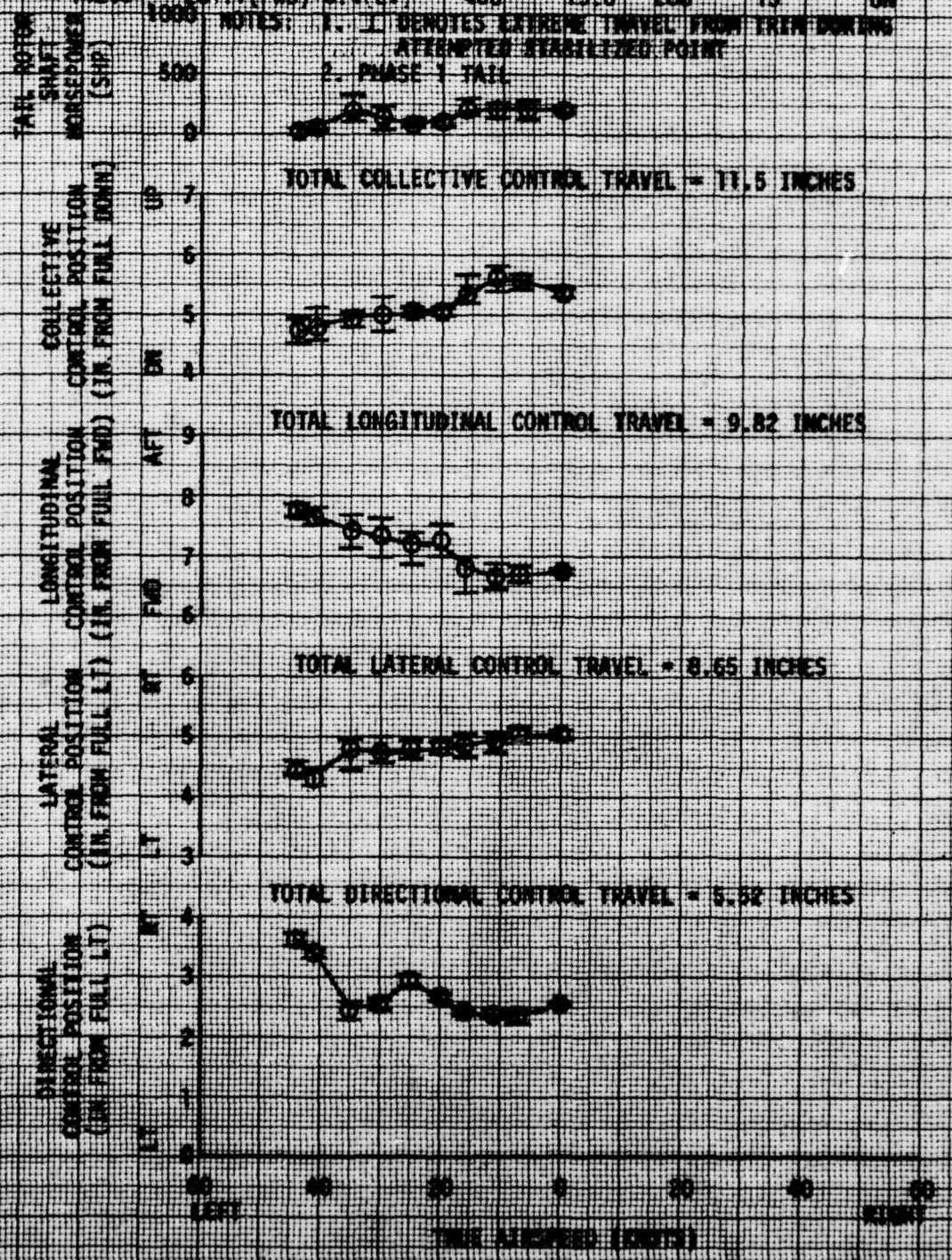

FIGURE 35  
STANDARD FLIGHT

YAG-64 USA S/N 74-22246

TIME (SEC)	AVG CR LOCATION		AVG DENSITY	AVG DPT	AVG ROTOR SPEED	WHEEL WEIGHT	SAS CONDITION
	LONG (FS)	LAT (BL)	ALTITUDE (FT)	(°C)	(RPM)	(FT)	
12.240	201.1 (FWD)	-0.4 (LT)	460	15.0	280	15	ON

NOTES: 1. I DENOTES EXTREME TRAVEL FROM TRIM DURING ATTEMPTED STABILIZED POINT  
2. PHASE 1 TAIL



**FIGURE 10  
SERVING FLIGHT  
NO. 74-22208**

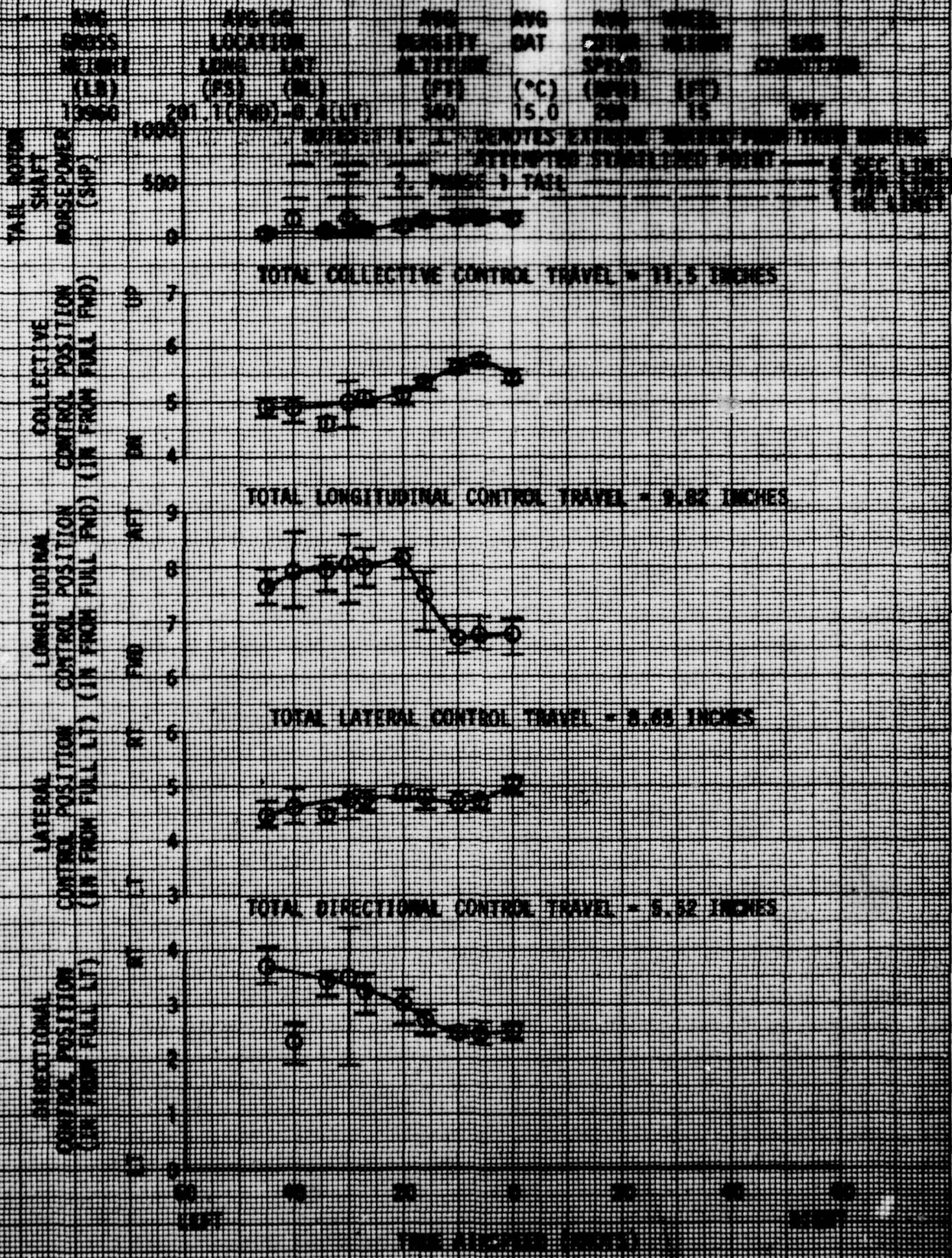

FIGURE 37  
STANDARD FLIGHT

TAH-6A USA S/N 74-22248

CRITICAL AIRSPEED: 260 DEGREES

AVG CG LOCATION	AVG DENSITY ALTITUDE	AVG OAT	AVG ROTOR SPEED	WHEEL HEIGHT	SAS CONDITION
LONG (FS) LAT (ML)	(FT)	(°C)	(RPM)	(FT)	
201.1 (FWD) -0.4 (LT)	600	15.0	268	15	ON

NOTES: 1. □ DENOTES EXTREME TRAVEL FROM TRIM DURING ATTEMPTED STABILIZED POINT  
2. PHASE 1 TAIL

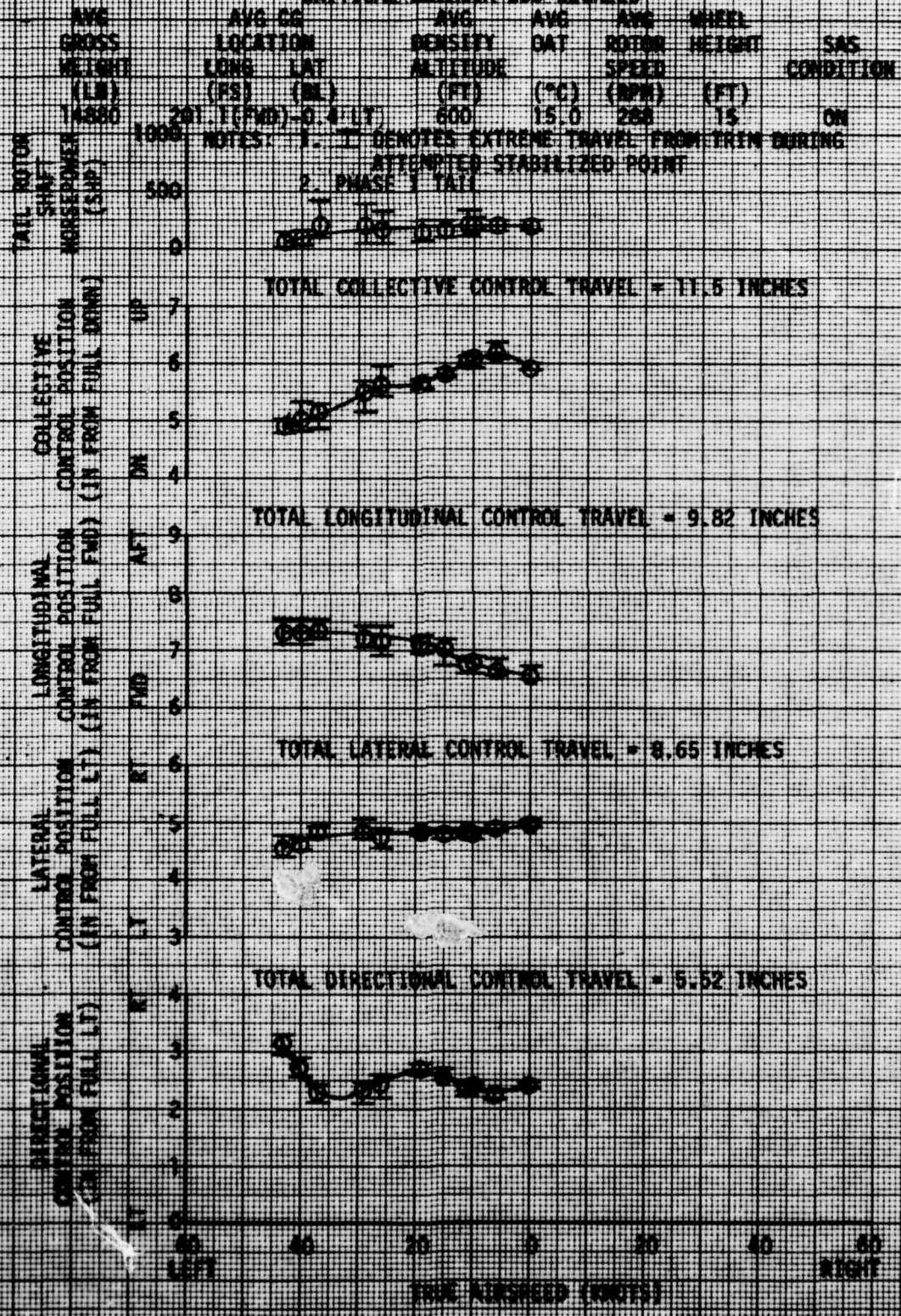

TOTAL COLLECTIVE CONTROL TRAVEL = 11.5 INCHES

TOTAL LONGITUDINAL CONTROL TRAVEL = 9.82 INCHES

TOTAL LATERAL CONTROL TRAVEL = 8.65 INCHES

TOTAL DIRECTIONAL CONTROL TRAVEL = 5.52 INCHES

**FIGURE 38**  
**SIDEMARK FLIGHT**  
**YAN-64 USA S/N 74-22248**  
**CRITICAL AZIMUTH 250 DEGREES**

AVG GROSS WEIGHT (LB)	AVG CG LOCATION LONG (FS) LAT (BL)	AVG DENSITY ALTITUDE (FT)	AVG OAT (°C)	AVG ROTOR SPEED (RPM)	WHEEL HEIGHT (FT)	SAS CONDITION
14600	201.1 (FWD) - 0.4 (LT)	440	14.5	288	15	OFF

NOTES: 1. I DENOTES EXTREME TRAVEL FROM TRIM DURING ATTEMPTED STABILIZED POINT  
 2. PHASE I TAIL



TOTAL COLLECTIVE CONTROL TRAVEL = 11.5 INCHES



TOTAL LONGITUDINAL CONTROL TRAVEL = 9.82 INCHES

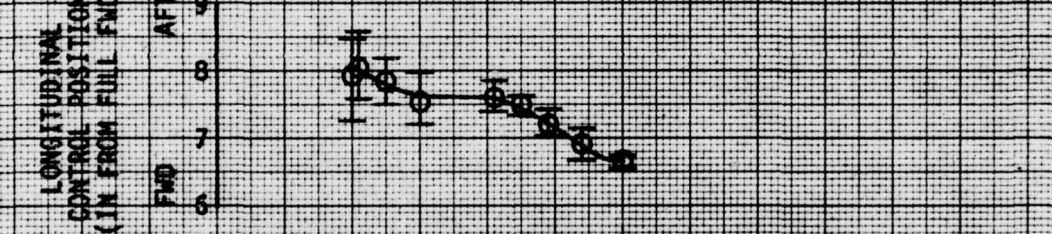

TOTAL LATERAL CONTROL TRAVEL = 8.65 INCHES

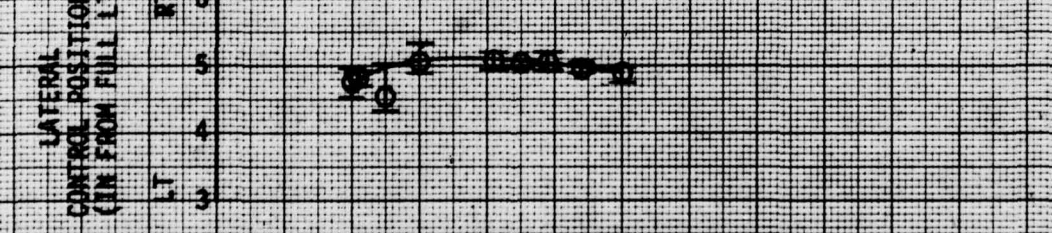

TOTAL DIRECTIONAL CONTROL TRAVEL = 5.52 INCHES

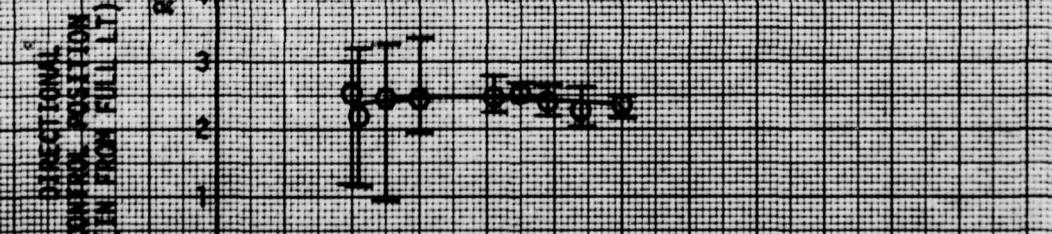

TRUE AIRSPEED (KNOTS)



FIGURE 39  
LOW-SPEED FORWARD AND REARWARD FLIGHT

YAH-64 USA S/N 74-22248

AVG GROSS WEIGHT (LB)	AVG CG LOCATION		AVG DENSITY	AVG BAT	AVG ROTOR SPEED	WHEEL HEIGHT	SAS CONDITION
	LONG (FS)	LAT (IN)	ALTITUDE (FT)	(°C)	(RPM)	(FT)	
14800	200.4 (FWD)	-0.4 (LT)	200	13.5	288	15	ON

NOTE 1. **I** DENOTES EXTREME TRAVEL FROM TRIM DURING ATTEMPTED STABILIZED POINT

2. MOD 1 TAIL

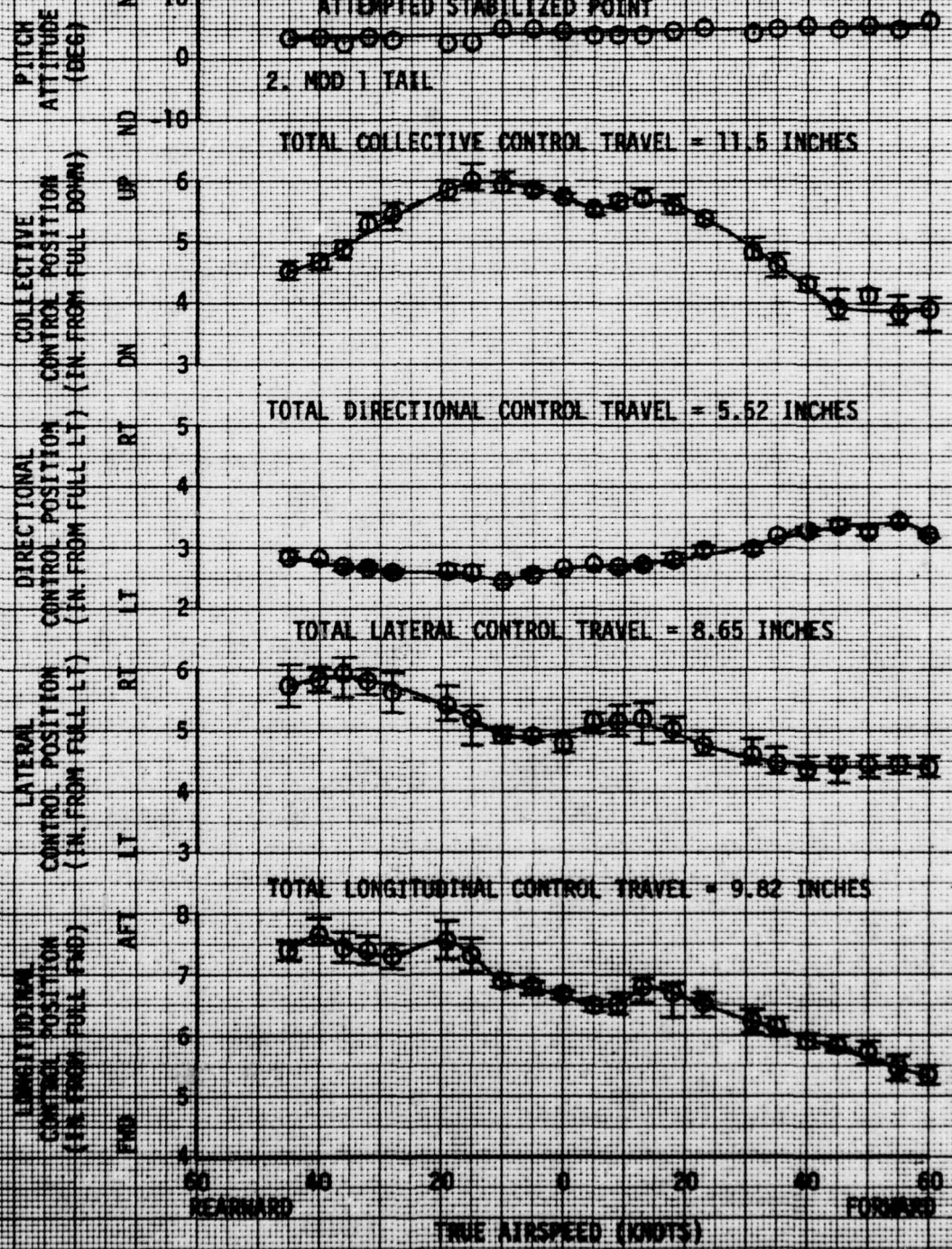

FIGURE 4B  
 LOW-SPEED FORWARD AND REARWARD FLIGHT

YAH-64 USA S/N 74-22248

AVG GROSS WEIGHT (LB)	AVG CG LOCATION		AVG DENSITY ALTITUDE (FT)	AVG OAT (°C)	AVG ROTOR SPEED (RPM)	WHEEL HEIGHT (FT)	SAS CONDITION
13920	LONG (FS)	LAT (BL)	480	15.5	288	15	DFF

NOTE: I.I. DENOTES EXTREME TRAVEL FROM TRIM DURING ATTEMPTED STABILIZED POINT

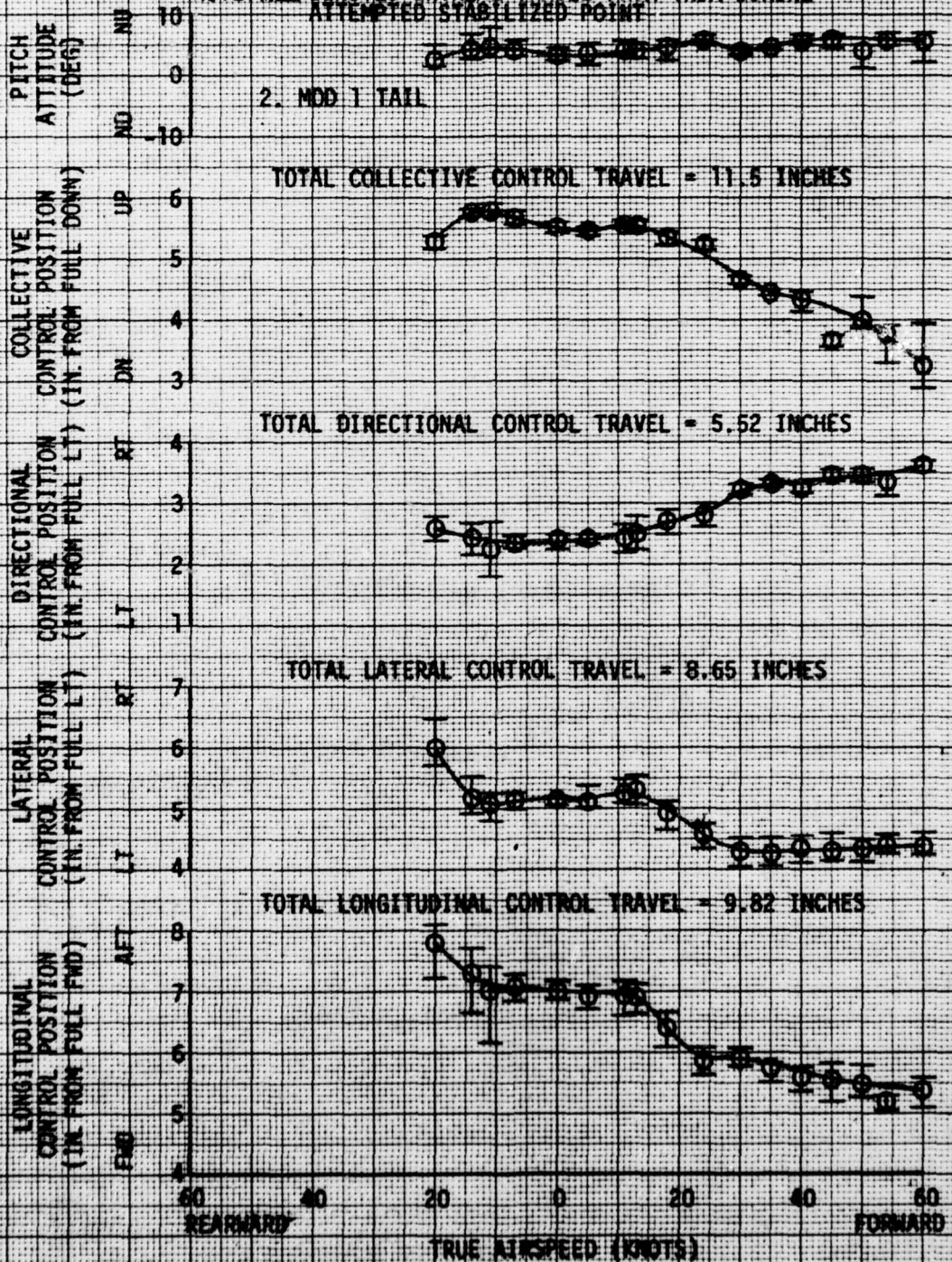
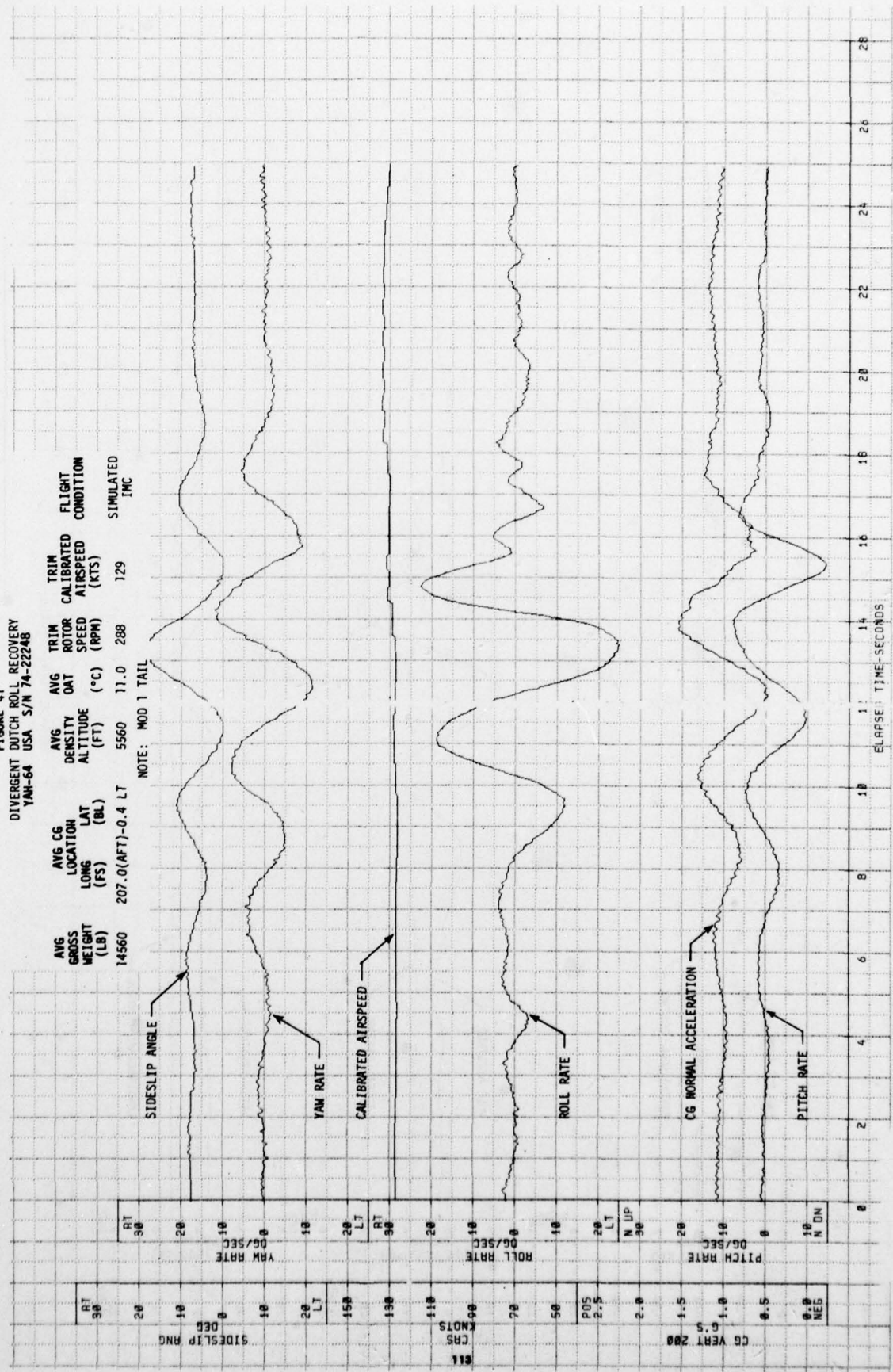

FIGURE 41  
 DIVERGENT DUTCH ROLL RECOVERY  
 YAH-64 USA S/N 74-22248



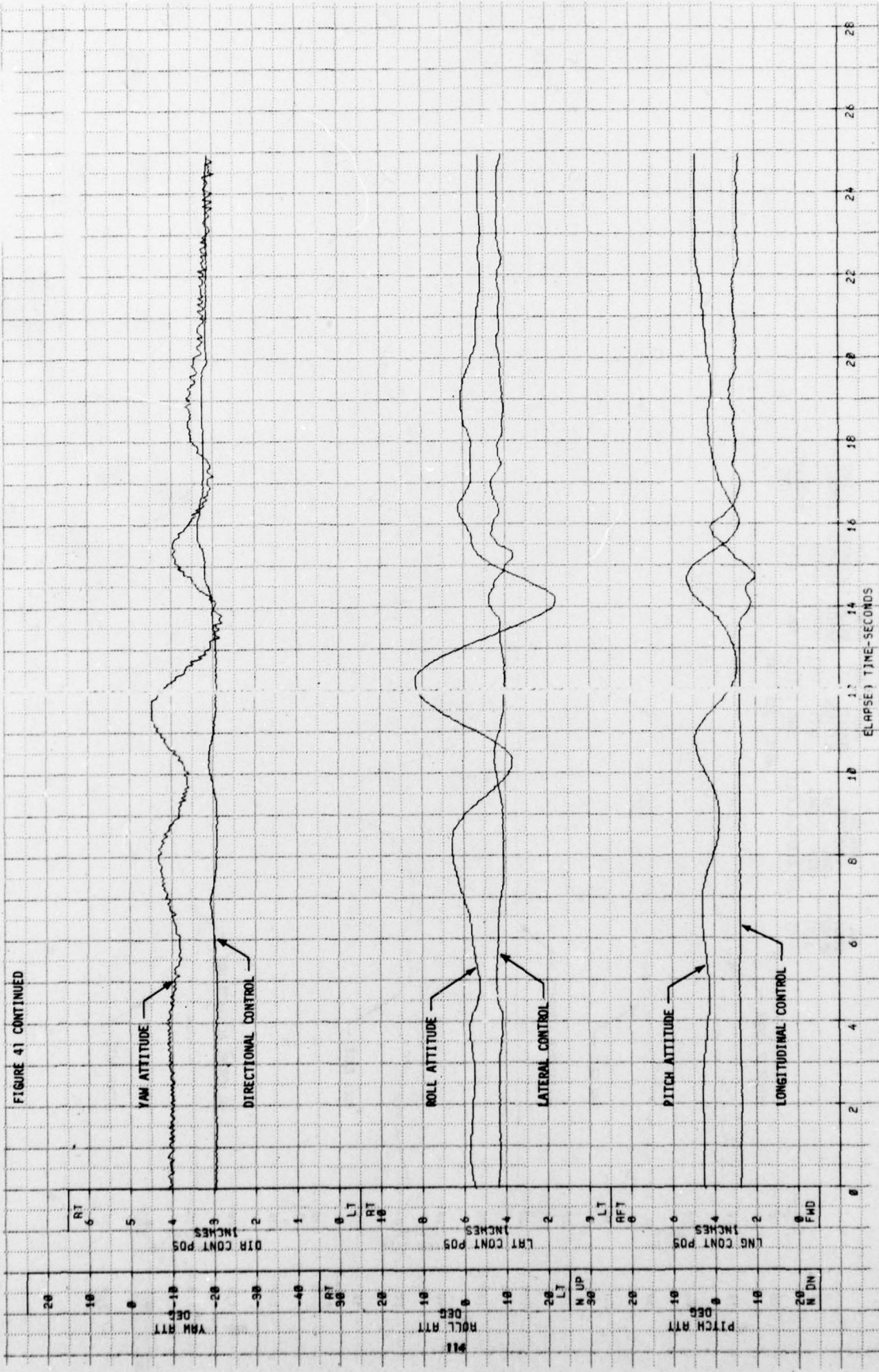

FIGURE 42

SAS DISENGAGEMENT  
 YAH-64 USA S/N 74-22248

AVG GROSS WEIGHT (LB)	AVG CG LOCATION (FS)	AVG DENSITY ALTITUDE (FT)	AVG OAT (°C)	TRIM MOTOR SPEED (RPM)	TRIM CALIBRATED AIRSPEED (KTS)	FLIGHT CONDITION
14900	206.8(AFT)-0.4 LT	5280	10.5	288	124	SIMULATED IMC

NOTE: MOD 1 TAIL

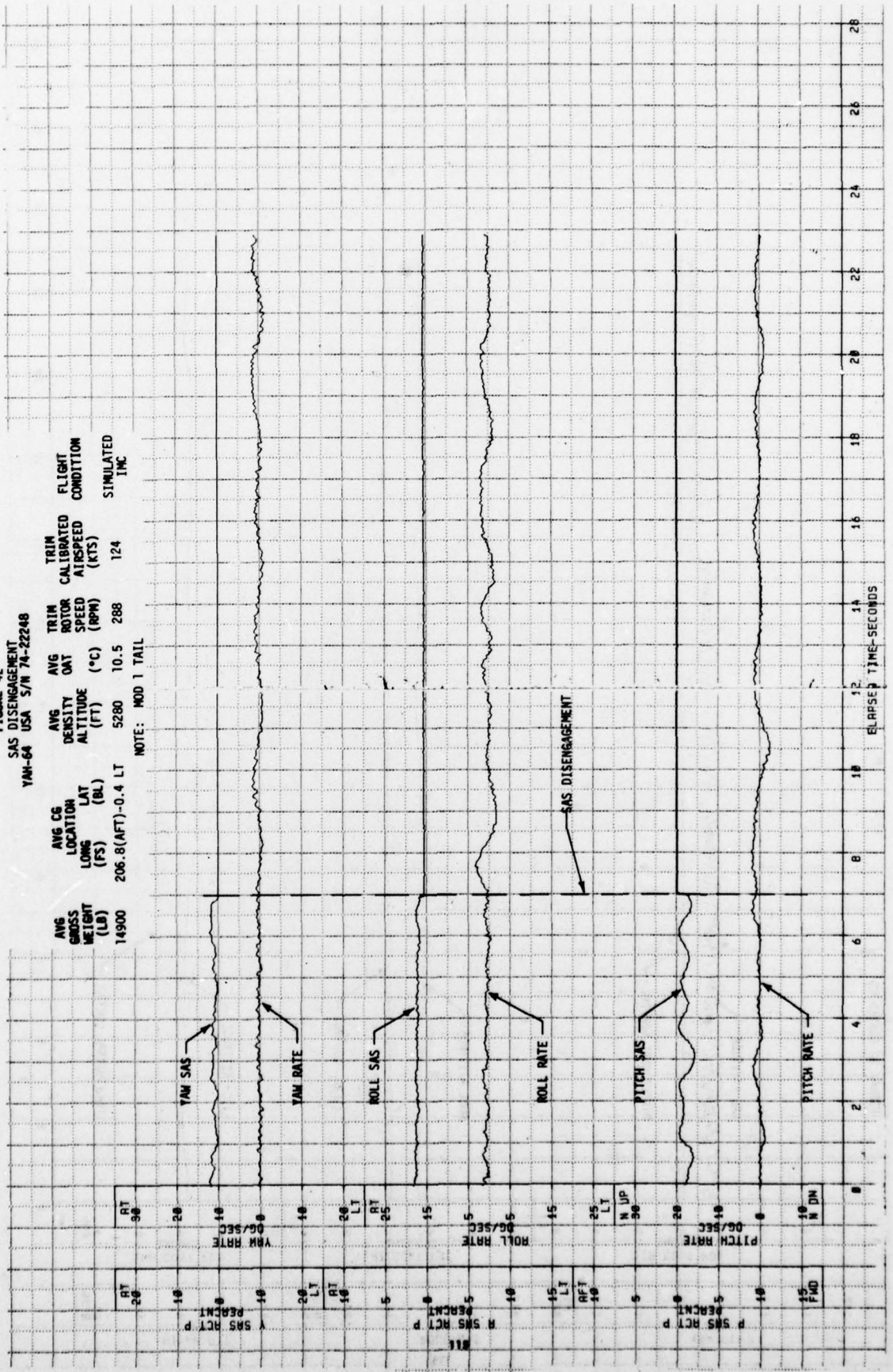

FIGURE 42 CONTINUED

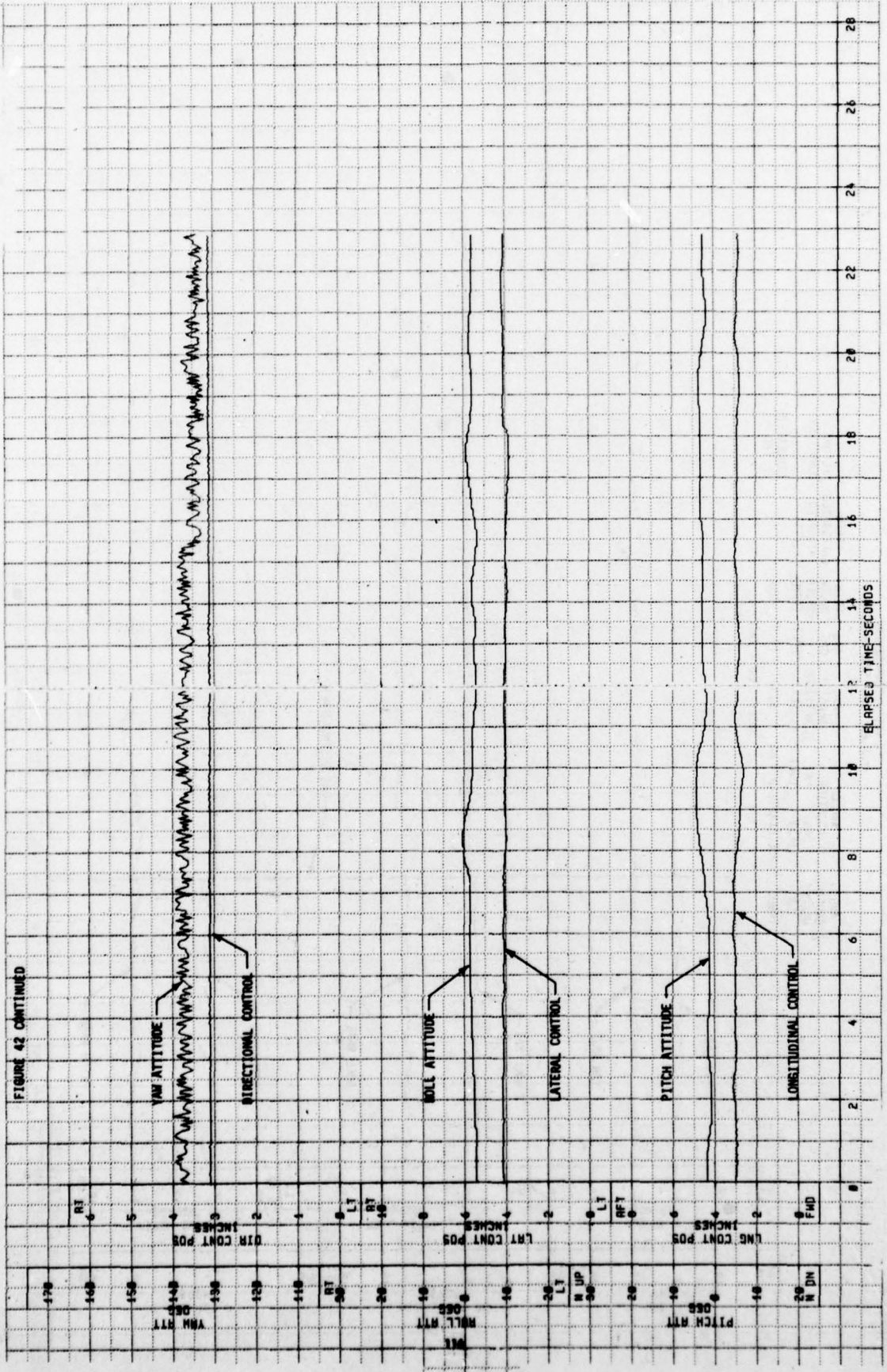

FIGURE 43  
 SAS DISENGAGEMENT  
 YAH-64 USA S/N 74-22248

AVG GROSS WEIGHT (LB)	AVG CG LOCATION LONG (FS)	AVG CG LOCATION LAT (BL)	AVG DENSITY ALTITUDE (FT)	AVG OAT (°C)	TRIM ROTOR SPEED (RPM)	TRIM CALIBRATED AIRSPEED (KTS)	FLIGHT CONDITION
14740	206.9(AFT)	-0.4 LT	5120	11.5	288	143	SIMULATED IMC

NOTE: MOD 1 TAIL

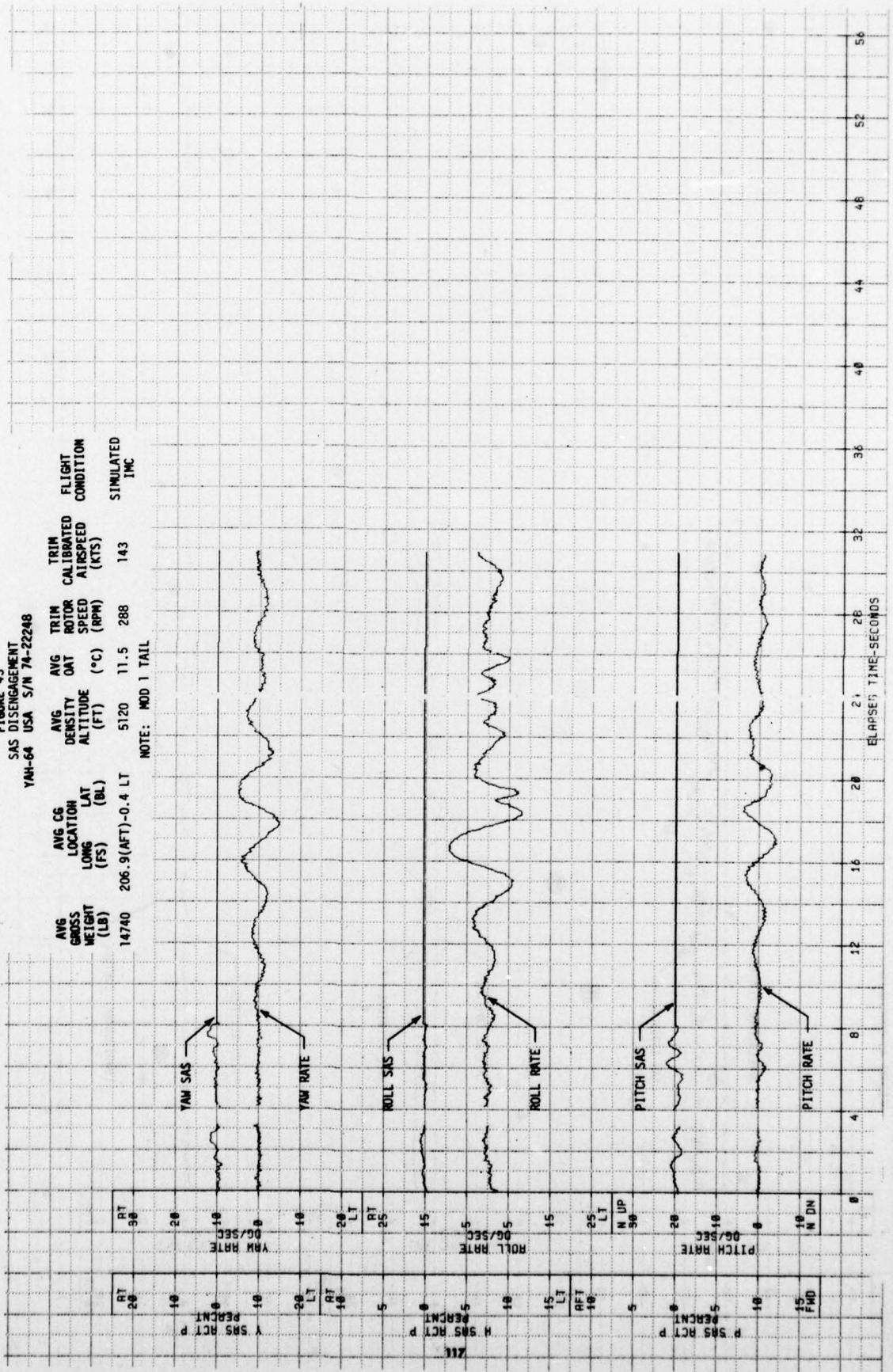

FIGURE 43 CONTINUED

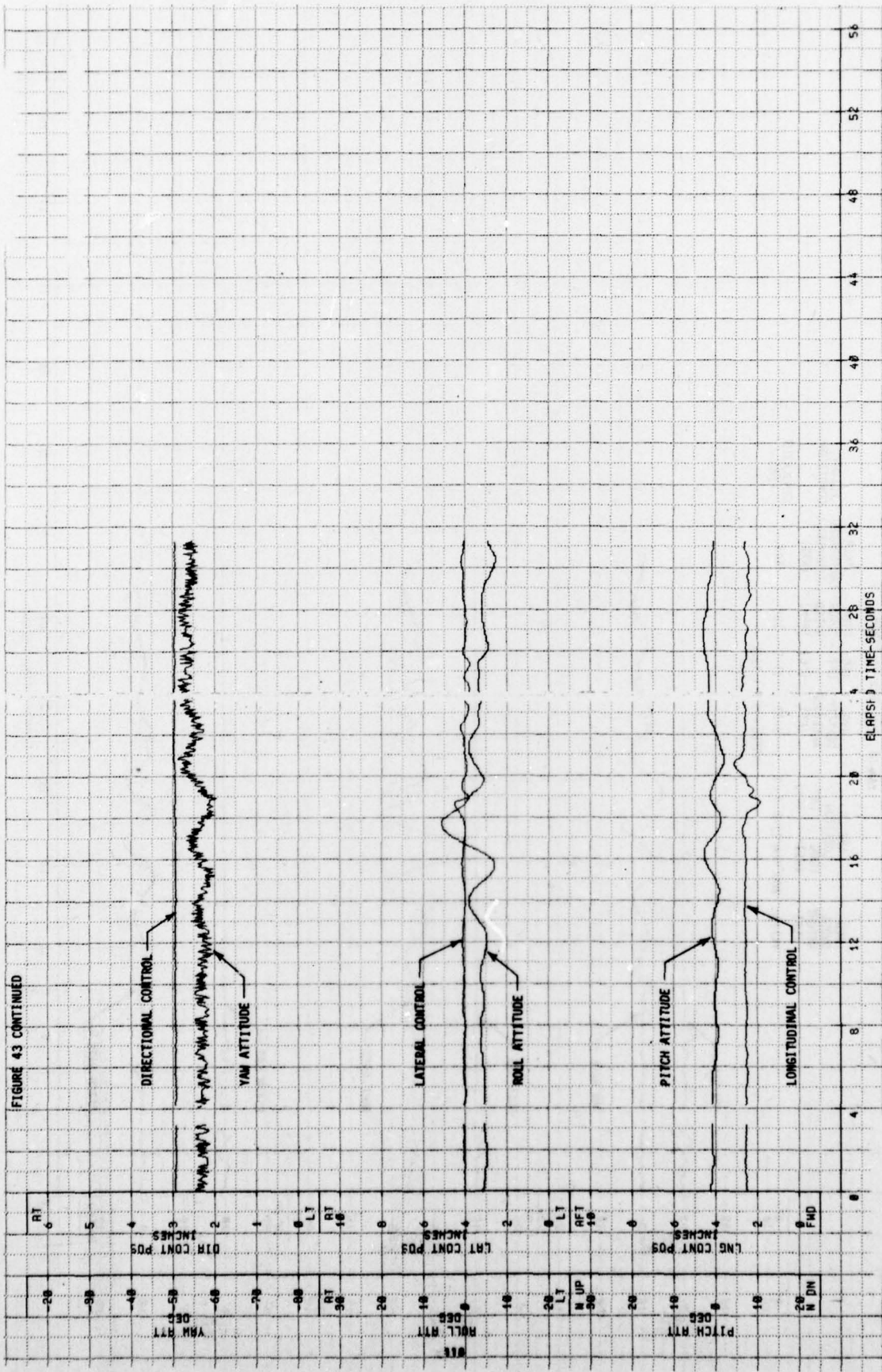



FIGURE 44  
SAS DISENGAGEMENT  
YAH-64 USA S/N 74-22248

AVG GROSS WEIGHT (LB) 13460  
 AVG CG LOCATION LONG (FS) 206.7(AFT)-0.4 LT  
 AVG DENSITY ALTITUDE (FT) 4180  
 AVG OAT (°C) 14.5  
 TRIM MOTOR SPEED (RPM) 288  
 TRIM CALIBRATED AIRSPEED (KTS) 142  
 FLIGHT CONDITION SIMULATED  
 TIME

NOTE: MOD 1 TAIL

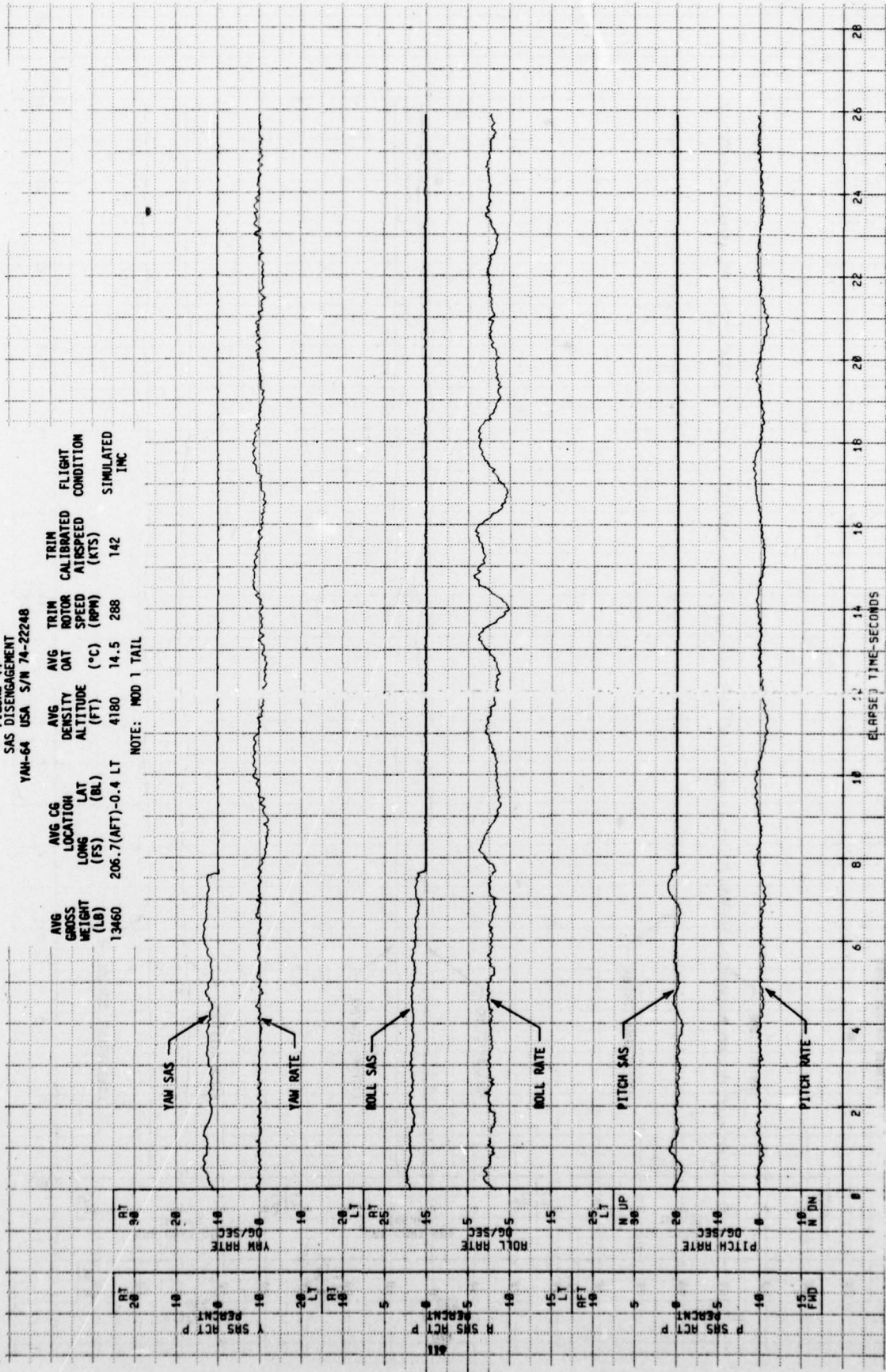
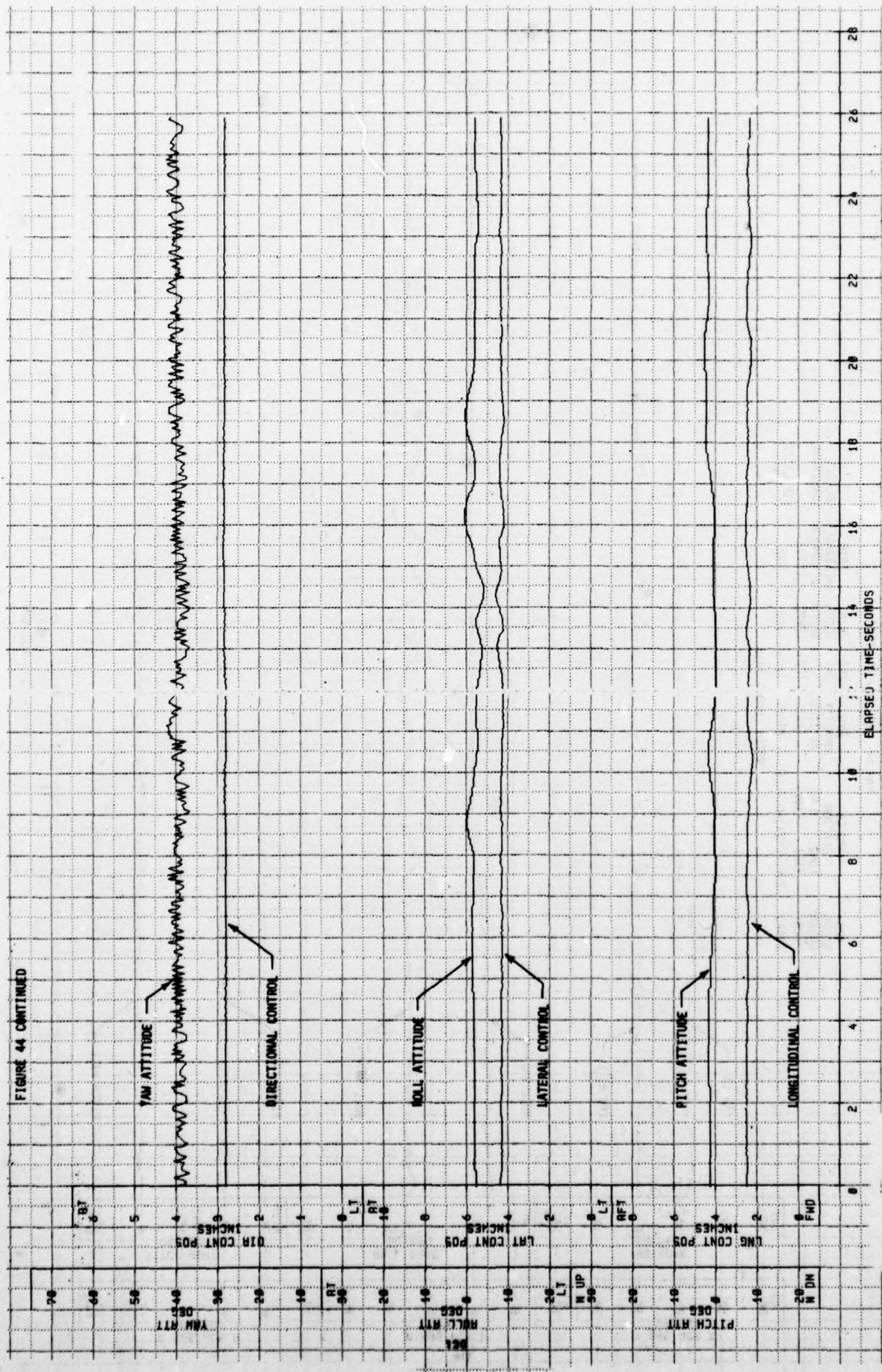

FIGURE 44 CONTINUED



**FIGURE 45**  
**ROLL SAS FAILURE**  
**YAH-64 USA S/N 74-22248**

<b>AVG GROSS WEIGHT (LB)</b>	14820	<b>AVG CG LONG (FS)</b>	206.9AFT	<b>AVG CG LAT (BL)</b>	-0.4 LT	<b>AVG DENSITY ALTITUDE (FT)</b>	5540	<b>AVG OAT (°C)</b>	10.5	<b>TRIM MOTOR SPEED (RPM)</b>	288	<b>TRIM CALIBRATED AIRSPEED (KTS)</b>	132	<b>FLIGHT CONDITION</b>	SIMULATED IMC
------------------------------	-------	-------------------------	----------	------------------------	---------	----------------------------------	------	---------------------	------	-------------------------------	-----	---------------------------------------	-----	-------------------------	---------------

NOTE: MOD 1 TAIL

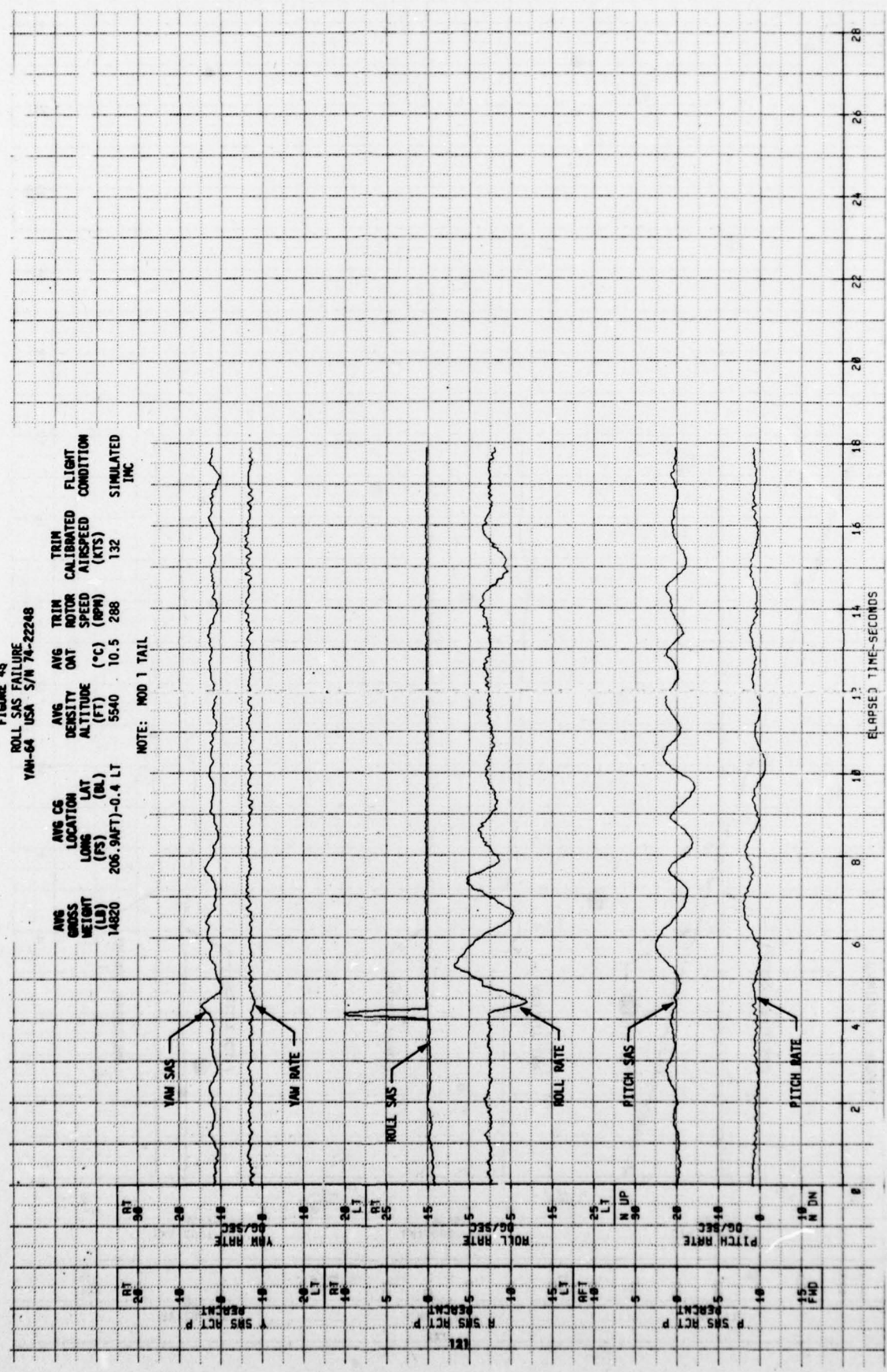

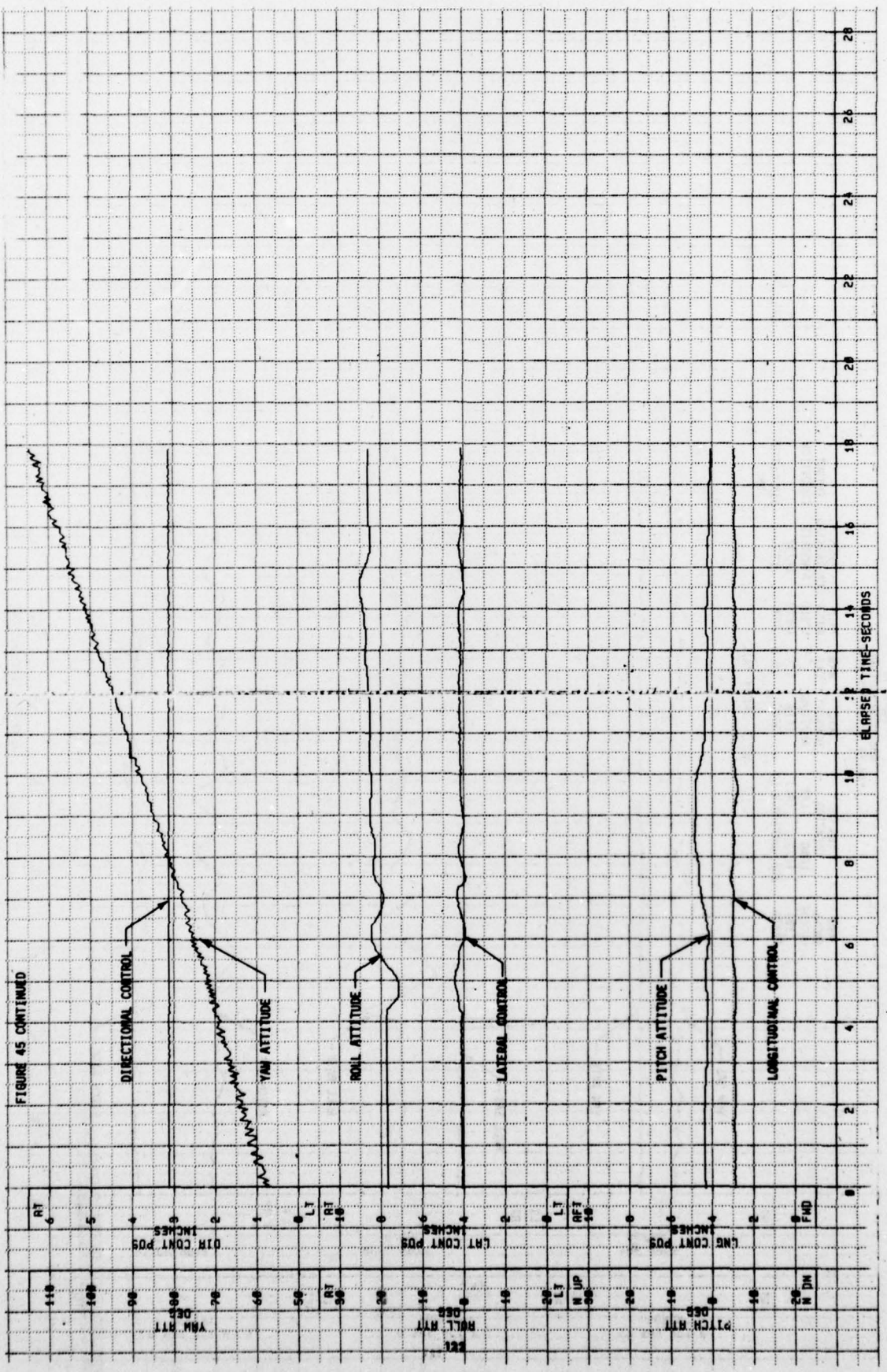

FIGURE 45 CONTINUED

FIGURE 46  
 VIBRATION CHARACTERISTICS  
 YAN-28 USA S/N 74-22248  
 PILOT SEAT VERTICAL

AVG GROSS WEIGHT (LB)	AVG CG LOCATION		AVG DENSITY ALTITUDE (FE)	AVG OAT (°C)	AVG ROTOR SPEED (RPM)	FLIGHT CONDITION
	LONG (FS)	LAT (BL)				
14640	206.8 (AFT)	0.4 (T)	5000	13.0	288	EVL FLT

NOTE: MOD 1 TAIL

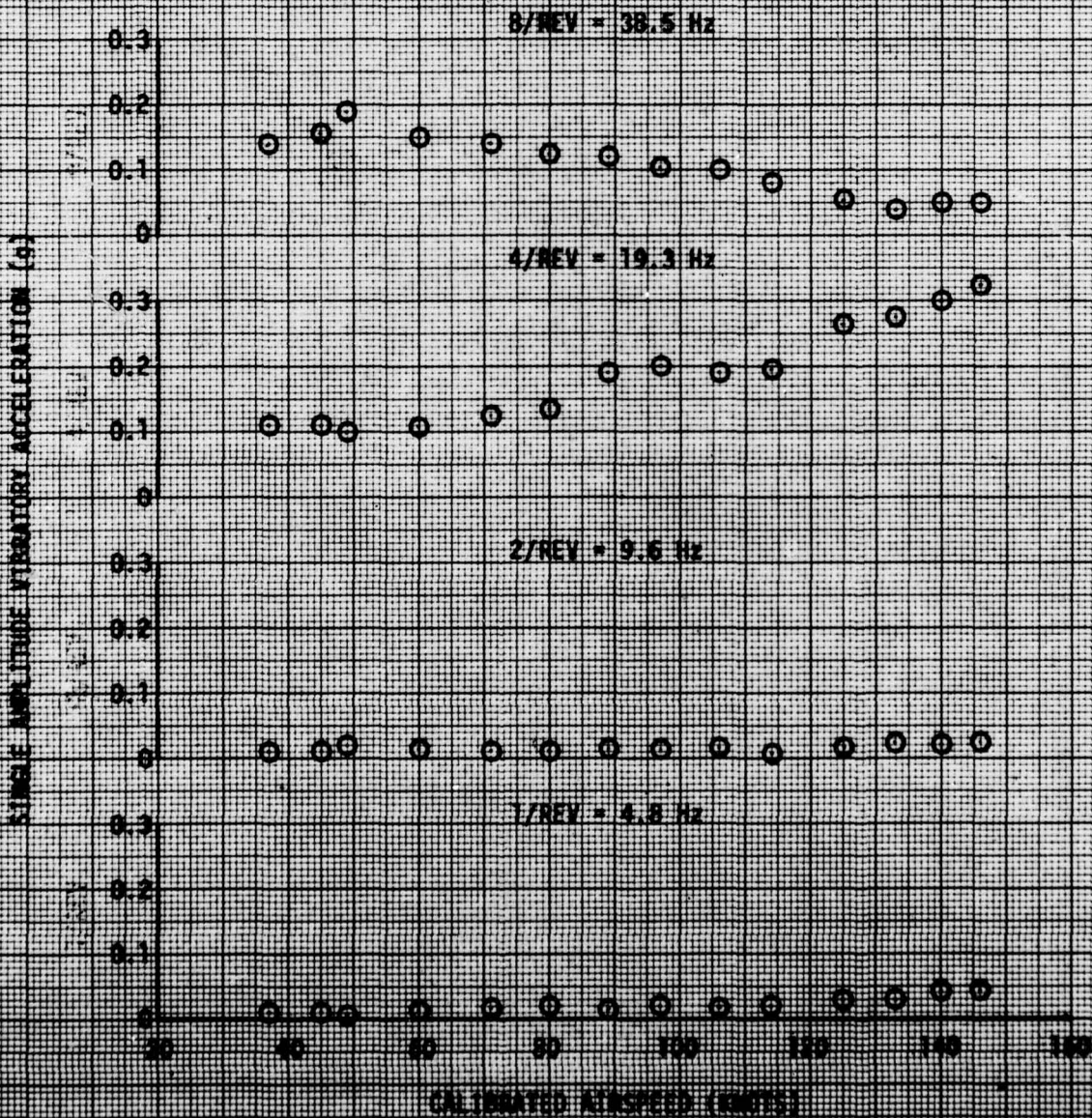

FIGURE 17  
 VIBRATION CHARACTERISTICS  
 TNO-62 USA 17474-2248  
 PILOT SEAT LATERAL

AWS GROSS WEIGHT (LB)	AWS OR LOCATION LONG (FS) LAT (DL)		AWS DENSITY ALTITUDE (FT)	AWS OAT (°C)	AWS MOTOR SPEED (RPM)	FLIGHT CONDITION	WIND DIRECTION (DEG)
14040	296.0(NPT)	0.4(SLT)	3000	15.0	200	EVL FLT	11.5PT

NOTE: MOD 1 TAIL

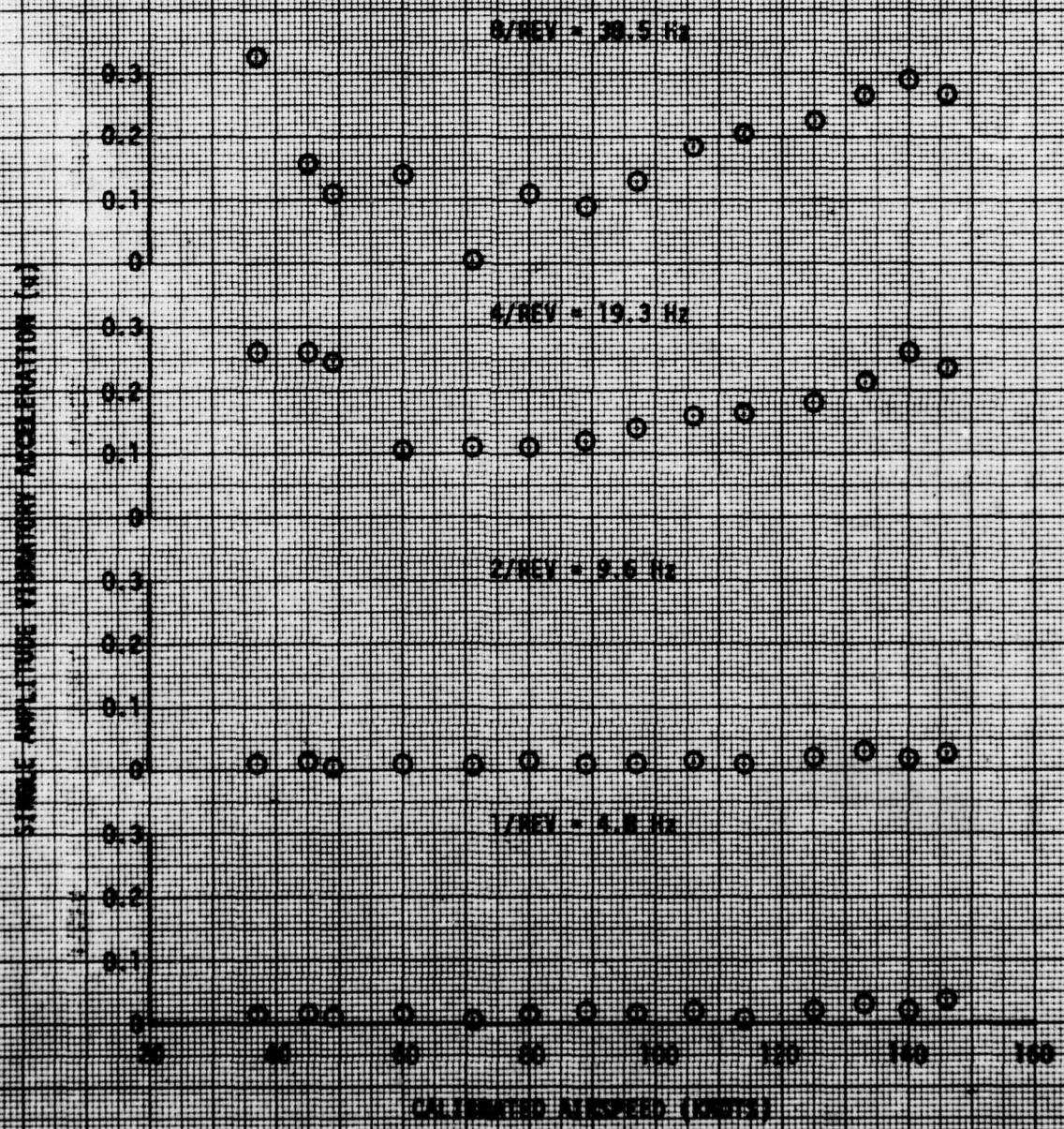

FIGURE 48  
 VIBRATION CHARACTERISTICS  
 YAH-64 USA S/N 74-22248  
 PILOT SEAT LONGITUDINAL

AVG GROSS WEIGHT (LB)	AVG CG LOCATION		AVG DENSITY ALTITUDE (FT)	AVG OAT (°C)	AVG ROTOR SPEED (RPM)	FLIGHT CONDITION	TIME (MM:SS)
	LONG (FS)	LAT (BL)					
14640	206.8(AFT)	-0.4(LT)	5000	13.0	288	EVL FLT	02:54

NOTE: MOD 1 TAIL

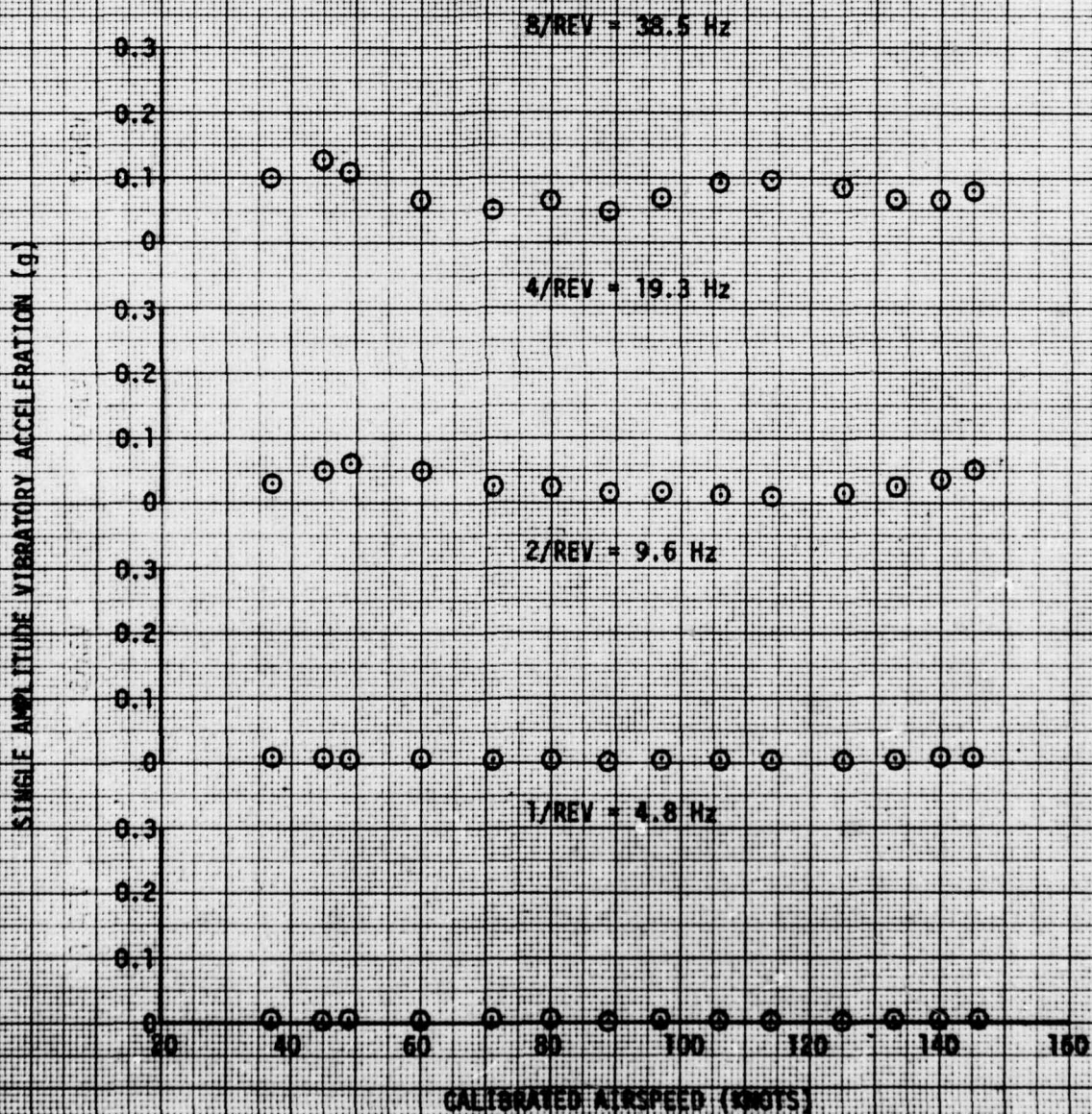

FIGURE 49  
 VIBRATION CHARACTERISTICS  
 YAL-6A USA S/N 74-22248  
 COPILOT SEAT VERTICAL

AVG GROSS WEIGHT (LB)	AVG CG LOCATION		AVG DENSITY ALTITUDE (FT)	AVG OAT (°C)	AVG ROTOR SPEED (RPM)	FLIGHT CONDITION
	LONG (FS)	LAT (IN)				
14840	206.8(AFT)	0.4 (T)	5000	13.0	288	LVL FLT

NOTE: MOD 1 TAIL

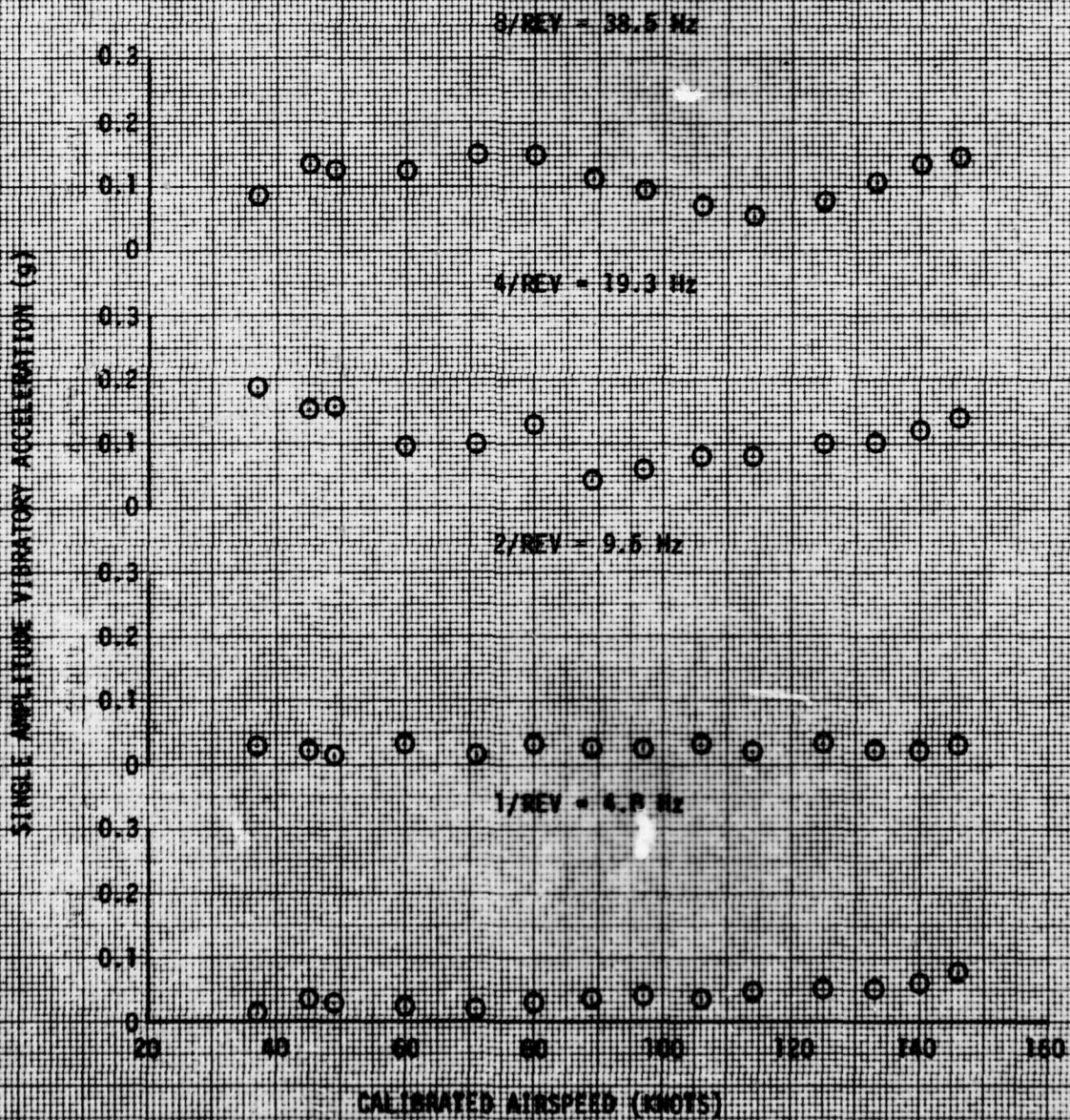



FIGURE 50  
 VIBRATION CHARACTERISTICS  
 YAF-64 USA S/N 74-22248  
 COPILOT SEAT LATERAL

AVG GROSS WEIGHT (LB)	AVG CG LOCATION		AVG DENSITY ALTITUDE (FT)	AVG CAT (°C)	AVG ROTOR SPEED (RPM)	FLIGHT CONDITION
	LONG (FS)	LAT (BL)				
18540	206.8(AFT)	-0.4 LT	3000	13.0	268	LVL FLT

NOTE: MOD 1 TAIL

8/REV = 38.5 Hz

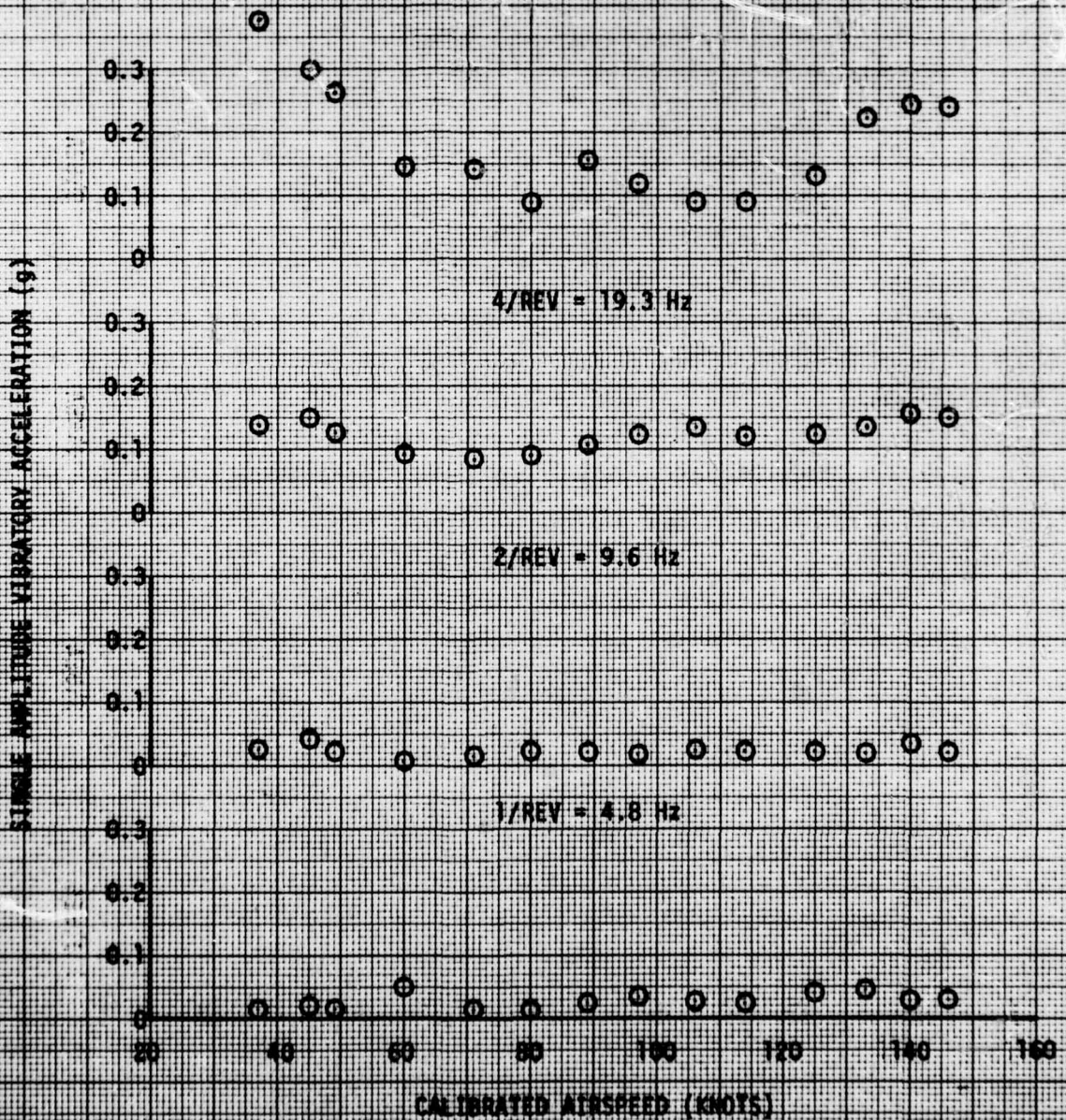

FIGURE 51  
 VIBRATION CHARACTERISTICS  
 FM-8A USA S/N 74-22248  
 COPLOT SEAT LONGITUDINAL

AVG DENSITY HEIGHT (CG)	AVG CR LOCATION		AVG DENSITY ALTITUDE (FT)	AVG OAT (°C)	AVG MOTOR SPEED (RPM)	FLIGHT CONDITION
	LONG (°)	LAT (°)				
14000	200.8(NPT)	0.4-LT	8000	13.0	288	LVL FLT

NOTE: MOD 1 TAIL

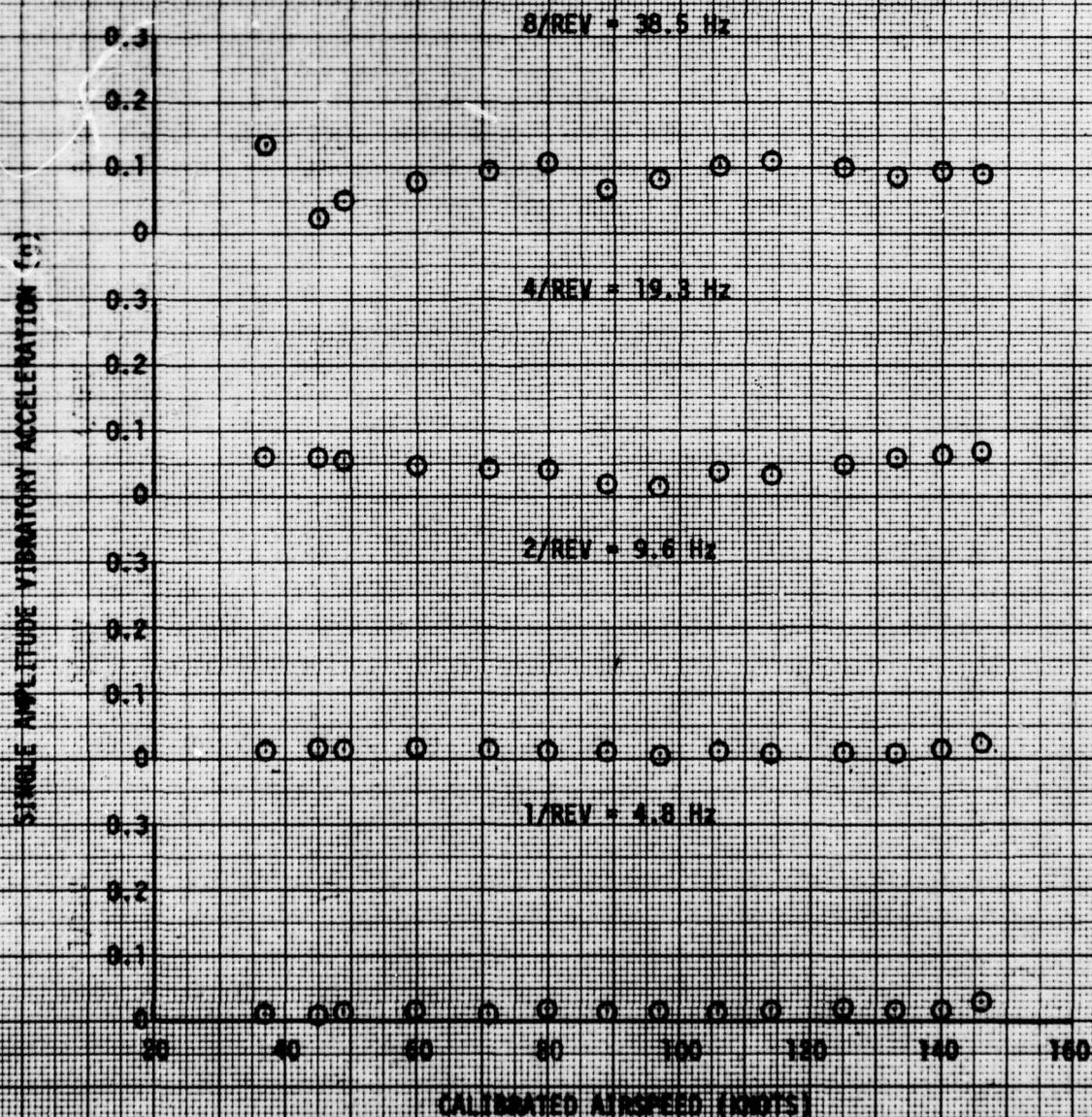

FIGURE 52  
 VIBRATION CHARACTERISTICS  
 YAH-64 USA S/N 74-22248  
 AIRCRAFT CG VERTICAL

AVG GROSS WEIGHT (LB)	AVG CG LOCATION		AVG DENSITY ALTITUDE (FT)	AVG OAT (°C)	AVG MOTOR SPEED (RPM)	FLIGHT CONDITION
	LONG (FS)	LAT (BL)				
14640	206.8(AFT)	0.4 LT	5000	13.0	288	LVL FLT

NOTE: MOD 1 TAIL

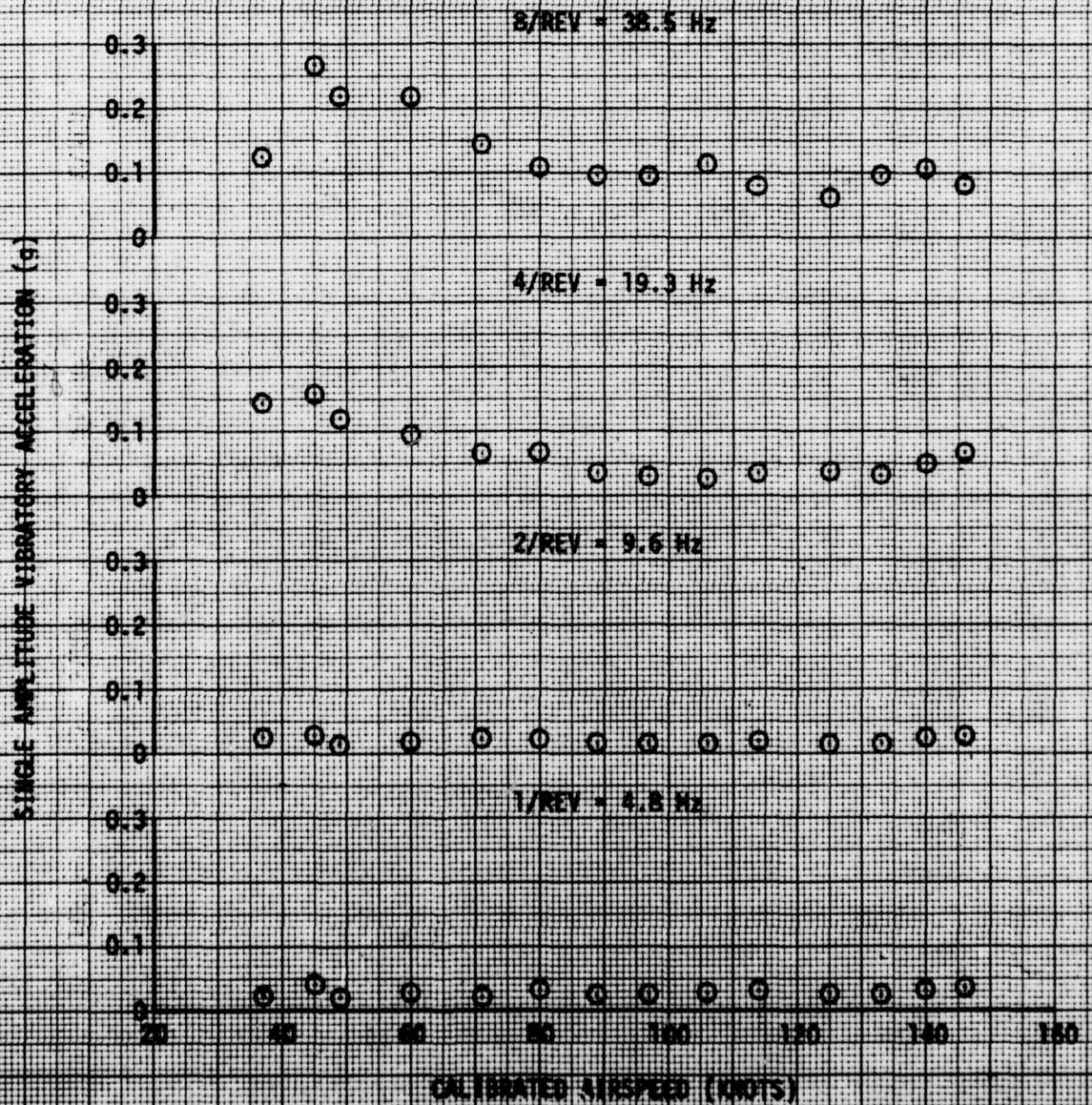

FIGURE 83  
 VIBRATION CHARACTERISTICS  
 T28-44 USA 3/4 74-22248  
 AIRCRAFT CG LATERAL

AVG GROSS WEIGHT (LB)	AVG CG LOCATION		AVG DENSITY ALTITUDE (FT)	AVG OAT (°C)	AVG MOTOR SPEED (RPM)	FLIGHT CONDITION
	LONG (FS)	LAT (BL)				
14640	206.8(APT)	0.4(LT)	5000	13.0	288	LVL FLT

NOTE: MOD 3 TAIL

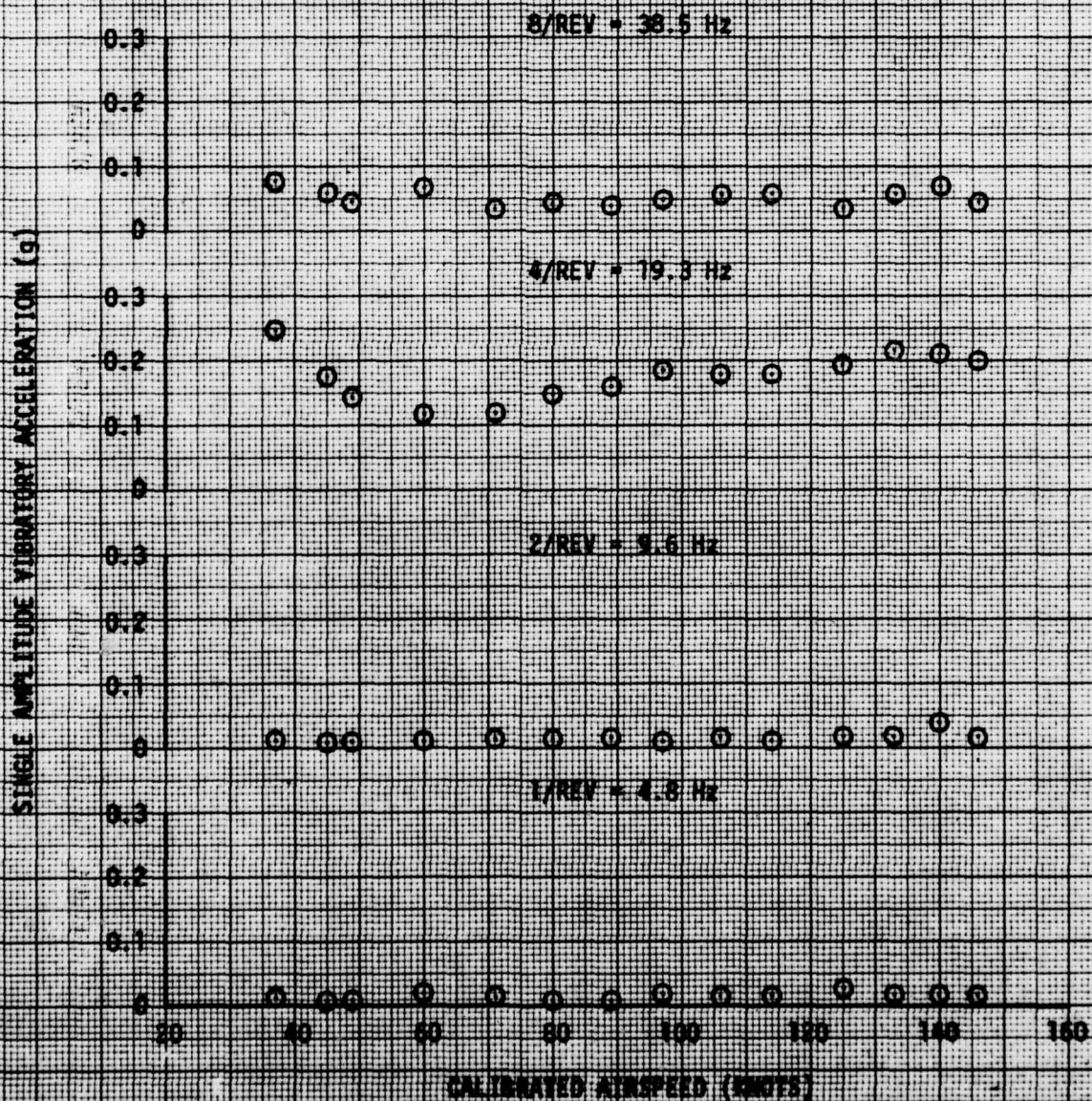

FIGURE 54  
 VIBRATION CHARACTERISTICS  
 YAC-64 USA S/N 79-22248  
 AIRCRAFT CG LONGITUDINAL

AVG GROSS WEIGHT (LB)	AVG CG LOCATION		AVG DENSITY ALTITUDE (FT)	AVG OAT (°C)	AVG MOTOR SPEED (RPM)	FLIGHT CONDITION
	LONG (FS)	LAT (BL)				
14640	206.8(AFT)	0.4(L)	5000	13.0	288	LVL FLT

NOTE: NOO 1 TAIL

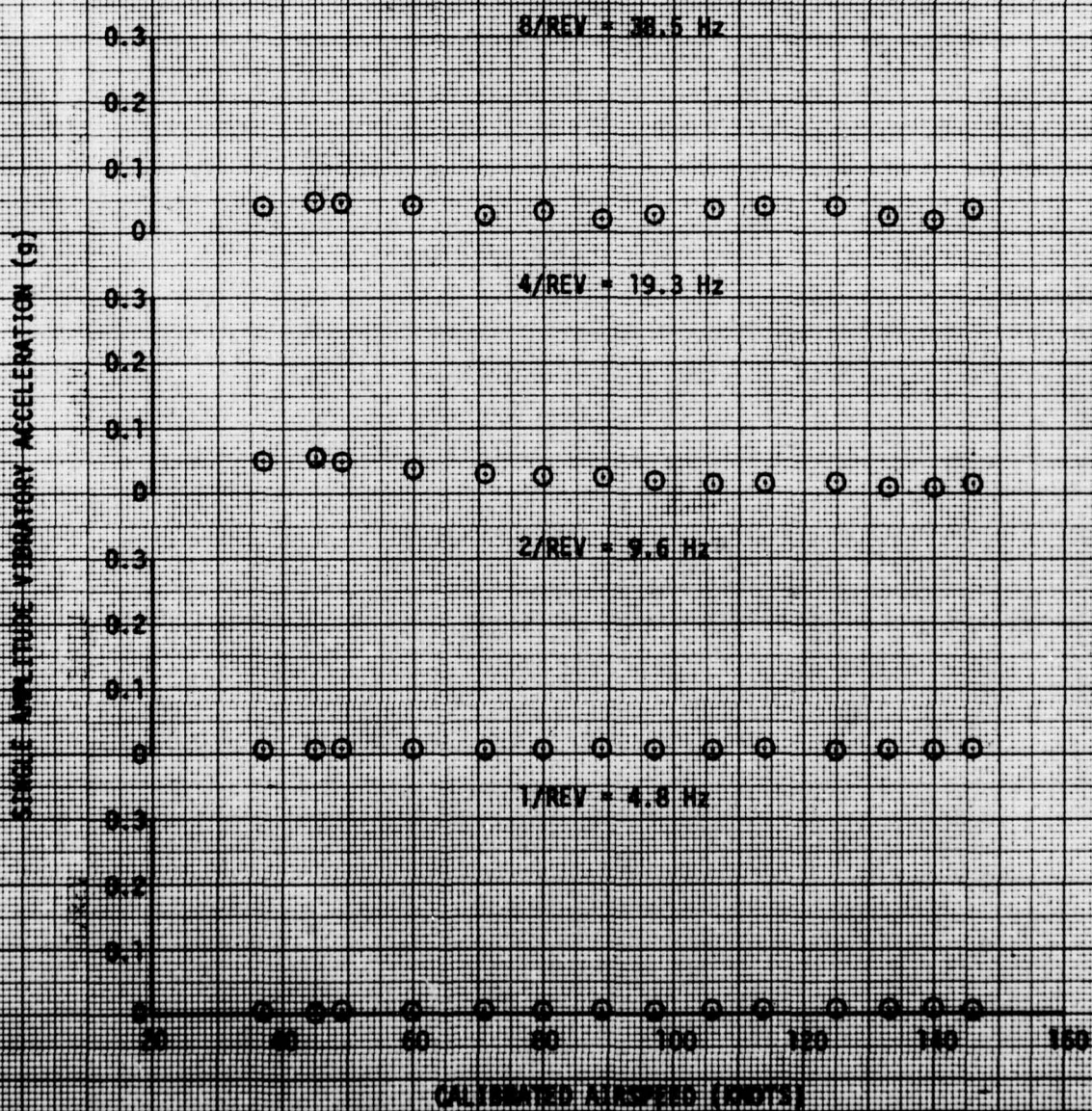

FIGURE 5  
 VIBRATION CHARACTERISTICS  
 MODEL SA 3757A-2228  
 PILOT SEAT VERTICAL

AVG GROSS WEIGHT (LB)	AVG CG LOCATION		AVG DENSITY ALTITUDE (FT)	AVG OAT (°C)	AVG ROTOR SPEED (RPM)	FLIGHT CONDITION	REMARKS
	LONG (FS)	LAT (IN)					
14740	296.7 (APT)	0.4 (T)	4740	8.0	280	ENR FLT	

NOTE: 1 PHASE 1 TAIL

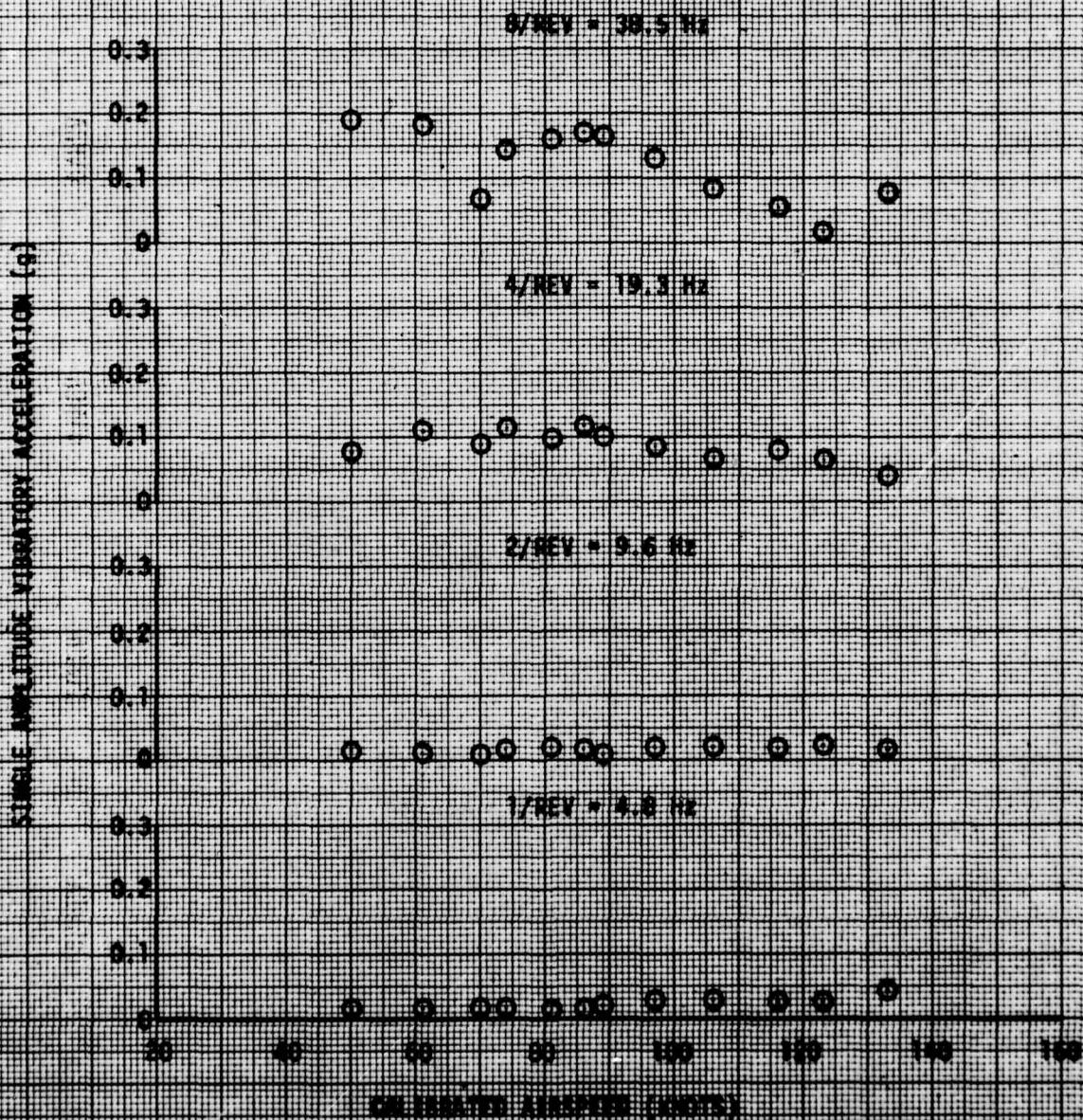

FIGURE 15  
 VIBRATION CHARACTERISTICS  
 AIRCRAFT NO. 579 74-27749  
 PILOT SEAT LATERAL

AIRCRAFT WEIGHT (LB)	AIRCRAFT LOCATION (FS) (BL)	AIRCRAFT DENSITY ALTITUDE (FT)	AIRCRAFT OAT (°C)	AIRCRAFT ROTOR SPEED (RPM)	FLIGHT CONDITION
14740	206 7(AFT)-0.4-LT	4740	6.0	288	EVC FLT

NOTE: PHASE 1 TAIL

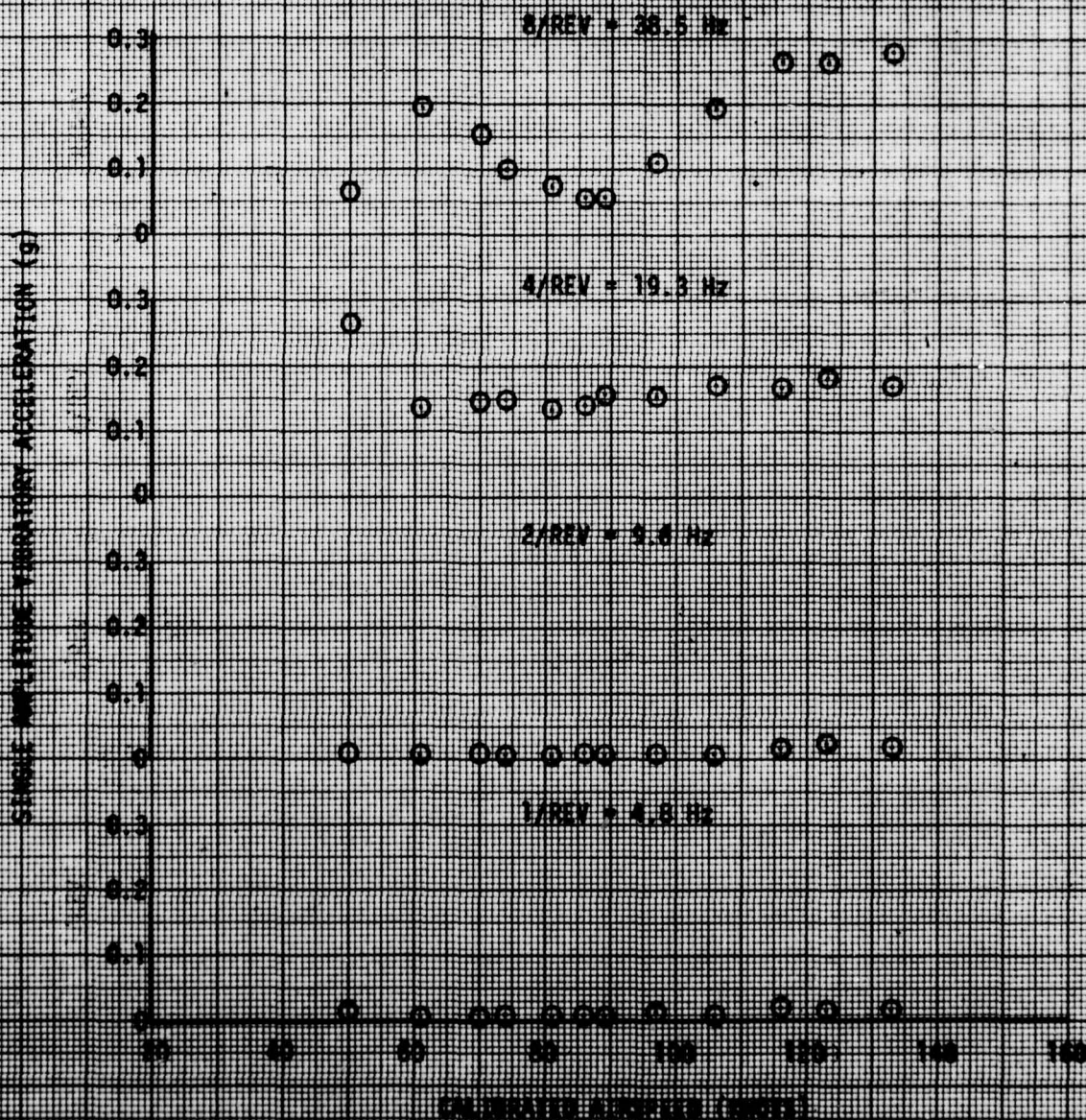

FIGURE 57  
 VIBRATION CHARACTERISTICS  
 YB-4A USA 57R 76-27249  
 PILOT SEAT LONGITUDINAL

AVG GROSS WEIGHT (LB)	AVG CG LOCATION LONG (FS) LAT (BL)	AVG DENSITY ALTITUDE (FT)	AVG OAT (°C)	AVG ROTOR SPEED (RPM)	FLIGHT CONDITION
16740	206.7(AFT)-0.4(L)	4740	6.0	285	EVL FLT

NOTE: PHASE 1 TAIL

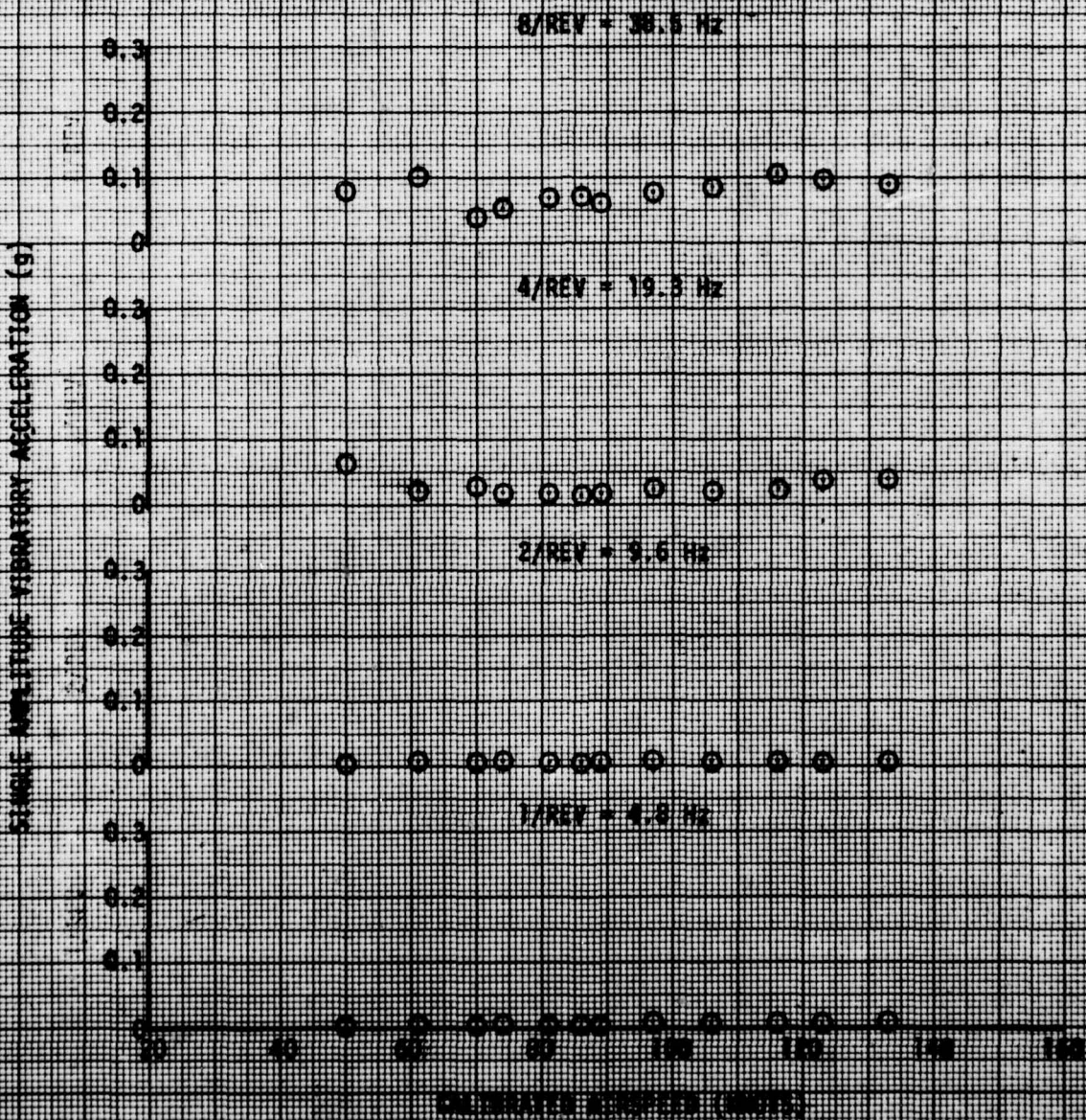



FIGURE 5B  
 VIBRATION CHARACTERISTICS  
 (CALC. USA S/N 74-2228)  
 COPILOT SEAT VERTICAL

AVG GROSS WEIGHT (LB)	AVG CG LOCATION LONG (FS) LAT (BL)	AVG DENSITY ALTITUDE (FT)	AVG DAT (°C)	AVG ROTOR SPEED (RPM)	FLIGHT CONDITION	INSTRUMENTATION
16740	206.7 (APT)-0.4 LT	4710	6.0	288	EVL FLT	TYPE 1

NOTE: PHASE 1 TAIL

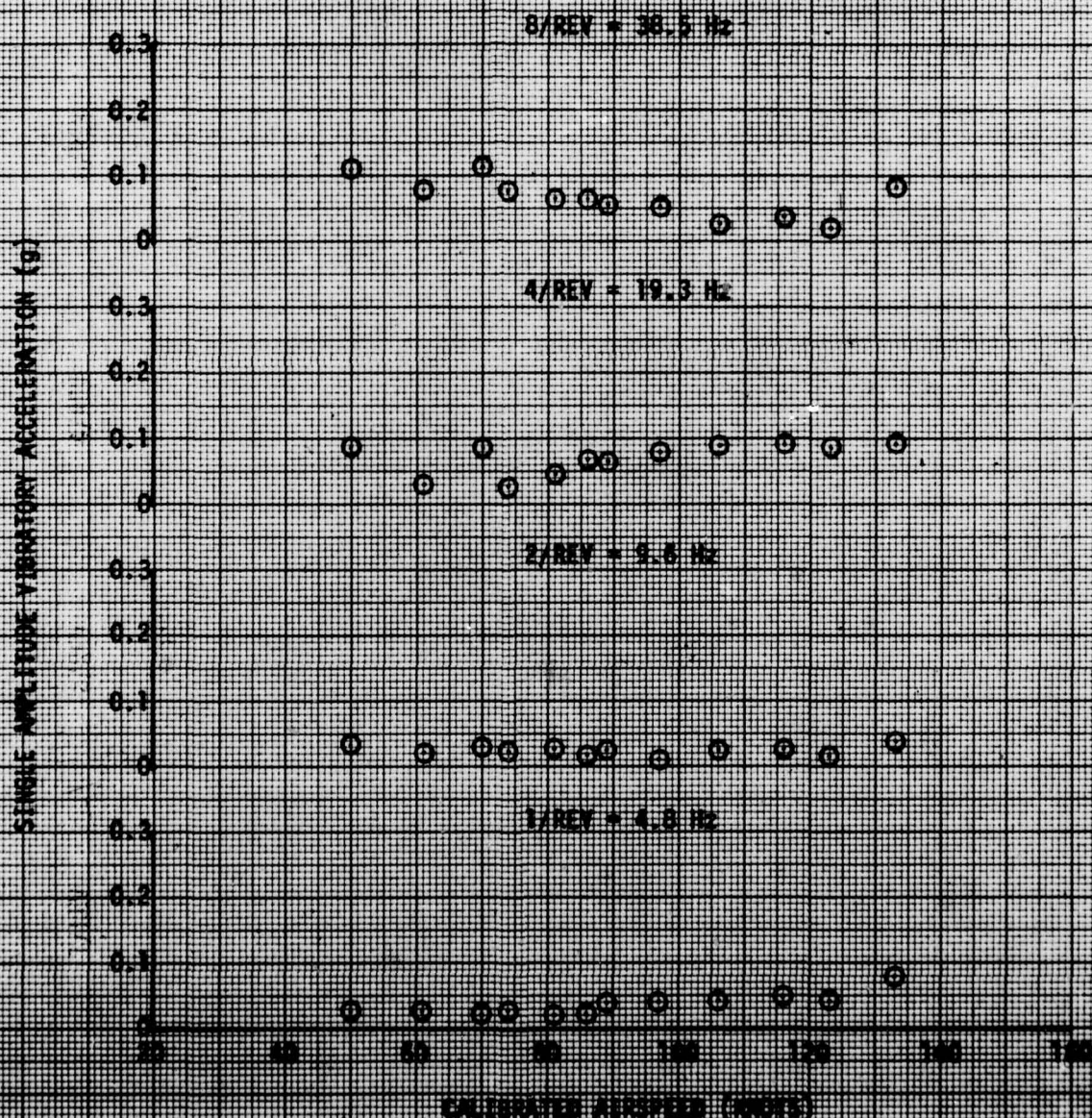

FIGURE 58  
 VIBRATION CHARACTERISTICS  
 YAN-64 USA S/N 74-22248  
 COPILOT SEAT LATERAL

AVG GROSS WEIGHT (LB)	AVG CG LOCATION		AVG DENSITY ALTITUDE (FT)	AVG OAT (°C)	AVG ROTOR SPEED (RPM)	FLIGHT CONDITION	TIME (HR:MM)
	LONG (FS)	LAT (BL)					
14740	206.7	(AFT)-0.4	4740	6.0	288	EVL FLT	109:32
			NOTE 1	PHASE 1 TAIL			

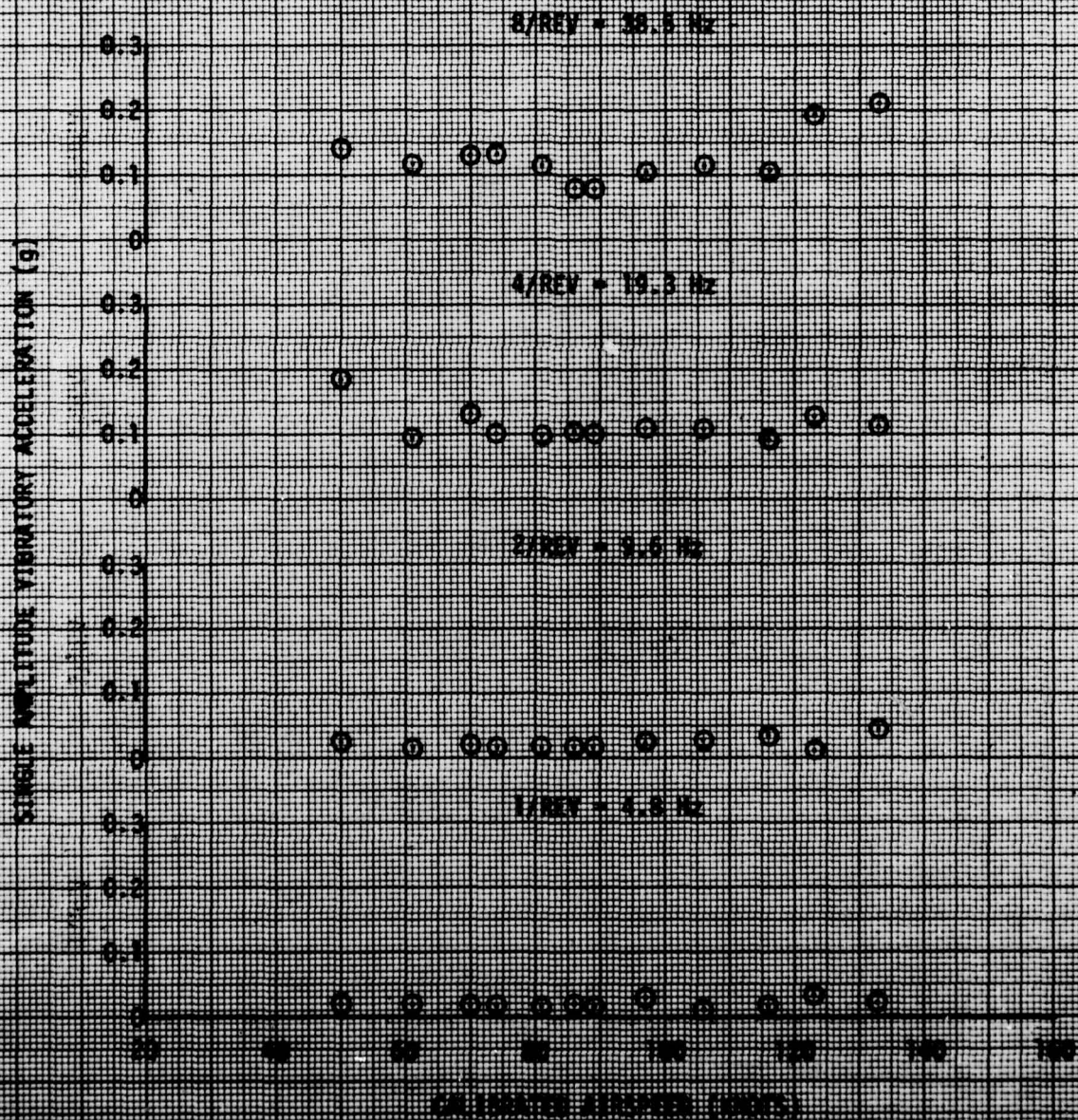

FIGURE 60  
 VIBRATION CHARACTERISTICS  
 YAF-64 USA S/N 74-22248  
 COPILOT SEAT LONGITUDINAL

Avg GROSS WEIGHT (LB)	Avg CG LOCATION LONG (FS) LAT (BL)	Avg DENSITY ALTITUDE (FT)	Avg OAT (°C)	Avg ROTOR SPEED (RPM)	FLIGHT CONDITION
14740	206.7(AFT)-0.4(L)	4780	6.0	288	LVL FLT

NOTE: PHASE 1 TAIL

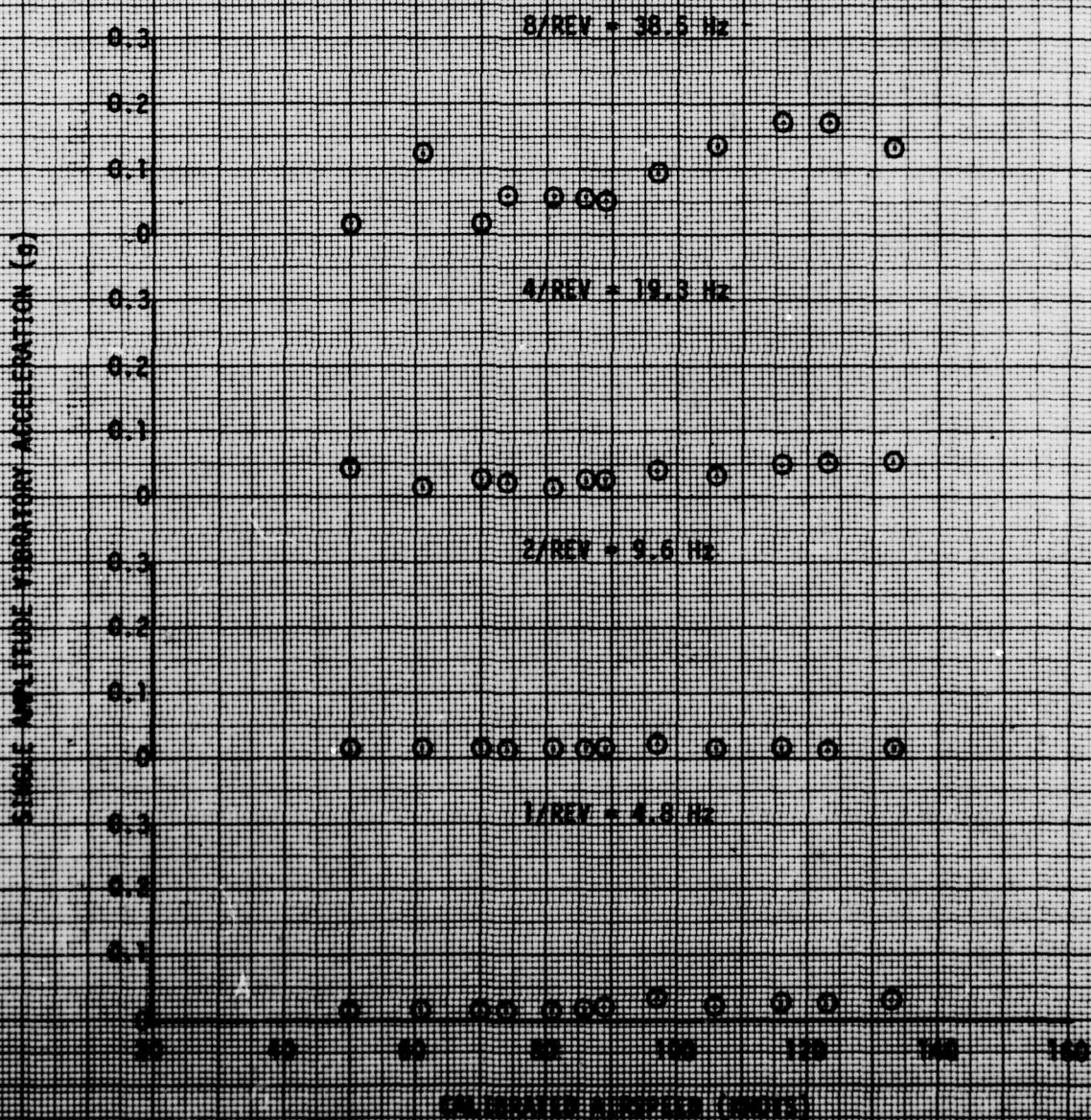

FIGURE 61  
 VIBRATION CHARACTERISTICS  
 YAN-64 USA S/N 74-22248  
 AIRCRAFT CG VERTICAL

AVG GROSS WEIGHT (LB)	AVG CG LOCATION		AVG DENSITY ALTITUDE (FT)	AVG OAT (°C)	AVG ROTOR SPEED (RPM)	FLIGHT CONDITION
	LONG (FS)	LAT (BL)				
14740	206.7 (AFT)	-0.4 (T)	4740	6.0	288	LVL FLT

NOTE: PHASE 1 TAIL

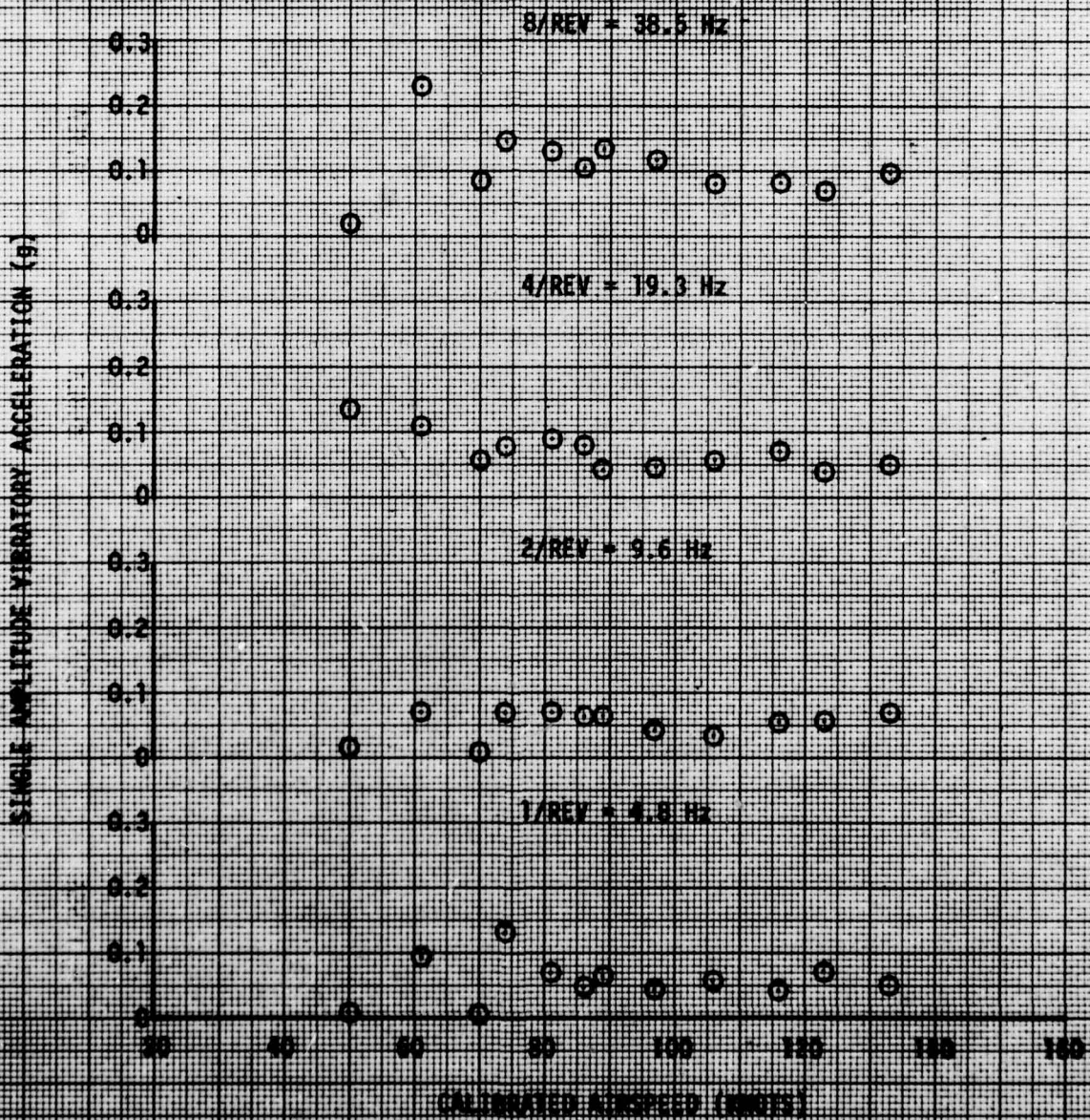

FIGURE 82  
 VIBRATION CHARACTERISTICS  
 YAM-64 USA S/N 74-22248  
 AIRCRAFT CB LATERAL

AVG GROSS WEIGHT (LB)	AVG CB LOCATION		AVG DENSITY ALTITUDE (FT)	AVG OAT (°C)	AVG ROTOR SPEED (RPM)	FLIGHT CONDITION
	LONG (FS)	LAT (BL)				
14780	206.7(AFT)	0.4(LT)	4780	8.0	288	LVL FLT

NOTE: PHASE 1 TAIL

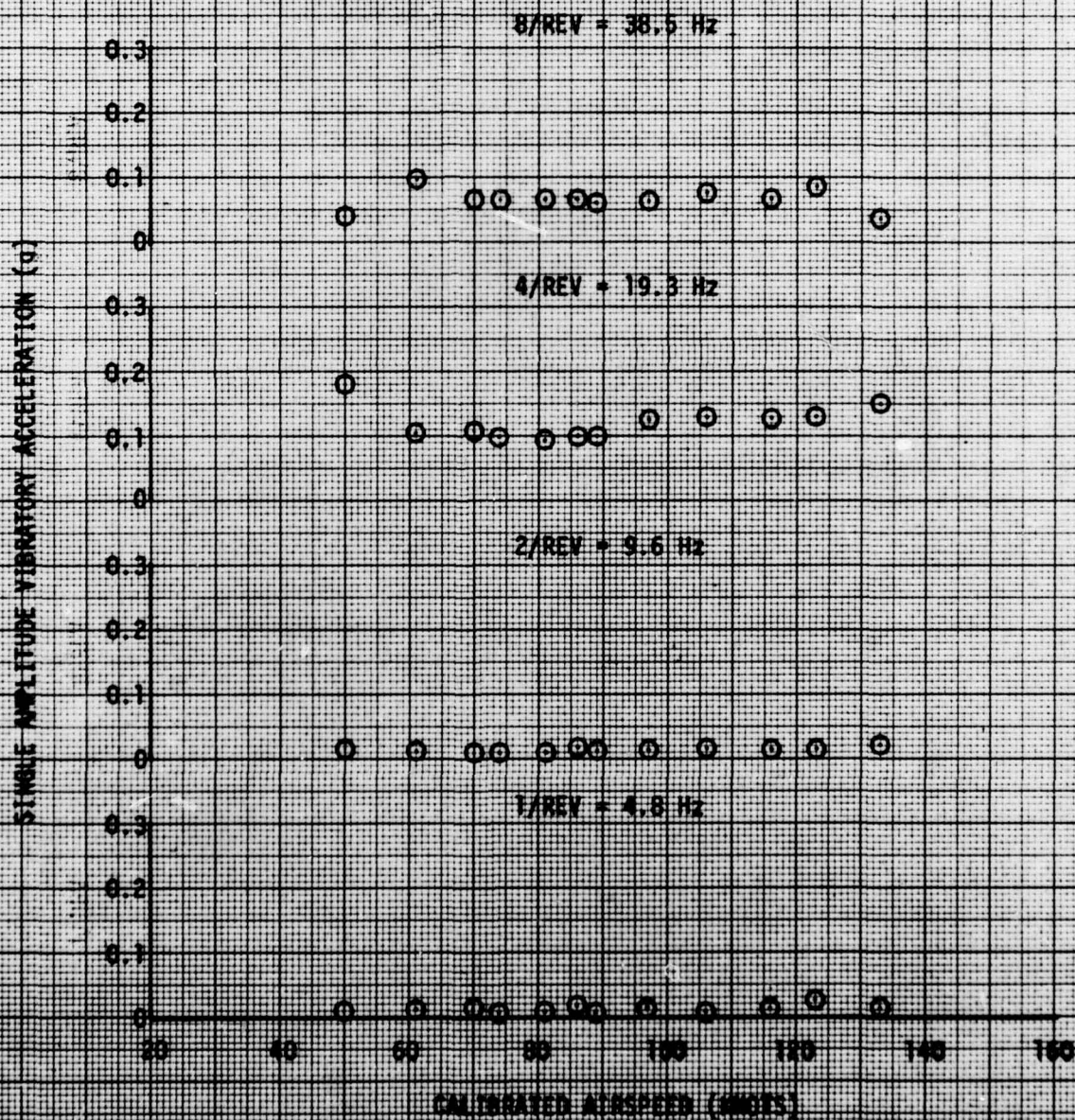

FIGURE 63  
 VIBRATION CHARACTERISTICS  
 YAH-64 USA S/N 74-22248  
 AIRCRAFT CG LONGITUDINAL

AVG GROSS WEIGHT (LB)	AVG CG LOCATION		AVG DENSITY ALTITUDE (FT)	AVG ONT (°C)	AVG ROTOR SPEED (RPM)	FLIGHT CONDITION	TYPE
	LONG (FS)	LAT (BL)					
16740	206.7(AFT)	-0.4(L)	4740	6.0	288	LVL FLT	TYPE 1C

NOTE: PHASE 1 TAIL

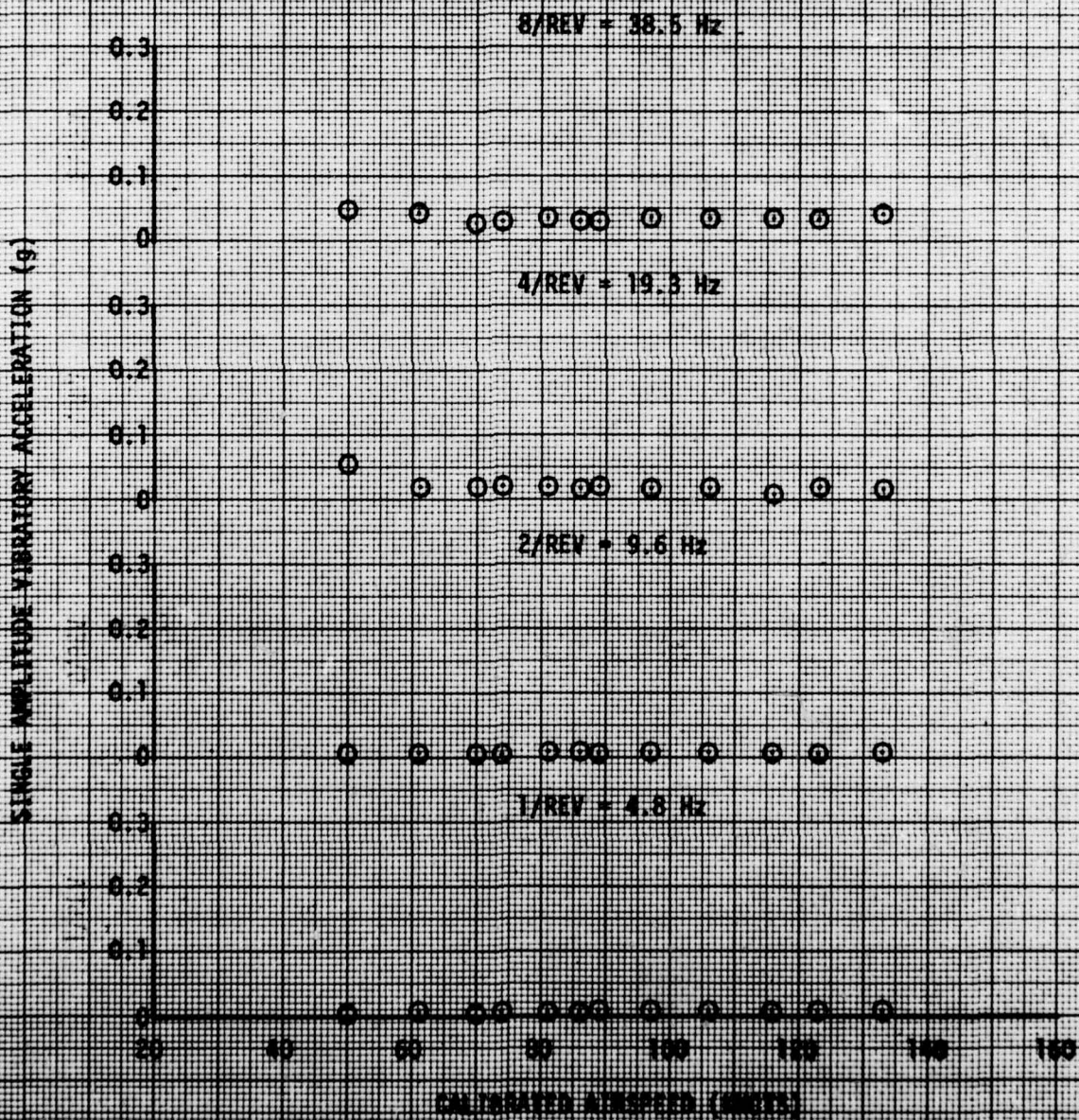

FIGURE 64  
PEDAL PULSE  
YAH-64 USA S/N 74-22248

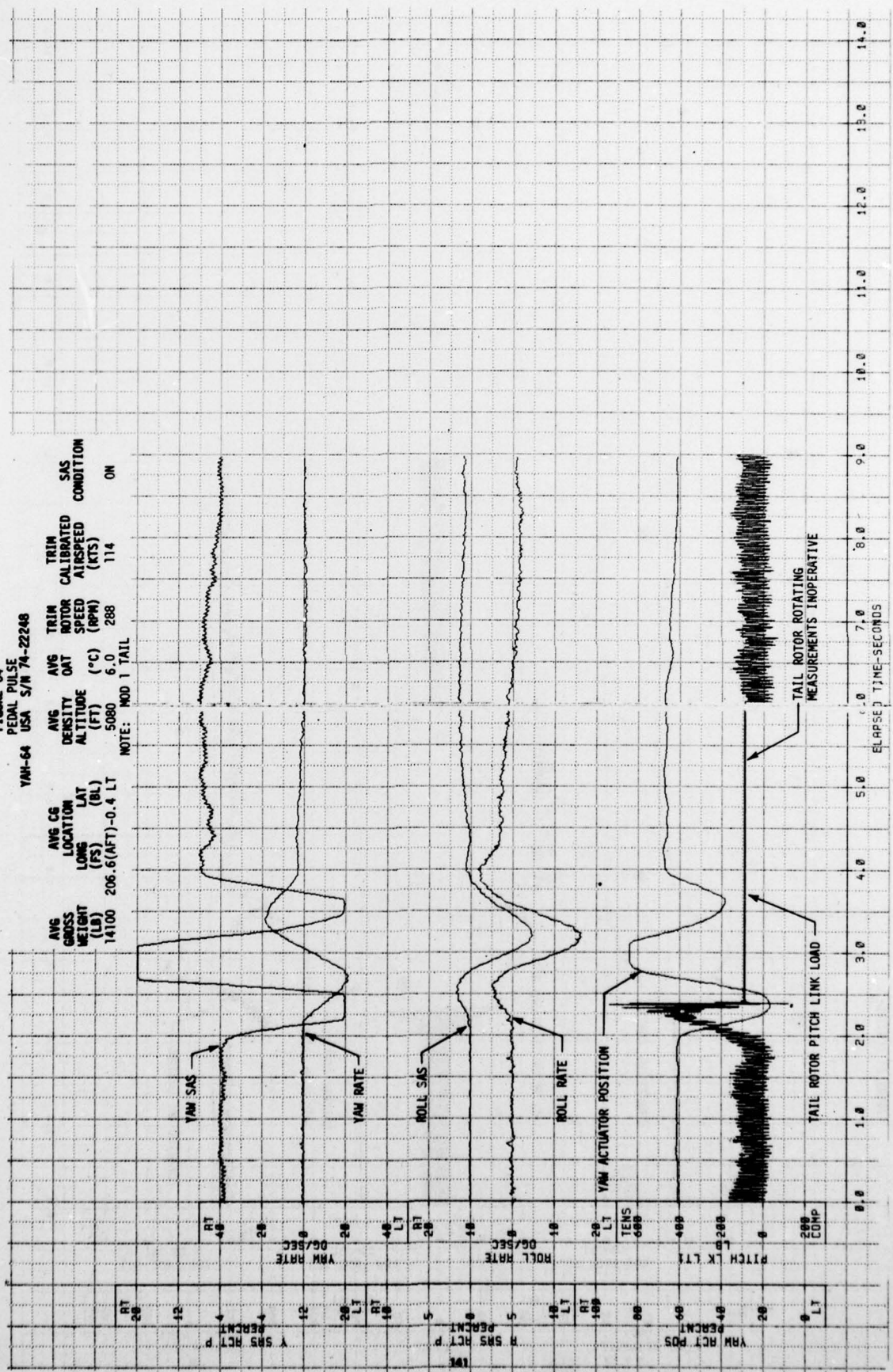

FIGURE 64 CONTINUED

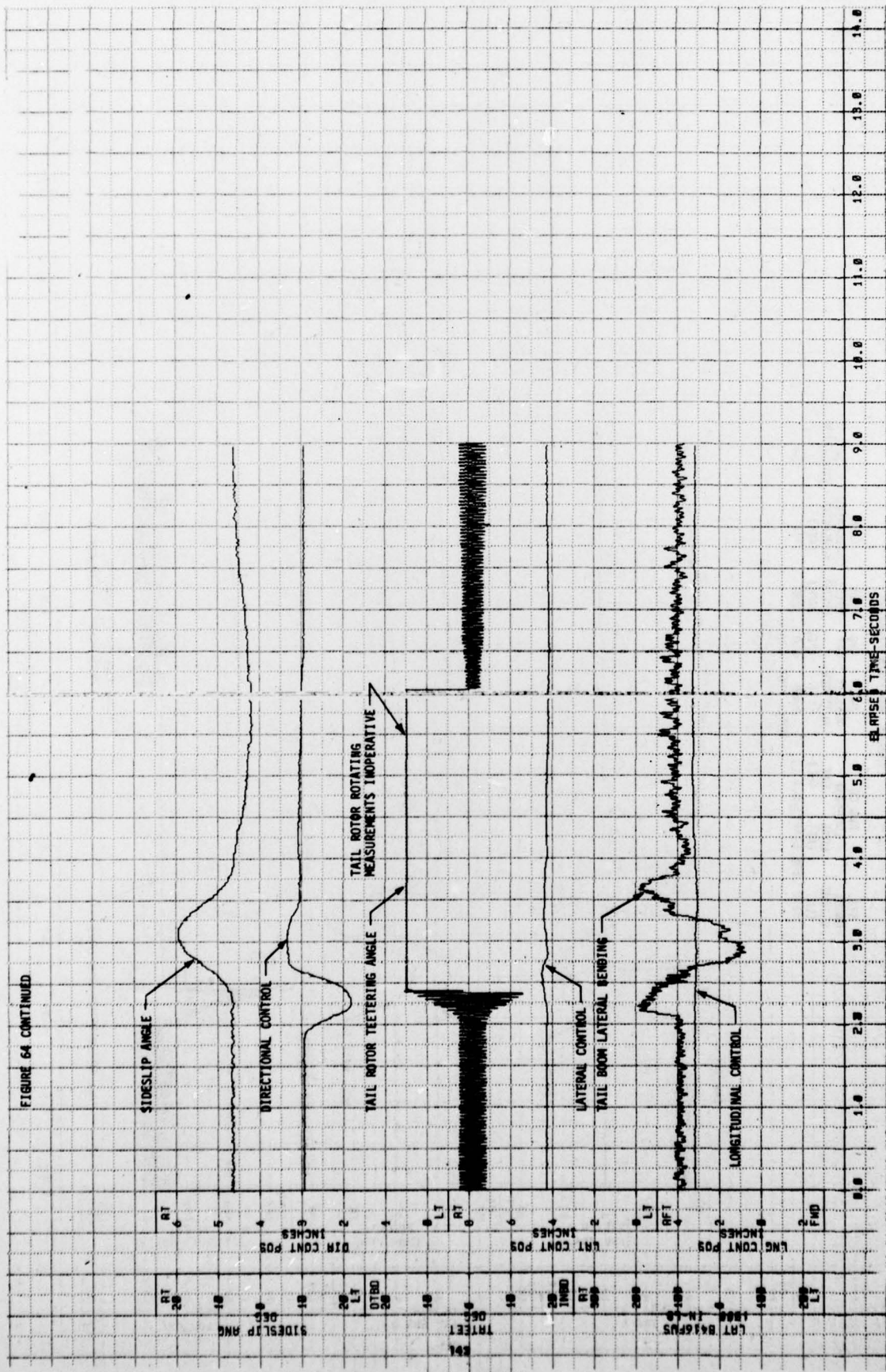
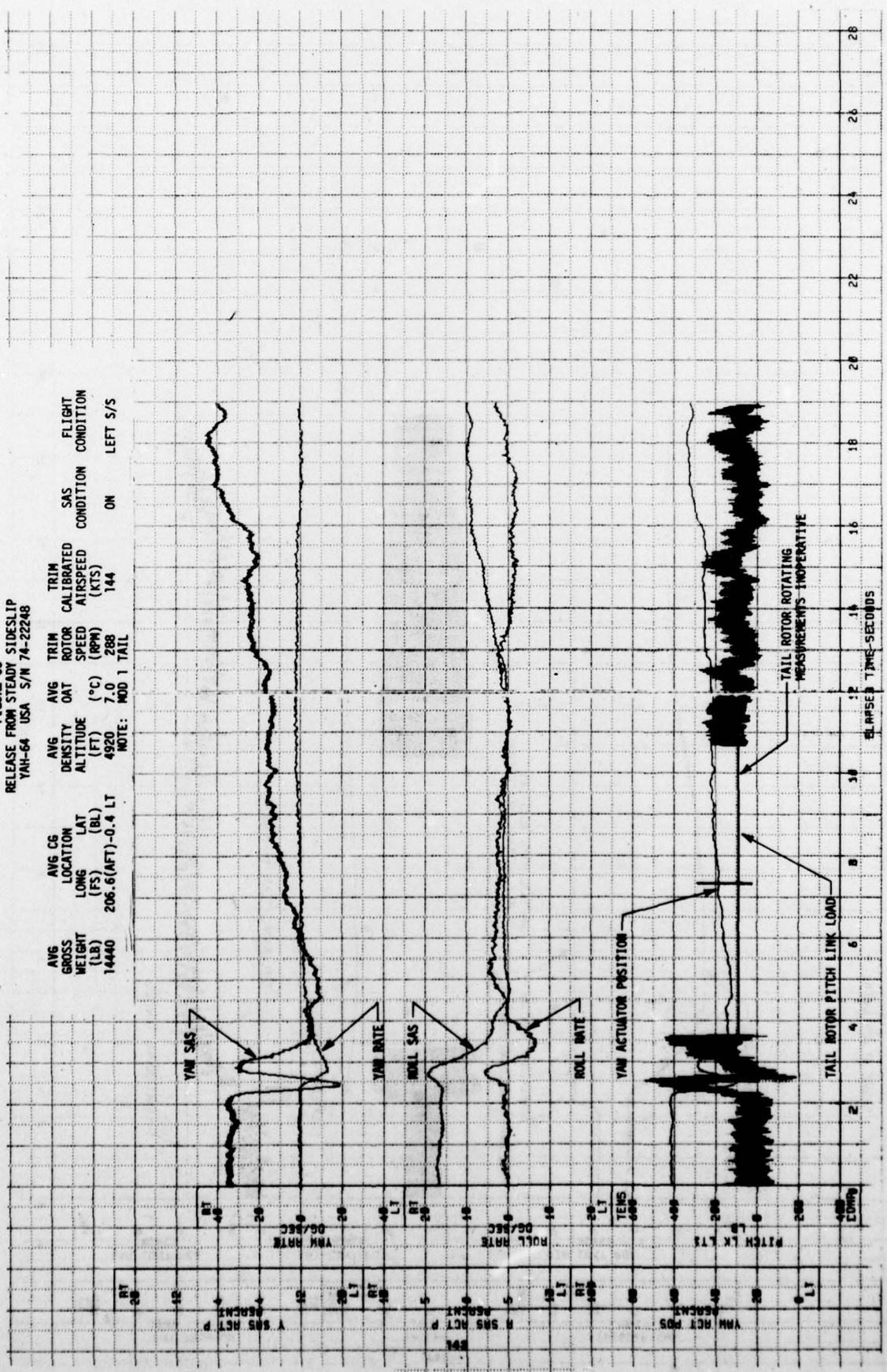



FIGURE 65  
RELEASE FROM STEADY SIDESLIP  
YAH-64 USA S/N 74-22248

AVG GROSS WEIGHT (LB) 14440  
AVG CG LONG (FS) 206.6(AFT)-0.4 LT  
LAT (BL)  
AVG DENSITY ALTITUDE (FT) 4920  
OAT (°C) 7.0  
TRIM ROTOR SPEED (RPM) 288  
CALIBRATED AIRSPEED (KTS) 144  
SAS CONDITION ON  
FLIGHT CONDITION LEFT S/S

NOTE: MOD 1 TAIL



TAIL ROTOR ROTATING MEASUREMENTS IMPROPERATIVE

FIGURE 6E CONTINUED

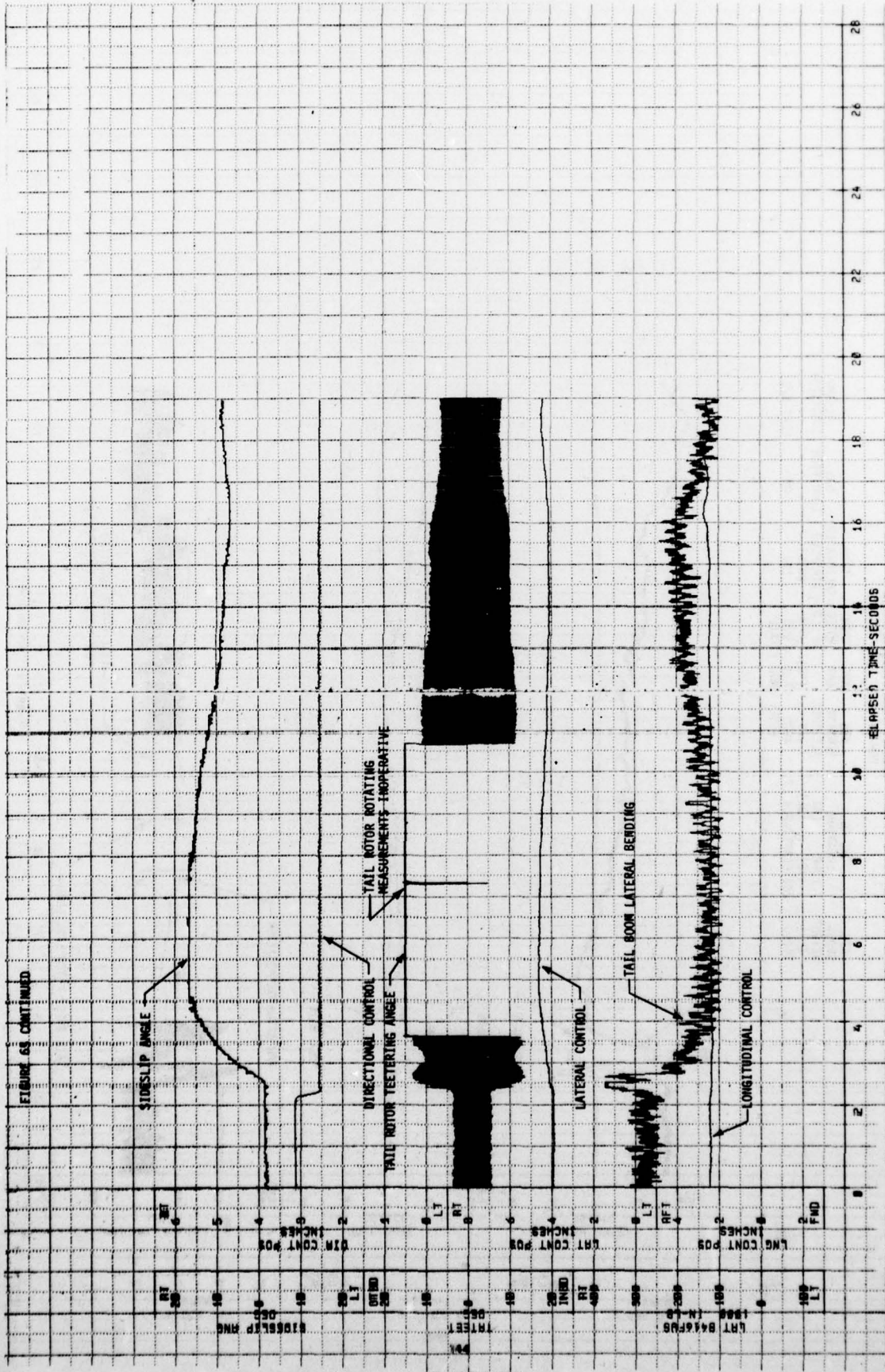

FIGURE 66  
FORWARD PULSE

YAH-64 USA S/N 74-22248

AVG GROSS WEIGHT (LB)	14440	AVG CG LOCATION LONG (FS)	207.0(AFT)	LAT (BL)	-0.4	LT	NOTE: MOD 1 TAIL
AVG DENSITY	5280	AVG OAT (°C)	18.0	TRIM MOTOR SPEED (RPM)	288	TRIM CALIBRATED AIRSPEED (KTS)	121
AVG ALTITUDE (FT)	5280	TRIM MOTOR SPEED (RPM)	288	TRIM CALIBRATED AIRSPEED (KTS)	121	SAS CONDITION	ON

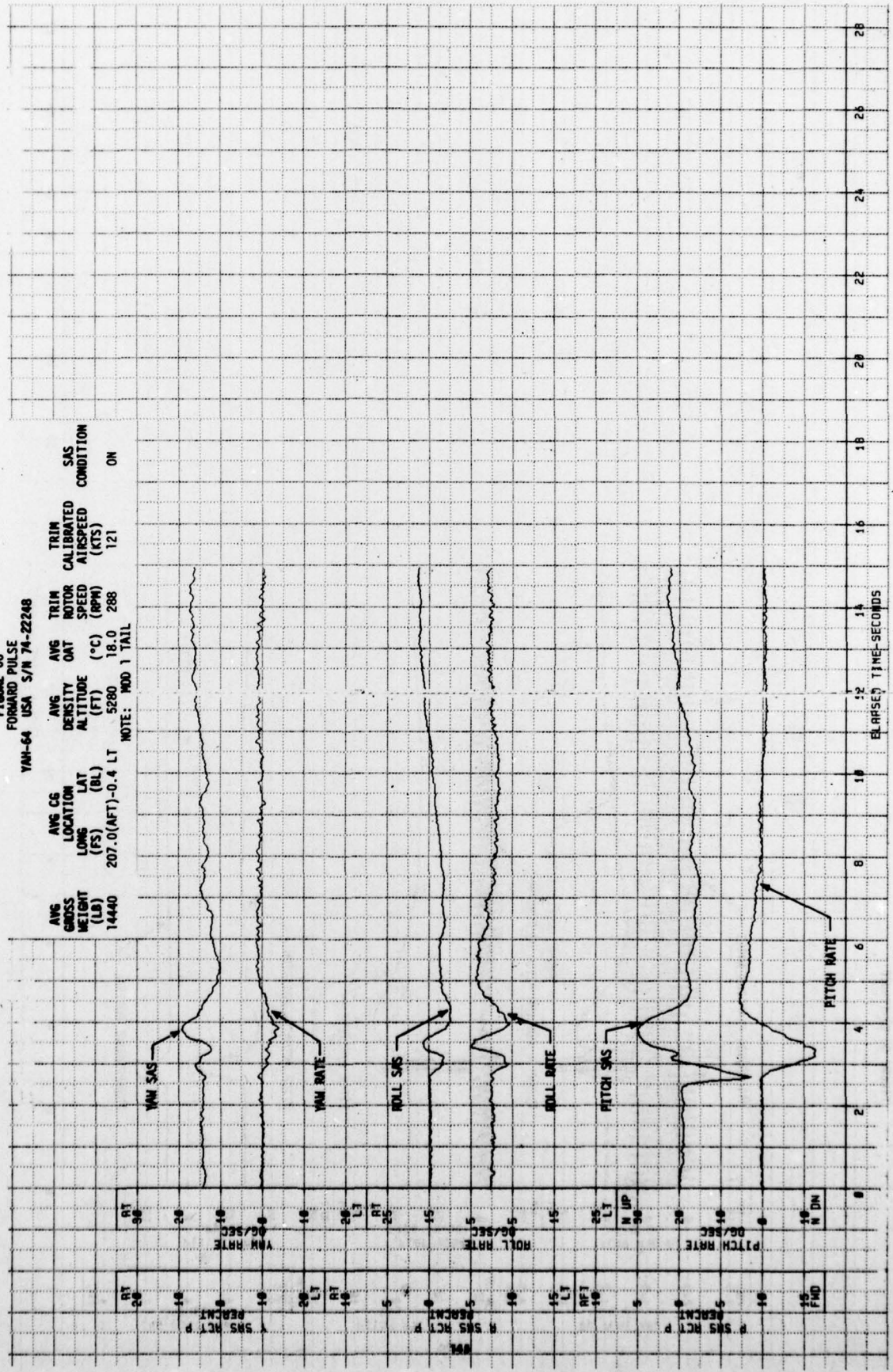
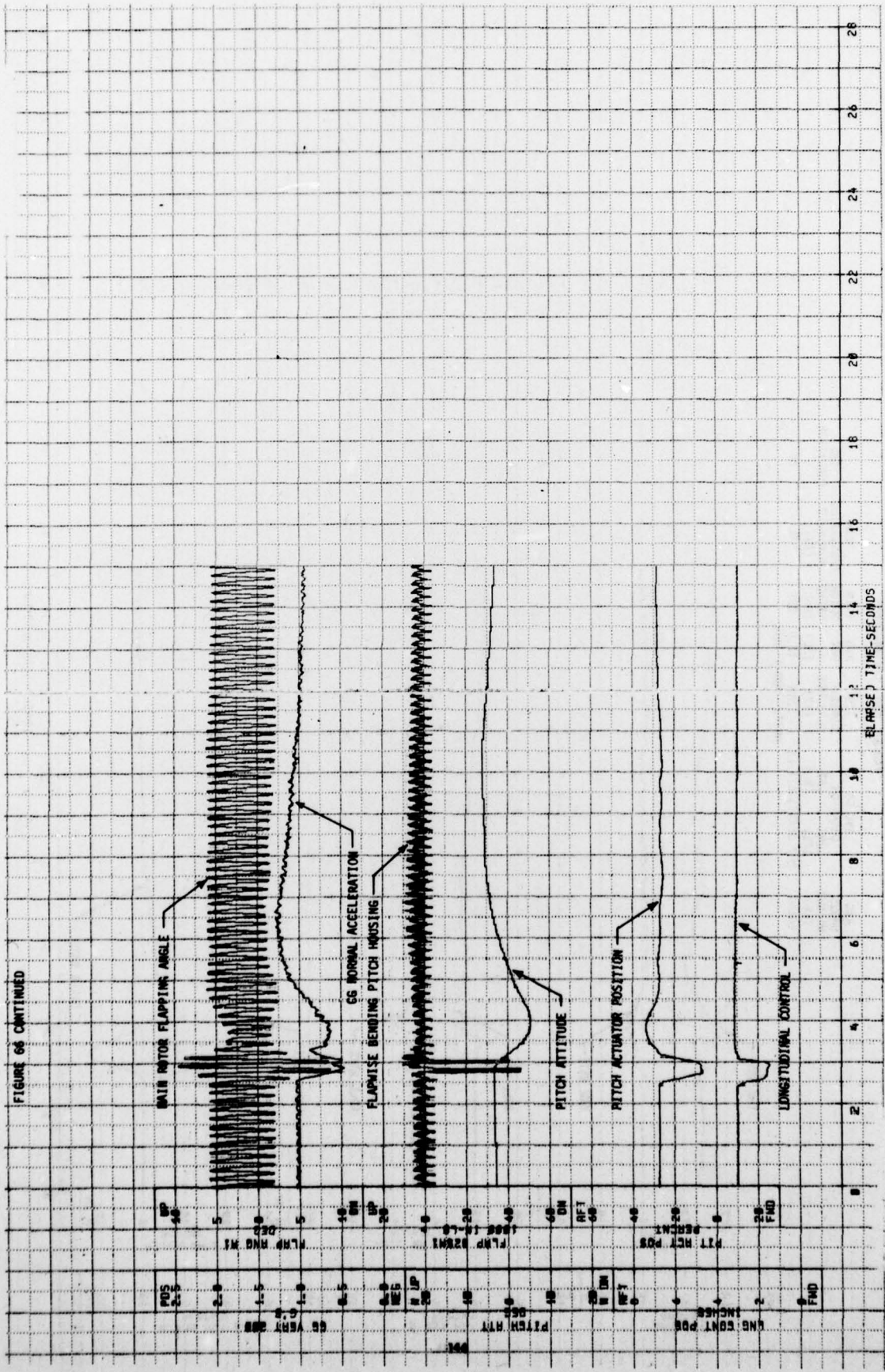

FIGURE 66 CONTINUED



## DISTRIBUTION

Director of Defense Research and Engineering	2
Deputy Director of Test and Evaluation, OSD (OAD(SSST&E))	1
Assistant Secretary of the Army (R&D), Deputy for Aviation	1
Deputy Chief of Staff for Research, Development, and Acquisition (DAMA-WSA, DAMA-RA, DAMA-PPM-T)	4
US Army Materiel Development and Readiness Command (DRCPM-AAH-TM-T, DRCDE-DW-A, DRCSF-A, DRCQA)	8
US Army Aviation Research and Development Command (DRDAV-EQ)	12
US Army Training and Doctrine Command (ATCD-CM-C)	1
US Army Materiel Systems Analysis Activity (DRXSY-CM, DRXSY-MP)	3
US Army Test and Evaluation Command (DRSTE-CT)	3
US Army Electronics Research & Development Command	1
US Army Forces Command (AFOP-AV)	1
US Army Armament Command (SARRI-LW)	2
US Army Missile Command (DRSMI-QT)	1
Director, Research & Technology Laboratories/Ames	2
Research & Technology Laboratory/Aeromechanics	2
Research & Technology Laboratory/Propulsion	2
Research & Technology Laboratory/Structures	2
Research & Technology Laboratories/Applied Technology Lab (DAVDL-EU-TSD, Tech Library)	1
Human Engineering Laboratory (DRXHE-HE)	1
US Army Aeromedical Research Laboratory	1
US Army Infantry School (ATSH-TSM-BH)	1
US Army Aviation Center (ATZQ-D-MT)	3
US Army Aviation Test Board (ATZQ-OT-C)	2
US Army Aviation School (ATZQ-AS, ATST-CTD-DPS)	3
US Army Aircraft Development Test Activity (PROV) (STEBG-CO-T, STEBG-PO, STEBG-MT)	5
US Army Agency for Aviation Safety (IGAR-TA, IGAR-Library)	2
US Army Maintenance Management Center (DRXMD-EA)	1
US Army Transportation School (ATSP-CD-MS)	1
US Army Logistics Management Center	1

DISTRIBUTION

US Army Foreign Science and Technology Center (AMXST-WS4)	1
US Military Academy	3
US Marine Corps Development and Education Command	2
US Naval Air Test Center	1
US Air Force Aeronautical Systems Division (ASD-ENFTA)	1
US Air Force Flight Dynamics Laboratory (TST/Library)	1
US Air Force Flight Test Center (SSD/Technical Library, DOEE)	3
US Air Force Electronic Warfare Center (SURP)	1
Department of Transportation Library	1
US Army Hughes Plant Activity	2
General Electric Company, Technical Information Center	2
Hughes Helicopter Company	5
Defense Documentation Center	12