

AD-A063 410

VIRGINIA POLYTECHNIC INST AND STATE UNIV BLACKSBURG --ETC F/6 6/6
THE CONSTRUCTION, DEVELOPMENT, AND OPERATION OF A FISH BIOLOGIC--ETC(U)
AUG 78 D GRUBER, J CAIRNS, K L DICKSON DAAA15-76-C-0047

UNCLASSIFIED

ARCSL-CR-78040

NL

| OF |
AD
A063410
1

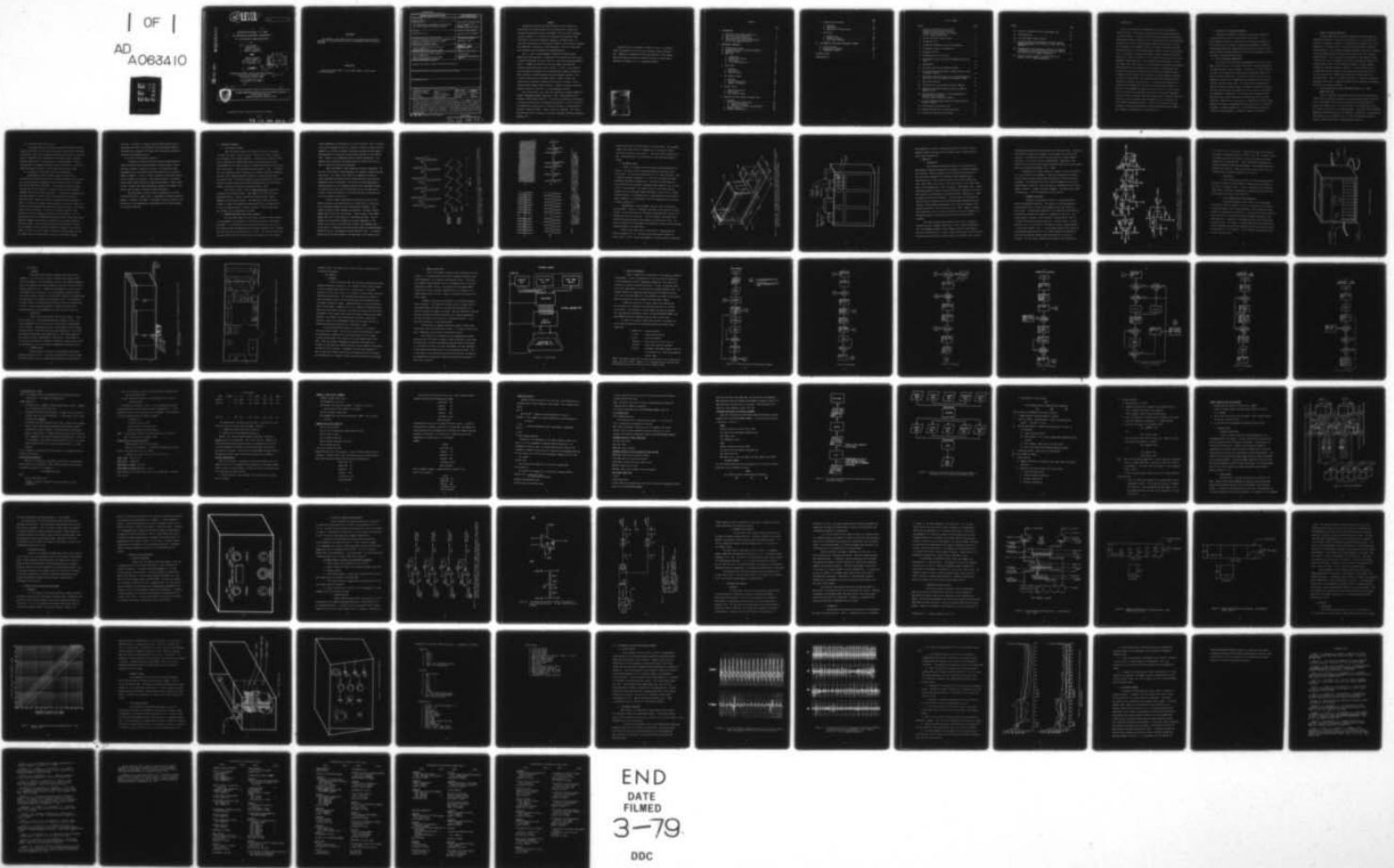

END
DATE
FILMED
3-79
DDC

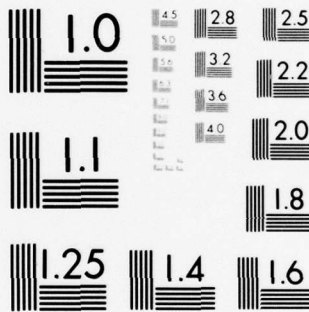

MICROCOPY RESOLUTION TEST CHART
NATIONAL BUREAU OF STANDARDS-1963-A

12 LEVEL II
NW

AD

AD A063410

18 17
CONTRACTOR REPORT ARCSL - CR - 78040
6 THE CONSTRUCTION, DEVELOPMENT, AND OPERATION
OF A FISH BIOLOGICAL MONITORING SYSTEM.

10 by
David Gruber,
John Cairns, Jr.,
Kenneth L. Dickson,
Albert C. Hendricks

Michael A. Cavell
J. David Landers, Jr.
William R. Miller, III
W. J. Showalter, Jr.

DDC
RECEIVED
JAN 17 1979
B

11 Aug 1978

12
87p.

DDC FILE COPY

VIRGINIA POLYTECHNIC INSTITUTE AND STATE UNIVERSITY
Center for Environmental Studies
Blacksburg, Virginia 24061

411027

Contract DAAA15-76-C-0047

9 15
Final rept. Dec 75 - Dec 77,



US ARMY ARMAMENT RESEARCH AND DEVELOPMENT COMMAND
Chemical Systems Laboratory
Aberdeen Proving Ground, Maryland 21010

Approved for public release; distribution unlimited.

411027
78 11 08 03 2 mt

Disclaimer

The findings in this report are not to be construed as an official Department of the Army position unless so designated by other authorized documents.

Disposition

Destroy this report when it is no longer needed. Do not return it to the originator.

UNCLASSIFIED

SECURITY CLASSIFICATION OF THIS PAGE (When Data Entered)

REPORT DOCUMENTATION PAGE		READ INSTRUCTIONS BEFORE COMPLETING FORM
1. REPORT NUMBER ARCSL-CR-78040 ✓	2. GOVT ACCESSION NO.	3. RECIPIENT'S CATALOG NUMBER
4. TITLE (and Subtitle) THE CONSTRUCTION, DEVELOPMENT, AND OPERATION OF A FISH BIOLOGICAL MONITORING SYSTEM	5. TYPE OF REPORT & PERIOD COVERED Final, December 1975 to December 1977.	
	6. PERFORMING ORG. REPORT NUMBER	
7. AUTHOR(s) David Gruber et al.	8. CONTRACT OR GRANT NUMBER(s) DAAA15-76-C-0047 <i>new</i>	
9. PERFORMING ORGANIZATION NAME AND ADDRESS Virginia Polytechnic Institute and State University Center for Environmental Studies <i>new</i> Blacksburg, Virginia 24061	10. PROGRAM ELEMENT, PROJECT, TASK AREA & WORK UNIT NUMBERS DAA57T4114 Task 6	
11. CONTROLLING OFFICE NAME AND ADDRESS Director Chemical Systems Laboratory Attn: DRDAR-CLJ-R Aberdeen Proving Ground, MD 21010	12. REPORT DATE AUGUST 1978	
	13. NUMBER OF PAGES 85	
14. MONITORING AGENCY NAME & ADDRESS (If different from Controlling Office) Director Chemical Systems Laboratory Attn: DRDAR-CLT-E Aberdeen Proving Ground, MD 21010 (CPO - Edward Bender 671-2586)	15. SECURITY CLASS. (of this report) UNCLASSIFIED	
	15a. DECLASSIFICATION/DOWNGRADING SCHEDULE NA	
16. DISTRIBUTION STATEMENT (of this Report) Approved for public release; distribution unlimited.		
17. DISTRIBUTION STATEMENT (of the abstract entered in Block 20, if different from Report)		
18. SUPPLEMENTARY NOTES		
19. KEY WORDS (Continue on reverse side if necessary and identify by block number) Biological monitoring Filter characteristics Holding tank monitoring Automatic Biological sensor Trailer Computer interface feeders Ventilatory behavior Computer system Water sampler Fish signals Amplifiers Computer programing Continuous flow Signal Fine tuning Diluter system Bioassay simulator		
20. ABSTRACT (Continue on reverse side if necessary and identify by block number) Recent concepts of biological monitoring are given. All components of the VPI and State University biological monitoring system are described. Maintenance and operating procedures for the latter system are given. This system rapidly and continuously monitors the breathing behavior of the bluegill sunfish by computer technology. Components of the system are housed in a trailer to centralize and preserve the equipment. Chlorinated tapwater and arbitrary Reference mixture (ARM) have been used in the system and have proven it to be feasible.		

DD FORM 1 JAN 73 1473

EDITION OF 1 NOV 65 IS OBSOLETE

UNCLASSIFIED

SECURITY CLASSIFICATION OF THIS PAGE (When Data Entered)

i

78 11 08 03 2

PREFACE

The National Pollution Discharge Elimination System (NPDES) was established by the Federal Water Pollution Control Act to control the discharge of pollutant-containing wastewaters into the nation's waterways. The goal of NPDES is to eliminate the discharge of pollutants by 1983. A pollutant is defined as substance, compound, or effluent which is in sufficient concentration to cause adverse effects on the biological organisms and communities of organisms in receiving waters. The list of pollutants has increased as more information has become available.

The U. S. Army's Project Manager for Munitions Production Base Modernization and Expansion is responsible for the design and construction of pollution abatement facilities that will treat manufacturing wastewaters from U. S. DARCOM installations so that they comply with applicable effluent standards and water quality criteria. In 1974, it was realized that the number of pollutants to be regulated would probably increase and that acceptable discharge concentrations would probably decrease. Thus, in order to comply with future NPDES permits, research, design, and construction of wastewater treatment facilities was initiated. At this time the project manager funded a project to design a biological monitoring system to measure the toxicity of a final wastewater effluent.

The work described in this report was authorized by contract DAAA15-76-C-0047, Project PAA 57T4114, Subproject 3, Task 2 "Monitoring of Toxic Effluents with Biological Sensors." This work was conducted in three phases: I, Design and Construction of a Biomonitoring System; II, Initial Testing of the Biomonitoring System; and III, Continuous Testing of the Biomonitoring System on a Complex Effluent. Phases I and II are complete. This report describes the results of that work initiated in December 1975 and completed in December 1977.

Reproduction of this document in whole or in part is prohibited
 except with permission of the Director, Chemical Systems Laboratory,
 Attn: DRDAR-CLJ-R, Aberdeen Proving Ground, Maryland 21010; however,
 DDC and the National Technical Information Service are authorized to
 reproduce the document for U. S. Government purposes.

DISCRETION for	
DTIC	White Section <input checked="" type="checkbox"/>
GOC	Buff Section <input type="checkbox"/>
UNANNOUNCED	<input type="checkbox"/>
JUSTIFICATION	
UNCLASSIFIED <small>CLASSIFIED BY: 000000000000</small>	
Dist.	WWW, WWW, WWW, SPECIAL
A	

CONTENTS

	Page
I. INTRODUCTION	1
A. Definition of Biological Monitoring	2
B. Why Use Biological Monitoring	2
C. Forms of Biological Monitoring	3
D. The Potential for Biological Monitoring at U.S. Army Ammunition Plants	3
II. MONITORING COMPONENTS	6
A. The Biological Sensor	6
B. Parameter Monitored (Ventilatory Behavior)	6
C. The Monitor Tanks	10
D. Amplifiers	13
1. Introduction	13
2. Hardware Description	14
3. Fine Tuning	16
4. Filter Characteristics	16
E. The Trailer	18
1. Rationale	18
2. Description	18
3. Internal Design	18
F. The Computer System	21
1. Rationale	21
2. Computer Description	22
3. Computer Programming	24
G. Diluter System	44
1. Physical Description	44
2. Water Sources	44
3. Distribution of Water	46
H. Chemical-Physical Analyses and Monitoring	46
1. Rationale	46
2. Chemical-Physical Monitoring	47
a. Properties Monitored	47
b. Interface to Computer and Adjustments	49
3. Chemical Analyses	49
4. Automatic Water Sampler	53

	Page
I. Continuous Flow Bioassay	53
1. Rationale	53
2. Description	54
3. Operation of Diluter System	55
J. Miscellany	59
1. Holding Tank	59
2. Automatic Feeders	61
3. Fish Signal Simulator	61
III. EXPERIMENTAL DESIGN AND SUPPLEMENTAL REMARKS	66
A. Initial Testing	66
B. Experimental Procedure	66
C. Supplemental Remarks	71
LITERATURE CITED	73
DISTRIBUTION LIST	76

LIST OF FIGURES

Figure	Page
1. A Typical Bimodal Ventilatory-Signal Pattern With Concurring Positions of the Mouth and Operculum for the Bluegill Sunfish, <u>Lepomis macrochirus</u>	8
2. Several Ventilatory Signal Patters	9
3. The Monitor Tank	11
4. The Monitoring Module and Auxiliary Components	12
5. A Schematic Diagram of the Amplifier	15
6. The Amplifier Rack	17
7. A Representation of the Trailer	19
8. The Internal Layout of the Major Components Within the Trailer	20
9. System Layout	23
10. Flow Chart Depicting the Computer Program	25
11. Flow Chart Representing General Program Creations within the Computer System	40
12. Flow Chart Illustrating the Files and System Programs as Incorporated into the Biomonitoring Computer System	41
13. The Diluter Apparatus	45
14. The control Unit of the Chemical-Physical Monitor	48
15. Interface from Chemical-Physical Monitor to ADAC of Computer System	50
16. (A) Connections for Output dc Offset Adjustments of Chemical-Physical Monitor. (B) Power Supply Decoupling Hardware.	51
17. + 15-Volt Regulated Power Supply for Chemical-Physical Monitor Interface	52
18. The Continuous Flow Bioassay Unit	56
19. Diagram and Dimensions of Proportioning Box	57
20. Diagram and Dimensions of Mixing Box	53

Figure	Page
21. Curves for Determining Partial Replacement Time	60
22. The Holding Tank	62
23. Fish Ventilatory Signal Simulator	63
24. The Initial Ventilatory Response of Bluegill Sunfish, <u>Lepomis macrochirus</u> , over 1-Minute to 0 and 5 ppm Total Chlorine	67
25. A Comparison of the 1st Minute of Exposure to Different Concentrations of Arbitrary Reference Mixture (ARM) by the Bluegill Sunfish, <u>Lepomis macrochirus</u>	68
26. A set of "Critical Limits" as Established for Two Bluegill Sunfish, <u>Lepomis macrochirus</u>	70

I. INTRODUCTION

Public law 92-500 and the Commonwealth of Virginia's State Water Control Act (Sec. 6.61) requires biological monitoring, where appropriate of waste discharges. A biological monitoring system capable of continuously and rapidly assessing effluent quality is currently being put into application through a joint effort of the Ecological Research Office of the U.S. Army and the Center for Environmental Studies at Virginia Polytechnic Institute and State University. The following report is meant to serve three functions. First, it attempts to introduce the reader to recent concepts of biological monitoring. Second, it presents a fairly complete description of all of the components incorporated into a fish biological monitoring system. Finally, this report takes into account all of the maintenance and operating procedures that have been thus far developed for this system. Continuous and rapid biological monitoring is accomplished by assessing the breathing behavior of bluegill sunfish through the incorporation of modern computer technology. In addition, considerations for analyzing and monitoring several chemical and physical parameters have been made. A continuous flow bioassay unit is currently being developed for incorporation into the overall system. All the assay unit components are housed within a 32 by 12 ft. (9.75 by 3.66 m) trailer to centralize the equipment and protect the electrical components from the corrosive atmospheric conditions common at most industrial facilities. The entire system has recently been relocated to an on-line testing site at the Radford Army Ammunition Plant. Initial testing using chlorinated tap water and the petroleum industry's Arbitrary Reference Mixture (ARM) as test effluents has demonstrated system feasibility.

A. DEFINITION OF BIOLOGICAL MONITORING

Biological monitoring is a means of assessing the strength of a given toxicant by using a living organism as the sensor. It is a term frequently applied to a wide variety of monitoring techniques, all of which utilize the response of organisms to environmental conditions. The biological monitoring system described herein and as applied to this present project, has been designed to function as an automated, continuous and rapid, in-plant monitoring system.

B. WHY USE BIOLOGICAL MONITORING?

First, public law 92-500 and the Commonwealth of Virginia's State Water Control Act (Sec. 6.61) require some form of biological monitoring for industrial waste water discharges. In addition, it is most difficult to assess the biological effects of an effluent by employing chemical and physical forms of monitoring. Ultimately the effect a toxicant has on a community of organisms will depend upon the interaction of the toxicant with the receiving system itself. This effect cannot be monitored by chemical or physical monitors because the number of parameters one would need for such monitoring could approach infinity, especially considering the phenomenon of interaction. On the other hand, although biological monitors serve as useful integrators of effluent and receiving system conditions, identification of the cause of a deleterious biological effect generally will require accompanying chemical and/or physical information. Therefore, it becomes apparent that a suitable monitoring program must include all three components: biological, chemical, and physical.

C. FORMS OF BIOLOGICAL MONITORING

The most common form of biological monitoring to date has been that employing the bioassay. A bioassay may be defined as "a test in which the quantity or strength of a material is determined by the reaction of a living organism to it" (Sprague, 1973). There are two major groups of bioassays: acute and chronic. *Acute* bioassays attempt to determine the relative lethality fo various concentrations of a toxicant over either a 24-, 48-, or 96-hour exposure period. *Chronic* bioassays are concerned with the sublethal effects a toxicant may have on an organism's life cycle. Bioassays have many merits and have played a major role in regulating (although, at times, somewhat arbitrarily) industrial effluents. However, it is most difficult to set up a traditional bioassay, assess the data received, and then finally make a decision regarding the effluent quality before the effluent enters the receiving system. Thus, it is evident that there is a need for a biological monitoring system that is capable of automatically and continuously monitoring the quality of industrial effluents.

D. THE POTENTIAL FOR BIOLOGICAL MONITORING SYSTEMS AT U.S. ARMY AMMUNITION PLANTS

The most significant contribution to be derived from installing the present type of automated, continuous, and rapid biological monitoring system at U.S. Army Arsenal Plants, would be the potential for maintaining the aquatic environmental quality at a high caliber. This concept would surely be of utmost concern to a U.S. Government agency. Future and similar biological monitoring systems could be built for \$40,000 to \$50,000 each. Considering cost effectiveness of such systems for the U.S. Army, the efficiency potential becomes so great that it merits some additional discussion:

(1) Protection from liability suits

The present concept of biological monitoring potentially protects industry from liability suits since effluent may be continuously monitored with regard to the effect the effluent may have on the biota of a receiving system. Furthermore, the incorporation of continuous chemical-physical monitors enables specific identification of causative agents. Finally, the application of computer technology allows for detection of a spill at a speed fast enough to prevent it from reaching the receiving system.

(2) Prevention of unnecessary and costly overtreatment

Often ammunition waste treatment plants may require the construction of elaborate facilities for advanced treatment of their wastes. Yet, for the most part, treatment of wastes through a series of holding and settling ponds may be sufficient. The biological monitoring system discussed here has the potential to regulate the use of these elaborate treatment facilities when they are present. If the monitors indicate waste's are safely treated, an arsenal could allow the effluent to enter the receiving system. However, with proper integration with the ammunition plant, if an alarm were sounded, indicating waste is not safely treated, the effluent could be prevented from entering the receiving system -- well before a spill could be disastrous. At this point, perhaps retention of the effluent in the last treatment pond would correct the problem. This is a decision which could be implemented through the biological monitoring system. Advanced treatment needs could be coordinated by this present biological monitoring system. If the system indicates that the problem has cleared up, the effluent could be considered suitable for passage to the receiving system. If time is a factor, and/or if additional retention does not clear the problem, then the effluent may be directed to additional treatment

facilities. The point is, proper biological monitoring can save U.S. Army Ammunition Plants the considerable cost and problems inherent in unnecessary over-treatment of effluents while continuously protecting the aquatic environmental quality.

(3) No specialized personnel required.

The present biological monitoring system has been designed to reduce the need for specialized biologists, computer analysts, and/or electronic engineers to operate the system. The computer has been programmed so that the operator need be concerned only with a minimum number of commands. In fact, to start a monitoring period from scratch, only two commands are necessary. Other design features of the overall system further reduce the need for specialized personnel. Some of these include: automatic day-night photoperiods, automatic fish feeders, and monitor tanks designed to minimize cleaning requirements.

The advantages to be gained from the incorporation of similar biological monitoring systems into U.S. Army Ammunition Plants are readily apparent. Therefore, the reader is encouraged to read this report in its entirety for a more comprehensive understanding of this present concept of biological monitoring.

II. MONITORING COMPONENTS

A. THE BIOLOGICAL SENSOR

Since the present concept of biological monitoring is designed to protect the aquatic receiving systems, a choice of an aquatic organism as a biological sensor becomes necessary. The evolution of research efforts at this laboratory has demonstrated that fish are good indicators when incorporated into the present concept of biological monitoring (Cairns et al., 1977; Cairns et al., 1973; Westlake and Van der Schalie, 1976). In general, fish can be relatively hardy organisms and are readily obtainable throughout the year, either through commercial suppliers or local capture programs. On the other hand, it should be noted that certain invertebrates, particularly crayfish, have been successfully tested for applicability for this present concept of biological monitoring (Maciorowski et al., 1976).

Specifically, bluegill sunfish, Lepomis macrochirus, have been selected as the biological sensor. They range in size from 8-15 cm and weight from 15-50 gm. Bluegill sunfish are relatively hardy, readily obtainable, and ubiquitous animals. They generate a strong ventilatory bioelectric signal (the behavioral parameter monitored), and there exists at least an adequate amount of related literature. Finally, they adapt most suitably to our experimental conditions.

B. PARAMETER MONITORED (VENTILATORY BEHAVIOR)

The ventilatory behavior of the bluegill sunfish has been selected as the parameter to be monitored for indicating the quality of the aquatic environment. On the one hand, this decision reflects earlier research at this laboratory where breathing behavior and other parameters (e.g., locomotor activity) have been studied (Cairns et al., 1975). Yet, the most significant rationale reflects the fact that the ventilatory behavior of fish responds

almost immediately to the presence of a host of toxicants; thus it provides an excellent parameter to serve as a potential indicator of aquatic quality. Manometric, or pressure transducer techniques have been the most commonly employed method for monitoring the ventilatory behavior of fish (Shelton, 1970). However, this methodology requires surgical implantation. The method we have selected for our project does not restrain the fish, nor does it require any specialized techniques.

When fish breathe, a small bioelectric current is generated. For the size of the bluegill sunfish employed, this potential ranges from about 40-50 μ volts. The signal is the result of a summation of electrical signals generated by the muscles which operate the buccal and opercular components of the fish breathing. The series of impulses generated is received through a pair of submerged stainless steel electrodes fastened to the monitor tank near the fish (Section II-C), and are amplified by a factor of about 10^5 (Section II-D) so that they may be interfaced with an on-line computer (Section II-F).

A typical signal, representing the ventilatory cycle for the bluegill sunfish in our monitoring set up is shown (Fig. I) along with the corresponding elements of buccal and opercular movements. This signal can change in both frequency and amplitude. The type of change depends upon the nature of the toxicant. Figure 2 depicts three common changes that occur in the presence of chlorinated tap water. Similar changes in the ventilatory response occur almost immediately in the presence of a variety of toxicants and irritants, and apparently occur as the result of information received from both chemo- and mechanoreceptors located on the gill and pharyngeal regions (Shelton, 1970). It should be pointed out that certain changes in the amplitudes of the signals result

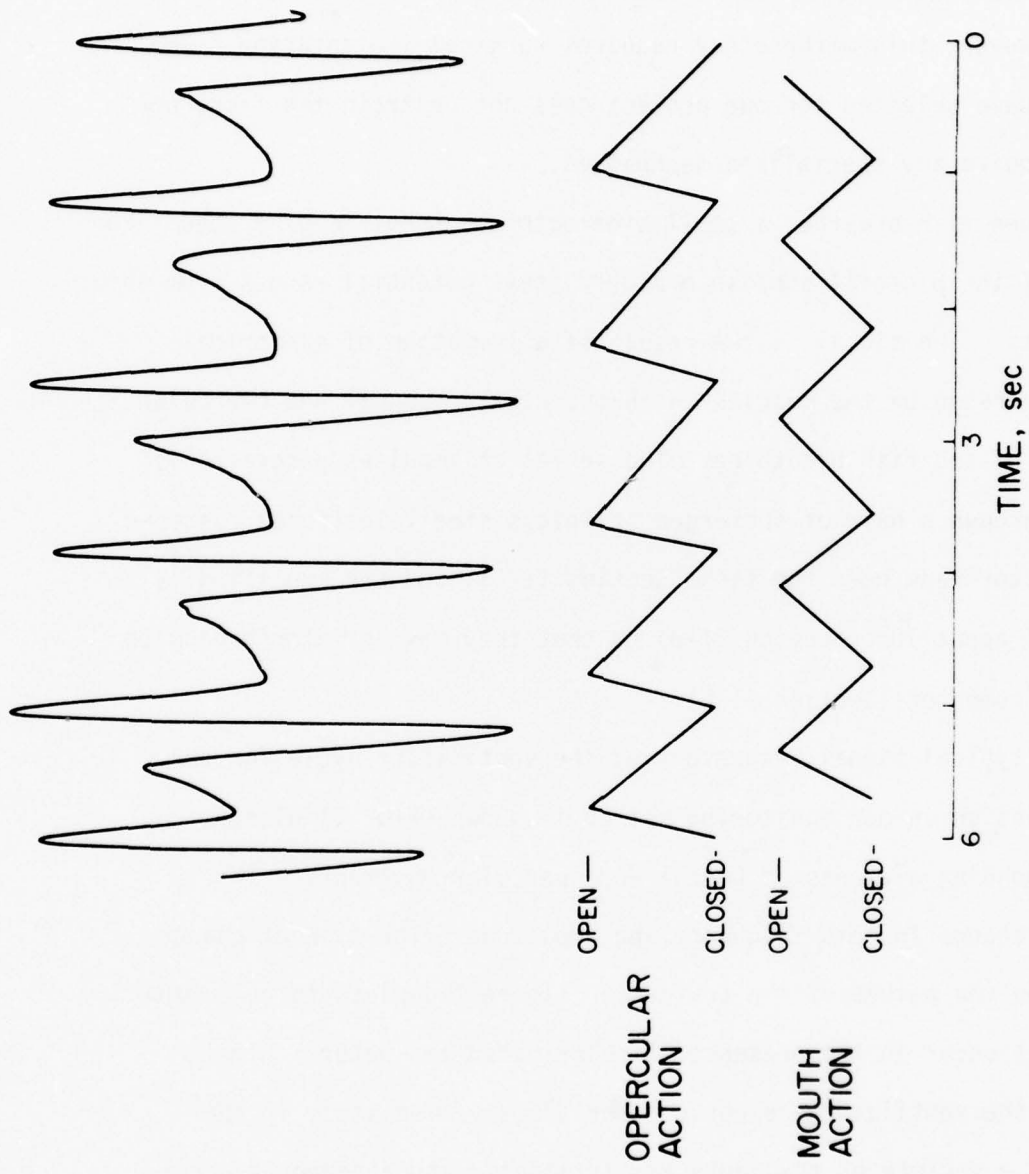

Figure 1. A typical Bimodal Ventilatory Signal Pattern with Concurring Positions of the Mouth and Operculum for the Bluegill Sunfish, *Lepomis macrochirus*. Peak-to-peak amplified signals approach 15 volts, chart speed = 2.5 cm/s.

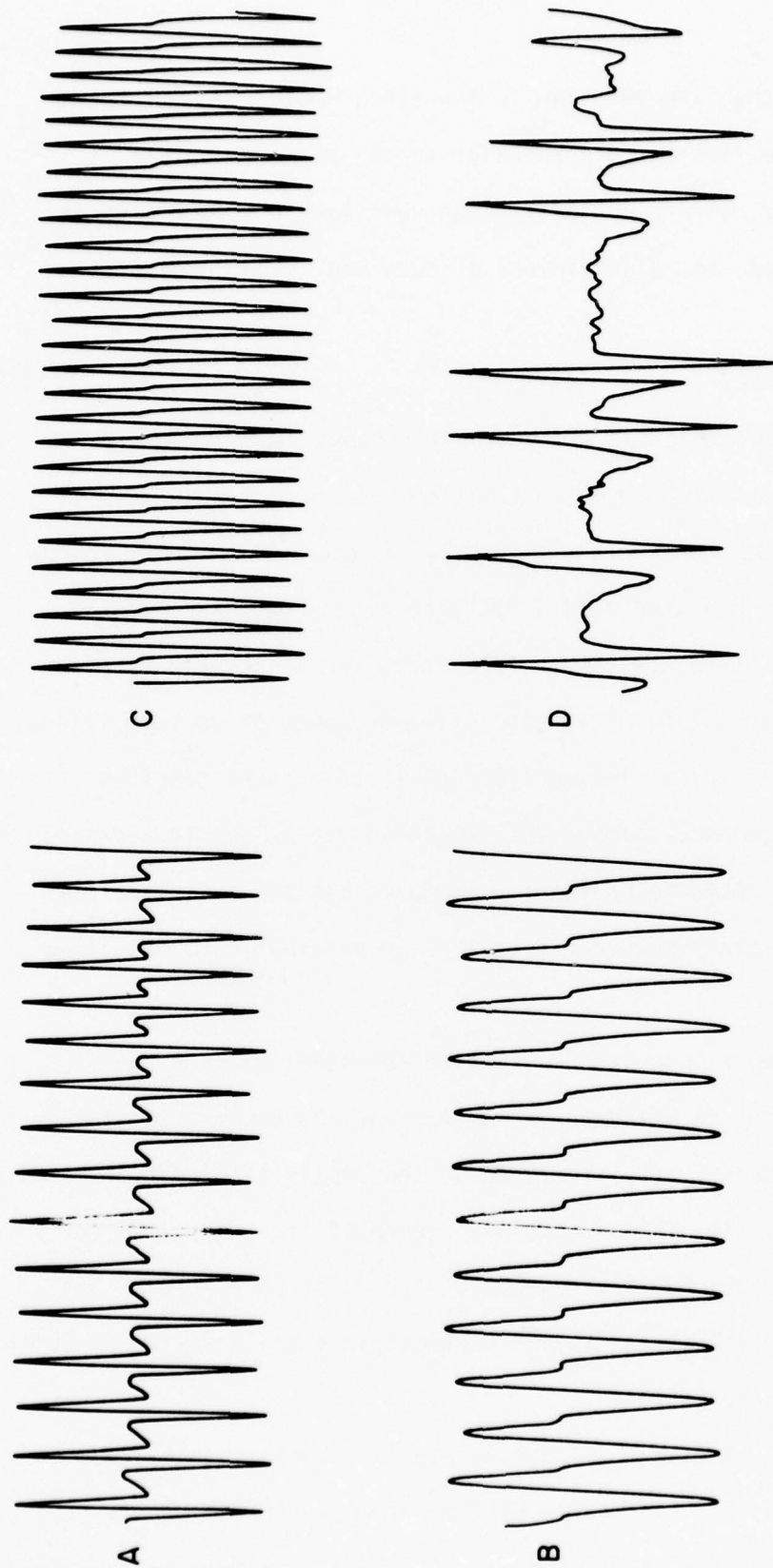

Figure 2. Several Ventilatory Signal Patterns. Peak-to-Peak Amplified Signals Approach 15 Volts, chart speed = 2.5 cm/s. (A) Typical Bimodal Signal from Bluegill Sunfish, *Lepomis macrochirus*. (B) Modified Bimodal Signal from Bluegill Sunfish, *L. macrochirus* and Fathead Minnows, *Pimephales promelas*. (C) Signals Approaching Single Modality. (D) Variation of Bimodal Signal.

from the position of the fish relative to the electrodes. The strongest signals occur when the fish is perpendicular to the plane of either electrode, and weakest, when parallel. Since ventilatory frequencies are what is being monitored, the significance of such amplitude changes is minimal.

C. THE MONITOR TANKS

Figure 3 illustrates one of the monitor tanks designed for this project. The design reflects minimum maintenance and maximum signal: noise ratios. The tanks are constructed of $\frac{1}{4}$ in. clear plexiglass. Water is supplied through an overhead $\frac{1}{2}$ in. PVC pipe (not shown) and leaves through the adjustable standpipe (SP). Flow rates are adjustable by a valve control and the adjustable standpipe allows volumes of up to 6 liters, 1.6 gal. to be monitored. The sloping floor (SF) facilitates detritus movement into the maintenance chamber (MC) where it may be easily siphoned off when necessary. A rectangular tank is employed because the electrical signal reception is at maximum when a fish lies perpendicular to the plane of either electrode (E).

Eighteen-gauge, single-stranded, stainless steel wires serve as the electrodes. Each set is attached to the ends of the tank with silicone sealant. The two electrodes are interfaced to the amplifiers (section II-D) through small barrier strips (BS). Fish are prevented from making direct contact with the electrodes by the presence of two false walls (FW). The walls are notched (not illustrated so the bioelectric signals may be conducted through the water to the electrodes.

Twelve similar tanks are all housed within a compartmentalized monitoring module (fig. 4). The module has been designed to support 36 monitor tanks. At this stage of development, 12 tanks have been incorporated.

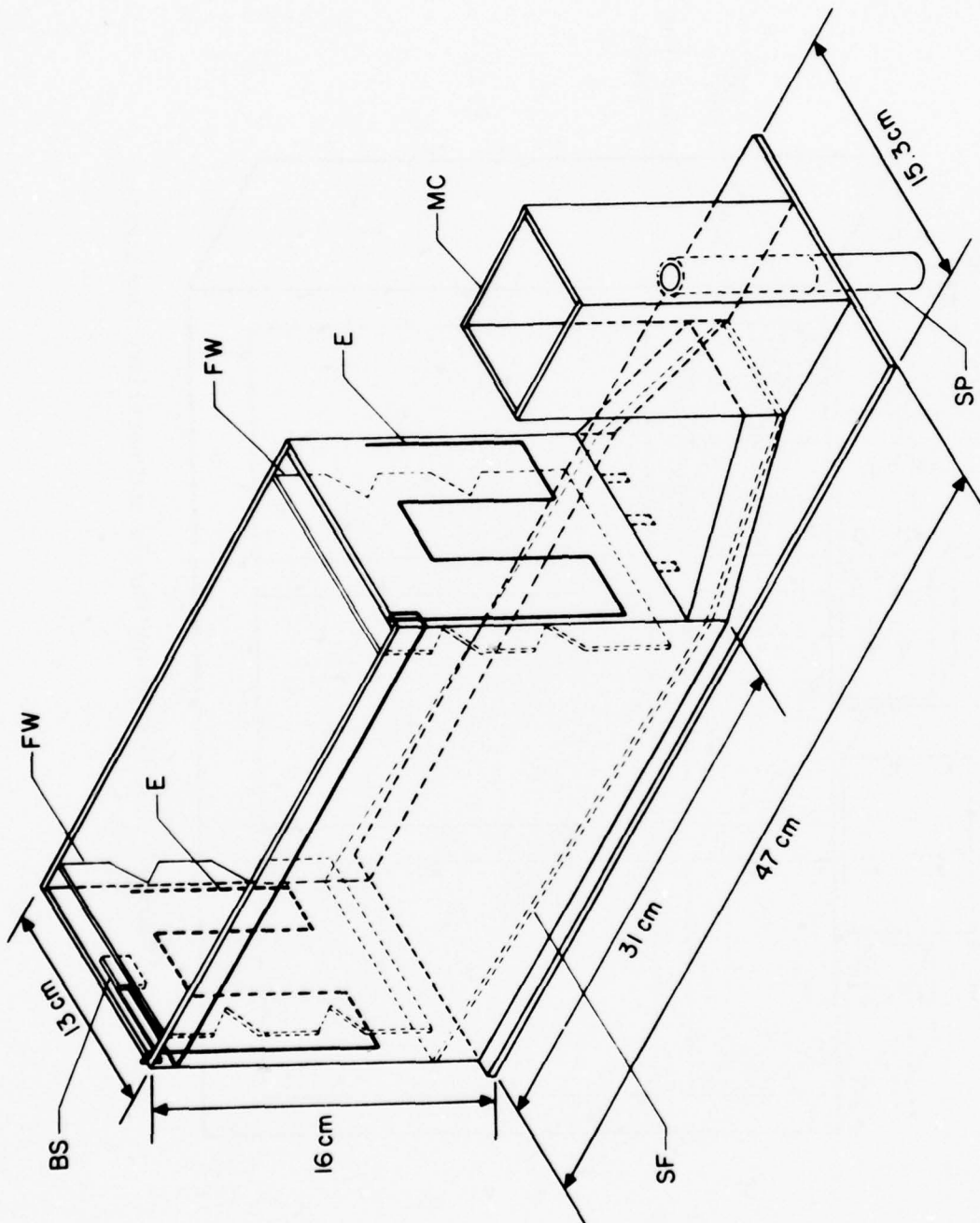

Figure 3. The Monitor Tank. BS represents the barrier strip to which the electrodes (E) are coupled to one amplifier. FW labels the false walls protecting the electrodes; SF, a sloping floor, SP is the adjustable standing pipe; and MC, the maintenance chamber.

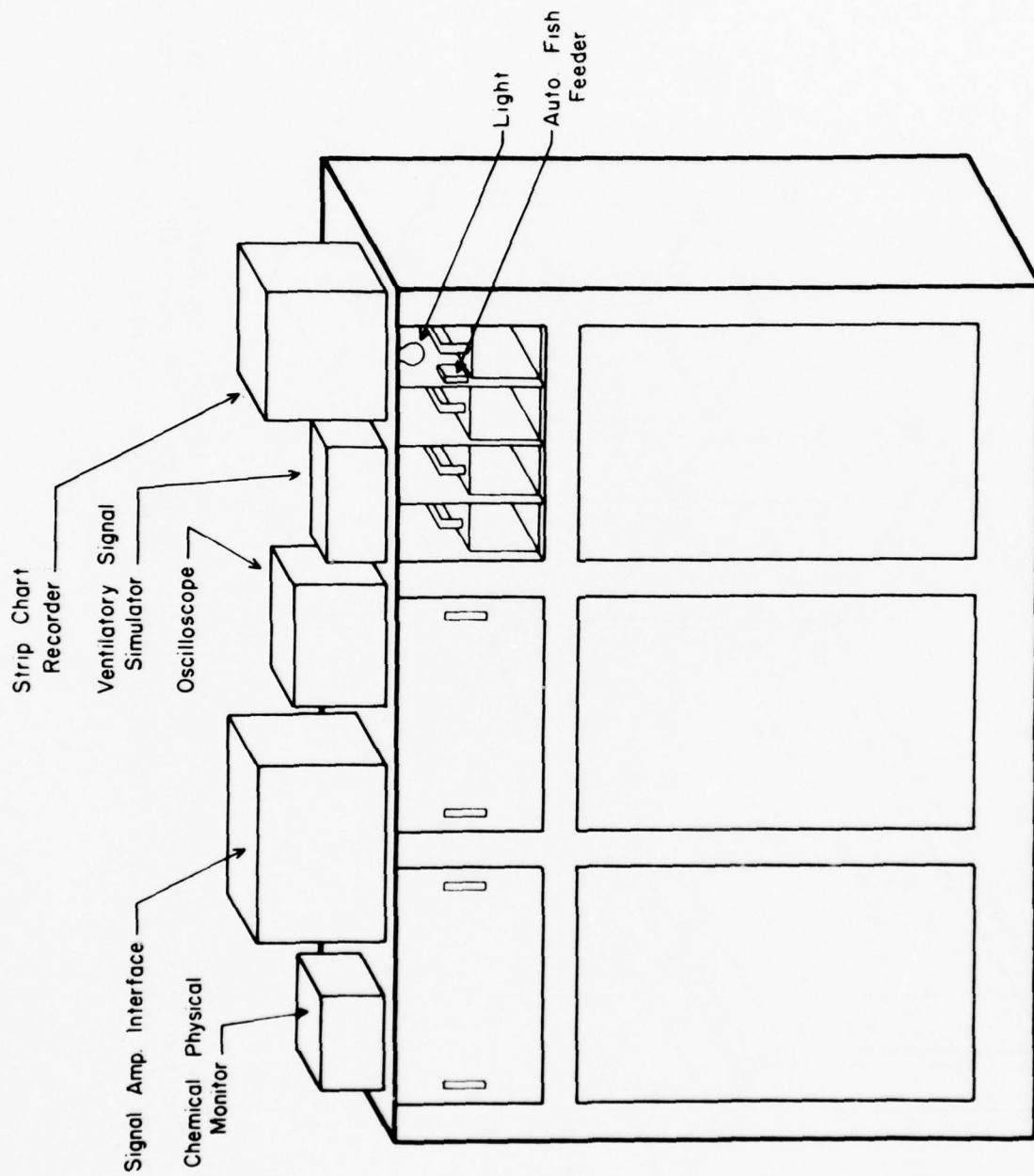

Figure 4. The Monitoring Module and Auxiliary Components.

Each compartment is totally isolated and consists of a monitor tank, an automatic feeder (twice/day), and an automatic light (simulating a day-night 12-hour photoperiod).

D. AMPLIFIERS

1. INTRODUCTION

The existence of widespread interest in the monitoring of physiological responses of organisms to toxicants is reflected throughout the literature. Many investigators have restricted such monitoring to the ventilatory movements of fish (Belding, 1929; Schaumburg *et al.*, 1967; Spoor *et al.*, 1971; Cairns and Sparks, 1971; Sparks, Cairns, and Heath, 1972; Sparks, Cairns *et al.*, 1972; Cairns *et al.*, 1973, 1974, 1975; Heath, 1972; Drummond *et al.*, 1974; Lunn *et al.*, 1976; Morgan, 1976). Normal breathing movements of small fish produce bioelectric potentials which have been reported to range between 0.01 and 40 microvolts (Barham *et al.*, 1969) but generally exceed 5-10 microvolts. For the purpose of investigations, these bioelectric potentials may be received through submerged electrodes (Camougis, 1960; Goodman and Weinberger, 1971; Spoor and Drummond, 1972; Lonsdale and Marshall, 1973; and Cairns *et al.*, 1975). However to extend these propagated signals to devices such as micro- and mini-computers, an inexpensive amplifier having qualities of noise resistance had to be developed.

Some amplifiers have been designed for the similar purpose of recording opercular movements (Spoor *et al.*, 1971; Lonsdale and Marshall, 1973; and Drummond and Dawson, 1974); however, almost no noise immunity was built into these units. In some of these applications the role of noise rejection was carried out by external devices; for example, chart recorders

that generally possess their own amplifier and filtering systems. Interfacing the bioelectric potential to computers with such amplifiers would not be practical. The amplifier we shall describe later on is highly immune to noise and is of relatively low cost (under \$80.00). Additionally, the amplifier can be used to monitor other biological events such as the locomotor activity of crayfish (Maciorowski et al., 1976).

Although the cost of this amplifier is small, its main contribution lies in the realm of noise immunity. Strip chart recorders have internal noise filters, but data obtained from such devices are difficult and bulky to analyze. The increased use of micro- and mini-computers for such data handling makes an amplifier, such as we used, an invaluable tool for linking analog bioelectric signals to digital computers. The reader should refer to Gruber et al. (1977) for publication of this section.

2. HARDWARE DESCRIPTION

The heart of the amplifier (Fig. 5) is the Analog Devices AD-521 Instrumentation Amplifier. This device is a high gain amplifier chip with the ability to reject noise common to both input leads (e.g., 60 Hz noise). The bioelectric potentials to be amplified are differential, and the AD-521 amplifies the signals ($\times 1,000$) but not the noise. The second stage is a low-gain, active low-pass filter possessing a gain of 1.56 while filtering out signals above 8 Hz. The next stage is a simple amplifier with a fixed gain of 12, followed by a similar stage possessing a variable gain between 1 and 11. These two gain stages are AC coupled by blocking capacitors (C2 and C3 in Fig. 5) which prevents DC from passing from stage to stage and thereby causing the amplifier to lock up or saturate. The last stage is another active low-pass filter identical to

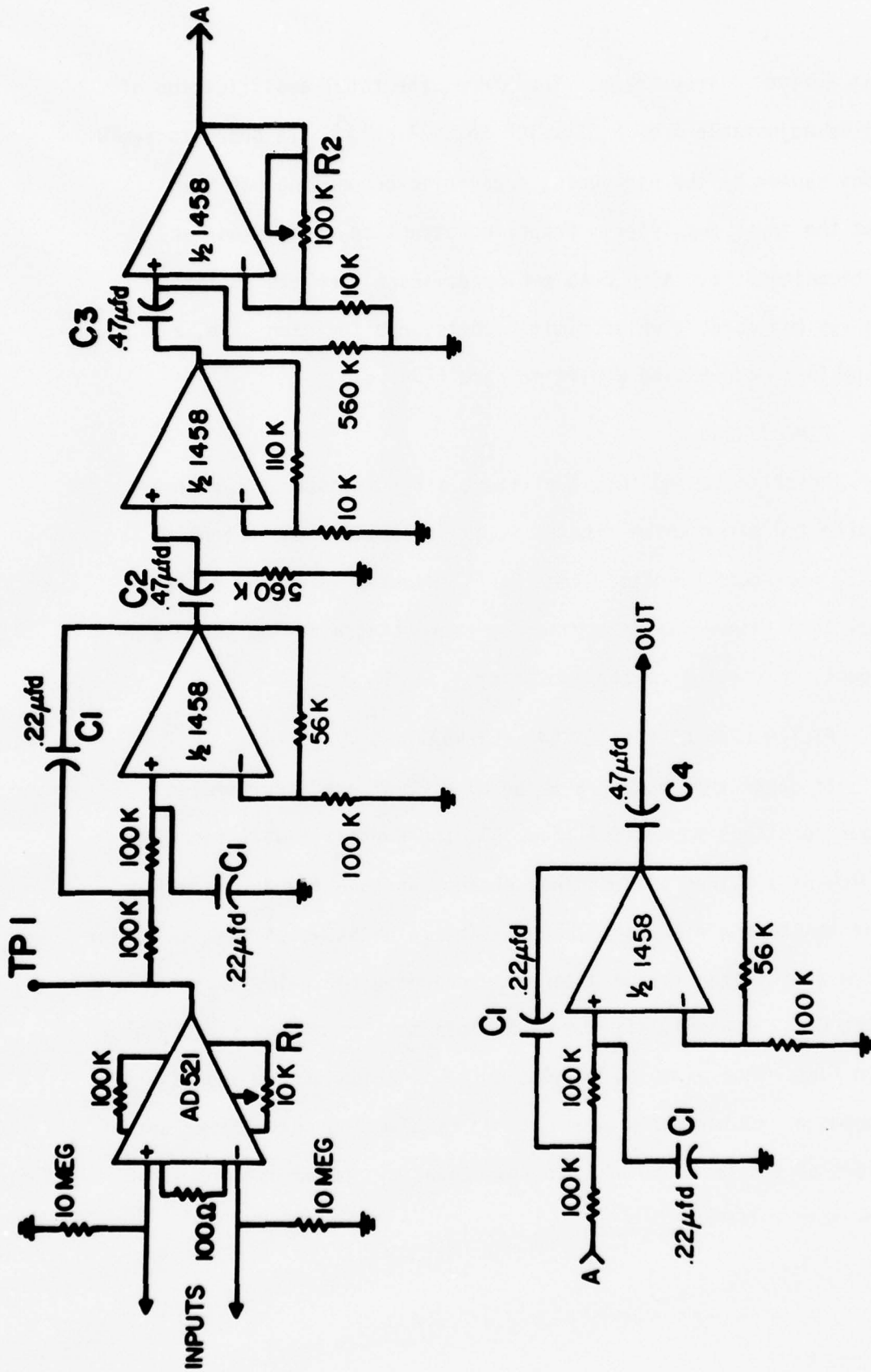

Figure 5. A Schematic Diagram of the Amplifier. C1 Determines Filter Characteristics, while C2 and C3 Represent Blocking Capacitors. TP1 depicts the test point. R1 is the offset adjust for the AD-521 and R2 symbolizes the gain control. (From Gruber et al., 1977.)

the initial active filter stage. Therefore, the total amplification of the signal is adjustable from 2.92×10^4 to 3.21×10^5 . In order to avoid oscillations caused by the high gain, capacitive decoupling has been employed at the input amplifier. Proper construction, shielding, and grounding techniques have also been employed. Each complete amplifier is mounted on its own card. Twelve similar units, one for each fish, are situated within a modularized amplifier rack (Fig. 6).

3. FINE TUNING

Prior to tuning this amplifier, a 5-10 minute warmup period should be allotted after which time R_1 is adjusted until the output at TP-I (Fig. 5) registers 0 volts. Then R_2 is adjusted until the desired signal level is obtained, as determined by connecting a device such as an oscilloscope to the output of the amplifier.

4. FILTER CHARACTERISTICS AND ALTERNATIVES

If capacitors having a value of $0.22 \mu\text{f}$ are incorporated into the four locations marked C-I (Fig. 5), the amplifier will function as an 8-Hz low-pass filter as described above. We have found this value suitable for monitoring fish ventilation. The value at which this amplifier will function as a filter may be altered by changing the values of the capacitors at C-I. However, all the capacitors must be of the same value at any given time. For example, in another application of the amplifiers, crayfish locomotor activity can be monitored by altering only the values of the capacitors at C-I to $0.068 \mu\text{F}$. In this capacity the amplifiers serve as 26-Hz low-pass filters.

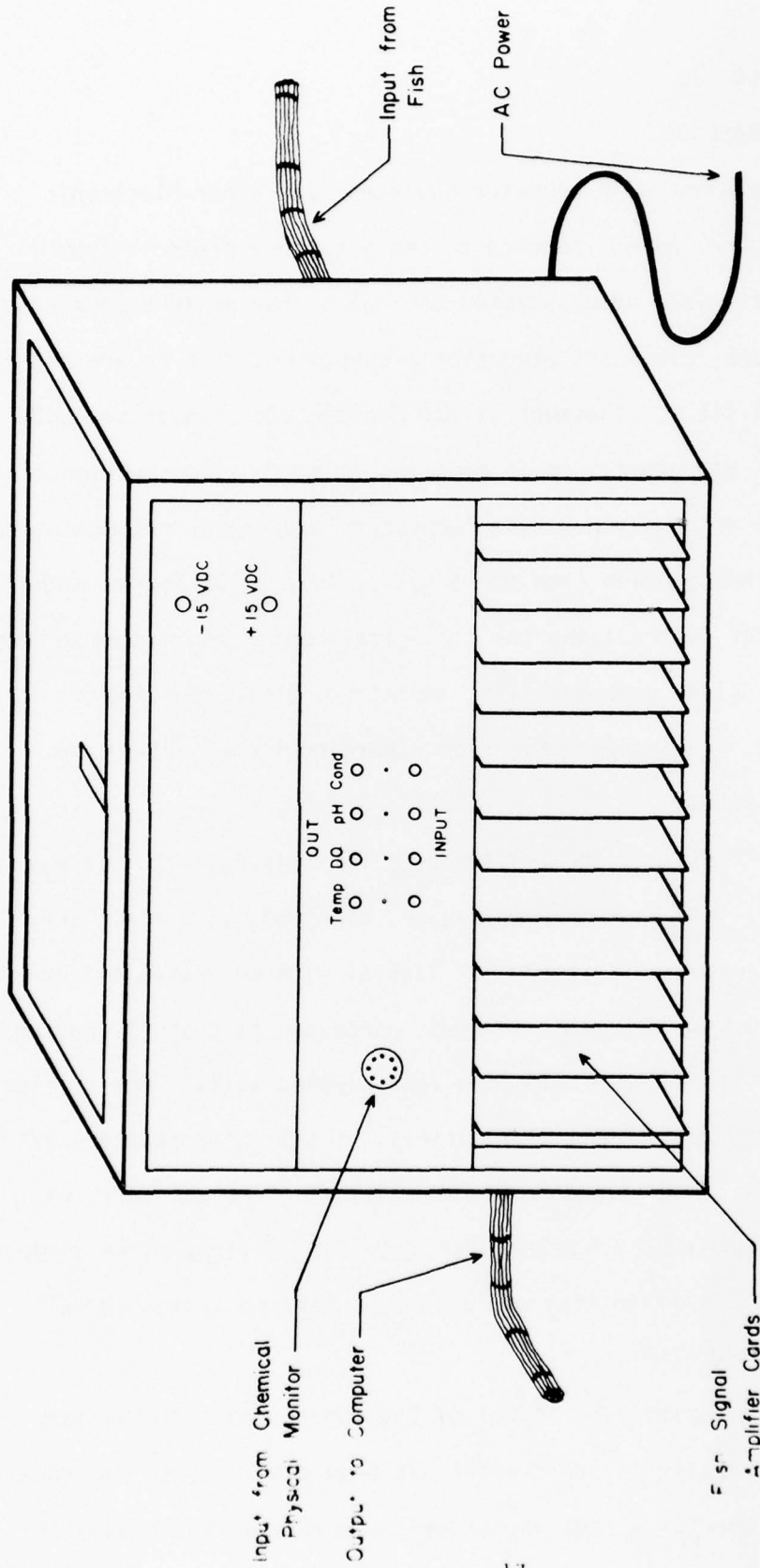

Figure 6. The Amplifier Rack.

E. THE TRAILER

1. RATIONALE

When dealing with computer equipment and other electronic hardware, it is of the utmost concern to protect these elements from a hostile environment. This necessitates control of the ambient temperature as well as protection from harsh atmospheric corrosives such as are often found at industrial sites. Inasmuch as the bioelectric signals are only of the magnitude of microvolts, it is most important to keep the signal: noise ratio as high as possible. Past laboratory experience has demonstrated the importance of this problem (van der Schalie, 1977). Of course there are other reasons for centralizing the biological monitoring system within a trailer. These include some mobility, isolation, protection from unauthorized visits, and independence from other industrial activities.

2. DESCRIPTION

Figure 7 depicts the trailer used for this project. It was built by USRY, Inc., 1415 Chamberlayne Avenue, Richmond, Virginia. The overall dimensions are 32 X 12 ft (9.75 X 3.66 m) with an inside height of 8 ft (2.44 m). Essentially, the unit was purchased as a shell, having sloping waterproof floors with drains and four paneled walls. The trailer was wired to provide both 110 and 220V outlets. Total rated capacity of the electrical system is 200 amperes at 240 volts AC. The two doors of the trailer are equipped with a deadbolt locking system. Present plans include the incorporation of a self-locking and automated warning system as well.

3. INTERNAL DESIGN

Figure 8 depicts the layout of the monitoring and auxiliary equipment within the trailer. The trailer has been divided into two rooms. The smaller room is used as a combination office/work area and houses the

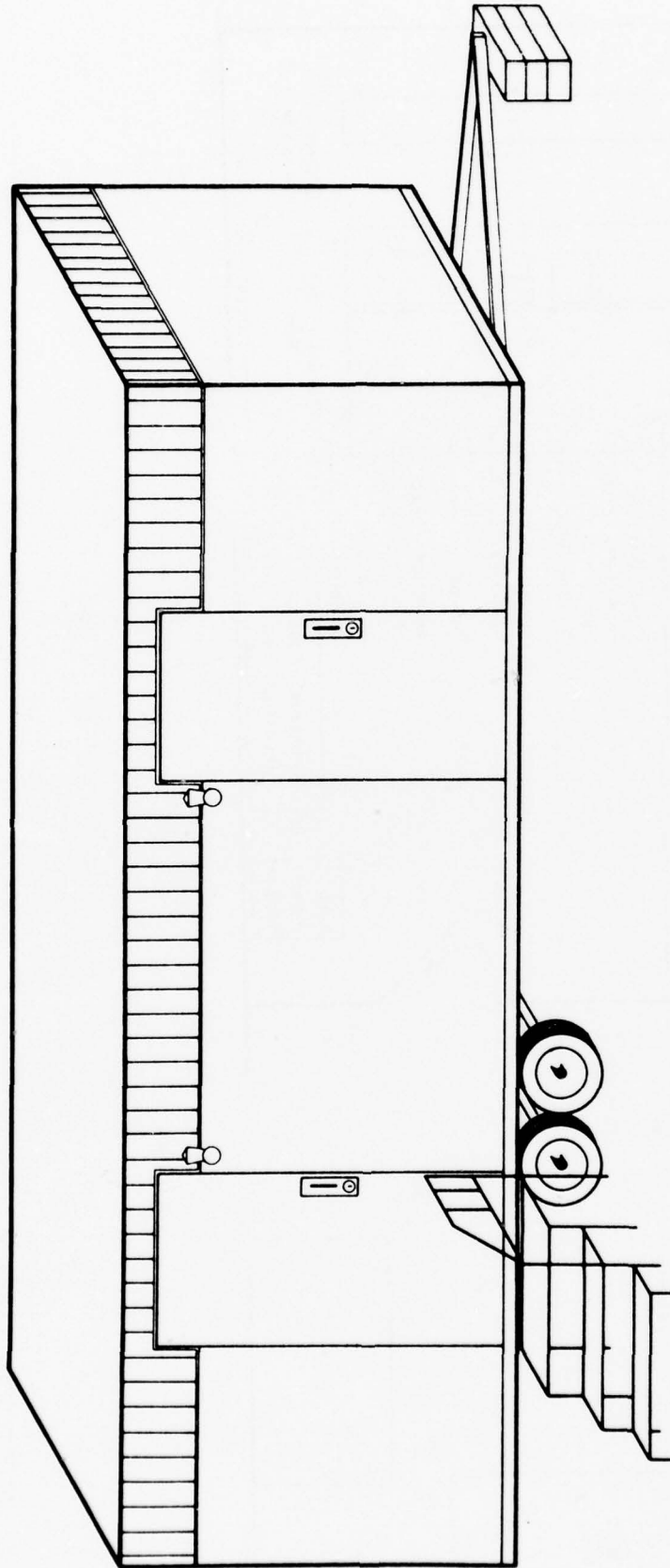

Figure 7. A Representation of the Trailer. The dimensions are 9.75 x 3.66 x 2.44 m (32 x 12 x 8 ft).

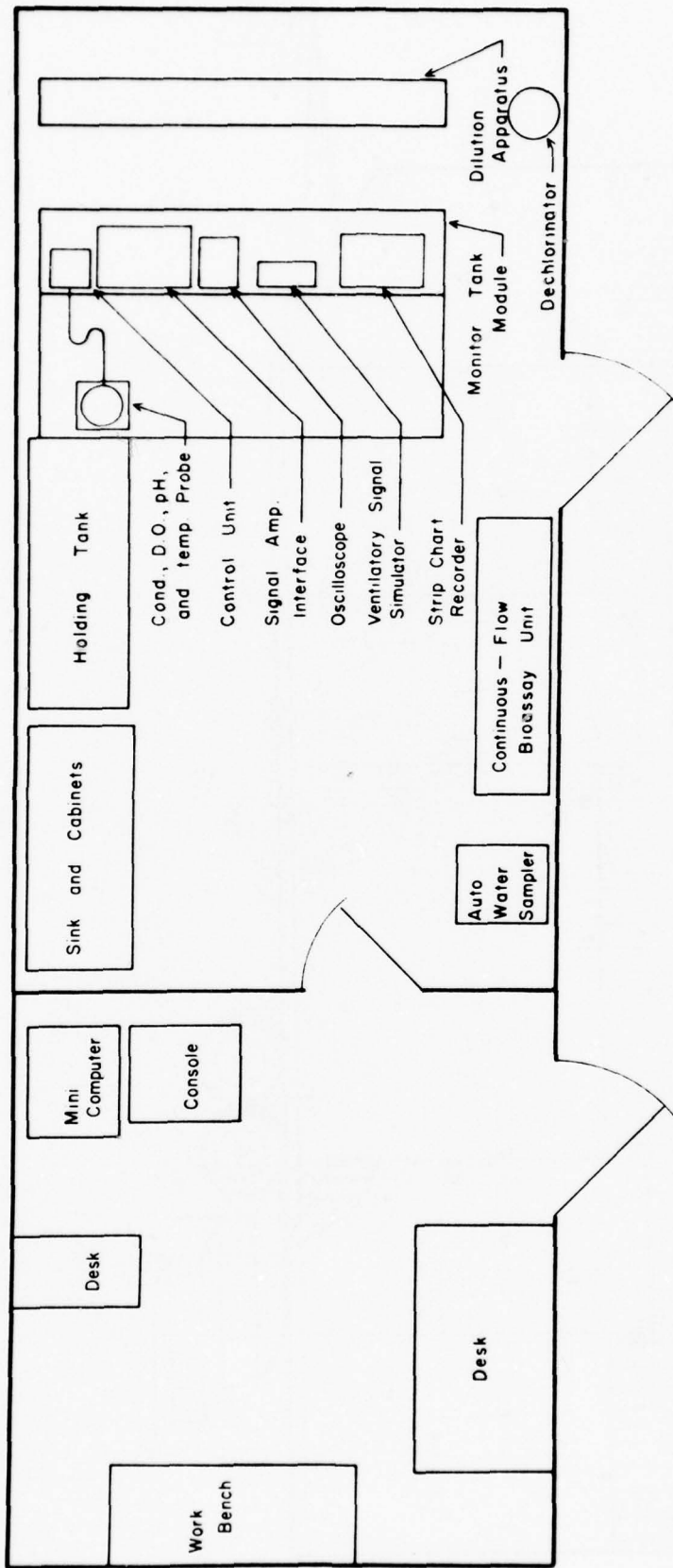

Figure 8. The Internal Layout of the Major Components Within the Trailer.

computer system. The larger room, as seen in Figure 8, contains most of the monitoring apparatus.

F. THE COMPUTER

1. RATIONALE

In order to maintain rapid and continuous biological monitoring, computer technology is essential. This rationale reflects the most modern use of minicomputer-data acquisition. In recent years, it has been necessary to collect data manually for research in various fields, one such field being biomonitoring. The researcher would spend hours looking at chart recordings of how a fish was breathing, then have to manually count the number of breaths or coughs. Computer analysis of early biomonitoring data has been minimal. However, the use of a computer for data acquisition would save time, energy, and money, thus making any analysis more efficient. Furthermore, as the speed of data acquisition would increase, the cost would diminish. For example, since there would be no need for specialized personnel, except at the developmental stages of the system, the cost of operation would decrease continually as the system is used.

After the biomonitoring system is in operation, its overall efficiency would increase. For once the criteria for recognizing a breath or cough have been established for a particular species of fish, these criteria could be coded into a program so that the computer would do the work. After the program is debugged and operating, there would be no hesitancy in deciding how to analyze the data, and the computer could process the data as fast as acquired. Furthermore, with the data recorded on a disk or tape, the problem of deciphering poor handwriting would be avoided and the human error of sometimes hitting the wrong digit would be eliminated.

2. COMPUTER DESCRIPTION

A PDP 11/V03 computer system has been incorporated into this project. It is manufactured by the Digital Equipment Corporation (DEC) whose headquarters are in Maynard, Massachusetts, 01754. Essentially, this computer system employs an LSI/11 minicomputer which is the most advanced of the PDP/11 series. The computer has the standard PDP/11 instruction set and is currently running with 16 K of memory--12 K of dynamic memory and 4 K of core. Figure 9 illustrates the layout of the entire system.

Located in the rear of the computer is a 32 channel analog-to-digital converter. The converter's primary task is to convert the 20 volt peak-to-peak fish signal, as received from the amplifier, to a binary form which the computer can digest. Once the computer has analyzed the data, the data may then be stored for use in future computations. The storing of data is facilitated by 2 peripheral devices: a disk-drive and a Decwriter II (hard copy console).

The disk-drive is capable of handling single or double sided floppy disks with the following restrictions: (1) floppy disks must have only 1 index hole, and (2) must be single density disks.

Each floppy disk is capable of holding approximately 256,000 characters per side (blanks included), or about 20-30 days of data (when recording every 15 minutes and depending upon the format of the output). If a printout of the data is desired, the computer can send information to the console device (Decwriter II) at any time period desired. Even if the console is not used during data acquisition periods, the data can be recorded on the floppy disk system and displayed on the console at a later date if desired.

SYSTEM LAYOUT

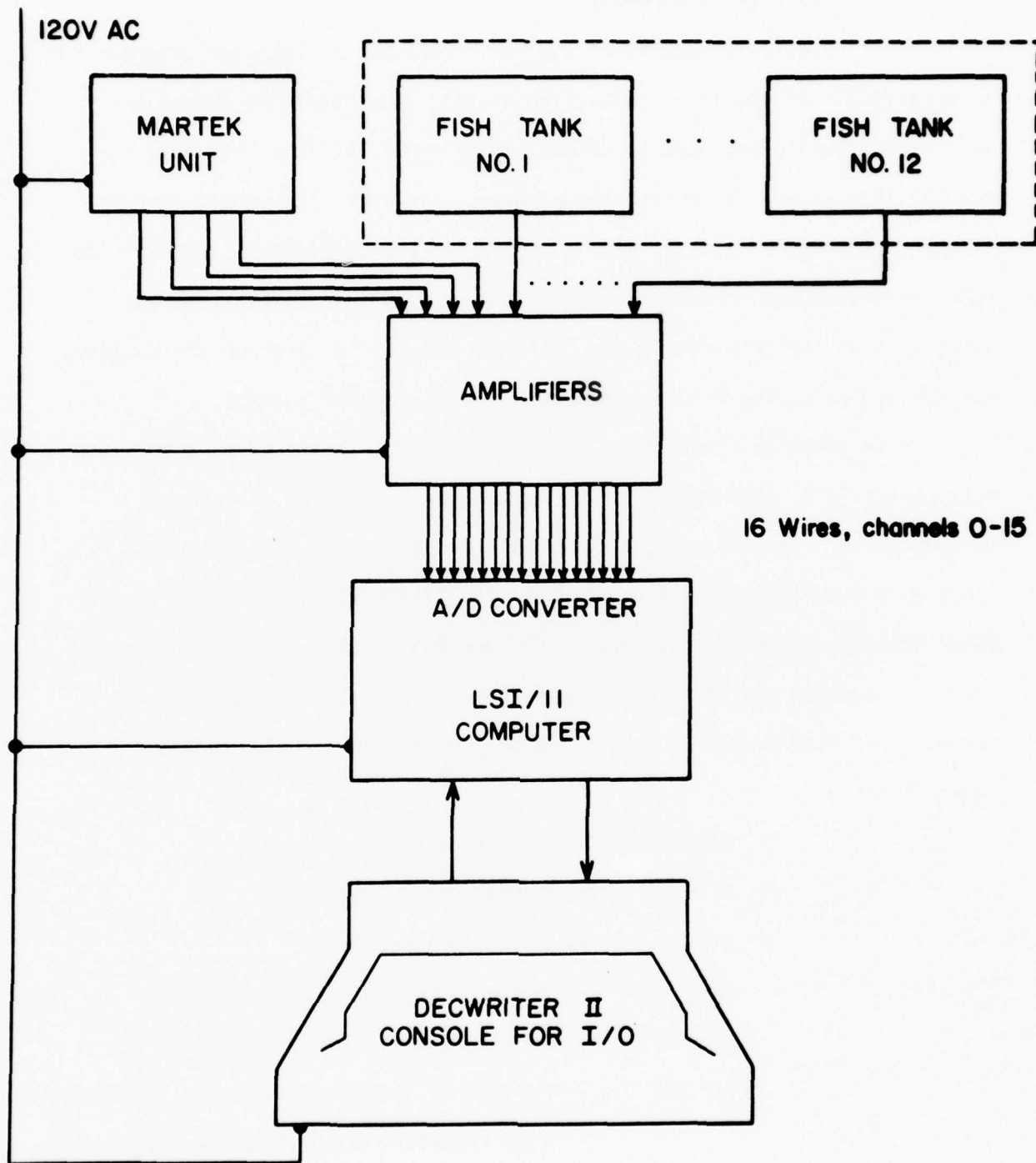

Figure 9. System Layout.

3. COMPUTER PROGRAMMING

Figure 10 summarizes the philosophy of the computer programming incorporated. It should be emphasized at this point that the design aim of the programming has been to absolutely minimize the input required to operate this system for monitoring purposes. In fact, the operator need type in only one command to run the monitoring program (RUN DX1:FISH)! The computer system will respond by requesting certain information from the user, such as the date (MM-DD-YY), time (HH:MM), and a name for the upcoming monitoring period for future reference (any name and/or number).

In addition, there are, of course, several key programs that will certainly be of interest to the technician and may be of interest to some users. The following is a brief summary of these key programs. For a more detailed explanation, consult the SYSTEM REFERENCE MANUAL (and other MANUALS) which are supplied by DEC and kept in the trailer.

In order for the user or technician to operate the computer and run the specified programs, the following programs must reside on the floppy disk:

- * MONITR.SYS. -- Operating System
- * TT.SYS -- Console device handler
- * DX.SYS -- Disk drive handler
- BAS8K.SAV -- Basic Interpreter (small version)
- FISH.SAV -- Actual data acquisition program
- PIP.SAV -- Peripheral interchange program. (Used for file transfer, etc.; detailed explanation follows later.)

*NOTE! Only those programs with an asterisk need reside on the system device, namely disk drive 0 (DX0). However, if all programs reside on the same disk, the other disk may be used entirely for the storage of data.

MAIN PROGRAM

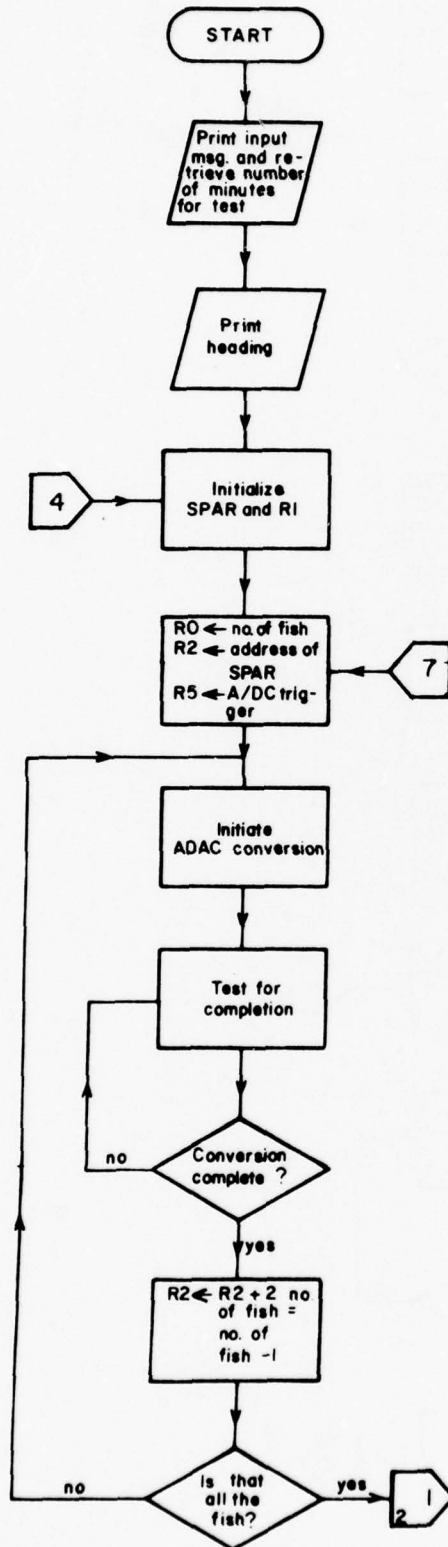

N is the number designating where execution is to begin.

m is the page number in which the section of code corresponding to N is located.

Figure 10. Flow Chart Depicting the Computer Program.

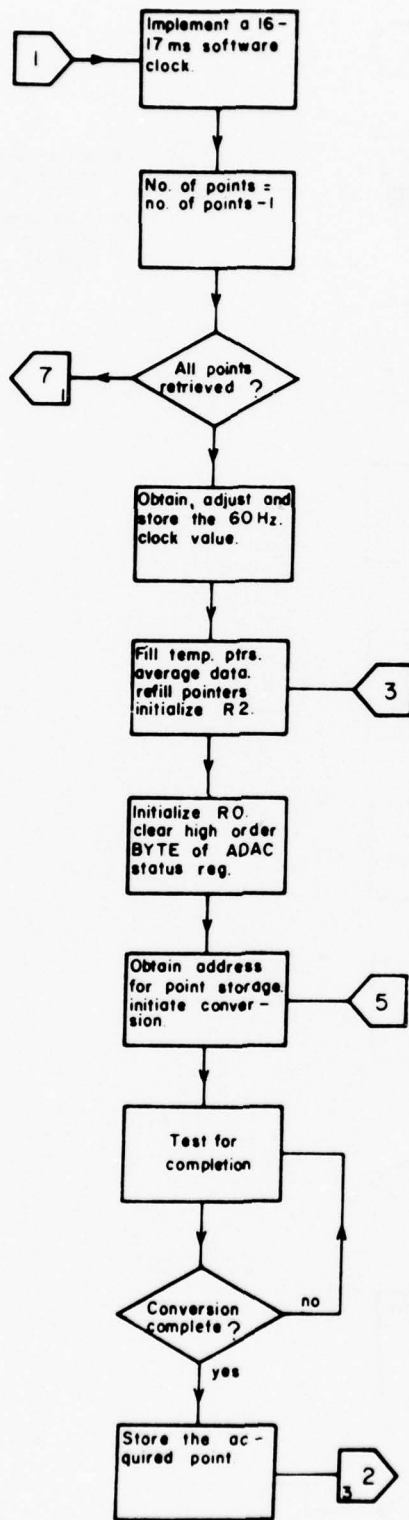

Figure 10 (Continued)

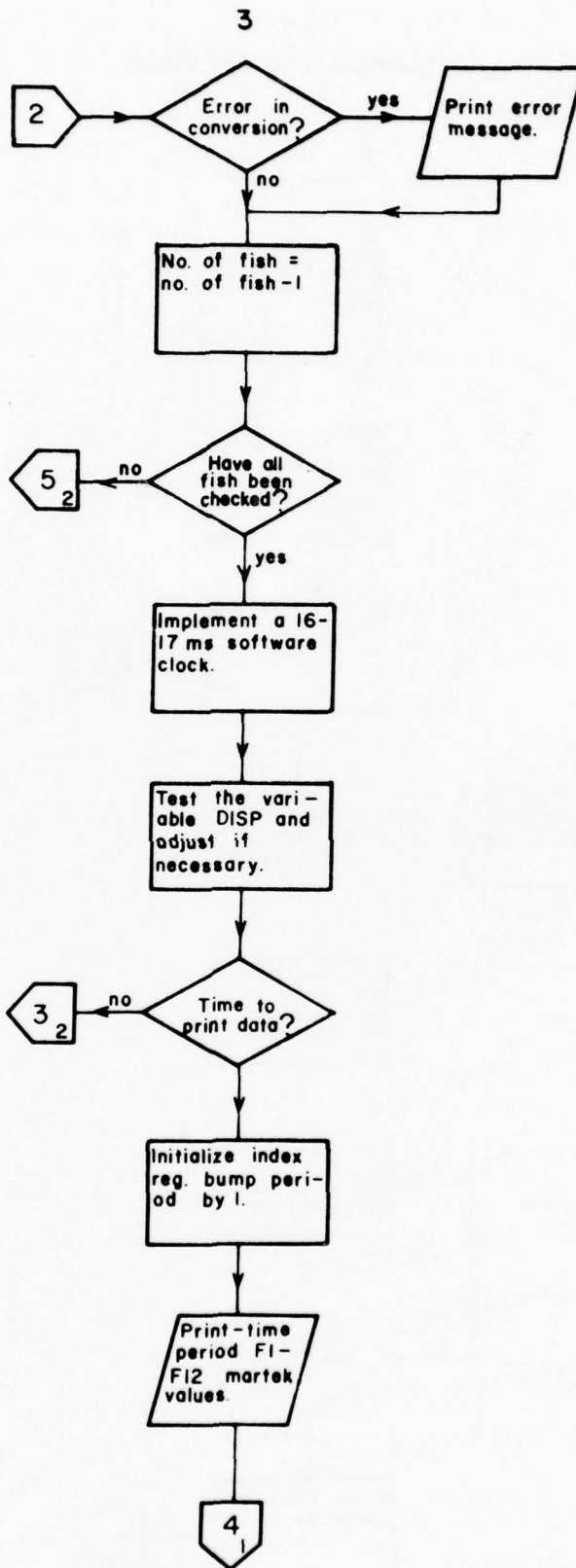

Figure 10 (Continued)

SUBROUTINE AVERAGE

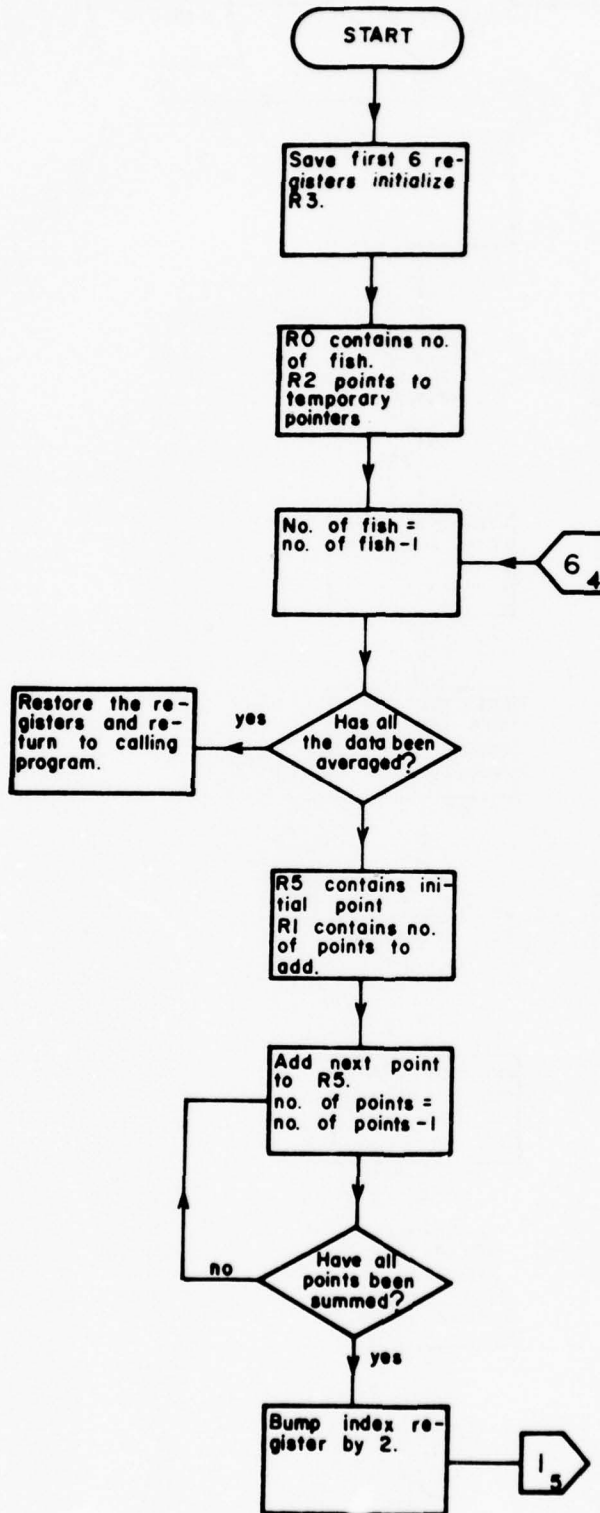

Figure 10 (Continued)

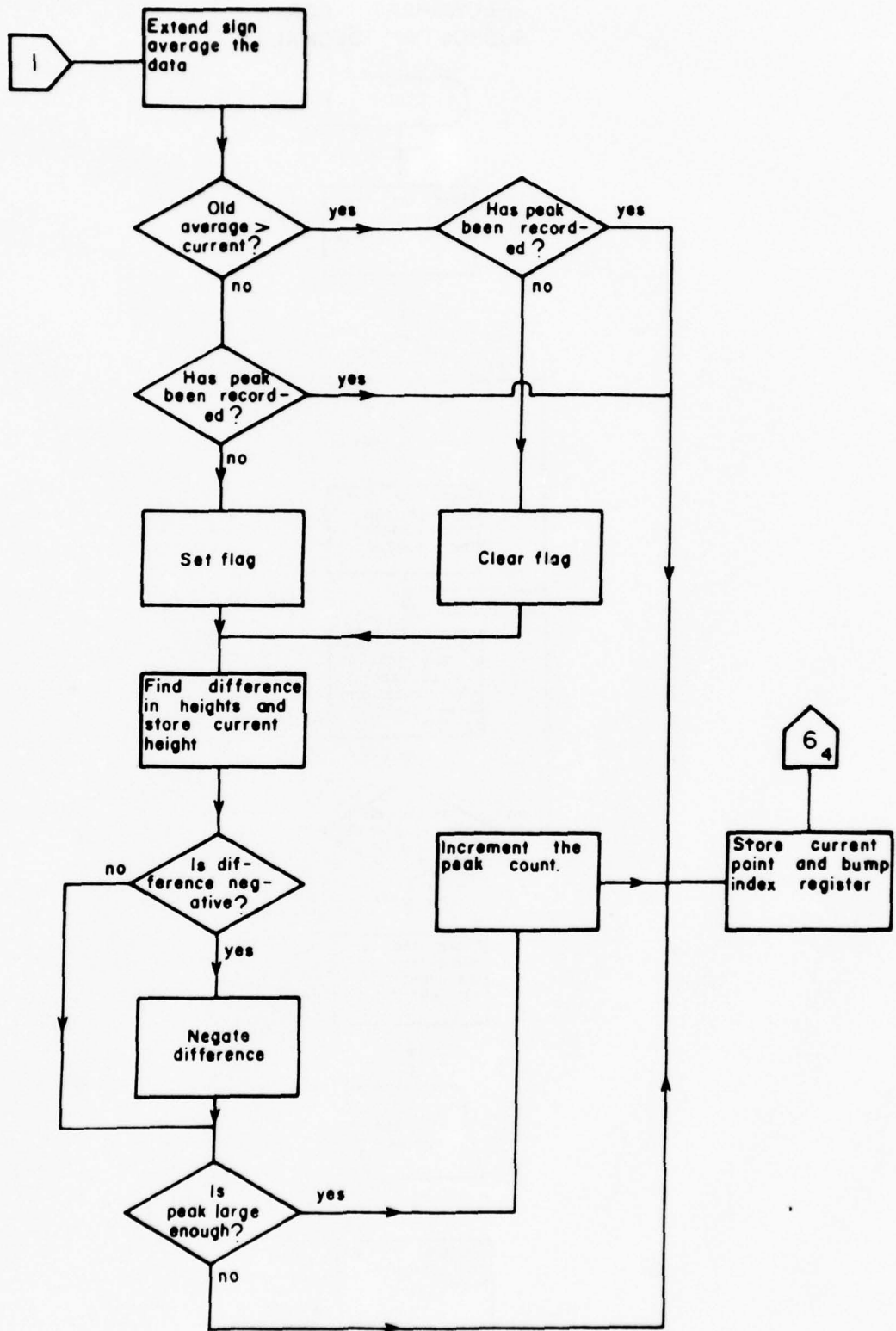

Figure 10 (Continued)

FLOWCHART FOR
SUBROUTINE DECIMAL

Figure 10 (Continued)

FLOWCHART FOR SUBROUTINE GETCHR

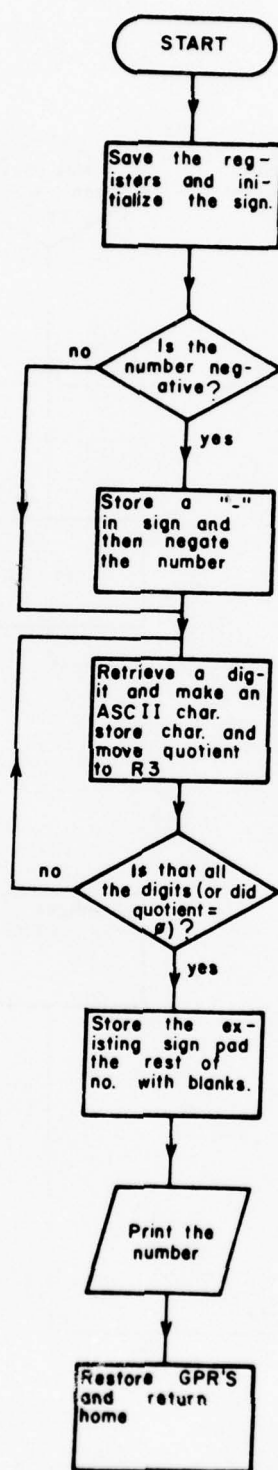
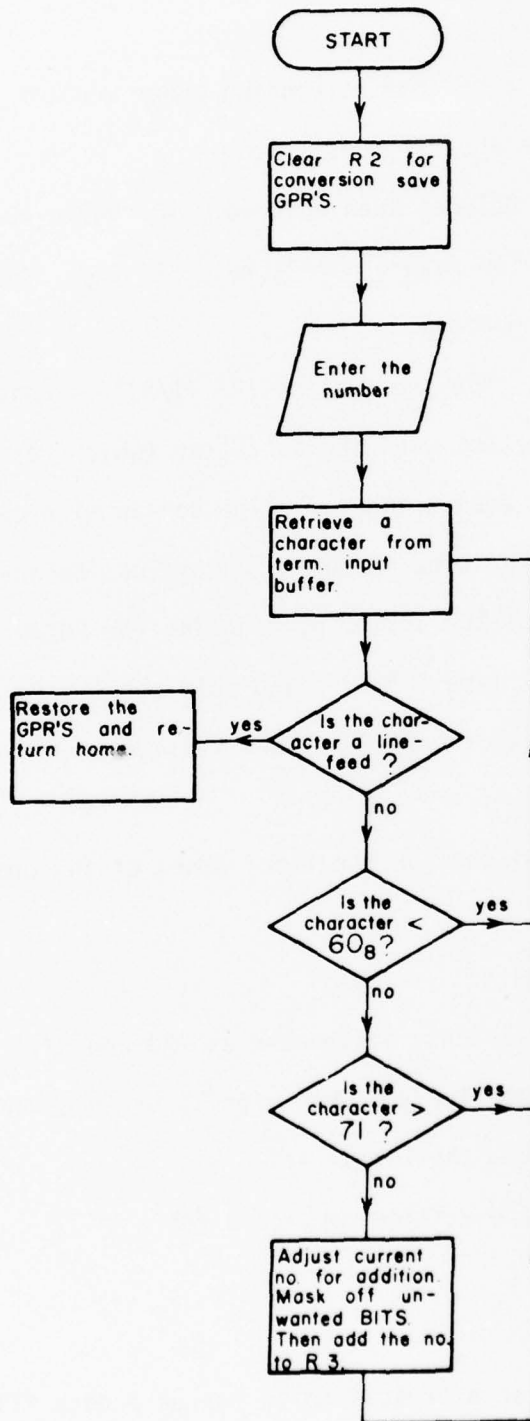

Figure 10 (Continued)

A few explanations follow:

Note: All computer output will be underlined to distinguish from user entered input. <CR> denotes carriage return.

Prompt characters--

- * -- designates that a program is running under monitor control. Examples of such programs are PIP, EDIT, etc.
- @ -- designates that ODT has been entered. To regain control of previous program, type P (no return necessary). If this doesn't work, system may need to be rebooted.
- . -- (a period) shows that the monitor (RT 11/SJ) is waiting for a command.
- \$ -- (dollar sign)--occurs when the bootstrap (which resides on ROM in the machine) has been triggered. The dollar sign can be prompted only by a power failure. A power failure can be artificially induced for a rebooting of the system by toggling the DC/ON switch. After the "\$" sign appears, type "DX<CR>" and wait about 5-10 secs. The system should respond with the RT11 version message and then a "." prompt character.

To run a program, all switches on the front panel of the computer should be in the up (on) position.

SYSTEM DEVICE EXPLANATION

There are 2 disk devices, designated as DX0 and DX1, which represent drive 0 and drive 1, respectively. When signifying which drive one wishes to perform an operation on, the format is:

dev:filename.ext/switch

where,

dev--is either DX0 or DX1

filename--is either a program to be run or a data file to be examined, etc.

ext--is an extension. Certain files have certain extensions which will be explained later.

switch-- determines operation to be performed on file; will be explained later.

The default system device is DX0. To run a program which resides in the system device the user need type only "R progname.ext." If the extension is SAV, the user need type only "R progname". The following is a list of alternative ways of running a program:

R Program.ext

R Program (if ext is SAV)

RUN in place of R will work also

*RUN DX1:Program or RUN DX0:Prog.ext.

*NOTE: If the program resides on the other disk only, this form will work. DX0 must also be changed to DX1.

Running the data acquisition program.

ReNote:(Computer output is underlined)

Assuming that the monitor is running and diskettes are in both drives, the program will be run as follows:

. RUN DX1:FISH (Note program is on disk in drive 1)

TODAY'S DATE: MM-DD-YY <CR>

TIME OF DAY: HH:MM <CR>

ENTER OUTPUT FILENAME: TEST <CR>

ENTER NUMBER OF MINUTES FOR TEST: 15 <CR>

then the heading will appear and data will be recorded every 15 minutes (user option).

12 fish total

TIME	PERIOD	F1	F2	F12	TEMP	DO	pH	COND
00:00:15	1	263	248.....	277	15.33	6.67	7.41	133
00:15:17	2	274	288.....	299	15.34	6.67	7.40	133
.
.
.
01:15:19	6	288	241.....	250	15.40	6.66	7.41	134

The program writes the data to disk on drive 1, one block at a time. There are 2 ways of exiting from the program. They are:

1. Holding the CTRL key down while typing a C.
2. Holding the CTRL key down while typing a Z.

Method 1 will stop the program execution and return to monitor without saving the recorded data. The file will be lost. Method 2 will stop program execution and return control to the monitor, but will also write the remainder of the buffer to the disk and then close the file, thus making it permanent. The file will be saved under the name issued in the beginning and will have a DAT extension placed on it by default.

POSSIBLE ERROR MESSAGES:

When a person enters a filename for output that already exists, the computer will print "FILE ALREADY EXISTS" and then give the person another chance to enter a unique filename. To erase or delete an already existing file, look under the section on PIP.

If the disk handler is not resident on the system device, the user will be informed.

SUMMARY OF SOME POSSIBLE COMMANDS:

TIM<CR>--displays time of day

TIM HH:MM:SS<CR>--sets time

RUN program--runs specified program. If program is on disk 1,
then substitute "DX1:program" for "program".

DAT<CR>--displays current date

DAT DD-MMM-YY<CR>--sets the specified date. MMM is first 3 letters
of month.

COMMANDS AND SWITCHES UNDER PIP

dev:/L--list directory

dev:/E--list directory and include unused listings

dev:/F--short listing

dev:/S--compress the disk

dev:/D--delete everything on the disk

dev:/Z--format the disk

dev can be either DX0 or DX1

Compressing the files on the diskette. There are 480 available blocks on
1 diskette. Assuming that 3 files of 20 blocks each are on the diskette,
these remaining blocks would be 420 and may be arranged thusly:

MYFILE.DAT 20

BLUGIL.DAT 20

TEMP1.DAT 20

<Unused> 420

60 blocks in use

420 free blocks

So the user has 420 blocks for one file. But if BLUGIL.DAT were deleted (D switch) the following would happen:

```
MYFILE.DAT  20
<Unused>    20
TEMP1.DAT   20
<Unused>    420
  40 blocks in use
  440 free blocks
```

The problem exists when a file needs 430 blocks of space. Logically, there would be no problem, since 430 is less than 440. But because the unused spaces are not contiguous with one another, the largest free area available is 420 blocks. To resolve this, a special switch (S) for compressing all unused areas in 1 is available.

EXAMPLE:

```
BEFORE
MYFILE.DAT  20
<Unused>    20
TEMP1.DAT   20
<Unused>    420
  40 Blocks in use
  440 Free Blocks
```

*DX1:/S compress diskette. Assume diskette 1 contains files

*DX1:/E list directory

```
AFTER
MYFILE.DAT  20
TEMP1.DAT   20
<Unused>    440
  40 Blocks in use
  440 Free Blocks
```

FORMATTING DISKETTE

Before a disk can be used for the first time, the directory must be allocated space, and the remaining tracks zeroed. This is done by the Z switch.

DXI:/Z

ARE YOU SURE? (Computer responds and waits for input.)

CAUTION! If this command is issued, everything on a used diskette will be erased.

. R PIP DISPLAYS DIRECTORY OF DISK 1 and LENGTH OF EACH ENTRY.
* DXI:/L

. R PIP

TT:=DXI:Filename.extension

Displays the file designated by file name, extension, where file-name is a six (6) alphanumeric character name and extension is a 3 alphanumeric character name. An asterisk may be used in place of the filename or extension in which case all files with the designated extension will be listed or all files with the designated filename will be listed.

For Example:

TT:=DXI:*.DAT

will display the contents of all files with extension DAT.

TT:=DXI:MYFILE.*

Will display the contents of all files with filename of MYFILE.

Copying files: format dest=source
 dev:name.exts=dev:name.ext.

DXO:MYFILE.DAT=DXI:MYFILE.DAT

Transfers the file from DX1 to DX0.

To make a duplicate copy of the file on the same disk do the following:

DX1:COPY.DAT=DX1:MYFILE.DAT

NOTE: As long as the source file exists the destination filename and extension may be changed as described.

For further information check SYSTEM REFERENCE MANUAL under PIP.

FILE VERIFICATION

DX1:filename.extension/L

Will display the file (name only) and length. If file does not exist, an appropriate message will be printed.

NOTE: When corrections or additions are to be added to the current software, the following information should be used only as a quick reference (For detailed information consult the SYSTEM REFERENCE MANUAL):

PROGRAMS NECESSARY TO MAKE CORRECTIONS

EDIT.SAV--text editor

LINK.SAV--linker

MACRO.SAV--macro assembler

PROGRAMS AVAILABLE IN WHICH CORRECTIONS MIGHT BE MADE

MARTEK.MAC--Water quality analysis program

FISHY.MAC--Main data acquisition program

FILOUT.MAC--section which writes data to disk

HOUR.MAC--keeps track of time

OPEN.MAC--opens file and loads disk device handler

HOW TO MAKE CORRECTIONS

. R EDIT

* EBDX1:prog.Ext\$\$

(to get a complete understanding of how "EDIT" works and the commands available, consult the SYSTEM REFERENCE MANUAL)

After the corrections have been made, the source files (designated by MAC extension) should be assembled under MACRO to produce an object file (OBJ extension) for each source file entered. Then the object files should be linked together to form 1 SAV file.

EXTENSIONS AND DEFAULTS FOR VARIOUS PROGRAMS

EDIT--All extensions are user-defined except when editing a backup program file (see SYSTEM REFERENCE MANUAL). In this case the extension is BAK (figs. 11 and 12).

MACRO

Default extension for input files is MAC.

For output files the default extensions are:

OBJ--Object code

LST--Assembled listing

LINK

Default extension for input is OBJ.

For output files the default extensions are:

SAV--Save image file

MAP--map of all c sects and global and local symbols (see SYSTEM REFERENCE MANUAL)

All user-defined extensions must be included on all I/O files or default extensions will be assigned as follows:

MACRO

dev:filename.ext,dev:filename.ext=dev:filename.ext
 ↑ ↑ ↑
 OBJ LST MAC

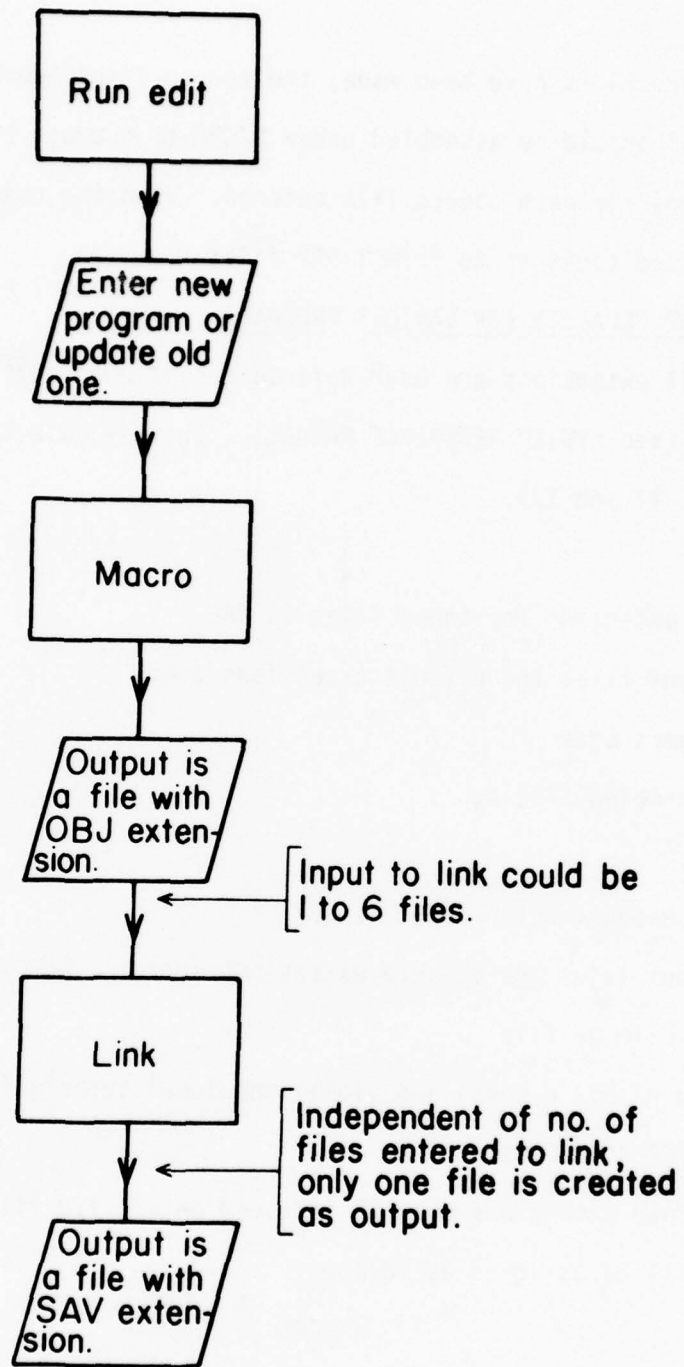

Figure 11. Flow Chart Representing General Program Creations Within the Computer System.

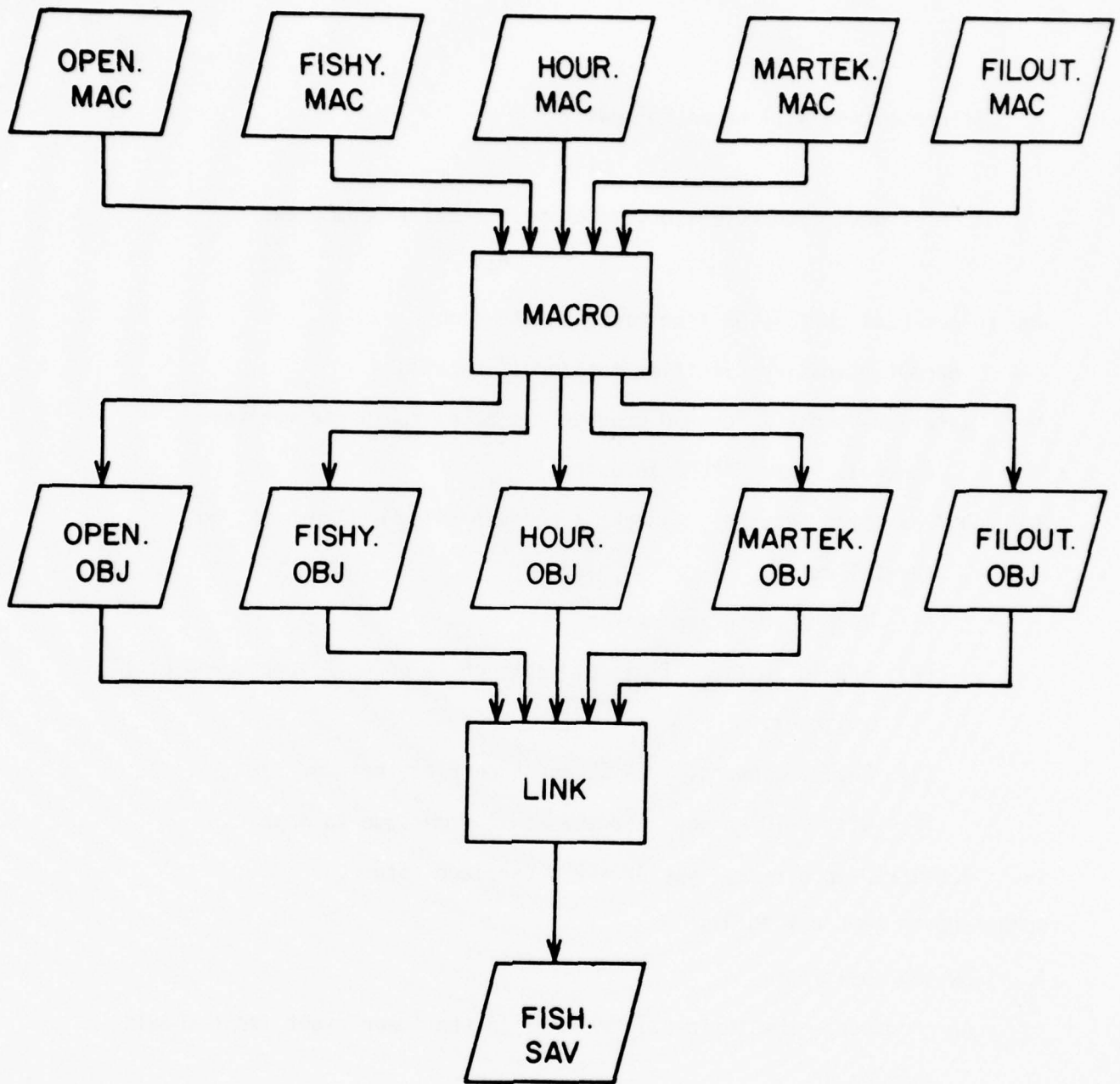

Figure 12. Flow Chart Illustrating the Files and System Programs as Incorporated into the Biomonitoring Computer System.

If unassigned will be as follows:

LINK

```
dev:filename.ext,dev:filename.ext=dev.filename.ext
          ↑           ↑           ↑
          SAV        MAP        OBJ
```

How to get back to MONITOR from various situations.

- .-- prompt character signifies monitor is running
- *-- asterisk--shows a "canned program" is being run under monitor control. Type CTRL C to exit.
- @-- ODT has been entered. To make sure everything will run OK, do the following:
 - (1) Toggle the DC/on switch.
 - (2) \$ should appear. If it did not, check power keyboard and panel switches.
 - (3) Once \$ appears, type DX and a carriage return.
 - (4) Wait 5-10 seconds for the monitor message to appear.
- \$-- Bootstrap occurred. Type DX and a carriage return.

SUMMATION OF SOME KEY POINTS

- I. Switch positions
 - A. Computer--the three (3) switches on the lower right front should all be up.
 - B. Decwriter--Top row of switches on left of console.
 1. Local/Line--should be up
 2. Full/half duplex--should be up
 3. 110 baud--should be up
 4. 300 baud--should be up

II. Startup procedure

- A. Make sure step 1 is taken
- B. Toggle the DC/on switch (located in the leftmost portion of the 3 switches on the front of the computer)
- C. After \$ appears, enter DX and a carriage return.
- D. Wait 5-10 seconds for the RT/11 monitor message to print which should be immediately followed by a '.' prompt character
- E. Next enter the date in the following format:

._ DAT DD-MMM-YY <CR>

e.g.

._ DAT 23-OCT-77 <CR>

- F. Next enter the time of day in 24 hour time. (Make sure zeroes are used as place holders.) Format is:

._ TIM HH:MM:SS <CR>

e.g.

._ TIM 9:06:00 <CR>

._ TIM 16:35:00 <CR>

NOTE: Date and Time must be added later so above steps are not necessary.

To exit a program type "CTRL C" (holding the CTRL and C buttons simultaneously). At times it may be necessary to type consecutive "CTRL C" twice.

If "ODT" has been entered (signified by the "@" prompt character; do the following:

1. First--try typing the character P for proceed (make sure the caps button is down). If this does not work go to statement 2 of section II. Once the monitor has been loaded in again the program running at the time of the interruption will have to be re-run.

PROMPT CHARACTERS AND THEIR MEANINGS

- '.' period--signifies monitor is waiting for a command
- '*' asterisk--canned program, run under monitor control is waiting for a command
- '\$' dollar sign--waiting for DX to be entered. Usually appears because of some sort of power failure.
- '@' at sign--ODT (on-line debugging technique) has been entered.

G. DILUTER SYSTEM

1. PHYSICAL DESCRIPTION

Figure 13 depicts the diluter system designed for, and incorporated into, this project. Two ten liter (2.64 gal) head boxes are kept filled with effluent and diluent respectively. The head boxes are fitted with overflow pipes. Effluent and/or diluent are pumped in continuously at a rate fast enough to ensure sufficient water to overflow through the overflow pipe, thus maintaining a constant head pressure. The same principle of maintaining constant head pressure has been incorporated into the mixing chambers. The mixing chambers each have a series of weirs which assures adequate mixing of diluent and effluent. Each mixing chamber has an 8 l (2.11 gal) capacity and feeds four monitor tanks through a manifold system (Fig. 13).

2. WATER SOURCES

Effluent water is supplied to the trailer via electric lift pumps. Radford Army Arsenal management has agreed to supply these pumps along with the necessary piping to carry the effluent to the laboratory trailer. It should be noted that the trailer unit was so designed that any of several effluents may be supplied and tested. For example, initial shakedown

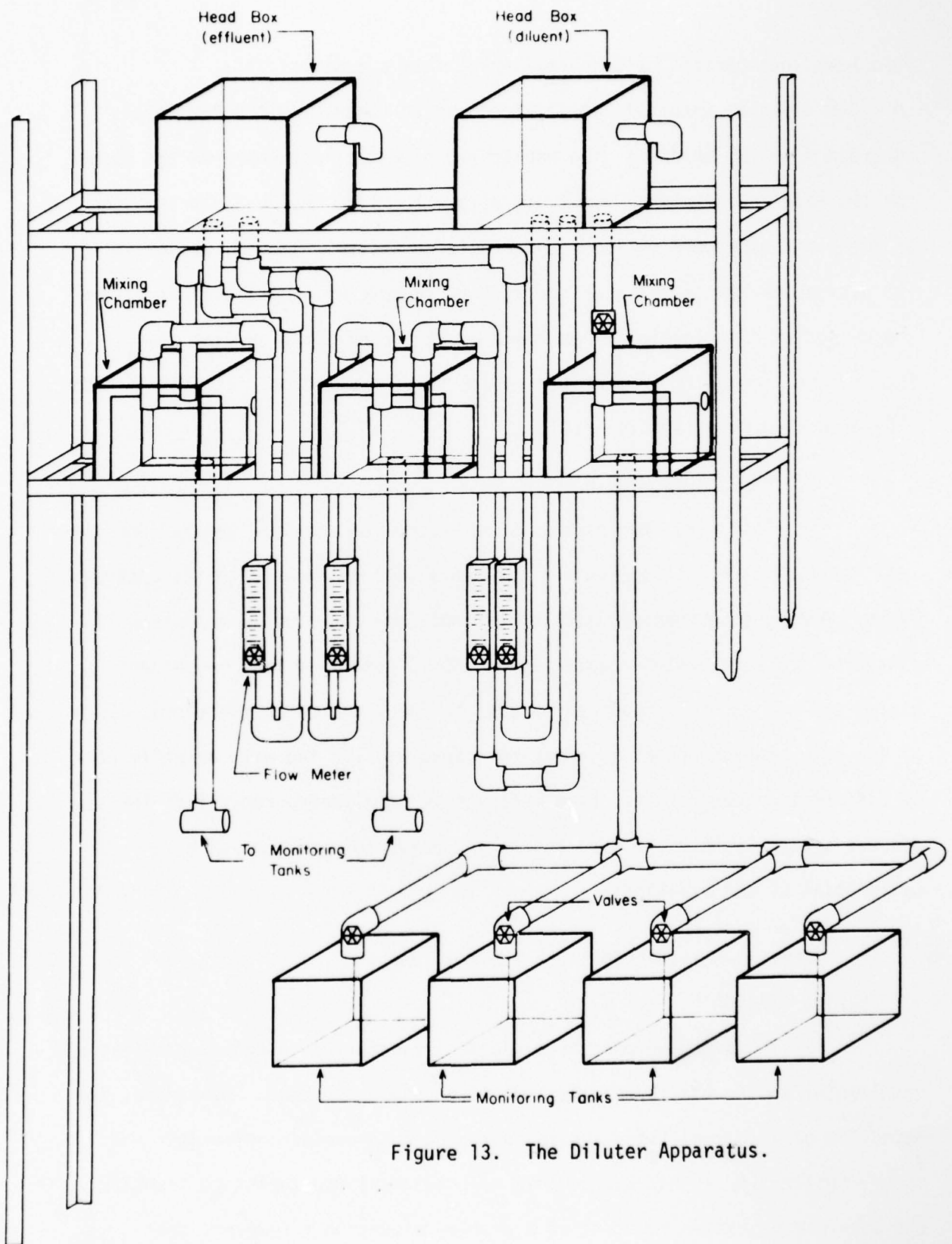

Figure 13. The Diluter Apparatus.

runs have incorporated chlorinated tapwater as a test effluent.

The dilution water will be filtered-water taken from the New River, upstream from the Arsenal. The monitoring of water upstream from the plant has two major advantages. First, it allows for some insight into problems of interaction between effluent and receiving system. Second, because of the design concept of this monitor system, the use of upstream water allows the detection of potentially hazardous aquatic conditions in that area. This feature serves to protect the interests of the industry as well as the experimental design (Section III).

3. DISTRIBUTION OF WATER

Initially, for establishing controlled critical limits (Section III) for each fish, all twelve monitor tanks will be exposed to the upstream water. During subsequent monitoring periods, one group of four tanks will always be fed with upstream water to have some assurance that subsequent alarms are not due to factors extraneous to the plant being monitored. Each of the other two groups of four monitor tanks will be fed with an effluent of different concentrations. Flow meters have been incorporated into the diluter system between the head and mixing boxes to permit precise calibration of the dilutions.

H. CHEMICAL-PHYSICAL ANALYSES AND MONITORING

1. RATIONALE

It is the purpose of biological monitoring to detect conditions detrimental to the quality of the aquatic receiving system. Furthermore, the detection of such conditions should be rapid, thus avoiding hazardous and costly spills. It is not the purpose of biological monitoring to identify the specific causative agent(s) of a problem situation. However, the

practice of biologically monitoring certain chemical and physical parameters of effluents has been widespread and, in general, is widely accepted by industry. But monitoring chemical and physical parameters alone will not predict an effluent's effect on the biota of a receiving system. Therefore, it is recommended that biological monitoring be coupled with some program of chemical and physical monitoring. And it is anticipated that certain correlations between chemical-physical parameters and warning signals, as generated from the biological monitor, will be found. Therefore, specific chemical-physical parameters will be continuously monitored. Furthermore, other more advanced chemical analyses will be incorporated into this project.

2. CHEMICAL-PHYSICAL MONITORING

a. PROPERTIES MONITORED

Conductivity, the amount of dissolved oxygen, the pH, and the temperature will be continuously monitored. Figure 14 depicts the control unit employed. The sensors have been submerged in a 19 liter (5 gal) continuous flow container. The entire apparatus, a Model Mark V Water Quality Analyzer, is manufactured by Martek Instruments, Inc., 879 West 16th Street, Newport Beach, California 92660. The unit was selected for its potential compatibility with a computer system. All four chemical-physical parameters are continuously and simultaneously represented at the output as 0-1 volt DC analog signals scaled for each parameter. A complete instruction manual for the Analyzer was provided by the manufacturer and is kept in the trailer. The user should refer to this manual for complete instructions, maintenance information, and unit specifications.

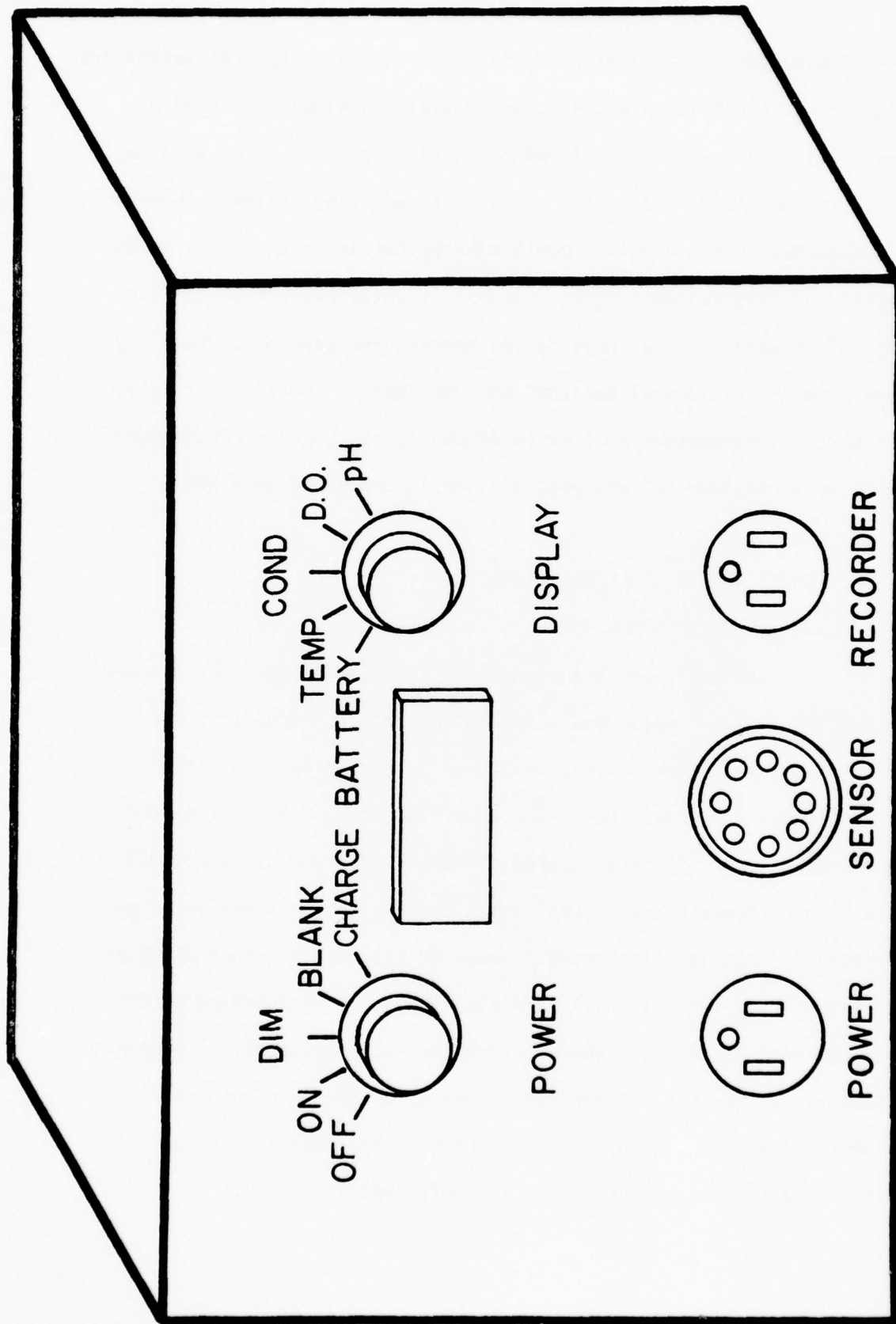

Figure 14. The Control Unit of the Chemical-Physical Monitor.

b. INTERFACE TO COMPUTER AND ADJUSTMENTS

A set of amplifiers has been constructed for the purpose of interfacing the Analyzer with the computer system employed (Figs. 15, 16, 17). The amplifiers are housed within the amplifier rack as illustrated in Figure 6. The amplifiers increase the 0-1 volt DC output of the Analyzer to the 1-10 volt DC range required for computer compatibility.

Calibration of these amplifiers should be checked routinely. This procedure will be described later on. Prior to checking, however, it is recommended that certain internal adjustments be made to the Analyzer three times a year to compensate for DC offset. To do this, the user should refer to the manufacturer's instruction manual. The routine amplifier calibration checks are as follows (referring to Figure 6):

Disconnect Martek from Amplifier Rack Before Proceeding.

1. Ground input at each parameter on rack (Fig. 6)
2. Adjust internal DC offsets until respective outputs equal zero.
3. Reconnect Martek
4. Take voltage reading at Input socket representing each of the four chemical-physical parameters being monitored.
5. Take voltage reading at output socket representing each of the four chemical-physical parameters.
6. Adjust respective gain controls so that the output for a given parameter equals 10X the input voltage.

3. CHEMICAL ANALYSES

Several complete water chemical analyses will be run by the personnel at the Radford Army Ammunition Plant. Routine samples will be assessed periodically. In addition, an on-line automatic water sampler enables the collection of water samples at will. Therefore, in addition to

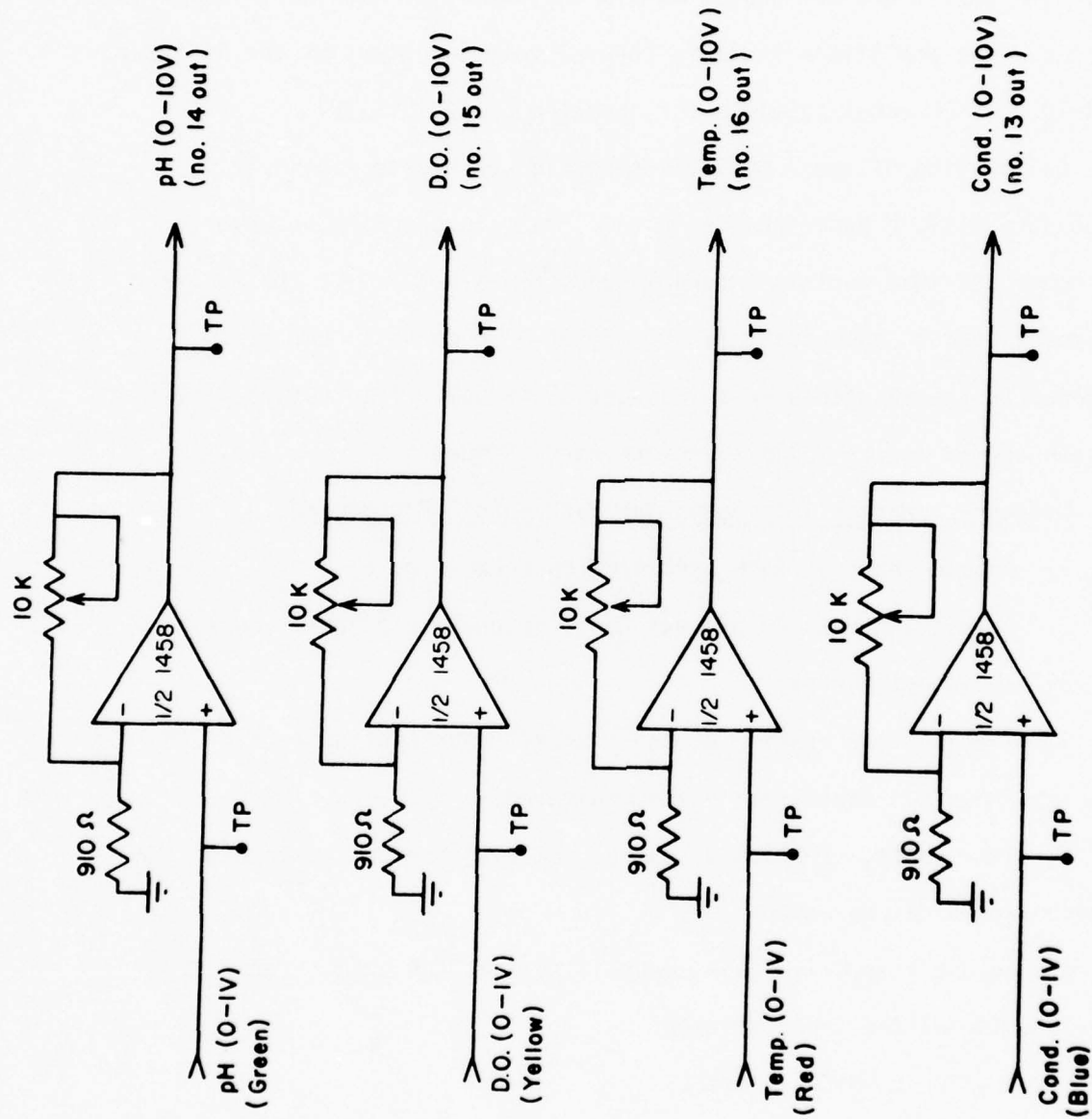
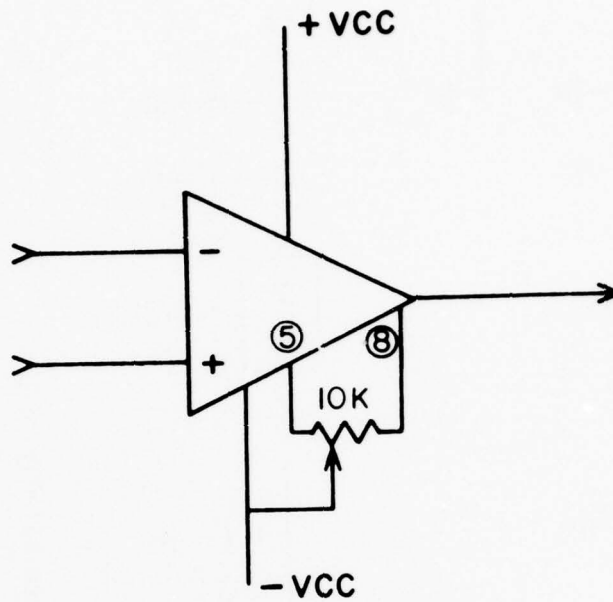

Figure 15. Interface from Chemical-Physical Monitor to ADAC of Computer System. Four dc Amplifiers raise the 0-1 volt outputs to 0-10 volts. Access to Gain Pots and Test Points (TP) for Inputs and Outputs are Located on Front Panel of Amplifier Rack.

(A)



(B)

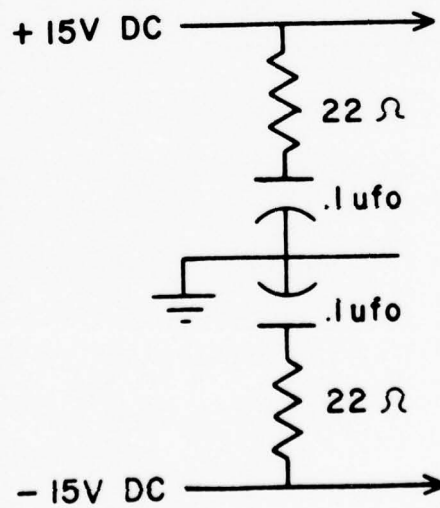

Figure 16. (A) Connections for Output dc Offset Adjustments of Chemical-Physical Monitor. (B) Power Supply Decoupling Hardware.

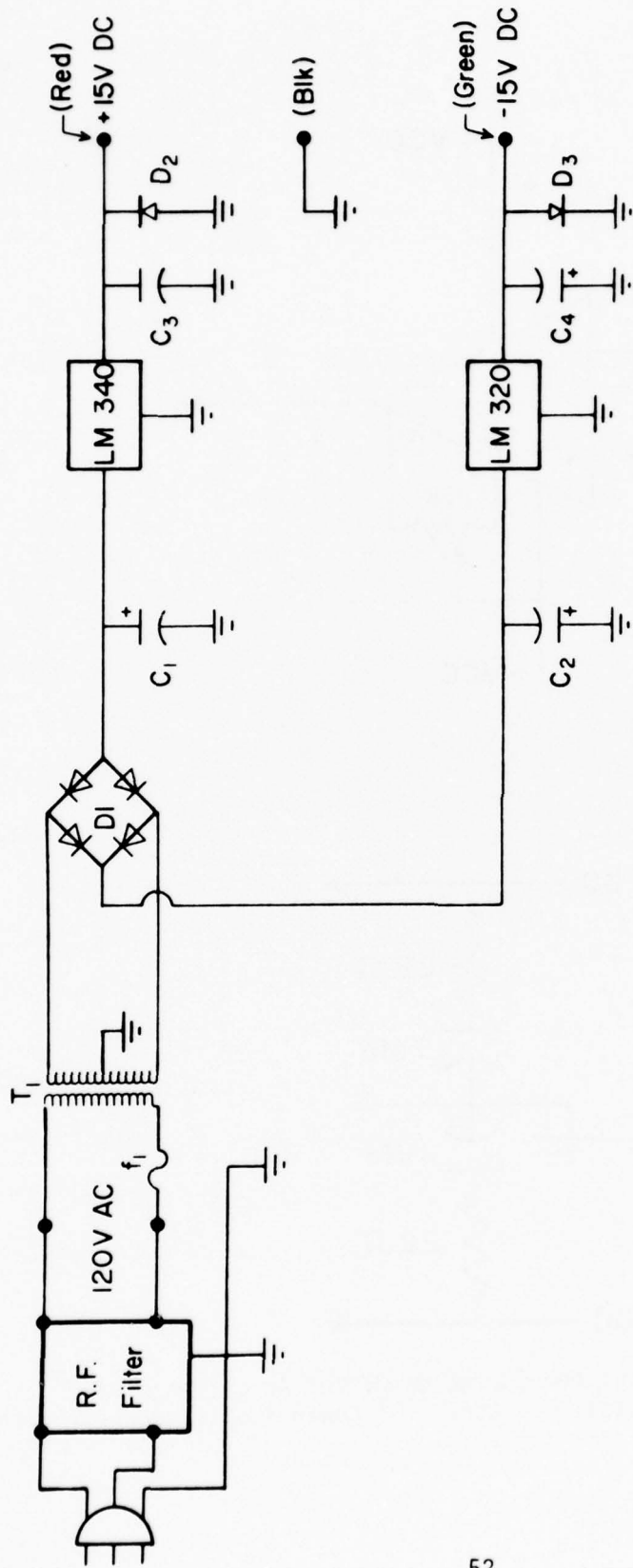

Figure 17. + 15-Volt Regulated Power Supply for Chemical-Physical Monitor In-interface.

C1, C2 = 5000 μ F 50 v dc

C3, C4 = 2.2 μ F 35 v dc (Tantalum)

R1, R2 = 10 Ω

D1 = 1 amp 100 v bridge rectifier

D2, D3 = 1N4720 or other 1 amp 100 v diode

1 heat sink for 2 voltage regulators in TO-3 cases

1 double fuse holder

routine sampling, samples presumably will be taken in response to warning signals generated by the biological monitor.

4. AUTOMATIC WATER SAMPLER

As previously stated, routine samples of effluent will be taken for advanced chemical analyses. Eventually, samples will be taken whenever the biological monitor generates the proper warning signals. This will be accomplished through interface hardware which is, at present, in the planning stages.

The water sampler incorporated into this system is a Sigmamotor Sampler, Model WM-1-24R manufactured by Sigmamotor, Inc., 14 Elizabeth Street, Middleport, N.Y. 14105. The unit is a discrete sampler which collects samples in 24 polyethylene containers. It has a fixed flow rate and a variable On, Off, and Purge Time. The sample containers are located in a refrigerated compartment where the temperature is adjustable and thermostatically controlled.

The manufacturer has provided a complete instruction manual which is kept in the trailer. The user should refer to this manual for a complete set of instructions and when engaged in troubleshooting.

I. CONTINUOUS FLOW BIOASSAY

1. RATIONALE

In recent years, the bioassay has become an important tool in the evaluation of a pollutant's impact on an aquatic environment. A bioassay has been defined as a test in which the quantity or strength of toxic material is determined by the reaction of a living organism to it (Sprague, 1973). Not only does the bioassay serve as an excellent addition to physical-chemical monitoring, but through the refinement of techniques and procedures, it presents an excellent format for the reporting of a

pollutant's toxicity. The recent standardization of bioassay procedures and nomenclature has made the interpretation of results less complicated, and increased the potential for replication.

It is not the purpose of this report to delve into the many aspects of a complete bioassay, but rather to provide an outline for the construction and use of the continuous-flow bioassay unit incorporated into this present system. The interested reader is referred to Sprague (1973) who deals with the bioassay and its interpretation in a rigorous manner.

There are basically two types of bioassays in current use: (1) batch testing and (2) continuous flow testing. The batch method represents the simplest bioassay. It requires a smaller expenditure than continuous flow testing with regard to initial materials for construction, operating expenses, and personnel expertise. The batch method today is used mainly in the study of a single pollutant at various concentrations. Its application to even the simplest of wastewater yields results that could at best be considered only approximate. Additionally, if the wastewater contains elements that are degradable or volatile, the batch method presents a less than ideal testing scheme.

The continuous flow bioassay should be the preferred method of testing and is the procedure that will be used during this project. Although the expense is considerably higher than batch testing, the results better reflect the true nature of a wastestream. Therefore, a continuous-flow bioassay unit has been incorporated into this project.

2. DESCRIPTION

The design of the continuous-flow bioassay unit incorporated was taken from Hendricks et al. (1977). A diagram of the unit is presented

in Figure 18. The major components of the system are: (1) two head boxes, one for the diluent water (either a synthetic or upstream water) and one for the wastewater; (2) two proportioning boxes: one diluent, one wastewater; (3) one mixing chamber for each concentration to ensure thorough mixing prior to discharge into the test tanks; and ten bioassay vessels in which 5-10 fish will be placed. The dilution system is designed to deliver a precisely measured continuous supply of wastewater along with a diluent. By varying the height of the standpipe in the proportioning box it is possible to deliver a broad range of dilutions. These dilutions, as suggested by Sprague (1973), should follow a logarithmic series.

The head boxes, proportioning boxes, and mixing chambers were constructed of $\frac{1}{2}$ -inch plexiglass. The dimensions for each are presented in Figures 18, 19, and 20. Should the wastewater contain elements that might react with plexiglass, an alternative, such as glass, may be used. The bulkhead fittings are made of Teflon^{*} and the solenoid valves are Teflon lined. The entire system has been mounted in a framework constructed of angle-iron supports and $\frac{1}{2}$ -inch exterior-grade plywood shelves.

3. OPERATION OF DILUTER SYSTEM

The diluter system is designed so that the experimenter need not be present for the duration of the test. The test sequence is begun when the solenoid valves at the effluent end of the head boxes are opened. The diluent and wastewater then flow to their respective proportioning boxes where the water flows over a series of plexiglass plates set at various heights. When the last chamber of the diluent box is full, a microswitch is

*Trade name of E. I. duPont de Nemours & Co., Inc.

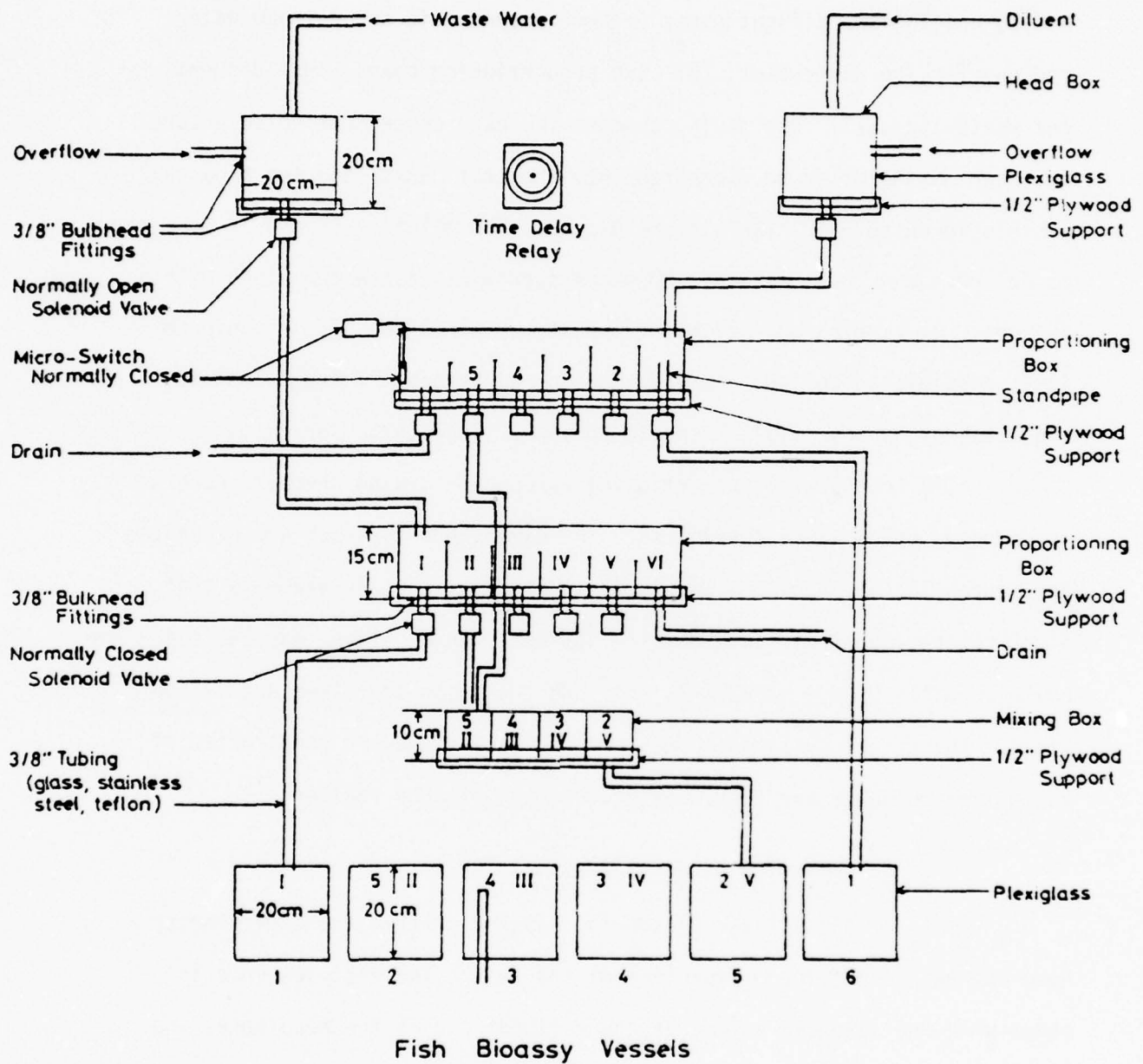

Figure 18. The Continuous Flow Bioassay Unit. (From Hendricks et al., 1977.)

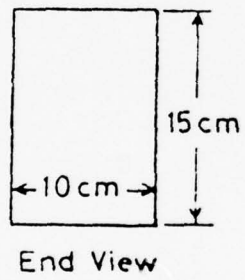
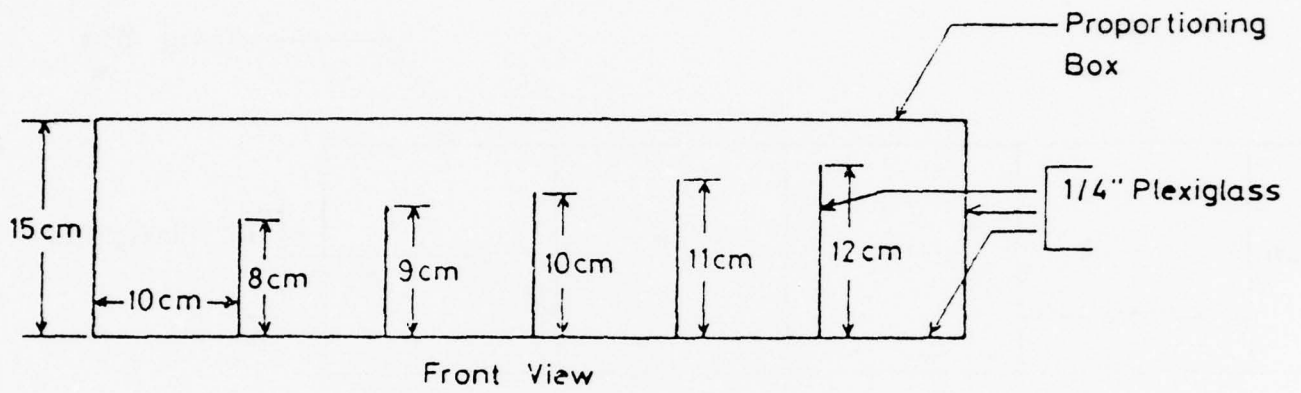

Figure 19. Diagram and Dimensions of Proportioning Box. (From Hendricks et al., 1977.)

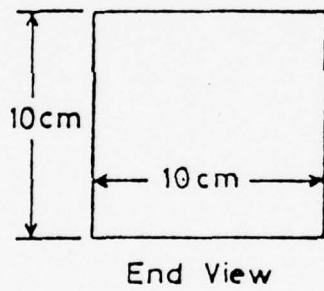
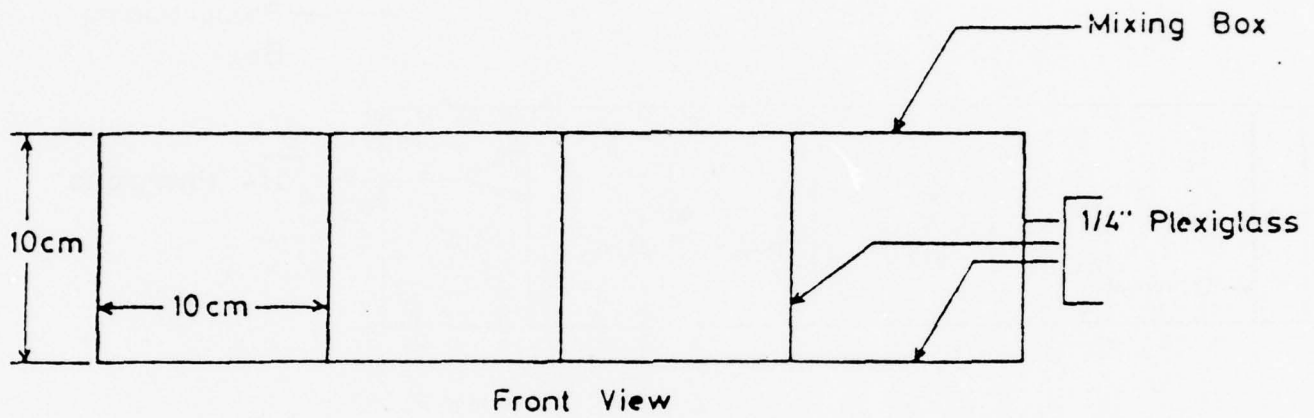

Figure 20. Diagram and Dimensions of Mixing Box. (From Hendricks et al., 1977.)

closed. This opens the solenoid valves at the effluent end of each proportioning box while at the same time activating a time-delay relay. The time-delay relay (TDR) shuts off the solenoid valves for the head boxes and is preset to allow each proportioning box to empty. The water from the diluent proportioning box is then combined via a T-connection with the water from the corresponding wastewater proportioning box. The result is diluted wastewater of known concentration. The combined waters then flow to a mixing chamber designed to ensure thorough mixing of diluent and wastewater. After mixing, the diluted wastewater is delivered to the fish vessels. There are two containers for each dilution. Each vessel will house 10 fish which serve as the sensors. At the end of the preset period, the head boxes' solenoid valves are opened and the proportioning boxes' valves are closed. At this time, the cycle begins again.

The experimenter is free to choose a wide range of dilutions through adjustments of the height of the standpipe in each chamber of the proportioning boxes. The detention times in each test vessel (fish containers) can be determined by using the graph shown in Figure 21. The experimenter simply chooses the replacement time desired (50-99%); by knowing the flow rate and tank volume, the approximate detention time can be discerned. This value becomes very important during the interpretive phase of any bioassay, because the fish weight-to-volume ratio is a significant parameter when reporting test results.

J. MISCELLANY

1. HOLDING TANK

The holding tank used measures 1.5 x 0.6 x 0.6 m (5x2x2 ft). It is constructed of 3/4-inch exterior grade plywood, painted with a two-part

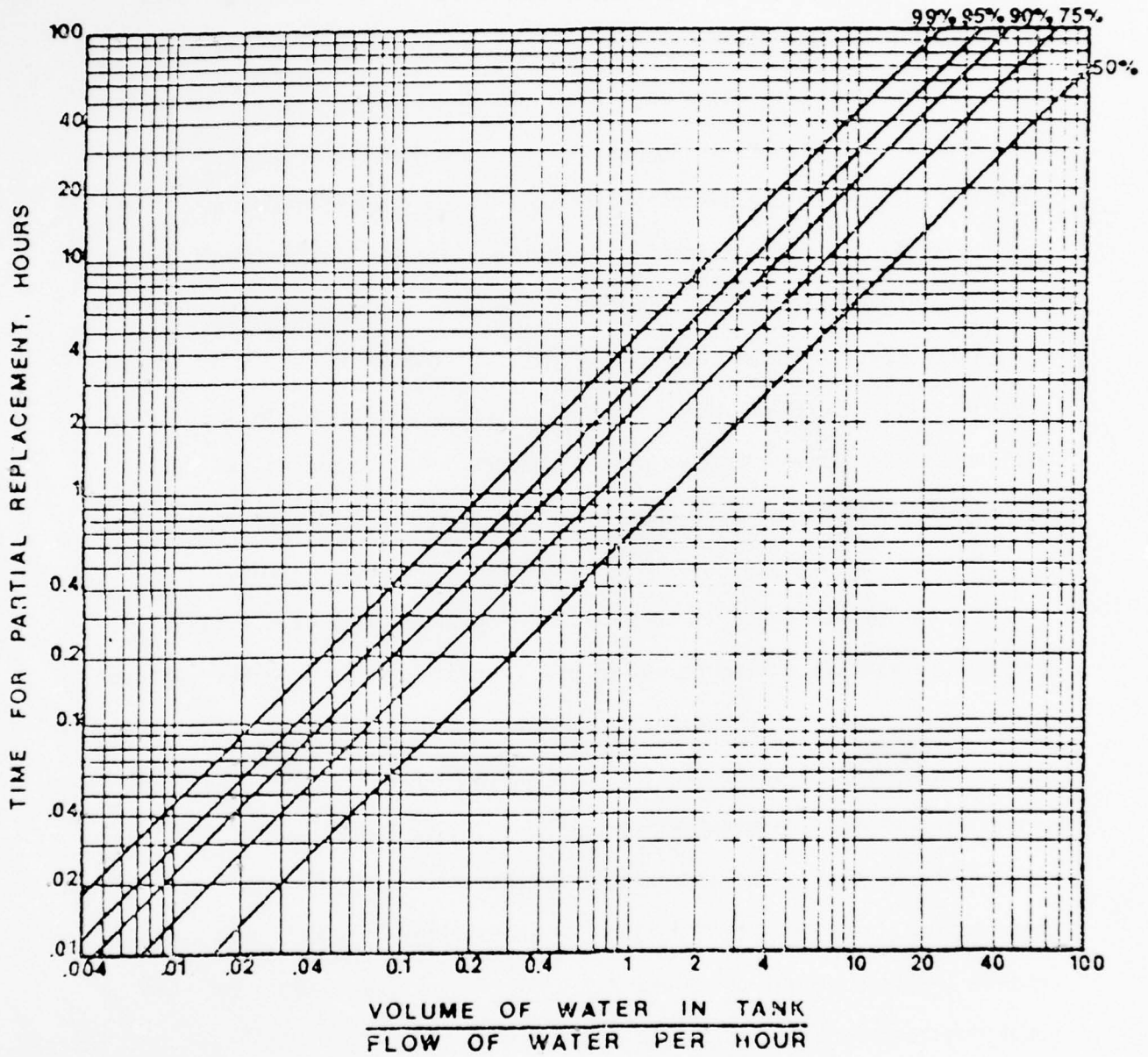

Figure 21. Curves for Determining Partial Replacement Time. (From Sprague, 1973).

epoxy marine paint, and caulked with a silicone sealant. The tank may be operated either as a closed or open system. Figure 22 illustrates the tank as a closed system. Essentially, as a closed system, the tank operates on the principle of a bubble-up biological filter. Therefore, cleaning should be limited to only occasional rinsing of the "filter fluff." For operation as an open system, the filter portion of the tank may be eliminated if desired. A standing pipe must also be added. When on site at the Radford Army Ammunition Plant, the holding tank will be converted to a continuous flow open system.

2. AUTOMATIC FEEDERS

Each compartment within the biological monitoring module and the holding tank will be supplied with automatic feeders. The fish will be fed twice per day. The feeders selected were manufactured by Luster Products Co., 101 Victory Road, Springfield, N.J. 07081, and were purchased through the Cappel Corporation, 4630 Eisenhower Avenue, Alexandria, Virginia 22304. A complete set of manufacturer's instructions are kept on board the trailer.

3. FISH SIGNAL SIMULATOR

For the purpose of programming the computer, as well as testing various aspects of the computer interfacing, an instrument capable of generating a fish breathing signal was built (Fig. 23). The basic type of signal generated depends upon the incorporation of a customized electronic chip. It was designed by Dr. Raymond Dessy, Professor of Chemistry, Virginia Polytechnic Institute and State University, Blacksburg, Virginia. In addition to the basic signal, various levels of noise may be added manually, thus

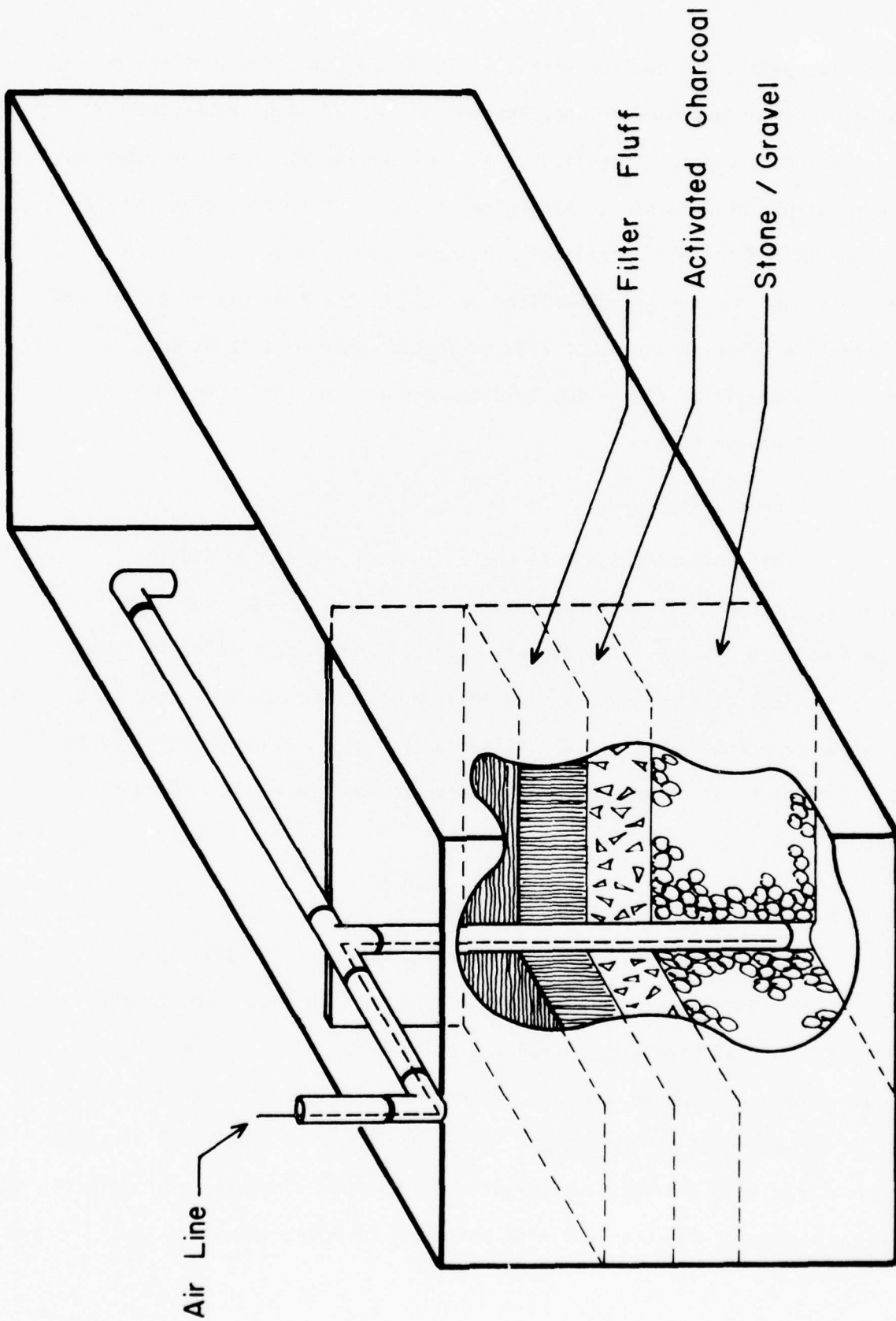

Figure 22. The Holding Tank.

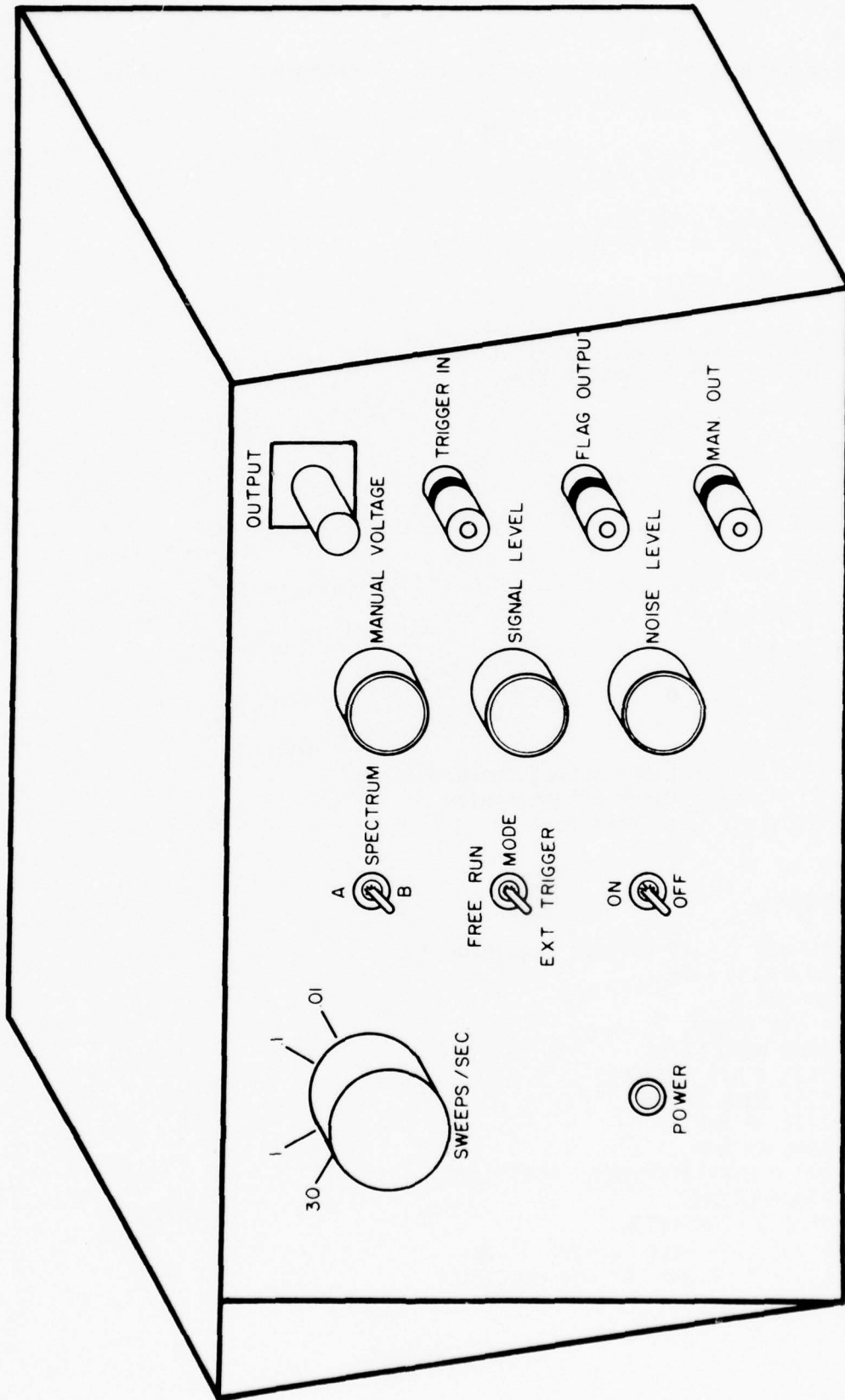

Figure 23. Fish Ventilatory Signal Simulator.

allowing for a variety of signal:noise ratios. A component list follows:

Capacitors

1	100 pf	
1	330 pf	
1	0.01 μ f	
6	0.1 μ f	
1	0.2 μ f	
1	1 μ f	
1	100 μ f	25V electrolytic (radial)
2	1000 μ f	25 V electrolytic

Resistors

2	330 Ω	1/4 watt
2	390 Ω	"
1	1 K	"
2	3.3 K	"
2	10 K	"
2	12 K	"
3	120 K	"
1	220 K	"
3	330 K	"
5	1 Meg	"
2	1.2 Meg	"
2	10 K	linear taper potentiometers
1	50 K	linear taper potentiometer
1	100 Ω	1/2 watt resistor

Semiconductors

1	LM 320 K	- 15 voltage regulator I.D.
1	LM 340 K	- 15 "
1	LM 340 K	- 5 "
1	NE555	timer
2	7400	NAND GATES
2	7493	4 bit counters
1	5558	DUAL OP AMP
1	741C	OP AMP
1	5556	OP AMP
1	371-8	HYBRID SYSTEMS 8 BIT DAC
2	1702A	EPROMS
1	2N2219	TRANSISTOR
1	9 volt	1 watt zener diode
1	100 PIV	2 amp bridge rectifier

Miscellaneous

- 4 8 pin dip sockets
- 4 14 pin dip sockets
- 2 24 pin dip sockets
- 1 16 pin dip sockets
- 1 Power Transformer (117 VAC PRI. 24 VAC C.T. SEC.)
- 2 SBDT mini toggle switches
- 1 DPST mini toggle switch
- 1 line cord (3 conductor)
- 1 neon pilot light
- 1 fuse holder
- 1 3 pole 4 position rotary switch
- 5 BNC chassis mount connectors
- 1 Chassis (Calectro Cat. No. H4-748)
- 1 Rubber Grommet (to fit line cord)
- 1 5 lug terminal strip
- 1 Assortment of 6-32 nuts and bolts

III. EXPERIMENTAL DESIGN AND SUPPLEMENTAL REMARKS

A. INITIAL TESTING

For the purpose of initial testing, as well as to demonstrate system feasibility, chlorinated tapwater and Arbitrary Reference Mixture (ARM) have been employed as test effluents. However, these tests were applied early in the development of the present biological monitoring system, and the experimental procedures described below were not necessarily adhered to. Figures depicting the initial effects of these test effluents on the breathing behavior of our biological sensors are presented in Figures 24 and 25. Initial response to chlorinated tapwater is illustrated as a decrease in both amplitude and frequency of the ventilatory signals (Fig. 24). Further analyses have demonstrated that, after the first several minutes of exposure, breathing rates and amplitudes will increase significantly more than the values representing both the initial exposure period and the controls. Only the initial response to ARM has been investigated (Fig. 25). ARM was developed by Buikema, *et al.* (1976) as standard for toxicity testing for the petroleum industry.

B. EXPERIMENTAL PROCEDURE

What follows is a combination of established criteria as well as a projected vision of the experimental design. It should be realized that, since the project has been recently located on site, certain aspects of the procedure have not been established.

1. One fish will be placed in each of the twelve monitor tanks and allowed at least four to five days acclimation time. During this period the fish will be fed twice a day and experience a 12-hour photoperiod. These conditions are the same in the holding facilities and during the monitoring phase.

control

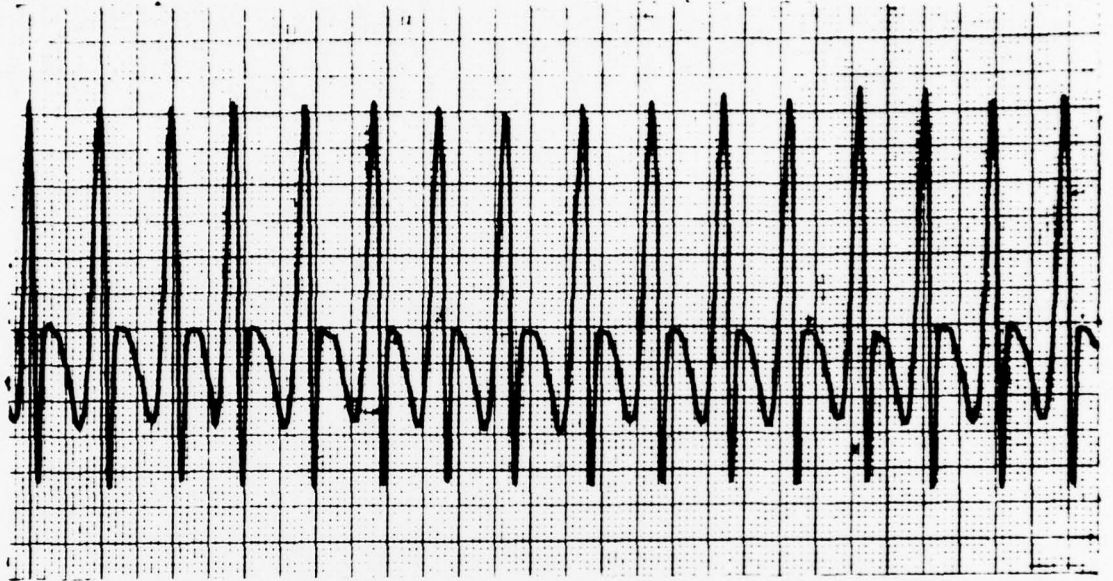

> 5ppm

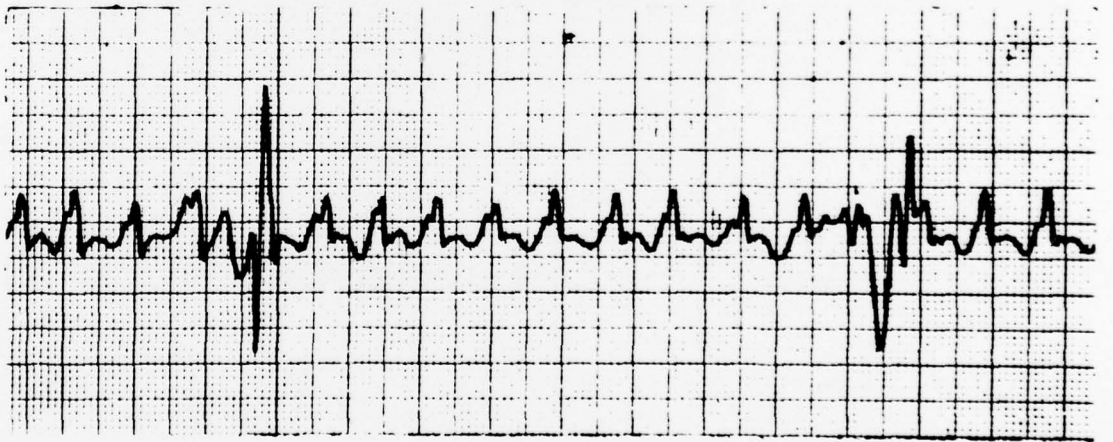

Figure 24. The Initial Ventilatory Response (15-Loser) of a Bluegill Sunfish, Lepomis macrochirus, exposed to 0 and 5 ppm Total Chlorine.

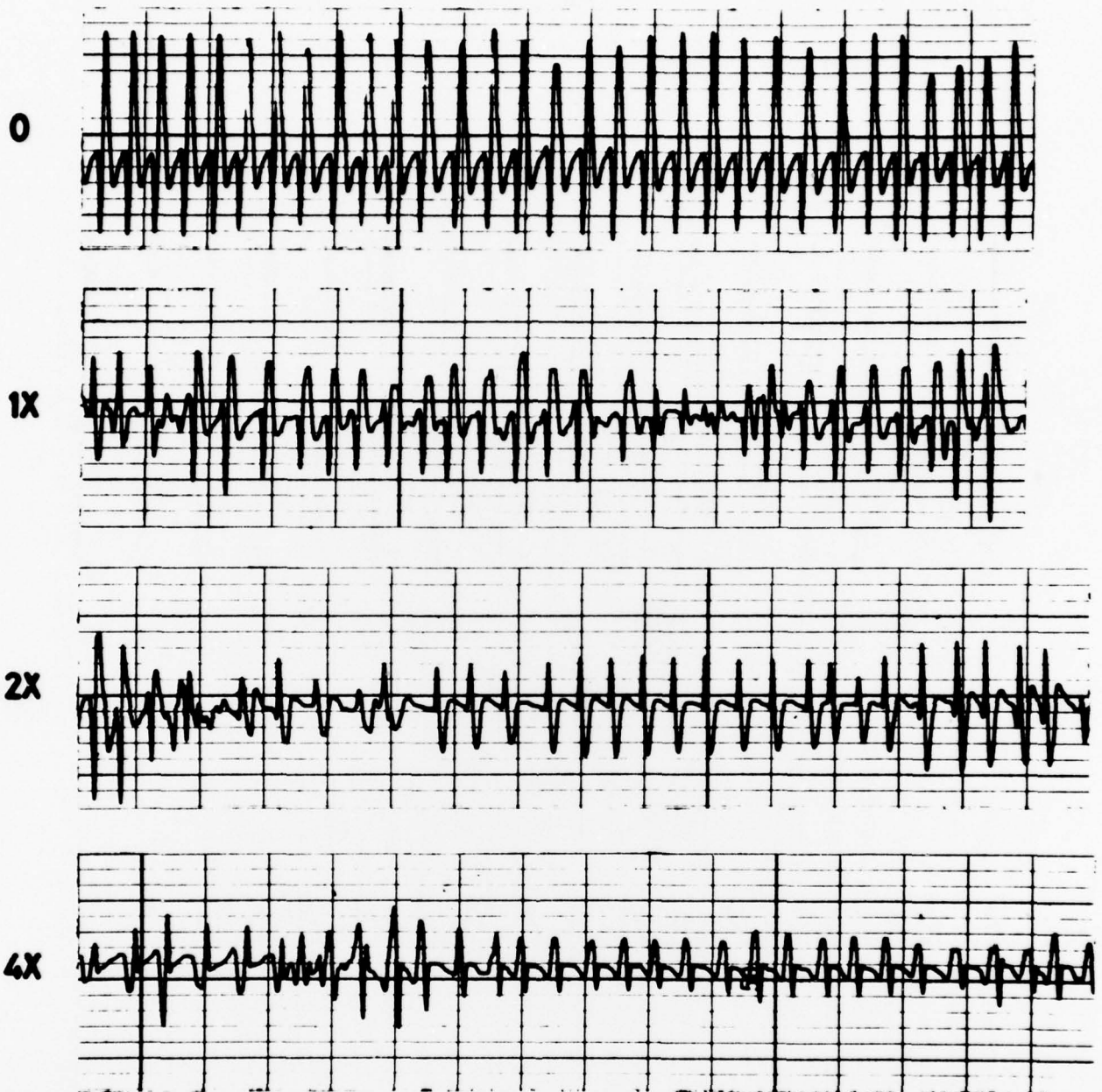

Figure 25. A Comparison of the 1st 20-30 seconds of Exposure to different Concentrations of Arbitrary Reference Mixture (ARM) by the Bluegill Sunfish, *Lepomis macrochirus*.

2. The "normal" breathing behavior will be established for each fish.

a. The breathing rates for each fish will be sampled at predetermined time intervals and stored in the computer system. Predetermined time intervals have initially been established at 15 minutes. This sampling will continue for a four to five-day period.

b. After this period, the computer will average the values obtained from each 15-minute interval of each day. This will yield an average breathing rate value for each of the 96 time periods (4 x 24) and will represent the average breathing behavior over a 24-hour period.

c. Some degree of confidence will be fitted to each of these 96 points. Therefore, a range of normality will be determined for each fish and for each time interval. These ranges will be called the "critical limits."

e. Figure 26 is a graphic representation of one possible set of critical limits that were established for one fish.

e. The critical limits for each fish, as well as the values used to obtain the critical limits, will be stored in the computer system.

3. After "critical limits" have been established, the monitoring period will commence. This period will probably be carried out for 2 weeks.

4. During the monitoring period, the breathing rates from each fish will be sampled for each time interval (initially 15-minute intervals).

5. The values sampled will be compared with the respective set of critical limits to see if the value falls within the previously determined range for that time of the day.

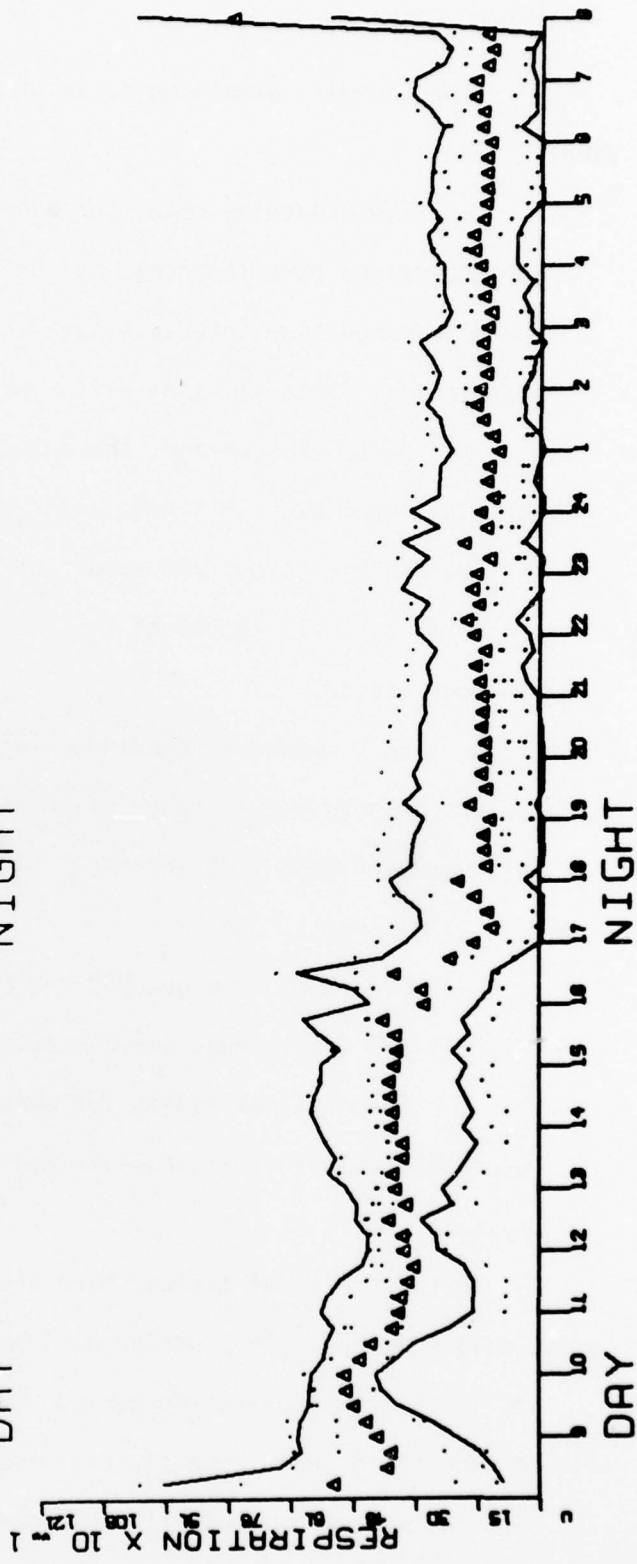
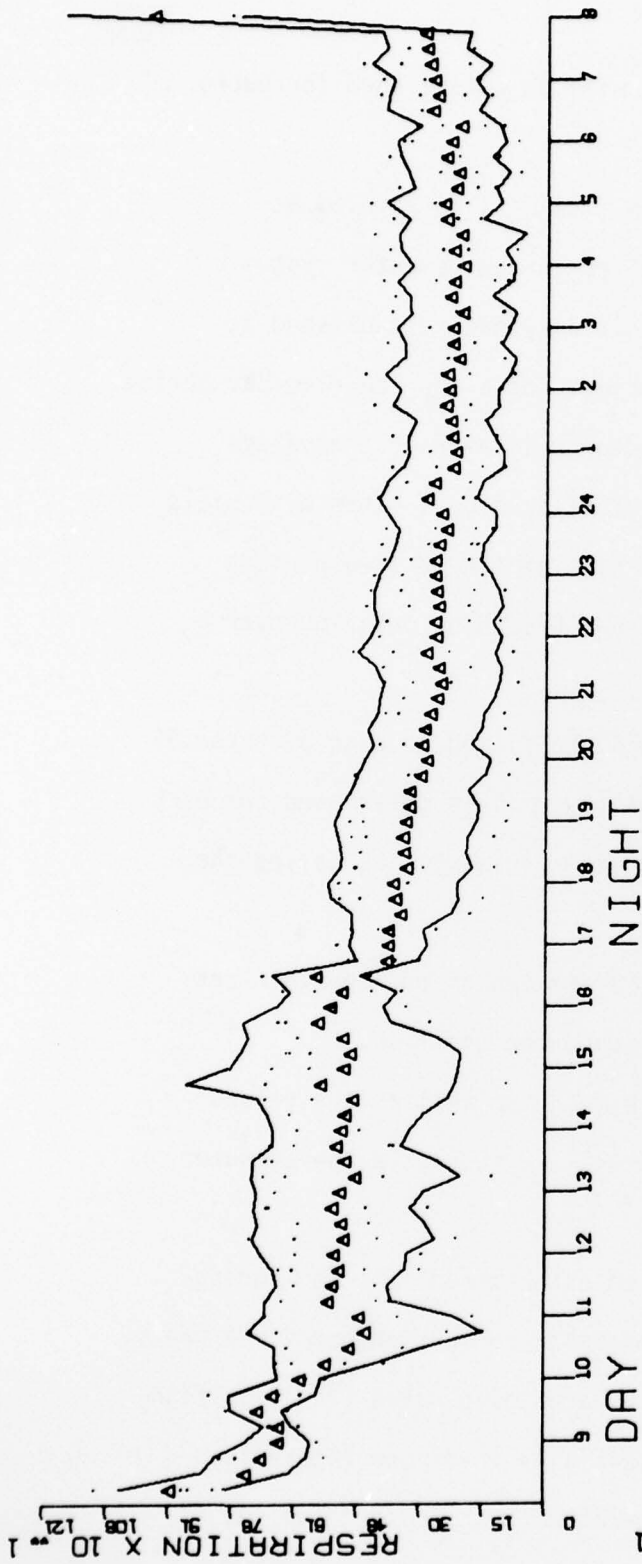

Figure 26. A Set of "Critical Limits" as Established for Two Bluegill Sunfish, *Lepomis macrochirus*.

6. These sampled values, along with the values of conductivity, dissolved oxygen, pH, and temperature will be stored on the computer diskette system.

7. If the value from one of the samples falls outside its respective "critical limit," a warning signal will be generated. This signal initially will be an asterisk printed out beside the value obtained and stored.

8. If enough fish display warning signals simultaneously, an "alarm" signal will be generated. The number can not be established until we are on site, but most likely this will be three of the four fish representing one of the three groups.

C. SUPPLEMENTAL REMARKS

It should be realized that this "alarm" signal is the basis of industrial control. Eventually, both the "warning" and "alarm" signals will be interfaced to a visual display for convenience. Furthermore, the signals will be interfaced to the automatic water sampler. In concept, however, these signals will ultimately have to be interfaced to the industry's water control facilities, for it is envisioned that when the appropriate "alarm" signals are generated, the effluent must be prevented from reaching the receiving system. After this has been accomplished, further chemical and physical monitoring and analyses would be carried out to determine the nature of the problem. At this point, simply increasing the retention time might solve the problem, an evaluation which could be made through the biological monitoring system. If retention time was not possible and/or effective, the effluent could be channeled through some advanced treatment facilities. It is envisioned that this approach of

rapid and continuous biological monitoring, coupled with the chemical and physical monitoring and occasional advanced chemical analyses, would not only prove itself cost effective, but it would protect the water quality of a receiving system most efficiently.

LITERATURE CITED

Barham, E. G., Huckabay, W. B., Gowdy, R., and Burns, B. Micro-volt electric signals from fishes and the environment. *Science* 164, 965-968 (1969).

Belding, D. L. The respiratory movements of fish as an indicator of a toxic environment. *Trans. Am. Fish. Soc.* 59, 238-246 (1929).

Buikema, A. L., Lee, D. R., and Cairns, J., Jr. A screening bioassay using *Daphnia pulex* for refinery wastes discharged into freshwater. *Journal of Testing and Evaluation* 4(2), 119-125 (1976).

Cairns, J. Jr., Dickson, K. L., and Westlake, G. F. Continuous biological monitoring to establish parameters for water pollution control. *Water Technol.* 7(516), 829-841 (1975).

Cairns, J. Jr., and Sparks, R. E. The use of bluegill breathing to detect zinc. *Water Pollut. Control Res. Ser. Contract 18050 EDP*, 55 p (1971).

Cairns, J. Jr., Sparks, R. E., and Waller, W. T. The use of fish as sensors in industrial waste lines to prevent fish kills. *Hydrobiologia* 41(2), 151-167 (1973).

Cairns, J. Jr., Sparks, R. E., and Waller, W. T. The design of a continuous flow biological early warning system for industrial use. *Eng. Bull. Purdue Univ. Enb. Ext. Ser.* 141(1), 242-255 (1974).

Camougis, G. Recording bioelectric potentials from aquatic animals. *Turtlox News* 38, 156-157 (1960).

Drummond, R. A., and Dawson, W. F. An inexpensive solid state amplifier for detecting movements and electrical potentials of fish. *Trans. AM. Fish. Soc.* 103(2), 391-392 (1974).

Drummond, R. A., Olson, G. F., and Batterman, A. R. Cough response and uptake of mercury by brook trout, *Salvelinus fontinalis*, exposed to mercuric compounds at various hydrogen ion concentrations. *Trans. Am. Fish. Soc.* 103(2), 244-249 (1974).

Goodman, D., and Weinberger, N. M. Submerged electrodes in an aquarium: validation of a technique for remote sensing of behavior. *Behav. Res. Methods Instrum.* 3(6), 281-286 (1971).

Gruber, D., Cairns, J. Jr., Dickson, K. L., Hummel, R. III, Maciorowski, A., and van der Schalie, W. H. An inexpensive, noise-immune amplifier designed for computer monitoring of ventilatory movements of fish and other biological events. *Trans. Am. Fish. Soc.* 106(5), 497-499 (1977).

Heath, A. G. A critical comparison of methods for measuring fish respiratory movements. *Water Res.* 6, 1-7 (1972).

Hendricks, A. C., Dickson, K. L., and Cairns, J. Jr. A mobile fish bioassay unit for effluent testing. A report prepared for the Manufacturing Chemists Association (1977).

Lonsdale, E. M., and Marshall, W. C. Jr. Noncontact sensing of electric fields surrounding trout. *ISA Trans.* 12, 82-87 (1973).

Lunn, C. R., Toures, D. P., and Pree, D. J. Effects of three pesticides on respiration, coughing, and heart rates of rainbow trout (*Salmo gairdneri*). *Can. J. Zool.* 54, 214-219 (1976).

Maciorowski, A. F., Westlake, G. F., Benfield, E. F., and Cairns, J. Jr. A technique utilizing crayfish locomotor activity as a sensor in an automated biological monitoring system. *Assoc. Southeast. Biol. Bull.* 23(2), 78 (1976).

Morgan, W. S. G. An electronic system to monitor the effects of changes in water quality on fish opercular rhythms, pp. 38-55 in Cairns, J. Jr., Dickson, K. L., and Westlake, G. F. (eds.), *Biological Monitoring of Water and Effluent Quality*, STP607, American Society for Testing and Materials, Philadelphia, Pa., 1976.

Schaumburg, F. D., Howard, T. E., and Walden, C. C. A method to evaluate the effects of water pollutants on fish respiration. *Water Res.* 1, 731-737 (1967).

Shelton, G. The regulation of breathing, pp. 293-360 in Hoar, W. S., and Randall, D. J. (eds.), *Fish Physiology IV*, Academic Press, New York, 1970.

Sparks, R. E., Cairns, J. Jr., and Heath, A. G. The use of blue-gill breathing rates to detect zinc. *Water Res.* 6, 895-911 (1972).

Sparks, R. E., J. Cairns, Jr., R. A. McNabb, and G. Suter, II. Monitoring zinc concentrations in water using the respiratory response of bluegills (*Lepomis macrochirus* Rafinesque). *Hydrobiologia* 40(3), 361-369 (1972).

Spoor, W. A., and Drummond, R. A. An electrode for detecting movement in gradient tanks. *Trans. Am. Fish. Soc.* 101, 714-715 (1972).

Spoor, W. A., Neiheisel, T. W., and Drummond, R. A. An electrode chamber for recording respiratory and other movements of free-swimming animals. *Trans. Am. Fish. Soc.* 100(1), 22-28 (1971).

Sprague, J. B. The ABC's of pollutant bioassay using fish, pp. 6-30, in Cairns, J. Jr., and Dickson, K. L. (eds.) *Biological Methods for the Assessment of Water Quality*, STP528, American Society for Testing and Materials, Philadelphia, Pa., 1973.

van der Schalie, William - Hendrik. The utilization of aquatic organisms for continuous and automatic monitoring of the toxicity of industrial waste effluents. Ph.D. Dissertation, Virginia Polytechnic Institute and State University, Blacksburg, Virginia, 1977.

Westlake, G. F., and van der Schalie, W. H. Evaluation of an automated biological monitoring system at an industrial site, pp. 30-37 in Cairns, J. Jr., Dickson, K. L., and Westlake, G. F. (eds.), Biological Monitoring of Water and Effluent Quality, STP607, American Society for Testing and Materials, Philadelphia, Pa., 1977.

DISTRIBUTION LIST FOR ARCSL-CR-78040

Names	Copies	Names	Copies
CHEMICAL SYSTEMS LABORATORY		HQDA (SGRD-EDE)	
OFFICE OF THE DIRECTOR		Attn: LTC Charles Dettor	1
Attn: DRDAR-CLG	1	WASH DC 20314	
SAFETY OFFICE		US ARMY HEALTH SERVICE COMMAND	
Attn: DRDAR-CLF	1	Commander	
PLANS & PROGRAMS OFFICE		US Army Environmental Hygiene Agency	
Attn: DRDAR-CLR-L	4	Attn: HSE-AA-L, Librarian,	1
		Bldg 2100	
AUTHOR'S COPIES: Environmental		Attn: HSE-AA-E	2
Technology		APG-Edgewood Area	
Division, Attn: DRDAR-CLT-E	40	Superintendent	
BIOMEDICAL LABORATORY		Academy of Health Sciences	
Attn: DRDAR-CLL	1	US Army	
CB DETECTION & ALARM DIVISION		Attn: HSA-CDC	1
Attn: DRDAR-CLC-C	1	Attn: HSA-IHE	1
		Fort Sam Houston, TX 78234	
DEVELOPMENTAL SUPPORT DIVISION		Commander	
Attn: DRDAR-CLJ-I	4	US Army Institute of Surgical	1
Attn: DRDAR-CLJ-M	1	Research	
		Brook Army Medical Center	
ENVIRONMENTAL TECHNOLOGY DIVISION		Fort Sam Houston, TX 73234	
Attn: DRDAR-CLT-E	1	US ARMY MATERIEL DEVELOPMENT AND	
		READINESS COMMAND	
MUNITIONS DIVISION		Commander	
Attn: DRDAR-CLN	1	US Army Materiel Development and	
PHYSICAL PROTECTION DIVISION		Readiness Command	
Attn: DRDAR-CLW	1	Attn: DRCSE	1
RESEARCH DIVISION		Attn: DRCRD-WB	1
Attn: DRDAR-CLB	1	Attn: DRCRD	1
		Attn: DRCRD-ES	1
DEPARTMENT OF DEFENSE		Attn: DRCIS-MD	1
Administrator		Attn: DRCPA-E	1
Defense Documentation Center		Attn: DRCRO-I	1
Attn: Accessions Division	12	5001 Eisenhower Ave	
Cameron Station		Alexandria, VA 22333	
Alexandria, VA 22314		Commander	
Director		US Army Foreign Science & Technology Center	
Defense Intelligence Agency		Attn: DRXST-IS1	2
Attn: DB-4G1	1	220 Seventh St., NE	
Washington, DC 20301		Charlottesville, VA 22901	
DEPARTMENT OF THE ARMY		Project Manager for Chemical Demilitarization	
		and Installation Restoration	
		Attn: DRCPM-DR, Bldg E4585	1

DISTRIBUTION LIST FOR ARCSL-CR-78040 (CONT.)

Names	Copies	Names	Copies
HQDA (DAMO-SSC) WASH DC 20310	1	APG-Edgewood Area	
OFFICE OF THE SUREGEON GENERAL		Redstone Scientific Information Center Attn: Chief, Documents	1
Commander US Army Medical Bioengineering Research & Development Laboratory Attn: SGRD-UBG	1	US Army Missile Command Redstone Arsenal, AL 35809	
Attn: LTC L. Reuter Fort Detrick, Bldg 568 Frederick, MD 21701 US ARMY ARMAMENT RESEARCH AND DEVELOPMENT COMMAND		Commander US Army Science & Technology Center-Far East Office	1
Commander US Army Armament Research and Development Command Attn: DRSAR-ASF	1	DEPARTMENT OF THE NAVY	
Attn: DRSAR-ASN	1	Chief of Naval Research Attn: Code 443	1
Attn: DRSAR-ISE	1	800 N. Quincy Street Arlington, VA 22217	
Dover, NJ 07801		Commander Naval Facilities Engineering Command Attn: Code 03	1
Commander Rocky Mountain Arsenal Attn: SARRM-MD	1	200 Stovall Street Alexandria, VA 22332	
Denver, CO 80240		Commander Naval Ordnance Systems Command Attn: ORD-03D	1
Commander Pine Bluff Arsenal Attn: SARPB-ETA	1	Washington, DC 20360	
Pine Bluff, AR 71611		Chief, Bureau of Medicine & Surgery Department of the Navy Attn: CODE 5	1
Commander Frankford Arsenal Attn: SARFA-T-4200	1	Washington, DC 20372	
Attn: Library Branch, TSP-L	1	Commander Naval Air Systems Command Attn: Code AIR-350E	1
Bldg 51-2 Philadelphia, PA 19137		Attn: Code AIR-53231B	1
US ARMY TEST & EVALUATION COMMAND		Washington, DC 20361	
Record Copy CDR, APG Attn: STEAP-AD-R/RHA	1	DEPARTMENT OF THE AIR FORCE	
APG-Edgewood Area, Bldg E5179		HQ Foreign Technology Division (AFSC) Attn: PDRR	1
CDR, APG Attn: STEAP-TL	1	Wright-Patterson AFB, OH 45433	
APG-Aberdeen Area		HG, USAF/SGPR Forestal Bldg WASH DC 20314	1

DISTRIBUTION LIST FOR ARCSL-CR-78040 (CONT.)

Names	Copies	Names	Copies
Commander US Army Tropic Test Center Attn: STETC-MO-A (Tech Library) 1 APO New York 09827		Director Air Force Inspection and Safety Center Attn: IGD(AFISC/SEV) 1 Norton AFB, CA 92409	
Commander Dugway Proving Ground Attn: STEDP-PO 1 Dugway, UT 84022		Commander Armament Development & Test Center Attn: DLOSL(Technical Library) 1 Eglin AFB, FL 32542	
Commander US Army Test & Evaluation Command Attn: DRSTE-LG 1 Attn: DRSTE-ME 1 Attn: DRSTE-NB 1 APG-Aberdeen Area		OUTSIDE AGENCIES Director of Toxicology 1 National Research Council 2101 Constitution Ave, NW Washington, DC 20418 US Public Health Service Room 17A46 (CPT Osheroff) 1 5600 Fishers Lane Rockville, MD 20857	
ADDITIONAL ADDRESSEES		Commander Newport Army Ammunition Plant Attn: SARNE-S 1 Newport, IN 47966	
Commander USDRC Installations & Services Agency Attn: DRCIS-RI-IU 1 Rock Island, IL 61201		Commander Radford Army Ammunition Plant Attn: SARRA-IE 1 Radford, VA 24141	
Commander US Army Materiel Development & Readiness Command Munition Production Base, Modernization & Expansion Attn: DRCPM-PBM-EC/Project 1 Manager Attn: DRCPM-PBM-EB/Mr. A 1 Selman Dover, NJ 07801		Commander Sunflower Army Ammunition Plant Attn: SARSU-0 1 Lawrence, KS 66044	
Commander DA-DCSLOG Attn: DALO-AMP 1 Washington, DC 20310		Commander Volunteer Army Ammunition Plant Attn: SARVO-T 1 Chattanooga, TN 37401	
Department of the Army Attn: DAEN-ZCE 1 Washington, DC 20310		Environmental Protection Agency Attn: Mr. Harry Ike 1 26 Federal Plaza/Rm 837 New York, NY 10007	

DISTRIBUTION LIST FOR ARCSL-CR-78040 (CONT.)

Names	Copies	Names	Copies
Commander US Army Construction Engineering Research Laboratory Attn: CERL-ER Champaign, IL 61820	1	Environmental Protection Agency Attn: Mr. Ben Lacey Curtis Building, 2d floor 6th and Walnut Sts Philadelphia, PA 19106	1
Office of Chief of Engineers Attn: DAEN-MCZ-E Washington, DC 20314	2	Environmental Protection Agency Attn: Mr. Arthur Linton 1421 Peachtree Street, NE Atlanta, GA 30309	1
District Engineer US Army Corps of Engineers 6014 US PO & Courthouse 215 N 17th Street Omaha, NB 68102	1	Environmental Protection Agency Attn: Mr. Don A Wallgren 1 North Wacker Drive Chicago, IL 60606	1
District Engineer US Army Corps of Engineers Attn: HNDED-M Attn: HNDED-FC PO Box 1600 West Station Huntsville, AL 35807	1 1	Environmental Protection Agency Attn: Mr. James Highland 1600 Patterson Street Dallas, TX 75201	1
Commander Holston Army Ammunition Plant Attn: SARHO-E Kingsport, TN 47662	1	Environmental Protection Agency Attn: Mr. Robert Koke (RM 249) 1735 Baltimore Street Kansas City, MO 64108	1
Commander Milan Army Ammunition Plant Attn: SARMI-S Milan, TN 38358	1	Environmental Protection Agency Attn: Mr. Keith Synder Lincoln Tower Suite 900 1860 Lincoln Street Denver, CO 80203	1
Environmental Protection Agency Attn: Mr. Irving Terzich 100 California Street San Francisco, CA 94111	1	US Army Engineer Waterways Experimental Station Environmental Systems Division PO Box 631 Vicksburg, MI 39180	1
Army Logistics Management Center Environmental Management Attn: LCDR/J.C. Bolander Fort Lee, VA 23801			
Commander Volunteer Army Ammunition Plant Attn: SARVO-0 Tyner, TN 37392	1		