

AD A 053473

12

AD

AD-E400 040

TECHNICAL REPORT ARPAD-TR-77002

THE USE OF LOW VISCOSITY 70/30 OCTOL
IN DRAGON WARHEADS M224

WALDMAR F. LARSEN

DDC
RECEIVED
MAY 3 1978
B

AD No. _____
DDG FILE COPY

DECEMBER 1977



US ARMY ARMAMENT RESEARCH AND DEVELOPMENT COMMAND
PRODUCT ASSURANCE DIRECTORATE
DOVER, NEW JERSEY

APPROVED FOR PUBLIC RELEASE; DISTRIBUTION UNLIMITED.

The findings in this report are not to be construed
as an official Department of the Army position.

DISPOSITION

Destroy this report when no longer needed. Do not
return to the originator.

UNCLASSIFIED

SECURITY CLASSIFICATION OF THIS PAGE (When Data Entered)

REPORT DOCUMENTATION PAGE		READ INSTRUCTIONS BEFORE COMPLETING FORM
1. REPORT NUMBER Technical Report ARPAD-TR-77002	2. GOVT ACCESSION NO.	3. RECIPIENT'S CATALOG NUMBER
4. TITLE (and Subtitle) 6 THE USE OF LOW VISCOSITY 70/30 OCTOL IN DRAGON WARHEADS M224	5. TYPE OF REPORT & PERIOD COVERED 2 Technical rept.	6. AUTHORING OR PERFORMING ORGANIZATION NUMBER
7. AUTHOR(s) 10 WALDEMAR F. LARSEN	8. CONTRACT OR GRANT NUMBER(s)	
9. PERFORMING ORGANIZATION NAME AND ADDRESS Product Assurance Directorate Picatinny Arsenal Dover, NJ 07801	10. PROGRAM ELEMENT, PROJECT, TASK AREA & WORK UNIT NUMBERS	
11. CONTROLLING OFFICE NAME AND ADDRESS ARRADCOM, PAD Artillery Systems Division (DRDAR-QAR-R) Dover, NJ 07801	12. REPORT DATE 17 December 1977	13. NUMBER OF PAGES 109 (12) 108 p.
14. MONITORING AGENCY NAME & ADDRESS (if different from Controlling Office) 4 ARPAD-TR-77002	15. SECURITY CLASS. (of this report) Unclassified	15a. DECLASSIFICATION/DOWNGRADING SCHEDULE
16. DISTRIBUTION STATEMENT (of this Report) Approved for public release; distribution unlimited.		
17. DISTRIBUTION STATEMENT (of the abstract entered in Block 20, if different from Report)		
18. SUPPLEMENTARY NOTES		
19. KEY WORDS (Continue on reverse side if necessary and identify by block number) Octol, high viscosity Octol density Octol, low viscosity HMX distribution Octol settling characteristics Penetration		
20. ABSTRACT (Continue on reverse side if necessary and identify by block number) DRAGON warheads are loaded with 70/30 octol. The original production loading method required TNT to be added to 75/25 octol to dilute it to 70/30 proportions. When the octol viscosity exceeded 10.5 seconds, it was difficult to obtain acceptable cast warheads. Octol can be made initially with 70% HMX and 30% TNT in different viscosities. For this test, two Octol batches with viscosities of 7.8 seconds and 4.5 seconds were used.		

D U C
 REPRODUCED
 MAY 3 1978
 REGISTERED
 B

DD FORM 1 JAN 73 1473 EDITION OF 1 NOV 65 IS OBSOLETE

UNCLASSIFIED
SECURITY CLASSIFICATION OF THIS PAGE (When Data Entered)

393 284 JPB

UNCLASSIFIED

SECURITY CLASSIFICATION OF THIS PAGE(When Data Entered)

20. ABSTRACT (Continued)

The report analyzes the test results of DRAGON warheads filled with octol of different viscosities for the purpose of:

1. Comparing penetration performance.
2. Determining the distribution of HMX by percentage and the density of octol within the warhead.
3. Determining if there is a correlation of the density of octol left in the riser to the density of octol in the warhead.
4. Evaluating the penetration performance in relation to the percentage of HMX and the octol density in the rise.

There was no significant difference in penetration performance for the octols tested.

Virgin 70/30 octol had slightly better "settling" characteristics than cut 75/25 octol.

The measured characteristics of the octol in the risers of the fired warheads were not good indicators, individually, of the penetration performance.

UNCLASSIFIED

SECURITY CLASSIFICATION OF THIS PAGE(When Data Entered)

TABLE OF CONTENTS

	<u>Page No.</u>
Introduction	1
Objectives	3
Analysis of Data	4
Penetration Performance, DRAGON Warheads, Virgin 70/30 Octol vs Cut 75/25 Octol	4
Percent HMX and Octol Density Distribution in Warheads and Risers - General	5
Percent HMX by Core, Rows and Weighted Average for Warheads and Risers	6
Weighted Averages	11
Octol Density by Core, Rows and Weighted Average for Warheads and Risers	11
Estimated Densities of Different Types of Octol	18
Estimated Octol Density in Warhead when Octol Density in Riser is Known	18
Comparison of Estimated Octol Characteristics with Measured Octol Characteristics	20
Octol Characteristics in Warheads on Either Side of Fired Warhead Versus Penetration	26
Adjusted Estimated Average Octol Character- istics in Warheads Versus Penetration	35
Octol Characteristics in Risers Versus Penetration	35
Conclusions	47
Recommendations	48
References	49
Distribution List	100

A



CONFIDENTIAL

Tables

1	Penetration Performance, DRAGON Warheads Virgin 70/30 Octols with Different Viscosities vs Select Octol Cut to 70/30 from 75/25 Octol	4
2	DRAGON 70/30 Virgin Octol 1st Test - 7.8 Second Viscosity - % HMX Distribution Summary	8
3	DRAGON 70/30 Virgin Octol 2nd Test - 5.4 Second Viscosity - % HMX Distribution Summary	9
4	DRAGON 70/30 Virgin Octol 1st Test - 7.8 Second Viscosity - Density Distribution Summary	13
5	DRAGON 70/30 Virgin Octol 2nd Test - 5.4 Second Viscosity - Density Distribution Summary	14
6.	Estimated Densities of Different Types of Octol	18
7.	Estimated Octol Density in Warhead Body Based on Riser Octol Density - 1st Test - 7.8 Second Viscosity	21
8.	Estimated Octol Density in Warhead Body Based on Riser Octol Density - 2nd Test - 5.4 Second Viscosity	22
9.	Adjusted Estimate of Octol Density in Warhead 1st Test - 7.8 Second Viscosity	23
10.	Adjusted Estimate of Octol Density in Warhead 2nd Test - 5.4 Second Viscosity	27
11.	% HMX & Octol Density in Warheads Either Side of Fired Warhead vs Penetration - 1st Test - 7.8 Second Viscosity	29
12.	% HMX & Octol Density in Warheads Either Side of Fired Warhead vs Penetration - 2nd Test - 5.4 Second Viscosity	30

13	Adjusted Estimate of Octol Density in Warhead vs Penetration - 1st Test - 7.8 Second Viscosity	36
14	Adjusted Estimate of Octol Density in Warhead vs Penetration - 2nd Test - 5.4 Second Viscosity	38
15	Octol Characteristics in Risers vs Penetration - 1st Test - 7.8 Second Viscosity	40
16	Octol Characteristics in Risers vs Penetration - 2nd Test - 5.4 Second Viscosity	41
17	Core Sample Analysis - 1st Test - % HMX - Virgin 70/30 Octol - 7.8 Second Viscosity	51
18	Core Sample Analysis - 1st Test - Octol Density - Virgin 70/30 Octol - 7.8 Second Viscosity	52
19	Core Sample Analysis - 2nd Test - % HMX - Virgin 70/30 Octol - 5.4 Second Viscosity	53
20	Core Sample Analysis - 2nd Test - Octol Density - Virgin 70/30 Octol - 5.4 Second Viscosity	54
21	DRAGON Riser Composition Analysis, Virgin 70/30 Octol, 1st Test and 2nd Test	55
22A-22F	% HMX by Core, Rows and Weighted Average for Warheads and Risers - 1st Test - 70/30 Virgin Octol - 7.8 Second Viscosity	56-61
23	DRAGON Average % HMX Distribution by Row Location - 1st Test - 70/30 Virgin Octol - 7.8 Second Viscosity	62
24A-24F	% HMX by Core, Rows and Weighted Average for Warheads and Risers - 2nd Test - 70/30 Virgin Octol - 5.4 Second Viscosity	64-69
25	DRAGON Average % HMX Distribution by Row Location - 2nd Test - 70/30 Virgin Octol - 5.4 Second Viscosity	70

26A-26F	Octol Density by Core, Rows and Weighted Average for Warheads and Risers - 1st Test	72-77
27	DRAGON Average Octol Density Distribution by Row Location - 1st Test - 70/30 Virgin Octol - 7.8 Second Viscosity	78
28A-28F	Octol Density by Core, Rows and Weighted Average for Warheads and Risers - 2nd Test	80-85
29	DRAGON Average Octol Density Distribution by Row Location - 2nd Test - 70/30 Virgin Octol - 5.4 Second Viscosity	86

Figures

1	DRAGON Location of Core Samples	7
2	DRAGON Warhead Average & HMX Distribution by Row Location	10
3	DRAGON Segment Volumes	12
4	DRAGON Warhead Average Density Distribution by Row Location	15
5	Average % HMX and Density Distribution by Row Location - 1st Test - 7.8 Second Viscosity	16
6	Average % HMX and Density Distribution by Row Location - 2nd Test - 5.4 Second Viscosity	17
7	Comparison of Estimated Warhead Octol Density with Weighted Average Density	24
8	Adjusted Estimated Octol Density in Warhead, 70/30 Octol - 7.8 Second Viscosity - 1st Test	25
9	Adjusted Estimated Octol Density in Warhead, 70/30 Octol - 5.4 Second Viscosity - 2nd Test	28
10	Octol Density in Warheads Either Side of Fired Warhead vs Penetration - 1st Test - 7.8 Second Viscosity	31
11	Octol Density in Warheads Either Side of Fired Warhead vs Penetration - 2nd Test - 5.4 Second Viscosity	32

12	% HMX in Warheads Either Side of Fired Warheads vs Penetration - 1st Test - 7.8 Second Viscosity	33
13	% HMX in Warheads Either Side of Fired Warheads vs Penetration - 2nd Test - 5.4 Second Viscosity	34
14	Adjusted Estimated Average Octol Density in Warhead vs Penetration - 1st Test - 7.8 Second Viscosity	37
15	Adjusted Estimated Average Octol Density in Warhead vs Penetration - 2nd Test - 5.4 Second Viscosity	39
16	% HMX in Riser vs Penetration - 1st Test - 7.8 Second Viscosity	43
17	% HMX in Riser vs Penetration - 2nd Test - 5.4 Second Viscosity	44
18	Octol Density in Riser vs Penetration - 1st Test - 7.8 Second Viscosity	45
19	Octol Density in Riser vs Penetration - 2nd Test - 5.4 Second Viscosity	46
20A-20F	Test Data by Loading Fixture - 1st Test - 70/30 Virgin Octol - 7.8 Second Viscosity	88-93
21A-21F	Test Data by Loading Fixture - 2nd Test - 70/30 Virgin Octol - 5.4 Second Viscosity	94-99

INTRODUCTION

A study was made by Mason & Hanger-Silas Mason Co., Inc., the contractor operating the Iowa Army Ammunition Plant (IAAP) on the effect of loading shaped charge warheads (TOW and DRAGON) with viscous Octol (10.5 to 15 seconds), and with less viscous Octol (below 10.5 seconds), Ref. 1. The less viscous Octol was referred to in the report as "Select" Octol while the more viscous Octol was referred to as "Regular" Octol.

For the DRAGON warheads, only, the 75/25 Octol was "cut" to 70/30 Octol by adding TNT to the mix.

It has been shown in DRAGON warheads that when the percent (%) HMX can be increased around the shaped charge copper cone the penetration performance is significantly increased. This can most easily be accomplished by vibrating the warhead after filling it with "Select" Octol. The higher percent HMX, in the warhead body must come from the riser in the settling process.

The IAAP contractor recommended that "Select" Octol be used on a regular basis for pouring TOW and DRAGON warheads.

As a result of this recommendation, Major James D. Tipton, ARMCOM, Rock Island, arranged a meeting at Iowa AAP for 13 January 1976 to discuss the problem. Invited to attend were representatives from Armament Command (6), Dragon Project Office (1), Holston Defense Corp. (1), Iowa AAP (3), Mason & Hanger (4) and Picatinny Arsenal (4).

It was decided that Holston would ship two batches of Type II Octol (70/30%) with viscosity limited to 8 seconds max. in accordance with Military Specification MIL-O-45445 to Iowa AAP for loading and testing in TOW and DRAGON warheads. In this study the following terms will be used for easy identification:

"Virgin" 70/30 Octol: MIL-O-45445, Type II Octol, with max. viscosity of 8 seconds.

"Select" Octol: 75/25 Octol with a maximum viscosity of 10.5 seconds.

"Regular" Octol: 75/25 Octol with viscosity between 10.5-15 seconds.

"Cut" Octol: 75/25 Octol diluted with TNT to make 70/30 Octol.

It was mutually agreed that a production subplot of 225 DRAGON warheads would be poured using the first batch of Virgin 70/30 Octol with approximately 8 seconds viscosity.

Six loading fixtures (Nos. 3, 10, 18, 26, 34, 42) would be selected. Two warheads would be fired for penetration performance and the remaining three warheads from each selected fixture would be sectioned and cored at prescribed locations to determine percent HMX, percent TNT and octol density.

Picatinny Arsenal was tasked with analyzing the test data. This report satisfies that task.

The 225 warheads for the first test were poured 9 March 1976 with the Virgin 70/30 octol (sublot B69). The random samples were test fired 11 March and cores analyzed 12-15 March 1976.

For the first test the Virgin 70/30 octol consisted of:		
HOL 505 - 4059	8.0 sec	1380 lb.
HOL 505 - 4060	5.6 sec	120 lb.
Estimated viscosity	<u>7.8</u> sec	<u>1500</u> lb. total

Another 225 DRAGON warheads were poured the same day on the same line 1 using 75/25 octol as follows:

HOL 530 - 2920	9.5 sec
HOL 530 - 2922	9.7 sec

This was diluted to 70/30 octol by adding TNT.

The octol used for the rest of the month of March 1976 was 75/25 octol cut to 70/30 with an attempt to keep the viscosity below 10.5 seconds.

The 225 warheads for the second test were poured 25 May 1976 with Virgin 70/30 octol (sublot B-146). The random samples were test fired 26 May 1976 and cores analyzed 1-17 June 1976.

For the second test the Virgin 70/30 octol consisted of:		
HOL 505 - 4060	5.6 sec	1255 lb.
HOL 505 - 4049	4.1 sec	241 lb.
Estimated viscosity	<u>5.4</u> sec	<u>1496</u> lb. total

For the first test the DRAGON warhead precision metals parts were from Firestone Lot 5-2 while for the second test they were from Firestone Lot 5-4. There is no reason to believe that these precision metal parts would be a significant factor contributing to variable test results.

OBJECTIVES

(Note: The following objectives are related to the DRAGON warhead only.)

1. To compare penetration performance of Virgin Type II 70/30 octol to Type I 75/25 octol cut to 70/30 octol.
2. To determine the distribution of percent HMX and density of Virgin 70/30 octol in warheads.
3. To determine if there is a correlation of octol density in the riser to octol density in the warhead.
4. To evaluate the penetration performance in relation to the percent HMX and the octol density in the riser.
5. To evaluate the penetration performance in relation to the percent HMX and the octol density in warheads on the loading fixture either side of the fired warhead.
6. To evaluate the penetration performance of warheads loaded with Virgin 70/30 octol of a 7.8 second viscosity and those loaded with Virgin 70/30 octol of a 5.4 second viscosity.

ANALYSIS OF DATA

Penetration Performance DRAGON Warheads; Virgin 70/30 Octol vs Cut 75/25 Octol and 7.8 Second Viscosity Octol vs 5.4 Second Viscosity Octol.

The penetration performance of DRAGON warheads loaded with Virgin 70/30 octol of two different viscosities (7.8 second and 5.4 second) was compared with each other and with warheads loaded with Cut 75/25 Octol.

The Virgin 70/30 Octol with 7.8 second viscosity was poured 9 March 1976 as subplot number B-69 using standard operating procedures. DRAGON warheads of subplot number C-69 were poured the same day, same line, different shift, with 75/25 octol from Holston #2920, 9.5 second viscosity, and Holston #2922, 9.7 second viscosity. This 75/25 octol was cut with TNT to make 70/30 octol.

The Virgin 70/30 Octol with 5.4 second viscosity was poured 25 May 1976 as subplot B-146. DRAGON warheads of subplot number B-147 were poured one day later on 26 May 1976, same line, same shift, with 75/25 octol from Holston #2937, 7.4 second viscosity, and Holston #3011, 7.5 second viscosity. This 75/25 octol was cut with TNT to make 70/30 octol.

TABLE 1

Penetration Performance, DRAGON Warheads:
Virgin 70/30 Octols with different viscosities
vs
Select Octol cut to 70/30 from 75/25 Octol

		Virgin 70/30 Octol 7.8 Sec. Vis. 1st Test	75/25 cut to 70/30 Octol Poured same day	Virgin 70/30 Octol 5.4 Sec. Vis. 2nd Test	75/25 cut to 70/30 Octol Poured day after 2nd Test
Sublot No.		B-69	C-69	B-146	B-147
No. of Test Shots	N	12	8	12	5
Average Penetration	\bar{X}	$X_L + 7.79"$	$X_L + 6.38"$	$X_L + 7.90"$	$X_L + 8.70"$

TABLE 1 (CONT)

		Virgin 70/30 Octol 7.8 Sec. Vis. 1st Test	75/25 cut to 70/30 Octol Poured same day	Virgin 70/30 Octol 5.4 Sec. Vis. 2nd Test	75/25 cut to 70/30 Octol Poured day after 2nd Test
Standard Deviation	S	1.93"	1.72"	1.49"	1.90"
Highest Penetration	Hi	$X_L + 10.00"$	$X_L + 7.75"$	$X_L + 10.25"$	$X_L + 10.50"$
Lowest Penetration	Lo	$X_L + 3.50"$	$X_L + 2.50"$	$X_L + 4.50"$	$X_L + 1.90"$
Range	R	6.50"	5.25"	5.75"	5.00"

It can be concluded by the "t" test that there is no reason to believe that the "Virgin" octol differs in average performance from the "Cut" octol, nor that the 7.8 second viscosity "Virgin" octol differs in average performance from the 5.4 second viscosity "Virgin" octol at the 90% confidence level.

Percent HMX and Octol Density Distribution in Warheads and Risers - General

From each of the predetermined six (6) loading fixtures, each holding five (5) DRAGON warheads, one poured warhead was randomly selected to be fired for the penetration test. The two warheads on either side of the first one were set aside for octol analysis. Of the remaining two warheads, one was selected for firing and the other for analysis. In summary, then, two warheads were fired for penetration evaluation for a total of 12 and three warheads were sectioned and cored for determination of percent HMX and octol density distribution for a total of 18.

By following the above procedure each fired warhead was surrounded by two warheads which produced octol information. In earlier studies there was no set pattern of relating octol analysis to penetration performance. In several cases, eight warheads were fired for penetration and two warheads analyzed Ref. 4.

In addition, the 30 risers from the sample warheads were analyzed for octol characteristics. This was accom-

plished by melting each riser and determining the percent HMX and the density of the octol in the whole riser.

The raw data giving the body and the riser octol information are given in Tables 17, 18, 19, 20 and 21. These results have been used and recorded in different forms throughout this report.

The location of core samples is shown in Figure 1.

The test done in March 1976 using Virgin 70/30 Octol with an estimated viscosity of 7.8 seconds will be referred to as the 1st Test, while the test done in May 1976 using Virgin 70/30 Octol with an estimated viscosity of 5.4 seconds will be referred to as the 2nd Test.

Percent HMX by Core, Rows and Weighted Average for Warheads and Risers

The raw core data was re-arranged in Tables 22A through 22F and in Tables 24A through 24F so that the percent HMX could be averaged by rows shown in Figure 1. This averaging simply consisted of adding the % HMX of each core in a row and dividing by the number of cores in the row.

The % HMX row averages were further listed in Tables 23 and 25 to see if there were any differences between loading fixtures. While there were small differences in the overall average % HMX in the warheads, they were not considered significant.

The % HMX row averages for the 18 DRAGON warheads examined were summarized in Tables 2 and 3. This information was plotted on Figure 2. Also plotted on Figure 2 was the data from Picatinny Arsenal Technical Memorandum 2134 for 75/25 octol cut to 70/30 Ref. 4. From these three graphs it would seem that the Virgin octol had better "settling" characteristics than the Cut octol. However, a generalization of this kind should be made with caution since the viscosity of the Cut octol was not recorded in TM 2134.

Further, these graphs indicate that the 5.4 second viscosity octol (2nd Test) has more HMX settlement than the 7.8 second viscosity octol (1st Test).

The % HMX in the risers has been recorded in Tables 22A through 22F and 24A through 24F.

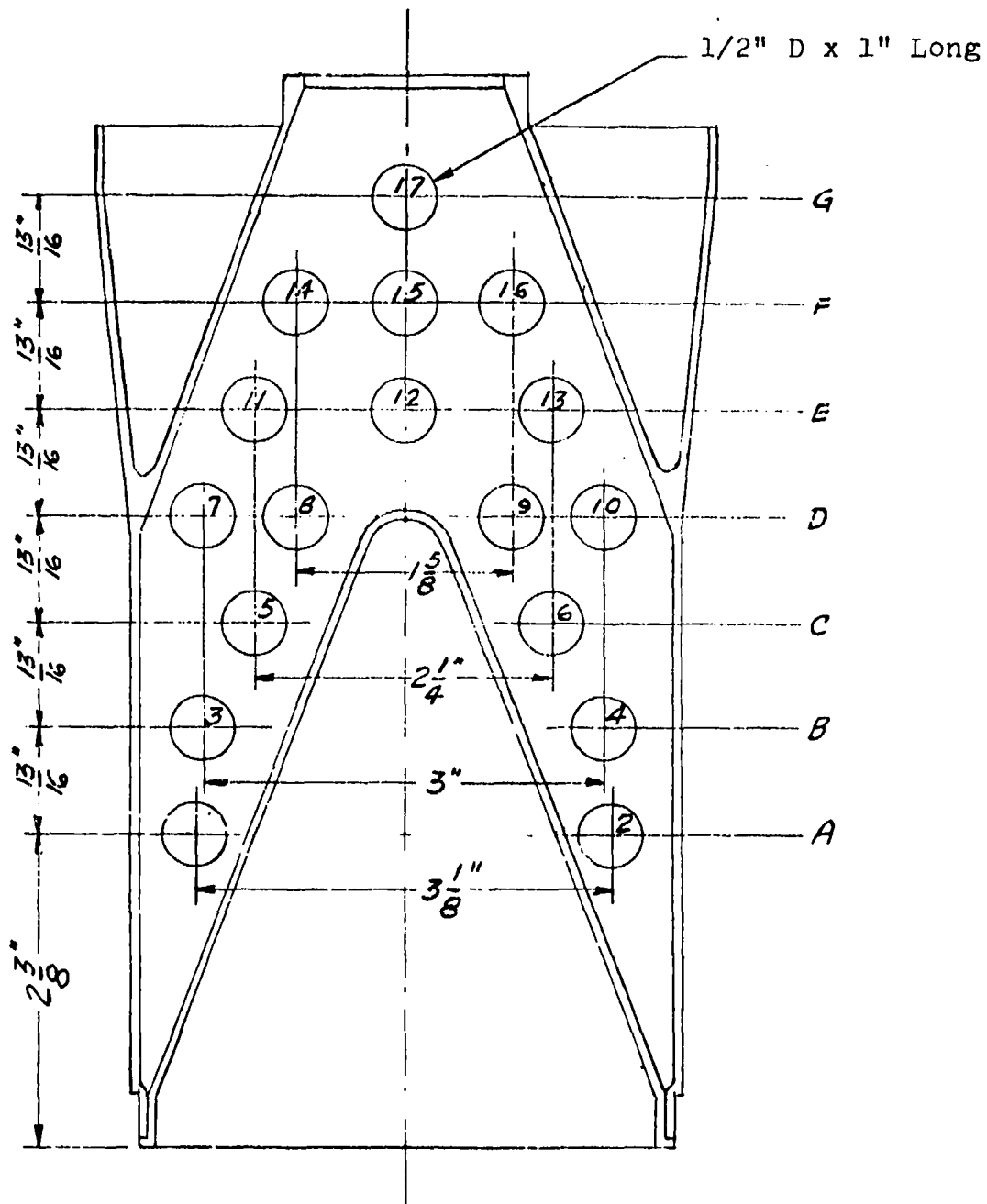

DRAGON
Location of Core Samples
Figure 1 ;

TABLE 2

DRAGON 70/30 VIRGIN OCTOL 1ST TEST - 7.8 SEC. VISC.
 5 HMX DISTRIBUTION SUMMARY
 (FROM TABLE 23)

LOAD FIXTURE NO.	ROW AVERAGES						
	ROW A	ROW B	ROW C	ROW D	ROW E	ROW F	ROW G
3	85.10	84.49	83.72	77.22	73.67	73.13	69.69
10	84.77	84.22	82.86	75.23	73.12	71.67	65.72
18	84.61	83.81	79.90	75.49	73.81	71.22	66.48
34	84.75	84.37	83.21	76.09	73.94	72.72	68.51
26	84.93	84.37	83.04	76.20	74.34	73.04	69.12
42	84.62	82.41	79.18	75.48	74.90	74.17	70.25
AVER. (18 WHDS.)	84.83	83.95	81.99	75.95	73.96	72.66	68.30
	84.42	78.95	74.85	73.19	71.87	71.15	66.43*
				* 75-25 CUT OCTOL			
				(4 WHDS. - TABLE 22 -			
				TECH. MEMO 2134)			

70-30
 VIRGIN
 OCTOL

TABLE 3
 DRAGON 70/30 VIRGIN OCTOL 2ND TEST - 5.4 SEC. VISC.
 & HMX DISTRIBUTION SUMMARY
 (FROM TABLE 25)

LOAD FIXTURE NO.	ROW AVERAGES						
	ROW A	ROW B	ROW C	ROW D	ROW E	ROW F	ROW G
3	84.25	84.07	83.23	81.23	79.00	72.94	73.58
10	83.76	84.16	83.40	81.30	76.55	73.61	74.80
18	84.50	84.19	83.71	82.09	78.03	74.66	74.33
25	84.76	84.36	83.89	80.82	76.84	74.12	74.17
34	84.59	84.62	84.33	82.80	78.31	73.93	74.55
42	<u>84.65</u>	<u>84.20</u>	<u>84.31</u>	<u>82.32</u>	<u>77.98</u>	<u>73.86</u>	<u>76.30</u>
AVER. (18 WHDS)	84.44	84.27	83.81	81.76	77.79	73.85	74.62

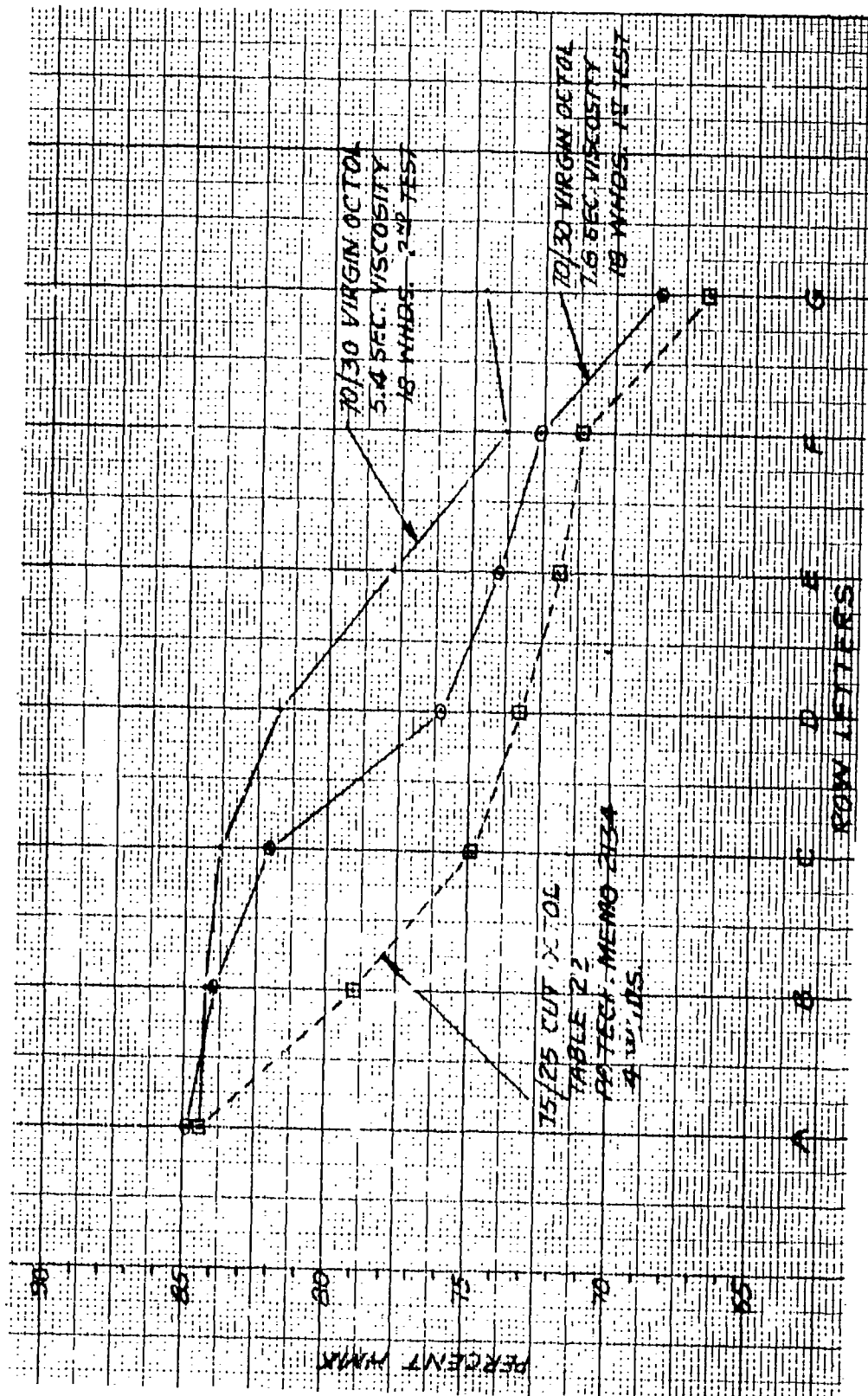

FIGURE 2

DRAGON WARHEAD

AVERAGE HMX DISTRIBUTION BY ROW LOCATION

Weighted Averages

In order to be able to compare the estimated octol density in the warhead based on the octol density in the riser it is necessary to manipulate the core data to obtain an average octol density in the warhead. This can be done by assuming the core data represents the octol in the segment from which it comes. By using standard mensuration formulas, the volumes of segments A through G were computed as shown in Figure 3.

Each row average is multiplied by the segment volume. These products are added together and divided by the total warhead volume to give a weighted average. Weighted averages are given for % HMX in Tables 22A through 22F and in Tables 24A through 24F. Weighted averages are also given for octol density in Tables 26A through 26F and in Tables 28A through 28F.

Octol Density by Core, Rows and Weighted Average for Warheads and Risers

The raw core data was rearranged in Tables 26A through 26F for the 1st test and in Tables 28A through 28F for the second test so that the Octol density could be averaged by rows.

The densities were listed in Tables 27 and 29 to investigate differences between loading fixtures. Nothing significant was apparent.

Tables 4 and 5 summarize the octol densities by row for the 36 DRAGON warheads inspected. This information was plotted on Figure 4. The information from PA Technical Memorandum 2134 was also plotted on Figure 4 for comparison purposes.

Inspection of Figure 4 does not show quite the same settling tendency, as measured by octol density, for the 5.4 second viscosity octol as was shown in Figure 3 when the % HMX was the characteristic being measured.

The average % HMX and the average octol density distribution by row location have been plotted on Figures 5 and 6 for the first and second tests respectively.

The octol density of the risers for the first and second tests has been recorded in Tables 26A through 26F and 28A through 28F.

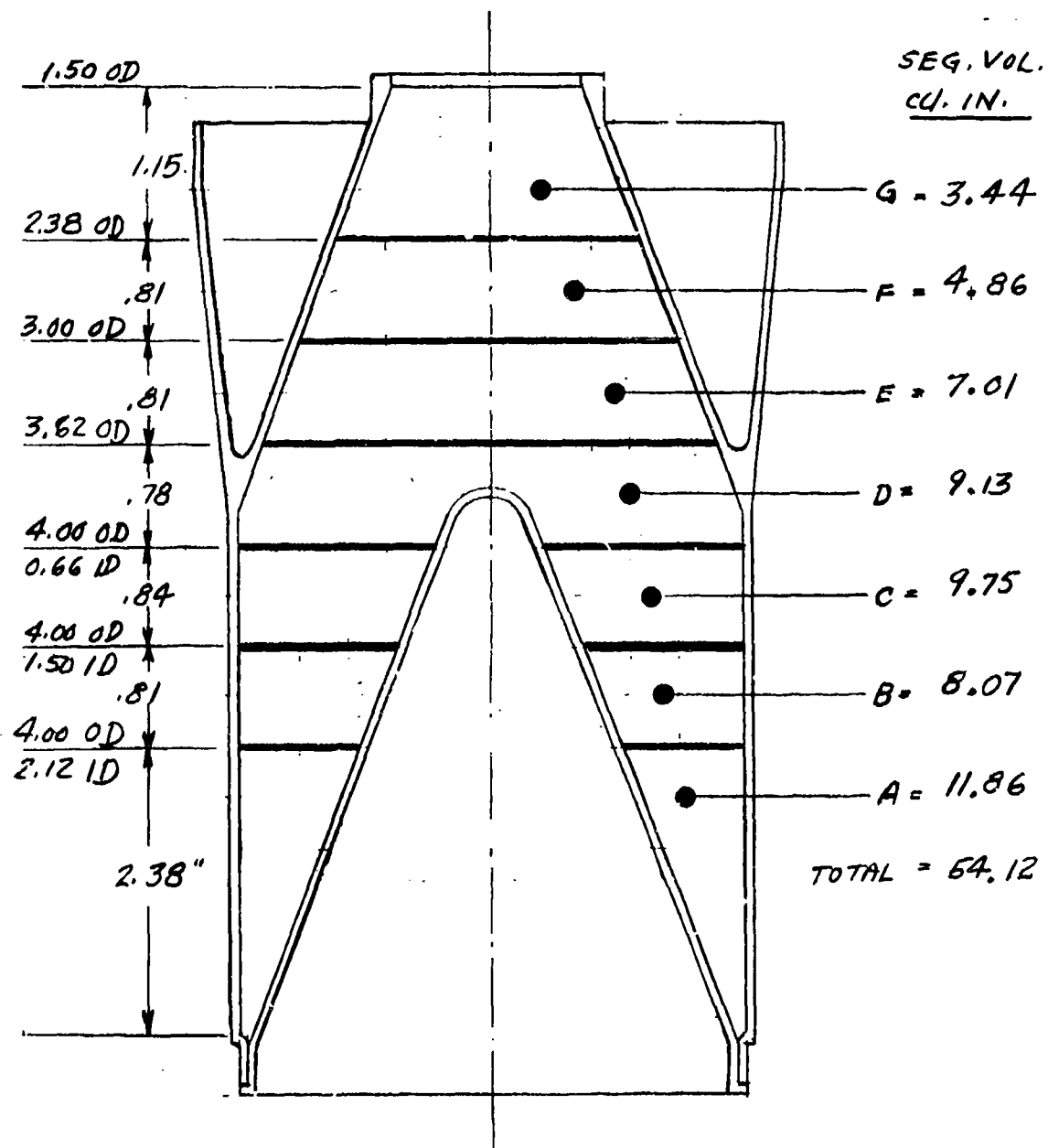

DRAGON
SEGMENT VOLUMES
Figure 3

TABLE 4
 DRAGON 70/30 VIRGIN OCTOL - 1st TEST - 7.8 SEC. VISC.
 DENSITY DISTRIBUTION SUMMARY
 (FROM TABLE 27)

LOAD FIXTURE NO.	ROW AVERAGES						
	ROW A	ROW B	ROW C	ROW D	ROW E	ROW F	ROW G
3	1.8457	1.8453	1.8408	1.8227	1.8142	1.8131	1.803
10	1.8435	1.8413	1.8383	1.8171	1.8133	1.8086	1.796
18	1.8432	1.8405	1.8293	1.8176	1.8136	1.8079	1.796
34	1.8427	1.8432	1.8370	1.8164	1.8114	1.8050	1.795
26	1.8430	1.8417	1.8358	1.8174	1.8119	1.8053	1.797
42	1.8417	1.8343	1.8228	1.8107	1.8100	1.8069	1.792
AVER.	1.8436	1.8411	1.8340	1.8170	1.8124	1.8078	1.7965
					70 - 30	VIRGIN OCTOL	
					(18 WHDS.)		
	1.846	1.832	1.822	1.814	1.814	1.811	1.801
					(4 WHDS.	- TABLE 23 -	
					TECH. MEMO 2134)		

TABLE 5
 DRAGON 70/30 VIRGIN OCTOL 2nd TEST - 5.4 SEC. VISC.
 DENSITY DISTRIBUTION SUMMARY
 (FROM TABLE 29)

LOAD FIXTURE NO.	ROW AVERAGES						
	ROW A	ROW B	ROW C	ROW D	ROW E	ROW F	ROW G
3	1.8383	1.8340	1.8363	1.8302	1.8246	1.8085	1.8113
10	1.8358	1.8350	1.8337	1.8281	1.8111	1.8007	1.7943
18	1.8352	1.8357	1.8320	1.8263	1.8101	1.8002	1.8000
26	1.8328	1.8317	1.8280	1.8183	1.8017	1.7929	1.7970
34	1.8332	1.8330	1.8295	1.8240	1.8086	1.7906	1.7920
AVER. (18 WHDS)	1.835	1.834	1.832	1.825	1.811	1.799	1.799

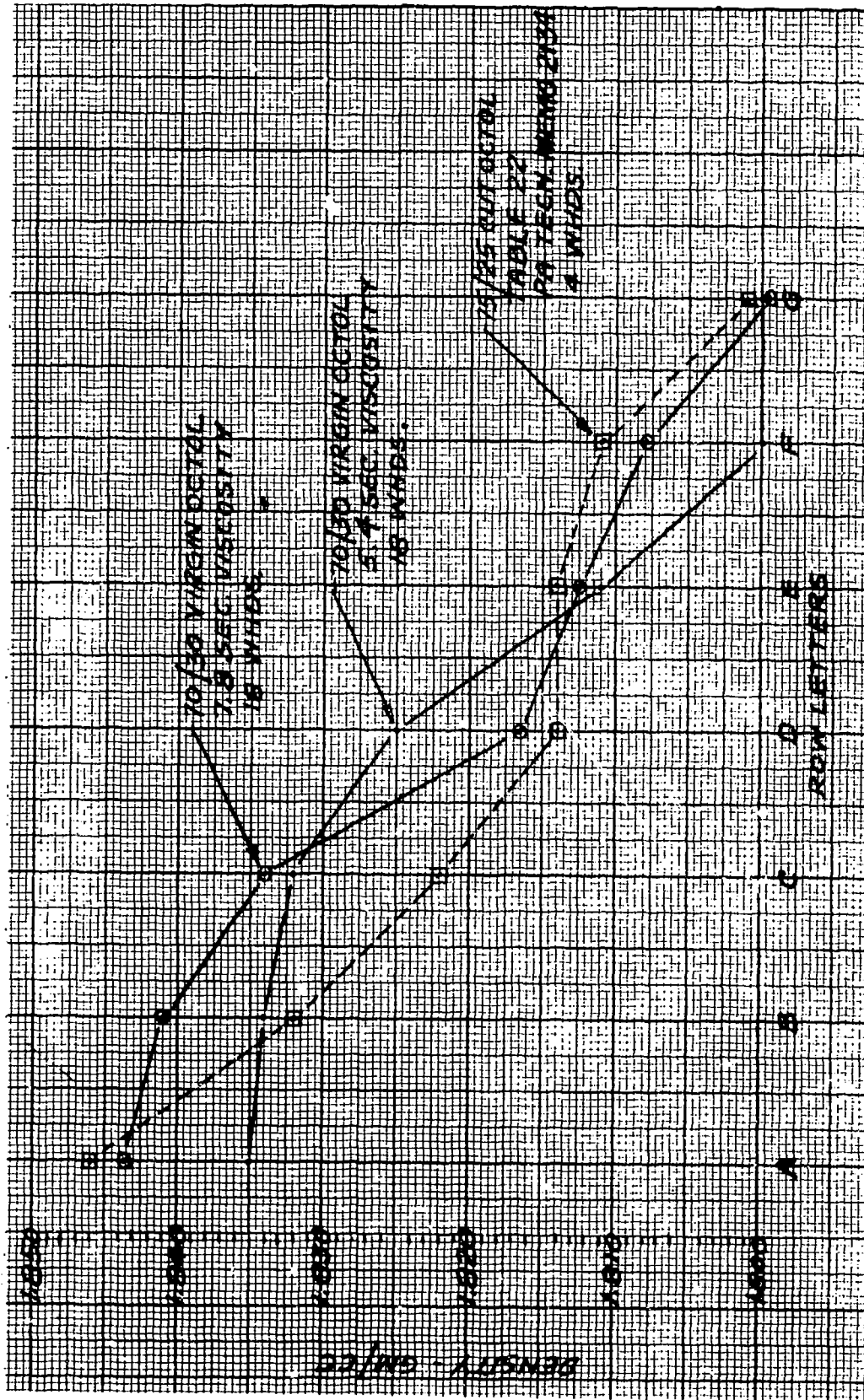

FIGURE 4
AVERAGE DENSITY DISTRIBUTION BY ROW LOCATION

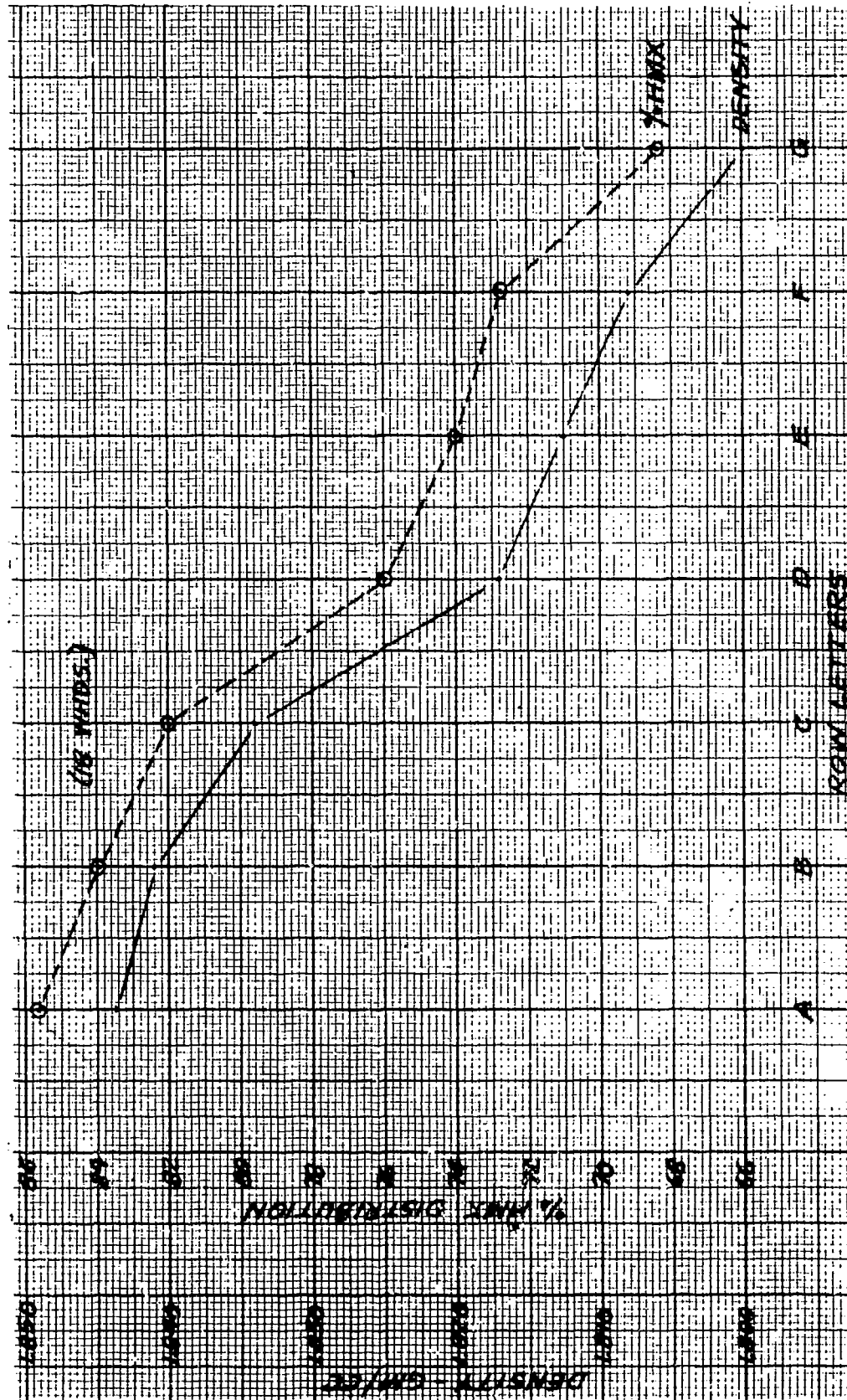

FIGURE 5

AVERAGE % HMX & DENSITY DISTRIBUTION BY ROW LOCATION

1st TEST - 7.8 SECOND VISCOSITY

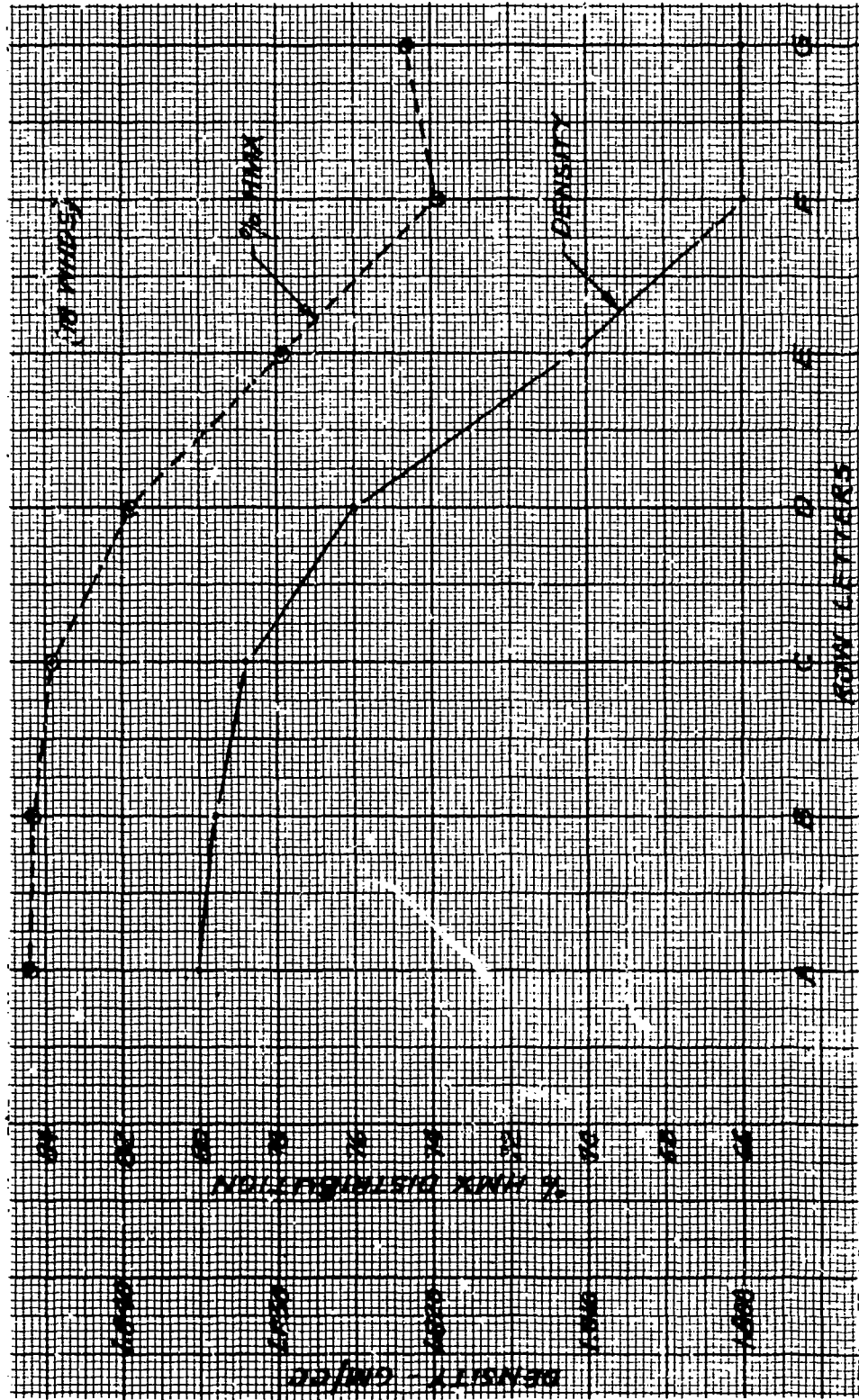

FIGURE 6
 AVERAGE HMX & DENSITY DISTRIBUTION BY ROW LOCATION
 2nd TEST - 5.4 SECOND VISCOSITY

Estimated Densities of Different Types of Octol

Throughout this report changes in octol characteristics are noted due to various factors such as viscosity, settling, location measured, etc. One important characteristic is octol density because it can be accurately measured and is a good indicator of a change. To have some basis to evaluate the density change, Table 6 lists the estimated densities of different types of octol.

TABLE 6

ESTIMATED DENSITIES OF DIFFERENT TYPES OF OCTOL

GIVEN: Density of HMX = 1.90 gm/cc

Density of TNT = 1.65 gm/cc

(Source: PA Tech. Rept. 1740 "Properties of Explosives of Military Interest" W. R. Tomlinson, Jr. April 1958)

$$\text{Formula: } \frac{100\%}{\text{Density of Octol}} = \frac{\% \text{ HMX}}{\text{Density of HMX}} + \frac{\% \text{ TNT}}{\text{Density of TNT}}$$

<u>Type of OCTOL</u>	<u>Density of OCTOL</u>
90/10	1.87 gm/cc
85/15	1.86
80/20	1.85
75/25	1.84
70/30	1.83
65/35	1.81
60/40	1.80

Estimated Octol Density in Warhead when Octol Density in Riser is Known

There are occasions, such as after a poor penetration performance, when it would be advantageous to know the average density of the octol in the warhead. Unfortunately at this time, there is no accepted production nondestructive method of measuring the density after pouring and before firing.

The following procedure has been developed by the author for the DRAGON warhead where settling of the HMX articles through the proper viscosity of the explosive mix and vibration of the warhead is so important to the penetration performance.

The procedure and formula is based on the proposition that the whole must be equal to the sum of its parts.

Stated another way, what is in the warhead body and the riser must have come from the mixing kettle. Therefore, the total weight of the explosive (octol) from the kettle equals the weight of the warhead octol plus (+) the weight of the riser octol. Further, weight equals density multiplied by volume. From these facts, the following density formula was developed.

FORMULA (DENSITY)

Total Volume Octol x Octol Density in Kettle
= Volume Octol in Body x Octol Density
in Body + Volume Octol in Riser
x Octol Density in Riser

$$V_T D_K = V_B D_B + V_R D_R \quad (1)$$

Where V_T = Vol. Octol in Whd. Body + Riser

D_K = Octol Density in Kettle

V_B = Vol. Octol in Body

D_B = Octol Density in Body (see paragraph on weighted averages)

V_R = Vol. Octol in Riser

D_R = Octol Density in Riser

Since the actual dimensions of the octol in the riser are not known the volume of the riser octol was calculated as follows:

Average weight of Octol from 10 risers = 2.3 lb/riser
Aver. density from 18 risers = 1.731 gm/cc
Conversion = 1.731 x .03613 = .0625 lb/cu. in.

$$V_R = \frac{2.3\#}{.0625} = 36.80 \text{ cu. in.}$$

$$V_T D_K = V_B D_B + V_R D_R$$

$$V_B D_B = V_T D_K - V_R D_R$$

$$D_B = \frac{V_T D_K}{V_B} - \frac{V_R D_R}{V_B}$$

where

$$V_B = 54.12 \text{ cu. in. (Fig. 3)}$$

$$V_R = 36.80 \text{ cu. in.}$$

$$V_T = 90.92 \text{ cu. in.}$$

$$D_K = 1.83 \text{ gm/cc (70/30 average-Table 6)}$$

$$D_R = \text{Octol density in Riser (Variable)}$$

$$D_B = \frac{90.92 \times 1.83}{54.12} - \frac{36.80}{54.12} D_R$$

$$D_B = 3.0743 - 0.6800 D_R \quad (2)$$

Using equation (2) the estimated octol density in each warhead was calculated as shown in Table 7 for the first test using 7.8 second viscosity octol and in Table 8 for the second test using 5.4 second viscosity octol.

Comparison of Estimated Octol Characteristics with Measured Octol Characteristics

To compare the estimated octol density in the warhead (based on riser data) with the measured (weighted average) density in the warhead, the necessary data from Table 7 and Tables 26A-26F were retabulated in Table 9. The weighted averages were put in sequential order so that the graph Figure 7 could be easily understood.

The weighted average and the estimated warhead octol densities were plotted on Figure 7. At first glance it would appear that the estimated density was greater than the measured density. It is. However, the general slope of the estimated graph is similar to the weighted average slope. To investigate this, the difference was found between the estimated density and the weighted average density. The average (\bar{X}) of these differences was calculated and the \bar{X} subtracted from the estimated density. These remainders are called "adjusted estimates". The adjusted estimates of octol density in warheads are listed in Table 9 and plotted on Figure 8. It can be seen that the adjusted density "straddles" the measured density.

TABLE 7
ESTIMATED OCTOL DENSITY IN WARHEAD BODY
BASED ON RISER OCTOL DENSITY
1st TEST - 7.8 SECOND VISCOSITY

LOADING FIXTURE	WARHEAD SERIAL	DENSITY IN RISER GM/CC	FORMULA		ESTIMATED OCTOL DENSITY IN WHD.
			3.0743 -	0.6800 DR	
3	312	1.712	3.0743 -	1.1641	1.9102
	314	1.703	" -	1.1580	1.9163
	315	1.732	" -	1.1778	1.8965
10	346	1.703	" -	1.1580	1.9163
	348	1.715	" -	1.1662	1.9081
	350	1.724	" -	1.1723	1.9020
18	387	1.761	" -	1.1975	1.8768
	389	1.742	" -	1.1846	1.8897
	390	1.734	" -	1.1791	1.8952
34	411	1.737	" -	1.1812	1.8931
	412	1.732	" -	1.1778	1.8965
	414	1.731	" -	1.1771	1.8972
26	471	1.744	" -	1.1859	1.8884
	473	1.722	" -	1.1710	1.9033
	474	1.732	" -	1.1778	1.8965
42	501	1.745	" -	1.1866	1.8877
	503	1.736	" -	1.1805	1.8938
	505	1.748	" -	1.1886	1.8857

TABLE 8
ESTIMATED OCTOL DENSITY IN WARHEAD BODY
BASED ON RISER OCTOL DENSITY
2nd TEST - 5.4 SECOND VISCOSITY OCTOL

LOADING	WARHEAD	DENSITY	FORMULA		ESTIMATED
FIXTURE	SERIAL	IN RISER	3.0743 -	0.6800 DR	OCTOL
NO.	NO.	GM/CC			DENSITY
		DR			IN WHD.
3	8411	1.633	3.0743 -	1.1104	1.9639
	8413	1.622	" -	1.1030	1.9713
	8414	1.630	" -	1.1084	1.9659
10	8447	1.673	" -	1.1376	1.9367
	8449	1.681	" -	1.1431	1.9312
	8450	1.662	" -	1.1302	1.9441
18	8487	1.716	" -	1.1669	1.9074
	8489	1.725	" -	1.1730	1.9013
	8490	1.733	" -	1.1784	1.8959
26	8526	1.732	" -	1.1778	1.8965
	8528	1.726	" -	1.1737	1.9006
	8529	1.728	" -	1.1750	1.8993
34	8566	1.718	" -	1.1682	1.9061
	8568	1.716	" -	1.1669	1.9074
	8570	1.707	" -	1.1608	1.9135
42	8606	1.679	" -	1.1417	1.9326
	8608	1.709	" -	1.1621	1.9122
	8609	1.692	" -	1.0894	1.9849

TABLE 9
 ADJUSTED ESTIMATE OF OCTOL DENSITY IN WARHEAD
 1st TEST - 7.8 SECOND VISCOSITY

	LOADING	WARHEAD	MEASURED	ESTIMATED	DIFFERENCE	ADJUSTED	MEASURED
	FIXTURE	SERIAL	DENSITY	DENSITY	(EST-AVER)	ESTIMATE	DENSITY
	NO.	NO.	IN WHD.	IN WHD.		IN DENSITY	IN
			WEIGHTED	FROM		IN WHD. BODY RISER	
			AVERAGE	RISER DATA		EST - .071	
			TABLE 26	TABLE 7			
			A-F				
1	42	505	1.8193	1.8857	.0664	1.815	1.748
2	42	501	1.8225	1.8877	.0652	1.817	1.745
3	42	503	1.8230	1.8938	.0708	1.823	1.736
4	18	389	1.8252	1.8897	.0645	1.820	1.742
5	18	387	1.8257	1.8768	.0511	1.806	1.761
6	34	414	1.8281	1.8972	.0711	1.827	1.731
7	26	473	1.8261	1.9033	.0772	1.833	1.722
8	10	346	1.8262	1.9163	.0901	1.846	1.703
9	34	412	1.8266	1.8965	.0699	1.826	1.730
10	26	471	1.8267	1.8884	.0617	1.818	1.744
11	18	390	1.8269	1.8952	.0683	1.825	1.734
12	10	350	1.8274	1.9020	.0746	1.832	1.724
13	34	411	1.8277	1.8931	.0654	1.823	1.737
14	26	474	1.8278	1.8965	.0687	1.826	1.732
15	10	348	1.9297	1.9081	.0784	1.838	1.715
16	3	315	1.8302	1.8965	.0663	1.826	1.732
17	3	314	1.8306	1.9163	.0857	1.846	1.703
18	3	312	1.8327	1.9102	.0775	1.840	1.712
					X=.0707		
					↑		

THIS COLUMN IN SEQUENTIAL ORDER

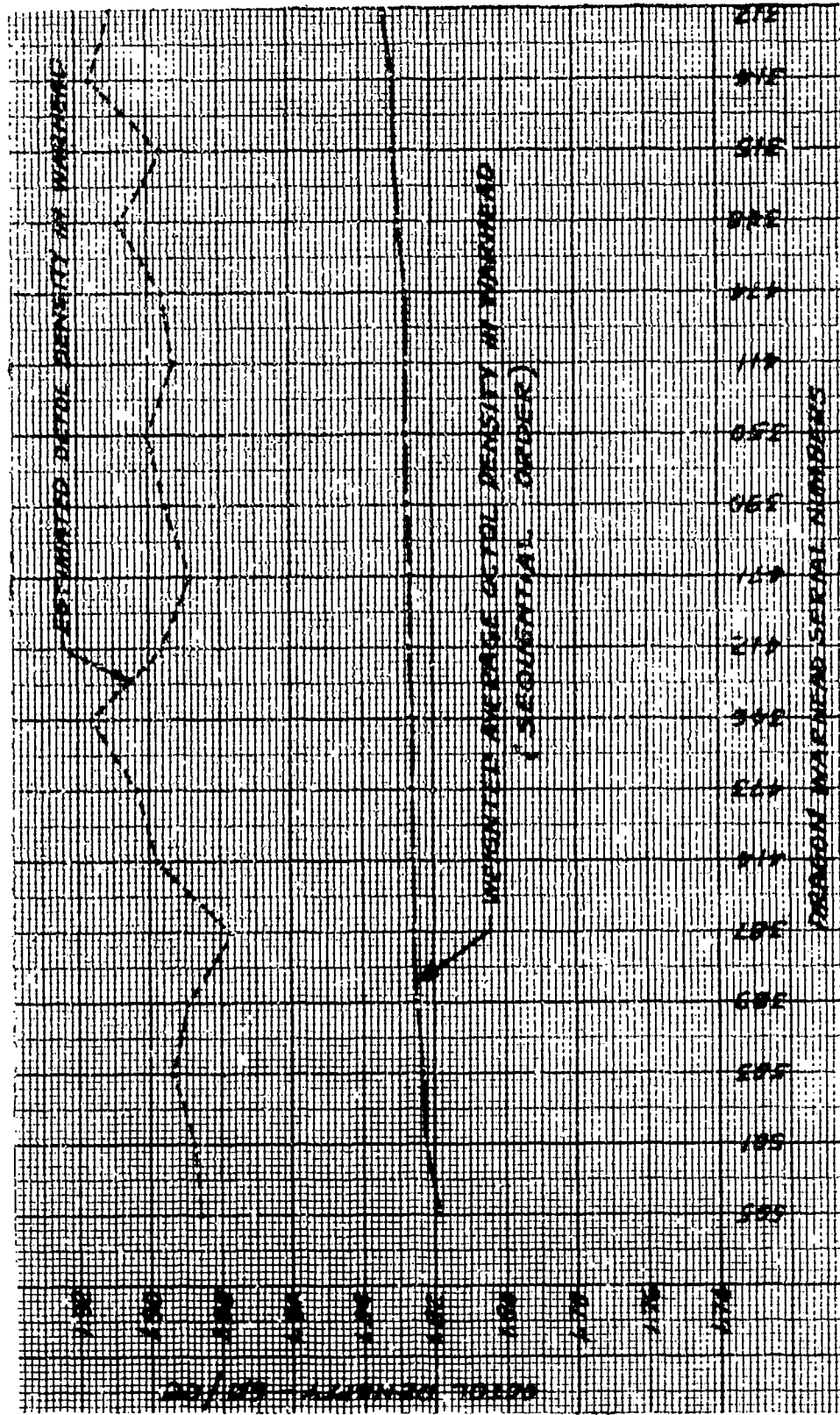

FIGURE 7

COMPARISON OF ESTIMATED WARHEAD OCTOL DENSITY WITH

WEIGHTED AVERAGE OCTOL DENSITY

70/30 OCTOL - 7.8 SECOND VISCOSITY - 1st TEST

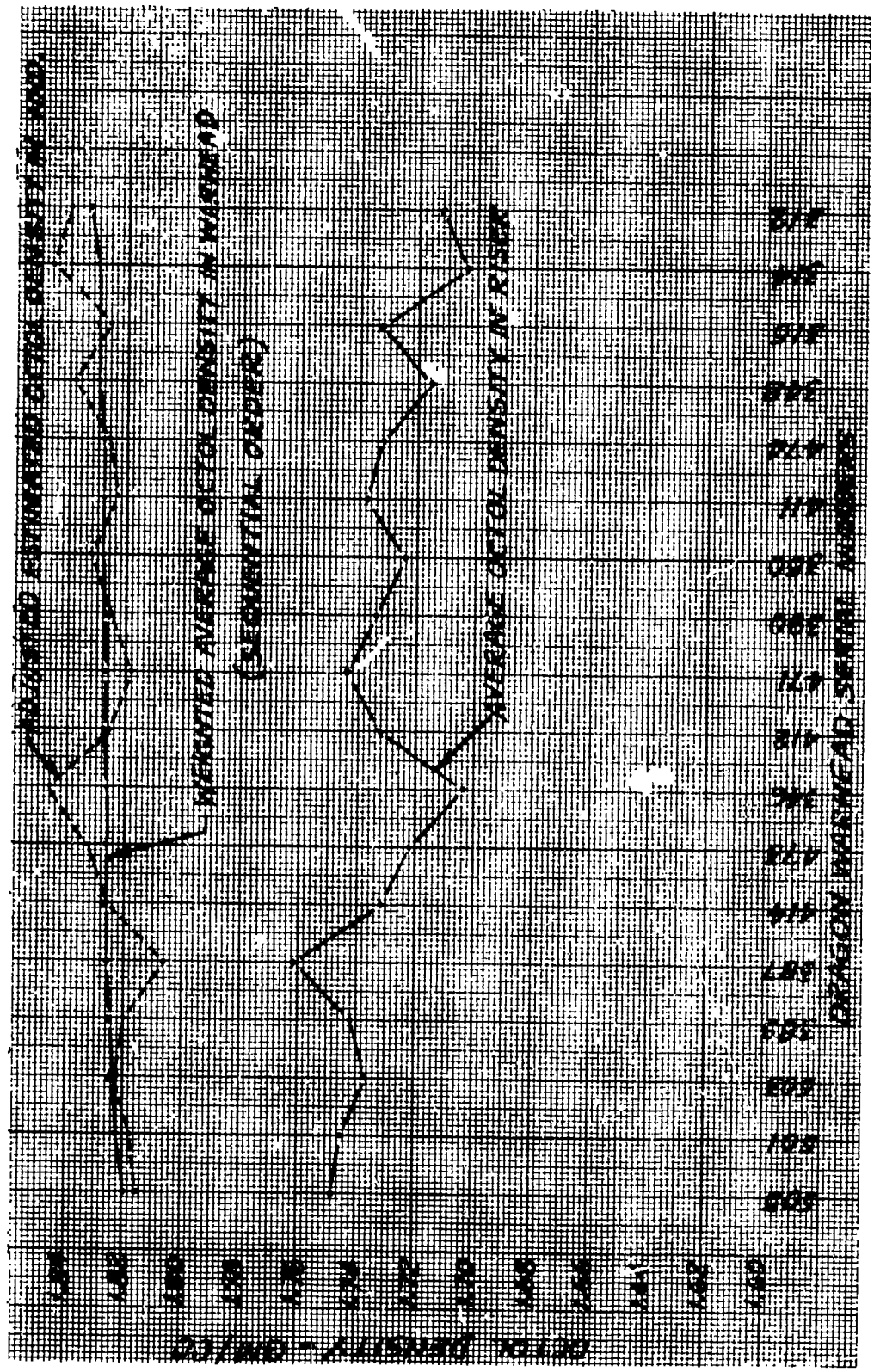

FIGURE 8
ADJUSTED ESTIMATED OCTOL DENSITY IN WARHEAD
70/30 OCTOL ~ 7.8 SEC VISCOSITY ~ 1st TEST

The density formula D_B (2) can now be rewritten as:

$$D_B = (3.0743 - 0.6800 D_R) - FF \quad (3)$$

where FF = a fudge factor,
= \bar{X} of differences
= .071 gm/cc, DRAGON

The same procedure was used for the second test (5.4 second viscosity). The adjusted estimates of density in the warheads are given in Table 10 and plotted on Figure 9. For the second test FF = .1035 gm/cc.

Octol Characteristics in Warheads on Either Side of Fired Warhead versus Penetration

Each DRAGON loading fixture accommodates five warheads at one time. The test plan specified that one warhead would be randomly selected for penetration testing. The two warheads on either side of the fired warhead would be sectioned and cored to determine the octol characteristics. One of the remaining two warheads was then selected for the second penetration test and the fifth warhead cored.

To graphically portray this test arrangement, figures 20A through 20F for the first test and figures 21A through 21F for the second test give the following information:

- a. Loading fixture number
- b. Warhead location by serial number
- c. Penetration results
- d. Percent HMX (weighted average) of each warhead
- e. Average percent HMX of the two warheads on either side of the fired warhead
- f. Octol density (weighted average) of each warhead
- g. Average octol density of the two warheads on either side of the fired warhead

The percent HMX and octol density in warheads on either side of fired warheads versus penetration are summarized in Tables 11 and 12. This information was plotted. Figures 12 and 13 has the weighted average % HMX in warheads, either side, vs. penetration. The observed points are scattered. By computer, using the least-squares method, a "best fit line" was determined and plotted.

In like manner, Figures 10 and 11 show the observed points and the best fit line for the octol density in warheads on either side of the fired warhead versus penetration.

TABLE 10
 ADJUSTED ESTIMATE OF OCTOL DENSITY IN WARHEAD
 2nd TEST
 5.4 SECOND VISCOSITY

	LOADING	WARHEAD	MEASURED	ESTIMATED	DIFFERENCE	ADJUSTED	MEASURED	
	FIXTURE	SERIAL	DENSITY	DENSITY	(EST-AVER)	ESTIMATE	DENSITY	
	NO.	NO.	IN WHD.	IN WHD.		IN DENSITY	IN	
			WEIGHTED	FROM		IN WHD. BODY RISER		
			AVERAGE	RISER DATA		EST - .1035		
			TABLE 28	TABLE 8				
			A-F					
1	42	8609	1.8142	1.9849	.1707	1.8814	1.602	
2	42	8608	1.8161	1.9122	.0961	1.8087	1.709	
3	26	8526	1.8165	1.8965	.0800	1.7930	1.732	
4	42	8606	1.8176	1.9326	.1150	1.8291	1.679	
5	26	8529	1.8200	1.8993	.0793	1.7958	1.728	
6	34	8566	1.8208	1.9061	.0853	1.8026	1.718	
7	34	8570	1.8214	1.9135	.0921	1.8100	1.707	
8	34	8568	1.8217	1.9074	.0857	1.8039	1.716	
9	26	8528	1.8221	1.9006	.0785	1.7971	1.726	
10	18	8490	1.8224	1.8959	.0735	1.7924	1.733	
11	10	8447	1.8232	1.9367	.1135	1.8332	1.686	
12	10	8450	1.8247	1.9441	.1194	1.8406	1.662	
13	18	8487	1.8250	1.9074	.0824	1.8039	1.716	
14	18	8489	1.8262	1.9013	.0751	1.7978	1.725	
15	10	8449	1.8272	1.9312	.1040	1.8277	1.681	
16	3	8411	1.8274	1.9639	.1365	1.8604	1.633	
17	3	8414	1.8306	1.9659	.1353	1.8624	1.630	
18	3	8413	1.8313	1.9713	.1400	1.8678	1.622	
					$\bar{x} = .1035$			
			THIS COLUMN IN SEQUENTIAL ORDER					

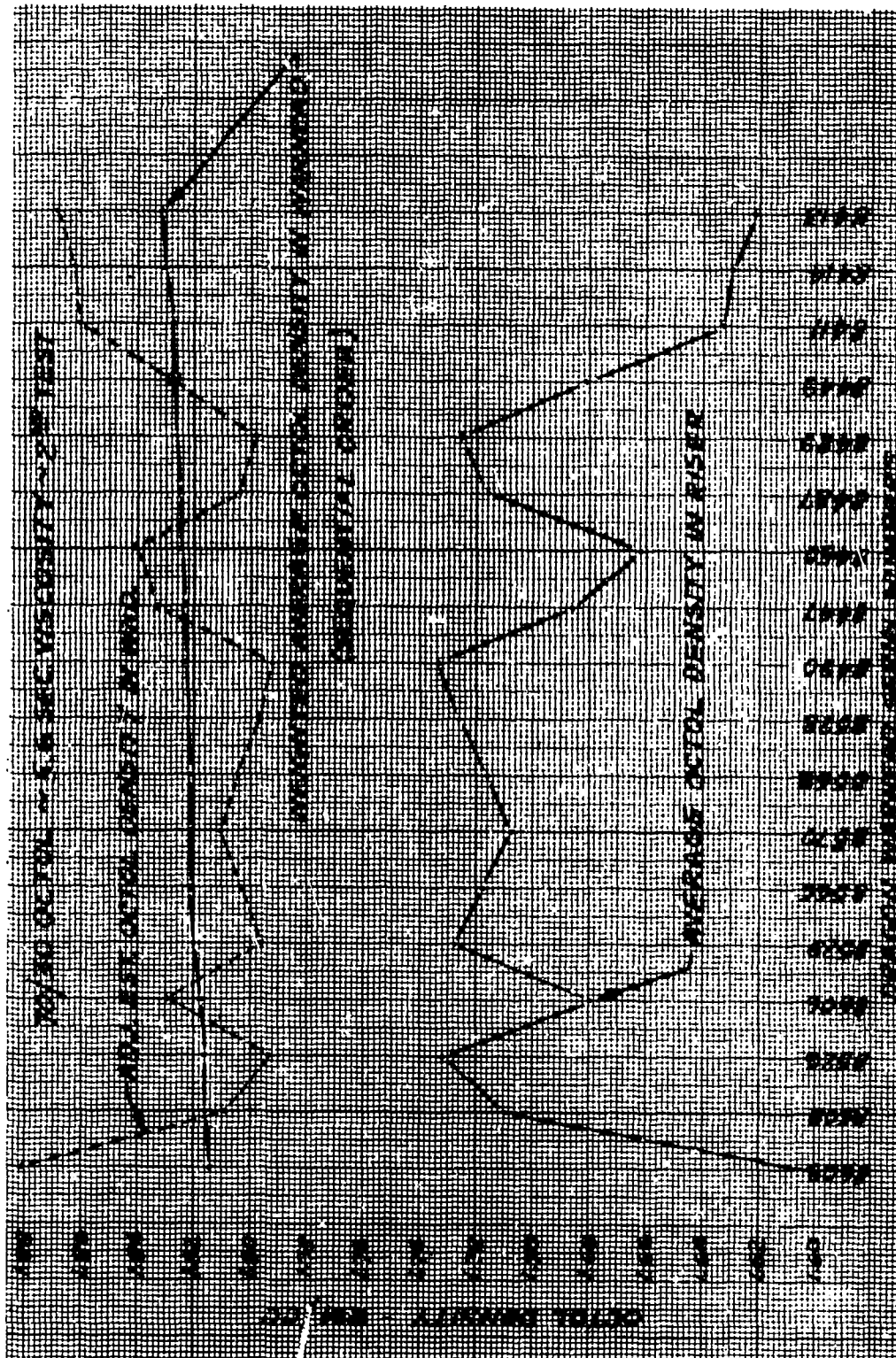

FIGURE 9
 ADJUSTED ESTIMATED OCTOL DENSITY IN MARHEAD
 70/30 OCTOL ~ 5.4 SEC VISCOSITY ~ 2nd TEST

TABLE 11
 % HMX & OCTOL DENSITY IN WHDS EITHER SIDE
 OF FIRED WHD. VS PENETRATION
 1st TEST - 7.8 SECOND VISCOSITY

LOADING FIXTURE NO.	FIRE D WHD. NO.	PENE- TRATION X _L +	AVERAGE % HMX IN WHDS EITHER SIDE (WEIGHTED)		OCTOL DENSITY IN WHDS EITHER SIDE (WEIGHTED)
3	311	6.50"	79.84%		1.8315
	313	9.50"	80.11	(HI)	1.8317 (HI)
10	347	7.00"	N/A		1.8280
	349	10.00"	"		1.8286
18	386	7.50"	78.63		1.8263
	388	6.50"	77.88	(LO)	1.8255
34	413	5.50"	79.38		1.8264
	415	3.50"	79.61		1.8269
26	472	9.25"	79.50		1.8264
	475	8.00"	79.55		1.8273
42	502	8.50"	78.99		1.8228
	504	9.75"	78.70		1.8212 (LO)
SEE FIGURES 20A THRU 20F					

TABLE 12
 % HMX & OCTOL DENSITY IN WHDS EITHER SIDE
 OF FIRED WHDS. VS. PENETRATION
 2nd TEST - 5.4 SECOND VISCOSITY

LOADING FIXTURE NO.	FIRED WHD. NO.	PENE- TRATION X _T +....	AVERAGE % HMX IN WHDS EITHER SIDE (WEIGHTED)	OCTOL DENSITY IN WHDS EITHER SIDE (WEIGHTED)
3	8412	7.25"	81.37%	1.8294 (HI)
	8415	8.25"	81.27	1.8290
10	8446	10.25	80.60 (LO)	1.8240
	8448	8.75	81.00	1.8252
18	8486	8.75	81.45	1.8238
	8488	8.00	81.71	1.8256
26	8527	8.50	81.03	1.8193
	8530	8.25	80.85	1.8183
34	8567	4.50	81.95 (HI)	1.8213
	8569	6.00	81.88	1.8216
42	8607	8.75	81.50	1.8169
	8610	7.25	81.66	1.8152 (LO)
SEE FIGURES 21A THRU 21F				

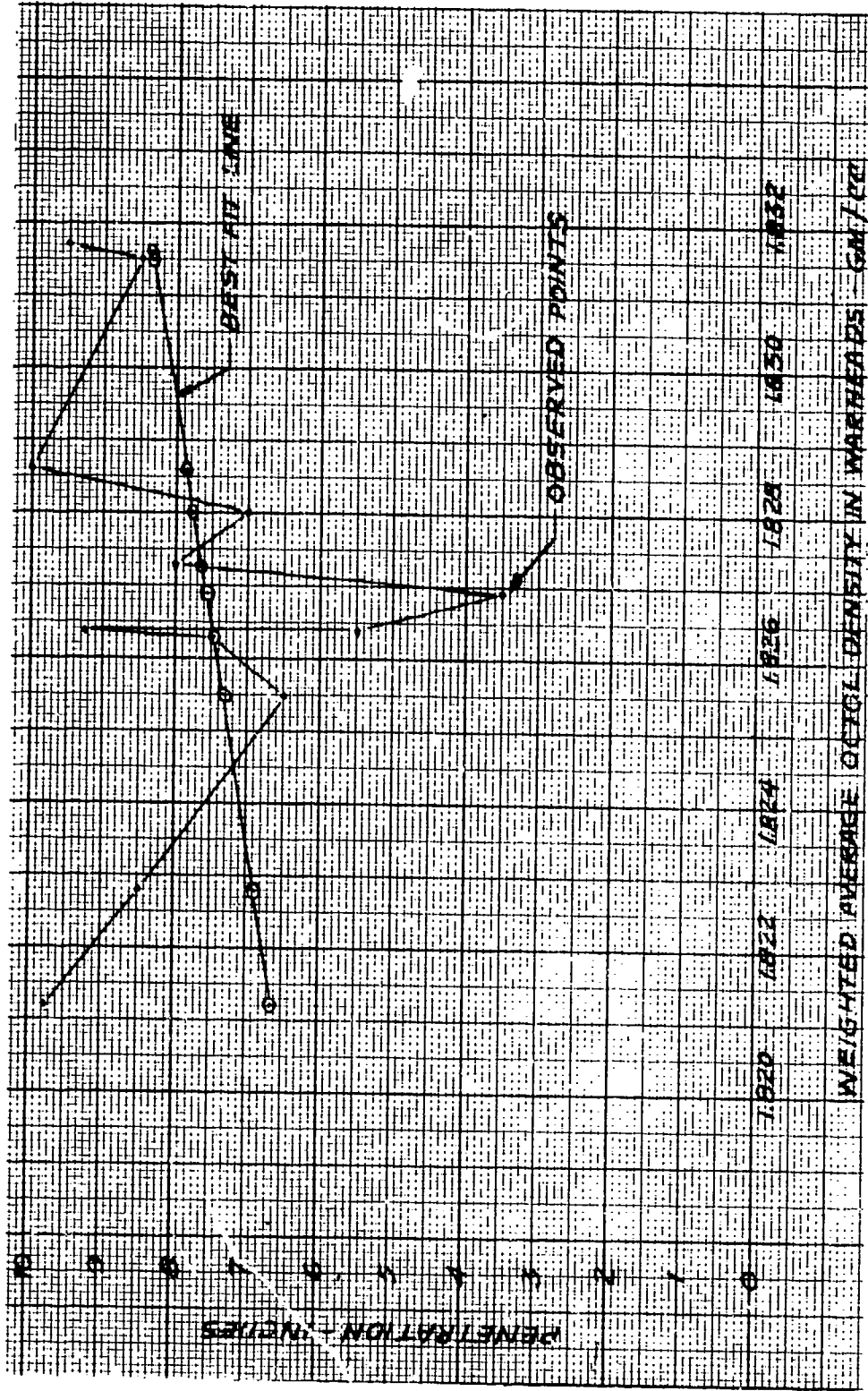

FIGURE 10

OCTOL DENSITY IN WBDs EITHER SIDE OF FIRED WBD VS PENETRATION

1st TEST - 7.8 SECOND VISCOSITY

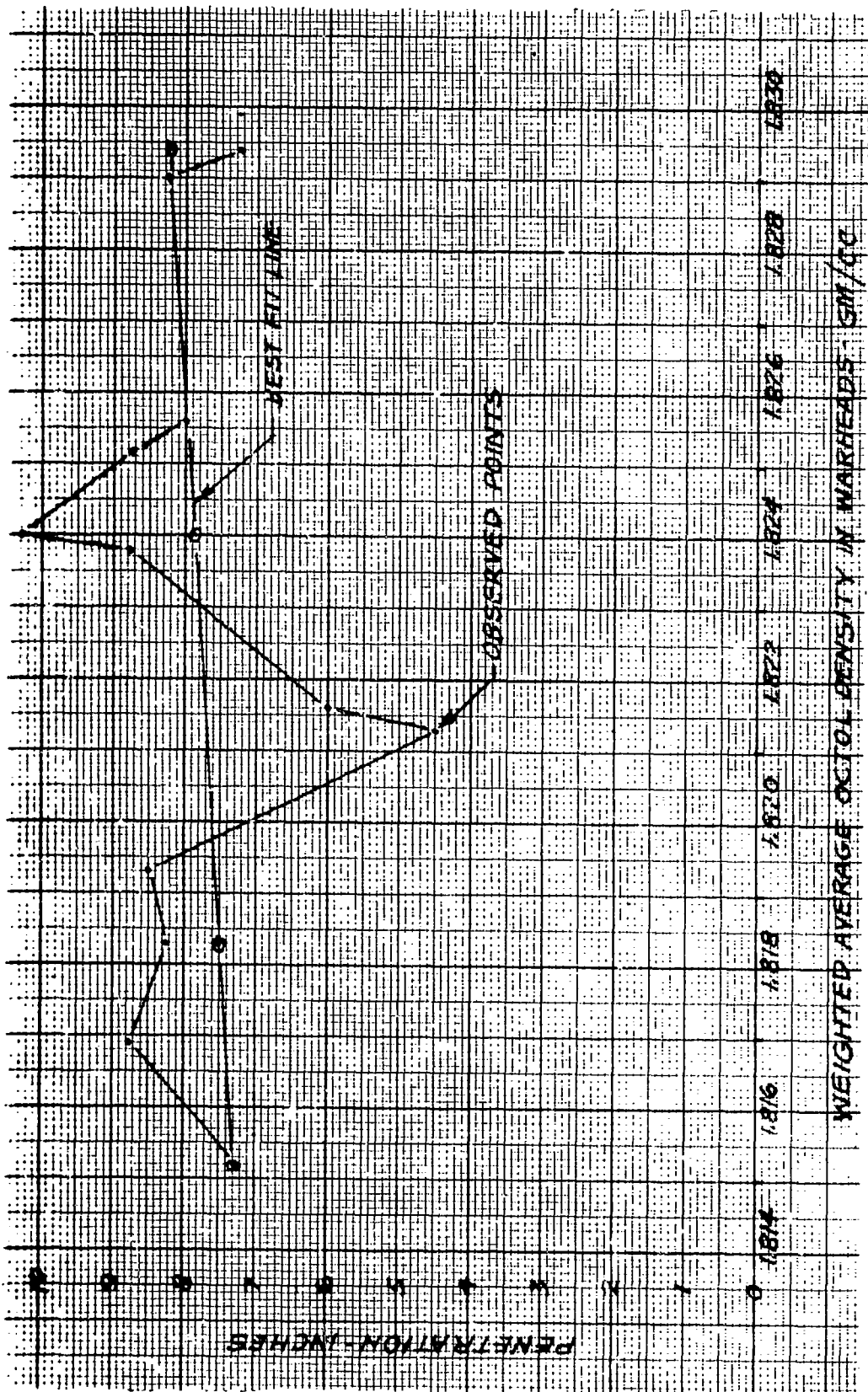

FIGURE 11

OCTOL DENSITY IN WHDS EITHER SIDE OF FIRED WHD VS PENETRATION

2nd TEST - 5.4 SECOND VISCOSITY

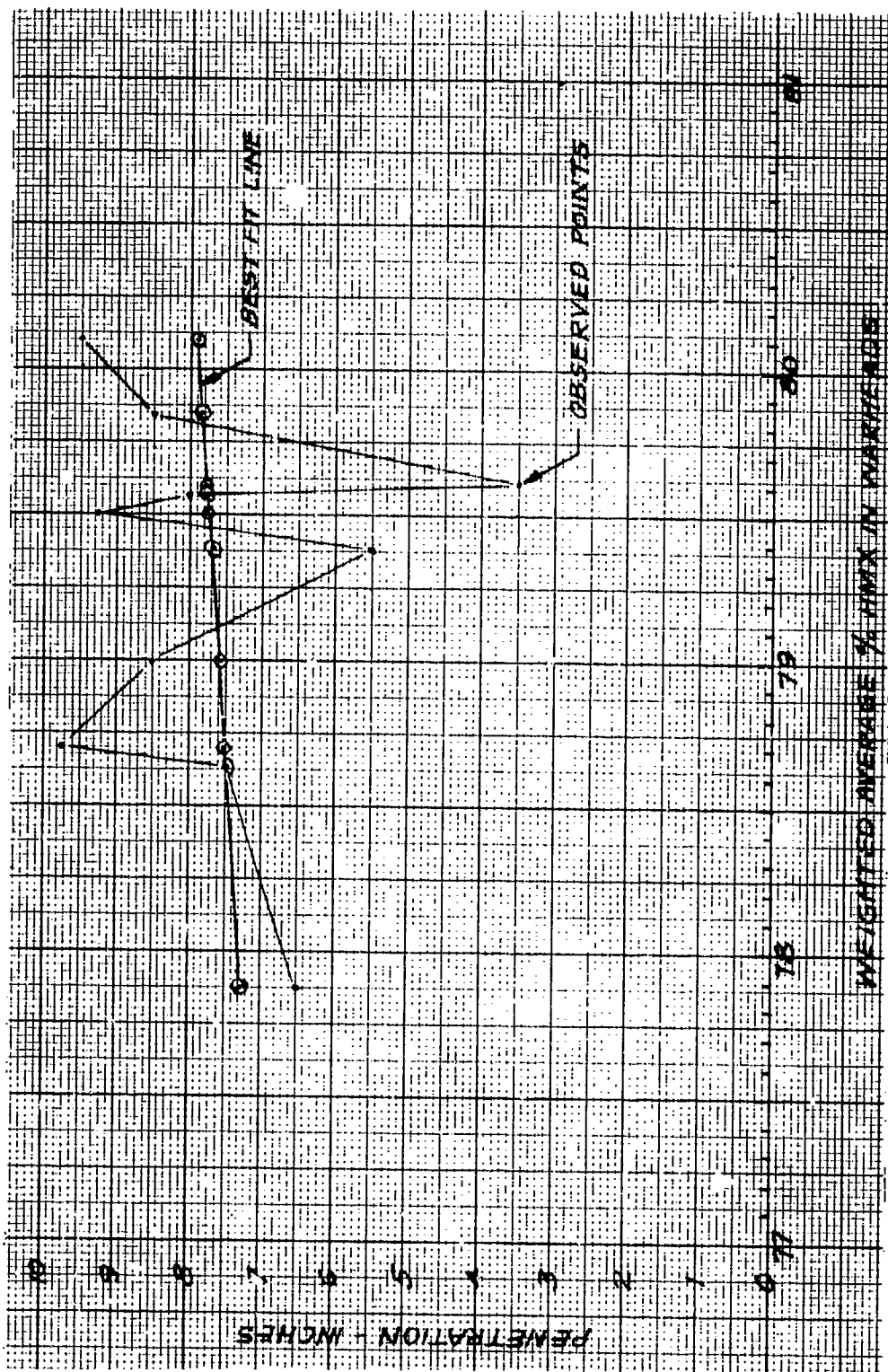

FIGURE 12

8 HMX IN WMDs EITHER SIDE OF FIRED WMD VS PENETRATION

1st TEST - 7.8 SECOND VISCOSITY

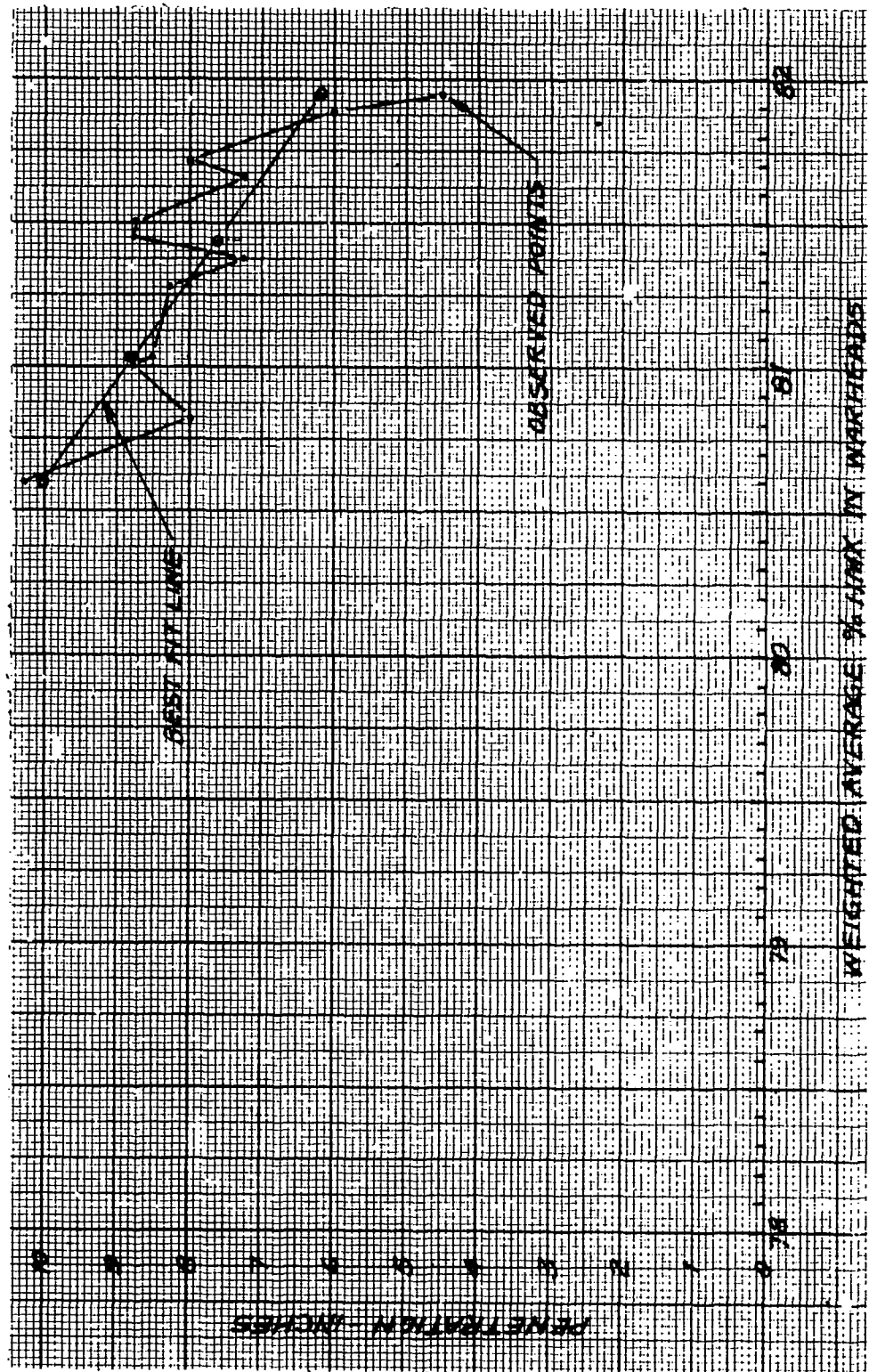

FIGURE 13

8 HMX IN WEDS EITHER SIDE OF FIRED WED VS PENETRATION
 2nd TEST - 5.4 SECOND VISCOSITY

Three figures (12, 10, 11) of the four show that more HMX in the warhead gives better penetration.

Adjusted Estimated Average Octol Characteristics in Warhead versus Penetration

Since it is not possible to chemically analyze warheads before they are fired, the formula developed in previous paragraph based on riser information was used to find the adjusted estimated average octol characteristics of the warhead proper.

These calculated values of octol density were plotted against the penetration achieved when fired into hardened steel plates.

The octol densities in the DRAGON warheads poured for the first and second tests were calculated from the formula #3. Table 13 shows the computations for the first test along with the penetration values. This information was plotted on Figure 14.

For the second test using 5.4 second viscosity 70/30 octol, the computations are shown in Table 14. These estimated warhead octol density values were plotted against the corresponding penetration values and are shown in Figure 15.

The first test plot in Figure 14 conforms to the expected performance, while the second test plot in Figure 15 does not.

Octol Characteristics in Risers versus Penetration

The octol characteristics (% HMX and octol density) were determined for each riser. For the first test there was a total of 30 risers analyzed of which 12 were from warheads which were fired for penetration performance. For the second test a total of 30 risers were also analyzed. However, the analysis of the first nine (9) risers gave inconclusive results for the % HMX due to improper laboratory technique. Of the 12 warheads fired for the second test, 8 risers were properly analyzed for % HMX and all 12 were properly analyzed for octol density. This information on the octol characteristics in the risers is given in Table 21. For the first test the riser information is retabulated in Table 15 and for the second test Table 16 gives the riser data. Both tables also list the penetration results.

It will be observed in Table 15 that the sequential order of the octol density in the riser is not the same

TABLE 13
 ADJUSTED ESTIMATE OF OCTOL DENSITY IN WARHEAD
 VS PENETRATION

1st TEST - 7.8 SEC. VISCOSITY

LOADING FIXTURE NO.	WARHEAD SERIAL NO.	OCTOL DENSITY IN RISER	FORMULA		ESTIMATED OCTOL DENSITY IN WHD	ADJUSTED ESTIMATE DENSITY IN WHD	PENE- TRATION
			3.0743 -	0.6800 D _R			
						EST. -.071	
3	311	1.674	3.0743 -	1.1383 =	1.9360	1.8650	8.50
	313	1.728	" -	1.1750 =	1.8993	1.8283	9.50
10	347	1.717	" -	1.1676 =	1.9067	1.8357	7.00
	349	1.723	" -	1.1716 =	1.9027	1.8317	10.00
18	386	1.744	" -	1.1859 =	1.8884	1.8174	7.50
	388	1.742	" -	1.1846 =	1.8897	1.8187	6.50
26	472	1.737	" -	1.1812 =	1.8931	1.8221	9.25
	475	1.731	" -	1.1771 =	1.8972	1.8262	8.00
34	413	1.744	" -	1.1859 =	1.8884	1.8174	5.50
	415	1.734	" -	1.1791 =	1.8952	1.8242	3.50
42	502	1.731	" -	1.1771 =	1.8972	1.8262	8.50
	504	1.722	" -	1.1710 =	1.9033	1.8323	9.75

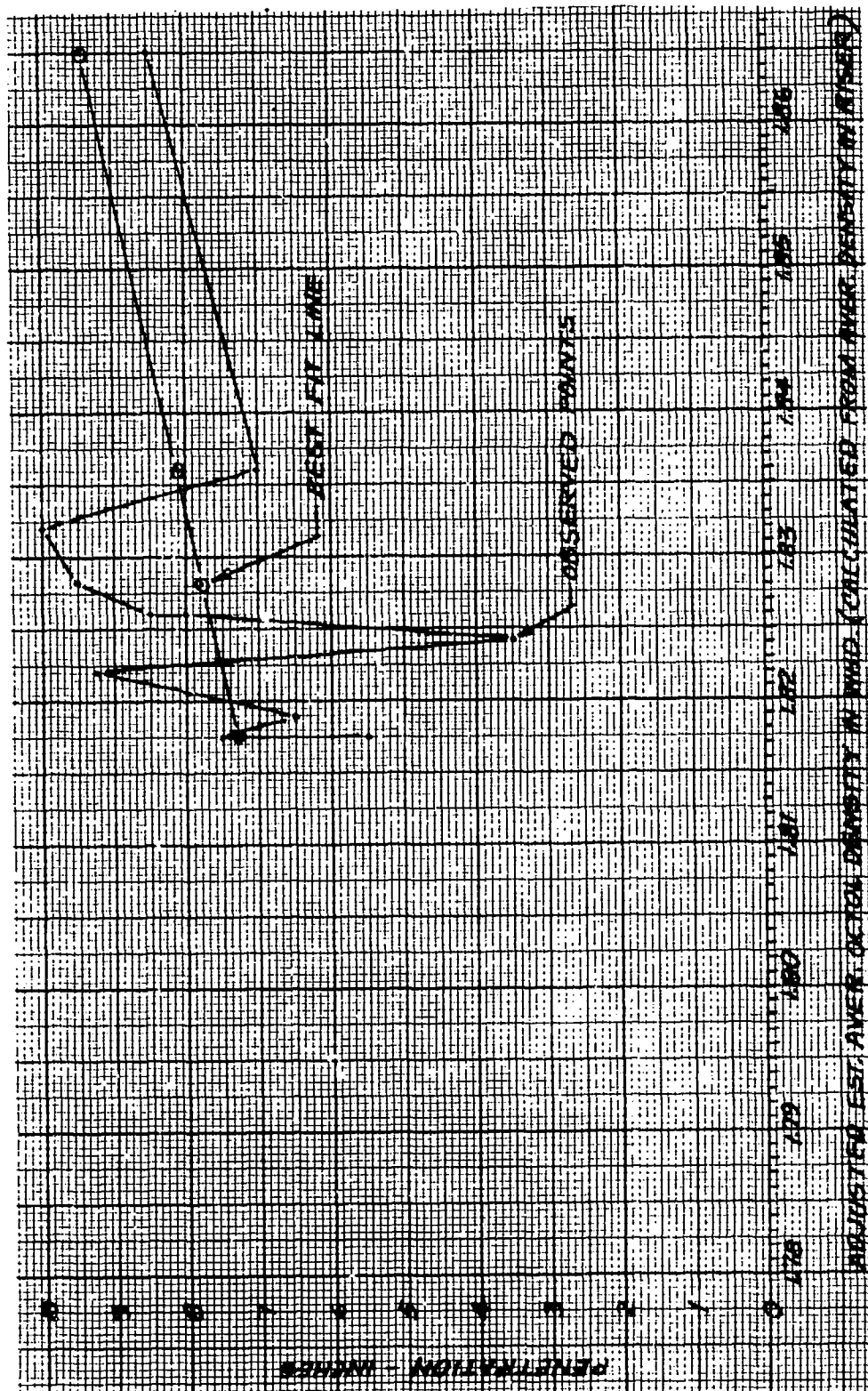

FIGURE 14

ADJUSTED ESTIMATED AVERAGE OCTOL DENSITY IN MARHEAD VS PENETRATION

1st TEST - 7.8 SECOND VISCOSITY

TABLE 14
 ADJUSTED ESTIMATE OF OCTOL DENSITY IN WARHEAD
 VS PENETRATION

2nd TEST - 5.4 SEC. VISCOSITY

LOADING FIXTURE NO.	WARHEAD SERIAL NO.	OCTOL DENSITY IN RISER	FORMULA 3.0743 -	OCTOL DENSITY IN WHD	ESTIMATED OCTOL DENSITY IN WHD	ADJUSTED ESTIMATE DENSITY IN WHD	PENE- TRATION
				0.6800 D _R		EST. -.1035	
3	8412	1.661	3.0743 -	1.1295 =	1.9448	1.8413	7.25
	8415	1.661	" -	1.1295 =	1.9448	1.8413	8.25
10	8446	1.686	" -	1.1465 =	1.9278	1.8243	10.25
	8448	1.620	" -	1.1016 =	1.9727	1.8692	8.75
18	8486	1.732	" -	1.1778 =	1.8965	1.7930	8.75
	8488	1.740	" -	1.1832 =	1.8911	1.7876	8.00
26	8527	1.733	" -	1.1784 =	1.8959	1.7924	8.50
	8530	1.714	" -	1.1655 =	1.9088	1.8053	8.25
34	8567	1.706	" -	1.1601 =	1.9142	1.8107	4.50
	8569	1.651	" -	1.1227 =	1.9516	1.8481	6.00
42	8607	1.692	" -	1.1506 =	1.9237	1.8202	8.75
	8610	1.670	" -	1.1356 =	1.9387	1.8352	7.25

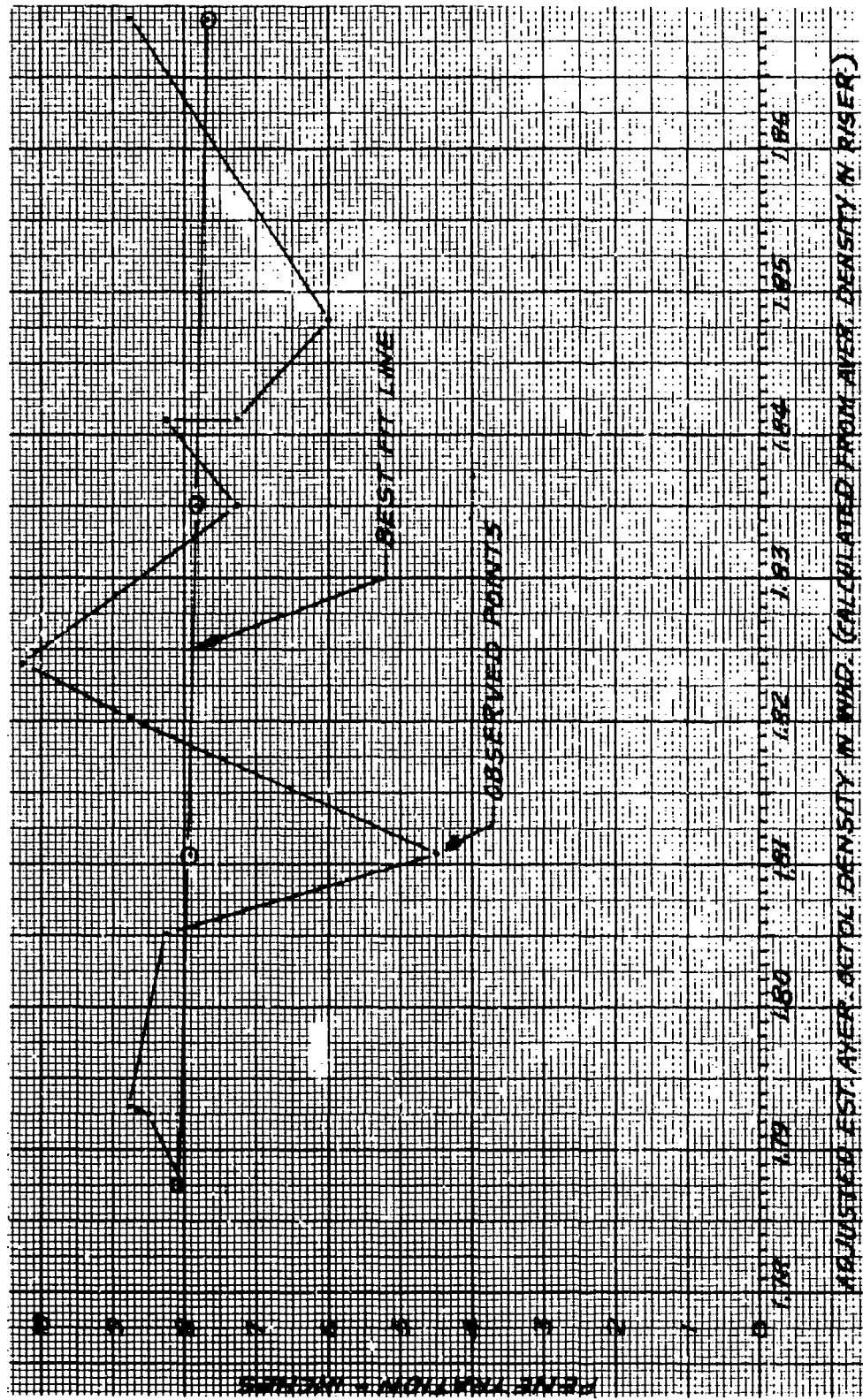

FIGURE 15

ADJUSTED ESTIMATED AVERAGE OCTOL DENSITY IN WARHEAD VS PENETRATION
 2nd TEST - 5.4 SECOND VISCOSITY

TABLE 15
 OCTOL CHARACTERISTICS IN RISERS
 VS PENETRATION

1st TEST - 7.8 SECOND VISCOSITY

WHD SERIAL NO.	% HMX IN RISER	PENE- TRATION $X_T + \dots$		WHD SERIAL NO.	OCTOL DENSITY IN RISER	PENE- TRATION $X_T + \dots$	
504	39.55%	9.75		311	1.674	8.50	
349	42.93	10.00		347	1.717	7.00	
347	43.98	7.00		504	1.722	9.75	
313	45.45	9.50		349	1.723	10.00	
172	47.63	9.25		313	1.728	9.50	
311	48.07	8.50		475	1.731	8.00	
415	48.42	3.50		502	1.731	8.50	
386	48.56	7.50		415	1.734	3.50	
413	49.69	5.50		472	1.737	9.25	
388	49.76	6.50	←	388	1.742	6.50	
502	50.41	8.50		386	1.744	7.50	
475	51.20	8.00		413	1.744	5.50	

TABLE 16

OCTOL CHARACTERISTICS IN RISERS
VS PENETRATION

2nd TEST - 5.4 SECOND VISCOSITY

WHD SERIAL NO.	% HMX IN RISER	PENE- TRATION $X_L + \dots$		WHD SERIAL NO.	OCTOL DENSITY IN RISER	PENE- TRATION $X_L + \dots$
8412	DATA NOT USABLE	7.25		8448	1.620	8.75
8415		8.25		8569	1.651	6.00
8446		10.25		8412	1.661	7.25
8448		8.75		8415	1.661	8.25
8567		36.68	4.50	8610	1.670	7.25
8569	36.88	6.00	8446	1.686	10.25	
8607	43.28	8.75	↔	8607	1.692	8.75
8530	47.63	8.25		8567	1.706	4.50
8486	47.79	8.75		8530	1.714	8.25
8610	48.37	7.25		8486	1.732	8.75
8527	48.74	8.50	↔	8527	1.733	8.50
8488	49.60	8.00	↔	8488	1.740	8.00
		↑	SEQUENTIAL ORDER	↑		

sequential order of the % HMX. Since it is logical to expect a correlation between % HMX and octol density the fact that the sequential orders do not agree would indicate that something is amiss. This may be the method of determining the octol characteristics, the accuracy of making the measurements, or because of some other factor not immediately apparent.

By comparison, the penetration of warhead #415 of 3.50" is low. The next lowest value is 5.50". The low penetration values of 3.50" and 5.50" were from warheads poured on the same loading fixture, No. 34 (See Fig. 26D). The highest value is 10.00" with an average for the eleven (without #415) DRAGON warheads at 8.18". The % HMX and the octol density for warhead #415 is in the mid-range of their respective values so the lower penetration must be due to one of the other variables which can cause poorer performance. This same type of situation also applies to Table 16.

The plots of the % HMX in the riser versus penetration are shown in Figure 16 for the first test using 7.8 second viscosity octol and in Figure 17 for the second test using 5.4 second viscosity octol. The slope of the "best fit line" in Figure 16 agrees with preconceived ideas as previously discussed.

The slope of the "best fit line" in Figure 17 is in the opposite direction.

The octol densities in the risers versus the penetration results are shown in Figures 18 and 19, first and second tests respectively.

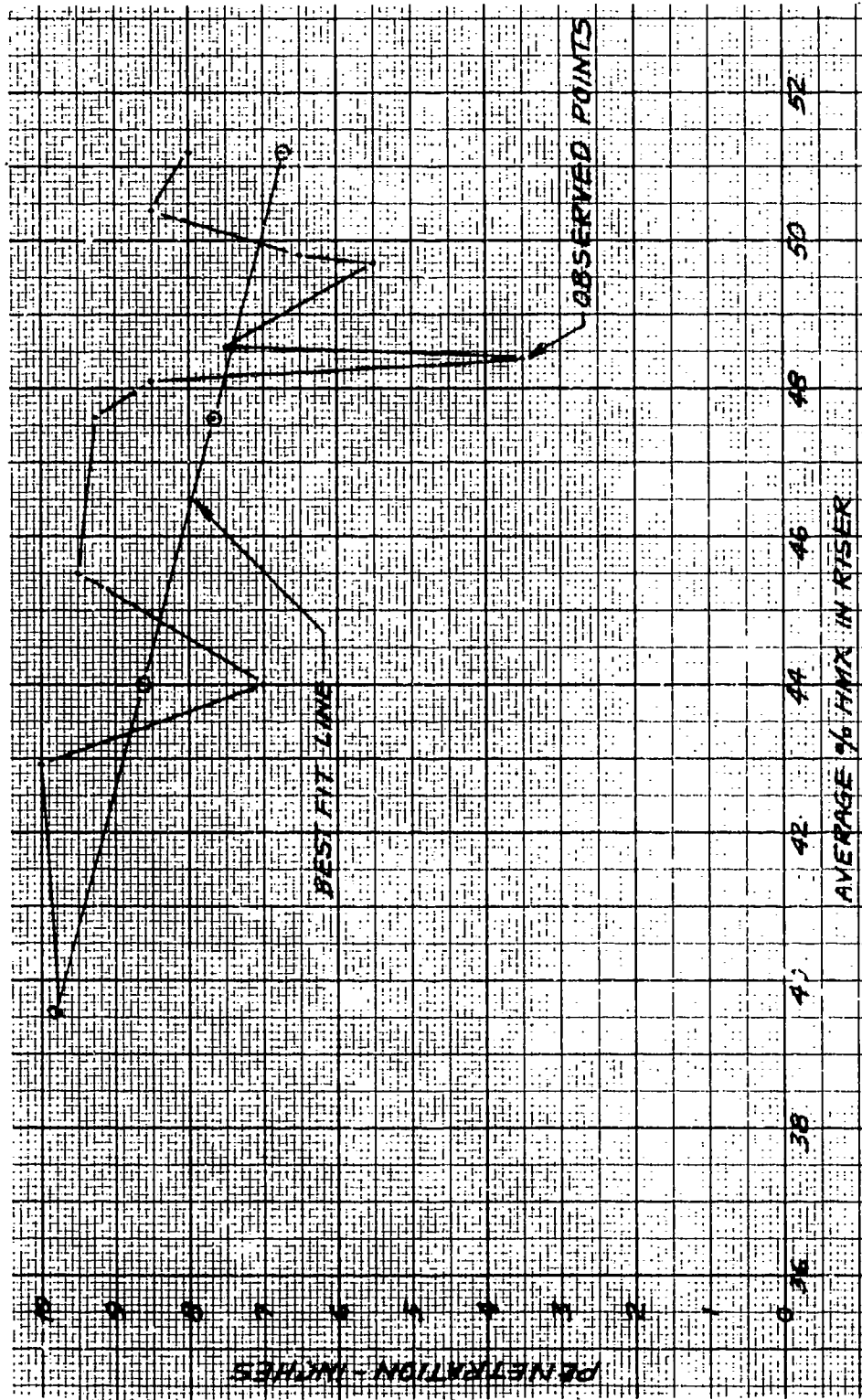

FIGURE 16

8 HMX IN RISER VS PENETRATION

1st TEST - 7.8 SECOND VISCOSITY

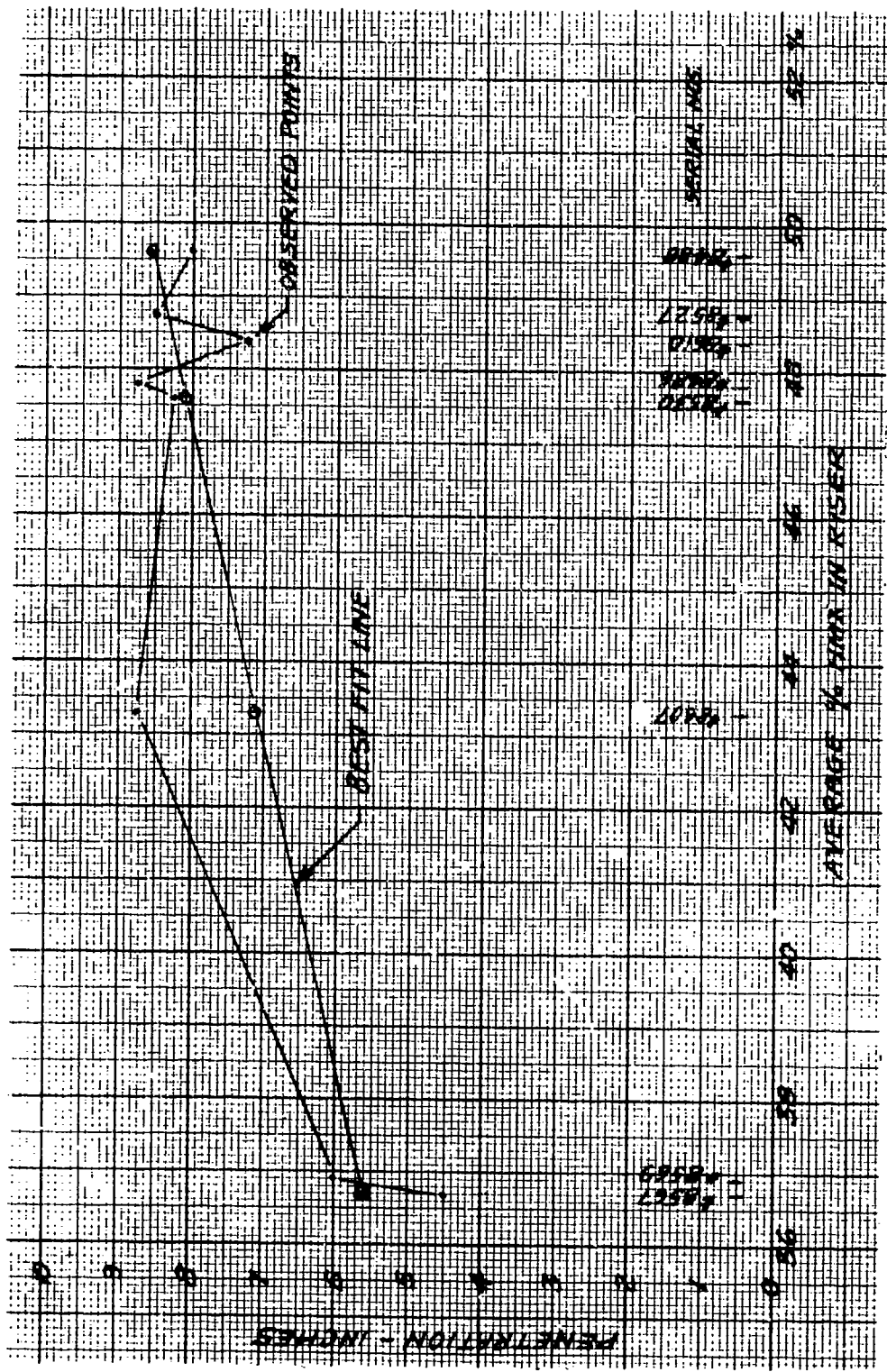

FIGURE 17

• HMX IN RISER VS PENETRATION

2nd TEST - 5.4 SECOND VISCOSITY

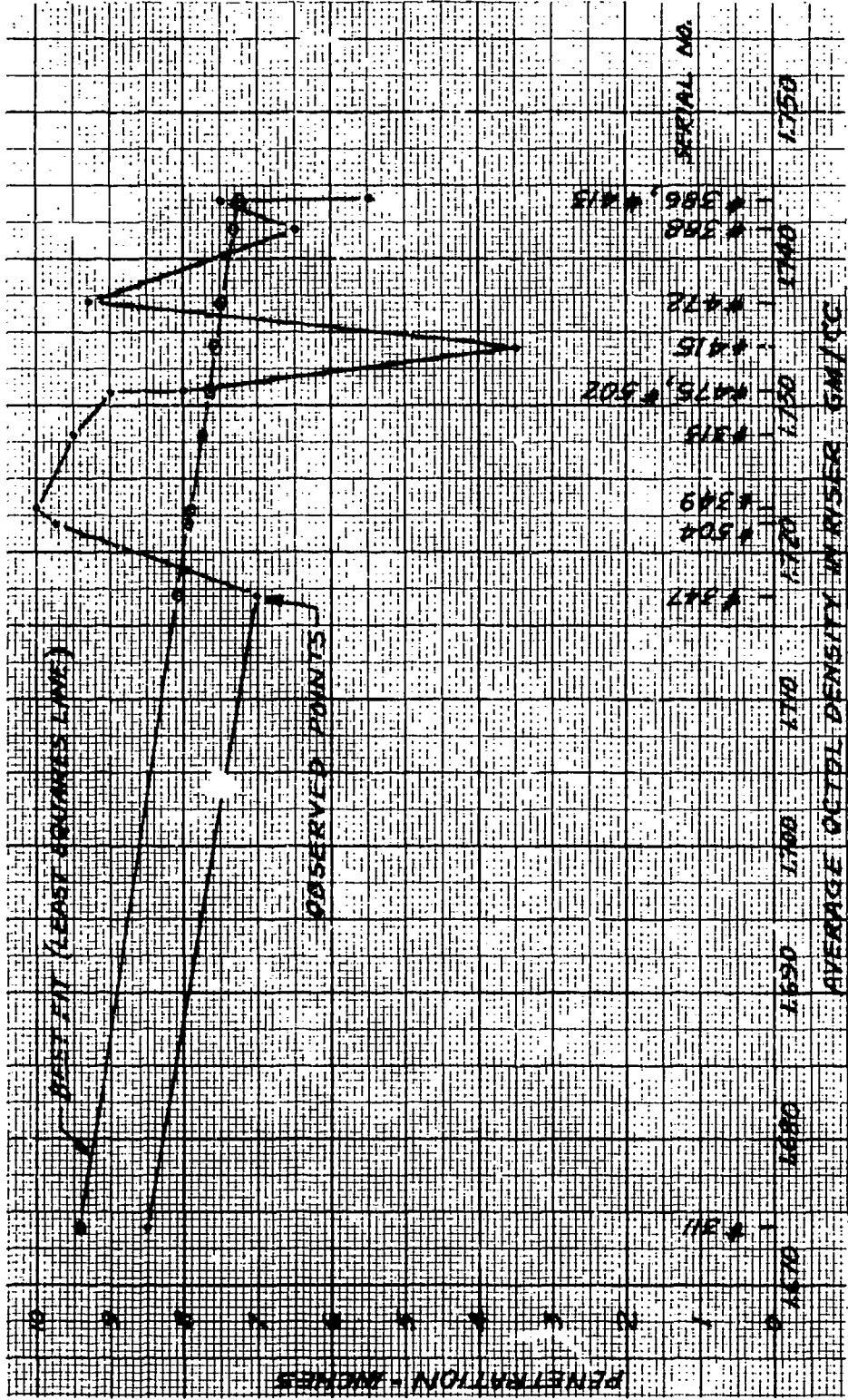

FIGURE 18
 OCTOL DENSITY IN RISER VS PENETRATION
 1st TEST - 7.8 SECOND VISCOSITY

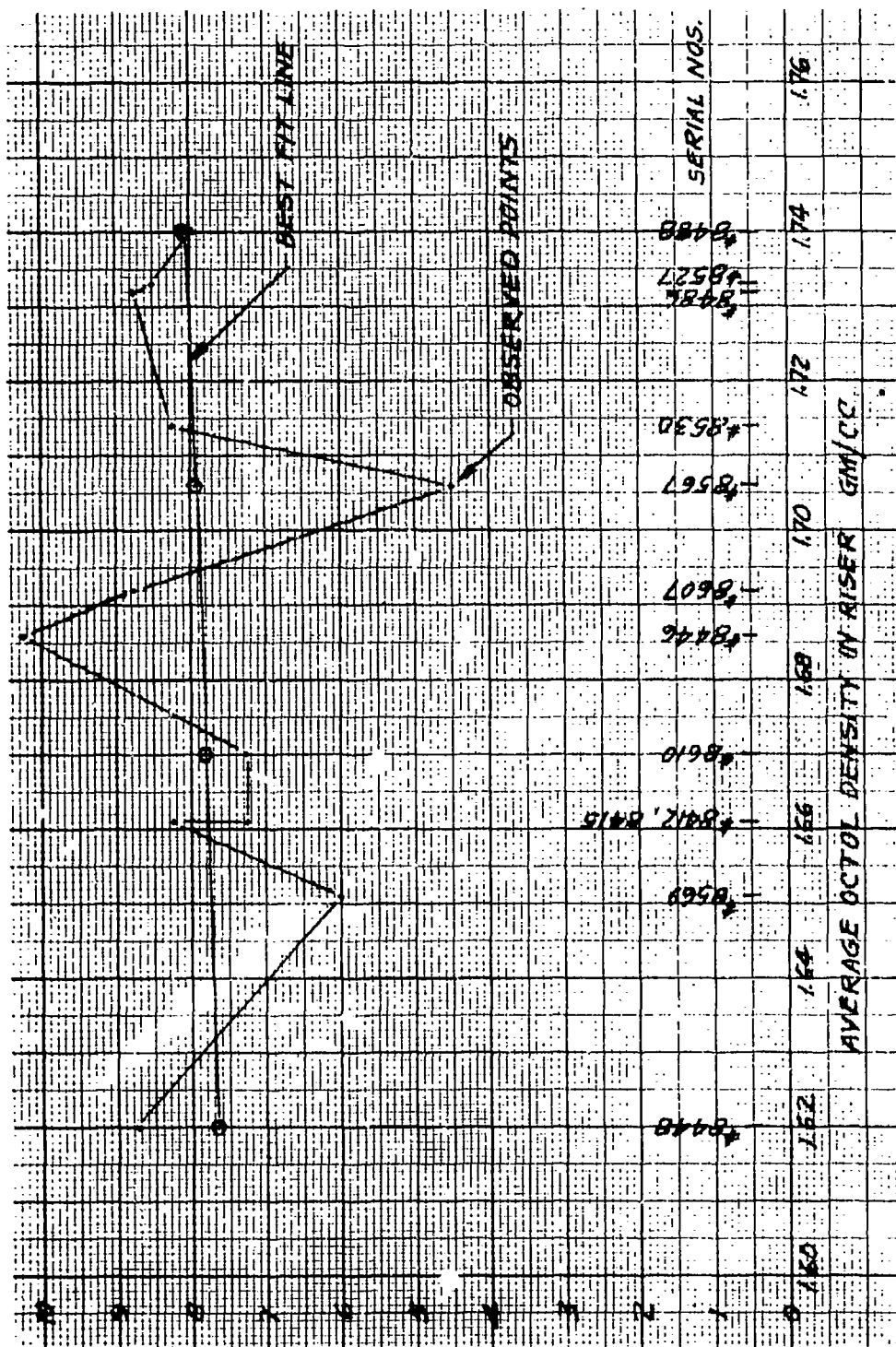

FIGURE 19

OCTOL DENSITY IN RISER VS PENETRATION

2nd TEST - 5.4 SECOND VISCOSITY

CONCLUSIONS

1. By the statistical "t" test at the 90% confidence level there is no reason to believe that the Virgin 70/30 octol differs in average penetration performance from the 75/25 octol diluted to 70/30 octol. See Table 1.
2. There were no significant differences in the octol characteristics (% HMX and density) between loading fixtures. See Tables 2, 3, 4 and 5.
3. There were no significant differences in the octol characteristics between the warheads on one loading fixture. See Tables 23, 25, 27 and 29.
4. From limited data, it appears that Virgin 70/30 octol has slightly better "settling" characteristics than cut 75/25 octol. See Figures 2 and 4.
5. There is reasonable correlation between octol density and % HMX distribution within the DRAGON warheads. See Figures 5 and 6.
6. Given the characteristics of the octol in the riser, a close approximation can be made of the octol density in the warhead. See Figures 8 and 9.
7. The weighted averages of the octol characteristics (density and % HMX) of the warheads on the loading fixture either side of the fired warheads were not good indicators of the penetration performance. See Figures 10, 11, 12 and 13.
8. The adjusted estimated average octol characteristics (calculated from octol characteristics in the risers) of the fired warheads were not good indicators, individually, of the penetration performance. See Figures 14 and 15.
9. The measured characteristics of the octol in the risers of the fired warheads were not good indicators, individually, of the penetration performance. See Figures 16, 17, 18 and 19.

RECOMMENDATIONS

1. In the interest of increasing our knowledge of the settling characteristics of octol in DRAGON warheads, it is recommended that the risers of DRAGON warheads which fail the lot acceptance penetration tests be chemically analyzed to determine the average octol density and the average percent HMX in those risers.
2. Further knowledge would be gained if the risers of DRAGON warheads which demonstrated extremely high penetration values were chemically analyzed as above.
3. One hundred (100) analyses for each of the above conditions for a total of 200 should indicate a difference in settling. The chemical analysis would cost about 4K.

REFERENCES

1. Technical Proposal for Octol 75/25, M207 TOW Warhead, M225 DRAGON Warhead 15 Oct 75, Mason & Hanger-Silas Mason Co., Inc.
2. 1st Status Report, 70/30 Octol Loading Program for the M225 DRAGON Warhead May 1976, Mason & Hanger-Silas Mason Co., Inc.
3. 2nd Status Report, Second 70/30 Octol Loading Program for the M225 DRAGON Warhead .
4. Technical Memorandum 2134, HMX Distribution and Octol Density Variation in Shaped Charge Warheads , Waldemar F. Larsen, April 1974.

TABLE 17
1st TEST
% HMX

VIRGIN 70/30 OCTOL - 7.8 SECOND VISCOSITY

CORE NO. & LOC. ROW	CORE SAMPLE ANALYSIS																	
	312	314	315	346	348	350	387	389	39C	411	412	414	471	473	474	501	503	505
1 A	85.25	84.84	84.89	84.54	84.83	84.20	84.50	84.60	84.62	84.51	84.39	84.81	85.00	84.86	84.10	84.63	85.37	83.71
2 A	85.26	85.22	85.17	85.00	85.22	84.81	85.01	85.17	84.96	84.83	84.81	85.19	85.47	85.14	84.98	84.85	85.60	83.55
3 B	84.36	84.46	84.22	84.07	84.45	84.00	83.96	82.80	84.40	84.37	84.56	84.34	84.45	84.08	84.42	83.56	84.25	78.56
4 B	84.64	84.80	84.46	84.17	84.51	84.12	84.24	83.11	84.32	84.29	84.30	84.35	84.52	84.23	84.49	83.53	84.45	80.12
5 C	83.96	83.70	83.72	81.97	83.20	82.37	77.66	78.71	83.79	84.28	82.86	83.04	81.98	83.69	83.97	79.69	80.61	75.89
6 C	83.90	83.91	83.11	83.59	83.71	82.30	77.02	78.73	83.91	82.72	82.40	83.98	81.67	83.31	83.68	80.40	80.69	77.81
7 D	77.13	76.56	74.72	73.53	75.12	73.92	74.76	74.16	76.14	77.76	74.80	75.50	74.46	75.51	75.49	74.17	75.12	77.20
8 D	80.26	78.38	76.17	74.71	77.73	74.66	74.99	75.61	78.23	79.85	75.34	77.32	75.66	79.00	77.56	74.96	76.21	74.83
9 D	80.49	77.99	76.13	76.43	78.60	74.53	75.54	75.16	77.66	75.74	75.34	77.82	75.95	78.12	77.25	74.98	76.15	77.10
10 D	78.13	76.07	74.66	73.94	75.59	73.96	74.61	73.95	75.04	73.75	74.49	75.35	74.29	75.07	75.58	73.74	75.07	76.28
11 E	72.98	73.62	73.43	71.87	73.33	72.93	74.44	73.05	72.85	73.88	73.50	73.63	73.63	73.28	73.58	72.65	74.31	76.37
12 E	74.05	73.93	74.44	74.35	74.61	73.31	74.36	74.11	74.96	74.96	75.54	74.25	76.17	76.17	75.81	76.75	75.31	74.70
13 E	73.30	73.90	73.40	73.44	*	72.81	74.78	72.97	72.77	72.86	73.36	73.53	73.54	73.36	73.50	73.39	74.24	76.38
14 F	71.67	72.74	76.67	70.87	*	71.64	73.08	71.07	71.29	71.83	72.93	72.57	72.47	72.33	72.43	71.85	73.82	76.17
15 F	73.84	73.89	75.52	72.22	*	72.25	71.61	72.02	73.06	73.34	74.27	72.94	74.33	73.73	74.84	74.56	74.74	73.71
16 F	71.76	73.23	72.82	71.47	*	71.57	66.43	71.44	70.95	71.85	72.38	72.35	72.45	71.91	72.85	71.97	73.36	77.33
17 G	70.06	70.57	68.43	65.65	*	65.79	65.24	66.68	67.53	68.94	67.47	69.12	69.72	67.94	69.70	69.38	70.53	70.85
FIXTURE NUMBER	3			10			18			34			36			42		

* Results not available.

NOTE: Above percents are for HMX Composition. Percent TNT may be found by subtracting percent HMX from 100.

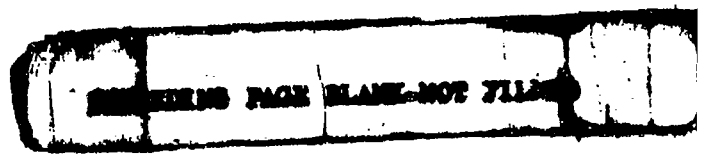

TABLE 18
1st TEST
OCTOL DENSITY GM/CC
VIRGIN 70/30 OCTOL - 7.8 SECOND VISCOSITY
CORE SAMPLE ANALYSIS

CORE LOC.	ROW	312	314	315	346	348	350	387	389	390	411	412	414	471	473	474	501	503	505
1	A	1.844	1.847	1.844	1.840	1.845	1.843	1.844	1.842	1.842	1.840	1.841	1.843	1.844	1.842	1.843	1.844	1.843	1.839
2	A	1.846	1.847	1.846	1.845	1.845	1.843	1.845	1.844	1.842	1.843	1.845	1.844	1.844	1.843	1.843	1.843	1.843	1.837
3	B	1.845	1.843	1.843	1.841	1.843	1.841	1.843	1.839	1.837	1.841	1.841	1.841	1.841	1.839	1.843	1.839	1.841	1.820
4	B	1.846	1.845	1.850	1.841	1.843	1.841	1.839	1.840	1.845	1.839	1.847	1.843	1.843	1.840	1.843	1.838	1.840	1.828
5	C	1.842	1.841	1.840	1.836	1.839	1.837	1.823	1.828	1.838	1.839	1.837	1.836	1.835	1.837	1.838	1.824	1.826	1.815
6	C	1.843	1.839	1.840	1.839	1.842	1.837	1.822	1.827	1.838	1.836	1.835	1.835	1.835	1.837	1.837	1.825	1.826	1.821
7	D	1.824	1.818	1.816	1.812	1.817	1.814	1.816	1.814	1.818	1.819	1.813	1.813	1.812	1.815	1.822	1.808	1.810	1.814
8	D	1.831	1.824	1.819	1.815	1.823	1.815	1.816	1.818	1.822	1.830	1.815	1.816	1.816	1.812	1.825	1.811	1.810	1.814
9	D	1.833	1.823	1.819	1.819	1.826	1.815	1.818	1.819	1.823	1.820	1.815	1.818	1.815	1.819	1.825	1.811	1.812	1.810
10	D	1.827	1.821	1.817	1.813	1.820	1.816	1.817	1.815	1.815	1.815	1.812	1.813	1.812	1.814	1.822	1.807	1.812	1.813
11	E	1.814	1.812	1.813	1.809	1.813	1.815	1.814	1.814	1.811	1.816	1.810	1.808	1.809	1.808	1.814	1.806	1.809	1.812
12	E	1.817	1.813	1.816	1.815	1.816	1.815	1.815	1.817	1.815	1.820	1.815	1.808	1.808	1.814	1.806	1.806	1.806	1.815
13	E	1.815	1.815	1.813	1.812	1.812	1.813	1.816	1.813	1.807	1.811	1.815	1.808	1.818	1.815	1.821	1.815	1.810	1.811
14	F	1.812	1.812	1.812	1.803	1.807	1.813	1.812	1.808	1.804	1.802	1.804	1.803	1.807	1.808	1.804	1.807	1.807	1.813
15	F	1.816	1.813	1.817	1.808	1.813	1.812	1.807	1.809	1.808	1.808	1.808	1.805	1.812	1.809	1.804	1.801	1.806	1.812
16	F	1.812	1.812	1.812	1.806	1.807	1.810	1.813	1.809	1.801	1.808	1.805	1.802	1.808	1.805	1.800	1.802	1.805	1.816
17	G	1.805	1.802	1.802	1.792	1.798	1.798	1.801	1.792	1.794	1.796	1.792	1.796	1.802	1.797	1.793	1.796	1.790	1.790

FIXTURE
NUMBER

3

10

18

34

26

42

TABLE 19
2nd TEST
% HMX
VIRGIN 70/30 OCTOL - 5.4 SECOND VISCOSITY

CORE SAMPLE ANALYSIS

CORE NO. & LOC. ROW	8411*	8413	8414	8447	8449	8450	8487	8489	8490	8526	8528	8529	8566	8568	8570	8606	8608	8609
1	84.85	83.98	83.68	84.45	84.44	84.25	84.47	84.14	84.50	84.03	85.67	84.90	85.46	83.90	84.14	84.18	84.08	85.44
2	84.86	83.89	84.25	80.34	84.73	84.36	84.54	84.58	84.79	83.51	85.37	85.09	85.53	84.53	84.58	84.42	84.07	85.68
3	83.84	83.73	84.54	84.18	84.09	84.24	84.28	84.20	84.39	83.75	84.60	84.58	85.02	85.09	84.50	82.80	84.56	85.02
4	84.23	83.92	84.11	84.18	84.09	84.18	84.09	84.18	83.97	84.06	84.48	84.65	84.35	84.38	84.36	83.62	84.28	84.92
5	83.29	83.38	83.16	83.41	83.60	83.46	83.66	83.64	83.65	83.23	84.03	84.25	84.39	84.13	84.10	83.90	84.53	84.88
6	83.44	83.00	83.10	83.02	83.17	83.73	83.78	83.76	83.75	83.66	84.27	83.91	84.12	84.62	84.62	83.99	83.80	84.72
7	81.17	81.28	81.53	84.95	81.27	79.14	81.72	82.09	81.00	76.94	81.69	81.62	82.89	82.40	82.12	82.73	82.96	82.27
8	83.01	82.82	82.54	82.66	83.40	80.50	83.18	83.05	82.22	77.73	83.87	83.17	82.17	83.87	83.59	83.61	82.72	84.06
9	82.66	82.64	82.34	80.71	83.26	80.69	83.32	82.81	82.35	79.2	83.60	82.59	83.33	83.89	83.23	81.99	83.36	*
10	80.58	81.28	81.37	78.72	81.47	78.80	81.67	81.71	79.97	76.86	81.55	80.86	81.91	82.53	81.68	82.38	83.05	77.43
11	78.23	79.26	77.89	74.75	79.47	74.14	77.84	78.79	75.50	74.82	76.58	80.43	76.60	80.34	78.73	77.03	77.99	82.25
12	79.83	80.66	80.42	75.03	81.32	75.44	80.84	81.08	76.30	74.53	79.76	77.30	75.35	81.54	79.76	76.75	76.88	79.08
13	78.61	78.59	77.49	74.55	80.01	74.20	78.71	77.53	75.66	74.65	78.00	75.46	76.03	79.52	76.92	77.86	75.72	78.28
14	73.04	73.00	72.44	73.12	74.42	72.99	74.35	74.18	74.72	74.63	73.63	73.75	73.48	74.17	73.17	74.23	74.51	69.41
15	74.76	74.07	73.00	73.73	74.37	73.67	75.03	75.50	75.10	74.27	75.19	74.47	77.14	74.45	72.69	74.12	75.55	75.20
16	71.95	72.79	72.27	73.47	74.00	72.73	74.19	74.23	74.65	74.32	73.08	73.69	73.74	73.64	72.85	74.26	73.98	73.49
17	73.59	74.35	72.81	74.20	71.96	78.25	73.93	74.48	74.58	74.17	74.92	73.42	75.08	74.06	74.50	74.51	75.36	79.03
FIXTURE NUMBER	5			10			18			26			34			42		

* Results not available.

NOTE: Above percents are for HMX Composition. Percent TNT may be found by subtracting percent HMX from 100.

TABLE 20
2nd TEST
OCTOL DENSITY GM/CC
VIRGIN 70/30 OCTOL - 5.4 SECOND VISCOSITY
CORE SAMPLE ANALYSIS

CORE LOC.	ROW	8411	8413	8414	8447	8449	8450	8487	8489	8490	8526	8528	8529	8566	8568	8573	8606	8608	8609
1	A	1.839	1.836	1.835	1.836	1.838	1.839	1.836	1.835	1.835	1.833	1.833	1.832	1.832	1.827	1.837	1.829	1.831	1.827
2	A	1.838	1.839	1.843	1.823	1.839	1.840	1.838	1.833	1.834	1.831	1.835	1.833	1.835	1.831	1.837	1.830	1.829	1.831
3	B	1.813	1.838	1.845	1.834	1.835	1.835	1.835	1.837	1.835	1.830	1.832	1.833	1.830	1.837	1.834	1.822	1.827	1.828
4	B	1.832	1.841	1.835	1.834	1.835	1.839	1.836	1.836	1.835	1.830	1.834	1.831	1.831	1.832	1.834	1.833	1.833	1.829
5	C	1.838	1.858	1.835	1.837	1.837	1.831	1.831	1.834	1.832	1.825	1.828	1.830	1.829	1.829	1.825	1.830	1.822	1.821
6	C	1.836	1.856	1.835	1.828	1.832	1.837	1.831	1.833	1.831	1.829	1.829	1.826	1.829	1.833	1.832	1.821	1.825	1.823
7	D	1.825	1.832	1.835	1.840	1.829	1.824	1.823	1.828	1.824	1.805	1.820	1.821	1.826	1.825	1.824	1.822	1.824	1.519
8	D	1.808	1.836	1.834	1.827	1.830	1.827	1.828	1.829	1.828	1.809	1.828	1.827	1.820	1.824	1.828	1.824	1.821	1.821
9	D	1.833	1.834	1.829	1.823	1.834	1.824	1.826	1.830	1.827	1.813	1.827	1.823	1.824	1.824	1.827	1.818	1.822	1.824
10	D	1.831	1.832	1.833	1.827	1.834	1.918	1.825	1.827	1.820	1.803	1.822	1.821	1.822	1.823	1.821	1.823	1.825	1.819
11	E	1.811	1.825	1.823	1.809	1.822	1.799	1.810	1.814	1.800	1.795	1.802	1.799	1.801	1.814	1.807	1.802	1.798	1.757
12	E	1.832	1.833	1.826	1.805	1.821	1.813	1.818	1.822	1.802	1.798	1.813	1.804	1.814	1.817	1.814	1.796	1.801	1.796
13	E	1.7	1.822	1.822	1.802	1.820	1.809	1.815	1.811	1.799	1.798	1.807	1.799	1.800	1.810	1.800	1.808	1.787	1.801
14	F	1.809	1.807	1.811	1.802	1.805	1.802	1.800	1.801	1.797	1.795	1.793	1.794	1.791	1.791	1.788	1.789	1.790	1.789
15	F	1.812	1.808	1.804	1.800	1.793	1.803	1.800	1.805	1.800	1.790	1.798	1.792	1.802	1.795	1.784	1.787	1.795	1.790
16	F	1.810	1.809	1.807	1.799	1.801	1.801	1.800	1.802	1.796	1.794	1.792	1.792	1.789	1.788	1.788	1.794	1.787	1.786
17	G	1.814	1.811	1.809	1.802	1.791	1.790	1.798	1.803	1.799	1.797	1.801	1.793	1.795	1.794	1.787	1.789	1.775	1.786

FIXTURE NUMBER 3 10 18 26 34 42

TABLE 21

DRAGON RISER COMPOSITION ANALYSIS
 VIRGIN 70/30 OCTOL

LOAD'G FIXTURE NO.	1st TEST - 7.8 SEC. VISC.			2nd TEST - 5.4 SEC VISC		
	WHD. SERIAL NO	% HMX	OCTOL DENSITY gm/cc	WHD. SERIAL NO	% HMX	OCTOL DENSITY gm/cc
3	311	48.07	1.674	8411	*	1.633
	312	39.54	1.712	8412	*	1.661
	313	45.45	1.728	8413	*	1.622
	314	43.35	1.703	8414	*	1.630
	315	46.56	1.732	8415	*	1.661
10	346	43.03	1.703	8446	*	1.686
	347	43.98	1.717	8447	*	1.673
	348	42.83	1.715	8448	*	1.620
	349	42.93	1.723	8449	*	1.681
	350	44.04	1.724	8450	37.60	1.662
18	386	48.56	1.744	8486	47.79	1.732
	387	54.73	1.761	8487	46.61	1.716
	388	49.76	1.742	8488	49.60	1.740
	389	46.69	1.742	8489	44.68	1.725
	390	47.99	1.734	8490	47.92	1.733
26	471	50.76	1.744	8526	51.23	1.732
	472	47.63	1.737	8527	48.74	1.733
	473	45.99	1.722	8528	46.30	1.726
	474	48.31	1.732	8529	47.61	1.728
	475	51.20	1.731	8530	47.63	1.714
34	411	49.33	1.737	8566	41.38	1.718
	412	51.29	1.732	8567	36.68	1.706
	413	49.69	1.744	8568	43.55	1.716
	414	47.78	1.731	8569	36.88	1.651
	415	48.42	1.734	8570	39.49	1.707
42	501	52.64	1.745	8606	44.08	1.679
	502	50.41	1.731	8607	43.28	1.692
	503	51.48	1.736	8608	46.19	1.709
	504	39.55	1.722	8609	42.35	1.602
	505	51.12	1.748	8610	48.37	1.670
						* ANALYSIS INCONCLUSIVE DUE TO IMPROPER LABORATORY TECHNIQUE

TABLE 22A 1st TEST
 70/30 VIRGIN OCTOL - 7.8 SECOND VISCOSITY
 LOADING FIXTURE NO. 3
 % HMX BY CORE, ROWS AND WEIGHTED AVERAGE FOR WARHEADS,
 AND RISERS

CORE/ROW	VS SEGMENT VOLUME	#312		#314		#315		
		% HMX	x VS	% HMX	x VS	% HMX	x VS	
1	(fig. 3)	85.25		84.84		84.89		
2		85.26		85.22		85.17		
A	11.86	85.25	1011.07	85.03	1008.46	85.03	1008.46	
3		84.36		84.46		84.22		
4		84.64		84.80		84.46		
B	8.07	84.50	681.92	84.63	682.96	84.34	680.62	
5		83.96		83.70		83.72		
6		83.90		83.91		83.11		
C	9.75	83.93	818.32	83.81	817.15	83.42	813.35	
7		77.13		76.56		74.72		
8		80.26		78.38		76.17		
9		80.49		77.99		76.13		
10		78.13		76.07		74.66		
D	9.13	79.00	721.27	77.25	705.29	75.42	688.58	
11		72.98		73.62		73.43		
12		74.05		73.93		74.44		
13		73.30		73.90		73.40		
E	7.01	73.44	514.81	73.82	517.48	73.76	517.06	
14		71.67		72.74		72.67		
15		73.84		73.89		75.52		
16		71.76		73.23		72.82		
F	4.86	72.42	351.96	73.29	356.19	73.67	358.04	
17	G	3.44	70.06	241.01	70.57	242.76	68.43	235.40
TOTAL	54.13		4340.36		4330.29		4301.51	
AVF'AGE		80.20		80.01		79.48		
RISER		39.54		43.35		46.56		

TABLE 22B
LOADING FIXTURE NO. 10
% HMX

CORE/ROW	SEGMENT VOLUME	#346		#348		#350	
		% HMX	x VS	% HMX	x VS	% HMX	x VS
1	(fig. 3)	84.54		84.83		84.20	
2		85.00		85.22		84.81	
A	11.86	84.77	1005.37	85.03		84.51	1002.29
3		84.07		84.45		84.00	
4		84.17		85.51		84.12	
B	8.07	84.12	678.01	84.48		84.06	678.36
5		81.97		83.20		82.37	
6		83.59		83.71		82.30	
C	9.75	82.78	807.11	83.46		82.34	802.82
7		73.53		75.12		73.92	
8		74.71		77.73		74.66	
9		76.43		78.60		74.53	
10		73.94		75.59		73.96	
D	9.13	74.65	681.55	76.76		74.27	678.09
11		71.87		73.33		72.93	
12		74.35		74.61		73.31	
13		73.44				72.81	
E	7.01	73.22	513.27			73.02	511.87
14		70.87				71.64	
15		72.22				72.25	
16		71.47				71.57	
F	4.86	71.52	347.59			71.82	349.05
17 G	3.44	65.65	225.84			65.79	226.32
TOTAL	54.12		4258.74				4248.80
AVERAGE		78.69				78.51	
RISER		43.03		42.83		44.04	

CORES DROPPED ON FLOOR

TABLE 22C
LOADING FIXTURE NO. 18
% HMX

CORE/ROW	SEGMENT VOLUME	VS		#387		#389		#390	
		% HMX	x VS	% HMX	x VS	% HMX	x VS		
1	(Fig. 3)	84.50		84.60		84.62			
2		85.01		85.17		84.96			
A	11.86	84.76	1005.25	84.89	1006.80	84.79	1005.61		
3		83.96		82.80		84.40			
4		84.24		83.11		84.32			
B	8.07	84.10	678.69	82.96	669.49	84.36	680.79		
5		77.66		78.71		83.79			
6		77.02		78.73		83.51			
C	9.75	77.34	754.07	78.72	767.52	83.65	815.59		
7		74.76		74.16		76.14			
8		74.99		75.61		78.23			
9		75.54		75.16		77.68			
10		74.61		73.95		75.04			
D	9.13	74.98	684.57	74.72	682.19	76.77	700.91		
11		74.44		73.05		72.85			
12		74.36		74.11		74.96			
13		74.78		72.97		72.77			
E	7.01	74.53	522.46	73.38	514.39	73.53	515.45		
14		73.08		71.07		71.29			
15		71.61		72.02		73.06			
16		66.43		71.44		70.95			
F	4.86	70.37	342.00	71.51	347.54	71.77	348.80		
17	G	3.44	65.24	224.43	66.68	229.38	67.53	232.30	
TOTAL	54.12		4211.47		4217.31		4299.45		
AVERAGE		77.82		77.93		79.44			
RISER		54.73		46.69		47.99			

TABLE 22D
LOADING FIXTURE NO. 34
% HMX

CORE/ROW	VS SEGMENT VOLUME	#411		#412		#414	
		% HMX	x vs	% HMX	x vs	% HMX	x vs
1	(fig. 3)	84.51		84.39		84.81	
2		84.83		84.81		85.19	
A	11.86	84.67	1004.19	84.60	1003.36	85.00	1008.10
3		84.37		84.56		84.34	
4		84.29		84.30		84.35	
B	8.07	84.33	680.54	84.43	681.35	84.35	680.70
5		84.28		82.86		83.04	
6		82.72		82.40		83.98	
C	9.75	83.50	814.13	82.63	805.64	83.51	814.22
7		77.76		74.80		78.50	
8		79.85		75.34		77.32	
9		75.74		75.34		77.82	
10		73.75		74.49		75.35	
D	9.13	76.78	701.00	74.99	684.66	76.50	698.45
11		73.88		73.50		73.63	
12		74.96		75.54		74.25	
13		72.86		73.36		73.53	
E	7.01	73.90	518.04	74.13	519.65	73.80	517.34
14		71.83		72.93		72.57	
15		73.34		74.27		72.94	
16		71.85		72.38		72.35	
F	4.86	72.34	351.57	73.19	355.70	72.62	352.93
17 G	<u>3.44</u>	68.94	<u>237.15</u>	67.47	<u>232.10</u>	69.12	<u>237.77</u>
TOTAL	54.12		4306.62		4282.46		4309.51
AVERAGE		79.58		79.13		79.63	
RISER		49.33		51.29		47.78	

TABLE 22E
LOADING FIXTURE NO. 26
% HMX

CORE/ROW	SEGMENT VOLUME	#471		#473		#474		
		% HMX	x vs	% HMX	x vs	% HMX	x vs	
1	(fig.3)	85.00		84.86		84.10		
2		85.47		85.14		84.98		
A	11.86	85.24	1010.95	85.00	1008.10	84.54	1002.64	
3		84.45		84.08		84.42		
4		84.52		84.23		84.49		
B	8.07	84.49	681.83	84.16	679.17	84.46	681.59	
5		81.88		83.69		83.97		
6		81.67		83.31		83.68		
C	9.75	81.78	797.36	83.50	814.13	83.83	817.34	
7		74.46		75.91		75.49		
8		75.66		79.00		77.56		
9		75.95		78.12		77.25		
10		74.29		75.07		75.58		
D	9.13	75.09	685.57	77.03	703.28	76.47	698.17	
11		73.63		73.28		73.58		
12		76.17		76.17		75.81		
13		73.54		73.36		73.50		
E	7.01	74.45	521.89	74.27	520.63	74.30	520.84	
14		72.47		72.33		72.43		
15		74.33		73.73		74.84		
16		72.45		71.91		72.85		
F	4.86	73.08	355.17	72.66	353.13	73.37	356.58	
17	G	3.44	69.72	239.84	67.94	233.71	69.70	239.77
TOTAL	54.12		4292.61		4312.15		4316.93	
AVERAGE		79.32		79.68		79.77		
RISER		50.76		45.99		48.31		

TABLE 22F
LOADING FIXTURE NO. 42
‡ HMX

CORE/ROW	VS SEGMENT VOLUME	‡501		‡503		‡505	
		% HMX	x vs	% HMX	x vs	% HMX	x vs
1	(fig.3)	84.63		85.37		83.71	
2		84.85		85.60		83.55	
A	11.86	84.74	1005.02	85.49	1013.91	83.63	991.85
3		83.56		84.25		78.56	
4		83.53		84.45		80.12	
B	8.07	83.55	674.25	84.35	680.70	79.34	640.27
5		79.69		80.61		75.89	
6		80.40		80.69		77.81	
C	9.75	80.05	780.49	80.65	786.34	76.85	749.29
7		74.17		75.12		77.20	
8		74.96		76.21		74.83	
9		74.98		76.15		77.10	
10		73.74		75.07		76.28	
D	9.13	74.46	679.82	75.64	690.59	76.35	697.08
11		72.65		74.31		76.37	
12		76.75		75.31		74.70	
13		73.39		74.24		76.38	
E	7.01	74.26	520.56	74.62	523.09	75.82	531.50
14		71.85		73.82		76.17	
15		74.56		74.74		73.71	
16		71.97		73.36		77.33	
F	4.86	72.79	353.76	73.97	359.49	75.74	368.10
17	G 3.44	69.38	238.67	70.53	242.62	70.85	243.72
TOTAL	54.12		4252.57		4296.74		4221.81
AVERAGE		78.58		79.39		78.01	
RISER		52.64		51.48		51.12	

TABLE 23 (CONT)
 DRAGON AVERAGE & HMX DISTRIBUTION BY ROW LOCATION
 1ST TEST - 70/30 VIRGIN OCTOL
 7.8 SEC. VISC.

LOAD FIXTURE NO.	MED SERIAL NO.	ROW AVERAGES						
		ROW A	ROW B	ROW C	ROW D	ROW E	ROW F	ROW G
	471	85.24	84.49	81.78	75.00	74.45	73.08	69.72
26	473	85.00	84.16	83.50	77.03	74.27	72.66	67.94
	474	84.54	84.46	83.83	76.47	74.30	73.37	69.70
	AVER.	84.93	84.37	83.04	76.20	74.34	73.04	69.12
	501	84.74	83.55	80.05	74.46	74.26	72.79	69.38
42	503	85.49	84.35	80.65	75.64	74.62	73.97	70.53
	505	83.63	79.34	76.85	76.35	75.82	75.74	70.85
	AVER.	84.62	82.41	79.18	75.48	74.90	74.17	70.25

TABLE 24A 2ND TEST
 70/30 VIRGIN OCTOL - 5.4 SECOND VISCOSITY
 LOADING FIXTURE NO. 3
 % HMX BY CORE, ROWS AND WEIGHTED AVERAGE
 FOR WARHEADS AND RISERS

CORE/ROW	SEGMENT VOLUME	#8411		#8413		#8414	
		% HMX	x vs	% HMX	x vs	% HMX	x vs
1	(fig. 3)	84.85		83.98		83.68	
2		84.86		83.89		84.25	
A	11.86	84.85	1006.32	83.94	995.53	83.97	995.82
3		83.84		83.73		84.54	
4		84.23		83.92		84.11	
B	8.07	84.04	678.16	83.83	676.47	84.33	680.50
5		83.29		83.38		83.16	
6		83.44		83.00		83.10	
C	9.75	83.37	812.81	83.19	811.10	83.13	810.52
7		81.17		81.28		81.53	
8		83.01		82.82		82.54	
9		82.66		82.64		82.34	
10		80.58		81.28		81.37	
D	9.13	81.86	747.34	82.01	748.71	81.95	748.75
11		78.23		79.26		77.89	
12		79.83		80.66		80.42	
13		78.61		78.59		77.49	
E	7.01	78.89	553.02	79.50	557.32	78.60	550.99
14		73.04		73.00		72.44	
15		74.76		74.07		73.00	
16		71.95		72.79		72.27	
F	4.86	73.25	356.00	73.29	355.17	72.57	352.69
17	G 3.44	73.59	253.15	74.35	255.76	72.81	250.47
TOTAL	54.12		4406.80		4400.06		4389.15
AVERAGE		81.43		81.30		81.10	
RISER		DATA NOT USABLE					

TABLE 24B
LOADING FIXTURE NO. 10
% HMX BY CORE, ROWS AND WEIGHTED AVERAGE
FOR WARHEADS, AND RISERS

CORE/ROW	SEGMENT VOLUME	#8447		#8449		#8450	
		% HMX	x vs	% HMX	x vs	% HMX	x vs
1	(fig. 3)	84.45		84.44		84.25	
2		80.34		84.73		84.36	
A	11.86	82.40	977.20	84.58	1002.05	84.30	1002.29
3		84.18		84.09		84.24	
4		84.18		84.09		84.18	
B	8.07	84.18	679.33	84.09	678.61	84.21	679.57
5		83.41		83.60		83.46	
6		83.02		83.17		83.73	
C	9.75	83.22	811.35	83.39	813.00	83.60	815.05
7		84.95		81.27		79.14	
8		82.66		83.40		80.50	
9		80.71		83.26		80.69	
10		78.72		81.47		78.80	
D	9.13	81.76	746.47	82.35	751.86	79.78	728.41
11		74.75		79.47		74.14	
12		75.03		81.32		75.44	
13		74.55		80.01		74.20	
E	7.01	74.78	524.18	80.27	562.67	74.59	522.90
14		73.12		74.42		72.99	
15		73.73		74.37		73.67	
16		73.47		74.00		72.73	
F	4.86	73.44	356.92	74.26	360.92	73.13	355.41
17	G 3.44	74.20	255.25	71.96	247.54	78.25	269.18
TOTAL	54.12		4350.70		4416.65		4372.81
AVERAGE		80.39		81.61		80.80	
RISER		UNUSABLE		UNUSABLE		37.60	

TABLE 24C
 LOADING FIXTURE NO. 18
 % HMX BY CORE, ROWS AND WEIGHTED AVERAGE
 FOR WARHEADS AND RISERS

CORE/ROW	SEGMENT VOLUME	#8487		#8489		#8490	
		% HMX	x vs	% HMX	x vs	% HMX	x vs
1	(fig. 3)	84.47		84.14		84.50	
2		84.54		84.58		84.79	
A	11.86	84.51	1007.23	84.36	1000.51	84.63	1003.71
3		84.28		84.20		84.39	
4		84.09		84.18		83.97	
B	8.07	84.19	679.41	84.19	679.41	84.18	679.33
5		83.66		83.64		83.65	
6		83.78		83.76		83.75	
C	9.75	83.72	816.27	83.70	816.08	83.70	816.08
7		81.72		82.09		81.00	
8		83.18		83.05		82.22	
9		83.32		82.81		82.35	
10		81.67		81.71		79.97	
D	9.13	82.47	752.97	82.42	752.45	81.39	743.05
11		77.84		78.79		75.50	
12		80.84		81.08		76.30	
13		78.71		77.53		75.66	
E	7.01	79.13	554.70	79.13	554.70	75.82	531.50
14		74.35		74.18		74.72	
15		75.03		75.50		75.10	
16		74.19		74.23		74.65	
F	4.86	74.52	362.18	74.64	362.73	74.82	363.64
17	G 3.44	73.93	254.32	74.48	256.21	74.58	256.56
TOTAL	54.12		4422.08		4422.09		4393.97
AVERAGE		81.71		81.71		81.19	
RISER		46.61		44.68		47.92	

TABLE 24D
LOADING FIXTURE NO. 26
% HMX BY CORE, ROWS AND WEIGHTED AVERAGE
FOR WARHEADS AND RISERS

CORE/ROW	SEGMENT VOLUME	vs #8526		vs #8528		vs #8529	
		% HMX	x vs	% HMX	x vs	% HMX	x vs
1	(fig. 3)	84.03		85.67		84.90	
2		83.51		85.37		85.09	
A	11.86	83.77	993.51	85.52	1014.27	85.00	1008.04
3		83.75		84.60		84.58	
4		84.06		84.48		84.65	
B	8.07	83.91	677.11	84.54	682.24	84.62	682.84
5		83.23		84.03		84.25	
6		83.66		84.27		83.91	
C	9.75	83.45	813.59	84.15	820.46	84.08	819.78
7		76.94		81.69		81.62	
8		77.73		83.87		83.17	
9		79.32		83.60		82.59	
10		76.86		81.55		80.86	
D	9.13	77.71	709.52	82.68	754.85	82.06	749.21
11		74.82		76.58		80.43	
12		74.53		79.76		77.30	
13		74.65		78.00		75.46	
E	7.01	74.67	523.41	78.11	547.57	77.73	544.89
14		74.63		73.63		73.75	
15		74.27		75.19		74.47	
16		74.32		73.08		73.69	
F	4.86	74.41	361.62	73.97	359.48	73.97	359.49
17	G 3.44	74.17	255.14	74.92	257.72	73.42	252.56
TOTAL	54.12		4333.90		4436.59		4416.81
AVERAGE		80.08		81.98		81.61	
RISER		51.23		46.30		47.61	

TABLE 24E

LOADING FIXTURE NO. 34
 % HMX BY CORE, ROWS AND WEIGHTED AVERAGE
 FOR WARHEADS AND RISERS

CORE/ROW	SEGMENT VOLUME	vs #8566		vs #8568		vs #8570	
		% HMX	x vs	% HMX	x vs	% HMX	x vs
1	(fig. 3)	85.46		83.90		84.14	
2		85.53		84.53		84.58	
A	11.86	85.50	1013.97	84.22	998.79	84.36	1000.51
3		85.02		85.09		84.50	
4		84.35		84.38		84.36	
B	8.07	84.69	683.41	84.74	683.81	84.43	681.35
5		84.39		84.13		84.10	
6		84.12		84.62		84.62	
C	9.75	84.26	821.49	84.38	822.66	84.36	822.51
7		82.89		82.40		82.12	
8		82.17		83.87		83.59	
9		83.33		83.89		83.23	
10		81.91		82.53		81.68	
D	9.13	82.58	753.91	83.17	759.36	82.66	754.64
11		76.60		80.34		78.73	
12		75.35		81.54		79.76	
13		76.03		79.52		76.92	
E	7.01	75.99	532.71	80.47	564.07	78.47	550.07
14		73.48		74.17		73.17	
15		77.14		74.45		72.69	
16		73.74		73.64		72.85	
F	4.86	74.79	363.46	74.09	360.06	72.90	354.29
17	G 3.44	75.08	258.28	74.06	254.77	74.50	256.28
TOTAL	54.12		4427.23		4444.52		4419.65
AVERAGE		81.80		82.10		81.66	
RISER		41.38		43.55		39.49	

TABLE 24F
LOADING FIXTURE NO. 42
% HMX BY CORE, ROWS AND WEIGHTED AVERAGE
FOR WARHEADS AND RISERS

CORE/ROW	SEGMENT VOLUME	#8606		#8608		#8609	
		% HMX	x VB	% HMX	x VB	% HMX	x VB
1	(fig. 3)	84.18		84.08		85.44	
2		84.42		84.07		85.68	
A	11.86	84.30	999.80	84.08	997.13	85.56	1014.74
3		82.80		84.56		85.02	
4		83.62		84.28		84.92	
B	8.07	83.21	671.50	84.42	681.27	84.97	685.71
5		83.90		84.58		84.88	
6		83.99		83.80		84.72	
C	9.75	83.95	818.51	84.19	820.85	84.80	826.80
7		82.73		82.96		82.27	
8		83.61		82.72		84.06	
9		81.99		83.36		BROKE	
10		82.38		83.05		77.43	
D	9.13	82.66	754.85	83.02	758.00	81.25	741.84
11		77.03		77.39		82.25	
12		76.75		76.80		79.08	
13		77.86		75.72		78.28	
E	7.01	77.21	541.27	76.86	538.81	79.87	559.89
14		74.23		74.51		69.41	
15		74.12		75.55		75.20	
16		74.26		73.98		73.49	
F	4.86	74.20	360.63	74.68	362.94	72.70	353.32
17	G 3.44	74.51	256.31	75.36	259.34	79.03	271.86
TOTAL	54.12		4402.87		4418.24		4454.16
AVERAGE		81.35		81.64		82.30	
RISER		44.08		46.19		42.35	

TABLE 25

DRAGON AVERAGE & HEX DISTRIBUTION BY ROW LOCATION
 2ND TEST - 70/36 VIRGIN OCTOL
 5.4 SEC. VISC

LOAD FIXTURE NO.	WED SERIAL NO.	ROW AVERAGES						
		ROW A	ROW B	ROW C	ROW D	ROW E	ROW F	ROW G
3	8411	84.85	84.04	83.37	81.86	78.89	73.25	73.59
	8413	83.94	83.83	83.19	82.01	79.50	73.29	74.35
	8414	83.97	84.33	83.13	81.95	78.60	72.29	72.81
	AVER.	84.25	84.07	83.23	81.94	79.00	72.94	73.58
10	8447	82.40	84.18	83.22	81.76	74.78	73.44	74.20
	8449	84.58	84.09	83.39	82.35	80.27	74.26	71.96
	8450	84.30	84.21	83.50	79.78	74.59	73.13	78.25
	AVER.	83.76	84.16	83.40	81.30	76.55	73.61	74.80
18	8487	84.51	84.19	83.72	82.47	79.13	74.52	73.93
	8489	84.36	84.19	83.70	82.42	79.13	74.64	74.48
	8490	84.63	84.18	83.70	81.39	75.82	74.82	74.58
	AVER.	84.50	84.19	83.71	82.09	78.03	74.66	74.33
26	8526	83.77	83.91	83.45	77.71	74.67	74.41	74.17
	8528	85.52	84.54	84.15	82.68	78.11	73.97	74.92
	8529	85.00	84.62	84.08	82.06	77.73	73.97	73.42
	AVER.	84.76	84.36	83.89	80.82	76.84	74.12	74.17

TABLE 25 (CONT)
 DRAGON AVERAGE & HMX DISTRIBUTION BY ROW LOCATION
 2ND TEST — 70/30 VIRGIN OCTOL
 5.4 SEC. VISC.

LOAD FIXTURE NO.	WHD SERIAL NO.	ROW AVERAGES						
		ROW A	ROW B	ROW C	ROW D	ROW E	ROW F	ROW G
34	8566	85.50	84.69	84.26	82.58	75.99	74.79	75.08
	8568	84.22	84.74	84.38	83.17	80.47	74.09	74.06
	8570	<u>84.36</u>	<u>84.43</u>	<u>84.36</u>	<u>82.66</u>	<u>78.47</u>	<u>72.90</u>	<u>74.50</u>
	AVER.	84.69	84.62	84.33	82.80	78.31	73.93	74.55
42	8606	84.30	83.21	83.95	82.68	77.21	74.20	74.51
	8608	84.08	84.42	84.19	83.02	76.86	74.68	75.36
	8609	<u>85.56</u>	<u>84.97</u>	<u>84.80</u>	<u>81.25</u>	<u>79.87</u>	<u>72.70</u>	<u>79.03</u>
	AVER.	84.65	84.20	84.31	82.32	77.98	73.86	76.30

TABLE 26A
LOADING FIXTURE NO. 3
OCTOL DENSITY BY CORE, ROWS AND WEIGHTED
AVERAGE FOR WARHEADS AND RISERS - 1ST TEST

CORE/ROW	SEGMENT VOLUME	#312		#314		#315	
		gm/cc	x vs	gm/cc	x vs	gm/cc	x vs
1	(fig. 3)	1.844		1.847		1.844	
2		1.846		1.847		1.846	
A	11.86	1.8450	21.8817	1.8470	21.9054	1.8450	21.8817
3		1.845		1.843		1.843	
4		1.846		1.845		1.850	
B	8.07	1.8455	14.8932	1.8440	14.8811	1.8465	14.9013
5		1.842		1.841		1.840	
6		1.843		1.839		1.840	
C	9.75	1.8425	17.9644	1.8400	17.9400	1.8400	17.9400
7		1.824		1.818		1.816	
8		1.831		1.824		1.819	
9		1.833		1.823		1.819	
10		1.827		1.821		1.817	
D	9.13	1.8288	16.6969	1.8215	16.6303	1.8178	16.5965
11		1.814		1.812		1.813	
12		1.817		1.813		1.816	
13		1.815		1.815		1.813	
E	7.01	1.8153	12.7253	1.8133	12.7112	1.8140	12.7161
14		1.812		1.812		1.812	
15		1.816		1.813		1.817	
16		1.812		1.812		1.812	
F	4.86	1.8133	8.8126	1.8123	8.8078	1.8137	8.8146
17 G	3.44	1.805	6.2092	1.802	6.1989	1.802	6.1989
TOTAL	54.12		99.1833		99.0747		99.0491
AVERAGE		1.8327		1.8306		1.8302	
RISER		1.712		1.703		1.732	

TABLE 26B
LOADING FIXTURE NO. 10
1ST TEST
OCIOIOL DENSITY

CORE/ROW	SEGMENT VOLUME	#346		#348		#350	
		gm/cc	x vs	gm/cc	x vs	gm/cc	x vs
1	(fig. 3)	1.840		1.845		1.843	
2		1.845		1.845		1.843	
A	11.86	1.8425	21.8521	1.8450	21.8817	1.8430	21.8580
3		1.841		1.843		1.841	
4		1.841		1.843		1.841	
B	8.07	1.8410	14.8569	1.8430	14.8730	1.8410	14.8569
5		1.836		1.839		1.837	
6		1.839		1.842		1.837	
C	9.75	1.8375	17.9156	1.8405	17.9449	1.8370	17.9108
7		1.812		1.817		1.814	
8		1.815		1.823		1.815	
9		1.819		1.826		1.815	
10		1.813		1.820		1.816	
D	9.13	1.8148	16.5691	1.8215	16.6303	1.8150	16.5710
11		1.809		1.813		1.815	
12		1.815		1.816		1.815	
13		1.812		1.812		1.813	
E	7.01	1.8120	12.7021	1.8137	12.7140	1.8143	12.7182
14		1.803		1.807		1.811	
15		1.808		1.813		1.812	
16		1.806		1.807		1.810	
F	4.86	1.8057	8.7757	1.8090	8.7917	1.8110	8.8015
17	G 3.44	1.792	6.1645	1.798	6.1851	1.798	6.1851
TOTAL	54.12		98.8360		99.0207		98.9015
AVERAGE		1.8262		1.8297		1.8274	
RISER		1.703		1.715		1.724	

TABLE 26C
LOADING FIXTURE NO. 18
1ST TEST
OCTOL DENSITY

CORE/ROW	SEGMENT VOLUME	#387		#389		#390	
		gm/cc	x vs	gm/cc	x vs	gm/cc	x vs
1	(fig. 3)	1.844		1.842		1.842	
2		1.845		1.844		1.842	
A	11.86	1.8445	21.8758	1.8430	21.8580	1.8420	21.8461
3		1.843		1.839		1.837	
4		1.839		1.840		1.845	
B	8.07	1.8410	14.8569	1.8395	14.8448	1.8410	14.8569
5		1.823		1.828		1.838	
6		1.822		1.827		1.838	
C	9.75	1.8225	17.7694	1.8275	17.8181	1.8380	17.9205
7		1.816		1.814		1.818	
8		1.816		1.818		1.822	
9		1.813		1.819		1.823	
10		1.817		1.815		1.815	
D	9.13	1.8168	16.5874	1.8165	16.5846	1.8195	16.6120
11		1.814		1.814		1.811	
12		1.815		1.817		1.815	
13		1.816		1.813		1.807	
E	7.01	1.8150	12.7232	1.8147	12.7210	1.8110	12.6951
14		1.812		1.808		1.804	
15		1.807		1.809		1.808	
16		1.813		1.809		1.801	
F	4.86	1.8107	8.8000	1.8087	8.7903	1.8043	8.7689
17	G 3.44	1.801	6.1954	1.792	6.1645	1.794	6.1714
TOTAL	54.12		98.8081		98.7813		98.8709
AVERAGE		1.8257		1.8252		1.8269	
RISER		1.761		1.742		1.734	

TABLE 26D
LOADING FIXTURE NO. 34
1ST TEST
OCTOL DENSITY

CORE/ROW	VM SEGMENT VOLUME	#411		#412		#414	
		gm/cc	x VB	gm/cc	x VB	gm/cc	x VB
1	(fig. 1)	1.840		1.841		1.843	
2		1.843		1.845		1.844	
A	11.86	1.8415	21.8402	1.8430	21.8580	1.8435	21.8619
3		1.841		1.848		1.841	
4		1.839		1.847		1.843	
B	8.07	1.8400	14.8488	1.8475	14.9093	1.8420	14.8649
5		1.839		1.837		1.836	
6		1.836		1.835		1.839	
C	9.75	1.8375	17.9156	1.8360	17.9010	1.8375	17.9156
7		1.819		1.813		1.813	
8		1.830		1.815		1.816	
9		1.820		1.813		1.818	
10		1.815		1.812		1.813	
D	9.13	1.8210	16.6257	1.8133	16.5554	1.8150	16.5710
11		1.816		1.810		1.808	
12		1.820		1.815		1.808	
13		1.811		1.807		1.807	
E	7.01	1.8157	12.7201	1.8107	12.6930	1.8077	12.6720
14		1.802		1.804		1.803	
15		1.808		1.808		1.805	
16		1.808		1.805		1.802	
F	4.86	1.8060	8.7772	1.8057	8.7757	1.8033	8.7640
17	G	3.44	6.1762	1.792	6.1645	1.796	6.1782
TOTAL	54.12		98.9138		98.8569		98.8296
AVERAGE		1.8277		1.8266		1.8261	
RISER		1.737		1.732		1.731	

TABLE 16E
LOADING FIXTURE NO. 26
1ST TEST
OCTOL DENSITY

CORK/ROW	VA SEGMENT VOLUME	#471		#473		#474	
		gm/cc	x va	gm/cc	x va	gm/cc	x va
1	(fig. 3)	1.844		1.842		1.843	
2		1.843		1.843		1.843	
A	11.86	1.8435	21.8639	1.8425	21.8521	1.8430	21.8580
3		1.842		1.839		1.843	
4		1.843		1.840		1.843	
B	8.07	1.8425	14.8690	1.8395	14.8448	1.8430	14.8730
5		1.833		1.837		1.838	
6		1.833		1.837		1.837	
C	9.75	1.8330	17.8718	1.8370	17.9108	1.8375	17.9156
7		1.812		1.815		1.822	
8		1.816		1.812		1.825	
9		1.815		1.819		1.824	
10		1.812		1.814		1.822	
D	9.13	1.8138	16.5600	1.8150	16.5710	1.8233	16.6467
11		1.809		1.808		1.814	
12		1.818		1.815		1.821	
13		1.810		1.808		1.804	
E	7.01	1.8123	12.7042	1.8103	12.6902	1.8130	12.7091
14		1.807		1.805		1.798	
15		1.812		1.809		1.804	
16		1.808		1.805		1.800	
F	4.86	1.8090	8.7917	1.8063	8.7786	1.8007	8.7514
17	G 3.44	1.802	6.1989	1.797	6.1817	1.793	6.1679
TOTAL	54.12		98.8595		98.8292		98.9217
AVERAGE		1.8267		1.8261		1.8278	
RISER		1.744		1.722		1.732	

TABLE 26F
LOADING FIXTURE NO. 42
1ST TEST
OCTOL DENSITY

CORE/ROW	SEGMENT VOLUME	#501		#503		#505	
		gm/cc	x vs	gm/cc	x vs	gm/cc	x vs
1	(fig. 3)	1.844		1.843		1.839	
2		1.843		1.844		1.837	
A	11.86	1.8435	21.8639	1.8435	21.8639	1.8380	21.7987
3		1.839		1.841		1.820	
4		1.838		1.840		1.828	
B	8.07	1.8385	14.9367	1.8405	14.8528	1.8240	14.7197
5		1.824		1.826		1.815	
6		1.825		1.826		1.821	
C	9.75	1.8245	17.7889	1.8260	17.8035	1.8180	17.7255
7		1.808		1.810		1.814	
8		1.811		1.812		1.810	
9		1.810		1.812		1.813	
10		1.807		1.809		1.812	
D	9.13	1.8090	16.5162	1.8108	16.5326	1.8123	16.5463
11		1.806		1.806		1.815	
12		1.815		1.810		1.811	
13		1.807		1.807		1.813	
E	7.01	1.8093	12.6832	1.8077	12.6720	1.8130	12.7091
14		1.801		1.806		1.812	
15		1.808		1.806		1.806	
16		1.802		1.805		1.816	
F	4.86	1.8037	8.7660	1.8057	8.7757	1.8113	8.8029
17	G 3.44	1.796	6.1782	1.790	6.1576	1.790	6.1576
TOTAL	54.12		98.6331		98.6581		98.4598
AVERAGE		1.8225		1.8230		1.8193	
RISER		1.745		1.736		1.748	

TABLE 27

DRAGON AVERAGE OCTOL DENSITY DISTRIBUTION BY ROW LOCATION
1st TEST - 70/30 VIRGIN OCTOL - 7.8 SEC. VISC.

LOAD FIXTURE NO.	WHD. SERIAL NO.	ROW AVERAGES						
		ROW A	ROW B	ROW C	ROW D	ROW E	ROW F	ROW G
3	312	1.8450	1.8455	1.8425	1.8289	1.8153	1.8133	1.805
	314	1.8470	1.8440	1.8400	1.8215	1.8133	1.8123	1.802
	315	1.8450	1.8465	1.8400	1.8178	1.8140	1.8137	1.802
	AVER.	1.8457	1.8453	1.8408	1.8227	1.8142	1.8131	1.803
10	346	1.8425	1.8410	1.8375	1.8148	1.8120	1.8057	1.792
	348	1.8450	1.8430	1.8405	1.8215	1.8137	1.8090	1.798
	350	1.8430	1.8410	1.8370	1.8150	1.8143	1.8110	1.798
	AVER.	1.8435	1.8413	1.8383	1.8171	1.8133	1.8086	1.796
18	387	1.8445	1.8410	1.8225	1.8168	1.8150	1.8107	1.801
	369	1.8410	1.8395	1.8275	1.8165	1.8147	1.8087	1.792
	390	1.8420	1.8410	1.8380	1.8195	1.8110	1.8043	1.794
	AVER.	1.8432	1.8405	1.8293	1.8176	1.8136	1.8079	1.796
34	411	1.8415	1.8400	1.8375	1.8210	1.8157	1.8060	1.796
	412	1.8430	1.8475	1.8360	1.8133	1.8107	1.8057	1.792
	414	1.8435	1.8420	1.8375	1.8150	1.8077	1.8033	1.796
	AVER.	1.8427	1.8432	1.8370	1.8164	1.8114	1.8050	1.795

TABLE 27 (Cont'd)

DRAGON AVERAGE OCTOL DENSITY DISTRIBUTION BY ROW LOCATION
 1st TEST - 70/30 VIRGIN OCTOL - 7.8 SEC. VISC.

LOAD FIXTURE NO.	WHD. SERIAL NO.	ROW AVERAGES						
		ROW A	ROW B	ROW C	ROW D	ROW E	ROW F	ROW G
26	471	1.8435	1.8425	1.8330	1.8138	1.8123	1.8030	1.802
	473	1.8425	1.8395	1.8370	1.8150	1.8103	1.8063	1.797
	474	1.8430	1.8430	1.8375	1.8233	1.8130	1.8007	1.793
	AVER.	1.8430	1.8417	1.8358	1.8174	1.8119	1.8053	1.797
42	501	1.8435	1.8385	1.8245	1.8090	1.8093	1.8037	1.796
	503	1.8435	1.8405	1.8260	1.8108	1.8077	1.8057	1.790
	505	1.8380	1.8240	1.8180	1.8123	1.8130	1.8113	1.790
	AVER.	1.8417	1.8343	1.8228	1.8107	1.8100	1.8069	1.792

TABLE 28A
LOADING FIXTURE NO. 3
OCTOL DENSITY BY CORE, ROWS & WEIGHTED AVERAGE
FOR WARHEADS AND RISER - 2nd TEST

CORE/ROW	SEGMENT VOLUME	#8411		#8413		#8414		
		gm/cc	X Vs	gm/cc	X Vs	gm/cc	X Vs	
1	(FIG. 3)	1.839		1.836		1.835		
2		1.838		1.839		1.843		
A	11.86	1.8385	21.8046	1.8375	21.7928	1.8390	21.8105	
3		1.813		1.838		1.845		
4		1.832		1.841		1.835		
B	8.07	1.8225	14.7076	1.8395	14.8448	1.8400	14.8488	
5		1.838		1.838		1.835		
6		1.836		1.836		1.835		
C	9.75	1.8370	17.9108	1.8370	17.9108	1.835	17.8913	
7		1.825		1.832		1.835		
8		1.808		1.836		1.834		
9		1.833		1.834		1.829		
10		1.831		1.832		1.833		
D	9.13	1.8243	16.6554	1.8335	16.7399	1.8328	16.7330	
11		1.811		1.825		1.823		
12		1.832		1.833		1.826		
13		1.827		1.822		1.822		
E	7.01	1.8233	12.7816	1.8267	12.8049	1.8237	12.7839	
14		1.809		1.807		1.811		
15		1.812		1.808		1.804		
16		1.810		1.809		1.807		
F	4.86	1.8103	8.7982	1.8080	8.7869	1.8073	8.7836	
17	G	3.44	1.814	6.2402	1.811	6.2298	1.809	6.2230
TOTAL	54.12		98.8984		99.1099		99.0741	
AVERAGE		1.8274		1.8313		1.8306		
RISER		1.633		1.622		1.630		

TABLE 20B
LOADING FIXTURE NO. 10
OCTOL DENSITY BY CORE, ROWS & WEIGHTED AVERAGE
FOR WARHEADS AND RISERS - 2nd TEST

CORE/ROW	SEGMENT VOLUME	Vs #8447		Vs #8449		Vs #8450	
		gm/cc	X Vs	gm/cc	X Vs	gm/cc	X Vs
1	(FIG. 3)	1.836		1.838		1.839	
2		1.823		1.839		1.840	
A	11.86	1.8295	21.6979	1.8385	21.8046	1.8395	21.8165
3		1.834		1.833		1.835	
4		1.834		1.835		1.839	
B	8.07	1.8340	14.8004	1.8340	14.8004	1.8370	14.8246
5		1.837		1.837		1.831	
6		1.828		1.832		1.837	
C	9.75	1.8325	17.8669	1.8345	17.8864	1.8340	17.8815
7		1.840		1.829		1.824	
8		1.827		1.830		1.827	
9		1.823		1.834		1.824	
10		1.827		1.834		1.818	
D	9.13	1.8293	16.7011	1.8318	16.7239	1.8233	16.6463
11		1.809		1.822		1.799	
12		1.805		1.821		1.813	
13		1.802		1.820		1.809	
E	7.01	1.8053	12.6554	1.8210	12.7652	1.8070	12.6671
14		1.802		1.805		1.802	
15		1.800		1.793		1.803	
16		1.799		1.801		1.801	
F	4.86	1.8003	8.7496	1.7997	8.7464	1.8020	8.7577
17	G	3.41	6.1989	1.791	6.1610	1.790	6.1576
TOTAL	54.12		98.6702		98.8879		98.7513
AVERAGE		1.8232		1.8272		1.8247	
RISER		1.686		1.681		1.662	

TABLE 28C
LOADING FIXTURE NO. 18
OCTOL DENSITY BY CORE, ROWS & WEIGHTED AVERAGE
FOR WARHEADS AND RISERS - 2nd TEST

CORE/ROW	V _n SEGMENT VOLUME	88487		88489		88490	
		gm/cc	X V _n	gm/cc	X V _n	gm/cc	X V _n
1	(fig. 3)	1.836		1.835		1.835	
2		1.838		1.833		1.834	
A	11.86	1.8370	21.7868	1.8340	21.7512	1.8345	21.7572
3		1.835		1.837		1.835	
4		1.836		1.836		1.835	
B	8.07	1.8355	14.8125	1.8365	14.8206	1.8350	14.8085
5		1.831		1.834		1.832	
6		1.831		1.831		1.831	
C	9.75	1.8310	17.8523	1.8335	17.8766	1.8315	17.8571
7		1.83		1.828		1.824	
8		1.828		1.829		1.828	
9		1.826		1.830		1.827	
10		1.825		1.827		1.820	
D	9.13	1.8255	16.6668	1.8255	16.6942	1.8248	16.6600
11		1.810		1.814		1.800	
12		1.818		1.822		1.802	
13		1.815		1.811		1.799	
E	7.01	1.8143	12.7185	1.8157	12.7278	1.8003	12.6203
14		1.800		1.801		1.797	
15		1.801		1.805		1.800	
16		1.800		1.802		1.796	
F	4.86	1.8003	8.7496	1.8027	8.7610	1.7977	8.7367
17	G	3.44	6.1851	1.803	6.2023	1.799	6.1886
TOTAL	54.12		98.7716		98.8337		98.6284
AVERAGE		1.8250		1.8262		1.8224	
RISER		1.716		1.725		1.733	

TABLE 28D
LOADING FIXTURE NO. 26
OCTOL DENSITY BY CORE, ROWS & WEIGHTED AVERAGE
FOR WARHEADS AND RISERS - 2nd TEST

CORE/ROW	SEGMENT VOLUME	Ø8526		Ø8528		Ø8529	
		gm/cc	X Vs	gm/cc	X Vs	gm/cc	X Vs
1	(fig. 3)	1.833		1.833		1.832	
2	A	1.831		1.835		1.833	
		11.86	1.8320	21.7275	1.8340	21.7512	1.8325
3	D	1.830		1.832		1.833	
4		8.07	1.8300	14.7681	1.8330	14.7923	1.8320
5	C	1.826		1.828		1.830	
6		9.75	1.8275	17.8141	1.8285	17.8279	1.8280
7	D	1.805		1.820		1.821	
8		9.13	1.8075	16.5025	1.8243	16.6554	1.8230
9	E	1.809		1.828		1.827	
10		7.01	1.7970	12.5970	1.8075	12.6706	1.8007
11	F	1.795		1.802		1.799	
12		4.86	1.7930	8.7140	1.7943	8.7205	1.7943
13	G	1.798		1.807		1.799	
14		3.44	1.797	6.1817	1.801	6.1954	1.793
15	TOTAL	54.12	98.3089		98.6133		98.4958
16	AVERAGE		1.8165		1.8221		1.8200
17	RISER		1.732		1.726		1.728

TABLE 28K
LOADING FIXTURE NO. 34
OCTOL DENSITY BY CORE, ROWS & WEIGHTED AVERAGE
FOR WARHEADS AND RISERS - 2nd TEST

CORE/ROW	V _s SEGMENT VOLUME	#8566		#8568		#8570	
		gm/cc	X V _s	gm/cc	X V _s	gm/cc	X V _s
1	(fig. 3)	1.832		1.827		1.837	
2		1.835		1.831		1.837	
A	11.86	1.8335	21.7453	1.8290	21.6919	1.8370	21.7868
3		1.830		1.837		1.834	
4		1.831		1.832		1.834	
B	8.07	1.8305	14.7721	1.8345	14.8044	1.8340	14.8004
5		1.829		1.829		1.825	
6		1.829		1.833		1.832	
C	9.75	1.8290	17.8328	1.8310	17.6523	1.8285	17.8279
7		1.826		1.825		1.824	
8		1.820		1.824		1.828	
9		1.824		1.824		1.827	
10		1.822		1.823		1.821	
D	9.13	1.8230	16.6440	1.8240	16.6531	1.8250	16.6623
11		1.801		1.814		1.807	
12		1.814		1.817		1.814	
13		1.800		1.810		1.800	
E	7.01	1.8050	12.6531	1.8137	12.7138	1.807	12.6671
14		1.791		1.790		1.788	
15		1.802		1.795		1.784	
16		1.789		1.788		1.788	
F	4.86	1.7940	8.7188	1.7910	8.7043	1.7867	8.6832
17	G	3.44	6.1748	1.794	6.1714	1.787	6.1473
TOTAL	54.12		98.5409		98.5912		98.5750
AVERAGE		1.8208		1.8217		1.8214	
RISER		1.718		1.716		1.707	

TABLE 38F
LOADING FIXTURE NO 42
OCTOL DENSITY BY CORE, ROWS & WEIGHTED AVERAGE
FOR WARHEADS AND RISERS - 2nd TEST

CORE/ROW	Vs SEGMENT VOLUME	#8606		#0608		#8609	
		gm/cc	X Vs	gm/cc	X Vs	gm/cc	X Vs
1	(fig. 3)	1.829		1.831		1.827	
2		1.830		1.829		1.831	
A	11.86	1.8295	21.6979	1.8300	21.7038	1.8290	21.6919
3		1.822		1.827		1.828	
4		1.833		1.833		1.829	
B	8.07	1.8275	14.7479	1.8300	14.7681	1.8285	14.7560
5		1.830		1.822		1.821	
6		1.821		1.825		1.823	
C	9.75	1.8255	17.7986	1.8235	17.7791	1.8220	17.7645
7		1.822		1.824		1.819	
8		1.824		1.821		1.821	
9		1.818		1.822		1.824	
10		1.823		1.825		1.819	
D	9.13	1.8218	16.6326	1.8230	16.6440	1.8208	16.6239
11		1.802		1.798		1.757	
12		1.799		1.801		1.796	
13		1.808		1.787		1.801	
E	7.01	1.8030	12.6390	1.7953	12.5853	1.7847	12.5105
14		1.789		1.790		1.789	
15		1.787		1.795		1.790	
16		1.794		1.787		1.786	
F	4.86	1.7900	8.6994	1.7907	8.7026	1.7883	8.6913
17	G	3.44	6.1542	1.775	6.1050	1.786	6.1438
TOTAL	54.12		98.3696		98.2889		98.1819
AVERAGE		1.8176		1.8161		1.8142	
RISER		1.679		1.709		1.602	

TABLE 29
 DRAGON AVERAGE OCTOL DENSITY DISTRIBUTION BY ROW LOCATION
 2nd TEST - 70/30 VIRGIN OCTOL - 5.4 SEC. VISC.

LOAD FIXTURE NO.	WJD. SERIAL NO.	ROW AVERAGES						
		ROW A	ROW B	ROW C	ROW D	ROW E	ROW F	ROW G
3	8411	1.8385	1.8225	1.8370	1.8243	1.8233	1.8103	1.8140
	8413	1.8375	1.8395	1.8370	1.8335	1.8267	1.8080	1.8110
	8414	1.8390	1.8400	1.8350	1.8328	1.8237	1.8073	1.8090
	AVER.	1.8383	1.8340	1.8363	1.8302	1.8246	1.8085	1.8113
10	8447	1.8295	1.8340	1.8325	1.8293	1.8053	1.8003	1.8020
	8449	1.8385	1.8340	1.8345	1.8318	1.8210	1.7997	1.7910
	8450	1.8395	1.8370	1.8340	1.8233	1.8070	1.8020	1.7900
	AVER.	1.8358	1.8350	1.8337	1.8281	1.8111	1.8007	1.7943
18	8487	1.8370	1.8355	1.8310	1.8255	1.8143	1.8003	1.7980
	8489	1.8340	1.8365	1.8335	1.8285	1.8157	1.8027	1.8030
	8490	1.8345	1.8350	1.8315	1.8248	1.8003	1.7977	1.7990
	AVER.	1.8352	1.8357	1.8320	1.8263	1.8101	1.8002	1.8000
26	8526	1.8320	1.8300	1.8275	1.8075	1.7970	1.7930	1.7970
	8528	1.8340	1.8330	1.8285	1.8243	1.8075	1.7943	1.8010
	8529	1.8325	1.8320	1.8280	1.8230	1.8007	1.7943	1.7930
	AVER.	1.8328	1.8317	1.8280	1.8183	1.8017	1.7039	1.7970

TABLE 29 (Cont'd)
 DRAGON AVERAGE OCTOL DENSITY DISTRIBUTION BY ROW LOCATION
 2nd TEST - 70/30 VIRGIN OCTOL - 5.4 SEC. VISC.

LOAD FIXTURE NO.	WHD. SERIAL NO.	ROW AVERAGES						
		ROW A	ROW B	ROW C	ROW D	ROW E	ROW F	ROW G
	8566	1.8335	1.8305	1.8290	1.8230	1.8050	1.7940	1.7950
34	8568	1.8290	1.8345	1.8310	1.8240	1.8137	1.7910	1.7940
	8570	1.8370	1.8340	1.8285	1.8250	1.807	1.7867	1.7870
	AVER.	1.8332	1.8330	1.8295	1.8240	1.8086	1.7906	1.7920
	8606	1.8295	1.8275	1.8255	1.8218	1.8030	1.7900	1.7890
42	8608	1.8300	1.8300	1.8235	1.8230	1.7953	1.7907	1.7750
	8609	1.8290	1.8285	1.8220	1.8208	1.7847	1.7883	1.7860
	AVER.	1.8295	1.8287	1.8237	1.8219	1.7943	1.7897	1.7833

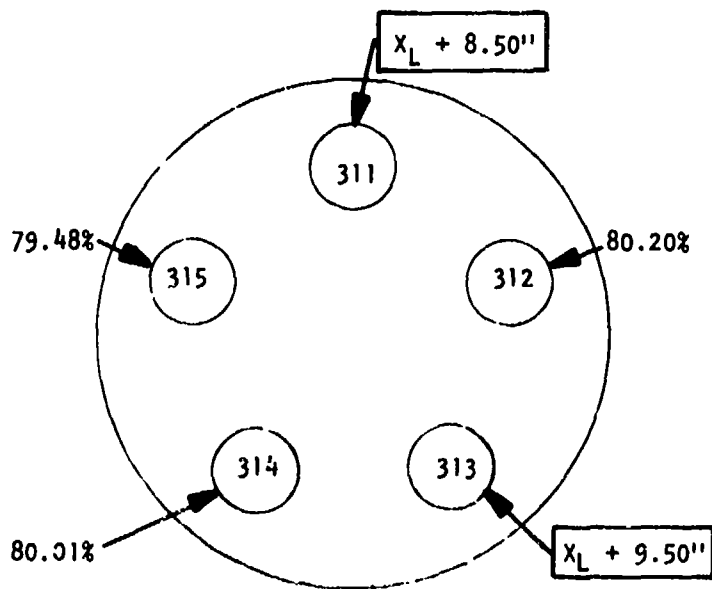

<u>% HMX</u>	
WHD	BODY
9.50" { 312	80.20%
314	80.01
AVER.	80.11%

8.50" { 315	79.48
312	80.20
AVER.	79.84%

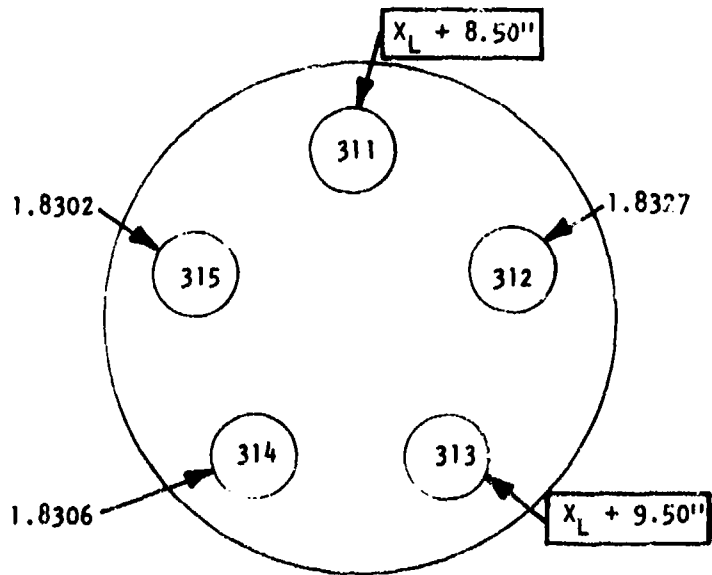

<u>OCTOL DENSITY</u>	
WHD	BODY
9.50" { 312	1.8327
314	1.8307
AVER.	1.8317

8.50" { 315	1.8302
312	1.8327
AVER.	1.8315

FIGURE 20A
1st TEST - 70/30 OCTOL - 7.8 SEC. VISC.
LOADING FIXTURE NO. 3

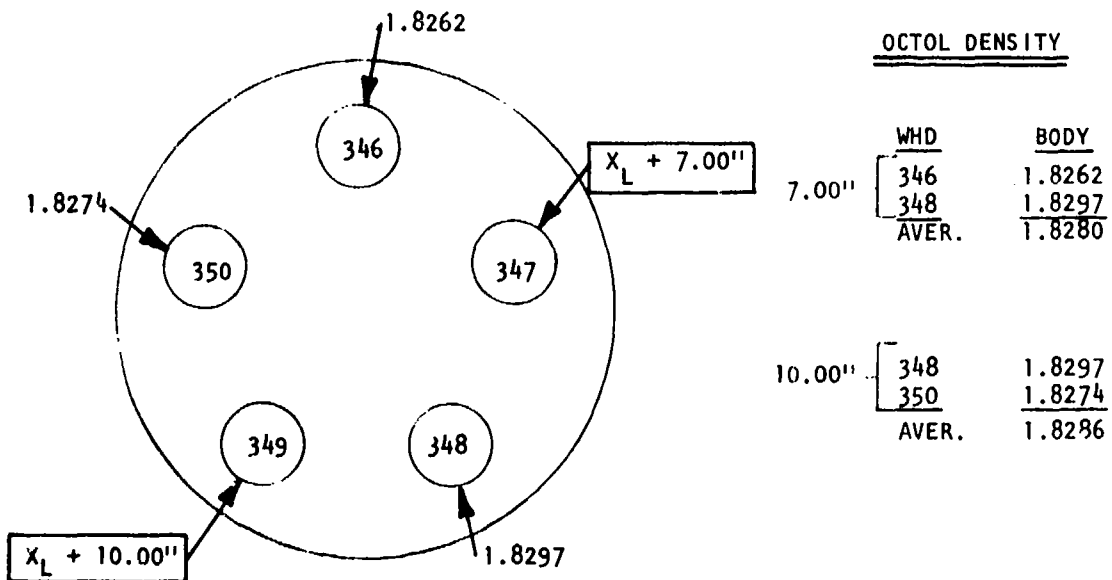
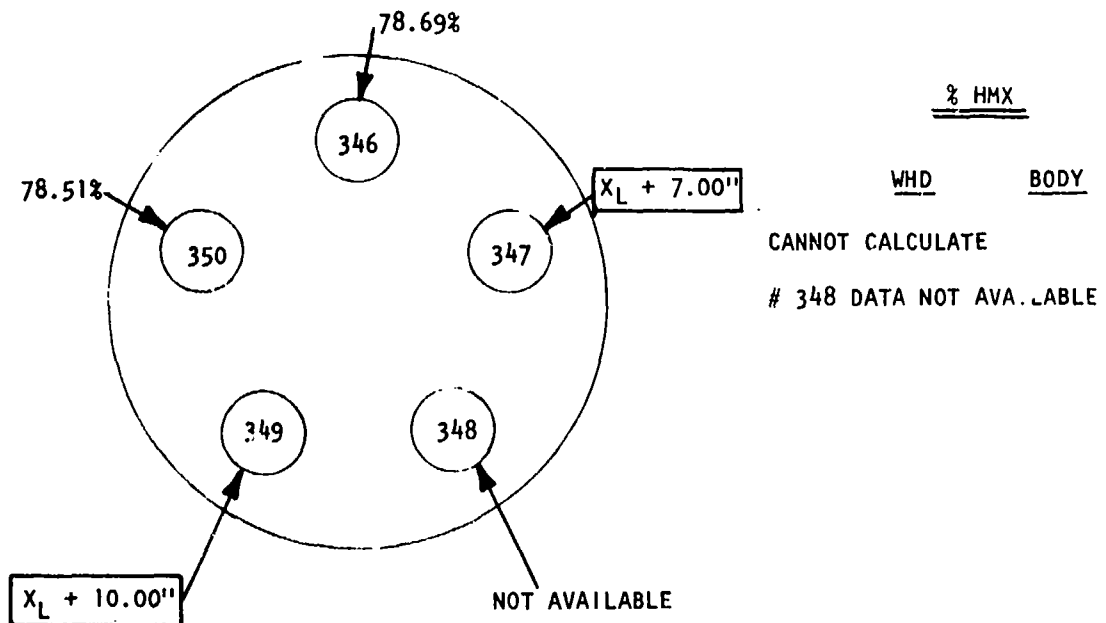

FIGURE 20B
1st TEST - 70/30 OCTOL - 7.8 SEC. VISC.
LOADING FIXTURE NO. 10

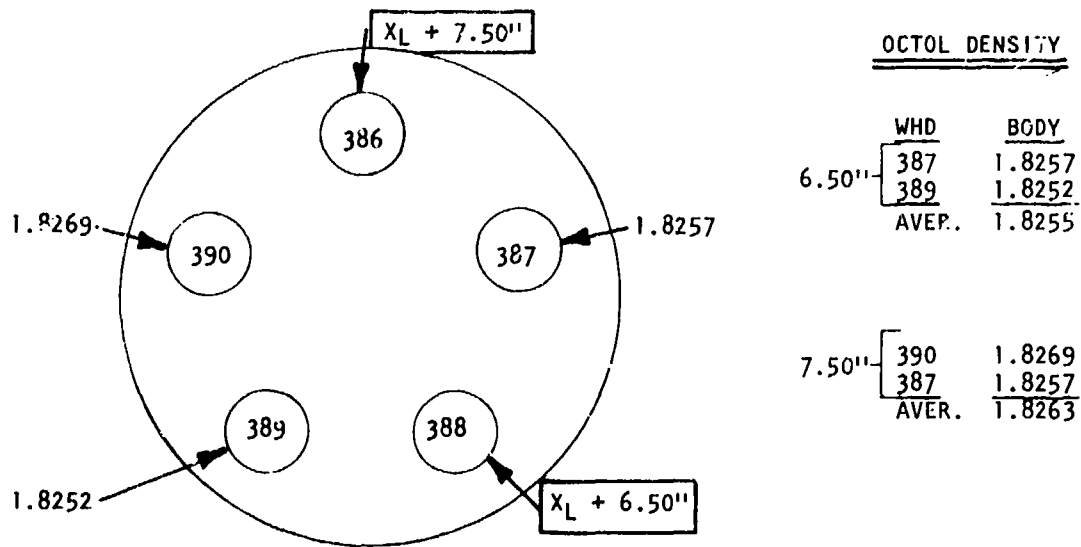
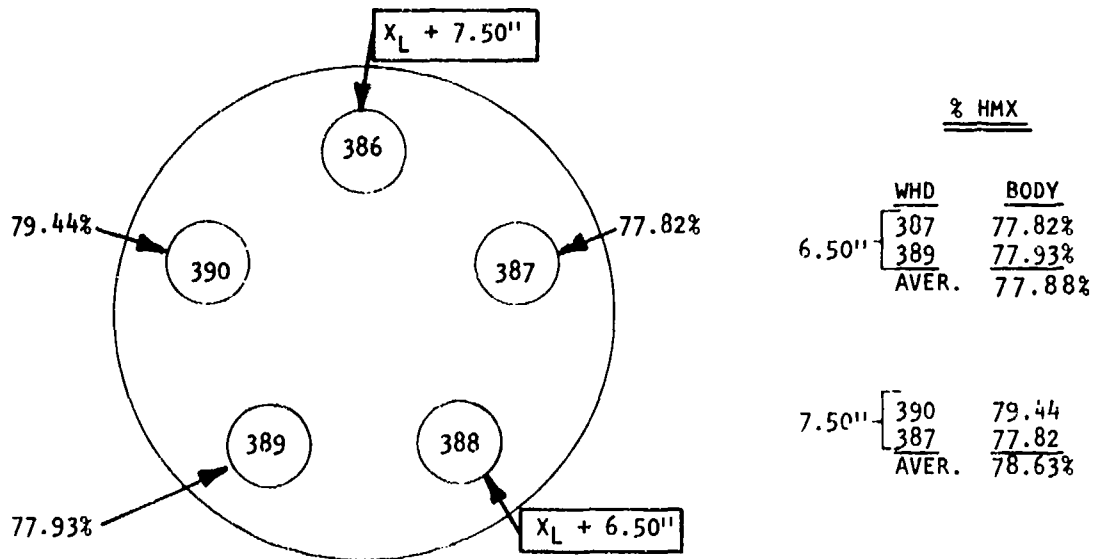
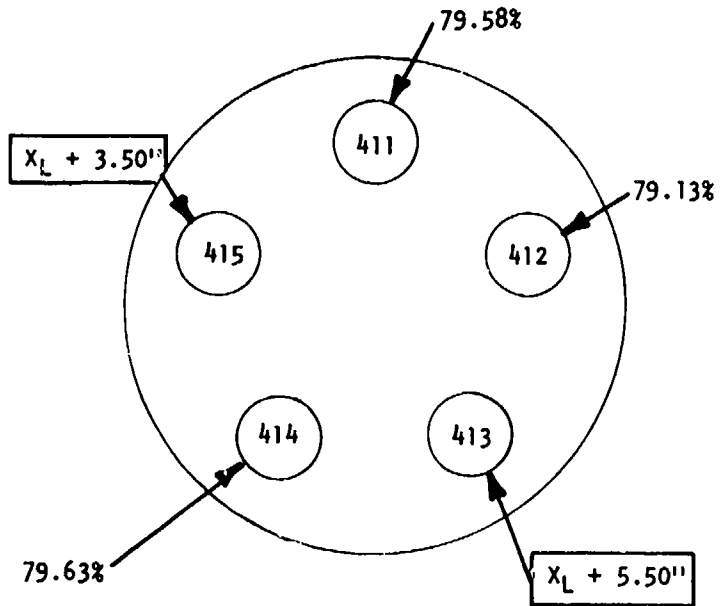
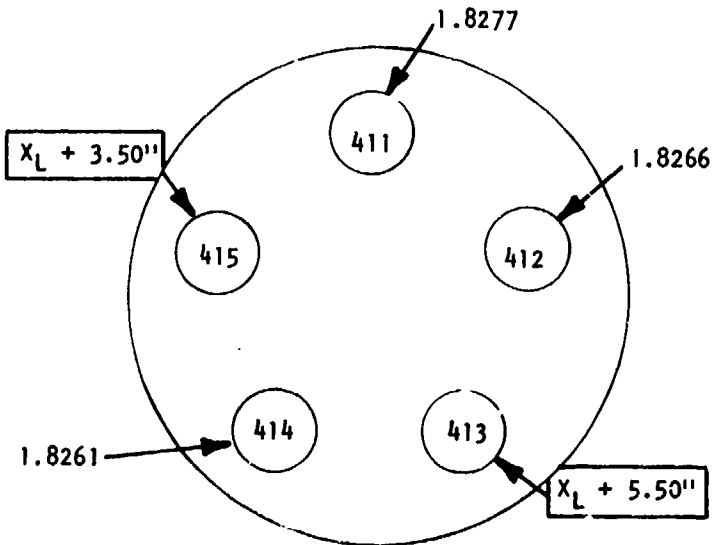

FIGURE 20C
 1st TEST - 70/30 OCTOL - 7.8 SEC. VISC.
 LOADING FIXTURE NO. 18



<u>% HMX</u>	
WHD	BODY
3.50''	411 79.58%
	414 79.63%
	AVER. 79.61%
5.50''	412 79.13%
	414 79.63%
	AVER. 79.38%



<u>OCTOL DENSITY</u>	
WHD	BODY
3.50''	411 1.8277
	414 1.8261
	AVER. 1.8269
5.50''	412 1.8266
	414 1.8261
	AVER. 1.8264

FIGURE 200
 1st TEST - 70/30 OCTOL - 7.8 SEC. VISC.
 LOADING FIXTURE NO. 34

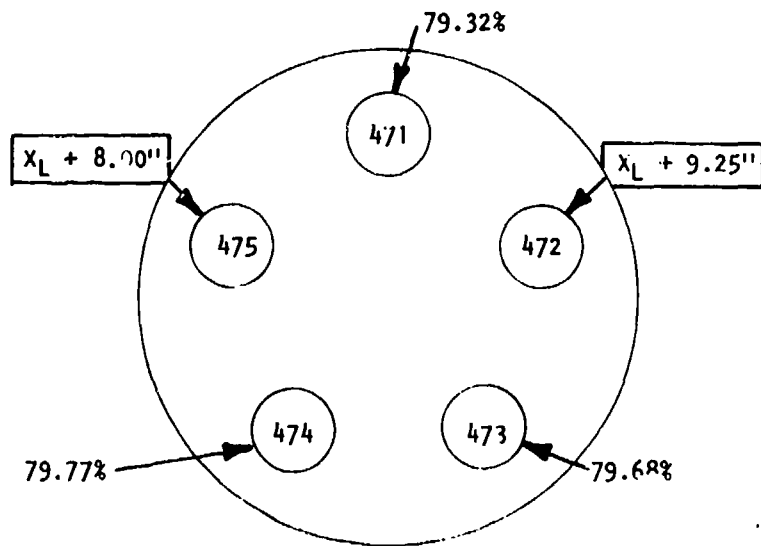

<u>% FMX</u>	
WHD	BODY
9.25" { 471	79.32%
473	79.68%
AVER.	79.50%
8.00" { 474	79.77%
471	79.32%
AVER.	79.55%

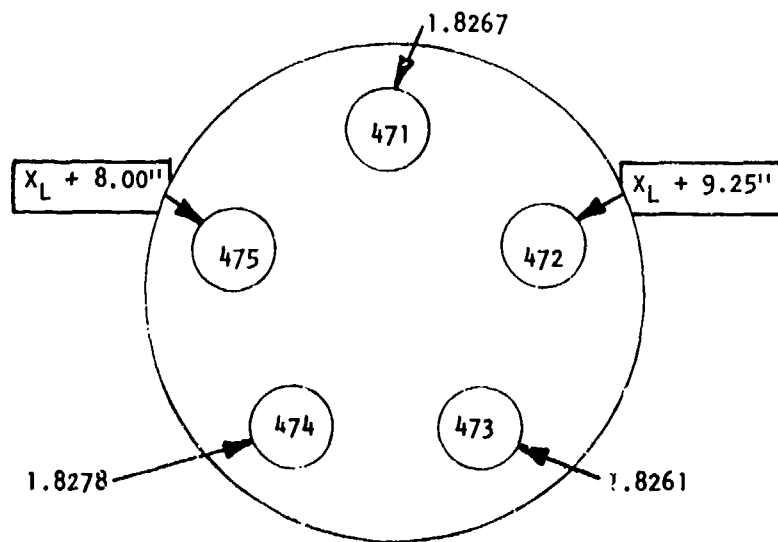

<u>OCTOL DENSITY</u>	
WHD	BODY
9.25" { 471	1.8267
473	1.8261
AVER.	1.8264
8.00" { 474	1.8278
471	1.8267
AVER.	1.8273

FIGURE 20E
1st TEST - 70/30 OCTOL - 7.8 SEC. VISC.
LOADING FIXTURE NO. 26

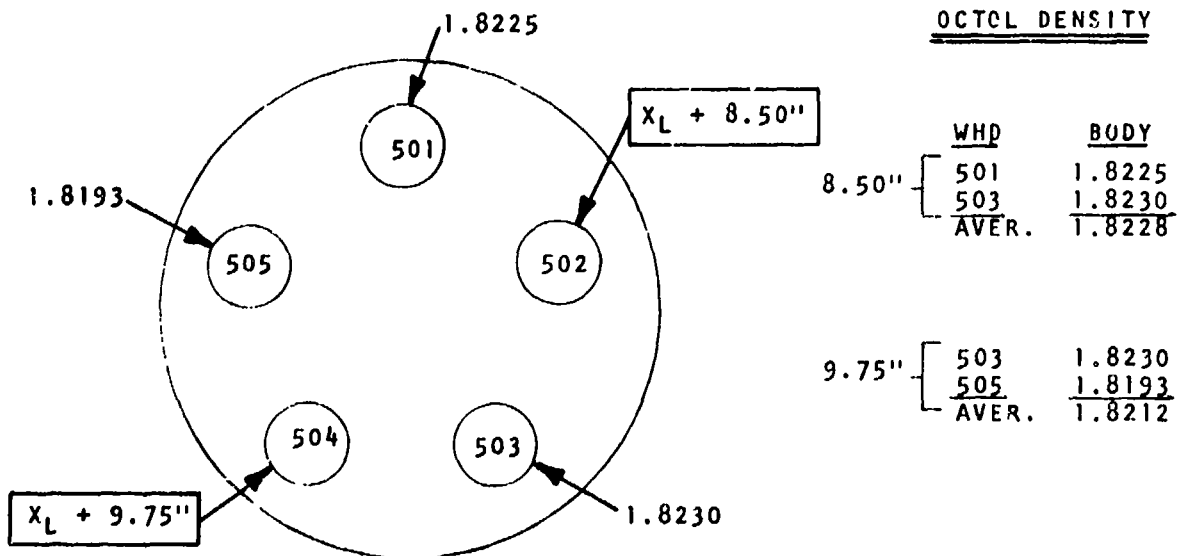
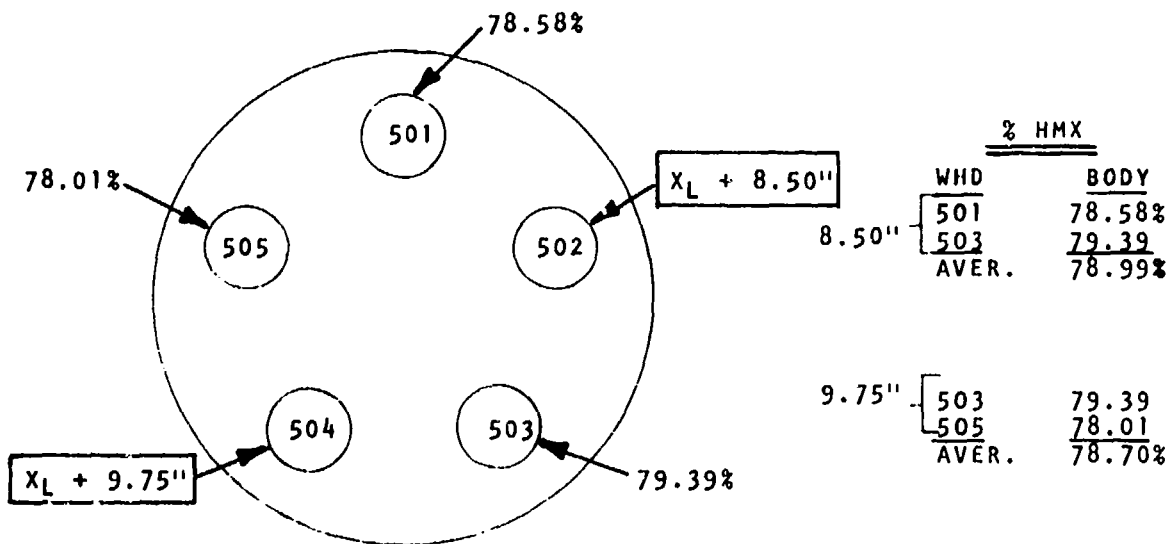

FIGURE 20F
 1st TEST - 70/30 OCTOL - 7.8 SEC. VISC.
 LOADING FIXTURE NO. 42

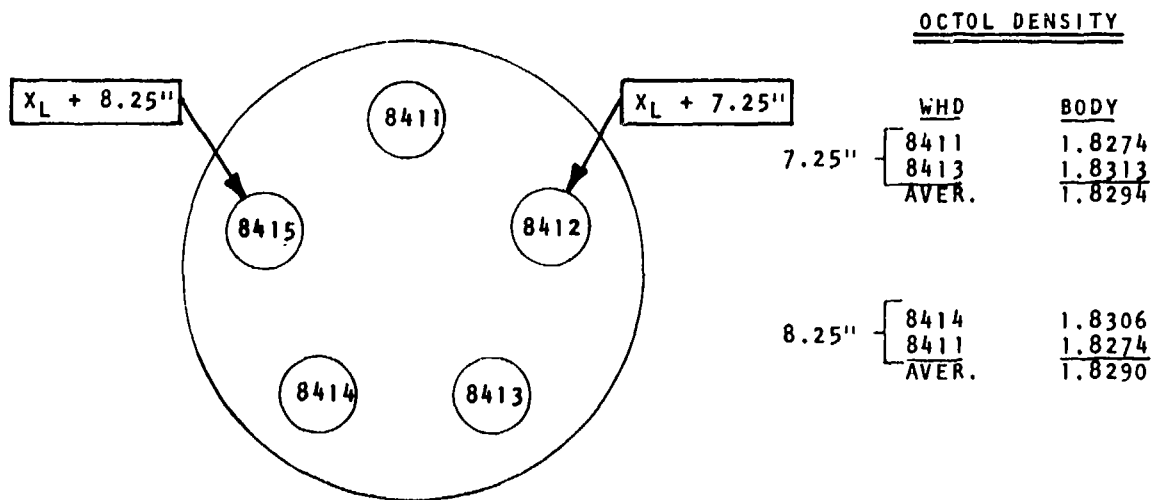
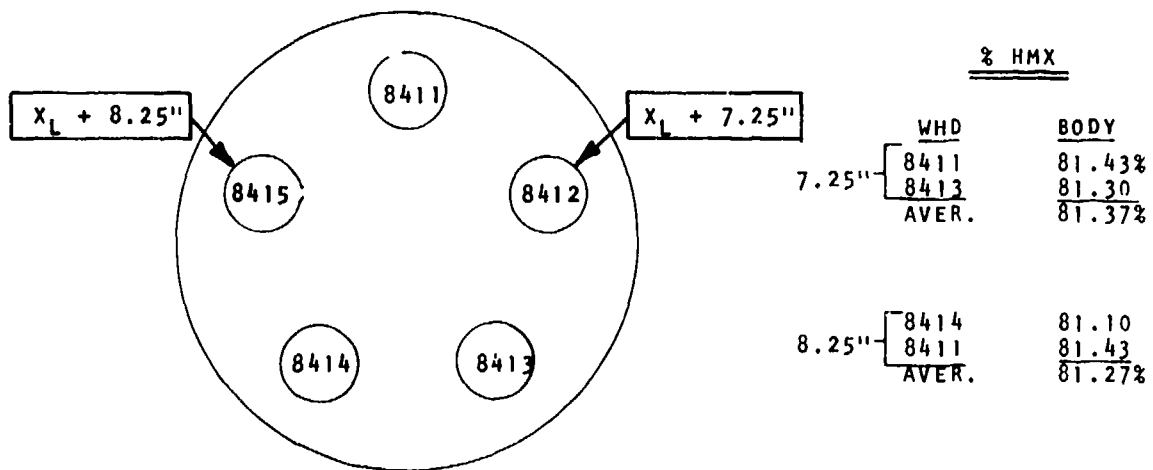
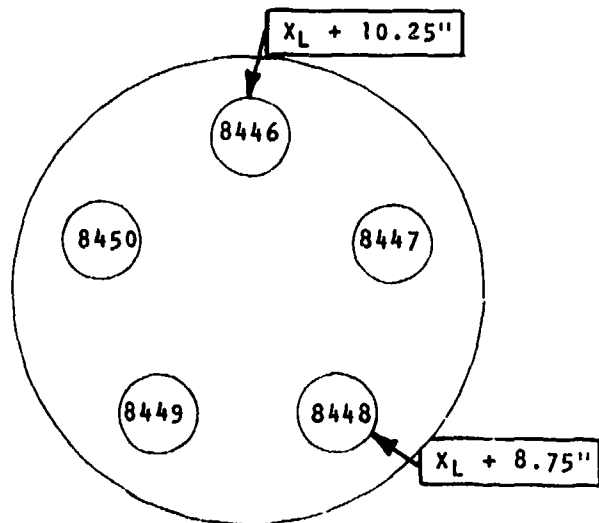
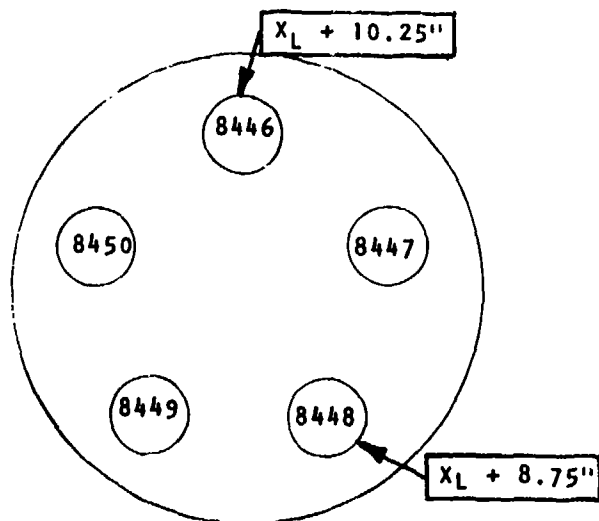

FIGURE 21A
 2nd TEST - 70/30 OCTOL - 5.4 SEC. VISC.
 LOADING FIXTURE NO. 3



<u>% HMX</u>	
WHD	BODY
8.75" [8447	80.39%
8449	81.61
AVER.	81.00%
10.25" [8450	80.80
8447	80.39
AVER.	80.60%



<u>OCTOL DENSITY</u>	
WHD	BODY
8.25" [8447	1.8232
8449	1.8272
AVER.	1.8252
10.25" [8450	1.8247
8447	1.8232
AVER.	1.8240

FIGURE 21B
2nd TEST - 70/30 OCTOL - 5.4 SEC. VISC.
LOADING FIXTURE NO. 10

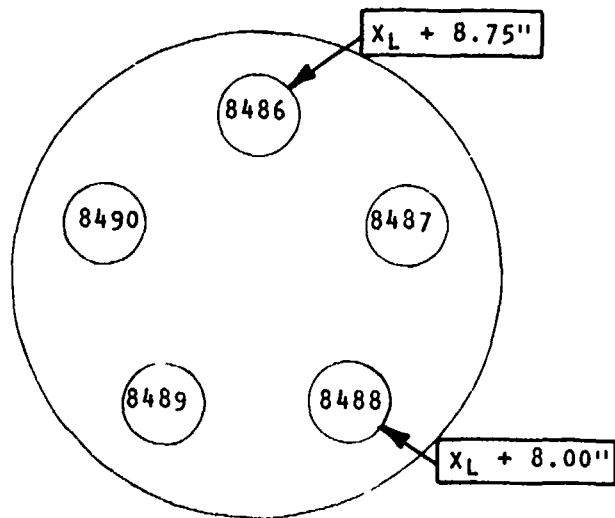

		<u>% HMX</u>	
		<u>WHD</u>	<u>BODY</u>
8.00"	8487		81.71%
	8489		81.71
	AVER.		81.71%
8.75"	8490		81.19
	8487		81.71
	AVER.		81.45%

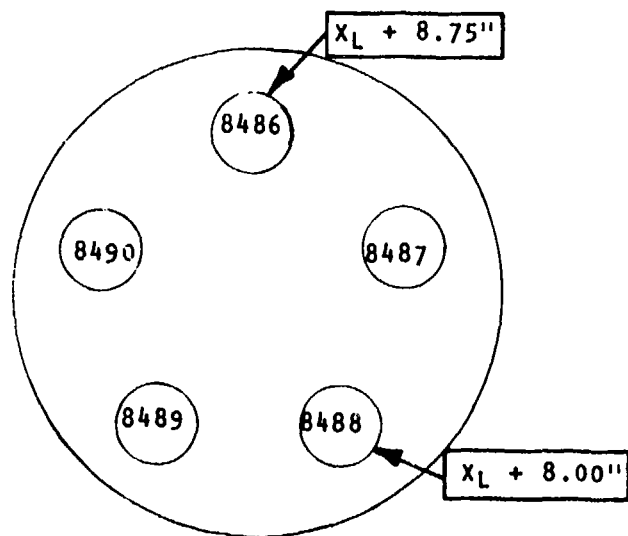

		<u>OCTOL DENSITY</u>	
		<u>WHD</u>	<u>BODY</u>
8.00"	8487		1.8250
	8489		1.8262
	AVER.		1.8256
8.75"	8490		1.8224
	8487		1.8250
	AVER.		1.8238

FIGURE 21C
 2nd TEST - 70/30 OCTOL - 5.4 SEC. VISC.
 LOADING FIXTURE NO. 18

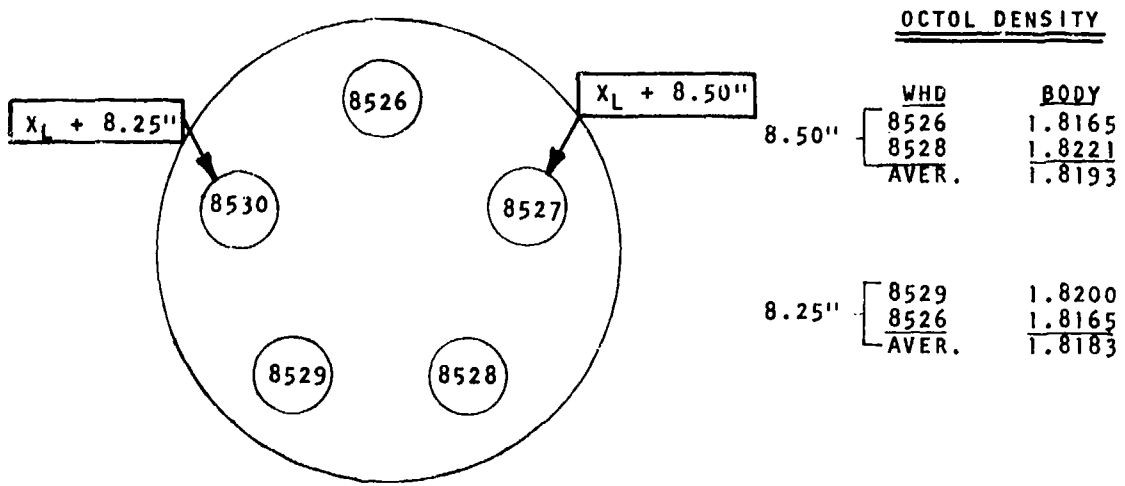
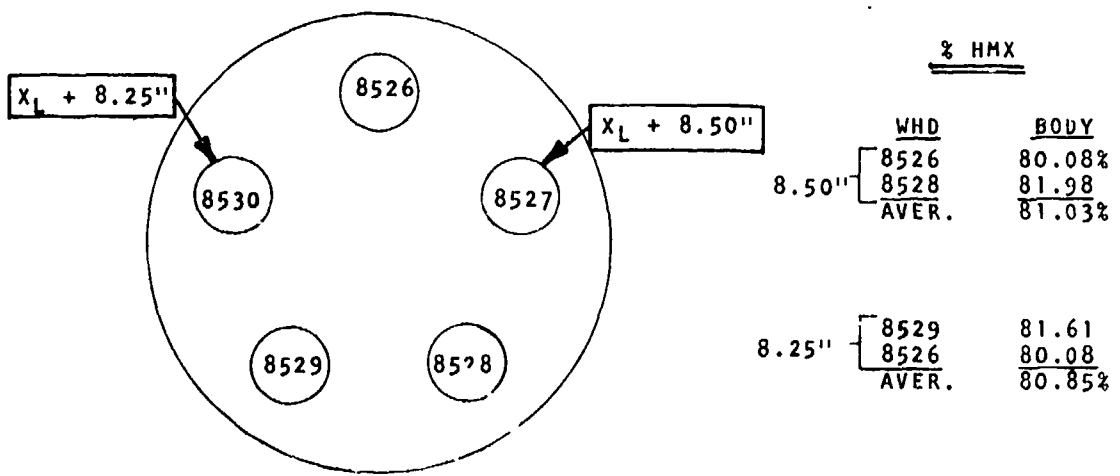

FIGURE 21D
 2nd TEST - 70/30 OCTOL - 5.4 SEC. VISC.
 LOADING FIXTURE NO. 26

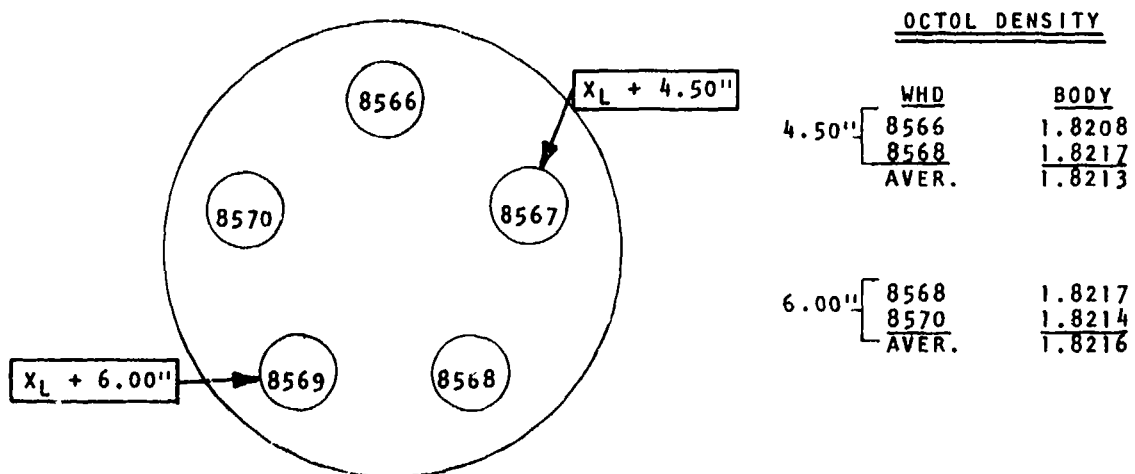
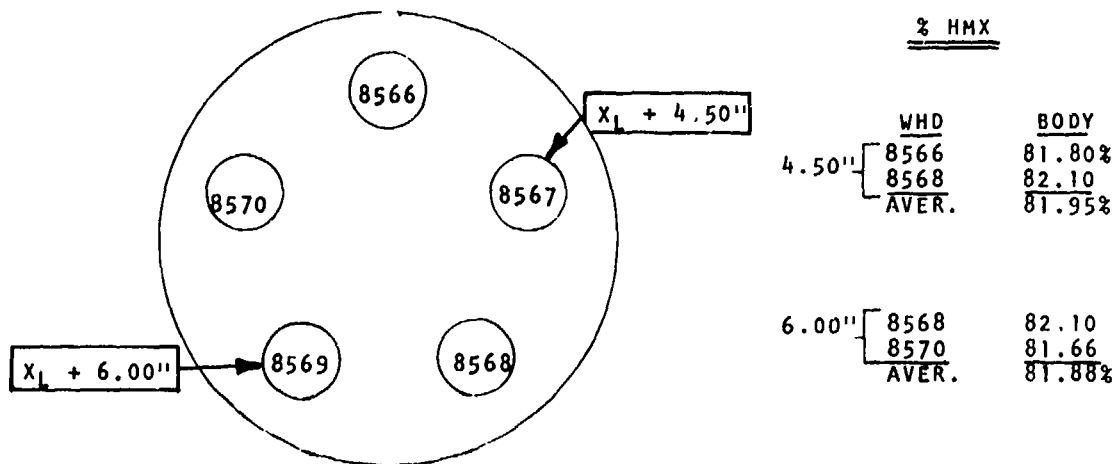

FIGURE 21E
 2nd TEST - 70/30 OCTOL - 5.4 SEC. VISC.
 LOADING FIXTURE NO. 34

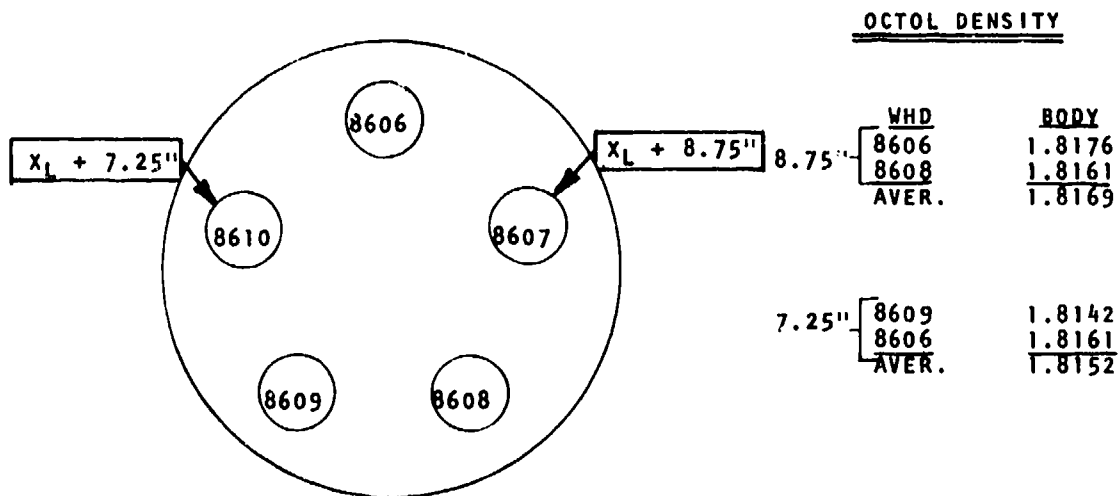
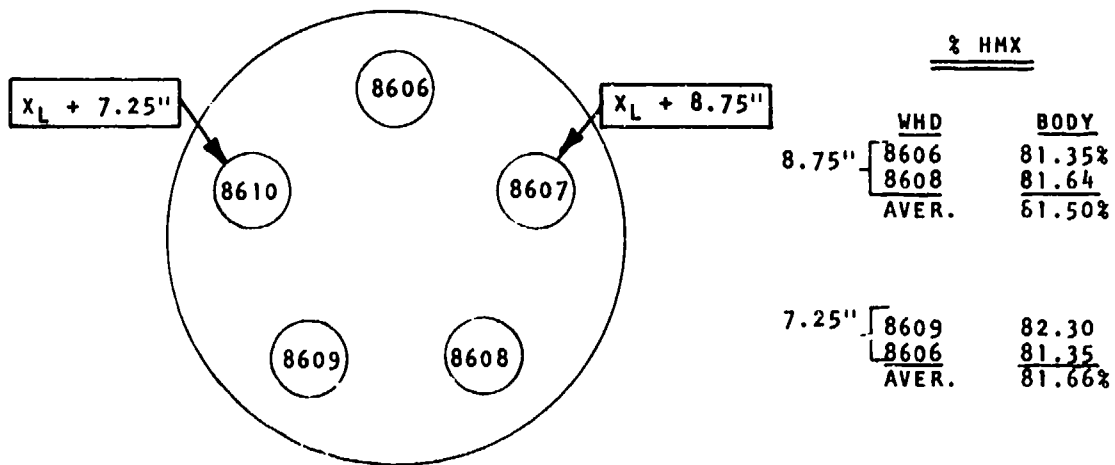

FIGURE 21F

2nd TEST - 70/30 OCTOL - 5.4 SEC. VISC.
LOADING FIXTURE NO. 42

DISTRIBUTION LIST

	<u>COPIES</u>
Commander US Army Materiel Development and Readiness Command ATTN: DRCDE-D	1
DRCQA-E	1
DRCRE-E	1
DRCMT	1
5001 Eisenhower Ave. Alexandria, VA 22333	
Commander US Army Armament Research and Development Command ATTN: DRDAR-LCE	1
DRDAR-LCM	1
DRDAR-LCU-E	3
DRDAR-QAR	1
DRDAR-QAR-Q	2
DRDAR-QAR-R	12
DRDAR-QAT-R	1
DRDAR-QAT-Q	1
DRDAR-TSS	5
Dover, NJ 07801	
Commander US Army Armament Research and Development Command ATTN: Ballistics Research Laboratory DRDAR-BLT (JULES SIMON)	2
DRDAR-BLT (JAMES E. COLE)	2
Aberdeen Proving Ground, MD 21005	
Commander Iowa Army Ammunition Plant ATTN: SARIO-Q	5
Middletown, IA 52638	
Commander US Army Armament Materiel Readiness Command ATTN: DRSAR-ASI	1
DRSAR-PDM	1
DRSAR-QAM-F	1
DRSAR-RDP	1
Rock Island, IL 61201	

DISTRIBUTION LIST (CONT)

	<u>COPIES</u>
Commander US Army Armament Materiel Readiness Command ATTN: DRSAR-MAD-C Dover, NJ 07801	1
Commander US Army Missile Materiel Readiness Command ATTN: DRCPM-MW DRCPM-MWG Huntsville, AL 35809	1 2
Defense Documentation Center Cameron Station Alexandria, VA 22314	12
Officer in Charge Naval Materiel Industrial Resources Office ATTN: Henry Shapiro Philadelphia, PA 19112	2
Commander Naval Surface Weapons Center ATTN: Jeffrey M. Warren Code DG-33 Dahlgren, VA 22448	2