

ADA 037186

AFML-TR-76-181

12

RIVET QUALIFICATION OF ALUMINUM ALLOY 7050

ALUMINUM COMPANY OF AMERICA
ALCOA TECHNICAL CENTER
ALCOA CENTER, PA 15069

DDC
MAY 22 1977
C

OCTOBER 1976

TECHNICAL REPORT AFML-TR-76-181
FINAL REPORT FOR PERIOD FEBRUARY 1975-JULY 1976

Approved for public release; distribution unlimited

COPY AVAILABLE TO REG DOES NOT
PERMIT FULLY LEGIBLE PROJECTION

AIR FORCE MATERIALS LABORATORY
AIR FORCE WRIGHT AERONAUTICAL LABORATORIES
AIR FORCE SYSTEMS COMMAND
WRIGHT-PATTERSON AIR FORCE, OHIO 45433

NOTICES

When Government drawings, specifications, or other data are used for any purpose other than in connection with a definitely related Government procurement operation, the United States Government thereby incurs no responsibility nor any obligation whatsoever; and the fact that the Government may have formulated, furnished, or in any way supplied the said drawings, specifications, or other data, is not to be regarded by implication or otherwise as in any manner licensing the holder or any other person or corporation, or conveying any rights or permission to manufacture, use, or sell any patented invention that may in any way be related thereto.

Copies of this report should not be returned unless return is required by security considerations, contractual obligations, or notice on a specific document.

This final report was submitted by the Aluminum Company of America, Alcoa Center, Pennsylvania, under Contract F33615-75-C-5117, Manufacturing Methods Project 808-5, "Rivet Qualification for Aluminum Alloy 7050." Mr. Kenneth L. Kojola, AFML/LTM, was the Program Manager.

This technical report has been reviewed and is approved for publication.

Kenneth L. Kojola
Kenneth L. Kojola
Program Manager

FOR THE DIRECTOR

H. A. Johnson
H. A. JOHNSON
Chief, Metals Branch
Manufacturing Technology Division

ADVISORY BOARD
NTC
DEC
US
LITTLE
BY
Dist: A

UNCLASSIFIED

SECURITY CLASSIFICATION OF THIS PAGE (When Data Entered)

REPORT DOCUMENTATION PAGE		READ INSTRUCTIONS BEFORE COMPLETING FORM	
1. REPORT NUMBER AFML-TR-76-181	2. GOVT ACCESSION NO.	3. RECIPIENT'S CATALOG NUMBER	
4. TITLE (and Subtitle) RIVET QUALIFICATION OF ALUMINUM ALLOY 7050	5. TYPE OF REPORT & PERIOD COVERED Final Technical Report February 1975-June 1976		
7. AUTHOR W. J. Dewalt, B. W. Lifka, G. E. Nordmark	8. CONTRACT OR GRANT NUMBER(s) F33615-75-C-5117		
9. PERFORMING ORGANIZATION NAME AND ADDRESS Aluminum Company of America Alcoa Laboratories Alcoa Center, Pa. 15069	10. PROGRAM ELEMENT, PROJECT, TASK AREA & WORK UNIT NUMBERS 78011F, 808-5 MTP 10257		
11. CONTROLLING OFFICE NAME AND ADDRESS Air Force Materials Laboratory (AFML/LTM) Air Force Systems Command Wright-Patterson Air Force Base, OH 45433	12. REPORT DATE October 1975	13. NUMBER OF PAGES 136	
14. MONITORING AGENCY NAME & ADDRESS (if different from Controlling Office)	15. SECURITY CLASS. (of this report) Unclassified		
12) 149p.	15a. DECLASSIFICATION/DOWNGRADING SCHEDULE		
16. DISTRIBUTION STATEMENT (of this Report) Approved for public release; distribution unlimited			
17. DISTRIBUTION STATEMENT (of the abstract entered in Block 20, if different from Report)			
18. SUPPLEMENTARY NOTES			
19. KEY WORDS (Continue on reverse side if necessary and identify by block number) Aluminum Casting Shear Ultimate Intergranular Heat Treatment Alloy Wire Fatigue Yield Stress-Corrosion Aging Practices 7050 Rivets Tests Load Driving Static Ingots Tensile Joints Analysis Formability Hole-Fill			
20. ABSTRACT (Continue on reverse side if necessary and identify by block number) Manufacturing methods were established for the production of aluminum alloy 7050 aircraft-size rivets. Alloy 7050 ingots were cast to two purity levels (iron and silicon content) both within the chemical composition limits for alloy 7050. The ingots were converted into wire and the wire into rivets. Strength, formability and corrosion tests were conducted on wire to establish the aging practices to be applied to the rivets. The purity level had no noticeable effect on rivet fabrication, strength			

DD FORM 1 JAN 73 1473

EDITION OF 1 NOV 65 IS OBSOLETE

Unclassified

SECURITY CLASSIFICATION OF THIS PAGE (When Data Entered)

017460

18

Unclassified

SECURITY CLASSIFICATION OF THIS PAGE(When Data Entered)

properties, formability or resistance to stress-corrosion cracking (SCC) of the wires. The rivets, in 3/32, 3/16 and 3/8-in. diameter sizes, were given second step agings of 8 hours at 345°, 350° and 355°F. Driving and hole-fill evaluations, static tests of lap-shear joints, fatigue tests of high load-transfer joints and SCC tests were conducted using the 7050 rivets. It was found that the driving and hole-fill quality, the static strength and resistance to SCC for 7050 alloy rivets equals or exceeds that of 2024-T31 ("ice-box") rivets. Driven shear strength values were at least 15 per cent greater than that typically found for 2024-T31 rivets. The fatigue strength of joints with 7050 rivets was less than similar joints containing 2024-T31 rivets. A production aging practice is recommended to place the 7050 rivets in the T73 temper. A small program showed that residual stress around the rivet hole can affect the resistance to stress-corrosion cracking of the material being joined.

UNCLASSIFIED

SECURITY CLASSIFICATION OF THIS PAGE(When Data Entered)

PREFACE

This final technical report submitted in September 1976 covers the work performed under Contract F33615-75-C-5117 from 10 February 1975 through 10 June 1976. This contract with the Aluminum Company of America was performed under Rivet Qualification of Aluminum Alloy 7050, Project 808-5. The program was initiated with Lieutenant Joseph Hager, and was completed under the technical direction of Mr. Kenneth L. Kojola (AFML/LTM) Manufacturing Technology Division, Air Force Materials Laboratory, Wright-Patterson Air Force Base, Ohio.

The program was accomplished at Alcoa Technical Center, Aluminum Company of America, Alcoa Center, PA. The program manager was Mr. W. J. Dewalt and project supervisors were Messrs. W. J. Dewalt, B. W. Lifka and R. H. Stevens. Mr. S. C. Ford was project leader for tests performed at Battelle Memorial Institute.

Mr. J. E. Jacoby supervised the casting of the ingots. Mr. J. V. Muncie was responsible for converting the ingots into rivet wires, and Mr. R. L. Dodson supervised the rivet production. Mr. J. T. Staley developed the aging practices for the rivet wire and rivets. Mr. G. E. Nordmark conducted the fatigue test program. Mr. F. C. Ford contributed to the analyses of the fatigue test results, and, along with Mr. M. L. Sharp, to the analyses of the static test results. Mr. D. O. Sprowls contributed to the analysis of the corrosion and stress-corrosion test results. Mr. R. H. Stevens supervised the metallographic examinations.

TABLE OF CONTENTS

<u>SECTION</u>	<u>PAGE NO.</u>
I. Introduction.	1
II. Phase I - Rivet Production and Wire Screening Tests	3
A. Production of Wire and Rivets	3
1. Ingots.	3
2. Rivet Wires	4
3. Rivets.	6
B. Wire Screening Tests.	7
1. Aging Practices	7
2. Mechanical Property and Conductivity Tests	8
3. Accelerated Stress-Corrosion Tests.	9
4. Driving and Hole-Fill Tests	11
C. Phase I - Briefing and Recommendations.	14
III. Phase II - Rivet Tests.	16
A. Aging and Anodizing	16
B. Mechanical Property and Conductivity Tests.	15
C. Joint Shear Strength Tests.	17
D. Driving and Hole-Fill Evaluations	22
E. Shear Joint Fatigue Tests	20
F. Accelerated Stress-Corrosion Tests.	32
IV. Conclusions	37
V. Recommendations	41
VI. Addendum.	42
VII. References.	45

LIST OF ILLUSTRATIONS

Figure		Page
1	Alcoa 181 Process.	85
2	Alcoa Level Pour Mold.	86
3	Sketch Showing Principal Dimensions of the SCC Round Tension Specimen and the Stressing Frame .	87
4	Intergranular Corrosion in Tension Specimen From 7050 Wire Aged 2 Hours at 350°F.	88
5	Driving and Hole-Fill Test Specimen.	89
6	Examples of "Good" (Top) and "Poor" Holes (Bottom) Drilled for Slug Driving Specimens. . .	90
7	Photograph of Subpress Setup in Testing Machine for Driving Slugs.	91
8	Typical Driving Test Specimen After All Slugs Upset to Form Flat Heads- 0.184-in. Diameter 7050 Slugs Driven in 0.190-in. 7075-T6 Sheet . .	92
9	Photograph of Some of the Completed Driving Specimens Containing 7050 Alloy 0.092, 0.184 and 0.372-in. Diameter Slugs	93
10	Driving Pressure versus Average Driven Flat Head Diameter Curves for 0.092, 0.184 and 0.372-in. Diameter 7050 Slugs Given Six Aging Practices. .	94
11	Shear Crack in Driven Head of 7050 Alloy Slug. .	95
12	Photomicrographs of Sectioned 0.092-in. Diameter (D) 7050 Slugs Driven With 1.5D Flat Head in 0.090-in. 2024-T3 Sheet	96
13	Photomicrographs of Sectioned 0.184-in. Diameter (D) 7050 Slugs Driven With 1.5D and 1.7D Diameter Flat Heads in 0.190-in. 7075-T6 Sheet .	97
14	Photomicrographs of Sectioned 0.184-in. Diameter (D) 2024-T31 Slugs Driven (in the "Freshly" Quenched Condition) With 1.5D Diameter Flat Heads in 0.190-in. 2024-T3 Sheet	98
15	Photomicrographs of Sectioned 0.184-in. Diameter (D) 7050 Slugs Driven With 1.5D Diameter Flat Heads in Good-Poor Holes in 0.281-in. 7075-T651 Plate Second Step Aging: 12 Hrs. at 350°F. . . .	99

LIST OF ILLUSTRATIONS (CONTINUED)

Figure		Page
16	Photomicrographs of Sectioned 0.184-in. Diameter (D) 2024-T31 Slugs Driven (in the "Freshly" Quenched Condition) With 1.5D Diameter Flat Heads in 0.281-in. 7075-T651 Plate.	100
17	Photomicrographs of Sectioned 0.372-in. Diameter (D) 7050 Slugs Driven With 1.5D Diameter Flat Heads in 0.375-in. 7075-T6 Plate - 2nd Step of Aging was 8 Hrs at 350°F.	101
18	Preferred Test Lap Joint Specimen Configuration .	102
19	Photograph of Setup for Static Tests of Riveted Lap-Joints.	103
20	Average Ultimate-Load Data for 7050-T7X Rivets (2nd Step of Aging = 8 Hrs at 345°F).	104
21	Average Ultimate-Load Data for 7050-T7X Rivets (2nd Step of Aging = 8 Hrs at 350°F).	105
22	Average Ultimate-Load Data for 7050-T7X Rivets (2nd Step of Aging = 8 Hrs at 355°F).	106
23	Average Yield-Load Data for 7050-T7X Rivets (2nd Step of Aging = 8 Hrs at 345°F).	107
24	Average Yield-Load Data for 7050-T7X Rivets (2nd Step of Aging = 8 Hrs at 350°F).	108
25	Average Yield-Load Data for 7050-T7X Rivets (2nd Step of Aging = 8 Hrs at 355°F).	109
26	Driving Pressure Versus Average Driven Flat Head Diameter Curves for 3/32, 3/16 and 3/8-in. Diameter 7050-T7X Rivets Given Three Aging Practices	110
27	Shear Cracks in Driven Head of 3/8-in. Dia. 7050-T7X Rivet - 2nd Step of Aging: 8 Hrs at 345°F	111
28	Photomicrographs of Sectioned 3/32-in. Diameter (D) 7050-T7X Rivets Driven With 1.5D Flat Heads in 0.090-in. 2024-T3 Sheet - 2nd Step of Aging: 8 Hrs at 345°F.	112
29	Photomicrographs of Sectioned 3/16-in. Diameter 2024-T31 Rivets	113

LIST OF ILLUSTRATIONS (CONTINUED)

Figure		Page
30	Photomicrographs of Sectioned 3/16-in. Dia. 7050-T7X Rivets - 2nd Step Aging: 8 Hrs at 350°F.	114
31	Photomicrographs of Sectioned 3/16-in. Diameter (D) 7050-T7X Rivets Driven With 1.5D Flat Heads in 0.281-in. 7075-T651 Plate - 2nd Step of Aging: 8 Hrs. at 355°F	115
32	Photomicrographs of Sectioned 3/8-in. Diameter (D) 7050-T7X Rivets Driven With 1.55D Flat Heads in 0.375-in. 2024-T351 Plate - 2nd Step of Aging: 8 Hrs at 355°F.	116
33	Driving and Hole-Fill Specimens for Pneumatic Hammer Driven Rivets	117
34	Pneumatic Hammer Driven 3/32-in. Dia. 7050-T7X Rivets - Second Step of Aging: 8 Hrs at 350°F.	118
35	Photomicrograph of Sectioned 3/16-in. Diameter 7050-T7X Rivet Driven in 0.190-in. Diameter Hole in 1/4-in. 7075-T6 Plate - 2nd Step of Aging: 8 Hrs at 350°F	119
36	Shear Joint Fatigue Specimen for 3/16-in. Dia. 100° Flat Ctsk Head Rivets	120
37	Photograph of Setup for Fatigue Tests of Riveted Joints Using Restraining Fixture	121
38	Specimen Retaining Fixture (Sandwich Type)	122
39	Fatigue Results for 7050-T7X and 2024-T31 Rivets In High Load Transfer Lap Joints at Alcoa Laboratories	123
40	Fatigue Results for 7050-T7X and 2024-T31 Rivets in High Load Transfer Lap Joints At Battelle Laboratories	124
41	Effect of Rivet Alloy on Fatigue Strength of High Load Transfer Joints.	125
42	Load-Strain Results for High-Load Transfer Joint - Battelle	126

LIST OF ILLUSTRATIONS (CONCLUDED)

Figure		Page
43	Load-Strain Results for High Load Transfer Joint - Alcoa.	127
44	Comparison of Strains in Alcoa and Battelle Tests.	128
45	Effect of Stress Ratio and Restraints on Fatigue Strength of High Load Transfer Joints.	129
46	Two Sizes of Stressed Assemblies Used In Corrosion Tests of Rivets.	130
47	Intergranular Corrosion and SCC in A 7050 Rivet 2 Hours at 350°F	131
48	SCC In A 7050 Rivet Aged 8 Hrs at 345°F.	132
49	Localized Corrosion in a 7050 Rivet Aged 8 Hrs At 345°F	133
50	Intergranular Corrosion and SCC In A Heated 2024-T31 Rivet	134
A1	Orientation of the Longitudinal Slice Used In Testing 2124 Plate	135
A2	SCC In 2124-T351 Coupon Containing 2024-T31 Rivets	136

LIST OF TABLES

Table		Page
1	Chemical Composition of 15-in. Diameter Ingots Cast for Alloy 7050 Rivet Program.	46
2	7050-H13 Wires Produced and Shipped from Massena Works.	47
3	Results of Mechanical Property Tests on 7050-H13 Wire Produced At Massena Works	48
4	Alloy 7050-F Rivet Items Manufactured At the Lancaster Works.	49

LIST OF TABLES (CONTINUED)

Table		Page
5	Results of Tests to Determine Effect of Solution Heat Treating Practice on Tensile Properties of 7050 Wire.	50
6	Results of Tensile Property Tests on Alloy 7050 Rivet Wires Using Six Aging Practices . .	51
7	Results of Shear Strength Tests On Alloy 7050 Rivet Wires Using Six Aging Practices.	52
8	Results of Electrical Conductivity Tests On Alloy 7050 Rivet Wires	53
9	Scope of SCC Screening Tests on 0.372-in. 7050 Wire.	54
10	Resistance to SCC of 7050 Rivet Wire - 0.125-in. Diameter Longitudinal Tension Specimens. .	55
11	Effect of "Low" and "High" Iron and Silicon Content on the Driving Pressure Required to Form Flat Heads On 7050 Alloy Slugs.	56
12	Average Driving Pressures Required to Form 1.5D Diameter X 0.5D Thick Flat Heads on 7050 Alloy Wires.	57
13	Alloy 7050-F Rivets Solution Heat Treated and Aged for Phase II Portion of Program	58
14	Results of Tensile Property and Electrical Conductivity Tests on Alloy 7050 Wire Aged with Rivets.	59
15	Results of Shear Strength Tests On Undriven 7050 Alloy Rivets Using Three Aging Practices. .	60
16	Sheet and Plate Thicknesses for Specimens for Joint Yield and Ultimate Strength Tests. . . .	61
17	Results of Tensile Property Tests of Alclad 2024 Sheet and Plate Items to be Used for Joint Shear Strength Tests	62
18	Computation of t/D and P/D^2 from Basic Data - 3/32-in. Dia. Rivets, Second Step of Aging: 8 Hrs at 345°F	63

LIST OF TABLES (CONTINUED)

Table		Page
19	Computation of t/D and P/D^2 from Basic Data -- 3/16-in. Dia. Rivets, Second Step Aging: 8 Hrs At 345°F.	64
20	Computation of t/D and P/D^2 from Basic Data - 3/8-in. Dia. Rivets, Second Step Aging: 8 Hrs at 345°F.	65
21	Computation of t/D and P/D^2 from Basic Data - 3/32-in. Dia. Rivets, Second Step Aging: 8 Hrs at 350°F.	66
22	Computation of t/D and P/D^2 from Basic Data - 3/16-in. Dia. Rivets, Second Step Aging: 8 Hrs At 350°F.	67
23	Computation of t/D and P/D^2 from Basic Data - 3/8-in. Dia. Rivets, Second Step Aging: 8 Hrs at 350°F.	68
24	Computation of t/D and P/D^2 from Basic Data - 3/32-in. Dia. Rivets, Second Step Aging: 8 Hrs At 355°F.	69
25	Computation of t/D and P/D^2 from Basic Data - 3/16-in. Dia. Rivets, Second Step Aging: 8 Hrs At 355°F.	70
26	Computation of t/D and P/D^2 from Basic Data - 3/8-in. Dia. Rivets, Second Step Aging: 8 Hrs At 355°F.	71
27	Average Shear Strength of Driven 7075-T7X Rivets.	72
28	Comparison of Shear Strengths of 2024-T31 and 7050-T7X Driven Rivets.	73
29	Comparison of Driven and Undriven Shear Strengths for 7050-T7X Rivets	74
30	Average Driving Pressures Required to Form 1.5D Diameter X 0.5 Thick Flat Heads on 7050-T7X Rivets.	75
31	Largest Size Flat Head Formed Without Shear Cracks	76

LIST OF TABLES (CONCLUDED)

Table		Page
32	Tensile Properties of 0.090-in. Thick 2024-T3 Sheet Used for Lap-Joint Fatigue Specimens. . .	77
33	Fatigue Test Program for Lap Joints Containing 3/16-in. Diameter 2024-T31 and 7050-T7X Rivets.	78
34	Lap-Shear Fatigue Test Results.	79
35	Scope of SCC Tests on Driven Rivets	80
36	Results of Metallographic Examination of Corroded, As-Driven Rivets.	81
37	Results of Metallographic Examination of Corroded Rivets from Assemblies That Were Heated After Driving But Prior to Exposure. . .	82
A1	SCC Tests of 1.5-in. 2124 Plate Stressed In the Short-Transverse Direction By Driven Rivets - 36 Tests.	83
A2	Results of Stress Corrosion Tests On 2124 Plate Containing Rivets. Hoop Stress from Rivets In the Longitudinal to Short Transverse Grain Direction	84

I. Introduction.

The Alcoa Laboratories conducted a program to establish manufacturing methods for the production of high-strength aluminum alloy 7050 small diameter rivets. Included were tests of alloy 7050 rivet wire and rivets at different strength levels obtained through selected aging practices. In a previous small program to demonstrate feasibility, a lot of rivets was made using alloy 7050 wire in which the iron (Fe) and silicon (Si) content were well below the limits specified for the alloy. Therefore, since it was thought that the Fe and Si content may affect formability, two purity levels were included in the test program; one with "low" Fe and Si content (duplicating the previous material) and the other with "high" Fe and Si content (both elements being within, but close to the maximums specified for alloy 7050).

The work was completed in two phases. Phase I covered the casting of the ingots, extrusion of billets, rolling of redraw rod, drawing of wire, heat-treatment and aging of wires, screening tests of wires (formability, strength and corrosion studies), and rivet production. Optimum aging practices established in Phase I were used for the rivets evaluated in Phase II.

The primary objective for this project was to establish manufacturing methods for the production of aluminum alloy 7050 rivets by determining a suitable aging practice and a range of purity level for which 7050 equals or exceeds the strength, heading and hole-filling, and stress-corrosion resistance characteristics of



of 2024-T31 ("ice-box") rivets. Preliminary qualification and acceptance of 7050 alloy as a production rivet will be thereby achieved.

II. Phase I - Rivet Production and Wire Screening Tests

A. Production of Wire and Rivets

1. Ingots

All ingots required for the program were cast by the Ingot Casting Division of Alcoa Laboratories. The metal was melted and alloyed in a 4,000 pound gas fired ladle furnace. Primary metal, pure alloying elements and master alloys were employed as charge components. The molten metal was fluxed in the furnace prior to casting. It was also filtered and degassed during transfer using the Alcoa A181 process* shown in Fig. 1. A small addition of titanium and boron was made in the transfer system in the form of TIBOR rod to grain refine the ingot structure. The casting procedure employed was Alcoa's level pour casting method shown in Fig. 2. An aluminum mold was used. The starting block was steel. A device to remove the ingot cooling water (wiper) was located 6 in. below the mold. Although some problems were initially encountered with cracking, both purity levels (S. No. 420927 - "low" Fe and Si and S. No. 420928 - "high" Fe and Si) were successfully cast using identical practices.

Both primary and backup ingots, 120 in. long, were cast to each of the purity levels desired (see Table 1). They were immediately stress relieved by heating at 650°F overnight. Slices were cut 10 in. from the head end (top) of each ingot to evaluate the quality. The ingots were also checked ultrasonically and found to be free of cracks and gross porosity.

* USP 3039864

The ingot slices revealed some very light porosity which was confined to an 8 in. center circle for primary ingot S. No. 420927C and to a 6 in. center circle for primary ingot S. No. 420928J. This was determined by dye penetrant techniques. The slices were also etched to reveal the grain size, and the macrostructure revealed a 1 in. layer of twinned columnar grains at the surface with the remainder equiaxed for both primary ingots. The layer of twinned columnar grains on the surface of the ingots was, in our opinion, not harmful for this rivet program.

The ingots were homogenized (preheated) for 16 hours at 860°F followed by 16 hours at 905°F prior to any fabrication to minimize the effects of dendritic coring that occurs during solidification and to dissolve virtually all of the Al_2CuMg constituent.

A 72-in. length of each of the two primary ingots described in Table 1, each weighing about 1,200 lb., were shipped to Alcoa's Massena (N.Y.) Works for conversion to rivet wires.

2. Rivet Wires

The sizes and quantities of 7050 rivet wire required for the program were fabricated at Alcoa's Massena (N.Y.) Works from the two 15-in. diameter ingots (one with "low" and the other with "high" Fe and Si content) cast at the Alcoa Laboratories. Three sizes of rivet wire were required: 0.092, 0.184 and 0.372-in. diameter for 3/32, 3/16 and 3/8-in. diameter rivets, respectively. Massena Works used alloy 7075 standard practices to fabricate the 7050 alloy rivet wire.

Each ingot was scalped to 14-1/4-in. diameter and then extruded into 6x6-in. bloom stock. The bloom stock, in the form of 42-in. long bars, was rolled into 3/8 and 7/16-in. diameter rod (starting stock). Both the 0.092 and 0.184-in. diameter rivet wires were drawn from 3/8-in. diameter rod, and the 0.372-in. diameter rivet wires were drawn from 7/16-in. diameter rod. For each ingot, four bars (bloom stock) were used to roll the 3/8-in. rod and three bars to roll the 7/16-in. rod. No problems were encountered during rolling of the bars of either purity level to rods; both rolled well. The procedures used in drawing the rods of both purity levels to the finished wire sizes were identical. No drawing differences were noted between the two purity levels, and it was found that 7050 alloy draws well to the H13 temper using existing procedures for drawing alloy 7075 to the H13 temper.

Table 2 lists number of coils and total weight of each size of wire shipped to Alcoa's Lancaster (Pa.) Works for rivet production, along with the amounts of each size of wire sent to Alcoa Laboratories for the Phase I screening tests of wire. In total, Massena Works fabricated and shipped 1,467 lbs. of 7050-H13 rivet wire. This amount is quite close to the amount set forth in the program work statement. It was more than sufficient for the Phase I tests and for the quantities of rivets to be produced for use in the Phase II tests and to be shipped to the Air Force Materials Laboratory.

The results of the tensile property and shear strength tests on samples taken from each coil in 7050-H13 wire are given in Table 3. The tensile strengths ranged from 39.6 to 43.5 ksi, the overall average being 41.1 ksi. As might be expected, these tensile strengths fall between the minimum and maximum values of 36 and 46 ksi, respectively, specified for alloy 7075-H13 wires in Federal Specification QQ-A-430B, "Aluminum Alloy Rod and Wire; for Rivets and Cold Heading". The results of these tests also show no significant differences in the properties of the wires of the two purity levels, although metallographic examinations showed that the wires of the composition having the "high" Fe and Si content had more constituent present in the structure. It should also be mentioned that the layer of twinned columnar grains present at the surface of both ingots did not cause any fabrication problems and was eliminated in the final product.

3. Rivets

Alcoa's Lancaster (Pa.) Works, using the 7050-H13 wires produced at the Massena Works, manufactured the quantities of the 26 rivet items given in Table 4. The manufactured head styles included the Universal Head (MS20470), the 100° Flat Countersunk Head (MS20426) and the 100° Countersunk Shear Head (NAS1097). Normal manufacturing practices and production equipment were used to produce these rivet items. No difficulties were encountered in producing the 7050-F rivets from the H13 temper wires. Also, there was no apparent difference in producing rivets from the wires of the two purity levels. All items listed

in Table 4 are within the dimensional tolerances required for aircraft rivets. In total, Lancaster Works produced 620 lbs of 7050-F rivets.

B. Wire Screening Tests

1. Aging Practices

The Physical Metallurgy Division of Alcoa Laboratories was responsible for recommending the solution heat treating and artificial aging practices to be applied to the 7050-H13 wires for the various scheduled screening tests. A modest program was conducted to establish a recommended solution heat treating practice for 7050 rivet wire and rivets. Nine 16-in. lengths of 0.372-in. diameter 7050-H13 wire of the composition having the "high" Fe and Si content (S. No. 420928J) were solution heat treated and artificially aged as described in Table 5. On the basis of the results of tensile tests conducted on these wires, a solution heat treatment of 15 minutes at 900°F was selected for use with 7050 rivet wire and rivets in this program.

The Physical Metallurgy Division, after a review of some previous test results from a lot of 7050 rivet wire, recommended the following six agings for the 7050 wires to be evaluated in the screening tests: 4 hours at 250°F (first step) + 2, 4, 6, 8, 10 and 12 hours at 350°F (second step). With these aging practices, tensile strengths ranging from about 75 ksi to about 90 ksi were expected. Sufficient quantities of wire of both purity levels in all three diameters were solution heat treated, cold-water quenched and aged (using the recommended six agings) for the screening test program. An air circulatory furnace was used for this work.

2. Mechanical Property and Conductivity Tests

Tensile tests, in duplicate, were conducted on all 7050 wires with the six different aging practices (a total of 72 tests). The results of these tests are given in Table 6. Average tensile strengths ranged from about 73 ksi to 86 ksi, with purity level ("low" or "high" Fe and Si content) having no effect on the tensile properties. The minimum and typical tensile strengths for 2024-T4 wires are 62 ksi and 68 ksi, respectively. Since the tensile properties obtained were considered satisfactory, the wires heat treated and aged with the tensile test samples were employed for the remaining screening tests.

Table 7 presents the results of shear tests made on all three diameters of 7050 wire of both compositions given the six aging practices. The average shear strengths obtained ranged from about 42 ksi to about 49 ksi, with, again, the wire purity level having no effect on the shear strengths for a given aging practice. The minimum and typical shear strengths for 2024-T4 wires are 37 ksi and 41 ksi, respectively. The ratios of average shear strength to average tensile strength for each test condition (purity level and aging practice) of the 7050 wires ranged from 0.56 to 0.58, which is about typical for aluminum alloys.

Electrical conductivity measurements were made using 16-in. lengths of 7050 wire of all three diameters from both ingot compositions given the six aging practices (a total of 36 measurements). Table 8 presents the readings obtained. As the time at temperature

(350°F) for the second step of the aging increased, from 2 to 12 hours, the conductivity, as expected, also increased. Slightly lower conductivity readings were obtained for the wires having the "high" Fe and Si content. However, these slight differences could be the result of differences in the compositions of the two ingots, Fe and Si being two of several possible elements contributing.

3. Accelerated Stress Corrosion (SCC) Tests

(a) Material

The materials tested were 0.372 in. diameter 7050 rivet wires of both purity levels, artificially aged four hours at 250°F and then by six second step aging practices: 2, 4, 6, 8, 10 and 12 hours at 350°F.

(b) Procedure

The scope of the SCC screening tests is outlined in Table 9. SCC tests were made with 0.125 inch diameter longitudinal tension specimens stressed in Alcoa's stressing frames, as shown in Fig. 3, to 75 and 90 per cent of the actual yield strengths. TriPLICATE specimens were exposed for 90 days to two corrosive environments, as follows:

(1) 3.5% NaCl by alternate immersion in accordance with Federal Test standard 151b, Method 823 and with ASTM Standard G44-75.

(2) Synthetic sea water by alternate immersion solution in accordance with ASTM Method D-1141-72, all other test conditions in accordance with Federal Standard 151b, Method 823 and ASTM G44-75.

(c) Results and Discussion

Nine of the 72 specimens exposed to the 3-1/2% NaCl solution failed in 34 to 84 days. The results of these tests are shown in Table 10. One specimen from each test condition that incurred failures, plus one specimen representative of each aging treatment that did not incur failure were examined metallographically. The examination showed that a second step aging treatment of two hours at 350°F resulted in marked susceptibility to intergranular corrosion. For both purity levels, the susceptibility to intergranular corrosion decreased as the second step age was lengthened and only pitting corrosion occurred with agings of eight or more hours at 350°F. The failed specimens showed rather deep intergranular corrosion with auxiliary cracks emanating from this corrosion. These cracks were primarily transgranular, but a few were a mixture of transgranular and intergranular cracking. Thus, some degree of susceptibility to SCC probably is associated with the short time agings. Photomicrographs, contained in Fig. 4, illustrate this condition.

All 72 of the specimens exposed to the synthetic sea water survived the 90 days of exposure. These specimens incurred only mild general corrosion. Metallographic examination of specimens from this environment showed intergranular corrosion for material aged two hours at 350°F, pitting plus slight intergranular corrosion for the four hours at 350°F aging, and only pitting corrosion for agings of six or more hours at 350°F, with the level of Fe and Si having no effect.

Susceptibility to SCC and to intergranular corrosion definitely is undesirable. Consequently, the following recommendations were made regarding the second step aging practices to be evaluated in Phase II on rivets:

- (1) The primary second step aging should be 8 hours at 350°F,
- (2) A more extensive aging, involving longer time or slightly higher temperature, should be included to assure high resistance to SCC,
- (3) The 6 hours at 350°F age, or the equivalent thereof, should be included to establish whether this indeed does result in an undesirable level of intergranular corrosion on rivets.

4. Driving and Hole-Fill Tests

(a) Preparation

The driving and hole-fill tests were conducted using slugs machined from 7050 rivet wires and the type of specimens shown in Fig. 5. Slugs were machined from all three wire diameters (0.092, 0.184 and 0.372-in.) of both purity levels with the six aging practices. In total, over 1000 slugs were prepared for the test program. The driving specimens were prepared from various thicknesses of 2024-T3 and 7075-T6 sheet to provide grip lengths of about 1 and 1.5 times the nominal wire diameter, as follows:

Wire Diam., D, in.	Slug Length, in.	Specimen Thickness, in.	Drill Size, in.	Min. No. of Specimens*	
				2024-T3	7075-T6
0.092	0.20	0.090	3/32	24	24
0.184	0.40	0.190	3/16	24	24
0.184	0.50	0.281	3/16	--	24
0.372	0.80	0.375	3/8	24	24

* In each case, half of the specimens contained holes with a poor finish and rifling ("poor" holes). Examples of "good" and "poor" holes are shown in Fig. 6.

The slug length for each wire diameter indicated in the foregoing tabulation is sufficient to fill the hole in the specimen and to form a flat head having a diameter and thickness equal to $1.5D$ and $0.5D$, respectively.

For comparison, 20 slugs were machined from a length of 0.184-in. diameter 2024-H13 rivet wire. These slugs were solution heat treated 20 min. at 920°F , cold-water quenched, and driven within 30 minutes.

(b) Procedure

All slugs were squeeze driven using a subpress with flat sets, as shown in Fig. 7, in a 30,000-lb capacity Satec testing machine. Various loads were selected in driving the slugs to produce flat driven heads having diameters ranging from about $1.3D$ to about $1.7D$. Each slug was loaded only one time. After loading, each driven flat head was examined for defects and the diameter was measured. The photograph in Fig. 8 shows a typical specimen after completion of the driving trials, and the photograph in Fig. 9 shows some of the completed driving specimens for all three wire diameters. After completion of the driving tests, certain specimens were sectioned at midwidth for metallurgical examination of hole-fill.

(c) Results

The comparative data in Table 11 shows that the purity level had no effect on the pressures required to form a flat head of a given size for any set of conditions (i.e., diameter and aging practice). Therefore, the relationship between driving pressure

and driven flat head diameter was the same for a given slug diameter and aging practice regardless of purity level. Plots of driving pressure versus average flat head diameter for all three sizes of slugs and the six aging practices are shown in Fig. 10. It will be noted in these plots that the driving pressure required to drive a given size of flat head, for a given slug diameter, decreases as the material strength decreases (i.e., as the time of the second step of the aging increases). This is consistent with past experience in driving aluminum alloy rivets in the as-received condition. The approximate driving pressures required to form 1.5D diameter flat heads on all three diameters of slugs given the six aging practices are presented in Table 12. The driving pressures to form the 1.5D diameter flat heads for slugs aged for 2 hours at 350°F (2nd step) were about 25 per cent greater than those for the slugs aged for 12 hours at 350°F (2nd step). As shown in Table 12 and Fig. 10, the driving pressure to form a 1.5D diameter flat head on a 2024-T31 0.184-in. diameter slug was from 350 to 1600 lb. less than that required for the 7050 slugs.

A visual examination with a 2X magnifying glass was made in each case for the occurrence of shear cracks, of the type shown in Fig. 11, in the driven flat heads. No shear cracks were obtained in 1.5D diameter flat heads in slugs given a 2nd step aging of 6, 8, 10 and 12 hours. When these slugs were driven with larger flat heads, about 1.6D diameter or greater, slight

shear cracks could be produced. Of the 770 slugs headed in the program, a total of only 36 slugs were observed to actually have or even suspected to have driven flat heads containing shear cracks. In every case, however, all of the shear cracks observed in these tests would be considered "acceptable" on the basis of the sketches shown in Fig. 2 of Amendment 1 of MIL-R-5674C. There was no pronounced tendency for shear cracks to occur on the basis of purity level.

Over 30 driven slugs, including a few of the 2024-T31 slugs, were sectioned and metallographically examined for defects and hole-fill quality. No defects were found in any of the sectioned slugs. Photomicrographs (6X) of some of the sectioned samples are shown in Figs. 12 through 17. Examination of these photomicrographs show that 7050 slugs appear to fill the holes about as well as the 2024-T31 slugs, regardless of the time at the second step of the aging. There does not appear to be any effect of purity level on the hole-filling ability of the 7050 slugs. It would be expected that the 7050 slugs will tend to have better hole filling qualities as the time of the second-step of the aging increases because of the resulting decrease in tensile and yield strength properties.

C. Phase I - Briefing and Recommendations

On the basis of the wire screening tests, it was recommended that the 7050 rivets to be used in Phase II of the program be as follows:

1. Be from the lots containing the "high" Fe and Si content, as they will probably be more representative of future commercial production lots of 7050 rivets.

2. Be solution heat treated for 15 minutes at 900°F, cold-water quenched and aged for 4 hours at 250°F (1st step) plus 8 hours at 345°, 350° and 355°F (2nd step). These three aging practices for the 2nd step are equivalent to the 6, 8 and 10 hours at 350°F practices used for the Phase I tests of wires, and are recommended because, in production, the time variable is the easiest to control.

Both recommendations were accepted at the Phase I briefing held at Wright-Patterson AFB on December 10, 1975.

III. Phase II - Rivet Tests

A. Aging and Anodizing

Table 13 lists the approximate number of each of 13 rivet items that were solution heat-treated and aged for the Phase II portion of the program. Three aging practices were employed (second step agings of 8 hours at 345°, 350° and 355°F)*, making three batches of rivets for the test program. These three aging practices were to optimize maximum strength along with maximum resistance to stress corrosion cracking. Therefore, rivets and wires given these aging practices were assigned the temporary "T7X" temper designation for the remainder of the program. Three 16-in. lengths of each diameter of rivet wire (0.092, 0.184 and 0.372-in.) used to produce the rivets were solution heat treated and aged with each batch of rivets. All rivet wires and rivets were from the same basic ingot, which had the "high" Fe and Si content.

After aging, the Alumilite** 205 finish was applied to all rivets. The Alumilite 205 finish meets the requirements of the Type II, Class 1 finish of MIL-A-8625.

B. Mechanical Property and Conductivity Tests

Tensile property tests were made on the wires solution heat-treated and aged with the rivets, and the results are presented in Table 14. The average tensile strengths ranged from 75 ksi to 80 ksi. The average tensile strength obtained for each aging

* The rivets were solution heat treated 15 minutes at 900°F, cold-water quenched, aged 4 hours at 250°F (first step).

** Trade name of Aluminum Company of America.

condition was quite close to the target tensile strength, the maximum difference being about 0.9 ksi. The published minimum and typical tensile strengths for 2024-T4 wire are 62 ksi and 68 ksi, respectively.

Electrical conductivity measurements were made on 16-in. lengths of the 7050 wire in all three diameters for all three aging practices. The results of these measurements are also given in Table 14. As expected the conductivity increased consistently with the increase in temperature employed for the second step of the aging (8 hours at 345°, 350° and 355°F).

Table 15 presents the results of shear tests made on all three diameters of rivets given the three aging practices. Rivets with both manufactured head styles (the Universal and the 100° Flat Countersunk) were utilized making a total of 18 lots employed for these tests. The average shear strength obtained for these undriven rivets ranged from 44 ksi to 46 ksi. The minimum and typical shear strengths for undriven 2024-T4 rivets are 37 ksi and 41 ksi, respectively. The ratio of average shear strength for the undriven 7050 rivets to average tensile strength of the 7050 wires for each test condition was 0.58, which is about typical for aluminum alloys.

C. Joint Shear Strength Tests

1. Materials and Preparation

Static strength tests of riveted lap-joints were conducted in accordance with the requirements of MIL-STD-1312, Test 4, using the preferred two-fastener configuration shown in Fig. 18. The tests

were made using 3/32, 3/16 and 3/8-in. diameter 100° Flat Counter-sunk head (MS20426) alloy 7050-T7X rivets given the three aging practices. The rivets were driven in machine countersunk holes in specimens prepared from Alclad 2024-T3 and T351 sheet and plate. The sheet or plate thickness and rivet diameter combinations ("t/D" ratios) used in the program are shown in Table 16.

As indicated in Table 16, tests were performed at both Alcoa Laboratories and Battelle Memorial Institute. The program called for tests on a total of 126 specimens by Alcoa, with Battelle duplicating 42 or one-third of the Alcoa tests. Battelle used sheet, plate and rivets supplied by Alcoa to prepare their own specimens for these tests.

Table 17 notes the 11 thicknesses of Alclad 2024-T3 and T351 sheet and plate items acquired for the program. The results of tensile property tests on specimens taken in the longitudinal direction for each item are also presented in Table 17. All tensile strength, yield strength and elongation values determined in these tests were above the minimum (A values) published in MIL-HDBK-5.

At both Alcoa and Battelle, the specimens were assembled by squeeze driving the rivets to form flat driven heads. The following driving pressures were used:

2nd Step of Aging, 8 hrs. at	Driving Pressure, lbs.		
	Rivet Diameter, D, in.		
	3/32	3/16	3/8
345°F	1,510	6,100	25,300
350°F	1,460	5,750	24,000
355°F	1,420	5,650	23,000

The lengths of the rivets used in each case, when using the above driving pressures, were sufficient to fill the holes in the specimens and to form flat driven heads with the following dimensions: a diameter equal to 1.5 times the rivet diameter and a thickness from 0.5 to 0.6 times the rivet diameter.

2. Procedure

All tests at Alcoa Laboratories were conducted in a 30,000-lb capacity Satec testing machine using the appropriate load range for each rivet diameter. The average loading rate in each case was 100,000 pounds per minute (± 10 per cent) per square inch of total fastener shear area. At Battelle, the tests were conducted in appropriately sized electrohydraulic machines programmed for a loading rate of 100,000 pounds per minute per square inch of fastener shear area. Joint deflection was determined using Instron strain gage extensometers (Model No. G51-13 at Battelle and Model Nos. G51-13 and 231-1002 at Alcoa). Calibration of the testing machines and extensometers at both Battelle and Alcoa, to insure proper accuracy of the autographic load-deflection recordings, were as specified in MIL-STD-1312, Test 4. A photograph of the test setup at Alcoa Laboratories is shown in Fig. 19. Yield loads were determined using the secondary modulus method and an offset at yield equal to 4 per cent of the nominal rivet hole diameter.

3. Results and Discussion

Specimen sheet thicknesses (t), hole diameter (D), yield (P_y) and ultimate (P_u) loads, along with computed t/D ratios, and $P/D^2 \times 10^4$ load values are presented in Tables 18 through 26.

Presented in Figs. 20 through 25 are nondimensional plots (in accordance with MIL-HDBK-5 Guidelines for Presentation of Data) for the experimental data obtained for each aging batch. With a few exceptions, the results of the tests duplicated by Alcoa and Battelle were in good agreement.

The average ultimate load data obtained for joints employing 7050-T7X rivets given the three aging practices are plotted in Figs. 20, 21 and 22. For comparison, in each of these figures is plotted the average ultimate load curve for 3/16 and 1/4-in. diameter 2024-T31 rivets driven in clad 2024-T4 sheet. This curve was obtained by multiplying the ultimate design values published in MIL-HDBK-5 by a factor of 1.15, since for design allowable loads the average curve determined from test data is divided by 1.15. It will be noted in Figs. 20, 21 and 22 that nearly all of the plotted points obtained for the 7050-T7X riveted joints were above the average curve plotted for the 2024-T31 riveted joints. On this basis, the data indicate that ultimate design allowables for 7050-T7X rivets should be slightly greater than those published for 2024-T31 rivets. Additional testing of other lots of 7050-T7X rivets is required to verify this trend and establish design values.

The average yield load data points for the joints driven with 7050-T7X rivets given the three aging practices are plotted in Figs. 23, 24 and 25. Again, for comparison, in each of these three figures are plotted the average yield load curves for both 3/16

and 1/4-in. diameter 2024-T31 rivets in Clad 2024-T4 sheet. The curves are also the design values published in MIL-HDBK-5, but are based on the "old" yield criteria (i.e., the specified permanent set value used to determine the yield load was, for hole filling fasteners, the larger of 0.005-in. or 2.5 per cent of the nominal shank diameter). It will be noted that the average yield load data points plotted in Figs. 23, 24 and 25 for the 7050-T7X rivets generally fall above the average yield curves for the 3/16 and 1/4-in. diameter 2024-T31 rivets. Additional testing of other lots of 7050-T7X rivets is required to verify this trend and to establish design values.

At the high D/t ratios (0.64 and above) all failures in these tests were by shearing of the rivets. The average shear strengths determined for the 7050-T7X driven rivets in this program ranged from 47.2 to 52.6 ksi. The average shear strength values for each rivet diameter given each of the three aging practices are shown in Table 27. As indicated in Table 28, the average shear strengths for the 7050-T7X rivets ranged from 15 to 21 per cent greater than the typical (B value) shear strength of 41 ksi for 2024-T31 rivets. Table 29 compares the driven versus the undriven shear strengths that were obtained for the 7050-T7X rivets in this program.

D. Driving and Hole-Fill Evaluations

1. Squeeze Driven Rivets

(a) Materials and Preparation

All three rivet diameters of alloy 7050-T7X with both the Universal and 100° Flat Countersunk manufactured head styles given the three aging practices were included in the test program. The driving specimens were also of the type shown in Fig. 5, and were prepared from the thicknesses of 2024-T3 and 7075-T6 sheet and plate to provide grip lengths of about 1 and 1.5 times the nominal rivet diameter as follows:

Rivet Diam., D in.	Rivet Length, in.	Specimen Thickness, in.	Hole Diam., in.	Min. No. of Specimens*	
				2024-T3	7075-T6
3/32	13/64	0.090	0.096	24	24
3/16	7/16	0.190	0.191	24	24
3/16	9/16	0.281	0.191	--	12
3/8	13/16	0.385	0.386	24	24

* In each case, half of the specimens contained holes with poor finish and rifling ("poor" holes). Examples of "good" and "poor" holes are shown in Fig. 6.

The length for each rivet diameter given in the foregoing tabulation is sufficient to fill the hole in the specimen and to form a flat head having a diameter and thickness equal to about 1.5D and 0.5D, respectively. For comparison, ten 3/16-in. diameter by 7/16-in. long 2024-T3 100° Flat Countersunk Head rivets were driven in specimens made of 0.190-in. thick 2024-T3 sheet. These rivets were solution heat treated 20 minutes at 920°F, cold-water quenched, and driven within 20 minutes.

(b) Procedure

All rivets were squeeze driven using a subpress with flat sets, as shown in Fig. 7, in a 30,000-lb capacity Satec testing machine. Various loads were selected in driving the rivets to produce flat driven heads having diameters ranging from about 1.4D to about 1.7D. Each rivet was loaded only one time for these tests. After loading, each driven flat head was examined for defects and the diameter measured. Over 400 rivets were squeeze driven. After completion of the driving tests, certain specimens were sectioned at midwidth and metallurgically examined for defects and hole-fill.

(c) Discussion and Results

Plots of driving pressure versus average flat head diameter for all three sizes of rivets given the three aging practices are shown in Fig. 26. These plots show that the driving pressure required to form a given size of flat head, for a given rivet diameter, decreases as the rivet strength decreases (i.e., as the temperature of the second step of the aging increases). This is consistent with past experience in driving aluminum alloy rivets in the as-received condition. The approximate driving pressures required to form 1.5D diameter flat heads are given in Table 30. As noted in Table 30, only in the case of the highest strength 3/8-in. diameter rivets (second step aging of 8 hours at 345°F) were severe shear cracks obtained when the driven flat head diameter was equal to 1.5D. The type of shear cracks obtained for this condition is shown in Fig. 27. The largest

diameter of driven flat head that could be formed without shear cracks in the three sizes of rivets given the three aging practices are listed in Table 31. It should be mentioned that shear cracks obtained at the diameters indicated in Table 31 would be classified as "acceptable" on the basis of the sketches shown in Fig. 2 of Amendment I of MIL-R-5674C.

At least two rivets of each of the three rivet diameters given the three aging practices and driven in each specimen thickness were sectioned for defects and hole filling qualities. No defects were found in any of the driven rivets. Photomicrographs (6X) of some of the sectioned samples are shown in Figs. 28 through 32. Examination of these photomicrographs indicate that the 7050-T7X rivets satisfactorily fill the rivet holes, about as well as the 2024-T31 rivets.

2. Pneumatic Hammer Driven Rivets

Specimens of the type shown in Fig. 33 were prepared for these tests. Rivets in all three diameters given only one aging practice (second step aging of 8 hours at 350°F) were employed for these tests. About 90 psi air pressure was used for the pneumatic hammers.

Flat driven heads were easily formed on the 3/32-in. diameter rivets using the lightest hammer available at Alcoa Laboratories. This gun weighed 2 pounds 7 ounces, and had a 0.403-in. diameter bore. It was model F2 produced by the Reed Roller Bit Company. The back-up bar weighed 1.5 lb.

A standard Boyer No. 1 riveting hammer was required to drive the 3/16-in. diameter rivets. Some difficulty was encountered in driving these rivets with flat driven heads as the hammer tended to drift off the rivet, making it difficult to form a flat head concentric with the rivet hole. A slight "cone-point" type configuration was machined into the driving set, and this helped to obtain rivet heads concentric with the hole diameter. A 15-lb. backup bar was used for these tests also.

A standard Boyer No. 40 riveting hammer was required to drive the 3/8-in. diameter rivets, and this was done by driving the rivets in a downhand position (backup set in a stationary anvil). As with the 3/16-in. diameter rivets, a small cone-point type of configuration was machined into the end of the drawing set in order to keep the hammer centered on the rivet during the driving operation.

Selected rivets of all three diameters were sectioned for defects and hole-fill qualities. Photomicrographs (6X) of some of the selected samples are shown in Figs. 34 and 35. Examination of these photomicrographs indicates that the hammer driven rivets are not as well driven as the squeeze-driven rivets. However, it is expected that this condition can be greatly improved by the use of more experienced aircraft riveters.

E. Shear Joint Fatigue Tests

1. Materials and Preparation

Sixty lap-shear joints with the dimensions shown in Fig. 36, a 100 per cent load transfer joint, were prepared at Alcoa Laboratories using 3/16-in. 100° Flat Countersunk head rivets. Thirty-six of the joints were assembled with 7050-T7X alloy rivets, and the other 24 joints with 2024-T31 alloy rivets. All specimens were taken from the same piece of 0.090-in. 2024-T3 sheet in the direction of rolling. Tests of triplicate sheet-type tensile specimens, also taken in the direction of rolling, gave the values shown in Table 32. These tensile properties are above the specified minimum values and are quite close to the typical values published for 2024-T3 sheet.

All rivets were squeeze driven by means of a subpress in a 30,000 lb. capacity Satec testing machine. The specimens were degreased prior to driving the rivets. The 2024-T4 rivets were driven in the "freshly-quenched" condition (solution heat treated 15 min. at 920°F, immediately cold-water quenched, placed in a container surrounded by dry-ice to retard natural aging, and driven within three hours after quenching). The 7050-T7X alloy rivets were driven at room temperature. These rivets had the second-step aging practice of 8 hours at 350°F. The driving pressures employed were 5,450 lb. for the 2024 rivets and 5,750 lb. for the 7050 rivets. At these pressures, flat heads with a diameter equal to 1.5 times the rivet diameter were obtained. Visual examination indicated all rivets to be free of shear cracks or other defects.

Static tension tests, using 0.090-in. thick doubles in the grips of the testing machine, were made on four of the assembled joints; two with 2024-T31 rivets and two with 7050-T7X rivets. As expected, all four joints failed by shearing of the rivets. The results of these tests were as follows:

Specimen Number	Rivet Alloy and Temper	Breaking Load, lb.	Shear Strength,* psi	Tensile Stress on NSA at Breaking Load,** psi
421424-F1	2024-T31	4,720	41,200	53,000
-F2	2024-T31	4,625	40,400	52,000
	Avg.	4,675	40,800	52,500
421367-BF1	7050-T7X	4,930	43,000	55,400
-FB36	7050-T7X	5,030	43,900	56,500
	Avg.	4,980	43,500	56,000

* Based on the area of four 0.191-in. diam. holes, 0.1146 sq. in.

** Net Section Area (NSA) = 0.089 sq. in.

On the basis of these test results and in accordance with Proposed Test 21 ("Shear Joint Fatigue-Constant Amplitude) of MIL-STD-1312, the load levels for the fatigue test program performed at both Battelle Memorial Institute and Alcoa Laboratories were selected as shown in Table 33. For this program, Battelle was provided 28 assembled joints; 11 with 2024-T31 rivets and 17 with 7050-T7X rivets.

2. Procedure

The fatigue tests were conducted in 5000 lb. capacity Krouse axial-load machines. The Alcoa machine operates at 18.3 Hz and the Battelle machines at 30 Hz. As called for in the specification, a sandwich-type bending restraint, Fig. 37, was applied to each specimen to reduce bending stresses at the faying surface. Both

laboratories used restraints made according to the dimensions shown in Fig. 38, which is Fig. 9 of Proposed Test 21 of MIL-STD-1312. Teflon sheet was utilized in the restraints by both laboratories; however, Alcoa also used teflon "T" spacers whereas Battelle used aluminum. A significant difference between the restraints was Battelle's use of locknuts under the wing nuts; with locknuts they were able to use a lower clamping torque on the nuts without having the nuts back off. The Battelle restraint was tightened during initial fatigue loading to a level such that it could readily be moved with the thumbs. The Alcoa restraint was applied before the specimen was installed and required considerably more force to move it during the test.

Alcoa tests were performed at a stress ratio* of 0.05 as specified in the March 1974 copy of MIL-STD-1312, Proposed Test 21. However, Battelle's tests were at R=0.10 as called for in subsequent committee notes of the Fastener Testing Development Group (MIL-STD-1312).

3. Discussion and Results

The results of the fatigue tests at the two laboratories are presented in Table 34 and Figs. 39 and 40. Tests at both laboratories showed longer lives for joints using 2024-T31 rivets compared to those with 7050-T7X rivets. It is believed that the longer lives result from the difference in springback characteristics of the two kinds of rivets after driving. The yield strength of the 2024 rivet in the driving condition (freshly heat treated) is much

* Stress ratio, $R = \frac{\text{Minimum Stress}}{\text{Maximum Stress}}$

lower than that of the 7050 rivets driven in the T7X condition. Accordingly, the elastic recovery of the 2024 rivet is less after driving so higher beneficial compressive residual stresses are retained around the rivet holes. Similar results were obtained previously at Alcoa Laboratories in an investigation on the fatigue strength of lap-joints containing 2024-T31 and 7075-T73 rivets.(1)

The failures of all of the 7050-T7X riveted joints and most of the 2024-T31 riveted joints initiated in the region of the knife edge produced by the countersink. Most such failures initiated at edges of the hole, although some fretting failures initiated at the surface under the rivet head. In the Alcoa tests of 2024-T31 riveted joints, failures at lives greater than 1,000,000 cycles initiated at fretting of the faying surfaces; two of the three such failures occurred in the non-countersunk sheet.

Figure 41 compares average curves representing the tests at the two laboratories. Because of the different stress ratios employed in the tests, the results are plotted on the basis of load range. The fatigue strengths obtained at Alcoa are consistently higher than those reported by Battelle. It was assumed that this resulted primarily from the difference in tightness of the restraint. Accordingly, investigations were made at both laboratories relative to the load carried by the restraint.

Battelle placed a Micromeasurements strain gage (EA-13-031-CF-120) centered on the faying surface and on a specimen edge at a distance of 0.032 in. from the edge of the joint. Evaluations

were made with the restraint set both at 1000 and 1490 lb fatigue loadings. The load-strain plot, Fig. 42, provides the following observations:

The load-strain relationship at the faying surface is not a linear function of applied load.

The load-strain relationship at the sheet midthickness is linear--indicating that the faying surface nonlinearity is a function of joint bending.

The midthickness data indicates that restraint adjustment affects load transfer in as much as neither condition allows the application of full unrestrained tensile strain at any given load level. However, the reduction is only 1% for the 1490 lb setting and 6% for the 1000 lb setting.

The faying surface data show reductions in bending strains from the unrestrained condition and little variation with the two restraint adjustments.

Strain gage positioning on an Alcoa specimen is indicated in Fig. 43. To determine bending stresses, gages were mounted on both surfaces at locations comparable to the Battelle locations and in the section midway between the grip and the restraint. Tightening of the restraint bolts by two technicians produced negligible differences in strains so only one set of data is shown in Fig. 43. Figure 44 compares the effect of the restraints at the two laboratories. The following observations supplement those noted by Battelle:

In the Alcoa tests the restraints reduced bending at the faying surface by about 80%, much more than in the Battelle test, and produced some bending in the section between the grips and the restraints.

Strains at mid-thickness were lowered only two to six per cent by use of the restraints. Thus, the proportion of load carried by the restraints does not appear to have been significantly greater in the Alcoa tests than in the Battelle tests.

Oscillograph readings for the Alcoa specimens showed that the dynamic strain ranges for the mid-thickness gages were the same as the static strain ranges. Thus, the load transfer during fatigue loading was the same as that indicated for the static readings shown in Fig. 43.

Fatigue tests of a few additional joints confirmed the variation of fatigue life with clamping of the restraints. Alcoa tests of specimens at $R=0.10$ and specimens not having any restraints are plotted on Fig. 45 with the other Alcoa and Battelle data for 2024 riveted joints on the basis of load range. In Alcoa tests at $R=0.10$, a specimen with restraints had a life double those obtained by Battelle at the same stress and, at a lower stress, an Alcoa specimen tested without restraints had a life half those reported by Battelle. The large reduction in life for specimens without restraints was also demonstrated in tests at $R=-0.05$.

F. Accelerated Stress-Corrosion (SCC) Tests of Rivets

1. Material

The SCC tests were made with 100° flat countersunk head (MS20426), 3/16 and 3/8 in. diameter, rivets. The primary test material was 7050 rivets given a first step age of four hours at 250°F and then second step agings of eight hours at 345, 350 and 355°F. One lot of 2024-T31 rivets, 3/16 in. diameter, was included to provide a comparison with the commercial material now in use. Finally, a reduced test program was conducted on 7050 rivets aged four hours at 250°F plus two hours at 350°F to provide a control on the corrosive environments. With this aging, the 7050 rivets essentially are in a peak strength, T6 type temper, and are expected to be susceptible to intergranular corrosion and to SCC.

Three sheet alloys, 2024-T3, 7075-T73 and Alc. 7075-T73, were used to represent the galvanic range of aluminum materials likely to be joined in service. The galvanic relationship between the rivets and sheet alloys is shown below.

<u>Sheet Alloy</u>	<u>Galvanic Relationship of the Rivet to the Sheet</u>	
	<u>7050 Rivets</u>	<u>2024 Rivets</u>
2024-T3	Anodic - corrosion accelerated	Similar - free corrosion
7075-T73	Similar - free corrosion	Cathodic - corrosion retarded
Alc. 7075-T73	Cathodic - corrosion retarded	Cathodic - corrosion retarded

2. Procedure

The scope of the SCC tests on rivets is outlined in Table 35. The rivets were driven in an assembly designed to apply a constant low level of tensile stress (5000 psi) on the rivet shank, superimposed on the forming stresses from riveting. The intent was to assist propagation of any cracking that initiated in susceptible rivets; hopefully to a degree that could be detected visually. The assembly consisted of two pieces of sheet with a spacer strip of the same sheet at either end, Fig. 46. The assembly was clamped together at the center, then the rivet was driven and the clamps removed. Several assemblies were taken apart to verify that no relaxation of the rivet loading had occurred as a result of plastic deformation in the sheet.

(a) As-Driven Rivets

Six assemblies of each rivet-sheet combinations were exposed to the two corrosive environments used in Phase I, namely: 3.5% NaCl and synthetic sea water by alternate immersion. Three of the assemblies were exposed for 90 days, while the others were removed for metallographic examination after 30, 50 and 65 days of exposure.

(b) Heated Assemblies

Riveted assemblies containing 2024-T31 rivets and both sizes of 7050-F7X rivets second step aged for 8 hours at 350°F were heated for 72 hours at 300°F and for 1/2 hour at 400°F. These heatings were selected from prior experience as being representative of heatings that cause appreciable sensitization of 2024-T31 rivets

to intergranular corrosion. The riveted assemblies were exposed for 90 days to the two alternate immersion tests.

3. Results and Discussion

None of the rivets incurred SCC of sufficient magnitude to cause complete fracture of the rivet. Thus, SCC had to be detected by metallographic examination after various periods of exposure.

(a) As-Driven Rivets

The results of the metallographic examinations on the as-driven rivets are listed in Table 36.

7050-T6 Type Controls: Both sizes of 7050-T6 type rivets showed evidence of SCC after 30 days exposure to 3.5% NaCl A.I. and after 50 days of exposure to synthetic sea water A.I. An example of the SCC detected is shown in Fig. 47. This verified that both corrosion test methods caused SCC of a 7050 rivet that was not aged sufficiently.

7050-T7X Rivets: Only three of the 83 7050-T7X rivets examined showed any adverse indications. All cases were rivets that had been second step aged 8 hours at 345°F and exposed to 3.5% NaCl A.I. A stress corrosion crack was detected in a 3/8 inch rivet driven in 2024-T3 sheet and exposed 30 days (Fig. 48) and in a 3/8 inch rivet driven in 7075-T73 sheet and exposed 90 days. Some intergranular corrosion was present on a 3/16 inch rivet driven in 7075-T73 sheet and exposed 50 days (Fig. 49). The intergranular corrosion on the 3/16 inch rivet occurred only

at a site of rather severe crevice corrosion between the driven head and the sheet. No SCC or intergranular corrosion was found on any of the 7050 rivets second step aged for 8 hours at 350 and 355°F.

The evidence of SCC in 7050 rivets second step aged 8 hours at 345°F was rather minimal but indicates some susceptibility when severe corrosive conditions are encountered, especially if the rivet is driven in a cathodic alloy. The conditions in both accelerated tests probably grossly exaggerate what is to be expected in service because:

(1) The specimens were wetted for the large majority of the time (80% or more) with a good electrolyte that supports galvanic corrosion,

(2) The sheet materials joined were exposed bare, thus freely able to corrode and result in a large cathodic area, and

(3) No effort (such as wet priming of rivet holes or painting of faying surfaces) was made to minimize corrosion or reduce electrical contact between the rivet and the sheet.

None the less, it is preferable that production rivets be given a minimum second step age of 8 hours at 350°F, or the equivalent, to assure high resistance to SCC.

The tendency towards susceptibility to SCC when the rivet contacts a cathodic alloy is not unique to 7050 alloy. This same trend was noted in early evaluations of 7075-T73 rivets, which resulted in development of the more extensively aged 7075-T731 temper that eliminated the problem.

2024-T31 Rivets: The particular lot of 3/16 in. 2024-T31 rivets did not incur SCC when evaluated in the as-driven condition. However, the resistance of 2024-T31 rivets is variable, being dependent primarily on the cooling rate achieved during quenching. Other lots could be susceptible, particularly larger sizes that inherently would cool somewhat slower during quenching and which would incur higher residual forming stresses during driving.

(b) Heated Assemblies

The results of the metallographic examinations on rivets that were heated after driving are listed in Table 37.

7050-T7X Rivets: No adverse effect was noted on either size of 7050-T7X rivets that were heated for 72 hours at 300°F or 1/2 hour at 400°F prior to exposure. No evidence of SCC was detected and the type of corrosion was pitting in all cases.

2024-T31 Rivets: Both of the heating periods used sensitized the 3/16 in. 2024-T31 rivets so that they became susceptible to intergranular corrosion and to SCC (Fig. 50).

At the Phase I briefing, the question arose as to whether the residual stresses imposed around the rivet holes, although beneficial to fatigue strength, might cause SCC of the materials being joined. The Addendum covers a small test program undertaken in this regard using 2024-T31 and 7075-T7X rivets driven in 2124 plate.

IV. Conclusions.

The results of the test program warrant the following conclusions:

A. Phase I - Rivet Production and Wire Screening Tests

1. Alloy 7050-H13 rivet wire up to 0.372-in. in diameter were produced using standard manufacturing methods and equipment.

2. Small diameter, aircraft-size (up to 3/8-in. diameter) alloy 7050-F rivets with MS20426, MS20470 and NAS1097 manufactured head styles were produced using standard manufacturing methods and equipment.

3. The purity level of the cast ingots ("low" Fe and Si content or "high" Fe and Si content, but within the chemical composition limits for alloy 7050 in either case) had no apparent effect on the production of the rivet wires and rivets, or on the strength properties, formability characteristics and resistance to stress-corrosion cracking of rivet wires.

4. The solution heat treating practice for alloy 7050 rivet wires and rivets up to 3/8-in. in diameter should be 15 minutes at 900°F, followed immediately with a cold-water quench.

5. In corrosion tests of 7050 wire, it was determined that second step agings of 4 or less hours at 350°F, or the equivalent, were insufficient to provide high resistance to intergranular corrosion and SCC.

6. Second step aging practices of 8 hours at 345°, 350° and 355°F should be applied to the 7050 rivets for the Phase II tests to attempt to optimize strength and resistance to SCC.

B. Phase II - Rivet Tests

1. Alloy 7050 rivets given the second step agings of 8 hours at 345°, 350° and 355°F developed average undriven shear strengths ranging from 44 ksi (355°F) to 46 ksi (345°F). These values are greater than the typical shear strength of 41 ksi for 2024-T4 undriven rivets.

2. Alloy 7050 rivet wires heat treated and aged with the rivets developed tensile strengths ranging from 75 ksi (355°F) to 80 ksi (345°F). These values are higher than the typical tensile strength of 68 ksi published for 2024-T4 wire.

3. In lap-shear joints with high D/t ratios (0.64 and above) the average driven shear strengths obtained for 7050-T7X rivets ranged from 47.2 ksi to 52.6 ksi. These values are from 15 to 22 per cent higher than the "B" value of 41 ksi given for 2024-T31 rivets in MIL-HDBK-5.

4. Average ultimate-load and yield-load data analysis of static test results on lap-joints of Alclad 2024-T3 and T351 sheet and plate at D/t ratios ranging from 0.38 to 1.0 indicate that design allowables for 7050-T7X rivets should be slightly greater than those published for 2024-T31 rivets.

5. In squeeze driving tests of 7050-T7X rivets, 1.5D diameter by 0.5D thick flat heads were formed without shear cracks in all but one case. The exception was for the highest strength 3/8-in. diameter rivets, which had the second step aging of 8 hours at 345°F.

6. As would be expected, driving pressures to form a given size of flat head in a given rivet diameter will be greater for 7050-T7X rivets than for 2024-T31 rivets. For 3/16-in. diameter rivets the difference ranged from 150 to 600 lbs.

7. The 7050-T7X rivets were successfully driven with pneumatic hammers; however, for a given rivet diameter, the 7050-T7X rivets will require a larger size pneumatic hammer than 2024-T31 rivets.

8. Metallographic examinations indicate that 7050-T7X driven rivets satisfactorily fill the rivet holes, about as well as the 2024-T31 rivets.

9. The fatigue strength of high load-transfer joints using 7050-T7X rivets were 10 to 50 per cent less than those of similar joints using 2024-T31 rivets.

10. In the fatigue tests of the high load-transfer joints, it was found that the use of the sandwich-type bending restraint produced constant variation between test results obtained by Alcoa Laboratories and Battelle because of differences in clamping pressure.

11. The corrosion test results showed that a minimum second step age of 8 hours at 350°F will assure high resistance to SCC of 7050-T7X rivets.

12. The high resistance to SCC of 7050-T7X rivets is unaffected by exposure to elevated temperatures that sensitize 2024-T31 rivets.

13. Galvanic corrosion of 7050-T7X rivets driven in cathodic alloys, such as 2024-T3, is expected to be negligible in service in view of the standard protective systems used on aircraft.

V. Recommendations.

On the basis of the foregoing conclusions, the 7050 alloy rivets have been assigned the T73 temper designation. Furthermore, it is recommended that:

1. The tentative production practice for the second step of the aging should be 8 hours at $355 \pm 5^\circ\text{F}$, or the equivalent.

2. The 7050-T73 and 2024-T31 rivets should be compared in fatigue using low load-transfer joints, which are more appropriate for most rivet applications. Some previous work at Alcoa Laboratories(2) and Douglas Aircraft Company(3) has indicated that the advantage found for 2024-T31 rivets may not be present in such joints.

3. The use of the sandwich-type bending restraint called for in MIL-STD-1312, Test 21, should be eliminated as it produces more, rather than less, scatter between laboratories.

ACCELERATED STRESS CORROSION TESTS OF 2124 PLATE
CONTAINING 7050-T7X AND 2024-T31 RIVETS

VI. Addendum

I. Introduction

In most applications, rivets are inserted through the thickness of the two materials joined, so that any hoop stress resulting from riveting acts in the longitudinal and long-transverse grain directions. However, attachments could be riveted to outstanding legs of integrally stiffened panels machined from thick plate, such that the resulting hoop stress has a short-transverse component. Because of concern expressed by the Air Force at the Phase I Briefing, a small pilot program was initiated to consider whether: (a) stresses resulting from riveting could cause SCC, and (b) how the effects of riveting with 7050-T7X rivets would compare to those of 2024-T31 rivets.

II. Material

The plate material used was a lot of 1.5 inch thick 2124 plate in the naturally aged T351 temper and after artificial aging to the T851 temper. Previous tests by Alcoa had shown the T351 temper plate was quite susceptible to SCC in the short-transverse direction, triplicate tensile specimens failing after 4 to 13 days exposure to 3.5% NaCl A.I. at a stress of 10 ksi. In contrast, the 2124-T851 plate had high resistance, triplicate short-transverse tensile specimens surviving 90 days of exposure at a stress of 32 ksi.

The rivets used were the 3/16 and 3/8 inch 7050-T7X rivets second step aged 8 hours at 350°F and the 3/16 inch 2024-T31 rivets.

III. Procedure

The scope of the SCC tests is outlined in Table A1. Short-transverse by longitudinal coupons were machined from the plate (Fig. A1) and then three rivets were inserted at the mid-plane of the plate. Hole spacing was proportional to the rivet diameter (D) being 2D between the end rivet and edge of the coupon, and 4D between rivets. The 12 coupons containing 36 rivets were exposed to the two alternate immersion tests.

IV. Results and Discussion

Results of the SCC tests are listed in Table A2. No cracking occurred in the highly resistant 2124-T851 plate, all six coupons surviving 90 days of exposure. Likewise, no cracking occurred in the less resistant 2124-T351 coupons that contained 7050-T7X rivets.

Cracking did occur in both the 2124-T351 coupons that contained 2024-T31 rivets. The cracks were visible after 13 days exposure in either environment. In the 3.5% NaCl A.I. test, a crack developed near one of the end rivets that eventually propagated to the edge of the coupon. A second crack also developed between the same end rivet and the center rivet. In the synthetic sea water test only one crack developed between an end rivet and the edge of the coupon.

The two 2124-T351 coupons containing 3/16 inch rivets and exposed to 3.5% NaCl A.I. were removed from test after 45 days for metallographic examination. The coupon containing the 7050-T7X rivets was verified to be free of cracks, while the cracks caused by the 2024-T31 rivets were shown to be SCC (Fig. A2).

No attempt had been made to try to measure the stress induced in the plate by the rivets. However, it is believed that the main reason the 7050-T7X rivets did not cause cracking is that they had more spring back (elastic recovery) and thus induced a lower stress than the 2024-T31 rivets. Another factor, however, is that the 7050-T7X rivets are anodic to the 2124-T351 plate by about 140 mv and reduced corrosion of the plate for a distance of about 1/16 inch around the rivet heads.

V. Conclusions

Based on these results it is concluded that:

1. A short-transverse stress from rivets can cause SCC in susceptible plate alloys.
2. The propensity for SCC in the plate depends on the:
(a) Inherent resistance of the plate, (b) Magnitude of stress induced, (c) Galvanic relationship between plate and rivet alloys.
3. 7050-T7X rivets appear less likely to cause cracking than 2024-T31 rivets because they induce less stress and are more anodic.

References

1. G. E. Nordmark and W. J. Dewalt, "Comparative Axial-Load Fatigue Tests Of Lap Joints Riveted With 2024-T31 and 7075-T73 Rivets", Alcoa Laboratories Report No. 12-67-26. Unpublished research. Aluminum Company of America, November 16, 1967.
2. G. E. Nordmark and W. J. Dewalt, "Comparative Flexural Fatigue Tests Of Box Beams Riveted With 2024-T31 and 7075-T73 Rivets", Alcoa Laboratories Report No. 12-69-19. Unpublished research. Aluminum Company of America, July 9, 1969.
3. E. L. Pampy, "7050-(XXX) Aluminum Rivet Material", Lab. Report No. LR-7031. Unpublished research. Douglas Aircraft Corporation. February 15, 1974.

TABLE 1
 CHEMICAL COMPOSITION OF 15-IN. DIAMETER INGOTS CAST FOR ALLOY 7050 RIVET PROGRAM(1)

Sample Number	Ingot		Elements(2), %									
	Purpose(3)	Length, in.	Iron and Silicon Content	Si	Fe	Cu	Mn	Mg	Cr	Zn	Ti	Zr
420927C	Primary	72	Low	0.04	0.05	2.20	0.00	2.25	0.00	6.00	0.01	0.12
420927A	Backup	40	Low	0.04	0.05	2.13	0.00	2.18	0.00	6.08	0.03	0.11
420927B	Backup	60	Low	0.04	0.05	2.13	0.00	2.20	0.00	6.05	0.02	0.12
420928J	Primary	72	High	0.10	0.15	2.31	0.00	2.27	0.00	6.12	0.01	0.11
420928A	Backup	48	High	0.12	0.14	2.26	0.00	2.22	0.00	6.24	0.02	0.12
420928G	Backup	48	High	0.12	0.14	2.26	0.00	2.28	0.00	6.24	0.01	0.11

Notes: (1) The chemical composition limits, in %, for alloy 7050 are as follows (values are maximum unless shown as a range):

Si	0.12	Mg	1.9-2.6	Zr	0.08-0.15
Fe	0.15	Cr	0.04	Others, Each	0.05
Cu	2.0-2.6	Zn	5.7-6.7	Others, Total	0.15
Mn	0.10	Ti	0.06	Balance Aluminum	

(2) Average of three samples taken during casting of the ingot.
 (3) A 32-in. length from each primary ingot is also available as backup material.

TABLE 2
7050-H13 WIRES PRODUCED AND SHIPPED FROM MASSENA WORKS

Wire Diameter, in.	Iron and Silicon Content ⁽¹⁾	Coils Shipped to Lancaster Works		No. of 8-ft Lengths Sent to Alcoa Laboratories ⁽²⁾
		No.	Total Weight, lb	
0.092	Low	2	103	15
0.092	High	3	111	15
0.184	Low	6	325	15
0.184	High	6	288	15
0.372	Low	6	294	20
0.372	High	6	338	20

Notes: (1) Low = Ingot S. No. 429027C (0.05% Fe, 0.04% Si).
High = Ingot S. No. 429028J (0.15% Fe, 0.10% Si).

(2) Total net weight for all items was 60 lb.

TABLE 3
RESULTS OF MECHANICAL PROPERTY TESTS ON 7050-H13 WIRE PRODUCED AT MASSENA WORKS

Wire diameter, in.	Iron and Silicon content(1)	Coil No.	Tensile Properties			Wire diameter, in.	Iron and Silicon content(1)	Coil No.	Tensile Properties			Shear strength, KSI	Elongation, %	Yield strength, KSI	Elongation, %	Shear strength, KSI		
			Tensile Strength, KSI	Yield Strength, KSI	Elongation, %				Tensile Strength, KSI	Yield Strength, KSI	Elongation, %							
0.092	Low	1	41.4	41.0	1.6	0.184	High	1	39.8	39.2	16.3	22.0	16.3	39.2	14.0	22.0		
		2	41.0	41.0	2.0			40.0	40.4	13.4	40.4						40.4	13.4
		AVG.	41.2	41.0	1.8			40.1	40.1	15.3	40.1						40.1	15.3
0.092	High	1	39.6	39.2	1.8	0.372	Low	1	42.4	40.4	13.4	22.2	13.4	40.4	14.0	22.2		
		2	40.5	40.0	1.7			42.5	40.7	12.7	42.5						40.7	12.7
		3	41.2	41.0	1.2			43.0	41.2	11.3	43.0						41.2	11.3
AVG.	40.4	40.1	1.6	41.7	40.1	13.1	41.7	40.1	13.1									
0.184	Low	1	41.0	40.1	16.3	0.372	High	1	41.2	39.8	12.7	22.2	12.7	39.8	12.2	22.2		
		2	40.0	39.2	17.6			42.0	40.7	11.3	42.0						40.7	11.3
		3	40.1	39.2	13.5			41.6	40.0	12.0	41.6						40.0	12.0
		4	41.5	41.1	14.9			42.2	40.0	12.7	42.2						40.0	12.7
		5	39.8	39.6	16.3			42.6	38.8	12.7	42.6						38.8	12.7
		6	41.0	40.2	16.3			42.9	40.2	12.7	42.9						40.2	12.7
AVG.	40.6	40.0	15.8	42.6	40.0	12.7	42.6	40.0	12.7									
		AVG.	41.0	41.0	14.0			AVG.	41.0	39.5	12.2			41.0	22.1			

Notes: (1) Low = Wires from Ingot C. No. 429027C (0.05% Fe, 0.04% Si), High = Wires from Ingot C. No. 429026A (0.15% Fe, 0.10% Si).

(2) Gage length of 10-in. used for 0.092-in. diam. wire. Gage length equal to 4 times wire diam. used for 0.184 and 0.372-in. diam. wires.

TABLE 4

ALLOY 7050-F RIVET ITEMS MANUFACTURED AT THE LANCASTER WORKS

Rivet Diam., in.	Rivet Length, in.	Manufactured Head (1) Style	Iron and Silicon (2) Content	Quantity Produced		Rivet Diam., in.	Rivet Length, in.	Manufactured Head (1) Style	Iron and Silicon (2) Content	Quantity Produced	
				lbs.	Approx. No. Of Pieces					lbs.	Approx. No. Of Pieces
3/32	1/4	MS20426	Low	10	49,000	3/16	9/16	MS20426	Low	25	14,000
3/32	1/4	MS20426	High	10	49,000	3/16	9/16	MS20426	High	25	14,000
3/32	1/4	MS20470	Low	10	46,000	3/16	9/16	MS20470	Low	25	13,000
3/32	1/4	MS20470	High	10	46,000	3/16	9/16	MS20470	High	25	13,000
3/32	5/16	MS20426	Low	10	40,000	3/8	7/8	MS20426	Low	40	3,500
3/32	5/16	MS20426	High	10	40,000	3/8	7/8	MS20426	High	40	3,500
3/32	5/16	MS20470	Low	10	34,000	3/8	7/8	MS20470	Low	40	2,900
3/32	5/16	MS20470	High	10	34,000	3/8	7/8	MS20470	High	40	2,900
3/16	7/16	MS20426	Low	25	17,000	3/8	1-1/4	MS20426	Low	40	2,600
3/16	7/16	MS20426	High	25	17,000	3/8	1-1/4	MS20426	High	40	2,600
3/16	7/16	MS20470	Low	25	14,000	3/8	1-1/4	MS20470	Low	40	2,200
3/16	7/16	MS20470	High	25	14,000	3/8	1-1/4	MS20470	High	40	2,200
3/16	7/16	NAS1097	Low	10	7,000						
3/16	7/16	NAS1097	High	10	7,000						

Notes: (1) MS20426 = 100-degree Flat Countersunk Head
 MS20470 = Universal Head
 NAS1097 = 100-degree Countersunk Shear Head

(2) Low = rivets made from wires from Ingot S. No. 429027C (0.05% Fe, 0.04% Si).
 High = rivets made from wires from Ingot S. No. 429028C (0.15% Fe, 0.10% Si).

TABLE 5

RESULTS OF TESTS TO DETERMINE EFFECT OF SOLUTION HEAT TREATING PRACTICE ON TENSILE PROPERTIES OF 7050 WIRE

Specimen Number	Solution Heat Treatments ⁽²⁾		Tensile Properties		
	Temp., °F	Time at Temp., min.	Tensile Strength, ksi	Yield Strength, ksi	Elongation in 4D, %
420928-1-1	890	15	78.9	72.2	16.7
-2	890	30	79.1	72.2	19.3
-3	890	60	<u>79.3</u>	<u>72.7</u>	<u>18.0</u>
		Avg.	79.1	72.4	18.0
420928-2-1	900	15	79.9	73.6	18.0
-2	900	30	80.3	73.5	16.7
-3	900	60	<u>80.1</u>	<u>73.8</u>	<u>19.3</u>
		Avg.	80.1	73.6	18.0
420928-3-1	910	15	79.9	73.1	18.7
-2	910	30	80.0	73.4	17.3
-3	910	60	<u>79.9</u>	<u>73.1</u>	<u>17.3</u>
		Avg.	79.9	73.2	17.8

Notes: (1) All specimens were 16-in. lengths of 0.372-in. diameter 7050-H13 wire. Wire was obtained from Ingot S. No. 420928J at Massena Works.

(2) Following solution heat treatments indicated, all specimens were immediately cold-water quenched and aged 4 hours at 250°F and 6 hours at 350°F.

TABLE 6
RESULTS OF TENSILE PROPERTY TESTS ON ALLOY 7050 RIVET WIRES USING SIX AGING PRACTICES (1)

2nd Step of Aging, hrs. at 350° F	Basic Lot S.No.	Iron and Silicon Level(2)	Tensile Strength, ksi		Yield Strength, ksi		Elongation (3), %					
			Wire Diam., in. 0.092	0.184	Wire Diam., in. 0.092	0.184	Wire Diam., in. 0.092	0.184				
2	420927C	Low	85.3	86.2	84.6	85.4	80.9	82.1	81.1	6.5(4)	13.3	14.0
	420928J	High	85.7	85.8	84.9	85.5	81.5	81.6	81.3	5.5	13.3	15.0
4	420927C	Low	83.3	84.1	82.2	83.2	78.2	79.3	77.5	7.8	12.6	13.2
	420928J	High	83.8	83.5	83.2	83.5	78.7	78.4	78.1	6.2	14.0	16.3
6	420927C	Low	79.1	79.9	78.6	79.2	72.5	73.6	72.3	6.4	16.0	14.7
	420928J	High	79.9	79.6	78.7	79.4	72.8	73.1	72.7	7.8	16.7	14.0
8	420927C	Low	77.3	77.8	76.5	77.2	70.0	70.3	69.0	7.8	14.7	17.3
	420928J	High	76.7	76.2	76.3	76.4	69.0	68.5	68.7	6.5	18.7	16.3
10	420927C	Low	75.2	75.6	74.6	75.1	66.8	67.6	66.0	8.1	14.7	16.0
	420928J	High	75.2	75.0	73.5	74.6	66.4	66.3	65.0	7.6	18.0	16.3
12	420927C	Low	73.6	74.4	73.0	73.7	65.3	65.9	64.3	8.0	16.0	15.3
	420928J	High	74.1	73.9	72.9	73.6	64.6	65.0	63.9	7.1	16.0	16.7

- Notes: (1) All wires solution heat treated 15 min. at 900° F, immediately cold-water quenched and aged 4 hrs. at 250° F (1st step) + number of hours shown in table at 350° F (2nd step). Unless otherwise indicated, all values are the average of two tests.
- (2) Low = 0.05% Fe, 0.04% Si and High = 0.15% Fe and 0.10% Si.
- (3) A gage length of 10-in. used for the 0.092-in. diam. wire. Gage lengths equal to 4 times wire diam. were used for the 0.184 and 0.372-in. diam. wires.
- (4) One test value.

TABLE 7
 RESULTS OF SHEAR STRENGTH TESTS ON ALLOY 7050 RIVET WIRES
 USING SIX AGING PRACTICES⁽¹⁾

2nd Step of Aging, hrs. at 350°F	Basic Lot S.No.	Iron. and Silicon Level ⁽²⁾	Shear Strength, ⁽³⁾ ksi				Avg Tensile Strength, ⁽⁵⁾ ksi	(6) Ratio
			Wire Diam., ⁽⁴⁾ in.		Avg.			
			0.092	0.184	0.372	Avg.		
2	420927C	Low	48.5	47.9	47.6	48.0	85.4	0.56
	420928J	High	48.5	47.8	49.1	48.5	85.5	0.57
4	420927C	Low	47.4	47.5	47.2	47.4	83.2	0.57
	420928J	High	46.6	47.1	48.4	47.4	83.5	0.57
6	420927C	Low	44.8	45.2	45.5	45.2	79.2	0.57
	420928J	High	44.9	45.0	45.9	45.3	79.4	0.57
8	420927C	Low	43.5	43.9	44.7	44.0	77.2	0.57
	420928J	High	43.1	43.4	44.4	43.6	76.4	0.57
10	420927C	Low	42.9	43.7	43.2	43.3	75.1	0.58
	420928J	High	42.2	42.8	43.6	42.9	74.6	0.57
12	420927C	Low	42.5	42.7	42.7	42.6	73.7	0.58
	420928J	High	42.1	43.0	43.4	42.8	73.6	0.58

Notes: (1) All wires solution heat treated 15 min. at 900°F, immediately cold-water quenched and aged 4 hrs. at 250°F (1st step) + number of hours shown in table at 350°F (2nd step).

(2) Low = 0.05% Fe, 0.04% Si and High = 0.15% Fe, 0.10% Si.

(3) Double-shear tests made using fixtures specified in ASTM B565-72.

(4) Each value shown is the average of three tests.

(5) Values are the average from tensile tests on all three wire diameters. See Table 6.

(6) Average shear strength divided by average tensile strength.

TABLE 8

RESULTS OF ELECTRICAL CONDUCTIVITY TESTS ON ALLOY 7050 RIVET WIRES⁽¹⁾

2nd Step of Aging, hrs. at 350°F	Basic Lot S.No.	Iron and Silicon Level ⁽²⁾	Electrical Conductivity, ⁽³⁾ % IACS			
			Wire Diam., in.			Avg.
			0.092	0.184	0.372	
2	420927C	Low	36.6	36.6	36.5	36.6
	420928J	High	36.2	36.1	36.0	36.1
4	420927C	Low	38.7	38.8	38.6	38.7
	420928J	High	38.5	38.2	38.0	38.2
6	420927C	Low	40.3	40.4	40.3	40.3
	420928J	High	39.8	39.9	39.6	39.8
8	420927C	Low	41.1	41.2	41.1	41.1
	420928J	High	40.9	40.9	40.9	40.9
10	420927C	Low	42.0	42.1	41.8	42.0
	420928J	High	41.6	41.6	41.5	41.6
12	420927C	Low	42.5	42.6	42.2	42.4
	420928J	High	41.7	41.8	41.7	41.7

Notes: (1) All wires solution heat treated 15 min. at 900°F, immediately cold-water quenched and aged 4 hours at 250°F (1st step) + number of hours shown in table at 350°F (2nd step).

(2) Low = 0.05% Fe, 0.04% Si and High = 0.15% Fe and 0.10% Si.

(3) Measured at 20°C.

Table 9

SCOPE OF SCC SCREENING TESTS ON 0.372 IN.
7050 WIRE

1/8" Dia. Tension Specimens

Test Variables:

- Two Compositions - High and low purity
- Six Agings - 4/250 + 2, 4, 6, 8, 10, 12/350°F

Test Procedures:

- Replication - Triplicate
- Two Stresses - 75 and 90% Y. S.
- Two Environments - 3.5% NaCl - A.I.
Synthetic Sea Water - A.I.

Total Tests - 144 Specimens

Table 10

RESISTANCE TO SCC OF 7050 RIVET WIRE - 0.125 IN. DIAMETER LONGITUDINAL TENSILE SPECIMENS. NUMBER FAILURES/NUMBER EXPOSED, F/N, AND DAYS TO FAILURE

S. - No.	Fe & Si Level	2nd Step Age Hrs/350 (3)	Y. S. ksi	Cond. % IACS	90 Days to 3.5% NaCl - A.I.(1) (2)		Str. 90% Y.S.		Str. 75% Y.S.	
					F/N	Days	F/N	Days	F/N	Days
420927	Low	2	80.3	36.5	3/3	34, 47, 64	2/3	51, 75, OK 90	0/3	OK 90
		4	77.5	38.6	0/3	3 OK 90	0/3	OK 90	0/3	OK 90
		6	72.3	40.3	0/3	3 OK 90	0/3	OK 90	0/3	OK 90
		8	69.0	41.1	0/3	3 OK 90	0/3	OK 90	0/3	OK 90
		10	66.0	41.8	0/3	3 OK 90	0/3	OK 90	0/3	OK 90
		12	64.3	42.2	0/3	3 OK 90	0/3	OK 90	0/3	OK 90
420928	High	2	80.7	36.0	2/2	51, 67, OK 90	0/3	OK 90	0/3	OK 90
		4	78.1	38.0	1/3	75, 2 OK 90	0/3	OK 90	0/3	OK 90
		6	72.7	39.6	1/3	84, 2 OK 90	0/3	OK 90	0/3	OK 90
		8	68.7	40.9	0/3	3 OK 90	0/3	OK 90	0/3	OK 90
		10	65.0	41.5	0/3	3 OK 90	0/3	OK 90	0/3	OK 90
		12	63.9	41.7	0/3	3 OK 90	0/3	OK 90	0/3	OK 90

Notes: (1) Metallographic examination of failed specimens showed susceptibility to intergranular corrosion. Auxiliary cracks were either solely transgranular or a mixture of transgranular and intergranular cracking.

(2) A second set of specimens was exposed 90 days to synthetic sea water solution (ASTM D-1141-52). No failure occurred.

(3) First step age was four hours at 250°F.

TABLE 11

EFFECT OF "LOW" OR "HIGH" IRON AND SILICON CONTENT ON THE DRIVING PRESSURE REQUIRED TO FORM FLAT HEADS ON 7050 ALLOY SLUGS⁽¹⁾

Driving Pressure, lb.	Ratio of Driven Flat Head Diameter to Slug Diameter ⁽²⁾					
	4 hr at 350°F ⁽³⁾		8 hr at 350°F ⁽³⁾		12 hr at 350°F ⁽³⁾	
	Fe and Si ⁽⁴⁾		Fe and Si ⁽⁴⁾		Fe and Si ⁽⁴⁾	
	"Low"	"High"	"Low"	"High"	"Low"	"High"
<u>Slug Diameter=0.092-in.</u>						
1,000	--	--	1.29	1.30	1.33	1.33
1,200	1.35	1.34	--	--	1.43	1.44
1,300	--	--	1.46	1.45	1.48	1.49
1,500	1.47	1.46	1.52	1.50	1.56	1.55
1,600	1.50	1.51	1.54	1.56	--	--
<u>Slug Diameter=0.184-in.</u>						
5,000	1.37	1.36	1.42	1.42	1.46	1.46
5,500	1.42	1.42	1.49	1.48	1.50	1.51
6,000	1.47	1.49	1.53	1.52	1.54	1.56
6,500	1.48	1.48	1.55	1.56	1.58	1.58
6,900	1.51	1.52	1.58	1.58	1.61	1.60
<u>Slug Diameter=0.372-in.</u>						
18,000	1.30	1.29	1.37	1.37	--	--
20,000	1.35	1.35	1.41	1.42	1.46	1.46
24,000	1.45	1.45	1.49	1.50	--	--
26,000	1.49	1.49	1.54	1.55	--	--
28,000	1.52	1.52	1.57	1.57	--	--

Notes: (1) Slugs were machined from wires solution heat treated 1 min. at 900°F, immediately cold-water quenched and aged 4 hours at 250°F (1st step) + 2, 4, 6, 8, 10 and 12 hours at 350°F (2nd step).

(2) Each value is the average of four tests.

(3) Second step of aging.

(4) Low=0.05% Fe, 0.04% Si and High=0.15% Fe and 0.10% Si.

TABLE 12

AVERAGE DRIVING PRESSURES REQUIRED TO FORM 1.5D
DIAMETER X 0.5D THICK FLAT HEADS ON 7050 ALLOY WIRES (1)

2nd Step of Aging, (2) hrs at 350°F	Driving Pressure, lb.		
	Wire Diameter, D, in.		
	0.092	0.184	0.372
2	1730	6800	27700
4	1610	6550	26800
6	1510	6100	25300
8	1460	5750	24000
10	1420	5650	23100
12	1360	5550	22400
2024-T31 (3)		5200	

- Notes: (1) Tests conducted using specimens machined from wire as shown in Fig. 5. The wire composition ("low" or "high" iron and silicon content) had no effect on driving pressures (see Table 11).
- (2) All 7050 alloy wires were solution heat treated 15 min. at 900°F, immediately cold-water quenched and aged 4 hrs at 250°F (1st step) + number of hours shown in table at 350°F (2nd step).
- (3) Specimens were machined from 0.184-in. diameter 2024-H13 rivet wire. These specimens were solution heat treated for 20 min. at 920°F, immediately cold-water quenched and driven within 30 min. (in the freshly quenched condition).

TABLE 13
 ALLOY 7050-F RIVETS SOLUTION HEAT TREATED AND AGED
 FOR PHASE II PORTION OF PROGRAM(1)

Rivet Lot Specimen No.	Manufactured Head Style(2)	Rivet Diam., in.	Rivet Length, in.	Total Quantity Aged(3)	
				lbs.	Approx. No. of Pcs.
421362	MS20470	3/32	1/4	0.3	1200
421363	MS20426	3/32	1/4	0.3	1400
421364	MS20470	3/32	5/16	0.3	1000
421365	MS20426	3/32	5/16	0.3	1200
421366	MS20470	3/16	7/16	3.0	1700
421367	MS20426	3/16	7/16	3.0	2000
421368	NAS1097	3/16	7/16	3.0	2100
421369	MS20470	3/16	9/16	3.0	1600
421370	MS20426	3/16	9/16	3.0	1700
421371	MS20470	3/8	7/8	4.5	330
421372	MS20426	3/8	7/8	4.5	390
421373	MS20470	3/8	1-1/4	4.5	250
421374	MS20426	3/8	1-1/4	4.5	290

- Notes: (1) All rivets from same basic ingot (S. No. 420928J), having the "High" iron and silicon content (0.15% Fe and 0.10% Si).
- (2) MS20426 = 100-degree Flat Countersunk Head
 MS20470 = Universal Head
 NAS1097 = 100-degree Countersunk Shear Head
- (3) All rivets solution heat treated 15 min. at 900°F, immediately cold-water quenched and aged 4 hrs. at 250°F (1st step); then one-third of each of the 13 rivets lots aged, respectively, 8 hrs. at 345°, 350° and 355°F (2nd step).

TABLE 14
RESULTS OF TENSILE PROPERTY AND ELECTRICAL CONDUCTIVITY TESTS ON ALLOY 7050 WIRES AGED WITH RIVETS (1)

2nd Step of Aging, 8 hrs at	Tensile Strength, ksi		Target Tensile Strength, (2) ksi	Difference, (3) ksi	Yield Strength, ksi		Elongation, (4) %		Electrical Conductivity, (5) % IACS						
	80.4	79.8			79.6	79.9	79.0	+0.9	72.9	73.0	72.4	6.8	15.3	18.4	39.3
	77.3	76.2	76.3	76.6	-0.2	68.5	67.9	68.7	68.3	7.6	17.3	18.0	40.1	40.3	40.5
	75.3	74.6	74.8	74.9	+0.6	66.6	65.6	65.1	65.8	6.4	16.6	18.0	40.7	40.8	40.9
Avg.	0.092	0.184	0.372			0.092	0.184	0.372		0.092	0.184	0.372			
345°F															
350°F															
355°F															
Avg.															

Notes: (1) Wires and rivets from same basic ingot (S.No. 4209287), having the "high" iron and silicon content. All wires and rivets solution heat treated 15 min. at 900°F, immediately cold-water quenched and aged 4 hrs. at 250°F (1st step) + 8 hrs. at temperatures shown in table (2nd step). Tensile property values are the average of two tests; conductivity values are from one measurement.

(2) The 2nd step agings of 8 hrs. at 345°, 350° and 355°F are equivalent to the 2nd step agings (Phase 1 tests) of 350°F at 6, 8 and 10 hrs respectively. The target values were calculated using the tensile properties obtained in the Phase 1 test (see Table 6).

(3) Difference between target - tensile strengths and average tensile strengths determined in these tests.

(4) A gage length of 10-in. used for the 0.092-in. diam. wire. Gage lengths equal to 4 times the wire diam. used for the 0.184 and 0.372-in. diam. wires.

(5) Measured at 20° C.

TABLE 15

RESULTS OF SHEAR STRENGTH TESTS ON UNDRIVEN 7050 ALLOYS RIVETS
USING THREE AGING PRACTICES(1)

2nd Step of Aging, 8 hrs at	Rivet Head Style(2)	Shear Strength,(3) Rivet Diam.,(4) in.			Avg.	Avg. Tensile Strength,(5) ksi	Ratio(6)
		3/32	3/16	3/8			
345°F	MS20426	45.5	47.1	46.4	46.2	79.9	0.58
	MS20470	<u>45.2</u>	<u>47.3</u>	<u>46.2</u>			
	Avg.	45.3	47.1	46.3			
350°F	MS20426	44.1	43.9	44.2	44.3	76.6	0.58
	MS20470	<u>44.6</u>	<u>44.6</u>	<u>44.6</u>			
	Avg.	44.3	44.3	44.4			
355°F	MS20426	43.0	43.9	44.0	43.8	74.9	0.58
	MS20470	<u>42.9</u>	<u>44.8</u>	<u>44.2</u>			
	Avg.	42.9	44.4	44.1			

Notes: (1) All rivets from same basic ingot (S.No. 420928J), having the "High" iron and silicon content. All rivets solution heat treated 15 min. at 900°F, immediately cold-water quenched and aged 4 hrs at 250°F (1st step) + 8 hrs at temperatures shown in table (2nd step).

(2) MS20426 = 100-degree Flat Countersunk Head
MS20470 - Universal Head

(3) Double-shear tests made using fixtures specified in ASTM B565-72.

(4) Each value shown is the average of 4 or 5 tests.

(5) Values are the average from tensile tests on all three wire diameters (see Table 14).

(6) Average shear strength divided by average tensile strength.

Table 16

SHEET AND PLATE THICKNESSES FOR SPECIMENS
FOR JOINT YIELD AND ULTIMATE STRENGTH TESTS(1)

Sheet or Plate Thickness ⁽²⁾ , t, in.	Ratio of Sheet or Plate Thickness to Rivet Diameter, D, (t/D)		
	D=3/32"	D=3/16"	D=3/8"
0.040	0.43 ⁽³⁾	-	-
0.050	0.53 ⁽³⁾	-	-
0.071	0.76 ⁽³⁾	0.38 ⁽³⁾	-
0.080	0.85	-	-
0.090	0.96	0.48 ⁽³⁾	-
0.125	-	0.67	-
0.160	-	0.86	0.43 ⁽³⁾
0.190	-	-	0.51 ⁽³⁾
0.250	-	-	0.67
0.313	-	-	0.84
0.375	-	-	1.00

Notes: (1) At least triplicate tests made in all cases, using rivets given the second step agings of 8 hours at 345°, 350° and 355°F. 100° Flat Countersunk Head (MS20426) 7050-T7X rivets driven in specimens of the type shown in Fig. 18.

(2) Alclad 2024-T3 sheet and Alclad 2024-T351 plate.

(3) In these cases, triplicate tests were also performed at Battelle using 7050-T7X rivets given second step agings of 8 hours at 345° and 355°F. Battelle prepared specimens using same sheet, plate and rivets employed at Alcoa Laboratories.

TABLE 17

RESULTS OF TENSILE PROPERTY TESTS OF ALCLAD 2024 SHEET AND PLATE ITEMS
TO BE USED FOR JOINT SHEAR STRENGTH TESTS(1)

Specimen Number	Temper	Thickness, in.		Tensile Strength, ksi			Yield Strength, ksi			Elongation, in 2 in., percent		
		Nom.	Meas.	Min.	Max.	Avg.	Min.	Max.	Avg.	Min.	Max.	Avg.
420967	T3	0.040	0.040	62.2	66.8	65.2	48.0	51.2	50.1	16.0	17.5	17.0
420968	T3	0.050	0.052	64.3	67.0	65.7	45.8	47.9	46.9	18.5	19.5	18.8
420976	T3	0.071	0.070	67.0	67.8	67.5	51.1	51.4	51.3	16.5	18.0	17.3
420969	T3	0.080	0.080	65.7	65.8	65.7	49.6	50.1	49.9	18.5	20.5	19.2
420970	T3	0.090	0.092	66.5	68.9	67.7	45.9	48.6	47.3	19.5	21.0	20.3
420971	T3	0.125	0.123	68.0	69.1	68.6	52.9	54.5	53.9	16.0	17.0	16.5
421253	T3	0.160	0.156	67.8	68.5	68.2	51.3	52.5	51.9	19.0	22.0	20.5
421271	T3	0.190	0.175	69.2	70.4	69.6	54.8	55.7	55.2	17.5	18.5	17.8
421272-A	T3	0.250	0.246	69.1	69.3	69.2	50.7	51.2	50.9	19.5	20.5	19.3
421329	T351	0.320	0.319	64.2	64.5	64.3	48.8	49.2	49.0	22.0	23.5	23.0
421330	T351	0.375	0.381	65.5	66.2	65.8	50.2	50.7	50.5	21.5	23.5	22.2

Notes: (1) All values the average of three tests using 1/2-in. standard sheet-type tensile specimens taken from the sheet or plate in the longitudinal direction (rolling direction). Minimum tensile properties (A values) published in MIL-HDBK-5 are as follows:

Alloy and Temper	Thickness, in.	Tensile Strength	Yield Strength	Elongation in 2 in.*
Alclad 2024-T3	0.021-0.062	60.0 ksi	44.0 ksi	15 per cent
Alclad 2024-T3	0.063-0.249	63.0 ksi	45.0 ksi	15 per cent
Alclad 2024-T351	0.250-0.499	62.0 ksi	45.0 ksi	12 per cent

* For Long Transverse direction; all other values are for Longitudinal direction.

TABLE 18
COMPUTATION OF t/D AND P/D² FROM BASIC DATA— 3/32 IN. DIA. RIVETS

Second Step of Aging : 8 Hrs. at 345°F

Sheet : Alclad 2024-T3

Test Specimen No.	Hole Dia., D, in.	D, ² sq. in.	Sheet Thick., t, in.	t/D	Yield Load, P _y , ⁽¹⁾ lb/ Fastener	P _y	Ultimate Load, P _u , lb/Fastener	P _u	Type of Failure ⁽²⁾
						10 ⁴ D ²		10 ⁴ D ²	
420967-3A1	.0988	.0098	.0406	.411	-	-	315	3.214	A
-3A2	.0988	.0098	.0403	.408	168	1.714	329	3.357	A
-3A3	.0988	.0098	.0404	.409	178	1.816	339	3.459	A
-3A4	.0988	.0098	.0403	.408	-	-	306	3.122	A
-3A5	.0988	.0098	.0404	.409	140	1.429	318	3.245	A
		Average	.0404	.409		1.653		3.279	
3-010-A-1(3)	.0945	.0089	.0400	.423	201	2.258	282	3.168	A
-2	.0945	.0089	.0401	.424	186	2.090	285	3.202	A
-3	.0945	.0089	.0401	.424	191	2.146	283	3.180	A
-4	.0945	.0089	.0402	.425	187	2.101	285	3.202	A
		Average	.0401	.424		2.149		3.188	
420968-3A1	.0987	.0097	.0520	.527	254	2.619	363	3.742	A
-3A2	.0987	.0097	.0521	.528	243	2.505	370	3.814	A
-3A3	.0987	.0097	.0521	.528	234	2.412	352	3.732	A
		Average	.0521	.528		2.512		3.763	
3-050-A-1(3)	.0948	.0090	.0515	.543	250	2.778	337	3.744	A
-2	.0948	.0090	.0516	.544	250	2.778	334	3.711	A
-3	.0948	.0090	.0511	.539	253	2.811	338	3.756	A
		Average	.0514	.542		2.789		3.737	
420976-3A1	.0981	.0096	.0695	.708	313	3.260	406	4.229	B
-3A2	.0981	.0096	.0698	.712	360	3.750	400	4.167	B
-3A3	.0981	.0096	.0698	.712	346	3.604	401	4.177	B
		Average	.0697	.711		3.538		4.191	
3-070-A-1(3)	.0948	.0090	.0691	.729	343	3.811	369	4.100	B
-2	.0948	.0090	.0690	.728	343	3.811	374	4.156	B
-3	.0948	.0090	.0690	.728	340	3.778	371	4.122	B
		Average	.0690	.728		3.800		4.126	
420969-3A1	.0980	.0096	.0796	.812	347	3.615	389	4.052	B
-3A2	.0980	.0096	.0793	.809	372	3.875	397	4.135	B
-3A3	.0980	.0096	.0793	.809	369	3.844	399	4.156	B
		Average	.0794	.810		3.778		4.114	
420970-3A1	.0976	.0095	.0924	.947	359	3.779	390	4.105	B
-3A2	.0976	.0095	.0922	.945	372	3.916	390	4.105	B
-3A3	.0976	.0095	.0922	.945	366	3.853	400	4.211	B
		Average	.0923	.946		3.849		4.140	

Notes: (1) Load determined at the permanent set of 0.04D.
(2) A = Bearing deformation of hole followed by shear-tension failure of countersunk head.
F = Shear of rivets.
(3) These specimens prepared and tested at Battelle.

TABLE 19

COMPUTATION OF t/D AND P/D^2 FROM BASIC DATA— 3/16 IN. DIA. RIVETS

Second Step of Aging : 8 Hrs. at 345°F

Sheet : Alclad 2024-T3

Test Specimen No.	Hole Dia., D, in.	D^2 , sq. in.	Sheet Thick., t, in.	t/D	Yield Load, P_y , ⁽¹⁾ lb/Fastener	$\frac{P_y}{10^4 D^2}$	Ultimate Load, P_u , lb/Fastener	$\frac{P_u}{10^4 D^2}$	Type of Failure ⁽²⁾
420976-6A1	0.1918	0.0368	.0698	.364	665	1.807	1 396	3.793	A
-6A2	0.1918	0.0368	.0699	.364	780	2.120	1 451	3.943	A
-6A3	0.1918	0.0368	.0696	.363	794	2.158	1 478	4.016	A
-6A4	0.1918	0.0368	.0697	.363	613	1.666	1 290	3.505	A
		Average	.0698	.364		1.938		3.814	
6-070-A-1(3)	0.1878	0.0353	.0695	.370	740	2.096	1 200	3.399	A
-2	0.1878	0.0353	.0695	.370	-	-	-	-	A
-3	0.1878	0.0353	.0693	.369	730	2.068	1 125	3.187	A
		Average	.0694	.370	735	2.082		3.293	
420970-6A1	0.1912	0.0366	.0920	.481	865	2.363	1 353	3.697	A
-6A2	0.1912	0.0366	.0925	.484	-	-	1 348	3.683	A
-6A3	0.1912	0.0366	.0925	.484	928	2.536	1 375	3.757	A
-6A4	0.1912	0.0366	.0920	.481	935	2.555	1 335	3.648	A
		Average	.0923	.483		2.485		3.696	
6-090-A-1(3)	0.1885	0.0355	.0920	.488	860	2.423	1 165	3.282	A
-2	0.1885	0.0355	.0916	.486	910	2.563	1 220	3.437	A
-3	0.1885	0.0355	.0918	.487	890	2.507	1 215	3.423	A
		Average	.0918	.487	887	2.498		3.380	
420971-6A1	.1909	.0364	.1230	.644	-	-	1 429	3.926	B
-6A2	.1909	.0364	.1230	.644	1320	3.626	1 443	3.964	B
-6A3	.1909	.0364	.1230	.644	1238	3.401	1 446	3.973	B
-6A4	.1909	.0364	.1228	.643	1263	3.470	1 415	3.887	B
		Average	.1230	.644		3.499		3.938	
421253-6A1	.1911	.0365	.1559	.816	1340	3.671	1 438	3.940	B
-6A2	.1911	.0365	.1555	.814	1338	3.666	1 438	3.940	B
-6A3	.1911	.0365	.1561	.817	1365	3.740	1 445	3.959	B
		Average	.1558	.816		3.692		3.946	

Notes: (1) Load determined at the permanent set of 0.04D.

(2) A = Bearing deformation of hole followed by shear-tension failure of countersunk head.

B = Shear of rivets.

(3) These specimens prepared and tested at Battelle.

TABLE 20

COMPUTATION OF t/D AND P/D^2 FROM BASIC DATA— 3/8 IN. DIA. RIVETS

Second Step of Aging : 8 Hrs. at 345°F

Sheet : Alclad 2024-T3, T351

Test Specimen No.	Hole Dia., D, in.	D^2 , sq. in.	Sheet Thick., t, in.	t/D	Yield Load, P_y , ⁽¹⁾ lb/ Fastener	$\frac{P_y}{10^4 D^2}$	Ultimate Load, P_u , lb/Fastener	$\frac{P_u}{10^4 D^2}$	Type of Failure ⁽²⁾
421253-12A1	0.3878	0.1504	.1562	.403	3 250	2.161	5 000	3.324	A
-12A2	0.3878	0.1504	.1561	.403	3 560	2.367	5 140	3.418	A
-12A3	0.3878	0.1504	.1561	.403	3 425	2.277	5 115	3.401	A
		Average	.1561	.403		2.268		3.381	
12-160-A-4(3)	0.3864	0.1493	.1560	.404	3 230	2.163	4 420	2.960	A
-5	0.3864	0.1493	.1563	.405	3 310	2.217	4 440	2.974	A
-6	0.3864	0.1493	.1560	.404	2 930	1.962	4 950	3.315	A
		Average	.1561	.404		2.114		3.083	
421271-12A1	0.3879	0.1505	.1789	.461	4 225	2.807	5 575	3.704	A
-12A2	0.3879	0.1505	.1788	.461	3 900	2.591	5 045	3.352	A
-12A3	0.3879	0.1505	.1788	.461	3 950	2.625	5 550	3.688	A
		Average	.1788	.461		2.674		3.581	
12-180-A-4(3)	0.3865	0.1494	.1796	.465	3 670	2.456	4 910	3.286	A
-5	0.3865	0.1494	.1798	.465	3 720	2.490	5 040	3.374	A
-6	0.3865	0.1494	.1794	.464	3 680	2.463	5 100	3.414	A
		Average	.1796	.465		2.470		3.358	
421272A-12A1	0.3873	.1500	.2473	.640	5 400	3.600	5 925	3.950	B
-12A2	0.3873	.1500	.2478	.640	5 625	3.750	5 910	3.940	B
-12A3	0.3873	.1500	.2481	.641	5 450	3.633	5 850	3.900	B
-12A4	0.3873	.1500	.2481	.641	4 950	3.300	5 875	3.917	B
		Average	.2480	.641		3.571		3.927	
421329-12A4	0.3870	.1498	.3189	.824	5 050	3.371	5 850	3.905	B
-12A5	0.3870	.1498	.3186	.823	4 750	3.171	5 950	3.972	B
-12A6	0.3870	.1498	.3185	.823	4 925	3.288	5 950	3.972	B
		Average	.3186	.823		3.277		3.950	
421330-12A1	0.3861	.1491	.3795	.983	5 090	3.414	5 825	3.907	B
-12A2	0.3861	.1491	.3794	.983	5 160	3.461	5 855	3.927	B
-12A3	0.3861	.1491	.3797	.983	5 355	3.592	5 995	4.021	B
		Average	.3795	.983		3.489		3.945	

Notes (1) Load determined at the permanent set of 0.04D.

(2) A = Bearing deformation of hole followed by shear-failure of countersunk head.

B = Shear of rivets.

(3) These specimens prepared and tested at Battelle.

TABLE 21

COMPUTATION OF t/D AND P/D² FROM BASIC DATA— 3/32 IN. DIA. RIVETS

Second Step of Aging : 8 Hrs. at 350°F

Sheet : Alclad 2024-T3

Test Specimen No.	Hole Dia., D, in.	D ² , sq. in.	Sheet Thick., t, in.	t/D	Yield Load, P _y ⁽¹⁾ lb/ Fastener	$\frac{P_y}{10^4 D^2}$	Ultimate Load, P _u , lb/Fastener	$\frac{P_u}{10^4 D^2}$	Type of Failure ⁽²⁾
420967-3B1	.0988	.0098	.0404	.409	162	1.653	321	3.276	A
-3B2	.0988	.0098	.0404	.409	157	1.602	320	3.265	A
-3B3	.0988	.0098	.0402	.407	178	1.816	317	3.235	A
-3B4	.0988	.0098	.0403	.408	150	1.531	306	3.122	A
-3B5	.0988	.0098	.0403	.408	161	1.643	294	3.000	A
		Average	.0403	.408		1.653		3.184	
420968-3B1	.0987	.0097	.0521	.528	246	2.536	364	3.753	A
-3B2	.0987	.0097	.0524	.531	253	2.608	362	3.732	A
-3B3	.0987	.0097	.0520	.527	245	2.526	358	3.691	A
-3B4	.0987	.0097	.0522	.529	200	2.062	359	3.701	A
-3B5	.0987	.0097	.0522	.529	178	1.835	342	3.526	A
		Average	.0522	.529		2.309		3.680	
420976-3B1	.0981	.0096	.0695	.709	343	3.573	385	4.010	B
-3B2	.0981	.0096	.0696	.709	338	3.521	386	4.021	B
-3B3	.0981	.0096	.0696	.709	336	3.500	379	3.948	B
		Average	.0696	.709		3.531		3.990	
420969-3B1	.0980	.0096	.0795	.811	344	3.583	370	3.854	B
-3B2	.0980	.0096	.0792	.808	343	3.573	387	4.031	B
-3B3	.0980	.0096	.0796	.812	354	3.688	381	3.969	B
		Average	.0794	.810		3.615		3.948	
420970-3B1	.0976	.0095	.0921	.944	328	3.453	360	3.789	B
-3B2	.0976	.0095	.0922	.945	341	3.589	372	3.916	B
-3B3	.0976	.0095	.0921	.944	320	3.368	362	3.811	B
-3B4	.0976	.0095	.0920	.943	338	3.558	375	3.947	B
		Average	.0921	.944		3.495		3.863	

- Notes: (1) Load determined at the permanent set of 0.04D.
(2) A = Bearing deformation at hole followed by shear-tension failure of countersunk head.
B = Shear of rivets.

TABLE 22
COMPUTATION OF t/D AND P/D² FROM BASIC DATA— 3/16 IN. DIA. RIVETS

Second Step of Aging : 8 Hrs. at 350°F

Sheet : Alclad 2024-T3

Test Specimen No.	Hole Dia., D, in.	D ² , sq. in.	Sheet Thick., t, in.	t/D	Yield Load, P _y , ⁽¹⁾ lb/ Fastener	$\frac{P_y}{10^4 D^2}$	Ultimate Load, P _u , lb/Fastener	$\frac{P_u}{10^4 D^2}$	Type of Failure ⁽²⁾
420976-6B1	.1918	.0368	.0696	.363	720	1.957	1 193	3.242	A
-6B2	.1918	.0368	.0698	.364	682	1.853	1 230	3.342	A
-6B2	.1918	.0368	.0700	.365	645	1.753	1 213	3.296	A
		Average	.0698	.364		1.853		3.293	
420970-6B1	.1912	.0366	.0924	.483	843	2.303	1 245	3.402	A
-6B2	.1912	.0366	.0921	.482	788	2.153	1 253	3.423	A
-6B3	.1912	.0366	.0919	.481	780	2.131	1 235	3.374	A
-6B4	.1912	.0366	.0920	.481	712	1.975	1 250	3.415	A
		Average	.0921	.482		2.134		3.404	
420971-6B1	.1909	.0364	.1229	.644	1 245	3.420	1 345	3.695	B
-6B2	.1909	.0364	.1226	.642	1 225	3.365	1 348	3.703	B
-6B3	.1909	.0364	.1230	.644	-	-	1342	3.687	B
-6B4	.1909	.0364	.1232	.645	1 155	3.173	1 338	3.676	B
		Average	.1229	.644		3.319		3.690	
421253-6B1	.1911	.0365	.1560	.816	1 290	3.534	1 360	3.726	B
-6B2	.1911	.0365	.1566	.820	1 313	3.597	1 410	3.863	B
-6B3	.1911	.0365	.1567	.820	1 265	3.466	1 340	3.671	B
-6B4	.1911	.0365	.1560	.816	-	-	1 390	8.8c8	B
		Average	.1563	.818		3.532		3.767	

Notes: (1) Load determined at the permanent set of 0.04D.
(2) A = Bearing deformation of hole followed by shear-tension failure of countersunk head.
B = Shear of rivets.

TABLE 23

COMPUTATION OF t/D AND P/D^2 FROM BASIC DATA— 3/8 IN. DIA. RIVETS

Second Step of Aging : 8 Hrs. at 350° F

Sheet : Alclad 2024-T3, T351

Test Specimen No.	Hole Dia., D, in.	D^2 , sq. in.	Sheet Thick., t, in.	t/D	Yield Load, P_y , ⁽¹⁾ lb/Fastener	$\frac{P_y}{10^4 D^2}$	Ultimate Load, P_u , lb/Fastener	$\frac{P_u}{10^4 D^2}$	Type of Failure ⁽²⁾
421253-12B1	.3878	.1504	.1561	.403	3 550	2.360	4 905	3.261	A
-12B2	.3878	.1504	.1560	.402	3 474	2.277	4 800	3.191	A
-12B3	.3878	.1504	.1562	.403	3 505	2.330	4 905	3.261	A
		Average	.1561	.403		2.322		3.238	
421271-12B1	.3879	.1505	.1790	.462	4 250	2.824	5 150	3.422	A
-12B2	.3879	.1505	.1793	.462	4 025	2.674	5 250	3.488	A
-12B3	.3879	.1505	.1795	.463	3 905	2.595	5 175	3.439	A
-12B4	.3879	.1505	.1801	.464	-	-	5 325	3.538	A
		Average	.1795	.463		2.698		3.472	
421272A-12B1	.3873	.1500	.2479	.640	4 875	3.250	5 700	3.800	B
-12B2	.3873	.1500	.2479	.640	4 650	3.100	5 625	3.750	B
-12B3	.3873	.1500	.2479	.640	4 655	3.103	5 550	3.700	B
-12B4	.3873	.1500	.2479	.640	4 705	3.137	5 625	3.750	B
		Average	.2479	.640		3.147		3.750	
421329-12	.3870	.1498	.3185	.823	4 940	3.298	5 705	3.808	B
-13	.3870	.1498	.3186	.823	4 850	3.238	5 735	3.828	B
-14	.3870	.1498	.3181	.822	4 760	3.178	5 655	3.775	B
		Average	.3184	.823		3.238		3.804	
421330-12B1	.3861	.1491	.3806	.986	4 925	3.303	5 540	3.716	B
-12B2	.3861	.1491	.3792	.982	5 025	3.370	5 595	3.753	B
-12B3	.3861	.1491	.3810	.987	5 000	3.353	5 650	3.789	B
		Average	.3803	.985		3.342		3.753	

Notes: (1) Load determined at the permanent set of 0.04D.

(2) A - Bearing deformation of hole followed by shear-tension failure of countersunk head.

B - Shear of rivets.

TABLE 24
COMPUTATION OF t/D AND P/D² FROM BASIC DATA— 3/32 IN. DIA. RIVETS

Second Step of Aging : 8 Hrs. at 355°F

Sheet : Alclad 2024-T3

Test Specimen No.	Hole Dia., D, in.	D ² , sq. in.	Sheet Thick., t, in.	t/D	Yield Load, P _y , ⁽¹⁾ lb/Fastener	$\frac{P_y}{10^4 D^2}$	Ultimate Load, P _u , lb/Fastener	$\frac{P_u}{10^4 D^2}$	Type of Failure ⁽²⁾
420967-3C1	.0988	.0098	.0403	.408	166	1.684	315	3.214	A
	-3C2	.0988	.0098	.0404	175	1.786	334	3.408	A
	-3C3	.0988	.0098	.0402	141	1.439	-	-	A
	-3C4	.0988	.0098	.0402	-	-	311	3.173	A
	-3C5	.0988	.0098	.0404	.409	-	309	3.153	A
		Average	.0403	.408		1.643		3.235	
12-040-C-1(3)	.0946	.0090	.0402	.425	170	1.889	267	2.967	A
	-2	.0946	.0090	.0402	174	1.933	280	3.111	A
	-3	.0946	.0090	.0402	185	2.056	270	3.000	A
		Average	.0402	.425		1.956		3.022	
420968-3C1	.0987	.0097	.0520	.527	250	2.577	350	3.608	A
	-3C2	.0987	.0097	.0520	250	2.577	360	3.711	A
	-3C3	.0987	.0097	.0521	265	2.732	355	3.660	A
	-3C4	.0987	.0097	.0519	220	2.268	341	3.515	A
	-3C5	.0987	.0097	.0521	.528	191	1.969	337	3.412
		Average	.0520	.527		2.423		3.577	
3-050-C-1(3)	.0944	.0089	.0515	.546	244	2.742	318	3.573	A
	-2	.0944	.0089	.0517	253	2.843	322	3.618	A
	-3	.0944	.0089	.0515	242	2.719	318	3.573	A
		Average	.0516	.546		2.764		3.588	
420976-3C1	.0981	.0096	.0700	.714	344	3.583	389	4.052	B
	-3C2	.0981	.0096	.0694	314	3.271	392	4.083	B
	-3C3	.0981	.0096	.0694	347	3.615	378	3.938	B
	-3C4	.0981	.0096	.0700	.714	254	2.645	384	4.000
		Average	.0697	.711		3.271		4.021	
3-070-C-1(3)	.0949	.0090	.0690	.727	317	3.522	341	3.788	B
	-2	.0949	.0090	.0690	325	3.611	342	3.800	B
	-3	.0949	.0090	.0689	327	3.633	344	3.822	B
		Average	.0690	.727		3.599		3.800	
420969-3C1	.0980	.0096	.0793	.809	339	3.531	370	3.854	B
	-3C2	.0980	.0096	.0798	345	3.594	372	3.875	B
	-3C3	.0980	.0096	.0791	347	3.615	378	3.938	B
		Average	.0794	.810		3.583		3.885	
420970-3C1	.0976	.0095	.0923	.946	309	3.253	362	3.811	B
	-3C2	.0976	.0095	.0922	333	3.505	367	3.863	B
	-3C3	.0976	.0095	.0920	321	3.379	365	3.842	B
		Average	.0922	.945		3.379		3.842	

- Notes: (1) Load determined at the permanent set of 0.04D.
(2) A = Bearing deformation of hole followed by shear-tension failure of countersunk head.
B = Shear of rivets.
(3) These specimens prepared and tested at Battelle.

TABLE 25
COMPUTATION OF t/D AND P/D² FROM BASIC DATA— 3/16 IN. DIA. RIVETS

Second Step of Aging : 8 Hrs. at 355°F

Sheet : Alclad 2024-T3

Test Specimen No.	Hole Dia., D, in.	D ² , sq. in.	Sheet Thick., t, in.	t/D	Yield Load, P _y (¹) lb/ Fastener	P _y / 10 ⁴ D ²	Ultimate Load, P _u , lb/Fastener	P _u / 10 ⁴ D ²	Type of Failure (²)
420976-6C1	.1918	.0368	.0698	.364	786	2.136	1 371	3.726	A
-6C2	.1918	.0368	.0699	.364	788	2.141	1 330	3.614	A
-6C3	.1918	.0368	.0696	.363	788	2.141	1 305	3.546	A
		Average	.0698	.364		2.139		3.628	
6-070-C-1(3)	.1886	.0356	.0692	.367	645	1.812	1 115	3.132	A
-2	.1886	.0356	.0695	.369	655	1.840	1 065	2.992	A
-3	.1886	.0356	.0692	.367	740	2.079	1 040	2.921	A
-4	.1886	.0356	.0693	.367	700	1.966	1 090	3.062	A
		Average	.0693	.367		1.924		3.025	
420970-6C1	.1912	.0366	.0924	.483	870	2.377	1 275	3.484	A
-6C2	.1912	.0366	.0925	.484	900	2.459	1 238	3.383	A
-6C3	.1912	.0366	.0922	.482	970	2.650	1 300	3.552	A
		Average	.0924	.483		2.495		3.473	
6-090-C-1(3)	.1889	.0357	.0920	.487	825	2.311	1 205	3.375	A
-2	.1889	.0357	.0915	.484	875	2.451	1 140	3.193	A
-3	.1889	.0357	.0916	.485	885	2.479	1 155	3.235	A
		Average	.0917	.485		2.415		3.269	
420971-6C1	.1909	.0364	.1232	.645	1 238	3.401	1 350	3.709	B
-6C2	.1909	.0364	.1226	.647	1 238	3.401	1 350	3.709	B
-6C3	.1909	.0364	.1233	.646	1 250	3.434	1 388	3.813	B
		Average	.1230	.644		3.412		3.745	
421253-6C1	.1911	.0365	.1559	.816	1 270	3.479	1 363	3.734	B
-6C2	.1911	.0365	.1560	.816	1 285	3.521	1 360	3.721	B
-6C3	.1911	.0365	.1563	.818	1 280	3.507	1 360	3.721	B
		Average	.1561	.817		3.501		3.729	

- Notes: (1) Load determined at the permanent set of 0.04D.
(2) A = Bearing deformation of hole followed by shear-tension failure of countersunk head.
B = Shear of rivets.
(3) These specimens prepared and tested at Battelle.

TABLE 26
COMPUTATION OF t/D AND P/D² FROM BASIC DATA— 3/8 IN. DIA. RIVETS

Second Step of Aging : 8 Hrs. at 355°F

Sheet : Alclad 2024-T3 , T351

Test Specimen No.	Hole Dia., D, in.	D, ² sq. in.	Sheet Thick., t, in.	t/D	Yield Load, P _y (¹) lb/ Fastener	$\frac{P_y}{10^4 D^2}$	Ultimate Load, P _u , lb/Fastener	$\frac{P_u}{10^4 D^2}$	Type of Failure (²)
421253-12C1	.3878	.1504	.1559	.402	3 475	2.311	5 030	3.344	A
-12C2	.3878	.1504	.1561	.403	3 650	2.427	5 130	3.411	A
-12C3	.3878	.1504	.1561	.403	3 675	2.443	5 110	3.398	A
		Average	.1560	.403		2.394		3.384	
12-160-C-5(³)	.3862	.1492	.1562	.404	2 975	1.994	4 520	3.029	A
-6	.3862	.1492	.1558	.403	2 979	1.997	4 413	2.958	A
-7	.3862	.1492	.1560	.404	3 080	2.064	4 260	2.855	A
		Average	.1560	.404		2.018		2.948	
421271-12C1	.3879	.1505	.1797	.463	4 300	2.857	5 155	3.425	A
-12C2	.3879	.1505	.1795	.463	4 150	2.757	5 200	3.455	A
-12C3	.3879	.1505	.1793	.462	3 975	2.641	5 100	3.389	A
		Average	.1795	.463		2.686		3.423	
12-180-C-4(³)	.3863	.1492	.1795	.464	3 620	2.426	4 820	3.231	A
-5	.3863	.1492	.1797	.465	3 530	2.369	4 940	3.311	A
-6	.3863	.1492	.1797	.465	3 610	2.420	4 925	3.301	A
		Average	.1796	.465		2.405		3.281	
421272A-12C1	.3873	.1500	.2479	.640	4 610	3.073	5 525	3.683	B
-12C2	.3873	.1500	.2479	.640	4 650	3.100	5 525	3.683	B
-12C3	.3873	.1500	.2480	.640	4 705	3.137	5 575	3.717	B
		Average	.2479	.640		3.093		3.695	
421329-12C1	.3870	.1498	.3186	.823	4 725	3.154	5 575	3.722	B
-12C2	.3870	.1498	.3184	.823	4 805	3.208	5 545	3.702	B
-12C3	.3870	.1498	.3184	.823	4 510	3.011	5 540	3.698	B
		Average	.3185	.823		3.124		3.707	
421330-12C1	.3861	.1491	.3803	.985	5 005	3.357	5 545	3.719	B
-12C2	.3861	.1491	.3802	.985	4 960	3.327	5 575	3.739	B
-12C3	.3861	.1491	.3806	.986	4 990	3.347	5 550	3.722	B
		Average	.3804	.986		3.343		3.727	

- Notes: (1) Load determined at the permanent set of 0.04D.
(2) A = Bearing deformation of hole followed by shear-tension failure of countersunk head.
B = Shear of rivets.
(3) These specimens prepared and tested at Battelle.

TABLE 27

AVERAGE SHEAR STRENGTH OF DRIVEN 7050-T7X RIVETS

2nd Step of Aging, 8 hrs. at.	Average Shear Strength, ⁽¹⁾ ksi		
	Rivet Diameter, in.		
	<u>3/32</u>	<u>3/16</u>	<u>3/32</u>
345°F	52.6	50.1	50.2
350°F	50.0	47.4	48.0
355°F	50.0	47.5	47.2

Note: (1) From static tests of lap joints of the type shown in Fig. 18 prepared from Alclad 2024-T3 sheet and Alclad 2024-T351 plate. Ratio of sheet or plate thickness (t) to rivet diameter (D) was 0.64 and above. Average values are for tests of at least 7 specimens (14 rivets). Shear areas were based on measured hole diameter.

TABLE 28

COMPARISON OF SHEAR STRENGTHS OF 2024-T31
AND 7050-T7X DRIVEN RIVETS(1)

2nd Step of Aging, 8 hrs. at	Rivet Diameter, in.		
	<u>3/32</u>	<u>3/16</u>	<u>3/8</u>
345°F	1.28	1.22	1.22
350°F	1.22	1.16	1.17
355°F	1.22	1.16	1.15

Notes: (1) The average shear strength determined for the 7050-T7X rivets (see Table 27) divided by 41 ksi, the B-value shear strength for 2024-T31 rivets in MIL-HDBK-5.

TABLE 29

COMPARISON OF DRIVEN AND UNDRIVEN SHEAR
STRENGTHS FOR 7050-T7X RIVETS(1)

2nd Step of Aging, 8 hrs. at	Rivet Diameter, in.		
	<u>3/32</u>	<u>3/16</u>	<u>3/8</u>
345°F	1.16	1.06	1.08
350°F	1.13	1.07	1.08
355°F	1.17	1.07	1.07

Notes: (1) The average driven rivet shear strength (see Table 27) divided by the average undriven rivet shear strength (see Table 15).

TABLE 30

AVERAGE DRIVING PRESSURES REQUIRED TO FORM 1.5D
DIAMETER X 0.5D THICK FLAT HEADS ON 7050-T7X RIVETS

2nd Step of Aging, 8 hrs. at	Average Driving Pressure, lb.		
	Rivet Diameter, D, in.		
	<u>3/32</u>	<u>3/16</u>	<u>3/8</u>
345°F	1 550	6 100	25 000(1)
350°F	1 500	5 800	24 000
355°F	1 450	5 650	23 500
2024-T31(2)		5 500	

- Notes: (1) Shear cracks occurred.
(2) These rivets were solution heat treated for 20 minutes at 920°F, immediately cold-water quenched and driven within 20 minutes (in the "freshly" quenched condition).

TABLE 31

LARGEST SIZE FLAT HEAD FORMED WITHOUT SHEAR CRACKS⁽¹⁾

2nd Step of Aging, 8 hrs. at	Rivet Diameter, D,		
	<u>3/32</u>	<u>1/16</u> 1n.	<u>3/8</u>
345°F	1.61	1.55	1.43
350°F	1.65	1.59	1.49 ⁽²⁾
355°F	1.64	1.64	1.54

- Notes: (1) The average measured flat head diameter divided by the nominal rivet diameter (D). Shank protrusion was sufficient, in each case, to fill the rivet hole and to form a 1.5D diameter x 0.5D thick flat head. MIL-R-5674C requires minimum 1.4D diameter and minimum 0.3D thickness.
- (2) Flat head diameters up to 1.56D formed without shear cracks.

TABLE 32

TENSILE PROPERTIES OF 0.090-IN. THICK 2024-T3 SHEET
USED FOR LAP-JOINT FATIGUE SPECIMENS(1)

Specimen Number	Tensile Strength, ksi	Yield Strength, ksi	Elongation in 2 in., %
420963-L1	71.3	53.9	17.5
-L2	71.1	53.6	17.8
-L3	<u>71.2</u>	<u>53.4</u>	<u>18.5</u>
Avg.	71.2	53.6	17.7
Minimum(2)	64	47	15
Typical(3)	70	50	18

- Notes: (1) Standard 1/2-in. sheet-type tensile specimens taken in the direction of rolling (longitudinal).
- (2) Minimum longitudinal tensile properties (A values) published in MIL-HDBK-5.
- (3) Typical tensile properties published in the Aluminum Association's "Aluminum Standards and Data, 1974-1975".

TABLE 33

FATIGUE TEST PROGRAM FOR LAP JOINTS CONTAINING
3/16-IN. DIAMETER 2024-T31 AND 7075-T7X RIVETS

Type of Test	Location of Test	Load Level, (1) lb.	Percent of Static Failure Load(2)	No. of Tests		Avg. Shear Stress on Rivets, psi	Tensile Stress on Net Section Area, psi
				7050 Rivets	2024 Rivets		
Static	Alcoa	4,980 ⁽³⁾	100	2	2	43,500	56,000
Fatigue	Alcoa	3340	67	3	-	29,100	37,500
	Battelle	3340	67	3	3	29,100	37,500
Fatigue	Alcoa	2490	50	3	3	21,700	28,000
	Battelle	2490	50	3	3	21,700	28,000
Fatigue	Alcoa	1490	30	3	-	13,000	16,700
	Battelle	1490	30	3	3	13,000	16,700
Fatigue	Alcoa	A		3	3		
	Battelle	A		3	-		
Fatigue	Alcoa	B		3	3		
	Battelle	B		3	-		

Notes: (1) A = Load level chosen which does not cause failure at less than 3,000,000 cycles.

B = Load level "as-necessary" to establish S-N curve. Will be mutually agreeable between Alcoa and Battelle.

(2) As specified in MIL-STD-1312, Proposed Test No. 21.

(3) Average load for two tests to fail lap-joints containing 7050 rivets. Lap-joints made of 0.090-in. thick 2024-T3 sheet (see Figure 36).

TABLE 34

LAP-SHEAR FATIGUE TEST RESULTS

Max. Load Level, lbs.	Percent of Static Failure Load	Alcoa Tests (a)			Battelle Tests (b)				
		7050-T7X Rivets Spec. No.	Cycles to Failure	2024-T31 Rivets Spec. No.	7050-T7X Rivets Spec. No.	Cycles to Failure	2024-T31 Rivets Spec. No.	Cycles to Failure	
3340	67	BF2	12,800		BF24	7,600	F17	14,300	
		BF7	11,800		BF12	8,900	F19	17,600	
		BF16	10,700		BF11	8,700	F3	13,600	
2490	50	BF10	33,200	F2	226,000	BF34	34,500	F22	94,000
		BF22	36,400	F8	139,900	BF35	30,500	F20	87,200
		BF25	34,600	F6(c)	147,900	BF5	31,000	F4	102,800
				F13(c)	125,400				
				F18(b,c)	228,700				
1490	30	BF8	99,600	F7	1,321,700	BF28	111,200	F5	865,000
		BF17	208,500	F10	16,046,300(d)	BF6	142,500	F15	1,111,100
		BF29	241,800	F14	1,984,400	BF15	115,500	F16	585,000
				F12	23,391,300(g)				
				F12(e)	319,100				
				F11(e)	389,200				
				F9(b,e)	316,400				
1400	28			F18	17,352,700(f)				
1250	25	BF9	151,700	F13	15,002,800(f)				
		BF26	187,700						
1150	23			F6	18,564,900(f)				
1000	20	BF4	3,524,000			BF19	523,600		
		BF27	2,130,800			BF21	893,500		
		BF30	714,100			BF14	562,000		
946	19	BF18	799,800						
890	18	BF3	16,232,200			BF31	1,228,800		
800	16					BF20	4,256,100		
						BF13	1,076,900		

(a) R, stress ratio = -0.05.

(b) R = 0.10.

(c) Previously stressed to lower load.

(d) Failure in non-countersunk sheet; all other failures in countersunk sheet.

(e) No restraint.

(f) No failure, load raised.

(g) No failure, restraint removed.

Table 35

SCOPE OF SCC TESTS ON DRIVEN RIVETS
 TRIPLICATE RIVETS IN TWO ENVIRONMENTS:
3.5% NaCl & SYNTHETIC SEA WATER - ALT. IMMERSION

I.	<u>As-Driven Assemblies</u>	276 Tests
	<u>A. 7050-T7X Rivets</u>	
	2 sizes	3/16 & 3/8 in.
	3 agings	8 hrs. at 245, 350, 355°F
	3 sheet alloys	2024-T3, 7075-T73 & Alc. 7075-T73
	2 periods	30 and 90 days
	<u>B. 2024-T31 Rivets</u>	36 Tests
	1 size	3/16 in.
	3 sheet alloys	2024-T3, 7075-T73 & Alc. 7075-T73
	2 periods	30 and 90 days
	<u>C. 7050-T6 Rivets</u>	24 Tests
	2 sizes	3/16 and 3/8 in.
	2 sheet alloys	2024-T3 & 7075-T73
	1 period	90 days
II.	<u>Heated Assemblies</u>	60 Tests
	<u>A. 7050-T7X Rivets</u>	
	2 sizes	3/16 & 3/8 in.
	1 aging	8 hrs. at 350°F
	2 heatings	72 hrs. at 300°F & 1/2 hr at 400°F
	2 sheet alloys	2024-T3 & 7075-T73
	1 period	90 days
	<u>B. 2024-T31 Rivets</u>	12 Tests
	1 size	3/16 in.
	2 heatings	72 hrs. at 300°F & 1/2 hr. at 400°F
	1 sheet alloy	2024-T3
	1 period	90 days

Table 36

RESULTS OF METALLOGRAPHIC EXAMINATION OF CORRODED, AS-DRIVEN RIVETS
 SCC = STRESS-CORROSION CRACKING DETECTED -- OK = NO EVIDENCE OF STRESS-CORROSION CRACKING (1)

Alloy	Rivet Size	Aging (2)	Sheet Alloy	3.5% NaCl-Alt. Imm.			Synthetic Sea Water-Alt. Imm.					
				30	50	65	30	50	65	90		
7050	3/8	8/345	2024	SCC	OK	OK	OK	OK	OK	--		
			7075	OK	OK	OK	OK	OK	OK	OK	--	
			A1C.7075	--	--	OK	OK	--	OK	OK	--	
7050	3/16	8/350	2024	OK	OK	OK	OK	OK	OK	--		
			7075	OK	OK	OK	OK	OK	OK	--		
			A1C.7075	--	--	OK	OK	--	OK	OK	--	
	8/355	2024	--	OK	OK	OK	OK	OK	OK	--		
		7075	--	OK	OK	OK	OK	OK	OK	--		
		A1C.7075	--	--	OK	OK	--	OK	OK	--		
7050	3/16	8/345	2024	OK	OK	OK	OK	OK	OK	--		
			7075	OK	OK (3)	OK	OK	OK	OK	OK	--	
			A1C.7075	--	--	OK	OK	--	OK	OK	--	
	8/350	2024	OK	OK	OK	OK	OK	OK	OK	--		
		7075	OK	OK	OK	OK	OK	OK	OK	--		
		A1C.7075	--	--	OK	OK	--	OK	OK	--		
7050	3/16	8/355	2024	--	OK	OK	OK	OK	OK	--		
			7075	--	OK	OK	OK	OK	OK	--		
			A1C.7075	--	--	OK	OK	--	OK	OK	--	
	2024	3/16	8/350	2024	OK	OK	OK	OK	OK	OK	OK	
				7075	OK	OK	OK	OK	OK	OK	OK	OK
				A1C.7075	--	--	OK	OK	--	OK	OK	OK
7050	3/8	2/350	2024	SCC	SCC	SCC	SCC	SCC	SCC	--		
			7075	SCC	SCC	SCC	SCC	SCC	SCC	SCC	--	
			A1C.7075	--	--	OK	OK	--	OK	OK	--	
	3/16	2/350	2024	SCC	SCC	SCC	SCC	SCC	SCC	SCC	--	
			7075	SCC	SCC	SCC	SCC	SCC	SCC	SCC	SCC	--
			A1C.7075	--	--	OK	OK	--	OK	OK	--	

Notes: (1) Dashes indicate no examination made.
 (2) Hrs/°F of second step aging, first step age was 4 hrs. at 250°F.
 (3) Some intergranular attack at a site of severe corrosion at fillet of the driven head.

Table 37

RESULTS OF METALLOGRAPHIC EXAMINATION OF CORRODED RIVETS FROM ASSEMBLIES
 THAT WERE HEATED AFTER DRIVING BUT PRIOR TO EXPOSURE
 SCC = STRESS-CORROSION CRACKING DETECTED -- OK = NO EVIDENCE OF STRESS-CORROSION CRACKING

Rivet Alloy	Rivet Size	Sheet Alloy	Heating Hrs/°F	3.5% NaCl-A.I.		Synthetic Sea Water - A.I.	
				Days Exposed 65	Days Exposed 90	Days Exposed 65	Days Exposed 90
7050-T7X (1)	3/8	2024	72/300	OK	OK	OK	OK
			0.5/400	OK	OK	OK	OK
7050-T7X (1)	3/16	2024	72/300	OK	OK	OK	OK
			0.5/400	OK	OK	OK	OK
2024-T31	3/16	2024	72/300	OK	OK	OK	OK
			0.5/400	OK	OK	OK	OK
2024-T31	3/16	2024	72/300	SCC	SCC	SCC	SCC
			0.5/400	SCC	SCC	SCC	SCC

Note: (1) Aged 4 hours at 250°F + 8 hours at 350°F.

Table A1

SCC TESTS OF 1.5 IN. 2124 PLATE STRESSED IN THE SHORT-
TRANSVERSE DIRECTION BY DRIVEN RIVETS - 36 TESTS

TRIPLICATE RIVETS, 90 DAY EXPOSURE TO 3.5% NaCl -
AI & SYNTHETIC SEA WATER - AI

<u>I.</u>	<u>7050-T7X Rivets</u>	24 Tests
	2 rivet sizes	3/16 & 3/8 in.
	1 rivet age	8 hrs. at 350°F
	2 plate tempers	
	A. low resistance (*):	T351
	B. high resistance (+):	T851
<u>II.</u>	<u>2024-T31 Rivets</u>	12 Tests
	1 rivet size	3/16 in.
	2 plate tempers	T351 & T851

(*) 1/8 in. tensile specimens failed in 4-13 days at 10 ksi stress.

(+) 1/8 in. tensile specimens survived 90 days at 32 ksi stress.

Table A2

RESULTS OF STRESS CORROSION TESTS ON 2124 PLATE CONTAINING RIVETS.
 HOOP STRESS FROM RIVETS ACTS IN THE LONGITUDINAL TO SHORT TRANSVERSE
 GRAIN DIRECTION

Plate Alloy	Rivet		SCC of Plate	
	Alloy (1)	Size - In.	3.5% NaCl - A. I.	Synthetic Sea Water - A. I.
2124-T351	2024-T31	3/16	Yes (2) (4)	Yes (3)
	7050-T7X	3/16	No-OK 45 days (4)	No- OK 90 days
	7050-T7X	3/8	No-OK 90 days	No- OK 90 days
2124-T851	2024-T31	3/16	No-CX 90 days	No- OK 90 days
	7050-T7X	3/16	No-OK 90 days	No- OK 90 days
	7050-T7X	3/8	No-OK 90 days	No- OK 90 days

Notes: (1) 7050-T7X rivets aged 4 hours at 250°F plus 8 hours at 350°F.

(2) Cracks caused by 2 of the 3 rivets, visible after 13 days.

(3) Crack caused by 1 of the 3 rivets, visible after 13 days.

(4) These two specimens were removed from test after 45 days for metallographic examination.

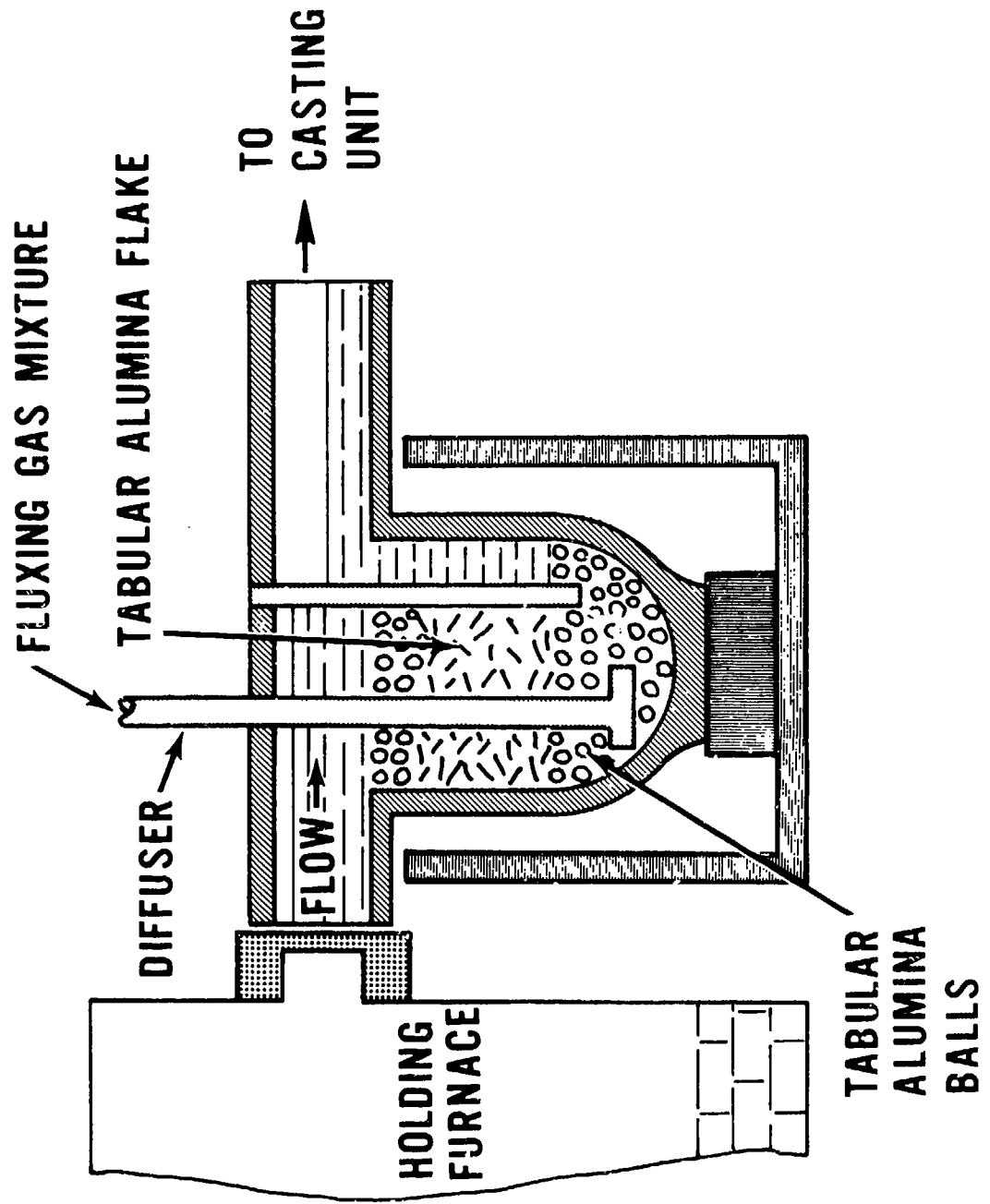

Figure 1 Alcoa 181 Process

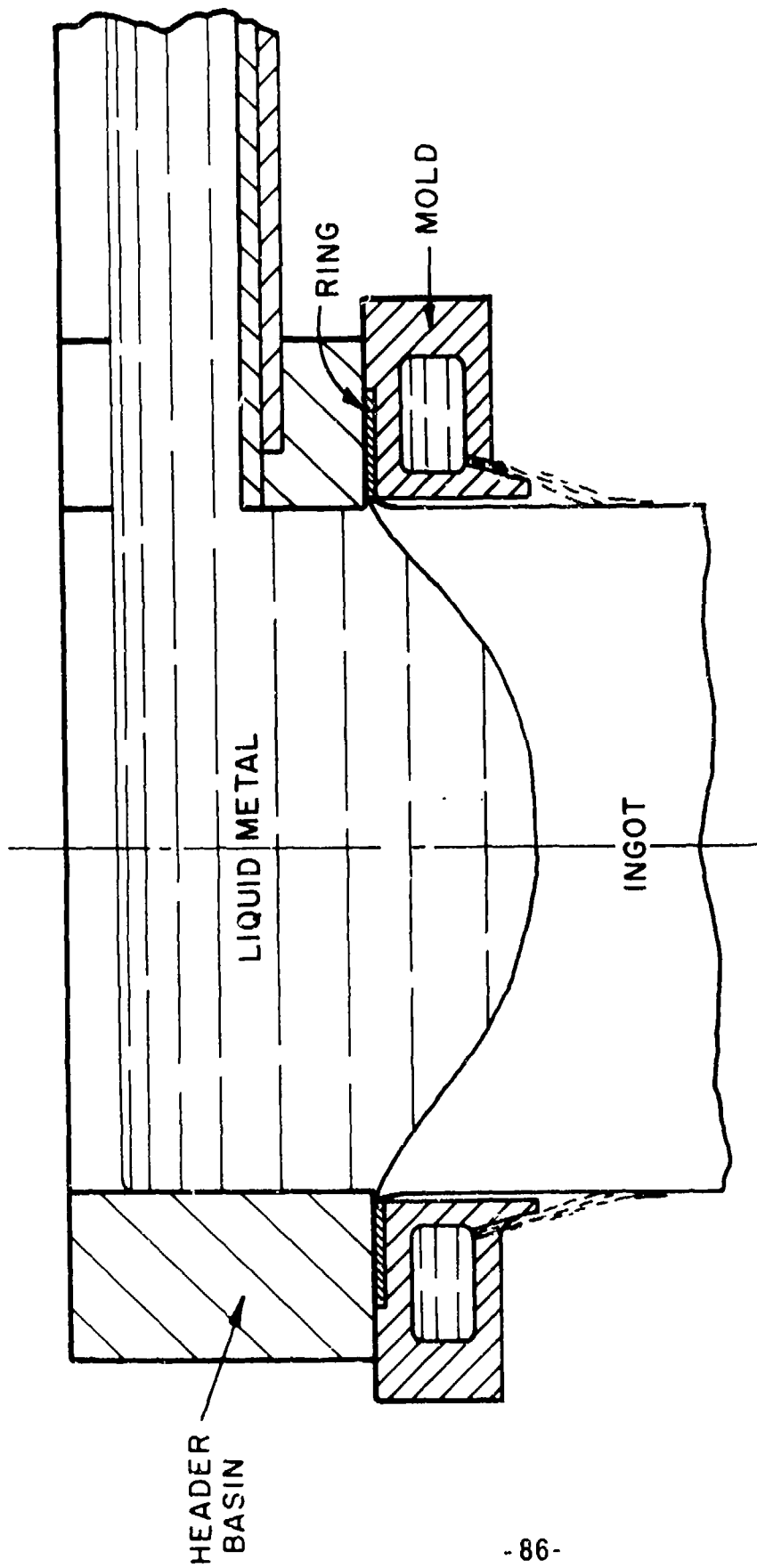
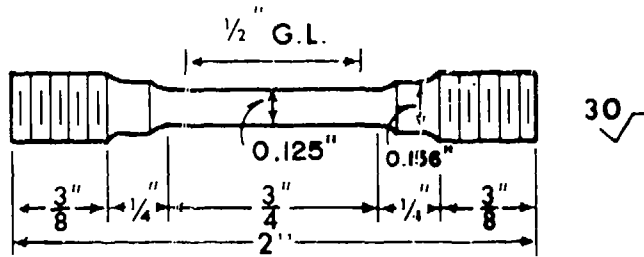
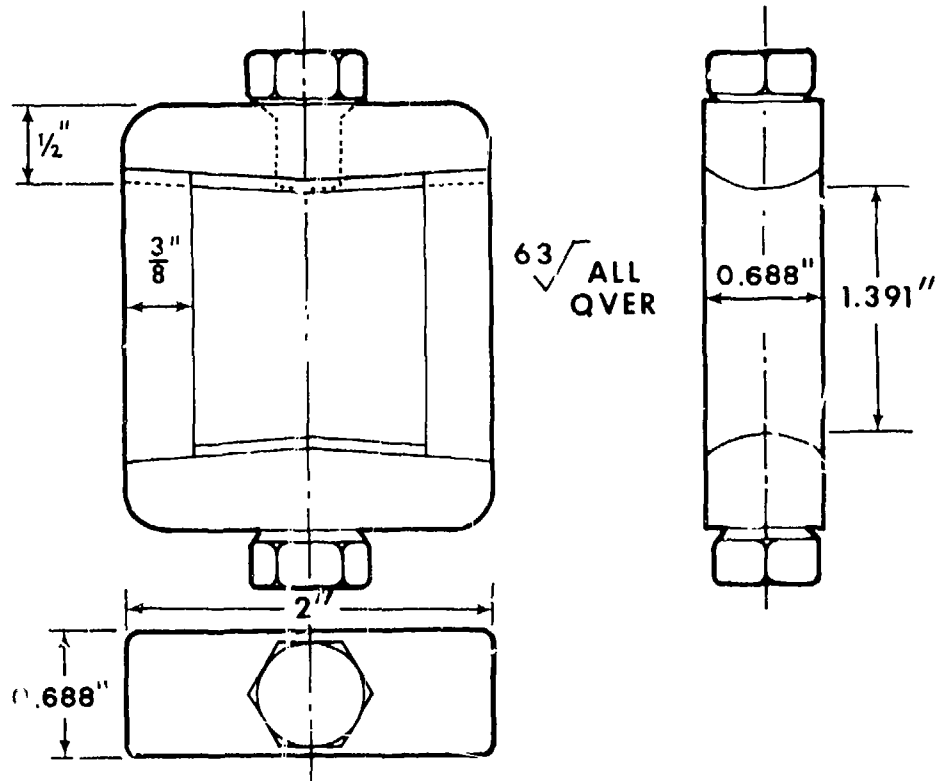

Figure 2 Alcoa Level Pour Mold



ROUND TENSION SPECIMEN



STRESSING FRAME

Figure 3 Sketch Showing Principal Dimensions of the SCC Round Tension Specimen and the Stressing Frame

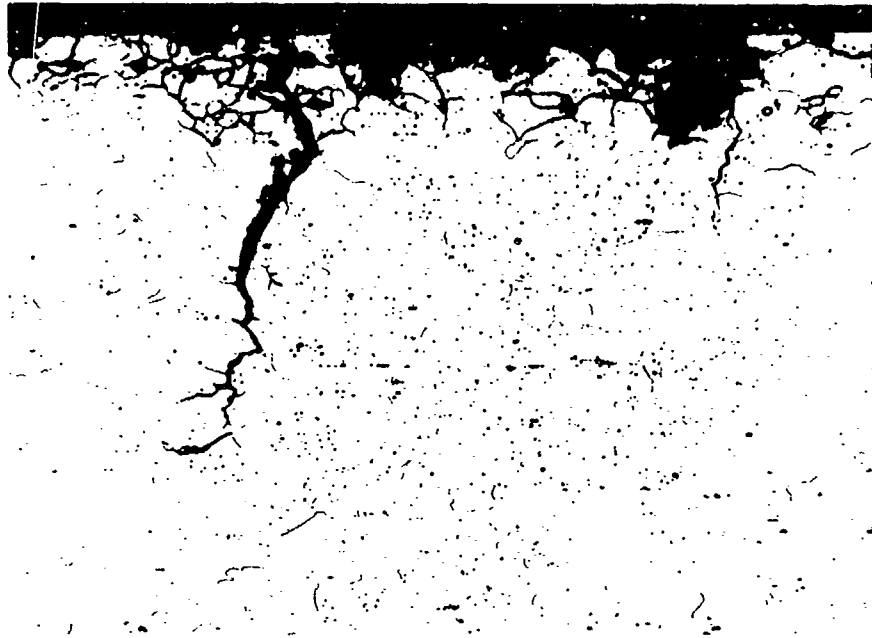

Figure 4A S. No. 420927-1-L4
Neg. 200035A

Mag: 100X
Keller's Etch

Section through tension specimen that failed after 51 days at a stress of 75% Y.S. showing intergranular corrosion of surface and two auxiliary cracks.

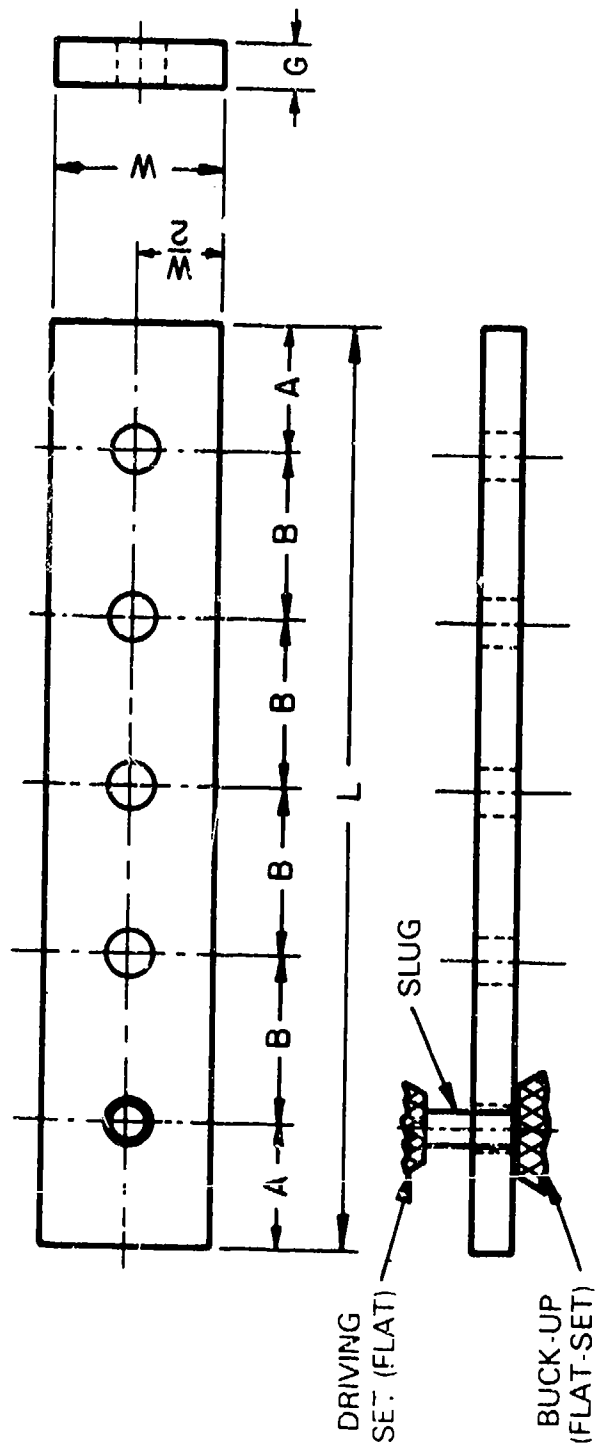

Figure 4B S. No. 420927-1-L4
Neg. 200036A

Mag: 500X
Keller's Etch

Higher magnification of the shorter auxiliary crack showing cracking is primarily transgranular and not typical of SCC.

Figure 4 Intergranular Corrosion in Tension Specimen
From 7050 Wire Aged 2 Hours at 350°F



ALL DIMENSIONS IN INCHES

SLUG DIAM.	HOLE DIAM.	GRIP	A	B	L	W
.092	3/32	3/32	3/16	3/8	1 7/8	3/8
.184	3/16	3/16	3/8	3/4	3 3/4	3/4
.184	3/16	9/32	3/8	3/4	3 3/4	3/4
.372	3/8	3/8	3/4	1 1/2	7 1/2	1 1/2

Figure 5 Driving and Hole-Fill Test Specimen

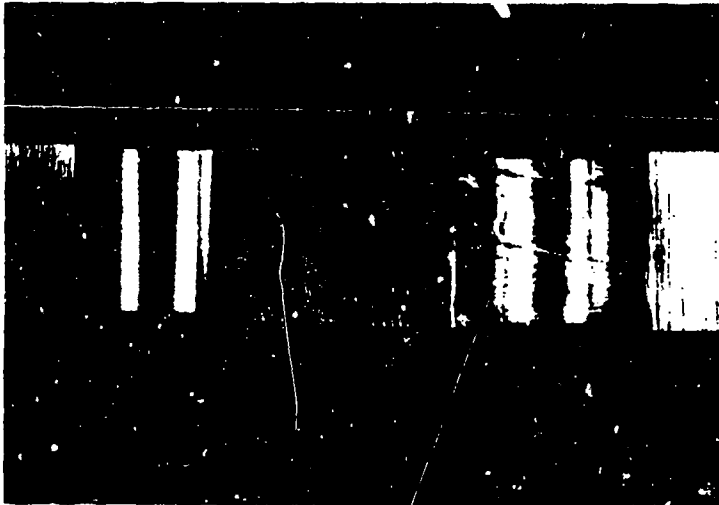
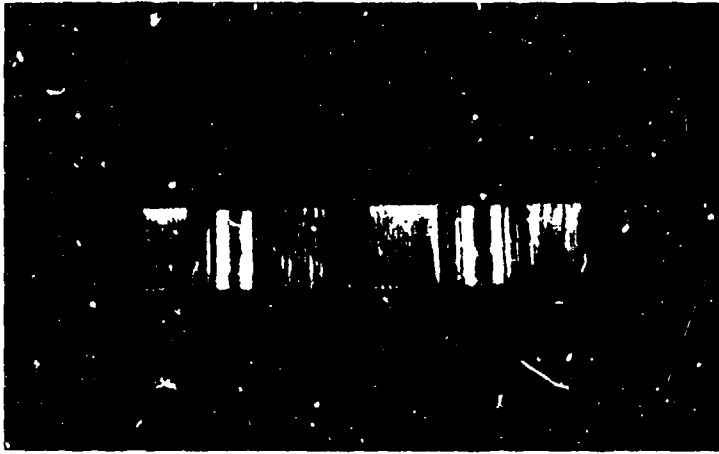
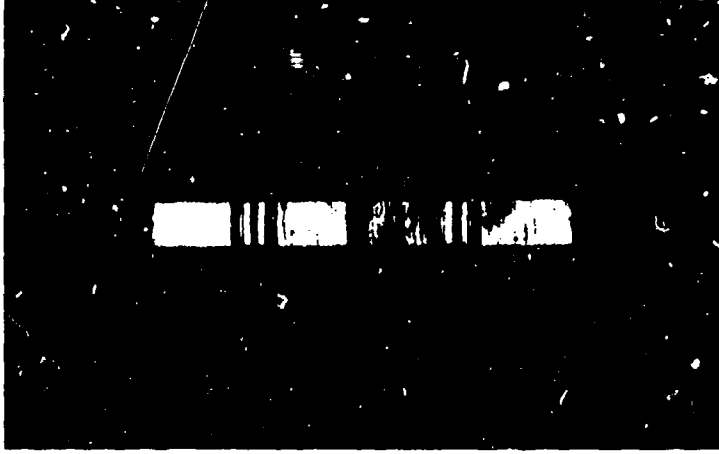

Plate: 0.375-in. 2024-T351
Hole: 3/8-in. Drill



Sheet: 0.190-in. 7075-T6
Hole: 3/16-in. Drill



Sheet: 0.090-in. 7075-T6
Hole: 3/32-in. Drill

Figure 6 Examples of "Good" Holes (Top) and "Poor" Holes (Bottom) Drilled
for Slug Driving Specimens

(Magnification: 3X)

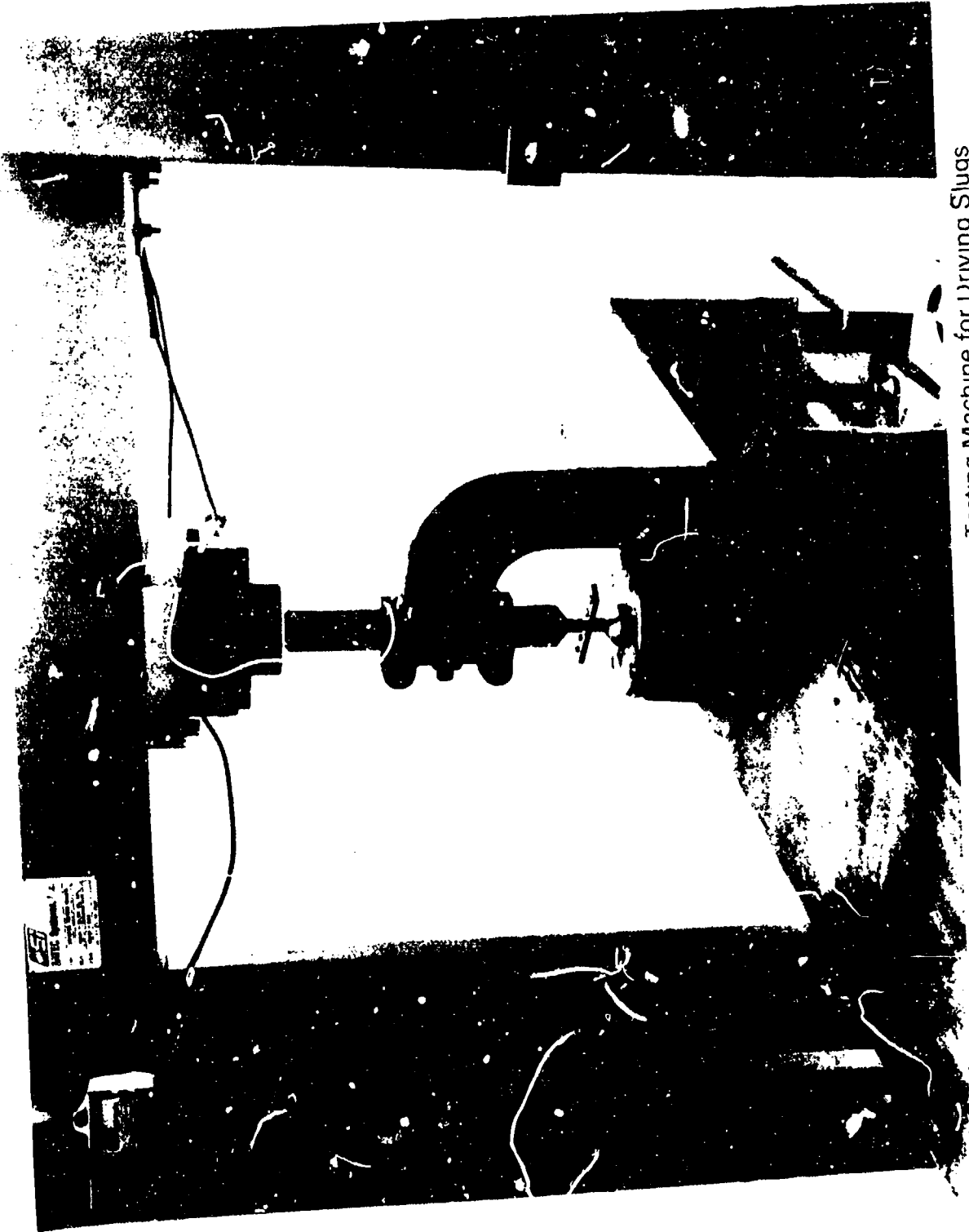

Figure 7 Photograph of Subpress Setup in Testing Machine for Driving Slugs



**Figure 8 Typical Driving Test Specimen After All Slugs Upset to Form Flat Heads
0.184-in. Diameter 7050 Slugs Driven in 0.190-in. 7075-T6 Sheet
(Magnification: 2.5X)**

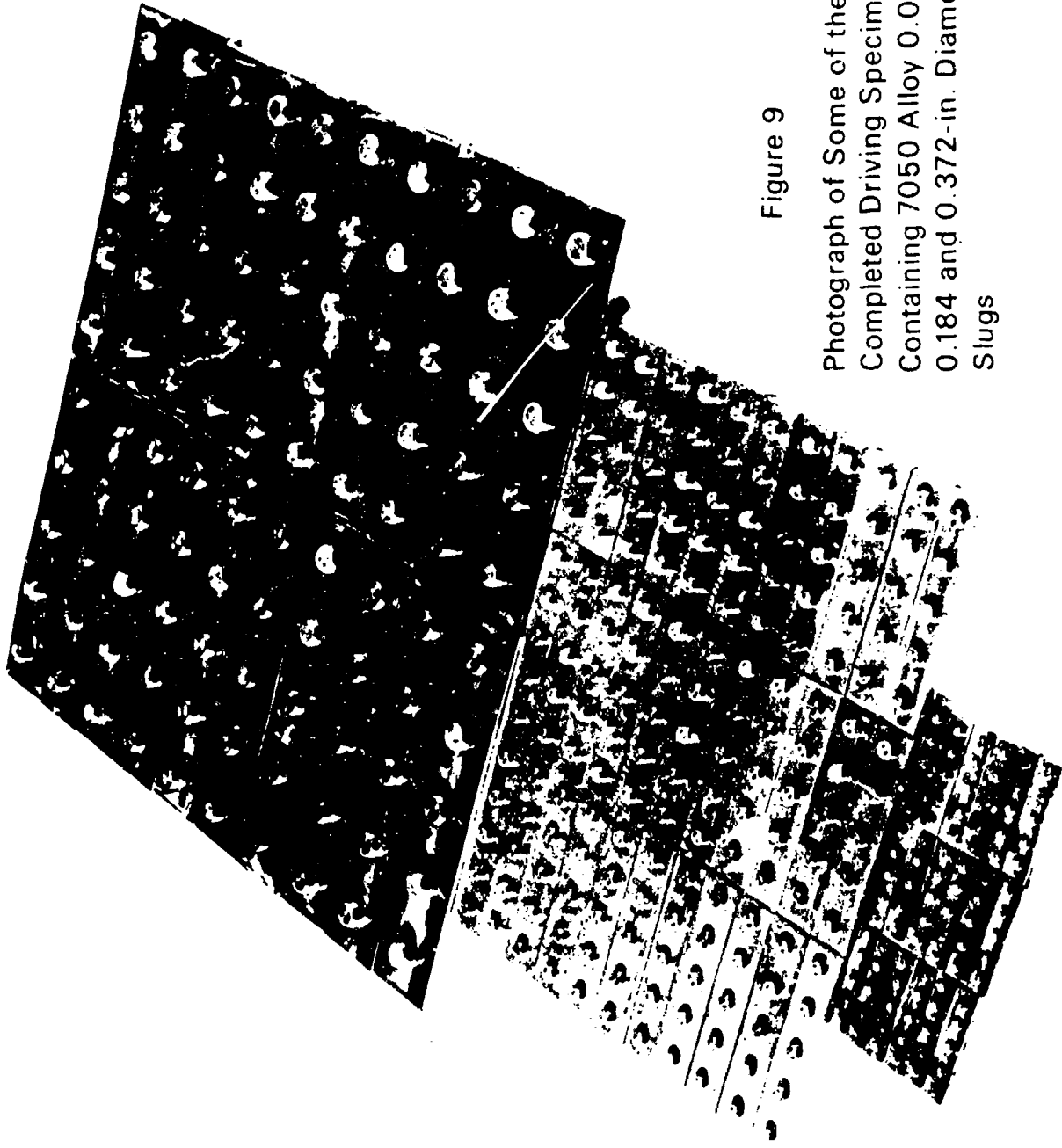

Figure 9

Photograph of Some of the
Completed Driving Specimens
Containing 7050 Alloy 0.092,
0.184 and 0.372-in. Diameter
Slugs

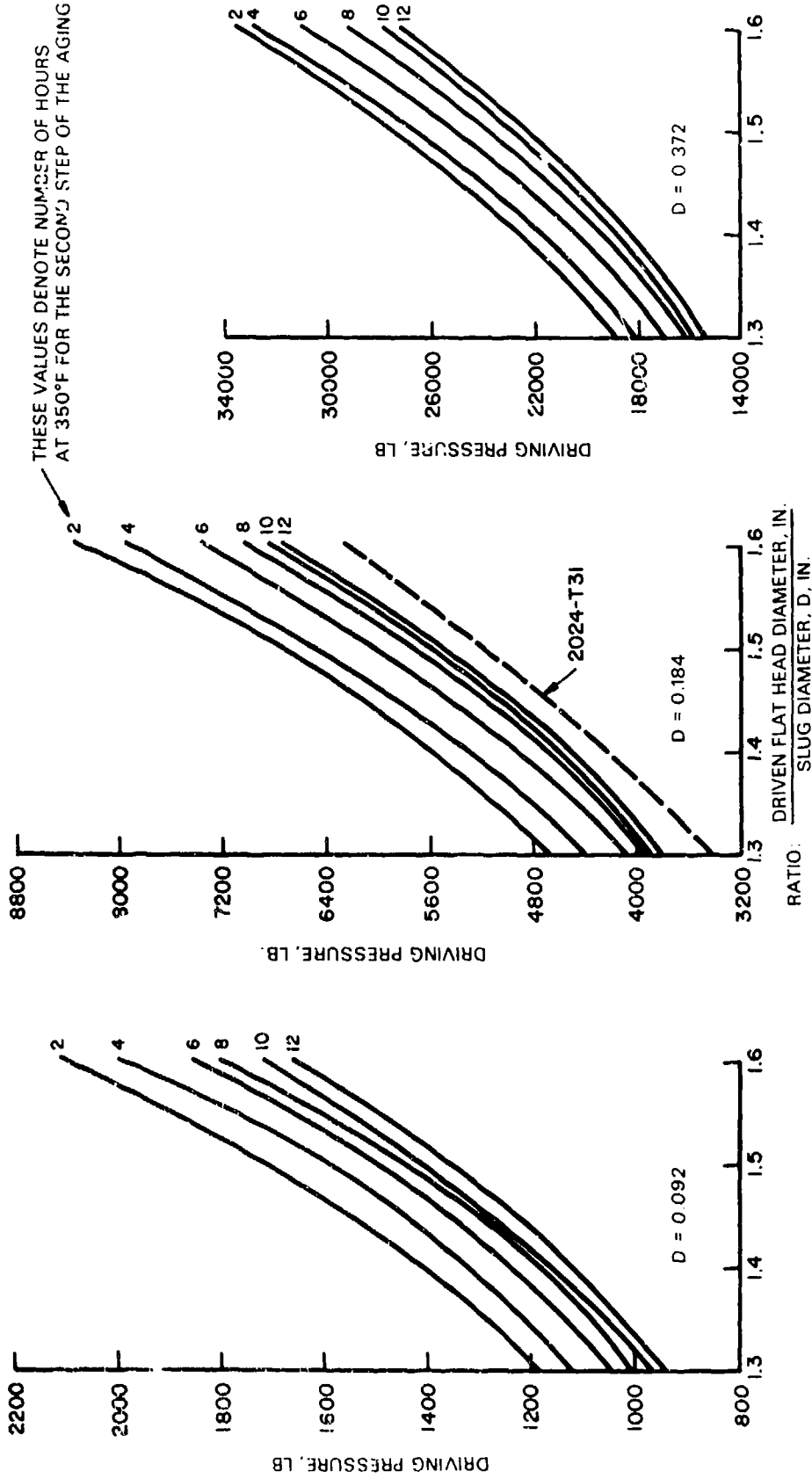

Figure 10 Driving Pressure versus Average Driven Flat Head Diameter Curves for 0.092, 0.184 and 0.372-in. Diameter 7050 Slugs Given Six Aging Practices.



Figure 11 Shear Crack in Driven Head of 7050 Alloy Slug

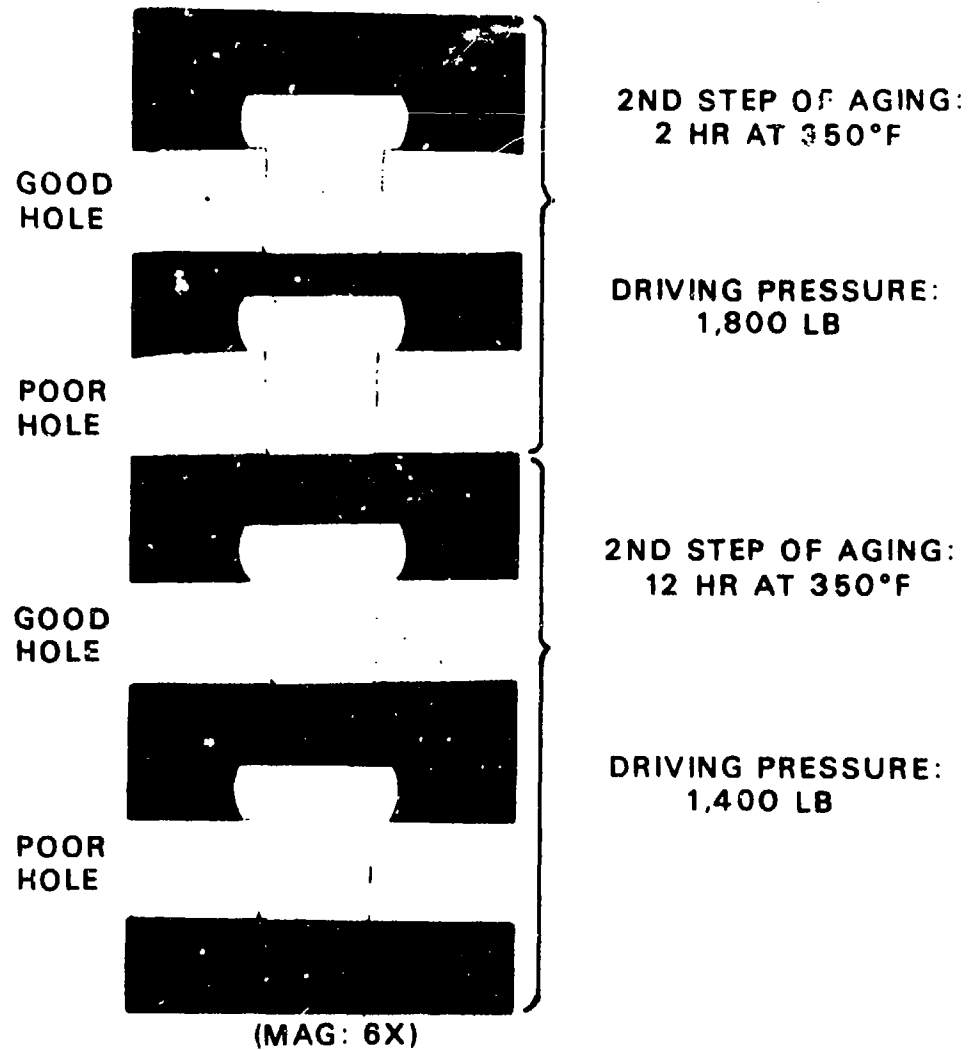

Figure 12 Photomicrographs of Sectioned 0.092-in. Diameter (D) 7050 Slugs Driven With 1.5D Flat Head in 0.090-in. 2024-T3 Sheet

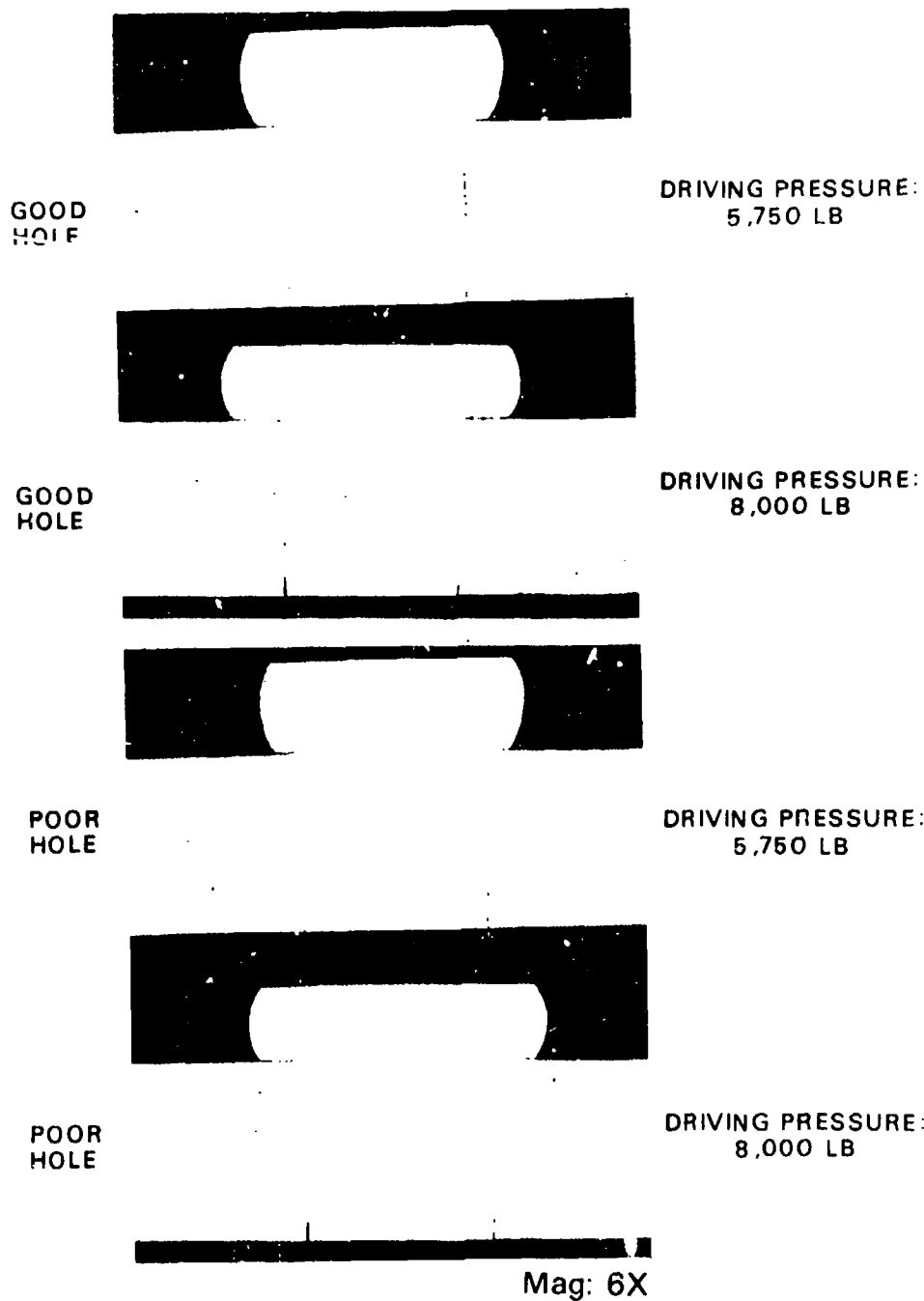

Figure 13 Photomicrographs of Sectioned 0.184-in. Diameter (D) 7050 Slugs Driven With 1.5D and 1.7D Diameter Flat Heads in 0.190-in. 7075-T6 Sheet.

Second Step Aging 8 Hrs. at 350°F

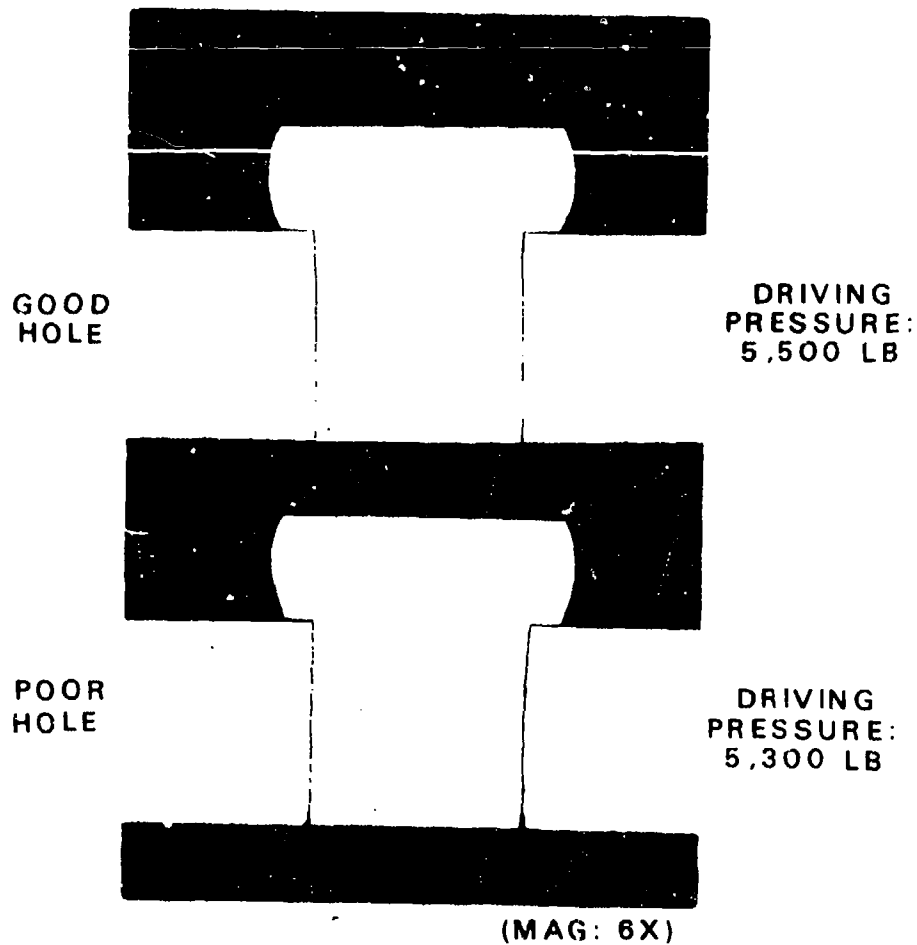

Figure 14 Photomicrographs of Sectioned 0.184-in. Diameter (D) 2024-T31 Slugs Driven (in the "Freshly" Quenched Condition) With 1.5D Diameter Flat Heads in 0.190-in. 2024-T3 Sheet



**GOOD
HOLE**

**DRIVING PRESSURE:
5,500 LB**



**POOR
HOLE**

**DRIVING PRESSURE:
5,500 LB**



(MAG: 6X)

**Figure 15 Photomicrographs of Sectioned 0.184-in. Diameter (D) 7050
Slugs Driven With 1.5D Diameter Flat Heads in Good-Poor
Holes in 0.281-in. 7075-T651 Plate
Second Step Aging: 12 Hrs. at 350°F**

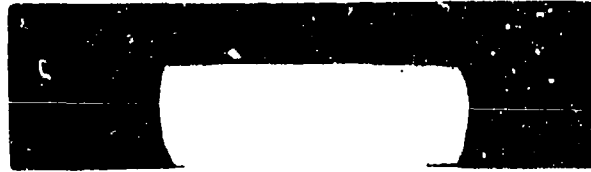

GOOD
HOLE

DRIVING
PRESSURE:
5,300 LB

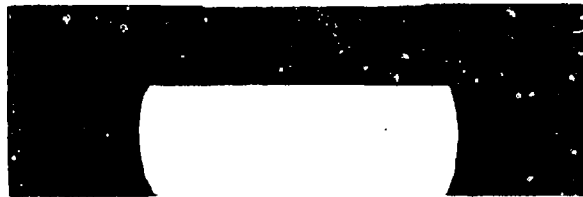

POOR
HOLE

DRIVING
PRESSURE:
5,200 LB



(MAG: 6X)

Figure 16 Photomicrographs of Sectioned 0.184-in. Diameter (D) 2024-T31 Slugs Driven (in the "Freshly" Quenched Condition) With 1.5D Diameter Flat Heads in 0.281-in. 7075-T651 Plate



GOOD
HOLE

DRIVING
PRESSURE:
24,000 LB

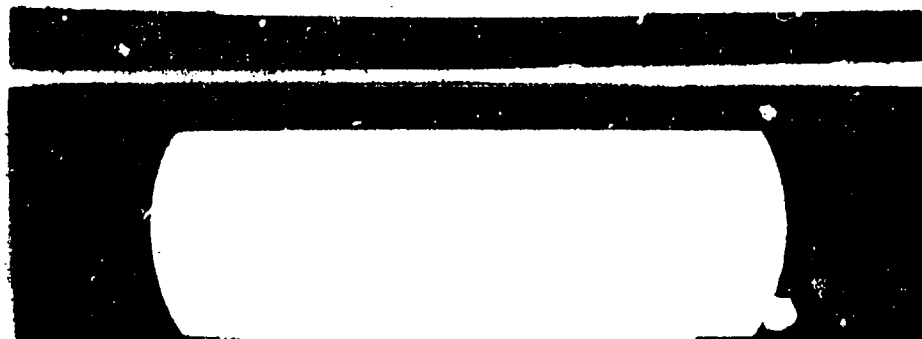

POOR
HOLE

DRIVING
PRESSURE:
24,000 LB

(MAG: 6X)

Figure 17 Photomicrographs of Sectioned 0.372-in. Diameter (D)
7050 Slugs Driven With 1.5D Diameter Flat Heads in
0.375-in. 7075-T6 Plate
2nd Step of Aging was 8 Hrs. at 350°F

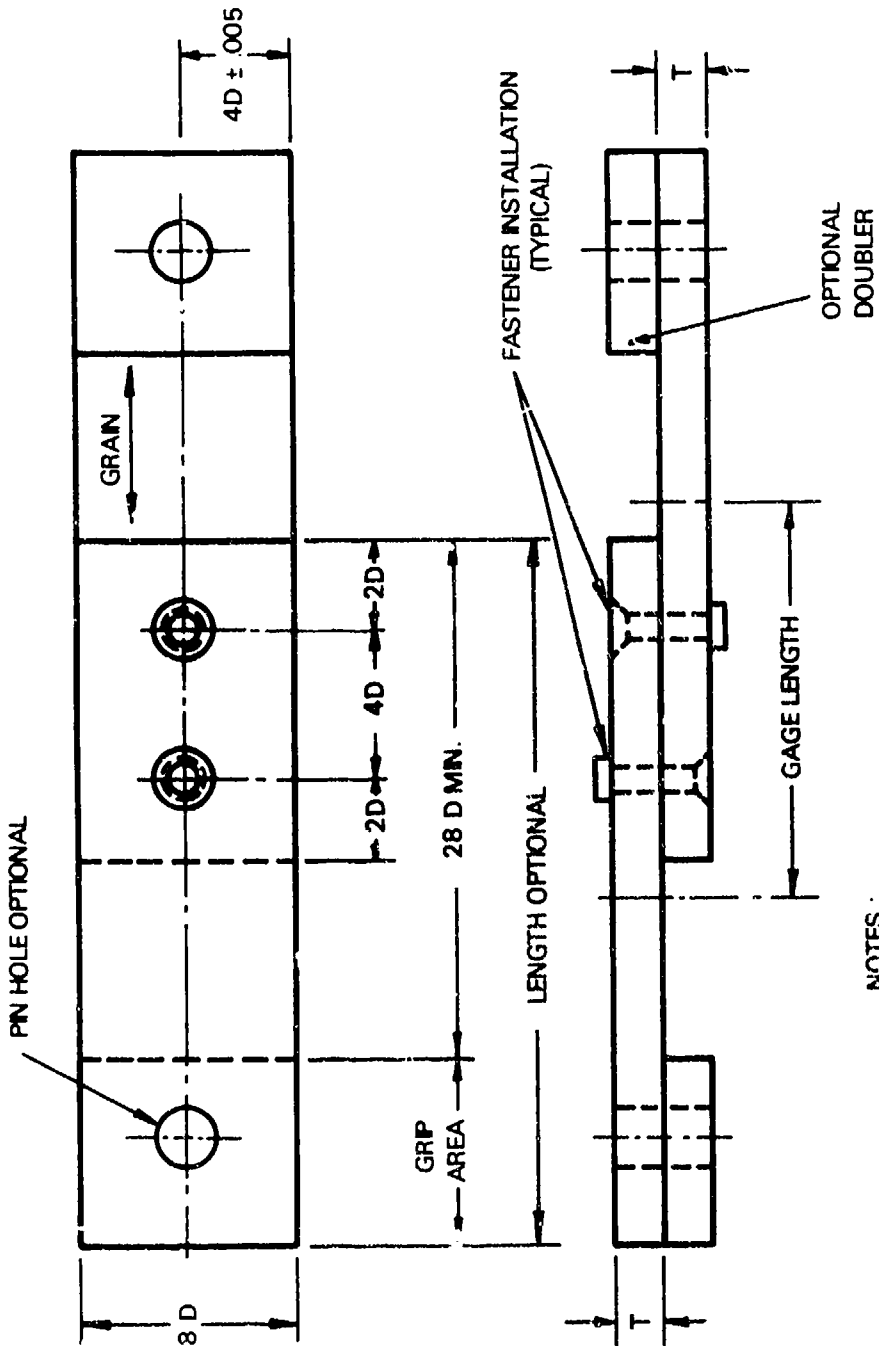

NOTES :

1. D = NOMINAL FASTENER DIAMETER
2. T = SHEET OR PLATE THICKNESS
3. FASTENER HOLES (SEE M.L. - STD - 1312)
4. TOLERANCE ON SPACING AND WIDTH ± 0.010
5. STANDARD EDGE DISTANCE = 2D

Figure 18 Preferred Test Lap Joint Specimen Configuration

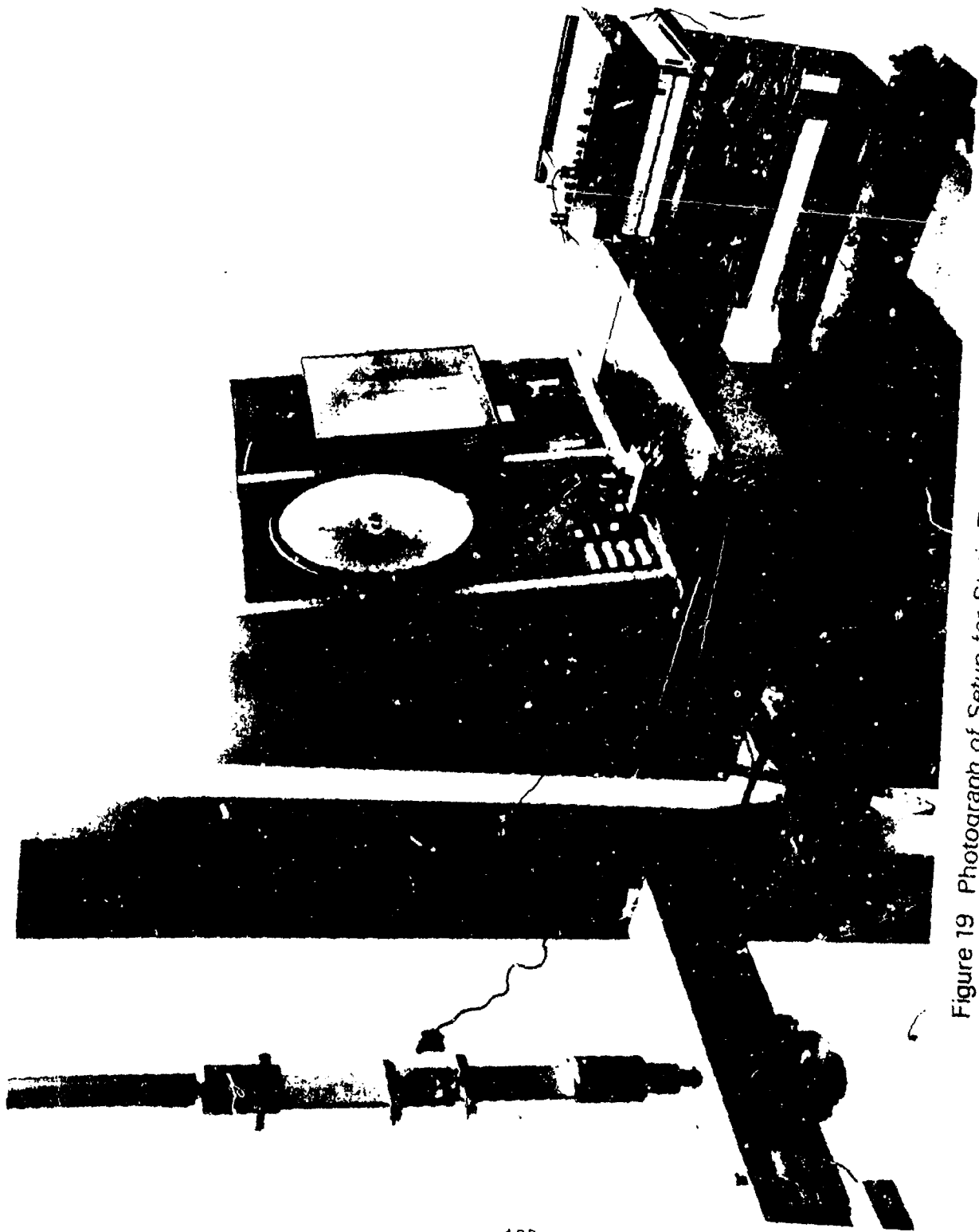

Figure 19 Photograph of Setup for Static Tests of Riveted Lap-Joints

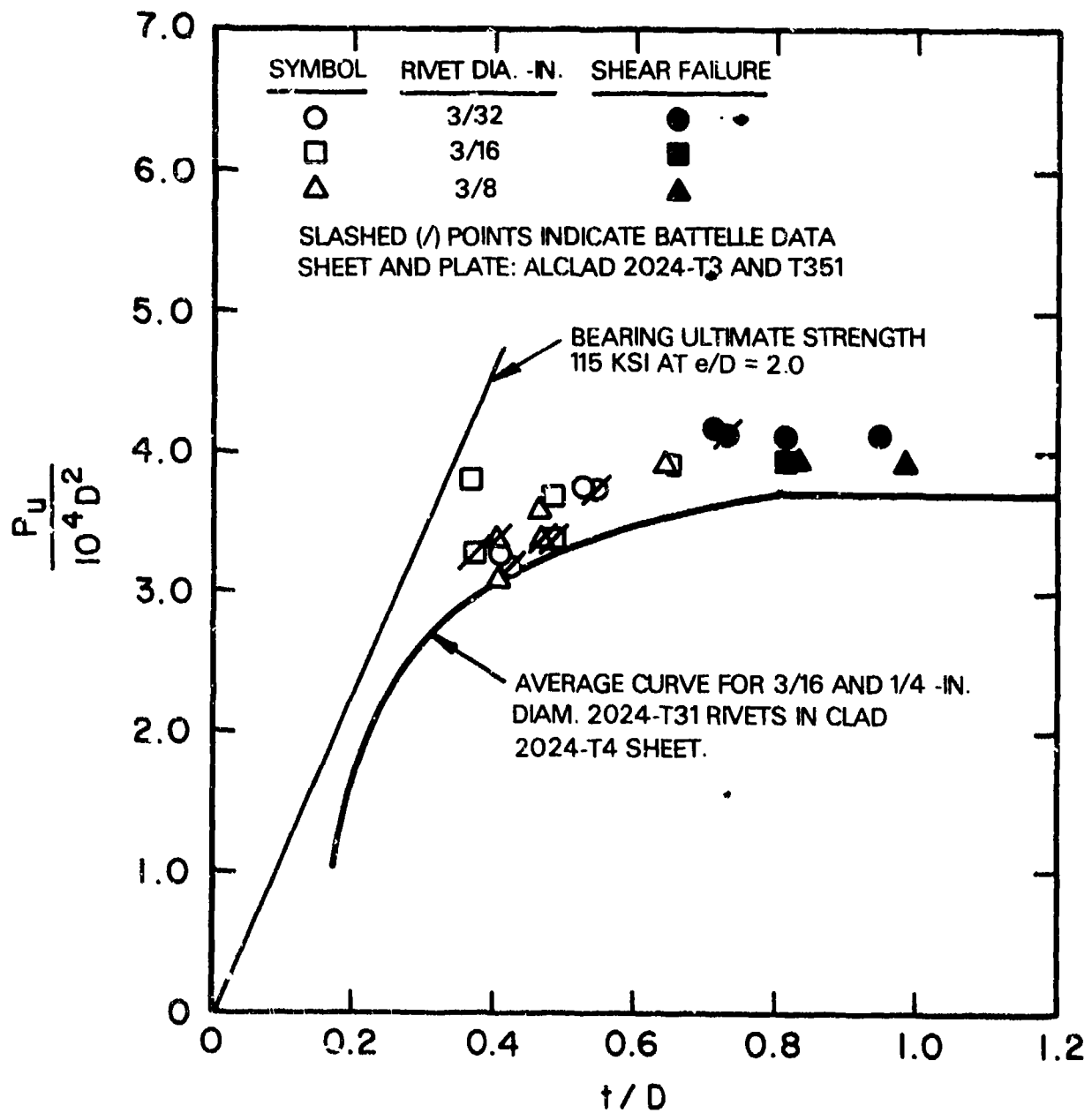

Figure 20 Average Ultimate-Load Data for 7050-T7X Rivets
(2nd Step of Aging = 8 Hrs at 345°F)

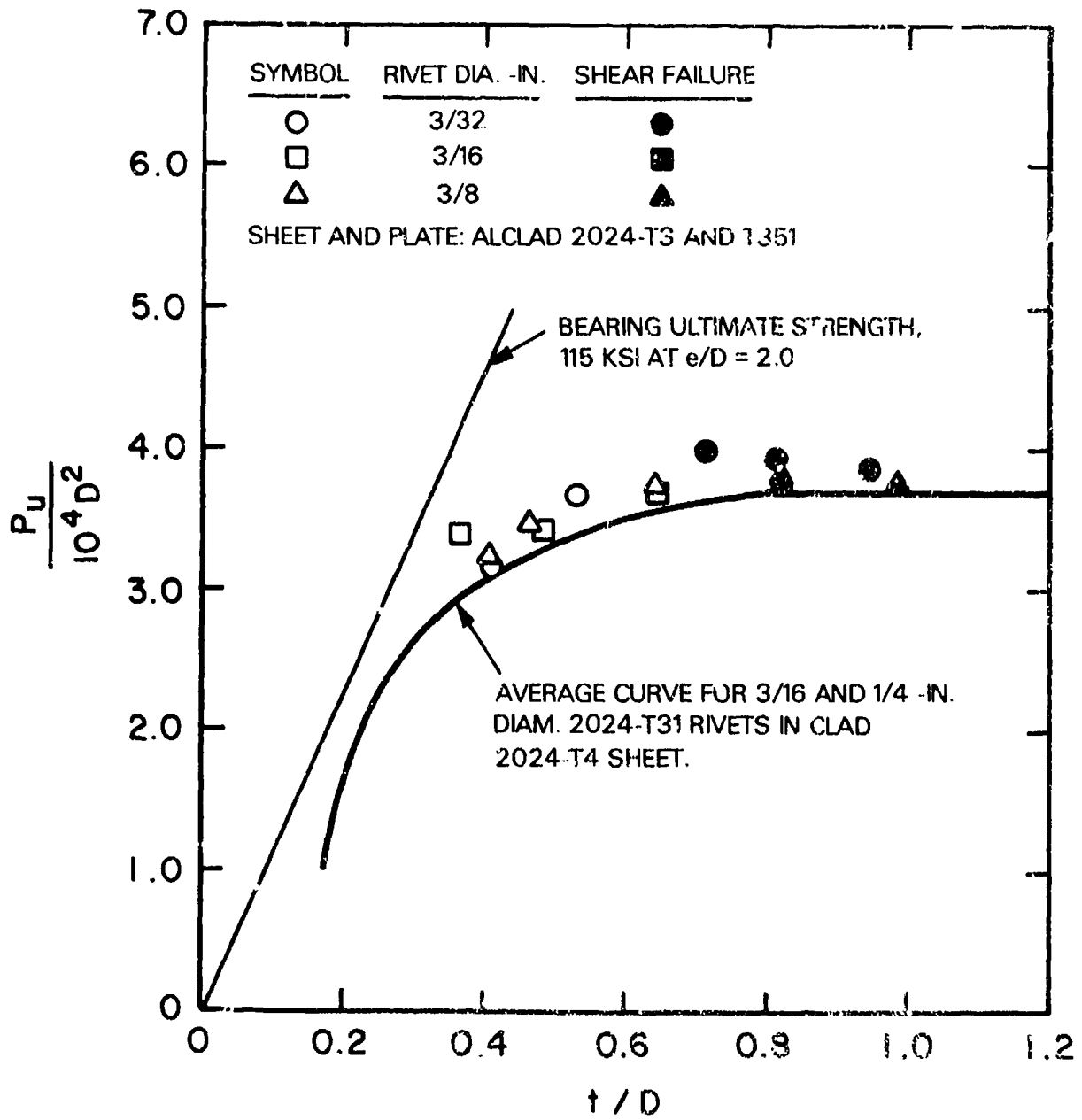

Figure 21 Average Ultimate-Load Data for 7050-T7X Rivets
(2nd Step of Aging = 8 Hrs at 350°F)

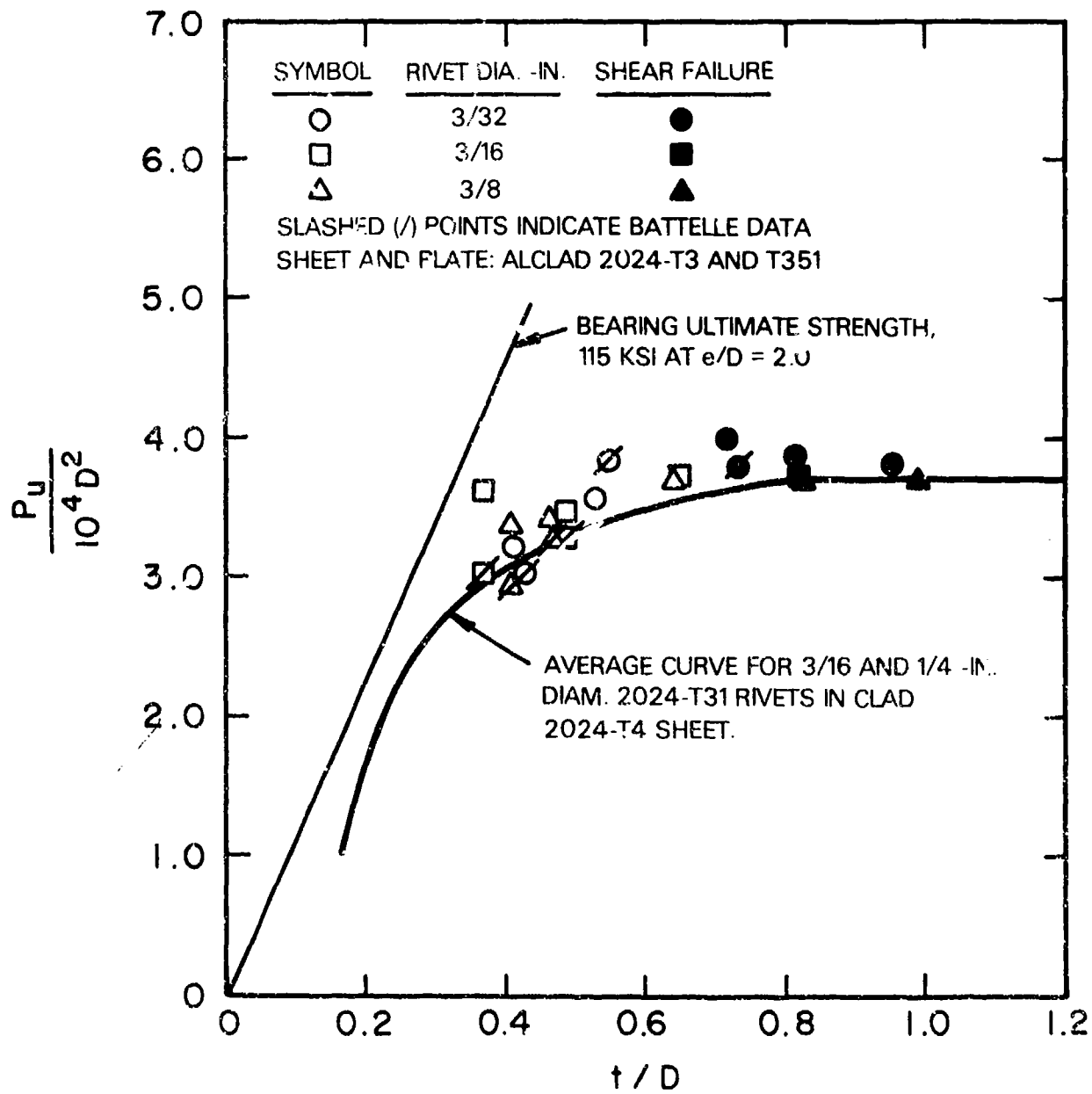

Figure 22 Average Ultimate-Load Data for 7050-T7X Rivets
(2nd Step of Aging = 8 Hrs at 355°F)

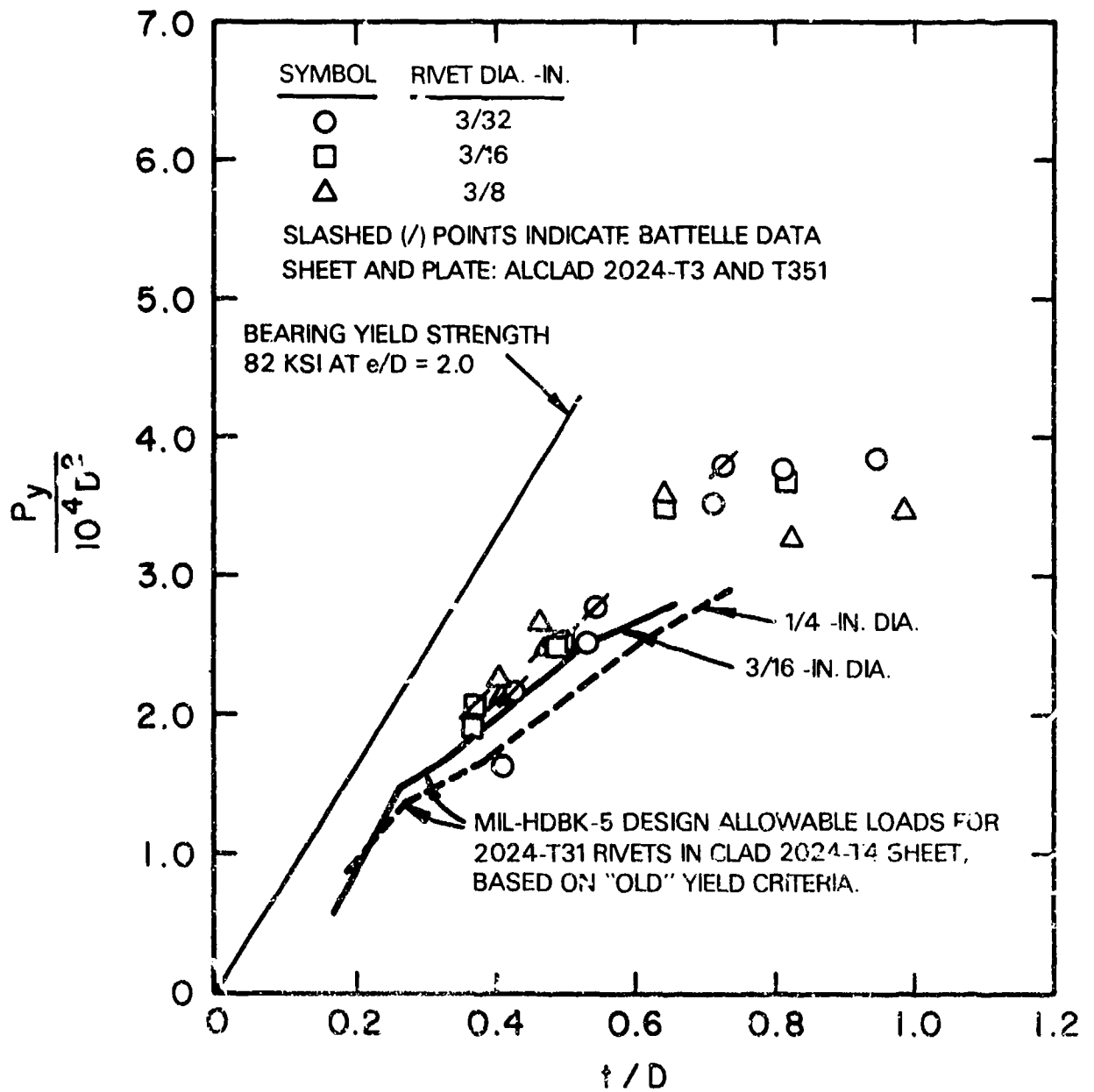

Figure 23 Average Yield-Load Data for 7050-T7X Rivets
(2nd Step of Aging = 8 Hrs at 345°F)

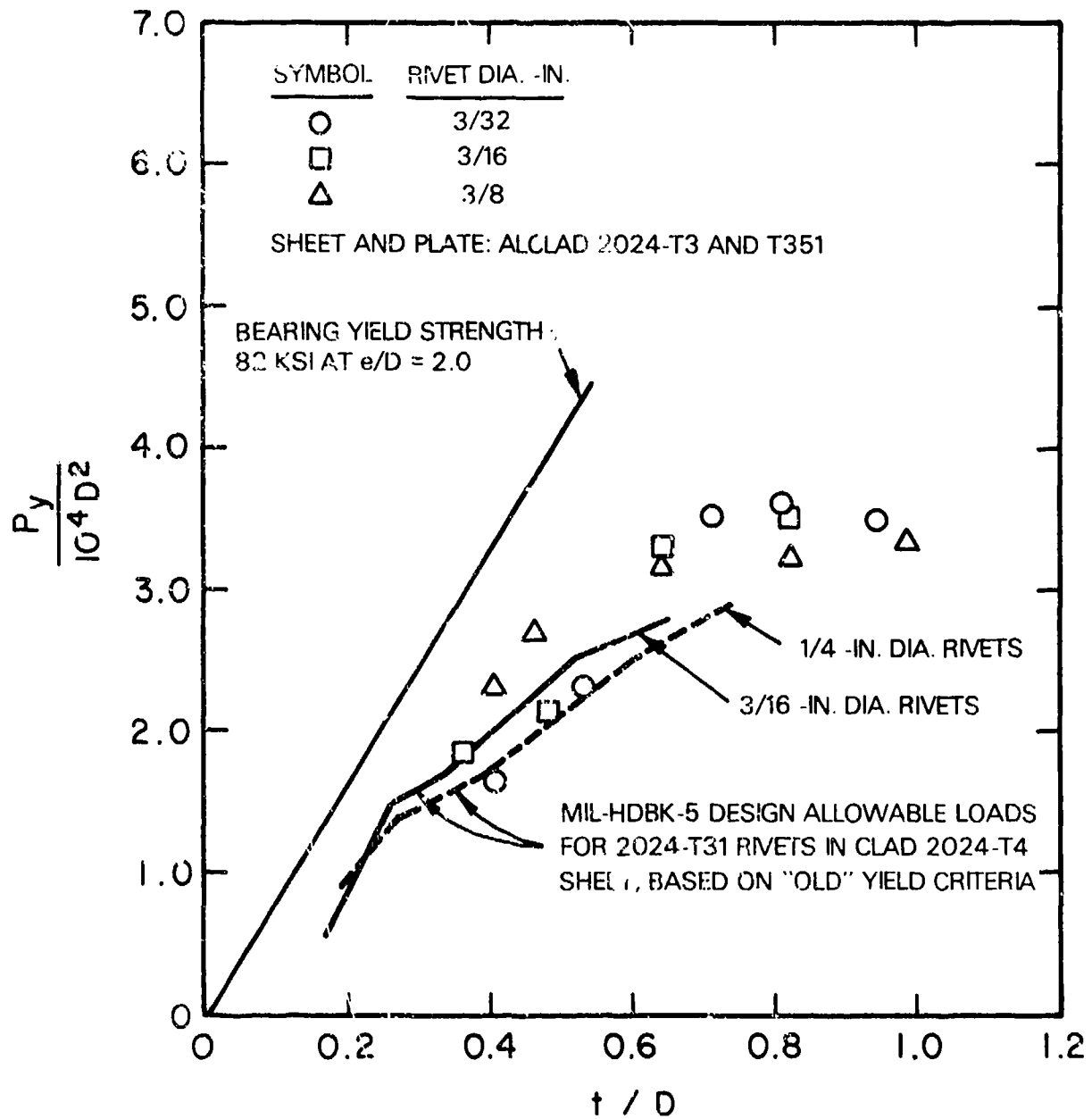

Figure 24 Average Yield-Load Analysis for 7050-T7X Rivets
(2nd Step of Aging = 8 Hrs at 350°F)

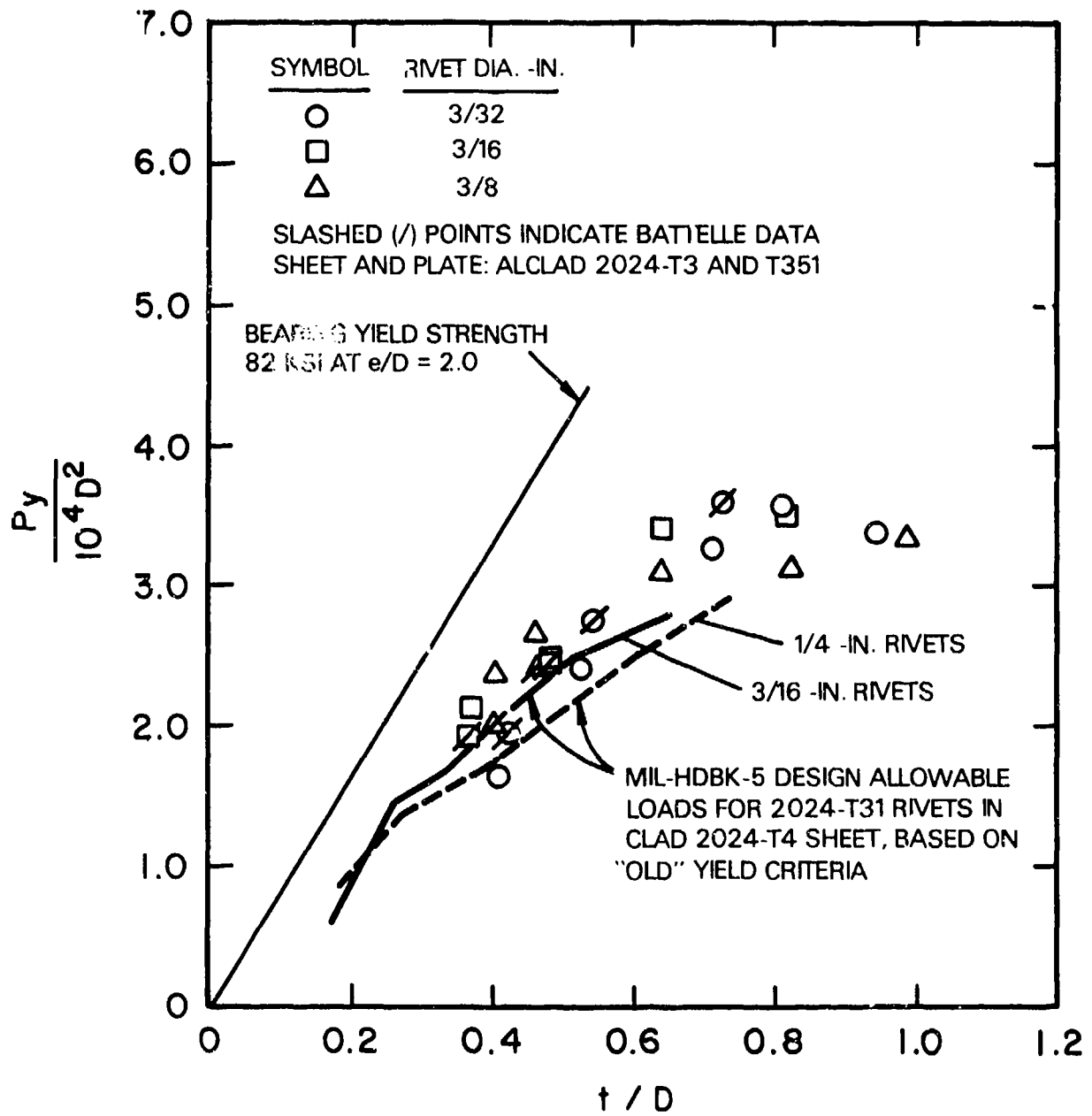

Figure 25 Average Yield-Load Analysis for 7050-T7X Rivets
(2nd Step of Aging = 8 Hrs at 355°F)

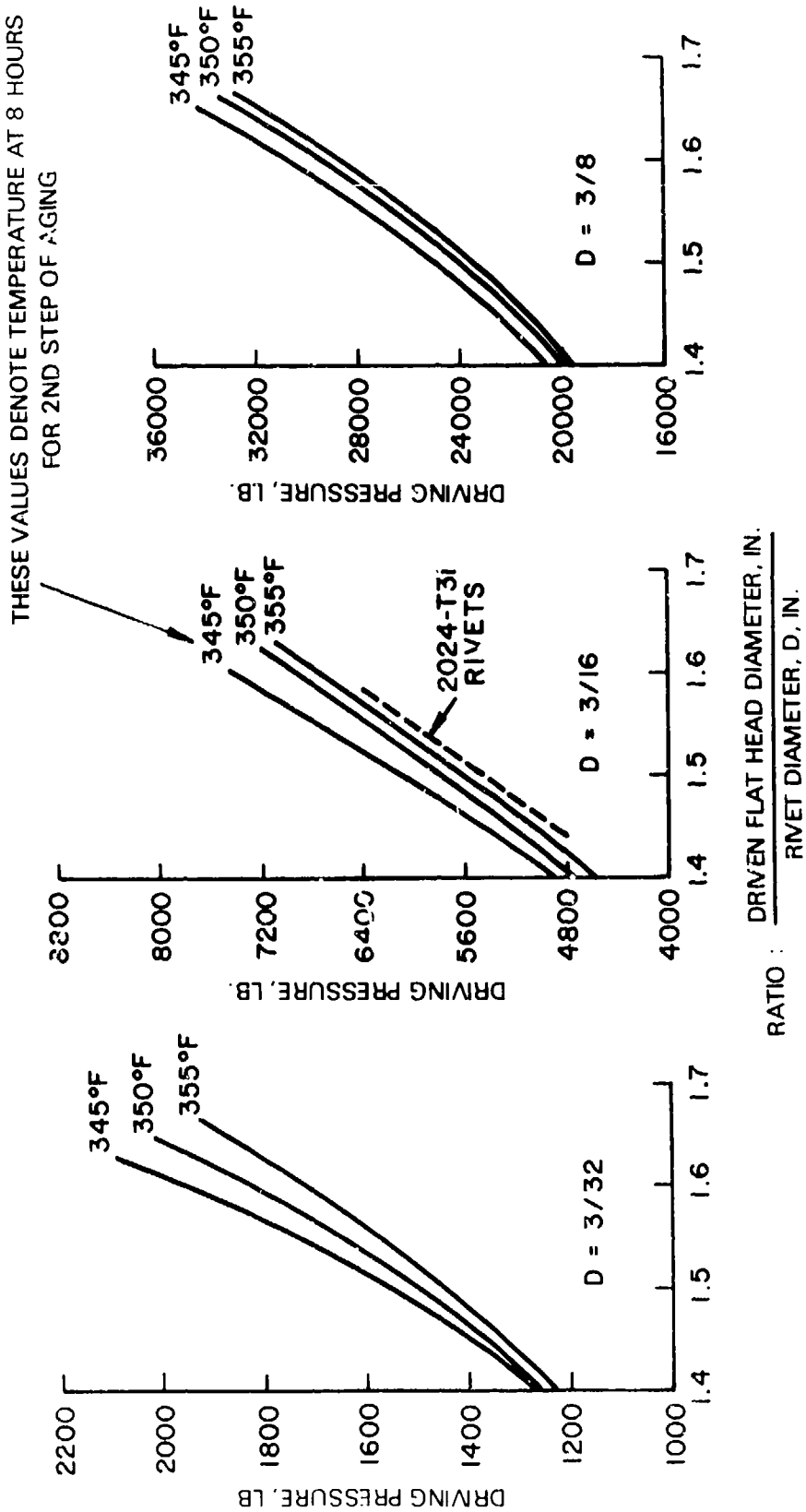

Figure 26 Driving Pressure versus Average Driven Flat Head Diameter: Curves for 3/32, 3/16 and 3/8 -in. Diameter 7050-T7X Rivets Given Three Aging Practices.

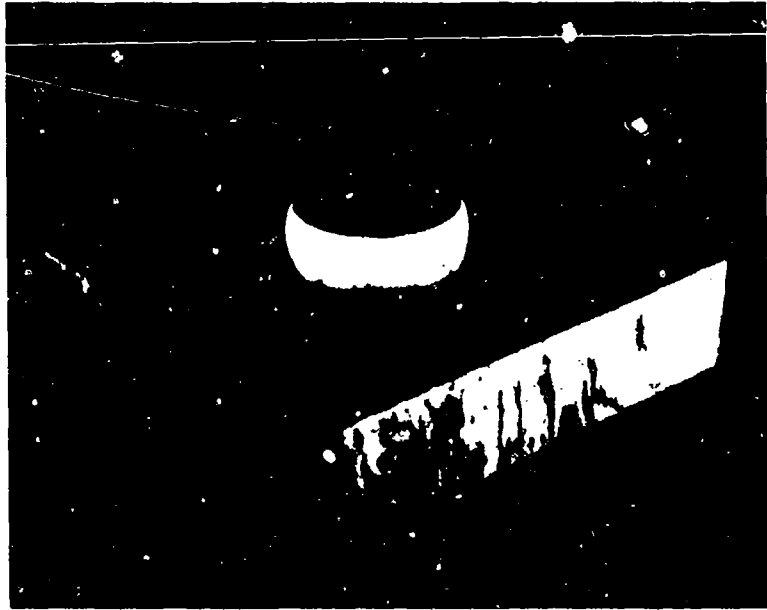

Figure 27 Shear Cracks in Driven Head of 3/8-IN. Dia. 7050-T7X Rivet
2nd Step of Aging: 8 Hrs. at 345°F

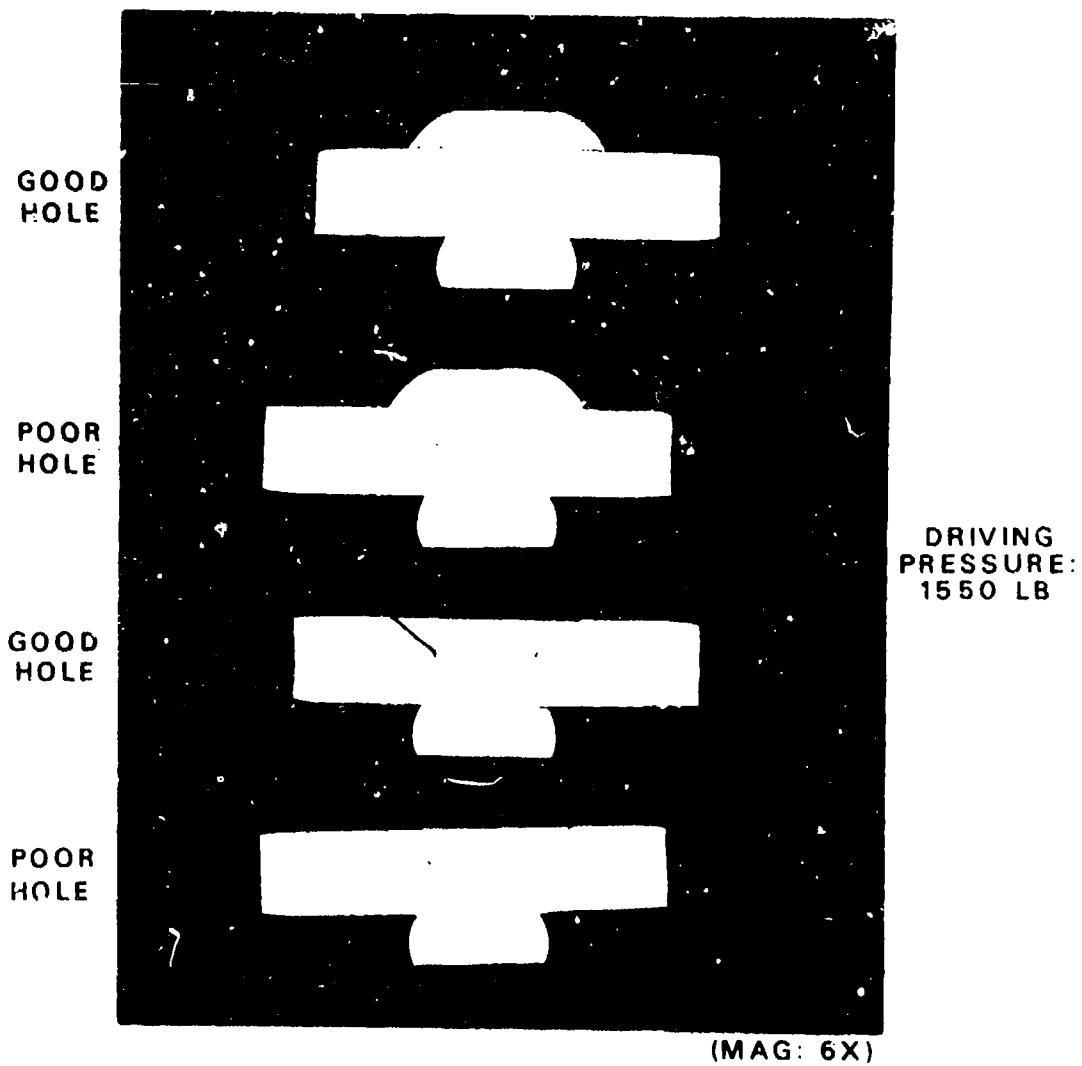

Figure 28 Photomicrographs of Sectioned 3/32-in. Diameter (D)
7050-T7X Rivets Driven With 1.5D Flat Heads in
0.090-in. 2024-T3 Sheet
2nd Step of Aging: 8 Hrs. at 345°F

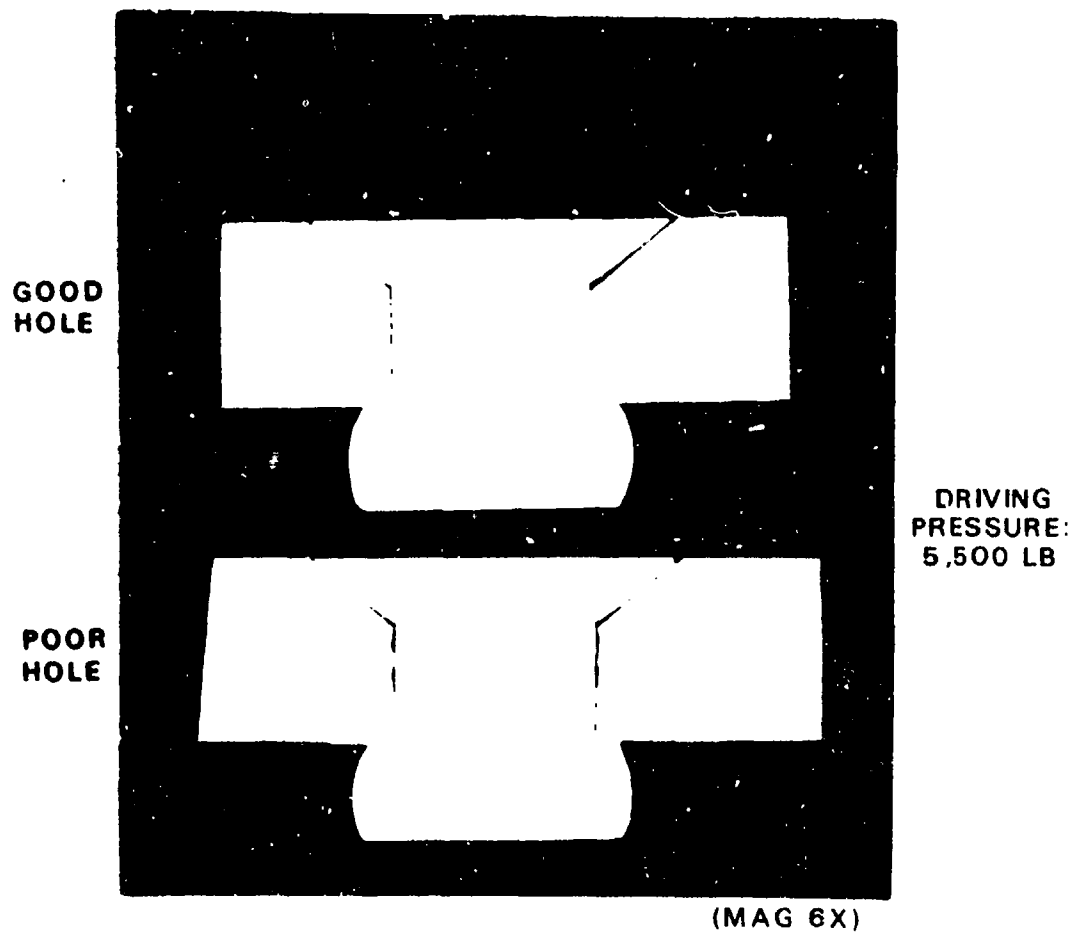

Figure 29 Photomicrographs of Sectioned 3/16-in. Diameter 2024-T31 Rivets

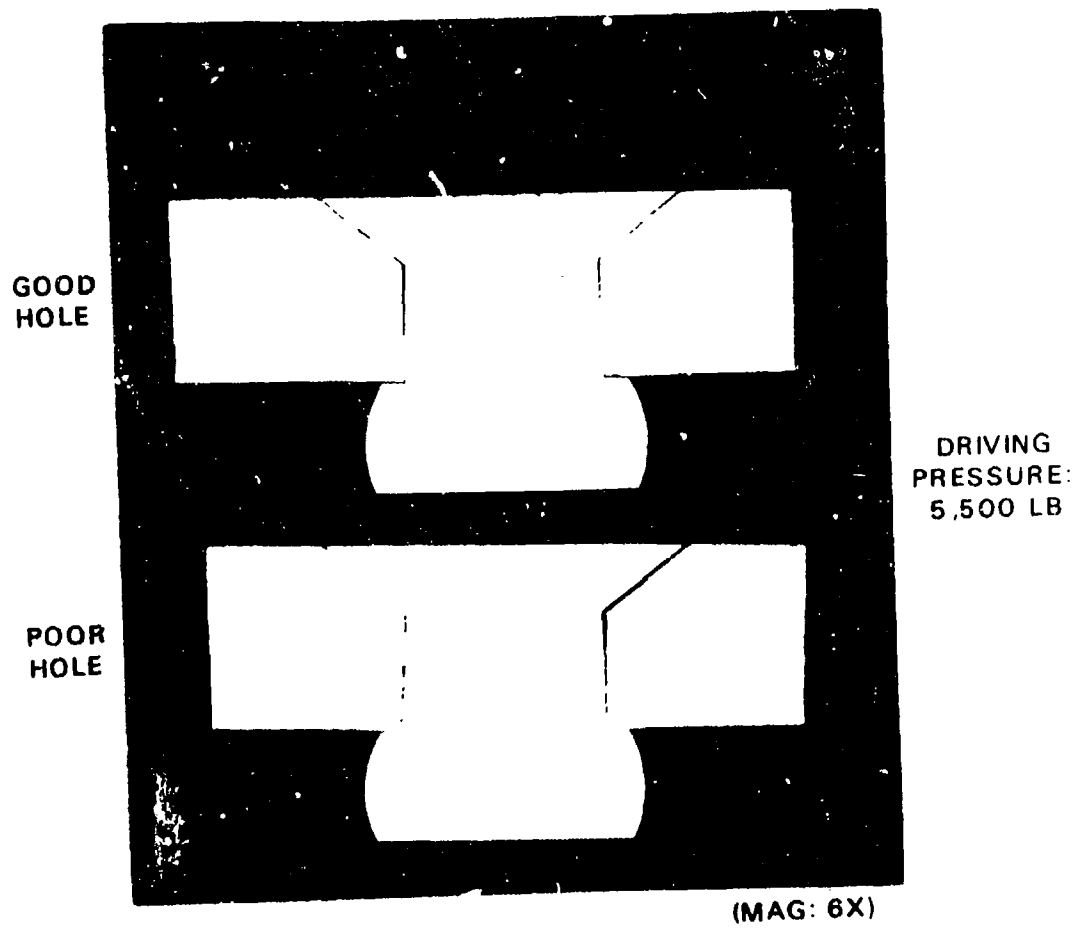

Figure 30 Photomicrographs of Sectioned 3/16-in. Dia. 7050-T7X Rivets
2nd Step Aging: 8 Hrs. at 350°F

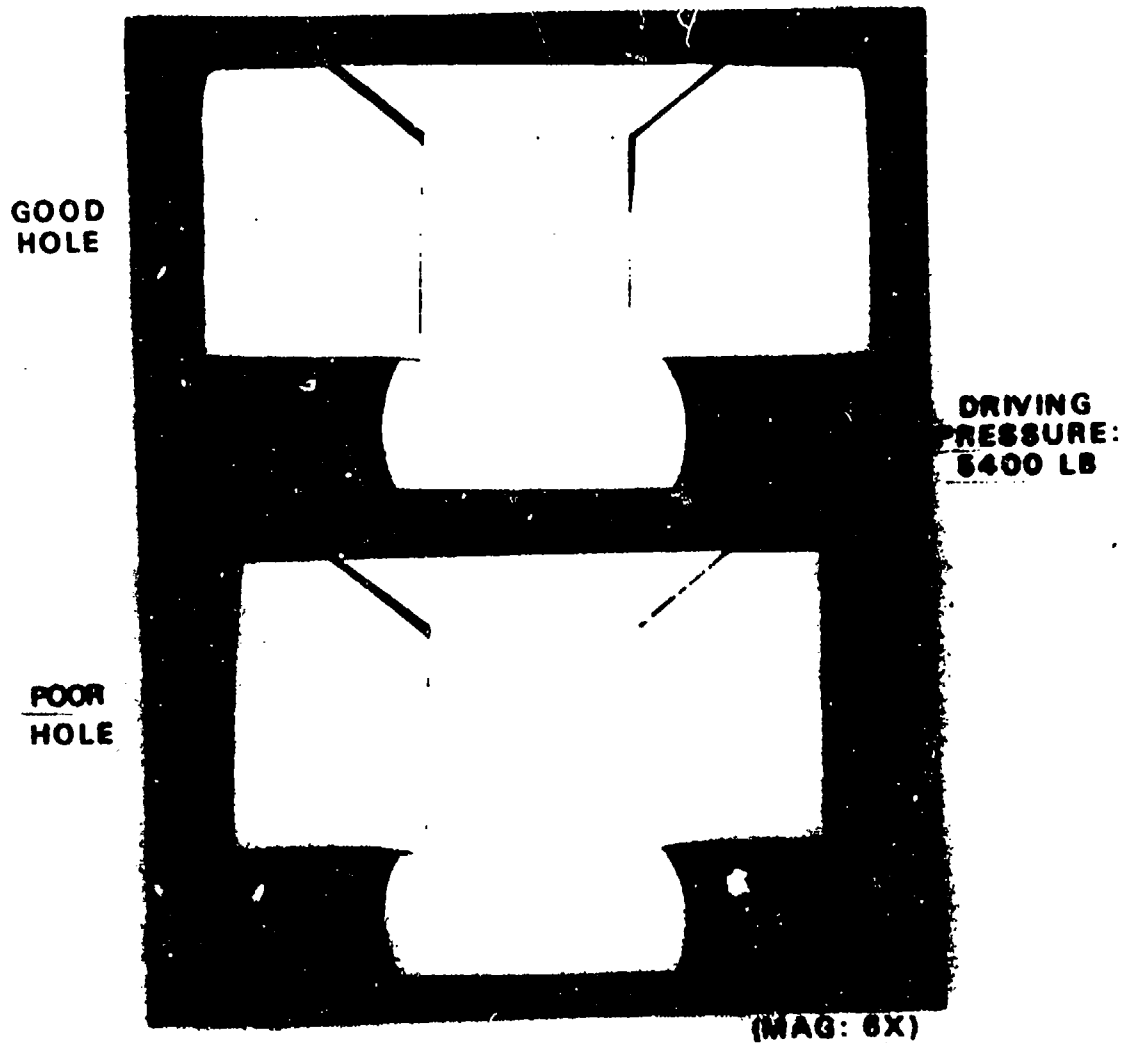

Figure 31 Photomicrographs of Sectioned 3/16-in. Diameter (D)
7050-T7X Rivets Driven With 1.5D Flat Heads in
0.281-in. 7075-T651 Plate
2nd Step of Aging: 8 Hrs. at 355°F

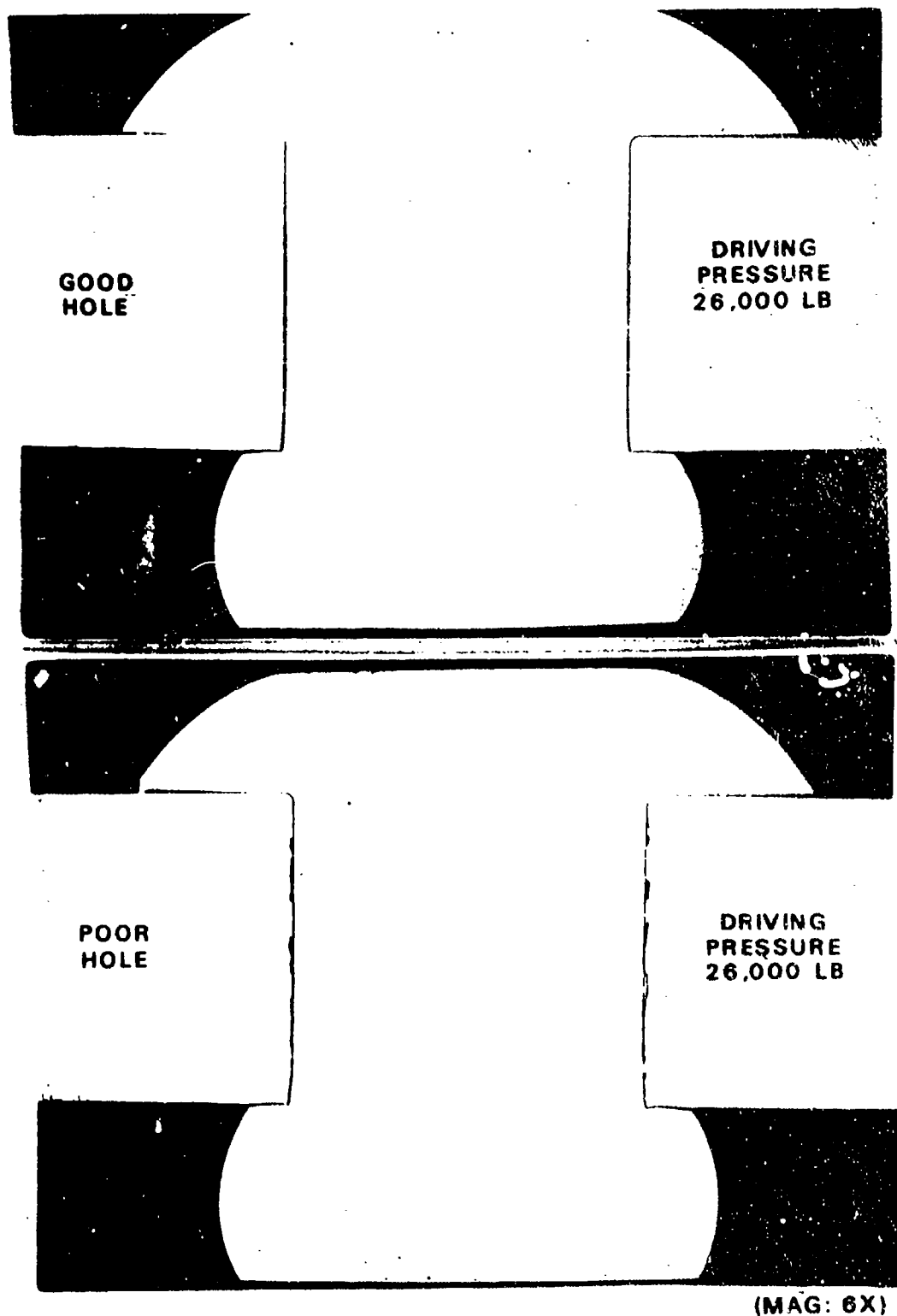
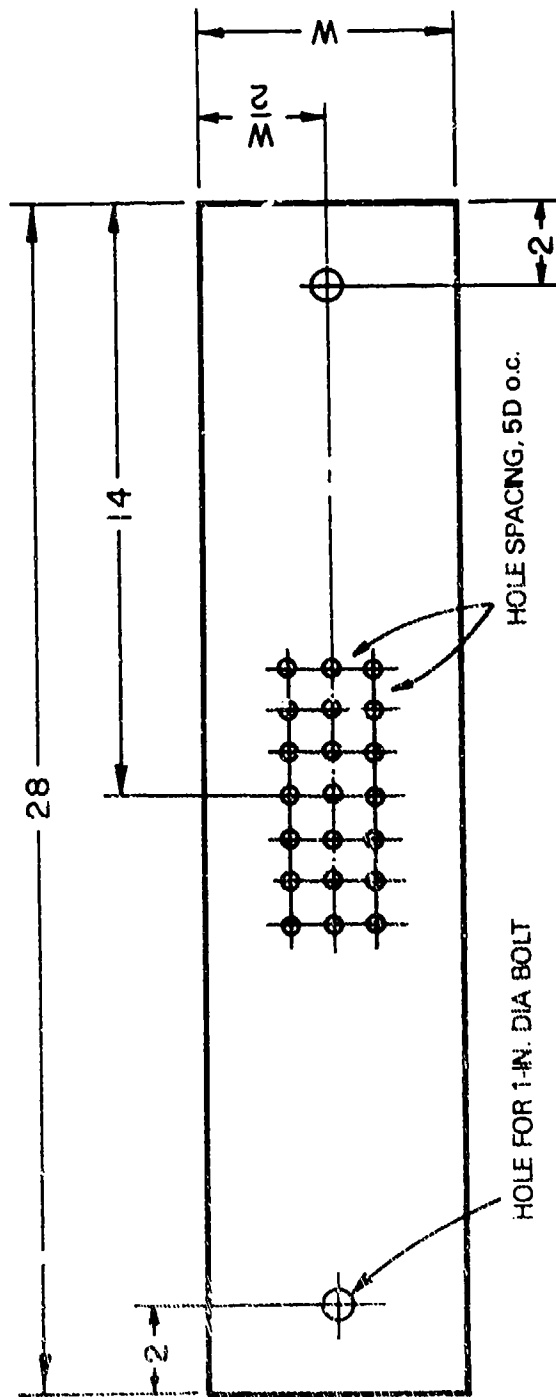

Figure 32 Photomicrographs of Sectioned 3/8-in. Diameter (D)
7050-T7X Rivets Driven With 1.55D Flat Heads in
0.375-in. 2024-T351 Plate
2nd Step of Aging: 8 Hrs. at 355°F



ALL DIMENSIONS IN INCHES

RIVET DIA D	HOLE DIA	THICKNESS	WIDTH W	MATERIAL
3/32	0.096	0.125	4	2024-T3
3/16	0.191	0.250	5	7075-T6
3/8	0.386	0.375	6	7075-T6

Figure 33 Driving and Hole-Fill Specimens for Pneumatic Hammer Driven Rivets

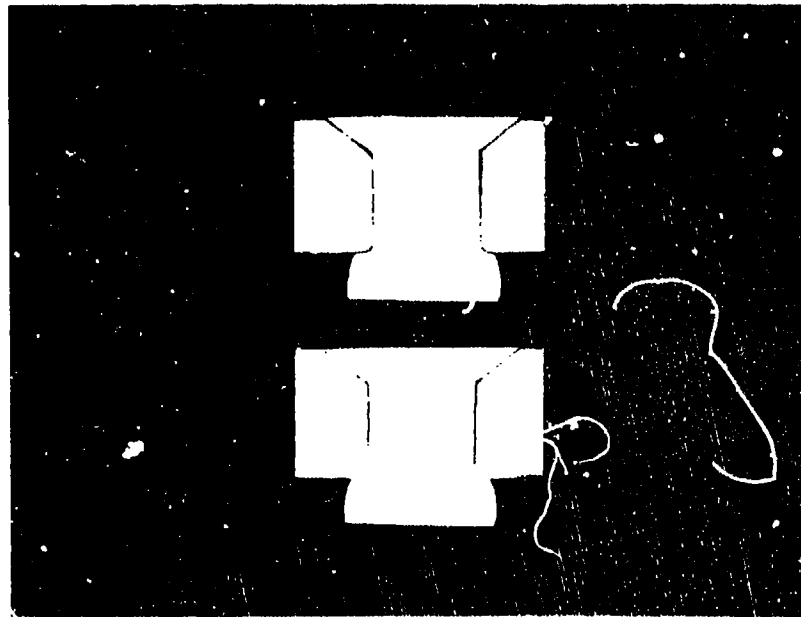

(MAG : 6X)

Figure 34 Pneumatic Hammer Driven 3/32-in. Dia. 7050-T7X Rivets
Second Step of Aging : 8 Hrs. at 350°F

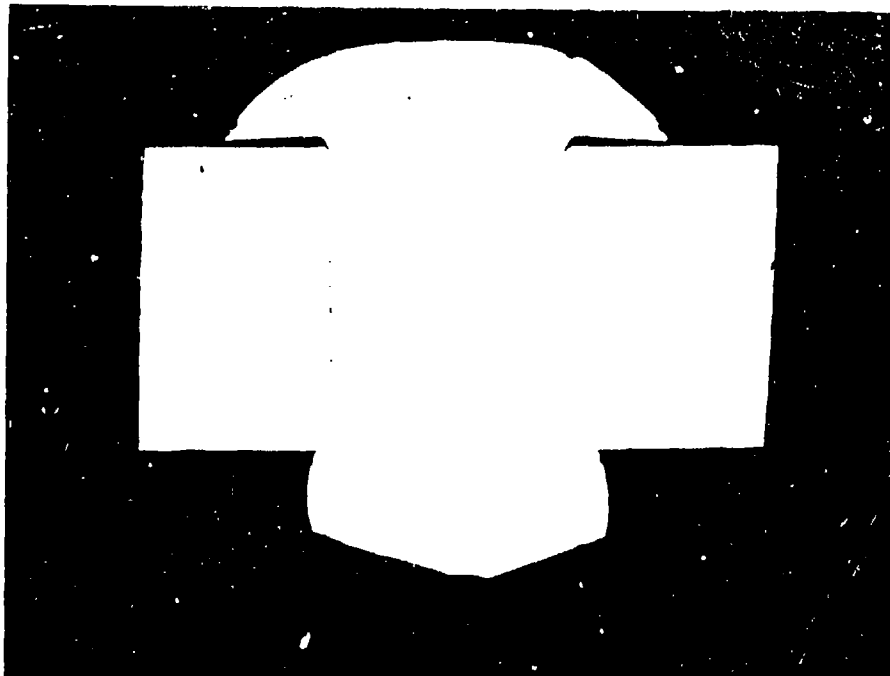

(Mag : 6X)

Rivet driven with Boyer No. 1 Pneumatic Hammer.
Note that fairly good hole filling was obtained, even
though buck-up set did not fit properly on
manufactured head

Figure 35 Photomicrograph of Sectioned 3/16-in. Diameter
7050-T7X Rivet Driven in 0.190-in. Diameter Hole
in 1/4-in. 7075-T6 Plate
2nd Step of Aging : 8 Hrs. at 350°F

1. MATERIAL IS 2024-T3 0.090-IN. SHEET
2. SIXTY (60) SPECIMENS REQUIRED. MATCH DRILL EACH SPECIMEN
3. MACHINE ALL EDGES $63\sqrt{\text{R}}$ OR BETTER
4. TOLERANCE ON ALL $3/8$ AND $3/4$ DIMENSIONS IS ± 0.005
5. CHAMFER OR RADIUS HOLES 0.005 -IN. MAX. AT THE FAYING SURFACE OR EXIT

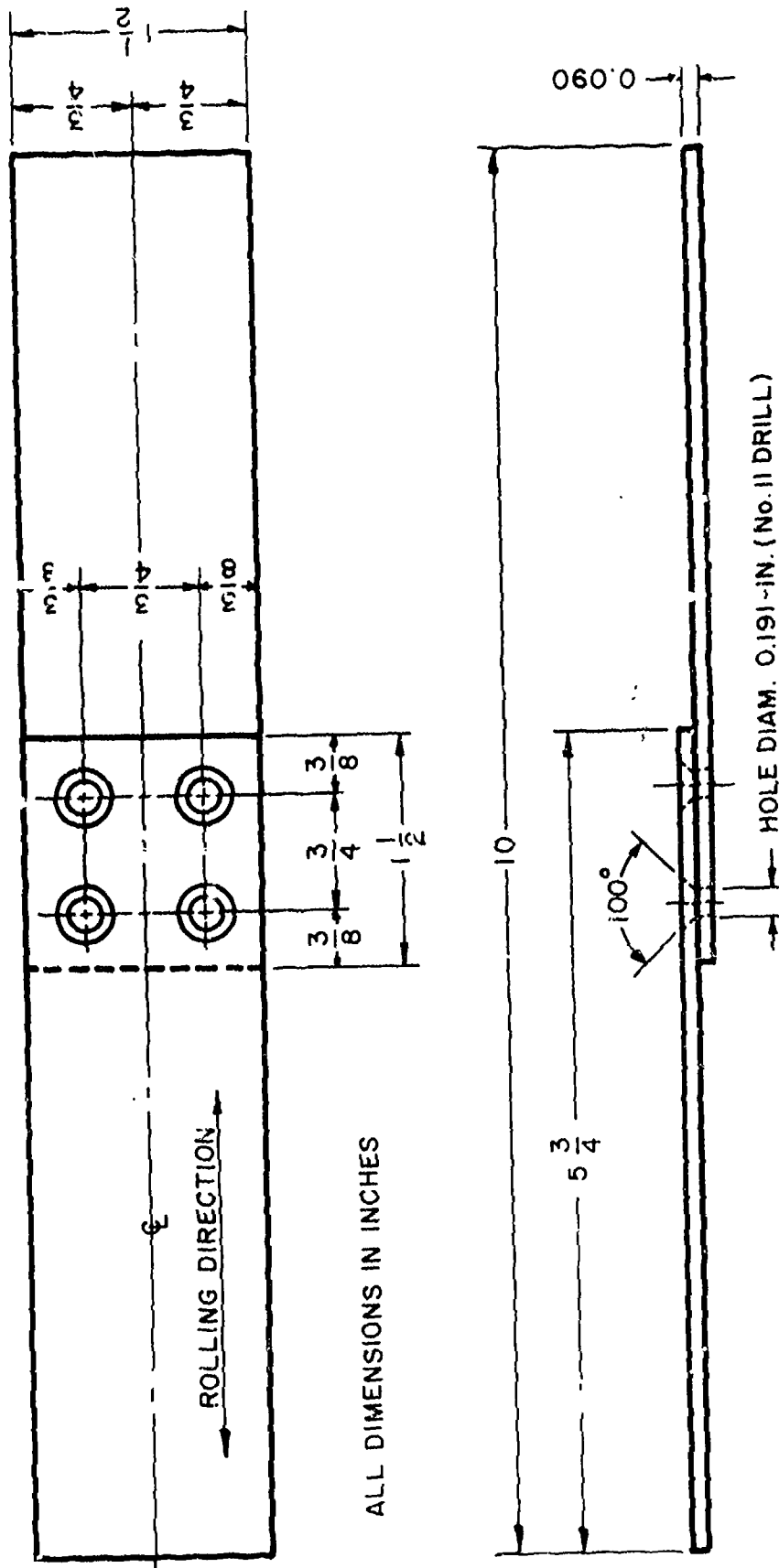

Figure 36 Shear Joint Fatigue Specimen for $3/16$ -in. Dia 100° Flat Countersunk Head Rivets

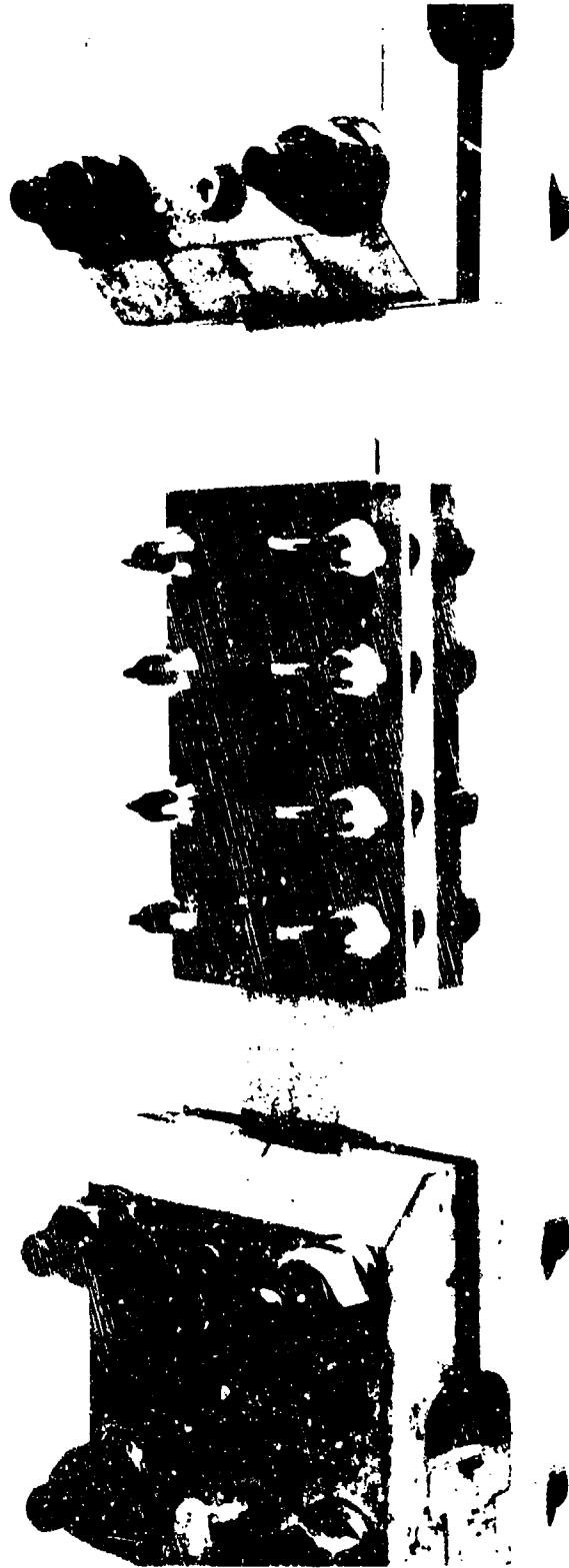
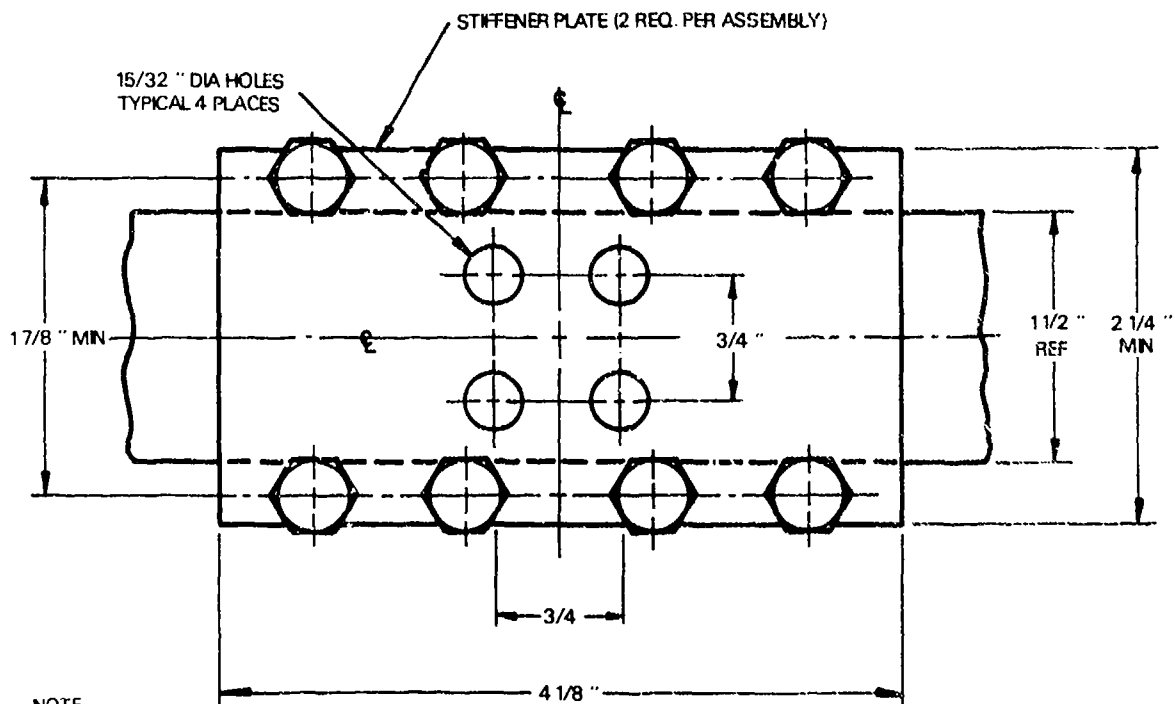
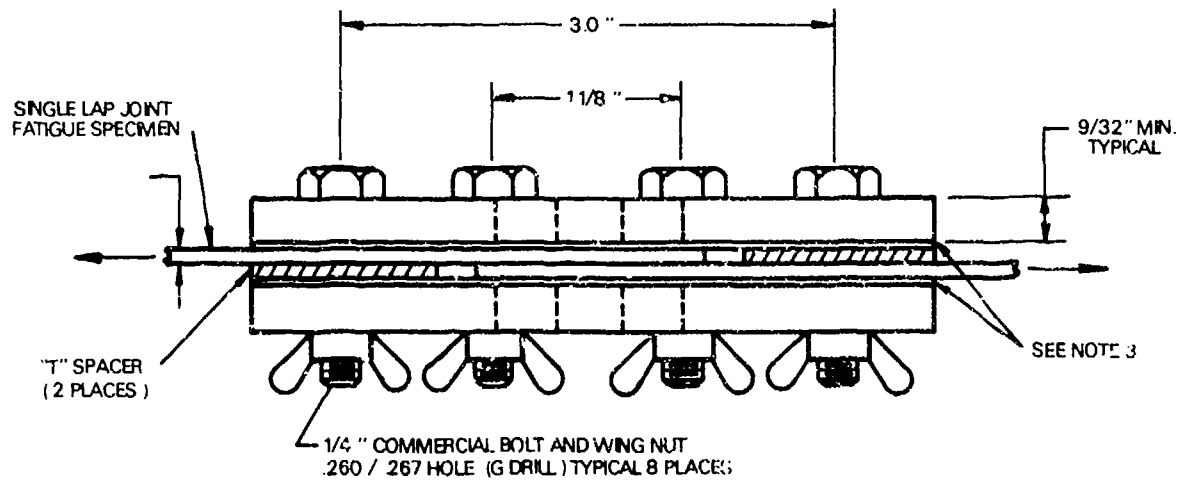

Figure 37 Photograph of Setup for Fatigue Tests of Riveted Joints Using Restraining Fixture



NOTE

1. NOMINAL FASTENER DIAMETER UNDER TEST .316 - IN.
2. STIFFENER PLATE AND BOLT MATERIAL - MILD STEEL
3. 1/32 IN TEFLON SHEET INTERFACED BETWEEN STIFFENER PLATES AND TEST SPECIMEN SURFACES
4. TIGHTEN WING NUTS ONLY FINGER TIGHT

Figure 38 Specimen Restraining Fixture (Sandwich Type)

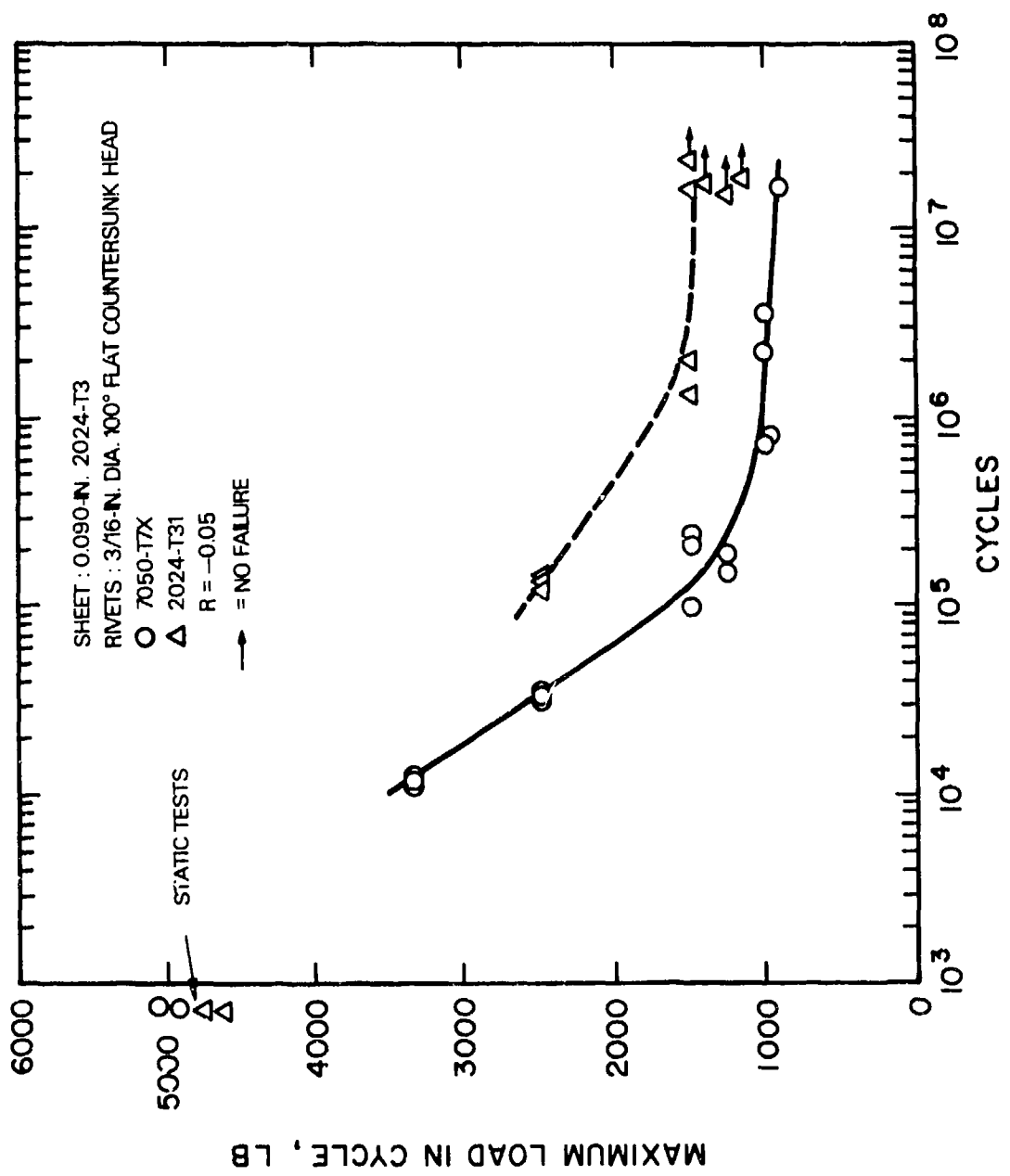

Figure 39 Fatigue Results for 7050-T7X and 2024-T31 Rivets in High Load Transfer Lap Joints at Alcoa Laboratories

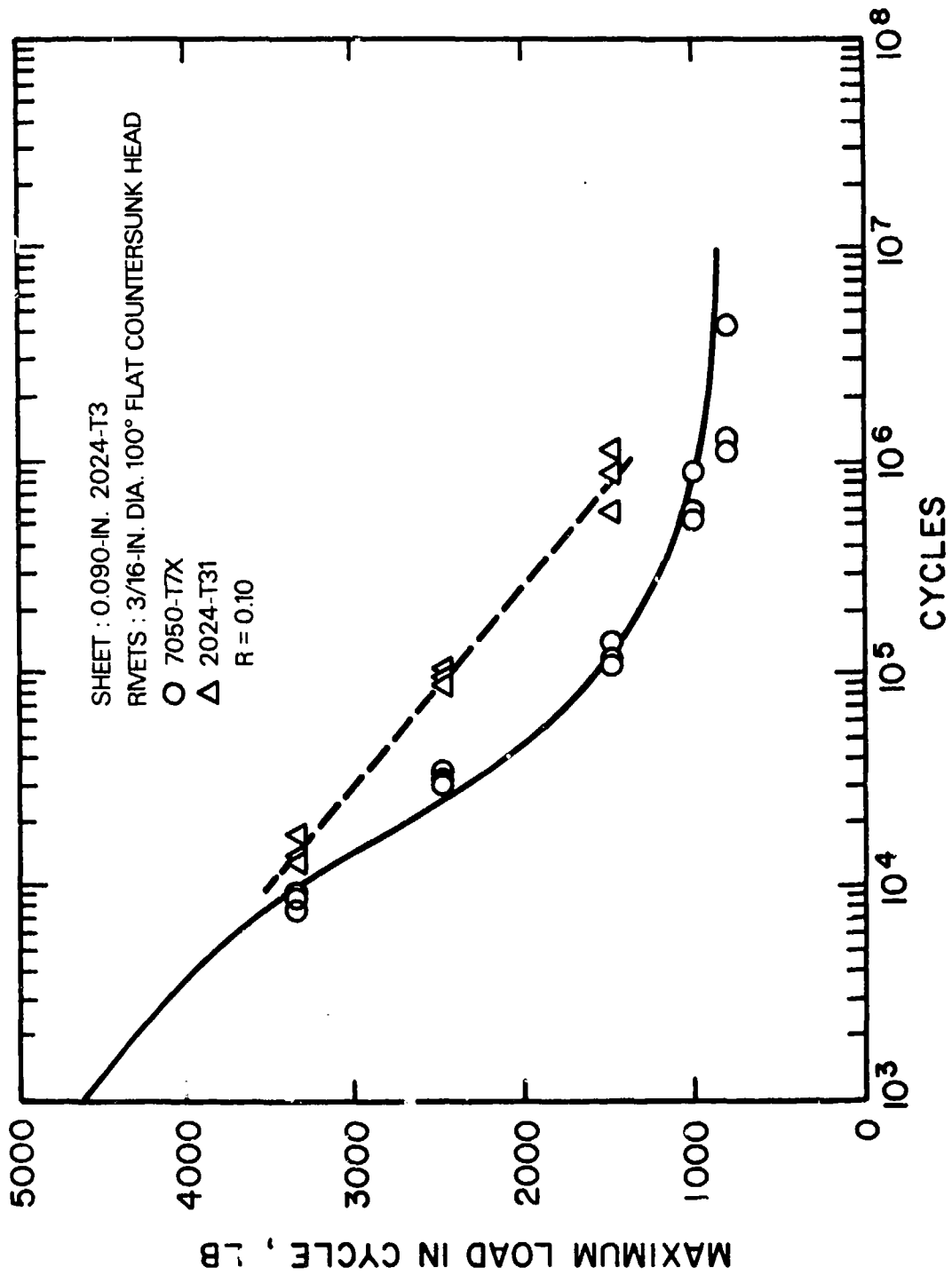

Figure 40 Fatigue Results for 7050-T7X and 2024-T31 Rivets in High Load Transfer Lap Joints at Battelle Laboratories.

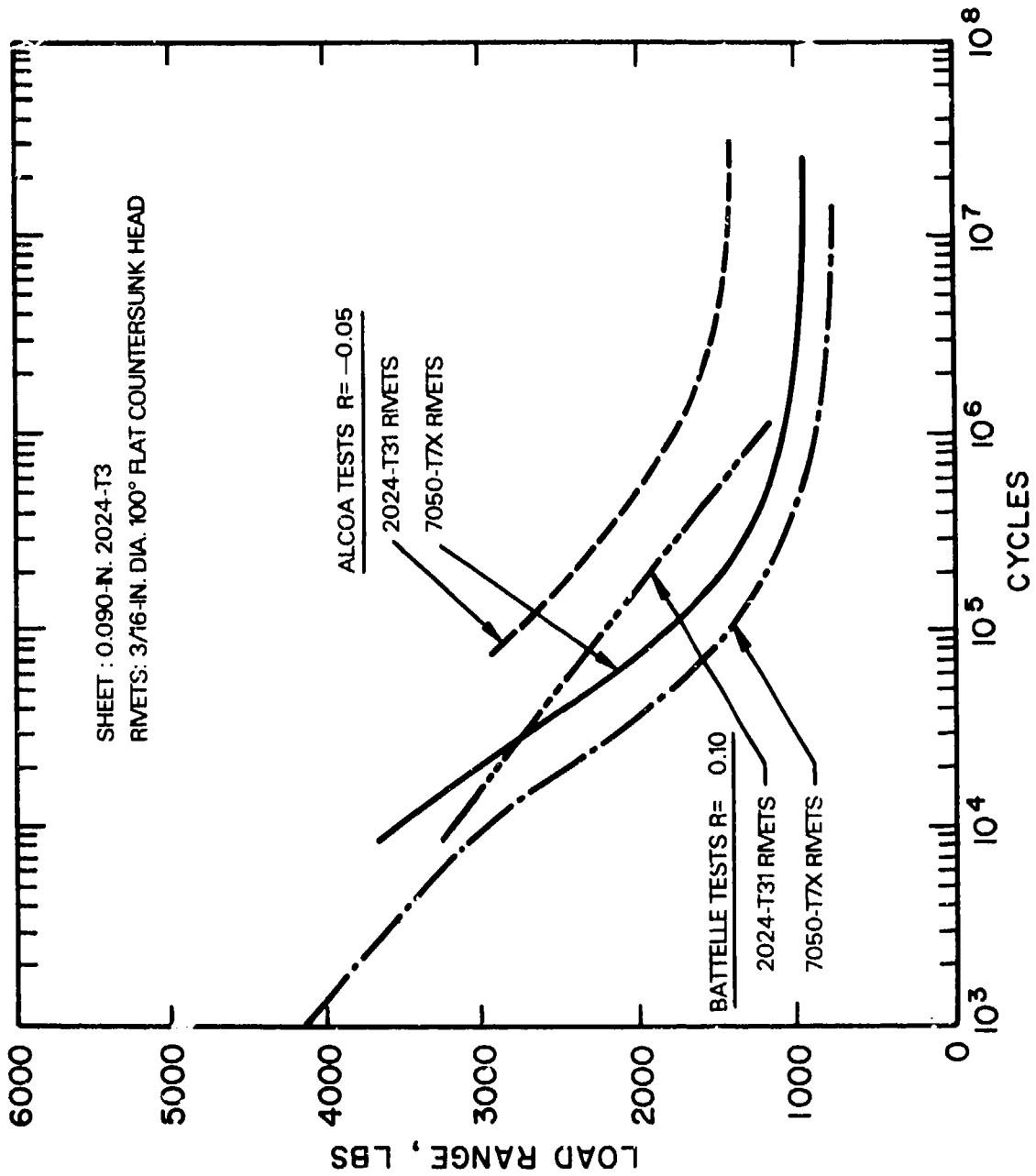

Figure 41 Effect of Rivet Alloy on Fatigue Strength of High Load Transfer Joints

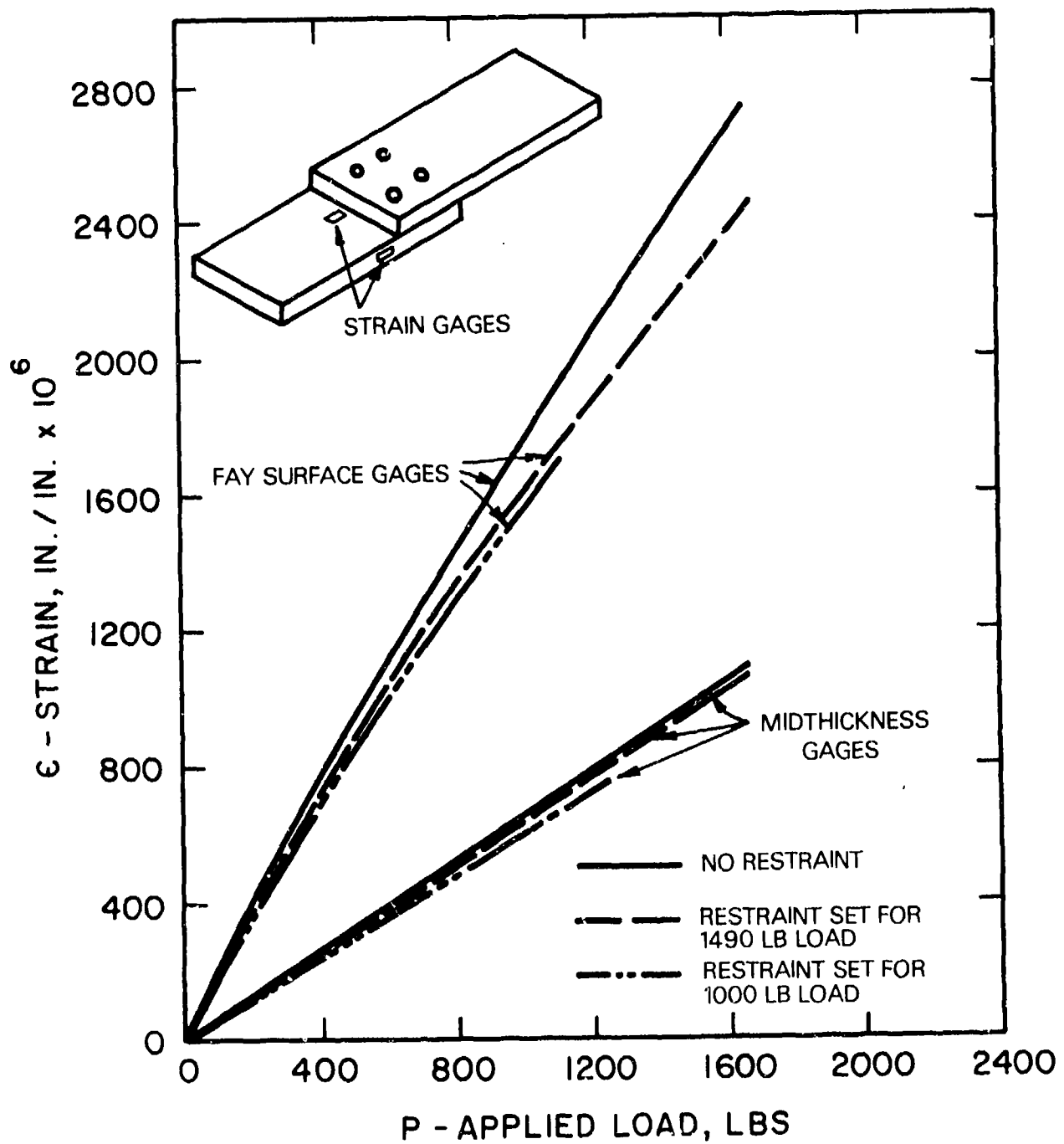

Figure 42 Load-Strain Results for High-Load Transfer Joint-Battelle

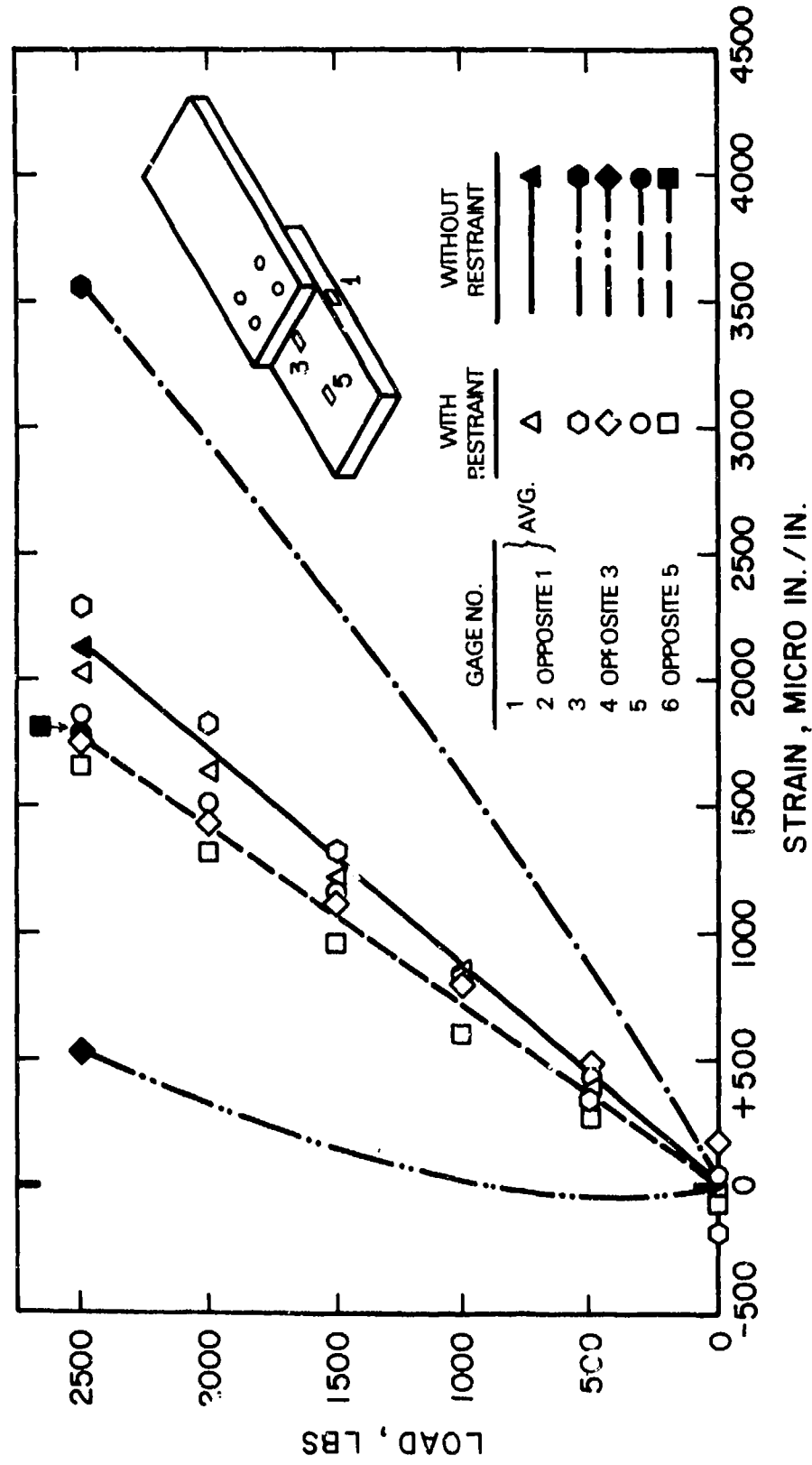

Figure 43 Load-Strain Results for High-Load Transfer Joints-Alcoa

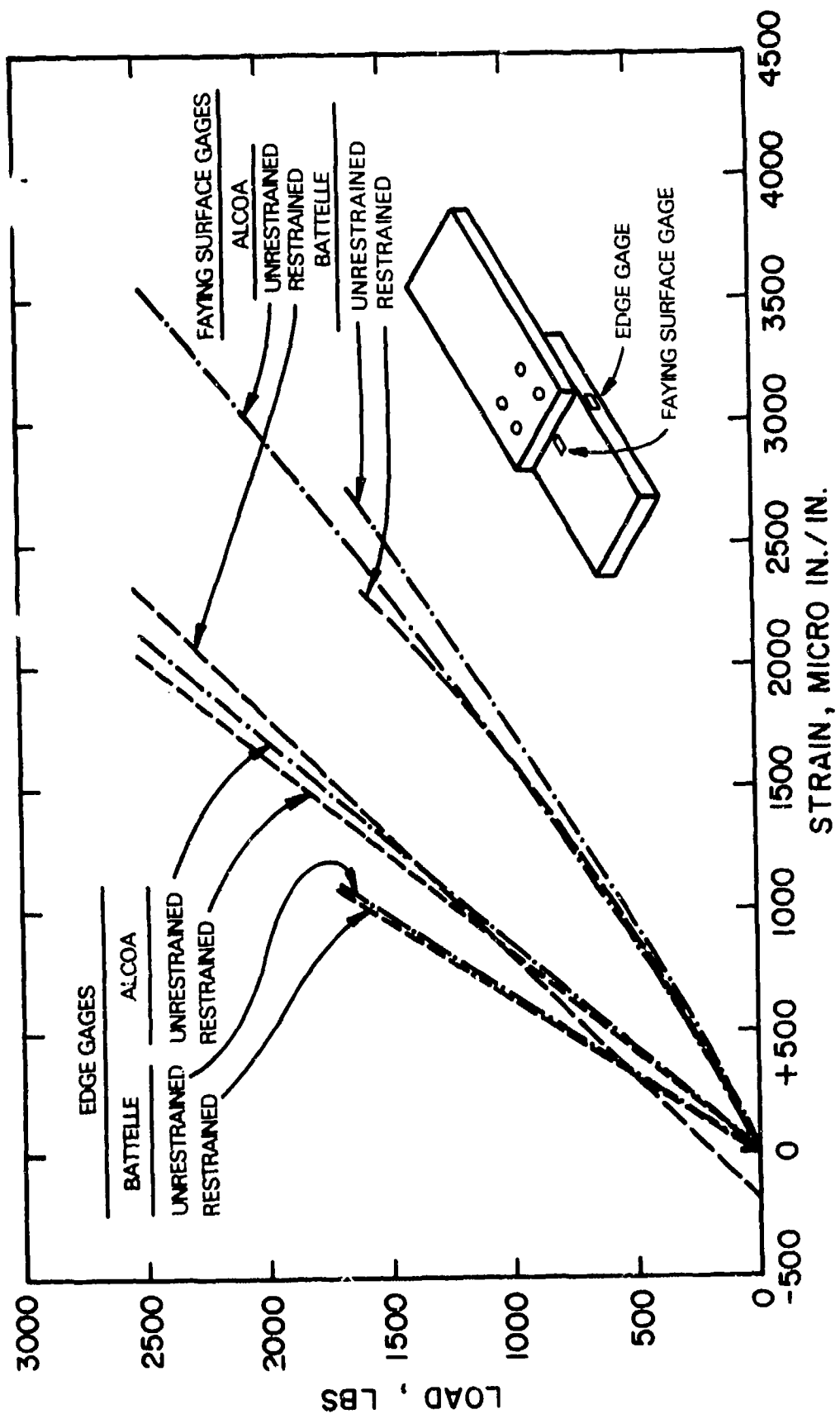

Figure 44 Comparisons of Strains in Alcoa and Battelle Tests

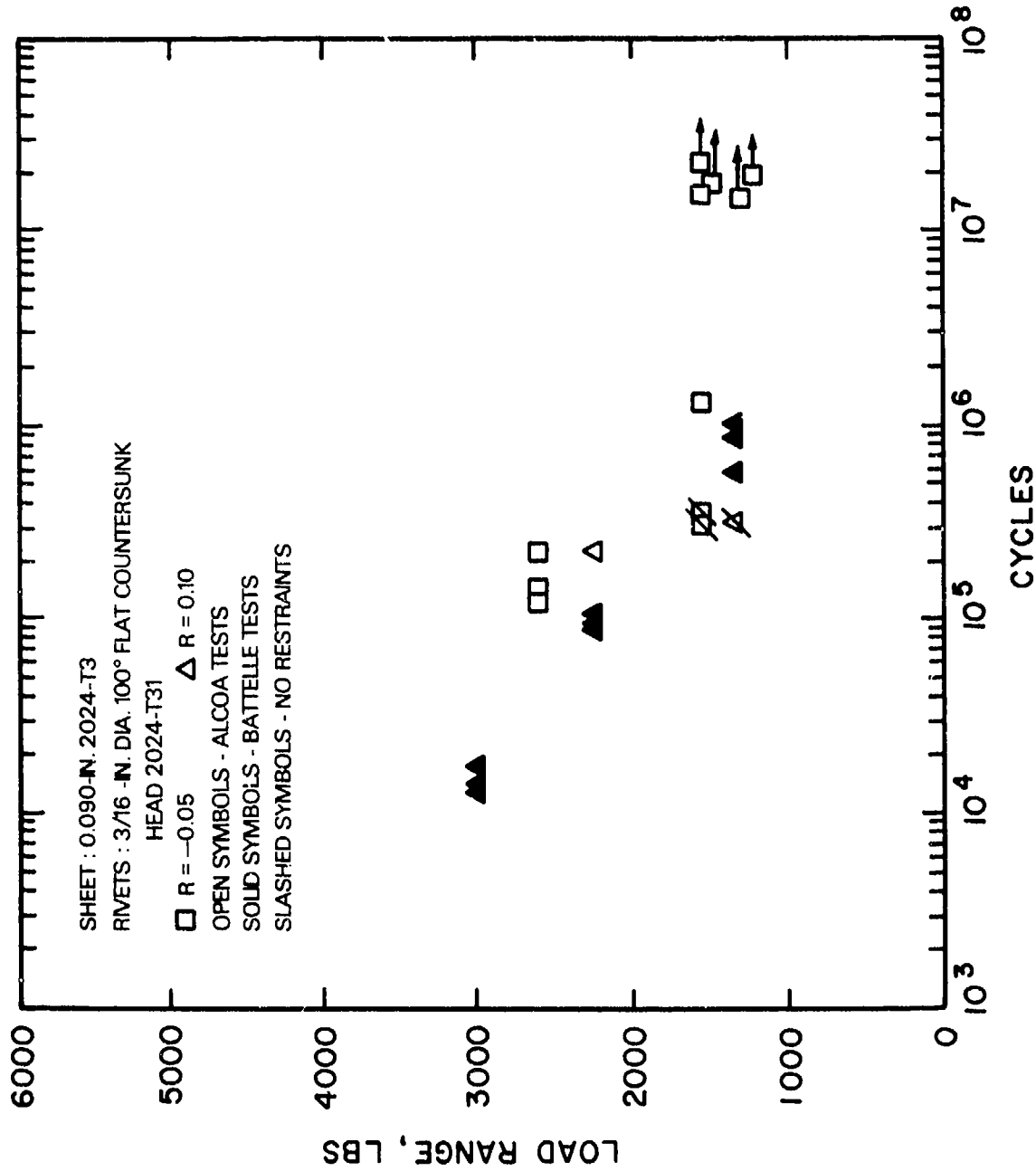
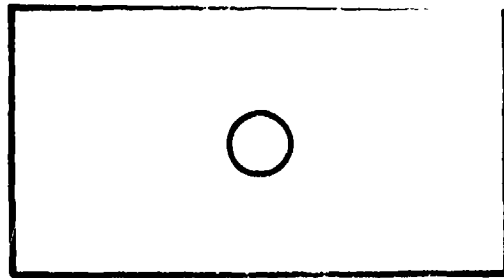
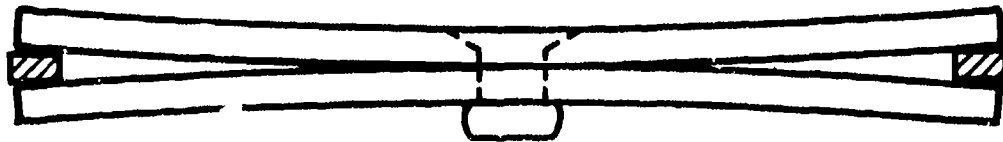
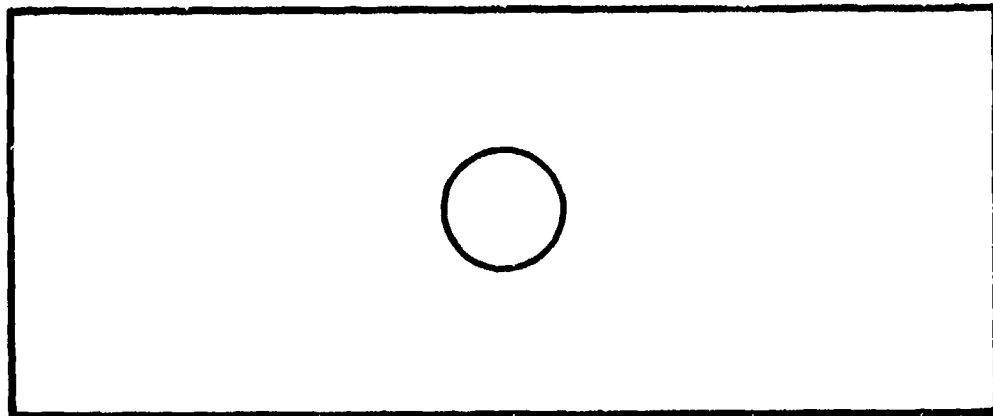

Figure 45 Effect of Stress Ratio and Restraints on Fatigue Strength of High Load Transfer Lap Joints



3/16 IN. RIVET WITH 0.090 x 1.5 x 2.75 IN. SHEET



3/8 IN. RIVET WITH 0.190 x 2.25 x 5.5-IN. SHEET

Figure 46 Two Sizes of Stressed Assemblies
Used in Corrosion Tests of Rivets



S. No. 420964-1
Neg. No. 202302A

Mag. 100X
As Polished

Section through a 3/8-in. diam., 7050-T6 type rivet (Aged 4 hrs/250F + 2 hrs/350F) driven in 2024-T3 sheet and exposed 30 days to 3.5% NaCl - A.I. Photomicrograph shows a 0.033 inch long intergranular stress-corrosion crack initiating at the base of the manufactured head and some intergranular corrosion on the shank of the rivet. No other cracks were detected. The maximum reduction in cross-section area as a result of cracking was estimated at 8%.

A replicate rivet examined after 50 days of exposure showed two diametrically located cracks at the base of the manufactured head, each about 0.063 inch long. The maximum reduction in cross-section area in this rivet was estimated at 28%.

Figure 47 Intergranular Corrosion and SCC in a 7050 Rivet Aged 2 Hours at 350°F



S.No. 420964-7
Neg. No. 202301A

Mag. 100X
As polished

Section through a 3/8-in. diam. 7050-T7X rivet (Aged 4 hrs/250F + 8 hrs/345F) driven in 2024-T3 sheet and exposed 30 days to 3.5% NaCl - A.I. Photomicrograph shows a 0.020 inch long intergranular stress-corrosion crack initiating at the base of the manufactured head. No other cracks were detected. The maximum reduction in cross-sectional area as a result of cracking was estimated at 5%.

Figure 48 SCC in a 7050 Rivet Aged 8 Hours at 345°F

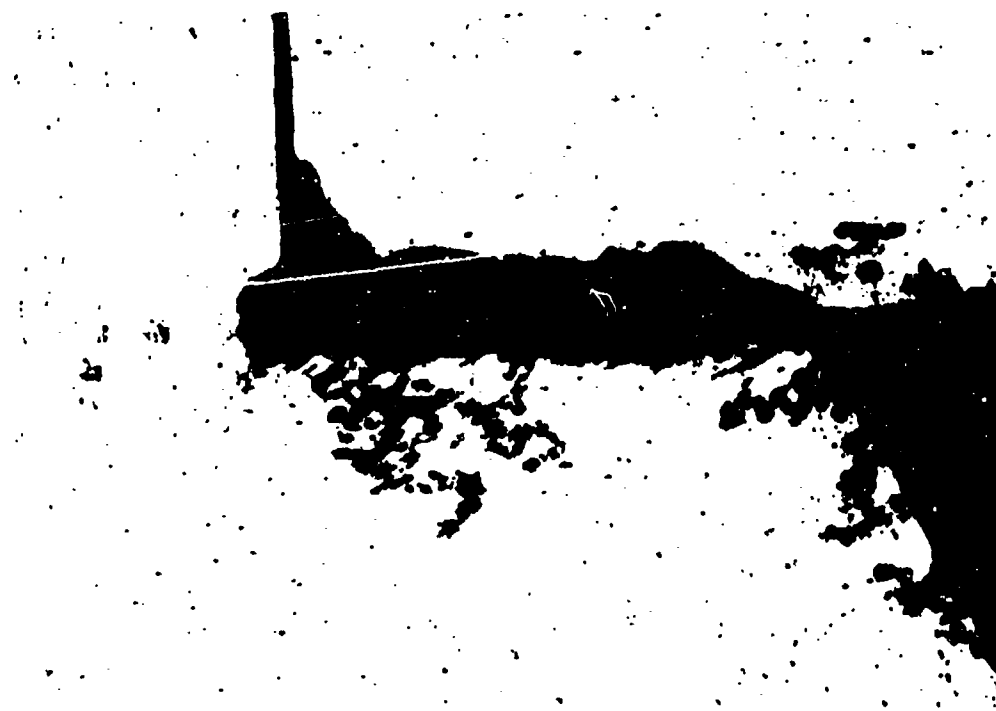

S. No. 420974-9
Neg. No. 202466A

Mag. 100X
As Polished

Section through a 3/16-in. diam. 7050-T7X rivet (aged 4 hrs at 250F plus 8 hrs at 345F) driven in 7075-T73 sheet and exposed 50 days to 3.5% NaCl - A. I. Section is at a site of rather severe crevice corrosion between the sheet and the driven head that would cause a localized, highly acidic environment. This condition was not present on any of the other 7050 rivets examined. Photomicrograph shows severe pitting of the 7075-T73 sheet and pitting plus intergranular corrosion of the 7050-T7X rivet. At other locations (surface of the driven head, shank and manufactured head) the corrosion on this rivet was much less extensive and only pitting in nature.

Figure 49 Localized Corrosion in a 7050 Rivet Aged 8 Hours at 345°F

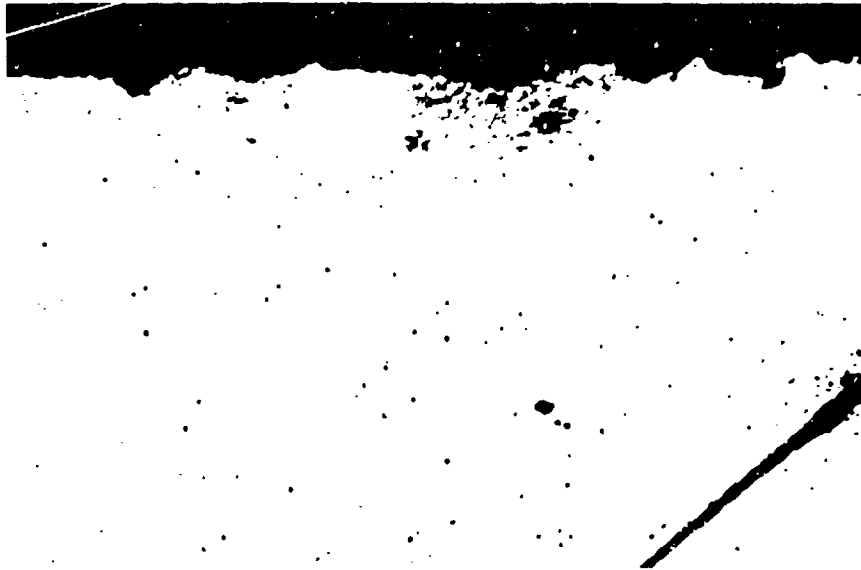

Figure 50 - S. No. 420963-75
Neg. No. 202860A

Mag. 100X
As Polished

Cross-section through the manufactured head of the 2024-T31 rivet that was heated 1/2 hour at 400°F and exposed 90 days to 3.5% NaCl - A. I. showing intergranular corrosion.

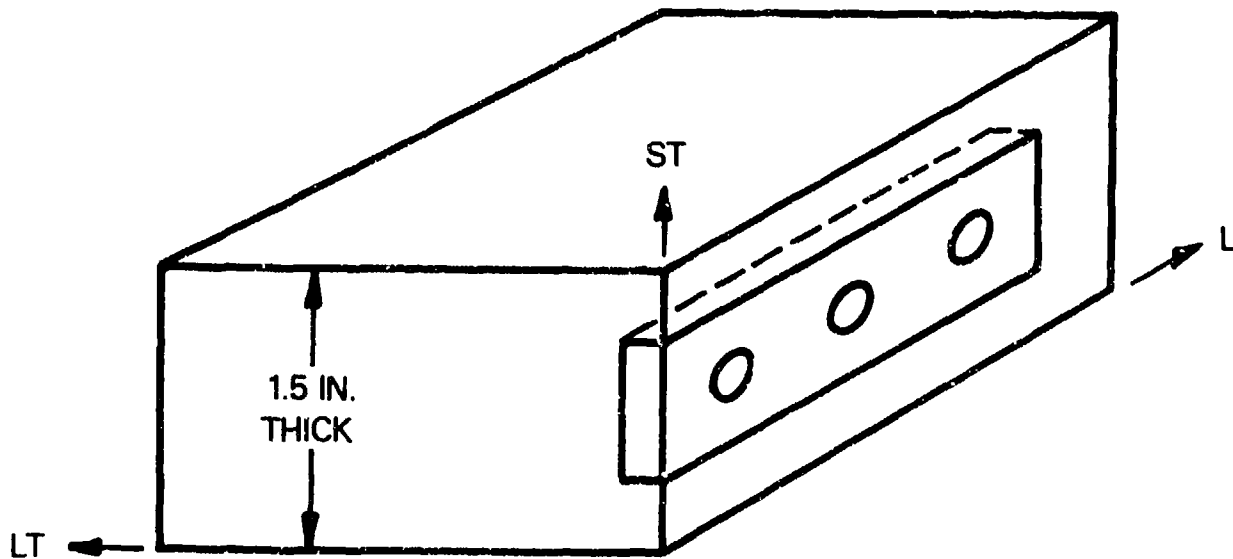

Figure 50A S. No. 420963-75
Neg. No. 202861A

Mag. 100X
As Polished

Cross-section through above rivet showing stress corrosion cracking in the fillet area and shank of the heated 2024-T31 rivet.

Figure 50 Intergranular Corrosion and SCC in a Heated 2024-T31 Rivet



3/16 IN. RIVET : 1/4 x 3/4 x 2-1/4 IN. SLICE

3/8 IN. RIVET : 1/2 x 1-1/2 x 4-1/2 IN. SLICE

RIVETS WERE DRIVEN IN THE LT DIRECTION SO
THAT THE RESULTANT HOOP STRESS IN THE
PLATE WOULD HAVE A ST COMPONENT

Figure A1 Orientation of the Longitudinal Slice
Used in Testing 2124 Plate

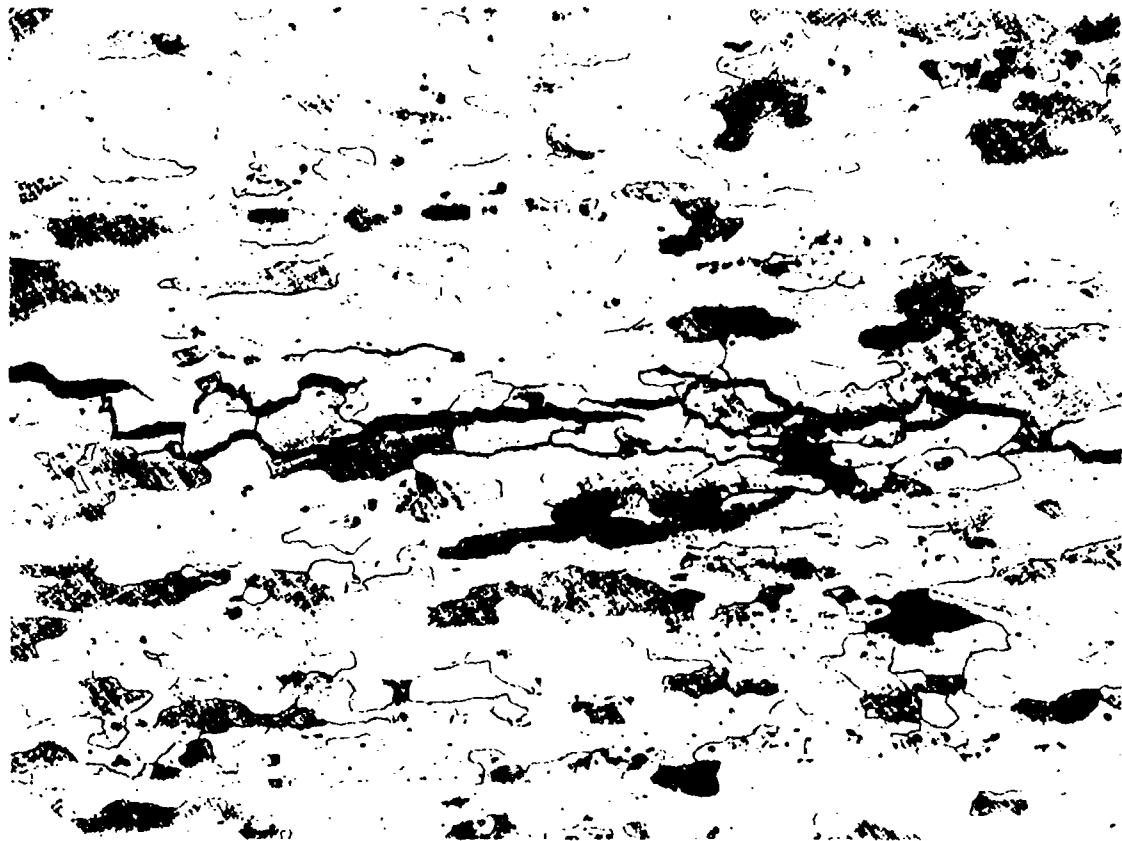

S. No. 446596-1
Neg. No. 202267A

Mag. 100X
Etch Keller's

Photomicrograph of a section from the 2124-T351 plate coupon containing 2024-T31 rivets after 45 days exposure to 3.5% NaCl - A. I. The intergranular nature of the cracks verified SCC as the cause of cracking.

The 2124-T351 plate coupon, S. No. 446596-3, containing 3/16-in. diam. 7050-T7X rivets was also sectioned after 45 days exposure to 3.5% NaCl - A. I. and was verified free of any cracking.

Figure A2 SCC in 2124-T351 Coupon Containing 2024-T31 Rivets