

JAN 18 1977

AEDC-TR-76-172

cy 3

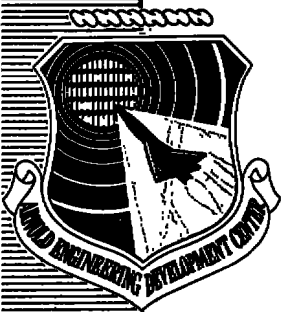

**VIBRATION TESTING OF THE TE-M-604-4 IUE
ROCKET MOTOR (THIOKOL P/N E 28639-03)**

**VON KÁRMÁN GAS DYNAMICS FACILITY
ARNOLD ENGINEERING DEVELOPMENT CENTER
AIR FORCE SYSTEMS COMMAND
ARNOLD AIR FORCE STATION, TENNESSEE 37389**

December 1976

Final Report for Period 3 – 28 May 1976

Approved for public release; distribution unlimited.

Property of U. S. Air Force
AEDC LIBRARY
F40600-75-C-0001

Prepared for

**NATIONAL AERONAUTICS AND SPACE ADMINISTRATION
GODDARD SPACE FLIGHT CENTER
GREENBELT, MARYLAND 20771**

NOTICES

When U. S. Government drawings specifications, or other data are used for any purpose other than a definitely related Government procurement operation, the Government thereby incurs no responsibility nor any obligation whatsoever, and the fact that the Government may have formulated, furnished, or in any way supplied the said drawings, specifications, or other data, is not to be regarded by implication or otherwise, or in any manner licensing the holder or any other person or corporation, or conveying any rights or permission to manufacture, use, or sell any patented invention that may in any way be related thereto.

Qualified users may obtain copies of this report from the Defense Documentation Center.

References to named commercial products in this report are not to be considered in any sense as an endorsement of the product by the United States Air Force or the Government.

This report has been reviewed by the Information Office (OI) and is releasable to the National Technical Information Service (NTIS). At NTIS, it will be available to the general public, including foreign nations.

APPROVAL STATEMENT

This technical report has been reviewed and is approved for publication.

FOR THE COMMANDER

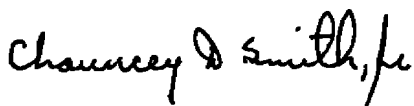

CHAUNCEY D. SMITH, JR.
Lt Colonel, USAF
Chief Air Force Test Director, VKF
Directorate of Test



ALAN L. DEVEREAUX
Colonel, USAF
Director of Test

UNCLASSIFIED

REPORT DOCUMENTATION PAGE		READ INSTRUCTIONS BEFORE COMPLETING FORM
1. REPORT NUMBER AEDC-TR-76-172	2. GOVT ACCESSION NO.	3. RECIPIENT'S CATALOG NUMBER
4. TITLE (and Subtitle) VIBRATION TESTING OF THE TE-M-604-IUE ROCKET MOTOR (THIOKOL P/N E 28639-03)		5. TYPE OF REPORT & PERIOD COVERED Final Report, 3 - 28 May 1976
		6. PERFORMING ORG. REPORT NUMBER
7. AUTHOR(s) R. E. Alt and J. T. Tosh, ARO, Inc.		8. CONTRACT OR GRANT NUMBER(s)
9. PERFORMING ORGANIZATION NAME AND ADDRESS Arnold Engineering Development Center (XO) Air Force Systems Command Arnold Air Force Station, TN 37389		10. PROGRAM ELEMENT, PROJECT, TASK AREA & WORK UNIT NUMBERS Program Element 921E
11. CONTROLLING OFFICE NAME AND ADDRESS National Aeronautics and Space Adminis- tration, Goddard Space Flight Center, Greenbelt, MD 20771		12. REPORT DATE December 1976
		13. NUMBER OF PAGES 292
14. MONITORING AGENCY NAME & ADDRESS (if different from Controlling Office)		15. SECURITY CLASS. (of this report) UNCLASSIFIED
		15a. DECLASSIFICATION/DOWNGRADING SCHEDULE N/A
16. DISTRIBUTION STATEMENT (of this Report) Approved for public release; distribution unlimited.		
17. DISTRIBUTION STATEMENT (of the abstract entered in Block 20, if different from Report)		
18. SUPPLEMENTARY NOTES Available in DDC.		
19. KEY WORDS (Continue on reverse side if necessary and identify by block number) test methods vibration rocket engines dynamic tests		
20. ABSTRACT (Continue on reverse side if necessary and identify by block number) The NASA International Ultraviolet Explorer (IUE) rocket motor (TE-M-604-4), a solid fuel, spherical rocket motor, was vibration tested in the Impact, Vibration, and Acceleration (IVA) Test Unit of the von Kármán Gas Dynamics Facility (VKF). The objective of the test program was to subject the motor to qualification levels of sinusoidal and random vibration prior to the altitude firing of the motor in the Propulsion Development Test Cell (T-3), Engine		

UNCLASSIFIED

UNCLASSIFIED

20. ABSTRACT (Continued)

Test Facility (ETF), AEDC. The vibration testing consisted of a low level sine survey from 5 to 2,000 Hz, followed by a qualification level sine sweep and qualification level random vibration. A second low level sine survey followed the qualification level testing. This sequence of testing was accomplished in each of three orthogonal axes. No motor problems were observed due to the imposition of these dynamic environments.

PREFACE

The work reported herein was conducted by the Arnold Engineering Development Center (AEDC), Air Force Systems Command (AFSC), at the request of the National Aeronautics and Space Administration (NASA/GSFC), for the Thiokol Chemical Corporation under Program Element 921E. The results of the test were obtained by ARO, Inc. (a subsidiary of Sverdrup Corporation), contract operator of AEDC, AFSC, Arnold Air Force Station, Tennessee, under ARO Project Number V41T-21A. The authors of this report were R. E. Alt and J. T. Tosh, ARO, Inc. The data analysis was completed on June 16, 1976, and the manuscript (ARO Control No. ARO-VKF-TR-76-65) was submitted for publication on June 25, 1976.

CONTENTS

	<u>Page</u>
1.0 INTRODUCTION.	7
2.0 APPARATUS	
2.1 Test Unit.	7
2.2 Test Motor.	9
2.3 Instrumentation.	9
3.0 PROCEDURE.	10
4.0 RESULTS AND DISCUSSION	
4.1 Lateral Axis Fixture and Procedure Evaluation.	10
4.2 Lateral Axis Testing: IUE Motor.	11
4.3 Thrust Axis Fixture and Procedure Evaluation.	12
4.4 Thrust Axis Testing: IUE Motor	12

ILLUSTRATIONS

Figure

1. IVA Test Unit and Test Equipment Locations	15
2. Data and Control Flow System	16
3. IUE Rocket Motor Accelerometer Locations	18
4. Vibration Input Levels.	19
5. IUE Mass Simulator.	20
6. Lateral Axis Fixture Evaluation: 0.5-g Sine Survey, Bare Fixture	21
7. Lateral Axis Procedure Evaluation: 0.5-g Sine Survey, Mass Simulator.	26
8. Lateral Axis Procedure Evaluation: Qualification Level Sine Sweep, Mass Simulator	27
9. Lateral Axis Procedure Evaluation: Qualification Level Random Vibration, Mass Simulator	28
10. Lateral Axis Procedure Evaluation: 0.5-g Sine Survey, Mass Simulator.	29
11. X-Axis Motor Installation Photographs	30
12. X-Axis Vibration Test: 0.5-g Sine Survey.	37

<u>Figure</u>	<u>Page</u>
13. X-Axis Vibration Test: Qualification Level Sine Sweep.	53
14. X-Axis Vibration Test: Qualification Level Random Vibration	76
15. X-Axis Vibration Test: 0.5-g Sine Survey	79
16. Y-Axis Motor Installation Photographs	95
17. Y-Axis Vibration Test: 0.5-g Sine Survey	104
18. Y-Axis Vibration Test: Qualification Level Sine Sweep.	122
19. Y-Axis Vibration Test: Qualification Level Random Vibration	146
20. Y-Axis Vibration Test: 0.5-g Sine Survey	149
21. Thrust Axis Fixture Evaluation: 0.5-g Sine Survey, Bare Fixture	167
22. Thrust Axis Installation Photographs: Mass Simulator	173
23. Thrust Axis Procedure Evaluation: 0.5-g Sine Survey, Mass Simulator	176
24. Thrust Axis Procedure Evaluation: Qualification Level Sine Survey, Mass Simulator (5 to 75 Hz)	177
25. Thrust Axis Procedure Evaluation: Qualification Level Sine Survey, Mass Simulator (75 to 2,000 Hz).	178
26. Thrust Axis Procedure Evaluation: Qualification Level Random Vibration, Mass Simulator.	179
27. Thrust Axis Procedure Evaluation: 0.5-g Sine Survey, Mass Simulator	180
28. Z-Axis Installation Photographs	181
29. Z-Axis Vibration Test: 0.5-g Sine Survey	185
30. Z-Axis Vibration Test: 1.0-g Sine Survey	206
31. Z-Axis Vibration Test: 5 to 75 Hz, Qualification Level Sine Sweep.	227
32. Z-Axis Vibration Test: 75 to 325 Hz, Qualification Level Sine Sweep.	239

<u>Figure</u>		<u>Page</u>
33.	Z-Axis Vibration Test: 300 to 2,000 Hz, Qualification Level Sine Sweep.	249
34.	Z-Axis Vibration Test: Qualification Level Random Vibration	260
35.	Z-Axis Vibration Test: 0.5-g Sine Survey	263

TABLES

1.	Instrumentation Calibration Traceability	283
2.	NASA IUE Rocket Motor Vibration Test Activity Record	290

1.0 INTRODUCTION

The International Ultraviolet Explorer (IUE) rocket motor (TE-M-604-4) is a solid fuel, spherical rocket motor designed and manufactured by the Thiokol Chemical Corporation, Elkton Division. Dynamics testing of the orbit insertion motor (OIM) was conducted as part of the qualification test program for the motor. The qualification test program required that the motor be subjected to sinusoidal and random vibration testing prior to test firing at simulated altitude.

The vibration testing of the TE-M-604-4 motor consisted of the following tests in each of three orthogonal axes.

1. A 5- to 2,000-Hz sine sweep at four octaves per minute at an input level of 0.5 g.
2. A 5- to 2,000-Hz sine sweep at specified g levels at a rate of four octaves per minute.
3. Random vibration for a duration of one minute per a specified input spectrum.
4. A 5- to 2,000-Hz sine sweep at four octaves per minute at an input level of 0.5 g.

In addition to the testing of the IUE motor, a mass simulator was subjected to similar tests in two axes for the purposes of evaluating the performance of the AEDC-designed vibration fixtures and for verifying the test procedures and equipment. The dynamics testing was conducted in the Impact, Vibration, and Acceleration (IVA) Test Unit of the von Kármán Gas Dynamics Facility (VKF) at AEDC.

2.0 APPARATUS

2.1 TEST UNIT

The Impact, Vibration, and Acceleration Test Unit consists of the vibration system, a shock machine, and a centrifuge. The equipment (Fig. 1) is housed in the "S" Building of the VKF. The test control room is separated from the test area by a reinforced concrete wall.

The vibration system consists of a Ling electrodynamic shaker, power amplifier, and sine and random vibration control equipment. The shaker (Ling Model 249A) is a wide-frequency-band electrodynamic force shaker capable of operating at a force rating of 30,000 lbf in the sine mode and 32,000 lbf in the random mode. The shaker operates in the 5- to 2,000-Hz frequency range.

The vibration control and monitoring equipment is located in the control room and is shown schematically in Figs. 2a and b. The sine vibration signal and rate of sweep are supplied by a sweep oscillator (Spectral Dynamics Corp. Model SD104) through an amplifier servo/monitor (SD1056). The servo/monitor output signal is fed to the power amplifier (Ling Model PP175/240) and then to the Ling 249A shaker. Four control accelerometers, mounted on the fixture to motor mounting ring, sense the vibration and send signals through charge amplifiers (Unholtz-Dickie Model D-11) to individual tracking filters (SD1012B), where the signal is filtered by preselected filters of specified bandwidths. A linear d-c proportional output signal from each tracking filter is fed to an averaging controller (SD22A), the output signal of which is fed directly to the servo/monitor or, for multilevel testing, through the automatic level programmer (SD115) to the servo/monitor. At the servo/monitor the control signal is automatically compared, for control purposes, to the preset acceleration level. The servo/monitor automatically adjusts its output to provide an acceleration level in accordance with a preset value.

The random vibration input signal is supplied by the random vibration analyzer/equalizer system (Ling Model ASDE-80) located in the test control room. This system analyzes the shaker acceleration output, the signal from the Unholtz-Dickie multifunction averaging control (MAC-8), from the average of the four control accelerometer signals and equalizes internally generated random noise to the desired spectral density. The ASDE-80 control system allows automatic control of the acceleration spectral density in each of 85 channels between 10 and 2,020 Hz by individual servoamplifiers in each channel. The output of the random noise generator is shaped to the desired spectral density by the control system and then is passed through preamplifiers to the power amplifier. The power amplifier increases the signal power level and feeds it to the electrodynamic shaker, which converts it into mechanical force which drives the motor. The power spectral density input to the motor is continuously monitored during testing with a Spectral Dynamics Model 301A Real Time Spectrum Analyzer.

When testing in a lateral axis, the vibration fixture is mounted on hydrostatic bearings (Team Corp. Models 1830 T-8 and 1830 V-8). A signal from a pressure switch in the hydraulic supply line is connected to a safety circuit of the Ling shaker to shut down the power amplifier in case of loss of hydraulic pressure.

Two additional safety circuits were provided to protect the motor and/or the shaker system from possible overtesting. A safety accelerometer, mounted on the test fixture, was connected electrically to a Ling AAL-100 armature acceleration limiter. This unit was set to shut down the power amplifier when the force level experienced by the armature reached approximately the maximum force rating of the Ling system (that is, when the product of the armature plus fixture plus motor weight and the input acceleration level at the fixture-armature mounting location approached 30,000 lbf). An accelerometer mounted on the motor nozzle in the test axis was connected electrically to an SD129A sine/random Signal Vibration Protector, and this unit shut down the power amplifier when a preset acceleration level was reached.

2.2 TEST MOTOR

The Thiokol TE-M-604-4 motor is a 24.58-in.-diam solid fuel rocket motor with a fixed nozzle. The design includes an integral attachment flange. The nominal motor weight is less than 500 lb, and the motor case is composed of two hemispheres connected by a short, straight, cylindrical section (Fig. 3). It is mounted by a ring containing 24 holes on a 25.075-in.-diam bolt circle attached to the aft hemisphere. The initiation system was not subjected to vibration.

2.3 INSTRUMENTATION

The test instrumentation for the vibration testing consisted of accelerometers placed at designated locations on the motor and test fixture (Fig. 3). The accelerometers were Endevco Model 2228-C tri-axis or Endevco 2226-C single axis mounted on phenolic blocks. The accelerometer output signals were routed to charge amplifiers for conditioning and then were recorded on a Bell and Howell Model 3700-B tape recording system operating at 15 in./sec (Figs. 2a and b).

Individual or average input control accelerometers are monitored during testing on RMS voltmeters (Thermo-Systems, Inc., Model

1060) or a spectral density voltmeter (M. B. Electronics Model N122) either directly or through a Ling Model LP-10 low pass filter in series with the voltmeter. Selected accelerometer signals are also displayed in real time on a Honeywell Model 1858 CRT photographically recording visicorder. Accelerometer signals are plotted in real-time (input control) or following testing on x-y plotters.

All instrumentation used during the vibration and acceleration tests was calibrated according to AEDC standard calibration procedures (Table 1).

3.0 PROCEDURE

The IUE rocket motor was received at the IVA test unit on May 3, 1976, in preparation for vibration testing. A bare fixture evaluation and mass simulator/fixture evaluation for both the lateral and thrust axes preceded motor testing. The fixture and fixture/mass simulator evaluations were based on 0.5-g sine surveys from 5 to 2,000 Hz at a sweep rate of four octaves per minute (Fig. 4). The mass simulator (Fig. 5) was also tested in both lateral and thrust axes at qualification levels of sine and random vibration for the purpose of verifying test procedures, vibration fixtures, and vibration control equipment.

A summary of system dynamic test activities is contained in Table 2. At the conclusion of vibration testing the mass simulator was returned to Thiokol Chemical Corp. and the IUE motor was transferred to the AEDC Radiographic Inspection Laboratory for X-ray inspection prior to the test firing in the AEDC Engine Test Facility (ETF) Propulsion Development Test Cell (T-3).

4.0 RESULTS AND DISCUSSION

4.1 LATERAL AXIS FIXTURE AND PROCEDURE EVALUATION

The lateral axis vibration fixture was evaluated by means of a 0.5-g sine survey following its installation on the hydraulic bearings and attachment to the shaker armature. The results of the survey are shown in Fig. 6. There were no significant fixture resonances below approximately 200 Hz. Above 200 Hz, although there was considerable variation in the vibratory input between the motor

attachment points as indicated by the four control accelerometers in the Y axis (accelerometers 1 through 4Y), the averaging control unit maintained the 0.5-g average input over the entire 5- to 2,000 Hz frequency range.

The motor mass simulator was then installed on the lateral axis vibration fixture for further evaluation of the fixture at qualification test stress levels and also for verifying the test procedures prior to conducting the IUE motor qualification test program. The mass simulator (Fig. 4) was composed of a number of plates and rods and accurately simulated the mass and inertia properties of the motor and undoubtedly loaded the vibration fixtures to higher levels than the IUE motor. However, due to its construction, it contained a large number of resonant frequencies and was therefore somewhat difficult to control. The simulator was run through the motor qualification test requirements, and the results are shown in Figs. 7 through 10.

4.2 LATERAL AXIS TESTING: IUE MOTOR

The IUE motor (S/N 0002) was installed in the lateral axis vibration fixture in preparation for X-axis testing. Installation photographs, including accelerometers, are shown in Fig. 11. The X-axis 0.5-g sine survey was then conducted. The X-Y plots of all acceleration signals recorded during this survey are shown in Fig. 12. All X-Y plots were made from the magnetic tape recording following completion of the entire test program, except for the closed loop control plot and the control average online plot. All data channels were displayed on the recording oscillograph following the individual vibration tests.

The qualification level sine sweep and qualification level random vibration tests were then conducted with no problems. The results of these tests are shown in Figs. 13 and 14. The random vibration equalization was accomplished at -20 db with the shaker operating and also following several short bursts of -10 db operation. The first attempt to run at full power input resulted in a shutdown by the nozzle peak limit accelerometer, 14X, which had been set to 40-g peak. The limiter was reset to 100-g peak and the one-minute full level run conducted. A final 0.5-g sine survey was then conducted, and the results are shown in Fig. 15. No significant differences were noted with the initial 0.5-g sine survey results.

The Y-axis test program was conducted in the same manner as the X-axis test. Installation photographs for the Y-axis are shown in Fig. 16. The 0.5-g sine surveys and qualification level sine and random vibration test results are shown in Figs. 17 through 20. No significant acceleration differences were noted with the X-axis test results, as would be expected due to the motor symmetry.

4.3 THRUST AXIS FIXTURE AND PROCEDURE EVALUATION

The thrust axis bare fixture was evaluated by conducting a 0.5-g sine survey from 5 to 2,000 Hz at a sweep rate of four octaves per minute. The results of the survey are shown in Fig. 21. Since the motor mounting points are symmetrical, there was very little variation in vibratory input between control accelerometer mounting points. The cross-axis response was insignificant except above 1,900 Hz in the direction normal to the motor mounting flange.

The thrust axis fixture/mass simulator installation photographs are shown in Fig. 22, and the vibration test results in Figs. 23-27. Due to the number of input level changes required in the qualification level sine sweep (Fig. 5a) this test was conducted in 5- to 75- and 75- to 2,000-Hz sweep ranges. The only problem encountered during the mass simulator test was the loosening of the mounting bolts, noted during the removal of the simulator from the fixture following the final 0.5-g sine survey. This was attributed to the use of a slightly overlength bolt. As this problem would not be encountered with the IUE motor installation, the thrust axis procedures and fixture were considered satisfactory.

4.4 THRUST AXIS TESTING: IUE MOTOR

The qualification testing of the IUE motor in the thrust (Z) axis was similar to the lateral axis program, a low level sine survey prior to and following qualification level sine and random testing. The photographs of the motor installed in the thrust axis fixture are shown in Fig. 28. The results of the first 0.5-g sine survey are shown in Fig. 29. A nozzle resonance mechanical transmissibility factor (Q) of approximately 40 was noted at the 328-Hz resonant point. Due to this higher than anticipated Q value, a second sine survey was conducted at a 1.0-g input to verify the linearity of the magnification. The results of this survey are shown in Fig. 30. A Q value of 44 at

the 328-Hz frequency was again noted. The 5- to 75-Hz portion of the qualification level sine test was then conducted, and no problems were encountered (Fig. 31).

The 0.001-in. double amplitude displacement specified between 200 and 420 Hz (Fig. 4) would have resulted in a 6-g input near the nozzle resonance point and a resulting nozzle acceleration level of approximately 260 g's. In order not to exceed the nozzle design level of approximately 150 g's, the vibration input level was reduced to 3 g's between 240 and 420 Hz. However, the nozzle peak limiter (accelerometer 112) shut down the 75- to 2,000-Hz sine sweep at the resonance point when the 150-g level was reached (Fig. 32). The input level was reduced to 2 g's below 420 Hz, and the sine sweep was restarted at 300 Hz. This test was completed satisfactorily, and the results are shown in Fig. 33.

The random vibration test was then conducted per the spectrum requirements of Fig. 4, with the nozzle peak limiter again set to shut down the vibration at 150 g peak. The first full level burst was shut down when this level was reached 15 sec into the run. However, the test was continued at the required spectrum input level, and the remaining 45 sec of the 1-min required operation were completed (Fig. 34). The final 0.5-g sine survey was then conducted, and the results are shown in Fig. 35. There were no significant response changes from the initial 0.5-g sine survey.

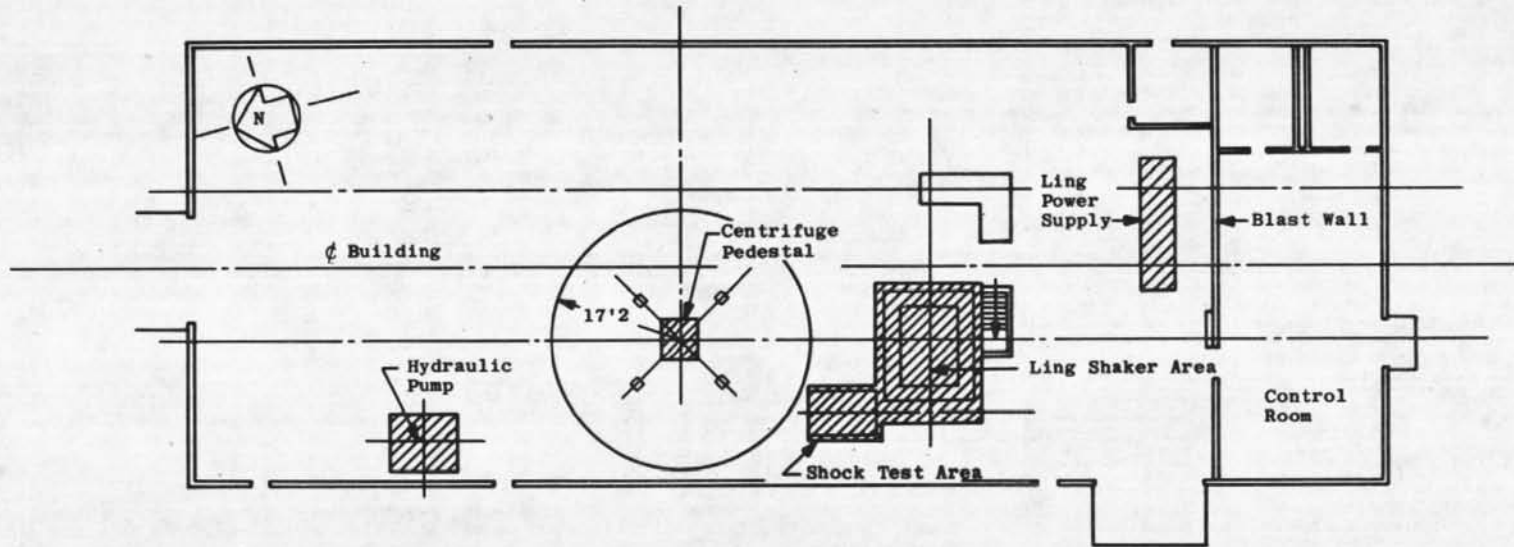
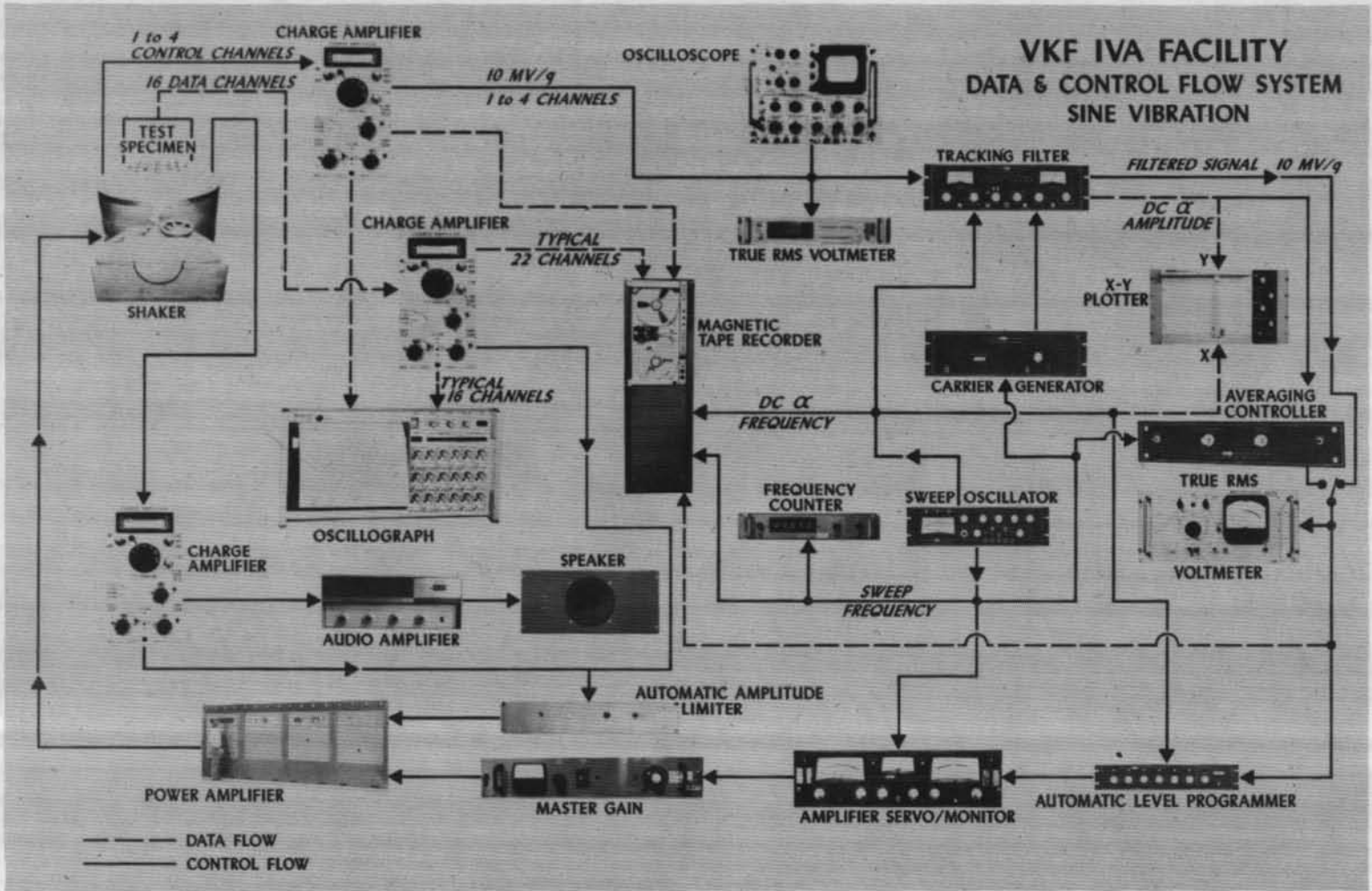
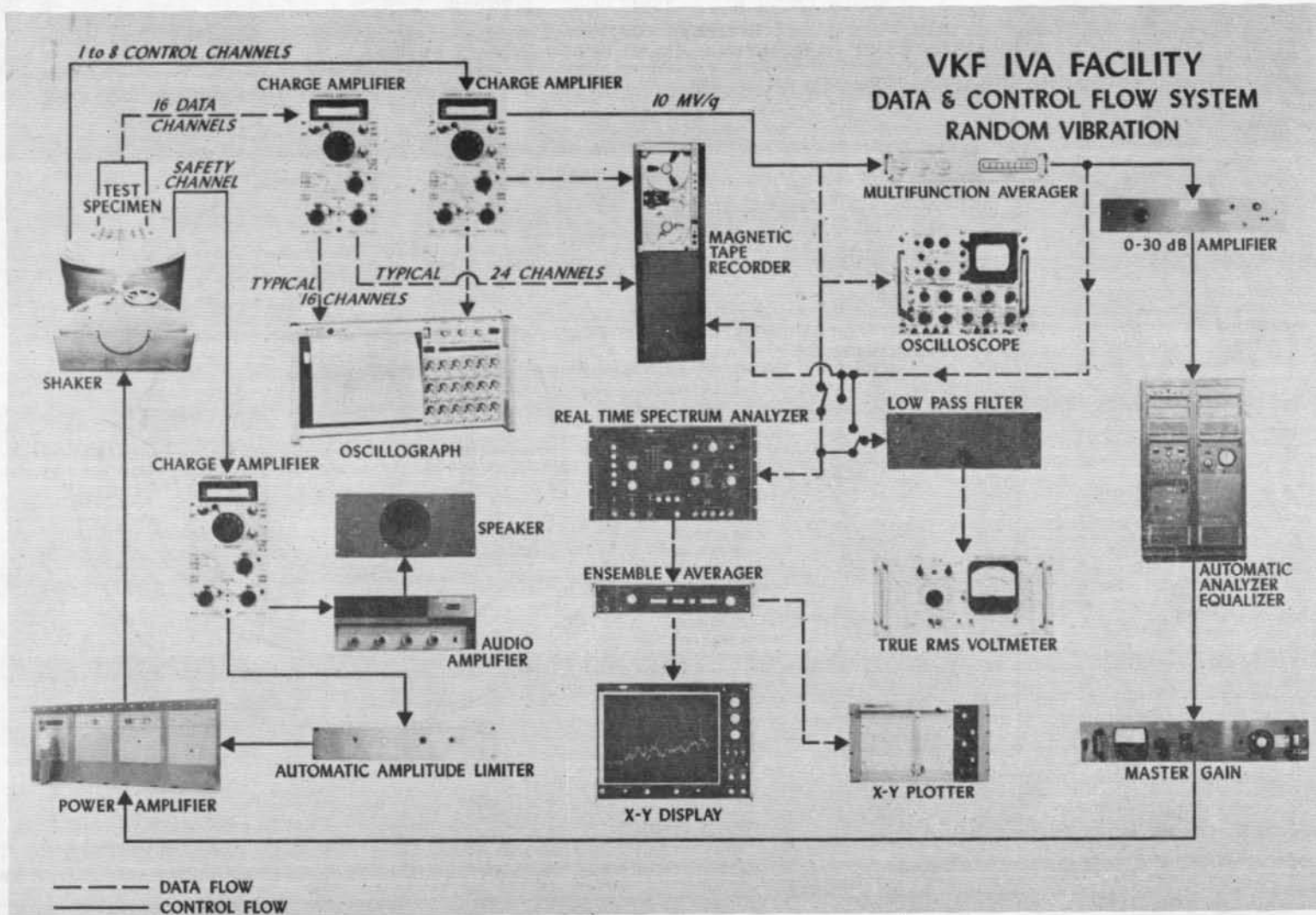

Figure 1. IVA test unit and test equipment locations.



a. Sine vibration
Figure 2. Data and control flow system.



b. Random vibration
Figure 2. Concluded.

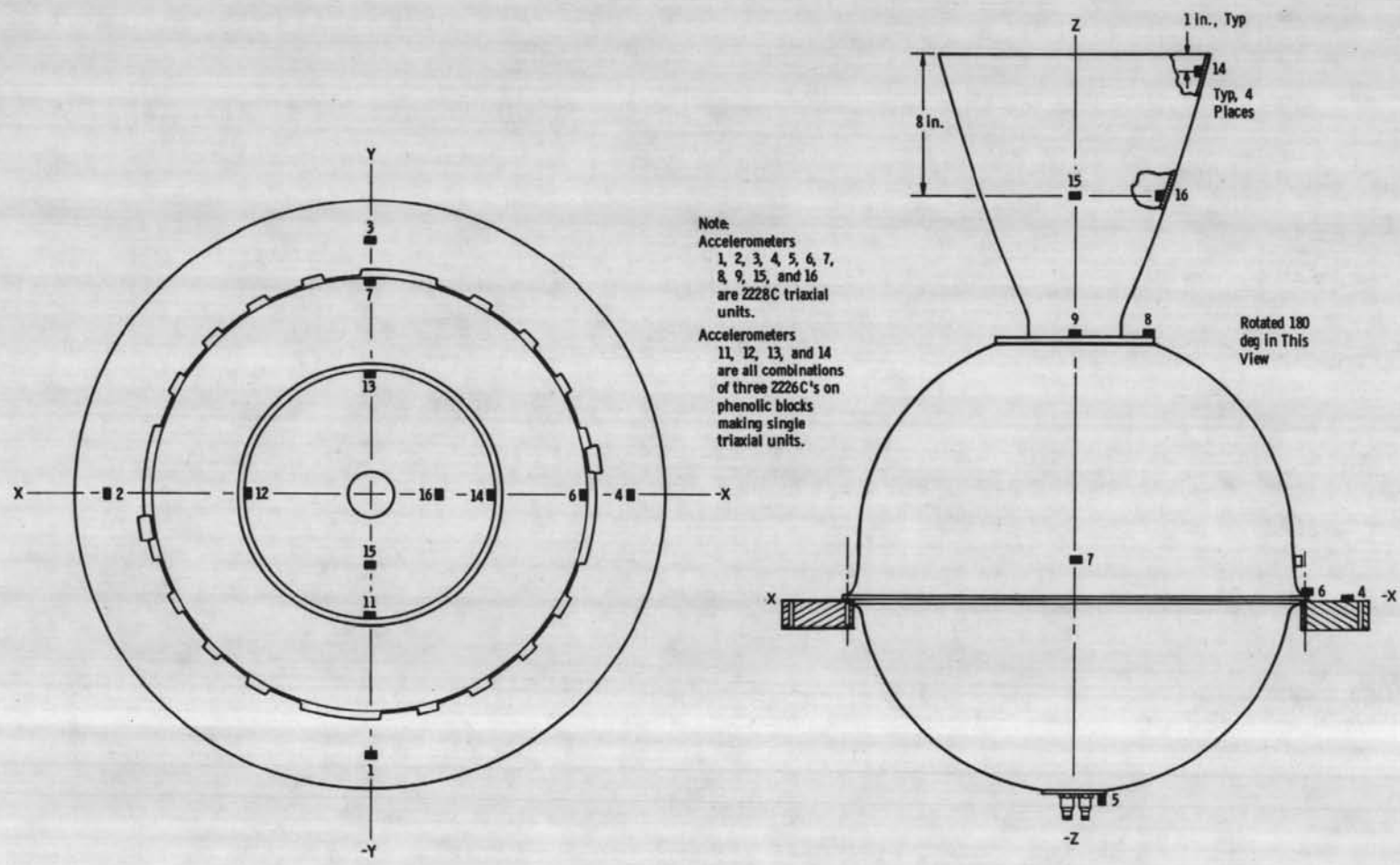

Figure 3. IUE rocket motor accelerometer locations.

Vibration Input Levels

Spacecraft Axis	Sinusoidal		
	Logarithmic Sweep at Four Octaves/min		
	Frequency Range, Hz	Acceleration g, 0 to Peak	Displacement, in. D.A.*
Thrust (Z)	5 to 7.2	---	0.75
	7.2 to 15	2.0	---
	15 to 21	7.0	---
	21 to 35	4.0	---
	35 to 75	8.5	---
	75 to 100	4.0	---
	100 to 198	2.0	---
	198 to 420	---	0.001
	420 to 2,000	9.0	---
Lateral (X-Y)	5 to 7	---	0.8 \approx D.A.
	7 to 25	2.0	---
	25 to 45	3.0	---
	45 to 200	1.5	---
	200 to 420	---	0.001
	420 to 2,000	9.0	---

Random Levels - All Axes - 1-min/Axis

<u>Frequency Range, Hz</u>	<u>PSD, g²/Hz</u>
20 to 150	0.032
150 to 250	6 db/oct
250 to 1,000	0.083
1,000 to 2,000	-3 db/oct

Overall = 11.39 g rms

*Double Amplitude

Figure 4. Vibration input levels.

Weight = 480 lb
 $I_{yy} = I_{zz} = 35,000 \text{ lb/in.}^2$
 $I_{xx} = 31,000 \text{ lb/in.}^2$

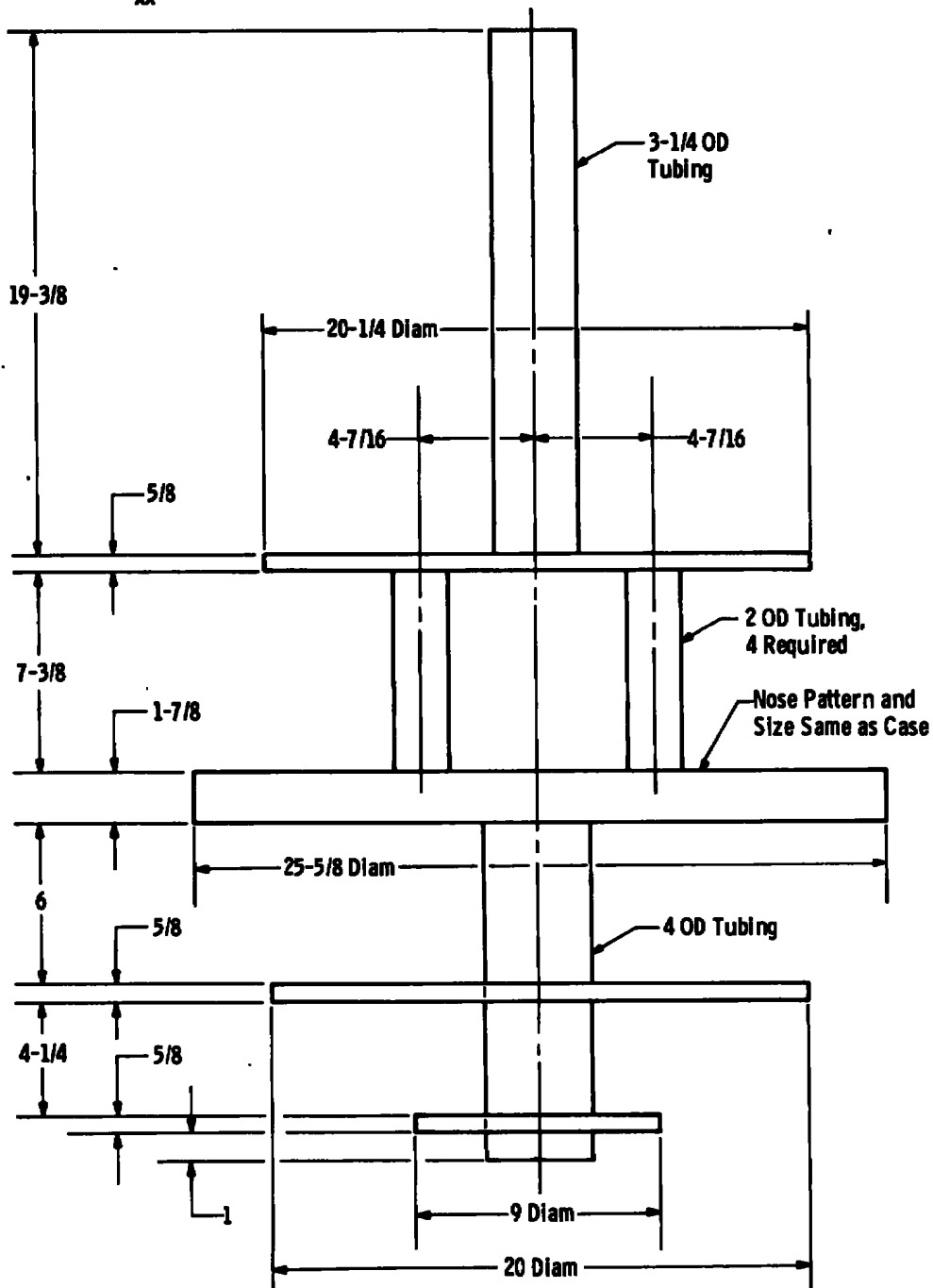

Measurements in Inches
 Scale: 1/4

Figure 5. IUE mass simulator.

VKF IVA Facility Dynamics Test

Test Article: Thiokol/IUE Fixture

Vibration Axis: Y

Tracking Filter: SD1012B

BW₁: 5 Hz, from 5 to 45 Hz

BW₂: 50 Hz, from 45 to 2,000 Hz

Date: 4-9-76

Remarks: Off Tape

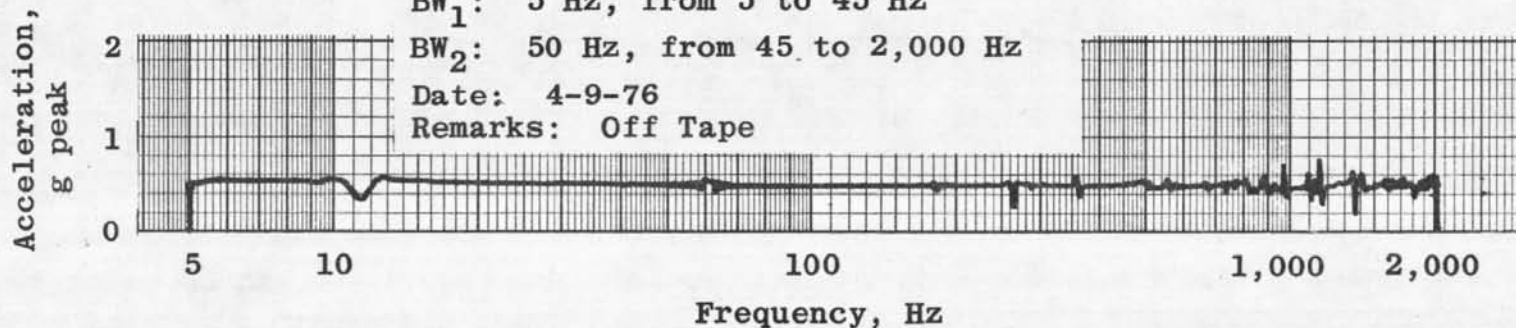

a. Average of accelerometers 1, 2, 3, and 4Y

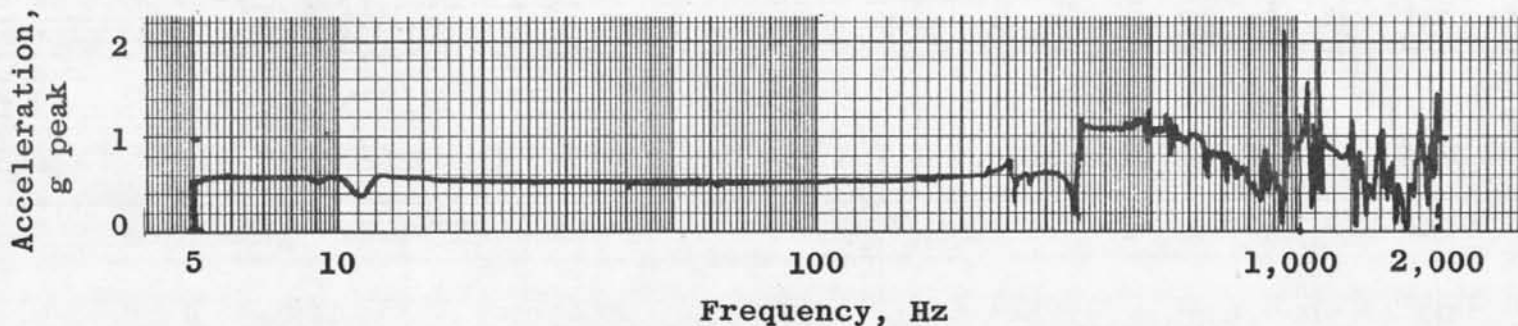

b. Accelerometer 1Y

Figure 6. Lateral axis fixture evaluation: 0.5-g sine survey, bare fixture.

Acceleration,
g peak

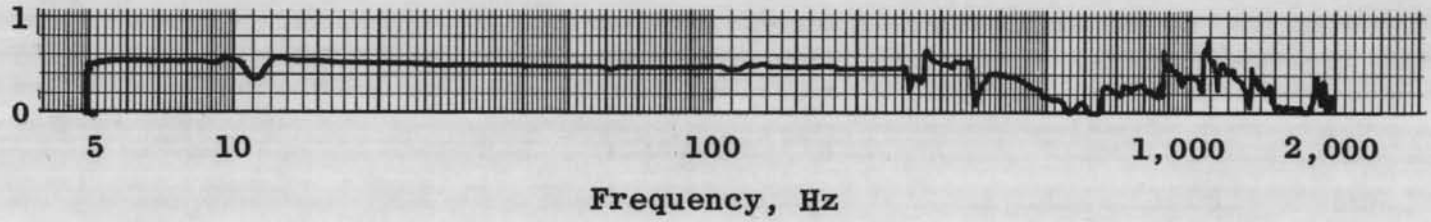

c. Accelerometer 2Y

Acceleration,
g peak

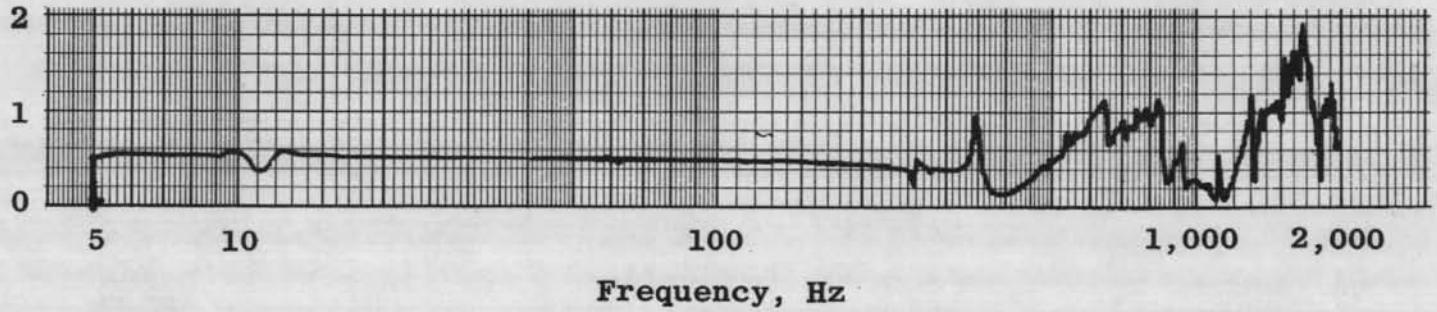

d. Accelerometer 3Y

Acceleration,
g peak

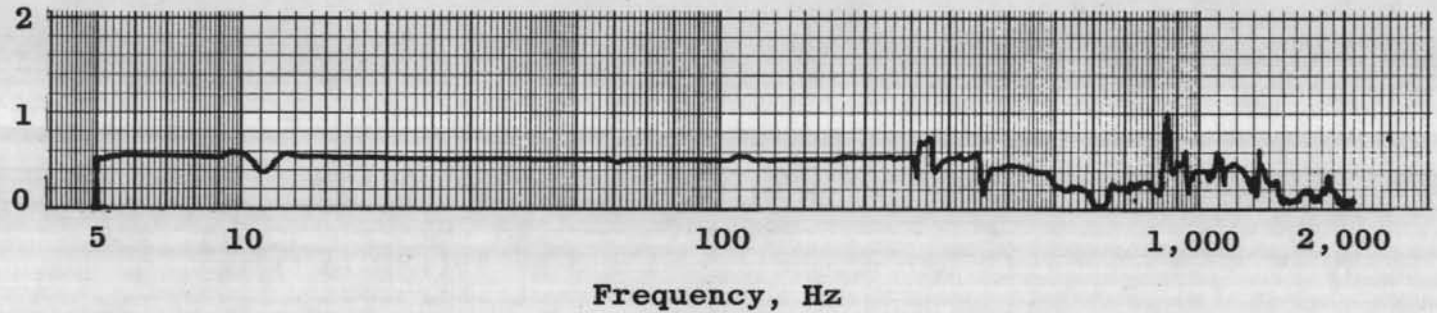

e. Accelerometer 4Y
Figure 6. Continued.

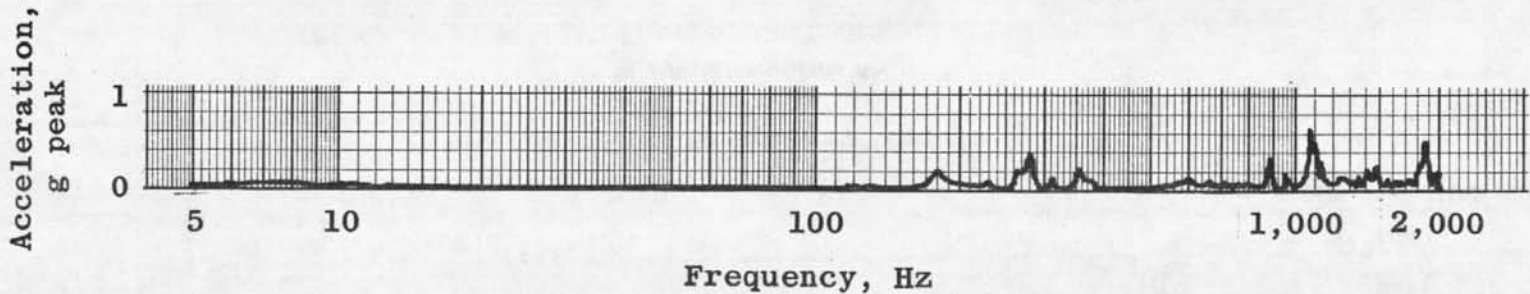

f. Accelerometer 1X

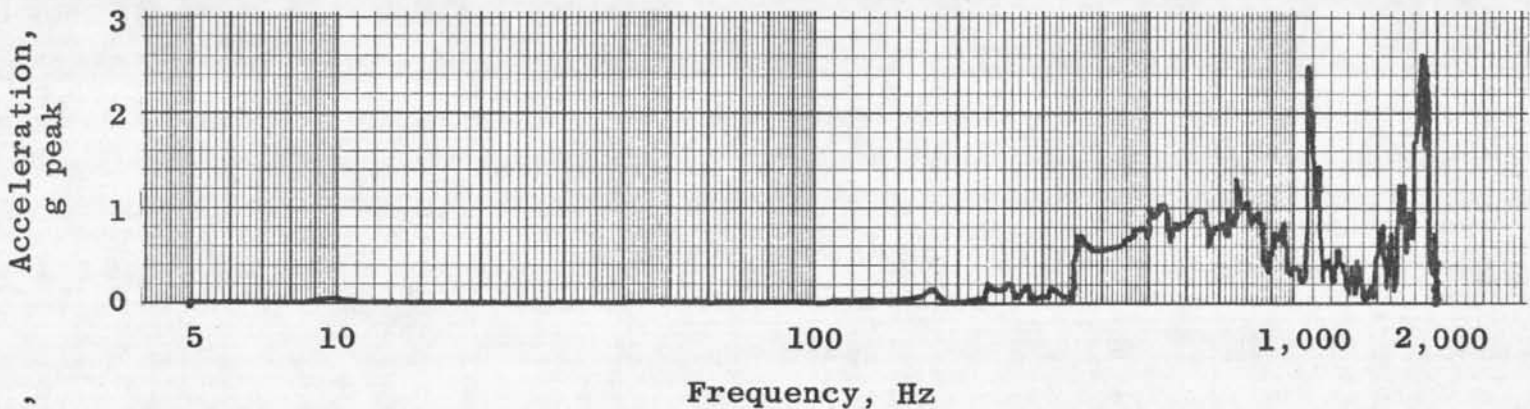

g. Accelerometer 2X

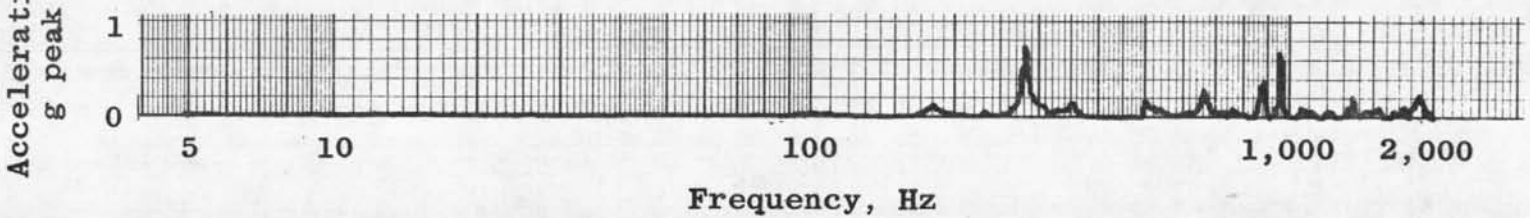

h. Accelerometer 3X

Figure 6. Continued.

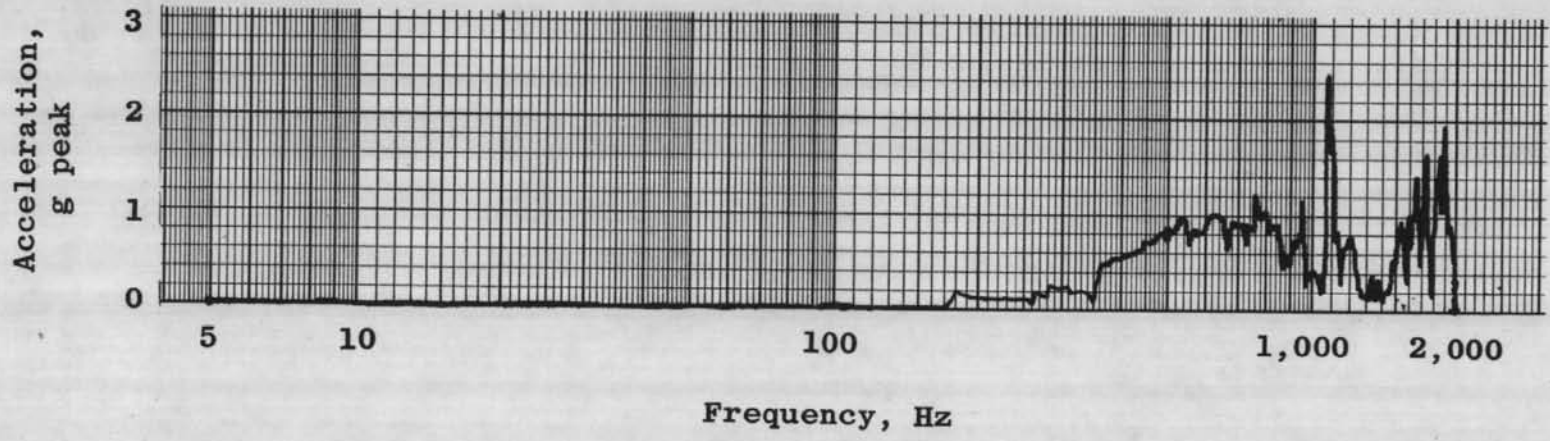

i. Accelerometer 4X

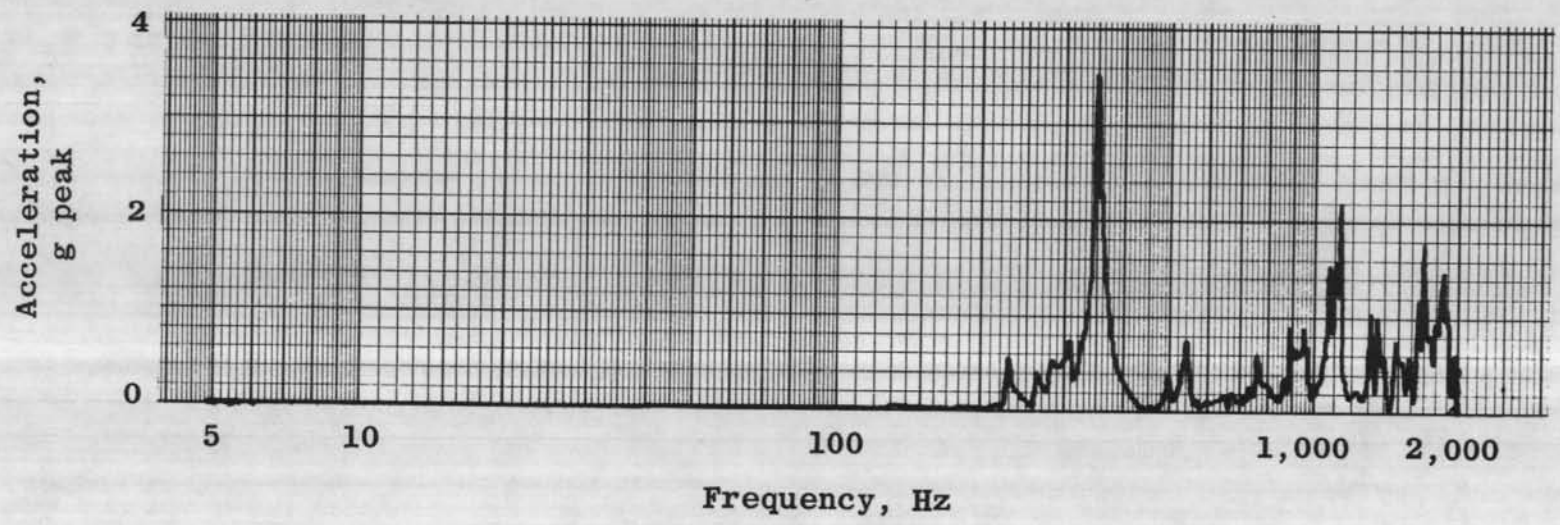

j. Accelerometer 2Z

Figure 6. Continued.

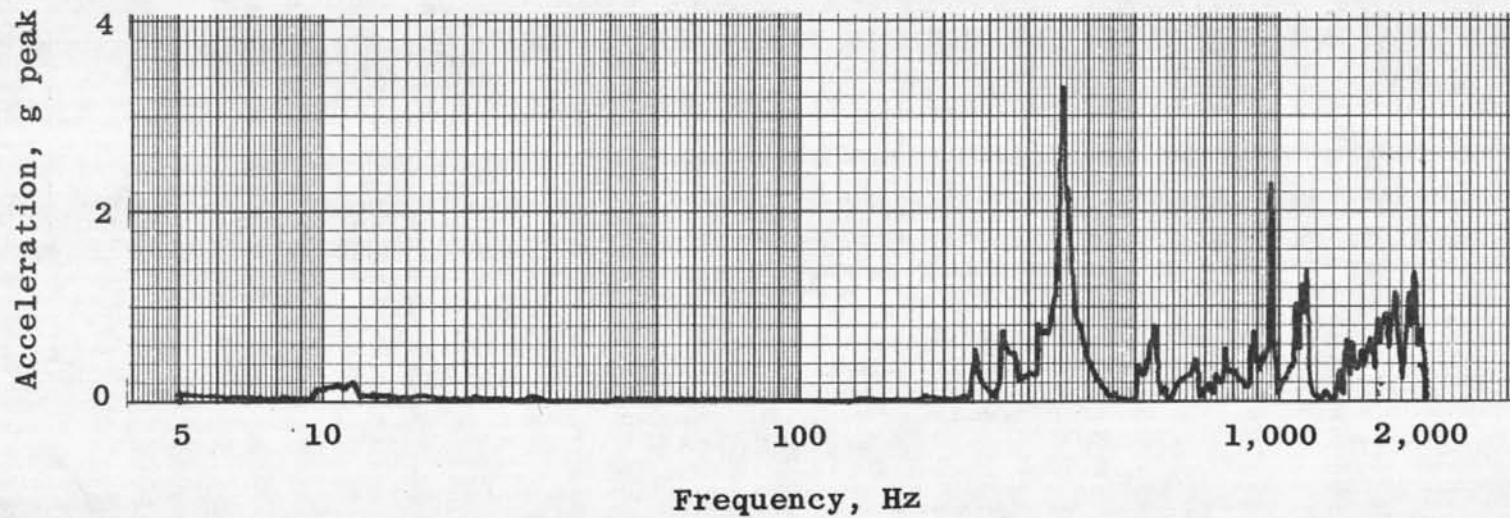

k. Accelerometer 4Z
Figure 6. Concluded.

VKF IVA Facility Dynamics Test

Test Article: IUE Dummy Mass

Vibration Axis: Y

Tracking Filter: 501012B

BW₁: 5 Hz from 5 to 45 HzBW₂: 50 Hz from 45 to 2,000 Hz

Accelerometer Ident.: Average

Date: 4-30-76

Remarks: Online Plot

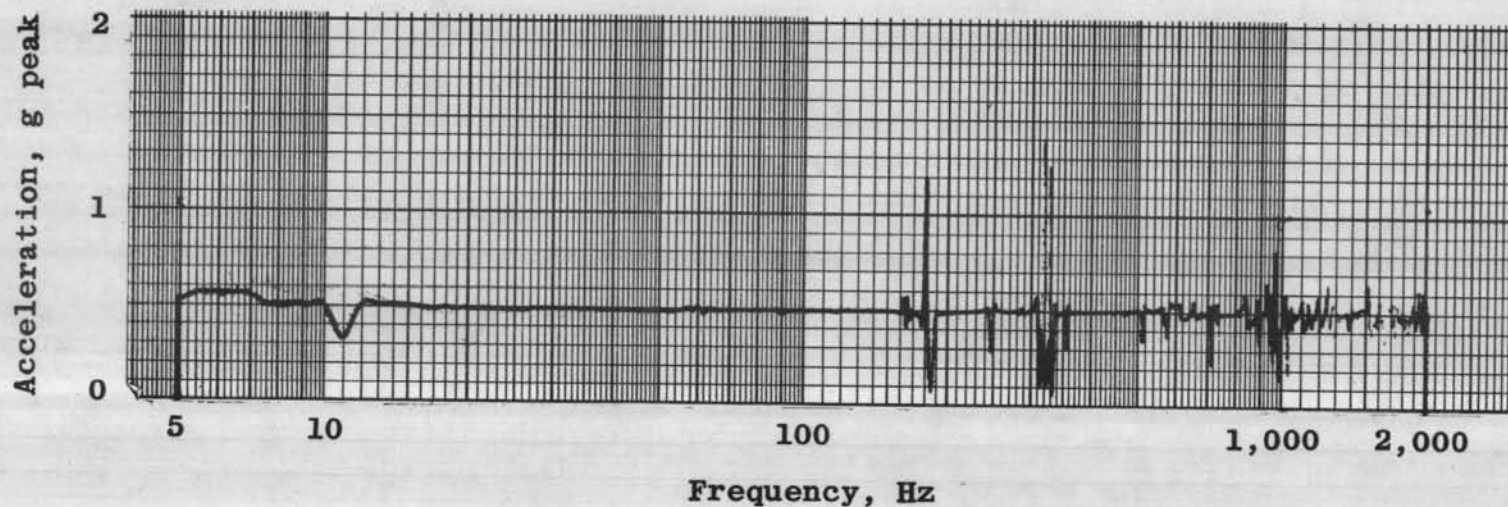

Figure 7. Lateral axis procedure evaluation: 0.5-g sine survey, mass simulator.

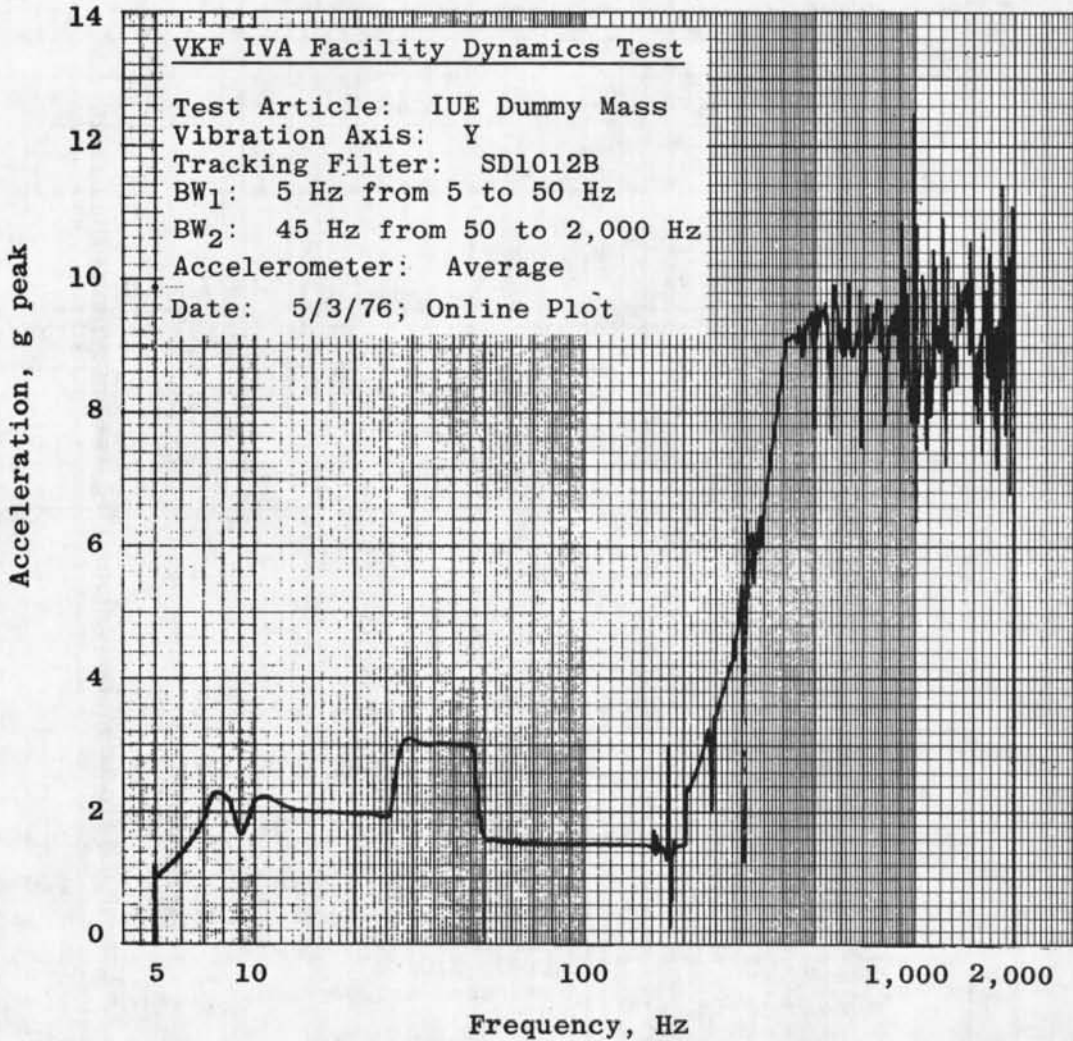

Figure 8. Lateral axis procedure evaluation: qualification level sine sweep, mass simulator.

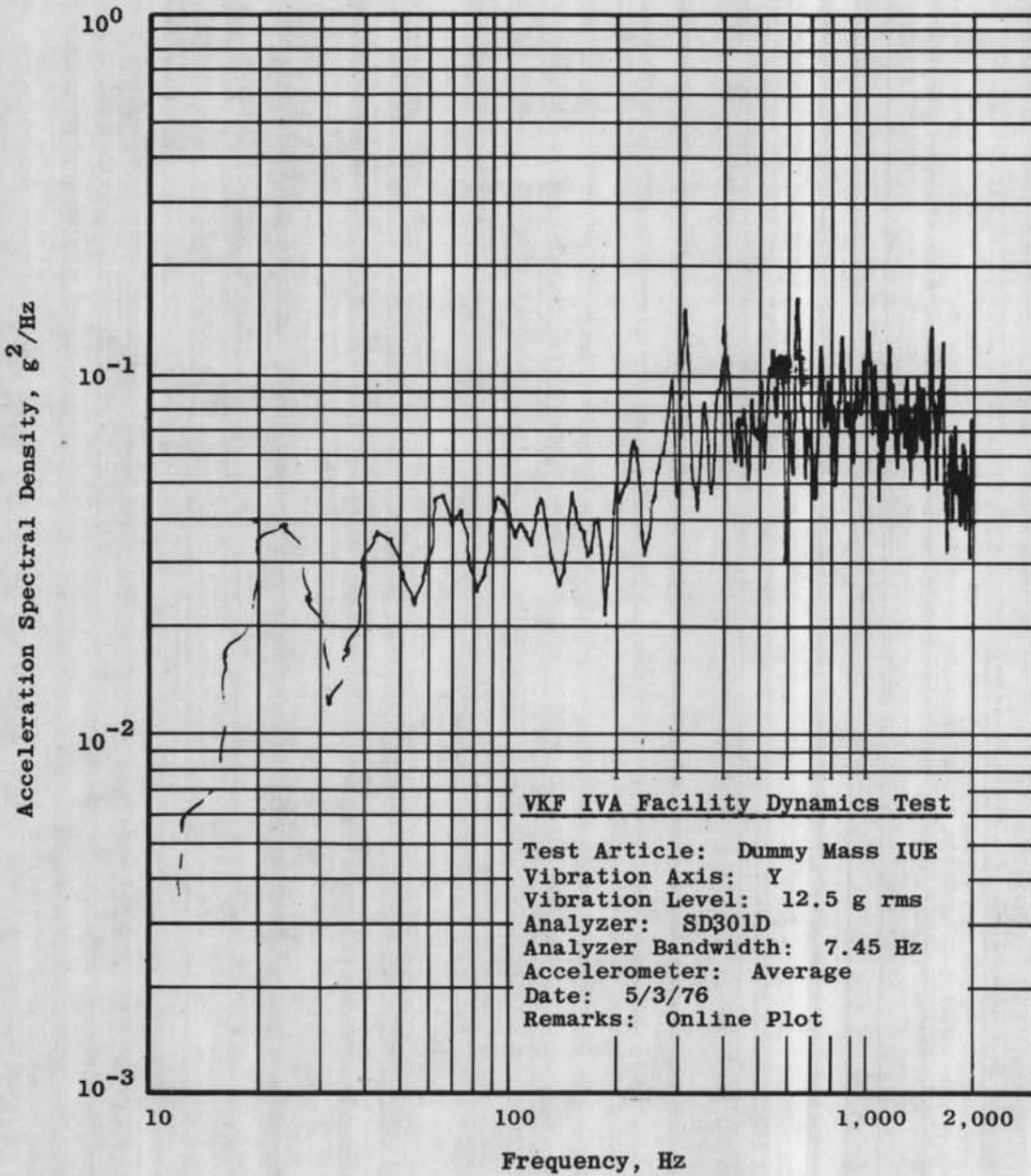

Figure 9. Lateral axis procedure evaluation: qualification level random vibration, mass simulator.

VKF IVA Facility Dynamics Test

Test Article: IUE Dummy Mass

Vibration Axis: Y

Tracking Filter Used: SD1012B

BW₁: 5 Hz from 5 to 45 Hz

BW₂: 50 Hz from 45 to 2,000 Hz

Accelerometer Ident.: Average

Date: 5/4/76

Remarks: Online Plot

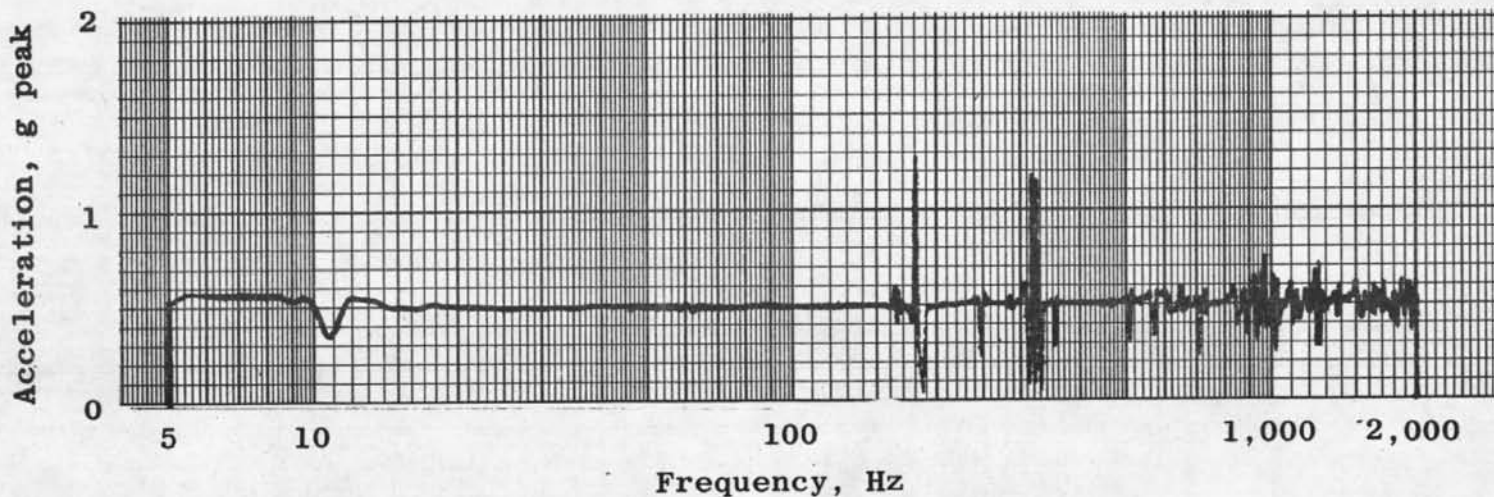

Figure 10. Lateral axis procedure evaluation: 0.5-g sine survey, mass simulator.



Figure 11. X-axis motor installation photographs.



Figure 11. Continued.

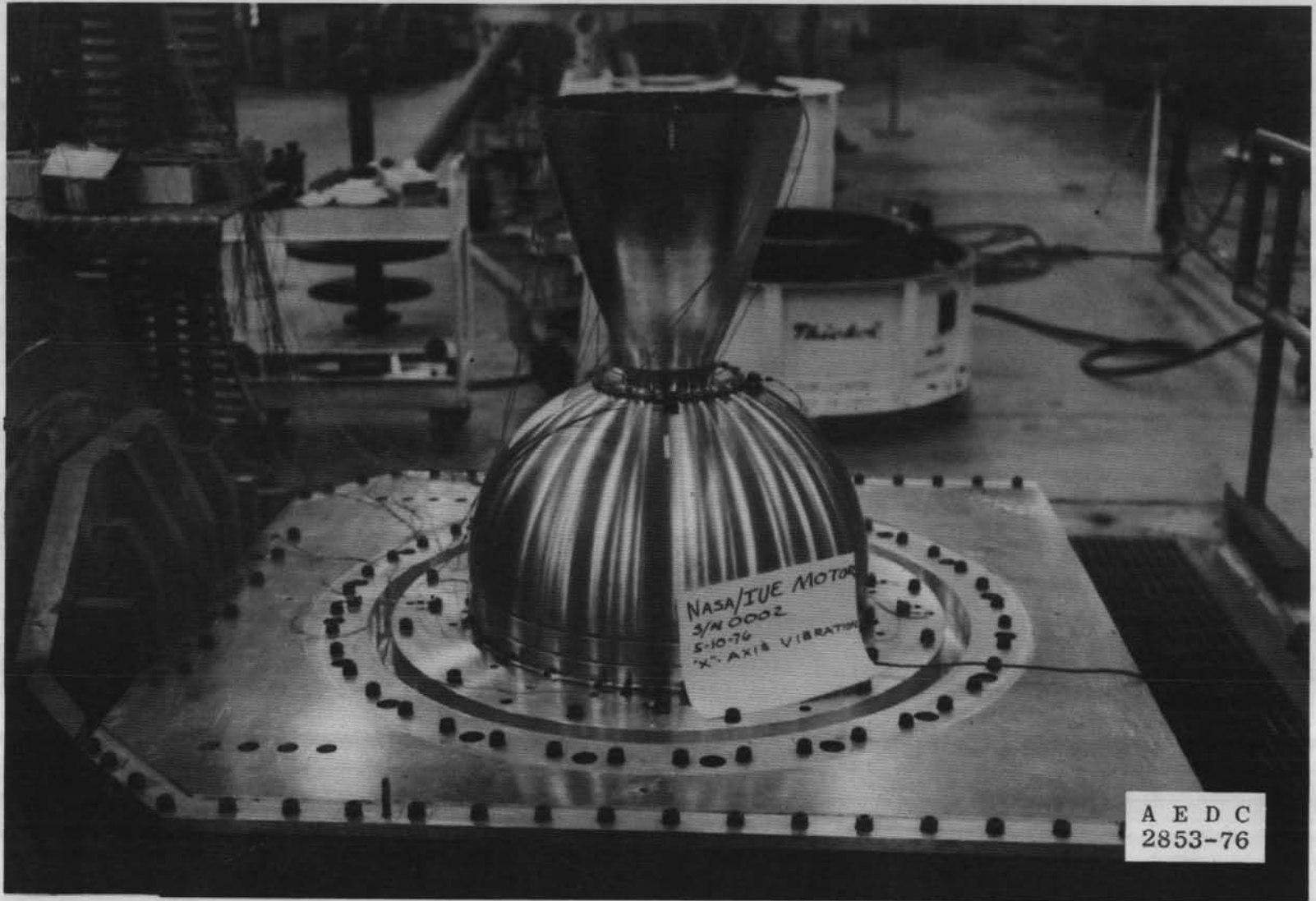

Figure 11. Continued.

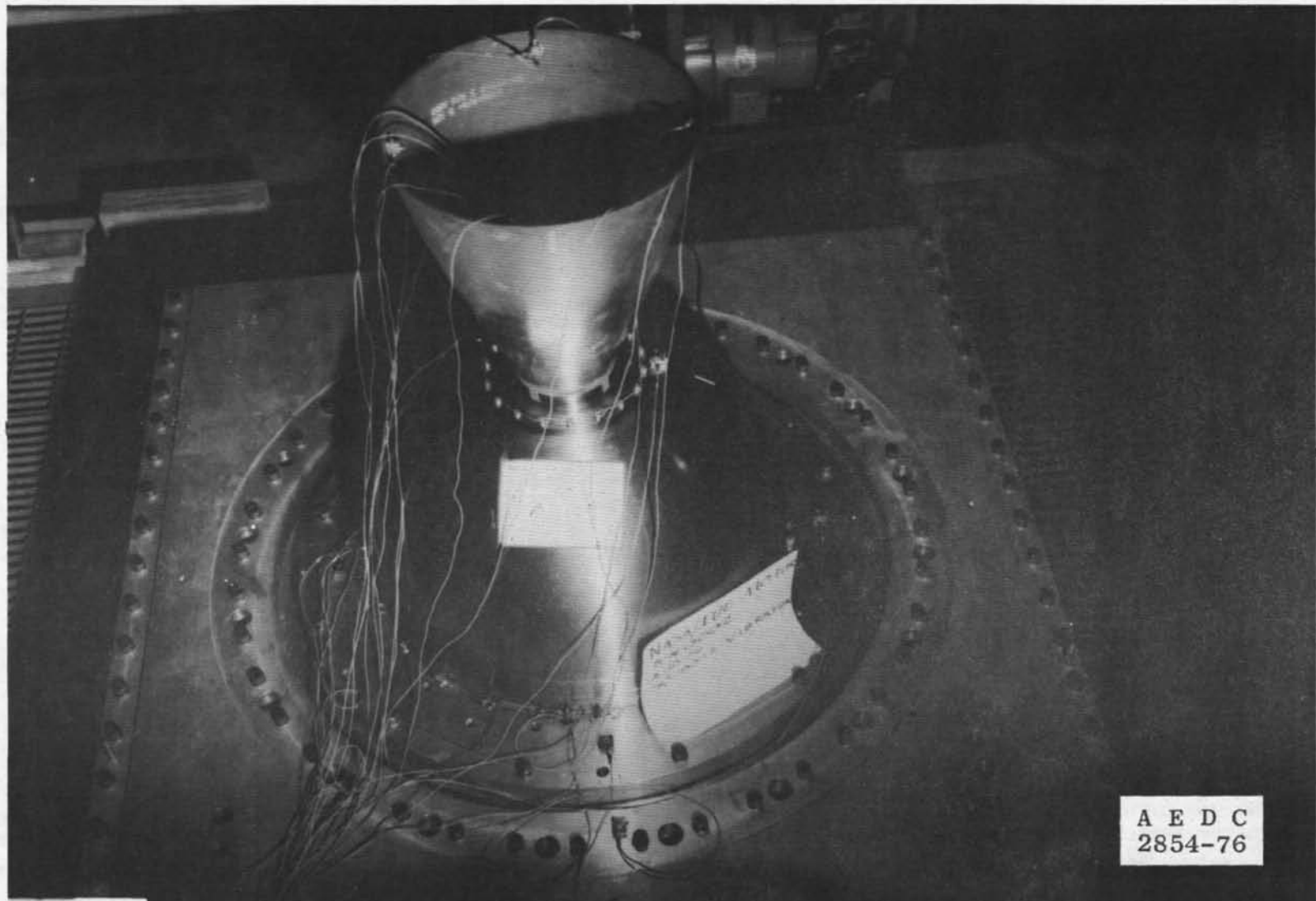

Figure 11. Continued.

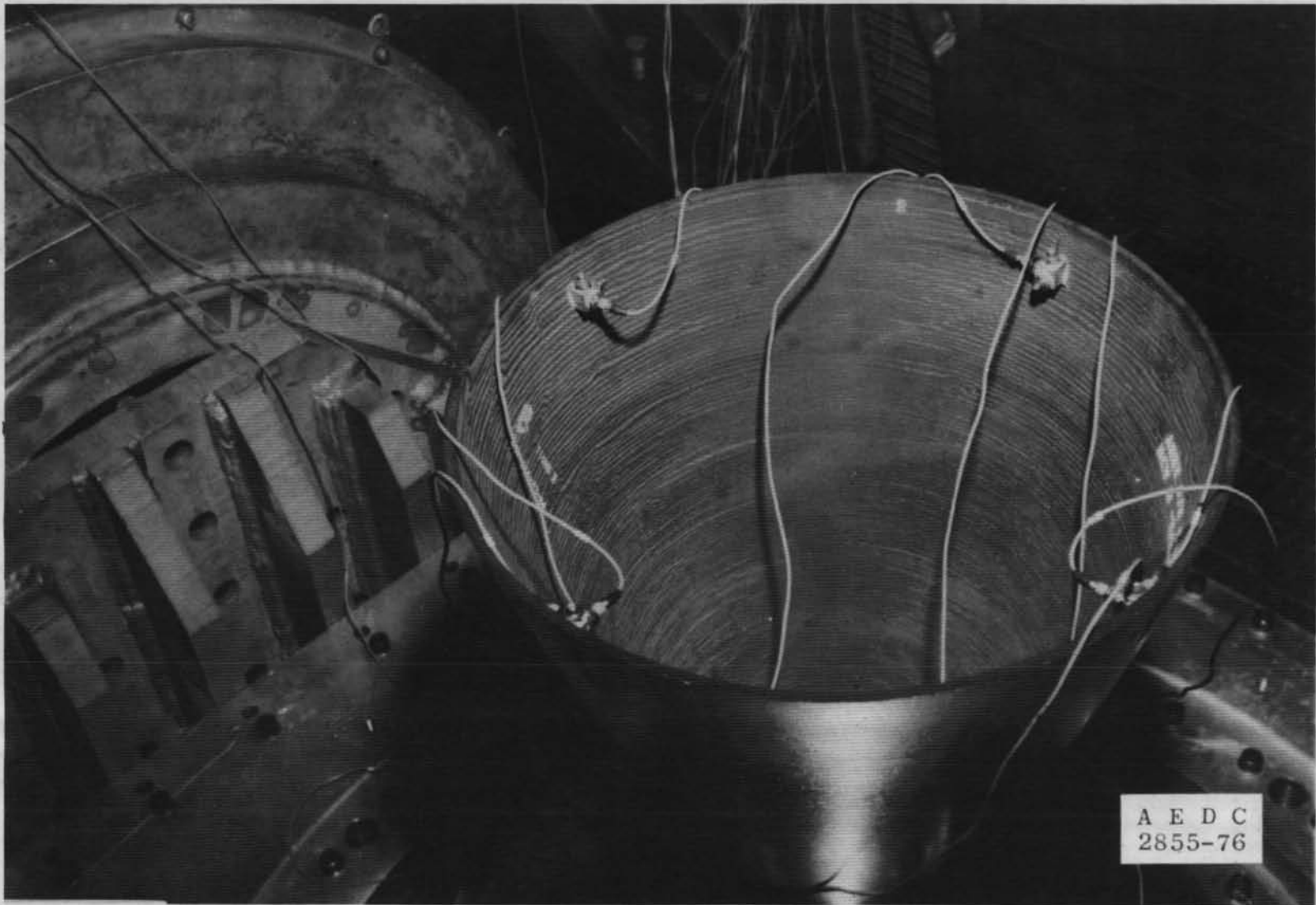

Figure 11. Continued.

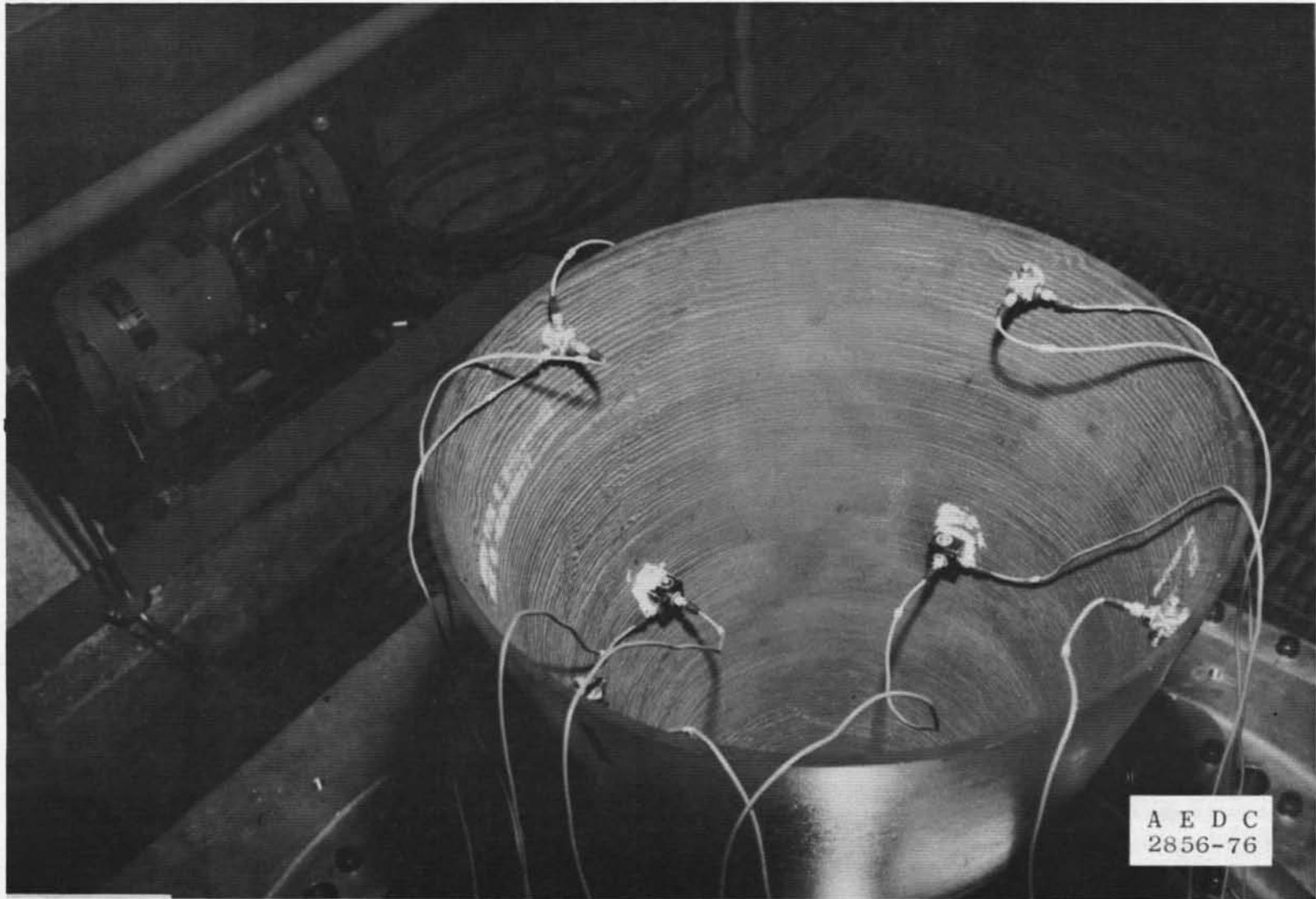
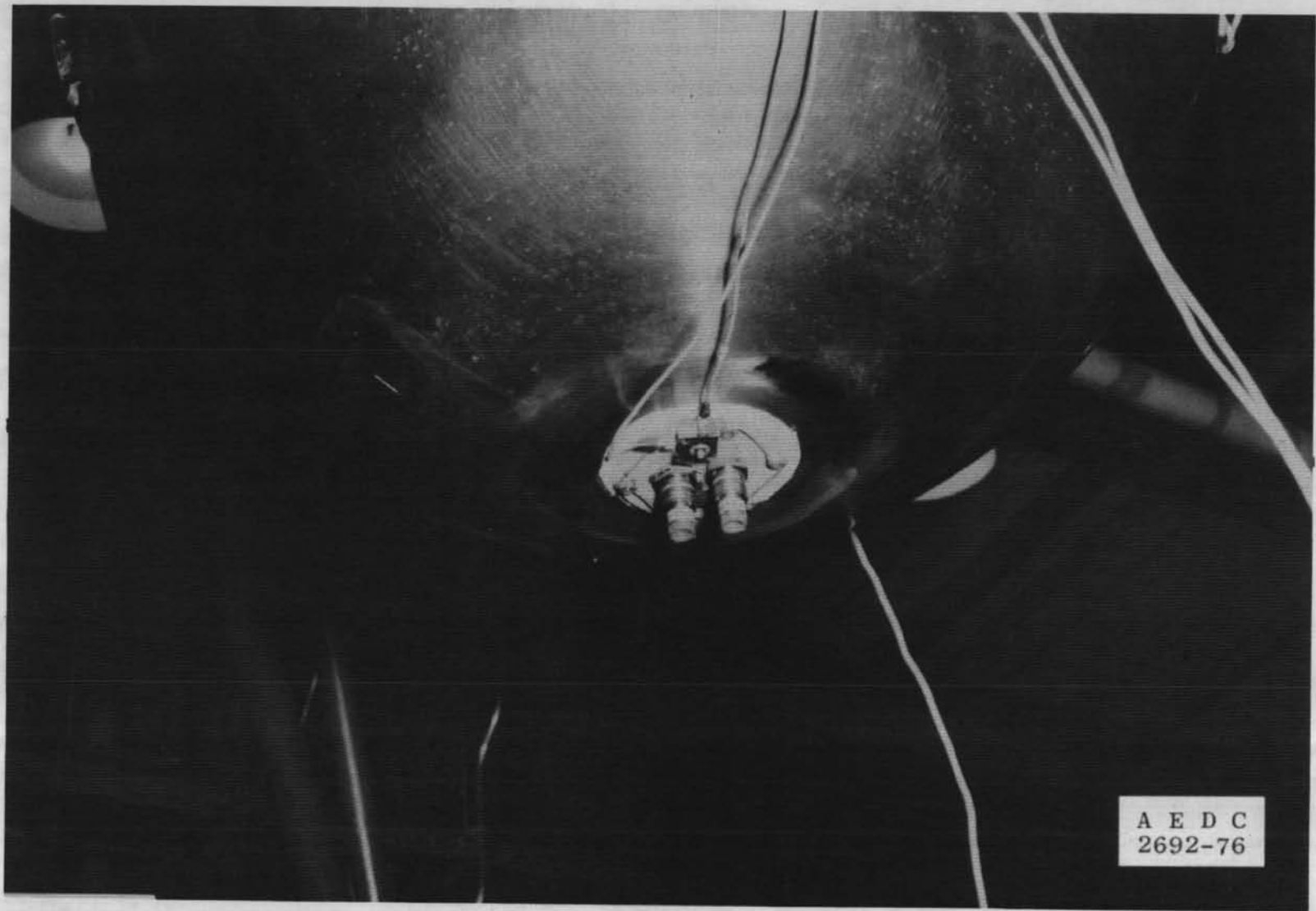

Figure 11. Continued.



A E D C
2692-76

Figure 11. Concluded.

VKF IVA Facility Dynamics Test

Test Article: NASA/IUE

Vibration Axis: X

Tracking Filter: SD1012B

BW₁: 5 Hz from 5 to 45 Hz

BW₂: 50 Hz from 45 to 2,000 Hz

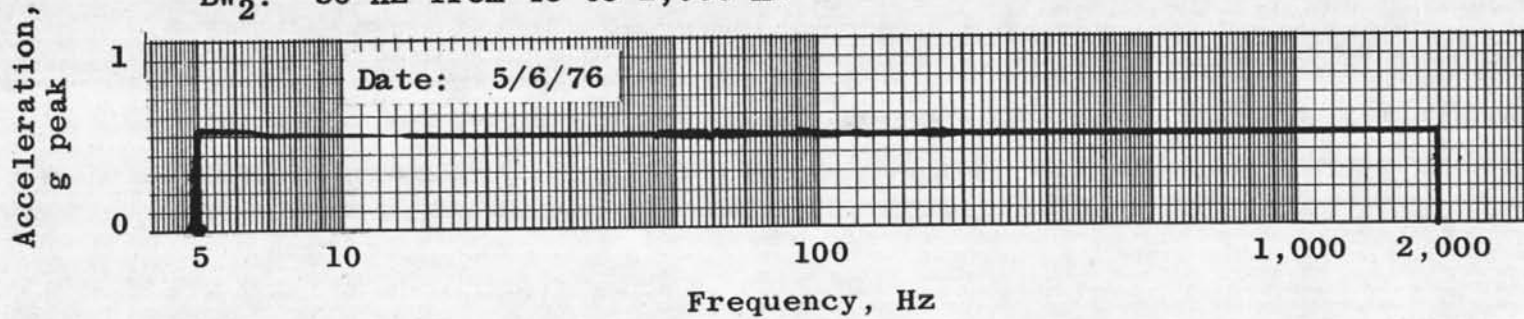

a. Closed loop plot

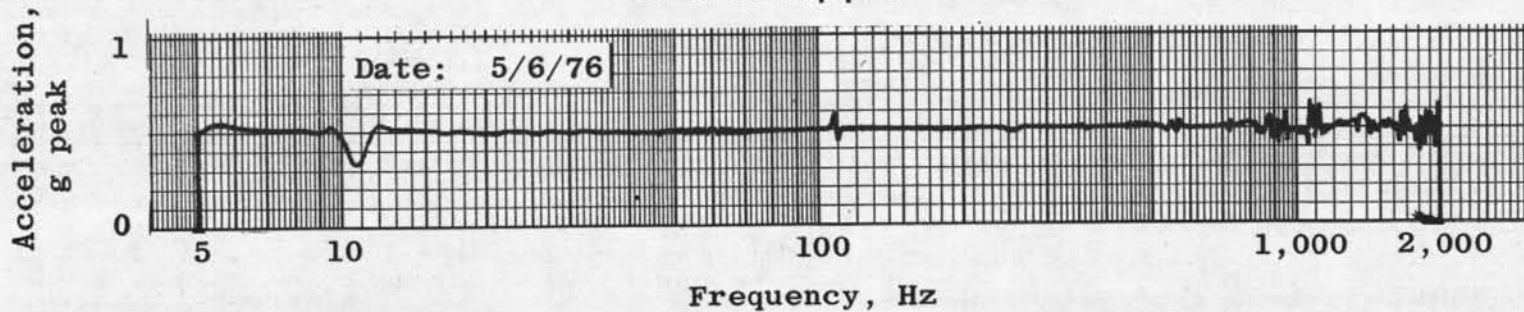

b. Accelerometers averaged, online

Figure 12. X-axis vibration test: 0.5-g sine survey.

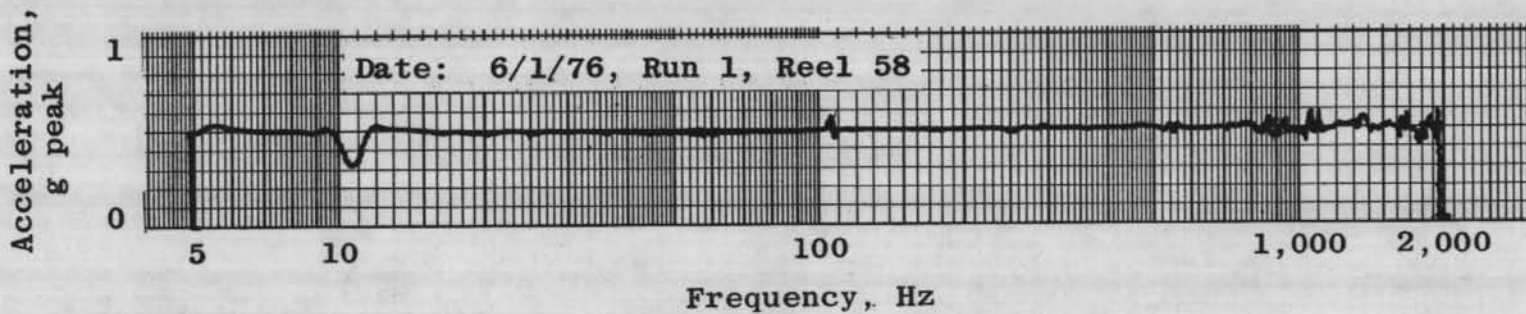

c. Accelerometers averaged, off tape

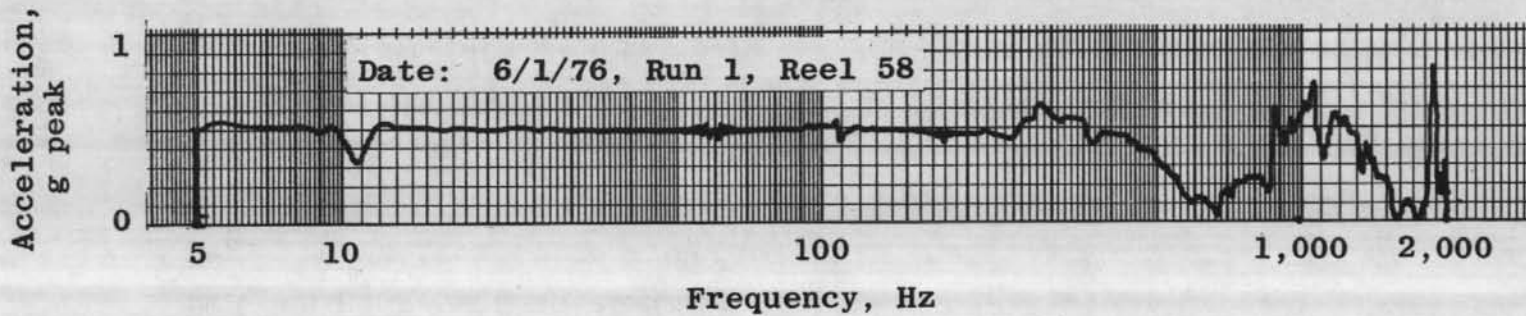

d. Accelerometer 1X
Figure 12. Continued.

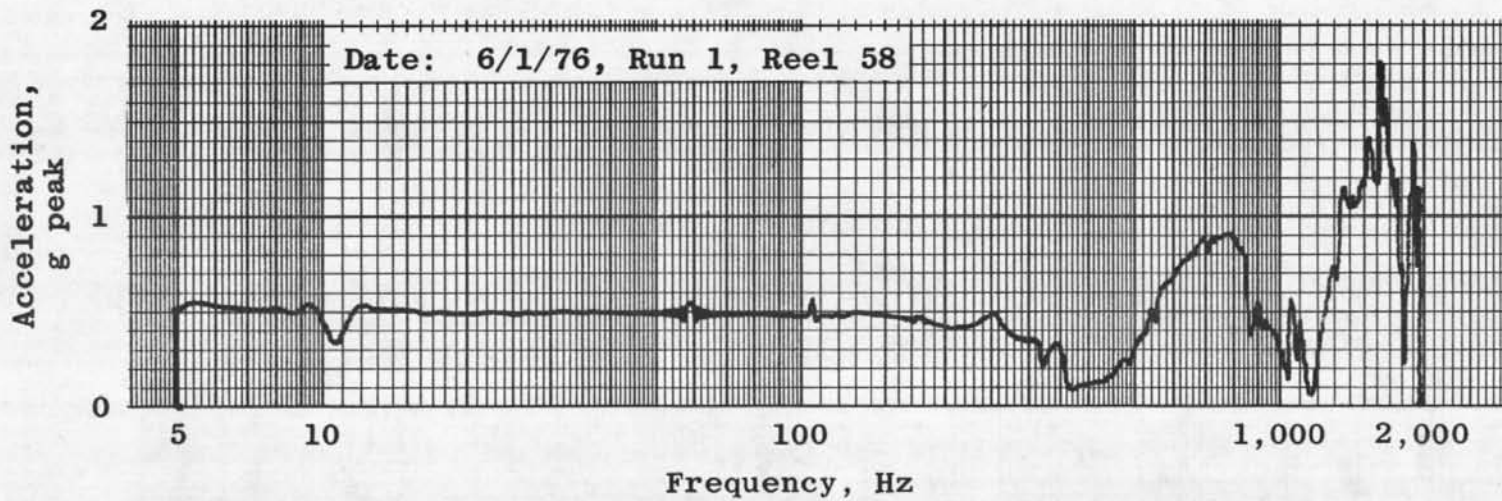

e. Accelerometer 2X

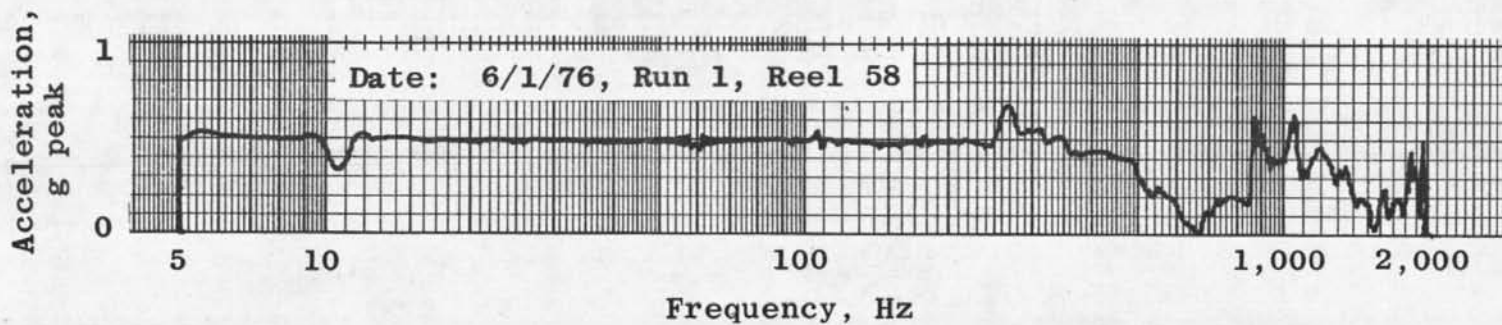
f. Accelerometer 3X
Figure 12. Continued.

40

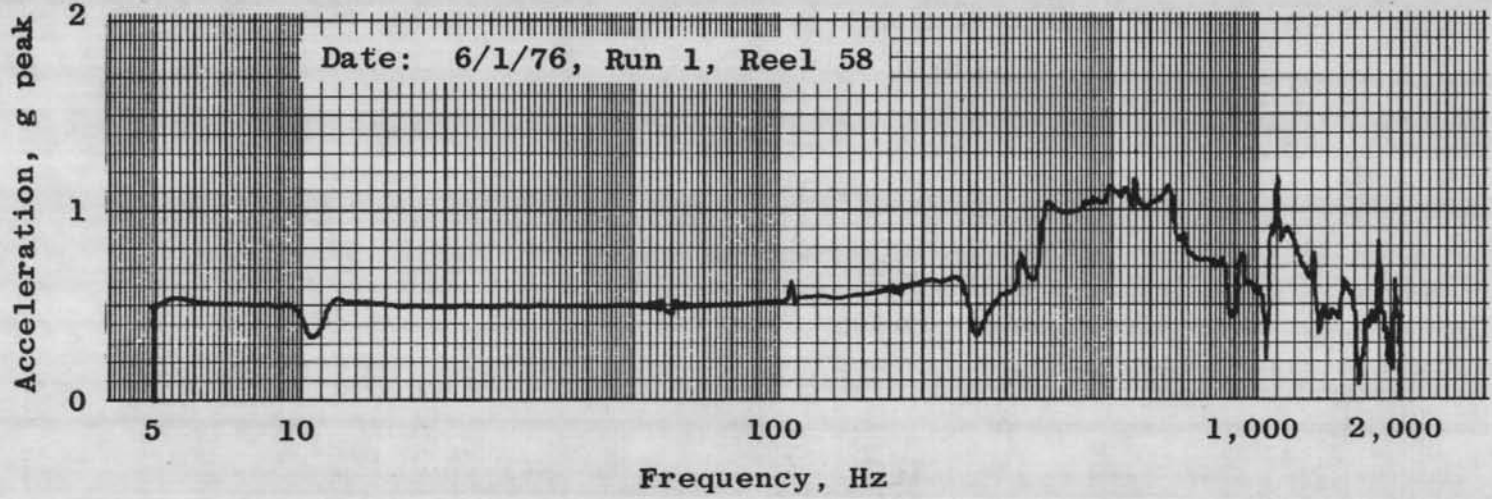

g. Accelerometer 4X
Figure 12. Continued.

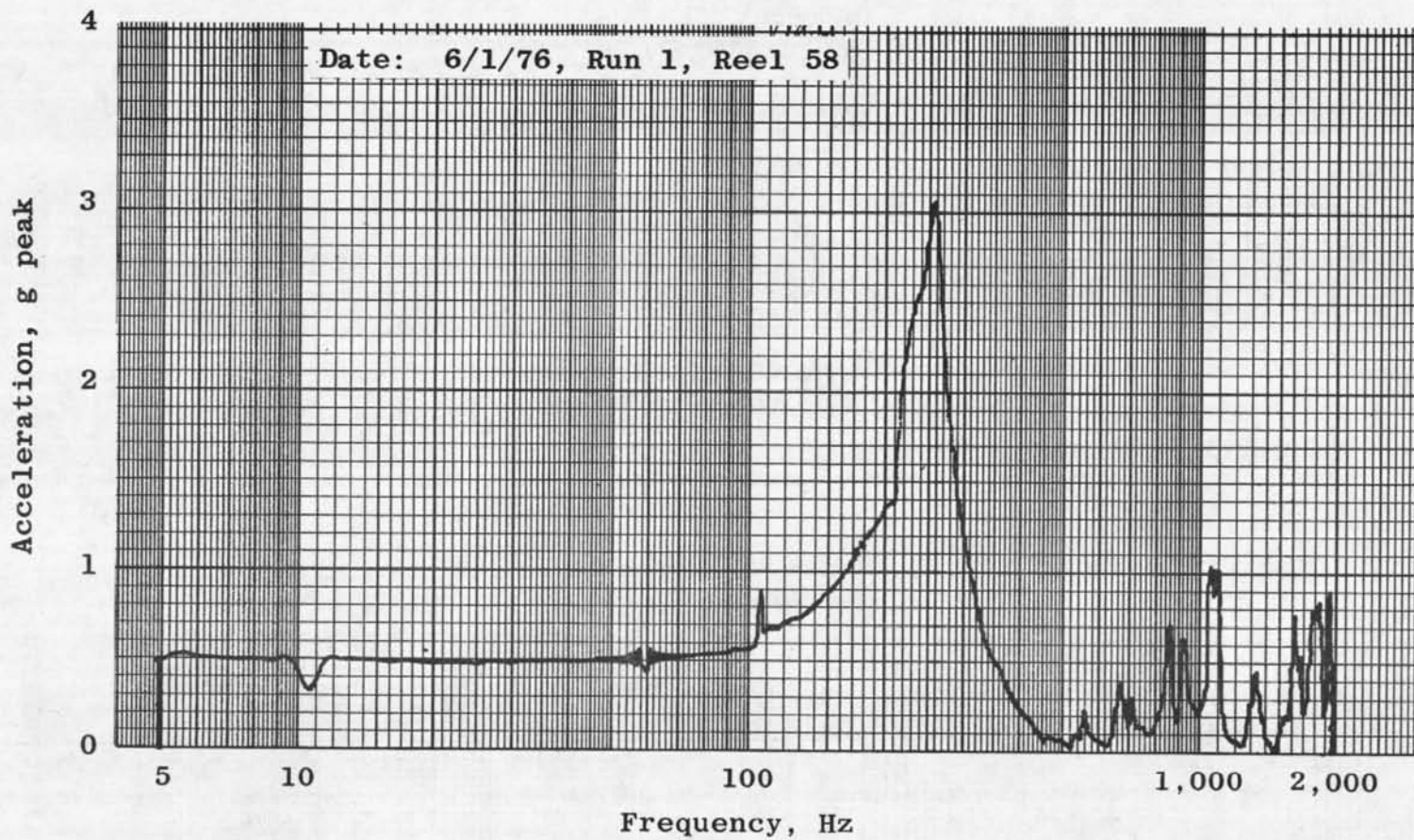

h. Accelerometer 5X
Figure 12. Continued.

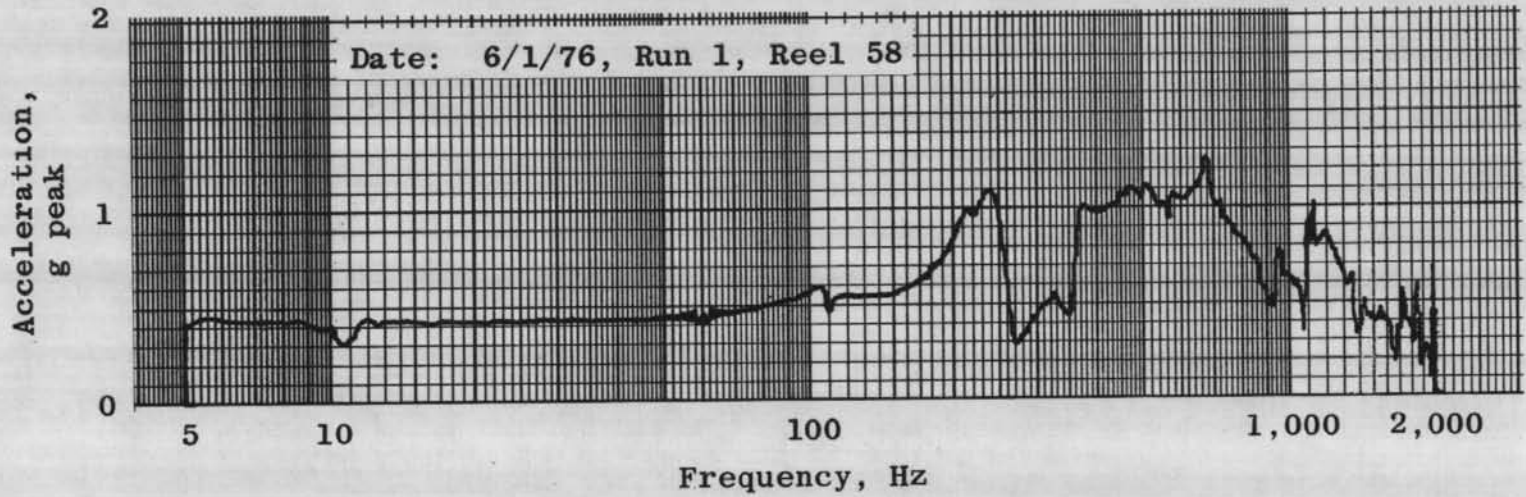

i. Accelerometer 6X

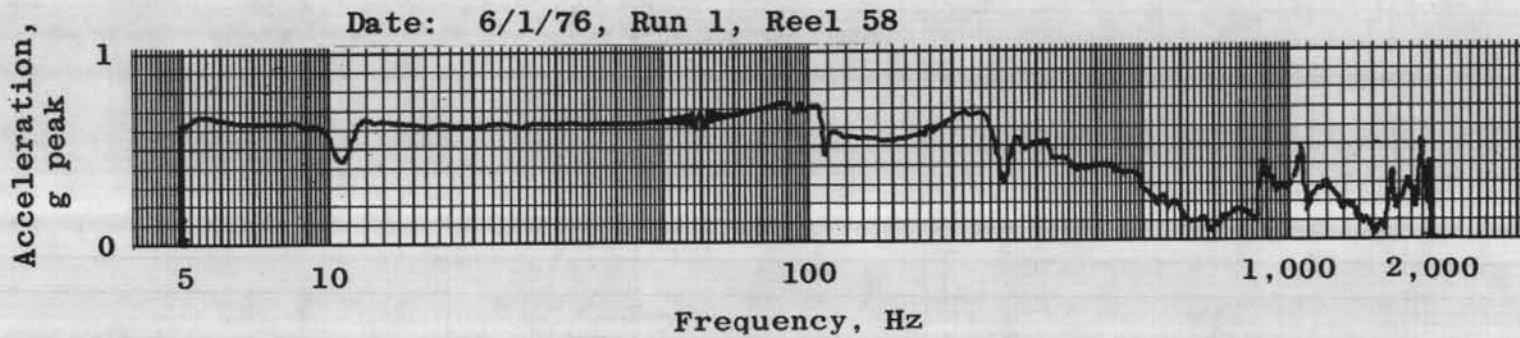

j. Accelerometer 7X
Figure 12. Continued.

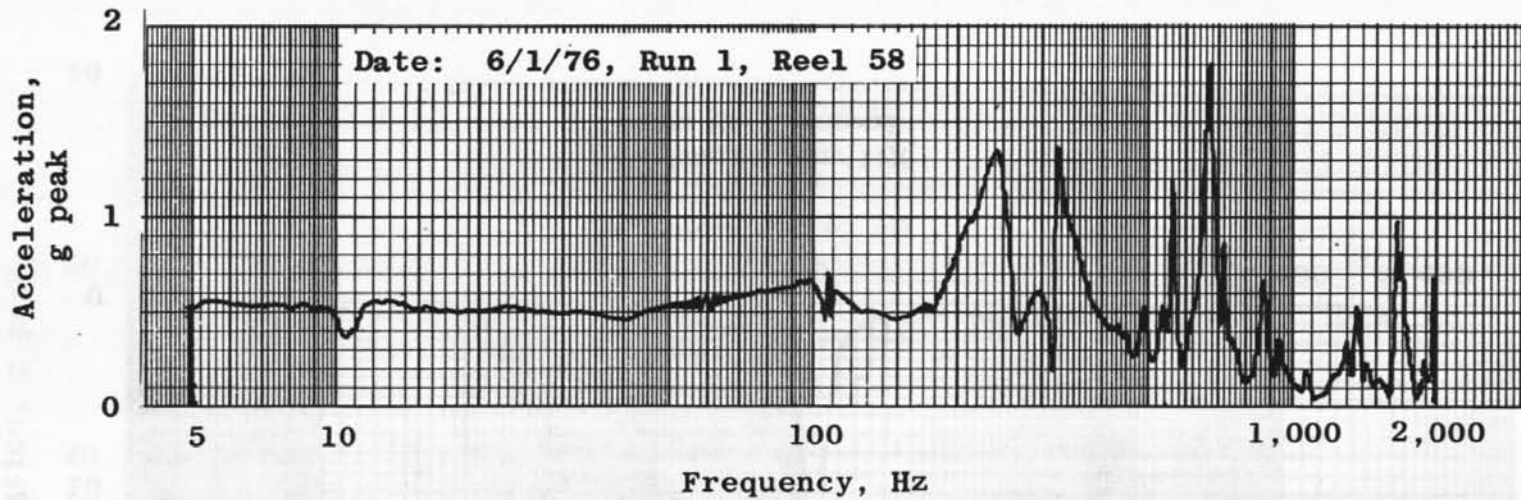

k. Accelerometer 8X

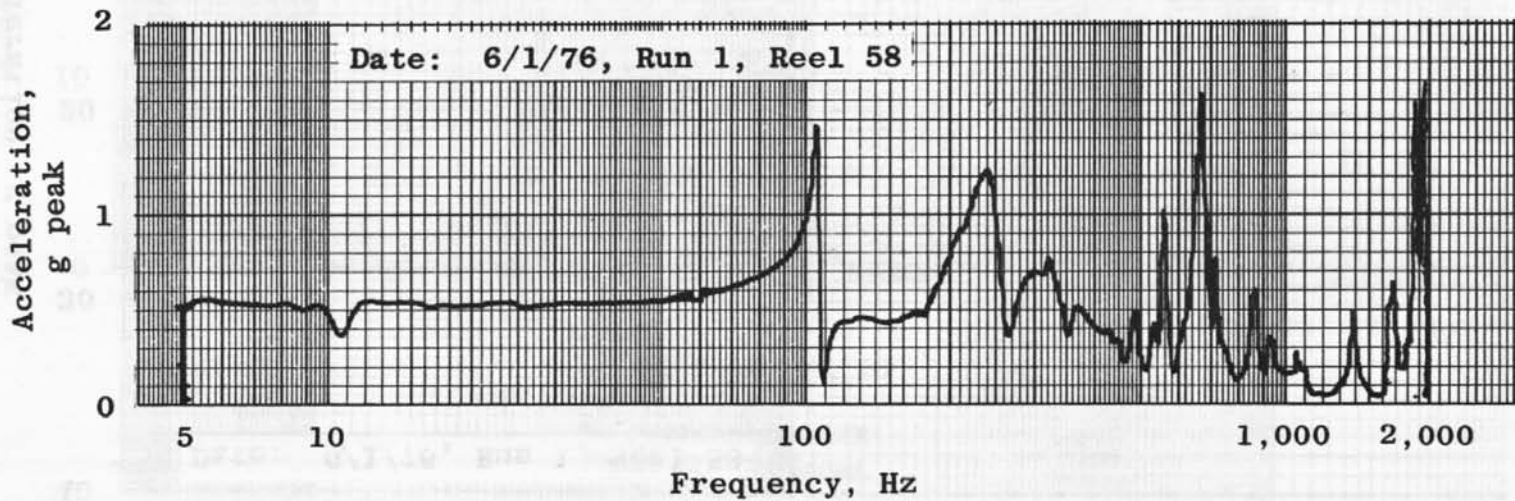

l. Accelerometer 9X
Figure 12. Continued.

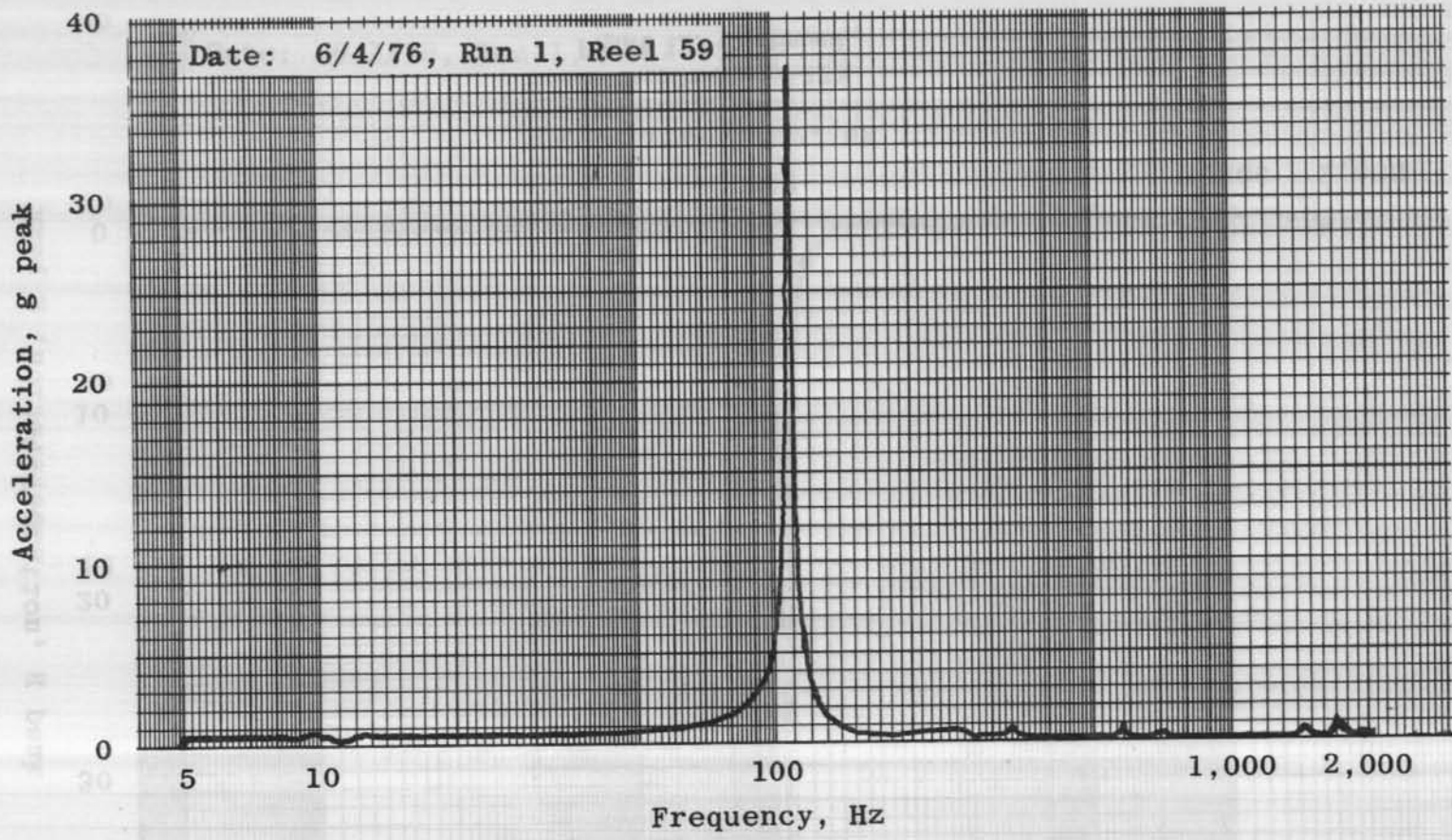

o. Accelerometer 13X
Figure 12. Continued.

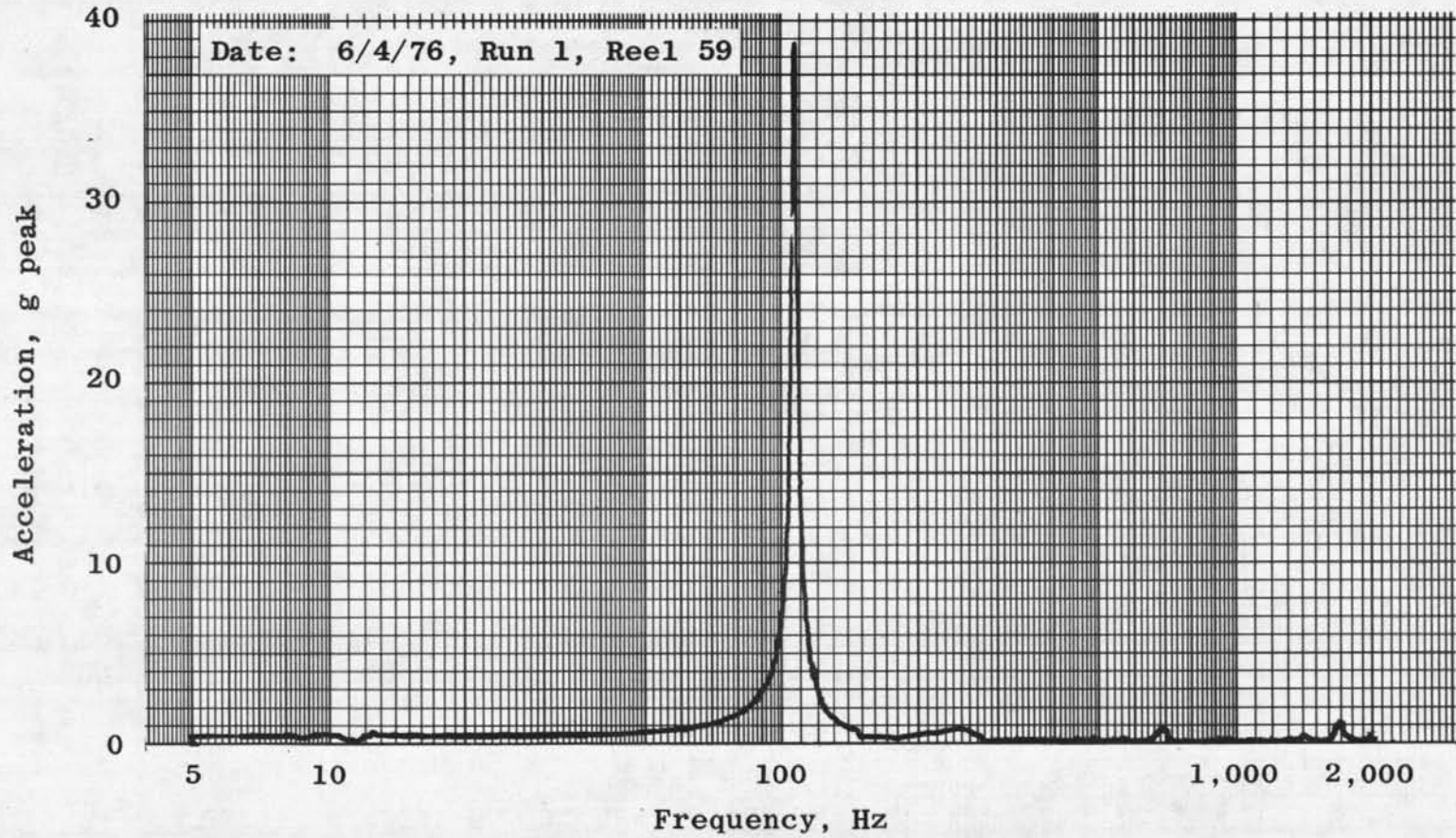

p. Accelerometer 14X
Figure 12. Continued.

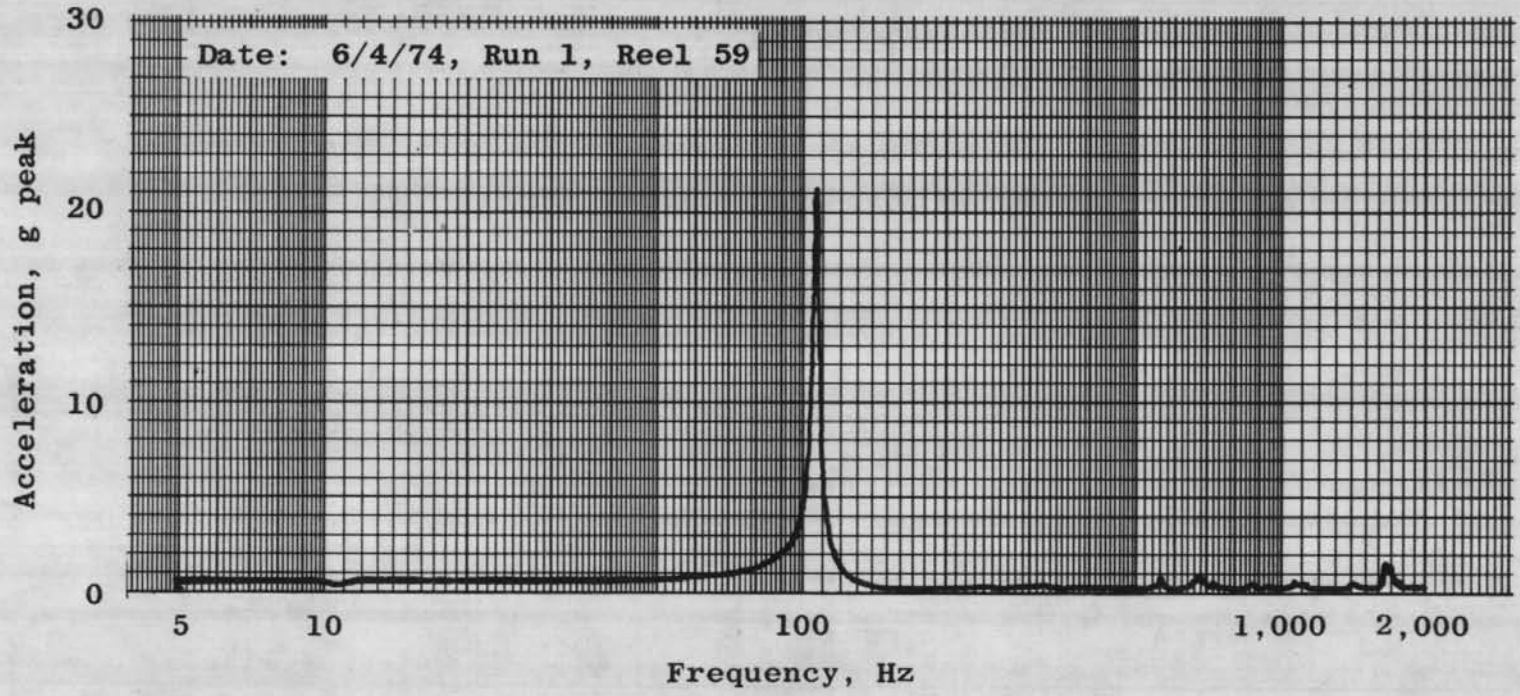

q. Accelerometer 15X
Figure 12. Continued.

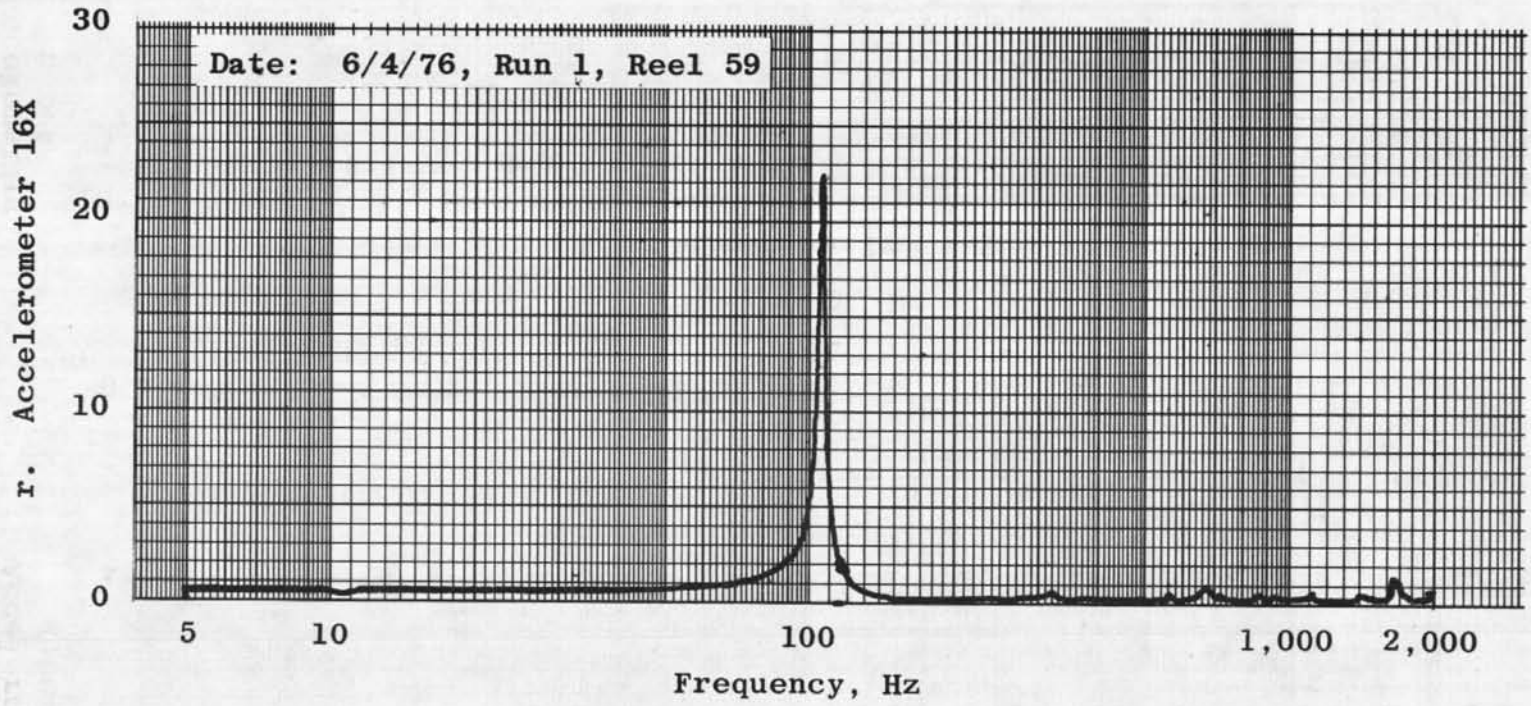

r. Accelerometer 16X
Figure 12. Continued.

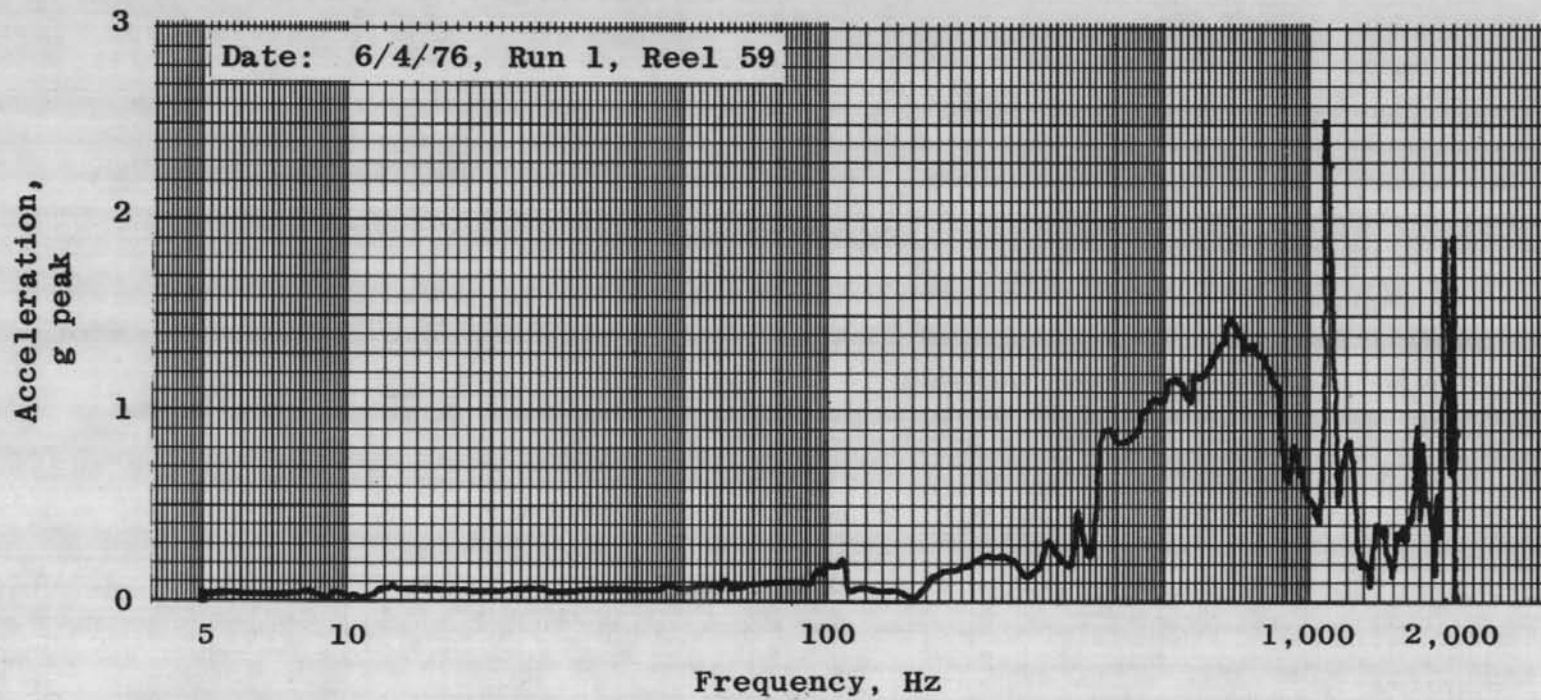

s. Accelerometer 7Y

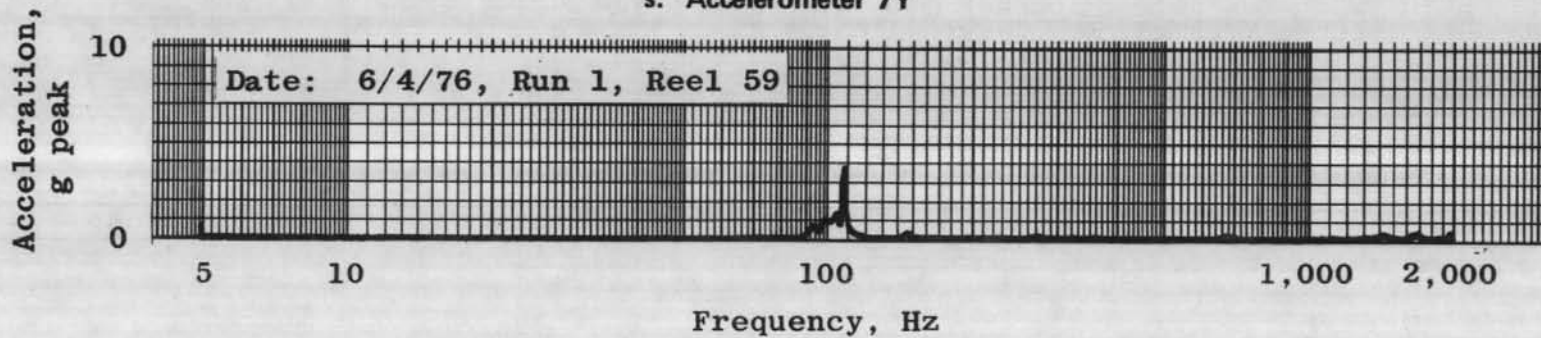

t. Accelerometer 11Y
Figure 12. Continued.

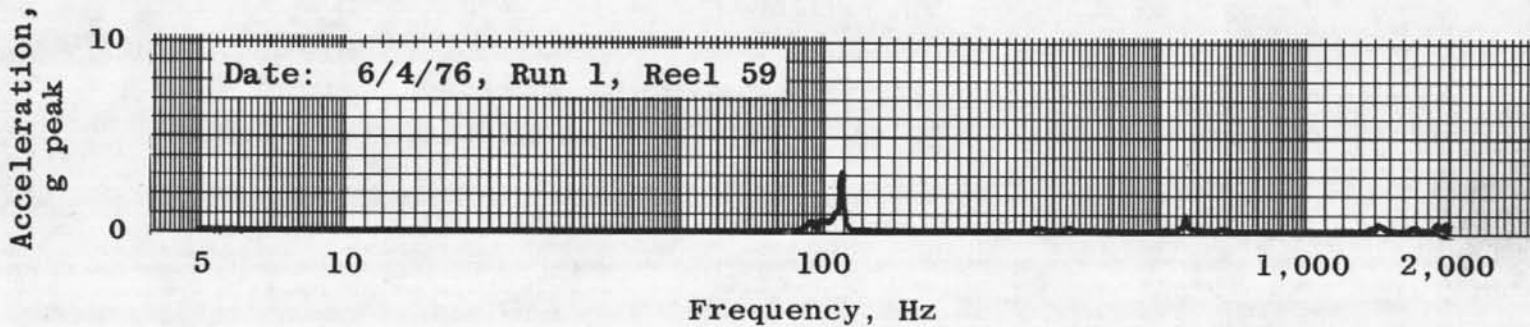

u. Acceleration 14Y

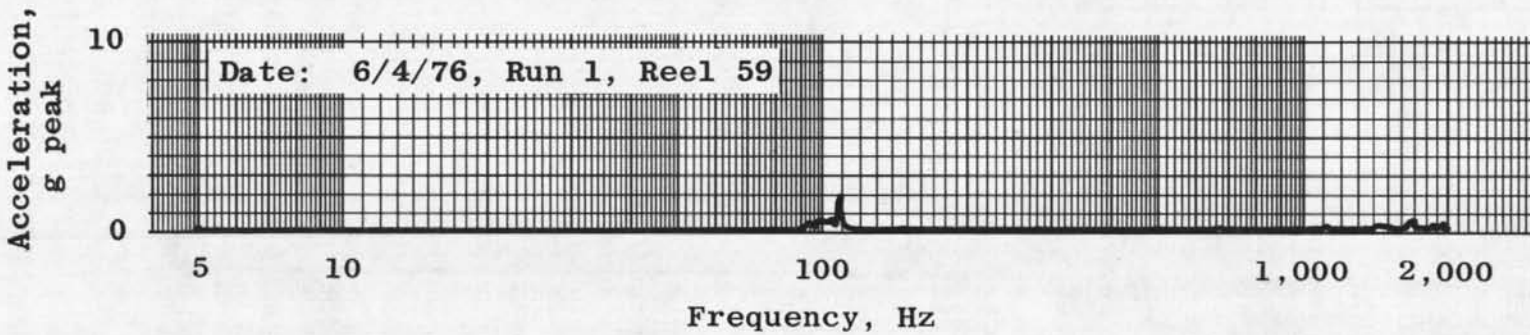

v. Accelerometer 15Y
Figure 12. Continued.

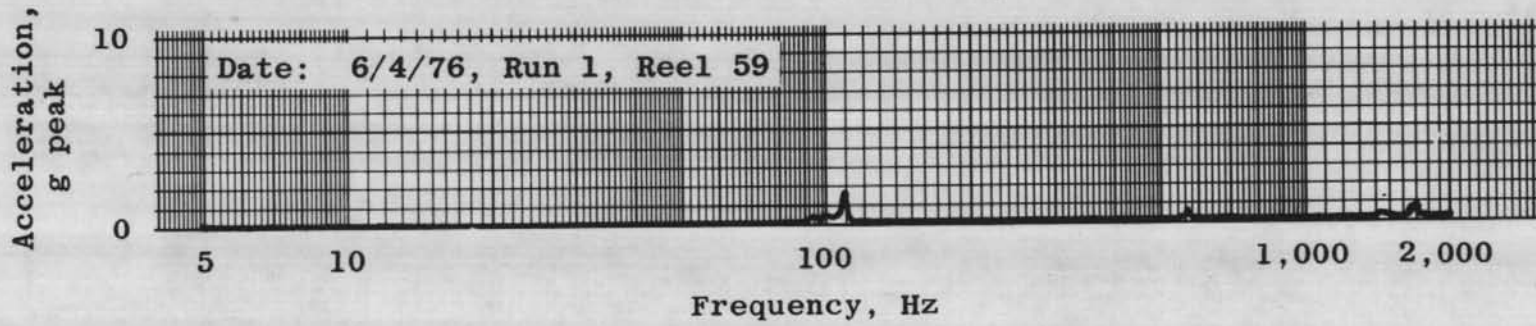

w. Accelerometer 16Y

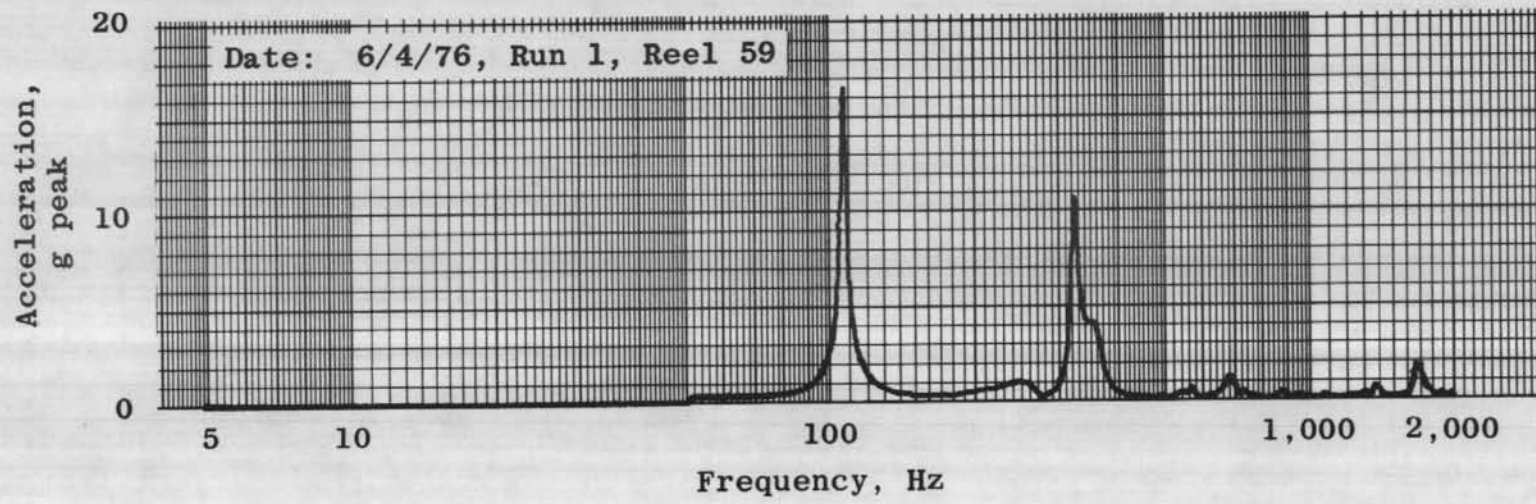

x. Accelerometer 14Z
Figure 12. Concluded.

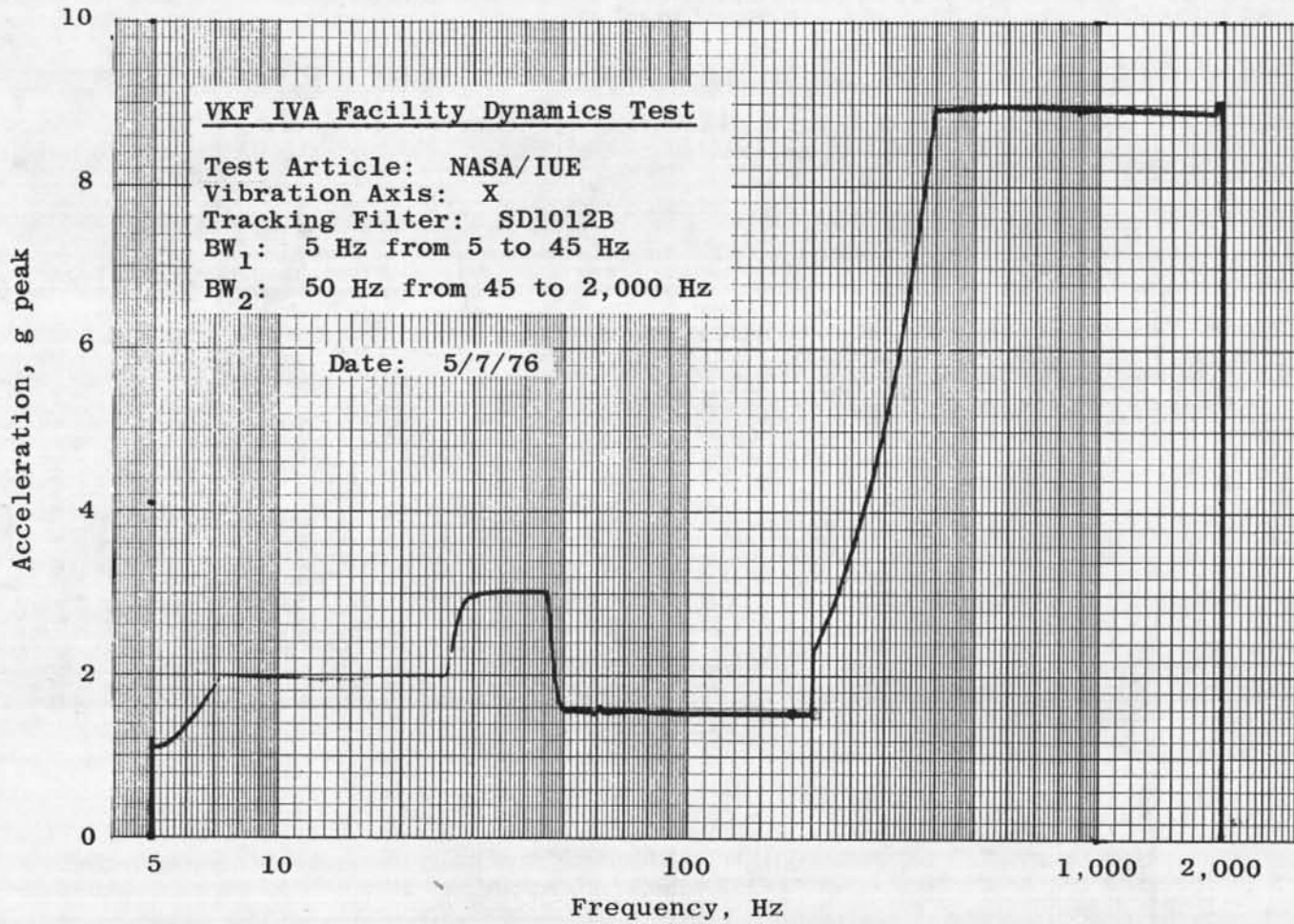

a. Closed loop plot

Figure 13. X-axis vibration test: qualification level sine sweep.

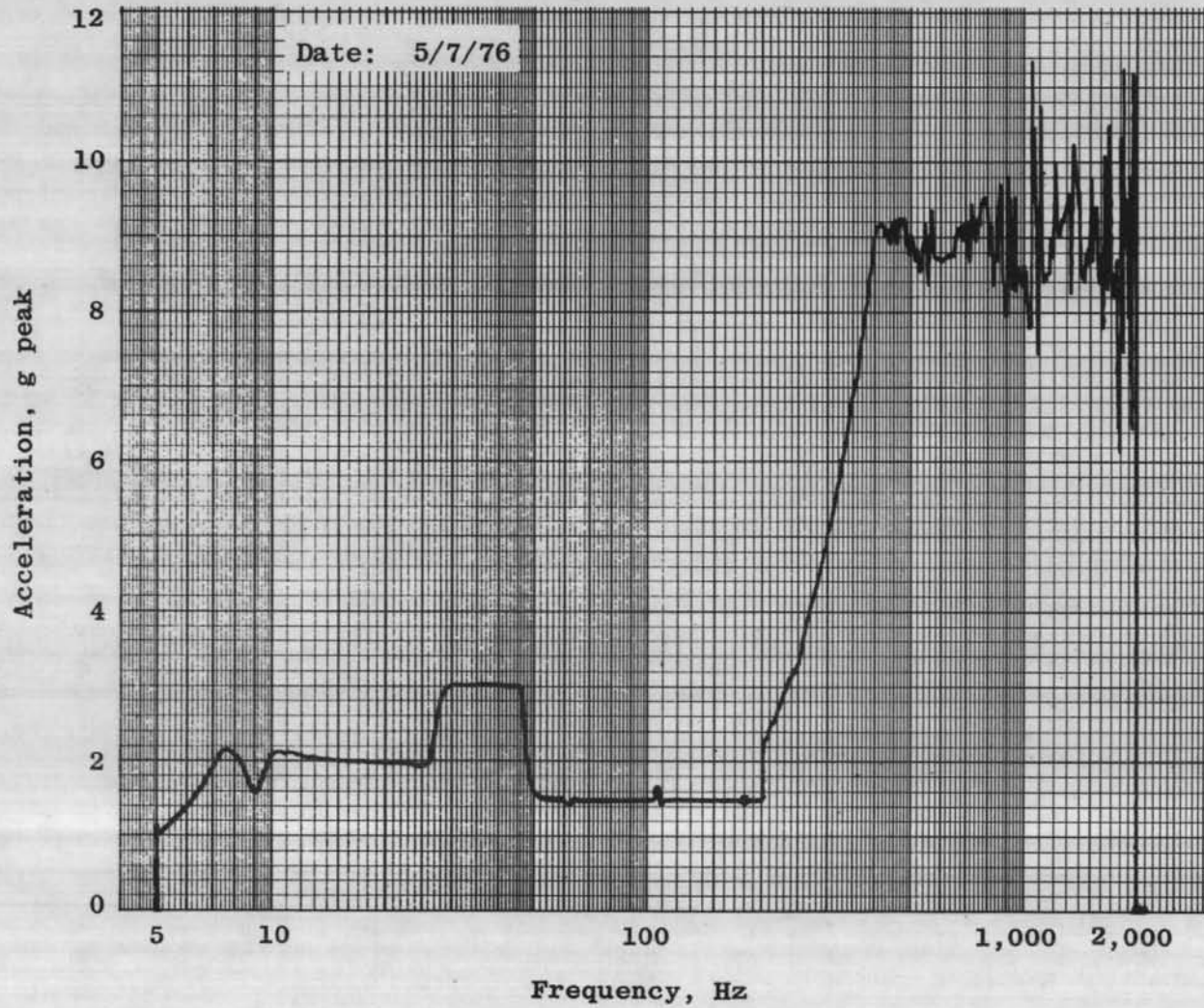

b. Accelerometers averaged, online
Figure 13. Continued.

SS

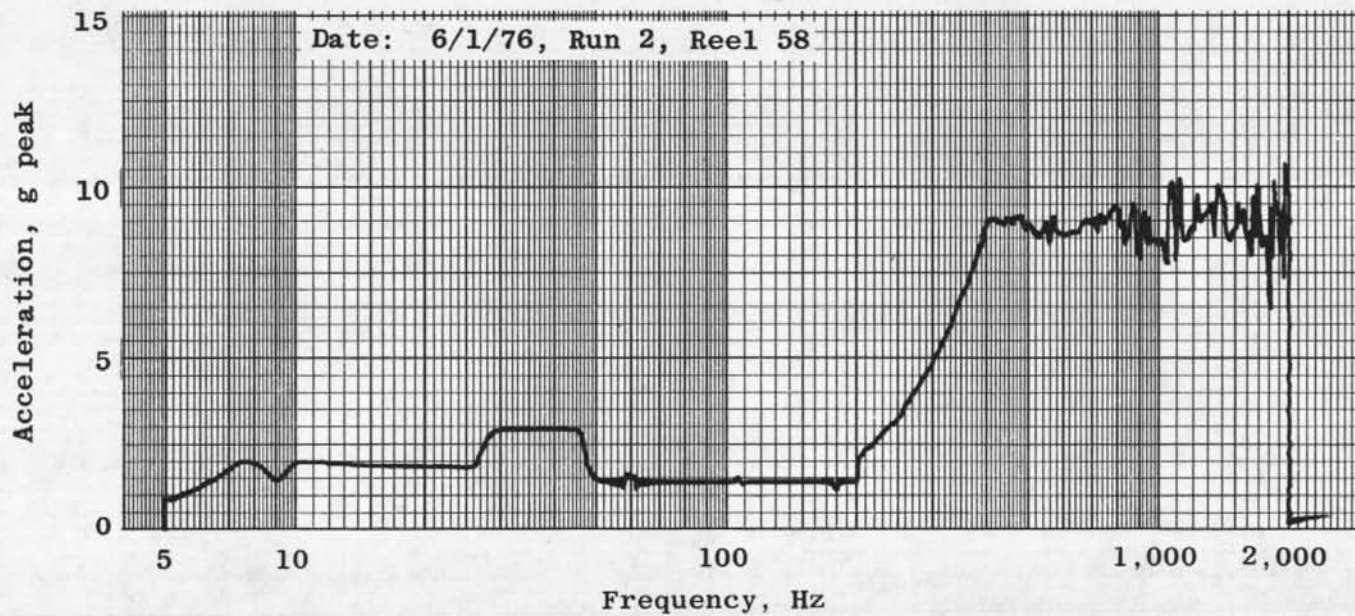

c. X accelerometers averaged
Figure 13. Continued.

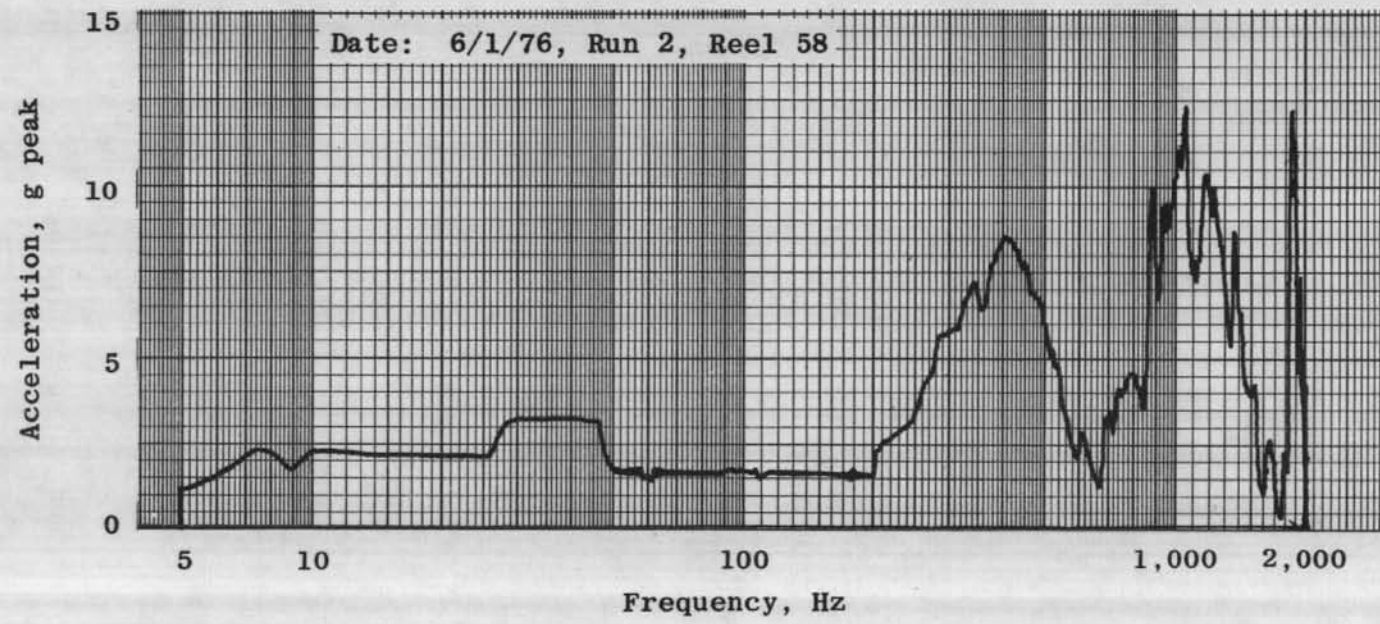

d. Accelerometer 1X
Figure 13. Continued.

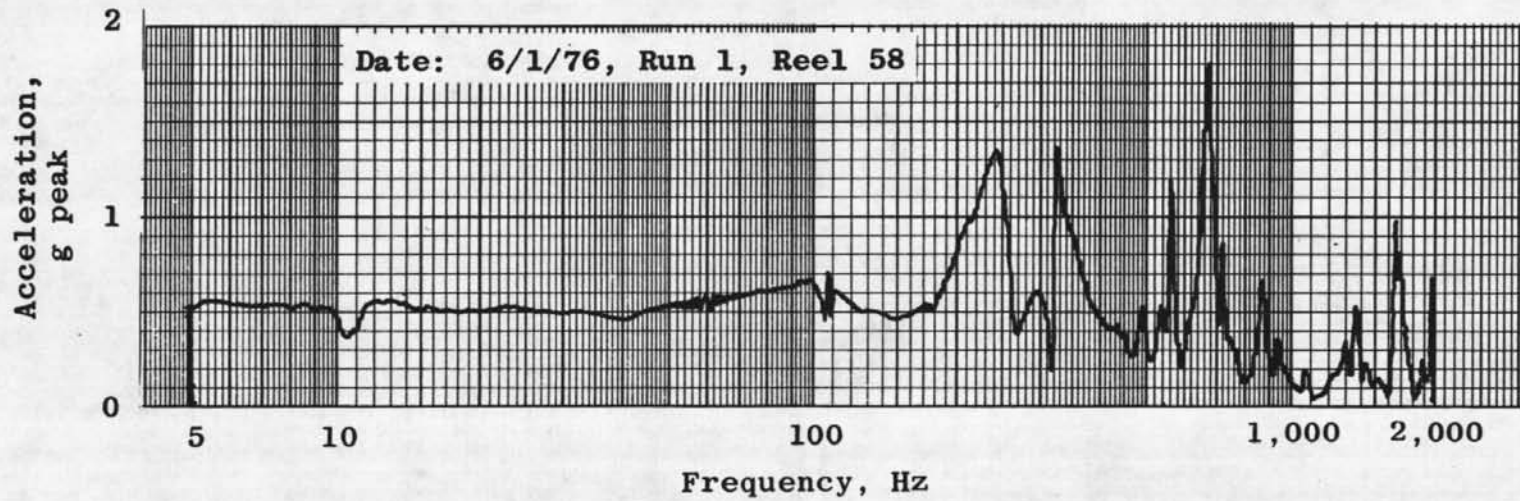

k. Accelerometer 8X

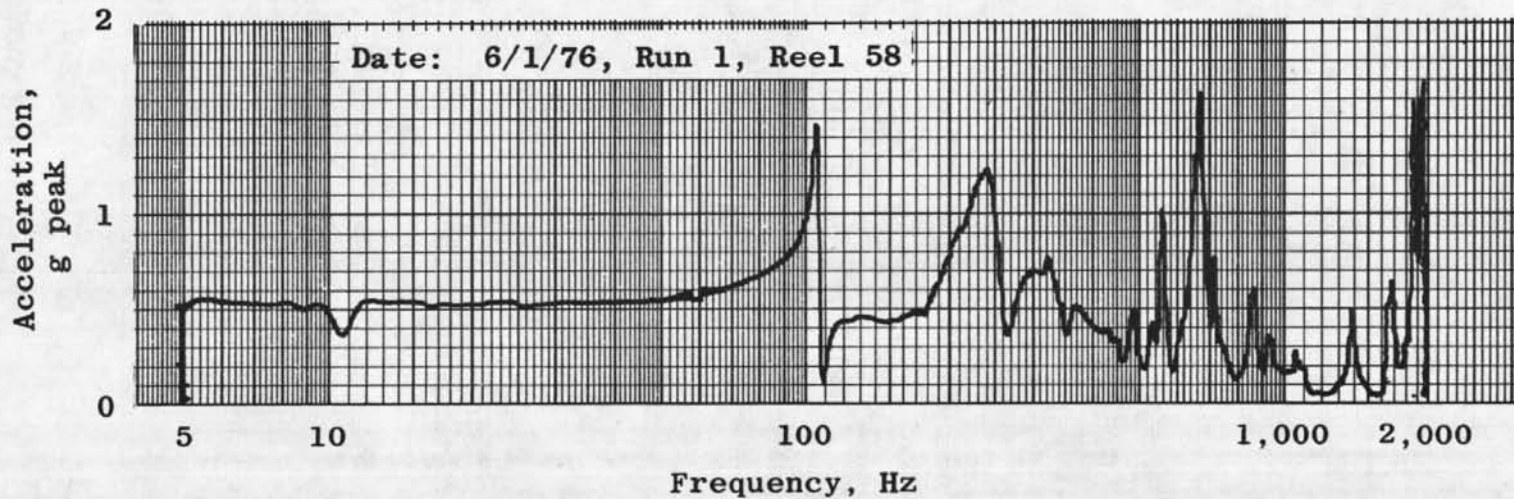
l. Accelerometer 9X
Figure 12. Continued.

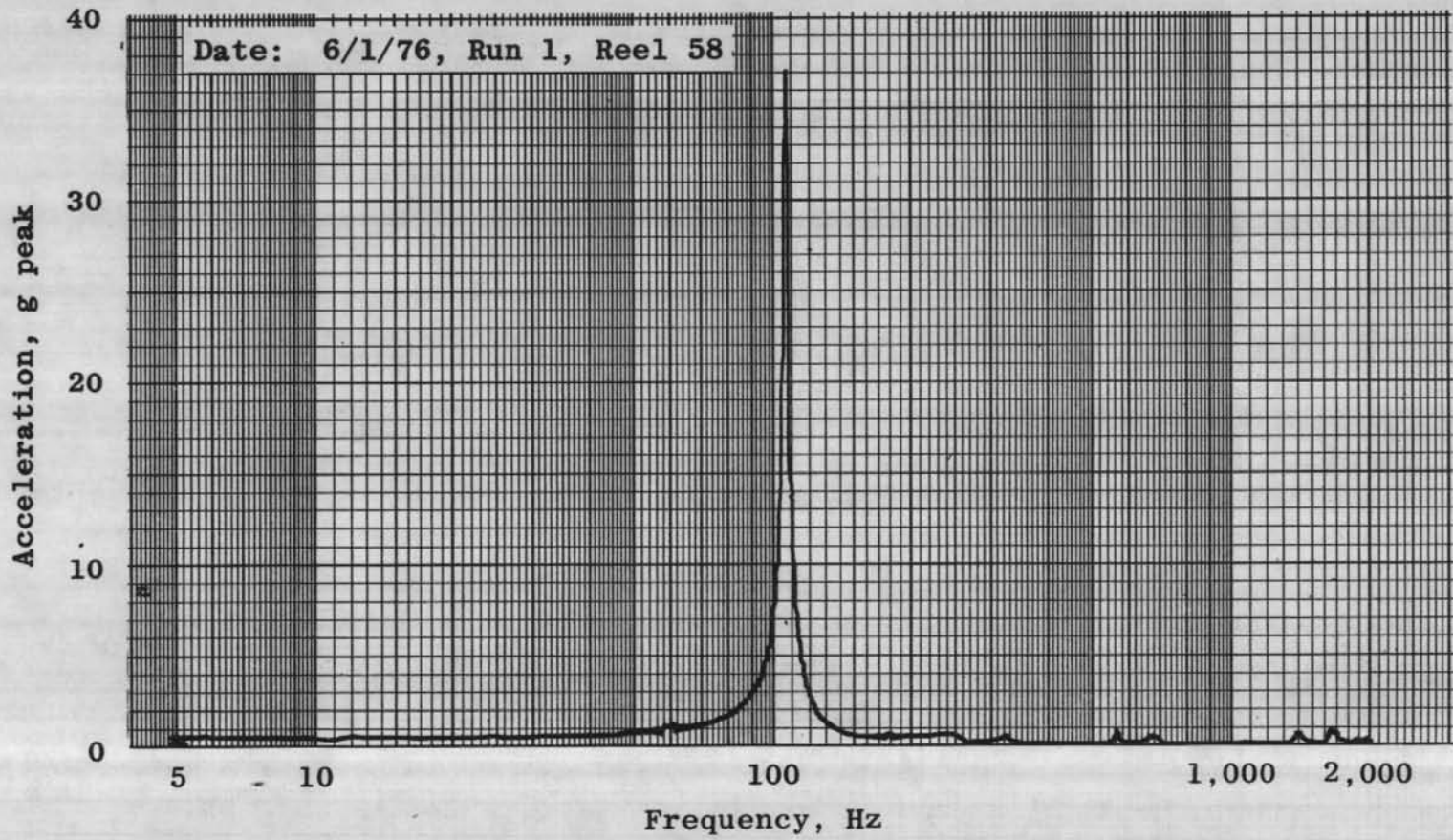

m. Accelerometer 11X
Figure 12. Continued.

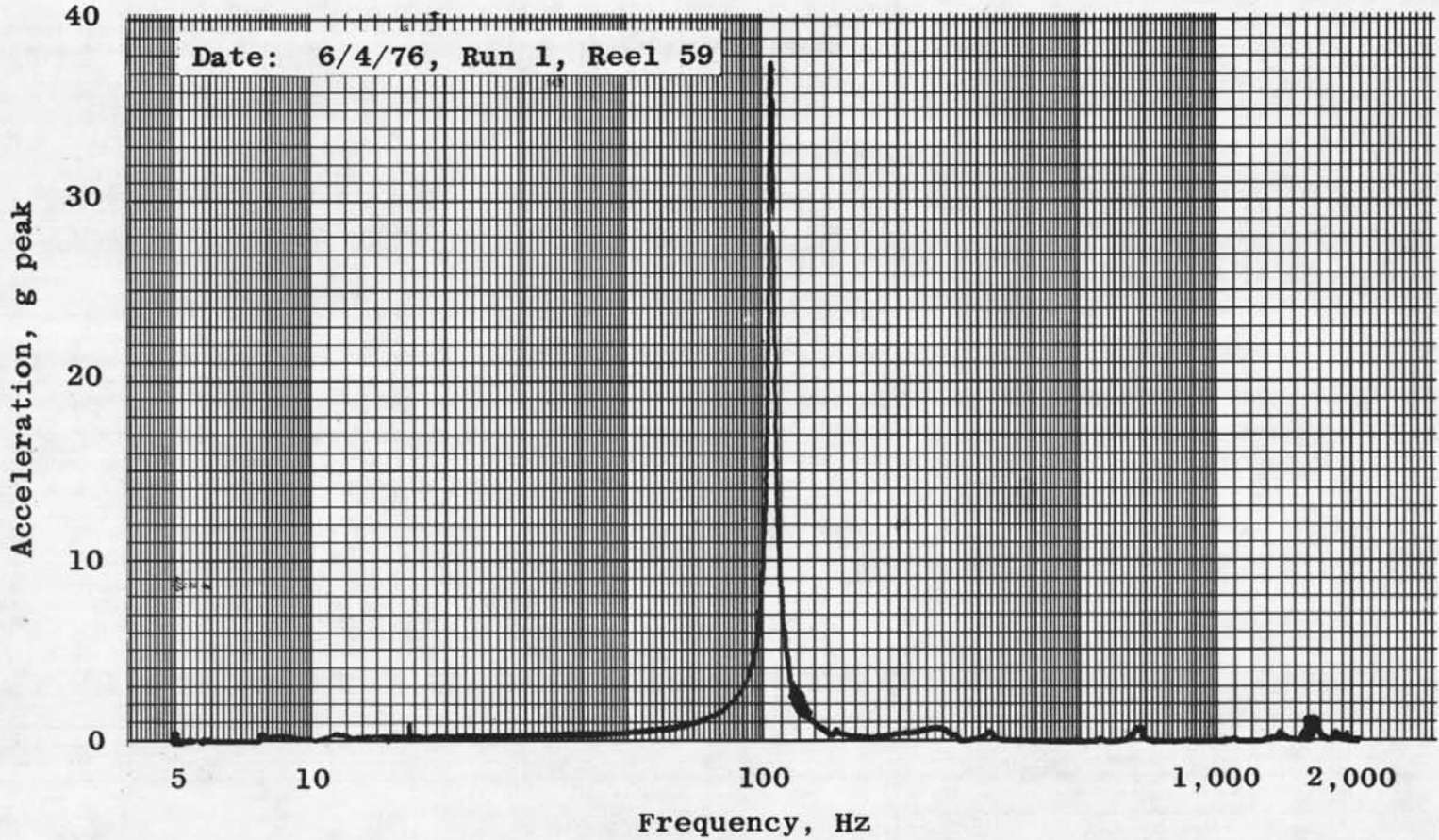

n. Accelerometer 12X
Figure 12. Continued.

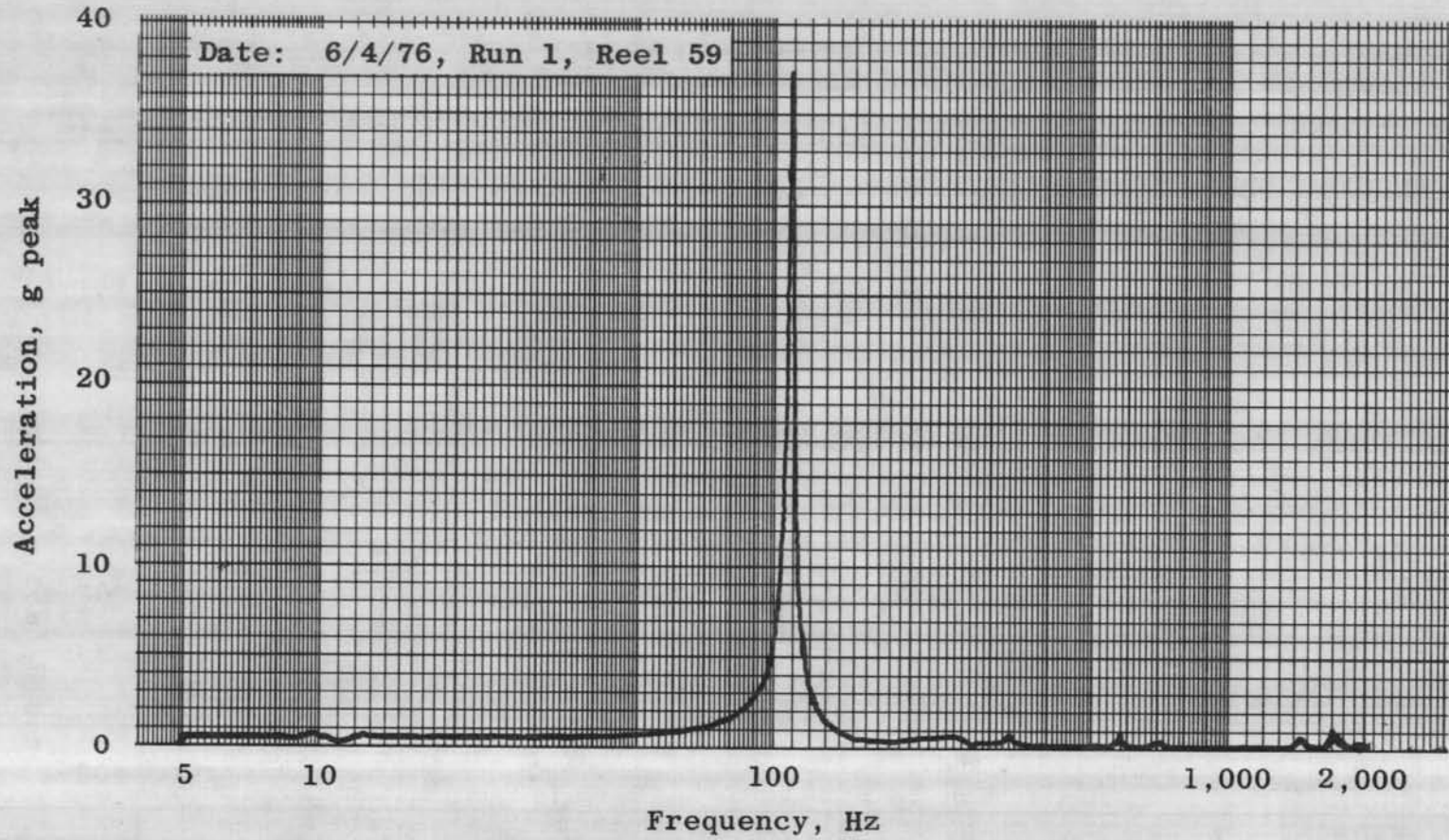

o. Accelerometer 13X
Figure 12. Continued.

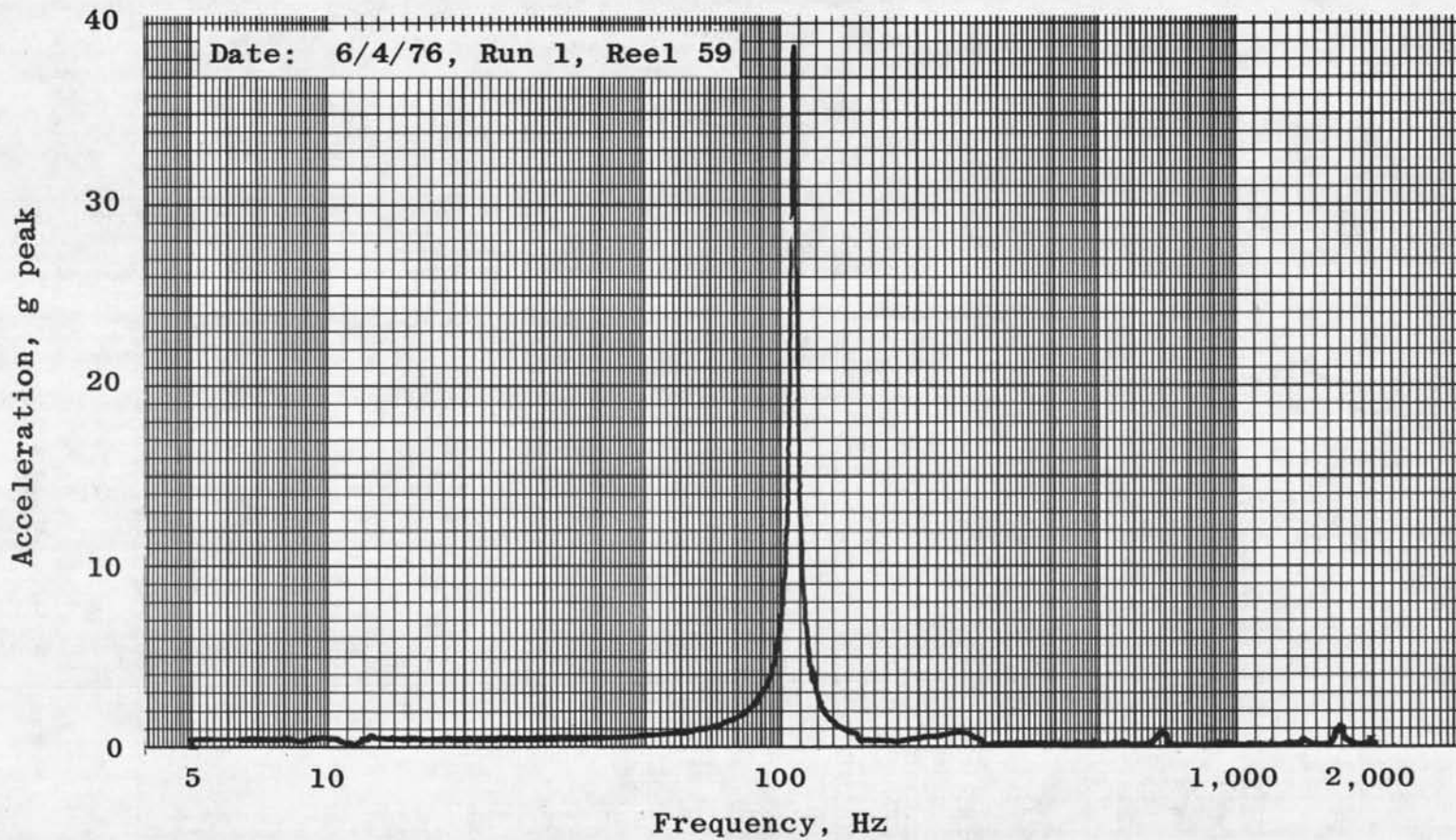

p. Accelerometer 14X
Figure 12. Continued.

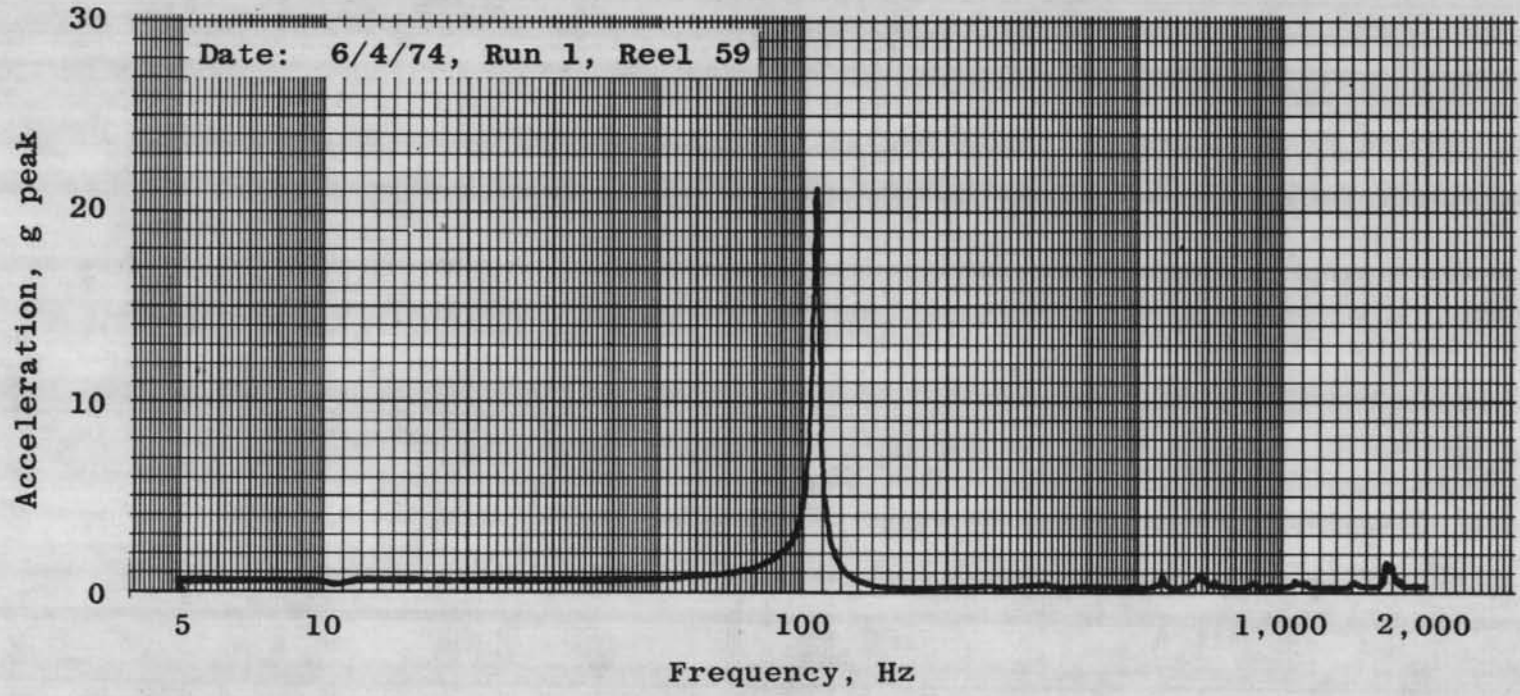

48

q. Accelerometer 15X
Figure 12. Continued.

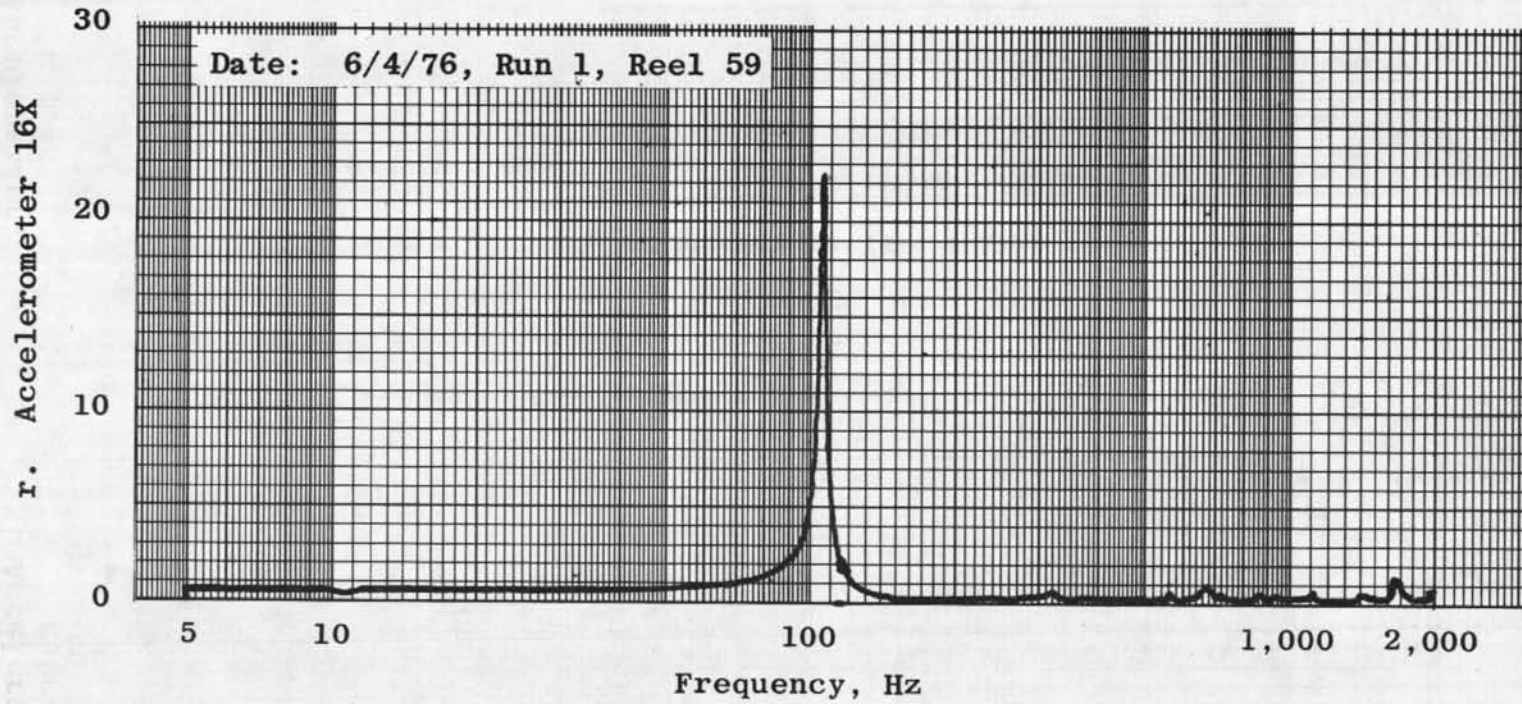

r. Accelerometer 16X
Figure 12. Continued.

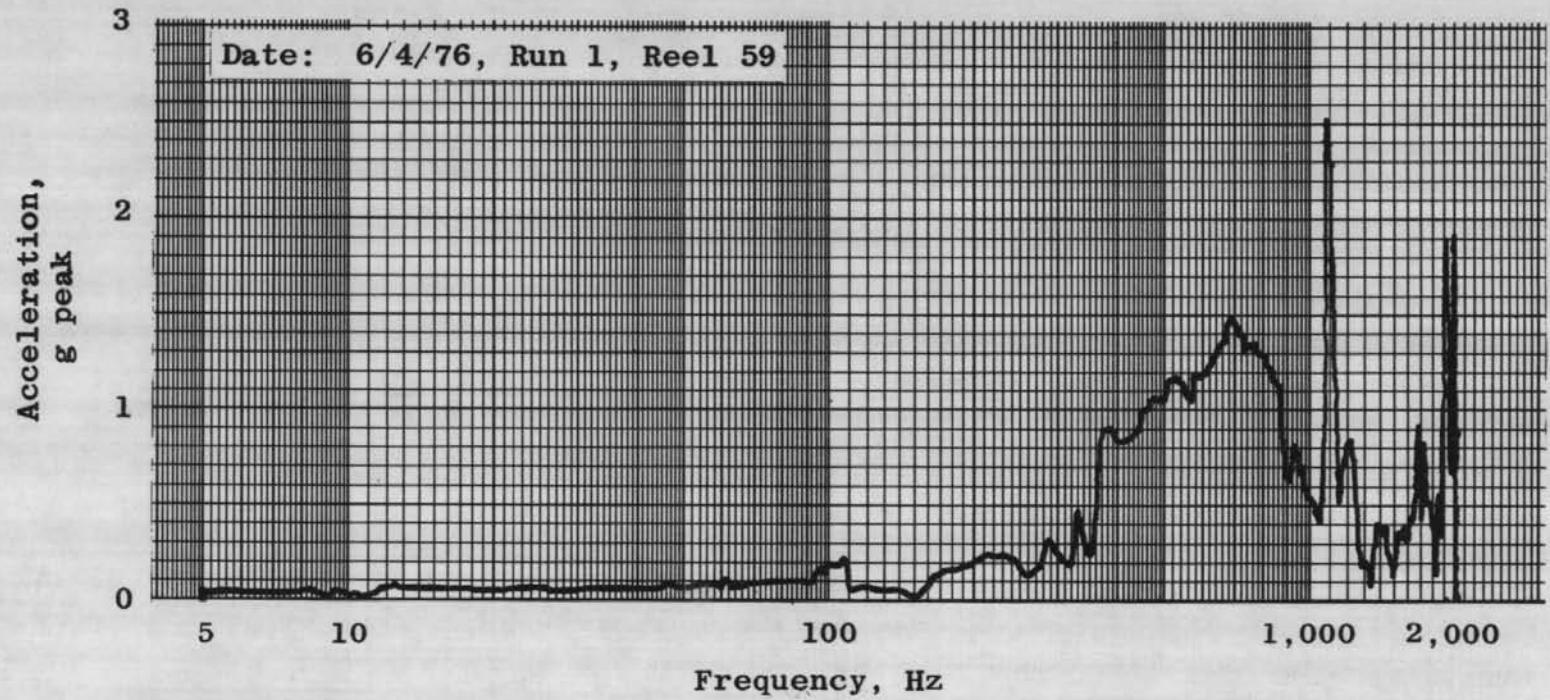

s. Accelerometer 7Y

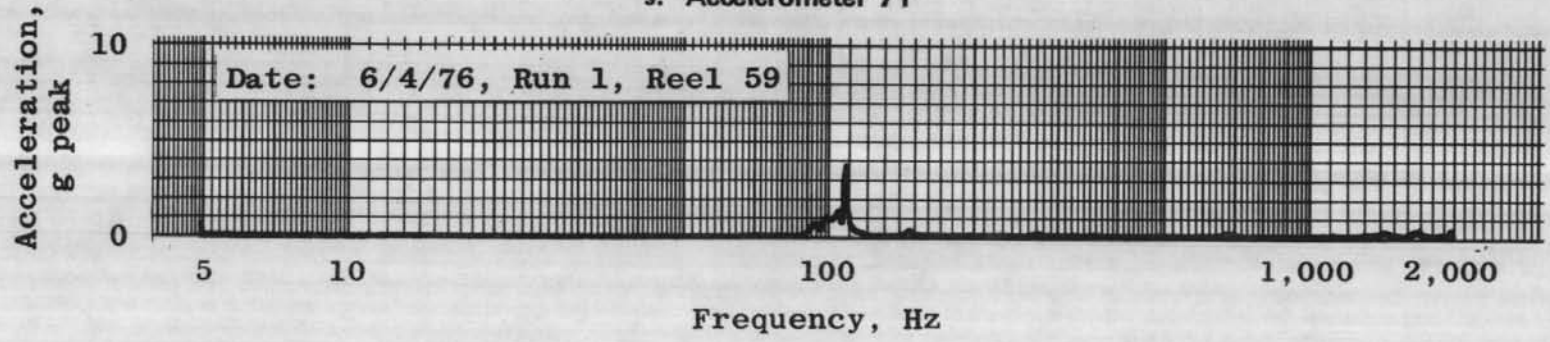

t. Accelerometer 11Y
Figure 12. Continued.

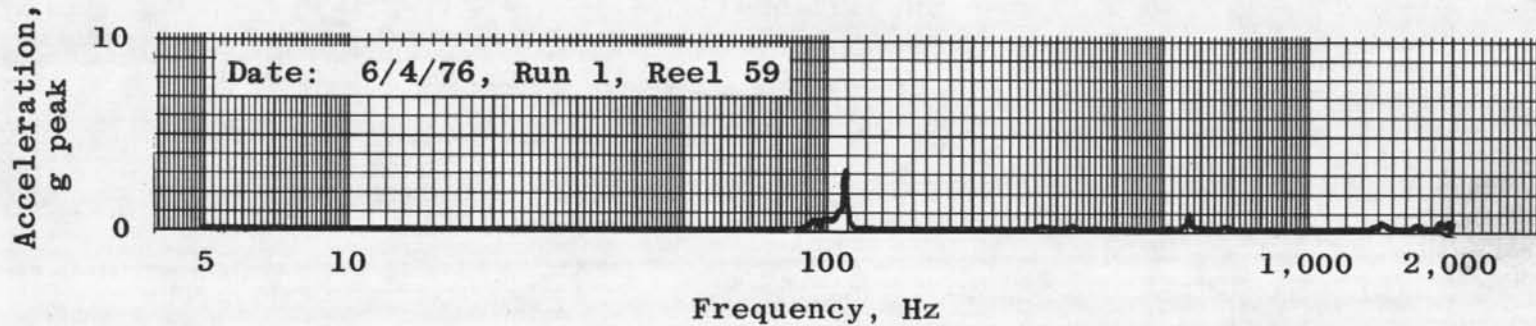

u. Acceleration 14Y

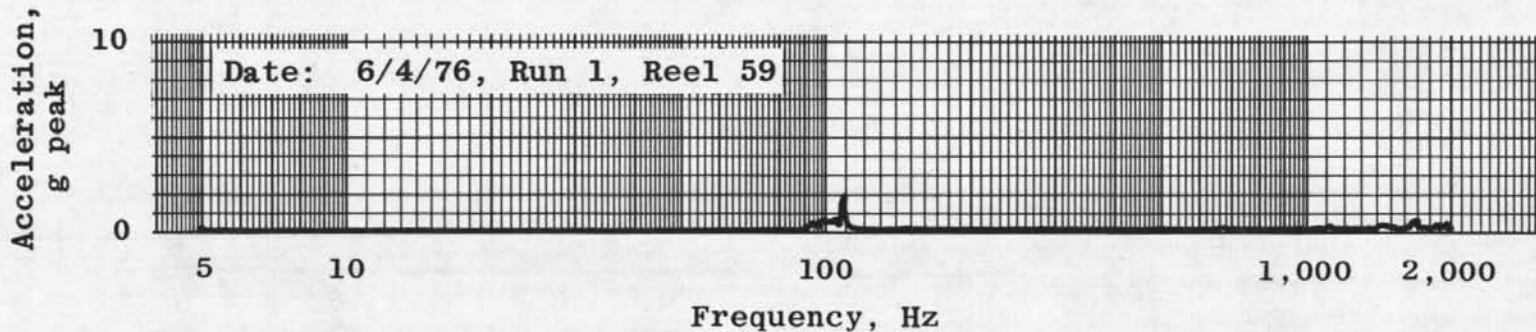

v. Accelerometer 15Y
Figure 12. Continued.

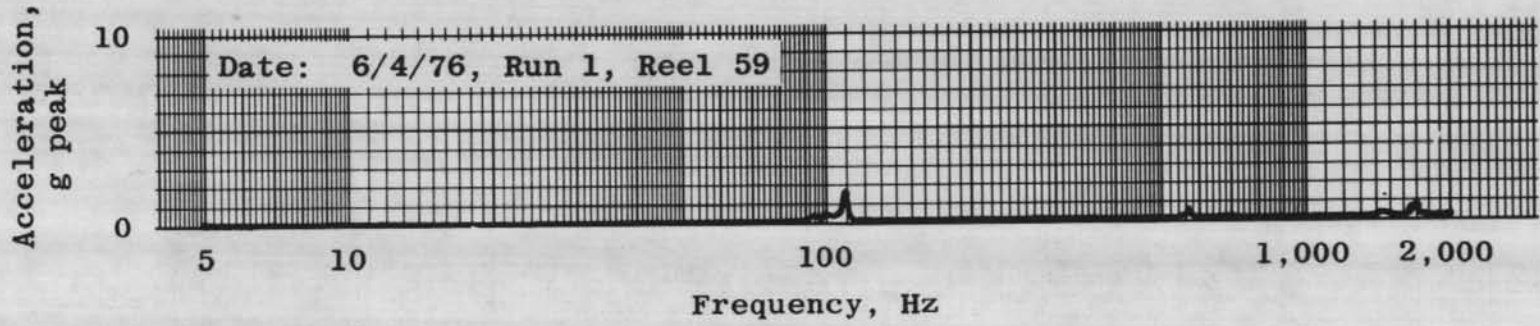

w. Accelerometer 16Y

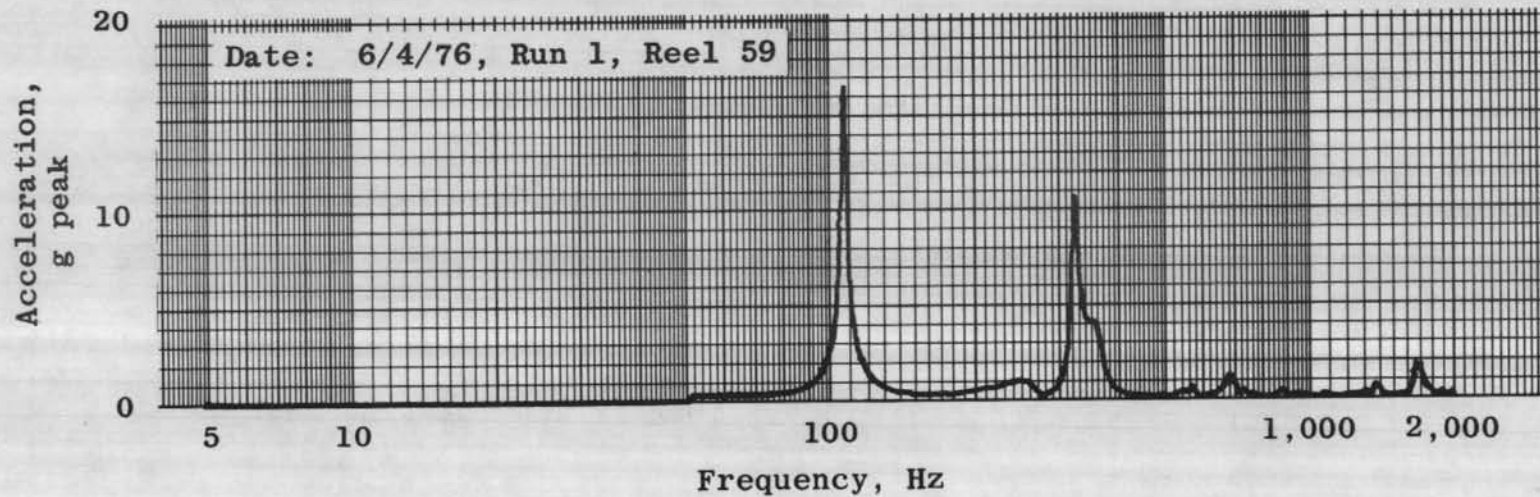

x. Accelerometer 14Z
Figure 12. Concluded.

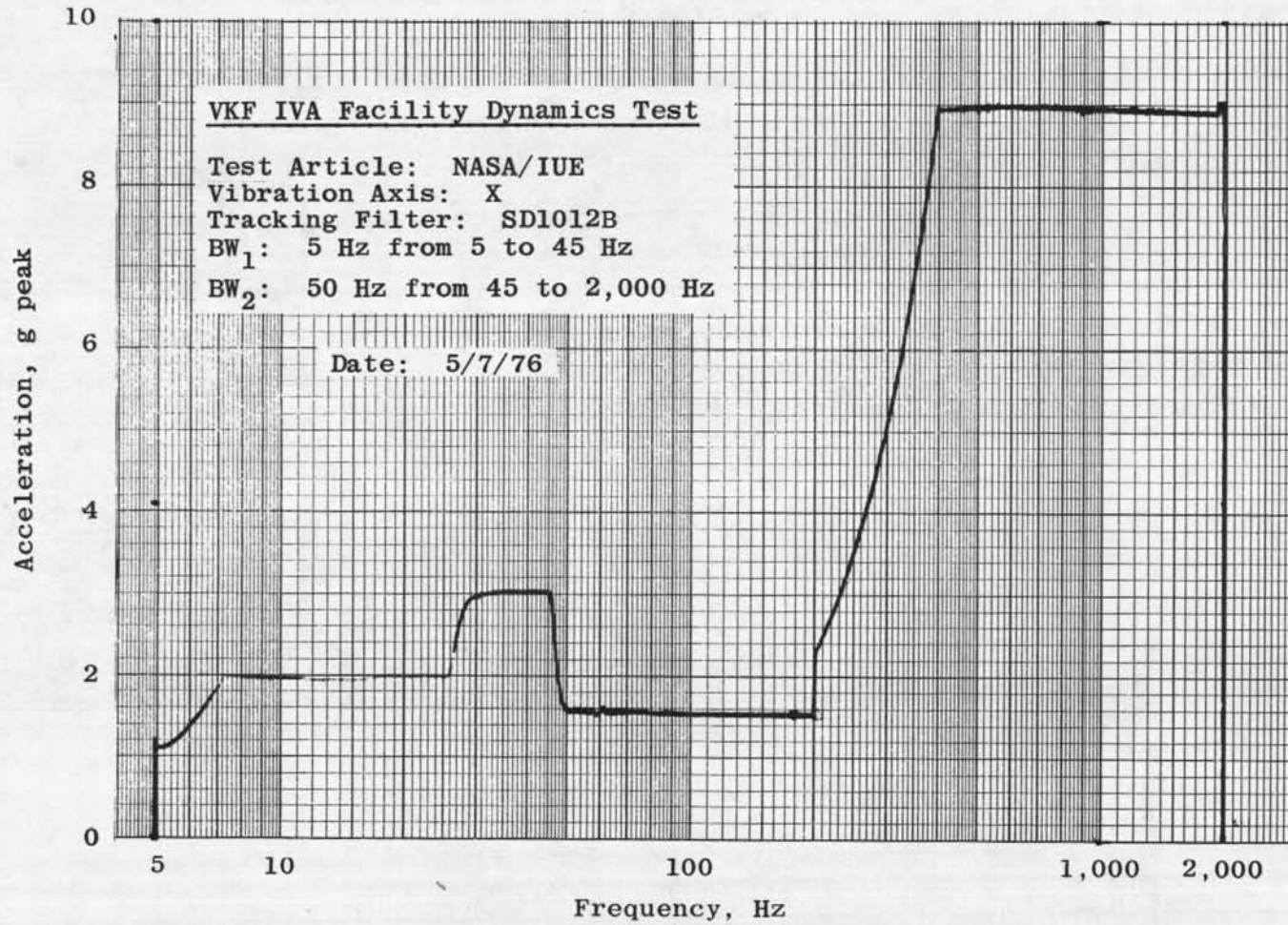

a. Closed loop plot

Figure 13. X-axis vibration test: qualification level sine sweep.

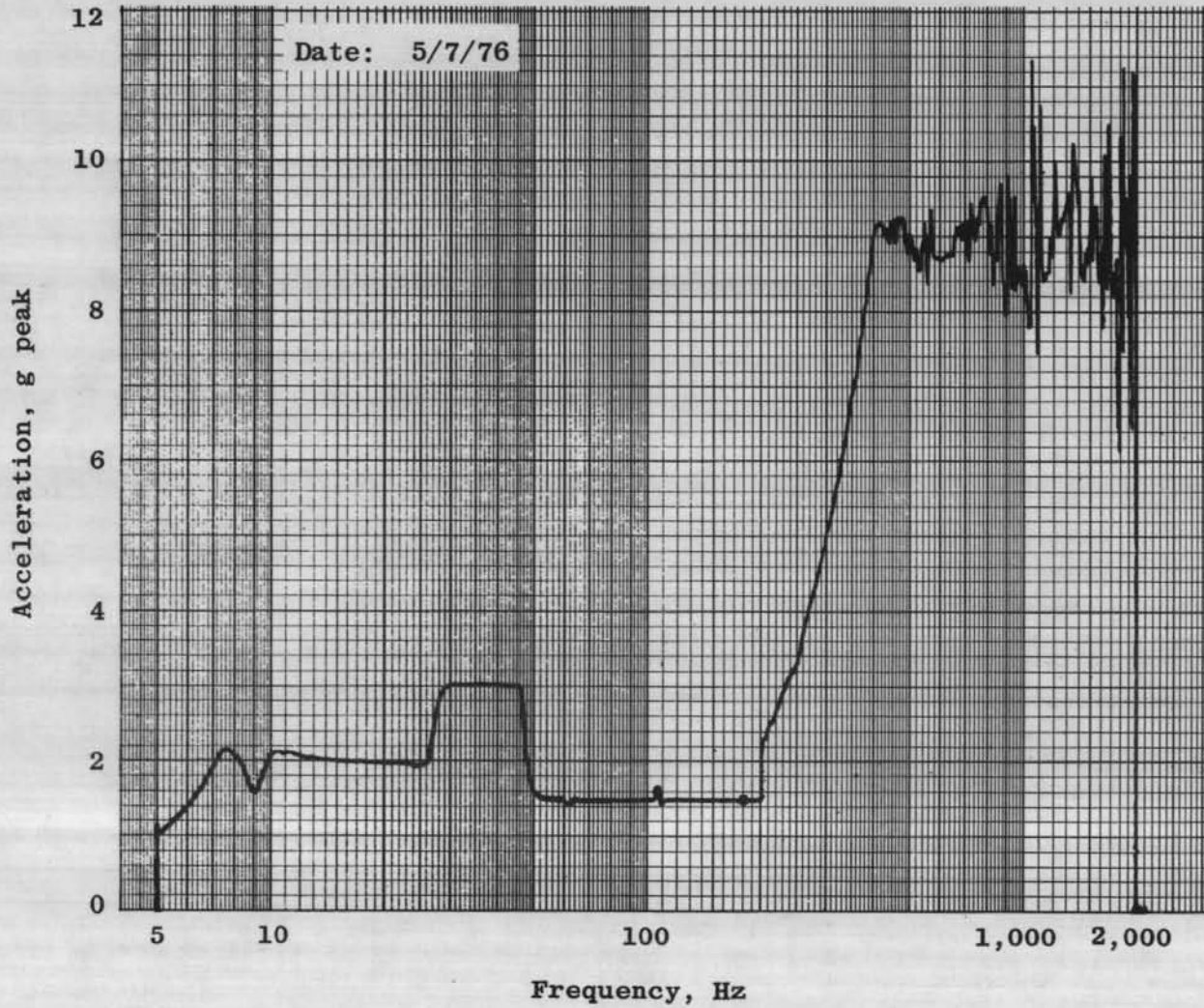

b. Accelerometers averaged, online
Figure 13. Continued.

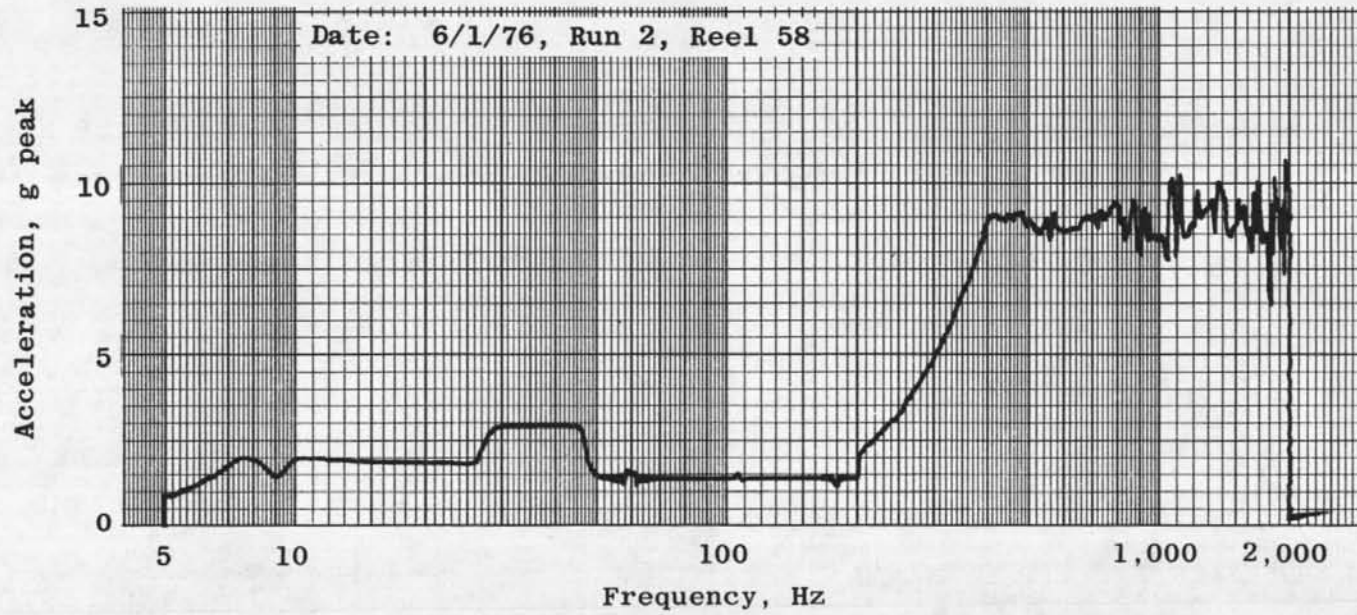

c. X accelerometers averaged
Figure 13. Continued.

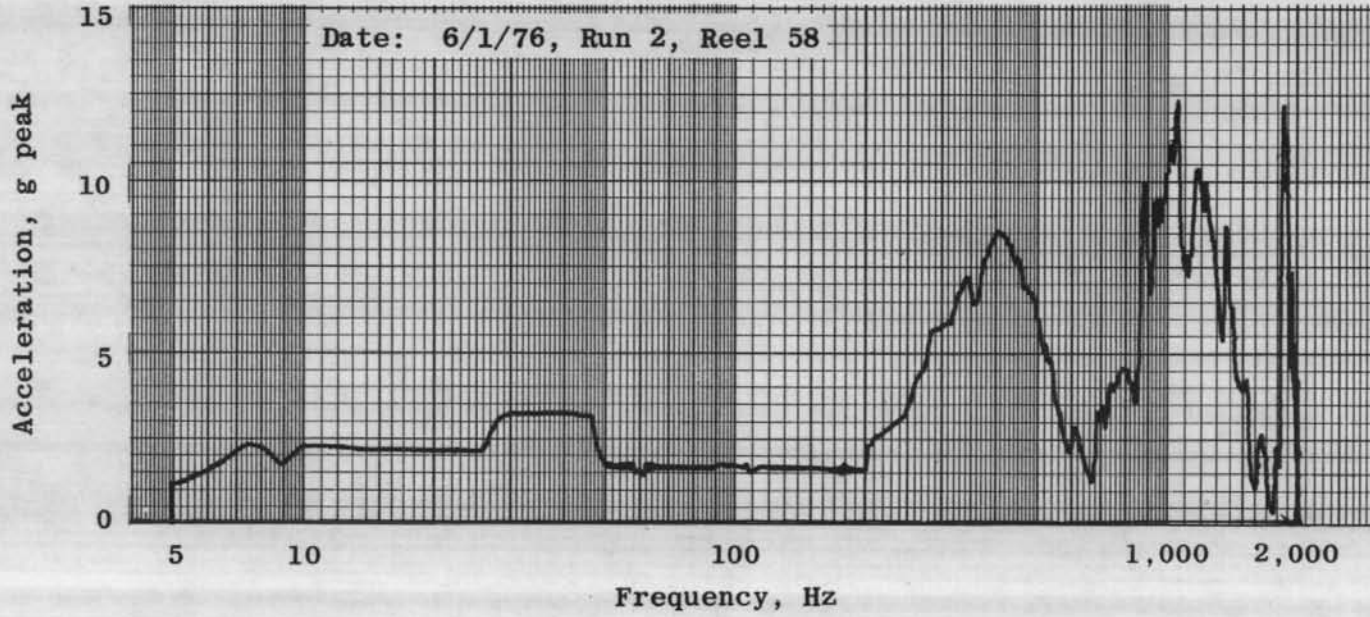

d. Accelerometer 1X
Figure 13. Continued.

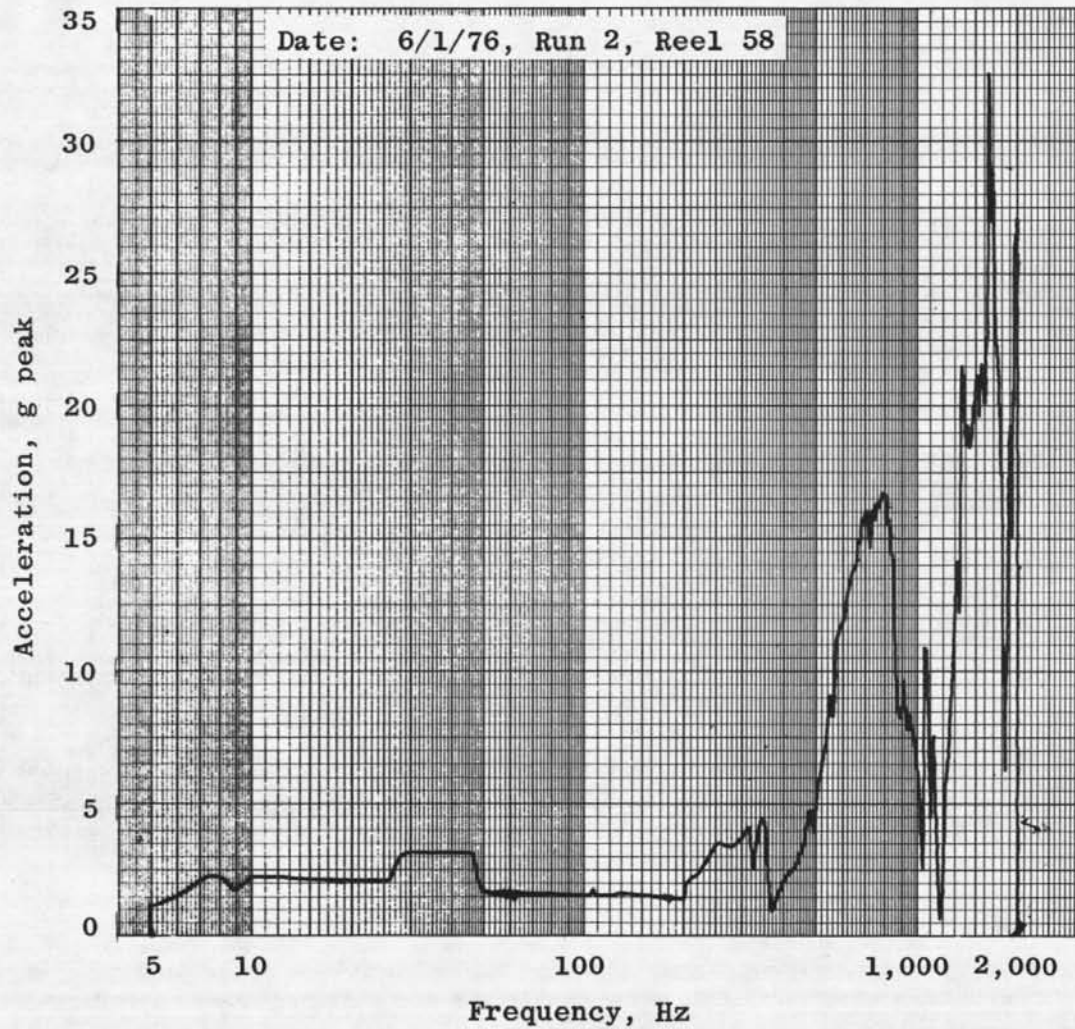

e. Accelerometer 2X
Figure 13. Continued.

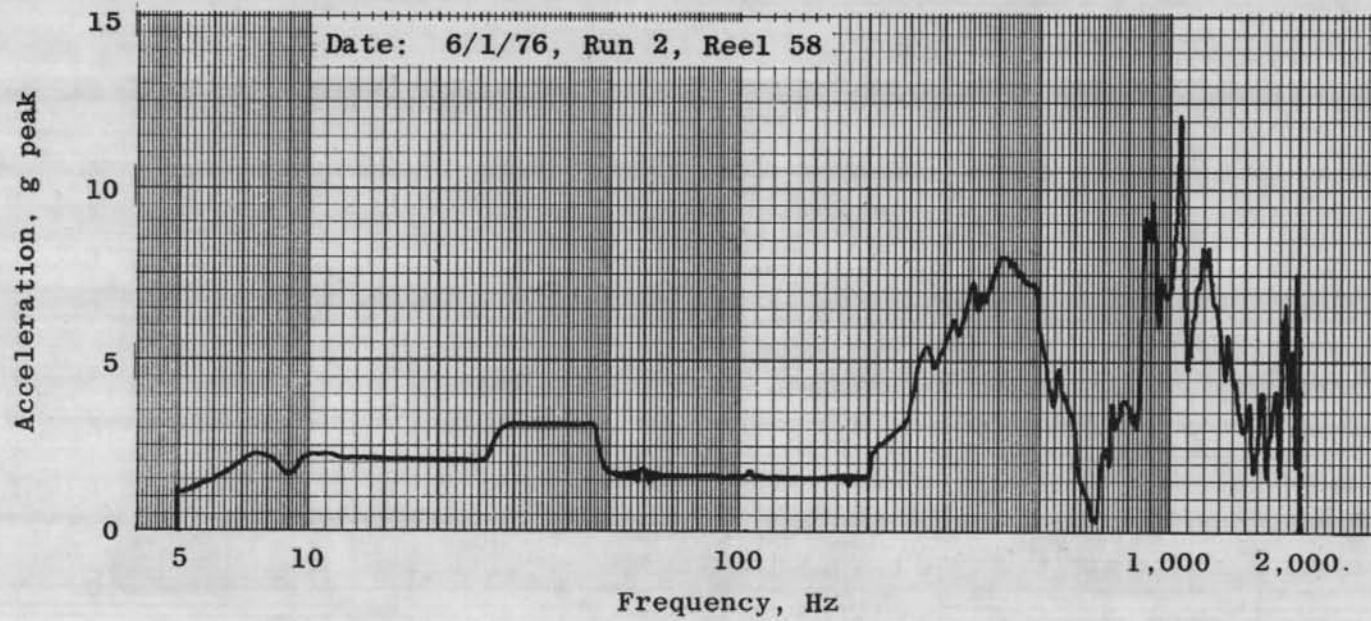

f. Accelerometer 3X
Figure 13. Continued.

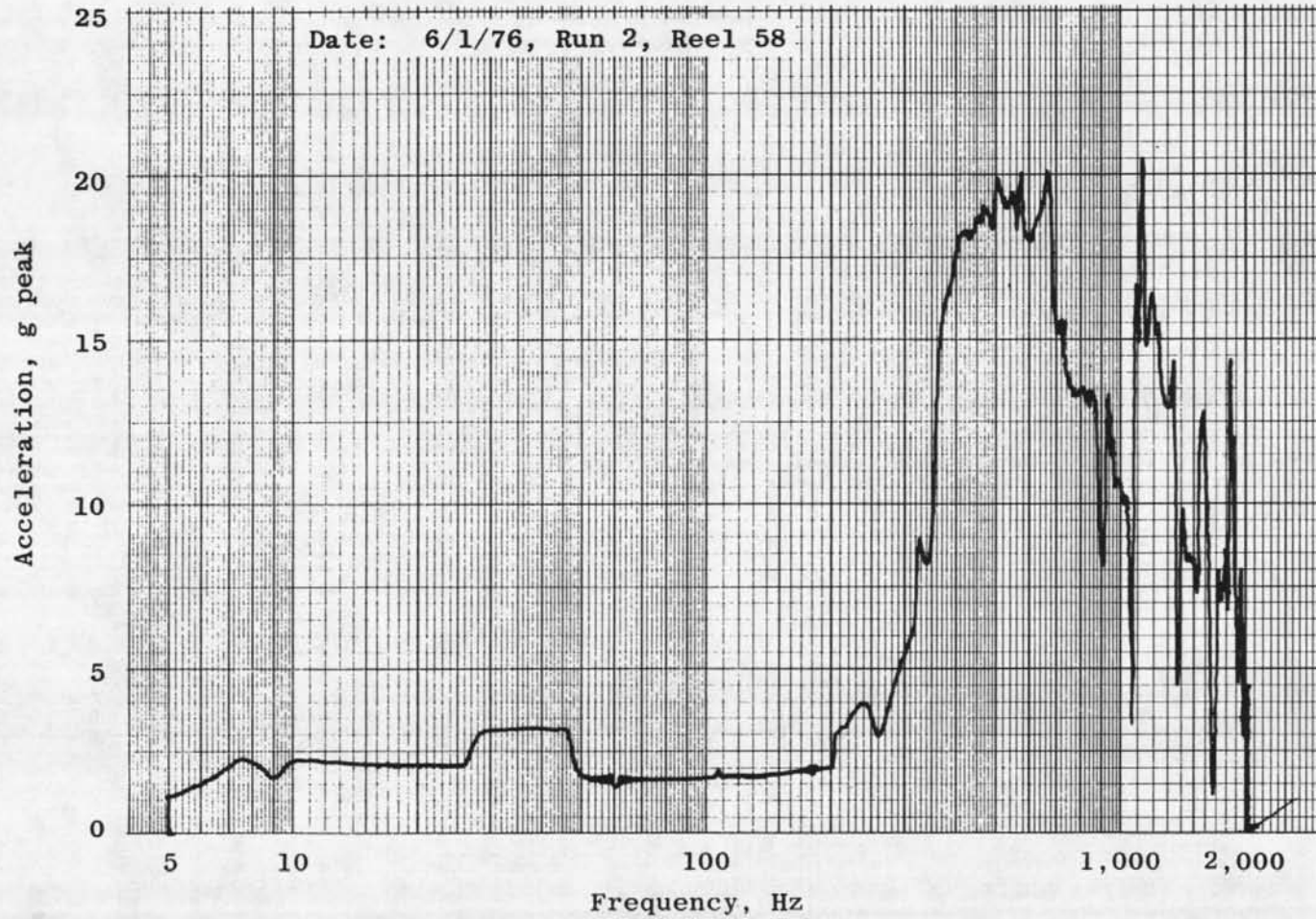

g. Accelerometer 4X
Figure 13. Continued.

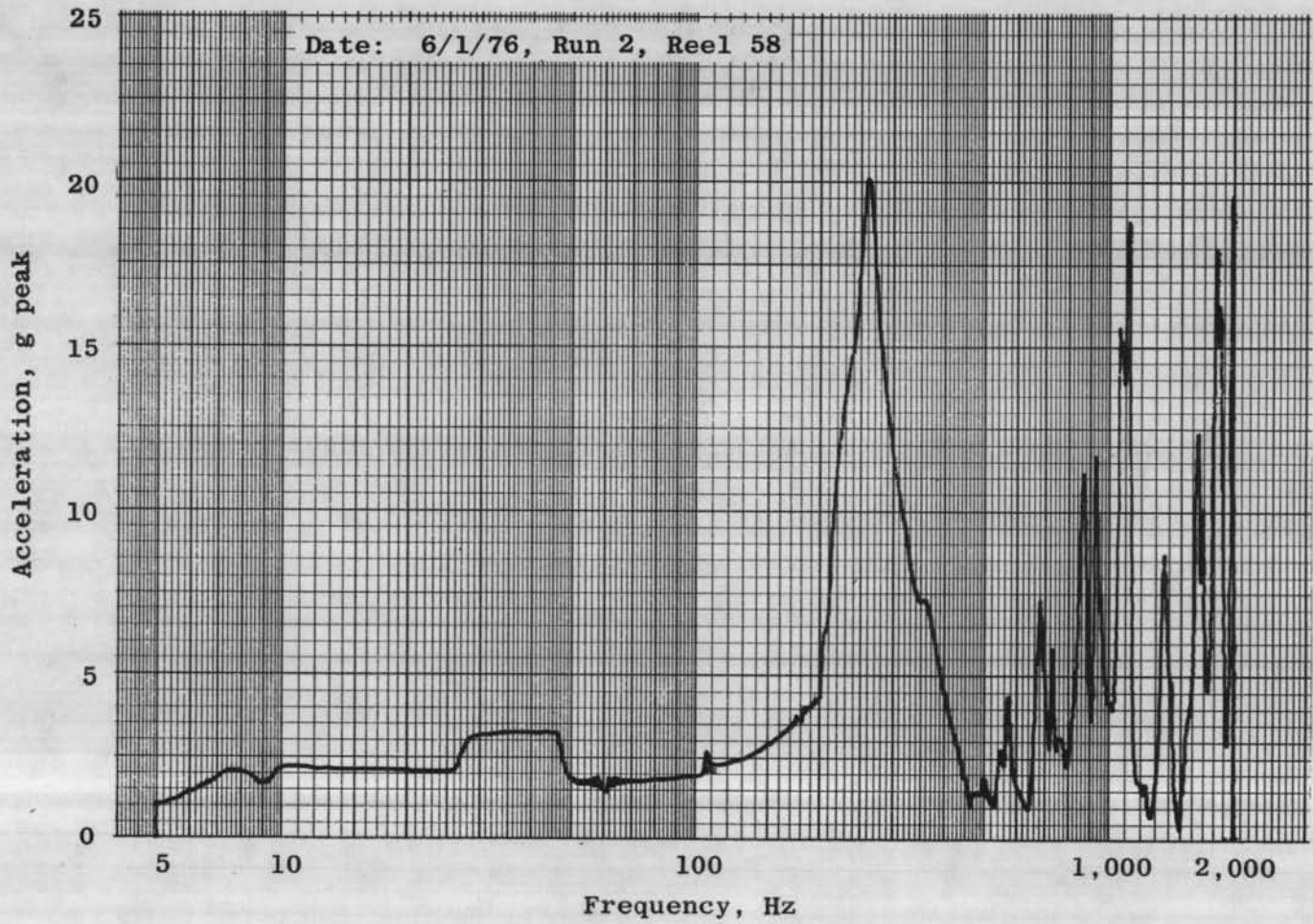

h. Accelerometer 5X
Figure 13. Continued.

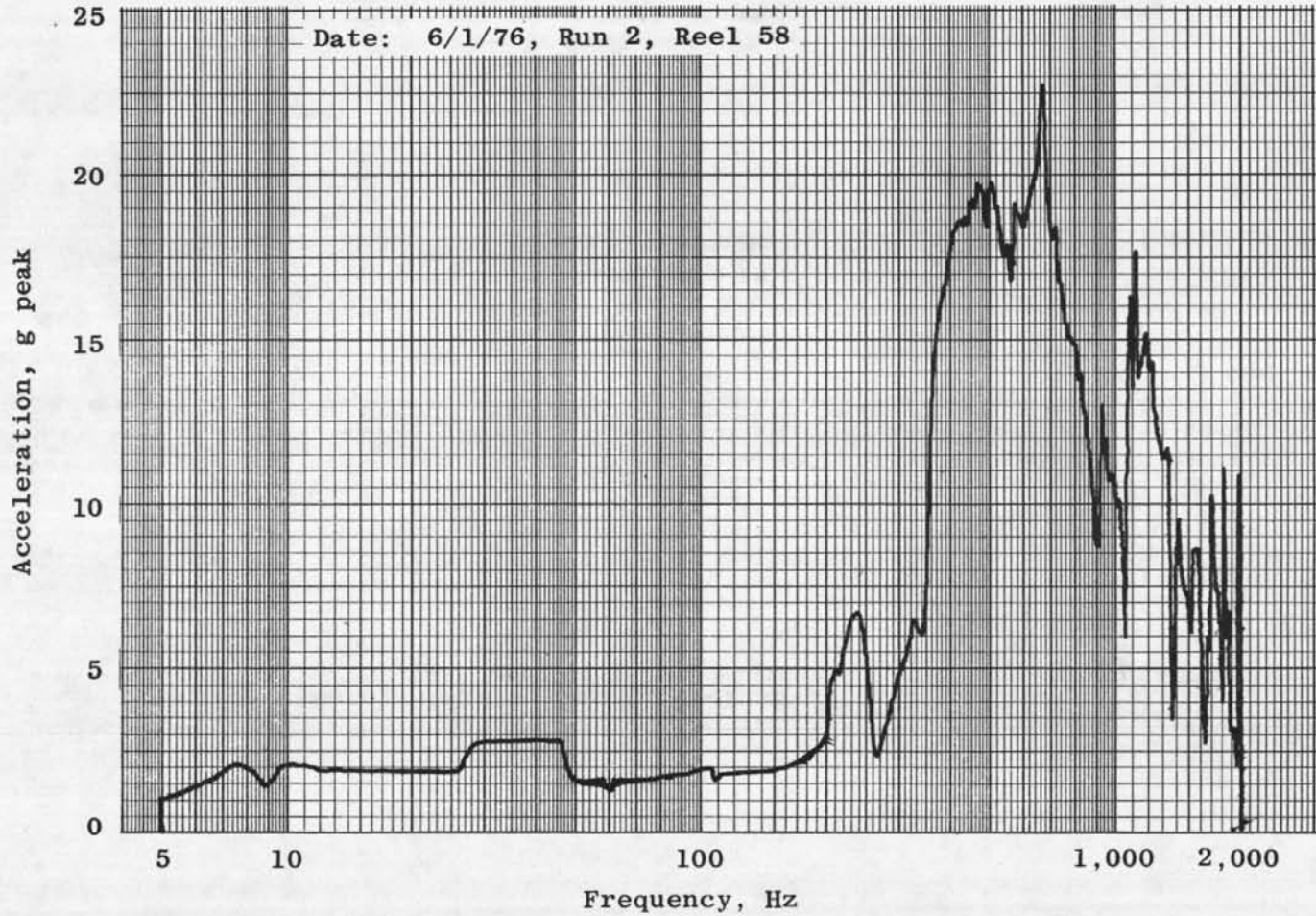

i. Accelerometer 6X
Figure 13. Continued.

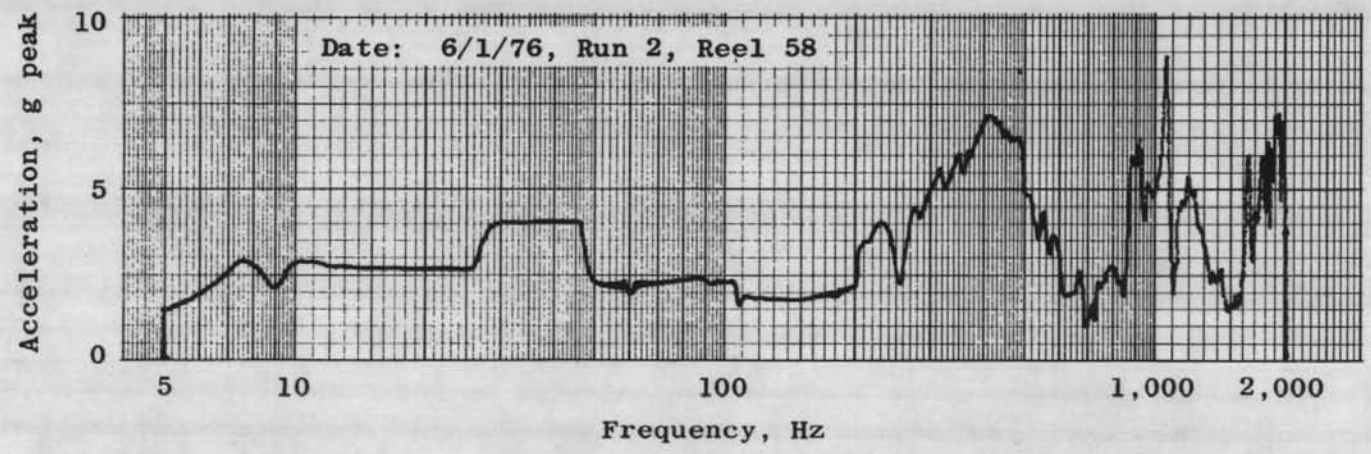

j. Accelerometer 7X
Figure 13. Continued.

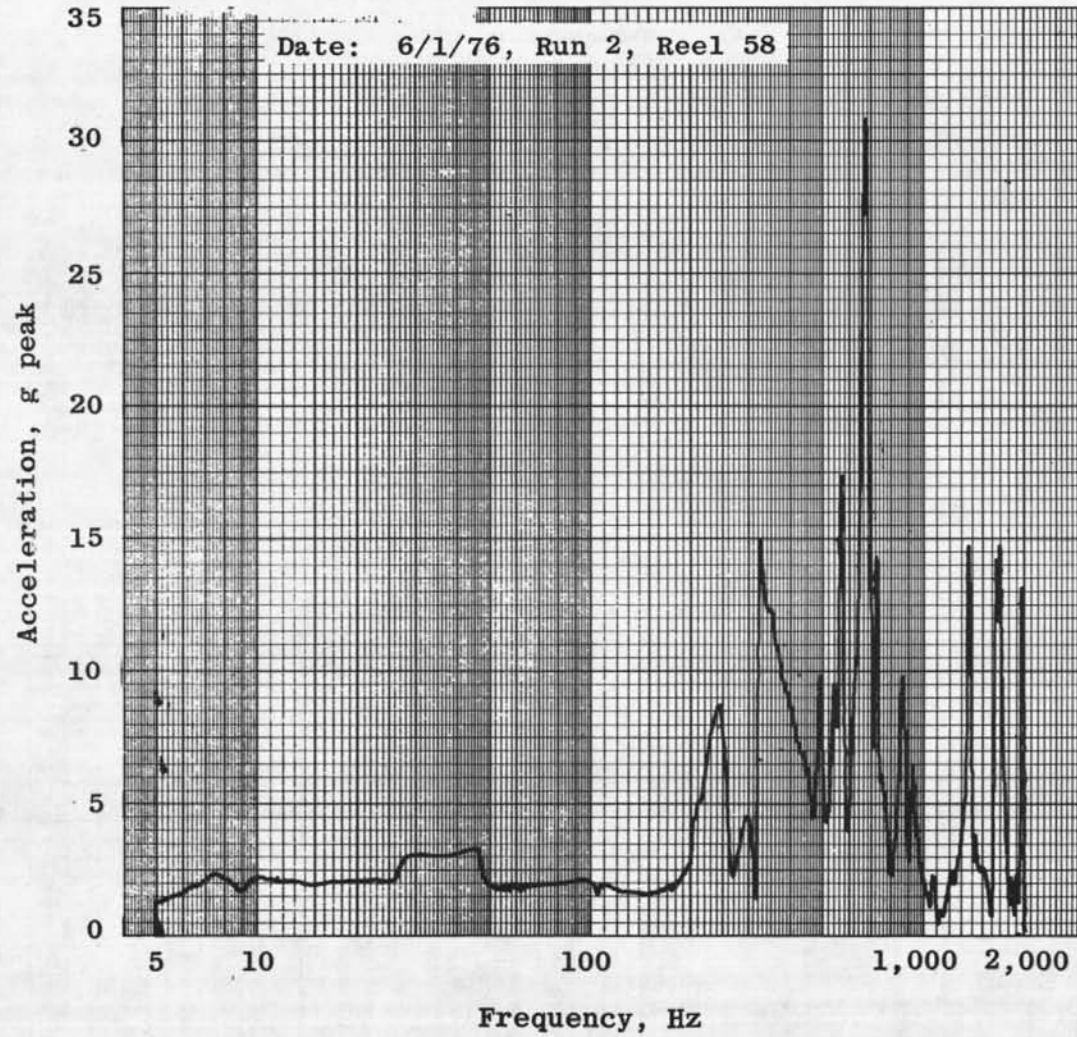

k. Accelerometer 8X
Figure 13. Continued.

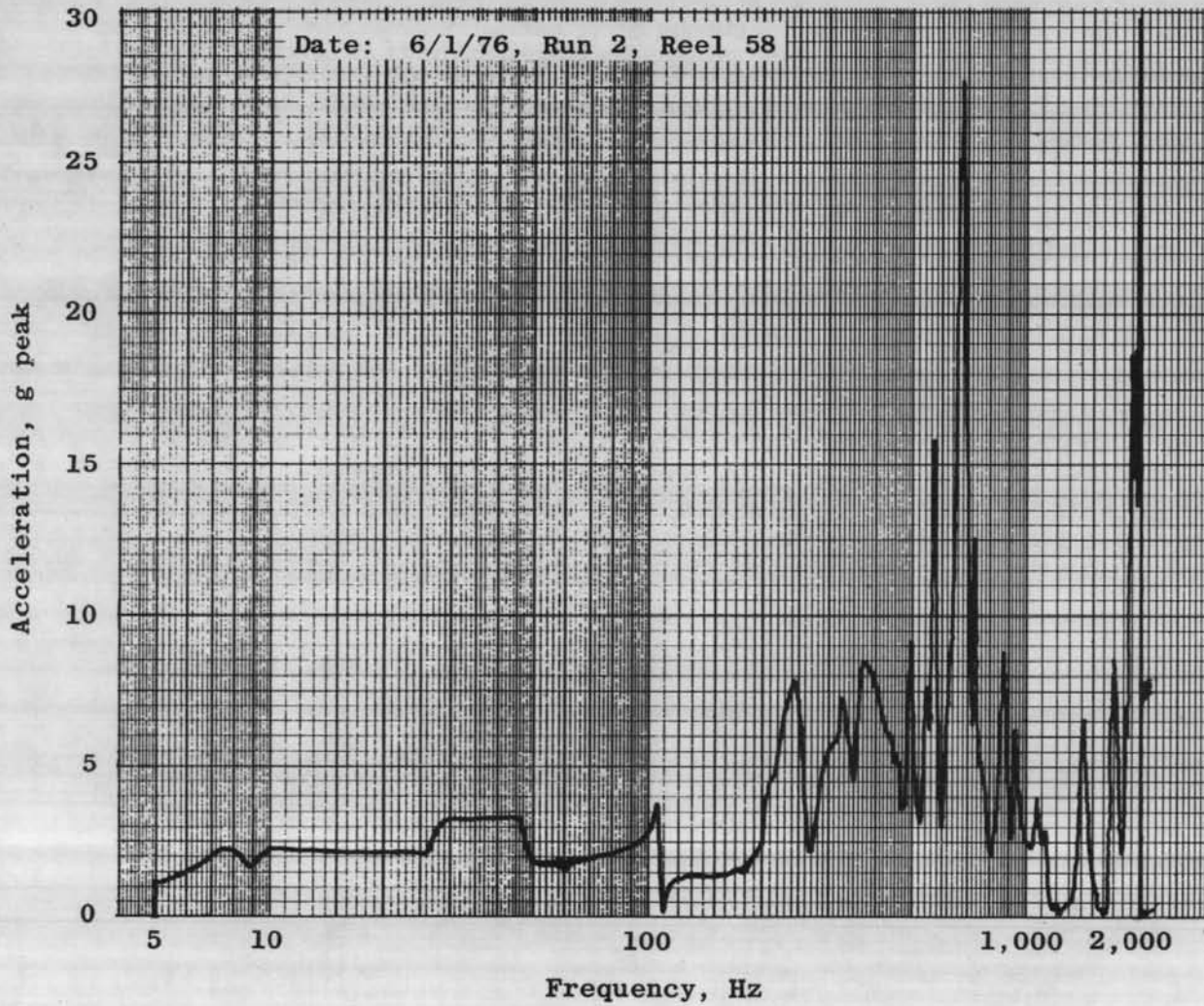

I. Accelerometer 9X
Figure 13. Continued.

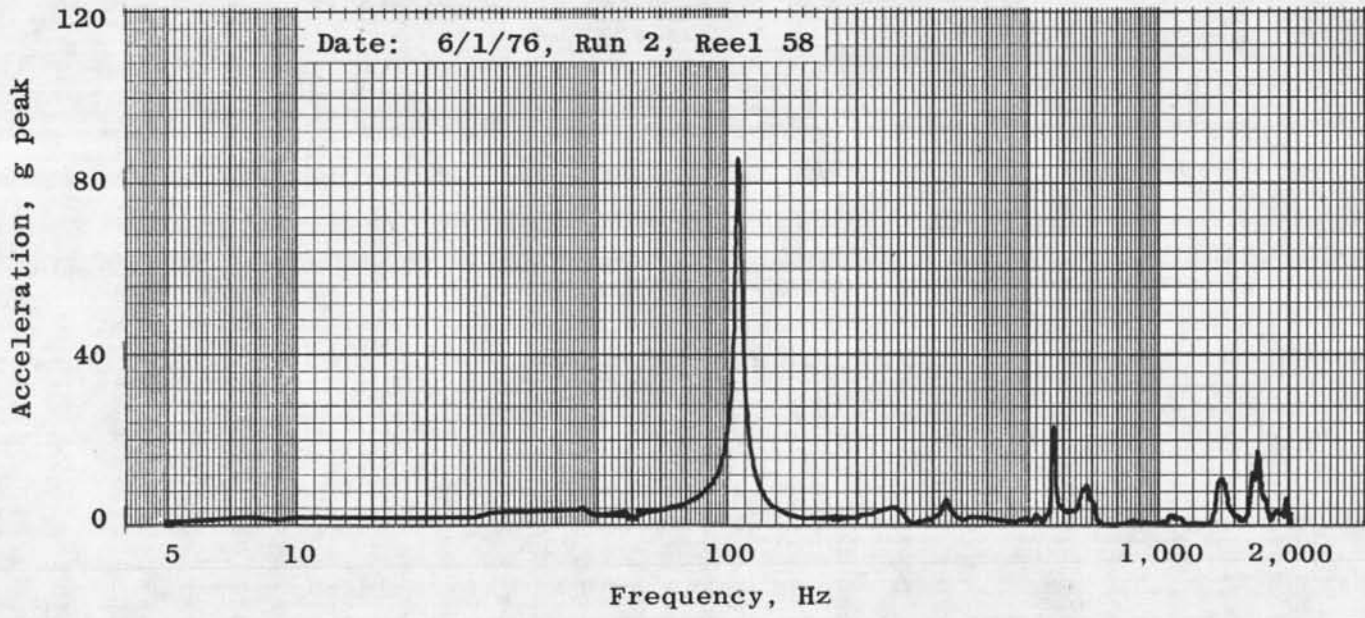

m. Accelerometer 11X
Figure 13. Continued.

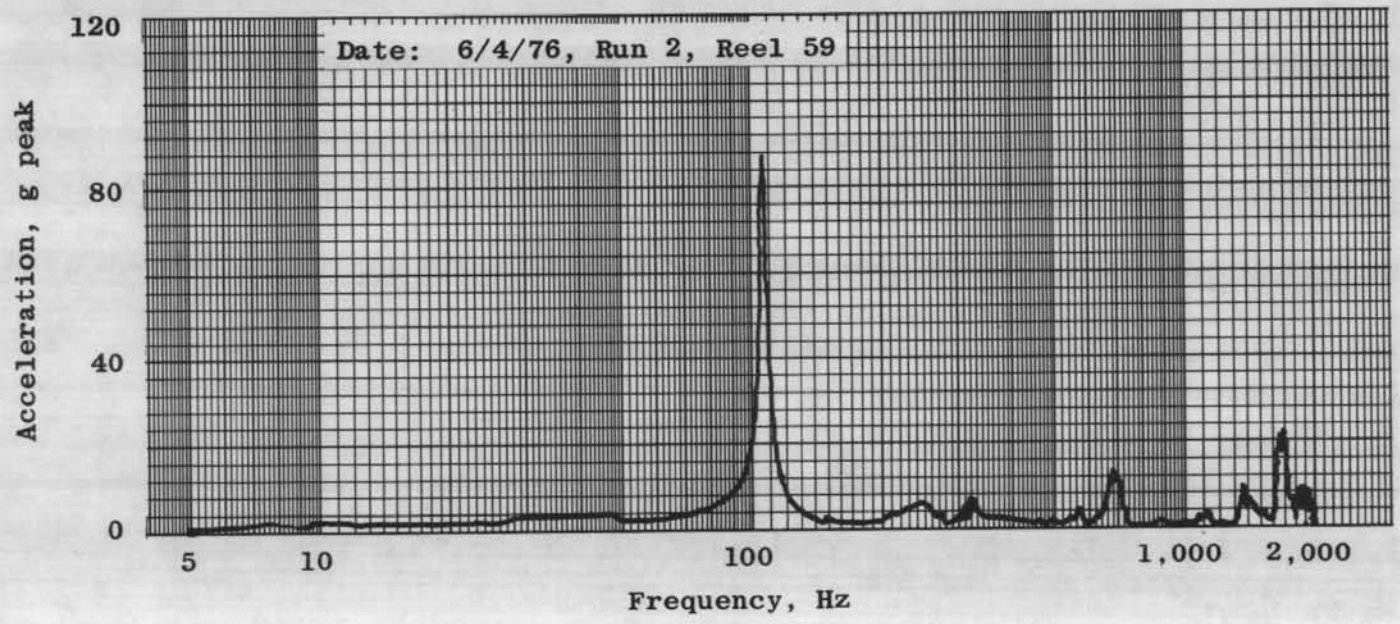

n. Accelerometer 12X
Figure 13. Continued.

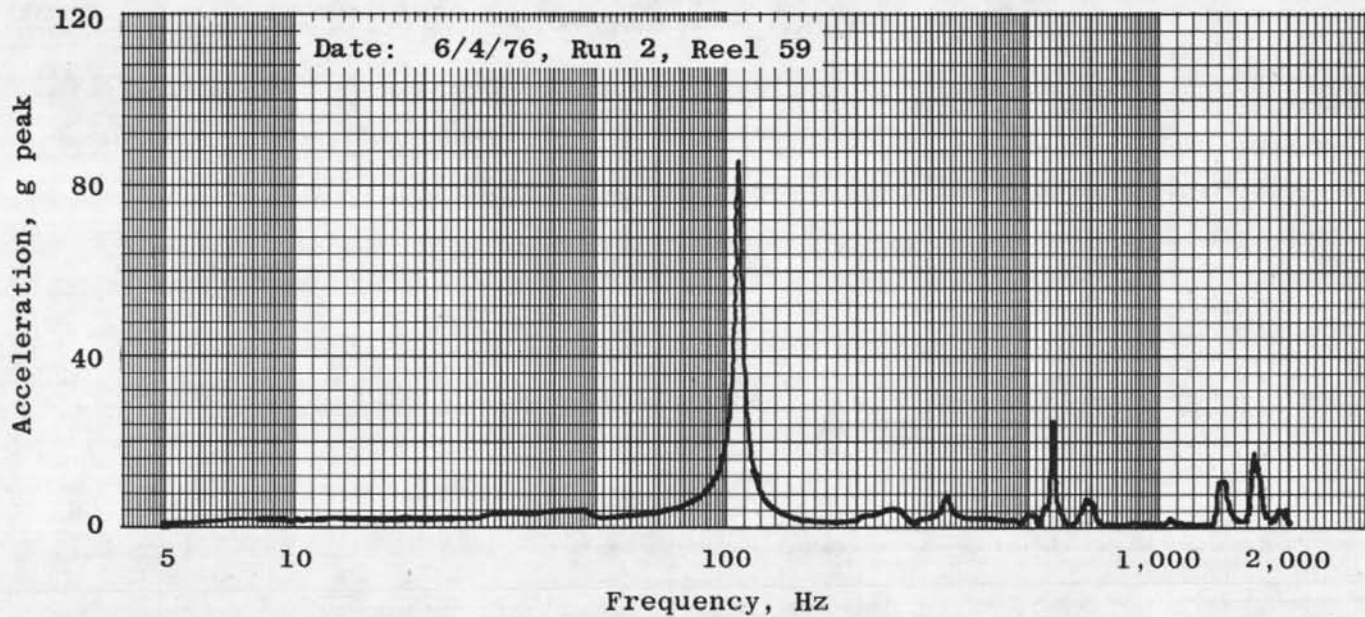

o. Accelerometer 13X
Figure 13. Continued.

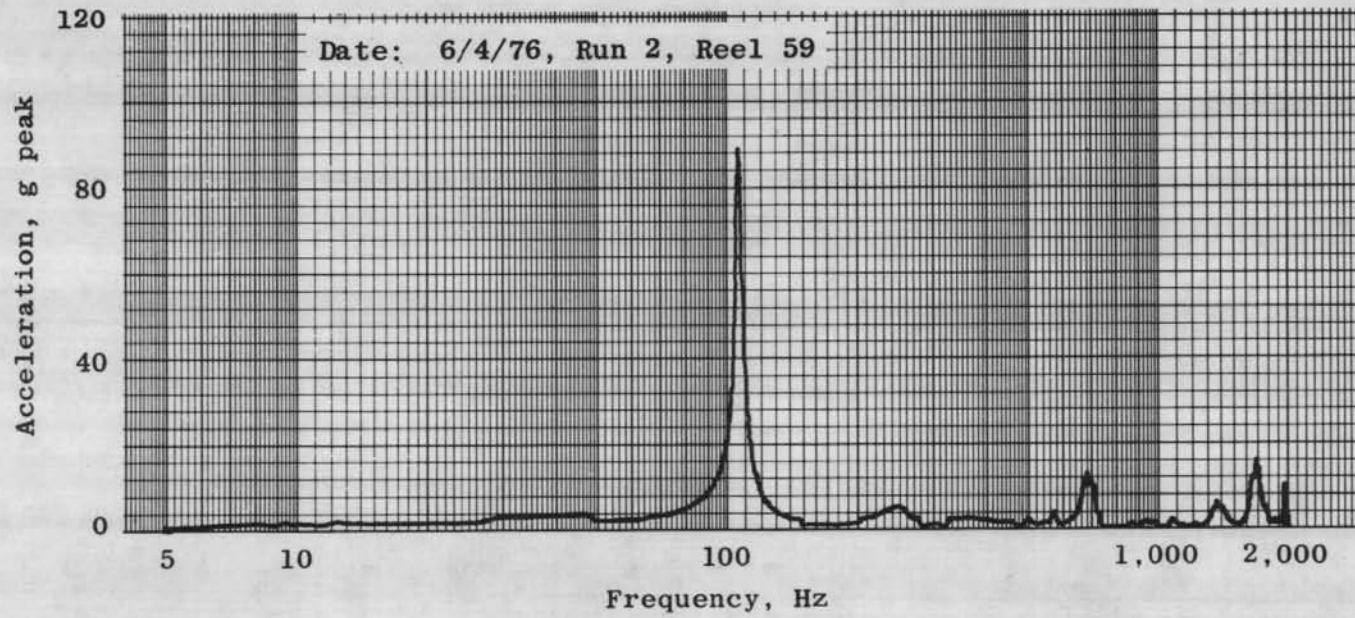

p. Accelerometer 14X
Figure 13. Continued.

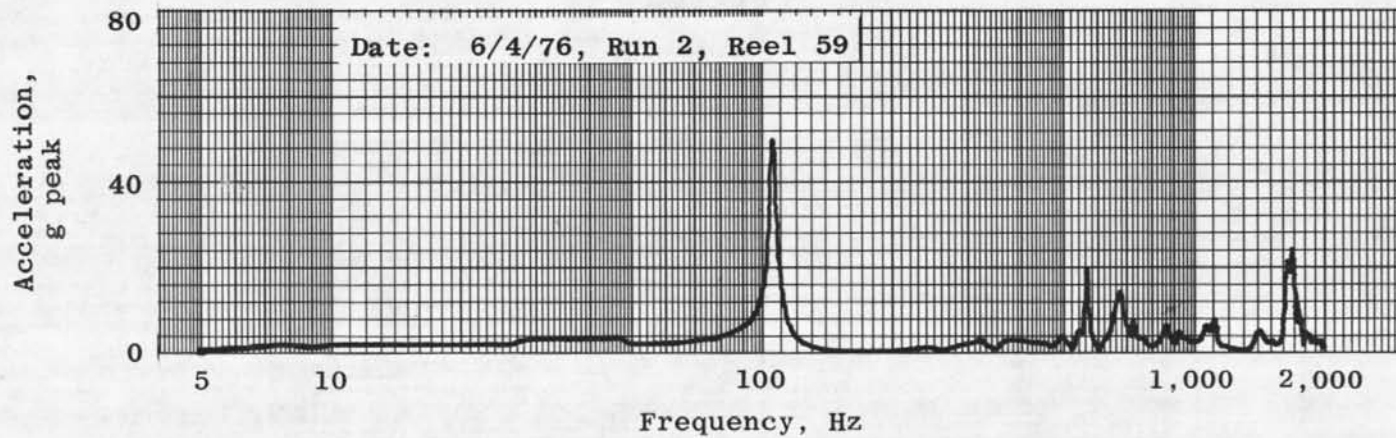

q. Accelerometer 15X

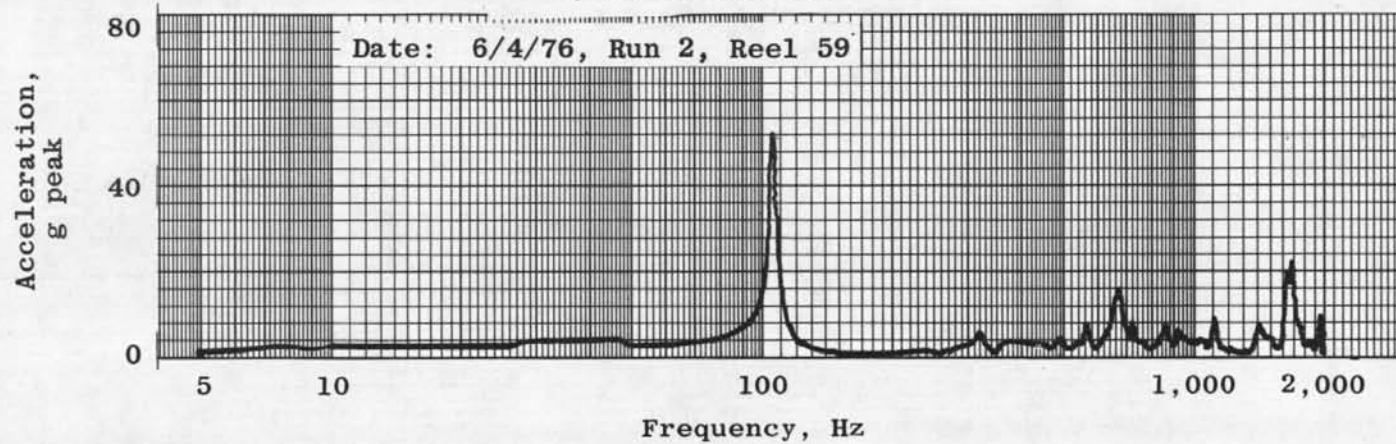
r. Accelerometer 16X
Figure 13. Continued.

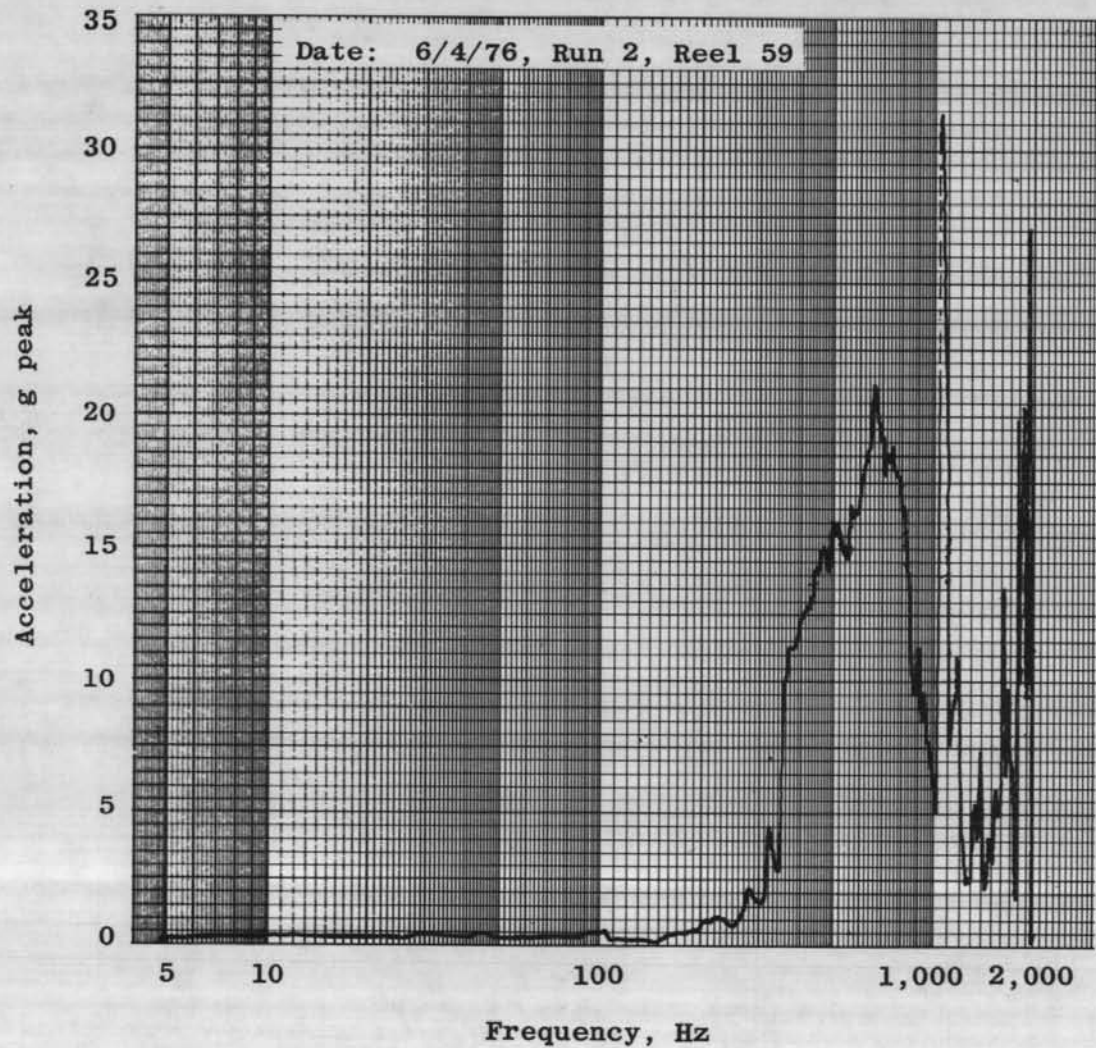

s. Accelerometer 7Y
Figure 13. Continued.

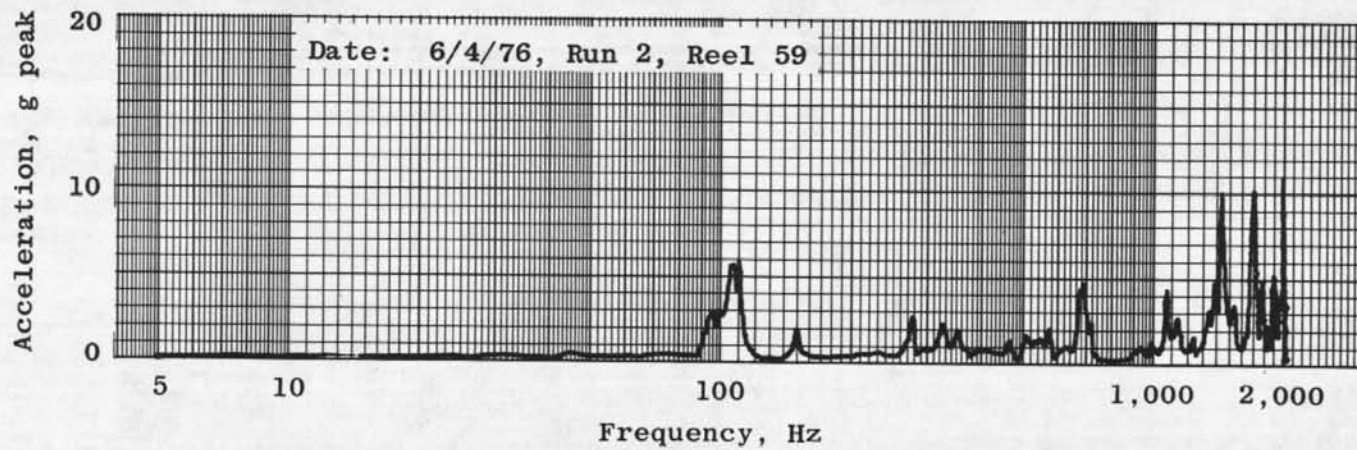

t. Accelerometer 11Y
Figure 13. Continued.

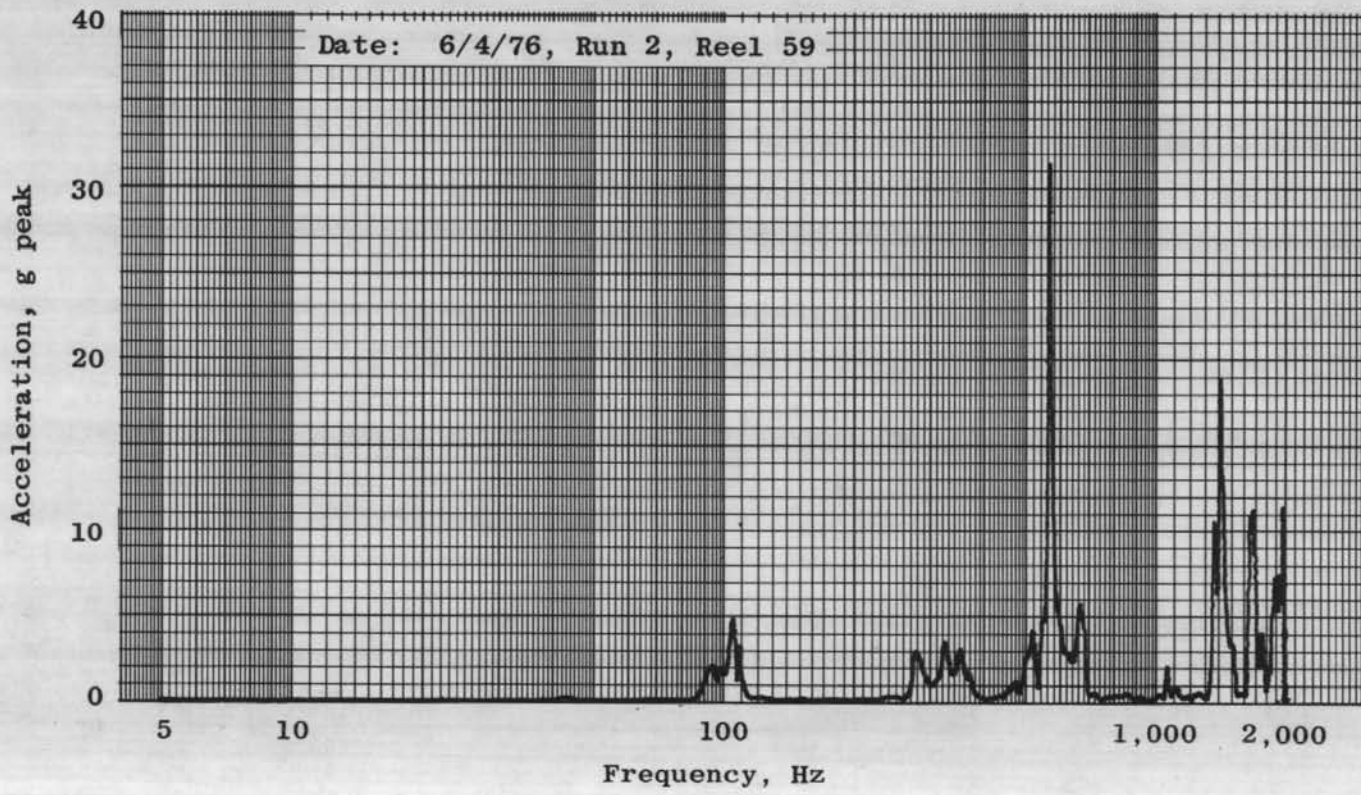

u. Accelerometer 14Y
Figure 13. Continued.

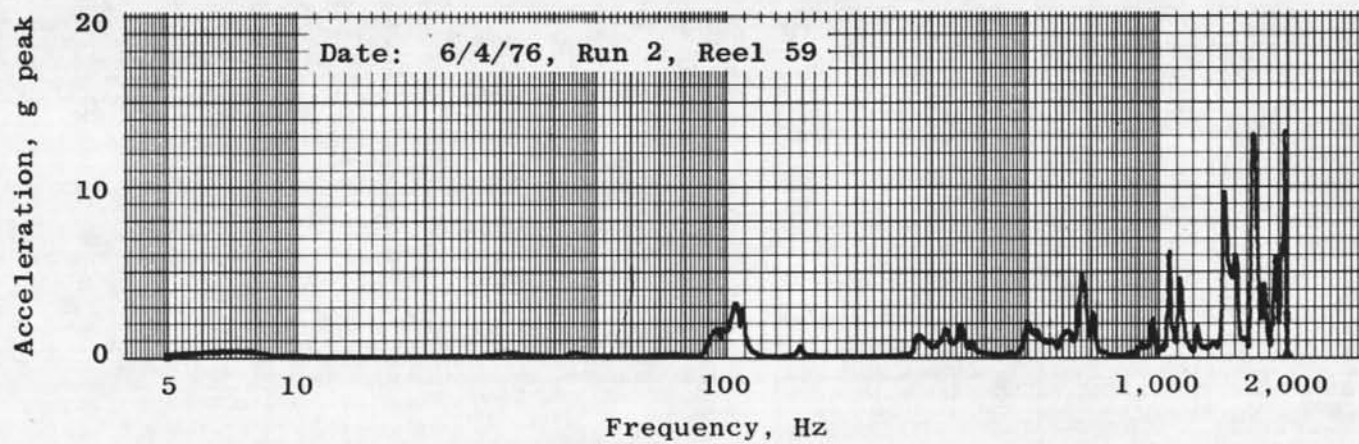

v. Accelerometer 15Y
Figure 13. Continued.

74

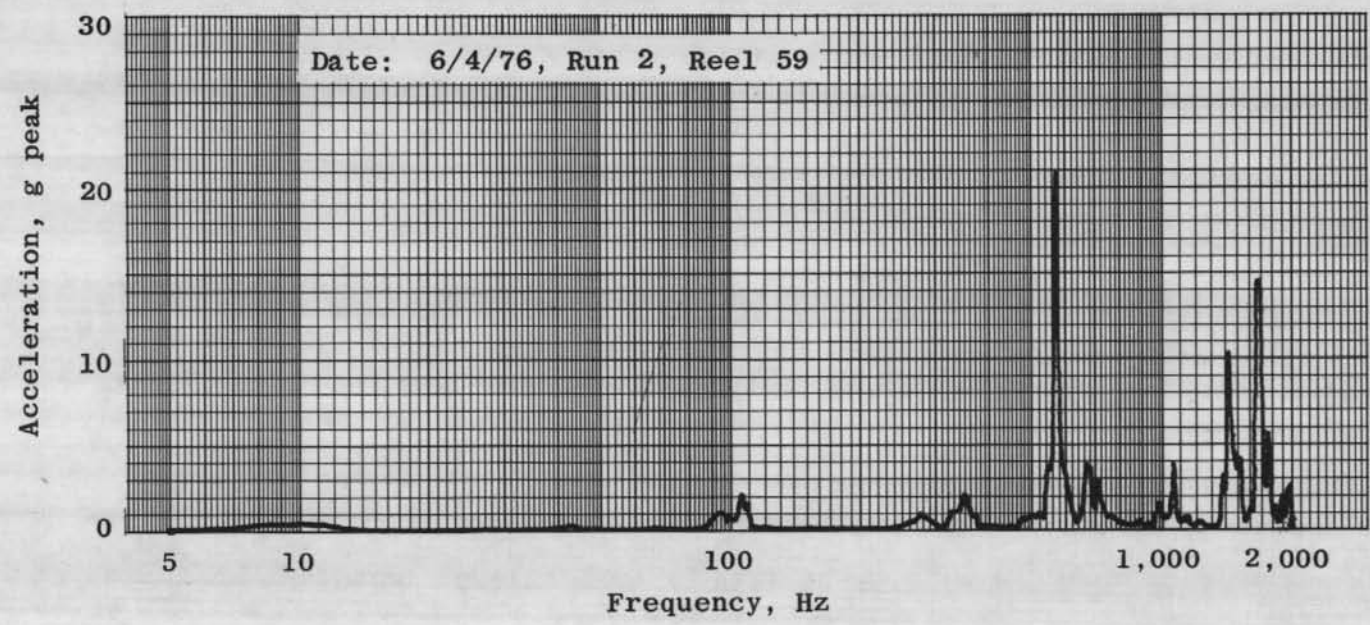

w. Accelerator 16Y
Figure 13. Continued.

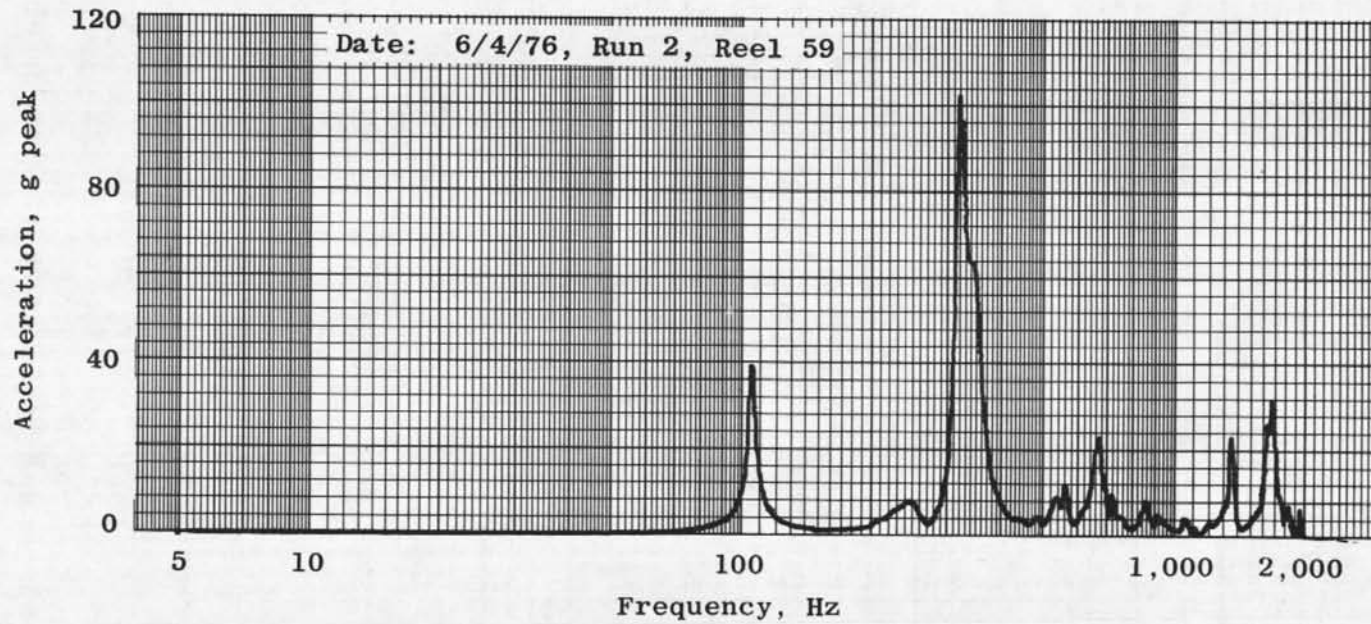

x. Accelerometer 14Z
Figure 13. Concluded.

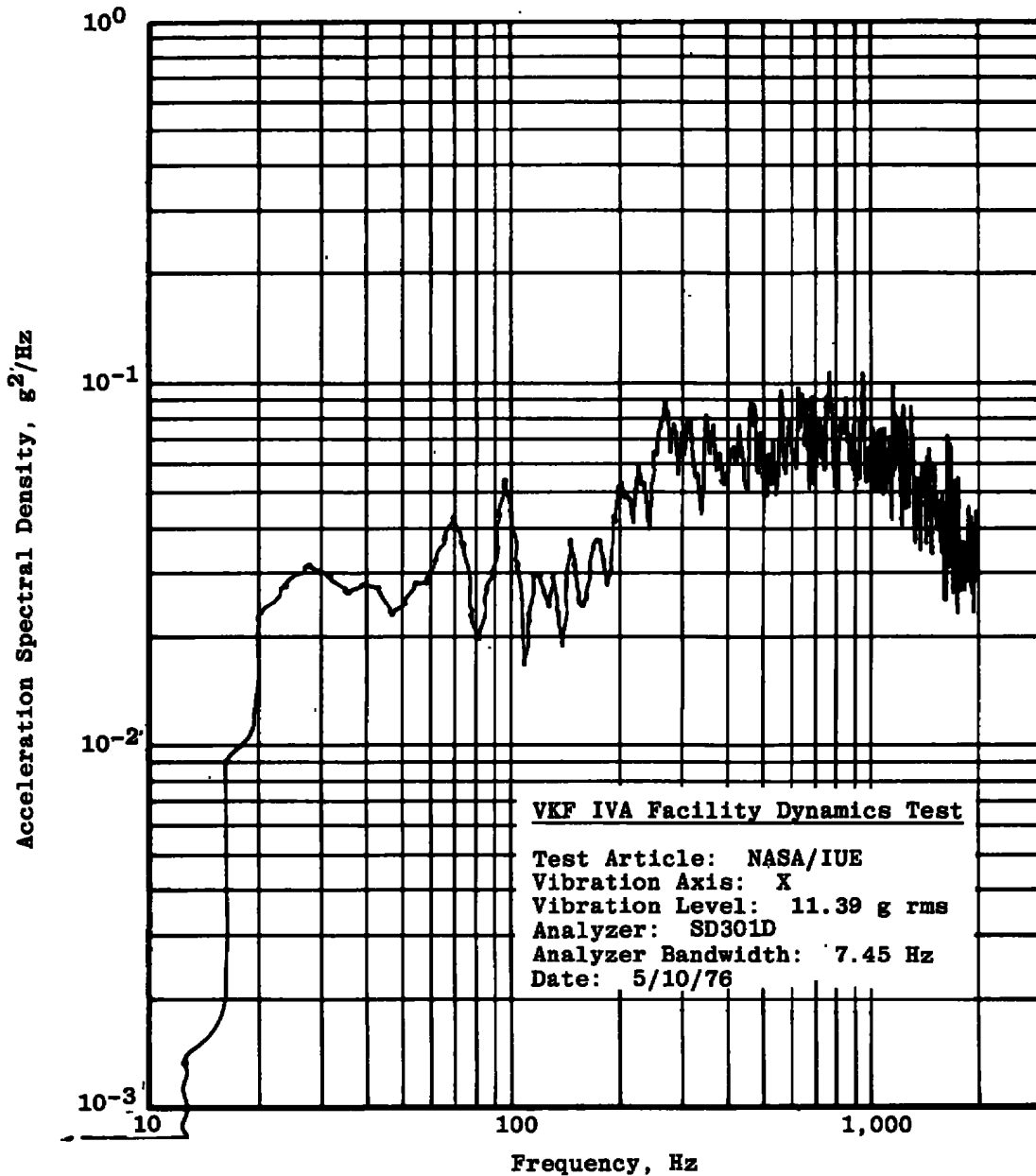

a. Closed loop plot

Figure 14. X-axis vibration test: qualification level random vibration.

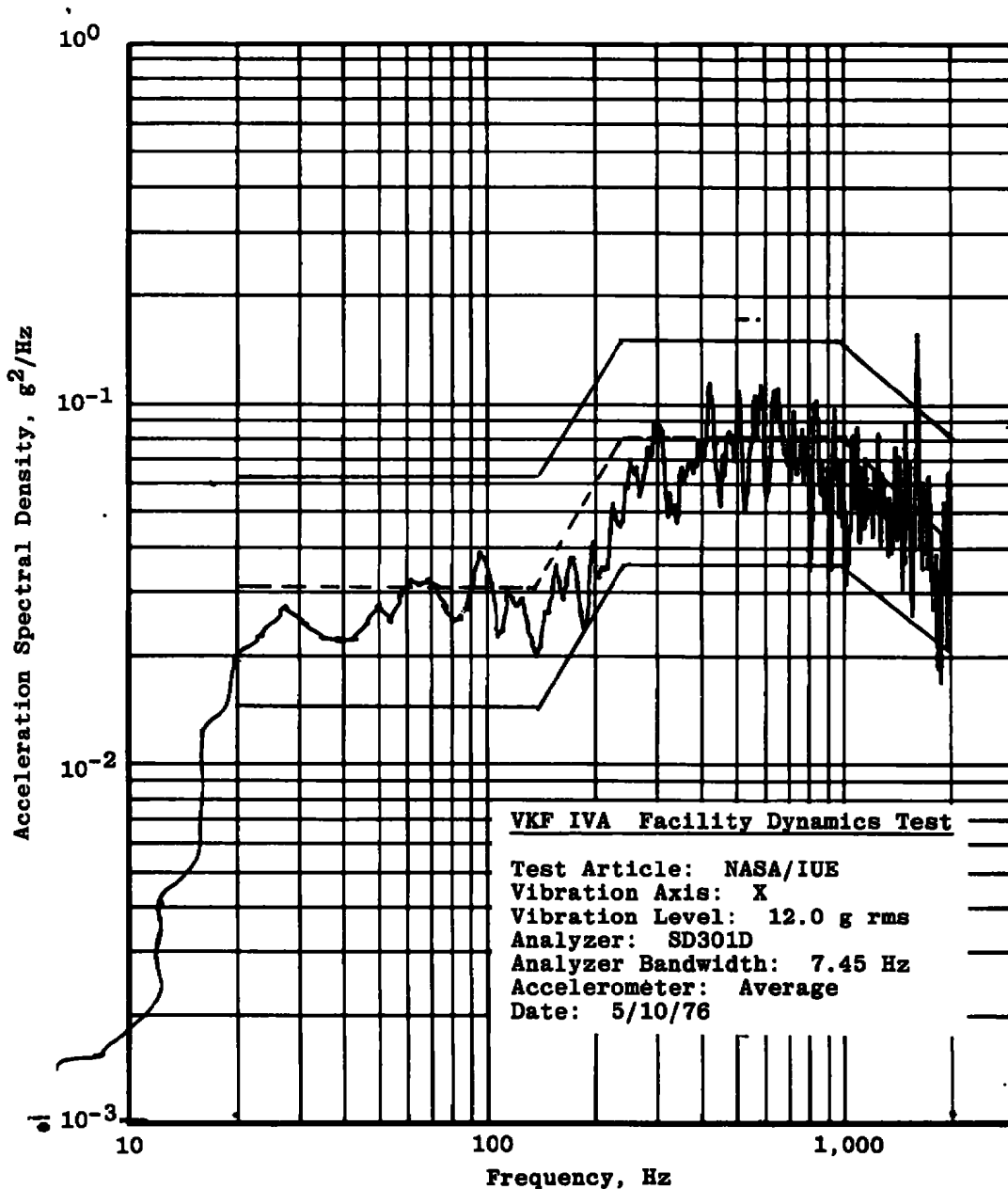

b. Online plot
 Figure 14. Continued.

<u>Accelerometer</u>	<u>g rms</u>
Average	12.0
1X	7.5
2X	14.5
3X	6.7
4X	14
5X	12.5
6X	13.5
7X	5.8
8X	8.7 to 9.2
9X	8.4 to 8.9
11X	20 to 31
12X	20 to 27.5
13X	20 to 30
14X	20 to 31
15X	11 to 17.5
16X	13 to 19
7Y	12.5
11Y	3.5
14Y	4.3
15Y	3.2
16Y	3.3
14Z	23 to 26
Safety	14

c. X-axis, random; 5/10/76
Figure 14. Concluded.

VKF IVA Facility Dynamics Test

Test Article: NASA/IUE

Vibration Axis: X

Tracking Filter: SD1012B

BW₁: 5 Hz from 5 to 45 Hz

BW₂: 50 Hz from 45 to 2,000 Hz

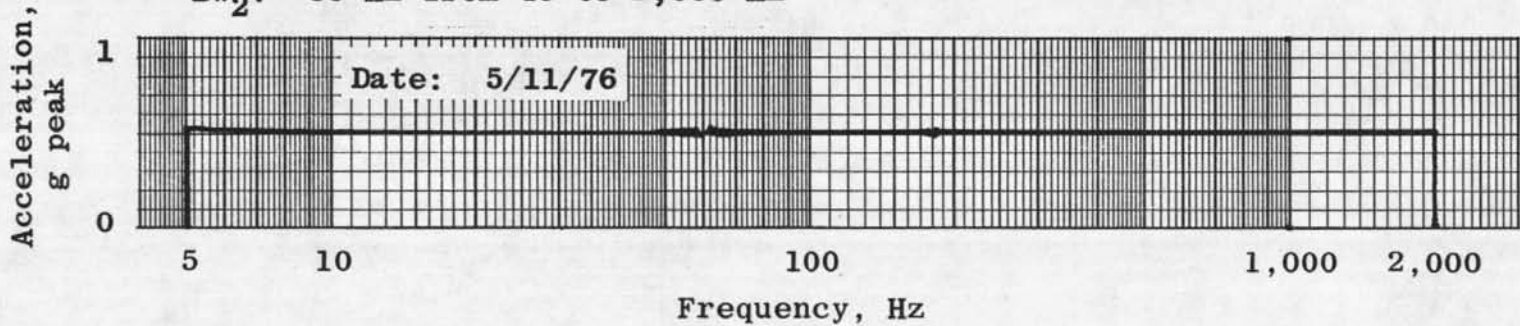

a. Closed loop plot

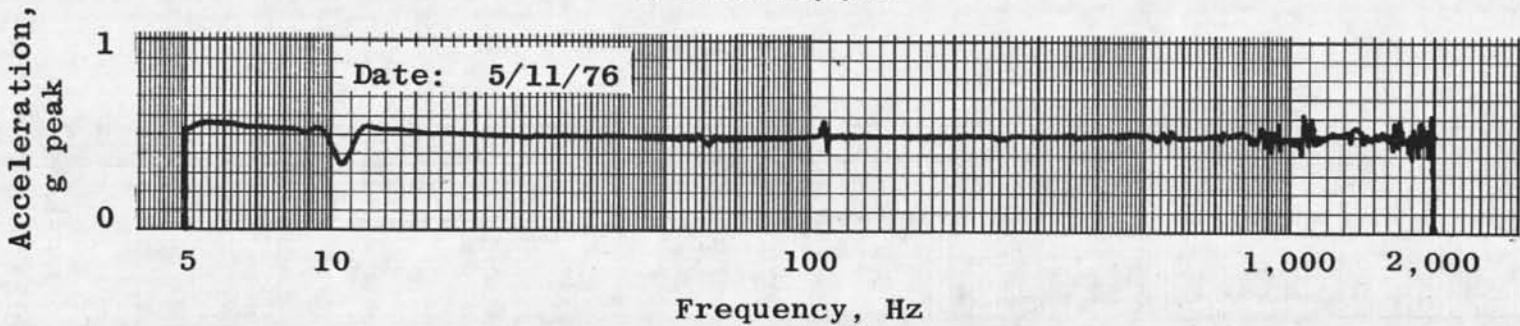

b. Accelerometers averaged, online

Figure 15. X-axis vibration test: 0.5-g sine survey.

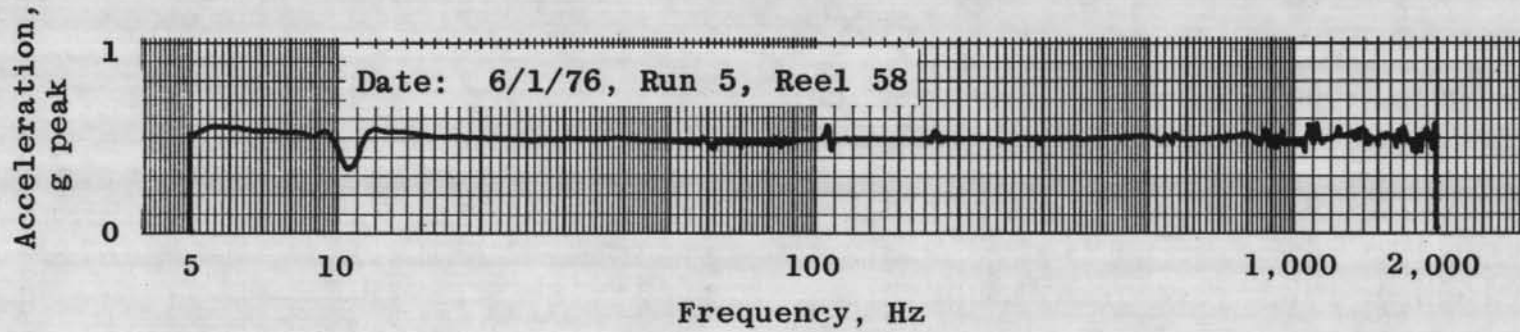

c. Accelerometers averaged

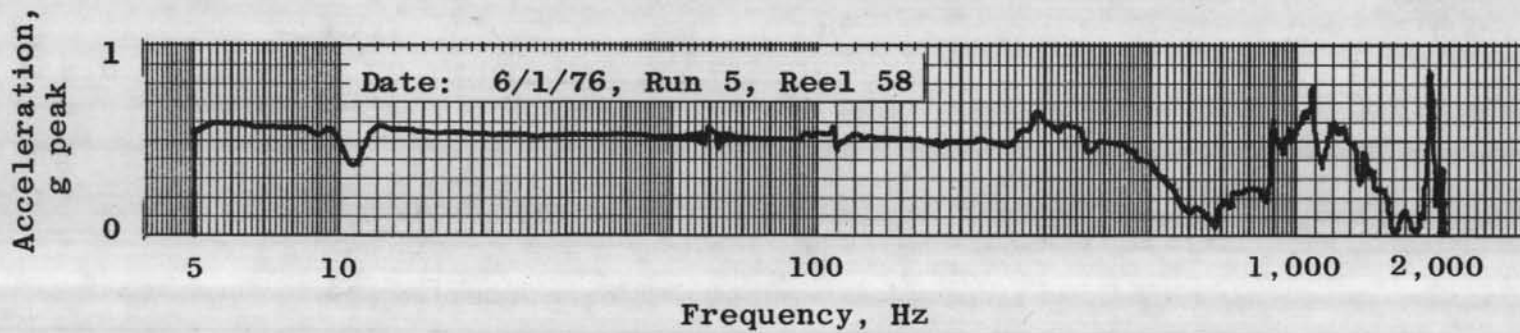

d. Accelerometer 1X
Figure 15. Continued.

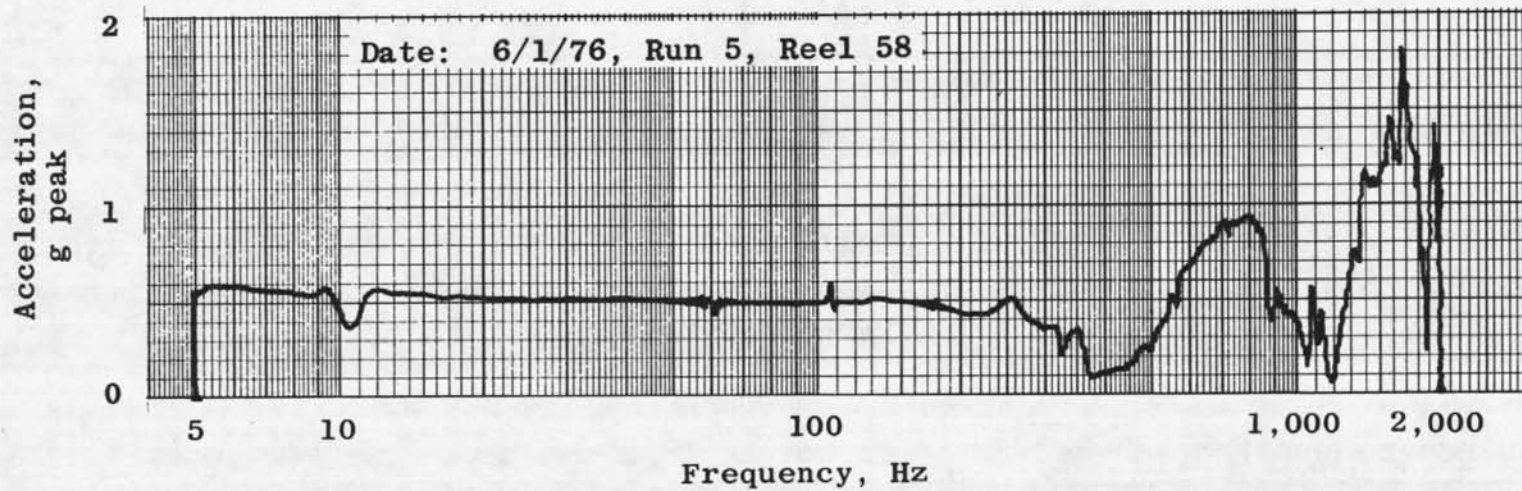

e. Accelerometer 2X

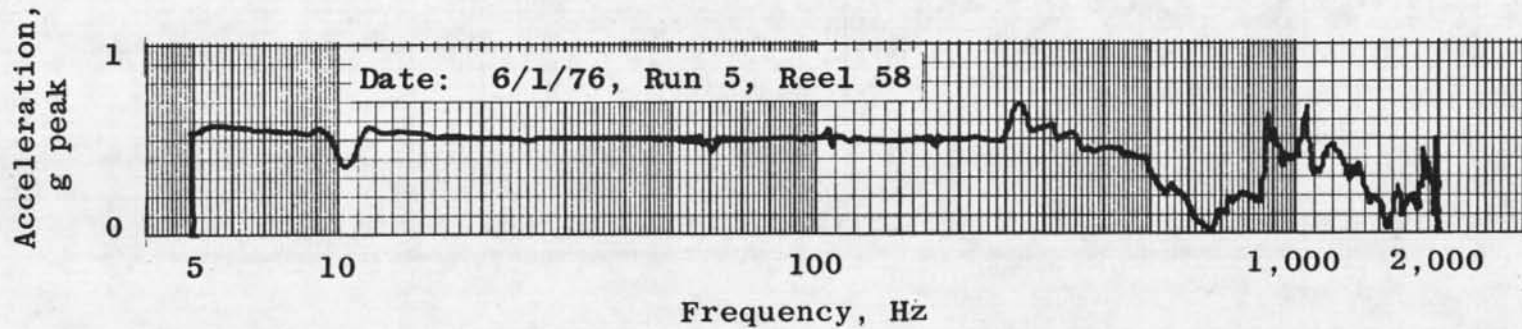
f. Accelerometer 3X
Figure 15. Continued.

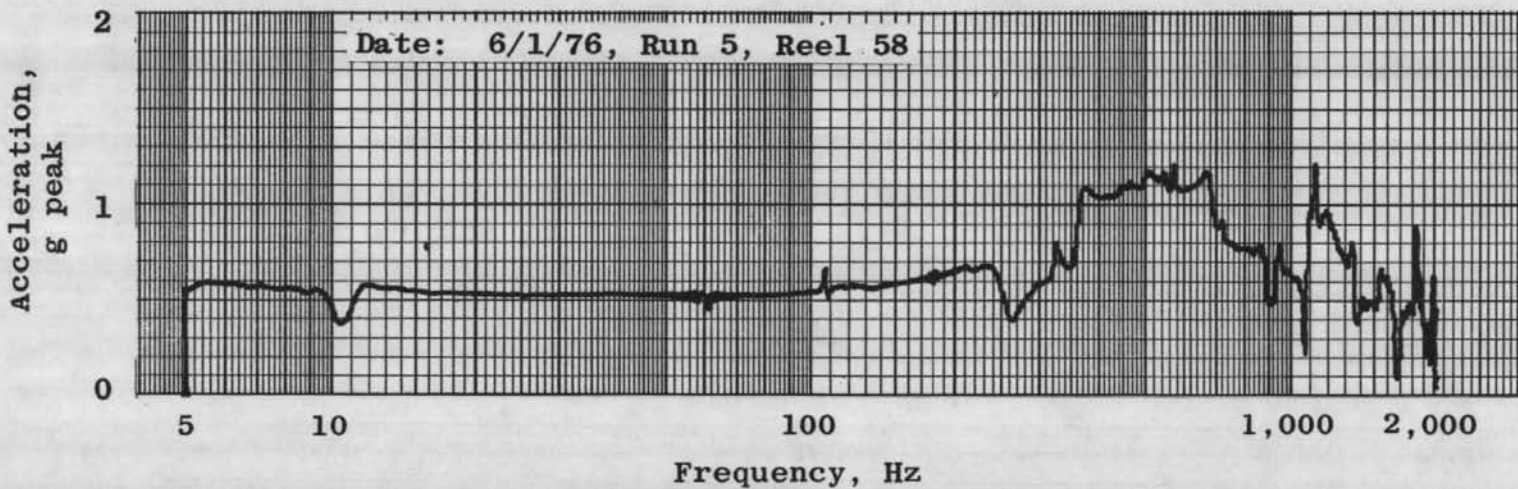

g. Accelerometer 4X
Figure 15. Continued.

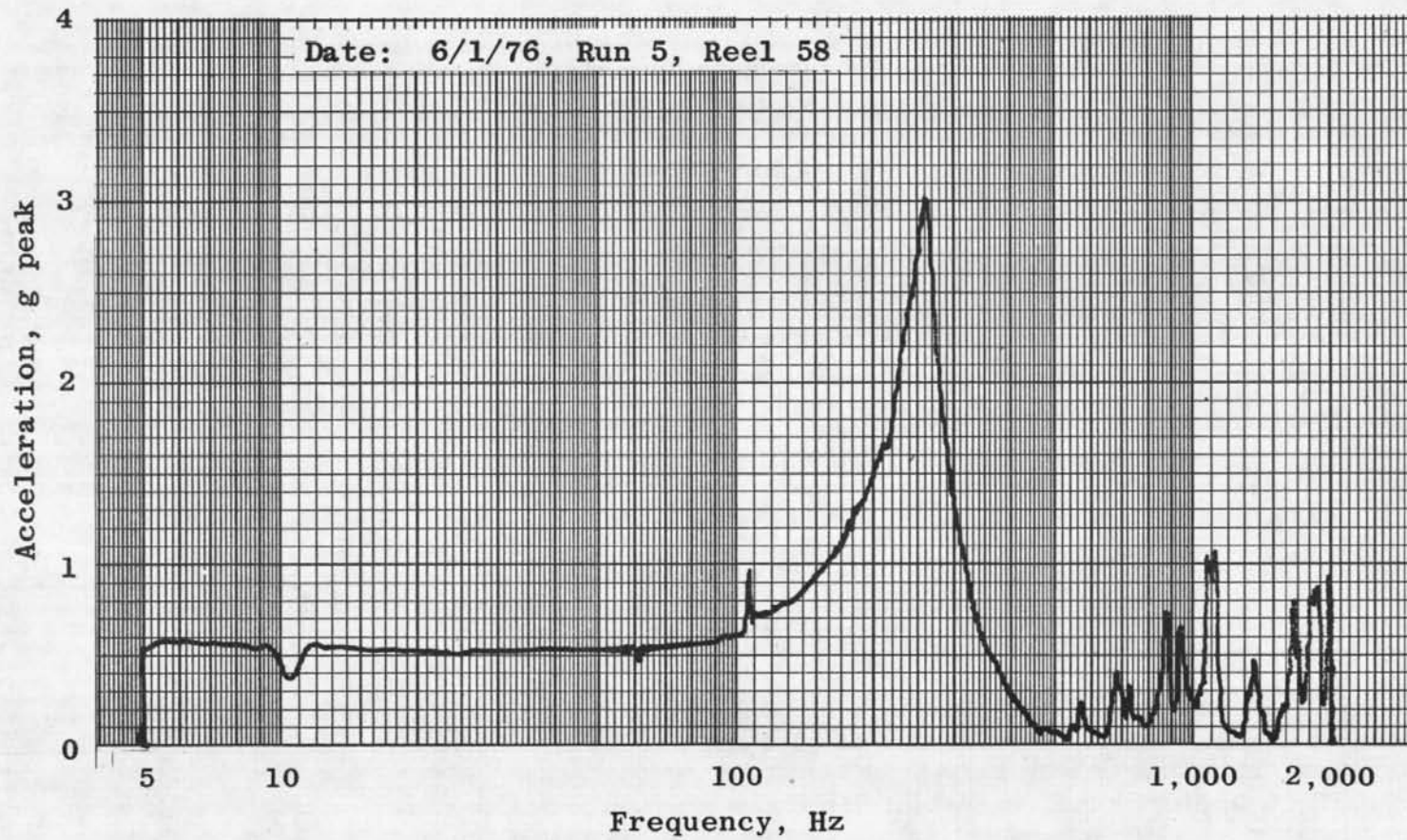

h. Accelerometer 5X
Figure 15. Continued.

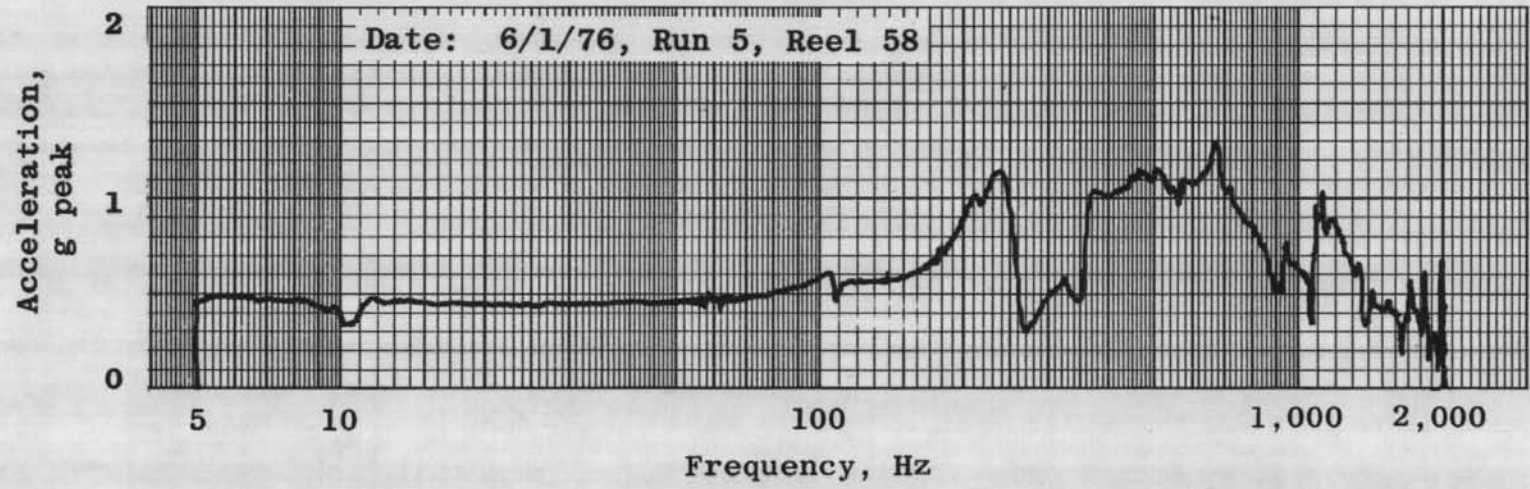

i. Accelerometer 6X

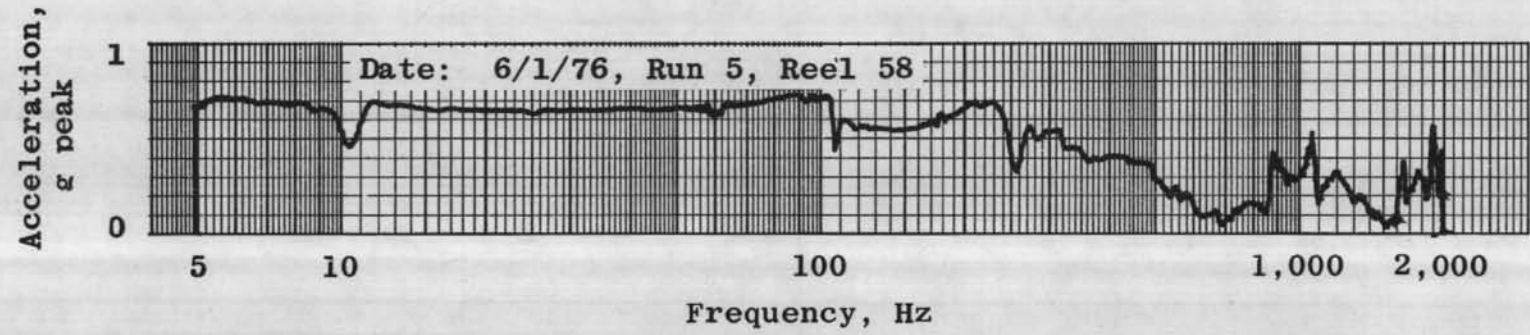

j. Accelerometer 7X
Figure 15. Continued.

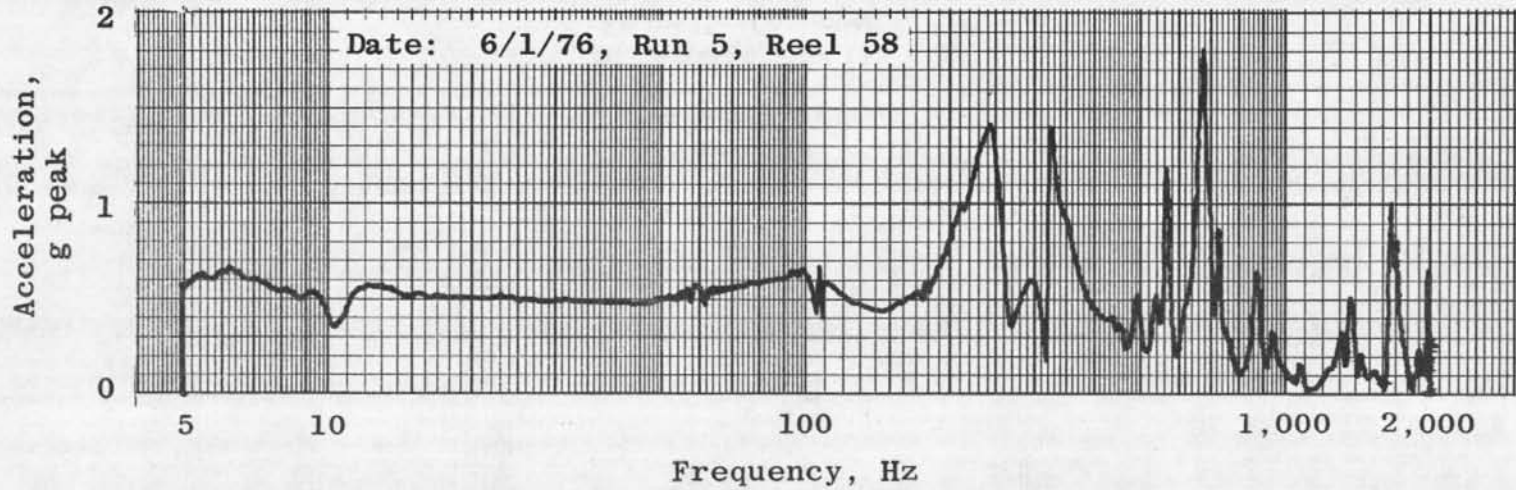

k. Accelerometer 8X

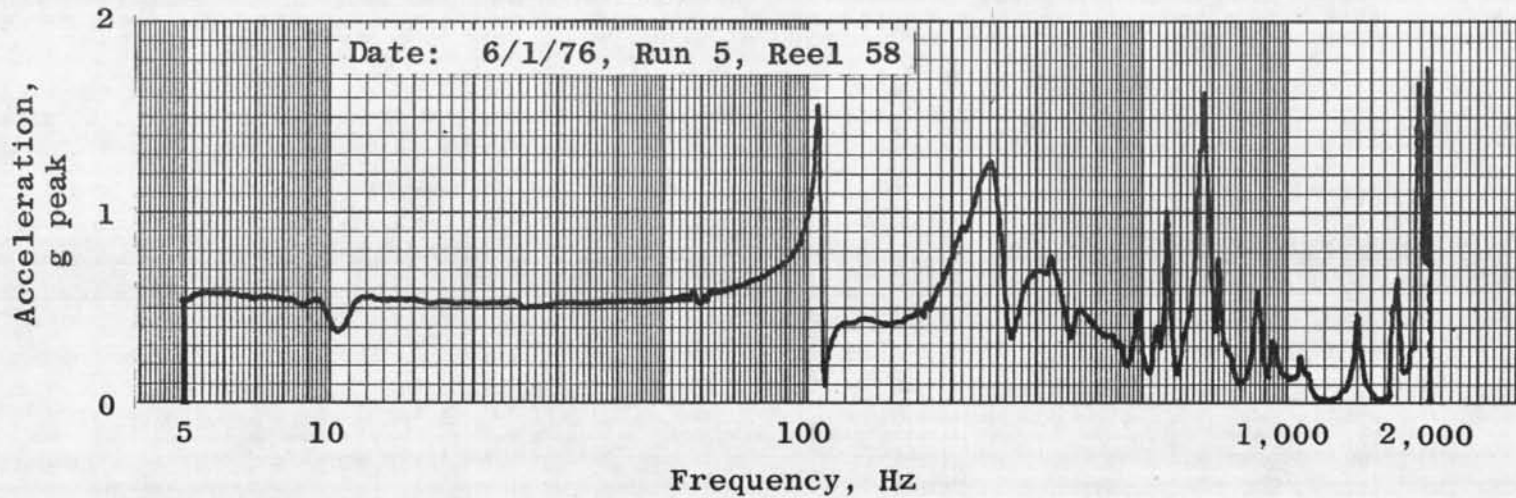
l. Accelerometer 9X
Figure 15. Continued.

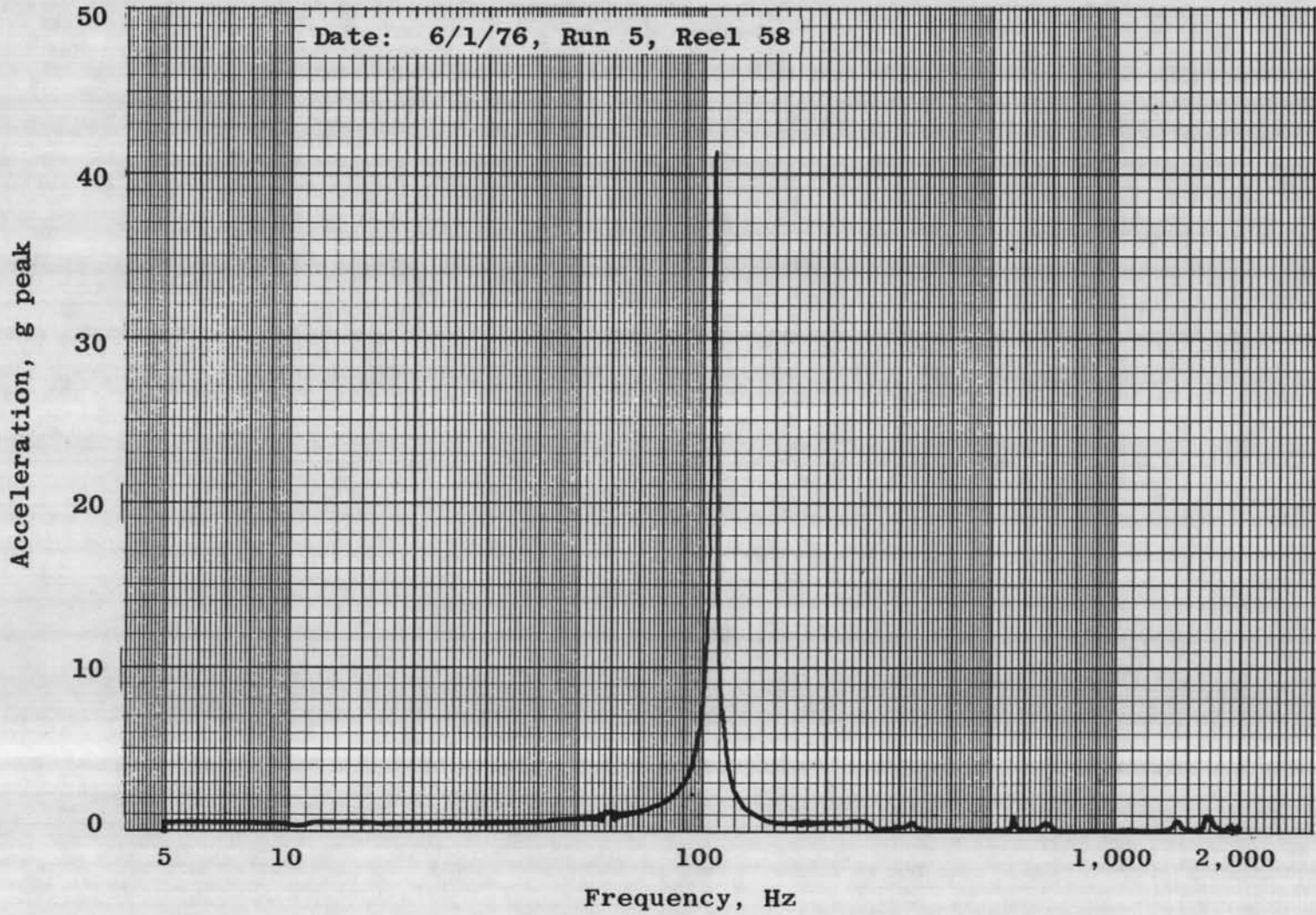

m. Accelerometer 11X
Figure 15. Continued.

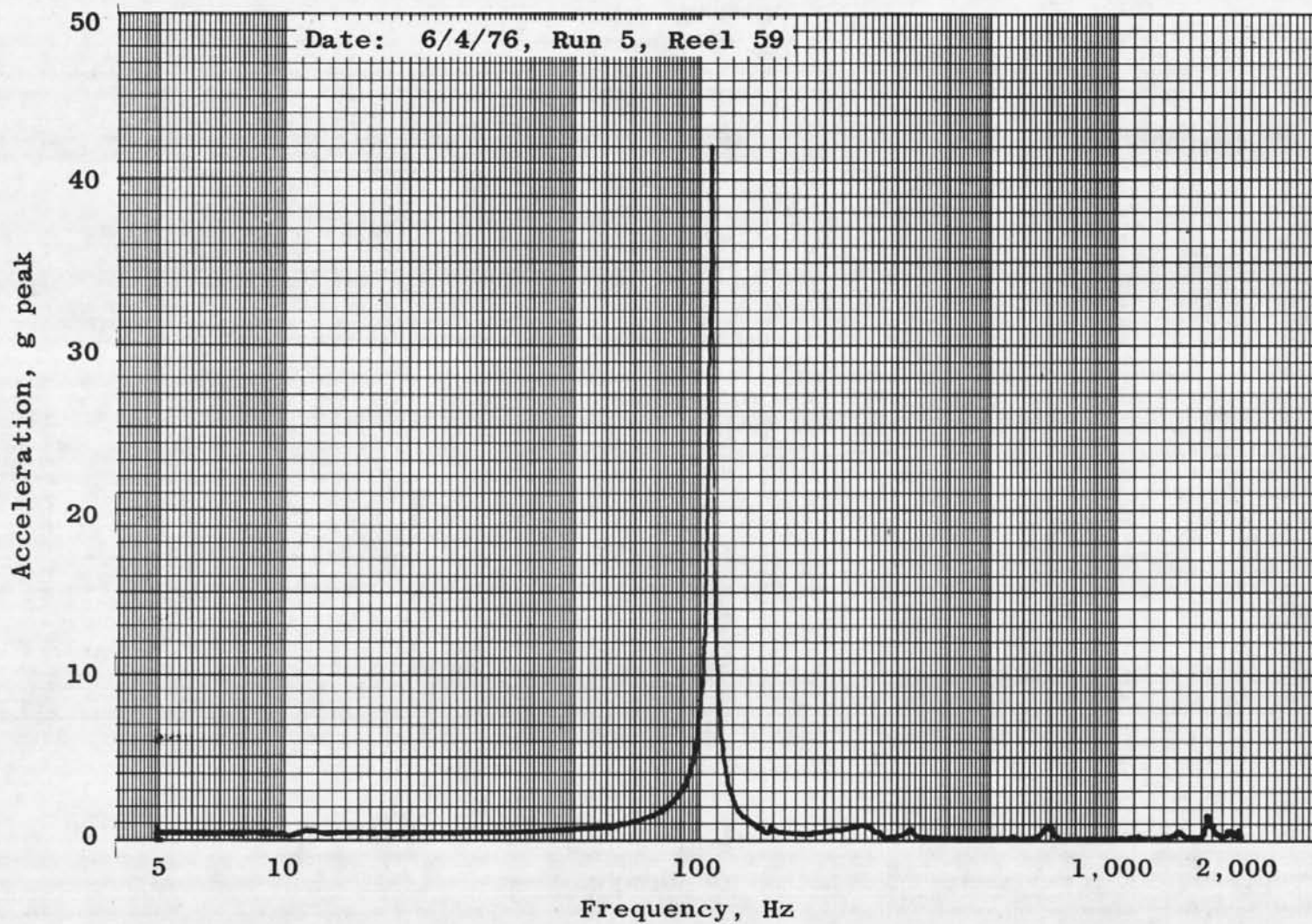

n. Accelerometer 12X
Figure 15. Continued.

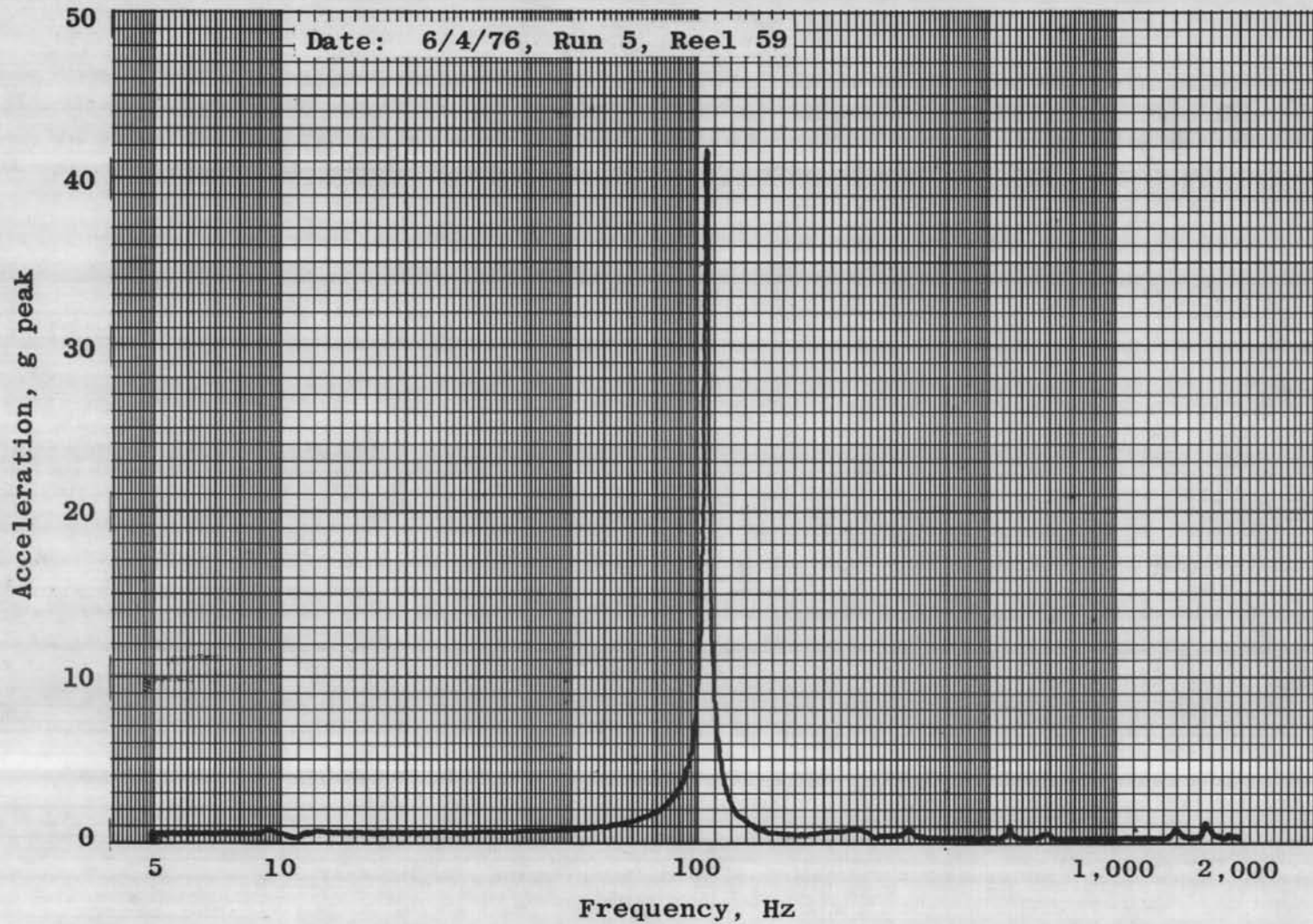

o. Accelerometer 13X
Figure 15. Continued.

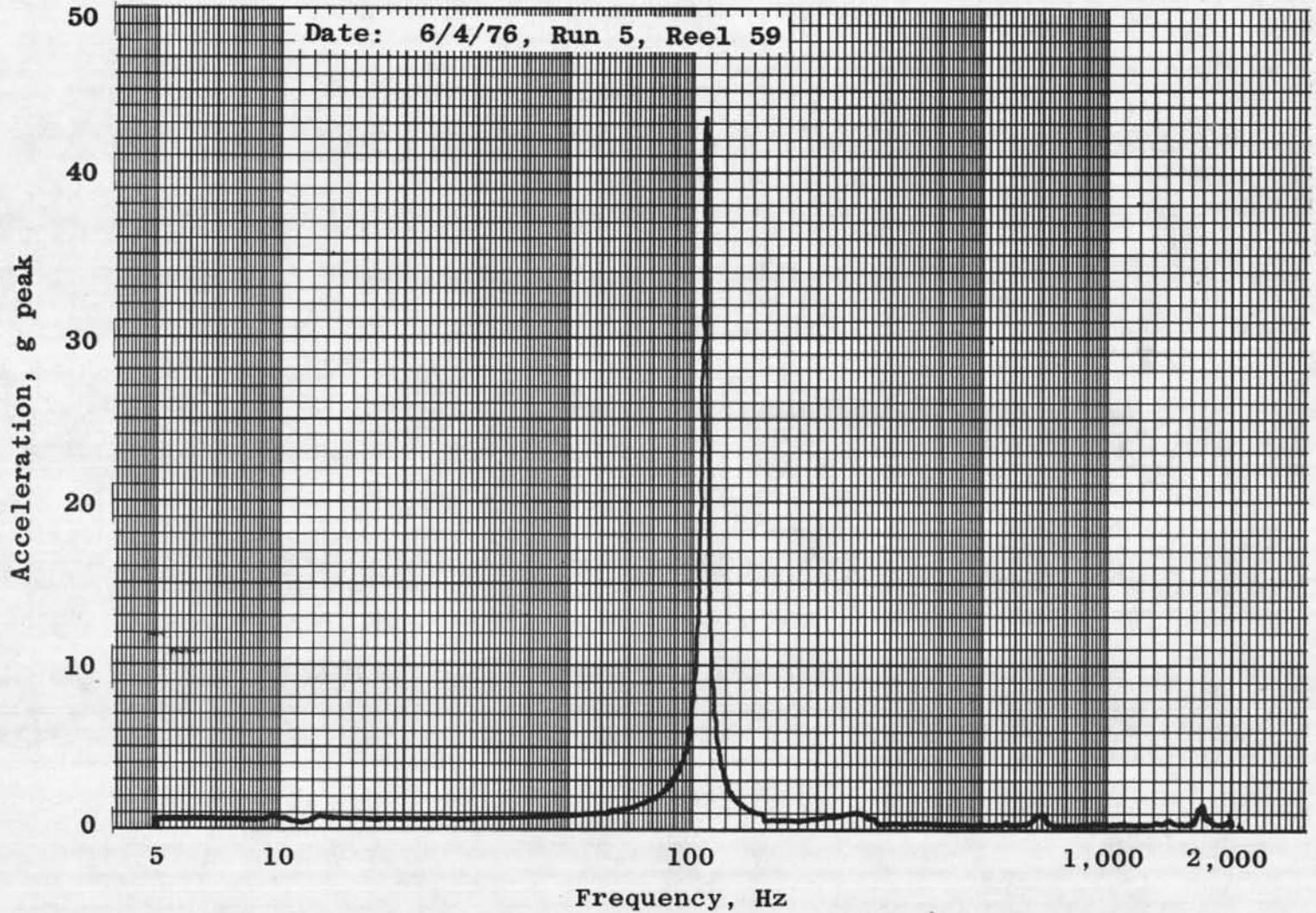

p. Accelerometer 14X
Figure 15. Continued.

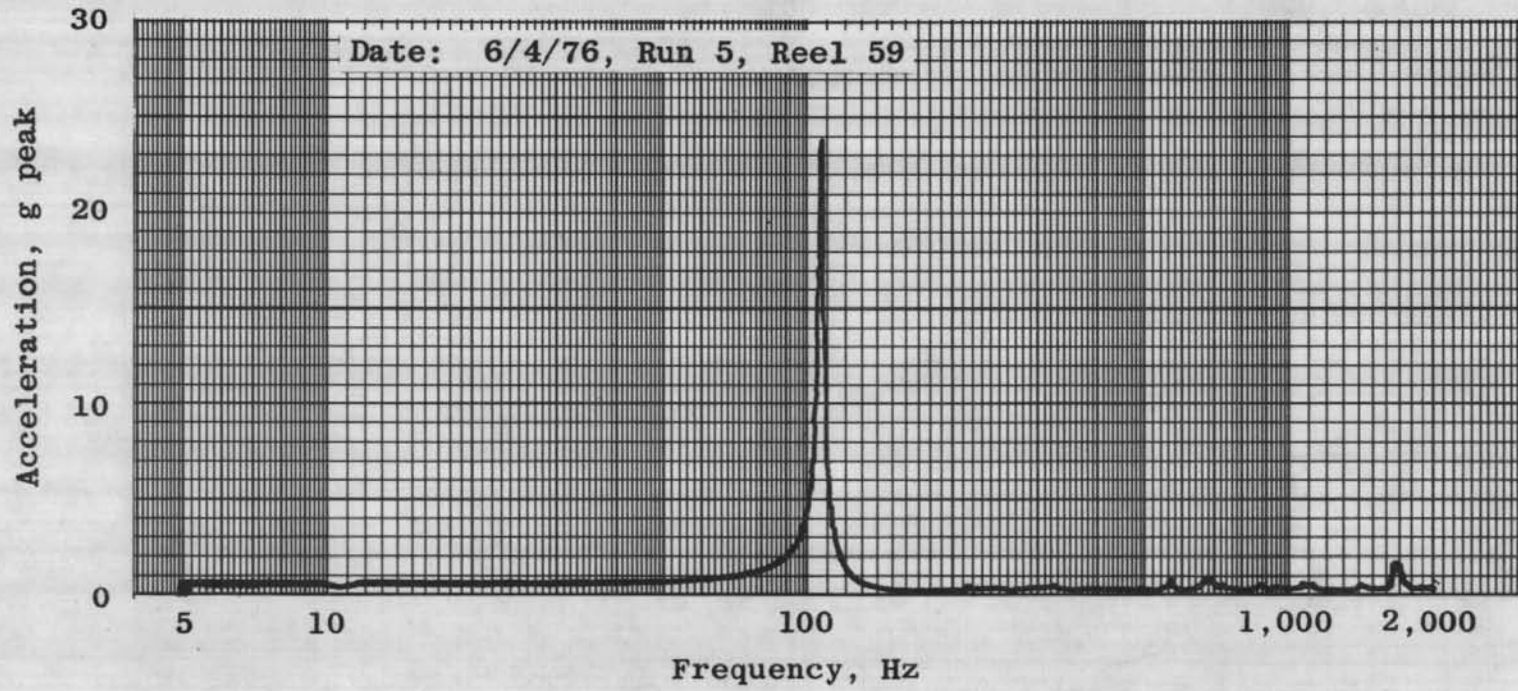

q. Accelerometer 15X
Figure 15. Continued.

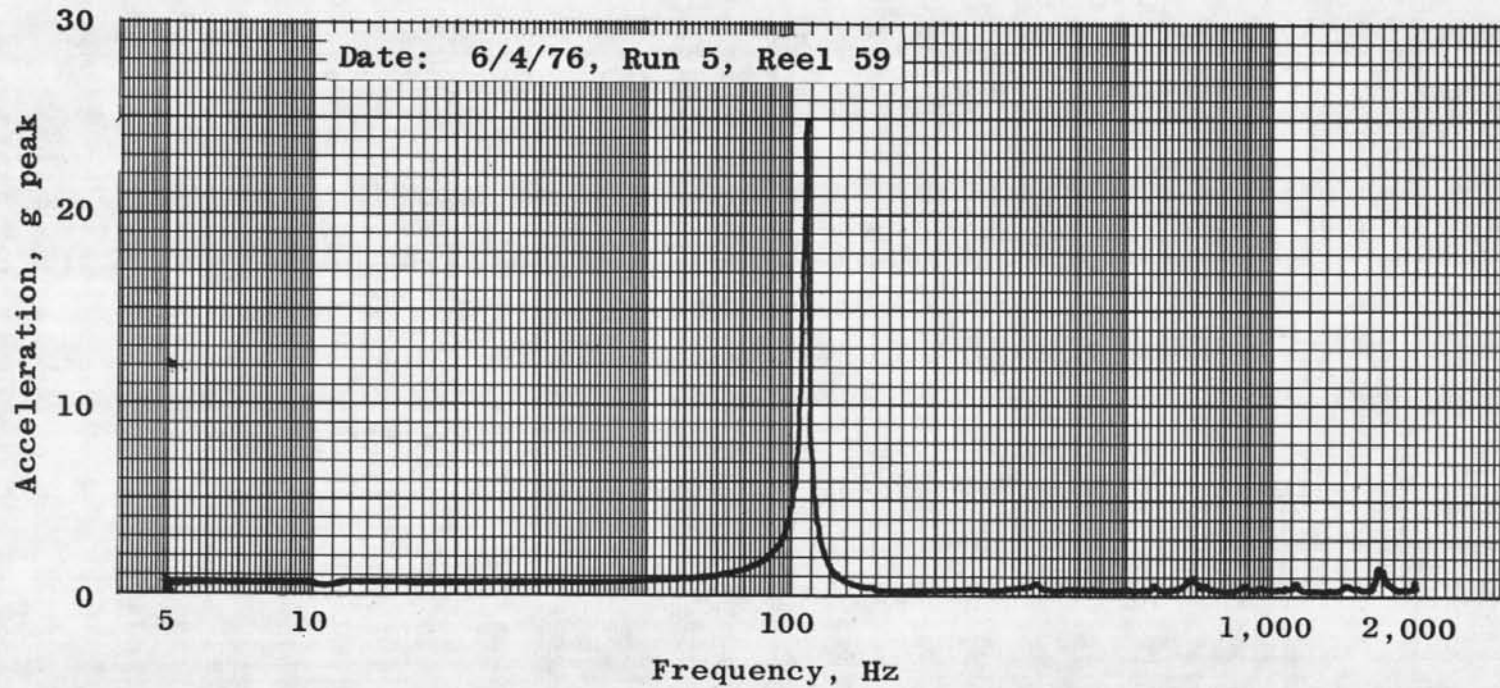

r. Accelerometer 16X
Figure 15. Continued.

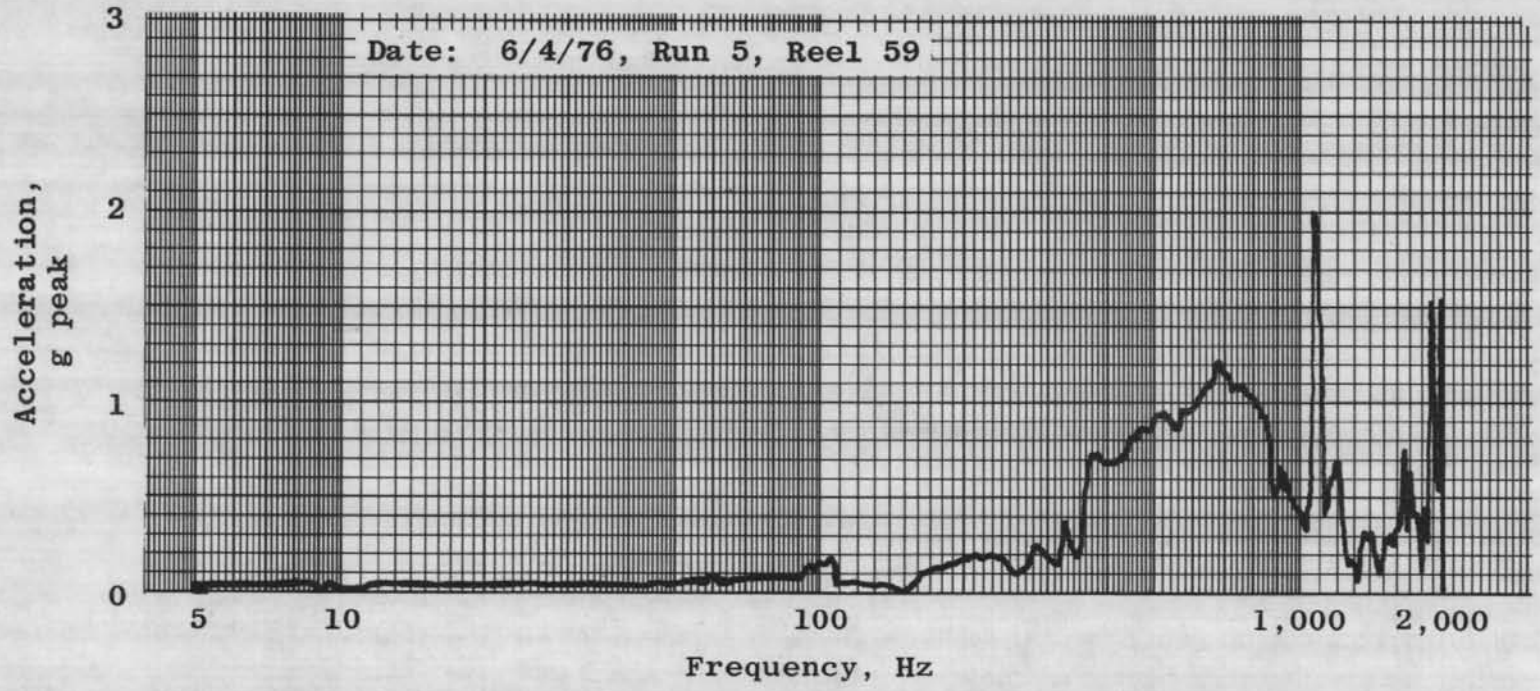

s. Accelerometer 7Y

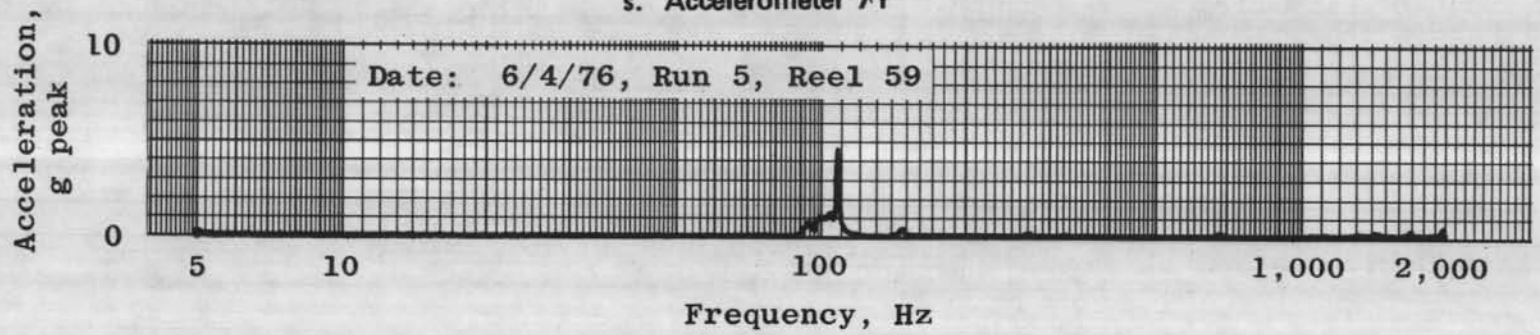

t. Accelerometer 11Y
Figure 15. Continued.

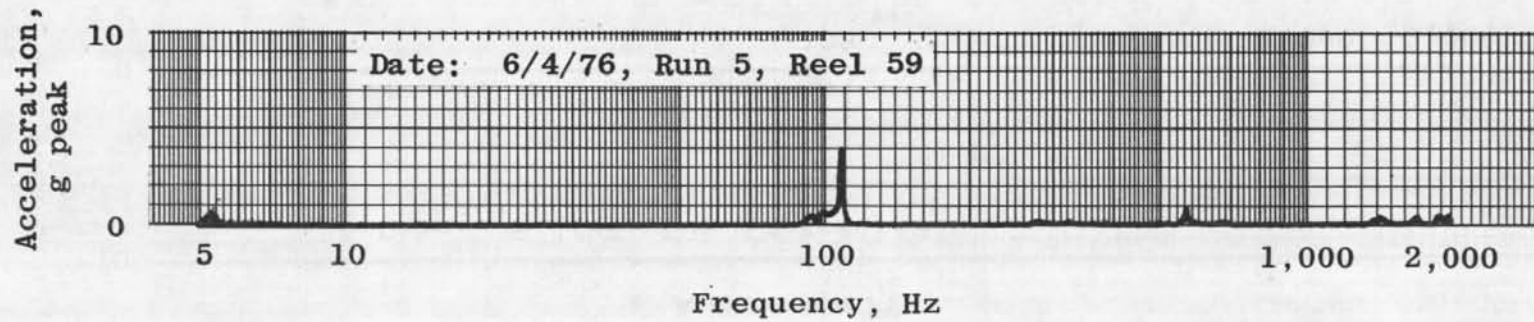

u. Accelerometer 14Y

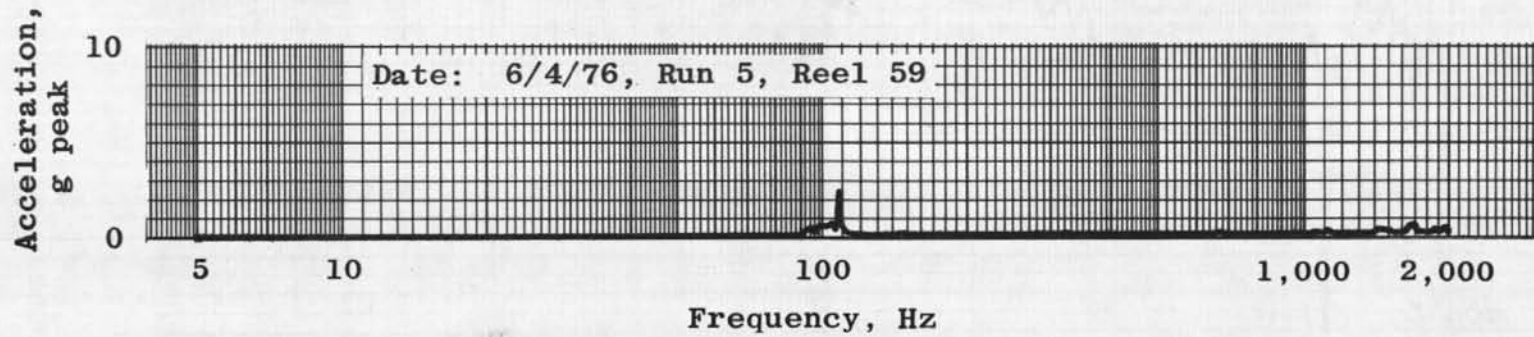

v. Accelerometer 15Y
Figure 15. Continued.

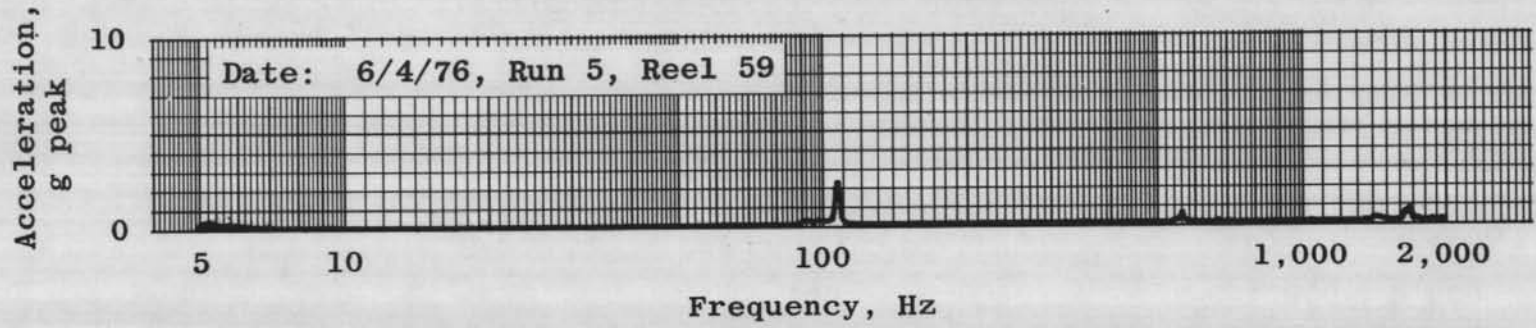

w. Accelerometer 16Y

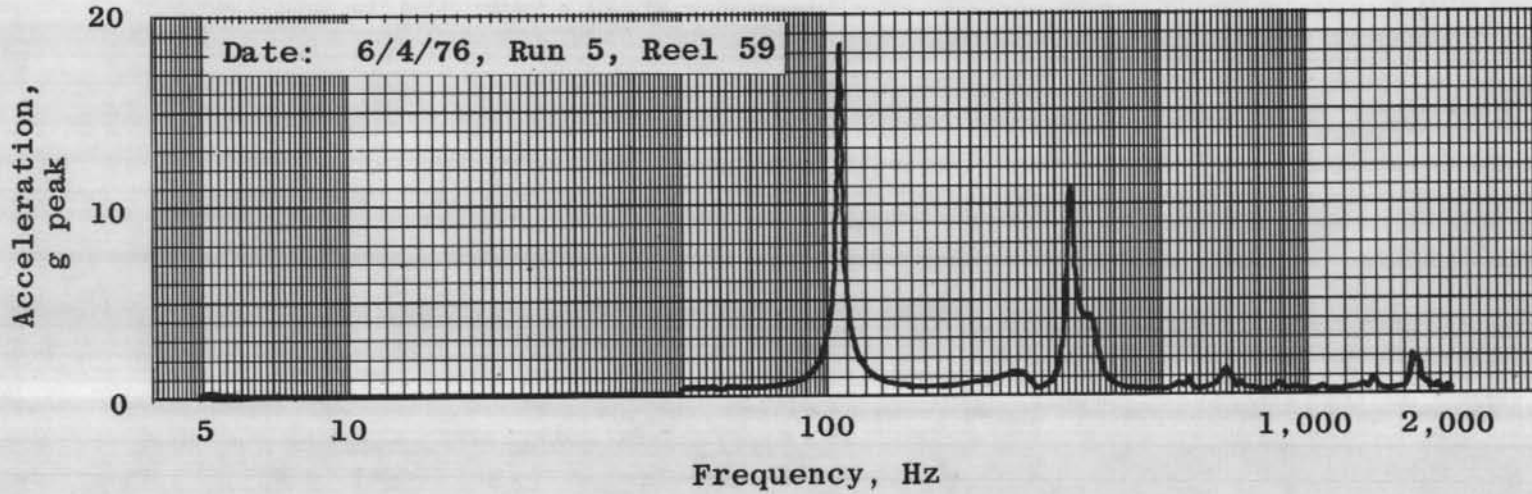

x. Accelerometer 14Z
Figure 15. Concluded.



Figure 16. Y-axis motor installation photographs.



Figure 16. Continued.

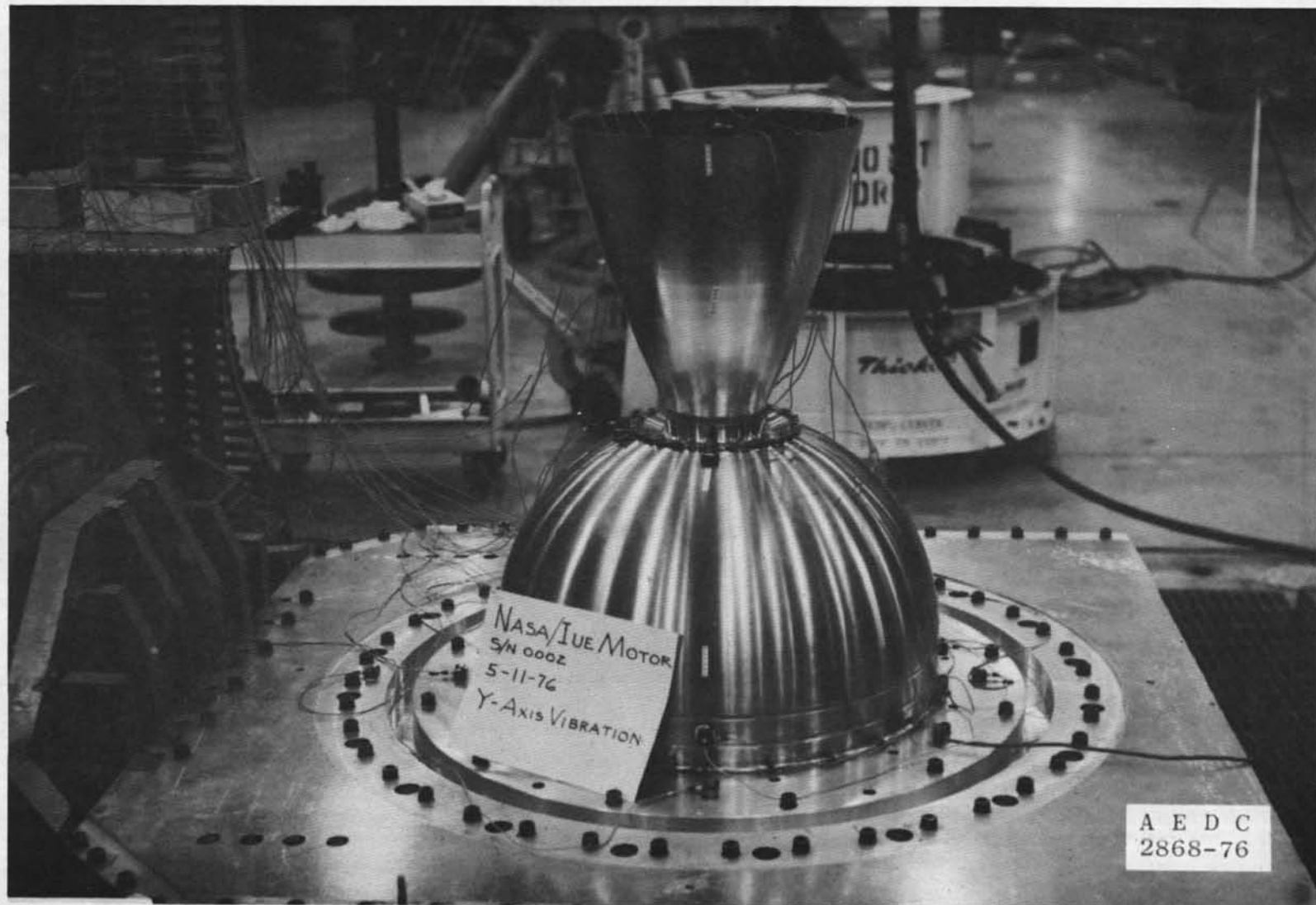
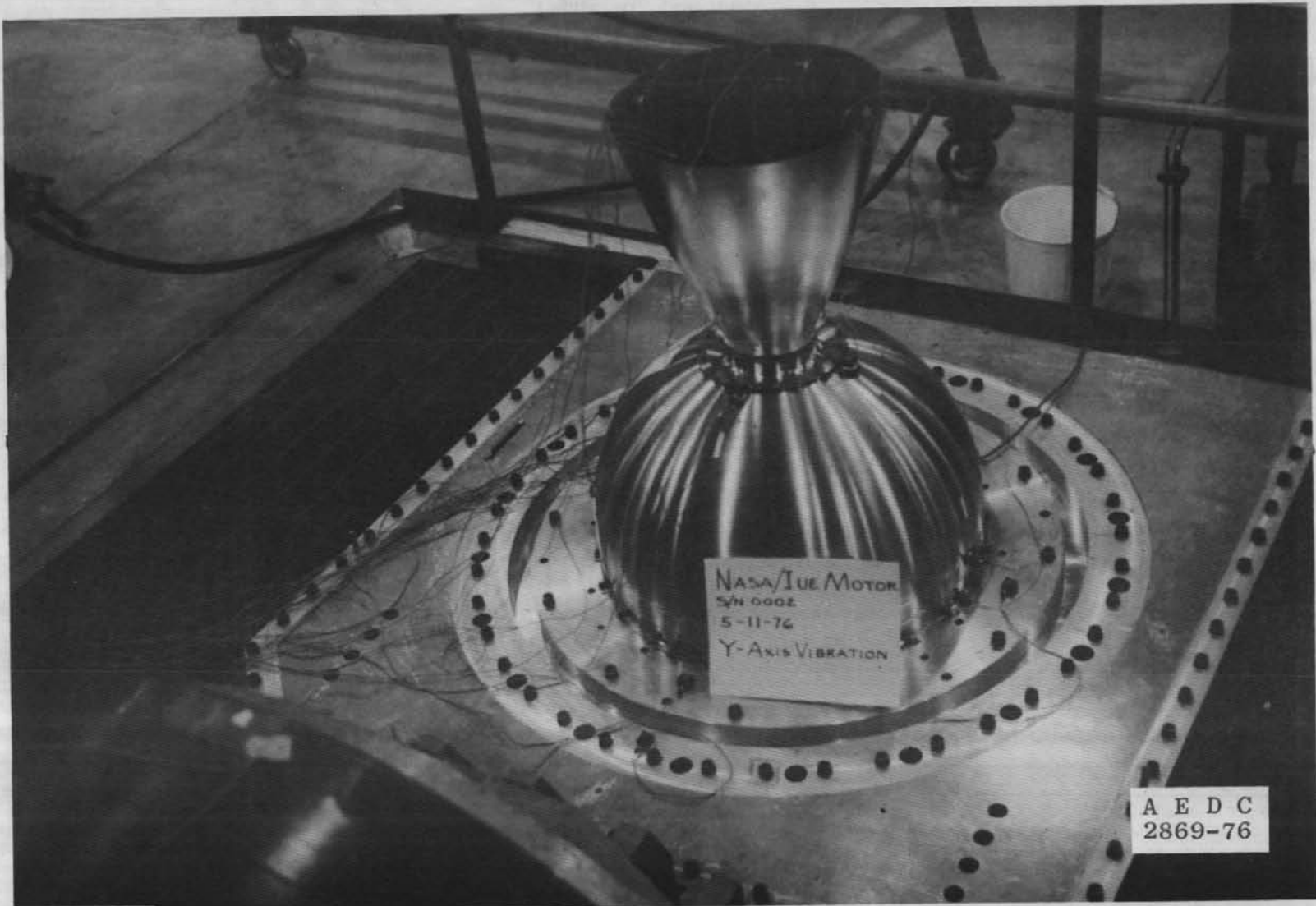

Figure 16. Continued.



A E D C
2869-76

Figure 16. Continued.

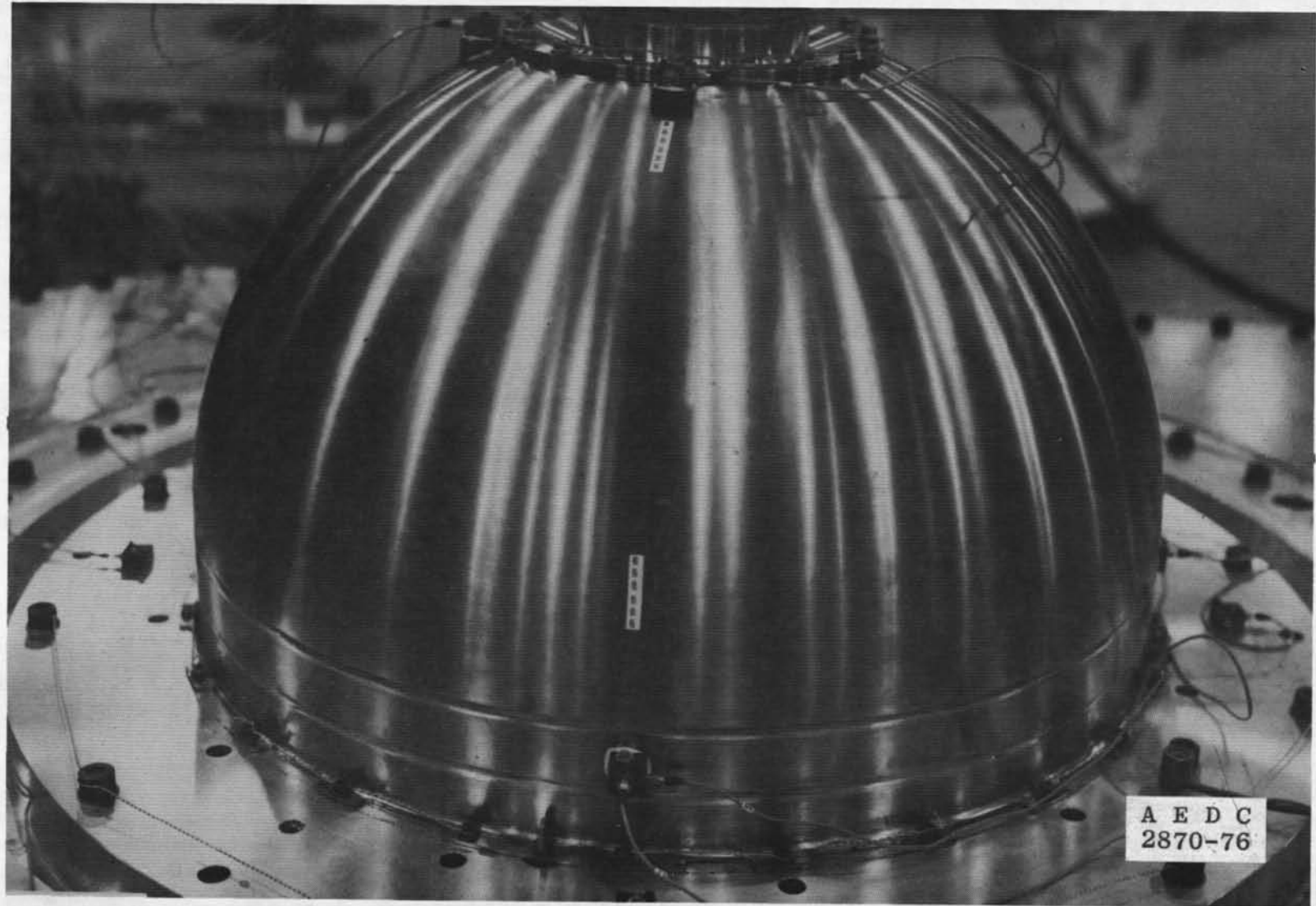
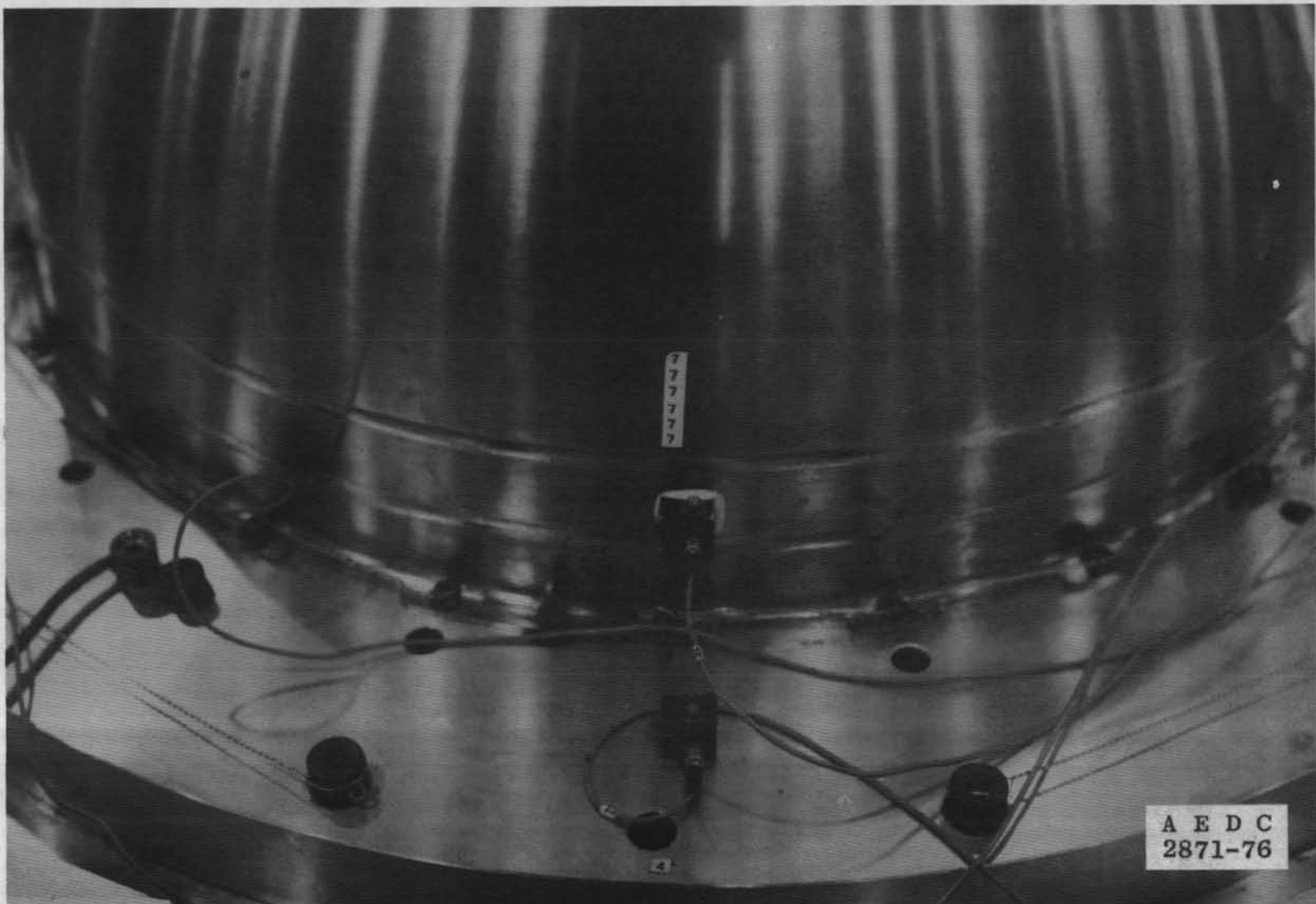

Figure 16. Continued.



100

Figure 16. Continued.



Figure 16. Continued.

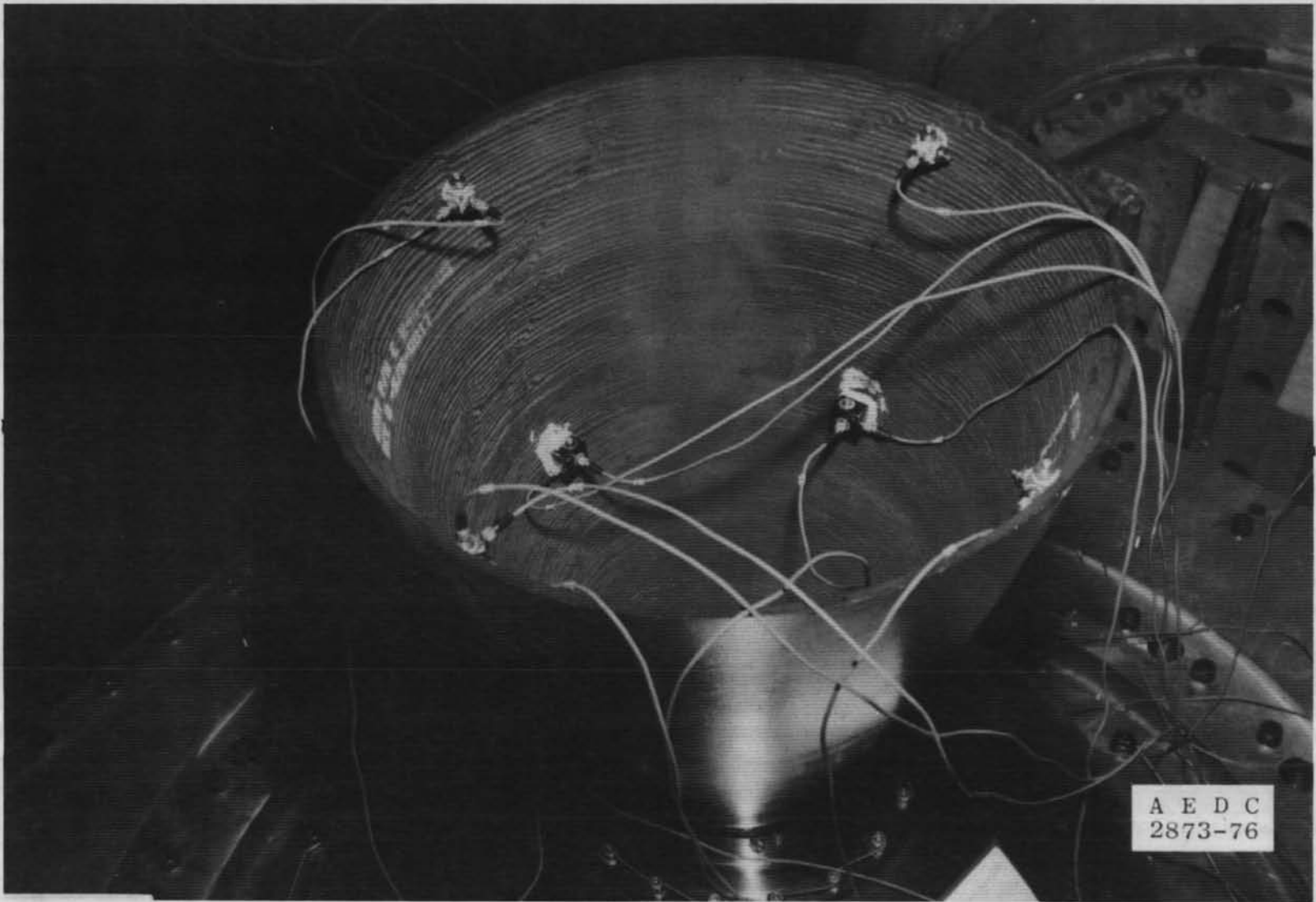

Figure 16. Continued.

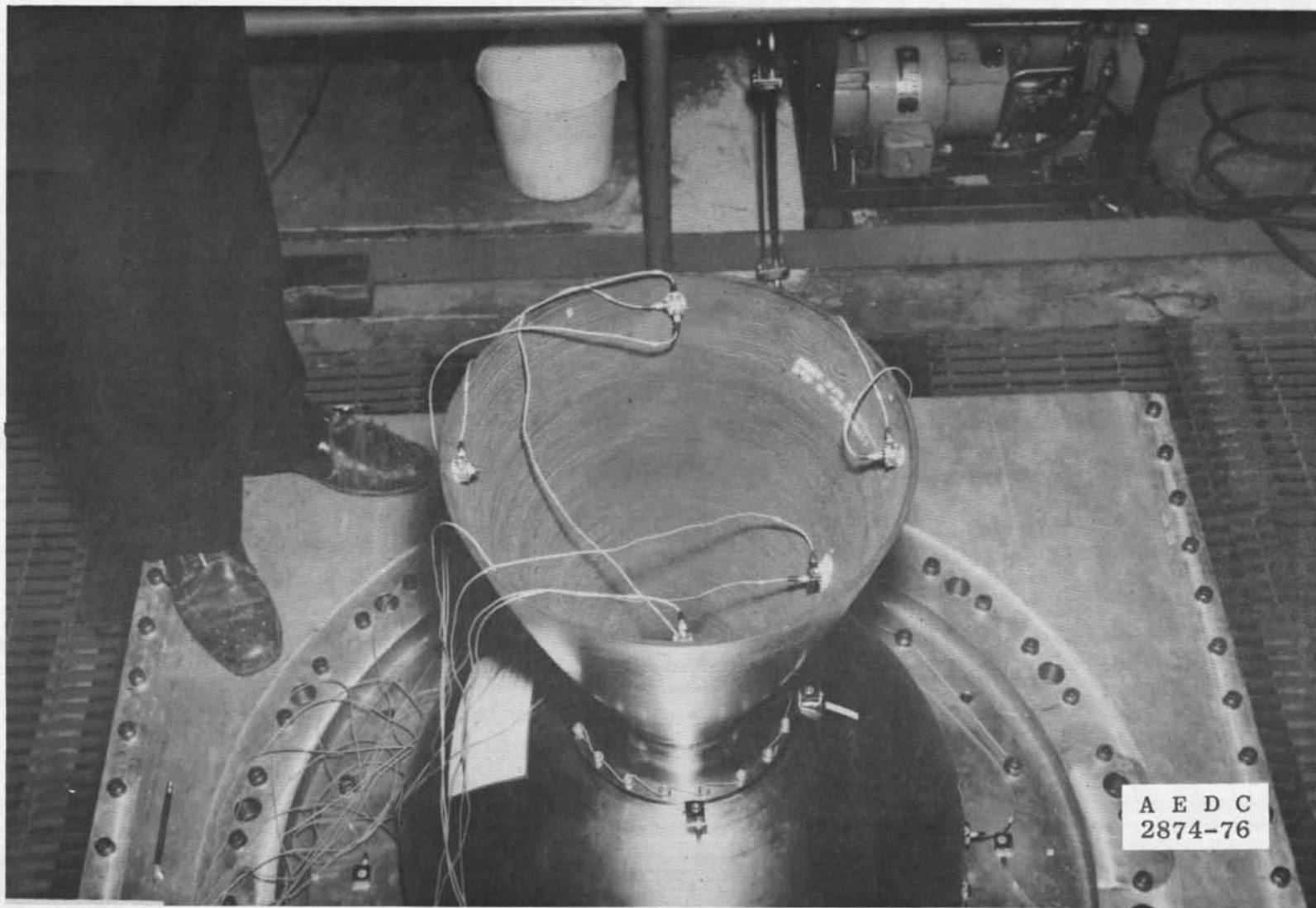

Figure 16. Concluded.

VKF IVA Facility Dynamics Test

Test Article: NASA/IUE

Vibration Axis: Y

Tracking Filter: SD1012B

BW₁: 5 Hz from 5 to 45 Hz

BW₂: 50 Hz from 45 to 2,000 Hz

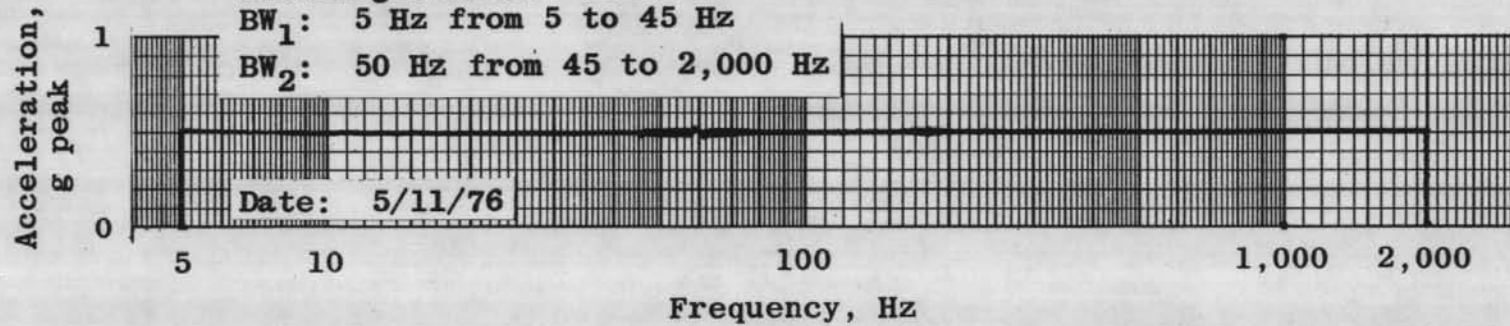

a. Closed loop plot

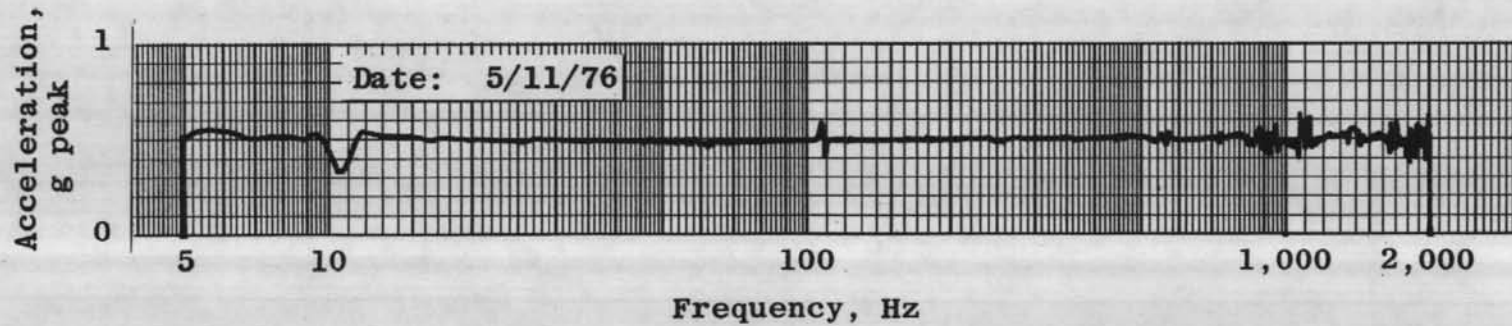

b. Accelerometers averaged, online

Figure 17. Y-axis vibration test: 0.5-g sine survey.

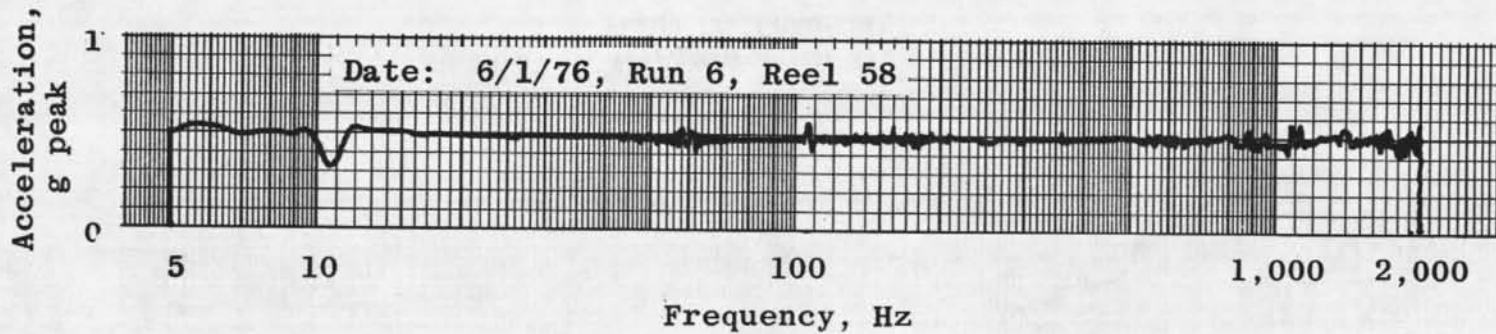

c. Accelerometers averaged

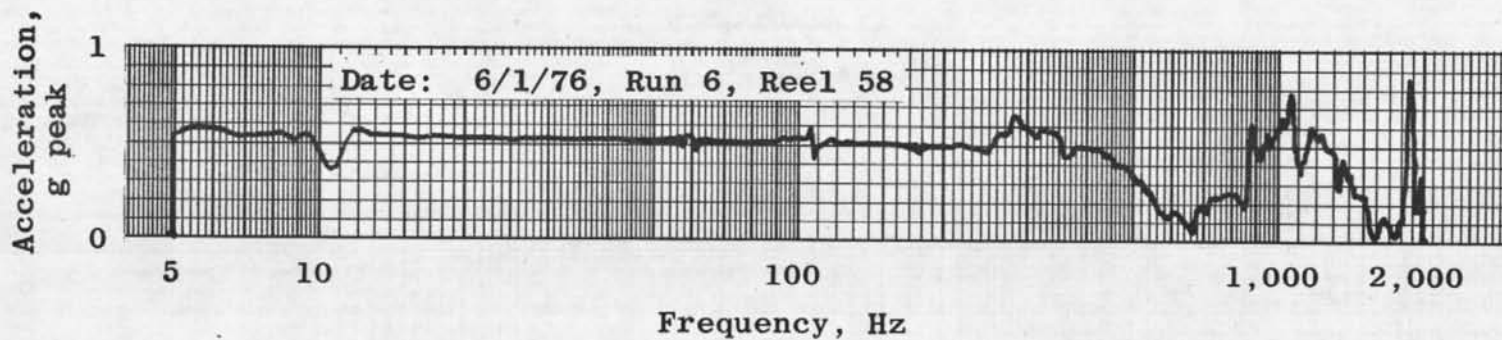

d. Accelerometer 1Y
Figure 17. Continued.

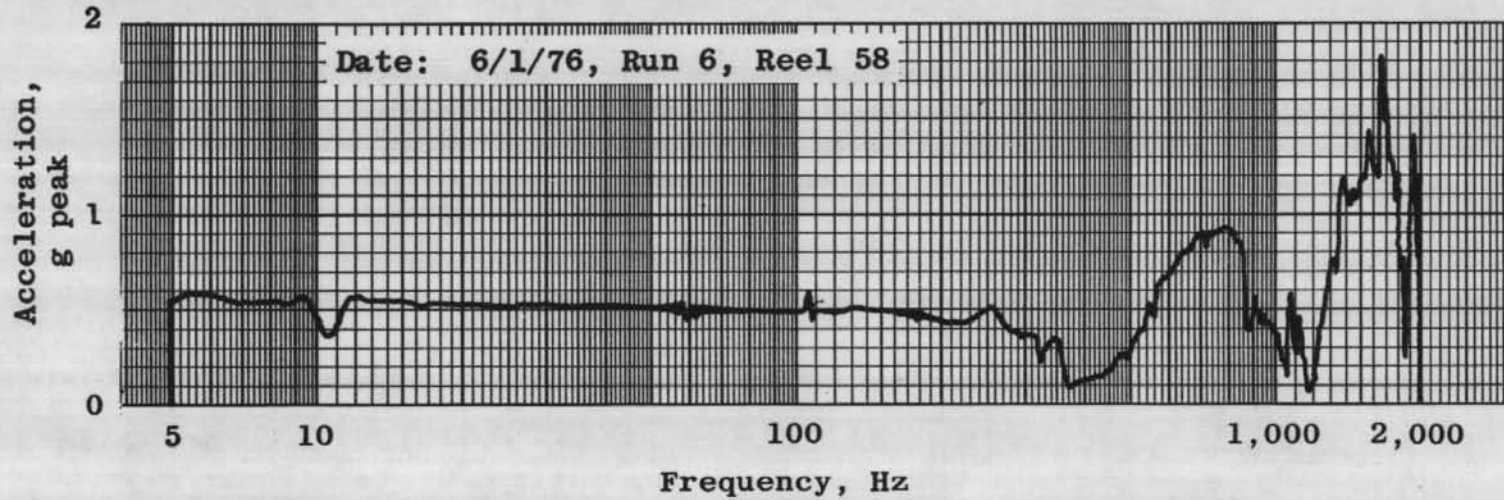

e. Accelerometer 2Y

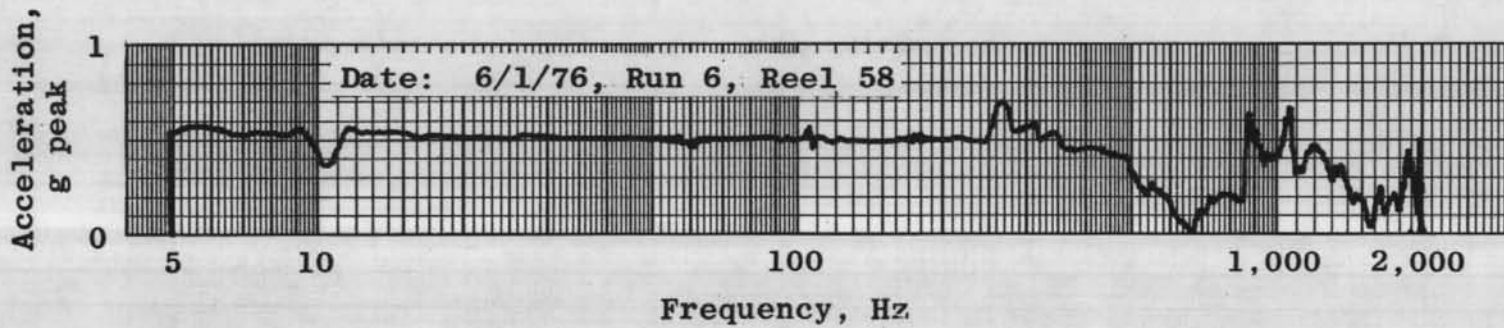
f. Accelerometer 3Y
Figure 17. Continued.

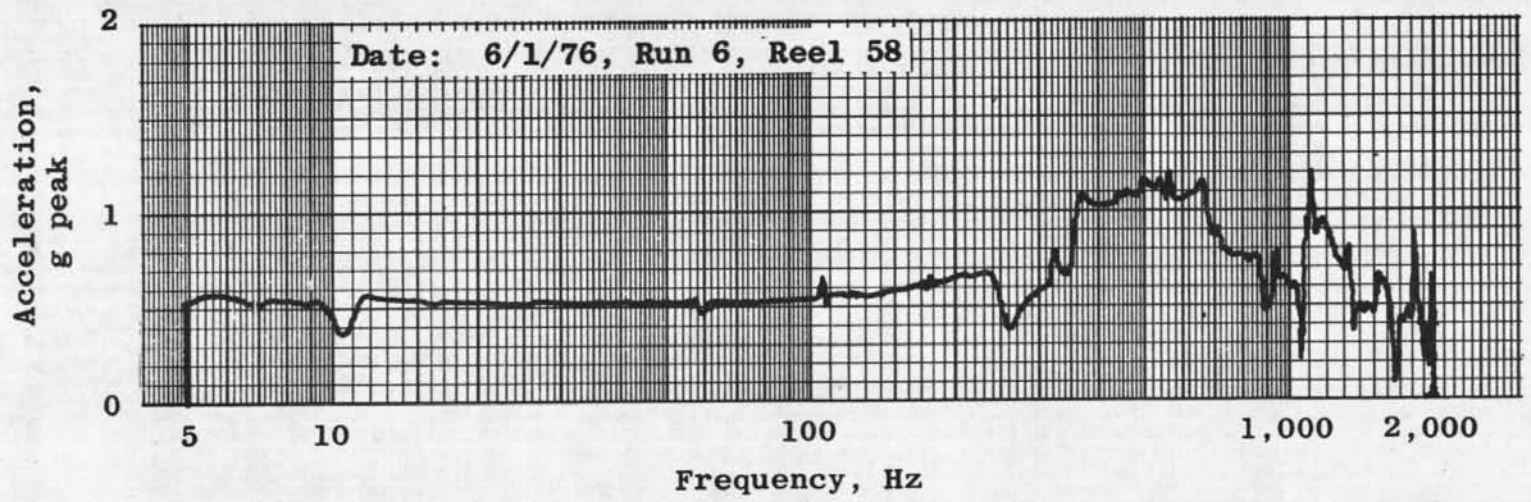

g. Accelerometer 4Y
Figure 17. Continued.

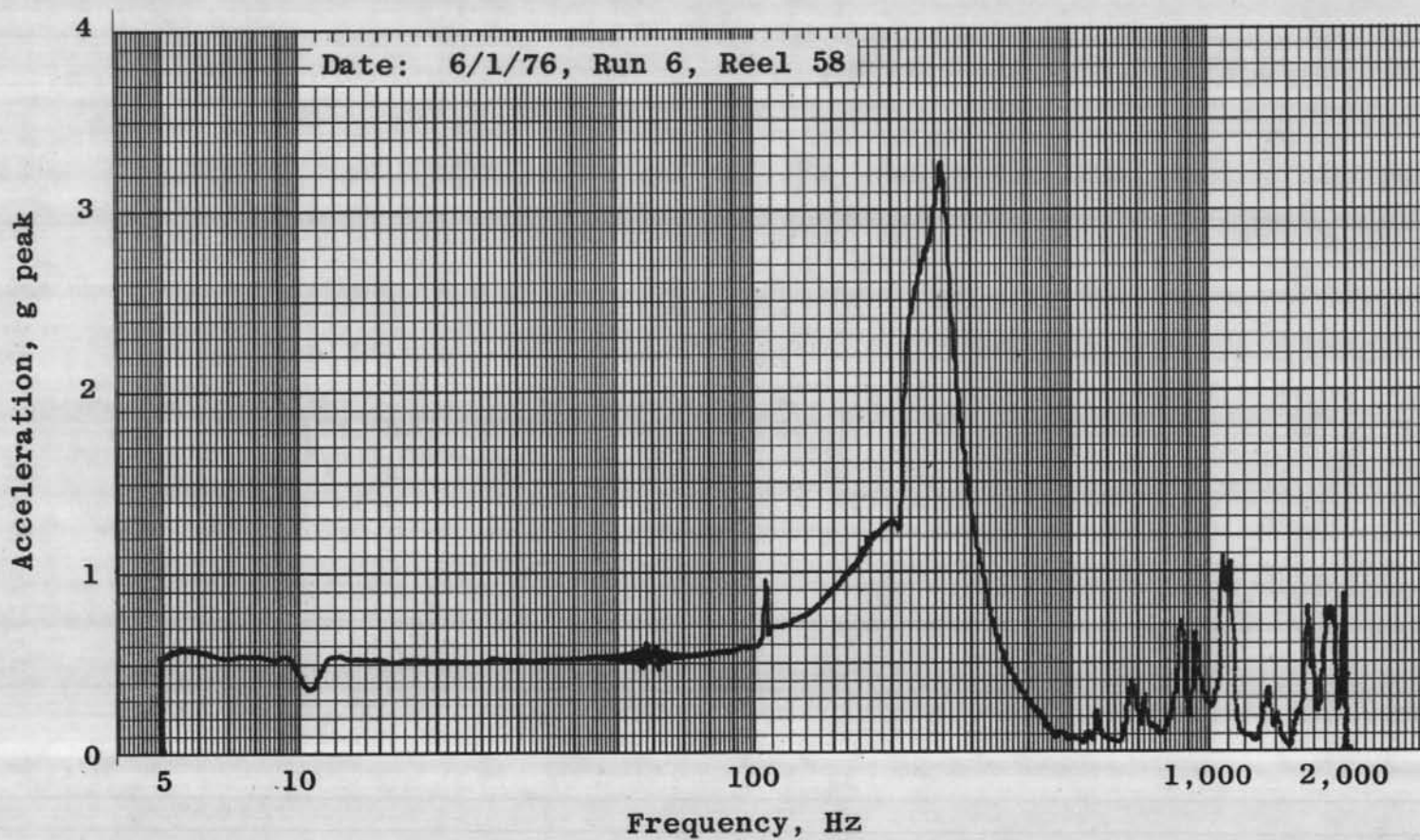

h. Accelerometer 5Y
Figure 17. Continued.

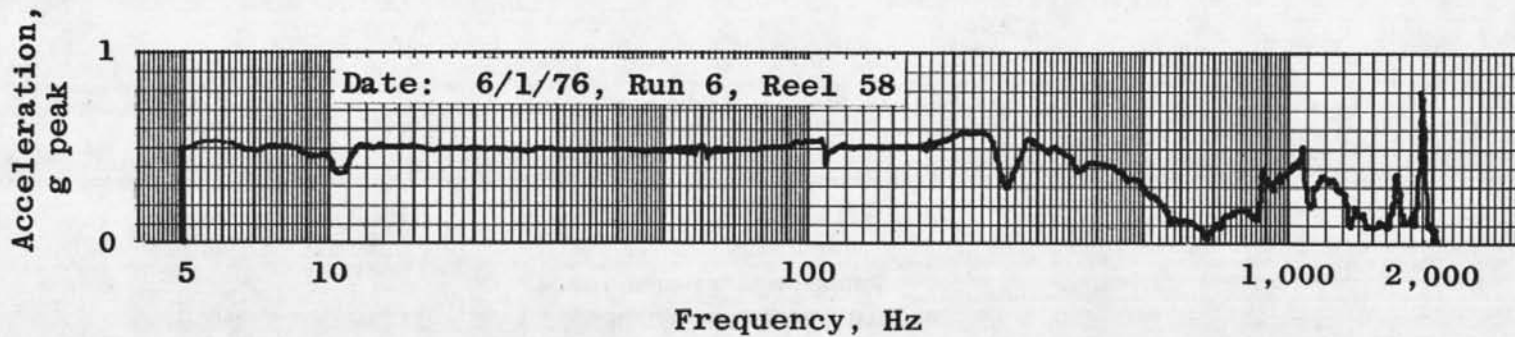

i. Accelerometer 6Y

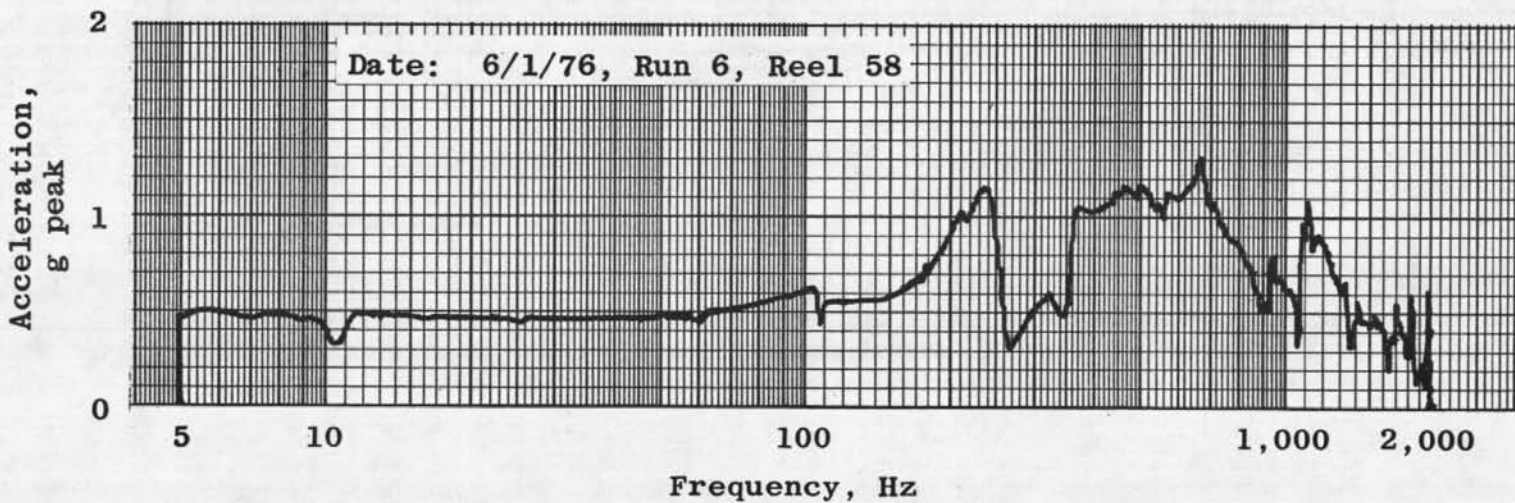

j. Accelerometer 7Y
Figure 17. Continued.

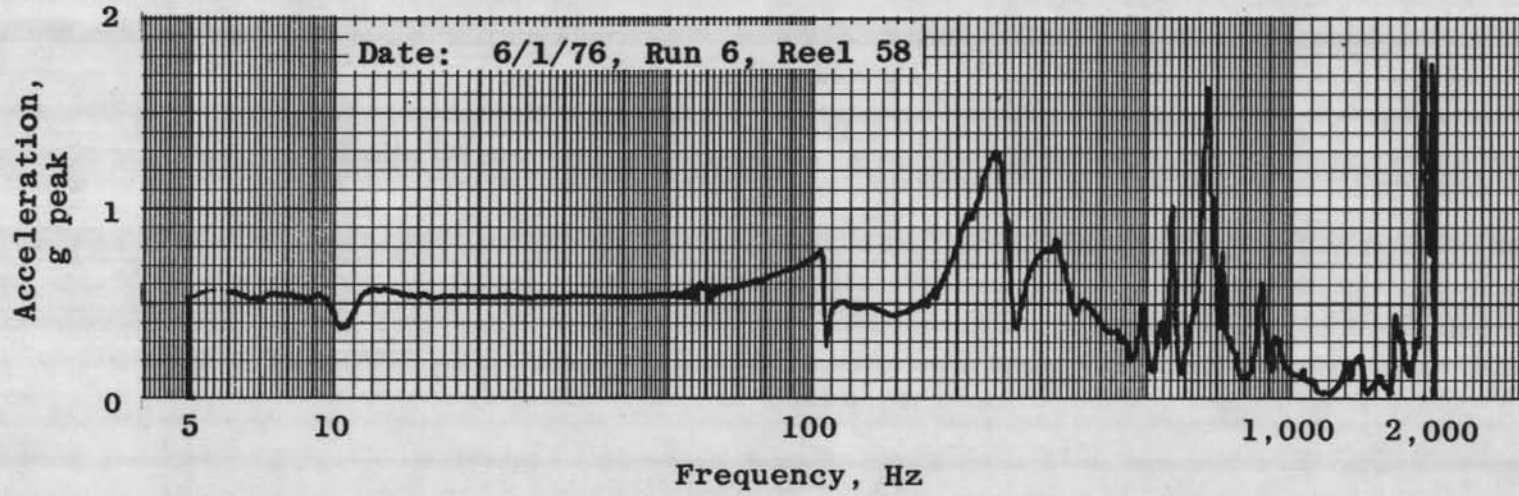

k. Accelerometer 8Y
Figure 17. Continued.

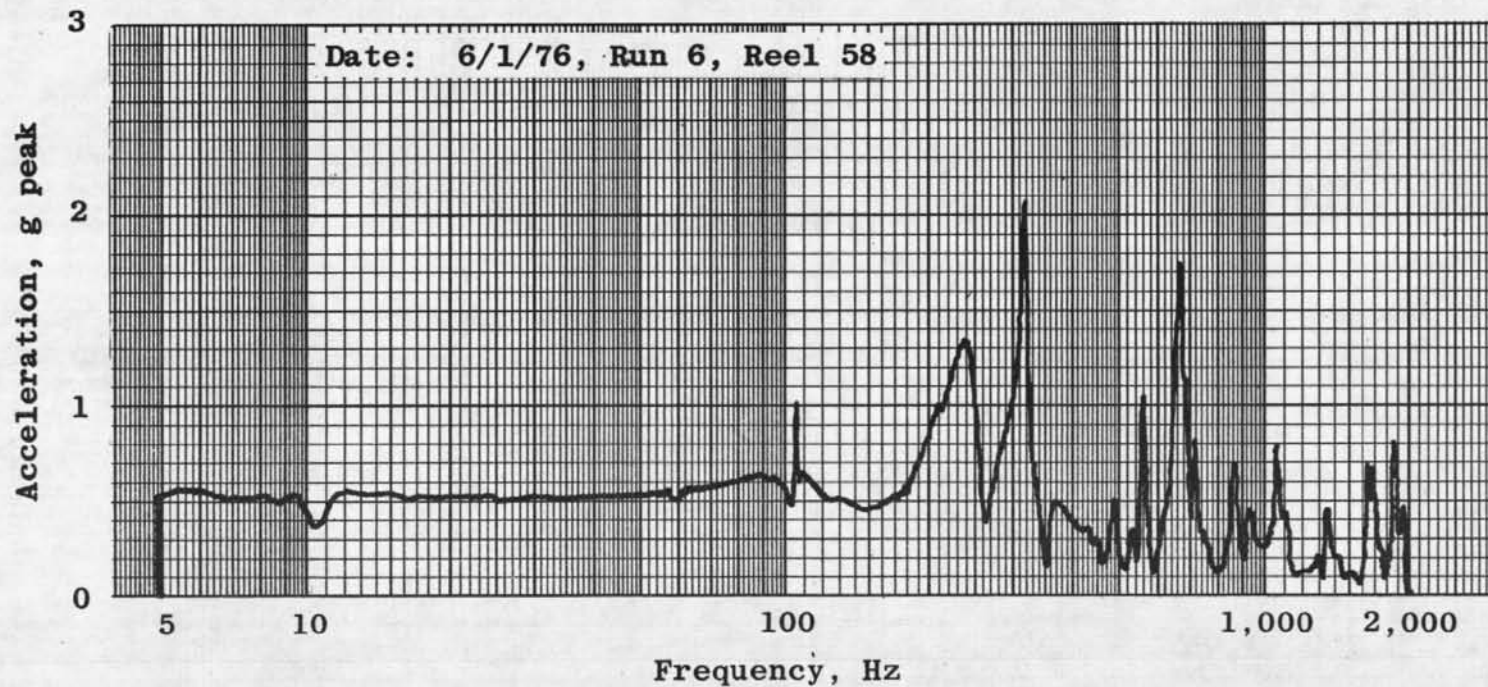

I. Accelerometer 9Y
 Figure 17. Continued.

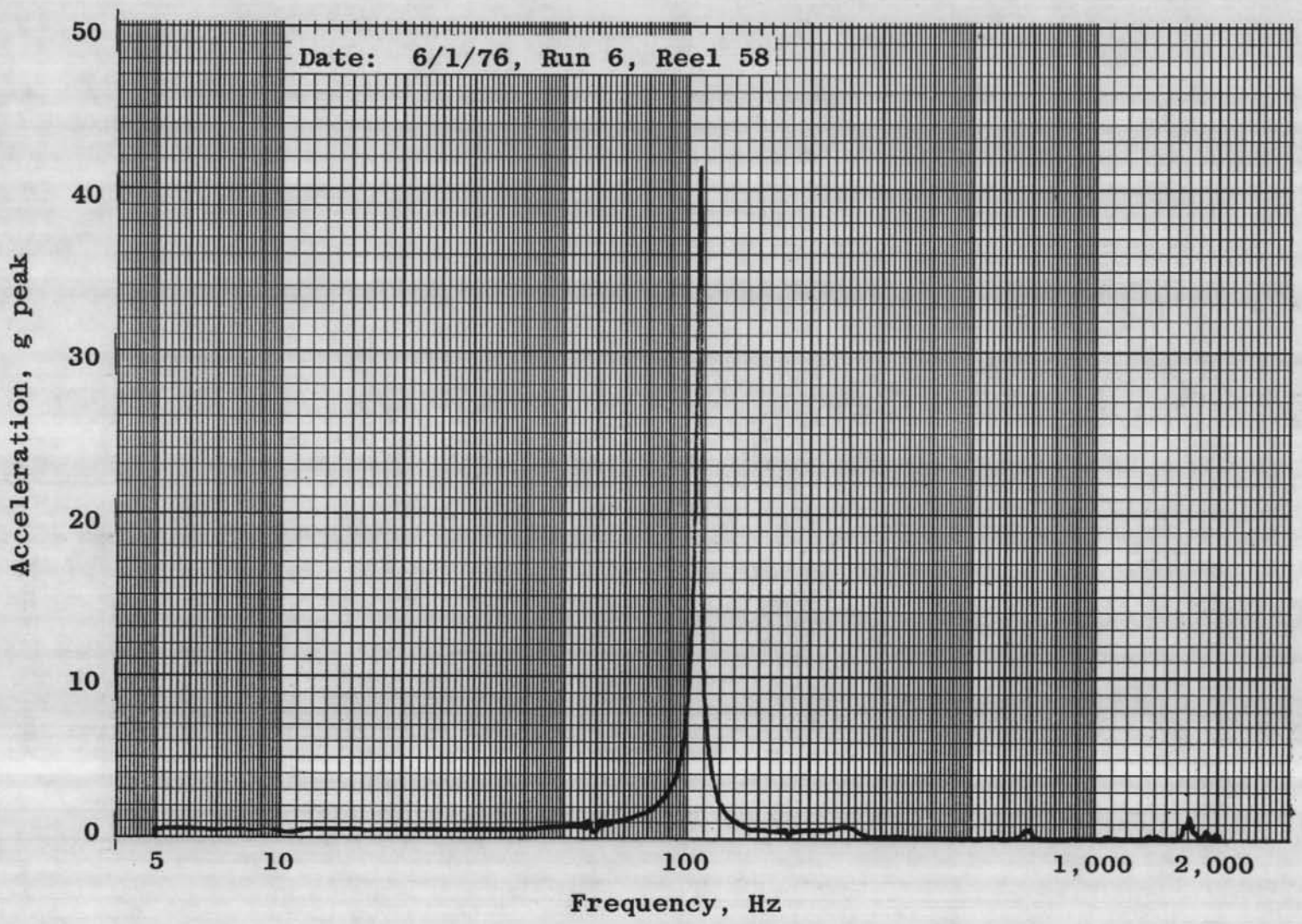

m. Accelerometer 11Y
Figure 17. Continued.

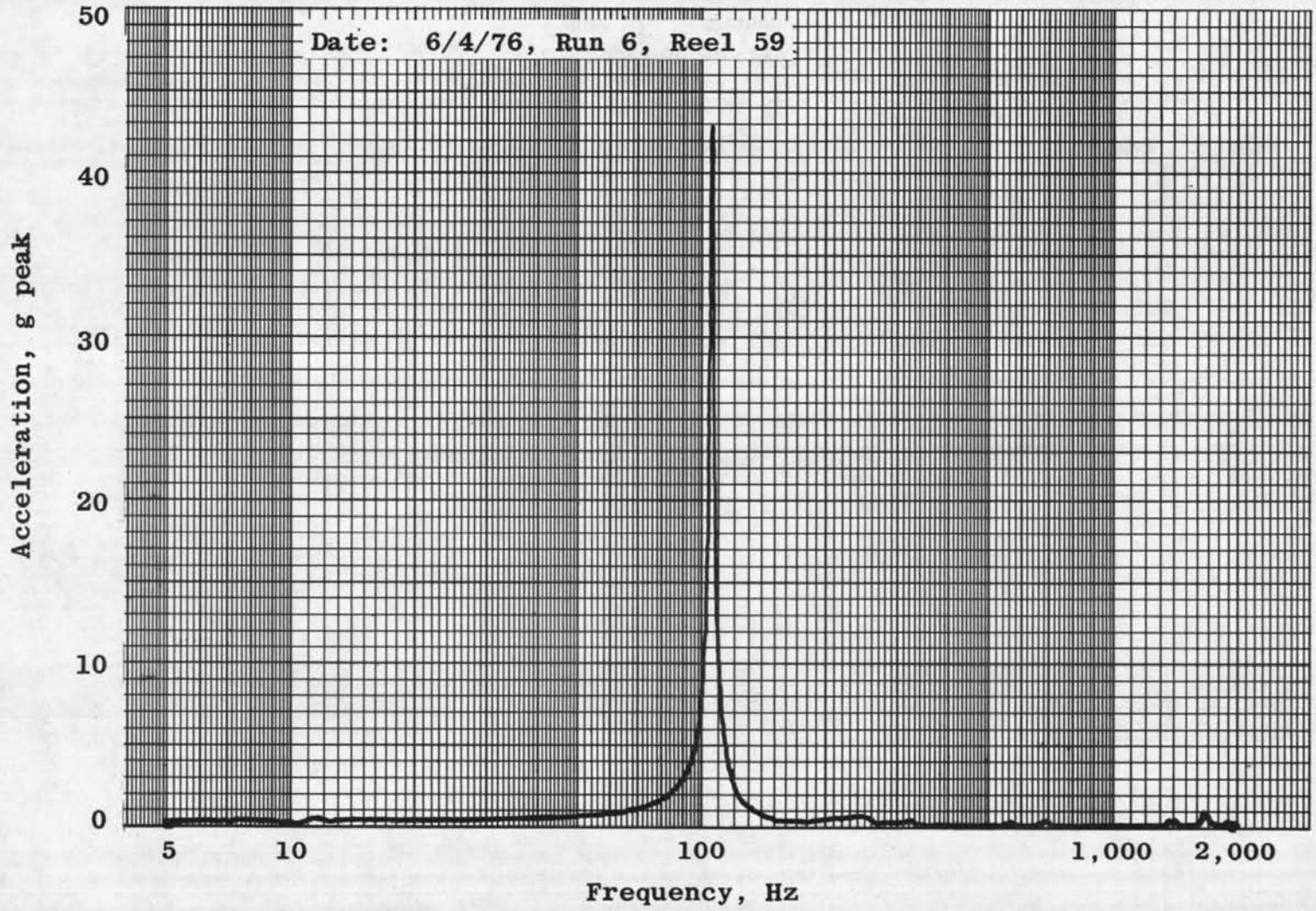

n. Accelerometer 12Y
Figure 17. Continued.

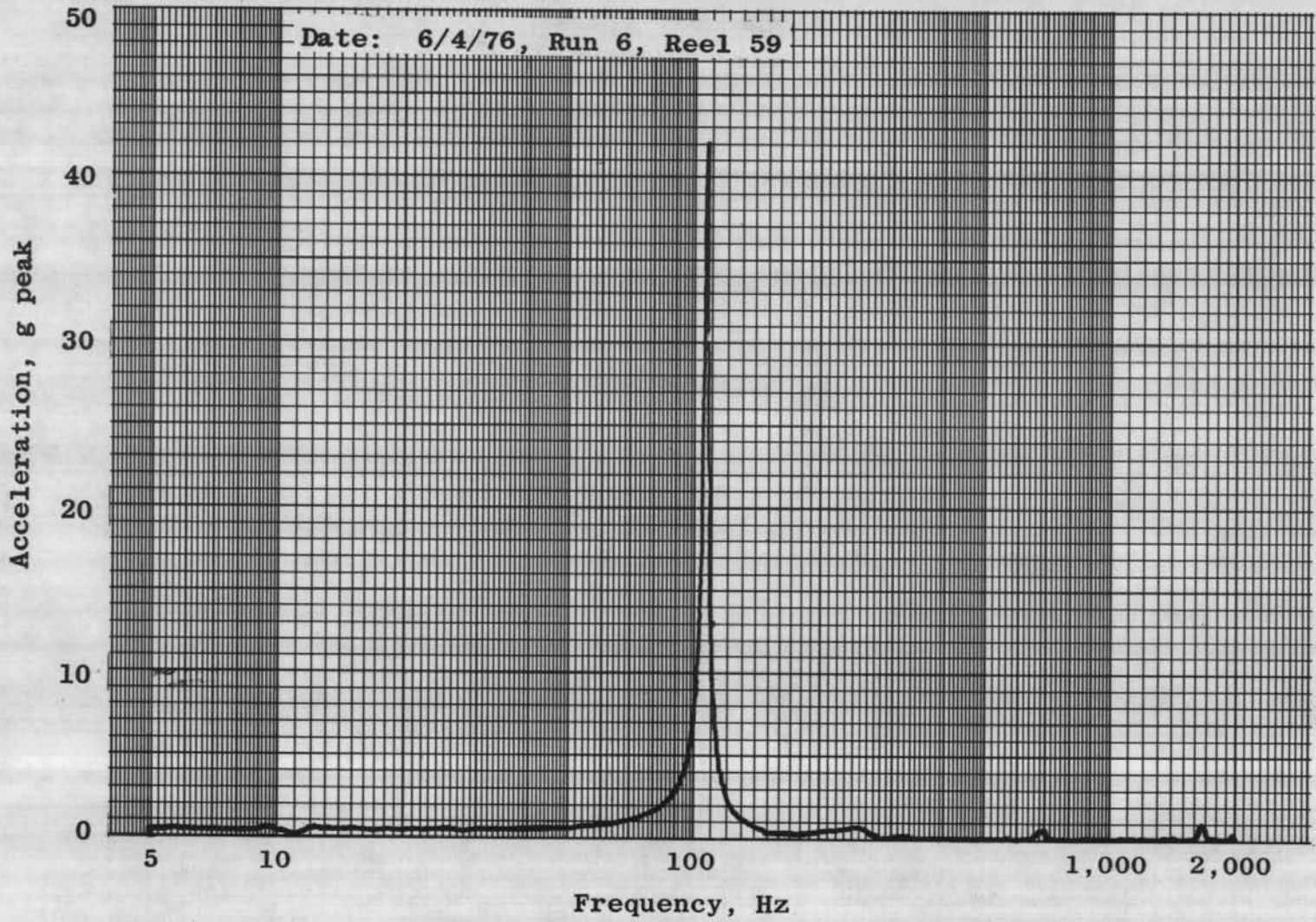

o. Accelerometer 13Y
Figure 17. Continued.

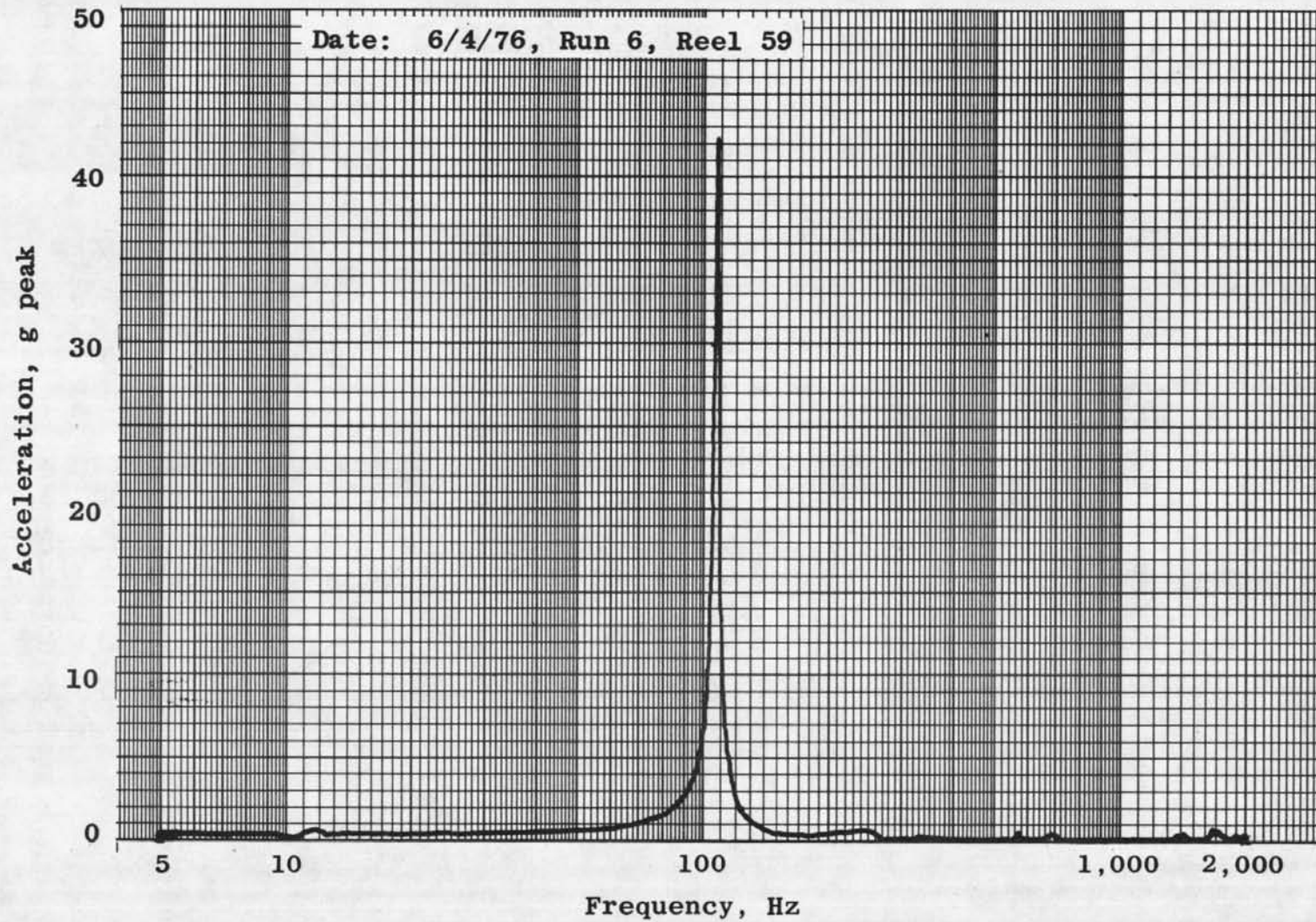

p. Accelerometer 14Y
Figure 17. Continued.

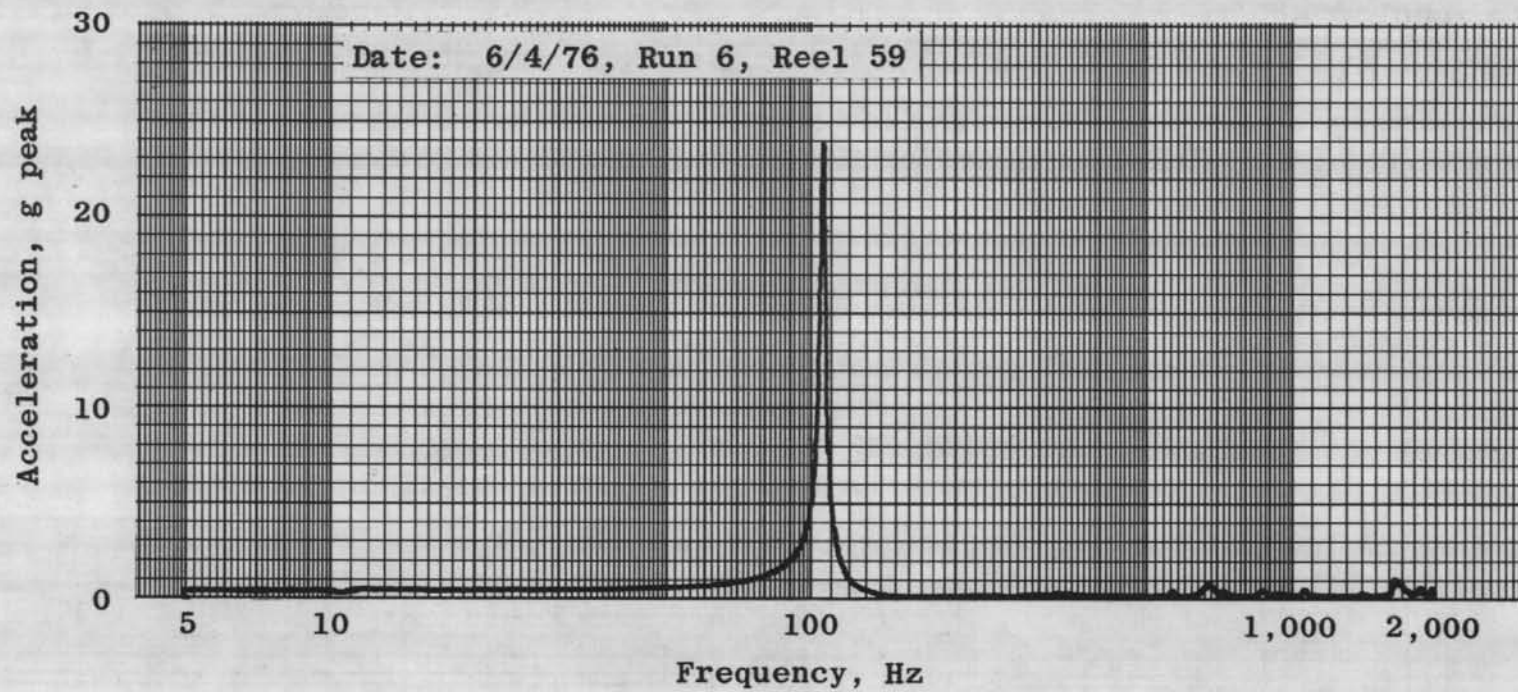

q. Accelerometer 15Y
Figure 17. Continued.

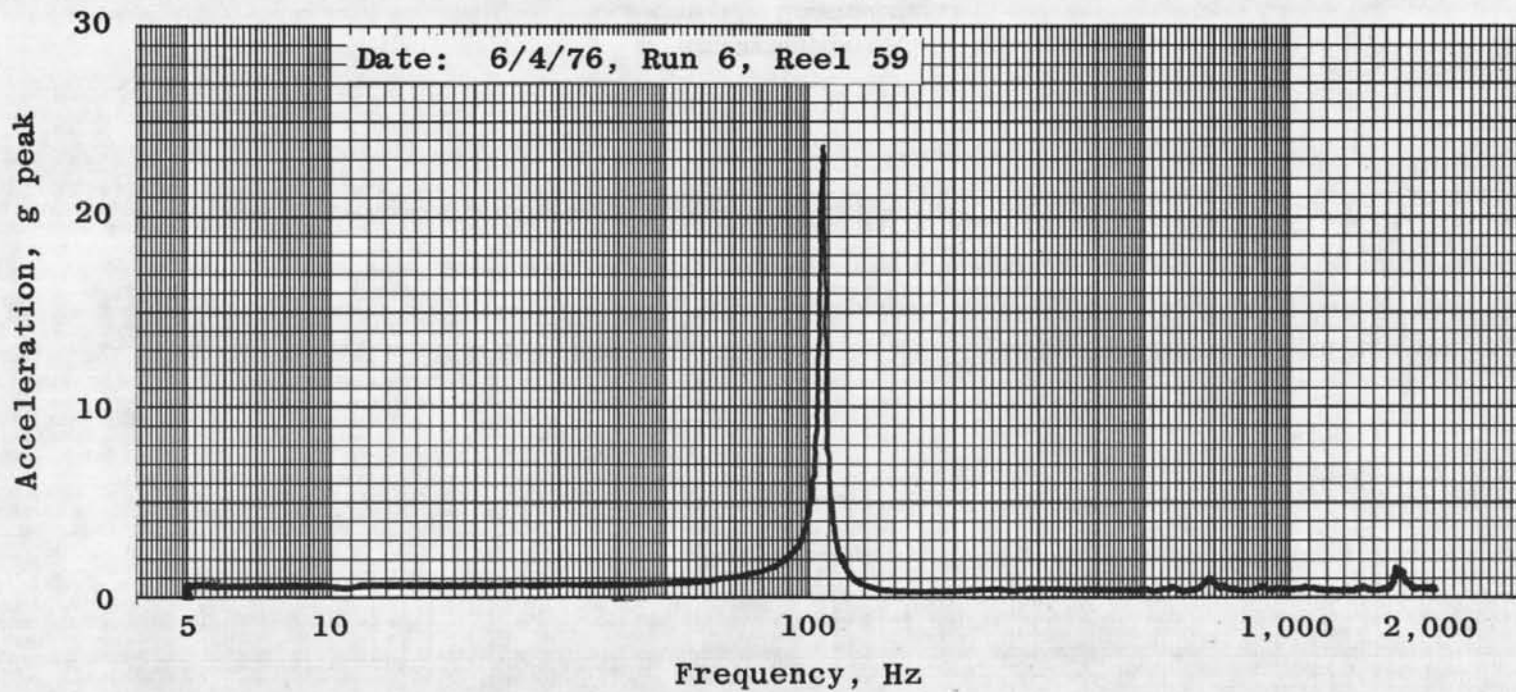

r. Accelerometer 16Y
Figure 17. Continued.

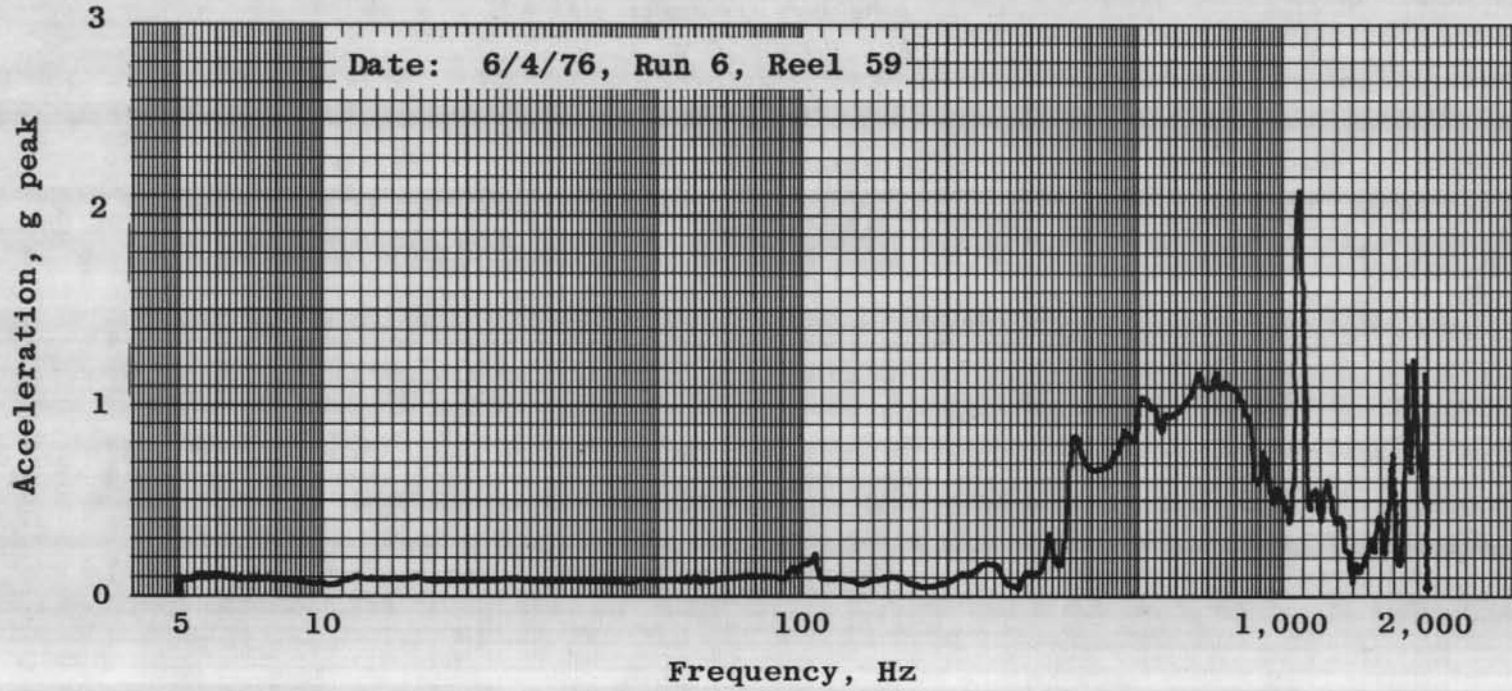

s. Accelerometer 6X
Figure 17. Continued.

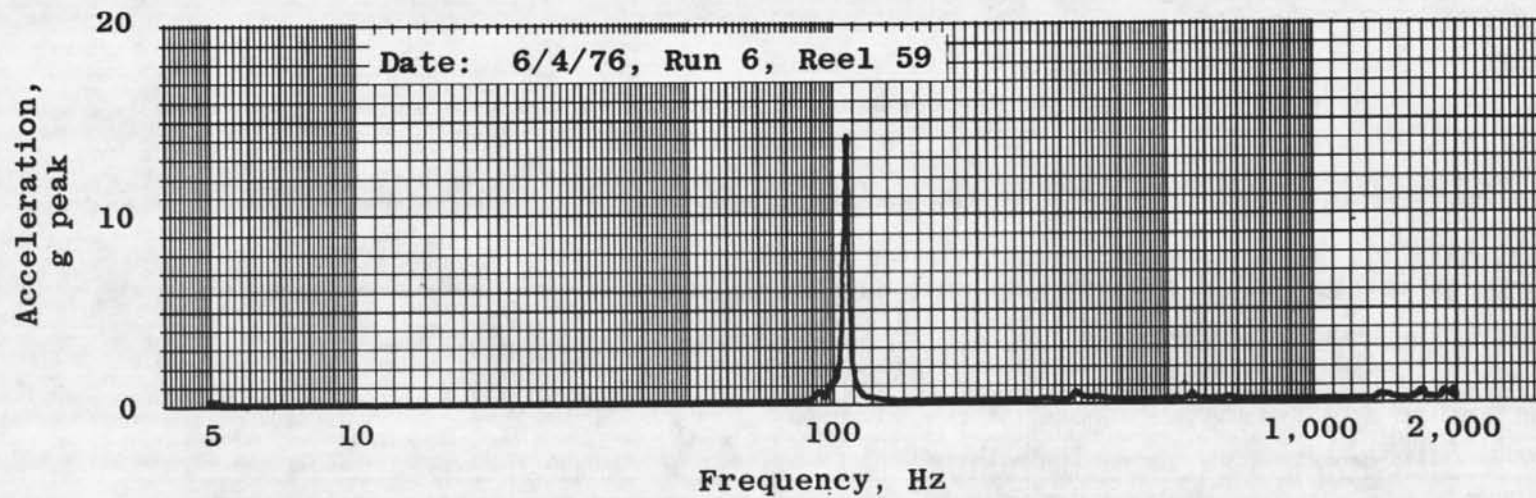

t. Accelerometer 13X

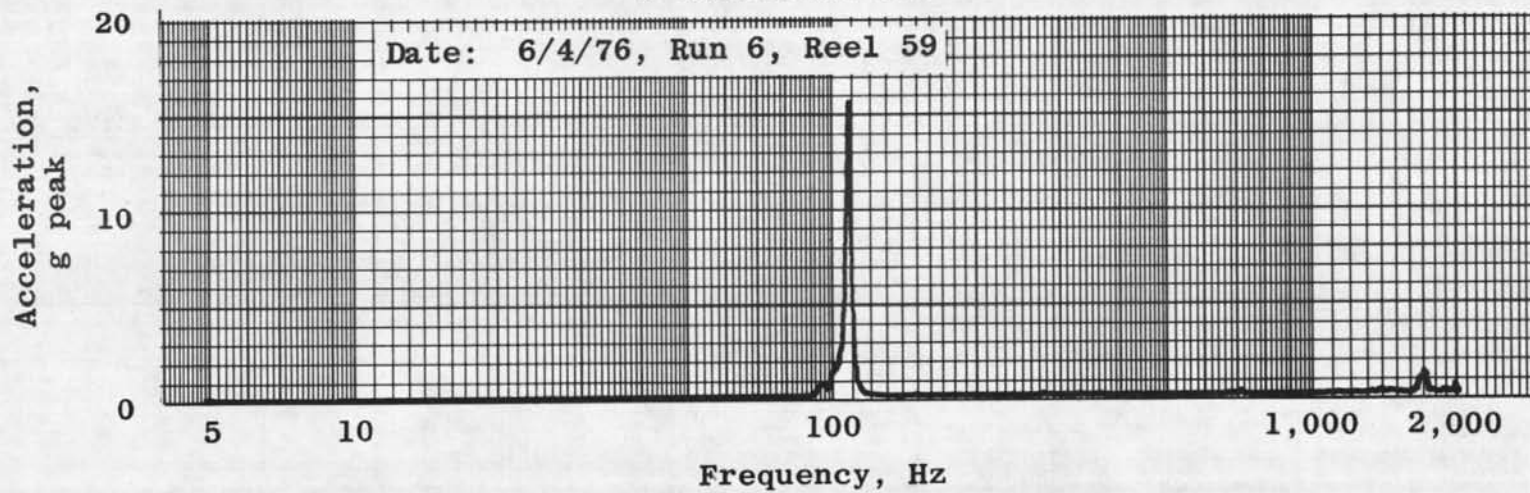
u. Accelerometer 14X
Figure 17. Continued.

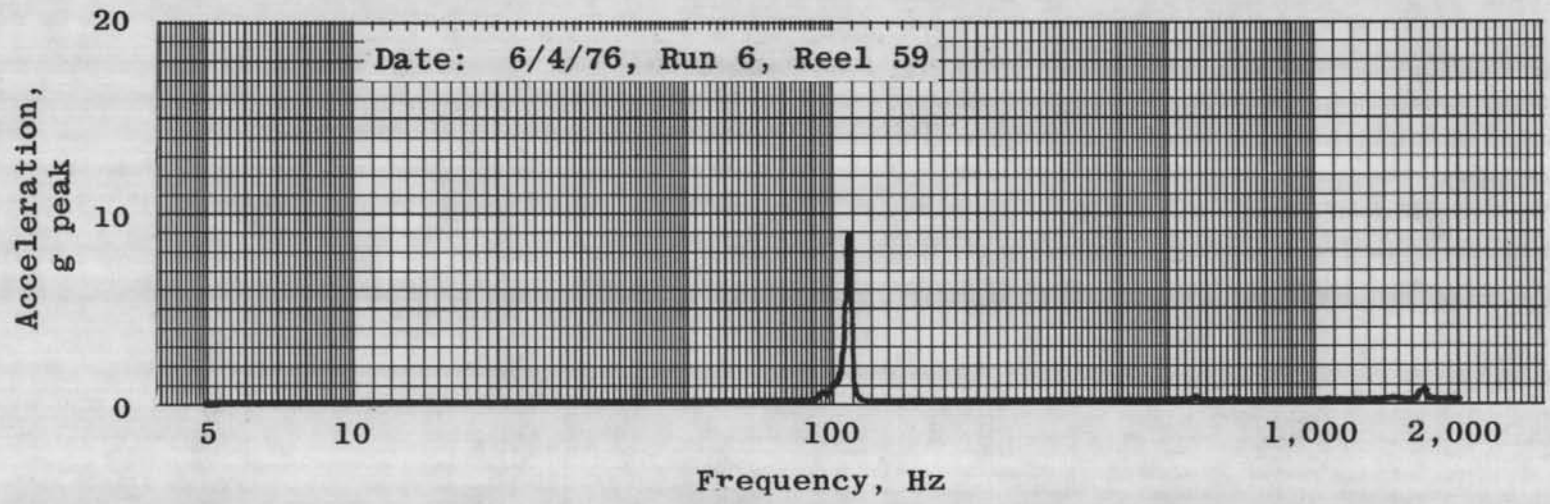

v. Accelerometer 15X

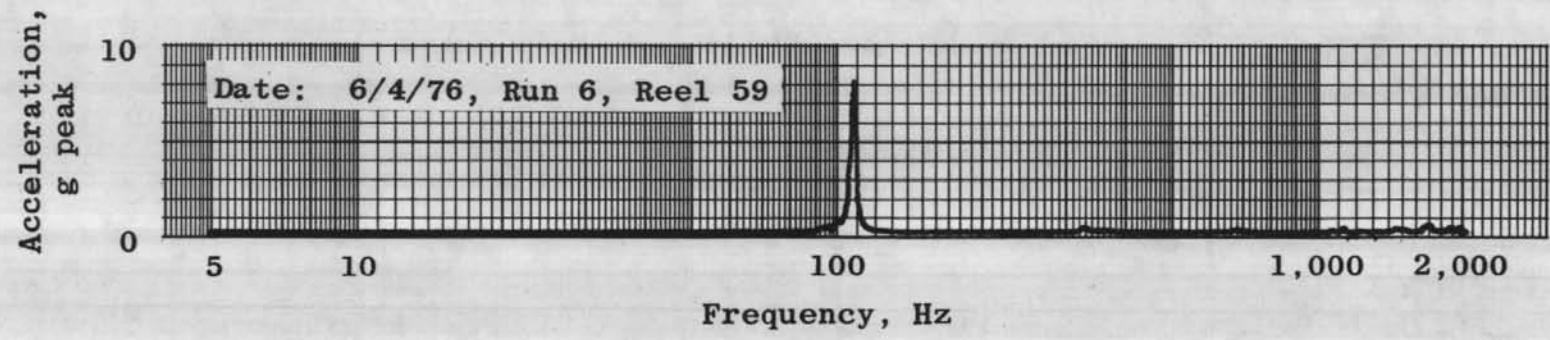

w. Accelerometer 16X
Figure 17. Continued.

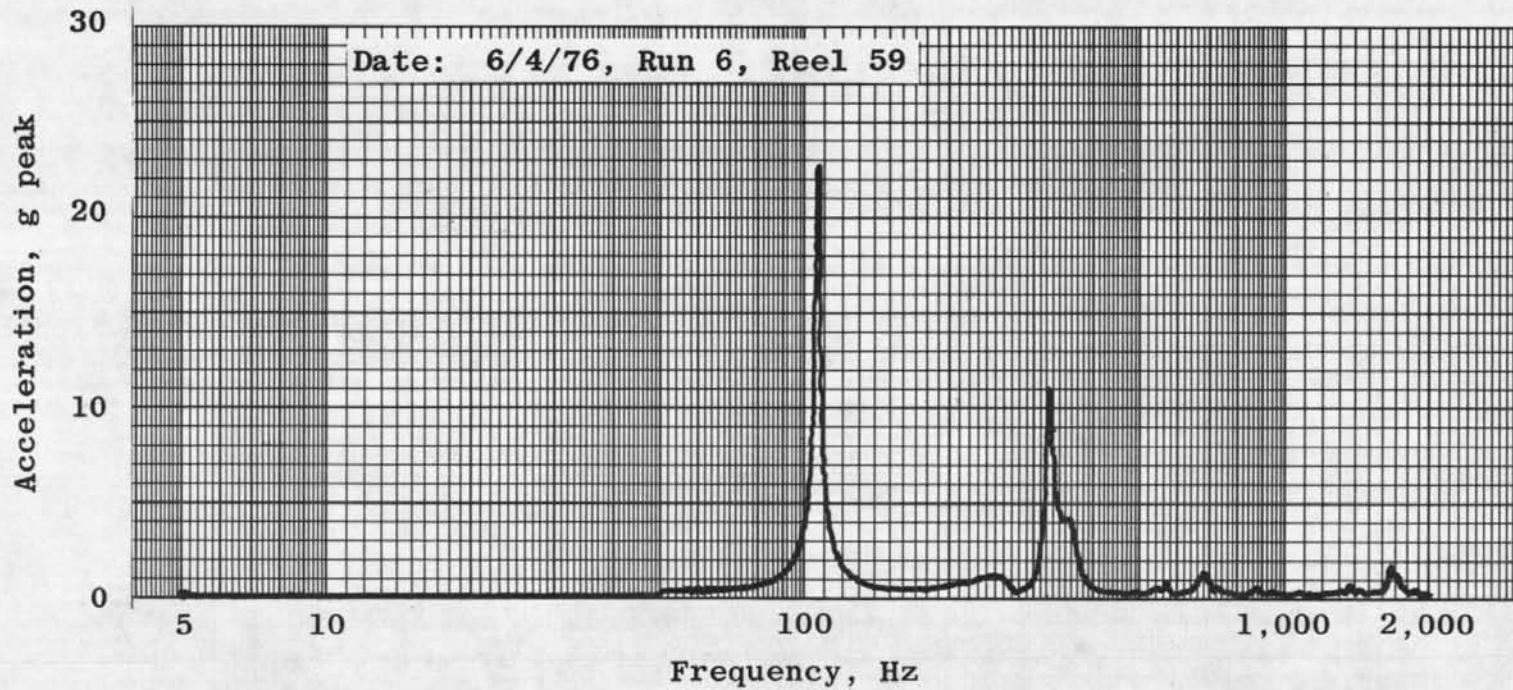

x. Accelerometer 13Z
Figure 17. Concluded.

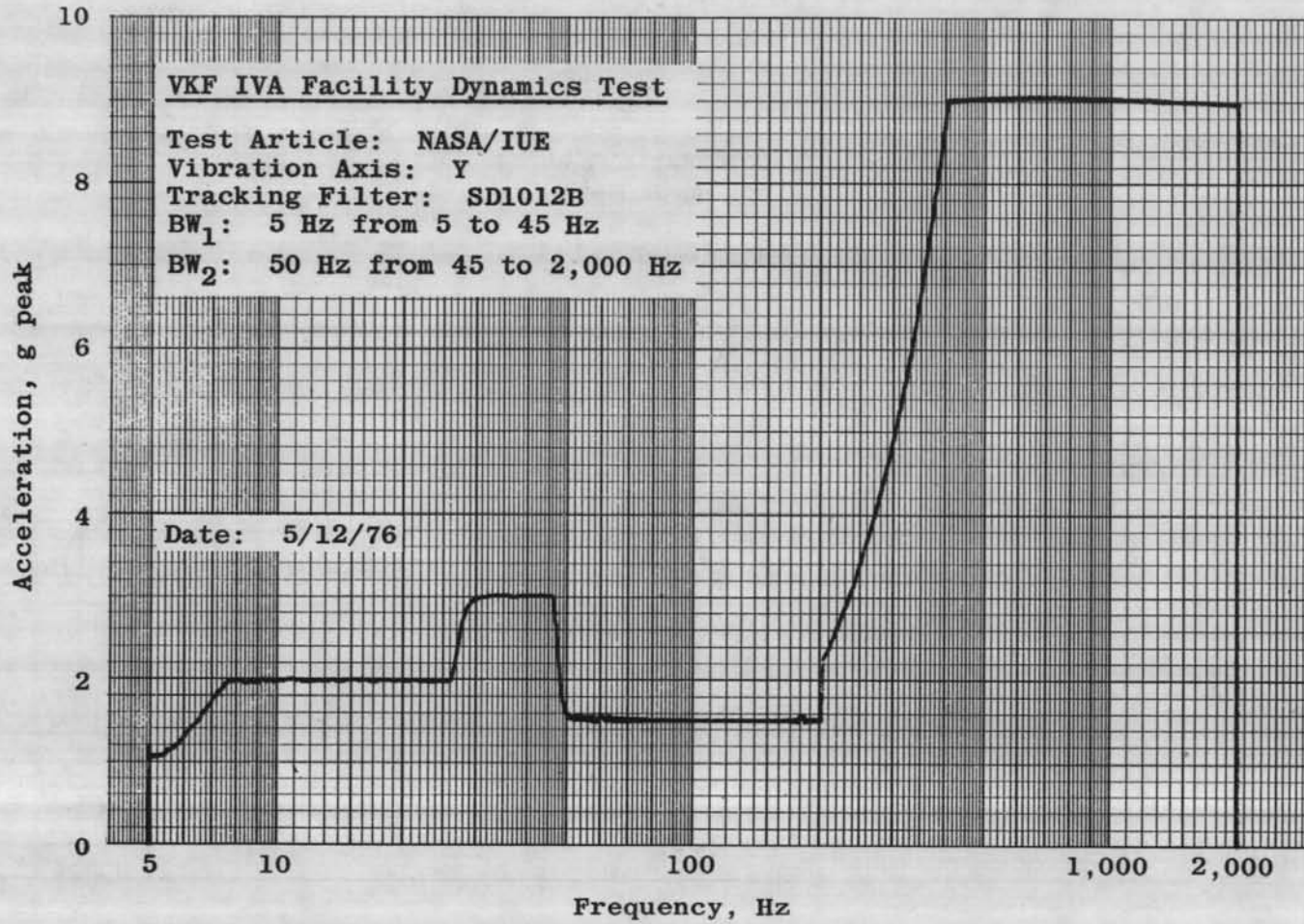

a. Closed loop plot

Figure 18. Y-axis vibration test: qualification level sine sweep.

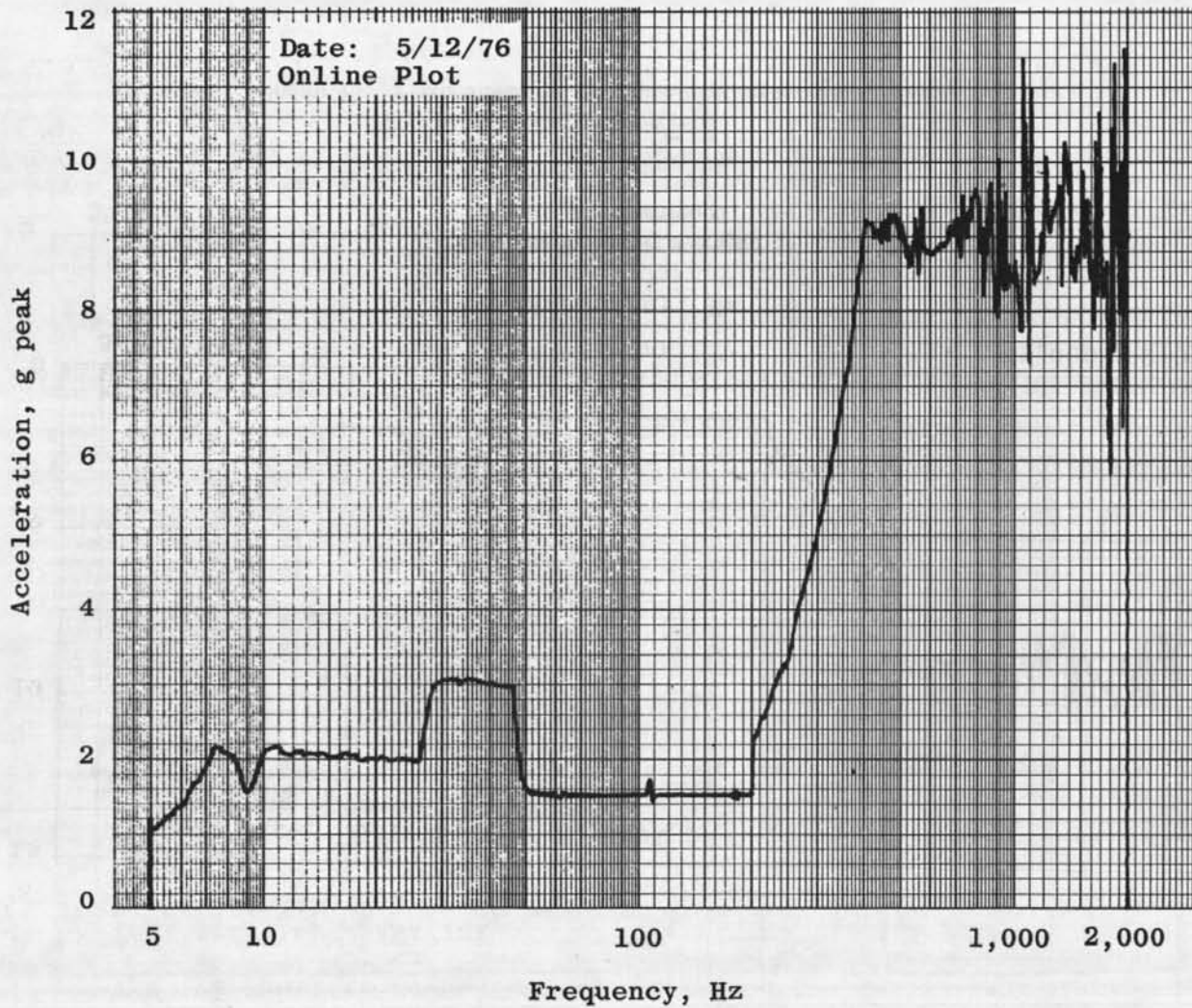

b. Accelerometers averaged
Figure 18. Continued.

124

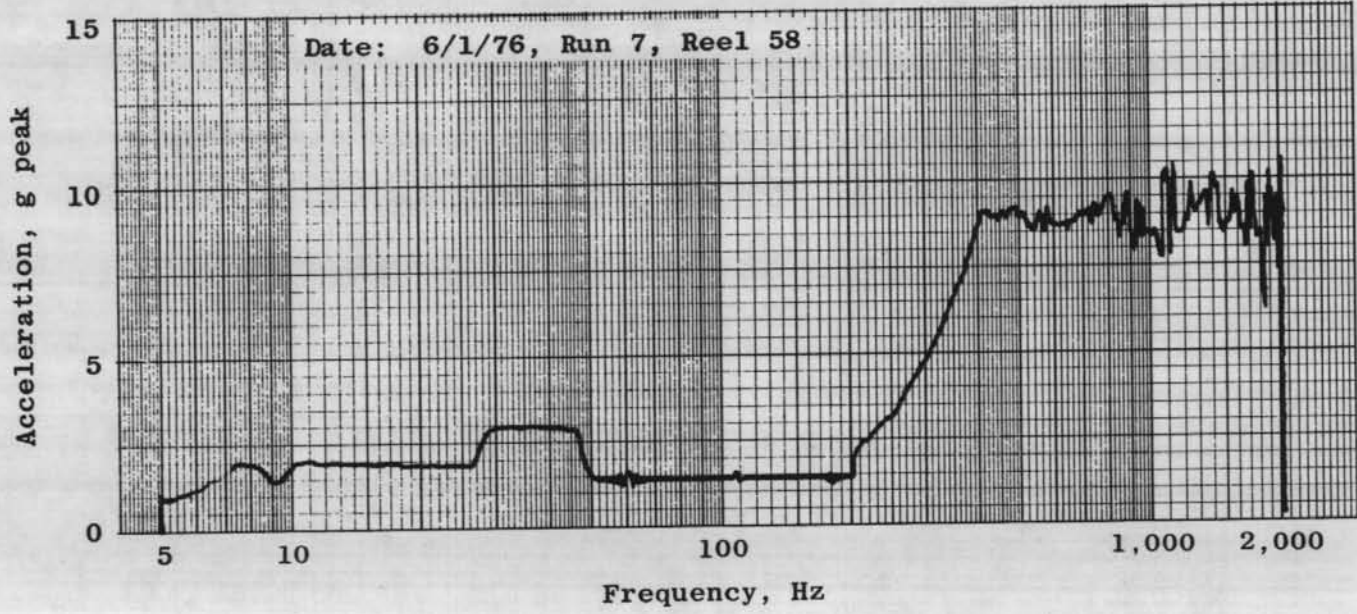

c. Accelerometers averaged
Figure 18. Continued.

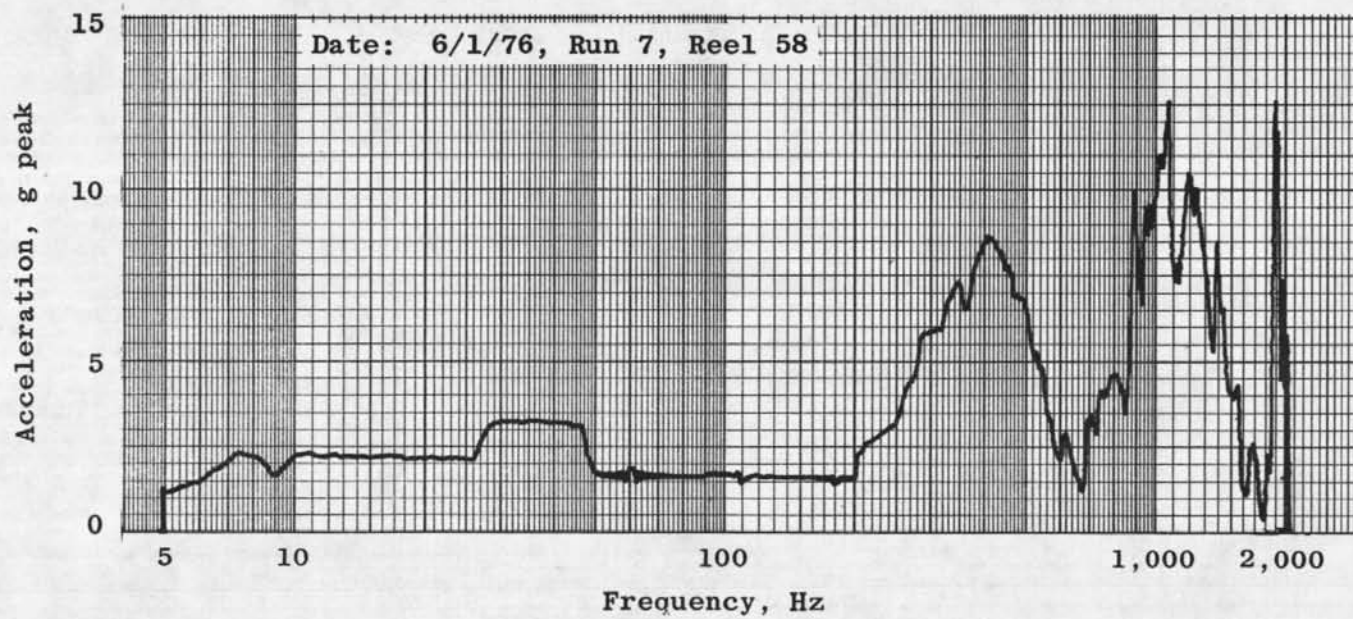

d. Accelerometer 1Y
Figure 18. Continued.

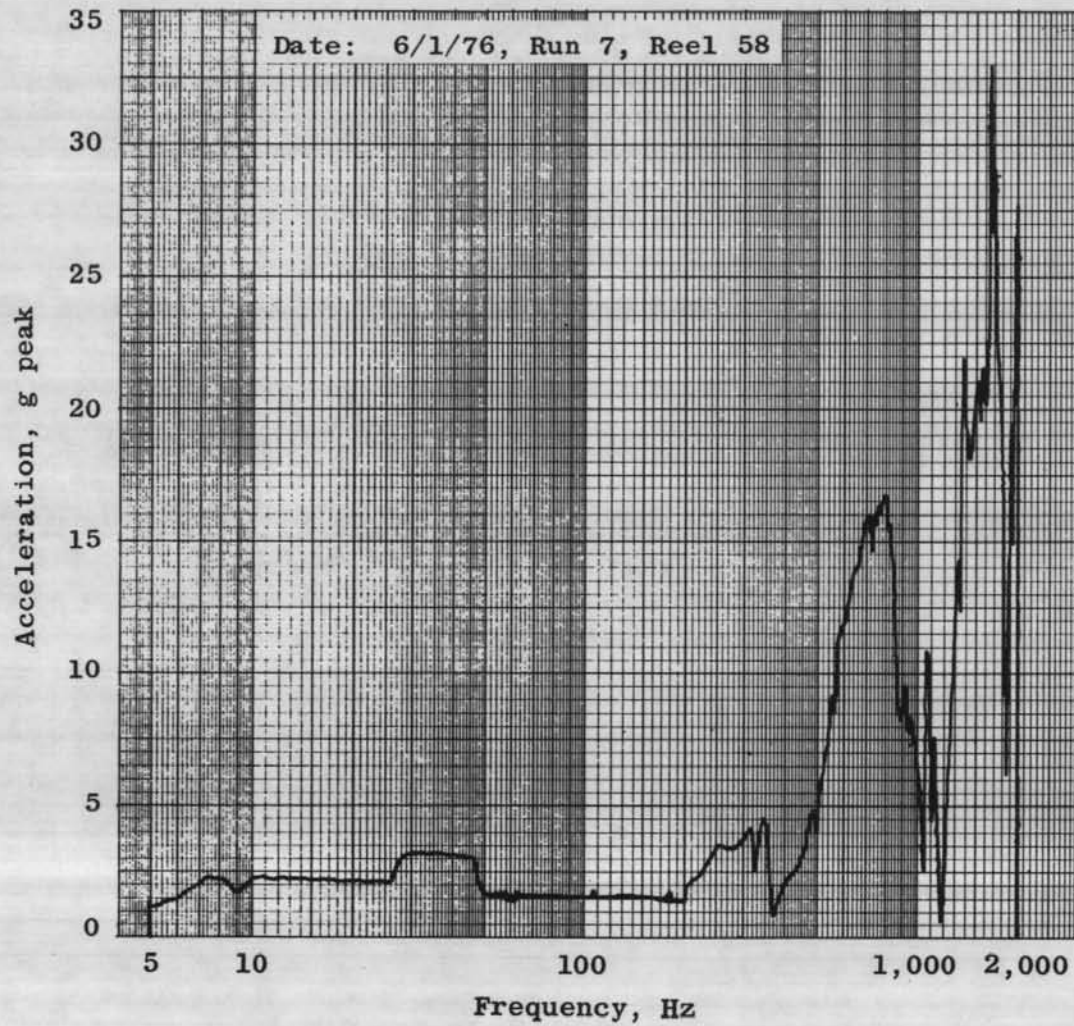

e. Accelerometer 2Y
Figure 18. Continued.

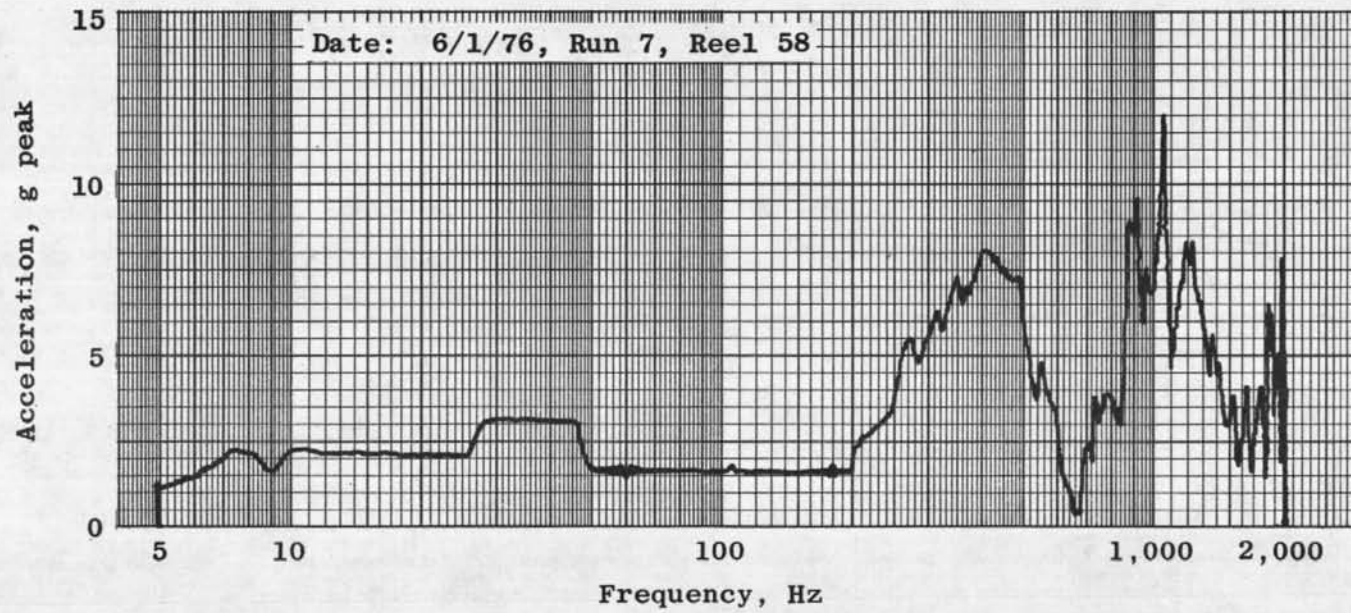

f. Accelerometer 3Y
Figure 18. Continued.

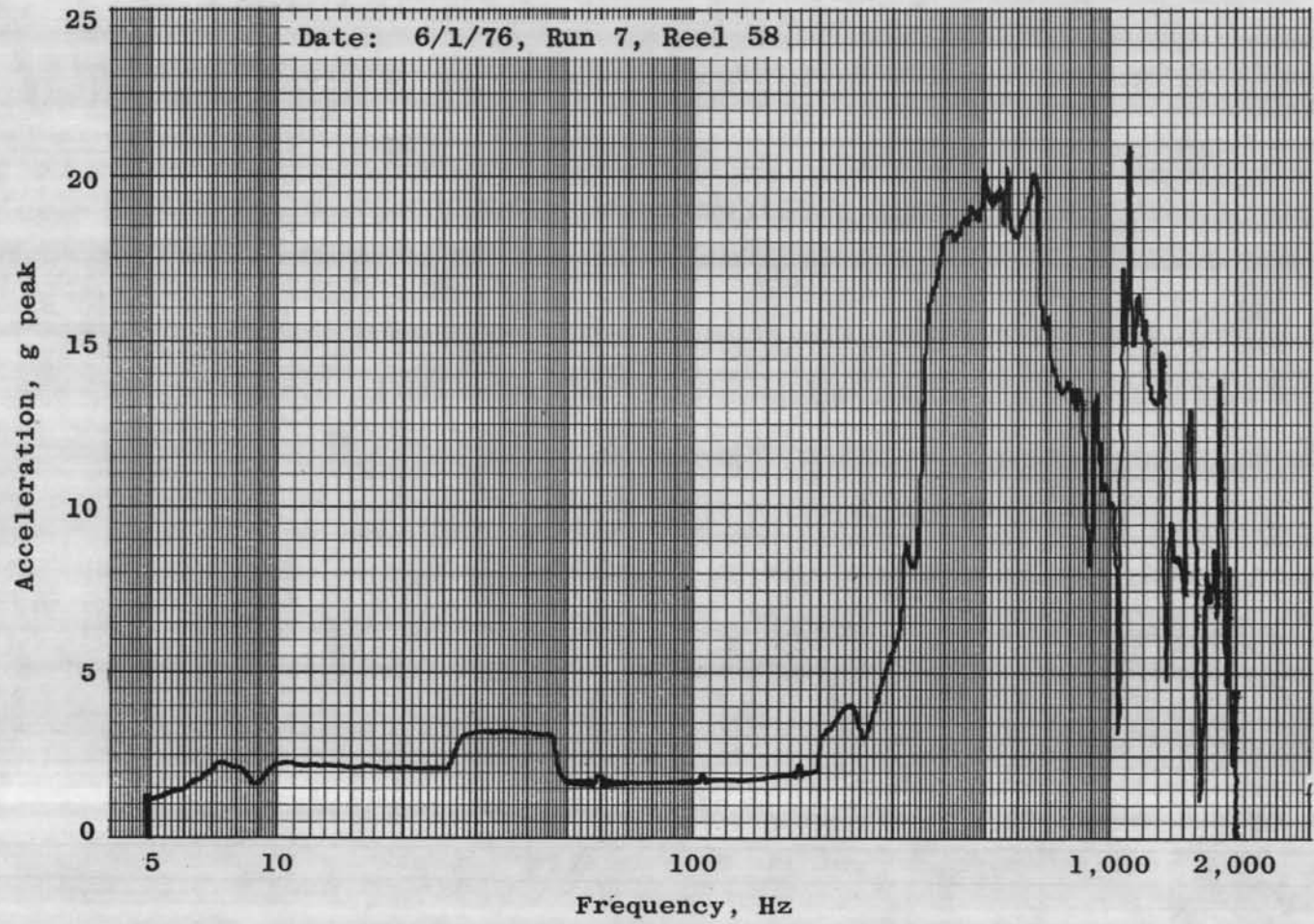

g. Accelerometer 4Y
Figure 18. Continued.

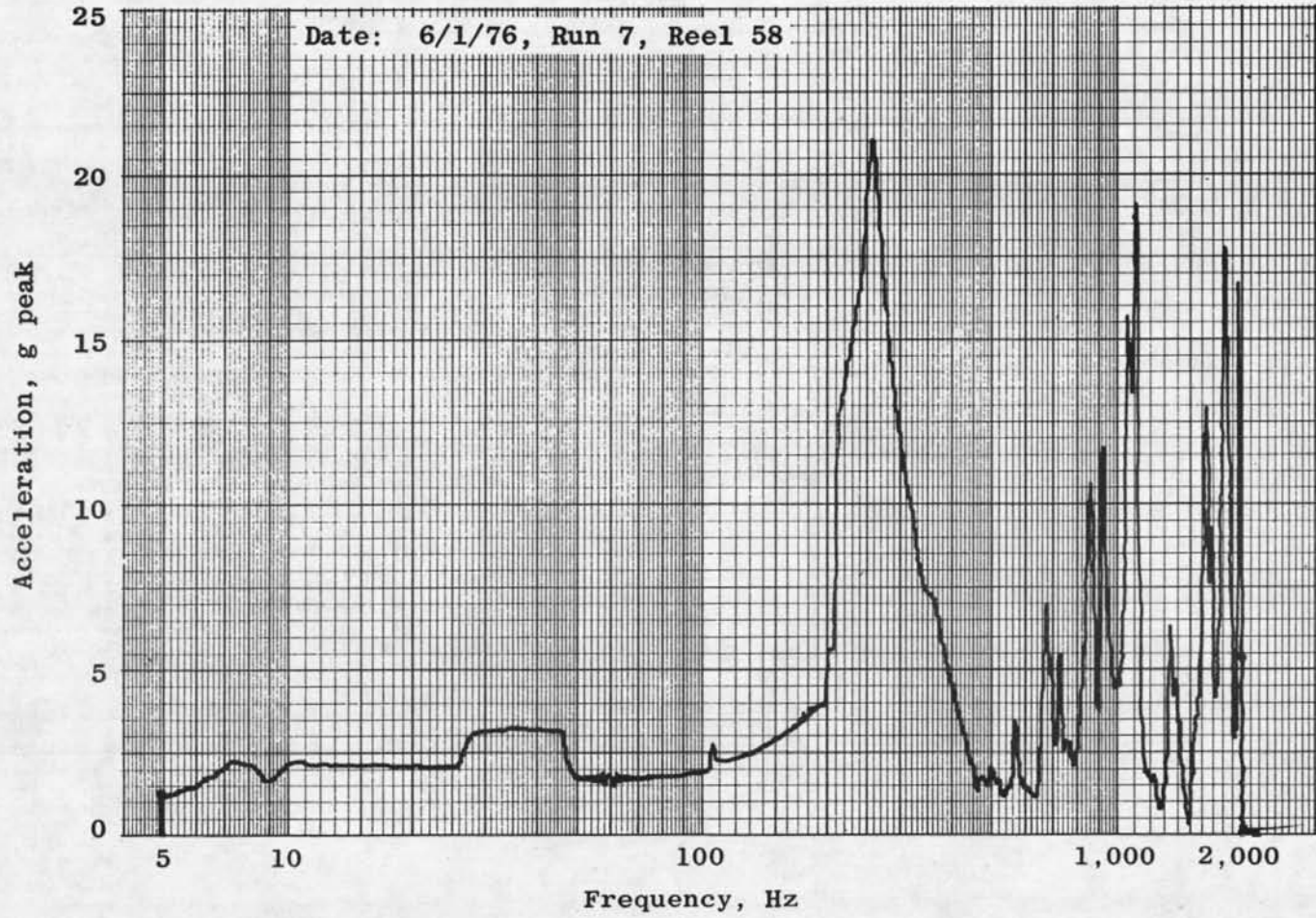

h. Accelerometer 5Y
Figure 18. Continued.

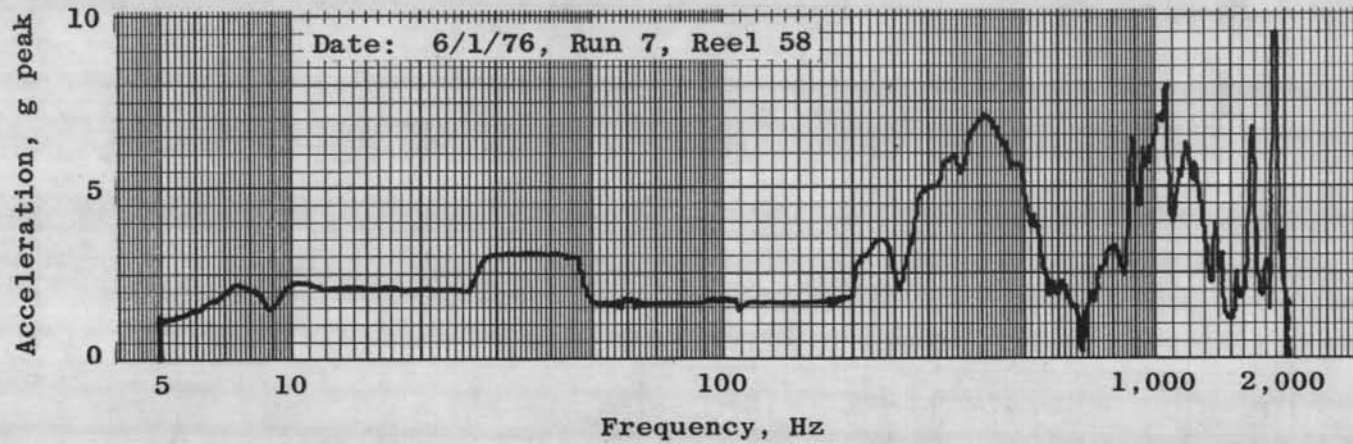

i. Accelerometer 6Y
Figure 18. Continued.

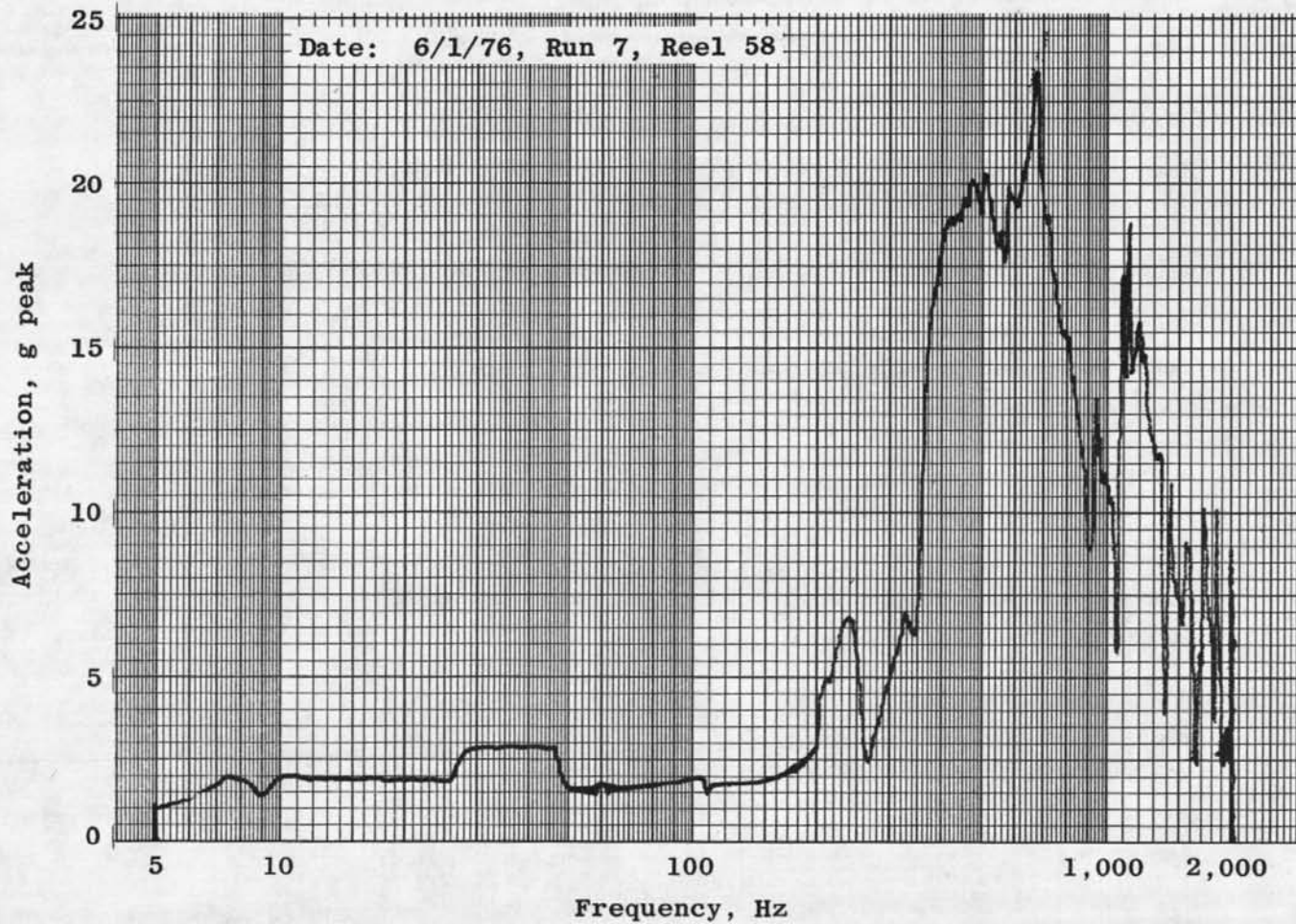

j. Accelerometer 7Y
Figure 18. Continued.

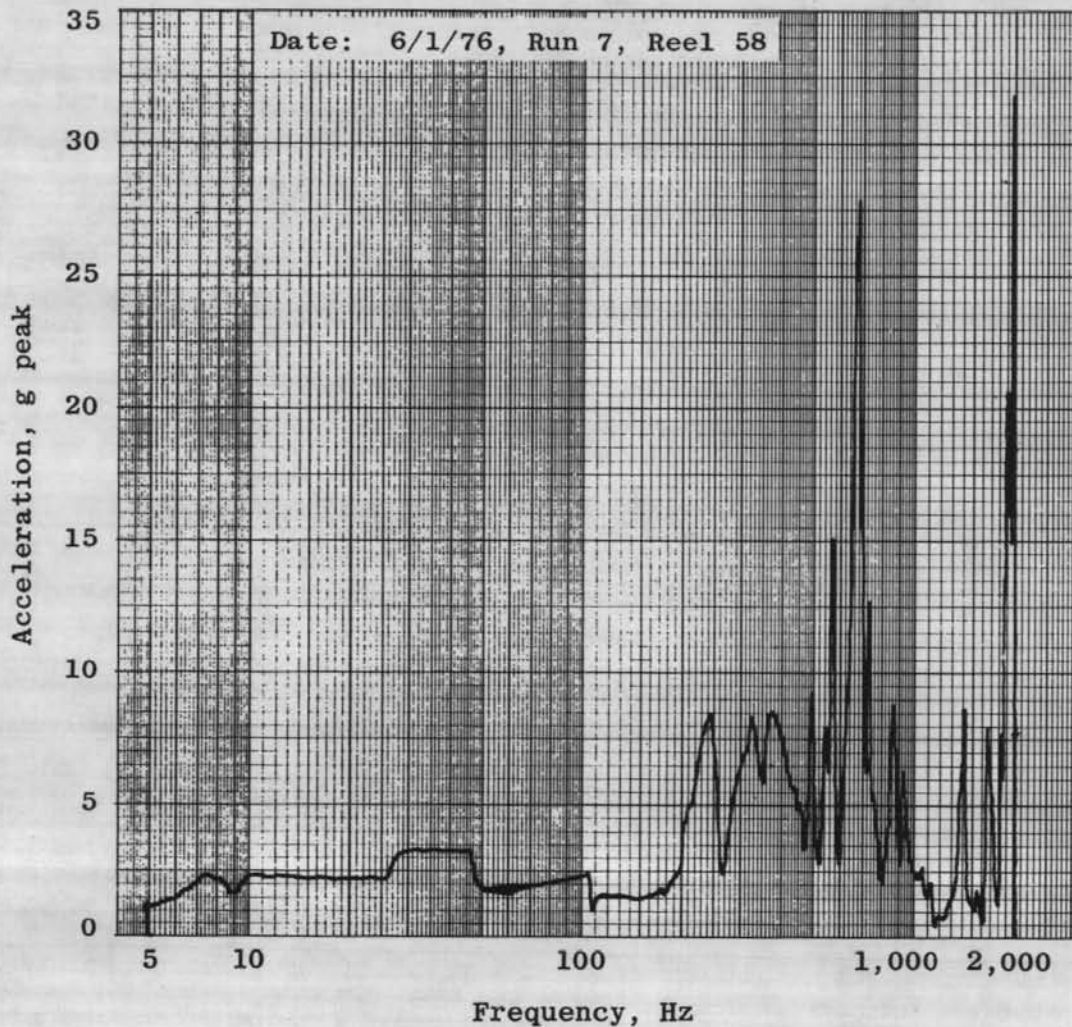

k. Accelerometer 8Y
Figure 18. Continued.

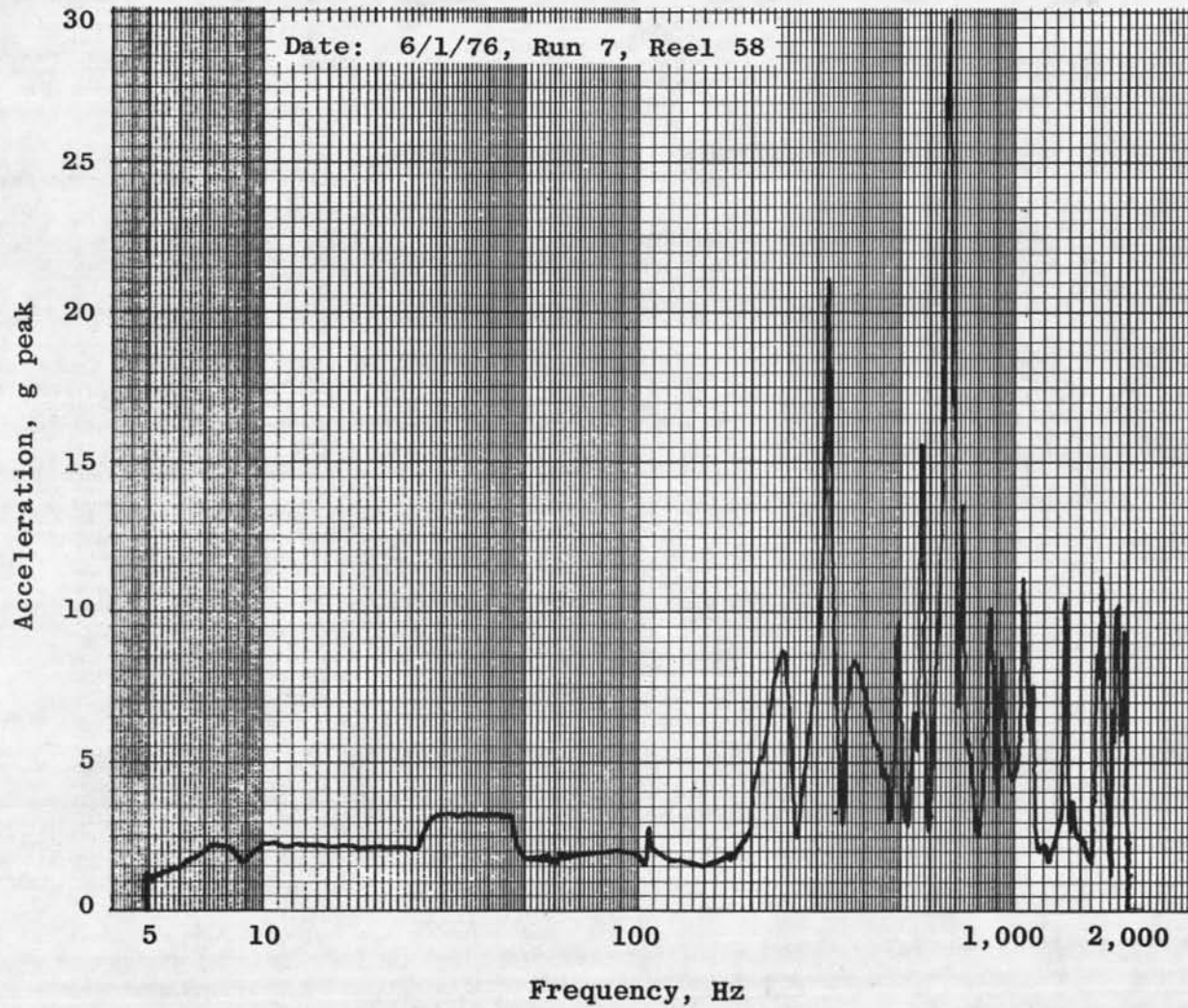

I. Accelerometer 9Y
Figure 18. Continued.

134

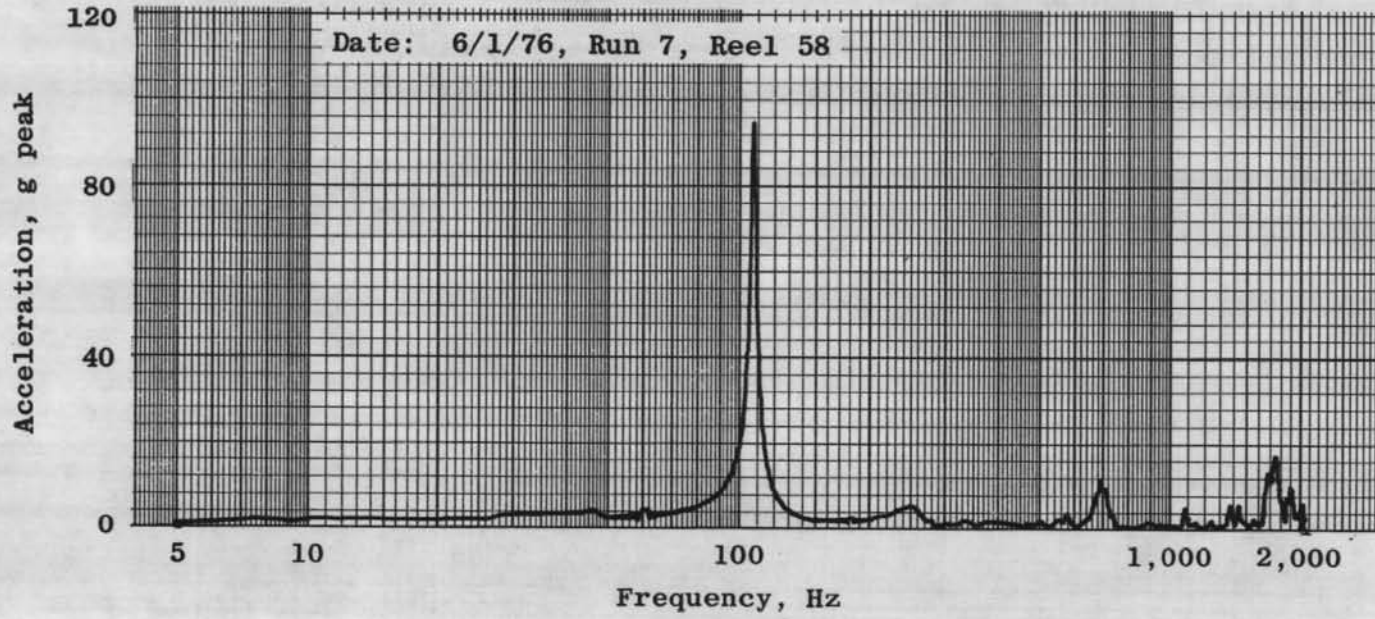

m. Accelerometer 11Y
Figure 18. Continued.

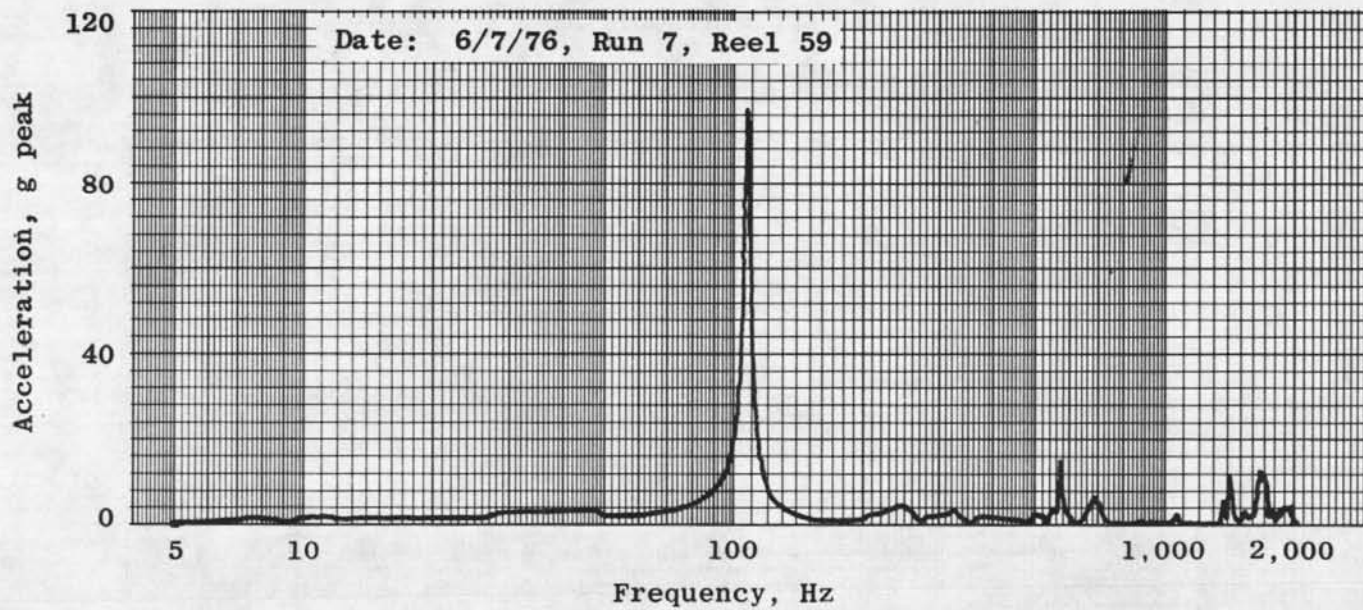

n. Accelerometer 12Y
Figure 18. Continued.

136

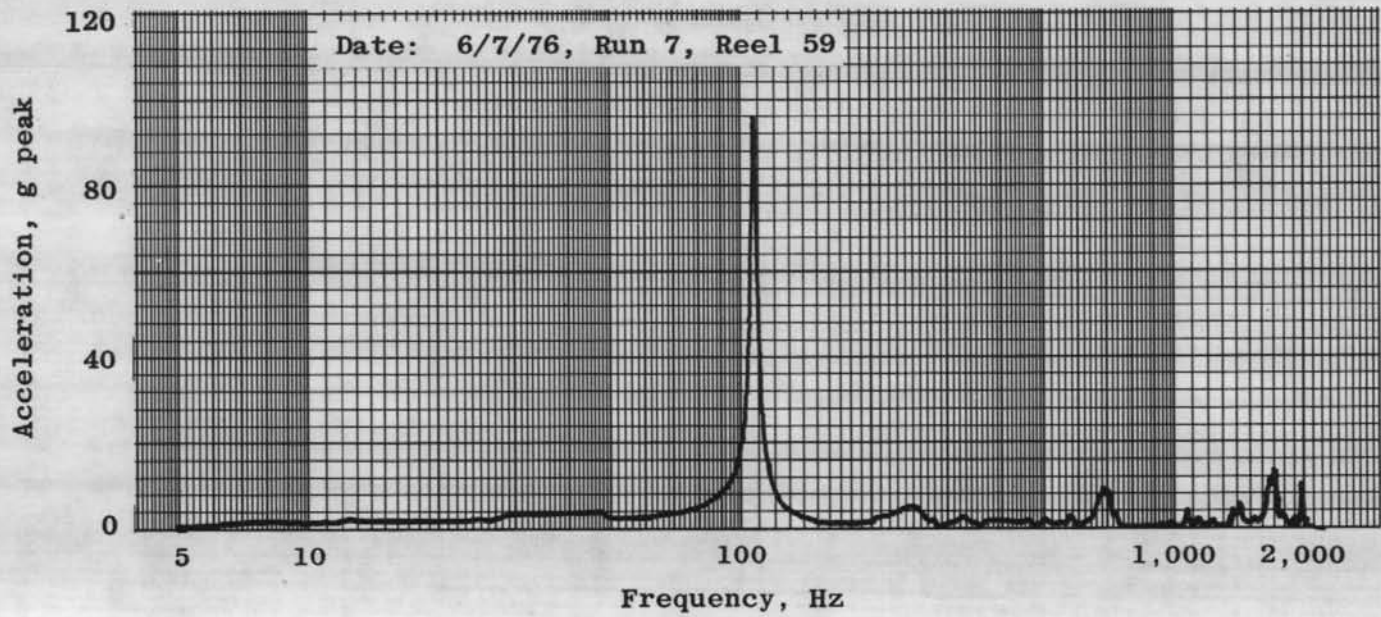

o. Accelerometer 13Y
Figure 18. Continued.

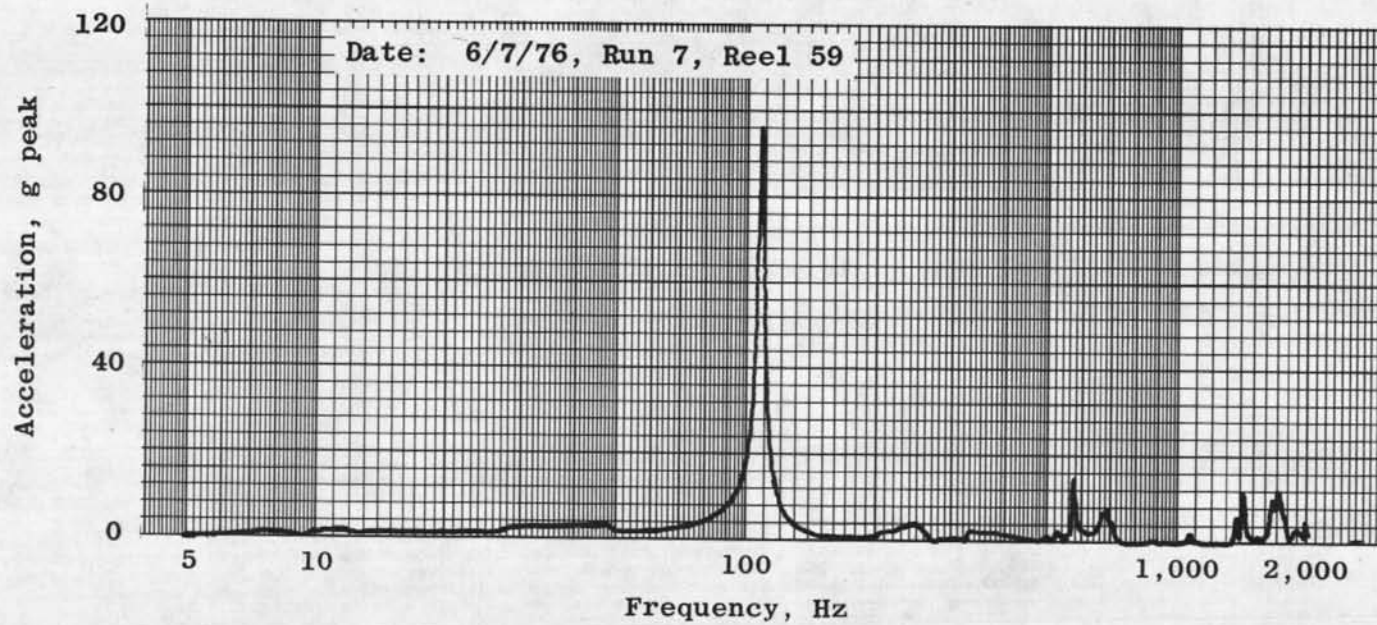

p. Accelerometer 14Y
Figure 18. Continued.

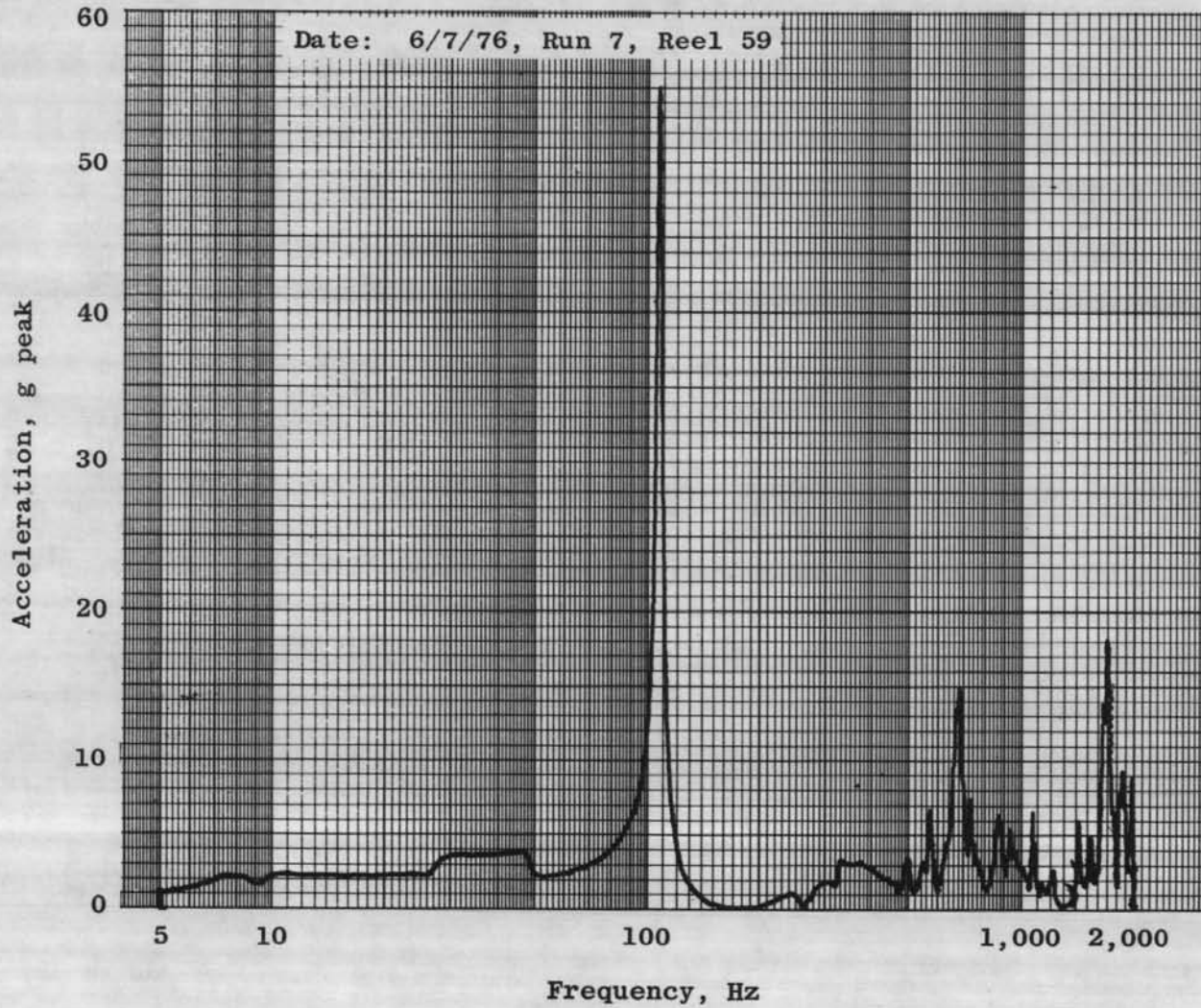

q. Accelerometer 15Y
Figure 18. Continued.

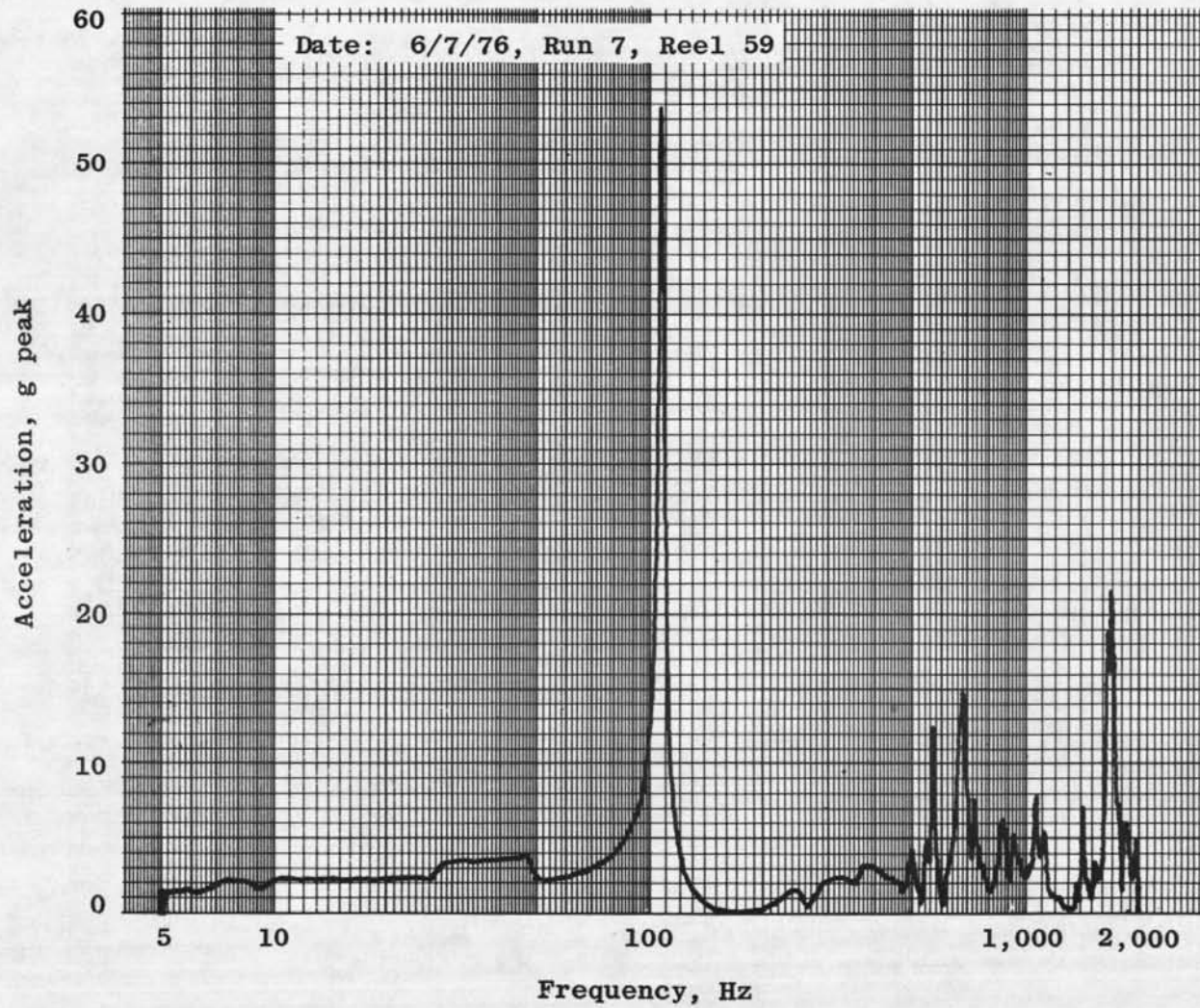

r. Accelerometer 16Y
Figure 18. Continued.

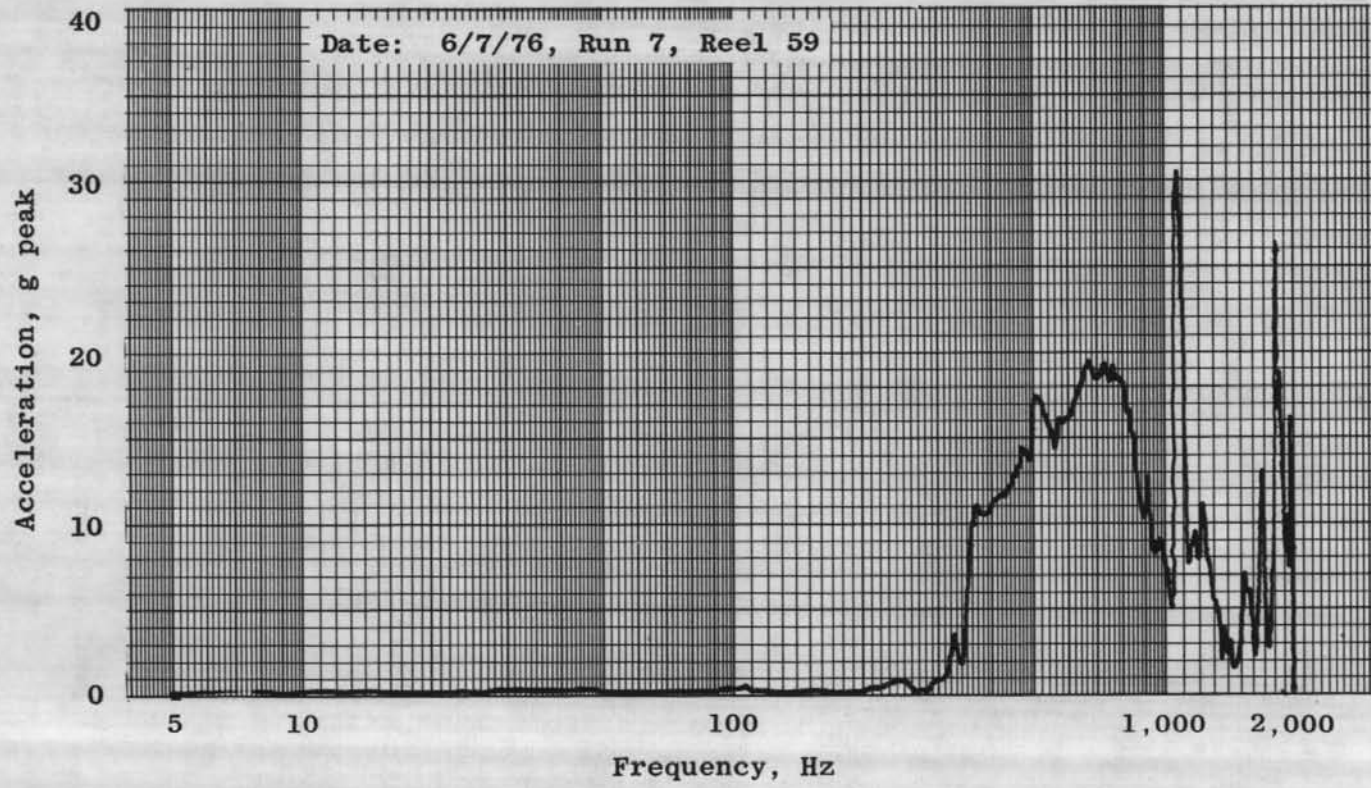

140

s. Accelerometer 6X
Figure 18. Continued.

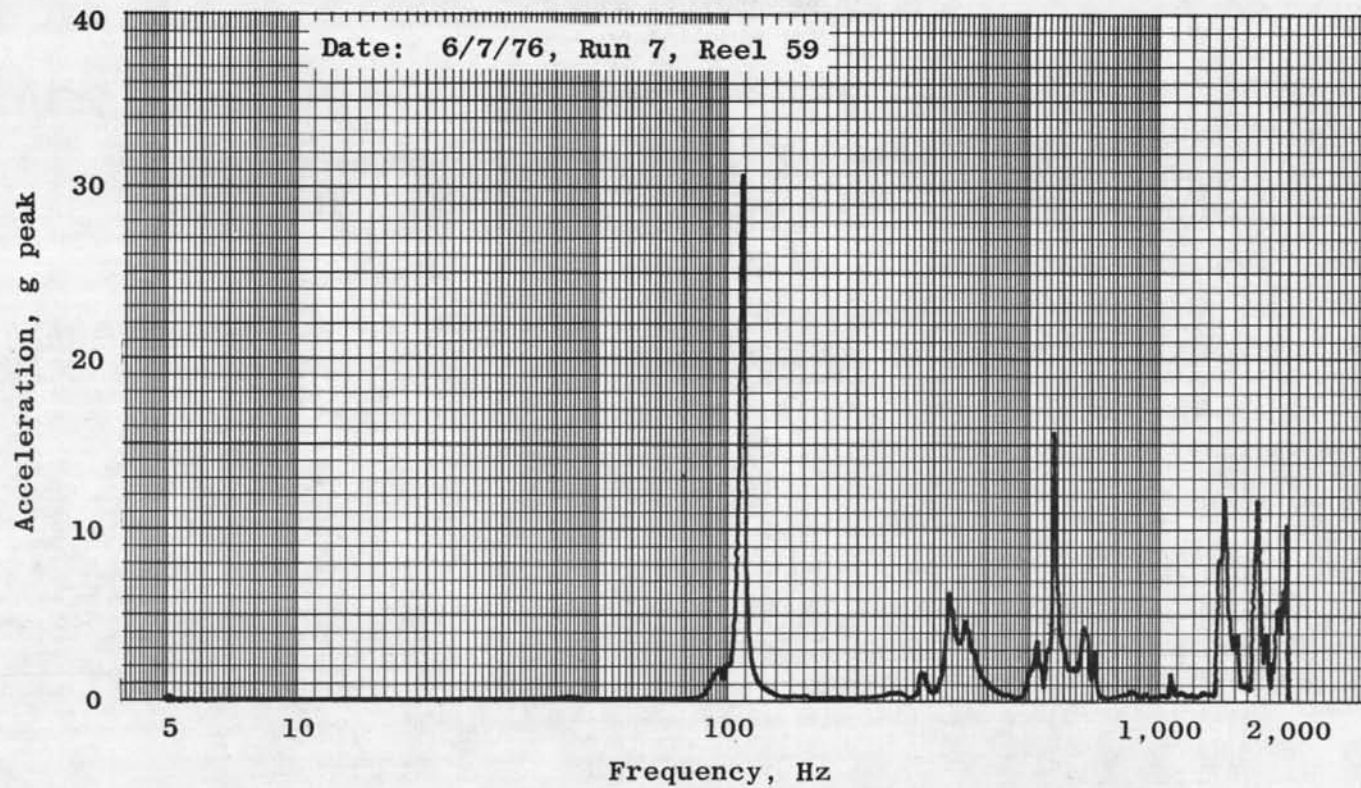

t. Accelerometer 13X
Figure 18. Continued.

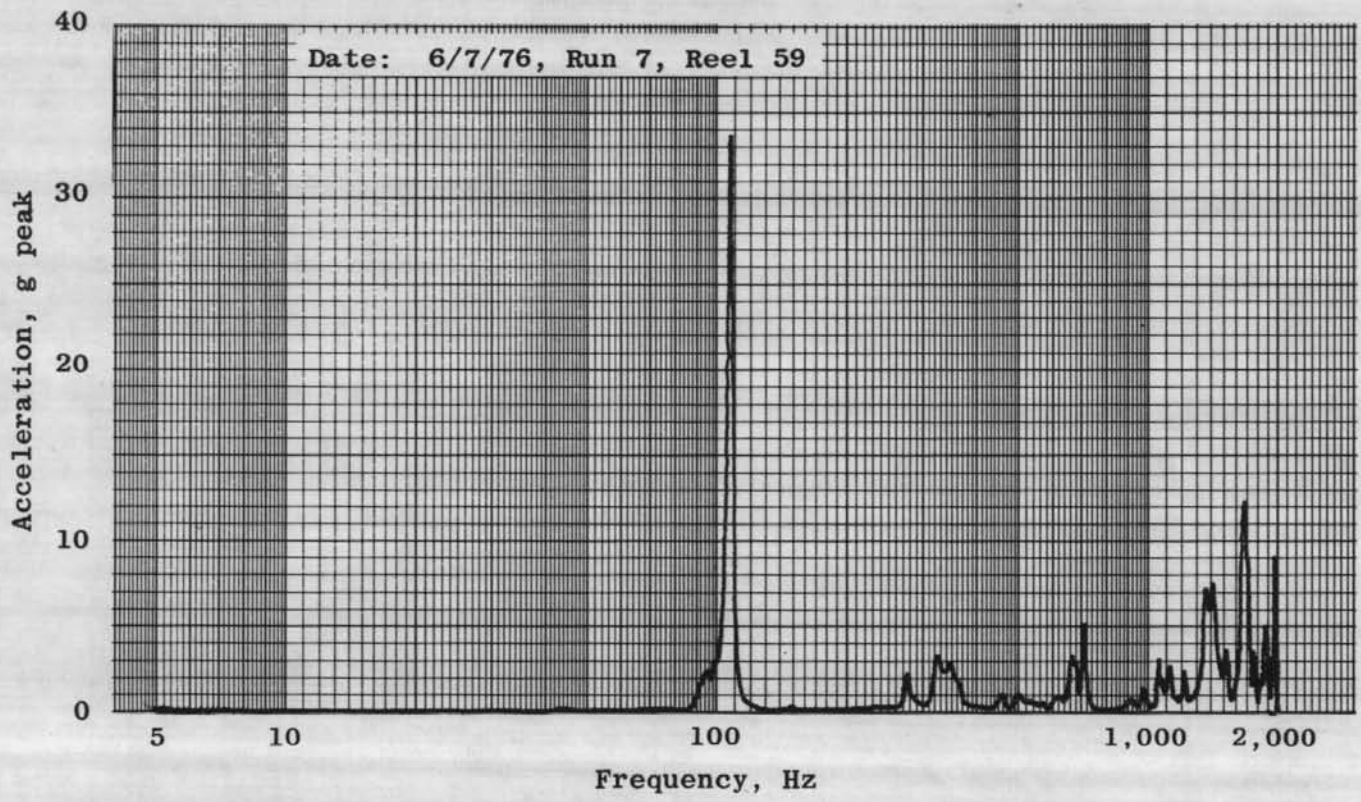

u. Accelerometer 14X
Figure 18. Continued.

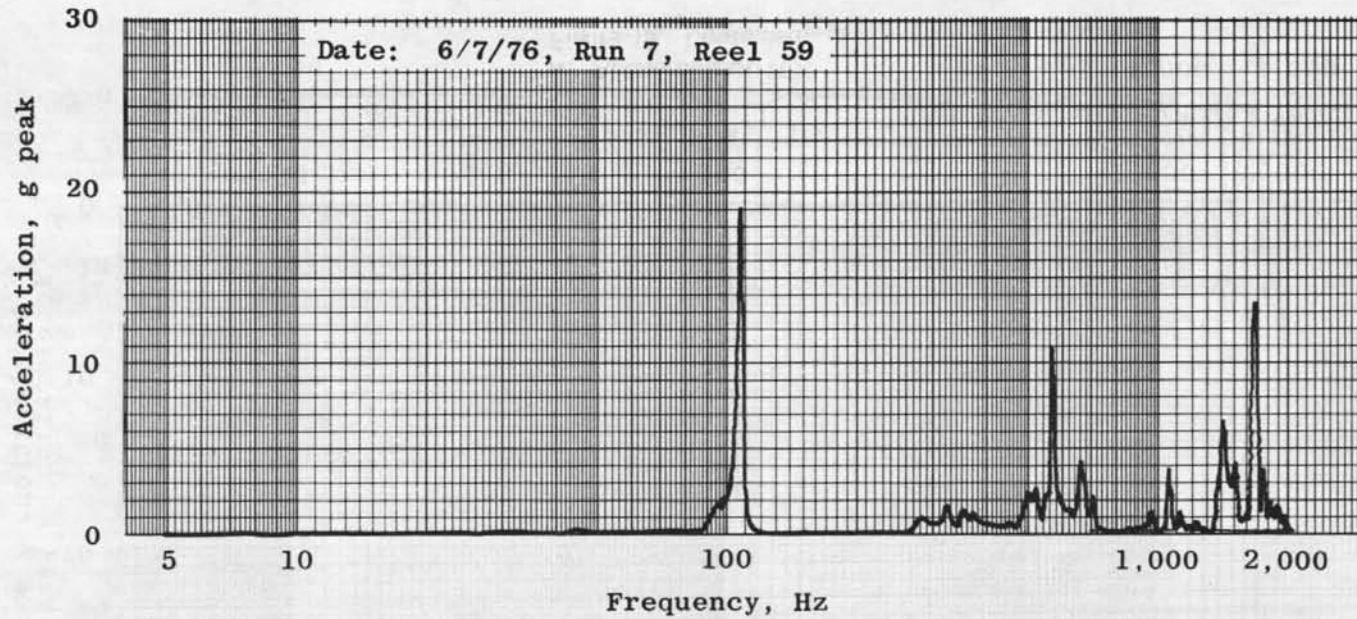

v. Accelerometer 15X
Figure 18. Continued.

144

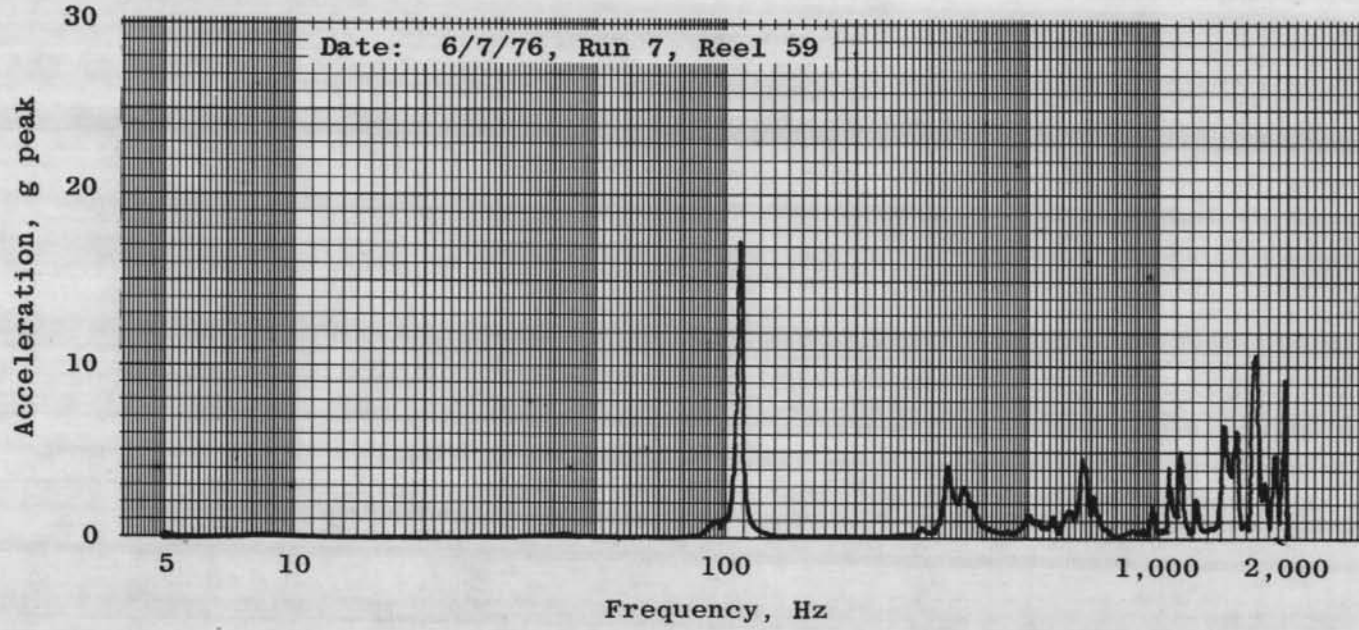

w. Accelerometer 16X
Figure 18. Continued.

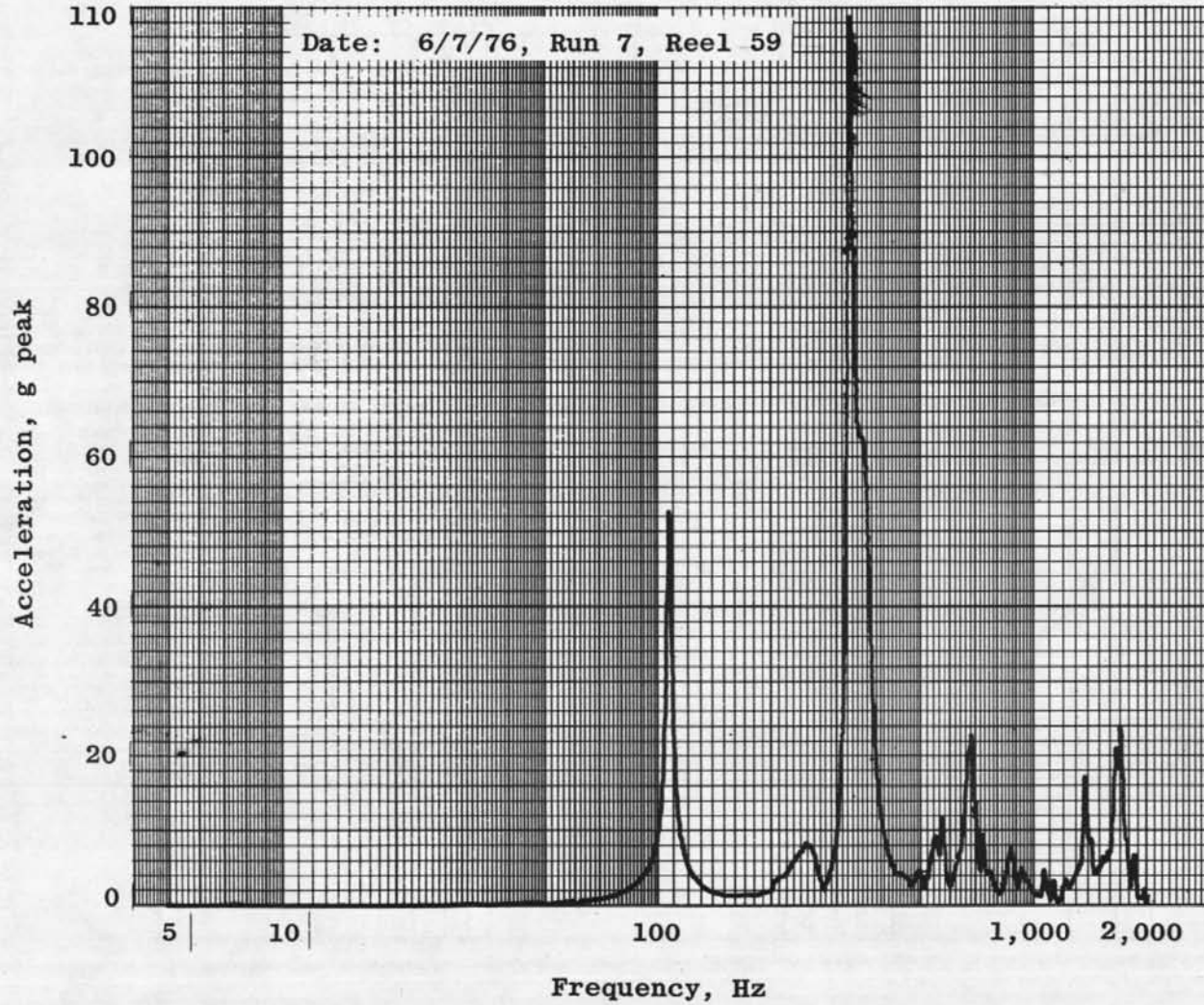

x. Accelerometer 13Z
Figure 18. Concluded.

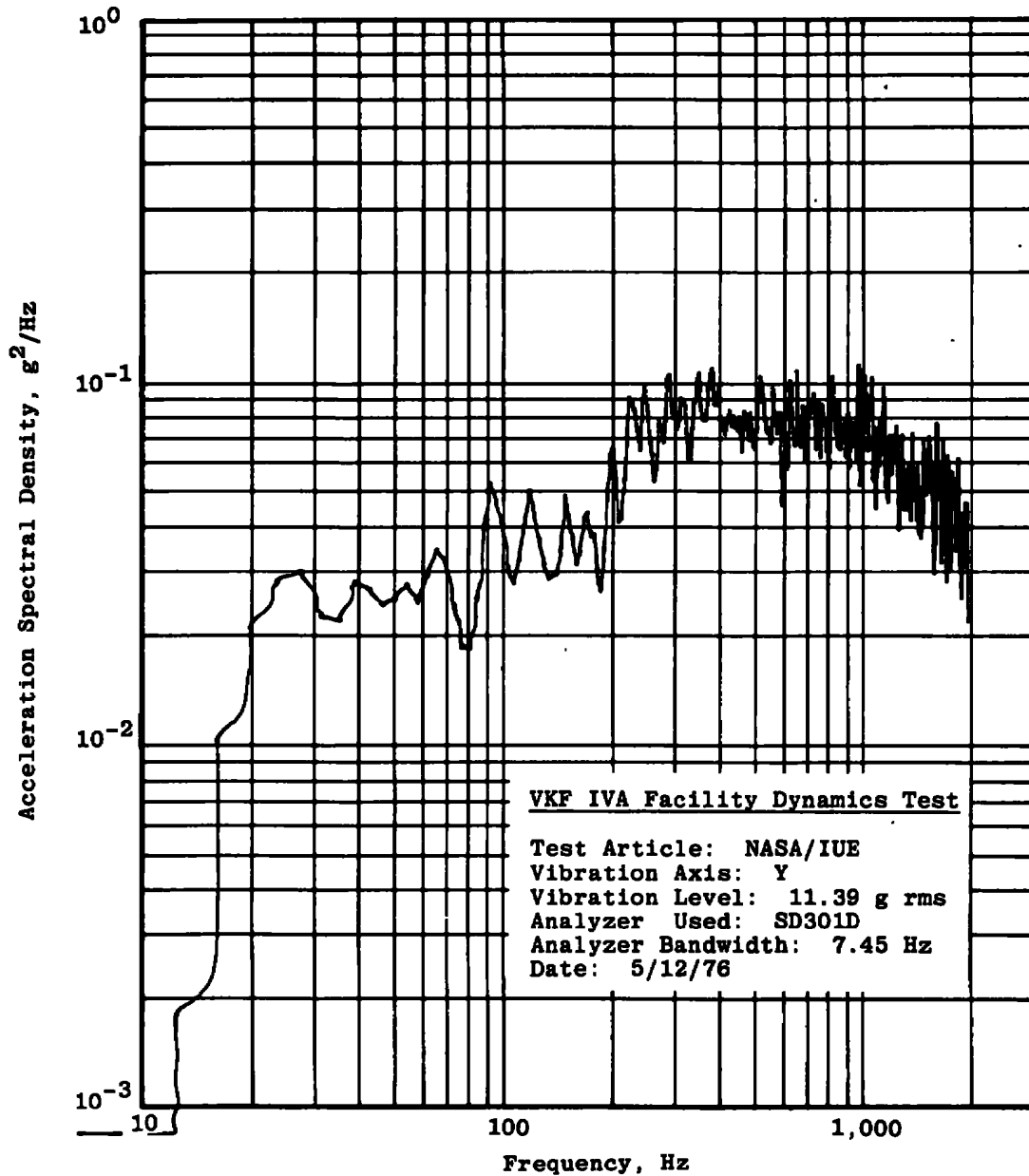

a. Closed loop plot

Figure 19. Y-axis vibration test: qualification level random vibration.

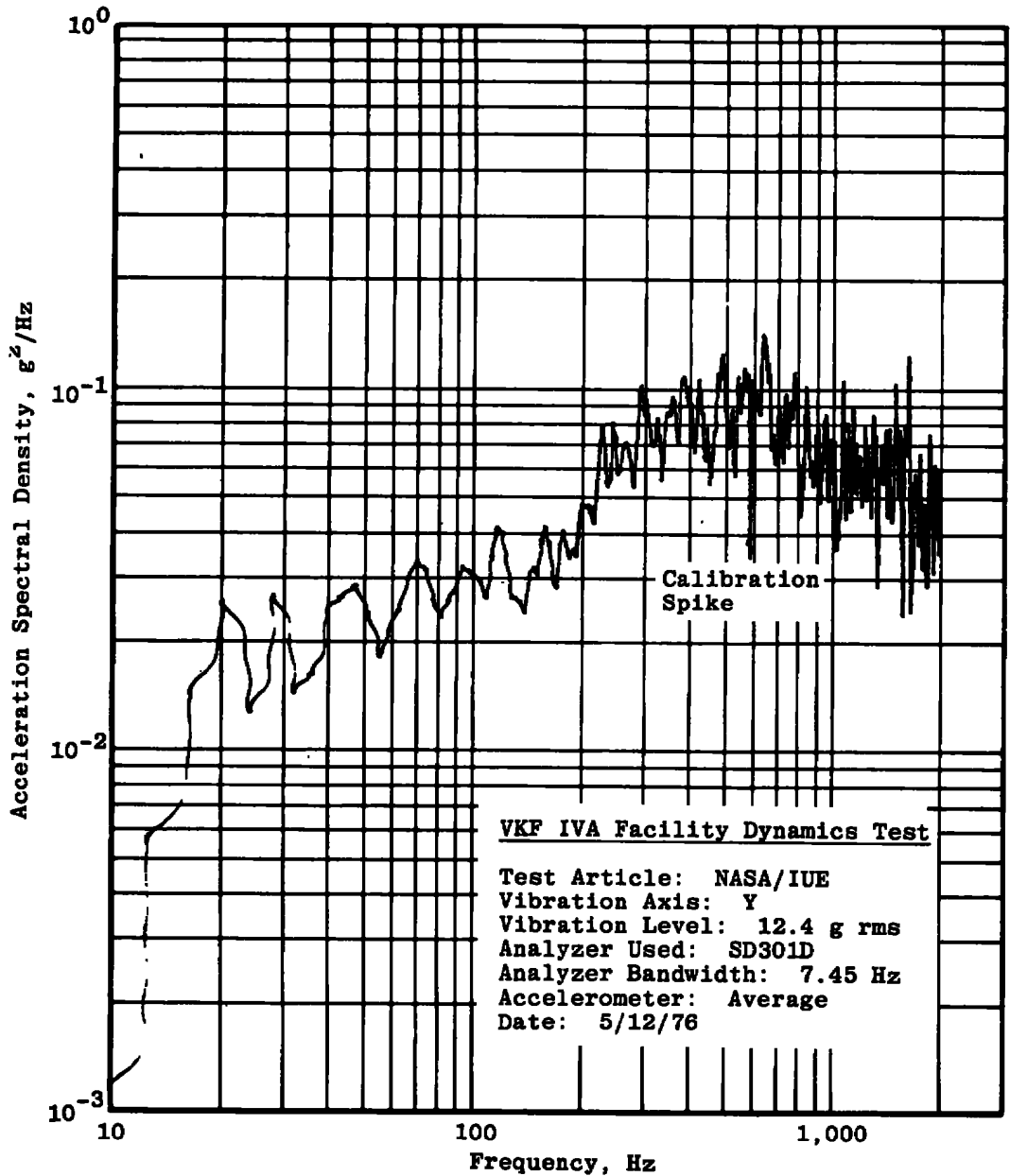

b. Online plot
 Figure 19. Continued.

<u>Accelerometer</u>	<u>g rms</u>
Average	12.2
1Y	8.5
2Y	14.5
3Y	7.5
4Y	14.5
5Y	13.5
6Y	5.7
7Y	14.5
8Y	10.5
9Y	10.5
11Y	20 to 30
12Y	20 to 30
13Y	18 to 25
14Y	20 to 25
15Y	12 to 16
16Y	12.5 to 17.5
6X	12.5
13X	5.5 to 7
14X	5 to 7
15X	4 to 4.5
16X	3.5 to 4.5
13Z	23 to 26
Safety	14.5

c. Y-axis, random; 5/12/76
Figure 19. Concluded.

VKF IVA Facility Dynamics Test

Test Article: NASA/IUE

Vibration Axis: Y

Tracking Filter: SD1012B

BW₁: 5 Hz from 5 to 45 Hz

BW₂: 50 Hz from 45 to 2,000 Hz

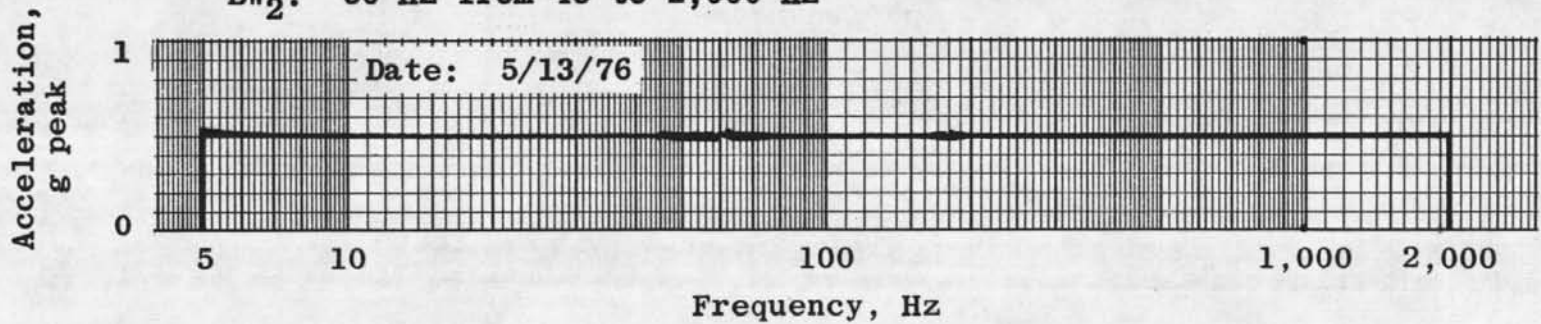

a. Closed loop plot

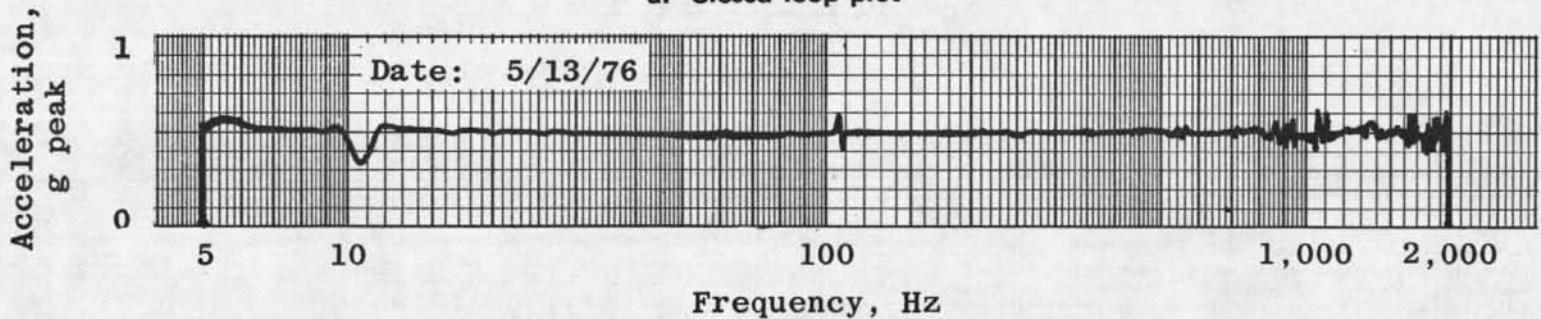

b. Accelerometers averaged, online
Figure 20. Y-axis vibration test: 0.5-g sine survey.

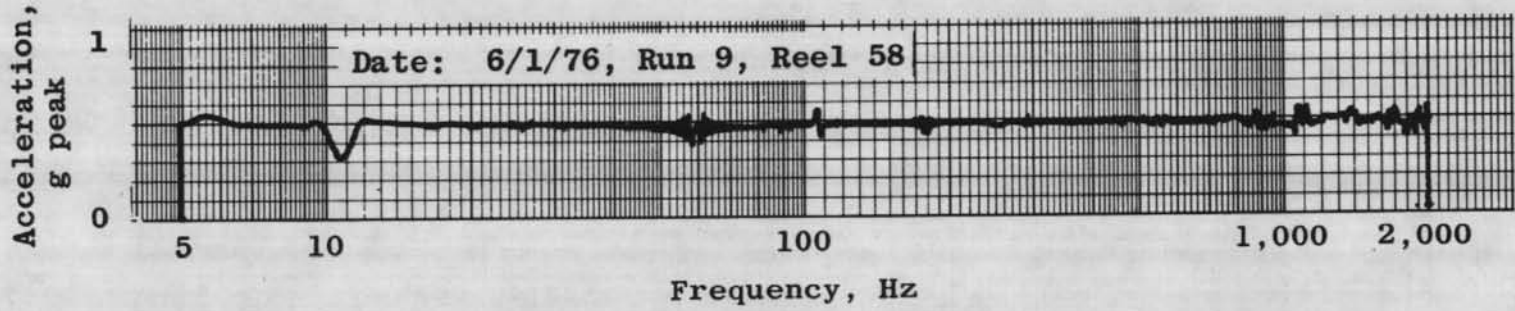

c. Accelerometers averaged

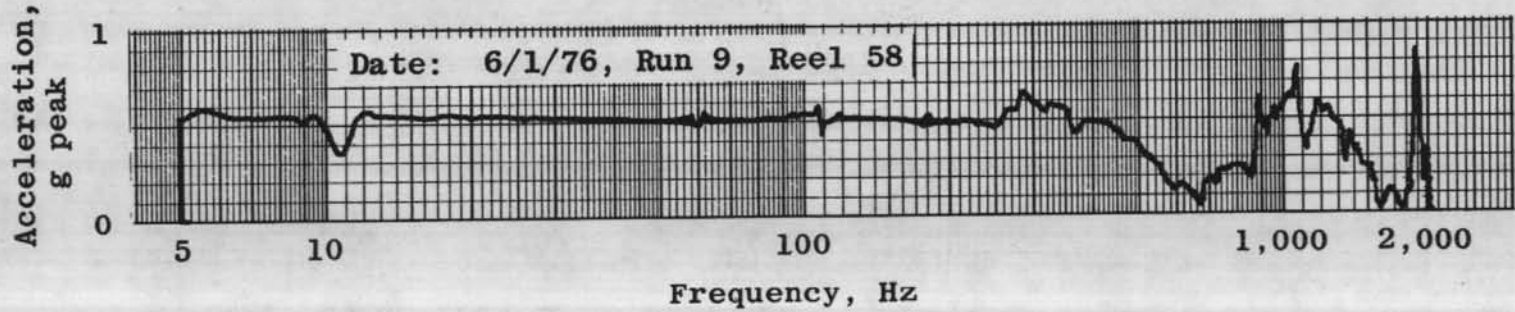

d. Accelerometer 1Y
Figure 20. Continued.

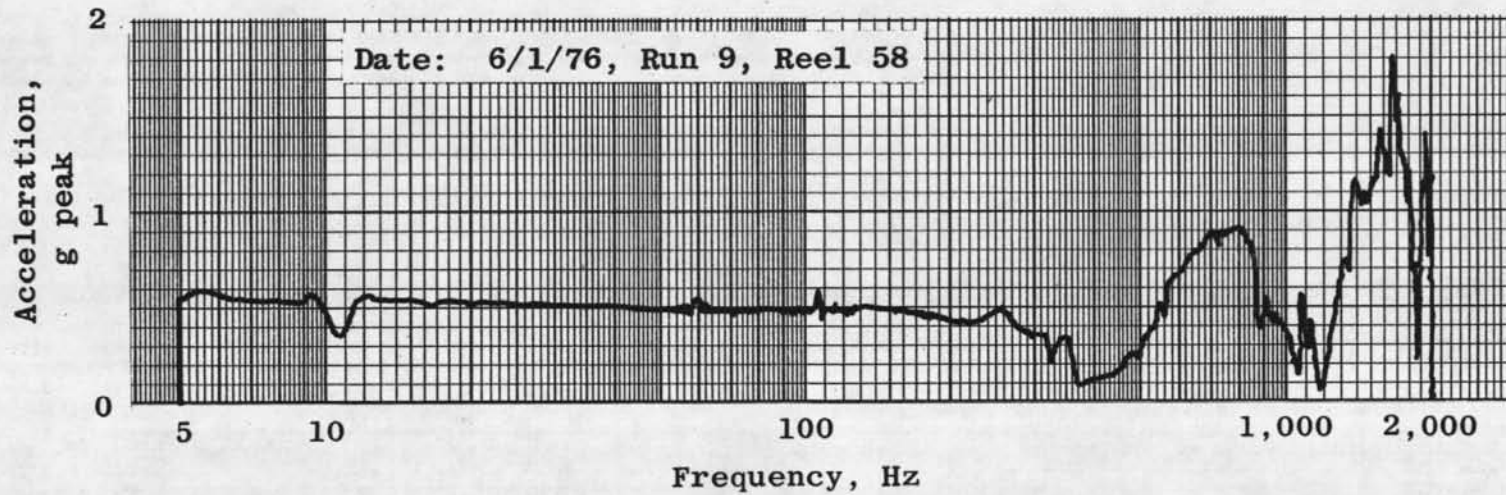

e. Accelerometer 2Y

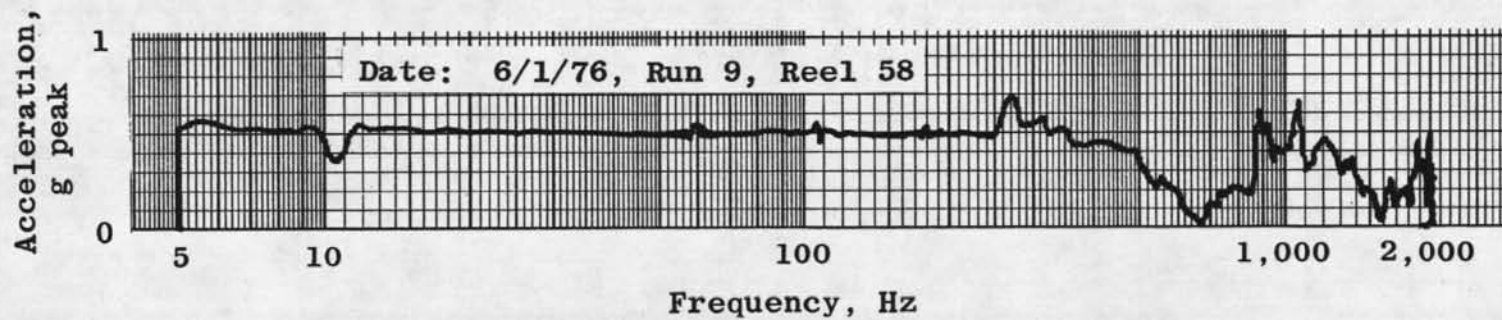
f. Accelerometer 3Y
Figure 20. Continued.

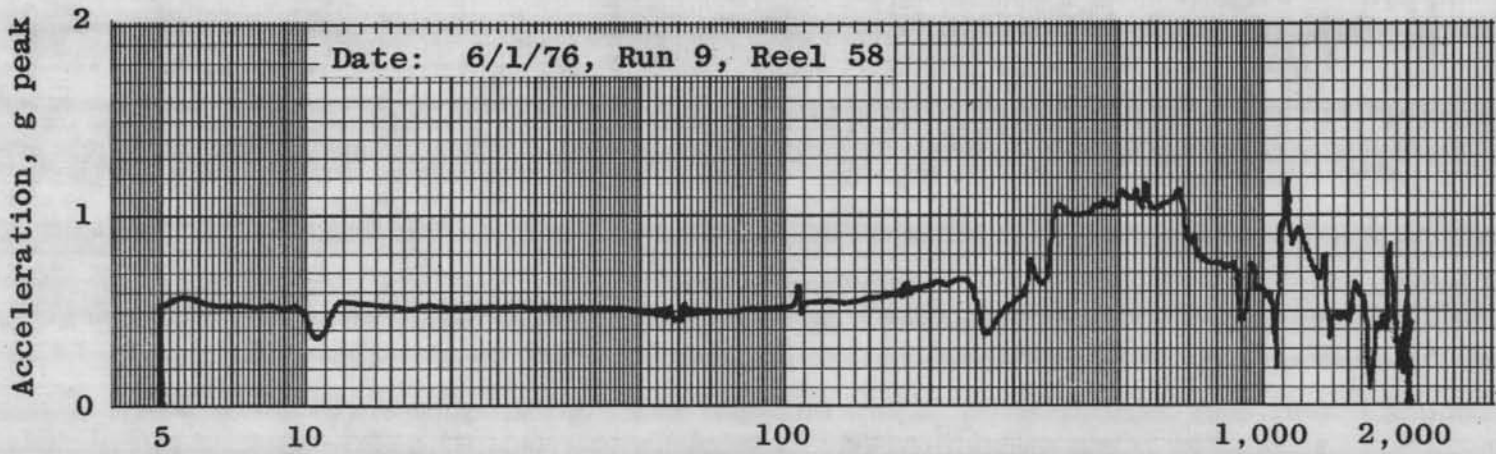

Frequency, Hz
g. Accelerometer 4Y
Figure 20. Continued.

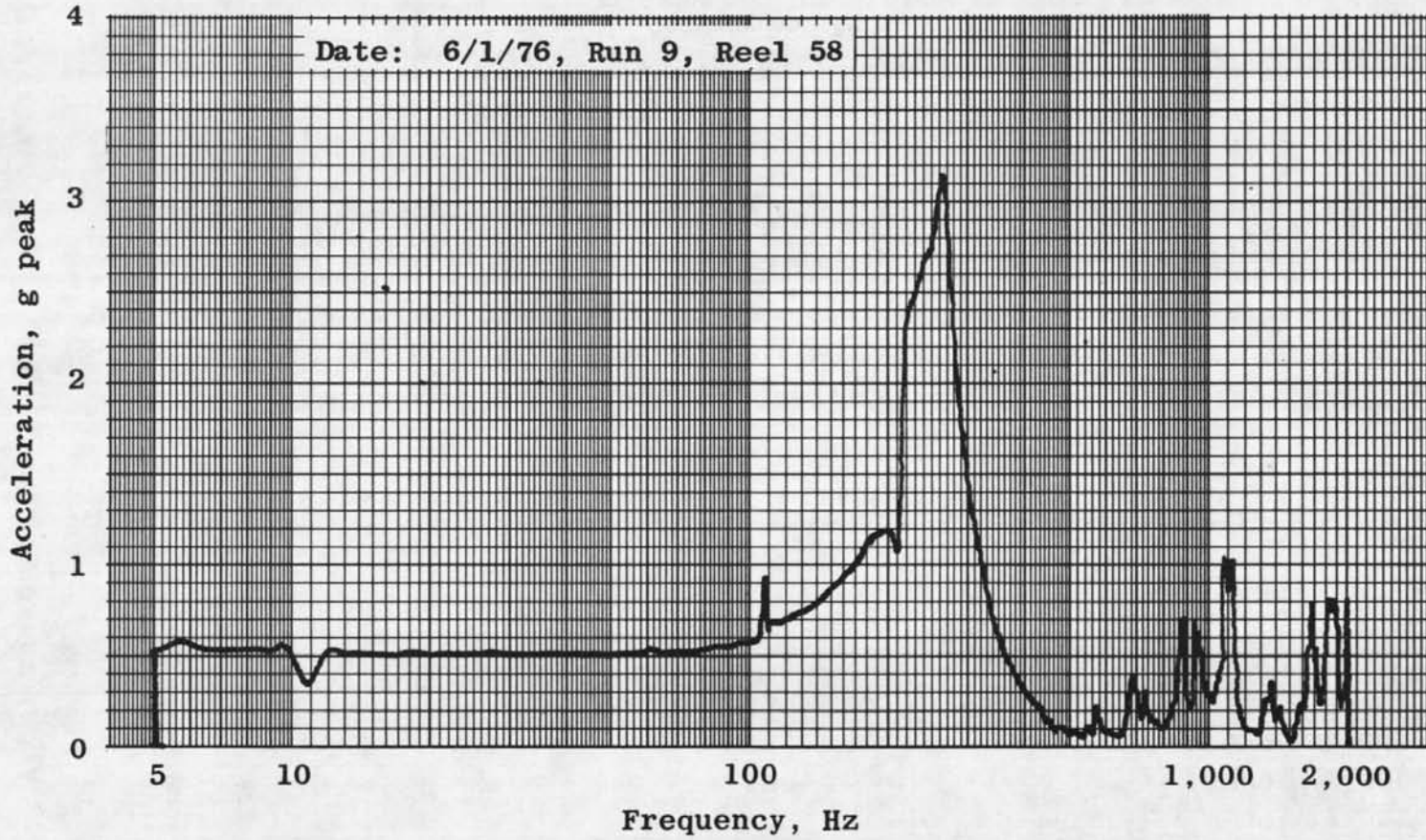

h. Accelerometer 5Y
Figure 20. Continued.

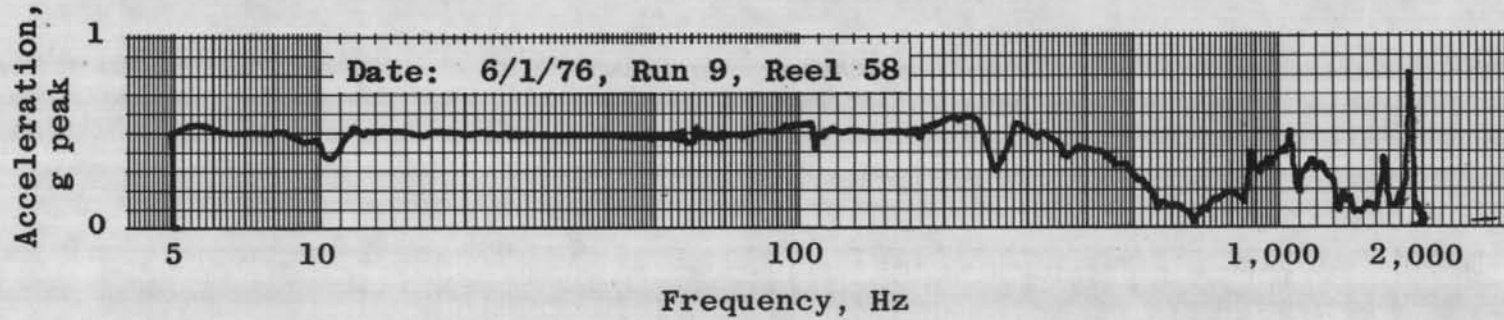

i. Accelerometer 6Y

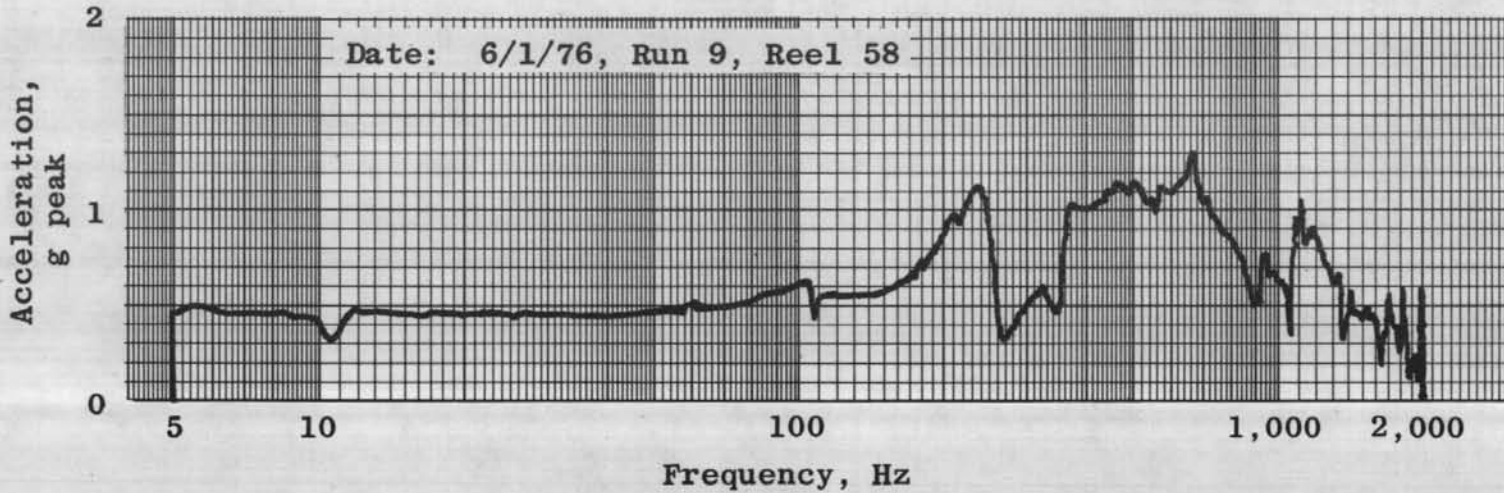

j. Accelerometer 7Y
Figure 20. Continued.

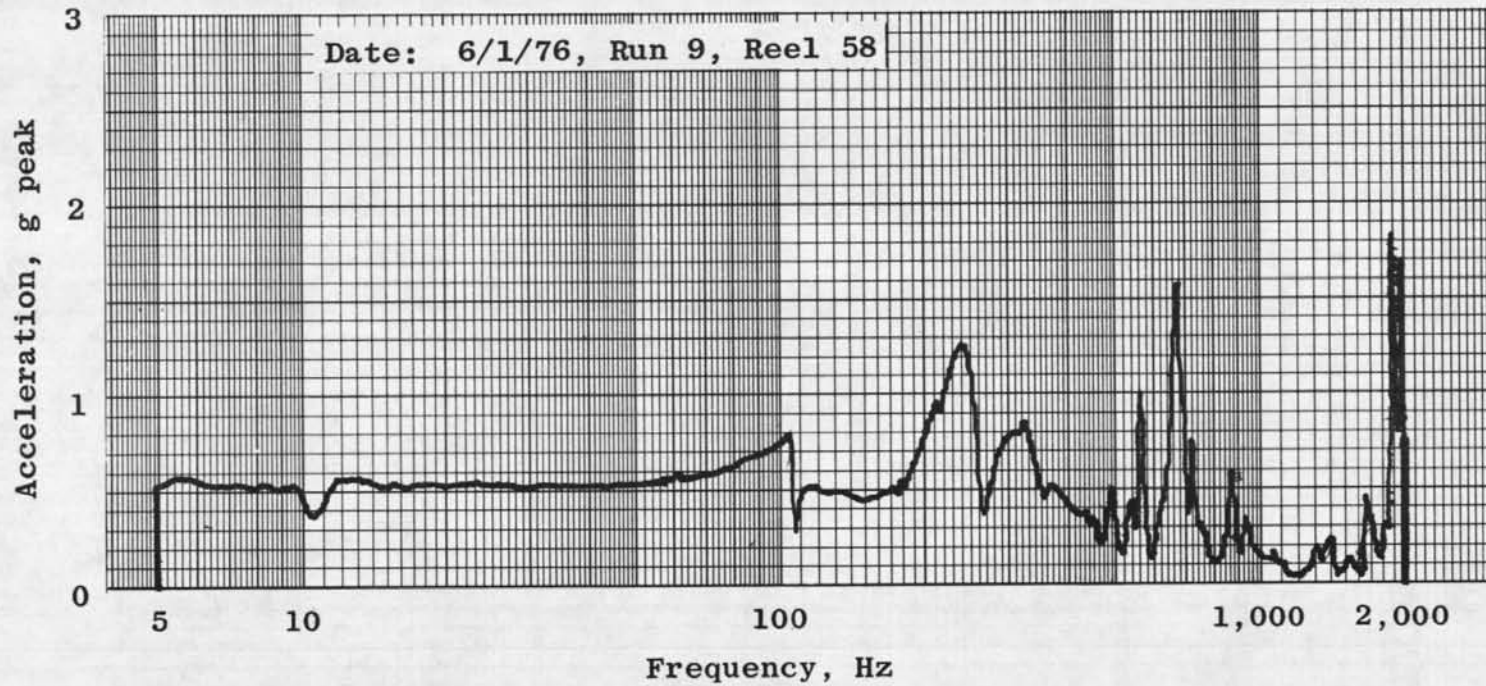

k. Accelerometer 8Y
Figure 20. Continued.

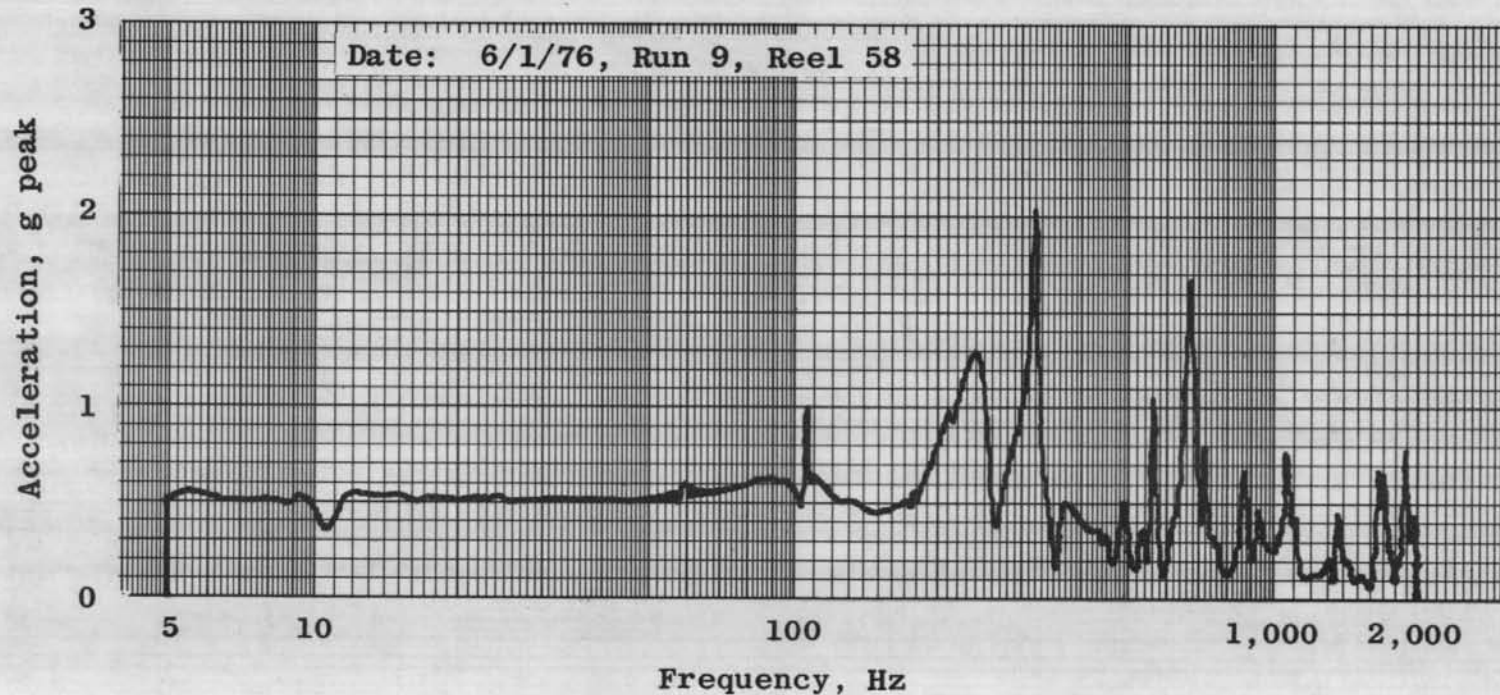

I. Accelerometer 9Y
Figure 20. Continued.

157

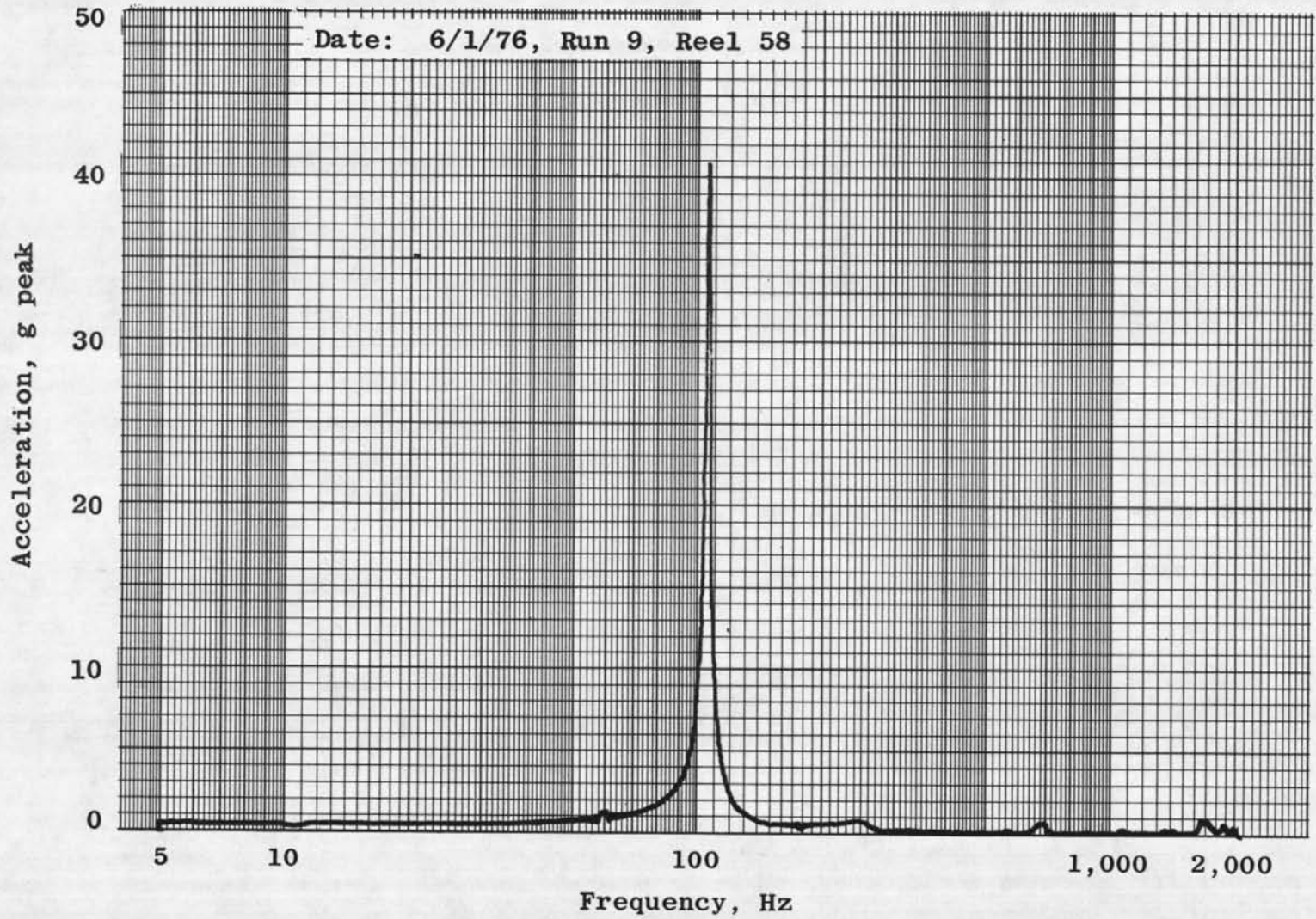

m. Accelerometer 11Y
Figure 20. Continued.

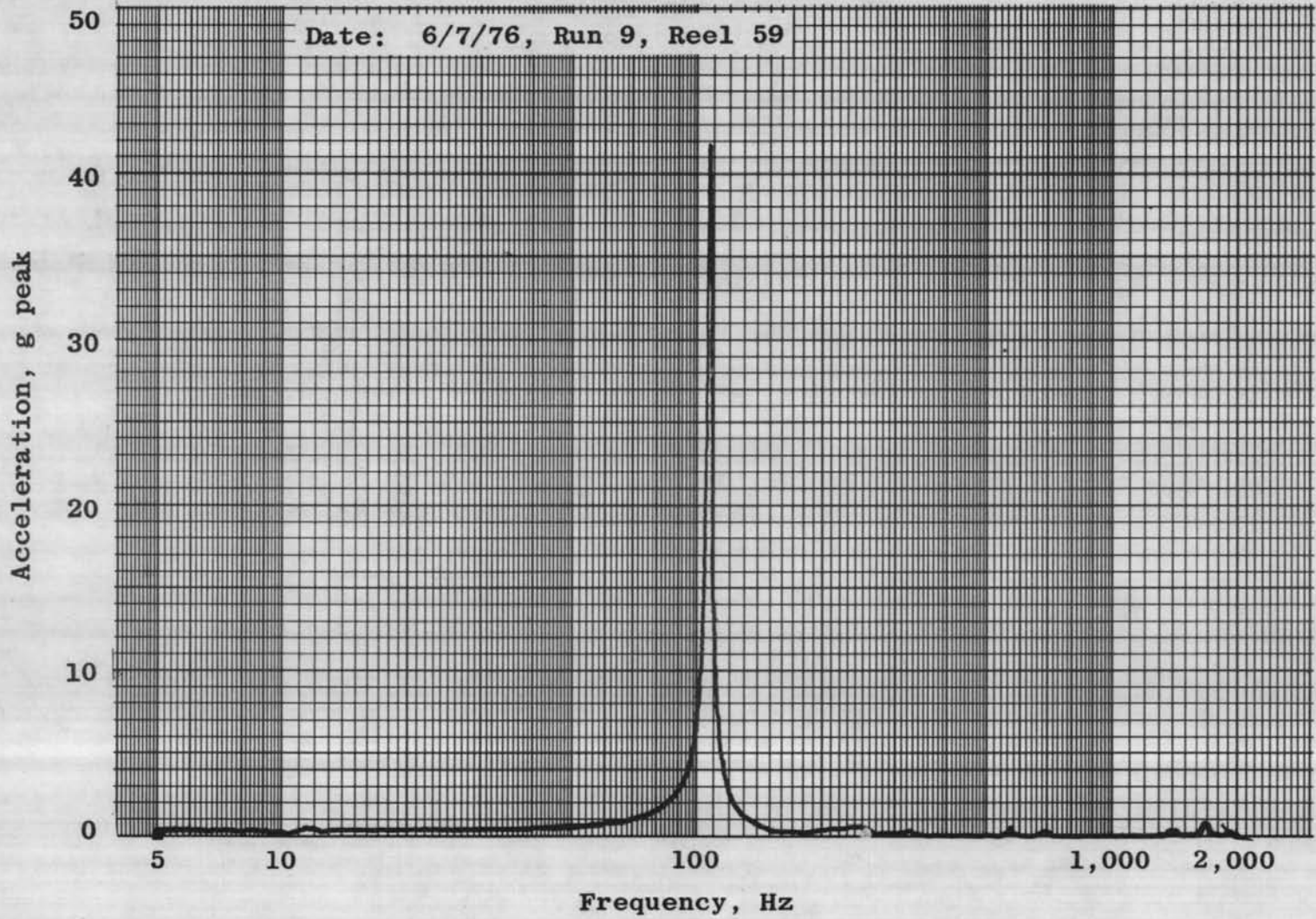

n. Accelerometer 12Y
Figure 20. Continued.

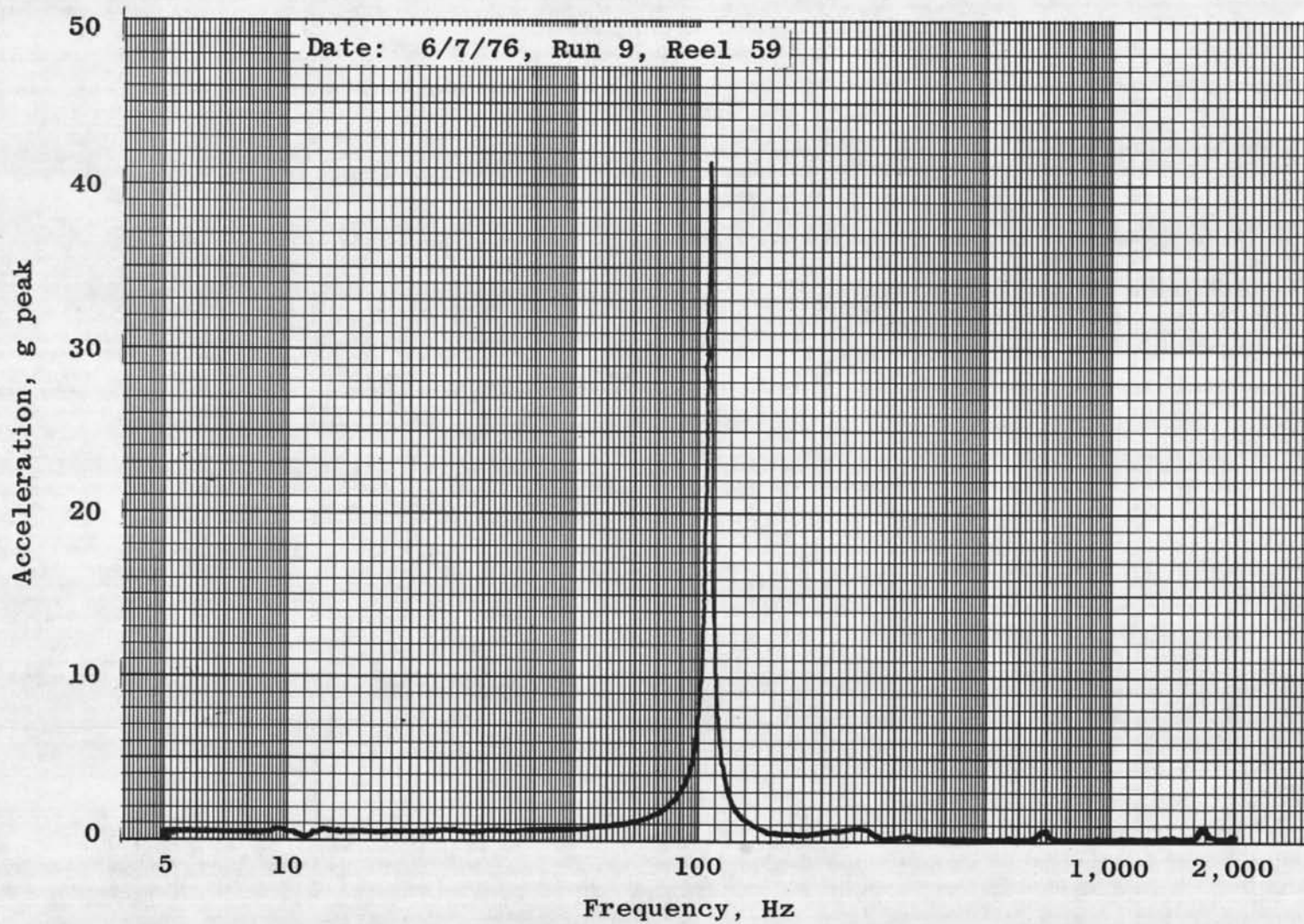

o. Accelerometer 13Y
Figure 20. Continued.

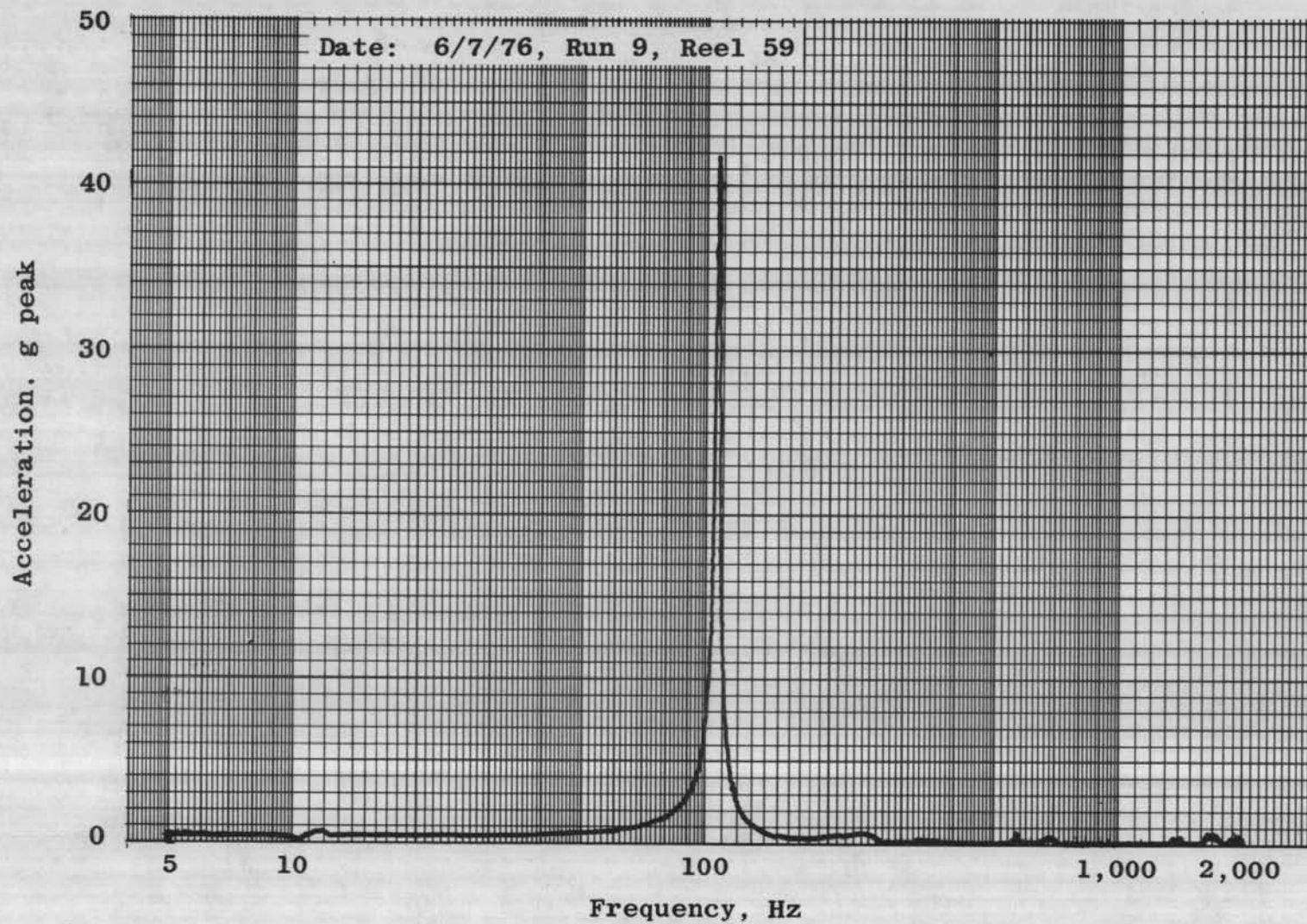

p. Accelerometer 14Y
Figure 20. Continued.

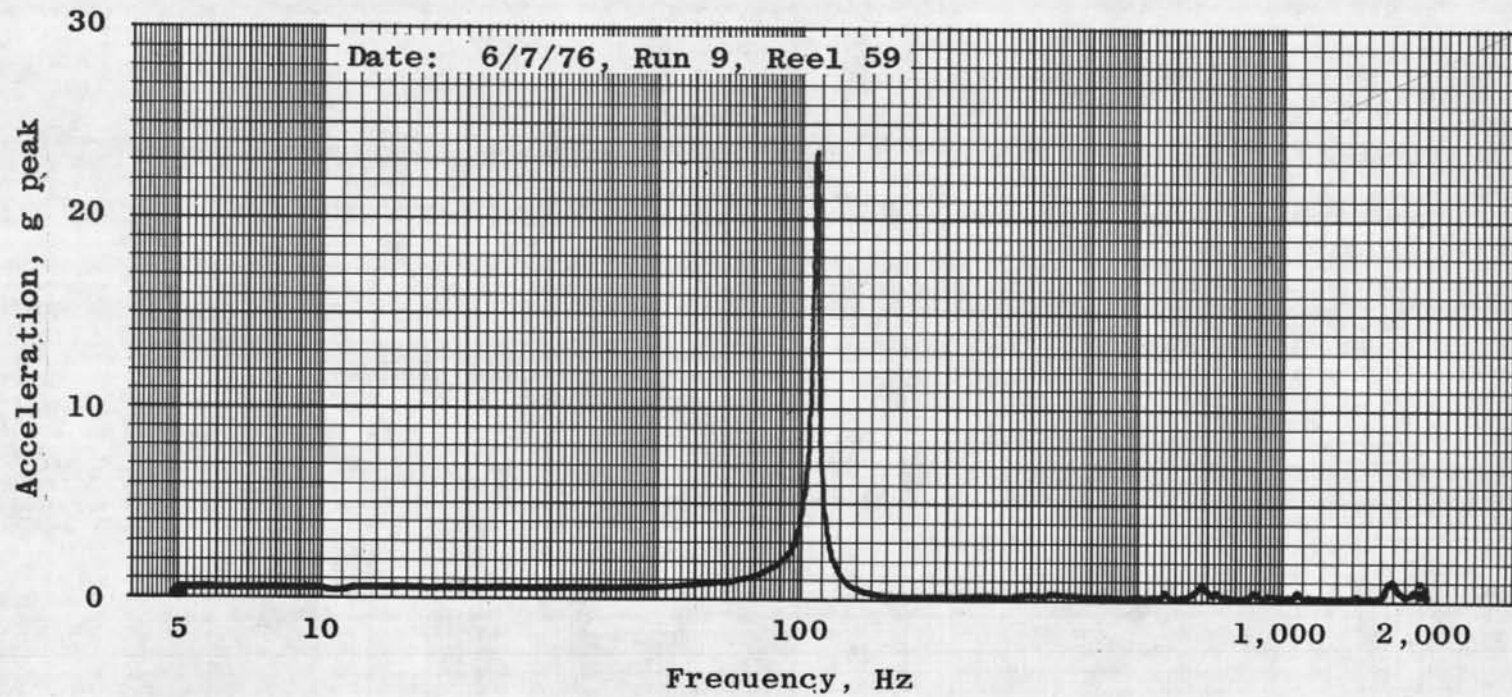

q. Accelerometer 15Y
Figure 20. Continued.

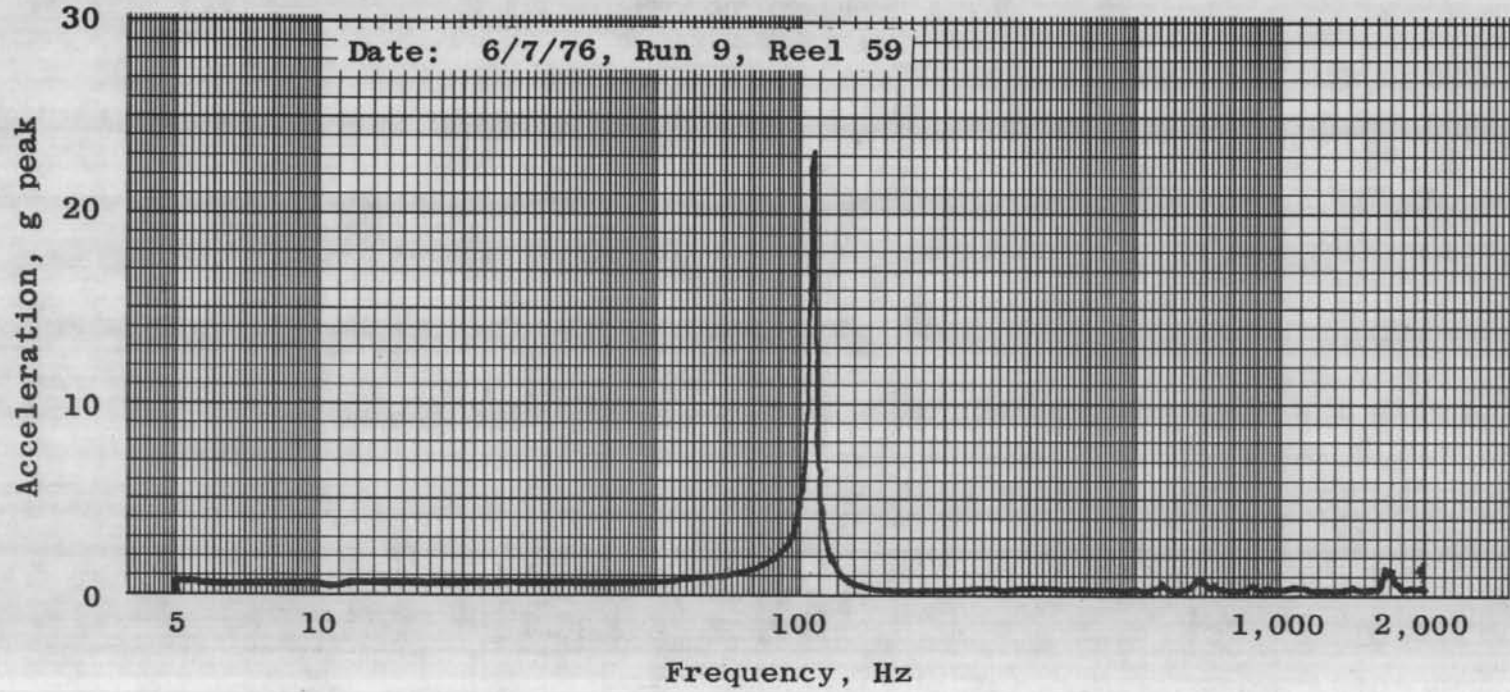

r. Accelerometer 16Y
Figure 20. Continued.

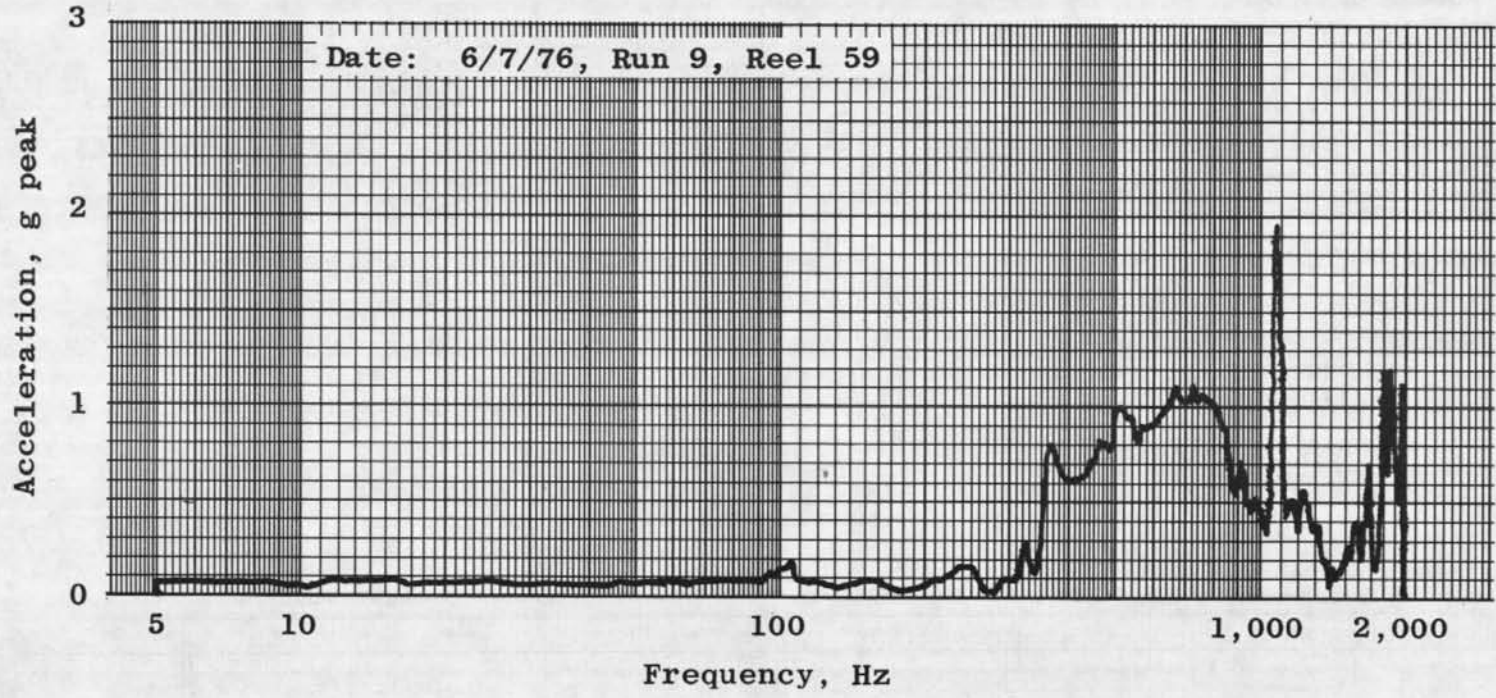

s. Accelerometer 6X
Figure 20. Continued.

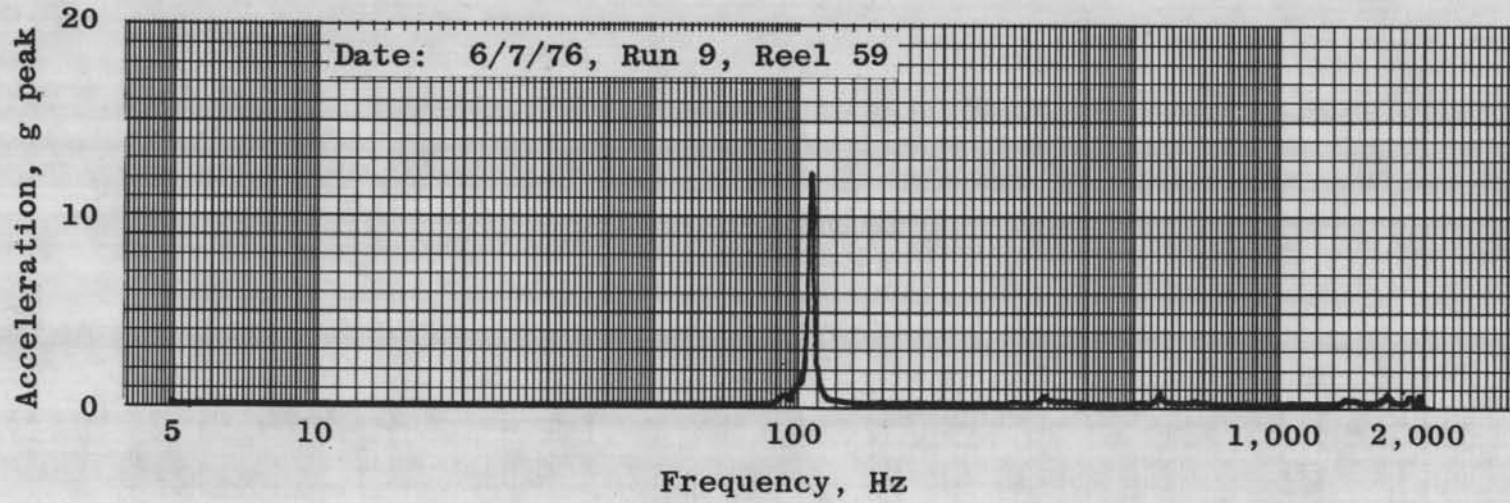

t. Accelerometer 13X

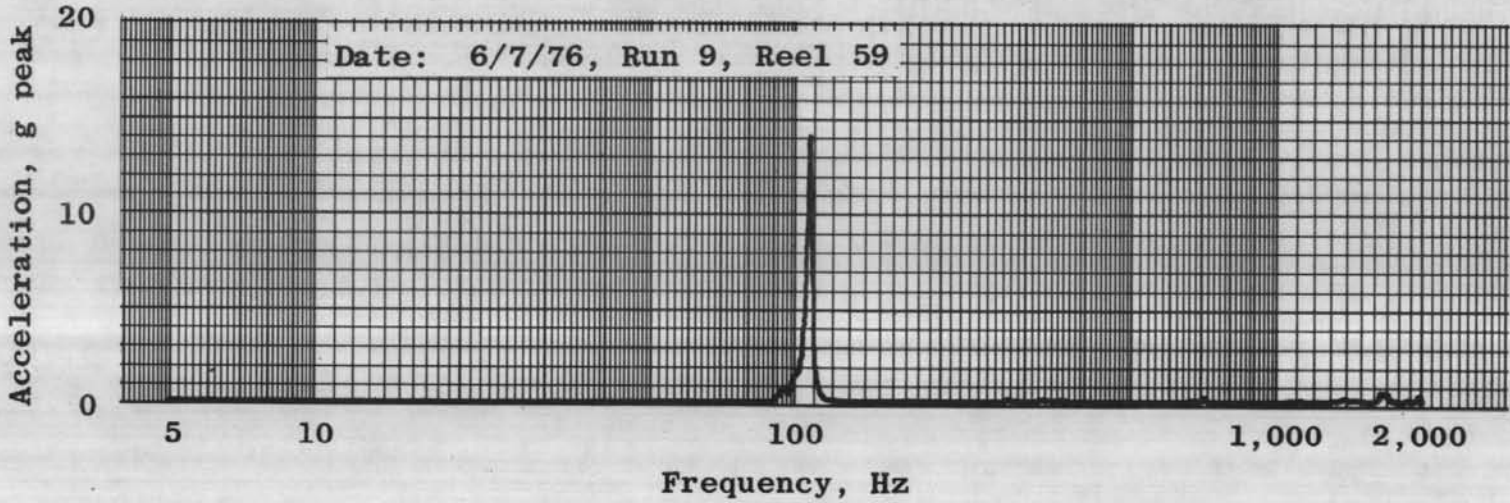

u. Accelerometer 14X

Figure 20. Continued.

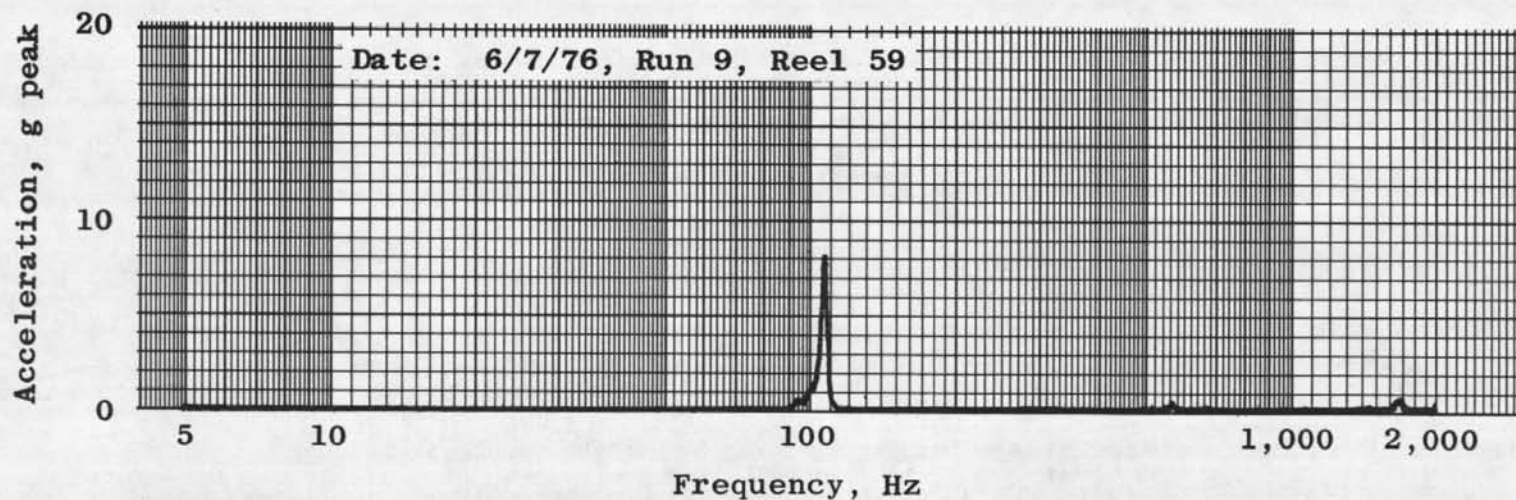

v. Accelerometer 15X

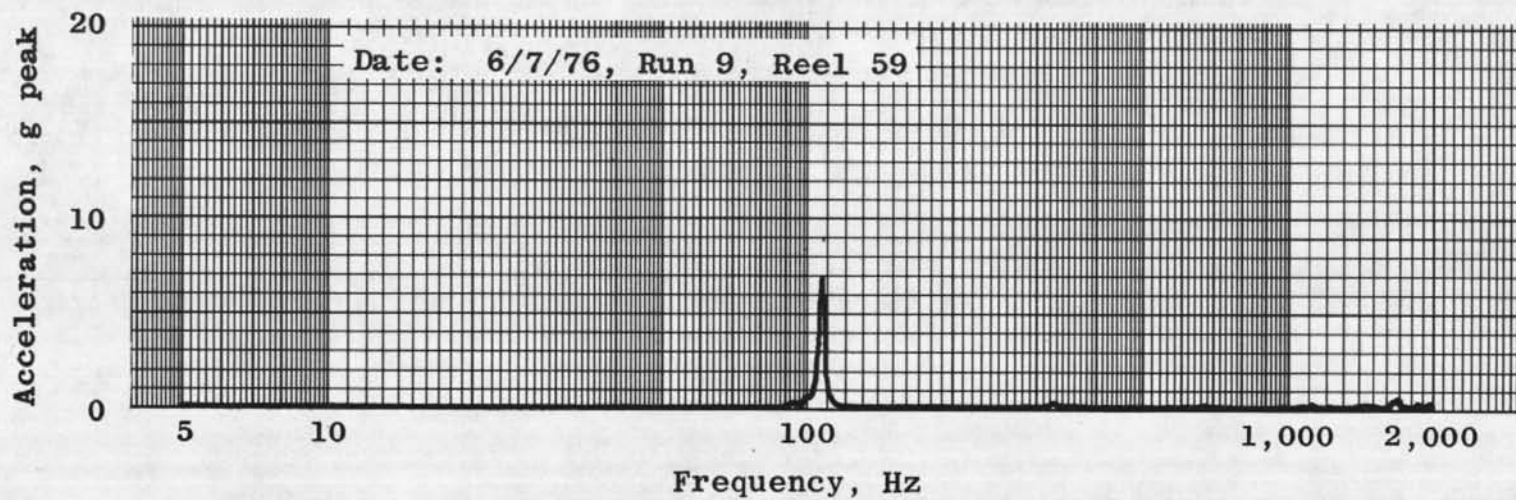

w. Accelerometer 16X
Figure 20. Continued.

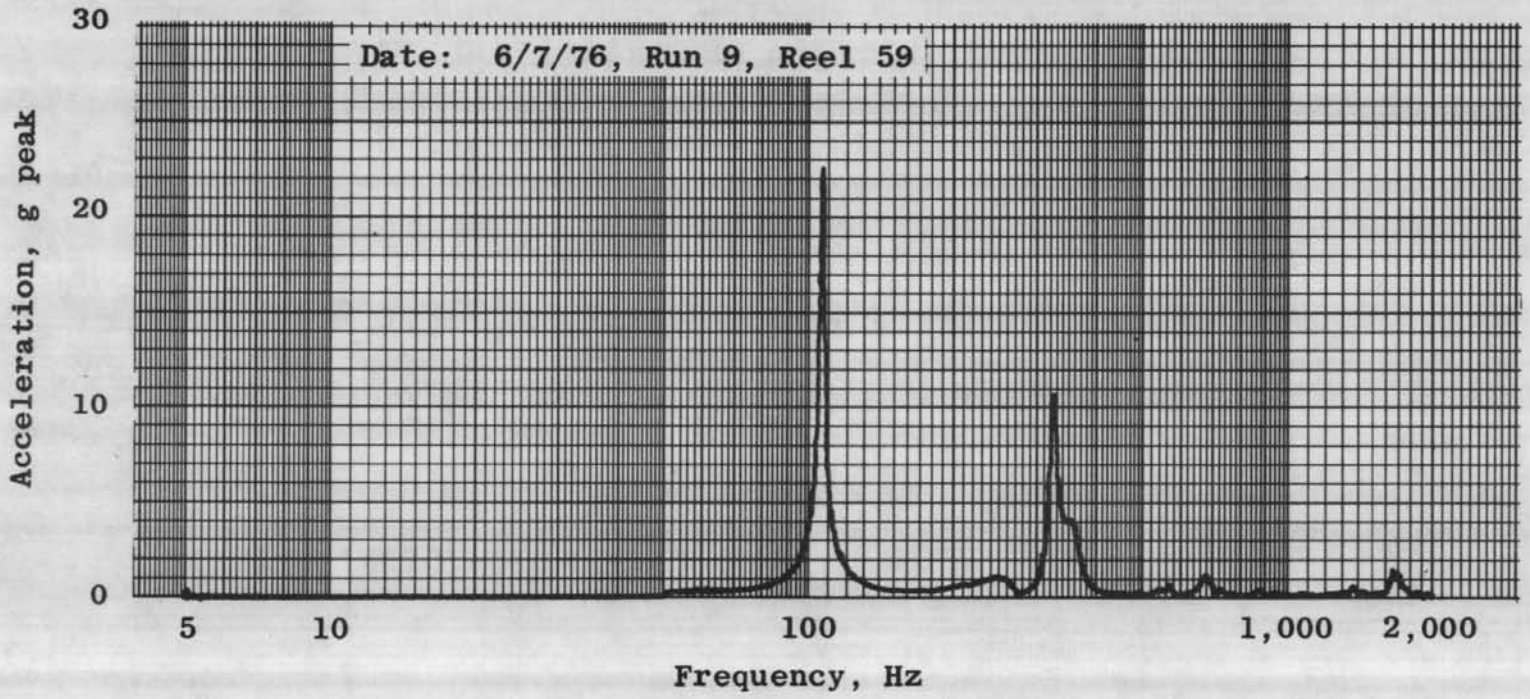

x. Accelerometer 13Z
Figure 20. Concluded.

VKF IVA Facility Dynamics Test

Test Article: NASA/IUE
Vibration Axis: Z
Tracking Filter: SD1012B
BW₁: 5 Hz from 5 to 75 Hz
BW₂: 50 Hz from 75 to 2,000 Hz

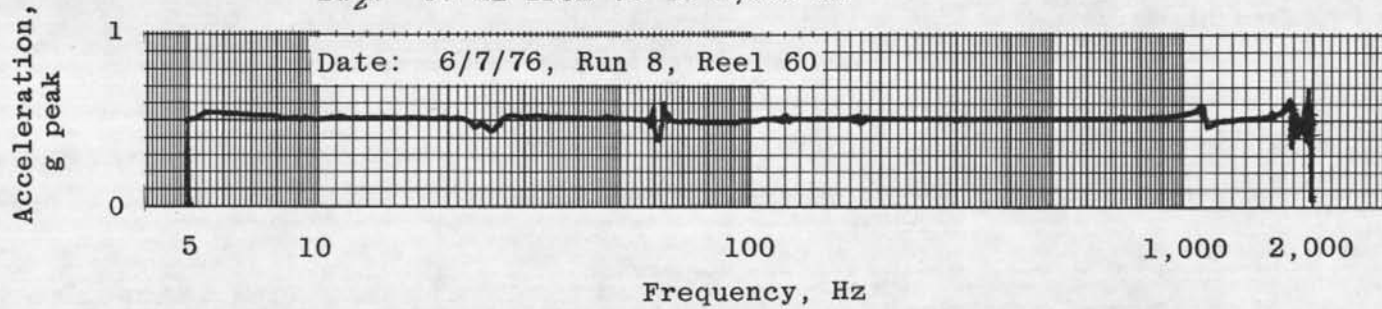

a. Accelerometer: Average Z

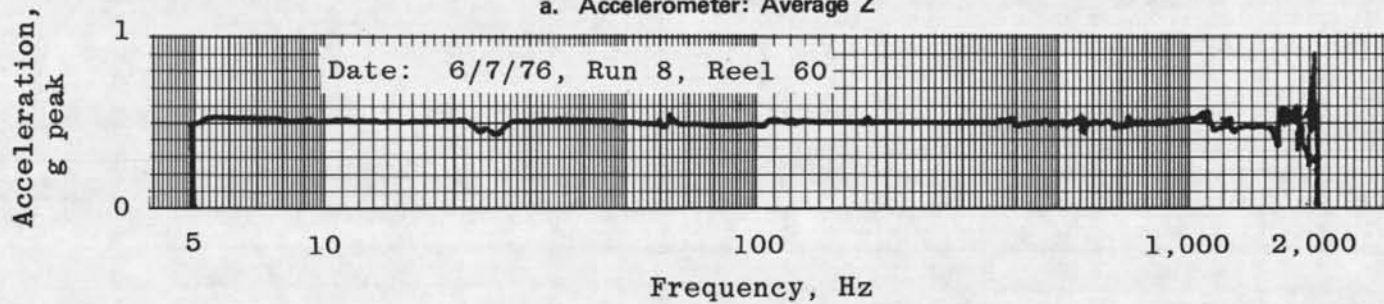

b. Accelerometer 1Z

Figure 21. Thrust axis fixture evaluation: 0.5-g sine survey, bare fixture.

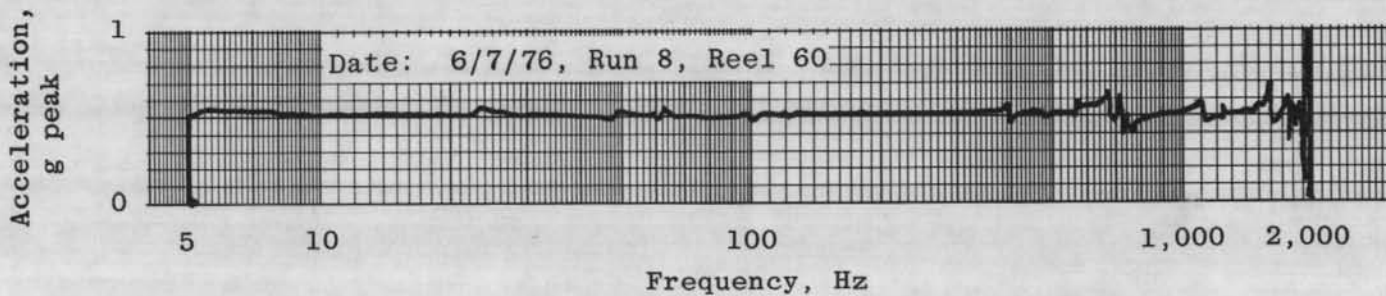

c. Accelerometer 2Z

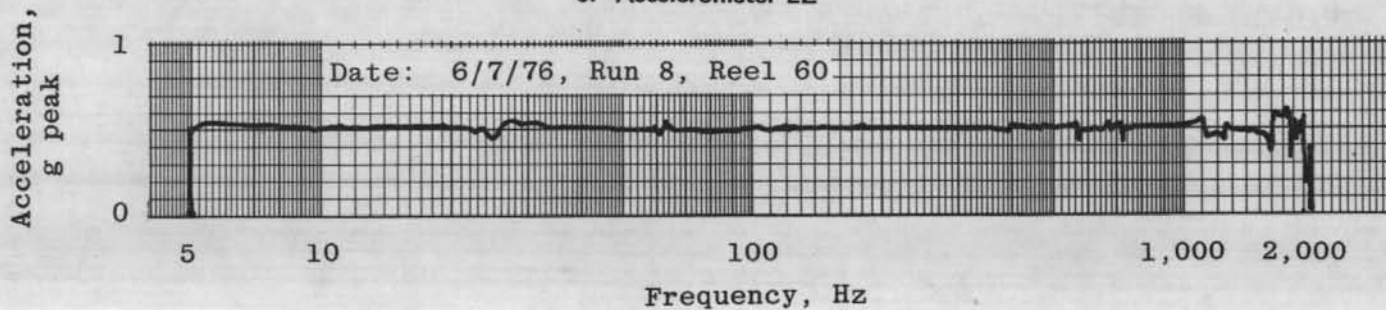

d. Accelerometer 3Z
Figure 21. Continued.

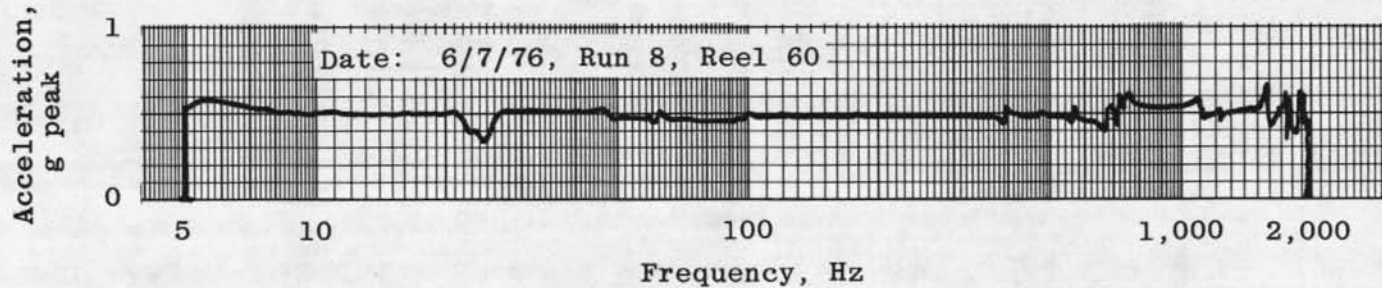

e. Accelerometer 4Z

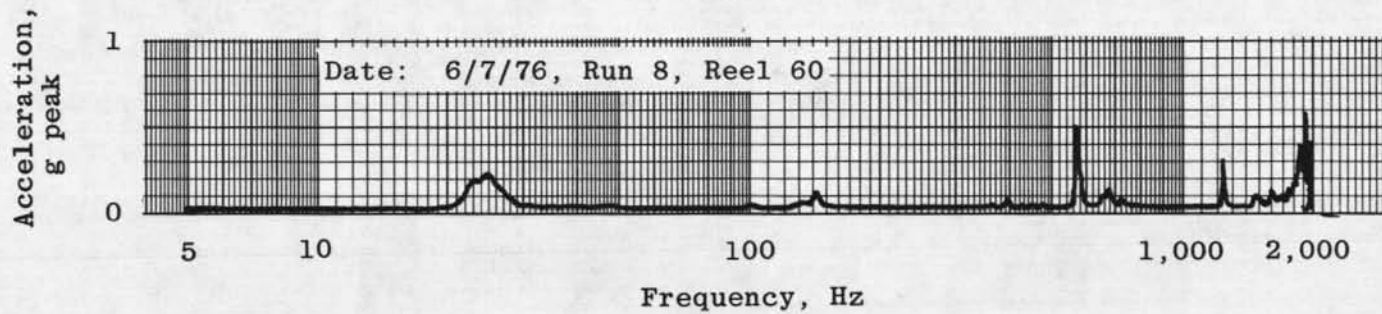
f. Accelerometer 1X
Figure 21. Continued.

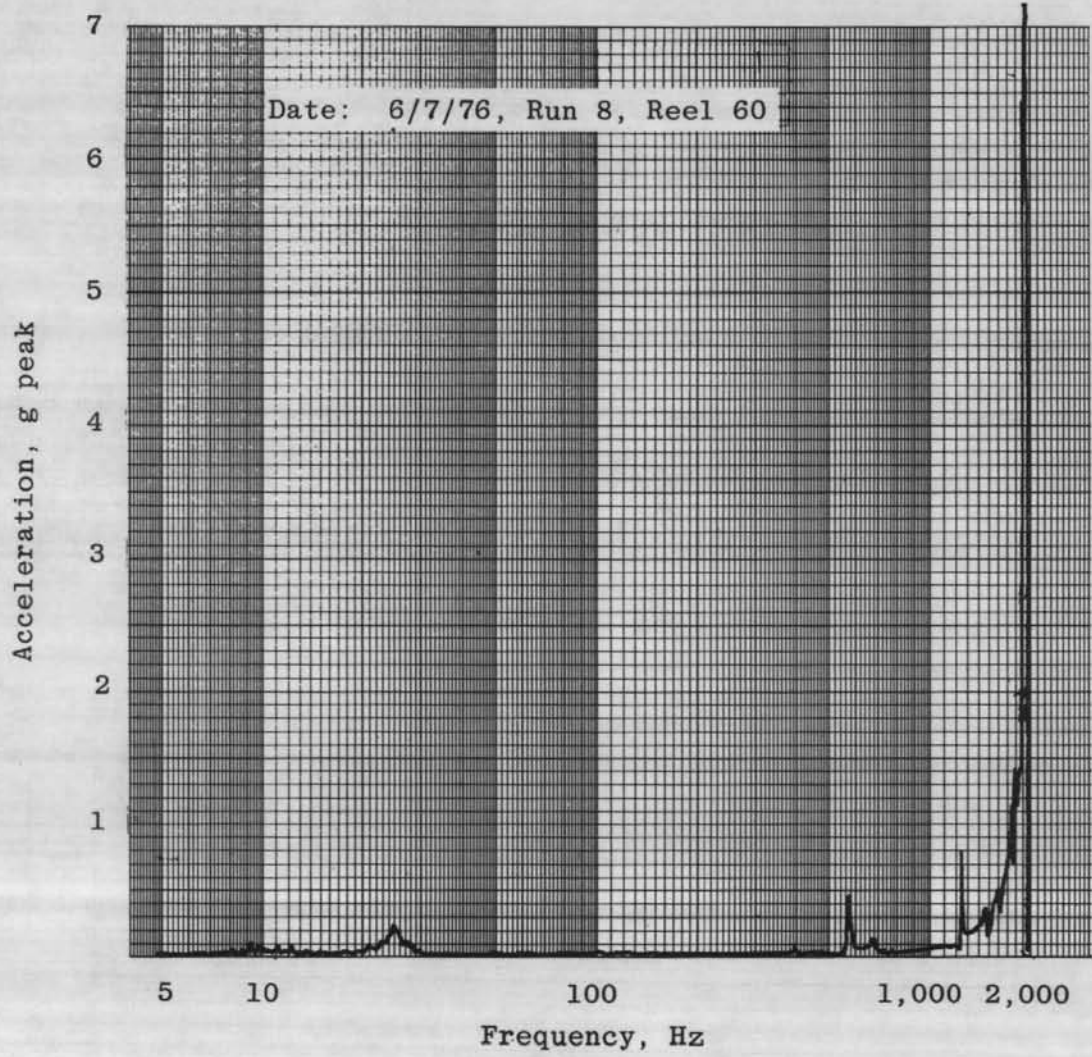

g. Accelerometer 2X
Figure 21. Continued.

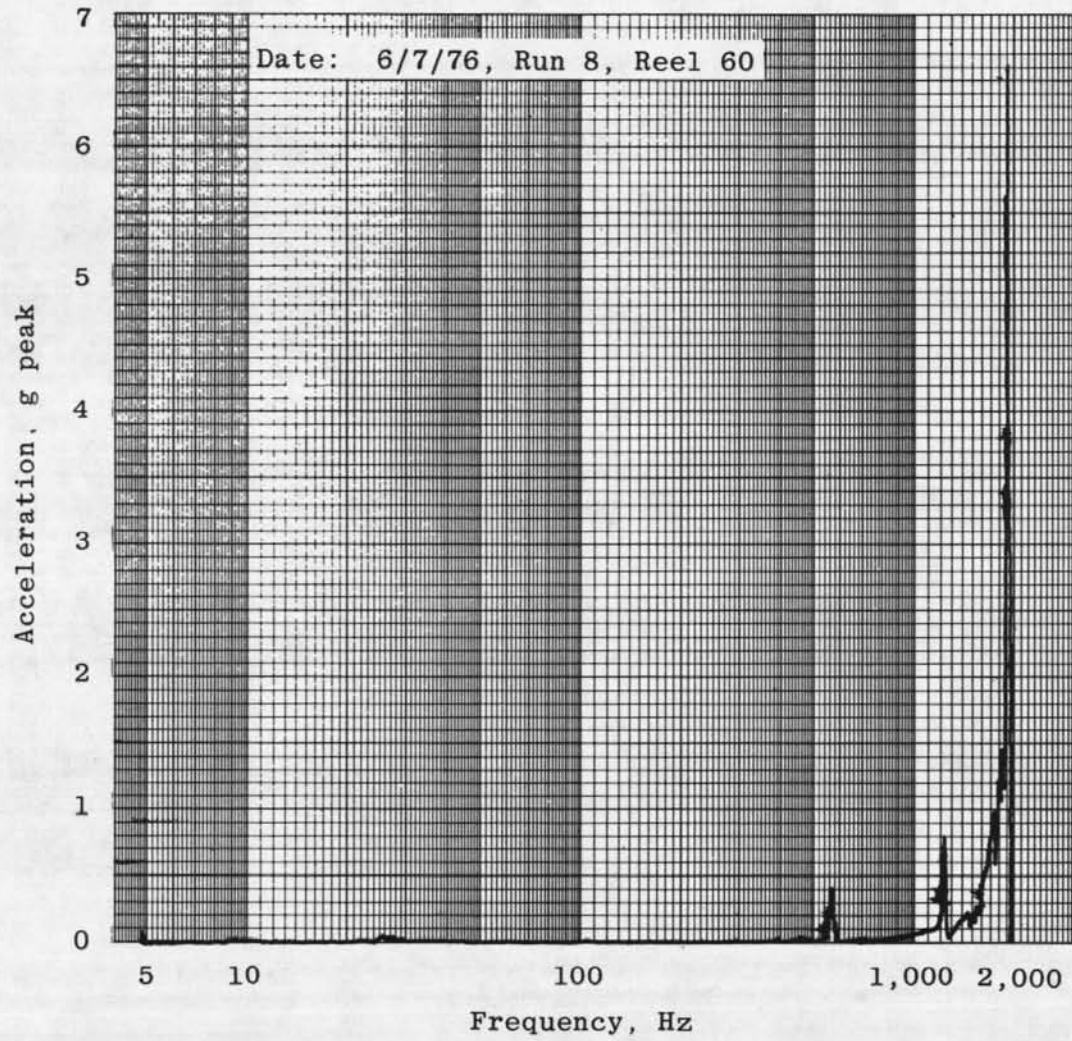

h. Accelerometer 1Y
Figure 21. Continued.

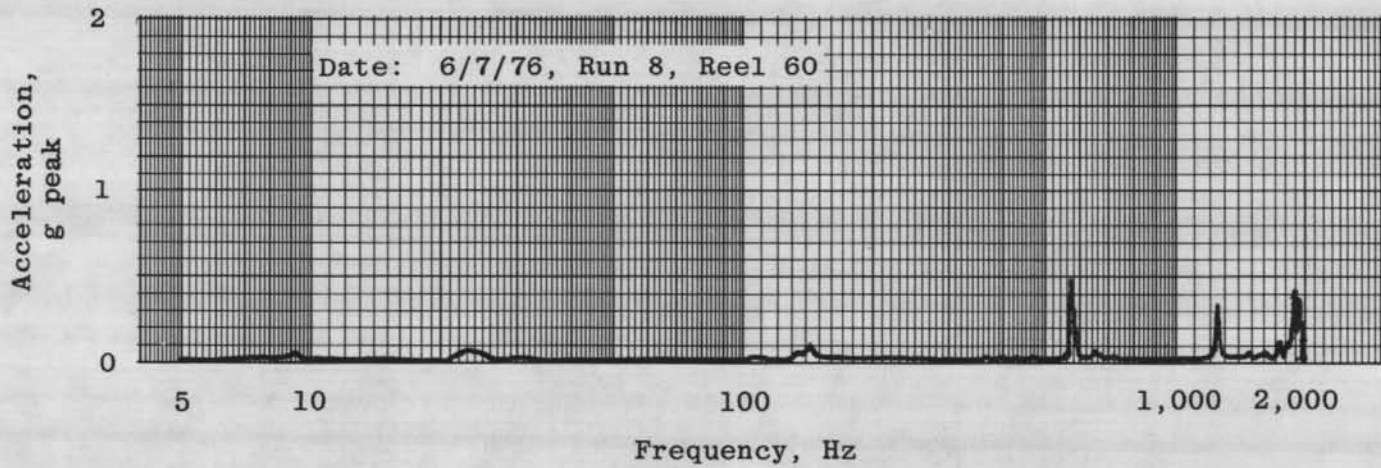

i. Accelerometer 2Y
Figure 21. Concluded.

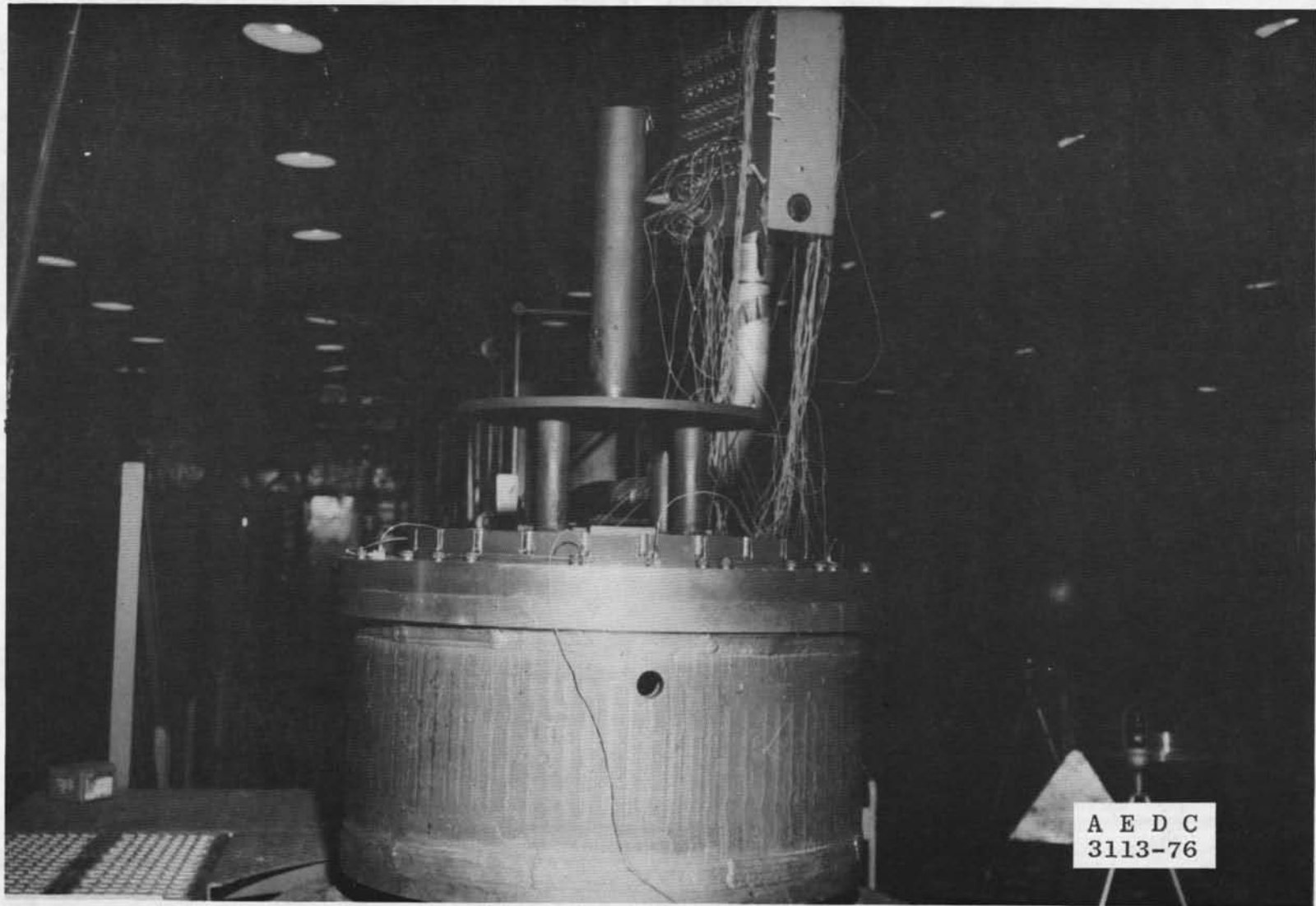

Figure 22. Thrust axis installation photographs: mass simulator.

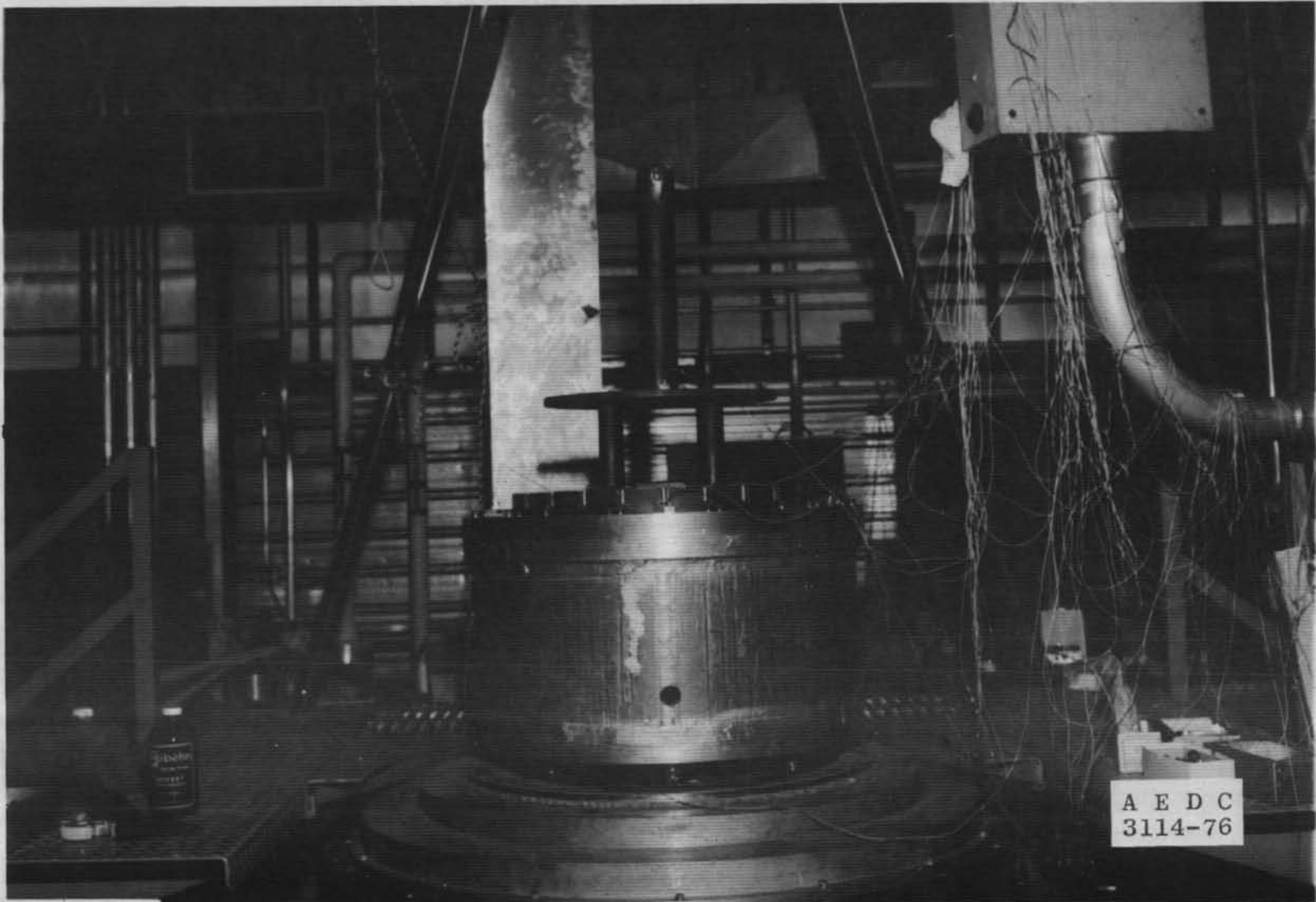

Figure 22. Continued.



Figure 22. Concluded.

VKF IVA Facility Dynamics Test

Test Article: NASA/IUE Dummy Mass

Vibration Axis: Z

Tracking Filter: SD1012B

BW₁: 5 Hz from 5 to 45 HzBW₂: 50 Hz from 45 to 2,000 Hz

Accelerometer: Average

Date: 5/17/76; Online Plot

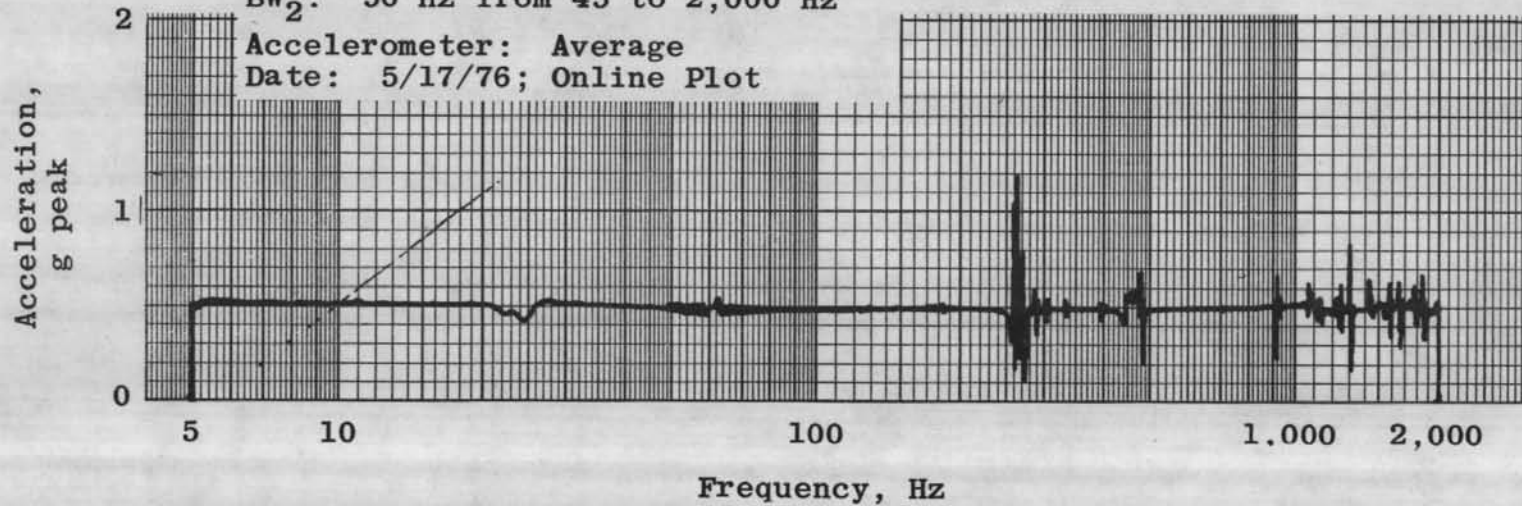

Figure 23. Thrust axis procedure evaluation: 0.5-g sine survey, mass simulator.

VKF IVA Facility Dynamics Test

Test Article: NASA/IUE Dummy Mass

Vibration Axis: Z

Tracking Filter: SD1012B

BW₁: 5 Hz from 5 to 75 Hz

Accelerometer: Average

Date: 5/20/76; Online Plot

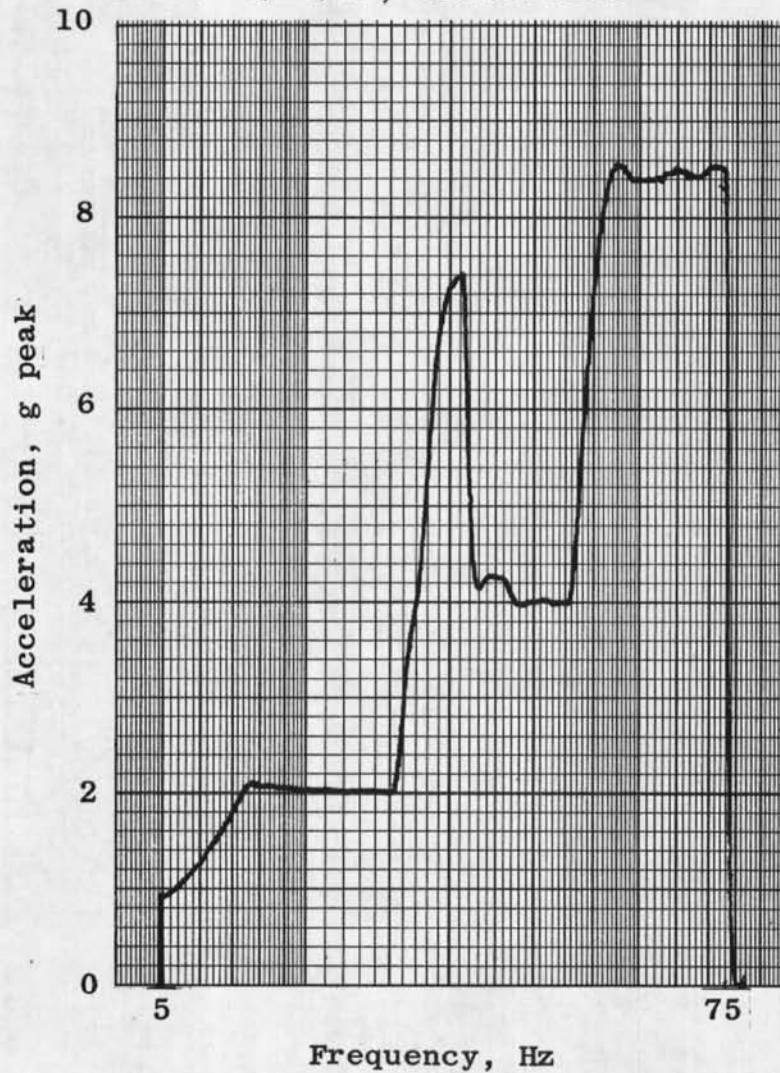

Figure 24. Thrust axis procedure evaluation: qualification level sine survey, mass simulator (5 to 75 Hz).

VKF IVA Facility Dynamics Test

Test Article: NASA/IUE
 Vibration Axis: Z
 Tracking Filter: SD1012B
 BW₂: 50 Hz from 75 to 2,000 Hz
 Accelerometer: Average
 Date: 5/18/76; Online Plot

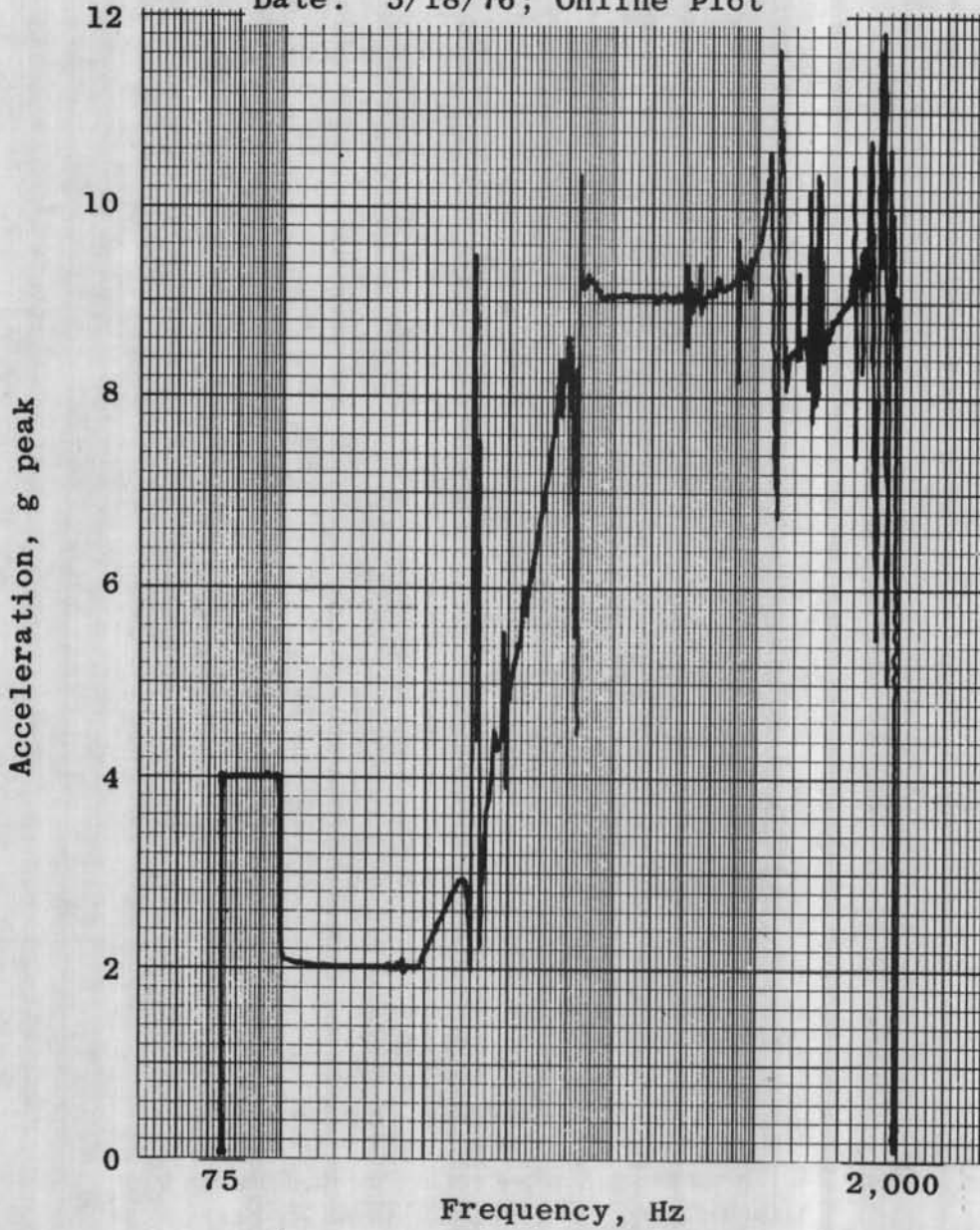

Figure 25. Thrust axis procedure evaluation: qualification level sine survey, mass simulator (75 to 2,000 Hz).

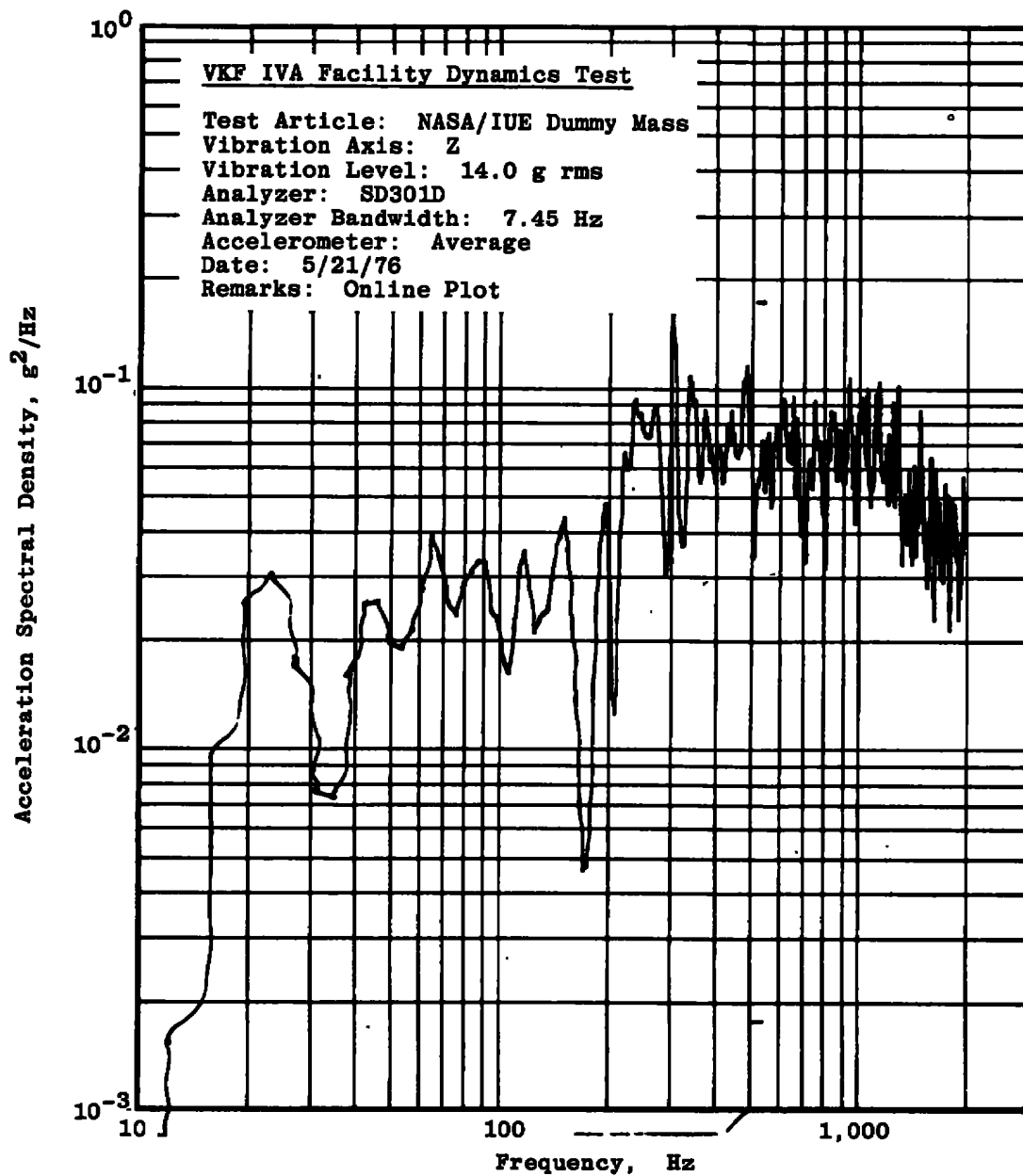

Figure 26. Thrust axis procedure evaluation: qualification level random vibration, mass simulator.

VKF IVA Facility Dynamics Test

Test Article: NASA/IUE Dummy Mass

Vibration Axis: Z

Tracking Filter: SD1012B

BW₁: 5 Hz from 5 to 45 HzBW₂: 50 Hz from 45 to 2,000 Hz

Accelerometer: Average

Date: 5/21/76; Online Plot

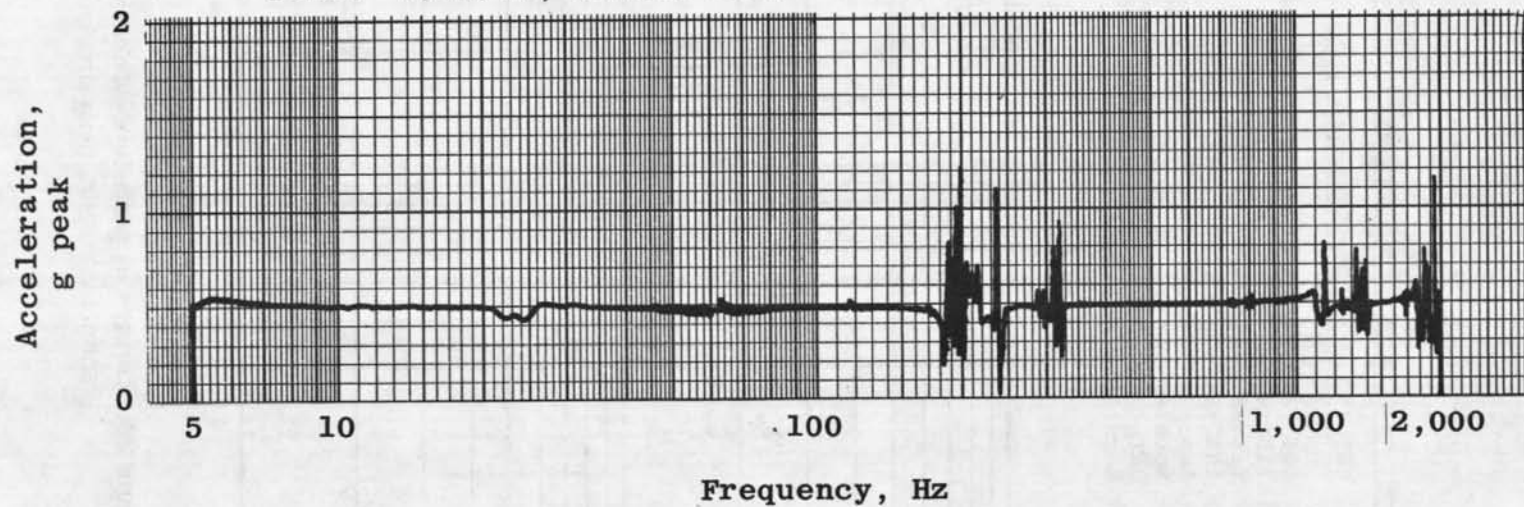

Figure 27. Thrust axis procedure evaluation: 0.5-g sine survey, mass simulator.



Figure 28. Z-axis installation photographs.

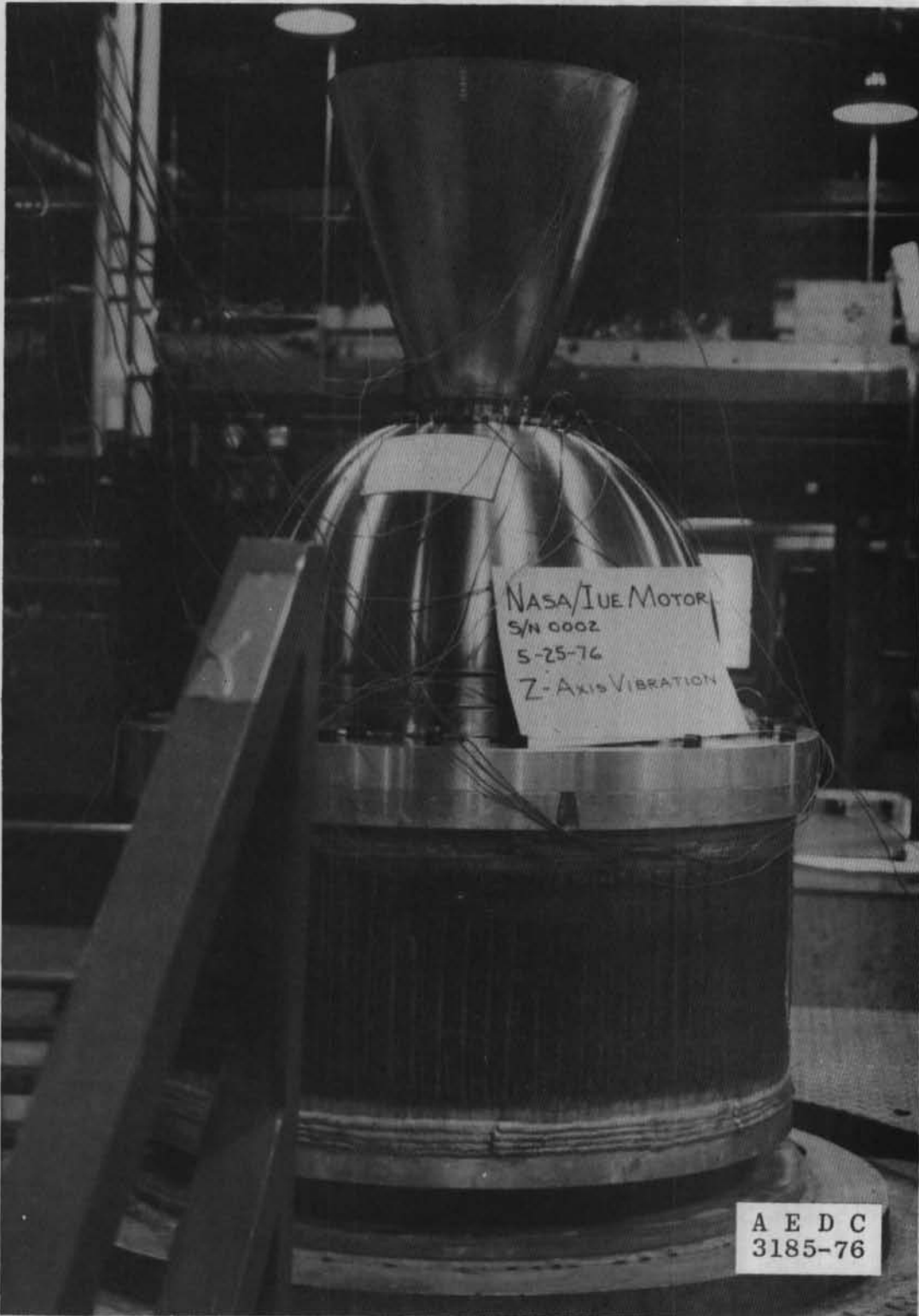
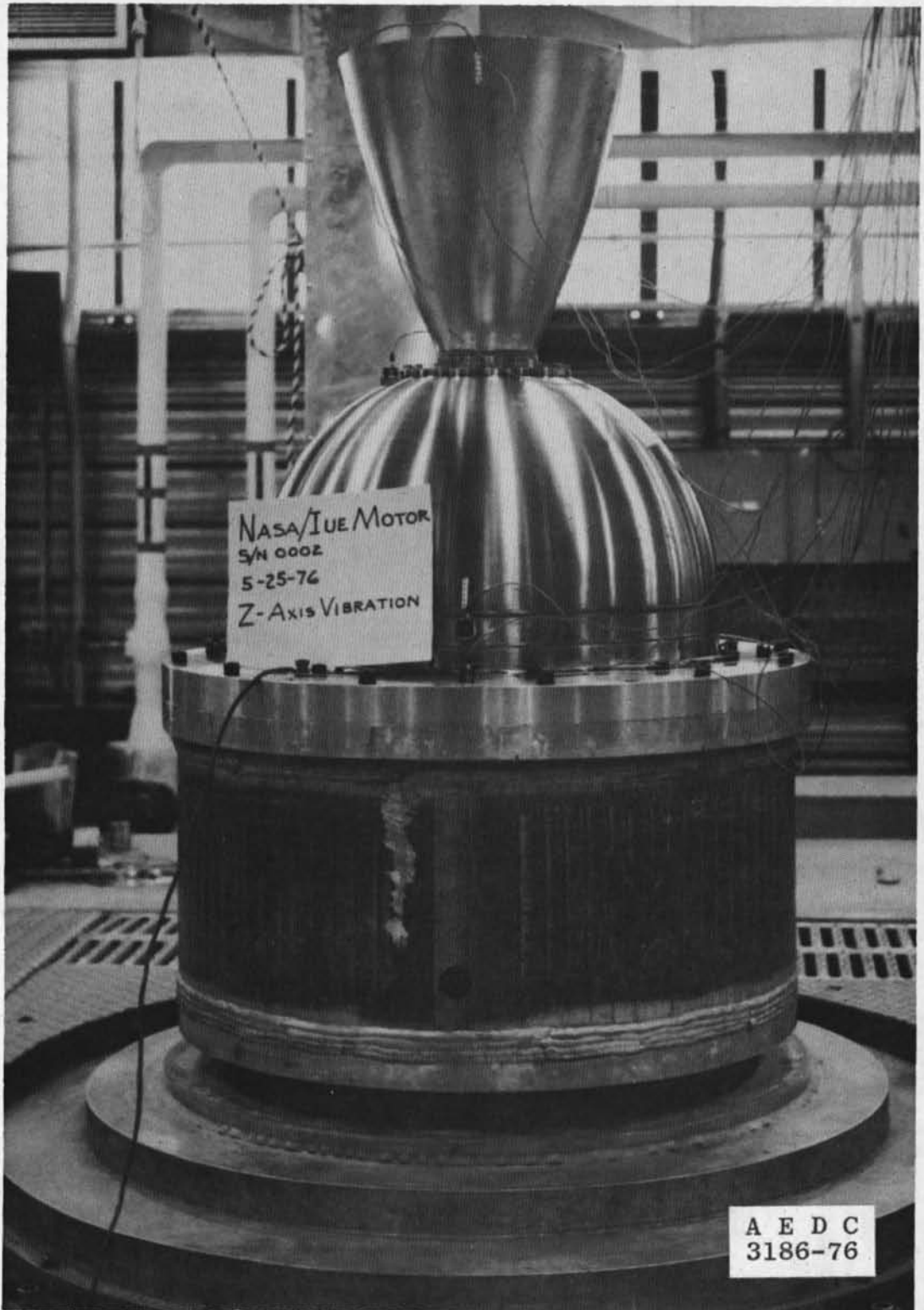

Figure 28. Continued.



NASA IUE MOTOR
S/N 0002
5-25-76
Z-AXIS VIBRATION

A E D C
3186-76

Figure 28. Continued.

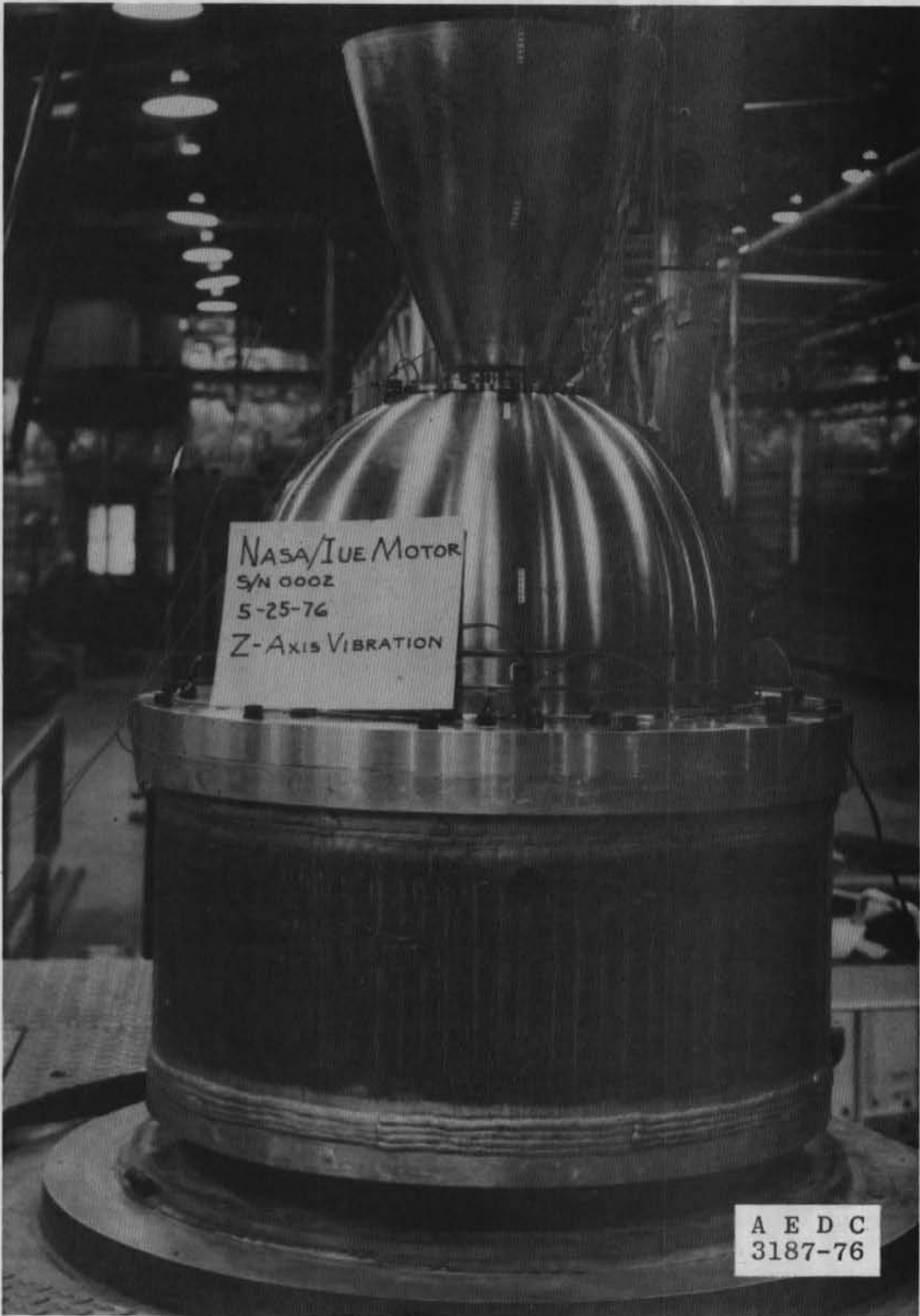

Figure 28. Concluded.

VKF IVA Facility Dynamics Test

Test Article: NASA/IUE

Vibration Axis: Z

Tracking Filter: SD1012B

BW₁: 5 Hz from 5 to 45 Hz

BW₂: 50 Hz from 45 to 2,000 Hz } Figs. u-d

BW₁: 5 Hz from 5 to 75 Hz

BW₂: 50 Hz from 75 to 2,000 Hz } Figs. e-z

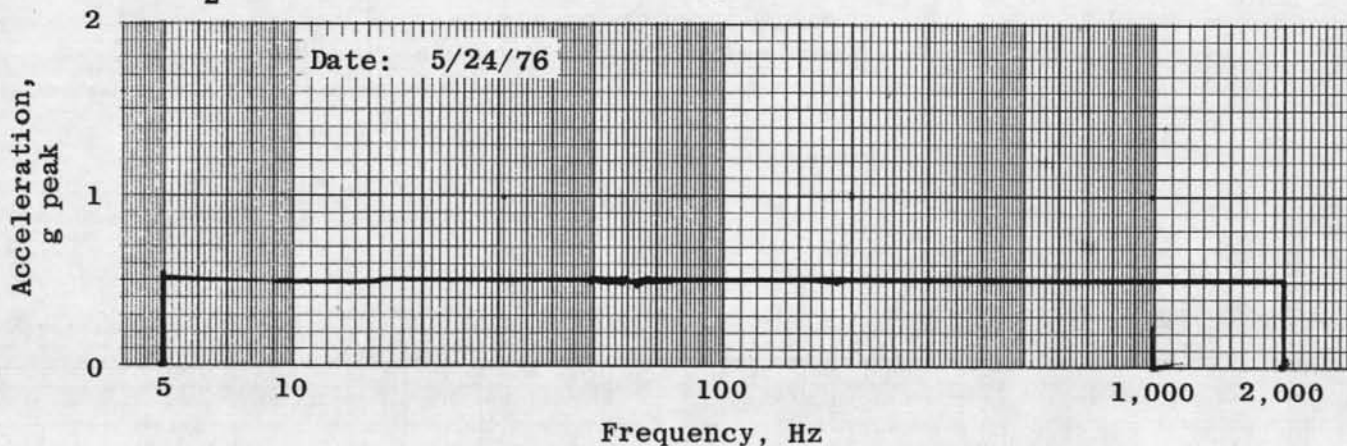

a. Closed loop plot

Figure 29. Z-axis vibration test: 0.5-g sine survey.

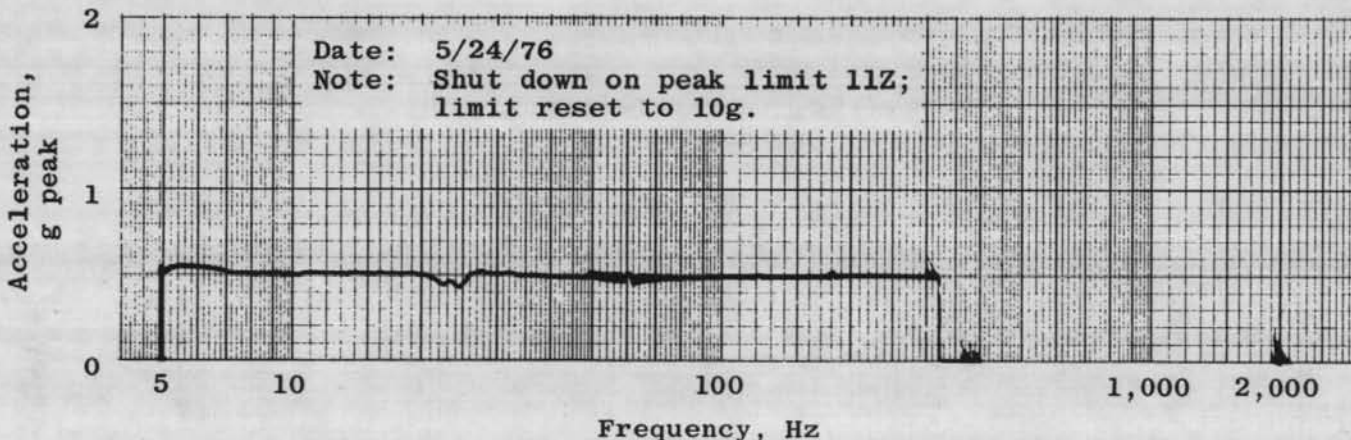

b. Online plot, Z accelerometers averaged

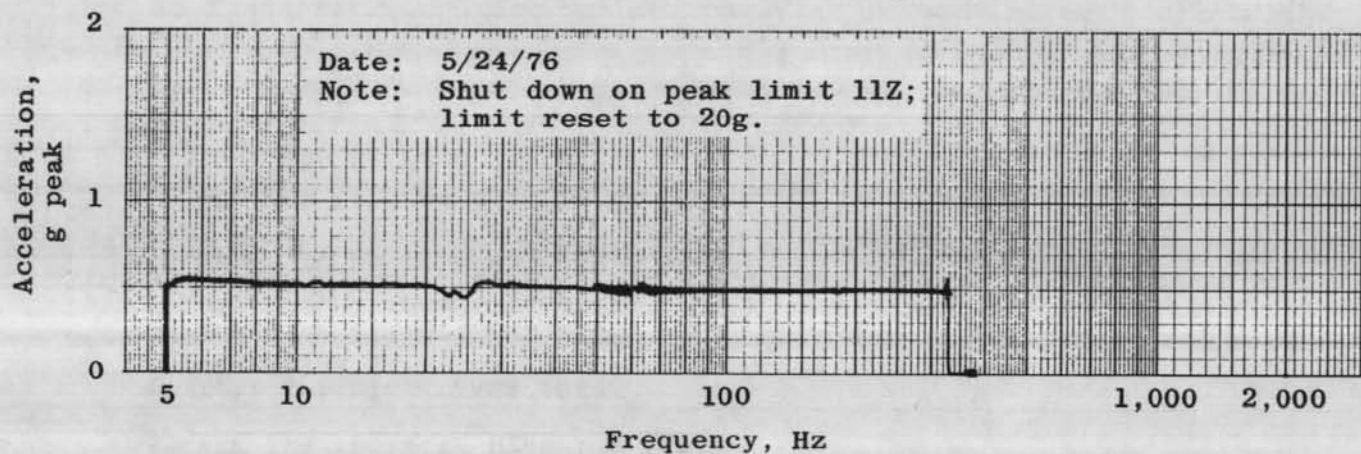

c. Online plot, accelerometers averaged
Figure 29. Continued.

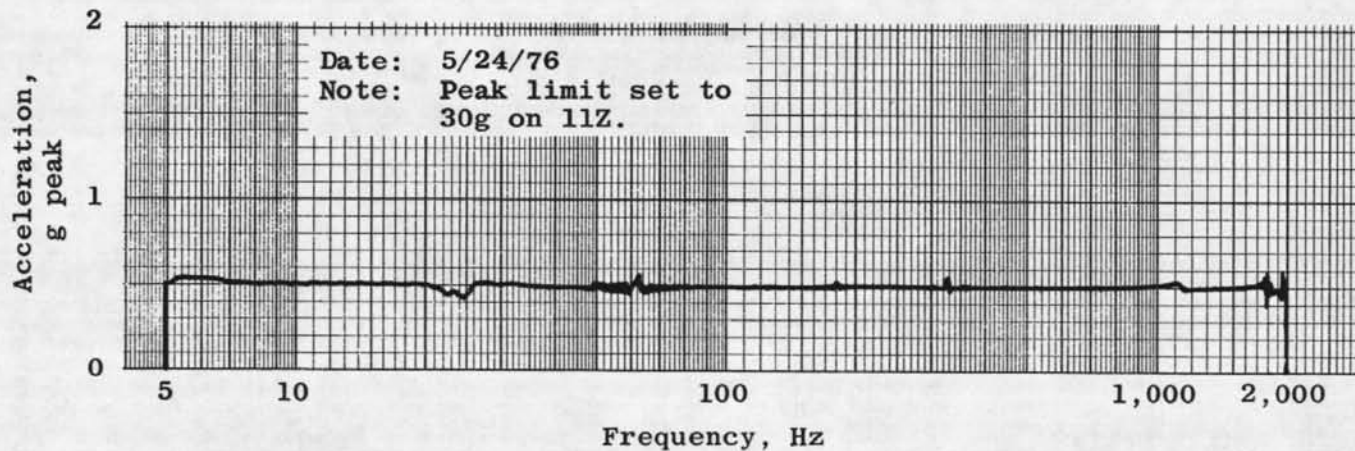

d. Online plot

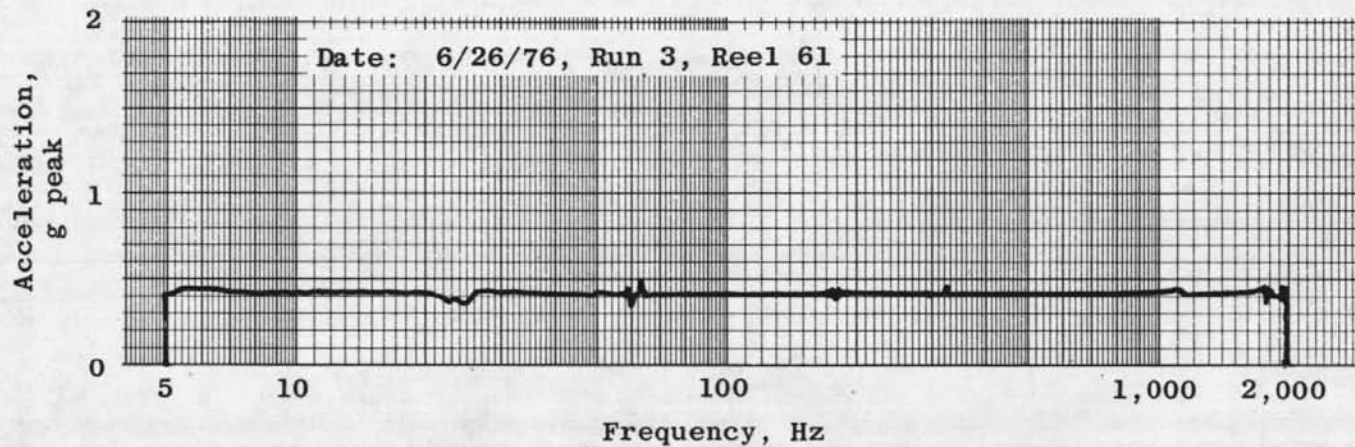

e. Accelerometers Averaged
Figure 29. Continued.

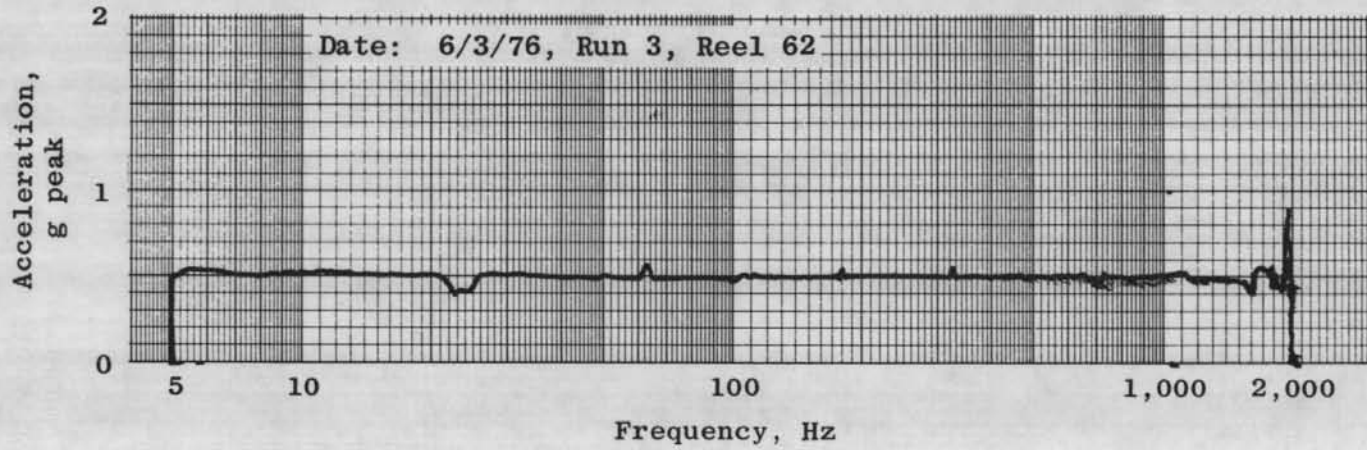

f. Accelerometer 1Z

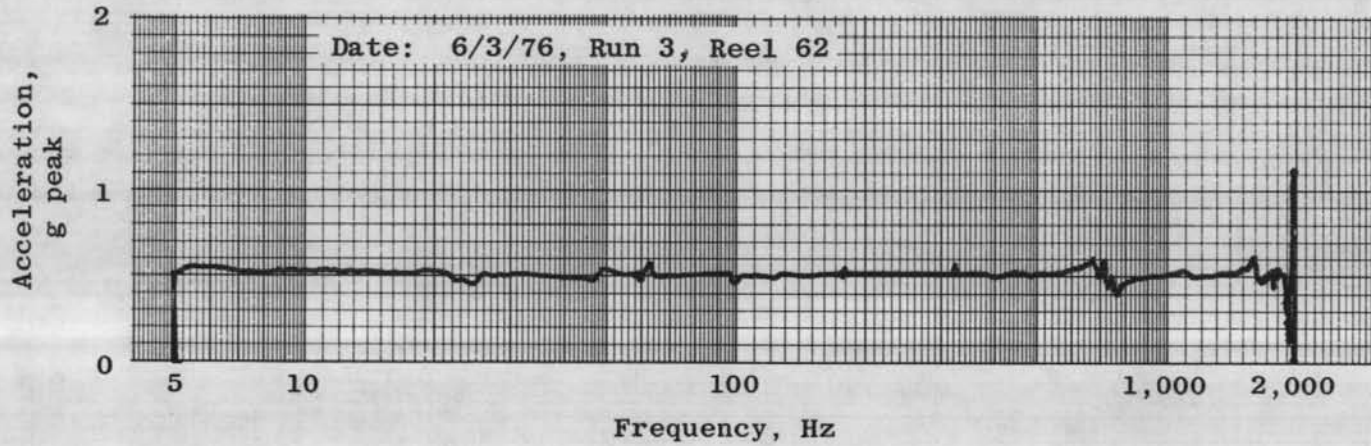

g. Accelerometer 2Z
Figure 29. Continued.

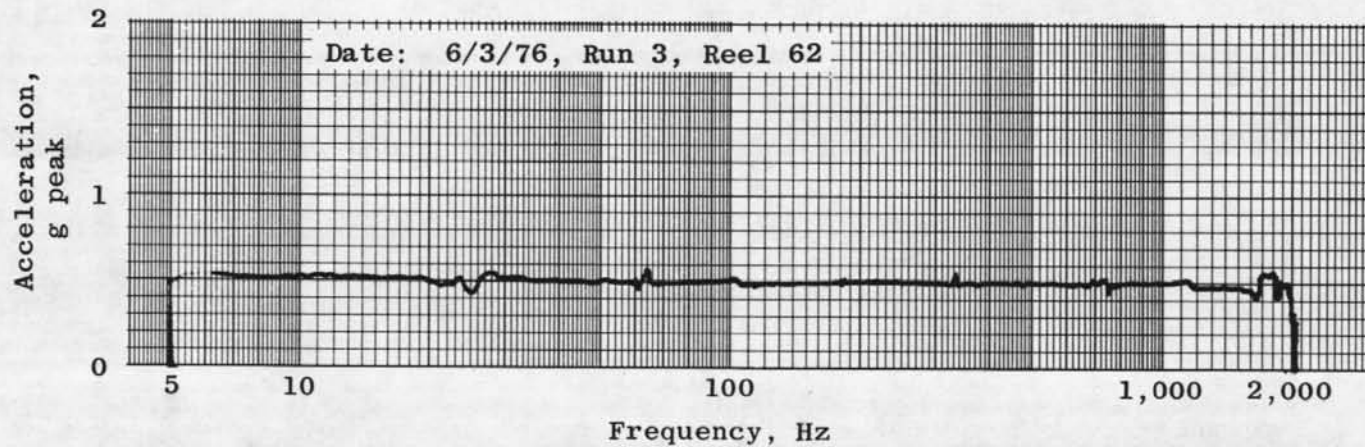

h. Accelerometer 3Z

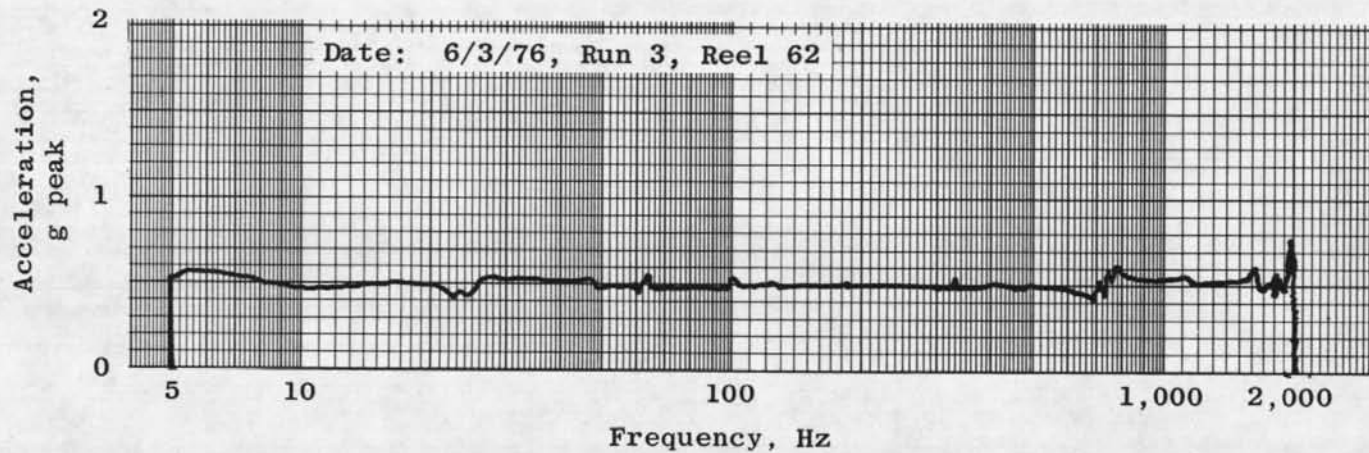
i. Accelerometer 4Z
Figure 29. Continued.

190

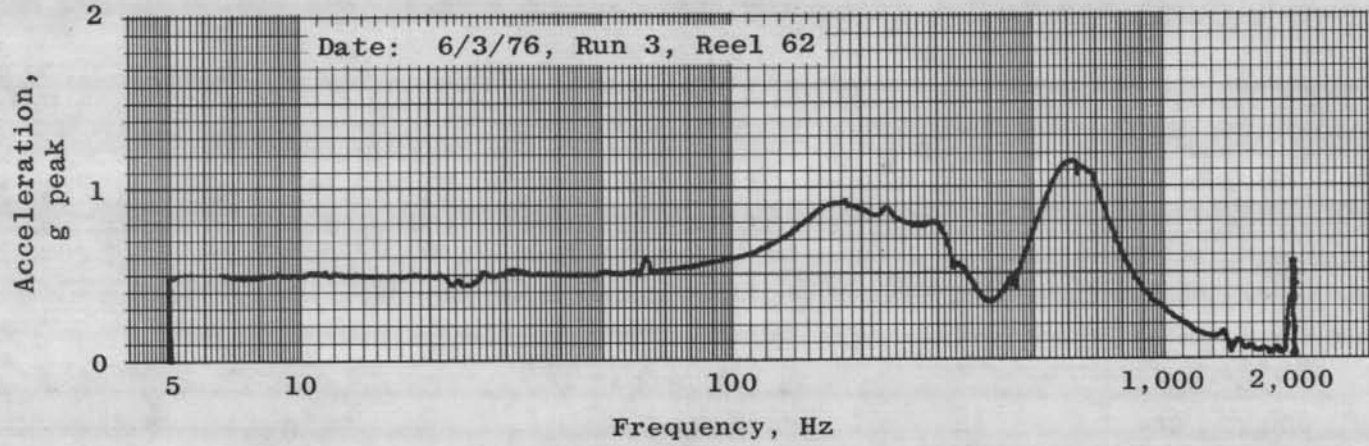

j. Accelerometer 5Z
Figure 29. Continued.

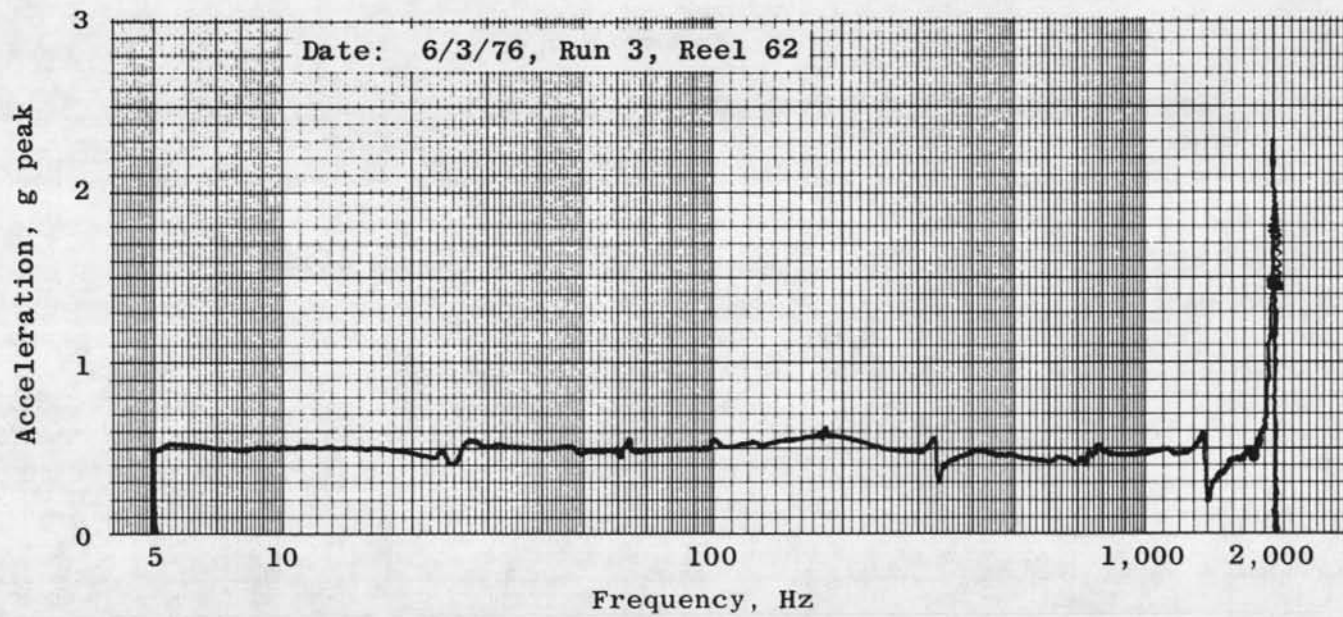

k. Accelerometer 6Z
Figure 29. Continued.

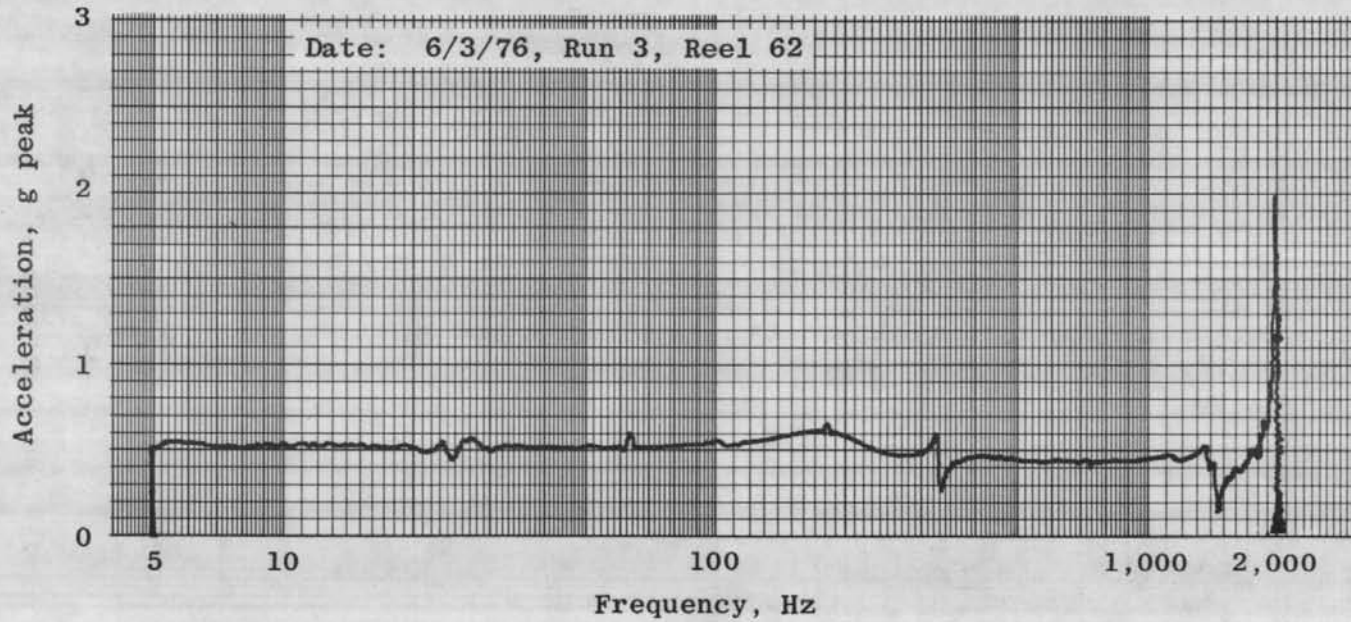

I. Accelerometer 7Z
Figure 29. Continued.

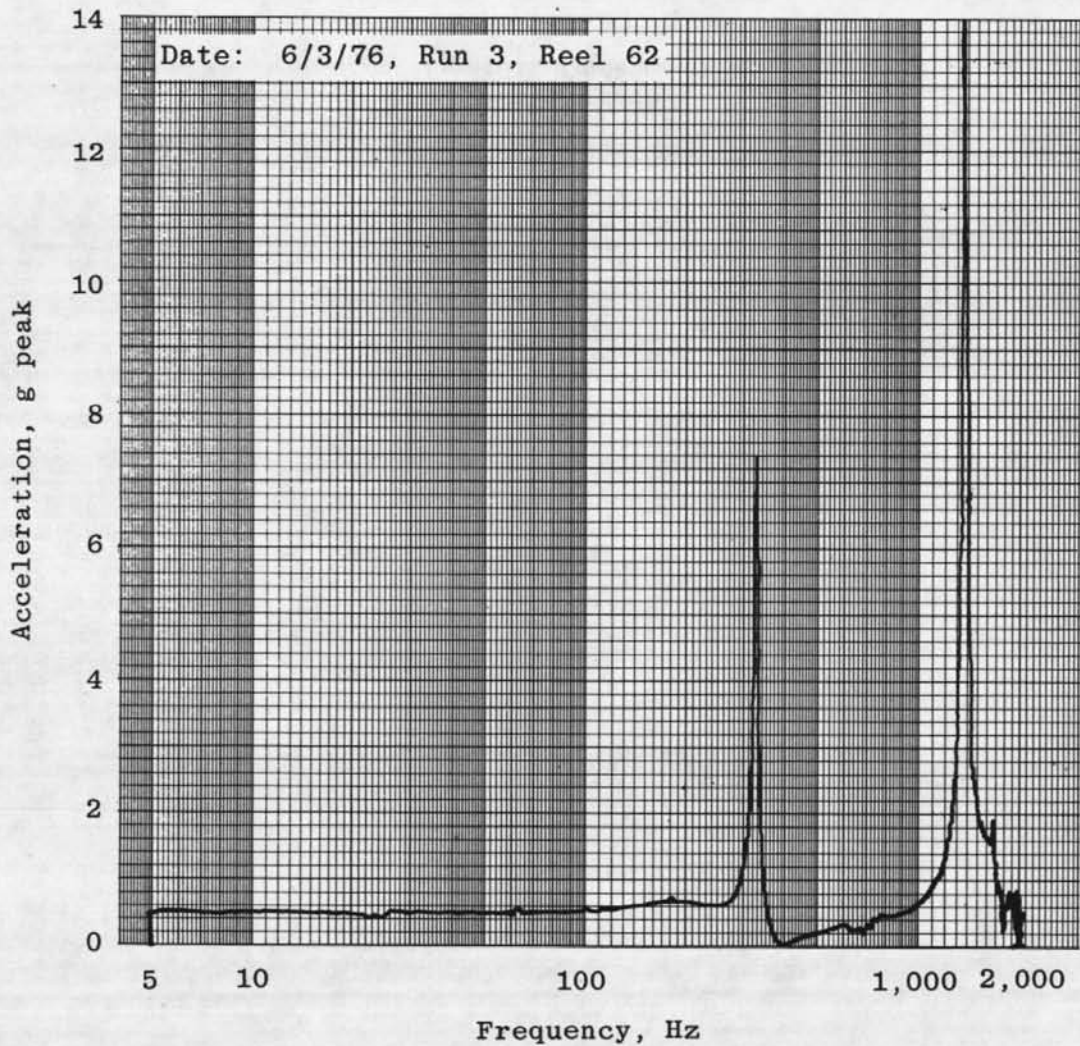

m. Accelerometer 8Z
Figure 29. Continued.

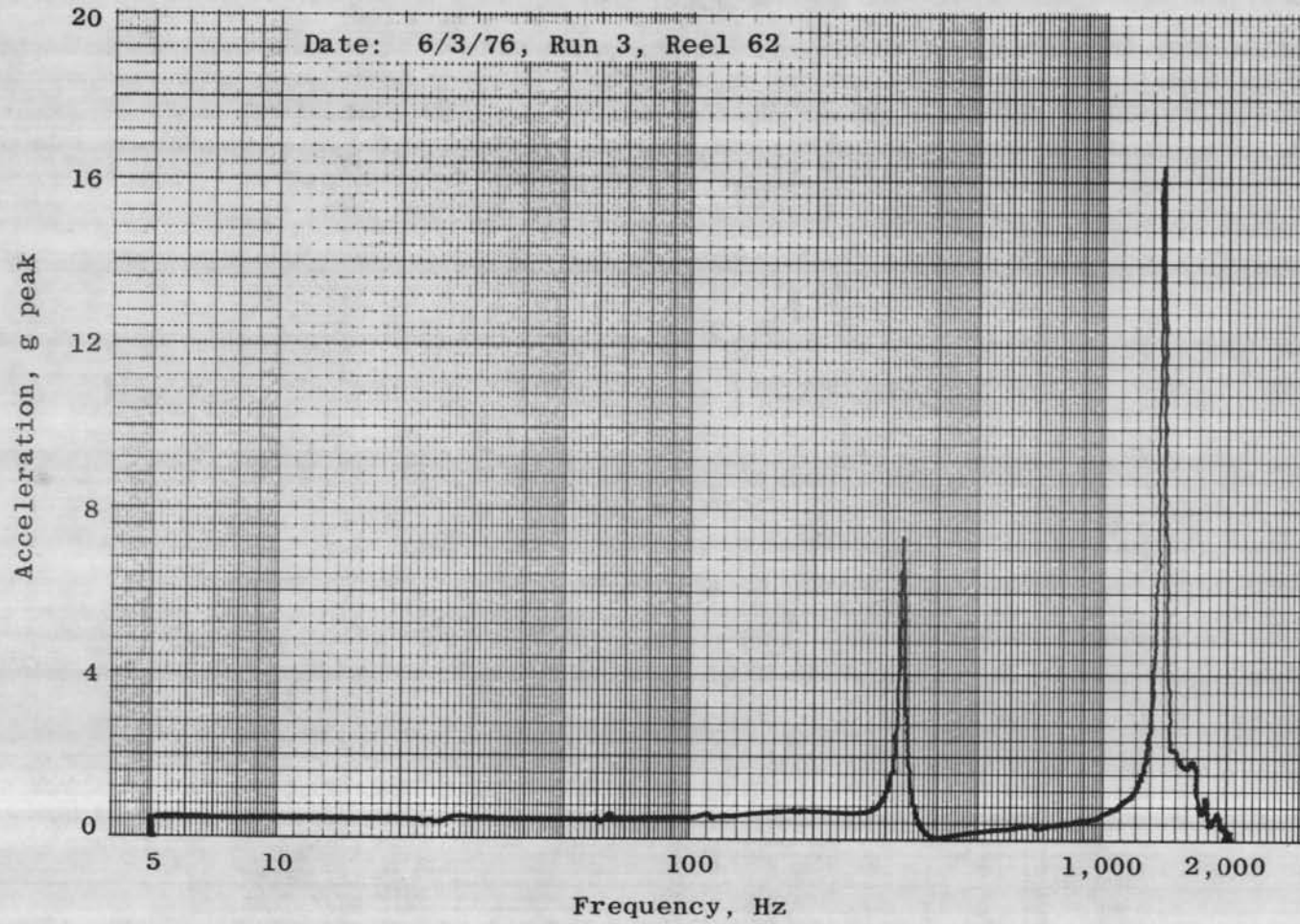

n. Accelerometer 9Z
Figure 29. Continued.

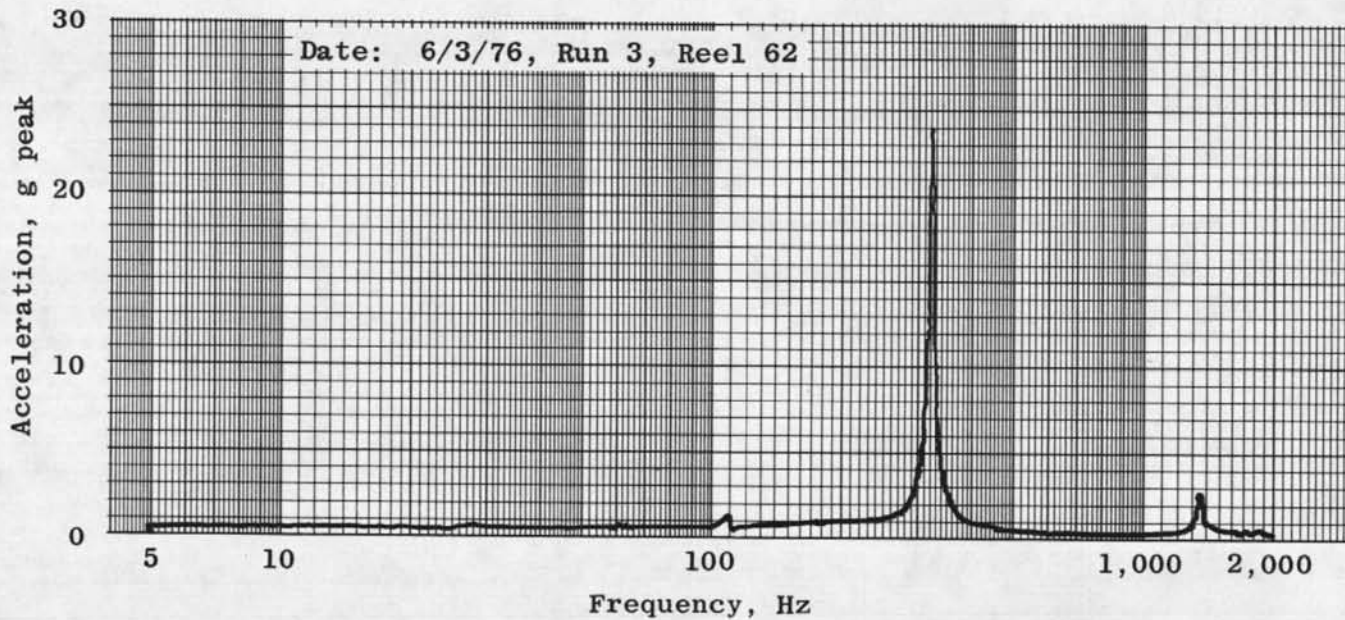

o. Accelerometer 11Z
Figure 29. Continued.

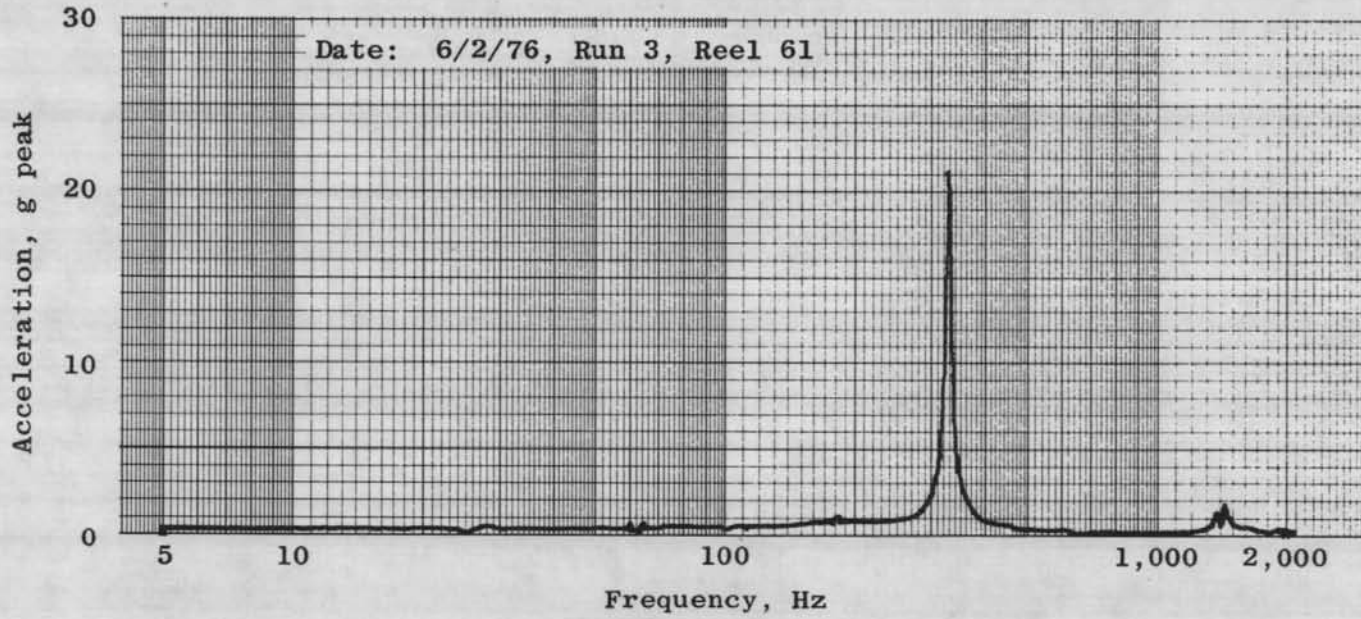

p. Accelerometer 12Z
Figure 29. Continued.

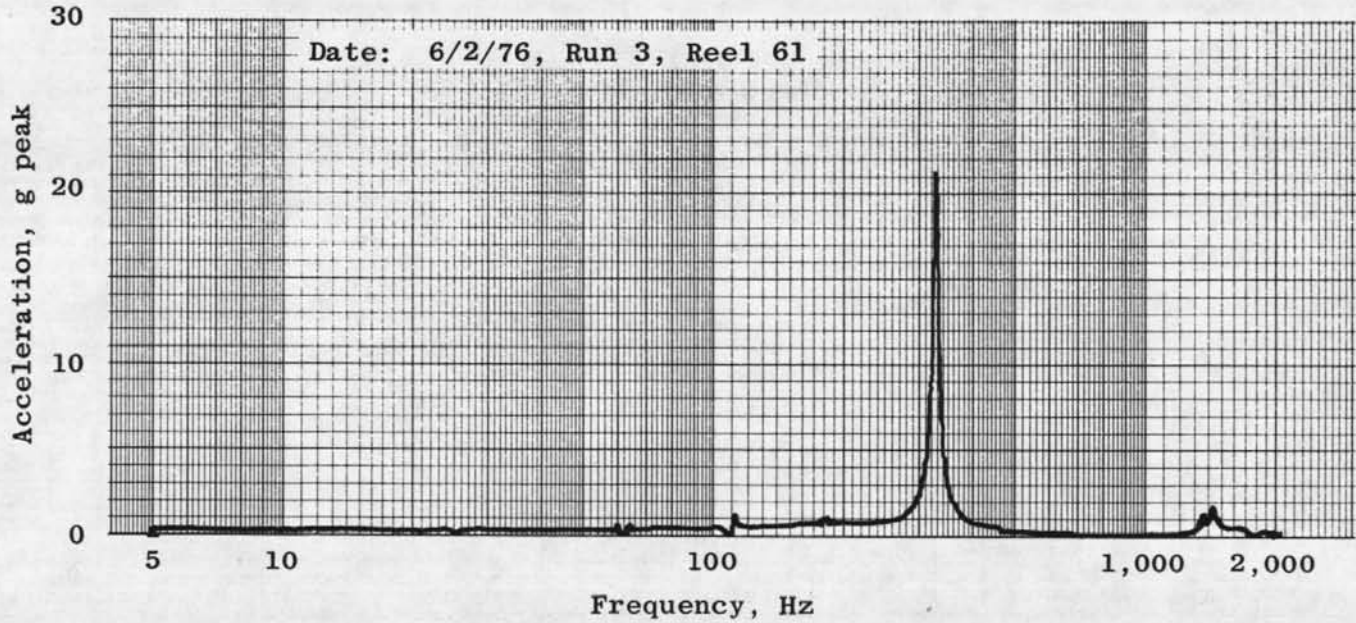

q. Accelerometer 13Z
Figure 29. Continued.

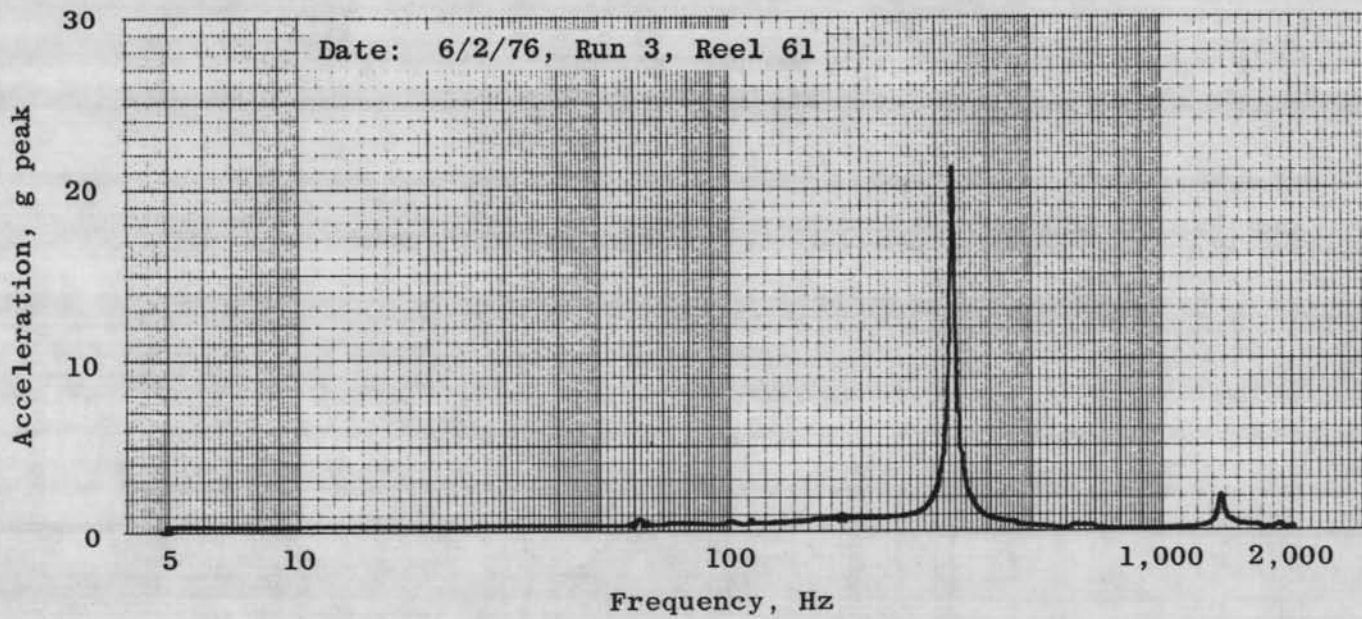

r. Accelerometer 14Z
Figure 29. Continued.

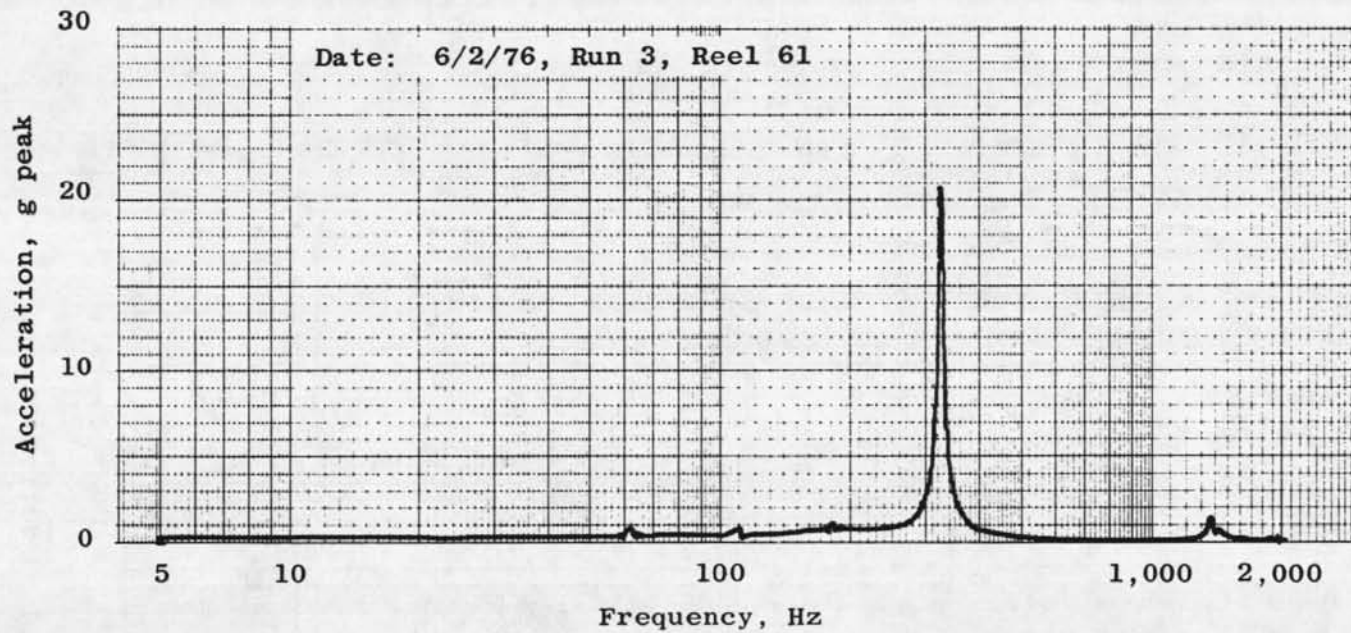

s. Accelerometer 15Z
Figure 29. Continued.

200

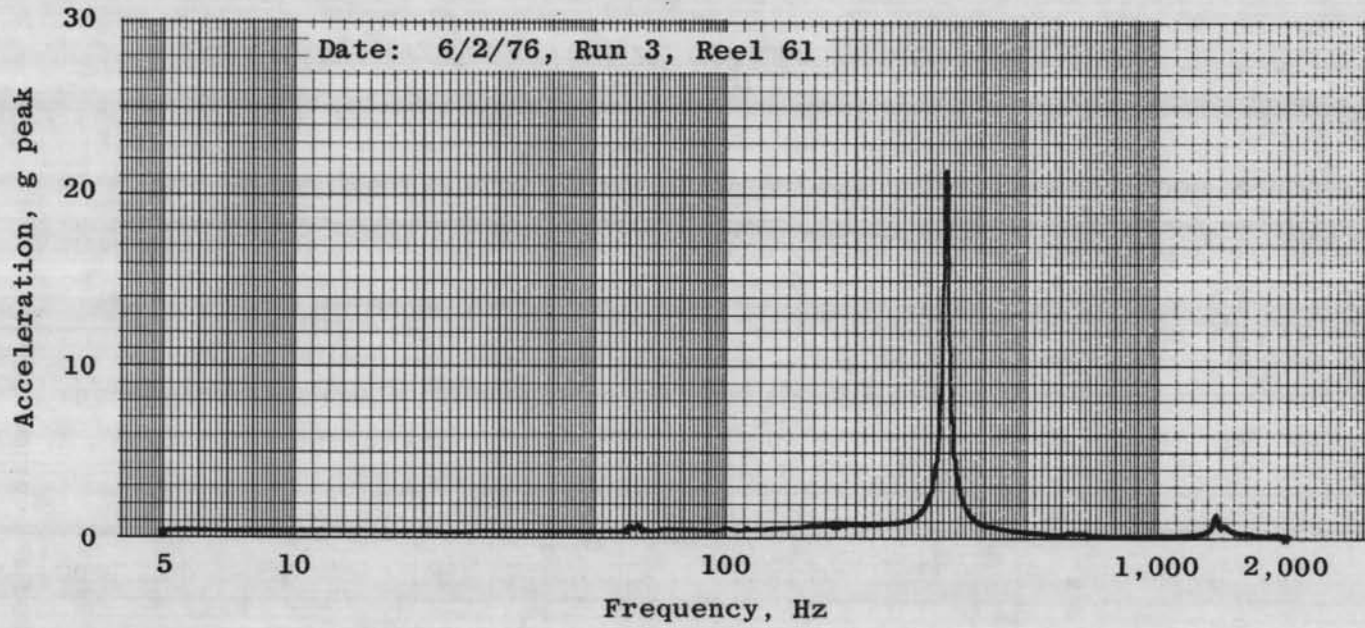

t. Accelerometer 16Z
Figure 29. Continued.

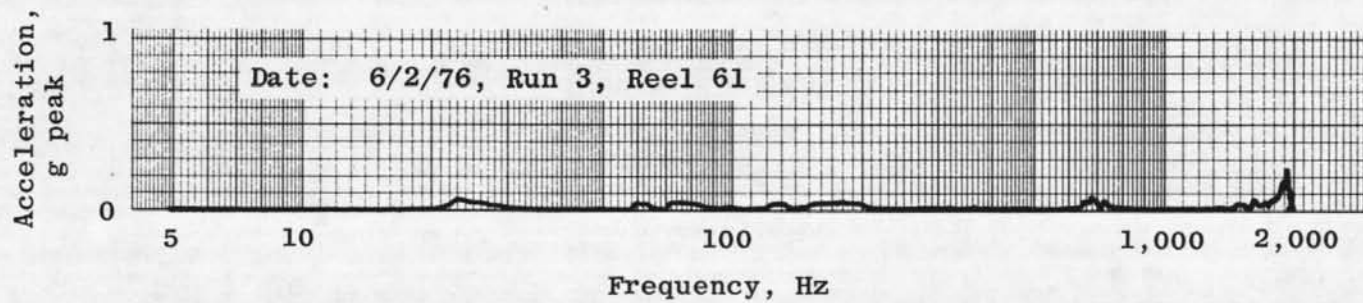

u. Accelerometer 1X

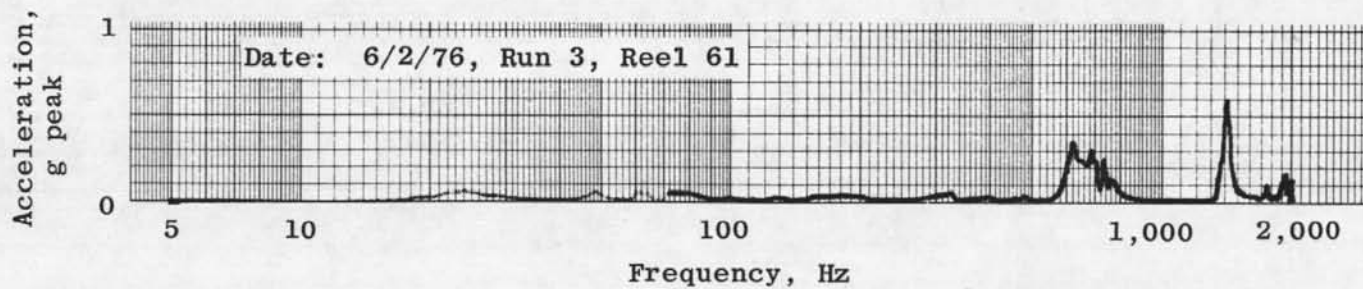
v. Accelerometer 9X
Figure 29. Continued.

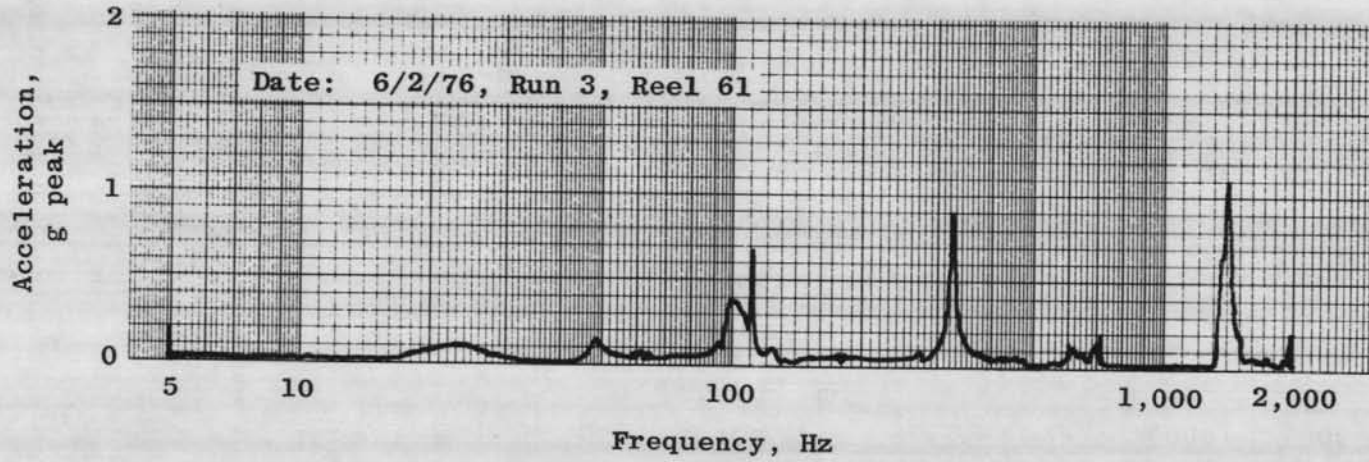

w. Accelerometer 11X
Figure 29. Continued.

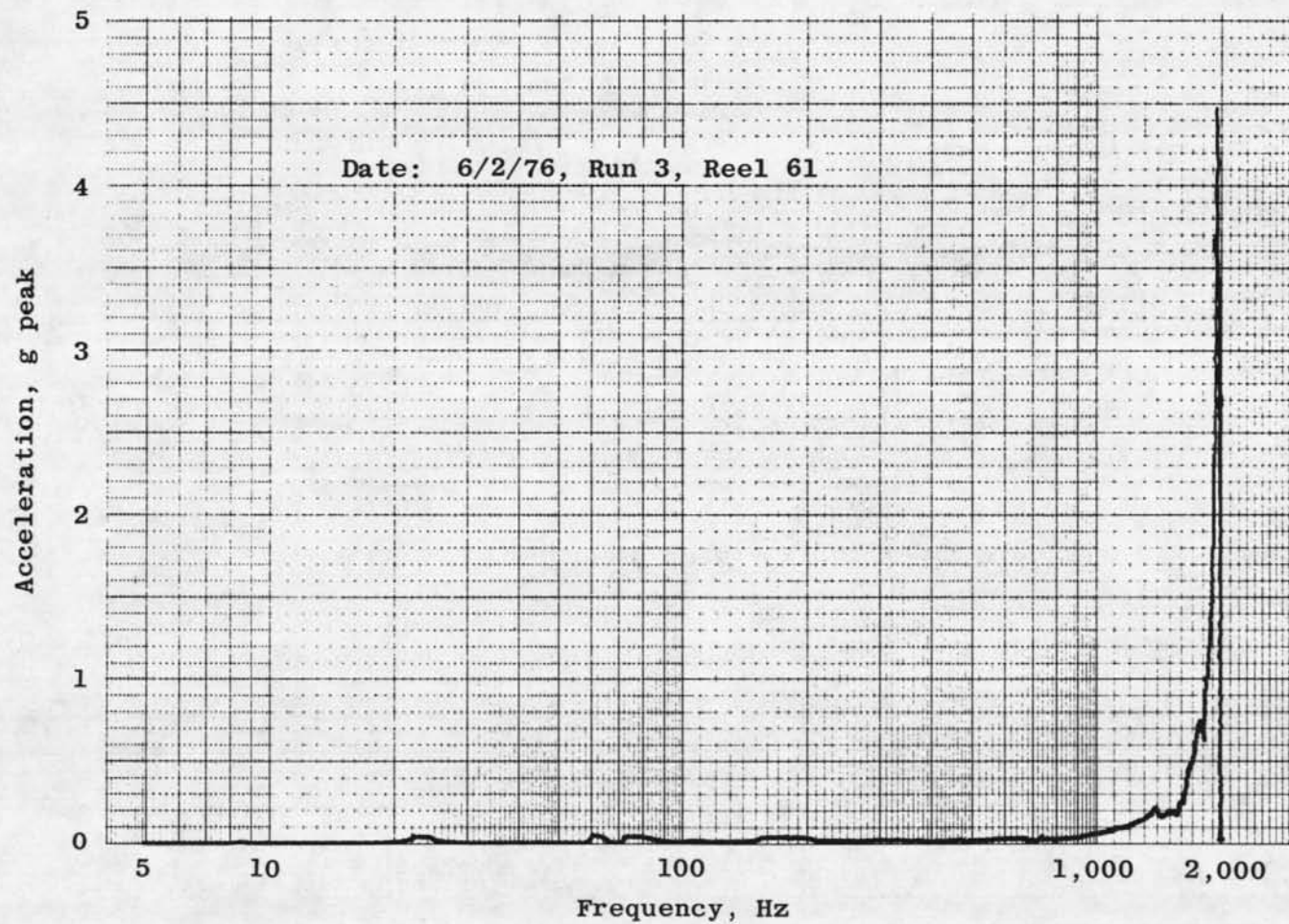

x. Accelerometer 1Y
Figure 29. Continued.

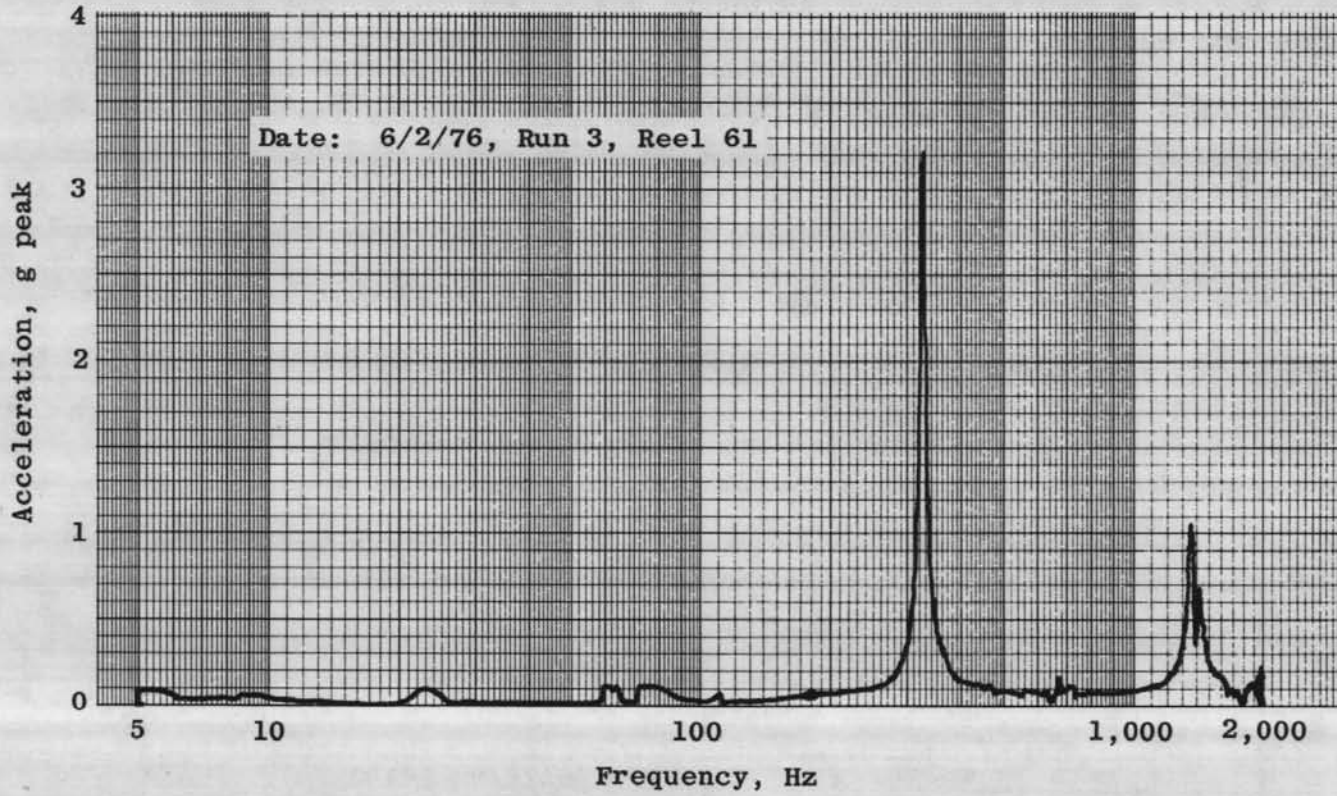

y. Accelerometer 9Y
Figure 29. Continued.

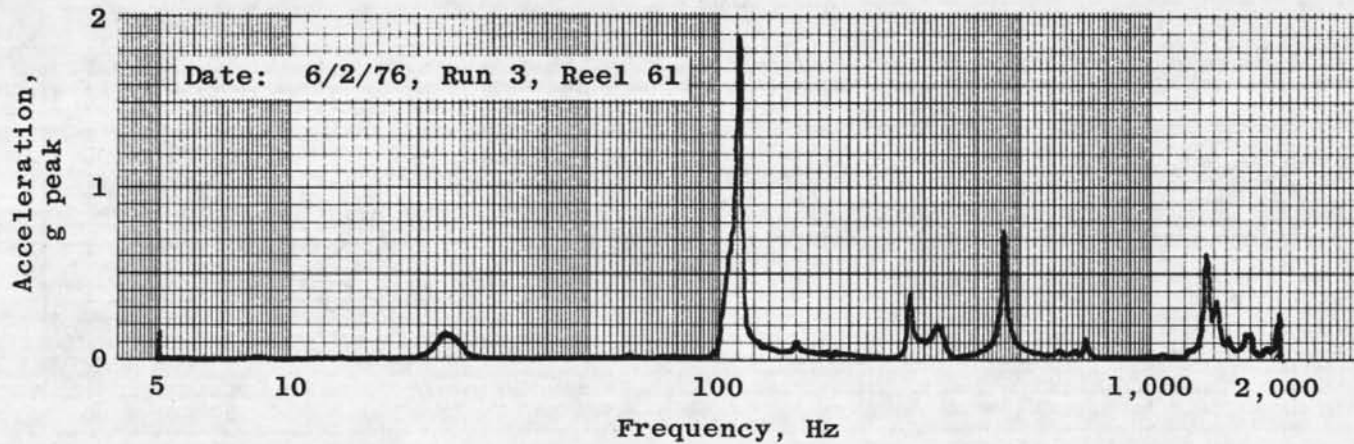

z. Accelerometer 11Y
Figure 29. Concluded.

VKF IVA Facility Dynamics Test

Test Article: NASA/IUE

Vibration Axis: Z

Tracking Filter: SD1012B

BW₁: 5 Hz from 5 to 45 Hz

BW₂: 50 Hz from 45 to 2,000 Hz

} Figs. a,b

BW₁: 5 Hz from 5 to 75 Hz

BW₂: 50 Hz from 75 to 2,000 Hz

} Figs. c-x

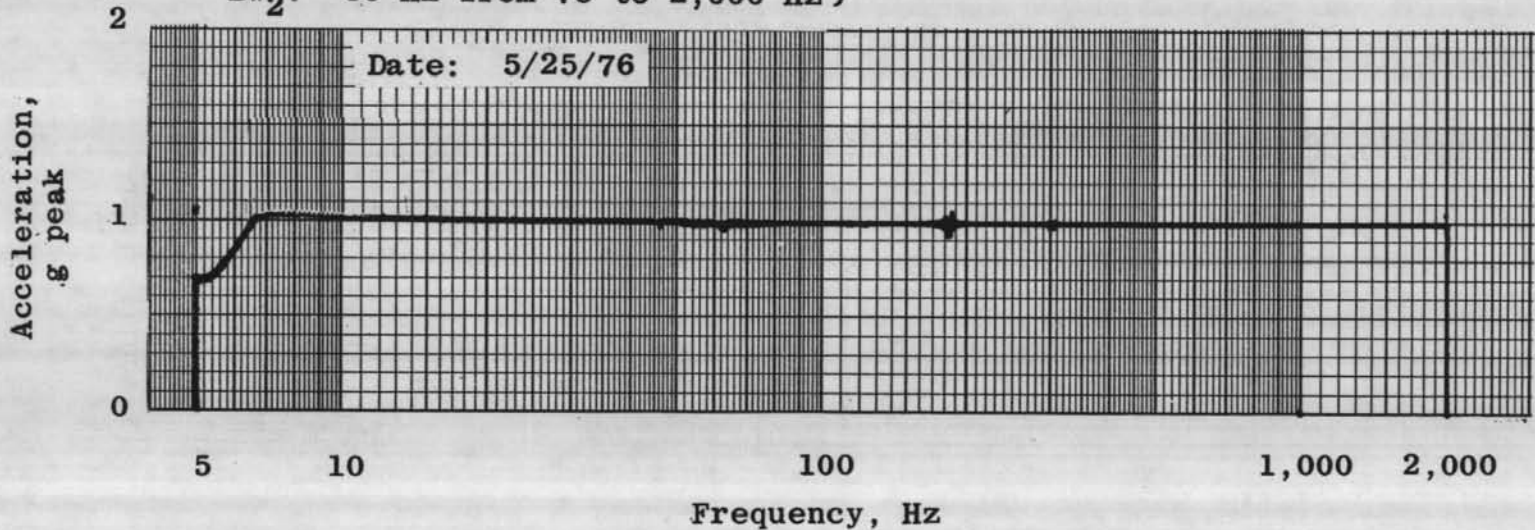

a. Closed loop plot

Figure 30. Z-axis vibration test: 1.0-g sine survey.

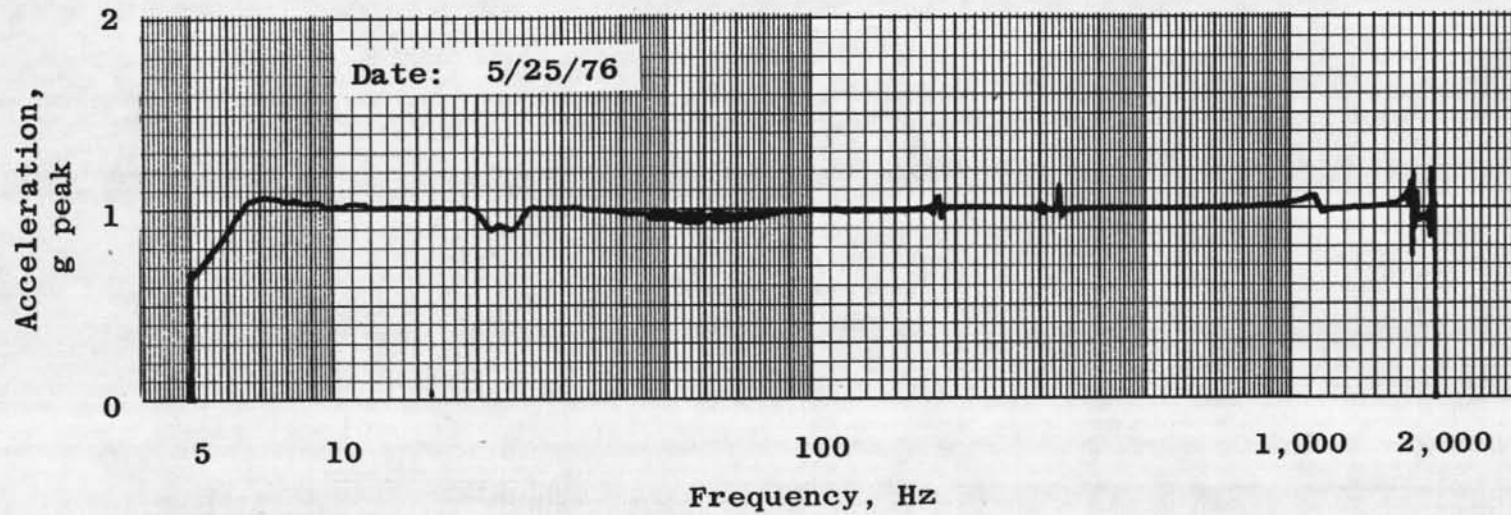

b. Online plot, accelerometers averaged

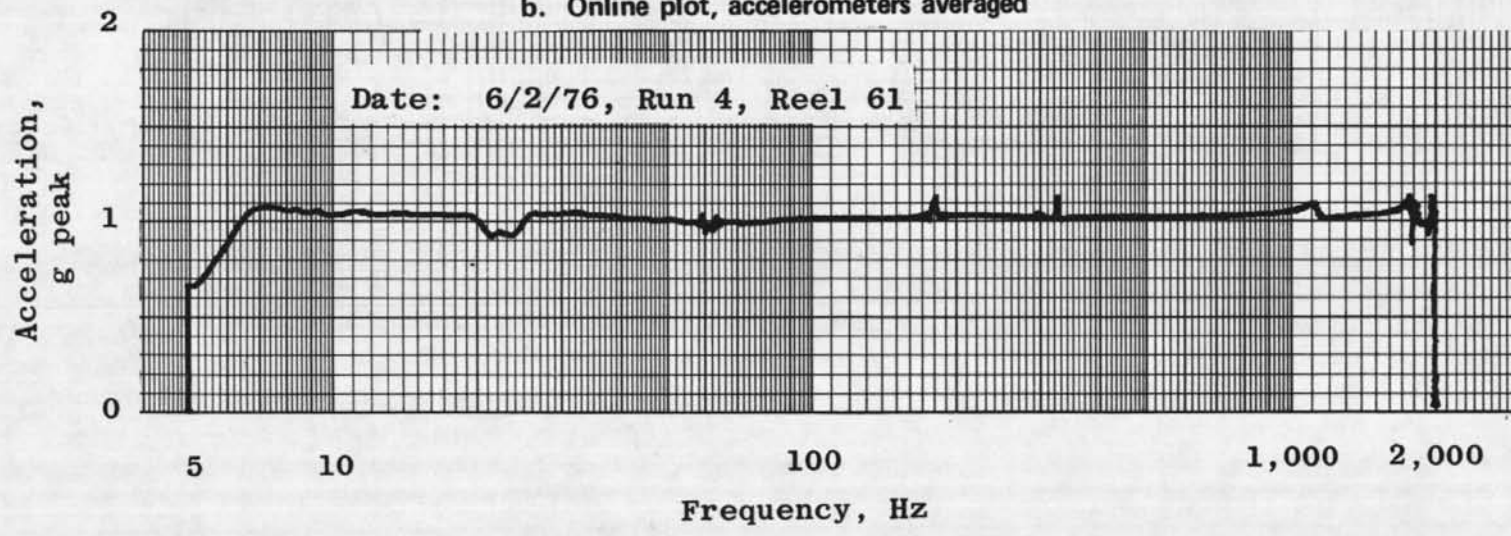

c. Accelerometers averaged
Figure 30. Continued.

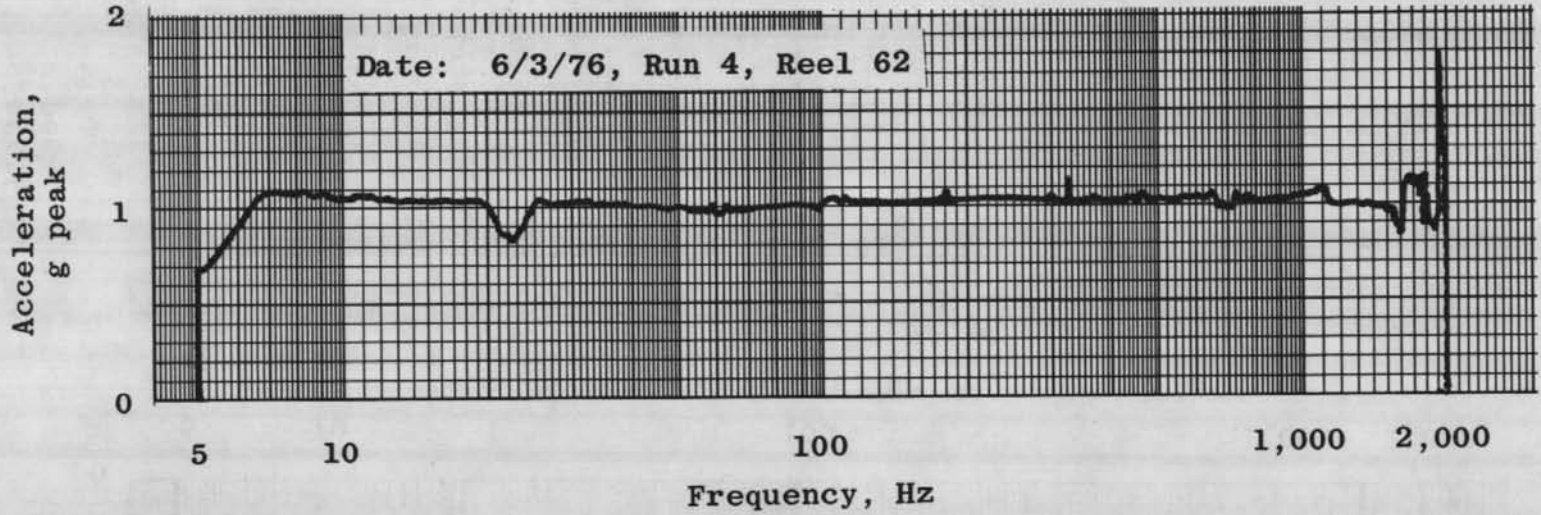

d. Accelerometer 1Z
Figure 30. Continued.

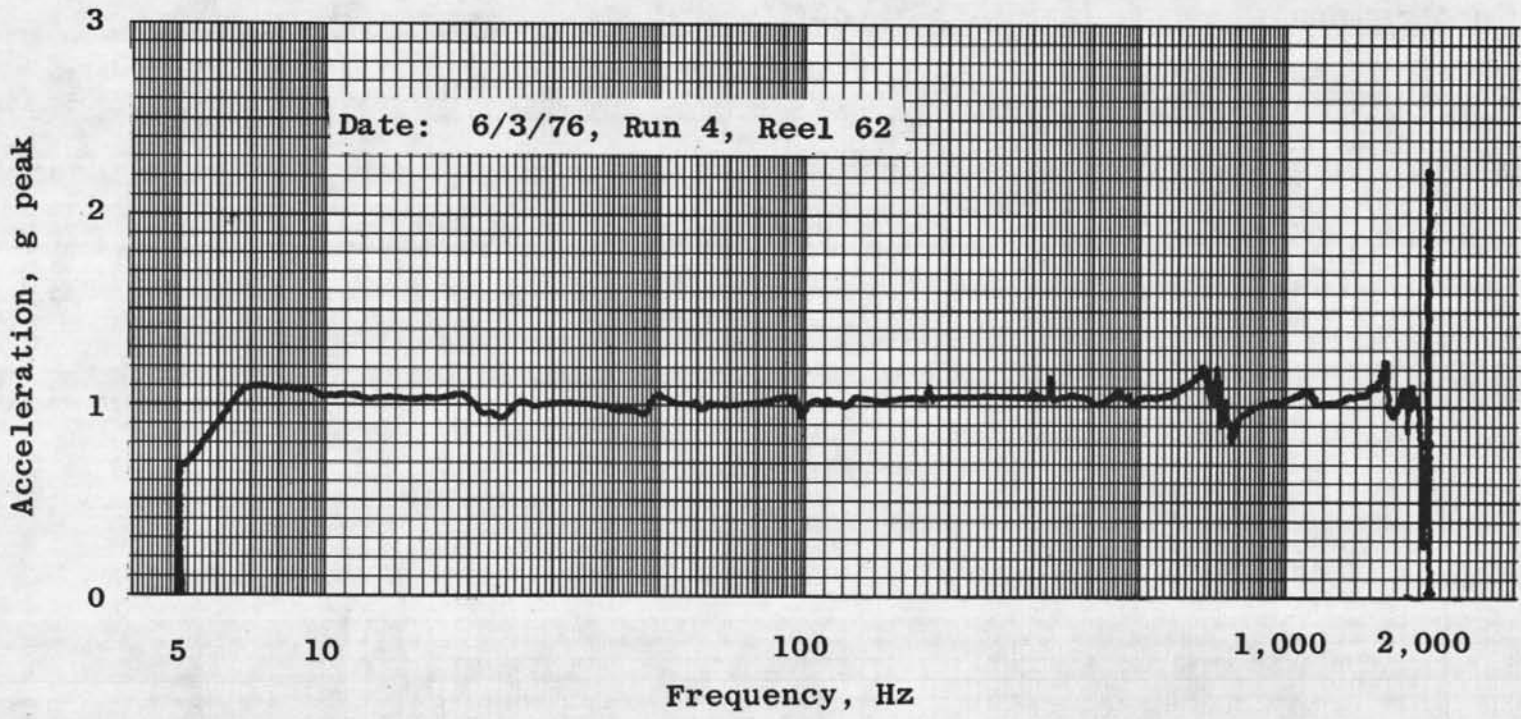

e. Accelerometer 2Z
Figure 30. Continued.

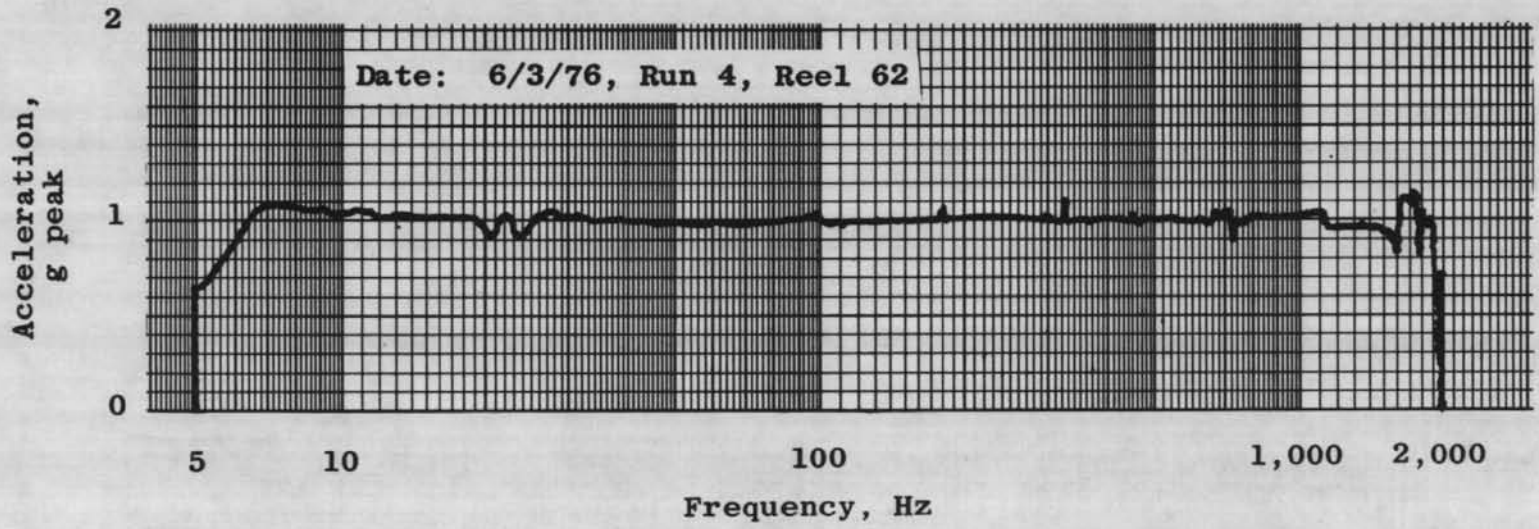

f. Accelerometer 3Z

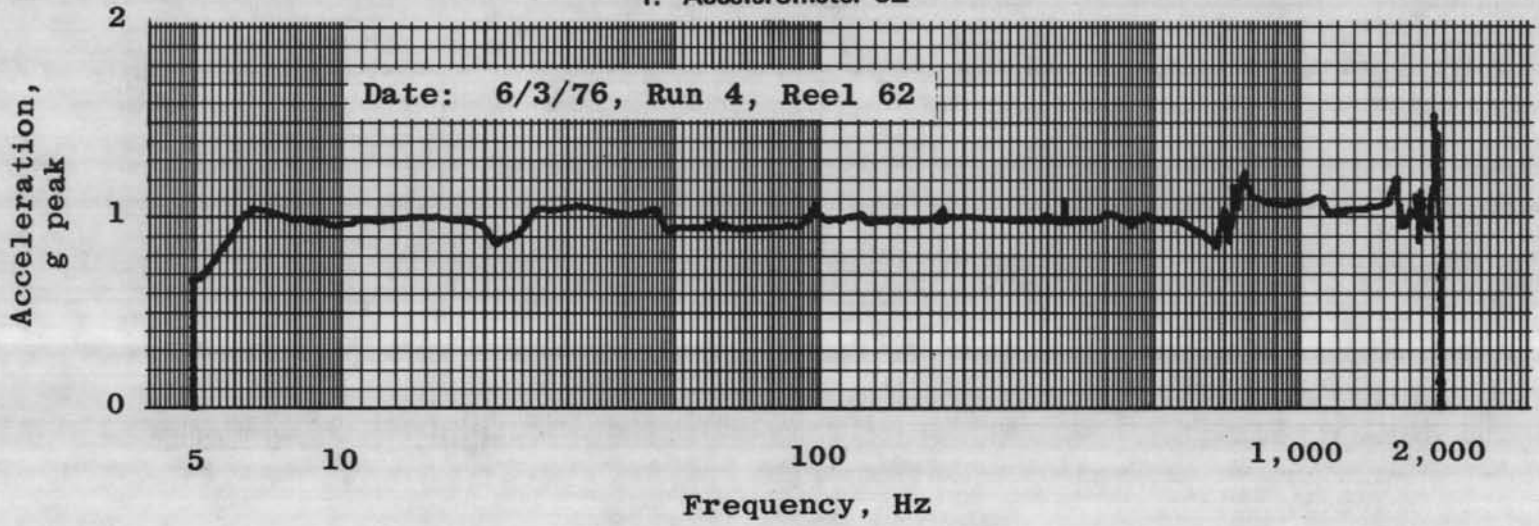

g. Accelerometer 4Z
Figure 30. Continued.

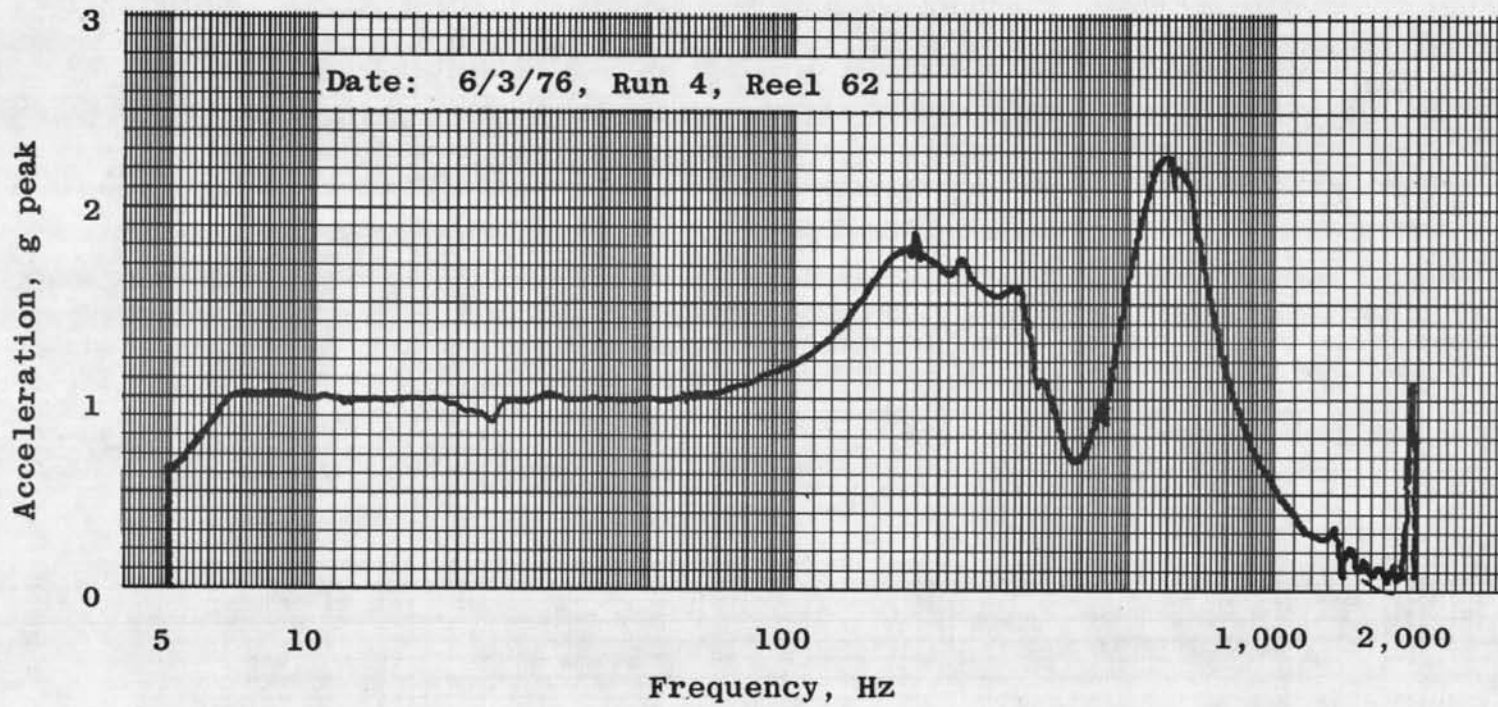

h. Accelerometer 5Z
Figure 30. Continued.

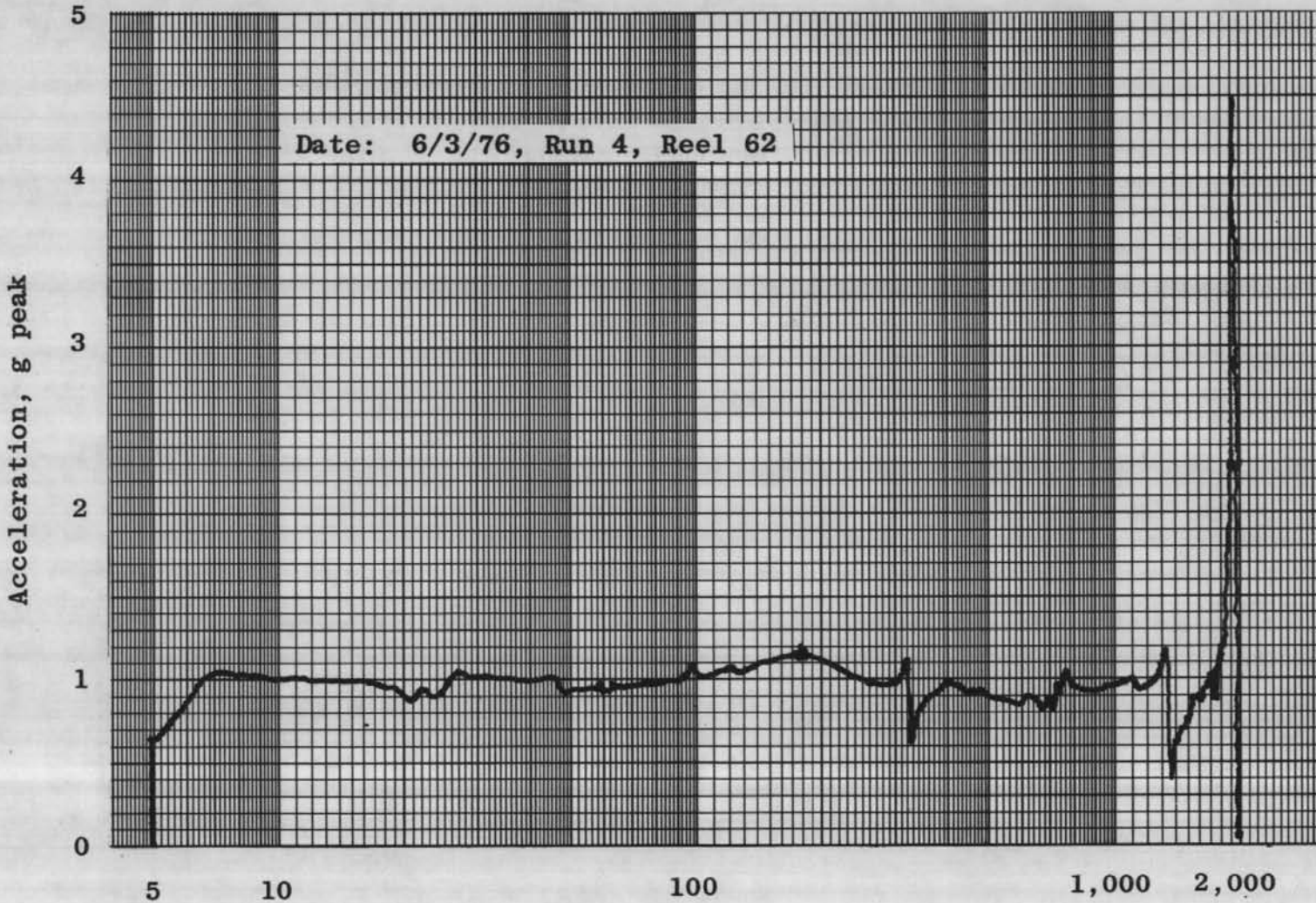

i. Accelerometer 6Z
Figure 30. Continued.

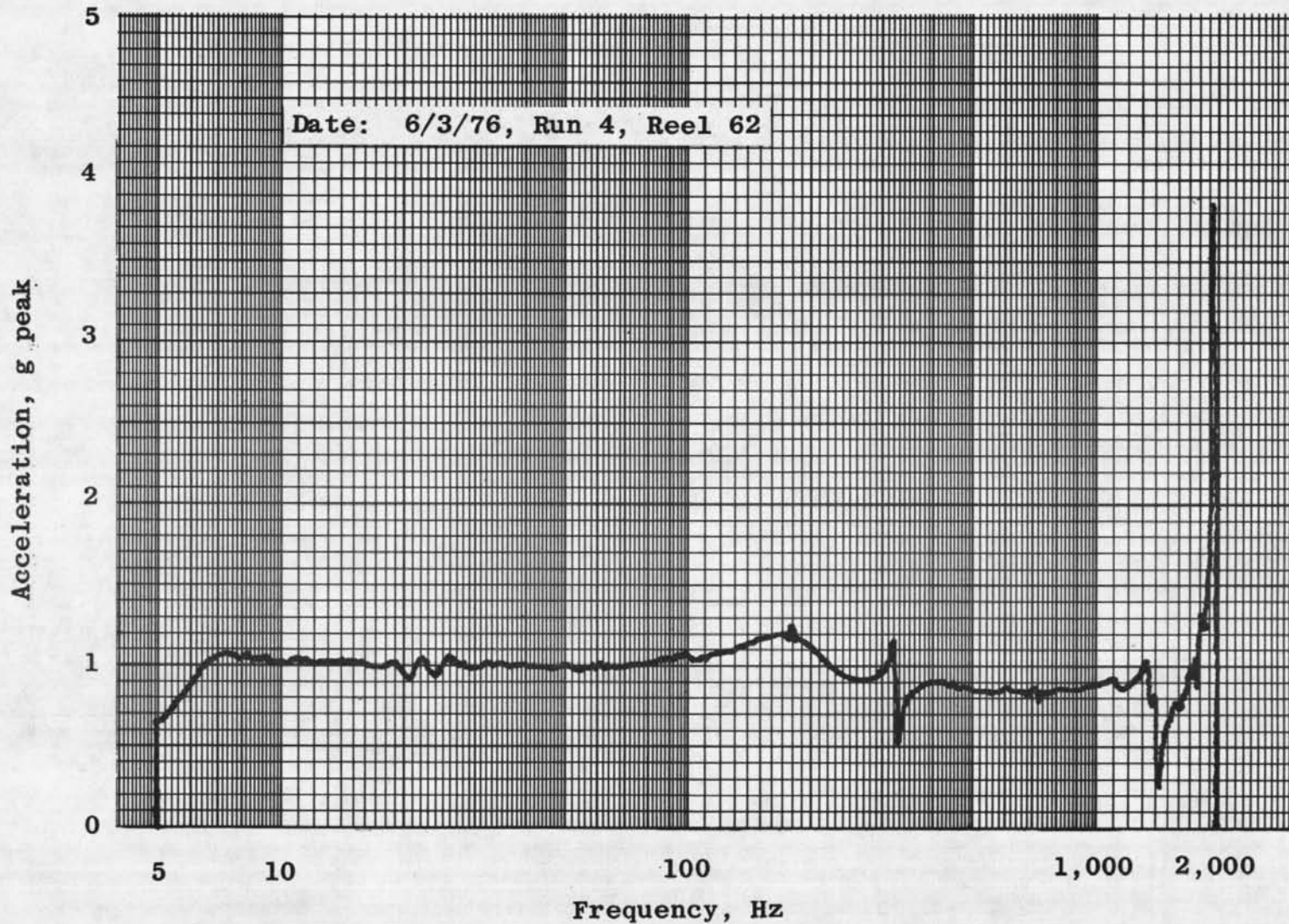

j. Accelerometer 7Z
Figure 30. Continued.

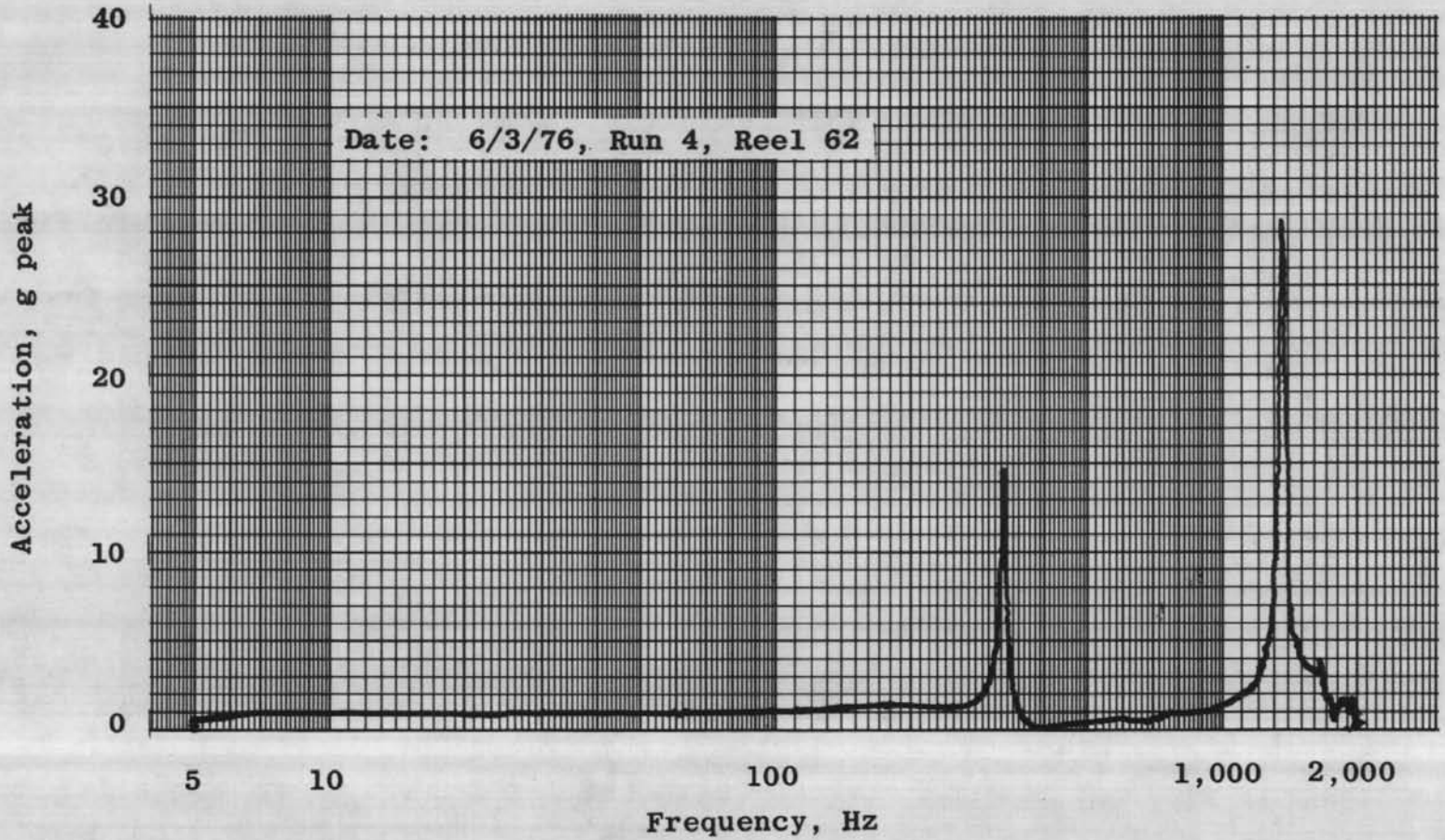

k. Accelerometer 8Z
Figure 30. Continued.

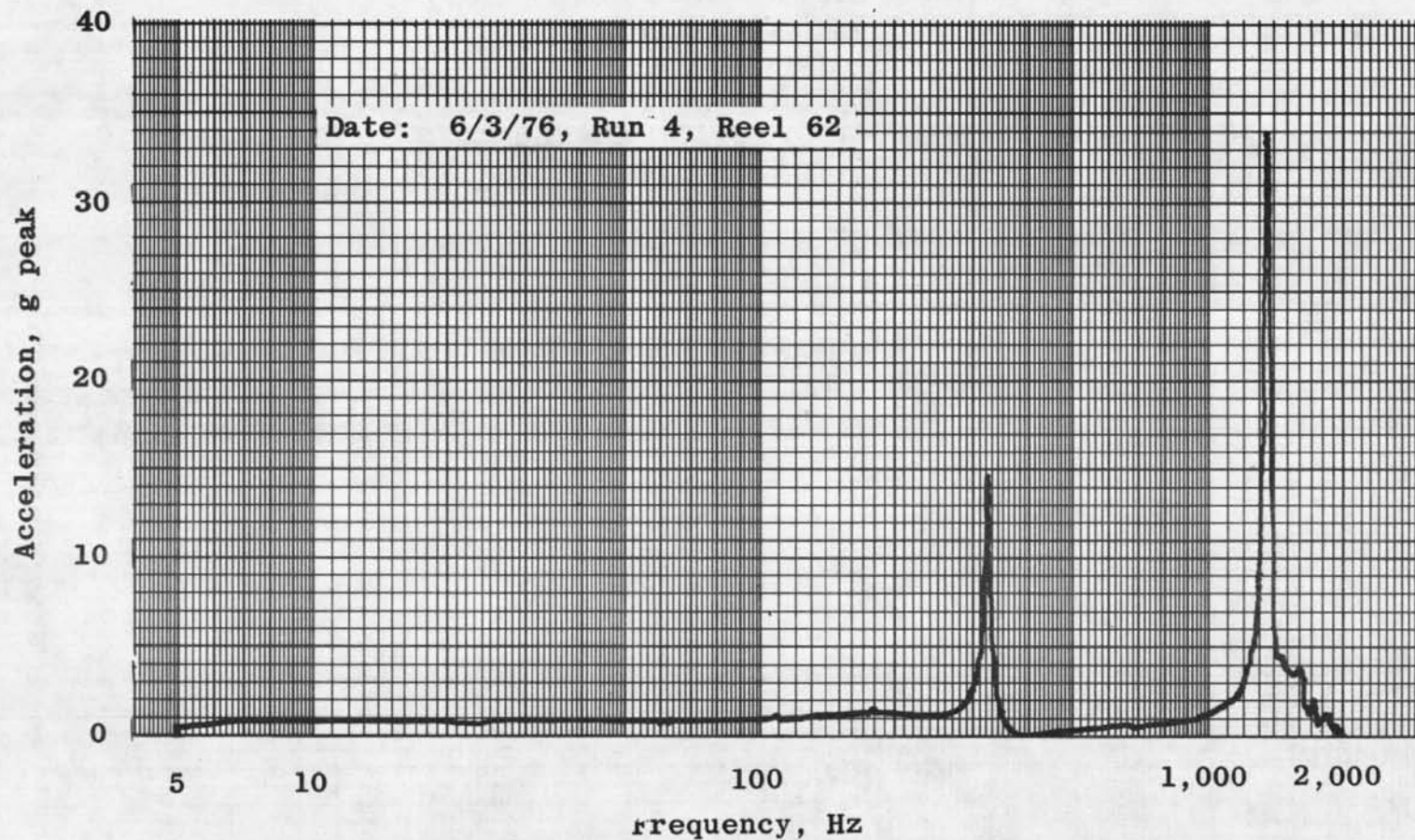

1. Accelerometer 9Z
Figure 30. Continued.

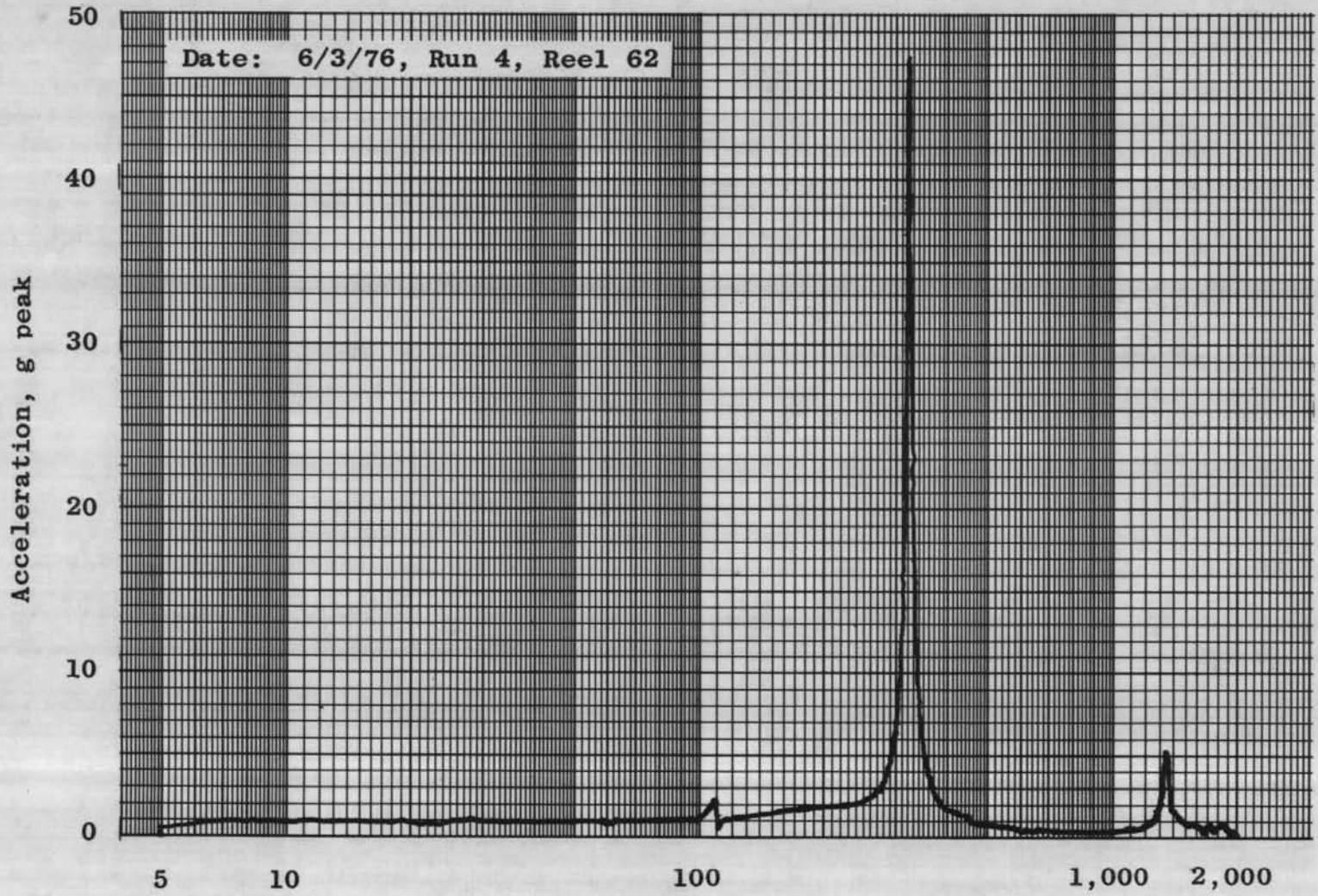

m. Accelerometer 11Z
Figure 30. Continued.

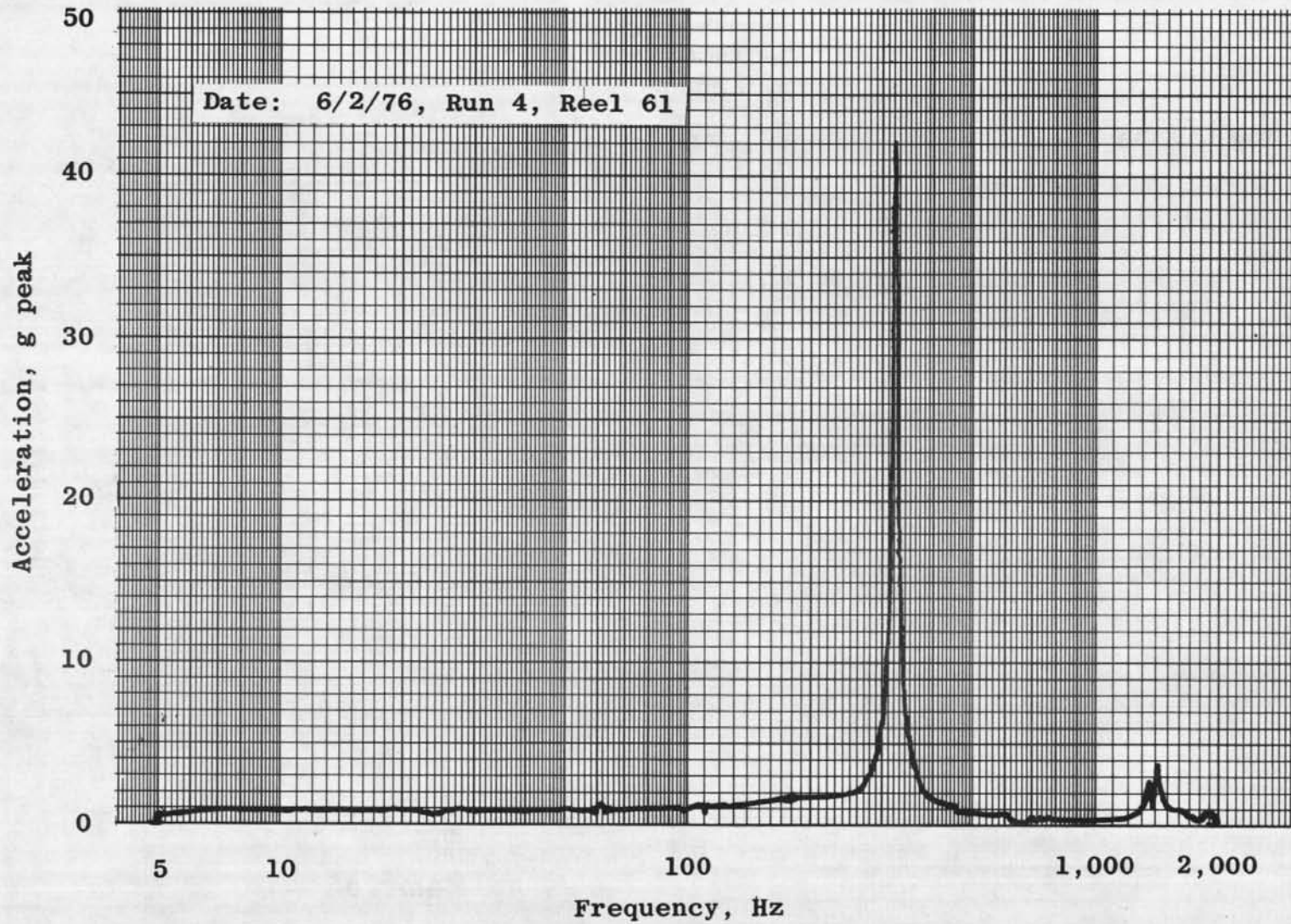

n. Accelerometer 12Z
Figure 30. Continued.

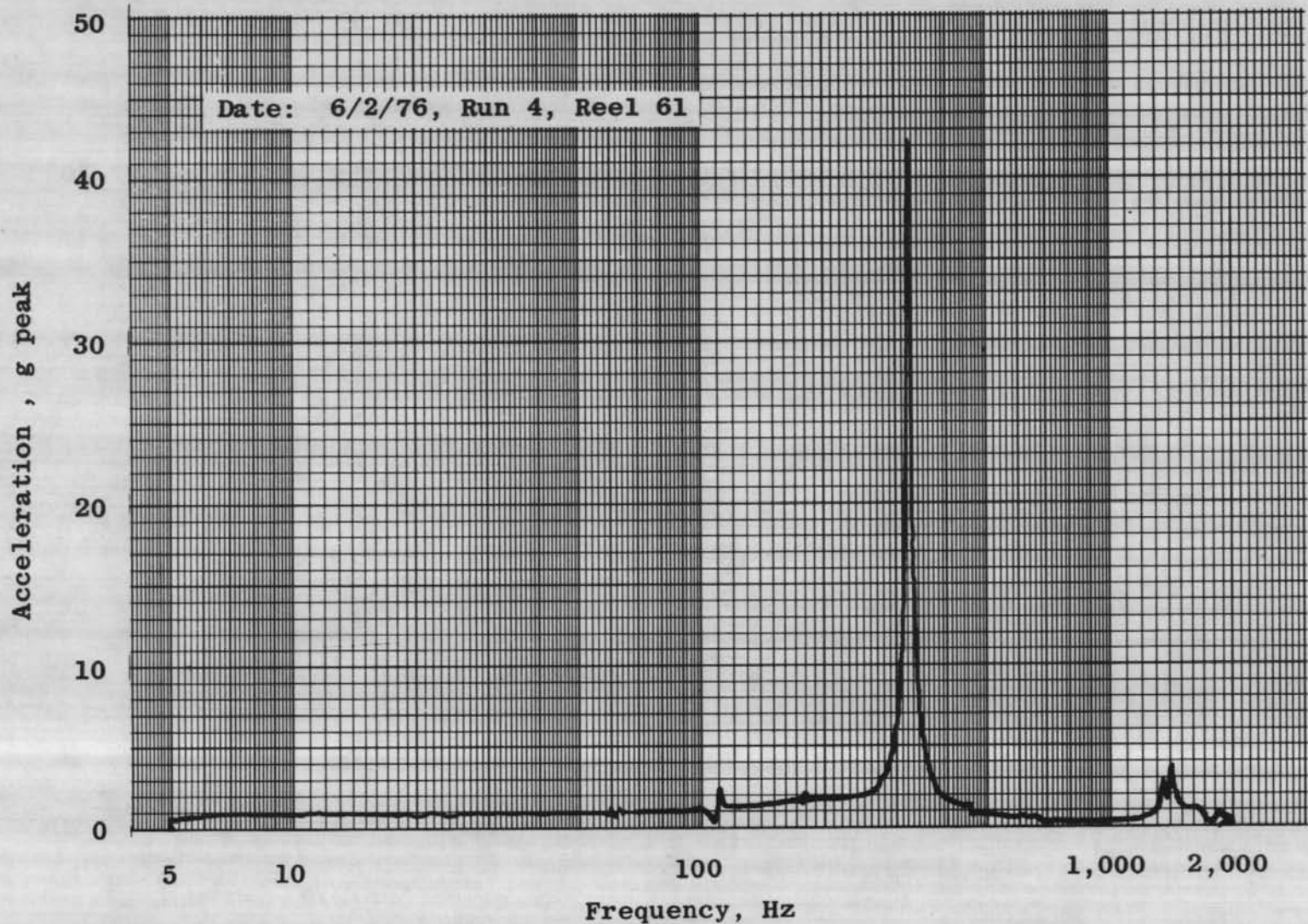

Frequency, Hz
o. Accelerometer 13Z
Figure 30. Continued.

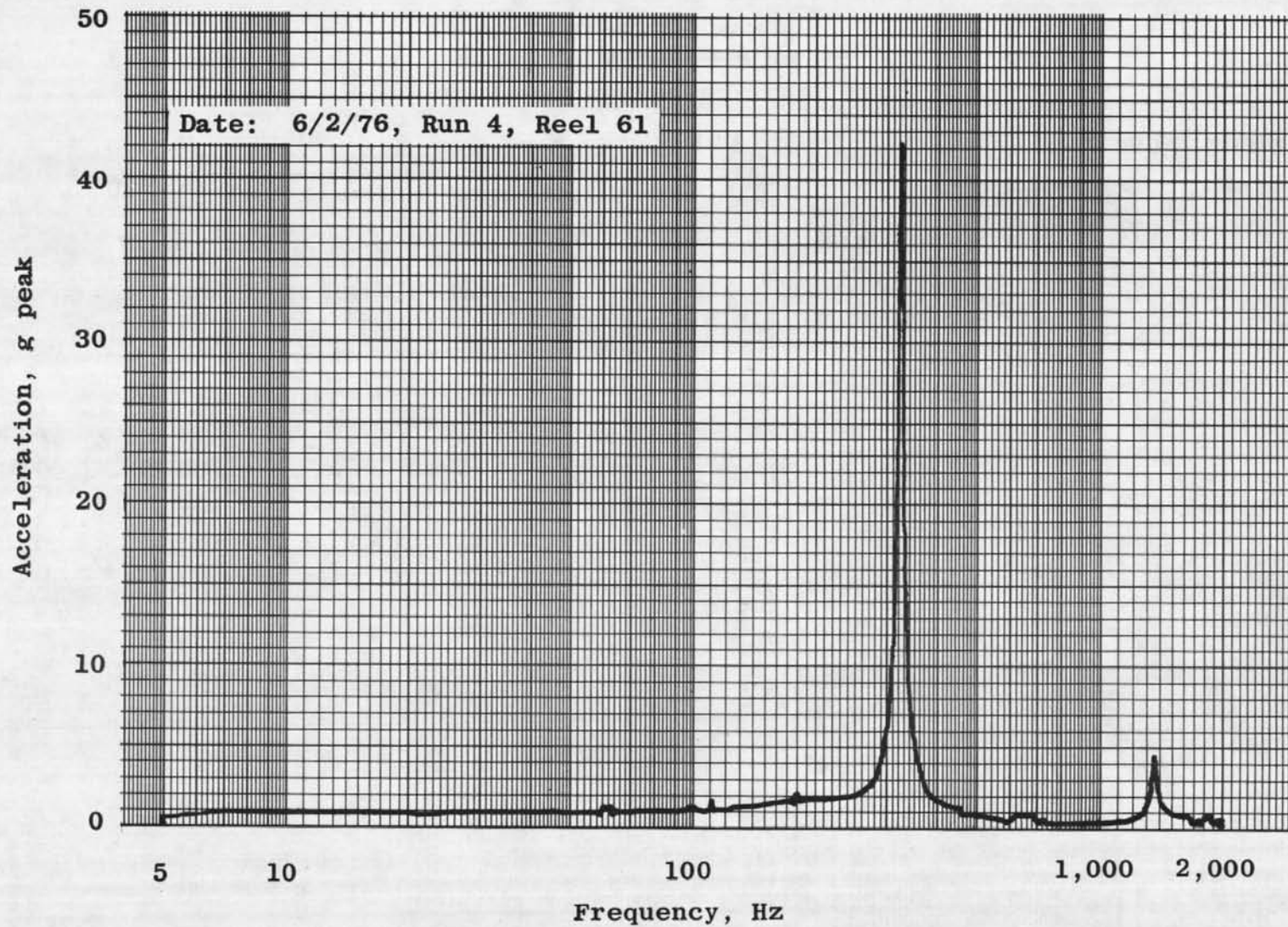

p. Accelerometer 14Z
Figure 30. Continued.

220

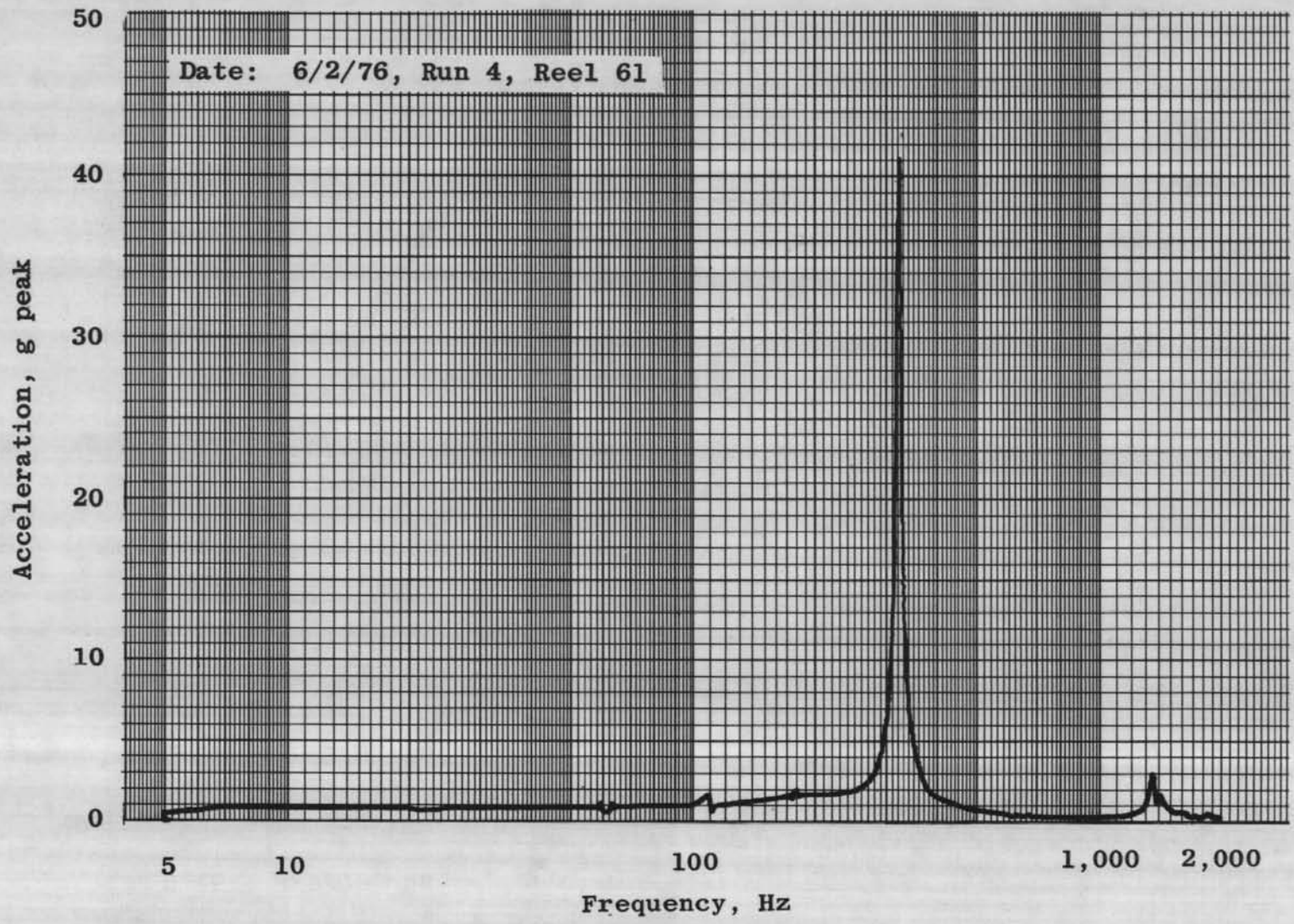

q. Accelerometer 15Z
Figure 30. Continued.

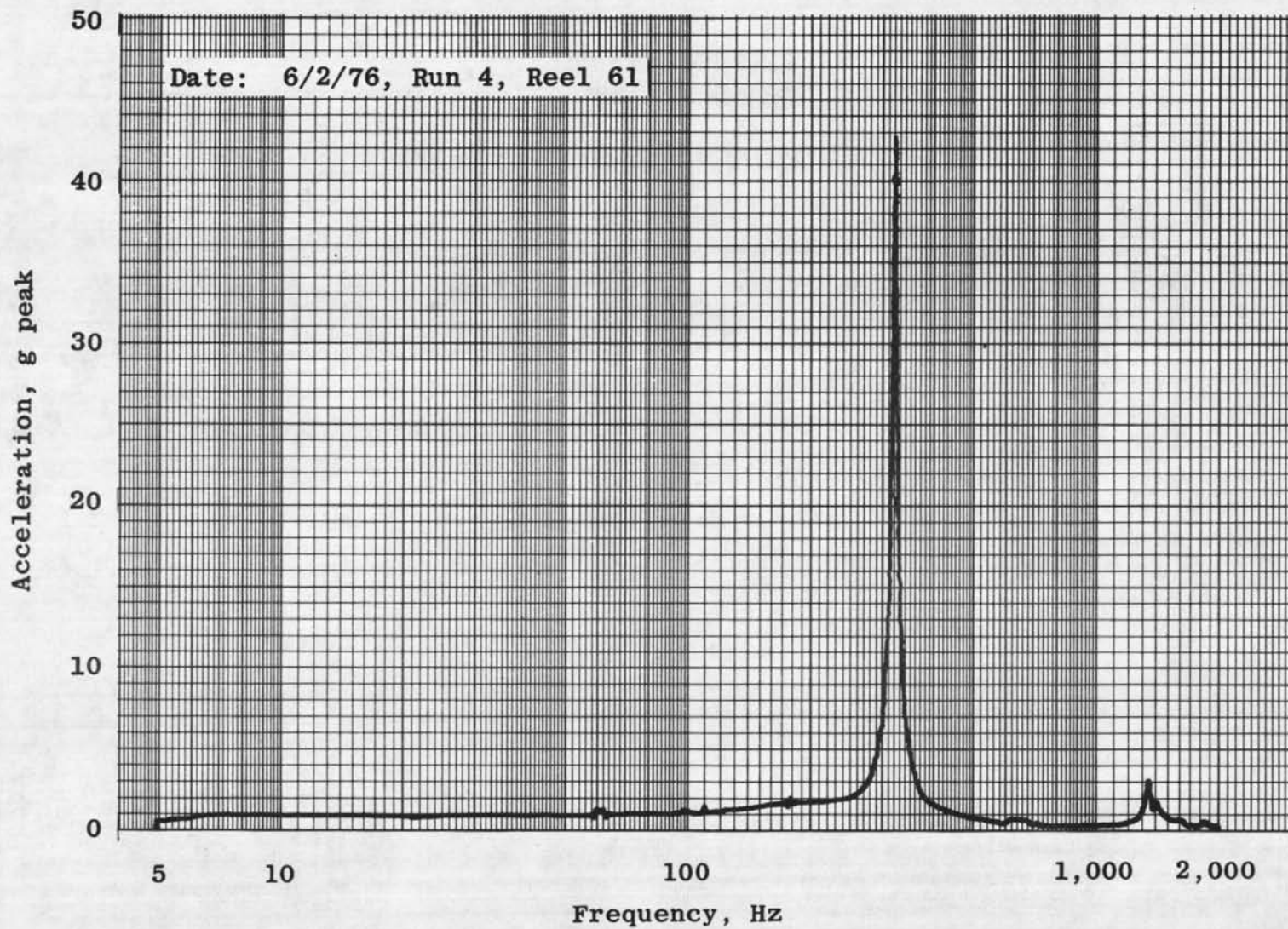

r. Accelerometer 16Z
Figure 30. Continued.

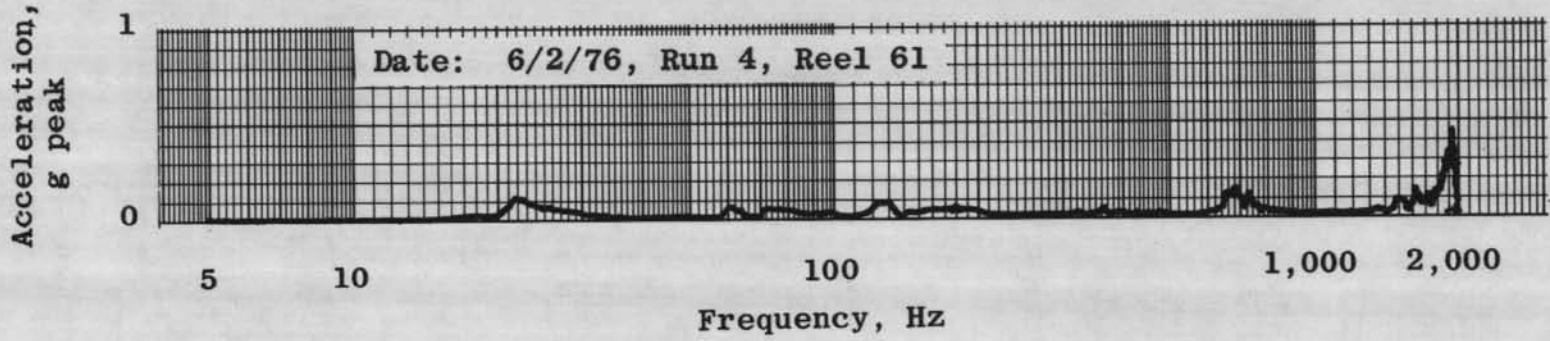

s. Accelerometer 1X

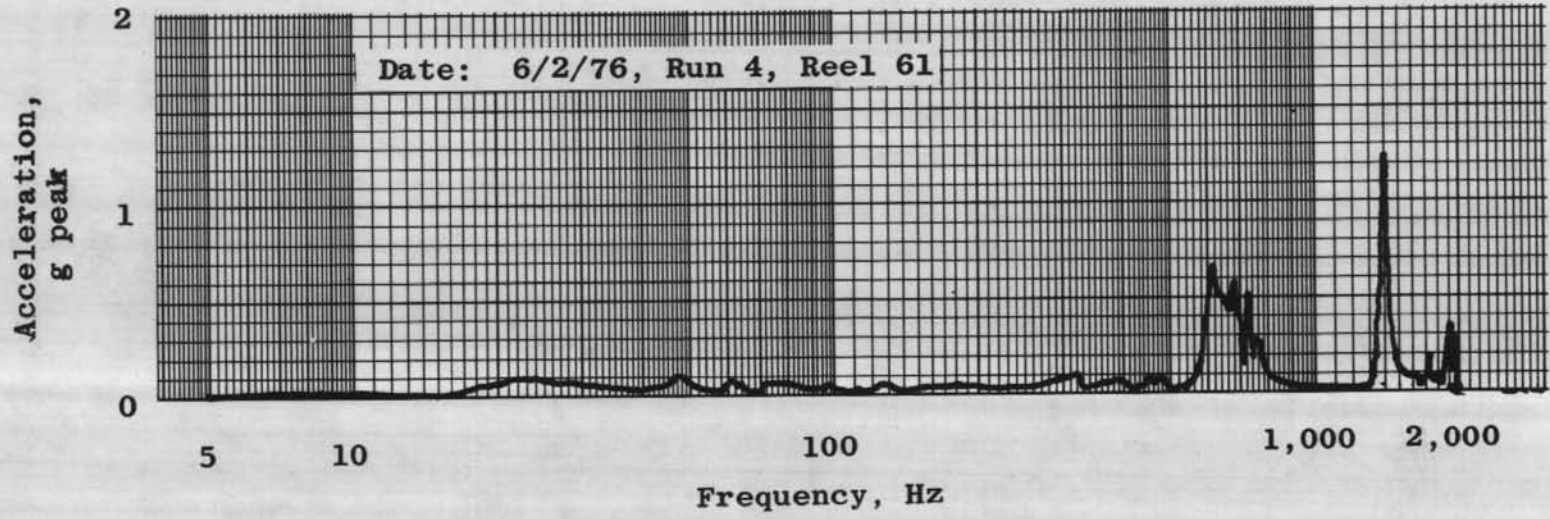

t. Accelerometer 9X
Figure 30. Continued.

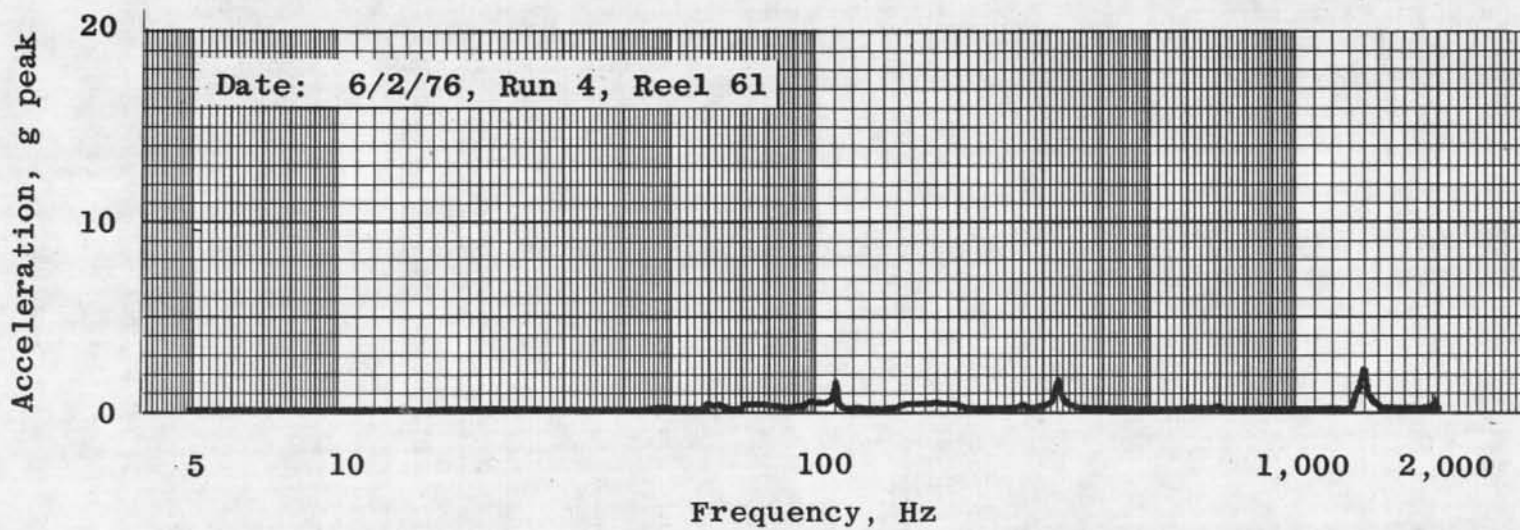

u. Accelerometer 11X
Figure 30. Continued.

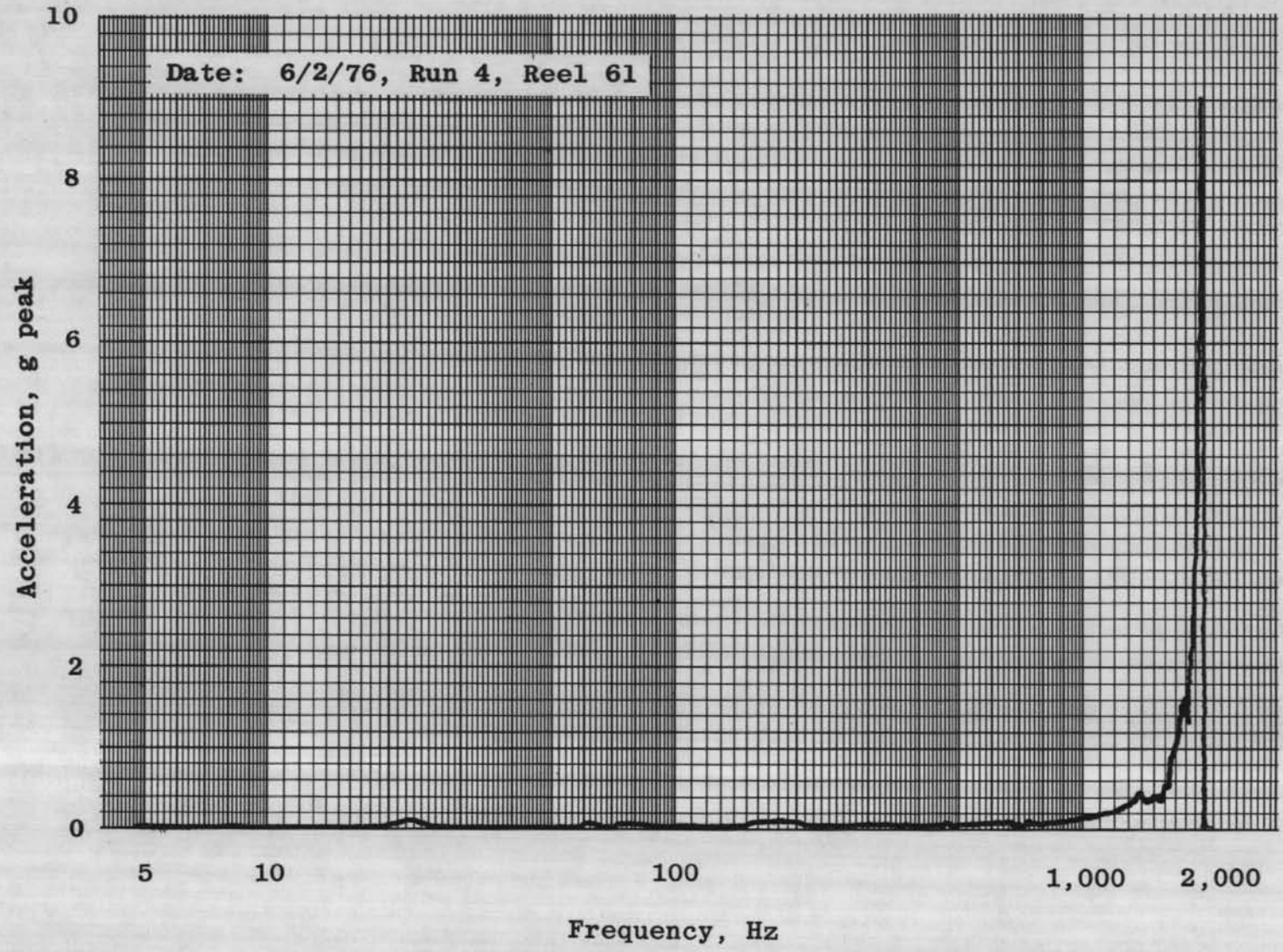

224

v. Accelerometer 1r
Figure 30. Continued

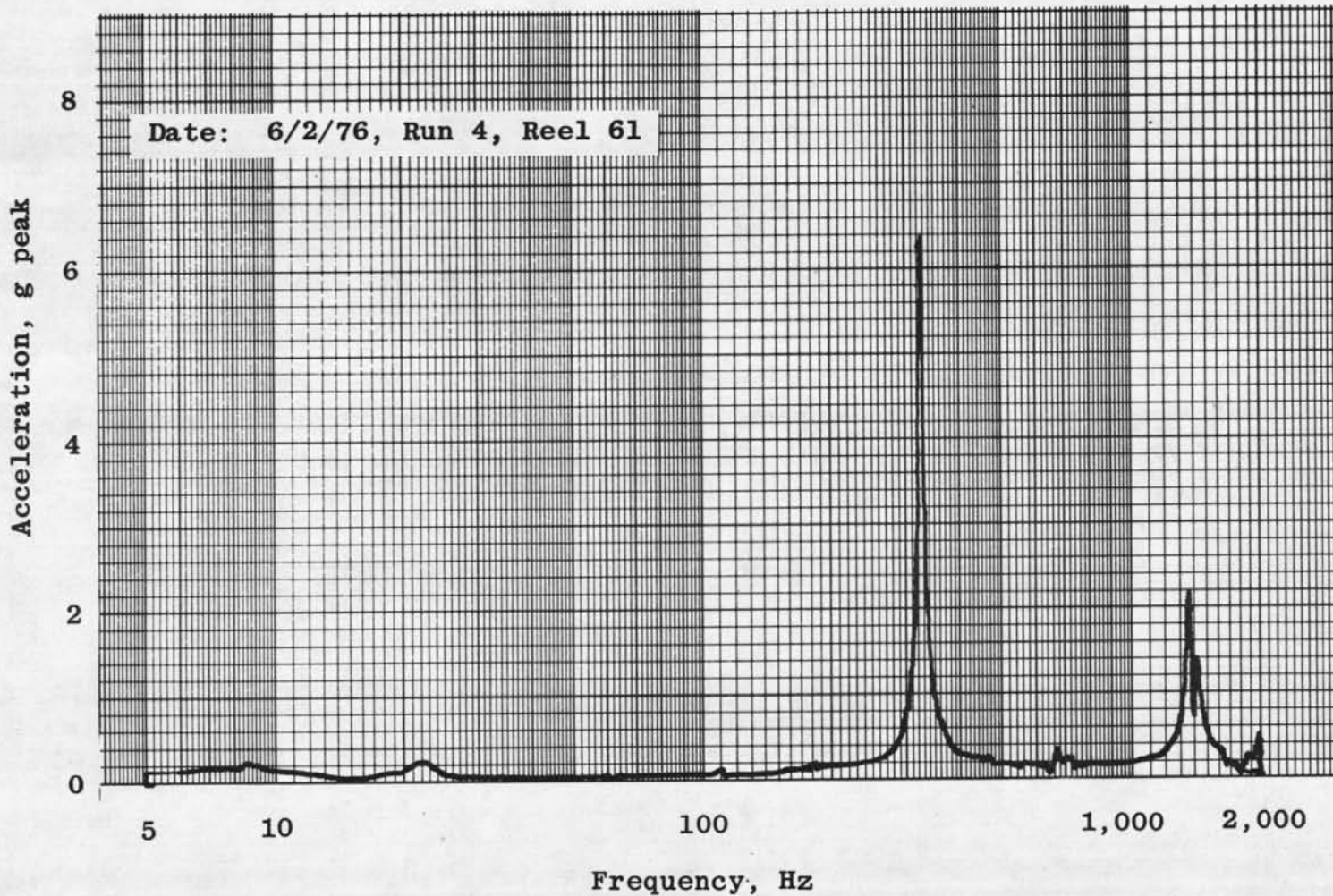

w. Accelerometer 9Y
Figure 30. Continued.

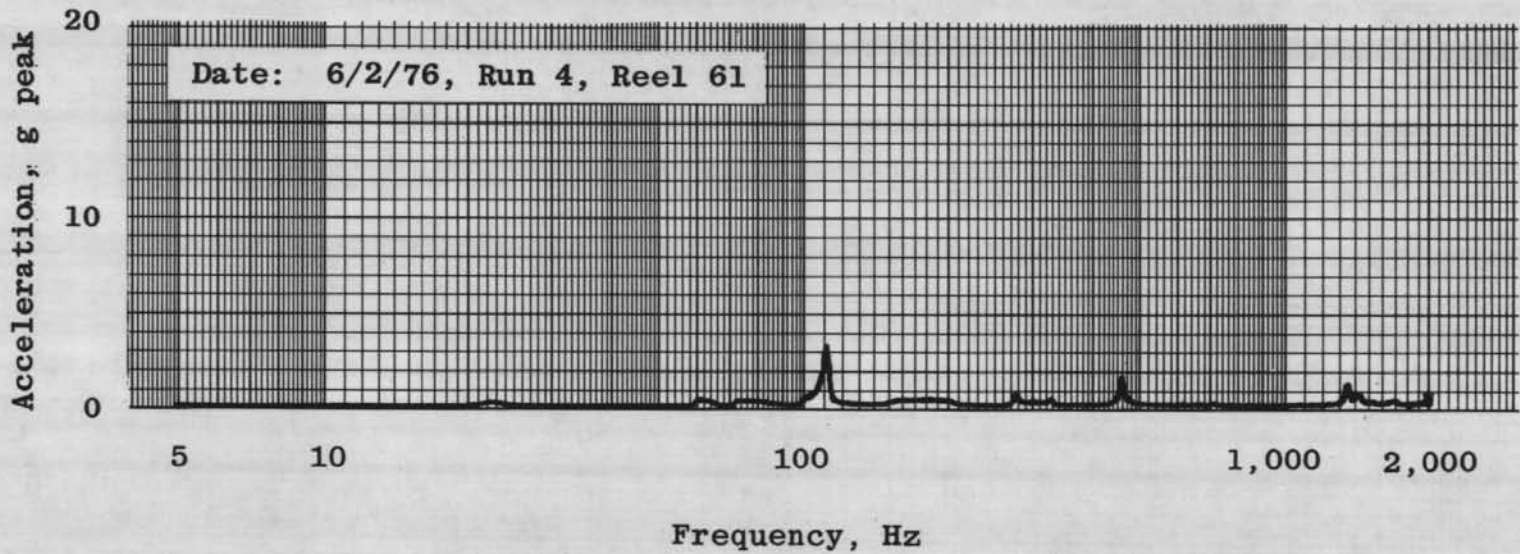

x. Accelerometer 11Y
Figure 30. Concluded.

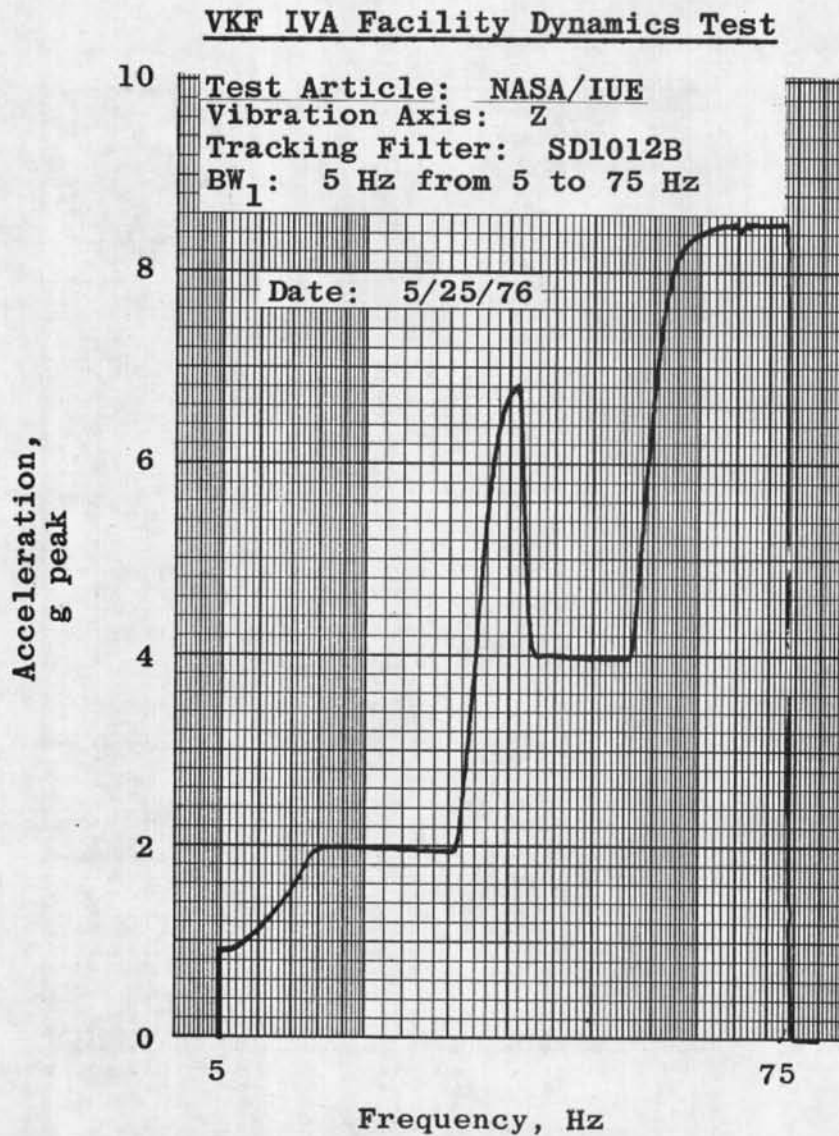

a. Closed loop plot

Figure 31. Z-axis vibration test: 5 to 75 Hz, qualification level sine sweep.

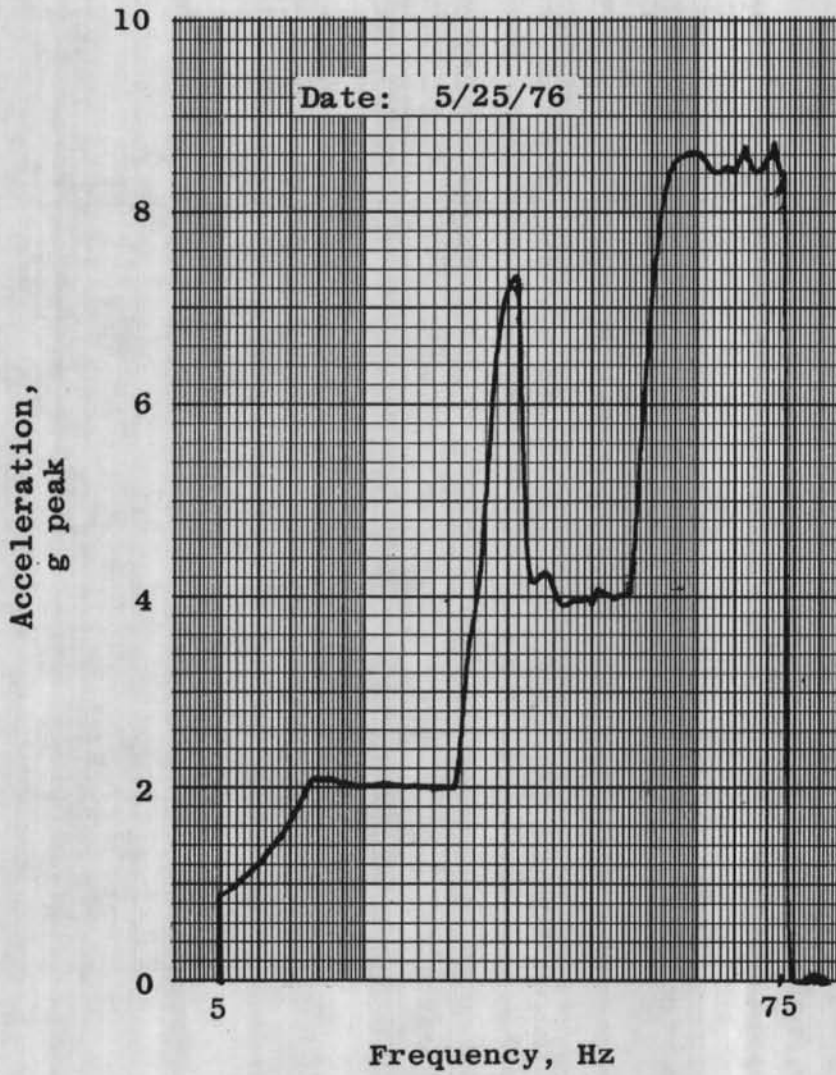

b. Online plot, accelerometers averaged
Figure 31. Continued.

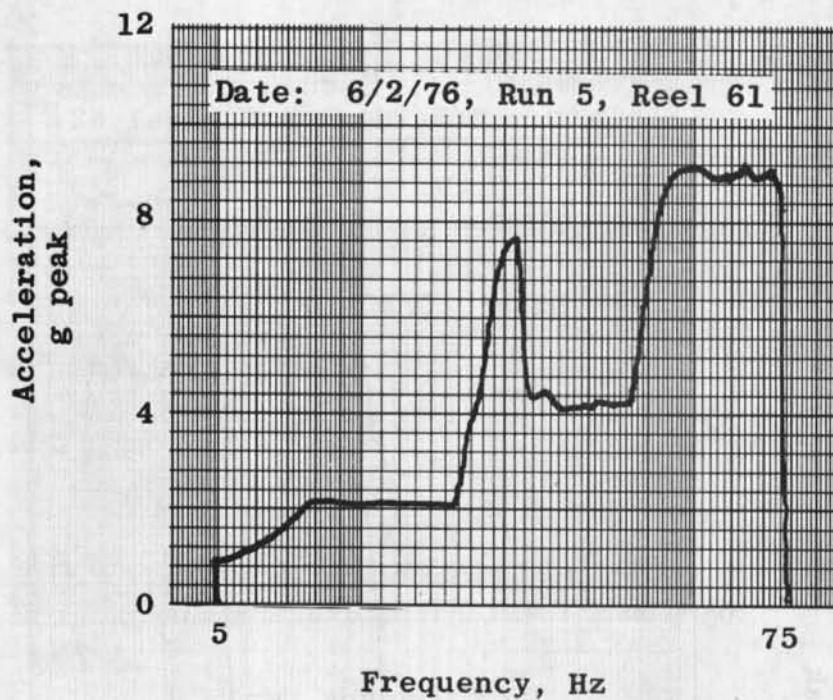

c. Accelerometers averaged

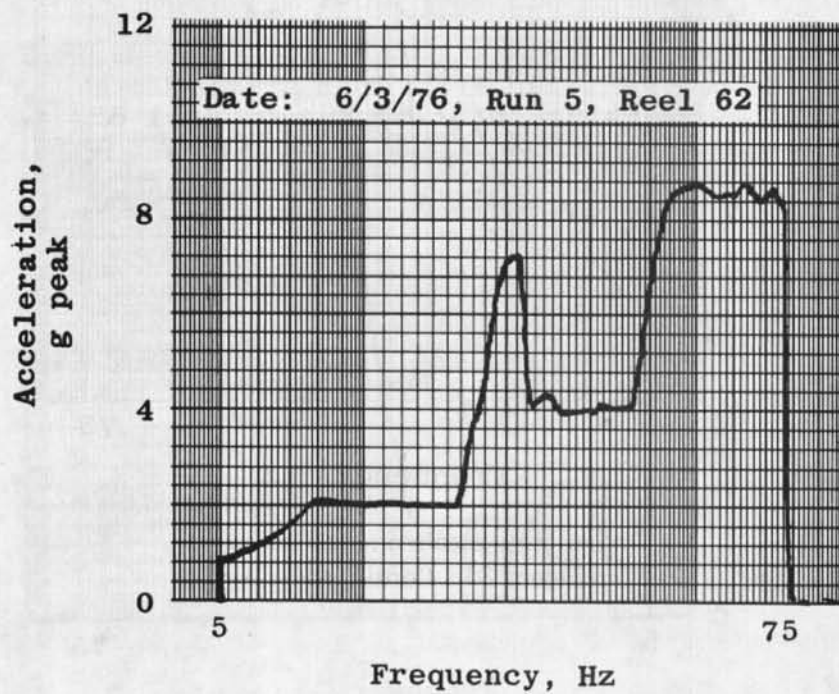
d. Accelerometer 12
Figure 31. Continued.

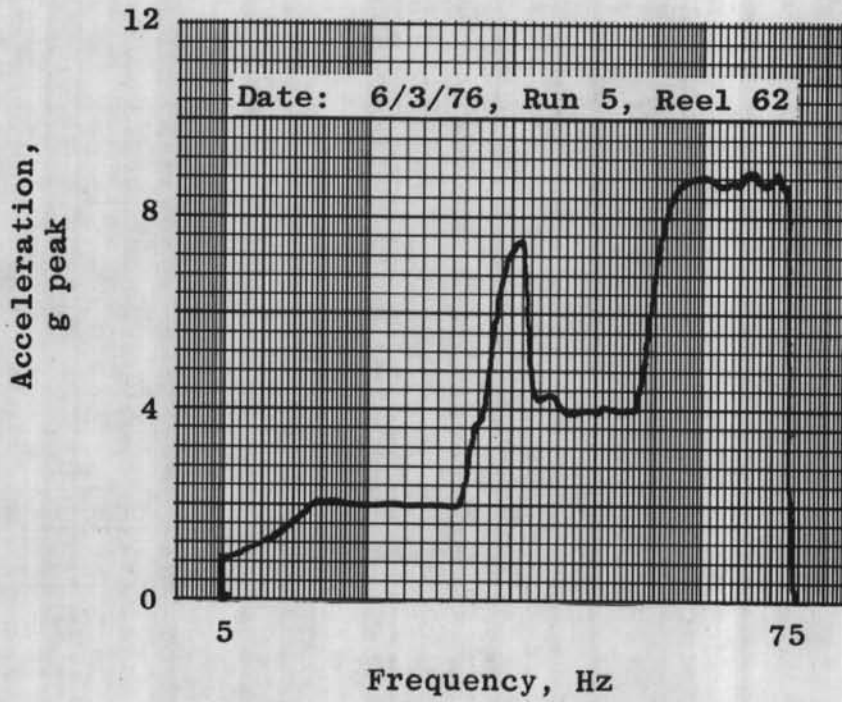

e. Accelerometer 2Z

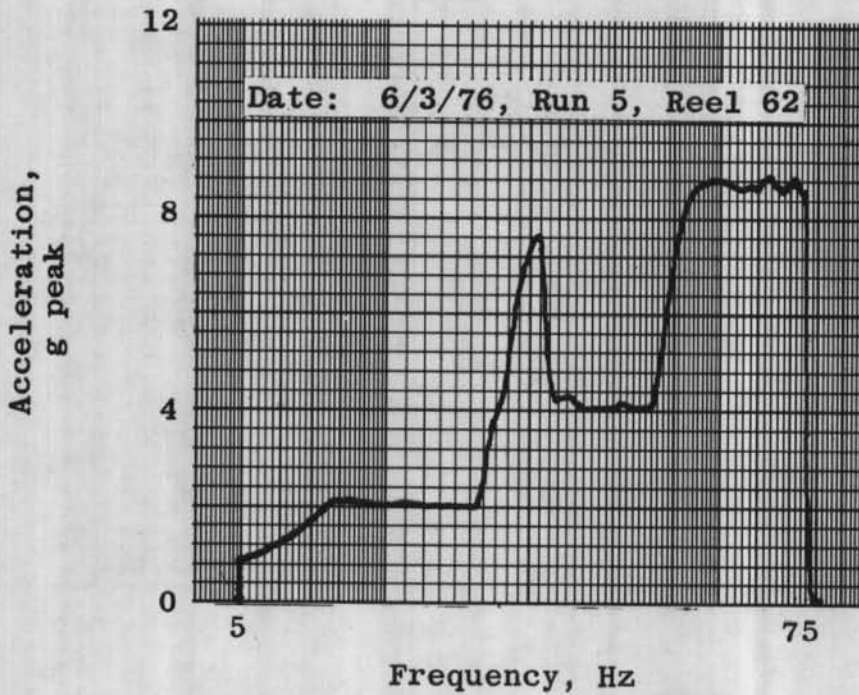

f. Accelerometer 3Z
Figure 31. Continued.

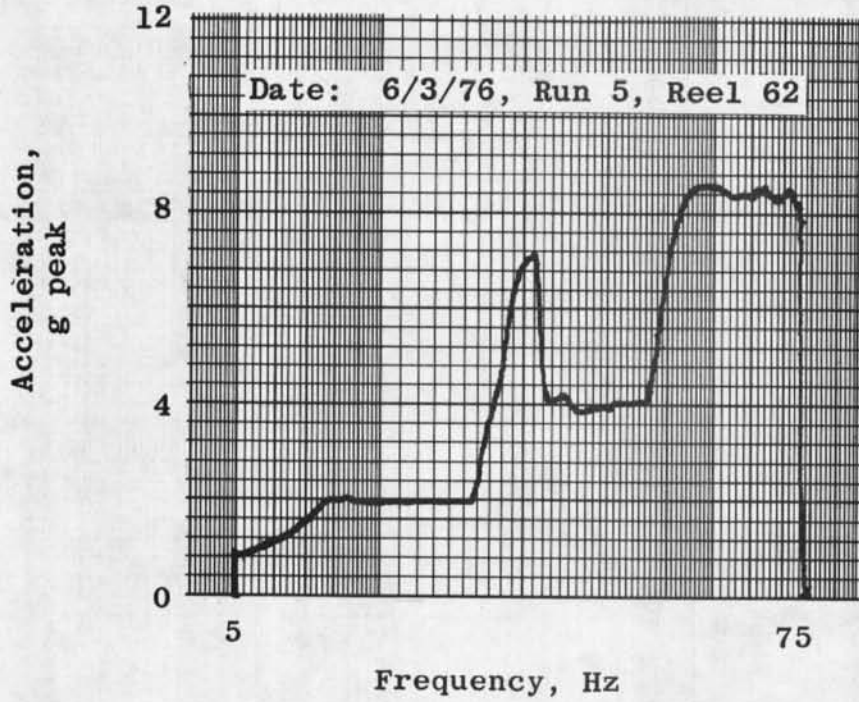

g. Accelerometer 4Z

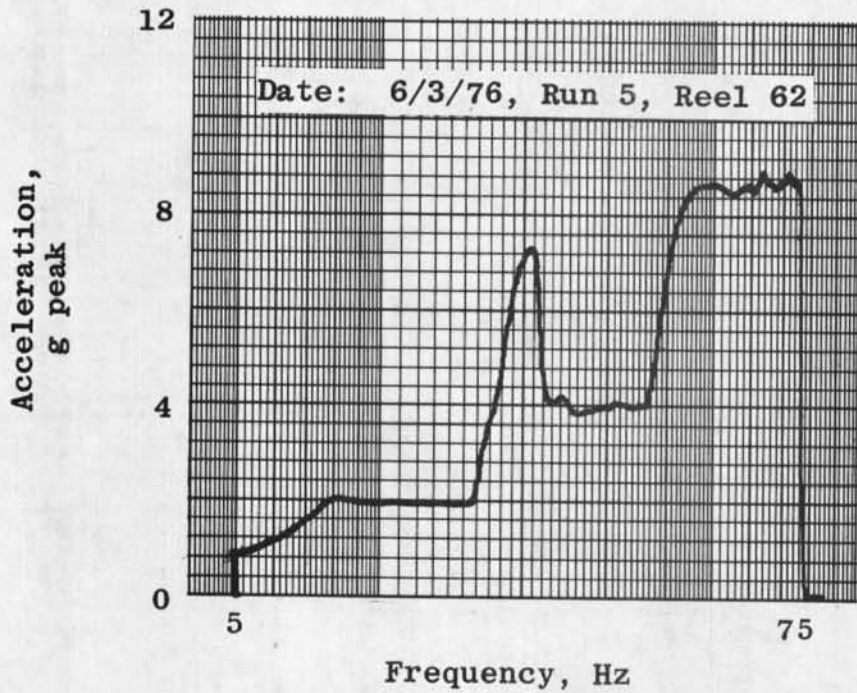

h. Accelerometer 5Z
Figure 31. Continued.

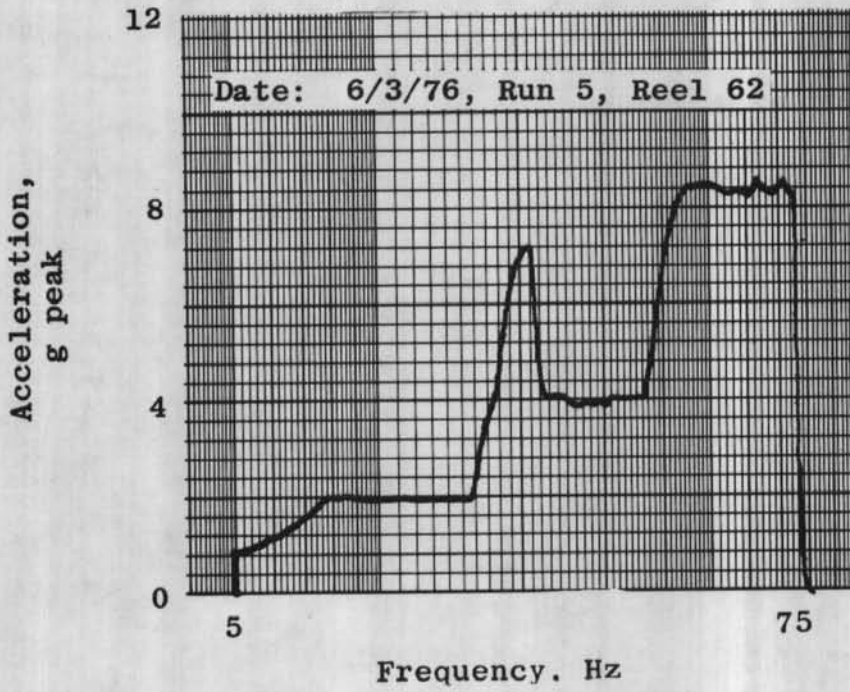

i. Accelerometer 6Z

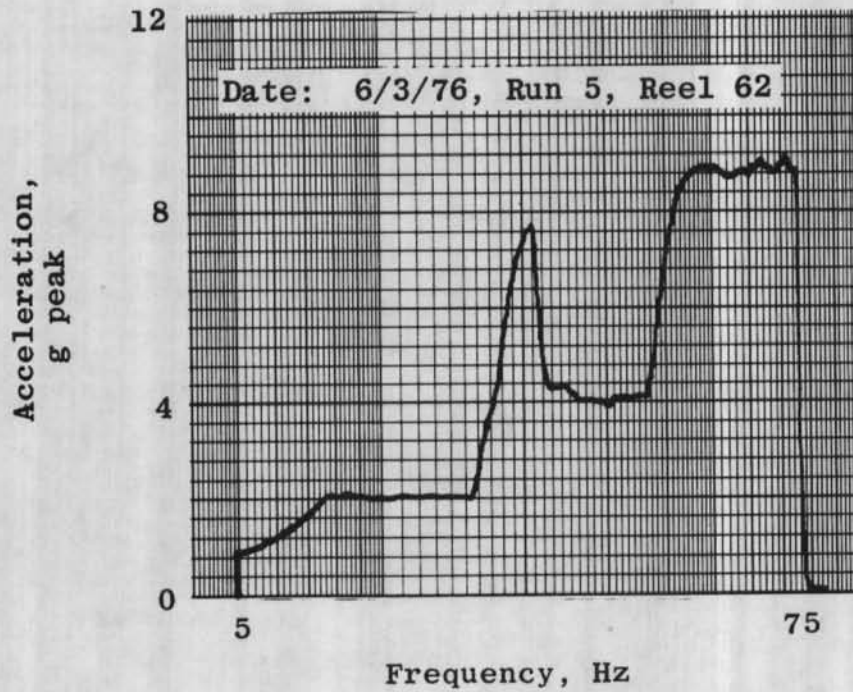

j. Accelerometer 7Z
Figure 31. Continued.

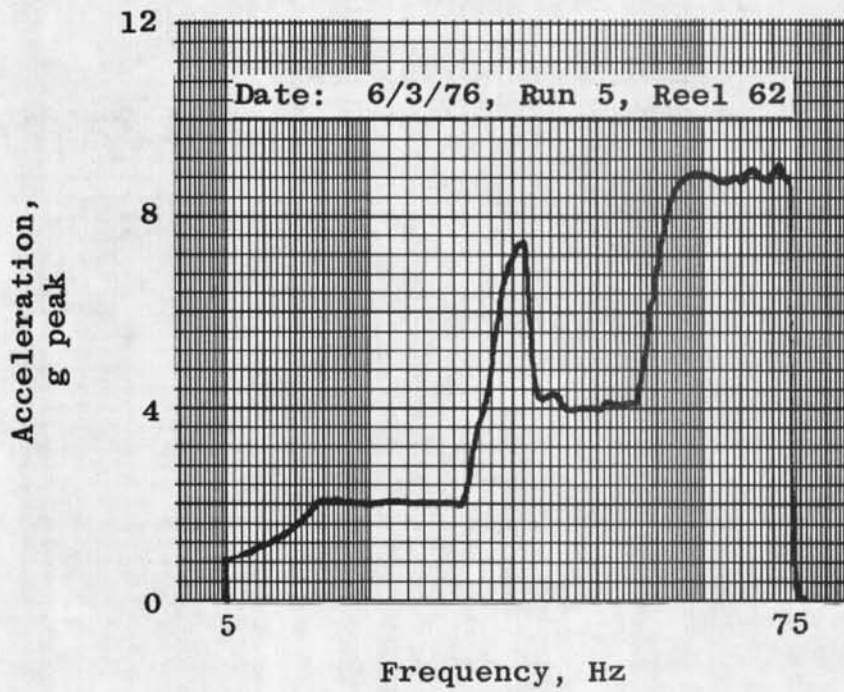

k. Accelerometer 8Z

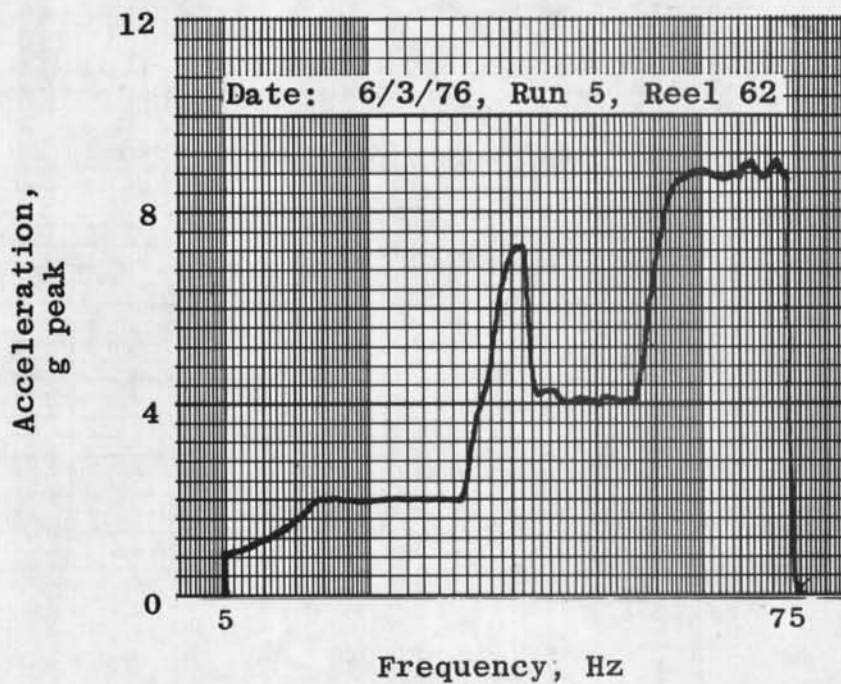
l. Accelerometer 9Z
Figure 31. Continued.

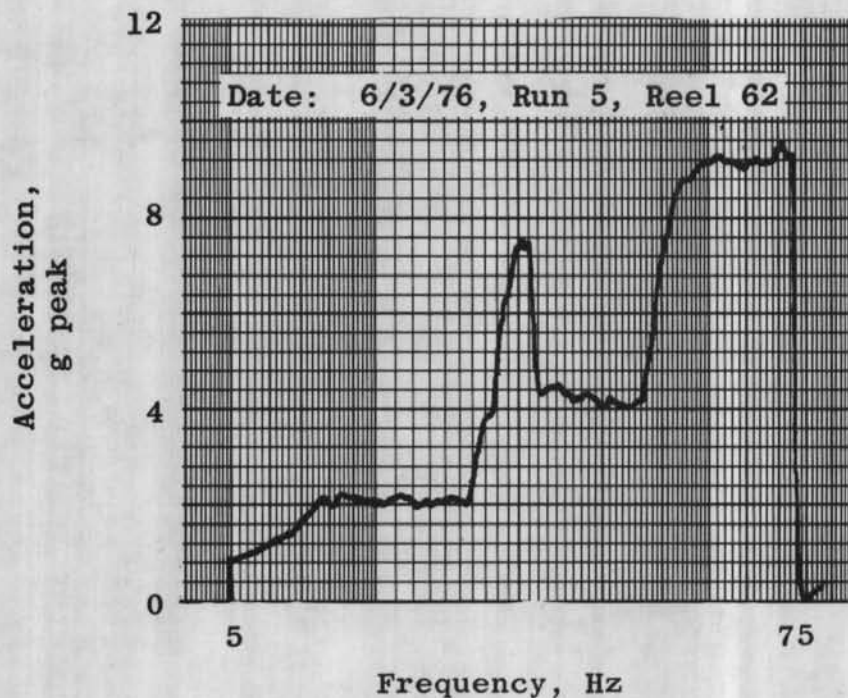

m. Accelerometer 11Z

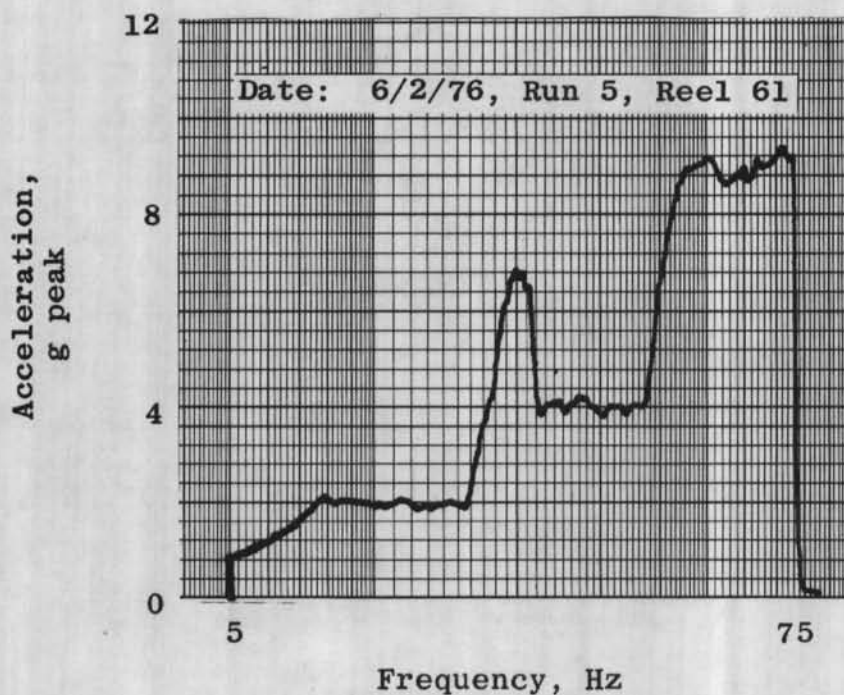

n. Accelerometer 12Z

Figure 31. Continued.

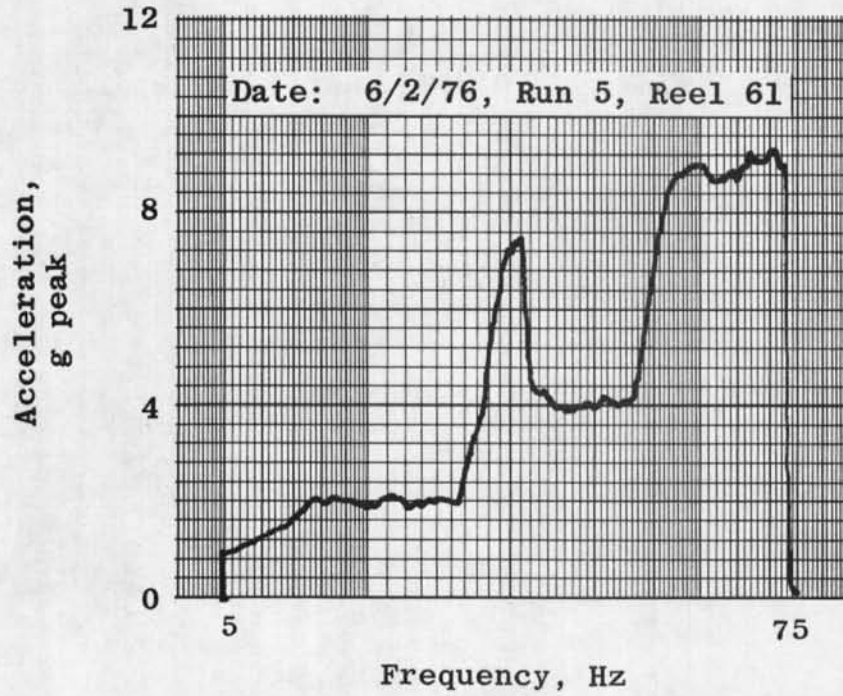

o. Accelerometer 13Z

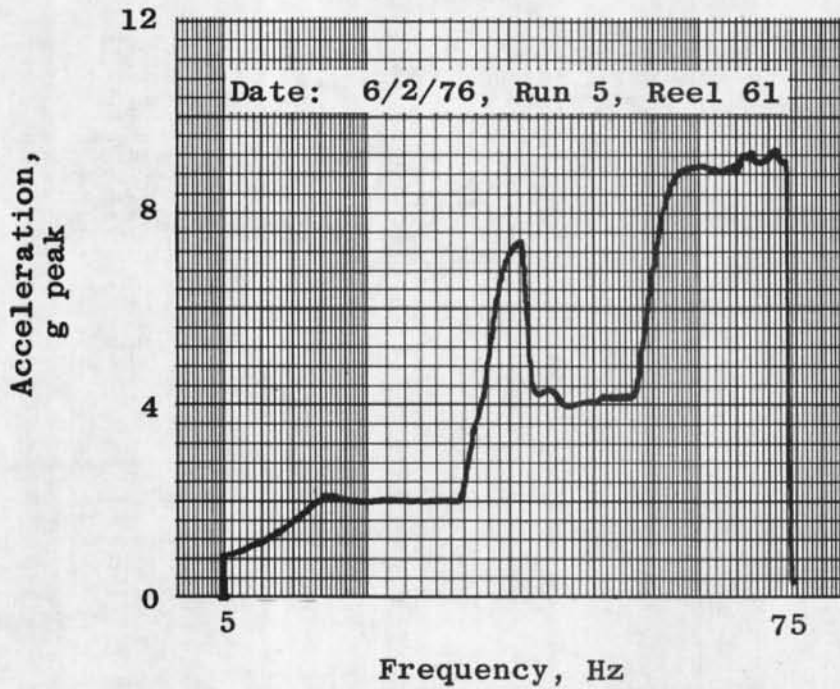
p. Accelerometer 14Z
Figure 31. Continued.

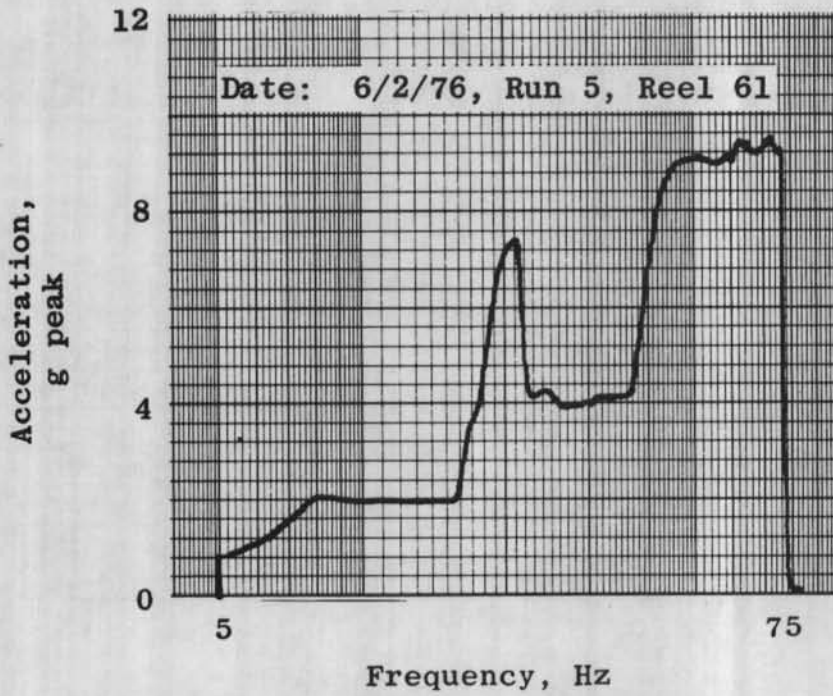

q. Accelerometer 15Z

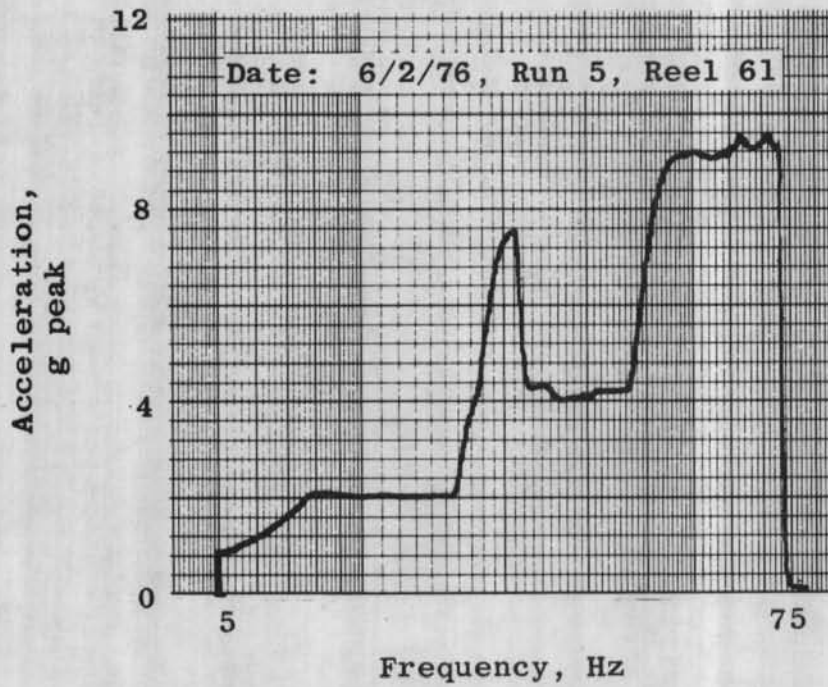

r. Accelerometer 16Z
Figure 31. Continued.

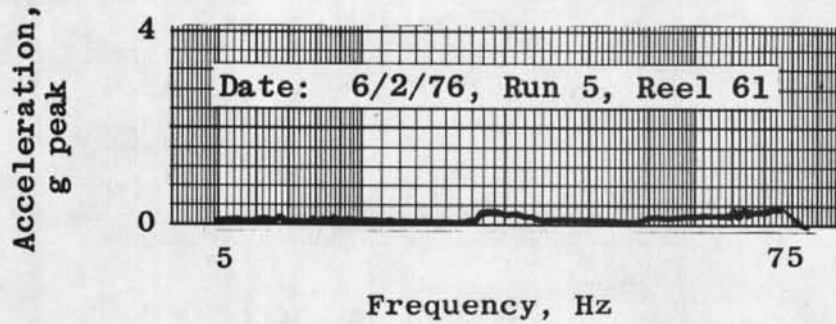

s. Accelerometer 1X

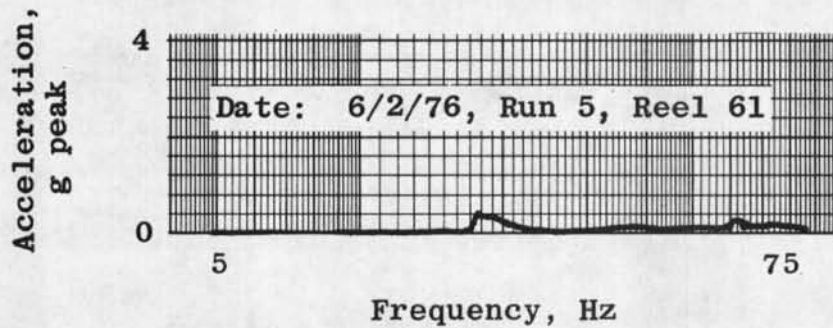

t. Accelerometer 9X

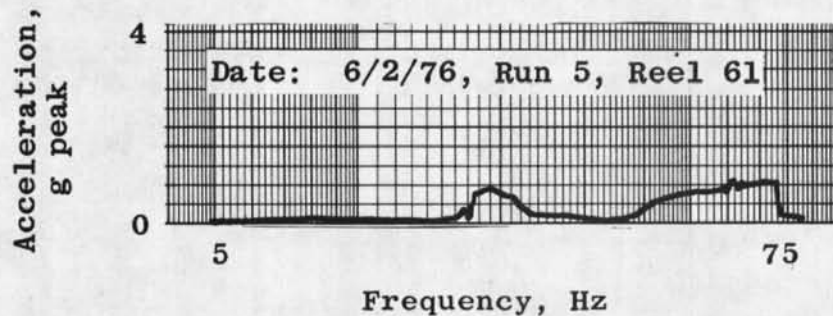
u. Accelerometer 11X
Figure 31. Continued.

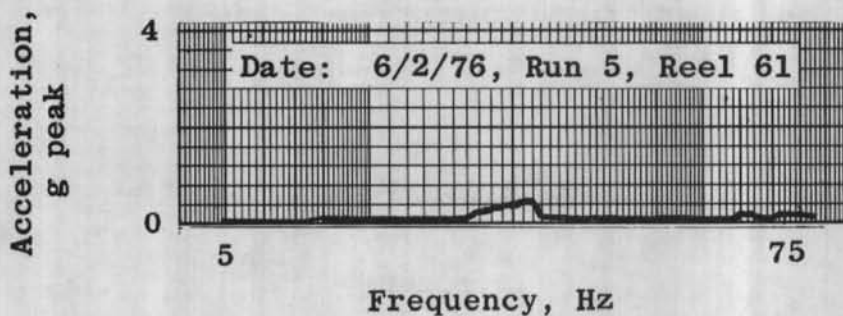

v. Accelerometer 1Y

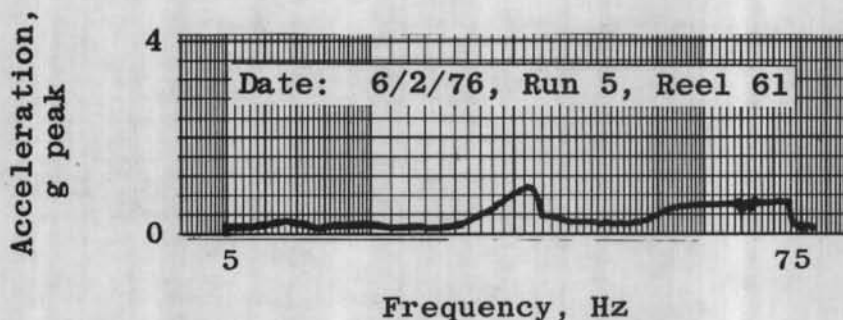

w. Accelerometer 9Y

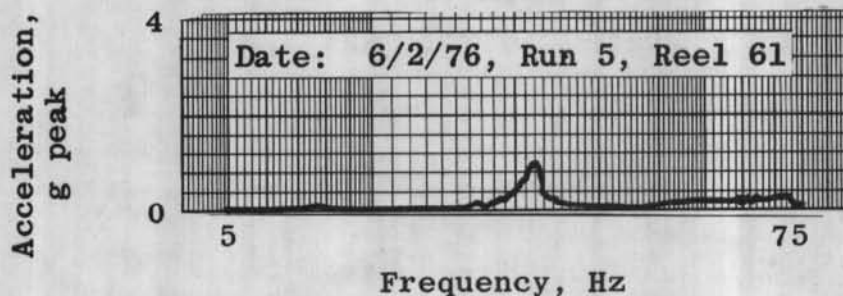

x. Accelerometer 11Y
Figure 31. Concluded.

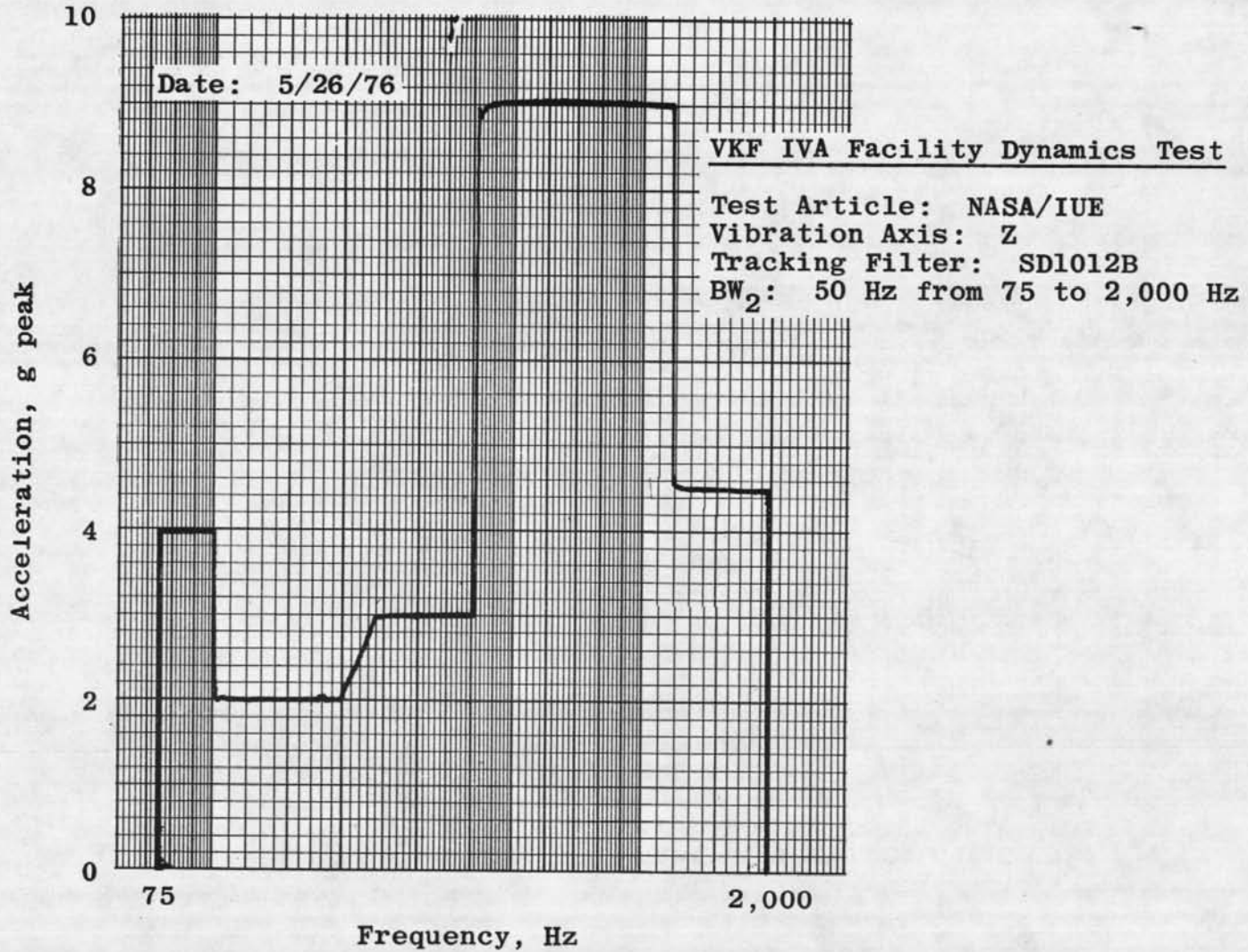

a. Closed loop plot

Figure 32. Z-axis vibration test: 75 to 325 Hz, qualification level sine sweep.

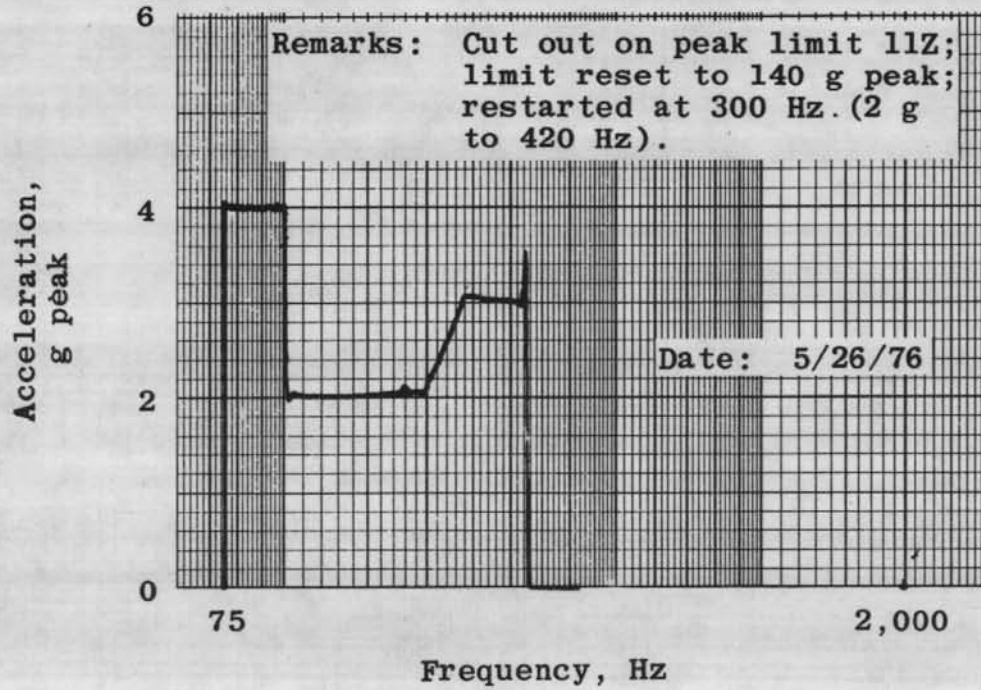

b. Online plot, accelerometers averaged
Figure 32. Continued.

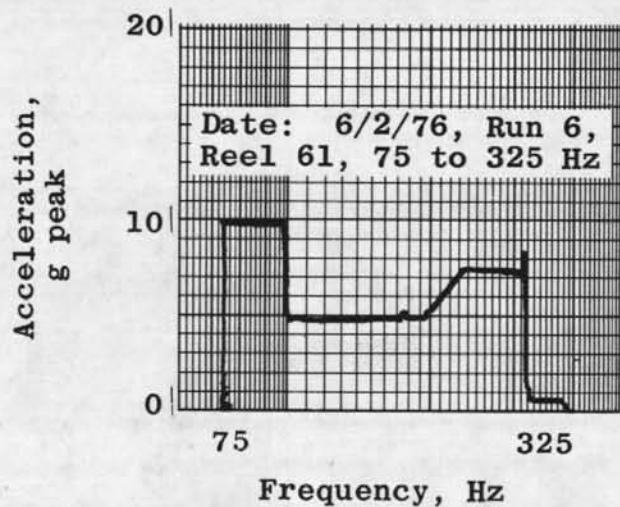

c. Accelerometers averaged

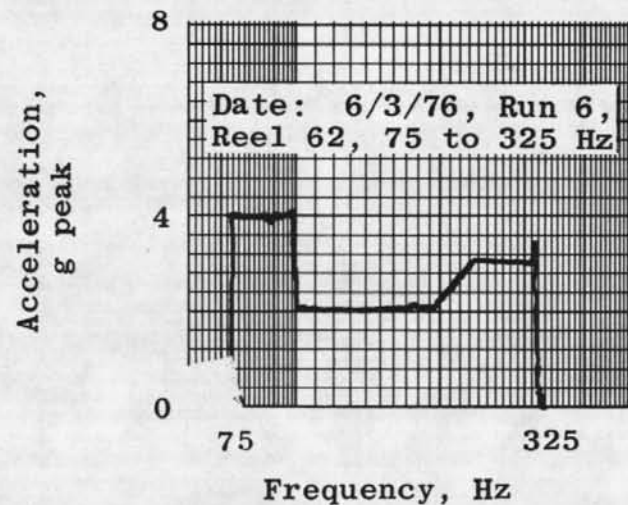

d. Accelerometer 1Z

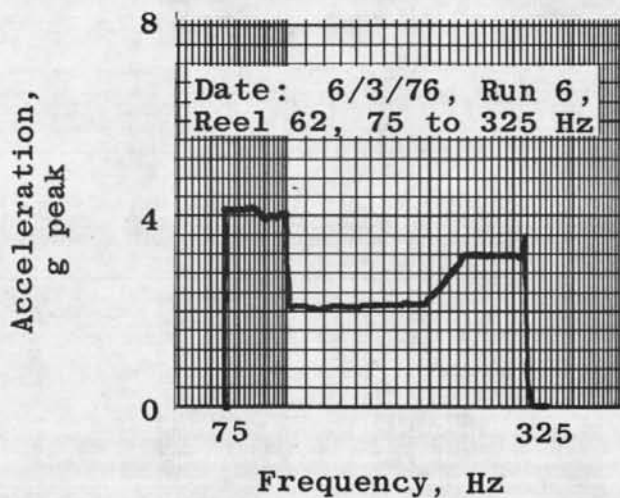

e. Accelerometer 2Z

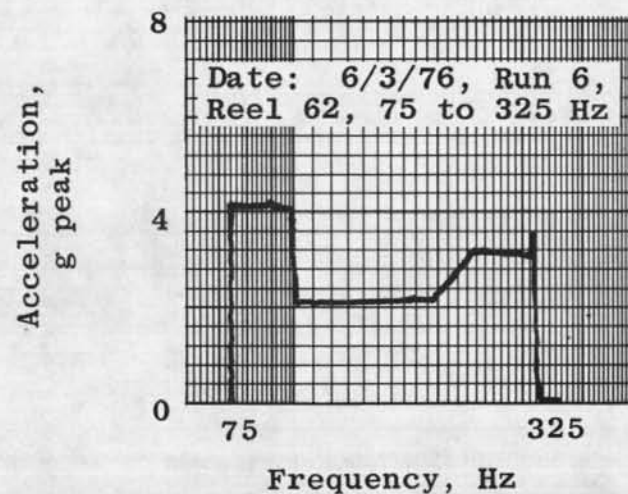

f. Accelerometer 3Z

Figure 32. Continued.

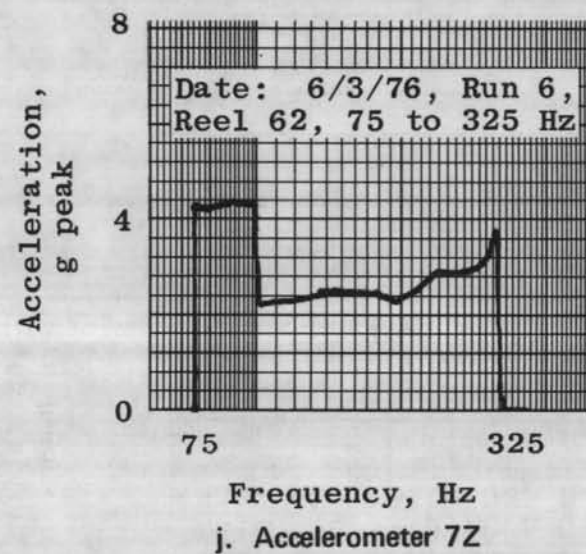
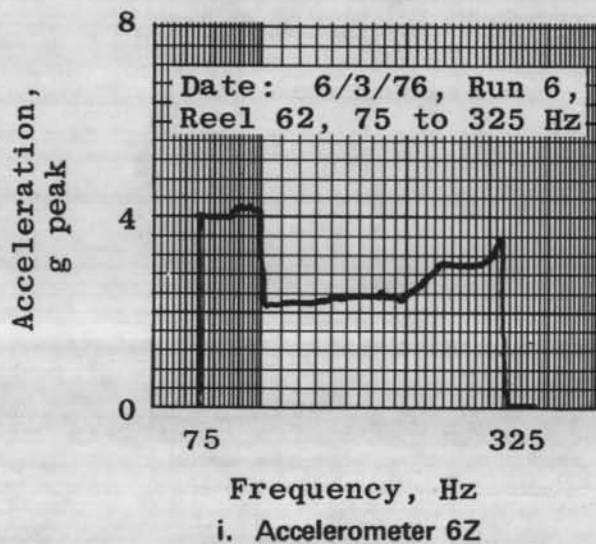
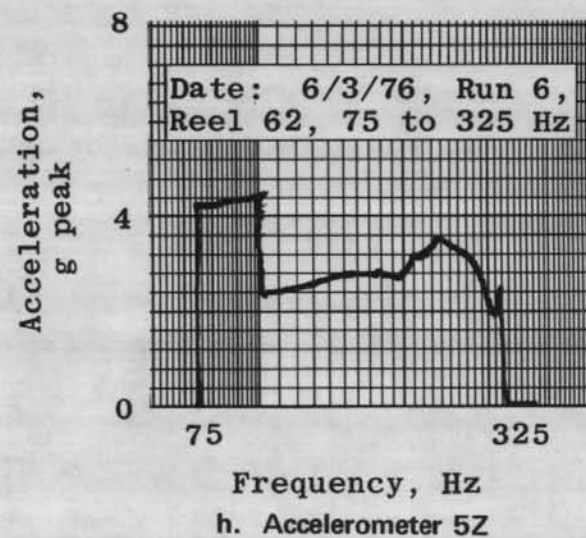
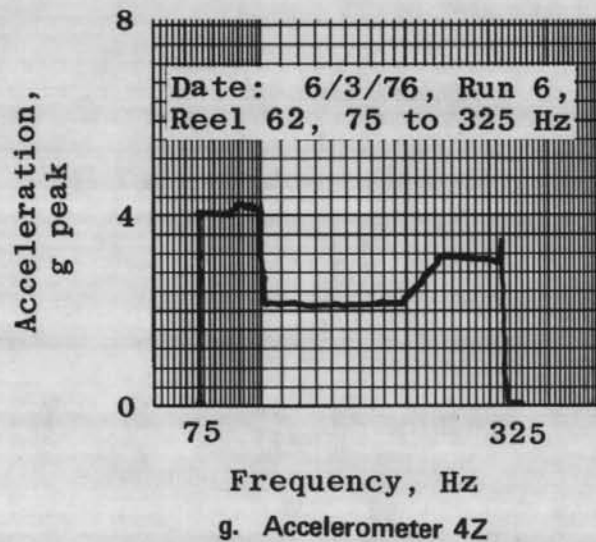
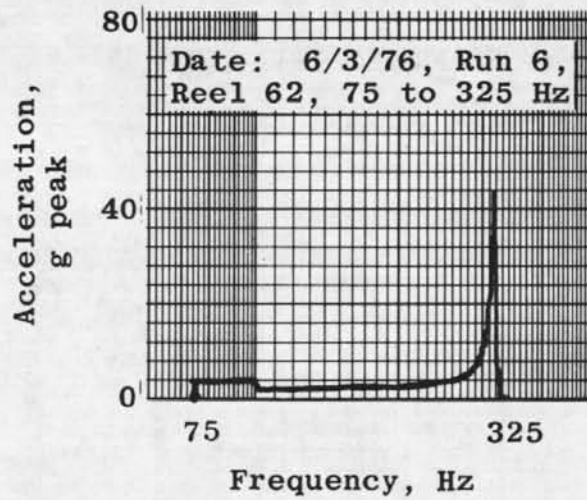
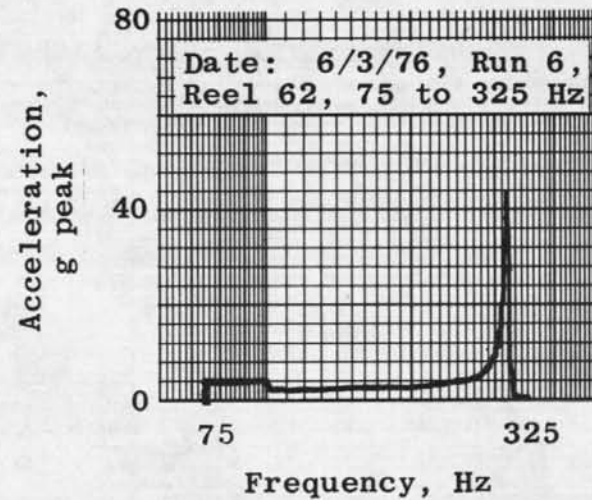

Figure 32. Continued.



k. Accelerometer 8Z



l. Accelerometer 9Z

Figure 32. Continued.

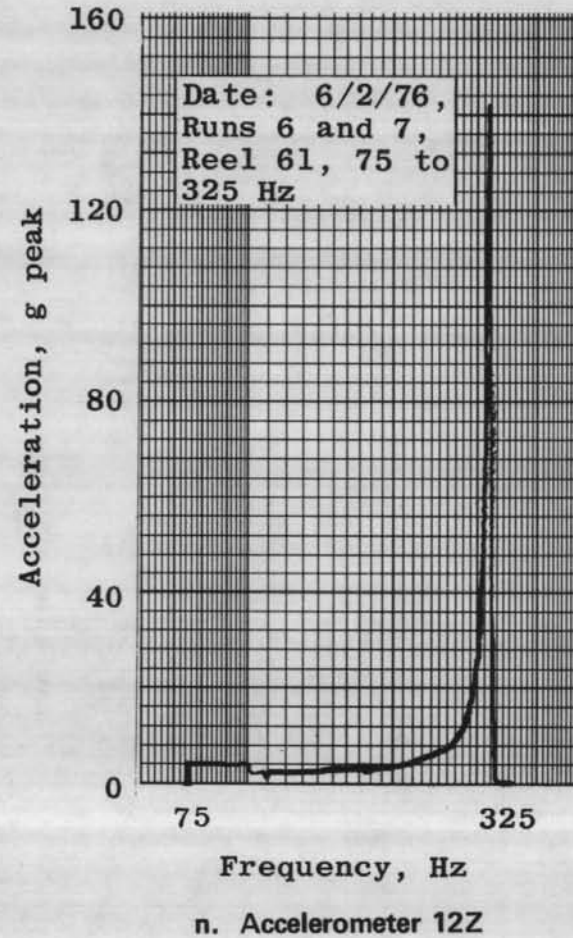
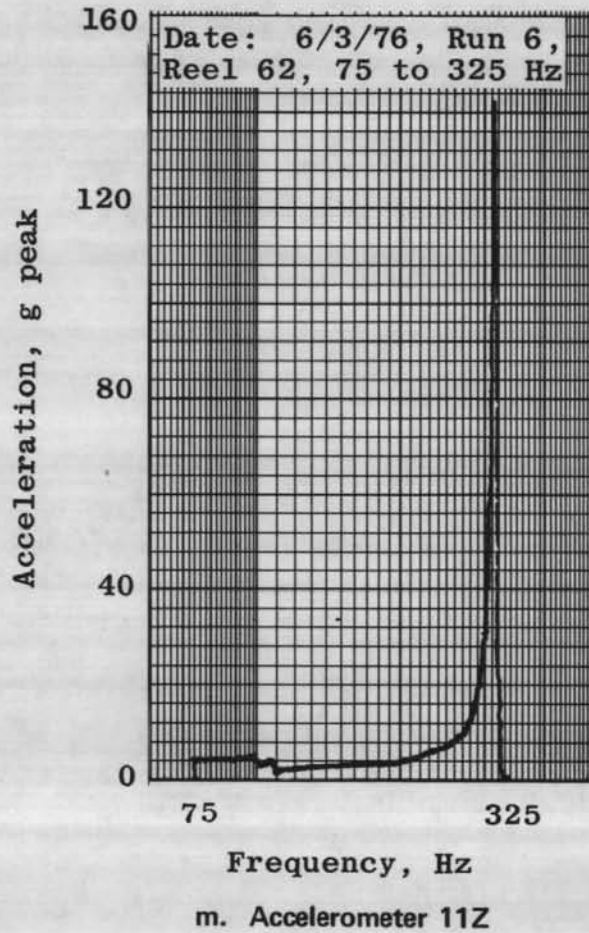

Figure 32. Continued.

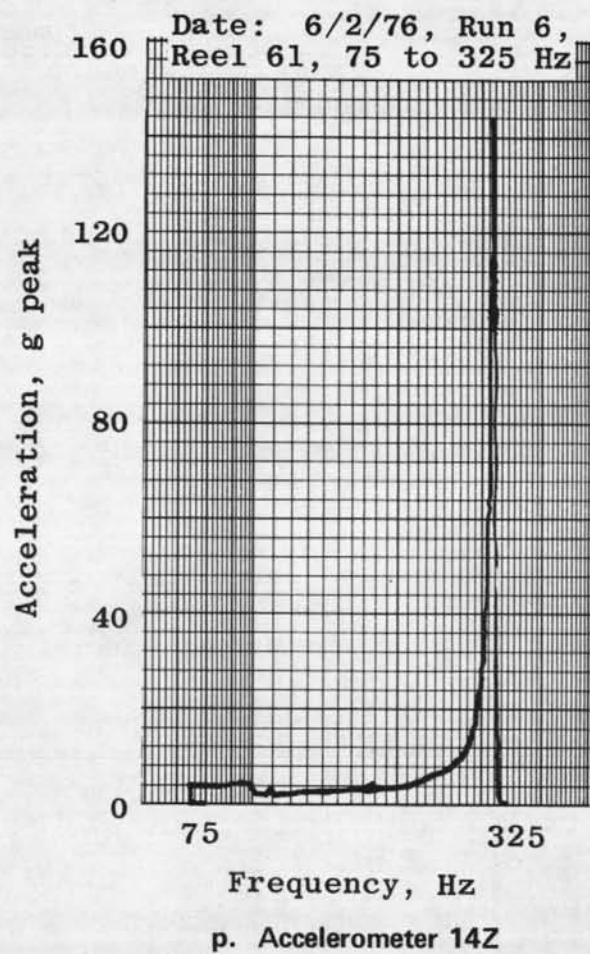
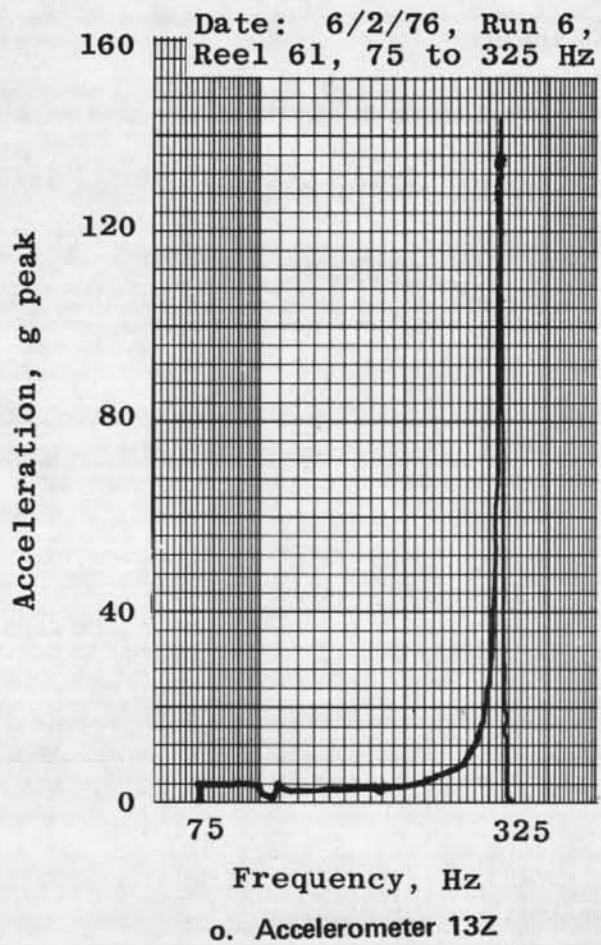
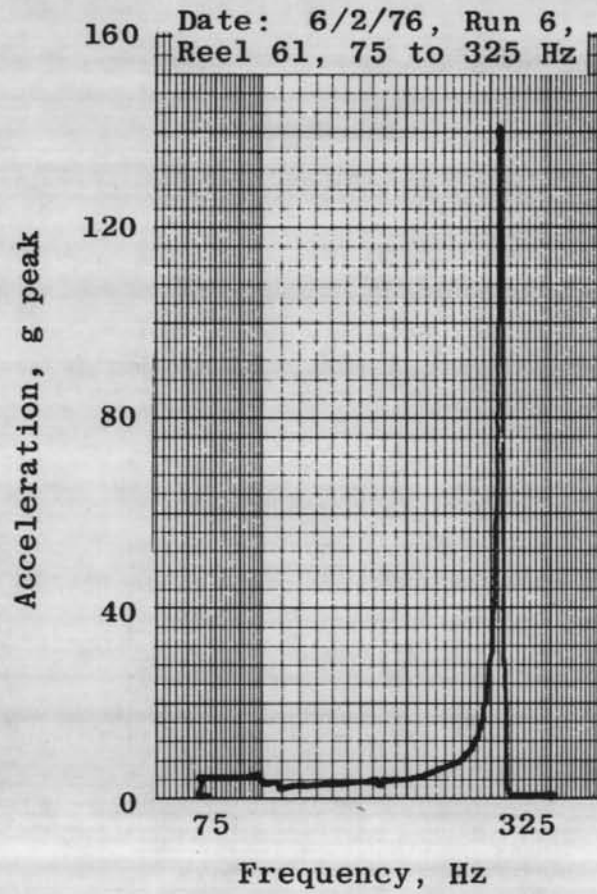
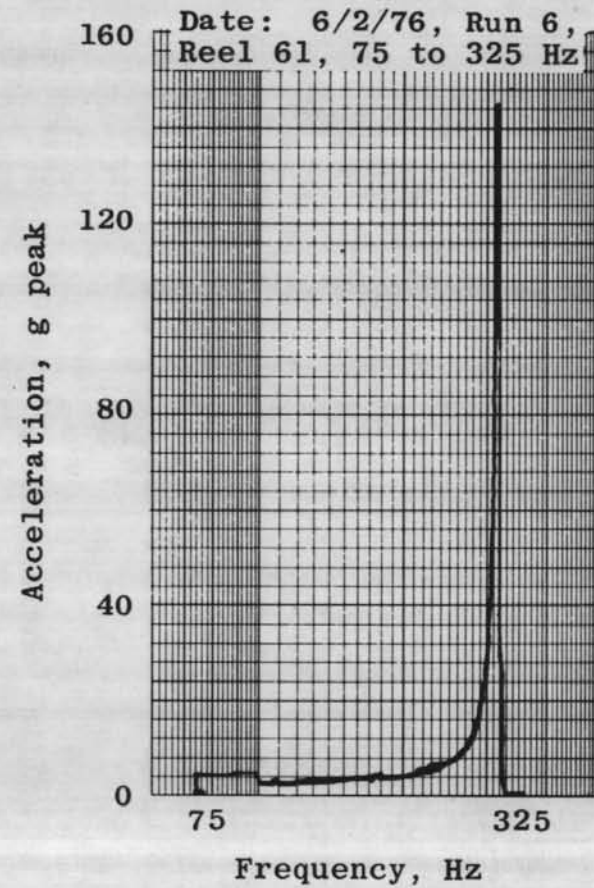

Figure 32. Continued.



q. Accelerometer 15Z



r. Accelerometer 16Z

Figure 32. Continued.

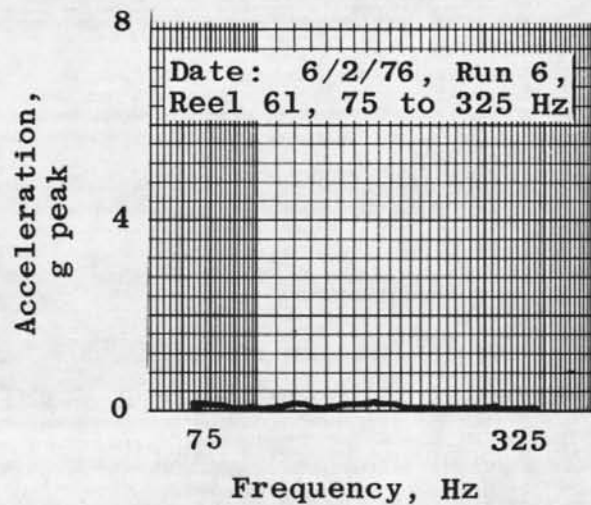

s. Accelerometer 1X

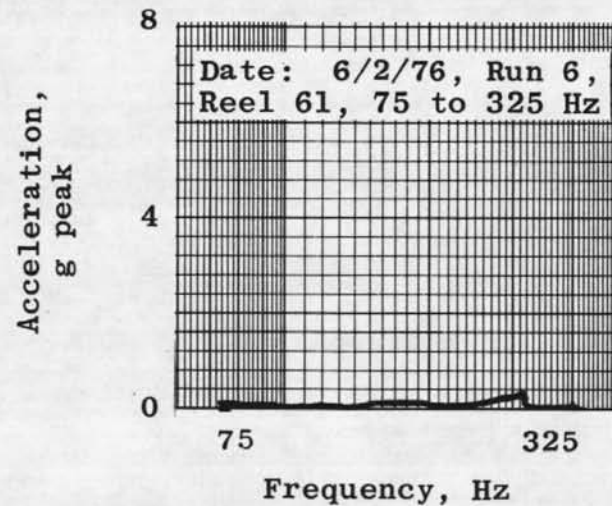

t. Accelerometer 9X

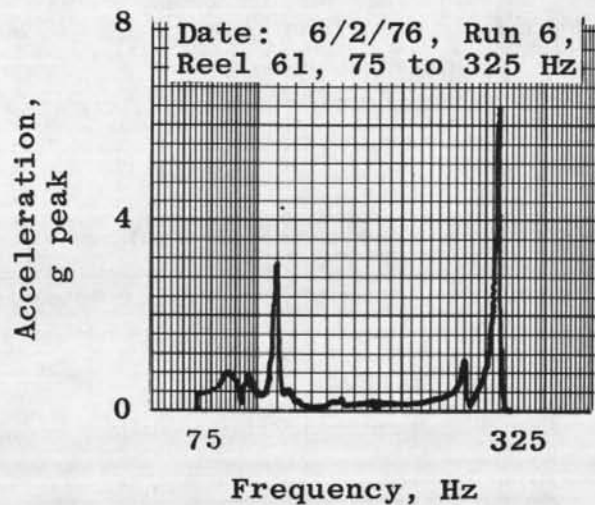

u. Accelerometer 11X

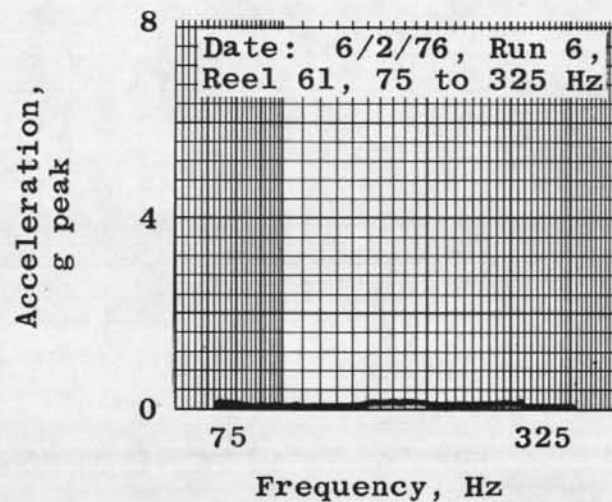

v. Accelerometer 1Y

Figure 32. Continued.

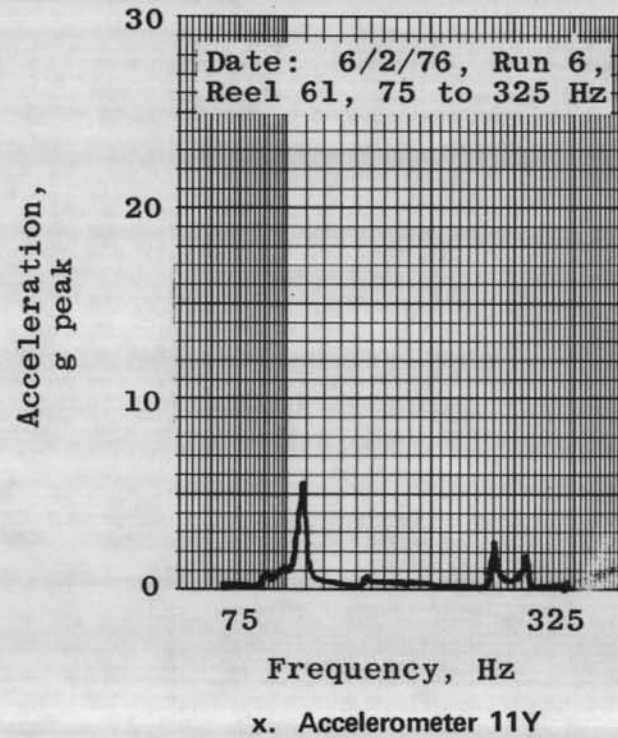
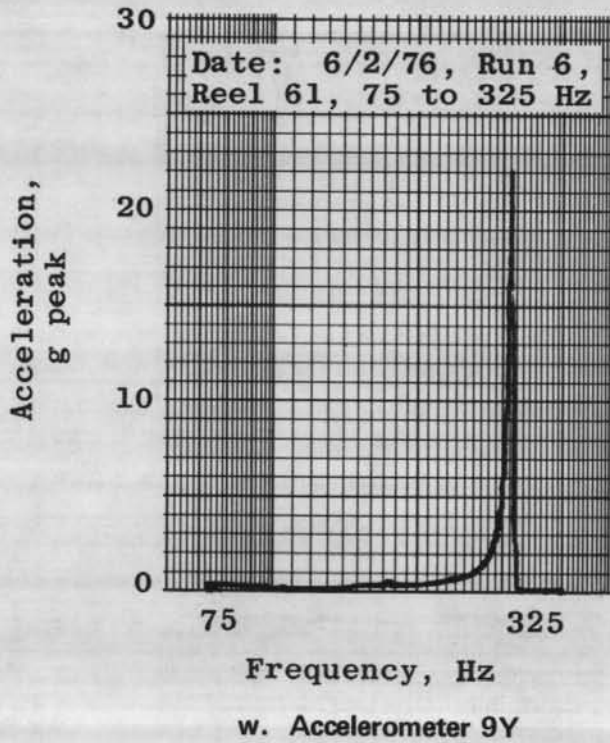

Figure 32. Concluded.

VKF IVA Facility Dynamics Test

Test Article: NASA/IUE
 Vibration Axis: Z
 Tracking Filter: SD1012B
 BW₂: 50 Hz from 75 to 2,000 Hz
 300 to 2,000 Hz

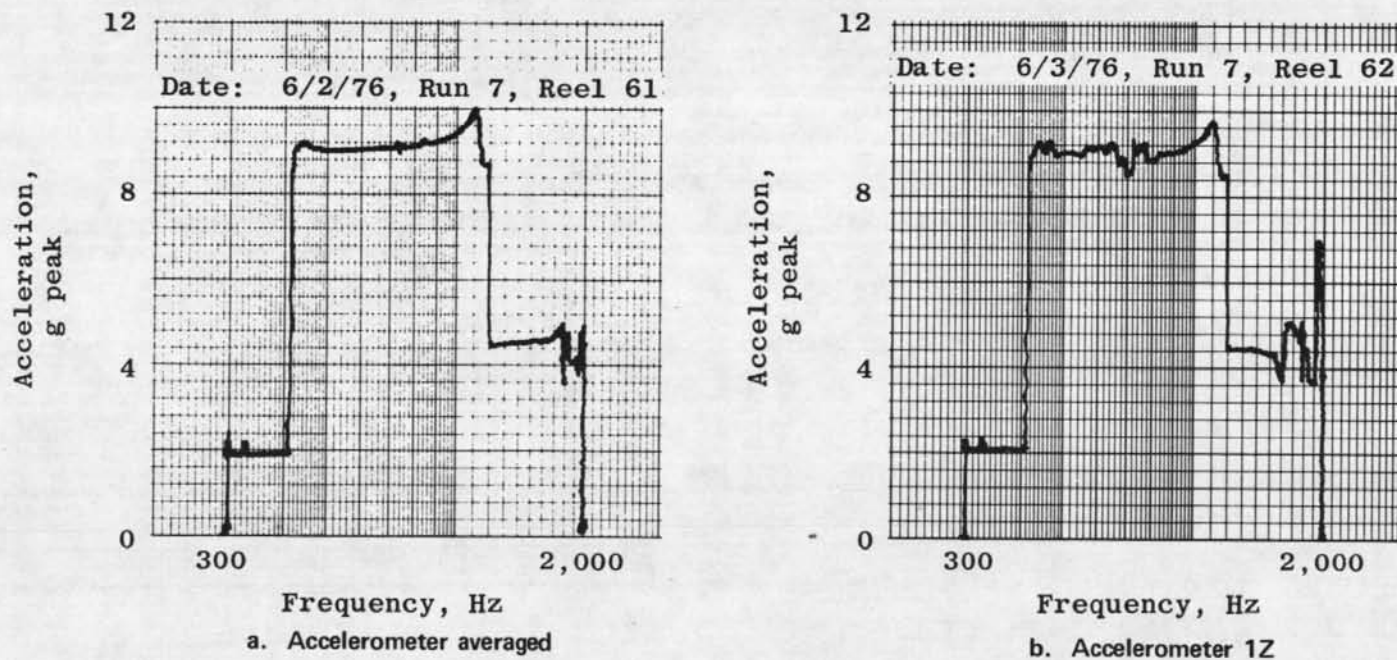
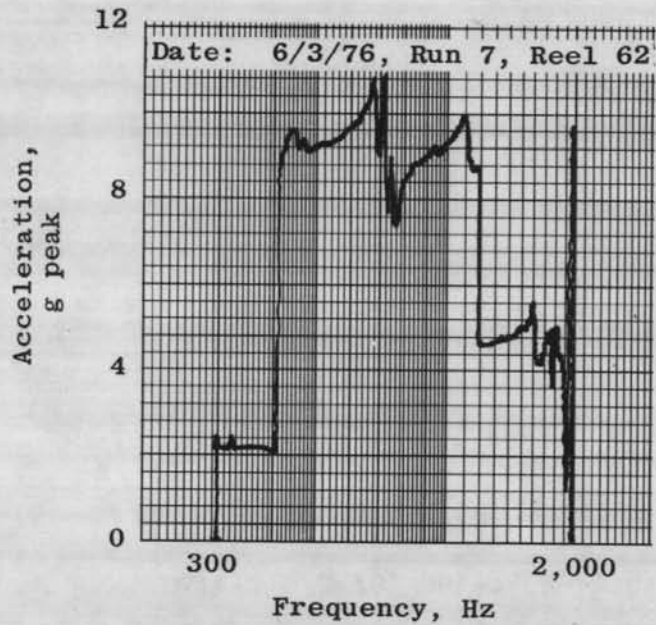
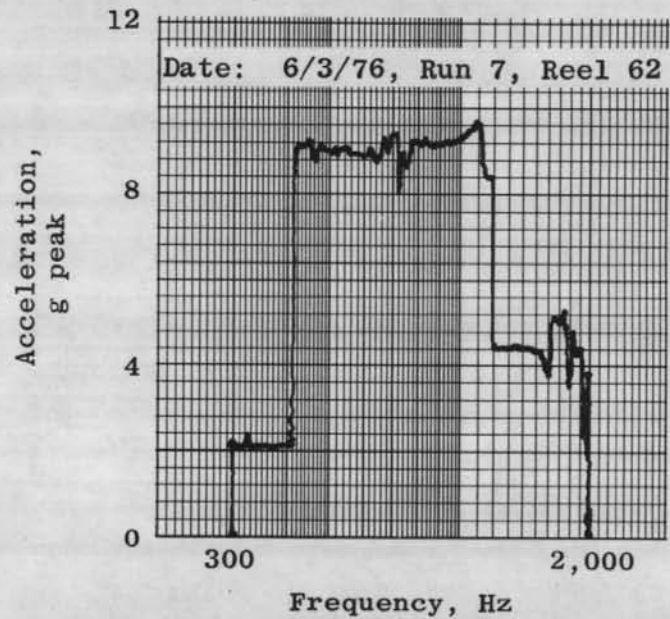

Figure 33. Z-axis vibration test: 300 to 2,000 Hz, qualification level sine sweep.



c. Accelerometer 2Z



d. Accelerometer 3Z

Figure 33. Continued.

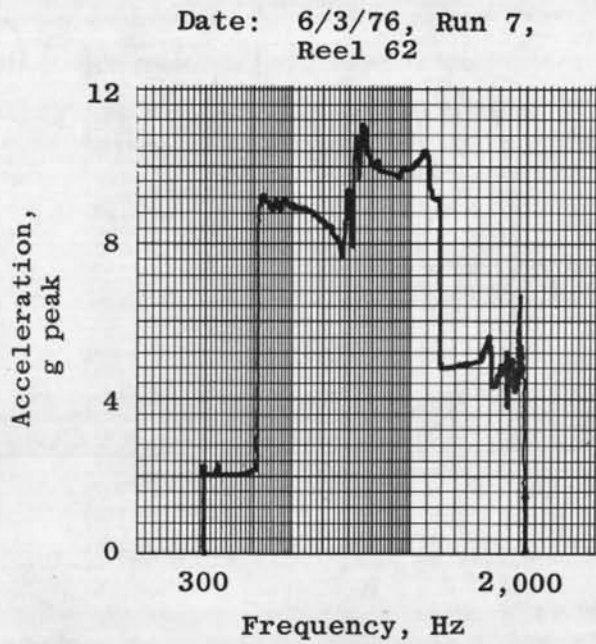

e. Accelerometer 4Z

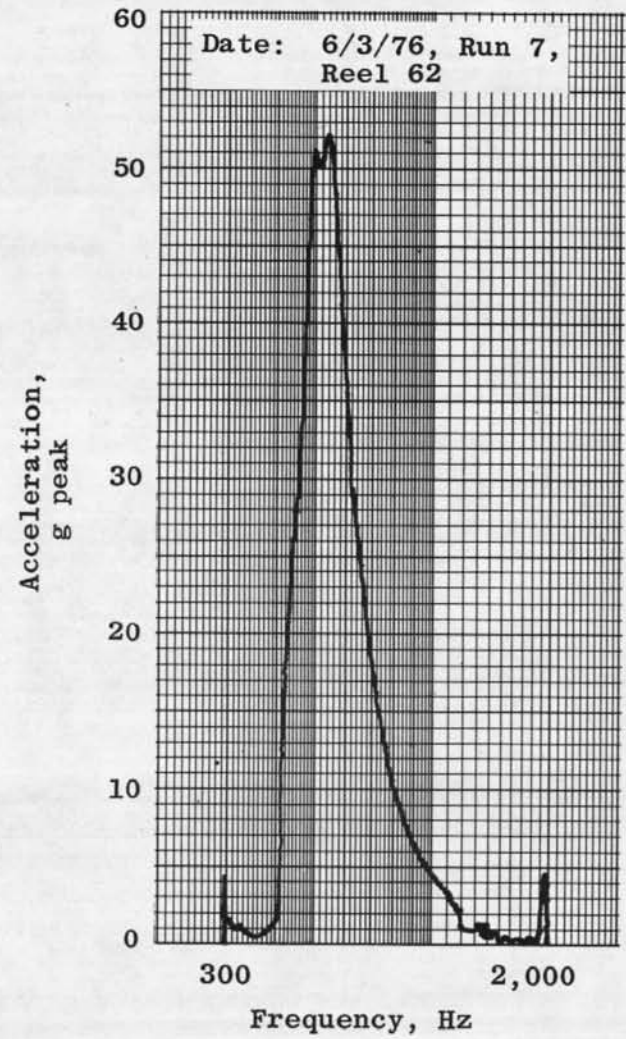

f. Accelerometer 5Z

Figure 33. Continued.

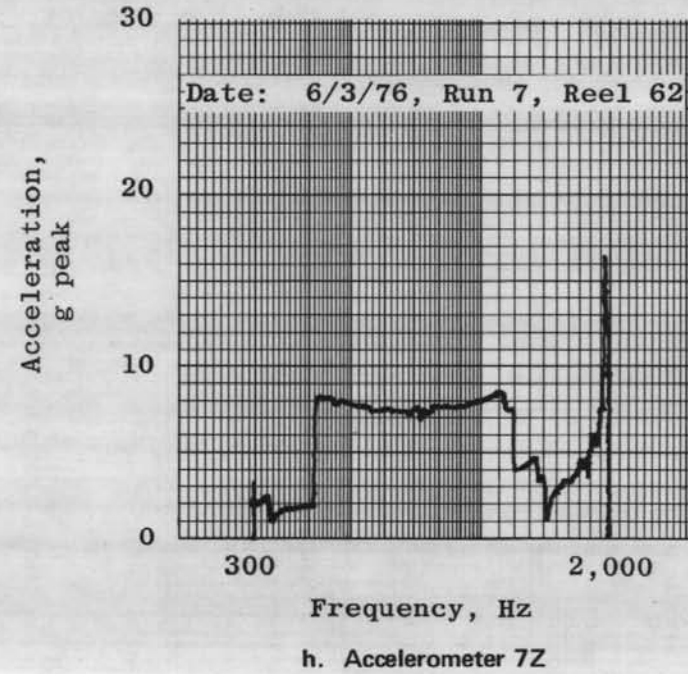
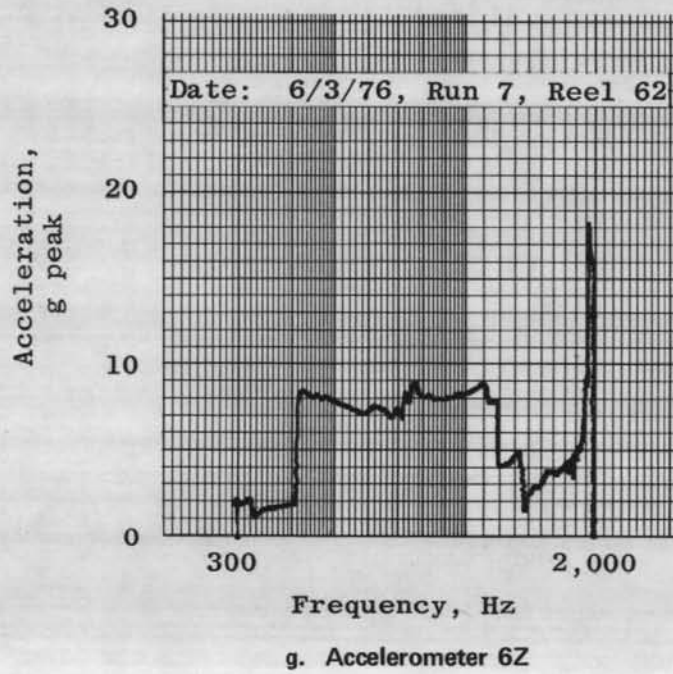
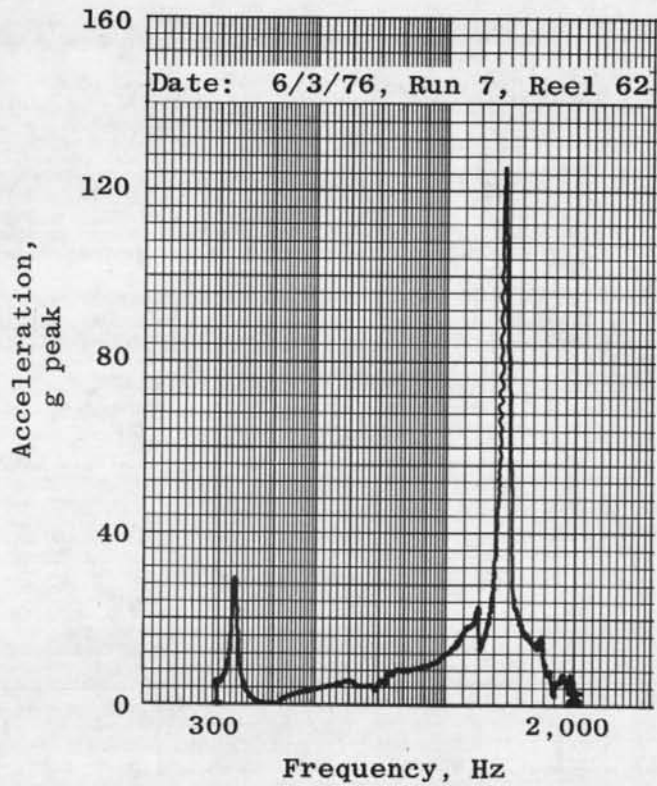
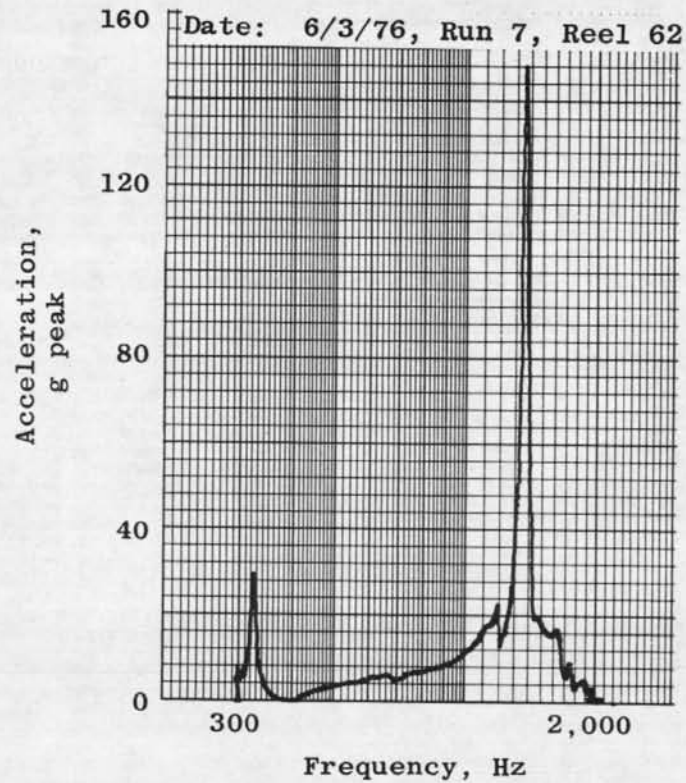

Figure 33. Continued.



i. Accelerometer 8Z



j. Accelerometer 9Z

Figure 33. Continued.

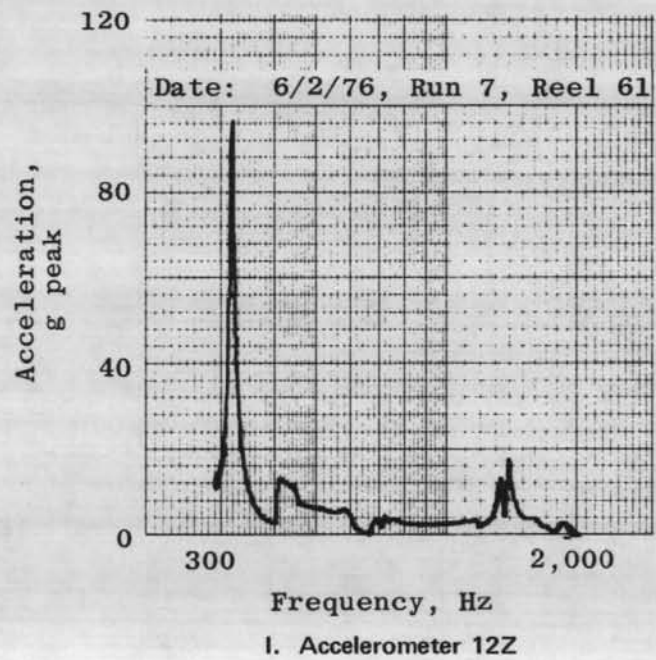
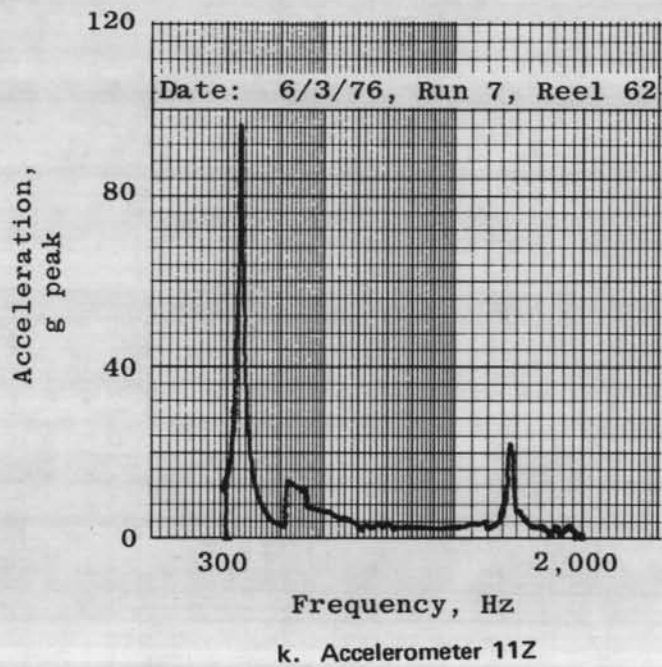

Figure 33. Continued.

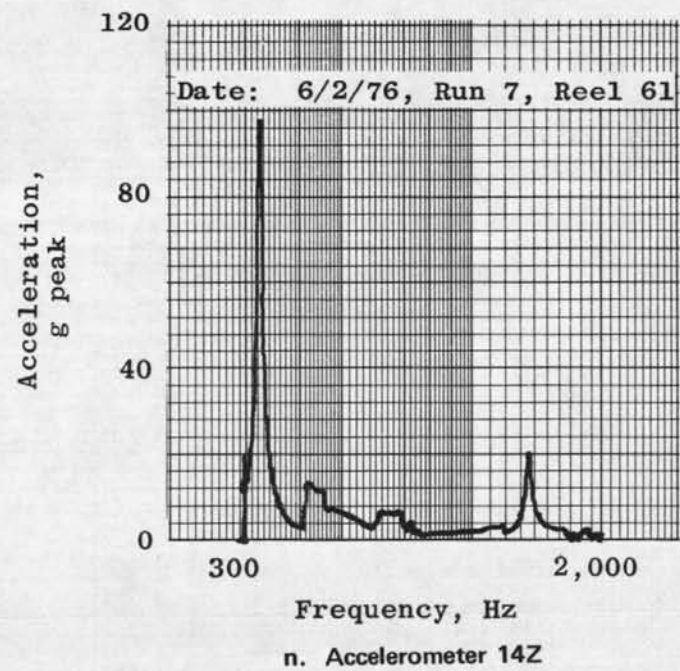
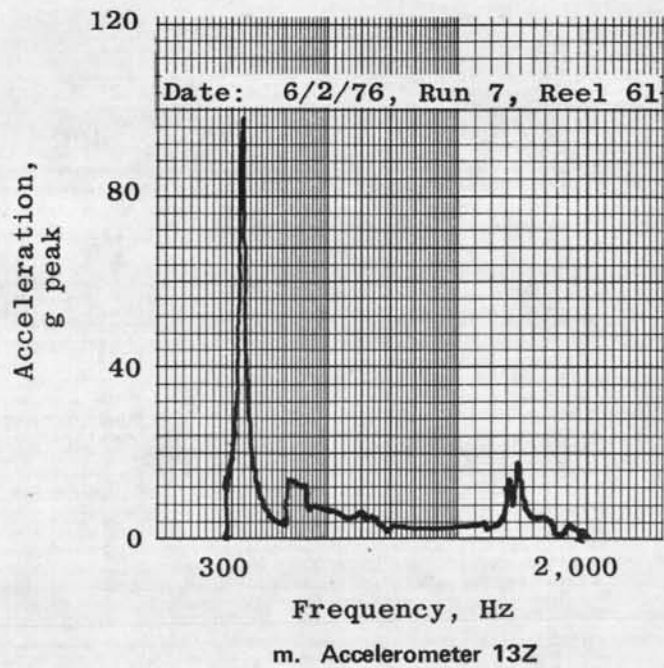
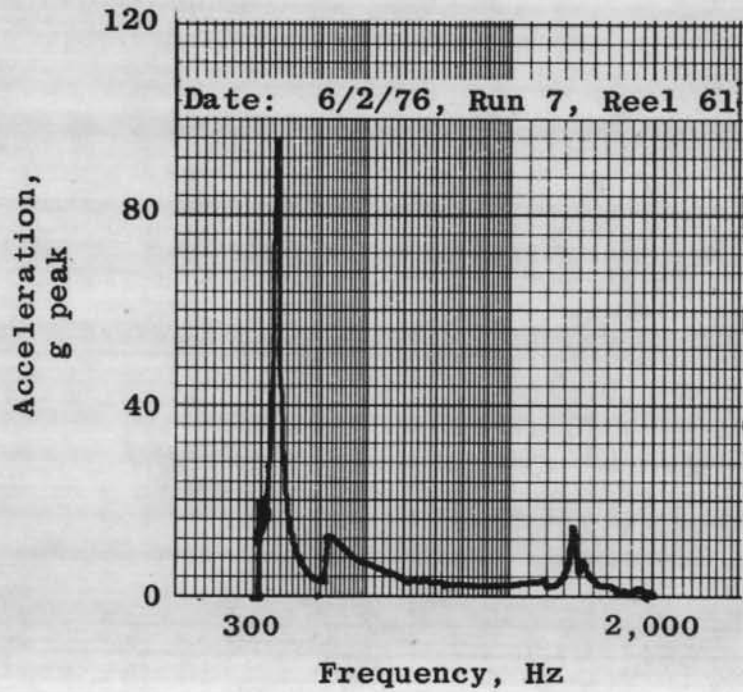
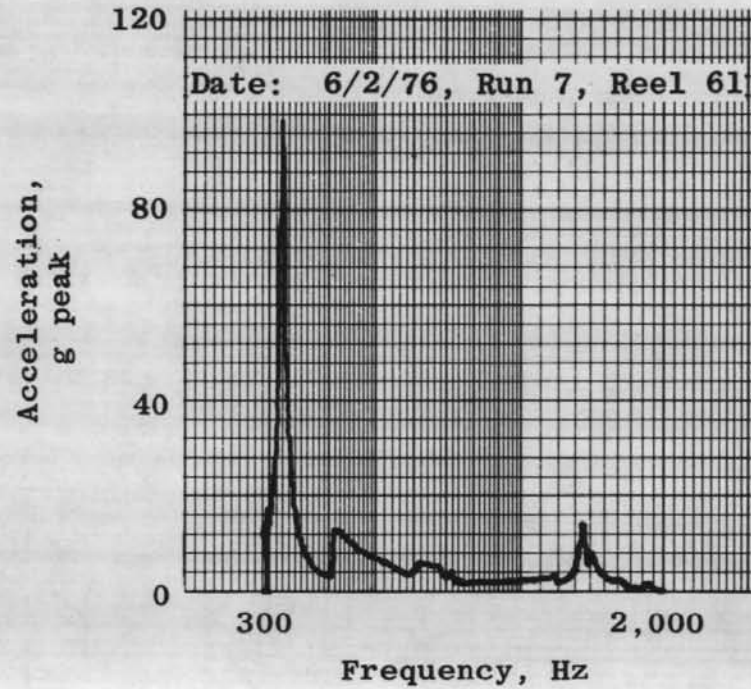

Figure 33. Continued.



o. Accelerometer 15Z



p. Accelerometer 16Z

Figure 33. Continued.

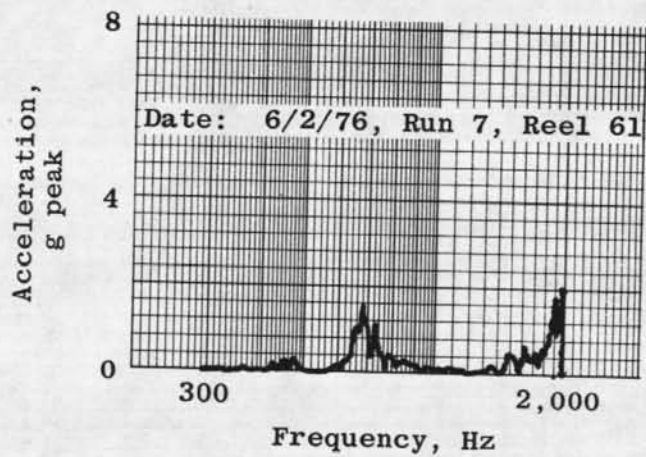

q. Accelerometer 1X

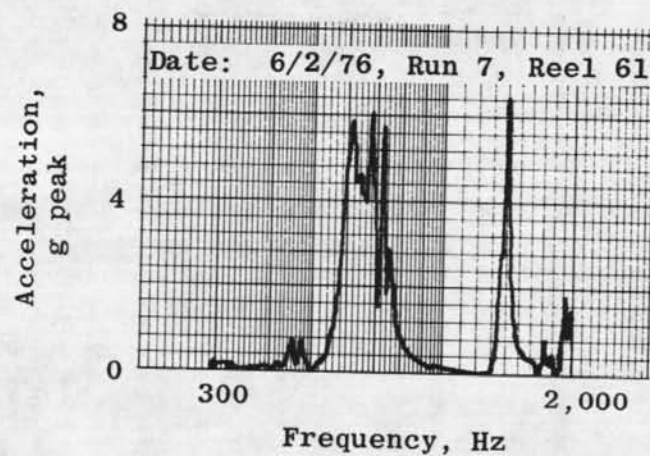

r. Accelerometer 9X

Figure 33. Continued.

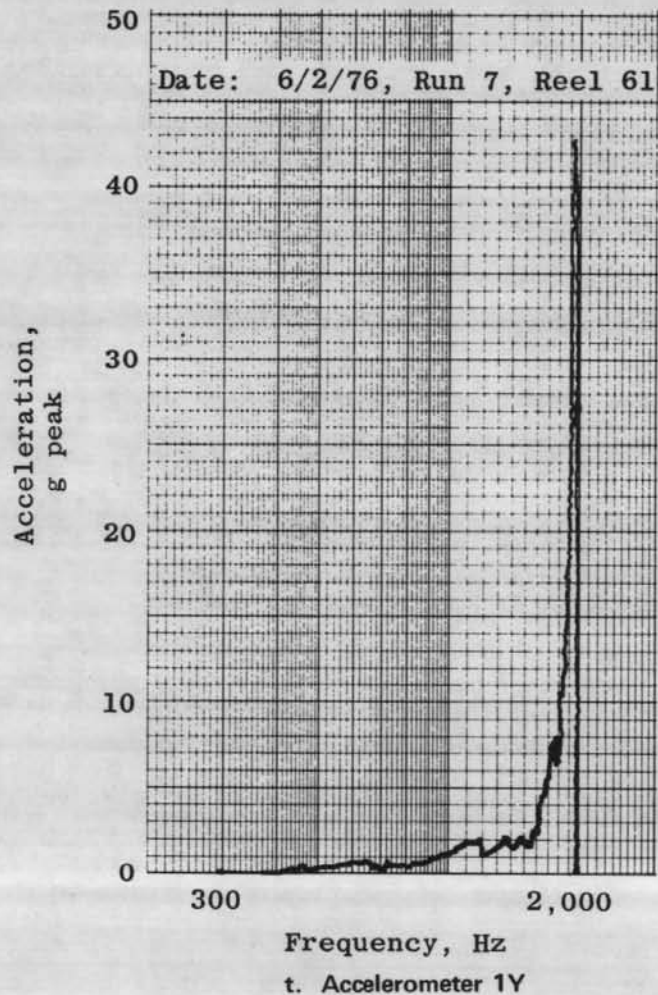
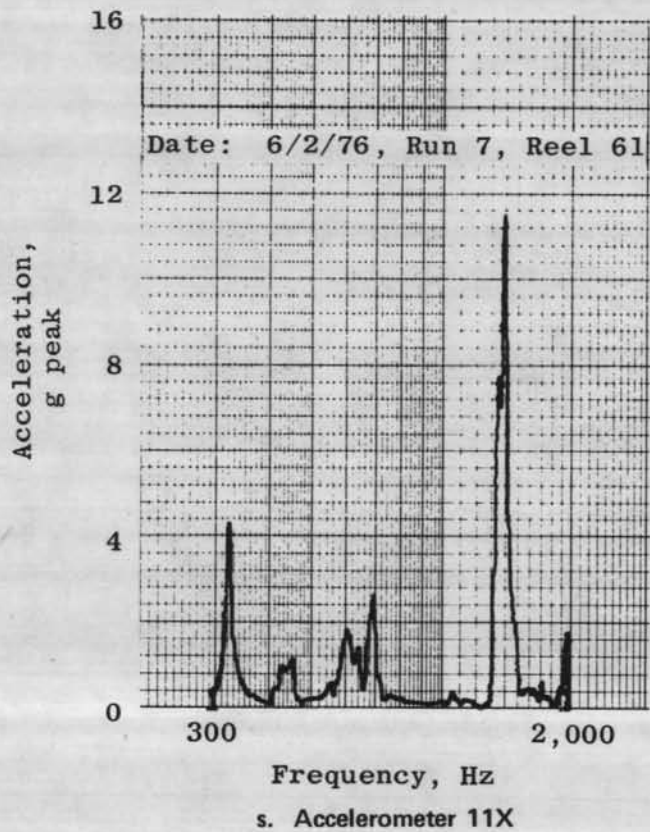
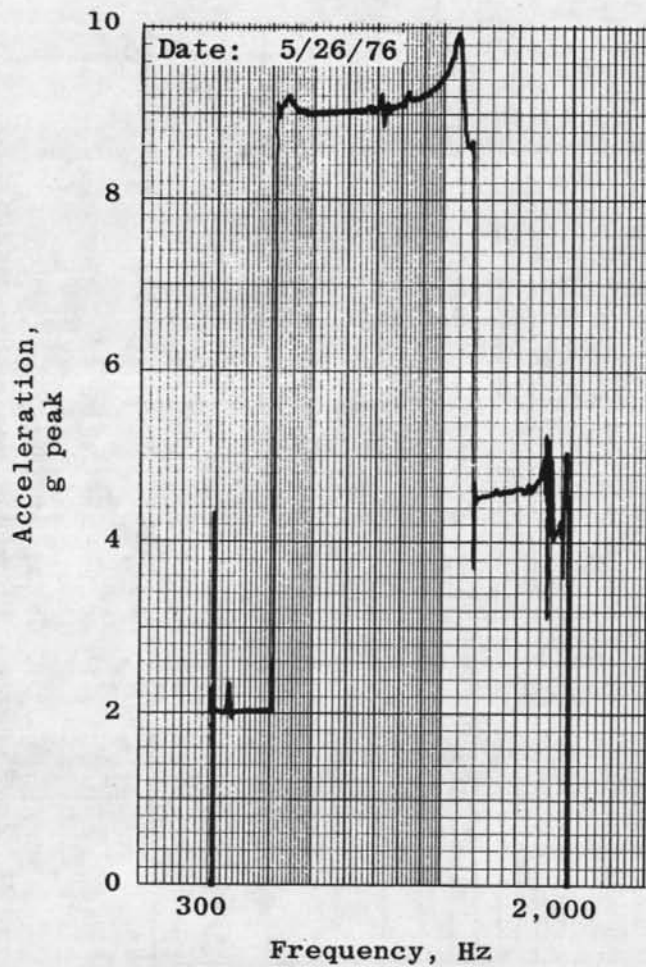
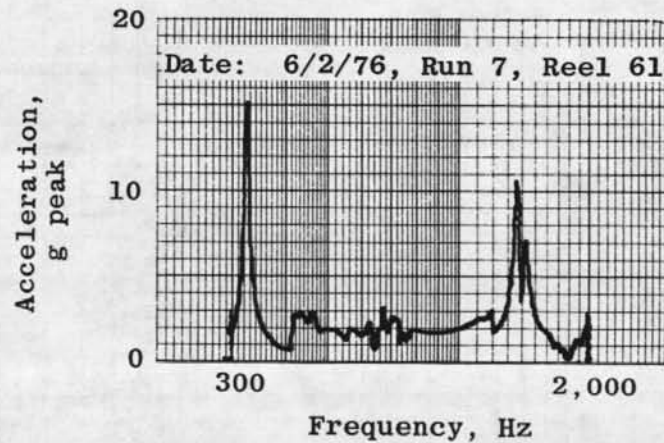

Figure 33. Continued.



u. Online plot, accelerometers averaged



v. Accelerometer 9Y

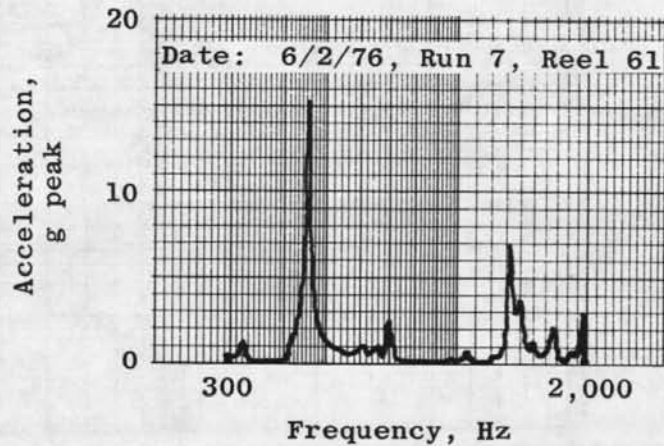

w. Accelerometer 11Y

Figure 33. Concluded.

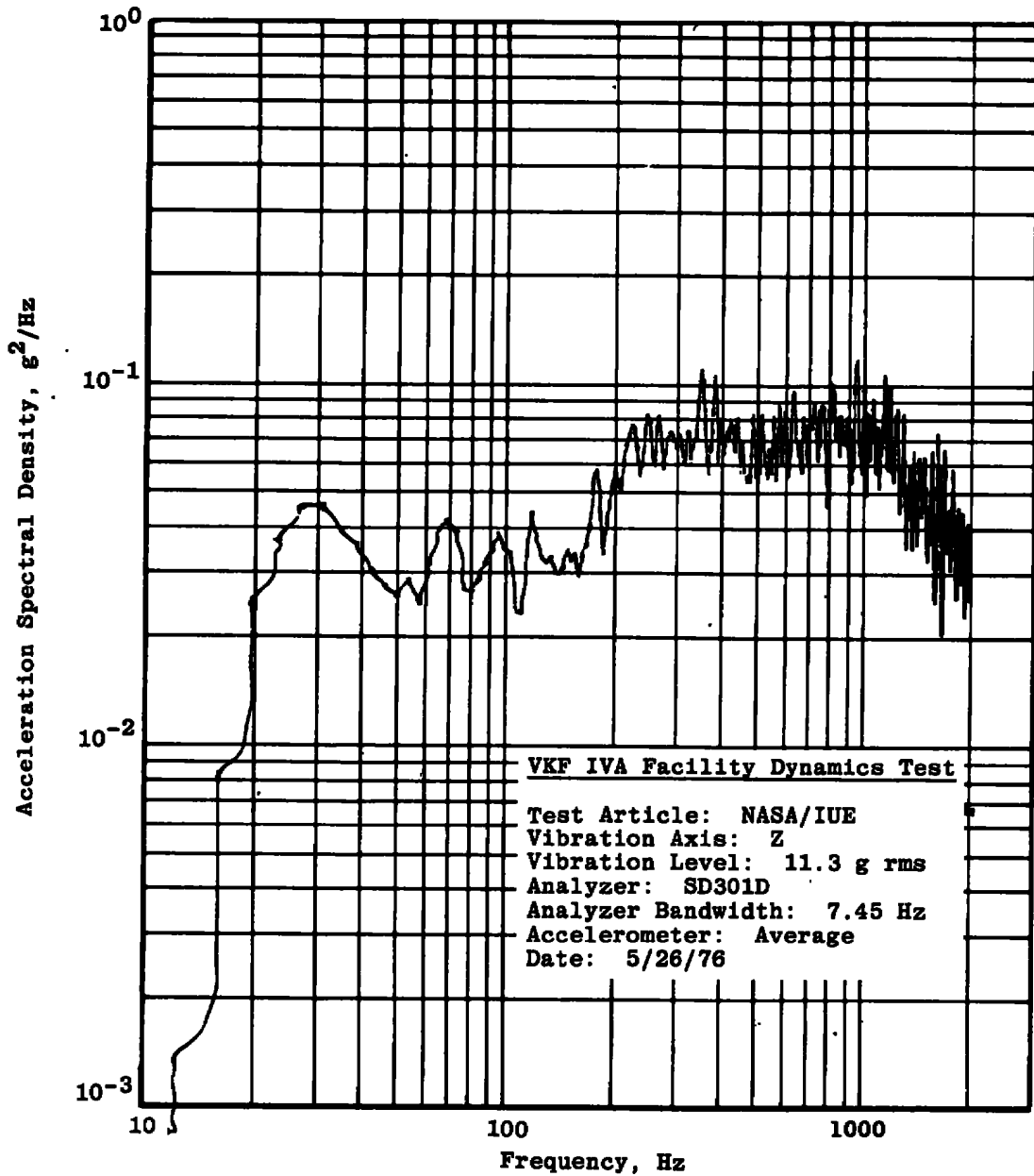

a. Closed loop plot

Figure 34. Z-axis vibration test: qualification level random vibration.

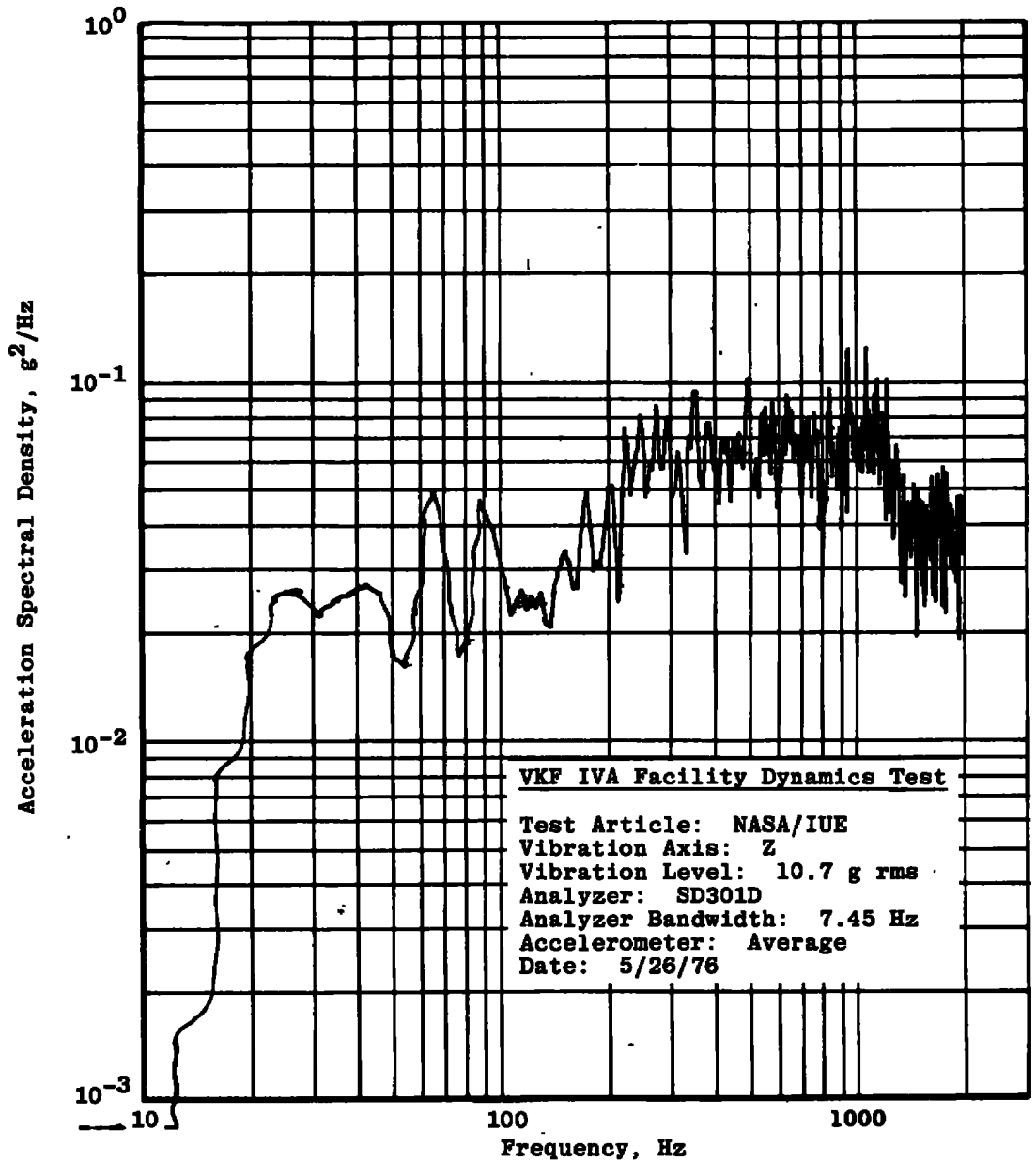

b. Accelerometers averaged
Figure 34. Continued.

<u>Accelerometer</u>	<u>g rms</u>
Average	10.5
1Z	10.5
2Z	11.0
3Z	10.5
4Z	11.0
5Z	22.0
6Z	11.5
7Z	10.5
8Z	45.0
9Z	48.0
11Z	35.0
12Z	35.0
13Z	37.0
14Z	35.0
15Z	35.0
16Z	35.0
1X	1.1
9X	2.6
11X	4.5
1Y	15.5
9Y	7
11Y	4.5

c. Z-axis, random; 5/27/76
Figure 34. Concluded.

VKF IVA Facility Dynamics Test

Test Article: NASA/IUE

Vibration Axis: Z

Tracking Filter: SD1012B

BW₁: 5 Hz from 5 to 45 Hz

BW₂: 50 Hz from 45 to 2,000 Hz

} Figs. a,b

BW₁: 5 Hz from 5 to 75 Hz

BW₂: 50 Hz from 75 to 2,000 Hz

} Figs. c-x

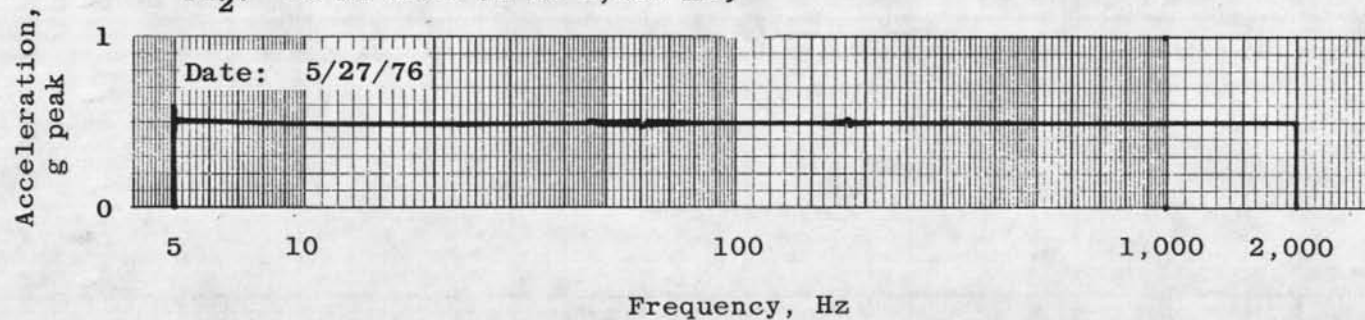

a. Closed loop plot

Figure 35. Z-axis vibration test: 0.5-g sine survey.

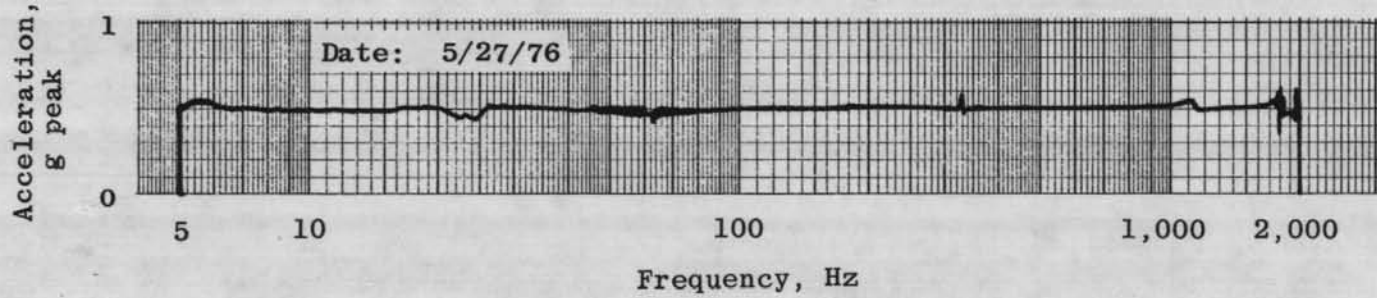

b. Online plot, accelerometers averaged

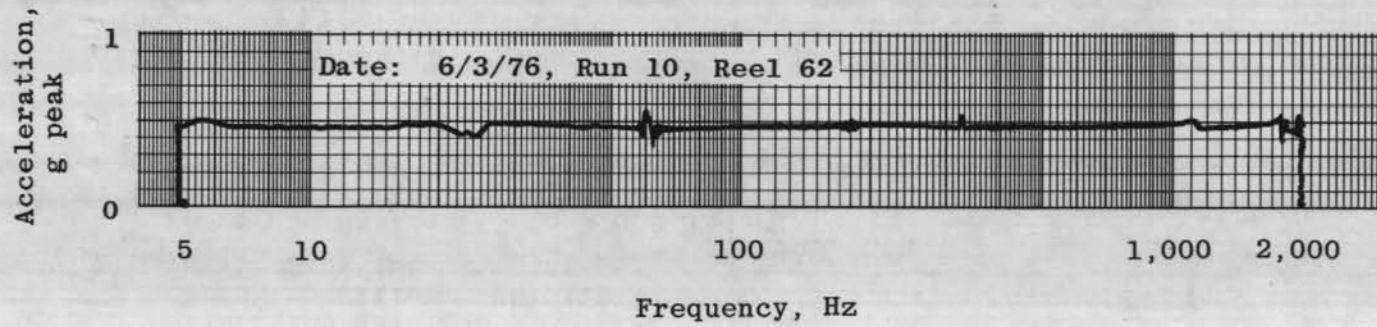

c. Accelerometers averaged
Figure 35. Continued.

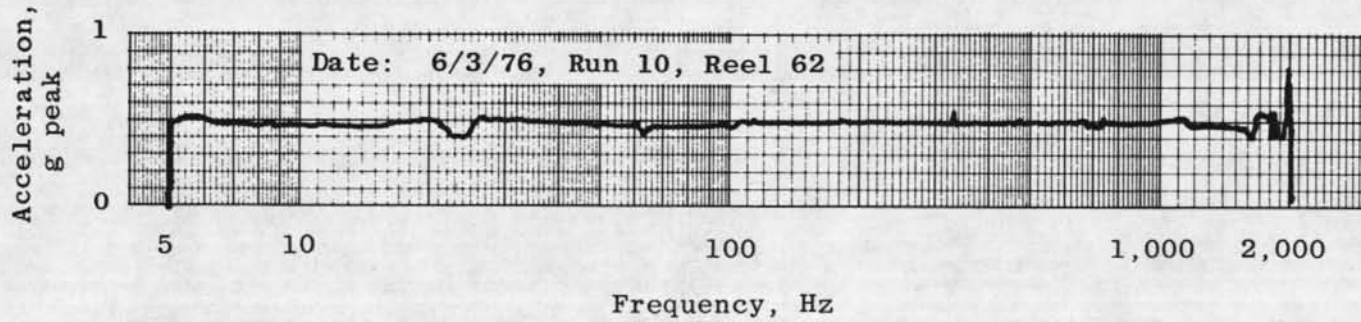

d. Accelerometer 1Z

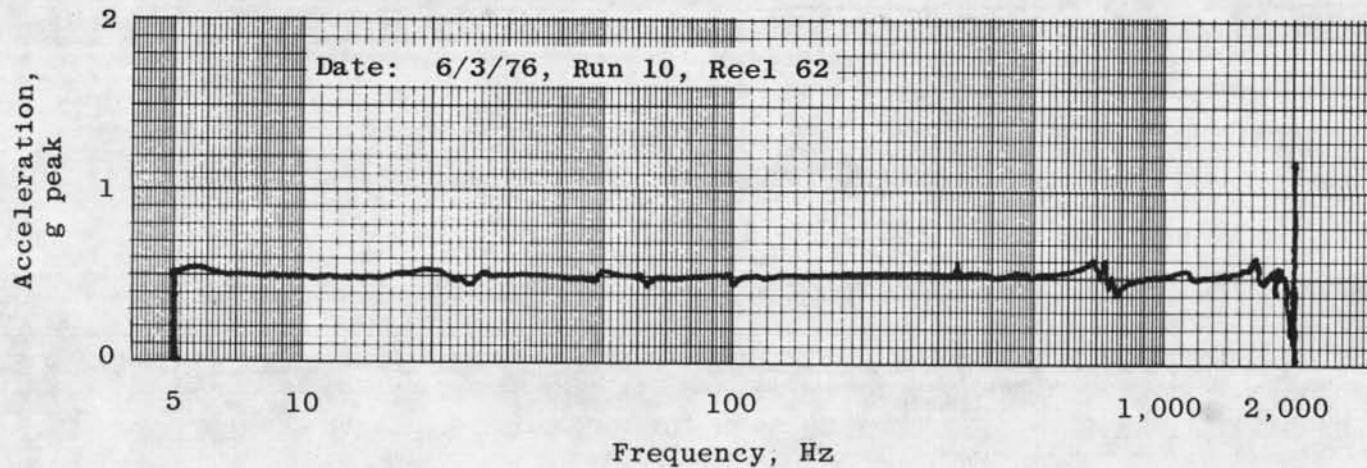

e. Accelerometer 2Z

Figure 35. Continued.

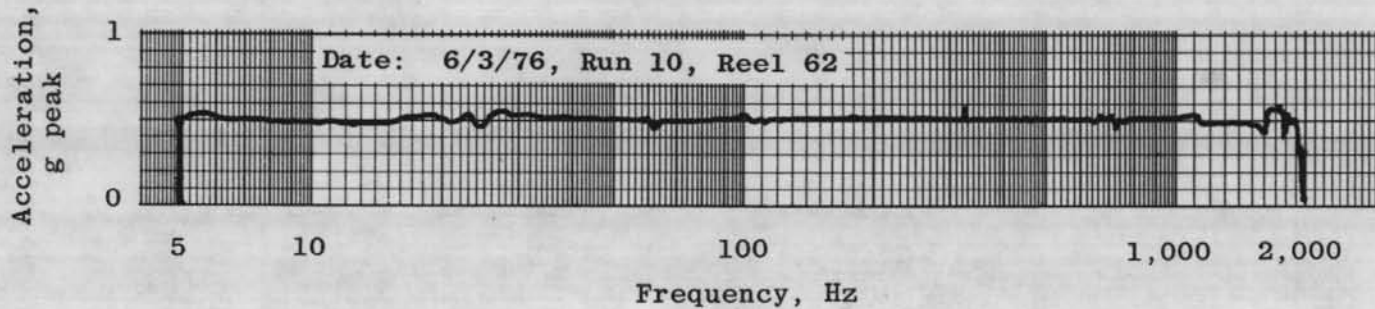

f. Accelerometer 3Z

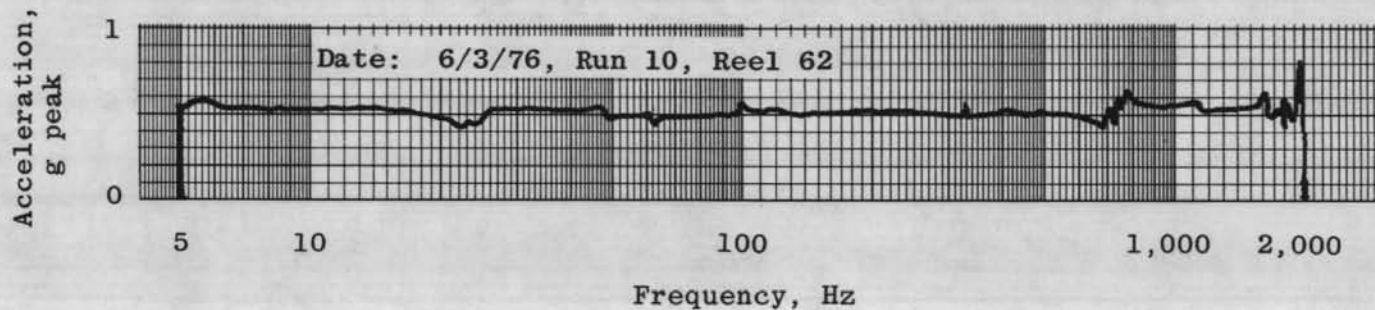

g. Accelerometer 4Z
Figure 35. Continued.

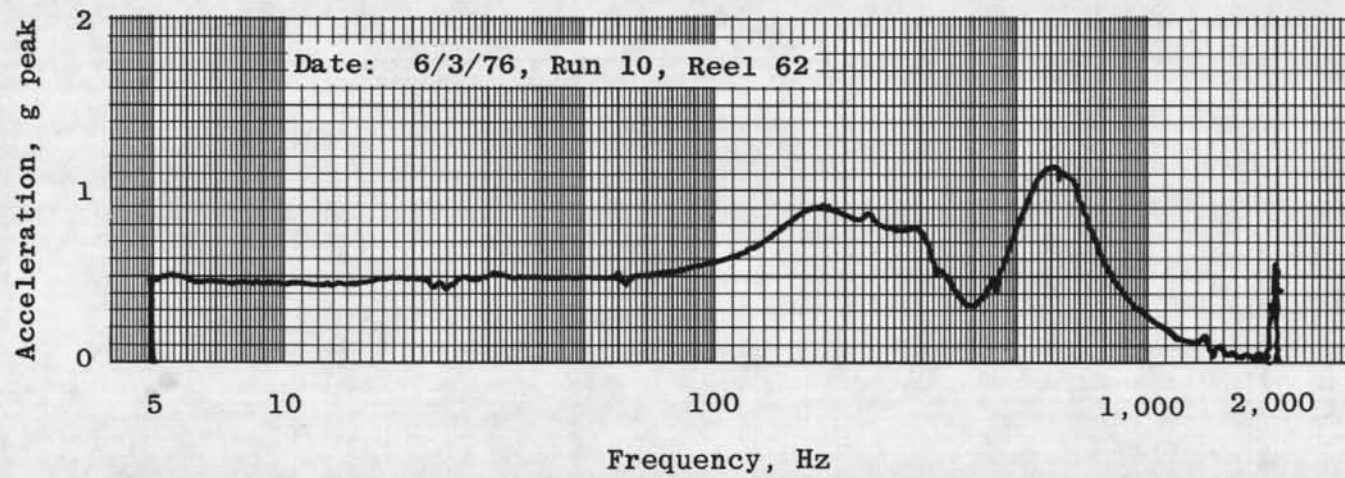

h. Accelerometer 5Z
Figure 35. Continued.

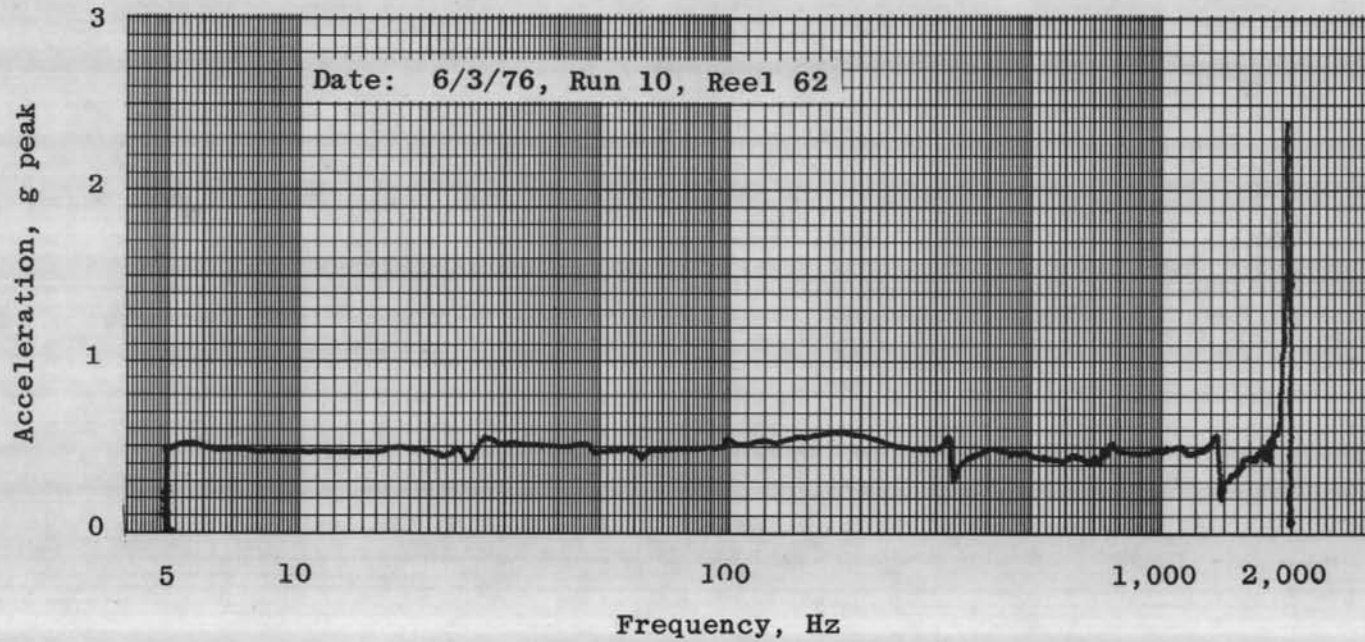

i. Accelerometer 6Z
Figure 35. Continued.

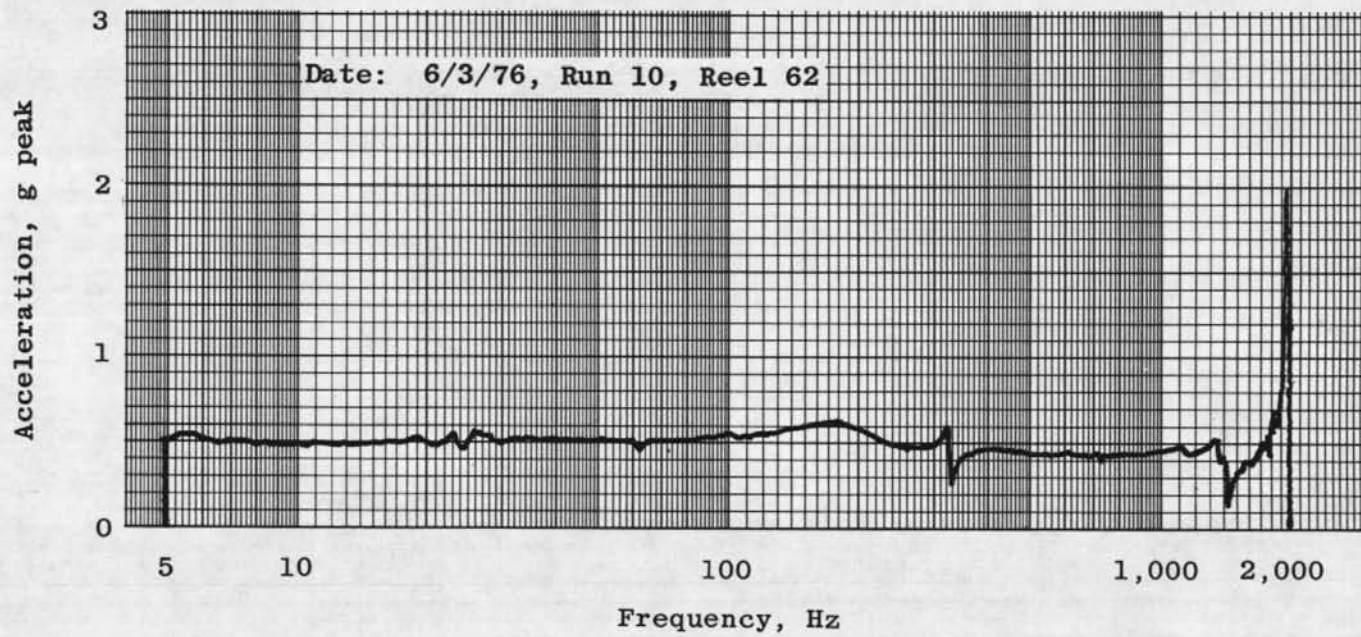

j. Accelerometer 7Z
Figure 35. Continued.

270

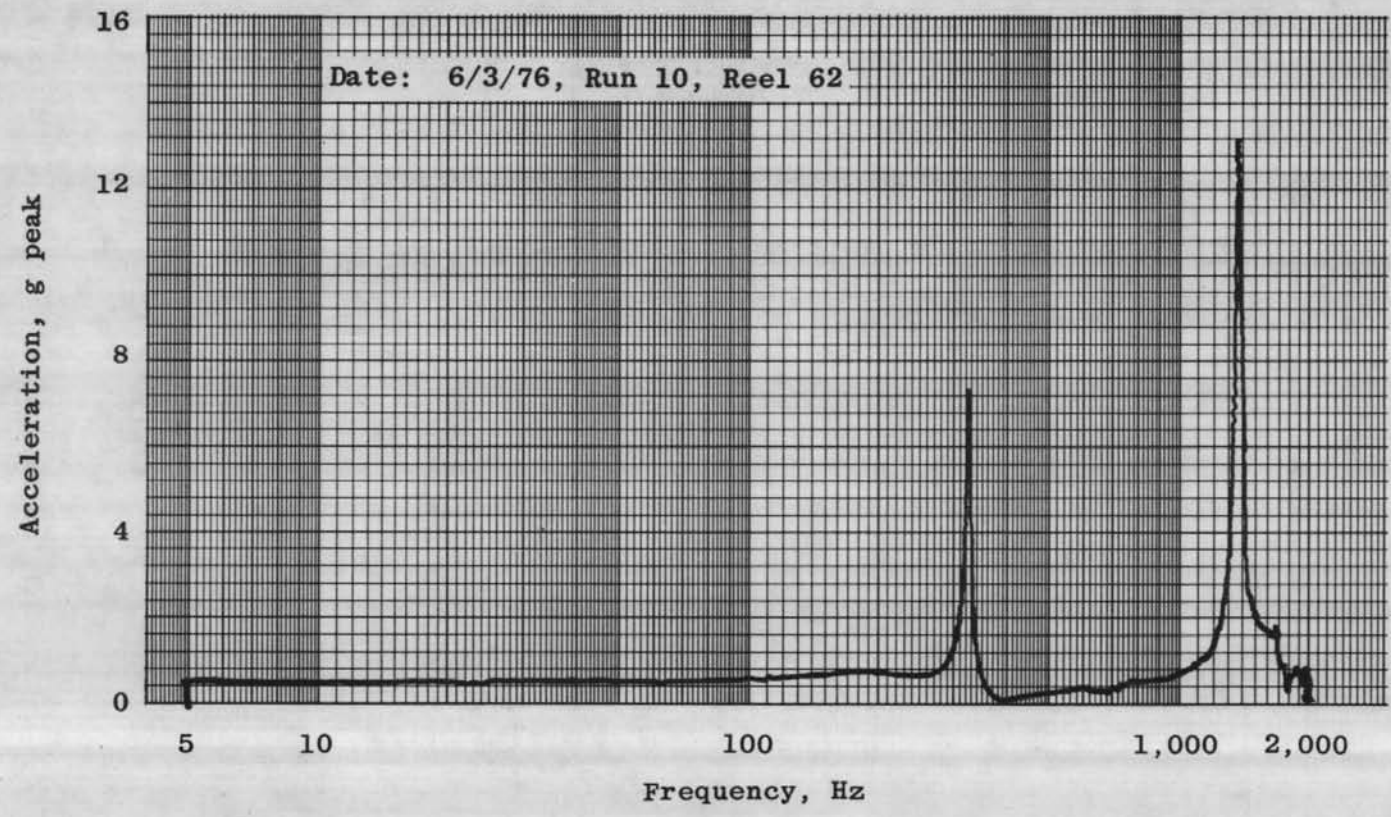

k. Accelerometer 8Z
Figure 35. Continued.

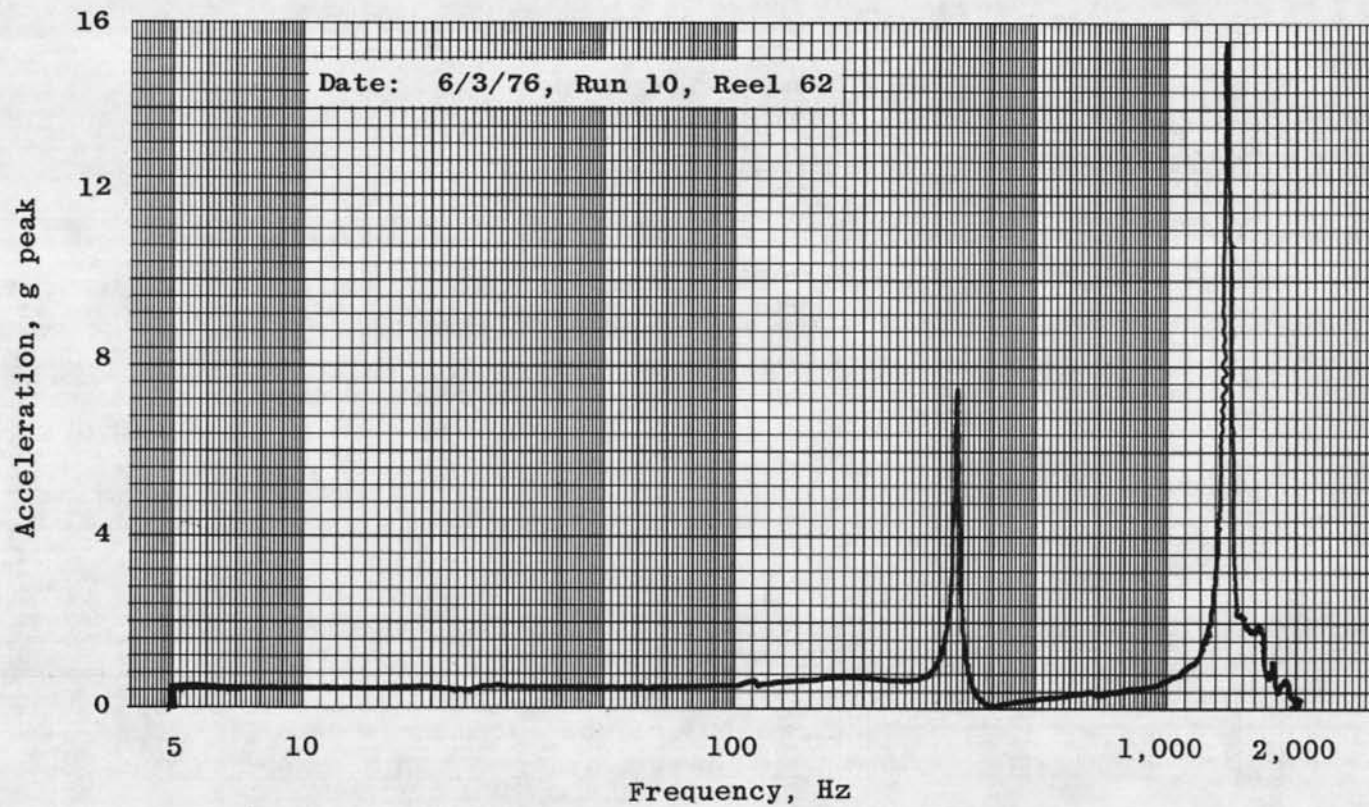

I. Accelerometer 9Z
Figure 35. Continued.

272

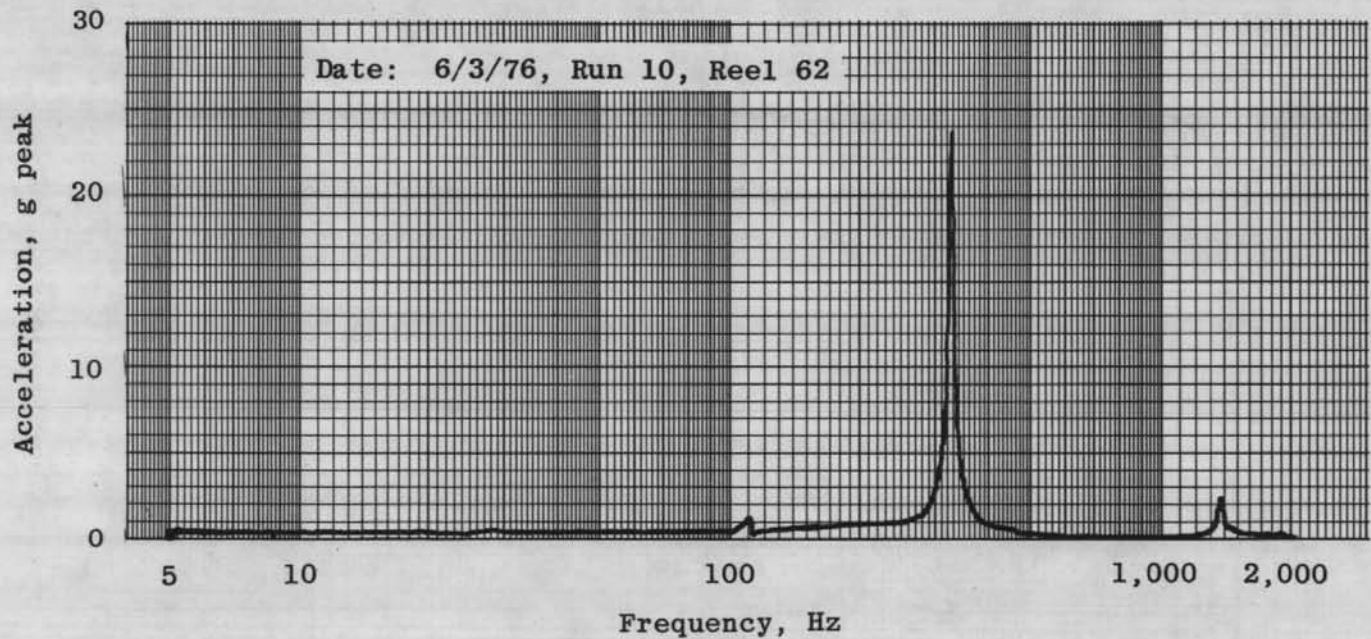

m. Accelerometer 11Z
Figure 35. Continued.

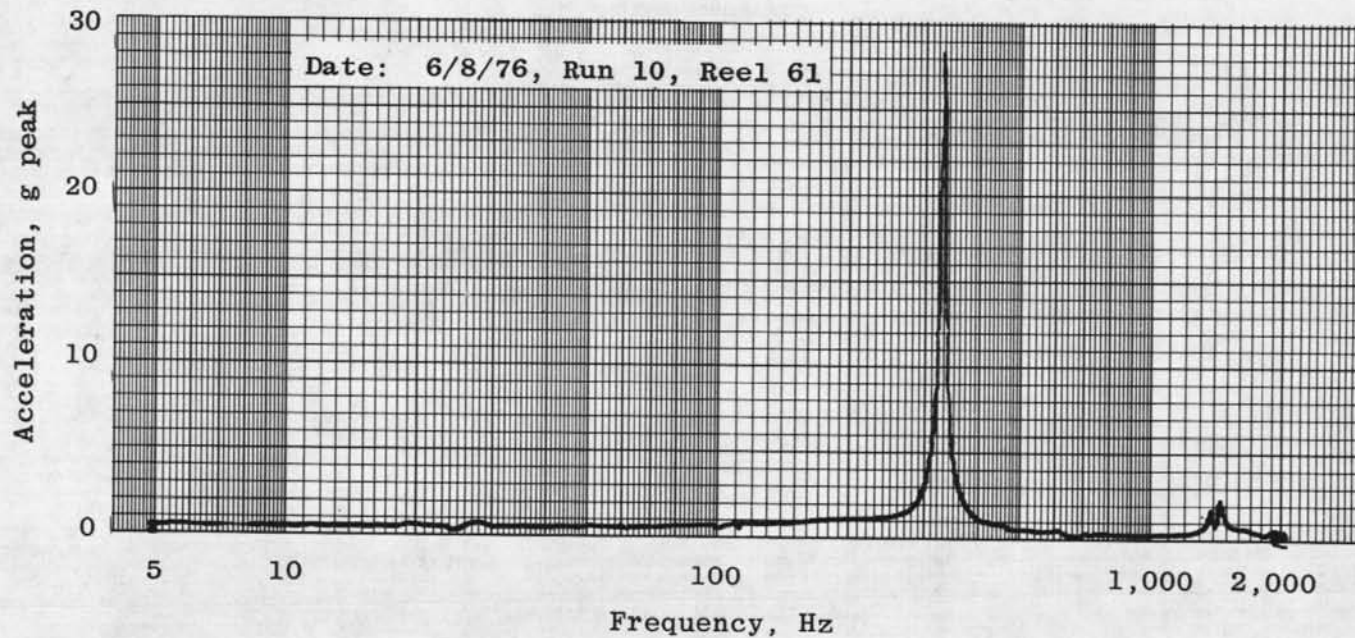

n. Accelerometer 12Z
Figure 35. Continued.

274

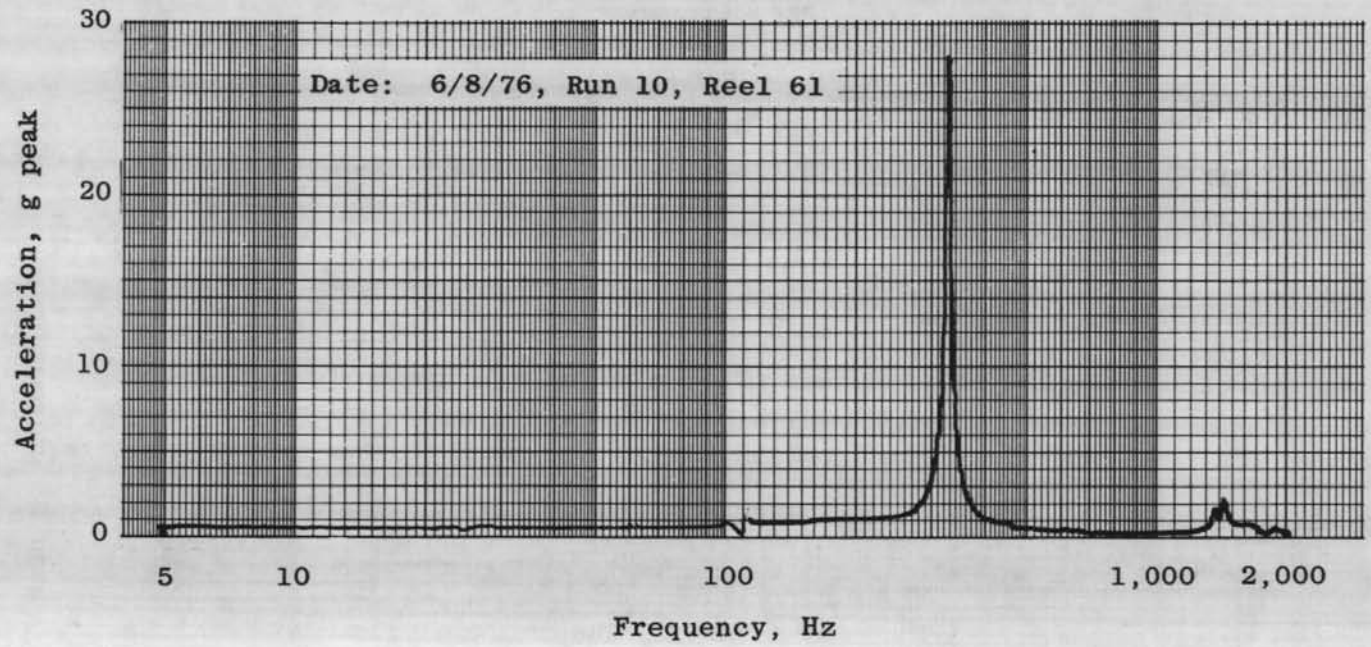

o. Accelerometer 13Z
Figure 35. Continued.

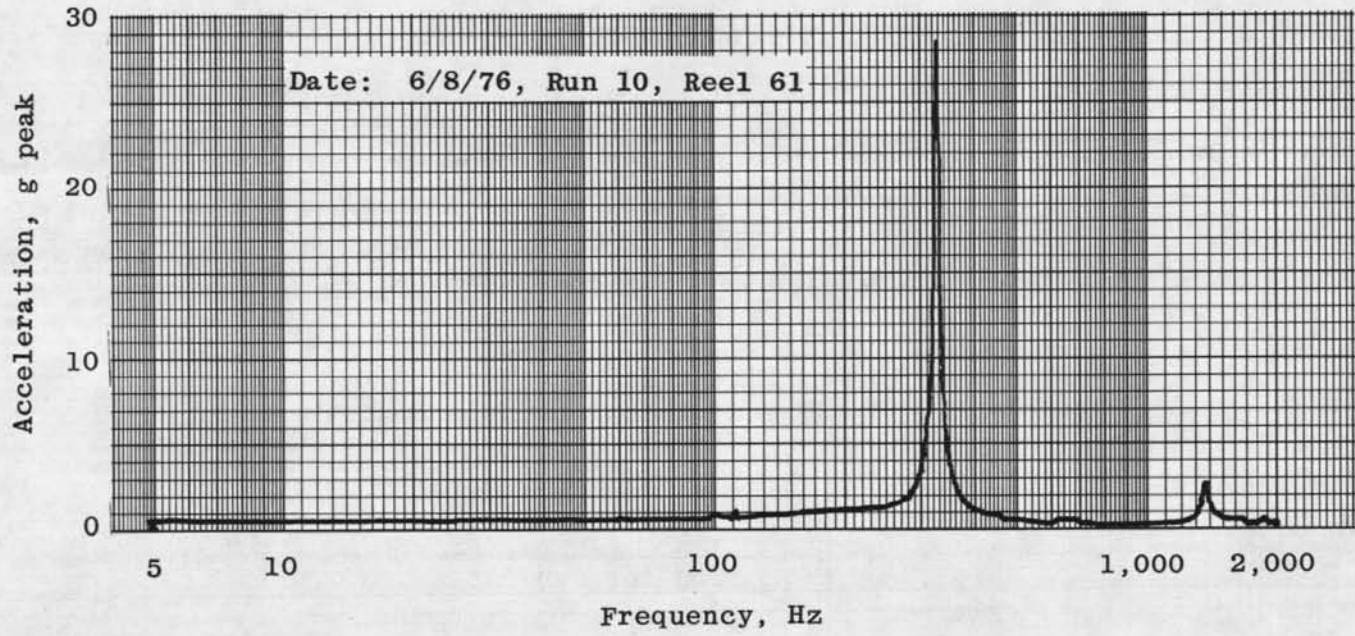

p. Accelerometer 14Z
Figure 35. Continued.

276

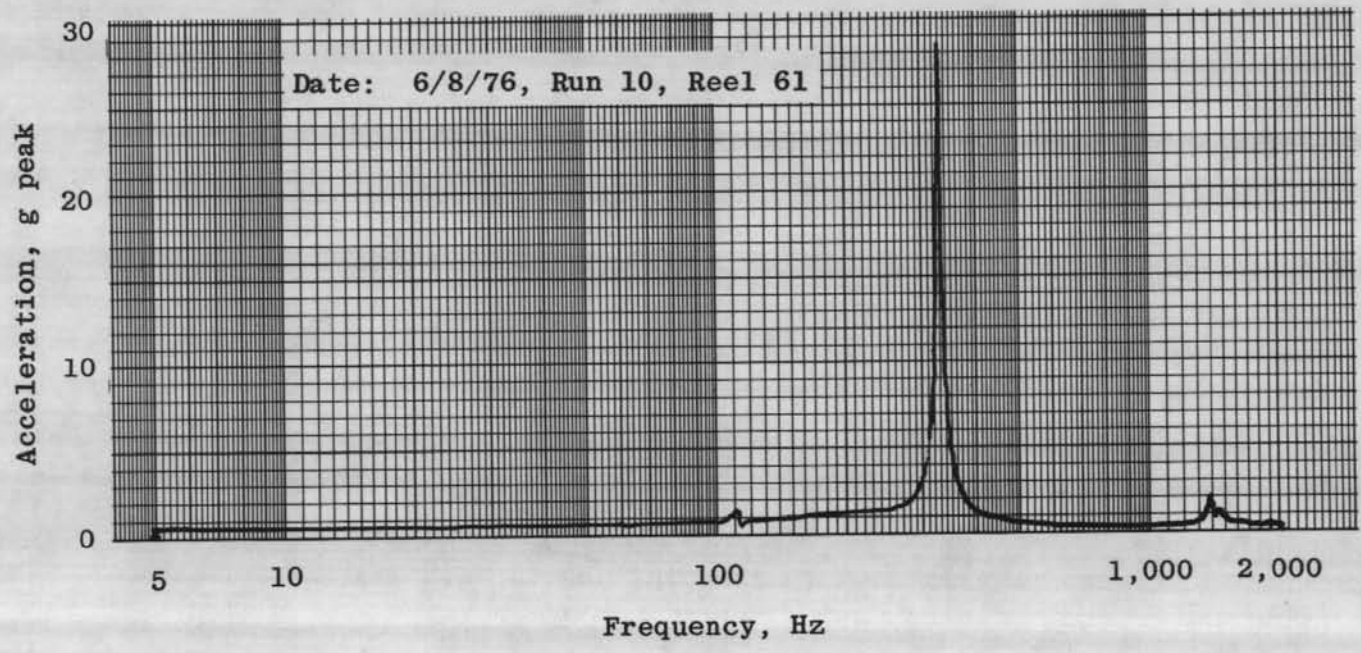

q. Accelerometer 15Z
Figure 35. Continued.

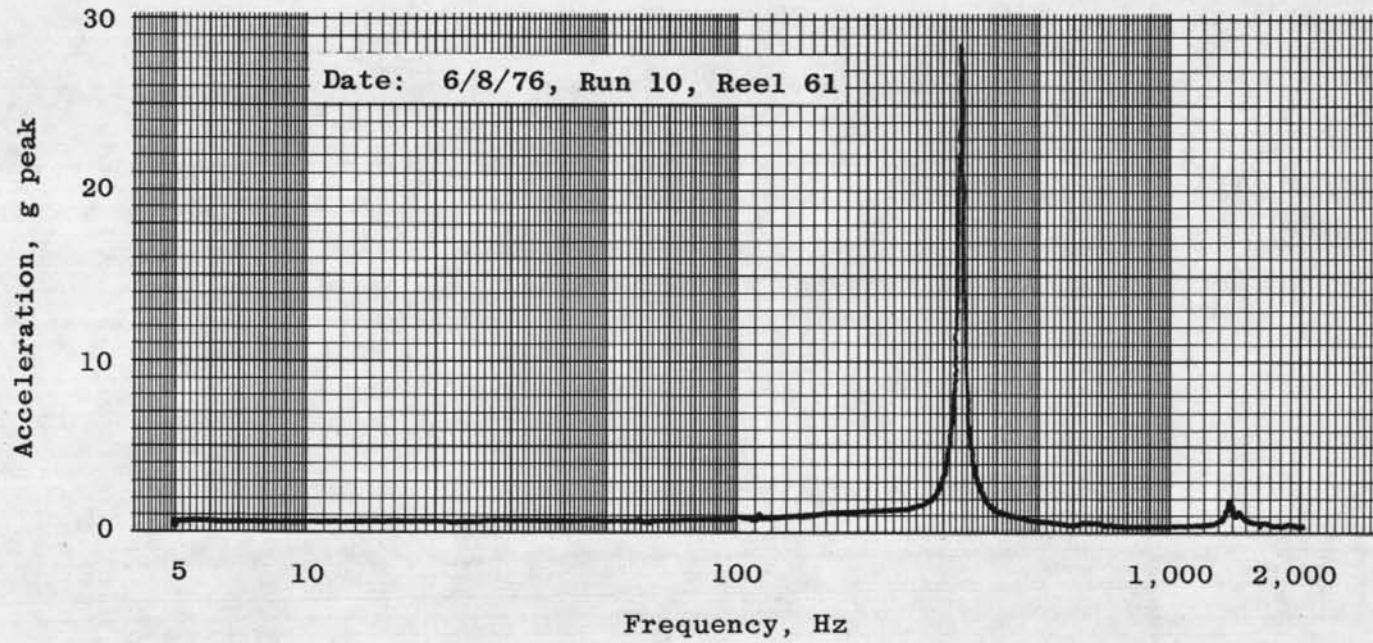

r. Accelerometer 16Z
Figure 35. Continued.

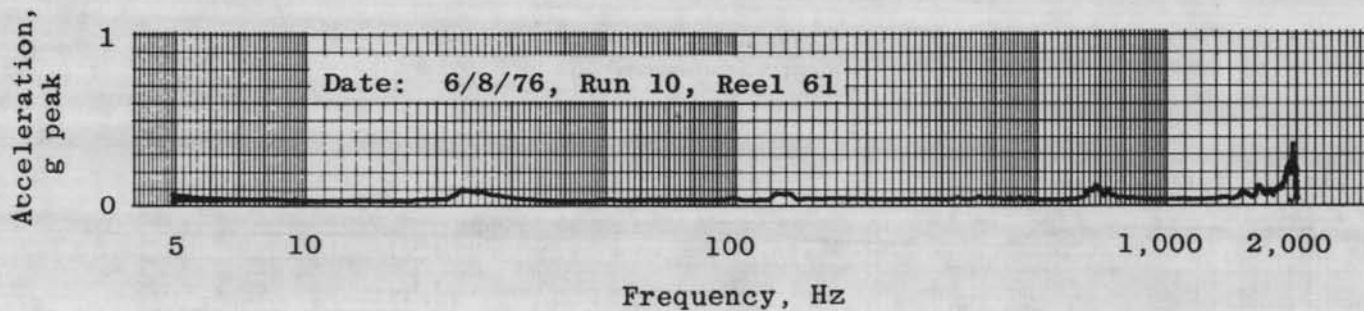

s. Accelerometer 1X

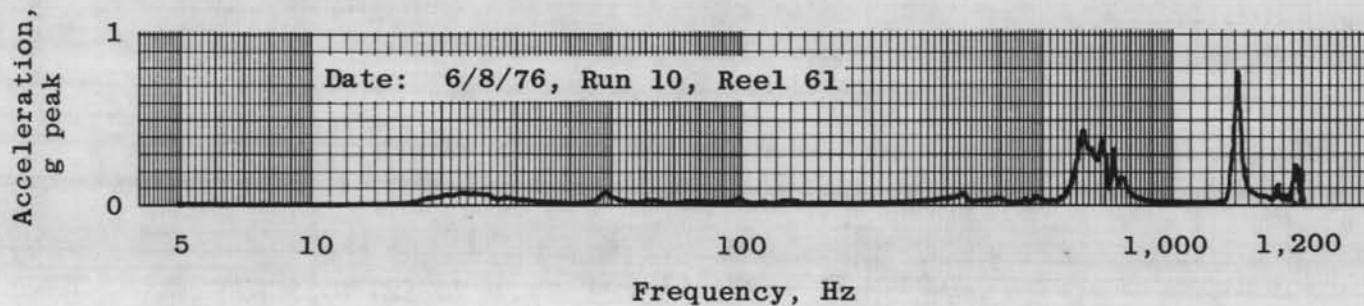

t. Accelerometer 9X
Figure 35. Continued.

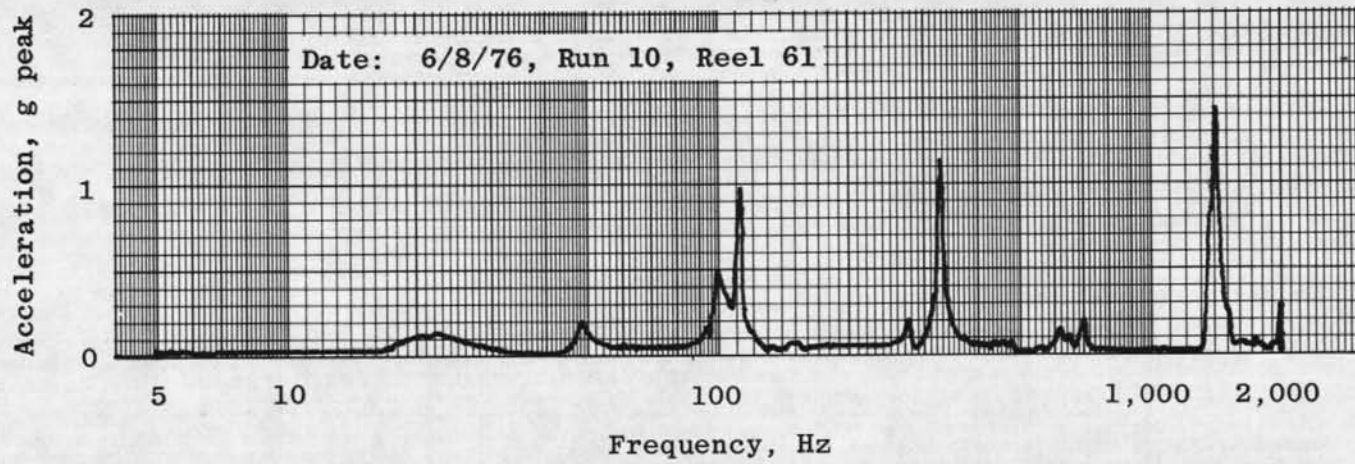

u. Accelerometer 11X
Figure 35. Continued.

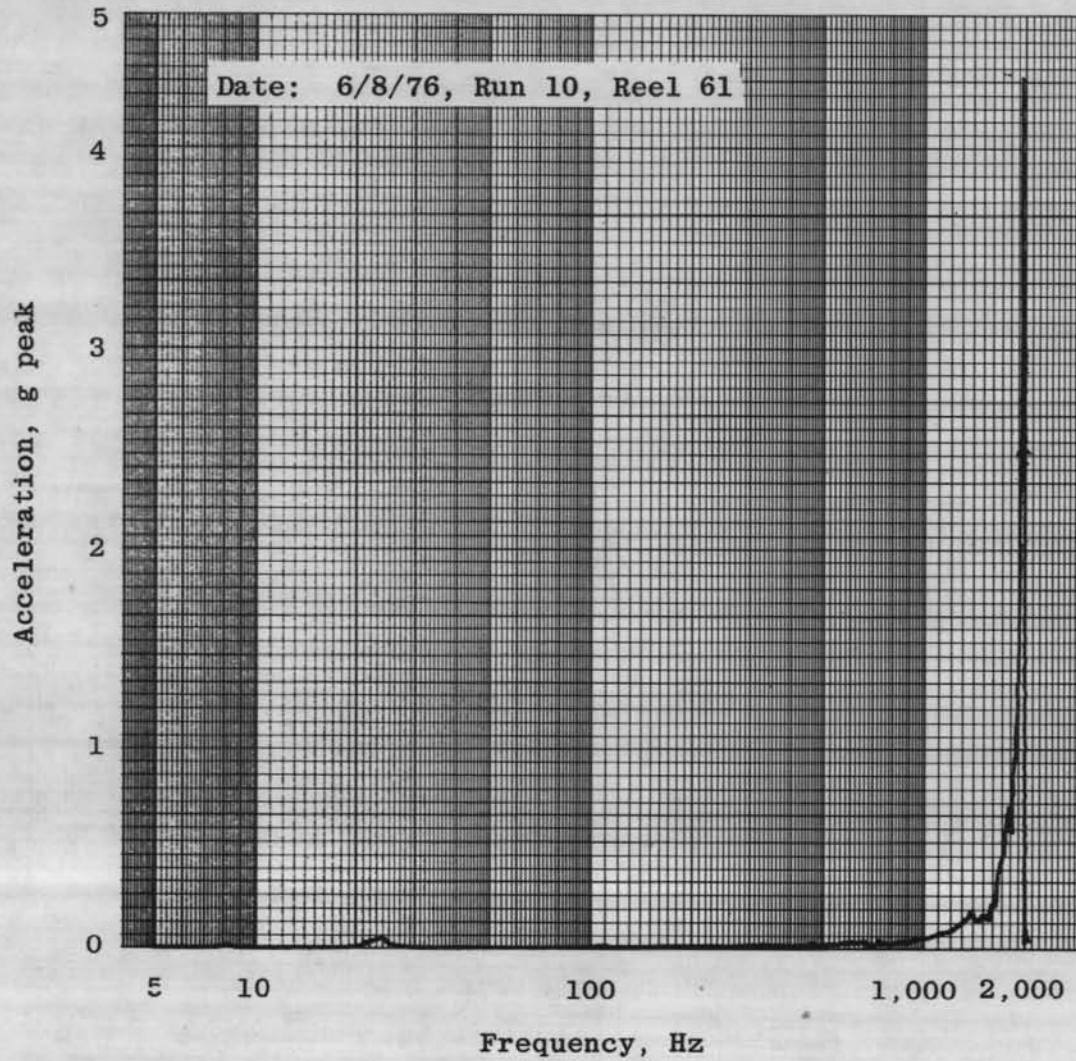

v. Accelerometer 1Y
Figure 35. Continued.

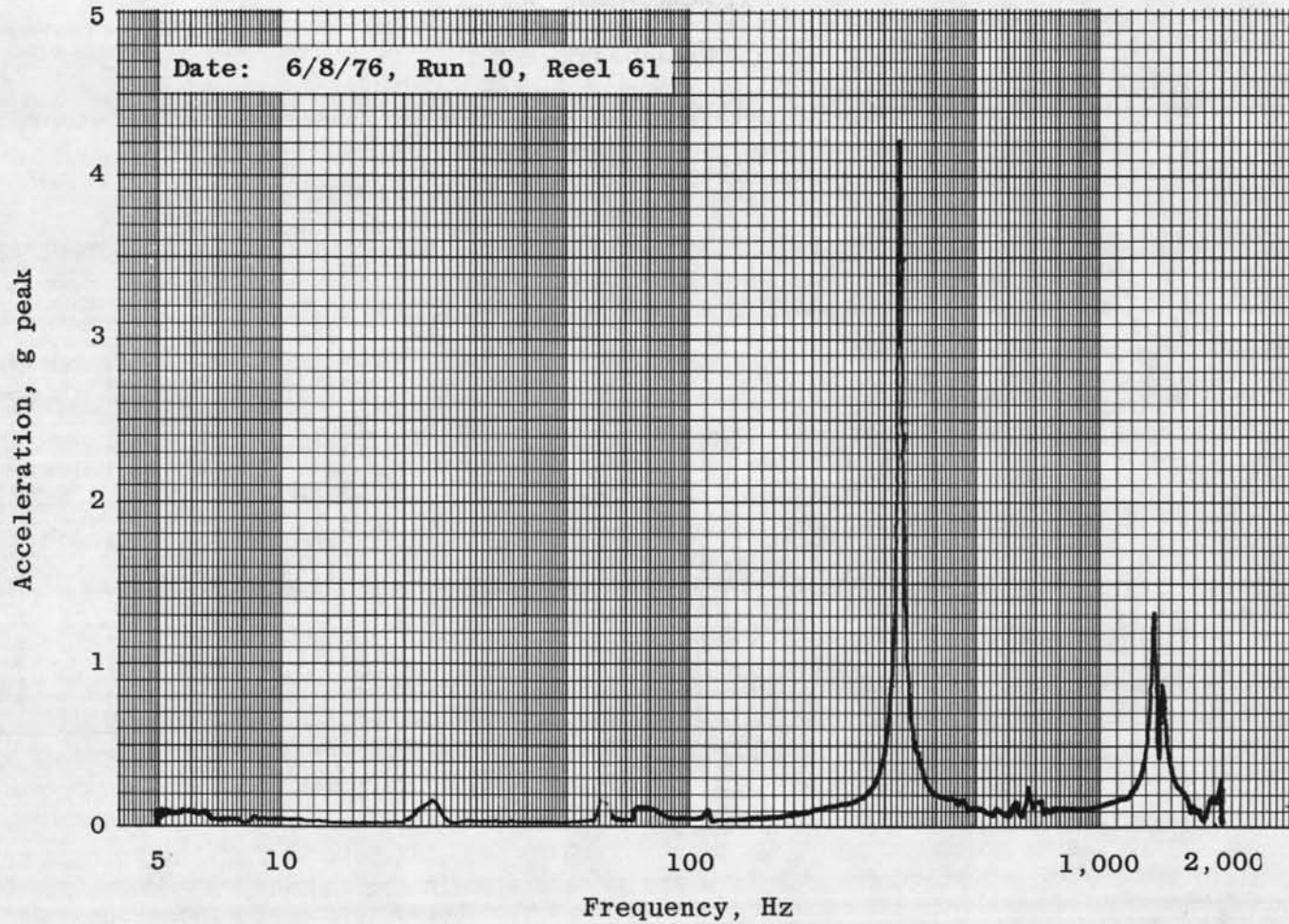

w. Accelerometer 9Y
Figure 35. Continued.

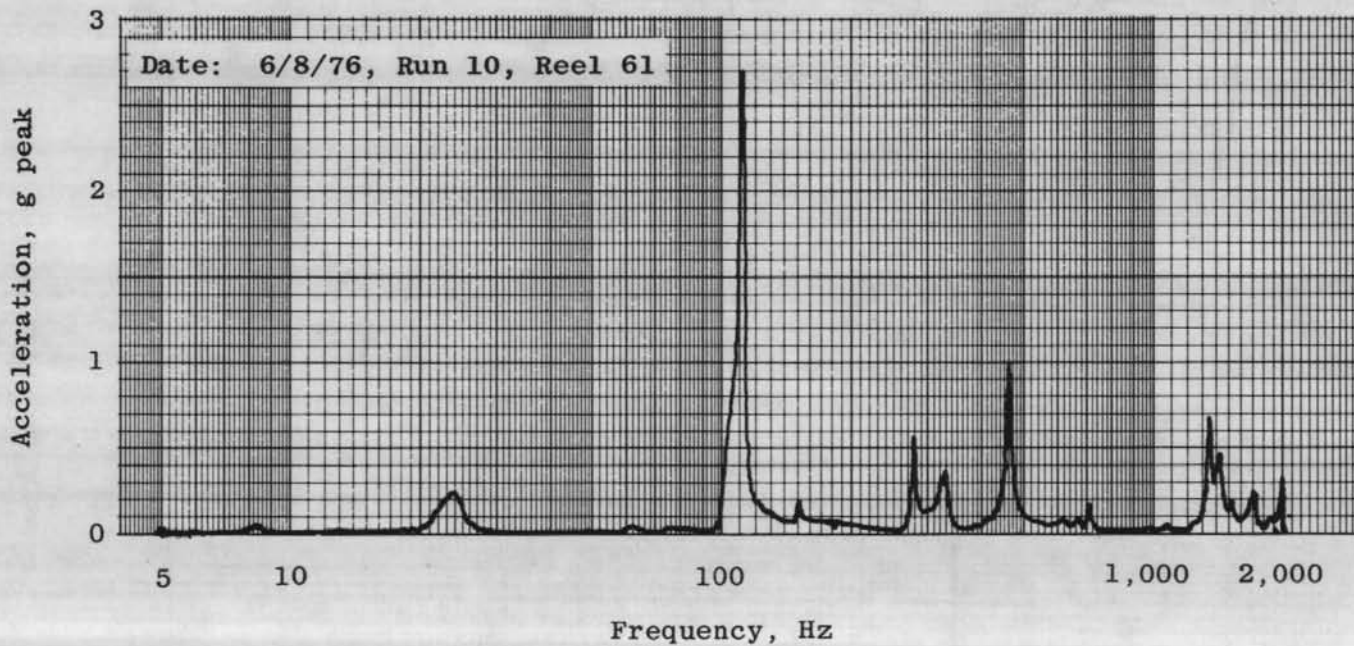

x. Accelerometer 11Y
Figure 35. Concluded.

Table 1. Instrumentation Calibration Traceability

Parameter Measured	Instrument Name	Instrument Number	Instrument Classification	Calibration Interval	Date of Last Calibration
Vibration Level ↓	Model 13116 X-Y Display	55354	T	A/R	2-16-76
	Model SD301D Real Time Analyzer	55356	T	↓	3-23-76
	Model SD309 Ensemble Averager	55355	T		2-16-76
	Model SD1010B Carrier Generator	54897	T		3-20-76
	X-Y Plotter	40170	T		4-30-76
	Model SD115A Auto Level Programmer	55570	T		3-25-76
	SD105C Amplitude Servo/Monitor				
	SD1012B Tracking Filter	54899	T		3-23-76
	SD1012B Tracking Filter	58006	T		3-22-76
	SD104A-2 Sweep Oscillator	54898	T		3-3-76
Frequency	5512A Electronic Counter	38886	T		

Table 1. Continued

Parameter Measured	Instrument Name	Instrument Number	Instrument Classification	Calibration Interval	Date of Last Calibration
Frequency	SD22A Averaging Control	58005		A/R	3-19-76
Frequency	MAC-8 Multifunction Averager	57992		↓	10-21-75
Vibration Level	1858 CRT Visicorder	55386	T	↓	1-12-76
↓	1060 RMS Voltmeter	49735		6 mos	4-5-76
↓	1060 RMS Voltmeter	49737		6 mos	4-5-76
Mag Tape Input Cal	Fluke 8375A Digital Multimeter	55154	S		5-76
	Model 1450 TBR Decade Attenuator	55661	T	12 mos	7-10-75
	LP-10 Low Pass Filter	38872		A/R	3-27-76
	RM31A Oscilloscope	40387		A/R	9-16-75
	Preston Amplifier	57493			
	Preston Amplifier	55089			

Table 1. Continued

Parameter Measured	Instrument Name	Instrument Number	Instrument Classification	Calibration Interval	Date of Last Calibration
Acceleration ↓	2226 Accelerometer ↓	53960	T	6 mos	3-22-76
		53961	↓	↓	3-22-76
		53956	↓	↓	2-16-76
		53955	↓	↓	3-22-76
		53957	↓	↓	2-16-76
		53962	↓	↓	3-22-76
		53965	↓	↓	3-22-76
		53958	↓	↓	3-22-76
		55253	↓	↓	3-22-76
		53966	↓	↓	3-29-76
53959	↓	↓	3-22-76		

Table 1. Continued

Parameter Measured	Instrument Name	Instrument Number	Instrument Classification	Calibration Interval	Date of Last Calibration
Acceleration ↓	2226 Accelcrometer	55252	T	6 mos	3-22-76
	↓	53964	↓	↓	3-22-76
	↓	53963			2-17-76
	2228 Accelerometer	52521			2-20-76
	↓	52520			3-23-76
	↓	52522			2-23-76
	↓	52525			3-25-76
	↓	52519			2-24-76
	↓	52526			3-24-76
	↓	52523			3-26-76
↓	52524	3-23-76			

Table 1. Continued

Parameter Measured	Instrument Name	Instrument Number	Instrument Classification	Calibration Interval	Date of Last Calibration
Acceleration	2228 Accelerometer	52527	T	6 mos	3-29-76
		52528			3-24-76
Vibration Level	Model D-11 Charge Amplifier	53865			3-25-76
		55251			4-23-76
		53864			3-29-76
		53863			3-26-76
		54095			2-12-76
		53890			
		54094			
		52622			
54092					

Table 1. Continued

Parameter Measured	Instrument Name	Instrument Number	Instrument Classification	Calibration Interval	Date of Last Calibration
Vibration Level	Model D-11 Charge Amplifier	52617	T	6 mos	2-12-76
↓	↓	54093	↓	↓	↓
		58221			
		52621			
		52626			
		52615			
		52619			
		52623			
		52625			
		52618			
		58201			

Table 1. Concluded

Parameter Measured	Instrument Name	Instrument Number	Instrument Classification	Calibration Interval	Date of Last Calibration
Vibration Level	Model D-11 Charge Amplifier	58202	T	6 mos	2-12-76
↓	↓	58220	↓	↓	↓
		52616			
		52620			
		52624			
		53889		↓	↓
Test Data	Mag Tape VR3700B Bell & Howell	53536		---	---
Test Data	Mag Tape VR3700B Bell & Howell	57884		---	---
Mag Tape Deviation	Beckman Freq. Counter	11700	↓	A/R	---

Table 2. NASA IUE Rocket Motor Vibration Test Activity Record

<u>Date</u>	<u>Activity</u>	<u>Remarks</u>
4-9-76	Lateral axis bare fixture evaluation with four-point average control.	0.5-g sine survey: fixture satisfactory.
4-30-76	Mass simulator/lateral axis fixture evaluation conducted.	0.5-g sine survey: control satisfactory.
5-3-76	Lateral axis qualification level sine survey conducted with mass simulator. Five- to 2,000-Hz sine sweep at 4 oct/min.	Control poor above 1,000 Hz due to combination of fixture and simulator resonances.
5-3-76	Lateral axis qualification level random vibration test conducted with mass simulator.	Control satisfactory at approx. 12.5 g rms.
5-4-76	Lateral axis 0.5-g sine survey conducted with mass simulator.	Control and response similar to pre-qualification level testing.
5-5-76	IUP motor installed on lateral axis fixture for X-axis testing. Response accelerometers installed on motor, and accelerometer checkout conducted.	Nozzle safety accelerometer 14X set to 50-g pk.
5-6-76	0.5-g sine survey conducted in X-axis from 5 to 2,000 Hz at 4 oct/min.	No problems encountered. Nozzle resonance of approx. 80 at 109 Hz. Accelerometer 15X, bad above 300 Hz, was replaced after survey.
5-7-76	Qualification level sine sweep conducted in X-axis from 5 to 2,000 Hz at 4 oct/min.	Nozzle safety set to 100-g pk. Reached 90-g pk at 109 Hz. Motor to fixture bolts torque checked after test. No problems encountered.
5-10-76	Qualification level random vibration test conducted in X-axis. Spectrum equalization required 2 min, 15 sec of -10 db operation.	Nozzle safety set to 40 g pk. Shut down shaker on first increase to full power. Safely reset to 100 g pk and 1-min run at full level (≈ 12 g rms) conducted. Spectrum satisfactory. One narrow band out-of-tolerance peak at 1,650 Hz.
5-11-76	0.5-g sine survey conducted in X-axis from 5 to 2,000 Hz at 4 oct/min.	No problems encountered. Control and responses nearly identical to those of first 0.5-g sine survey.
5-11-76	Motor to fixture bolts torque checked prior to rotating motor on fixture for Y-axis testing.	Torque unchanged from pretest level.

Table 2. Continued

<u>Date</u>	<u>Activity</u>	<u>Remarks</u>
5-11-76	0.5-g sine survey conducted in Y-axis from 5 to 2,000 Hz at 4 oct/min.	No problems.
5-12-76	Qualification level sine sweep conducted in Y-axis from 5 to 2,000 Hz at 4 oct/min.	No problems. Motor to fixture bolts torque checked following test.
5-12-76	Qualification level random vibration test conducted in Y-axis. Spectrum equalizations required 1 min, 25 sec of -10 db operation.	Spectrum satisfactory for one minute run at full level of ≈ 12.5 g rms.
5-13-76	0.5-g sine survey conducted in Y-axis from 5 to 2,000 Hz at 4 oct/min.	No problems.
5-13-76	IUE motor installed in shipping container in preparation for thrust axis mass simulator procedure/fixture evaluation.	
5-14-76	Set up test equipment for thrust axis testing.	
5-17-76	Mass simulator installed on thrust axis vibration fixture for Z-axis testing. 0.5-g sine survey conducted with mass simulator from 5 to 2,000 Hz at 4 oct/min.	No problems.
5-18-76	Qualification level sine survey conducted from 75 to 2,000 Hz at 4 oct/min using mass simulator.	Control poor because of simulator.
5-19-76	Qualification level sine survey from 5 to 75 Hz conducted, but procedural problems were encountered with control equipment.	
5-20-76	Qualification level sine survey conducted with mass simulator from 5 to 75 Hz at 4 oct/min after procedural problem corrected.	No problems.
5-21-76	Qualification level random vibration test conducted using mass simulator.	Spectrum equalization difficult from 180 to 220 Hz. Remainder of spectrum equalized satisfactorily.

Table 2. Concluded

<u>Date</u>	<u>Activity</u>	<u>Remarks</u>
5-21-76	0.5-g sine survey conducted with mass simulator from 5 to 2,000 Hz at 4 oct/min. Examination of mass simulator/fixture following testing revealed loose fixture-to-simulator bolts. Looseness possibly caused by bolts being slightly longer than required and exceeding length of helicoil inserts in fixture, resulting in a lower than required simulator-to-fixture torquing.	Control and response somewhat different from that in pre-qualification level testing. No serious problems caused by bolts loosening.
5-21-76	Thrust axis bare fixture 0.5-g sine survey conducted to check for fixture/shaker damage.	No problems encountered.
5-24-76	IUE motor installed on thrust axis fixture for Z-axis testing.	
5-24-76	Conducted 0.5-g sine survey in Z-axis from 5 to 2,000 Hz at 4 oct/min.	Sweep was shut down twice by nozzle peak limit accelerator 11Z, first set to 10 g, then to 20 g. Sweep completed with limit at 20 g as 11Z reached \approx 22-g peak.
5-25-76	Conducted 1.0-g sine survey in Z-axis from 5 to 2,000 Hz at 4 oct/min.	Nozzle peak limiter set to 50 g, reached 44 g. No problems encountered.
5-25-76	Qualification level sine survey conducted from 5 to 75 Hz at 4 oct/min. Motor/fixture bolts torque checked following test.	No problems. Torque values at pretest levels.
5-26-76	Conducted qualification level sine survey from 75 to 2,000 Hz at 4 oct/min.	Nozzle peak limit shutdown at 3-g input with peak limiter 11Z set to 140-g pk. Input level reduced to 2 g between 300 and 400 Hz; test completed with no problems.
5-27-76	Qualification level random vibration test conducted.	Nozzle peak limiter shutdown occurred at 15 sec into full level run with limiter set to 140-g pk. Spectrum lowered slightly from 300 to 350 Hz; test completed with no problems.
5-27-76	0.5-g Z-axis sine survey conducted from 5 to 2,000 Hz at 4 oct/min.	No problems.
5-28-76	IUE motor installed in shipping container in preparation for transfer to x-ray inspection laboratory.	No loosening of motor/fixture bolts occurred during Z-axis testing.